



**HAL**  
open science

# Stabilité des profils de chocs dans les systèmes de lois de conservation

Pauline Lafitte-Godillon

► **To cite this version:**

Pauline Lafitte-Godillon. Stabilité des profils de chocs dans les systèmes de lois de conservation. Mathématiques [math]. Ecole normale supérieure de lyon - ENS LYON, 2001. Français. NNT : . tel-00396376

**HAL Id: tel-00396376**

**<https://theses.hal.science/tel-00396376>**

Submitted on 17 Jun 2009

**HAL** is a multi-disciplinary open access archive for the deposit and dissemination of scientific research documents, whether they are published or not. The documents may come from teaching and research institutions in France or abroad, or from public or private research centers.

L'archive ouverte pluridisciplinaire **HAL**, est destinée au dépôt et à la diffusion de documents scientifiques de niveau recherche, publiés ou non, émanant des établissements d'enseignement et de recherche français ou étrangers, des laboratoires publics ou privés.

ECOLE NORMALE SUPÉRIEURE DE LYON  
UNITÉ DE MATHÉMATIQUES PURES ET APPLIQUÉES

N<sup>o</sup> attribué par la bibliothèque | 0 | 1 | E | N | S | L | 0 | 2 | 0 | 8 |

**THESE**

pour obtenir le grade de

**DOCTEUR DE L'ECOLE  
NORMALE SUPERIEURE DE LYON**

*Discipline* : Mathématiques

présentée et soutenue publiquement

par

Pauline Godillon-Lafitte

le 10 décembre 2001

**Titre :**

STABILITE DES PROFILS DE CHOCS DANS LES SYSTEMES DE LOIS DE  
CONSERVATION

---

***Directeur de thèse :***

Denis Serre

---

**Jury**

M. François Bouchut, Rapporteur  
M. Thierry Gallay  
M. Roberto Natalini  
M. Denis Serre  
M. Kevin Zumbrun, Rapporteur



## REMERCIEMENTS

Je tiens à remercier Denis Serre pour m'avoir posé les questions qui ont abouti à ce travail et pour ses conseils. Il m'a appris beaucoup, et m'a laissé apprendre beaucoup en m'accordant une grande liberté. Il a été très disponible pour moi et m'a toujours aidée en cas de problème. Je lui en suis grandement redevable.

Je remercie aussi François Bouchut et Kevin Zumbrun, qui a apporté un grand intérêt à mon travail tout au long de ma thèse et avec qui j'ai eu de nombreuses discussions, d'avoir accepté d'être mes rapporteurs. Ils m'ont fait un grand honneur.

Je remercie Thierry Gallay et Roberto Natalini d'avoir bien voulu me faire l'honneur d'être présents dans ce jury.

Je remercie également les membres de l'U.M.P.A., et plus particulièrement Claire, David, Emmanuel, Frédéric, Gérard, Julien, Magali, Pierre, Stéphane et Sylvie pour m'avoir si bien accueillie et aidée tout au long de ma thèse, et plus particulièrement depuis mon "expatriation".

Merci à Emmanuel pour son aide précieuse, pour ses conseils et ses suggestions. Merci à Frédéric pour nos nombreuses discussions. Merci à Stéphane et à Julien pour leurs encouragements et leur gentillesse. Merci aussi à Sylvie pour avoir relu une bonne partie de ce mémoire. Merci enfin à Gérard pour sa disponibilité et toutes les réponses qu'il m'a fournies et à Virginia pour son efficacité.

Je remercie Emmanuel Lorin du C.M.L.A. pour sa collaboration et Théodore Vasilakis pour ses conseils.

Je tiens également à remercier Karine et Stéphane, et Julien de m'avoir si gentiment hébergée.

Merci enfin à ma famille pour son soutien et à Christophe et Viane pour tout !

*Ευχαριστώ πολύ !*

# TABLE DES MATIÈRES

|                                    |  |    |
|------------------------------------|--|----|
| <i>Notations de l'introduction</i> |  | v  |
| <i>I : Introduction</i>            |  | 1  |
| 1                                  | Introduction   | 2  |
| 2                                  | Approximations   | 2  |
| 2.1                                | Viscosité  | 2  |
| 2.2                                | Relaxation semi-linéaire   | 3  |
| 2.3                                | Diffusion-dispersion   | 4  |
| 2.4                                | Schémas de Lax-Wendroff et de Lax-Friedrichs modifié                         | 4  |
| 3                                  | Profils de chocs   | 5  |
| 3.1                                | Chocs  | 5  |
| 3.2                                | Chocs admissibles  | 5  |
| 3.3                                | Profils de chocs   | 6  |
| 3.4                                | Stabilité  | 8  |
| 4                                  | Fonction d'Evans [18]  | 9  |
| 4.1                                | Système dynamique associé  | 9  |
| 4.2                                | Comportement des solutions aux limites                                       | 10 |
| 4.3                                | Signe de la fonction d'Evans à l'origine                                     | 11 |
| 4.4                                | Signe de la fonction d'Evans à l'infini                                      | 11 |
| 4.5                                | Limite de la fonction d'Evans quand la vitesse de relaxation devient infinie | 12 |
| 5                                  | Conditions de stabilité  | 12 |
| 5.1                                | Viscosité  | 12 |
| 5.2                                | Relaxation semi-linéaire   | 14 |
| 5.3                                | Illustration dans le cas $d = 2$   | 15 |
| 5.4                                | Diffusion-dispersion   | 16 |

---

|   |   |    |
|---|---|----|
| 5.5   | Schéma de Lax-Wendroff . . . . .  | 16 |
| 6   | Fonction de Green pour le schéma de Lax-Friedrichs modifié . . . . .                      | 17 |
| <i>II : Approximations en variable d'espace continue : relaxation semi-linéaire, diffusion-dispersion</i> |   | 23 |
| 1.  | <i>Relaxation semi-linéaire : condition nécessaire de stabilité spectrale</i> . . . . .   | 24 |
| 1.1   | Introduction . . . . .  | 24 |
| 1.2   | Background . . . . .  | 26 |
| 1.2.1   | Assumptions . . . . .   | 26 |
| 1.2.2   | Shock profiles . . . . .  | 27 |
| 1.2.3   | Asymptotic behavior of $\bar{U}$ . . . . .  | 29 |
| 1.3   | Main results . . . . .  | 30 |
| 1.3.1   | Linear stability . . . . .  | 30 |
| 1.3.2   | Necessary conditions for linear stability . . . . .                                       | 31 |
| 1.4   | Preliminaries . . . . .   | 32 |
| 1.4.1   | Stationary shocks . . . . .   | 32 |
| 1.4.2   | The essential spectrum of $M$ . . . . .   | 33 |
| 1.4.3   | Eigenvalue equation of $M$ . . . . .  | 36 |
| 1.5   | Construction of an Evans function . . . . .   | 37 |
| 1.6   | Lax shocks . . . . .  | 39 |
| 1.6.1   | Sign of $D$ about $\lambda = 0$ . . . . .   | 39 |
| 1.6.2   | Large $ \lambda $ behavior . . . . .  | 42 |
| 1.7   | Undercompressive shocks . . . . .   | 46 |
| 1.8   | Overcompressive shocks . . . . .  | 50 |
| 1.9   | Remarque : amélioration du théorème sur les chocs surcompressifs . . . . .                | 53 |
| 2.  | <i>Relaxation semi-linéaire : exemple de profil de choc de Lax spectralement instable</i> | 54 |
| 2.1   | Introduction . . . . .  | 54 |
| 2.2   | Sufficient condition of spectral instability . . . . .                                    | 56 |
| 2.2.1   | Assumptions . . . . .   | 56 |
| 2.2.2   | Shock profiles . . . . .  | 56 |
| 2.2.3   | Sketch of the method of getting (11) . . . . .  | 58 |

---

|   |   |     |
|---|---|-----|
| 2.3   | Construction of an example of spectrally unstable profile . . . . .   | 59  |
| 2.3.1   | Construction of a suitable function . . . . .   | 59  |
| 2.3.2   | Construction of a flux . . . . .  | 60  |
| 2.4   | Numerical simulations . . . . .   | 62  |
| 2.4.1   | Numerical Analysis . . . . .  | 62  |
| 2.5   | Conclusion . . . . .  | 65  |
| 2.6   | Appendix : Numerical determination of the Evans function . . . . .  | 66  |
| 3.  | <i>Relaxation semi-linéaire : lien entre la viscosité et la relaxation semi-linéaire</i> . .                    | 71  |
| 3.1   | Introduction . . . . .  | 71  |
| 3.2   | Résultat . . . . .  | 74  |
| 3.3   | Preuve de la proposition . . . . .  | 75  |
| 4.  | <i>Diffusion-dispersion</i> . . . . .   | 79  |
| 4.1   | Introduction . . . . .  | 79  |
| 4.2   | Démonstration de la proposition . . . . .   | 82  |
| 4.2.1   | Spectre essentiel de $M$ . . . . .  | 82  |
| 4.2.2   | Définition de la fonction d'Evans . . . . .   | 84  |
| 4.3   | Etude de la fonction d'Evans au voisinage de $0$ . . . . .  | 85  |
| 4.4   | Etude du signe de la fonction d'Evans au voisinage de $+\infty$ . . . . .                                       | 90  |
| <br><i>III : Approximations en variable d'espace discrète : schémas numériques de Lax-Wendroff et de Lax-Friedrichs modifié</i> |   | 93  |
| 1.  | <i>Condition nécessaire de stabilité spectrale de profils stationnaires du schéma de Lax-Wendroff</i> . . . . . | 94  |
| 1.1   | Introduction . . . . .  | 94  |
| 1.1.1   | Assumptions . . . . .   | 94  |
| 1.1.2   | Discrete stationary shock profiles . . . . .  | 95  |
| 1.1.3   | Main result . . . . .   | 97  |
| 1.2   | Definition of the Evans function . . . . .  | 98  |
| 1.3   | Study of the Evans function near $\lambda = 1$ . . . . .  | 102 |
| 1.4   | Study of the Evans function at $\lambda = +\infty$ . . . . .  | 105 |
| 1.5   | Appendix : Geometric dichotomy . . . . .  | 110 |

---

|  |     |
|--|-----|
| 2. Estimations de la fonction de Green du schéma de Lax-Friedrichs modifié . . . . | 118 |
| 2.1 Introduction . . . . .   | 118 |
| 2.2 Construction of an Evans function . . . . .                                    | 127 |
| 2.2.1 Asymptotic behavior of the solutions of the homogeneous recurrence           | 128 |
| 2.2.2 Extension to a neighborhood of $\lambda = 0$ . . . . .                       | 130 |
| 2.3 Estimates on $G_\lambda$ . . . . .   | 134 |
| 2.4 Proof of Theorem 2.1.1 . . . . .   | 141 |
| 2.5 Numerical simulations . . . . .  | 153 |
| <i>Bibliographie</i> . . . . .   | 160 |
| <i>Table des figures</i> . . . . .   | 165 |



## NOTATIONS DE L'INTRODUCTION

|  |    |
|--|----|
| $\mathbf{a}$ , vitesse de relaxation.....  | 9  |
| $(a_1^\pm, \dots, a_d^\pm)$ , valeurs propres de $df(u^\pm)$ .....   | 13 |
| $\mathbb{A}(\lambda, x)$ , système dynamique continu.....  | 15 |
| $\mathbb{A}_j(\lambda)$ , système dynamique discret.....   | 16 |
| $B(u)$ , matrice de viscosité.....   | 8  |
| $c = f(u^+) - su^+ = f(u^-) - su^-$ .....  | 12 |
| $\mathbf{D}$ , paramètre de (LFM).....   | 10 |
| $\mathcal{D} : (\lambda, j) \mapsto \mathcal{D}(\lambda, j)$ , fonction d'Evans pour une approximation discrète..... | 16 |
| $D : \lambda \mapsto D(\lambda)$ , fonction d'Evans pour une approximation continue.....                             | 16 |
| (DD), diffusion-dispersion.....  | 10 |
| $df$ , différentielle de $f$ .....   | 11 |
| $\epsilon, \tau$ , temps de relaxation.....  | 9  |
| $\eta = ks/h$ , vitesse discrète.....  | 13 |
| $[f(u)] = f(u^+) - f(u^-)$ , saut de $f$ à travers le choc $(u^-, u^+; s)$ .....                                     | 11 |
| $(x, t; y) \mapsto G(x, t; y)$ , fonction de Green du problème linéarisé.....  | 24 |
| $(x; y) \mapsto G_\lambda(x; y)$ , transformée de Laplace de la fonction de Green.....                               | 24 |
| $h$ , pas d'espace.....  | 10 |
| $k$ , pas de temps.....  | 10 |
| $L$ , opérateur linéarisé.....   | 14 |

---

|  |    |
|--|----|
| $\mathcal{L}$ , opérateur d'évolution .....                                      | 14 |
| $\lambda, \mu$ , valeur propre .....   | 15 |
| (LFM), schéma de Lax-Friedrichs modifié .....                                    | 10 |
| (LW), schéma de Lax-Wendroff .....   | 10 |
| $\Omega = \{\lambda \in \mathbb{C} / \operatorname{Re}(\lambda) > 0\}$ .....     | 14 |
| $\mathcal{O} = \{\lambda \in \mathbb{C} /  \lambda + 1  > 1\}$ .....             | 14 |
| $(r_1^\pm, \dots, r_d^\pm)$ , vecteurs propres de $df(u^\pm)$ .....              | 18 |
| (RSL), relaxation semi-linéaire .....  | 9  |
| $\rho$ , rayon spectral .....  | 10 |
| $s$ , vitesse du choc .....  | 11 |
| $(s_1^\pm, \dots, s_d^\pm)$ , vecteurs propres de $B(u^\pm)^{-1}df(u^\pm)$ ..... | 18 |
| $\sigma$ , spectre .....   | 11 |
| $\sigma_{ess}(L)$ , spectre essentiel de $L$ .....                               | 14 |
| $S^+(\lambda)$ , espace stable en $+\infty$ .....                                | 16 |
| $(u^-, u^+; s)$ , choc .....   | 11 |
| $\bar{u}$ , profil de choc .....   | 12 |
| $U^-(\lambda)$ , espace instable en $-\infty$ .....                              | 16 |
| $\mathcal{V}$ , voisinage de $\lambda = 0$ .....                                 | 17 |
| (V), viscosité .....   | 8  |
| $\xi = (x - st)/\epsilon$ .....  | 12 |
| $z = (x - st)/h$ .....   | 13 |

Première partie

INTRODUCTION

## 1 Introduction

Ce travail de thèse a eu pour but l'étude de la stabilité de profils de chocs sous diverses approximations. Le cadre global de cette analyse est l'étude des solutions de systèmes de lois de conservation, qui régissent quantité de phénomènes physiques, comme la mécanique des milieux continus, et font intervenir à la fois le temps et des variables d'espace. On considèrera par la suite des lois monodimensionnelles, c'est à dire à une seule variable d'espace. Etant donné un type d'approximation, on s'intéresse à une classe particulière de solutions, celle des ondes progressives reliant deux états de l'espace ambiant satisfaisant à une condition de choc, solutions également appelées *profils de choc*. Celles-ci présentent l'avantage d'être solutions d'équations différentielles ordinaires, c'est à dire à une seule variable, pour lesquelles on dispose de nombreux outils mathématiques, développés lors de l'étude des systèmes dynamiques : les profils peuvent être vus comme des orbites hétéroclines de tels systèmes.

Une fois l'existence de ces profils assurée se pose la question de leur stabilité : si la donnée initiale est une perturbation de profil, la solution du système de lois de conservation considéré va-t-elle rester proche du profil choisi ?

## 2 Approximations

Soit un système de lois de conservation du premier ordre

$$u_t + f(u)_x = 0, \quad t \geq 0, \quad x \in \mathbb{R}, \quad (1)$$

où  $f : \mathcal{U} \subset \mathbb{R}^d \rightarrow \mathbb{R}^d$ ,  $d \geq 1$ ,  $\mathcal{U}$  ouvert convexe, est une fonction de classe  $\mathcal{C}^\infty$ . On suppose que (1) est strictement hyperbolique, c'est à dire que la différentielle de  $f$  est diagonalisable à valeurs propres distinctes dans  $\mathbb{R}$  pour tous les points  $u \in \mathcal{U}$ , ce qui permet d'assurer que le problème (1) avec condition initiale est bien posé.

Dans ce mémoire, on s'intéresse à deux approximations en variables continues, celles par relaxation semi-linéaire et par diffusion-dispersion, et à deux approximations en variables discrètes, les schémas de Lax-Wendroff et de Lax-Friedrichs modifié. Cependant, commençons par décrire l'approximation par viscosité, car elle a de multiples liens avec celles étudiées par la suite.

### 2.1 Viscosité

Quand on considère un système du type (1), l'approximation "naturelle" consiste à rajouter des termes de diffusion, que l'on prend généralement sous forme conservative, comportant une dérivée seconde en "u" dans le membre de droite, et à multiplier par un petit paramètre  $\epsilon$ , ce qui donne

$$u_t + f(u)_x = \epsilon(B(u)u_x)_x. \quad (2)$$

Ce type d'approximation est dit *par viscosité* (nous l'abrègerons en (V)) et la matrice  $B(u)$  est appelée matrice de viscosité et est supposée à coefficients réguliers. C. Dafermos, dans ([16], Paragraphe 4.4, pages 54-55), indique que la terminologie "viscosité" provient

de la dynamique des milieux continus, fluides ou matériaux élastiques (ci-dessous une traduction) :

“ les lois régissant les matériaux thermoélastiques sous des conditions adiabatiques sont des systèmes hyperboliques du premier ordre alors que celles correspondant aux matériaux thermoviscoélastiques, qui conduisent la chaleur, impliquent des équations du second ordre en  $x$  et des termes diffusifs. Par nature, tout matériau a une réaction visqueuse et conduit la chaleur, à un certain niveau. Cataloguer un certain matériau comme étant non conducteur et élastique veut seulement dire que la viscosité et la conductivité thermique sont considérés comme négligeables, bien que non complètement absents. Par conséquent, la théorie de la thermoélasticité adiabatique n'a un sens physique qu'en tant que cas limite de thermoviscoélasticité, la viscosité et la conductivité thermique tendant vers 0.”

Le passage à la limite lorsque  $\epsilon$  tend vers 0 fait partie des problèmes ouverts [16]. L'exemple académique est celui d'une viscosité “scalaire”, c'est à dire celle qui consiste à considérer une matrice  $B$  de la forme  $B(u) = aI_n$  où  $a$  est un scalaire.

Malheureusement, la modélisation des systèmes physiques fait le plus souvent intervenir des matrices de viscosité non inversibles, comme dans le cas de la dynamique des gaz à cause de la loi de conservation de la masse.

Même si ce n'est pas très réaliste, l'hypothèse standard dans le contexte de ce mémoire dans le cas de la viscosité est celle de *stricte parabolicité*

**H.V.1** les valeurs propres (complexes) de la matrice de viscosité  $B(u)$  sont de partie réelle strictement positive pour tout  $u \in \mathcal{U}$ .

## 2.2 Relaxation semi-linéaire

La première des approximations étudiée (Partie I, Chapitres 1, 2 et 3) est la relaxation semi-linéaire, que nous désignerons désormais par (RSL) , qui s'écrit sous la forme :

$$u_t + v_x = 0, \quad (3)$$

$$v_t + \mathbf{a}^2 u_x = \frac{1}{\epsilon}(f(u) - v), \quad (4)$$

où  $\mathbf{a}$  désigne la *vitesse de relaxation* et  $\epsilon$  est le *temps de relaxation*. Elle a été formulée par S. Jin et Z. Xin [42] dans le but d'obtenir des schémas numériques stables. Le petit paramètre  $\epsilon$  représente ici le temps de relaxation. En effet, la limite formelle du système (3) quand  $\epsilon$  tend vers 0 donne le système de lois de conservation de départ (1) et la loi dite d'*équilibre local*  $v = f(u)$ . Les phénomènes de relaxation sont présents dans un grand nombre de domaines de la physique tels la théorie cinétique des gaz monoatomiques, la mécanique du continu, les phénomènes d'élasticité avec mémoire... Un mémoire très complet sur la relaxation a été publié par Natalini [66]. A l'ordre 1 en  $\epsilon$ , un développement à la Chapman-Enskog [11] donne

$$u_t + f(u)_x = \epsilon(\mathbf{a}^2 - df(u)^2)u_{xx} + O(\epsilon^2). \quad (5)$$

Même si ce développement asymptotique est formel et donc n'est pas nécessairement valide, on demande que sa viscosité soit positive (H.V.1) en supposant remplie la *condition sous-caractéristique*

**H.RSL**  $\rho(df(u)) < \mathbf{a}$ ,

$\rho$  représentant le rayon spectral. Cette condition, adaptée au cas présent par S. Jin et Z. Xin [42], a été développée par T.-P. Liu [54] dans le cadre de la relaxation générale et est tout à fait essentielle dans l'analyse.

### 2.3 Diffusion-dispersion

La deuxième approximation abordée (Paragraphe 4) est celle dite par diffusion-dispersion (DD) pour une loi de conservation scalaire avec flux non-convexe, c'est à dire que le signe de  $f''$  n'est pas constant. On introduit un terme d'ordre 3 dans le membre de droite de (2), ce qui donne

$$u_t + f(u)_x = \epsilon(B(u)u_x)_x + \epsilon^2(C(u)u_{xx} + D(u)(u_x)^2)_x. \quad (6)$$

### 2.4 Schémas de Lax-Wendroff et de Lax-Friedrichs modifié

On s'intéresse ensuite à des approximations discrètes : en considérant un maillage uniforme de pas  $h$  en espace et de pas  $k$  en temps, les schémas de Lax-Wendroff (LW) et de Lax-Friedrichs modifié (LFM) (Partie III, Chapitres 2 et 1) s'écrivent sous forme conservative

$$u_j^{n+1} = u_j^n - \frac{k}{h}(g^{k/h}(u_j^n, u_{j+1}^n) - g^{k/h}(u_{j-1}^n, u_j^n)), \quad (7)$$

avec

$$\begin{aligned} g_{LFM}^{k/h}(a, b) &= \frac{f(a) + f(b)}{2} + \mathbf{D}(a - b), \\ g_{LW}^{k/h}(a, b) &= \frac{f(a) + f(b)}{2} - \frac{k}{2h} \left( df \left( \frac{a+b}{2} \right) (f(b) - f(a)) \right), \end{aligned}$$

$\mathbf{D}$  étant un nombre scalaire positif.

Ces deux schémas sont à trois points, consistants ( $g_{LFM, LW}(a, a) = f(a)$ ), mais d'ordres différents : (LFM) est d'ordre 1 et (LW) d'ordre 2. La condition standard assurant la stabilité linéaire des états constants est dite de *Courant-Friedrichs-Lewy*, *CFL*, et s'écrit, dans le cas de (LW),

**H.LW**  $\frac{k}{h}\rho(df(u)) < 1, \forall u \in \mathcal{U}$ ,

et, dans le cas de (LFM),

**H.LFM.1**  $\sup_{u \in \mathcal{U}} \rho(df(u)) < 2\mathbf{D} < \frac{h}{k}$ .

On peut se référer au livre de E. Godlewski et P.-A. Raviart [33].

### 3 Profils de chocs

Les profils de chocs sont des ondes progressives, solutions des systèmes approchés, reliant des états donnés à une certaine vitesse. L'intérêt porté à ces profils de chocs est dû au fait qu'ils ne dépendent que d'une variable, et satisfont par conséquent des équations *a priori* plus simples qu'une quelconque solution.

#### 3.1 Chocs

Commençons par quelques définitions :

**Définition 3.1** Un *choc* est un triplet  $(u^-, u^+; s) \in \mathbb{R}^d \times \mathbb{R}^d \times \mathbb{R}$  qui vérifie la *condition de Rankine-Hugoniot* :

$$[f(u)] = s[u], \quad (8)$$

où  $[f(u)] := f(u^+) - f(u^-)$  désigne le saut de  $G$  à travers le choc  $(u^-, u^+; s)$ .

Les vecteurs  $u^-$  et  $u^+$  sont les *états extrêmes* et  $s$  est la *vitesse* du choc.

Dans la suite, étant donné un choc  $(u^-, u^+; s)$ , on changera l'hypothèse de stricte hyperbolicité globale en hypothèse de *stricte hyperbolicité aux états extrêmes* :

**K 1** le système (1) est strictement hyperbolique aux états  $u^-$  et  $u^+$ , c'est à dire que les différentielles  $df(u^-)$  et  $df(u^+)$  sont diagonalisables à valeurs propres réelles et distinctes.

De plus, on fera l'hypothèse de choc non-caractéristique :

**K 2**  $s \notin \sigma(df(u^\pm))$ ,

où  $\sigma$  représente le spectre.

#### 3.2 Chocs admissibles

Un choc est dit *admissible* s'il répond à des critères qui permettent de le choisir comme solution "physique". Il existe plusieurs notions d'admissibilité : celle de Lax s'exprime au moyen d'inégalités sur les valeurs propres de  $df(u^\pm)$ , celle de Liu fait intervenir les courbes de choc, celle d'entropie a pour expression une inégalité sur des paires entropie-flux d'entropie [74, 16]. Il est à noter que ces conditions ont été développées pour des chocs de faible amplitude, dits *faibles* et qu'elles ne se recoupent pas nécessairement (voir [16]). Elles ne s'appliquent pas forcément dans le cas de chocs forts. En particulier, dans ce cas, seule la condition de Lax est directement mathématiquement applicable, et elle sera envisagée pour toutes les approximations abordées, sauf pour la loi de conservation scalaire approchée par diffusion-dispersion, pour laquelle seront étudiés les chocs forts dits *non-classiques* [37], c'est à dire les chocs qui vérifient une condition d'entropie, mais pas la condition d'Oleinik (nom donné à la condition de Liu pour une loi scalaire). Il est à noter que si la condition d'Oleinik est vérifiée, toutes les inégalités d'entropie sont satisfaites. Inversement, si toutes les inégalités d'entropie sont vérifiées, la condition d'Oleinik est

remplie. En revanche, on ne peut a priori pas retrouver celle-ci à partir d'une seule inégalité d'entropie, sauf dans le cas de flux convexes. Dans notre étude, nous nous bornerons aux chocs non-classiques qui ne satisfont pas la condition de Lax.

Un autre type de condition d'admissibilité repose sur la notion d'existence de profils de chocs, que nous détaillons dans le paragraphe suivant.

### 3.3 Profils de chocs

Dans la suite, on considère des chocs  $(u^-, u^+; s)$  d'**amplitude quelconque**.

Les profils de chocs sont des ondes progressives des systèmes approchés considérés : dans le cas d'approximations continues, ce sont des solutions d'équations différentielles ordinaires, obtenues en considérant des solutions régulières de la forme  $u(x, t) = \bar{u}(\xi)$ , avec  $\xi := (x - st)/\epsilon$ , qui tendent vers  $u^+$  (resp.  $u^-$ ) quand  $\xi$  tend vers  $+\infty$  (resp. vers  $-\infty$ ). En intégrant ces équations entre  $-\infty$  et  $\xi$  et entre  $\xi$  et  $+\infty$ , on obtient les propriétés suivantes pour les trois approximations continues évoquées dans le paragraphe précédent :

(V) le profil  $\bar{u}$  vérifie

$$\epsilon(B(\bar{u}))\bar{u}' = f(\bar{u}) - s\bar{u} - c, \quad (9)$$

avec  $c := f(u^+) - su^+ = f(u^-) - su^-$  (on reconnaît ici la condition de Rankine-Hugoniot (8)) et on fait l'hypothèse supplémentaire que les états  $u^+$  et  $u^-$  sont strictement hyperboliques au sens des systèmes dynamiques :

**H.V.2** les matrices  $B(u^\pm)^{-1}(df(u^\pm) - sId)$  ont des valeurs propres de partie réelle non nulle ;

(RSL)  $\bar{U} = (\bar{u}, \bar{v})^T$  est solution de

$$\epsilon\zeta^2\bar{u}' = f(\bar{u}) - s\bar{u} - c, \quad (10)$$

$$\bar{v} = s\bar{u} + c, \quad (11)$$

où  $\zeta := \sqrt{\mathbf{a}^2 - s^2}$  est bien défini grâce à l'hypothèse (H.RSL) ; on modifie légèrement la condition sous-caractéristique (H.RSL) [52] :

**H.RSL'**  $\mathbf{a} > \max(\rho(df(u^+)), \rho(df(u^-)), |s|)$  ;

(DD) l'équation différentielle régissant  $\bar{u}$  est la suivante

$$f(\bar{u}(\xi)) - s\bar{u} = \epsilon B(\bar{u})\bar{u}' + \epsilon^2 C(\bar{u})\bar{u}'' + c, \quad (12)$$

et on suppose de plus, afin que (12) reste toujours d'ordre 2, que

**H.DD.1**  $C : \mathcal{U} \rightarrow \mathbb{R}$  ne s'annule pas,

Sous l'hypothèse supplémentaire

**H.DD.2**  $B(u^\pm) > 0$ ,

qui s'apparente à la condition de parabolicité (H.V.1),  $(u^-, u^+; s)$  est un choc non-classique ne vérifiant pas la condition de Lax si et seulement si on fait l'hypothèse

**H.DD.3**  $f'(u^\pm) - s$  et  $C : \mathcal{U} \rightarrow \mathbb{R}$  sont de même signe (par exemple positifs).



L'étude des profils de viscosité a été menée par Majda et Pego [61] à l'aide de techniques provenant des systèmes dynamiques et l'existence a été montrée pour des chocs de faible amplitude sous des hypothèses de non-linéarité [20, 65, 34]. L'existence des profils de relaxation semi-linéaire découle des cas plus complexes cités précédemment, comme on peut le voir en comparant (10) à (9) avec comme matrice de viscosité scalaire  $\zeta^2 I_d$ . En ce qui concerne l'approximation par diffusion-dispersion, l'existence des profils a été étudiée pour l'équation de Korteweg-deVries-Burgers modifiée [37, 40].

L'existence de profils de chocs, notamment visqueux, fournit une nouvelle condition d'admissibilité et justifie l'étude de chocs qui ne satisfont pas à la condition de Lax : dans la suite, nous nous intéresserons ainsi à des chocs sous-compressifs et surcompressifs, nommés ainsi par référence aux chocs de Lax, qui sont également appelés compressifs, car, en dynamique des gaz parfaits, la pression augmente à travers de tels chocs.

Un choc est dit *sous-compressif* si les caractéristiques traversent le choc sans perdre d'information [71]. Notamment, dans le cas de l'approximation par diffusion-dispersion, l'hypothèse (H.DD.3) implique que les seuls chocs considérés sont sous-compressifs. Quand il s'agit d'un choc de Lax,  $d + 1$  caractéristiques rentrent dans le choc, et  $d - 1$  ressortent [16, 74]. Dans le cas d'un choc surcompressif de degré  $\varpi$ , avec  $\varpi \geq 1$ , il y a  $d + \varpi + 1$  caractéristiques entrantes et  $d - \varpi - 1$  caractéristiques sortantes [21, 54, 56] et une famille à  $\varpi + 1$  paramètres de profils.

Ces trois conditions se résument par

### K 3

$$\begin{aligned} a_p^+ &< s < a_q^- , \\ a_{q-1}^- &< s < a_{p+1}^+ \end{aligned}$$

avec  $\varpi = p - q \in \{-1, \dots, d - 1\}$ ,

où  $(a_1^\pm, \dots, a_d^\pm)$  désignent les valeurs propres de  $df(u^\pm)$  rangées dans l'ordre croissant. Une interprétation graphique est donnée par la figure 2.1 page 119.

Plaçons-nous à présent dans le cas d'une approximation discrète. On définit l'analogie de la variable  $\xi$  par  $z := (x - st)/h$ , le pas d'espace  $h$  étant analogue au petit paramètre  $\epsilon$ . Or, au point  $(n, j) \in \mathbb{N} \times \mathbb{Z}$ ,  $z_j^n$  vaut  $j - \eta n$ , avec  $\eta := ks/h$  la vitesse discrète du choc. Si  $\eta$  est rationnel,  $z$  appartient à  $\mathbb{Q}$ , sinon  $x$  appartient à  $\mathbb{R}$ . Notons  $\Upsilon_\eta$  le domaine de  $z$ . Un profil de choc  $\bar{v} : \Upsilon_\eta \rightarrow \mathcal{U} \subset \mathbb{R}^d$  est une fonction de  $z$  qui satisfait l'équation fonctionnelle

$$\begin{aligned} \bar{v}(z - \eta) &= \bar{v}(z) - \frac{k}{h}(g^{k/h}(\bar{v}(z), \bar{v}(z + 1)) - g^{k/h}(\bar{v}(z - 1), \bar{v}(z))), \\ \lim_{z \rightarrow +\infty} \bar{v}(z) &= u^+ \text{ et } \lim_{z \rightarrow -\infty} \bar{v}(z) = u^- \end{aligned} \quad (13)$$

La question de l'existence de profils discrets a fait l'objet de nombreuses études [41, 62, 64]. Si on considère des chocs stationnaires, c'est à dire de vitesse nulle, l'équation (13) est une récurrence d'ordre 2. Pour des vitesses discrètes rationnelles, en itérant le schéma, on peut se ramener à un choc stationnaire, mais au prix de l'augmentation significative du nombre de points du schéma... Enfin, le problème de l'existence pour  $\eta$  irrationnel reste largement ouvert à ce jour [72], bien que T.-P. Liu et S.-H. Yu [57, 58] aient trouvé une condition diophantienne sous laquelle ils ont prouvé que de tels profils existent. L'étude des profils semi-discrets représente une approche intermédiaire entre profils continus et

profils discrets. Leur existence a été prouvée dans le cas de schémas à trois points par S. Benzoni et P. Huot [3].

Dans la partie III, qui concerne les approximations discrètes, ne seront considérés que des profils de chocs stationnaires. Dans ce cas, la variable  $z$  dans l'équation (13) peut être considérée comme entière et on note le profil comme une suite  $\bar{v} = (\bar{v}_j)_{j \in \mathbb{Z}}$ . L'équation de profil se ramène alors à

$$g^{k/h}(\bar{v}_j, \bar{v}_{j+1}) = c \quad (14)$$

avec  $c = f(u^+) = f(u^-)$ .

### 3.4 Stabilité

Pour toutes les approximations que nous allons aborder, on fera l'hypothèse suivante

**K 4** *il existe un profil de choc, noté  $\bar{U}$  pour (RSL),  $\bar{u}$  pour (DD) (resp.  $\bar{v} = (\bar{v}_j)_{j \in \mathbb{Z}}$  pour les schémas), reliant les états  $u^-$  et  $u^+$  à la vitesse  $s$  (resp. à la vitesse nulle).*

Dans la suite, on note  $\mathcal{L}$  l'opérateur "d'évolution", c'est à dire celui défini par

- dans le cas d'une approximation continue :

$$u_t = \mathcal{L}(u, u_x, u_{xx}, \dots),$$

- dans le cas d'une approximation discrète :

$$u_j^{n+1} = u_j^n + (\mathcal{L}(u^n))_j.$$

La stabilité spectrale des profils de chocs est le premier "niveau" de stabilité : on linéarise  $\mathcal{L}$  au voisinage du profil de choc choisi et on étudie le spectre de l'opérateur obtenu, que l'on note  $L$ .

**Définition 3.2** Lorsqu'il s'agit d'une approximation continue (resp. discrète), on dit qu'un profil de choc est *spectralement stable* si le spectre de l'opérateur linéarisé associé  $L$  n'a pas de spectre dans le demi-plan  $\Omega := \{\lambda \in \mathbb{C} / \operatorname{Re}(\lambda) > 0\}$  (resp. dans  $\mathcal{O} := \{\lambda \in \mathbb{C} / |\lambda + 1| > 1\}$ ).

Il est important, dans ce contexte, d'analyser la nature du spectre : on introduit la notion de *spectre essentiel*, dont on peut trouver différentes définitions dans la littérature. Ici, on s'intéresse à celle donnée par Henry [38] dans le cadre de des équations paraboliques semi-linéaires

**Définition 3.3** le spectre essentiel, noté  $\sigma_{ess}^1(M)$ , d'un opérateur  $M$  sur un espace de Hilbert  $H$  est le complémentaire de l'union de l'ensemble résolvant de  $M$  et des valeurs propres isolées de multiplicité finie de  $M$ ,

et à celle introduite par M. Schechter [70]

**Définition 3.4** le spectre essentiel, noté  $\sigma_{ess}^2(M)$ , est l'intersection du spectre de tous les opérateurs  $M + K$ , avec  $K$  opérateur compact.

On a alors le théorème suivant

**Théorème 3.1**

si  $M$  est un opérateur fermé,  $\sigma_{ess}^2(M)$  est le complémentaire de l'ensemble des complexes  $\lambda$  tels que l'opérateur  $M - \lambda$  soit Fredholm d'indice 0.

La définition 3.3 est celle utilisée par R. Gardner et K. Zumbrun [24] et vaut par sa compréhension intuitive; la définition 3.1 est, quant à elle, plus précise. Sa mise en œuvre repose sur la théorie de la dichotomie exponentielle, développée par Coppel [14]. Ces deux définitions ne coïncident a priori que dans le cas auto-adjoint; dans le cas d'un opérateur quelconque fermé sur un espace de Hilbert,  $\sigma_{ess}^2(M)$  est inclus dans  $\sigma_{ess}^1(M)$  et  $\sigma_{ess}^2(M)$  contient le bord de  $\sigma_{ess}^1(M)$  [39]. A l'aide de la transformée de Fourier, on étudie le spectre des opérateurs limites de  $M$  quand la variable d'espace tend vers  $\pm\infty$  pour délimiter le spectre essentiel de  $M$  : on "raccorde" le comportement des solutions de  $M - \lambda$  entre  $-\infty$  et  $+\infty$ . En dehors du spectre essentiel ne restera comme spectre que les valeurs propres isolées. On notera que cette définition s'applique aussi bien au cas des approximations continues qu'aux approximations discrètes. Dans les cas traités ci-après, on démontre que, sous les hypothèses standard, le spectre essentiel de l'opérateur linéarisé  $L$  se trouve dans le demi-plan stable, c'est à dire  $\{\lambda \in \mathbb{C}/\text{Re}(\lambda) \leq 0\}$ , (resp. dans le disque  $\{\lambda \in \mathbb{C}/|\lambda + 1| \leq 1\}$ ) ce qui permet de ramener l'étude de la stabilité spectrale à l'étude des valeurs propres dans le demi-plan  $\Omega$  (resp.  $\mathcal{O}$ ).

## 4 Fonction d'Evans [18]

La première étape, classique dans l'analyse des ondes progressives, consiste à changer de repère galiléen en faisant un changement de variable  $x \leftrightarrow x - st$  pour se ramener à un choc stationnaire.

### 4.1 Système dynamique associé

Une fois défini et délimité le spectre essentiel de l'opérateur linéarisé  $L$ , que nous noterons dorénavant  $\sigma_{ess}(L)$ , on étudie aux solutions de l'équation aux valeurs propres  $L - \lambda$  avec  $\lambda$  appartenant au complémentaire de  $\sigma_{ess}(L)$ ,  $\mathbb{C} \setminus \sigma_{ess}(L)$ . A cette fin, on récrit le système  $Lv = \lambda v$  comme un système du premier ordre à  $2d$  équations. Dans le cas d'une approximation continue, on obtient une équation différentielle ordinaire, qu'on note

$$W' = \mathbb{A}(\lambda, x)W, \quad x \in \mathbb{R}, \quad (15)$$

$W$  étant un vecteur dont les composantes sont  $v$  et éventuellement des dérivées successives de  $v$ , typiquement  $W = v$  pour la relaxation semi-linéaire,  $W = (v, v')^T$  pour la viscosité,  $W = (v, v', v'')^T$  pour l'approximation avec diffusion et dispersion. Pour les approximations (V) et (DD), les hypothèses (H.V.1) et (H.DD.1) garantissant la non-dégénérescence des équations régissant les profils assure que le système (15) est bien défini. Le cas de (RSL) ne pose pas de problème puisque l'hypothèse d'inversibilité de la matrice de diffusion découle de (H.RSL').

Dans le cas d'une approximation discrète, on obtient un système dynamique discret du premier ordre

$$W_{j+1} = \mathbb{A}_j(\lambda)W_j, \quad j \in \mathbb{Z}, \quad (16)$$

où les composantes de  $W_j$  sont des combinaisons linéaires de  $v_j$  et  $v_{j-1}$ . Dans le cas du schéma (LFM), l'hypothèse CFL (H.LFM.1) assure que le système (16) est bien défini. En revanche, il faut une hypothèse supplémentaire pour le schéma (LW) :

**H.DIS** pour tout  $j \in \mathbb{Z}$ ,  $df(\bar{v}_j)$  est inversible.

## 4.2 Comportement des solutions aux limites

L'étude des solutions nécessite les définitions suivantes :

### Définitions 4.1

1. l'espace stable  $S^+(\lambda)$  de (15) quand  $x$  tend vers  $+\infty$  est l'espace vectoriel des solutions tendant exponentiellement vers 0 quand  $x$  tend vers  $+\infty$ ,
2. l'espace instable  $U^-(\lambda)$  de (15) quand  $x$  tend vers  $-\infty$  est l'espace vectoriel des solutions tendant exponentiellement vers 0 quand  $x$  tend vers  $-\infty$ .

Ces définitions sont très aisément transposables au cas discret. Quand  $\lambda$  n'appartient pas au spectre essentiel,  $\lambda$  est valeur propre de  $L : H^1 \rightarrow L^2$  si et seulement si les espaces  $S^+(\lambda)$  et  $U^-(\lambda)$  ont une intersection non nulle. En prenant le déterminant d'une base de l'espace  $S^+(\lambda)$  et de l'espace  $U^-(\lambda)$ , on définit une fonction  $\Delta$  dépendant de  $\lambda$  et de la variable d'espace, analytique en  $\lambda$  sur  $\mathbb{C} \setminus \sigma_{ess}(L)$  et qui s'annule en  $\lambda$  si et seulement si  $\lambda$  est une valeur propre de  $L$ .

Dans le cas d'une approximation continue, on multiplie  $\Delta$  par une fonction  $g$  de  $x$  telle que  $g \cdot \Delta$  soit un Wronskien de (16).

**Notation** On appelle *fonction d'Evans*, [18], notée  $D : \lambda \mapsto D(\lambda)$  la fonction  $g \cdot \Delta$ .

Dans le cas d'une approximation discrète, on constate que  $\Delta(\lambda, j+1) = \det(\mathbb{A}_j(\lambda))\Delta(\lambda, j)$  et que par conséquent, si la matrice  $\mathbb{A}$  est toujours inversible, l'annulation de  $\Delta$  pour un certain couple  $(\lambda, j_0) \in \mathbb{C} \setminus \sigma_{ess}(L) \times \mathbb{Z}$  entraîne l'annulation de  $\Delta$  en tous points de  $\{\lambda\} \times \mathbb{Z}$ .

**Notation** On appelle *fonction d'Evans*, notée  $\mathcal{D} : (\lambda, j) \mapsto \mathcal{D}(\lambda, j)$ , le déterminant  $\Delta$ .

De plus, on s'aperçoit que, comme les opérateurs d'évolution de départ étaient à valeurs réelles, si  $\lambda$  est réel, le système dynamique associé à l'opérateur linéarisé est à valeurs réelles : par conséquent, pour  $\lambda$  réel, on peut choisir la fonction d'Evans de telle sorte qu'elle soit à valeurs dans  $\mathbb{R}$ .

L'idée d'une condition nécessaire de stabilité, développée tout d'abord par J. Evans [19] puis reprise dans de nombreux contextes [80, 24, 4, 2, 89, 73] vient de la constatation précédente : si l'opérateur linéarisé  $L$  n'a pas de valeur propre le long de l'axe réel, la fonction d'Evans doit avoir le même signe au voisinage de l'origine  $\lambda = 0$  et au voisinage de  $+\infty$ . Par conséquent, grâce au théorème des valeurs intermédiaires, le produit des signes de la fonction d'Evans au voisinage de  $\lambda = 0$  et de l'infini doit être positif. Récemment,

le lien entre le comportement de la fonction d'Evans en  $\lambda = 0$  et le système dynamique régissant les profils de chocs et le système hyperbolique sous-jacent a été démontré par R. Gardner et K. Zumbrun [24].

### 4.3 Signe de la fonction d'Evans à l'origine

Le premier problème qui se pose est celui du calcul de  $D$  en  $\lambda = 0$ , puisque  $D$  n'est pas définie a priori en ce point. On remédie à cette difficulté en prolongeant par continuité. Cependant, pour une approximation continue, quelle que soit la nature du choc, comme tous les translatés du profil sont encore des profils, la dérivée du profil appartient au noyau de  $L$ , c'est à dire que  $D$  s'annule en  $\lambda = 0$ . Afin de pouvoir étudier le signe de  $D$  près de 0, R. Gardner et K. Zumbrun [24] ont prouvé le "lemme de l'écart" (Gap Lemma), par lequel on peut prolonger *analytiquement* la fonction d'Evans  $D$  à un voisinage de 0, et grâce auquel on peut envisager le calcul des dérivées successives de  $D$  en 0. Ce résultat a été également obtenu par Kapitula et Sandstede [45].

Dans le cas des approximations discrètes, si le choc est sous-compressif le noyau de  $L$  peut être de dimension nulle. En revanche, dès lors que le choc est compressif,  $\mathcal{D}(0)$  est nul et la dimension du noyau de  $L$  est supérieure à 1. Il faut alors prolonger la fonction d'Evans analytiquement à un voisinage  $\mathcal{V}$  de  $\lambda = 0$ . Dans les cas de (LW) et (LFM), la matrice du système dynamique discret (16) est diagonalisable dans  $\mathbb{R}$  au voisinage de 0 et on prolonge le déterminant colonne par colonne.

**Remarque 4.1** *Pour toutes les approximations, il faut souligner le fait que, pour des chocs surcompressifs de degré  $\varpi$ , il y a en général une famille à  $\varpi + 1$  paramètres de profils et, par conséquent, comme le noyau de  $L$  est de dimension  $\varpi$  au moins, les  $\varpi$  premières dérivées de la fonction d'Evans s'annulent. Il faut donc calculer la  $\varpi + 1$ -ème dérivée. Cependant, un simple calcul par récurrence montre que seules les dérivées premières des éléments d'une base du noyau de  $L$  apparaissent dans l'expression de cette  $(\varpi + 1)$ -ème dérivée.*

### 4.4 Signe de la fonction d'Evans à l'infini

Pour la relaxation semi-linéaire et la diffusion-dispersion, on a utilisé l'approche homotopique décrite par S. Benzoni, D. Serre et K. Zumbrun pour les systèmes de  $d$  lois de conservation avec viscosité [4], qui consiste à relier par une combinaison convexe l'opérateur linéarisé  $L$  à un opérateur très simple dont on peut calculer la fonction d'Evans pour  $\lambda$  réel grand : on prend  $L_0 := (u, v)^T \mapsto M \cdot (u', v')^T$ , avec  $M$  une matrice de  $\mathcal{M}_d(\mathbb{R})$  constante pour (RSL), et  $L_0 := v \mapsto \lambda_0 v'''$ , avec  $\lambda_0 \in \mathbb{R}^{+*}$  pour (DD).

On définit ainsi une famille d'opérateurs  $(L_\theta)_{\theta \in [0,1]}$  par

$$\theta \in [0, 1] \mapsto L_\theta := \theta L + (1 - \theta)L_0.$$

Ayant vérifié que le spectre essentiel des opérateurs  $L_\theta$  est inclus dans  $\mathbb{C} \setminus \Omega$  et que le système dynamique associé est bien défini, on note  $(\theta, \lambda) \mapsto \tilde{D}(\theta, \lambda)$  la fonction d'Evans étendue. Il faut ensuite montrer qu'il existe  $\Lambda \in \mathbb{R}^{+*}$  tel que la fonction d'Evans étendue

ne s'annule pas sur  $[0, 1] \times ]\Lambda, +\infty[$  : ainsi, en calculant le signe de  $\tilde{D}(0, \lambda)$  pour  $\lambda > \Lambda$ , on obtient le signe de  $\tilde{D}(1, +\infty)$ , c'est à dire celui de  $D(+\infty)$ .

Le calcul pour le schéma de Lax-Wendroff a nécessité une méthode radicalement différente : on a utilisé une version discrète simplifiée d'une proposition démontrée par K. Zumbrun et P. Howard ([88], Proposition 3.1) qui permet d'exprimer les solutions du système discret (16) sous la forme  $W(\lambda, j) = \mu(\lambda)^j V(\lambda, j)$ , avec  $\mu(\lambda)$  une valeur propre de  $\mathbb{A}^+(\lambda)$  (resp. de  $\mathbb{A}^-(\lambda)$ ) et  $V(\lambda, j)$  tendant vers  $\mathbf{V}(\lambda)$  un vecteur propre associé à  $\mu(\lambda)$  de  $\mathbb{A}^+(\lambda)$  (resp. de  $\mathbb{A}^-(\lambda)$ ) quand  $j$  tend vers  $+\infty$  (resp. vers  $-\infty$ ).

#### 4.5 Limite de la fonction d'Evans quand la vitesse de relaxation devient infinie

La similarité des récents résultats de stabilité spectrale obtenus pour la viscosité par R. Gardner et K. Zumbrun [24] et S. Benzoni, D. Serre et K. Zumbrun [4] et pour la relaxation semi-linéaire [30] incitent à penser qu'il existe un lien entre la limite de la fonction d'Evans pour la relaxation semi-linéaire quand la vitesse de relaxation  $\mathbf{a}$  devient infinie à  $s$  fixé et la fonction d'Evans pour un profil de viscosité scalaire  $\zeta^2$ . En effet, le système dynamique associé à l'opérateur linéarisé autour d'un tel profil, moyennant un changement élémentaire, est clairement la limite de celui associé au profil  $(\bar{u}, s\bar{u} + c)^T$ , avec  $c = f(u^+) - su^+ = f(u^-) - su^-$ , pour la relaxation semi-linéaire. Les techniques de dichotomie exponentielle développées par Coppel [14], outre leur utilité dans la détermination du spectre essentiel, permettent de construire simultanément les fonctions d'Evans associées aux équations pour la valeur propre  $\lambda$  des deux systèmes dynamiques, et de trouver des estimations de la différence de ces fonctions en  $1/\zeta^2$  locales en  $\lambda$  (Partie II, Chapitre 3). L'application du théorème de Rouché permet ensuite de montrer que, pour  $\zeta$  assez grand, il existe pour chaque zéro de la fonction d'Evans de viscosité un voisinage dans lequel se trouve un zéro de la fonction d'Evans pour la relaxation semi-linéaire de même multiplicité.

## 5 Conditions de stabilité

On présente ici des conditions de stabilité spectrale obtenues grâce à la méthode utilisant la fonction d'Evans développée par R. Gardner et K. Zumbrun [24].

On note désormais  $(r_1^\pm, \dots, r_d^\pm)$  une base de vecteurs propres de  $df(u^\pm)$  associés aux valeurs propres  $(a_1^\pm, \dots, a_d^\pm)$  et  $(s_1^\pm, \dots, s_d^\pm)$  une base de vecteurs propres de  $B(u^\pm)^{-1}df(u^\pm)$ .

### 5.1 Viscosité

En ce qui concerne (V), R. Gardner et K. Zumbrun ont montré, pour  $d = 2$ , le théorème suivant

#### **Théorème 5.1 ([24], Théorème 3.7, pp 831-836)**

*On suppose vérifiées les hypothèses (H.V.1-2) et (K1-4). Alors, si le profil  $\bar{u}$  est spectralement stable, on a*

- si le choc est sous-compressif ( $\varpi = -1$ ) et  $\det(r_1^-, r_2^+) \neq 0$  :

$$? \cdot \det(s_1^+, r_2^+) \cdot \det(r_1^-, s_2^-) \cdot \det(r_1^-, r_2^+) \geq 0,$$

avec

$$? := \int_{-\infty}^{+\infty} e^{-\int_0^x \text{tr}(B(\bar{u})^{-1} df(\bar{u}))} \det(\bar{u}', B(\bar{u})^{-1}(\bar{u} - u^*)),$$

où  $u^*$  est le seul point de  $\mathbb{R}^2$  tel que  $u^* \in (u^- + \mathbb{R}r_1^-) \cap (u^+ + \mathbb{R}r_2^+)$  et  $s_2^-$  et  $s_1^+$  sont orientés comme la limite de  $\bar{u}'$  en (respectivement)  $\mp\infty$  ;

- si le choc est de type Lax ( $\varpi = 0$ ) et  $p = 2$  :

$$\det(r_1^-, [u]) \cdot \det(r_1^-, s_2^-) \geq 0$$

où  $s_2^-$  est orienté comme  $\bar{u}'$  en  $-\infty$  ;

- si le choc est surcompressif de degré 1 ( $\varpi = 1$ ) et  $\bar{u}^\alpha$  est une famille de profils :

$$\det\left(\left(\int_{-\infty}^{+\infty} \bar{u}^\alpha\right), [u]\right) \cdot \det(s_1^-, s_2^-) \geq 0 \quad (17)$$

où  $s_1^-$  et  $s_2^-$  sont orientés comme (respectivement)  $\bar{u}'$  et  $\bar{u}^\alpha$  en  $-\infty$ .

Plus précisément, si ces quantités sont positives, l'opérateur  $L$  a un nombre pair de modes instables et un nombre impair sinon.

S. Benzoni, D. Serre et K. Zumbrun [4] ont étendu la méthode au cas des systèmes  $d \times d$  et ils ont montré la condition pour des *chocs de Lax extrêmes*, condition que R. Gardner et K. Zumbrun avaient conjecturée dans [24], en utilisant les hypothèses supplémentaires

**H.V.3** il existe  $\varepsilon > 0$  tel que

$$\forall y \in \mathbb{R}, \text{Re}(\sigma(iydf(u^\pm) - y^2 B(u^\pm))) \leq -\varepsilon y^2,$$

appelée *condition de stabilité de Majda-Pego* [61] et

**H.V.4** dans le voisinage des états constants  $u^\pm$ , le système de lois de conservation (1) est compatible avec une inégalité d'énergie de la forme

$$E(u)_t + F(u, u_x)_x + \omega \|u_x\|^2 \leq 0,$$

avec  $D^2 E(u^\pm) > 0_d$  et  $\omega > 0$ .

Cette condition s'énonce

**Théorème 5.2** ([4], **Théorème 2, page 33**)

En supposant (H.V.1-H.V.4) et (K1-4) satisfaites avec  $\varpi = 0$  et  $p = d$ , une condition nécessaire de stabilité spectrale du profil  $\bar{u}$  est

$$\det(r_1^-, \dots, r_{d-1}^-, s_d^-) \cdot \det(r_1^-, \dots, r_{d-1}^-, [u]) \geq 0. \quad (18)$$

## 5.2 Relaxation semi-linéaire

Dans le Chapitre 1, Partie II, on développe pour l'approximation par relaxation semi-linéaire des conditions similaires à celles présentées ci-dessus. Intéressons-nous au système obtenu en linéarisant (10) au voisinage de  $\bar{U} = (\bar{u}, 0)^T$  dont on a supposé l'existence par (K4) :

$$\phi' = \frac{1}{\zeta^2} (df(\bar{u}) - sI_d)\phi, \quad (19)$$

Notons  $S^+$  (resp.  $U^-$ ) le sous-espace stable en  $+\infty$  (resp. instable en  $-\infty$ ) de (19) avec les notations du paragraphe 4.2 précédent. Les hypothèses sur la nature du choc (K2-3) impliquent que la dimension de  $S^+$  est  $p$  et que celle de  $U^-$  est  $d - q + 1$  : par conséquent, la dimension de l'intersection de  $S^+$  et de  $U^-$  est supérieure à  $\varpi + 1$  et à 1, puisque la dérivée du profil est toujours solution de (19). On choisit une base de solutions de  $S^+$  (resp. de  $U^-$ ) sous la forme  $(\phi_1, \dots, \phi_{p-1}, \bar{u}')$ , (resp.  $(\bar{u}', \phi_{q+1}, \dots, \phi_d)$ ) de sorte que, en réordonnant correctement les valeurs propres de  $df(u^\pm) - sI_d$ , on ait les comportements suivants

$$\lim_{x \rightarrow +\infty} e^{(s-a_m^+)x/\zeta^2} \phi_m(x) = r_m^+, \quad m \in \{1, \dots, p-1\}, \quad (20)$$

$$\lim_{x \rightarrow +\infty} e^{(s-a_p^+)x/\zeta^2} \bar{u}' = r_p^+, \quad (21)$$

$$\lim_{x \rightarrow -\infty} e^{(s-a_q^-)x/\zeta^2} \bar{u}' = r_q^-, \quad (22)$$

$$\lim_{x \rightarrow -\infty} e^{(s-a_m^-)x/\zeta^2} \phi_m(x) = r_m^-, \quad m \in \{q+1, \dots, d\}. \quad (23)$$

Si le choc est sous-compressif, on fait l'hypothèse supplémentaire

**K 5**  $(r_1^-, \dots, r_{p-1}^-, r_p^+, \dots, r_d^+)$  est une base de  $\mathbb{R}^d$ .

On écrit le saut de  $u$  dans cette base :

$$[u] = \beta_1^- r_1^- + \dots + \beta_{p-1}^- r_{p-1}^- + \beta_p^+ r_p^+ + \dots + \beta_d^+ r_d^+$$

et on définit le point

$$u^* := u^- + \beta_1^- r_1^- + \dots + \beta_{p-1}^- r_{p-1}^- = u^+ - \beta_p^+ r_p^+ + \dots + \beta_d^+ r_d^+.$$

**Remarque 5.1** Cette condition et la définition de  $u^*$  sont les généralisations de l'hypothèse supplémentaire faite dans le théorème 5.1 pour les chocs sous-compressifs et du point  $u^*$  cité.

Si le choc est surcompressif, quitte à réordonner une nouvelle fois les valeurs propres de  $df(u^\pm) - sI_d$ , on note

$$\psi_m := \phi_{p-m} = \phi_{p+m+1}, \quad m \in \{1, \dots, \varpi\},$$

de sorte que  $(\bar{u}', \psi_1, \dots, \psi_\varpi)$  est une base de  $S^+ \cap U^-$ . On obtient alors les conditions nécessaires suivantes



**Théorème 5.3 (Partie II, Théorèmes 1.3.1, 1.3.2, 1.3.3, 1.9.1)**

Supposons (H.RSL') et (K1-4) satisfaites. Alors, si le profil  $\bar{U}$  est spectralement stable, les inégalités suivantes ont lieu :

- si le choc est sous-compressif ( $\varpi = -1$ ) et (K5) est satisfaite :

$$? \cdot \det(r_1^-, \dots, r_{p-1}^-, r_p^+, \dots, r_d^+) \cdot \det(r_1^+, \dots, r_d^+) \geq 0$$

avec

$$? := \frac{1}{\zeta^2} \int_{-\infty}^{+\infty} e^{-\int_0^x \text{tr}(df(\bar{u}))/\zeta^2} \det(\phi_1, \dots, \phi_{p-2}, (\bar{u} - u^*), \bar{u}', \phi_{p+1}, \dots, \phi_d);$$

- si le choc est de type Lax ( $\varpi = 0$ ) :

$$\det(\phi_1, \dots, \phi_{p-1}, \bar{u}', \phi_{p+1}, \dots, \phi_d) \cdot \det(r_1^-, \dots, r_{p-\varpi-1}^-, [u], r_p^+, \dots, r_d^+) \\ \cdot \det(r_1^-, \dots, r_d^-) \cdot \det(r_1^+, \dots, r_d^+) \geq 0.$$

- si le choc est surcompressif ( $\varpi \geq 1$ ) :

$$\det(\phi_1, \dots, \phi_{p-1}, \bar{u}', \psi_1, \dots, \psi_\varpi, \phi_{p+\varpi+1}, \phi_d) \\ \cdot \det(r_1^-, \dots, r_{p-\varpi-1}^-, \int_{\mathbb{R}} \psi_\varpi, \dots, \int_{\mathbb{R}} \psi_1, [u], r_p^+, \dots, r_d^+) \cdot \det(r_1^-, \dots, r_d^-) \cdot \det(r_1^+, \dots, r_d^+) \geq 0.$$

Remarquons que, dans le cas d'un  $d$ -choc de Lax, en faisant tendre  $x$  vers  $+\infty$  et en utilisant le comportement des solutions ( $\phi$ ) décrit en (20)-(23), on obtient la même condition que (18) obtenue par S. Benzoni, D. Serre et K. Zumbrun [4] en prenant une matrice de viscosité scalaire  $B = \zeta^2 I_d$  : si le profil  $\bar{U}$  est stable, alors

$$\det(r_1^-, \dots, r_{d-1}^-, [u]) \cdot \det(r_1^-, \dots, r_d^-) \geq 0.$$

L'interprétation géométrique est la suivante : le segment  $[u^-, u^+]$  et  $r_d^-$  doivent se trouver dans le même demi-espace par rapport à l'hyperplan engendré par  $(r_1^-, \dots, r_{d-1}^-)$  (voir la figure 1.1 page 31 pour le cas  $d = 3$ ).

### 5.3 Illustration dans le cas $d = 2$

H. Freistühler et K. Zumbrun [23] ont exhibé des profils ne satisfaisant pas la condition (17) dans le cas de chocs surcompressifs, c'est à dire des profils instables.

Dans le même esprit, E. Lorin et moi avons réfléchi à l'existence de profils dans le cas d'un choc de Lax extrême, plus précisément d'un 2-choc. La méthode utilisée (Partie II, Chapitre 2) est la suivante : ayant analysé les caractéristiques que doit avoir un profil instable grâce à la représentation géométrique de la condition suffisante d'instabilité (voir figure 2.1 page 57), on choisit un tel profil et on construit un système dynamique dont il est solution, ce qui donne un flux  $f$  et un système de lois de conservation. On simule ensuite l'instabilité à l'aide d'un schéma de splitting : les résultats obtenus (voir figure 1) montrent l'explosion de la solution quand on a donné comme condition initiale le profil avec une perturbation.

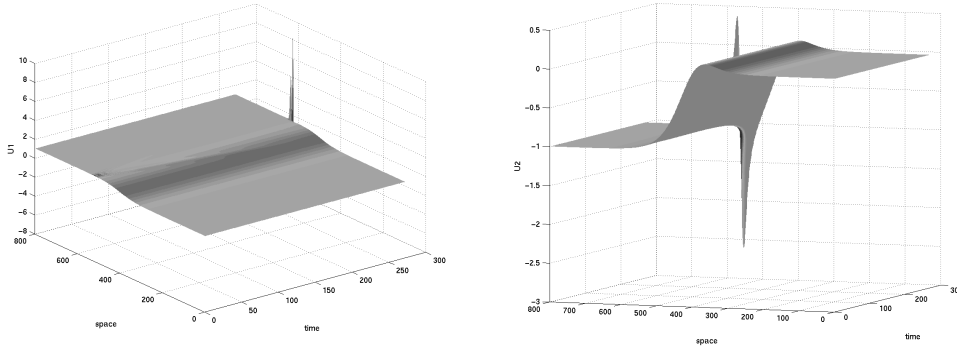

Fig. 1: Explosion de la solution obtenue par un schéma de splitting

#### 5.4 Diffusion-dispersion

La condition trouvée dans le Chapitre 4, Partie II, a été développée indépendamment de celle de K. Zumbrun [87]. Les seuls chocs considérés étant des chocs sous-compressifs (hypothèse H.DD.3), on a la condition nécessaire de stabilité suivante, en supposant (H.DD.1-3) et (K1-2) et (K4) satisfaites :

$$\int_{-\infty}^{+\infty} \exp\left(-\int_t^0 \frac{b(s)}{c(s)} ds\right) \bar{u}'(t)(\bar{u}(t) - u^-) dt > 0.$$

Ce résultat se rapproche de ceux cités plus haut pour des chocs sous-compressifs, la particularité étant ici le point  $u^*$  qui est en fait le point  $u^-$ , car on est dans le cas scalaire.

#### 5.5 Schéma de Lax-Wendroff

On ne considère ici que des profils de chocs stationnaires. On linéarise l'équation de profil (14) au voisinage du profil  $\bar{v}$  et on la réécrit comme un système dynamique du premier ordre

$$\varphi_{j+1} = -df(\bar{v}_{j+1})^{-1} \left( I_d - df\left(\frac{\bar{v}_{j+1} + \bar{v}_j}{2}\right) \right)^{-1} \left( I_d + df\left(\frac{\bar{v}_j + \bar{v}_{j-1}}{2}\right) \right) df(\bar{v}_j) \varphi_j =: N_j \varphi_j.$$

D'après la condition CFL (H.LW) et la condition (H.DIS), ce système est bien défini et, comme les valeurs propres de la matrice  $N_j$  tendent vers  $-(1+a)/(1-a)$ , où  $a$  désigne une valeur propre de  $df(u^\pm)$ , l'espace stable  $S^+$  est de dimension  $p$  et l'espace instable  $U^-$  de dimension  $d - q + 1$ , sous l'hypothèse (K3) concernant la nature du choc. Par conséquent, on peut définir une base  $(\phi^1, \dots, \phi^p)$  de  $S^+$  et une base  $(\phi^q, \dots, \phi^d)$  de  $U^-$  telles que l'on ait :

pour  $m \in \{1, \dots, p\}$

$$\begin{aligned} \phi_j^m &\xrightarrow{j \rightarrow +\infty} 0, \\ \lim_{j \rightarrow +\infty} \frac{\phi_j^m}{|\phi_j^m|} &= r_m^+, \end{aligned}$$

et pour  $m \in \{q, \dots, d\}$

$$\begin{aligned} \phi_j^m &\xrightarrow{j \rightarrow -\infty} 0, \\ \lim_{j \rightarrow -\infty} \frac{\phi_j^m}{|\phi_j^m|} &= r_m^-. \end{aligned}$$

Au contraire du cas des approximations continues, pour un choc sous-compressif, cette intersection peut-être nulle. Ceci tient au fait que dans le cas discret, seules les translations de paramètres entiers des profils sont encore des profils, contrairement au cas continu où il y a automatiquement une famille à un paramètre de profils dès qu'on a prouvé l'existence d'un profil. En revanche, dès que le choc est compressif ( $\varpi \geq 0$ ), l'intersection de  $S^+$  et de  $U^-$  est au moins de dimension 1. On appelle  $(\psi^0, \dots, \psi^\varpi)$  une base de l'intersection de  $S^+$  et de  $U^-$  tels que, quitte à réordonner les valeurs propres de  $df(u^\pm)$ ,

$$\psi^m = \phi_{p-m} = \phi_{q+m}, \quad m \in \{0, \dots, \varpi\}.$$

La condition nécessaire de stabilité spectrale trouvée par les techniques de fonction d'Evans est la suivante

#### **Théorème 5.4**

si les hypothèses (K1-4), (H.LW) et (H.DIS) sont satisfaites, si  $\bar{v}$  est spectralement stable, il existe  $J \in \mathbb{N}$  tel que, pour tout  $j \geq J$ , l'inégalité suivante soit vérifiée

$$\begin{aligned} (-1)^{\varpi-1+j(d+\varpi-1)} \cdot \det(\phi_j^1, \dots, \phi_j^p, \phi_j^{q+\varpi+1}, \dots, \phi_j^d) \cdot \Theta^\varpi(\Sigma_j^0, \dots, \Sigma_j^\varpi) \\ \cdot \det(r_1^+, \dots, r_d^+) \cdot \det(r_1^-, \dots, r_d^-) > 0, \end{aligned} \quad (24)$$

où  $\Sigma_j^m = (I_d - N_j)^{-1} \sum_{l \in \mathbb{Z}} \psi_l^m$ ,  $m \in \{0, \dots, \varpi\}$  et  $\Theta^\varpi$  est une forme linéaire définie par

$$\Theta^\varpi(\vec{e}_0, \dots, \vec{e}_\varpi) := \det(r_1^+ \dots, r_{q-1}^-, \vec{e}_0, \dots, \vec{e}_\varpi, r_{p+1}^+, \dots, r_d^+).$$

Le signe de cette inégalité ne dépend en fait pas du choix du point  $j \geq J$  considéré car on a l'identité

$$\mathcal{D}(\lambda, j+1) = (-1)^d \mathcal{D}(\lambda, j)$$

pour  $j$  assez grand. De plus, la convergence rapide du profil  $\bar{v}$  vers ses états extrêmes implique que la condition (24) est calculable en pratique pour des valeurs de  $j$  raisonnables. Une condition similaire a été démontrée dans le cas des  $d$ -chocs de Lax pour le schéma de Godunov par M. Bultelle, M. Grassin et D. Serre [9].

## 6 Fonction de Green pour le schéma de Lax-Friedrichs modifié

Décrivons tout d'abord le rôle des fonctions de Green dans l'étude de la stabilité des profils visqueux réalisée par K. Zumbrun et P. Howard dans [88].

Sous les hypothèses (K1-4), (H.V.1) et (H.V.3), on s'intéresse au problème d'évolution linéarisé au voisinage d'un profil de choc visqueux  $\bar{u}$

$$\partial_t v - Lv = \tilde{v}, \quad \forall t > 0, \quad \forall x \in \mathbb{R}, \quad (25)$$

$$v(x, t) \xrightarrow{x \rightarrow \pm\infty} 0, \quad \forall t > 0, \quad (26)$$

$$v(\cdot, 0) = v^0, \quad (27)$$

où  $\tilde{v}$  et  $v^0$  sont données et l'opérateur  $L$  est défini par

$$Lv := (-(df(\bar{u}) - dB(\bar{u})\bar{u}_x)v)_x + (B(\bar{u})v_x)_x \quad (28)$$

On peut obtenir des estimations très précises des solutions de (25)-(26)-(27) au moyen de la fonction de Green, notée  $G : (x, t; y) \mapsto G(x, t; y)$ , c'est à dire la solution matricielle du problème homogène avec comme donnée initiale une masse de Dirac  $\delta_y$  en un point  $y$  fixé :

$$\begin{aligned} \partial_t G - LG &= 0, \quad \forall t > 0, \forall x \in \mathbb{R}, \\ G(x, t; y) &\xrightarrow{x \rightarrow \pm\infty} 0, \quad \forall t > 0, \\ G(\cdot, 0; y) &= \delta_y I_d, \end{aligned}$$

grâce à la formule

$$v(x, t) = \int_{\mathbb{R}} G(x, t; y)v^0(y)dy + \int_{\mathbb{R}} \int_0^t G(x, t-s; y)\tilde{v}(y, s)dy. \quad (29)$$

Cette méthode permet de contourner la difficulté liée au fait que la valeur propre 0 fait partie du spectre essentiel, ce qui rend inapplicables les techniques classiques de semi-groupes. Dans le cas scalaire, D. Sattinger [69] évite cette difficulté à l'aide de normes à poids, qui permettent de "décoller" le spectre essentiel de l'axe imaginaire. T. Kapitula [44] a montré que cette technique s'applique également pour les systèmes dans le cas de chocs totalement compressifs. Dans [88], K. Zumbrun et P. Howard considèrent tous les types de chocs en introduisant de nouvelles méthodes ponctuelles de semi-groupes, qui s'apparentent plutôt aux techniques de transformation de Fourier utilisées par Y. Zeng [85, 59]. Les estimations ainsi obtenues sur la fonction de Green, et plus particulièrement le découpage de cette dernière en termes "excité" (excited), "dispersif" (scattering) et "résiduel" (residual), permettent de comprendre le comportement des solutions élémentaires du problème linéarisé, et pour des perturbations faibles, du problème non-linéaire. K. Zumbrun et P. Howard en déduisent une condition nécessaire et suffisante de stabilité s'exprimant à l'aide d'une fonction d'Evans.

L'outil utilisé pour étudier la fonction de Green est la transformée de Laplace, définie par

$$v \mapsto \left( \lambda \mapsto \int_0^{+\infty} e^{-\lambda s} v(s) ds \right).$$

La transformée de la fonction de Green par rapport à la variable de temps  $t$ , notée  $(x; y) \mapsto G_\lambda(x; y)$  est solution du problème suivant à  $y$  fixé :

$$\begin{aligned} (L - \lambda)G_\lambda &= -\delta_y I_d, \\ G_\lambda(x; y) &\xrightarrow{x \rightarrow \pm\infty} 0. \end{aligned}$$

On récrit l'équation aux valeurs propres  $Lv = \lambda v$  de  $L$  comme un système dynamique du premier ordre de la forme (15). En étudiant les systèmes limites quand  $x$  tend vers  $\pm\infty$ , et plus précisément les solutions tendant vers 0 quand  $x$  tend vers  $+\infty$  ou  $-\infty$ , on peut construire la fonction d'Evans  $D : \lambda \mapsto D(\lambda)$ , qui est analytique dans le demi-plan  $\Omega$ . Comme le précise le paragraphe 4.3, la valeur propre 0 est toujours dans le spectre

essentiel, du fait de l'invariance par translation, et le prolongement par continuité de la fonction d'Evans s'annule donc en ce point.

On écrit ensuite  $G_\lambda$  au point  $(x; y)$  comme une matrice dont les colonnes représentent une base de l'espace stable (en  $x$ ) en  $+\infty$  (resp. instable (en  $x$ ) en  $-\infty$ ) du système dynamique (15) quand  $x > y$  (resp.  $x < y$ ). La continuité de  $G_\lambda$  en  $x = y$  induit des conditions de compatibilité sous la forme d'un système linéaire dont le déterminant est la fonction d'Evans en  $\lambda$ . Par conséquent,  $\lambda \mapsto G_\lambda$  est méromorphe sur  $\Omega$  privé des zéros de  $\mathcal{D}$  et on peut calculer des estimations de  $G_\lambda$ .

On utilise ensuite la transformation de Laplace inverse

$$G(x, t; y) = \frac{1}{2\pi} \int_\gamma e^{\lambda t} G_\lambda(x; y) d\lambda, \quad (30)$$

en veillant à choisir des contours permettant d'obtenir des estimations de  $G$  : on distingue des cas selon que  $t$  est grand, petit ou du même ordre que  $at$ , où  $a$  est une valeur propre de  $df(u^\pm)$  et on prend des chemins d'intégration, dépendant de  $x, y$  et  $t$ , qui permettent de calculer des équivalents de  $G$  exprimée comme une intégrale de la forme (30), grâce à la méthode des points-selles de Riemann [6].

Dans le cas des couches-limites, E. Grenier et F. Rousset ont utilisé ce type d'estimations avec la construction itérative de fonctions de Green pour obtenir un théorème de convergence de la méthode de viscosité sous des conditions spectrales [36]. F. Rousset a montré un théorème similaire dans le contexte des chocs compressifs ( $\varpi \geq 0$ ) [68].

Le dernier chapitre de ce mémoire est consacré à l'obtention d'estimations du même genre que celles obtenues par K. Zumbrun et P. Howard [88] dans le cas des profils de chocs discrets pour le schéma de Lax-Friedrichs modifié. Pour les raisons qui sont données dans le paragraphe 3.4 précédent, on ne considère que des chocs stationnaires. On s'intéresse au problème linéarisé autour d'un profil

$$u^{n+1} - u^n - Lu^n = \tilde{u}^n, \quad \forall n \geq 0, \quad (31)$$

$$u_j^n \xrightarrow{j \rightarrow \pm\infty} 0, \quad \forall n \geq 1, \quad (32)$$

$$u^0 = \mathbf{u}, \quad (33)$$

où  $\tilde{u} = (\tilde{u}_j^n)_{j \in \mathbb{Z}, n \in \mathbb{N}}$  et  $\mathbf{u} = (\mathbf{u}_j)_{j \in \mathbb{Z}}$  sont données. Le fonction de Green discrète associée, que l'on note  $(G(j, n; l))_{j \in \mathbb{Z}, n \in \mathbb{N}; l \in \mathbb{Z}}$ , est une suite de matrices carrées de taille  $d$  qui sont solutions du problème suivant, à  $l \in \mathbb{Z}$  fixé :

$$G(j, n+1; l) - G(j, n; l) - LG(j, n; l) = 0, \quad \forall n \geq 0, \forall j \in \mathbb{Z}, \quad (34)$$

$$G(j, n; l) \xrightarrow{j \rightarrow \pm\infty} 0, \quad \forall n \geq 1, \quad (35)$$

$$G(j, 0; l) = \delta_{jl} I_d, \quad j \in \mathbb{Z}, \quad (36)$$

où  $\delta$  désigne le symbole de Kronecker.

La solution formelle de (31)-(32)-(33) est donnée par

$$u_j^n = \sum_{l=-\infty}^{+\infty} G(j, n; l) \mathbf{u}_l + \sum_{\bar{n}=0}^{n-1} \sum_{l=-\infty}^{+\infty} G(j, n - \bar{n}; l) \tilde{u}_l^{\bar{n}}, \quad j \in \mathbb{Z}, n \in \mathbb{N}.$$

Pour éviter les valeurs propres instables de l'opérateur  $L$  (voir paragraphe 3.4), on suppose que

**H.LFM.2**  $L$  n'a pas de valeur propre dans  $\mathcal{O}$ . Plus précisément,  $L$  n'a pas de spectre dans  $\{\lambda, |\lambda + 1| \geq 1\}$ , à part éventuellement  $\lambda = 0$ .

En effet, dans le cas compressif  $\varpi \geq 0$ , 0 est nécessairement une valeur propre de  $L$  (paragraphe 4.3 précédent). Afin de savoir quel rôle joue  $\lambda = 0$ , on utilise la fonction d'Evans, et plus particulièrement, comme ses  $\varpi$  premières dérivées s'annulent (Remarque 4.1), on suppose

**H.LFM.3**  $\frac{\partial^{\varpi+1} \mathcal{D}}{\partial \lambda^{\varpi+1}}(0, j) \neq 0$ .

L'objectif du dernier chapitre de ce mémoire est de prouver le théorème suivant

### Théorème 6.1

En supposant (H.LFM.1-3) et (K1-4) satisfaites, la fonction de Green du problème linéarisé (31)-(32)-(33) a le comportement suivant

$$\begin{aligned}
 & \text{for } \vec{e} \in \mathbb{R}^d, \\
 G(j, n; l) \cdot \vec{e} &= \chi_{h|j| < kn \min(|a_q^\pm|, q \in \{1, \dots, d\})} \mathcal{R}_0(l, j) \cdot \vec{e} \\
 &+ \sum_{q/ja_q^\pm > 0} \frac{1}{\sqrt{n}} O \left( \exp \left( -\frac{(hj - ka_q^\pm n)^2}{Mh^2 n} \right) \right) r_q^\pm \\
 &+ O \left( e^{-\kappa n} \exp \left( -\frac{(l-j)^2}{Mn} \right) \right), \quad l, j \in \mathbb{Z}, \\
 \Delta_j G(j, n; l) \cdot \vec{e} &= \chi_{h|j| < kn \min(|a_q^\pm|, q \in \{1, \dots, d\})} \Delta_j \mathcal{R}_0(l, j) \cdot \vec{e} \\
 &+ \sum_{q/ja_q^\pm > 0} \frac{1}{n} O \left( \exp \left( -\frac{(hj - ka_q^\pm n)^2}{Mh^2 n} \right) \right) r_q^\pm \\
 &+ O \left( e^{-\kappa n} \exp \left( -\frac{(l-j)^2}{Mn} \right) \right), \quad l, j \in \mathbb{Z},
 \end{aligned}$$

où

- $h$  est le pas d'espace et  $k$  le pas de temps,
- $\Delta_j G(j, \cdot; \cdot)$  désigne  $G(j, \cdot; \cdot) - G(j-1, \cdot; \cdot)$ ,
- la notation  $q/ja_q^\pm > 0$  correspond aux indices  $q \in \{1, \dots, d\}$  tels que  $j$  et  $a_q^{\text{sign}(j)}$  sont de même signe,
- le terme excité  $\mathcal{R}_0(l, j)$  est une projection sur le noyau de  $L$ ,
- toutes les constantes sont bornées localement en  $l$  et uniformément en  $n$  et en  $j$  et les constantes  $M$  et  $\kappa$  sont positives.

Ces estimations sont analogues à celles obtenues par K. Zumbrun et P. Howard pour les profils visqueux [88], bien que notre analyse soit limitée au cas où  $l$  est bornée, alors que la leur considère aussi le cas où  $y$  (qui correspond à  $l$ ) n'est pas borné. La signification physique de ce résultat est la suivante : tout d'abord, la masse de Dirac initiale se divise en ondes qui se propagent selon les caractéristiques entrantes et sortantes. Celles portées par les caractéristiques sortantes, c'est à dire les vecteurs propres correspondant aux valeurs propres négatives (resp. positives) de  $df(u^-)$  (resp.  $df(u^+)$ ) si la masse de Dirac était à gauche (resp. à droite) du choc prennent la forme de Gaussiennes qui s'éloignent du choc et dont l'amplitude diminue à cause de la viscosité. Les autres vont vers le choc, et, à chaque

fois qu'une onde atteint le choc, des ondes sont émises sur les caractéristiques sortantes : ce sont également des Gaussiennes qui s'amortissent. De plus, dès que la première onde atteint le choc, il y a interaction et une onde stationnaire, liée au noyau de  $L$ , apparaît. Enfin, il y a un terme de décroissance rapide en temps. La propagation des ondes sortantes sous forme de Gaussiennes est compatible avec la conservation de la masse dans  $\ell^1$ .

On énonce également un théorème analogue au théorème 6.1 dans le cas des couches-limites, car les deux démonstrations sont proches.

La figure 2 représente, pour un 3-choc de Lax, les composantes de la fonction de Green

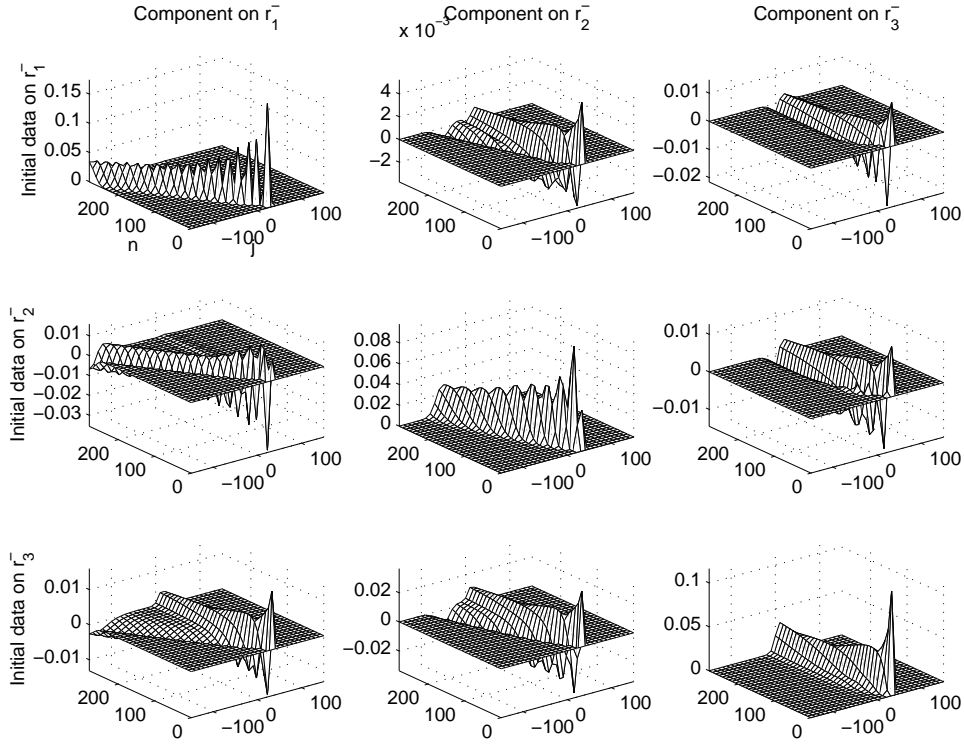

Fig. 2: Représentation de  $G(j, n; 39)$  sur la base  $(r_1^-, r_2^-, r_3^-)$

appliquée successivement à  $r_1^-$ ,  $r_2^-$ ,  $r_3^-$  dans la base des vecteurs propres  $(r_1^-, r_2^-, r_3^-)$  de  $df(u^-)$  dans le cas où  $l$  est positif. On voit les ondes se propager vers la gauche dans un premier temps (toutes les valeurs propres de  $df(u^+)$  sont négatives). Une onde stationnaire apparaît dès que la première onde a atteint le choc, et deux ondes sont émises vers la gauche selon  $r_1^-$  et  $r_2^-$  ( $df(u^-)$  a deux valeurs propres négatives et une valeur propre positive). On ne voit malheureusement pas les autres émissions d'ondes, car celles-ci sont amorties par la viscosité.

La démonstration du théorème repose sur la transformation de Laplace discrète définie par

$$v = (v^n)_{n \in \mathbb{N}} \mapsto \left( \lambda \in \mathbb{D} \mapsto \hat{v}(\lambda) := \sum_{n \in \mathbb{N}} e^{-\lambda n} v^n \right), \quad (37)$$

où  $\mathbb{D}$  est une partie de  $\mathbb{C}$  choisie de façon à ce que la somme converge. En particulier, comme (37) est  $i2\pi$  périodique en  $\lambda$ ,  $\mathbb{D}$  peut être choisi comme étant inclus dans la bande  $\mathcal{S} := \{\lambda \in \mathbb{C} / -\pi \leq \text{Im}(\lambda) \leq \pi\}$ . Etant donné  $l \in \mathbb{Z}$ , la transformée de Laplace de  $G(\cdot, \cdot; l)$

par rapport à  $n$ , notée  $G_\lambda(j; l)$  est solution du problème

$$(L^s - e^\lambda + 1)G_\lambda(j; l) = -\delta_{lj}I_d, \quad j \in \mathbb{Z}, \quad (38)$$

$$G_\lambda(j; l) \xrightarrow{j \rightarrow \pm\infty} 0. \quad (39)$$

Comme dans le cas continu, on réécrit l'équation aux valeurs propres

$$(L^s - e^\lambda + 1)v = 0$$

comme un système dynamique du premier ordre de la forme

$$V_j = \mathbb{A}_j(\lambda)V_{j-1}, \quad V_j = \begin{pmatrix} v_j \\ v_{j+1} - v_j \end{pmatrix} \in \mathbb{C}^{2d}, \quad j \in \mathbb{Z}. \quad (40)$$

On écrit ensuite  $G_\lambda(\cdot; l)$  sous forme de combinaisons linéaires bien choisies de solutions du système (40) formant une base de  $S^+(\lambda)$  (resp. de  $U^-(\lambda)$ ) pour  $j \geq l$  (resp. pour  $j \leq l$ ), ce qui permet d'établir que, comme la fonction d'Evans  $\mathcal{D}(\lambda, l)$  est liée au dénominateur de  $G_\lambda(\cdot; l)$ ,  $G_\lambda(\cdot; l)$  est méromorphe dans  $\Omega \cup \mathcal{V}$  pour un choc compressif ( $\varpi \geq 0$ ), avec  $\lambda = 0$  pôle d'ordre 1, et holomorphe dans  $\Omega$  pour un choc sous-compressif : on obtient ainsi des estimations en  $\lambda$  sur  $G_\lambda$  pour  $l$  borné. Comme le prolongement de  $\mathcal{D}(\cdot, l)$  ne s'annule pas sur le segment  $[-i\pi, i\pi]$  sauf éventuellement en 0, on prolonge  $\lambda \mapsto G_\lambda(\cdot; l)$  à une bande de largeur  $\nu$  à gauche de l'axe imaginaire. On calcule la transformée inverse de  $G_\lambda$  par la formule

$$G(j, n; l) = \frac{1}{2i\pi} \int_\gamma e^{\lambda n} G_\lambda(l, j) d\lambda,$$

où  $\gamma$  est a priori un chemin se trouvant dans  $\Omega$ . Mais grâce au prolongement de  $\lambda \mapsto G_\lambda(\cdot; l)$  et à la formule de Cauchy, on peut choisir des contours qui traversent éventuellement l'axe des imaginaires. Il faut prendre un soin très particulier à la valeur  $\lambda = 0$  qui peut être un pôle de  $\lambda \mapsto G_\lambda(\cdot; l)$  : un résidu stationnaire peut apparaître. Cette technique peut être appliquée au schéma de Lax-Wendroff, mais les calculs sont plus compliqués.



## Deuxième partie

APPROXIMATIONS EN VARIABLE D'ESPACE CONTINUE :  
RELAXATION SEMI-LINÉAIRE, DIFFUSION-DISPERSION

# 1. RELAXATION SEMI-LINÉAIRE : CONDITION NÉCESSAIRE DE STABILITÉ SPECTRALE

L'article suivant a été publié sous le titre "Linear Stability of Shock Profiles for Systems of Conservation Laws with Semi-linear Relaxation" dans la revue *Physica D.*, 148 :289–316, 2001. Le résultat sur la condition de stabilité pour les chocs de Lax avait été obtenue de façon indépendante par Kevin Zumbrun [87].

## 1.1 Introduction

Let  $n \geq 1$  and consider the  $n \times n$  hyperbolic system of conservation laws

$$u_t + f(u)_x = 0, \quad x \in \mathbb{R}, t \geq 0, \quad (1)$$

where  $f$  is a smooth flux. Relaxation approximations of (1) involve introducing lower-order terms and adjoining closure laws in order to model viscosity, memory and other effects. The time lag is referred to as the relaxation time. The relaxation phenomena appear in various physical models such as the kinetic theory of monatomic gases, continuum mechanics, elasticity with memory, phase and multiphase transitions. Whitham [81] was the first to introduce a mathematical formulation of relaxation problems. A fundamental paper by Liu [52] gives the first properties and results for the general quasilinear  $2 \times 2$  systems. Chen and Liu [13] together with Levermore [12] started the rigorous study of the limits of zero relaxation time for weak solution. Initial-boundary value problems for the general relaxation were investigated by Yong [82, 83]. Further details can be found in Natalini's monograph [66].

The semi-linear relaxation approximation is obtained by introducing a stiff source term in (1) :

$$\begin{cases} u_t + v_x = 0, \\ v_t + \mathbf{a}^2 u_x = \frac{1}{\tau}(f(u) - v), \end{cases} \quad (2)$$

where  $\tau$  is the (positive) relaxation parameter and  $\mathbf{a}$  is a positive constant. Taking the formal limit of (2) as  $\tau$  tends to 0, one recovers the *local equilibrium*

$$v = f(u)$$

and the *equilibrium system*, which is in fact the original system (1). Performing an asymptotic Chapman-Enskog type expansion [52] of (2), one finds formally

$$u_t + f(u)_x = \tau((\mathbf{a}^2 - df(u)^2)u_x)_x + O(\tau^2). \quad (3)$$

To ensure stability, (3) must be dissipative, that is the viscosity must be positive. So the classical assumption, known as the *subcharacteristic condition* [42] is

$$\mathbf{a} > \rho(df(u)), \forall u, \quad (4)$$

where  $\rho$  denotes the spectral radius. This condition is equivalent to the characteristics of the equilibrium system (1) being subcharacteristic to the characteristics  $\pm \mathbf{a}$  of (2). This model was introduced by Jin and Xin [42] in order to obtain non-oscillatory schemes for systems of conservation laws. Assuming (4) together with conditions from [17], Serre [75] proved that, as  $\tau$  tends to 0, the solutions of (2) converge to an entropy solution of (1). The convergence rate [51] and the BV framework [5] have also been investigated in the scalar case ( $n = 1$ ).

We consider a non-characteristic discontinuity  $(u^-, u^+; s)$  of system (1) of *arbitrary strength* satisfying the Rankine-Hugoniot condition. To guarantee the existence of a shock profile  $\bar{U}_\tau = (\bar{u}_\tau, \bar{v}_\tau)^T$  for (2) asymptotically connecting the end states  $(u^-, f(u^-))^T$  and  $(u^+, f(u^+))^T$  with speed  $s$ , we must assume  $s$  is subcharacteristic [52]. Our subcharacteristic condition thus reads

$$\mathbf{a} > \max(\rho(df(u^-)), \rho(df(u^+)), |s|).$$

We also assume that (1) is strictly hyperbolic at the end states  $u^\pm$ .

The linearized system about  $\bar{U}$  can be expressed as

$$U_t = L_\tau(\partial_x, \bar{U}_\tau(x))U. \quad (5)$$

The subcharacteristic condition and the assumption of non-characteristic shocks imply that the essential spectrum lies in the left half-plane, so that the restriction of the spectrum of  $L_\tau$  to the right half-plane consists only of isolated eigenvalues of finite multiplicity. Let  $\lambda$  be such an eigenvalue. Since  $L_\tau$  is a conjugate of  $(1/\tau)L_1$  (see 1.3.1), a perturbation leads to an exponential amplification of  $U$  of order  $\exp(\operatorname{Re}(\lambda)t/\tau)$ . So, if  $\operatorname{Re}(\lambda)$  is positive, the shock is not observable after a small time of order  $\tau$ . We thus say that a shock profile is **linearly stable** if the spectrum of the differential operator associated with the linearized system lies in the left half of the complex plane. Our aim is to obtain necessary conditions for linear stability of Lax, undercompressive and overcompressive shock profiles by means of an Evans function [18] as in [24, 4]. This technique has also been developed for semi-discrete shock profiles by Benzoni-Gavage [2].

We proceed as follows : noting that the linearized system about  $\bar{U}_\tau$  is very simply linked to the linearized system about  $\bar{U}_1$ , we set  $\tau = 1$  and denote  $\bar{U} := \bar{U}_1$ . We then change to a stationary shock using a moving frame and we denote by  $M$  the differential operator associated with the linearized system. This standard trick simplifies the computations by allowing us to compare the eigenvalues of  $df(u^\pm)$  to 0 rather than to the speed  $s$ . Computational difficulties still arise from the change of variable in (5), unlike the viscous case.

We rewrite the eigenvalue equation  $M\phi = \lambda\phi$ , which is a first order ODE, in terms of a linear dynamical system with variable coefficients

$$\phi' = \mathbb{A}(x, \lambda)\phi. \quad (6)$$

Using Wronskians of solutions of (6), we then construct an analytic function  $D(\lambda)$  on  $\operatorname{Re}(\lambda) > 0$  (see [24]) whose zeros correspond to unstable eigenvalues of  $M$  (see [43]).

Since  $M$  has real coefficients,  $D$  is real-valued on  $\mathbb{R}^+$ . A necessary condition for stability is therefore that  $D(\lambda)$  has the same sign near  $\lambda = 0$  and near  $\lambda = +\infty$ . At  $\lambda = 0$ , we note that  $\bar{U}'$  is a solution of  $\phi' = \mathbb{A}(x, 0)\phi$  which decays at  $\pm\infty$ , so that  $D(0) = 0$  and the sign of  $D(\lambda)$  for small  $\lambda$  is governed by that of  $D'(0)$ . Since the essential spectrum of the linearized operator  $M$  intersects the imaginary axis, we must use the Gap Lemma [24] to define an analytic continuation of  $D$  to a neighborhood of  $\lambda = 0$ . Thus  $D'(0)$  makes sense and turns out to be computable. For large real  $\lambda$ , we use a homotopy method given by Benzoni-Gavage, Serre and Zumbrun [4] to do the calculation.

Our main theorem gives necessary conditions for the stability of Lax, undercompressive and overcompressive shock profiles in  $n \times n$  systems. These conditions are similar to the ones that Gardner and Zumbrun obtained for viscous profiles with  $n = 2$  and to the ones they conjectured for general  $n$ . These conjectures were later proved by Benzoni-Gavage, Serre and Zumbrun.

Necessary conditions for linear stability, as well as the study of  $D'(0)$ , are valuable steps in the search for non-linear stability, as it has already been studied for viscous approximations by Zumbrun and Howard [88].

This paper is organized as follows : Section 2 is devoted to the assumptions and the properties of shock profiles. In Section 3, we state our main results. We prove that we can apply the Gap Lemma in Section 4. Finally, we devote Sections 5, 6, 7 to the proofs of the theorems we stated in Section 3.

## 1.2 Background

### 1.2.1 Assumptions

Let  $(u^-, u^+; s)$  be a discontinuity for (1) satisfying the Rankine-Hugoniot condition

$$f(u^+) - f(u^-) = s(u^+ - u^-). \quad (7)$$

Our first hypothesis is the *subcharacteristic condition*

$$\mathbf{H\ 1} \quad \mathbf{a} > \max(\rho(df(u^-)), \rho(df(u^+)), |s|).$$

Following [24], we also assume that

**H 2** *system (1) is strictly hyperbolic at  $u^\pm$ , i.e. ,  $\mathcal{A}^\pm := df(u^\pm)$  has distinct real eigenvalues  $\alpha_1^\pm < \dots < \alpha_n^\pm$ ,*

and

**H 3** *the discontinuity is non-characteristic :  $s \notin \sigma(\mathcal{A}^\pm)$ ,*

where  $\sigma$  denotes the spectrum.

As far as the nature of the discontinuity is concerned, we are going at first to assume that, given  $j \in \{1, \dots, n\}$ ,  $(u^-, u^+; s)$  is a Lax  $j$ -shock :

**H 4** the eigenvalues of  $\mathcal{A}^\pm$  satisfy the following inequalities

$$\begin{aligned} \alpha_j^+ &< s < \alpha_{j+1}^+, \\ \alpha_{j-1}^- &< s < \alpha_j^-. \end{aligned}$$

This condition means that there are  $n + 1$  characteristics entering the shock and  $n - 1$  outgoing ones. For further details, see [74].

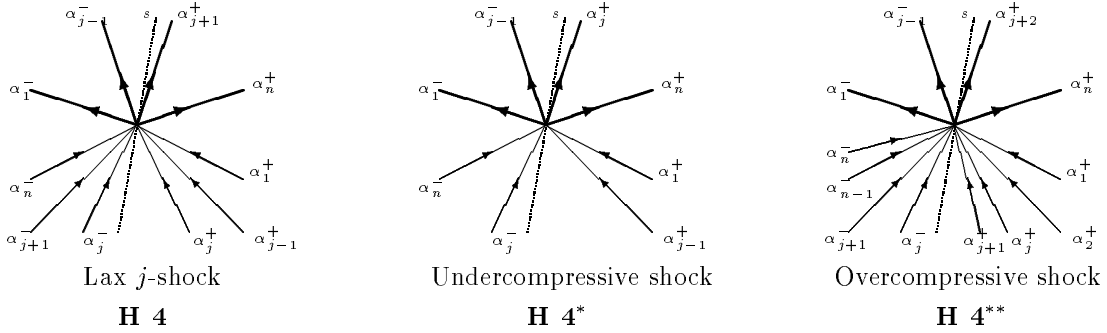

When we investigate undercompressive shocks, we will use instead :

**H 4\*** there is an integer  $j \in \{2, \dots, n\}$  such that

$$\begin{aligned} \alpha_{j-1}^+ &< s < \alpha_j^+, \\ \alpha_{j-1}^- &< s < \alpha_j^-. \end{aligned}$$

We only consider here undercompressive shocks of degree  $n$ , that is those with  $n$  incoming and  $n$  outgoing characteristics (see [71]).

When we consider overcompressive shocks, we will use instead :

**H 4\*\*** the eigenvalues of  $\mathcal{A}^\pm$  satisfy the following inequalities for some  $j \in \{1, \dots, n - 1\}$ :

$$\begin{aligned} \alpha_{j+1}^+ &< s < \alpha_{j+2}^+, \\ \alpha_{j-1}^- &< s < \alpha_j^-. \end{aligned}$$

These inequalities express the fact that all  $n + 2$  characteristics enter the shock and that there are  $n - 2$  outgoing ones, i.e., these shocks are overcompressive of degree  $n + 2$ . Further information about this type of shock can be found in [74], [54], [56].

**Remark 1.2.1** The hypotheses **(H4)**, **(H4\*)** and **(H4\*\*)** complete the non-characteristic assumption **(H3)**.

### 1.2.2 Shock profiles

A shock profile  $\bar{U}_\tau = (\bar{u}_\tau, \bar{v}_\tau)^T : \xi = x - st \mapsto (\bar{u}_\tau(\xi), \bar{v}_\tau(\xi))^T$  for  $(u^-, u^+; s)$  is a traveling wave of (2) asymptotically connecting  $U^- := (u^-, v^-)^T$  and  $U^+ := (u^+, v^+)^T$  with speed

s. This profile obeys

$$-s\bar{u}'_\tau + \bar{v}'_\tau = 0, \quad (8a)$$

$$-s\bar{v}'_\tau + \mathbf{a}^2\bar{u}'_\tau = \frac{1}{\tau}(f(\bar{u}_\tau) - \bar{v}_\tau), \quad (8b)$$

$$\lim_{x \rightarrow \pm\infty} \bar{u}_\tau(\xi) = u^\pm, \quad \lim_{x \rightarrow \pm\infty} \bar{v}_\tau(\xi) = v^\pm. \quad (8c)$$

Integrating (8a) from  $-\infty$  to  $\xi$ , we find that

$$\bar{v}_\tau(\xi) - v^- = s(\bar{u}_\tau(\xi) - u^-).$$

Substituting in (8b), we obtain the ODE

$$(\mathbf{a}^2 - s^2)\bar{u}'_\tau = \frac{f(\bar{u}_\tau) - s(\bar{u}_\tau - u^-) - v^-}{\tau}.$$

So if  $u^-$  is a stationary point of this equation, then  $v^- = f(u^-)$ .

Similarly, integrating from  $\xi$  to  $+\infty$ , we obtain  $v^+ = f(u^+)$ . Moreover, as  $s[u] = [v] = [f]$ , we have that  $f(u^+) - su^+ = f(u^-) - su^- =: \bar{f}$  (one recovers the Rankine-Hugoniot condition (7)). We can define  $\zeta := \sqrt{\mathbf{a}^2 - s^2}$  because of the subcharacteristic condition **(H1)**. Consequently, the shock profile  $\bar{U}_\tau$  satisfies

$$\begin{cases} \bar{u}'_\tau = \frac{1}{\tau\zeta^2}(f(\bar{u}_\tau) - \bar{f} - s\bar{u}_\tau), \\ \bar{v}_\tau = s\bar{u}_\tau + \bar{f}, \\ \lim_{\xi \rightarrow \pm\infty} \bar{u}_\tau(\xi) = u^\pm, \quad \lim_{\xi \rightarrow \pm\infty} \bar{v}_\tau(\xi) = f(u^\pm). \end{cases} \quad (9)$$

The end states  $u^\pm$  are hyperbolic in the ODE sense. Indeed,  $\mathbf{a} > |s|$  because of **(H1)** and the eigenvalues of  $A^\pm := \mathcal{A}^\pm - sI_n$  are non-zero because of **(H2)**. Consequently,  $\zeta^{-2}A^\pm$  has non-zero, distinct, real eigenvalues.

We make the standard assumption :

**H 5** *There exists a profile  $\bar{U}$  for (10) asymptotically connecting  $U^-$  and  $U^+$  with speed  $s$ .*

Since system (9) is decoupled, we see that there is a one-to-one correspondence for a given shock between the semi-linear relaxation profiles and the viscous profiles with scalar viscosity  $B = \zeta^2 I_n$ . The existence of these profiles, which are heteroclinic orbits of a vector field, has been studied using dynamical system techniques (see [61]) and was proved for all weak Lax shocks under some nonlinearity assumption, for instance the E-criterion of Liu and Hsiao [20, 65, 34]. A qualitative analysis for larger strengths is possible with topological arguments (see [26, 76]). A much finer analysis is available in the undercompressive case (see [22, 71]). Finally, overcompressive shocks admit a larger set of profiles as can be seen in the cubic model

$$\begin{aligned} u_t + (|u|^2 u)_x &= 0, \\ u : \mathbb{R} \times \mathbb{R}^+ &\longrightarrow \mathbb{R}^2 \end{aligned}$$

studied by Liu and Freistuhler [53, 21]. Further references can be found in Dafermos' book [16]. Though scalar viscosity is not exactly the case that appears in most interesting physical models (like gas dynamics), we expect that most observable shocks admit a viscous profile with  $B = I_n$  and therefore a relaxation profile.

**Remark 1.2.2** Note that  $\bar{U} : \xi \mapsto \bar{U}_\tau(\xi/\tau)$  does not depend on  $\tau$  since  $\bar{U} := (\bar{u}, \bar{v})^T$  satisfies

$$\begin{cases} \zeta^2 \bar{u}' = f(\bar{u}) - \bar{f} - s\bar{u}, \\ \bar{v} = s\bar{u} + \bar{f}, \\ \lim_{\xi \rightarrow \pm\infty} \bar{u}(\xi) = u^\pm, \quad \lim_{\xi \rightarrow \pm\infty} \bar{v}(\xi) = f(u^\pm). \end{cases} \quad (10)$$

Moreover, taking  $\tau = 1$  in system (9), we find system (10).

### 1.2.3 Asymptotic behavior of $\bar{U}$

Let  $\bar{U}$  be a solution of (10). There is only one negative eigenvalue of  $A^+$ , that we denote  $a_p^+$ , such that

$$\lim_{x \rightarrow +\infty} e^{-a_p^+ x / \zeta^2} \bar{u}'(x) \neq 0,$$

and we set  $a_k^+ < 0$  for all  $k \in \{1, \dots, p\}$ . In other words, at  $x = +\infty$ ,  $a_p^+ / \zeta^2$  is the decay rate of  $\bar{u}$ , which is tangent to an eigenvector  $r_p^+$  of  $A^+$  associated with  $a_p^+$ .

Now let  $(r_1^+, \dots, r_p^+)$  a basis of  $\text{TW}^s(u^+)$  consisting of eigenvectors of  $A^+$  associated with the eigenvalues  $\{a_k^+\}_{k \in \{1, \dots, p\}}$ . We stress the fact that the eigenvalues  $(a_k^+)_{k \in \{1, \dots, p\}}$  are not ordered in increasing order to cover all the cases of decaying rate of  $\bar{u}$ . Similarly, we denote by  $a_q^-$  the positive eigenvalue of  $A^-$  such that

$$\lim_{x \rightarrow -\infty} e^{-a_q^- x / \zeta^2} \bar{u}'(x) \neq 0,$$

and  $a_k^- > 0$  for all  $k \in \{q, \dots, n\}$ . At  $x = -\infty$ ,  $\bar{u}$  is tangent to an eigenvector  $r_q^-$  of  $A^-$  associated with  $a_q^-$ . We also let  $(r_q^-, \dots, r_n^-)$  a basis of  $\text{TW}^u(u^-)$  consisting of eigenvectors of  $A^-$  associated with the eigenvalues  $\{a_k^-\}_{k \in \{q, \dots, n\}}$ . We then consider the ODE

$$\varphi' = \frac{1}{\zeta^2} (df(\bar{u}) - sI_n) \varphi. \quad (11)$$

The dimension of the stable (respectively unstable) subspace at  $x = +\infty$  (resp.  $x = -\infty$ ) is  $p$  (resp.  $n - q + 1$ ). Let  $(\varphi_k^+)_{k \in \{1, \dots, p\}}$  be a basis of the subspace of solutions of (11) which are exponentially decaying as  $x$  tends to  $+\infty$  such that

$$\lim_{x \rightarrow +\infty} e^{-a_k^+ x / \zeta^2} \varphi_k^+(x) = r_k^+, \quad k \in \{1, \dots, p\}.$$

Also, let  $(\varphi_k^-)_{k \in \{q, \dots, n\}}$  a basis of the solutions of equation (11) which are exponentially decaying to 0 as  $x$  tends to  $-\infty$  such that

$$\lim_{x \rightarrow -\infty} e^{-a_k^- x / \zeta^2} \varphi_k^-(x) = r_k^-, \quad k \in \{q, \dots, n\}.$$

A suitable normalisation of the vectors  $r_p^+$  and  $r_q^-$  allows us to choose  $\varphi_p^+ = \varphi_q^- = \bar{u}'$ . In the case of an *undercompressive* shock, we make for convenience an additional hypothesis. Considering eigenvectors  $(r_k^+)_{k \in \{j, \dots, n\}}$  associated with the positive eigenvalues  $(a_k^+)_{k \in \{j, \dots, n\}}$  of  $A^+$  and eigenvectors  $(r_k^-)_{k \in \{1, \dots, j-1\}}$  associated with the negative eigenvalues  $(a_k^-)_{k \in \{1, \dots, j-1\}}$  of  $A^-$ , we assume an additional nondegeneracy condition holds :

**H 6**  $(r_1^-, \dots, r_{j-1}^-, r_j^+, \dots, r_n^+)$  is a basis of  $\mathbb{R}^n$ .

Writing  $[u]$  in this basis as  $[u] = \beta_1^- r_1^- + \dots + \beta_{j-1}^- r_{j-1}^- + \beta_j^+ r_j^+ + \dots + \beta_n^+ r_n^+$ , we define  $u^*$  as being the only point in  $\mathbb{R}^n$  such that

$$u^* = \begin{cases} u^- + \beta_1^- r_1^- + \dots + \beta_{j-1}^- r_{j-1}^-, \\ u^+ - \beta_j^+ r_j^+ - \dots - \beta_n^+ r_n^+. \end{cases}$$

For an *overcompressive* shock of degree  $n + 2$ , we have  $p = j + 1$  and  $q = j$ , so we set  $\varphi_{j+1}^+ = \varphi_j^- = \bar{u}'$ . Moreover, as we assumed the existence of a profile, there is generically a one-parameter ( $\alpha$ ) family,  $(x, \alpha) \mapsto \bar{U}(x, \alpha)$  of traveling waves connecting  $U^\pm$  : indeed,  $U^-$  is repulsive and  $U^+$  attractive. Let  $U_0$  be a point of  $\bar{U}$ . We study the traveling wave about this point and we solve the ODE with this initial condition. We thus obtain a shock profile which is close to  $\bar{U}$ , considering the limits at  $+\infty$  and  $-\infty$ . Moreover,  $\partial_\alpha \bar{U} := \bar{U}_\alpha$  satisfies the equation  $\partial_x \bar{U}_\alpha = \mathbb{A}(x, 0) \bar{U}_\alpha$ . Since in most cases  $\bar{u}'$  and  $\bar{u}_\alpha$  have the same decay rate at  $x = \pm\infty$ , there is a linear combination  $\bar{u}^+ = \bar{u}_\alpha - m^+ \bar{u}'$ ,  $m^+ \in \mathbb{R}$ , (respectively  $\bar{u}^- = \bar{u}_\alpha - m^- \bar{u}'$ ,  $m^- \in \mathbb{R}$ ) whose decay rate at  $x = +\infty$  is smaller (resp. larger) than the decay rate of  $\bar{u}'$ . Consequently, we denote by  $a_j^+$  (respectively  $a_{j+1}^-$ ) the only negative (resp. positive) eigenvalue of  $A^+$  (resp.  $A^-$ ) such that

$$\lim_{x \rightarrow +\infty} e^{-a_j^+ x / \zeta^2} \bar{u}^+(x) \neq 0, \\ \left( \text{resp. } \lim_{x \rightarrow -\infty} e^{-a_{j+1}^- x / \zeta^2} \bar{u}^-(x) \neq 0, \right)$$

associated with an eigenvector  $r_j^+$  (resp.  $r_{j+1}^-$ ) of  $A^+$  (resp.  $A^-$ ) oriented as  $\bar{u}^+$  at  $x = +\infty$  (resp. as  $\bar{u}^-$  at  $x = -\infty$ ). We set  $\varphi_j^+ := \bar{u}^+$  and  $\varphi_{j+1}^- := \bar{u}^-$ .

### 1.3 Main results

#### 1.3.1 Linear stability

Let us linearize system (2) about  $\bar{U}_\tau$  :

$$\begin{cases} u_t + v_x = 0, \\ v_t + \mathbf{a}^2 u_x = \frac{1}{\tau} (df(\bar{u}_\tau)u - v), \end{cases}$$

that is

$$\begin{aligned} \begin{pmatrix} u \\ v \end{pmatrix}_t &= - \begin{pmatrix} 0_n & I_n \\ \mathbf{a}^2 I_n & 0_n \end{pmatrix} \begin{pmatrix} u \\ v \end{pmatrix}_x + \frac{1}{\tau} \begin{pmatrix} 0_n & 0_n \\ df(\bar{u}_\tau) & -I_n \end{pmatrix} \begin{pmatrix} u \\ v \end{pmatrix} \\ &=: L_\tau(\partial_x, \bar{U}_\tau(x)) \begin{pmatrix} u \\ v \end{pmatrix}. \end{aligned}$$

The profile  $\bar{U}_\tau$  of (2) is **linearly stable** if the differential operator  $L_\tau$  has no spectrum in the right half-plane. Let  $P_\tau$  be such that  $P_\tau(U) = U(\cdot/\tau)$  for all functions  $U$ . Note that  $L_\tau \circ P_\tau = \tau^{-1} P_\tau \circ L_1$  (see remark 1.2.2). As we are only interested in the real part of the spectrum of  $L_\tau$ , we set  $\tau = 1$  and study the spectrum of  $L_1$ .



## 1.3.2 Necessary conditions for linear stability

Our main result is :

**Theorem 1.3.1**

Assume **(H1)**-**(H5)**. For a Lax shock, the function  $x \mapsto \text{sgn}(\varphi_1^+(x) \wedge \dots \wedge \varphi_{j-1}^+(x) \wedge \bar{u}'(x) \wedge \varphi_{j+1}^-(x) \wedge \dots \wedge \varphi_n^-(x))$  is constant. Furthermore, if  $\bar{U}$  is stable, then necessarily

$$\begin{aligned} & (\varphi_1^+ \wedge \dots \wedge \varphi_{j-1}^+ \wedge \bar{u}' \wedge \varphi_{j+1}^- \wedge \dots \wedge \varphi_n^-) \cdot (r_1^- \wedge \dots \wedge r_{j-1}^- \wedge [u] \wedge r_{j+1}^+ \wedge \dots \wedge r_n^+) \\ & \cdot (r_1^- \wedge \dots \wedge r_n^-) \cdot (r_1^+ \wedge \dots \wedge r_n^+) \geq 0. \end{aligned} \quad (12)$$

**Remark 1.3.1** In the case of extreme Lax shocks, we obtain computable formulae because we can easily determine the sign of the first term by taking the limit at  $+\infty$  for  $n$ -shocks and at  $-\infty$  for 1-shocks.

For a Lax  $n$ -shock,  $r_n^-$  being oriented as  $\bar{u}'(-\infty)$ , a necessary condition is

$$(r_1^- \wedge \dots \wedge r_{n-1}^- \wedge [u]) \cdot (r_1^- \wedge \dots \wedge r_n^-) \geq 0. \quad (13)$$

For a Lax 1-shock,  $r_1^+$  being oriented as  $\bar{u}'(+\infty)$ , a necessary condition is

$$([u] \wedge r_2^+ \wedge \dots \wedge r_n^+) \cdot (r_1^+ \wedge \dots \wedge r_n^+) \geq 0. \quad (14)$$

These conditions are the same as the ones Gardner and Zumbrun [24] obtained in the  $2 \times 2$  case and conjectured for larger  $n$ ; these conditions were later verified by Benzoni-Gavage, Serre and Zumbrun [4]. Condition (13) can be interpreted as follows : let  $\Pi = \text{span}\{r_1^-, \dots, r_{n-1}^-\}$ . The hyperplane  $\Pi$  divides  $\mathbb{R}^n$  into two halves. If the profile  $\bar{U}$  is linearly stable, then the segment  $[u^-, u^+]$  and  $r_n^-$ , which is tangent to  $\bar{u}$  at  $-\infty$ , are in the same half-space of  $\mathbb{R}^n$ .

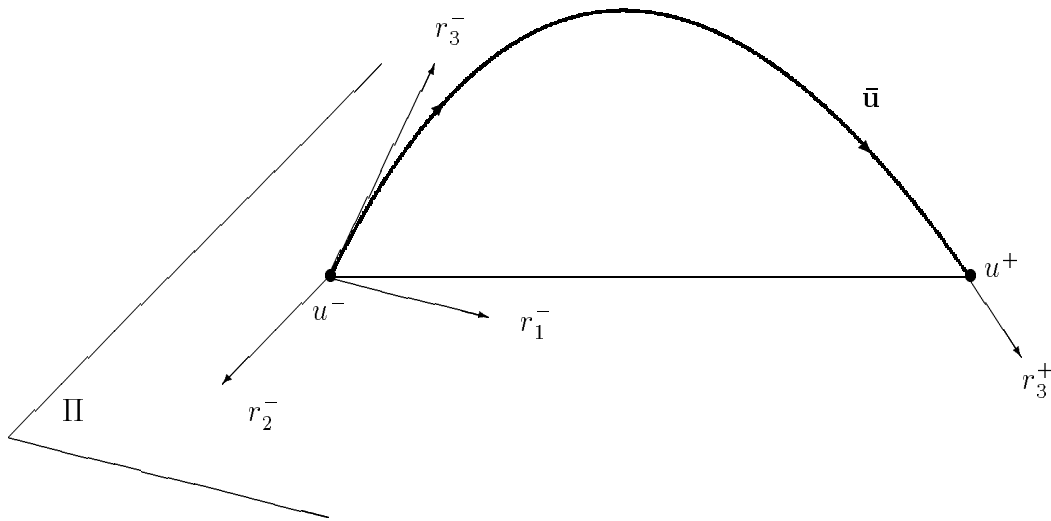

Fig. 1.1: Lax 3-shock satisfying Condition (13) for  $n = 3$

**Theorem 1.3.2**

For undercompressive shocks, substituting **(H4\*)** for **(H4)** and making the additional assumption **(H6)**, a necessary condition for linear stability of  $\bar{U}$  is

$$(-1)^{n-j} \cdot ? \cdot (r_1^- \wedge \dots \wedge r_{j-1}^- \wedge r_j^+ \wedge \dots \wedge r_n^+) \cdot (r_1^- \wedge \dots \wedge r_n^-) \cdot (r_1^+ \wedge \dots \wedge r_n^+) \geq 0, \quad (15)$$

with

$$\begin{aligned} ? := & \frac{1}{a^2 - s^2} \int_{-\infty}^{+\infty} \exp\left(-\int_0^y \frac{\text{tr}(df(\bar{u}(\sigma)))}{a^2 - s^2} d\sigma\right) \varphi_1^+(y) \wedge \dots \wedge \varphi_{j-2}^+(y) \wedge \bar{u}'(y) \\ & \wedge \varphi_{j+1}^-(y) \wedge \dots \wedge \varphi_n^-(y) \wedge (\bar{u}(y) - u^*) dy, \end{aligned}$$

**Remark 1.3.2** The constant  $?$  is called a Melnikov integral (see [24], p.832).

**Theorem 1.3.3**

For an overcompressive shock, substituting **(H4\*\*)** for **(H4)**, the function  $x \mapsto \text{sgn}(\varphi_1^+(x) \wedge \dots \wedge \varphi_{j-1}^+(x) \wedge \bar{u}'(x) \wedge \bar{u}_\alpha(x) \wedge \varphi_{j+2}^-(x) \wedge \dots \wedge \varphi_n^-(x))$  is constant. Furthermore, a necessary condition for  $\bar{U}$  to be stable is

$$\begin{aligned} & (\varphi_1^+ \wedge \dots \wedge \varphi_{j-1}^+ \wedge \bar{u}' \wedge \bar{u}_\alpha \wedge \varphi_{j+2}^- \wedge \dots \wedge \varphi_n^-) \cdot (r_1^- \wedge \dots \wedge r_{j-1}^-) \\ & \wedge \left( \int_{-\infty}^{+\infty} \bar{u}_\alpha(x) dx + m^+ u^+ - m^- u^- - (m^+ - m^-) \bar{u}(0) \right) \wedge [u] \\ & \wedge r_{j+2}^+ \wedge \dots \wedge r_n^+ \cdot (r_1^- \wedge \dots \wedge r_n^-) \cdot (r_1^+ \wedge \dots \wedge r_n^+) \geq 0. \quad (16) \end{aligned}$$

**Remark 1.3.3** Freistühler and Zumbrun produced examples of unstable viscous shock profiles in [23].

Note that correctly orienting the eigenvectors that do not appear an even number of times in the formulae (12), (15), (16) is crucial! Here, these orientations are given by our choices of the solutions  $\varphi^\pm$  of (11) (Subsection 1.2.3).

## 1.4 Preliminaries

### 1.4.1 Stationary shocks

Recall that we have set  $\tau = 1$ . We change coordinates to  $\xi = x - st$  in the evolution system (2) so that the shock becomes steady. Let  $\tilde{u}(\xi, t) := u(x, t)$  and  $\tilde{v}(\xi, t) := v(x, t)$ . System (2) is equivalent to

$$\begin{cases} \tilde{u}_t - s\tilde{u}_\xi + \tilde{v}_\xi = 0, \\ \tilde{v}_t - s\tilde{v}_\xi + a^2\tilde{u}_\xi = f(\tilde{u}) - \tilde{v}, \end{cases}$$

that is,

$$\begin{cases} \tilde{u}_t + \tilde{v}_\xi = 0, \\ \tilde{v}_t + s\tilde{u}_t + \zeta^2\tilde{u}_\xi - s\tilde{v}_\xi = \tilde{f}(\tilde{u}) - \tilde{v}, \end{cases} \quad (17)$$

where  $\tilde{v} = \tilde{v} - s\tilde{u} - \bar{f}$  and  $\tilde{f}(\tilde{u}) = f(\tilde{u}) - s\tilde{u} - \bar{f}$ . Combining the two equations of system (17), we have

$$\begin{cases} \tilde{u}_t + \tilde{v}_\xi = 0, \\ \tilde{v}_t + \zeta^2 \tilde{u}_\xi - 2s\tilde{v}_\xi = \tilde{f}(\tilde{u}) - \tilde{v}. \end{cases} \quad (18)$$

**Remark 1.4.1** 1. Since  $(a_k^\pm)_{k \in \{1, \dots, n\}}$  are the eigenvalues of  $df(u^\pm)$ , the subcharacteristic condition **(H1)** can be written

$$\forall k \in \{1, \dots, n\}, |a_k^\pm + s| < \mathbf{a} \text{ and } |s| < \mathbf{a}.$$

2. The change in  $v$  induces a change for the profile :

$$\tilde{v}(\xi) = 0, \quad \forall \xi.$$

From now on, we drop tildes and rename  $\xi$  to  $x$ . We shall now consider the following system

$$\begin{cases} u_t + v_x = 0, \\ v_t + \zeta^2 u_x - 2sv_x = f(u) - v, \end{cases} \quad (19)$$

the profile of which is now  $\bar{U} = (\bar{u}, 0)^T$ . Linearizing (19) along  $\bar{U}$ , we obtain

$$\begin{cases} u_t + v_x = 0, \\ v_t + \zeta^2 u_x - 2sv_x = df(\bar{u})u - v, \end{cases}$$

that is

$$\begin{aligned} \begin{pmatrix} u \\ v \end{pmatrix}_t &= - \begin{pmatrix} 0_n & I_n \\ \zeta^2 I_n & -2sI_n \end{pmatrix} \begin{pmatrix} u \\ v \end{pmatrix}_x + \begin{pmatrix} 0_n & 0_n \\ df(\bar{u}) & -I_n \end{pmatrix} \begin{pmatrix} u \\ v \end{pmatrix} \\ &=: M \begin{pmatrix} u \\ v \end{pmatrix}. \end{aligned}$$

The (unbounded) operator  $M : D(M) \subset L^2(\mathbb{R}, \mathbb{R}^{2n}) \rightarrow L^2(\mathbb{R}, \mathbb{R}^{2n})$  is densely defined in  $L^2(\mathbb{R}, \mathbb{R}^{2n})$ . Its domain  $D(M)$  is  $H^1(\mathbb{R}, \mathbb{R}^{2n})$ .

#### 1.4.2 The essential spectrum of $M$

In order to be able to construct an analytic Evans function in the open right half-plane, we must check that the spectrum of  $M$  in the right half-plane consists only of eigenvalues [24]. We choose here the definition of essential spectrum used by Gardner and Zumbrun (see [38]) : the essential spectrum of  $M$ ,  $\sigma_{ess}(M)$ , is the complementary set of the union of the resolvent of  $M$  and of the set of isolated eigenvalues of  $M$  of finite multiplicity. It is well known that the essential spectrum is linked to the spectrum of the limit operators [38, 63]. Let  $M^\pm$  be the limits of  $M$  at  $x = \pm\infty$ , that is

$$M^\pm \begin{pmatrix} u \\ v \end{pmatrix} = - \begin{pmatrix} 0_n & I_n \\ \zeta^2 I_n & -2sI_n \end{pmatrix} \begin{pmatrix} u \\ v \end{pmatrix}_x + \begin{pmatrix} 0_n & 0_n \\ A^\pm & -I_n \end{pmatrix} \begin{pmatrix} u \\ v \end{pmatrix}.$$

Note that, since  $f$  is smooth and  $\bar{u}$  tends to its limits at an exponential rate, the convergence of  $M$  towards  $M^\pm$  is exponential too. As the coefficients of  $M^\pm$  are constant,

$\sigma_{ess}(M^\pm)$  is equal to the spectrum  $\sigma(M^\pm)$  of  $M^\pm$  and can be computed by Fourier transform. A complex number  $\lambda$  is in  $\sigma(M^\pm)$  if and only if

$$\exists \xi \in \mathbb{R}, \det \left( -i\xi \begin{pmatrix} 0_n & I_n \\ \zeta^2 I_n & -2sI_n \end{pmatrix} + \begin{pmatrix} 0_n & 0_n \\ A^\pm & -I_n \end{pmatrix} \right) = 0,$$

that is

$$\sigma(M^\pm) = \{ \lambda \in \mathbb{C} / \exists \xi \in \mathbb{R}, \det(\lambda(\lambda + 1) - i2s\xi\lambda I_n + i\xi A^\pm + \zeta^2 \xi^2 I_n) = 0 \}.$$

We begin with a crucial technical result

**Lemma 1.4.1**

$$\sigma(M^\pm) \subset \{ \operatorname{Re}(\lambda) < 0 \} \cup \{0\}.$$

**Proof**

Let  $\lambda \in \sigma_{ess}(M^\pm)$ . There is  $\xi \in \mathbb{R}$  such that

$$\det(\lambda(\lambda + 1) - i2s\xi\lambda I_n + i\xi A^\pm + \zeta^2 \xi^2 I_n) = 0. \quad (20)$$

The matrices  $A^\pm$  are diagonalizable because of **(H2)**, so

$$\det(\lambda(\lambda + 1) - i2s\xi\lambda I_n + i\xi A^\pm + \zeta^2 \xi^2 I_n) = \prod_{k=1}^n (\zeta^2 \xi^2 - i(2s\lambda - a_k^\pm)\xi + \lambda(\lambda + 1)).$$

Equation (20) implies that there is  $k \in \{1, \dots, n\}$  such that \*

$$-\zeta^2 \xi^2 + i(2s\lambda - a_k)\xi - \lambda(\lambda + 1) = 0. \quad (21)$$

Assume  $\operatorname{Re}(\lambda) \geq 0$ .

We split (21) into real and imaginary parts :

$$\zeta^2 \xi^2 + 2s\beta\xi + \operatorname{Re}(\lambda)(\operatorname{Re}(\lambda) + 1) - \beta^2 = 0, \quad (21a)$$

$$(2s\operatorname{Re}(\lambda) - a_k)\xi = (2\operatorname{Re}(\lambda) + 1)\beta. \quad (21b)$$

If  $\operatorname{Re}(\lambda) = 0$ , then

$$\begin{aligned} \zeta^2 \xi^2 + 2s\beta\xi - \beta^2 &= 0, \\ -a_k \xi &= \beta, \end{aligned}$$

that is

$$\begin{cases} (\zeta^2 - 2sa_k - a_k^2)\xi^2 = 0, \\ -a_k \xi = \beta. \end{cases}$$

But  $\zeta^2 - 2sa_k - a_k^2 = \mathbf{a}^2 - (s + a_k)^2$  is positive because of **(H1)**. So  $\xi = 0$  and  $\beta = 0$  since the shock is non-characteristic **(H3)** and

$$\operatorname{Re}(\lambda) = 0 \Rightarrow \lambda = 0.$$

---

\* For notational convenience, we drop the  $\pm$  superscript.

Thus the essential spectrum of  $M^\pm$  only intersects the imaginary axis at  $\lambda = 0$ . Now assume  $\operatorname{Re}(\lambda) > 0$ . The first necessary condition for the existence of a real root  $\xi$  is that (21a) has a non-negative discriminant, that is

$$\mathbf{a}^2\beta^2 \geq \zeta^2\operatorname{Re}(\lambda)(\operatorname{Re}(\lambda) + 1). \quad (22)$$

Assume that (21) holds and  $2s\operatorname{Re}(\lambda) = a_k$ . Then  $(2\operatorname{Re}(\lambda) + 1)\beta = 0$ . But

$$\begin{cases} \beta = 0 & \Rightarrow \operatorname{Re}(\lambda)(\operatorname{Re}(\lambda) + 1) \leq 0, \text{ because of (22),} \\ 2\operatorname{Re}(\lambda) + 1 = 0 & \Rightarrow \operatorname{Re}(\lambda) = -1/2, \end{cases}$$

contradicting the assumption  $\operatorname{Re}(\lambda) > 0$ . Therefore  $2s\operatorname{Re}(\lambda) \neq a_k$  and (21b) implies that

$$\xi = \frac{(2\operatorname{Re}(\lambda) + 1)\beta}{2s\operatorname{Re}(\lambda) - a_k}.$$

Substituting in (21a), we obtain

$$P(\operatorname{Re}(\lambda))\beta^2 = \operatorname{Re}(\lambda)(\operatorname{Re}(\lambda) + 1)(2s\operatorname{Re}(\lambda) - a_k)^2, \quad (23)$$

where  $P(\operatorname{Re}(\lambda)) = (2s\operatorname{Re}(\lambda) - a_k)^2 - 2s(2\operatorname{Re}(\lambda) + 1)(2s\operatorname{Re}(\lambda) - a_k) - \zeta^2(2\operatorname{Re}(\lambda) + 1)^2$ . Since  $\operatorname{Re}(\lambda)(\operatorname{Re}(\lambda) + 1)(2s\operatorname{Re}(\lambda) - a_k)^2 > 0$ , equation (23) shows that  $P(\operatorname{Re}(\lambda))$  must be positive. But the polynomial  $P$  can be rewritten as

$$P(\operatorname{Re}(\lambda)) = -4\mathbf{a}^2(\operatorname{Re}(\lambda) - b_-)(\operatorname{Re}(\lambda) - b_+),$$

with

$$b_\pm = -\frac{1}{2} \pm \frac{s + a_k}{2\mathbf{a}}.$$

Since we have  $|s + a_k| < \mathbf{a}$  because of **(H1)**, the roots  $b_\pm$  of  $P$  are negative. Hence  $\operatorname{Re}(\lambda) > 0$  lies outside the roots  $b_\pm$  and consequently  $P(\operatorname{Re}(\lambda))$  is negative.

So there is a contradiction : equation (20) has no solution  $\lambda$  in  $\mathcal{O} := \{\operatorname{Re}(\lambda) \geq 0\} \setminus \{0\}$  and the essential spectrum of  $M^\pm$  only intersects the imaginary axis at  $\lambda = 0$ .

□

**Remark 1.4.2** *The constant states  $u^\pm$  are  $L^2$ -linearly stable and the  $n$  curves  $(\operatorname{Re}(\lambda), \operatorname{Im}(\lambda))$  lie in  $\mathbb{C} \setminus \mathcal{O}$  and can be parametrized with respect to  $\xi$ .*

If  $\omega$  is any open connected set in  $\mathbb{C} \setminus (\sigma(M^+) \cup \sigma(M^-))$ , either  $\omega \cap \sigma(M) = \omega$ , or  $\omega \cap \sigma_{\text{ess}}(M) = \emptyset$  (see [38], Lemma 2, Appendix, pp.136-142). But, Lemma 1.6.1 provides a priori estimates and a positive  $\Lambda$  such that when  $\lambda > \Lambda$  the bilinear form  $((u, v)^T, \Phi) \mapsto ((M - \lambda)(u, v)^T | \Phi)$ , where  $(\cdot | \cdot)$  denotes the scalar product in  $L^2$ , is continuous and coercive. Thus, by the Lax-Migran Theorem, the operator  $M - \lambda$  is invertible. Considering the connected component of  $\mathbb{C} \setminus (\sigma(M^+) \cup \sigma(M^-))$  containing  $(0, +\infty)$ , we are in the second case and  $\sigma_{\text{ess}}(M) \cap \mathcal{O} = \emptyset$ .

### Theorem 1.4.1

*The differential operator  $M$  has no essential spectrum in  $\{\operatorname{Re}(\lambda) \geq 0\} \setminus \{0\}$ .*

In conclusion, the only possible unstable modes of  $M$  are isolated eigenvalues of finite multiplicities with non-negative real part. Since 0 is in the essential spectrum of  $M$  and is also an eigenvalue of  $M$ , the case  $\lambda = 0$  is the most difficult, and we thus need to use the ‘‘Gap Lemma’’ (see [24]).

1.4.3 Eigenvalue equation of  $M$ 

The eigenvalue equation associated with the differential operator  $M$  is

$$M\phi = \lambda\phi,$$

that is

$$-\begin{pmatrix} 0_n & I_n \\ \zeta^2 I_n & -2sI_n \end{pmatrix} \phi' = \lambda\phi - \begin{pmatrix} 0_n & 0_n \\ df(\bar{u}) & -I_n \end{pmatrix} \phi.$$

It is equivalent to the first-order ODE with variable coefficients

$$\phi' = \frac{1}{\zeta^2} \begin{pmatrix} df(\bar{u}) - 2s\lambda I_n & -(\lambda + 1)I_n \\ -\lambda\zeta^2 I_n & 0_n \end{pmatrix} \phi =: \mathbb{A}(x, \lambda)\phi. \quad (24)$$

The matrix  $\mathbb{A}$  is clearly analytic in  $\lambda$  and  $\mathcal{C}^\infty$  in  $x$  because  $f$  is smooth. Since  $df(\bar{u}(x)) \xrightarrow{x \rightarrow \pm\infty} A^\pm$ , the matrices  $\mathbb{A}(x, \lambda)$  admit limits  $\mathbb{A}^\pm(\lambda)$  at  $x = \pm\infty$ . From now on, we consider equation (24) at  $x = +\infty$  and at  $x = -\infty$ .

**Lemma 1.4.2**

Let  $\lambda \in \mathbb{C}$  be such that  $\operatorname{Re}(\lambda) > 0$  or  $\lambda = 0$ . Then the following statements hold :

1. The matrix  $\mathbb{A}^\pm(\lambda)$  is diagonalizable.
2. The stable and unstable eigenspaces of  $\mathbb{A}^\pm(\lambda)$ ,  $S^\pm(\lambda)$  and  $U^\pm(\lambda)$ , are  $n$ -dimensional.

**Proof :**

Let  $\mu$  be an eigenvalue of  $\mathbb{A}^\pm(\lambda)$  and  $(X, Y)^T$  an associated eigenvector. We rewrite the eigenvalue equation  $\mathbb{A}^\pm(\lambda)(X, Y)^T = \mu(X, Y)^T$  as

$$\begin{cases} (A^\pm - (2s\lambda + \zeta^2\mu)I_n)X = (\lambda + 1)Y, \\ -\lambda X = \mu Y. \end{cases} \quad (25)$$

1. Two cases arise :

- First case:  $\lambda = 0$ .

Clearly,  $\mu = 0$  is an eigenvalue of  $\mathbb{A}^\pm(0)$ , of multiplicity  $n$  and the associated eigenspace is generated by  $(r_k^\pm, a_k^\pm r_k^\pm)_{k \in \{1, \dots, n\}}^T$ . The matrix  $\mathbb{A}^\pm(0)$  must also have the  $a_k^\pm/\zeta^2$  as eigenvalues. By **(H2)**-**(H3)**, these are distinct and non-zero with associated eigenvectors  $(r_k^\pm, 0)_{k \in \{1, \dots, n\}}^T$ . Thus the matrix  $\mathbb{A}^\pm(0)$  is diagonalizable.

- Second case:  $\operatorname{Re}(\lambda) > 0$ .

System (25) can be rewritten as

$$\begin{cases} -\lambda X = \mu Y, \\ (\zeta^2\mu^2 I_n + \mu(2s\lambda I_n - A^\pm) - \lambda(\lambda + 1)I_n)Y = 0. \end{cases}$$

Projecting on the eigenspaces of  $A^\pm$ , we obtain, for some  $k$  with  $1 \leq k \leq n$ ,

$$\zeta^2\mu^2 + (2s\lambda - a_k^\pm)\mu - \lambda(\lambda + 1) = 0. \quad (26)$$

Let us show that the eigenvalues of  $\mathbb{A}^\pm$  are all of multiplicity 1. If (26) has a double root, then the imaginary part of the discriminant of (26) is equal to 0, i.e.,  $4\beta(2s^2\text{Re}(\lambda) - sa_k^\pm + \zeta^2(2\text{Re}(\lambda) + 1)) = 0$ . But  $\zeta^2 = \mathbf{a}^2 - s^2$ , so  $4\beta(2\mathbf{a}^2\text{Re}(\lambda) - sa_k^\pm + \zeta^2) = 0$ , i.e., either  $\beta = 0$  or  $2\mathbf{a}^2\text{Re}(\lambda) - sa_k^\pm + \zeta^2 = 0$ . If  $\beta = 0$ , the discriminant of (26) is a positive real number, so necessarily  $2\mathbf{a}^2\text{Re}(\lambda) - sa_k^\pm + \zeta^2 = 0$ . But  $\text{Re}(\lambda) > 0$ , so  $\zeta^2 < sa_k^\pm$ , meaning that  $\mathbf{a}^2 - s^2 < sa_k^\pm$ . Consequently,  $\mathbf{a}^2 < s(s + a_k^\pm)$ . But **(H1)** implies that  $|s| < \mathbf{a}$  and  $|s + a_k^\pm| < \mathbf{a}$ . So there is a contradiction and (26) has no double root. Besides, if there are two integers  $k_1$  and  $k_2$  in  $\{1, \dots, n\}$  such that

$$\begin{cases} \zeta^2\mu^2 + (2s\lambda - a_{k_1}^\pm)\mu - \lambda(\lambda + 1) = 0, \\ \zeta^2\mu^2 + (2s\lambda - a_{k_2}^\pm)\mu - \lambda(\lambda + 1) = 0, \end{cases}$$

one finds that  $a_{k_1}^\pm$  necessarily equals  $a_{k_2}^\pm$  since  $\mu$  cannot vanish because  $\lambda \neq 0$ . So  $\mathbb{A}^\pm(\lambda)$  has only simple eigenvalues and is diagonalizable for  $\text{Re}(\lambda) > 0$ .

Consequently, for  $\text{Re}(\lambda) > 0$ , we choose eigenvectors associated with  $\mu$  to be

$$\begin{pmatrix} r_k^\pm \\ \lambda \\ -\frac{\lambda}{\mu}r_k^\pm \end{pmatrix}.$$

2. We proved in Section 1.4.2 that equation (26) has no purely imaginary solutions. Therefore, because of the continuity of roots in  $\lambda$ , the number of eigenvalues of  $\mathbb{A}^\pm(\lambda)$  with positive (respectively negative) real part is constant and so are the dimensions of the stable and unstable eigenspaces. Whenever  $\lambda$  is real and positive, we note that the coefficients of (26) are real and that the product of its roots is negative. So these roots are real and of opposite signs. It follows that the dimension of both the stable and unstable eigenspaces is  $n$ .

## 1.5 Construction of an Evans function

An Evans function  $D$  associated with the differential operator  $M$  is a Wronskian of solutions of (24) such that the zeros of  $D$  in the open right half-plane correspond to unstable eigenvalues of  $M$ . We define such a function and show it is analytic in  $\text{Re}(\lambda) > 0$ . In order to construct an Evans function which is analytic in  $\{\lambda/\text{Re}(\lambda) > 0\} \cup \{0\}$ , we apply R. Gardner and K. Zumbrun's *Gap Lemma* [24]. It allows to extend a Wronskian of solutions of (24), analytic in the open right-half plane, to a neighborhood of 0. We recall the hypotheses of the Gap Lemma and show they are satisfied in our case :

- **h-1 : Consistent splitting**

*The asymptotic matrices  $\mathbb{A}^\pm(\lambda)$  are both hyperbolic for  $\text{Re}(\lambda) > 0$ ; the dimension of the stable (respectively unstable) subspace of  $\mathbb{A}^+(\lambda)$  (resp.  $\mathbb{A}^-(\lambda)$ ) is the same for all such  $\lambda$ .*

This is Lemma 1.4.2.

- **h-2 : Exponential decay**

*$\mathbb{A}(x, \lambda) = \mathbb{A}^\pm(\lambda) + O(e^{-\gamma|x|})$  as  $x \rightarrow \pm\infty$  for some  $\gamma > 0$  uniformly for  $\lambda$  in compact*

sets.

As the shock is non-characteristic by **(H3)**, this hypothesis is satisfied because we assumed that the rest points  $u^\pm$  are strictly hyperbolic for (PDE) system (1) by **(H2)** and for (ODE) system (24), because of **(H3)**.

- **h-3 : Geometric separation**

The eigenvalues and the spectral projection operators associated with the stable eigenspace  $S^\pm(\lambda)$  and the unstable eigenspace  $U^\pm(\lambda)$  of  $\mathbb{A}^\pm(\lambda)$  extend analytically to a simply connected domain  $\Omega$  containing  $\mathcal{O} = \{\operatorname{Re}(\lambda) > 0\} \cup \{0\}$ .

Equation (26) admits two distinct solutions at  $\lambda = 0$ . Consequently, these solutions admit analytic continuations and so do the associated spectral projectors around  $\lambda = 0$  (because of the explicit formulae for the eigenvectors). We then can find such analytic continuations in a simply connected domain containing the right half-plane. Moreover,  $S^\pm(\lambda) \oplus U^\pm(\lambda)$  equals to  $\mathbb{C}^{2n}$ .

- **h-4 : Gap condition**

Let us define the spectral gap  $\sigma^\pm(\lambda)$  of  $\mathbb{A}^\pm(\lambda)$  as

$$\sigma^\pm(\lambda) := \min\{\operatorname{Re}(\mu^\pm(\lambda)), \mu^\pm(\lambda) \in \sigma(\mathbb{A}^\pm(\lambda)|_{U^\pm(\lambda)})\} \\ - \max\{\operatorname{Re}(\mu^\pm(\lambda)), \mu^\pm(\lambda) \in \sigma(\mathbb{A}^\pm(\lambda)|_{S^\pm(\lambda)})\}.$$

The spectral gap must be larger than the decay rate for all  $\lambda \in \Omega$  :

$$\sigma^\pm(\lambda) > -\gamma.$$

This hypothesis is satisfied because  $\mu_k^\pm(\lambda)$  is analytic in  $\lambda$ , so  $\sigma^\pm(\lambda) \geq 0 > -\gamma$  when  $\operatorname{Re}(\lambda) > 0$ . Moreover, as  $\sigma(0) = 0$ ,  $\sigma^\pm(\lambda)$  remains larger than  $-\gamma$  in a neighborhood of the origin.

We now consider a differential equation in the subspace  $\Lambda^n(\mathbb{C}^{2n})$  of the exterior algebra :

$$\eta' = \mathbb{A}_{[n]}(\cdot, \lambda)\eta, \quad (27)$$

where

$$\mathbb{A}_{[n]}(\cdot, \lambda)(V_1 \wedge \dots \wedge V_n) := \mathbb{A}(\cdot, \lambda)V_1 \wedge V_2 \wedge \dots \wedge V_n + \dots + V_1 \wedge \dots \wedge \mathbb{A}(\cdot, \lambda)V_n, \\ \text{for } V_j \in \mathbb{C}^{2n}, j \in \{1, \dots, n\}.$$

For  $\operatorname{Re}(\lambda) > 0$ , we define  $c^+(\lambda)$  (respectively  $c^-(\lambda)$ ) as the (simple) smallest (resp. largest) eigenvalue of  $\mathbb{A}_{[n]}^+(\lambda) = \lim_{x \rightarrow +\infty} \mathbb{A}_{[n]}(x, \lambda)$  (resp.  $\mathbb{A}_{[n]}^-(\lambda) = \lim_{x \rightarrow -\infty} \mathbb{A}_{[n]}(x, \lambda)$ ), that is

$$c^+(\lambda) = \sum_{\mu(\lambda) \in \sigma(\mathbb{A}^+(\lambda)) \cap \{\mu / \operatorname{Re}(\mu) < 0\}} \mu(\lambda),$$

$$\left( \text{resp. } c^-(\lambda) = \sum_{\mu(\lambda) \in \sigma(\mathbb{A}^-(\lambda)) \cap \{\mu / \operatorname{Re}(\mu) > 0\}} \mu(\lambda). \right)$$

Let  $\eta^+(\lambda)$  (respectively  $\eta^-(\lambda)$ ) be an eigenvector of  $\mathbb{A}_{[n]}$  associated with  $c^+(\lambda)$  (resp.  $c^-(\lambda)$ ) :  $\eta^+(\lambda)$  and  $\eta^-(\lambda)$  belong to  $\Lambda^n(\mathbb{C}^{2n})$ .



**Theorem 1.5.1 (Gap Lemma [24])**

Let  $\mathbb{A}(x, \lambda)$  be  $C^1$  in  $x$  and analytic in  $\lambda$  and assume that (h-1)-(h-4) hold for some simply connected domain  $\Omega$  containing  $\operatorname{Re}(\lambda) > 0$  and a neighborhood of  $\lambda = 0$ . Then  $c^+$  and  $c^-$  can be extended analytically to  $\Omega$ . Furthermore, when  $\lambda \in \Omega$ , there exist solutions  $\eta^\pm(x, \lambda) \in \Lambda^n(\mathbb{C}^{2n})$  of equation (27) depending analytically on  $\lambda$ . These solutions are uniquely determined by

- a)  $\eta^\pm(x, \lambda) \in \Lambda^n(\mathbb{C}^{2n})$ ,
- b)  $\eta^+(x, \lambda) \exp(-c^+(\lambda)x)$  converges to  $\eta^+(\lambda)$  as  $x \rightarrow +\infty$ ,
- c)  $\eta^-(x, \lambda) \exp(-c^-(\lambda)x)$  converges to  $\eta^-(\lambda)$  as  $x \rightarrow -\infty$ .

Finally,  $\eta^\pm(x, \lambda)$  are analytic in  $\lambda$  for all  $\lambda$  in  $\Omega$ .

The key argument of the proof is the analytic extension to  $\Omega$  with respect to  $\lambda$  of the sets of eigenvalues of  $\mathbb{A}^+(\lambda)$  with negative real part and of eigenvalues of  $\mathbb{A}^-(\lambda)$  with positive real part.

We define

$$D(\lambda) = \eta^+(0, \lambda) \wedge \eta^-(0, \lambda) = \exp\left(-\int_0^x \operatorname{tr}(\mathbb{A}(s, \lambda)) ds\right) \eta^+(x, \lambda) \wedge \eta^-(x, \lambda)$$

for  $\lambda \in \Omega$ . According to the Gap Lemma,  $D$  is analytic in  $\lambda \in \Omega$  and  $D$  is scalar-valued, once we identify  $\Lambda^{2n}(\mathbb{C}^{2n})$  to  $\mathbb{C}$ , which amounts to considering  $D$  as a Wronskian of solutions of (24). As  $\mathbb{A}(\cdot, \lambda)$  is real for real  $\lambda$ , we can set on  $\eta^\pm(x, \lambda)$  to be real, which forces  $D$  to be real also. Since  $M$  has only eigenvalues in the open right half-plane, we derive a necessary condition for linear stability of  $\bar{U}$  from the fact that  $D$  must have the same sign in a neighborhood of  $\lambda = 0$  and at  $\lambda = +\infty$  for positive real  $\lambda$ . But, at  $\lambda = 0$ ,  $\bar{U}'$  is a solution of  $\phi' = \mathbb{A}(x, 0)\phi$  which decays at  $x = \pm\infty$ , so  $D$  vanishes at  $\lambda = 0$ . The Gap Lemma allows us to compute  $D'(0)$  which has the same sign as  $D$  about  $\lambda = 0$ . Our necessary condition thus reads

$$D'(0) \cdot D(+\infty) \geq 0.$$

## 1.6 Lax shocks

Applying the Gap Lemma (Theorem 1.5.1), we study the sign of our Evans function  $D$  in a neighborhood of  $\lambda = 0$  by computing  $D'(0)$ . Then we compute the sign of  $D$  for large real  $\lambda$ .

### 1.6.1 Sign of $D$ about $\lambda = 0$

By [24], the behavior about  $\lambda = 0$  of the eigenvalues and eigenvectors of  $\mathbb{A}^\pm(\lambda)$  which vanish at  $\lambda = 0$  is known to be

$$\mu \sim -\frac{\lambda}{a_k^\pm}.$$

The associated eigenvector tends to

$$\begin{pmatrix} r_k^\pm \\ a_k^\pm r_k^\pm \end{pmatrix}.$$

About  $\lambda = 0$ , the asymptotic behaviors in  $x$  of the eigenvalues and eigenvectors of  $\mathbb{A}(x, \lambda)$  are summarized in Tables 1 and 2.

| at $x = -\infty$ :  |     | $a_1^-, \dots, a_{j-1}^- < 0$ and $0 < a_j^-, \dots, a_n^-$                       |   |     |   |
|---|-----|---|---|-----|---|
| $\mu_1^-(0) = \frac{a_1^-}{\zeta^2}$                                | ... | $\mu_{j-1}^-(0) = \frac{a_{j-1}^-}{\zeta^2}$                                      | $\mu_j^- \sim -\frac{\lambda}{a_j^-}$                           | ... | $\mu_n^- \sim -\frac{\lambda}{a_n^-}$                           |
| $V_1^-(0) = \begin{pmatrix} r_1^- \\ 0 \end{pmatrix}$               | ... | $V_{j-1}^-(0) = \begin{pmatrix} r_{j-1}^- \\ 0 \end{pmatrix}$                     | $V_j^-(0) = \begin{pmatrix} r_j^- \\ a_j^- r_j^- \end{pmatrix}$ | ... | $V_n^-(0) = \begin{pmatrix} r_n^- \\ a_n^- r_n^- \end{pmatrix}$ |
| $\mu_{n+1}^- \sim -\frac{\lambda}{a_1^-}$                           | ... | $\mu_{n+j-1}^- \sim -\frac{\lambda}{a_{j-1}^-}$                                   | $\mu_{n+j}^-(0) = \frac{a_j^-}{\zeta^2}$                        | ... | $\mu_{2n}^-(0) = \frac{a_n^-}{\zeta^2}$                         |
| $V_{n+1}^-(0) = \begin{pmatrix} r_1^- \\ a_1^- r_1^- \end{pmatrix}$ | ... | $V_{n+j-1}^-(0) = \begin{pmatrix} r_{j-1}^- \\ a_{j-1}^- r_{j-1}^- \end{pmatrix}$ | $V_{n+j}^-(0) = \begin{pmatrix} r_j^- \\ 0 \end{pmatrix}$       | ... | $V_{2n}^-(0) = \begin{pmatrix} r_n^- \\ 0 \end{pmatrix}$        |

Tab. 1: Asymptotic behavior at  $x = -\infty$

| at $x = +\infty$ :  |     | $a_1^+, \dots, a_j^+ < 0$ and $0 < a_{j+1}^+, \dots, a_n^+$         |   |     |   |
|---|-----|---|---|-----|---|
| $\mu_1^+(0) = \frac{a_1^+}{\zeta^2}$                                | ... | $\mu_j^+(0) = \frac{a_j^+}{\zeta^2}$                                | $\mu_{j+1}^+ \sim -\frac{\lambda}{a_{j+1}^+}$                                   | ... | $\mu_n^+ \sim -\frac{\lambda}{a_n^+}$                           |
| $V_1^+(0) = \begin{pmatrix} r_1^+ \\ 0 \end{pmatrix}$               | ... | $V_j^+(0) = \begin{pmatrix} r_j^+ \\ 0 \end{pmatrix}$               | $V_{j+1}^+(0) = \begin{pmatrix} r_{j+1}^+ \\ a_{j+1}^+ r_{j+1}^+ \end{pmatrix}$ | ... | $V_n^+(0) = \begin{pmatrix} r_n^+ \\ a_n^+ r_n^+ \end{pmatrix}$ |
| $\mu_{n+1}^+ \sim -\frac{\lambda}{a_1^+}$                           | ... | $\mu_{n+j}^+ \sim -\frac{\lambda}{a_j^+}$                           | $\mu_{n+j+1}^+(0) = \frac{a_{j+1}^+}{\zeta^2}$                                  | ... | $\mu_{2n}^+(0) = \frac{a_n^+}{\zeta^2}$                         |
| $V_{n+1}^+(0) = \begin{pmatrix} r_1^+ \\ a_1^+ r_1^+ \end{pmatrix}$ | ... | $V_{n+j}^+(0) = \begin{pmatrix} r_j^+ \\ a_j^+ r_j^+ \end{pmatrix}$ | $V_{n+j+1}^+(0) = \begin{pmatrix} r_{j+1}^+ \\ 0 \end{pmatrix}$                 | ... | $V_{2n}^+(0) = \begin{pmatrix} r_n^+ \\ 0 \end{pmatrix}$        |

Tab. 2: Asymptotic behavior at  $x = +\infty$ .

We then apply the Gap Lemma : there are  $2n$  functions  $\phi_1, \dots, \phi_{2n}$  of  $(x, \lambda)$ , depending analytically on  $\lambda$ , which satisfy the equation

$$\phi' = \mathbb{A}(x, \lambda)\phi$$

and whose asymptotic behavior in  $x$  is

$$\begin{aligned} \phi_1(x, \lambda) & \underset{x \rightarrow +\infty}{=} e^{\mu_1^+(\lambda)x} (V_1^+(\lambda) + O(e^{-\gamma|x|})), \\ & \vdots \\ \phi_n(x, \lambda) & \underset{x \rightarrow +\infty}{=} e^{\mu_n^+(\lambda)x} (V_n^+(\lambda) + O(e^{-\gamma|x|})), \\ \phi_{n+1}(x, \lambda) & \underset{x \rightarrow -\infty}{=} e^{\mu_{n+1}^-(\lambda)x} (V_{n+1}^-(\lambda) + O(e^{-\gamma|x|})), \\ & \vdots \\ \phi_{2n}(x, \lambda) & \underset{x \rightarrow -\infty}{=} e^{\mu_{2n}^-(\lambda)x} (V_{2n}^-(\lambda) + O(e^{-\gamma|x|})). \end{aligned} \tag{28}$$

We are now able to give an explicit formula for the Evans function about  $\lambda = 0$  :

$$D(\lambda) := e^{-\int_0^x \text{tr}(\mathbb{A}(\sigma, \lambda)) d\sigma} \phi_1(x, \lambda) \wedge \dots \wedge \phi_{2n}(x, \lambda).$$

Since  $\bar{U}$  satisfies  $\bar{U}'' = \mathbb{A}(\cdot, 0)\bar{U}'$ , we choose, at  $\lambda = 0$ ,

$$\phi_{n+j}(\cdot, 0) := \bar{U}' = \begin{pmatrix} \bar{u}' \\ 0 \end{pmatrix},$$

referring to the asymptotic behavior of the eigenfunctions  $\phi$  given by (28). Similarly, we choose

$$\phi_j(\cdot, 0) := \bar{U}' = \begin{pmatrix} \bar{u}' \\ 0 \end{pmatrix}.$$

Consequently,  $D(0)$  vanishes since  $\bar{U}'$  appears twice in the wedge product. Thanks to the Gap Lemma, we know that  $D$  is analytic in a neighborhood of  $\lambda = 0$  so that we can compute  $\text{sgn}(D'(0))$ . Moreover, we know that  $\mathbb{A}(\sigma, 0)$  is a real-valued matrix, so  $\exp(-\int_0^x \text{tr}(\mathbb{A}(\sigma, 0)) d\sigma)$  is positive. So

$$\begin{aligned} \text{sgn}(D'(0)) &= \text{sgn} \left( \left( \phi_1(x, 0) \wedge \dots \wedge \phi_{j-1}(x, 0) \wedge \frac{\partial \phi_j}{\partial \lambda}(x, 0) \wedge \phi_{j+1}(x, 0) \wedge \dots \right. \right. \\ &\quad \left. \wedge \phi_{2n}(x, 0) + \phi_1(x, 0) \wedge \dots \wedge \phi_{n+j-1}(x, 0) \wedge \frac{\partial \phi_{n+j}}{\partial \lambda}(x, 0) \wedge \phi_{n+j+1}(x, 0) \right. \\ &\quad \left. \wedge \dots \wedge \phi_{2n}(x, 0) \right) \\ &= (-1)^{n-j} \text{sgn} \left( \phi_1(x, 0) \wedge \dots \wedge \phi_{n+j-1}(x, 0) \wedge \phi_{n+j+1}(x, 0) \wedge \dots \right. \\ &\quad \left. \wedge \phi_{2n}(x, 0) \wedge \left( \frac{\partial \phi_{n+j}}{\partial \lambda} - \frac{\partial \phi_j}{\partial \lambda} \right) (x, 0) \right) \end{aligned} \quad (29)$$

Let  $\phi_k(\cdot, 0) = \begin{pmatrix} u_k \\ v_k \end{pmatrix}$  for some  $k \in \{1, \dots, n\}$ . Since

$$\mathbb{A}(x, 0) = \frac{1}{\zeta^2} \begin{pmatrix} df(\bar{u}(x)) & -I_n \\ 0_n & 0_n \end{pmatrix},$$

we have  $v'_k = 0$  and consequently  $v_k = 0$  for  $k \in \{1, \dots, j\} \cup \{n+j, \dots, 2n\}$ , because of the asymptotic behavior of  $v_k$  (28). Besides, for  $j+1 \leq k \leq n$ ,  $v_k = a_k^+ r_k^+$ , and for  $n+1 \leq k \leq n+j-1$ ,  $v_k = a_{k-n}^- r_{k-n}^-$  because of the limits given by (28).

Let  $z_k = \frac{\partial \phi_k}{\partial \lambda} \Big|_{\lambda=0} = \begin{pmatrix} w_k \\ t_k \end{pmatrix}$ ,  $k \in \{j, n+j\}$ .

As  $\phi_k$  and system (24) depend analytically on  $\lambda$ ,  $z_k$  is a solution of

$$z' = \mathbb{A}(\cdot, 0)z - \frac{1}{\zeta^2} \begin{pmatrix} 2sI_n & I_n \\ \zeta^2 I_n & 0_n \end{pmatrix} \phi(\cdot, 0).$$

Consequently,  $t'_k = -\bar{u}'$ . Integrating from  $x$  to  $+\infty$ , we find  $t_j = u^+ - \bar{u}$  and integrating from  $-\infty$  to  $x$ , we obtain  $t_{n+j} = u^- - \bar{u}$ . Consequently,

$$t_{n+j} - t_j = -[u].$$

Thus

$$\begin{aligned}
\operatorname{sgn}(D'(0)) &= (-1)^{n-j} \operatorname{sgn} \left( \left( \begin{array}{c} u_1 \\ 0 \end{array} \right) \wedge \dots \wedge \left( \begin{array}{c} u_j \\ 0 \end{array} \right) \wedge \left( \begin{array}{c} u_{j+1} \\ a_{j+1}^+ r_{j+1}^+ \end{array} \right) \wedge \dots \\
&\quad \wedge \left( \begin{array}{c} u_n \\ a_n^+ r_n^+ \end{array} \right) \wedge \left( \begin{array}{c} u_{n+1} \\ a_1^- r_1^- \end{array} \right) \wedge \dots \wedge \left( \begin{array}{c} u_{n+j-1} \\ a_{j-1}^- r_{j-1}^- \end{array} \right) \wedge \left( \begin{array}{c} u_{n+j+1} \\ 0 \end{array} \right) \wedge \dots \\
&\quad \wedge \left( \begin{array}{c} u_{2n} \\ 0 \end{array} \right) \wedge \left( \begin{array}{c} w_{n+j} - w_j \\ -[u] \end{array} \right) \\
&= (-1)^{n-j+(n-1)(n-j)} \operatorname{sgn} ((u_1 \wedge \dots \wedge u_j \wedge u_{n+j+1} \wedge \dots \wedge u_{2n}) \\
&\quad \cdot (a_{j+1}^+ r_{j+1}^+ \wedge \dots \wedge a_n^+ r_n^+ \wedge a_1^- r_1^- \wedge \dots \wedge a_{j-1}^- r_{j-1}^- \wedge -[u])) \\
&= (-1)^{n(n-j)+1+j(n-j)} \operatorname{sgn} ((u_1 \wedge \dots \wedge u_j \wedge u_{n+j+1} \wedge \dots \wedge u_{2n}) \\
&\quad \cdot \prod_{k=j+1}^n a_k^+ \cdot \prod_{k=1}^{j-1} a_k^- \cdot (r_1^- \wedge \dots \wedge r_{j-1}^- \wedge [u] \wedge r_{j+1}^+ \wedge \dots \wedge r_n^+))
\end{aligned}$$

Since  $\operatorname{sgn}(D'(0))$  does not depend on  $x$ , we find that

$$\begin{aligned}
\operatorname{sgn}(D'(0)) &= (-1)^n \cdot \operatorname{sgn}(u_1 \wedge \dots \wedge u_{j-1} \wedge \bar{u}' \wedge u_{n+j+1} \wedge \dots \wedge u_{2n}) \\
&\quad \cdot \operatorname{sgn}(r_1^- \wedge \dots \wedge r_{j-1}^- \wedge [u] \wedge r_{j+1}^+ \wedge \dots \wedge r_n^+).
\end{aligned}$$

But  $u_k, k \in \{1, \dots, j\} \cup \{n+j, \dots, n\}$  are the solutions of  $\zeta^2 \varphi' = df(\bar{u})\varphi$  such that

$$\begin{aligned}
u_j &= u_{n+j} = \bar{u}', \\
\lim_{x \rightarrow +\infty} e^{-a_k^+ x / \zeta^2} u_k(x) &= r_k^+, \quad k \in \{1, \dots, j\}, \\
\lim_{x \rightarrow -\infty} e^{-a_k^- x / \zeta^2} u_k(x) &= r_k^-, \quad k \in \{n+j, \dots, 2n\},
\end{aligned}$$

Thus  $u_k = \varphi_k^+$  for  $k \in \{1, \dots, j\}$  and  $u_k = \varphi_{k-n}^-$  for  $k \in \{n+j, \dots, 2n\}$ .

So,

$$\begin{aligned}
\operatorname{sgn}(D'(0)) &= (-1)^n \cdot \operatorname{sgn}(\varphi_1^+ \wedge \dots \wedge \varphi_{j-1}^+ \wedge \bar{u}' \wedge \varphi_{j+1}^- \wedge \dots \wedge \varphi_n^-) \\
&\quad \cdot \operatorname{sgn}(r_1^- \wedge \dots \wedge r_{j-1}^- \wedge [u] \wedge r_{j+1}^+ \wedge \dots \wedge r_n^+). \quad (30)
\end{aligned}$$

### 1.6.2 Large $|\lambda|$ behavior

From now on, we only consider positive real  $\lambda$ .

#### Theorem 1.6.1

There is a positive real  $\Lambda$  such that

$$\forall \lambda > \Lambda, \operatorname{sgn}(D(\lambda)) = (-1)^n \cdot \operatorname{sgn}(r_1^+ \wedge \dots \wedge r_n^+) \cdot \operatorname{sgn}(r_1^- \wedge \dots \wedge r_n^-).$$

#### Proof

We are going to use a homotopy method [4] to join  $M$  and the operator  $M_0$ , defined by

$$M_0 \begin{pmatrix} u \\ v \end{pmatrix} := \begin{pmatrix} 0_n & -I_n \\ -\zeta^2 I_n & -2s I_n \end{pmatrix} \begin{pmatrix} u \\ v \end{pmatrix}_x.$$

Let  $\theta$  be in  $[0, 1]$  and  $M_\theta$  be the following operator :

$$\begin{aligned} M_\theta \begin{pmatrix} u \\ v \end{pmatrix} &:= \theta M \begin{pmatrix} u \\ v \end{pmatrix} + (1 - \theta) M_0 \begin{pmatrix} u \\ v \end{pmatrix} \\ &= \begin{pmatrix} 0_n & 0_n \\ \theta \text{d}f(\bar{u}) & -\theta I_n \end{pmatrix} \begin{pmatrix} u \\ v \end{pmatrix} + \begin{pmatrix} 0_n & -I_n \\ -\zeta^2 I_n & 2s I_n \end{pmatrix} \begin{pmatrix} u \\ v \end{pmatrix}_x. \end{aligned}$$

The operator  $M_\theta : D(M_\theta) \subset L^2(\mathbb{R}, \mathbb{R}^{2n}) \rightarrow L^2(\mathbb{R}, \mathbb{R}^{2n})$  is densely defined in  $L^2(\mathbb{R}, \mathbb{R}^{2n})$ . Its domain  $D(M_\theta)$  is  $H^1(\mathbb{R}, \mathbb{R}^{2n})$ . In order to define a continuation of the Evans function to the variables  $(\theta, \lambda)$  we need to describe the behavior of  $M_\theta$  at  $\lambda = +\infty$ .

**Lemma 1.6.1**

*There exists  $\Lambda > 0$  such that*

$$\forall \lambda > \Lambda, \forall \theta \in [0, 1], \lambda \text{ is not an eigenvalue of } M_\theta.$$

**Proof**

Let  $\lambda$  be an eigenvalue of  $M_\theta$  and  $(u, v)^T$  be an associated eigenfunction in the domain  $D(M_\theta) = H^1(\mathbb{R}, \mathbb{R}^{2n})$ , that is

$$M_\theta \begin{pmatrix} u \\ v \end{pmatrix} = \lambda \begin{pmatrix} u \\ v \end{pmatrix}. \quad (31)$$

Then we have the following system :

$$\lambda u = -v', \quad (31.a)$$

$$\lambda v = \theta \text{d}f(\bar{u})u - \theta v - \zeta^2 u' + 2s v'. \quad (31.b)$$

Taking the scalar product  $(\cdot | \cdot)$  of (31.a) and  $u$  in  $L^2(\mathbb{R}^n, \mathbb{R}^{2n})$ , we obtain

$$\lambda(u|u) = -(v'|u) = (v|u').$$

Furthermore, taking the scalar product of (31.b) and  $v$ , we obtain

$$(\lambda + \theta)(v|v) + \zeta^2(v|u') = \theta(\text{d}f(\bar{u})u|v).$$

So

$$\lambda \zeta^2 \|u\|_{L^2}^2 + \lambda \|v\|_{L^2}^2 \leq \lambda \zeta^2 \|u\|_{L^2}^2 + (\lambda + \theta) \|v\|_{L^2}^2 \leq \|\text{d}f(\bar{u})\|_\infty \|u\|_{L^2} \|v\|_{L^2}.$$

Thus,

$$\lambda \zeta^2 \left( \|u\|_{L^2} - \frac{\|\text{d}f(\bar{u})\|_\infty \|v\|_{L^2}}{2\lambda \zeta^2} \right)^2 + \left( \lambda - \frac{\|\text{d}f(\bar{u})\|_\infty^2}{4\lambda \zeta^2} \right) \|v\|_{L^2}^2 \leq 0.$$

It follows that  $\|u\|_{L^2} = \|v\|_{L^2} = 0$  for  $\lambda > \|\text{d}f(\bar{u})\|_\infty / 2\zeta =: \Lambda$ .

□

**Corollary 1.6.1**

*There exists  $\Lambda > 0$  such that*

$$\forall \lambda > \Lambda, \forall \theta \in [0, 1], M_\theta - \lambda \text{ is invertible.}$$

**Proof**

The essential spectrum of  $M_\theta$  is contained in the domain  $\{\lambda, \operatorname{Re}(\lambda) < 0\} \cup \{0\}$  since the coefficients of  $M_\theta$  satisfy the same hypotheses as the ones of  $M$  (Theorem 1.4.1). So, in the open right half-plane, the spectrum of  $M_\theta$  consists only of eigenvalues. Consequently,  $(\Lambda, +\infty)$  lies in the resolvent set of  $M_\theta$ .

□

Let us now study the dynamical system

$$\phi' = \mathbb{A}(\theta, x, \lambda)\phi,$$

which we derive from system (31) as we did previously for system (24) and where

$$\mathbb{A}(\theta, x, \lambda) := \frac{1}{\zeta^2} \begin{pmatrix} \theta \operatorname{d}f(\bar{u}) - 2s\lambda I_n & -(\lambda + \theta)I_n \\ -\lambda\zeta^2 I_n & 0_n \end{pmatrix}.$$

Let  $\nu$  be an eigenvalue of  $\mathbb{A}^\pm(\theta, \lambda) = \lim_{x \rightarrow \pm\infty} \mathbb{A}(x, \theta, \lambda)$  and  $(X, Y)^T$  an associated eigenvector. Then

$$\mathbb{A}^\pm(\theta, \lambda) \begin{pmatrix} X \\ Y \end{pmatrix} = \nu \begin{pmatrix} X \\ Y \end{pmatrix}$$

$$\Updownarrow$$

$$\begin{cases} (\zeta^2\nu^2 I_n + \nu(2s\lambda I_n - \theta A^\pm) - \lambda(\lambda + \theta)I_n)Y = 0, \\ -\lambda X = \nu Y. \end{cases}$$

The eigenvalues are the roots of the  $n$  equations

$$\zeta^2\nu^2 + (2s\lambda - \theta a_k^\pm)\nu - \lambda(\lambda + \theta) = 0, \quad k \in \{1, \dots, n\}. \quad (32)$$

The coefficients are real and the products of the roots are negative, so each equation has two real, distinct roots of opposite sign. Moreover, since we assumed that the eigenvalues of  $A^\pm$  are real and distinct by **(H2)**, the eigenvalues of  $\mathbb{A}^\pm(\theta, \lambda)$  are simple and  $\mathbb{A}^\pm$  is diagonalizable. Let  $1 \leq k \leq n$  and  $\nu$  be a root of (32) with associated eigenvector  $(r_k^\pm, -\lambda r_k^\pm / \nu)^T$ . We note that taking  $\theta = 1$ , the eigenvectors keep the same orientation as  $\lambda \rightarrow 0$ . Having chosen some bases  $\phi_1^+(\lambda), \dots, \phi_n^+(\lambda)$  of  $S^+(\lambda)$  and  $\phi_{n+1}^-(\lambda), \dots, \phi_{2n}^-(\lambda)$  of  $U^-(\lambda)$  depending continuously on  $\lambda$ , we can extend these bases continuously in  $(\theta, \lambda)$ . We then define

$$\tilde{D}(\theta, \lambda) = \tilde{\phi}_1^+(\theta, \lambda) \wedge \dots \wedge \tilde{\phi}_n^+(\theta, \lambda) \wedge \tilde{\phi}_{n+1}^-(\theta, \lambda) \wedge \dots \wedge \tilde{\phi}_{2n}^-(\theta, \lambda).$$

We must now study the sign of  $\tilde{D}$  in  $(\{\theta = 1\} \times [0, \lambda_0]) \cup ([0, 1] \times \{\lambda = \lambda_0\})$ , with  $\lambda_0 > \Lambda$ . As  $\tilde{D}$  does not vanish along  $[0, 1] \times (\Lambda, +\infty)$ , its sign is constant and

$$\operatorname{sgn}(D(+\infty)) = \operatorname{sgn}(\tilde{D}(1, +\infty)) = \operatorname{sgn}(\tilde{D}(0, +\infty)) = \operatorname{sgn}(\tilde{D}(0, \lambda_0)).$$

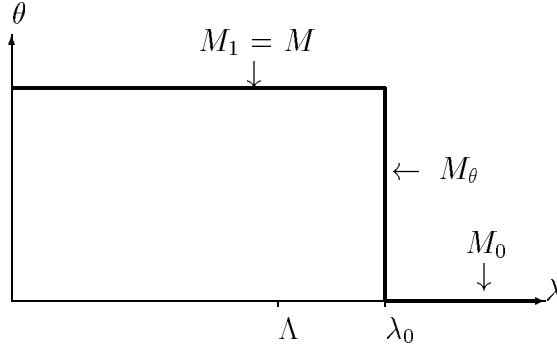

Let us study the case  $\theta = 0$ . The eigenvalues of  $\mathbb{A}^\pm(0, \lambda)$  are  $\nu_\pm = \lambda/(\mathbf{a} + s)$  both with multiplicity  $n$ . By **(H3)**, we know that  $\nu_- > 0$  and  $\nu_+ < 0$ : the eigenspace associated with  $\nu_-$  (respectively  $\nu_+$ ) is the unstable (resp. stable) subspace of  $\mathbb{A}^-(0, \lambda)$  (resp.  $\mathbb{A}^+(0, \lambda)$ ). So, for  $k \in \{1, \dots, n\}$ ,

$$\phi_k(0, x, \lambda) = e^{(\nu_+)x} \begin{pmatrix} r_k^+ \\ \lambda \\ -\frac{\lambda}{\nu_+} r_k^+ \end{pmatrix}$$

and

$$\phi_{n+k}(0, x, \lambda) = e^{(\nu_-)x} \begin{pmatrix} r_k^- \\ \lambda \\ -\frac{\lambda}{\nu_-} r_k^- \end{pmatrix}.$$

But  $\{(r_1^+, -\lambda r_1^+/\nu_+)^T, \dots, (r_n^+, -\lambda r_n^+/\nu_+)^T\}$  and  $\{(r_1^-, -\lambda r_1^-/\nu_-)^T, \dots, (r_n^-, -\lambda r_n^-/\nu_-)^T\}$  have the same orientation as  $\{V_1^+(\lambda), \dots, V_n^+(\lambda)\}$  and  $\{V_{n+1}^-(\lambda), \dots, V_{2n}^-(\lambda)\}$  respectively, because these bases have been chosen continuously with respect to  $\lambda$ . We thus obtain

$$\begin{aligned} \tilde{D}(0, +\infty) &= \begin{vmatrix} r_1^+ & \dots & r_n^+ & r_1^- & \dots & r_n^- \\ -\frac{\lambda_0 r_1^+}{\nu_+} & \dots & -\frac{\lambda_0 r_n^+}{\nu_+} & -\frac{\lambda_0 r_1^-}{\nu_-} & \dots & -\frac{\lambda_0 r_n^-}{\nu_-} \end{vmatrix} \\ &= \begin{vmatrix} I_n & 0_n \\ -\frac{\lambda_0}{\nu_+} I_n & I_n \end{vmatrix} \begin{vmatrix} r_1^+ & \dots & r_n^+ & r_1^- & \dots & r_n^- \\ 0 & \dots & 0 & -\frac{\lambda_0(\nu_- - \nu_+)}{\nu_- \nu_+} r_1^- & \dots & -\frac{\lambda_0(\nu_- - \nu_+)}{\nu_- \nu_+} r_n^- \end{vmatrix} \\ &= \lambda_0^n \left( \frac{\nu_- - \nu_+}{\nu_- \nu_+} \right)^n \cdot (r_1^+ \wedge \dots \wedge r_n^+) \cdot (r_1^- \wedge \dots \wedge r_n^-), \end{aligned}$$

that is,

$$\text{sgn}(D(+\infty)) \text{sgn}(\tilde{D}(0, +\infty)) = (-1)^n (r_1^+ \wedge \dots \wedge r_n^+) \cdot (r_1^- \wedge \dots \wedge r_n^-). \quad (33)$$

In conclusion, using (30) and (33) and keeping in mind that the bases do not twist along the real axis from  $\lambda = 0$  to  $\lambda = \lambda_0$  at  $\theta = 1$ , we obtain

$$\begin{aligned} &(\varphi_1^+ \wedge \dots \wedge \varphi_{j-1}^+ \wedge \bar{u}' \wedge \varphi_{j+1}^- \wedge \dots \wedge \varphi_n^-) \cdot (r_1^- \wedge \dots \wedge r_{j-1}^- \wedge [u] \wedge r_{j+1}^+ \wedge \dots \wedge r_n^+) \\ &\quad \cdot (r_1^- \wedge \dots \wedge r_n^-) \cdot (r_1^+ \wedge \dots \wedge r_n^+) \geq 0. \end{aligned} \quad (34)$$

□

**Remark 1.6.1** Note that this proof does not depend on the nature of the discontinuity  $(u^-, u^+; s)$ . Consequently, Theorem 1.6.1 also holds for undercompressive and overcompressive shocks.

### 1.7 Undercompressive shocks

In outline, the proofs of Theorems 1.3.1 and 1.3.2 in the Lax and undercompressive cases are the same : the computations about  $\lambda = 0$  in the undercompressive case are more complicated than in the Lax case, but the behavior for large  $|\lambda|$  is the same.

About  $\lambda = 0$ , the asymptotic behaviors in  $x$  of the eigenvalues and eigenvectors of  $\mathbb{A}(x, \lambda)$  are given in Tables 3 and 4.

| at $x = -\infty$ :  |     | $a_1^-, \dots, a_{j-1}^- < 0$ and $0 < a_j^-, \dots, a_n^-$                       |   |     |   |
|---|-----|---|---|-----|---|
| $\mu_1^-(0) = \frac{a_1^-}{\zeta^2}$                                | ... | $\mu_{j-1}^-(0) = \frac{a_{j-1}^-}{\zeta^2}$                                      | $\mu_j^- \sim -\frac{\lambda}{a_j^-}$                           | ... | $\mu_n^- \sim -\frac{\lambda}{a_n^-}$                           |
| $V_1^-(0) = \begin{pmatrix} r_1^- \\ 0 \end{pmatrix}$               | ... | $V_{j-1}^-(0) = \begin{pmatrix} r_{j-1}^- \\ 0 \end{pmatrix}$                     | $V_j^-(0) = \begin{pmatrix} r_j^- \\ a_j^- r_j^- \end{pmatrix}$ | ... | $V_n^-(0) = \begin{pmatrix} r_n^- \\ a_n^- r_n^- \end{pmatrix}$ |
| $\mu_{n+1}^- \sim -\frac{\lambda}{a_1^-}$                           | ... | $\mu_{n+j-1}^- \sim -\frac{\lambda}{a_{j-1}^-}$                                   | $\mu_{n+j}^-(0) = \frac{a_j^-}{\zeta^2}$                        | ... | $\mu_{2n}^-(0) = \frac{a_n^-}{\zeta^2}$                         |
| $V_{n+1}^-(0) = \begin{pmatrix} r_1^- \\ a_1^- r_1^- \end{pmatrix}$ | ... | $V_{n+j-1}^-(0) = \begin{pmatrix} r_{j-1}^- \\ a_{j-1}^- r_{j-1}^- \end{pmatrix}$ | $V_{n+j}^-(0) = \begin{pmatrix} r_j^- \\ 0 \end{pmatrix}$       | ... | $V_{2n}^-(0) = \begin{pmatrix} r_n^- \\ 0 \end{pmatrix}$        |

Tab. 3: Asymptotic behavior at  $x = -\infty$

| at $x = +\infty$ :  |     | $a_1^+, \dots, a_{j-1}^+ < 0$ and $0 < a_j^+, \dots, a_n^+$                       |   |     |   |
|---|-----|---|---|-----|---|
| $\mu_1^+(0) = \frac{a_1^+}{\zeta^2}$                                | ... | $\mu_{j-1}^+(0) = \frac{a_{j-1}^+}{\zeta^2}$                                      | $\mu_j^+ \sim \frac{\lambda}{a_j^+}$                            | ... | $\mu_n^+ \sim -\frac{\lambda}{a_n^+}$                           |
| $V_1^+(0) = \begin{pmatrix} r_1^+ \\ 0 \end{pmatrix}$               | ... | $V_{j-1}^+(0) = \begin{pmatrix} r_{j-1}^+ \\ 0 \end{pmatrix}$                     | $V_j^+(0) = \begin{pmatrix} r_j^+ \\ a_j^+ r_j^+ \end{pmatrix}$ | ... | $V_n^+(0) = \begin{pmatrix} r_n^+ \\ a_n^+ r_n^+ \end{pmatrix}$ |
| $\mu_{n+1}^+ \sim -\frac{\lambda}{a_1^+}$                           | ... | $\mu_{n+j-1}^+ \sim -\frac{\lambda}{a_{j-1}^+}$                                   | $\mu_{n+j}^+(0) = \frac{a_j^+}{\zeta^2}$                        | ... | $\mu_{2n}^+(0) = \frac{a_n^+}{\zeta^2}$                         |
| $V_{n+1}^+(0) = \begin{pmatrix} r_1^+ \\ a_1^+ r_1^+ \end{pmatrix}$ | ... | $V_{n+j-1}^+(0) = \begin{pmatrix} r_{j-1}^+ \\ a_{j-1}^+ r_{j-1}^+ \end{pmatrix}$ | $V_{n+j}^+(0) = \begin{pmatrix} r_j^+ \\ 0 \end{pmatrix}$       | ... | $V_{2n}^+(0) = \begin{pmatrix} r_n^+ \\ 0 \end{pmatrix}$        |

Tab. 4: Asymptotic behavior at  $x = +\infty$

We then apply the gap lemma : there are  $2n$  functions  $\phi_1, \phi_2, \dots, \phi_{2n}$  of  $(x, \lambda)$ , depending analytically on  $\lambda$ , which satisfy the equation

$$\phi' = \mathbb{A}(x, \lambda)\phi$$



and whose asymptotic behavior in  $x$  is

$$\begin{aligned} \phi_1(x, \lambda) & \underset{x \rightarrow +\infty}{=} e^{\mu_1^+(\lambda)x} (V_1^+(\lambda) + O(e^{-\gamma|x|})), \\ & \vdots \\ \phi_n(x, \lambda) & \underset{x \rightarrow +\infty}{=} e^{\mu_n^+(\lambda)x} (V_n^+(\lambda) + O(e^{-\gamma|x|})), \\ \phi_{n+1}(x, \lambda) & \underset{x \rightarrow -\infty}{=} e^{\mu_{n+1}^-(\lambda)x} (V_{n+1}^-(\lambda) + O(e^{-\gamma|x|})), \\ & \vdots \\ \phi_{2n}(x, \lambda) & \underset{x \rightarrow -\infty}{=} e^{\mu_{2n}^-(\lambda)x} (V_{2n}^-(\lambda) + O(e^{-\gamma|x|})). \end{aligned}$$

Let  $D(\lambda) := e^{-\int_0^x \text{tr}(A(s, \lambda)) ds} \phi_1(x, \lambda) \wedge \dots \wedge \phi_{2n}(x, \lambda)$ .

Using the same kind of arguments as we did in the Lax case, we choose

$$\phi_{j-1}(\cdot, 0) = \phi_{n+j}(\cdot, 0) = \begin{pmatrix} \bar{u}' \\ \bar{v}' \end{pmatrix},$$

where

$$\begin{aligned} \phi_{n+j}(x, \lambda) e^{-\mu_{n+j}^- x} & \underset{(x, \lambda) \rightarrow (-\infty, 0)}{\longrightarrow} \begin{pmatrix} r_j^- \\ \mathbf{0} \end{pmatrix}, \\ \phi_{j-1}(x, \lambda) e^{-\mu_{j-1}^+ x} & \underset{(x, \lambda) \rightarrow (+\infty, 0)}{\longrightarrow} \begin{pmatrix} r_{j-1}^+ \\ \mathbf{0} \end{pmatrix}, \end{aligned}$$

so  $r_j^-$  has the same orientation as  $\bar{u}'$  at  $x = -\infty$  and  $r_{j-1}^+$  as  $\bar{u}'$  at  $x = +\infty$ .

Using the computations we previously carried out, we obtain

$$\text{sgn}(D'(0)) = (-1)^{n-j} \text{sgn} \left( \phi_1 \wedge \dots \wedge \phi_{n+j-1} \wedge \phi_{n+j+1} \wedge \dots \wedge \left( \frac{\partial \phi_{n+j}}{\partial \lambda} - \frac{\partial \phi_{j-1}}{\partial \lambda} \right) \Big|_{\lambda=0} \right).$$

Since  $v'_k = 0$  at  $\lambda = 0$ , we find  $v_k = 0$  for  $k \in \{1, \dots, j-1\} \cup \{n+j, \dots, 2n\}$ ,  $v_k = a_k^+ r_k^+$  for  $k \in \{j, \dots, n\}$ , and  $v_k = a_{k-n}^- r_{k-n}^-$  for  $k \in \{n+1, \dots, n+j-1\}$ .

Let  $\phi_k = \begin{pmatrix} u_k \\ v_k \end{pmatrix}$  and  $z_k = \frac{\partial \phi_k}{\partial \lambda} \Big|_{\lambda=0} = \begin{pmatrix} w_k \\ t_k \end{pmatrix}$ ,  $k \in \{j-1, n+j\}$ .

As in the Lax case,  $t'_k = -\bar{u}'$ . So, integrating from  $x$  to  $+\infty$ , we obtain  $t_{j-1} = u^+ - \bar{u}$  and integrating from  $-\infty$  to  $x$ , we find  $t_{n+j} = u^- - \bar{u}$ . We then have

$$z_{n+j} - z_{j-1} = \begin{pmatrix} w_{n+j} - w_{j-1} \\ -[u] \end{pmatrix}.$$

Recall that  $[u] = \beta_1^- r_1^- + \dots + \beta_{j-1}^- r_{j-1}^- + \beta_j^+ r_j^+ + \dots + \beta_n^+ r_n^+$ , and that  $u^*$  is the only point in  $\mathbb{R}^n$  such that

$$u^* = \begin{cases} u^- + \beta_1^- r_1^- + \dots + \beta_{j-1}^- r_{j-1}^-, \\ u^+ - \beta_j^+ r_j^+ - \dots - \beta_n^+ r_n^+. \end{cases}$$

Let  $\alpha_k = \beta_k/a_k$ . Then,

$$\begin{aligned} \operatorname{sgn}(D'(0)) &= (-1)^{n-j} \operatorname{sgn} \left( \begin{pmatrix} u_1 \\ 0 \end{pmatrix} \wedge \dots \wedge \begin{pmatrix} u_{j-1} \\ 0 \end{pmatrix} \wedge \begin{pmatrix} u_j \\ a_j^+ r_j^+ \end{pmatrix} \wedge \dots \right. \\ &\quad \wedge \begin{pmatrix} u_n \\ a_n^+ r_n^+ \end{pmatrix} \wedge \begin{pmatrix} u_{n+1} \\ a_1^- r_1^- \end{pmatrix} \wedge \dots \wedge \begin{pmatrix} u_{n+j-1} \\ a_{j-1}^- r_{j-1}^- \end{pmatrix} \\ &\quad \left. \wedge \begin{pmatrix} u_{n+j+1} \\ 0 \end{pmatrix} \wedge \dots \wedge \begin{pmatrix} u_{2n} \\ 0 \end{pmatrix} \wedge \begin{pmatrix} w_{n+j} - w_{j-1} \\ -[u] \end{pmatrix} \right). \end{aligned}$$

So, performing elementary matrix manipulations,

$$\begin{aligned} \operatorname{sgn}(D'(0)) &= (-1)^{n(n-j+1)+n-j+(j-1)(n-j+1)} \operatorname{sgn} \left( \begin{pmatrix} u_1 \\ 0 \end{pmatrix} \wedge \dots \wedge \begin{pmatrix} u_{j-1} \\ 0 \end{pmatrix} \right. \\ &\quad \wedge \begin{pmatrix} u_{n+j+1} \\ 0 \end{pmatrix} \wedge \dots \wedge \begin{pmatrix} u_{2n} \\ 0 \end{pmatrix} \wedge \begin{pmatrix} w_{n+j} - w_{j-1} \\ -[u] \end{pmatrix} \\ &\quad \left. \wedge \begin{pmatrix} u_{n+1} \\ a_1^- r_1^- \end{pmatrix} \wedge \dots \wedge \begin{pmatrix} u_{n+j-1} \\ a_{j-1}^- r_{j-1}^- \end{pmatrix} \wedge \begin{pmatrix} u_j \\ a_j^+ r_j^+ \end{pmatrix} \wedge \dots \wedge \begin{pmatrix} u_n \\ a_n^+ r_n^+ \end{pmatrix} \right). \end{aligned}$$

Therefore,

$$\begin{aligned} \operatorname{sgn}(D'(0)) &= -\operatorname{sgn} \left( \begin{pmatrix} u_1 \\ 0 \end{pmatrix} \wedge \dots \wedge \begin{pmatrix} u_{j-1} \\ 0 \end{pmatrix} \wedge \begin{pmatrix} u_{n+j+1} \\ 0 \end{pmatrix} \wedge \dots \wedge \begin{pmatrix} u_{2n} \\ 0 \end{pmatrix} \right. \\ &\quad \wedge \begin{pmatrix} w_{n+j} - w_{j-1} + \alpha_j^+ u_j + \dots + \alpha_n^+ u_n + \alpha_1^- u_{n+1} + \dots + \alpha_{j-1}^- u_{n+j-1} \\ 0 \end{pmatrix} \\ &\quad \left. \wedge \begin{pmatrix} u_{n+1} \\ a_1^- r_1^- \end{pmatrix} \wedge \dots \wedge \begin{pmatrix} u_{n+j-1} \\ a_{j-1}^- r_{j-1}^- \end{pmatrix} \wedge \begin{pmatrix} u_j \\ a_j^+ r_j^+ \end{pmatrix} \wedge \dots \wedge \begin{pmatrix} u_n \\ a_n^+ r_n^+ \end{pmatrix} \right). \end{aligned}$$

Finally,

$$\begin{aligned} \operatorname{sgn}(D'(0)) &= -\operatorname{sgn} \left( \left\{ (u_1 \wedge \dots \wedge u_{j-1} \wedge u_{n+j+1} \wedge \dots \wedge u_{2n} \right. \right. \\ &\quad \left. \left. \wedge (w_{n+j} - w_{j-1} + \alpha_j^+ u_j + \dots + \alpha_n^+ u_n + \alpha_1^- u_{n+1} + \dots + \alpha_{j-1}^- u_{n+j-1}) \right\} \right. \\ &\quad \left. \cdot \prod_{k=j}^n a_k^+ \cdot \prod_{k=1}^{j-1} a_k^- \cdot (r_1^- \wedge \dots \wedge r_{j-1}^- \wedge r_j^+ \wedge \dots \wedge r_n^+) \right). \end{aligned}$$

Let  $\tilde{w}_{n+j} = w_{n+j} + \alpha_1^- u_{n+1} + \dots + \alpha_{j-1}^- u_{n+j-1}$  and  $\tilde{w}_{j-1} = w_{j-1} - \alpha_j^+ u_j - \dots - \alpha_n^+ u_n$ . Since, for  $m \in \{j-1, n+j\}$ ,  $k \in \{1, \dots, 2n\}$ ,

$$\begin{cases} \zeta^2 w'_m &= df(\bar{u})w_m - t_m - 2su_m - v_m, \\ \zeta^2 u'_k &= df(\bar{u})u_k - v_k, \end{cases}$$

we have

$$\begin{aligned} \zeta^2 \tilde{w}'_{n+j} &= df(\bar{u})w_{n+j} + u^- - \bar{u} - 2su_{n+j} - v_{n+j} + \alpha_1^- df(\bar{u})u_{n+1} - \alpha_1^- v_{n+1} \\ &\quad + \dots + \alpha_{j-1}^- df(\bar{u})u_{n+j-1} - \alpha_{j-1}^- v_{n+j-1} \\ &= df(\bar{u})\tilde{w}_{n+j} - 2su_{n+j} + u^- + \alpha_1^- a_1^- r_1^- + \dots + \alpha_{j-1}^- a_{j-1}^- r_{j-1}^- \\ &= df(\bar{u})\tilde{w}_{n+j} - 2su_{n+j} + u^* - \bar{u}, \end{aligned}$$

because  $v_{n+j} = 0$ ,  $v_{n+k} = a_k^- r_k^-$  for  $k \in \{1, \dots, n\}$ , and  $t_{n+j} = u^- - \bar{u}$ . In the same way,

$$\zeta^2 \tilde{w}'_{j-1} = df(\bar{u})\tilde{w}_{j-1} - 2su_{j-1} + u^* - \bar{u},$$

for  $v_{j-1} = v_{n+j} = 0$ ,  $v_2 = a_2^+ r_2^+$  and  $t_{j-1} = u^+ - \bar{u}$ . But, having chosen  $\phi_{j-1} = \phi_{n+j} = (\bar{u}', \bar{v}')^T$ ,  $u_{n+j} = u_{j-1} = \bar{u}'$ . So  $\tilde{w}_{j-1}$  and  $\tilde{w}_{n+j}$  both solve

$$\zeta^2 \tilde{w}' = df(\bar{u})\tilde{w} - 2s\bar{u}' + u^* - \bar{u}.$$

Moreover,  $w_{n+j}(x, 0) \xrightarrow{x \rightarrow -\infty} 0$ , for  $\phi_{n+j}(x, 0) \xrightarrow{x \rightarrow -\infty} 0$  and the convergence is uniform for  $\lambda$  in compact sets. In the same way,  $w_{j-1}(x, 0) \xrightarrow{x \rightarrow +\infty} 0$ . In addition, for  $k \in \{j, \dots, n\}$ ,  $u_k$  is bounded at  $x = +\infty$  because  $u_k(x, \lambda) \xrightarrow{(x, \lambda) \rightarrow (+\infty, 0)} r_k^+$ . Similarly, for  $k \in \{1, \dots, j-1\}$ ,  $u_{n+k}$  is bounded at  $x = -\infty$  because  $u_{n+k}(x, \lambda) \xrightarrow{(x, \lambda) \rightarrow (-\infty, 0)} r_k^-$ .

Let  $\Delta := u_1 \wedge \dots \wedge \bar{u}' \wedge u_{n+j+1} \wedge \dots \wedge u_{2n}$ .

$$\begin{aligned} \zeta^2(\Delta \wedge \tilde{w}_{n+j})' &= (df(\bar{u})u_1) \wedge \dots \wedge \bar{u}' \wedge u_{n+j+1} \wedge \dots \wedge u_{2n} \wedge \tilde{w}_{n+j} + \dots \\ &\quad + u_1 \wedge \dots \wedge \bar{u}' \wedge u_{n+j+1} \wedge \dots \wedge u_{2n} \wedge (df(\bar{u})\tilde{w}_{n+j} - 2s\bar{u}' - u^* + \bar{u}) \\ &= \text{tr}(df(\bar{u}))(\Delta \wedge \tilde{w}_{n+j}) - \Delta \wedge (u^* - \bar{u}). \end{aligned}$$

Applying Duhamel's principle from  $-\infty$  to 0 and given that  $\Delta \wedge \tilde{w}_{n+j}$  is bounded at  $-\infty$ ,

$$\begin{aligned} (\Delta \wedge \tilde{w}_{n+j})|_{x=0} &= \lim_{y \rightarrow -\infty} \left[ \exp \left( \int_y^0 \frac{\text{tr}(df(\bar{u}(\sigma)))}{\zeta^2} d\sigma \right) (\Delta(y) \wedge \tilde{w}_{n+j}(y)) \right. \\ &\quad \left. + \frac{1}{\zeta^2} \int_y^0 \exp \left( \int_t^0 \frac{\text{tr}(df(\bar{u}(\sigma)))}{\zeta^2} d\sigma \right) (\Delta(t) \wedge (\bar{u}(t) - u^*)) dt \right]. \end{aligned}$$

Moreover,

$$|\Delta(y)| \underset{y \rightarrow -\infty}{\sim} \exp \left( \sum_{k \in \{1, \dots, n\} \setminus \{j-1\}} a_k^- y / \zeta^2 \right)$$

because, for  $k \in \{1, \dots, j-2\}$ ,  $\|u_1 \wedge \dots \wedge u_{j-2}\| \sim \exp((a_1^- + \dots + a_{j-2}^-)y / \zeta^2)$ , for  $k \in \{j+1, \dots, n\}$ ,  $|u_{n+k}| \sim \exp(a_k^- y / \zeta^2)$  and  $|\bar{u}'| \sim \exp(a_j^- / \zeta^2)$ . Moreover, as  $\mathbb{A}(x, \lambda) \rightarrow \mathbb{A}^\pm(\lambda) + O(e^{-\gamma|x|})$  when  $x \rightarrow \pm\infty$  for some  $\gamma > 0$  uniformly for  $\lambda$  in compact sets, we obtain

$$\exp \left( \int_y^0 \frac{\text{tr}(df(\bar{u}(\sigma)))}{\zeta^2} d\sigma \right) \underset{y \rightarrow -\infty}{\sim} C \exp \left( -\frac{\sum_{k=1}^n a_k^- y}{\zeta^2} \right),$$

where  $C$  is a constant. Finally, as  $\tilde{w}_{n+j}$  is bounded in  $-\infty$ , we have

$$g(y) = \exp \left( \int_y^0 \frac{\text{tr}(df(\bar{u}(\sigma)))}{\zeta^2} d\sigma \right) (\Delta(y) \wedge \tilde{w}_{n+j}(y)) \underset{y \rightarrow -\infty}{\sim} C \exp \left( -\frac{a_{j-1}^-}{\zeta^2} y \right).$$

But  $a_{j-1}^- < 0$ , so  $g(y) \xrightarrow{y \rightarrow -\infty} 0$ . Then

$$(\Delta \wedge \tilde{w}_{n+j})|_{x=0} = \frac{1}{\zeta^2} \int_{-\infty}^0 \exp \left( -\int_0^y \frac{\text{tr}(df(\bar{u}(\sigma)))}{\zeta^2} d\sigma \right) (\Delta(y) \wedge (\bar{u}(y) - u^*)) dy.$$

In the same way,

$$(\Delta \wedge \tilde{w}_{j-1})|_{x=0} = -\frac{1}{\zeta^2} \int_0^{+\infty} \exp\left(-\int_0^y \frac{\text{tr}(\text{d}f(\bar{u}(\sigma)))}{\zeta^2} \text{d}\sigma\right) (\Delta(y) \wedge (\bar{u}(y) - u^*)) \text{d}y.$$

In addition,  $(\Delta \wedge (\tilde{w}_{n+j} - \tilde{w}_{j-1}))|_{x=0} = (\Delta \wedge \tilde{w}_{n+j})|_{x=0} - (\Delta \wedge \tilde{w}_{j-1})|_{x=0}$ ,  $\text{sgn}\left(\prod_{k=1}^{j-1} a_k\right) = (-1)^{j-1}$  and  $u_{n+j} = \bar{u}'$ .

We thus obtain

$$\text{sgn}(D'(0)) = (-1)^j \text{sgn}(r_1^- \wedge \dots \wedge r_j^- \wedge r_{j+1}^+ \wedge \dots \wedge r_n^+) \cdot \text{sgn}(?),$$

with

$$\begin{aligned} ? &:= \frac{1}{\zeta^2} \int_{-\infty}^{+\infty} \exp\left(-\int_0^y \frac{\text{tr}(\text{d}f(\bar{u}(\sigma)))}{\zeta^2} \text{d}\sigma\right) u_1(y) \wedge \dots \wedge u_{j-2}(y) \wedge \bar{u}'(y) \wedge u_{n+j+1}(y) \\ &\quad \wedge \dots \wedge u_{2n}(y) \wedge (\bar{u}(y) - u^*) \text{d}y. \end{aligned}$$

Using the notations we introduced in subsection 1.2.3, we rewrite ? as

$$\begin{aligned} ? &:= \frac{1}{a^2 - s^2} \int_{-\infty}^{+\infty} \exp\left(-\int_0^y \frac{\text{tr}(\text{d}f(\bar{u}(\sigma)))}{a^2 - s^2} \text{d}\sigma\right) \varphi_1^+(y) \wedge \dots \wedge \varphi_{j-2}^+(y) \wedge \bar{u}'(y) \\ &\quad \wedge \varphi_{j+1}^-(y) \wedge \dots \wedge \varphi_n^-(y) \wedge (\bar{u}(y) - u^*) \text{d}y. \end{aligned}$$

As the proof of Theorem 1.6.1 does not depend on the nature of the shock, we can apply it to the undercompressive case and get :

$$\text{sgn}(D(+\infty)) = (-1)^n \text{sgn}(r_1^+ \wedge \dots \wedge r_n^+) \cdot \text{sgn}(r_1^- \wedge \dots \wedge r_n^-).$$

## 1.8 Overcompressive shocks

About  $\lambda = 0$ , the asymptotic behavior in  $x$  of the eigenvalues and associated eigenvectors of  $\mathbb{A}(x, \lambda)$  is summarized in Tables 5 and 6.

| at $x = -\infty$ :  |     | $a_1^-, \dots, a_{j-1}^- < 0$ and $0 < a_j^-, \dots, a_n^-$                       |   |     |   |
|---|-----|---|---|-----|---|
| $\mu_1^-(0) = \frac{a_1^-}{\zeta^2}$                                | ... | $\mu_{j-1}^-(0) = \frac{a_{j-1}^-}{\zeta^2}$                                      | $\mu_j^- \sim -\frac{\lambda}{a_j^-}$                           | ... | $\mu_n^- \sim -\frac{\lambda}{a_n^-}$                           |
| $V_1^-(0) = \begin{pmatrix} r_1^- \\ 0 \end{pmatrix}$               | ... | $V_{j-1}^-(0) = \begin{pmatrix} r_{j-1}^- \\ 0 \end{pmatrix}$                     | $V_j^-(0) = \begin{pmatrix} r_j^- \\ a_j^- r_j^- \end{pmatrix}$ | ... | $V_n^-(0) = \begin{pmatrix} r_n^- \\ a_n^- r_n^- \end{pmatrix}$ |
| $\mu_{n+1}^- \sim -\frac{\lambda}{a_1^-}$                           | ... | $\mu_{n+j-1}^- \sim -\frac{\lambda}{a_{j-1}^-}$                                   | $\mu_{n+j}^-(0) = \frac{a_j^-}{\zeta^2}$                        | ... | $\mu_{2n}^-(0) = \frac{a_n^-}{\zeta^2}$                         |
| $V_{n+1}^-(0) = \begin{pmatrix} r_1^- \\ a_1^- r_1^- \end{pmatrix}$ | ... | $V_{n+j-1}^-(0) = \begin{pmatrix} r_{j-1}^- \\ a_{j-1}^- r_{j-1}^- \end{pmatrix}$ | $V_{n+j}^-(0) = \begin{pmatrix} r_j^- \\ 0 \end{pmatrix}$       | ... | $V_{2n}^-(0) = \begin{pmatrix} r_n^- \\ 0 \end{pmatrix}$        |

Tab. 5: Asymptotic behavior at  $x = -\infty$

There are  $2n$  functions  $\phi_1, \dots, \phi_{2n}$  of  $(x, \lambda)$ , analytic in  $\lambda$ , which are solutions of the equation

$$\phi' = \mathbb{A}(x, \lambda)\phi,$$

| at $x = +\infty$ :  |     | $a_1^+, \dots, a_{j+1}^+ < 0$ and $0 < a_{j+2}^+, \dots, a_n^+$                   |   |     |   |
|---|-----|---|---|-----|---|
| $\mu_1^+(0) = \frac{a_1^+}{\zeta^2}$                                | ... | $\mu_{j+1}^+(0) = \frac{a_{j+1}^+}{\zeta^2}$                                      | $\mu_{j+2}^+ \sim -\frac{\lambda}{a_{j+2}^+}$                                   | ... | $\mu_n^+ \sim -\frac{\lambda}{a_n^+}$                           |
| $V_1^+(0) = \begin{pmatrix} r_1^+ \\ 0 \end{pmatrix}$               | ... | $V_{j+1}^+(0) = \begin{pmatrix} r_{j+1}^+ \\ 0 \end{pmatrix}$                     | $V_{j+2}^+(0) = \begin{pmatrix} r_{j+2}^+ \\ a_{j+2}^+ r_{j+2}^+ \end{pmatrix}$ | ... | $V_n^+(0) = \begin{pmatrix} r_n^+ \\ a_n^+ r_n^+ \end{pmatrix}$ |
| $\mu_{n+1}^+ \sim -\frac{\lambda}{a_1^+}$                           | ... | $\mu_{n+j+1}^+ \sim -\frac{\lambda}{a_{j+1}^+}$                                   | $\mu_{n+j+2}^+(0) = \frac{a_{j+2}^+}{\zeta^2}$                                  | ... | $\mu_{2n}^+(0) = \frac{a_n^+}{\zeta^2}$                         |
| $V_{n+1}^+(0) = \begin{pmatrix} r_1^+ \\ a_1^+ r_1^+ \end{pmatrix}$ | ... | $V_{n+j+1}^+(0) = \begin{pmatrix} r_{j+1}^+ \\ a_{j+1}^+ r_{j+1}^+ \end{pmatrix}$ | $V_{n+j+2}^+(0) = \begin{pmatrix} r_{j+2}^+ \\ 0 \end{pmatrix}$                 | ... | $V_{2n}^+(0) = \begin{pmatrix} r_n^+ \\ 0 \end{pmatrix}$        |

Tab. 6: Asymptotic behavior at  $x = +\infty$ .

and whose asymptotic behavior in  $x$  is

$$\begin{aligned}
\phi_1(x, \lambda) & \underset{x \rightarrow +\infty}{=} e^{\mu_1^+(\lambda)x} (V_1^+(\lambda) + O(e^{-\gamma|x|})), \\
& \vdots \\
\phi_n(x, \lambda) & \underset{x \rightarrow +\infty}{=} e^{\mu_n^+(\lambda)x} (V_n^+(\lambda) + O(e^{-\gamma|x|})), \\
\phi_{n+1}(x, \lambda) & \underset{x \rightarrow -\infty}{=} e^{\mu_{n+1}^-(\lambda)x} (V_{n+1}^-(\lambda) + O(e^{-\gamma|x|})), \\
& \vdots \\
\phi_{2n}(x, \lambda) & \underset{x \rightarrow -\infty}{=} e^{\mu_{2n}^-(\lambda)x} (V_{2n}^-(\lambda) + O(e^{-\gamma|x|})).
\end{aligned} \tag{35}$$

As before, we choose

$$\phi_{j+1}(\cdot, 0) = \phi_{n+j}(\cdot, 0) = \begin{pmatrix} \bar{u}' \\ \bar{v}' \end{pmatrix}, \quad \phi_j(\cdot, 0) = \bar{u}^+ \quad \text{and} \quad \phi_{n+j+1}(\cdot, 0) = \bar{u}^-,$$

noting that  $r_j^\pm$  must have the same orientation as  $\bar{u}^+$  at  $x = +\infty$  and  $r_{j+1}^\pm$  as  $\bar{u}'$  at  $x = +\infty$ .

Then, recalling the expressions of  $D(0)$  and  $D'(0)$  that we found in the previous cases, we obtain  $D(0) = D'(0) = 0$ , since linear combinations of  $\bar{u}_\alpha$  and  $\bar{u}'$  appear twice in the formula of  $D'(0)$  (29). It follows that we must compute  $D''(0)$ .

$$\begin{aligned}
\text{sgn}(D''(0)) &= \text{sgn} \left( \left[ \phi_1 \wedge \dots \wedge \phi_{j-1} \wedge \frac{\partial \phi_j}{\partial \lambda} \wedge \frac{\partial \phi_{j+1}}{\partial \lambda} \wedge \phi_{j+2} \wedge \dots \wedge \phi_{2n} \right. \right. \\
&\quad + \phi_1 \wedge \dots \wedge \phi_{j-1} \wedge \frac{\partial \phi_j}{\partial \lambda} \wedge \phi_{j+1} \wedge \dots \wedge \phi_{n+j-1} \wedge \frac{\partial \phi_{n+j}}{\partial \lambda} \wedge \phi_{n+j+1} \wedge \dots \wedge \phi_{2n} \\
&\quad + \phi_1 \wedge \dots \wedge \phi_j \wedge \frac{\partial \phi_{j+1}}{\partial \lambda} \wedge \phi_{j+2} \wedge \dots \wedge \phi_{n+j} \wedge \frac{\partial \phi_{n+j+1}}{\partial \lambda} \wedge \phi_{n+j+2} \wedge \dots \wedge \phi_{2n} \\
&\quad \left. + \phi_1 \wedge \dots \wedge \phi_{n+j-1} \wedge \frac{\partial \phi_{n+j}}{\partial \lambda} \wedge \frac{\partial \phi_{n+j+1}}{\partial \lambda} \wedge \phi_{n+j+2} \wedge \dots \wedge \phi_{2n} \right] \Big) \\
&= \text{sgn} \left( \phi_1 \wedge \dots \wedge \phi_{j-1} \wedge \left( \frac{\partial \phi_j}{\partial \lambda} - \frac{\partial \phi_{n+j+1}}{\partial \lambda} \right) \wedge \left( \frac{\partial \phi_{j+1}}{\partial \lambda} - \frac{\partial \phi_{n+j}}{\partial \lambda} \right) \right. \\
&\quad \left. \wedge \phi_{j+2} \wedge \dots \wedge \phi_{2n} \right).
\end{aligned}$$

But, using the previous computations and again writing  $z_j$  for  $(w_j, t_j)^T$ , we find

$$t_{n+j} - t_{j+1} = -[u]$$

and

$$t'_{n+j+1} = -\bar{u}_\alpha + m^- \bar{u}', t'_j = -\bar{u}_\alpha + m^+ \bar{u}'.$$

Integrating from  $-\infty$  to 0 and recalling that  $t_{2n}(-\infty) = 0$ , we get

$$t_{n+j+1}(0) = - \int_{-\infty}^0 \bar{u}_\alpha(x) dx + m^- (\bar{u}(0) - u^-).$$

Similarly, we find

$$t_j(0) = \int_0^{+\infty} \bar{u}_\alpha(x) dx - m^+ (u^+ - \bar{u}(0)).$$

Thus

$$(t_j - t_{n+j+1})|_{x=0} = \int_{-\infty}^{+\infty} \bar{u}_\alpha(x) dx + m^+ u^+ - m^- u^- - (m^+ - m^-) \bar{u}(0).$$

Using the asymptotic behavior of  $\phi_k$ ,  $k \in \{1, \dots, 2n\}$ , we obtain

$$\begin{aligned} \text{sgn}(D''(0)) &= \text{sgn} \left( \begin{pmatrix} u_1 \\ 0 \end{pmatrix} \wedge \dots \wedge \begin{pmatrix} u_{j-1} \\ 0 \end{pmatrix} \wedge \begin{pmatrix} w_j - w_{n+j+1} \\ t_j - t_{n+j+1} \end{pmatrix} \wedge \begin{pmatrix} w_{j+1} - w_{n+j} \\ [u] \end{pmatrix} \right) \\ &\quad \wedge \begin{pmatrix} r_{j+2}^+ \\ a_{j+2}^+ r_{j+2}^+ \end{pmatrix} \wedge \dots \wedge \begin{pmatrix} r_n^+ \\ a_n^+ r_n^+ \end{pmatrix} \wedge \begin{pmatrix} r_1^+ \\ a_1^- r_1^- \end{pmatrix} \wedge \dots \wedge \begin{pmatrix} r_{j-1}^- \\ a_{j-1}^- r_{j-1}^- \end{pmatrix} \\ &\quad \wedge \begin{pmatrix} u_{n+j} \\ 0 \end{pmatrix} \wedge \dots \wedge \begin{pmatrix} u_{2n} \\ 0 \end{pmatrix} \Big). \end{aligned}$$

Performing elementary manipulations, we find

$$\begin{aligned} \text{sgn}(D''(0)) &= (-1)^n \text{sgn}(u_1 \wedge \dots \wedge u_{j-1} \wedge u_{n+j} \wedge \dots \wedge u_{2n}) \\ &\quad \cdot \text{sgn}(r_1^- \wedge \dots \wedge r_{j-1}^- \wedge ((t_j - t_{n+j+1})|_{x=0}) \wedge [u] \wedge r_{j+2}^+ \wedge \dots \wedge r_n^+). \end{aligned}$$

Using the notations we set in Subsection 1.2.3, we obtain

$$\begin{aligned} \text{sgn}(D''(0)) &= (-1)^n \text{sgn}(\varphi_1^+ \wedge \dots \wedge \varphi_{j-1}^+ \wedge \bar{u}' \wedge \bar{u}_\alpha \wedge \varphi_{j+2}^- \wedge \dots \wedge \varphi_n^-) \cdot \text{sgn}(r_1^- \wedge \dots \wedge r_{j-1}^- \\ &\quad \wedge \left( \int_{-\infty}^{+\infty} \bar{u}_\alpha(x) dx + m^+ u^+ - m^- u^- - (m^+ - m^-) \bar{u}(0) \right) \wedge [u] \wedge r_{j+2}^+ \wedge \dots \wedge r_n^+). \end{aligned}$$

The computation of the sign of  $D$  at  $\lambda = +\infty$  is the same as in the Lax case so we can apply Theorem 1.6.1 and therefore

$$\text{sgn}(D(+\infty)) = (-1)^n \text{sgn}(r_1^+ \wedge \dots \wedge r_n^+) \cdot \text{sgn}(r_1^- \wedge \dots \wedge r_n^-).$$

**Acknowledgements** I would like to thank my advisor, Denis Serre, for suggesting this problem to me and answering my numerous questions, Sylvie Benzoni-Gavage for her advice, Kevin Zumbrun for his encouragement and remarks and Theodore Vassilakis for proof reading the paper. I would also like to thank the referees who read the manuscript very carefully and provided numerous corrections.

### 1.9 Remarque : amélioration du théorème sur les chocs surcompressifs

On peut étendre le résultat du théorème 1.3.3 aux chocs surcompressifs de degré supérieur à 1 qui sont définis par les inégalités

$$(H4^{***}) \quad \begin{aligned} \alpha_{j+p}^+ &< s < \alpha_{j+p+1}^+, \\ \alpha_{j+q-1}^- &< s < \alpha_{j+q}^-, \end{aligned}$$

où  $p - q =: \varpi$  est le degré de surcompressivité. On a alors en général une famille à  $\varpi + 1$  paramètres de profils et on peut définir, quitte à réordonner correctement les valeurs propres de  $df(u^\pm)$ , une base  $(\phi_1, \dots, \phi_{p-1}, \bar{u}')$  (resp.  $(\bar{u}', \phi_{q+1}, \dots, \phi_n)$ ) de l'espace stable en  $+\infty$  noté  $\mathcal{S}^+$  (resp. de l'espace instable en  $-\infty$  noté  $\mathcal{U}^-$ ) de l'EDO (11) et dont le comportement asymptotique est le suivant

$$\begin{aligned} \lim_{x \rightarrow +\infty} e^{(s-a_m^+)x/\zeta^2} \phi_m(x) &= r_m^+, \quad m \in \{1, \dots, p-1\}, \\ \lim_{x \rightarrow +\infty} e^{(s-a_p^+)x/\zeta^2} \bar{u}' &= r_p^+, \\ \lim_{x \rightarrow -\infty} e^{(s-a_q^-)x/\zeta^2} \bar{u}' &= r_q^-, \\ \lim_{x \rightarrow -\infty} e^{(s-a_m^-)x/\zeta^2} \phi_m(x) &= r_m^-, \quad m \in \{q+1, \dots, n\}. \end{aligned}$$

Quitte à faire des combinaisons linéaires, on impose

$$\phi_{p-m} = \phi_{p+m+1} =: \psi_m, \quad m \in \{1, \dots, \varpi\}.$$

On peut alors énoncer le théorème

#### **Théorème 1.9.1**

*Supposons satisfaites les hypothèses (H1-3)-(H4<sup>\*\*\*</sup>)-(H5) avec  $\varpi \geq 1$ . Alors si le profil  $\bar{u}$  est spectralement stable, l'inégalité suivante est vérifiée*

$$\det(\phi_1, \dots, \phi_{p-1}, \bar{u}', \psi_1, \dots, \psi_\varpi, \phi_{p+\varpi+1}, \phi_n) \cdot \det(r_1^-, \dots, r_{p-\varpi-1}^-, \int_{\mathbb{R}} \psi_\varpi, \dots, \int_{\mathbb{R}} \psi_1, [u], r_p^+, \dots, r_n^+) \cdot \det(r_1^-, \dots, r_n^-) \cdot \det(r_1^+, \dots, r_n^+) \geq 0.$$

La démonstration est très proche de celle du cas  $\varpi = 1$  développée dans cet article. En effet, la détermination du signe de la fonction d'Evans à l'infini se fait comme dans le cas de chocs de Lax (paragraphe 1.6.2). Pour le calcul en  $\lambda = 0$ , il faut cependant apporter quelques précisions : comme l'intersection de  $\mathcal{S}^+$  et de  $\mathcal{U}^-$  est de dimension  $\varpi + 1$ , on constate que les  $\varpi$  premières dérivées de la fonction d'Evans s'annulent et il faut calculer la  $(\varpi + 1)$ -ème. Mais ce calcul n'est en fait pas beaucoup plus compliqué que dans le cas  $\varpi = 1$  car une récurrence simple [4] montre que seules les dérivées premières des fonctions formant une base de l'intersection de l'espace stable en  $+\infty$  et de l'espace instable en  $-\infty$  du système dynamique (24) interviennent dans l'expression de la  $(\varpi + 1)$ -ème dérivée de la fonction d'Evans. On pourra se référer à [86] et aux calculs menés dans le cas discret pour les schémas de Lax-Wendroff et de Lax-Friedrichs modifié (Partie III, chapitres 1 et 2 de ce mémoire).

## 2. RELAXATION SEMI-LINÉAIRE : EXEMPLE DE PROFIL DE CHOC DE LAX SPECTRALEMENT INSTABLE

Cet article a été écrit en collaboration avec Emmanuel Lorin, doctorant au Centre de Mathématiques et de Leurs Applications, ENS Cachan et a fait l'objet d'une prépublication au CMLA.

### 2.1 Introduction

Recently, a technique using Evans functions has been developed to study the spectral stability of shock profiles *of arbitrary strength* under various approximations : given a system of conservation laws

$$\begin{aligned} u_t + f(u)_x &= 0, \\ u : \mathbb{R} \times \mathbb{R}_+ &\longrightarrow \mathbb{R}^n, \quad n \geq 2, \\ f : \mathcal{U} \subset \mathbb{R}^n &\longrightarrow \mathbb{R}^n, \quad f \text{ smooth}, \end{aligned} \tag{1}$$

if there exists a shock profile for a given method of approximation, one may be able to derive a sufficient condition of spectral instability of this shock profile. These computations were carried out for the viscous approximation [24, 4], the semi-discrete shock profiles [2], for the semi-linear relaxation [30] and for general quasilinear relaxation systems, for general real viscosity and for combustion [86]. The semi-linear relaxation approximation was developed by Jin and Xin [42] in order to obtain stable relaxation schemes with a stiff source term :

$$\begin{aligned} u_t + v_x &= 0, \\ v_t + \mathbf{a}^2 u_x &= \frac{1}{\varepsilon} (f(u) - v), \end{aligned} \tag{2}$$

where  $\mathbf{a} \in \mathbb{R}_*^+$  is the *relaxation speed* and  $\varepsilon \in \mathbb{R}_*^+$  is the *time lag*. Taking the formal limit  $\varepsilon \rightarrow 0$  in (2) leads to the original system of conservation laws (1) and to the so-called local equilibrium  $v = f(u)$ . Since the Chapman-Enskog expansion [52] of (2) of order 1 reads

$$u_t + f(u)_x = \varepsilon ((\mathbf{a}^2 - \mathrm{d}f(u))u_x)_x + O(\varepsilon^2), \tag{3}$$

the so-called *subcharacteristic condition* [52]

$$\mathbf{a} > \rho(\mathrm{d}f(u)), \quad \forall u \in \mathcal{U},$$

where  $\rho$  denotes the spectral radius, implies the positivity of the viscosity in (3) and thus the stability.



Let us consider now two states  $u^-$  and  $u^+$  in  $\mathbb{R}^n$  where (1) is strictly hyperbolic and a real number  $\sigma$  such that the Rankine-Hugoniot condition is satisfied, that is

$$f(u^+) - f(u^-) = \sigma(u^+ - u^-).$$

We assume that the discontinuity  $(u^-, u^+; \sigma)$  satisfies the Lax shock admissibility criterion (see [74, 16]), that is we assume that there are  $n+1$  characteristics that enter the shock and  $n-1$  ones that outgo. This assumption can be expressed as inequalities on the eigenvalues of  $df(u^\pm)$ . A shock profile  $(\bar{u}, \bar{v})^T$  of (2) is a traveling wave, namely a solution regular of the single variable  $\xi := (x - \sigma t)/\varepsilon$  such that  $(\bar{u}(\xi), \bar{v}(\xi))^T = (u(x, t), v(x, t))^T$ . Substituting in (2), we note that  $\bar{u}$  satisfies the same ODE system as the viscous shock profiles for a scalar viscosity  $(\mathbf{a}^2 - \sigma^2)I_n$ . Brin [8] used a sufficient Evans function condition developed by Howard and Zumbrun [88] to test numerically the stability of viscous shock profiles. Freistühler and Zumbrun [23] produced examples of unstable viscous overcompressive shock profiles through the study of a similar condition [24]. We aim here to construct an unstable Lax shock profile for the semi-linear approximation by using a sufficient condition of instability that was obtained in [87] and [30] through the study of an Evans function  $D$  which is a Wronskian of a dynamical system linked to the eigenvalue equation of the linearized operator  $L$  of semi-relaxation about the shock profile  $(\bar{u}, \bar{v})^T$ . More specifically, we construct  $D$  so that its zeros in the right-half plane correspond to unstable eigenvalues of  $L$ . In the numerical simulation of this instability, the difficulty comes from the fact that the relaxation system constitutes, when  $\varepsilon$  is numerically “small”, a stiff source term system. The notion of stiffness for a physical system characterizes systems for which there are at least two “very different” physical (time, space) scales, etc... In physics a lot of these systems occur : for example, in a turbulence problem, different physical scales appear and the small scales phenomena influence the large scales phenomena. A good reference for the description of such systems is [7]. Usually, it is, numerically, very hard to approach accurately the solutions of such systems and then to take into account all the physical phenomena. Nevertheless, we will see that it is possible to approximate correctly the relaxation system for some values of  $\varepsilon$  with a splitting method. This last one is a technique, developed by Strang [79], to solve inhomogeneous partial differential systems. A detailed study of this method is performed in [78]. After the presentation of the numerical splitting scheme, we will focus on the calculus of the Evans function. As seen before, the reason why the profile is unstable comes from the cancellation of the Evans function for  $\lambda > 0$ . To this aim, many approaches are possible, but we will use an effective method from Brin [8] which avoids the problems caused by the stiffness of the dynamical system that appears.

We devote Section 2 to the introduction of the sufficient condition of spectral instability that we are going to apply. In Section 3, choosing arbitrarily two states  $u^-$  and  $u^+$  of  $\mathbb{R}^2$ , we construct a smooth function  $\bar{u} : \mathbb{R} \rightarrow \mathbb{R}^2$ , such that  $(\bar{u}, 0)^T$  is a spectrally unstable stationary Lax shock profile for the semi-linear relaxation approximation, asymptotically connecting  $u^-$  and  $u^+$ , of a  $2 \times 2$  system of conservation laws, to show that the associated evolution problem linearized about  $\bar{u}$  is actually numerically unstable. Next, Section 4 tackles the problem of simulating the behavior of the unstable profile determined in Section 3. Although we have not reached a definite conclusion on the numerical computation of the Evans function, we present our current work in the appendix of this paper.

## 2.2 Sufficient condition of spectral instability

Consider a system of two conservation laws

$$\begin{aligned} u_t + f(u)_x &= 0, \\ u &= (u_1, u_2)^T : \mathbb{R} \times \mathbb{R}^+ \rightarrow \mathbb{R}^2, \\ f &= (f_1, f_2)^T \in \mathcal{C}^\infty(\mathbb{R}^2, \mathbb{R}^2), \end{aligned} \tag{4}$$

of (4) via the semi-linear relaxation :

$$\begin{aligned} u_t + v_x &= 0, \\ v_t + \mathbf{a}^2 u_x &= \frac{1}{\varepsilon}(f(u) - v), \\ v &= (v_1, v_2)^T : \mathbb{R} \times \mathbb{R}^+ \rightarrow \mathbb{R}^2, \\ \mathbf{a} &\in \mathbb{R}_*^+, \varepsilon \in \mathbb{R}_*^+. \end{aligned} \tag{5}$$

$$\tag{6}$$

### 2.2.1 Assumptions

Consider a discontinuity  $(u^-, u^+; \sigma)$  satisfying the Rankine-Hugoniot condition (H0) associated with (4) :

$$f(u^+) - f(u^-) = \sigma(u^+ - u^-),$$

that is

$$f(u^+) - \sigma u^+ = f(u^-) - \sigma u^- =: \bar{f}.$$

Moreover, we assume that  $(u^-, u^+; \sigma)$  satisfies the following conditions :

- (H1) the flux  $f$  is strictly hyperbolic at  $u^\pm$ , that is  $df(u^\pm)$  has two *distinct* real eigenvalues  $a^\pm, b^\pm$  and we note  $r^\pm, s^\pm$  some associated eigenvectors,
- (H2)  $\mathbf{a} > \max(|a^\pm|, |b^\pm|, |\sigma|)$  (subcharacteristic condition),
- (H3)  $a^\pm, b^\pm \neq \sigma, i \in \{1, 2\}$  (non-characteristic discontinuity),
- (H4)  $(u^-, u^+; \sigma)$  is a Lax 2-shock, that is

$$\begin{aligned} a^- &< \sigma < b^-, \\ a^+ &< b^+ < \sigma. \end{aligned}$$

### 2.2.2 Shock profiles

A shock profile  $\bar{U} := (\bar{u}, \bar{v})^T : \xi := (x - \sigma t)/\varepsilon \mapsto (\bar{u}(\xi), \bar{v}(\xi))^T$  connecting  $(u^-, v^-)^T$  and  $(u^+, v^+)^T$  at the speed  $\sigma$  for (5)-(6) satisfies the following ODE system

$$(\mathbf{a}^2 - \sigma^2)\bar{u}' = \frac{1}{\varepsilon}(f(\bar{u}) - \bar{f} - \sigma\bar{u}), \tag{7}$$

$$\bar{v} = \sigma\bar{u} + \bar{f}, \tag{8}$$

$$\lim_{\xi \rightarrow \pm\infty} \bar{u}(\xi) = u^\pm, \tag{9}$$

$$\lim_{\xi \rightarrow \pm\infty} \bar{v}(\xi) = f(u^\pm). \tag{10}$$

**Remark 2.2.1** *It is important to note that viscous profiles of viscosity  $(a^2 - \sigma^2)I_2$  connecting  $u^-$  and  $u^+$  at the speed  $\sigma$  also satisfy (7)-(9).*

Linearizing system (5)-(6) about  $\bar{U}$ , we obtain

$$\begin{aligned} u_t + v_x &= 0, \\ v_t + a^2 u_x &= \frac{1}{\varepsilon}(df(\bar{u})u - v), \end{aligned}$$

that we rewrite as

$$\begin{pmatrix} u \\ v \end{pmatrix}_t = L(\partial_x, \bar{u}(x)) \begin{pmatrix} u \\ v \end{pmatrix}.$$

**Definition 2.2.1** The profile  $\bar{U}$  of (2) is *spectrally stable* if the differential operator  $L$  has no spectrum in the right half-plane.

A sufficient condition of spectral instability [30] of  $(\bar{u}, \bar{v})^T$  is

$$\det(r^-, (u^+ - u^-)) \cdot \det(r^-, s^-) < 0, \tag{11}$$

where  $s^-$  is oriented as  $\bar{u}'$  at  $\xi = -\infty$ , or, equivalently, the segment  $[u^-, u^+]$  and the tangent vector of  $\bar{u}$  at  $\xi = -\infty$  are on both sides of the line  $u^- + \mathbb{R}r^-$  (Figure 2.1).

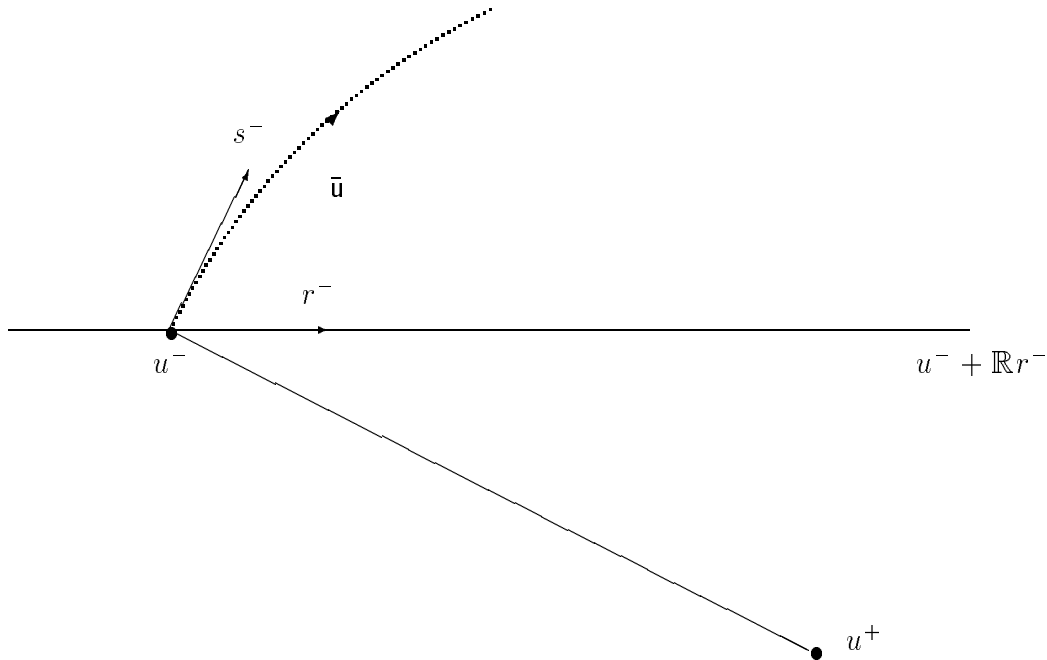

Fig. 2.1: Lax 2-shock satisfying Condition (11)

**Remark 2.2.2** *There is a symmetric condition for a Lax 1-shock.*

### 2.2.3 Sketch of the method of getting (11)

Let us describe briefly the way (11) was obtained.

The first step is to change the coordinates to obtain a stationary shock, and a time lag  $\varepsilon$  equal to 1 :

$$x \leftrightarrow \frac{x - \sigma t}{(\mathbf{a}^2 - \sigma^2)\varepsilon}, \quad t \leftrightarrow \frac{t}{(\mathbf{a}^2 - \sigma^2)\varepsilon}.$$

We change the flux  $f$  to  $f - \bar{f}$ . Note that assumption (H2) changes to

$$(H2)' \quad \max(|a^\pm + \sigma|, |b^\pm + \sigma|)$$

and  $\bar{v} = 0$ .

The second step is to check that the spectrum of the operator  $L$  in the open right half-plane consists only of isolated eigenvalues [14, 24].

The third step is to rewrite the eigenvalue equation  $LU = \lambda U$  as a first-order system :

$$\begin{pmatrix} u \\ v \end{pmatrix}' = \frac{1}{\mathbf{a}^2 - \sigma^2} \begin{pmatrix} df(\bar{u}) - 2\sigma\lambda I_2 & -(\lambda + 1)I_2 \\ -\lambda(\mathbf{a}^2 - \sigma^2)I_2 & 0_2 \end{pmatrix} \begin{pmatrix} u \\ v \end{pmatrix} =: \mathbb{A}(\lambda, x) \begin{pmatrix} u \\ v \end{pmatrix}. \quad (12)$$

A crucial point is to prove that

$$\mathcal{S}(\lambda) := \{U \in L^2(\mathbb{R}, \mathbb{R}^2)/U \text{ solves (12) and } U \xrightarrow{+\infty} 0\}$$

and

$$\mathcal{U}(\lambda) := \{U \in L^2(\mathbb{R}, \mathbb{R}^2)/U \text{ solves (12) and } U \xrightarrow{-\infty} 0\}$$

are both 2-dimensional for  $\lambda$  with positive real part. We then construct a basis  $\mathcal{B}_{\mathcal{S}(\lambda)}$  (resp.  $\mathcal{B}_{\mathcal{U}(\lambda)}$ ) of  $\mathcal{S}(\lambda)$  (resp. of  $\mathcal{U}(\lambda)$ ). Taking the determinant of the elements of  $\mathcal{B}_{\mathcal{S}(\lambda)} \cup \mathcal{B}_{\mathcal{U}(\lambda)}$  at the point  $x$ , we obtain a function of  $(\lambda, x)$  that vanishes at the points  $\lambda$  that are eigenvalues of  $L$ . Taking the product of this function and of  $x \mapsto \exp(\int_0^x \text{tr}(\mathbb{A}(\lambda, y))dy)$ , we obtain an Evans function  $\lambda \mapsto D(\lambda)$ , depending only of  $\lambda$ , that is actually a Wronskian of (12).

Note that, as the coefficients of  $\mathbb{A}(\lambda, x)$  are real for real  $\lambda$ ,  $D$  can be chosen to be real on  $\mathbb{R}$ .

*Consequently, the intermediate value theorem implies that if the signs of  $D$  in a neighborhood of 0 and in a neighborhood of  $+\infty$  are not the same,  $D$  necessarily vanishes at a real point.*

Note however that  $\bar{U}'$  solves  $U' = \mathbb{A}(0, x)U$ , so that  $D$  vanishes at  $\lambda = 0$ .

The fourth step is to apply the Gap Lemma [24], that allows to extend  $D$  to a neighborhood of  $\lambda = 0$ , so that we can compute the derivative of  $D$  at 0.

The fifth step is to compute effectively the sign of  $D'(0)$  through the study of the asymptotic behavior of the solutions of (12) in a neighborhood of  $\lambda = 0$ .

The last step is to compute the sign of  $D(+\infty)$  by using a homotopy method that was introduced in [4].

For details, we refer to [30] for the general case of a Lax  $p$ -shock and to [32] for the case of an extreme Lax shock.

### 2.3 Construction of an example of spectrally unstable profile

Let us now assume that a flux  $f$  satisfying (H0-4) exists : we will find it explicitly in the next subsections. We consider a stationary shock (i.e  $\sigma = 0$ ) by taking an appropriate coordinate frame. We set on the relaxation speed  $\mathbf{a}$  to be equal to 1. Moreover, changing the flux, we set  $(\bar{f}_1, \bar{f}_2)^T = (0, 0)^T$ . Considering (8), we see at once that, since we changed  $\sigma$  to 0 and  $\bar{f}$  to  $(0, 0)^T$ , we have

$$\bar{v}(\xi) = \begin{pmatrix} 0 \\ 0 \end{pmatrix}, \quad \forall \xi \in \mathbb{R}.$$

#### 2.3.1 Construction of a suitable function

Let us begin with the construction of a function that behaves as suggested by condition (11).

Let us point out at first that the following choices are made out of sake of simplicity. We choose  $u^- = (0, 0)^T$  and  $u^+ = (1, -1)^T$ . In order to ensure that  $df(u^-)$  has a very simple expression, we also choose  $r^- = (1, 0)^T$  and  $s^- = (1, 1)^T$ . Indeed, we have

$$df(u^-) = \begin{pmatrix} a^- & b^- - a^- \\ 0 & b^- \end{pmatrix}.$$

Condition (11) is obviously satisfied here. Let  $\bar{u} = (\bar{u}_1, \bar{u}_2)^T$  and  $\bar{v} = (\bar{v}_1, \bar{v}_2)^T$ . To be able to construct a profile connecting  $u^-$  and  $u^+$ , we need to make some remarks about  $u_1$  and  $u_2$  :

1. since  $s^-$  is tangent to  $\bar{u}$ ,  $\bar{u}'_1(\xi) \underset{\xi \rightarrow -\infty}{\sim} \bar{u}'_2(\xi)$ , that is  $\bar{u}_1(\xi) \underset{\xi \rightarrow -\infty}{\sim} \bar{u}_2(\xi)$ , thus  $\bar{u}_2$  must be increasing then decreasing since it connects 0 and  $-1$  (Figure 2.3),
2. since  $\bar{u}_1$  connects 0 and 1, and to avoid points where  $f_1$  and  $f_2$  vanish simultaneously, we set on  $\bar{u}_1$  to be increasing,
3. expanding  $\bar{u}'_1(\xi)$  in a neighborhood of  $-\infty$ , we find

$$\bar{u}'_1 = a^- \bar{u}_1 + (b^- - a^-) \bar{u}_2 + O(|\bar{u}|^2);$$

since  $a^- < 0$  and since we want  $\bar{u}_1$  to be increasing,  $(b^- - a^-) \bar{u}_2$  needs to be larger than  $a^- \bar{u}_1$  as  $t$  tends to  $-\infty$ . Moreover, as  $\bar{u}_1(\xi) \sim \bar{u}_2(\xi)$  as  $\xi \rightarrow -\infty$ , since  $b^-$  is positive,  $\bar{u}'_1(\xi)$  and  $\bar{u}_1(\xi)$  are positive in a neighborhood of  $-\infty$ .

Let us now choose an explicit function  $\bar{u}$  : since  $\lim_{\xi \rightarrow -\infty} \bar{u}_1(\xi) = 0$  and  $\lim_{\xi \rightarrow +\infty} \bar{u}_1(\xi) = 1$ , let

$$\bar{u}_1(\xi) = \frac{\tanh(\xi) + 1}{2} = \frac{e^{2\xi}}{e^{2\xi} + 1}, \quad \xi \in \mathbb{R},$$

(see Figure 2.2). To find  $\bar{u}_2$ , let us add a perturbation to

$$\xi \mapsto -\frac{\tanh(\xi) + 1}{2} = -\frac{e^{2\xi}}{e^{2\xi} + 1}.$$

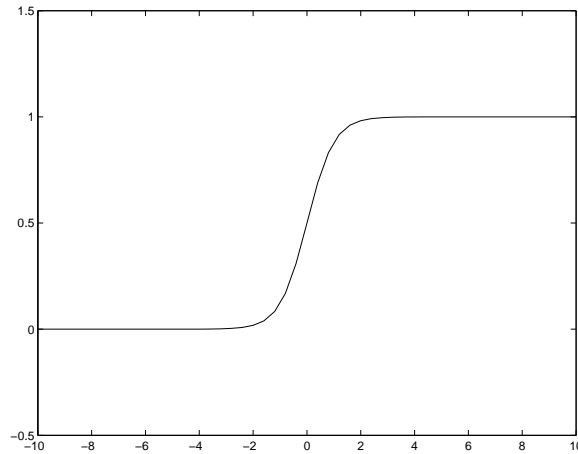

Fig. 2.2: First component of  $\bar{u}$

Noting that  $\xi \mapsto 1 - \tanh^2(\xi)$  tends to 0 as  $t$  tends to  $\pm\infty$ , we choose

$$\bar{u}_2(\xi) = -\frac{\tanh(\xi) + 1}{2} + \frac{1 - \tanh^2(\xi)}{2} = \frac{e^{2\xi}(1 - e^{2\xi})}{(e^{2\xi} + 1)^2},$$

so that  $\bar{u}_1(\xi) \sim \bar{u}_2(\xi)$  as  $\xi \rightarrow -\infty$  (see Figure 2.3).

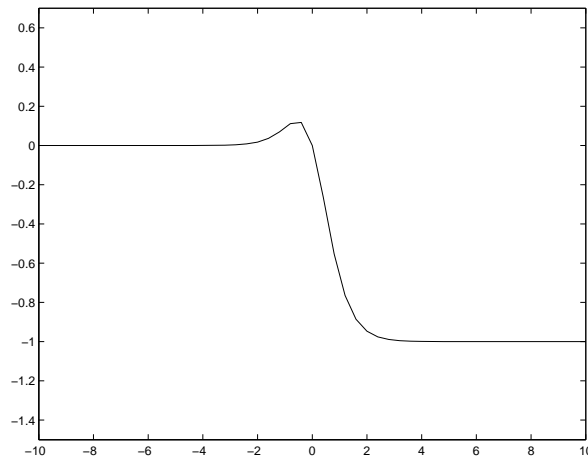

Fig. 2.3: Second component of  $\bar{u}$

### 2.3.2 Construction of a flux

Once we have built an appropriate function  $\bar{u}$ , we must search for a flux  $f$  such that  $\bar{u}$  be a stationary profile of (2), that is, recalling (7), such that

$$\bar{u}' = f(\bar{u}) \text{ and } f \text{ satisfies (H0)-(H4).}$$

We note that, for  $\xi \in \mathbb{R}$ ,

$$\begin{aligned}\bar{u}_1(\xi) &= \frac{e^{2\xi}}{e^{2\xi} + 1}, \\ \bar{u}'_1(\xi) &= \frac{2e^{2\xi}}{(e^{2\xi} + 1)^2}, \\ \bar{u}_2(\xi) &= \frac{e^{2\xi}(1 - e^{2\xi})}{(e^{2\xi} + 1)^2}, \\ \bar{u}'_2(\xi) &= \frac{2e^{2\xi}(1 - 3e^{2\xi})}{(e^{2\xi} + 1)^3}.\end{aligned}$$

Consequently, searching  $f_1$  in the form  $f_1(u_1, u_2) = P_1(u_1) + Q_1(u_2)$ , with  $P_1$  a polynomial of the fourth degree and  $Q_1$  a polynomial of the second degree, we find that necessarily

$$P_1\left(\frac{e^{2\xi}}{e^{2\xi} + 1}\right) + Q_1\left(\frac{e^{2\xi}(1 - e^{2\xi})}{(e^{2\xi} + 1)^2}\right) = \frac{2e^{2\xi}}{(e^{2\xi} + 1)^2}.$$

using a symbolic computing software (MuPad, Maple), we obtain a linear system of 5 equations with 5 unknowns of range 3, that is

$$\begin{aligned}P_1(X) &= -4\alpha X^4 + 4\alpha X^3 - (\alpha + 2\beta - 2)X^2 + \beta X, \\ Q_1(Y) &= \alpha Y^2 + (2 - \beta)Y,\end{aligned}$$

with  $\alpha, \beta$  in  $\mathbb{R}$ .

Similarly, if  $f_2(u_1, u_2) = P_2(u_1) + Q_2(u_2)$ , we obtain

$$\begin{aligned}P_2(X) &= -4\gamma X^4 + 4(\gamma + 2)X^3 - (\gamma + 2\delta + 6)X^2 + \delta X, \\ Q_2(Y) &= \gamma Y^2 + (2 - \delta)Y.\end{aligned}$$

with  $\delta, \gamma$  in  $\mathbb{R}$ .

Since  $\partial_{u_1} f_2(0, 0) = 0$ ,  $\delta = 0$ . Let us compute  $df$  at  $u^-$  and  $u^+$  :

$$\begin{aligned}df(u^-) &= \begin{pmatrix} \beta & 2 - \beta \\ 0 & 2 \end{pmatrix}, \\ df(u^+) &= \begin{pmatrix} -6\alpha - 3\beta + 4 & -2\alpha - \beta + 2 \\ -6\gamma + 12 & -2\gamma + 2 \end{pmatrix}.\end{aligned}$$

Since the shock is a Lax 2-shock (H4),  $\beta = a^-$  must be negative. Moreover, as  $\bar{u}'_1(\xi)/\bar{u}'_2(\xi)$  tends to  $-1/3$  as  $\xi$  tends to  $+\infty$ ,  $(1, -3)^T$  is an eigenvector of  $df(u^+)$  associated with  $-2$ , for all  $\beta < 0$ ,  $\gamma, \alpha \in \mathbb{R}$ . The other eigenvalue of  $df(u^+)$ ,  $b^+ = -6\alpha - 3\beta - 2\gamma + 6$  must be negative (H4). Let us choose  $\alpha = \gamma = 3/2$  and  $\beta = -1/2$ . Thus  $a^+ = -5/2$ , so  $df(u^+)$  is diagonalizable and satisfies (H4).

In conclusion, the flux of the  $2 \times 2$  system we are going to study numerically is

$$\begin{aligned}f_1(u_1, u_2) &= -6u_1^4 + 6u_1^3 + \frac{1}{2}u_1^2 - \frac{a}{2}u_1 + \frac{3}{2}u_2^2 + \frac{5}{2}u_2, \\ f_2(u_1, u_2) &= -6u_1^4 + 14u_1^3 - \frac{15}{2}u_1^2 + \frac{3}{2}u_2^2 + 2u_2,\end{aligned}$$

the derivatives at  $u^\pm$  are

$$df(u^-) = \begin{pmatrix} -\frac{7}{2} & -\frac{1}{2} \\ 3 & -1 \end{pmatrix} \text{ and } df(u^+) = \begin{pmatrix} -\frac{1}{2} & \frac{5}{2} \\ 0 & 2 \end{pmatrix},$$

and the associated eigenvalues and eigenvectors are

|                      |   |            |   |
|----------------------|---|------------|---|
| $a^- = -\frac{1}{2}$ | $r^- = \begin{pmatrix} 1 \\ 0 \end{pmatrix}$  | $b^- = 2$  | $s^- = \begin{pmatrix} 1 \\ 1 \end{pmatrix}$  |
| $a^+ = -\frac{5}{2}$ | $r^+ = \begin{pmatrix} 1 \\ -2 \end{pmatrix}$ | $b^+ = -2$ | $s^+ = \begin{pmatrix} 1 \\ -3 \end{pmatrix}$ |

## 2.4 Numerical simulations

### 2.4.1 Numerical Analysis

In this section, we simulate the instability of the profile that we have determined above. In [47], Lattanzio and Serre consider a second order MUSCL discrete approximation of 2 coupled with a second-order TVD Runge-Kutta splitting scheme. They prove the convergence of the numerical solutions towards an entropy solution of 1. Because of the stiffness of the system when  $\varepsilon$  is small, a particular attention will be paid to approach accurately (2). It is, indeed, necessary to check that the blow up of the numerical results is not due to the stiffness of the source term. To this end, *ad hoc* techniques exist. For example [49] constitutes a good approach for this kind of systems. Here, we suggest a simple but effective method : for small enough time and space steps the system is accurately approximated by a splitting method (see 4.1.2) with implicitation of the source term. Some studies have been performed to observe the behavior of an unstable profile. For example, in [9] M. Bultelle, M. Grassin and D. Serre prove the existence of an unstable strong stationary profile for the Godunov scheme and simulate its behavior. As in their work it has been necessary to perturb the profile to observe “quickly” the instability.

#### *Stiff source terms*

The difficulty to approximate the previous system is due to the source term:

$$\frac{1}{\varepsilon}(f(u) - v).$$

Indeed, since no scheme can accurately approach (2) for very small  $\varepsilon$ , we cannot observe very accurately the relaxation to the equilibrium defined as :

$$\mathcal{Z}(S) = \{(\mathbf{u}, \mathbf{v}) \mid f(\mathbf{u}) - \mathbf{v} = \mathbf{0}\}.$$

We will say that a source term is *stiff* when there is an extremely large range of (coupled or not) spatial and temporal modes. This notion can not be mathematically defined, so



to well-understand what a stiff problem is, we give a simple example :

$$\begin{cases} u_t + au_x = -\frac{1}{\varepsilon}u, \\ u(x, 0) = u_0(x) = \mathbb{1}_{[\gamma, 0]}(x). \end{cases} \quad (13)$$

Here  $\gamma$  is a real constant such that there exists  $\bar{k} \in \mathbb{Z}_-$  such that  $\bar{k}\Delta x \leq \gamma < (\bar{k} + 1)\Delta x$  and  $a, \varepsilon \in \mathbb{R}_+^*$ . The exact solution of (13) is  $u(x, t) = u_0(x - at)e^{-t/\varepsilon}$ . The aim is now to compare the exact solution of (13) with those calculated with a splitting method. We recall that the principle of a splitting method to solve :

$$u_t + f(u)_x = S(u), \quad (14)$$

is the following : we solve (14) in, at least, two steps :

$$\begin{cases} V_t + f(V)_x = 0 = L_f(V), & t \in ]t_n, t_{n^*}[, \\ V_t - S(V) = 0 = L_S(V), & t \in [t_{n^*}, t_{n+1}], \end{cases} \quad (15)$$

where  $L_f$  et  $L_S$  are respectively the convection and the source operator. Here, we choose the simplest splitting method. So, finally what is solved is :  $V^{n+1} = (L_f^n L_S^n)V^n$ , where  $L_f^n$  and  $L_S^n$  are approximations of  $L_f$  and  $L_S$ . The Strang splitting would consist in taking as an approximation  $V^{n+1} = (L_f^{n/2} L_S^n L_f^{n/2})V^n$ . We can prove that the solution of (15) tends to the solution of (14) [50]. Here, the convection operator is approached by an explicit upwind scheme, and the source operator by an explicit Euler scheme. Then, for a linear equation the splitting scheme simply reads : setting  $\alpha = (1 - \lambda)(1 - \frac{\Delta t}{\varepsilon})$  and  $\beta = \lambda(1 - \frac{\Delta t}{\varepsilon})$  :

$$u_j^{n+1} = \alpha u_j^n + \beta u_{j-1}^n.$$

So, we solve this equation using a Fourier transform :

$$\hat{u}^n(\xi) = (\alpha + \beta e^{i(\Delta x)\xi})^n \hat{u}^0(\xi),$$

that gives :

$$\hat{u}^n(\xi) = \sum_{k=0, n} C_n^k \alpha^k \beta^{n-k} e^{-i(\Delta x)\xi(n-k)} \hat{u}^0(\xi).$$

Now using the inverse Fourier transform yields :

$$u^n(x) = \left( \sum_{k=0, n} C_n^k \alpha^k \beta^{n-k} \delta_{k\Delta x} \right) * u^0(x).$$

Assuming now that  $\gamma$  is very "large", we finally have :

$$u^n(x) = \sum_{k \in [\frac{x}{\Delta x}, n]} C_n^k \alpha^k \beta^{n-k}.$$

Knowing the values of  $\alpha$  and  $\beta$ , we obtain, with  $\lambda = a \frac{\Delta t}{\Delta x}$  :

$$u^n(x) = \left(1 - \frac{\Delta t}{\varepsilon}\right)^n \sum_{k \in [\frac{x}{\Delta x}, n]} C_n^k \lambda^k (1 - \lambda)^{n-k}. \quad (16)$$

Finally the central point is that when  $\frac{\Delta t}{\varepsilon} \ll 1$  we get :

$$\left(1 - \frac{\Delta t}{\varepsilon}\right)^n \sim e^{-\frac{n\Delta t}{\varepsilon}}. \quad (17)$$

The equivalence (17) represents the central point of the previous calculus. Indeed, it shows that even if  $\Delta t$  and  $\Delta x$  are very small, the splitting can not approximate accurately (13) when  $\varepsilon$  tends to zero. So in this case we can talk about *stiff source term* problem. We can add that in equation (16) the diffusion of the numerical solution appears clearly :

$$\sum_{k \in [\frac{x}{\Delta x}, n]} C_n^k \lambda^k (1 - \lambda)^{n-k}.$$

**Remark 2.4.1** *The numerical diffusion is then equal to 0 and the error  $|u^n - u(n\Delta t)|$  is equal to  $\left| \left(1 - \frac{\Delta t}{\varepsilon}\right)^n - e^{-\frac{n\Delta t}{\varepsilon}} \right|$ , when  $\lambda = 1$ .*

In conclusion, when  $\frac{\Delta t}{\varepsilon} \ll 1$  is not satisfied, the numerical scheme does not approach correctly the system, and the numerical solution is then incorrect; this involves, for example, some wrong propagation speeds and then some spurious solutions. It is the main problem that is observed in this kind of relaxation problem.

Nevertheless, in our case this difficulty can be avoided by considering not too small  $\varepsilon$ . Indeed, the result of spectral instability is independent of the value of  $\varepsilon$  and then can be chosen as wished. Furthermore, since the diffusion of the scheme stabilizes the numerical solution, the risk is to stabilize the unstable profile. We will see that it does not happen.

### The numerical scheme

The scheme that we are going to use is then a splitting scheme which is a good approach for this system when  $\varepsilon$  is not too small.

1. The approximation of the first step of (15),  $L_f^n$ , is based on the VFFC (“Volume Finis à Flux Caractéristiques”) method [25]. This scheme can be written for  $t \in ]t_n, t_{n*}[$  in an explicit form as :

$$V_j^{n*} = V_j^n - \frac{\Delta t_n}{\Delta x_j} (f_{j+1/2}^{n*} - f_{j-1/2}^{n*}).$$

We set  $U_{j+1/2}^n = U(V_j^n, V_{j+1}^n)$ . With these notations we have :

$$f_{j+1/2}^{n*} = \frac{f(V_j^{n*}) + f(V_{j+1}^{n*})}{2} - U_{j+1/2}^n \left( \frac{f(V_{j+1}^{n*}) - f(V_j^{n*})}{2} \right),$$

where the matrix  $U$  is the sign matrix of the jacobian matrix  $df$ .

2. In the second step we approach  $L_S$  with :

$$V_j^{n+1} = V_j^{n*} + \Delta t_n S(V_j^{n+1}).$$

In [60] we have studied this system in detail and observed that for  $\frac{\Delta t}{\varepsilon}$  over  $10^{-1}$  this (splitting) scheme is stable, but is a little diffusive.

### Numerical results

We have simulated the instability of the profile found in the first part, taking  $\varepsilon = \frac{1}{9}$ , and  $\varepsilon = \frac{1}{100}$ . As mentioned in Subsection 2.4.1, it is important to set on  $\frac{\Delta t}{\varepsilon}$  to be small enough to simulate the exponential behavior of the solution. The value of this ratio has been taken equal to  $10^{-2}$  in the two cases. Furthermore to avoid a too “large” diffusion due to the grid,  $\Delta x$  has been set on to be  $10^{-2}$ . Finally in the two studied cases the CFL number has been chosen equal to 0.5. At this CFL number the diffusion remains important but not enough to stabilize the profile. The results are presented as follows : in a first step, we give a representation of the solution of system (2) with our unperturbed profile, as initial data. Note that without perturbation, the profile remains steady and stable, at least when the simulated time is not too large. Afterwards the numerical perturbations destabilize the profile. In a second step, the initial profile has been perturbed. We will see that this perturbation involves a destabilization of the profile. At first, we draw the initial profiles of  $u_1, u_2$ .

*First case :  $a = 3$  and  $\varepsilon = \frac{1}{9}$*  We have simulated the phenomenon with  $\varepsilon = \frac{1}{9}$ . The following graphs show the shock profile in the phase space  $(u, v)$  at three different times. The last one represents the components of the profile with respect to time and space variables. We can observe that, as expected, the profile becomes unstable when the time grows. Note that at this time the unperturbated profile has not blown up.

*Second case :  $a = 10$  and  $\varepsilon = \frac{1}{100}$*  In that configuration, the CFL number is equal to 0.3. As in the previous paragraph we show the profile in the phase space, and its components with respect to time and space.

## 2.5 Conclusion

In this paper we have exhibited an unstable strong shock profile satisfying the Lax shock condition. We point out that the existence of such a spectrally unstable Lax shock profile emphasizes the fact that the Lax shock condition for a strong shock does not ensure stability. Since our system is not a physical one the next step would be to discuss the use of the Lax condition for strong shock profiles in physical contexts. Besides, an improvement of the calculation of the Evans function would be necessary to evaluate precisely the rate of blowing up with respect to time.

## 2.6 Appendix : Numerical determination of the Evans function

The Evans function is the Wronskian of a linear dynamical system depending of a parameter  $\lambda$ . We refer to [32] for the construction of the Evans function for the semi-linear relaxation. Using the notations of Subsection 2.2.3 we have to solve :

$$W' = \mathbb{A}(\lambda, x)W. \quad (18)$$

Then, we describe the general behavior of the solutions of the unstable (resp. stable) manifold through the wedge product of a basis  $(W_1^-, W_2^-)$  (resp.  $(W_1^+, W_2^+)$ ) of these spaces :

$$\begin{aligned} \mathcal{W}^-(\lambda, x) &= \{W_1^-(\lambda, x), W_2^-(\lambda, x)\}, \\ \mathcal{W}^+(\lambda, x) &= \{W_1^+(\lambda, x), W_2^+(\lambda, x)\}. \end{aligned}$$

The Evans function is given by

$$D(\lambda) = \mathcal{W}^+(\lambda, x) \wedge \mathcal{W}^-(\lambda, x). \quad (19)$$

**Remark 2.6.1** *The easiest way to determine  $D(\lambda)$  would be to compute explicitly the determinant  $\det(W_i^\pm)$  after having computed  $W_i$  using (18) and evaluated it at  $x = 0$ . Nevertheless we have observed that such a direct approach using an explicit Euler method to perform the computation of  $W_{1,2}^\pm$  fails.*

It is possible to discretize (18) with a Runge Kutta method to obtain more precise results. Another idea to circumvent this difficulty is to use a technique developed by L. Brin [8] : we compute  $\mathcal{W}^+$  and  $\mathcal{W}^-$  using a dynamical system obtained from (18). Indeed, there exists a matrix  $\mathcal{A} \in M_6(\mathbb{R})$  such that

$$\begin{cases} (W_1 \wedge W_2)' = \mathcal{A}(W_1 \wedge W_2), \\ W(\pm\infty) = 0. \end{cases} \quad (20)$$

Note that  $\mathcal{W}^\pm$  both solve

$$\begin{cases} (\mathcal{W}^\pm)'(x) = \mathcal{A}\mathcal{W}^\pm(x), \\ \mathcal{W}^\pm = 0. \end{cases} \quad (21)$$

We conclude using (19). The advantage of such a technique is to avoid solving a stiff dynamical system. Numerically system (21) is solved using a Runge-Kutta method of order 4 (described in [15], p106), which is robust and precise. Here is the value of the matrix  $\mathcal{A}$  :

$$\mathcal{A} = \begin{pmatrix} \frac{\partial_1 f_1 + \partial_2 f_2}{a^2} & 0 & -\frac{\lambda+1}{a^2} & \frac{\lambda+1}{a^2} & 0 & 0 \\ 0 & \frac{\partial_1 f_1}{a^2} & 0 & \frac{\partial_2 f_1}{a^2} & 0 & 0 \\ -\lambda & 0 & \frac{\partial_1 f_1}{a^2} & 0 & \frac{\partial_2 f_1}{a^2} & -\frac{\lambda+1}{a^2} \\ \lambda & \frac{\partial_1 f_2}{a^2} & 0 & \frac{\partial_2 f_2}{a^2} & 0 & \frac{\lambda+1}{a^2} \\ 0 & 0 & \frac{\partial_1 f_2}{a^2} & 0 & \frac{\partial_2 f_2}{a^2} & 0 \\ 0 & 0 & -\lambda & \lambda & 0 & 0. \end{pmatrix}.$$

The results we obtained numerically with a Runge Kutta method of order 4 coupled with the Brin's method show a function which vanishes very close to zero. Unfortunately, at the moment we are not able to prove numerically that the Evans function vanishes for a positive  $\lambda$ .

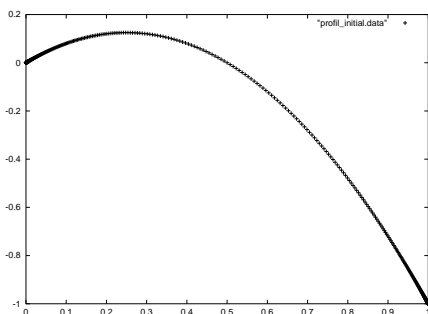

Fig. 2.4: initial profile in the space phase for  $(u_1, u_2)$

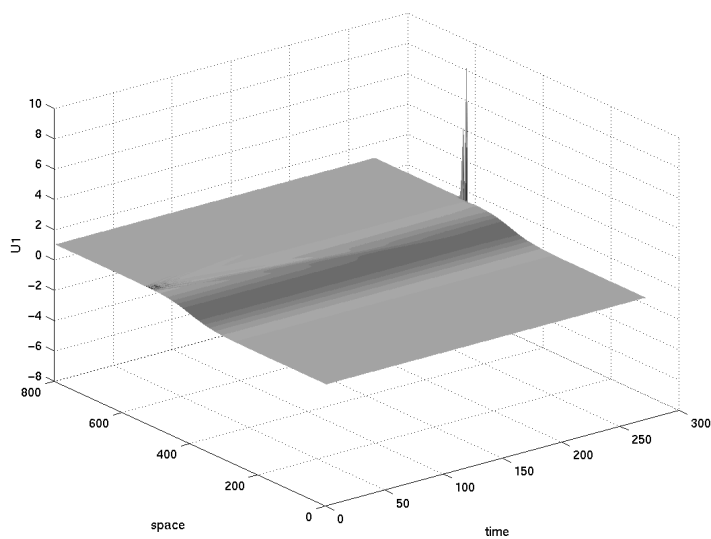

Fig. 2.5:  $u_1$  profile with respect to the time and the space variables

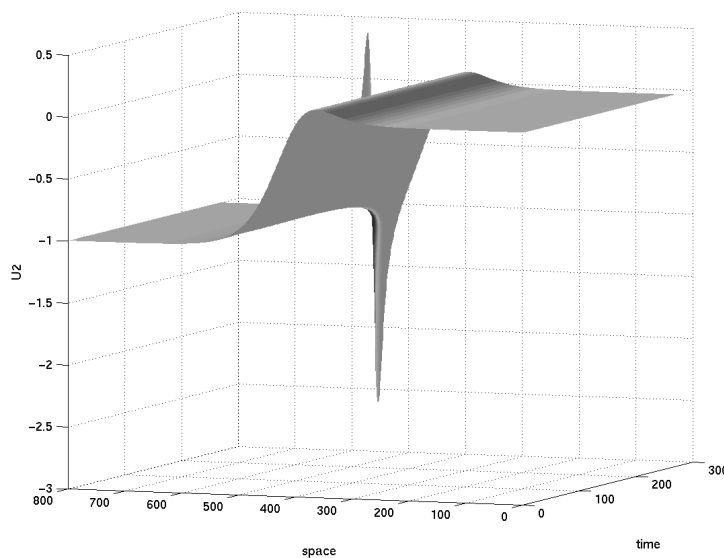

Fig. 2.6:  $u_2$  profile with respect to the time and the space variables

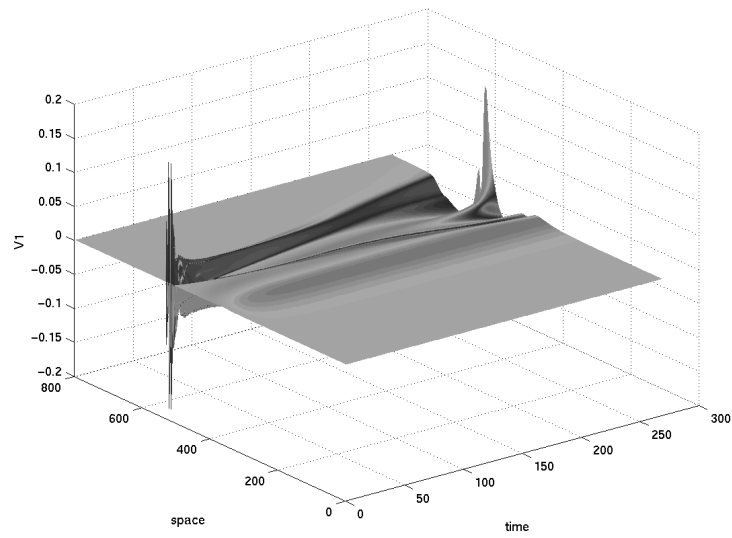

Fig. 2.7:  $v_1$  profile during the explosion with respect to the time and the space variables

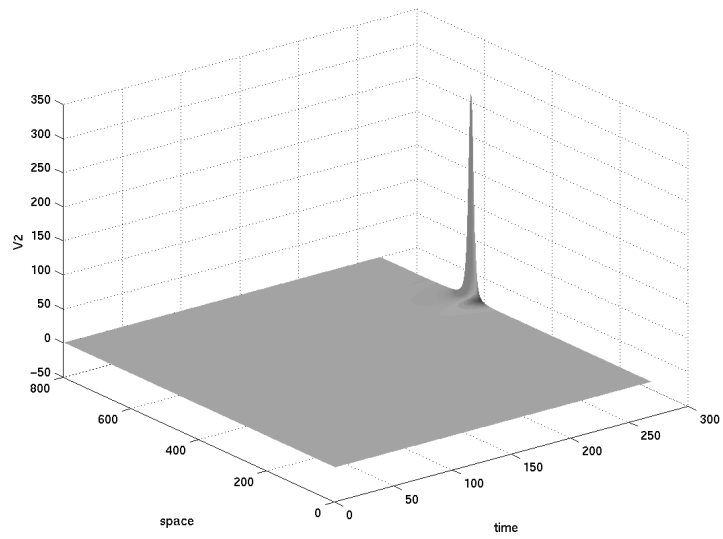

Fig. 2.8:  $v_2$  profile during the explosion with respect to the time and the space variables

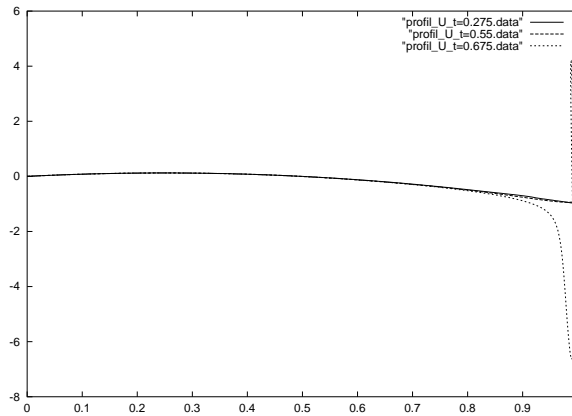

Fig. 2.9:  $(u_1, u_2)$  profile in the space with respect to time

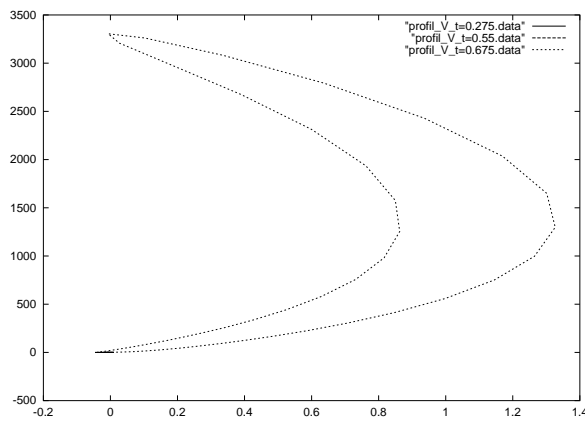

Fig. 2.10:  $(v_1, v_2)$  profile in the space with respect to time

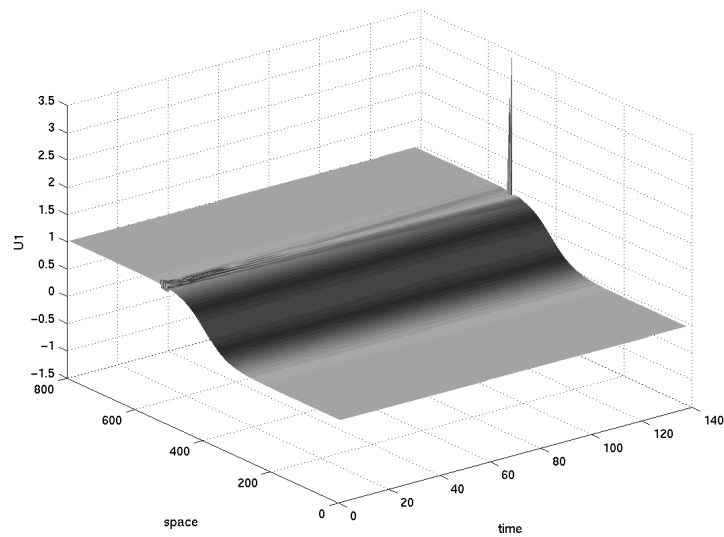

Fig. 2.11:  $u_1$  profile with respect to the time and the space variables

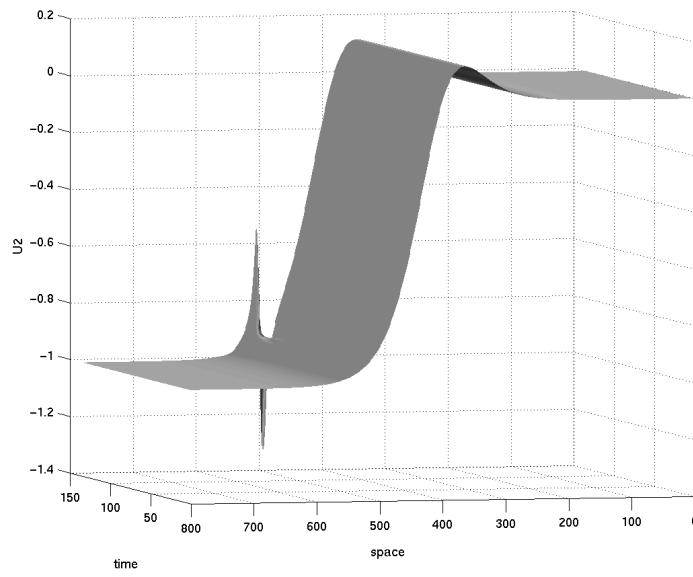

Fig. 2.12:  $u_2$  profile with respect to the time and the space variables

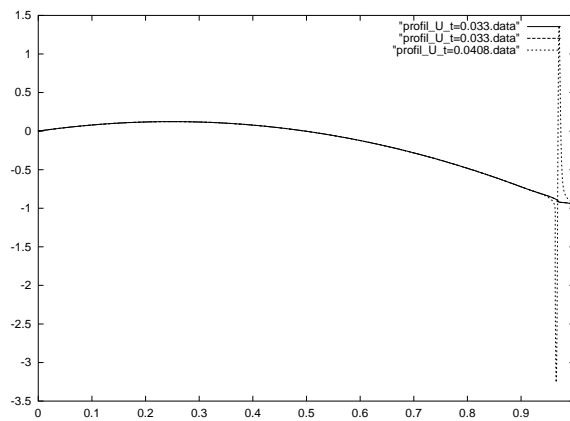

Fig. 2.13:  $(u_1, u_2)$  profile in the space phase at 3 different times

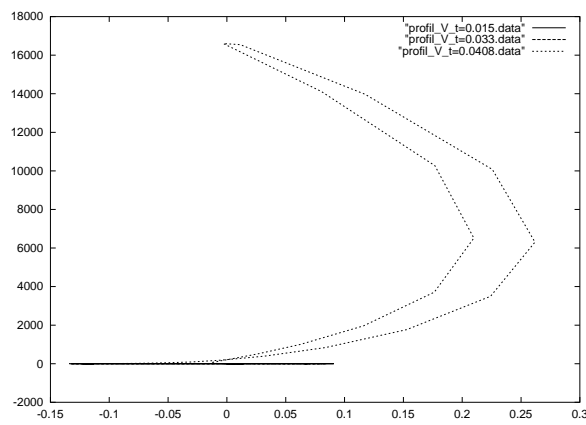

Fig. 2.14:  $(v_1, v_2)$  profile in the space phase at 3 different times



### 3. RELAXATION SEMI-LINÉAIRE : LIEN ENTRE LA VISCOSITÉ ET LA RELAXATION SEMI-LINÉAIRE

#### 3.1 Introduction

Soit un système hyperbolique de  $n$  lois de conservation,  $n \geq 2$ ,

$$u_t + f(u)_x = 0, \quad x \in \mathbb{R}, t \geq 0, \quad (1)$$

$$f \in C^\infty(\mathbb{R}^n, \mathbb{R}^n). \quad (2)$$

On veut approcher les solutions de (1) au moyen de la relaxation semi-linéaire

$$u_t + v_x = 0, \quad (3)$$

$$v_t + \mathbf{a}^2 u_x = \frac{1}{\tau}(f(u) - v), \quad (4)$$

où  $\mathbf{a}$  est une constante positive et  $\tau$  représente le temps de relaxation. Cette approximation a été introduite par Jin et Xin [42] pour obtenir des schémas numériques stables. Introduisons la notation suivante

$$\begin{pmatrix} u \\ v \end{pmatrix}_t = - \begin{pmatrix} v \\ \mathbf{a}^2 u \end{pmatrix}_x + \frac{1}{\tau} \begin{pmatrix} 0 \\ f(u) - v \end{pmatrix} =: \mathcal{L}_r \begin{pmatrix} u \\ v \end{pmatrix}.$$

Soit  $(u^-, u^+; s)$  une discontinuité de (1) vérifiant la condition de Rankine-Hugoniot

$$\mathbf{H} \mathbf{1} \quad f(u^+) - f(u^-) = s(u^+ - u^-);$$

on suppose (1) strictement hyperbolique aux points  $u^-$  et  $u^+$ , c'est à dire

$\mathbf{H} \mathbf{2}$  *les différentielles  $df(u^\pm)$  sont diagonalisables à valeurs propres simples et réelles.*

Un profil de choc reliant  $(u^-, v^-)^T$  et  $(u^+, v^+)^T$  à la vitesse  $s$  est une onde progressive  $\bar{U} : \xi = (x - st)/\tau \mapsto (\bar{u}(\xi), \bar{v}(\xi))^T$  qui vérifie

$$(\mathbf{a}^2 - s^2)\bar{u}' = f(\bar{u}) - s\bar{u} - \bar{f}, \quad (5)$$

$$\bar{v} = s\bar{u} + \bar{f}, \quad (6)$$

$$\lim_{\xi \rightarrow \pm\infty} \bar{u}(\xi) = u^\pm, \quad \lim_{\xi \rightarrow \pm\infty} \bar{v}(\xi) = f(u^\pm), \quad \bar{f} := f(u^\pm) - su^\pm. \quad (7)$$

La condition sous-caractéristique nécessaire à l'existence de profils de chocs a été formulée dans le cadre de la relaxation générale par Liu [52] et s'énonce comme suit dans le cas semi-linéaire

**H 3** la condition sous-caractéristique est vérifiée aux états  $u^\pm$

$$\mathbf{a} > \max(\rho(df(u^\pm)), |s|), \quad (8)$$

où  $\rho$  désigne le rayon spectral.

L'existence de profils de chocs requiert des hypothèses supplémentaires sur le triplet  $(u^-, u^+; s)$  : les plus fréquemment rencontrées sont l'hypothèse de choc de Lax, celle de choc sous-compressif ou de choc surcompressif [16], qui s'expriment comme inégalités sur  $df(u^\pm)$ . On suppose que

**H 4** il existe un profil de choc satisfaisant (5)-(6)-(7).

Linéarisons l'opérateur  $\mathcal{L}_r$  au voisinage de  $(\bar{u}, \bar{v})^T$  et notons  $L_r$  l'opérateur ainsi obtenu. On dit qu'un profil de choc est *spectralement stable* si l'opérateur  $L_r$  n'a pas de spectre dans le demi-plan  $\{\operatorname{Re}(\lambda) > 0\}$ .

On veut étudier le cas où  $\mathbf{a}$  devient grand, à  $\mathbf{s}$  fixé, et plus précisément la limite du spectre de l'opérateur  $L_r$ .

Ramenons-nous tout d'abord au cas d'un choc stationnaire et d'un temps de relaxation égal à 1. Appliquons le changement de variables suivant à (3)-(4) :

$$\tilde{x} = \frac{x - st}{\tau(\mathbf{a}^2 - s^2)}, \quad \tilde{t} = \frac{t}{\tau(\mathbf{a}^2 - s^2)}.$$

Notons  $\tilde{u}(\tilde{x}, \tilde{t}) := u(x, t)$ ,  $\tilde{v}(\tilde{x}, \tilde{t}) := v(x, t)$ . Sachant, d'après la condition sous-caractéristique (H8), que  $\mathbf{a} > |s|$ , on peut définir  $\zeta := \sqrt{\mathbf{a}^2 - s^2}$ . Le système (3)-(4) devient alors

$$\begin{aligned} -s\tilde{u}_{\tilde{x}} + \tilde{u}_{\tilde{t}} + \tilde{v}_{\tilde{x}} &= 0, \\ -s\tilde{v}_{\tilde{x}} + \tilde{v}_{\tilde{t}} + \mathbf{a}^2\tilde{u}_{\tilde{t}} &= \zeta^2(f(\tilde{u}) - \tilde{v}). \end{aligned}$$

En introduisant  $\tilde{\tilde{v}} := \tilde{v} - s\tilde{u} - \bar{f}$  et  $\tilde{\tilde{f}}(u) := f(u) - su - \bar{f}$ , on aboutit à

$$\begin{aligned} \tilde{u}_{\tilde{t}} + \tilde{\tilde{v}}_{\tilde{x}} &= 0, \\ \tilde{\tilde{v}}_{\tilde{t}} + \zeta^2\tilde{u}_{\tilde{x}} - 2s\tilde{\tilde{v}}_{\tilde{x}} &= \zeta^2(\tilde{\tilde{f}}(\tilde{u}) - \tilde{\tilde{v}}). \end{aligned}$$

Pour simplifier, on supprime désormais la notation  $\tilde{\tilde{\cdot}}$  (tilde).

On s'intéresse dorénavant au système

$$u_t + v_x = 0, \quad (9)$$

$$v_t + \zeta^2 u_x - 2s v_x = \zeta^2(f(u) - v). \quad (10)$$

Le nouveau système dynamique régissant les profils de chocs associés est

$$\bar{u}' = f(\bar{u}), \quad (11)$$

$$\bar{v} = 0, \quad (12)$$

$$\lim_{\xi \rightarrow \pm\infty} \bar{u}(\xi) = u^\pm \quad (13)$$

et on s'intéresse dorénavant au cas où  $\zeta$  tend vers  $+\infty$ .

En faisant un développement de Chapman-Enskog en  $1/\zeta^2$  de (9)-(10), on obtient (formellement)

$$u_t + f(u)_x = u_{xx} + \mathcal{O}\left(\frac{1}{\zeta^2}\right). \quad (14)$$

On remarque que (14) est une approximation par viscosité de matrice de viscosité  $B(u) := I_n$  moyennant le changement d'échelle effectué en  $1/\tau$ . De plus, les profils  $\bar{u}_v$  de choc stationnaire reliant  $u^-$  à  $u^+$  sont solutions de

$$\begin{aligned} \bar{u}'_v &= f(\bar{u}_v), \\ \bar{u} &\xrightarrow{\pm\infty} u^\pm. \end{aligned}$$

On obtient le même système d'EDO que pour les profils stationnaires de (9)-(10), avec  $\bar{v} = 0$ .

Linéarisons maintenant (9)-(10) autour d'un profil  $(\bar{u}, 0)$  :

$$u_t + v_x = 0, \tag{15}$$

$$v_t + \zeta^2 u_x - 2sv_x = \zeta^2(A(x)u - v). \tag{16}$$

c'est à dire

$$\begin{pmatrix} u \\ v \end{pmatrix}_t = \begin{pmatrix} 0_n & -I_n \\ -\zeta^2 I_n & 2sI_n \end{pmatrix} \begin{pmatrix} u \\ v \end{pmatrix}_x + \begin{pmatrix} 0_n & 0_n \\ \zeta^2 A(x) & -\zeta^2 I_n \end{pmatrix} \begin{pmatrix} u \\ v \end{pmatrix} =: L^r(\zeta) \begin{pmatrix} u \\ v \end{pmatrix},$$

avec  $A(x) := df(\bar{u}(x))$ . En linéarisant l'approximation par viscosité autour du même profil  $\bar{u}$ , on obtient

$$u_t = -(A(x)u)_x + u_{xx} =: L^v u.$$

D'après les résultats exposés dans [24, 30], le spectre essentiel des opérateurs  $L^v$  et  $L^r(\zeta)$  est situé dans  $\{\lambda \in \mathbb{C}/\text{Re}(\lambda) < 0\} \cup \{0\}$ . L'étude du spectre de ces opérateurs dans  $\Omega := \{\text{Re}(\lambda) > 0\}$  se résume alors à la recherche de valeurs propres. On considère le système dynamique dérivé de l'équation aux valeurs propres de l'opérateur  $L^v$  : soit  $\lambda \in \mathbb{C}$ ,  $\text{Re}(\lambda) > 0$ , une valeur propre de  $L^v$  et  $(u, v)^T \in H^1(\mathbb{R}, \mathbb{R}^{2n})$  une fonction propre associée ; alors, en notant  $v = A(x)u - u'$ , on obtient

$$\begin{pmatrix} u \\ v \end{pmatrix}' = \begin{pmatrix} A(x) & -I_n \\ -\lambda I_n & 0_n \end{pmatrix} \begin{pmatrix} u \\ v \end{pmatrix} =: \mathbb{A}^v(x, \lambda) \begin{pmatrix} u \\ v \end{pmatrix}. \tag{17}$$

De façon similaire, on associe à l'équation aux valeurs propres de  $L^r(\zeta)$  le système dynamique du premier ordre suivant :

$$\begin{pmatrix} u \\ v \end{pmatrix}' = \begin{pmatrix} A(x) - \frac{2s\lambda}{\zeta^2} I_n & -\left(1 + \frac{\lambda}{\zeta^2}\right) I_n \\ -\lambda I_n & 0_n \end{pmatrix} \begin{pmatrix} u \\ v \end{pmatrix} =: \mathbb{A}^r(\zeta, \lambda, x) \begin{pmatrix} u \\ v \end{pmatrix}. \tag{18}$$

On remarque aisément que

$$\lim_{\zeta \rightarrow +\infty} \mathbb{A}^r(\zeta, \cdot, \cdot) = \mathbb{A}^v(\cdot, \cdot),$$

et que, plus précisément,

$$\mathbb{A}^r(\zeta, \cdot, \cdot) = \mathbb{A}^v(\cdot, \cdot) + \frac{1}{\zeta^2} \begin{pmatrix} -2s\lambda & -\lambda I_n \\ 0_n & 0_n \end{pmatrix} =: \mathbb{A}^v(\cdot, \cdot) + \frac{\lambda}{\zeta^2} B. \tag{19}$$

D'après les travaux de Gardner et Zumbrun [24] et Benzoni, Serre et Zumbrun [4], on construit alors une fonction d'Evans  $D^v : \lambda \mapsto D^v(\lambda)$  associée à  $L^v$ , analytique dans  $\Omega$

comme un Wronskien de  $2n$  solutions de (18), dont les  $n$  premières forment une base de l'espace des solutions tendant vers 0 en  $+\infty$  et les  $n$  dernières une base de l'espace des solutions tendant vers 0 en  $-\infty$ . Parallèlement, en suivant la construction donnée dans [30], on définit une fonction d'Evans  $D^r : (\zeta, \lambda) \mapsto D^r(\zeta, \lambda)$  similaire pour l'opérateur  $L^r(\zeta)$ . D'après sa définition, la fonction d'Evans  $D^v$  (resp.  $D^r(\zeta, \cdot)$ ) s'annule en  $\lambda$  si et seulement si  $\lambda$  est une valeur propre de  $L^v$  (resp. de  $L^r(\zeta)$ ).

### 3.2 Résultat

Le but de cette note est de montrer la proposition suivante

#### Proposition 3.2.1

Soit  $\lambda \in \Omega$ . On suppose les hypothèses (H1-4) satisfaites. Pour  $\zeta \in V$ , avec  $V$  un voisinage de  $+\infty$ , on a

$$|D^r(\zeta, \lambda) - D^v(\lambda)| \leq \frac{C}{\zeta^2}, \quad (20)$$

avec  $C$  une constante indépendante de  $\zeta$  et localement bornée en  $\lambda$ .

**Remarque 3.2.1** La similarité des résultats de conditions nécessaires de stabilité spectrale donnés pour l'approximation par viscosité par Gardner et Zumbrun [24] et par Benzoni, Serre et Zumbrun [4] et pour la relaxation semi-linéaire [30] donnaient l'intuition d'un tel résultat.

On en tire le corollaire suivant, grâce à l'application du théorème de Rouché :

#### Corollaire 3.2.1

Soient  $\gamma$  un chemin fermé de  $\Omega$ . On suppose  $\gamma$  d'indice 0 par rapport à tout point extérieur à  $\Omega$  et d'indice 1 ou 0 pour tout point dans  $\Omega \setminus \gamma$ . On appelle  $\Omega_1$  l'ensemble des points tel que l'indice de  $\gamma$  par rapport à ces points soit 1.

On suppose que  $D^v$  n'a pas de zéros sur  $\gamma$ .

Soit  $C_\gamma := \sup_{\lambda \in \gamma} \{C > 0, \text{ tel que (20) soit vérifiée}\}$ .

Alors, pour

$$\zeta > \sqrt{\frac{C_\gamma}{\inf_\gamma |D^v|}},$$

$D^r(\zeta, \cdot)$  et  $D^v$  ont le même nombre de zéros avec la même multiplicité dans la région  $\Omega_1$ .

D'après le corollaire, on peut suivre les valeurs propres instables de l'opérateur de relaxation semi-linéaire linéarisé avec leur multiplicité, quand la vitesse de relaxation  $\mathbf{a}$  devient très grande (voir figure 3.1) : leurs limites sont les valeurs propres de l'opérateur de viscosité, comme le laissait prévoir le développement formel de Chapman-Enskog (14).

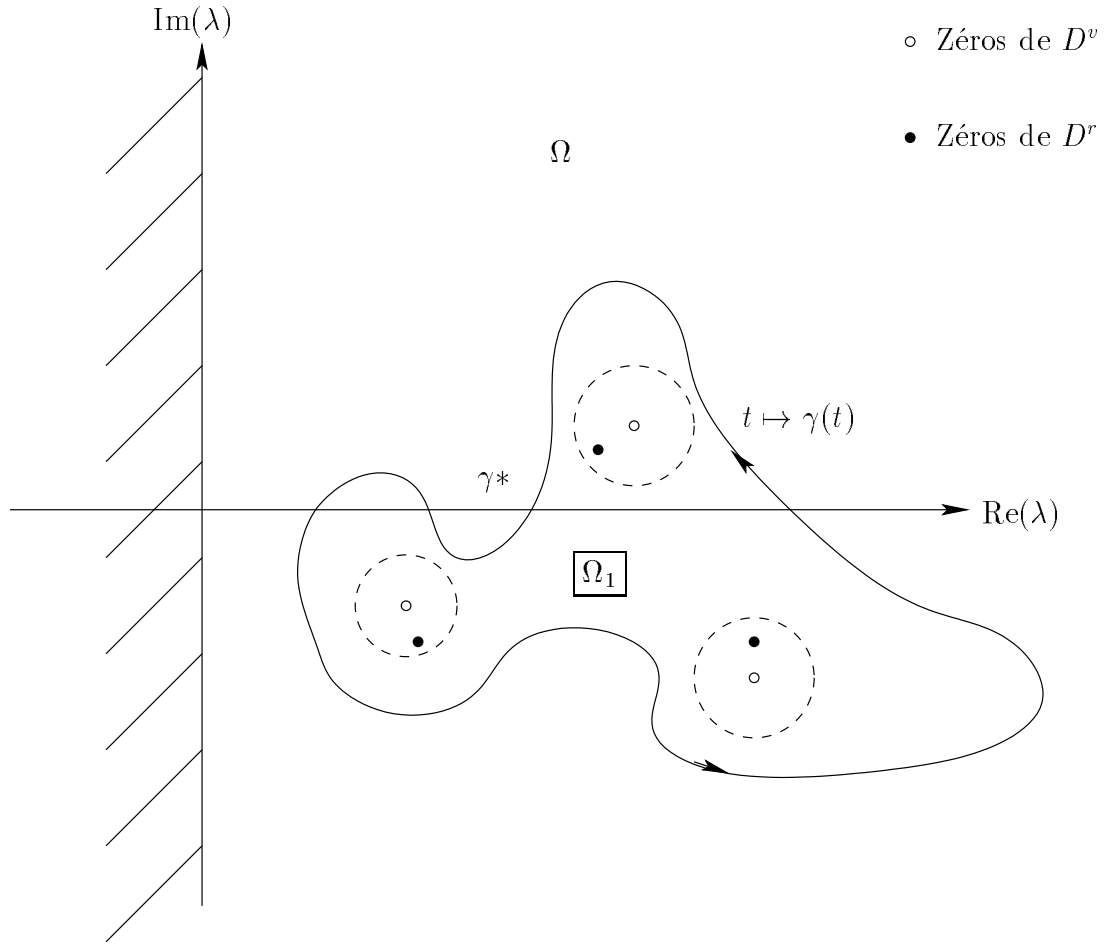
Fig. 3.1: Zéros de  $D^v$  et de  $D^r$ 

### 3.3 Preuve de la proposition

Pour aborder la construction de la fonction d'Evans, on étudie tout d'abord le comportement asymptotique des solutions des systèmes dynamiques (18) et (17).

Notons

$$\mathbb{A}^{v,\pm}(\lambda) := \lim_{x \rightarrow \pm\infty} \mathbb{A}^v(x, \lambda)$$

et

$$\mathbb{A}^{r,\pm}(\zeta, \lambda) := \lim_{x \rightarrow \pm\infty} \mathbb{A}^r(\zeta, \lambda, x).$$

Du fait de l'hypothèse de stricte hyperbolicité de (1) aux états  $u^\pm$ , les valeurs propres de  $df(u^\pm)$  sont réelles et distinctes : notons-les  $(a_i^\pm)_{i \in \{1, \dots, n\}}$ . Ainsi, le polynôme caractéristique de  $\mathbb{A}^{v,\pm}(\lambda)$  se décompose en

$$P^{v,\pm}(\mu) := \prod_{i=1}^n (\mu^2 - a_i^\pm \mu - \lambda)$$

et ses racines sont

$$\mu_{\varepsilon,i}^{v,\pm} = \frac{a_i^\pm + \varepsilon \sqrt{(a_i^\pm)^2 + 4\lambda}}{2}, \quad \varepsilon = \pm 1, \quad i \in \{1, \dots, n\}.$$

En prenant  $\lambda$  réel et très grand et en faisant un développement asymptotique en  $\lambda$ , on note que  $\mu_{\varepsilon,i}^{v,\pm}$  et  $\varepsilon$  ont le même signe. Grâce au théorème de continuité de l'ensemble des solutions par rapport au paramètre  $\lambda$ , on en conclut que  $\mathbb{A}^{v,\pm}(\lambda)$  a exactement  $n$  valeurs propres de partie réelle strictement positive et  $n$  valeurs propres de partie réelle strictement négative pour  $\lambda \in \Omega$ . Classons-les de la façon suivante

$$\operatorname{Re}(\mu_1^{v,\pm}(\lambda)) \leq \dots \leq \operatorname{Re}(\mu_n^{v,\pm}(\lambda)) < 0 < \operatorname{Re}(\mu_{n+1}^{v,\pm}(\lambda)) \leq \dots \leq \operatorname{Re}(\mu_{2n}^{v,\pm}(\lambda)).$$

Le polynôme caractéristique de  $\mathbb{A}^{r,\pm}(\zeta, \lambda)$  s'écrit

$$P^{r,\pm}(\mu) := \prod_{i=1}^n \left( \mu^2 - \left( a_i^\pm - \frac{2s\lambda}{\zeta^2} \right) \mu - \lambda \left( 1 + \frac{\lambda}{\zeta^2} \right) \right)$$

et ses racines sont

$$\mu_{\varepsilon,i}^{r,\pm} = \frac{a_i^\pm - 2s\lambda/\zeta^2 + \varepsilon \sqrt{(a_i^\pm)^2 + 4\lambda + 4\lambda a_i^\pm (a_i^\pm \lambda - \zeta^2 s)/\zeta^4}}{2}, \quad \varepsilon = \pm 1, \quad i \in \{1, \dots, n\}.$$

Les matrices  $\mathbb{A}^{r,\pm}$  et  $\mathbb{A}^{v,\pm}$  n'ont pas de valeur propre de partie réelle nulle pour tout  $\lambda$  tel que  $\operatorname{Re}(\lambda) > 0$  et leurs sous-espaces propres stables et instables sont de dimension  $n$  [24, 30]. En faisant un développement asymptotique de  $\mu_{\varepsilon,i}^{r,\pm}$  en  $1/\zeta^2$ , on obtient alors

$$\mu_{\varepsilon,i}^{r,\pm} = \mu_{\varepsilon,i}^{v,\pm} - \frac{\lambda s}{\zeta^2} \left( 2 - \varepsilon \frac{a_i^\pm}{\sqrt{(a_i^\pm)^2 + 4\lambda}} \right) + o\left(\frac{|\lambda|}{\zeta^2}\right), \quad i \in \{1, \dots, n\}, \quad \varepsilon = \pm 1. \quad (21)$$

On note  $((x, \lambda) \mapsto \Phi_1(x, \lambda), \dots, (x, \lambda) \mapsto \Phi_n(x, \lambda))$  (resp.  $((x, \lambda) \mapsto \Phi_{n+1}(x, \lambda), \dots, (x, \lambda) \mapsto \Phi_{2n}(x, \lambda))$ ) une base des solutions du système dynamique

$$\Phi' = \mathbb{A}^v(x, \lambda)\Phi \quad (22)$$

tendant vers 0 quand  $x$  tend vers  $+\infty$  (resp. quand  $x$  tend vers  $-\infty$ ) et telles que

$$\begin{aligned} |\Phi_j(x, \lambda)| &\underset{x \rightarrow +\infty}{\sim} \exp(\operatorname{Re}(\mu_j^{v,+}(\lambda))x), \quad \forall j \in \{1, \dots, n\}, \\ |\Phi_{n+j}(x, \lambda)| &\underset{x \rightarrow -\infty}{\sim} \exp(\operatorname{Re}(\mu_j^{v,-}(\lambda))x), \quad \forall j \in \{n+1, \dots, 2n\}. \end{aligned}$$

On appelle  $\mathcal{B}_v$  la famille  $(\Phi_j)_{j \in \{1, \dots, 2n\}}$ .

De même, il existe un voisinage  $V$  de  $+\infty$  pour lequel, pour tout  $\zeta \in V$ , on peut définir une base  $(\Psi_1(\zeta, x, \lambda), \dots, \Psi_n(\zeta, x, \lambda))$  (resp.  $(\Psi_{n+1}(\zeta, x, \lambda), \dots, \Psi_{2n}(\zeta, x, \lambda))$ ) de solutions de

$$\Psi' = \mathbb{A}^r(x, \lambda)\Psi \quad (23)$$

tendant vers 0 quand  $x$  tend vers  $+\infty$  (resp. quand  $x$  tend vers  $-\infty$ ) et dont les éléments se comportent comme suit :

$$\begin{aligned} |\Psi_j(\zeta, x, \lambda)| &\underset{x \rightarrow +\infty}{\sim} \exp(\operatorname{Re}(\mu_j^{r,+}(\zeta, \lambda))x), \quad \forall j \in \{1, \dots, n\}, \\ |\Psi_{n+j}(\zeta, x, \lambda)| &\underset{x \rightarrow -\infty}{\sim} \exp(\operatorname{Re}(\mu_j^{r,-}(\zeta, \lambda))x), \quad \forall j \in \{n+1, \dots, 2n\}. \end{aligned}$$

Le développement asymptotique (21) des valeurs propres  $\mu^r$  permet d'associer le même ordre aux  $\Phi$  et aux  $\Psi$ . On appelle  $\mathcal{B}_r$  la famille  $(\Psi_j)_{1 \leq j \leq 2n}$ .

On définit la fonction d'Evans  $D^v(\lambda)$  comme le déterminant des  $(\Phi_j(0, \lambda))_{j \in \{1, \dots, 2n\}}$  prises en  $x = 0$  et  $D^r(\zeta, \lambda)$  comme le déterminant des  $(\Psi_j(\zeta, 0, \lambda))_{j \in \{1, \dots, 2n\}}$ .

Etudions maintenant la différence  $\Phi_j(x, \lambda) - \Psi_j(\zeta, x, \lambda) =: \varphi_j(\zeta, x, \lambda)$ , avec  $1 \leq j \leq n$ . On se restreint à l'intervalle  $\mathbb{R}^+$ .

### Lemme 3.3.1

Soient  $j \in \{1, \dots, n\}$ ,  $\lambda \in \Omega$ . Alors il existe un voisinage  $W$  de  $+\infty$  tel que, pour  $\zeta \in W$ , on a

$$|\varphi_j(\zeta, 0, \lambda)| \leq 2 \frac{|\lambda| \|B\|}{\zeta^2 \alpha_v(\lambda)} \sup_{x \in [0, +\infty[} |\Phi_j(x, \lambda)|, \quad (24)$$

où  $\alpha_v$  est une constante ne dépendant que de  $\lambda$ .

### Preuve du lemme

D'après Coppel [14] et grâce au fait que ni  $\mathbb{A}^{v,+}(\lambda)$  ni  $\mathbb{A}^{r,+}(\lambda)$  n'ont de valeurs propres imaginaires pures, le système (22) admet une dichotomie exponentielle sur la demi-droite  $\mathbb{R}^+$ , c'est à dire qu'il existe une projection  $P_v(\lambda)$ , des coefficients  $C_v(\lambda) > 0$ ,  $\alpha_v(\lambda) > 0$  tels que

$$\begin{aligned} |X(x, \lambda)P_v(\lambda)X(y, \lambda)^{-1}| &\leq C_v(\lambda)e^{-\alpha_v(\lambda)(x-y)}, \quad x \geq y \geq 0, \\ |X(x, \lambda)(I_n - P_v(\lambda))X(y, \lambda)^{-1}| &\leq C_v(\lambda)e^{-\alpha_v(\lambda)(y-x)}, \quad y \geq x \geq 0, \end{aligned}$$

où  $X$  représente la matrice résolvante de (22). En appliquant la Proposition 1, Section 4 (pp 34) dans [14], pour  $\mathbb{A}^r$  écrit comme perturbation de  $\mathbb{A}^v$  (19), on montre que le système dynamique (18) admet également une dichotomie exponentielle. On obtient donc les inégalités suivantes :

$$\begin{aligned} |Y(\zeta, x, \lambda)P_r(\zeta, \lambda)Y(\zeta, y, \lambda)^{-1}| &\leq C_r(\zeta, \lambda)e^{-\alpha_r(\zeta, \lambda)(x-y)}, \quad x \geq y \geq 0, \\ |Y(\zeta, x, \lambda)(I_n - P_r(\zeta, \lambda))Y(\zeta, y, \lambda)^{-1}| &\leq C_r(\zeta, \lambda)e^{-\alpha_r(\zeta, \lambda)(y-x)}, \quad y \geq x \geq 0, \end{aligned}$$

avec  $P_r(\zeta, \lambda)$  une projection,  $C_r(\zeta, \lambda)$  et  $\alpha_r(\zeta, \lambda)$  deux constantes positives. En suivant pas à pas la démonstration de la Proposition 1 (pp 28–34 de [14]), on obtient :

$$C_r(\zeta, \lambda) = C_v(\lambda) + \frac{5|\lambda|C_v(\lambda)^3}{2\zeta^2} + o\left(\frac{1}{\zeta^3}\right), \quad (25)$$

$$\alpha_r(\zeta, \lambda) = \alpha_v(\lambda) \left(1 - \frac{|\lambda|C_v(\lambda)}{\zeta^2}\right) + o\left(\frac{1}{\zeta^3}\right). \quad (26)$$

En réécrivant  $\mathbb{A}^v$  comme

$$\mathbb{A}^v = \mathbb{A}^r + \frac{\lambda}{\zeta^2}B,$$

on constate que la différence  $\varphi_j$  est solution de l'équation différentielle

$$\varphi' = \mathbb{A}^r \varphi + \frac{\lambda}{\zeta^2}B\Phi_j,$$

et on peut par conséquent l'exprimer comme

$$\begin{aligned} \varphi_j(\zeta, x, \lambda) &= \frac{\lambda}{\zeta^2} \left( \int_0^x Y(\zeta, x, \lambda)P_r(\zeta, \lambda)Y(\zeta, y, \lambda)^{-1}B\Phi_j(y, \lambda)dy \right. \\ &\quad \left. - \int_x^{+\infty} Y(\zeta, x, \lambda)(I_n - P_r(\zeta, \lambda))Y(\zeta, y, \lambda)^{-1}B\Phi_j(y, \lambda)dy \right), \end{aligned}$$

d'où, grâce à (25) et (26), on tire la majoration

$$|\varphi_j(\zeta, x, \lambda)| \leq 2 \frac{|\lambda| \|B\|}{\zeta^2 \alpha_v(\lambda)} |\Phi_j(\cdot, \lambda)|_{L_x^\infty([0, +\infty])}.$$

□

On fait le même raisonnement pour les solutions tendant vers 0 en  $-\infty$ , correspondant aux indices  $j \in \{n+1, \dots, 2n\}$  dans les bases  $\mathcal{B}_v$  et  $\mathcal{B}_r$ .

Ainsi, en développant  $D^r(\zeta, \lambda)$  en utilisant sa multilinéarité et le lemme 3.3.1, on obtient

$$\begin{aligned} D^r(\zeta, \lambda) &= \det(\Psi_1(\zeta, 0, \lambda), \dots, \Psi_{2n}(\zeta, 0, \lambda)) \\ &= \det(\Phi_1(0, \lambda), \dots, \Phi_{2n}(0, \lambda)) \\ &\quad + \sum_{j=1}^{2n} \det(\Phi_1(0, \lambda), \dots, \Phi_{j-1}(0, \lambda), \varphi_j(\zeta, 0, \lambda), \Phi_{j+1}(0, \lambda), \dots, \Phi_{2n}(0, \lambda)) + O\left(\frac{1}{\zeta^4}\right), \end{aligned}$$

d'où

$$|D^r(\zeta, \lambda) - D^v(\lambda)| \leq \frac{C}{\zeta^2},$$

avec  $C$  une constante indépendante de  $\zeta$  et localement bornée en  $\lambda$ .



## 4. DIFFUSION-DISPERSION

Les calculs présentés ici ont été faits de manière indépendante par Kevin Zumbrun [87].

### 4.1 Introduction

On considère la loi de conservation scalaire monodimensionnelle

$$\begin{aligned}u_t + f(u)_x &= 0, \\ u : \mathbb{R} \times \mathbb{R}^+ &\longrightarrow \mathbb{R},\end{aligned}\tag{1}$$

où  $f$  est une fonction régulière de  $\mathbb{R}$  dans  $\mathbb{R}$  non convexe, c'est à dire que  $f''$  n'a pas un signe constant.

On étudie le modèle dispersif-diffusif

$$u_t + f(u)_x = \varepsilon(B(u)u_x)_x + \varepsilon^2(C(u)u_{xx} + D(u)(u_x)^2)_x.\tag{2}$$

Soit  $(u^-, u^+; s)$  un choc du système (1) satisfaisant aux conditions habituelles, c'est à dire la condition de Rankine-Hugoniot

$$\mathbf{H\ 1} \quad f(u^+) - f(u^-) = s(u^+ - u^-),$$

et l'hypothèse de choc non caractéristique

$$\mathbf{H\ 2} \quad \text{les dérivées } f'(u^\pm) \text{ sont différentes de } s.$$

De plus, on suppose vérifiée la condition suivante

$$\mathbf{H\ 3} \quad B(u^\pm) > 0$$

qui s'apparente à la condition de parabolicité rencontrée quand on a affaire à une approximation par viscosité pure (cas où  $C$  et  $D$  sont nulles).

Afin de sélectionner les chocs admissibles, on introduit la notion de couples entropie-flux d'entropie : une fonction  $\eta$  est une entropie de (1) de flux  $q$  associé si pour toute solution  $u$  régulière de (1), l'égalité suivante est vérifiée

$$\eta(u)_t + q(u)_x = 0.\tag{3}$$

Dans le cas où  $f$  est convexe et où  $u$  est la solution

$$\begin{aligned}u(x, t) &= u^-, \quad x > st, \\ &= u^+, \quad x < st,\end{aligned}$$

une seule inégalité d'entropie de la forme

$$\eta(u)_t + q(u)_x \leq 0 \quad (4)$$

avec  $\eta$  strictement convexe suffit à sélectionner une unique solution au problème de Cauchy [48]. Cette condition est équivalente à celle d'Oleinik

$$\frac{f(\mathbf{u}) - f(u^-)}{\mathbf{u} - u^-} \geq s \geq \frac{f(u^+) - f(\mathbf{u})}{u^+ - \mathbf{u}}, \quad (5)$$

pour tout  $\mathbf{u}$  compris entre  $u^-$  et  $u^+$ .

Pour les flux  $f$  non-convexes, alors que la condition d'Oleinik sélectionne les chocs admissibles, une seule inégalité d'entropie est insuffisante à déterminer des chocs physiquement admissibles [37].

Soit  $\eta$  une entropie strictement convexe, de flux associé  $q$ . Un choc de (1) de flux non-convexe  $f$  est dit *non-classique* s'il vérifie une inégalité d'entropie (4) mais pas la condition d'Oleinik. De plus, on impose ici que les chocs ne satisfassent pas la condition de Lax.

On s'intéresse aux *profils de choc* de (2)  $\bar{u} : \xi = (x - st)/\varepsilon \rightarrow \bar{u}(\xi)$  qui sont des ondes progressives reliant  $u^-$  à  $u^+$  et satisfaisant

$$\begin{aligned} f(\bar{u})' - s\bar{u}' &= (B(\bar{u})\bar{u}')' + (C(\bar{u})\bar{u}'')' + (D(\bar{u})(\bar{u}')^2)', \\ \lim_{\xi \rightarrow \pm\infty} \bar{u}(\xi) &= u^\pm, \end{aligned} \quad (6)$$

Dorénavant, pour assurer que (6) reste du troisième ordre, on supposera de plus que

**H 4**  $C$  ne s'annule pas.

En intégrant (6) entre  $-\infty$  et  $\xi$  (resp. entre  $\xi$  et  $+\infty$ ), on obtient

$$f(\bar{u}(\xi)) - s\bar{u}(\xi) = B(\bar{u}(\xi))\bar{u}'(\xi) + D(\bar{u}(\xi))(\bar{u}')^2(\xi) + C(\bar{u}(\xi))\bar{u}''(\xi) + j. \quad (7)$$

Les conditions aux limites impliquent que  $j = f(u^+) - su^+ = f(u^-) - su^-$ .

On reformule maintenant (7) comme un système (non-linéaire) du premier ordre

$$\begin{cases} \bar{u}' = \bar{v}, \\ \bar{v}' = \frac{f(\bar{u}) - s\bar{u} - B(\bar{u})\bar{v} - D(\bar{u})\bar{v}^2 - j}{C(\bar{u})}, \end{cases}$$

dont les points d'équilibre vérifient

$$\begin{cases} v^* = 0, \\ f(u^*) - su^* = j. \end{cases}$$

Prenons comme notation

$$\begin{pmatrix} \bar{u}' \\ \bar{v}' \end{pmatrix} =: F \begin{pmatrix} \bar{u} \\ \bar{v} \end{pmatrix}. \quad (8)$$

Les points  $U^\pm := (u^\pm, 0)^T$  sont donc des points d'équilibre et la différentielle de  $F$  aux points  $U^\pm$  s'écrit

$$dF \begin{pmatrix} u^\pm \\ 0 \end{pmatrix} = \begin{pmatrix} 0 & 1 \\ \frac{f'(u^\pm) - s}{C(u^\pm)} & -\frac{B(u^\pm)}{C(u^\pm)} \end{pmatrix}.$$

Examinons les cas où  $(f'(u^\pm) - s)/C(u^\pm) < 0$  et  $(f'(u^-) - s)(f'(u^+) - s) < 0$  :

- cas où  $(f'(u^\pm) - s)/C(u^\pm) < 0$  :  
les valeurs propres de  $dF(U^\pm)$  sont toutes les quatre de même signe ou de partie réelle de même signe. Les points  $U^\pm$  sont donc ou bien tous les deux attracteurs ou bien tous les deux répulsifs : il n'y a pas d'orbite hétérocline entre  $u^-$  et  $u^+$  ;
- cas où  $(f'(u^-) - s)(f'(u^+) - s) < 0$  :  
supposons  $C(u^\pm) > 0$ . Alors soit la condition de Lax est vérifiée soit on a  $f'(u^-) < s < f'(u^+)$ . Or, dans ce cas,  $dF(U^-)$  a deux valeurs propres de même partie réelle ou réelles de même signe égal à l'opposé de  $B(u^-)$ , qui est positif d'après (H3) : le point  $U^-$  est attracteur et il n'y a pas d'orbite hétérocline entre  $u^-$  et  $u^+$ . De même, si  $C(U^\pm) < 0$ , on trouve que  $U^+$  est répulsif.

Ainsi, on doit nécessairement supposer que les inégalités suivantes sont vérifiées

$$\frac{f'(u^\pm) - s}{C(u^\pm)} > 0,$$

qui sont équivalentes ici au fait que  $U^\pm$  sont des points-selles de  $F$ .

Etant donné que  $C$  ne s'annule pas et donc garde le même signe,  $f'(u^\pm) - s$  et  $C(u^\pm)$  doivent être de même signe. En fait, en faisant le changement de variable  $x$  en  $-x$ , on se rend compte que les deux cas  $(f'(u^\pm) - s > 0, C(u^\pm) > 0)$  et  $(f'(u^\pm) - s < 0, C(u^\pm) < 0)$  sont équivalents. Désormais, on suppose que

**H 5** *les points  $(u^\pm, 0)^T$  sont des points-selles de  $F$  et que  $f'(u^\pm) - s$  et  $C$  sont positifs.*

Les chocs satisfaisant cette condition sont sous-compressifs, c'est à dire que deux caractéristiques rentrent dans le chocs et deux en ressortent [71]. Supposons que le choc vérifie une inégalité d'entropie (4), afin que  $(u^-, u^+; s)$  soit un choc non-classique. Enfin on fait l'hypothèse

**H 6** *il existe un profil de choc  $\bar{u}$  qui joint asymptotiquement les états  $u^-$  et  $u^+$ .*

Ces profils de chocs dans le cas du modèle Korteweg-deVries-Burgers modifié

$$u_t + (u^3)_x = \varepsilon u_{xx} + \delta u_{xxx}, \quad (9)$$

ont été étudiés par D. Jacobs, B. McKinney et M. Shearer [40] et par B. Hayes et P. LeFloch [37], plus précisément pour  $\delta > 0$  et  $\varepsilon/\sqrt{\delta}$  fixé.

Soit  $u(x, t) = \tilde{u}(\xi, \tau)$  avec  $\xi = (x - st)/\varepsilon$  et  $\tau = t/\varepsilon$ . L'équation (2) devient

$$\tilde{u}_t + (f'(\tilde{u}) - s)\tilde{u}_\xi = (B(\tilde{u})\tilde{u}_\xi)_\xi + (C(\tilde{u})\tilde{u}_{\xi\xi} + D(\tilde{u})\tilde{u}_\xi^2)_\xi.$$

En notant  $\tilde{f} : u \mapsto f(u) - su - j$  et en omettant les tildes pour simplifier les notations, on change le choc en un choc stationnaire, tout en n'oubliant pas que  $s$  est un paramètre, et on ramène le petit paramètre  $\varepsilon$  à 1. Le système que l'on considère est maintenant

$$u_t + (f(u))_x = (B(u)u_x)_x + (C(u)u_{xx} + D(u)(u_x)^2)_x. \quad (10)$$

Linéarisons le système (10) au voisinage du profil  $\bar{u}$ . Soit  $u = \bar{u} + v$ , alors  $v$  est solution de

$$v_t = -(a(x)v)_x + (b(x)v_x)_x + (c(x)v_{xx})_x =: Mv, \quad (11)$$

avec

$$\begin{aligned} a(x) &= f'(\bar{u}(x)) - B'(\bar{u}(x))\bar{u}'(x) - C'(\bar{u}(x))\bar{u}''(x) - D'(\bar{u}(x))(\bar{u}'(x))^2, \\ b(x) &= B(\bar{u}(x)) + 2D(\bar{u}(x))\bar{u}'(x), \\ c(x) &= C(\bar{u}(x)). \end{aligned}$$

On dit que le profil  $\bar{u}$  est *spectralement stable* si  $M$  n'a pas de spectre dans le demi-plan  $\{\operatorname{Re}(\lambda) > 0\}$ . On a le résultat suivant

**Proposition 4.1.1**

*Si le profil  $\bar{u}$  est spectalement stable, alors*

$$\operatorname{sgn} \left( \int_{-\infty}^{+\infty} \exp \left( - \int_t^0 \frac{b(s)}{c(s)} ds \right) \bar{u}'(t)(\bar{u}(t) - u^-) dt \right) > 0.$$

Pour trouver cette condition nécessaire de stabilité spectrale, on va utiliser les techniques de fonction d'Evans, développées notamment par R. Gardner et K. Zumbrun [24] : après avoir montré que le spectre de  $M$  dans  $\{\operatorname{Re}(\lambda) > 0\}$  n'est constitué que de valeurs propres, on va transformer l'équation aux valeurs propres en  $\lambda \in \mathbb{C}$  en système dynamique du premier ordre. On définit une fonction d'Evans  $D$  comme un Wronskien de ce système dynamique ne dépendant que de  $\lambda$ , analytique dans le demi-plan droit ouvert et s'annulant si et seulement si  $\lambda$  est une valeur propre de  $M$ . De plus, elle est réelle pour des valeurs de  $\lambda$  réelles. Par conséquent, si  $D$  ne s'annule pas sur  $\mathbb{R}$ , elle a nécessairement le même signe au voisinage de 0 et de  $+\infty$ . L'étude en 0 se révèle compliquée car la dérivée du profil est une fonction propre de  $M$  pour la valeur propre 0 du fait de l'invariance par translation. Cependant, grâce au lemme de l'écart (Gap Lemma) de R. Gardner et K. Zumbrun [24], on peut prolonger analytiquement  $D$  à un voisinage de  $\lambda = 0$ , et par conséquent déterminer le signe de  $D$  au voisinage de 0. En ce qui concerne le signe de  $D$  en  $+\infty$ , on utilise une méthode homotopique due à S. Benzoni, D. Serre et K. Zumbrun [4].

## 4.2 Démonstration de la proposition

On commence par étudier le spectre de  $M$  dans le demi-plan droit ouvert.

### 4.2.1 Spectre essentiel de $M$

On considère le *spectre essentiel* de  $M$  par rapport à  $L^2(\mathbb{R})$ , noté  $\sigma_{ess}(M)$ , que l'on définit par :

$$\sigma_{ess}(M) = \mathbb{C} \setminus \{ \lambda/M - \lambda \text{ est un opérateur de Fredholm d'index } 0 \}.$$

En effet, le spectre de l'opérateur  $M$  dans le complémentaire de  $\sigma_{ess}(M)$  n'est constitué que de valeurs propres [39] et, de plus,  $\sigma_{ess}(M)$  est délimité par le spectre des opérateurs limites de  $M$ , qui sont donnés par

$$M^\pm v := -a^\pm v_x + b^\pm v_{xx} + c^\pm v_{xxx},$$

avec

$$\begin{aligned} a(x) &\xrightarrow{x \rightarrow \pm\infty} a^\pm &:= f'(u^\pm), \\ b(x) &\xrightarrow{x \rightarrow \pm\infty} b^\pm &:= B(u^\pm), \\ c(x) &\xrightarrow{x \rightarrow \pm\infty} c^\pm &:= C(u^\pm). \end{aligned}$$

Le spectre de  $M^\pm$ , qui sont à coefficients constants, est aisément calculable grâce à la transformée de Fourier. On a le résultat suivant :

**Proposition 4.2.1**

*Le spectre essentiel de  $M$  et  $\Omega := \{\lambda/\text{Re}(\lambda) \geq 0\} \setminus \{0\}$  ont une intersection vide.*

**Démonstration**

Pour  $v$  une solution de  $v_t = M^\pm v$ , la transformée de Fourier de  $v$  satisfait

$$\hat{v}_t = -(ia^\pm \xi a^\pm + b^\pm \xi^2 + ic^\pm \xi^3) \hat{v},$$

d'où

$$\sigma(M^\pm) = \bigcup_{\xi \in \mathbb{R}} \{\lambda \in \mathbb{C} / ia^\pm \xi a^\pm + b^\pm \xi^2 + ic^\pm \xi^3 + \lambda = 0\}.$$

Soit  $\lambda \in \sigma_{ess}(M^\pm)$ . Alors il existe  $\xi \in \mathbb{R}$  tel que

$$ia^\pm \xi a^\pm + b^\pm \xi^2 + ic^\pm \xi^3 + \lambda = 0. \quad (12)$$

En considérant la partie réelle de (12), on constate que, nécessairement,  $\text{Re}(\lambda) \leq 0$  et que  $\text{Re}(\lambda) = 0$  si et seulement si  $\xi = 0$ . Or,  $\xi = 0$  implique que  $\lambda = 0$ . Donc le spectre de  $M^\pm$  est inclus dans  $\mathbb{C} \setminus \Omega$ .

L'équation aux valeurs propres de  $M$  s'écrit, pour  $\lambda$  une valeur propre et  $\varphi$  une fonction propre associée,

$$\lambda\varphi = -a'\varphi + (b - a')\varphi' + (b + c')\varphi'' + c\varphi'''. \quad (13)$$

En notant  $\phi = (\varphi', \varphi'', \varphi''')^T$ , on récrit (13) comme un système dynamique du premier ordre à coefficients variables

$$\phi' = \begin{pmatrix} 0 & 1 & 0 \\ 0 & 0 & 1 \\ \frac{\lambda + a'}{c} & \frac{a - b'}{c} & -\frac{b + c'}{c} \end{pmatrix} \phi =: \mathbb{A}(\lambda, x)\phi. \quad (14)$$

Les matrices  $\mathbb{A}$  sont analytiques en  $\lambda$  et régulières en  $x$ , et leurs limites en  $x$  en  $\pm\infty$  s'écrivent

$$\mathbb{A}^\pm(\lambda) = \begin{pmatrix} 0 & 1 & 0 \\ 0 & 0 & 1 \\ \frac{\lambda}{c^\pm} & \frac{a^\pm}{c^\pm} & -\frac{b^\pm}{c^\pm} \end{pmatrix}.$$

**Lemme 4.2.1**

*Si  $\lambda$  est de partie réelle strictement positive, les matrices  $\mathbb{A}^\pm(\lambda)$  ont deux valeurs propres de partie réelle négative, que l'on notera  $\mu_1^\pm(\lambda)$  et  $\mu_2^\pm(\lambda)$ , et une valeur propre réelle positive, que l'on notera  $\mu_3^\pm(\lambda)$ .*

**Preuve**

Comme  $\mathbb{A}^\pm$  sont des matrices de Frobenius, on sait que leurs polynômes caractéristiques sont

$$P_\lambda^\pm(\mu) = c^\pm \mu^3 + b^\pm \mu^2 - a^\pm \mu - \lambda$$

et que le vecteur propre associé à une valeur propre  $\mu$  s'écrit  $(1, \mu, \mu^2)^T$ . Supposons  $\lambda$  réel et positif et notons  $\mu_1^\pm(\lambda)$ ,  $\mu_2^\pm(\lambda)$  et  $\mu_3^\pm(\lambda)$  les racines de  $P_\lambda^\pm$ . Au moins l'une de ces racines est réelle. On omet momentanément la notation  $\pm$  par souci de simplicité. Il y a en fait deux cas :

Cas 1 : Il y a une racine réelle négative que nous appelons  $\mu_1$ . Alors, comme  $\lambda/c$  est positif grâce à (H5), le produit  $\mu_2\mu_3$  est négatif et on note  $\mu_2$  la racine négative et  $\mu_3$  la racine positive.

Cas 2 : Il y a une racine réelle positive que nous appelons  $\mu_3$ . Alors  $\mu_1\mu_2$  est positif.

Cas 2.1 : Si  $\mu_1$  et  $\mu_2$  sont réelles, elles ont même signe. Mais  $\mu_1 + \mu_2 + \mu_3 = -b/c$ , donc si  $\mu_1$  et  $\mu_2$  sont positives, il y a contradiction. Les racines  $\mu_1$  et  $\mu_2$  sont donc négatives.

Cas 2.2 : Si  $\mu_1$  et  $\mu_2$  ne sont pas réelles, elles sont conjuguées et ont donc la même partie réelle. Comme  $\mu_1 + \mu_2 + \mu_3 = 2\text{Re}(\mu_1) + \mu_3 = -b/c$ , on en conclut que  $\text{Re}(\mu_1) < 0$ .

Par conséquent, il y a toujours deux valeurs propres  $(\mu_1, \mu_2)$  de partie réelle négative et une racine réelle positive ( $\mu_3$ ). Par continuité de l'ensemble des racines de  $P$  par rapport au paramètre  $\lambda$ , on en conclut que si  $\lambda \in \Omega$ ,  $P_\lambda$  a exactement deux racines de partie réelle négative et une racine réelle positive.

□

Soit  $\lambda \in \Omega$ . Comme  $P_\lambda$  n'a pas de racine dans  $i\mathbb{R}$ , l'espace stable (resp. instable) de  $\mathbb{A}^\pm(\lambda)$ ,  $\mathcal{S}^\pm(\lambda)$  (resp.  $\mathcal{S}^\pm(\lambda)$ ), c'est à dire l'espace caractéristique associé aux valeurs propres de  $\mathbb{A}^\pm$  de partie réelle négative (resp. de partie réelle positive) est de dimension 2 (resp. de dimension 1). En appliquant les résultats de [67], on obtient

$$\text{ind}(\mathbb{A}(\cdot, \lambda)) = \dim(\mathcal{U}^-(\lambda)) - \dim(\mathcal{U}^+(\lambda)) = 0.$$

En conclusion, pour  $\lambda \in \mathbb{C} \setminus \Omega$ ,  $M^\pm - \lambda$  est un opérateur de Fredholm d'indice 0.

□

## 4.2.2 Définition de la fonction d'Evans

Caractérisons tout d'abord l'espace des solutions de (14) tendant vers 0 quand  $x$  tend vers  $-\infty$ , espace dit *instable en*  $-\infty$ .

D'après le lemme 4.2.1, on sait que  $\mu_3^\pm(\lambda)$  est simple. Il y a donc une unique solution  $W$  au système  $Z' = \mathbb{A}^\pm(\lambda)Z$  telle que

1.  $W(\lambda, x) \underset{x \rightarrow -\infty}{\sim} \exp(\mu_3^-(\lambda)x)V_3^-(\lambda)$  avec  $V_3^-(\lambda)$  un vecteur propre de  $\mathbb{A}^-(\lambda)$  associé à  $\mu_3^-(\lambda)$ ,
2.  $\lambda \mapsto V_3^-(\lambda)$  est analytique en  $\lambda$  sur  $\mathcal{U} = \{\text{Re}(\lambda) > 0\}$ .

| en $x = -\infty$ :   |  | $a^- > 0$  |  |
|--|--|--|--|
| $\mu_1^-(0) = m_1^-$   | $\mu_2^-(\lambda) \sim -\frac{\lambda}{a^-}$           | $\mu_2^-(0) = m_2^-$   |  |
| $V_1^-(0) = \begin{pmatrix} 1 \\ m_1^- \\ (m_1^-)^2 \end{pmatrix}$ | $V_2^-(0) = \begin{pmatrix} 1 \\ 0 \\ 0 \end{pmatrix}$ | $V_3^-(0) = \begin{pmatrix} 1 \\ m_2^- \\ (m_2^-)^2 \end{pmatrix}$ |  |

Tab. 1: Comportement asymptotique quand  $x \rightarrow -\infty$  et  $\lambda \rightarrow 0$ 

De plus,  $\overline{V_3^-(\bar{\lambda})}$  est un vecteur propre de  $\mathbb{A}^-(\lambda)$  associé à  $\mu_3^-(\lambda)$  car

$$\mathbb{A}^-(\lambda)\overline{V_3^-(\bar{\lambda})} = \overline{\mathbb{A}^-(\bar{\lambda})V_3^-(\bar{\lambda})} = \mu_3^-(\lambda, \theta)\overline{V_3^-(\bar{\lambda})}.$$

Par conséquent, pour des  $\lambda$  réels positifs, on peut toujours choisir un vecteur propre  $V_3^-(\lambda)$ , associé à  $\mu_3^-(\lambda)$ , dans  $\mathbb{R}^3$ .

Caractérisons maintenant l'espace *stable en*  $+\infty$ , c'est à dire l'espace des solutions de (14) tendant vers 0 en  $+\infty$ . Pour cela, on étudie le système

$$(X \wedge Y)' = \mathbb{A}_{[2]}^+(\lambda)(X \wedge Y) := (\mathbb{A}^+(\lambda)X) \wedge Y + X \wedge (\mathbb{A}^+(\lambda)Y)$$

de la même façon, car  $\mathbb{A}_{[2]}^+$  a une unique valeur propre de plus petite partie réelle,  $\mu_{[2]}^+(\lambda) = \mu_1^+(\lambda) + \mu_2^+(\lambda)$ . Par conséquent, il y a une unique solution  $\eta(\lambda, x) \in \Lambda^2(\mathbb{C}^3)$  telle que

$$\eta(\lambda, x) \underset{x \rightarrow +\infty}{\sim} e^{\mu^+(\lambda)x} \eta^+(\lambda),$$

avec  $\eta^+(\lambda)$  un vecteur propre de  $\mathbb{A}_{[2]}^+$  associé à  $\mu_{[2]}^+(\lambda)$ ,  $\eta^+(\lambda)$  analytique sur  $\mathcal{U}$ . Considérons un nombre  $\lambda$  réel positif. Comme  $\mu_1^+(\lambda)$  et  $\mu_2^+(\lambda)$  sont réelles ou conjuguées,  $\mu_{[2]}^+(\lambda)$  est réelle et négative. On peut donc choisir  $\eta^+(\lambda)$  à composantes réelles pour  $\lambda$  réel.

On définit la fonction d'Evans comme

$$D(\lambda) := g(x)(\eta(\lambda, x) \wedge W(\lambda, x)),$$

avec  $g$  telle que  $D$  ne dépende que de  $\lambda$ . La fonction  $D$  est analytique sur  $\mathcal{U}$ , s'annule si et seulement si  $\lambda$  est valeur propre de  $M$  du fait que le spectre essentiel de  $M$  étant contenu dans  $\mathbb{C} \setminus \Omega$  (Proposition 4.2.1), et peut être choisie à valeurs réelles si  $\lambda$  est réel.

**Remarque 4.2.1** Si  $M$  n'a pas de valeur propre sur  $\mathbb{R}^{+*}$ , alors nécessairement  $D$  ne s'annule pas sur  $\mathbb{R}^{+*}$  et elle a le même signe au voisinage de 0 et de  $+\infty$ .

### 4.3 Etude de la fonction d'Evans au voisinage de 0

En  $\lambda = 0$ , les valeurs propres de  $\mathbb{A}^\pm(0)$  sont  $\{0, m_1^\pm, m_2^\pm\}$ , avec  $c^\pm(m_k^\pm)^2 + b^\pm m_k^\pm - a^\pm = 0$ , pour  $k \in \{1, 2\}$ . On choisit de prendre  $\text{Re}(m_1^\pm) < 0$  et  $\text{Re}(m_2^\pm) > 0$ . Soit  $V_k^\pm$  un vecteur propre de  $\mathbb{A}^\pm(0)$  associé à la valeur propre  $\mu_k^\pm$ , pour  $k \in \{1, 2\}$ . Le comportement asymptotique de  $V_k^\pm$  et de  $\mu_k^\pm$  au voisinage de  $\lambda$  est résumé dans les tableaux 1 et 2. Grâce

| en $x = +\infty$ :   |  | $a^+ > 0$  |  |
|--|--|--|--|
| $\mu_1^+(0) = m_1^+$   | $\mu_2^+(\lambda) \sim -\frac{\lambda}{a^+}$           | $\mu_2^+(0) = m_2^+$   |  |
| $V_1^+(0) = \begin{pmatrix} 1 \\ m_1^+ \\ (m_1^+)^2 \end{pmatrix}$ | $V_2^+(0) = \begin{pmatrix} 1 \\ 0 \\ 0 \end{pmatrix}$ | $V_3^+(0) = \begin{pmatrix} 1 \\ m_2^+ \\ (m_2^+)^2 \end{pmatrix}$ |  |

Tab. 2: Comportement asymptotique quand  $x \rightarrow +\infty$  et  $\lambda \rightarrow 0$ 

au Gap Lemma [24], on définit trois fonctions  $\phi_1, \phi_2, \phi_3$ , dépendant de  $\lambda$  (analytiquement) et de  $x$ , solutions de (14) et qui se comportent de la façon suivante

$$\phi_1(\lambda, x) \underset{x \rightarrow +\infty}{=} \exp(\mu_1^+(\lambda)x) (V_1^+(\lambda) + O(e^{-\gamma|x|})), \quad (15)$$

$$\phi_2(\lambda, x) \underset{x \rightarrow +\infty}{=} \exp(\mu_2^+(\lambda)x) (V_2^+(\lambda) + O(e^{-\gamma|x|})), \quad (16)$$

$$\phi_3(\lambda, x) \underset{x \rightarrow -\infty}{=} \exp(\mu_3^-(\lambda)x) (V_3^-(\lambda) + O(e^{-\gamma|x|})), \quad (17)$$

avec  $\gamma$  une constante positive. Grâce au Gap Lemma [24], on prolonge la fonction d'Evans  $D$  à un voisinage  $\mathcal{V}$  de  $\lambda = 0$ , et on l'écrit comme

$$D : \Omega \cup \mathcal{V} \rightarrow \mathbb{C}$$

$$\begin{aligned} \lambda \mapsto D(\lambda) &= \exp\left(-\int_0^x \text{tr}(\mathbb{A}(\lambda, s)) ds\right) \det(\phi_1(\lambda, x), \phi_2(\lambda, x), \phi_3(\lambda, x)) \\ &= g(x) \det(\phi_1(\lambda, x), \phi_2(\lambda, x), \phi_3(\lambda, x)) \end{aligned}$$

avec

$$g : x \mapsto \exp\left(-\int_0^x \frac{b(s)}{c(s)} ds\right).$$

Par ailleurs, on remarque que

$$\begin{pmatrix} \bar{u}'' \\ \bar{u}''' \\ \bar{u}'''' \end{pmatrix} = \mathbb{A}(x, 0) \begin{pmatrix} \bar{u}' \\ \bar{u}'' \\ \bar{u}''' \end{pmatrix},$$

et, comme  $\bar{u}^{(d)}$  décroît exponentiellement vers 0 en  $\pm\infty$  pour  $d \in \mathbb{N}$ , on choisit donc, en  $\lambda = 0$ ,

$$\phi_1(0, \cdot) = \phi_3(0, \cdot) = \begin{pmatrix} \bar{u}' \\ \bar{u}'' \\ \bar{u}''' \end{pmatrix},$$

d'après le comportement décrit en (15) et (17). De plus, on oriente  $V_1^+(0)$  comme la limite de  $(\bar{u}', \bar{u}'', \bar{u}''')^T$  quand  $x$  tend vers  $+\infty$ . Comme l'intersection de  $S^+(0)$  et de  $U^-(0)$  contient  $\phi_1$ ,  $D$  s'annule en 0. Or, on veut étudier le signe de  $D$  au voisinage de 0 (voir Remarque 4.2.1), et il nous faut par conséquent calculer la dérivée de  $D$  en  $\lambda = 0$  au moyen des techniques développées dans [24, 4] :

$$\begin{aligned} D'(0) &= g \cdot \det\left(\frac{\partial \phi_1}{\partial \lambda} \Big|_{\lambda=0}, \phi_2, \phi_3\right) + \left(\phi_1, \phi_2, \frac{\partial \phi_3}{\partial \lambda} \Big|_{\lambda=0}\right) \\ &= g \cdot \left(\phi_1, \phi_2, \left(\frac{\partial \phi_3}{\partial \lambda} - \frac{\partial \phi_1}{\partial \lambda}\right) \Big|_{\lambda=0}\right). \end{aligned}$$



Notons  $z_k := \partial\phi_k/\partial\lambda$  pour  $k \in \{1, 3\}$ . Les dérivées  $z_k$ ,  $k \in \{1, 3\}$ , sont solutions de

$$z' = \mathbb{A}(\lambda, x)z + \begin{pmatrix} 0 & 0 & 0 \\ 0 & 0 & 0 \\ c^{-1} & 0 & 0 \end{pmatrix} \phi_1, \quad (18)$$

Par ailleurs, en notant  $\phi_k = (u_k, u'_k, u''_k)^T$ ,  $k \in \{1, 2, 3\}$ , avec  $u_k$  solution de  $Mu_k = 0$ , on a

$$(cu''_k)' + (bu'_k)' - (au_k)' = 0. \quad (19)$$

On intègre (19) entre  $-\infty$  et  $x$  et on obtient

$$c(x)u''_k(x) + b(x)u'_k(x) - a(x)u_k(x) + M_k = 0,$$

avec  $M_k$  une constante. Grâce à (15) et (17), on trouve  $M_1 = M_3 = 0$ . Comme  $u_2$  tend vers  $a^+$  quand  $x$  tend vers  $+\infty$ ,  $M_2 = a^+$ . Par conséquent, on récrit maintenant  $\phi_k$  comme

$$\begin{aligned} \phi_1 = \phi_3 &= \begin{pmatrix} 1 & 0 & 0 \\ 0 & 1 & 0 \\ \frac{a}{c} & -\frac{b}{c} & 1 \end{pmatrix} \begin{pmatrix} \bar{u}' \\ \bar{u}'' \\ 0 \end{pmatrix} =: \mathbb{B} \begin{pmatrix} \bar{u}' \\ \bar{u}'' \\ 0 \end{pmatrix}, \\ \phi_2 &= \mathbb{B} \begin{pmatrix} u_2 \\ u'_2 \\ 0 \end{pmatrix} + \begin{pmatrix} 0 \\ 0 \\ -\frac{a^+}{c} \end{pmatrix}. \end{aligned}$$

Notons à présent  $z_k = (p_k, p'_k, p''_k)^T$ , pour  $k \in \{1, 3\}$ . De même que pour  $u_k$ ,  $p_k$  est solution de

$$(cp''_k)' + (bp'_k)' - (ap_k)' - \bar{u}' = 0. \quad (20)$$

Pour  $k = 1$  (resp. pour  $k = 3$ ), on intègre (20) entre  $x$  et  $+\infty$  (resp.  $-\infty$  et  $x$ ) et on trouve

$$c(x)p''_1(x) + b(x)p'_1(x) - a(x)p_1(x) - (\bar{u}(x) - u^+) = 0$$

(resp.

$$c(x)p''_3(x) + b(x)p'_3(x) - a(x)p_3(x) - (\bar{u}(x) - u^-) = 0.)$$

En reformulant ces équations en terme de  $z_k$ , on obtient

$$\begin{aligned} z_1 &= \mathbb{B} \begin{pmatrix} p_1 \\ p'_1 \\ 0 \end{pmatrix} + \begin{pmatrix} 0 \\ 0 \\ \frac{\bar{u} - u^+}{c} \end{pmatrix}, \\ z_3 &= \mathbb{B} \begin{pmatrix} p_3 \\ p'_3 \\ 0 \end{pmatrix} + \begin{pmatrix} 0 \\ 0 \\ \frac{\bar{u} - u^-}{c} \end{pmatrix}. \end{aligned}$$

On introduit ces expressions dans  $D'$  et on trouve

$$\begin{aligned}
D'(0) &= g \cdot \det \left( \mathbb{B} \begin{pmatrix} \bar{u}' \\ \bar{u}'' \\ 0 \end{pmatrix}, \mathbb{B} \begin{pmatrix} u_2 \\ u_2' \\ -\frac{a^+}{c} \end{pmatrix}, \mathbb{B} \begin{pmatrix} p_3 - p_1 \\ p_3' - p_1' \\ \frac{[u]}{c} \end{pmatrix} \right) \\
&= g \cdot \begin{vmatrix} \bar{u}' & u_2 & p_3 - p_1 \\ \bar{u}'' & u_2' & p_3' - p_1' \\ 0 & -\frac{a^+}{c} & \frac{[u]}{c} \end{vmatrix}, \quad (\text{car } \det(\mathbb{B}) = 1), \\
&= \frac{g}{c} \cdot \begin{vmatrix} \bar{u}' & [u]u_2 + a^+(p_3 - p_1) \\ \bar{u}'' & [u]u_2' + a^+(p_3' - p_1') \end{vmatrix}
\end{aligned}$$

avec  $[u] := u^+ - u^-$ .

En notant  $\tilde{z}_3 = a^+(p_3, p_3')^T$ ,  $\tilde{z}_1 = a^+(p_1, p_1')^T - [u](u_2, u_2')^T$  et  $\tilde{\phi}_1 = (\bar{u}', \bar{u}'')^T$ , on obtient

$$D'(0) = c^{-1} \det(\tilde{\phi}_1, (\tilde{z}_3 - \tilde{z}_1)).$$

Comme  $\tilde{\phi}_1$  tend vers 0 quand  $x$  tend vers  $\pm\infty$  et que  $\tilde{z}_3$  tend vers 0 quand  $x$  tend vers  $-\infty$ , on a

$$\det(\tilde{\phi}_1(x), \tilde{z}_3(x)) \xrightarrow{x \rightarrow -\infty} 0. \quad (21)$$

De plus,  $(u_2, v_2)^T$  tend vers  $(1, 0)^T$  quand  $x$  tend vers  $+\infty$ , donc  $\tilde{z}_1$  est borné sur  $\mathbb{R}^+$  et

$$\det(\tilde{\phi}_1, \tilde{z}_1) \xrightarrow{x \rightarrow +\infty} 0. \quad (22)$$

Sachant que

$$\begin{pmatrix} p_3' \\ p_3'' \end{pmatrix} = \mathbb{G} \begin{pmatrix} p_3 \\ p_3' \end{pmatrix} + \begin{pmatrix} 0 \\ \frac{\bar{u} - u^-}{c} \end{pmatrix},$$

avec

$$\mathbb{G} := \begin{pmatrix} 0 & 1 \\ \frac{a}{c} & -\frac{b}{c} \end{pmatrix}$$

on trouve

$$\tilde{z}_3' = \mathbb{G}\tilde{z}_3 + \begin{pmatrix} 0 \\ \frac{a^+}{c}(\bar{u} - u^-) \end{pmatrix}.$$

De même, comme

$$\begin{pmatrix} p_1' \\ p_1'' \end{pmatrix} = \mathbb{G} \begin{pmatrix} p_1 \\ p_1' \end{pmatrix} + \begin{pmatrix} 0 \\ \frac{\bar{u} - u^+}{c} \end{pmatrix}$$

et

$$\begin{pmatrix} u_2' \\ u_2'' \end{pmatrix} = \mathbb{G} \begin{pmatrix} u_2 \\ u_2' \end{pmatrix} + \begin{pmatrix} 0 \\ -\frac{a^+}{c} \end{pmatrix},$$

on obtient

$$\tilde{z}'_1 = \mathbb{G}\tilde{z}_1 + \begin{pmatrix} 0 \\ \frac{a^+}{c}(\bar{u} - u^-) \end{pmatrix}.$$

Donc  $\tilde{z}_1$  et  $\tilde{z}_3$  satisfont à l'équation différentielle

$$\tilde{z}' = \mathbb{G}\tilde{z} + \begin{pmatrix} 0 \\ \frac{a^+}{c}(\bar{u} - u^-) \end{pmatrix}.$$

La fonction définie par  $\Delta := \det(\tilde{\phi}_1, \tilde{z}_3)$  satisfait

$$\begin{aligned} \Delta' &= \det(\mathbb{G}\tilde{\phi}_1, \tilde{z}_3) + \det(\tilde{\phi}_1, \mathbb{G}\tilde{z}_3) + \det\left(\tilde{\phi}_1, \begin{pmatrix} 0 \\ \frac{a^+}{c}(\bar{u} - u^-) \end{pmatrix}\right) \\ &= \operatorname{tr}(\mathbb{G})\Delta + \frac{a^+}{c}\bar{u}'(\bar{u} - u^-) \\ &= -\frac{b}{c}\Delta + \frac{a^+}{c}\bar{u}'(\bar{u} - u^-). \end{aligned}$$

En utilisant (21), on applique le principe de Duhamel de  $-\infty$  à  $0$  :

$$\begin{aligned} \Delta(0) &= \lim_{y \rightarrow -\infty} \left[ \exp\left(\int_y^0 -\frac{b(s)}{c(s)} ds\right) \det(\tilde{\phi}_1(y), \tilde{z}_3(y)) \right. \\ &\quad \left. + \int_y^0 \exp\left(-\int_t^0 \frac{b(s)}{c(s)} ds\right) \bar{u}'(t)(\bar{u}(t) - u^-) dt \right]. \end{aligned}$$

Mais, étant donné que l'espace instable en  $-\infty$  est de dimension 2, on a

$$|\tilde{\phi}_1(y)|_{y \rightarrow -\infty} \sim e^{m_2^- y}$$

et

$$\exp\left(\int_y^0 -\frac{b(s)}{c(s)} ds\right)_{y \rightarrow -\infty} \sim \exp(-(m_1^- + m_2^-)y).$$

Par conséquent,

$$\exp\left(\int_y^0 -\frac{b(s)}{c(s)} ds\right) \tilde{\phi}_1(y) \wedge \tilde{z}_3(y) \xrightarrow{y \rightarrow -\infty} 0.$$

En conclusion,

$$\Delta(0) = \int_{-\infty}^0 \exp\left(-\int_t^0 \frac{b(s)}{c(s)} ds\right) \bar{u}'(t)(\bar{u}(t) - u^-) dt.$$

De même,

$$\det(\tilde{\phi}_1, \tilde{z}_1)(0) = \int_{-\infty}^0 \exp\left(-\int_t^0 \frac{b(s)}{c(s)} ds\right) \bar{u}'(t)(\bar{u}(t) - u^-) dt.$$

Le signe de  $D'(0)$  et donc de  $D$  au voisinage de  $\lambda = 0$  est donné par

$$\operatorname{sgn}(D'(0)) = \operatorname{sgn}\left(\int_{-\infty}^{+\infty} \exp\left(-\int_t^0 \frac{b(s)}{c(s)} ds\right) \bar{u}'(t)(\bar{u}(t) - u^-) dt\right).$$

**Remarque 4.3.1** *L'intégrale présente dans l'expression est une intégrale de Melnikov [24].*

#### 4.4 Etude du signe de la fonction d'Evans au voisinage de $+\infty$

Etant donné l'orientation des vecteurs propres de  $\mathbb{A}^\pm(\lambda)$  choisie au voisinage de  $\lambda = 0$ , on a le théorème suivant

**Proposition 4.4.1**

*Il existe  $\Lambda$  positif tel que pour tout  $\lambda > \Lambda$ , la fonction d'Evans  $D$  soit toujours positive.*

**Preuve**

On va utiliser la méthode d'homotopie développée par S. Benzoni, D. Serre et K. Zumbrun dans [4].

Pour  $\theta \in [0, 1]$ , on définit l'opérateur  $M_\theta v := -(a_\theta(x)v)_x + (b_\theta(x)v_x)_x + (c_\theta(x)v_{xx})_x$ , avec

$$\begin{aligned} a_\theta &: x \mapsto \theta a(x), \\ b_\theta &: x \mapsto \theta b(x), \\ c_\theta &: x \mapsto \theta c(x) + (1 - \theta)c_0, \quad c_0 \text{ fixé.} \end{aligned}$$

Prouvons tout d'abord que, pour  $\lambda$  assez grand, on a le lemme suivant

**Lemme 4.4.1**

*Il existe  $\Lambda > 0$  tel que  $\forall \lambda \in ]\Lambda, +\infty[$ ,  $\forall \theta \in [0, 1]$ ,  $M_\theta - \lambda$  n'a pas de valeur propre.*

**Preuve**

On ne considère dans cette preuve que des nombres  $\lambda$  réels positifs. Raisonnons par l'absurde :

soit  $\lambda \in \mathbb{R}_*^+$  une valeur propre de  $M_\theta$  et  $v$  une fonction propre réelle associée, qui satisfont

$$-(a_\theta v)_x + (b_\theta v_x)_x + (c_\theta v_{xx})_x = \lambda v. \quad (23)$$

Le produit scalaire dans  $L^2(\mathbb{R})$  de (23) et de  $v$  suivi d'une intégration par parties donne

$$\begin{aligned} \lambda(v, v) &= \theta(av, v') - \theta(bv', v') - \theta(cv'', v') \\ &= -\theta \int_{-\infty}^{+\infty} a' \frac{v^2}{2} - \theta \int_{-\infty}^{+\infty} b v'^2 + \theta \int_{-\infty}^{+\infty} c' \frac{v'^2}{2} \\ &\leq \left\| \frac{a'}{2} \right\|_{\infty} \|v\|^2 + \left\| \frac{c'}{2} - b \right\|_{\infty} \|v'\|^2. \end{aligned}$$

De plus, comme  $\|v'\|^2 \leq \|v\| \|v''\|$ , on a

$$\lambda \|v\|^2 \leq \left\| \frac{a'}{2} \right\|_{\infty} \|v\|^2 + \left\| \frac{a'}{2} - b \right\|_{\infty} \|v\| \|v''\|. \quad (24)$$

En prenant cette fois-ci le produit scalaire dans  $L^2$  de (23) et de  $v'$  et en intégrant par parties, on trouve

$$0 = \theta \int_{-\infty}^{+\infty} a v v'' - \theta \int_{-\infty}^{+\infty} b v' v'' - \theta \int_{-\infty}^{+\infty} c v''^2 - (1 - \theta)c_0 \int_{-\infty}^{+\infty} v''^2,$$

qui entraîne

$$\begin{aligned} c_0 \|v''\|^2 &\leq -\theta \int_{-\infty}^{+\infty} a v'^2 + \theta \int_{-\infty}^{+\infty} a' \frac{v^2}{2} + \theta \int_{-\infty}^{+\infty} b' \frac{v'^2}{2} \\ &\leq \left\| \frac{b'}{2} - a \right\|_{\infty} \|v'\|^2 + \left\| \frac{a'}{2} \right\|_{\infty} \|v\|^2 \\ &\leq \left\| \frac{b'}{2} - a \right\|_{\infty} \|v\| \|v''\| + \left\| \frac{a'}{2} \right\|_{\infty} \|v\|^2. \end{aligned}$$

La variable  $h = \|v''\|/\|v\|$  satisfait à l'inéquation

$$c_0 h^2 \leq \left\| \frac{b'}{2} - a \right\|_{\infty} h + \left\| \frac{a'}{2} \right\|_{\infty},$$

c'est à dire que  $h$ , qui est positif, est inférieur à  $h_0$ , avec  $h_0$  la solution positive de

$$c_0 h_0^2 - \left\| \frac{b'}{2} - a \right\|_{\infty} h_0 - \left\| \frac{a'}{2} \right\|_{\infty} = 0.$$

Donc (24) implique

$$\lambda \|v\|^2 \leq \left\| \frac{a'}{2} \right\|_{\infty} \|v\|^2 + \left\| \frac{c'}{2} - b \right\|_{\infty} h_0 \|v\|^2,$$

et on choisit  $\Lambda = \left\| \frac{a'}{2} \right\|_{\infty} + \left\| \frac{c'}{2} - b \right\|_{\infty} h_0$ .

□

Définissons à présent une fonction d'Evans étendue à la bande  $\mathbb{R}^+ \times [0, 1]$ .

Soit  $\lambda \in \Omega$ . Le système dynamique associé à l'équation aux valeurs propres (24) est similaire à celui qu'on a étudié précédemment (14) :

$$W' = \begin{pmatrix} 0 & 1 & 0 \\ 0 & 0 & 1 \\ \frac{\lambda + \theta a'}{\theta c + (1 - \theta)c_0} & \theta \frac{a - b'}{\theta c + (1 - \theta)c_0} & -\theta \frac{b + c'}{\theta c + (1 - \theta)c_0} \end{pmatrix} W =: \mathbb{A}(\lambda, \theta, x)W. \quad (25)$$

De même que lors de l'étude des valeurs propres et vecteurs propres de  $\mathbb{A}^{\pm}(\lambda)$ , on trouve que  $\mathbb{A}^{\pm}(\lambda, \theta)$  a toujours deux valeurs propres de partie réelle négative, que l'on appelle  $\mu_1^{\pm}(\lambda, \theta)$  et  $\mu_2^{\pm}(\lambda, \theta)$ , et une valeur propre réelle positive, notée  $\mu_3^{\pm}(\lambda, \theta)$ . On fait la même étude des espaces stables et instables qu'au paragraphe 4.2.2 :

1. comme  $\mu_3^{\pm}(\lambda, \theta)$  est simple, il y a une unique solution  $W$  au système  $Z' = \mathbb{A}^{\pm}(\lambda, \theta)Z$  telle que

$$W(\lambda, \theta, x) \underset{x \rightarrow -\infty}{\sim} \exp(\mu_3^-(\lambda, \theta)x) V_3^-(\lambda, \theta)$$

avec  $V_3^-(\lambda, \theta)$  un vecteur propre de  $\mathbb{A}^-(\lambda, \theta)$  associé à  $\mu_3^-(\lambda, \theta)$  et  $\lambda \mapsto V_3^-(\lambda, \theta)$  est analytique en  $\lambda$  sur  $\mathcal{U} \cup \mathcal{V}$  avec les notations des paragraphes 4.2.2 et 4.3 et peut être choisi réel pour  $\lambda$  réel,

2. comme  $\mathbb{A}_{[2]}^+$  a une unique valeur propre de plus petite partie réelle,  $\mu_{[2]}^+(\lambda, \theta) = \mu_1^+(\lambda, \theta) + \mu_2^+(\lambda, \theta)$ , il y a une unique solution  $\eta(\lambda, \theta) \in \Lambda^2(\mathbb{C}^3)$  telle que

$$\eta(\lambda, \theta, x) \underset{x \rightarrow +\infty}{\sim} e^{\mu^+(\lambda, \theta)x} \eta^+(\lambda, \theta),$$

avec  $\eta^+(\lambda, \theta)$  un vecteur propre, analytique en  $\lambda$  sur  $\mathcal{U} \cup \mathcal{V}$ , de  $\mathbb{A}_{[2]}^+$  associé à  $\mu_{[2]}^+(\lambda, \theta)$ , et qui peut être choisi à valeurs réelles pour  $\lambda$  réel.

On définit à présent une fonction d'Evans étendue

$$\tilde{D}(\lambda, \theta) := \tilde{g}(x)(\eta(\lambda, \theta, x) \wedge W(\lambda, \theta, x)),$$

avec  $\tilde{g}$  choisie de telle sorte que  $\tilde{D}$  ne dépende pas de  $x$ .

Comme  $M_\theta$  n'a pas de valeurs propres dans la bande  $[0, 1] \times ]\Lambda, +\infty[$  (lemme 4.4.1), on obtient

$$\text{sgn}(D(+\infty)) = \text{sgn}(\tilde{D}(1, +\infty)) = \text{sgn}(\tilde{D}(0, +\infty)) = \text{sgn}(\tilde{D}(0, \lambda)), \text{ with } \lambda > \Lambda.$$

Par ailleurs, comme  $W(\lambda, 0, x) = \exp(x\sqrt[3]{\lambda/c_0})V_3^-(0, \lambda)$  et  $\eta(x, 0, \lambda) = \exp(-x\sqrt[3]{\lambda/c_0})\eta^-(0, \lambda)$ , on a  $\text{sgn}(\tilde{D}(0, \lambda)) = \text{sgn}(\eta^+(0, \lambda) \wedge V_3^-(0, \lambda))$ , pour  $\lambda > \Lambda$ .

On choisit à présent les vecteurs

$$\begin{pmatrix} 1 \\ \text{Re}(\mu_1^+(\lambda, \theta)) \\ \text{Re}(\mu_1^+(\lambda, \theta)^2) \end{pmatrix} \text{ et } \begin{pmatrix} 0 \\ 1 \\ \mu_2^+(\lambda, \theta) \end{pmatrix}$$

comme base holomorphe de  $S^+(\lambda, \theta)$  par rapport à  $\lambda$ . Mais, comme,  $\mu_1^+(\lambda, \theta)$  et  $\mu_2^+(\lambda, \theta)$  sont les racines de  $P_{\lambda, \theta}(\mu)/(\mu - \mu_3^+(\lambda, \theta))$ , on note  $\mu_k^{+2} = \alpha\mu_k + \beta$ ,  $k \in \{1, 2\}$ , où  $P_{\lambda, \theta}$  est le polynôme caractéristique de  $\mathbb{A}^\pm(\lambda, \theta)$  et les nombres  $\alpha$  et  $\beta$  dépendent de  $\mu_3^+(\lambda, \theta)$ ,  $a^+$ ,  $b^+$ ,  $c^+$ ,  $c_0$ ,  $\theta$  et  $\lambda$ .

Par conséquent, on obtient

$$\text{sgn}(\tilde{D}(\lambda, \theta)) = \text{sgn} \left( \det \begin{pmatrix} 1 & 0 & 1 \\ \text{Re}(\mu_1^+) & 1 & \mu_3^- \\ \text{Re}(\mu_1^{+2}) & \mu_1^+ + \mu_2^+ & (\mu_3^-)^2 \end{pmatrix} \right).$$

Nous avons choisi les bases de vecteurs propres de  $\mathbb{A}^\pm(\lambda)$  continûment par rapport à  $\lambda$  le long de l'axe réel de façon à ce que l'orientation de ces bases ne soit pas modifiée. Or, pour  $\theta = 0$ , on a  $\mu_1^+(\lambda, 0) = j\sqrt[3]{\frac{\lambda}{c_0}}$ ,  $\mu_2^+(\lambda, 0) = j^2\sqrt[3]{\frac{\lambda}{c_0}}$  et  $\mu_3^-(\lambda, 0) = \sqrt[3]{\frac{\lambda}{c_0}}$ . On en conclut donc

$$\begin{aligned} \text{sgn}(\tilde{D}(\lambda, 0)) &= \text{sgn} \left( \det \begin{pmatrix} 1 & 0 & 1 \\ -\frac{1}{2}\sqrt[3]{\frac{\lambda}{c_0}} & 1 & \sqrt[3]{\frac{\lambda}{c_0}} \\ -\frac{1}{2}\sqrt[2/3]{\frac{\lambda}{c_0}} & -\sqrt[3]{\frac{\lambda}{c_0}} & \sqrt[2/3]{\frac{\lambda}{c_0}} \end{pmatrix} \right) \\ &= 3\sqrt[2/3]{\frac{\lambda}{c_0}}. \end{aligned}$$

Par homotopie, la fonction d'Evans  $D(\lambda)$  est donc strictement positive pour  $\lambda > \Lambda$ .

□

Troisième partie

APPROXIMATIONS EN VARIABLE D'ESPACE DISCRÈTE :  
SCHÉMAS NUMÉRIQUES DE LAX-WENDROFF ET DE  
LAX-FRIEDRICHS MODIFIÉ

# 1. CONDITION NÉCESSAIRE DE STABILITÉ SPECTRALE DE PROFILS STATIONNAIRES DU SCHÉMA DE LAX-WENDROFF

L'article suivant a fait l'objet d'une prépublication à l'U.M.P.A.

## 1.1 Introduction

We consider a monodimensional system of conservation laws

$$\begin{aligned} u_t + f(u)_x &= 0, & x \in \mathbb{R}, t \geq 0 \\ u &: \mathbb{R} \times \mathbb{R}^+, & f : \mathcal{U} \rightarrow \mathbb{R}^d, d \geq 1 \end{aligned} \quad (1)$$

where  $\mathcal{U}$  is an open set of  $\mathbb{R}^d$  and  $f$  is a smooth flux. Choosing a regular mesh of  $\mathbb{R}$  consisting of cells  $(jh, (j+1)h]$  of size  $h$ , with  $j \in \mathbb{Z}$  and a time step  $k$ , one obtains the Lax-Wendroff scheme through a Taylor expansion of a (smooth) solution  $u$  of (1), neglecting the terms of order strictly larger than 2. Consequently, the LW scheme is a second-order scheme which reads, for  $n \in \mathbb{N}$  and  $j \in \mathbb{Z}$ ,

$$\begin{aligned} u_j^{n+1} &= u_j^n - \frac{\sigma}{2} (f_{j+1}^n - f_{j-1}^n) + \frac{\sigma^2}{2} (A_{j+1/2}^n (f_{j+1}^n - f_j^n) - A_{j-1/2}^n (f_j^n - f_{j-1}^n)), \\ &:= \mathcal{L}(u^n)_j \end{aligned} \quad (2)$$

where  $u_j^n = u(jh, nk)$ ,  $\sigma = k/h$ ,  $f_j^n = f(u_j^n)$  and  $A_{j+1/2}^n = df((u_{j+1}^n + u_j^n)/2)$ .

### 1.1.1 Assumptions

First of all, we assume that

**H 1** *the strict Courant-Friedrichs-Lewy condition is satisfied*

$$\sigma \sup_{u \in \mathcal{U}} \rho(df(u)) < 1, \quad (3)$$

where  $\rho$  denotes the spectral radius. The CFL condition is equivalent to the fact that the constant states are stable under  $\ell^2$ -perturbations, but it does not necessarily imply the nonlinear stability. From now on, we consider that  $\sigma$  is fixed and, in order to simplify the notations, we rename  $\sigma f$  in  $f$ . We will need the conservative form of the LW scheme : one can rewrite the iteration as

$$u_k^{n+1} = u_k^n - (g(u_k^n, u_{k+1}^n) - g(u_{k-1}^n, u_k^n)), \quad (4)$$



for  $k \in \mathbb{Z}$ ,  $n \in \mathbb{N}$ ,  $g$  being the numerical flux defined as

$$g(a, b) = \frac{1}{2}(f(a) + f(b)) - \frac{1}{2}df\left(\frac{a+b}{2}\right)(f(b) - f(a)).$$

The numerical flux  $g$  is consistent, that is  $g(a, a) = f(a)$ ,  $\forall a \in \mathbb{R}^n$ .

Let  $(u^+, u^-)$  be a stationary discontinuity of (1) satisfying the Rankine-Hugoniot condition

**H 2**  $f(u^+) = f(u^-).$

Following [24, 4, 30], we assume that

**H 3** *system (1) is strictly hyperbolic at  $u_{\pm}$ , that is,  $A_{\pm} := df(u_{\pm})$  has distinct real eigenvalues, that we denote by  $\alpha_1^{\pm} < \dots < \alpha_d^{\pm}$  and we denote by  $r_1^{\pm}, \dots, r_d^{\pm}$  some associated eigenvectors,*

and

**H 4** *the discontinuity is non-characteristic :  $0 \notin \sigma(A_{\pm})$ .*

Let us now assume that

**H 5** *the eigenvalues of  $A_{\pm}$  satisfy*

$$\begin{aligned} \alpha_p^+ &< 0 < \alpha_q^-, \\ \alpha_{q-1}^- &< 0 < \alpha_{p+1}^+, \end{aligned}$$

with  $\delta := p - q \in \{-1, \dots, d - 1\}$ .

If  $\delta = -1$ , the shock  $(u^-, u^+)$  is *undercompressive*, that is  $d$  characteristics enter the shock, and  $d$  outgo from it [71]. If  $\delta = 0$ , we are dealing with a *Lax-shock* ( $d + 1$  entering characteristics,  $d - 1$  outgoing ones) [74, 16]. If  $\delta \geq 1$ , the shock is called *overcompressive* ( $d + \delta$  entering characteristics,  $d - \delta$  outgoing ones) [56, 54, 21].

### 1.1.2 Discrete stationary shock profiles

A stationary discrete shock profile is a sequence  $(v_j)_{j \in \mathbb{Z}}$  satisfying

$$v_j = \mathcal{L}(v)_j, \quad \forall j \in \mathbb{Z}, \tag{5}$$

$$\lim_{j \rightarrow -\infty} v_j = v^-, \quad \lim_{j \rightarrow +\infty} v_j = v^+, \tag{6}$$

the convergence to the end states being geometric.

The existence of discrete shock profiles for first-order schemes was studied by Jennings [41], Majda and Ralston [62] and Liu and Xin [55]. In the case of the LW scheme, the existence of a one-parameter family of weak stationary shock profiles was shown in the scalar case [77]. This result was extended to nonstationary shocks with rational speeds under a weakness assumption to systems of conservation laws by Yu [84]. The existence of shock profiles for irrational speed remains today a widely open field [72], although Liu

and Yu formulated a diophantine condition [57, 58].

We will now study a discrete stationary shock profile  $\bar{v}$  of the lax-Wendroff scheme, noting that, in the particular case of the LW scheme, the sequence  $\bar{v}^0$  that is defined by

$$\begin{aligned}\bar{v}_j^0 &= u^-, \quad j \leq 0, \\ &= u^+, \quad j \geq 1\end{aligned}$$

is a discrete stationary shock profile of (2), thanks to the Rankine Hugoniot condition (H2).

We are interested in the notion of *spectral stability* of the discrete profile  $\bar{v}$ , that is, we say that  $\bar{v}$  is *spectrally stable* if the linearized scheme about  $\bar{v}$  has no spectrum outside the closed unit-ball centered at 0.

Let us linearize the LW scheme about  $\bar{v}$  :

$$\begin{aligned}w_j^{n+1} &= w_j^n - \frac{1}{2} \left[ ((I_d - A_{j+1/2})A_{j+1}w_{j+1}^n + (I_d + A_{j+1/2})A_jw_j^n) \right. \\ &\quad \left. - ((I_d - A_{j-1/2})A_jw_j^n + (I_d + A_{j-1/2})A_{j-1}w_{j-1}^n) \right] \\ &=: (Lw^n)_j,\end{aligned}\tag{7}$$

where

$$\begin{aligned}A_j &:= df(\bar{v}_j) \\ A_{j+1/2} &:= df\left(\frac{\bar{v}_{j+1} + \bar{v}_j}{2}\right).\end{aligned}$$

To ensure that the eigenvalue equation associated with (7) never degenerates to a first-order system,  $(I_d - A_{j+1/2})A_{j+1}$  and  $(I_d + A_{j-1/2})A_{j-1}$  must be invertible for all  $j \in \mathbb{Z}$ . The CFL condition (H1) implies that  $I_d \pm A_{j\pm 1/2}$  is always invertible. We then need the following additional hypothesis

**H 6** for all  $j \in \mathbb{Z}$ ,  $A_j$  is invertible.

Thanks to the Cauchy-Schwarz inequality, it is straightforward to show that the operator  $L : \ell^2(\mathbb{Z}) \rightarrow \ell^2(\mathbb{Z})$  is continuous. The eigenvalue equation  $L\phi = \lambda\phi$  associated with  $\lambda = 1$  is equivalent to

$$G_j \begin{pmatrix} \phi_j \\ \phi_{j+1} \end{pmatrix} = G_{j-1} \begin{pmatrix} \phi_{j-1} \\ \phi_j \end{pmatrix},\tag{8}$$

where

$$G_j := dg(\bar{v}_j, \bar{v}_{j+1}) = \begin{pmatrix} (I_d + A_{j+1/2})A_j & (I_d - A_{j+1/2})A_{j+1} \end{pmatrix}.$$

So, considering the solutions  $\phi$  that tend to 0 at  $+\infty$  or  $-\infty$ , we find that

$$\phi_{j+1} = A_j^{-1}(I_d + A_{j+1/2})^{-1}(I_d - A_{j+1/2})A_{j+1}\phi_j.\tag{9}$$

Assumption (H5) implies that the stable subspace at  $j = +\infty$  (resp. the unstable subspace at  $j = -\infty$ ) of (9), that is the vector space of solutions tending to 0 as  $j$  tends to  $+\infty$  (resp. as  $j$  tends to  $-\infty$ ) is  $p$ -dimensional (resp.  $d - q + 1$ -dimensional). We now define

some notations. There exist  $\phi^1, \dots, \phi^d$  such that we have :  
for  $m \in \{1, \dots, p\}$ ,

$$\begin{aligned} \phi_j^m &\xrightarrow{j \rightarrow +\infty} 0, \\ \lim_{j \rightarrow +\infty} \frac{\phi_j^m}{|\phi_j^m|} &= r_m^+, \end{aligned}$$

and, for  $m \in \{q, \dots, d\}$ ,

$$\begin{aligned} \phi_j^m &\xrightarrow{j \rightarrow -\infty} 0, \\ \lim_{j \rightarrow -\infty} \frac{\phi_j^m}{|\phi_j^m|} &= r_m^-. \end{aligned}$$

### 1.1.3 Main result

The aim of this paper is to prove the following theorem

#### Theorem 1.1.1

Assuming (H1-7) are satisfied, a necessary condition of spectral stability of  $\bar{v}$  is that there exists a large enough  $J \in \mathbb{N}$  such that, for all  $j \geq J$ , the following inequality holds

$$\begin{aligned} (-1)^{\delta-1+j(d+\delta-1)} \cdot \det(\phi_j^1, \dots, \phi_j^p, \phi_j^{q+\delta+1}, \dots, \phi_j^d) \cdot \Theta^\delta(\Sigma_j^0, \dots, \Sigma_j^\delta) \\ \cdot \det(r_1^+, \dots, r_d^+) \cdot \det(r_1^-, \dots, r_d^-) > 0, \end{aligned}$$

the notations being those of Proposition 1.3.1.

The product of the left-side of this inequality is in fact the spectral stability index of  $\bar{v}$ , that is, if it is positive, the linearized operator  $L$  has an even number of eigenvalues in  $(1, +\infty)$  and if it is negative, there is an odd number of eigenvalues in  $(1, +\infty)$ . The Theorem can also be reformulated as a sufficient condition of spectral instability.

These conditions are similar to the ones obtained for continuous approximations, such as viscosity [24, 4], semi-linear relaxation [30] and for the semi-discrete approach [2].

We now give a sketch of the proof of this theorem, that relies mostly on the Evans function method that was developed by Alexander, Gardner and Jones [1], Gardner and Zumbrun [24], Serre and Zumbrun [89] in the multi-dimensional case. The notion of discrete Evans function was introduced for the Lax-Friedrichs scheme by Serre [73], who used a similar method for the Godunov scheme with Bultelle and Grassin [9].

In Section 2, we show that the essential spectrum of  $L$  lies in  $\{\lambda/|\lambda| < 1\} \cup \{1\}$ , that is the only spectrum outside the unit-disc consists of eigenvalues, so that our study of the spectral stability of  $L$  reduces to the eigenvalues of  $L$  of modulus larger than 1. We also rewrite the eigenvalue equation  $Lw = \lambda w$  as a first-order dynamical system

$$W_{j+1} = \mathbb{A}_j(\lambda)W_j \tag{10}$$

and prove that the stable and unstable subspaces of (10) are  $d$ -dimensional, thanks to the geometric dichotomy (Appendix, Section 5), that is parallel to the exponential dichotomy developed by Coppel [14]. We then turn to the construction of the Evans function  $\mathcal{D}(\lambda, j)$ ,

that we define as the determinant of the elements of a basis of the stable subspace at  $j = +\infty$  of (10) and a basis of the unstable subspace at  $j = -\infty$ . Thus,  $\mathcal{D}$  vanishes at points  $\lambda$  that are eigenvalues of  $L$ , the choice of the point  $j \in \mathbb{Z}$  being unimportant, since  $\mathcal{D}(\lambda, j+1) = s_j \mathcal{D}(\lambda, j)$  where  $s$  never vanishes. Besides,  $\mathcal{D}$  is analytic with respect to  $\lambda$  outside the closed unit-disc and can be chosen real-valued for real  $\lambda$ . Consequently, if there is no eigenvalue in  $(1, +\infty)$ ,  $\mathcal{D}$  must have the same sign near  $\lambda = 1$  and in a neighborhood of  $\lambda = +\infty$ . In Section 3, we develop the computation of  $\mathcal{D}$  in a neighborhood of  $\lambda = 1$ . At first, we define  $\mathcal{D}(1, j)$  by continuity. Generically, in the undercompressive case, under the additional assumption

**H 7** *the set  $(r_1^-, \dots, r_p^-, r_{p+1}^+, \dots, r_d^+)$  is a basis of  $\mathbb{R}^d$ ,*

the Evans function does not vanish at  $\lambda = 1$ , so the computation of  $\mathcal{D}(1, j)$  is straightforward. However, in the compressive case,  $\mathcal{D}(1, j)$  vanishes for all  $j \in \mathbb{Z}$ . This situation is similar to the one we have in the continuous case, where  $\lambda = 0$  is always an eigenvalue of the linearized operator, because of the translation invariance : the derivative of the profile is always, even in the undercompressive case, an eigenfunction associated with  $\lambda = 0$ .

In order to derive  $\mathcal{D}$  with respect to  $\lambda$  in a neighborhood of  $\lambda = 1$ , we use the fact that  $\mathcal{D}$  can be extended analytically with respect to  $\lambda$ . We compute the sign of  $\mathcal{D}$  near  $\lambda = +\infty$  in Section 4 thanks to a lemma that allows to describe the solutions of (10) in the form  $(\mu(\lambda)^j \mathbf{V}(\lambda, j))_j$ , where  $\mu(\lambda)$  is an eigenvalue of  $\lim_{j \rightarrow \pm\infty} \mathbb{A}_j(\lambda)$  and  $\mathbf{V}(\lambda, j)$  tends to an eigenvector associated with  $\mu(\lambda)$  when  $j$  tends to  $\pm\infty$ .

## 1.2 Definition of the Evans function

At first, we need to prove that, outside the closed unit-ball, the spectrum of  $L$  consists only of eigenvalues. We define the essential spectrum  $\sigma_{ess}$  of  $L$  as

$$\sigma_{ess}(L) := \mathbb{C} \setminus \{\lambda \in \mathbb{C} / L - \lambda \text{ is a Fredholm operator with index } 0\}.$$

### Proposition 1.2.1

*The operator  $L$  has no essential spectrum in  $\{\lambda \in \mathbb{C}, |\lambda| \geq 1\} \setminus \{1\} =: \mathcal{O}$ .*

### Proof

Let  $\lambda \in \mathcal{O}$ . Let us rewrite the eigenvalue equation  $Lw = \lambda w$  as a discrete dynamical system : denoting  $W_j = (w_j, w_{j+1})^T \in \mathbb{C}^{2n}$ , we obtain

$$\begin{aligned} W_{j+1} &= \begin{pmatrix} 0 & I_d \\ A_{j+1}^{-1} M_j A_{j-1} & A_{j+1}^{-1} (I_d - A_{j+1/2})^{-1} (2(1 - \lambda) I_d - (A_{j-1/2} + A_{j+1/2}) A_j) \end{pmatrix} W_j \\ &=: \mathbb{A}_j(\lambda) W_j, \end{aligned} \tag{11}$$

where

$$M_j := (I_d - A_{j+1/2})^{-1} (I_d + A_{j-1/2}). \tag{12}$$

**Remarks 1.2.1**

1. Note that, thanks to Hypotheses (H1) and (H6), since

$$\det(\mathbb{A}_j(\lambda)) = (-1)^d \det(A_{j+1})^{-1} \det(M_j) \det(A_{j-1}) \quad (13)$$

$\mathbb{A}_j(\lambda)$  is invertible for every  $j \in \mathbb{Z}$ .

2. For a large enough  $j$ , we have  $\text{sgn}(\det(\mathbb{A}_{j+1}(\lambda))) = (-1)^d \text{sgn}(\det(\mathbb{A}_j(\lambda)))$ .

3. The definition of a stationary shock profile implies that there exists  $\omega \in (0, 1)$  such that

$$|\mathbb{A}_j(\lambda) - \mathbb{A}^\pm(\lambda)|_{j \rightarrow \pm\infty} = O(\omega^j). \quad (14)$$

To study the behaviors of the solutions  $W$  of (11), we need the following lemma

**Lemma 1.2.1**

1. The limit-matrices  $\mathbb{A}^\pm(\lambda) := \lim_{j \rightarrow \pm\infty} \mathbb{A}_j(\lambda)$  have no eigenvalue of modulus 1.

2. Moreover, the stable and unstable subspaces of  $\mathbb{A}^\pm(\lambda)$  are  $d$ -dimensional.

**Proof**

1. Let  $\lambda \in \mathbb{C}$  and  $(\mu, (X, Y)^T)$  be an eigenvalue and an associated eigenvector of  $\mathbb{A}^\pm(\lambda)$ . Then,

$$\begin{aligned} \mathbb{A}^\pm(\lambda) \begin{pmatrix} X \\ Y \end{pmatrix} &= \mu \begin{pmatrix} X \\ Y \end{pmatrix} \\ \Leftrightarrow (Y = \mu X, \quad (\mu^2 - 2(A^\pm)^{-1}(I_d - A^\pm)^{-1}((1 - \lambda)I_d - (A^\pm)^2)\mu - M^\pm) Y = 0) \end{aligned}$$

Projecting (15) on the eigenvectors of  $A^\pm$ , we obtain, for at least some  $m$  such that  $1 \leq m \leq d$ ,

$$a_m^\pm(1 - a_m^\pm)\mu^2 - 2(1 - \lambda - (a_m^\pm)^2)\mu - a_m^\pm(1 + a_m^\pm) = 0. \quad (16)$$

Let us recall that, thanks to (H1), we have  $|a_m^\pm| < 1$ . If there exists  $\theta \in \mathbb{R}$  such that, for some  $m \in \{1, \dots, d\}$   $\mu = e^{i\theta}$ , then (16) implies, dropping the subscripts  $m, \pm$  for notational convenience,

$$a(1 - a)e^{i\theta} + 2(1 - \lambda - a^2) - a(1 + a)e^{-i\theta} = 0,$$

that is

$$\lambda = 1 - a^2(1 - \cos(\theta)) - ia \sin(\theta).$$

Consequently,

$$|\lambda|^2 = 1 - a^2(1 - a^2) \sin^4\left(\frac{\theta}{2}\right),$$

so that  $|\lambda| \leq 1$  and

$$|\lambda| = 1 \Leftrightarrow \sin(\theta) = 0,$$

that is  $|\lambda| = 1$  if and only if  $\lambda = 1$ , because of the CFL condition (H1). So if  $\lambda \in \mathcal{O}$ ,  $\mathbb{A}^\pm(\lambda)$  are hyperbolic.

2. Let  $\lambda \in (1, +\infty)$ . Solving (16), we obtain the expressions of the eigenvalues  $\mu$  of  $\mathbb{A}^\pm(\lambda)$  :

$$\mu = \frac{1 - a^2 - \lambda + \varepsilon \lambda \sqrt{1 - \frac{2(1 - a^2)}{\lambda} + \frac{1 - a^2}{\lambda^2}}}{a(1 - a)}, \text{ with } \varepsilon = \pm 1,$$

that is, as  $\lambda$  tends to  $+\infty$ ,

$$\mu = \frac{(\varepsilon - 1)(\lambda - 1 + a^2) + \frac{\varepsilon a^2(1 - a^2)}{2\lambda}}{a(1 - a)} + o\left(\frac{1}{\lambda}\right). \quad (17)$$

In conclusion, as  $\lambda \rightarrow +\infty$ ,

$$|\mu| \sim \frac{|a|(1 + a)}{2\lambda} < 1 \text{ or } |\mu| \sim \frac{2\lambda}{|a|(1 - a)} > 1, \quad (18)$$

that is  $\mathbb{A}^\pm(\lambda)$  have exactly  $n$  eigenvalues of modulus larger than 1 and  $n$  eigenvalues of modulus smaller than 1. Since  $\lambda \mapsto \mathbb{A}^\pm(\lambda)$  are continuous, the continuity of the set of eigenvalues with respect to  $\lambda$  implies that the stable and unstable subspaces of  $\mathbb{A}^\pm(\lambda)$  are  $d$ -dimensional for all  $\lambda \in \mathcal{O}$ .

□

Since the spectra of  $\mathbb{A}^\pm(\lambda)$  do not intersect the unit-circle (Lemma 1.2.1), we can apply Theorem 1.5.1 : the dynamical systems  $W_{j+1} = \mathbb{A}^+ W_j$  (resp.  $W_{j+1} = \mathbb{A}^- W_j$ ) has a geometric dichotomy on  $\mathbb{N}$  of projection  $P^+$  (resp.  $-\mathbb{N}$  of projection  $Q^-$ ). Knowing that  $(\mathbb{A}_j(\lambda))_j$  tend to  $\mathbb{A}^\pm(\lambda)$  as  $j$  tends to  $\pm\infty$ , we use Theorem 1.5.2 and Lemma 1.5.1, so that (11) has a geometric dichotomy on  $\mathbb{N}$  of projection  $P(\lambda)$ , whose range and kernel are  $d$ -dimensional since  $\ker(P(\lambda)) = \ker(P^+)$ . Similarly, (11) has also a geometric dichotomy on  $-\mathbb{N}$  of projection  $Q(\lambda)$ , whose range and kernel are also  $d$ -dimensional. Let

$$E(\lambda) := \left\{ (W_j)_{j \in \mathbb{N}} / (W_j)_{j \in \mathbb{N}} \text{ solves (11) and } W_j \xrightarrow{x \rightarrow +\infty} 0 \right\}, \quad (19)$$

$$E_0(\lambda) := \{W_0, (W_j)_{j \in \mathbb{N}} \in E\},$$

$$F(\lambda) := \left\{ (W_j)_{j \in -\mathbb{N}} / (W_j)_{j \in -\mathbb{N}} \text{ solves (11) and } W_j \xrightarrow{x \rightarrow -\infty} 0 \right\} \quad (20)$$

and

$$F_0(\lambda) := \{W_0, (W_j)_j \in F\}.$$

It is clear that if the intersection of  $E_0$  and  $F_0$  is not zero,  $\lambda$  is an eigenvalue of  $L$ . Assume now that

$$E_0 \cap F_0 = \{0\}.$$

Obviously,

$$R(P(\lambda)) \subset E_0$$

and similarly,

$$\ker(Q(\lambda)) \subset F_0.$$

Since  $\mathbf{R}(P(\lambda))$  and  $\ker(Q(\lambda))$  are  $d$ -dimensional, we obtain

$$\mathbf{R}(P(\lambda)) \oplus \ker(Q(\lambda)) = \mathbb{C}^{2n}.$$

We then apply Theorem 1.5.3 and conclude that (11) has a geometric dichotomy on  $\mathbb{Z}$ . Consequently, Proposition 1.5.4 implies that the equation  $(L - \lambda)w = f$ , where  $f \in \ell^2(\mathbb{Z})$  has a unique solution  $w \in \ell^2(\mathbb{Z})$  and  $f \mapsto w$  is linear and continuous, so that  $\sigma_{ess}(L) \cap \mathcal{O} = \emptyset$ .

□

Let  $\Omega := \{\lambda \in \mathbb{C}/|\lambda| > 1\}$  and  $\lambda \in \Omega$ . Since the stable subspace at  $j = +\infty$  and the unstable subspace at  $j = -\infty$  are  $d$ -dimensional, there exist  $\mathcal{B}_{E(\lambda)}$  and  $\mathcal{B}_{F(\lambda)}$  that are bases respectively of  $E(\lambda)$  (see (19)) and  $F(\lambda)$  (see (20)). These bases can be chosen to be analytical with respect to  $\lambda$ . We define the Evans function  $\mathcal{D}(\lambda, j)$  at the point  $(\lambda, j) \in \Omega \times \mathbb{Z}$  as the determinant of all the elements of both  $\mathcal{B}_{E(\lambda)}$  and  $\mathcal{B}_{F(\lambda)}$  taken at some point  $j \in \mathbb{Z}$ . As all the columns of the determinant are solutions of (11), it is straightforward to see that

$$\mathcal{D}(\lambda, j + 1) = \det(\mathbb{A}_j(\lambda))\mathcal{D}(\lambda, j), \quad (21)$$

so that if  $\mathcal{D}(\lambda, \cdot)$  vanishes for some  $j_0$ , it vanishes for all  $j \in \mathbb{Z}$ , since  $\det(\mathbb{A}_j(\lambda))$  never vanishes (see Remark 1.2.1).

**Remark 1.2.2** *Note that this definition is slightly different from the definition that is usually taken in the continuous case [24, 4, 30], in which the Evans function is actually a Wronskian of the dynamical system associated with the eigenvalue equation of the linearized operator, so that this Evans function does not depend on the continuous space variable unlike ours.*

Since  $L$  has only point spectrum in  $\Omega$  (Proposition 1.2.1), the very definition of  $\mathcal{D}$  implies that it vanishes at points  $\lambda$  where  $E(\lambda)$  and  $F(\lambda)$  have a non-zero intersection, that is when  $\lambda$  is an eigenvalue of the linearized operator  $L$ . The converse is also true, so that the zeros of  $\mathcal{D}(\cdot, j)$  characterize the point spectrum of  $L$  in  $\Omega$ . Note that, for  $\lambda \in \mathbb{R}$ , the matrix  $\mathbb{A}_j(\lambda)$  is real-valued. So we can set on  $\mathcal{D}$  to be also real-valued. Our goal is now to compute the signs of  $\mathcal{D}$  near  $\lambda = 1$  and in a neighborhood of  $\lambda = +\infty$ , so that, thanks to the intermediate value theorem, if  $\bar{v}$  is spectrally stable, or equivalently, if  $L$  has no eigenvalue in  $(1, +\infty)$ , we have, for  $j \in \mathbb{Z}$ ,

$$\operatorname{sgn}_{\lambda \in \mathcal{V}}(\mathcal{D}(\lambda, j)) = \operatorname{sgn}(\mathcal{D}(+\infty, j)), \quad (22)$$

where  $\mathcal{V}$  is a neighborhood of  $\lambda = 1$ . The technique that we are going to use to compute the sign of  $\mathcal{D}$  at  $\lambda = +\infty$  requires that we work with large  $j$  (Remarks 1.2.1). Note that, thanks to Remarks 1.2.1, if (22) holds for a large enough  $j$ , it holds for all  $j' \geq j$ . In practice, since the convergence of the profile is geometric, the “large enough”  $j$  may be quite reasonable : for example, for the profile  $v^0$ , we have  $j = 2$ .

### 1.3 Study of the Evans function near $\lambda = 1$

We note that for  $\lambda = 1$ , the solutions of (16) are 1 and  $\beta_m^\pm := -(1 + a_m^\pm)/(1 - a_m^\pm)$  and that, since the function  $x \mapsto -(1 + x)/(1 - x)$  is decreasing on  $(-1, 1)$ , the eigenvalues of the limit-matrices  $\mathbb{A}^\pm(1)$  which are not equal to 1 are distinct. From now on, we choose to denote the eigenvectors of  $\mathbb{A}^\pm(\lambda)$  associated with  $\mu_m^\pm(\lambda)$  by

$$V_m^\pm(\lambda) = \begin{pmatrix} r_m^\pm \\ \mu_m^\pm(\lambda)r_m^\pm \end{pmatrix}, \quad m \in \{1, \dots, d\}, \quad (23)$$

$$V_{d+m}^\pm(\lambda) = \begin{pmatrix} r_m^\pm \\ \mu_{d+m}^\pm(\lambda)r_m^\pm \end{pmatrix}, \quad m \in \{1, \dots, d\}. \quad (24)$$

Let  $\lambda$  be such that  $|\lambda| > 1$  and  $\mu$  be a solution of (16). The complex number  $\tilde{\mu} := \mu - 1$  is a solution of

$$(1 - a_m^\pm)\tilde{\mu}^2 + 2\left(1 + \frac{\lambda - 1}{a_m^\pm}\right)\tilde{\mu} + 2\left(\frac{\lambda - 1}{a_m^\pm}\right) = 0. \quad (25)$$

So the behavior of the eigenvalues of  $\mathbb{A}^\pm(\lambda)$  as  $\lambda$  tends to 1 is known to be

$$\mu - 1 \underset{\lambda \rightarrow 1}{\sim} -\frac{\lambda - 1}{a_m^\pm} \text{ or } \mu \underset{\lambda \rightarrow 1}{\rightarrow} \beta_k^\pm.$$

The asymptotic behavior in  $j$  of the eigenvalues and eigenvectors of  $\mathbb{A}_j(\lambda)$  about  $\lambda = 1$  is summarized in Tables 1 and 2.

| at $j = -\infty$ :  |   | $a_1^-, \dots, a_q^- < 0$ and $0 < a_{q+1}^- < \dots < a_p^-$           |  |
|---|---|---|--|
| $\mu_1^-(1) = \beta_1^-$  | $\mu_{q-1}^-(1) = \beta_{q-1}^-$  | $\mu_q^- - 1 \sim -\frac{\lambda-1}{a_q^-}$                             | $\mu_d^- - 1 \sim -\frac{\lambda-1}{a_d^-}$                            |
| $V_1^-(1) = \begin{pmatrix} r_1^- \\ \beta_1^- r_1^- \end{pmatrix}$ | $V_{q-1}^-(1) = \begin{pmatrix} r_{q-1}^- \\ \beta_{q-1}^- r_{q-1}^- \end{pmatrix}$ | $V_q^-(1) = \begin{pmatrix} r_q^- \\ r_q^- \end{pmatrix}$               | $V_d^-(1) = \begin{pmatrix} r_d^- \\ r_d^- \end{pmatrix}$              |
| $\mu_{d+1}^- - 1 \sim -\frac{\lambda-1}{a_1^-}$                     | $\mu_{d+q-1}^- - 1 \sim -\frac{\lambda-1}{a_{q-1}^-}$                               | $\mu_{d+q}^-(1) = \beta_q^-$  | $\mu_{2d}^-(1) = \beta_d^-$  |
| $V_{d+1}^-(1) = \begin{pmatrix} r_1^- \\ r_1^- \end{pmatrix}$       | $V_{d+q-1}^-(1) = \begin{pmatrix} r_{q-1}^- \\ r_{q-1}^- \end{pmatrix}$             | $V_{d+q}^-(1) = \begin{pmatrix} r_q^- \\ \beta_q^- r_q^- \end{pmatrix}$ | $V_{2d}^-(1) = \begin{pmatrix} r_d^- \\ \beta_d^- r_d^- \end{pmatrix}$ |

Tab. 1: Asymptotic behavior at  $j = -\infty$

Consider  $\lambda \in \mathcal{O}$ . Let  $(\Phi_k^j(\lambda))_{k \in \mathbb{Z}} = \mathcal{B}_{E(\lambda)}$ ,  $j \in \{1, \dots, n\}$ , be a basis of the subspace  $E(\lambda)$

| at $j = +\infty$ :  |   | $a_1^+ < \dots < a_p^+ < 0 < a_{p+1}^+ < \dots < a_d^+$                               |  |
|---|---|---|--|
| $\mu_1^+(1) = \beta_1^+$  | $\mu_p^+(1) = \beta_p^+$  | $\mu_{p+1}^+ - 1 \sim -\frac{\lambda-1}{a_{p+1}^+}$                                   | $\mu_d^+ - 1 \sim -\frac{\lambda-1}{a_d^+}$                            |
| $V_1^+(1) = \begin{pmatrix} r_1^+ \\ \beta_1^+ r_1^+ \end{pmatrix}$ | $V_p^+(1) = \begin{pmatrix} r_p^+ \\ \beta_p^+ r_p^+ \end{pmatrix}$ | $V_{p+1}^+(1) = \begin{pmatrix} r_{p+1}^+ \\ r_{p+1}^+ \end{pmatrix}$                 | $V_d^+(1) = \begin{pmatrix} r_d^+ \\ r_d^+ \end{pmatrix}$              |
| $\mu_{d+1}^+ - 1 \sim -\frac{\lambda-1}{a_1^+}$                     | $\mu_{d+p}^+ - 1 \sim -\frac{\lambda-1}{a_p^+}$                     | $\mu_{d+p+1}^+(1) = \beta_{p+1}^+$  | $\mu_{2d}^+(1) = \beta_d^+$  |
| $V_{d+1}^+(1) = \begin{pmatrix} r_1^+ \\ r_1^+ \end{pmatrix}$       | $V_{d+p}^+(1) = \begin{pmatrix} r_p^+ \\ r_p^+ \end{pmatrix}$       | $V_{d+p+1}^+(1) = \begin{pmatrix} r_{p+1}^+ \\ \beta_{p+1}^+ r_{p+1}^+ \end{pmatrix}$ | $V_{2d}^+(1) = \begin{pmatrix} r_d^+ \\ \beta_d^+ r_d^+ \end{pmatrix}$ |

Tab. 2: Asymptotic behavior at  $j = +\infty$ .



defined by (19) and  $(\Phi_k^j(\lambda))_{k \in \mathbb{Z}} = \mathcal{B}_{F(\lambda)}$ ,  $j \in \{n+1, \dots, 2n\}$ , be a basis of the subspace  $F(\lambda)$  defined by (20). We can define explicitly  $\mathcal{D}$  as

$$\mathcal{D}(\lambda, j) := \det(\Phi_k^1, \dots, \Phi_k^n, \Phi_k^{n+1}, \dots, \Phi_k^{2n}), \quad \forall \lambda \in \Omega, \quad j \in \mathbb{Z}.$$

Since the limit-matrices  $\mathbb{A}_\pm(\lambda)$  are diagonalizable, the behaviors of the sequences  $\Phi$  in a neighborhood of  $\lambda = 1$  are known to be

$$\Phi_j^m(\lambda) \underset{j \rightarrow +\infty}{=} (\mu_m^+(\lambda))^j (V_m^+(\lambda) + O(\gamma^j)), \quad \text{for } m \in \{1, \dots, d\}, \quad (26)$$

$$\Phi_j^m(\lambda) \underset{j \rightarrow -\infty}{=} (\mu_j^-(\lambda))^j (V_j^-(\lambda) + O(\gamma^{-j})), \quad \text{for } m \in \{d+1, \dots, 2d\}, \quad (27)$$

where  $|\gamma| < 1$ ,

so that we can extend  $\mathcal{D}(\cdot, j)$  to a neighborhood  $V$  of  $\lambda = 1$  analytically.

Let us at first compute  $\mathcal{D}(1)$ .

When  $\lambda = 1$ , the solutions of (11) that tend to 0 as  $j$  tends to  $+\infty$  (resp. to  $-\infty$ ) are  $\{(\Phi^m(1)), m \in ?^+\}$ , with  $?^+ := \{1, \dots, p\}$  (resp.  $\{(\Phi^m(1)), m \in ?^-\}$ , with  $?^- := \{d+q, \dots, 2d\}$ ). Denoting  $\Phi_j^m(1) =: (\phi_j^m, \phi_{j+1}^m)^T$  for  $m \in ?^+$  and  $\Phi_j^m(1) =: (\phi_j^{m-d}, \phi_{j+1}^{m-d})^T$  for  $m \in ?^-$ , we obtain from the conservative form (7)

$$(I_d - A_{j+1/2})A_{j+1}\phi_{j+1}^m + (I_d + A_{j+1/2})A_j\phi_j^m = (I_d - A_{j-1/2})A_j\phi_j^m + (I_d + A_{j-1/2})A_{j-1}\phi_{j-1}^m. \quad (28)$$

Since  $\phi^m$  tends to 0 as  $j$  tends to  $+\infty$  (resp. to  $-\infty$ ) if  $m \in ?^+$  (resp. if  $m \in ?^-$ ), taking the limit towards  $+\infty$  (resp.  $-\infty$ ) of (28) implies

$$\phi_{j+1}^m = -A_{j+1}^{-1}M_jA_j\phi_j^m =: N_j\phi_j^m, \quad \forall j \in \mathbb{Z}, \quad (29)$$

$M_j$  having been defined by (12).

Besides, according to Tables 1 and 2 and to (26)-(27), if  $m \notin ?$ ,  $\Phi_m(1)$  is constant and we set

$$\Phi_j^{p+1} := \begin{pmatrix} r_{p+1}^+ \\ r_{p+1}^+ \end{pmatrix}, \dots, \Phi_j^d := \begin{pmatrix} r_d^+ \\ r_d^+ \end{pmatrix}, \Phi_j^{d+1} := \begin{pmatrix} r_1^- \\ r_{p+1}^- \end{pmatrix}, \dots, \Phi_j^{d+q-1} := \begin{pmatrix} r_{q-1}^- \\ r_{q-1}^- \end{pmatrix}.$$

Thus, for  $j \in \mathbb{Z}$ , we have

$$\begin{aligned} \mathcal{D}(1, j) &= \det \begin{pmatrix} \phi_j^1 & \dots & \phi_j^p & r_{p+1}^+ & \dots & r_d^+ & r_1^- & \dots & r_{q-1}^- & \phi_j^q & \dots & \phi_j^d \\ N_j\phi_j^1 & \dots & N_j\phi_j^p & r_{p+1}^+ & \dots & r_d^+ & r_1^- & \dots & r_{q-1}^- & N_j\phi_j^q & \dots & N_j\phi_j^d \end{pmatrix} \\ &= \det \begin{pmatrix} \phi_j^1 & \dots & \phi_j^p & r_{p+1}^+ & \dots & r_d^+ & & & & & & \\ 0 & \dots & 0 & (I_d - N_j)r_{p+1}^+ & \dots & (I_d - N_j)r_d^+ & & & & & & \\ & & & r_1^- & \dots & r_{q-1}^- & \phi_j^{d+q} & \dots & \phi_j^{2d} & & & \\ & & & (I_d - N_j)r_1^- & \dots & (I_d - N_j)r_{q-1}^- & 0 & \dots & 0 & & & \end{pmatrix}. \quad (30) \end{aligned}$$

Thanks to (30), we note that the rank of the matrix  $\mathcal{M}(\lambda, j) := (\Phi_j^1(\lambda), \dots, \Phi_j^{2d}(\lambda))$  is  $d - \delta - 1$ , so that if  $p \geq q$ , that is if the shock is compressive, this determinant is obviously equal to 0, which means that 1 is necessarily an eigenvalue of  $L$ . However, note that, contrary to the continuous case where the derivative of the shock profile is always an eigenfunction of the linearized operator associated with the eigenvalue 0, that corresponds to 1 in the discrete setting, there is no reason that the shock profile should be linked to

the kernel of  $L - 1$ .

If  $p \geq q$ , since the kernel of  $\mathcal{M}(\lambda, j)$  is  $\delta + 1$ -dimensional, we can set, without loss of generality,

$$\phi^{p-m} = \phi^{q+m} =: \psi^m, \quad \text{for } 0 \leq m \leq \delta.$$

Since the discrete dynamical system (11) is real-valued for real  $\lambda$ , we can set on the Evans function to be real for real values of  $\lambda \geq 1$ . So, for some  $j \in \mathbb{Z}$ , the sign of  $\mathcal{D}(\lambda, j)$  near  $\lambda = 1$  is given by the sign of  $\partial^{\delta+1}\mathcal{D}/\partial\lambda^{\delta+1}(1, j)$  that we compute below :

**Proposition 1.3.1**

Let  $\delta \geq 0$ ,  $m \in \{0, \dots, \delta\}$  and  $j \in \mathbb{Z}$ . Then

$$\frac{\partial^m \mathcal{D}}{\partial \lambda^m}(1, j) = 0$$

and

$$\frac{\partial^{\delta+1} \mathcal{D}}{\partial \lambda^{\delta+1}}(1, j) = (-1)^{d-p} \det(\phi_j^1, \dots, \phi_j^{p-\delta-1}, \psi_j^\delta, \dots, \psi_j^0 \phi_j^{q+\delta+1}, \dots, \phi_j^d) \det(I_d - N_j) \Theta^\delta(\Sigma_j^0, \dots, \Sigma_j^\delta), \quad (31)$$

where

$$\begin{aligned} \Theta^\delta &:= \mathbb{C}^{\delta+1} \longrightarrow \mathbb{C} \\ (\vec{e}_0, \dots, \vec{e}_\delta) &\mapsto \det(r_1^-, \dots, r_{q-1}^-, \vec{e}_0, \dots, \vec{e}_\delta, r_{p+1}^+, \dots, r_d^+), \\ \Sigma_j^m &:= 2((I_d - A_{j+1/2})A_{j+1} + (I_d + A_{j-1/2})A_j)^{-1} \sum_{l \in \mathbb{Z}} \psi_l^m, \end{aligned}$$

$N_j$  being defined by (29).

**Proof**

The case  $\delta = -1$  can be treated straightforwardly from (30) by manipulating the columns of the determinant.

If  $\delta \geq 0$ , we obtain, through a classical computation [24, 2, 30, 89],

$$\begin{aligned} \frac{\partial^{\delta+1} \mathcal{D}}{\partial \lambda^{\delta+1}}(1, j) &= \det \left( \Phi_j^1(1), \dots, \Phi_j^{d+q-1}(1), \left( \frac{\partial \Phi_j^{d+q}}{\partial \lambda} - \frac{\partial \Phi_j^p}{\partial \lambda} \right) (1), \dots, \right. \\ &\quad \left. \left( \frac{\partial \Phi_j^{d+q+\delta}}{\partial \lambda} - \frac{\partial \Phi_j^{p-\delta}}{\partial \lambda} \right) (1), \Phi_j^{d+q+\delta+1}(1), \dots, \Phi_j^{2d}(1) \right). \end{aligned}$$

The sequences  $\lambda \mapsto A_j(\lambda)$  and  $\lambda \mapsto \Phi_j^m(\lambda)$  are analytic in  $\Omega \cup V$ , so denoting

$$Z_j^m := \frac{\partial \Phi_j^m}{\partial \lambda}(1), \quad \text{for } m \in \{p - \delta, \dots, p\} \cup \{q, \dots, q + \delta\}$$

and

$$\begin{pmatrix} z_j^m \\ z_{j+1}^m \end{pmatrix} := Z_j^m, \quad \text{for } m \in \{p - \delta, \dots, p\} \cup \{q, \dots, q + \delta\},$$

the derivatives  $z^{p-m}$  and  $z^{q+m}$ ,  $m \in \{0, \dots, \delta\}$ , satisfy the same recurrence equation

$$\psi_j^m + (I_d - A_{j+1/2})A_{j+1}z_{j+1} + (I_d + A_{j+1/2})A_jz_j = (I_d - A_{j-1/2})A_jz_j + (I_d + A_{j-1/2})A_{j-1}z_{j-1}, \quad (32)$$

that we obtain by deriving the eigenvalue equation corresponding to (7) with respect to the eigenvalue  $\lambda$  and taking  $\lambda = 1$ . Since, for  $m \in \{0, \dots, \delta\}$ ,  $z_j^{p-m} \rightarrow 0$  as  $j \rightarrow +\infty$ , by taking the sum of (32) from  $l = j + 1$  to  $+\infty$ , we get

$$z_{j+1}^{p-m} = N_j z_j^{p-m} - 2A_{j+1}^{-1}(I_d + A_{j+1/2})^{-1} \sum_{l=j+1}^{+\infty} \psi_l^m. \quad (33)$$

Similarly, since  $z_j^{q+m} \rightarrow 0$  as  $j \rightarrow -\infty$ , we obtain

$$z_{j+1}^{q+m} = N_j z_j^{q+m} + 2A_{j+1}^{-1}(I_d + A_{j+1/2})^{-1} \sum_{l=-\infty}^j \psi_l^m. \quad (34)$$

So, combining (33) and (34), we have

$$z_{j+1}^{p-m} - z_{j+1}^{d+q+m} = N_j(z_j^{p-m} - z_j^{d+q+m}) + 2A_{j+1}^{-1}(I_d - A_{j+1/2})^{-1} \Sigma_m, \quad \text{for } 0 \leq m \leq \delta.$$

Consequently, performing some elementary matrix manipulations, we get the expected result.

□

### 1.4 Study of the Evans function at $\lambda = +\infty$

At first, note that, since the linearized operator  $L$  is continuous, its spectrum is bounded by its norm, so that there exists  $\Lambda$  such that  $L$  has no real eigenvalue larger than  $\Lambda$ , and  $\mathcal{D}(\lambda, j)$  does not vanish for  $\lambda > \Lambda$ .

Let us now compute the sign of  $\mathcal{D}$  for large real  $\lambda$ .

#### Theorem 1.4.1

There exists  $j_0 \in \mathbb{N}$  such that, for  $\lambda > \Lambda$  and  $j \geq j_0$ , the sign of  $\mathcal{D}(\lambda, j)$  is given by

$$\text{sgn}(\mathcal{D}(\lambda, j)) = (-1)^{j(d_p+q-1)+d+q-1} \text{sgn}(\det(r_1^+, \dots, r_d^+) \cdot \det(r_1^-, \dots, r_d^-)). \quad (35)$$

**Remark 1.4.1** Note that, recalling the link between  $\mathcal{D}(\lambda, j + 1)$  and  $\mathcal{D}(\lambda, j)$  given by (21)-(13) and the fact that (H1) implies that  $\det(M_j) > 0$  for all  $j \in \mathbb{Z}$ , we know that

$$\text{sgn}(\mathcal{D}(\lambda, j + 1)) = (-1)^d \text{sgn}(\det(A_{j+1})) \text{sgn}(\det(A_{j-1})) \text{sgn}(\mathcal{D}(\lambda, j)).$$

#### Proof

To be able to compute the sign of  $\mathcal{D}(\lambda, j)$  for large real  $\lambda$ , we need to describe precisely the behavior of the elements  $\Phi$  of the base  $\mathcal{B}_{E(\lambda)}$  and  $\mathcal{B}_{F(\lambda)}$  (see Section 1.3 for notations) at  $\lambda = +\infty$  and we need also to be sure their behaviors match those we described near  $\lambda = 1$  by (26)-(27).

We use a discrete (simplified) approach of Zumbrun and Howard's Proposition 3.1 [88].

**Lemma 1.4.1**

Let  $l \in \mathbb{Z}$ ,  $V(\lambda)$  be an eigenvector of  $\mathbb{A}^+(\lambda)$  (resp. of  $\mathbb{A}^-(\lambda)$ ) associated with  $\mu(\lambda)$  that never vanishes. Assuming that  $\mu, V$  are analytic and that

(K+) there exists  $\omega \in (0, 1)$ , that does not depend on  $\lambda$ , such that  $|\mu^{-1}(\lambda)(\mathbb{A}_j(\lambda) - \mathbb{A}^+(\lambda))| = O(\omega^j)$  as  $j$  tends to  $+\infty$

(resp.

(K-) there exists  $\zeta \in (1, +\infty)$ , that does not depend on  $\lambda$ , such that  $|\mu(\lambda)(\mathbb{A}_j^{-1}(\lambda) - (\mathbb{A}^+(\lambda))^{-1})| = O(\zeta^j)$  as  $j$  tends to  $-\infty$ ),

there exists a solution  $W(\lambda, j)$  of  $W_j = \mathbb{A}_j(\lambda)W_{j-1}$ , such that

$$W(\lambda, j) = \mathbf{V}(\lambda, j)\mu^j(\lambda), \tag{36}$$

where  $\mathbf{V}(\lambda, j)$  is analytic with respect to  $\lambda$  and satisfies

$$\forall m \geq 0, \forall j \geq l, \frac{\partial^m \mathbf{V}}{\partial \lambda^m}(\lambda, j) = \frac{\partial^m V}{\partial \lambda^m}(\lambda) + O(\omega^j), \tag{37}$$

(resp.

$$\forall m \geq 0, \forall j \leq l, \frac{\partial^m \mathbf{V}}{\partial \lambda^m}(\lambda, j) = \frac{\partial^m V}{\partial \lambda^m}(\lambda) + O(\zeta^j). \tag{38}$$

This lemma is proved in [29].

Assumptions (K+) and (K-) are satisfied pointwise with respect to  $\lambda$  (see 14).

Moreover, note that, for  $\lambda \in (1, +\infty)$ , Assumption (K+) is satisfied for  $(\mu_m^+(\lambda))_{m \in \{1, \dots, d\}}$  because, for  $m \in \{1, \dots, d\}$ ,  $\lambda \mapsto (\mu_m^+(\lambda))$  is bounded on  $(1, +\infty)$ , since  $\mu_m^+(\lambda)$  tends to 0 as  $\lambda$  tends to  $+\infty$  (see (18)).

Similarly, Assumption (K-) is satisfied for  $(\mu_m^-(\lambda))_{m \in \{d+1, \dots, 2d\}}$  because  $(\mu_m^-(\lambda))^{-1}$  tends to 0 as  $\lambda$  tends to  $+\infty$  (see (18)).

Next, we prove that the eigenvalues of  $\mathbb{A}^\pm(\lambda)$  are simple for large enough  $\lambda$ , so that for such large  $\lambda$ 's the set  $(W_m(\lambda, \cdot))_{m \in \{1, \dots, d\}}$  (resp.  $(W_m(\lambda, \cdot))_{m \in \{d+1, \dots, 2d\}}$ ) that we obtain by using Lemma 1.4.1 with all the eigenvalues and associated eigenfunctions of  $\mathbb{A}^+(\lambda)$  (resp. of  $\mathbb{A}^-(\lambda)$ ) is indeed a basis of  $E(\lambda)$  (resp. a basis of  $F(\lambda)$ ).

**Lemma 1.4.2**

There exists  $\Lambda > 1$  such that, for  $\lambda > \Lambda$ , the characteristic polynomials  $\pi^\pm$  of  $\mathbb{A}^\pm(\lambda)$  have no double root.

**Proof**

Thanks to (16), we can express the characteristic polynomials of  $\mathbb{A}^\pm(\lambda)$  as

$$\pi^\pm(\mu) = \prod_{m=1}^d \tilde{\pi}_m^\pm(\mu),$$

with

$$\tilde{\pi}_m^\pm(\mu) := \mu^2 - \frac{2(1 - \lambda - (a_m^\pm)^2)}{a_m^\pm(1 - a_m^\pm)}\mu - \frac{a_m^\pm(1 + a_m^\pm)}{a_m^\pm(1 - a_m^\pm)}, \quad m \in \{1, \dots, d\}.$$

Let  $\lambda_1 > 1$  be such that  $\pi^\pm$  has a double root  $\mu_0$ . Then either

(C1) there is an integer  $m_0 \in \{1, \dots, d\}$  such that

$$\tilde{\pi}_{m_0}^{\pm}(\mu_0) = 0,$$

or

(C2) there are two different integers  $m_1, m_2$  in  $\{1, \dots, d\}$  such that  $\tilde{\pi}_{m_1}^{\pm}(\mu_0) = 0$  and  $\tilde{\pi}_{m_2}^{\pm}(\mu_0) = 0$ .

Assume that (C1) is satisfied.

If  $\mu_0$  is a double root of  $\tilde{\pi}_{m_0}^{\pm}$ , the discriminant of  $\tilde{\pi}_{m_0}^{\pm}$  vanishes. Since the discriminant of  $\tilde{\pi}_{m_0}^{\pm}$  is  $\Delta := (1 - \lambda_1 - (a_{m_0}^{\pm})^2)^2 + (a_{m_0}^{\pm})^2(1 - (a_{m_0}^{\pm})^2)$ , the fact that  $\lambda_1$  is real implies that (C1) is impossible.

Assume now that (C2) is satisfied.

Let us drop momentarily the superscript  $\pm$ . By computing  $\tilde{\pi}_{m_1} - \tilde{\pi}_{m_2}$ , we obtain

$$(1 - a_{m_1} - a_{m_2})\mu_0^2 - 2(a_{m_1} + a_{m_2})\mu_0 - 1 - a_{m_1} - a_{m_2} = 0,$$

that is,

$$\mu_0^2 - 1 - a_{m_1}(\mu_0 - 1)^2 - a_{m_2}(\mu_0 - 1)^2 = 0.$$

If  $\mu_0 = 1$ , we proved that necessarily  $\lambda_1 = 1$  (see the proof of Proposition 1.2.1), and since we assumed  $\lambda_1 > 1$ , this case is impossible. So we are left with

$$(1 - a_{m_1} - a_{m_2})\mu_0 + 1 + a_{m_1} + a_{m_2} = 0. \quad (39)$$

If  $a_{m_1} + a_{m_2} = 1$ , (39) becomes  $2 = 0$  so for all  $\lambda_1 > 1$ ,  $\Pi$  has no double root.

Else, if  $a_{m_1} + a_{m_2} \neq 1$ , we obtain

$$\mu_0 = -\frac{1 + a_{m_1} + a_{m_2}}{1 - a_{m_1} - a_{m_2}},$$

so, plugging the value of  $\mu_0$  in  $\tilde{\pi}_{m_1}(\mu_0) = 0$ , we get

$$\lambda_1 = \frac{1}{2} \left( a_{m_1}(1 + a_{m_1}) - a_{m_1}(1 - a_{m_1}) \left( \frac{1 + a_{m_1} + a_{m_2}}{1 - a_{m_1} - a_{m_2}} \right)^2 - 2(1 - a_{m_1}^2) \frac{1 + a_{m_1} + a_{m_2}}{1 - a_{m_1} - a_{m_2}} \right).$$

For  $\lambda > \lambda_1$ ,  $\pi^{\pm}$  has no double root.

□

Let  $\lambda > \max\{\Lambda, \lambda_1\}$ . Denoting by  $\Phi_m(\lambda, j) := W_m(\lambda, j)$ ,  $m \in \{1, \dots, d\}$  (resp.  $m \in \{d + 1, \dots, 2d\}$ ) obtained by Lemma 1.4.1 for the eigenvalue  $\mu_m^+$  and the associated eigenvector  $V_m^+$  (resp. for the eigenvalue  $\mu_m^-$  and the associated eigenvector  $V_m^-$ ), the order of the elements of the bases  $\mathcal{B}_{E(\lambda)}$  and  $\mathcal{B}_{F(\lambda)}$  is kept and we can continuously follow these elements with respect to  $\lambda$ . So, for  $\lambda > \Lambda$  and  $j \in \mathbb{Z}$ , we have

$$\begin{aligned} \Phi_j^m(\lambda) &= (\mu_m^+(\lambda))^j \mathbf{V}^m(\lambda, j), \text{ for } m \in \{1, \dots, d\}, \\ \Phi_j^m(\lambda) &= (\mu_m^-(\lambda))^j \mathbf{V}^m(\lambda, j), \text{ for } m \in \{d + 1, \dots, 2d\} \end{aligned}$$

and the Evans function can be expressed as

$$\mathcal{D}(\lambda, j) = \left( \prod_{m=1}^d \mu_m^+(\lambda) \prod_{m=d+1}^{2d} \mu_m^-(\lambda) \right)^j \det(\mathbf{V}^1(\lambda, j), \dots, \mathbf{V}^{2d}(\lambda, j)).$$

Thanks to the asymptotic development (17) of the eigenvalues of  $\mathbf{A}^\pm(\lambda)$  for large real  $\lambda$ 's, we see at once that

$$\mu_m^+(\lambda) \underset{\lambda \rightarrow +\infty}{\sim} \frac{a_m^+(1 + a_m^+)}{2\lambda}, \quad m \in \{1, \dots, d\}, \quad (40)$$

$$\mu_{d+m}^-(\lambda) \underset{\lambda \rightarrow +\infty}{\sim} \frac{-2\lambda}{a_m^-(1 - a_m^+)}, \quad m \in \{1, \dots, d\}, \quad (41)$$

Thanks to (40)-(41) and using (H1) and (H5), we get

$$\begin{aligned} \operatorname{sgn} \left( \prod_{m=1}^d \mu_m^+(\lambda) \prod_{m=d+1}^{2d} \mu_m^-(\lambda) \right) &= (-1)^d \operatorname{sgn} \left( \prod_{m=1}^d \frac{a_m^+(1 + a_m^+)}{a_m^-(1 + a_m^-)} \right) \\ &= (-1)^d \operatorname{sgn} \left( \prod_{m=1}^d \frac{a_m^+}{a_m^-} \right) \\ &= (-1)^{d+p+q-1}. \end{aligned} \quad (42)$$

Moreover, recalling the behaviors of  $\mathbf{V}^m$  given by (37)-(38) and the formulae (23)-(24) we chose for the eigenvectors of  $\mathbf{A}^\pm(\lambda)$ , we have

$$\mathbf{V}^m(\lambda, j) = \begin{pmatrix} r_m^+ \\ \mu_m^+(\lambda)r_m^+ \end{pmatrix} + O(\omega^j), \quad m \in \{1, \dots, d\}, \quad (43)$$

$$\mathbf{V}^{d+m}(\lambda, j) = \begin{pmatrix} r_m^- \\ \mu_{d+m}^-(\lambda)r_m^- \end{pmatrix} + O(\zeta^j), \quad m \in \{1, \dots, d\}. \quad (44)$$

Using (43)-(44) and denoting the determinant  $\det(\mathbf{V}^1(\lambda, j), \dots, \mathbf{V}^{2d}(\lambda, j))$  by  $\mathcal{D}(\lambda, j)$ , we obtain

$$\begin{aligned} \mathcal{D}(\lambda, j) &= \zeta^{dj} \det \left( \begin{pmatrix} r_1^+ \\ \mu_1^+(\lambda)r_1^+ \end{pmatrix} + O(\omega^j), \dots, \begin{pmatrix} r_d^+ \\ \mu_d^+(\lambda)r_d^+ \end{pmatrix} + O(\omega^j), \right. \\ &\quad \left. \begin{pmatrix} \zeta^{-j}r_1^- \\ \zeta^{-j}\mu_{d+1}^-(\lambda)r_1^- \end{pmatrix} + O(1), \dots, \begin{pmatrix} \zeta^{-j}r_d^- \\ \zeta^{-j}\mu_{2d}^-(\lambda)r_d^- \end{pmatrix} + O(1) \right) \\ &= \zeta^{dj} (K_1(\lambda, j) + \omega^j K_2(\lambda, j)), \end{aligned}$$

where

$$\begin{aligned} K_1(\lambda, j) &= \det \left( \begin{pmatrix} r_1^+ \\ \mu_1^+(\lambda)r_1^+ \end{pmatrix}, \dots, \begin{pmatrix} r_d^+ \\ \mu_d^+(\lambda)r_d^+ \end{pmatrix}, \begin{pmatrix} \zeta^{-j}r_1^- \\ \zeta^{-j}\mu_{d+1}^-(\lambda)r_1^- \end{pmatrix} + O(1), \dots, \right. \\ &\quad \left. \begin{pmatrix} \zeta^{-j}r_d^- \\ \zeta^{-j}\mu_{2d}^-(\lambda)r_d^- \end{pmatrix} + O(1) \right), \end{aligned}$$

and  $K_2(\lambda, j)$  is the remaining term. Let us now set on  $\lambda$  to be of the form

$$\lambda_j = \zeta^{(1+\alpha)j},$$

with  $\alpha$  a positive constant. Note that, since, thanks to (40), we know that

$$\mu_m^+(\lambda_j) = o(1),$$

so that  $K_1(\lambda_j, j)$  can be rewritten as

$$K_1(\lambda_j, j) = \det \begin{pmatrix} I_d & 0 \\ B^+ & I_d \end{pmatrix} \det \begin{pmatrix} r_1^+ & \dots & r_d^+ & \zeta^{-j} r_1^- + O(1) & \dots & \zeta^{-j} r_d^- + O(1) \\ 0 & \dots & 0 & \zeta^{-j} \mu_{d+1}^-(\lambda_j) r_1^- + O(1) & \dots & \zeta^{-j} \mu_{2d}^-(\lambda_j) r_d^- + O(1) \end{pmatrix},$$

where  $B^+ := \text{diag}(\mu_1^+(\lambda), \dots, \mu_d^+(\lambda))$ . So, using the behaviors of  $\mu_m^-(\lambda_j)$  given by (41), we have

$$\begin{aligned} K_1(\lambda_j, j) &= \det(r_1^+, \dots, r_d^+) \cdot \det(\mu_{d+1}^-(\lambda_j) r_1^- + O(1), \dots, \mu_{2d}^-(\lambda_j) r_d^- + O(1)) \\ &= \left( \prod_{m=d+1}^{2d} \mu_m^-(\lambda_j) \right) \det(r_1^+, \dots, r_d^+) \cdot \det \left( r_1^- + O\left(\frac{1}{\zeta^{(1+\alpha)j}}\right), \dots, r_d^- + O\left(\frac{1}{\zeta^{(1+\alpha)j}}\right) \right) \\ &= \left( \prod_{m=d+1}^{2d} \mu_m^-(\lambda_j) \right) \det(r_1^+, \dots, r_d^+) \cdot \left( \det(r_1^-, \dots, r_d^-) + O\left(\frac{1}{\zeta^{(1+\alpha)j}}\right) \right). \end{aligned}$$

So, choosing  $j$  to be large enough and recalling that  $(r_m^+)_{m \in \{1, \dots, d\}}$  and  $(r_m^-)_{m \in \{1, \dots, d\}}$  are bases, we see that  $K_1(\lambda_j, j)$  does not vanish and that its sign is given by

$$\text{sgn}(K_1(\lambda_j, j)) = (-1)^{d+q-1} \text{sgn}(\det(r_1^+, \dots, r_d^+)) \cdot \text{sgn}(\det(r_1^-, \dots, r_d^-)). \quad (45)$$

Moreover, we choose the constant  $\alpha$  such that

$$\omega^j \zeta^{-dj} \lambda_j^d \xrightarrow{j \rightarrow +\infty} 0,$$

that is,  $\alpha$  is such that

$$\omega \zeta^{d\alpha} < 1.$$

Consequently, since  $K_1(\lambda_j, j)$  does not vanish and the Evans function has the same sign for all  $\lambda > \Lambda$ , we gather (42) and (45) and we obtain the expected result.

□

## 1.5 Appendix : Geometric dichotomy

We consider the discrete dynamical system

$$x_{j+1} = A_j x_j, \quad j \in I \subset \mathbb{Z}, \quad (A_j) \in M_d(\mathbb{R}), \quad (46)$$

and its fundamental matrix  $(X_j)$  such that  $X_0 = I_d$ .

**Definition** Following [14], we say that (46) has a *geometric dichotomy on  $I$*  if there exist a projection  $P$ , some constants  $K > 0$  and  $\alpha > 0$  such that

$$|X_j P X_k^{-1}| \leq K e^{-\alpha(j-k)}, \quad k, j \in I, k \leq j, \quad (47)$$

$$|X_j (I_d - P) X_k^{-1}| \leq K e^{-\alpha(k-j)}, \quad k, j \in I, j \leq k. \quad (48)$$

### Theorem 1.5.1 (Constant matrices)

Consider the dynamical system

$$x_{j+1} = A x_j, \quad j \in \mathbb{N} \quad (49)$$

and assume that the spectrum of  $A$  does not intersect the unit-circle. Then (49) has a geometric dichotomy on  $\mathbb{N}$  and the range of its projection  $P$  is the unstable space of  $A$ .

### Proof

Let  $P$  denote the projection on the stable subspace of  $A$  of nullspace the unstable subspace of  $A$ . If there exist some constants  $L, M > 0$  such that

$$\begin{aligned} |X_j P X_k^{-1}| &\leq L e^{-\beta(j-k)}, & 0 \leq k \leq j, \\ |X_j (I_d - P) X_k^{-1}| &\leq M e^{-\gamma(k-j)}, & 0 \leq j \leq k, \end{aligned}$$

where  $\beta := -\ln(\max\{|\lambda|, \lambda \in \sigma(A), |\lambda| < 1\})$  and  $\gamma := \ln(\min\{|\lambda|, \lambda \in \sigma(A), |\lambda| > 1\})$ . Taking  $K := \max(L, M)$  and  $\alpha := \min(\beta, \gamma)$ , we conclude that (46) has a geometric dichotomy on  $\mathbb{N}$ .

□

Following Coppel's work in the continuous case, we state the following theorem

### Theorem 1.5.2 (Perturbed system)

Consider the following perturbed system

$$y_{j+1} = (A_j + B_j) y_j, \quad j \in \mathbb{N}, \quad (50)$$

where  $(A_j)$  and  $(B_j)$  are not necessarily constant. We assume that (46) has a geometric dichotomy on  $\mathbb{N}$ , with the notations taken in (47)-(48).

If the sequence  $(B_j)$  satisfies

$$\|B\| = \sup_{j \in \mathbb{N}} |B_j| < \frac{4 \sinh(\alpha)}{(2K + 1)^2}, \quad (51)$$

then (50) has a geometric dichotomy on  $\mathbb{N}$  of projection  $Q$  such that  $\ker(Q) = \ker(P)$ .



**Proof**

Define

$T : Y \in \ell^\infty(\mathbb{N}) \mapsto TY$  such that  $\forall j \in \mathbb{N}$ ,

$$(TY)_j := X_j P + \sum_{k=1}^j X_j P X_k^{-1} B_{k-1} Y_{k-1} - \sum_{k=j+1}^{+\infty} X_j (I_d - P) X_k^{-1} B_{k-1} Y_{k-1} \quad (52)$$

For some  $j \in \mathbb{N}$ , we thus obtain

$$\begin{aligned} |(TY)_j| &\leq K e^{-\alpha j} + \|Y\| \sum_{j \in \mathbb{N}} K e^{-\alpha |j-k|}, \\ &\leq K \left( 1 + \|B\| \|Y\| \left( \frac{1 + e^{-\alpha}}{1 - e^{-\alpha}} \right) \right), \end{aligned}$$

that is the sequence  $TY$  is bounded. Similarly, if  $Y$  and  $\tilde{Y}$  are bounded sequences of  $n \times n$  matrices,

$$\|TY - T\tilde{Y}\| \leq \|B\| K \left( \frac{1 + e^{-\alpha}}{1 - e^{-\alpha}} \right) \|Y - \tilde{Y}\|.$$

So, applying the fixed point theorem, if we assume that  $\theta := \|B\| K (1 + e^{-\alpha}) / (1 - e^{-\alpha}) < 1$ , we conclude that  $T$  has a unique fixed point  $(Y_j^1)_{j \in \mathbb{N}}$ . Since  $TY^1 = Y^1$ , we have, for some  $j \in \mathbb{N}$ ,

$$Y_j^1 = X_j P + \sum_{k=1}^j X_j P X_k^{-1} B_{k-1} Y_{k-1}^1 - \sum_{k=j+1}^{+\infty} X_j (I_d - P) X_k^{-1} B_{k-1} Y_{k-1}^1, \quad (53)$$

so that

$$\begin{aligned} Y_{j+1}^1 &= A_j X_j P + \sum_{k=1}^j A_j X_j P X_k^{-1} B_{k-1} Y_{k-1}^1 + X_{j+1} P X_{j+1}^{-1} B_j Y_j^1 \\ &\quad - \sum_{k=j+1}^{+\infty} A_j X_j (I_d - P) X_k^{-1} B_{k-1} Y_{k-1}^1 + X_{j+1} (I_d - P) P X_{j+1}^{-1} B_j Y_j^1 \\ &= A_j Y_j^1 + B_j Y_j^1, \end{aligned}$$

that is  $Y^1$  solves (50). Since  $P^2 = P$ ,  $Y^1 P$  is also a fixed point of  $T$ , so  $Y^1 P = Y^1$  and, in particular, if  $Q = Y_0^1$ ,  $QP = Q$ . Besides, since  $P(I_d - P) = 0$ , we find for some  $j, k \in \mathbb{N}$

$$X_j P X_k^{-1} Y_k^1 = X_j P + \sum_{l=1}^k X_j P X_l^{-1} B_{l-1} Y_{l-1}^1, \quad (54)$$

and, consequently, using (53) and (54), we obtain

$$Y_j^1 = X_j P X_k^{-1} Y_k^1 + \sum_{l=k+1}^j X_j P X_l^{-1} B_{l-1} Y_{l-1}^1 - \sum_{l=j+1}^{+\infty} X_j (I_d - P) X_l^{-1} B_{l-1} Y_{l-1}^1. \quad (55)$$

Taking  $k = j = 0$  in (54),  $PQ = P$ , so that  $Y^1 Q = Y^1$ , since  $Y^1 Q$  is a fixed point of  $T$ . Consequently,  $Q^2 = Q$  and  $Q$  is a projection.

Let  $(Y_j)$  be the resolvent matrix of (50) such that  $Y_0 = I_d$ . Since  $Y_0^1 = Q$  and  $Y^1$  solves (50),  $Y^1 = YQ$ . Let  $Y^2 = Y(I_d - Q)$  so that  $Y = Y^1 + Y^2$ . Using the variation of constants formula on (50), we find for some  $j \in \mathbb{N}$

$$Y_j^2 = X_j(I_d - Q) + \sum_{l=1}^j X_j X_l^{-1} Y_{l-1}^2.$$

Since  $(I_d - P)(I_d - Q) = I_d - Q$ , we obtain similarly as in (55),

$$Y_j^2 = X_j(I_d - P)X_k^{-1}Y_k^2 + \sum_{l=1}^j X_j P X_l^{-1} B_{l-1} Y_{l-1}^2 - \sum_{l=j+1}^k X_j(I_d - P)X_l^{-1} B_{l-1} Y_{l-1}^2. \quad (56)$$

In conclusion, for some  $\xi \in \mathbb{R}^n$ , we have

$$\begin{aligned} \text{for } j \geq k \geq 0, |Y_j^1 \xi| &\leq K e^{-\alpha(j-k)} |Y_k^1 \xi| + \theta \left( \frac{1 - e^{-\alpha}}{1 + e^{-\alpha}} \right) \sum_{l=k+1}^{+\infty} e^{-\alpha|l-j|} |Y_{l-1}^1 \xi|, \\ \text{for } k \geq j \geq 0, |Y_j^2 \xi| &\leq K e^{-\alpha(k-j)} |Y_k^2 \xi| + \theta \left( \frac{1 - e^{-\alpha}}{1 + e^{-\alpha}} \right) \sum_{l=1}^k e^{-\alpha|l-j|} |Y_{l-1}^2 \xi|. \end{aligned}$$

**Lemma 1.5.1**

Let  $(y_j)_{j \in \mathbb{N}}$  be a bounded sequence which satisfies

$$y_j \leq K e^{-\alpha j} + \theta \left( \frac{1 - e^{-\alpha}}{1 + e^{-\alpha}} \right) \sum_{k=1}^{+\infty} e^{-\alpha|k-j|} y_{k-1}, \quad \forall j \in \mathbb{N}. \quad (57)$$

Then there exist  $\rho > 0$  and  $r \in (0, 1)$  such that

$$y_j \leq \rho r^j, \quad \forall j \in \mathbb{N}.$$

**Proof**

Let us at first solve the following recurrence

$$z_j = K e^{-\alpha j} + \theta \left( \frac{1 - e^{-\alpha}}{1 + e^{-\alpha}} \right) \sum_{k=1}^{+\infty} e^{-\alpha|k-j|} z_{k-1}, \quad \forall j \in \mathbb{N}. \quad (58)$$

Performing elementary computations on (58), we find

$$z_{j+1} - 2 \cosh(\alpha) z_j + \left( 1 + 4\theta \sinh^2 \left( \frac{\alpha}{2} \right) \right) z_{j-1} = 0. \quad (59)$$

Since the discriminant of the characteristic polynomial of (59) is

$$\Delta = 16 \sinh^2(\alpha/2) (\cosh^2(\alpha/2) - \theta)$$

is positive, the solutions of (58) are linear combinations of  $(r_{\pm}^j)_j$ , where

$$r_{\pm} = \cosh(\alpha) \pm \sinh(\alpha/2) \sqrt{\cosh^2(\alpha/2) - \theta}.$$

Moreover, the sum and the product of  $r_+$  and  $r_-$  are positive, so  $r_+$  and  $r_-$  are also positive. We are searching a bounded solution of (58), so, as  $r_+ > 1$ , we have to determine whether  $r_- < 1$ . But

$$r_- - 1 = \frac{2 \sinh(\alpha/2)(\theta - 1)}{\sinh(\alpha/2) + \sqrt{\cosh^2(\alpha/2) - \theta}} < 0.$$

Thus

$$z_j = \rho K r^j, \forall j \in \mathbb{N}, \quad (60)$$

where  $r := r_-$ . Plugging (60) in (58), we find

$$\rho = \frac{1}{1 - \theta \frac{e^{-\alpha}(1 - e^{-\alpha})}{(1 + e^{-\alpha})(1 - r e^{-\alpha})}}. \quad (61)$$

If  $(y_j)$  is a solution of (58) and  $M = \sup_j y_j$ , for some  $j \in \mathbb{N}$  we obtain

$$x_j \leq K e^{-\alpha j} + \theta \frac{1 - e^{-\alpha}}{1 + e^{-\alpha}} \sum_{k=1}^{+\infty} e^{-\alpha|j-k|} y_{k-1} \leq K + \theta M,$$

so that, taking the supremum on  $j$ ,

$$M \leq \frac{K}{1 - \theta}.$$

Let  $L \geq K/(1 - \theta)$ . We find that for some  $j \in \mathbb{N}$ ,

$$K e^{-\alpha j} + \theta \frac{1 - e^{-\alpha}}{1 + e^{-\alpha}} \sum_{k=1}^{+\infty} L e^{-\alpha|j-k|} \leq K + L\theta \leq L.$$

Let us show now the existence of  $(z_j)$  such that

$$\forall j \in \mathbb{N}, y_j \leq z_j \leq L. \quad (62)$$

Define, for all  $j \in \mathbb{N}$ ,  $z_j^0 = y_j$  and for all  $n \geq 1$ ,  $j \in \mathbb{N}$ ,

$$z_j^n = K e^{-\alpha j} + \theta \frac{1 - e^{-\alpha}}{1 + e^{-\alpha}} \sum_{k=1}^{+\infty} e^{-\alpha|j-k|} z_{k-1}^{n-1}.$$

Let  $p \leq q$  and  $j \in \mathbb{N}$ .

$$\begin{aligned} |z_j^q - z_j^p| &\leq \theta \frac{1 - e^{-\alpha}}{1 + e^{-\alpha}} \sum_{k=1}^{+\infty} e^{-\alpha|j-k|} |z_{k-1}^{q-1} - z_{k-1}^{p-1}| \\ &\leq \theta \sup_k |z_k^{q-1} - z_k^{p-1}| \end{aligned}$$

Consequently,

$$\sup_k |z_k^q - z_k^p| \leq \theta^p |z_k^{q-p} - y_k| \leq 2L\theta^q. \quad (63)$$

Since  $\theta < 1$ , taking the limit as  $q \rightarrow +\infty$  in (63), we find that  $(z^n)$  is a Cauchy sequence of  $\ell^\infty(\mathbb{N})$ , so  $(z^n)$  converges. Since the fixed point is unique,  $z^n \rightarrow z$ . So, since  $z$  satisfies (60) and (62),

$$\forall j \in \mathbb{N}, y_j \leq \rho K r^j. \quad (64)$$

Let  $l \in \mathbb{N}$  and apply (64) to  $(y'_j)_{0 \leq j \leq l}$ , defined by  $y'_j = y_{l-j}$ ,  $0 \leq j \leq l$  :

$$y'_j \leq K e^{-\alpha(l-j)} + \theta \frac{1 - e^{-\alpha}}{1 + e^{-\alpha}} \sum_{k=1}^{+\infty} e^{-\alpha|l-j-k|} x_{l-k-1},$$

so that

$$y'_j \leq \rho K r^{l-j}.$$

□

We proved that, for all  $\xi \in \mathbb{R}^n$ ,

$$|Y_j^1 \xi| \leq \rho K r^{j-k} |Y_k^1 \xi|, \quad j \geq k \geq 0, \quad (65)$$

$$|Y_j^2 \xi| \leq \rho K r^{k-j} |Y_k^2 \xi|, \quad k \geq j \geq 0. \quad (66)$$

To conclude, we need to prove that  $(Y_j Q Y_j^{-1})$  is bounded.

Using (53), we obtain

$$X_j (I_d - P) X_j^{-1} Y_j^1 = - \sum_{k=j+1}^{+\infty} X_j (I_d - P) X_k^{-1} B_{k-1} Y_{k-1}^1,$$

so that, using (47) and (65),

$$\begin{aligned} |X_j (I_d - P) X_j^{-1} Y_j^1 \xi| &\leq \sum_{k=j+1}^{+\infty} K e^{-\alpha(k-j)} \|B\| \rho r^{k-j} |Y_j^1 \xi| \\ &\leq \|B\| \rho K^2 \frac{e^{-\alpha}}{1 - r e^{-\alpha}} |Y_j^1 \xi|. \end{aligned} \quad (67)$$

Similarly, using (56), we obtain

$$X_j P X_j^{-1} Y_j^2 = \sum_{k=1}^j X_j P X_k^{-1} B_{k-1} Y_{k-1}^2,$$

and, using (48) and (66),

$$\begin{aligned} |X_j P X_j^{-1} Y_j^2 \xi| &\leq \sum_{k=1}^j K e^{-\alpha(j-k)} \|B\| \rho r^{j-k} |Y_j^2 \xi| \\ &\leq \|B\| \rho K^2 \frac{e^{-\alpha}}{1 - r e^{-\alpha}} |Y_j^2 \xi|. \end{aligned} \quad (68)$$

Let

$$\eta := \frac{K^2 \|B\| \rho}{1 - r e^{-\alpha}} = K(\rho - 1).$$

Since  $r e^{-\alpha} < 1$ , (67) and (68) imply that, for all  $j \in \mathbb{N}$ ,

$$|X_j (I_d - P) X_j^{-1} Y_j^1 \xi| \leq \eta |Y_j^1 \xi|, \quad (69)$$

$$|X_j (I_d - P) X_j^{-1} Y_j^2 \xi| \leq \eta |Y_j^2 \xi|. \quad (70)$$

Moreover, since

$$Y_j Q Y_j^{-1} - X_j P X_j^{-1} = X_j (I_d - P) X_j^{-1} Y_j Q Y_j^{-1} - X_j P X_j^{-1} Y_j (I_d - Q) Y_j^{-1},$$

changing  $\xi$  to  $Y_j^{-1} \xi$  in (69) and (70), we obtain

$$|X_j P X_j^{-1} Y_j^1 Y_j^{-1} \xi| \leq \eta |Y_j^1 Y_j^{-1} \xi|, \quad (71)$$

$$|X_j P X_j^{-1} Y_j^2 Y_j^{-1} \xi| \leq \eta |Y_j^2 Y_j^{-1} \xi|, \quad (72)$$

so that

$$|Y_j Q Y_j^{-1} - X_j P X_j^{-1}| \leq \eta (|Y_j Q Y_j^{-1}| + |Y_j (I_d - Q) Y_j^{-1}|)$$

and

$$|Y_j Q Y_j^{-1}| \leq \eta (|Y_j Q Y_j^{-1}| + |Y_j (I_d - Q) Y_j^{-1}|) + K.$$

Moreover, as  $Y_j Q Y_j^{-1} - X_j P X_j^{-1} = Y_j (I_d - Q) Y_j^{-1} - X_j (I_d - P) X_j^{-1}$ , we get

$$|Y_j (I_d - Q) Y_j^{-1}| \leq \eta (|Y_j Q Y_j^{-1}| + |Y_j (I_d - Q) Y_j^{-1}|) + K.$$

So

$$|Y_j Q Y_j^{-1}| + |Y_j (I_d - Q) Y_j^{-1}| \leq 2\eta (|Y_j Q Y_j^{-1}| + |Y_j (I_d - Q) Y_j^{-1}|) + 2K.$$

If  $\eta < 1/2$ ,

$$|Y_j Q Y_j^{-1}| \leq \frac{K}{1 - 2\eta}, \quad (73)$$

$$|Y_j (I_d - Q) Y_j^{-1}| \leq \frac{K}{1 - 2\eta}. \quad (74)$$

Replacing  $\xi$  with  $Y_k^{-1}$  in (65) and (66), we obtain

$$|Y_j^1 \xi| \leq \frac{\rho K^2}{1 - 2\eta} r^{j-k}, \quad j \geq k \geq 0, \quad (75)$$

$$|Y_j^2 \xi| \leq \frac{\rho K^2}{1 - 2\eta} r^{k-j}, \quad k \geq j \geq 0. \quad (76)$$

The condition  $\eta < 1/2$  is satisfied if  $\theta < 8K/(2K + 1)^2$ , that is if  $\|B\| < 4 \sinh(\alpha)/(2K + 1)^2$ .

□

### Lemma 1.5.2

If (46) has a geometric dichotomy on  $\{N, N + 1, \dots\}$ , that is (46) satisfies (47) and (48), then (46) has also a geometric dichotomy on  $\mathbb{N}$ .

### Proof

Let  $0 \leq k \leq N \leq j$ . Then, since

$$X_j P X_k^{-1} = X_j P X_N^{-1} X_N P X_k^{-1}, \quad (77)$$

using (47), we get

$$|X_j P X_k^{-1}| \leq K e^{-\alpha(j-N)} |X_N P X_k^{-1}|.$$

Let  $L := e^{\alpha N} \max |X_N P X_k^{-1}|$ ,  $k \in \{0, \dots, N\}$ . It follows that

$$|X_j P X_k^{-1}| \leq K L e^{-\alpha N} e^{-\alpha(j-N)} \leq K L e^{-\alpha(j-k)}. \quad (78)$$

Let  $0 \leq j \leq N \leq k$ . Using (48) and defining  $L' := e^{-\alpha N} \max |X_j P X_N^{-1}|$ ,  $j \in \{0, \dots, N\}$ , we obtain

$$|X_j P X_k^{-1}| \leq K L' e^{-\alpha N} e^{-\alpha(k-N)} \leq K L' e^{-\alpha(k-j)}. \quad (79)$$

Let  $0 \leq k, j \leq N$ . Using (77), we obtain

$$|X_j^P X_k^{-1}| \leq L L' e^{-2\alpha N} \leq L L' e^{-\alpha(j-k)}.$$

□

### Theorem 1.5.3 (Extension)

Assume that (46) has a geometric dichotomy on  $\mathbb{N}$  of projection  $P$  and a geometric dichotomy on  $-\mathbb{N}$  of projection  $Q$  and that  $\mathbb{R}(P) \oplus \ker(Q) = \mathbb{R}^n$ . Then (46) has a geometric dichotomy on  $\mathbb{Z}$  of projection  $R$  satisfying  $\mathbb{R}(R) = \mathbb{R}(P)$  and  $\ker(R) = \ker(Q)$ .

### Proof

Since we assumed  $\mathbb{R}(P) \oplus \ker(Q) = \mathbb{R}^n$ , there exists a unique projection  $R$  on  $\mathbb{R}(P)$  and whose kernel is  $\ker(Q)$ . It implies that

$$P R = R, \quad R P = P, \quad (80)$$

$$Q R = Q, \quad R Q = R. \quad (81)$$

Without loss of generality, we assume that the dichotomy coefficients  $\alpha$  and  $K$  are the same on  $\mathbb{N}$  and  $-\mathbb{N}$ .

Since  $R - P = R(I_d - P)$ , if  $j, k \in \mathbb{N}$ ,

$$|X_j (R - P) X_k^{-1}| \leq |X_j R| K e^{-\alpha k} \leq |K^2 e^{-\alpha(j+k)}| |R|,$$

so that

$$|X_j R X_k^{-1}| \leq |X_j P X_k^{-1}| + |K^2 e^{-\alpha(j+k)}| |R|.$$

If  $j \geq k \geq 0$ , since (47) is satisfied,

$$\begin{aligned} |X_j R X_k^{-1}| &\leq K e^{-\alpha(j-k)} (1 + e^{-2\alpha k} K |R|) \\ &\leq K (1 + K |R|) e^{-\alpha(j-k)}. \end{aligned}$$

Similarly, if  $k \geq j \geq 0$ ,

$$\begin{aligned} |X_j (I_d - R) X_k^{-1}| &\leq |X_j (I_d - P) X_k^{-1}| + |X_j (P - R) X_k^{-1}| \\ &\leq K (1 + K |R|) e^{-\alpha(k-j)}. \end{aligned}$$

If  $j, k \leq 0$ , since  $(I_d - Q)R = R - Q$ ,

$$|X_j (R - Q) X_k^{-1}| \leq K^2 |R| e^{\alpha(j+k)}.$$

So, if  $k \leq j \leq 0$ ,

$$|X_j R X_k^{-1}| \leq K (1 + K |R|) e^{-\alpha(j-k)},$$

and if  $j \leq k \leq 0$ ,

$$|X_j(I_d - R)X_k^{-1}| \leq K(1 + K|R|)e^{-\alpha(k-j)}.$$

If  $j \geq 0 \geq k$ , since  $X_jRX_k^{-1} = X_jRRX_k^{-1}$ ,

$$|X_jRX_k^{-1}| \leq K(1 + K|R|)e^{-\alpha j}K(1 + K|R|)e^{\alpha k},$$

that is

$$|X_jRX_k^{-1}| \leq (K(1 + K|R|))^2 e^{-\alpha(j-k)}.$$

Similarly, if  $k \geq 0 \geq j$ ,

$$|X_j(I_d - R)X_k^{-1}| \leq (K(1 + K|R|))^2 e^{-\alpha(k-j)}.$$

□

**Proposition 1.5.4 (Inhomogeneous systems)**

Consider

$$x_{j+1} = A_j x_j + t_j, \quad j \in \mathbb{Z} \tag{82}$$

where  $(t_j)_{j \in \mathbb{Z}} \in \ell^2(\mathbb{Z})$  and the homogeneous system  $x_{j+1} = A_j x_j$  has a geometric dichotomy on  $\mathbb{Z}$  of projection  $R$ . Then (82) has a unique solution

$$x_j = \sum_{k=-\infty}^j X_j R X_k^{-1} f_{k-1} - \sum_{k=j+1}^{+\infty} X_j (I_d - R) X_k^{-1} f_{k-1}.$$

Moreover,  $f \mapsto x$  is linear and continuous.

This property is in fact proved in the proof of Theorem 1.5.2, using the variation of constants formula, and using (47) and (48), we get

$$\begin{aligned} |x_j| &\leq \|f\|_{\ell^2(\mathbb{Z})} \left( \sqrt{\sum_{k=-\infty}^j |X_j R X_k^{-1}|^2} + \sqrt{\sum_{k=j+1}^{+\infty} |X_j (I_d - R) X_k^{-1}|^2} \right) \\ &\leq \|f\| K \frac{1 + e^{-\alpha}}{\sqrt{1 - e^{-2\alpha}}}. \end{aligned}$$

## 2. ESTIMATIONS DE LA FONCTION DE GREEN DU SCHÉMA DE LAX-FRIEDRICHS MODIFIÉ

### 2.1 Introduction

We consider at first the case of discrete shock profiles : let  $d \geq 1$  and consider the one-dimensional  $d \times d$  system of conservation laws

$$u_t + f(u)_x = 0, \quad t \geq 0, \quad x \in \mathbb{R}, \quad (1)$$

$$u : \mathbb{R} \times \mathbb{R}^+ \longrightarrow \mathcal{U}, \quad \mathcal{U} \text{ an open set of } \mathbb{R}^d, \quad (2)$$

$$f : \mathcal{U} \subset \mathbb{R}^d \longrightarrow \mathbb{R}^d \text{ smooth,}$$

with an initial datum

$$u(x, 0) = \mathbf{u}_0(x), \quad x \in \mathbb{R}. \quad (3)$$

We are interested here in the approximation of (1) by means of the *modified Lax-Friedrichs scheme* (MLF). We consider a uniform mesh of  $\mathbb{R}$  consisting of cells  $M_j := (jh, (j+1)h]$  of size  $h$ ,  $j \in \mathbb{Z}$ . We denote by  $x_j := (j - 1/2)h$  the center of  $M_j$ . The time step is  $k$  and we set  $t^n = nk$ ,  $n \in \mathbb{N}$ . Let  $\mathcal{L}$  be the (nonlinear) evolution operator associated with the MLF scheme

$$(\mathcal{L}u)_j = u_j - \frac{k}{h}(\mathcal{F}(u_j, u_{j+1}) - \mathcal{F}(u_{j-1}, u_j)), \quad j \in \mathbb{Z}, \quad (4)$$

where the numerical flux  $\mathcal{F}$  is

$$\mathcal{F}(u, v) = \frac{f(u) + f(v)}{2} + \mathbf{D}(u - v), \quad (5)$$

with  $\mathbf{D}$  a scalar constant.

The numerical problem associated with (1)-(3) is

$$u^{n+1} = \mathcal{L}(u^n), \quad n \geq 1, \quad (6)$$

$$u_j^0 = \frac{1}{|M_j|} \int_{M_j} \mathbf{u}_0(x) dx, \quad j \in \mathbb{Z}. \quad (7)$$

Let us now make the standard assumptions. Let  $(u^-, u^+)$  be a stationary shock of (1) of *arbitrary strength*, that satisfies the following hypotheses (H1)-(H5):

- the Rankine-Hugoniot condition is satisfied:

$$\mathbf{H} \mathbf{1} \quad f(u^+) = f(u^-),$$

- system (1) is strictly hyperbolic at the points  $u^\pm$  :



**H 2**  $df(u^\pm)$  is diagonalizable and its eigenvalues are real and simple; we denote them by  $\mathbf{a}_1^\pm < \dots < \mathbf{a}_d^\pm$  and by  $(r_q^\pm)_{q \in \{1, \dots, d\}}$  some associated eigenvectors,

- the shock is non-characteristic :

**H 3**  $0 \notin \sigma(df(u^\pm))$ , where  $\sigma$  denotes the spectrum,

- there are at least  $d$  characteristics entering the shock, that is, the eigenvalues of  $df(u^\pm)$  satisfy the following inequalities :

**H 4**

$$\begin{aligned} \mathbf{a}_{p^+}^+ &< 0 < \mathbf{a}_{p^-}^-, \\ \mathbf{a}_{p^- - 1}^- &< 0 < \mathbf{a}_{p^+ + 1}^+, \end{aligned}$$

with  $p^+ = p^- + \varpi$ ,  $\varpi \in \{-1, \dots, d - 1\}$ .

This last condition implies that there are  $d + \varpi + 1$  characteristics entering the shock and  $d - \varpi - 1$  outgoing ones. The case  $p^+ = p^- - 1$  corresponds to an undercompressive shock [71]. When  $p^+ \geq p^-$ , the shock is said to be compressive, in reference to the case of gas dynamics [74, 16], where the pressure increases through such a shock. More precisely, if  $\varpi = 0$ , the shock is said to be of *Lax*-type and if  $\varpi \geq 1$ , the shock is overcompressive of degree  $\varpi$  [53, 56].

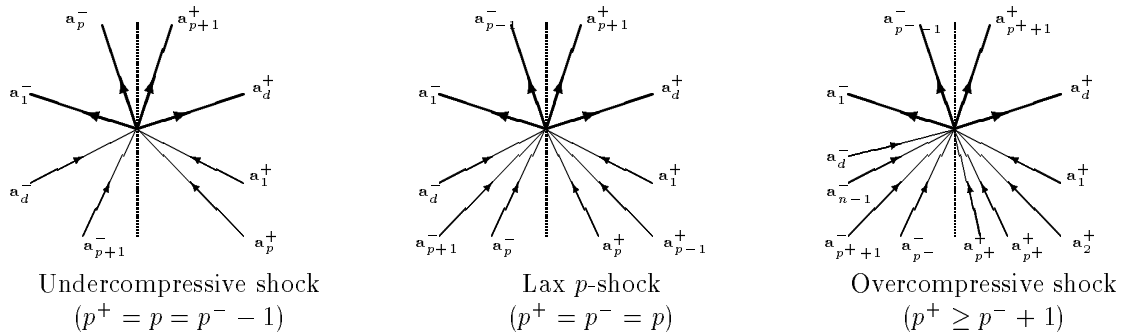

Fig. 2.1: Compressivity of the shock

Our last standard assumption is that the well-known CFL condition is satisfied

**H 5**  $\sup_{u \in \mathcal{U}} \rho(df(u)) < 2\mathbf{D} < \frac{h}{k},$

where  $\rho$  denotes the spectral radius.

We are interested here in stationary discrete shock profiles of the MLF scheme, that is, fixed points of the operator  $\mathcal{L}$  that connect the end states  $u^-$  and  $u^+$ . The existence of stationary discrete shock profiles has been studied for quite a long time ([41, 62, 64]). When the speed of the shock is not zero, however, the search for discrete shock profiles

is much more difficult : in the case of rational speeds, we need to iterate the operator  $\mathcal{L}$  to change to a stationary shock, but the iterated operator is much more complicated than the original one; Liu and Yu [57, 58] developed a Diophantine condition under which they proved the existence of discrete shock profiles for weak shocks. The case of irrational speeds remains open [72]. Let us assume now the existence of a stationary discrete shock profile for the MLF scheme :

**H 6** *there exists a sequence  $\bar{u}^s = (\bar{u}_j^s)_{j \in \mathbb{Z}}$  that satisfies*

$$\begin{aligned} \mathcal{L}(\bar{u}^s) &= \bar{u}^s, \\ \bar{u}_j^s &\xrightarrow{j \rightarrow \pm\infty} u^\pm. \end{aligned}$$

Let us now linearize  $\mathcal{L}$  about  $\bar{u}^s$

$$u_j^{n+1} = u_j^n - \left( \frac{F_{j+1}u_{j+1}^n - F_{j-1}u_{j-1}^n}{2} - \mathbf{D}(u_{j+1}^n - 2u_j^n + u_{j-1}^n) \right) =: (L^s u^n)_j, \quad j \in \mathbb{Z}, \quad (8)$$

where

$$\begin{aligned} F_j &:= \frac{k}{h} \mathrm{d}f(\bar{u}_j^s), \quad \forall j \in \mathbb{Z}, \\ D &:= \frac{k\mathbf{D}}{h}. \end{aligned}$$

In the following, we denote

$$\begin{aligned} F^\pm &:= \frac{k}{h} \mathrm{d}f(u^\pm), \\ a_q^\pm &:= \frac{k}{h} \mathbf{a}_q^\pm, \quad q \in \{1, \dots, d\}. \end{aligned}$$

Note that  $(a_q^\pm)_{q \in \{1, \dots, n\}}$  are the eigenvalues of  $F^\pm$  and that  $(r_q^\pm)_{q \in \{1, \dots, n\}}$  are associated eigenvectors.

The numerical linearized problem that we are interested in is

$$u^{n+1} - L^s u^n = \tilde{u}^n, \quad \forall n \geq 0, \quad (9)$$

$$u_j^n \xrightarrow{j \rightarrow \pm\infty} 0, \quad \forall n \geq 0, \quad (10)$$

$$u^0 = \mathbf{u}, \quad (11)$$

where  $\tilde{u}$  and  $\mathbf{u}$  are given sequences.

A way to describe the solutions of (9)-(10)-(11) is by using the Green's function, that is a sequence  $(G(n, l, j))_{n \in \mathbb{N}, l \in \mathbb{Z}, j \in \mathbb{Z}}$  of  $d \times d$  matrices that solves the following problem,  $l$  being given in  $\mathbb{Z}$ ,

$$G(n+1, l, j) - L^s G(n, l, j) = 0, \quad \forall n \geq 0, j \in \mathbb{Z}, \quad (12)$$

$$G(n, l, j) \xrightarrow{j \rightarrow \pm\infty} 0, \quad \forall n \geq 1, \quad (13)$$

$$G(0, l, j) = \delta_{lj} I_d, \quad j \in \mathbb{Z}, \quad (14)$$

where  $\delta$  is the Kronecker symbol. Indeed, the formal solution of (9)-(10)-(11) is given by

$$u_j^n = \sum_{l=-\infty}^{+\infty} G(n, l, j) \mathbf{u}_l + \sum_{\bar{n}=0}^{n-1} \sum_{l=-\infty}^{+\infty} G(n - \bar{n}, l, j) \tilde{u}_l^{\bar{n}}, \quad \text{for } j \in \mathbb{Z}, n \geq 1.$$

The aim of this paper is to find estimates of  $G$ , in order to be able to better understand its behavior, in the same way as Zumbrun and Howard [88] did in the case of (continuous) viscous shock profiles.

The operator  $L^s$  is said to be spectrally stable if  $L$  has no eigenvalue outside the open unit disc, since such eigenvalues are unstable modes of  $L^s$  [43]. Consequently, to avoid instability, we assume that

**H 7** *the operator  $L^s$  has no eigenvalue of modulus larger or equal to 1 other than 1.*

Indeed, in the compressive case ( $\varpi \geq 0$ ), 1 is an eigenvalue of  $L^s$  and must be dealt with very carefully (see [72, 9, 73]). An analogous role is played by the eigenvalue 0 in the continuous case : every translation of the shock profile is also a shock profile, so that the derivative of the profile is always an eigenfunction of the linearized operator for the eigenvalue 0 [88]. In the discrete case, however, the translation invariance parameter is an integer and there is no such generality. That is the reason why we must study the operator  $L^s - 1$  very precisely. To investigate the role of 1, we use an Evans function, that is a function  $\mathcal{D}(j, \mu)$  which is defined for  $|\mu| > 1$  by a determinant of  $2d$  solutions of

$$(L^s - \mu)v = 0. \tag{15}$$

The main feature of the Evans function is that it vanishes at points  $\mu$  that are eigenvalues of  $L^s$ . More precisely, considering a basis  $v_1(\mu, j), \dots, v_d(\mu, j)$  (resp.  $v_{j+1}(\mu, j), \dots, v_{2d}(\mu, j)$ ) of the solutions of (15) that decrease exponentially towards 0 as  $j$  tends to  $+\infty$  (resp. to  $-\infty$ ), we define, for  $|\mu| > 1$  and  $j \in \mathbb{Z}$ ,

$$\mathcal{D}(\mu, j) = \det \begin{pmatrix} v_1(\mu, j) & \dots & v_d(\mu, j) & v_{d+1}(\mu, j) & \dots & v_{2d}(\mu, j) \\ \Delta v_1(\mu, j) & \dots & \Delta v_d(\mu, j) & \Delta v_{d+1}(\mu, j) & \dots & \Delta v_{2d}(\mu, j) \end{pmatrix},$$

where  $\Delta v_j = v_j - v_{j-1}$ . Up to a product factor depending only on  $j$ ,  $\mathcal{D}$  is a Wronskian of (15). Besides,  $\mathcal{D}$  is holomorphic with respect to  $\mu$  in  $|\mu| > 1$ .

In the continuous setting, the Gap Lemma [24] allows to extend  $\mathcal{D}$  to a neighborhood of the origin. Thanks to this technique, necessary conditions of spectral stability have been obtained for various approximations, such as Gardner and Zumbrun's [24] and Benzoni, Serre and Zumbrun's [4] for the viscous case, Serre's for the Lax-Friedrichs scheme [73], Bultelle, Grassin and Serre's for the Godunov scheme [9], Benzoni's for the semi-discrete profiles [2], Godillon's for the semi-linear relaxation [30]. Zumbrun and Serre linked, in the multi-dimensional setting, the Evans function and the Lopatinski condition [89].

Here, the study of  $(v_q)_{q \in \{1, \dots, 2d\}}$  in a neighborhood of  $\mu = 1$  shows that  $\mathcal{D}$  necessarily vanishes at  $\mu = 1$  if the shock is compressive ( $\varpi \geq 0$ ). Furthermore, if  $\varpi > 0$ , the  $\varpi$  first derivatives of  $\mathcal{D}$  with respect to  $\mu$  necessarily vanish at  $\mu = 1$ . Consequently, we assume that the shock is minimally degenerated, that is,

**H 8**  $\frac{\partial^{\varpi+1} \mathcal{D}}{\partial \lambda^{\varpi+1}}(\cdot, j)$  *does not vanish at  $\mu = 1$  for all  $j \in \mathbb{Z}$ .*

Note that Hypothesis (H7) can be reformulated equivalently as

**H 7** if  $\varpi \geq 0$  (resp. if  $\varpi = -1$ ), the Evans function  $\mathcal{D}(\mu, \cdot)$  does not vanish in  $\{\mu \in \mathbb{C}/|\mu| \geq 1\} \setminus \{1\}$  (resp.  $|\mu| \geq 1$ ).

The aim of this paper is to prove the following theorem

**Theorem 2.1.1 (Green's function of a shock profile)**

Assuming (H1-7), the Green's function of the linearized problem (9)-(10)-(11) behaves as follows :

$$\begin{aligned} \text{for } \vec{e} \in \mathbb{R}^d, \\ G(n, l, j) \cdot \vec{e} &= \chi_{|j| < n \min(|a_q^\pm|, q \in \{1, \dots, d\})} \mathcal{R}_0(l, j) \cdot \vec{e} + \sum_{q/ja_q^\pm > 0} \frac{1}{\sqrt{n}} O\left(\exp\left(-\frac{(j - a_q^\pm n)^2}{Mn}\right)\right) r_q^\pm \\ &\quad + O\left(e^{-\gamma n} \exp\left(-\frac{(l-j)^2}{Mn}\right)\right), \quad l, j \in \mathbb{Z}, \\ \Delta_j G(n, l, j) \cdot \vec{e} &= \chi_{|j| < n \min(|a_q^\pm|, q \in \{1, \dots, d\})} \Delta_j \mathcal{R}_0(l, j) \cdot \vec{e} + \sum_{q/ja_q^\pm > 0} \frac{1}{n} O\left(\exp\left(-\frac{(j - a_q^\pm n)^2}{Mn}\right)\right) r_q^\pm \\ &\quad + O\left(e^{-\gamma n} \exp\left(-\frac{(l-j)^2}{Mn}\right)\right), \quad l, j \in \mathbb{Z}, \end{aligned}$$

where

- the notation  $\Delta_j G(\cdot, \cdot, j)$  refers to  $G(\cdot, \cdot, j) - G(\cdot, \cdot, j - 1)$ ,
- the notation  $q/ja_q^\pm > 0$  addresses the indices  $q \in \{1, \dots, d\}$  such that  $j$  and the eigenvalues  $a_q^{\text{sign}(j)}$  have the same sign,
- the residual term  $\mathcal{R}_0(l, j)$  is a projection on the eigenspace of  $L^s$  associated with the eigenvalue 1 (see equation 58),
- all the constants are locally bounded on  $l$  and uniformly bounded on  $n$  and  $j$ , and the constants  $M$  and  $\gamma$  are positive.

This result is analogous to the ones proved by Zumbrun and Howard [88] in the case of viscous shock profiles, although they do not set on  $y$  (the continuous analogue of our discrete variable  $l$ ) to be bounded. At first, the Dirac mass splits into waves that propagate along the outgoing characteristics and waves that propagate along the entering characteristics. The waves that are carried by the outgoing characteristics, that is eigenvectors corresponding to negative (respectively positive) eigenvalues if the Dirac mass was on the left-hand (resp. right-hand) side of the shock, take the shape of moving Gaussians that are damped by the numerical viscosity. Their asymptotic speeds are the corresponding eigenvalues of the derivatives of the flux at the end states multiplied by the ratio  $k/h$ . The waves propagating along the entering characteristics move towards the shock, and when each wave corresponding to a different characteristic reaches the position of the shock ( $j = 0$ ), similar outgoing waves as described above are emitted. Furthermore, if the shock

is compressive, as soon as the first entering waves has reached the shock, a stationary residual wave that is strongly related to the kernel of  $L^s - 1$  may appear, depending on the position of the Dirac mass as initial datum. There is also a fast-time decaying term. Note that the fact that the outgoing waves are Gaussian-shaped is compatible with the  $\ell^1$  conservation of the mass.

We give in Section 2.5 a numerical illustration of Theorem 2.1.1 : we treat the case of a Lax 3-shock for the  $3 \times 3$  system of gas dynamics in conservative variables. We include graphics displaying the three components of the Green's function in the canonical basis (see Figure 2.12) and in the basis of the eigenvectors of  $df(u^-)$  (see Figure 2.14), in order to show the different speeds and directions of the waves that appear when the Dirac mass splits. We also compute an eigenfunction of  $L^s - 1$  (see Figures 2.13 and 2.15) in order to compare it with the residual wave  $\mathcal{R}_0$ . The evolution of the Green's function is compared to the theoretical Gaussians in movies that are available at

<http://www.umpa.ens-lyon.fr/~pgodillo>.

Let us now give a few hints of the proof of Theorem 2.1.1. Following the work of Zumbrun and Howard for viscous shock profiles [88], the main tool that we are going to use is the Laplace transform of a sequence that we define by

$$v = (v^n)_{n \in \mathbb{N}} \mapsto \left( \lambda \in \mathbb{D} \mapsto \hat{v}(\lambda) := \sum_{n \in \mathbb{N}} e^{-\lambda n} v^n \right), \tag{16}$$

where  $\mathbb{D}$  is a subset of  $\mathbb{C}$  suitably chosen to ensure the convergence of the sum. In particular, since (16) is  $i2\pi$  periodic in  $\lambda$ , we set on  $\mathbb{D}$  to lie in the strip  $\mathcal{S} := \{\lambda \in \mathbb{C} / -\pi \leq \text{Im}(\lambda) \leq \pi\}$ . Given  $l \in \mathbb{Z}$ , the Laplace transform of the Green's function  $G(\cdot, l, \cdot)$  with respect to time, that we denote by  $G_\lambda(l, \cdot)$  satisfies the following problem

$$(L^s - e^\lambda)G_\lambda(l, j) = -\delta_{lj}I_d, \quad j \in \mathbb{Z}, \tag{17}$$

$$G_\lambda(l, j) \xrightarrow{j \rightarrow \pm\infty} 0. \tag{18}$$

In Section 2.2, rewriting the homogeneous equation

$$(L^s - e^\lambda)v = 0,$$

as a first-order dynamical system

$$V_j = \mathbb{A}_j(\lambda)V_{j-1}, \quad V_j = \begin{pmatrix} v_j \\ v_{j+1} - v_j \end{pmatrix} \in \mathbb{C}^{2d}, \quad j \in \mathbb{Z}, \tag{19}$$

we study the limit systems of (19) as  $j$  tends to  $\pm\infty$ , and more specifically the behavior of the solutions decreasing to 0 at  $\pm\infty$  : it allows us to construct the Evans function  $\mathcal{D}(\lambda, j)$ , (we take hereafter the variable  $\lambda$ , that is linked to the variable  $\mu$ , that we used in (15), through  $e^\lambda = \mu$ ) as an analytic function in the open right half-plane and to extend it to a neighborhood of  $\lambda = 0$ . In Section 2.3, we express  $G_\lambda$  as a sum of suitably chosen solutions of (19), so that we are able to establish that  $G_\lambda$  is meromorphic (if the shock is compressive) with  $\lambda = 0$  as its only pole in a carefully chosen neighborhood of 0 and thus to find bounds of  $G_\lambda$  for small and medium values of  $\lambda$ . We do not have to consider

large values of  $\lambda$  since, the scheme having a finite propagation speed,  $G(n, l, j)$  vanishes for  $n + 1 \leq |l - j|$ .

In Section 2.4, we use the inverse Laplace transform to get bounds of  $G$  :

$$G(n, l, j) = \frac{1}{2i\pi} \int_{\Gamma} e^{\lambda n} G_{\lambda}(l, j) d\lambda, \tag{20}$$

where  $\Gamma$  is a path of  $\mathcal{S}$  that lies a priori in the open right half-plane. But thanks to the Cauchy formula, this path can be changed to better suit the behavior of  $G_{\lambda}$  : we choose moving contours, that depend on  $n, l$ , and  $j$ , and that may partly lie in the left half-plane, as in the work of Zumbrun and Howard [88]. We take a particular care to deal with the compressive shocks, since in these cases the Laplace transform of  $G$  has a pole (of finite order) at the origin : the choice of contours may then yield a stationary residual term, which is a projection on the eigenspace associated with the eigenvalue 1 of  $L^s$ , as stated in Theorem 2.1.1.

A similar technique can be applied to the Lax-Wendroff scheme, but the computations are rather more complicated.

Let us now consider the boundary layer setting : let a  $d \times d$  system of conservation laws on the half-line  $\mathbb{R}^+$  with initial datum be

$$u_t + f(u)_x = 0, \quad x \geq 0 \tag{21}$$

$$u(x, 0) = u_0(x), \quad x \geq 0. \tag{22}$$

We are still considering the MLF scheme, but now we consider a mesh of  $\mathbb{R}^+$  that consists of cells  $M_j = (jh, (j + 1)h]$  of size  $h, j \in \mathbb{N}, x_j = (j - 1/2)h$  being the center of  $M_j$ . We denote by  $k$  the time step and  $t^n = nk, n \in \mathbb{N}$ . The nonlinear evolution operator associated with the MLF scheme is still denoted by  $\mathcal{L}$  (see (4) and (5)).

We assume as usual that  $df(u)$  is symmetrizable, that is

**K 1** *there exist smooth matrices  $P$ , being invertible, and  $D$ , being diagonal, such that  $df(u) = P(u)D(u)P(u)^{-1}$ .*

Boundary conditions at  $x = 0$  are needed : choosing Neuman's condition leads to small boundary layers of size  $h$  and Dirichlet's condition to large boundary layers of size 1. Here we consider Dirichlet's boundary conditions : the numerical problem becomes

$$u^{n+1} = \mathcal{L}(u^n), \quad u = (u_j)_{j \in \mathbb{N}}, \tag{23}$$

$$u_j^0 = \frac{1}{|M_j|} \int_{M_j} u_0(x) dx, \quad j \geq 1, \tag{24}$$

$$u_0^n = 0, \quad n \in \mathbb{N}, \tag{25}$$

where  $\mathcal{L}$  is once again the MLF (nonlinear) operator.

We also assume that the boundary is non-characteristic, that is,

**K 2** *the value 0 is never an eigenvalue of  $df(u)$ ,*

and that the CFL condition is satisfied along the boundary layer profile

**K 3**  $\sup_{u \in \mathcal{U}} \rho(df(u)) < 2D < \frac{k}{h}$ ,

$\rho$  denoting the spectral radius.

Under a smallness assumption, Chainais-Hillairet and Grenier [10] proved the convergence of the numerical solutions to the solutions of (21)-(22) with boundary conditions

$$u(0, t) \in \mathcal{C}_{num},$$

where  $\mathcal{C}_{num}$  is the set of vectors  $w$  such that there exists a solution  $v = (v_j)_{j \in \mathbb{N}}$  to

$$\mathcal{F}(w + v_j, u + v_{j+1}) = f(w), \quad v_0 = w, \quad v_{+\infty} = 0, \tag{26}$$

$\mathcal{F}$  being the numerical flux of  $\mathcal{L}$ . This result is similar to the one obtained for the Godunov scheme by Gisclon and Serre [28]. This condition is analogous to setting on the solution to be zero on the entering characteristics when the flux is linear.

This situation is the discrete analogue of the non-viscous limit of

$$\begin{aligned} u_t^\varepsilon + f(u^\varepsilon)_x - \varepsilon u_{xx}^\varepsilon &= 0, \\ u^\varepsilon(0) &= 0, \end{aligned}$$

as  $\varepsilon$  tends to 0, the numerical viscosity of the MLF scheme being  $Dh$ . Indeed, as proved in [27], under specific assumptions, the solutions  $u^\varepsilon$  tend to solutions of

$$\begin{aligned} u_t + f(u)_x &= 0, \\ u(0, t) &\in \mathcal{C}_{vis}, \end{aligned}$$

where  $\mathcal{C}_{vis}$  is the subset of  $\mathbb{R}^d$  consisting of vectors  $w$  that satisfy

$$\partial_x f(v + w) = \partial_{xx} v \text{ for } x > 0, \quad v \xrightarrow{x \rightarrow \pm\infty} 0, \quad v(0) = -w.$$

The stability of these solutions has been proved under a smallness assumption by Grenier and Guès [35] and under some spectral assumptions by Grenier and Rousset [36].

We assume here the existence of a boundary layer profile, that is

**K 4** *there exists a sequence  $\bar{u}^{bl} = (\bar{u}_j^{bl})_{j \in \mathbb{N}}$  that satisfies*

$$\begin{aligned} \mathcal{L}(\bar{u}^{bl}) &= \bar{u}^{bl}, \\ \bar{u}^{bl} &\xrightarrow{j \rightarrow +\infty} u^+, \\ \bar{u}_0 &= 0, \end{aligned}$$

where  $u^+$  belongs to  $\mathcal{C}_{num}$ .

Similarly as in the shock profile setting, we assume that

**K 5** *the eigenvalues of  $df(u^+)$  are distinct.*

Next, we linearize the operator  $\mathcal{L}$  about  $\bar{u}_{bl}$  and, denoting by  $L^{bl}$  the linearized operator, we study

$$u^{n+1} - L^{bl}u^n = \tilde{u}^n, \forall n \geq 0, \tag{27}$$

$$u_j^n \xrightarrow{j \rightarrow +\infty} 0, \forall n \geq 0, \tag{28}$$

$$u^0 = \mathbf{u}, \tag{29}$$

$$u_0^n = 0, \forall n \geq 0, \tag{30}$$

where  $\tilde{u}$  and  $\mathbf{u}$  are given sequences. The Green's function of  $L^{bl}$  is defined similarly as the one of  $L^s$  and satisfies the following problem,  $l$  being given in  $\mathbb{N}$ ,

$$G(n + 1, l, j) - L^{bl}G(n, l, j) = 0, \tag{31}$$

$$G(n, l, j) \xrightarrow{j \rightarrow +\infty} 0, \tag{32}$$

$$G(0, l, j) = \delta_{lj}I_d, \tag{33}$$

$$G(n, l, 0) = 0. \tag{34}$$

Similarly as in the case of shock profiles, the formal solution of (27)-(28)-(29)-(30) is given by

$$u_j^n = \sum_{l=0}^{+\infty} G(n, l, j)\mathbf{u}_l + \sum_{\bar{n}=0}^{n-1} \sum_{l=0}^{+\infty} G(n - \bar{n}, l, j)\tilde{u}_l^{\bar{n}}, \text{ for } j \in \mathbb{Z}, n \geq 1.$$

Our aim is to obtain analogous estimates as the ones Grenier and Rousset found in the continuous viscous case [36]. The construction of the Evans function  $\mathcal{D}$  in the case of numerical boundary layers is much like what we described for the shock profiles, the main difference being that we need  $(v_1(\mu, j), \dots, v_d(\mu, j))$  (resp.  $(v_{d+1}(\mu, j), \dots, v_{2d}(\mu, j))$ ) a basis of the space of solutions of

$$(L^{bl} - \mu)v = 0$$

satisfying  $v_q(\mu, 0) = 0$  for  $q \in \{1, \dots, d\}$  (resp.  $v_q(\mu, j)$  tends to 0 as  $j$  tends to  $+\infty$ ) instead of the condition at  $j = -\infty$  that we used in the shock profile setting. For  $|\mu| > 1$ , we define the Evans function as

$$\mathcal{D}(\mu, j) = \det \begin{pmatrix} v_1(\mu, j) & \dots & v_d(\mu, j) & v_{d+1}(\mu, j) & \dots & v_{2d}(\mu, j) \\ \Delta v_1(\mu, j) & \dots & \Delta v_d(\mu, j) & \Delta v_{d+1}(\mu, j) & \dots & \Delta v_{2d}(\mu, j) \end{pmatrix}.$$

As in the case of shock profiles, the zeroes of  $\mathcal{D}(\cdot, j)$  correspond to unstable eigenvalues of  $L^{bl}$ . Since the eigenvalues of modulus larger than 1 induce instability, we assume that there are none in  $|\mu| > 1$  and extending  $\mathcal{D}$  to a neighborhood of the circle  $|\mu| = 1$ , we also assume that 1 is not an eigenvalue of  $L^{bl}$ , that is

**K 6** *the Evans function does not vanish outside the open unit-disc, that is*

$$\mathcal{D}(\mu, j) \neq 0, \forall j \in \mathbb{N}, \forall \mu, |\mu| \geq 1.$$

Performing the same kind of analysis as in the case of shock profiles, we obtain the following theorem



**Theorem 2.1.2 (Green’s function of a pure boundary layer)**

Assuming (K1-5), the Green’s function of (27)-(28)-(29)-(30) behaves as follows :

given  $\vec{e} \in \mathbb{R}^d$ , we have  $\forall l, j \in \mathbb{N}$ ,

$$G(n, l, j) \cdot \vec{e} = \sum_{q/a_q > 0} \frac{1}{\sqrt{n}} O \left( \exp \left( -\frac{(j - a_q n)^2}{Mn} \right) \right) r_q + O \left( e^{-\gamma n} \exp \left( -\frac{(l - j)^2}{Mn} \right) \right),$$

and

$$\Delta_j G(n, l, j) \cdot \vec{e} = \sum_{q/a_q > 0} \frac{1}{n} O \left( \exp \left( -\frac{(j - a_q n)^2}{Mn} \right) \right) r_q + O \left( e^{-\gamma n} \exp \left( -\frac{(l - j)^2}{Mn} \right) \right),$$

where

- we denote by  $a_1 < \dots < a_d$  the eigenvalues of  $(k/h)df(u^+)$  and by  $(r_q)_{q \in \{1, \dots, d\}}$  some associated eigenvectors,
- the notation  $q/a_q > 0$  addresses the indices  $q \in \{1, \dots, d\}$  such that  $a_q$  is positive,
- all the constants are locally bounded with respect to  $l$  and uniformly bounded with respect to  $n, j$  and  $M, \gamma$  are positive.

This result is analogous to the one obtained in the viscous case developed in Section 4 of [36]. Physically, Theorem 2.1.2 states that the Dirac mass splits upon both the outgoing and entering characteristics. Along each outgoing characteristic, a Gaussian-shaped wave enters the domain with an asymptotic speed that is equal to the eigenvalue of  $df(u^+)$  corresponding to the considered characteristic multiplied by the ratio  $k/h$ . These waves are damped by the numerical viscosity. Each time a wave that is carried by an entering characteristic reaches the boundary, new waves behaving as described above leave the boundary to enter the domain.

We do not give the proof of Theorem 2.1.2 hereafter, since it is very close to the one of the shock wave setting. Note however that the main differences appear in the statement of the problems and that once they have been linearized about respectively a shock profile and a boundary layer, they are remarkably similar.

Finding bounds on the Green’s function is a valuable step in the search for nonlinear stability as it was proved by Grenier and Rousset in [36] for the viscous boundary layers.

## 2.2 Construction of an Evans function

From now on, we only consider the case of the shock profiles and consequently, we rename the linearized operator  $L^s$  in  $L$ . We aim here to construct a basis of the spaces consisting of solutions  $v$  of the equation

$$(L - e^\lambda)v = 0$$

that decrease to 0 as  $j$  tends to  $\pm\infty$ .

Noting  $\Delta v_{j-1} := v_j - v_{j-1}$  for any sequence  $(v_j)_{j \in \mathbb{Z}}$  and rewriting (17) with no right-hand term as a first-order recurrence on  $V_j := (v_j, \Delta v_j)^T$ , we get

$$V_j = \mathbb{A}_j(\lambda)V_{j-1}, \quad j \in \mathbb{Z}. \tag{35}$$

where

$$\mathbb{A}_j(\lambda) = \left( \begin{array}{c} I_d \\ \left( \frac{F_{j+1}}{2} - DI_d \right)^{-1} \left( 1 - e^\lambda + \frac{F_{j-1} - F_{j+1}}{2} \right) \\ \left( \frac{F_{j+1}}{2} - DI_d \right)^{-1} \left( (1 - e^\lambda - D)I_d - \frac{F_{j+1}}{2} \right) \end{array} \right)$$

### 2.2.1 Asymptotic behavior of the solutions of the homogeneous recurrence

Let us now study the asymptotic behaviors of the solutions of (35). As  $j$  tends to  $\pm\infty$ , the sequence of matrices  $(\mathbb{A}_j(\lambda))$  tends to

$$\mathbb{A}^\pm(\lambda) := \left( \begin{array}{c} I_d \\ (e^\lambda - 1) \left( DI_d - \frac{F^\pm}{2} \right)^{-1} \\ \left( DI_d - \frac{F^\pm}{2} \right)^{-1} \left( e^\lambda - 1 + D + \frac{F^\pm}{2} \right) \end{array} \right).$$

Using the strict hyperbolicity of (1) at the end states  $u^\pm$ , we obtain the following formula of the characteristic polynomial of  $\mathbb{A}^\pm(\lambda)$

$$\Pi^\pm(\rho, \lambda) := \prod_{q=1}^d (\rho^2 + 2(2D - a_q^\pm)^{-1}(1 - 2D - e^\lambda)\rho + (2D - a_q^\pm)^{-1}(2D + a_q^\pm)). \quad (36)$$

Thus, the eigenvalues of  $\mathbb{A}^\pm(\lambda)$  are

$$\rho_{\varepsilon,q}^\pm(\lambda) = \frac{1}{(2D - a_q^\pm)} \left( 2D + e^\lambda - 1 + \varepsilon \sqrt{(e^\lambda - 1)^2 + 4D(e^\lambda - 1) + (a_q^\pm)^2} \right), \quad \varepsilon = \pm 1,$$

for  $q \in \{1, \dots, d\}$  and

$$R_{q,\varepsilon}^\pm(\lambda) = \begin{pmatrix} r_q^\pm \\ (\rho_{\varepsilon,q}^\pm(\lambda) - 1)r_q^\pm \end{pmatrix}$$

are associated eigenvectors. The eigenlements  $\rho_{\varepsilon,q}^\pm$  and  $R_{\varepsilon,q}^\pm$  associated with  $a_q^\pm$  are holomorphic if  $\lambda \in \mathbb{C} \setminus (-\infty, \Lambda]$ , with

$$\Lambda := \min_{q \in \{1, \dots, d\}} \ln \left( 1 - 2D \left( 1 - \sqrt{1 - \frac{(a_q^\pm)^2}{4D^2}} \right) \right). \quad (37)$$

We denote by

$$\mathcal{E}_q^\pm := \{ \lambda \in \mathbb{C} / \exists \theta \in \mathbb{R} / e^\lambda = 1 - 2D(1 - \cos(\theta)) - ia_q^\pm \sin(\theta) \}$$

the set of complex points  $\lambda$  such that the modulus of a solution  $\rho$  of (36) is 1. Note that, since  $2D < 1$  and  $|a_q^\pm| < 1$ ,  $(-\infty, \Lambda]$  and  $\mathcal{E}_q^\pm$  lie in the left half-plane. Besides,  $\mathcal{E}_q^\pm$  only intersects the imaginary axis at  $\lambda = 0$ . From now on,  $\mathcal{E}$  will denote the biggest of the  $\mathcal{E}_a$ , i.e  $\mathcal{E}_{\max(a_q^\pm)}$ . Let  $\Omega$  be the (open) connected component of  $\mathcal{S} \setminus (\mathcal{E} \cup (-\infty, \Lambda])$  containing  $+\infty$  and consider  $\lambda \in \Omega$  (see Figure 2.2).

#### Lemma 2.2.1

Let  $\lambda \in \Omega$ . The matrices  $\mathbb{A}^\pm(\lambda)$  have  $d$  eigenvalues of modulus strictly larger than 1 and  $d$  eigenvalues of modulus strictly less than 1.

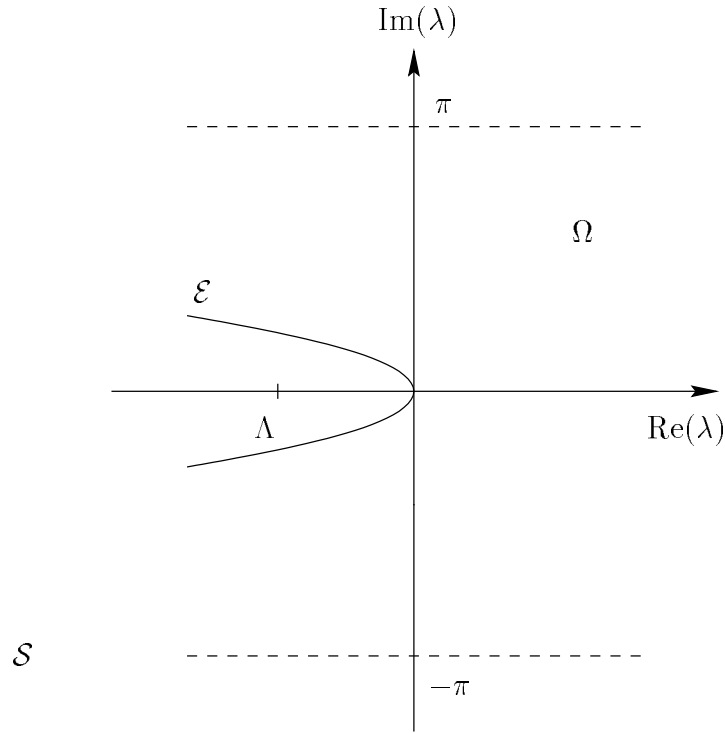
Fig. 2.2: Spectrum of  $L$  in the complex plane**Proof**

We drop temporarily the superscript  $\pm$  for the sake of simplicity :  $a_q$  denotes any eigenvalue of  $F^\pm$ .

Developing  $\rho_{\varepsilon,q}$  in a neighborhood of  $\lambda = 0$ , we obtain

$$\rho_{-\operatorname{sgn}(a_q),q} = 1 - \frac{\lambda}{a_q} - \frac{1}{2a_q} \left( 1 - \frac{2D + a_q}{a_q^2} \right) \lambda^2 + O(|\lambda|^3) \quad (38)$$

and

$$\rho_{\operatorname{sgn}(a_q),q} = \frac{2D + a_q}{2D - a_q} + O(|\lambda|).$$

We see at once that, for small real  $\lambda$ , we have

$$|\rho_{\operatorname{sgn}(a_q),q}| > 1 \Leftrightarrow (\lambda > 0 \text{ and } a_q < 0).$$

Consequently, since  $q \in \{1, \dots, d\}$ , there are  $d$  eigenvalues of modulus larger than 1 and  $d$  eigenvalues of modulus less than 1 for small positive  $\lambda$ . Since the definitions of  $\mathcal{E}$  and  $\Omega$  imply that there are no eigenvalue of modulus 1 if  $\lambda \in \Omega$ , the holomorphy of the set of solutions of the characteristic polynomial of  $\mathbb{A}(\lambda)$  outside  $(-\infty, \Lambda]$  allows us to conclude that  $\mathbb{A}(\lambda)$  has  $d$  eigenvalues of modulus larger than 1 and  $d$  eigenvalues of modulus less than 1.

□

The matrices  $\mathbb{A}^+(\lambda)$  and  $\mathbb{A}^-(\lambda)$  have no eigenvalue of modulus 1 in  $\Omega$  because of the definition of  $\mathcal{E}$ . By Theorem 6.1 in the appendix of [31],  $\mathbb{A}^+(\lambda)$  (resp.  $\mathbb{A}^-(\lambda)$ ) has an

exponential dichotomy on  $\mathbb{N}$  (resp.  $-\mathbb{N}$ ). Since  $(\mathbb{A}_j(\lambda))_{j \in \mathbb{Z}}$  tends to  $\mathbb{A}^\pm(\lambda)$  as  $j$  tends to  $\pm\infty$  exponentially, we can apply Theorem 6.2 ([31], Appendix) and  $(\mathbb{A}_j(\lambda))_j$  has an exponential dichotomy on  $\mathbb{N}$  (resp.  $-\mathbb{N}$ ) of projection  $P(\lambda)$  (resp.  $Q(\lambda)$ ) and  $\ker(P(\lambda))$  (resp.  $\ker(Q(\lambda))$ ) and  $R(P(\lambda))$  (resp.  $R(Q(\lambda))$ ) are  $d$ -dimensional (Lemma 2.2.1). Let

$$E(\lambda) := \{(V_j)_{j \in \mathbb{Z}} / V_{j+1} = \mathbb{A}_j(\lambda)V_j \text{ and } V_j \xrightarrow{j \rightarrow +\infty} 0\}, \tag{39}$$

$$E_0(\lambda) := \{V_0 / (V_j)_{j \in \mathbb{Z}} \in E(\lambda)\},$$

$$F(\lambda) := \{(V_j)_{j \in \mathbb{Z}} / V_{j+1} = \mathbb{A}_j(\lambda)V_j \text{ and } V_j \xrightarrow{j \rightarrow -\infty} 0\} \tag{40}$$

and

$$F_0(\lambda) := \{V_0 / (V_j)_{j \in \mathbb{Z}} \in F(\lambda)\}.$$

If  $E_0(\lambda) \cap F_0(\lambda) \neq \{0\}$ ,  $e^\lambda$  is an eigenvalue of  $L$ . Otherwise, we have

$$R(P(\lambda)) \oplus \ker(Q(\lambda)) = \mathbb{C}^{2d}.$$

Consequently, using Theorem 6.3 ([31], Appendix), we conclude that the dynamical system 35 has an exponential dichotomy on  $\mathbb{Z}$  if and only if  $e^\lambda$  is not an eigenvalue of  $L$ , for all  $\lambda \in \Omega$  (see Figure 2.2). Furthermore, if we consider a basis  $\mathcal{B}_{E(\lambda)}$  (resp.  $\mathcal{B}_{F(\lambda)}$ ) of  $E(\lambda)$  (resp.  $F(\lambda)$ ) consisting of  $d$  eigenfunctions of (35) geometrically decreasing towards 0 at  $+\infty$  (resp.  $-\infty$ ), we conclude at once that the set  $\mathcal{B}_{E(\lambda)} \cup \mathcal{B}_{F(\lambda)}$  is a basis of the whole space of solutions of (35) if and only if  $e^\lambda$  is not an eigenvalue of  $L$ . Thus we can define an Evans function  $(\lambda, j) \mapsto \mathcal{D}(\lambda, j)$  as a determinant of the elements of  $\mathcal{B}_{E(\lambda)} \cup \mathcal{B}_{F(\lambda)}$  taken at the point  $j \in \mathbb{Z}$ . A most interesting feature of  $\mathcal{D}(\cdot, j)$  is its vanishing at the points  $\lambda$  such that  $e^\lambda$  is an eigenvalue of  $L$ . Moreover, the function  $\mathcal{D}$  is analytic on  $\Omega$ .

### 2.2.2 Extension to a neighborhood of $\lambda = 0$

Besides, for  $\lambda \in D(0, \sigma)$  with  $\sigma$  sufficiently small, the asymptotic behaviors of the eigenelements of  $\mathbb{A}^\pm(\lambda)$  are given in Tables 1 and 2 where

$$\zeta_q^\pm := \frac{2D + a_q^\pm}{2D - a_q^\pm}.$$

Thus, in a neighborhood of  $\lambda = 0$ , the matrices  $\mathbb{A}^\pm(\lambda)$  are diagonalizable, because the strict hyperbolicity assumption (H2) implies that the  $\rho_{\varepsilon, q}^\pm$  are distinct. Consequently, we can easily choose  $(\Phi_q(\lambda, j))_{q \in \{1, \dots, d\}}$  (resp.  $(\Phi_q(\lambda, j))_{q \in \{d+1, \dots, 2d\}}$ ) a basis of solutions of (35) which decay towards 0 as  $j$  tends to  $+\infty$  (resp.  $-\infty$ ), which depend analytically on  $\lambda$  for  $\lambda \in D(0, \sigma)$  and that can be extended analytically to a neighborhood of  $\lambda = 0$  such that their behaviors are as follows

$$\begin{aligned} \Phi_q(\lambda, j) &\underset{j \rightarrow +\infty, \lambda \rightarrow 0}{=} (\rho_q^+(\lambda))^j (R_q^+(\lambda) + O(\omega^{-j})), \text{ for } q \in \{1, \dots, d\}, \\ \Phi_q(\lambda, j) &\underset{j \rightarrow -\infty, \lambda \rightarrow 0}{=} (\rho_q^-(\lambda))^j (R_q^-(\lambda) + O(\omega^j)), \text{ for } q \in \{d+1, \dots, 2d\}, \end{aligned} \tag{41}$$

| $a_1^- < \dots < a_{p^-}^- < 0$ and $0 < a_{p^-}^- < \dots < a_d^-$  |  |
|--|--|
| $\rho_1^-(\lambda) = \zeta_1^- + O( \lambda )$<br>$R_1^-(\lambda) = \begin{pmatrix} r_1^- \\ (\zeta_1^- - 1)r_1^- \end{pmatrix} + O\left(\frac{ \lambda }{ \lambda ^2}\right)$   | $\rho_{d+1}^-(\lambda) = 1 - \frac{\lambda}{a_1^-} + O( \lambda ^2)$<br>$R_{d+1}^-(\lambda) = \begin{pmatrix} r_1^- \\ -\frac{\lambda}{a_1^-} r_1^- \end{pmatrix} + O\left(\frac{ \lambda }{ \lambda ^2}\right)$                               |
| $\vdots$   | $\vdots$   |
| $\rho_{p^-}^-(\lambda) = \zeta_{p^-}^- + O( \lambda )$<br>$R_{p^-}^-(\lambda) = \begin{pmatrix} r_1^- \\ (\zeta_{p^-}^- - 1)r_{p^-}^- \end{pmatrix} + O\left(\frac{ \lambda }{ \lambda ^2}\right)$                               | $\rho_{d+p^-}^-(\lambda) = 1 - \frac{\lambda}{a_{p^-}^-} r_{p^-}^- + O( \lambda ^2)$<br>$R_{d+p^-}^-(\lambda) = \begin{pmatrix} r_{p^-}^- \\ -\frac{\lambda}{a_{p^-}^-} r_{p^-}^- \end{pmatrix} + O\left(\frac{ \lambda }{ \lambda ^2}\right)$ |
| $\rho_{p^-}^-(\lambda) = 1 - \frac{\lambda}{a_{p^-}^-} + O( \lambda ^2)$<br>$R_{p^-}^-(\lambda) = \begin{pmatrix} r_{p^-}^- \\ -\frac{\lambda}{a_{p^-}^-} r_{p^-}^- \end{pmatrix} + O\left(\frac{ \lambda }{ \lambda ^2}\right)$ | $\rho_{d+p^-}^-(\lambda) = \zeta_{p^-}^- + O( \lambda )$<br>$R_{d+p^-}^-(\lambda) = \begin{pmatrix} r_{p^-}^- \\ (\zeta_{p^-}^- - 1)r_{p^-}^- \end{pmatrix} + O\left(\frac{ \lambda }{ \lambda ^2}\right)$                                     |
| $\vdots$   | $\vdots$   |
| $\rho_d^-(\lambda) = 1 - \frac{\lambda}{a_d^-} + O( \lambda ^2)$<br>$R_d^-(\lambda) = \begin{pmatrix} r_d^- \\ -\frac{\lambda}{a_d^-} r_d^- \end{pmatrix} + O\left(\frac{ \lambda }{ \lambda ^2}\right)$                         | $\rho_{2d}^-(\lambda) = \zeta_d^- + O( \lambda )$<br>$R_{2d}^-(\lambda) = \begin{pmatrix} r_d^- \\ (\zeta_d^- - 1)r_d^- \end{pmatrix} + O\left(\frac{ \lambda }{ \lambda ^2}\right)$   |

Tab. 1: Asymptotic behavior as  $j \rightarrow -\infty$  and  $\lambda \rightarrow 0$ 

with  $\omega > 1$ . Consequently, the Evans function  $\mathcal{D}$  can also be analytically extended with respect to  $\lambda$  to a neighborhood of  $\lambda = 0$  because of (41), so that it can be expressed explicitly in  $D(0, \sigma)$  as the following determinant

$$\mathcal{D}(\lambda, l) = \det \left( \Phi_1(\lambda, l), \dots, \Phi_d(\lambda, l), \Phi_{d+1}(\lambda, l), \dots, \Phi_{2d}(\lambda, l) \right).$$

Rewriting the linearized scheme (8) in the conservative form, we have

$$(e^\lambda - 1)v_j + \left( \frac{F_j}{2} + DI_d \right) v_j + \left( \frac{F_{j+1}}{2} - DI_d \right) v_{j+1} = \left( \frac{F_{j-1}}{2} + DI_d \right) v_{j-1} + \left( \frac{F_j}{2} - DI_d \right) v_j. \quad (42)$$

Thus, at  $\lambda = 0$ , if  $(v_j)_{j \in \mathbb{Z}}$  decreases towards 0 as  $j$  tends to  $\pm\infty$ , taking the limit of the right member of (42) at  $j = \pm\infty$ , we get

$$v_{j+1} - v_j = ((2DI_d - F_{j+1})^{-1}(2DI_d + F_j) - I_d)v_j =: M_j v_j. \quad (43)$$

Denoting generically  $\Phi = (\Phi^I, \Phi^{II})^T$ , with  $\Phi^I, \Phi^{II} \in \mathbb{C}^d$ , we then apply (43) to  $\Phi_q^I(0, \cdot)$  for  $q \in \{1, \dots, p^+\} \cup \{d+p^-, \dots, 2d\}$ , according to Tables 1 and 2 and to (41). Besides, if  $\lambda = 0$ ,  $\rho = 1$  is an eigenvalue of multiplicity  $d$  of  $\mathbb{A}^\pm(\lambda)$ , that is  $\Phi_{p+1}(0, \cdot), \dots, \Phi_{d+p-1}(0, \cdot)$  are constant and we can set

$$\begin{aligned} \Phi_{p+1}(0, j) &= \begin{pmatrix} r_{p^+}^+ \\ 0 \end{pmatrix}, \dots, \Phi_d(0, j) = \begin{pmatrix} r_d^+ \\ 0 \end{pmatrix}, \\ \Phi_{d+1}(0, j) &= \begin{pmatrix} r_1^- \\ 0 \end{pmatrix}, \dots, \Phi_{d+p^-}^-(0, j) = \begin{pmatrix} r_{p^-}^- \\ 0 \end{pmatrix}. \end{aligned} \quad (44)$$

| $a_1^+ < \dots < a_{p^+}^+ < 0$ and $0 < a_{p^++1}^+ < \dots < a_d^+$  |  |
|--|--|
| $\rho_1^+(\lambda) = \zeta_1^+ + O( \lambda )$<br>$R_1^+(\lambda) = \begin{pmatrix} r_1^+ \\ (\zeta_1^+ - 1)r_1^+ \end{pmatrix} + O\left(\frac{ \lambda }{ \lambda ^2}\right)$   | $\rho_{d+1}^+(\lambda) = 1 - \frac{\lambda}{a_1^+} + O( \lambda ^2)$<br>$R_{d+1}^+(\lambda) = \begin{pmatrix} r_1^+ \\ -\frac{\lambda}{a_1^+} r_1^+ \end{pmatrix} + O\left(\frac{ \lambda }{ \lambda ^2}\right)$                               |
| $\vdots$   | $\vdots$   |
| $\rho_{p^+}^+(\lambda) = \zeta_{p^+}^+ + O( \lambda )$<br>$R_{p^+}^+(\lambda) = \begin{pmatrix} r_{p^+}^+ \\ (\zeta_{p^+}^+ - 1)r_{p^+}^+ \end{pmatrix} + O\left(\frac{ \lambda }{ \lambda ^2}\right)$                                       | $\rho_{d+p^+}^+(\lambda) = 1 - \frac{\lambda}{a_{p^+}^+} r_{p^+}^+ + O( \lambda ^2)$<br>$R_{d+p^+}^+(\lambda) = \begin{pmatrix} r_{p^+}^+ \\ -\frac{\lambda}{a_{p^+}^+} r_{p^+}^+ \end{pmatrix} + O\left(\frac{ \lambda }{ \lambda ^2}\right)$ |
| $\rho_{p^++1}^+(\lambda) = 1 - \frac{\lambda}{a_{p^++1}^+} + O( \lambda ^2)$<br>$R_{p^++1}^+(\lambda) = \begin{pmatrix} r_{p^++1}^+ \\ -\frac{\lambda}{a_{p^++1}^+} r_{p^++1}^+ \end{pmatrix} + O\left(\frac{ \lambda }{ \lambda ^2}\right)$ | $\rho_{d+p^++1}^+(\lambda) = \zeta_{p^++1}^+ + O( \lambda )$<br>$R_{d+p^++1}^+(\lambda) = \begin{pmatrix} r_{p^++1}^+ \\ (\zeta_{p^++1}^+ - 1)r_{p^++1}^+ \end{pmatrix} + O\left(\frac{ \lambda }{ \lambda ^2}\right)$                         |
| $\vdots$   | $\vdots$   |
| $\rho_d^+(\lambda) = 1 - \frac{\lambda}{a_d^+} + O( \lambda ^2)$<br>$R_d^+(\lambda) = \begin{pmatrix} r_d^+ \\ -\frac{\lambda}{a_d^+} r_d^+ \end{pmatrix} + O\left(\frac{ \lambda }{ \lambda ^2}\right)$                                     | $\rho_{2d}^+(\lambda) = \zeta_d^+ + O( \lambda )$<br>$R_{2d}^+(\lambda) = \begin{pmatrix} r_d^+ \\ (\zeta_d^+ - 1)r_d^+ \end{pmatrix} + O\left(\frac{ \lambda }{ \lambda ^2}\right)$   |

Tab. 2: Asymptotic behavior as  $j \rightarrow +\infty$  and  $\lambda \rightarrow 0$

Thus

$$\mathcal{D}(0, j) = \det \begin{bmatrix} \Phi_1^I(0, j) & \dots & \Phi_{p^+}^I(0, j) & r_{p^++1}^+ & \dots & r_d^+ & r_1^- & \dots & r_{p^-}^- & \Phi_{d+p^-}^I(0, j) & \dots & \Phi_{2d}^I(0, j) \\ M_j \Phi_1^I(0, j) & \dots & M_j \Phi_{p^+}^I(0, j) & 0 & \dots & 0 & 0 & \dots & 0 & M_j \Phi_{d+p^-}^I(0, j) & \dots & M_j \Phi_{2d}^I(0, j) \end{bmatrix} \quad (45)$$

We can see at once that the kernel of the matrix inside the determinant (45) is  $\varpi + 1$ -dimensional, which means that 1 is necessarily an eigenvalue of  $L$  if the shock  $(u^-, u^+)$  is compressive. Moreover, for  $\varpi \geq 0$ , without loss of generality, we can set

$$\Phi_{p^+-m}^I(0, \cdot) = \Phi_{d+p^-+m}^I(0, \cdot) =: \Psi_m(j), \text{ for } m \in \{0, \dots, \varpi\}. \quad (46)$$

**Remark 2.2.1** *If the discontinuity is undercompressive,  $\mathcal{D}(\lambda, \cdot)$  does not necessarily vanish at  $\lambda = 0$ , contrary to the continuous case. Indeed, the discrete derivative of a shock profile of  $\mathcal{L}$  does not belong, in general, to the kernel of  $L - 1$ .*

**Proposition 2.2.1**

*For  $m \in \{0, \dots, \varpi\}$ , the  $m$ -th derivative of the Evans function vanishes at  $\lambda = 0$  and its  $(\varpi + 1)$ -th derivative is*

$$\frac{\partial^{\varpi+1} \mathcal{D}}{\partial \lambda^{\varpi+1}}(0, j) = (-1)^{p^+} \det(M_j) \mathcal{W}(j) \phi_j^\varpi(S_0, \dots, S_q), \quad \forall j \in \mathbb{Z}, \quad (47)$$

where

$$\mathcal{W}(j) := \det(\Phi_1^I(0, j), \dots, \Phi_{p^+ - \varpi - 1}^I(0, j), \Psi_0(j), \dots, \Psi_\varpi(j), \Phi_{d+p^- + \varpi + 1}^I(0, j), \dots, \Phi_{2d}^I(0, j)),$$

$$\begin{aligned} \phi_j^\varpi &:= \mathbb{C}^{\varpi+1} \longrightarrow \mathbb{C} \\ (\vec{e}_0, \dots, \vec{e}_\varpi) &\mapsto \det(r_1^-, \dots, r_{p-1}, 2(F_j + F_{j+1})^{-1} \vec{e}_0, \dots, 2(F_j + F_{j+1})^{-1} \vec{e}_\varpi, r_{p^+ + 1}^+, \dots, r_d^+) \end{aligned}$$

and

$$S_m := \sum_{j \in \mathbb{Z}} \Psi_m(j), \quad \forall m \in \{0, \dots, \varpi\}.$$

**Proof**

The computation in the case  $\varpi = -1$  is straightforward from (45).

Consider now the case  $\varpi \geq 0$ .

We see at once that, since the rank of the matrix inside the determinant (45) is  $d - \varpi - 1$ , at least two identical columns appear in the  $m$ -th derivative of the Evans function at  $\lambda = 0$  for  $m \in \{0, \dots, \varpi + 1\}$ , so it vanishes.

Using the recurrence principle, a classical computation [24, 2, 30, 89] gives

$$\begin{aligned} \frac{\partial^{\varpi+1} \mathcal{D}}{\partial \lambda^{\varpi+1}}(0, j) &= \det [\Phi_1(0, j), \dots, \Phi_{d+p^- - 1}(0, j), \\ &\quad \left( \frac{\partial \Phi_{d+p^-}}{\partial \lambda} - \frac{\partial \Phi_{p^+}}{\partial \lambda} \right) (0, j), \dots, \left( \frac{\partial \Phi_{d+p^- + \varpi}}{\partial \lambda} - \frac{\partial \Phi_{p^+ - \varpi}}{\partial \lambda} \right) (0, j), \\ &\quad \Phi_{d+p^- + \varpi + 1}(0, j), \dots, \Phi_{2d}(0, j)] \end{aligned} \tag{48}$$

Since  $\lambda \mapsto \Phi_{p^+ - m}(\lambda, \cdot)$  and  $\lambda \mapsto \Phi_{d+p^- + m}(\lambda, \cdot)$  are analytic in  $\Omega \cup D(0, \sigma)$  for  $m \in \{0, \dots, \varpi\}$ ,  $z_{p^+ - m}(\cdot) := (\partial \Phi_{p^+ - m}^I / \partial \lambda)(0, \cdot)$  and  $z_{d+p^- + m}(\cdot) := (\partial \Phi_{d+p^- + m}^I / \partial \lambda)(0, \cdot)$  satisfy the same discrete dynamical system, which is obtained by deriving (42) with respect to  $\lambda$  and taking  $\lambda = 0$  :

$$\Psi_m(j) + \left( \frac{F_j}{2} + DI_d \right) z(j) + \left( \frac{F_{j+1}}{2} - DI_d \right) z(j+1) = \left( \frac{F_{j-1}}{2} + DI_d \right) z(j-1) + \left( \frac{F_j}{2} - DI_d \right) z(j). \tag{49}$$

noting however that  $z_{p^+ - m}(j)$  tends to 0 as  $j$  tends to  $+\infty$  and  $z_{d+p^- + m}(j)$  tends to 0 as  $j$  tends to  $-\infty$ . Thus, making the sum from  $j$  to  $+\infty$ , we get

$$\Delta z_{p^+ - m}(j) = M_j z_{p^+ - m}(j) - C_j^{-1} \sum_{l=j+1}^{+\infty} \Psi_m(l) \tag{50}$$

and similarly

$$\Delta z_{d+p^- + m}(j) = M_j z_{d+p^- + m}(j) + C_j^{-1} \sum_{l=-\infty}^j \Psi_m(l). \tag{51}$$

Plugging (44), (43), (50) and (51) in the expression (48) of  $\partial^{\varpi+1}\mathcal{D}/\partial\lambda^{\varpi+1}$ , we get, performing elementary matrix manipulations,

$$\begin{aligned} \frac{\partial^{\varpi+1}\mathcal{D}}{\partial\lambda^{\varpi+1}}(0, j) = \det & \begin{bmatrix} \Phi_1^I(0, j) & \cdots & \Phi_{p^+-\varpi-1}^I(0, j) & \Psi_{p^+-\varpi}(j) & \cdots & \Psi_0(j) \\ 0 & \cdots & 0 & 0 & \cdots & 0 \\ & & r_{p^++1}^+ & \cdots & r_d^+ & r_1^- & \cdots & r_{p^- -1}^- \\ -M_j r_{p^++1}^+ & \cdots & -M_j r_d^+ & -M_j r_1^- & \cdots & -M_j r_{p^- -1}^- \\ & & z_{d+p^-}(j) - z_{p^+}(j) & \cdots & z_{d+p^-+\varpi}(j) - z_{p^+-\varpi}(j) \\ \left(DI_d - \frac{F_{j+1}}{2}\right)^{-1} \sum_{l \in \mathbb{Z}} \Psi_0(l) & \cdots & \left(DI_d - \frac{F_{j+1}}{2}\right)^{-1} \sum_{l \in \mathbb{Z}} \Psi_{\varpi}(l) \\ & & \Phi_{d+p^-+\varpi+1}^I(0, j) & \cdots & \Phi_{2d}^I(0, j) \\ & & 0 & \cdots & 0 \end{bmatrix}. \end{aligned}$$

Changing the order of the columns in the determinant, we obtain a block determinant and the claimed equality. □

**Remark 2.2.2** *Note that this expression is analogous to the expression one finds in the continuous case [24, 4, 30].*

Since the Evans function is analytic in a neighborhood of  $\lambda = 0$ , Assumption 8 implies the existence of a positive  $\sigma$  such that

$$\text{the Evans function } \mathcal{D}(\cdot, j) \text{ does not vanish in } D(0, \sigma) \setminus \{0\}. \tag{52}$$

The continuity of the Evans function in  $\Omega$  and Assumption 7 imply that there exists a positive  $\eta$  such that

$$\mathcal{D}(\cdot, j) \text{ does not vanish in } \{\lambda \in \mathbb{C} / \operatorname{Re}(\lambda) \geq -\eta, |\operatorname{Im}(\lambda)| \leq \pi\}. \tag{53}$$

We choose a small enough  $\eta$  so that  $\{\operatorname{Re}(\lambda) = -\eta\}$  intersects  $\partial D(0, \sigma)$  outside  $\mathcal{E}$  (see Figure 2.3). We thus define the region

$$\Omega' := \Omega \cap \{\lambda \in \mathbb{C} / -\eta \leq \operatorname{Re}(\lambda) \leq 1, |\operatorname{Im}(\lambda)| \leq \pi\}$$

in which  $\mathcal{D}$  is analytic and does not vanish.

### 2.3 Estimates on $G_\lambda$

Let  $\lambda \in \Omega' \setminus \{0\}$ ,  $l \in \mathbb{Z}$  and  $\vec{e} \in \mathbb{C}^d$ . The Green's function  $j \mapsto G_\lambda(l, j) \cdot \vec{e}$  of (9) is the solution of

$$\begin{aligned} (L - e^\lambda)G_\lambda(l, j) \cdot \vec{e} &= \delta_{lj} \vec{e}, \quad j \in \mathbb{Z}, \\ G_\lambda(l, j) &\xrightarrow{j \rightarrow \pm\infty} 0, \end{aligned} \tag{54}$$

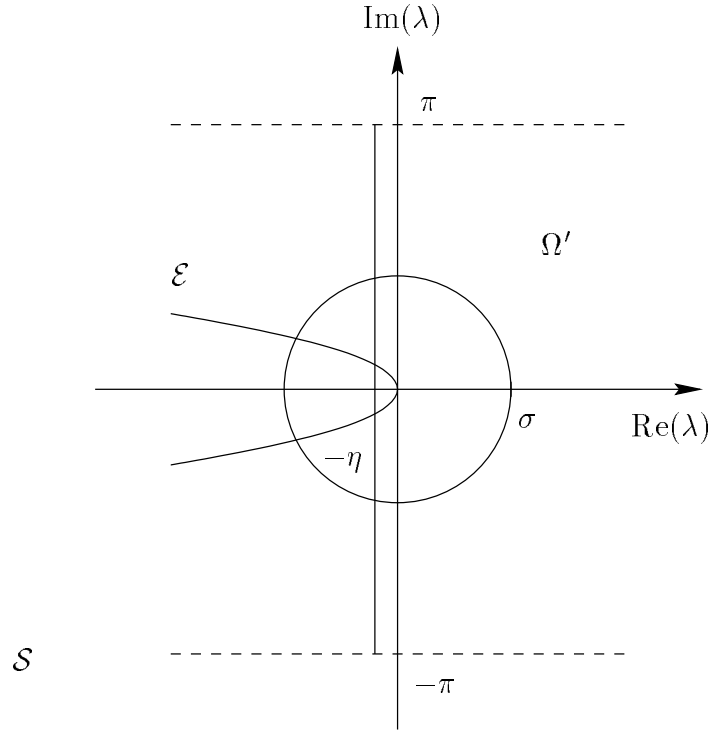

Fig. 2.3: Definition of  $\Omega'$ 

where  $\delta$  is the Kronecker symbol. We want to compute estimates on

$$\begin{pmatrix} G_\lambda(l, j) \\ \Delta_j G_\lambda(l, j) \end{pmatrix}$$

where  $\Delta_j G_\lambda(\cdot, j) := G_\lambda(\cdot, j) - G_\lambda(\cdot, j-1)$ .

Since  $G_\lambda(l, \cdot)$  tends to 0 as  $j$  tends to  $\pm\infty$ , we want to express  $G_\lambda(l, j)$  at  $j \geq l$  (resp. at  $j \leq l$ ) in an appropriate basis of the vector space of solutions of  $L - \lambda = 0$  that tends to 0 as  $j$  tends to  $+\infty$  (resp. as  $j$  tends to  $-\infty$ ).

### Proposition 2.3.1

For  $\Omega' \setminus \{0\}$ ,  $\ell \in \mathbb{N}$ ,  $l \in \{-\ell, \dots, \ell\}$ , and  $\vec{e} \in \mathbb{C}^d$ ,  $G_\lambda(l, \cdot) \cdot \vec{e}$  satisfies

$$\begin{pmatrix} G_\lambda(l, j) \cdot \vec{e} \\ \Delta_j G_\lambda(l, j) \cdot \vec{e} \end{pmatrix} = \sum_{q=1}^d (\nu_q(\lambda, l) \cdot \vec{e}) W_q(\lambda, j), \quad j \geq l, \quad (55)$$

$$= \sum_{q=d+1}^{2d} (\nu_q(\lambda, l) \cdot \vec{e}) W_q(\lambda, j), \quad j \leq l. \quad (56)$$

where  $(W_q(\lambda, \cdot))_{q \in \{1, \dots, d\}}$  (resp.  $(W_q(\lambda, \cdot))_{q \in \{d+1, \dots, 2d\}}$ ) is an analytic basis of  $E(\lambda)$  (see (39)) (resp. a basis of  $F(\lambda)$  (see (40))), such that  $W_q(\lambda, j) = V_q(\lambda, j) \rho_q^j(\lambda)$  (see Lemma 2.3.1 for notations),  $\nu_q(\lambda, l) : \mathbb{R}^d \rightarrow \mathbb{R}$  is a linear form which is holomorphic in  $D(0, \sigma)$  if  $\varpi = -1$  or if  $q \in \{1, \dots, 2d\} \setminus (\Upsilon^+ \cup \Upsilon^-)$ , with  $\Upsilon^+ := \{p^+ - \varpi, \dots, p^+\}$  and  $\Upsilon^- := \{d + p^-, \dots, d + p^- + \varpi\}$ ; and meromorphic with a pole of order 1 at  $\lambda = 0$  otherwise, such that

$$\|\nu_q(\lambda, l)\| \leq \frac{C(\ell)}{|\lambda|}, \quad q \in \Upsilon \cup \Upsilon^-, \quad \varpi \geq 0. \quad (57)$$

Moreover, with the notations of Proposition 2.2.1, the residual term  $\mathcal{R}_0(l, j)$  that appears in Theorem 2.1.1 is the residue of  $G_\lambda$  at  $\lambda = 0$  and, for  $l, j \in \mathbb{Z}$ , it is given by the formula

$$\begin{aligned} \mathcal{R}_0(l, j) &: \mathbb{C}^d \longrightarrow \mathbb{C}^d \\ \vec{e} &\mapsto \chi_{\varpi \geq 0} \sum_{m=0}^{\varpi} \frac{\phi_l^{\varpi}(S_0, \dots, S_{m-1}, \vec{e}, S_{m+1}, \dots, S_{\varpi})}{\phi_l^{\varpi}(S_0, \dots, S_{\varpi})} \Psi_m(j), \end{aligned} \tag{58}$$

**Proof**

Let us find an appropriate basis of the vector spaces  $E(\lambda)$  and  $F(\lambda)$ . In order to find a basis of  $E(\lambda)$  that matches the behavior of the solutions we considered in Section 2.2 at  $\lambda = 0$ , we prove the following lemma

**Lemma 2.3.1**

Let  $l \in \mathbb{Z}$ ,  $\mathbf{V}(\lambda)$  be an eigenvector of  $\mathbb{A}^+(\lambda)$  associated with  $\rho(\lambda)$  that never vanishes. Assuming that  $\rho, \mathbf{V}$  are analytic and that there exists  $\omega \in (0, 1)$  such that  $|\rho^{-1}(\lambda)(\mathbb{A}_j(\lambda) - \mathbb{A}^+(\lambda))| = O(\omega^j)$  as  $j$  tends to  $+\infty$ , there exists a solution  $W(\lambda, j)$  of

$$W_j = \mathbb{A}_j(\lambda)W_{j-1},$$

such that  $W(\lambda, j) = V(\lambda, j)\rho^j(\lambda)$ , where  $V(\lambda, j)$  is analytic with respect to  $\lambda$  and satisfies

$$\forall m \geq 0, \forall j \geq l, \frac{\partial^m V}{\partial \lambda^m}(\lambda, j) = \frac{\partial^m \mathbf{V}}{\partial \lambda^m}(\lambda) + O(\omega^j). \tag{59}$$

**Remark 2.3.1** This lemma is a simplified (discrete) version of Zumbrun and Howard’s Proposition 3.1 [88].

**Proof**

We set  $l = 0$ . Let  $W_j = V_j \rho^j(\lambda)$  be a solution of  $W_j = \mathbb{A}_j(\lambda)W_{j-1}$ . The sequence  $(V_j)_j$  satisfies the recurrence

$$V_j = \rho^{-1}(\lambda)\mathbb{A}_j(\lambda)V_{j-1}$$

that we rewrite as

$$V_j = \rho^{-1}(\lambda)\mathbb{A}^+(\lambda)V_{j-1} + \rho^{-1}(\lambda)(\mathbb{A}_j(\lambda) - \mathbb{A}^+)V_{j-1}. \tag{60}$$

We search a sequence  $(V(\lambda, j))_j$  such that  $V(\lambda, j) \rightarrow \mathbf{V}(\lambda)$  as  $j$  tends to  $+\infty$ .

In a neighborhood of a fixed  $\lambda_0$ , we define the projection  $P(\lambda)$  (resp.  $Q(\lambda)$ ) on the direct sum of the eigenspaces associated with the eigenvalues of  $\mathbb{A}^+(\lambda)$  of modulus strictly smaller than  $|\rho(\lambda)|$  (resp. larger or equal to  $|\rho(\lambda)|$ ) such that  $P(\lambda)$  and  $Q(\lambda)$  are complementary. The projections  $P(\lambda)$  and  $Q(\lambda)$  are analytic in a neighborhood of  $\lambda_0$  by classical matrix perturbation theory [46]. We also have the following estimates

$$|\rho^{-j}(\lambda)(\mathbb{A}^+(\lambda))^j P(\lambda)| \leq \theta^j, \forall j \in \mathbb{N}, \tag{61}$$

$$|\rho^{-j}(\lambda)(\mathbb{A}^+(\lambda))^j Q(\lambda)| \leq 1, \forall j \in \mathbb{N}, \tag{62}$$

where  $\theta \in (0, 1)$  is defined by  $\theta = \min\{|\tilde{\rho}/\rho(\lambda)|, \tilde{\rho} \in \sigma(\mathbb{A}^+(\lambda)) \text{ and } \tilde{\rho} < \rho(\lambda)\}$ . Let  $J \in \mathbb{Z}$ . We define the map  $T$  on  $\ell^\infty(\{J, \dots, +\infty\})$  by

$$\begin{aligned} (TV)_j &= \mathbf{V}(\lambda) + \sum_{l=J}^j \rho^{j-l}(\lambda)(\mathbb{A}^+(\lambda))^{j-l} P(\lambda) \rho^{-1}(\lambda)(\mathbb{A}_{l-1}(\lambda) - \mathbb{A}^+(\lambda))V_{l-1} \\ &\quad - \sum_{l=j+1}^{+\infty} \rho^{j-l}(\lambda)(\mathbb{A}^+(\lambda))^{j-l} Q(\lambda) \rho^{-1}(\lambda)(\mathbb{A}_{l-1}(\lambda) - \mathbb{A}^+(\lambda))V_{l-1}. \end{aligned}$$

Let  $V_1$  and  $V_2$  be two sequences. By using (61) and (62), we have

$$\begin{aligned} |TV_1 - TV_2|_j &\leq \sum_{l=J}^j \theta^{j-l} \omega^{l-1} |V_1 - V_2|_\infty + \sum_{l=j+1}^{+\infty} \omega^{l-1} |V_1 - V_2|_\infty \\ &\leq \left( \sum_{l=J}^j \theta^{j-l} \omega^{l-1} + \sum_{j+1}^{+\infty} \omega^{l-1} \right) |V_1 - V_2|_\infty \\ &\leq C\omega^J |V_1 - V_2|_\infty, \end{aligned}$$

where  $C$  is a positive constant that does not depend on  $j$ .

By choosing a large enough  $J$ , we can set

$$C\omega^J \leq \frac{1}{2},$$

so that the map  $\mathcal{T}$  is a contraction of  $\ell^\infty(\{J, \dots, +\infty\})$ . Iterating  $\mathcal{T}$  on  $V_0 = 0$ , we obtain a solution  $V \in \ell^\infty(\{J, \dots, +\infty\})$  of the equation  $\mathcal{T}V = V$ . Computing  $V_{j+1}$  shows that  $V$  is a bounded solution of  $\mathcal{T}V = V$  if and only if  $V$  is a bounded solution of (60). We conclude by noting that  $\mathcal{T}$  preserves analyticity in  $\lambda$ .

□

A similar result holds for the eigenvalues and eigenvectors of  $\mathbb{A}^-(\lambda)$ .

Next, we prove that, if  $\eta$  (see (53)) is small enough, the eigenvalues of  $\mathbb{A}^\pm(\lambda)$  remain simple for all  $\lambda \in \Omega' \setminus \{0\}$ , so that, considering the set of sequences  $(W_q(\lambda, \cdot))_{q \in \{1, \dots, d\}}$  (resp.  $(W_q(\lambda, \cdot))_{q \in \{d+1, \dots, 2d\}}$ ) given by Lemma 2.3.1 for each eigenvalue of  $\mathbb{A}^+(\lambda)$  (resp. of  $\mathbb{A}^-(\lambda)$ ) of modulus strictly smaller than 1 (resp. of modulus strictly larger than 1), we obtain a basis of  $E(\lambda)$  (resp. of  $F(\lambda)$ ).

### Lemma 2.3.2

Let  $\lambda \in \Omega' \setminus \{0\}$ . The characteristic polynomial  $\Pi^\pm(\cdot, \lambda)$  of  $\mathbb{A}^\pm(\lambda)$  has no double root.

**Proof** Recalling the expression of  $\Pi^\pm$  given by (36), we rewrite it as  $\Pi^\pm = (2D + a) \prod_{q \in \{1, \dots, d\}} \Pi_q^\pm$ , with

$$\Pi_q^\pm := (2D + a_q^\pm) \rho^2 + 2(1 - 2D - e^\lambda) \rho + 2D - a_q^\pm = 0.$$

For the sake of simplicity, we drop the superscript  $\pm$ .

Let  $\rho$  be a root of  $\Pi$  with a strictly larger than 1 multiplicity. We must consider two cases :

*case 1* : there exists  $q \in \{1, \dots, d\}$  such that  $\rho$  is a double root of  $\Pi_q$ ,

*case 2* : there exist  $q_1, q_2$  in  $\{1, \dots, d\}$ ,  $q_1 \neq q_2$ , such that  $\rho$  is a root of both  $\Pi_{q_1}$  and  $\Pi_{q_2}$ .

Let us deal at first with case 1 :

if  $\rho$  is a double root of  $\Pi_q$ , then the discriminant of  $\Pi_q$  vanishes, that is

$$(1 - 2D - e^\lambda)^2 = 4D^2 - a_q^2,$$

which is equivalent to

$$(1 - e^\lambda)^2 - 4D(1 - e^\lambda) + a_q^2 = 0. \tag{63}$$

Denoting  $s := 1 - e^\lambda$  and splitting (63) into real and imaginary parts, we obtain the following system

$$\operatorname{Re}(s)^2 - \operatorname{Im}(s)^2 - 4D\operatorname{Re}(s) + a_q^2 = 0, \tag{64}$$

$$(\operatorname{Re}(s) - 2D)\operatorname{Im}(s) = 0, \tag{65}$$

so that, considering (65), either  $\operatorname{Im}(s) = 0$  and  $\operatorname{Re}(s) = 2D \pm \sqrt{4D^2 - a_q^2}$ , that is  $\lambda \leq \Lambda$  (see 37), and  $\lambda$  does not belong to  $\Omega'$ , or  $\operatorname{Im}(s) \neq 0$  and  $\operatorname{Re}(s) = 2D$  : plugging the value of  $\operatorname{Re}(s)$  in (64), we get  $\operatorname{Im}(s) = \pm a_q$ , that is  $e^\lambda = 1 - 2D \pm a_q$ . Using the CFL condition (H5), we show that the modulus of  $e^\lambda$  is strictly less than 1 :

$$\begin{aligned} |e^\lambda|^2 - 1 &= (1 - 2D)^2 + a_q^2 - 1 \\ &= 4D^2 - 4D + a_q^2 \\ &< 8D^2 - 4D \\ &< 0. \end{aligned}$$

Consequently, choosing a small enough  $\eta$ ,  $\lambda$  does not belong to  $\Omega'$ .

Secondly, we consider case 2 :

if  $\rho$  solves both  $\Pi_{q_1} = 0$  and  $\Pi_{q_2} = 0$ , it also solves the equation  $\Pi_{q_1} - \Pi_{q_2} = 0$  :

$$(a_{q_1} - a_{q_2})\rho^2 + (a_{q_2} - a_{q_1}) = 0.$$

Since the eigenvalues of  $df(u^\pm)$  are real and simple (H2),  $\rho$  necessarily satisfies  $\rho^2 - 1 = 0$ . But, by definition,  $\Omega'$  does not contain any  $\lambda$  such that the modulus of corresponding eigenvalues of  $\mathbb{A}^\pm(\lambda)$  is 1.

□

Let  $l \in \mathbb{Z}$ . Comparing the behaviors of  $(W_q)$  (see 59) and of the sequences  $(\Phi_q)$  that were defined in Subsection 2.2.2 (see (41)), and reordering the indices appropriately, we can take

$$\begin{aligned} \Phi_q(\lambda, j) &\underset{\lambda \rightarrow 0}{=} W_q(\lambda, j), \quad j \geq l, \quad q \in \{1, \dots, d\}, \\ \Phi_q(\lambda, j) &\underset{\lambda \rightarrow 0}{=} W_q(\lambda, j), \quad j \leq l, \quad q \in \{d+1, \dots, 2d\}. \end{aligned}$$

From now on, we only keep the “ $\Phi$ ” notation.

Let  $l \in \{-\ell, \dots, \ell\}$ ,  $j \in \mathbb{Z}$  and  $\vec{e} \in \mathbb{C}^d$ . Knowing that  $G_\lambda(l, j) \cdot \vec{e}$  solves (54), that is  $G_\lambda(l, j) \cdot \vec{e}$  satisfies

$$\left( DI_d + \frac{F_{j-1}}{2} \right) G_\lambda(l, j-1) \cdot \vec{e} + (1 - 2D - e^\lambda) G_\lambda(l, j) \cdot \vec{e} + \left( DI_d - \frac{F_{j+1}}{2} \right) G_\lambda(l, j+1) \cdot \vec{e} = \delta_{jl} \vec{e}, \quad j, l \in \mathbb{Z}, \tag{66}$$

we search  $G_\lambda(l, j) \cdot \vec{e}$  of (66) in the form

$$\begin{aligned} G_\lambda(l, j) \cdot \vec{e} &= \sum_{q=1}^d \nu_q(\lambda, l) \Phi_q^I(\lambda, j), \quad \text{if } j \geq l, \\ &= \sum_{q=d+1}^{2d} \nu_q(\lambda, l) \Phi_q^I(\lambda, j), \quad \text{if } j \leq l, \end{aligned} \tag{67}$$

where  $\nu_q(\lambda, l) \in \mathbb{C}$ .

Taking (66) at  $j = l$ , we have :

$$\sum_{q=1}^d \nu_q(\lambda, l) \Phi_q^I(\lambda, l) = \sum_{q=d+1}^{2d} \nu_q(\lambda, l) \Phi_q^I(\lambda, l), \tag{68}$$

$$\sum_{q=1}^d \nu_q(\lambda, l) \Phi_q^{II}(\lambda, l) = \sum_{q=d+1}^{2d} \nu_q(\lambda, l) \Phi_q^{II}(\lambda, l) + C_l^{-1} \vec{e}. \tag{69}$$

Let  $\mathcal{G}(\lambda, l) := (\Phi_1(\lambda, l), \dots, \Phi_{2d}(\lambda, l))$ . Its determinant is  $\mathcal{D}(\lambda, l)$  (see (45)). The assumption (H8) gives

$$|\mathcal{D}(\lambda, l)^{-1}| \leq \frac{C(l)}{|\lambda|^{\varpi+1}}, \tag{70}$$

locally in  $\lambda$  and in  $l$ , that is, if  $\varpi = -1$ ,  $\mathcal{G}(\cdot, l)^{-1}$  is holomorphic in  $\Omega'$ ; otherwise,  $\mathcal{G}(\lambda, l)^{-1}$  is meromorphic for  $\lambda \in \Omega'$ ,  $\lambda = 0$  being a pole of order at most  $\varpi + 1$  because of (H8). Consequently, the linear forms  $(\nu_q(\lambda, l))$  are also holomorphic in  $\Omega'$  if  $\varpi = -1$  and meromorphic with a pole at  $\lambda = 0$  if  $\varpi \geq 0$ .

Let us now examine the behavior of  $\mathcal{G}(\lambda, l)$  and of  $(\nu_q(\lambda, l))$  as  $\lambda$  tends to 0 when  $\varpi \geq 0$  to determine the order of the pole.

Let  $\lambda \in \Omega' \setminus \{0\}$ . We have

$$(\nu_1(\lambda, l), \dots, \nu_d(\lambda, l), -\nu_{d+1}(\lambda, l), \dots, -\nu_{2d}(\lambda, l))^T = \mathcal{G}(\lambda, l)^{-1}(0, C_l^{-1} \vec{e})^T. \tag{71}$$

Denote by  $\text{com}(\mathcal{G})(\lambda, l)$  the comatrix of  $\mathcal{G}(\lambda, l)$ . For  $\lambda \in \Omega'$ , we have

$$\mathcal{G}(\lambda, l) \text{com}(\mathcal{G})^T(\lambda, l) = \mathcal{D}(\lambda, l) I_d. \tag{72}$$

Applying Leibniz's formula and recalling (H8), the  $\varpi$ -th derivative of (72) reads

$$\begin{aligned} \sum_{m=0}^{\varpi} \binom{\varpi}{m} \frac{\partial^{\varpi-m} \mathcal{G}}{\partial \lambda^{\varpi-m}}(\lambda, l) \frac{\partial^m \text{com}(\mathcal{G})^T}{\partial \lambda^m}(\lambda, l) &= \frac{\partial^{\varpi} \mathcal{D}}{\partial \lambda^{\varpi}}(\lambda, l) I_{2d} \\ &\underset{\lambda \rightarrow 0}{=} \lambda \frac{\partial^{\varpi+1} \mathcal{D}}{\partial \lambda^{\varpi+1}}(0, l) + o(|\lambda|). \end{aligned} \tag{73}$$

Let  $\text{com}(\mathcal{G})(\lambda, l) =: ((-1)^{q+q'} g_{qq'}(\lambda, l))_{1 \leq q, q' \leq 2d}$ . The coefficient  $g_{qq'}(\lambda, l)$  is a determinant of order  $2d-1$  that we obtain by removing the  $q$ -th line and the  $q'$ -th column of  $\det(\mathcal{G}(\lambda, l))$ . Consequently,  $(g_{qq'}(\lambda, l))$  are polynomial in the coefficients of  $\mathcal{G}(\lambda, l)$  so that  $(g_{qq'}(\lambda, l))$  tend to finite limits as  $\lambda$  tends to 0.

If  $m \in \{0, \dots, \varpi - 1\}$ , a similar computation as the one carried out in Subsection 2.2.1 yields

$$\frac{\partial^m g_{qq'}}{\partial \lambda^m}(0, l) = 0, \quad \forall q, q' \in \{1, \dots, 2d\}.$$

So (73) reduces to

$$\lambda \mathcal{G}^{-1}(\lambda, l) \underset{\lambda \rightarrow 0}{\longrightarrow} \frac{\frac{\partial^{\varpi} \text{com}(\mathcal{G})^T}{\partial \lambda^{\varpi}}(0, l)}{\frac{\partial^{\varpi+1} \mathcal{D}}{\partial \lambda^{\varpi+1}}(0, l)}. \tag{74}$$

Moreover, taking the derivative of  $\text{com}(\mathcal{G}(\lambda, l))$  a step further, if  $q' \in \{1, \dots, 2d\} \setminus (\Upsilon^+ \cup \Upsilon^-)$ , with  $\Upsilon^+ := \{p^+ - \varpi, \dots, p^+\}$  and  $\Upsilon^- := \{d + p^-, \dots, d + p^- + \varpi\}$ , we have

$$\frac{\partial^\varpi g_{qq'}}{\partial \lambda^\varpi}(0, l) = 0$$

because of our choice (46) of  $\Psi$  (see the computation of the  $(\varpi + 1)$ -th derivative of  $\mathcal{D}$  at  $\lambda = 0$  in Subsection 2.2.1 for details).

Thus, on the one hand, for  $q \in \{1, \dots, 2d\} \setminus (\Upsilon^+ \cup \Upsilon^-)$ , we get

$$\lim_{\lambda \rightarrow 0} \lambda \nu_q(\lambda, l) = 0,$$

that is  $\nu_q(\cdot, l)$  is in fact holomorphic in  $\Omega'$  for  $q \in \{1, \dots, 2d\} \setminus (\Upsilon^+ \cup \Upsilon^-)$ .

On the other hand, for  $q \in \Upsilon^\pm$ , we obtain

$$\lim_{\lambda \rightarrow 0} \lambda \nu_q(\lambda, l) = \pm \frac{\frac{\partial^\varpi \widehat{\mathcal{D}}_q(0, l)}{\partial \lambda^\varpi}}{\frac{\partial^{\varpi+1} \mathcal{D}(0, l)}{\partial \lambda^{\varpi+1}}},$$

where

$$\widehat{\mathcal{D}}_q(\lambda, j) := \det \left( \Phi_1(0, l), \dots, \Phi_{q-1}(0, l), \begin{pmatrix} 0 \\ C_l^{-1} \vec{e} \end{pmatrix}, \Phi_{q+1}(0, l), \dots, \Phi_{2d}(0, l) \right).$$

The same computation as for the  $(\varpi + 1)$ -th derivative of  $\mathcal{D}$  yields, for  $q \in \Upsilon^\pm$ ,  $m \in \{0, \dots, \varpi\}$ ,

$$\frac{\partial^\varpi \widehat{\mathcal{D}}_q}{\partial \lambda^\varpi}(0, l) = \pm (-1)^{p^-+1} \det(M_l) \mathcal{W}(l) \phi_l^\varpi(S_0, \dots, S_{m-1}, \vec{e}, S_{m+1}, \dots, S_\varpi),$$

so that, recalling the expression (47) of  $(\partial^{\varpi+1} \mathcal{D}(\lambda, l) / \partial \lambda^{\varpi+1})$ , we finally get the equality

$$\lim_{\lambda \rightarrow 0} \lambda \nu_{d+p^-+m}(\lambda, l) = \lim_{\lambda \rightarrow 0} \lambda \nu_{p^+-m}(\lambda, l) = \frac{\phi_l^\varpi(S_0, \dots, S_{m-1}, \vec{e}, S_{m+1}, \dots, S_\varpi)}{\phi_l^\varpi(S_0, \dots, S_\varpi)}, \quad \forall m \in \{0, \dots, \varpi\}. \tag{75}$$

So the order of the pole of  $\nu_q(\lambda, l)$ , for  $q \in \{1, \dots, 2d\}$ , is 1 and (57) is proved.

Gathering (74) and (75), we have

$$\lim_{\lambda \rightarrow 0} \lambda G_\lambda(l, j) \cdot \vec{e} = \sum_{m=0}^{\varpi} \left( \frac{\phi_l^\varpi(S_0, \dots, S_{m-1}, \vec{e}, S_{m+1}, \dots, S_\varpi)}{\phi_l^\varpi(S_0, \dots, S_\varpi)} \right) \Psi_m(j) = \mathcal{R}_0(l, j), \quad \forall j \in \mathbb{Z}.$$

Furthermore, a straightforward computation shows that the linear mapping  $u = (u_l) \mapsto \sum_{l \in \mathbb{Z}} \mathcal{R}_0(l, \cdot) u_l$  is a projection on the kernel of  $L - 1$ .

□

### 2.4 Proof of Theorem 2.1.1

We want to compute estimates on the Green's function of (9) by using an inverse Laplace transform

$$G(n, l, j) = \frac{1}{2i\pi} \int_{\Gamma} e^{\lambda n} G_{\lambda}(l, j) d\lambda. \tag{76}$$

Recall that  $G$  solves

$$G(n + 1, l, j) - L G(n, l, j) = 0, \text{ for } n \geq 1 \tag{77}$$

$$G(0, l, j) = \delta_{lj} I_d, \tag{78}$$

so, since  $L$  is a second-order recurrence operator, the speed of propagation is finite (see Figure 2.4)

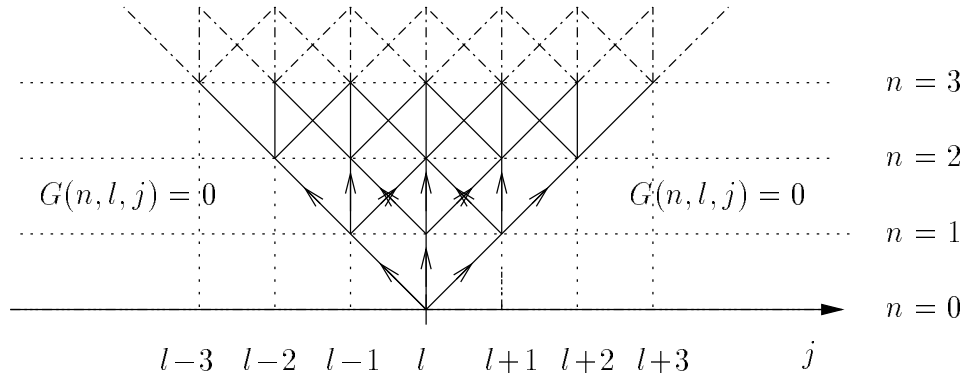

Fig. 2.4: Propagation

and

$$G(n, l, j) = 0 \text{ for } |l - j| \geq n + 1.$$

Since we assumed that the only pole of  $G_{\lambda}$  in  $\{\lambda/\text{Re}(\lambda) \geq -2\eta\}$  is at  $\lambda = 0$ , the initial path of integration in the formula of the inverse Laplace transform can be any segment  $\gamma := [s - i\pi, s + i\pi]$  with  $s > 0$ . However, thanks to the Cauchy formula, we can change this path to better suit the behavior of  $G_{\lambda}$ , noting that if the pole  $\lambda = 0$  is inside the area enclosed in the closed path  $\gamma \cup S_l \cup \gamma' \cup S_u$ , where  $\gamma'$  is the new path of integration and  $S_l$  and  $S_u$  are the lower (resp. upper) segment that is enclosed in  $\{\text{Im}(\lambda) = -\pi\}$  (resp.  $\{\text{Im}(\lambda) = \pi\}$ ) that appears when we modify  $\gamma$  as in Figure 2.5, the residue of  $G_{\lambda}$  at  $\lambda = 0$ ,  $\mathcal{R}_0$  (see Subsection 2.3.1), will appear in the formula (76).

**Remark 2.4.1** *Since the orientations of  $S_l$  and  $S_u$  are opposite and  $\lambda \mapsto e^{\lambda n} G_{\lambda}(l, j)$  is  $i2\pi$ -periodic, the integrals along  $S_u$  and  $S_l$  compensate each other. Therefore, we will no longer mention them.*

Let us now treat the case of medium  $(l - j)^2/n^2$ .

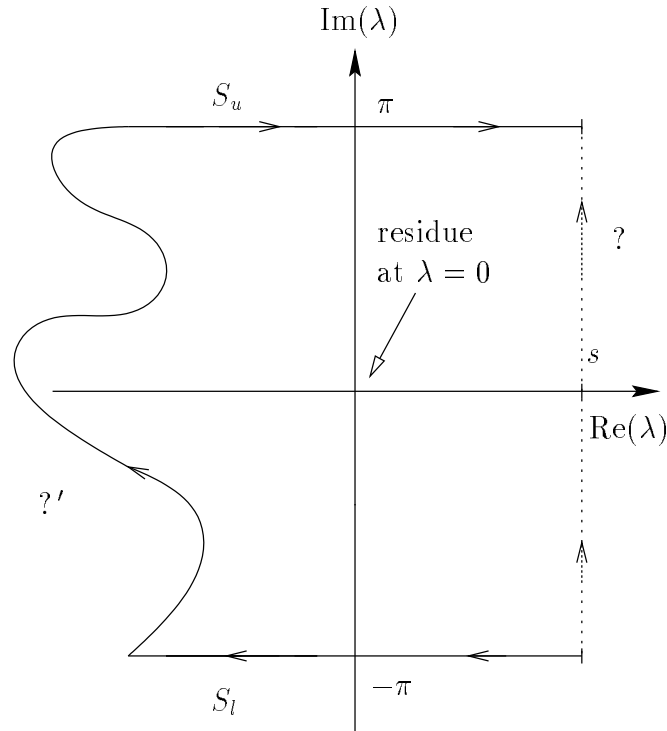
 Fig. 2.5: Path of integration  $\Gamma$  and  $\Gamma'$ 
**Proposition 2.4.1**

There exists a positive constant  $\beta$  such that, for all  $\ell \in \mathbb{N}$ , there exist  $C(\ell) > 0$  and  $\tau(\ell) > 0$  so that for all  $l \in \{-\ell, \dots, \ell\}$ ,  $j \in \mathbb{Z}$  and  $n \in \mathbb{N}$  satisfying

$$\beta\sigma n^2 \leq (l - j)^2 \leq n^2,$$

the following estimate holds

$$\left\| \begin{array}{c} G(n, l, j) \\ \Delta_j G(n, l, j) \end{array} \right\| \leq C(\ell) \exp\left(-\tau(\ell) \frac{(l - j)^2}{n}\right). \quad (79)$$

**Proof**

In the following,  $C(\ell)$  will denote a generic constant depending on  $\ell$ . Let  $\ell \in \mathbb{N}$ ,  $l \in \{-\ell, \dots, \ell\}$  and  $j \in \mathbb{Z}$ . Let

$$\lambda_m := \gamma(\ell)(l - j)^2 / (\beta n)^2.$$

We will integrate on  $\gamma_1 := \gamma_1^- \cup \gamma_1^m \cup \gamma_1^+$  (see Figure 2.6), where, assuming that  $\eta$  is so small that  $\gamma_1$  does not intersect  $\mathcal{E}$ ,

$$\begin{aligned} \gamma_1^- &:= \{\lambda = -\eta + iy, -\pi \leq y \leq -\eta - \lambda_m\}, \\ \gamma_1^m &:= \{|\operatorname{Im}(\lambda)| = \lambda_m - \operatorname{Re}(\lambda), -\eta \leq \operatorname{Re}(\lambda) \leq \lambda_m\}, \\ \gamma_1^+ &:= \{\lambda = -\eta + iy, \eta + \lambda_m \leq y \leq \pi\}. \end{aligned}$$

We have here

$$G(n, l, j) = \frac{1}{2i\pi} \left[ \left( \int_{\gamma_1^-} + \int_{\gamma_1^m} + \int_{\gamma_1^+} \right) e^{\lambda n} G_\lambda(l, j) d\lambda \right] = I_1^- + I_1^m + I_1^+. \quad (80)$$

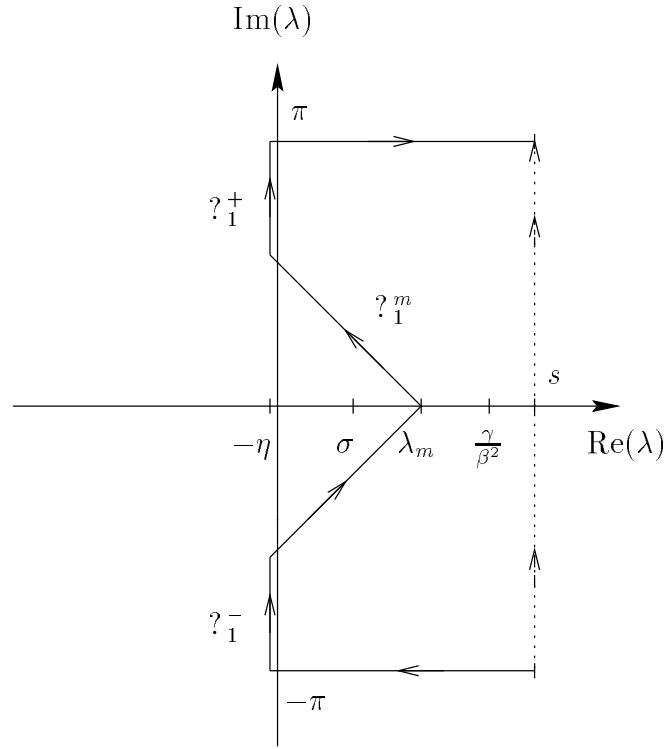

 Fig. 2.6: Path of integration  $\Gamma_1$ 

Using Proposition 2.3.1, we get at once

$$|I_1^\pm| \leq \frac{1}{2\pi} e^{-\eta n} C(\ell) \int_{\Gamma_1^\pm} \frac{1}{|\lambda|} |d\lambda|,$$

so, since  $|\lambda| \geq \eta$  on  $\Gamma_1^\pm$ , and  $|\Gamma_1^\pm| \leq \pi$ ,

$$|I_1^-| + |I_1^+| \leq \frac{C(\ell)}{\eta} e^{-\eta n}. \quad (81)$$

We consider now  $I_1^m$ . Since  $\operatorname{Re}(\lambda) \leq \lambda_m$  and  $|\lambda| \geq \lambda_m \sqrt{2} \geq \gamma(\ell)\sigma$ , we obtain, by applying Proposition 2.3.1,

$$\begin{aligned} |I_1^m| &\leq C(\ell) e^{\lambda_m n - \gamma(\ell)|l-j|} \int_{\Gamma_1^m} \frac{1}{|\lambda|} |d\lambda| \\ &\leq C(\ell) \frac{\sqrt{2}}{\sigma} |\Gamma_1^m| e^{\lambda_m n - \gamma(\ell)|l-j|} \end{aligned}$$

So, since  $|\Gamma_1^m| \leq 2\sqrt{2}(\lambda_m + \eta) \leq 2\sqrt{2}(\gamma(\ell)/\beta + \eta) \leq C$  and  $-|l-j| \leq -\frac{(l-j)^2}{n}$ , we have

$$|I_1^m| \leq C(\ell) \frac{\sqrt{2}}{\sigma} \exp\left(\gamma(\ell)(1-\beta)\frac{(l-j)^2}{\beta n}\right).$$

Since we can always assume that  $\sigma < 1$ , we take  $\beta \in (1, 1/\sigma)$ .

The bounds on  $\Delta_j G(n, l, j)$  are obtained through the same computations.

□

We now have to consider the case of small  $(l-j)^2/n^2$ , that is  $(l-j)^2 \leq \sigma\beta n^2$ .

**Remark 2.4.2** *Note that in this case, the following inequality holds*

$$e^{-\eta n} \leq e^{-\eta n/2} e^{-\eta(l-j)^2/(2\sigma\beta n)}.$$

• **Case  $|l-j| \leq \ell$**

Let us consider at first the case of bounded  $n$  : we integrate  $G_\lambda$  along  $\Gamma_2 := \Gamma_2^- \cup \Gamma_2^m \cup \Gamma_2^+$  (see Figure 2.7), where

$$\Gamma_2^- := \{\lambda = -\eta + iy, -\pi \leq y \leq -\eta - \sigma\},$$

$$\Gamma_2^m = \{|\operatorname{Im}(\lambda)| = \sigma - \operatorname{Re}(\lambda), -\eta \leq \operatorname{Re}(\lambda) \leq \sigma\},$$

$$\Gamma_2^+ := \{\lambda = -\eta + iy, \eta + \sigma \leq y \leq \pi\}.$$

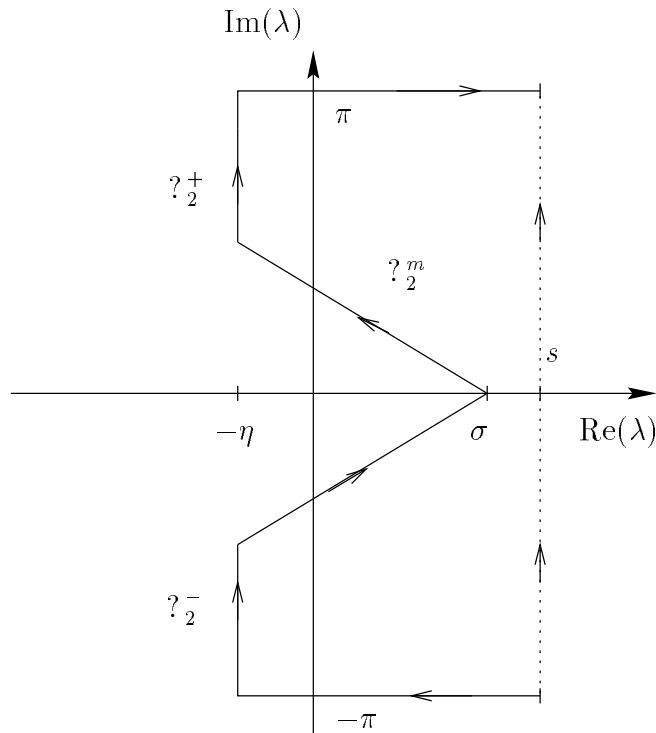

Fig. 2.7: Path of integration  $\Gamma_2$

Using the same notations as in (80), we get at once, similarly as in (81),

$$|I_2^-| + |I_2^+| \leq \frac{C(\ell)}{\eta}.$$

Since  $\Gamma_2^m \subset D(0, \sigma) \setminus D(0, \sigma/\sqrt{2})$ , we apply Proposition 2.3.1 and we get

$$|I_2^m| \leq C(\ell) \frac{\sqrt{2}}{\sigma} \leq C(\ell) e^{-\eta n},$$

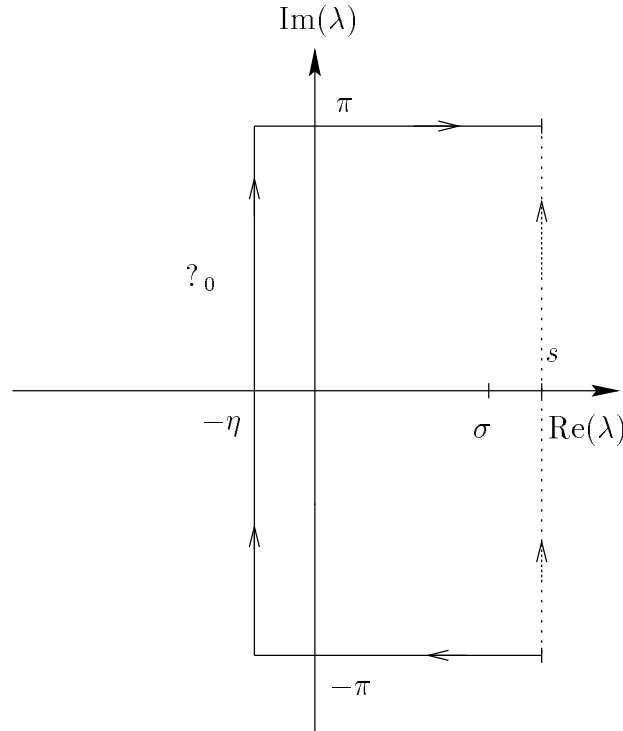
 Fig. 2.8: Path of integration  $\Gamma_0$ 

because  $n$  is bounded. The claimed estimate follows from Remark 2.4.2.

Let us deal now with the case of large  $n$  : we integrate  $G_\lambda$  along  $\gamma_0$  (see Figure 2.8).

Define now  $\gamma_0 := \{\lambda = -\eta + iy / -\pi \leq y \leq \pi\}$ .

We thus obtain

$$|G(n, l, j) - \mathcal{R}_0(l, j)| \leq \frac{C(\ell)}{2\pi} \int_{-\pi}^{\pi} e^{-\eta n} dy \leq C(\ell) e^{-\eta n}.$$

We conclude by using once again Remark 2.4.2.

The computations are the same for the bounds on  $\Delta_j G(n, l, j)$

- **Case  $|j| > \ell \geq |l|$**

Thanks to Proposition 2.3.1, we know that

$$\int_{\Gamma} G_\lambda(l, j) d\lambda = \sum_{q=1}^d \int_{\Gamma} \nu_q(\lambda, l) \Phi_q(\lambda, j), \quad \forall j \geq l \quad (82)$$

$$= \sum_{q=d+1}^{2d} \int_{\Gamma} \nu_q(\lambda, l) \Phi_q(\lambda, j), \quad \forall l \geq j \quad (83)$$

for  $\lambda \in D(0, \sigma)$ , so that we need only estimate each of the  $\|\nu_q(\lambda, l) \Phi_q(\lambda, j)\|$  for  $q \in \{1, \dots, d\}$  (resp.  $q \in \{d+1, \dots, 2d\}$ ) as  $j$  tends to  $+\infty$  (resp.  $-\infty$ ).

For the sake of simplicity, let us now drop the superscript  $\pm$  : from now on,  $\rho_q(\lambda)$  and  $R_q(\lambda)$  will denote an eigenvalue and an associated eigenvector of  $\mathbb{A}^\pm(\lambda)$ , and  $a(\rho_q)$  and  $r(\rho_q)$  will be the corresponding eigenvalue and eigenvectors of  $F^\pm$  (see Tables 1 and 2).

There are two cases depending on the limit of  $\rho_q$  as  $\lambda$  tends to 0 (see Tables 1 and 2) :

– **Case  $\text{ja}(\rho_q) < 0$**

Recalling Tables 1 and 2, we see at once that, in this case, the index  $q$  belongs to  $\{1, \dots, p^+\} \cup \{d + p^-, \dots, 2d\}$ . Thanks to Proposition 2.3.1, we know that the corresponding  $\lambda \mapsto \nu_q(\lambda, l)\Phi_q(\lambda, j)$  is analytic for  $q \in \{1, \dots, p^+ - \varpi - 1\} \cup \{d + p^- + \varpi + 1, \dots, 2d\}$  and meromorphic in  $D(0, \sigma)$ ,  $\lambda = 0$  being its only pole for  $q \in \Upsilon^+ \cup \Upsilon^-$ , so that

$$\|\nu_q(\lambda, l)\Phi_q(\lambda, j)\| \leq \frac{C(\ell)}{|\lambda|} |\rho(\lambda)|^j, \quad \forall \lambda \in D(0, \sigma) \setminus \{0\}.$$

Consequently, in the following, whenever the path of integration goes to the left-hand side of the point  $\lambda = 0$ , a residue appears for  $q \in \Upsilon^+ \cup \Upsilon^-$ .

The modulus of the associated eigenvalue  $|\rho_q(0)|^j$  is strictly less than 1, that is, choosing  $\kappa > 0$ , if we take  $\sigma$  to be small enough, we have, for  $\lambda \in D(0, \sigma)$ ,

$$j \ln(|\rho_q(\lambda)|) \leq -\kappa|j|.$$

Let us consider at first the case  $n \leq |j/a|$  : this artificial choice of bound is explained by the bounds appearing in the case of  $ja > 0$ . Let  $\varepsilon$  be such that that  $0 < \varepsilon < \min(\kappa|a|, \sigma)/2$ , so that our path of integration

$$?_3 := ?_3^- \cup ?_3^m \cup ?_3^+,$$

with  $?_3^m := \{|\text{Im}(\lambda)| = \varepsilon - \text{Re}(\lambda), -\eta \leq \text{Re}(\lambda) \leq \varepsilon\}$ , is such that  $?_3^m$  intersects  $\{\text{Re}(\lambda) = -\eta$  inside  $D(0, \sigma)$  (see Figure 2.9).

Using once again the notations of (80), we obtain

$$|I_3^-| + |I_3^+| \leq C(\ell)e^{-\eta n}.$$

Noting that  $|\lambda| \geq \varepsilon/\sqrt{2}$  for  $\lambda \in ?_3$ , we obtain

$$|G(n, l, j)| \leq C(\ell)e^{\varepsilon n - \kappa|j|} \leq C(\ell)e^{-\kappa|a|n/2}.$$

No residue appears since  $\lambda = 0$  remains on the left-hand side of  $?_3$ . We find the right estimate using Remark 2.4.2.

Let us consider now the case  $n > |j/a|$ . We integrate along  $?_0$  (see Figure 2.8). Noting that  $\|\nu_q(\lambda, l)\Phi_q(\lambda, j)\| \leq C(\ell)e^{-\kappa|j|} \leq C(\ell)$ , it is the same computation as in the case of  $|l - j| \leq \ell$  and large  $n$  : a residue appears in the terms corresponding to  $q \in \Upsilon^+ \cup \Upsilon^-$ . We conclude again by using Remark 2.4.2.

– **Case  $\text{ja}(\rho_q) > 0$**

Referring to Tables 1 and 2, we know that  $\rho_q(\lambda)$  tends to 1 as  $\lambda$  tends to 0, so that the index  $q$  in the integral (82) belongs to  $\{p^+ + 1, \dots, d\} \cup \{d + 1, \dots, d + p^- - 1\}$  : Proposition 2.3.1 implies that the corresponding  $\lambda \mapsto \nu_q(\lambda, l)$  is holomorphic in  $D(0, \sigma)$ , so that

$$\|\nu_q(\lambda, l)\| \leq C(\ell).$$

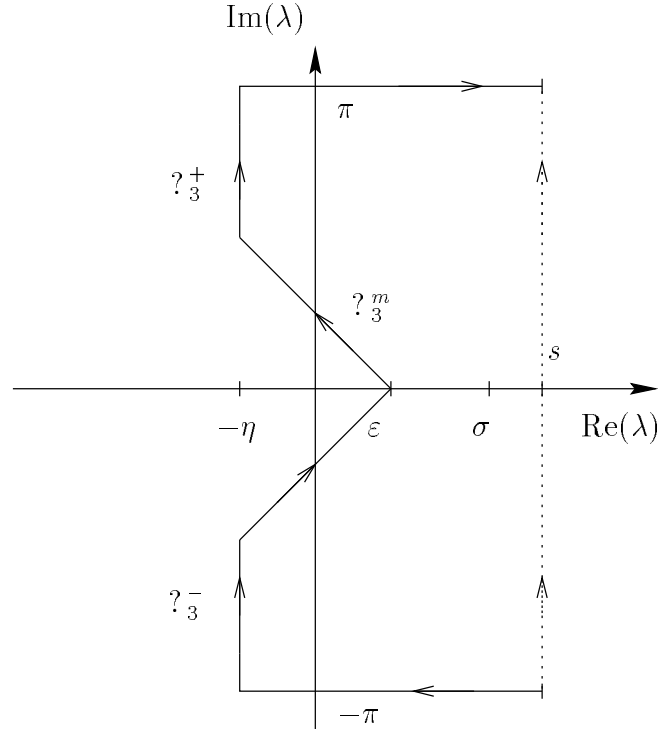
 Fig. 2.9: Path of integration  $\Gamma_3$ 

Let us now drop the subscript  $q$  and note  $a := a(\rho_q)$  and  $r := r(\rho_q)$ . We derive an expansion of  $\ln(|\rho(\lambda)|) = \ln(\rho(\lambda)\overline{\rho(\lambda)})/2$  from the expansion (38) :

$$\ln(|\rho(\lambda)|) = -\frac{\operatorname{Re}(\lambda)}{a} + \frac{\alpha}{2a}(\operatorname{Re}(\lambda)^2 - \operatorname{Im}(\lambda)^2) + o(|\lambda|^2), \quad (84)$$

where

$$\alpha := \frac{2D}{a^2} - 1.$$

Note that  $\alpha > 0$  because  $a^2 < |a| < 2D < 1$  (H5). Define

$$\xi := \frac{\frac{j}{a} - n}{\alpha \frac{j}{a}}.$$

Following the method of [88], let us change the initial path of integration  $?$  to  $?_4 := ?_4^- \cup \mathcal{H}_{\lambda_0} \cup ?_4^+$ ,  $\mathcal{H}_{\lambda_0}$  being the portion contained in  $\operatorname{Re}(\lambda) \geq -\eta$  of the hyperbola

$$-\operatorname{Re}(\lambda) + \frac{\alpha}{2}(\operatorname{Re}(\lambda)^2 - \operatorname{Im}(\lambda)^2) = -\lambda_0 + \frac{\alpha}{2}\lambda_0^2, \quad (85)$$

that intersects the real axis at

$$\begin{aligned} \lambda_0 &:= \xi, & \text{if } |\xi| \leq \epsilon, \\ &:= \epsilon, & \text{if } \xi > \epsilon, \\ &:= -\epsilon, & \text{if } -\epsilon > \xi, \end{aligned}$$

where  $\epsilon$  is chosen small enough to ensure that  $\mathcal{H}_\epsilon$  intersects  $\gamma_0$  inside  $D(0, \sigma)$  (see Figures 2.10, 2.11). These choices are carefully explained in [88].

We have the following expansion for  $\lambda \in \mathcal{H}_{\lambda_0}$

$$\operatorname{Re}(\lambda) = \lambda_0 - \frac{\alpha}{2} \operatorname{Im}(\lambda)^2 + O(|\operatorname{Im}(\lambda)|^3), \tag{86}$$

that leads to

$$C_1(|\lambda_0| + |\operatorname{Im}(\lambda)|) \leq |\lambda| \leq C_2(|\lambda_0| + |\operatorname{Im}(\lambda)|), \tag{87}$$

where  $C_1$  and  $C_2$  are some positive constants. Using (87), we have for  $m \in \mathbb{N} \setminus \{0\}$

$$|\lambda|^m \leq C(|\lambda_0|^m + |\operatorname{Im}(\lambda)|^m). \tag{88}$$

Recall that, if  $\xi$  is negative, that is, if  $j/a < n$ , the path  $\mathcal{H}_{\lambda_0}$  lies in the left half-plane. But here, we are dealing with  $\lambda \mapsto \nu(\lambda, l)\Phi(\lambda, j)$  that are holomorphic in  $D(0, \sigma)$ , so that no residue appears.

Using the notations of (80) for  $\nu(\lambda, l)\Phi(\lambda, j)$  instead of  $G_\lambda(l, j)$ , we obtain at once

$$|I_4^-| + |I_4^+| \leq C(\ell)e^{-\eta n}.$$

Let us now focus on the integration along  $\mathcal{H}_{\lambda_0}$ . Remembering the behaviors (41) of the solutions of (35) in  $D(0, \sigma)$ , we can write

$$\begin{aligned} |I_4^m| &\leq C(\ell) \int_{\mathcal{H}_{\lambda_0}} e^{\operatorname{Re}(\lambda)n} |\rho(\lambda)|^j |R(\lambda)| |d\lambda| + O\left(\int_{\mathcal{H}_{\lambda_0}} e^{\operatorname{Re}(\lambda)n} |\rho(\lambda)|^j \omega^{-|j|} |d\lambda|\right) \\ &\leq C(\ell) \int_{\mathcal{H}_{\lambda_0}} e^{\varphi(n, j, \lambda)} \left| \begin{pmatrix} r \\ \lambda \\ -\frac{\lambda}{a} \end{pmatrix} \right| + O\left(\frac{|\lambda|}{|\lambda|^2}\right) |d\lambda| + \omega^{-|j|} O\left(\int_{\mathcal{H}_{\lambda_0}} e^{\varphi(n, j, \lambda)} |d\lambda|\right) \\ &= J_1 + J_2, \end{aligned} \tag{89}$$

where

$$\varphi(n, j, \lambda) := \operatorname{Re}(\lambda)n + j \ln(|\rho(\lambda)|).$$

Note that  $|d\lambda| \leq C_4$ , for some positive  $C_4$  and that, since  $|\xi| \leq \epsilon$ , we have

$$(1 - \alpha\sigma)\frac{j}{a} \leq n \leq (1 + \alpha\sigma)\frac{j}{a}. \tag{90}$$

\* **Case**  $|\xi| \leq \epsilon$  (see Figure 2.10)

Using (86), we get

$$\begin{aligned} \varphi(n, j, \lambda) &= n(\operatorname{Re}(\lambda) - \xi) + n\xi - \frac{j}{a} \left(\xi - \frac{\alpha}{2}\xi^2\right) + O(|\lambda|^3) \\ &= -\frac{\alpha}{2}n\operatorname{Im}(\lambda)^2 - \frac{\left(\frac{j}{a} - n\right)^2}{2\alpha\frac{j}{a}} + \frac{j}{a}O(|\lambda|^3). \end{aligned}$$

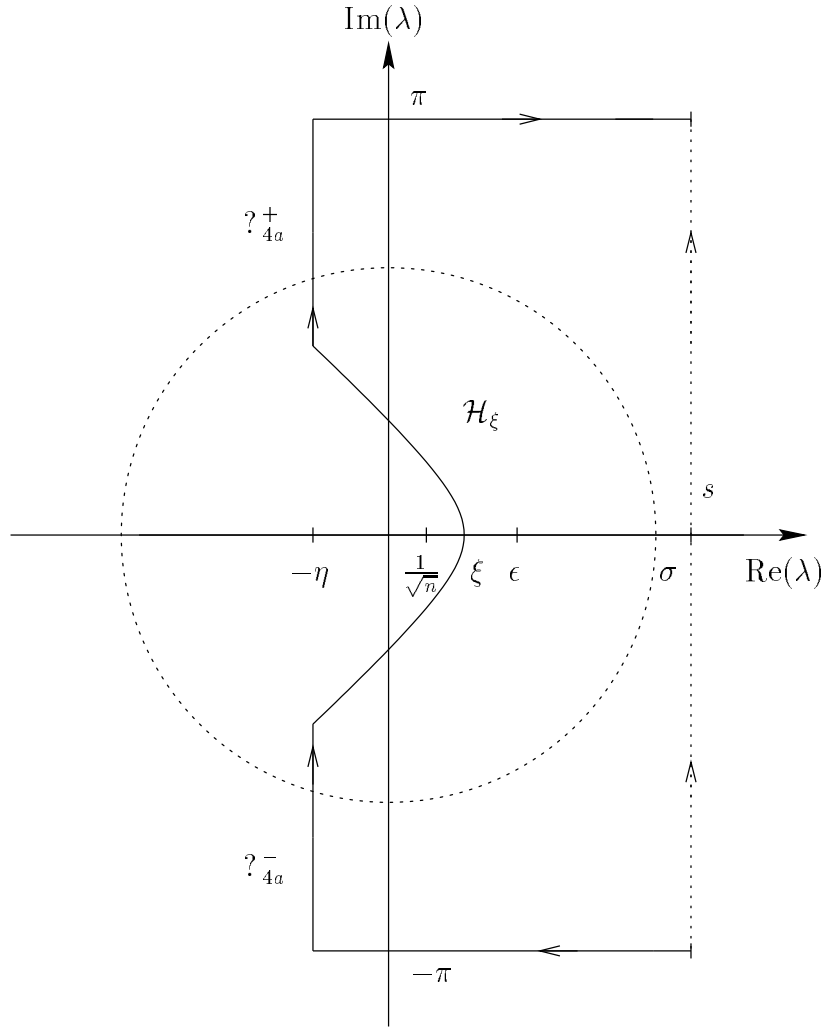
 Fig. 2.10: Path of integration  $\Gamma_{4a}$ 

Thanks to (88), we obtain

$$\begin{aligned} \varphi(n, j, \lambda) &\leq \frac{j}{a} \left( -\frac{\alpha}{2} \xi^2 + O(|\xi|^3) \right) - \frac{j}{a} \left( \frac{\alpha}{2} \text{Im}(\lambda)^2 + O(|\text{Im}(\lambda)|^3) \right) \\ &\leq -\frac{j}{a} \frac{\xi^2}{M} - \frac{j}{a} \frac{\text{Im}(\lambda)^2}{M'}, \end{aligned} \quad (91)$$

for some positive  $M, M'$ . Let us now denote by

$$\bar{\xi} := \frac{\frac{j}{a} - n}{n}$$

the variable we expect to appear by comparison with the continuous case that is treated in [88] for the shock wave setting and in [36] for the pure boundary layer one. Choosing  $\sigma$  to be small enough, (90) implies that there exists  $c > 0$  such that

$$|\bar{\xi}| \leq c\epsilon. \quad (92)$$

Since  $|\xi| \leq \epsilon$ , we have

$$\begin{aligned} \frac{j}{a} \frac{\xi^2}{M} &= \frac{\left(\frac{j}{a} - n\right)^2}{M\alpha^2 \frac{j}{a}} = \frac{\left(\frac{j}{a} - n\right)^2}{M\alpha^2 n} \left(1 + O\left(\frac{\frac{j}{a} - n}{n}\right)\right) \\ &= n \frac{\bar{\xi}^2}{M\alpha^2} + nO(\bar{\xi}^3) \\ &\leq n \frac{\bar{\xi}^2}{M''}, \end{aligned} \tag{93}$$

where  $M''$  is a positive constant.

Let us deal at first with the second term  $J_2$  of (89).

We get at once

$$J_2 \leq C(\ell)\omega^{-|j|} \int_{\mathcal{H}_{\lambda_0}} e^{\varphi(n,l,j)} |d\lambda|.$$

The bounds given in (90) imply that there exists a positive  $\gamma$  such that

$$\omega^{-|j|} \leq C e^{-\gamma n}, \tag{94}$$

so that (91) and (93) imply

$$J_2 \leq C(\ell)e^{-\gamma n} e^{-n\bar{\xi}^2/M''}.$$

**Remark 2.4.3** *Note that (94) is satisfied in the two cases on  $\xi$  we consider.*

Let us now deal with the first term  $J_1$  of (89), we integrate the term of order 0 with respect to  $\lambda$ .

$$\begin{aligned} \int_{\mathcal{H}_{\lambda_0}} e^{\varphi(n,j,\lambda)} |d\lambda| &\leq e^{-n\bar{\xi}^2/M''} \int_{\mathcal{H}_{\lambda_0}} \exp\left(-\frac{j}{a} \frac{y^2}{M'}\right) dy \\ &\leq e^{-n\bar{\xi}^2/M''} \sqrt{\frac{aM'}{j}} \int_{-\infty}^{+\infty} e^{-y^2} dy \end{aligned}$$

Using (90), we have

$$\sqrt{n} \sqrt{\frac{a}{j}} \leq C_4,$$

where  $C_4$  is a positive constant that does not depend on  $n$  nor on  $j$ . In conclusion, we get

$$\int_{\mathcal{H}_{\lambda_0}} e^{\varphi(n,j,\lambda)} |d\lambda| = \frac{1}{\sqrt{n}} O\left(e^{-n\bar{\xi}^2/M''}\right).$$

Using (88) for  $m \in \{1, 2\}$ , (91) and (93), we have

$$\begin{aligned} \int_{\mathcal{H}_{\lambda_0}} |\lambda|^m e^{\varphi(n,j,\lambda)} |d\lambda| &\leq e^{-n\bar{\xi}^2/M''} \int_{-\infty}^{+\infty} C_5(|\bar{\xi}|^m + |y|^m) e^{-jy^2/(aM')} dy \\ &\leq C_6 \left( |\bar{\xi}|^m e^{-n\bar{\xi}^2/M''} + e^{-n\bar{\xi}^2/M''} \int_{-\infty}^{+\infty} |y|^m e^{-jy^2/(aM')} dy \right), \end{aligned}$$



where  $C_5$  and  $C_6$  are positive constants.  
Using the well-known inequality

$$|X|e^{-X^2} \leq e^{-X^2/2},$$

we finally get

$$\int_{\mathcal{H}_{\lambda_0}} |\lambda|^m e^{\varphi(n,j,\lambda)} |d\lambda| = \frac{1}{n} O\left(e^{-n\bar{\xi}^2/M''}\right).$$

In the next case, we only develop the estimates of  $\varphi(n,l,j)$ , since the remaining computations are exactly the same as in the case we just considered.

\* **Case**  $|\xi| > \epsilon$

We only treat here the case  $\xi > \epsilon$  (see Figure 2.11) because the case  $\xi < -\epsilon$  is completely similar.

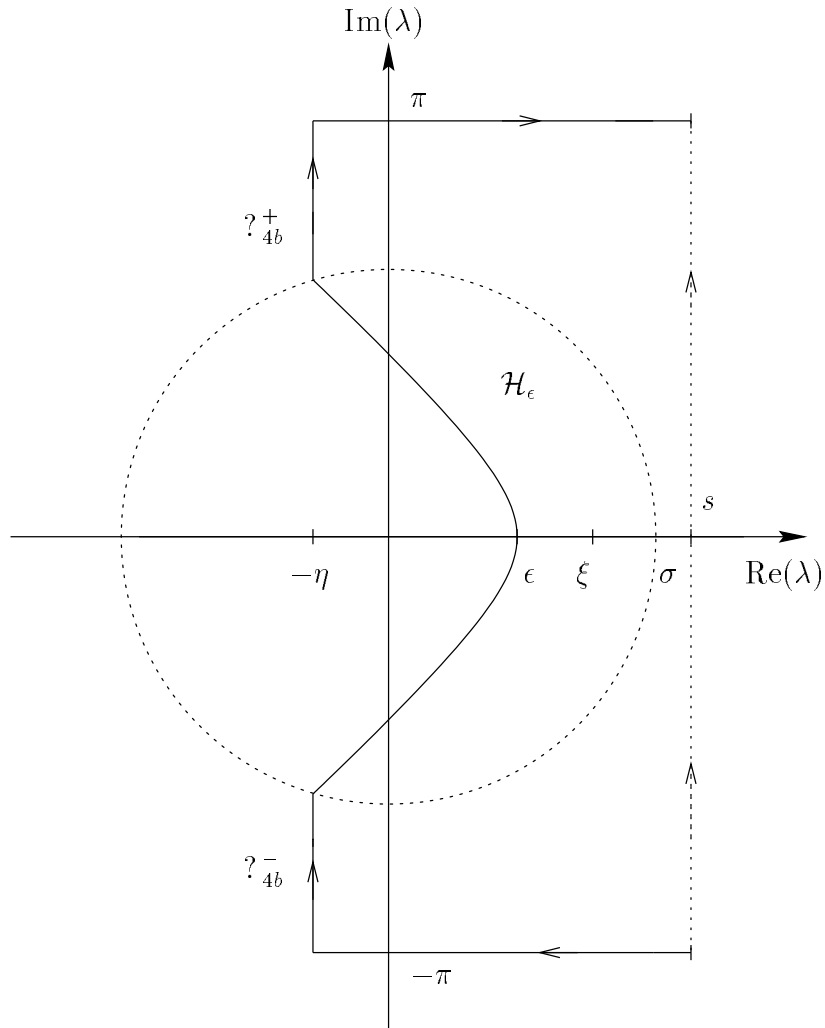

Fig. 2.11: Path of integration  $\Gamma_{4b}$

Using the expansion (86) and (88), we obtain

$$\begin{aligned}
\varphi(n, j, \lambda) &= n(\operatorname{Re}(\lambda) - \epsilon) + \left(n - \frac{j}{a}\right)\epsilon + \frac{j}{a}\frac{\alpha}{2}\epsilon^2 + O(|\lambda|^3) \\
&= -n\frac{\alpha}{2}\operatorname{Im}(\lambda)^2 + \frac{j}{a}O(|\operatorname{Im}(\lambda)|^3) - \frac{j}{a}\left(\frac{\alpha}{2}\epsilon^2 + O(\epsilon^3)\right) \\
&\leq -n\frac{\operatorname{Im}(\lambda)^2}{M'} - \frac{j}{a}\frac{\epsilon^2}{M} \\
&\leq -n\frac{\operatorname{Im}(\lambda)^2}{M'} - n\frac{\bar{\xi}^2}{M''}
\end{aligned}$$

We get the claimed estimates through the same computations as in the previous case.

## 2.5 Numerical simulations

We show here some numerical simulations that we obtained by considering a Lax 3-shock for the  $3 \times 3$  system of gas dynamics

$$\begin{aligned} \rho_t + (\rho v)_x &= 0, \\ (\rho v)_t + (\rho v^2 + (\gamma - 1)\rho e)_x &= 0, \\ \left(\frac{1}{2}\rho v^2 + \rho e\right)_t + \left(v\left(\frac{1}{2}\rho v^2 + \gamma\rho e\right)\right)_x &= 0, \end{aligned}$$

where  $\rho$  is the density of the gas,  $v$  its velocity and  $e$  its internal energy. We take here the law of pressure of the perfect gases :

$$P(\rho, e) = (\gamma - 1)\rho e.$$

The adiabatic constant  $\gamma$  is larger than 1; physically,  $\gamma$  is equal to  $5/3$  for monatomic gases and  $7/5$  for diatomic gases. Taking the same notations as in [9], we have

$$u = \begin{pmatrix} \rho \\ \rho v \\ \frac{1}{2}\rho v^2 + \rho e \end{pmatrix}, \quad f(u) = \begin{pmatrix} \rho v \\ \rho v^2 + (\gamma - 1)\rho e \\ v\left(\frac{1}{2}\rho v^2 + \gamma\rho e\right) \end{pmatrix}.$$

Let  $u^- = \left(\rho^-, \rho^- v^-, \frac{1}{2}\rho^-(v^-)^2 + \rho^- e^-\right)^T$  and  $u^+ = \left(\rho^+, \rho^+ v^+, \frac{1}{2}\rho^+(v^+)^2 + \rho^+ e^+\right)^T$  two states of  $\mathbb{R}^3$  satisfying the Rankine-Hugoniot condition (H1) with null speed

$$\rho^+ v^+ - \rho^- v^- = 0, \quad (95)$$

$$\rho^+(v^+)^2 + (\gamma - 1)\rho^+ e^+ - \rho^-(v^-)^2 - (\gamma - 1)\rho^- e^- = 0, \quad (96)$$

$$v^+ \left(\frac{1}{2}\rho^+(v^+)^2 + \gamma\rho^+ e^+\right) - v^- \left(\frac{1}{2}\rho^-(v^-)^2 + \gamma\rho^- e^-\right) = 0. \quad (97)$$

In order to be able to apply the modified Lax-Friedrichs scheme to the system  $u_t + f(u)_x = 0$ , we change to the conservative variables

$$R = \rho, \quad V = \rho v, \quad E = \frac{1}{2}\rho v^2 + \rho e,$$

and

$$U = \begin{pmatrix} R \\ V \\ E \end{pmatrix}, \quad F(U) = f(u) = \begin{pmatrix} V \\ \frac{3 - \gamma}{2} \frac{V^2}{R} + (\gamma - 1)E \\ \frac{V}{R} \left( \gamma E - \frac{\gamma - 1}{2} \frac{V^2}{R} \right) \end{pmatrix}.$$

We get at once

$$dF(U) = \begin{pmatrix} 0 & 1 & 0 \\ \frac{\gamma - 3}{2} \frac{V^2}{R^2} & (3 - \gamma) \frac{V}{R} & \gamma - 1 \\ \frac{V}{R} \left( (\gamma - 1) \frac{V^2}{R^2} - \gamma \frac{E}{R} \right) & \gamma \frac{E}{R} - 3 \frac{(\gamma - 1)}{2} \frac{V^2}{R^2} & \gamma \frac{V}{R} \end{pmatrix}.$$

The eigenvalues of  $dF(U)$  are

$$a_1(U) = \frac{V}{R} - c(U), \quad a_2(U) = \frac{V}{R}, \quad a_3(U) = \frac{V}{R} + c(U),$$

where  $c(U)$  is the sound speed and is given by

$$c(U) = \sqrt{\gamma(\gamma - 1) \left( \frac{E}{R} - \frac{V^2}{2R^2} \right)}.$$

We choose as associated eigenvectors

$$r_1(U) = \begin{pmatrix} R \\ V - Rc(U) \\ \frac{(1-\gamma)V^2}{2} \frac{1}{R} + \gamma E - Vc(U) \end{pmatrix}, \quad r_2(U) = \begin{pmatrix} R \\ V \\ \frac{V^2}{2R} \end{pmatrix}, \quad r_3(U) = \begin{pmatrix} R \\ V + Rc(U) \\ \frac{(1-\gamma)V^2}{2} \frac{1}{R} + \gamma E + Vc(U) \end{pmatrix}.$$

The stationary discontinuity  $(U^-, U^+)$  is a Lax 3-shock, that is (H4) is satisfied with  $p^+ = p^- = 3$ , so that

$$V^+ + R^+ c^+ < 0 < V^- + R^- c^-, \tag{98}$$

$$V^- < 0, \tag{99}$$

where  $c^\pm := c(U^\pm)$ . Consequently, plugging (98) and (99) in (95), (96), (97), we can completely define the end states  $U^\pm$  by three parameters  $(R^-, r := R^-/R^+, V^-)$  in the following way

$$\begin{aligned} R^-, \quad R^+ &= rR^-, \\ V^-, \quad V^+ &= V^-, \\ E^- &= \frac{\gamma^2 + \gamma(r-2) + r + 1}{2\gamma(\gamma-1)} \left( \frac{(V^-)^2}{R^-} \right), \quad E^+ = \frac{r\gamma(r-1) + r + 1 + \gamma(\gamma-1)}{2\gamma(\gamma-1)} \left( \frac{(V^-)^2}{R^-} \right), \end{aligned}$$

where

$$1 < r < \frac{\gamma + 1}{\gamma - 1}$$

(see [9] for details).

Referring to Table 1 and to (41), we see at once that  $\Phi_6^I = \Psi$ , and that  $\Psi(j) = (\zeta_3^-)^j (r_3^- + O(\omega^{-|j|}))$  as  $j$  tends to  $-\infty$ .

The algorithm is the following :

1. We choose the size  $N$  of the mesh.
2. We set the values of  $R^-$ ,  $r$  and  $V^-$  and compute  $U^\pm$ .
3. Having computed the eigenvalues of  $dF(U^\pm)$ , we set  $D = 1.1 * \max(|a_i^\pm|, i \in \{1, 2, 3\})$  and  $\sigma = 0.9/(2 * D)$  so that (H5) is satisfied.
4. We compute numerically a profile by iterating the Lax-Friedrichs scheme in conservative coordinates on the step sequence  $U_j = U^-$  if  $j \leq 0$  and  $U_j = U^+$  if  $j \geq 1$  : the convergence is quite fast [41].

5. We solve numerically (9) with  $\tilde{v} = 0$  and  $v_j^0 = \delta_{jl}$ , for  $l \in \{-N/2, \dots, N/2\}$ .

Let us consider the cases  $l \geq 0$  and  $l \leq 0$  :

Case  $l \geq 0$  in accordance with Theorem 2.1.1, in Figure 2.12, three waves propagate towards the shock with speeds  $a_1^+$ ,  $a_2^+$ ,  $a_3^+$  since the three of them are negative. When the fastest one reaches the shock, i.e. the one corresponding to  $a_1^+$ , a residue appears (see Figure 2.13), and outgoing waves are emitted on the left side with speeds  $a_1^-$  and  $a_2^-$  along the eigenvectors  $r_1^-$  and  $r_2^-$ . We cannot see clearly in Figure 2.12 the waves that are emitted by the waves that are carried by  $r_1^+$  and  $r_2^+$  because they are damped by the numerical viscosity and, besides, the scale of the residue is large and the waves are all the more damped. No wave outgoes on the right since the eigenvalues  $a_1^+$ ,  $a_2^+$ ,  $a_3^+$  are all negative.

Case  $l \leq 0$  Since all the eigenvalues of  $df(u^+)$  are negative, no wave propagates to the right : all the waves are in the left side of the mesh. Thus, since all the waves propagate along  $r_1^-$ ,  $r_2^-$  and  $r_3^-$ , we chose the three of them as a basis for the computations we show in Figure 2.14. We see that a single wave propagates along the entering characteristic with speed  $a_3^- > 0$  until it reaches the shock; then, a stationary residue appears (see Figure 2.15 for the projection on each vector of the basis  $(r_1^-, r_2^-, r_3^-)$  of the eigenspace associated with 1), along with two waves propagating to the left with speeds  $a_1^- < 0$  and  $a_2^- < 0$ .

In order to compare the numerical results to our expectations a time step at a time, we resume our study with

6. We compute the residue up to a multiplicative constant by iterating the linearized scheme (8) from  $-3N/4$  to  $N/2$  on the initial data  $\Psi(-3N/4) = (\zeta_3^-)^{-3N/4} r_3^-$ .
7. We compute the Gaussians through the formula given in Theorem 2.1.1.

Movies displaying the evolution of the Green's function with respect to time are available at

<http://www.umpa.ens-lyon.fr/~pgodillo/>.

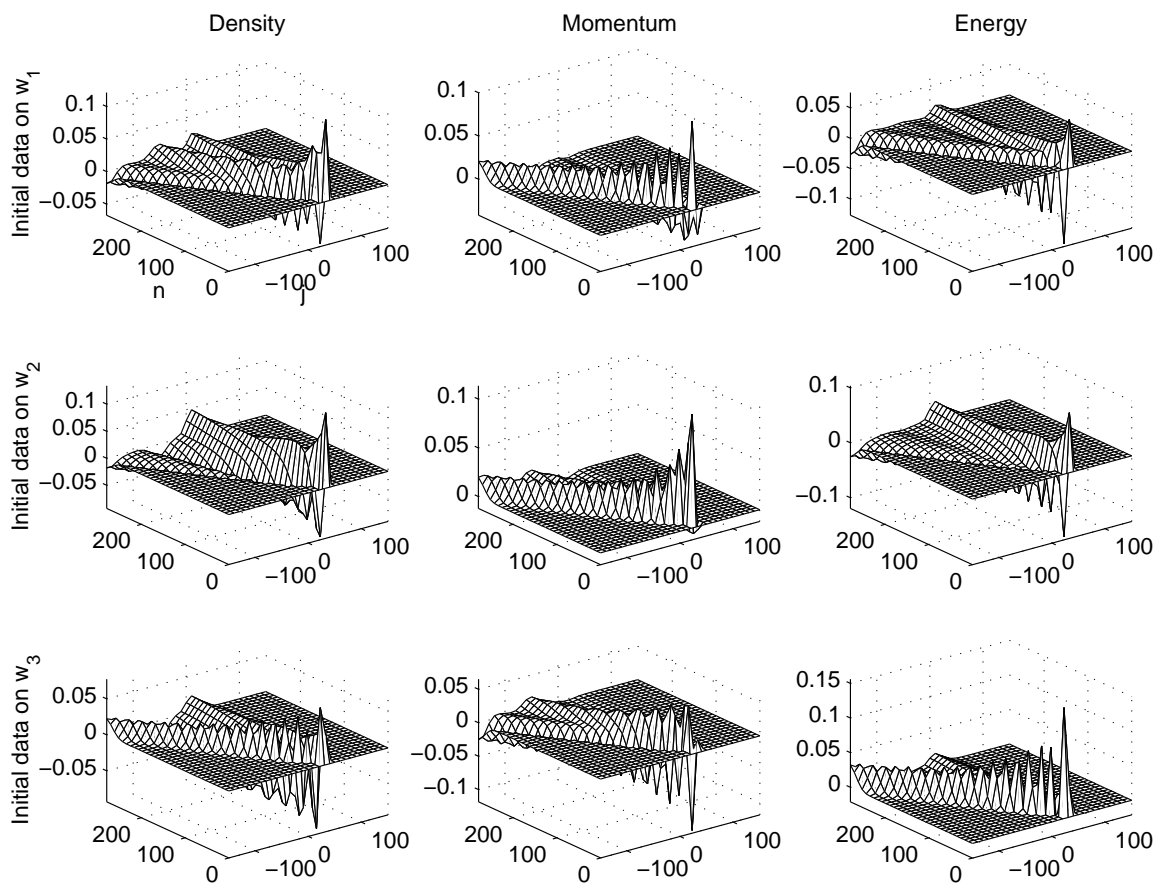

Fig. 2.12:  $G(n, 39, j)$  displayed on the canonical basis  $(w_1, w_2, w_3)$

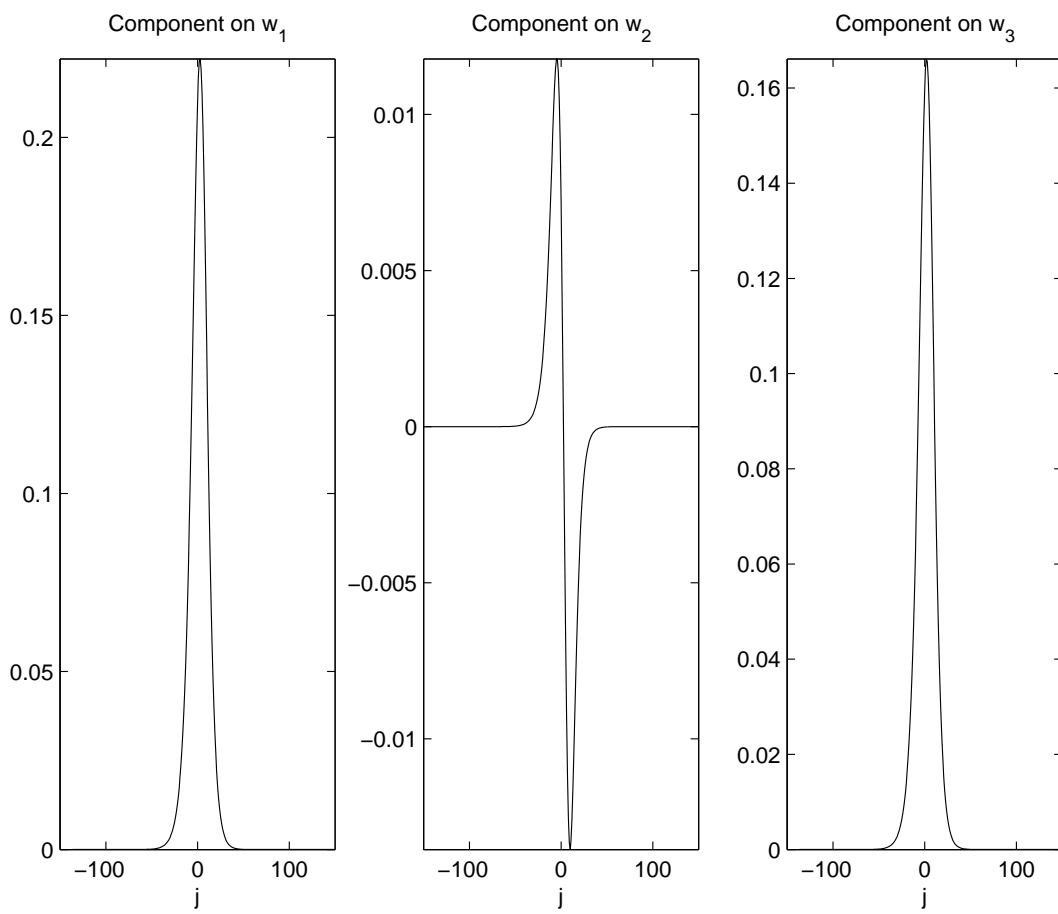

Fig. 2.13: Eigenspace associated to 1 in the canonical basis

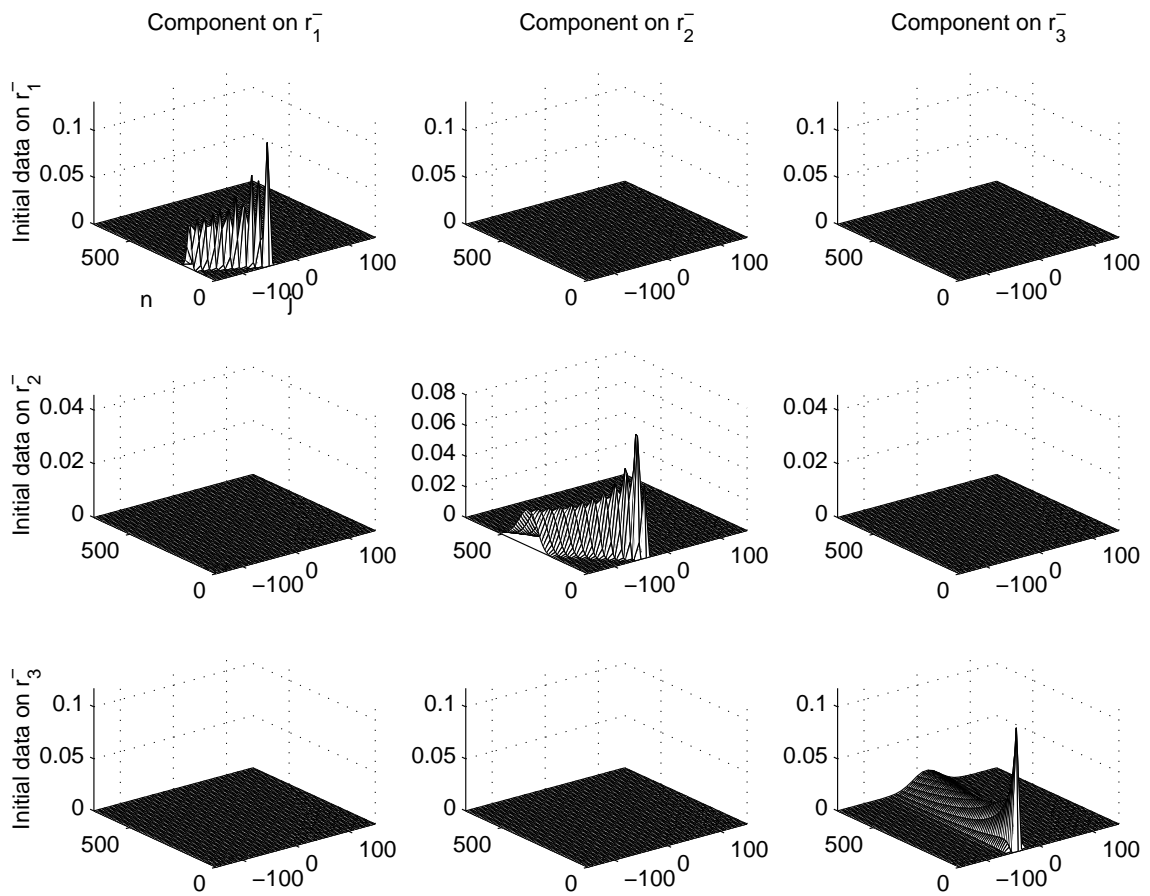

Fig. 2.14:  $G(n, -41, j)$  displayed on the basis  $(r_1^-, r_2^-, r_3^-)$



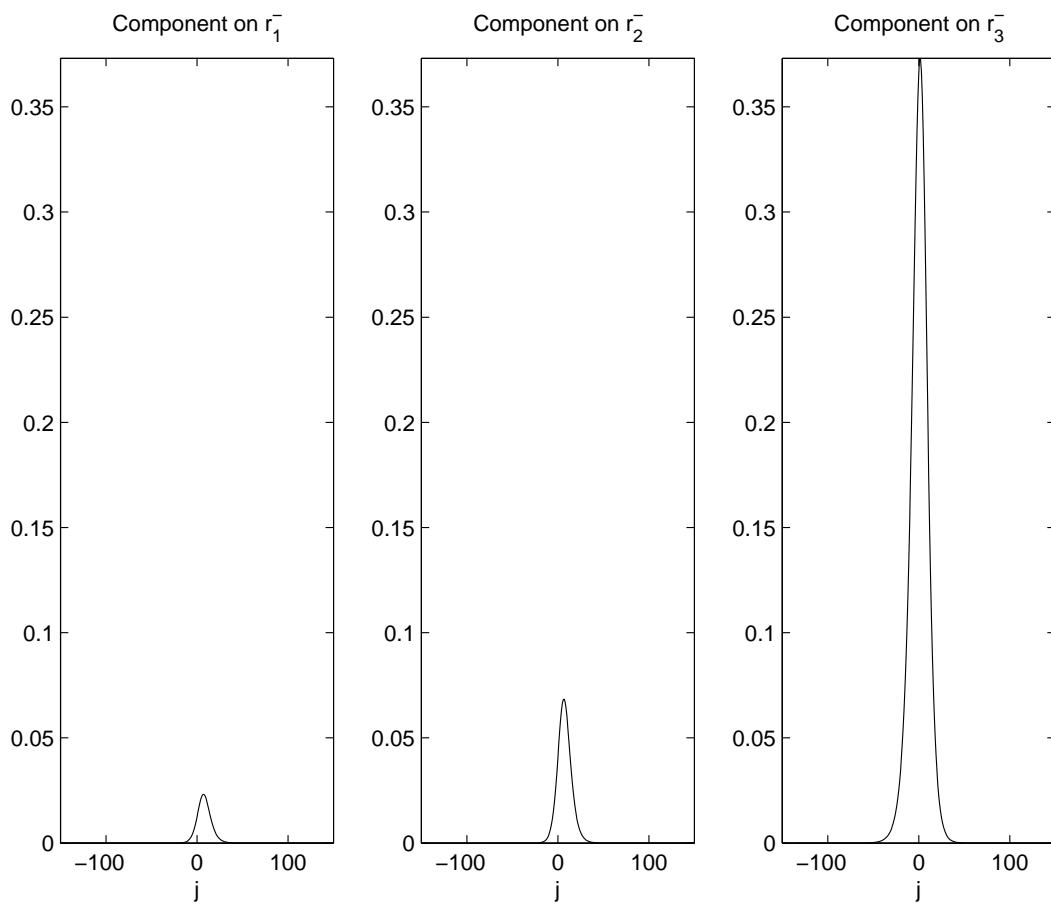

Fig. 2.15: Eigenspace associated to 1 in the basis  $(r_1^-, r_2^-, r_3^-)$

## BIBLIOGRAPHIE

- [1] Alexander J., Gardner R. et Jones C. – A topological invariant arising in the stability analysis of travelling waves. *J. Reine Angew. Math.*, vol. 410, 1990, pp. 167–212.
- [2] Benzoni-Gavage S. – Stability of semi-discrete shock profiles by means of an Evans function in infinite dimensions. *Available at* <http://www.umpa.ens-lyon.fr/~benzoni>, 2000.
- [3] Benzoni-Gavage S. et Huot P. – Existence of semi-discrete shocks. *Soumis*, 2001.
- [4] Benzoni-Gavage S., Serre D. et Zumbrun K. – Alternate Evans functions and viscous shock waves. *SIAM J. Math. Anal.*, vol. 32, n° 5, 2001, pp. 929–962 (electronic).
- [5] Bianchini S. – A Glimm type functional for a special Jin-Xin relaxation model. *Ann. Inst. H. Poincaré Anal. Non Linéaire*, vol. 18, n° 1, 2001, pp. 19–42.
- [6] Bleistein N., Cohen J. K. et Stockwell, Jr. J. W. – *Mathematics of multidimensional seismic imaging, migration, and inversion*. – New York, Springer-Verlag, 2001, xxx+510p. Geophysics and Planetary Sciences.
- [7] Brackbill J.I. et Cohen B.I. – *Multiple time scales*. – New York, Computational Techniques, Academic press, Inc., 1985.
- [8] Brin L. Q. – *Numerical testing of the stability of viscous shock waves*. – Thèse de PhD, Department of Mathematics, Indiana University, 1998.
- [9] Bultelle M., Grassin M. et Serre D. – Unstable Godunov discrete profiles for steady shock waves. *SIAM J. Numer. Anal.*, vol. 35, n° 6, 1998, pp. 2272–2297 (electronic).
- [10] Chainais-Hillairet C. et Grenier E. – Numerical boundary layers for hyperbolic systems in 1-D. *M2AN Math. Model. Numer. Anal.*, vol. 35, n° 1, 2001, pp. 91–106.
- [11] Chapman S. et Cowling T. G. – *The mathematical theory of non-uniform gases. An account of the kinetic theory of viscosity, thermal conduction and diffusion in gases*. – London, Cambridge University Press, 1970. Third edition, prepared in co-operation with D. Burnett.
- [12] Chen G. Q., Levermore C. D. et Liu T.-P. – Hyperbolic conservation laws with stiff relaxation terms and entropy. *Comm. Pure Appl. Math.*, vol. 47, n° 6, 1994, pp. 787–830.
- [13] Chen G. Q. et Liu T.-P. – Zero relaxation and dissipation limits for hyperbolic conservation laws. *Comm. Pure Appl. Math.*, vol. 46, n° 5, 1993, pp. 755–781.
- [14] Coppel W. A. – *Dichotomies in stability theory*. – Berlin, Springer-Verlag, 1978, ii+98p. Lecture Notes in Mathematics, Vol. 629.
- [15] Crouzeix M. et Mignot A. – *Analyse numérique des équations différentielles*. – Paris, Masson, 1984, viii+171p.

- 
- [16] Dafermos C. – *Hyperbolic conservation laws in continuum physics.* – Springer, 2000.
- [17] DiPerna R. J. – Convergence of approximate solutions to conservation laws. *Arch. Rational Mech. Anal.*, vol. 82, n° 1, 1983, pp. 27–70.
- [18] Evans J. W. – Nerve axon equations. I. Linear approximations. *Indiana Univ. Math. J.*, vol. 21, 1971/72, pp. 877–885.
- [19] Evans J. W. – Nerve axon equations III : Stability of the nerve impulse. *Indiana Univ. Math. J.*, vol. J. 22, 1972/73, pp. 577–593.
- [20] Foy L. R. – Steady state solutions of hyperbolic systems of conservation laws with viscosity terms. *Comm. Pure Appl. Math.*, vol. 17, 1964, pp. 177–188.
- [21] Freistühler H. et Liu T.-P. – Nonlinear stability of overcompressive shock waves in a rotationally invariant system of viscous conservation laws. *Comm. Math. Phys.*, vol. 153, n° 1, 1993, pp. 147–158.
- [22] Freistühler H. et Szmolyan P. – Existence and bifurcation of viscous profiles for all intermediate magnetohydrodynamic shock waves. *SIAM J. Math. Anal.*, vol. 26, n° 1, 1995, pp. 112–128.
- [23] Freistühler H. et Zumbrun K. – *Examples of unstable viscous shock waves.* – Rapport technique, Institut für Mathematik, 1998.
- [24] Gardner R. A. et Zumbrun K. – The gap lemma and geometric criteria for instability of viscous shock profiles. *Comm. Pure Appl. Math.*, vol. 51, n° 7, 1998, pp. 797–855.
- [25] Ghidaglia J.-M., Kumbaro A. et Le Coq G. – Une méthode “volumes finis” à flux caractéristiques pour la résolution numérique des systèmes hyperboliques de lois de conservation. *C. R. Acad. Sci. Paris Sér. I Math.*, vol. 322, n° 10, 1996, pp. 981–988.
- [26] Gilbarg D. – The existence and limit behavior of the one-dimensional shock layer. *Amer. J. Math.*, vol. 73, 1951, pp. 256–274.
- [27] Gisclon M. et Serre D. – Étude des conditions aux limites pour un système strictement hyperbolique via l’approximation parabolique. *C. R. Acad. Sci. Paris Sér. I Math.*, vol. 319, n° 4, 1994, pp. 377–382.
- [28] Gisclon M. et Serre D. – Conditions aux limites pour un système strictement hyperbolique fournies par le schéma de Godunov. *RAIRO Modél. Math. Anal. Numér.*, vol. 31, n° 3, 1997, pp. 359–380.
- [29] Godillon P. – Green’s function pointwise estimates for the modified Lax-Friedrichs scheme. *Soumis*, 2001.
- [30] Godillon P. – Linear stability of shock profiles for systems of conservation laws with semi-linear relaxation. *Phys. D*, vol. 148, n° 3-4, 2001, pp. 289–316.
- [31] Godillon P. – Necessary condition of spectral stability for a stationary Lax-Wendroff shock profile. *Soumis*, 2001.
- [32] Godillon P. – Linear stability of shock profiles for systems of conservation laws with semi-linear relaxation. *In : Proceedings of the Eighth Conference on Hyperbolic Problems.*
- [33] Godlewski E. et Raviart P.-A. – *Numerical approximation of hyperbolic systems of conservation laws.* – Springer, 1996.

- 
- [34] Goodman J. – Nonlinear asymptotic stability of viscous shock profiles for conservation laws. *Arch. Rational Mech. Anal.*, vol. 95, n° 4, 1986, pp. 325–344.
- [35] Grenier E. et Guès O. – Boundary layers for viscous perturbations of non-characteristic quasilinear hyperbolic problems. *J. Differential Equations*, 1998.
- [36] Grenier E. et Rousset F. – Stability of one-dimensional boundary layers by using Green’s functions. *Comm. Pure Appl. Math.*, vol. 54, n° 11, 2001, pp. 1343–1385.
- [37] Hayes B. T. et LeFloch P. G. – Non-classical shocks and kinetic relations : scalar conservation laws. *Arch. Rational Mech. Anal.*, vol. 139, n° 1, 1997, pp. 1–56.
- [38] Henry D. – *Geometric theory of semilinear parabolic equations. Lecture Notes in Mathematics (840)*. – Berlin, Springer-Verlag, 1981, iv+348p.
- [39] Hislop P. D. et Sigal I. M. – *Introduction to spectral theory*. – New York, Springer-Verlag, 1996, x+337p.
- [40] Jacobs D., McKinney B. et Shearer M. – Travelling wave solutions of the modified Korteweg-de Vries-Burgers equation. *J. Differential Equations*, vol. 116, n° 2, 1995, pp. 448–467.
- [41] Jennings G. – Discrete shocks. *Comm. Pure Appl. Math.*, vol. 27, 1974, pp. 25–37.
- [42] Jin S. et Xin Z. – The relaxation schemes for systems of conservation laws in arbitrary space dimensions. *Comm. Pure Appl. Math.*, vol. 48, n° 3, 1995, pp. 235–276.
- [43] Jones C. K. R. T. – Stability of the travelling wave solution of the FitzHugh-Nagumo system. *Trans. Amer. Math. Soc.*, vol. 286, n° 2, 1984, pp. 431–469.
- [44] Kapitula T. – On the stability of travelling waves in weighted  $L^\infty$  spaces. *J. Differential Equations*, vol. 112, n° 1, 1994, pp. 179–215.
- [45] Kapitula T. et Sandstede B. – Stability of bright solitary-wave solutions to perturbed nonlinear Schrödinger equations. *Phys. D*, vol. 124, n° 1-3, 1998, pp. 58–103.
- [46] Kato T. – *Perturbation theory for linear operators*. – Springer-Verlag, 1985.
- [47] Lattanzio C. et Serre D. – Convergence of a relaxation scheme for hyperbolic systems of conservation laws. *Numer. Math.*, vol. 88, n° 1, 2001, pp. 121–134.
- [48] Lax P. – *Hyperbolic systems of conservation laws and the mathematical theory of shock waves*. – Philadelphia, Pa., Society for Industrial and Applied Mathematics, 1973, v+48p. Conference Board of the Mathematical Sciences Regional Conference Series in Applied Mathematics, No. 11.
- [49] Leveque R.-J. et Yee H. – A study of numerical methods for hyperbolic conservation laws with stiff source terms. *Journal of computational physics*, vol. 86, 1990, pp. 187–210.
- [50] Lions J.-L. et Dautray R. – *Mathematical analysis and numerical methods for science and technology*. – Springer, 1986.
- [51] Liu H. et Warnecke G. – Convergence rates for relaxation schemes approximating conservation laws. *SIAM J. Numer. Anal.*, vol. 37, n° 4, 2000, pp. 1316–1337 (electronic).
- [52] Liu T.-P. – Hyperbolic conservation laws with relaxation. *Comm. Math. Phys.*, vol. 108, n° 1, 1987, pp. 153–175.

- 
- [53] Liu T.-P. – On the viscosity criterion for hyperbolic conservation laws. *In : Viscous profiles and numerical methods for shock waves (Raleigh, NC, 1990)*, pp. 105–114. – Philadelphia, PA, SIAM, 1991.
- [54] Liu T.-P. – Nonlinear stability and instability of overcompressive shock waves. *In : Shock induced transitions and phase structures in general media*. pp. 159–167. – Springer-Verlag, New York.
- [55] Liu T.-P. et Xin Z. – Nonlinear stability of discrete shocks for systems of conservation laws. *En préparation*.
- [56] Liu T.-P. et Xin Z. – Overcompressive shock waves. *In : Nonlinear evolution equations that change type*. pp. 139–145. – Springer-Verlag, New York.
- [57] Liu T.-P. et Yu S.-H. – Continuum shock profiles for discrete conservation laws. I. Construction. *Comm. Pure Appl. Math.*, vol. 52, n° 1, 1999, pp. 85–127.
- [58] Liu T.-P. et Yu S.-H. – Continuum shock profiles for discrete conservation laws. II. Stability. *Comm. Pure Appl. Math.*, vol. 52, n° 9, 1999, pp. 1047–1073.
- [59] Liu T.-P. et Zeng Y. – Large time behavior of solutions for general quasilinear hyperbolic-parabolic systems of conservation laws. *AMS Memoirs*, vol. 599, 1997.
- [60] Lorin E. et Seignole V. – Convection systems with stiff source terms. analytical review and numerical approach. *In : Workshop of trends in Numerical and Physical Modeling for Industrial Multiphase Flows, Cargese 25th-27th September 2000*.
- [61] Majda A. et Pego R. L. – Stable viscosity matrices for systems of conservation laws. *J. Differential Equations*, vol. 56, n° 2, 1985, pp. 229–262.
- [62] Majda A. et Ralston J. – Discrete shock profiles for systems of conservation laws. *Comm. Pure Appl. Math.*, vol. 32, n° 4, 1979, pp. 445–482.
- [63] Mallet-Paret J. – The Fredholm alternative for functional-differential equations of mixed type. *J. Dynam. Differential Equations*, vol. 11, n° 1, 1999, pp. 1–47.
- [64] Michelson D. – Discrete shocks for difference approximations to systems of conservation laws. *Adv. in Appl. Math.*, vol. 5, n° 4, 1984, pp. 433–469.
- [65] Mock M. S. – A topological degree for orbits connecting critical points of autonomous systems. *J. Differential Equations*, vol. 38, n° 2, 1980, pp. 176–191.
- [66] Natalini R. – Recent results on hyperbolic relaxation problems. *In : Analysis of systems of conservation laws (Aachen, 1997)*. pp. 128–198. – Chapman and Hall, CRC, Boca Raton, FL.
- [67] Palmer K. – Exponential dichotomies and transversal homoclinic points. *J. Differential Equations*, vol. 55, n° 2, 1984, pp. 225–256.
- [68] Rousset F. – Viscous limits for strong shocks of systems of conservation laws. *Soumis*, 2001.
- [69] Sattinger D. – On the stability of waves of nonlinear parabolic systems. *Advances in Math.*, vol. 22, n° 3, 1976, pp. 312–355.
- [70] Schechter M. – *Spectra of partial differential operators*. – Amsterdam, North-Holland Publishing Co., 1986, second édition, xiv+310p.
- [71] Schechter S. et Shearer M. – Transversality for undercompressive shocks in Riemann problems. *In : Viscous profiles and numerical methods for shock waves (Raleigh, NC, 1990)*. pp. 142–154. – SIAM, Philadelphia, PA.

- 
- [72] Serre D. – Remarks about the discrete profiles of shock waves. *Mat. Contemp.*, vol. 11, 1996, pp. 153–170. – Fourth Workshop on Partial Differential Equations, Part II (Rio de Janeiro, 1995).
- [73] Serre D. – Discrete shock profiles and their stability. In : *Hyperbolic problems : theory, numerics, applications, Vol. II (Zürich, 1998)*, pp. 843–853. – Basel, Birkhäuser, 1999.
- [74] Serre D. – *Systems of conservation laws. 1.* – Cambridge, Cambridge University Press, 1999, xxii+263p. Hyperbolicity, entropies, shock waves, Translated from the 1996 French original by I. N. Sneddon.
- [75] Serre D. – Relaxations semi-linéaire et cinétique des systèmes de lois de conservation. *Ann. IHP, Anal. non-linéaire*, vol. 17, 2000, pp. 169–192.
- [76] Smoller J. – *Shock waves and reaction-diffusion equations.* – New York, Springer-Verlag, 1994, second édition, xxiv+632p.
- [77] Smyrlis Y. S. – Existence and stability of stationary profiles of the LW scheme. *Comm. Pure Appl. Math.*, vol. 43, n° 4, 1990, pp. 509–545.
- [78] Sportisse B. – An analysis of operator splitting techniques in the stiff case. *J. Comput. Phys.*, vol. 161, n° 1, 2000, pp. 140–168.
- [79] Strang G. – *Introduction to applied mathematics.* – Wellesley-Cambridge Press, 1986.
- [80] Swinton J. – The stability of homoclinic pulses : a generalisation of Evans’s method. *Phys. Lett. A*, vol. 163, n° 1-2, 1992, pp. 57–62.
- [81] Whitham G. B. – *Linear and nonlinear waves.* – New York, Wiley-Interscience [John Wiley & Sons], 1974, xvi+636p.
- [82] Yong W.-A. – Boundary conditions for hyperbolic systems with stiff source terms. *Indiana Univ. Math. J.*, vol. 48, n° 1, 1999, pp. 115–137.
- [83] Yong W.-A. – Singular perturbations of first-order hyperbolic systems with stiff source terms. *J. Differential Equations*, vol. 155, n° 1, 1999, pp. 89–132.
- [84] Yu S.-H. – Existence of discrete shock profiles for the Lax-Wendroff scheme. *En préparation.*
- [85] Zeng Y. –  $l^1$  asymptotic behavior of compressible, isentropic, viscous 1-d flow. *Comm. Pure Appl. Math.*, vol. 47, 1994, pp. 1053–1092.
- [86] Zumbrun K. – Multidimensional stability of planar viscous shock waves. In : *Advances in the theory of shock waves*, pp. 307–516. – Boston, MA, Birkhäuser Boston, 2001.
- [87] Zumbrun K. – *Stability course notes.* – En préparation.
- [88] Zumbrun K. et Howard P. – Pointwise semigroup methods and stability of viscous shock waves. *Indiana Univ. Math. J.*, vol. 47, n° 3, 1998, pp. 741–871.
- [89] Zumbrun K. et Serre D. – Viscous and inviscid stability of multidimensional planar shock fronts. *Indiana Univ. Math. J.*, vol. 48, n° 3, 1999, pp. 937–992.

## TABLE DES FIGURES

|      |   |     |
|------|---|-----|
| 1    | Explosion de la solution obtenue par un schéma de splitting . . . . .                         | 16  |
| 2    | Représentation de $G(j, n; 39)$ sur la base $(r_1^-, r_2^-, r_3^-)$ . . . . .                 | 21  |
| 1.1  | Lax 3-shock satisfying Condition (13) for $n = 3$ . . . . .                                   | 31  |
| 2.1  | Lax 2-shock satisfying Condition (11) . . . . .   | 57  |
| 2.2  | First component of $\bar{u}$ . . . . .  | 60  |
| 2.3  | Second component of $\bar{u}$ . . . . .   | 60  |
| 2.4  | initial profile in the space phase for $(u_1, u_2)$ . . . . .                                 | 67  |
| 2.5  | $u_1$ profile with respect to the time and the space variables . . . . .                      | 67  |
| 2.6  | $u_2$ profile with respect to the time and the space variables . . . . .                      | 67  |
| 2.7  | $v_1$ profile during the explosion with respect to the time and the space variables . . . . . | 68  |
| 2.8  | $v_2$ profile during the explosion with respect to the time and the space variables . . . . . | 68  |
| 2.9  | $(u_1, u_2)$ profile in the space with respect to time . . . . .                              | 69  |
| 2.10 | $(v_1, v_2)$ profile in the space with respect to time . . . . .                              | 69  |
| 2.11 | $u_1$ profile with respect to the time and the space variables . . . . .                      | 69  |
| 2.12 | $u_2$ profile with respect to the time and the space variables . . . . .                      | 70  |
| 2.13 | $(u_1, u_2)$ profile in the space phase at 3 different times . . . . .                        | 70  |
| 2.14 | $(v_1, v_2)$ profile in the space phase at 3 different times . . . . .                        | 70  |
| 3.1  | Zéros de $D^v$ et de $D^r$ . . . . .  | 75  |
| 2.1  | Compressivity of the shock . . . . .  | 119 |
| 2.2  | Spectrum of $L$ in the complex plane . . . . .  | 129 |
| 2.3  | Definition of $\Omega'$ . . . . .   | 135 |
| 2.4  | Propagation . . . . .   | 141 |
| 2.5  | Path of integration $?$ and $?'$ . . . . .  | 142 |
| 2.6  | Path of integration $?_1$ . . . . .   | 143 |

---

|      |  |     |
|------|--|-----|
| 2.7  | Path of integration $?_2$  | 144 |
| 2.8  | Path of integration $?_0$  | 145 |
| 2.9  | Path of integration $?_3$  | 147 |
| 2.10 | Path of integration $?_{4a}$                                     | 149 |
| 2.11 | Path of integration $?_{4b}$                                     | 151 |
| 2.12 | $G(n, 39, j)$ displayed on the canonical basis $(w_1, w_2, w_3)$ | 156 |
| 2.13 | Eigenspace associated to 1 in the canonical basis                | 157 |
| 2.14 | $G(n, -41, j)$ displayed on the basis $(r_1^-, r_2^-, r_3^-)$    | 158 |
| 2.15 | Eigenspace associated to 1 in the basis $(r_1^-, r_2^-, r_3^-)$  | 159 |



## Stabilité des profils de chocs dans les systèmes de lois de conservation

On s'intéresse dans cette thèse à l'étude théorique de la stabilité des profils de chocs pour différentes approximations de systèmes de lois de conservation hyperboliques monodimensionnels. On considère dans la première partie des profils continus pour la relaxation semi-linéaire et pour des équations avec effets diffusifs et dispersifs. On obtient des conditions nécessaires de stabilité spectrale à l'aide de la théorie de la fonction d'Evans et plus précisément du lemme de l'écart dû à R. Gardner et K. Zumbrun. Pour la relaxation semi-linéaire, on fournit une illustration de la nécessité de la condition obtenue pour un 2-choc de Lax dans un système à deux lois de conservation en exhibant un profil de choc instable, simulé numériquement par un schéma de pas fractionnaires. On montre également que la fonction d'Evans associée à la relaxation semi-linéaire tend vers la fonction d'Evans associée à une viscosité scalaire quand la vitesse de relaxation tend vers l'infini. La deuxième partie est consacrée aux profils de chocs stationnaires discrets. On montre une condition de stabilité spectrale pour le schéma de Lax-Wendroff en adaptant les théories utilisées dans le cadre continu. Enfin, on étudie la fonction de Green discrète associée au schéma de Lax-Friedrichs modifié et on obtient des estimations à la manière de celles obtenues par K. Zumbrun et P. Howard pour l'approximation par viscosité.

## Stability of shock profiles in systems of conservation laws

We are interested here in the theoretical study of the stability of shock profiles for several approximations of hyperbolic monodimensional systems of conservation laws. We consider in the first part the continuous profiles for the semi-linear approximation and for equations with diffusive and dispersive effects. We obtain necessary conditions of spectral stability using Evans function techniques and more precisely the Gap Lemma that was proved by Gardner and Zumbrun. For the semi-linear relaxation, we illustrate the necessity of the condition for a Lax 2-shock of a system of two conservation laws by computing an unstable shock profile, that we simulate numerically through a splitting scheme. We also show that, when the relaxation speed tends to infinity, the limit of the Evans function that is associated to the semi-linear relaxation approximation is the Evans function associated to a scalar viscous approximation. The second part is devoted to discrete stationary shock profiles. We obtain a necessary condition of spectral stability for the Lax-Wendroff scheme by adapting the techniques we used in the continuous case. At last, we study the Green's function associated with the modified Lax-Friedrichs scheme and we get estimates that are similar to the ones Zumbrun and Howard obtained for the viscous approximation.