

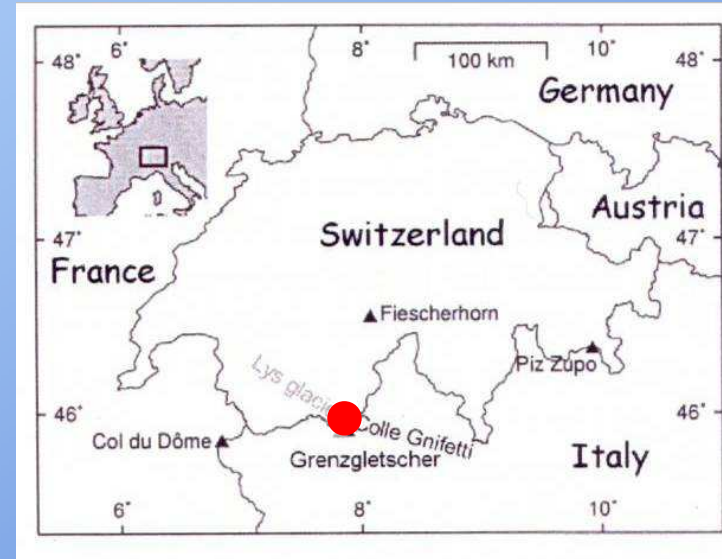

**Trace elements and Polycyclic
Aromatic Hydrocarbons (PAHs)
in snow and ice sampled at
Colle Gnifetti, Monte Rosa (4450 m),
during the last 10,000 years:
Environmental and climatic implications**

The Colle Gnifetti drilling site



Jacopo Gabrieli PhD defence
Venezia, November 28th 2008

The Colle Gnifetti core

What we have done in Villigen (PSI)

Storage, visual stratigraphy, density calculations, log, first processing

Discontinuous analysis

Major ions

Stable H, O isotopes

Dating

Volcanoes

Saharan dust depositions

Annual Layer Counting

^3H , Pu , ^{210}Pb (core2)

^{14}C



Jacopo Gabrieli PhD defence
Venezia, November 28th 2008

Analysis carried out at PSI

What we have done in Villigen (PSI): dating

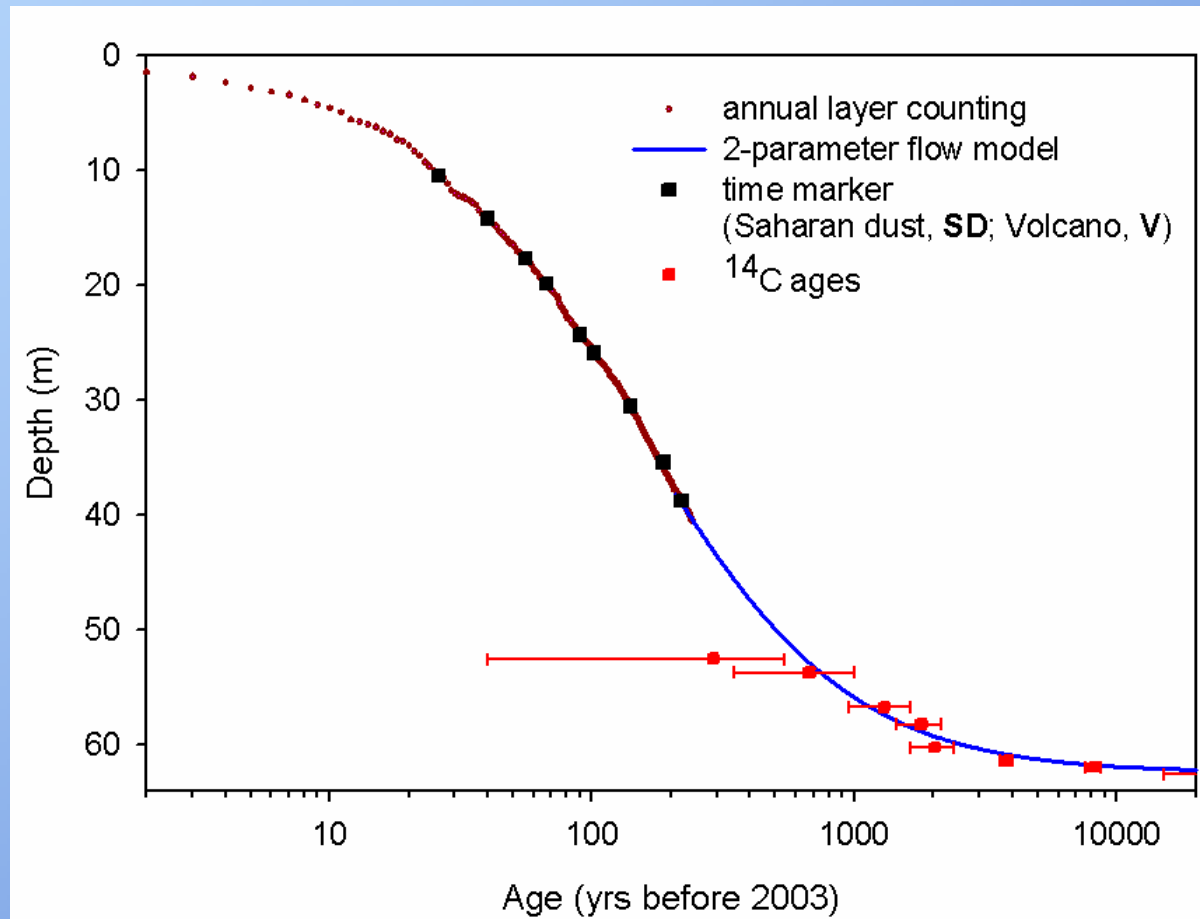

Jacopo Gabrieli PhD defence
Venezia, November 28th 2008

CG dating

What we have done in Venezia

Designing, building and testing of a new melting system for continuous decontamination and on-line analysis of alpine ice/firn core

On-line continuous analysis

Trace elements by ICP-QMS
Conductivity

On-line solid-phase extraction for semi-continuous PAHs analysis

Discontinuous analysis

Trace elements by ICP-SFMS
Trace elements by ICP-OES
Pb isotopes
 ^{239}Pu



Jacopo Gabrieli PhD defence
Venezia, November 28th 2008

Analysis carried out in Venezia

The "Venetian" melting system draft

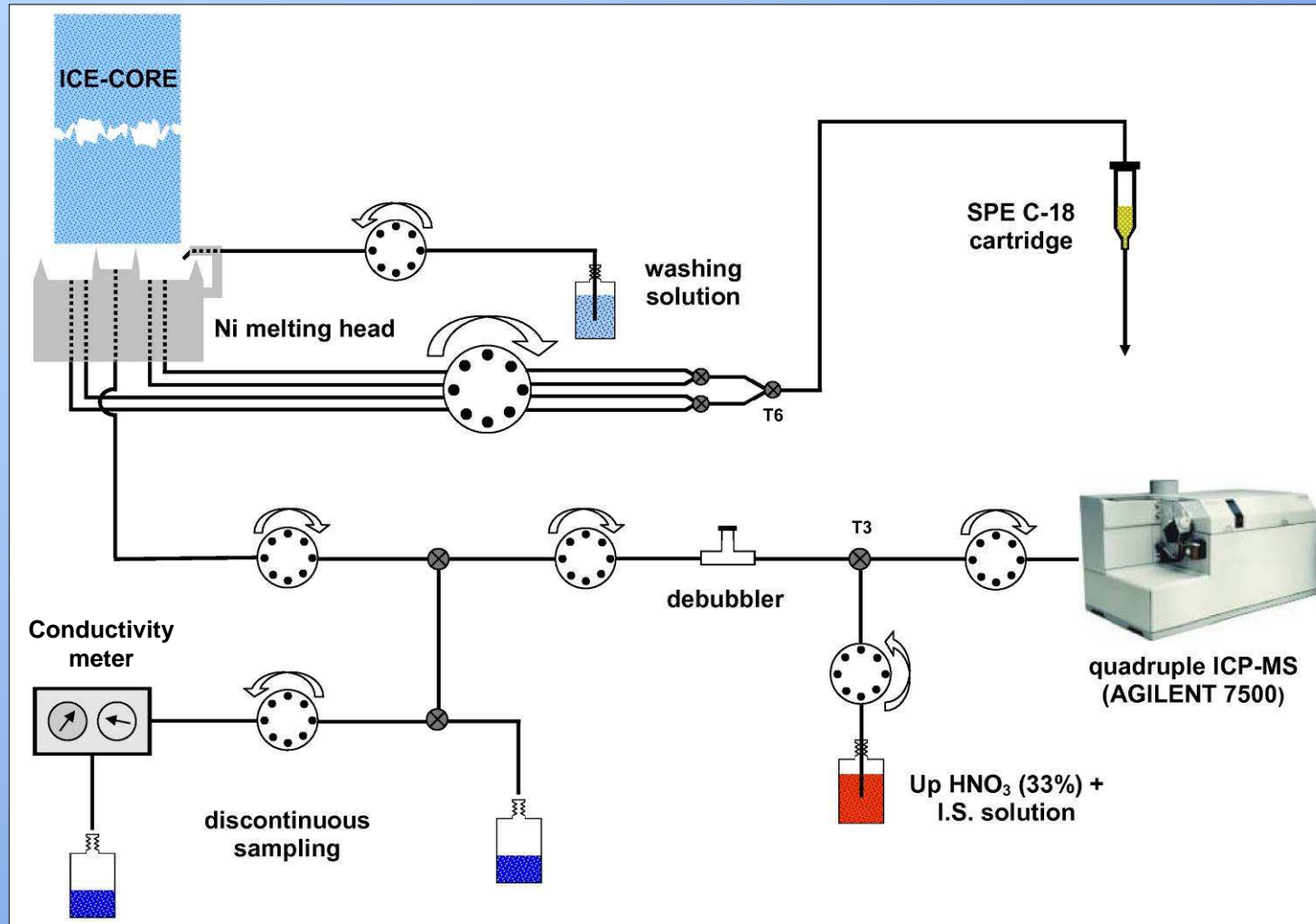

Jacopo Gabrieli PhD defence
Venezia, November 28th 2008

The melting system

The "Venetian" melting system picture

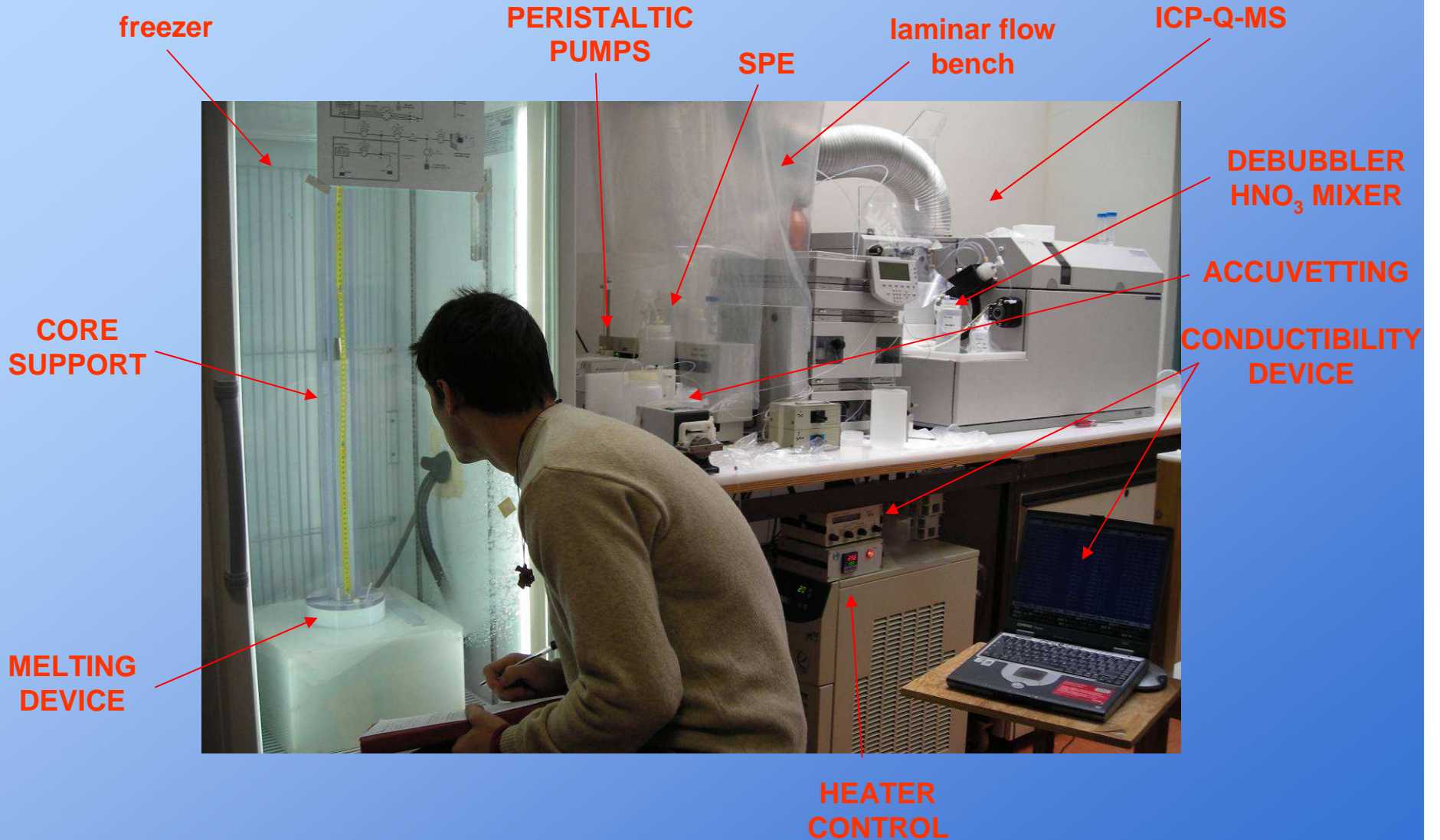

Jacopo Gabrieli PhD defence
Venezia, November 28th 2008

The Colle Gnifetti core

The "Venetian" melting heads

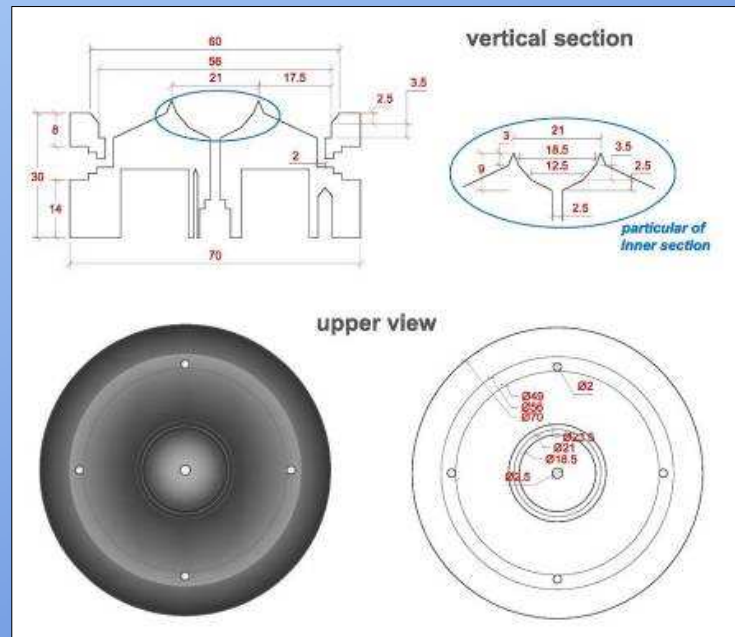

Jacopo Gabrieli PhD defence
Venezia, November 28th 2008

The melting system

Continuous ICP-QMS analysis: reproducibility test

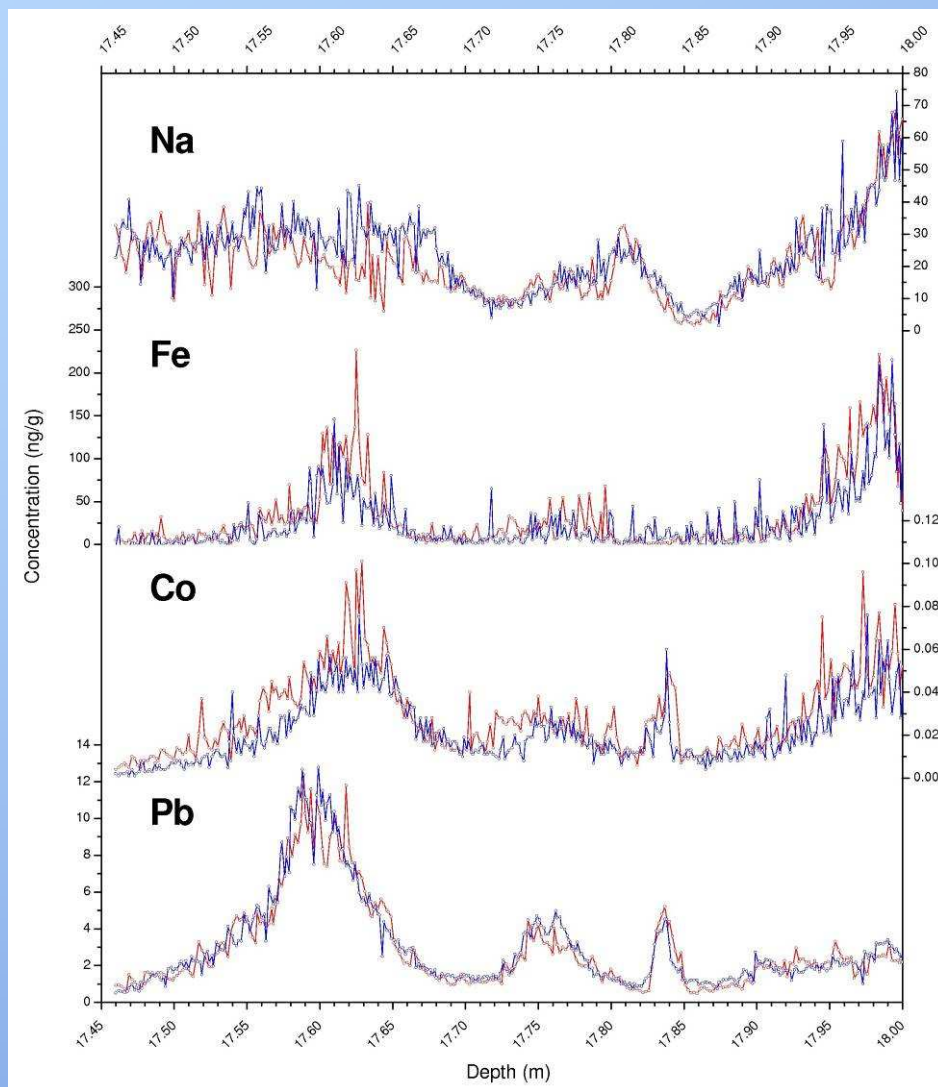

Analysis of parallel ice and firn sections during different analytical sessions

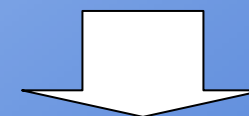

Very good fitting except for Zn which is strongly affected by external contaminations



Jacopo Gabrieli PhD defence
Venezia, November 28th 2008

Validation

Continuous ICP-QMS analysis: recovery test

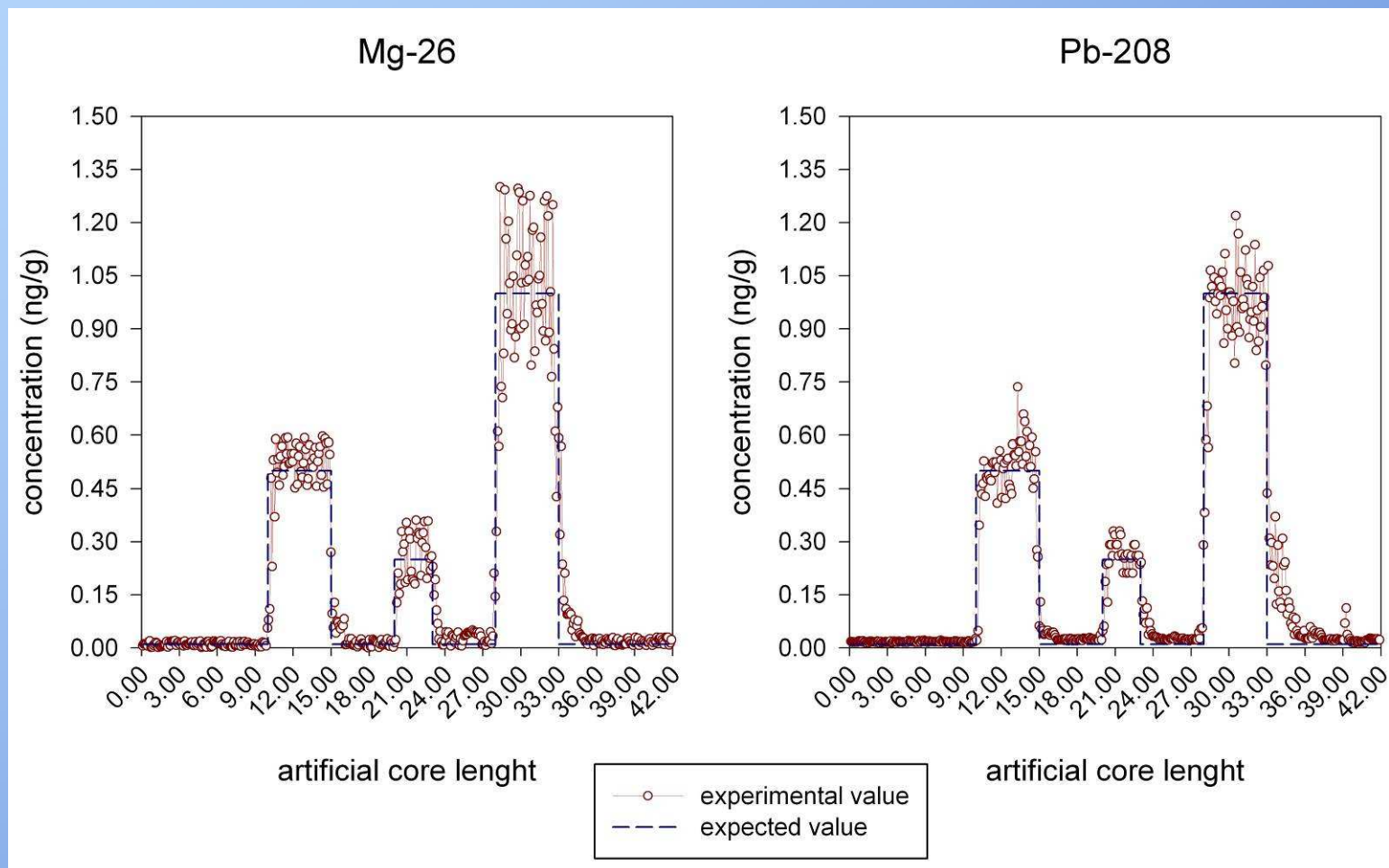

Jacopo Gabrieli PhD defence
Venezia, November 28th 2008

Validation



Tofana di Rozes - Dolomites

Continuous and discontinuous trace elements analysis

21 elements by continuous ICP-QMS

42,000 measurements
900,000 concentration data

Resolution 0.9 – 2.5 mm (interpolation 10 mm)

22 isotopes by ICP-SFMS

6 elements by ICP-OES (Ca, Mg, Na, K, Fe, Al)

214 measurements

Resolution 20 - 30 cm



Jacopo Gabrieli PhD defence
Venezia, November 28th 2008

Trace elements determination

Principal component analysis

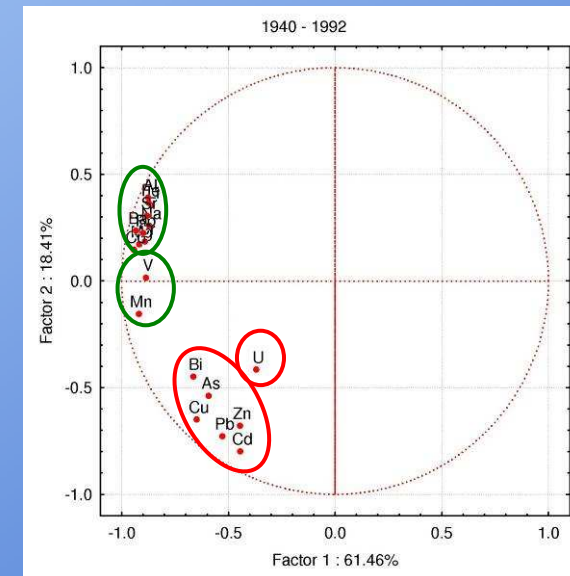
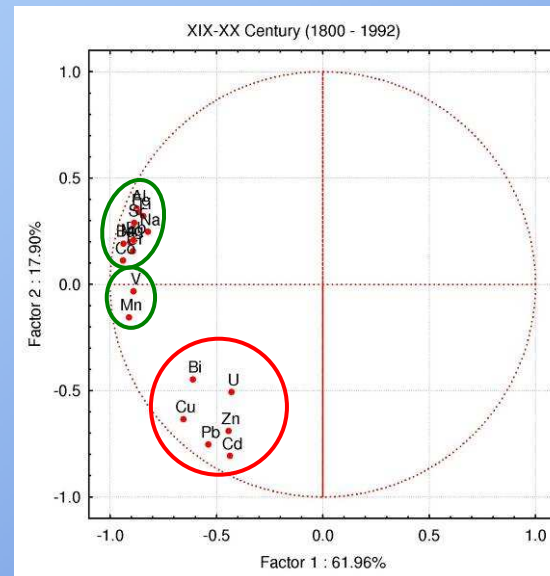
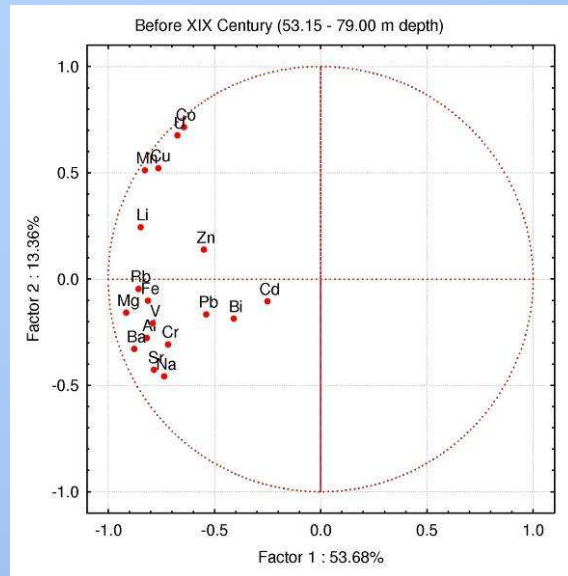

Jacopo Gabrieli PhD defence
Venezia, November 28th 2008

Multivariate statistics

Short-term variations

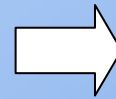
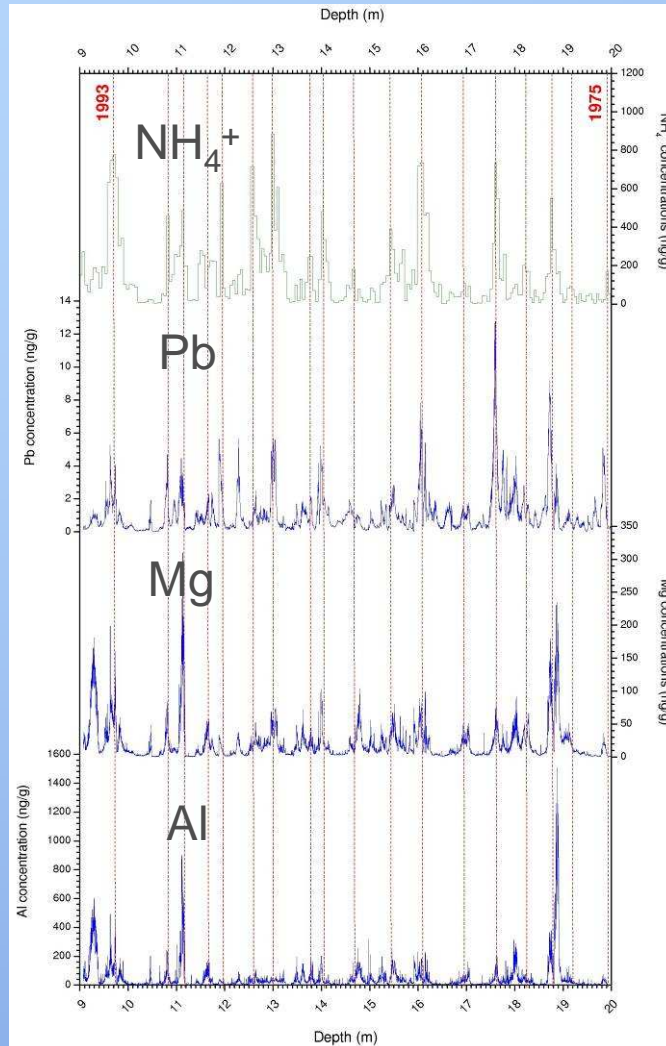

ALC from 1200 (~) to 2003 AD

Not consistent with ¹⁴C dating

1200 AD { 66.45 m (ALC)
71.10 m (¹⁴C)

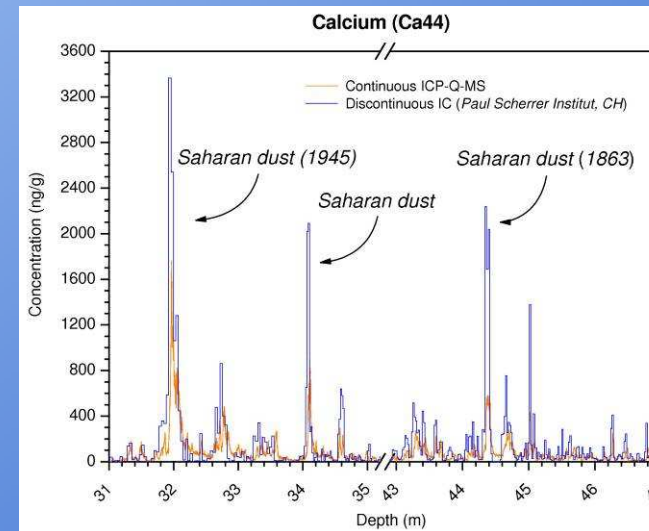

Jacopo Gabrieli PhD defence
Venezia, November 28th 2008

Trace elements profiles

Long-term variations: crustal elements

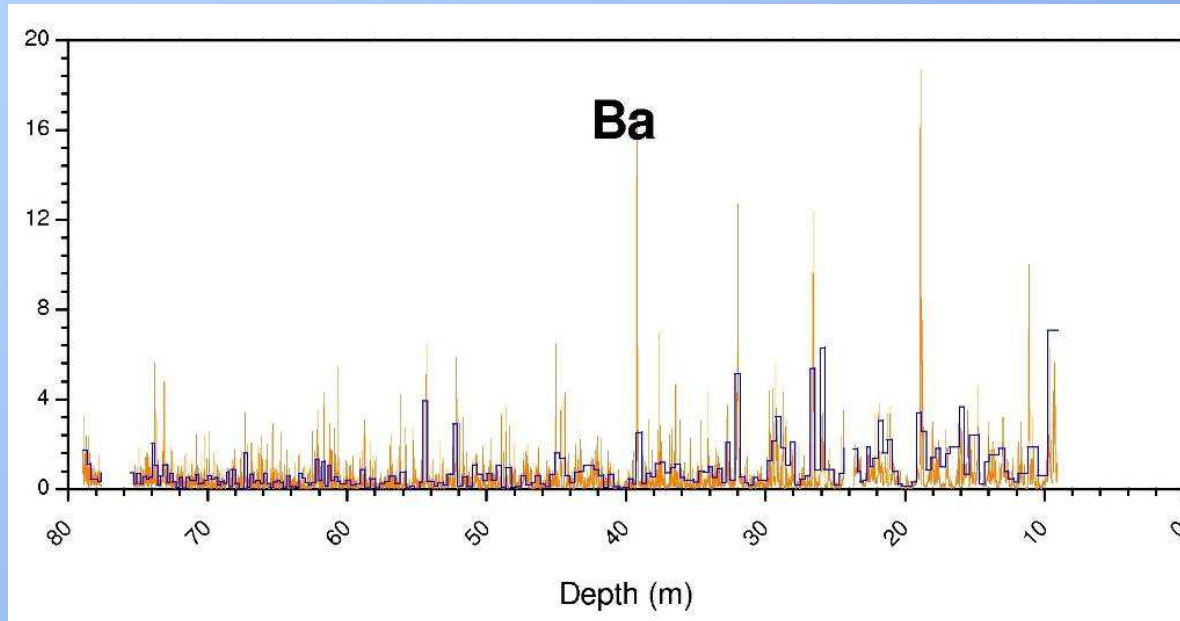

	XX Century			Pre-XX Century			Increase factor
	mean	median	max	mean	median	max	
Li	0.045	0.018	1.6	0.034	0.015	1.3	1.2
Na	28	17	725	24	12	477	1.4
Mg	19	10	236	16	10	266	1.0
Al	38	15	1258	28	11	682	1.4
Sc	0.015	0.011	0.098	0.0098	0.0085	0.052	1.3
Ti	0.20	0.10	1.6	0.094	0.067	0.70	1.4
Cr	0.085	0.040	2.2	0.060	0.038	0.92	1.1
Mn	1.3	0.70	17	0.79	0.50	35	1.4
Fe	26	9.7	807	24	13	479	0.7
Co	0.029	0.021	0.42	0.016	0.013	0.179	1.5
Pb	0.089	0.041	2.8	0.064	0.034	0.97	1.2
Sr	0.75	0.34	17	0.56	0.35	11	1.0
Ba	0.59	0.28	15	0.36	0.21	5.3	1.3



Jacopo Gabrieli PhD defence
Venezia, November 28th 2008

Trace elements profiles

Long-term variations: anthropogenic elements

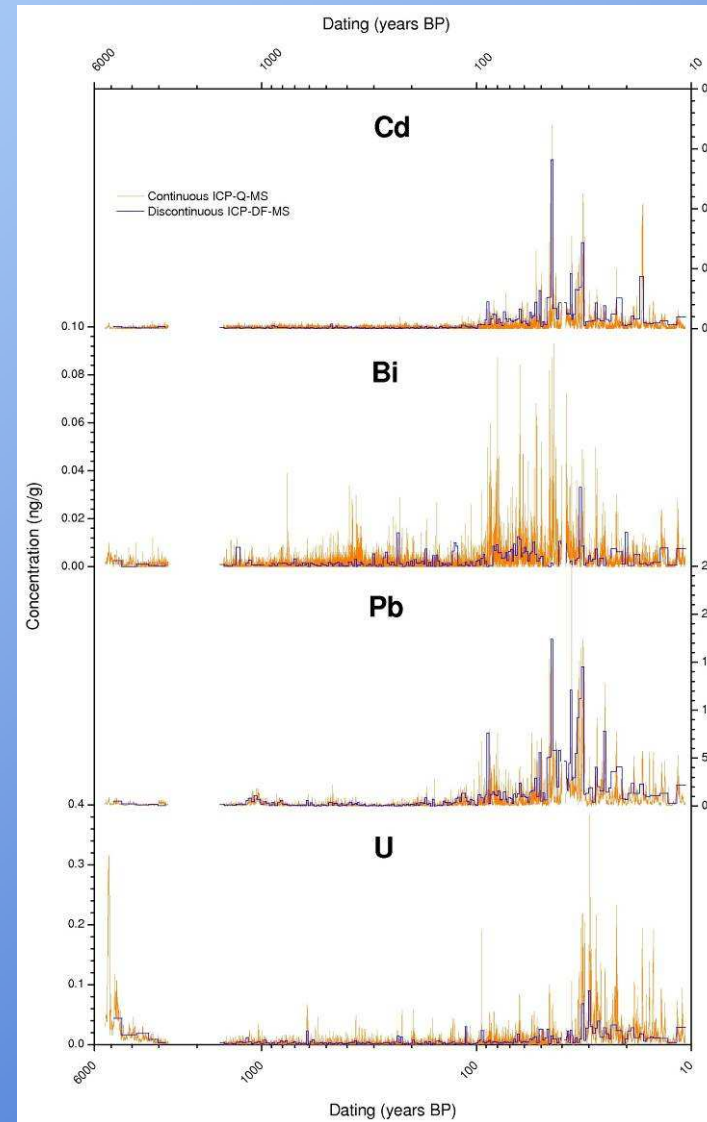
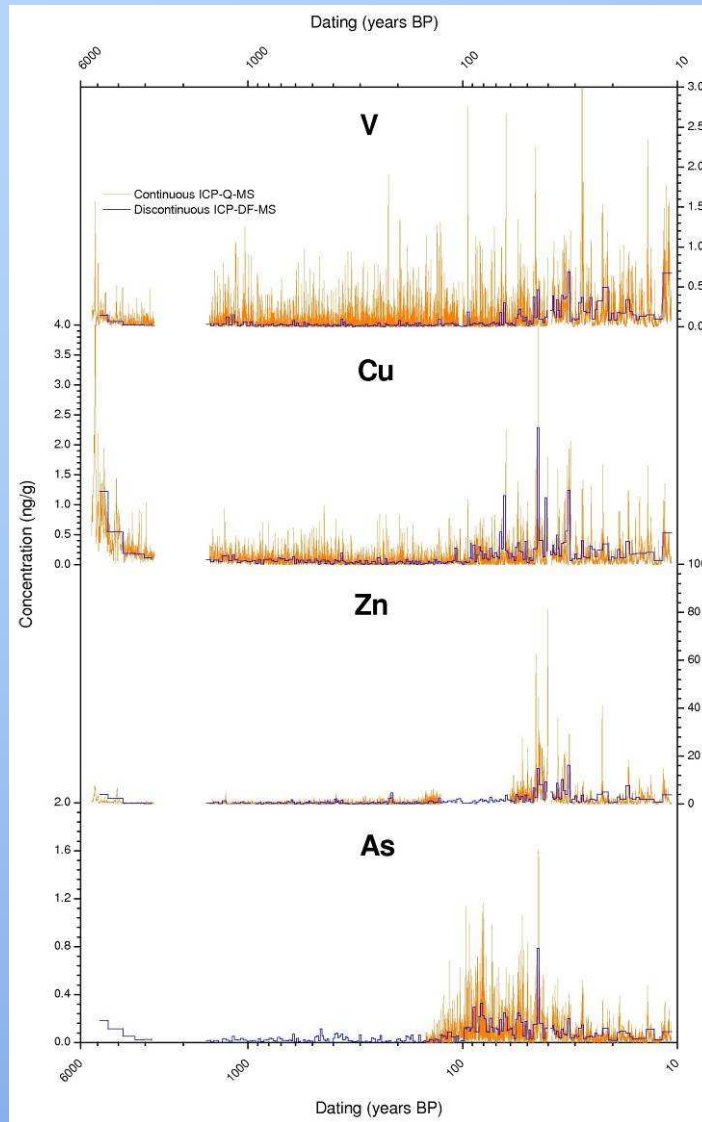

Jacopo Gabrieli PhD defence
Venezia, November 28th 2008

Trace elements profiles

Anthropogenic metals: Pb

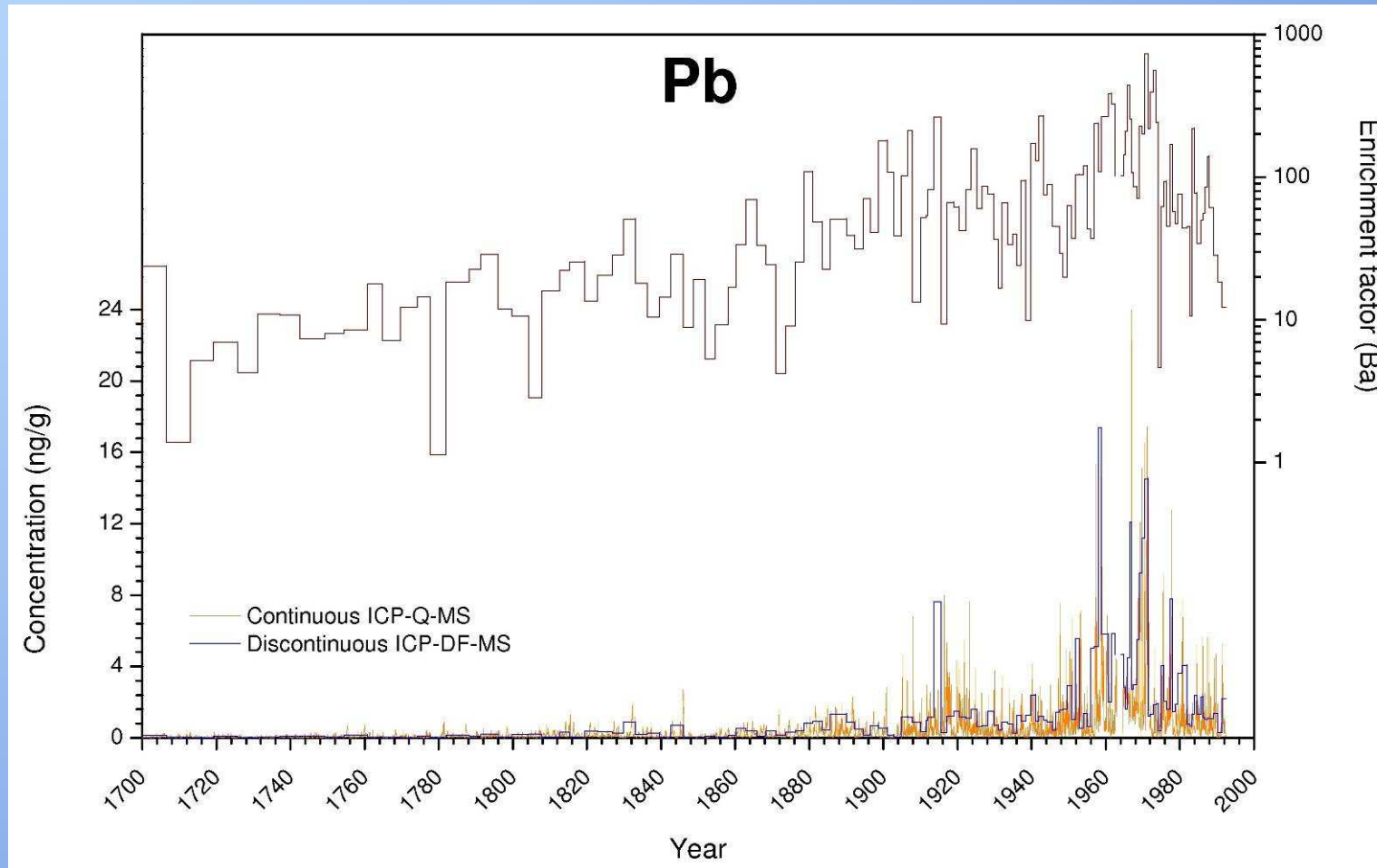

Jacopo Gabrieli PhD defence
Venezia, November 28th 2008

Trace elements profiles

Anthropogenic metals: Pb

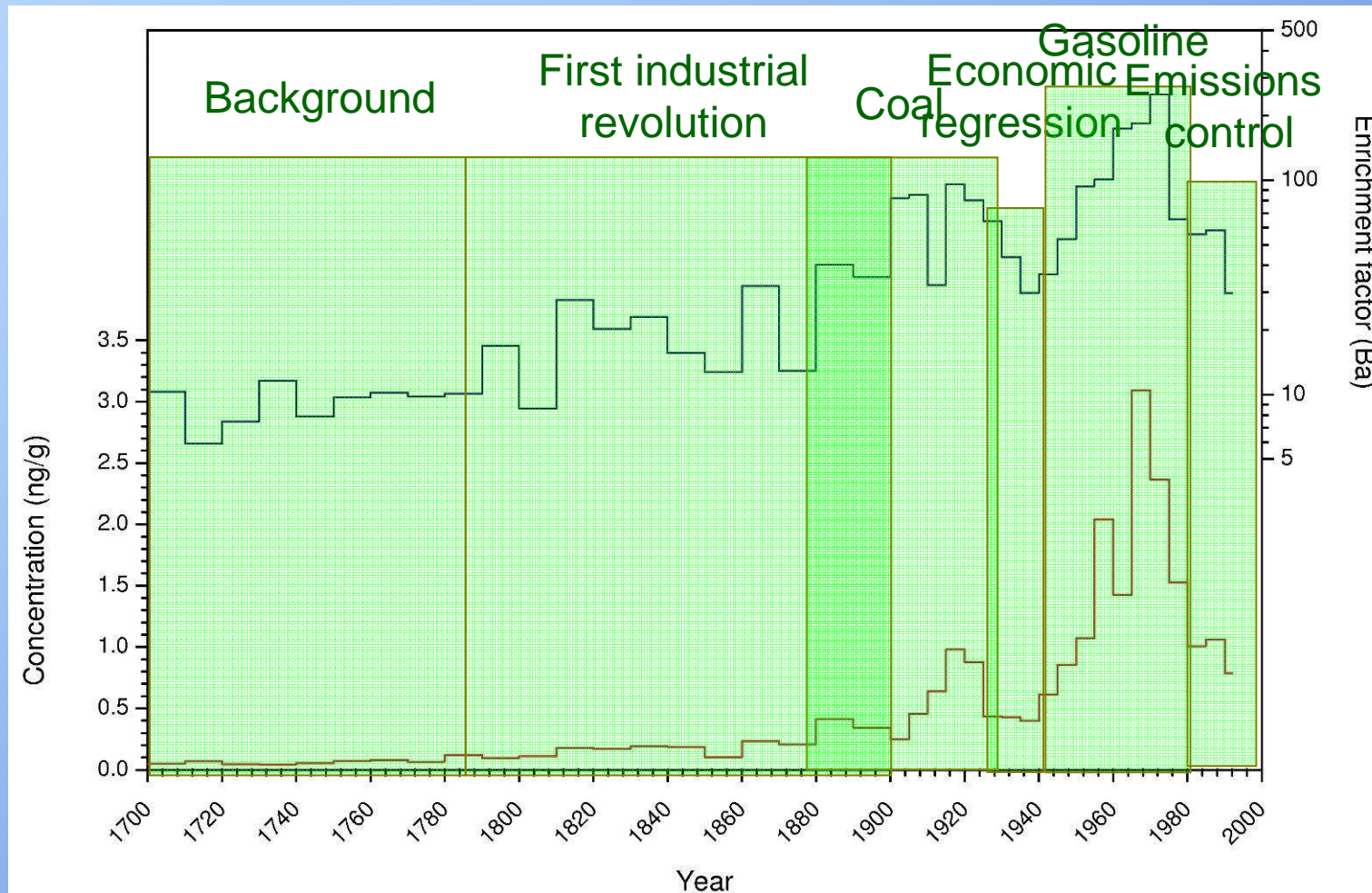

Jacopo Gabrieli PhD defence
Venezia, November 28th 2008

Trace elements profiles

Anthropogenic metals: Pb

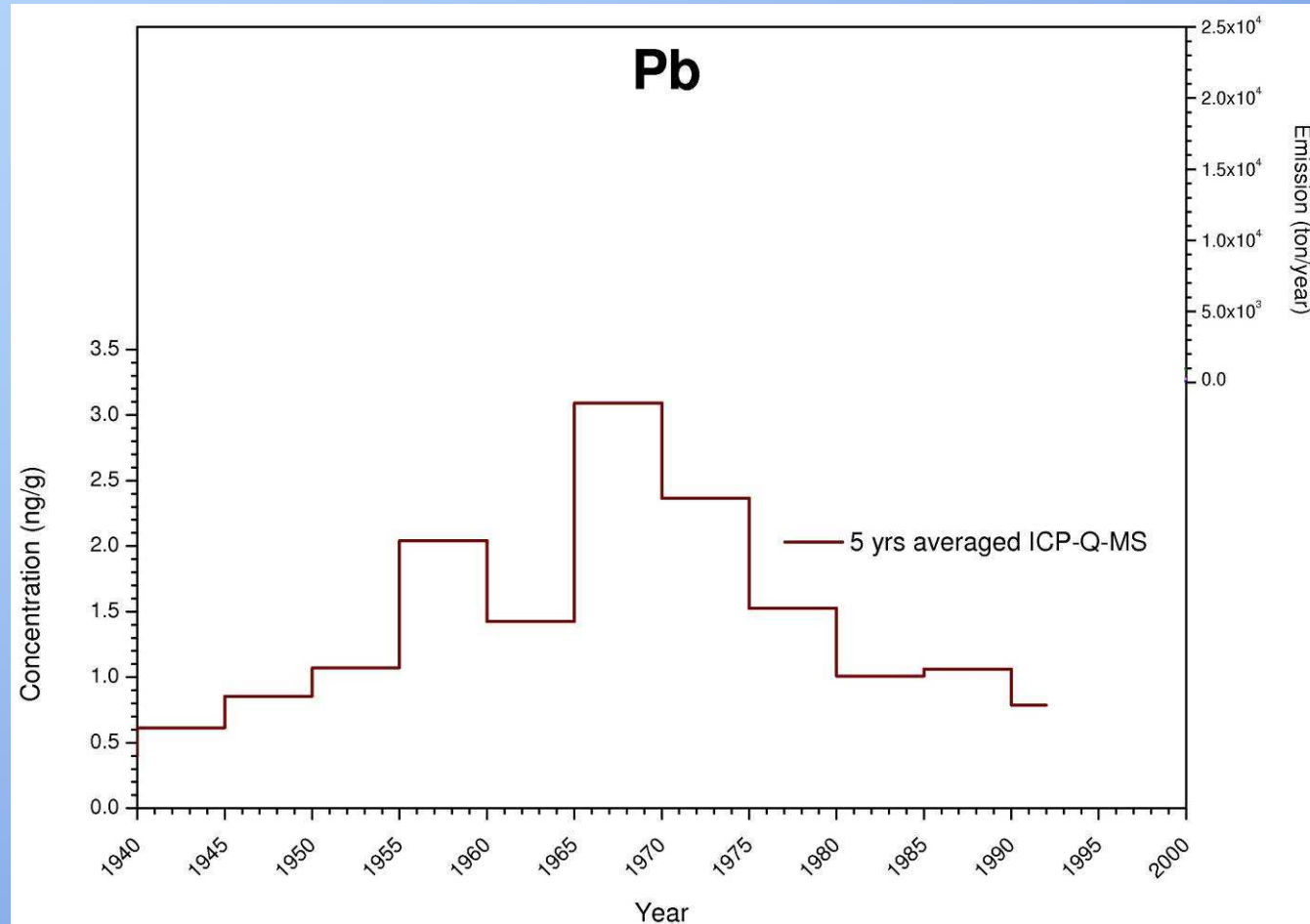

Jacopo Gabrieli PhD defence
Venezia, November 28th 2008

Trace elements profiles

Anthropogenic metals: U

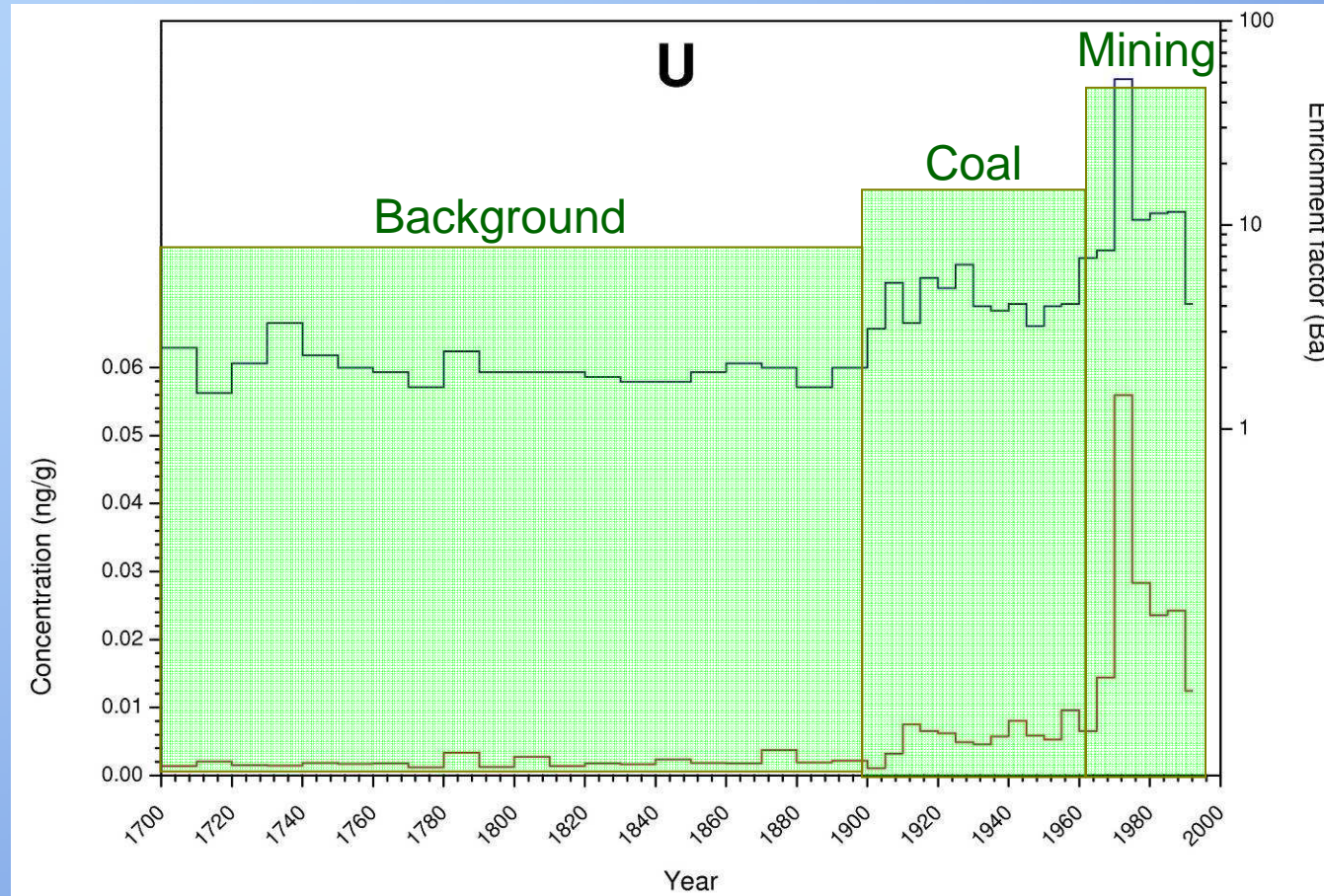

Jacopo Gabrieli PhD defence
Venezia, November 28th 2008

Trace elements profiles

Anthropogenic metals: U

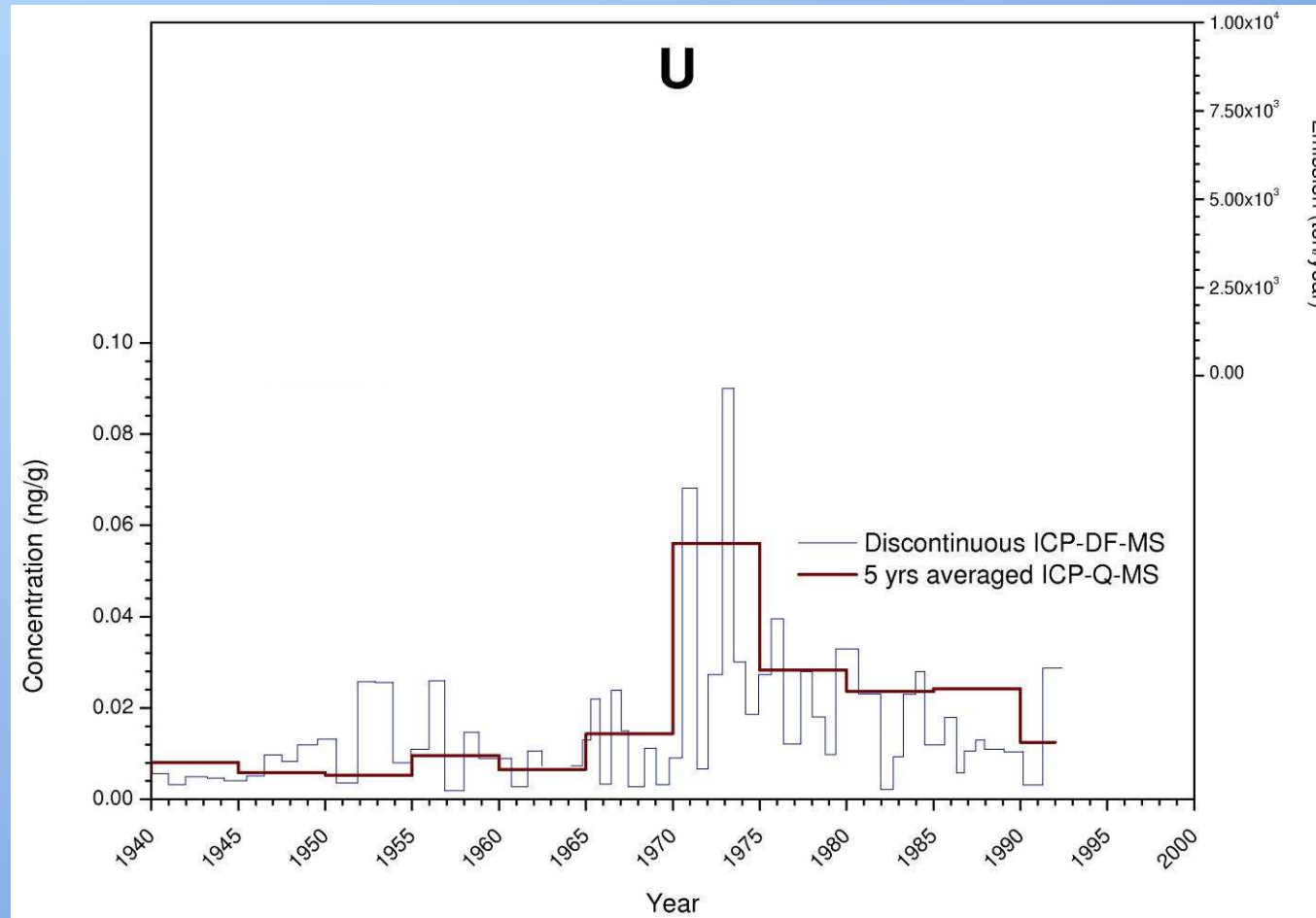

Jacopo Gabrieli PhD defence
Venezia, November 28th 2008

Trace elements profiles

Pb: a useful tool for dating validation?

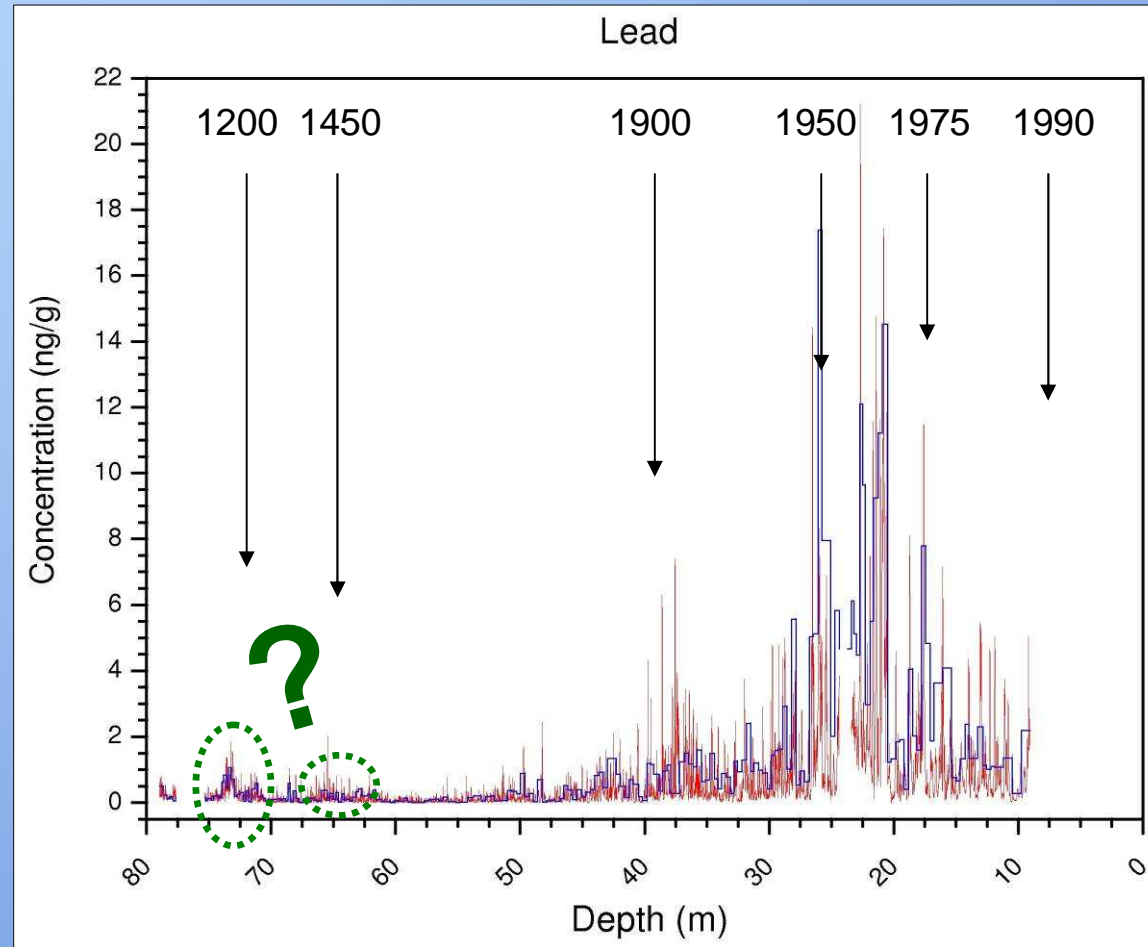

Jacopo Gabrieli PhD defence
Venezia, November 28th 2008

Trace elements profiles

Pb profile: a tool in dating validation?

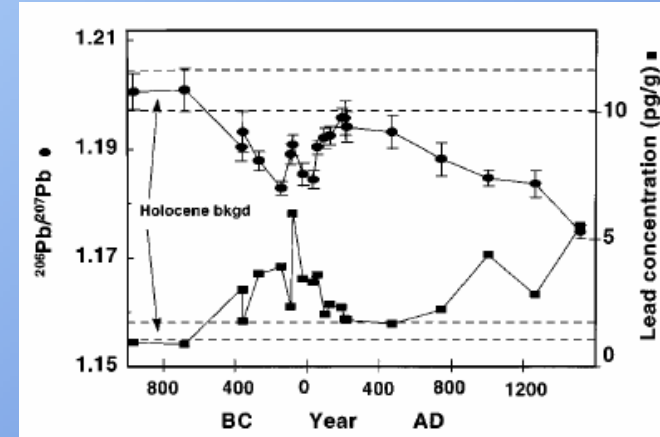
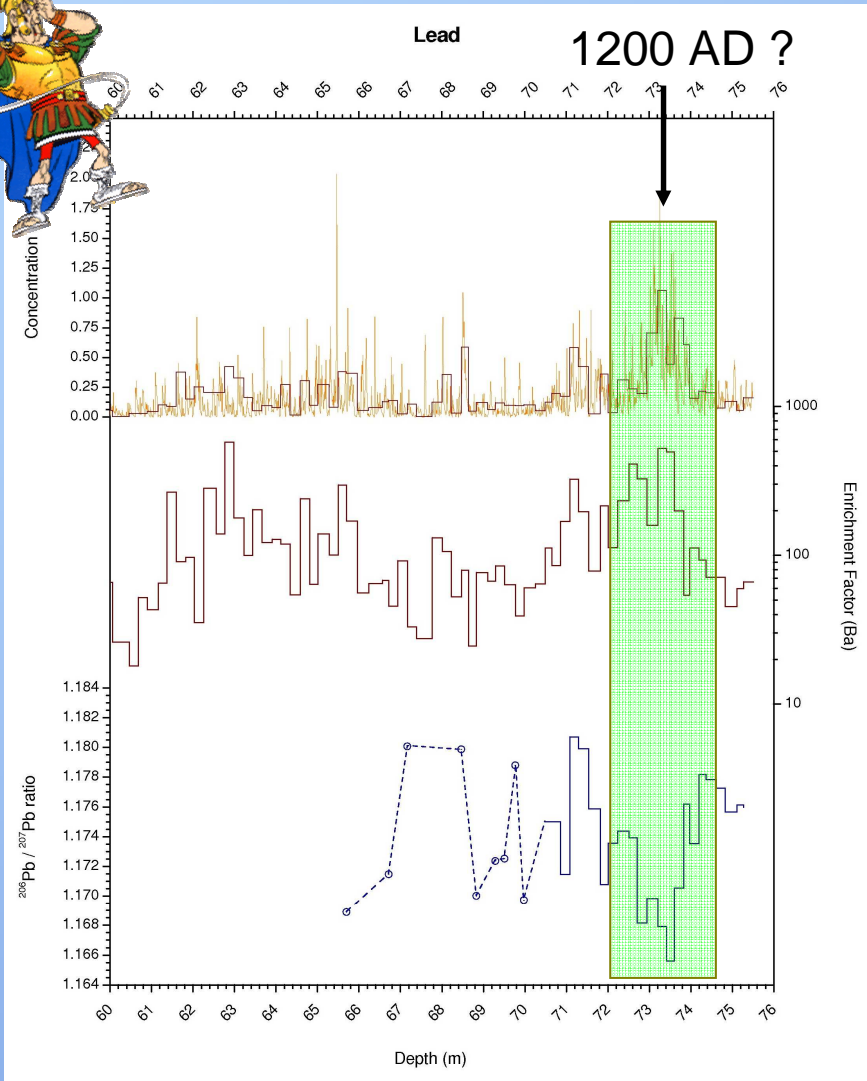

Rosman, 1997

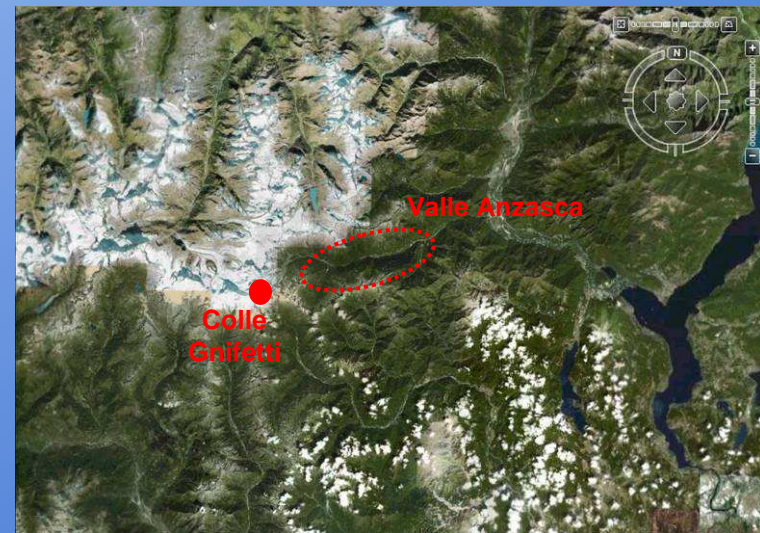

Jacopo Gabrieli PhD defence
Venezia, November 28th 2008

Trace elements profiles

Pb: a useful tool for dating validation?

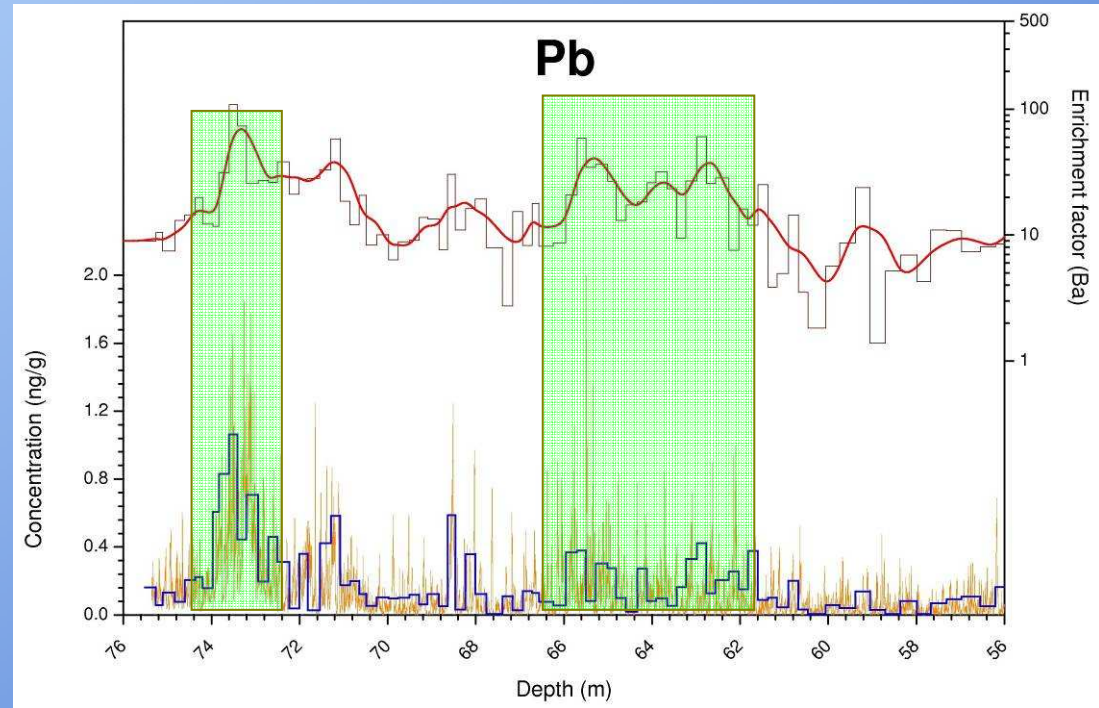
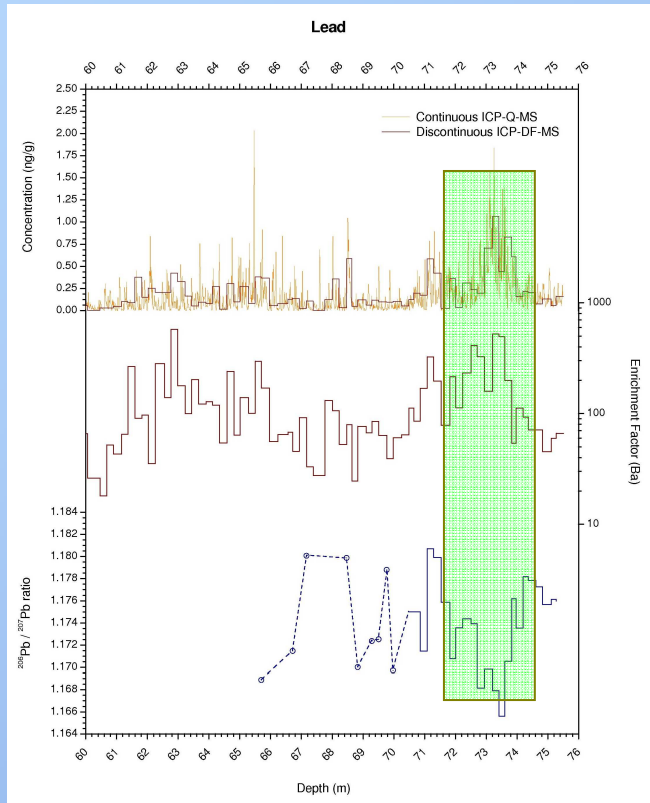

Roman
Empire

Middle Ages

(ALC 1200 AD at 66.5m)



Jacopo Gabrieli PhD defence
Venezia, November 28th 2008

Trace elements profiles

Lead isotopes in industrial period

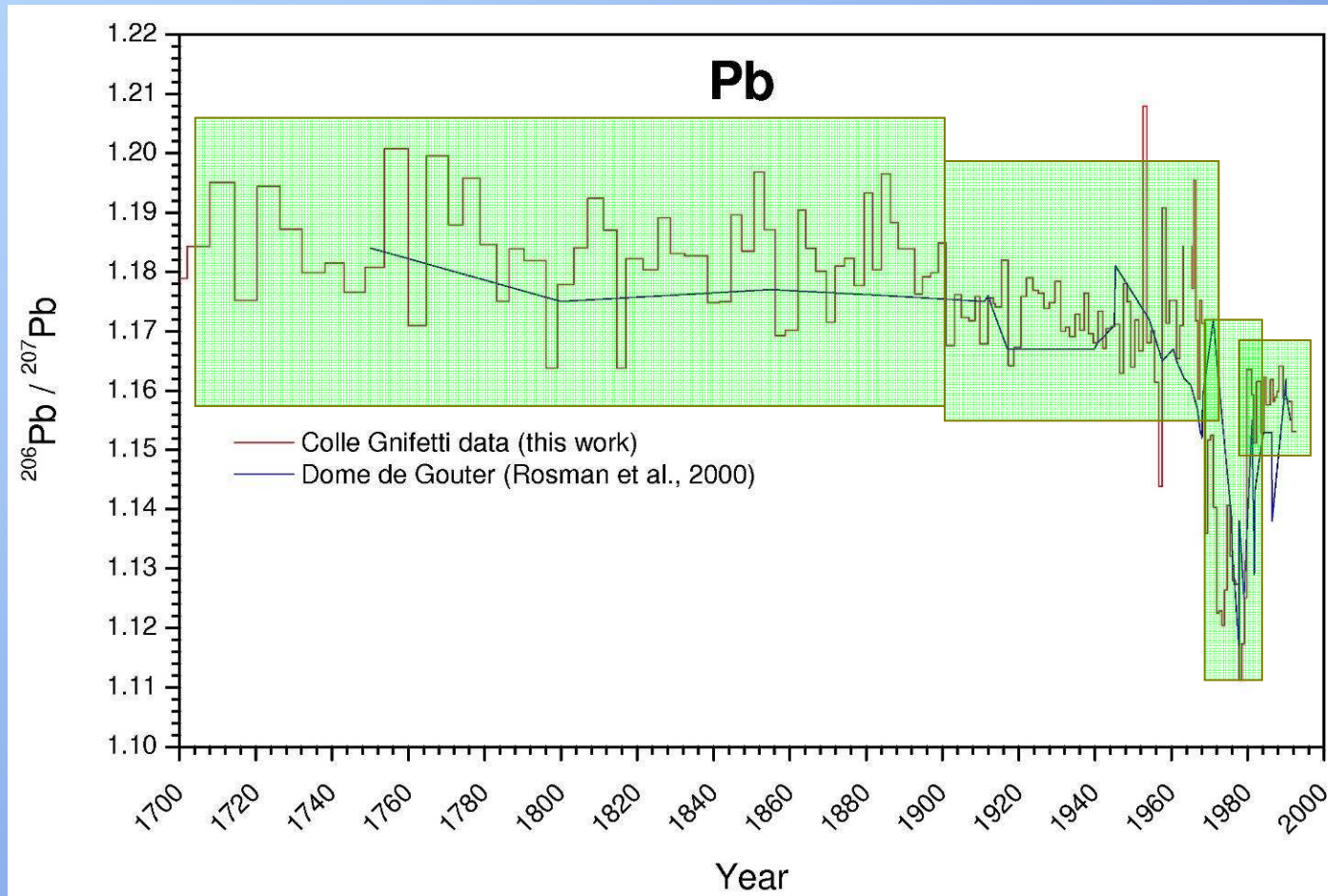

Jacopo Gabrieli PhD defence
Venezia, November 28th 2008

Pb isotopic ratio profile

Pu: a worldwide "cold war" pollutant

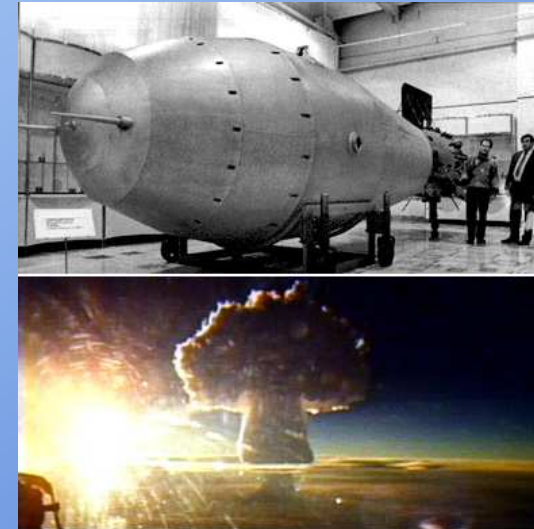
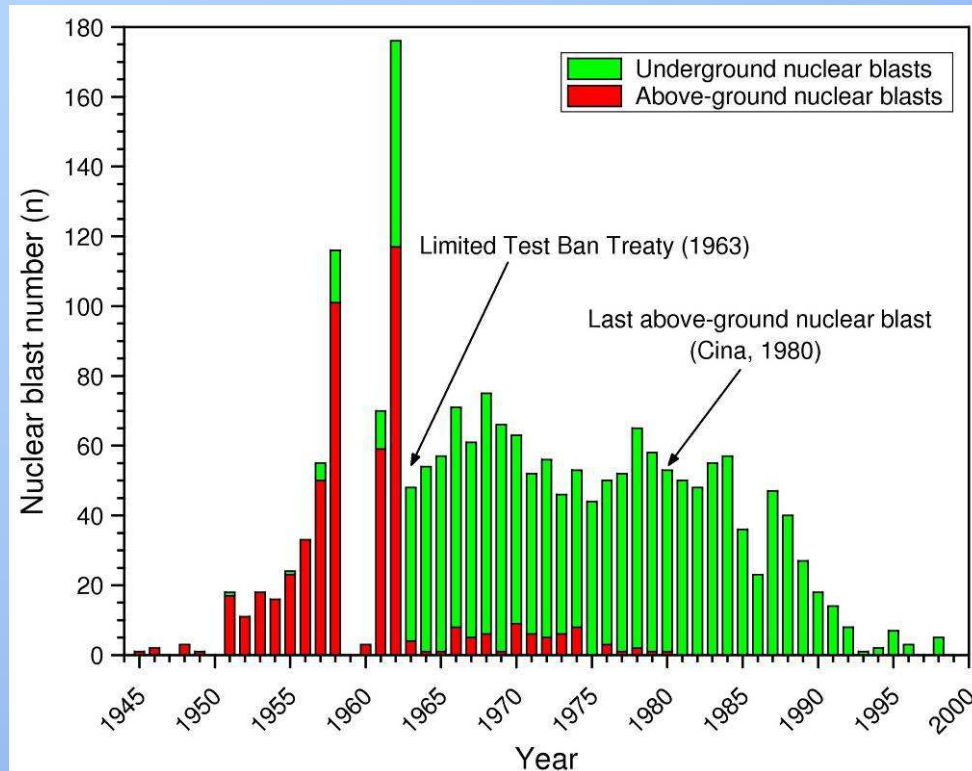

Tsar bomb, Arctic Siberia; 30 October 1961

57 Mton (more than 5 times the total amount of traditional explosives during 2°World War)

Blast at 4000 m a.s.l.; nuclear mushroom cloud high about 60 km



Jacopo Gabrieli PhD defence
Venezia, November 28th 2008

Pu determination

Pu profile in CG firn core

Semi-quantitative determination



Without external calibration and/or IS spiking (^{241}Pu) only semi-quantitative analysis

Calibration using ^{238}U linear regression parameters

UH^+ interference doesn't affect the method for $[\text{U}] < 50 \text{ pg/g}$

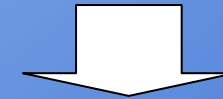

Fast screening method for “clean” matrix analysis; not appropriate for complex samples (soil, sediments, biological) without a purification step

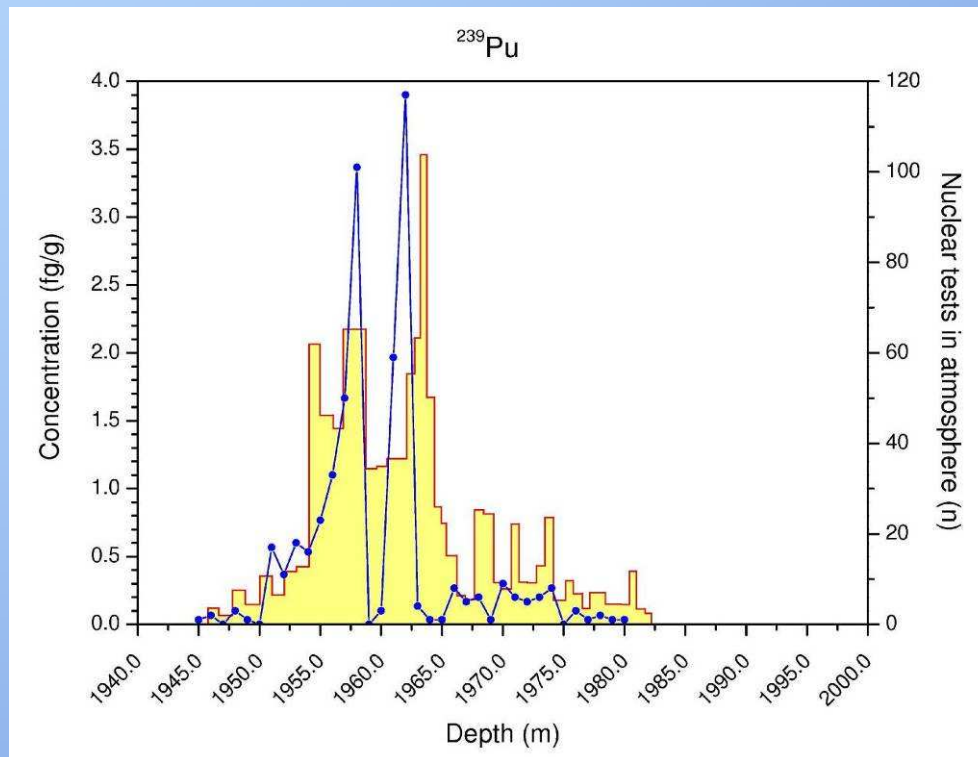

Jacopo Gabrieli PhD defence
Venezia, November 28th 2008

Pu determination

Pu profile in CG firn core

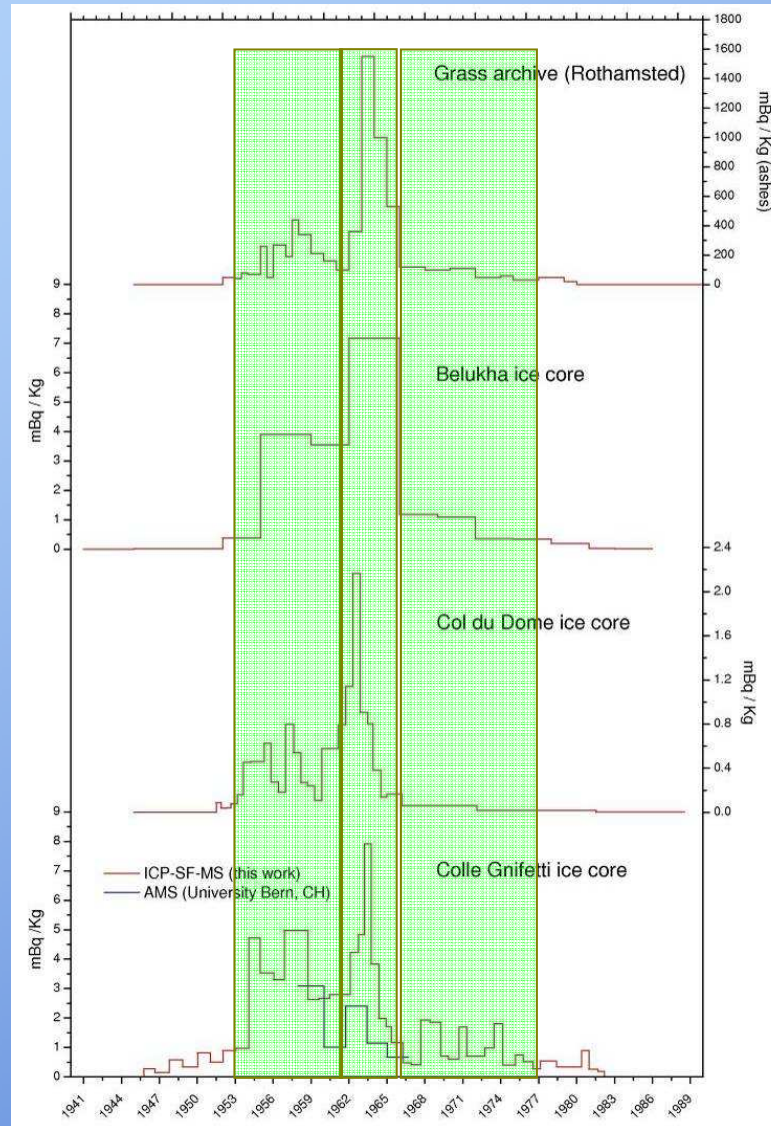

Jacopo Gabrieli PhD defence
Venezia, November 28th 2008

Pu determination

Pelmo, Antelao - Dolomites

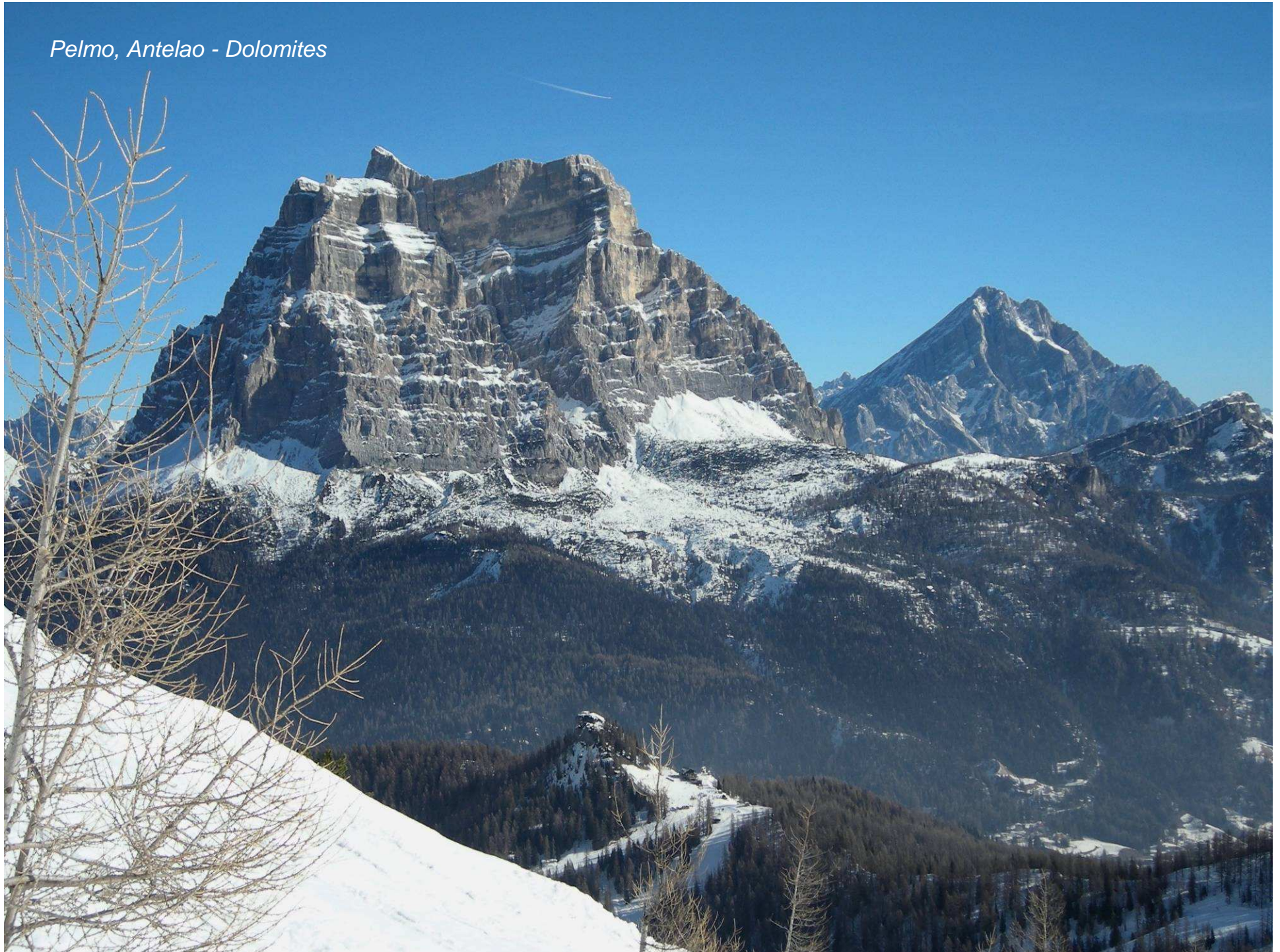

PAHs pattern

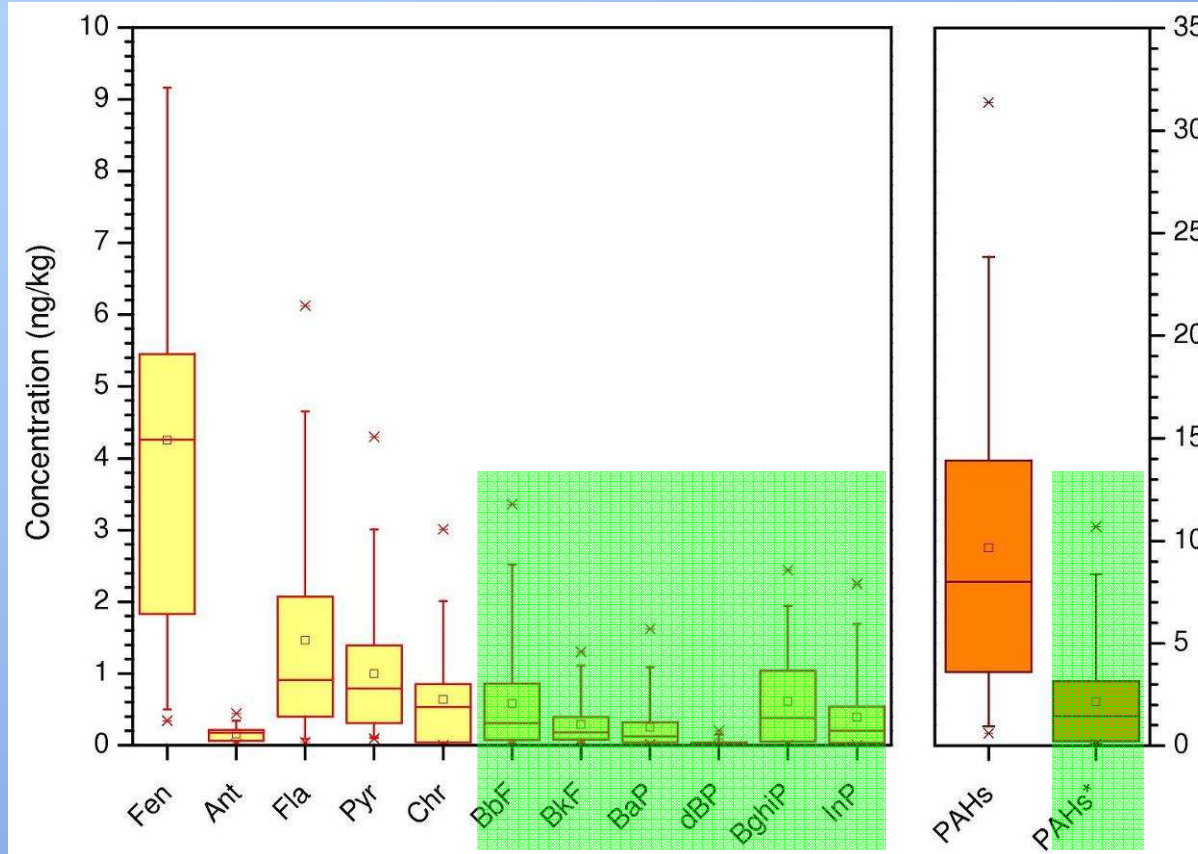

Jacopo Gabrieli PhD defence
Venezia, November 28th 2008

Polycyclic Aromatic Hydrocarbons

Fluoranthene

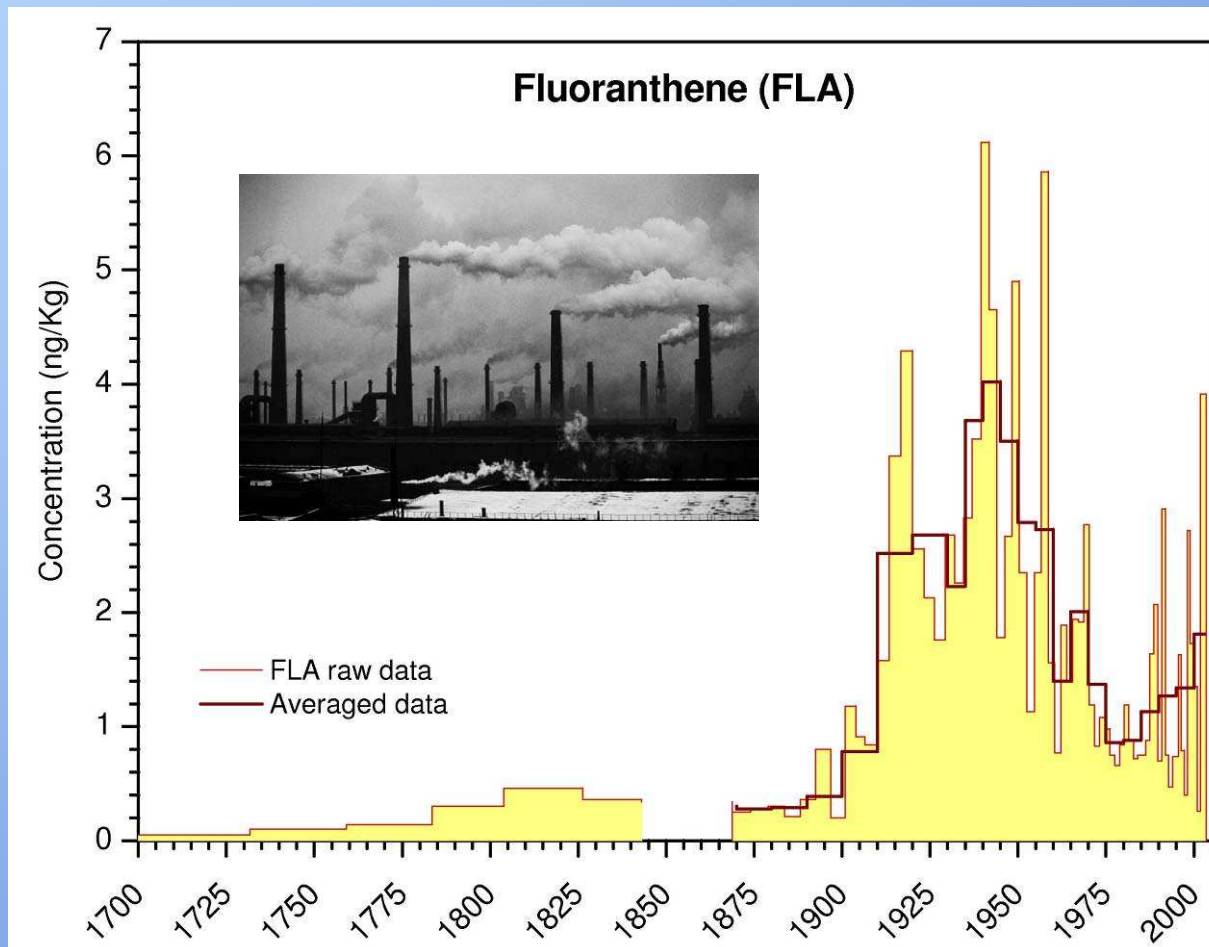

Jacopo Gabrieli PhD defence
Venezia, November 28th 2008

Polycyclic Aromatic Hydrocarbons

Indeno[1,2,3-cd]pyrene

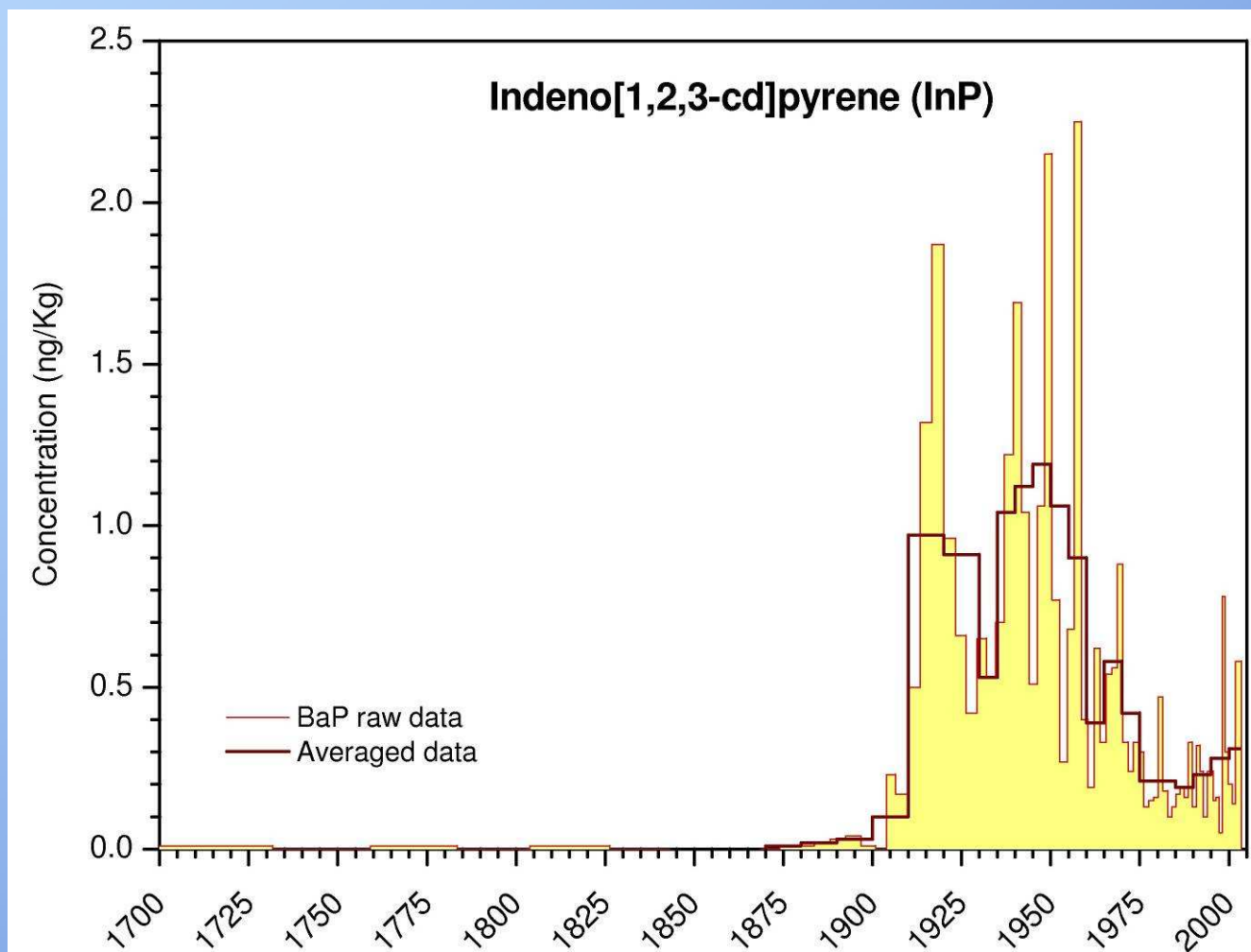

Jacopo Gabrieli PhD defence
Venezia, November 28th 2008

Polycyclic Aromatic Hydrocarbons

Benzo[a]pyrene

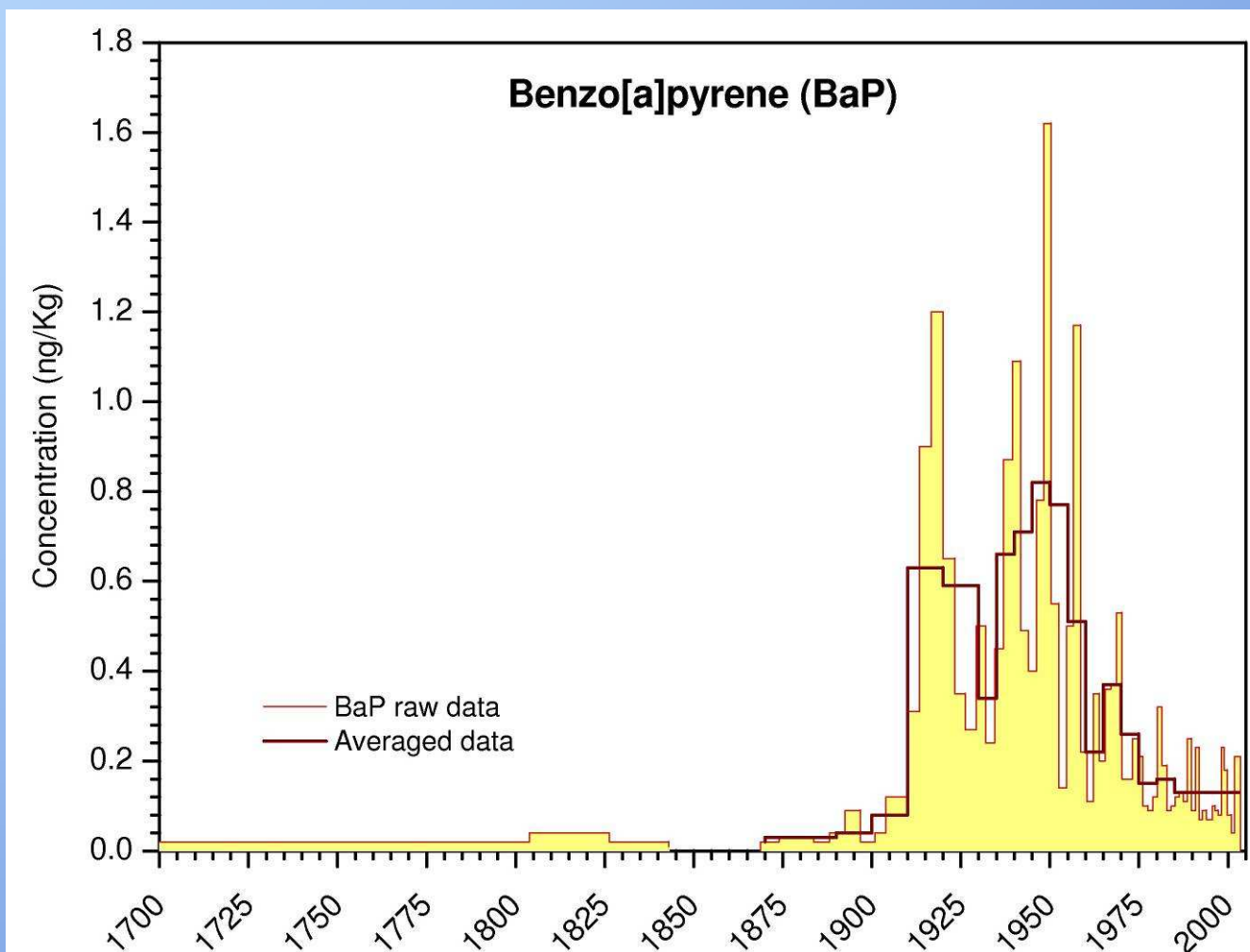

Jacopo Gabrieli PhD defence
Venezia, November 28th 2008

Polycyclic Aromatic Hydrocarbons

PAHs short-term variation and temperature

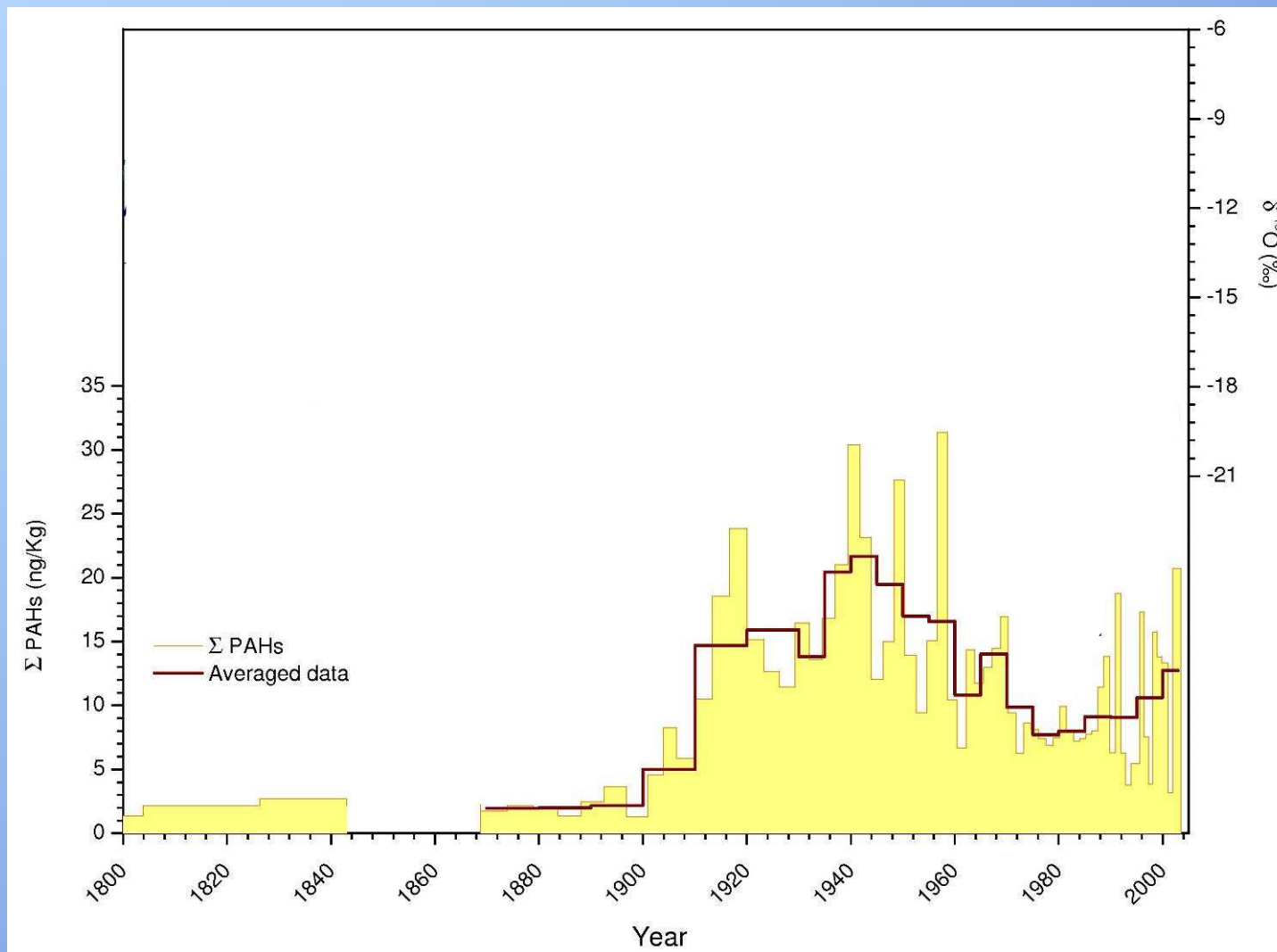

Jacopo Gabrieli PhD defence
Venezia, November 28th 2008

Polycyclic Aromatic Hydrocarbons

PAHs short-term variation and temperature

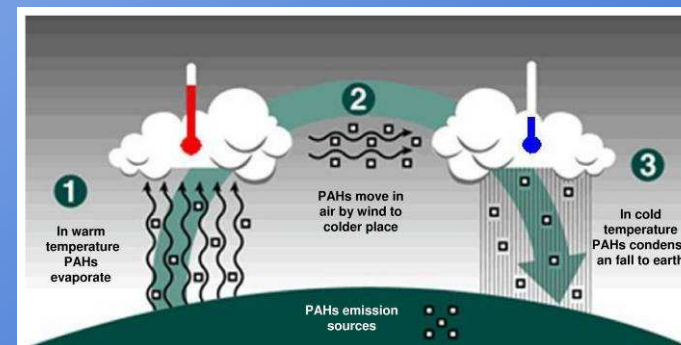
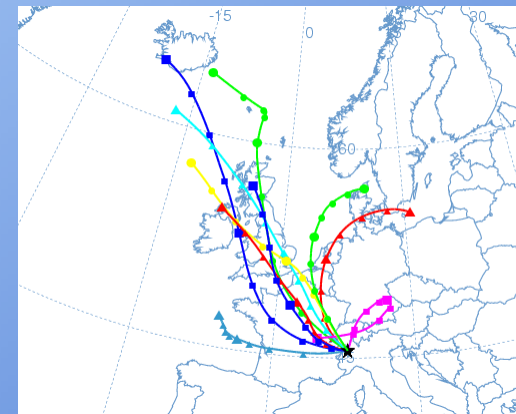
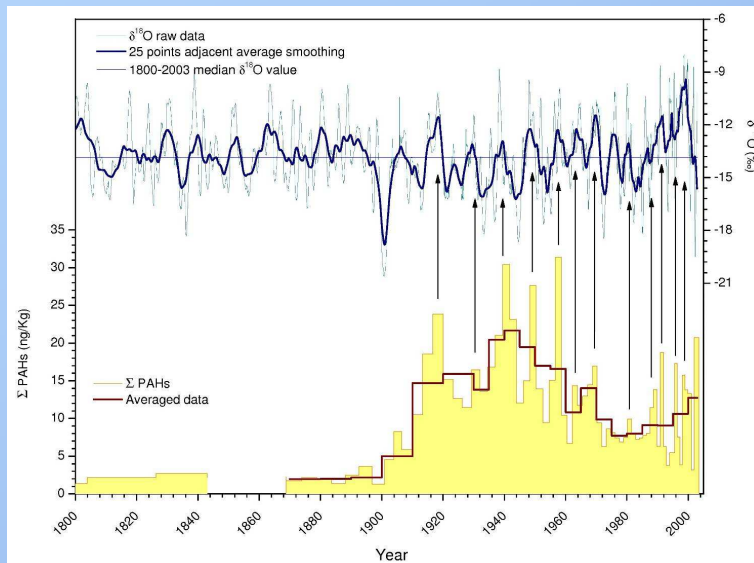

Jacopo Gabrieli PhD defence
Venezia, November 28th 2008

Polycyclic Aromatic Hydrocarbons

Marmolada, South Face - Dolomites



Conclusions

Designing, building and testing of a new melting system for continuous decontamination and on-line analysis of alpine ice/firn core

Continuous trace elements (ICP-QMS) and conductivity determination; semi-continuous solid phase extraction (SPE)

Discrete sampling and discontinuous analysis of trace elements, Pb isotopes and ^{239}Pu (ICP-SFMS)

Trace elements profiles

Short-term variations due to boundary layer and air masses trajectories seasonal changes; ALC implications

Increase of crustal TE concentrations during warm periods

Variations of anthropogenic TE concentrations during industrial revolution consistent with emission inventories in Europe

Conclusions

Polycyclic Aromatic Hydrocarbons profiles

First high-resolution PAHs record in ice and firn core

Long-term depositions influenced by anthropogenic emissions

Short-term PAHs profiles as function of climatic conditions: higher concentrations in warm periods

^{239}Pu profile reflects main periods of nuclear testing in atmosphere

High resolution profile

Validation of a rapid semi-quantitative method

Pb isotopes profile

High resolution profile

Evidences of "Turin isotopic experiment"

Prospectives

Searching for new evidences to support or reject current dating

Analyzing chips sections for TE and dust

Analyzing deepest sections of this ice core

High resolution POPs analysis (PAHs, PCBs, ...) and TE on a new shallow firn core drilled on Colle Gnifetti

Comparing CG data with other archives (lake sediments, peat-bogs) collected in the Alps

Acknowledgments



Prof. Carlo Barbante
Dr. Giulio Cozzi
Dr. Warren Cairns
Dr. Paolo Gabrielli
Dr. Paul Vallelonga



Dr. Alberto Luchetta
Dr. Fabio Decet
Dr. Roberto Fiabane



Prof. Heinz Gaggler
Dr. Margit Schwikowski
Dr. Michael Sigl
Dr. Theo Jenk



Dr. Barbara Delmonte



A dramatic mountain landscape at dawn or dusk. The scene is filled with mist and low-hanging clouds. Sunlight breaks through the clouds from the left, creating a series of rays that illuminate the scene. The mountains are dark and silhouetted against the lighter sky. The overall mood is serene and majestic.

thanks for your attention!