



HAL
open science

Contributions à l'étude de quelques problèmes unilatéraux de la mécanique des solides

Patrick Ballard

► **To cite this version:**

Patrick Ballard. Contributions à l'étude de quelques problèmes unilatéraux de la mécanique des solides. Sciences de l'ingénieur [physics]. Université de la Méditerranée - Aix-Marseille II, 2010. tel-00461525

HAL Id: tel-00461525

<https://theses.hal.science/tel-00461525>

Submitted on 4 Mar 2010

HAL is a multi-disciplinary open access archive for the deposit and dissemination of scientific research documents, whether they are published or not. The documents may come from teaching and research institutions in France or abroad, or from public or private research centers.

L'archive ouverte pluridisciplinaire **HAL**, est destinée au dépôt et à la diffusion de documents scientifiques de niveau recherche, publiés ou non, émanant des établissements d'enseignement et de recherche français ou étrangers, des laboratoires publics ou privés.

UNIVERSITÉ DE LA MÉDITERRANÉE AIX-MARSEILLE II

Contributions à l'étude de
quelques problèmes unilatéraux
de la mécanique des solides

PATRICK BALLARD

Habilitation à Diriger les Recherches

soutenue le 11 Février 2010 devant le jury composé de :

MM.	NGUYEN Quoc Son	Président
	CIMETIÈRE Alain	Rapporteur
	MONTEIRO-MARQUES Manuel	Rapporteur
	ATTOUCH Hédý	Examineur
	DEL PIERO Gianpietro	Examineur
	LÉGER Alain	Examineur

Avant-Propos

Ma première prise de contact (si l'on peut dire) avec les problèmes unilatéraux de la mécanique des solides remonte au *Contact Mechanics International Symposium* organisé en 1994 à Carry-Le-Rouet par Michel JEAN, Jean Jacques MOREAU et Michel RAOUS. J'étais alors un jeune Chargé de Recherche récemment recruté au CNRS en quête d'un domaine de recherche à investir. C'est Quoc Son NGUYEN, que je salue au passage, qui m'avait signalé la mécanique du contact comme un champ de recherche intéressant et recelant de nombreuses questions ouvertes (voire défis) intéressantes. Il m'avait alors proposé de l'accompagner à Carry-Le-Rouet pour me faire ma propre idée.

J'en suis revenu enthousiaste. Il y avait là une communauté internationale, nombreuse et dynamique, qui n'hésitait pas à convoquer les mathématiques chaque fois que les questions de mécanique le requérait. Le frottement, en particulier, et son couplage à l'élasticité avait l'air porteur d'une grande richesse mécanique (crissement) dont la compréhension était balbutiante. L'analyse du problème quasi-statique de contact avec frottement de Coulomb en élasticité linéarisée, envisagée par Georges DUVAUT et Jacques-Louis LIONS dans les *Inéquations en Mécanique et en Physique*, était très largement inachevée.

Je mis un peu de temps à prendre la mesure de la difficulté des questions qui se posaient et fus conduit à faire quelques détours. Intéressé par la question d'unicité de solution d'inclusion différentielle non-monotone, je lus avec intérêt les articles de Michelle SCHATZMAN sur la dynamique unilatérale discrète et constatait à cette occasion que les pathologies de non-unicité qu'elle exhibait se retrouvaient dans la situation de l'évolution quasi-statique en présence de frottement de Coulomb. Je consacrais alors une parenthèse de quelques années à la dynamique unilatérale discrète et parvins à démontrer un résultat d'unicité conjecturé pour la première fois en 1959 et conjecturé plusieurs fois ensuite. Les techniques mises en jeu seront vraisemblablement à réutiliser lors de l'étude de l'unicité de solution au problème quasi-statique de contact avec frottement en élasticité linéarisée. Une autre parenthèse a été ouverte plus récemment après que j'ai remarqué que les difficultés rencontrées dans l'analyse du problème tridimensionnel disparaissent dans le cas des structures minces. On se retrouve alors dans une situation épurée, très proche de la plasticité parfaite, où les points de vue dégagés par Jean Jacques MOREAU et Pierre SUQUET à la fin des années 70, apparaissent de façon dépouillée. Cette parenthèse n'est pas encore refermée. Je me suis également rapproché de Jiří JARUŠEK qui dans sa thèse encadrée par NEČAS au tout début des années 80, avait obtenu un progrès remarquable dans le programme suggéré par Georges DUVAUT et Jacques-Louis LIONS dans les *Inéquations en Mécanique et en Physique*, qui donnait en particulier l'existence de solution au problème dit « statique » (en fait, le problème qui se pose à chaque pas de temps, lors de l'introduction d'une discrétisation temporelle dans le problème d'évolution quasi-statique). Décidés à progresser conjointement sur la question

de l'unicité, nous avons fait une investigation plus poussée (grâce à l'analyse harmonique) d'une géométrie particulière : celle du demi-espace. Il s'agissait initialement de mettre en évidence des solutions multiples dans le cas de coefficient de frottement arbitrairement petits. Les résultats obtenus nous orientent dorénavant vers la conjecture opposée : l'unicité est probablement vraie pour le problème « statique » lorsque le coefficient de frottement est inférieur à une valeur critique.

On l'aura compris, il s'agit là d'un travail en devenir dont j'espère qu'il pourra déboucher dans un futur proche sur l'objectif initial. Me sentant par moment plus proche que je n'étais en fait, du but, j'ai probablement repoussé le moment de rédiger ce mémoire plus que je n'aurais dû.

Table des matières

I	Dynamique des systèmes de solides rigides	1
1	Contexte et motivation	3
2	Problèmes sans frottement	9
2.1	Dynamique des systèmes de solides rigides	10
2.1.1	Le solide rigide	10
2.1.2	Formulation de la dynamique	11
2.1.3	Caractère bien-posé de la dynamique	12
2.2	Liaisons bilatérales parfaites	14
2.2.1	Description géométrique	14
2.2.2	Formulation de la dynamique	14
2.2.3	Caractère bien-posé de la dynamique	15
2.3	Liaisons unilatérales parfaites	16
2.3.1	La description géométrique	16
2.3.2	Formulation de la dynamique	17
2.3.3	Analyse du problème de Cauchy	23
2.3.4	Continuité de la dépendance à la condition initiale	26
3	Prise en compte du frottement	29
3.1	Analyse d'un problème modèle	29
3.1.1	Description du problème	29
3.1.2	Existence et unicité de solution	31
3.2	Extension aux systèmes mécaniques discrets	32
II	Problèmes de contact avec frottement en élasticité 3D linéarisée	37
4	Contexte et motivation	39
4.1	Le système de Klarbring	41
4.1.1	Le cas du problème statique	41
4.1.2	Cas du problème quasi-statique	43
4.2	Retour au système de l'élasticité	44
5	Étude d'un problème modèle	47
5.1	L'opérateur de Dirichlet-Neumann	47
5.1.1	Expression explicite	47

5.1.2	Analyse de l'opérateur de Dirichlet-Neumann	50
5.2	Application au problème de Signorini sur le demi-espace	51
5.3	Formulation du problème avec frottement	53
5.4	Forme qualitative d'une solution arbitraire	54
5.5	Estimations asymptotiques d'une solution quelconque	55
5.6	Investigations sur l'unicité	56
6	Conclusions et perspectives	59
III	Contact avec frottement pour les structures minces élastiques	61
7	Contexte et motivation	63
8	Structures minces élastiques	65
8.1	Position du problème	65
8.2	Forme générale du problème d'évolution	65
8.2.1	Solutions faibles de processus de raffle	67
8.3	Contact avec frottement pour le fil élastique	68
8.3.1	Un exemple où $s \in BV([t_0, T]; \mathcal{M})$	69
8.3.2	Un exemple où $s \notin BV([t_0, T]; \mathcal{M})$	71
8.4	Remplacer le fil par une poutre	73
9	Questions ouvertes et perspectives	75
IV	Curriculum Vitae et liste de publications	77
10	Notice scientifique	79
10.1	Curriculum vitæ	79
10.2	Autres activités liées au métier de chercheur	79
10.2.1	Encadrement doctoral	79
10.2.2	Activités d'enseignement	80
10.2.3	Actions de formation, hors enseignement supérieur	81
10.2.4	Transfert technologique et valorisation	81
10.2.5	Évaluation de projets d'articles	81
11	Liste de publications	83
11.1	Livres	83
11.2	Chapitres dans des ouvrages	83
11.3	Articles	83
11.4	Colloques	84
11.5	Séminaires	86

Première partie

Dynamique des systèmes
de solides rigides

Chapitre 1

Contexte et motivation

Considérons une particule ponctuelle astreinte à se mouvoir le long d'une ligne. Sa position sur la ligne à l'instant t peut alors être caractérisée par la connaissance d'un seul nombre réel $q(t) \in \mathbb{R}$. Supposons que cette particule soit soumise à une force colinéaire à la ligne dont l'amplitude $f(t)$ est une fonction prescrite du temps. Faisant un choix approprié pour l'unité de masse, l'équation de la dynamique est :

$$\forall t, \quad \ddot{q}(t) = f(t).$$

Si l'on se donne la position q_0 et la vitesse v_0 de la particule à un instant initial $t = 0$, une double intégration fournit une unique trajectoire $t \mapsto q(t)$ ($t \in \mathbb{R}^+$), sous la seule hypothèse que la fonction donnée $f(t)$ soit une fonction localement intégrable.

Considérons maintenant la situation où il existe un obstacle sur la ligne de sorte que la particule est maintenant astreinte à rester sur une moitié de la ligne :

$$\forall t, \quad q(t) \leq 0. \tag{1.1}$$

On décide de se poser le problème de l'extension à cette nouvelle situation du résultat d'existence et d'unicité de trajectoire à partir d'une condition initiale donnée. L'examen de cette question nécessite le préalable d'une formulation précise du problème de Cauchy correspondant.

La réalisation de la liaison unilatérale (1.1) induit l'existence d'un effort de réaction noté r de sorte que l'équation de la dynamique s'écrit dorénavant :

$$\ddot{q} = f + r. \tag{1.2}$$

On suppose que l'interaction entre la particule et l'obstacle est de type *contact*, c'est-à-dire :

- il n'y a pas d'action à distance de l'obstacle sur la particule,
- l'effort de réaction exercé par l'obstacle est un effort de répulsion, c'est-à-dire toujours dirigé vers la demi-ligne où se meut la particule.

Il résulte du premier point qu'une particule libre de force extérieure, initialement à distance non nulle de l'obstacle avec une vitesse non nulle dirigée vers l'obstacle va nécessairement arriver sur l'obstacle avec une vitesse non nulle. Le respect de la liaison unilatérale (1.1) est alors incompatible avec l'existence d'une vitesse (dérivée par rapport au temps) au sens classique à l'instant où la particule rencontre l'obstacle. Il en résulte que l'équation de la dynamique (1.2) ne peut certainement pas s'entendre au sens classique, mais seulement

au sens des distributions. L'accélération \ddot{q} , et donc l'effort de réaction r doivent donc se comprendre comme des distributions. Mais, en vertu du second point, la distribution r doit être *négative*, ce qui ne peut que signifier qu'elle prend une valeur négative ou nulle sur toute fonction test C^∞ à support compact qui soit positive ou nulle. Cette propriété entraîne alors classiquement que la distribution r est une *mesure*. Si on se limite au cas où la force extérieure $f(t)$ est une fonction localement intégrable (identifiée à la mesure absolument continue par rapport à la mesure de Lebesgue correspondante), les trajectoires $t \mapsto q(t)$ sont donc à chercher dans la classe MAM des mouvements à accélération mesure. Il s'agit des distributions définies sur \mathbb{R}^+ dont la dérivée seconde \ddot{q} est une mesure. De telles distributions s'identifient à des fonctions $q(t)$ *continues*, admettant des dérivées au sens classique $\dot{q}^-(t)$, $\dot{q}^+(t)$ à gauche et à droite de tout $t > 0$ et telles que les fonctions $\dot{q}^-(t)$ et $\dot{q}^+(t)$ soient localement à variation bornée.

Si l'on se donne une condition initiale compatible avec la liaison unilatérale ($q_0 \leq 0$ et $\dot{q}_0 = 0 \Rightarrow v_0 \leq 0$), le problème est alors de trouver $q \in \text{MAM}$ tel que :

- $q(0) = q_0, \quad \dot{q}^+(0) = v_0,$
- $\forall t, \quad q(t) \leq 0,$
- $r \stackrel{\text{déf}}{=} \ddot{q} - f$ est une mesure *négative*,
- $\text{supp } r \subset \{t ; q(t) = 0\}.$

Le problème d'évolution ayant été ainsi formulé, on observe très facilement qu'on ne peut s'attendre à l'unicité de solution, en général. En effet, une particule libre d'effort extérieur ($f \equiv 0$), initialement à distance non nulle de l'obstacle et avançant vers lui à vitesse non nulle, peut admettre n'importe quelle valeur de vitesse négative ou nulle après impact et s'éloigner ensuite de l'obstacle en conservant cette valeur de vitesse indéfiniment. Tous les mouvements correspondants fournissent une solution au problème d'évolution ainsi que formulé plus haut. En d'autres termes, et cette remarque avait été faite par Newton, l'équation de la dynamique associée aux seules conditions de contact ne permet pas de prédire le mouvement. Cela vient du fait que ce qui gouverne effectivement le rebond d'un corps sur un autre est la propagation des ondes dans ces corps qui sont nécessairement déformables. Le niveau de description en terme de particule ponctuelle étant trop grossier pour permettre la description de ces phénomènes de propagation d'ondes, il en résulte cette indétermination. Si l'on veut s'en tenir à ce niveau de schématisation des corps en jeu, il faut donc, en suivant Newton, réinjecter une partie de l'information perdue au travers d'une *équation constitutive des impacts*, il s'agit d'une équation phénoménologique supplémentaire destinée à résumer la complexité des phénomènes en jeu lors de l'impact qui exprime la vitesse après impact comme une fonction, supposée connue (par exemple empiriquement), de la vitesse avant impact :

$$q(t) = 0 \quad \Longrightarrow \quad \dot{q}^+(t) = \mathcal{F}(q^-(t)).$$

Le statut de cette équation constitutive d'impact est exactement le même que celui de la loi de comportement en mécanique des milieux continus. Notons que c'est l'unicité au problème de Cauchy qui guide implicitement son introduction pour lever une indétermination. Un exemple classique d'une telle équation constitutive d'impact est l'équation *élastique* :

$$q(t) = 0 \quad \Longrightarrow \quad \dot{q}^+(t) = -q^-(t),$$

et qui est aussi celle que nous retiendrons dans la suite de cette discussion introductive.

On est alors amené à vouloir étudier le problème de Cauchy suivant.

Problème \mathcal{P} . Trouver $q \in MAM$ tel que :

- $q(0) = q_0, \quad \dot{q}^+(0) = v_0,$
- $\forall t, \quad q(t) \leq 0,$
- $r \stackrel{\text{déf}}{=} \ddot{q} - f$ est une mesure *négative*,
- $\text{supp } r \subset \{t ; q(t) = 0\},$
- $q(t) = 0 \quad \implies \quad \dot{q}^+(t) = -q^-(t).$

L'existence de solution pour ce type de problème a été démontrée pour la première fois par Michelle Schatzman [6] dans sa thèse. Sous la faible hypothèse $f \in L^1(0, T; \mathbb{R})$, elle introduit un problème approché plus régulier en pénalisant la pénétration de la particule dans l'obstacle, démontre les estimations nécessaires permettant de passer à la limite sur la pénalisation (modulo l'extraction de sous-suites), et montre que la fonction limite est bien solution du problème unilatéral. À ma connaissance, Michelle Schatzman est aussi la première à introduire la classe des mouvement à accélération mesure dans ce contexte, dans le but de parvenir à une formulation cohérente du problème d'évolution correspondant. Une autre démonstration d'existence basée sur l'introduction d'une discrétisation du temps a été donnée par la suite par Manuel Monteiro-Marques [3].

Dans sa thèse, Michelle Schatzman a aussi fourni un contre-exemple frappant montrant que, même si la fonction f est C^∞ , il n'y a pas unicité de solution au problème \mathcal{P} , en général. En fait, il semble qu'un tel contre-exemple ait été exhibé pour la première fois par Aldo Bressan [2] en 1960.

Ce contre-exemple concerne le cas particulier où la particule se trouve initialement au repos et en contact avec l'obstacle ($q_0 = 0, v_0 = 0$), et où la force, supposée être une fonction C^∞ du temps t , reste constamment dirigée *vers* l'obstacle ($f \geq 0$). L'immobilité ($q \equiv 0$) fournit alors une solution au problème \mathcal{P} correspondant et il s'agit d'ajuster alors la fonction f de manière à ce que le problème \mathcal{P} admette éventuellement une autre solution, distincte de l'immobilité. On considère alors une suite infinie d'instant t_n décroissant strictement vers 0. On coupe alors chaque intervalle $]t_{n+1}, t_n[$ en deux :

$$]t_{n+1}, t_n[=]t_{n+1}, \tau_n] \cup]\tau_n, t_n[,$$

et on définit la restriction de la fonction f sur l'intervalle $]t_{n+1}, t_n[$, de sorte qu'elle soit identiquement nulle sur la première partie et égale à une « bosse de Massin » (qui se raccorde de façon C^∞ avec 0) sur la deuxième partie :

$$f(t) = \begin{cases} 0, & \text{si } t \in]t_{n+1}, \tau_n], \\ f_n \exp\left(-\frac{1}{(t_n-t)(t-\tau_n)}\right), & \text{si } t \in]\tau_n, t_n[, \end{cases}$$

où f_n désigne le terme général d'une suite strictement positive pour lors encore arbitraire. La fonction f ainsi définie est clairement C^∞ sur $]0, t_0[$. Elle le sera sur $[0, t_0]$, si la suite f_n décroît suffisamment vite quand n tend vers l'infini. On cherche alors à construire un

mouvement $q(t)$ associé à cette loi de force correspondant à un vol libre de la particule sur l'intervalle $]t_{n+1}, t_n[$ avec des impacts élastiques en chaque instant t_n :

$$q^-(t_n) = v_n = -q^+(t_n), \quad (1.3)$$

où v_n désigne une nouvelle suite strictement positive encore arbitraire. La question est alors d'ajuster les suites t_n , f_n , τ_n et v_n de manière à garantir :

- $f \in C^\infty([0, t_0], \mathbb{R})$,
- $\ddot{q} = f$ sur chaque intervalle $]t_{n+1}, t_n[$ est cohérent $q(t_n) = 0$ ainsi que (1.3).

Un tel ajustement est toujours possible (voir par exemple [1]), et, pour la fonction f associée à cet ajustement, le problème \mathcal{P} correspondant admet au moins deux solutions : l'immobilité et une solution avec accumulation infinie d'impacts à droite de l'origine des temps.

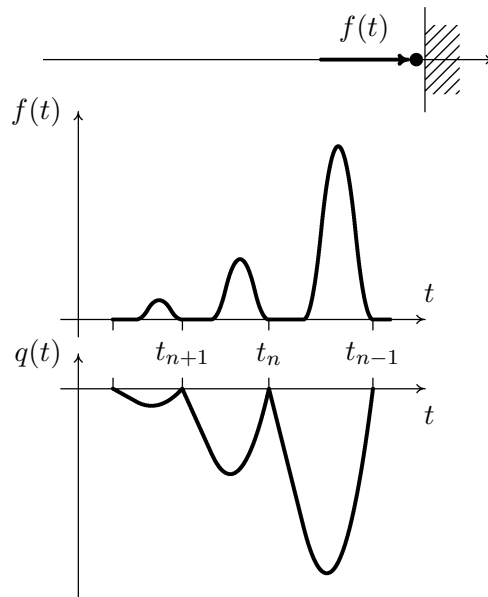

FIG. 1.1 – Le contre-exemple de Bressan-Schatzman.

La morale de ce contre-exemple spectaculaire est la suivante. L'équation constitutive des impacts a été introduite de façon à garantir l'unicité de solution du problème en vitesse (connaissant l'histoire du mouvement, il n'y a qu'une seule valeur possible pour la vitesse à droite à l'instant t). Il se passe cependant que cette unicité de solution du problème en vitesse n'est pas suffisante pour garantir l'unicité de l'évolution.

La question est alors de savoir si cette non-unicité pose problème. Rappelons d'abord la situation posée par la mécanique « régulière » gouvernée par le problème de Cauchy :

$$\begin{cases} \ddot{q} = f(q, \dot{q}; t), \\ (q(0), \dot{q}(0)) = (q_0, v_0), \end{cases} \quad (1.4)$$

dans \mathbb{R}^n . Si f est assez régulière (par exemple de classe C^1) alors le théorème de Cauchy-Lipschitz garantit l'existence et l'unicité d'une solution maximale. Si f ne croît pas trop vite lorsque le couple (q, \dot{q}) tend vers l'infini, on peut montrer que la solution maximale est définie

pour tout temps (dynamique dite « éternelle »). En revanche, si f est seulement supposée continue, l'existence de solution au problème (1.4) est encore garantie par le théorème de Peano, mais des exemples simples montrent que l'unicité de solution est perdue en général. Il n'est pas restrictif du point de vue des applications de se limiter au cas où f est C^1 et le déterminisme de la mécanique classique à liberté finie qui résulte de cette analyse mathématique est utilisé dans la définition classique de la stabilité d'un équilibre, ainsi que dans la formulation même des problèmes de contrôle posés par la robotique.

Or, un nombre croissant de problèmes posés par la robotique actuelle nécessite la formulation de problèmes de stabilité et de contrôle de systèmes à liberté finie avec conditions unilatérales de non-pénétration, et donc susceptibles d'exhiber des impacts. On peut penser à l'exemple type de la commande d'un robot marcheur modélisé comme un assemblage articulé de solides rigides qui ne peuvent évidemment pas pénétrer le sol.

La formulation même de ces problèmes de stabilité et contrôle réclame donc un pendant du théorème de Cauchy-Lipschitz dans la situation non-régulière en jeu. Une idée pour y parvenir a été suggérée par Percivale [5] qui a remarqué dans sa thèse que le problème \mathcal{P} formulé à la page 5, dont l'existence de solution est garantie par un théorème de Michelle Schatzman dès que $f \in L^1$, admet une solution unique pour les fonctions f *analytiques* (ou analytiques par morceaux, bien sûr).

Je suis donc parti de cette remarque de Percivale pour essayer d'obtenir un résultat d'existence et d'unicité pour le problème de Cauchy associé à la dynamique d'une collection finie de solides rigides en présence de liaisons unilatérales et impacts, suffisamment général pour couvrir les applications. Je me suis bien sûr restreint dans un premier temps, au cas des liaisons unilatérales *sans frottement* et pense, dans ce cadre, avoir atteint l'objectif que je m'étais imparti. Ces résultats vont être décrits dans le chapitre suivant (et la bibliographie associée).

Bibliographie

- [1] P. BALLARD (2000), The dynamics of discrete mechanical systems with perfect unilateral constraints. *Archive for Rational Mechanics and Analysis* **154**, pp. 199–274.
- [2] A. BRESSAN (1960), Incompatibilità dei teoremi di esistenza e di unicità del moto per un tipo molto comune e regolare di sistemi meccanici. *Annali della Scuola Normale Superiore di Pisa, Serie III* **XIV**, pp. 333–348.
- [3] M. MONTEIRO-MARQUES (1993), *Differential inclusions in nonsmooth mechanical problems*, Birkhäuser, Basel-Boston-Berlin.
- [4] J. J. MOREAU (1983), Standard inelastic shocks and the dynamics of unilateral constraints. In *Unilateral problems in structural analysis* (G. D. Piero and F. Maceri, eds.), Springer-Verlag, pp. 173–221.
- [5] D. PERCIVALE (1985), Uniqueness in the elastic bounce problem, i. *Journal of Differential Equations* **56**, pp. 206–215.
- [6] M. SCHATZMAN (1978), A class of nonlinear differential equations of second order in time. *Nonlinear Analysis, Theory, Methods & Applications* **2**, pp. 355–373.

Chapitre 2

Contributions à l'analyse des problèmes sans frottement

Dans cette partie, on se propose de faire une présentation générale de la dynamique des systèmes de solides rigides, articulés ou non, en présence de liaisons unilatérales parfaites (sans frottement). L'objectif est de construire la théorie la plus générale possible permettant d'assurer l'existence et l'unicité de solution au problème de Cauchy correspondant.

La formulation de ce type de problèmes repose sur les contributions antérieures essentielles de Michelle Schatzman [11] et Jean Jacques Moreau [9], qui sont les premiers à suggérer une formulation globale des équations de la dynamique en considérant la classe des mouvements à accélération mesurée. Les résultats d'existence de solution au problème de Cauchy qui étaient disponibles étaient ceux de Michelle Schatzman [11] et Manuel Monteiro-Marques [8], et étaient restreints au cas d'une *seule* liaison unilatérale. Enfin, une remarque astucieuse de Danilo Percivale [10] pour un problème très particulier à un seul degré de liberté suggérait la possibilité de lever des pathologies connues de non-unicité en requérant la régularité *analytique* des données.

Pour l'anecdote, Michelle Schatzman [12] et moi, nous sommes posés en même temps (vers 1997), et indépendamment la question d'étendre le résultat de Percivale au cas général à un degré de liberté (c'est-à-dire le cas où la force $f(t)$ n'est plus une seule fonction du temps, mais peut dépendre également de l'état actuel $f(q, \dot{q}; t)$). En d'autres termes, il s'agissait d'étendre le résultat d'unicité de Percivale au cas où la force $f(q, \dot{q}; t)$ est supposée être une fonction analytique de ses arguments, et ce toujours dans le cas $q \in \mathbb{R}$ à un seul degré de liberté. Nous avons chacun produit une démonstration différente, qui utilisait l'existence d'une relation d'ordre sur la variété \mathbb{R} des configurations, et qui donc ne pouvait s'étendre à une situation plus générale.

J'ai réussi par la suite à construire une démonstration qui n'utilisait pas cette relation d'ordre et ai alors été en mesure d'obtenir un résultat général d'existence et d'unicité pour le problème de Cauchy posé par la dynamique des systèmes discrets avec liaisons unilatérales parfaites. Une première version de cette théorie générale a été publiée [1] en se limitant à une équation constitutive des impacts, dite canonique, introduite par Moreau. Mais le résultat d'existence et d'unicité n'utilise en fait que la propriété pour l'équation constitutive des impacts de ne pas créer d'énergie cinétique au cours d'un impact. Dans une référence ultérieure [2], j'ai donc pu exhiber *toutes* les équations constitutives d'impact compatibles avec l'existence et l'unicité du problème de Cauchy sous réserve d'analyticité

des données. Ces résultats ont ensuite été rassemblés dans la référence [3] dont le présent chapitre résume la première partie. La deuxième partie qui discute la prise-en-compte du frottement sera évoquée au chapitre suivant. Une présentation sans recours au langage des variétés de configuration et de la géométrie différentielle a récemment été publiée dans [4]. Elle consiste à se placer dans une paramétrisation locale du système pour obtenir une écriture des résultats dans \mathbb{R}^n . Ce point-de-vue est moins naturel et beaucoup plus lourd à écrire, mais il a l'avantage d'être accessible sans aucune connaissance du langage de la géométrie différentielle.

2.1 Dynamique des systèmes de solides rigides

2.1.1 Le solide rigide

La mécanique classique postule l'existence d'un espace affine Euclidien \mathcal{E} , orienté, de dimension 3, appelé parfois *espace réel* (Galiléen), et une chronologie absolue représentée (après le choix d'une origine) par un nombre réel, souvent noté t . On notera E l'espace vectoriel associé à \mathcal{E} .

Un solide est représenté par sa *configuration de référence dans l'espace réel* qui n'est rien d'autre qu'un lieu géométrique envisageable de tous ses points matériels dans \mathcal{E} . L'hypothèse de rigidité consiste alors à supposer que les seules configurations observables du solide dans l'espace réel s'obtiennent à partir de la configuration de référence dans l'espace réel au moyen d'*isométries directes*. Ainsi, une fois donnée la configuration de référence dans l'espace réel, toute autre configuration dans l'espace réel est représentée par une isométrie directe q . Comme toute isométrie directe de \mathcal{E} est la composée d'une translation et d'une rotation, l'ensemble de toutes ces isométries directes s'identifie à $E \times \mathbb{SO}3$ (où $\mathbb{SO}3$ est l'ensemble de toutes les rotations de E , muni de sa structure habituelle de variété différentiable). On dit alors que $E \times \mathbb{SO}3$ est la *variété de configuration* (abstraite) du solide rigide. Comme cette variété est de dimension 6, on dit que le solide rigide a 6 *degrés de liberté* (ddl).

D'autres idéalizations de solides rigides peuvent apparaître : la barre rigide infiniment fine dont la variété de configuration est $E \times \mathbb{S}2$ (où $\mathbb{S}2$ est la sphère à deux dimensions équipée de sa structure habituelle de variété différentiable) et la particule ponctuelle dont la variété de configuration est simplement E .

Un mouvement du solide rigide est une courbe sur la variété de configuration Q (une application d'un intervalle de temps I dans Q). La dérivée du mouvement à l'instant t est notée $\dot{q}(t)$. On l'appelle vitesse (abstraite ou parfois, généralisée). C'est un élément du fibré tangent TQ de la variété de configuration. On rencontre le nom « d'espace d'état » pour TQ , auquel cas $\dot{q}(t)$ est aussi appelé *état* du système.

La distribution de masse du solide rigide est la donnée d'une mesure de Radon sur la configuration de référence de l'espace réel. Elle permet d'associer classiquement à tout état du système, son *énergie cinétique* $K(q, \dot{q})$, qui définit une forme quadratique définie positive, sur chaque espace tangent à Q , munissant ainsi la variété des configuration d'une structure Riemannienne. La métrique Riemannienne correspondante est classiquement appelée *métrique cinétique*. Dorénavant, lorsque l'on parlera de variété de configuration, elle sera toujours supposée équipée de sa structure Riemannienne.

Un système de solides rigides est une collection finie de solides rigides. La variété de configuration d'un système de solides rigides est alors le produit Cartésien $Q_1 \times Q_2 \times \cdots \times Q_n$

des variétés de configuration Q_i de chaque solide rigide constitutif du système.

Notations. Pour Q variété Riemannienne de dimension d , on note :

- TQ et T^*Q , les fibrés tangent et cotangent,
- Π_Q et Π_Q^* , les opérateurs de projection naturels de TQ et T^*Q ,
- $\langle \cdot, \cdot \rangle_q$, le produit de dualité local entre l'espace tangent T_qQ et l'espace cotangent T_q^*Q ,
- $(\cdot, \cdot)_q$ et $\|\cdot\|_q$, le produit scalaire et la norme de T_qQ (une $*$ sera ajoutée dans le cas des produits scalaires et norme sur T^*Q),
- \flat (et $\sharp = \flat^{-1}$, son inverse), l'isomorphisme de fibrés vectoriel entre TQ et T^*Q , naturellement induit par la métrique Riemannienne de Q .

La vitesse abstraite $\dot{q}(t) \in TQ$ d'un mouvement $q(t)$ sera notée alternativement $(q(t), \dot{q}(t))$. Cette notation est clairement redondante puisque le point de base $q = \Pi_Q(\dot{q})$ est contenu dans la dérivée, mais cette notation facilite néanmoins la lecture. Plus généralement, un élément v de TQ sera aussi noté (q, v) où q est le point de base de v .

Toute carte (locale) ψ de la variété de configuration est appelée *paramétrisation (locale)*. Pour toute configuration abstraite $q \in Q$, $\psi(q)$ est un élément de \mathbb{R}^d que l'on notera (q^1, q^2, \dots, q^d) . On commettra systématiquement l'abus de notation consistant à confondre $\psi(q)$ et q , est on pourra ainsi écrire $q = (q^1, q^2, \dots, q^d)$. La base naturelle de T_qQ (resp. T_q^*Q) naturellement associée à la carte ψ est notée $(e_1(q), e_2(q), \dots, e_d(q))$ (resp. $(e^1(q), e^2(q), \dots, e^d(q))$). Pour (q, v) élément de TQ , on notera v^i ($i = 1, 2, \dots, d$) ses composantes dans la base naturelle et on écrira :

$$v = v^i e_i(q).$$

La convention d'Einstein de sommation sur les indices répétés s'appliquera toujours, sauf mentionné explicitement. Comme souvent, $g_{ij}(q)$ seront les composantes covariantes de la métrique dans la carte considérée et $g^{ij}(q)$ ses composantes contravariantes ; $\Gamma_{jk}^i(q)$ seront les symboles de Christoffel associés :

$$\Gamma_{jk}^i(q) = \frac{1}{2} g^{ih}(q) \left(\frac{\partial g_{hk}}{\partial q^j}(q) + \frac{\partial g_{jh}}{\partial q^k}(q) - \frac{\partial g_{jk}}{\partial q^h}(q) \right).$$

Si $q(t)$ désigne une courbe sur Q et v un champ de vecteur sur cette courbe, la dérivée covariante de v suivant $q(t)$ sera notée :

$$\frac{D}{dt}v(t) = \left(\frac{d}{dt}v^i(t) + \Gamma_{jk}^i(q(t))v^j(t)\dot{q}^k(t) \right) e_i(q(t)).$$

2.1.2 Formulation de la dynamique

Considérons un système de solides rigides de variété de configuration Q , et un mouvement $q(t)$ de ce système. La *puissance des efforts d'inertie* à l'instant t est, par définition, la dérivée par rapport au temps, à t , de l'énergie cinétique :

$$\frac{d}{dt}K(q, \dot{q}) = \frac{1}{2} \frac{d}{dt} (\dot{q}(t), \dot{q}(t))_{q(t)} = \left(\frac{D}{dt} \dot{q}(t), \dot{q}(t) \right)_{q(t)} = \left\langle \flat \frac{D}{dt} \dot{q}(t), \dot{q}(t) \right\rangle_{q(t)}.$$

Ainsi, la puissance des efforts d'inertie à l'instant t fait apparaître le vecteur cotangent $\flat D\dot{q}(t)/dt \in T_{q(t)}^*Q$. Comme les éléments de T_qQ sont souvent appelés *vitesse virtuelle* du

système dans la configuration q , la forme linéaire $\flat D\dot{q}(t)/dt$ est appelée *puissance virtuelle des efforts d'inertie*.

L'analyse de la dynamique est amenée à prendre en considération des efforts extérieurs et intérieurs au système. Ils définissent une forme linéaire $f \in T_q^*Q$ sur chaque espace tangent à la variété de configuration, que l'on appelle classiquement *puissance virtuelle des efforts extérieurs et intérieurs*. La raison qui sous-tend cette modélisation des efforts par dualité est que cela assure la cohérence de la modélisation des efforts avec la description géométrique du système. La forme linéaire $f(q, \dot{q}; t) \in T_q^*Q$ est autorisée à dépendre du temps, mais aussi de l'état actuel du système.

Le principe fondamental de la mécanique classique requiert que la puissance virtuelle des efforts d'inertie soit égale, à chaque instant, à la puissance virtuelle des efforts extérieurs et intérieurs :

$$\forall t, \quad \flat \frac{D}{dt} \dot{q}(t) = f(q(t), \dot{q}(t), t). \quad (2.1)$$

On appellera dans la suite, l'équation (2.1), ainsi obtenue, *l'équation du mouvement*. Il s'agit d'une équation différentielle du second ordre sur la variété de configuration. Pour l'exprimer dans une paramétrisation donnée du système, la proposition suivante est utile.

Proposition 1 (Lagrange) *Soient ψ une carte locale et $q(t)$ un mouvement de classe C^2 sur Q . Alors :*

$$\flat \frac{D}{dt} \dot{q}(t) = \left(\frac{d}{dt} \frac{\partial}{\partial \dot{q}^i} K(q(t), \dot{q}(t)) - \frac{\partial}{\partial q^i} K(q(t), \dot{q}(t)) \right) e^i(q(t)).$$

Se donnant un instant initial t_0 et un état initial $(q_0, v_0) \in TQ$, la problème d'évolution associé à la dynamique du système de solides rigides est le problème de Cauchy :

Problème I. Trouver $T > t_0$ et $q \in C^2([t_0, T]; Q)$ tels que :

- $(q(t_0), \dot{q}(t_0)) = (q_0, v_0)$,
- $\forall t \in [t_0, T[, \quad \flat \frac{D}{dt} \dot{q}(t) = f(q(t), \dot{q}(t), t)$.

2.1.3 Caractère bien-posé de la dynamique

Pour étudier le caractère bien-posé (existence et unicité de solution) du problème I, il faut se donner des hypothèses de régularité sur Q et f .

Contre-exemple 1. Considérons le problème d'évolution

$$\frac{d^2}{dt^2} q(t) = 6 |q(t)|^{\frac{1}{3}}$$

($q \in \mathbb{R}$) à partir de la condition initiale $(q(0), \dot{q}(0)) = (0, 0)$. On vérifie immédiatement que les deux mouvement définis sur \mathbb{R}^+ $q(t) = 0$ et $q(t) = t^3$ fournissent deux solutions distinctes.

Pour obtenir existence et unicité de solution au problème de Cauchy, on est donc amené à devoir faire des hypothèses supplémentaires. On distinguera deux classes de telles hypothèses : les hypothèses dites *constitutives*, et les hypothèses dites de *régularité*. Une hypothèse constitutive est une hypothèse qui véhicule un contenu physique, alors que les

hypothèses de régularité ne véhiculent aucun contenu physique et sont faites uniquement en vue d'éliminer des pathologies mathématiques. L'hypothèse de régularité suivante est légèrement plus forte que nécessaire.

Hypothèse de régularité. La variété Riemannienne de configuration est de classe C^2 et l'application $f : TQ \times \mathbb{R} \rightarrow T^*Q$ est de classe C^1 .

Il faut souligner que la première partie de cette hypothèse n'est, en fait, pas une hypothèse. La variété de configuration du solide rigide tridimensionnel, ou de la barre infiniment fine, ou de la particule ponctuelle, avec des distributions de masse arbitraires, définissent des variétés Riemanniennes de classe C^∞ (ou même, analytiques). La variété de configuration d'un système de solides rigides (sans liaisons), étant produit Cartésien de telles variétés, peut être supposée de régularité arbitraire. Il ne s'agit ni d'une restriction sur la géométrie du système, ni sur la distribution de masse, mais sur la classe des paramétrisations admissibles.

Sous cette hypothèse de régularité, on a le résultat d'existence et d'unicité suivant.

Théorème 2 (Cauchy) *Le problème I admet une unique solution maximale.*

Plus précisément, le théorème 2 exprime qu'il existe $T_m > t_0$ ($T_m \in \mathbb{R} \cup \{+\infty\}$) et $q_m \in C^2([t_0, T_m[, Q)$ solution du problème I telle que toute autre solution du problème I est une restriction de q_m . Bien sûr, on attend $T_m = +\infty$, auquel cas la dynamique est dite *éternelle*. Ce fait peut cependant être mis en défaut.

Contre-exemple 2. Considérons le problème d'évolution :

$$\frac{d^2}{dt^2}q(t) = (\dot{q}(t))^2$$

($q \in \mathbb{R}$) à partir de la condition initiale $(q(0), \dot{q}(0)) = (0, 1)$. On vérifie aisément que la solution maximale est définie seulement sur l'intervalle $[0, 1[$.

Dans les cas rencontrés habituellement en mécanique, l'éternité de la dynamique est assurée par la condition suffisante générale suivante.

Théorème 3 *La variété de configuration Q est supposée être une variété Riemannienne complète (aucune hypothèse dans le cas d'un système de solides rigides sans liaisons). L'application f est supposée satisfaire l'estimation suivante :*

$$\|f(q, v; t)\|_q^* \leq l(t) \left(1 + d(q, q_0) + \|v\|_q\right),$$

pour tout $(q, v) \in TQ$ et presque tout $t \in [t_0, +\infty[$, où $d(\cdot, \cdot)$ est la distance Riemannienne et $l(t)$, une fonction (nécessairement positive) de $L_{loc}^1(\mathbb{R}; \mathbb{R})$.

Alors, la dynamique est éternelle : $T_m = +\infty$.

La preuve du théorème 3 repose sur le lemme de Gronwall.

2.2 Liaisons bilatérales parfaites

Une liaison décrit un effort (extérieur ou intérieur) qui n'est pas pris en compte par l'application f . En effet, il est possible de spécifier (partiellement) des efforts par leurs effets cinématiques. Ces effets cinématiques laissent, en général, les efforts associés indéterminés et il faut ajouter des hypothèses phénoménologiques sur la manière dont la liaison agit, au travers d'une *loi constitutive* de la liaison.

2.2.1 Description géométrique

Une *liaison bilatérale* (holonome) est une restriction sur les mouvements admissibles du système, qui s'exprime à l'aide d'un nombre fini n de fonctions numériques régulières φ_i sur la variété de configuration Q , définissant un ensemble S de configurations admissibles :

$$S = \left\{ q \in Q \mid \forall i \in \{1, 2, \dots, n\}, \quad \varphi_i(q) = 0 \right\}. \quad (2.2)$$

L'hypothèse suivante est habituelle dans ce contexte.

Hypothèse de régularité I. Les fonctions φ_i sont *fonctionnellement indépendantes*, c'est-à-dire que, pour tout $q \in S$, les $d\varphi_i(q)$ ($i \in \{1, 2, \dots, n\}$) sont linéairement indépendants dans T^*Q .

Une conséquence immédiate de cette hypothèse est que S est une sous-variété de Q de dimension $d - n$. Il en résulte que S hérite de Q d'une structure Riemannienne. On dira que S est la variété de configuration du système contraint.

2.2.2 Formulation de la dynamique

La réalisation de la liaison (2.2) exige nécessairement une modification de l'équation du mouvement (2.1). Elle est acquise par l'ajout à la puissance virtuelle des efforts extérieurs et intérieurs $f(q, \dot{q}; t)$ d'un terme correctif inconnu R appelé *puissance virtuelle des efforts de réaction* :

$$\forall t, \quad \mathfrak{b} \frac{D}{dt} \dot{q}(t) = f(q(t), \dot{q}(t), t) + R(t).$$

On pourrait s'attendre à ce que R soit déterminé par la liaison géométrique (2.2). Ce n'est pas le cas en général. Il faut ajouter des hypothèses phénoménologiques sur la manière dont la liaison agit. C'est *l'équation constitutive* de la liaison.

Hypothèse constitutive II. La liaison bilatérale (2.2) est supposée *parfaite* (on dit aussi *idéale*), c'est-à-dire que la puissance virtuelle des efforts de réaction R s'annule dans toute vitesse virtuelle compatible avec le maintien de la liaison bilatérale :

$$\forall v \in \left\{ v \in T_q Q ; \forall i \in \{1, 2, \dots, n\}, \quad \langle d\varphi_i(q), v \rangle_q = 0 \right\} \simeq TS, \quad \langle R, v \rangle_q = 0.$$

Grâce aux hypothèses I et II, on peut écrire :

$$R(t) = \sum_{i=1}^n \lambda_i(t) d\varphi_i(q),$$

pour certaines fonctions numériques λ_i .

On est maintenant en mesure de formuler le problème d'évolution associé à la dynamique des systèmes de solides rigides avec liaisons bilatérales parfaites. La condition initiale est supposée compatible avec la réalisation de la liaison : $(q_0, v_0) \in TS$.

Problème II. Trouver $T > t_0$, $q \in C^2([t_0, T]; Q)$ et n fonctions $\lambda_i \in C^0([t_0, T]; \mathbb{R})$ tels que :

- $(q(t_0), \dot{q}(t_0)) = (q_0, v_0)$,
- $\forall t \in [t_0, T], \quad q(t) \in S$,
- $\forall t \in [t_0, T], \quad \flat \frac{D_Q}{dt} \dot{q}(t) = f(q(t), \dot{q}(t), t) + \sum_{i=1}^n \lambda_i(t) d\varphi_i(q(t))$.

On a utilisé ici la notation D_Q/dt pour la dérivée covariante pour souligner le fait que la dérivée covariante s'entend par rapport à la structure Riemannienne de Q (et non par rapport à celle de S).

Soit q un point de Q , v un vecteur de $T_q Q$, et E un sous-espace de $T_q Q$. La projection orthogonale de v sur E pour le produit scalaire de $T_q Q$ induit par la structure Riemannienne de Q est noté $\text{Proj}_q [v; E]$. De même, $\text{Proj}_q^* [v^*; E^*]$ est la projection orthogonale du vecteur cotangent v^* sur le sous-espace E^* de $T_q^* Q$. Si $q(t)$ est une courbe sur la sous-variété S de Q et v un champ de vecteur sur cette courbe, alors on a ([6], p. 54) :

$$\frac{D_S v}{dt} = \text{Proj}_q \left[\frac{D_Q v}{dt}; T_q S \right].$$

Ainsi, toute solution du problème II est aussi solution du

Problème II'. Trouver $T > t_0$ et $q \in C^2([t_0, T]; S)$ tels que :

- $(q(t_0), \dot{q}(t_0)) = (q_0, v_0)$,
- $\forall t \in [t_0, T], \quad \flat \frac{D_S}{dt} \dot{q}(t) = \text{Proj}_{q(t)}^* \left[f(q(t), \dot{q}(t); t); T_{q(t)}^* S \right]$.

Réciproquement, toute solution du problème II' engendre une solution du problème II : les deux problèmes d'évolution sont équivalents.

La forme linéaire (vecteur cotangent) $\text{Proj}_q^* [f(q, \dot{q}; t); T_q^* S]$ se confond avec la restriction de la forme linéaire $f(q, \dot{q}; t)$ sur l'espace $T_q S$ des vitesses virtuelles compatibles avec la liaison bilatérale. C'est donc la puissance virtuelle des efforts extérieurs et intérieurs dans toute vitesse virtuelle compatible avec la liaison.

2.2.3 Caractère bien-posé de la dynamique

Le problème II' a formellement la même structure que le problème I. Comme les problèmes II' et II sont équivalents, les résultats de la section 2.1.3 donnent le caractère bien-posé de la dynamique des systèmes de solides rigides avec liaisons bilatérales parfaites.

Hypothèse de régularité III. La variété de configuration Q et les fonctions φ_i sont de classe C^2 et l'application $f : TQ \times \mathbb{R} \rightarrow T^*Q$ est de classe C^1 .

Proposition 4 *Les problèmes II et II' admettent une solution maximale q_m , unique.*

Un résultat d'éternité de la dynamique est fourni par le théorème 3.

L'hypothèse de régularité I peut sembler restrictive. Cependant, ne pas la faire peut conduire à des ennuis.

Contre-exemple 3. Considérons une barre rigide de longueur l , et de masse volumique homogène. Les deux extrémités de la barre sont astreintes à rester sur un cercle fixe de diamètre l . Les deux liaisons bilatérales correspondantes sont supposées parfaites. C'est un exemple simple de liaison bilatérale ne satisfaisant pas l'hypothèse de régularité I. À l'instant initial, la barre est au repos. Une force constante de direction non colinéaire à la barre est appliquée au point milieu de la barre. Le lecteur se convaincra que le problème d'évolution II correspondant, n'admet aucune solution.

Comme la modélisation des systèmes de solides rigides sans liaisons ou avec liaisons bilatérales parfaites conduit à la construction de structures mathématiques semblables, on est amené à poser la définition suivante.

Définition 5 *Un système mécanique discret est un couple (Q, f) où :*

- Q est une variété différentiable Riemannienne appelée variété de configuration.
- $f : TQ \times \mathbb{R} \rightarrow T^*Q$ est une application régulière satisfaisant :

$$\forall (q, v) \in TQ, \quad \forall t \in \mathbb{R}, \quad \Pi_Q^*(f(q, v; t)) = q,$$

appelée application d'efforts.

2.3 Liaisons unilatérales parfaites

La considération d'exemples élémentaires montre que la dynamique des systèmes de solides rigides peut conduire à des mouvements au cours desquels certains solides du système s'interpénètrent dans l'espace réel. Cela doit, bien sûr, être exclu. On est ainsi très souvent amené à vouloir ajouter des conditions supplémentaires de non-pénétration dans l'étude des systèmes mécaniques discrets. C'est un exemple simple de liaison unilatérale. Dans cette section, on se propose de discuter la prise-en-compte systématique de liaison unilatérale dans les systèmes mécaniques discrets.

2.3.1 La description géométrique

On considère un système mécanique discret de variété de configuration Q . Une *liaison unilatérale* est une restriction sur les mouvements admissibles du système qui s'exprime à l'aide d'un nombre fini n de fonctions numériques φ_i , régulières, définies sur la variété de configuration Q , de sorte que l'ensemble des configurations admissibles A est donné par :

$$A = \left\{ q \in Q \mid \forall i \in \{1, 2, \dots, n\}, \quad \varphi_i(q) \leq 0 \right\}. \quad (2.3)$$

L'ensemble de toutes les contraintes actives dans la configuration admissible $q \in A$ est défini par :

$$J(q) = \left\{ i \in \{1, 2, \dots, n\} \mid \varphi_i(q) = 0 \right\}.$$

L'hypothèse suivante est à rapprocher de l'hypothèse de régularité I de la section 2.2.1.

Hypothèse de régularité I. Les fonctions φ_i sont *fonctionnellement indépendantes* dans le sens où, pour tout $q \in A$, les $d\varphi_i(q)$ ($i \in J(q)$) sont linéairement indépendants dans T^*Q .

Considérons un mouvement $q(t)$ dans A et supposons qu'il admette une vitesse à droite $\dot{q}^+(t) \in T_{q(t)}Q$ à l'instant t . Alors $\dot{q}^+(t)$ est nécessairement élément du cône convexe fermé $V(q(t))$ de $T_{q(t)}Q$, défini par :

$$V(q(t)) = \left\{ v \in T_{q(t)}Q \mid \forall i \in J(q(t)), \quad \langle d\varphi_i(q(t)), v \rangle_{q(t)} \leq 0 \right\}.$$

On appelle $V(q)$ le cône des vitesses à droite admissibles dans la configuration q . En particulier,

$$q \in \overset{\circ}{A} \quad (i.e. \ J(q) = \emptyset) \quad \implies \quad V(q) = T_qQ.$$

Si une vitesse à gauche $\dot{q}^- \in T_qQ$ existe, alors $\dot{q}^- \in -V(q)$.

2.3.2 Formulation de la dynamique

La formulation de la dynamique suit les lignes de MOREAU [9].

Équation du mouvement

Comme pour les liaisons bilatérales, la réalisation des liaisons nécessite un certain effort de réaction R . On fait les hypothèses suivantes.

Hypothèse constitutive II. Les liaisons unilatérales sont de type *contact sans adhésion* :

$$\forall v \in V(q), \quad \langle R, v \rangle_q \geq 0.$$

Hypothèse constitutive III. Les liaisons unilatérales sont *parfaites* :

$$\forall v \in \left\{ v \in T_qQ \mid \forall i \in J(q), \quad \langle d\varphi_i(q), v \rangle_q = 0 \right\}, \quad \langle R, v \rangle_q = 0.$$

Une conséquence facile des hypothèses constitutives II and III est :

$$\exists (\lambda_i)_{i=1,2,\dots,n} \in \mathbb{R}^n, \quad R = \sum_{i=1}^n \lambda_i d\varphi_i(q), \quad \text{et} \quad \left\{ \begin{array}{l} i \in J(q) \Rightarrow \lambda_i \leq 0, \\ i \notin J(q) \Rightarrow \lambda_i = 0. \end{array} \right.$$

Ainsi, l'effort de réaction $R \in T^*Q$ est tel que :

$$-R \in N^*(q) \stackrel{\text{def}}{=} \left\{ \sum_{i=1}^n \lambda_i d\varphi_i(q) ; \forall i \in J(q), \lambda_i \geq 0, \quad \forall i \notin J(q), \lambda_i = 0 \right\}. \quad (2.4)$$

$N^*(q)$ est un cône convexe fermé de T_q^*Q et c'est le cône polaire de $V(q)$ dans la dualité (T_qQ, T_q^*Q) , le cône polaire de $V(q)$ pour la structure Euclidienne de T_qQ étant $N(q) = \#(N^*(q))$.

Considérons maintenant un mouvement $q(t)$, commençant en $q_0 \in \overset{\circ}{A}$ à l'instant t_0 avec la vitesse v_0 . Supposé continu, $q(t)$ reste dans $\overset{\circ}{A}$ pendant tout un voisinage à droite de t_0 .

Par la formule (2.4), l'effort de réaction R s'annule identiquement pendant que $q(t)$ est dans $\overset{\circ}{A}$ et le mouvement est alors gouverné par l'équation différentielle ordinaire :

$$\begin{aligned} (q(t_0), \dot{q}(t_0)) &= (q_0, v_0), \\ \flat \frac{D\dot{q}}{dt} &= f(q, \dot{q}; t). \end{aligned}$$

Supposons que la solution de ce problème de Cauchy rencontre ∂A à un instant ultérieur. Notons T le plus petit de ces instants. Le mouvement admet une vitesse à gauche v_T^- en T . Bien sûr, il se peut que : $v_T^- \notin V(q(T))$. Dans ce cas, aucun prolongement différentiable du mouvement ne peut exister dans A au-delà de T . Il faut donc abandonner l'exigence de différentiabilité. Un instant tel que T est appelé un instant *d'impact*.

La vitesse n'est donc plus nécessairement une fonction continue du temps. En supposant l'existence d'une vitesse à droite $\dot{q}^+ \in V(q)$ à chaque instant, l'équation du mouvement :

$$\flat \frac{D\dot{q}^+}{dt} = f(q, \dot{q}^+; t) + R,$$

doit donc s'entendre au sens des distributions. Comme la distribution R prend ses valeurs dans un cône, en vertu de (2.4), c'est une mesure (vectorielle) plutôt qu'une distribution générale.

On note $MAM(I; Q)$ (mouvements à accélération mesure) l'ensemble des fonctions continues $q(t)$ de l'intervalle réel I dans Q admettant une vitesse à droite $\dot{q}^+(t)$ à chaque instant t de I et telles que la fonction $\dot{q}^+(t)$ soit localement à variation bornée sur I . Naturellement, la variation bornée n'est classiquement définie que pour les fonctions à valeur dans un espace normé. Cependant, pour toute courbe absolument continue $q(t)$ sur une variété Riemannienne, le transport parallèle le long de $q(t)$ permet classiquement l'identification intrinsèque des espaces tangents à différents points de la courbe, de sorte que la définition de variation bornée s'étend facilement à la situation en jeu (on trouve une définition précise dans [1]). Tout mouvement $q \in MAM(I; Q)$ admet une vitesse à gauche \dot{q}^- et une vitesse à droite \dot{q}^+ , au sens classique à chaque instant. De plus, à chaque mouvement $q \in MAM(I; Q)$, on peut associer intrinsèquement la mesure de Stieltjes $D\dot{q}^+$ de sa vitesse à droite \dot{q}^+ . L'équation du mouvement prend alors la forme :

$$\flat D\dot{q}^+ = f(q, \dot{q}^+; t) dt + R,$$

où dt est la mesure de Lebesgue. Il nous faut maintenant donner un sens précis à la condition (2.4) lorsque R est une mesure vectorielle.

Convention. On écrira :

$$R \in -N^*(q(t))$$

pour signifier : il existe n mesures réelles négatives λ_i telles que :

$$R = \sum_{i=1}^n \lambda_i d\varphi_i(q(t)) \quad \text{et} \quad \forall i \in \{1, 2, \dots, n\}, \quad \text{Supp } \lambda_i \subset \{t \mid \varphi_i(q(t)) = 0\}. \quad (2.5)$$

Avec cette convention, la forme finale de l'équation du mouvement est :

$$R = \flat D\dot{q}^+ - f(q(t), \dot{q}^+(t); t) dt \in -N^*(q(t)) \quad (2.6)$$

Une conséquence immédiate de l'équation du mouvement est qu'un impact (c'est-à-dire, une discontinuité de la vitesse à droite \dot{q}^+) ne peut se produire qu'à un instant t tel que $J(q(t)) \neq \emptyset$. Ce fait justifie la définition suivante.

Définition 6 *Un impact se produisant à un instant t est dit simple si $J(q(t))$ contient exactement un seul élément. Si $J(q(t))$ contient au moins deux éléments, l'impact est dit multiple.*

L'équation constitutive des impacts

Commençons cette section par un exemple. On considère le système mécanique à un degré de liberté dont la variété de configuration est \mathbb{R} muni de sa structure Euclidienne canonique. L'application d'effort f est supposée identiquement nulle et on considère la liaison unilatérale représentée par la seule fonction $\varphi_1(q) = q$ de sorte que l'ensemble A des configurations admissibles est \mathbb{R}^- . À l'instant initial $t_0 = 0$, le système est dans l'état initial (q_0, v_0) tel que $q_0 < 0$ et $v_0 > 0$. Il résulte immédiatement de l'équation du mouvement (2.6) qu'un impact se produit nécessairement à l'instant $t = -q_0/v_0$. À cet instant, la vitesse à gauche est v_0 . La vitesse à droite peut alors prendre n'importe quelle valeur négative et quoi qu'elle soit, elle est compatible avec l'équation du mouvement.

La raison de cette indétermination réside dans la nature phénoménologique de l'interaction du système avec l'obstacle. L'information manquante doit être rajoutée.

Hypothèse constitutive IV. L'interaction du système avec l'obstacle à l'instant t est complètement déterminée par la configuration courante $q(t)$ et la vitesse à gauche courante $\dot{q}^-(t)$. En d'autres termes, on postule l'existence d'une application $\mathcal{F} : TQ \rightarrow TQ$ décrivant l'interaction du système avec l'obstacle au cours d'un impact :

$$\forall t, \quad \dot{q}^+(t) = \mathcal{F}(q(t), \dot{q}^-(t)). \quad (2.7)$$

Pour assurer sa compatibilité avec l'équation du mouvement (2.6), l'application \mathcal{F} doit satisfaire :

$$\forall q \in A, \quad \forall v^- \in -V(q), \quad \begin{aligned} \mathcal{F}(q, v^-) &\in V(q), \\ \mathcal{F}(q, v^-) - v^- &\in -N(q). \end{aligned} \quad (2.8)$$

On ajoute en plus l'exigence que l'énergie cinétique du système ne peut augmenter au cours d'un impact :

$$\forall q \in A, \quad \forall v^- \in -V(q), \quad \|\mathcal{F}(q, v^-)\|_q \leq \|v^-\|_q. \quad (2.9)$$

Commentons un peu l'hypothèse IV. Lorsque deux solides se percutent, leur rebond est en fait gouverné par la propagation des ondes de déformations dans chacun de ces deux solides. Mais, depuis le début, le choix a été fait de se placer dans le cadre où les deux solides ont été idéalisés comme rigides, c'est-à-dire, que par commodité, on a choisi de ne pas prendre en considération les déformations éventuelles de ces solides. Il en résulte qu'on ne peut évidemment pas attendre de la théorie qu'elle prédise l'issue d'une expérience d'impact. Le but de l'hypothèse constitutive IV est de réintroduire dans la théorie l'information manquante. Bien sûr, en pratique, il faudra identifier l'application \mathcal{F} . Comme pour toute loi constitutive, cela pourra être fait, soit au moyen d'expériences, soit en utilisant une théorie plus fine. Par exemple, la théorie de l'élastodynamique pourrait être utilisée pour

calculer l'issue d'un impact dans chaque configuration d'impact. Le résultat serait alors une proposition pour l'application \mathcal{F} . Dans tous les cas, l'identification de l'application \mathcal{F} requiert un très gros travail, qu'il soit théorique ou expérimental. C'est le prix à payer pour décrire des phénomènes physiques complexes dans un cadre de travail simplifié. En fait, ce problème se rencontre dans toute théorie mécanique, et quelle qu'elle soit la question se pose de savoir quelle est la quantité d'information constitutive à rajouter dans la théorie. La plupart du temps, le caractère bien posé du problème d'évolution associé à la dynamique sert de guide.

Définition 7 L'équation (2.7), où l'application \mathcal{F} satisfait les axiomes (2.8) et (2.9) est appelée l'équation constitutive des impacts. Une équation constitutive des impacts qui assure la conservation de l'énergie cinétique au cours d'un impact :

$$\forall q \in A, \quad \forall v^- \in -V(q), \quad \|\mathcal{F}(q, v^-)\|_q = \|v^-\|_q,$$

est dite élastique.

Il existe toujours beaucoup d'applications \mathcal{F} satisfaisant les axiomes (2.8) et (2.9).

Exemple 4. Soit $e : TQ \rightarrow [0, 1]$ une fonction arbitraire. On vérifie facilement que l'application \mathcal{F} définie par :

$$\mathcal{F}(q, v^-) = \text{Proj}_q[v^-; V(q)] - e(q, v^-)\text{Proj}_q[v^-; N(q)], \quad (2.10)$$

satisfait toujours les axiomes (2.8) et (2.9). L'équation constitutive des impacts associée est souvent appelée l'équation constitutive *canonique*. Elle est élastique si et seulement si $e \equiv 1$. La fonction e est classiquement appelée le coefficient de *restitution*.

La raison pour laquelle l'équation constitutive canonique est distinguée est que dans les situations où seuls des impacts *simples* peuvent se produire (par exemple, si la contrainte unilatérale est représentée par une seule fonction φ_1), alors, l'équation constitutive des impacts ne peut être que l'équation canonique (c'est une conséquence directe des axiomes (2.8) et (2.9)). Cependant, en cas d'impacts multiples l'équation canonique n'a plus de pertinence physique. Un exemple simple d'impact multiple est fourni par le berceau de Newton. Le principe de l'expérience est schématisé sur la figure 2.1.a. L'issue habituellement observée est représentée sur la figure 2.1.b. Elle est à comparer avec la prédiction de l'équation constitutive canonique qui est schématisée sur la figure 2.1.c.

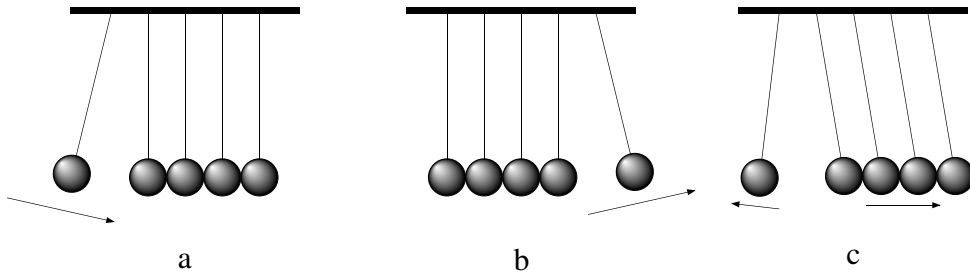

FIG. 2.1 – Le berceau de Newton.

La proposition suivante est une conséquence immédiate et utile des axiomes (2.8) et (2.9).

Proposition 8 Soit \mathcal{F} une application constitutive satisfaisant les axiomes (2.8) et (2.9). Alors, on a :

$$\forall q \in A, \quad \forall v^- \in V(q) \cap (-V(q)), \quad \mathcal{F}(q, v^-) = v^-.$$

On conclut cette section par un commentaire sur l'axiome (2.9). À première vue, il peut paraître superfétatoire. Le contre-exemple qui suit montre que, sans lui, il n'y a aucune chance de pouvoir montrer une quelconque unicité de solution au problème de Cauchy.

Contre-exemple 5. Considérons le système mécanique à un degré de liberté dont la variété de configuration est \mathbb{R} muni de sa structure Euclidienne canonique. L'application d'effort est supposée constante : $f(q, \dot{q}; t) \equiv 2$. On lui ajoute la liaison unilatérale décrite par la seule fonction $\varphi_1(q) = q$, de sorte que $A = \mathbb{R}^-$. L'équation constitutive des impacts est donnée par la formule (2.10) où le coefficient de restitution est supposé être la constante $1/2$: $e(q, \dot{q}^-) \equiv 1/2$. Ce système mécanique est une description formelle d'une particule ponctuelle soumise à la gravité et rebondissant sur un sol rigide. On considère l'état initial $(q_0, v_0) = (-1, 0)$ à l'instant $t_0 = 0$. Il est alors immédiat de vérifier que la fonction $q : \mathbb{R}^+ \rightarrow \mathbb{R}^-$ définie par :

$$\begin{aligned} \forall t \in [0, 1], & \quad q(t) = t^2 - 1, \\ \forall t \in \left[3 - \frac{1}{2^{n-1}}, 3 - \frac{1}{2^n}\right], & \quad q(t) = t^2 + \left(-6 + \frac{3}{2^n}\right)t + \left(3 - \frac{1}{2^{n-1}}\right)\left(3 - \frac{1}{2^n}\right), \\ \forall t \in [3, +\infty[, & \quad q(t) = 0, \end{aligned}$$

($n \in \mathbb{N}$), appartient à $MAM(\mathbb{R}^+; \mathbb{R}^-)$ et satisfait :

- la condition initiale,
- l'équation du mouvement (2.6) (avec $f(q, \dot{q}; t) \equiv 2$),
- l'équation constitutive des impacts (2.10) (avec $e(q, \dot{q}) \equiv 1/2$).

Le mouvement est représenté sur la figure 2.2. Remarquons au passage qu'il présente un nombre infini d'impacts sur un intervalle de temps compact. On pourrait d'ailleurs montrer qu'aucun mouvement, présentant un nombre fini d'impact sur tout sous-intervalle compact de $[0, +\infty[$, ne peut exister.

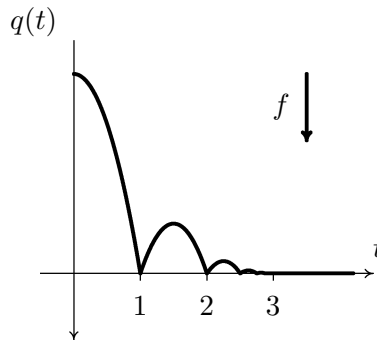

FIG. 2.2 – Mouvement d'une particule soumise à la gravité et rebondissant sur le sol.

Examinons maintenant l'effet d'un renversement de l'écoulement du temps. Définissons q' par :

$$q' \begin{cases} [0, 4] & \rightarrow \mathbb{R}^- \\ t & \mapsto q(4 - t) \end{cases}$$

Considérant l'état initial $(q_0, v_0) = (0, 0)$ à $t_0 = 0$, il est facile de voir que q' satisfait :

- la condition initiale,
- l'équation du mouvement (2.6) (avec $f(q, \dot{q}; t) \equiv 2$),
- l'équation constitutive des impacts (2.10) (avec $e(q, \dot{q}) \equiv 2$).

Mais, $q'' \equiv 0$ satisfait également les mêmes condition initiale, équation du mouvement et équation constitutive des impacts. Cet exemple montre que nous ne pouvons attendre d'unicité au problème de Cauchy en adoptant l'équation constitutive canonique (2.10) avec un coefficient de restitution $e \equiv 2$ (ou tout nombre réel strictement supérieur à 1). Mais, l'équation constitutive canonique avec coefficient de restitution coefficient strictement supérieur à 1 viole l'axiome (2.9).

Le problème d'évolution

On formule maintenant le problème d'évolution général associé à la dynamique des systèmes de solides rigides avec liaisons bilatérales et unilatérales parfaites. La condition initiale est supposée compatible avec la réalisation des liaisons : $v_0 \in V(q_0)$.

Problème III. Trouver $T > t_0$ et $q \in MAM([t_0, T[; Q)$ tels que :

- $(q(t_0), \dot{q}^+(t_0)) = (q_0, v_0)$,
- $\forall t \in [t_0, T[, \quad q(t) \in A$,
- $R \stackrel{\text{déf}}{=} \text{bD}\dot{q}^+ - f(q(t), \dot{q}^+(t); t) dt \in -N^*(q(t))$,
- $\forall t \in]t_0, T[, \quad \dot{q}^+(t) = \mathcal{F}(q(t), \dot{q}^-(t))$.

L'équation du mouvement s'entend au sens de la convention (2.5) et l'équation constitutive des impacts est supposée satisfaire les axiomes (2.8) et (2.9).

Pour l'instant, aucune hypothèse de régularité n'a été faite sur l'application f . Ce sera fait dans la prochaine section où sera donné un résultat d'existence et d'unicité de solution au problème III. On peut cependant induire de la section 2.1.3 que f sera au moins supposée de classe C^1 . On peut alors énoncer une propriété élémentaire de toute solution (s'il y en a) du problème III.

Proposition 9 (Inégalité de l'énergie) *Toute solution (T, q) au problème III satisfait :*

$$\forall t_1, t_2 \in [t_0, T[, \quad t_1 \leq t_2, \quad K(q(t_2), \dot{q}^+(t_2)) - K(q(t_1), \dot{q}^+(t_1)) = \\ \frac{1}{2} \|\dot{q}^+(t_2)\|_{q(t_2)}^2 - \frac{1}{2} \|\dot{q}^+(t_1)\|_{q(t_1)}^2 \leq \int_{t_1}^{t_2} \left\langle f(q(s), \dot{q}^+(s); s), \dot{q}^+(s) \right\rangle_{q(s)} ds$$

Preuve. Puisque :

$$\frac{1}{2} \|\dot{q}^+(t_2)\|_{q(t_2)}^2 - \frac{1}{2} \|\dot{q}^+(t_1)\|_{q(t_1)}^2 = \\ \int_{t_1}^{t_2} \left\langle \dot{q}^+(t), f(q(t), \dot{q}^+(t); t) \right\rangle_{q(t)} dt + \int_{]t_1, t_2]} \left\langle \frac{\dot{q}^+ + \dot{q}^-}{2}, R \right\rangle_q,$$

il suffit de montrer que la dernière intégrale est négative ou nulle. Posons :

$$D = \left\{ t \in]t_1, t_2] \mid \dot{q}^-(t) \neq \dot{q}^+(t) \right\}.$$

L'ensemble D est (au plus) dénombrable et donc Lebesgue-négligeable. D'un côté, on a :

$$\int_{]t_1, t_2] \setminus D} \left\langle \frac{\dot{q}^+ + \dot{q}^-}{2}, R \right\rangle_q = \int_{]t_1, t_2] \setminus D} \langle \dot{q}^+, R \rangle_q = \int_{]t_1, t_2] \setminus D} \langle \dot{q}^-, R \rangle_q,$$

où la seconde intégrale est positive en vertu de la convention (2.5) tandis que la troisième est négative. Les trois intégrales sont donc nulles. De l'autre côté,

$$\begin{aligned} \int_D \left\langle \frac{\dot{q}^+(t) + \dot{q}^-(t)}{2}, R \right\rangle_{q(t)} &= \int_D \left(\frac{\dot{q}^+(t) + \dot{q}^-(t)}{2}, D\dot{q}^+ \right)_{q(t)}, \\ &= \frac{1}{2} \sum_{t \in D} \left(\|\dot{q}^+(t)\|_{q(t)}^2 - \|\dot{q}^-(t)\|_{q(t)}^2 \right), \end{aligned}$$

qui est négatif ou nul en vertu de l'axiome (2.9). \square

2.3.3 Analyse du problème de Cauchy

Pour étudier l'existence et l'unicité de solution au problème III, il faut se donner des hypothèses régularité sur les données. Au vu de celles de la section 2.2.3, on pourrait espérer démontrer un résultat d'existence et d'unicité sous l'hypothèse que les fonctions φ_i et l'application f sont de classes C^2 et C^1 respectivement. Le contre-exemple de Bressan-Schatzman [5, 11, 1] évoqué au chapitre 1 montre que l'on ne peut pas espérer l'unicité même si les données sont de classe C^∞ .

Aldo Bressan [5] avait conjecturé que l'unicité pourrait être prouvée si les données étaient supposées *polynomiales*. Danilo Percivale [10] avait, par la suite, montré que c'était vrai (en remplaçant même l'adjectif *polynomiales* par *analytiques*) dans un cas particulier très simple à un seul degré de liberté. Le fait que l'analyticité des données était susceptible d'entraîner l'unicité de solution au problème de Cauchy a aussi été conjecturé par Michelle Schatzman [12] qui l'a montré pour le problème à un seul degré de liberté.

Hypothèse de régularité V. La variété Riemannienne de configuration, les fonctions φ_i et l'application $f : TQ \times \mathbb{R} \rightarrow T^*Q$ sont *analytiques*.

La proposition suivante montre l'existence systématique d'une solution locale *analytique*. Une preuve détaillée peut être trouvée dans [1]. Elle repose sur le fait que l'on peut construire un voisinage à droite de l'instant considéré sur lequel le statut de chaque liaison unilatérale (actif ou non-actif) est invariant. Il faut signaler qu'une démonstration similaire dans un cas un peu moins général avait été donné par Lötstedt [7] en 1982.

Proposition 10 Soient $q_0 \in A$ et $v_0 \in V(q_0)$. Alors, il existe $T_a > t_0$, une courbe analytique $q_a : [t_0, T_a[\rightarrow Q$ et n fonctions analytiques $\lambda_{ai} : [t_0, T_a[\rightarrow \mathbb{R}$ tels que :

- $(q_a(0), \dot{q}_a^+(0)) = (q_0, v_0)$,
- $\forall t \in [t_0, T_a[, \quad \mathfrak{b} \frac{D}{dt} \dot{q}_a(t) = f(q_a(t), \dot{q}_a(t); t) + \sum_{i=1}^n \lambda_{ai}(t) d\varphi_i(q_a(t))$,
- $\forall t \in [t_0, T_a[, \quad \lambda_{ai}(t) \leq 0, \quad \varphi_i(q_a(t)) \leq 0, \quad \lambda_{ai}(t) \varphi_i(q_a(t)) = 0.$
 $\forall i = 1, 2, \dots, n,$

De plus, la solution de ce problème d'évolution est unique au sens où toute autre solution analytique $(T, q, \lambda_1, \dots, \lambda_n)$ est, soit une restriction, soit un prolongement analytique de $(T_a, q_a, \lambda_{a1}, \dots, \lambda_{an})$.

Corollaire 11 *Le problème III admet une solution analytique (T_a, q_a) .*

Preuve. Considérons le mouvement q_a fourni par la proposition 10. Il satisfait, de toute évidence, la condition initiale, la liaison unilatérale et l'équation du mouvement. La seule chose qui reste à prouver est donc qu'il satisfait l'équation constitutive des impacts. Comme q_a est analytique and satisfait la liaison unilatérale, on a :

$$\forall t \in]t_0, T_a[, \quad \dot{q}_a^-(t) = \dot{q}_a^+(t) \in V(q_a(t)) \cap (-V(q_a(t))),$$

et donc :

$$\forall t \in]t_0, T_a[, \quad \dot{q}_a^+(t) = \dot{q}_a^-(t) = \mathcal{F}(q_a(t), \dot{q}_a^-(t)),$$

par la proposition 8. \square

Des résultats d'existence de solution préexistaient. Ils reposaient, soit sur l'introduction d'une pénalisation de la liaison unilatérale (comme dans [11]), soit sur l'introduction d'une discrétisation temporelle (comme dans [8]). La philosophie en était un peu différente de celle du corollaire 11. Il sont plus généraux au sens où ils travaillent sur un intervalle de temps fixé à l'avance, et dans lequel la solution va éventuellement présenter des impacts. Mais ils sont aussi moins généraux au sens où l'une et l'autre approche requièrent que la liaison unilatérale soit représentée par *une seule* fonction, ce qui est beaucoup trop réducteur pour les applications à la mécanique.

Dans le corollaire 11, cette limitation est levée, mais la solution *analytique* qu'il fournit va évidemment cesser d'exister à l'instant du premier impact. Il importe alors d'en construire un prolongement dans la classe *MAM* qui est justement assez large pour pouvoir décrire les discontinuités de vitesse des impacts. Mais la discussion de la possibilité d'un tel prolongement nécessite un résultat d'unicité local. C'est l'objet du théorème suivant qui a été prouvé pour la première fois dans [1].

Théorème 12 *Soient (T_a, q_a) la solution du problème III fournie par le corollaire 11, et (T, q) une solution arbitraire au problème III. Alors, il existe un instant T_0 ($t_0 < T_0 \leq \min\{T_a, T\}$) tel que :*

$$q|_{[t_0, T_0[} \equiv q_a|_{[t_0, T_0[}.$$

En d'autres termes, il y a unicité locale de solution au problème III.

L'unicité locale est la partie difficile de la démonstration du caractère bien-posé du problème III. Pour la preuve détaillée, le lecteur est renvoyé à [1]. En fait, dans cette référence,

la preuve est rédigée pour le cadre de travail de l'équation constitutive des impacts canonique (2.10), mais un examen attentif de cette preuve montre que l'équation constitutive des impacts canonique n'intervient qu'à travers l'inégalité de l'énergie (proposition 9). Comme cette inégalité d'énergie est satisfaite dans le cas de n'importe quelle équation constitutive des impacts satisfaisant les axiomes (2.8) and (2.9), il en est de même pour l'unicité locale.

Corollaire 13 *Le problème III admet une solution maximale unique.*

Il avait été remarqué ci-dessus que la solution analytique au problème III, fournie par le corollaire 11 cesse d'exister à l'instant du premier impact. Pour surmonter ce fait, il a été ensuite prouvé qu'il y a unicité locale dans la classe plus large de mouvement MAM qui permet de décrire les impacts. Mais, le doute subsiste que cette solution maximale puisse éventuellement cesser d'exister en temps fini pour des raisons non-physiques. Le théorème suivant, qui devrait être rapproché du théorème 3 a pour objectif de lever ces doutes.

Théorème 14 *La variété de configuration Q est supposée être une variété Riemannienne complète et l'application d'effort f est supposée satisfaire l'estimation :*

$$\|f(q, v; t)\|_q^* \leq l(t) \left(1 + d(q, q_0) + \|v\|_q\right),$$

pour tout $(q, v) \in TQ$ et presque tout $t \in [t_0, +\infty[$, où $d(\cdot, \cdot)$ est la distance Riemannienne et $l(t)$, une fonction (nécessairement positive) dans $L_{loc}^1(\mathbb{R}; \mathbb{R})$.

Alors, la dynamique est éternelle, c'est-à-dire, que la solution maximale du problème III est définie sur $[t_0, +\infty[$.

On trouvera une preuve détaillée dans [1]. Là encore, l'équation constitutive des impacts n'y intervient qu'au travers de l'inégalité de l'énergie.

Il est immédiat de vérifier que la fonction q explicitée dans le contre-exemple 5 est l'unique solution maximale du problème III correspondant à la situation en jeu. Ce mouvement présente une accumulation d'impacts à gauche de l'instant $t = 3$. Néanmoins, il existe un voisinage à droite $[t, t + \eta[$ de chaque instant $t \in \mathbb{R}^+$, tel que la restriction de q à $[t, t + \eta[$ soit analytique, ainsi que prédit par le corollaire 11. Une conséquence immédiate et générale de ceci est la suivante.

Proposition 15 *Soit q la solution maximale du problème III fournie par le corollaire 13. Bien qu'une infinité d'impacts puissent s'accumuler à gauche d'un instant donné, une telle accumulation d'impacts ne peut jamais se produire à droite d'un instant quelconque. De plus, dans le cas particulier où l'équation constitutive des impacts est élastique, les instants d'impact sont isolés et donc en nombre fini dans tout intervalle de temps compact.*

Le fait qu'une infinité d'impacts puisse s'accumuler à gauche d'un instant donné mais pas à droite est une spécificité du cadre analytique qui est perdue dans le cadre C^∞ , comme le montre l'exemple de Bressan-Schatzman. En fait, ce contre-exemple montre que les pathologies de non-unicité du cadre C^∞ sont intimement liées à la possibilité d'accumulation d'impacts à droite. Le fait que le cadre analytique empêche ces accumulations à droite est la raison profonde qui a permis de montrer l'unicité dans ce cas.

On pourrait penser que l'ensemble de cette analyse réalise pour la dynamique des systèmes discrets avec impacts sans frottement exactement ce qu'amène le théorème de Cauchy-Lipschitz à la dynamique des systèmes discrets réguliers.

En fait, il subsiste une différence de fond liée à la continuité de la dépendance à la condition initiale.

2.3.4 Continuité de la dépendance à la condition initiale

Considérons un système mécanique à deux degrés de liberté dont la variété de configuration s'identifie à \mathbb{R}^2 muni de sa structure Euclidienne canonique. On lui ajoute la liaison unilatérale décrite par les deux fonction $\varphi_1(q_1, q_2) \equiv q_2$ et $\varphi_2(q_1, q_2) \equiv q_1 + q_2$, de sorte que l'ensemble A des configurations admissibles est caractérisé par :

$$q_2 \leq 0, \quad q_1 + q_2 \leq 0.$$

L'équation constitutive des impacts est supposée être *élastique*. Cette propriété, associée à l'axiome (2.8), la détermine en toute configuration du bord de A correspondant à un impact simple et la seule indétermination qui subsiste se trouve en la seule configuration correspondant à un impact multiple, à savoir $q_1 = q_2 = 0$.

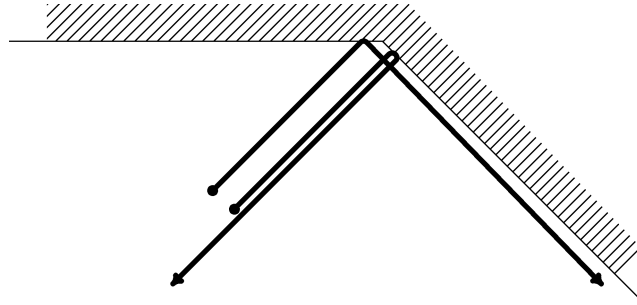

FIG. 2.3 – Dépendance non-continue de la solution par rapport à la configuration initiale.

Considérons une condition initiale telle que la trajectoire présente un impact multiple. En modifiant un tout petit peu la configuration initiale, tout en laissant inchangée la vitesse initiale, comme représenté sur la figure 2.3, on voit facilement que l'on peut obtenir des trajectoires après impact très différentes.

Cet exemple peut donner des doutes sur la pertinence de l'effort fourni pour garantir le déterminisme de la dynamique (existence et unicité de solution au problème de Cauchy). En effet, si la dépendance de la solution par rapport à la condition initiale n'est pas continue au sens de la topologie de la convergence uniforme sur tout intervalle de temps compact, comme c'est le cas dans l'exemple considéré plus haut, alors le déterminisme associé à l'unicité de solution au problème de Cauchy est purement théorique et n'est porteur d'aucune pertinence pratique. En particulier, une telle trajectoire, bien qu'unique, ne peut faire l'objet d'aucune méthode de calcul d'approximation, puisque toute erreur, aussi petite soit-elle, a de grosses conséquences.

En fait, le lecteur se convaincra facilement que la pathologie exhibée provient du fait que l'angle entre les deux liaisons unilatérales, au point où elles se croisent, *n'est pas un*

angle droit, et qu'en fait, un angle droit restaurerait la continuité. Ce fait a un caractère général, comme le montre le théorème ci-dessous, dont la démonstration se trouve aussi dans la référence [1]. La notion d'angle droit est, bien sûr, à analyser en terme du produit scalaire local sur la variété Riemannienne de configuration, c'est-à-dire en terme du produit scalaire induit par l'énergie cinétique. Pour fixer les idées, dans l'exemple d'un billard (ou bien du gaz de Boltzmann), on obtient un exemple d'impact non orthogonal, lorsque trois boules se percutent au même instant, et un impact orthogonal lorsque deux paires de boules entrent en collision au même instant, en deux endroits différents.

Théorème 16 *Soit (T, q) la solution maximale du problème III issue d'une condition initiale donnée (q_0, v_0) supposée compatible avec les liaisons à l'instant initial t_0 . On fait l'hypothèse d'orthogonalité de tous les impacts multiples que présente cette solution maximale :*

$$\forall t \in [t_0, T[, \quad (d\varphi_i(q(t)))_{i \in J(q(t))} \text{ est orthogonal dans } T_{q(t)}^*Q,$$

(avec la convention que l'ensemble vide est orthogonal). On considère une suite (q_{0n}, v_{0n}) de conditions initiales compatibles avec les liaisons et convergeant vers (q_0, v_0) dans TQ . Pour tout n , on note (T_n, q_n) la solution maximale du problème III issue de la condition initiale (q_{0n}, v_{0n}) à l'instant t_0 . Alors :

- $\liminf_{n \rightarrow +\infty} T_n \geq T$,
- (q_n) converge vers q , uniformément sur tout sous-intervalle compact de $[t_0, T[$:

$$\forall \tau \in [t_0, T[, \quad \lim_{n \rightarrow +\infty} \sup_{t \in [t_0, \tau]} d(q_n(t), q(t)) = 0,$$

- $(q_n(t), \dot{q}_n^+(t))$ converge vers $(q(t), \dot{q}^+(t))$ dans TQ , pour presque tout t appartenant à $[t_0, T[$.

Le théorème 16 redonne du poids à l'existence et unicité au problème de Cauchy III dans la mesure où les impacts non orthogonaux, et mêmes multiples seraient, comme on peut s'y attendre, des événements exceptionnels. Pour donner un statut mathématique précis à ça, il faudrait énoncer et démontrer un théorème qui dirait, en substance, « pour presque toute condition initiale, la solution maximale du problème III ne présente que des impacts simples ».

Bibliographie

- [1] P. BALLARD (2000), The dynamics of discrete mechanical systems with perfect unilateral constraints. *Archive for Rational Mechanics and Analysis* **154**, pp. 199–274.
- [2] P. BALLARD (2001), Formulation and well-posedness of the dynamics of rigid-body systems with perfect unilateral constraints. *Philosophical Transactions of the Royal Society, A* **359**, pp. 2327–2346.
- [3] P. BALLARD (2002), Formulation and well-posedness of the dynamics of rigid bodies systems with unilateral or frictional constraints. In *Advances in Mechanics and Mathematics* (D. Gao and R. Ogden, eds.), Kluwer, pp. 3–88.

- [4] P. BALLARD (2009), Frictionless unilateral multibody dynamics. In *Micromechanics of Granular Materials* (B. Cambou, M. Jean, and F. Radjaï, eds.), ISTE Ltd, pp. 317–341.
- [5] A. BRESSAN (1960), Incompatibilità dei teoremi di esistenza e di unicità del moto per un tipo molto comune e regolare di sistemi meccanici. *Annali della Scuola Normale Superiore di Pisa, Serie III* **XIV**, pp. 333–348.
- [6] I. CHAVEL (1993), *Riemannian geometry : a modern introduction*, Cambridge University Press.
- [7] P. LÖTSTEDT (1982), Mechanical systems of rigid bodies subject to unilateral constraints. *SIAM Journal of Applied Mathematics* **42**, no. 2, pp. 281–296.
- [8] M. MONTEIRO-MARQUES (1993), *Differential inclusions in nonsmooth mechanical problems*, Birkhäuser, Basel-Boston-Berlin.
- [9] J. J. MOREAU (1983), Standard inelastic shocks and the dynamics of unilateral constraints. In *Unilateral problems in structural analysis* (G. D. Piero and F. Maceri, eds.), Springer-Verlag, pp. 173–221.
- [10] D. PERCIVALE (1985), Uniqueness in the elastic bounce problem, i. *Journal of Differential Equations* **56**, pp. 206–215.
- [11] M. SCHATZMAN (1978), A class of nonlinear differential equations of second order in time. *Nonlinear Analysis, Theory, Methods & Applications* **2**, pp. 355–373.
- [12] M. SCHATZMAN (1998), Uniqueness and continuous dependence on data for one dimensional impact problems. *Mathematical and Computational Modelling* **28**, no. 4-8, pp. 1–18.

Chapitre 3

Prise en compte du frottement — Problèmes ouverts et perspectives.

La théorie présentée dans le chapitre précédent est à la fois mathématiquement cohérente et suffisamment générale pour englober les problèmes concrets issus de la mécanique, du moins tant que ceux-ci ne requièrent pas la prise en compte de frottement sec. Or, les applications, qu’elles concernent le mouvement des milieux granulaires ou les problèmes de contrôle posés par la robotique, requièrent la prise en compte du frottement. Sans lui, un robot marcheur sur un sol plat rigide et initialement au repos, est condamné à devoir rester indéfiniment au même endroit...

Il s’avère cependant que vouloir étendre la théorie pour qu’elle prenne en compte le frottement sec, ne pose pas seulement des difficultés d’ordre mathématique. La formulation même de ces problèmes ne va pas de soi. Ma conviction est que l’on ne peut pas séparer les étapes de formulation et d’analyse du problème d’évolution obtenu : il faut utiliser existence et unicité de solution au problème de Cauchy comme guide systématique de la formulation de la dynamique.

3.1 Analyse d’un problème modèle

Dans cette section, on considère un exemple simple de système discret avec contact unilatéral et frottement de Coulomb. Cet exemple est en quelque sorte le plus simple qui soit où le contact unilatéral est couplé avec des conditions de frottement sec, et il a été utilisé pour débroussailler l’analyse de stabilité d’une position d’équilibre en présence de contact et frottement [3]. Dans cet exemple, la formulation de la dynamique ne pose pas de difficulté. On montre alors que la stratégie basée sur l’analyticité des données permet ici aussi d’obtenir existence et unicité de solution au problème de Cauchy.

3.1.1 Description du problème

Le système considéré est celui introduit par Klarbring [4] dans un autre contexte. Il fournit un exemple simple de système avec obstacle où l’opérateur de rigidité élastique couple le degré de liberté normal à l’obstacle avec le degré de liberté tangentiel.

Soit $n \geq 2$ un entier. Une particule ponctuelle de masse unité dans \mathbb{R}^n évolue dans un potentiel quadratique d’énergie élastique représenté par une matrice de rigidité \mathbf{K} symé-

trique définie positive. Cette particule est astreinte à rester d'un même côté d'un hyperplan (contact unilatéral) et est supposée satisfaire la loi de frottement de Coulomb lorsque le contact avec l'hyperplan est actif. La dynamique est excitée par une force extérieure \mathbf{f} , supposée être une fonction donnée du temps. Pour $\mathbf{x} \in \mathbb{R}^n$, on note x_n sa première composante

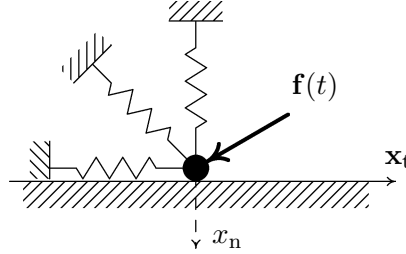

FIG. 3.1 – Le système de KLARBRING.

(« composante normale ») et \mathbf{x}_t le vecteur de \mathbb{R}^{n-1} formé par les $n - 1$ dernières composantes de \mathbf{x} (« composantes tangentielles »). On s'est donné une matrice réelle symétrique définie positive \mathbf{K} d'ordre n (matrice de rigidité). On adopte la notation :

$$\mathbf{K} = \begin{pmatrix} k_n & {}^t\mathbf{w} \\ \mathbf{w} & \mathbf{K}_t \end{pmatrix},$$

où $k_n \in \mathbb{R}$, $\mathbf{w} \in \mathbb{R}^{n-1}$ et \mathbf{K}_t est une matrice symétrique définie positive d'ordre $n - 1$. Les deux propositions suivantes sont équivalentes.

- (i) La matrice \mathbf{K} est définie positive.
- (ii) La matrice \mathbf{K}_t est définie positive et $k_n > {}^t\mathbf{w} \cdot \mathbf{K}_t^{-1} \cdot \mathbf{w}$.

Le terme \mathbf{w} couple les degrés de liberté normaux et tangentiels et sera une source de difficulté dans l'analyse du système.

On note $MAM([0, T]; \mathbb{R}^n)$ (mouvements à accélération mesure) l'espace vectoriel des fonctions intégrables de $[0, T]$ dans \mathbb{R}^n dont la dérivée seconde au sens des distributions est une mesure. On rappelle qu'une fonction \mathbf{u} dans MAM admet des dérivées à gauche et à droite (au sens classique) $\dot{\mathbf{u}}^-$ et $\dot{\mathbf{u}}^+$, en tout point, les deux étant des fonctions à variation bornée. Le problème d'évolution correspondant s'écrit au fil de la plume :

Problème \mathcal{P} . Trouver $\mathbf{u} \in MAM([0, T]; \mathbb{R}^n)$ et $\mathbf{r} \in \mathcal{M}([0, T]; \mathbb{R}^n)$ tels que :

- $\mathbf{u}(0) = \mathbf{u}_0$; $\dot{\mathbf{u}}^+(0) = \mathbf{v}_0$ (condition initiale),
- $\ddot{\mathbf{u}} + \mathbf{K} \cdot \mathbf{u} = \mathbf{f} + \mathbf{r}$, dans $[0, T]$ (équation du mouvement),
- $u_n \leq 0$, $r_n \leq 0$, $u_n r_n = 0$ (contact unilatéral),
- $\int_{[0, T]} \mathbf{r}_t \cdot (\mathbf{v} - \dot{\mathbf{u}}_t^+) - \mathcal{F} r_n (|\mathbf{v}| - |\dot{\mathbf{u}}_t^+|) \geq 0$, $\forall \mathbf{v} \in C^0([0, T]; \mathbb{R}^{n-1})$ (Coulomb),
- $u_n(t) = 0 \implies \dot{u}_n^+(t) = -e \dot{u}_n^-(t)$, dans $]0, T]$ (équation des impacts),

où \mathbf{f} est une fonction intégrable donnée de $[0, T]$ dans \mathbb{R}^n (force extérieure), \mathcal{F} une constante réelle positive ou nulle (coefficient de frottement), $e \in [0, 1]$ une constante réelle (coefficient

de restitution) et $(\mathbf{u}_0, \mathbf{v}_0)$ une condition initiale, supposée compatible avec la liaison unilatérale :

$$u_{0n} \leq 0 \quad \text{et} \quad u_{0n} = 0 \quad \implies \quad v_{0n} \leq 0.$$

3.1.2 Existence et unicité de solution

Dans le cas où la mesure \mathbf{r} est absolument continue par rapport à la mesure de Lebesgue, c'est-à-dire qu'elle s'identifie à une fonction intégrable, la loi de Coulomb admet la formulation équivalente :

$$-\dot{\mathbf{u}}_t(t) \in \partial I_{-\mathcal{F}r_n(t).B}[\mathbf{r}_t(t)], \quad \text{p. p. t. } t \in [0, T],$$

où $R.B$ désigne la boule de rayon R dans \mathbb{R}^{n-1} Euclidien et $I_{R.B}$ sa fonction indicatrice au sens de l'analyse convexe (elle vaut 0 en tout point de l'ensemble et $+\infty$ ailleurs), le sous-différentiel $\partial I_{R.B}$ s'entendant au sens de la structure Euclidienne canonique de \mathbb{R}^{n-1} . Introduisant la fonction conjuguée $\Gamma_{R.B}$ (dite fonction d'appui du convexe $R.B$), cette formulation est elle-même équivalente à :

$$\mathbf{r}_t(t) \in \partial \Gamma_{-\mathcal{F}r_n(t).B}[-\dot{\mathbf{u}}_t(t)], \quad \text{p. p. t. } t \in [0, T].$$

Exprimant \mathbf{r}_t en terme de \mathbf{u} à l'aide de l'équation du mouvement, il vient alors l'inclusion différentielle :

$$\ddot{\mathbf{u}}_t(t) + \mathbf{K}_t \cdot \mathbf{u}_t(t) + \mathbf{w} u_n(t) - \mathbf{f}_t(t) \in \partial \Gamma_{-\mathcal{F}r_n(t).B}[-\dot{\mathbf{u}}_t(t)], \quad \text{p. p. t. } t \in [0, T].$$

Le théorème suivant, dont le lecteur trouvera une démonstration détaillée dans [2], fournit une solution analytique locale et est le pendant dans la situation en jeu du théorème 10 cité dans le chapitre sur la dynamique des systèmes discrets avec liaisons unilatérales sans frottement.

Théorème 17 *Soit $\mathbf{f} : [0, T] \rightarrow \mathbb{R}^n$ une fonction analytique. Alors, il existe $T_a > 0$ et des fonctions analytiques $\mathbf{u}_a : [0, T_a[\rightarrow \mathbb{R}^n$ et $r_{an} : [0, T_a[\rightarrow \mathbb{R}$, solutions du problème :*

- $\mathbf{u}_a(0) = \mathbf{u}_0 \quad ; \quad \dot{\mathbf{u}}_a(0) = \mathbf{v}_0,$
- $\ddot{u}_{an} + k_n u_{an} + \mathbf{w} \cdot \mathbf{u}_{at} = f_n + r_{an}, \quad \text{dans } [0, T_a[,$
- $\ddot{\mathbf{u}}_{at} + \mathbf{K}_t \cdot \mathbf{u}_{at} + \mathbf{w} u_{an} - \mathbf{f}_t \in \partial \Gamma_{-\mathcal{F}r_{an}.B}[-\dot{\mathbf{u}}_{at}], \quad \text{dans } [0, T_a[,$
- $u_{an} \leq 0, \quad r_{an} \leq 0, \quad u_{an} r_{an} \equiv 0.$

De plus, toute autre solution analytique de ce problème d'évolution, est, soit une restriction, soit un prolongement analytique de cette solution.

Comme dans le cas sans frottement, on peut montrer [2] l'unicité locale de cette solution dans MAM.

Théorème 18 *Soient $F : [0, T] \rightarrow \mathbb{R}^n$ une fonction analytique, $\mathbf{u}_a : [0, T_a[\rightarrow \mathbb{R}^n$, la solution analytique locale du problème \mathcal{P} , fournie par le théorème 17 et $\mathbf{u} \in \text{MAM}([0, T]; \mathbb{R}^n)$, une solution arbitraire du problème \mathcal{P} . Alors, \mathbf{u}_a et \mathbf{u} sont identiquement égales sur un voisinage à droite de $t = 0$:*

$$\exists T' \leq T_a, \quad \forall t \in [0, T'[, \quad \mathbf{u}_a(t) = \mathbf{u}(t).$$

Le théorème 18 fournit l'existence et l'unicité d'une solution maximale dans *MAM* pour le problème \mathcal{P} . Exploitant le fait que la force extérieure :

$$f(\mathbf{u}, \dot{\mathbf{u}}; t) = \mathbf{f}(t) - \mathbf{K} \cdot \mathbf{u},$$

ne croît pas plus vite que linéairement en fonction de $(\mathbf{u}, \dot{\mathbf{u}})$, comme dans les hypothèses du théorème 14 du chapitre précédent, on peut alors montrer [2] que la dynamique est définie pour tout temps.

Corollaire 19 *Si $\mathbf{f} : [0, T] \rightarrow \mathbb{R}^n$ est analytique (ou analytique par morceaux), alors, le problème \mathcal{P} admet une unique solution dans $MAM([0, T]; \mathbb{R}^n)$.*

3.2 Extension aux systèmes mécaniques discrets

Il ne fait aucun doute que les résultats de la section précédente peuvent s'étendre au cas d'un nombre fini N de particules ponctuelles en interaction et obéissant à des conditions de contact avec frottement de Coulomb vis-à-vis d'un obstacle décrit par un nombre fini de fonctions analytiques sur la variété de configuration E^N (avec les notations du chapitre précédent).

Dans le cas où l'on a affaire à des solides rigides qui ne sont pas que des particules ponctuelles, il apparaît une difficulté que l'on va décrire au travers d'un exemple emprunté à Jean Jacques Moreau. On considère une barre rigide de masse unité répartie de façon homogène, et astreinte à se mouvoir dans un plan sous l'effet de la gravité comme représenté sur la figure 3.2. À l'instant initial, la barre est au repos dans une configuration où

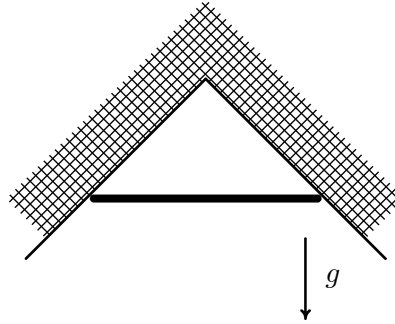

FIG. 3.2 – Un exemple simple d'indétermination.

les deux extrémités sont en contact avec un obstacle en forme de coin à angle droit. En plus des conditions de contact unilatéral, on souhaite prendre en compte des conditions de frottement. Dans ce type de situation, il est d'usage d'écrire la loi de Coulomb en chacune des deux extrémités de la barre. Si on se place dans la situation où le coefficient de frottement \mathcal{F} est strictement supérieur à 1, alors on vérifie facilement que l'immobilité est un mouvement possible de la barre, de même que la chute en position horizontale. Il peut y avoir également d'autres mouvements possibles. Cette indétermination ne peut pas être levée par des arguments de régularité.

Mon opinion concernant cette indétermination est la suivante. En mécanique classique, les efforts sont, par nature, des cofacteurs de vitesse. Les puissances virtuelles systématisent

ce point de vue, en assurant que la modélisation des efforts est cohérente (ni trop fine, ni trop grossière) avec la description géométrique adoptée. La barre décrite ci-dessus a trois degrés de liberté (deux de translation et un de rotation). Par dualité, il y aura donc trois composantes d'effort (deux de force et une de moment). La loi de frottement doit donc pouvoir se traduire en terme de ces composantes d'effort généralisé. *Ce n'est pas le cas de la loi de frottement envisagée plus haut pour la barre.* L'origine de l'indétermination évoquée ci-dessus vient du fait que l'on mélange deux points de vue : un point de vue de milieu déformable pour pouvoir parler de forces ponctuelles exercées sur les deux extrémités du système et un point de vue de solide rigide. Il faut faire un choix.

- Soit on s'en tient au point de vue de solide rigide. L'effort de réaction généralisé a alors trois composantes : une composante normale à l'obstacle et deux composantes tangentielles. La loi de frottement *doit* être formulée en terme de ces composantes. La difficulté pratique qui se pose est que cette loi ne peut être déduite de la loi de Coulomb postulée ponctuellement.
- Soit on introduit un degré de liberté supplémentaire en modélisant la barre comme un ressort dont la longueur totale est susceptible de varier. On récupère alors une quatrième composante d'effort généralisé et l'on a une relation biunivoque entre les quatre composantes d'effort généralisé d'une part et le couple de réactions de l'espace réel en chaque extrémité, d'autre part. Il est alors loisible d'identifier la loi de frottement en terme des composantes d'effort généralisé à partir de la loi de Coulomb postulée ponctuellement.

En d'autres termes, on ne peut discuter du coincement éventuel de la barre contre l'obstacle sans donner un peu d'élasticité à la barre. Plus généralement, on ne peut pas vouloir le beurre et l'argent du beurre. Si on s'en tient à un point de vue de solide rigide, la loi de frottement s'écrira en terme de convexe admissible pour la réaction tangentielle, le convexe en question étant dépendant de la réaction (généralisée) normale. La question de savoir comment ce convexe dépend de la réaction normale est un problème de loi constitutive impossible à décider en restant dans le cadre du point de vue de système de solides rigides et, en général, impossible à décider en utilisant la loi de Coulomb postulée ponctuellement. Si on veut absolument utiliser cette loi de Coulomb postulée ponctuellement (parce que c'est la seule information disponible, par exemple), alors il faudra introduire des degrés de liberté supplémentaire en rendant (partiellement) déformables les solides rigides du système.

Cette confusion de point de vue me semble très répandue, tant dans l'étude des milieux granulaires que dans les problèmes à liberté finie posés par la robotique.

La situation est encore pire si on pense au cas d'une liaison *bilatérale* avec frottement de Coulomb. Dans le cas de la dynamique d'une particule ponctuelle astreinte à rester sur une surface, le problème d'évolution écrit naïvement est un cas particulier de celui envisagé ci-dessous (problème \mathcal{P}'). Il y a donc existence et unicité de solution au problème de Cauchy. Si on veut généraliser à un solide rigide non ponctuel comme la barre évoquée plus haut, en écrivant une loi de Coulomb postulée ponctuellement comme dans l'exemple ci-dessus, alors des exemples simples montrent que l'on peut *ne pas avoir de solution* au problème de Cauchy. Un tel exemple est décrit dans la référence [5].

Pour écrire de manière systématique et cohérente, le problème d'évolution associé à la dynamique des systèmes discret avec liaisons bilatérale et frottement, on revient aux notations du chapitre précédent. On considère donc un système mécanique discret dont la variété Riemannienne de configuration est Q dont la dimension est notée d . Ce système

est astreint à satisfaire une liaison bilatérale (holonome) caractérisée par n fonctions régulières φ_i , fonctionnellement indépendantes, de sorte que l'ensemble des configurations admissibles :

$$S = \left\{ q \in Q \mid \forall i = 1, 2, \dots, n, \quad \varphi_i(q) = 0 \right\}$$

hérite d'une structure de variété Riemannienne de dimension $d - n$. La loi de frottement est caractérisée par la donnée d'un sous-ensemble convexe fermé $C(q, \dot{q}; r; t)$ de T_q^*S , dit « convexe des réactions tangentielles admissibles », où r est un élément de \mathbb{R}^n destiné à représenter l'intensité de la réaction normale. Sa fonction d'appui (au sens de la dualité (T_qS, T_q^*S)) et notée $\Gamma_{C(q, \dot{q}; r; t)}$, et le sous-différentiel de sa fonction d'appui $\partial_S \Gamma_{C(q, \dot{q}; r; t)}$ où le S rappelle que ce sous-différentiel s'entend au sens de la dualité (T_qS, T_q^*S) . Se donnant une condition initiale $(q_0, v_0) \in TS$, le problème de Cauchy correspondant à la dynamique du système discret avec liaison bilatérale et frottement s'écrit de la manière suivante.

Problème \mathcal{P}' . Trouver $T > t_0$, $q \in W^{2, \infty}([t_0, T[; Q)$ et $\lambda_i \in C^0([t_0, T[; \mathbb{R})$ ($i = 1, 2, \dots, n$) tels que :

- $(q(t_0), \dot{q}(t_0)) = (q_0, v_0)$,
- $\forall t \in [t_0, T[, \quad q(t) \in S$,
- $b \frac{D_S}{dt} \dot{q}(t) - \text{Proj}_{q(t)}^* \left[f(q(t), \dot{q}(t); t); T_{q(t)}^*S \right] \in \partial_S \Gamma_{C(q(t), \dot{q}(t); r(t))} [-\dot{q}(t)]$,
- $b \frac{D_Q}{dt} = b \frac{D_S}{dt} \dot{q}(t) + \text{Proj}_{q(t)}^* \left[f(q(t), \dot{q}(t); t); \bigoplus_{i=1}^n \mathbb{R} d\varphi_i(q(t)) \right] + \sum_{i=1}^n \lambda_i(t) d\varphi_i(q(t))$,
- $r(t) = (\lambda_1(t), \lambda_2(t), \dots, \lambda_n(t))$.

En pratique, il suffit pour les applications (voir [1]) de postuler le convexe $C(q, \dot{q}; r; t)$ sous la forme :

$$C(q, \dot{q}; r) = \left\{ \sum_{i=1}^m x_i \alpha_i(q) \mid (x_1, x_2, \dots, x_m) \in M(q) \cdot \left[C_0 + \sum_{i=1}^l \kappa_i(q, \dot{q}; r) C_i \right] \right\},$$

où :

- les α_i sont m 1-formes dans T^*S , linéairement indépendantes,
- C_0 est un convexe fermé donné dans \mathbb{R}^n , éventuellement non borné et contenant l'origine,
- les C_i ($i = 1, 2, \dots, l$) sont des convexes fermés *bornés* donnés dans \mathbb{R}^n , contenant l'origine,
- $M(q)$ est une matrice réelle, carrée d'ordre m , inversible, dépendant de façon régulière de $q \in S$,
- les $\kappa_i : TQ \times \mathbb{R} \times (\mathbb{R})^n \rightarrow \mathbb{R}^+$ sont des fonctions régulières données.

Rappelant que le domaine $\text{Dom } \Gamma_{C(q, \dot{q}; r; t)}$ est l'ensemble des points où la fonction convexe Γ prend des valeurs finies, la condition initiale $(q_0, v_0) \in TQ$ est supposée compatible avec la liaison bilatérale frottante :

$$-v_0 \in \text{Dom } \Gamma_{C(q_0, v_0; r; t_0)} \subset T_{q_0}S,$$

où il suffit que l'inclusion soit satisfaite pour un $r \in \mathbb{R}^n$, pour l'être pour tous les $r \in \mathbb{R}^n$. Sous l'hypothèse :

Hypothèse de régularité. La variété de configuration Q est de classe C^2 , l'application $f : TQ \times \mathbb{R} \rightarrow T^*Q$, les 1-formes α_i et l'application $M : q \mapsto M(q)$ sont de classe C^1 . De plus, les fonctions $\kappa_i : TQ \times \mathbb{R} \times (\mathbb{R})^n \rightarrow \mathbb{R}^+$ sont localement lipschitziennes,

on a le résultat suivant dont la démonstration est détaillée dans [1].

Théorème 20 *Le problème \mathcal{P}' admet une unique solution maximale.*

Il ne fait guère de doute qu'en suivant la démarche de la section précédente, ce résultat pourrait être étendu au cas des liaisons *unilatérales* avec frottement, dans le cas où les données sont supposées analytiques.

Bibliographie

- [1] P. BALLARD (2002), Formulation and well-posedness of the dynamics of rigid bodies systems with unilateral or frictional constraints. In *Advances in Mechanics and Mathematics* (D. Gao and R. Ogden, eds.), Kluwer, pp. 3–88.
- [2] P. BALLARD AND S. BASSEVILLE (2005), Existence and uniqueness for dynamical unilateral contact with coulomb friction : a model problem. *Mathematical Modelling and Numerical Analysis* **39**, pp. 59–77.
- [3] S. BASSEVILLE AND A. LÉGER (2006), Stability of equilibrium states of a simple system with unilateral contact and coulomb friction. *Archive of Applied Mechanics* **76**, pp. 403–428.
- [4] A. KLARBRING (1990), Example of non-uniqueness and non-existence of solutions to quasistatic contact problems. *Ingenieur-Archiv* **60**, pp. 529–541.
- [5] P. LÖTSTEDT (1982), Mechanical systems of rigid bodies subject to unilateral constraints. *SIAM Journal of Applied Mathematics* **42**, no. 2, pp. 281–296.

Deuxième partie

Problèmes de contact avec frottement en élasticité tridimensionnelle linéarisée

Chapitre 4

Contexte et motivation

On considère un corps élastique tridimensionnel évoluant en présence d'un obstacle rigide et fixe. On suppose réunies les conditions permettant de négliger l'accélération à chaque instant de sorte que l'évolution sera une succession d'équilibres (évolution quasi-statique). On supposera également toutes les transformations considérées infinitésimales à partir de la configuration de référence dénuée de contrainte, justifiant l'utilisation des équations de l'équilibre *linéarisées*.

Le problème général de contact en élasticité linéarisée ainsi posé s'écrit alors comme suit.

$$\left. \begin{array}{l} \operatorname{div} \boldsymbol{\sigma}(\mathbf{u}) + \mathbf{f}^P = \mathbf{0}, \\ \mathbf{u} = \mathbf{u}^P, \\ \mathbf{t} \stackrel{\text{déf}}{=} \boldsymbol{\sigma} \cdot \mathbf{n} = \mathbf{t}^P, \\ u_n - g^P \leq 0, \quad t_n \leq 0, \quad (u_n - g^P)t_n = 0, \\ \text{et « conditions aux limites tangentielles »,} \end{array} \right\} \begin{array}{l} \text{dans } \Omega, \\ \text{sur } \Gamma_u, \\ \text{sur } \Gamma_t, \\ \text{sur } \Gamma_c. \end{array} \quad (4.1)$$

Ici, Ω est un ouvert borné régulier donné dans \mathbb{R}^2 ou \mathbb{R}^3 , $\Gamma_u \cup \Gamma_t \cup \Gamma_c = \partial\Omega$, une partition de sa frontière en trois sous-ensembles réguliers, et \mathbf{n} la normale unitaire sortante. Comme à l'accoutumée, \mathbf{u} est le champ de déplacement (inconnu), $\boldsymbol{\sigma}(\mathbf{u})$ la contrainte de Cauchy qui lui est associée par la loi de comportement élastique linéarisée, et $\mathbf{t} = \boldsymbol{\sigma} \cdot \mathbf{n}$ les tractions surfaciques. Pour tout champ de vecteur \mathbf{v} défini sur une partie de la frontière, on écrira $\mathbf{v} = v_n \mathbf{n} + \mathbf{v}_t$, sa décomposition en parties normales et tangentielles. Les conditions de chargement sont définie par \mathbf{u}^P (déplacement de surface prescrit sur Γ_u), \mathbf{t}^P (effort surfacique prescrit sur Γ_t), \mathbf{f}^P (forces volumiques), et g^P (écart initial à l'obstacle).

Les conditions aux limites tangentielles sur Γ_c les plus simples que l'on puisse considérer sont celles associées à l'absence de frottement :

$$\mathbf{t}_t = \mathbf{0}, \quad \text{on } \Gamma_c,$$

auquel cas, le problème (4.1) se réduit au problème dit de Signorini. En lui donnant une formulation faible appropriée en terme d'inéquation, Fichera démontra en 1964 l'existence et l'unicité de solution au problème de Signorini sous des hypothèses adéquates de régularité des données. Pendant que la théorie générale des inéquations variationnelles se développait rapidement durant les années qui ont suivi, rendant possible la résolution d'une large classe

de problèmes dits à frontière libre, la question de résoudre le problème (4.1) avec des conditions aux limites tangentielles plus générales apparût [4]. Un intérêt tout particulier se concentra autour de la loi de frottement sec de Coulomb :

$$|\mathbf{t}_t| \leq -\mathcal{F}t_n, \quad \text{et,} \quad \left| \begin{array}{ll} |\mathbf{t}_t| < -\mathcal{F}t_n & \Rightarrow \quad \dot{\mathbf{u}}_t = \mathbf{0}, \\ |\mathbf{t}_t| = -\mathcal{F}t_n & \Rightarrow \quad \mathbf{t}_t = -\lambda \dot{\mathbf{u}}_t \quad \text{avec } \lambda \in \mathbb{R}^+, \end{array} \right.$$

ou bien, et c'est équivalent :

$$\forall \mathbf{v}, \quad \mathbf{t}_t \cdot (\mathbf{v} - \dot{\mathbf{u}}_t) - \mathcal{F}t_n(|\mathbf{v}| - |\dot{\mathbf{u}}_t|) \geq 0. \quad (4.2)$$

Ici, $\mathcal{F} > 0$ est le coefficient de frottement, supposé connu et le point signifie la dérivée temporelle. À cause de cette dérivée en temps, le problème (4.1) correspondant est un problème d'*évolution*, appelé parfois le problème de Signorini avec frottement de Coulomb quasi-statique. La résolution de ce problème se révéla rapidement très difficile, et beaucoup d'effort fut d'abord consacré à la situation où la vitesse tangentielle dans la loi de frottement de Coulomb, est remplacé par le déplacement tangentiel :

$$\forall \mathbf{v}, \quad \mathbf{t}_t \cdot (\mathbf{v} - \mathbf{u}_t) - \mathcal{F}t_n(|\mathbf{v}| - |\mathbf{u}_t|) \geq 0. \quad (4.3)$$

La terminologie usuelle (sans doute pas très heureuse, mais consacrée par l'usage) est d'appeler la loi (4.2), loi de Coulomb « quasi-statique » (ou tout simplement loi de Coulomb), tandis que la loi (4.3) est appelée « loi de Coulomb statique ». La raison qui motive l'étude de problème de contact avec la loi de Coulomb statique est que c'est formellement le problème qui apparaît à chaque pas de temps lorsque l'on introduit une discrétisation temporelle dans l'analyse du problème avec frottement de Coulomb quasistatique [5]. De plus, pour certains problèmes spécifiques ou modèles comme celui considéré par Spence [10] et sur lequel on reviendra par la suite, la considération de la loi statique (4.3) rend possible la résolution du problème (4.1) avec la loi de frottement originale (4.2), en multipliant simplement la solution statique par une fonction croissante du temps.

Il a été reconnu très tôt [4] que, si on remplace le seuil $\mathcal{F}t_n$ par une fonction donnée G , alors, le problème correspondant (dit problème de contact avec seuil de frottement donné) peut être résolu au moyen des techniques standards de l'optimisation qui fournissent existence et unicité de solution, sous les hypothèses de régularité appropriées pour les données. Bien entendu, ce problème de contact avec seuil de frottement donné a peu de pertinence physique puisque le frottement peut se produire y compris sur les parties du bords qui ne sont pas en contact actif avec l'obstacle. Mais, comme $\mathcal{F}t_n$ peut être calculé à partir de la solution du problème de contact avec seuil de frottement donné, on est naturellement conduit vers une stratégie de point fixe. Comme aucune propriété de contraction n'apparaît spontanément dans l'analyse, le théorème de point fixe à appliquer s'oriente vers celui de Schauder ou Tikhonov. Mais, cela nécessite de prouver des résultats techniques de régularité pour la solution du problème de contact à seuil de frottement donné. Ces résultats ont été obtenus d'abord pour une bande infinie par Nečas, Jarušek and Haslinger dans [9] en utilisant une technique de translations tangentielles, puis étendues au corps de forme arbitraire par Jarušek, dans [7]. La conséquence en était la preuve de l'existence d'une solution (solvabilité) pourvu que le coefficient de frottement soit suffisamment petit $\mathcal{F} < \mathcal{F}_c$.

4.1 Le système de Klarbring

Pour éclairer l'analyse du problème décrit précédemment, Klarbring a introduit dans [8] sa contrepartie à nombre fini de degré de liberté la plus simple qui soit.

4.1.1 Le cas du problème statique

Soit $n \geq 2$ un entier. Pour $\mathbf{u} \in \mathbb{R}^n$, on note u_n sa première composante. On considère le problème suivant.

Problème $\mathcal{P}_{\text{stat}}$. Trouver $\mathbf{u}, \mathbf{r} \in \mathbb{R}^n$ tels que :

- $\mathbf{K} \cdot \mathbf{u} = \mathbf{f} + \mathbf{r}$, (équilibre),
- $u_n \leq 0, \quad r_n \leq 0, \quad u_n r_n = 0$ (contact unilatéral),
- $\forall \mathbf{v} \in \mathbb{R}^{n-1}, \quad \mathbf{r}_t \cdot (\mathbf{v} - \mathbf{u}_t) - \mathcal{F} r_n (|\mathbf{v}| - |\mathbf{u}_t|) \geq 0$, (loi de Coulomb statique),

où les données sont $\mathbf{f} \in \mathbb{R}^n$, le coefficient de frottement $\mathcal{F} \geq 0$ et la matrice de rigidité \mathbf{K} symétrique définie positive que l'on écrira sous la forme :

$$\mathbf{K} = \begin{pmatrix} k_n & {}^t \mathbf{w} \\ \mathbf{w} & \mathbf{K}_t \end{pmatrix},$$

où $k_n \in \mathbb{R}$, $\mathbf{w} \in \mathbb{R}^{n-1}$ et \mathbf{K}_t est une matrice symétrique définie positive d'ordre $n - 1$. Les deux propositions suivantes sont équivalentes.

- (i) La matrice \mathbf{K} est définie positive.
- (ii) La matrice \mathbf{K}_t est définie positive et $k_n > {}^t \mathbf{w} \cdot \mathbf{K}_t^{-1} \cdot \mathbf{w}$.

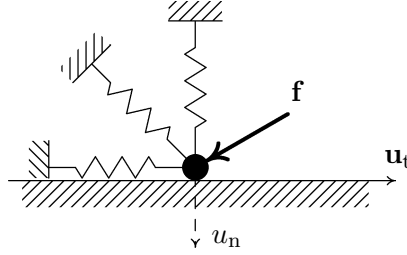

FIG. 4.1 – Le système de KLARBRING.

Le terme \mathbf{w} couple les degrés de liberté normaux et tangentiels et sera une source de difficulté dans l'analyse du système.

La contrepartie du problème à seuil de frottement imposé est alors la suivante.

Problème \mathcal{P}_{fd} . Trouver $\mathbf{u}, \mathbf{r} \in \mathbb{R}^n$ tels que :

- $\mathbf{K} \cdot \mathbf{u} = \mathbf{f} + \mathbf{r}$, (équilibre),
- $u_n \leq 0, \quad r_n \leq 0, \quad u_n r_n = 0$ (contact unilatéral),
- $\forall \mathbf{v} \in \mathbb{R}^{n-1}, \quad \mathbf{r}_t \cdot (\mathbf{v} - \mathbf{u}_t) - \mathcal{G} (|\mathbf{v}| - |\mathbf{u}_t|) \geq 0$, (loi de Coulomb statique),

où $\mathcal{G} \geq 0$ est le seuil de frottement supposé ici faire partie des données.

Proposition 21 *Pour tout $\mathcal{G} \geq 0$, le problème \mathcal{P}_{fd} admet une solution unique.*

Preuve. Introduisant le sous-ensemble fermé convexe non-vide \mathcal{K} de \mathbb{R}^n défini par :

$$\mathcal{K}(\mathcal{G}) = \left\{ \mathbf{x} \in \mathbb{R}^n \mid x_n \leq 0, \quad |\mathbf{x}_t| \leq \mathcal{G} \right\},$$

le problème \mathcal{P}_{fd} admet la reformulation équivalente :

- $\mathbf{K} \cdot \mathbf{u} = \mathbf{f} + \mathbf{r}$,
- $\mathbf{r} \in \mathcal{K}(\mathcal{G})$,
- $\forall \hat{\mathbf{r}} \in \mathcal{K}(\mathcal{G}), \quad (\mathbf{f} + \mathbf{r}) \cdot \mathbf{K}^{-1} \cdot (\hat{\mathbf{r}} - \mathbf{r}) \geq 0$,

c'est-à-dire que \mathbf{r} est la projection de $-\mathbf{f}$ sur $\mathcal{K}(\mathcal{G})$ au sens du produit scalaire \mathbf{K}^{-1} de \mathbb{R}^n . On déduit alors la conclusion annoncée de la structure d'espace de Hilbert de \mathbb{R}^n . \square

La résolution du problème \mathcal{P}_{fd} par la proposition 21 permet alors de définir l'application :

$$\Theta \begin{cases} \mathbb{R}^+ & \rightarrow \mathbb{R}^+ \\ \mathcal{G} & \mapsto \mathcal{F}r_n \end{cases}$$

où r_n est la première composante du vecteur \mathbf{r} de la solution du problème \mathcal{P}_{fd} associé à \mathcal{G} . Il est alors clair que tout point fixe de Θ définit une solution du problème $\mathcal{P}_{\text{stat}}$ et réciproquement.

Proposition 22 *L'application Θ est Lipschitzienne, de module de Lipschitz inférieur ou égal à :*

$$\mathcal{F} |\mathbf{K}_t^{-1} \cdot \mathbf{w}|,$$

où $|\cdot|$ désigne la norme Euclidienne sur \mathbb{R}^{n-1} .

Preuve. Soient $0 \leq \mathcal{G} \leq \mathcal{G}'$. On note (\mathbf{u}, \mathbf{r}) et $(\mathbf{u}', \mathbf{r}')$ les solutions des deux problèmes \mathcal{P}_{fd} correspondants. Les vecteurs \mathbf{r} et \mathbf{r}' sont donc les projections de $-\mathbf{f}$ au sens du produit scalaire \mathbf{K}^{-1} , respectivement sur $\mathcal{K}(\mathcal{G})$ et $\mathcal{K}(\mathcal{G}')$. Mais, compte-tenu de la forme particulière de ces convexes, on vérifie aisément que \mathbf{r} est la projection de $\mathbf{r}' \in \mathcal{K}(\mathcal{G}')$ sur $\mathcal{K}(\mathcal{G})$. En notant \mathbf{e} un vecteur colinéaire à \mathbf{r} arbitraire, on en déduit :

$$|r'_n - r_n| \leq |\mathcal{G}' - \mathcal{G}| \frac{\mathbf{w} \cdot \mathbf{e}}{\mathbf{K}_t \cdot \mathbf{e}} \leq |\mathcal{G}' - \mathcal{G}| |\mathbf{K}_t^{-1} \cdot \mathbf{w}|,$$

qui donne la conclusion attendue. \square

Corollaire 23 *Sous la condition :*

$$\mathcal{F} |\mathbf{K}_t^{-1} \cdot \mathbf{w}| < 1,$$

le problème $\mathcal{P}_{\text{stat}}$ admet une solution unique.

En fait, si on considère seulement l'existence de solution, on peut se passer de la condition restrictive sur le coefficient de frottement.

Proposition 24 *Quel que soit le coefficient de frottement $\mathcal{F} \geq 0$, le problème $\mathcal{P}_{\text{stat}}$ admet toujours au moins une solution.*

Preuve. On vérifie facilement :

$$\forall \mathcal{G} \in \mathbb{R}^+, \quad 0 \leq \Theta(\mathcal{G}) \leq \mathcal{F} \left(\langle f_n \rangle^+ + |\mathbf{K}_t^{-1} \cdot \mathbf{w}| |\mathbf{f}_t| \right),$$

où $\langle x \rangle = \max\{x, 0\}$ désigne la partie positive. Il en résulte que la restriction de Θ à l'intervalle

$$\left[0, \mathcal{F} \left(\langle f_n \rangle^+ + |\mathbf{K}_t^{-1} \cdot \mathbf{w}| |\mathbf{f}_t| \right) \right],$$

est une application Lipschitzienne, donc continue, à valeur dans ce même intervalle. Elle admet donc au moins un point fixe en vertu de théorème de Brouwer. \square

En se plaçant dans le cas particulier $n = 2$ (où l'on a $w, K_t \in \mathbb{R}$), il est alors facile de compter le nombre de point fixe de Θ lorsque :

$$\mathcal{F} |K_t^{-1} w| \geq 1.$$

On constate alors que ce nombre de points fixes est strictement plus grand que 1 (non-unicité de solution au $\mathcal{P}_{\text{stat}}$) si et seulement si :

$$f_n > 0, \quad \text{et} \quad f_n \leq K_t^{-1} w f_t \leq \mathcal{F} K_t^{-1} w f_n,$$

dans le cas $w > 0$.

4.1.2 Cas du problème quasi-statique

Le problème quasi-statique associé au système de Klarbring s'écrit immédiatement.

Problème $\mathcal{P}_{\text{quasistat}}$. Trouver $\mathbf{u}, \mathbf{r} \in W^{1,1}([0, T]; \mathbb{R}^n)$ tels que :

- $\mathbf{u}(0) = \mathbf{u}_0$,
- $\mathbf{K} \cdot \mathbf{u}(t) = \mathbf{f}(t) + \mathbf{r}(t), \quad \forall t \in [0, T]$,
- $u_n(t) \leq 0, \quad r_n(t) \leq 0, \quad u_n(t) r_n(t) = 0, \quad \forall t \in [0, T]$,
- $\forall \mathbf{v} \in \mathbb{R}^{n-1}, \quad \mathbf{r}_t(t) \cdot (\mathbf{v} - \dot{\mathbf{u}}_t(t)) - \mathcal{F} r_n(t) (|\mathbf{v}| - |\dot{\mathbf{u}}_t(t)|) \geq 0, \quad \text{p.p.t. } t \in [0, T]$,

où la donnée initiale est choisie telle que la réaction initiale $\mathbf{K} \cdot \mathbf{u}(0) - \mathbf{f}(0)$ est compatible avec la loi de Coulomb. On supposera aussi $\mathbf{f} \in W^{1,1}([0, T]; \mathbb{R}^n)$. La référence [3] contient le premier résultat d'existence de solution pour ce type de problème. Il est obtenu sous la condition que le coefficient de frottement \mathcal{F} est inférieur à une valeur qui s'exprime uniquement en terme de la matrice de rigidité \mathbf{K} . Pour le cas particulier qui nous occupe, on a le résultat suivant [1] (qui donne une meilleure limite sur le coefficient de frottement que [3]).

Proposition 25 *Sous la condition :*

$$\mathcal{F} < \sqrt{\frac{\lambda_{\mathbf{K}_t}^{\min}}{t_{\mathbf{w}} \cdot \mathbf{K}_t^{-1} \cdot \mathbf{w}}}, \quad (4.4)$$

où $\lambda_{\mathbf{K}_t}^{\min}$ désigne la plus petite valeur propre de la matrice \mathbf{K}_t (pas de condition si $\mathbf{w} = \mathbf{0}$), le problème $\mathcal{P}_{\text{quasistat}}$ admet au moins une solution.

Évidemment, la question de l'unicité se pose. Dans [8], Klarbring dénombre les solutions du problème en vitesse associé à problème $\mathcal{P}_{\text{quasistat}}$ dans le cas particulier de la dimension $n = 2$. Lorsque la condition (4.4) est remplie (pour $n = 2$, elle se réduit à $\mathcal{F} < K_t/|w|^{-1}$), il montre l'unicité de solution pour le problème en vitesse. Lorsque que cette condition est violé, il exhibe des exemples de non-unicité de solution du problème en vitesse ou bien de non-existence, suivant les valeurs de la vitesse de chargement $\dot{\mathbf{f}}$.

Ces résultats peuvent conduire à penser que, lorsque la condition (4.4) est remplie, non seulement le problème $\mathcal{P}_{\text{quasistat}}$ admet une solution, mais que celle-ci est unique. En fait, dans [1], j'ai montré que c'est vrai si $n = 2$ ou $\mathbf{w} = \mathbf{0}$, mais, que c'est faux sinon, en général, même si $\mathbf{f} \in C^\infty([0, T]; \mathbb{R}^n)$.

Dans le cas $\mathbf{w} = \mathbf{0}$, les problèmes d'évolution qui gouvernent les degrés de liberté normaux et tangentiels sont découplés. On résoud d'abord le problème qui gouverne le degré de liberté normal. Il s'agit, à chaque instant, d'une inéquation variationnelle justiciable du théorème de Lions-Stampacchia. Une fois ce problème résolu, la fonction $r_n(t)$ devient une donnée dans l'étude du problème tangentiel. Or, on constate assez facilement que celui-ci est gouverné par un processus de raffle de Moreau. On montrera dans la partie 3 de ce mémoire que cette structure et la stratégie correspondante se retrouvent de manière systématique dans les problèmes de contact avec frottement pour les structures minces élastiques.

En revanche, dès que $\mathbf{w} \neq \mathbf{0}$, le couplage entre degrés de liberté normaux et tangentiels détruit la monotonie. Lorsque $n = 2$, la pauvreté de la géométrie contraint trop les choses pour que l'on puisse exploiter ce fait pour construire des solutions multiples. En revanche, dès que $n = 3$, on peut exploiter l'absence de monotonie pour augmenter l'écart entre deux solutions durant un intervalle de temps de durée non nulle, en ajustant correctement le chargement $\mathbf{f}(t)$. En réalisant l'accumulation d'une infinité de tels cycles de chargement sur des intervalle $[t_{n+1}, t_n]$ comme dans le contre-exemple de Bressan-Schatzman, on parvient alors à fabriquer un problème d'évolution admettant des solutions multiples, et ce, aussi petit que soit le coefficient de frottement $\mathcal{F} > 0$ (on trouvera une construction détaillée dans [1]).

Je n'ai pas beaucoup de doute qu'en supposant l'analyticité de la donnée $\mathbf{f}(t)$, et en mettant en œuvre une stratégie similaire à celle que j'ai déployée en dynamique, on parviendrait vraisemblablement à récupérer l'unicité de solution pour ce problème d'évolution. Je n'ai pas encore cherché à l'écrire, car cela ne me semble pas être la question prioritaire aujourd'hui comme je vais le développer dans la section suivante.

4.2 Retour au système de l'élasticité

La stratégie de point fixe décrite plus haut est d'un usage courant dans la pratique de construction d'approximation numérique du problème de contact avec frottement de

Coulomb. L'analyse du problème statique discrétisé se mène exactement comme celle du système de Klarbring et on montre ainsi l'existence d'un frottement critique \mathcal{F}_c pour le problème discrétisé en-dessous duquel une propriété de contraction garantit la convergence de l'algorithme itératif vers l'unique point fixe cherché. Cependant, toutes les estimations (par défaut, bien entendu) qui ont été obtenues à ce jour pour \mathcal{F}_c tendent vers zéro lorsque la finesse du maillage (sur lequel est basée la discrétisation spatiale) augmente. Ce point pose crucialement la question de l'unicité de solution pour le problème de contact (continu) avec frottement de Coulomb statique, de coefficient suffisamment faible. Cette question est toujours ouverte aujourd'hui. Hild [6] a bien exhibé des exemples de solutions multiples, mais, à condition que le coefficient de frottement \mathcal{F} soit assez grand. La question qui se pose est donc, de tels exemples de solutions multiples peuvent-ils être construits pour des coefficients de frottement \mathcal{F} arbitrairement petits, à géométrie fixée? Ou bien, existe-t-il un coefficient de frottement \mathcal{F}_c en-dessous duquel le problème de contact avec frottement statique admettrait une solution unique?

Cette problématique dépasse la simple justification de la stratégie itérative de recherche de point fixe pour calculer une approximation numérique de la solution.

Il est un fait d'expérience quotidienne qui est qu'une sollicitation lente d'un système élastique avec frottement peut être à même d'exciter une réponse vibratoire : ce serait l'origine des bruits (crissements) induits par frottement. Cependant, les résultats listés plus haut concernant tant le système de l'élasticité que le système de Klarbring rendent plausible le fait que, lors de l'évolution d'un corps élastique au-dessus d'un obstacle en présence de frottement de Coulomb, il pourrait exister une valeur critique du coefficient de frottement (dépendant de la géométrie et des modules élastiques) en dessous de laquelle l'analyse quasi-statique serait pertinente. Si tel est le cas (tout cela reste encore à prouver et à préciser), il importe de pouvoir *définir* un coefficient de frottement critique vis-à-vis de l'analyse quasi-statique.

C'est ce souhait qui avait conduit Jarušek à vouloir évaluer le coefficient de frottement critique \mathcal{F}_c en dessous duquel fonctionnait la technique de point fixe permettant de montrer la solvabilité du problème de contact avec frottement statique. Dans [5], on trouve une démonstration de solvabilité du problème de contact avec frottement statique sous la condition :

$$\mathcal{F} < \frac{\sqrt{3-4\nu}}{2(1-\nu)}, \quad \text{en dimension 2 (déformation plane),}$$

$$\mathcal{F} < \frac{1}{2}\sqrt{\frac{3-4\nu}{1-\nu}}, \quad \text{en dimension 3,}$$

dans le cas de l'élasticité homogène isotrope (ν désigne ici le coefficient de Poisson). Ces conditions sont, bien entendu, des conditions *suffisantes* de solvabilité. Cependant, vouloir définir un coefficient de frottement critique en terme de perte de solvabilité pour tout chargement ne serait pas utilisable en pratique (aucun exemple de non existence de solution pour le problème continu n'a jamais pu être exhibé à ce jour). Une définition en terme de perte d'unicité serait beaucoup plus maniable (surtout si la perte d'unicité est associée à la perte d'une propriété de contraction).

Toutes ces considérations rendent motivantes une investigation plus poussée de la question d'unicité de solution pour le problème de contact avec frottement statique. Ce sont ces considérations qui ont conduit au travail présenté dans le chapitre suivant et mené en

collaboration avec Jiří Jarušek, sur la géométrie du demi-espace dont la simplicité permet d'obtenir des résultats plus fins que ceux habituellement connus.

Bibliographie

- [1] P. BALLARD (1999), A counter-example to uniqueness in quasi-static elastic contact problems with friction. *International Journal of Engineering Science* **37**, pp. 163–178.
- [2] P. BALLARD AND J. JARUŠEK (2010), Indentation of an elastic half-space by a rigid flat punch as a model problem for analysis of contact problems with coulomb friction. *Journal of Elasticity (soumis)*.
- [3] M. COCOU, E. PRATT, AND M. RAOUS (1996), Formulation and approximation of quasistatic frictional contact. *International Journal of Engineering Science* **34**, pp. 783–798.
- [4] G. DUVAUT AND J. L. LIONS (1972), *Les inéquations en mécanique et en physique*, Dunod, Paris.
- [5] C. ECK, J. JARUŠEK, AND M. KRBEK (2005), *Unilateral contact problems in mechanics. variational methods and existence theorems.*, Monographs & Textbooks in Pure & Appl. Math. No. 270. Chapman & Hall/CRC (Taylor & Francis Group), Boca Raton - London - New York - Singapore.
- [6] P. HILD (2004), Non-unique slipping in the coulomb friction model in two-dimensional linear elasticity. *The Quarterly Journal of Mechanics and Applied Mathematics* **57**, pp. 225–235.
- [7] J. JARUŠEK (1983), Contact problems with bounded friction. *Czechoslovak Mathematical Journal* **33**, no. 108, pp. 237–261.
- [8] A. KLARBRING (1990), Example of non-uniqueness and non-existence of solutions to quasistatic contact problems. *Ingenieur-Archiv* **60**, pp. 529–541.
- [9] J. NEČAS, J. JARUŠEK, AND J. HASLINGER (1980), On the solution of the variational inequality to the signorini problem with small friction. *Bollettino dell'Unione Matematica Italiana* **5**, no. 17-B, pp. 796–811.
- [10] D. A. SPENCE (1973), An eigenvalue problem for elastic contact with finite friction. *Proceedings of the Cambridge Philosophical Society* **73**, pp. 249–268.

Chapitre 5

Étude d'un problème modèle

Dans cette partie, on considère le problème de contact avec frottement de Coulomb statique en élasticité linéarisée. On focalise l'attention sur l'exemple le plus simple qui soit : le problème de l'indentation du demi-espace bidimensionnel par un poinçon plat rigide. Ce problème a déjà fait l'objet d'un travail très astucieux de D.A Spence en 1973 [4]. La puissance de l'analyse harmonique permet une investigation plus poussée de la question d'unicité de solution pour cette géométrie particulière. L'objectif initial consistait à essayer d'exhiber des solutions multiples dans le cas de coefficient de frottement arbitrairement petit. On a, en fait, constaté que toutes les solutions ont une structure simple identique : un intervalle adhérent entouré de deux zones glissantes. En particulier, les solutions présentant des mélanges fins de zones glissantes et adhérentes sont exclues. La frontière étant franche, il est alors pertinent de faire une étude asymptotique du déplacement et des tractions surfaciques de part et d'autre de cette frontière. Des singularités, plus douces que celles de la mécanique linéaire de la rupture, sont exhibées explicitement. Elles ont une valeur universelle (elles s'appliquent au cas de géométries régulières arbitraires).

5.1 L'opérateur de Dirichlet-Neumann du demi-espace élastique bidimensionnel

5.1.1 Expression explicite

On considère un demi-espace élastique homogène isotrope en transformation infinitésimale. Un système de coordonnées Cartésiennes orthonormé (x, y, z) est choisi de telle sorte que le demi-espace est défini par : $y > 0$. Comme on se limitera dans la suite aux déformations planes, il sera commode de noter :

$$\Omega = \{(x, y) \in \mathbb{R}^2 ; y > 0\},$$

une « tranche » du demi-espace. Le coefficient de Poisson du matériau élastique sera noté $\nu \in]-1, 1/2[$, et le choix des unités sera toujours fait de sorte que le module d'Young $E = 1$.

On va d'abord rappeler l'expression explicite de la solution fondamentale du problème de Neumann pour ce demi-espace restreint à la situation des déformations planes. En d'autres termes, on va exhiber les champs de déplacement et de contrainte (indépendants de z) dans le cas où la sollicitation se réduit à une force homogène (F_x, F_y) , appliquée sur la ligne

$x = y = 0$ du bord. Le déplacement sera noté \mathbf{u} , le tenseur des déformations linéarisées $\boldsymbol{\varepsilon}(\mathbf{u})$, et le tenseur des contraintes de Cauchy $\boldsymbol{\sigma}(\mathbf{u})$.

Théorème 26 Soit $(F_x, F_y) \in \mathbb{R}^2$. Toutes les distributions tempérées $\mathbf{u} \in \mathcal{S}'(\overline{\Omega}; \mathbb{R}^2)$ telles que :

$$\forall \varphi \in C_c^\infty(\overline{\Omega}; \mathbb{R}^2), \quad \left\langle \sigma_{ij}(\mathbf{u}), \varepsilon_{ji}(\varphi) \right\rangle_{\mathcal{S}', \mathcal{S}} = F_x \varphi_x(0, 0) + F_y \varphi_y(0, 0),$$

$(C_c^\infty(\overline{\Omega}; \mathbb{R}^2))$ est l'espace des fonctions-test C^∞ à support compact dans le demi-espace fermé $\overline{\Omega}$ sont données par :

$$\begin{aligned} u_x &= F_x U_{xx}^0(x, y) + F_y U_{xy}^0(x, y) + D_x - \Omega y + (1 - \nu^2)\Sigma x, \\ u_y &= F_x U_{yx}^0(x, y) + F_y U_{yy}^0(x, y) + D_y + \Omega x - \nu(1 + \nu)\Sigma y, \end{aligned}$$

où D_x, D_y, Ω, Σ sont quatre constantes réelles arbitraires, et $U_{xx}^0, U_{xy}^0, U_{yx}^0, U_{yy}^0$ les quatre fonctions de $C^\infty(\Omega; \mathbb{R})$ définies par :

$$\begin{aligned} U_{xx}^0 &= -\frac{1 - \nu^2}{\pi} \log(x^2 + y^2) - \frac{1 + \nu}{\pi} \cdot \frac{y^2}{x^2 + y^2}, \\ U_{xy}^0 &= -\frac{(1 - 2\nu)(1 + \nu)}{\pi} \arctan \frac{x}{y} + \frac{1 + \nu}{\pi} \cdot \frac{xy}{x^2 + y^2}, \\ U_{yx}^0 &= +\frac{(1 - 2\nu)(1 + \nu)}{\pi} \arctan \frac{x}{y} + \frac{1 + \nu}{\pi} \cdot \frac{xy}{x^2 + y^2}, \\ U_{yy}^0 &= -\frac{1 - \nu^2}{\pi} \log(x^2 + y^2) + \frac{1 + \nu}{\pi} \cdot \frac{y^2}{x^2 + y^2}. \end{aligned}$$

Le champ de contrainte correspondant est donné par les trois fonctions de $C^\infty(\Omega; \mathbb{R})$ définies par :

$$\begin{aligned} \sigma_{xx}(\mathbf{u}) &= -\frac{2F_x}{\pi} \cdot \frac{x^3}{(x^2 + y^2)^2} - \frac{2F_y}{\pi} \cdot \frac{x^2 y}{(x^2 + y^2)^2} + \Sigma, \\ \sigma_{xy}(\mathbf{u}) &= -\frac{2F_x}{\pi} \cdot \frac{x^2 y}{(x^2 + y^2)^2} - \frac{2F_y}{\pi} \cdot \frac{xy^2}{(x^2 + y^2)^2}, \\ \sigma_{yy}(\mathbf{u}) &= -\frac{2F_x}{\pi} \cdot \frac{xy^2}{(x^2 + y^2)^2} - \frac{2F_y}{\pi} \cdot \frac{y^3}{(x^2 + y^2)^2}. \end{aligned}$$

En particulier, on peut prescrire la condition supplémentaire : $\lim_{\infty} \boldsymbol{\sigma}(\mathbf{u}) = \mathbf{0}$, qui fixe $\Sigma = 0$ et détermine $\boldsymbol{\sigma}(\mathbf{u})$ de façon unique. L'arbitraire qui subsiste dans \mathbf{u} , à travers les trois constantes D_x, D_y, Ω , peut être interprété comme un déplacement rigide (linéarisé) arbitraire.

Preuve. On prend la transformée de Fourier par rapport à la variable x , puis, on résout l'équation différentielle ordinaire en y ainsi obtenue, et enfin, on prend la transformée de Fourier inverse. \square

La connaissance explicite de la solution fondamentale permet de résoudre, par convolution, le problème de Neumann avec distribution arbitraire de traction surfacique (t_x, t_y) , à support compact :

$$\begin{aligned} u_x &= t_x * U_{xx}^0(x, y) + t_y * U_{xy}^0(x, y) + D_x - \Omega y, \\ u_y &= t_x * U_{yx}^0(x, y) + t_y * U_{yy}^0(x, y) + D_y + \Omega x, \end{aligned}$$

où la condition supplémentaire : $\lim_{\infty} \boldsymbol{\sigma}(\mathbf{u}) = \mathbf{0}$, a été prescrite. En conséquence, le champ de contrainte est déterminé uniquement. Il est dans $C^\infty(\Omega; \mathbb{R}^3)$, mais n'est pas de carré intégrable, en général. Il en résulte qu'aucune énergie élastique ne peut être associée à cette solution. On constate aussi que le déplacement est infini à l'infini, et, qu'aucune condition du type : $\lim_{\infty} \mathbf{u} = \mathbf{0}$, ne permet de fixer le déplacement rigide arbitraire. La seule possibilité consiste à rajouter la condition :

$$\mathbf{u} = O(\log(x^2 + y^2)), \quad \text{quand } x^2 + y^2 \rightarrow \infty,$$

pour fixer $\Omega = 0$, ce qui sera toujours supposé fait dans la suite. Dans ce cas, le déplacement de surface (\bar{u}_x, \bar{u}_y) est donné par :

$$\begin{aligned} \bar{u}_x &= -\frac{2(1-\nu^2)}{\pi} \log|x| * t_x - \frac{(1-2\nu)(1+\nu)}{2} \operatorname{sgn}(x) * t_y + D_x, \\ \bar{u}_y &= +\frac{(1-2\nu)(1+\nu)}{2} \operatorname{sgn}(x) * t_x - \frac{2(1-\nu^2)}{\pi} \log|x| * t_y + D_y. \end{aligned}$$

Pour éliminer les constantes arbitraires D_x, D_y , il est naturel de prendre la dérivée par rapport à x .

On est alors amené à prendre la dérivée au sens des distributions de la fonction localement intégrable $\log|x|$. Cette dérivée au sens des distributions ne peut pas être la fonction $g(x) = 1/x$ qui, n'étant pas localement intégrable, ne définit pas une distribution. La dérivée au sens des distributions de $f(x) = \log|x|$ est définie par l'identité :

$$\forall \varphi \in C_c^\infty(\mathbb{R}; \mathbb{R}), \quad -\int_{-\infty}^{\infty} \varphi'(x) \log|x| dx = \lim_{\varepsilon \rightarrow 0^+} \int_{-\infty}^{-\varepsilon} + \int_{\varepsilon}^{\infty} \frac{\varphi(x)}{x} dx,$$

(C_c^∞ l'espace des fonctions-test C^∞ à support compact), où la limite existe, grâce à la dérivabilité de φ en 0. Ainsi, on a, au sens des distributions :

$$\frac{d}{dx} \log|x| = \operatorname{pv} \frac{1}{x},$$

où $\operatorname{pv} 1/x$ est la distribution sur \mathbb{R} définie par :

$$\forall \varphi \in C_c^\infty(\mathbb{R}; \mathbb{R}), \quad \left\langle \operatorname{pv} \frac{1}{x}, \varphi \right\rangle = \lim_{\varepsilon \rightarrow 0^+} \int_{-\infty}^{-\varepsilon} + \int_{\varepsilon}^{\infty} \frac{\varphi(x)}{x} dx.$$

La distribution $\operatorname{pv} 1/x$ est une distribution tempérée qui n'est ni une fonction, ni même une mesure. On adopte la notation :

$$\oint_{-\infty}^{\infty} \frac{\varphi(x)}{x} dx \stackrel{\text{def}}{=} \lim_{\varepsilon \rightarrow 0^+} \int_{-\infty}^{-\varepsilon} + \int_{\varepsilon}^{\infty} \frac{\varphi(x)}{x} dx,$$

et on parlera d'intégrale en valeur principale de Cauchy.

On obtient alors le théorème suivant qui rend explicite l'opérateur de Dirichlet-Neumann du demi-espace élastique isotrope bidimensionnel.

Théorème 27 (N.I. Muskhelishvili) *Pour t_x, t_y intégrables arbitraires, on considère le problème de Neumann pour le demi-espace élastique homogène isotrope en déformation plane, associé à :*

- tractions surfaciques (t_x, t_y) ,
- pas de forces volumiques,
- les conditions suivantes à l'infini :

$$\lim_{\infty} \boldsymbol{\sigma}(\mathbf{u}) = \mathbf{0}, \quad \mathbf{u} = O(\log(x^2 + y^2)), \quad \text{quand } x^2 + y^2 \rightarrow \infty.$$

Alors, le déplacement de surface $(\bar{u}_x(x), \bar{u}_y(x))$ est donné par :

$$\begin{aligned} \frac{1}{2(1-\nu^2)} \frac{d}{dx} \bar{u}_x &= \frac{1}{\pi} \oint_{-1}^1 \frac{t_x(t)}{t-x} dt - \frac{1-2\nu}{2(1-\nu)} t_y(x), \\ \frac{1}{2(1-\nu^2)} \frac{d}{dx} \bar{u}_y &= \frac{1}{\pi} \oint_{-1}^1 \frac{t_y(t)}{t-x} dt + \frac{1-2\nu}{2(1-\nu)} t_x(x). \end{aligned}$$

Dans toute la suite, on utilisera la notation :

$$\gamma = \frac{1-2\nu}{2(1-\nu)} \in]0, 3/4[.$$

5.1.2 Analyse de l'opérateur de Dirichlet-Neumann

À cause du fait que les solutions des problèmes statiques posés sur le demi-espace 2D élastique sont en général d'énergie infinie (elles ne sont pas dans H^1), les arguments permettant de montrer existence et unicité de solution dans le cas des corps bornés ne se transposent pas directement à la situation du demi-espace. Cela vaut, en particulier, pour le problème de Signorini du demi-espace dont les solutions ne sont jamais dans H^1 .

L'expression explicite de l'opérateur de Dirichlet-Neumann du demi-espace, rappelée à la section précédente, est utilisée couramment pour ramener sur le bord les équations de problèmes élastiques posés sur le demi-espace lorsque les forces de volumes sont nulles.

Connaissant l'expression explicite de l'opérateur de Dirichlet-Neumann du demi-espace, donnée par le théorème 27, on peut faire le produit scalaire des forces surfaciques avec le déplacement de surface et intégrer sur le bord. Explicitant le déplacement de surface en terme des tractions surfaciques, cela fournit une forme quadratique prenant en argument la distribution des forces surfaciques. Le résultat suivant exprime que cette forme quadratique définit un produit scalaire sur l'espace de Hilbert $H^{-1/2}(-1, 1) \times H^{-1/2}(-1, 1)$, qui induit une norme équivalente à la norme $H^{-1/2}$. Ce fait qui ne semble pas avoir été remarqué jusqu'ici, a la vertu suivante. On a vu plus haut que le champ de contrainte de la solution fondamentale n'est pas de carré intégrable. Il en résulte que les solutions de problèmes de Neumann sur le demi-espace élastique 2D sont, en général, d'énergie infinie. Tous les résultats généraux obtenus sur les corps bornés en faisant usage de la forme bilinéaire de l'énergie élastique ne se transposent donc pas directement. Cependant, le produit scalaire induit sur $H^{-1/2}(-1, 1)$ par l'opérateur de Dirichlet-Neumann peut jouer le rôle du produit scalaire sur $H^1(\Omega)$ induit par l'énergie élastique (et l'inégalité de Korn) dans le cas du corps borné. On verra un exemple de cela dans la suite pour l'analyse du problème de Signorini sur le demi-espace.

Un élément arbitraire $f \in H^{-1/2}(-1, 1)$, prolongé par 0, définit une distribution de $H^{-1/2}(\mathbb{R})$, permettant de définir le produit de convolution $f * \log|x|$ qui est dans $H_{\text{loc}}^{1/2}$. On a alors les résultats suivants dont les démonstrations précises pourront être trouvées dans [1].

Théorème 28 *La forme bilinéaire symétrique définie sur $H^{-1/2}(]-1, 1[) \times H^{-1/2}(]-1, 1[)$ par :*

$$b(f, g) = -\frac{1}{\pi} \left\langle f, g * \log |x| \right\rangle_{H^{-1/2}, H^{1/2}},$$

est un produit scalaire qui induit une norme équivalente à celle de $H^{-1/2}(]-1, 1[)$.

On rappelle la notation :

$$\gamma = \frac{1 - 2\nu}{2(1 - \nu)} \in]0, 3/4[.$$

Le résultat suivant jouera le même rôle que l'inégalité de Korn pour le demi-espace 2D.

Théorème 29 *Sur $H^{-1/2}(]-1, 1[) \times H^{-1/2}(]-1, 1[)$, la forme bilinéaire symétrique :*

$$\begin{aligned} a[(p_1, q_1), (p_2, q_2)] &\stackrel{\text{def}}{=} -\frac{1}{\pi} \left\langle p_1, p_2 * \log |x| \right\rangle_{H^{-1/2}, H^{1/2}} + \frac{\gamma}{2} \left\langle p_1, q_2 * \text{sgn}(x) \right\rangle_{H^{-1/2}, H^{1/2}} \\ &\quad - \frac{\gamma}{2} \left\langle q_1, p_2 * \text{sgn}(x) \right\rangle_{H^{-1/2}, H^{1/2}} - \frac{1}{\pi} \left\langle q_1, q_2 * \log |x| \right\rangle_{H^{-1/2}, H^{1/2}}, \end{aligned}$$

est continue et coercive. Ainsi, elle induit une norme équivalente à celle de $H^{-1/2}(]-1, 1[) \times H^{-1/2}(]-1, 1[)$.

5.2 Application au problème de Signorini sur le demi-espace

On considère le problème de l'indentation sans frottement du demi-espace élastique de la section précédente par un poinçon plat rigide de largeur finie (voir figure 5.1). Le système d'unité est supposé choisi de sorte que la largeur du poinçon soit 2 et le module d'Young soit 1. Utilisant la connaissance explicite de l'opérateur de Neumann-Dirichlet du demi-espace (théorème 27) et étant donnée la force totale $F \geq 0$ exercée sur le poinçon, le problème est alors de trouver $t_y, u'_y \in L^1(-1, 1; \mathbb{R})$ tels que :

- $\frac{1}{\pi} \oint_{-1}^1 \frac{t_y(t)}{t-x} dt = \frac{1}{2(1-\nu^2)} u'_y(x),$ pour p.t. $x \in]-1, 1[,$
- $t_y(x) \geq 0, \quad t_y(x) \left\{ \int_0^x u'_y(t) dt - \min_{x \in [-1, 1]} \int_0^x u'_y(t) dt \right\} = 0,$ pour p.t. $x \in]-1, 1[,$
- $\int_{-1}^1 t_y(t) dt = F.$

Le théorème suivant fournit une *unique* solution explicite pour ce problème. Il semble qu'elle ait été exhibée par Muskhelishvili, qui a cherché à construire une solution réalisant un contact actif partout sous le poinçon. Le fait qu'elle soit unique résulte de l'observation faite à la section précédente de ce que l'opérateur de Dirichlet-Neumann induit une forme quadratique *définie positive*, l'énergie élastique dans le demi-espace ne pouvant être utilisée à cet effet.

Théorème 30 *Il existe une unique paire de fonctions $t_y, u'_y \in L^1(-1, 1; \mathbb{R})$ satisfaisant :*

- $\frac{1}{\pi} \oint_{-1}^1 \frac{t_y(t)}{t-x} dt = \frac{1}{2(1-\nu^2)} u'_y(x),$ pour p.t. $x \in]-1, 1[$,
- $t_y(x) \geq 0, \quad \int_0^x u'_y(t) dt \geq 0, \quad t_y(x) \int_0^x u'_y(t) dt = 0,$ pour p.t. $x \in]-1, 1[$,
- $\int_{-1}^1 t_y(t) dt = F.$

Elle est donnée par :

$$t_y(x) = \frac{F}{\pi\sqrt{1-x^2}}, \quad u'_y(x) = 0.$$

Preuve. L'espace de Hilbert $H^{-1/2}(]-1, 1[)$ est équipé du produit scalaire :

$$b(f, g) = -\frac{1}{\pi} \left\langle f, g * \log|x| \right\rangle_{H^{-1/2}, H^{1/2}},$$

en vertu du théorème 28. On pose :

$$K = \left\{ f \in H^{-1/2}(]-1, 1[) \mid \langle f, 1 \rangle_{H^{-1/2}, H^{1/2}} = F, \right. \\ \left. \text{and } \forall \varphi \in H^{1/2}(]-1, 1[), \varphi \geq 0, \langle f, \varphi \rangle \geq 0 \right\},$$

qui est clairement convexe fermé non-vidé. Alors, toute solution du problème en jeu est solution de l'inéquation variationnelle :

$$\forall p \in K, \quad b(t_y, t_y - p) \leq 0,$$

c'est-à-dire, est une projection de 0 sur K . Cela fournit existence et unicité de la solution $t_y \in H^{-1/2}(]-1, 1[)$.

L'explicitation de cette solution s'appuie sur des résultats classique concernant certaines équations intégrales singulières linéaires (voir [1]). \square

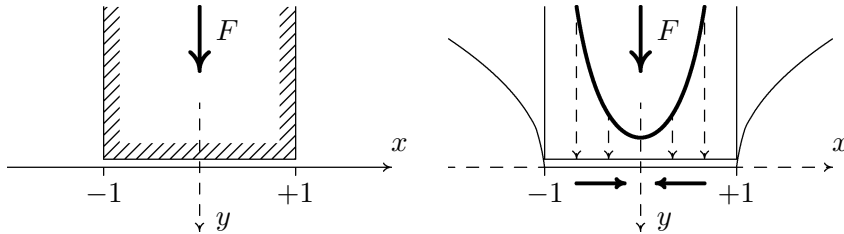

FIG. 5.1 – Indentation sans frottement du demi-espace élastique par un poinçon plat rigide.

Remarque 1. Remarquons que $t_y \notin L^2$. Le déplacement de surface peut être calculé

(modulo une constante additive arbitraire) en utilisant le théorème 27.

$$\bar{u}_x(x) = \begin{cases} -\frac{(1-2\nu)(1+\nu)F}{\pi} \arcsin(x), & \text{si } |x| < 1, \\ -\frac{(1-2\nu)(1+\nu)F}{2} \operatorname{sgn}(x) & \text{si } |x| > 1. \end{cases}$$

$$\bar{u}_y(x) = \begin{cases} 0, & \text{si } |x| < 1, \\ -\frac{2(1-\nu^2)F}{\pi} \log\left(|x| + \sqrt{x^2-1}\right), & \text{si } |x| > 1. \end{cases}$$

On voit que la composante normale du déplacement de surface est infinie à l'infini, avec la conséquence que le déplacement d'ensemble du poinçon rigide n'est pas défini. Ceci est cohérent avec le fait que, le champ de contrainte n'étant pas de carré intégrable, aucune énergie élastique ne peut être associée à cette solution. Le problème doit être paramétrisé par la force totale exercée sur le poinçon, et non pas par son déplacement. Notons aussi que le déplacement tangentiel se fait *vers l'intérieur*.

5.3 Formulation du problème d'indentation avec frottement de Coulomb

On rappelle la notation :

$$\gamma = \frac{1-2\nu}{2(1-\nu)} \in]0, 3/4[.$$

Il sera également commode de poser :

$$u(x) = \frac{1}{2(1-\nu^2)} u_y(x), \quad v(x) = \frac{1}{2(1-\nu^2)} u_x(x),$$

et, pour garder la cohérence des notations, $p = t_y$ et $q = t_x$. Étant donné le coefficient de frottement $\mathcal{F} > 0$, la composante normale $P > 0$ et la composante tangentielle $Q \in]-\mathcal{F}P, \mathcal{F}P[$ de la résultante des efforts exercés par l'expérimentateur sur le poinçon, le problème est de trouver $p, q \in L^1(-1, 1; \mathbb{R})$ et $u, v \in W^{1,1}(-1, 1; \mathbb{R})$ satisfaisant :

- $\int_{-1}^1 p(t) dt = P, \quad \int_{-1}^1 q(t) dt = Q,$
- $\frac{1}{\pi} \oint_{-1}^1 \frac{p(t)}{t-x} dt + \gamma q(x) = u'(x), \quad \text{pour p.t. } x \in]-1, 1[,$
- $\frac{1}{\pi} \oint_{-1}^1 \frac{q(t)}{t-x} dt - \gamma p(x) = v'(x), \quad \text{pour p.t. } x \in]-1, 1[,$
- $p(x) \geq 0, \quad u(x) \geq 0, \quad p(x) u(x) = 0, \quad \text{pour p.t. } x \in]-1, 1[,$
- $|q(x)| \leq \mathcal{F}p(x), \quad v(x) q(x) \leq 0, \quad \left[\mathcal{F}p(x) - |q(x)| \right] v(x) = 0, \quad \text{p.p.}$

Dans toute la suite, on se référera à ce problème de contact avec frottement de Coulomb (statique) en parlant du « problème \mathcal{P} ».

Le problème \mathcal{P} est donc le problème de contact avec frottement de Coulomb (statique) pour un milieu continu élastique, le plus simple qui soit. Comme très peu de choses sont connues sur les solutions éventuelles de ce problème (l'essentiel des résultats existant ne concernent que les problèmes discrets ou discrétisés), on se propose de mettre à profit cette simplicité pour obtenir des résultats sur cette géométrie particulière pour essayer de faire progresser l'analyse du problème général pour un corps de forme arbitraire.

5.4 Forme qualitative d'une solution arbitraire

Dans cette section, on montre que toute solution du problème \mathcal{P} présente un intervalle adhérent d'intérieur non-vide entouré de deux zones glissantes avec glissement intérieur. Ce résultat exclut en particulier les solutions qui présenteraient des mélanges fins de zones adhérentes et glissantes.

Plus précisément, on établit successivement les propositions suivantes dont les démonstrations précises se trouvent dans [1].

Proposition 31 *Toute solution du problème \mathcal{P} réalise un contact actif partout sous le poinçon :*

$$\forall x \in]-1, 1[, \quad u(x) = 0.$$

Proposition 32 *Toute zone glissante associée à une solution du problème \mathcal{P} atteint un bord du poinçon. Plus précisément :*

- si $]a, b[$ est une composante connexe de l'ouvert $\{x \in]-1, 1[\mid v(x) < 0\}$, alors $b = 1$.
- si $]a, b[$ est une composante connexe de l'ouvert $\{x \in]-1, 1[\mid v(x) > 0\}$, alors $a = -1$.

De plus, la restriction de $v(x)$ à un tel intervalle est une fonction décroissante de x .

Proposition 33 *La zone adhérente $\{x \in]-1, 1[\mid v(x) = 0\}$ est un intervalle non-vide qui ne se réduit pas à un singleton.*

Proposition 34 *La zone adhérente n'atteint aucun des bords du poinçon :*

$$\{x \in]-1, 1[\mid v(x) = 0\} = [a, b],$$

où $-1 < a < b < 1$.

Rassemblant les propositions 31, 32, 33 et 34, on a, en fait, le théorème suivant.

Théorème 35 *Toute solution du problème \mathcal{P} réalise un contact actif partout sous le poinçon ($u \equiv 0$) et présente un intervalle adhérent $[a, b]$ ($-1 < a < b < 1$) entouré de deux zones glissantes, le glissement s'effectuant vers l'intérieur :*

$$\begin{aligned} \{x \in]-1, 1[\mid v(x) > 0\} &=]-1, a[, \\ \{x \in]-1, 1[\mid v(x) = 0\} &= [a, b], \\ \{x \in]-1, 1[\mid v(x) < 0\} &=]b, 1[. \end{aligned}$$

De plus, le déplacement tangentiel $v(x)$ est une fonction décroissante de $x \in]-1, 1[$.

5.5 Estimations asymptotiques d'une solution quelconque

Le théorème 35 permet d'affirmer que la frontière entre zone adhérente et glissante est « franche ». Les résultats de cette section permettent de décrire localement la solution au voisinage d'une telle frontière. Déplacement et tractions surfaciques y présentent des singularités (douces). Compte-tenu du caractère elliptique des équations de l'élasto-statique, ces singularités sont universelles, c'est-à-dire se retrouvent dans le cas de toute géométrie régulière.

Théorème 36 *Toute solution du problème \mathcal{P} est telle que les fonctions p, q, v' sont continues sur $] -1, 1[$ et leurs restrictions à chacun des intervalles ouverts $] -1, a[$, $] a, b[$ et $] b, 1[$ sont C^∞ . De plus, elles admettent les équivalents suivants aux bords du poinçon :*

$$\begin{aligned}
 p(x) &\sim \frac{C_{-1}}{(1+x)^{1/2-\alpha}}, & q(x) &\sim -\frac{\mathcal{F}C_{-1}}{(1+x)^{1/2-\alpha}}, & v'(x) &\sim -\frac{\gamma(1+\mathcal{F}^2)C_{-1}}{(1+x)^{1/2-\alpha}}, & \text{qd } x \rightarrow -1+, \\
 p(x) &\sim \frac{C_1}{(1-x)^{1/2-\alpha}}, & q(x) &\sim \frac{\mathcal{F}C_1}{(1-x)^{1/2-\alpha}}, & v'(x) &\sim -\frac{\gamma(1+\mathcal{F}^2)C_1}{(1-x)^{1/2-\alpha}}, & \text{qd } x \rightarrow 1-,
 \end{aligned}$$

où :

$$\alpha = \frac{1}{\pi} \arctan \gamma \mathcal{F} \in]0, 1/2[,$$

et C_{-1}, C_1 sont deux constantes strictement positives. De plus, on a les équivalents suivants en a et b (transitions entre zones adhérente et glissante) :

$$\begin{aligned}
 v'(x) &\sim -C_a \sin \pi \alpha \frac{1-\gamma^2}{\gamma} (a-x)^{1/2-\alpha}, & \text{qd } x \rightarrow a-, \\
 p(x) - p(a) &\sim -C_a \sin \pi \alpha (a-x)^{1/2-\alpha} & \text{qd } x \rightarrow a-, \\
 p(x) + q(x)/\mathcal{F} &\sim C_a (x-a)^{1/2-\alpha}, & \text{qd } x \rightarrow a+, \\
 p(x) - q(x)/\mathcal{F} &\sim C_b (b-x)^{1/2-\alpha}, & \text{qd } x \rightarrow b-, \\
 v'(x) &\sim -C_b \sin \pi \alpha \frac{1-\gamma^2}{\gamma} (x-b)^{1/2-\alpha}, & \text{qd } x \rightarrow b+, \\
 p(x) - p(b) &\sim -C_b \sin \pi \alpha (x-b)^{1/2-\alpha}, & \text{qd } x \rightarrow b+,
 \end{aligned}$$

où C_a, C_b sont deux constantes strictement positives. De plus, $p(x)$ admet une dérivée à droite strictement négative en $x = a$ et une dérivée à gauche strictement positive en $x = b$.

Preuve. voir [1]. \square

Le théorème précédent permet de lire les régularités de *n'importe quelle* solution dans les échelles de Sobolev et Hölder.

Corollaire 37 *Pour toute solution du problème \mathcal{P} , les fonctions p, q, v' appartiennent à $L^{2/(1-2\alpha)-}$, et satisfont localement une condition de Hölder d'exposant $1/2 - \alpha$, où :*

$$\alpha = \frac{1}{\pi} \arctan \gamma \mathcal{F} \in]0, 1/2[.$$

Il est intéressant de remarquer que le frottement a un effet régularisant sur les singularités aux bords du poinçon : plus le coefficient de frottement \mathcal{F} est grand, plus les singularités sont faibles. En particulier, les tractions surfaciques sont dans L^2 dès que le coefficient de frottement \mathcal{F} est strictement plus grand que zéro, tandis que, dans le cas sans frottement, il a été constaté à la section 5.2 que les singularités aux bords ne sont *pas* de carré intégrable.

5.6 Investigations sur l'unicité

Dans la section 5.4, il a été montré que, pour toute solution, il existe $-1 < a < b < 1$ tels que la zone adhérente soit exactement l'intervalle $[a, b]$.

Pour l'instant, on n'est pas capable de démontrer qu'une telle solution est unique, même lorsque le coefficient de frottement \mathcal{F} est suffisamment petit. Cependant, on va montrer l'existence d'une constante $\mathcal{F}_c > 0$, dépendant seulement du coefficient de Poisson ν , telle que, pourvu que $\mathcal{F} < \mathcal{F}_c$, les intervalles adhérents $[a, b]$, $[\bar{a}, \bar{b}]$ de deux solutions distinctes ne peuvent pas se chevaucher, c'est-à-dire :

$$b \leq \bar{a}, \quad \text{or} \quad \bar{b} \leq a.$$

Cela implique, en particulier, que le nombre de solution est au plus dénombrable, pour $\mathcal{F} < \mathcal{F}_c$.

Théorème 38 *On suppose $\mathcal{F} < \mathcal{F}_c$, où \mathcal{F}_c est une constante strictement positive dépendant seulement de ν . Alors, les intervalles adhérents $[a, b]$, $[\bar{a}, \bar{b}]$ de deux solutions distinctes ne peuvent pas se chevaucher.*

Preuve. On considère deux solutions distinctes du problème \mathcal{P} d'intervalles adhérents $[a, b]$ et $[\bar{a}, \bar{b}]$. On va supposer que ces intervalles se chevauchent, c'est-à-dire, sans perte de généralité :

$$l \stackrel{\text{def}}{=} b - \bar{a} \geq 0,$$

et essayer d'exhiber une constante \mathcal{F}_c , dépendant seulement de ν , telle qu'une contradiction apparaisse pour $\mathcal{F} < \mathcal{F}_c$.

Introduisant la forme bilinéaire du théorème 29, on constate immédiatement que :

$$a \left[(p, q) - (\bar{p}, \bar{q}), (p, q) - (\bar{p}, \bar{q}) \right] \leq \mathcal{F} \int_{-1}^1 [p(x) - \bar{p}(x)] [|v(x)| - |\bar{v}(x)|] dx.$$

On note c le milieu de \bar{a} et b . Par le théorème 35, on sait que v et \bar{v} sont positives sur $] -1, c[$ et négatives sur $] c, 1[$. Dès lors :

$$\begin{aligned} a \left[(p, q) - (\bar{p}, \bar{q}), (p, q) - (\bar{p}, \bar{q}) \right] &\leq \mathcal{F} \int_{-1}^c [p(x) - \bar{p}(x)] [v(x) - \bar{v}(x)] dx \\ &\quad - \mathcal{F} \int_c^1 [p(x) - \bar{p}(x)] [v(x) - \bar{v}(x)] dx, \\ &= \mathcal{F} \left\langle p - \bar{p}, \text{sgn}(x) * [\text{sgn}(c - x)(v' - \bar{v}')] \right\rangle_{H^{-1/2}, H^{1/2}}, \\ &\leq C \mathcal{F} \|p - \bar{p}\|_{H^{-1/2}} \|v' - \bar{v}'\|_{H^{-1/2}}, \end{aligned}$$

pour une certaine constante universelle C . Maintenant, le théorème 29 entraîne :

$$\begin{aligned} \|p - \bar{p}\|_{H^{-1/2}} &\leq C_1 a \left[(p, q) - (\bar{p}, \bar{q}), (p, q) - (\bar{p}, \bar{q}) \right], \\ \|v' - \bar{v}'\|_{H^{-1/2}} &\leq C_2 a \left[(p, q) - (\bar{p}, \bar{q}), (p, q) - (\bar{p}, \bar{q}) \right], \end{aligned}$$

pour des constantes strictement positives C_1 et C_2 dépendant seulement du coefficient de Poisson ν . Mais, comme $a \left[(p, q) - (\bar{p}, \bar{q}), (p, q) - (\bar{p}, \bar{q}) \right] > 0$ pour deux solutions *distinctes*, une contradiction est atteinte dès que $CC_1C_2\mathcal{F} < 1$. \square

Bibliographie

- [1] P. BALLARD AND J. JARUŠEK (2010), Indentation of an elastic half-space by a rigid flat punch as a model problem for analysis of contact problems with coulomb friction. *Journal of Elasticity (soumis)*.
- [2] N. MUSKHELISHVILI, *Singular integral equations*, Moscow, 1946, english translation : P. Noordhoff N.V., Groningen, 1953.
- [3] H. SÖHNGEN (1954), Zur theorie der endlichen hilbert-transformation. *Mathematik Zeitschrift* **60**, pp. 31–51.
- [4] D. A. SPENCE (1973), An eigenvalue problem for elastic contact with finite friction. *Proceedings of the Cambridge Philosophical Society* **73**, pp. 249–268.
- [5] E. TITCHMARSH (1937), *Introduction to the theory of fourier integrals*, Oxford University Press.
- [6] F. TRICOMI (1957), *Integral equations*, Interscience Publishers, New York.

Chapitre 6

Conclusions et perspectives

De nombreux domaines d'applications nécessitent de décrire les couplages entre l'élasticité et le frottement sec au bord. Ces couplages semblent receler une importante richesse physique. En effet, le crissement des freins suggère que dans ces systèmes, une réponse vibratoire puisse être excitée par des chargements variants arbitrairement lentement au cours du temps, au moins dans la circonstance où le coefficient de frottement est suffisamment élevé.

Ces phénomènes ne sont pas compris aujourd'hui.

Un objectif envisageable à court ou moyen terme serait la définition (et le calcul) d'un coefficient de frottement critique (dépendant de la géométrie, du comportement et, peut-être, de la sollicitation) en dessous duquel l'analyse quasi-statique ferait sens. Cet objectif nécessite un progrès dans l'analyse du problème mathématique posé par l'évolution quasi-statique d'un corps élastique en transformation infinitésimale au-dessus d'un obstacle rigide en présence de frottement de Coulomb.

Rappelons l'état de l'art. Après introduction d'une discrétisation de l'échelle de temps, on est amené à étudier le problème avec loi de Coulomb dite « statique ».

Ce problème « statique » est lui-même encore imparfaitement compris. La contribution historique de Duvaut & Lions a consisté à remarquer que si le seuil de frottement est donné (problème statique avec frottement donné), alors les théorèmes généraux sur les inéquations variationnelles donnent immédiatement existence et unicité de solution. Cette solution contient en particulier la composante normale de la réaction exercée par l'obstacle, ce qui permet de réévaluer le seuil de frottement par la loi de Coulomb et suggère une stratégie de point fixe. Cette stratégie de point fixe est d'ailleurs utilisée sans justification tangible dans le calcul numérique de solution approchée.

Comme la propriété de contraction attendue n'apparaît pas spontanément dans l'analyse du problème, le théorème de point fixe à invoquer s'oriente vers celui de Schauder ou Tikhonov. C'est Jarušek, dans sa thèse encadrée par Nečas, qui a réussi le premier à montrer l'existence d'un tel point fixe, et donc l'existence d'une solution, pourvu que le coefficient de frottement soit suffisamment petit. Par la suite, il a obtenu des bornes explicites (en terme des modules d'élasticité) pour le coefficient de frottement. Ces bornes ne donnent que des conditions suffisantes de solvabilité. Il n'existe pas à ce jour d'évidence de non-solvabilité du problème statique pour un coefficient de frottement assez grand, et le résultat de Jarušek ne permet pas de définir de coefficient de frottement critique vis-à-vis de l'analyse quasi-statique.

En revanche, un exemple de solution multiple pour le problème statique à grand coefficient de frottement a été exhibé [1]. L'analyse qui précède, dont l'objectif initial était d'exhiber des solutions multiples, dans le cas de coefficient de frottement arbitrairement petit, rend plausible qu'un résultat d'unicité de solution pour le problème statique soit vrai lorsque le coefficient de frottement est suffisamment petit. Utilisant la situation du demi-espace comme guide de pensée, nous espérons parvenir à une démonstration dans un futur proche.

Un tel résultat ouvrirait la voix vers la définition d'un coefficient de frottement critique vis-à-vis de l'analyse quasi-statique et peut-être un premier pas vers la compréhension du crissement.

Bibliographie

- [1] P. HILD (2004), Non-unique slipping in the coulomb friction model in two-dimensional linear elasticity. *The Quarterly Journal of Mechanics and Applied Mathematics* **57**, pp. 225–235.

Troisième partie

Problèmes de contact avec frottement
pour les structures minces élastiques

Chapitre 7

Contexte et motivation

Les difficultés rencontrés dans l'analyse des problèmes de contact avec frottement en élasticité tridimensionnelle, viennent de ce que les équations de l'équilibre (même linéarisées) couplent composantes normales et tangentielles du déplacement de surface et des forces surfaciques.

On peut alors penser aux structures minces rectilignes élastiques telles que fil, barre, membrane, plaque pour lesquelles les équations de l'équilibre *linéarisées* découplent les composantes normales et tangentielles des forces exercées et déplacements. On peut donc s'attendre à ce que l'étude de l'évolution d'une telle structure, dans le contexte restreint de l'hypothèse de la transformation infinitésimale, au-dessus d'un obstacle rigide en présence de frottement de Coulomb, présente moins de difficulté que dans le cas d'une structure tridimensionnelle.

Compte-tenu du découplage sus-mentionné, les équations qui gouvernent la composante normale du déplacement sont les mêmes que dans la situation plus usuelle où le frottement est négligé. Il s'agit donc, à chaque instant, d'une inéquation variationnelle dans l'espace de Hilbert H^1 . Sa résolution fournit la composante normale de la réaction exercée par l'obstacle (qui dépend de l'espace et du temps). Dans l'étude du problème d'évolution qui gouverne la composante tangentielle du déplacement, la réaction normale (et donc le seuil de la loi de frottement) peut donc être supposée connue. Cela restaure la monotonie et rend formellement le problème très proche de l'élasto-plasticité parfaite. On ne sera donc pas étonné de constater [1] que ce problème fournit un exemple archétypal de raffle par un convexe mobile dans l'espace de Hilbert H^1 dont la théorie avait justement été développée par Moreau [2] en vue de l'analyse de l'élasto-plasticité parfaite. Compte-tenu de l'existence bien connu des surfaces de glissement en plasticité parfaite qui sont des surfaces de discontinuité pour le champ des vitesses [3], on ne sera donc pas non plus étonné de mettre en évidence des discontinuités spatiales mobiles pour le champ des vitesses tangentielles pour le problème de contact avec frottement des structures minces élastiques, alors même que les données peuvent être aussi régulières que l'on veut.

Bibliographie

- [1] P. BALLARD (2009), Frictional contact problems for thin elastic structures and weak solutions of sweeping process. *Archive for Rational Mechanics and Analysis* (à paraître).

- [2] J. J. MOREAU (1977), Evolution problem associated with a moving convex set in a hilbert space. *Journal of Differential Equations* **26**, pp. 347–374.
- [3] P. SUQUET (1988), Discontinuities and plasticity. In *Nonsmooth mechanics and applications* (J. J. Moreau and P. Panagiotopoulos, eds.), CISM Courses No 302, Springer-Verlag, pp. 279–341.

Chapitre 8

Problèmes de contact et frottement des structures minces élastiques et solutions faibles de processus de rafle

8.1 Position du problème

L'équilibre sans frottement d'un fil ou d'une poutre élastique (ou membrane ou plaque) au-dessus d'un obstacle rigide fournit un exemple archétypal d'inéquation variationnelle, dont la théorie a été développée dans les années 70. On s'intéresse ici à la situation où le frottement sec entre la structure élastique et l'obstacle doit également être pris en compte. Plus précisément, on se restreindra à la circonstance où les équations d'équilibre linéarisées sont utilisables et on considèrera le problème d'évolution quasi-statique associé à la loi de frottement de Coulomb. Une spécificité (confortable) de ces problèmes est que les équations d'équilibre linéarisées ne couplent pas les composantes transverses et longitudinales des déplacements. Il en résulte que le problème qui gouverne le déplacement transverse est le même que dans le cas sans frottement, à savoir une inéquation variationnelle à chaque instant. Sa résolution fournit la composante normale de la réaction exercée par l'obstacle et donc le seuil de la loi de frottement de Coulomb, qui dépend naturellement, en général, de la position et du temps. On constate alors que le problème d'évolution gouvernant le déplacement longitudinal fournit un exemple archétypal de processus de rafle dans un espace de Hilbert (en l'occurrence H^1), dont la théorie a été développée par Moreau [2] dans les années 70, en vue de l'étude de l'évolution des systèmes élasto-plastiques.

8.2 Forme générale du problème d'évolution

Considérons un fil élastique, uniformément tendu dans sa configuration de référence, et une base orthonormale $(\mathbf{e}_x, \mathbf{e}_y)$ telle que \mathbf{e}_x soit colinéaire à la direction du fil. Un obstacle rigide et fixe est décrit par la fonction $y = \psi(x)$. Le fil est chargé par une distribution de force extérieure $f \mathbf{e}_x + g \mathbf{e}_y$, tandis que les déplacements $u_0^p \mathbf{e}_x + v_0^p \mathbf{e}_y$, $u_1^p \mathbf{e}_x + v_1^p \mathbf{e}_y$ sont prescrits aux extrémités $x = 0, 1$. On note $u \mathbf{e}_x + v \mathbf{e}_y$ le champ de déplacement et $r \mathbf{e}_x + s \mathbf{e}_y$ la distribution de force de réaction exercée par l'obstacle sur le fil. En supposant les équations d'équilibre linéarisées légitimes, l'évolution quasi-statique du fil au-dessus de

l'obstacle avec contact unilatéral et frottement de Coulomb, est gouvernée, sur l'intervalle de temps $[t_0, T]$, par :

$$\left\{ \begin{array}{ll} u'' + f + r = 0, & \text{dans }]0, 1[\times [t_0, T], \\ r(\hat{u} - \dot{u}) + \mathcal{F}s(|\hat{u}| - |\dot{u}|) \geq 0, \quad \forall \hat{u} \in \mathbb{R}, & \text{dans }]0, 1[\times [t_0, T], \\ u(0) = u_0^P, \quad u(1) = u_1^P, & \text{dans } [t_0, T], \\ v'' + g + s = 0, & \text{dans }]0, 1[, \\ v - \psi \geq 0, \quad s \geq 0, \quad s(v - \psi) \equiv 0, & \text{dans }]0, 1[\times [t_0, T], \\ v(0) = v_0^P, \quad v(1) = v_1^P, & \text{dans } [t_0, T]. \end{array} \right. \quad (8.1)$$

où \mathcal{F} est le coefficient de frottement, supposé donné.

Les trois dernières lignes du système (8.1) gouvernent la composante transverse v du déplacement, et ne sont pas couplées avec les autres équations du système (8.1). De ce fait, v obéit, à chaque instant, à la même inéquation variationnelle que dans le cas plus usuel d'absence de frottement. Supposant ce problème résolu, la composante normale s de la réaction est maintenant une donnée dans l'étude du problème longitudinal, c'est-à-dire, celui des trois premières lignes du système (8.1). L'analyse détaillée du problème transverse gouverné par l'inéquation variationnelle permet d'établir la régularité que l'on peut attendre pour s . Comme on le verra dans la suite, la régularité de s joue un rôle crucial dans l'analyse du problème longitudinal.

Introduisant, pour tout $t \in [t_0, T]$, le sous-ensemble convexe fermé de $H^1(0, 1; \mathbb{R})$ défini par :

$$\mathcal{C}(t) = \left\{ u \in H^1 \mid u(x=0) = u_0^P, \quad u(x=1) = u_1^P, \right. \\ \left. \text{et } \forall \varphi \in H_0^1, \quad \langle u'' + f, \varphi \rangle_{H^{-1}, H_0^1} \leq \langle \mathcal{F}s, |\varphi| \rangle_{H^{-1}, H_0^1} \right\}, \quad (8.2)$$

et munissant H^1 du produit scalaire :

$$(\varphi \mid \psi)_{H^1} = \int_0^1 \bar{\varphi}'(x) \bar{\psi}'(x) dx + \varphi(0) \psi(0) + \varphi(1) \psi(1),$$

où :

$$\bar{\varphi}(x) = \varphi(x) - \varphi(0) - x(\varphi(1) - \varphi(0)) \in H_0^1,$$

le problème d'évolution qui gouverne le déplacement longitudinal u peut s'écrire [1] sous la forme concise :

$$-\dot{u}(t) \in \partial I_{\mathcal{C}(t)}[u(t)],$$

après élimination de la force de réaction inconnue r . Dans cette inclusion différentielle, on a noté $I_{\mathcal{C}(t)}[\cdot]$ la fonction indicatrice de $\mathcal{C}(t)$ (qui vaut 0 en tout point de $\mathcal{C}(t)$ et $+\infty$ ailleurs), et $\partial I_{\mathcal{C}(t)}[\cdot]$ son sous-différentiel au sens du produit scalaire de H^1 défini ci-dessus, c'est-à-dire, le cône de toutes les normales sortantes à $\mathcal{C}(t)$ (qui est vide en tout point n'appartenant pas à $\mathcal{C}(t)$, et est réduit à $\{0\}$ en tout point intérieur, s'il y en a).

8.2.1 Solutions faibles de processus de raffe

Soit H un espace de Hilbert et $\mathcal{C}(t)$ une application multivoque définie sur l'intervalle de temps $[t_0, T]$ et dont les valeurs sont convexes fermées non vide. Un processus de raffe est le problème d'évolution défini par :

$$\begin{cases} -\dot{u}(t) \in \partial I_{\mathcal{C}(t)}[u(t)], & \text{dans } [t_0, T], \\ u(t_0) = u_0, \end{cases}$$

où $u_0 \in \mathcal{C}(t_0)$ est une condition initiale donnée. Ce problème d'évolution abstrait a été introduit et étudié par Jean Jacques Moreau [2] en vue de l'analyse des systèmes élastoplastiques. En termes cinématiques, $\mathcal{C}(t)$ est un convexe mobile et $u(t)$ un point dans cet ensemble ($u(t) \in \mathcal{C}(t)$ puisque $\partial I_{\mathcal{C}(t)}[\cdot]$ est vide en tout point hors de $\mathcal{C}(t)$). Le problème d'évolution en jeu a donc une interprétation géométrique particulièrement claire lorsque $\mathcal{C}(t)$ est d'intérieur non-vide. En effet, lorsque $u(t)$ est un point intérieur, $\partial I_{\mathcal{C}(t)}[u(t)]$ est réduit à $\{0\}$ et le point $u(t)$ reste au repos jusqu'à ce qu'il soit rejoint par le bord de $\mathcal{C}(t)$. Il avance alors suivant une direction normale intérieure, comme poussé par la frontière de $\mathcal{C}(t)$ de manière à rester dans le convexe. Le nom de « processus de raffe » donné par Jean Jacques Moreau, se réfère à cette expressive interprétation géométrique.

Pour discuter de l'existence de solution d'un processus de raffe, il faut se donner des hypothèses de régularité pour l'application multivoque $\mathcal{C}(t)$. En fait, cette régularité n'est requise que dans les phases où le convexe $\mathcal{C}(t)$ se rétracte, entraînant alors potentiellement le point $u(t)$. Jean Jacques Moreau a défini et étudié la classe des applications multivoques $\mathcal{C}(t)$ à rétraction bornée [2]. En particulier, les applications multivoques $\mathcal{C}(t)$ à rétraction bornée admettent une limite à gauche $\mathcal{C}(t-)$, au sens de Kuratowski, pour tout $t \in]t_0, T]$ et une limite à droite $\mathcal{C}(t+)$, pour tout $t \in [t_0, T[$.

Si on se donne une subdivision (partition finie en intervalles de toutes sortes) arbitraire P de $[t_0, T]$, et notant I_i les intervalles correspondants (indités suivant l'ordre successif) d'origine t_i (extrémité gauche appartenant ou non à I_i), on construit l'approximation constante par morceaux \mathcal{C}_P de \mathcal{C} à l'aide de la définition :

$$\mathcal{C}_P(I_i) = \mathcal{C}_i = \begin{cases} \mathcal{C}(t_i) & \text{si } t_i \in I_i, \\ \mathcal{C}(t_i+) & \text{si } t_i \notin I_i. \end{cases}$$

Étant donnée la condition initiale $u_0 \in \mathcal{C}(t_0)$, l'algorithme de « rattrapage » s'appuie sur les projections successives :

$$u_{i+1} = \text{proj}(u_i, \mathcal{C}_{i+1}),$$

pour construire l'approximation constante par morceaux $u_P : [t_0, T] \rightarrow H$, définie par :

$$u_P(I_i) = u_i.$$

Il s'agit tout simplement d'une version de l'algorithme d'Euler implicite adaptée à l'inclusion différentielle en jeu. Supposant l'application multivoque $\mathcal{C}(t)$ à rétraction bornée, Moreau montre dans [2] que la suite généralisée u_P (P parcourant toutes les subdivisions de $[t_0, T]$), converge *fortement* dans H , *uniformément* pour $t \in [t_0, T]$, vers une fonction $u : [t_0, T] \rightarrow H$ que Moreau baptise *solution faible* du processus de raffe. Il prouve ensuite que cette solution faible $u : [t_0, T] \rightarrow H$ est à variation bornée et est solution du processus de raffe au sens

des « mesures différentielles » [2]. Si $\mathcal{C}(t)$ est non seulement à rétraction bornée, mais à rétraction absolument continue, alors la solution $u : [t_0, T] \rightarrow H$ est absolument continue et est alors solution forte du processus de rafle au sens où :

$$-\dot{u}(t) \in \partial I_{\mathcal{C}(t)}[u(t)], \quad \text{pour presque tout } t \in [t_0, T].$$

L'évolution quasi-statique du fil élastique au-dessus d'un obstacle rigide en présence de frottement de Coulomb fournit un exemple naturel de processus de rafle dans l'espace de Hilbert $H = H^1$. Dans certains cas, il s'avère que le convexe mobile du processus de rafle sous-jacent satisfait la condition de rétraction bornée, et les résultats de Moreau garantissent la convergence de l'algorithme de rattrapage vers une solution faible qui est aussi forte, au sens des mesures différentielles. Plus intéressant, il est facile d'exhiber un problème d'évolution pour le fil élastique où le convexe mobile sous-jacent *ne satisfait pas* la condition de rétraction bornée. Conservant le point-de-vue du calcul numérique, de tels exemples requièrent l'extension de la définition de solution faible de processus de rafle pour une classe d'application multivoque $\mathcal{C}(t)$ plus large que celles à rétraction bornée. Comme l'algorithme de rattrapage requiert l'existence d'une limite à droite $\mathcal{C}(t+)$, il s'avère que la classe des $\mathcal{C}(t)$ appropriée pour définir la notion de solution faible de processus de rafle en général est exactement la classe des applications $\mathcal{C}(t)$ à valeurs convexes fermées admettant une limite à gauche, au sens de Kuratowski, pour tout $t \in]t_0, T]$ et une limite à droite $\mathcal{C}(t+)$, pour tout $t \in [t_0, T[$. De telles applications sont caractérisées par la condition que, pour tout $x \in H$, la fonction :

$$t \mapsto \text{proj}[x; \mathcal{C}(t)]$$

est réglée (c'est-à-dire, limite uniforme d'une suite de fonctions constantes par morceaux, ou bien—et c'est équivalent—admettant une limite à gauche et à droite en tout point). Ces applications multivoques sont exactement les applications multivoques réglées pour une topologie métrisable et complète sur la classe des parties convexes fermées non-vides de H , appelée topologie de Wijsman (c'est la topologie la moins faible rendant continues toutes les fonctions d'ensemble $C \rightarrow d(x, C)$ quand x parcourt H). On les appellera, en bref, applications multivoques Wijsman-réglées.

Les solutions faibles de processus de rafle basés sur des applications Wijsman-réglées satisfont à toutes les propriétés générales établies par Moreau dans le cas plus restreint des applications multivoques à rétraction bornée. Un exemple de solution faible de processus de rafle basé sur une application Wijsman-réglée, qui n'est pas une fonction à variation bornée sera donnée dans la suite de ce texte. En revanche, on peut exhiber des applications Wijsman-réglées $\mathcal{C}(t)$ telles que le processus de rafle associé puisse ne pas avoir de solution faible [1].

8.3 Problèmes de contact avec frottement pour le fil élastique

On rappelle que le déplacement longitudinal du fil élastique est gouverné par un processus de rafle par le convexe mobile (8.2). On peut montrer [1] qu'une condition suffisante pour que cette application multivoque $\mathcal{C}(t)$ soit à rétraction bornée est :

$$\begin{aligned} u_0^p, u_1^p &\in BV([t_0, T]; \mathbb{R}), \\ f &\in BV([t_0, T]; H^{-1}), \\ s &\in BV([t_0, T]; \mathcal{M}). \end{aligned}$$

Si les deux premières lignes concernent la régularité des données du problème d'évolution, la dernière ligne concerne la régularité de la solution du problème transverse et ne peut donc être contrôlée directement. On va maintenant présenter un exemple de problème où cette dernière condition est satisfaite, puis, après, un exemple où cette condition ne l'est pas.

8.3.1 Un exemple où $s \in BV([t_0, T]; \mathcal{M})$

Il peut arriver que la condition $s \in BV([t_0, T]; \mathcal{M})$ soit spontanément satisfaite et dans ce cas les résultats de Moreau fournissent une unique solution :

$$u \in BV([t_0, T]; H^1).$$

Si la régularité des données permet de remplacer « variation bornée » partout par « absolue continuité », alors il en est de même pour la solution, et dans ce cas, la vitesse \dot{u} est dans $H^1(0, 1; \mathbb{R})$, pour presque tout $t \in [t_0, T]$, et est donc spatialement continue.

Considérons l'évolution d'un fil élastique au dessus d'un coin rigide et fixe. À l'instant $t = 0$, le milieu du fil est en contact affleurant avec le sommet de l'obstacle. Entre les instants $t = 0$ and $t = 1$, on impose un déplacement « vertical » d'amplitude $y = -1/4$ à chacune des deux extrémités du fil. Puis, entre les instants $t = 1$ and $t = 2$, un déplacement « horizontal » vers la droite est prescrit aux deux extrémités à vitesse constante (voir la figure 8.1).

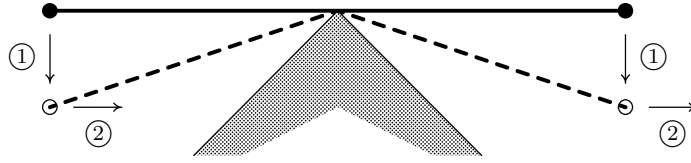

FIG. 8.1 – Fil élastique en contact frottant avec un coin rigide.

Plus précisément, cela revient à étudier le problème d'évolution quasi-statique du fil avec les données : $\psi(x) = -|x - 1/2|$, et :

$$\begin{aligned} u_0^p(t) &= 0, & v_0^p(t) &= -\frac{t}{4}, & \text{pour } 0 \leq t \leq 1, \\ u_1^p(t) &= 0, & v_1^p(t) &= -\frac{t}{4}, \\ u_0^p(t) &= \frac{t-1}{4}, & v_0^p(t) &= -\frac{1}{4}, & \text{pour } 1 \leq t \leq 2. \\ u_1^p(t) &= \frac{t-1}{4}, & v_1^p(t) &= -\frac{1}{4}, \end{aligned}$$

On vérifie aisément que l'unique solution de ce problème d'évolution est donnée par :

$$\begin{aligned} v(x, t) &= -\frac{t}{2} \left| x - \frac{1}{2} \right|, & u(x, t) &= 0, \\ s &= t \delta_{x=1/2}, & r &= 0, \end{aligned}$$

pour $0 \leq t \leq 1$,

$$\begin{aligned} v(x, t) &= -\frac{1}{2}\left|x - \frac{1}{2}\right|, & u(x, t) &= \frac{t-1}{2}\left|x - \frac{1}{2}\right|, \\ s &= \delta_{x=1/2}, & r &= (1-t)\delta_{x=1/2}, \end{aligned}$$

pour $1 \leq t \leq \min(2, 1 + \mathcal{F})$, et enfin, dans le cas $\mathcal{F} < 1$:

$$\begin{aligned} v(x, t) &= -\frac{1}{2}\left|x - \frac{1}{2}\right|, & u(x, t) &= \frac{1}{4}(t-1-\mathcal{F}) + \frac{\mathcal{F}}{2}\left|x - \frac{1}{2}\right|, \\ s &= \delta_{x=1/2}, & r &= -\mathcal{F}\delta_{x=1/2}, \end{aligned}$$

pour $1 + \mathcal{F} \leq t \leq 2$. On vérifie alors que le convexe mobile $\mathcal{C}(t)$ sous-jacent, est de rétraction absolument continue (et même Lipschitzienne, voir [2]), et u est solution forte (au sens de Moreau) du processus de rafle associé.

Comme le frottement sec est une loi indépendante du temps physique, il est naturel de vouloir concentrer les épisodes de déplacement prescrit des extrémités en les instants isolés $t = 0, 1$. Posant $u_0^p(0) = u_1^p(0) = v_0^p(0) = v_1^p(0) = 0$, cela revient à considérer les données suivantes :

$$\begin{aligned} u_0^p(t) &= 0, & v_0^p(t) &= -\frac{1}{4}, & & \text{for } 0 < t < 1, \\ u_1^p(t) &= 0, & v_1^p(t) &= -\frac{1}{4}, & & \\ u_0^p(t) &= \frac{1}{4}, & v_0^p(t) &= -\frac{1}{4}, & & \text{for } 1 \leq t \leq 2. \\ u_1^p(t) &= \frac{1}{4}, & v_1^p(t) &= -\frac{1}{4}, & & \end{aligned}$$

Le mouvement du fil est maintenant donné par :

$$\begin{aligned} v(x, t) &= -\frac{1}{2}\left|x - \frac{1}{2}\right|, & u(x, t) &= 0, \\ s &= \delta_{x=1/2}, & r &= 0, \end{aligned}$$

par $0 < t < 1$, puis, dans le cas où $\mathcal{F} \leq 1$, par :

$$\begin{aligned} v(x, t) &= -\frac{1}{2}\left|x - \frac{1}{2}\right|, & u(x, t) &= \frac{1}{2}\left|x - \frac{1}{2}\right|, \\ s &= \delta_{x=1/2}, & r &= -\delta_{x=1/2}, \end{aligned}$$

pour $1 \leq t \leq 2$, et enfin, dans le cas où $\mathcal{F} \geq 1$, par :

$$\begin{aligned} v(x, t) &= -\frac{1}{2}\left|x - \frac{1}{2}\right|, & u(x, t) &= \frac{1}{4}(1-\mathcal{F}) + \frac{\mathcal{F}}{2}\left|x - \frac{1}{2}\right|, \\ s &= \delta_{x=1/2}, & r &= -\mathcal{F}\delta_{x=1/2}, \end{aligned}$$

pour $1 \leq t \leq 2$. Dans cette situation, le convexe $\mathcal{C}(t)$ ne subit que deux translations rigides instantanées. La convexe mobile est à rétraction bornée, continue à droite, mais la rétraction n'est plus absolument continue, et la fonction u est solution du processus de rafle seulement au sens des « mesures différentielles » (voir [2]). Dans le cas $\mathcal{F} \leq 1$, les épisodes de non-glissement puis glissement, se retrouvent concentrés dans l'instant $t = 1$. L'état final résultant de ces deux épisodes concentrés au même instant est obtenu par projection sur la nouvelle position du convexe $\mathcal{C}(t)$.

8.3.2 Un exemple où $s \notin BV([t_0, T]; \mathcal{M})$

Il peut arriver que la condition $s \in BV([t_0, T]; \mathcal{M})$ tombe en défaut. Un exemple est fourni par le problème suivant. On considère un fil rectiligne tendu juste au-dessus d'un support rigide plat. L'extrémité amont $x = 0$ est encadrée. Une force ponctuelle d'amplitude unité est alors exercée au milieu du fil. Supposant le coefficient de frottement assez grand (supérieur à 2), un déplacement d'une unité vers l'aval est prescrit sur l'autre extrémité $x = 1$ du fil. La force ponctuelle est alors déplacée vers l'amont à vitesse constante (voir la

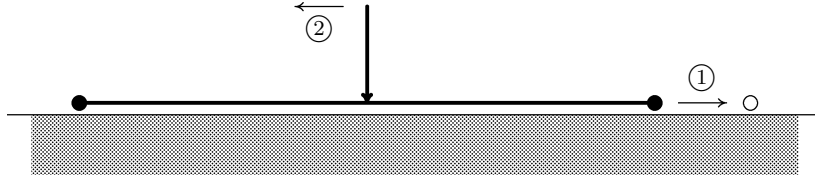

FIG. 8.2 – Contact frottant d'un fil élastique sur un sol rigide.

figure 8.2).

Plus précisément, cela revient à étudier le problème de l'évolution quasi-statique du fil avec les données suivantes : $\psi \equiv 0$, $u_0^p = v_0^p = v_1^p \equiv 0$ et u_1^p est la fonction qui prend la valeur 0 à $t = 0$ et 1 pour tout $t > 0$. On considère également la distribution de force extérieure :

$$f = \delta_{x=1/2-t}.$$

L'unique solution du problème transverse est donnée par $v \equiv 0$, qui entraîne $s \equiv -f$. Comme, pour tout $t_1 < t_2 \in]0, 1[$:

$$\begin{aligned} \|\delta_{t_2} - \delta_{t_1}\|_{\mathcal{M}} &= 2, \\ \|\delta_{t_2} - \delta_{t_1}\|_{H^{-1}} &= \sqrt{t_2 - t_1} \sqrt{1 - (t_2 - t_1)}, \end{aligned}$$

on dispose pour s de la régularité suivante :

$$\begin{aligned} s &\notin BV([0, 1/3]; \mathcal{M}), & s &\notin BV([0, 1/3]; H^{-1}), \\ s &\notin C^0([0, 1/3]; \mathcal{M}), & s &\in C^0([0, 1/3]; H^{-1}). \end{aligned}$$

Cette régularité n'est pas assez forte pour garantir que le processus de rafle sous-jacent soit à rétraction bornée et donc pour utiliser les résultats de Moreau. Il est cependant toujours possible de considérer une subdivision arbitraire de $[t_0, T]$, de procéder aux projections successives de l'algorithme de rattrapage, puis d'essayer de passer à la limite sur les subdivisions. Dans l'exemple en jeu, on obtient une convergence forte dans H^1 , uniforme par rapport à $[t_0, T]$, vers la fonction :

$$u(x, t) = \begin{cases} 0, & \text{si } 0 \leq x \leq 1/2 - t, \\ \frac{x + t - 1/2}{t + 1/2}, & \text{si } 1/2 - t \leq x \leq 1. \end{cases}$$

qui est donc solution faible du processus de rafle. Cependant, le champ des vitesses associé :

$$\dot{u}(x, t) = \begin{cases} 0, & \text{si } 0 \leq x < 1/2 - t, \\ \frac{1-x}{(t+1/2)^2}, & \text{si } 1/2 - t < x \leq 1, \end{cases}$$

présente une discontinuité spatiale localisée sous la charge (voir la figure 8.3). De ce fait, cette solution faible n'est pas dans $BV([0, 1/3]; H^1)$, et l'application multivoque $\mathcal{C}(t)$ sous-jacente ne peut donc pas être à rétraction bornée dans l'espace de Hilbert H^1 . Notons au passage que la valeur de la vitesse juste sous le chargement n'est pas définie, de sorte que l'on ne peut vérifier que la loi de Coulomb est satisfaite ponctuellement.

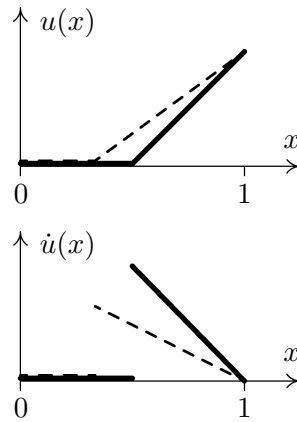

FIG. 8.3 – Déplacement et vitesse longitudinaux à l'instant initial et à un instant ultérieur (pointillés).

Le concept de solution faible correspond à l'introduction de subdivisions de l'intervalle de temps et aux positions discrètes de la charge associées à ces subdivisions. Un manière alternative de procéder est « d'étaler » un peu la charge, au moyen d'une convolution spatiale avec une approximation de l'identité. Cela suffit à obtenir $s \in BV([t_0, T]; \mathcal{M})$ et donc à garantir que le convexe mobile sous-jacent est à rétraction bornée (et même lipschitzienne) et donc à assurer l'existence d'une solution forte, dont la vitesse est, en particulier, dans H^1 (et donc continue) à chaque instant. Cela pose naturellement la question de l'existence d'une limite, lorsque la régularisation tend vers l'identité, et de l'éventualité que cette limite coïncide avec la solution faible, c'est-à-dire la limite des problèmes discrétisés en temps.

À ce sujet, considérons l'exemple d'un chargement d'amplitude $1/(2\varepsilon)$, homogène sur l'intervalle spatial $[1/2 - t - \varepsilon, 1/2 - t + \varepsilon]$, où $0 < \varepsilon < 1/6$. On vérifie facilement que la solution forte du processus de rafle sous-jacent est :

$$u_\varepsilon(x, t) = \begin{cases} 0, & \text{si } 0 \leq x \leq x_\varepsilon(t), \\ \frac{\mathcal{F}}{4\varepsilon}(x - x_\varepsilon(t))^2, & \text{si } x_\varepsilon(t) \leq x \leq \frac{1}{2} - t + \varepsilon, \\ 1 + \frac{\mathcal{F}}{2\varepsilon}\left(\frac{1}{2} - t + \varepsilon - x_\varepsilon(t)\right)(x - 1), & \text{si } \frac{1}{2} - t + \varepsilon \leq x \leq 1. \end{cases}$$

où :

$$x_\varepsilon(t) = 1 - \sqrt{\left(\frac{1}{2} + t - \varepsilon\right)^2 + \frac{4\varepsilon}{\mathcal{F}}} \in \left[\frac{1}{2} - t - \varepsilon, \frac{1}{2} - t + \varepsilon\right].$$

On constate alors sur cet exemple que u_ε converge vers u quand ε tends to 0, fortement dans H^1 , uniformément par rapport à $t \in [0, 1/3]$.

L'étude de u_ε fournit une explication d'une particularité étonnante de la solution u du problème non-régularisé : bien que le coefficient de frottement ait été choisi assez grand pour empêcher tout glissement, l'énergie élastique associée à u décroît strictement au cours du temps. Ce fait peut s'expliquer de la manière suivante. La solution u_ε du problème régularisé présente toujours du glissement, et on peut vérifier que la dissipation accumulée (l'intégrale sur le temps de la puissance de la force de frottement) tend, quand $\varepsilon \rightarrow 0$, non pas vers zéro, mais vers une valeur finie. Il est donc cohérent que la solution faible u du problème « limite » conserve une trace de cette dissipation, bien que ne présentant pas de glissement elle-même.

8.4 Remplacer le fil par une poutre

Remplacer le fil par une poutre élastique dans le problème d'évolution (8.1) laisse inchangées les trois premières lignes, les modifications n'affectant que le problème gouvernant le déplacement transverse v . En particulier, l'équation d'équilibre satisfaite par v est maintenant d'ordre 4. La composante normale s de la force de réaction, qui est maintenant obtenue par la résolution d'une inéquation variationnelle associée à l'opérateur biharmonique, peut dorénavant être « une masse de Dirac mobile » alors même que toutes les données du problème sont C^∞ par rapport à l'espace et au temps (comme dans l'exemple représenté sur la figure 8.4). Cela signifie en particulier que, dans le cas de la poutre, il faut s'attendre

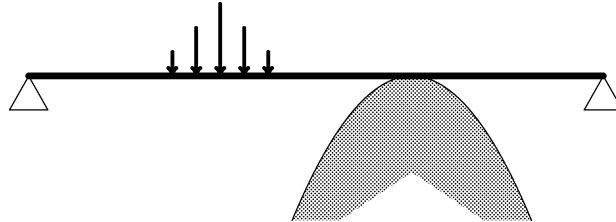

FIG. 8.4 – Contact frottant d'une poutre simplement appuyée.

à l'apparition spontanée de discontinuités mobiles de vitesse longitudinale alors même que les données sont aussi régulières que l'on veut.

L'utilisation de résultats fins sur la régularité des solutions d'inéquation variationnelle associée à l'opérateur biharmonique permettent d'établir que si les données :

$$\begin{aligned} u_0^p, u_1^p, v_0^p, v_1^p &: [t_0, T] \rightarrow \mathbb{R}, \\ f, g &: [t_0, T] \rightarrow H^{-1}, \end{aligned}$$

sont des fonctions *réglées*, alors le convexe mobile $\mathcal{C}(t)$ associé au processus de rafle gouvernant le problème longitudinal, est Wijsman-réglé, de sorte que l'on peut poser le problème

de l'existence d'éventuelle solution faible. Ce résultat vaut d'ailleurs aussi bien dans le cas du fil que de la poutre. Cependant, ces hypothèses de régularité sont trop faibles pour permettre de garantir l'existence d'une solution faible.

Bibliographie

- [1] P. BALLARD (2009), Frictional contact problems for thin elastic structures and weak solutions of sweeping process. *Archive for Rational Mechanics and Analysis* (à paraître).
- [2] J. J. MOREAU (1977), Evolution problem associated with a moving convex set in a hilbert space. *Journal of Differential Equations* **26**, pp. 347–374.

Chapitre 9

Questions ouvertes et perspectives

Ce travail est en cours. Il reste à montrer que ce qui a été observé ici sur l'exemple de la charge ponctuelle mobile sur le fil a bien une portée générale. Plus précisément, il s'agit de montrer que sous des hypothèses de régularité des données « raisonnables », la solution u_ε du problème régularisé, fournit par la théorie de Moreau des rafles à rétraction bornée, converge, fortement dans H^1 , uniformément par rapport au temps, vers une limite u qui est solution faible du processus de rafle Wijsman-réglé, c'est-à-dire, que les approximations u_P , fournies par l'algorithme de rattrapage, convergent, fortement dans H^1 , uniformément par rapport au temps, vers u . On peut aussi conjecturer que la vitesse \dot{u} est alors, à chaque instant, une fonction à variation bornée de x .

L'ensemble de ces résultats devraient pouvoir s'étendre au cas des membranes et des plaques élastiques. On s'attend alors à ce que la vitesse \dot{u} soit alors, à chaque instant, une fonction à déformation bornée de x comme en élasto-plasticité parfaite (voir [1]).

Bibliographie

- [1] P. SUQUET (1988), Discontinuities and plasticity. In *Nonsmooth mechanics and applications* (J. J. Moreau and P. Panagiotopoulos, eds.), CISM Courses No 302, Springer-Verlag, pp. 279–341.

Quatrième partie

Curriculum Vitae et
liste de publications

Chapitre 10

Notice scientifique

Patrick BALLARD
Tél. : 04 91 16 40 59
ballard@lma.cnrs-mrs.fr

Né le 7 Février 1965 à ANGERS (Maine & Loire).

10.1 Curriculum vitæ

- 1984 → 1987 : Scolarité à l'École Polytechnique (X84).
- 1987 → 1991 : Préparation d'une thèse de doctorat dans le cadre d'une convention CIFRE avec PSA Études & Recherches au Laboratoire d'utilisation des Lasers Intenses à l'École Polytechnique. Cette thèse de doctorat intitulée *Contraintes résiduelles induites par impact rapide — Application au choc-laser* a été soutenue le 24 Avril 1991 à l'École Polytechnique.
- 1991 → 2004 : Chargé de Recherche CNRS (SPI - section 9) au Laboratoire de Mécanique des Solides (UMR CNRS 7649, École Polytechnique, 91128 PALAISEAU Cédex).
- actuellement : Chargé de Recherche CNRS (section 9) au Laboratoire de Mécanique et d'Acoustique (dir. D. HABAULT, UPR CNRS 7051, 13402 MARSEILLE Cédex 20).

Prix *Jean Mandel* en 1995.

10.2 Autres activités liées au métier de chercheur

10.2.1 Encadrement doctoral

Co-encadrement de la thèse de Stéphanie BASSEVILLE (directeur de thèse Alain LÉGER), *Dynamique et stabilité d'un système discret en présence de contact et de frottement*, soutenue au LMA le 14 Décembre 2004.

10.2.2 Activités d'enseignement

De 1995 à 2002, j'ai assuré les travaux dirigés du cours de Mécanique des Milieux Continus enseigné par Michel AMESTOY à l'École Nationale Supérieure des Mines de Paris.

Professeur Chargé de Cours à l'École Polytechnique depuis 2000, j'ai assuré les petites classes de cours de Mécanique des Milieux Continus enseigné par Jean SALENÇON de 2000 à 2005. En 2006, j'ai créé un nouveau cours pour la Majeure de Mécanique des Solides : *Modélisation et Calcul des Structures Élancées* qui expose essentiellement la théorie non-linéaire des poutres élastiques. Ce cours a pour l'instant été enseigné trois fois (2006, 2007 et 2008) a un effectif variant de 55 à 75 élèves polytechniciens. J'ai assumé la responsabilité du cours magistral, d'une partie des petites classes ainsi que du problème d'examen.

Le contenu, tel qu'il est résumé dans le catalogue des cours de l'École Polytechnique, est le suivant :

De nombreuses structures solides, rencontrées en génie civil ou industriel, ont une dimension caractéristique beaucoup plus grande que les deux autres : de tels solides sont élancés. Cela conduit naturellement à la préoccupation de développer une théorie du milieu continu curviligne.

La théorie non-linéaire des poutres élastiques est construite pas-à-pas suivant la démarche générale déjà rencontrée lors de l'étude de la théorie non-linéaire du milieu continu tridimensionnel élastique.

- Etude des cinématiques lagrangienne et eulerienne de poutre.
- Modélisation des efforts intérieurs et extérieurs en s'appuyant sur la dualité et application du principe fondamental de la mécanique classique (principe des puissances virtuelles) pour l'obtention des équations du mouvement.
- Forme générale de la loi de comportement élastique et prise-en-compte des liaisons internes.
- Linéarisation des équations autour de l'état naturel et étude des problèmes d'élastostatique et d'élastodynamique en transformation infinitésimale. Calculs de treillis.
- Linéarisation des équations autour de l'état précontraint et étude des points de bifurcation de courbe d'équilibre (flambage) ainsi que des points limites (claquage). Stabilité. Déstabilisation par flottement.
- Cohérence des deux points-de-vue de poutre élastique et de milieu tridimensionnel élastique : la théorie des poutres élastiques en transformation infinitésimale est obtenue asymptotiquement à partir de l'élasticité tridimensionnelle en transformation infinitésimale à la limite des très grands élancements. Application au calcul de la loi de comportement d'une poutre élastique à partir de la connaissance du comportement tridimensionnel.

J'ai rédigé un support écrit de 300 pages, co-signé avec Alain MILLARD, dont une version PDF est téléchargeable à l'adresse suivante :

<http://catalogue.polytechnique.fr/cours.php?id=2792&type=site>

et qui me semble être une présentation originale du sujet. Un livre sera distribué par ELIPSES sous le titre « Poutres et arcs élastiques » à partir de Septembre 2009.

10.2.3 Actions de formation, hors enseignement supérieur

Intervenant et membre du comité scientifique d'une École thématique du CNRS (sections 1 et 9) intitulée *Dynamique non-linéaire* organisée par M. SCHATZMAN à Praz-sur-Arly (Haute-Savoie) du 3 au 7 Juin 2002.

Idem pour la réédition à Autrans (Isère) du 27 au 31 Octobre 2003.

10.2.4 Transfert technologique et valorisation

Participation au projet Européen SICONOS : Modelling, Simulation and Control of Nonsmooth Dynamical Systems (European Project IST 2001-37172, from September 1, 2002, to August 31, 2006), en tant que membre de l'équipe AC3 (modélisation mathématique en dynamique non-régulière), coordonnée par M. SCHATZMAN.

10.2.5 Évaluation de projets d'articles

- *European Journal of Mechanics, A/Solids* (4),
- *ASME Journal of Applied Mechanics* (2),
- *Quarterly Journal of Mechanics and Applied Mathematics* (1),
- *Archive of Applied Mechanics* (1),
- *Nonlinear Analysis, Theory, Methods & Applications* (1)
- *Compte-Rendus à l'Académie des Sciences, Série II* (3)
- *Philosophical Transactions of the Royal Society, A* (2)
- *Material Science & Engineering, A* (1)
- *International Journal for Numerical Methods in Engineering* (1)

Également expertise de demande de financement ANR (projets jeunes chercheurs) et ACI (« interface des mathématiques »). Participation aux jurys de thèse d'Adrien Petrov (2002) et Florent Cadoux (2009).

Chapitre 11

Liste de publications

11.1 Livres

- [1] P. BALLARD ET A. MILLARD (2009), *Poutres et arcs élastiques*, Éditions de l'École Polytechnique, distribué par Ellipses (300 pages).

11.2 Chapitres dans des ouvrages

- [2] P. BALLARD (2009), Frictionless unilateral multibody dynamics. In *Micromechanics of Granular Materials* (B. Cambou, M. Jean, and F. Radjaï, eds.), ISTE Ltd, pp. 317–341.
- [3] P. BALLARD (2002), Formulation and well-posedness of the dynamics of rigid bodies systems with unilateral or frictional constraints. In *Advances in Mechanics and Mathematics* (D. Y. Gao and R. W. Ogden, eds.), Kluwer Academic Publishers, Dordrecht/Boston/London, pp. 3–88.

11.3 Articles

- [4] P. BALLARD AND J. JARUŠEK (2010), Indentation of an elastic half-space by a rigid flat punch as a model problem for analysing contact problems with coulomb friction. *Journal of Elasticity* (37 pages, soumis).
- [5] P. BALLARD (2009), Frictional contact problems for thin elastic structures and weak solutions of sweeping process. *Archive for Rational Mechanics and Analysis* (46 pages, à paraître).
- [6] P. BALLARD AND S. BASSEVILLE (2005), Existence and uniqueness for dynamical unilateral contact with coulomb friction : a model problem. *Mathematical Modelling and Numerical Analysis* **39**, no. 1, pp. 59–78.
- [7] P. BALLARD (2001), Formulation and well-posedness of the dynamics of rigid-body systems with perfect unilateral constraints. *Philosophical Transactions of the Royal Society, A* **359**, pp. 2327–2346.
- [8] P. BALLARD (2000), The dynamics of discrete mechanical systems with perfect unilateral constraints. *Archive for Rational Mechanics and Analysis* **154**, pp. 199–274.

- [9] P. BALLARD (1999), A counter-example to uniqueness in quasi-static elastic contact problems with friction. *International Journal of Engineering Science* **37**, pp. 163–178.
- [10] P. BALLARD (1999), Dynamique des systèmes mécaniques discrets avec liaisons unilatérales parfaites. *Compte-Rendus à l'Académie des Sciences, Série II* **327**, pp. 953–958.
- [11] P. BALLARD, K. DANG-VAN, A. DEPERROIS, AND I. PAPADOPOULOS (1995), High cycle fatigue and a finite element analysis. *Fatigue & Fracture of Engineering Materials & Structures* **18**, no. 3, pp. 397–411.
- [12] P. BALLARD, J. FRELAT, Y. ROUGIER, AND D. GIRARDOT (1995), Plastic strain and residual stress fields induced by a homogeneous impact over the boundary of an elastic-plastic half-space. *European Journal of Mechanics, A/Solids* **14**, no. 6, pp. 1005–1016.
- [13] P. BALLARD AND A. CONSTANTINESCU (1994), On the inversion of subsurface residual stresses from surface stress measurements. *Journal of the Mechanics and Physics of Solids* **42**, no. 11, pp. 1767–1787.
- [14] P. BALLARD AND A. CONSTANTINESCU (1994), Sur l'inversion d'un champ de contraintes résiduelles en fonction des contraintes mesurées en surface. *Compte-Rendus à l'Académie des Sciences, Série II* **318**, pp. 859–863.
- [15] P. BALLARD, A. CONSTANTINESCU, AND M. BULIGA (1994), Reconstruction d'un champ de contraintes résiduelles à partir des contraintes mesurées sur des surfaces successives. existence et unicité. *Compte-Rendus à l'Académie des Sciences, Série II* **319**, pp. 1117–1122.
- [16] R. FABBRO, J. FOURNIER, P. BALLARD, D. DEVAUX, AND J. VIRMONT (1990), Physical study of laser induced plasma in confined geometry. *Journal of Applied Physics* **68**, no. 2, pp. 775–784.

11.4 Colloques

Les conférences [26, 25, 23, 27, 29] sont invitées (avec prise en charge des frais).

- [17] P. BALLARD, Frictional contact problems for thin elastic structures and weak solutions of sweeping process. In *Proceedings of the fifth Contact Mechanics International Symposium* (G. Stavroulakis, ed.), Kluwer. Chania, Greece, April 2009.
- [18] P. BALLARD, Frictional contact problems on elastic strings/beams and weak solutions of sweeping processes. *7th Euromech Solid Mechanics Conference*, Lisboa (Portugal), September 2009.
- [19] P. BALLARD, Problèmes de contact avec frottement dans les structures minces élastiques et solutions faibles de processus de raSSes. In *Actes du 19^{ème} Congrès Français de Mécanique* (AUM, ed.), cédérom. Marseille, France, Août 2009.
- [20] P. BALLARD, Frictional contact problems on elastic strings as a paradigm of moreau's sweeping process. *International Conference on Mathematics and Continuum Mechanics*, Porto, Portugal, February 2008.
- [21] P. BALLARD, Investigations on uniqueness of solutions for elastic contact problems with coulomb friction. *Unilateral problems in structural analysis, Sixth Meeting*, Siracusa, Italy, June 2007.

- [22] P. BALLARD, Uniqueness for contact problems with (static) coulomb friction in elasticity : study of a model problem. *Huitième colloque Franco-Roumain de Mathématiques Appliquées*, Chambéry, August 2006.
- [23] P. BALLARD, Unicité pour les problèmes de contact avec frottement de coulomb (statique) en élasticité linéarisée : étude d'un problème modèle. *Workshop Inequality and Contact Problems in Mechanics*, Besançon, June 2006.
- [24] P. BALLARD, A. LÉGER, AND E. PRATT, Stability of discrete systems involving shocks and friction. In *Proceedings of the fourth Contact Mechanics International Symposium* (P. Wriggers, ed.), Kluwer. Hannover, Germany, July 2005.
- [25] P. BALLARD, Non-uniqueness of solutions for elastic problems with coulomb friction at the boundary. *Workshop Free Boundary Problems*, Saint-Étienne, September 2003.
- [26] P. BALLARD, Formulation and well-posedness of impact problems in solid mechanics. 277. *Heraeus Seminar on contact and fracture problems*, Bad Honnef (Deutschland), May 2002.
- [27] P. BALLARD, Dynamique des systèmes de solides rigides avec liaisons unilatérales ou frottement. *Workshop Problèmes de contact et frottement*, Nice, September 2001.
- [28] P. BALLARD, Formulation and well-posedness of unilateral multibody dynamics. In *Proceedings of the third Contact Mechanics International Symposium* (J. Martins and M. Monteiro-Marques, eds.), Kluwer, pp. 25–32. Peniche, Portugal, June 2001.
- [29] P. BALLARD, Non-unicité dans les problèmes quasi-statiques avec frottement. *Colloque Instabilité du frottement*, Chambéry, September 1999.
- [30] P. BALLARD, Well-posedness of the dynamics of discrete mechanical systems with perfect unilateral constraints. *Euromech 397 Impact in Mechanical Systems*, Grenoble, June 1999.
- [31] A. CONSTANTINESCU AND P. BALLARD, On the reconstruction formulae of subsurface residual stresses after matter removal. In *Proceedings of the Fifth International Conference on Residual Stresses* (T. Ericsson, M. Oden, and A. Andersson, eds.), pp. 703–708. Linköping, Sweden, December 1997.
- [32] P. BALLARD AND A. CONSTANTINESCU, On the inversion of subsurface residual stresses from surface stress measurements. In *Proceedings of IUTAM Symposium on Variations of Domain and Free-Boundary Problems in Solid Mechanics* (P. Argoul, M. Frémond, and Q. S. Nguyen, eds.), Kluwer Academic Publishers, pp. 285–292. Paris, April 1997.
- [33] P. BALLARD, H. D. BUI, A. DEPERROIS, AND K. DANG-VAN, On a discontinuity relation between stresses and plastic strains at the interface of a bidimensional plastic body. In *Proceedings of the International Symposium on Micromechanics, Homogenization, Heterogenization and Strength*. 1991.
- [34] P. BALLARD, J. FOURNIER, R. FABBRO, AND J. FRELAT, Residual stresses induced by laser-shocks. In *Proceedings of Dymat 91*, Journal de physique IV, pp. 487–494. Strasbourg, October 1991.

11.5 Séminaires

- [35] P. BALLARD, À propos d'unicité de solution des problèmes élastiques avec frottement de coulomb au bord. *Séminaire de Mécanique Théorique. Laboratoire de Modélisation en Mécanique.*, Laboratoire de Modélisation en Mécanique, Université Pierre et Marie Curie, Paris, Avril 2005.
- [36] P. BALLARD, À propos d'unicité dans les problèmes élastiques avec frottement de coulomb au bord. *Séminaire d'analyse appliquée.*, Laboratoire d'Analyse, Topologie et Probabilités, Marseille, Novembre 2004.
- [37] P. BALLARD, Non-unicité de solution pour les problèmes élastiques avec frottement de coulomb au bord. *Journée du programme thématique prioritaire Rhône-Alpes : Mathématiques appliquées aux systèmes dynamiques complexes.*, INSA de Lyon, Avril 2004.
- [38] P. BALLARD, Non-unicité de solution des problèmes élastiques de contact avec frottement de coulomb. *Séminaire du LMA (Laboratoire de Mécanique et d'Acoustique)*, Marseille, Juillet 2003.
- [39] P. BALLARD, Formulation et analyse des problèmes d'impact en mécanique des solides. *Séminaire de MAPLY (laboratoire d'analyse numérique de l'université Lyon-I)*, Lyon, Février 2002.
- [40] P. BALLARD, Formulation et analyse des problèmes d'impact en mécanique des solides. *Séminaire CMAPX-LMS*, Palaiseau, Janvier 2002.
- [41] P. BALLARD, Formulation et analyse des problèmes d'impact en mécanique des solides. *Journée EDF spéciale Dynamique non-linéaire*, Clamart, Décembre 2001.
- [42] P. BALLARD, Dynamique des systèmes mécaniques discrets avec liaisons unilatérales parfaites. *Séminaire CRESPO de l'INRIA*, Rocquencourt, Février 1999.



A counter-example to uniqueness in quasi-static elastic contact problems with small friction

Patrick Ballard *

Laboratoire de Mécanique des Solides, Ecole Polytechnique, 91128 Palaiseau Cédex, France

Received 22 January 1998

(Communicated by E. SOÓS)

Abstract

It is often conjectured that the existence and uniqueness of solutions to the quasi-static Signorini problem with Coulomb friction should hold, provided that the friction coefficient is lower than a critical value. Recently, the existence of solutions to the quasi-static Signorini problem with non-local Coulomb friction was shown (M. Cocu, E. Pratt, M. Raous, *Int. J. Engng. Sci.* **34** (1996) 783–798) in functional spaces of type $W^{1,p}(0, T)$ and for a sufficiently low friction coefficient. In this paper, it is proved that uniqueness *does not hold*, in general, for an arbitrarily small friction coefficient. © 1998 Elsevier Science Ltd. All rights reserved.

1. Introduction: the Signorini problem with Coulomb friction

The problem of the equilibrium of a linear elastic body submitted to unfrictional unilateral contact conditions with a rigid obstacle was first considered by Signorini [1] and solved by Fichera [2]. Fichera's existence and uniqueness proof was followed immediately by general results on abstract variational inequalities [3]. These results allowed the solution of many non-linear boundary problems [4–6].

From a mechanical point of view, the will to incorporate friction in Fichera's analysis of the Signorini problem rapidly emerged [7] and what is often called the Signorini problem with Coulomb friction began to be considered. This problem is not an equilibrium problem any more but an *evolution* problem. This problem faced great mathematical difficulties. For this reason, only an equilibrium problem (the so-called static one), obtained by a simplification of

* Tel.: 00-69-33-35-06; Fax: 00-69-33-30-26; e-mail: ballard@athena.polytechnique.fr.

the equations, was first considered [4]. Having introduced a regularization (the non-local friction law), existence and uniqueness of the solution to the regularized static problem was shown by Duvaut [8–10] under a condition on the friction coefficient: it must be lower than a critical value. This result was followed by an existence result of the static problem without regularization and under a similar condition on the friction coefficient [11,12]. The results concerning the static problem allowed Klarbring to prove the existence and uniqueness of solutions of the rate problem associated with the regularized (by non-local friction law) *quasi-static* problem [13]. This result was still obtained under the condition on the friction coefficient. It is worth underlining that, as far as systems with a finite number of degrees of freedom (dof) are considered, the non-local regularized problem reduces to the unregularized one. To stress the importance of the condition on the friction coefficient, Klarbring [15] performed the complete analysis of the *rate* problem associated with a 2 dof quasi-static problem and exhibited explicitly the condition on the friction coefficient for which existence and uniqueness for the *rate* problem was achieved. He showed that as soon as this condition is violated, non-uniqueness of solution to the evolution problem may be observed. From a mechanical point of view, the non-uniqueness for great friction coefficient is attributed to the physical irrelevancy of the model, since inertia forces are neglected.

These results have led the community to conjecture that, provided the condition on the friction coefficient, existence and uniqueness of solutions to the quasi-static Signorini problem with Coulomb friction should hold. A first step towards this direction was accomplished recently by Cocu et al. [14] who proved the existence of solutions to the non-local regularized quasi-static problem in functional spaces of type $W^{1,p}(0, T)$.

In this paper, an n dof problem is considered. A complete analysis of this problem is provided. For $n = 2$, this problem reduces to Klarbring's one [15]. In this case, it is proved that, under Klarbring's condition, existence and uniqueness of the solution to the *evolution* problem is achieved in an appropriate functional framework (let us recall that Klarbring proved only the existence and uniqueness for the associated rate problem). For the case $n \geq 3$, existence is proved under a condition which generalizes Klarbring's one. A counter-example is constructed which shows that in this case, uniqueness *does not hold*, in general, for an arbitrarily small friction coefficient.

2. Presentation of the problem and a statement of the results

2.1. Description of the problem and notations

Let n ($n \geq 2$) be an arbitrary integer (the interesting cases will be $n = 2$ and $n = 3$). $(0, \mathbf{e}_N, \mathbf{e}_{T1}, \dots, \mathbf{e}_{T(n-1)})$ is an orthonormal coordinate system in euclidean \mathbb{R}^n . A punctual particle, whose position at time t is given by $\mathbf{U}(t) = U_N(t)\mathbf{e}_N + \mathbf{U}_T(t)$, is considered, where $\mathbf{U}_T(t)$ is the orthogonal projection of $\mathbf{U}(t)$ on the subspace of \mathbb{R}^n spanned by $(\mathbf{e}_{T1}, \mathbf{e}_{T2}, \dots, \mathbf{e}_{T(n-1)})$. All inertia effects are neglected. The particle is "kept" by a system of linear springs (see Fig. 1) so that the force exerted by the springs on the particle is (after linearization) $-\mathbf{K}\mathbf{U}(t)$, where \mathbf{K} is a symmetric positive definite matrix of order n (the stiffness matrix). Reciprocally, if \mathbf{K} is an arbitrary symmetric positive definite matrix, it always corresponds to such a system of springs. An external force $\mathbf{F}(t)$, varying with time, is also applied on the particle. Moreover, the particle

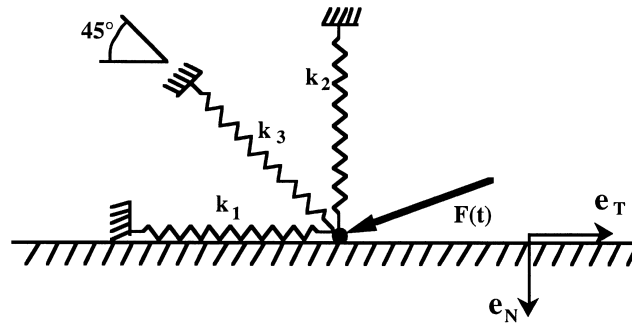

Fig. 1. Geometry and notations.

is supposed to obey to unilateral contact conditions with the half-space $U_N \geq 0$ and Coulomb friction law. Denoting by $\mathbf{R}(t) = R_N(t)\mathbf{e}_N + \mathbf{R}_T(t)$ the instantaneous reaction exerted by the obstacle on the particle, the equations of movement are given by:

$$\begin{cases} \mathbf{K}\mathbf{U} = \mathbf{F} + \mathbf{R} & \text{(equilibrium)} \\ U_N \leq 0, R_N \leq 0, U_N R_N = 0 & \text{(unilateral contact)} \\ \forall \mathbf{V} \in \mathbb{R}^{n-1}, \mathbf{R}_T(\mathbf{V} - \dot{\mathbf{U}}_T) - \mu R_N(\|\mathbf{V}\| - \|\dot{\mathbf{U}}_T\|) \geq 0 & \text{(Coulomb friction)} \end{cases} \quad (1)$$

where $\dot{\mathbf{U}}_T$ denotes the time derivative of \mathbf{U}_T (supposed regular enough), μ the friction coefficient and $\|\cdot\|$ the usual norm in euclidean \mathbb{R}^{n-1} .

The variational formulation in part three of Eq. (1) of the Coulomb friction law was introduced by Duvaut & Lions [4] and Moreau [16]. It is equivalent to the classical formulation. Note that Eq. (1) has formally the same structure as the equations of the Signorini problem with Coulomb friction for a continuum. The stiffness matrix \mathbf{K} plays the role of the elastic energy bilinear form. In the sequel, \mathbf{K} will be written under the form:

$$\mathbf{K} = \begin{pmatrix} k_N & {}^t\mathbf{w} \\ \mathbf{w} & \mathbf{K}_T \end{pmatrix}, \quad (2)$$

where \mathbf{w} is an element of \mathbb{R}^{n-1} and \mathbf{K}_T is a real matrix of order $n - 1$. Note that the positive definiteness of \mathbf{K} is equivalent to demand:

$$k_N - {}^t\mathbf{w} \cdot \mathbf{K}_T^{-1} \cdot \mathbf{w} > 0, \quad \text{and} \quad \mathbf{K}_T \text{ symmetric positive definite.} \quad (3)$$

2.2. Statement of problem

Let T be an arbitrary strictly positive real number and \mathbf{F} an arbitrary element of $W^{1,p}(0, T; \mathbb{R}^n)$ ($1 \leq p \leq \infty$) such that $\mathbf{F}(0) = 0$. The following problem is considered:

Problem \mathcal{P}_n : find \mathbf{U} and \mathbf{R} in $W^{1,p}(0, T; \mathbb{R}^n)$, such that:

$$\begin{aligned} \mathbf{U}(0) &= 0 \\ \mathbf{K}\mathbf{U}(t) &= \mathbf{F}(t) + \mathbf{R}(t), & \forall t \in [0, T] \\ U_N(t) &\leq 0, R_N(t) \leq 0, U_N(t)R_N(t) = 0, & \forall t \in [0, T] \\ \mathbf{R}_T(t)(\mathbf{V} - \dot{\mathbf{U}}_T(t)) - \mu R_N(t)(\|\mathbf{V}\| - \|\dot{\mathbf{U}}_T(t)\|) &\geq 0, & \forall \mathbf{V} \in \mathbb{R}^{n-1} \text{ and for a.a. } t \in [0, T]. \end{aligned} \quad (4)$$

2.3. Statement of the results obtained from existing literature

It is known from existing literature that:

- There exists a critical value μ_c of the friction coefficient depending on the stiffness matrix \mathbf{K} , such that for a strictly lower friction coefficient μ , there exists a unique solution to the rate problem associated with problem \mathcal{P}_n [13]. With the notations introduced above, the condition on the friction coefficient can be written:

$$\mu < \frac{\lambda_K^{\min}}{\sqrt{k_N^2 + \|w\|^2}}, \quad (5)$$

where λ_K^{\min} denotes the lowest eigenvalue of the stiffness matrix \mathbf{K} .

- There exists a critical value μ_c of the friction coefficient depending on the stiffness matrix \mathbf{K} , such that for a strictly lower friction coefficient μ , there exists at least one solution in $W^{1,p}(0, T; \mathbb{R}^n) \times W^{1,p}(0, T; \mathbb{R}^n)$ of problem \mathcal{P}_n [14]. The condition on the friction coefficient is expressed by condition (5).
- Under the condition:

$$\mu < \frac{K_T}{|w|}, \quad (6)$$

the *rate* problem associated with problem \mathcal{P}_2 (note that in the case $n = 2$, w and K_T reduce to real numbers) admits a unique solution in \mathbb{R}^2 . If condition (6) is violated, then, the existence of the solution for the rate problem may be lost for certain load rates and uniqueness may also be lost for some other load rates [15]. In the case where condition (6) is violated, Klarbring gives also an example of a load history for which an infinite number of solutions to the *evolution* problem \mathcal{P}_2 are possible.

2.4. Statement of the results obtained in this paper

Denoting by $\lambda_{K_T}^{\min}$ the lowest eigenvalue of the matrix \mathbf{K}_T , and assuming that the following condition hold:

$$\mu < \sqrt{\frac{\lambda_{K_T}^{\min}}{w \cdot \mathbf{K}_T^{-1} \cdot w}}, \quad (7)$$

then, problem \mathcal{P}_n admits at least one solution in $W^{1,p}(0, T; \mathbb{R}^n) \times W^{1,p}(0, T; \mathbb{R}^n)$. Moreover, if $n = 2$ or $w = \mathbf{0}$ this solution is unique and, if $n \geq 3$ and $w \neq \mathbf{0}$ uniqueness *does not hold*, in general, whatever the strictly positive friction coefficient μ fulfilling condition (7) is.

2.5. Comments

Problem \mathcal{P}_n is a particular case of the general quasi-static Signorini problem with Coulomb friction considered in Ref. [14]. For this particular case, condition (7) on the friction coefficient for which existence holds is always less restrictive than condition (5) under which Cocu et al. proved the existence in the general case. This demonstrates that the Cocu et al. condition is not optimal. However, condition (7) is not optimal either in general. From a mechanical point of view, it is interesting to precise the optimal value of the critical friction coefficient, since it is related to a transition of the qualitative behaviour of the system. However, even for the simple system which is considered here, this optimal critical value cannot be explicitly expressed, in general, in terms of the matrix \mathbf{K} .

When the condition on the friction coefficient holds, uniqueness of the solution of Signorini problem with Coulomb friction is often conjectured since one knows from Ref. [13] that the associated rate problem is well posed. The aim of this paper is to show that one has to answer by the negative to this conjecture, at least in the functional framework $W^{1,p}(0, T; \mathbb{R}^n)$ in which the problem is usually considered.

3. Proof of the announced results

3.1. Solution for the normal degree of freedom

Proposition 1. *Assuming that condition (7) holds the existence (respectively uniqueness) of a solution of problem \mathcal{P}_n is equivalent to the existence (respectively uniqueness) of a solution of the following problem:*

Problem \mathcal{P}'_{n-1} : find \mathbf{U}_T and \mathbf{R}_T in $W^{1,p}(0, T; \mathbb{R}^{n-1})$, such that:

$$\begin{cases} \mathbf{U}_T(0) = 0 \\ \mathbf{K}_T \mathbf{U}_T(t) = -U_N(t) \mathbf{w} + \mathbf{F}_T(t) + \mathbf{R}_T(t), & \forall t \in [0, T] \\ \mathbf{R}_T(t) [\mathbf{V} - \dot{\mathbf{U}}_T(t)] + [S(t) - \mu^t \mathbf{w} \cdot \mathbf{K}_T^{-1} \cdot \mathbf{R}_T(t)] (\|\mathbf{V}\| - \|\dot{\mathbf{U}}_T(t)\|) \geq 0, & \forall \mathbf{V} \in \mathbb{R}^{n-1} \text{ and for a.a. } t \in [0, T] \end{cases} \quad (8)$$

where:

$$U_N(t) = - \frac{1}{k_N - {}^t \mathbf{w} \cdot \mathbf{K}_T^{-1} \cdot \mathbf{w}} \langle F_N(t) - {}^t \mathbf{w} \cdot \mathbf{K}_T^{-1} \cdot \mathbf{F}_T(t) \rangle^-,$$

$$S(t) = \mu \langle F_N(t) - {}^t \mathbf{w} \cdot \mathbf{K}_T^{-1} \cdot \mathbf{F}_T(t) \rangle^+.$$

If x is a real number, $\langle x \rangle^+ = \max(x, 0)$ and $\langle x \rangle^- = \max(-x, 0)$ denote, respectively, the positive and negative parts of x .

Proof. First, one considers a solution \mathbf{U} , \mathbf{R} of problem \mathcal{P}_n and it is going to be proved that their tangential part \mathbf{U}_T and \mathbf{R}_T form a solution of problem \mathcal{P}'_{n-1} . Let us define:

$$\mathbf{F}^*(t) = \mathbf{K}^{-1} \mathbf{F}(t), \quad \mathbf{R}^*(t) = \mathbf{K}^{-1} \mathbf{R}(t). \quad (10)$$

It is clear that \mathbf{F}^* and \mathbf{R}^* belong to $W^{1,p}(0, T; \mathbb{R}^n)$. The coordinate R_N^* of \mathbf{R}^* along \mathbf{e}_N is:

$$R_N^*(t) = \frac{R_N(t) - {}^t \mathbf{w} \cdot \mathbf{K}_T^{-1} \cdot \mathbf{R}_T(t)}{k_N - {}^t \mathbf{w} \cdot \mathbf{K}_T^{-1} \cdot \mathbf{w}}. \quad (11)$$

Moreover, part four of Eq. (4) implies:

$$\forall t \in [0, T], \quad \|\mathbf{R}_T(t)\| \leq -\mu R_N(t). \quad (12)$$

Since $R_N(t)$ is negative, it is deduced from Eqs. (11) and (12):

$$\forall t \in [0, T], \quad \frac{1 + \mu \|\mathbf{K}_T^{-1} \cdot \mathbf{w}\|}{k_N - {}^t \mathbf{w} \cdot \mathbf{K}_T^{-1} \cdot \mathbf{w}} R_N(t) \leq R_N^*(t) \leq \frac{1 - \mu \|\mathbf{K}_T^{-1} \cdot \mathbf{w}\|}{k_N - {}^t \mathbf{w} \cdot \mathbf{K}_T^{-1} \cdot \mathbf{w}} R_N(t). \quad (13)$$

It is readily seen that condition (7) implies:

$$\mu \|\mathbf{K}_T^{-1} \cdot \mathbf{w}\| < 1. \quad (14)$$

Multiplying each members of Eq. (13) by $U_N(t)$ which is negative, and using condition (14), one obtains, thanks to part three of Eq. (4):

$$\forall t \in [0, T], \quad U_N(t) \leq 0, \quad R_N^*(t) \leq 0, \quad U_N(t) R_N^*(t) = 0, \quad (15)$$

This, coupled with

$$\forall t \in [0, T], \quad U_N(t) = F_N^*(t) + R_N^*(t) \quad (16)$$

leads to the following variational inequality:

$$\forall t \in [0, T], \quad \forall V \in \mathbb{R}^-, \quad U_N(t)[V - U_N(t)] \geq F_N^*(t)[V - U_N(t)] \quad (17)$$

The use of Lions–Stampacchia theorem [3] allows us to conclude that there exists a unique negative function $U_N(t)$ satisfying Eq. (17). Actually, one necessary has:

$$U_N(t) = -\langle F_N^*(t) \rangle^- = -\frac{1}{k_N - {}^t \mathbf{w} \cdot \mathbf{K}_T^{-1} \cdot \mathbf{w}} \langle F_N(t) - {}^t \mathbf{w} \cdot \mathbf{K}_T^{-1} \cdot \mathbf{F}_T(t) \rangle^-,$$

$$R_N^*(t) = -\langle F_N^*(t) \rangle^+ = -\frac{1}{k_N - {}^t \mathbf{w} \cdot \mathbf{K}_T^{-1} \cdot \mathbf{w}} \langle F_N(t) - {}^t \mathbf{w} \cdot \mathbf{K}_T^{-1} \cdot \mathbf{F}_T(t) \rangle^+.$$

A standard result ([6], Theorem A.1) shows that the functions $U_N(t)$ and $R_N^*(t)$ given by Eq. (18) belongs to $W^{1,p}(0, T; \mathbb{R})$. Then, it is easily seen that the tangential parts \mathbf{U}_T and \mathbf{R}_T of \mathbf{U} and \mathbf{R} constitute a solution of problem \mathcal{P}'_{n-1} .

Reciprocally, let \mathbf{U}_T and \mathbf{R}_T be a solution of problem \mathcal{P}'_{n-1} . From part three of Eq. (8), it is readily seen that, for all t in $[0, T]$, $S(t) - \mu {}^t \mathbf{w} \cdot \mathbf{K}_T^{-1} \cdot \mathbf{R}_T(t)$ is positive. Let us define:

$$R_N(t) = -\frac{1}{\mu} [S(t) - \mu {}^t \mathbf{w} \cdot \mathbf{K}_T^{-1} \cdot \mathbf{R}_T(t)], \quad (19)$$

which clearly belongs to $W^{1,p}(0, T; \mathbb{R})$. Then, it is readily seen that the functions \mathbf{U} and \mathbf{R}

whose tangential parts are \mathbf{U}_T and \mathbf{R}_T and normal parts are given respectively by Eqs. (9) and (19), constitute a solution of problem \mathcal{P}_n .

3.2. Existence of a solution for problem \mathcal{P}'_{n-1}

Proposition 2. *Assuming that condition (7) holds, problem \mathcal{P}'_{n-1} admits at least one solution in $W^{1,p}(0, T; \mathbb{R}^{n-1}) \times W^{1,p}(0, T; \mathbb{R}^{n-1})$. Moreover, if $n = 2$ or $\mathbf{w} = 0$, this solution is unique.*

Proof. First, notice that \mathbf{K}_T defines a scalar product on \mathbb{R}^{n-1} , the associated norm being denoted by $\|\cdot\|_{\mathbf{K}_T}$.

Let us introduce the following closed convex sets of \mathbb{R}^{n-1} :

$$E(t) = \{\mathbf{x} \in \mathbb{R}^{n-1} / \|\mathbf{x}\| + \mu^t \mathbf{w} \cdot \mathbf{K}^{-1} \cdot \mathbf{x} \leq S(t)\}$$

$$B(t, \mathbf{r}) = \{\mathbf{x} \in \mathbb{R}^{n-1} / \|\mathbf{x}\| \leq \langle S(t) - \mu^t \mathbf{w} \cdot \mathbf{K}_T^{-1} \cdot \mathbf{r} \rangle^+\}.$$

One obviously has:

$$\forall \mathbf{r} \in E(t), \quad \mathbf{r} \in B(t, \mathbf{r}). \tag{21}$$

Owing to Eq. (14), $E(t)$ is a closed set bounded by an ellipsoid with one focus at the origin, and $B(t, \mathbf{r})$ is a ball centered at the origin. $E^\circ(t)$ and $\partial E(t)$ denoting as usual the interior and the boundary of $E(t)$, one defines the multivocal operator $A(t)$ by:

$$A(t)\mathbf{x} = \begin{cases} \{0\} & \text{if } \mathbf{x} \in E^\circ(t) \\ \{\lambda \mathbf{K}_T \mathbf{x} / \lambda \in \mathbb{R}^+\} & \text{if } \mathbf{x} \in \partial E(t) \\ \emptyset & \text{if } \mathbf{x} \notin E(t) \end{cases} \tag{22}$$

whenever $S(t) \neq 0$ [that is, $E(t) \neq \{0\}$]. When $S(t) = 0$ [that is, $E(t) = \{0\}$], $A(t)$ is defined by:

$$A(t)\mathbf{x} = \begin{cases} \mathbb{R}^{n-1} & \text{if } \mathbf{x} \in E(t) = \{0\} \\ \emptyset & \text{if } \mathbf{x} \notin E(t). \end{cases} \tag{23}$$

With these notations, problem \mathcal{P}'_{n-1} is easily seen to be equivalent to one or the other of the two following problems:

$$\begin{cases} \mathbf{R}_T(0) = 0 \\ -\dot{\mathbf{R}}_T(t) - \dot{\mathbf{F}}_T(t) \in A(t) \cdot \mathbf{U}_T(t) & \text{for a.a. } t \in [0, T] \\ \mathbf{K}_T \mathbf{U}_T(t) = -U_N(t) \mathbf{w} + \mathbf{F}_T(t) + \mathbf{R}_T(t), & \forall t \in [0, T] \end{cases} \tag{24}$$

$$\begin{cases} \mathbf{R}_T(0) = 0 \\ -\dot{\mathbf{R}}_T(t) - \dot{\mathbf{F}}_T(t) \in \partial_{\mathbf{K}_T^{-1}} I_{B[t, \mathbf{R}_T(t)]} \cdot \mathbf{R}_T(t) & \text{for a.a. } t \in [0, T] \\ \mathbf{K}_T \mathbf{U}_T(t) = -U_N(t) \mathbf{w} + \mathbf{F}_T(t) + \mathbf{R}_T(t), & \forall t \in [0, T], \end{cases} \tag{25}$$

where $\partial_{\mathbf{K}_T^{-1}} I_{B[t, \mathbf{R}_T(t)]}$ is the subdifferential of the indicatrix function of $B[t, \mathbf{R}_T(t)]$ for the scalar product \mathbf{K}_T^{-1} . To obtain formulations (24) and (25), we have used the fact that $S(t) \neq 0$ implies $\dot{U}_N(t) = 0$. One may also obtain equivalent formulations by using unknown $\mathbf{U}_T(t)$ instead of $\mathbf{R}_T(t)$. For this, we define:

$$\begin{aligned}
K(t) &= \{\mathbf{x} \in \mathbb{R}^{n-1} / \mathbf{K}_T \mathbf{x} + U_N(t) \mathbf{w} - \mathbf{F}_T(t) \in E(t)\}, \\
C(t, \mathbf{u}) &= \{\mathbf{x} \in \mathbb{R}^{n-1} / \mathbf{K}_T \mathbf{x} + U_N(t) \mathbf{w} - \mathbf{F}_T(t) \in B[t, \mathbf{K}_T \mathbf{u} + U_N(t) \mathbf{w} - \mathbf{F}_T(t)]\}.
\end{aligned}
\tag{26}$$

One has:

$$\forall \mathbf{u} \in K(t), \quad \mathbf{u} \in C(t, \mathbf{u}). \tag{27}$$

The multivocal operator $B(t)$ is defined by:

$$\begin{aligned}
B(t) \mathbf{x} &= \begin{cases} \{0\} & \text{if } \mathbf{x} \in K^\circ(t) \\ \{\lambda[\mathbf{K}_T \mathbf{x} + U_N(t) \mathbf{w} - \mathbf{F}_T(t)] / \lambda \in \mathbb{R}^+\} & \text{if } \mathbf{x} \in \partial K(t) \\ \emptyset & \text{if } \mathbf{x} \notin K(t) \end{cases}
\end{aligned}
\tag{28}$$

whenever $S(t) \neq 0$. When $S(t) = 0$, $B(t)$ is defined by:

$$\begin{aligned}
B(t) \mathbf{x} &= \begin{cases} \mathbb{R}^{n-1} & \text{if } \mathbf{x} \in K(t) \\ \emptyset & \text{if } \mathbf{x} \notin K(t). \end{cases}
\end{aligned}
\tag{29}$$

With these notations, problem \mathcal{P}'_{n-1} is easily seen to be equivalent to one or the other of the two following problems:

$$\begin{cases} \mathbf{U}_T(0) = 0 \\ -\dot{\mathbf{U}}_T(t) \in B(t) \cdot \mathbf{U}_T(t) & \text{for a.a. } t \in [0, T] \\ \mathbf{K}_T \mathbf{U}_T(t) = -U_N(t) \mathbf{w} + \mathbf{F}_T(t) + \mathbf{R}_T(t) & \forall t \in [0, T] \end{cases}
\tag{30}$$

$$\begin{cases} \mathbf{U}_T(0) = 0 \\ -\dot{\mathbf{U}}_T(t) \in \partial_{\mathbf{K}_T} I_{C[t, U_T(t)]} \cdot \mathbf{U}_T(t) & \text{for a.a. } t \in [0, T], \\ \mathbf{K}_T \mathbf{U}_T(t) = -U_N(t) \mathbf{w} + \mathbf{F}_T + \mathbf{R}_T(t), & \forall t \in [0, T] \end{cases}
\tag{31}$$

where $\partial_{\mathbf{K}_T} I_{C[t, U_T(t)]}$ is the subdifferential of the indicatrix function of $C[t, \mathbf{U}_T(t)]$ for the scalar product \mathbf{K}_T .

Note that, in general, part two of problem (30) is not monotone except for the cases $n = 2$ or $\mathbf{w} = 0$. For these cases, a standard argument gives uniqueness of a solution in $W^{1,p}(0, T; \mathbb{R}^{n-1})$. Now, it is going to be proved that problem (31) admits a solution by use of the Leray–Schauder fixed point theorem.

Let $\mathcal{H}[\cdot, \cdot]$ denote the Hausdorff distance associated with the norm $\|\cdot\|_{\mathbf{K}_T}$ in \mathbb{R}^{n-1} (for the definition and properties of the Hausdorff distance, see, for example, Ref. [6]).

Lemma 1. *Let t be an element of $[0, T]$ and \mathbf{U}_1 and \mathbf{U}_2 be in $K(t)$. One has:*

$$\mathcal{H}[C(t, \mathbf{U}_1), C(t, \mathbf{U}_2)] \leq \alpha \|\mathbf{U}_1 - \mathbf{U}_2\|_{\mathbf{K}_T} \tag{32}$$

where:

$$\alpha = \mu \sqrt{\frac{t \mathbf{w} \cdot \mathbf{K}_T^{-1} \cdot \mathbf{w}}{\lambda_{\mathbf{K}_T}^{\min}}} < 1. \tag{33}$$

Proof. Let S_1, S_2 be two positive real numbers and C_1, C_2 be the sets defined by:

$$C_i = \{\mathbf{x} \in \mathbb{R}^{n-1} / \|\mathbf{K}_T \mathbf{x}\| \leq S_i\}, \quad i = 1, 2. \tag{34}$$

From the properties of the Hausdorff distance, one has:

$$\mathcal{H}[C_1, C_2] \leq \mu |S_2 - S_1| \text{Max } \|\mathbf{u}\|_{K_T}, \tag{35}$$

where the maximum runs over the set of \mathbf{u} such that $\|\mathbf{K}_T \mathbf{u}\| = 1$. This maximum is readily seen to be $1/\sqrt{\lambda_{K_T}^{\min}}$ and inequality (35) is actually an equality. Hence,

$$\mathcal{H}[C(t, \mathbf{U}_1), C(t, \mathbf{U}_2)] = \frac{\mu}{\sqrt{\lambda_{K_T}^{\min}}} |(\mathbf{U}_2 - \mathbf{U}_1) \cdot \mathbf{w}|. \tag{36}$$

The Cauchy–Schwartz inequality ends the proof of Lemma 1.

Lemma 2. *There exist three positive real constants A, B and C, such that, for every \mathbf{U}_T in $W^{1,p}(0, T; \mathbb{R}^{n-1})$:*

$$\forall s, t \in [0, T] \quad \mathcal{H}[C(t, \mathbf{U}_T(t)), C(s, \mathbf{U}_T(s))] \leq A \|\mathbf{F}_T(t) - \mathbf{F}_T(s)\|_{K_T} + B |U_N(t) - U_N(s)| + C |S(t) - S(s)| + \alpha \|\mathbf{U}_T(t) - \mathbf{U}_T(s)\|_{K_T}.$$

Proof. The proof is straightforward by use of the following properties of the Hausdorff distance:

$$\begin{aligned} \mathcal{H}[C + \{\mathbf{x}\}, C] &\leq \|\mathbf{x}\|_{K_T} \\ \mathcal{H}[C_1, C_3] &\leq \mathcal{H}[C_1, C_2] + \mathcal{H}[C_2, C_3] \end{aligned}$$

and inequality (35). One may choose:

$$\begin{aligned} A &= 1 + \frac{1}{\lambda_{K_T}^{\min}}, \\ B &= 1 + \|\mathbf{w}\|_{K_T}, \\ C &= \frac{1}{\sqrt{\lambda_{K_T}^{\min}}}. \end{aligned} \tag{39}$$

Now, one can prove proposition 2. The proof is adapted from that of Monteiro Marques [17] who considered a similar problem. Let $\mathcal{C}([0, T], \mathbb{R}^{n-1})$ be the Banach space of the continuous functions from $[0, T]$ into \mathbb{R}^{n-1} , equipped with the uniform convergence norm (relative to the norm $\|\cdot\|_{K_T}$) denoted by $\|\cdot\|_{K_T, \infty}$. $\text{Var}(\mathbf{f}; a, b)$, where \mathbf{f} belongs to $W^{1,p}(0, T; \mathbb{R}^{n-1})$ and a, b to $[0, T]$ will be the classical variation of the function \mathbf{f} over the interval $[a, b]$ in the sense of the norm $\|\cdot\|_{K_T}$. Let \mathcal{K} be the subset of $\mathcal{C}([0, T], \mathbb{R}^{n-1})$, constituted by the elements \mathbf{u} such that $\mathbf{u}(0) = 0$ and:

$$\forall 0 \leq s \leq t \leq T, \|\mathbf{u}(t) - \mathbf{u}(s)\|_{K_T} \leq \frac{A}{1 - \alpha} \text{Var}(\mathbf{F}_T; s, t) + \frac{B}{1 - \alpha} \text{Var}(U_N; s, t) + \frac{C}{1 - \alpha} \text{Var}(S; s, t). \tag{40}$$

It is obvious that \mathcal{K} is non-empty, closed and convex. Moreover, it is equibounded (since \mathbf{F}_T , U_N and S have bounded variation over $[0, T]$ and equicontinuous by Eq. (40) (since \mathbf{F}_T , U_N and S are absolutely continuous); thus, by the Ascoli–Arzelà theorem, \mathcal{K} is a compact subset of $\mathcal{C}([0, T], \mathbb{R}^{n-1})$.

Note that if $\mathbf{u} \in \mathcal{K}$ then \mathbf{u} is absolutely continuous [and even in $W^{1,p}(0, T; \mathbb{R}^{n-1})$] and by lemma 2, $t \rightarrow C[t, \mathbf{u}(t)]$ is an absolutely continuous function. More precisely:

$$\begin{aligned} \text{Var}(C; s, t) &\leq A \text{Var}(\mathbf{F}_T; s, t) + B \text{Var}(U_N; s, t) + C \text{Var}(S; s, t) \\ &\quad + \frac{\alpha A}{1-\alpha} \text{Var}(\mathbf{F}_T; s, t) + \frac{\alpha B}{1-\alpha} \text{Var}(U_N; s, t) + \frac{\alpha C}{1-\alpha} \text{Var}(S; s, t) \\ &\leq \frac{A}{1-\alpha} \text{Var}(\mathbf{F}_T; s, t) + \frac{B}{1-\alpha} \text{Var}(U_N; s, t) + \frac{C}{1-\alpha} \text{Var}(S; s, t). \end{aligned} \quad (41)$$

Hence, by Moreau's results on sweeping processes [18], to every $\mathbf{u} \in \mathcal{K}$ one may associate $\Phi(\mathbf{u}) = \mathbf{v}$, the unique absolutely continuous solution to the sweeping process:

$$\begin{cases} \mathbf{v}(0) = 0 \\ -\dot{\mathbf{v}}(t) \in \partial_{K_T} I_{C[t, \mathbf{u}(t)]} \cdot \mathbf{v}(t), \quad \text{for a.a. } t \in [0, T]. \end{cases} \quad (42)$$

In order to apply the Leray–Schauder fixed point theorem, we have to prove that $\Phi(\mathbf{u}) \in \mathcal{K}$ and that $\mathbf{u} \rightarrow \Phi(\mathbf{u})$ is continuous in \mathcal{K} . In fact, $\Phi(\mathbf{u})$ is a continuous function, $\Phi(\mathbf{u})(0) = 0$, and by Ref. [18] and Eq. (41), the following estimate holds:

$$\begin{aligned} \|\Phi(\mathbf{u})(t) - \Phi(\mathbf{u})(s)\|_{K_T} &\leq \text{Var}(C; s, t) \\ &\leq \frac{A}{1-\alpha} \text{Var}(\mathbf{F}_T; s, t) + \frac{B}{1-\alpha} \text{Var}(U_N; s, t) + \frac{C}{1-\alpha} \text{Var}(S; s, t), \end{aligned} \quad (43)$$

showing that $\Phi(\mathbf{u}) \in \mathcal{K}$. To prove that Φ is continuous, let \mathbf{u} and \mathbf{v} be two elements of \mathcal{K} . By the results of moreau on the dependence of solutions to sweeping processes on the data [18], we have:

$$\|\Phi(\mathbf{u})(t) - \Phi(\mathbf{v})(t)\|_{K_T}^2 \leq 2m(t) \langle \text{Var}[C(s, \mathbf{u}(s)); 0, t] + \text{Var}\{C[s, \mathbf{v}(s)]; 0, t\} \rangle, \quad (44)$$

where $m(t)$ is the least upper bound of $\mathcal{H}\{C[s, \mathbf{u}(s)], C[s, \mathbf{v}(s)]\}$ for $s \in [0, t]$. By lemma 1, $m(t) \leq \alpha \|\mathbf{u} - \mathbf{v}\|_{K_T, \infty}$, which, by Eq. (41) gives:

$$\|\Phi(\mathbf{u}) - \Phi(\mathbf{v})\|_{K_T, \infty}^2 \leq \frac{4\alpha}{1-\alpha} [A \text{Var}(\mathbf{F}_T; 0, T) + B \text{Var}(U_N; 0, T) + C \text{Var}(S; 0, T)] \|\mathbf{u} - \mathbf{v}\|_{K_T, \infty}, \quad (45)$$

which shows the continuity of Φ .

From the Leray–Schauder theorem, there is a function $\mathbf{U}_T \in \mathcal{K}$ such that $\Phi(\mathbf{U}_T) = \mathbf{U}_T$. Clearly, $\mathbf{U}_T \in W^{1,p}(0, T; \mathbb{R}^{n-1})$ [because of Eq. (40)] and is a solution of problem (31) and, therefore of problem \mathcal{P}'_{n-1} .

3.3. A counter-example to uniqueness

In this section, we consider problem \mathcal{P}_3 with the following particular form of the stiffness matrix:

$$\mathbf{K} = \begin{pmatrix} 1 & e & 0 \\ e & 1 & 0 \\ 0 & 0 & 1 \end{pmatrix}, \tag{46}$$

where e is a given real number in the open interval $]0,1[$. Given an arbitrary element \mathbf{F} in $W^{1,p}(0, T; \mathbb{R}^{n-1})$ such that $\mathbf{F}(0) = 0$, it is known from Section 3.1 and 3.2 that there exists at least one solution of this particular case of problem \mathcal{P}_3 provided that the following condition holds:

$$\mu < \frac{1}{e}. \tag{47}$$

Now, a load history $\mathbf{F}(t)$ in $W^{1,p}(0, T; \mathbb{R}^3)$ is going to be constructed for an arbitrary μ in $]0,1/e[$. For this load history, two distinct solutions of problem \mathcal{P}_3 in $W^{1,\infty}(0, T; \mathbb{R}^3)$ are going to be exhibited. This construction is not specific to the particular form of Eq. (46). Actually, such a construction can be performed whenever $n \geq 3$ and $\mathbf{w} \neq 0$. This particular case has been chosen for the sake of simplicity.

We start from the problem \mathcal{P}'_2 associated with the particular form of Eq. (46) of the stiffness matrix. It has been seen that this problem can be written as:

$$\begin{cases} \mathbf{R}_T(0) = 0 \\ -\mathbf{R}_T(t) - \dot{\mathbf{F}}_T \in A(t) \cdot \mathbf{R}_T(t), & \text{for a.a } t \in [0, T] \\ \mathbf{U}_T(t) = -U_N(t)\mathbf{w} + \mathbf{F}_T(t) + \mathbf{R}_T(t), & \forall t \in [0, T], \end{cases} \tag{48}$$

where $A(t)$ is, in this case the multivocal operator defined by:

$$A(t)\mathbf{x} = \begin{cases} \{0\} & \text{if } \mathbf{x} \in E^\circ(t) \\ \mathbb{R}^+\mathbf{x} & \text{if } \mathbf{x} \in \partial E(t) \\ \emptyset & \text{if } \mathbf{x} \notin E(t), \end{cases} \tag{49}$$

whenever $E(t) \neq \{0\}$. For $E(t) = \{0\}$, $A(t)$ is defined by:

$$A(t)\mathbf{x} = \begin{cases} \mathbb{R}^2, & \text{if } \mathbf{x} \in E(t) = \{0\} \\ \emptyset, & \text{if } \mathbf{x} \notin E(t). \end{cases} \tag{50}$$

Let us recall that $E(t)$ is the closed convex set:

$$E(t) = \{(x_1, x_2) \in \mathbb{R}^2 / \sqrt{x_1^2 + x_2^2} + ex_1 \leq S(t)\}. \tag{51}$$

We are now going to construct a function $S(t)$ in $W^{1,\infty}(0, 1; \mathbb{R})$ such that $S(0) = 0$ and a

function $\mathbf{F}_T(t)$ in $W^{1,\infty}(0, 1; \mathbb{R}^2)$, such that $\mathbf{F}_T(0) = 0$ and two distinct solutions $\mathbf{R}_T^a(t)$ and $\mathbf{R}_T^b(t)$ of the associated problem (48). Then, as stated in proposition 1, these solutions will be used to construct two distinct solutions of problem \mathcal{P}_3 associated with the particular form of Eq. (46) of the stiffness matrix.

Let us begin to introduce the following notation:

$$\beta = 1 + \frac{1 - \sqrt{1 - e^2}}{\sqrt{4 - e^2}}. \quad (52)$$

β is readily seen to be strictly greater than one.

Lemma 3. Let T_1, T_2 ($T_1 < T_2$), be two real numbers. Let $S(t)$. ($T_1 \leq t \leq T_2$) be a constant function on $[T_1, T_2]$ with value S ($S > 0$). Then, there exists a function \mathbf{F}'_T in $L^\infty(T_1, T_2; \mathbb{R}^2)$ and two solutions \mathbf{R}_T^a and \mathbf{R}_T^b in $W^{1,\infty}(T_1, T_2; \mathbb{R}^2)$ of problem:

$$-\dot{\mathbf{R}}_T(t) - \mathbf{F}'_T(t) \in A(t) \cdot \mathbf{R}_T(t), \quad \text{for a.a. } t \in [T_1, T_2], \quad (53)$$

with initial conditions:

$$\mathbf{R}_T^a(T_1) = (0, 0) \quad \mathbf{R}_T^b(T_1) = \left(-\frac{S}{\beta} \frac{e}{1 - e^2}, 0 \right), \quad (54)$$

and such that the following holds:

$$\mathbf{R}_T^a(T_2) = (0, 0) \quad \mathbf{R}_T^b(T_2) = \left(-S \frac{e}{1 - e^2}, 0 \right) \quad (55)$$

Proof. It is easy to check that one may choose:

$$\begin{aligned} \mathbf{F}'_T(t) &= -\frac{5S}{T_2 - T_1} (0, 1) & \forall t \in [T_1, T_1 + \frac{T_2 - T_1}{5}] [\\ \mathbf{F}'_T(t) &= -\frac{5S}{T_2 - T_1} \left(0, \frac{1 - \sqrt{1 - e^2}}{\beta \sqrt{1 - e^2}} \right) & \forall t \in [T_1 + \frac{T_2 - T_1}{5}, T_1 + \frac{2(T_2 - T_1)}{5}] [\\ \mathbf{F}'_T(t) &= -\frac{5S}{T_2 - T_1} \left(-\frac{1}{2} \frac{e}{1 - e^2} - 1 - \frac{1}{2} \sqrt{\frac{4 - e^2}{1 - e^2}} \right) & \forall t \in [T_1 + \frac{2(T_2 - T_1)}{5}, T_1 + \frac{3(T_2 - T_1)}{5}] [\\ \mathbf{F}'_T(t) &= -\frac{5S}{T_2 - T_1} \left(\frac{1 - \beta}{\beta} \frac{e}{1 - e^2} - \frac{1 - \sqrt{1 - e^2}}{\beta \sqrt{1 - e^2}} \right) & \forall t \in [T_1 + \frac{3(T_2 - T_1)}{5}, T_1 + \frac{4(T_2 - T_1)}{5}] [\\ \mathbf{F}'_T(t) &= -\frac{5S}{T_2 - T_1} \left(\frac{1}{2} \frac{e}{1 - e^2}, \frac{1}{2} \sqrt{\frac{4 - e^2}{1 - e^2}} \right) & \forall t \in [T_1 + \frac{4(T_2 - T_1)}{5}, T_2] [\end{aligned} \quad (56)$$

as well as the functions $\mathbf{R}_T^a(t)$ and $\mathbf{R}_T^b(t)$ defined by the linear interpolations of the values:

$$\begin{cases} \mathbf{R}_T^a(T_1) = (0, 0) \\ \mathbf{R}_T^b(T_1) = S\left(-\frac{1}{\beta} \frac{e}{1-e^2}, 0\right) \\ \mathbf{R}_T^a\left(T_1 + \frac{T_2 - T_1}{5}\right) = S(0, 1) \\ \mathbf{R}_T^b\left(T_1 + \frac{T_2 - T_1}{5}\right) = S\left(-\frac{1}{\beta} \frac{e}{1-e^2}, 1\right) \\ \mathbf{R}_T^a\left[T_1 + \frac{2(T_2 - T_1)}{5}\right] = S(0, 1) \\ \mathbf{R}_T^b\left[T_1 + \frac{2(T_2 - T_1)}{5}\right] = S\left(-\frac{1}{\beta} \frac{e}{1-e^2}, 1 + \frac{1 - \sqrt{1-e^2}}{\beta\sqrt{1-e^2}}\right) \\ \mathbf{R}_T^a\left[T_1 + \frac{3(T_2 - T_1)}{5}\right] = S\left(-\frac{1}{2} \frac{e}{1-e^2}, -\frac{1}{2} \sqrt{\frac{4-e^2}{1-e^2}}\right) \\ \mathbf{R}_T^b\left[T_1 + \frac{3(T_2 - T_1)}{5}\right] = S\left(-\left(\frac{1}{2} + \frac{1}{\beta}\right) \frac{e}{1-e^2}, -\frac{1}{2} \sqrt{\frac{4-e^2}{1-e^2}} + \frac{1 - \sqrt{1-e^2}}{\beta\sqrt{1-e^2}}\right) \\ \mathbf{R}_T^a\left[T_1 + \frac{4(T_2 - T_1)}{5}\right] = S\left(-\frac{1}{2} \frac{e}{1-e^2}, -\frac{1}{2} \sqrt{\frac{4-e^2}{1-e^2}}\right) \\ \mathbf{R}_T^b\left[T_1 + \frac{4(T_2 - T_1)}{5}\right] = S\left(-\frac{3}{2} \frac{e}{1-e^2}, -\frac{1}{2} \sqrt{\frac{4-e^2}{1-e^2}}\right) \\ \mathbf{R}_T^a(T_2) = (0, 0) \\ \mathbf{R}_T^b(T_2) = S\left(-\frac{e}{1-e^2}, 0\right). \end{cases} \tag{57}$$

The corresponding evolution of the segment $[\mathbf{R}_T^a, \mathbf{R}_T^b]$ is sketched on Fig. 2. The step function $\mathbf{F}_T'(t)$ and the functions $\mathbf{R}_T^a(t)$ and $\mathbf{R}_T^b(t)$ defined by Eqs. (56) and (57) will be denoted in the sequel by $\mathcal{F}'(T_1, T_2, S; t)$, $\mathcal{R}^a(T_1, T_2, S; t)$ and $\mathcal{R}^b(T_1, T_2, S; t)$ ($T_1 \leq t \leq T_2$). It should be noted that there exists a constant $C(e)$ depending only on e such that:

$$\forall t \in [T_1, T_2], \quad \|\mathcal{F}'(T_1, T_2, S; t)\| \leq \frac{S}{T_2 - T_1} C(e). \tag{58}$$

Now, the intervals $[1/(\beta^{m+1}), 1/\beta^m[$, where m is an arbitrary integer, define a partition of the interval $]0,1[$. For every m in \mathbb{N} , we define the function $S'(t)$ on $[1/\beta^{m+1}, 1/\beta^m[$ by:

$$S'(t) = \begin{cases} 2 & \text{if } t \in \left[\frac{1}{\beta^{m+1}}, \frac{1}{\beta^{m+1}} \frac{\beta+1}{2} \right[\\ 0 & \text{if } t \in \left[\frac{1}{\beta^{m+1}} \frac{\beta+1}{2}, \frac{1}{\beta^m} \right[\end{cases} \tag{59}$$

Hence, the function $S'(t)$ is defined all over the interval $]0,1[$, it is clearly measurable, bounded

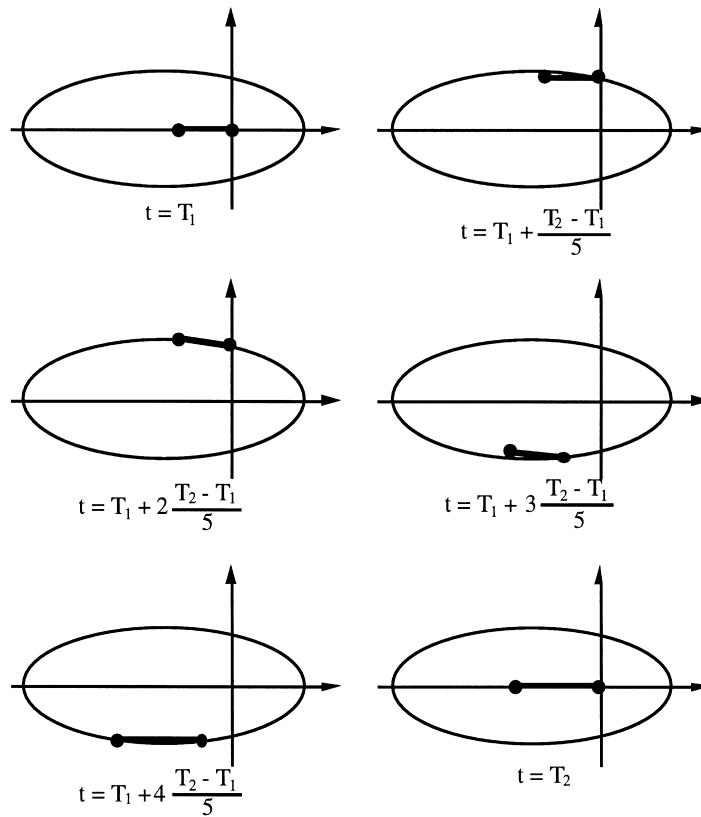

Fig. 2. Evolution of the two solutions constructed in lemma 3.

and therefore integrable. Let $S(t)$ be the absolutely continuous function defined by:

$$S(t) = \int_0^t S'(s) \, ds. \tag{60}$$

The function $S(t)$ is easily seen to belong to $W^{1,\infty}(0,1; \mathbb{R})$, to be positive and such that $S(0) = 0$. Moreover, one has:

$$\forall m \in \mathbb{N}, \quad \forall t \in \left[\frac{1}{\beta^{m+1}} \frac{\beta + 1}{2}, \frac{1}{\beta^m} \right], \quad S(t) = \frac{1}{\beta^m}. \tag{61}$$

Similarly, we define the function $\mathbf{F}'_T(t)$ on the interval $[1/\beta^{m+1}, 1/\beta^m[$ by:

$$\mathbf{F}'_T(t) = \begin{cases} 0 & \text{if } t \in \left[\frac{1}{\beta^{m+1}}, \frac{1}{\beta^{m+1}} \frac{\beta + 1}{2} \right[\\ \mathcal{F}'\left(\frac{1}{\beta^{m+1}} \frac{\beta + 1}{2}, \frac{1}{\beta^m}, \frac{1}{\beta^m}; t \right) & \text{if } t \in \left[\frac{1}{\beta^{m+1}} \frac{\beta + 1}{2}, \frac{1}{\beta^m} \right[\end{cases} \tag{62}$$

The function $\mathbf{F}_T'(t)$ is defined all over $]0,1[$. From Eq. (58), it is bounded:

$$\forall t \in]0, 1], \quad \|\mathbf{F}'_T(t)\| \leq \frac{2\beta}{\beta - 1} C(e). \tag{63}$$

Since $\mathbf{F}_T'(t)$ is clearly measurable, it is integrable and $\mathbf{F}_T(t)$ will be defined by:

$$\mathbf{F}_T(t) = \int_0^t \mathbf{F}'_T(s) \, ds. \tag{64}$$

$\mathbf{F}_T(t)$ clearly belongs to $W^{1,\infty}(0, 1; \mathbb{R}^2)$ and is such that $\mathbf{F}_T(0) = 0$, and $\dot{\mathbf{F}}_T(t) = \mathbf{F}'_T(t)$ almost everywhere in $[0, 1]$. Finally, $\mathbf{R}_T^a(t)$ and $\mathbf{R}_T^b(t)$ are defined by:

$$\mathbf{R}_T^a = \begin{cases} (0, 0) & \text{if } t \in \left[\frac{1}{\beta^{m+1}}, \frac{1}{\beta^{m+1}} \frac{\beta + 1}{2} \right[\\ \mathcal{R}^a \left(\frac{1}{\beta^{m+1}} \frac{\beta + 1}{2}, \frac{1}{\beta^m}, \frac{1}{\beta^m}; t \right) & \text{if } t \in \left[\frac{1}{\beta^{m+1}} \frac{\beta + 1}{2}, \frac{1}{\beta^m} \right[\end{cases} \tag{65}$$

$$\mathbf{R}_T^b(t) = \begin{cases} \left(\frac{1}{\beta^{m+1}} \frac{e}{1 - e^2}, 0 \right) & \text{if } t \in \left[\frac{1}{\beta^{m+1}}, \frac{1}{\beta^{m+1}} \frac{\beta + 1}{2} \right[\\ \mathcal{R}^b \left(\frac{1}{\beta^{m+1}} \frac{\beta + 1}{2}, \frac{1}{\beta^m}, \frac{1}{\beta^m}; t \right) & \text{if } t \in \left[\frac{1}{\beta^{m+1}} \frac{\beta + 1}{2}, \frac{1}{\beta^m} \right[\end{cases} \tag{66}$$

where $\mathcal{R}^a(T_1, T_2, S; t)$ and $\mathcal{R}^b(T_1, T_2, S; t)$ are the functions defined by lemma 3. $\mathbf{R}_T^a(t)$ and $\mathbf{R}_T^b(t)$ are readily seen to belong to $W^{1,\infty}(0, 1; \mathbb{R}^2)$. Moreover, one checks that $\mathbf{R}_T^a(0) = \mathbf{R}_T^b(0) = 0$ and also that one has:

$$-\dot{\mathbf{R}}_T(t) - \dot{\mathbf{F}}_T(t) \in A(t) \cdot \mathbf{R}_T(t) \quad \text{for a.a. } t \in [0, 1], \tag{67}$$

where $\mathbf{R}_T(t)$ may be either $\mathbf{R}_T^a(t)$ or $\mathbf{R}_T^b(t)$. \mathbf{R}_T^a and \mathbf{R}_T^b lead to two solutions of problem \mathcal{P}'_2 with the particular form of Eq. (46) of the stiffness matrix and the particular choices of the functions \mathbf{F}_T and $S(t)$ constructed above. These solutions are distinct since:

$$\forall m \in \mathbb{N}, \quad \mathbf{R}_T^a \left(\frac{1}{\beta^m} \right) = (0, 0), \quad \mathbf{R}_T^b \left(\frac{1}{\beta^m} \right) = \left(\frac{1}{\beta^m} \frac{e}{1 - e^2}, 0 \right). \tag{68}$$

Using this result and proposition 1, one may easily construct two distinct solutions of problem \mathcal{P}_3 with the particular form of Eq. (46) of the stiffness matrix. Let $U_N^a(t)$, $U_N^b(t)$, $\mathbf{U}_T^a(t)$, $\mathbf{U}_T^b(t)$, $R_N^a(t)$, $R_N^b(t)$ and $F_N(t)$ be the functions defined on $]0,1[$ by:

$$\begin{aligned}
U_N^a(t) &= U_N^b(t) = 0, \\
\mathbf{U}_T^a(t) &= \mathbf{R}_T^a + \mathbf{F}_T, \\
\mathbf{U}_T^b(t) &= \mathbf{R}_T^b + \mathbf{F}_T, \\
R_N^a(t) &= R_N^b(t) = -\frac{1}{\mu}S(t), \\
F_N(t) &= \frac{1}{\mu}S(t) + eF_{T1}(t),
\end{aligned} \tag{69}$$

where $F_{T1}(t)$ is the first component of $\mathbf{F}_T(t)$. Defining $\mathbf{F}(t)$ by $\mathbf{F}(t) = F_N(t)\mathbf{e}_N + F_{T1}(t)\mathbf{e}_{T1} + F_{T2}(t)\mathbf{e}_{T2}$ and $\mathbf{U}^a, \mathbf{U}^b, \mathbf{R}^a, \mathbf{R}^b$, similarly, one gets two distinct solutions in $W^{1,\infty}(0, 1; \mathbb{R}^3)$ of problem \mathcal{P}_3 with the particular form of Eq. (46) of the stiffness matrix. These two solutions exist for any value of the friction coefficient in the interval $]0, 1/e[$.

Therefore, the solution of a quasi-static Signorini problem with Coulomb friction is not unique, in general, at least in the functional framework $W^{1,\infty}(0, T)$, [and therefore in $W^{1,p}(0, T)$].

References

- [1] A. Signorini, *Rend. di Matematica, Roma* 18 (1959) 1–45.
- [2] G. Fichera, *Mem. Accad. Naz. Lincei, Ser. 8 7* (1964) 91–140.
- [3] J.L. Lions, G. Stampacchia, *Comm Pure Appl Math* 20 (1967) 493–519.
- [4] G. Duvaut, J.L. Lions, *Les Inéquations en Mécanique et en Physique*. Dunod, Paris, 1972.
- [5] D. Kinderlehrer, G. Stampacchia, *An Introduction to Variational Inequalities and Their Applications*. Academic Press, New York, 1980.
- [6] C. Baiocchi, A. Capelo, *Variational and Quasivariational Inequalities*. Wiley, New York, 1984.
- [7] G. Duvaut, J.L. Lions, *Journal de Mécanique* 10 (1971) 409–420.
- [8] G. Duvaut, *C. R. Acad. Sci. Paris Série A* 290 (1980) 263–265.
- [9] J.T. Oden, E.B. Pires, *ASME J Appl Mech* 50 (1983) 67–76.
- [10] M. Cocu, *Int. J. Engng Sci.* 22 (1984) 567–575.
- [11] J. Jarušek, *Czec. Mat. J.* 33 (1983) 237–261.
- [12] J. Jarušek, *Czec. Mat. J.* 34 (1984) 619–629.
- [13] A. Klarbring, *Eur J Mech A/Solids* 9 (1990) 53–85.
- [14] M. Cocu, E. Pratt, M. Raous, *Int. J. Engng Sci.* 34 (1996) 783–798.
- [15] A. Klarbring, *Ingenieur-Archiv* 60 (1990) 529–541.
- [16] J.J. Moreau, in G. Capriz, G. Stampacchia (Eds.), *New Variational Techniques in Mathematical Physics*, Edizioni Cremonese, Roma, 1973, pp. 173–322.
- [17] Marques M.D.P. Monteiro, *Differential Inclusions in Nonsmooth Mechanical Problems*. Birkhäuser, Basel, Boston, Berlin, 1993.
- [18] J.J. Moreau, *J Differential Equations* 26 (1977) 347–374.

The Dynamics of Discrete Mechanical Systems with Perfect Unilateral Constraints

PATRICK BALLARD

Communicated by A. BRESSAN

Abstract

The dynamics of discrete mechanical systems with perfect unilateral constraints is formulated in a very general setting. The well-posedness of the resulting evolution problem is studied. It is proved that existence and uniqueness of a maximal solution is ensured provided strong assumptions are made on the regularity of the data: they are supposed to be analytic. Simple examples show that this regularity assumption may not be relaxed. Sufficient conditions to ensure that the maximal solution is defined for all time are supplied. The continuous dependence of the solution on initial conditions is also studied and the numerical computation of the solution is discussed.

1. Introduction

The aim of the Dynamics of Discrete Mechanical Systems (sometimes called Rational Mechanics or, after Lagrange, Analytical Mechanics) is the prediction of the motion of collections of bodies supposed to be perfectly indeformable. The theory classically distinguishes two types of interactions between the bodies themselves and between the bodies and the rest of the universe: the efforts and the constraints. The constraints are kinematical specifications of the motion with which some efforts are associated. A constraint is said to be perfect or ideal if the associated efforts do not dissipate energy. A constraint is said to be bilateral, or unilateral, if the kinematical specification gives rise to equalities, or inequalities respectively. A typical occurrence of unilateral constraints is the handling of non-penetration conditions.

When all the constraints are bilateral and perfect, the motion is classically governed by a second-order ordinary differential equation on a finite dimensional Riemannian manifold. When the data are smooth enough, the Cauchy-Lipschitz theorem guarantees that a unique motion is associated with any given initial state of the system.

When dealing with the dynamics of discrete mechanical systems with unilateral constraints, there is no such theorem, although many steps in this direction have been made during the past twenty years. To my knowledge, the first investigation of this question using modern mathematical tools (i.e., introducing motions whose acceleration is a measure with respect to time) is that of SCHATZMAN [18]. She studied the particular case where the configuration space is \mathbb{R}^d equipped with its canonical Euclidean structure and the admissible configuration set is convex. Her setting was also limited to the elastic impact constitutive equation. Using Yosida-type regularization and compactness arguments, she was able to prove the existence of solutions under very weak regularity assumptions. She also discussed uniqueness but proved it only in a very specific case. Further investigation on uniqueness was performed by PERCIVALE in [14] and [15]. He is the first to introduce analyticity hypothesis in this respect. But, his results apply also only to very specific cases. The formulation of the problem with completely inelastic impacts has been extensively studied by MOREAU [12]. An existence result was proved by MONTEIRO MARQUES [10] in the particular case in which the configuration space is Euclidean \mathbb{R}^d and the unilateral constraints are described by a single smooth function. Very recently, SCHATZMAN [19] studied the general one-degree-of-freedom problem with arbitrary impact constitutive law. In this case, she proved uniqueness under analyticity assumption on the data.

None of these results has the generality required by Mechanics. The existence and uniqueness results are proved under assumptions which are obviously not fulfilled in most discrete mechanical systems which may generally be encountered, except the last result of Schatzman, but it is limited to the one-degree-of-freedom problem.

In this paper, the dynamics of discrete mechanical systems with perfect unilateral constraints is formulated in a very general setting. To reach full generality, the configuration space is supposed to be an arbitrary Riemannian manifold instead of an Euclidean space. However, only the most elementary level of differential geometry is needed. The resulting general evolution problem is studied. The existence and uniqueness of a solution associated with given initial condition is proved provided the data are analytic.

In Section 2, we give a precise mathematical definition of what we call discrete mechanical system and system of bilateral constraints. We also recall some basic results connected to these definitions that we shall use subsequently.

In Section 3, a formulation of the equations of the dynamics of discrete mechanical systems with perfect unilateral constraints is presented. The content of this section follows very closely the work of MOREAU [12]. It is included since Moreau restricts himself to completely inelastic impacts. More generality, including the case of elastic impacts, is obtained here with no supplementary difficulty.

In Section 4, we prove a local existence and uniqueness result concerning the general problem of the dynamics of discrete mechanical systems with perfect unilateral constraints, under the single assumption that the data are analytic. Existence and uniqueness of a maximal solution follows immediately. A sufficient condition to ensure that this maximal solution is defined for all time is also presented.

In Section 5, three examples are discussed. One is due to Moreau and another one to Schatzman. They are included for the sake of completeness. The aim of these examples is to show that the regularity assumptions made in the previous section are, in some sense, minimal.

In Section 6, we illustrate the generality of the theorems of Section 3 in applying them to simple examples issuing from Mechanics.

In Section 7, the continuous dependence of the solution on initial conditions is discussed. Dependence on initial conditions is seen to be not continuous in general. However, a restrictive case where continuity holds is exhibited.

In Section 8, the numerical computation of the solution is discussed. Problems arise in connection with non-continuous dependence on initial conditions. However, we recall an algorithm, which was first described by Moreau, and prove its convergence in some restrictive cases.

The main results in this paper were announced in BALLARD [3].

2. Discrete mechanical systems and perfect bilateral constraints

The aim of this section is to give a precise definition of what we call a discrete mechanical system, to introduce notation and to recall some basic results that we shall use later on. For a comprehensive presentation, the reader is referred to ARNOLD [2] and ABRAHAM & MARSDEN [1].

2.1. Discrete mechanical systems

Definition 1. A *discrete mechanical system* is:

- A Hausdorff, smooth (of class C^p with $2 \leq p \leq \infty$) connected manifold Q of dimension d whose topology has a countable basis.

The manifold Q is called the configuration space of the discrete mechanical system; d is its number of degrees of freedom. The tangent bundle TQ of Q is called the phase space or the state space. A point q of Q is a configuration of the system and a point of TQ a state of the system. The cotangent bundle is denoted by T^*Q ; $\Pi_Q : TQ \rightarrow Q$ and $\Pi_Q^* : T^*Q \rightarrow Q$ are the natural projections. The tangent space at q will be denoted by T_qQ , and, to designate an element v of TQ , we shall often use the redundant notation (q, v) where $q = \Pi_Q(v)$ and $v \in T_qQ$. A curve on Q (i.e., a continuous mapping from a real interval I to Q) is also called a motion of the system. If a motion $q : I \rightarrow Q$ admits a tangent vector at t , it will be denoted by $(q(t), \dot{q}(t))$. This notation is an abuse consecrated by tradition. The dot will also be used in general to denote a derivative with respect to time. A local chart on Q is also called a local parametrization of the system.

- A Riemannian metric on Q denoted by $(\cdot, \cdot)_q$. The mapping

$$K \begin{cases} TQ \rightarrow \mathbb{R}^+ \\ (q, v) \mapsto \frac{1}{2}(v, v)_q = \frac{1}{2} \|v\|_q^2 \end{cases} \quad (1)$$

is the kinetic energy of the system.

- A real interval I and a smooth (of class $C^{p'}$ with $1 \leq p' \leq p$) mapping $f : TQ \times I \rightarrow T^*Q$ such that

$$\forall (q, v) \in TQ, \quad \forall t \in I, \quad \Pi_Q^*(f(q, v; t)) = \Pi_Q(q, v) = q.$$

The mapping f is called the virtual power of internal, external and inertial efforts acting on the system or, in short, the efforts mapping. We will denote by $\langle \cdot, \cdot \rangle_q$ the local duality product on $T_q^*Q \times T_qQ$ and \flat (and $\sharp = \flat^{-1}$ its inverse) the isomorphism of vector bundles from TQ onto T^*Q canonically associated with the Riemannian metric on Q .

The Fundamental Principle of Dynamics asserts that any motion of the system is of class C^2 and has to satisfy

$$\forall t \in I, \quad \flat \frac{D\dot{q}(t)}{dt} = f(q(t), \dot{q}(t); t), \quad (2)$$

where $\frac{D}{dt}$ denotes the operator of covariant derivation along $q(t)$ canonically associated with the Riemannian metric of Q .

In what follows, for (U, ψ) a local chart on Q , $(e_1(q), e_2(q), \dots, e_d(q))$ and $(e^1(q), e^2(q), \dots, e^d(q))$ will denote the dual basis of T_qQ and T_q^*Q naturally associated with the considered chart; $\psi(q)$, which we shall abusively continue to denote by q , is an element (q^1, q^2, \dots, q^d) of \mathbb{R}^d . If $q(t)$ is a smooth motion on Q , $(\dot{q}^1(t), \dot{q}^2(t), \dots, \dot{q}^d(t))$ will be the components of its tangent vector (also called velocity) in the local basis:

$$\dot{q}(t) = \dot{q}^i(t)e_i(q(t)),$$

where Einstein's summation convention applies. It will always apply unless explicitly stated. No confusion induced by this notation should be expected since

$$\forall i \in \{1, 2, \dots, d\}, \quad \dot{q}^i(t) = \frac{d}{dt}q^i(t).$$

In general, we shall use the same notation to denote a function and its representative in a chart. As usual, $g_{ij}(q)$ will denote the covariant components of the metric in the considered chart and $g^{ij}(q)$ its contravariant components, while $\Gamma_{jk}^i(q)$ will be the associated Christoffel symbols:

$$\Gamma_{jk}^i(q) = \frac{1}{2}g^{ih}(q) \left(\frac{\partial g_{hk}}{\partial q^j}(q) + \frac{\partial g_{jh}}{\partial q^k}(q) - \frac{\partial g_{jk}}{\partial q^h}(q) \right). \quad (3)$$

Proposition 2 (Lagrange). *Let (U, ψ) be a local chart and $q(t)$ a C^2 motion on Q . One has*

$$\flat \frac{D\dot{q}(t)}{dt} = \left(\frac{d}{dt} \frac{\partial}{\partial \dot{q}^i} K(q(t), \dot{q}(t)) - \frac{\partial}{\partial q^i} K(q(t), \dot{q}(t)) \right) e^i(q(t)).$$

Proof. It is straightforward since

$$\begin{aligned}
 {}^b\frac{D\dot{q}}{dt} &= g_{ij} \left(\frac{d}{dt} \dot{q}^j + \Gamma_{kl}^j \dot{q}^k \dot{q}^l \right) e^i \\
 &= g_{ij} \left(\frac{d}{dt} \dot{q}^j + \frac{1}{2} g^{jh} \left(\frac{\partial g_{hl}}{\partial q^k} + \frac{\partial g_{hk}}{\partial q^l} - \frac{\partial g_{kl}}{\partial q^h} \right) \dot{q}^k \dot{q}^l \right) e^i \\
 &= \left(g_{ij} \frac{d}{dt} \dot{q}^j + \frac{1}{2} \delta_i^h \left(\frac{\partial g_{hl}}{\partial q^k} + \frac{\partial g_{hk}}{\partial q^l} - \frac{\partial g_{kl}}{\partial q^h} \right) \dot{q}^k \dot{q}^l \right) e^i \\
 &= \left(g_{ij} \frac{d}{dt} \dot{q}^j + \frac{\partial g_{ij}}{\partial q^k} \dot{q}^j \dot{q}^k - \frac{1}{2} \frac{\partial g_{jk}}{\partial q^i} \dot{q}^j \dot{q}^k \right) e^i \\
 &= \left(\frac{d}{dt} \frac{\partial}{\partial \dot{q}^i} \left(\frac{1}{2} \dot{q}^j g_{jk} \dot{q}^k \right) - \frac{\partial}{\partial q^i} \left(\frac{1}{2} \dot{q}^j g_{jk} \dot{q}^k \right) \right) e^i. \quad \square
 \end{aligned}$$

Coming back to the equation of motion (2), suppose we are given in supplement an element t_0 of I , called the initial instant, and an element (q_0, v_0) of TQ , called the initial state. Then, we obtain the following Cauchy problem \mathcal{C} on Q :

$$\mathcal{C} \begin{cases} {}^b\frac{D\dot{q}}{dt} = f(q(t), \dot{q}(t); t) \\ (q(t_0), \dot{q}(t_0)) = (q_0, v_0). \end{cases}$$

The Cauchy-Lipschitz theorem guarantees existence and uniqueness of a maximal C^2 solution (J_m, q_m) where J_m is an open subinterval of I including t_0 , and q_m a C^2 motion defined on J_m . This expresses the fact that any other solution (J, q) of \mathcal{C} is necessarily a restriction of q_m :

$$J \subset J_m \quad \text{and} \quad q_m|_J = q.$$

This result allows us to associate with any discrete mechanical system a dynamical system, that is, a two-real-parameters collection $F_{s,t}$ of mappings from TQ into TQ such that

$$F_{t_3, t_2} \circ F_{t_2, t_1} = F_{t_3, t_1} \quad \text{and} \quad F_{t, t} = \text{Id}.$$

To illustrate these basic definitions and results, we give a simple example that we shall reuse later on in a slightly different context. Consider a plane system of two homogeneous rigid bars 1 and 2. The bar 1, of length l_1 and mass m_1 is connected to a fixed support by means of a perfect ball-and-socket joint equipped with a spiral spring of stiffness k_1 . The bar 2, of length l_2 and mass m_2 is connected to the free extremity of the bar 1 by means of another ball-and-socket joint also equipped with a spiral spring of stiffness k_2 . A force acts on the free extremity of the bar 2. This force remains parallel to the direction of the bar 2 and is of constant magnitude $\lambda > 0$ (see Fig. 1). With this system is associated the following discrete mechanical system:

- The configuration space is \mathbb{R}^2 equipped with its canonical structure of C^∞ manifold (it is not the 2-torus since we have to count the “number of turns” because of the spiral springs). This manifold may be represented by a single chart; in

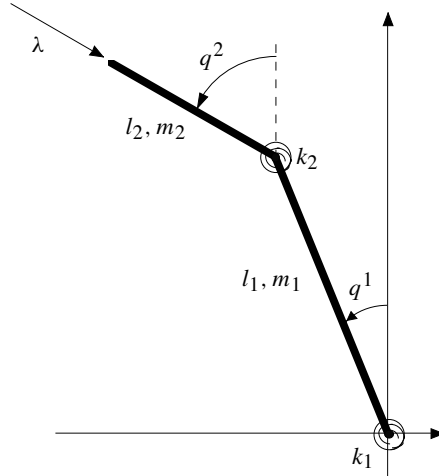

Fig. 1. Geometry of the double pendulum.

other words, there exists a global parametrization of the system. In the sequel, we shall only use the chart (q^1, q^2) defined by the angular measures associated with each of the joints.

- The kinetic energy is

$$\begin{aligned}
 K &= \frac{1}{2} \int_0^{l_1} \frac{m_1}{l_1} s^2 (\dot{q}^1)^2 ds \\
 &\quad + \frac{1}{2} \int_0^{l_2} \frac{m_2}{l_2} \left(l_1^2 (\dot{q}^1)^2 + s^2 (\dot{q}^2)^2 + 2l_1 s \cos(q^1 - q^2) \dot{q}^1 \dot{q}^2 \right) ds \\
 &= \frac{1}{2} \left(\frac{1}{3} m_1 l_1^2 (\dot{q}^1)^2 + m_2 l_1^2 (\dot{q}^1)^2 \right. \\
 &\quad \left. + \frac{1}{3} m_2 l_2^2 (\dot{q}^2)^2 + m_2 l_1 l_2 \cos(q^1 - q^2) \dot{q}^1 \dot{q}^2 \right).
 \end{aligned}$$

This kinetic energy defines a Riemannian structure on the configuration space. The expression of the metric tensor in the considered chart is

$$\begin{aligned}
 g_{11}(q^1, q^2) &= \left(\frac{1}{3}m_1 + m_2\right) l_1^2, \\
 g_{12}(q^1, q^2) &= \frac{1}{2}m_2 l_1 l_2 \cos(q^1 - q^2) = g_{21}(q^1, q^2), \\
 g_{22}(q^1, q^2) &= \frac{1}{3}m_2 l_2^2.
 \end{aligned}$$

- The efforts mapping has for expression in the considered chart:

$$\begin{aligned}
 f(q, \dot{q}; t) &= \left[\lambda l_1 \sin(q^1 - q^2) - (k_1 + k_2) q^1 + k_2 q^2 \right] e^1(q) \\
 &\quad + \left[k_2 q^1 - k_2 q^2 \right] e^2(q).
 \end{aligned}$$

Proposition 2 allows us to form easily the equation of motion in the considered chart:

$$\left\{ \begin{array}{l} \left(\frac{1}{3}m_1 + m_2 \right) l_1^2 \ddot{q}^1 + \frac{1}{2}m_2 l_1 l_2 \cos(q^1 - q^2) \ddot{q}^2 + \frac{1}{2}m_2 l_1 l_2 \sin(q^1 - q^2) (\dot{q}^2)^2, \\ = \lambda l_1 \sin(q^1 - q^2) - (k_1 + k_2) q^1 + k_2 q^2 \\ \frac{1}{2}m_2 l_1 l_2 \cos(q^1 - q^2) \ddot{q}^1 + \frac{1}{3}m_2 l_2^2 \ddot{q}^2 - \frac{1}{2}m_2 l_1 l_2 \sin(q^1 - q^2) (\dot{q}^1)^2 \\ = k_2 (q^1 - q^2). \end{array} \right. \quad (4)$$

The deterministic conclusion of the Cauchy-Lipshitz theorem on the dynamic evolution of the system is illusive. Indeed, if we add to the differential system (4) the initial condition

$$q^1(0) = q^2(0) = \dot{q}^1(0) = \dot{q}^2(0) = 0,$$

it is easily seen that the maximal solution is the identically vanishing function on the real line. But, Poincaré-Lyapunov theory shows that this solution is unstable for some value of λ and the real motion will differ in this case from this trivial solution. The correct analysis of the motion should in this case refer to some investigation of topological nature on the dynamical system generated by the equation of motion. In any case, one has to abandon the objective of predicting exactly the motion of the system. One has to be content with only partial information on this motion: this is a consequence of the over-idealization made during the modelling process. However, the Cauchy-Lipschitz theorem is at the basis of any further analysis which has to be performed on the equation of motion. This fact will be discussed with more details in Section 7 in the context of the dynamics of discrete mechanical systems with perfect unilateral constraints.

2.2. Bilateral constraints

One may introduce on a discrete mechanical system another type of effort, not taken into account by the efforts mapping f . Indeed, one may specify some efforts by their kinematical effects: one speaks of constraint. A constraint induces a restriction on the admissible motions of the system which is expressed by means of a finite number n of smooth real functions defined on Q :

$$\forall i \in \{1, 2, \dots, n\}, \quad \varphi_i(q) = 0. \quad (5)$$

The word constraint in the singular will be used indifferently to refer to either a constraint specifically associated with a single function φ_i or to the constraint associated with all the functions φ_i . In this terminology, a set of constraints is still a constraint. In formula (5), the constraint is said to be holonomic (because it applies on the configuration and not on the state), scleronomic (because it does not depend explicitly on time) and bilateral (because it is expressed only by equalities and not inequalities). We denote by S the following subset of Q :

$$S = \{q \in Q ; \forall i \in \{1, 2, \dots, n\}, \quad \varphi_i(q) = 0\},$$

and we add the assumption that the functions φ_i are functionally independent: for all q in S , the $d\varphi_i(q)$ ($i \in \{1, 2, \dots, n\}$) are linearly independent in T^*Q . As a consequence, S is a submanifold of Q of dimension $d - n$. The realization of kinematical specifications (5) necessarily involves a virtual power of reaction efforts mapping R taking values in T^*Q . It is *a priori* unknown.

Now, consider an initial instant t_0 in I and an initial state (q_0, v_0) compatible with the constraint (i.e., $(q_0, v_0) \in TS \subset TQ$). The evolution problem associated with the discrete mechanical system with bilateral constraint is: find $T > t_0, q \in C^2([t_0, T[; Q)$ and $R \in C^0([t_0, T[; T^*Q)$ such that

$$\begin{cases} \forall t \in [t_0, T[, & \flat \frac{D\dot{q}(t)}{dt} = f(q(t), \dot{q}(t); t) + R(t), \\ \forall t \in [t_0, T[, & q(t) \in S, \\ (q(t_0), \dot{q}(t_0)) &= (q_0, v_0). \end{cases}$$

These equations fail to determine the motion of the system: one has to supply additional information on the mapping R by means of a phenomenological assumption on the way the constraint acts. A constraint will be said to be perfect if the associated reaction efforts do not produce work in any virtual velocity compatible with the constraint

$$\forall v \in \{v \in T_qM \ \forall i \in \{1, 2, \dots, n\}, \langle d\varphi_i(q), v \rangle_q = 0\} \simeq TS, \quad \langle R, v \rangle_q = 0.$$

As a result:

$$\exists (\lambda_i)_{i=1,2,\dots,n} \in \mathbb{R}^n \quad R = \sum_{i=1}^n \lambda_i d\varphi_i(q).$$

Therefore, if the bilateral constraint is perfect, the evolution problem may be written as: find $T > t_0, q \in C^2([t_0, T[; Q)$ and $(\lambda_i)_{i=1,2,\dots,n} \in (C^0([t_0, T[; \mathbb{R}))^n$ such that

$$\mathcal{E}_Q \begin{cases} \forall t \in [t_0, T[, & \flat \frac{D_Q \dot{q}(t)}{dt} = f(q(t), \dot{q}(t); t) + \sum_{i=1}^n \lambda_i(t) d\varphi_i(q(t)), \\ \forall t \in [t_0, T[, & q(t) \in S, \\ (q(t_0), \dot{q}(t_0)) &= (q_0, v_0), \end{cases}$$

where $\frac{D_Q}{dt}$ is the operator of covariant derivation on Q .

Let q be a point of Q , v a vector of T_qQ , and E a subspace of T_qQ . The orthogonal projection of v on E for the scalar product of T_qQ induced by the Riemannian structure of Q will be denoted by $\text{Proj}_q[v; E]$. Similarly, $\text{Proj}_q^*[v^*; E^*]$ will denote the orthogonal projection of the 1-form v^* on the subspace E^* of T_q^*Q . Then, consider the evolution problem \mathcal{E}_S : find $T > t_0$ and $q \in C^2([t_0, T[; S)$ such that

$$\mathcal{E}_S \begin{cases} \forall t \in [t_0, T[, & \flat \frac{D_S \dot{q}(t)}{dt} = \text{Proj}_{q(t)}^* \left[f(q(t), \dot{q}(t); t); T_{q(t)}^*S \right], \\ (q(t_0), \dot{q}(t_0)) &= (q_0, v_0), \end{cases}$$

where T_q^*S is considered as a subspace of T_q^*Q and $\frac{D_S}{dt}$ is the operator of covariant derivation on S equipped with the Riemannian structure inherited from that of Q . We have:

Proposition 3. *Problems \mathcal{E}_Q and \mathcal{E}_S are equivalent: any solution of \mathcal{E}_Q generates a solution of \mathcal{E}_S and vice versa. Moreover, if Q and the functions φ_i are of class C^p ($p \geq 2$), and f of class C^{p-1} , then the unique maximal solution of \mathcal{E}_Q and \mathcal{E}_S is of class C^p . If Q , f and the φ_i are analytic functions, then so is the maximal solution of \mathcal{E}_Q and \mathcal{E}_S .*

Proof. First, let us identify T_qS and T_q^*S as subspaces of T_qQ and T_q^*Q . We have $T_q^*S = \flat(T_qS)$. Also T_q^*S and $\bigoplus_{i=1}^n \mathbb{R}d\varphi_i(q)$ are complementary orthogonal subspaces of T_q^*Q and (see CHAVEL [7, p. 54])

$$\frac{D_S \dot{q}}{dt} = \text{Proj}_q \left[\frac{D_Q \dot{q}}{dt}; T_qS \right].$$

Now, let q be a solution of \mathcal{E}_Q :

$$\text{Proj}_q^* \left[\flat \frac{D_Q \dot{q}}{dt}; T_q^*S \right] = \text{Proj}_q^* \left[f(q, \dot{q}; t) + \sum_{i=1}^n \lambda_i d\varphi_i(q); T_q^*S \right].$$

But,

$$\text{Proj}_q^* \left[f(q, \dot{q}; t) + \sum_{i=1}^n \lambda_i d\varphi_i(q); T_q^*S \right] = \text{Proj}_q^* \left[f(q, \dot{q}; t); T_q^*S \right],$$

and,

$$\text{Proj}_q^* \left[\flat \frac{D_Q \dot{q}}{dt}; T_q^*S \right] = \flat \text{Proj}_q \left[\frac{D_Q \dot{q}}{dt}; T_qS \right] = \flat \frac{D_S \dot{q}}{dt},$$

which show that q is a solution of \mathcal{E}_S .

Reciprocally, let q be a solution of \mathcal{E}_S . From

$$\flat \frac{D_S \dot{q}}{dt} = \flat \frac{D_Q \dot{q}}{dt} + \sum_{i=1}^n \alpha_i d\varphi_i(q),$$

$$\text{Proj}_q^* \left[f(q, \dot{q}; t); T_q^*S \right] = f(q, \dot{q}; t) + \sum_{i=1}^n \beta_i d\varphi_i(q),$$

we deduce the existence of n functions $\lambda_i : [t_0, T[\rightarrow \mathbb{R}$ such that

$$\flat \frac{D_Q \dot{q}}{dt} = f(q, \dot{q}; t) + \sum_{i=1}^n \lambda_i d\varphi_i(q).$$

It follows that

$$\begin{pmatrix} \vdots \\ \lambda_i \\ \vdots \end{pmatrix} = \begin{pmatrix} \vdots & & \\ \cdots & (d\varphi_i(q), d\varphi_j(q))_q & \cdots \\ \vdots & & \end{pmatrix}^{-1} \begin{pmatrix} \vdots \\ \left(b \frac{D_Q \dot{q}}{dt} - f(q, \dot{q}; t), d\varphi_i(q) \right)_q \\ \vdots \end{pmatrix},$$

where the Gram matrix is invertible because of the assumption on the functions φ_i . This shows that the functions λ_i are uniquely determined and that they are continuous. Therefore, q generates a solution of \mathcal{E}_Q .

The second part of Proposition 3 follows from standard results on ordinary differential equations (see, for example, CODDINGTON & LEVINSON [8]).

The moral of Proposition 3 is that adding a perfect bilateral constraint to a discrete mechanical system generates another discrete mechanical system with smaller number of degrees of freedom.

3. Discrete mechanical systems with perfect unilateral constraints

This section deals with the formulation of the equation of motion of a discrete mechanical system when some perfect unilateral constraints are added. All the basic ideas of this section are due to MOREAU [12]. It is included since Moreau restricts himself to the special case of completely inelastic impacts and also because Moreau does not consider the general case of an arbitrary configuration manifold equipped with an arbitrary Riemannian structure.

3.1. Kinematical setting

Consider a discrete mechanical system according to Section 2.1 and suppose that a finite number n of unilateral constraints are taken into account:

$$\forall i \in \{1, 2, \dots, n\}, \quad \varphi_i(q) \leq 0, \tag{6}$$

where the $\varphi_i : Q \rightarrow \mathbb{R}$ are C^1 functions. The closed subset A of Q defined by

$$A = \{q \in Q \mid \forall i \in \{1, 2, \dots, n\}, \varphi_i(q) \leq 0\}$$

is called the admissible configuration set. We define the mapping J by

$$J \begin{cases} Q \rightarrow \mathcal{P}(\{1, 2, \dots, n\}), \\ q \mapsto J(q) = \{i \in \{1, 2, \dots, n\} \mid \varphi_i(q) \geq 0\}, \end{cases}$$

where $\mathcal{P}(\{1, 2, \dots, n\})$ denotes the set of all subsets of $\{1, 2, \dots, n\}$. The set $J(q)$ is called the set of all active constraints in the configuration q . As in the case of bilateral constraints, a functional independence assumption is made on the functions φ_i :

$$\forall q \in A, \quad (d\varphi_i(q))_{i \in J(q)} \text{ is linear independent in } T_q^* Q. \tag{7}$$

As an easy consequence of the regularity assumptions made on the functions φ_i , the boundary ∂A and the interior $\overset{\circ}{A}$ of A in Q are such that

$$\partial A \subset \bigcup_{i=1}^n \varphi_i^{-1}(\{0\}), \quad (8)$$

$$\overset{\circ}{A} = J^{-1}(\{\emptyset\}). \quad (9)$$

Consider a motion in A (i.e., a continuous mapping from a real interval I to A) and assume that a right velocity $\dot{q}^+(t) \in T_{q(t)}Q$ exists for all instant t of I . We necessarily have

$$\forall i \in \{1, 2, \dots, n\}, \quad \forall t \in I, \quad \varphi_i(q(t)) = 0 \implies \langle d\varphi_i(q(t)), \dot{q}^+(t) \rangle_{q(t)} \leq 0$$

or, equivalently,

$$\forall i \in \{1, 2, \dots, n\}, \quad \forall t \in I, \quad \varphi_i(q(t)) = 0 \implies (\nabla\varphi_i(q(t)), \dot{q}^+(t))_{q(t)} \leq 0,$$

where $\nabla\varphi_i(q)$ is the gradient of φ_i at q defined by

$$\nabla\varphi_i(q) = \sharp(d\varphi_i(q)).$$

Thus, if the system has configuration q , then the right velocity \dot{q}^+ is necessarily in the closed convex cone $V(q)$ of T_qQ defined by:

$$V(q) = \{v \in T_qQ \mid \forall i \in J(q), \quad \langle d\varphi_i(q), v \rangle_q \leq 0\}.$$

The cone $V(q)$ is called the cone of admissible right velocities at the configuration q . In particular,

$$q \in \overset{\circ}{A} \text{ (i.e. } J(q) = \emptyset) \implies V(q) = T_qQ.$$

Similarly, if a left velocity $\dot{q}^- \in T_qQ$ exists, then,

$$\dot{q}^- \in -V(q).$$

3.2. Equation of motion

As for bilateral constraints, the realization of the constraints induces some reaction effort R . The following hypothesis are made:

- $\mathcal{H}1$: the unilateral constraints are of type contact without adhesion:

$$\forall v \in V(q), \quad \langle R, v \rangle_q \geq 0,$$

- $\mathcal{H}2$: the unilateral constraints are perfect:

$$\forall v \in \{v \in T_qM \mid \forall i \in J(q), \quad \langle d\varphi_i(q), v \rangle_q = 0\}, \quad \langle R, v \rangle_q = 0.$$

There results from hypothesis $\mathcal{H}1$ and $\mathcal{H}2$ and Farkas' lemma (see, e.g., ROCK-AFELLAR [16], p. 200) the following:

$$\begin{aligned} \exists (\lambda_i)_{i=1,2,\dots,n} \in \mathbb{R}^n, \quad R &= \sum_{i=1}^n \lambda_i d\varphi_i(q), \\ i \in J(q) &\Rightarrow \lambda_i \leq 0, \\ i \notin J(q) &\Rightarrow \lambda_i = 0. \end{aligned}$$

Thus, the reaction effort $R \in T^*Q$ must be such that

$$-R \in N^*(q) \stackrel{\text{def}}{=} \left\{ \sum_{i=1}^n \lambda_i d\varphi_i(q) \quad \forall i \in J(q), \quad \lambda_i \geq 0, \quad \forall i \notin J(q), \quad \lambda_i = 0 \right\}, \tag{10}$$

where $N^*(q)$ is a closed convex cone of T_q^*Q and the polar cone of $V(q)$ in the duality (T_qQ, T_q^*Q) . We will also have to consider the polar cone $N(q)$ of $V(q)$ for the Euclidean structure of T_qQ :

$$N(q) = \left\{ \sum_{i=1}^n \lambda_i \nabla \varphi_i(q) \quad \forall i \in J(q), \quad \lambda_i \geq 0, \quad \forall i \notin J(q), \quad \lambda_i = 0 \right\}.$$

Now, consider a motion $q(t)$ starting at $q_0 \in \overset{\circ}{A}$ at time t_0 with velocity v_0 . Assumed to be continuous, $q(t)$ remains in $\overset{\circ}{A}$ on a right neighborhood of t_0 . By formula (10), the reaction effort R vanishes as long as $q(t)$ is in $\overset{\circ}{A}$ and the motion is governed by the ordinary differential equation:

$$\begin{cases} \mathop{\text{b}}\frac{D}{\dot{q}} dt = f(q, \dot{q}; t), \\ (q(t_0), \dot{q}(t_0)) = (q_0, v_0). \end{cases}$$

Suppose that the solution of this Cauchy problem meets ∂A at some instant greater than t_0 . Denote by T the smallest of these instants. The motion admits a left velocity vector v_T^- at time T . Of course, it may happen that $v_T^- \notin V(q(T))$. In this case, no differentiable prolongation of the motion can exist in A for t greater than T . The requirement of differentiability has to be dropped. An instant such T is called an instant of *impact*. However, we are still going to require the existence of a right velocity vector $\dot{q}^+(t) \in V(q(t))$ at every instant t . The right velocity need not be a continuous function of time and the equation of motion,

$$\mathop{\text{b}}\frac{D\dot{q}^+}{dt} = f(q, \dot{q}^+; t) + R,$$

should be understood in the sense of Schwartz's distribution. Actually, we require R to be a *vector valued measure* rather than a general distribution. We denote by $\text{MMA}(I; Q)$ (motions with measure acceleration) the set of all absolutely continuous motions $q(t)$ from a real interval I to Q admitting a right velocity $\dot{q}^+(t)$ at

every instant t of I and such that the function $\dot{q}^+(t)$ has locally bounded variation over I . Naturally, bounded variation is classically defined only for functions taking values in a normed vector space. However, for any absolutely continuous curve $q(t)$ on a Riemannian manifold, parallel translation along $q(t)$ classically provides intrinsic identification of the tangent spaces at different points of the curve and so, the definitions can easily be carried over to this case. The precise mathematical setting is postponed to the appendix. The reader will notice from the appendix that with any motion $q \in \text{MMA}(I; Q)$ is intrinsically associated the covariant Stieljes measure $D\dot{q}^+$ of its right velocity \dot{q}^+ . The equation of motion takes the form

$$\flat D\dot{q}^+ = f(q, \dot{q}^+; t) dt + R,$$

where dt denotes the Lebesgue measure. We have to give a precise meaning to condition (10) with R being a vector valued measure. By convention, we shall take

$$R \in -N^*(q(t))$$

to mean: if $\theta \in L^1_{\text{loc}}(I, q, |R|; T^*Q)$ is the density of measure R with respect to its modulus measure $|R|$ defined by Proposition 25 of the appendix, then

$$\theta(t) \in -N^*(q(t)) \quad \text{for } |R| \text{-a.e. } t \in I. \tag{11}$$

This requirement is easily seen to be equivalent to the requirement of the existence of n nonpositive real measures λ_i such that

$$R = \sum_{i=1}^n \lambda_i d\varphi_i(q(t)), \tag{12}$$

$$\forall i \in \{1, 2, \dots, n\}, \quad \text{Supp } \lambda_i \subset \{t; \varphi_i(q(t)) = 0\}.$$

Using this convention, the final form of the equation of motion is:

$$R = \flat D\dot{q}^+ - f(q(t), \dot{q}^+(t); t) dt \in -N^*(q(t)) \tag{13}$$

3.3. The impact constitutive equation

We begin this section with an example. Consider the one-degree-of-freedom mechanical system whose configuration space is \mathbb{R} equipped with its canonical Euclidean structure. The efforts mapping f vanishes identically and the unilateral constraint is represented by the single function $\varphi_1(q) = q$ so that the admissible configuration set A is \mathbb{R}^- . At initial time $t_0 = 0$, we consider an initial state (q_0, v_0) such that $q_0 < 0$ and $v_0 > 0$. It is readily seen from the equation of motion (13) that an impact necessarily occurs at time $t = -q_0/v_0$. At this time, the left velocity is v_0 . But, the right velocity can take any negative value and whatever it is, it is compatible with the equation of motion.

The reason for this indetermination lies in the phenomenological nature of the interaction of the system with the obstacle. Thus, we are led to make the following general hypothesis:

- $\mathcal{H}3$: the interaction of the system with the obstacle at time t is completely determined by the present configuration $q(t)$ and the present left velocity $\dot{q}^-(t)$. In other words, we postulate the existence of a mapping $\mathcal{F} : TQ \rightarrow TQ$ describing the interaction of the system with the obstacle during an impact:

$$\forall t, \quad \dot{q}^+(t) = \mathcal{F}(q(t), \dot{q}^-(t)). \quad (14)$$

To ensure compatibility with the equation of motion (13), the mapping \mathcal{F} should satisfy:

$$\forall q \in A, \quad \forall v^- \in -V(q), \quad \begin{aligned} \mathcal{F}(q, v^-) &\in V(q), \\ \mathcal{F}(q, v^-) - v^- &\in -N(q). \end{aligned} \quad (15)$$

First, consider the particular case of a motion with no more than one active constraint at any time ($\forall t, \text{Card}J(q(t)) \leq 1$). The normal cone $N(q(t))$ is either $\{0\}$ or a half-line and hypothesis $\mathcal{H}3$ is equivalent to postulating the existence of an *impact function* $\phi : TQ \rightarrow \mathbb{R}$ such that

$$\forall t, \quad \dot{q}^+(t) = \dot{q}^-(t) - [1 + \phi(q(t), \dot{q}^-(t))] \text{Proj}_{q(t)}[\dot{q}^-(t); N(q(t))]. \quad (16)$$

Equation (16) admits the equivalent form:

$$\dot{q}^+(t) = \text{Proj}_{q(t)}[\dot{q}^-(t); V(q(t))] - \phi(q(t), \dot{q}^-(t)) \text{Proj}_{q(t)}[\dot{q}^-(t); N(q(t))]. \quad (17)$$

For the general case where more than one constraint may be active at a time, we recall the following (MOREAU [11]):

Lemma 4 (Moreau). *Let V and N be two closed convex polar cones of a real Hilbert space H . Then,*

$$\forall x \in H, \quad x = \text{Proj}[x; V] + \text{Proj}[x; N] \quad \text{and} \quad (\text{Proj}[x; V], \text{Proj}[x; N])_H = 0.$$

As a consequence, the ‘impact constitutive equations’ (16) and (17) still make sense and are still equivalent when more than one constraint may be active at a time. Therefore, it is natural to retain only the particular forms (16) and (17) of the general impact constitutive equation (14). As a result of this further hypothesis, the phenomenology of the interaction of the system with the obstacle during an impact is described by the single impact function $\phi : TQ \rightarrow \mathbb{R}$. The impact function is also often called the “restitution coefficient”. Naturally, the impact function ϕ cannot be arbitrary and has to satisfy some consistency conditions. For example, the normality condition in (15) requires

$$\forall q, \dot{q}^-, \quad \phi(q, \dot{q}^-) \geq -1.$$

But, this is not enough, we have to impose supplementary conditions on ϕ in order to ensure that

$$\dot{q}^- \in -V(q) \implies \dot{q}^+ \in V(q). \quad (18)$$

With respect to this, we have:

Proposition 5. *Let V and N be two closed convex polar cones of a real Hilbert space H . Consider $v^- \in -V$ such that $\text{Proj}[v^-; N] \neq 0$ and $\phi \in \mathbb{R}$. Then,*

$$[v^+ = v^- - (1 + \phi)\text{Proj}[v^-; N] \in V] \iff [\phi \geq 0].$$

Proof. For the “if” part, suppose $\phi \geq 0$. By Lemma 4, one gets

$$\text{Proj}[v^-; N] = v^- - \text{Proj}[v^-; V] \in -V.$$

But,

$$v^+ = \text{Proj}[v^-; V] + \phi(-\text{Proj}[v^-; N]),$$

and therefore, $v^+ \in V$, since V is a convex cone.

For the “only if” part, we have by hypothesis,

$$\text{Proj}[v^-; V] - \phi\text{Proj}[v^-; N] \in V.$$

Evaluating the scalar product with $\text{Proj}[v^-; N]$ and using Lemma 4, one gets

$$-\phi \|\text{Proj}[v^-; N]\|_H^2 \leq 0,$$

and therefore the desired conclusion $\phi \geq 0$. \square

There results from Proposition 5, the requirement that the impact function ϕ should be nonnegative. This consistency assumption ensures that conditions (15) and (18) will automatically be fulfilled.

At this stage, it should be underlined that hypothesis $\mathcal{H}3$ implies the general forms (16) or (17) for the impact constitutive equation only in the restrictive case where only at most one constraint is active at a time. In case of multiple impacts, the choice we made is only motivated by aesthetic considerations and also to fix ideas, since the concept of restitution coefficient is so firmly anchored in people’s minds. We shall discuss more completely the relevance of that choice in Section 6.4.

Now, let us look at another example. Consider the one-degree-of-freedom discrete mechanical system whose configuration space is \mathbb{R} equipped with its canonical structure of Riemannian manifold. The efforts mapping is supposed to be constant: $f(q, \dot{q}; t) \equiv 2$. To this discrete mechanical system, we add the unilateral constraint described by the single function $\varphi_1(q) = q$. Thus, $A = \mathbb{R}^-$. The impact constitutive equation is given by formula (16) where the impact function is supposed to be the constant $1/2$: $\phi \equiv 1/2$. This mechanical system is a formal description of the physical occurrence of a single particle subjected to gravity and bouncing on the floor. Consider the initial instant $t_0 = 0$ and the initial state $(q_0, v_0) = (-1, 0)$. It is readily seen that the function $q : \mathbb{R}^+ \rightarrow \mathbb{R}^-$ defined by

$$\begin{aligned} \forall t \in [0, 1], & \quad q(t) = t^2 - 1, \\ \forall t \in [1, 2], & \quad q(t) = t^2 - 3t + 2, \\ \forall t \in \left[3 - \frac{1}{2^{n-1}}, 3 - \frac{1}{2^n}\right], & \quad q(t) = t^2 + \left(-6 + \frac{3}{2^n}\right)t + \left(3 - \frac{1}{2^{n-1}}\right)\left(3 - \frac{1}{2^n}\right), \\ \forall t \in [3, +\infty[, & \quad q(t) = 0 \end{aligned}$$

$(n \in \mathbb{N})$ belongs to $\text{MMA}(\mathbb{R}^+; \mathbb{R}^-)$, satisfies the equation of motion (13) and also the impact constitutive equation (16). Note, by the way, that this motion exhibits an infinite number of impacts on a compact time subinterval. It could easily be proved that no motion, defined on $[0, \pm\infty[$, with finite number of impact on every compact interval can exist. Now, we are going to analyse what happens when the flow of time is reversed. Let us define q' by

$$q' \begin{cases} [0, 4] \rightarrow \mathbb{R}^- \\ t \mapsto q(4 - t). \end{cases}$$

Considering the initial state $(q_0, v_0) = (0, 0)$ at $t_0 = 0$, it is easily seen that q' satisfies both the equation of motion and the impact constitutive equation as soon as the impact function is replaced by $\phi' \equiv 2$. But, $q'' \equiv 0$ is also seen to satisfy the same initial condition, the equation of motion and the impact constitutive equation. To eliminate this pathological nonuniqueness, we are led to add the following hypothesis:

- $\mathcal{H}4$: the kinetic energy of the system can not increase during an impact:

$$\forall t, \quad \frac{1}{2} \|\dot{q}^+(t)\|_{q(t)}^2 \leq \frac{1}{2} \|\dot{q}^-(t)\|_{q(t)}^2. \tag{19}$$

Taking into account the impact constitutive equation (16), condition (19) can be rewritten as

$$\text{Proj}_q [\dot{q}^-; V]^2 + \phi^2 \text{Proj}_q [\dot{q}^-; N]^2 \leq \text{Proj}_q [\dot{q}^-; V]^2 + \text{Proj}_q [\dot{q}^-; N]^2,$$

which implies $\phi \leq 1$ as soon as $\text{Proj}_q [\dot{q}^-; N] \neq 0$.

The final form of the impact constitutive equation is therefore:

$$\forall t, \quad \dot{q}^+(t) = \dot{q}^-(t) - [1 + \phi(q(t), \dot{q}^-(t))] \text{Proj}_{q(t)} [\dot{q}^-(t); N(q(t))],$$

where the impact function ϕ is an arbitrary function from TQ to $[0, 1]$. The two extreme cases $\phi \equiv 0$ and $\phi \equiv 1$ are called, respectively, the completely inelastic and the elastic impact function.

3.4. Formulation of the evolution problem

In this subsection, the results of the previous subsections are brought together in order to formulate the resulting evolution problem which will be studied in the subsequent sections. We add an assumption on the regularity of the data: they are supposed to be *real-analytic*. This assumption will be motivated by the counterexamples of Section 5. The precise mathematical setting is:

- Q is an *analytic* Riemannian manifold of dimension d .

- φ_i ($i = 1, 2, \dots, n$) are n real *analytic* functions defined on Q . We define

$$\begin{aligned} J(q) &= \{i \in \{1, 2, \dots, n\} \mid \varphi_i(q) \geq 0\}, \\ A &= \{q \in Q \mid \forall i \in \{1, 2, \dots, n\}, \varphi_i(q) \leq 0\}, \\ V(q) &= \{v \in T_q Q \mid \forall i \in J(q), \langle d\varphi_i(q), v \rangle_q \leq 0\}, \\ TA^+ &= \{(q, v) \in TQ \mid q \in A \text{ and } v \in V(q)\}, \\ TA^- &= \{(q, v) \in TQ \mid q \in A \text{ and } v \in -V(q)\}, \\ N^*(q) &= \left\{ \sum_{i=1}^n \lambda_i d\varphi_i(q); \quad \forall i \in J(q), \lambda_i \geq 0, \quad \forall i \notin J(q), \lambda_i = 0 \right\}, \\ N(q) &= \left\{ \sum_{i=1}^n \lambda_i \nabla \varphi_i(q); \quad \forall i \in J(q), \lambda_i \geq 0, \quad \forall i \notin J(q), \lambda_i = 0 \right\}. \end{aligned}$$

The functions φ_i are assumed to be *functionally independent* in the sense that

$$\forall q \in A, \quad (d\varphi_i(q))_{i \in J(q)} \text{ is linearly independent in } T_q^* Q. \quad (20)$$

- The impact function ϕ is an arbitrary function from TA^- into $[0, 1]$. No regularity assumption is made on ϕ .
- I is a real interval and O an open neighborhood of TA^+ in TQ and the efforts mapping is supposed to be an *analytic* mapping from $O \times I$ into T^*Q such that

$$\forall (q, v) \in O, \quad \forall t \in I, \quad \Pi_Q^*(f(q, v; t)) = \Pi_Q(q, v) = q.$$

- We are given an initial time t_0 in I such that I contains a right neighborhood of t_0 and an initial state (q_0, v_0) in TA^+ .

According to the previous subsections, the evolution problem associated with the dynamics of discrete mechanical systems with perfect unilateral constraints can be formulated as:

Problem \mathcal{P} : find $T \in \bar{I} \cup \{+\infty\}$, $T > t_0$ and $q \in \text{MMA}([t_0, T[; Q)$ such that:

$$\bullet (q(t_0), \dot{q}^+(t_0)) = (q_0, v_0), \quad (21)$$

$$\bullet \forall t \in [t_0, T[\quad (q(t), \dot{q}^+(t)) \in TA^+, \quad (22)$$

$$\bullet R = \mathbb{b}D\dot{q}^+ - f(q, \dot{q}^+; t) dt \in -N^*(q) \quad \text{for } |R|\text{-a.e. } t \in [t_0, T[, \quad (23)$$

$$\bullet \forall t \in]t_0, T[, \quad \dot{q}^+ = \dot{q}^- - [1 + \phi(q, \dot{q}^-)] \text{Proj}_q [\dot{q}^-; N(q)], \quad (24)$$

where equation (23) is to be understood in the sense of convention (11).

The existence and uniqueness of solutions for problem \mathcal{P} will be studied in Section 4. Before studying this question, let us state two almost obvious results.

Proposition 6. Any solution (T, q) of problem \mathcal{P} satisfies:

- $\text{Supp } R \subset \{t \in [t_0, T[; q(t) \in \partial A\}$.

– For all open subinterval J of $[t_0, T[$ such that $q(J) \subset \overset{\circ}{A}$, $q|_J$ is analytic and

$$\flat \frac{D\dot{q}(t)}{dt} = f(q(t), \dot{q}(t); t), \quad \forall t \in J.$$

Proof. Let J be an open subinterval of $[t_0, T[$ such that $q(J) \subset \overset{\circ}{A}$. By equality (9), we have

$$\forall t \in J, \quad N^*(q(t)) = \{0\}.$$

As a consequence of relation (23) and convention (11), we get:

$$\forall \varphi \in C_c^0(J, q|_J; TQ), \quad \int_J \langle \varphi(t), dR \rangle_{q(t)} = 0,$$

which is $R|_J = 0$ or $\text{Supp } R \subset [t_0, T[\setminus J$. The first item of Proposition 6 follows.

We have

$$\flat D\dot{q}|_J^+ = f(q, \dot{q}^+; t) dt,$$

which is,

$$D\dot{q}|_J^+ = \sharp \circ f(q, \dot{q}^+; t) dt.$$

Proposition 28 shows that $\dot{q}|_J^+$ is locally absolutely continuous, and, therefore,

$$\forall t \in J, \quad \dot{q}^+(t) = \dot{q}^-(t) = \dot{q}(t),$$

by Proposition 32. We get

$$\flat \frac{D\dot{q}}{dt} = \flat \frac{D\dot{q}^+}{dt} = f(q, \dot{q}; t), \quad \text{for } dt \text{-a.e. } t \in J,$$

again by Proposition 28. The conclusion follows by use of classical results on ordinary differential equations. \square

Proposition 7 (Energy inequality). *Any solution (T, q) of problem \mathcal{P} satisfies the following*

$$\begin{aligned} \forall t_1, t_2 \in [t_0, T[, \quad t_1 \leq t_2, \\ K(q(t_2), \dot{q}^+(t_2)) - K(q(t_1), \dot{q}^+(t_1)) &= \frac{1}{2} \|\dot{q}^+(t_2)\|_{q(t_2)}^2 - \frac{1}{2} \|\dot{q}^+(t_1)\|_{q(t_1)}^2 \\ &\leq \int_{t_1}^{t_2} \langle f(q(s), \dot{q}^+(s); s), \dot{q}^+(s) \rangle_{q(s)} ds. \end{aligned}$$

Proof. We have the following equality between real measures:

$$\left(\frac{\dot{q}^+(t) + \dot{q}^-(t)}{2}, D\dot{q}^+ \right)_{q(t)} = \left\langle \frac{\dot{q}^+(t) + \dot{q}^-(t)}{2}, f(q(t), \dot{q}^+(t); t) \right\rangle_{q(t)} dt + \left\langle \frac{\dot{q}^+(t) + \dot{q}^-(t)}{2}, R \right\rangle_{q(t)} .$$

Integrating over $]t_1, t_2]$ and using Propositions 30 and 32, we get

$$\begin{aligned} & \frac{1}{2} \|\dot{q}^+(t_2)\|_{q(t_2)}^2 - \frac{1}{2} \|\dot{q}^+(t_1)\|_{q(t_1)}^2 \\ &= \int_{]t_1, t_2]} \left\langle \frac{\dot{q}^+(t) + \dot{q}^-(t)}{2}, f(q(t), \dot{q}^+(t); t) \right\rangle_{q(t)} dt \\ &+ \int_{]t_1, t_2]} \left\langle \frac{\dot{q}^+ + \dot{q}^-}{2}, dR \right\rangle_q . \end{aligned} \tag{25}$$

Consider

$$D = \left\{ t \in]t_1, t_2] ; \frac{\dot{q}^+(t) + \dot{q}^-(t)}{2} \neq \dot{q}^+(t) \right\} ;$$

D is (at most) countable and therefore Lebesgue-negligible. The result is

$$\int_D \left\langle \frac{\dot{q}^+(t) + \dot{q}^-(t)}{2}, f(q(t), \dot{q}^+(t); t) \right\rangle_{q(t)} dt = 0.$$

Similarly,

$$\begin{aligned} & \int_{]t_1, t_2] \setminus D} \left\langle \frac{\dot{q}^+(t) + \dot{q}^-(t)}{2}, f(q(t), \dot{q}^+(t); t) \right\rangle_{q(t)} dt \\ &= \int_{t_1}^{t_2} \langle \dot{q}^+(t), f(q(t), \dot{q}^+(t); t) \rangle_{q(t)} dt \end{aligned}$$

Let us denote by θ_R the density of measure R with respect to its modulus measure $|R|$ provided by Proposition 26. Since

$$\forall t \in]t_1, t_2] \setminus D, \quad \frac{\dot{q}^+(t) + \dot{q}^-(t)}{2} = \dot{q}^+(t) = \dot{q}^-(t),$$

we get

$$\begin{aligned} & \int_{]t_1, t_2] \setminus D} \left\langle \frac{\dot{q}^+(t) + \dot{q}^-(t)}{2}, dR \right\rangle_{q(t)} = \int_{]t_1, t_2] \setminus D} \langle \dot{q}^+(t), \theta_R(t) \rangle_{q(t)} d|R| \\ &= \int_{]t_1, t_2] \setminus D} \langle \dot{q}^-(t), \theta_R(t) \rangle_{q(t)} d|R| . \end{aligned} \tag{26}$$

But

$$\theta_R(t) \in -N^*(q(t)) \quad \text{for } |R| \text{-a.e. } t \in]t_1, t_2] \setminus D,$$

and therefore the second integral in (26) is nonnegative whereas the third is non-positive since $V(q(t))$ and $N^*(q(t))$ are polar cones. As a consequence:

$$\int_{]t_1, t_2[\setminus D} \left\langle \frac{\dot{q}^+(t) + \dot{q}^-(t)}{2}, dR \right\rangle_{q(t)} = 0.$$

The following integral,

$$\begin{aligned} \int_D \left\langle \frac{\dot{q}^+(t) + \dot{q}^-(t)}{2}, dR \right\rangle_{q(t)} &= \int_D \left(\frac{\dot{q}^+(t) + \dot{q}^-(t)}{2}, D\dot{q}^+ \right)_{q(t)} \\ &= \frac{1}{2} \sum_{t \in D} \left(\|\dot{q}^+(t)\|_{q(t)}^2 - \|\dot{q}^-(t)\|_{q(t)}^2 \right), \end{aligned}$$

is nonpositive by virtue of hypothesis $\mathcal{H}4$.

The proposition results from equation (25) and from the estimation of these four integrals. \square

4. Existence and uniqueness of solutions for problem \mathcal{P}

This section is devoted to proving existence and uniqueness of a maximal solution for problem \mathcal{P} . Sufficient conditions to ensure that this maximal solution is defined for all time are also given. More precisely, we are going to prove the following results.

Theorem 8. *There is local existence and uniqueness of solution of problem \mathcal{P} in the sense that:*

- *There exists a solution (T, q) of problem \mathcal{P} . Actually, there exists $T > t_0$ and an analytic function $q : [t_0, T[\rightarrow Q$ which is a solution of problem \mathcal{P} .*
- *If (T_1, q_1) and (T_2, q_2) are two solutions of problem \mathcal{P} , then*

$$\exists T, \quad t_0 < T \leq \min\{T_1, T_2\}, \quad q_1|_{[t_0, T[} = q_2|_{[t_0, T[}.$$

Then, a standard argument yields:

Corollary 9. *Problem \mathcal{P} admits a unique maximal solution (T_m, q_m) ($t_0 < T_m \leq +\infty$) in the sense that if (T, q) denotes an arbitrary solution of problem \mathcal{P} , then*

$$T \leq T_m \quad \text{and} \quad q = q_m|_{[t_0, T[}.$$

Moreover, for each $t \in [t_0, T_m[$, there exists a right neighborhood $[t, t + \eta[$ of t such that the restriction of q_m to $[t, t + \eta[$ is analytic.

We shall say that the maximal solution of problem \mathcal{P} is global if it is defined on $I \cap [t_0, +\infty[$.

Theorem 10. Assume that the configuration space Q is a complete Riemannian manifold and that the efforts mapping f admits the estimate:

$$\begin{aligned} \forall (q, v) \in TA^+, \quad \text{for } dt\text{-a.e. } t \in I \cap [t_0, +\infty[, \\ \|f(q, v; t)\|_q \leq l(t) (1 + d(q, q_0) + \|v\|_q), \end{aligned}$$

where $l(t)$ is a (necessarily nonnegative) function of $L^1_{\text{loc}}(\mathbb{R}; \mathbb{R})$. Then, the maximal solution of problem \mathcal{P} is global.

Let us say a word about how the proof of these results is going to be structured. First, we construct $T_a > t_0$ and an analytic function $q_a : [t_0, T_a[\rightarrow Q$ such that (T_a, q_a) is a solution of problem \mathcal{P} : this is the object of Section 4.1. In Section 4.2, we prove that if $q \in \text{MMA}([t_0, T[; Q)$ is any other solution, then q and q_a coincide identically on a right neighborhood of t_0 . This is the most difficult part to prove but it is also the crucial one. For the proof of Theorem 10, we first notice that for $q \in \text{MMA}([t_0, T[; Q)$ (T finite) satisfying the equation of motion (23), boundedness of \dot{q}^+ implies finiteness of $\text{Var}(\dot{q}^+; [t_0, T])$: this is the object of Proposition 18 of Section 4.3. Note that the impact constitutive equation (24) plays no role in this property. Then, Theorem 10 is deduced from the energy inequality (Proposition 7) and the Gronwall-Bellman lemma.

In the proof of these results, we shall use the following notation. If J is any subset of $\{1, 2, \dots, n\}$, $\text{Gram}(J)$ will be the Gram matrix:

$$\text{Gram}(J) = \begin{pmatrix} & & \vdots & & \\ \cdots & (\nabla\varphi_i(q_0), \nabla\varphi_j(q_0))_{q_0} & \cdots & & \\ & & \vdots & & \\ & & & & \end{pmatrix}_{i, j \in J}.$$

If x is an arbitrary element of \mathbb{R}^J whose components are x_i with $i \in J$, then $(x_i)_{i \in J}$ will denote the column matrix,

$$(x_i)_{i \in J} = \begin{pmatrix} \vdots \\ x_i \\ \vdots \end{pmatrix}_{i \in J},$$

and ${}^T(x_i)_{i \in J}$ the associated row matrix,

$${}^T(x_i)_{i \in J} = (\cdots x_i \cdots)_{i \in J}.$$

4.1. Proof of local existence

Local existence is rather easy to prove in the setting of analytic data. The proof is a little bit lengthy but involves no specific difficulty. We begin with technical lemmas.

Let $X(t)$ be a C^∞ vector field along a C^∞ curve $q(t)$ on Q . The covariant derivative $\frac{D}{dt}X(t)$ of X along q defines a C^∞ vector field along q . So, one may consider its covariant derivative along q which will be denoted by $\frac{D^2}{dt^2}X(t)$. By induction, we get the definition of $\frac{D^i}{dt^i}X(t)$ ($i \in \mathbb{N}^*$). We have:

Lemma 11. Let X be a C^∞ vector field on Q and q^I, q^{II} two C^∞ curves on Q . With m being a nonnegative integer, one assumes that

$$q^I(t_0) = q^{II}(t_0), \quad \dot{q}^I(t_0) = \dot{q}^{II}(t_0),$$

and

$$\forall i \in \{1, 2, \dots, m\}, \quad \frac{D^i}{dt^i} \dot{q}^I(t_0) = \frac{D^i}{dt^i} \dot{q}^{II}(t_0).$$

Then,

$$\forall i \in \{1, 2, \dots, m+1\}, \quad \frac{D^i}{dt^i} X(q^I(t_0)) = \frac{D^i}{dt^i} X(q^{II}(t_0)).$$

Proof. Consider a local chart at $q^I(t_0) = q^{II}(t_0)$. If $q(t)$ is either $q^I(t)$ or $q^{II}(t)$:

$$\begin{aligned} \dot{q}(t) &= \dot{q}^i(t) e_i(q(t)), \\ X(q(t)) &= X^i(q(t)) e_i(q(t)), \\ \frac{D}{dt} X(q(t)) &= \left[\left(\nabla X^i(q(t)), \dot{q}(t) \right)_{q(t)} + \Gamma_{jk}^i(q(t)) X^j(q(t)) \dot{q}^k(t) \right] e_i(q(t)). \end{aligned}$$

Then,

$$\begin{aligned} \frac{D^2}{dt^2} X(q(t)) &= \left[\left(\frac{D}{dt} \nabla X^i(q(t)), \dot{q}(t) \right)_{q(t)} + \left(\nabla X^i(q(t)), \frac{D}{dt} \dot{q}(t) \right)_{q(t)} \right. \\ &\quad + \left(\nabla \Gamma_{jk}^i(q(t)), \dot{q}(t) \right)_{q(t)} X^j(q(t)) \dot{q}^k(t) \\ &\quad + \Gamma_{jk}^i(q(t)) \left(\nabla X^j(q(t)), \dot{q}(t) \right)_{q(t)} \dot{q}^k(t) \\ &\quad + \Gamma_{jk}^i(q(t)) X^j(q(t)) \left(\left(\frac{D\dot{q}(t)}{dt} \right)^k - \Gamma_{lm}^k(q(t)) \dot{q}^l(t) \dot{q}^m(t) \right) \\ &\quad \left. + \Gamma_{jk}^i(q(t)) \left(\frac{DX(q(t))}{dt} \right)^j \dot{q}^k(t) \right] e_i(q(t)), \end{aligned}$$

which gives the desired conclusion for the case $m = 1$. For arbitrary m , an easy induction based on the same type of computation in a local chart shows the existence of functions $h_i : (TQ)^{i-1} \rightarrow TQ$ independent of the considered curve $q(t)$ and such that

$$\frac{D^i X(q(t))}{dt^i} = h_i \left(q(t), \dot{q}(t), \frac{D\dot{q}(t)}{dt}, \dots, \frac{D^{i-1}\dot{q}(t)}{dt^{i-1}} \right). \quad \square$$

Exactly the same technique applies to prove

Lemma 12. Let $X : TQ \times I \rightarrow TQ$ a C^∞ mapping such that: $\Pi_Q(X(q, v; t)) = \Pi_Q(q, v) = q$, where I denotes a real interval containing t_0 . Let m be an arbitrary nonnegative integer and q^I, q^{II} two C^∞ curves on Q such that

$$q^I(t_0) = q^{II}(t_0), \quad \dot{q}^I(t_0) = \dot{q}^{II}(t_0),$$

and

$$\forall i \in \{1, 2, \dots, m\}, \quad \frac{D^i}{dt^i} \dot{q}^I(t_0) = \frac{D^i}{dt^i} \dot{q}^II(t_0).$$

Then,

$$\forall i \in \{1, 2, \dots, m\}, \quad \frac{D^i}{dt^i} X \left(q^I(t_0), \dot{q}^I(t_0); t_0 \right) = \frac{D^i}{dt^i} X \left(q^II(t_0), \dot{q}^II(t_0); t_0 \right).$$

Lemma 13. Consider $(q_0, v_0) \in TA^+$ and $J \subset J(q_0)$ an arbitrary subset of

$$\{i \in J(q_0); \langle d\varphi_i(q_0), v_0 \rangle_{q_0} = 0\}.$$

We denote by q_u and q_c some local solutions of problems:

$$\begin{cases} \mathcal{E}_u \left\{ \begin{array}{l} \flat \frac{D\dot{q}_u}{dt} = f(q_u, \dot{q}_u; t), \\ (q_u(t_0), \dot{q}_u(t_0)) = (q_0, v_0), \end{array} \right. \\ \mathcal{E}_c \left\{ \begin{array}{l} \flat \frac{D\dot{q}_c}{dt} = f(q_c, \dot{q}_c; t) + \sum_{i \in J(q_0)} \lambda_i(t) d\varphi_i(q_c), \\ \forall i \in J \quad \varphi_i(q) \equiv 0, \\ \forall i \in J(q_0) \setminus J \quad \lambda_i(t) \equiv 0, \\ (q_c(t_0), \dot{q}_c(t_0)) = (q_0, v_0), \end{array} \right. \end{cases}$$

furnished respectively by the Cauchy-Lipschitz theorem and Proposition 3. Then,

$$\text{Gram}(J(q_0)) (\lambda_i(t_0))_{i \in J(q_0)} = \left(\frac{d^2}{dt^2} \varphi_i(q_c(t_0)) - \frac{d^2}{dt^2} \varphi_i(q_u(t_0)) \right)_{i \in J(q_0)}.$$

Moreover, if

$$\exists m \in \mathbb{N}^*, \quad \forall i = 0, 1, \dots, m-1, \quad \forall j \in J(q_0), \quad \frac{d^i}{dt^i} \lambda_j(t_0) = 0,$$

then

$$\begin{aligned} \text{Gram}(J(q_0)) \left(\frac{d^m}{dt^m} \lambda_i(t_0) \right)_{i \in J(q_0)} \\ = \left(\frac{d^{m+2}}{dt^{m+2}} \varphi_i(q_c(t_0)) - \frac{d^{m+2}}{dt^{m+2}} \varphi_i(q_u(t_0)) \right)_{i \in J(q_0)}. \end{aligned}$$

Proof. First, from

$$(q_u(t_0), \dot{q}_u(t_0)) = (q_c(t_0), \dot{q}_c(t_0)) = (q_0, v_0),$$

it follows that

$$\forall i \in J(q_0), \quad \frac{D}{dt} \nabla \varphi_i(q_u(t_0)) = \frac{D}{dt} \nabla \varphi_i(q_c(t_0)),$$

on one hand, and

$$\frac{D}{dt}\dot{q}_u(t_0) - \frac{D}{dt}\dot{q}_c(t_0) = - \sum_{i \in J(q_0)} \lambda_i(t_0) \nabla \varphi_i(q_0),$$

on the other hand. Therefore, for all $i \in J(q_0)$,

$$\begin{aligned} & \frac{d^2}{dt^2} \varphi_i(q_c(t_0)) - \frac{d^2}{dt^2} \varphi_i(q_u(t_0)) \\ &= \left(\frac{D}{dt} \nabla \varphi_i(q_c(t_0)), v_0 \right)_{q_0} + \left(\nabla \varphi_i(q_c(t_0)), \frac{D}{dt} \dot{q}_c(t_0) \right)_{q_0} \\ & \quad - \left(\frac{D}{dt} \nabla \varphi_i(q_u(t_0)), v_0 \right)_{q_0} - \left(\nabla \varphi_i(q_u(t_0)), \frac{D}{dt} \dot{q}_u(t_0) \right)_{q_0} \\ &= \sum_{j \in J(q_0)} \lambda_j(t_0) (\nabla \varphi_i(q_0), \nabla \varphi_j(q_0))_{q_0}, \end{aligned}$$

which is the announced result.

Second, assume that

$$\forall j \in J(q_0), \quad \forall i = 0, 1, \dots, m-1, \quad \frac{d^i}{dt^i} \lambda_j(t_0) = 0.$$

An easy induction based on Lemmas 11 and 12 gives, for all $i = 1, 2, \dots, m$,

$$\begin{aligned} \frac{D^i}{dt^i} \dot{q}_u(t_0) &= \frac{D^i}{dt^i} \dot{q}_c(t_0), \\ \frac{D^{m+1}}{dt^{m+1}} \dot{q}_u(t_0) &= \frac{D^{m+1}}{dt^{m+1}} \dot{q}_c(t_0) - \sum_{j \in J(q_0)} \frac{d^m}{dt^m} \lambda_j(t_0) \nabla \varphi_j(q_0), \end{aligned}$$

and,

$$\forall j \in J(q_0), \quad \forall i = 1, 2, \dots, m+1, \quad \frac{D^i}{dt^i} \nabla \varphi_j(q_u(t_0)) = \frac{D^i}{dt^i} \nabla \varphi_j(q_c(t_0)).$$

Therefore, $\forall i \in J(q_0)$,

$$\begin{aligned} & \frac{d^{m+2}}{dt^{m+2}} \varphi_i(q_c(t_0)) - \frac{d^{m+2}}{dt^{m+2}} \varphi_i(q_u(t_0)) \\ &= \sum_{j \in J(q_0)} \frac{d^m}{dt^m} \lambda_j(t_0) (\nabla \varphi_i(q_0), \nabla \varphi_j(q_0))_{q_0}. \quad \square \end{aligned}$$

Proposition 14. *Considering the data of problem \mathcal{P} , we denote by \mathcal{P}' the following evolution problem.*

Problem \mathcal{P}' : find $T \in I$ ($T > t_0$), an analytic curve $q : [t_0, T[\rightarrow Q$ and n analytic functions $\lambda_i : [t_0, T[\rightarrow \mathbb{R}$ such that:

- $\forall t \in [t_0, T[, \quad \text{b} \frac{D\dot{q}(t)}{dt} = f(q(t), \dot{q}(t); t) + \sum_{i=1}^n \lambda_i(t) d\varphi_i(q(t)),$
- $\forall t \in [t_0, T[, \quad \forall i = 1, 2, \dots, n, \quad \lambda_i(t) \leq 0, \quad \varphi_i(q(t)) \leq 0, \quad \lambda_i(t)\varphi_i(q(t)) = 0$
- $(q(t_0), \dot{q}(t_0)) = (q_0, v_0)$

Then, problem \mathcal{P}' admits a solution $(T, q, \lambda_1, \dots, \lambda_n)$ unique in the sense that any other solution is either a restriction or an analytic extension of $(T, q, \lambda_1, \dots, \lambda_n)$.

Proof. First, let us state, once and for all, that the meaning of an analytic function on a not necessarily open set S is that there is an analytic extension to an open set O containing S .

Step 1. Construction of some functions q and λ_i .

Define

$$J_0 = \{i \in \{1, 2, \dots, n\} \mid \varphi_i(q_0) = 0 \text{ and } \langle d\varphi_i(q_0), v_0 \rangle_{q_0} = 0\},$$

and $I_0 = K_0 = \emptyset$. We denote by $q^{(1)}$ a solution of the Cauchy problem:

$$C^{(1)} \begin{cases} \text{b} \frac{D\dot{q}(t)}{dt} = f(q(t), \dot{q}(t); t), \\ (q(t_0), \dot{q}(t_0)) = (q_0, v_0). \end{cases}$$

Define

$$C^{(1)} = \{(\lambda_i^*) \in \mathbb{R}^{J_0} \mid \forall i \in J_0, \lambda_i^* \leq 0 \text{ and } \forall i \in K_0, \lambda_i^* = 0\} = (\mathbb{R}^-)^{J_0},$$

$$C^{(1)'} = \{(\mu_i^*) \in \mathbb{R}^{J_0} \mid \forall i \in I_0, \mu_i^* = 0 \text{ and } \forall i \in J_0, \mu_i^* \leq 0\} = (\mathbb{R}^-)^{J_0}.$$

Let $(\lambda_i^{(1)})_{i \in J_0} \in C^{(1)}$ be the solution of the variational inequality

$$\forall (\lambda_i^*)_{i \in J_0} \in C^{(1)},$$

$$T \left((\lambda_i^{(1)})_{i \in J_0} \mid \text{Gram}(J_0) \left(\lambda_i^* - \lambda_i^{(1)} \right)_{i \in J_0} \right) \geq T \left(-\frac{d^2}{dt^2} \varphi_i(q^{(1)}(t_0)) \right)_{i \in J_0} \left(\lambda_i^* - \lambda_i^{(1)} \right)_{i \in J_0}$$

furnished by the Lions-Stampacchia theorem (see [9]). Let $(\mu_i^{(1)})_{i \in J_0} \in C^{(1)'}$ be defined by

$$\left(\mu_i^{(1)} \right)_{i \in J_0} = \text{Gram}(J_0) \left(\lambda_i^{(1)} \right)_{i \in J_0} + \left(\frac{d^2}{dt^2} \varphi_i(q^{(1)}(t_0)) \right)_{i \in J_0}, \quad (27)$$

and I_1, J_1, K_1 by

$$\begin{aligned} I_1 &= I_0 \cup \left\{ i \in J_0 \quad \lambda_i^{(1)} < 0 \quad \text{and} \quad \mu_i^{(1)} = 0 \right\}, \\ J_1 &= \left\{ i \in J_0 \quad \lambda_i^{(1)} = 0 \quad \text{and} \quad \mu_i^{(1)} = 0 \right\}, \\ K_1 &= K_0 \cup \left\{ i \in J_0 \quad \lambda_i^{(1)} = 0 \quad \text{and} \quad \mu_i^{(1)} < 0 \right\}. \end{aligned}$$

Now suppose $q^{(n)}, (\lambda_i^{(n)}), (\mu_i^{(n)}), I_n, J_n$ and K_n are constructed. Then, $q^{(n+1)}$ is defined to be a local solution of the Cauchy problem:

$$\mathcal{C}^{(n+1)} \begin{cases} \text{b} \frac{D\dot{q}(t)}{dt} = f(q(t), \dot{q}(t); t) + \sum_{j \in J_0} \sum_{i=1}^n \lambda_j^{(i)} \frac{(t-t_0)^{j-1}}{(j-1)!} d\varphi_j(q(t)), \\ (q(t_0), \dot{q}(t_0)) = (q_0, v_0). \end{cases}$$

$$\begin{aligned} \mathcal{C}^{(n+1)} &= \left\{ (\lambda_i^*) \in \mathbb{R}^{J_0} \quad \forall i \in J_n, \quad \lambda_i^* \leq 0, \quad \text{and} \quad \forall i \in K_n, \quad \lambda_i^* = 0 \right\}, \\ \mathcal{C}^{(n+1)'} &= \left\{ (\mu_i^*) \in \mathbb{R}^{J_0} \quad \forall i \in I_n, \quad \mu_i^* = 0, \quad \text{and} \quad \forall i \in J_n, \quad \mu_i^* \leq 0 \right\}. \end{aligned}$$

Also $(\lambda_i^{(n+1)})_{i \in J_0} \in \mathcal{C}^{(n+1)}$ is defined to be the solution of the variational inequality

$$\forall (\lambda_i^*)_{i \in J_0} \in \mathcal{C}^{(n+1)},$$

$$\begin{aligned} T \left(\lambda_j^{(n+1)} \right)_{i \in J_0} \text{Gram}(J_0) \left(\lambda_i^* - \lambda_i^{(n+1)} \right)_{i \in J_0} \\ \geq T \left(-\frac{d^{n+2}}{dt^{n+2}} \varphi_i(q^{(n+1)}(t_0)) \right)_{i \in J_0} \left(\lambda_i^* - \lambda_i^{(n+1)} \right)_{i \in J_0}, \end{aligned}$$

$(\mu_i^{(n+1)})_{i \in J_0} \in \mathcal{C}^{(n+1)'}$ is defined by

$$\left(\mu_i^{(n+1)} \right)_{i \in J_0} = \text{Gram}(J_0) \left(\lambda_i^{(n+1)} \right)_{i \in J_0} + \left(\frac{d^{n+2}}{dt^{n+2}} \varphi_i(q^{(n+1)}(t_0)) \right)_{i \in J_0},$$

and $I_{n+1}, J_{n+1}, K_{n+1}$ by

$$\begin{aligned} I_{n+1} &= I_n \cup \left\{ i \in J_n \quad \lambda_i^{(n+1)} < 0 \quad \text{and} \quad \mu_i^{(n+1)} = 0 \right\}, \\ J_{n+1} &= \left\{ i \in J_n \quad \lambda_i^{(n+1)} = 0 \quad \text{and} \quad \mu_i^{(n+1)} = 0 \right\}, \\ K_{n+1} &= K_n \cup \left\{ i \in J_n \quad \lambda_i^{(n+1)} = 0 \quad \text{and} \quad \mu_i^{(n+1)} < 0 \right\}. \end{aligned}$$

Thus, the sequences $q^{(n)}, (\lambda_i^{(n)})_{i \in J_0}, (\mu_i^{(n)})_{i \in J_0}, I_n, J_n$ and K_n are defined by induction for $n \in \mathbb{N}^*$ and for all n in \mathbb{N}^* , I_n, J_n, K_n is a partition of J_0 . Moreover, one has:

$$\begin{aligned} I_n &\subset I_{n+1}, \\ \forall n \in \mathbb{N}, \quad J_{n+1} &\subset J_n, \\ K_n &\subset K_{n+1}. \end{aligned}$$

Define

$$I = \bigcup_{n=0}^{\infty} I_n, \quad J = \bigcap_{n=0}^{\infty} J_n, \quad K = \bigcup_{n=0}^{\infty} K_n.$$

It is readily seen that I, J, K form a partition of J_0 . We denote by $(q, (\lambda_i)_{i \in I})$ a local solution of the evolution problem

$$\mathcal{C} \begin{cases} \flat \frac{D\dot{q}(t)}{dt} = f(q(t), \dot{q}(t); t) + \sum_{i \in I} \lambda_i(t) d\varphi_i(q(t)), \\ \forall i \in I, \quad \varphi_i(q(t)) \equiv 0, \\ (q(t_0), \dot{q}(t_0)) = (q_0, v_0), \end{cases}$$

furnished by Proposition 3. The functions q and λ_i are analytic. For any i in $\{1, 2, \dots, n\} \setminus I$, the functions λ_i are defined to be the identically vanishing function:

$$\forall i \in \{1, 2, \dots, n\} \setminus I, \quad \lambda_i \equiv 0.$$

Step 2. We have:

$$\begin{aligned} \forall j \in J_0, \quad \forall i \in \mathbb{N}, \quad \frac{d^i}{dt^i} \lambda_j(t_0) &= \lambda_j^{(i+1)}, \\ \forall j \in J_0, \quad \forall i \in \mathbb{N}, \quad \frac{d^{i+2}}{dt^{i+2}} \varphi_j(q(t_0)) &= \mu_j^{(i+1)}. \end{aligned}$$

Indeed, applying Lemma 13 to Cauchy problems $\mathcal{C}^{(1)}$ and \mathcal{C} yields, thanks to equation (27),

$$\left(\mu_j^{(1)} - \frac{d^2}{dt^2} \varphi_j(q(t_0)) \right)_{j \in J_0} = \text{Gram}(J_0) \left(\lambda_j^{(1)} - \lambda_j(t_0) \right)_{j \in J_0}.$$

But, by definition of I ,

$$I_1 \subset I \subset J_0 \setminus K_1,$$

and so,

$$\begin{aligned} \forall j \in I, \quad \mu_j^{(1)} &= \frac{d^2}{dt^2} \varphi_j(q(t_0)) = 0, \\ \forall j \in J_0 \setminus I, \quad \lambda_j^{(1)} &= \lambda_j(t_0) = 0. \end{aligned}$$

Therefore,

$${}^T \left(\lambda_j^{(1)} - \lambda_j(t_0) \right)_{j \in J_0} \text{Gram}(J_0) \left(\lambda_j^{(1)} - \lambda_j(t_0) \right)_{j \in J_0} = 0,$$

and the conclusion follows for $i = 0$, since the Gram matrix is positive definite. For $i \geq 1$, we only have to apply successively lemma 13 to Cauchy problems $\mathcal{C}^{(i+1)}$ and \mathcal{C} .

Step 3. The functions q and λ_i define a solution of problem \mathcal{P}' .

By construction of the real numbers $\lambda_i^{(j)}$ and $\mu_i^{(j)}$ and by step 2, we have:

$$\forall i \in I, \quad \exists n_i \in \mathbb{N}, \quad \frac{d^{n_i}}{dt^{n_i}} \lambda_i(t_0) < 0 \quad \text{and} \quad \forall n < n_i, \quad \frac{d^n}{dt^n} \lambda_i(t_0) = 0,$$

and,

$$\begin{aligned} \forall i \in K, \quad \exists n_i \geq 2, \quad \frac{d^{n_i}}{dt^{n_i}} \varphi_i(q(t_0)) < 0 \quad \text{and} \quad \forall n < n_i, \quad \frac{d^n}{dt^n} \varphi_i(q(t_0)) = 0, \\ \forall i \in J_0 \setminus K, \quad \forall n \in \mathbb{N}, \quad \frac{d^n}{dt^n} \varphi_i(q(t_0)) = 0. \end{aligned}$$

Each function $\lambda_i(t)$ and $\varphi_i(q(t))$ being real-analytic, there results:

$$\exists \alpha > 0, \quad \forall t \in [t_0, t_0 + \alpha[, \quad \forall i \in J_0, \quad \lambda_i(t) \leq 0, \quad \text{and} \quad \varphi_i(q(t)) \leq 0.$$

Actually, $\alpha > 0$ is assumed to be sufficiently small to ensure:

$$\forall i \in \{1, 2, \dots, n\} \setminus J_0, \quad \forall t \in]t_0, t_0 + \alpha[, \quad \varphi_i(q(t)) < 0,$$

which is possible simply by continuity.

Now, it is easily seen that $(t_0 + \alpha, q, (\lambda_i)_{i \in \{1, 2, \dots, n\}})$ defines a solution of problem \mathcal{P}' .

Step 4. Uniqueness part of the proposition.

By the Cauchy-Lipshitz theorem, q is uniquely determined by the functions λ_j ($j = 1, 2, \dots, n$). Being analytic, these functions λ_j are uniquely determined by the collection of real numbers $d^i \lambda_j(t_0)/dt^i$, ($i \in \mathbb{N}$, $j \in \{1, 2, \dots, n\}$). Therefore, to prove uniqueness, one has only to show that these real numbers are determined by the data of the evolution problem.

Consider an arbitrary analytic solution $(T, q, \lambda_1, \dots, \lambda_n)$ of problem \mathcal{P}' . A repeated use of Lemma 13, similar to the one of Step 2 yields:

$$\forall j \in J_0, \quad \forall i \in \mathbb{N}, \quad \frac{d^i}{dt^i} \lambda_j(t_0) = \lambda_j^{(i+1)}.$$

Moreover,

$$\forall j \in \{1, 2, \dots, n\} \setminus J_0, \quad \forall i \in \mathbb{N}, \quad \frac{d^i}{dt^i} \lambda_j(t_0) = 0,$$

and the conclusion follows. \square

Proof of the local existence part of Theorem 8. Let $(T_a, q_a, \lambda_a^1, \dots, \lambda_a^n)$ be an analytic solution of problem \mathcal{P}' . It is readily seen that (T_a, q_a) is a local solution of problem \mathcal{P} . \square

4.2. Proof of local uniqueness

Local uniqueness is the most difficult part of Theorem 8. First, we recall a standart result:

Lemma 15 (Gronwall-Bellman). *Consider two functions $m_1 \in BV([0, T]; \mathbb{R})$ and $m_2 \in L^1(0, T; \mathbb{R})$ such that*

$$\text{for a.e. } t \in]0, T[, \quad m_2(t) \geq 0.$$

Let $\phi \in BV([0, T]; \mathbb{R})$ such that

$$\forall t \in [0, T], \quad \phi(t) \leq m_1(t) + \int_0^t m_2(s)\phi(s) ds.$$

Then,

$$\forall t \in [0, T], \quad \phi(t) \leq m_1(t) + \int_0^t m_1(s)m_2(s)e^{\int_s^t m_2(\sigma) d\sigma} ds.$$

We have the following corollary of the Gronwall-Bellman lemma:

Lemma 16. *Let m be a nonnegative integer, and $\psi : [0, T] \rightarrow \mathbb{R}$ an integrable function. If $\phi : [0, T] \rightarrow \mathbb{R}$ is any absolutely continuous function such that $\phi(t) = o(t^{m+1})$ when t tends towards 0 and such that there exists a nonnegative real constant C such that*

$$\text{for } dt\text{-a.e. } t \in]0, T[, \quad t \frac{d}{dt} \phi(t) \leq (1 + m + Ct) \phi(t) + t^{m+2} \psi(t),$$

then,

$$\forall t \in [0, T], \quad \phi(t) \leq t^{m+1} e^{Ct} \int_0^t \psi(s) e^{-Cs} ds.$$

Proof. This is almost obvious. Dividing each member of the inequality by t^{m+2} , we obtain:

$$\text{for } dt\text{-a.e. } t \in]0, T[, \quad \frac{d}{dt} \left(\frac{\phi(t)}{t^{m+1}} \right) \leq C \frac{\phi(t)}{t^{m+1}} + \psi(t).$$

After integration, the Gronwall-Bellman lemma yields:

$$\forall t \in]0, T[, \quad \frac{\phi(t)}{t^{m+1}} \leq \int_0^t \psi(s) ds + \int_0^t C e^{C(t-s)} \int_0^s \psi(\sigma) d\sigma ds.$$

Then, an integration by part gives the desired conclusion. \square

Proof of the local uniqueness part of Theorem 8. Consider, on one hand, the analytic solution $(T_a, q_a, \lambda_a^1, \dots, \lambda_a^n)$ of problem \mathcal{P} supplied by Proposition 14, and on the other hand, an arbitrary solution (T, q) of problem \mathcal{P} . We have to prove that q and q_a identically coincide on a right neighborhood of t_0 .

Step 1. Parametrization of the problem and notations.

Consider a local chart $\psi : U \subset \mathcal{Q} \rightarrow \mathbb{R}^d$ on \mathcal{Q} centered at q_0 such that the $\text{card}J(q_0)$ first components of $\psi(q)$ are $(\varphi_i(q))_{i \in J(q_0)}$. Recall that such a chart exists since $(d\varphi_i(q_0))_{i \in J(q_0)}$ is linearly independent in $T_{q_0}^* \mathcal{Q}$. We choose $\alpha > 0$, sufficiently small to have:

- $\forall t \in [t_0, t_0 + \alpha], q_a(t) \in U, q(t) \in U,$ (28)
- $\forall i \in J(q_0), \forall t \in [t_0, t_0 + \alpha], \frac{d}{dt} \varphi_i(q_a(t)) = \langle d\varphi_i(q_a(t)), \dot{q}_a(t) \rangle_{q_a(t)} \leq 0$
- $\forall i \in \{1, 2, \dots, n\} \setminus J(q_0), \forall t \in [t_0, t_0 + \alpha], \varphi_i(q_a(t)) < 0, \varphi_i(q(t)) < 0.$

Such a choice for α is possible because:

- the functions $q_a(t)$ and $\varphi_i(q_a(t))$ are real analytic,
- the functions $q(t)$ and $\varphi_i(q(t))$ are continuous.

We denote by f_i the components of f in the natural basis (e^i) associated with the chart under consideration. Since q_a is an analytic local solution of problem \mathcal{P} , we have

$$\forall i \in \{1, 2, \dots, d\}, \quad \forall s \in [t_0, t_0 + \alpha],$$

$$\left\{ g_{ij}(q_a) \left(\ddot{q}_a^j + \Gamma_{kl}^j(q_a) \dot{q}_a^k \dot{q}_a^l \right) - f_i(q_a, \dot{q}_a; s) \right\} = \lambda_a^i(s), \quad (29)$$

after appropriate renumbering of the functions λ_a^i . In what follows, d_0 will stand for $\text{card}J(q_0)$. The result of these choice is that

$$\forall i > d_0, \quad \lambda_a^i \equiv 0.$$

We denote by $|\cdot|$ the standard Euclidean norm on \mathbb{R}^d . Confusing (abusively) q and $\psi(q)$, we shall write

$$|q|^2 = \sum_{i=1}^d (q^i)^2,$$

and

$$|\dot{q}^+|^2 = \sum_{i=1}^d (\dot{q}^{+i})^2.$$

Step 2. There exists some positive real constants C_1 and C_2 such that the following estimate:

$$\begin{aligned} \forall t \in [t_0, t_0 + \alpha], \quad & \int_{t_0}^t \left(|q - q_a|^2(s) + |\dot{q}^+ - \dot{q}_a|^2(s) \right) ds \\ & \leq -\frac{1}{C_1} \int_{t_0}^t e^{C_2(t-s)} \int_{t_0}^s \sum_{i=1}^{d_0} \lambda_a^i(\sigma) \dot{q}^{+i}(\sigma) d\sigma ds. \end{aligned} \quad (30)$$

holds.

To prove this assertion, we first write the equation of motion (23) in the chart under consideration using Proposition 29:

$$\forall i \in \{1, 2, \dots, d\}, \quad \forall t \in [t_0, t_0 + \alpha],$$

$$g_{ij}(q) \left(d\dot{q}^{+j} + \Gamma_{kl}^j(q) \dot{q}^{+k} \dot{q}^{+l} dt \right) = f_i(q, \dot{q}^+; t) dt + \sum_{j=1}^{d_0} \delta_{ij} \mu_j,$$

where the μ_j are nonpositive real measures. But, by Propositions 29 and 30,

$$\begin{aligned} & d \left(\frac{1}{2} \left(\dot{q}^{+i} - \dot{q}_a^I \right) g_{ij}(q) \left(\dot{q}^{+j} - \dot{q}_a^J \right) \right) \\ & = \left(\frac{\dot{q}^{-i} + \dot{q}^{+i}}{2} - \dot{q}_a^I \right) g_{ij}(q) \left(d\dot{q}^{+j} - \ddot{q}_a^J dt + \Gamma_{kl}^j(q) \dot{q}^{+k} \left(\dot{q}^{+l} - \dot{q}_a^L \right) dt \right). \end{aligned}$$

Therefore,

$$\begin{aligned} & d \left(\frac{1}{2} \left(\dot{q}^{+i} - \dot{q}_a^I \right) g_{ij}(q) \left(\dot{q}^{+j} - \dot{q}_a^J \right) \right) \\ & = \left(\dot{q}^{+i} - \dot{q}_a^I \right) f_i(q, \dot{q}^+; t) dt - \left(\dot{q}^{+i} - \dot{q}_a^I \right) g_{ij}(q) \left(\ddot{q}_a^J + \Gamma_{kl}^j(q) \dot{q}^{+k} \dot{q}_a^L \right) dt \\ & \quad + \sum_{j=1}^{d_0} \left(\frac{\dot{q}^{-j} + \dot{q}^{+j}}{2} - \dot{q}_a^J \right) \mu_j. \end{aligned}$$

But,

$$\forall j \in \{1, 2, \dots, d_0\}, \quad \exists i \in J(q_0), \quad \forall t \in [t_0, t_0 + \alpha],$$

$$\dot{q}_a^j(t) = \frac{d}{dt} \varphi_i(q_a(t)) \leq 0,$$

by formulae (28), and,

$$\sum_{j=1}^{d_0} \frac{\dot{q}^{-j} + \dot{q}^{+j}}{2} \mu_j = \left\langle \frac{\dot{q}^- + \dot{q}^+}{2}, R \right\rangle_q,$$

which is a nonpositive real measure by Proposition 7. Therefore,

$$d \left(\frac{1}{2} (\dot{q}^{+i} - \dot{q}_a^I) g_{ij}(q) (\dot{q}^{+j} - \dot{q}_a^j) \right) \\ \leq \left((\dot{q}^{+i} - \dot{q}_a^I) f_i(q, \dot{q}^+; t) - (\dot{q}^{+i} - \dot{q}_a^I) g_{ij}(q) (\ddot{q}_a^j + \Gamma_{kl}^j(q) \dot{q}^{+k} \dot{q}_a^l) \right) dt,$$

in the sense of ordering of real measures. Integrating over $]t_0, t]$ ($t \in [t_0, t_0 + \alpha]$), we get

$$\frac{1}{2} (\dot{q}^{+i} - \dot{q}_a^I) g_{ij}(q) (\dot{q}^{+j} - \dot{q}_a^j) \\ \leq \int_{t_0}^t \left((\dot{q}^{+i} - \dot{q}_a^I) f_i(q, \dot{q}^+; s) - (\dot{q}^{+i} - \dot{q}_a^I) g_{ij}(q) (\ddot{q}_a^j + \Gamma_{kl}^j(q) \dot{q}^{+k} \dot{q}_a^l) \right) ds.$$

The term within the integral sign is an analytic function of the three variables q , \dot{q}^+ and s . Therefore, it is also an analytic function of the three variables $q - q_a$, $\dot{q}^+ - \dot{q}_a$ and s . It is written in the form

$$(\dot{q}^{+i} - \dot{q}_a^I) F_i(q - q_a, \dot{q}^+ - \dot{q}_a; s).$$

But, each function F_i can be decomposed in the following manner:

$$F_i(q - q_a, \dot{q}^+ - \dot{q}_a; s) = F_i(0, 0; s) + G_i(q - q_a, \dot{q}^+ - \dot{q}_a; s),$$

where the G_i are analytic and $G_i(0, 0; s) \equiv 0$. Hence, there exist d positive constants M_i such that, for all $s \in [t_0, t_0 + \alpha]$,

$$|G_i(q(s) - q_a(s), \dot{q}^+(s) - \dot{q}_a(s); s)| \leq M_i \sqrt{|q(s) - q_a(s)|^2 + |\dot{q}^+(s) - \dot{q}_a(s)|^2}.$$

Defining M to be the maximum of the constants M_i , we have proved that, for all $t \in [t_0, t_0 + \alpha]$,

$$\frac{1}{2} (\dot{q}^{+i} - \dot{q}_a^I) g_{ij}(q) (\dot{q}^{+j} - \dot{q}_a^j) \\ \leq \int_{t_0}^t \left\{ (\dot{q}^{+i} - \dot{q}_a^I) \left(f_i(q_a, \dot{q}_a; s) - g_{ij}(q_a) (\ddot{q}_a^j + \Gamma_{kl}^j(q_a) \dot{q}_a^k \dot{q}_a^l) \right) \right. \\ \left. + Md |\dot{q}^+ - \dot{q}_a| \sqrt{|q - q_a|^2 + |\dot{q}^+ - \dot{q}_a|^2} \right\} ds.$$

Moreover, by a compactness argument,

$$\exists C_1 > 0, \quad \forall t \in [t_0, t_0 + \alpha],$$

$$\frac{1}{2} (\dot{q}^{+i} - \dot{q}_a^I) g_{ij}(q) (\dot{q}^{+j} - \dot{q}_a^j) \geq C_1 |\dot{q}^+ - \dot{q}_a|^2,$$

and therefore, for all $t \in [t_0, t_0 + \alpha]$,

$$\begin{aligned} & |\dot{q}^+(t) - \dot{q}_a(t)|^2 \\ & \leq \frac{1}{C_1} \int_{t_0}^t (\dot{q}^{+i} - \dot{q}_a^i) \left(f_i(q_a, \dot{q}_a; s) - g_{ij}(q_a) \left(\ddot{q}_a^j + \Gamma_{kl}^j(q_a) \dot{q}_a^k \dot{q}_a^l \right) \right) ds \\ & \quad + \frac{Md}{C_1} \int_{t_0}^t |\dot{q}^+ - \dot{q}_a| \sqrt{|q - q_a|^2 + |\dot{q}^+ - \dot{q}_a|^2} ds. \end{aligned}$$

Moreover, by use of the Cauchy-Schwartz inequality,

$$\forall t \in [t_0, t_0 + \alpha], \quad |q(t) - q_a(t)|^2 \leq \alpha \int_{t_0}^t |\dot{q}^+(s) - \dot{q}_a(s)|^2 ds.$$

We obtain, for all $t \in [t_0, t_0 + \alpha]$,

$$\begin{aligned} & |q - q_a|^2(t) + |\dot{q}^+ - \dot{q}_a|^2(t) \\ & \leq \left(\frac{Md}{C_1} + \alpha \right) \int_{t_0}^t \left(|q - q_a|^2(s) + |\dot{q}^+ - \dot{q}_a|^2(s) \right) ds \\ & \quad - \frac{1}{C_1} \int_{t_0}^t \sum_{i=1}^{d_0} \lambda_a^i(s) (\dot{q}^{+i} - \dot{q}_a^i) ds, \end{aligned} \tag{31}$$

where formulae (29) have been used. We define

$$C_2 = \frac{Md}{C_1} + \alpha.$$

Notice that, actually

$$\forall i \in \{1, 2, \dots, d_0\}, \quad \lambda_a^i q_a^i \equiv 0,$$

and, so, by the analyticity of functions q_a^i and λ_a^i ,

$$\forall i \in \{1, 2, \dots, d_0\}, \quad \lambda_a^i \dot{q}_a^i \equiv 0.$$

Multiplying both terms of inequality (31) by $e^{-C_2 t}$ and integrating, we get

$$\begin{aligned} & \int_{t_0}^t \left(|q - q_a|^2(s) + |\dot{q}^+ - \dot{q}_a|^2(s) \right) ds \\ & \leq -\frac{1}{C_1} \int_{t_0}^t e^{C_2(t-s)} \int_{t_0}^s \sum_{i=1}^{d_0} \lambda_a^i(\sigma) \dot{q}^{+i}(\sigma) d\sigma ds, \end{aligned}$$

for all $t \in [t_0, t_0 + \alpha]$, which is nothing but estimate (30).

Step 3. Estimate (30) implies that the function $t \mapsto \sum_{i=1}^{d_0} \lambda_a^i(t) \dot{q}^{+i}(t)$ vanishes identically on a right neighborhood of t_0 .

Indeed, by estimate (30),

$$\forall t \in [t_0, t_0 + \alpha], \quad \int_{t_0}^t e^{-C_2 s} \int_{t_0}^s \sum_{i=1}^{d_0} \lambda_a^i(\sigma) \dot{q}^{+i}(\sigma) d\sigma ds \leq 0,$$

which is, after integration by parts,

$$\int_{t_0}^t e^{-C_2s} \sum_{i=1}^d \lambda_a^i(s) q^i(s) ds \leq \int_{t_0}^t e^{-C_2s} \int_{t_0}^s \sum_{i=1}^{d_0} q^i(\sigma) \dot{\lambda}_a^i(\sigma) d\sigma ds. \tag{32}$$

But, since,

$$\forall i \in \{1, 2, \dots, d_0\}, \quad \forall s \in [t_0, t_0 + \alpha], \quad \lambda_a^i(s) \leq 0 \text{ and } q^i(s) \leq 0,$$

the two members of inequality (32) are nonnegative and, therefore, the inequality is preserved when taking the absolute value of each member. We get:

$$\begin{aligned} \forall t \in [t_0, t_0 + \alpha], \\ \int_{t_0}^t e^{-C_2s} \sum_{i=1}^{d_0} \lambda_a^i(s) q^i(s) ds &\leq \int_{t_0}^t e^{-C_2s} \int_{t_0}^s \sum_{i=1}^{d_0} |q^i(\sigma)| |\dot{\lambda}_a^i(\sigma)| d\sigma ds, \\ &\leq \int_{t_0}^t \int_{t_0}^s e^{-C_2\sigma} \sum_{i=1}^{d_0} |q^i(\sigma)| |\dot{\lambda}_a^i(\sigma)| d\sigma ds. \end{aligned}$$

We define

$$\begin{aligned} Q^i(s) &= -e^{-C_2(s+t_0)} q^i(s + t_0), \\ L^i(s) &= -\dot{\lambda}_a^i(s + t_0). \end{aligned}$$

With this notation, we obtain:

$$\forall t \in [0, \alpha], \quad \int_0^t \sum_{i=1}^{d_0} L^i(s) Q^i(s) ds \leq \int_0^t \int_0^s \sum_{i=1}^{d_0} |L^i(s)| |Q^i(s)| d\sigma ds, \tag{33}$$

where the L^i are nonnegative real-analytic functions and the Q^i are nonnegative continuous functions which all vanish at $t = 0$ and which are differentiable at the origin. We are going to prove that inequality (33) implies that

$$\exists \beta \in]0, \alpha], \quad \forall t \in [0, \alpha], \quad \forall i \in \{1, 2, \dots, d_0\}, \quad L^i(t) Q^i(t) = 0.$$

The functions L^i being nonnegative real-analytic, there exist nonnegative integers $n_1 < n_2 < \dots < n_m$, a partition I_1, I_2, \dots, I_m of $\{1, 2, \dots, d_0\}$, and nonnegative real-analytic functions G^i such that

$$\forall k \in \{1, 2, \dots, m\}, \quad \forall i \in I_k, \quad L^i(s) = s^{n_k} G^i(s),$$

with either $G^i(0) > 0$ or $G^i \equiv 0$. Inequality (33) may be rewritten as:

$$\begin{aligned} \forall t \in [0, \alpha], \quad \int_0^t \sum_{k=1}^m \sum_{i \in I_k} \sigma^{n_k} G^i(\sigma) Q^i(\sigma) d\sigma \\ \leq \int_0^t \int_0^s \sum_{k=1}^m \sum_{i \in I_k} n_k \sigma^{n_k-1} G^i(\sigma) Q^i(\sigma) d\sigma ds \\ + \int_0^t \int_0^s \sum_{k=1}^m \sum_{i \in I_k} \sigma^{n_k} |\dot{G}^i(\sigma)| |Q^i(\sigma)| d\sigma ds. \end{aligned}$$

But, by the analyticity of the functions G^i ,

$$\exists \beta > 0, \quad \exists N > 0, \quad \forall i \in J(q_0), \quad \forall \sigma \in [0, \beta], \quad \left| \dot{G}^i(\sigma) \right| \leq NG^i(\sigma).$$

Therefore, for all $t \in [0, \beta]$,

$$\begin{aligned} \int_0^t \sum_{k=1}^m \sum_{i \in I_k} \sigma^{n_k} G^i(\sigma) Q^i(\sigma) d\sigma &\leq \int_0^t \int_0^s \sum_{k=1}^m \sum_{i \in I_k} n_k \sigma^{n_k-1} G^i(\sigma) Q^i(\sigma) d\sigma ds \\ &+ Nt \int_0^t \int_0^s \sum_{k=1}^m \sum_{i \in I_k} \sigma^{n_k-1} G^i(\sigma) Q^i(\sigma) d\sigma ds. \end{aligned}$$

Integrating by parts the left member of the inequality, we obtain, for all $t \in [0, \beta]$,

$$\begin{aligned} t \int_0^t \sum_{k=1}^m \sum_{i \in I_k} \sigma^{n_k-1} G^i(\sigma) Q^i(\sigma) d\sigma &\leq \int_0^t \int_0^s \sum_{k=1}^m \sum_{i \in I_k} (n_k + 1) \sigma^{n_k-1} G^i(\sigma) Q^i(\sigma) d\sigma ds \\ &+ Nt \int_0^t \int_0^s \sum_{k=1}^m \sum_{i \in I_k} \sigma^{n_k-1} G^i(\sigma) Q^i(\sigma) d\sigma ds. \quad (34) \end{aligned}$$

Since each function $G^i(\sigma)Q^i(\sigma)/\sigma$ is bounded over $[0, \beta]$, there exists a nonnegative real constant H such that

$$\begin{aligned} \forall k \in \{1, 2, \dots, m\}, \quad \forall t \in [0, \beta], \\ \int_0^t \int_0^s \sum_{i \in I_k} \sigma^{n_k-1} G^i(\sigma) Q^i(\sigma) d\sigma ds \leq Ht^{n_k+2}. \end{aligned}$$

Inequality (34) gives

$$\begin{aligned} t \int_0^t \sum_{i \in I_1} \sigma^{n_1-1} G^i(\sigma) Q^i(\sigma) d\sigma &\leq (1 + n_1 + Nt) \int_0^t \int_0^s \sum_{i \in I_1} \sigma^{n_1-1} G^i(\sigma) Q^i(\sigma) d\sigma ds + H_1 t^{n_2+2}, \end{aligned}$$

for all $t \in [0, \beta]$, where H_1 is a non negative real constant. As a consequence of Lemma 16, we obtain

$$\int_0^t \int_0^s \sum_{i \in I_1} \sigma^{n_1-1} G^i(\sigma) Q^i(\sigma) d\sigma ds = O(t^{n_2+2}).$$

Coming back to inequality (34), we get, for all $t \in [0, \beta]$,

$$\begin{aligned} & t \int_0^t \sum_{k=1}^2 \sum_{i \in I_k} \sigma^{n_k-1} G^i(\sigma) Q^i(\sigma) d\sigma \\ & \leq (1 + n_2 + Nt) \int_0^t \int_0^s \sum_{k=1}^2 \sum_{i \in I_k} \sigma^{n_k-1} G^i(\sigma) Q^i(\sigma) d\sigma ds + H_2 t^{n_3+2}. \end{aligned}$$

Applying once more Lemma 16, we obtain

$$\int_0^t \int_0^s \sum_{k=1}^2 \sum_{i \in I_k} \sigma^{n_k-1} G^i(\sigma) Q^i(\sigma) d\sigma ds = O(t^{n_3+2}).$$

Proceeding inductively, we obtain

$$\int_0^t \int_0^s \sum_{k=1}^{m-1} \sum_{i \in I_k} \sigma^{n_k-1} G^i(\sigma) Q^i(\sigma) d\sigma ds = O(t^{n_m+2}).$$

But, by inequality (34), for all $t \in [0, \beta]$,

$$\begin{aligned} & t \int_0^t \sum_{k=1}^m \sum_{i \in I_k} \sigma^{n_k-1} G^i(\sigma) Q^i(\sigma) d\sigma \\ & \leq (1 + n_m + Nt) \int_0^t \int_0^s \sum_{k=1}^m \sum_{i \in I_k} \sigma^{n_k-1} G^i(\sigma) Q^i(\sigma) d\sigma ds. \end{aligned}$$

Using Lemma 16 for the last time, we get

$$\forall t \in [0, \beta], \quad \int_0^t \int_0^s \sum_{k=1}^m \sum_{i \in I_k} \sigma^{n_k-1} G^i(\sigma) Q^i(\sigma) d\sigma ds = 0,$$

which implies

$$\forall i \in \{1, 2, \dots, d_0\}, \quad \forall t \in [0, \beta], \quad G^i(t) Q^i(t) = 0,$$

which is nothing but

$$\forall i \in \{1, 2, \dots, d_0\}, \quad \forall t \in [t_0, t_0 + \beta], \quad \lambda_a^i(t) q^i(t) = 0.$$

But, the analyticity of the functions λ_a^i implies

$$\forall i \in \{1, 2, \dots, d_0\}, \quad \forall t \in [t_0, t_0 + \beta], \quad \lambda_a^i(\sigma)\dot{q}^{+i}(\sigma) = 0,$$

and the assertion of Step 3 is proved.

Step 4. Conclusion of the proof of local uniqueness. Bringing together the results of Steps 2 and 3, we get:

$$\forall t \in [t_0, t_0 + \beta], \quad \int_{t_0}^t \left(|q - q_a|^2(s) + |\dot{q}^+ - \dot{q}_a|^2(s) \right) ds \leq 0,$$

which gives the desired conclusion:

$$\forall t \in [t_0, t_0 + \beta], \quad q(t) = q_a(t). \quad \square$$

4.3. Global solutions: proof of Theorem 10

First, we recall a classical lemma whose proof may be found, for example, in [5, p. 157].

Lemma 17. *Let m be in $L^1(0, T; \mathbb{R})$ such that $m(t) \geq 0$ for almost all t in $]0, T[$ and a be a real nonnegative constant. Consider $\phi \in \text{BV}([0, T]; \mathbb{R})$ such that*

$$\forall t \in [0, T], \quad \frac{1}{2}\phi^2(t) \leq \frac{1}{2}a^2 + \int_0^t m(s)\phi(s) ds,$$

then

$$\forall t \in [0, T], \quad |\phi(t)| \leq a + \int_0^t m(s) ds.$$

Proposition 18. *The Riemannian manifold Q is assumed to be complete. Let (T, q) be a solution of problem \mathcal{P} such that:*

- $T \in \overset{\circ}{I}$ (and, in particular, $T \neq +\infty$),
- $\|\dot{q}^+(t)\|_{q(t)}$ is bounded:

$$\exists V_m, \quad \forall t \in [t_0, T[, \quad \|\dot{q}^+(t)\|_{q(t)} \leq V_m.$$

Then \dot{q}^+ has bounded variation over $[t_0, T[$:

$$\text{Var}(\dot{q}^+; [t_0, T[) < \infty.$$

Proof. We denote by d the distance function associated with the metric space Q . Since,

- $\forall s_1, s_2 \in [t_0, T[, \quad s_1 \leq s_2, \quad d(q(s_1), q(s_2)) \leq \int_{s_1}^{s_2} \|\dot{q}^+(\sigma)\|_{q(\sigma)} d\sigma,$
- $\forall \sigma \in [t_0, T[, \quad \|\dot{q}^+(\sigma)\|_{q(\sigma)} \leq V_m,$
- Q is complete,

we deduce that $\lim_{t \rightarrow T^-} q(t)$ exists in Q . It is denoted by

$$q_T = \lim_{t \rightarrow T^-} q(t).$$

Let (U, ψ) be a local chart at q_T on Q such that the $\text{card} J(q_T)$ first components of $\psi(q)$ in \mathbb{R}^d are $(\varphi_i(q))_{i \in J(q_T)}$. Consider a compact neighborhood K of q_T in Q such that

- $K \subset U,$
- $\forall q \in K, \quad J(q) \subset J(q_T).$

We define

$$t'_0 = \min \{t \in [t_0, T[\mid \forall s \in [t, T[, \quad q(s) \in K\}.$$

Since $[t_0, t'_0]$ is compact, we have

$$\text{Var}(\dot{q}^+; [t_0, t'_0]) < \infty.$$

Therefore, it remains only to prove:

$$\text{Var}(\dot{q}^+;]t'_0, T]) < \infty.$$

Here, λ^{\max} and λ^{\min} will denote the maximum and the minimum of, respectively, the greatest and least eigenvalue of the matrix $(g_{ij}(q))_{i,j=1,2,\dots,d}$ when q wanders in K . With this notation, we obtain immediately:

$$\forall i \in \{1, 2, \dots, d\}, \quad \forall t \in [t'_0, T[, \quad \begin{aligned} |g_{ij}(q(t))\dot{q}^{+j}(t)| &\leq \sqrt{\lambda^{\max}} V_m, \\ |\dot{q}^{+i}(t)| &\leq \frac{V_m}{\sqrt{\lambda^{\min}}}. \end{aligned} \tag{35}$$

We denote by $B_q(0, V_m)$ the closed ball of $T_q Q$ with radius V_m and centered at the origin. Considering the following compact subset K' of TQ ,

$$K' = \bigcup_{q \in K} B_q(0, V_m),$$

we define the following nonnegative real constant,

$$F = \max_{i \in \{1, 2, \dots, d\}} \max_{(q, v; t) \in K' \times [t'_0, T]} |f_i(q, v; t)|,$$

and

$$G = \max_{i, j, k \in \{1, 2, \dots, d\}} \max_{q \in K} \left| \frac{\partial g_{ij}(q)}{\partial q^k} \right|.$$

Writing inclusion (23) in the local chart (U, ψ) , we obtain:

$$\forall i \in \{1, 2, \dots, d\}, \quad g_{ij}(q) \left(d\dot{q}^{+j} + \Gamma_{kl}^j(q) \dot{q}^{+k} \dot{q}^{+l} dt \right) = f_i(q, \dot{q}^+; t) dt + \lambda_i,$$

where the λ_i are d nonpositive real measures on $]t'_0, T[$. Expressing the Christoffel symbols in terms of the metric, we have

$$\begin{aligned} \forall i \in \{1, 2, \dots, d\}, \\ g_{ij}(q) d\dot{q}^{+j} + \frac{\partial g_{ij}(q)}{\partial q^k} \dot{q}^{+j} \dot{q}^{+k} dt - \frac{1}{2} \frac{\partial g_{kl}(q)}{\partial q^i} \dot{q}^{+k} \dot{q}^{+l} dt \\ = f_i(q, \dot{q}^+; t) dt + \lambda_i, \end{aligned} \quad (36)$$

or, equivalently,

$$\begin{aligned} \forall i \in \{1, 2, \dots, d\}, \\ d \left(g_{ij}(q) \dot{q}^{+j} \right) = \frac{1}{2} \frac{\partial g_{kl}(q)}{\partial q^i} \dot{q}^{+k} \dot{q}^{+l} dt + f_i(q, \dot{q}^+; t) dt + \lambda_i. \end{aligned} \quad (37)$$

We deduce:

$$\begin{aligned} \forall i \in \{1, 2, \dots, d\}, \quad \forall s_1, s_2 \in]t'_0, T[, \quad s_1 < s_2, \\ \int_{]s_1, s_2]} (-\lambda_i) = g_{ij}(q(s_1)) \dot{q}^{+j}(s_1) - g_{ij}(q(s_2)) \dot{q}^{+j}(s_2) \\ + \int_{s_1}^{s_2} \left(f_i(q, \dot{q}^+; t) + \frac{1}{2} \frac{\partial g_{kl}(q)}{\partial q^i} \dot{q}^{+k} \dot{q}^{+l} \right) dt \\ \leq 2\sqrt{\lambda^{\max}} V_m + \left(F + \frac{d^2 G V_m^2}{2\lambda^{\min}} \right) (s_2 - s_1). \end{aligned} \quad (38)$$

The result is that the λ_i are d bounded measures on $]t'_0, T[$. Thanks to equation (36), it is readily seen that the measures $d\dot{q}^{+i}$ are also bounded measures on $]t'_0, T[$. Therefore, the d functions $\dot{q}^{+i} :]t'_0, T[\rightarrow \mathbb{R}$ have bounded variation over the interval $]t'_0, T[$. By Proposition 29, we have the result that \dot{q}^+ has also bounded variation over $]t'_0, T[$. \square

Proof of Theorem 10. We assume that the maximal solution q of problem \mathcal{P} is defined on $[t_0, T[$ with T in $\overset{\circ}{I}$ and try to obtain contradiction. By Proposition 7, this maximal solution satisfies:

$$\forall t \in [t_0, T[, \quad \frac{1}{2} \|\dot{q}^+(t)\|_{q(t)}^2 - \frac{1}{2} \|v_0\|_{q_0}^2 \leq \int_{t_0}^t \langle f(q(s), \dot{q}^+(s); s), \dot{q}^+(s) \rangle_{q(s)} ds.$$

Thus,

$$\begin{aligned} \forall t \in [t_0, T[, \\ \frac{1}{2} \|\dot{q}^+(t)\|_{q(t)}^2 \leq \frac{1}{2} \|v_0\|_{q_0}^2 + \int_{t_0}^t \|f(q(s), \dot{q}^+(s); s)\|_{q(s)} \|\dot{q}^+(s)\|_{q(s)} ds. \end{aligned}$$

By Lemma 17, we obtain

$$\forall t \in [t_0, T[, \quad \|\dot{q}^+(t)\|_{q(t)} \leq \|v_0\|_{q_0} + \int_{t_0}^t \|f(q(s), \dot{q}^+(s); s)\|_{q(s)} ds,$$

which gives, using the hypothesis of the theorem,

$$\forall t \in [t_0, T[, \\ \|\dot{q}^+(t)\|_{q(t)} \leq \|v_0\|_{q_0} + \int_{t_0}^t l(s) \left(1 + d(q(s), q_0) + \|\dot{q}^+(s)\|_{q(s)}\right) ds.$$

But,

$$\forall t \in [t_0, T[, \quad d(q(t), q_0) \leq \int_{t_0}^t \|\dot{q}^+(s)\|_{q(s)} ds,$$

therefore, for all $t \in [t_0, T[$,

$$d(q(t), q_0) + \|\dot{q}^+(t)\|_{q(t)} \\ \leq \|v_0\|_{q_0} + \int_0^t l(s) ds + \int_{t_0}^t (1 + l(s)) \left(d(q(s), q_0) + \|\dot{q}^+(s)\|_{q(s)}\right) ds.$$

By the Gronwall-Bellman lemma (Lemma 15), we get:

$$\forall t \in [t_0, T[, \\ d(q(t), q_0) + \|\dot{q}^+(t)\|_{q(t)} \leq \left(\|v_0\|_{q_0} + \int_0^t l(s) ds\right) e^{\int_{t_0}^t (1+l(s)) ds},$$

which shows that the function $t \mapsto \|\dot{q}^+(t)\|_{q(t)}$ is bounded over $[t_0, T[$. By the completeness of Q , we deduce, on one hand that

$$q_T = \lim_{t \rightarrow T^-} q(t)$$

exists in Q and, on the other hand, that

$$\text{Var}(\dot{q}^+; [t_0, T[) < \infty,$$

thanks to Proposition 18. Thus,

$$(q_T, v_T^-) = \lim_{t \rightarrow T^-} (q(t), \dot{q}^+(t)) \text{ exists in } TQ.$$

Define

$$v_T = v_T^- - [1 + \phi(q_T, v_T^-)] \text{Proj}_{q_T} [v_T^-; N(q_T)].$$

Then, Theorem 8 furnishes $T' \in I$ with $T' > T$ and a prolongation of q on $[T, T'[$ such that $q \in MMA([t_0, T'[; Q])$ is a solution of problem \mathcal{P} . But, this contradicts the definition of T . \square

5. Three counterexamples

The existence and uniqueness of solution for problem \mathcal{P} has been proved under the assumption of functional independence for the constraint and of analyticity for the data. The three examples which are developed in this section aim at showing that these assumptions cannot be weakened very much. In Example 1, we show that, in the case where the functional independence of the constraints does not hold, the existence of solution may be lost. For the question of the regularity assumptions on the data, the existence of solution can be proved with much weaker assumptions. However, the uniqueness of solutions is generally lost in such a case as seen in Examples 2 and 3. In these examples, the data are supposed to have only regularity C^∞ and two different solutions can be exhibited.

Example 1 is extracted from MOREAU [12] and Example 2 is due to SCHATZMAN [18], but an earlier counterexample in the same spirit is also to be found in BRESSAN [4].

5.1. Example 1

Consider a discrete mechanical system whose configuration space is Euclidean \mathbb{R}^3 . The unilateral constraints are kinematically described by the three following functions ($n = 3$):

$$\begin{aligned}\varphi_1(q) &= -q^1, \\ \varphi_2(q) &= q^1 - q^2 \cdot q^3, \\ \varphi_3(q) &= -q^2 - q^3,\end{aligned}$$

where $q = (q^1, q^2, q^3) \in \mathbb{R}^3$. The initial instant is supposed to be $t_0 = 0$ and the initial state is given by $q_0 = (0, 0, 0)$ and $v_0 = (0, 2, -1)$. It follows that

$$\begin{aligned}J(q_0) &= \{1, 2, 3\}, \\ V(q_0) &= \left\{ v = (v^1, v^2, v^3) \in \mathbb{R}^3 ; v^1 = 0 \text{ and } v^2 + v^3 \geq 0 \right\}.\end{aligned}$$

It is readily seen that v_0 belongs to $V(q_0)$.

Let now $\alpha > 0$ be an arbitrary positive real number. Any motion $q(t)$ in $\text{MMA}([0, \alpha[; \mathbb{R}^3)$ compatible with this initial data may be written as:

$$\begin{aligned}q^1(t) &= o(t), \\ q^2(t) &= 2t + o(t), \\ q^3(t) &= -t + o(t).\end{aligned}$$

Therefore,

$$\varphi_1(q(t)) + \varphi_2(q(t)) = 2t^2 + o(t^2),$$

which cannot be compatible with

$$\forall t \in [0, \alpha[, \quad \varphi_1(q(t)) + \varphi_2(q(t)) \leq 0.$$

We deduce that no motion in $\text{MMA}([0, \alpha[; \mathbb{R}^3)$ can be compatible with this initial data whatever $\alpha > 0$ is.

Note that, in this particular case, $d\varphi_1(q_0) = -d\varphi_2(q_0)$ and the unilateral constraints are not functionally independent.

5.2. Example 2

Consider a discrete mechanical system whose configuration space is \mathbb{R} equipped with its canonical structure of Riemannian manifold. This is the configuration space of a particle with unit mass constrained to move along a line. A fixed obstacle at the origin is taken into consideration. It gives rise to a unilateral constraint kinematically described by the single function ($n = 1$)

$$\varphi_1(q) = q.$$

Therefore, the admissible configuration set is $A = \mathbb{R}^-$. It is assumed that the impact constitutive equation is the elastic one, $\phi(q, \dot{q}^-) \equiv 1$, and that the efforts mapping f does not depend on the state but only on time. It will be denoted by $f(t)$. The initial instant is $t_0 = 0$ and the initial state is $(q_0, v_0) = (0, 0)$. Denoting by $\text{RCLBV}(I; \mathbb{R})$ the space of right continuous functions with locally bounded variation from a real interval I to \mathbb{R} , problem \mathcal{P} admits here the equivalent formulation:

Find $T > 0$ and $v \in \text{RCLBV}([0, T[; \mathbb{R})$ such that:

- $v(0) = 0,$
 - $q(t) = \int_0^t v(s) ds \in \mathbb{R}^-, \quad \forall t \in [0, T[,$
 - $R = dv - f(t) dt$ is a nonpositive real measure such that $\text{Supp } R \subset \{t \in [0, T[; q(t) = 0\}$
- $$\forall t \in]0, T[, \quad \begin{cases} q(t) \neq 0 \Rightarrow v(t) = v^-(t), \\ q(t) = 0 \Rightarrow v(t) = -v^-(t). \end{cases}$$

We investigate uniqueness under the assumption that f is of class C^∞ . Suppose, in addition, that f is nonnegative:

$$\forall t \in \mathbb{R}^+, \quad f(t) \geq 0.$$

It is readily seen that the null function $v \equiv 0$ on \mathbb{R}^+ is a solution of problem \mathcal{P} whatever is the nonnegative C^∞ function f . Now, we are going to construct an explicit example of such a function f in such a way that the associated problem \mathcal{P} admits another solution, different from the identically vanishing one.

First, let us define a function ρ by:

$$\rho \begin{cases} \mathbb{R} \rightarrow \mathbb{R}, \\ x \mapsto \begin{cases} 0 & \text{if } x \in]-\infty, 0] \cup [1, +\infty[, \\ \frac{e^{\frac{1}{x(x-1)}}}{\int_0^1 e^{\frac{1}{x(x-1)}} dx} & \text{if } x \in]0, 1[. \end{cases} \end{cases}$$

We have:

$$\begin{aligned} \rho &\in C^\infty(\mathbb{R}; \mathbb{R}^+), \\ \text{Supp}\rho &= [0, 1], \\ \forall n \in \mathbb{N}, \quad \frac{d^n}{dx^n}\rho(0) &= \frac{d^n}{dx^n}\rho(1) = 0, \\ 2 \int_0^1 (1-s)\rho(s) ds &= 1. \end{aligned} \tag{39}$$

The last assertion comes from the fact that

$$\int_0^1 s\rho(s) ds = \int_0^1 (1-s)\rho(s) ds,$$

so,

$$\int_0^1 s\rho(s) ds = \frac{1}{2} \int_0^1 \rho(s) ds = \frac{1}{2}.$$

Consider also the real convergent series:

$$\left[\frac{(n+5)^2}{(n+1)(n+2)(n+3)(n+4)} \right]_{n \in \mathbb{N}}.$$

We define

$$\begin{aligned} T &= \sum_{n=0}^{\infty} \frac{(n+5)^2}{(n+1)(n+2)(n+3)(n+4)} > 0, \\ a_n &= \sum_{i=n}^{\infty} \frac{(i+5)^2}{(i+1)(i+2)(i+3)(i+4)}. \end{aligned}$$

Clearly, $a_0 = T$ and the sequence $(a_n)_{n \in \mathbb{N}}$ decreases strictly and converges towards 0 when n tends toward infinity. Actually,

$$a_n \sim \frac{1}{n} \quad \text{when } n \rightarrow +\infty \tag{40}$$

by a very classical and elementary argument. We denote by $(\delta_n)_{n \in \mathbb{N}}$, $(f_n)_{n \in \mathbb{N}}$, $(v_n)_{n \in \mathbb{N}}$ the real sequences defined by

$$\begin{aligned} \delta_n &= \frac{n+5}{(n+1)(n+2)(n+4)} \quad (\text{i.e., } \delta_n = \frac{n+3}{n+5} (a_n - a_{n+1}) < a_n - a_{n+1}), \\ f_n &= \frac{1}{n!}, \\ v_n &= -\frac{1}{(n+3)!}, \end{aligned}$$

and by $f(t), v(t)$ the functions from $[0, T[$ to \mathbb{R} defined by

$$\begin{aligned}
 f(0) &= 0, \\
 f(t) &= \begin{cases} 0 & \text{if } t \in [a_{n+1}, a_{n+1} + \delta_n[, \\ \frac{f_n}{2} \rho\left(\frac{t-a_{n+1}-\delta_n}{a_n-a_{n+1}-\delta_n}\right) & \text{if } t \in [a_{n+1} + \delta_n, a_n[, \end{cases} \quad (41)
 \end{aligned}$$

and

$$\begin{aligned}
 v(0) &= 0, \\
 v(t) &= \begin{cases} v_{n+1} & \text{if } t \in [a_{n+1}, a_{n+1} + \delta_n[, \\ v_{n+1} + \frac{f_n}{2} \int_{a_{n+1}+\delta_n}^t \rho\left(\frac{s-a_{n+1}-\delta_n}{a_n-a_{n+1}-\delta_n}\right) ds & \text{if } t \in [a_{n+1} + \delta_n, a_n[. \end{cases} \quad (42)
 \end{aligned}$$

First, we claim that *the function f belongs to $C^\infty([0, T[; \mathbb{R})$* .

Proof. The only thing which is not obvious is that f is C^∞ at 0. Since

$$\forall t \in [a_{n+1}, a_n], \quad |f(t)| \leq \frac{f_n}{2} \max_{s \in [0,1]} |\rho(s)|,$$

then, $\lim_{t \rightarrow 0^+} f(t) = 0$ and f is continuous at 0. Now, we are going to prove

$$\forall r \in \mathbb{N}, \quad \lim_{t \rightarrow 0^+} \frac{1}{t} \frac{d^r}{dt^r} f(t) = 0 \quad (43)$$

which will imply by an easy induction that $f \in C^\infty([0, T[; \mathbb{R})$ and

$$\forall r \in \mathbb{N}, \quad \frac{d^r}{dt^r} f(0) = 0.$$

Let us fix an arbitrary r in \mathbb{N} . We have

$$\forall t \in [a_{n+1}, a_n], \quad \left| \frac{1}{t} \frac{d^r}{dt^r} f(t) \right| \leq \frac{f_n}{2a_{n+1}} \frac{(n+5)^r}{2^r (a_n - a_{n+1})^r} \max_{s \in [0,1]} \left| \frac{d^r \rho(s)}{dt^r}(t) \right|.$$

Therefore, to prove (43), it suffices to verify

$$\lim_{n \rightarrow \infty} \frac{f_n (n+5)^r}{a_{n+1} (a_n - a_{n+1})^r} = 0,$$

but, by estimate (40), we have

$$\frac{f_n (n+5)^r}{a_{n+1} (a_n - a_{n+1})^r} \sim \frac{n^{3r+1}}{n!}. \quad \square$$

Second, we claim that:

- $v \in \text{RCLBV}([0, T[; \mathbb{R}),$
- $dv - f(t) dt$ is a real nonpositive measure on $[0, T[$ whose support is $\{0\} \cup \{a_n; n \in \mathbb{N}^*\},$
- v is continuous on $[0, T[\setminus \{a_n; n \in \mathbb{N}^*\}$ and $\forall n \in \mathbb{N}^* \quad v(a_n) = -v^-(a_n).$

Proof. It is clear that v is continuous on each interval $]a_{n+1}, a_n[$ and right continuous on $[0, T[.$ Moreover,

$$\begin{aligned} v^-(a_n) &= v_{n+1} + \frac{f_n}{2} \int_{a_{n+1}+\delta_n}^{a_n} \rho \left(\frac{s - a_{n+1} - \delta_n}{a_n - a_{n+1} - \delta_n} \right) ds \\ &= v_{n+1} + \frac{f_n}{2} (a_n - a_{n+1} - \delta_n) \\ &= -\frac{1}{(n+4)!} + \frac{1}{n!} \frac{n+5}{(n+1)(n+2)(n+3)(n+4)} \\ &= \frac{1}{(n+3)!} \\ &= -v(a_n). \end{aligned}$$

Since v is nondecreasing on each interval $[a_{n+1}, a_n[,$

$$\begin{aligned} \text{Var}(v; [0, T[) &= \sum_{n=0}^{\infty} (|v(a_{n+1}) - v^-(a_{n+1})| + |v(a_{n+1}) - v^-(a_n)|) \\ &= \sum_{n=0}^{\infty} (-3v_{n+1} - v_n) \\ &= 3 \sum_{n=0}^{\infty} \frac{1}{(n+4)!} + \sum_{n=0}^{\infty} \frac{1}{(n+3)!} < +\infty. \end{aligned}$$

Denoting by δ_t the dirac measure located at $t,$ we have

$$dv - f(t) dt = -2 \sum_{n=1}^{\infty} \frac{\delta_{a_n}}{(n+3)!},$$

which is a (bounded) nonpositive measure whose support is $\{0\} \cup \{a_n; n \in \mathbb{N}^*\}.$ \square

Third, we claim that: *If q is defined by*

$$\forall t \in [0, T[, \quad q(t) = \int_0^t v(s) ds,$$

then

$$\begin{aligned} \forall t \in [0, T[\quad q(t) &\leq 0, \\ \{t \in [0, T[\quad q(t) = 0\} &= \{0\} \cup \{a_n; n \in \mathbb{N}^*\}. \end{aligned}$$

Proof. An easy calculation using the last assertion of formulae (39) shows that

$$\int_{a_{n+1}}^{a_n} v(s) ds = 0$$

$$\int_{a_{n+1}}^t v(s) ds < 0 \quad \forall t \in]a_{n+1}, a_n[. \quad \square$$

We deduce that, if we make the choice described by relations (41) for the function f , then the function v defined by relations (42) is a solution of the corresponding problem \mathcal{P} whereas the identically vanishing function is also a solution. Therefore, the uniqueness of solution does not hold in general if f and the functions φ_i are supposed to be of class C^∞ only.

5.3. Example 3

In Example 2, we considered a particle at rest at the initial instant and in contact with the obstacle. Then, a force acts on the particle, constantly pushing it against the obstacle ($f \geq 0$). For the particular choice of the function f we made, immobility is a possible motion whereas a bouncing motion is also possible. It is intuitively clear that the assumed elastic impact constitutive equation plays a central role in such a phenomenon. The question arises as to whether such a pathology is possible with the *completely inelastic impact constitutive equation* $\phi(q, \dot{q}^-) \equiv 0$.

Sticking to the notation of Example 2, the evolution problem takes in this case the form:

Find $T > 0$ and $v \in \text{RCLBV}([0, T[; \mathbb{R})$ such that

- $v(0) = 0,$
- $q(t) = \int_0^t v(s) ds \in \mathbb{R}^- \quad \forall t \in [0, T[,$
- $R = dv - f(t) dt$ is a nonpositive real measure such that $\text{Supp } R \subset \{t \in [0, T[; q(t) = 0\},$
- $\forall t \in]0, T[, \quad \begin{cases} q(t) \neq 0 \Rightarrow v(t) = v^-(t), \\ q(t) = 0 \Rightarrow v(t) = 0, \end{cases}$

If we still assume in this case that f is nonnegative, then it is easy to see that the only possible motion is immobility.

Indeed, if, $\exists t_2, q(t_2) < 0,$ define $t_1 = \inf \{t \in \mathbb{R}^+; \forall s \in]t, t_2] \quad q(s) < 0\}.$ Then, by continuity of $q: t_1 < t_2$ and $q(t_1) = 0.$ By the completely inelastic impact constitutive equation, we get: $v(t_1) = 0,$ and, so: $q(t_2) = \int_{t_1}^{t_2} \int_{t_1}^t f(s) ds dt \geq 0,$ which is absurd.

Nevertheless, we are going to construct an example similar to Example 2, which shows that, even in the case of the completely inelastic impact constitutive equation and f of class $C^\infty,$ we can obtain multiple solutions for the corresponding problem $\mathcal{P}.$ Of course, f should not be of constant sign.

The function f assumes the form:

$$\begin{aligned}
 f(0) &= 0, \\
 f(t) &= \begin{cases} -f_{1,n}\rho\left(\frac{t-\frac{1}{n+1}}{\delta_{1,n}}\right) & \text{if } t \in \left[\frac{1}{n+1}, \frac{1}{n+1} + \delta_{1,n}\right], \\ 0 & \text{if } t \in \left[\frac{1}{n+1} + \delta_{1,n}, \frac{1}{n} - \delta_{2,n}\right], \\ f_{2,n}\rho\left(\frac{t-\frac{1}{n} + \delta_{2,n}}{\delta_{2,n}}\right) & \text{if } t \in \left[\frac{1}{n} - \delta_{2,n}, \frac{1}{n}\right], \end{cases} \quad (44)
 \end{aligned}$$

where $n \in \mathbb{N}^*$; $(f_{1,n})_{n \in \mathbb{N}^*}$, $(f_{2,n})_{n \in \mathbb{N}^*}$, $(\delta_{1,n})_{n \in \mathbb{N}^*}$ and $(\delta_{2,n})_{n \in \mathbb{N}^*}$ are positive real sequences which are to be determined. We demand:

$$\delta_{1,n} \leq \frac{1}{2} \left(\frac{1}{n} - \frac{1}{n+1} \right) \quad \text{and} \quad \delta_{2,n} \leq \frac{1}{2} \left(\frac{1}{n} - \frac{1}{n+1} \right).$$

These sequences are to be determined in such a way that the corresponding problem \mathcal{P} admits two distinct solutions v^I and v^{II} . We demand that v^I , v^{II} and the corresponding functions q^I , q^{II} are such that :

$$\begin{aligned}
 q^I\left(\frac{1}{n}\right) &= 0 & q^{II}\left(\frac{1}{n}\right) &= -q_n & \text{if } n \text{ is even,} \\
 v^I\left(\frac{1}{n}\right) &= 0 & v^{II}\left(\frac{1}{n}\right) &= v_n \\
 q^I\left(\frac{1}{n}\right) &= -q_n & q^{II}\left(\frac{1}{n}\right) &= 0 & \text{if } n \text{ is odd,} \\
 v^I\left(\frac{1}{n}\right) &= v_n & v^{II}\left(\frac{1}{n}\right) &= 0
 \end{aligned}$$

where $(q_n)_{n \in \mathbb{N}^*}$ and $(v_n)_{n \in \mathbb{N}^*}$ are positive real sequences which are to be determined.

Consider the time interval $[\frac{1}{n+1}, \frac{1}{n}]$ for some $n \geq 2$. Under the action of f on $[\frac{1}{n+1}, \frac{1}{n+1} + \delta_{1,n}]$, the position of a particle which is at $q = -q_{n+1}$ with velocity $v = v_{n+1}$ at time $t = \frac{1}{n+1}$ should increase from $-q_{n+1}$ to 0. This is written as

$$-q_{n+1} + v_{n+1}\delta_{1,n} - \frac{1}{2}f_{1,n}\delta_{1,n}^2 = 0,$$

where $\delta_{1,n}$ has to be the smallest root of this second degree equation

$$\delta_{1,n} = \frac{v_{n+1} - \sqrt{v_{n+1}^2 - 2f_{1,n}q_{n+1}}}{f_{1,n}}. \quad (45)$$

We have also to express that, under the action of f on $[\frac{1}{n+1}, \frac{1}{n}]$, a particle at rest with position $q = 0$ at time $t = \frac{1}{n+1}$ should have position $q = -q_n$ and velocity $v = v_n$ at time $t = \frac{1}{n}$. That is:

$$\begin{aligned}
 v_n &= -f_{1,n}\delta_{1,n} + f_{2,n}\delta_{2,n}, \\
 -q_n &= -\frac{1}{2}f_{1,n}\delta_{1,n}^2 - f_{1,n}\delta_{1,n} \left(\frac{1}{n(n+1)} - \delta_{1,n} \right) + \frac{1}{2}f_{2,n}\delta_{2,n}^2,
 \end{aligned}$$

which is

$$\begin{aligned} v_n &= -f_{1,n}\delta_{1,n} + f_{2,n}\delta_{2,n}, \\ -q_n &= \frac{1}{2}f_{1,n}\delta_{1,n}^2 - f_{1,n}\delta_{1,n}\frac{1}{n(n+1)} + \frac{1}{2}f_{1,n}\delta_{1,n}\delta_{2,n} + \frac{1}{2}v_n\delta_{2,n}. \end{aligned} \quad (46)$$

Now, let us try to make the following choice:

$$\forall n \in \mathbb{N}^*, \quad q_n = \frac{1}{n^4 2^n}, \quad v_n = \frac{1}{2^n}, \quad f_{1,n} = \frac{n^3}{2^n}. \quad (47)$$

Formula (45) yields the result that, for sufficiently great n ,

$$\delta_{1,n} = \frac{1}{2n^3} \left(1 - \sqrt{1 - \frac{4n^3}{(n+1)^4}} \right), \quad (48)$$

which gives the estimate

$$\delta_{1,n} \sim \frac{1}{n^4} \quad \text{when } n \rightarrow \infty. \quad (49)$$

Equations (46) allow us to determine $\delta_{2,n}$ and $f_{2,n}$:

$$\begin{aligned} \delta_{2,n} &= \frac{\frac{2n^2}{n+1}\delta_{1,n} - n^3\delta_{1,n}^2 - \frac{2}{n^4}}{1 + n^3\delta_{1,n}}, \\ f_{2,n} &= f_{1,n}\frac{\delta_{1,n}}{\delta_{2,n}} + \frac{v_n}{\delta_{2,n}}, \end{aligned}$$

which provide the estimates

$$\begin{aligned} \delta_{2,n} &\sim \frac{2}{n^3} \\ f_{2,n} &\sim \frac{n^3}{2^{n+1}} \end{aligned} \quad \text{when } n \rightarrow \infty. \quad (50)$$

From estimates (49) and (50), we get

$$\begin{aligned} \exists n_0, \quad n \geq n_0 \quad \Rightarrow \quad & 0 < \delta_{1,n} < \frac{1}{2n(n+1)}, \\ & 0 < \delta_{2,n} < \frac{1}{2n(n+1)}. \end{aligned}$$

We define $T = \frac{1}{n_0}$. In exactly the same way as for example 2, it is readily seen from estimate (50) that $f \in C^\infty([0, T[; \mathbb{R})$. Define

$$u^I(0) = 0, \quad ; u^{II}(0) = 0, \quad \text{and for } n \geq n_0:$$

$$u^I(t) = \begin{cases} v_{n+1} - f_{1,n} \int_{\frac{1}{n+1}}^t \rho \left(\frac{s - \frac{1}{n+1}}{\delta_{1,n}} \right) ds & \text{if } t \in [\frac{1}{n+1}, \frac{1}{n+1} + \delta_{1,n}[, \\ 0 & \text{if } t \in [\frac{1}{n+1} + \delta_{1,n}, \frac{1}{n}[, \end{cases}$$

$$u^{II}(t) = \begin{cases} -f_{1,n} \int_{\frac{1}{n+1}}^t \rho \left(\frac{s - \frac{1}{n+1}}{\delta_{1,n}} \right) ds & t \in [\frac{1}{n+1}, \frac{1}{n+1} + \delta_{1,n}[, \\ -f_{1,n} \delta_{1,n} & t \in [\frac{1}{n+1} + \delta_{1,n}, \frac{1}{n} - \delta_{2,n}[, \\ -f_{1,n} \delta_{1,n} + f_{2,n} \int_{\frac{1}{n} - \delta_{2,n}}^t \rho \left(\frac{s - \frac{1}{n} + \delta_{2,n}}{\delta_{2,n}} \right) ds & t \in [\frac{1}{n} - \delta_{2,n}, \frac{1}{n}[, \end{cases}$$

and

$$v^I(0) = 0, \quad v^{II}(0) = 0,$$

$$\begin{aligned} v^I(t) &= u^I(t) \\ v^{II}(t) &= u^{II}(t) \end{aligned} \quad \text{if } t \in [\frac{1}{2p+1}, \frac{1}{2p}[\quad (2p \geq n_0),$$

$$\begin{aligned} v^I(t) &= u^{II}(t) \\ v^{II}(t) &= u^I(t) \end{aligned} \quad \text{if } t \in [\frac{1}{2p}, \frac{1}{2p-1}[\quad (2p - 1 \geq n_0),$$

Proceeding as in Example 2, we readily see that the two functions v^I and v^{II} belong to $RCLBV([0, T[; \mathbb{R})$ and furnish two distinct solutions of the problem \mathcal{P} associated with the C^∞ function f defined by equations (44).

6. Illustrative examples and comments

6.1. Punctual particle subjected to gravity and bouncing on the floor. Accumulation of impacts

Let us come back to the example of Section 3.3. The configuration space is \mathbb{R} equipped with its canonical structure of Riemannian manifold, the unilateral constraint is described by the single function $\varphi_1(q) = q$ (which gives $A = \mathbb{R}^-$). The efforts mapping is supposed to be constant, $f(q, \dot{q}; t) \equiv 2$, and the impact function (restitution coefficient) is the constant $1/2$: $\phi \equiv 1/2$. Considering the initial instant $t_0 = 0$ and the initial state $(q_0, v_0) = (-1, 0)$, we have seen in

Section 3.3 that the function $q : \mathbb{R}^+ \rightarrow \mathbb{R}^-$ defined by

$$\begin{aligned} \forall t \in [0, 1], & \quad q(t) = t^2 - 1, \\ \forall t \in [1, 2], & \quad q(t) = t^2 - 3t + 2, \\ \forall t \in \left[3 - \frac{1}{2^{n-1}}, 3 - \frac{1}{2^n}\right], & \quad q(t) = t^2 + \left(-6 + \frac{3}{2^n}\right)t + \left(3 - \frac{1}{2^{n-1}}\right)\left(3 - \frac{1}{2^n}\right), \\ \forall t \in [3, +\infty[, & \quad q(t) = 0 \end{aligned}$$

($\forall n \in \mathbb{N}$) belongs to $\text{MMA}(\mathbb{R}^+; \mathbb{R}^-)$ and is readily seen to be *the* maximal solution, according to Corollary 9, of the corresponding problem \mathcal{P} . The solution $q(t)$ is represented in Fig. 2. It is seen that infinitely many impacts accumulate in any left neighborhood of instant $t = 3$.

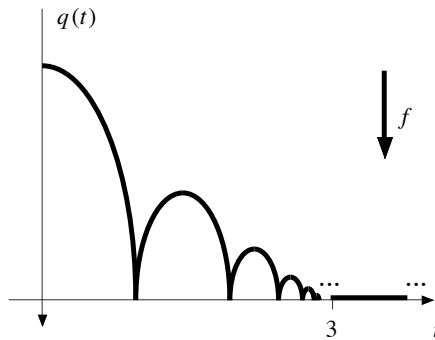

Fig. 2. Motion of a punctual particle subjected to gravity and bouncing on the floor.

However, as predicted by corollary 9, for each instant $t \in \mathbb{R}^+$, there exists a right neighborhood $[t, t + \eta[$ of t , such that the restriction of q to $[t, t + \eta[$ is analytic. A straightforward and general consequence of this is the following.

Proposition 19. *Let q be the maximal solution of problem \mathcal{P} furnished by corollary 9. Although infinitely many impacts can accumulate at the left of a given instant, this phenomenon can never occur at the right of any instant. Moreover, in the particular case where the impact constitutive equation is the elastic one ($\phi \equiv 1$), the instants of impact are isolated and therefore in finite number in any compact interval of time.*

Proof. Since for each instant $t \in [t_0, T[$, there exists a right neighborhood $[t, t + \eta[$ of t , such that the restriction of q to $[t, t + \eta[$ is analytic, we get the first part of the proposition. For the second part, let τ be an arbitrary instant in $]t_0, T[$ and consider the problem \mathcal{P} associated with the initial condition $(q(\tau), -\dot{q}^-(\tau))$, the elastic constitutive impact equation and the effort mapping $g(q, v; t)$ defined by

$$g(q, v; t) = f(q, -v; \tau - t)$$

which is analytic. By Theorem 8, there exists an analytic function $q_a : [0, T_a[\rightarrow \mathcal{Q}$ which is a solution of this problem \mathcal{P} . Another solution of problem \mathcal{P} coincides with q_a on a right neighborhood of $t = 0$. Actually, as seen in the proof of local uniqueness (Section 4.2), a little bit more is proved: any function $q' \in \text{MMA}([0, T[; \mathcal{Q})$ satisfying the initial condition (21), the unilateral constraint (22), the equation of motion (23) and the energy inequality (Proposition 7) has to coincide with q_a on a right neighborhood of $t = 0$. But, it is readily seen that the function

$$q'(t) = q(\tau - t), \quad t \in [0, \tau - t_0[$$

fulfill these requirements. Thus, q' cannot have right accumulation of impacts at $t = \tau$ and, therefore, q cannot have left accumulation of impacts at $t = \tau$ and the instants of impact are isolated. Of course, if q is the maximal solution defined on $[t_0, T[$, impacts can still accumulate at the left of T , as seen on simple examples. \square

The fact that infinitely many impacts can accumulate at *the left* of a given instant but *not at the right* is a specific feature of the analytical setting that is lost in the C^∞ setting as seen in Counter-examples 2 and 3. Actually, these counter-examples show that pathologies of nonuniqueness in the C^∞ setting are intimately connected to the possibility of right accumulations of impacts. The fact that the analytical setting prevents such right accumulations is the true reason why we could prove uniqueness in this case.

6.2. The double pendulum

In this section, we come back to the double pendulum described in Section 2.1 but we add to the system a rigid obstacle on the vertical coordinate axis as represented in Fig. 3. This obstacle may be represented by two analytic functions whose expressions in the global chart of \mathcal{Q} described in Section 2.1 are

$$\begin{aligned} \varphi_1(q^1, q^2) &= -l_1 \sin q^1 \leq 0, \\ \varphi_2(q^1, q^2) &= -l_1 \sin q^1 - l_2 \sin q^2 \leq 0. \end{aligned}$$

It is readily seen that, except in the particular case where $l_1 = l_2$, these constraints are functionally independent:

$$\forall q \in A, \quad (d\varphi_i(q))_{i \in J(q)} \text{ is linear independent in } T_q^* \mathcal{Q}.$$

These unilateral constraints are assumed to be perfect and we consider an impact function ϕ supposed to be constant on TA^- :

$$\forall (q, v^-) \in TA^-, \quad \phi(q, v^-) \equiv \phi \in [0, 1].$$

The constant ϕ is often called the restitution coefficient (of normal velocities). We recall that the particular cases $\phi = 0$ and $\phi = 1$ describe the completely inelastic and the elastic impact constitutive equations.

An initial state $(q_0, v_0) \in TA^+$ is given at time $t_0 = 0$. This initial state is represented in the considered chart by four real numbers $(q_0^1, q_0^2; v_0^1, v_0^2)$. According

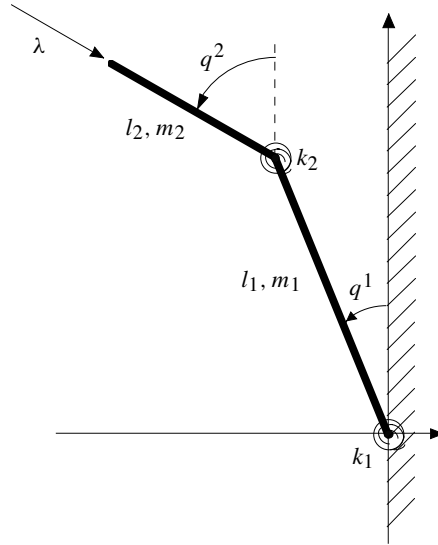

Fig. 3. Double pendulum with obstacle.

to Section 3, the motion of the system is governed by the evolution problem: Find $T \in]0, +\infty]$ and $q \in \text{MMA}([0, T[; Q)$ such that:

- $(q(0), \dot{q}^+(0)) = (q_0, v_0)$,
- $\forall t \in [0, T[, \quad (q(t), \dot{q}^+(t)) \in TA^+$,
- $R = \text{b}D\dot{q}^+ - f(q(t), \dot{q}^+(t); t) dt, \in -N^*(q(t))$ for $|R|$ -a.e. $t \in [0, T[,$
- $\forall t \in]0, T[, \quad \dot{q}^+(t) = \dot{q}^-(t) - (1 + \phi) \text{Proj}_{q(t)} [\dot{q}^-(t); N(q(t))]$,

where the Riemannian structure on Q and the mapping f are those described in Section 2.1. Corollary 9 ensures existence and uniqueness of a maximal solution. Now, we are going to check that assumptions of Theorem 10 are satisfied so that the maximal solution is defined all over \mathbb{R}^+ .

First, Q is a complete Riemannian manifold since the quotient topology on the torus T^2 derives from a Riemannian structure and T^2 is compact and therefore complete. Second, we have the estimate

$$\forall (q, v) \in TQ, \quad \|v\|_q \geq \alpha |(v_1, v_2)|, \tag{51}$$

where

$$\alpha = \sqrt{\frac{\frac{1}{9}m_1m_2l_1^2l_2^2 + \frac{1}{12}m_2^2l_1^2l_2^2}{\frac{1}{3}m_2l_2^2 + (\frac{m_1}{3} + m_2)l_1^2}}.$$

Indeed,

$$\|v\|_q^2 \geq \lambda^{\min}(q) |(v^1, v^2)|^2,$$

where $\lambda^{\min}(q)$ is the least eigenvalue of the matrix $(g_{ij}(q))_{i,j=1,2}$. But

$$\lambda^{\min}(q) = \frac{1}{2} \left(\frac{1}{3} m_2 l_2^2 + \left(\frac{m_1}{3} + m_2 \right) l_1^2 \right) \times \left[1 - \sqrt{1 - \frac{4 \left(\frac{1}{9} m_1 m_2 l_1^2 l_2^2 + \frac{1}{3} m_2^2 l_1^2 l_2^2 - \frac{1}{4} m_2^2 l_1^2 l_2^2 \cos(q^1 - q^2) \right)}{\left(\frac{1}{3} m_2 l_2^2 + \left(\frac{m_1}{3} + m_2 \right) l_1^2 \right)^2}} \right].$$

Using

$$\forall x \in [0, 1], \quad 1 - \sqrt{1 - x} \geq \frac{x}{2},$$

we get

$$\lambda^{\min}(q) \geq \frac{1}{4} \frac{4 \left(\frac{1}{9} m_1 m_2 l_1^2 l_2^2 + \frac{1}{3} m_2^2 l_1^2 l_2^2 - \frac{1}{4} m_2^2 l_1^2 l_2^2 \cos(q^1 - q^2) \right)}{\frac{1}{3} m_2 l_2^2 + \left(\frac{m_1}{3} + m_2 \right) l_1^2} \geq \alpha^2,$$

which achieves the proof of estimate (51). Now, let q_I, q_{II} be two points of Q represented by their components in the considered chart (q_I^1, q_I^2) and (q_{II}^1, q_{II}^2) . Q being complete, there is a geodesic $g : [s_1, s_2] \rightarrow Q$ of minimal length between them. We have

$$\begin{aligned} d(q_I, q_{II}) &= \int_{s_1}^{s_2} \|\dot{g}(s)\|_{g(s)} ds \geq \int_{s_1}^{s_2} \alpha |\dot{g}(s)| ds \\ &\geq \alpha \sqrt{(q_I^1 - q_{II}^1)^2 + (q_I^2 - q_{II}^2)^2}. \end{aligned}$$

Moreover, recalling

$$\begin{aligned} f_1(q^1, q^2) &= \lambda l_1 \sin(q^1 - q^2) - (k_1 + k_2) q^1 + k_2 q^2, \\ f_2(q^1, q^2) &= k_2 q^1 - k^2 q^2, \end{aligned}$$

we have

$$\|f(q)\|_q^2 \leq \frac{1}{\lambda^{\min}(q)} |(f_1, f_2)|^2.$$

Therefore,

$$\begin{aligned} \|f(q)\|_q &\leq \frac{1}{\alpha} |(f_1, f_2)| \\ &\leq \frac{1}{\alpha} \left[\lambda l_1 + (k_1 + k_2) |q^1| + k_2 |q^1| + 2k_2 |q^2| \right] \\ &\leq \frac{1}{\alpha} \left[\lambda l_1 + 4(k_1 + k_2) |(q_0^1, q_0^2)| + 4(k_1 + k_2) |(q^1 - q_0^1, q^2 - q_0^2)| \right] \\ &\leq \frac{1}{\alpha} \left[\lambda l_1 + 4(k_1 + k_2) |(q_0^1, q_0^2)| \right] + \frac{4(k_1 + k_2)}{\alpha^2} d(q, q_0), \quad \forall q \in Q. \end{aligned}$$

By virtue of Theorem 10, the motion of the system is defined for all $t \in \mathbb{R}^+$.

6.3. Boltzmann's gas

Consider a collection of N rigid homogeneous balls of mass m and radius R in a rigid rectangular box. The balls cannot interpenetrate. The balls are free of internal or external forces except for the reaction efforts induced by the unilateral constraints. The impact constitutive equation is supposed to be the elastic one. Such a system was introduced by Boltzmann to model the interactions between molecules in a gas in order to perform a statistical analysis to connect the microscopical and macroscopical point of view.

Let us describe the discrete mechanical system associated with this situation. The configuration space is \mathbb{R}^{3N} . Indeed, any configuration is described by the coordinates of the center of the balls in the three-dimensional ambient space equipped with an origin. Strictly speaking, the configuration space should be $\mathbb{R}^{3N} \times (SO3)^N$ to incorporate the possible rotations of the balls. But, in this case, it would be readily seen that the rotation velocity of any ball in any motion of the system keeps its value at the initial instant. Therefore, rotations play no role in the motion of the system and we may consider only the restricted configuration space \mathbb{R}^{3N} equipped with its canonical Riemannian structure. The forces mapping vanishes identically $f(q, \dot{q}^+; t) \equiv 0$. There are $N(N + 1)/2$ functions φ_i , since $N(N - 1)/2$ of them are necessary to express the non-interpenetration constraints,

$$\forall i, j \in \{1, 2, \dots, N\}, \quad i \neq j, \quad (x^i - x^j)^2 + (y^i - y^j)^2 + (z^i - z^j)^2 \geq R^2,$$

and $6N$ of them are necessary to express that the balls remains inside the box:

$$\begin{aligned} \forall i, j \in \{1, 2, \dots, N\}, \quad & -a + R \leq x^i \leq a - R, \\ & -b + R \leq y^i \leq b - R, \\ & -c + R \leq z^i \leq c - R, \end{aligned}$$

where $2a$, $2b$ and $2c$ are the lengths of the sides of the box. The functions φ_i are defined by arbitrary numbering. They are easily seen to be analytic and functionally independent. Adding the elastic impact constitutive equation $\phi(q, \dot{q}^-) \equiv 1$, and an initial condition at time $t_0 = 0$, the corresponding evolution problem turns out to belong to the class of problem \mathcal{P} formulated at the beginning of Section 4. Then, Corollary 9 and Theorem 10 state that, to any initial condition compatible with the constraints, there corresponds a unique maximal motion and it is defined all over \mathbb{R}^+ . By Proposition 19, we may also state that there are at most finitely many impacts on any bounded time interval. As a conclusion, the results developed in this paper allow us to associate a dynamical system with Boltzmann's gas.

Related to this question, let us mention Boltzmann's famous ergodic hypothesis. Roughly speaking, Boltzmann postulated that in any motion of the system, time averages can be replaced by space averages. The modern mathematical transcript is: for almost every initial condition in an energy level set of the phase space, the associated phase curve spends an amount of time in every measurable piece of the level set proportional to the measure of that piece. Whether Boltzmann's gas is ergodic, or not, is still an open question. However, a positive answer was given in

1970 by SINAI [20] for a two balls gas in a plane rectangular box. Let us underline that this question makes sense only when we are able to associate a dynamical system with Boltzmann’s gas.

6.4. Newton’s balls and the impact constitutive equation

In Section 3.3, we used two phenomenological assumptions $\mathcal{H}3$ and $\mathcal{H}4$ to show that the general constitutive impact equation

$$\dot{q}^+ = \mathcal{F}(q, \dot{q}^-) \tag{52}$$

should satisfy:

$$\begin{aligned} & \mathcal{F}(q, v^-) \in V(q), \\ \forall q \in A, \quad \forall v^- \in -V(q), \quad & \mathcal{F}(q, v^-) - v^- \in -N(q), \\ & \|\mathcal{F}(q, v^-)\|_q \leq \|v^-\|_q. \end{aligned} \tag{53}$$

In the particular case of a motion with no more than one active constraint at any time ($\forall t, \text{Card}J(q(t)) \leq 1$), it has been seen in Section 3.3 that the general impact constitutive equation (52) necessarily takes the form

$$\dot{q}^+ = \text{Proj}_q [\dot{q}^-; V(q)] - \phi(q, \dot{q}^-) \text{Proj}_q [\dot{q}^-; N(q)], \tag{54}$$

with ϕ an arbitrary function taking values in the interval $[0, 1]$. Actually, (54) makes sense even in the case of multiple impacts and it is a simple example of an impact constitutive equation satisfying requirements (53). For the sake of simplicity, we have adopted this particular form of the impact constitutive equation even in the case where multiple impacts occur. However, the reader should keep in mind the arbitrariness of this choice and we shall show that it could be irrelevant in some cases. A simple occurrence of multiple impact is Newton’s balls experiment.

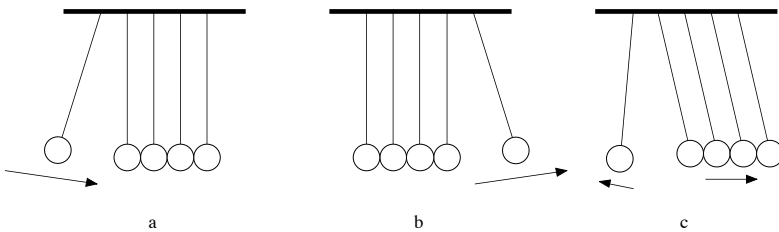

Fig. 4. Newton’s balls experiment.

The principle of Newton’s balls experiment is well known. It is sketched in Fig. 4a. As a result of this multiple impact experiment, we have the familiar picture drawn in Fig. 4b. But, testing the simple impact constitutive equation (54) (with $\phi \equiv 1$) to predict the outcome of the experiment, we get the situation drawn in Fig. 4c.

The question arises as to whether the results of Section 4 remain true if we abandon the simple impact constitutive equation (54) and adopt the general impact constitutive equation (52) defined by an arbitrary function \mathcal{F} fulfilling requirements (53). Actually, a careful examination of the proofs of Section 4 shows that the impact constitutive equation is only used through the energy inequality (Proposition 7). Moreover, it is readily seen that Proposition 7 still holds when the simple impact constitutive equation (24) is replaced by a general one (equation (52)) provided requirements (53) hold true. As a result, *all the results of Section 4, and in particular, Theorem 8, Corollary 9 and Theorem 10 remain true if we adopt an arbitrary impact constitutive equation instead of equation (24) in the definition of problem \mathcal{P} .*

A general impact constitutive equation will be said to be elastic if the last requirement in (53) is replaced by:

$$\forall q \in A, \quad \forall v^- \in -V(q), \quad \|\mathcal{F}(q, v^-)\|_q = \|v^-\|_q.$$

It is readily seen that Proposition 19 still holds with an arbitrary impact constitutive equation. In particular, for a solution of problem \mathcal{P} with an arbitrary *elastic* impact constitutive equation, the impacts are isolated.

7. Continuous dependence on initial conditions

The theory developed in the previous sections allows us to replace the analysis of the motion of a collection of rigid bodies subjected to perfect constraints either bilateral or unilateral by the analysis of the motion of a point in a piece of a d -dimensional manifold bounded by analytic hypersurfaces which intersect transversally. With appropriate regularity assumptions on the data, the motion is completely determined by the initial condition.

The picture seems to be fairly good and the generalization of the dynamics of discrete systems with bilateral constraints to the case of unilateral constraints seems to be achieved. However, there remains a big difference between unilateral and bilateral dynamics of discrete systems that we want to underline in this section.

A pleasant feature of a dynamical system generated by the flow of an ordinary differential equation is that it is smooth. More precisely, if F_{t,t_0} is the mapping which associates the state of the system at time t with an arbitrary initial condition at time t_0 , then the mapping F_{t,t_0} is a local diffeomorphism. In particular, the state of the system at a given instant t depends in a differentiable way of the state at time t_0 . Of course, this smooth dependence may be stiff. In such a case, a small uncertainty on the initial state will produce a big one on the actual state and the motion of the system may turn out to be quantitatively unpredictable from both the physical and the numerical point of view for large time. In certain circumstances, the theory of smooth dynamical systems allow us to get some qualitative information on the motion for large time.

As we shall see, the picture is strongly different in the case of the dynamics of discrete systems with perfect unilateral constraint. The theorems of Section 4 allow us to define a mapping F_{t,t_0} similar to the flow generated by an ordinary differential

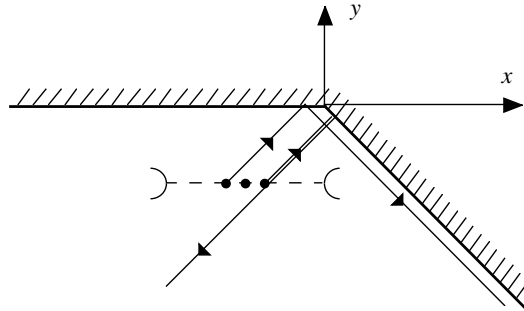

Fig. 5. The generated dynamical system is not continuous in general.

equation. But, the mapping F_{t,t_0} is not smooth any more, it is not even continuous in general. In other words, the generated dynamical system does not belong to the large class of topological dynamical systems.

Let us check this assertion on a simple example. Consider as a configuration space \mathbb{R}^2 supplied with its canonical structure of Riemannian manifold. A configuration is denoted by a pair (x, y) . No forces act on the system: $f \equiv 0$. Consider a unilateral constraint associated with the two functions

$$\begin{aligned} \varphi_1(x, y) &= y \leq 0, \\ \varphi_2(x, y) &= x + y \leq 0, \end{aligned}$$

and the elastic impact constitutive equation $\phi \equiv 1$. At time $t_0 = 0$, we consider the following set of initial conditions:

$$\{(-1 + \varepsilon, -1; 1, 1); \varepsilon \in]-1, 1[\}.$$

A straightforward calculation gives the state of the system for all instant in \mathbb{R}^+ . In particular, for t greater than 1, one gets:

$$\begin{aligned} F_{t,0}(-1 + \varepsilon, -1; 1, 1) &= (-1 + \varepsilon + t, 1 - t, 1, -1) & \text{if } \varepsilon \in]-1, 0[, \\ F_{t,0}(-1 + \varepsilon, -1; 1, 1) &= (1 - t, 1 - \varepsilon - t, -1, -1) & \text{if } \varepsilon \in [0, 1[. \end{aligned}$$

It is readily seen on this example that, if t is greater than 1, the mapping $F_{t,0}$ is not continuous at initial condition $(-1, -1, 1, 1)$ (see Fig. 5). Coming back to the two examples of Section 6, such a situation occurs if, during the motion of the double pendulum, the two bars hit the obstacle at the same time. In the case of Boltzmann’s gas, the pathology occurs when three balls hit at the same time. Let us underline that if we consider an initial condition such as the one in the above example, the solution of the associated problem \mathcal{P} has no physical meaning. In such a case, one has to abandon any hope of predicting the motion of the system: this is a consequence of the over-idealization made in the indeformability assumption.

However, in the particular case of the one-degree-of-freedom problem, where no multiple impacts are possible, SCHATZMAN [19] proved that continuous dependence on initial conditions holds. In the general case, her result admits the following generalization which is proved along the same lines:

Theorem 20. Consider the problem \mathcal{P} described in Section 3.4. Assume furthermore that the impact function ϕ is constant. Consider the initial condition $(q_0, v_0) \in TA^+$ at initial instant t_0 , and denote by (T, q) the corresponding maximal solution of problem \mathcal{P} . Make the following hypothesis:

$$\forall t \in [t_0, T[, \quad (d\varphi_i(q(t)))_{i \in J(q(t))} \text{ is orthogonal in } T_{q(t)}^*Q,$$

(with the convention that the empty set is orthogonal). Consider a sequence (q_{0n}, v_{0n}) of elements of TA^+ converging towards (q_0, v_0) . For all n , we denote by (T_n, q_n) the maximal solution of the problem \mathcal{P} associated with the initial condition (q_{0n}, v_{0n}) at instant t_0 . Then,

- (1) $\liminf_{n \rightarrow +\infty} T_n \geq T$,
- (2) q_n converges towards q uniformly on every compact subset of $[t_0, T[$:

$$\forall \tau \in [t_0, T[, \quad \lim_{n \rightarrow +\infty} \sup_{t \in [t_0, \tau]} d(q_n(t), q(t)) = 0,$$

- (3) $(q_n(t), \dot{q}_n^+(t))$ converges towards $(q(t), \dot{q}^+(t))$ in TQ for almost all t in $[t_0, T[$.

Proof. The proof of Theorem 20 is divided into five steps. Before describing these steps, let us introduce a some new notation.

We fix, once for all, an arbitrary τ in $[t_0, T[$ and a compact neighborhood K' of the compact subset $q([t_0, \tau])$ of Q . We define:

$$V = 1 + \sup_{t \in [t_0, \tau]} \|\dot{q}^+(t)\|_{q(t)},$$

and,

$$K = \{(q, v) \in TQ; q \in K' \quad \text{and} \quad \|v\|_q \leq 4V\}.$$

The subset K of TQ is compact in TQ . We define also:

$$F = 1 + \max_{(q, v; t) \in K \times [t_0, \tau]} \|f(q, v; t)\|_q,$$

and

$$d_0 = \min_{(q', t) \in \partial K \times [t_0, \tau]} d(q', q(t)),$$

and

$$\delta = \min \left(\frac{V}{F}, \frac{d_0}{6V} \right).$$

Notice that we have $\delta > 0$.

Step I. Consider $t_1 \in [t_0, \tau[$. We denote $q(t_1)$ by q_1 and $\dot{q}^+(t_1)$ by v_1 . Consider an element (q'_1, v'_1) of TA^+ such that

$$d(q_1, q'_1) \leq \frac{d_0}{4} \quad \text{and} \quad \|v'_1\|_{q'_1} \leq 2V.$$

Then, the maximal solution q' of the problem \mathcal{P} associated with the initial condition (q'_1, v'_1) at initial instant t_1 is defined on an interval containing $[t_1, \min(\tau, t_1 + \delta)]$ and is such that

$$\forall t \in [t_1, \min(\tau, t_1 + \delta)], \quad (q'(t), \dot{q}'^+(t)) \in K.$$

Let us denote by $[t_1, T'_1[$ the maximal definition interval of q' . Define

$$t'_1 = \sup \left\{ t \in [t_1, T'_1[; \forall s \in [t_1, t], \quad (q'(s), \dot{q}'^+(s)) \in K \right\}.$$

We have to prove

$$t'_1 \geq \min(\tau, t_1 + \delta).$$

Assume the contrary is true:

$$t'_1 < \min(\tau, t_1 + \delta).$$

By Proposition 7 and Lemma 17, we have:

$$\begin{aligned} \forall t \in [t_1, t'_1[, \quad \|\dot{q}'^+(t)\|_{q'(t)} &\leq \|v'_1\|_{q'_1} + \int_{t_1}^t F ds \\ &\leq 2V + F(t'_1 - t_1) \\ &\leq 3V. \end{aligned}$$

We deduce

$$t'_1 < T'_1,$$

by Proposition 18, and

$$\|\dot{q}'^+(t'_1)\|_{q'(t'_1)} \leq \|\dot{q}'^-(t'_1)\|_{q'(t'_1)} = \lim_{t \rightarrow t'_1-} \|\dot{q}'^+(t)\|_{q'(t)} \leq 3V,$$

by Proposition 32. Moreover,

$$\begin{aligned} d(q'(t'_1), q_1) &\leq d(q'(t'_1), q'_1) + d(q'_1, q_1) \\ &\leq 3V(t'_1 - t_1) + \frac{d_0}{4} \\ &\leq \frac{3}{4}d_0. \end{aligned}$$

By the continuity of the function $t \mapsto d(q'(t), q_1)$ and the right-continuity of the function $t \mapsto \|\dot{q}'^+(t)\|_{q'(t)}$, we have

$$\exists \alpha > 0, \quad \forall t \in [t'_1, t'_1 + \alpha], \quad (q'(t), \dot{q}'^+(t)) \in K.$$

But, this contradicts the definition of t'_1 and achieves the proof of Step 1.

Step 2 For n large enough, q_n is defined on (an interval containing) the interval $[t_0, \min(\tau, t_0 + \delta)]$. Moreover, there exists a subsequence of (q_n) , also denoted by (q_n) , such that:

- q_n converges uniformly on $[t_0, \min(\tau, t_0 + \delta)]$ towards a function q_{lim} belonging to $\text{MMA}([t_0, \min(\tau, t_0 + \delta)]; Q)$,
- $(q_n(t), \dot{q}_n^+(t))$ converges towards $(q_{\text{lim}}(t), \dot{q}_{\text{lim}}^+(t))$ in TQ for almost all t in $[t_0, \min(\tau, t_0 + \delta)]$.

For all q in $K' \cap A$, there exists a compact neighborhood K'_q of q which is included in the domain U_q of a local chart (U_q, ψ_q) at q such that:

- $\forall q' \in U_q, \quad J(q') \subset J(q)$,
- $\forall q' \in U_q, \quad$ the $\text{card}J(q)$ first components of $\psi_q(q')$ are the $\varphi_i(q')$ ($i \in J(q)$).

Being compact, $K' \cap A$ can be covered by a finite number, say L , of K'_{q_l} . We denote by λ^{max} and λ^{min} the maximum and the minimum of, respectively, the greatest and least eigenvalue of the matrix $(g_{ij}(q))_{i,j=1,2,\dots,d}$ when q wanders in K'_{q_l} and l in $\{1, 2, \dots, L\}$. We define

$$G = \max_{\substack{i,j,k \in \{1,2,\dots,d\} \\ l \in \{1,2,\dots,L\}}} \max_{q \in K'_{q_l}} \left| \frac{\partial g_{ij}(q)}{\partial q^k} \right|.$$

We pick an integer N_0 , large enough to ensure:

$$\forall n \geq N_0, \quad \begin{aligned} d(q_0, q_{0n}) &\leq \frac{d_0}{4}, \\ \|v_{0n}\|_{q_{0n}} &\leq 2V. \end{aligned}$$

By Step 1,

$$\forall n \geq N_0, \quad \begin{aligned} T_n &\geq \min(\tau, t_0 + \delta), \\ \forall t \in [t_0, \min(\tau, t_0 + \delta)], \quad (q_n(t), \dot{q}_n^+(t)) &\in K. \end{aligned}$$

By a compactness argument, we have

$$\exists \alpha > 0, \quad \forall l \in \{1, 2, \dots, L\}, \quad \forall q \in \partial K_{q_l}, \quad \exists l', \quad B(q, \alpha) \subset K'_{q_{l'}}.$$

As a consequence, for n larger than N_0 , the interval $[t_0, \min(\tau, t_0 + \delta)]$ is the disjoint union of a finite number, say N_n , of intervals I_{ni} such that

$$\forall i \in \{1, 2, \dots, N_n\}, \quad \exists l \in \{1, 2, \dots, L\}, \quad q_n(I_{ni}) \subset K'_{q_l}.$$

Moreover, the intervals I_{ni} can be constructed in such a way that:

$$\forall n \geq N_0, \quad N_n \leq 1 + \frac{4V\delta}{\alpha}.$$

Furthermore, recalling

$$\forall n, \quad \flat D\dot{q}_n^+ = f(q_n, \dot{q}_n^+; t) dt + \sum_{i=1}^n \lambda_{ni} d\varphi_i(q_n(t)), \quad (55)$$

where the λ_{ni} are nonpositive real measures on $[t_0, \min(\tau, t_0 + \delta)]$, and performing the same job as in the proof of Proposition 18 (estimate (38)), we obtain

$$\forall n \geq N_0, \quad \forall i \in \{1, 2, \dots, N\}, \quad \forall j \in \{1, 2, \dots, N_n\},$$

$$\int_{I_{nj}} (-\lambda_{ni}) \leq 2\sqrt{\lambda^{\max}}(4V) + \left(F + \frac{d^2 G(4V)^2}{2\lambda^{\min}} \right) \delta.$$

There results:

$$\forall n \geq N_0, \quad \forall i \in \{1, 2, \dots, N\}, \tag{56}$$

$$\int_{[t_0, \min(\tau, t_0 + \delta)]} (-\lambda_{ni}) \leq \left[1 + \frac{4V\delta}{\alpha} \right] \left[2\sqrt{\lambda^{\max}}(4V) + \left(F + \frac{d^2 G(4V)^2}{2\lambda^{\min}} \right) \delta \right].$$

The measures λ_{ni} are uniformly bounded with respect to n . Using the equation of motion (55), we find that the real numbers $\text{Var}(\dot{q}_n^+; [t_0, \min(\tau, t_0 + \delta)])$ are uniformly bounded with respect to n , for n larger than N_0 . The assertion of Step 2 is now a direct consequence of Proposition 34.

Step 3 The function q_{lim} constructed in Step 2 satisfies the equation of motion:

$$R_{\text{lim}} = \flat D\dot{q}_{\text{lim}}^+ - f(q_{\text{lim}}, \dot{q}_{\text{lim}}^+; t) dt \in -N^*(q_{\text{lim}}).$$

Moreover, the real measure $\langle R_{\text{lim}}, (\dot{q}_{\text{lim}}^+ + \dot{q}_{\text{lim}}^-) \rangle_{q_{\text{lim}}}$ is a nonpositive measure on the interval $[t_0, \min(\tau, t_0 + \delta)]$.

We denote by $\mathcal{M}_b([a, b], \mathbb{R})$ the Banach space of all bounded real measures on an interval $[a, b]$. By estimate (56), we can find N bounded real measures $\lambda_{i\text{lim}}$ such that

$$\lim_{n \rightarrow +\infty} \lambda_{in} = \lambda_{i\text{lim}} \quad \text{in } \mathcal{M}_b([t_0, \min(\tau, t_0 + \delta)], \mathbb{R}) \text{ weak}^*,$$

where another subsequence has been extracted, if necessary. Writing the equation of motion (55) in local charts, we have

$$\lim_{n \rightarrow +\infty} d\dot{q}_n^{+i} = d\dot{q}_{\text{lim}}^{+i} \quad \text{in } \mathcal{M}_b \text{ weak}^*.$$

Furthermore,

$$\lim_{n \rightarrow +\infty} \int f(q_n, \dot{q}_n^+; t) dt = \int f(q_{\text{lim}}, \dot{q}_{\text{lim}}^+; t) dt \quad \text{in } \mathcal{M}_b \text{ weak}^*,$$

by Lebesgue's Dominated Convergence Theorem. Therefore, we obtain easily:

$$\flat D\dot{q}_{\text{lim}}^+ = \int f(q_{\text{lim}}, \dot{q}_{\text{lim}}^+; t) dt + \sum_{i=1}^n \lambda_{i\text{lim}} d\varphi_i(q_{\text{lim}}),$$

the weak* topology being Hausdorff. Now, by formulae (12) we have to prove

$$\text{Supp } \lambda_{i\text{lim}} \subset \{t \in [t_0, \min(\tau, t_0 + \delta)]; \varphi_i(q_{\text{lim}}(t)) = 0\}. \tag{57}$$

Consider $]a, b[\subset [t_0, \min(\tau, t_0 + \delta)]$ such that

$$\forall s \in]a, b[, \quad \varphi_i(q_{\text{lim}}(s)) < 0.$$

The interval $]a, b[$ is the union of the compact intervals $K_j = [a + 1/j, b - 1/j]$ ($j \in \mathbb{N}^*$). Fix $j \in \mathbb{N}^*$. For n large enough,

$$\forall s \in K_j, \quad \varphi_i(q_n(s)) < 0,$$

so $\lambda_{in|K_j} = 0$. We deduce:

$$\forall g \in C_c^0(K_j; \mathbb{R}), \quad \text{int}_{K_j} g \, d\lambda_{i\text{lim}} = 0.$$

Therefore, $\lambda_{i\text{lim}}|_{]a, b[} = 0$ and this achieves the proof of inclusion (57) and therefore of the first assertion of Step 3.

For the second assertion of Step 3, we are going to prove actually:

$$\forall t_1, t_2 \in [t_0, \min(\tau, t_0 + \delta)[, \quad t_1 < t_2, \quad \int_{]t_1, t_2[} \langle R_{\text{lim}}, (\dot{q}_{\text{lim}}^+ + \dot{q}_{\text{lim}}^-) \rangle_{q_{\text{lim}}} \leq 0. \tag{58}$$

Fix such t_1, t_2 and arbitrary $\varepsilon > 0$. We have

$$\begin{aligned} \int_{]t_1, t_2[} \langle R_{\text{lim}}, (\dot{q}_{\text{lim}}^+ + \dot{q}_{\text{lim}}^-) \rangle_{q_{\text{lim}}} &= \|\dot{q}_{\text{lim}}^+(t_2)\|_{q_{\text{lim}}(t_2)}^2 - \|\dot{q}_{\text{lim}}^+(t_1)\|_{q_{\text{lim}}(t_1)}^2 \\ &\quad - 2 \int_{t_1}^{t_2} \langle f(q_{\text{lim}}(t), \dot{q}_{\text{lim}}^+(t); t), \dot{q}_{\text{lim}}^+(t) \rangle dt. \end{aligned}$$

By the right-continuity of the function $t \mapsto \|\dot{q}_{\text{lim}}^+(t)\|_{q_{\text{lim}}(t)}$ and the results of Step 2, we can find $t'_1, t'_2 \in [t_0, \min(\tau, t_0 + \delta)[$ ($t'_1 < t'_2$) and an integer N_0 such that

$$\begin{aligned} t_i \leq t'_i \leq t_i + \frac{\varepsilon}{8VF}, \quad \text{and} \\ \forall n \geq N_0, \quad \left| \|\dot{q}_{\text{lim}}^+(t_i)\|_{q_{\text{lim}}(t_i)}^2 - \|\dot{q}_n^+(t'_i)\|_{q_n(t'_i)}^2 \right| \leq \frac{\varepsilon}{8} \quad (i = 1, 2). \end{aligned}$$

Moreover, by Lebesgue's Dominated Convergence Theorem, N_0 may be assumed large enough to ensure:

$$\begin{aligned} \forall n \geq N_0, \\ \left| \int_{t'_1}^{t'_2} \{ \langle f(q_{\text{lim}}(t), \dot{q}_{\text{lim}}^+(t); t), \dot{q}_{\text{lim}}^+(t) \rangle - \langle f(q_n(t), \dot{q}_n^+(t); t), \dot{q}_n^+(t) \rangle \} dt \right| \leq \frac{\varepsilon}{8}. \end{aligned}$$

It is easily deduced that

$$\forall n \geq N_0, \quad \left| \int_{]t_1, t_2[} \langle R_{\text{lim}}, (\dot{q}_{\text{lim}}^+ + \dot{q}_{\text{lim}}^-) \rangle_{q_{\text{lim}}} - \int_{]t'_1, t'_2[} \langle R_n, (\dot{q}_n^+ + \dot{q}_n^-) \rangle_{q_n} \right| \leq \varepsilon.$$

Since ε is arbitrary and $\int_{]t'_1, t'_2[} \langle R_n, (\dot{q}_n^+ + \dot{q}_n^-) \rangle_{q_n}$ is nonpositive (Proposition 7), the conclusion (assertion (58)) follows.

Step 4. Consider an arbitrary instant $t_g \in]t_0, \min(\tau, t_0 + \delta)[$ such that

$$(d\varphi_i(q_{\text{lim}}(t_g)))_{i \in J(q_{\text{lim}}(t_g))} \text{ is orthogonal in } T_{q_{\text{lim}}(t_g)}^* \mathcal{Q}.$$

Then, q_{lim} satisfies the impact constitutive equation at instant t_g :

$$\dot{q}_{\text{lim}}^+(t_g) = \dot{q}_{\text{lim}}^-(t_g) - (1 + \phi) \text{Proj}_{q_{\text{lim}}(t_g)} [\dot{q}_{\text{lim}}^-(t_g); N(q_{\text{lim}}(t_g))].$$

Consider a local chart (U, ψ) centered at $q_{\text{lim}}(t_g)$ such that:

- the $\text{card}J(q_{\text{lim}}(t_g))$ first components of $\psi(q)$ are $\alpha_i \varphi_i(q)$ ($i \in J(q_{\text{lim}}(t_g))$), where the α_i are some fixed positive real constants,
- $\forall q \in U, \quad J(q) \subset J(q_{\text{lim}}(t_g))$,
- the matrix $(g_{ij}(\text{lim}(t_g)))$ is the identity matrix

$$(g_{ij}(\text{lim}(t_g))) = \delta_{ij}.$$

We have to prove

$$\begin{aligned} \dot{q}_{\text{lim}}^{+i}(t_g) &= -\phi \dot{q}_{\text{lim}}^{-i}(t_g), & 1 \leq i \leq \text{Card}J(q_{\text{lim}}(t_g)), \\ \dot{q}_{\text{lim}}^{+i}(t_g) &= \dot{q}_{\text{lim}}^{-i}(t_g), & \text{Card}J(q_{\text{lim}}(t_g)) + 1 \leq i \leq d. \end{aligned} \tag{59}$$

First, we are going to prove:

$$\begin{aligned} \forall \varepsilon > 0, \quad \exists N_0, \eta > 0, \quad \forall n \geq N_0, \quad \forall t_1, t_2 \in [t_g - \eta, t_g + \eta], \quad t_1 < t_2, \\ |\dot{q}_n^{+i}(t_2)| \leq |\dot{q}_n^{+i}(t_1)| + \varepsilon, \end{aligned} \tag{60}$$

and

$$\begin{aligned} \forall \varepsilon > 0, \quad \exists N_0, \eta > 0, \quad \forall n \geq N_0, \quad \forall t_1, t_2 \in [t_g - \eta, t_g + \eta], \quad t_1 < t_2, \\ \{\forall t \in [t_1, t_2], \quad q_n^i(t) < 0\} \implies \{|\dot{q}_n^{+i}(t_2) - \dot{q}_n^{+i}(t_1)| \leq \varepsilon\}. \end{aligned} \tag{61}$$

Fix $\varepsilon > 0$ arbitrary, and pick a positive real number η small enough and an integer N_0 large enough to ensure:

$$\forall t \in [t_g - \eta, t_g + \eta], \quad \forall n \geq N_0, \quad q_{\text{lim}}(t) \in U \quad \text{and} \quad q_n(t) \in U.$$

Let V' be a positive real constant, large enough to majorize all the quantities

$$|q_n^{+i}(t)| \quad \text{and} \quad \text{Var}(q_n^{+i}; [t_g - \eta, t_g + \eta]),$$

when i, t and n wander respectively in the sets $\{1, 2, \dots, d\}$, $[t_g - \eta, t_g + \eta]$ and $\{n \in \mathbb{N}; n \geq N_0\}$. We may assume that η is small enough and N_0 large enough to ensure:

$$\forall t \in [t_g - \eta, t_g + \eta], \quad \forall n \geq N_0, \quad |g_{ij}(q_n(t)) - \delta_{ij}| \leq \min\left(\frac{\varepsilon}{4dV'}, \frac{\varepsilon^2}{8dV'^2}\right).$$

Multiplying the equation of motion (36) by $(\dot{q}_n^{+i} + \dot{q}_n^{-i})/2$ and integrating over $[t_1, t_2]$, we obtain easily:

$$\forall n \geq N_0, \quad \forall t_1, t_2 \in [t_g - \eta, t_g + \eta], \quad t_1 < t_2,$$

$$\frac{1}{2} \left| \dot{q}_n^{+i}(t_2) \right|^2 \leq \frac{1}{2} \left| \dot{q}_n^{+i}(t_1) \right|^2 + \frac{1}{2} \left(\frac{\varepsilon}{2} \right)^2 + \int_{t_1}^{t_2} \left(F + \frac{3}{2} d^2 G V^2 \right) \left| \dot{q}_n^{+i}(s) \right| ds,$$

which gives,

$$\forall n \geq N_0, \quad \forall t_1, t_2 \in [t_g - \eta, t_g + \eta], \quad t_1 < t_2,$$

$$\left| \dot{q}_n^{+i}(t_2) \right| \leq \left| \dot{q}_n^{+i}(t_1) \right| + \frac{\varepsilon}{2} + 2\eta \left(F + \frac{3}{2} d^2 G V^2 \right),$$

by Lemma 17 and the desired conclusion (60) for sufficiently small η . For the second assertion (61), suppose we have in addition

$$\forall t \in [t_1, t_2], \quad q_n^i(t) < 0.$$

The result is that λ_{in} vanishes on $[t_1, t_2]$ and integration of the equation of motion (37) gives

$$\left| \dot{q}_n^{+i}(t_2) - \dot{q}_n^{+i}(t_1) \right| \leq \frac{\varepsilon}{2} + 2\eta \left(F + \frac{3}{2} d^2 G V^2 \right),$$

and therefore the desired conclusion (61) for sufficiently small η .

Now, let us come back to the proof of assertions (59). Fix $i \in \{1, 2, \dots, d\}$. Only the following four cases are possible:

- Case 1: $\text{Card}J(q_{\text{lim}}(t_g)) + 1 \leq i \leq d$;
- Case 2: $1 \leq i \leq \text{Card}J(q_{\text{lim}}(t_g))$ and $\dot{q}_{\text{lim}}^{-i}(t_g) = 0$;
- Case 3: $1 \leq i \leq \text{Card}J(q_{\text{lim}}(t_g))$, $\dot{q}_{\text{lim}}^{-i}(t_g) > 0$ and $\phi = 0$;
- Case 4: $1 \leq i \leq \text{Card}J(q_{\text{lim}}(t_g))$, $\dot{q}_{\text{lim}}^{-i}(t_g) > 0$ and $\phi > 0$.

We examine them successively.

Case 1. $\text{Card}J(q_{\text{lim}}(t_g)) + 1 \leq i \leq d$.

Fix $\varepsilon > 0$ arbitrary. By assertion (61), we can pick a positive real number η small enough and an integer N_0 large enough to ensure that

$$\forall n \geq N_0, \quad \forall t_1, t_2 \in [t_g - \eta, t_g + \eta], \quad t_1 < t_2, \quad \left| \dot{q}_n^{+i}(t_2) - \dot{q}_n^{+i}(t_1) \right| \leq \varepsilon,$$

since

$$\forall t \in [t_g - \eta, t_g + \eta], \quad \forall n \geq N_0, \quad q_n^i(t) < 0,$$

by the choice of the chart we made. Actually, η can be assumed small enough to ensure:

$$\forall t \in [t_g - \eta, t_g[, \quad \left| \dot{q}_{\text{lim}}^{+i}(t) - \dot{q}_{\text{lim}}^{-i}(t_g) \right| \leq \varepsilon,$$

$$\forall t \in]t_g, t_g + \eta], \quad \left| \dot{q}_{\text{lim}}^{+i}(t) - \dot{q}_{\text{lim}}^{+i}(t_g) \right| \leq \varepsilon,$$

by Proposition 32. By Step 2, we can find $t_1 \in [t_g - \eta, t_g[$ and $t_2 \in]t_g, t_g + \eta]$ such that

$$\lim_{n \rightarrow +\infty} \dot{q}_n^{+i}(t_k) = \dot{q}_{\text{lim}}^{+i}(t_k) \quad (k = 1, 2)$$

and, therefore, N_0 can be assumed large enough to ensure:

$$\forall n \geq N_0, \quad \left| \dot{q}_n^{+i}(t_k) - \dot{q}_{\text{lim}}^{+i}(t_k) \right| \leq \varepsilon \quad (k = 1, 2).$$

Then, we have

$$\begin{aligned} \left| \dot{q}_{\text{lim}}^{+i}(t_g) - \dot{q}_{\text{lim}}^{-i}(t_g) \right| &\leq \left| \dot{q}_{\text{lim}}^{+i}(t_g) - \dot{q}_{\text{lim}}^{-i}(t_2) \right| + \left| \dot{q}_{\text{lim}}^{+i}(t_2) - \dot{q}_n^{-i}(t_2) \right| \\ &\quad + \left| \dot{q}_n^{+i}(t_2) - \dot{q}_n^{-i}(t_1) \right| + \left| \dot{q}_n^{+i}(t_1) - \dot{q}_{\text{lim}}^{-i}(t_1) \right| \\ &\quad + \left| \dot{q}_{\text{lim}}^{+i}(t_1) - \dot{q}_{\text{lim}}^{-i}(t_g) \right| \\ &\leq 5\varepsilon. \end{aligned}$$

Since ε is arbitrary, we get the desired conclusion:

$$\dot{q}_{\text{lim}}^{+i}(t_g) = \dot{q}_{\text{lim}}^{-i}(t_g).$$

Case 2. $1 \leq i \leq \text{Card}J(q_{\text{lim}}(t_g))$ and $\dot{q}_{\text{lim}}^{-i}(t_g) = 0$.

Fix $\varepsilon > 0$ arbitrary. By assertion (60), we can pick a positive real number η small enough and an integer N_0 large enough to ensure:

$$\forall n \geq N_0, \quad \forall t_1, t_2 \in [t_g - \eta, t_g + \eta], \quad t_1 < t_2, \quad \left| \dot{q}_n^{+i}(t_2) \right| \leq \left| \dot{q}_n^{+i}(t_1) \right| + \varepsilon.$$

Exactly as in case 1, η is assumed sufficiently small to ensure that

$$\begin{aligned} \forall t \in [t_g - \eta, t_g[, \quad \left| \dot{q}_{\text{lim}}^{+i}(t) \right| &\leq \varepsilon, \\ \forall t \in]t_g, t_g + \eta], \quad \left| \dot{q}_{\text{lim}}^{+i}(t) - \dot{q}_{\text{lim}}^{+i}(t_g) \right| &\leq \varepsilon, \end{aligned}$$

and N_0 large enough to have

$$\forall n \geq N_0, \quad \left| \dot{q}_n^{+i}(t_k) - \dot{q}_{\text{lim}}^{+i}(t_k) \right| \leq \varepsilon \quad (k = 1, 2),$$

for some $t_1 \in [t_g - \eta, t_g[$ and some $t_2 \in]t_g, t_g + \eta]$. We get

$$\begin{aligned} \left| \dot{q}_{\text{lim}}^{+i}(t_g) \right| &\leq \left| \dot{q}_{\text{lim}}^{+i}(t_g) - \dot{q}_{\text{lim}}^{-i}(t_2) \right| + \left| \dot{q}_{\text{lim}}^{+i}(t_2) - \dot{q}_n^{+i}(t_2) \right| + \left| \dot{q}_n^{+i}(t_2) \right| \\ &\leq \left| \dot{q}_n^{+i}(t_1) \right| + 3\varepsilon \\ &\leq 5\varepsilon, \end{aligned}$$

which gives the desired conclusion

$$\dot{q}_{\text{lim}}^{+i}(t_g) = 0,$$

since ε is arbitrary.

Case 3. $1 \leq i \leq \text{Card}J(q_{\text{lim}}(t_g)), \dot{q}_{\text{lim}}^{-i}(t_g) > 0$ and $\phi = 0$.

Fix ε arbitrary in $]0, \dot{q}_{\text{lim}}^{-i}(t_g)/16[$. We pick η and N_0 such that both assertions (60) and (61) hold. Actually, η is assumed small enough to ensure that

$$\begin{aligned} \forall t \in [t_g - \eta, t_g[, & \left| \frac{q_{\text{lim}}^i(t)}{t - t_g} - \dot{q}_{\text{lim}}^{-i}(t_g) \right| \leq \varepsilon, \\ \forall t \in [t_g - \eta, t_g[, & \left| \dot{q}_{\text{lim}}^{+i}(t) - \dot{q}_{\text{lim}}^{-i}(t_g) \right| \leq \varepsilon, \\ \forall t \in]t_g, t_g + \eta], & \left| \dot{q}_{\text{lim}}^{+i}(t) - \dot{q}_{\text{lim}}^{+i}(t_g) \right| \leq \varepsilon, \end{aligned}$$

and, by Step 2, N_0 is assumed large enough to get

$$\begin{aligned} \forall n \geq N_0, \quad \forall t \in [t_g - \eta, t_g + \eta], \quad & \left| q_n^i(t) - q_{\text{lim}}^i(t) \right| \leq \eta\varepsilon, \\ \forall n \geq N_0, \quad \left| \dot{q}_n^{+i}(t_1) - \dot{q}_{\text{lim}}^{+i}(t_1) \right| & \leq \varepsilon, \\ \forall n \geq N_0, \quad \left| \dot{q}_n^{+i}(t_2) - \dot{q}_{\text{lim}}^{+i}(t_2) \right| & \leq \varepsilon, \end{aligned}$$

for some fixed $t_1 \in [t_g - \eta/2, t_g - \eta/4]$ and $t_2 \in [t_g + 3\eta/4, t_g + \eta]$. From these inequalities, it is easily deduced that

$$-\frac{17}{16} \frac{\eta}{2} \dot{q}_{\text{lim}}^{-i}(t_g) \leq q_{\text{lim}}^i(t_1) \leq -\frac{15}{16} \frac{\eta}{4} \dot{q}_{\text{lim}}^{-i}(t_g),$$

and therefore,

$$\forall n \geq N_0, \quad -\frac{10}{16} \eta \dot{q}_{\text{lim}}^{-i}(t_g) \leq q_n^i(t_1) \leq -\frac{2}{16} \eta \dot{q}_{\text{lim}}^{-i}(t_g). \tag{62}$$

Furthermore,

$$\dot{q}_n^{+i}(t_1) \geq \dot{q}_{\text{lim}}^{+i}(t_1) - 2\varepsilon \geq \frac{14}{16} \dot{q}_{\text{lim}}^{-i}(t_g). \tag{63}$$

Then, by estimates (62) and (63) and assertion (61), it is readily seen that

$$\forall n \geq N_0, \quad \exists t_n \in]t_1, t_1 + \eta[, \quad q_n^i(t_n) = 0.$$

But, since $\phi = 0$, we have

$$\forall n \geq N_0, \quad \dot{q}_n^{+i}(t_n) = 0,$$

and, therefore,

$$\forall n \geq N_0, \quad \left| \dot{q}_n^{+i}(t_2) \right| \leq \varepsilon,$$

by assertion (60). We deduce:

$$\left| \dot{q}_{\text{lim}}^{+i}(t_g) \right| \leq 3\varepsilon,$$

and the desired conclusion $\dot{q}_{\text{lim}}^{+i}(t_g) = 0$, since arbitrarily small ε can be chosen.

Case 4. $1 \leq i \leq \text{Card}J(q_{\text{lim}}(t_g)), \dot{q}_{\text{lim}}^{-i}(t_g) > 0$ and $\phi > 0$.

Fix ε arbitrary in $]0, \phi \dot{q}_{\text{lim}}^{-i}(t_g)/16[$. We pick η, N_0, t_1 and t_2 exactly in the same way as for case 3. As in step 3, we have

$$\forall n \geq N_0, \quad \exists t_n \in]t_1, t_1 + \eta[, \quad q_n^i(t_n) = 0,$$

but, here, it is readily seen that t_n is the unique instant in $[t_1, t_g + \eta]$ such that $q_n^i(t_n) = 0$. Now, we obtain

$$\begin{aligned} \left| \dot{q}_{\text{lim}}^{+i}(t_g) + \phi \dot{q}_{\text{lim}}^{-i}(t_g) \right| &\leq \left| \dot{q}_{\text{lim}}^{+i}(t_g) - \dot{q}_n^{+i}(t_2) \right| + \left| \dot{q}_n^{+i}(t_2) - \dot{q}_n^{+i}(t_n) \right| + \\ &\quad \phi \left| \dot{q}_n^{-i}(t_n) - \dot{q}_n^{+i}(t_1) \right| + \phi \left| \dot{q}_n^{+i}(t_1) - \dot{q}_{\text{lim}}^{-i}(t_g) \right| \\ &\leq 6\varepsilon, \end{aligned}$$

by use of assertion (60). Since ε can be arbitrarily small, we have the desired conclusion:

$$\dot{q}_{\text{lim}}^{+i}(t_g) = -\phi \dot{q}_{\text{lim}}^{-i}(t_g).$$

This achieves the Proof of Step 4.

Step 5. Conclusion of the proof of Theorem 20.

First, we are going to prove:

$$\forall t \in [t_0, \min(\tau, t_0 + \delta)], \quad q_{\text{lim}}(t) = q(t). \tag{64}$$

Define:

$$t_1 = \sup \{ t \in [t_0, \min(\tau, t_0 + \delta)] \mid \forall s \in [t_0, t], \quad q_{\text{lim}}(s) = q(s) \}.$$

Notice that the set in the above definition is non empty, since it contains t_0 . By continuity, we have

$$\forall t \in [t_0, t_1], \quad q_{\text{lim}}(t) = q(t).$$

Now, assume:

$$t_1 < \min(\tau, t_0 + \delta).$$

By the assumption made on q in the theorem and by Step 4, the function q_{lim} is readily seen to satisfy the impact constitutive equation at instant t_1 . Therefore,

$$(q_{\text{lim}}(t_1), \dot{q}_{\text{lim}}^+(t_1)) = (q(t_1), \dot{q}^+(t_1)).$$

Furthermore, we have seen in Step 3 that q_{lim} satisfies the equation of motion and that $\langle R_{\text{lim}}, (\dot{q}_{\text{lim}}^+ + \dot{q}_{\text{lim}}^-) \rangle_{q_{\text{lim}}}$ is a nonpositive real measure. But, the proof of local uniqueness (Theorem 8) uses nothing more than that. We deduce that there exists a right-neighborhood of t_1 on which the functions q_{lim} and q coincide identically. But, this contradicts the definition of t_1 and achieves the proof of assertion (64). As a result, the function q_{lim} is uniquely determined and the conclusions of Step 2 are valid not only for a subsequence but for the whole sequence (q_n) .

Now, if $t_0 + \delta < \tau$, we pick $t'_0 \in [t_0 + \delta/2, t_0 + \delta[$ such that

$$\lim_{n \rightarrow +\infty} (q_n(t'_0), \dot{q}_n^+(t'_0)) = (q(t'_0), \dot{q}^+(t'_0)).$$

Performing the same job for instant t'_0 instead of t_0 , we extend the conclusion to interval $[t_0, \min(\tau, t_0 + 3\delta/2)]$. Processing so inductively a large enough number of times, we obtain the desired conclusion. \square

Remark. A straightforward modification of the proof of Step 4 shows that the conclusions of theorem 20 hold if we only assume that ϕ is continuous and constant on each fiber:

$$\forall q, \quad \forall v_1, v_2 \in T_q Q, \quad \phi(q, v_1) = \phi(q, v_2).$$

The conclusions of Theorem 20 also hold if ϕ is only assumed continuous and if, moreover, we have

$$\forall t \in [t_0, T[, \quad \text{Card}J(q(t)) \leq 1.$$

8. Indications on the numerical computation of the solutions

Consider the problem \mathcal{P} described in Section 3.4. Assume furthermore, for the sake of simplicity, that the impact function ϕ is constant. The maximal solution associated with the initial condition (q_0, v_0) at time $t_0 = 0$, is denoted by (T_m, q) . We consider a local chart (U, ψ) at q_0 and a positive real number T such that

$$\forall t \in [0, T], \quad q(t) \in U.$$

By assumption (20), we may assume:

$$\forall q \in U, \quad (d\varphi_i(q))_{i \in J(q)} \quad \text{is linear independent in } T_q^* Q,$$

taking a smaller U if necessary. We consider a sequence of approximants, defining for every $n \geq 1$:

- $h_n = 2^{-n} T,$
- $t_{n,k} = kh_n = k2^{-n} T \quad (k = 0, 1, 2, \dots, 2^n),$
- $(q_{n,0}, v_{n,0}) = (q_0, v_0),$
- $q_{n,k} = q_{n,k-1} + h_n v_{n,k-1} \quad (k = 1, 2, \dots, 2^n),$

- $v'_{n,k}{}^\alpha = v_{n,k-1}^\alpha + \left[g^{\alpha\beta}(q_{n,k}) f_\beta(q_{n,k}, v_{n,k-1}; t_{n,k}) - \Gamma_{\beta\gamma}^\alpha(q_{n,k}) v_{n,k-1}^\beta v_{n,k-1}^\gamma \right] h_n$
 $(k = 1, 2, \dots, 2^n, \alpha = 1, 2, \dots, d),$
- $v_{n,k} = v'_{n,k} - (1 + \phi) \text{Proj}_{q_{n,k}} [v'_{n,k}, N(q_{n,k})] \quad (k = 1, 2, \dots, 2^n),$
- $v_n(t) = \begin{cases} v_{n,k}, & \text{if } t \in [t_{n,k}, t_{n,k+1}[\text{ with } k = 0, 1, \dots, 2^n - 1, \\ v_{n,2^n}, & \text{if } t = T = t_{n,2^n}, \end{cases}$
- $q_n(t) = q_0 + \int_0^t v_n(s) ds.$

Actually, it may happen that the function q_n cannot be defined on $[0, T]$ if there exists an integer k_n such that $q_{n,k_n+1} \notin U$. In such a case, the function q_n is defined only on $[0, t_{n,k_n}]$.

This type of algorithm was introduced by Moreau and used without further justifications. It should be stressed that one cannot hope that the sequence of approximants (q_n) converges in general towards the solution q , since continuous dependence on initial condition does not hold in general. Actually, it is easy to build an explicit example, in the spirit of the example of Section 7, where the sequence (q_n) does not converge pointwisely towards any function at all. However, in the special case where all the multiple impacts are orthogonal, things behave nicely and we have:

Theorem 21. *Suppose that the solution q is such that all multiple impacts are orthogonal:*

$$\forall t \in [0, T], \quad (d\varphi_i(q(t)))_{i \in J(q(t))} \text{ is orthogonal in } T_{q(t)}^* Q,$$

(with the convention that the empty set is orthogonal). Then, there exists an integer N_0 such that the function q_n is well defined on $[0, T]$ for $n \geq N_0$. Moreover, the sequence (q_n) converges uniformly on $[0, T]$ towards q (or more precisely towards $\psi(q)$).

Theorem 21 can be proved along the same steps as those of the proof of Theorem 20. The necessary adaptation of the details is left to the reader.

Appendix: the class of motion $\text{MMA}(I; Q)$

In this section, we are going to define the concept of vector field with bounded variation along a locally absolutely continuous curve on a Riemannian manifold. The definition and basic properties of absolutely continuous functions and functions with bounded variation from a real interval to a finite-dimensional normed vector space are supposed to be known. The reader is referred to RUDIN [17] and MOREAU [13]. These concepts are intimately connected with measure theory. Two expositions of measure theory compete: the set-theoretic approach (see for example RUDIN [17]) and the duality approach (see for example BOURBAKI [6]). These approaches are

connected by Riesz’s representation theorem. In this paper, we stick to the duality approach. If I is a real interval and E a real finite-dimensional normed vector space, $C_c^0(I; E)$ will denote the space of continuous functions from I to E with compact support. A measure on I with values in E (or E^*) will be any linear form μ on $C_c^0(I; E^*)$ (or, respectively, $C_c^0(I; E)$) satisfying the following continuity property:

$$\forall a, b \in I, \quad a < b \quad \exists M_{a,b} \geq 0, \quad \forall \varphi \text{ with } \text{Supp } \varphi \subset [a, b],$$

$$|\mu(\varphi)| \leq M_{a,b} \max_{t \in I} \|\varphi(t)\|.$$

When the constant $M_{a,b}$ can be found independent of a and b , the measure μ is said bounded. For everything concerning measure theory, the reader is referred to BOURBAKI [6] where he will note the definition of the support $\text{Supp } \mu$ of a measure μ (BOURBAKI [6], p. 64).

The following list of definitions and propositions aims at carrying these concepts over Riemannian manifolds. The cornerstone is, of course, the identification of tangent spaces at different points of a curve by means of parallel translation.

This appendix is also an occasion to state precisely the classical theorems which are used in this paper.

Definition 22. Let I be a real interval and $q : I \rightarrow Q$ a curve on Q . The curve q is said to be *locally absolutely continuous* if, for all t in I , there exists a compact neighborhood J of t in I and a chart (U, ψ) such that:

- $q(J) \subset U$,
- $\psi \circ q : J \rightarrow \mathbb{R}^d$ is absolutely continuous.

Since Q can be covered by a countable collection of chart domains, Lebesgue’s theorem yields the result that $q(t)$ admits a tangent vector $\dot{q}(t) \in T_{q(t)}Q$ for dt -almost all t in I where dt denotes the Lebesgue measure on the real line (and also its restriction on I). The Riemannian structure on Q and the Cauchy-Lipschitz-Caratheodory theorem allow us to define classically a parallel translation operator along q , $\tau_{t,s} : T_{q(s)}Q \rightarrow T_{q(t)}Q$ (see, for example, CHAVEL [7],p. 7). $\tau_{t,s}$ is defined for all $(s, t) \in I^2$.

Definition 23. Let q be a locally absolutely continuous curve from I to Q . A vector field X on $q(t)$ (or a 1-form field X^* on $q(t)$) is a mapping from I to TQ (resp. T^*Q) with the property

$$\forall t \in I, \quad \Pi_Q(X(t)) = q(t) \text{ (resp. } \Pi_Q^*(X^*(t)) = q(t)).$$

A vector field X on $q(t)$ (or a 1-form field X^* on $q(t)$) will be said to be *locally absolutely continuous* (resp. *absolutely continuous*, or *locally with bounded variation*, or with *bounded variation*) if there exists t_0 in I such that the mapping

$$\theta_{t_0} \left\{ \begin{array}{l} I \rightarrow T_{q(t_0)}Q \\ s \mapsto \tau_{t_0,s}(X(s)) \end{array} \right. \quad \left(\text{resp. } \theta_{t_0}^* \left\{ \begin{array}{l} I \rightarrow T_{q(t_0)}^*Q \\ s \mapsto \flat \circ \tau_{t_0,s}(\sharp \circ X^*(s)) \end{array} \right. \right),$$

is locally absolutely continuous (resp. absolutely continuous, or locally with bounded variation, or with bounded variation). If X has bounded variation on I , its variation over I is by definition:

$$\text{Var}(X(s); I) = \text{Var}(\tau_{t_0,s}(X(s)); I). \tag{65}$$

From the identity:

$$\forall s_1, s_2, t_1, t_2 \in I, \\ \|\tau_{t_1,s_1}(X(s_1)) - \tau_{t_1,s_2}(X(s_2))\|_{q(t_1)} = \|\tau_{t_2,s_1}(X(s_1)) - \tau_{t_2,s_2}(X(s_2))\|_{q(t_2)},$$

it is easily deduced that the above definition is independent on a particular choice of t_0 and so is the real number $\text{Var}(X(s); I)$.

The covariant derivative of a locally absolutely continuous vector field X along q can be defined for dt -almost every t in I by:

$$\frac{DX(t)}{dt} = \frac{d}{ds} (\tau_{t,s}(X(s)))|_{s=t} \quad \text{for } dt\text{-a.e. } t \in I.$$

Definition 24. Let (I, q) be a continuous curve on Q . We denote by $C_c^0(I, q; TQ)$ (or $C_c^0(I, q; T^*Q)$) the space of continuous functions φ from I to TQ (resp. T^*Q) with compact support and such that:

$$\forall t \in I, \quad \Pi_Q(\varphi(t)) = q(t) \quad (\text{resp. } \Pi_Q^*(\varphi(t)) = q(t)).$$

We define a measure on the curve (I, q) taking values in TQ (or T^*Q) as any linear form μ on $C_c^0(I, q; T^*Q)$ (or $C_c^0(I, q; TQ)$) enjoying the following continuity property:

$$\forall a, b \in I, \quad a < b \quad \exists M_{a,b} \geq 0, \quad \forall \varphi \text{ with } \text{Supp } \varphi \subset [a, b], \\ |\mu(\varphi)| \leq M_{a,b} \max_{t \in I} \|\varphi(t)\|_{q(t)}.$$

The real number $\mu(\varphi)$ will also be defined by $\int_I \langle \varphi(t), d\mu \rangle_{q(t)}$.

Proposition 25. Let (I, q) be a continuous curve on Q and μ a measure on q taking values in T^*Q . For any nonnegative function f of $C_c^0(I; \mathbb{R})$, we define

$$|\mu|(f) = \sup_{\substack{g \in C_c^0(I,q;TQ) \\ \|g(t)\|_{q(t)} \leq f(t)}} \left| \int_I g(t) d\mu \right|,$$

where the supremum is finite thanks to the continuity properties included in the definition of measures. For arbitrary f in $C_c^0(I; \mathbb{R})$, we define

$$|\mu|(f) = |\mu|(\langle f \rangle^+) - |\mu|(\langle f \rangle^-),$$

where $\langle x \rangle^\pm = \max\{\pm x, 0\}$ are the classical positive and negative parts.

Then, the functional $|\mu|$ is a real measure called the modulus measure of μ .

The proof is omitted since it is completely identical to the proof of the similar statement for complex measures (see BOURBAKI [6, p. 54]).

The support $\text{Supp } \mu$ of a measure μ on $q(t)$ taking values in T^*Q is, by definition, the support $\text{Supp } |\mu|$ of its modulus measure.

We define $L^1_{\text{loc}}(I, q, |\mu|; T^*Q)$ by the space of functions θ defined for $|\mu|$ -almost all t in I , taking values in T^*Q and such that:

- $\Pi^*_Q(\theta(t)) = q(t)$ for $|\mu|$ -almost every $t \in I$,
- $\forall \varphi \in C^0_c(I, q; TQ), \quad t \mapsto \langle \varphi(t), \theta(t) \rangle_{q(t)} \in L^1(I, |\mu|; \mathbb{R})$.

Proposition 26. *Let μ be a measure on $q(t)$ taking values in T^*Q . Then, there exists a unique (class of) function $l_\mu \in L^1_{\text{loc}}(I, q, d|\mu|; T^*Q)$ such that:*

- $\Pi^*_Q(l_\mu(t)) = q(t)$ for $d|\mu|$ -almost every $t \in I$,
- $\forall \varphi \in C^0_c(I, q; TQ), \quad \int_I \langle \varphi(t), d\mu \rangle_{q(t)} = \int_I \langle \varphi(t), l_\mu(t) \rangle_{q(t)} d|\mu|$.

This fact will be denoted by: $d\mu = l_\mu d|\mu|$. We shall say that l_μ is the density of measure μ with respect to measure $|\mu|$.

Proof. For measure taking values in a finite-dimensional vector space, the above statement is a classical direct consequence of the Lebesgue-Radon-Nikodym theorem (see RUDIN [17]). It is readily carried over manifolds by means of a locally finite partition of unity modelled on chart domains.

Definition 27. Let X be a vector field with locally bounded variation on an absolutely continuous curve (I, q) and t_0 an arbitrary element of I . We denote by $d_{t_0}X$ the Stieljes measure (see MOREAU [13]) associated with the mapping with locally bounded variation:

$$\theta_{t_0} \begin{cases} I \rightarrow T_{q(t_0)}Q, \\ s \mapsto \tau_{t_0,s}(X(s)). \end{cases}$$

For $Y \in C^0_c(I, q; TQ)$ and $Y^* \in C^0_c(I, q; T^*Q)$, the linear forms

$$Y \mapsto \int_I (\tau_{t_0,s}(Y(s)), d_{t_0}X)_{q(t_0)} \quad \text{and} \quad Y^* \mapsto \int_I (\tau_{t_0,s}(\sharp \circ Y^*(s)), d_{t_0}X)_{q(t_0)}$$

turn out to be independent of a particular choice of t_0 and define measures on q taking, respectively, values in T^*Q and TQ . They are denoted by $\flat DX$ and DX and called the *covariant* and *contravariant representative* of the covariant Stieljes measure associated with X .

Proposition 28. *If X is a locally absolutely continuous vector field on a locally absolutely continuous curve from I to Q , then*

$$DX = \frac{DX}{dt} dt \quad \text{and} \quad \flat DX = \flat \frac{DX}{dt} dt. \tag{66}$$

Reciprocally, if X is locally with bounded variation and such that its covariant Stieljes measure DX admits a density with respect to the Lebesgue measure, then X is locally absolutely continuous and relations (66) hold.

Proof. This is an immediate consequence of Definition 27 and of the similar statement for functions taking values in a finite-dimensional normed vector space.

Proposition 28 ensures the consistency of our notation. Let us now turn to practical calculations in charts.

Proposition 29. *Let (U, ψ) be a chart on Q , (I, q) an absolutely continuous curve on Q such that $q(I) \subset U$ and X a vector field on (I, q) . The components (X^i) ($i = 1, 2, \dots, d$) of X in the natural chart of TQ associated with ψ are real functions defined on I . The vector field X is locally absolutely continuous (resp. absolutely continuous, or locally with bounded variation, or with bounded variation) if and only if every function X^i is locally absolutely continuous (resp. absolutely continuous, or locally with bounded variation, or with bounded variation). Moreover, in such a case, we have:*

$$\begin{aligned} DX &= \left(dX^i + \Gamma_{jk}^i(q(t))X^j(t)\dot{q}^k(t) dt \right) e_i(q(t)), \\ {}^bDX &= g_{ij}(q(t)) \left(dX^j + \Gamma_{kl}^j(q(t))X^k(t)\dot{q}^l(t) dt \right) e^i(q(t)). \end{aligned}$$

Proof. This is an immediate consequence of Definition 27.

Proposition 30. *Let X be a vector field with locally bounded variation of an absolutely continuous curve (I, q) . Then, for any t_0 in I , the two limits $\lim_{t \rightarrow t_0^-} X(t)$ and $\lim_{t \rightarrow t_0^+} X(t)$ exist in TQ and are such that*

$$\Pi_Q \left(\lim_{t \rightarrow t_0^-} X(t) \right) = \Pi_Q \left(\lim_{t \rightarrow t_0^+} X(t) \right) = q(t_0).$$

These limits are denoted by $X^-(t_0)$ and $X^+(t_0)$ and can be different only on an at most countable subset of I . The mapping

$$\begin{cases} I \rightarrow \mathbb{R}^+ \\ t \mapsto \frac{1}{2} \|X(t)\|_{q(t)}^2 \end{cases}$$

has locally bounded variation and

$$d \left(\frac{1}{2} \|X(t)\|_{q(t)}^2 \right) = \left(\frac{X^-(t) + X^+(t)}{2}, DX \right)_{q(t)}.$$

Proof. It is a direct consequence of the similar statement for functions taking values in Euclidean \mathbb{R}^d (see MOREAU [13]) and of Definition 27.

Definition 31. We denote by $MMA(I; Q)$ (motions with measure acceleration) the set of all locally absolutely continuous motions $q(t)$ from I to Q such that the right velocity $\dot{q}^+(t)$ exists for all t in I and defines a vector field with locally bounded variation on $q(t)$.

Proposition 32. *Let q be in $\text{MMA}(I; Q)$. Then, $\dot{q}^+ : I \rightarrow TQ$ is right continuous:*

$$\forall t \in I, \quad (\dot{q}^+(t))^+ = \dot{q}^+(t).$$

Moreover, $q(t)$ admits a left velocity vector at each instant of I and

$$\forall t \in I, \quad \dot{q}^-(t) = (\dot{q}^+(t))^-.$$

Proof. Use the Mean Value Inequality in a local chart.

Proposition 33. *Let $q \in \text{MMA}(I; Q)$ with $q(I) \subset U$ domain of a chart. Then,*

$$\flat D\dot{q}^+ = \left(d \frac{\partial K(q(t), \dot{q}^+(t))}{\partial \dot{q}^{+i}} - \frac{\partial K(q(t), \dot{q}^+(t))}{\partial q^i} dt \right) e^i(q(t)).$$

Proof. Reproduce the proof of Proposition 2 with the help of Proposition 29.

Proposition 34. *Let $(q_n)_{n \in \mathbb{N}}$ be a sequence of elements of $\text{MMA}([0, T]; Q)$ such that:*

– *there exists a compact subset K of TQ such that*

$$\forall n \in \mathbb{N}, \quad \forall t \in [0, T], \quad (q_n(t), \dot{q}_n^+(t)) \in K,$$

– $\exists M > 0, \quad \forall n \in \mathbb{N}, \quad \text{Var}(\dot{q}_n^+; [0, T]) \leq M.$

Then, there exists a subsequence of $(q_n)_{n \in \mathbb{N}}$, also denoted by $(q_n)_{n \in \mathbb{N}}$, such that:

- $(q_n)_{n \in \mathbb{N}}$ *converges uniformly on $[0, T]$ for the Riemannian metric towards a function q_{lim} belonging to $\text{MMA}([0, T]; Q)$,*
- *The sequence $(q_n(t), \dot{q}_n^+(t))$ converges towards $(q_{\text{lim}}(t), \dot{q}_{\text{lim}}^+(t))$ in TQ for almost all t in $]0, T[$.*

Proof. This is a generalization of Helly’s theorem to the case of a Riemannian manifold. The set $K' = \Pi_Q(K)$ being compact, there exists $\varepsilon > 0$ such that (cf. CHAVEL [7, p. 23]):

- for all q in $K', B(q, \varepsilon) (= \{q' \in K'; d(q, q') < \varepsilon\})$ is the domain of a chart ψ_q ,
- for all q in K' , the distance defined by $|\psi_q(q_1) - \psi_q(q_2)|$ and the Riemannian distance d are equivalent on $B(q, \varepsilon)$.

First, we extract a subsequence of (q_n) , also denoted by (q_n) , such that:

$$\lim_{n \rightarrow +\infty} (q_n(0), \dot{q}_n^+(0)) = (q_0, v_0) \quad \text{in } TQ,$$

and there exists $N_0 \in \mathbb{N}$ large enough to have

$$\forall n \geq N_0, \quad d(q_0, q_n(0)) < \frac{\varepsilon}{2}.$$

Now, by:

$$\forall t \in [0, T], \quad \forall n \in \mathbb{N}, \quad \|\dot{q}_n^+(t)\|_{q_n(t)} \leq \|\dot{q}_n^+(0)\|_{q_n(0)} + \text{Var}(\dot{q}_n^+; [0, T]), \tag{67}$$

there exists α_0 ($0 < \alpha_0 \leq T$) small enough to have:

$$\forall t_0 \in [0, T], \quad \forall t \in [t_0, \min(T, t_0 + \alpha_0)], \quad \forall n \in \mathbb{N}, \quad d(q_n(t), q_n(t_0)) < \frac{\varepsilon}{2}.$$

Then, it is easily checked that the functions $\psi_{q_0}(q_n(t))|_{[0, \alpha_0]}$ ($n \geq N_0$) satisfy the hypothesis of Helly’s theorem and therefore the conclusion of the proposition holds on $[0, \alpha_0]$.

Now, choose $t_1 \in [\alpha_0/2, \alpha_0]$ such that:

$$\lim_{n \rightarrow +\infty} (q_n(t_1), \dot{q}_n^+(t_1)) = (q_{\text{lim}}(t_1), \dot{q}_{\text{lim}}^+(t_1)) \quad \text{in } TQ,$$

and N_1 large enough to have:

$$\forall n \geq N_1, \quad d(q_{\text{lim}}(t_1), q_n(t_1)) < \frac{\varepsilon}{2}.$$

Performing the same job as above on the chart of domain $B(q_{\text{lim}}(t_1), \varepsilon)$, we find that the conclusion of the proposition holds on $[0, \min(T, 3\alpha_0/2)]$. Processing so inductively a large enough number of times, we obtain the desired conclusion. \square

Remark. If the Riemannian manifold Q is assumed to be complete, the first hypothesis in Proposition 34 can be weakened and replaced by: there exists a compact subset K_0 of TQ such that

$$\forall n \in \mathbb{N}, \quad (q_n(0), \dot{q}_n^+(0)) \in K_0.$$

Indeed, this hypothesis allows us to extract a subsequence of (q_n) such that

$$\lim_{n \rightarrow +\infty} (q_n(0), \dot{q}_n^+(0)) = (q_0, v_0) \quad \text{in } TQ.$$

By estimate (67), we get:

$$\exists D > 0, \quad \forall t \in [0, T], \quad \forall n \in \mathbb{N}, \quad \|\dot{q}_n^+(t)\|_{q_n(t)} \leq D, \quad \text{and } d(q_0, q_n(t)) \leq D.$$

The Riemannian manifold Q being complete, by the Hopf-Rinow theorem (cf. CHAVEL [7, p. 26]), the functions $(q_n, \dot{q}_n^+(t))$ take values in a compact subset K of TQ .

Acknowledgements. I would like to thank particularly MICHELLE SCHATZMAN for her always relevant remarks. The final form of this article owes very much to her circumspect and disinterested advice.

References

1. R. ABRAHAM & J. E. MARSDEN, *Foundations of Mechanics* (Addison-Wesley, 1985).
2. V. I. ARNOLD, *Mathematical Methods of Classical Mechanics* (Springer-Verlag, 1978).
3. P. BALLARD, Dynamique des systèmes mécaniques discrets avec liaisons unilatérales parfaites. *Compte-Rendus à l'Académie des Sciences, Série II*, **327**, (1999) pp. 953–958.
4. A. BRESSAN, Incompatibilità dei Teoremi di Esistenza e di Unicità del Moto per un Tipo molto Comune e Regolare di Sistemi Meccanici, *Annali della Scuola Normale Superiore di Pisa, Serie III*, **14**, (1960) pp. 333–348.
5. H. BREZIS, *Opérateurs Maximaux Monotones et Semi-groupes de Contractions dans les Espaces de Hilbert* (North-Holland Publishing Company 1973).
6. N. BOURBAKI, *Intégration*, Hermann, Paris, chaps 1, 2, 3, 4 (2nd ed., 1965), chap. 5 (1956), chap. 6 (1959).
7. I. CHAVEL, *Riemannian Geometry: a Modern Introduction* (Cambridge University Press 1993).
8. E. A. CODDINGTON & N. LEVINSON, *Theory of Ordinary Differential Equations* (McGraw-Hill Book Company 1955).
9. J. L. LIONS & G. STAMPACCHIA, Variational inequalities. *Communications on Pure and Applied Mathematics*, **20**, (1967) pp. 493–519.
10. M. D. P. MONTEIRO MARQUES, *Differential Inclusions in Nonsmooth Mechanical Problems* (Birkhäuser, Basel, Boston, Berlin 1993).
11. J. J. MOREAU, Décomposition orthogonale d'un espace hilbertien selon deux cônes mutuellement polaires, *Compte-Rendus à l'Académie des Sciences de Paris*, **255**, (1962) pp. 238–240.
12. J. J. MOREAU, Standard inelastic shocks and the dynamics of unilateral constraints, in *Unilateral problems in structural analysis* (G. Del Piero & F. Maceri Eds, Springer-Verlag, Wien, New-York 1983), pp. 173–221.
13. J. J. MOREAU, Bounded variation in time, in *Topics in Non-smooth Mechanics* (J. J. Moreau, P. D. Panagiotopoulos, G. Strang, Eds., Birkhäuser Verlag, Basel-Boston-Berlin 1988), pp. 1–74.
14. D. PERCIALE, Uniqueness in the Elastic Bounce Problem, I, *Journal of Differential Equations*, **56**, (1985) pp. 206–215.
15. D. PERCIALE, Uniqueness in the Elastic Bounce Problem, II, *Journal of Differential Equations*, **90**, (1991) pp. 304–315.
16. R. T. ROCKAFELLAR, *Convex Analysis* (Princeton University Press 1970).
17. W. RUDIN, *Real and complex analysis* (McGraw-Hill 1966).
18. M. SCHATZMAN, A Class of Nonlinear Differential Equations of Second Order in Time, *Nonlinear Analysis, Theory, Methods & Applications*, **2**, (1978) pp. 355–373.
19. M. SCHATZMAN, Uniqueness and continuous dependence on data for one dimensional impact problems, *Mathematical and Computational Modelling*, **28**, (1998) pp. 1–18.
20. Y. G. SINAI, Dynamical systems with elastic reflexions, *Russian Mathematical Surveys*, **25**, (1970) pp. 137–189.

Laboratoire de Mécanique des Solides
Ecole Polytechnique
91128 Palaiseau Cédex
France
e-mail: ballard@lms.polytechnique.fr

(Accepted April 18, 2000)

Published online September 18, 2000 – © Springer-Verlag (2000)

Formulation and well-posedness of the dynamics of rigid-body systems with perfect unilateral constraints

Patrick Ballard

Phil. Trans. R. Soc. Lond. A 2001 **359**, 2327-2346

doi: 10.1098/rsta.2001.0854

Rapid response

[Respond to this article](#)

<http://rsta.royalsocietypublishing.org/letters/submit/roypta;359/1789/2327>

Email alerting service

Receive free email alerts when new articles cite this article - sign up in the box at the top right-hand corner of the article or click [here](#)

To subscribe to *Phil. Trans. R. Soc. Lond. A* go to: <http://rsta.royalsocietypublishing.org/subscriptions>

Formulation and well-posedness of the dynamics of rigid-body systems with perfect unilateral constraints

BY PATRICK BALLARD

*Laboratoire de Mécanique des Solides, Ecole Polytechnique,
91128 Palaiseau Cédex, France (ballard@lms.polytechnique.fr)*

The classical theory of rigid-body systems dynamics with perfect bilateral constraints is extended in order to take perfect unilateral constraints into account. A systematic formulation of the dynamics is derived and the most general admissible form of the impact-constitutive equation is obtained. Well-posedness of the evolution problem is proved under the assumption that the data are analytic.

Keywords: analytical dynamics; non-smooth mechanics; impact

1. Introduction

Rigid-body systems dynamics with perfect bilateral constraints has been well established on firm mathematical foundations for a long time. In this paper, we aim at giving such a status to the dynamics of rigid-body systems with perfect unilateral constraints.

Any mechanical theory relies on a geometric description of the system under study. This is always a schematization. As a consequence, most of the time, the equation of motion has to be completed with some constitutive equation. A constitutive equation conveys the physical information that has been removed by the over-schematization of the geometric description. In fact, the well-posedness of the dynamics generally serves implicitly as a guideline to the identification of the general form of the constitutive law, although thermodynamic considerations can also play an important part.

The dynamics of rigid-body systems with perfect unilateral constraints necessarily involves an impact-constitutive equation. We shall try to identify the most general form of the impact-constitutive equation that is compatible with the well-posedness of the dynamics. Thus, we shall build the theory step by step, justifying the necessity of each hypothesis by a counter-example. These hypotheses will be classified into two categories. Those which convey a physical assumption will be called ‘constitutive’ hypotheses and the others, whose aim is to prevent mathematical pathologies, will be called ‘regularity’ hypotheses. Since one aim is to obtain general forms of constitutive laws, one has to make sure that the constitutive laws do not depend on any particular parametrization of the system. For this reason, we are going to try to obtain intrinsic formulations of dynamics, that is, formulations which do not rely on a particular choice for the parametrization of the system. This necessarily requires the use of the language of differential geometry. However, only the most elementary level of differential geometry is needed.

2. The dynamics of rigid-body systems

(a) *The geometric assumption: rigidity*

Classical mechanics postulates the existence of a three-dimensional oriented affine Euclidean space \mathcal{E} , sometimes called the (Galilean) *real world*, and an absolute chronology represented (after the choice of an origin) by a real number, generally denoted by t . The vector space associated with \mathcal{E} will be denoted by E .

A solid is represented by its *real world reference configuration*, which is nothing but a possible geometric locus of all the material points of the solid in \mathcal{E} . The geometric assumption of rigidity can be stated as follows: the only real-world configuration of that solid which can be observed are obtained from the real-world reference configuration by *direct isometries*. Therefore, once the real-world reference configuration has been fixed, any real-world configuration of the solid is represented by a direct isometry q . Since any direct isometry on \mathcal{E} can be split into a translation and a rotation, the set of all direct isometries can be identified with $E \times \mathbb{S}\mathbb{O}3$ (where $\mathbb{S}\mathbb{O}3$ denotes the set of all direct orthogonal endomorphisms on E , endowed with its standard manifold structure). It is said that $E \times \mathbb{S}\mathbb{O}3$ is the (abstract) *configuration manifold* of the rigid solid. Since its dimension is 6, we say that the rigid solid has six *degrees of freedom* (DOF).

Other idealizations of rigid solids can appear: the infinitely thin rigid bar whose configuration manifold is $E \times \mathbb{S}2$ ($\mathbb{S}2$ denotes the two-dimensional sphere equipped with its standard manifold structure) and the punctual particle whose configuration manifold is simply E .

A motion of a rigid solid is a curve on its configuration manifold Q (a mapping from a time-interval I into Q). The derivative of the motion at instant t is denoted by $\dot{q}(t)$. This is called the abstract (or, sometimes, generalized) velocity and is an element of the tangent bundle TQ of the configuration manifold. One often encounters the name ‘state space’ for TQ , in which case $\dot{q}(t)$ is also called a state of the system.

The mass distribution in the rigid solid is a bounded positive measure on the real-world reference configuration. It allows, classically, the association of any state of the system with its *kinetic energy* $K(q, \dot{q})$. It defines a positive-definite quadratic form on each tangent space of Q , endowing the configuration manifold with a Riemannian structure. This Riemannian metric is naturally called the *kinetic metric*. From now on, whenever we speak of a configuration manifold, it will always be supposed to be equipped with its Riemannian structure.

A rigid-body system is a finite collection of rigid bodies. The configuration manifold of a rigid-body system is the cross-product $Q_1 \times Q_2 \times \cdots \times Q_n$ of the individual configuration manifold Q_i of each rigid body of the system.

Notation. For Q being a smooth Riemannian manifold of dimension d , we shall denote by

- (i) TQ and T^*Q , the tangent and cotangent bundles;
- (ii) Π_Q and Π_Q^* , the natural projection mappings of TQ and T^*Q ;
- (iii) $\langle \cdot, \cdot \rangle_q$, the local duality product between tangent space T_qQ and cotangent space T_q^*Q ;

- (iv) $(\cdot, \cdot)_q$ and $\|\cdot\|_q$, the local scalar product and norm on T_qQ (a $*$ will be added when referring to the scalar product and norm on T^*Q);
- (v) \flat (and $\sharp = \flat^{-1}$, its inverse), the isomorphism of vector bundles from TQ onto T^*Q naturally associated with the Riemannian metric of Q .

The abstract velocity $\dot{q}(t) \in TQ$ of a motion $q(t)$ will alternatively be denoted by $(q(t), \dot{q}(t))$. This is clearly a redundant notation since the base-point $q = \Pi_Q(\dot{q})$ is contained in the derivative, but I believe that this notation will be an aid to understanding. More generally, an element v of TQ will also be denoted by (q, v) with q being the base-point of v .

Any (local) chart ψ on the configuration manifold is called a (*local*) *parametrization*. For an abstract configuration $q \in Q$, $\psi(q)$ is an element of \mathbb{R}^d that we denote by (q^1, q^2, \dots, q^d) . Each time a given parametrization will be under consideration, we shall write $q = (q^1, q^2, \dots, q^d)$. The natural basis of T_qQ (respectively, T_q^*Q) naturally associated with the chart ψ is denoted by $(e_1(q), e_2(q), \dots, e_d(q))$ (respectively, $(e^1(q), e^2(q), \dots, e^d(q))$). For (q, v) belonging to TQ , we denote by v^i ($i = 1, 2, \dots, d$) its components in the natural basis and we shall write

$$v = v^i e_i(q).$$

Einstein's summation convention will always apply, unless explicitly stated otherwise. As usual, $g_{ij}(q)$ will be the covariant components of the metric in the considered chart and $g^{ij}(q)$ its contravariant components; $\Gamma_{jk}^i(q)$ will be the associated Christoffel symbols:

$$\Gamma_{jk}^i(q) = \frac{1}{2} g^{ih}(q) \left(\frac{\partial g_{hk}}{\partial q^j}(q) + \frac{\partial g_{jh}}{\partial q^k}(q) - \frac{\partial g_{jk}}{\partial q^h}(q) \right).$$

For $q(t)$ being a curve on Q and v being a vector field on that curve, the covariant derivative of v along $q(t)$ is denoted by

$$\frac{D}{dt}v(t) = \left(\frac{d}{dt}v^i(t) + \Gamma_{jk}^i(q(t))v^j(t)\dot{q}^k(t) \right) e_i(q(t)).$$

(b) Formulation of the dynamics

Consider a rigid-body system of configuration manifold Q and a motion $q(t)$ of that system. The *power of inertial forces* at instant t is, by definition, the time derivative at t of the kinetic energy:

$$\frac{d}{dt}K(q, \dot{q}) = \frac{1}{2} \frac{d}{dt}(\dot{q}(t), \dot{q}(t))_{q(t)} = \left(\frac{D}{dt}\dot{q}(t), \dot{q}(t) \right)_{q(t)} = \left\langle \flat \frac{D}{dt}\dot{q}(t), \dot{q}(t) \right\rangle_{q(t)}.$$

Hence, it is seen that the power of inertial forces at time t defines the cotangent vector $\flat D\dot{q}(t)/dt \in T_{q(t)}^*Q$. An arbitrary element T_qQ is often called a *virtual velocity* of the system in the configuration q . Then, the linear form $\flat D\dot{q}(t)/dt$ is called the virtual power of inertial forces.

The analysis of the dynamics has to take into account external and internal efforts. They define a linear form $f \in T_q^*Q$ on each tangent space of the configuration manifold, which is classically named the *virtual power of external and internal efforts*. The reason for such a modelling of efforts by duality is that it ensures the consistency

of the modelling of the efforts with the geometric description of the system. The linear form $f(q, \dot{q}; t) \in T_q^*Q$ is allowed to depend not only on time but also on the current state of the system.

The fundamental principle of classical mechanics asserts that the virtual power of inertial forces should equal at every instant the virtual power of external and internal efforts:

$$\forall t, \quad \flat \frac{D}{dt} \dot{q}(t) = f(q(t), \dot{q}(t), t). \quad (2.1)$$

Equation (2.1) is referred to as the *equation of motion*. It is a second-order differential equation on the configuration manifold. To express it in a particular parametrization of the system, the following is useful.

Proposition 2.1 (Lagrange). *Let ψ be a local chart and $q(t)$ a C^2 motion on Q . One has*

$$\flat \frac{D}{dt} \dot{q}(t) = \left(\frac{d}{dt} \frac{\partial}{\partial \dot{q}^i} K(q(t), \dot{q}(t)) - \frac{\partial}{\partial q^i} K(q(t), \dot{q}(t)) \right) e^i(q(t)).$$

We are given an initial instant t_0 and an initial state $(q_0, v_0) \in TQ$. Then, the evolution problem associated with the dynamics of a rigid-body system is the Cauchy problem, as follows.

Problem I. Find $T > t_0$ and $q \in C^2([t_0, T]; Q)$ such that

- (i) $(q(t_0), \dot{q}(t_0)) = (q_0, v_0)$,
- (ii) $\forall t \in [t_0, T[, \flat \frac{D}{dt} \dot{q}(t) = f(q(t), \dot{q}(t), t)$.

(c) *Well-posedness of the dynamics*

To study the well-posedness (existence and uniqueness of solution) of problem I, we have to specify regularity assumptions on Q and f .

Counter-example 1. Consider the evolution equation

$$\frac{d^2}{dt^2} q(t) = 6|q(t)|^{1/3} \quad (q \in \mathbb{R})$$

with initial condition $(q(0), \dot{q}(0)) = (0, 0)$. It is readily checked that the two motions defined on \mathbb{R}^+ $q(t) = 0$ and $q(t) = t^3$ provide two distinct solutions.

To get well-posedness, we are led to make further hypotheses. Throughout this paper, we shall distinguish two classes of hypotheses: the *constitutive* hypotheses and the *regularity* hypotheses. A constitutive hypothesis is one which conveys physical meaning. A regularity hypothesis conveys no physical meaning and is stated to eliminate mathematical pathologies. The following regularity hypothesis is slightly stronger than necessary.

Regularity hypothesis. The Riemannian configuration manifold is of class C^2 and the mapping $f : TQ \times \mathbb{R} \rightarrow T^*Q$ is of class C^1 .

It should be pointed out that the first part of this hypothesis is actually no hypothesis at all. The configuration manifold of the three-dimensional rigid solid, of the infinitely thin rigid bar or of the punctual particle, with arbitrary mass distribution is C^∞ (or, even more, analytic) Riemannian manifolds. The configuration manifold of a rigid-body system (with no constraints), being a cross-product of such manifolds, can be assumed to have arbitrary regularity. This is not a restriction either on the geometry nor on the mass distribution of the system, but on the class of admissible parametrizations.

Under this regularity assumption, we have the following well-posedness result.

Theorem 2.2 (Cauchy). *There exists a unique maximal solution for problem I.*

More precisely, theorem 2.2 states that there exists $T_m > t_0$ ($T_m \in \mathbb{R} \cup \{+\infty\}$) and $q_m \in C^2([t_0, T_m[, Q)$, being a solution of problem I such that any other solution of problem I is a restriction of q_m . Of course, we expect that $T_m = +\infty$, in which case the dynamics is said to be *eternal*. This situation cannot be taken for granted, in general.

Counter-example 2. Consider the evolution equation

$$\frac{d^2}{dt^2}q(t) = (\dot{q}(t))^2$$

($q \in \mathbb{R}$) with initial condition $(q(0), \dot{q}(0)) = (0, 1)$. It is readily checked that the maximal solution is defined on the interval $[0, 1[$.

In the usual cases encountered in mechanics, eternal dynamics is ensured by the following general sufficient condition.

Theorem 2.3. *The configuration manifold Q is assumed to be a complete Riemannian manifold (this is no hypothesis in the case of rigid-body system with no constraints). The mapping f is supposed to admit the following estimate,*

$$\|f(q, v; t)\|_q^* \leq l(t)(1 + d(q, q_0) + \|v\|_q),$$

for all $(q, v) \in TQ$ and almost all $t \in [t_0, +\infty[$, where $d(\cdot, \cdot)$ is the Riemannian distance and $l(t)$ is a (necessarily non-negative) function of $L^1_{\text{loc}}(\mathbb{R}; \mathbb{R})$. Then, the dynamics is eternal: $T_m = +\infty$.

The proof of theorem 2.3 relies on Gronwall's lemma.

3. Perfect bilateral constraints

A constraint describes a type of effort which is not taken into account by the efforts mapping f . Indeed, it is possible to specify (partly) some efforts by their kinematical effects. In general, these kinematical effects leave the associated efforts partly undetermined and we have to add phenomenological assumptions about how the constraint acts through a *constitutive law* of the constraint.

(a) The geometric description

A (holonomic) *bilateral constraint* is a restriction on the admissible motions of the system which is expressed by means of a finite number n of smooth real-valued

functions φ_i on the configuration manifold Q , defining a set S of admissible configurations:

$$S = \{q \in Q; \forall i \in \{1, 2, \dots, n\}, \varphi_i(q) = 0\}. \quad (3.1)$$

The following hypothesis is usual in this framework.

Regularity hypothesis I. The functions φ_i are *functionally independent*, that is, for all $q \in S$, the $d\varphi_i(q)$ ($i \in \{1, 2, \dots, n\}$) are linearly independent in T^*Q .

A straightforward consequence of this hypothesis is that S is a submanifold of Q of dimension $d - n$. As a result, S inherits a Riemannian structure from Q . We shall say that S is the configuration manifold of the constrained system.

(b) *Formulation of the dynamics*

The realization of the constraint (3.1) necessarily involves a modification of the equation of motion (2.1). This is done by adding to the virtual power of efforts $f(q, \dot{q}; t)$ a corrective unknown term R called the *virtual power of reaction efforts*:

$$\forall t, \quad \flat \frac{D}{dt} \dot{q}(t) = f(q(t), \dot{q}(t), t) + R(t).$$

We might expect R to be determined by the geometric constraint (3.1), but, in general, this does not work. We have to add phenomenological assumptions on the way the constraint acts. This is the *constitutive law* of the constraint.

Constitutive hypothesis II. The bilateral constraint (3.1) is supposed to be *perfect* (one also says synonymously *ideal*), that is, the virtual power of the reaction efforts R vanishes in any virtual velocity compatible with the bilateral constraint:

$$\forall v \in \{v \in T_q Q; \forall i \in \{1, 2, \dots, n\}, \langle d\varphi_i(q), v \rangle_q = 0\} \simeq TS, \quad \langle R, v \rangle_q = 0.$$

Thanks to hypotheses I and II, we can write

$$R(t) = \sum_{i=1}^n \lambda_i(t) d\varphi_i(q),$$

for some real-valued functions λ_i .

Now, we formulate the evolution problem associated with the dynamics of rigid-body systems with perfect bilateral constraints. The initial condition is assumed to be compatible with the realization of the constraint $(q_0, v_0) \in TS$.

Problem II. Find $T > t_0$, $q \in C^2([t_0, T[; Q)$ and n functions $\lambda_i \in C^0([t_0, T[; \mathbb{R})$ such that

- (i) $(q(t_0), \dot{q}(t_0)) = (q_0, v_0)$,
- (ii) $\forall t \in [t_0, T[, q(t) \in S$,
- (iii) $\forall t \in [t_0, T[, \flat \frac{D_Q}{dt} \dot{q}(t) = f(q(t), \dot{q}(t), t) + \sum_{i=1}^n \lambda_i(t) d\varphi_i(q(t))$.

Here, we used the notation D_Q/dt for the covariant derivative to underline the fact that the covariant derivative is understood with respect to the Riemannian structure of Q (and not to that of S).

Let q be a point of Q , v a vector in T_qQ , and E a subspace of T_qQ . The orthogonal projection of v on E for the scalar product of T_qQ , induced by the Riemannian structure of Q , is denoted by $\text{Proj}_q[v; E]$. Similarly, $\text{Proj}_q^*[v^*; E^*]$ denotes the orthogonal projection of the cotangent vector v^* on the subspace E^* of T_q^*Q . If $q(t)$ is a curve on the Riemannian submanifold S of Q and v a vector field on that curve, then we have (see Chavel 1993, p. 54)

$$\frac{D_S v}{dt} = \text{Proj}_q \left[\frac{D_Q v}{dt}; T_q S \right].$$

Therefore, any solution of problem II is seen to be a solution of the following problem.

Problem II'. Find $T > t_0$ and $q \in C^2([t_0, T[; S])$ such that

- (i) $(q(t_0), \dot{q}(t_0)) = (q_0, v_0)$,
- (ii) $\forall t \in [t_0, T[, \flat \frac{D_S}{dt} \dot{q}(t) = \text{Proj}_{q(t)}^*[f(q(t), \dot{q}(t); t); T_{q(t)}^* S]$.

Reciprocally, any solution of problem II' is readily seen to generate a solution of problem II: the two evolution problems are equivalent.

The linear form (cotangent vector) $\text{Proj}_q^*[f(q, \dot{q}; t); T_q^* S]$ equals the restriction of the linear form $f(q, \dot{q}; t)$ on the space $T_q S$ of virtual velocities compatible with the bilateral constraint. Therefore, it is the virtual power of external and internal efforts in any virtual velocity compatible with the constraint.

(c) Well-posedness of the dynamics

Problem II' has formally the same structure of problem I. Since problems II' and II are equivalent, the results of § 2c give the well-posedness of the dynamics of rigid-body systems with perfect bilateral constraints.

Regularity hypothesis III. The configuration manifold Q and the functions φ_i are of class C^2 and the mapping $f : TQ \times \mathbb{R} \rightarrow T^*Q$ is of class C^1 .

Proposition 3.1. *Problems II and II' have a unique maximal solution q_m .*

The analysis of the eternity of the dynamics is provided by theorem 2.3.

Regularity hypothesis I could seem very restrictive. However, dropping it would lead to difficulties.

Counter-example 3. Consider a rigid homogeneous bar of length l . The two extremities of the bar are constrained to remain on a fixed circle of diameter l . The two corresponding bilateral constraints are supposed to be perfect. This is a simple occurrence of a bilateral constraint, which does not satisfy regularity hypothesis I. At the initial instant, the bar is at rest. A constant force is applied at the middle point of the bar. This force is directed in the plane of the circle but not along the bar. The reader will be convinced that the corresponding evolution problem II admits no solution.

Since the modelling of a rigid-body system with no constraint or with perfect bilateral constraint leads to the construction of mathematical structures of the same type, we state the following definition.

Definition 3.2. A simple discrete mechanical system is a pair (Q, f) , where

- (i) Q is a finite-dimensional smooth Riemannian manifold called the configuration manifold.
- (ii) $f : TQ \times \mathbb{R} \rightarrow T^*Q$ is a smooth mapping satisfying

$$\forall (q, v) \in TQ, \quad \forall t \in \mathbb{R}, \quad \Pi_Q^*(f(q, v; t)) = q,$$

called the efforts mapping.

4. Perfect unilateral constraints

The consideration of elementary examples shows that the dynamics of rigid-body systems can lead to some prediction of the motion where some bodies of the system *overlap* in the real world. Of course, this should not be allowed. Hence, very often, one has to add the statement of non-penetration conditions to a simple discrete mechanical system. This is a simple occurrence of unilateral constraint. In this section, we shall discuss the consideration of perfect unilateral constraints in simple discrete mechanical systems.

(a) The geometric description

Consider a simple discrete mechanical system with configuration manifold Q . A *unilateral constraint* is a restriction on the admissible motions of the system, which is expressed by means of a finite number n of smooth real-valued functions φ_i on the configuration manifold Q , so that the set of all admissible configurations A is given by

$$A = \{q \in Q; \forall i \in \{1, 2, \dots, n\}, \varphi_i(q) \leq 0\}. \quad (4.1)$$

The set of all active constraints in the admissible configuration $q \in A$ is defined by

$$J(q) = \{i \in \{1, 2, \dots, n\}; \varphi_i(q) = 0\}.$$

The following hypothesis should be compared with regularity hypothesis I of §3 a.

Regularity hypothesis I. The functions φ_i are *functionally independent* in the sense that, for all $q \in A$, the $d\varphi_i(q)$ ($i \in J(q)$) are linearly independent in T^*Q .

Consider a motion $q(t)$ in A and assume that a right velocity $\dot{q}^+(t) \in T_{q(t)}Q$ exists at instant t ; then $\dot{q}^+(t)$ necessarily belongs to the closed convex cone $V(q(t))$ of $T_{q(t)}Q$ defined by

$$V(q(t)) = \{v \in T_{q(t)}Q; \forall i \in J(q(t)), \langle d\varphi_i(q(t)), v \rangle_{q(t)} \leq 0\}.$$

$V(q)$ is called the cone of admissible right velocities at the configuration q . In particular,

$$q \in \overset{\circ}{A} \text{ (i.e. } J(q) = \emptyset) \implies V(q) = T_qQ.$$

Similarly, if a left velocity $\dot{q}^- \in T_qQ$ exists, then $\dot{q}^- \in -V(q)$.

(b) Formulation of the dynamics

The formulation of the dynamics follows Moreau (1983).

(i) *Equation of motion*

As for bilateral constraints, the realization of the constraints induces some reaction effort R . The following hypotheses are made.

Constitutive hypothesis II. The unilateral constraints are of type contact without adhesion:

$$\forall v \in V(q), \quad \langle R, v \rangle_q \geq 0.$$

Constitutive hypothesis III. The unilateral constraints are perfect:

$$\forall v \in \{v \in T_q Q; \forall i \in J(q), \langle d\varphi_i(q), v \rangle_q = 0\}, \quad \langle R, v \rangle_q = 0.$$

As an easy consequence of constitutive hypotheses II and III, we get

$$\exists (\lambda_i)_{i=1,2,\dots,n} \in \mathbb{R}^n, \quad R = \sum_{i=1}^n \lambda_i d\varphi_i(q), \quad \text{and} \quad \left\{ \begin{array}{l} i \in J(q) \Rightarrow \lambda_i \leq 0, \\ i \notin J(q) \Rightarrow \lambda_i = 0. \end{array} \right.$$

Thus, the reaction effort $R \in T^*Q$ must be such that

$$-R \in N^*(q) \stackrel{\text{def}}{=} \left\{ \sum_{i=1}^n \lambda_i d\varphi_i(q); \forall i \in J(q), \lambda_i \geq 0, \quad \forall i \notin J(q), \lambda_i = 0 \right\}. \quad (4.2)$$

$N^*(q)$ is a closed convex cone of T_q^*Q and it is the polar cone of $V(q)$ in the duality $(T_q Q, T_q^* Q)$, the polar cone of $V(q)$ for the Euclidean structure of $T_q Q$ being $N(q) = \#(N^*(q))$.

Now, consider a motion $q(t)$ starting at $q_0 \in \overset{\circ}{A}$ at time t_0 with velocity v_0 . Assumed to be continuous, $q(t)$ remains in $\overset{\circ}{A}$ on a right neighbourhood of t_0 . By formula (4.2), the reaction effort R vanishes as long as $q(t)$ is in $\overset{\circ}{A}$ and the motion is governed by the following ordinary differential equation.

$$\begin{aligned} (q(t_0), \dot{q}(t_0)) &= (q_0, v_0), \\ \flat \frac{D\dot{q}}{dt} &= f(q, \dot{q}; t). \end{aligned}$$

Suppose that the solution of this Cauchy problem meets ∂A at some instant greater than t_0 . Denote by T the smallest of these instants. The motion admits a left velocity vector v_T^- at time T . Of course, the following may happen: $v_T^- \notin V(q(T))$. In this case, no differentiable extension of the motion can exist in A for t greater than T . The requirement of differentiability has to be dropped. An instant such as T is called an instant of *impact*.

However, we are still going to require the existence of a right velocity vector $\dot{q}^+(t) \in V(q(t))$ at every instant t . The right velocity need not be a continuous function of time and the equation of motion,

$$\flat \frac{D\dot{q}^+}{dt} = f(q, \dot{q}^+; t) + R,$$

should be understood in the sense of Schwartz's distribution. Actually, we require R to be a *vector-valued measure* rather than a general distribution.

We denote by $\text{MMA}(I; Q)$ (motions with measure acceleration) the set of all absolutely continuous motions $q(t)$ from a real interval I to Q admitting a right velocity

$\dot{q}^+(t)$ at every instant t of I and such that the function $\dot{q}^+(t)$ has locally bounded variation over I . Naturally, bounded variation is classically defined only for functions taking values in a normed vector space. However, for any absolutely continuous curve $q(t)$ on a Riemannian manifold, parallel translation along $q(t)$ classically provides intrinsic identification of the tangent spaces at different points of the curve and, therefore, the definitions can easily be carried over to this case (for the precise mathematical setting, see Ballard (2000)). Any motion $q \in \text{MMA}(I; Q)$ admits a left and a right velocity, \dot{q}^- and \dot{q}^+ , in the classical sense at any instant. Moreover, the covariant Stieltjes measure $D\dot{q}^+$ of its right velocity \dot{q}^+ is intrinsically associated with any motion $q \in \text{MMA}(I; Q)$. The equation of motion takes the form,

$$\flat D\dot{q}^+ = f(q, \dot{q}^+; t) dt + R,$$

where dt denotes the Lebesgue measure. We have to give a precise meaning to condition (4.2) with R being a vector-valued measure.

Convention. We shall write

$$R \in -N^*(q(t))$$

to mean that there exist n non-positive real measures λ_i such that

$$R = \sum_{i=1}^n \lambda_i d\varphi_i(q(t)) \quad \text{and} \quad \forall i \in \{1, 2, \dots, n\}, \quad \text{Supp } \lambda_i \subset \{t; \varphi_i(q(t)) = 0\}. \quad (4.3)$$

Using this convention, the final form of the equation of motion is

$$R = \flat D\dot{q}^+ - f(q(t), \dot{q}^+(t); t) dt \in -N^*(q(t)). \quad (4.4)$$

A straightforward consequence of the equation of motion is that an impact (that is, a discontinuity of the right velocity \dot{q}^+) can only occur at an instant t such that $J(q(t)) \neq \emptyset$. This fact is a justification for the following definition.

Definition 4.1. An impact occurring at time t is said to be *simple* if $J(q(t))$ contains exactly one element. If $J(q(t))$ contains at least two elements, the impact is said to be *multiple*.

(ii) *The impact-constitutive equation*

We begin this section with an example. Consider the one-degree-of-freedom mechanical system whose configuration space is \mathbb{R} equipped with its canonical Euclidean structure. The efforts mapping f vanishes identically and the unilateral constraint is represented by the single function $\varphi_1(q) = q$ so that the admissible configuration set A is \mathbb{R}^- . At initial time $t_0 = 0$, we consider an initial state (q_0, v_0) such that $q_0 < 0$ and $v_0 > 0$. It is readily seen from the equation of motion (4.4) that an impact necessarily occurs at time $t = -q_0/v_0$. At this time, the left velocity is v_0 . But, the right velocity can take any negative value and whatever it is, it is compatible with the equation of motion.

The reason for this indetermination lies in the phenomenological nature of the interaction of the system with the obstacle. This missing information has to be added.

Constitutive hypothesis IV. The interaction of the system with the obstacle at time t is completely determined by the current configuration $q(t)$ and the current left velocity $\dot{q}^-(t)$. In other terms, we postulate the existence of a mapping $\mathcal{F} : TQ \rightarrow TQ$ describing the interaction of the system with the obstacle during an impact:

$$\forall t, \quad \dot{q}^+(t) = \mathcal{F}(q(t), \dot{q}^-(t)). \quad (4.5)$$

To ensure compatibility with the equation of motion (4.4), the mapping \mathcal{F} should satisfy

$$\forall q \in A, \quad \forall v^- \in -V(q), \quad \begin{aligned} \mathcal{F}(q, v^-) &\in V(q), \\ \mathcal{F}(q, v^-) - v^- &\in -N(q). \end{aligned} \quad (4.6)$$

Moreover, we add the assumption that the kinetic energy of the system cannot increase during an impact.

$$\forall q \in A, \quad \forall v^- \in -V(q), \quad \|\mathcal{F}(q, v^-)\|_q \leq \|v^-\|_q. \quad (4.7)$$

Let us comment on hypothesis IV. When two solids hit, their bouncing is actually governed by the propagation of deformation waves in each of the two solids. But, from the very beginning, we have adopted the simple framework in which each solid is supposed to be rigid, that is, for the sake of simplicity, we have chosen not to take into consideration any phenomena relying on the deformation of the solids. Thus, we cannot expect the theory to be able to predict the outcome of an impact experiment. The aim of constitutive hypothesis IV is to introduce the missing information into the theory. Of course, in practical situations, we have to identify the unknown mapping \mathcal{F} . This can be done either by means of experiments or by use of a refined theory. For example, the theory of elastodynamics could be used to predict the outcome of an impact in every impact configuration. The result would be an identification of the mapping \mathcal{F} . In any case, there is a very large amount of work in precisely identifying \mathcal{F} . This is the price we have to pay for describing sophisticated physical phenomena in a very simple framework. Actually, this issue is faced in any mechanical theory (for example, the theory of elasticity). Naturally, in each mechanical theory, the question arises as to what amount of missing constitutive information should be introduced. Most of the time, well-posedness of the resulting evolution problem serves as a guideline to stating the constitutive hypotheses.

Definition 4.2. Equation (4.5), with mapping \mathcal{F} satisfying requirements (4.6) and (4.7) is called the *impact-constitutive equation*. An impact-constitutive equation which ensures the conservation of kinetic energy during an impact,

$$\forall q \in A, \quad \forall v^- \in -V(q), \quad \|\mathcal{F}(q, v^-)\|_q = \|v^-\|_q,$$

is called *elastic*.

There always exist many mappings \mathcal{F} satisfying requirements (4.6) and (4.7).

Example 4.3. Let $e : TQ \rightarrow [0, 1]$ be an arbitrary function. The mapping \mathcal{F} defined by

$$\mathcal{F}(q, v^-) = \text{Proj}_q[v^-; V(q)] - e(q, v^-) \text{Proj}_q[v^-; N(q)], \quad (4.8)$$

is easily seen to satisfy requirements (4.6) and (4.7). The associated impact-constitutive equation is often called the *canonical* impact-constitutive equation. It is elastic if and only if $e \equiv 1$. The function e is classically called the *restitution* coefficient.

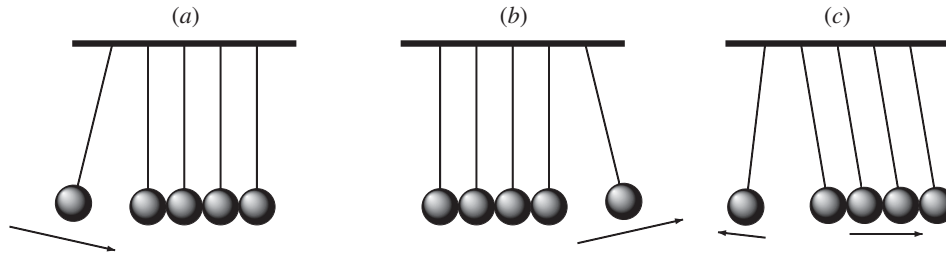

Figure 1. Newton's cradle.

The reason why the canonical impact-constitutive equation is distinguished is that, in situations where only simple impacts can occur (for example, if the unilateral constraint is represented by a single function φ_1), then the impact-constitutive equation must be the canonical one (this is a simple consequence of requirements (4.6) and (4.7)). However, in the case of multiple impacts, the canonical impact-constitutive equation has no specific physical relevance. A simple occurrence of a multiple impact is provided by Newton's cradle. The principle of the experiment is sketched in figure 1a. Its outcome is sketched in figure 1b. It should be compared with the prediction of the canonical elastic impact-constitutive equation, which is sketched in figure 1c.

The following proposition is a straightforward and useful consequence of requirements (4.6) and (4.7).

Proposition 4.4. *Let \mathcal{F} be a constitutive mapping satisfying requirements (4.6) and (4.7). Then, we have*

$$\forall q \in A, \quad \forall v^- \in V(q) \cap (-V(q)), \quad \mathcal{F}(q, v^-) = v^-.$$

We conclude this section by a comment on requirement (4.7). At first glance, it could seem to be unnecessary. The following counter-example proves that if it were omitted, then uniqueness of solution for the resulting evolution problem would surely not hold.

Counter-example 4. Consider the one-degree-of-freedom discrete mechanical system whose configuration space is \mathbb{R} equipped with its canonical Euclidean structure. The efforts mapping is supposed to be constant: $f(q, \dot{q}; t) \equiv 2$. To this simple discrete mechanical system we add the unilateral constraint described by the single function $\varphi_1(q) = q$. Thus, $A = \mathbb{R}^-$. The impact-constitutive equation is given by formula (4.8), where the restitution coefficient is supposed to be the constant $1/2$: $e(q, \dot{q}^-) \equiv 1/2$. This mechanical system is a formal description of the physical occurrence of a single particle subjected to gravity and bouncing on the floor. Consider the initial instant $t_0 = 0$ and the initial state $(q_0, v_0) = (-1, 0)$. It is readily seen that the function $q : \mathbb{R}^+ \rightarrow \mathbb{R}^-$ defined by

$$\begin{aligned} \forall t \in [0, 1], & \quad q(t) = t^2 - 1, \\ \forall t \in \left[3 - \frac{1}{2^{n-1}}, 3 - \frac{1}{2^n}\right], & \quad q(t) = t^2 + \left(-6 + \frac{3}{2^n}\right)t + \left(3 - \frac{1}{2^{n-1}}\right)\left(3 - \frac{1}{2^n}\right), \\ \forall t \in [3, +\infty[, & \quad q(t) = 0, \end{aligned}$$

($n \in \mathbb{N}$) belongs to $\text{MMA}(\mathbb{R}^+; \mathbb{R}^-)$ and satisfies

- (i) the initial condition,

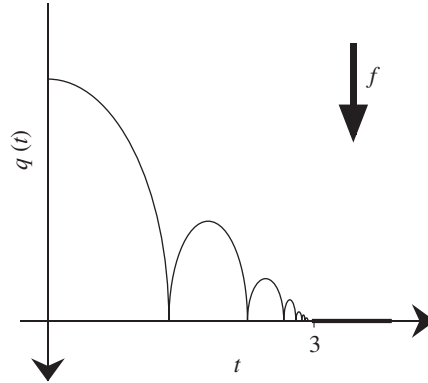

Figure 2. Motion of a punctual particle subjected to gravity and bouncing on the floor.

- (ii) the equation of motion (4.4) (with $f(q, \dot{q}; t) \equiv 2$),
- (iii) the impact-constitutive equation (4.8) (with $e(q, \dot{q}) \equiv 1/2$).

This motion is pictured in figure 2. Note, by the way, that it exhibits an infinite number of impacts on a compact time subinterval. It could easily be proved that no motion, defined on $[0, +\infty[$, with finite number of impacts on every compact interval can exist.

Now, we are going to analyse what happens when the flow of time is reversed. Define q' by

$$q' \begin{cases} [0, 4] \rightarrow \mathbb{R}^- \\ t \mapsto q(4 - t). \end{cases}$$

Considering the initial state $(q_0, v_0) = (0, 0)$ at $t_0 = 0$, it is easily seen that q' satisfies

- (i) that initial condition,
- (ii) the equation of motion (4.4) (with $f(q, \dot{q}; t) \equiv 2$),
- (iii) the impact-constitutive equation (4.8) (with $e(q, \dot{q}) \equiv 2$).

However, $q'' \equiv 0$ is also seen to satisfy the same initial condition, equation of motion and impact-constitutive equation. This example demonstrates that we cannot expect uniqueness of solution when adopting the canonical impact-constitutive equation (4.8) with restitution coefficient $e \equiv 2$ (or any real number strictly greater than 1). However, the canonical impact-constitutive equation with a restitution coefficient strictly greater than 1 violates requirement (4.7).

(iii) *The evolution problem I*

Now, we formulate the evolution problem associated with the dynamics of rigid-body systems with perfect bilateral and unilateral constraints. The initial condition is assumed to be compatible with the realization of the constraint $v_0 \in V(q_0)$.

Problem III. Find $T > t_0$ and $q \in \text{MMA}([t_0, T]; Q)$ such that

- (i) $(q(t_0), \dot{q}^+(t_0)) = (q_0, v_0)$,

- (ii) $\forall t \in [t_0, T[, q(t) \in A,$
(ii) $R \stackrel{\text{def}}{=} } bD\dot{q}^+ - f(q(t), \dot{q}^+(t); t) dt \in -N^*(q(t)),$
(iv) $\forall t \in]t_0, T], \dot{q}^+(t) = \mathcal{F}(q(t), \dot{q}^-(t)).$

The equation of motion is understood in the sense of convention (4.3) and the impact-constitutive equation is supposed to fulfil requirements (4.6) and (4.7).

No regularity assumption has yet been made on the mapping f . This will be done in the next section, where the well-posedness of problem III is studied. However, we can infer from §2c that f will be assumed to be at least of class C^1 . We can state an elementary property of any solution (if there are any) of problem III.

Proposition 4.5 (Energy inequality). *Any solution (T, q) of problem III satisfies*

$$\begin{aligned} \forall t_1, t_2 \in [t_0, T[, \quad t_1 \leq t_2, \\ K(q(t_2), \dot{q}^+(t_2)) - K(q(t_1), \dot{q}^+(t_1)) &= \frac{1}{2} \|\dot{q}^+(t_2)\|_{q(t_2)}^2 - \frac{1}{2} \|\dot{q}^+(t_1)\|_{q(t_1)}^2 \\ &\leq \int_{t_1}^{t_2} \langle f(q(s), \dot{q}^+(s); s), \dot{q}^+(s) \rangle_{q(s)} ds. \end{aligned}$$

Proof. Since

$$\begin{aligned} \frac{1}{2} \|\dot{q}^+(t_2)\|_{q(t_2)}^2 - \frac{1}{2} \|\dot{q}^+(t_1)\|_{q(t_1)}^2 = \\ \int_{t_1}^{t_2} \langle \dot{q}^+(t), f(q(t), \dot{q}^+(t); t) \rangle_{q(t)} dt + \int_{]t_1, t_2]} \left\langle \frac{\dot{q}^+ + \dot{q}^-}{2}, R \right\rangle_q, \end{aligned}$$

we have only to prove that the last integral is non-positive. Set

$$D = \{t \in]t_1, t_2]; \dot{q}^-(t) \neq \dot{q}^+(t)\}.$$

D is (at most) countable and, therefore, Lebesgue-negligible. On the one hand, we have

$$\int_{]t_1, t_2] \setminus D} \left\langle \frac{\dot{q}^+ + \dot{q}^-}{2}, R \right\rangle_q = \int_{]t_1, t_2] \setminus D} \langle \dot{q}^+, R \rangle_q = \int_{]t_1, t_2] \setminus D} \langle \dot{q}^-, R \rangle_q,$$

where the second integral is non-negative by convention (4.3), whereas the third integral is non-positive. As a consequence, the three integrals vanish. On the other hand,

$$\begin{aligned} \int_D \left\langle \frac{\dot{q}^+(t) + \dot{q}^-(t)}{2}, R \right\rangle_{q(t)} &= \int_D \left(\frac{\dot{q}^+(t) + \dot{q}^-(t)}{2}, D\dot{q}^+ \right)_{q(t)} \\ &= \frac{1}{2} \sum_{t \in D} (\|\dot{q}^+(t)\|_{q(t)}^2 - \|\dot{q}^-(t)\|_{q(t)}^2), \end{aligned}$$

which is non-positive by virtue of requirement (4.7). ■

(c) *Well-posedness of the dynamics*

To study the well-posedness of problem III, we need to state regularity assumptions on the data. Looking at those of §3c, we could expect to be able to prove the well-posedness of problem III under the assumption that the functions φ_i and the mapping f are of class C^2 and C^1 , respectively. The following counter-example originally due to Bressan (1960) and Schatzman (1978) shows that uniqueness does not hold in general even if the data are supposed to be of class C^∞ .

Counter-example 5. Consider a simple discrete mechanical system whose configuration space is \mathbb{R} , equipped with its canonical Euclidean structure. This is the configuration space of a particle with unit mass constrained to move along a line. A fixed obstacle at the origin is taken into consideration. It gives rise to a unilateral constraint described by the single function:

$$\varphi_1(q) = q.$$

Therefore, the admissible configuration set is $A = \mathbb{R}^-$. The impact-constitutive equation is supposed to be elastic. Here, the geometry is so poor that this statement determines completely the impact-constitutive equation. It is necessarily the canonical one with restitution coefficient $e \equiv 1$. The efforts mapping f is supposed not to depend on the state but only on time. It will be denoted by $f(t)$. The initial instant is $t_0 = 0$ and the initial state is $(q_0, v_0) = (0, 0)$. The corresponding problem III admits here the following simple formulation.

Find $T > 0$ and $q \in \text{MMA}([0, T[; \mathbb{R})$ such that

- (i) $(q(0), \dot{q}^+(0)) = (0, 0)$,
- (ii) $\forall t \in [0, T[, q(t) \leq 0$,
- (iii) $R \stackrel{\text{def}}{=} d\dot{q}^+ - f(t) dt$ is a non-positive real measure such that

$$\text{Supp } R \subset \{t \in [0, T[; q(t) = 0\},$$

- (iv) $\forall t \in]0, T[, \begin{cases} q(t) \neq 0 \Rightarrow \dot{q}^+(t) = \dot{q}^-(t), \\ q(t) = 0 \Rightarrow \dot{q}^+(t) = -\dot{q}^-(t). \end{cases}$

Here $d\dot{q}^+$ is merely the classical Stieltjes measure associated with the function with locally bounded variation \dot{q}^+ . We investigate uniqueness under the assumption that f is of class C^∞ and non-negative:

$$\forall t \in \mathbb{R}^+, f(t) \geq 0.$$

Then, it is readily seen that the null function $\tilde{q} \equiv 0$ on \mathbb{R}^+ is a solution of that problem, whatever is the non-negative C^∞ function f . Now, we are going to construct an explicit example of such a function f in such a way that the associated evolution problem III admits another solution, distinct from the identically vanishing one.

First, define a Massin function ρ by

$$\rho \begin{cases} \mathbb{R} \rightarrow \mathbb{R} \\ x \mapsto \begin{cases} 0 & \text{if } x \in]-\infty, 0] \cup [1, +\infty[, \\ Ce^{1/x(x-1)} & \text{if } x \in]0, 1[. \end{cases} \end{cases}$$

where C is a real constant which is chosen to get $\int_{-\infty}^{+\infty} \rho(x) dx = 1$. Define

$$T = \sum_{n=0}^{\infty} \frac{(n+5)^2}{(n+1)(n+2)(n+3)(n+4)},$$

and, for every $n \in \mathbb{N}$,

$$\begin{aligned} a_n &= \sum_{i=n}^{\infty} \frac{(i+5)^2}{(i+1)(i+2)(i+3)(i+4)}, \\ \delta_n &= \frac{n+5}{(n+1)(n+2)(n+4)} \quad \left(\text{i.e. } \delta_n = \frac{n+3}{n+5} (a_n - a_{n+1}) < a_n - a_{n+1} \right), \\ f_n &= \frac{1}{n!}, \\ v_n &= -\frac{1}{(n+3)!}. \end{aligned}$$

Now, the functions $f(t)$ and $v(t)$, from $[0, T[$ to \mathbb{R} , are defined by

$$\begin{aligned} f(0) &= 0, \\ f(t) &= \begin{cases} 0, & \text{if } t \in [a_{n+1}, a_{n+1} + \delta_n[, \\ \frac{1}{2} f_n \rho\left(\frac{t - a_{n+1} - \delta_n}{a_n - a_{n+1} - \delta_n}\right), & \text{if } t \in [a_{n+1} + \delta_n, a_n], \end{cases} \end{aligned}$$

and

$$\begin{aligned} v(0) &= 0, \\ v(t) &= \begin{cases} v_{n+1}, & \text{if } t \in [a_{n+1}, a_{n+1} + \delta_n[, \\ v_{n+1} + \frac{1}{2} f_n \int_{a_{n+1} + \delta_n}^t \rho\left(\frac{s - a_{n+1} - \delta_n}{a_n - a_{n+1} - \delta_n}\right) ds, & \text{if } t \in [a_{n+1} + \delta_n, a_n]. \end{cases} \end{aligned}$$

Finally, the function $q : [0, T[\rightarrow \mathbb{R}$ is defined by

$$q(t) = \int_0^t v(s) ds.$$

The graph of the functions $f(t)$ and $q(t)$ is sketched in figure 3. The reader will easily check that

- (i) $f(t)$ is a C^∞ non-negative function on $[0, T[$,
- (ii) (T, q) is a solution of the considered evolution problem,
- (iii) the only instants at which $q(t) = 0$ are 0 and the a_n .

Therefore, q and \tilde{q} provide two solutions of the evolution problem. These two solutions do not coincide on any open subinterval of $[0, T[$. Therefore, uniqueness of solution for problem III cannot be asserted, even in the case where the data are supposed to be of class C^∞ . Percivale (1985) was the first to notice that, in the above example, if $f(t)$ is supposed to be *analytic*, then uniqueness of solution does hold. Recently, a complete

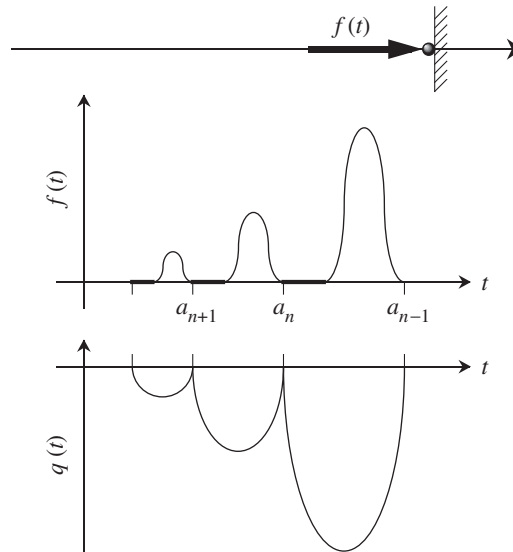

Figure 3. Bressan–Schatzman counter-example.

discussion of the one-degree-of freedom problem was obtained by Schatzman (1998). The general case is treated in Ballard (2000) and is now recalled. Let us just mention that prior existence results had been obtained, but they were limited to the case where the unilateral constraint is represented by a single function (see Schatzman 1978; Monteiro Marques 1993).

Regularity hypothesis V. The Riemannian configuration manifold, the functions φ_i and the mapping $f : TQ \times \mathbb{R} \rightarrow T^*Q$ are *analytic*.

The proof of the following proposition can be found in Ballard (2000). An earlier proof can also be found in Lötstedt (1982).

Proposition 4.6. *Let $q_0 \in A$ and $v_0 \in V(q_0)$. Then, there exist $T_a > t_0$, an analytic curve $q_a : [t_0, T_a[\rightarrow Q$ and n analytic functions $\lambda_{ai} : [t_0, T_a[\rightarrow \mathbb{R}$ such that*

$$(i) \quad (q_a(0), \dot{q}_a^+(0)) = (q_0, v_0),$$

$$(ii) \quad \forall t \in [t_0, T_a[, \quad b \frac{D}{dt} \dot{q}_a(t) = f(q_a(t), \dot{q}_a(t); t) + \sum_{i=1}^n \lambda_{ai}(t) d\varphi_i(q_a(t)),$$

$$(iii) \quad \forall t \in [t_0, T_a[, \quad \forall i = 1, 2, \dots, n, \quad \lambda_{ai}(t) \leq 0, \quad \varphi_i(q_a(t)) \leq 0, \quad \lambda_{ai}(t) \varphi_i(q_a(t)) = 0.$$

Moreover, the solution of this evolution problem is unique in the sense that any other analytic solution $(T, q, \lambda_1, \dots, \lambda_n)$ is either a restriction or analytic extension of $(T_a, q_a, \lambda_{a1}, \dots, \lambda_{an})$.

Corollary 4.7. *There exists an analytic solution (T_a, q_a) for problem III.*

Proof. Consider the motion q_a furnished by proposition 4.6. It obviously satisfies the initial condition, the unilateral constraint and the equation of motion. The only

thing which remains to be proven is that it satisfies the impact-constitutive equation. Since q_a is analytic and satisfies the unilateral constraint, we have

$$\forall t \in]t_0, T_a[, \quad \dot{q}_a^-(t) = \dot{q}_a^+(t) \in V(q_a(t)) \cap (-V(q_a(t))),$$

and, therefore,

$$\forall t \in]t_0, T_a[, \quad \dot{q}_a^+(t) = \dot{q}_a^-(t) = \mathcal{F}(q_a(t), \dot{q}_a^-(t)),$$

by proposition 4.4. ■

Naturally, the analytic solution furnished by corollary 4.7 will cease to exist at the first instant of impact. This is the reason why we have considered the wider class MMA, which contains motions that are not differentiable in the classical sense. Considering motions in MMA will allow us to extend the solution beyond the first instant of impact. But we must make sure that admitting the wider class of solutions MMA will not introduce parasitic solutions. This is the aim of the following theorem.

Theorem 4.8. *Let (T_a, q_a) be the solution for problem III furnished by corollary 4.7, and (T, q) be an arbitrary solution for problem III. Then, there exists a real number T_0 ($t_0 < T_0 \leq \min\{T_a, T\}$) such that*

$$q|_{[t_0, T_0]} \equiv q_a|_{[t_0, T_0]}.$$

In other words, there is local uniqueness for problem III.

Local uniqueness is the difficult part in the study of the well-posedness of problem III. A detailed proof of the local uniqueness theorem 4.8 can be found in Ballard (2000). It is written in the framework of the canonical impact-constitutive equation (4.8), but careful examination of the proof shows that the canonical impact-constitutive equation is only used through the energy inequality (proposition 4.5). Since the energy inequality holds for any impact-constitutive equation satisfying requirements (4.6) and (4.7), so does local uniqueness.

Corollary 4.9. *There exists a unique maximal solution for problem III.*

It was noticed above that the analytical solution for problem III furnished by corollary 4.7 stops existing at the first instant of impact. To overcome this fact, we have proved that local uniqueness still holds in the wider class of motion MMA which allows impacts. But this does not guarantee that the maximal solution for problem III is not going to stop to exist at finite time for unphysical reasons. In other terms, we still do not know if the class MMA is wide enough. Actually, it is wide enough as shown by the following theorem which should be brought aside theorem 2.3.

Theorem 4.10. *The configuration manifold Q is assumed to be a complete Riemannian manifold and the mapping f is supposed to admit the following estimate,*

$$\|f(q, v; t)\|_q^* \leq l(t)(1 + d(q, q_0) + \|v\|_q),$$

for all $(q, v) \in TQ$ and almost all $t \in [t_0, +\infty[$, where $d(\cdot, \cdot)$ is the Riemannian distance and $l(t)$, a (necessarily non-negative) function of $L_{\text{loc}}^1(\mathbb{R}; \mathbb{R})$.

Then, the dynamics is eternal, that is, the maximal solution for problem III is defined on $[t_0, +\infty[$.

For detailed proof the reader is referred to Ballard (2000). Here also, the impact-constitutive equation is only used through the energy inequality.

(d) *Comments*

It is readily seen that the function q displayed in counter-example 4 is the unique maximal solution of problem III corresponding to the situation under consideration. This solution exhibits an accumulation of impacts on the *left* side of instant $t = 3$. However, as predicted by corollary 4.7, for each instant $t \in \mathbb{R}^+$, there exists a right neighbourhood $[t, t + \eta[$ of t , such that the restriction of q to $[t, t + \eta[$ is analytic. A straightforward and general consequence of this is the following.

Proposition 4.11. *Let q be the maximal solution of problem III furnished by corollary 4.9. Although infinitely many impacts can accumulate at the left of a given instant, such an accumulation of impacts can never occur at the right of any instant. Moreover, in the particular case where the impact-constitutive equation is elastic, the instants of impact are isolated and therefore in finite number in any compact interval of time.*

Proof. Since for each instant $t \in [t_0, T[$, there exists a right neighbourhood $[t, t + \eta[$ of t , such that the restriction of q to $[t, t + \eta[$ is analytic, we get the first part of the proposition. For the second part, let τ be an arbitrary instant in $]t_0, T[$ and consider the problem III associated with the initial condition $(q(\tau), -\dot{q}^-(\tau))$, the elastic constitutive impact equation and the effort mapping $g(q, v; t)$ defined by

$$g(q, v; t) = f(q, -v; \tau - t),$$

which is analytic. By theorem 4.8, there exists an analytic function $q_a : [0, T_a[\rightarrow Q$ which is a solution of this problem III. Any other solution of problem III coincides with q_a on a right neighbourhood of $t = 0$. Actually, as seen in the proof of local uniqueness (theorem 4.8), a little bit more is proved: any function $q' \in MMA([0, T[; Q)$ satisfying the initial condition, the unilateral constraint, the equation of motion (4.4) and the energy inequality (proposition 4.5) has to coincide with q_a on a right neighbourhood of $t = 0$. But, it is readily seen that the function defined by

$$q'(t) = q(\tau - t), \quad t \in [0, \tau - t_0[,$$

fulfil these requirements. Thus, q' cannot have right accumulation of impacts at $t = \tau$ and, therefore, q cannot have left accumulation of impacts at $t = \tau$ and the instants of impact are isolated. Of course, if q is the maximal solution defined on $[t_0, T[$, impacts can still accumulate at the left of T , as seen in simple examples. ■

The fact that infinitely many impacts can accumulate at the left of a given instant but not at the right is a specific feature of the analytical setting that is lost in the C^∞ setting as seen in counter-example 5. Actually, this counter-example shows that pathologies of non-uniqueness in the C^∞ setting are intimately connected to the possibility of right accumulations of impacts. The fact that the analytical setting prevents such right accumulations is the fundamental reason why we can prove uniqueness in this case.

References

Ballard, P. 2000 The dynamics of discrete mechanical systems with perfect unilateral constraints. *Arch. Ration. Mech. Analysis* **154**, 199–274.

Phil. Trans. R. Soc. Lond. A (2001)

- Bressan, A. 1960 Incompatibilità dei teoremi di esistenza e di unicità del moto per un tipo molto comune e regolare di sistemi meccanici. *Annali Scuola Norm. Superiore Pisa III* **14**, 333–348.
- Chavel, I. 1993 *Riemannian geometry: a modern introduction*. Cambridge University Press.
- Lötstedt, P. 1982 Mechanical systems of rigid bodies subject to unilateral constraints. *SIAM J. Appl. Math.* **42**, 281–296.
- Monteiro Marques, M. D. P. 1993 *Differential inclusions in nonsmooth mechanical problems*. Birkhäuser.
- Moreau, J. J. 1983 Standard inelastic shocks and the dynamics of unilateral constraints. In *Unilateral problems in structural analysis* (ed. G. Del Piero & F. Maceri), pp. 173–221. Springer.
- Percivale, D. 1985 Uniqueness in the elastic bounce problem. I. *J. Diff. Eqns* **56**, 206–215.
- Schatzman, M. 1978 A class of nonlinear differential equations of second order in time. *Nonlin. Analysis* **2**, 355–373.
- Schatzman, M. 1998 Uniqueness and continuous dependence on data for one dimensional impact problems. *Math. Computat. Model.* **28**, 1–18.

Chapter 1

DYNAMICS OF RIGID BODIES SYSTEMS WITH UNILATERAL OR FRICTIONAL CONSTRAINTS

Formulation And Well-Posedness

Patrick Ballard

Laboratoire de Mécanique des Solides, Ecole Polytechnique,

91128 Palaiseau Cédex, France

ballard@lms.polytechnique.fr

Abstract The classical theory of rigid bodies systems dynamics is extended into two directions. First, systematic formulation of the dynamics of systems undergoing perfect unilateral constraints is derived. The general admissible form of the impact constitutive equation is obtained. Well-posedness of the evolution problem is proved under the assumption that the data are analytic. Second, systematic formulation of systems undergoing frictional bilateral constraints is discussed. Well-posedness of the associated evolution problem is also demonstrated.

Keywords: Analytical Dynamics, Non-smooth Mechanics, Impact, Friction

Introduction

The point of departure of any mechanical theory is a geometric description of the system under study and all its possible (or, more exactly, admissible) evolutions. This is always a schematization. Linear forms on the space of admissible (virtual) velocities define on turn the most general representation of internal and external forces which is consistent with the geometric description. Naturally, obtaining their precise expression for a given system remains a part of the modelling process. The mass distribution leads to the definition of the kinetic energy of the system which is a positive definite quadratic form on the space of velocities. Taking a time derivative, we obtain the expression of the virtual power of inertia forces (or acceleration) in any virtual velocity. The Fundamental Principle of Classical Mechanics asserts that the virtual power of inertia forces should equal the virtual power of external and internal forces

in any admissible virtual velocity. As a consequence, we derive the equation of motion. For some class of geometric descriptions, the equation of motion, associated with some initial conditions, determines completely the subsequent motion of the system. We shall say that the evolution problem associated with the dynamics is well-posed. On the opposite, there are many examples of mechanical theories in which initial conditions and equation of motion are not enough to determine the subsequent motion of the system. This is generally attributed to the excess of schematization of the geometric description. The missing physical information is added through a constitutive law. Actually, well-posedness of the resulting evolution problem serves generally implicitly as a guideline to identify the general form of the constitutive law, although some thermodynamical considerations can also play an important part.

In this paper, we are concerned with the dynamics of rigid bodies systems. Speaking of rigid bodies systems is, actually, the geometric description of the system. It could be said that this is the most simple geometric description of solids. Working in the framework of rigid bodies system means that we are not interested in the prediction of the deformation of the bodies. It does not mean that we do not consider physical situations in which bodies deformability play a role. Let us illustrate this by examining the impact of two billiard balls. Billiard balls are always deformable. But, generally we are not interested in the deformations of the balls but only on their 'global' motion. Thus, we shall use a geometric description based on the rigidity assumption. However, we know that impacts are governed by deformation wave propagation in each of the balls. So, we can not expect the simple theory based on the geometric assumption of rigidity to be able to predict the outcome of an impact experiment. We must expect that some indetermination will remain. To get well-posedness of the theory (this is necessary to make predictions which is the final aim of any mechanical theory), we are led to add to the theory an impact constitutive equation. This is nothing but injecting back in the theory the outcome of the impact, since the physical phenomena which governs the impact have been eliminated. Of course, in practical situations, we have to identify the impact constitutive equation. The choices are, either to make experiments or to use a refined theory (the elasticity theory which is based on a refined geometric assumption) in order to get the outcome of each situation of impacts. In some situations, identifying the impact constitutive equation can represent a huge amount of work. In such a case, depending on the desired precision of the predictions of the theory, one may be led to question the relevance of the simple geometric assumption that has been adopted. The use of one geometric description or another to model a given real situation is always a compromise between the desired precision of the predictions, the amount of computation which is possible and the physical informations on the system which are available.

Since applica
ics whe
new fie
granula
termini
applicat
theory.

accept v
emerged
the moc
of them
often ca

Actua
constrai
some fo
specifi
law of t
the way

At the
holonon
that the
the dyna
and well
tems inv
As seen
constitu
to chara
the well
be consi
idea in n
discussi
the final
of Class
are nece
we shall
classifie
be called
from ma
one aim
that the c
system.

Since in this case, no constitutive law has to be identified, the main field of application of rigid bodies dynamics has been for a long time, celestial mechanics where remarkable precision of the predictions was reached. Recently, some new fields of application of rigid bodies dynamics have emerged: robotics, granular dynamics, virtual reality, . . . All these fields have in common that determining the deformation in the bodies is of no interest. Nevertheless, in these applications, impacts are possible events that have to be incorporated in the theory. Very often, precision of the predictions is not so important and one may accept very approximate impact constitutive equations. Hence, the need has emerged to enrich the well-established theory of rigid bodies dynamics with the modelling of more complicated phenomena like impacts or friction, some of them relying physically on the deformation of the bodies. This new field is often called, after Jean Jacques Moreau, *Non-smooth mechanics*.

Actually, those more complicated phenomena are taken into account through constraints. A constraint is a kinematical specification of the motion with which some forces are associated: the reaction forces. In general, the kinematical specification in itself is not enough to determine the reaction force: a constitutive law of the constraint has to be added. It conveys some physical assumption on the way the constraint acts.

At the time being, it seems that only the rigid bodies dynamics with perfect holonomic bilateral constraints has firm mathematical foundations in the sense that the theory ensures the well-posedness of the evolution problem describing the dynamics. In this paper, we are concerned by the systematic formulation and well-posedness of the evolution problem describing the dynamics of systems involving more general constraints such as unilateral or frictional ones. As seen above, this program will necessarily involve the discussion of some constitutive law. Our aim will not be to try to identify any realistic one but just to characterize the general forms of constitutive laws that are compatible with the well-posedness of the theory. My opinion is that well-posedness should be considered as a requirement of any theory in classical dynamics. With this idea in mind, the discussion of well-posedness is intimately connected with the discussion of constitutive laws. Actually, we shall consider well-posedness as the final aim of the theory. After having written the Fundamental Principle of Classical Dynamics, we shall look for the supplementary hypotheses that are necessary to get well-posedness. Each time an hypothesis will be made, we shall try to motivate it by a counter-example. These hypotheses will be classified into two categories. Those which convey physical assumption will be called 'constitutive' hypotheses and the other one whose aim is to prevent from mathematical pathologies will be called 'regularity' hypotheses. Since one aim is to obtain general forms of constitutive laws, one has to make sure that the constitutive laws do not depend on any particular parametrization of the system. For this reason, we are going to try to obtain intrinsic formulations of

dynamics, that is, formulations which do not rely on a particular choice for the parametrization of the system. This necessarily requires the use of the language of differential geometry. But, only the most elementary level of differential geometry is required.

The major enhancement of mathematical consistency which seems to be desired at the time being concerns the modelling of impacts and that of friction. These two subjects are the major concerns in this paper and I believe that a mathematically satisfactory theory is obtained on both points-of-view of general formulation as well as well-posedness. However, the task is far from being achieved. In this paper, we examine the cases of impacts and friction *separately*. There remains to mix the two theories to discuss, for example, frictional unilateral constraints, which is not done here. The result would be a general theory of the evolution of mechanisms consisting of rigid bodies.

Section 1 recalls briefly the basics of intrinsic formulation and well-posedness of the dynamics of rigid bodies systems. The aim of this section is to provide precise description of the framework and notations. Section 2 contains also only well-known material. It shows that superimposing perfect holonomic bilateral constraints does not modify the structure of the theory. In Section 3, perfect unilateral constraints are discussed. The general form for the impact constitutive equation is provided and the general formulation for the evolution problem is derived. Well-posedness is fully discussed. In Section 4, the case of general perfect non-holonomic bilateral constraints is examined. Actually, this type of constraint is a particular case of non-firm constraints which are the concern of Section 5. A complete theory of non-firm constraints is derived, including systematic formulation and well-posedness. In Section 6, the formalism of non-firm constraints is applied to the description of frictional bilateral constraints. The underlying idea is that friction should be considered as a dissipation mechanism obeying the Principle of Maximal Dissipation. In some cases (for example, systems of punctual particles), we recover standard dry friction laws such as Coulomb friction and, in some cases, we do not. Section 7 provides a brief description of the situations that are not contained in the above theories and the extensions of the content of the paper that could be done later on.

1. The dynamics of rigid bodies systems

1.1 The geometric assumption: rigidity

Classical mechanics postulates the existence of a three-dimensional oriented affine Euclidean space \mathcal{E} , sometimes called the (Galilean) *real world*, and an absolute chronology represented (after the choice of an origin) by a real number, generally denoted by t . The vector space associated with \mathcal{E} will be denoted by E .

Unilatera

A sol
nothing b
 \mathcal{E} . The g
world co
real worl
world ref
solid is r
solid iden
the curre

Since any
set of all
set of all
manifold
manifold
has 6 deg
is called
denoted b
by q . A lo
a rigid so

Other
whose cor
equipped
configura

A moti
from a tim
by $\dot{q}(t)$. I
element o
encounter
state of th
smooth, th
by:

where ∂_q
 E .

The *ma*
configurat
Considerin
 K at insta

A solid is represented by its *real world reference configuration* which is nothing but a possible geometric locus of all the material points of the solid in \mathcal{E} . The geometric assumption of rigidity can be stated as follows: the only real world configuration of that solid which can be observed are obtained from the real world reference configuration by *direct isometries*. Therefore, once the real world reference configuration has been fixed, any real world configuration of the solid is represented by a direct isometry q . Considering a material point of the solid identified by its location $M \in \mathcal{E}$ in the real world reference configuration, the current location of that material point in the configuration defined by q is:

$$m(M, q) = q(M). \quad (1.1)$$

Since any direct isometry on \mathcal{E} can be split into a translation and a rotation, the set of all direct isometries can be identified to $E \times \text{SO}3$ (where $\text{SO}3$ denotes the set of all direct orthogonal endomorphisms on E , endowed with its standard manifold structure). It is said that $E \times \text{SO}3$ is the (abstract) *configuration manifold* of the rigid solid. Since its dimension is 6, we say that the rigid solid has 6 *degrees of freedom* (dof). Any (local) chart on the configuration manifold is called a (*local*) *parametrization*. The configuration manifold is generally denoted by Q and a configuration (an element of the configuration manifold), by q . A local chart (parametrization) will be denoted generally by ψ . Thus, for a rigid solid, the symbol $\psi(q)$ denotes an element of \mathbb{R}^6 .

Other idealizations of rigid solids can appear: the infinitely thin rigid bar whose configuration manifold is $E \times \text{S}2$ ($\text{S}2$ denotes the two-dimensional sphere equipped with its standard manifold structure) and the punctual particle whose configuration manifold is simply E .

A motion of a rigid solid is a curve on its configuration manifold (a mapping from a time interval I into Q). The derivative of the motion at instant t is denoted by $\dot{q}(t)$. It is called the (abstract or sometimes, generalized) velocity. It is an element of the tangent bundle TQ of the configuration manifold. One often encounters the name 'state space' for TQ , in which case $\dot{q}(t)$ is also called a state of the system. Since the mapping m defined by formula (1.1) is obviously smooth, the material velocities are expressed in terms of the (abstract) velocity by:

$$\dot{m} = \partial_q m(M, q) \cdot \dot{q}, \quad (1.2)$$

where $\partial_q m(M, q)$ is a linear operator from the tangent space $T_q Q$ into $T_m \mathcal{E} = E$.

The *mass distribution* in the rigid solid is specified on the real world reference configuration. It is a *bounded positive measure on \mathcal{E}* . It is denoted by μ . Considering an arbitrary motion $(I, q(t))$ of the rigid solid, the *kinetic energy* K at instant t is by definition:

$$K = \frac{1}{2} \int_{\mathcal{E}} \|\dot{m}\|_E^2 d\mu(M). \quad (1.3)$$

Combining formulae (1.2) and (1.3), we obtain easily the expression of the kinetic energy in terms of the (abstract) velocity. Then, it is easily noticed that the kinetic energy defines a nonnegative quadratic form on each tangent space $T_q Q$ of the configuration manifold. The mass distribution is said to be consistent with the geometric description if this quadratic form is positive definite. The following are easily proved:

- A mass distribution μ in the three-dimensional solid $E \times \mathbb{S}^3$ is consistent *if and only if* its support $\text{Supp } \mu$ contains at least three non-aligned points.
- A mass distribution μ in the infinitely thin bar $E \times \mathbb{S}^2$ is consistent *if and only if* $\text{Supp } \mu$ contains at least two distinct points.
- A mass distribution μ in the punctual particle E is consistent *if and only if* $\text{Supp } \mu$ is non-void.

>From now on, we shall assume that the mass distribution is always consistent with the geometric description. As a result, the kinetic energy defines a scalar product on each tangent space of Q , endowing the configuration manifold with a Riemannian structure. This Riemannian metric is naturally called the *kinetic metric*. From now on, whenever we speak of a configuration manifold, it will always be supposed to be equipped with its Riemannian structure.

A rigid bodies system is a finite collection of rigid bodies. The configuration manifold of a rigid bodies system is the cross-product $Q_1 \times Q_2 \times \dots \times Q_n$ of the individual configuration manifold Q_i of each rigid body of the system.

The fundamental idea which is behind these definitions is that the configuration manifold conveys all the necessary information on the system and no more. For example, we should keep aware that the kinetic metric conveys all the relevant information about the mass distribution but, one can not, generally, recover the mass distribution from the kinetic metric.

Remark 1. The reader who is not familiar with elementary differential geometry could have the feeling that we have expressed very simple (and well known) things in a complicated way. Such a reader would probably prefer a presentation where the parametrization of the system is introduced at first and each definition (the abstract configuration, the kinetic metric, ...) is made in terms of real matrices. Such a presentation should then precise what are the effects on these matrices of a change of parametrization. This leads to heavy and boring formulae and is often left aside, but this is not the main reason why I have chosen the above presentation. The possibility of defining every concept without any reference to a given parametrization ensures that all what has been defined is *intrinsic* (that is, does not depend on the particular parametrization under consideration). This fact is particularly crucial when one deals with constitutive equations and introducing constraints necessarily involves constitutive

Unilatera

equation
ent the s
reader w
tion man
positive
parametr
on that p

Notation
shall den

- TQ

- Π_Q

- $\langle \cdot, \cdot \rangle$
sp

- (\cdot, \cdot)
ad

- $b(\cdot, \cdot)$
on

For $q(t)$
at t by q
remark 1
not be to
base-poi
notation
also be d
chart on
to be con
notation
write $q =$
we will k
usual, the
 ψ is deno
(q, v) be
natural b

Einstein'
 $q(t)$ bein

equations. In the end, I believe that the intrinsic presentation, making apparent the structure of the theory, provides deeper understanding. However, the reader who feels more comfortable with it, might consider that the configuration manifold Q is an open subset of \mathbb{R}^d equipped with a 'variable' symmetric positive definite matrix $(g_{ij}(q))$, which is nothing but considering a particular parametrization of the system. The following convention notations are made on that purpose.

Notations. For Q being a smooth Riemannian manifold of dimension d , we shall denote by:

- TQ and T^*Q , the tangent and cotangent bundles,
- Π_Q and Π_Q^* , the natural projection mappings of TQ and T^*Q ,
- $\langle \cdot, \cdot \rangle_q$, the local duality product between tangent space T_qQ and cotangent space T_q^*Q ,
- $(\cdot, \cdot)_q$ and $\|\cdot\|_q$, the local scalar product and norm on T_qQ (a * will be added when referring to the scalar product and norm on T^*Q),
- \flat (and $\sharp = \flat^{-1}$, its inverse), the isomorphism of vector bundles from TQ onto T^*Q naturally associated with the Riemannian metric of Q .

For $q(t)$ being a curve on Q , we have decided above to denote the derivative at t by $\dot{q}(t) \in TQ$. In order to be consistent with the suggestion made in remark 1; we shall alternatively use the notation $(q(t), \dot{q}(t))$ as often as it will not be too heavy or confusing. This is clearly a redundant notation since the base-point $q = \Pi_Q(\dot{q})$ is contained in the derivative, but I believe that this notation may help the understanding. More generally, an element v of TQ will also be denoted by (q, v) with q being the base-point of v . For ψ being a local chart on Q , $\psi(q)$ is an element of \mathbb{R}^d that we denote by (q^1, q^2, \dots, q^d) . Still to be consistent with the suggestion of remark 1, we shall sometimes keep the notation q to refer to $\psi(q)$. Thus, for q being an abstract configuration, we might write $q = (q^1, q^2, \dots, q^d)$. More generally, each time it will not be confusing, we will keep the same notation for an object and its representative in a chart. As usual, the natural basis of T_qQ (resp. T_q^*Q) naturally associated with the chart ψ is denoted by $(e_1(q), e_2(q), \dots, e_d(q))$ (resp. $(e^1(q), e^2(q), \dots, e^d(q))$). For (q, v) belonging to TQ , we denote by v^i ($i = 1, 2, \dots, d$) its components in the natural basis and we shall write:

$$v = v^i e_i(q).$$

Einstein's summation convention will always apply unless explicitly stated. For $q(t)$ being a curve, we shall write:

$$\dot{q}(t) = \dot{q}^i(t) e_i(q(t)),$$

and $\dot{q}^i(t)$ is the derivative at time t of the real-valued function $q^i(t)$. As usual, $g_{ij}(q)$ will be the covariant components of the metric in the considered chart and $g^{ij}(q)$ its contravariant components; $\Gamma_{jk}^i(q)$ will be the associated Christoffel symbols:

$$\Gamma_{jk}^i(q) = \frac{1}{2} g^{ih}(q) \left(\frac{\partial g_{hk}}{\partial q^j}(q) + \frac{\partial g_{jh}}{\partial q^k}(q) - \frac{\partial g_{jk}}{\partial q^h}(q) \right).$$

For $q(t)$ being a curve on Q and v a vector field on that curve, the covariant derivative of v along $q(t)$ is denoted by:

$$\frac{D}{dt}v(t) = \left(\frac{d}{dt}v^i(t) + \Gamma_{jk}^i(q(t))v^j(t)\dot{q}^k(t) \right) e_i(q(t)).$$

1.2 Formulation of the dynamics

Consider a rigid bodies system of configuration manifold Q and a motion $q(t)$ of that system. The *power of inertial forces* at instant t is, by definition, the time derivative at t of the kinetic energy:

$$\begin{aligned} \frac{d}{dt}K(q, \dot{q}) &= \frac{1}{2} \frac{d}{dt} (\dot{q}(t), \dot{q}(t))_{q(t)}, \\ &= \left(\frac{D}{dt} \dot{q}(t), \dot{q}(t) \right)_{q(t)}, \\ &= \left\langle \flat \frac{D}{dt} \dot{q}(t); \dot{q}(t) \right\rangle_{q(t)}. \end{aligned}$$

Hence, it is seen that the power of inertial forces at time t defines the cotangent vector $\flat D\dot{q}(t)/dt \in T_{q(t)}^*Q$. An arbitrary element T_qQ is often called a *virtual velocity* of the system in the configuration q . Then, the linear form $\flat D\dot{q}(t)/dt$ is called virtual power of inertial forces.

The analysis of the dynamics has to take into account external and internal forces. They are usually given as a force distribution on the current real world configuration. This is an E -valued measure which may depend on the current state (q, \dot{q}) and on time t . We shall denote it by $\phi(q, \dot{q}; t)$. The power of the internal and external forces at time t in the motion $q(t)$ is:

$$\begin{aligned} \int_E (\dot{m}, d\phi(q, \dot{q}; t)(m(M, q)))_E \\ = \int_E (\partial_q m(M, q) \cdot \dot{q}, d\phi(q, \dot{q}; t)(m(M, q)))_E, \end{aligned}$$

which also defines a linear form $f(q, \dot{q}; t)$ on T_qQ by:

$$\langle f(q, \dot{q}; t), v \rangle_q \stackrel{\text{def}}{=} \int_E (\partial_q m(M, q) \cdot v, d\phi(q, \dot{q}; t)(m(M, q)))_E,$$

for any virtual velocity $v \in T_q Q$. This linear form $f(q, \dot{q}, t) \in T_q^* Q$ is called *virtual power of external and internal forces*. The reason for such a modelling of forces by duality is that it ensures the consistency of the forces modelling with the geometrical description of the system. The virtual power mapping $f(q, \dot{q}, t)$ extracts from the force field ϕ only the information which is relevant to the dynamics analysis in the framework of the geometrical assumption of rigidity.

The fundamental principle of classical mechanics asserts that the virtual power of inertial forces should equal at every instant the virtual power of external and internal forces:

$$\forall t, \quad \flat \frac{D}{dt} \dot{q}(t) = f(q(t), \dot{q}(t), t). \quad (1.4)$$

Equation (1.4) is referred to as the *equation of motion*. It is a second-order differential equation on the configuration manifold. To express it in a particular parametrization of the system, the following is useful.

Proposition 1 (Lagrange) *Let ψ be a local chart and $q(t)$ a C^2 motion on Q . One has:*

$$\flat \frac{D}{dt} \dot{q}(t) = \left(\frac{d}{dt} \frac{\partial}{\partial \dot{q}^i} K(q(t), \dot{q}(t)) - \frac{\partial}{\partial q^i} K(q(t), \dot{q}(t)) \right) e^i(q(t)).$$

Proof. It is straightforward since:

$$\begin{aligned} \flat \frac{D}{dt} \dot{q} &= g_{ij} \left(\frac{d}{dt} \dot{q}^j + \Gamma_{kt}^j \dot{q}^k \dot{q}^t \right) e^i, \\ &= g_{ij} \left(\frac{d}{dt} \dot{q}^j + \frac{1}{2} g^{jh} \left(\frac{\partial g_{hl}}{\partial q^k} + \frac{\partial g_{hk}}{\partial q^l} - \frac{\partial g_{kl}}{\partial q^h} \right) \dot{q}^k \dot{q}^l \right) e^i, \\ &= \left(\frac{d}{dt} \frac{\partial}{\partial \dot{q}^i} \left(\frac{1}{2} \dot{q}^j g_{jk} \dot{q}^k \right) - \frac{\partial}{\partial q^i} \left(\frac{1}{2} \dot{q}^j g_{jk} \dot{q}^k \right) \right) e^i. \end{aligned}$$

□

We are given an initial instant t_0 and an initial state $(q_0, v_0) \in TQ$. Then, the evolution problem associated with the dynamics of rigid bodies system is the Cauchy problem:

Problem I. Find $T > t_0$ and $q \in C^2([t_0, T[; Q)$ such that:

- $(q(t_0), \dot{q}(t_0)) = (q_0, v_0)$,
- $\forall t \in [t_0, T[, \quad \flat \frac{D}{dt} \dot{q}(t) = f(q(t), \dot{q}(t), t)$.

1.3 Well-posedness of the dynamics

To study the well-posedness (existence and uniqueness of solution) of problem I, we have to specify regularity assumptions on Q and f .

Counter-example 1. Consider the evolution equation

$$\frac{d^2}{dt^2}q(t) = 6|q(t)|^{\frac{1}{3}}$$

($q \in \mathbb{R}$) with initial condition $(q(0), \dot{q}(0)) = (0, 0)$. It is readily checked that the two motions defined on \mathbb{R}^+ $q(t) = 0$ and $q(t) = t^3$ provide two distinct solutions.

To get well-posedness, we have to make further hypotheses. Throughout this paper, we shall distinguish two classes of hypotheses: the *constitutive* hypotheses and the *regularity* hypotheses. A constitutive hypothesis is an hypothesis which conveys physical meaning. A regularity hypothesis conveys no physical meaning and is stated to eliminate mathematical pathologies. The following regularity hypothesis is slightly stronger than necessary.

Regularity hypothesis. The Riemannian configuration manifold is of class C^2 and the mapping $f : TQ \times \mathbb{R} \rightarrow T^*Q$ is of class C^1 .

It should be pointed out that the first part of this hypothesis is actually no hypothesis at all. The configuration manifold of the three-dimensional rigid solid, of the infinitely thin rigid bar or of the punctual particle, with arbitrary consistent mass distribution are C^∞ (or, even more, analytic) Riemannian manifolds. The configuration manifold of a rigid bodies system (with no constraint), being a cross-product of such manifolds, can be assumed to have arbitrary regularity. This is a restriction neither on the geometry nor on the mass distribution of the system, but on the class of admissible parametrizations.

Under this regularity hypothesis, we have the following well-posedness result.

Theorem 2 (Cauchy) *There exists a unique maximal solution for problem I.*

More precisely, theorem 2 states that there exists $T_m > t_0$ ($T_m \in \mathbb{R} \cup \{+\infty\}$) and $q_m \in C^2([t_0, T_m], Q)$ being a solution of problem I such that any other solution of problem I is a restriction of q_m . Of course, we expect that $T_m = +\infty$, in which case the dynamics is said to be *eternal*. This situation can not be taken for granted, in general.

Counter-example 2. Consider the evolution equation

$$\frac{d^2}{dt^2}q(t) = (\dot{q}(t))^2$$

($q \in \mathbb{R}$) with initial condition $(q(0), \dot{q}(0)) = (0, 1)$. It is readily checked that the maximal solution is defined on the interval $[0, 1[$.

In the usual cases encountered in mechanics, eternal dynamics is ensured by the following general sufficient condition.

Theorem 3 *The configuration manifold Q is assumed to be a complete Riemannian manifold (this is no hypothesis in the case of rigid bodies system with no constraints). The mapping f is supposed to admit the following estimate:*

$$\forall (q, v) \in TQ, \quad \text{for almost all } t \in [t_0, +\infty[,$$

$$\|f(q, v; t)\|_q^* \leq l(t) \left(1 + d(q, q_0) + \|v\|_q\right),$$

where $d(\cdot, \cdot)$ is the Riemannian distance and $l(t)$, a (necessarily nonnegative) function of $L^1_{loc}(\mathbb{R}; \mathbb{R})$.

Then, the dynamics is eternal: $T_m = +\infty$.

The proof of theorem 3 relies on the Gronwall-Bellman lemma which is now recalled.

Lemma 4 (Gronwall-Bellman) *Let $m_1 \in BV([t_0, T]; \mathbb{R})$ and $m_2 \in L^1(t_0, T; \mathbb{R})$ be two functions such that:*

$$\text{for almost all } t \in]t_0, T[, \quad m_2(t) \geq 0.$$

Let $\phi \in BV([t_0, T]; \mathbb{R})$ be such that:

$$\forall t \in [t_0, T], \quad \phi(t) \leq m_1(t) + \int_{t_0}^t m_2(s)\phi(s) ds.$$

Then,

$$\forall t \in [t_0, T], \quad \phi(t) \leq m_1(t) + \int_{t_0}^t m_1(s)m_2(s)e^{\int_s^t m_2(\sigma) d\sigma} ds.$$

Lemma 5 *Let m be in $L^1(t_0, T; \mathbb{R})$ such that $m(t) \geq 0$ for almost all t in $]t_0, T[$ and a be a real nonnegative constant. Consider $\phi \in BV([t_0, T]; \mathbb{R})$ such that:*

$$\forall t \in [t_0, T], \quad \frac{1}{2}\phi^2(t) \leq \frac{1}{2}a^2 + \int_{t_0}^t m(s)\phi(s) ds,$$

then:

$$\forall t \in [t_0, T], \quad |\phi(t)| \leq a + \int_{t_0}^t m(s) ds.$$

Elementary proofs of lemmas 4 and 5 can be found in BREZIS (1973), p. 156.

Proof of theorem 3. Suppose T_m is finite. From the equation of motion (1.4), we have, for all $t \in [t_0, T_m[$,

$$\begin{aligned} \frac{1}{2} \|\dot{q}_m(t)\|_{q_m(t)}^2 - \frac{1}{2} \|v_0\|_{q_0}^2 &\leq \int_{t_0}^t \langle f(q_m(s), \dot{q}_m(s); s), \dot{q}_m(s) \rangle_{q_m(s)} ds, \\ &\leq \int_{t_0}^t l(s) \left(1 + d(q_m(s), q_0) + \|\dot{q}_m(s)\|_{q_m(s)} \right) \|\dot{q}_m(s)\|_{q_m(s)} ds, \end{aligned}$$

which gives, by lemma 5,

$$\|\dot{q}_m(t)\|_{q_m(t)} \leq \|v_0\|_{q_0} + \int_{t_0}^t l(s) \left(1 + d(q_m(s), q_0) + \|\dot{q}_m(s)\|_{q_m(s)} \right) ds.$$

But, by definition of the Riemannian distance,

$$\forall t \in [t_0, T_m[, \quad d(q_m(t), q_0) \leq \int_{t_0}^t \|\dot{q}_m(s)\|_{q_m(s)} ds,$$

therefore,

$$\begin{aligned} \forall t \in [t_0, T_m[, \quad d(q_m(t), q_0) + \|\dot{q}_m(t)\|_{q_m(t)} &\leq \\ \|v_0\|_{q_0} + \int_{t_0}^t l(s) ds + \int_{t_0}^t (1 + l(s)) \left(d(q_m(s), q_0) + \|\dot{q}_m(s)\|_{q_m(s)} \right) ds. \end{aligned}$$

By lemma 4, one gets:

$$d(q_m(t), q_0) + \|\dot{q}_m(t)\|_{q_m(t)} \leq \left(\|v_0\|_{q_0} + \int_{t_0}^t l(s) ds \right) e^{\int_{t_0}^t (1+l(s)) ds},$$

which shows that the function $t \mapsto \|\dot{q}_m(t)\|_{q_m(t)}$ is bounded over $[t_0, T_m[$. By the completeness of Q , we deduce that

$$q_T = \lim_{t \rightarrow T_m^-} q_m(t)$$

exists in Q . Then, it is an easy matter to deduce that

$$(q_T, v_T) = \lim_{t \rightarrow T_m^-} (q_m(t), \dot{q}_m(t)) \quad \text{exists in } TQ,$$

and that the function q_m , extended by continuity at T_m satisfies the equation of motion on $[t_0, T_m]$. Then, theorem 2 furnishes $T'_m > T_m$ and an extension of q_m , belonging to $C^2([t_0, T'_m]; Q)$ and being a solution of problem I. But, this contradicts the definition of T_m . \square

2.

A con
the force
by their
associate
assumpti
constrain

2.1

A hold
of the sy
real-value

The word
a constrain
associated
of constr
configura

The follo
Regularit
is, for all
 T^*Q .

A strai
of Q of d
 Q . We sh

2.2

The re
of the equ
of forces
reaction f

We might
not work

2. Perfect holonomic bilateral constraints

A constraint describes a type of forces which are not taken into account by the forces mapping f . Indeed, it is possible to specify (partially) some forces by their kinematical effects. These kinematical effects leave in general the associated forces partially undetermined and we have to add phenomenological assumptions on the way the constraint acts, through a *constitutive law* of the constraint.

2.1 The geometric description

A *holonomic bilateral constraint* is a restriction on the admissible motions of the system which is expressed by means of a finite number n of smooth real-valued functions φ_i defined on the configuration manifold Q :

$$\forall i \in \{1, 2, \dots, n\}, \quad \varphi_i(q) = 0. \quad (1.5)$$

The word constraint in the singular will be used indifferently to speak either of a constraint specifically associated with a single function φ_i or of the constraint associated with all the functions φ_i . In this terminology, a finite collection of constraints is still a constraint. We denote by S the set of all admissible configurations:

$$S = \{q \in Q; \forall i \in \{1, 2, \dots, n\}, \varphi_i(q) = 0\}.$$

The following hypothesis is usual in this framework.

Regularity hypothesis I. The functions φ_i are *functionally independent*, that is, for all $q \in S$, the $d\varphi_i(q)$ ($i \in \{1, 2, \dots, n\}$) are linearly independent in T^*Q .

A straightforward consequence of this hypothesis is that S is a submanifold of Q of dimension $d - n$. As a result, S inherits a Riemannian structure from Q . We shall say that S is the configuration manifold of the constrained system.

2.2 Formulation of the dynamics

The realization of the constraint (1.5) necessarily involves a modification of the equation of motion (1.4). This is done by adding to the virtual power of forces $f(q, \dot{q}; t)$ a corrective unknown term R called the *virtual power of reaction forces*:

$$\forall t, \quad \frac{D}{dt} \dot{q}(t) = f(q(t), \dot{q}(t), t) + R(t).$$

We might expect R to be determined by the geometric constraint (1.5). It does not work in general. We have to add phenomenological assumptions on the

way the constraint acts. This is the *constitutive law* of the constraint. At this point, we restrict ourselves to the following.

Constitutive hypothesis II. The holonomic bilateral constraint (1.5) is supposed to be *perfect* (one also says synonymously *ideal*), that is, the virtual power of the reaction forces R vanishes in any virtual velocity compatible with the bilateral constraint:

$$\forall v \in \left\{ v \in T_q Q; \forall i \in \{1, 2, \dots, n\}, \langle d\varphi_i(q), v \rangle_q = 0 \right\} \simeq TS, \\ \langle R, v \rangle_q = 0.$$

Hypotheses I and II imply that there exists n real-valued functions λ_i , unique, such that:

$$R(t) = \sum_{i=1}^n \lambda_i(t) d\varphi_i(q).$$

Now, we formulate the evolution problem associated with the dynamics of rigid bodies systems with perfect bilateral constraints. The initial condition is assumed to be compatible with the realization of the constraint: $(q_0, v_0) \in TS$.

Problem II. Find $T > t_0, q \in C^2([t_0, T[; Q)$ and n functions $\lambda_i \in C^0([t_0, T[; \mathbb{R})$ such that:

- $(q(t_0), \dot{q}(t_0)) = (q_0, v_0),$
- $\forall t \in [t_0, T[, \quad q(t) \in S,$
- $\forall t \in [t_0, T[, \quad \frac{D_Q}{dt} \dot{q}(t) = f(q(t), \dot{q}(t), t) + \sum_{i=1}^n \lambda_i(t) d\varphi_i(q(t)).$

Here, we used the notation D_Q/dt for the covariant derivative to underline the fact the covariant derivative is understood with respect to the Riemannian structure of Q (and not to that of S).

Let q be a point of Q , v a vector in $T_q Q$, and E a subspace of $T_q Q$. The orthogonal projection of v on E for the scalar product of $T_q Q$ induced by the Riemannian structure of Q is denoted by $\text{Proj}_q [v; E]$. Similarly, $\text{Proj}_q^* [v^*; E^*]$ denotes the orthogonal projection of the cotangent vector v^* on the subspace E^* of $T_q^* Q$. If $q(t)$ is a curve on the Riemannian submanifold S of Q and v a vector field on that curve, then we have (CHAVEL (1993), p. 54):

$$\frac{D_S v}{dt} = \text{Proj}_q \left[\frac{D_Q v}{dt}; T_q S \right].$$

Unilatera

Therefor

Problem

Recipro

of proble

The lin

tion of the

with the

internal f

2.3

Proble

and II ar

the dyna

Regular

are of cla

Proposit

over, if Q

then q_m i

The se

differenti

The an

The re

it would

Counter

extremiti

The two c

simple oc

initial ins

of the bar

The read

admits no

Therefore, any solution of problem II is seen to be a solution of

Problem II'. Find $T > t_0$ and $q \in C^2([t_0, T]; S)$ such that:

- $(q(t_0), \dot{q}(t_0)) = (q_0, v_0),$
- $\forall t \in [t_0, T[, \quad b \frac{D_S}{dt} \dot{q}(t) = \text{Proj}_{q(t)}^* [f(q(t), \dot{q}(t); t); T_{q(t)}^* S].$

Reciprocally, any solution of problem II' is readily seen to generate a solution of problem II: the two evolution problems are equivalent.

The linear form (cotangent vector) $\text{Proj}_q^* [f(q, \dot{q}; t); T_q^* S]$ equals the restriction of the linear form $f(q, \dot{q}; t)$ on the space $T_q S$ of virtual velocities compatible with the bilateral constraint. Therefore, it is the virtual power of external and internal forces in any virtual velocity compatible with the constraint.

2.3 Well-posedness of the dynamics

Problem II' has formally the same structure of problem I. Since problems II' and II are equivalent, the results of Section 1(1.3) give the well-posedness of the dynamics of rigid bodies systems with perfect bilateral constraints.

Regularity hypothesis III. The configuration manifold Q and the functions φ_i are of class C^2 and the mapping $f : TQ \times \mathbb{R} \rightarrow T^*Q$ is of class C^1 .

Proposition 6 *Problems II and II' have a unique maximal solution q_m . Moreover, if Q and the functions φ_i are of class C^p ($p \geq 2$), and f of class C^{p-1} then q_m is of class C^p . If Q, f and the φ_i are analytic functions then so is q_m .*

The second part of proposition 6 follows from standard results on ordinary differential equations (see, for example, CODDINGTON & LEVINSON (1955)).

The analysis of the eternity of the dynamics is provided by theorem 3.

The regularity hypothesis I could seem very restrictive. However, dropping it would make us run into troubles.

Counter-example 3. Consider a rigid homogeneous bar of length l . The two extremities of the bar are constrained to remain on a fixed circle of diameter l . The two corresponding bilateral constraints are supposed to be perfect. This is a simple occurrence of bilateral constraint which does not satisfy hypothesis I. At initial instant, the bar is at rest. A constant force is applied at the middle point of the bar. This force is directed in the plane of the circle but not along the bar. The reader will convince himself that the corresponding evolution problem II admits no solution.

2.4 Illustrations and comments

The configuration manifold Q of the rigid body system with no constraint is often referred to as the *primitive* configuration manifold, whereas the submanifold S is called the *reduced* configuration manifold. In practice, the reduced configuration manifold can be often constructed directly, without introducing first a primitive configuration manifold. In such a case, the forces mapping is directly introduced with respect to the reduced configuration manifold.

Example 4. Consider a plane system of two homogeneous rigid bars 1 and 2. The bar 1, of length l_1 and mass m_1 is connected to a fixed support by means of a perfect ball-and-socket joint equipped with a spiral spring of stiffness k_1 . The bar 2, of length l_2 and mass m_2 is connected to the free extremity of the bar 1 by means of another ball-and-socket joint also equipped with a spiral spring of stiffness k_2 . A force acts on the free extremity of the bar 2. This force remains parallel to the direction of the bar 2 and is of constant magnitude $\lambda > 0$ (see Figure 1.1).

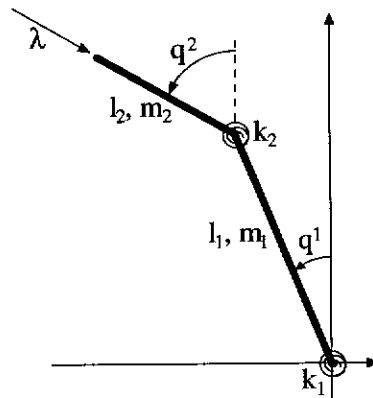

Figure 1.1. Geometry of the double pendulum.

- The configuration space is \mathbb{R}^2 equipped with its canonical structure of C^∞ manifold (it is not the 2-torus since the spiral springs impose to be able to count the 'number of turns'). This manifold may be represented by a single chart; in other terms, there exists a global parametrization of the system. In the sequel, we shall only use the chart (q^1, q^2) defined by the angular measures associated with each of the joints.

Unilatera

■ Th

Th
spa

■ Th

The equal
use of pro

$(\frac{m_1}{3})$

$\frac{m_2}{2} l_1$

By propos
with any
defined fo
constant C

$\|f\|$

- The kinetic energy is:

$$\begin{aligned}
 K &= \frac{1}{2} \int_0^{l_1} \frac{m_1}{l_1} s^2 (\dot{q}^1)^2 ds + \frac{1}{2} \int_0^{l_2} \frac{m_2}{l_2} (l_1^2 (\dot{q}^1)^2 \\
 &\quad + s^2 (\dot{q}^2)^2 + 2l_1 s \cos(q^1 - q^2) \dot{q}^1 \dot{q}^2) ds, \\
 &= \frac{1}{2} \left(\frac{1}{3} m_1 l_1^2 (\dot{q}^1)^2 + m_2 l_1^2 (\dot{q}^1)^2 \right. \\
 &\quad \left. + \frac{1}{3} m_2 l_2^2 (\dot{q}^2)^2 + m_2 l_1 l_2 \cos(q^1 - q^2) \dot{q}^1 \dot{q}^2 \right).
 \end{aligned}$$

This kinetic energy defines a Riemannian structure on the configuration space. The expression of the metric tensor in the considered chart is:

$$\begin{aligned}
 g_{11}(q^1, q^2) &= \left(\frac{m_1}{3} + m_2 \right) l_1^2, \\
 g_{12}(q^1, q^2) &= \frac{1}{2} m_2 l_1 l_2 \cos(q^1 - q^2) = g_{21}(q^1, q^2), \\
 g_{22}(q^1, q^2) &= \frac{1}{3} m_2 l_2^2.
 \end{aligned}$$

- The forces mapping has for expression in the considered chart:

$$\begin{aligned}
 f(q, \dot{q}; t) &= [\lambda l_1 \sin(q^1 - q^2) - (k_1 + k_2) q^1 + k_2 q^2] e^1(q) \\
 &\quad + [k_2 q^1 - k_2 q^2] e^2(q).
 \end{aligned}$$

The equations of motion in the chart under consideration is easily formed by use of proposition 1:

$$\begin{aligned}
 \left(\frac{m_1}{3} + m_2 \right) l_1^2 \ddot{q}^1 + \frac{m_2}{2} l_1 l_2 \cos(q^1 - q^2) \ddot{q}^2 + \frac{m_2}{2} l_1 l_2 \sin(q^1 - q^2) (\dot{q}^2)^2 \\
 = \lambda l_1 \sin(q^1 - q^2) - (k_1 + k_2) q^1 + k_2 q^2, \\
 \frac{m_2}{2} l_1 l_2 \cos(q^1 - q^2) \ddot{q}^1 + \frac{m_2}{3} l_2^2 \ddot{q}^2 - \frac{m_2}{2} l_1 l_2 \sin(q^1 - q^2) (\dot{q}^1)^2 \\
 = k_2 (q^1 - q^2).
 \end{aligned}$$

By proposition 6, one can conclude that a unique maximal motion is associated with any initial condition. Moreover, this maximal motion is analytic and is defined for all time. Indeed, it is easily seen that there exists a positive real constant C , depending only on (l_1, l_2, m_1, m_2) such that:

$$\|f(q)\|_q^* \leq C \left[\lambda l_1 + 4(k_1 + k_2) |(q_0^1, q_0^2)| + 4(k_1 + k_2) d(q, q_0) \right],$$

where $|\cdot|$ denotes the canonical Euclidean norm on \mathbb{R}^2 . Therefore, the assumptions of theorem 3 are satisfied.

It should be underlined that the framework of perfect bilateral constraints does not require that there should be no energy dissipation physically associated with a constraint. Indeed, such an energy dissipation can be described, in some cases, in terms of internal forces. For example, suppose that, in the system described above, some viscous damping with coefficients η_1 and η_2 is associated with each ball-and-socket joint. Then, it is incorporated in the forces mapping f which should be changed into

$$\begin{aligned} f(q, \dot{q}; t) = & [\lambda_1 \sin(q^1 - q^2) - (k_1 + k_2)q^1 + k_2q^2 \\ & - (\eta_1 + \eta_2)\dot{q}^1 + \eta_2\dot{q}^2] e^1(q) \\ & + [k_2q^1 - k_2q^2 + \eta_2\dot{q}^1 - \eta_2\dot{q}^2] e^2(q). \end{aligned}$$

The above remark does not apply to the case of Coulomb type friction.

Remark 2. As problems II and II' are equivalent, we see that the dynamics of the constrained system depends only on the geometry of the submanifold S and *not* on the particular choice of the functions φ_i used to define it. In other words, consider a constraint, say constraint 1, defined by n functionally independent functions φ_i and another constraint, say constraint 2, defined by n functionally independent functions φ'_i . Suppose, in addition, that:

$$S = \{q \in Q; \forall i, \varphi_i(q) = 0\} = \{q \in Q; \forall i, \varphi'_i(q) = 0\}.$$

Then, the dynamics of the system subjected to constraint 1 is identical to the dynamics of the system subjected to constraint 2. Moreover, the reaction forces in the motion are the same in both cases.

Since the modelling of rigid bodies system with no constraint or with perfect holonomic bilateral constraint leads to the construction of mathematical structures of the same type, we state the following definition.

Definition 7 A simple discrete mechanical system is a pair (Q, f) where:

- Q is a finite-dimensional smooth Riemannian manifold called the configuration manifold.
- $f : TQ \times \mathbb{R} \rightarrow T^*Q$ is a smooth mapping satisfying:

$$\forall (q, v) \in TQ, \quad \forall t \in \mathbb{R}, \quad \Pi_Q^*(f(q, v; t)) = q,$$

called the forces mapping.

Unilater

3.

The o
bodies s
of the sy
Hence, v
to a sim
lateral o
unilatera

3.1

Const
Q. A ut
system v
function

We deno

The set o
by:

The follo
Section 2

Regular
sense tha
 T^*Q .

Straigh

- A
- ∂A
- \dot{A}

Consid
exists at i

3. Perfect unilateral constraints

The consideration of elementary examples shows that the dynamics of rigid bodies systems can lead to some prediction of the motion where some bodies of the system *overlap* in the real world. Of course, this should not be allowed. Hence, very often, one has to add the statement of non-penetration conditions to a simple discrete mechanical system. This is a simple occurrence of unilateral constraint. In this section, we shall discuss the consideration of perfect unilateral constraints in simple discrete mechanical systems.

3.1 The geometric description

Consider a simple discrete mechanical system with configuration manifold Q . A *unilateral constraint* is a restriction on the admissible motions of the system which is expressed by means of a finite number n of smooth real-valued functions φ_i defined on the configuration manifold Q :

$$\forall i \in \{1, 2, \dots, n\}, \quad \varphi_i(q) \leq 0. \quad (1.6)$$

We denote by A the set of all admissible configurations:

$$A = \{q \in Q; \forall i \in \{1, 2, \dots, n\}, \varphi_i(q) \leq 0\}.$$

The set of all active constraints in the admissible configuration $q \in A$ is defined by:

$$J(q) = \{i \in \{1, 2, \dots, n\}; \varphi_i(q) = 0\}.$$

The following hypothesis should be brought aside regularity hypothesis I of Section 2.2.1.

Regularity hypothesis I. The functions φ_i are *functionally independent* in the sense that, for all $q \in A$, the $d\varphi_i(q)$ ($i \in J(q)$) are linearly independent in T^*Q .

Straightforward consequences of this hypothesis are:

- A is a closed subset of Q ,
- $\partial A \subset \bigcup_{i=1}^n \varphi_i^{-1}(\{0\})$ (∂A is the boundary of A),
- $\overset{\circ}{A} = J^{-1}(\{\emptyset\})$ ($\overset{\circ}{A}$ is the interior of A).

Consider a motion $q(t)$ in A and assume that a right velocity $\dot{q}^+(t) \in T_{q(t)}Q$ exists at instant t , then we necessarily have:

$$\forall i \in J(q(t)), \quad \langle d\varphi_i(q(t)), \dot{q}^+(t) \rangle_{q(t)} \leq 0,$$

or, equivalently,

$$\forall i \in J(q(t)), \quad (\nabla\varphi_i(q(t)), \dot{q}^+(t))_{q(t)} \leq 0,$$

where $\nabla\varphi_i(q)$ is the gradient of φ_i at q defined by $\nabla\varphi_i(q) = \#(d\varphi_i(q))$. Thus, if the system has configuration q and if a right velocity \dot{q}^+ exists, then \dot{q}^+ necessarily belongs to the closed convex cone $V(q)$ of T_qQ defined by:

$$V(q) = \{v \in T_qQ; \forall i \in J(q), \quad \langle d\varphi_i(q), v \rangle_q \leq 0\}.$$

$V(q)$ is called the cone of admissible right velocities at the configuration q . In particular,

$$q \in \overset{\circ}{A} \text{ (i.e. } J(q) = \emptyset) \implies V(q) = T_qQ.$$

Similarly, if a left velocity $\dot{q}^- \in T_qQ$ exists, then $\dot{q}^- \in -V(q)$

3.2 Formulation of the dynamics

The formulation of the dynamics follows the lines of MOREAU (1983, 1988a).

3.2.1 Equation of motion. As for bilateral constraints, the realization of the constraints induces some reaction force R . The following hypotheses are made.

Constitutive hypothesis II. The unilateral constraints are of type contact without adhesion:

$$\forall v \in V(q), \quad \langle R, v \rangle_q \geq 0.$$

Constitutive hypothesis III. The unilateral constraints are perfect:

$$\forall v \in \left\{ v \in T_qQ; \forall i \in J(q), \quad \langle d\varphi_i(q), v \rangle_q = 0 \right\}, \quad \langle R, v \rangle_q = 0.$$

As an easy consequence of constitutive hypotheses II and III, we get:

$$\exists (\lambda_i)_{i=1,2,\dots,n} \in \mathbb{R}^n, \quad R = \sum_{i=1}^n \lambda_i d\varphi_i(q), \text{ and } \begin{cases} i \in J(q) & \Rightarrow \lambda_i \leq 0, \\ i \notin J(q) & \Rightarrow \lambda_i = 0. \end{cases}$$

Thus, the reaction force $R \in T^*Q$ must be such that:

$$-R \in N^*(q) \stackrel{\text{def}}{=} \left\{ \sum_{i=1}^n \lambda_i d\varphi_i(q); \forall i \in J(q), \lambda_i \geq 0, \forall i \notin J(q), \lambda_i = 0 \right\}. \quad (1.7)$$

Unilatera

$N^*(q)$ is
duality
 $V(q)$ for

$N(q)$

Now,

Assume

By form
motion i

Suppose
greater t
left veloc
In this c
greater t
instant s

Howe
for $\dot{q}^+(t)$
continu

should b
 R to be a

We de
absolutel
velocity
bounded
only for
absolutel
along $q(t)$
different
to this c
The read
admits a
Moreove

$N^*(q)$ is a closed convex cone of T_q^*Q and it is the polar cone of $V(q)$ in the duality (T_qQ, T_q^*Q) . We will also have to consider the polar cone $N(q)$ of $V(q)$ for the Euclidean structure of T_qQ :

$$N(q) = \left\{ \sum_{i=1}^n \lambda_i \nabla \varphi_i(q) ; \forall i \in J(q), \lambda_i \geq 0, \quad \forall i \notin J(q), \lambda_i = 0 \right\}.$$

Now, consider a motion $q(t)$ starting at $q_0 \in \overset{\circ}{A}$ at time t_0 with velocity v_0 . Assumed to be continuous, $q(t)$ remains in $\overset{\circ}{A}$ on a right neighbourhood of t_0 . By formula (1.7), the reaction force R vanishes as long as $q(t)$ is in $\overset{\circ}{A}$ and the motion is governed by the ordinary differential equation:

$$\begin{aligned} (q(t_0), \dot{q}(t_0)) &= (q_0, v_0), \\ \mathfrak{b} \frac{D\dot{q}}{dt} &= f(q, \dot{q}; t). \end{aligned}$$

Suppose that the solution of this Cauchy problem meets ∂A at some instant greater than t_0 . Denote by T the smallest of these instants. The motion admits a left velocity vector v_T^- at time T . Of course, there may happen: $v_T^- \notin V(q(T))$. In this case, no differentiable prolongation of the motion can exist in A for t greater than T . The requirement of differentiability has to be dropped. An instant such T is called an instant of *impact*.

However, we are still going to require the existence of a right velocity vector $\dot{q}^+(t) \in V(q(t))$ at every instant t . The right velocity need not to be a continuous function of time and the equation of motion

$$\mathfrak{b} \frac{D\dot{q}^+}{dt} = f(q, \dot{q}^+; t) + R,$$

should be understood in sense of Schwartz's distribution. Actually, we require R to be a *vector valued measure* rather than a general distribution.

We denote by $MMA(I; Q)$ (motions with measure acceleration) the set of all absolutely continuous motions $q(t)$ from a real interval I to Q admitting a right velocity $\dot{q}^+(t)$ at every instant t of I and such that the function $\dot{q}^+(t)$ has locally bounded variation over I . Naturally, bounded variation is classically defined only for functions taking values in a normed vector space. However, for any absolutely continuous curve $q(t)$ on a Riemannian manifold, parallel translation along $q(t)$ classically provides intrinsic identification of the tangent spaces at different points of the curve and so, the definitions can easily be carried over to this case. The precise mathematical setting is postponed to Appendix A. The reader will notice from Appendix A that any motion $q \in MMA(I; Q)$ admits a left and right velocity, \dot{q}^- and \dot{q}^+ , in the classical sense at any instant. Moreover, with any motion $q \in MMA(I; Q)$ is intrinsically associated the

covariant Stieltjes measure $D\dot{q}^+$ of its right velocity \dot{q}^+ . The equation of motion takes the form:

$$bD\dot{q}^+ = f(q, \dot{q}^+; t) dt + R,$$

where dt denotes the Lebesgue measure. We have to give a precise meaning to condition (1.7) with R being a vector valued measure.

Convention. We shall write:

$$R \in -N^*(q(t))$$

to mean: there exist n nonpositive real measures λ_i such that:

$$R = \sum_{i=1}^n \lambda_i d\varphi_i(q(t)),$$

$$\forall i \in \{1, 2, \dots, n\}, \quad \text{Supp } \lambda_i \subset \{t; \varphi_i(q(t)) = 0\}. \quad (1.8)$$

Using this convention, the final form of the equation of motion is:

$$R = bD\dot{q}^+ - f(q(t), \dot{q}^+(t); t) dt \in -N^*(q(t)) \quad (1.9)$$

A straightforward consequence of the equation of motion is that an impact (that is, a discontinuity of the right velocity \dot{q}^+ by proposition 43) can only occur at an instant t such that $J(q(t)) \neq \emptyset$. This fact is a justification for the following definition.

Definition 8 *An impact occurring at time t is said simple if $J(q(t))$ contains exactly one element. If $J(q(t))$ contains at least two elements, the impact is said multiple.*

3.2.2 The impact constitutive equation. We begin this section by an example. Consider the one degree-of-freedom mechanical system whose configuration space is \mathbb{R} equipped with its canonical Euclidean structure. The forces mapping f vanishes identically and the unilateral constraint is represented by the single function $\varphi_1(q) = q$ so that the admissible configuration set A is \mathbb{R}^- . At initial time $t_0 = 0$, we consider an initial state (q_0, v_0) such that $q_0 < 0$ and $v_0 > 0$. It is readily seen from the equation of motion (1.9) that an impact necessarily occurs at time $t = -q_0/v_0$. At this time, the left velocity is v_0 . But, the right velocity can take any negative value and whatever it is, it is compatible with the equation of motion.

The reason for this indetermination lies in the phenomenological nature of the interaction of the system with the obstacle. This missing information has to be added.

Constitutive hypothesis IV. The interaction of the system with the obstacle at time t is completely determined by the present configuration $q(t)$ and the

Unilater

present
mapping
obstacle

To ensu
should s

$\forall q$

Moreove
increase

\forall

Let us
actually
solids. I
in which
have cho
deforma
the outc
is to intr
situation
either by
theory o
in every
mapping
identific
physical
any mec
in each r
constitut
of the res
hypothes

Definitio
and (1.1
equation

is called

present left velocity $\dot{q}^-(t)$. In other terms, we postulate the existence of a mapping $\mathcal{F} : TQ \rightarrow TQ$ describing the interaction of the system with the obstacle during an impact:

$$\forall t, \quad \dot{q}^+(t) = \mathcal{F}(q(t), \dot{q}^-(t)). \tag{1.10}$$

To ensure compatibility with the equation of motion (1.9), the mapping \mathcal{F} should satisfy:

$$\forall q \in A, \quad \forall v^- \in -V(q), \quad \begin{aligned} \mathcal{F}(q, v^-) &\in V(q), \\ \mathcal{F}(q, v^-) - v^- &\in -N(q). \end{aligned} \tag{1.11}$$

Moreover, we add the assumption that the kinetic energy of the system can not increase during an impact:

$$\forall q \in A, \quad \forall v^- \in -V(q), \quad \|\mathcal{F}(q, v^-)\|_q \leq \|v^-\|_q. \tag{1.12}$$

Let us comment on hypothesis IV. When two solids hit, their bouncing is actually governed by the propagation of deformation waves in each the two solids. But, from the very beginning, we have adopted the simple framework in which each solid is supposed to be rigid, that is, for sake of simplicity, we have chosen to do not take under consideration any phenomena relying on the deformation of the solids. Thus, we cannot expect the theory to be able to predict the outcome of an impact experiment. The aim of constitutive hypothesis IV is to introduce in the theory the missing information. Of course, in practical situations, we have to identify the unknown mapping \mathcal{F} . This can be done either by means of experiments or by use of a refined theory. For example, the theory of elastodynamics could be used to predict the outcome of an impact in every impact configuration. The result would be an identification of the mapping \mathcal{F} . In any case, there is a very big amount of work to get a precise identification of \mathcal{F} . This is the price we have to pay to describe sophisticated physical phenomena in a very simple framework. Actually, this issue is faced in any mechanical theory (one could think of the theory of elasticity). Naturally, in each mechanical theory, the question arises to know what amount of lacking constitutive information should be introduced. Most of the time, well-posedness of the resulting evolution problem serves as a guideline to state the constitutive hypotheses.

Definition 9 Equation (1.10), with mapping \mathcal{F} fulfilling both requirements (1.11) and (1.12) is called the impact constitutive equation. An impact constitutive equation which ensures the conservation of kinetic energy during an impact:

$$\forall q \in A, \quad \forall v^- \in -V(q), \quad \|\mathcal{F}(q, v^-)\|_q = \|v^-\|_q,$$

is called elastic.

There always exist many mappings \mathcal{F} satisfying requirements (1.11) and (1.12).

Example 5. Let $e : TQ \rightarrow [0, 1]$ be an arbitrary function. The mapping \mathcal{F} defined by:

$$\mathcal{F}(q, v^-) = \text{Proj}_q [v^-; V(q)] - e(q, v^-) \text{Proj}_q [v^-; N(q)], \quad (1.13)$$

is easily seen to satisfy requirements (1.11) and (1.12). The associated impact constitutive equation is often called the *canonical* impact constitutive equation. It is elastic if and only if $e \equiv 1$. The function e is classically called the *restitution coefficient*.

The reason why the canonical impact constitutive equation is distinguished is that in situations where only simple impact can occur (for example, if the unilateral constraint is represented by a single function φ_1), then the impact constitutive equation must be the canonical one (it is a simple consequence of requirements (1.11) and (1.12)). However, in case of multiple impacts, the canonical impact constitutive equation has no specific physical relevance. A simple occurrence of multiple impact is provided by Newton's cradle. The principle of the experiment is sketched on Figure 1.2.a. Its outcome is sketched on Figure 1.2.b. It should be compared with the prediction of the canonical elastic impact constitutive equation which is sketched on Figure 1.2.c.

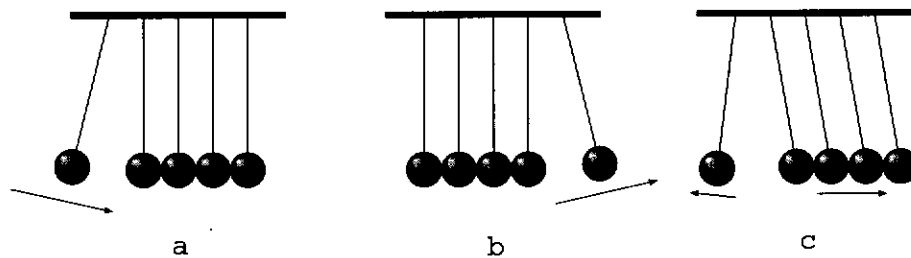

Figure 1.2. Newton's cradle.

The following proposition is a straightforward and useful consequence of requirements (1.11) and (1.12).

Proposition 10 *Let \mathcal{F} be a constitutive mapping satisfying requirements (1.11) and (1.12). Then, we have:*

$$\forall q \in A, \quad \forall v^- \in V(q) \cap (-V(q)), \quad \mathcal{F}(q, v^-) = v^-.$$

Unilater

Proof.
 $N(q)$.

that is,

The use
result.

We c
glance,
that if i
problem

Counte
system
of Riem
 $f(q, \dot{q}; t$
constrai
impact o
coefficie
system i
subjecte
 $t_0 = 0$
function

$\forall t \in [0$
 $\forall t \in [1$
 $\forall t \in [3$
 $\forall t \in [3$

$(n \in \mathbb{N})$

- th
- th
- th

This mo
infinite
proved th
compact

Proof. Define $v^+ = \mathcal{F}(q, v^-)$. By requirement (1.11), we have $v^- - v^+ \in N(q)$. Since $v^- \in V(q) \cap (-V(q))$, we obtain:

$$(v^- - v^+, v^-)_q = 0,$$

that is,

$$(v^+, v^-)_q = \|v^-\|_q^2.$$

The use of Cauchy-Schwarz inequality and requirement (1.12) gives the desired result. \square

We conclude this section by a comment on requirement (1.12). At first glance, it could seem to be unnecessary. The following counter-example proves that if it was omitted, then, uniqueness of solution for the resulting evolution problem would surely not hold.

Counter-example 6. Consider the one degree of freedom discrete mechanical system whose configuration space is \mathbb{R} equipped with its canonical structure of Riemannian manifold. The forces mapping is supposed to be constant: $f(q, \dot{q}; t) \equiv 2$. To this simple discrete mechanical system, we add the unilateral constraint described by the single function $\varphi_1(q) = q$. Thus, $A = \mathbb{R}^-$. The impact constitutive equation is given by formula (1.13) where the restitution coefficient is supposed to be the constant $1/2$: $e(q, \dot{q}^-) \equiv 1/2$. This mechanical system is a formal description of the physical occurrence of a single particle subjected to gravity and bouncing on the floor. Consider the initial instant $t_0 = 0$ and the initial state $(q_0, v_0) = (-1, 0)$. It is readily seen that the function $q : \mathbb{R}^+ \rightarrow \mathbb{R}^-$ defined by:

$$\begin{aligned} \forall t \in [0, 1], & \quad q(t) = t^2 - 1, \\ \forall t \in [1, 2], & \quad q(t) = t^2 - 3t + 2, \\ \forall t \in [3 - \frac{1}{2^{n-1}}, 3 - \frac{1}{2^n}], & \quad q(t) = t^2 - (6 - \frac{3}{2^n})t + (3 - \frac{1}{2^{n-1}})(3 - \frac{1}{2^n}), \\ \forall t \in [3, +\infty[, & \quad q(t) = 0, \end{aligned}$$

($n \in \mathbb{N}$) belongs to $MMA(\mathbb{R}^+; \mathbb{R}^-)$ and satisfies:

- the initial condition,
- the equation of motion (1.9) (with $f(q, \dot{q}; t) \equiv 2$),
- the impact constitutive equation (1.13) (with $e(q, \dot{q}) \equiv 1/2$).

This motion is pictured on Figure 1.3. Note, by the way, that it exhibits an infinite number of impacts on a compact time subinterval. It could easily be proved that no motion, defined on $[0, \infty[$, with finite number of impact on every compact interval can exist.

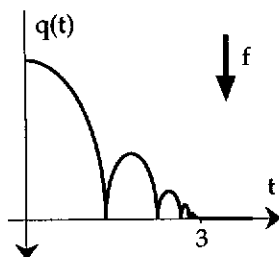

Figure 1.3. Motion of a punctual particle subjected to gravity and bouncing on the floor.

Now, we are going to analyse what happens when the flow of time is reversed. Define q' by:

$$q' \begin{cases} [0, 4] & \rightarrow \mathbb{R}^- \\ t & \mapsto q(4 - t) \end{cases}$$

Considering the initial state $(q_0, v_0) = (0, 0)$ at $t_0 = 0$, it is easily seen that q' satisfies:

- that initial condition,
- the equation of motion (1.9) (with $f(q, \dot{q}; t) \equiv 2$),
- the impact constitutive equation (1.13) (with $e(q, \dot{q}) \equiv 2$).

But, $q'' \equiv 0$ is also seen to satisfy the same initial condition, equation of motion and impact constitutive equation. This example demonstrates that we cannot expect uniqueness of solution when adopting the canonical impact constitutive equation (1.13) with restitution coefficient $e \equiv 2$ (or any real number strictly greater than 1). But the canonical impact constitutive equation with restitution coefficient strictly greater than 1 violates requirement (1.12).

3.2.3 The evolution problem. Now, we formulate the evolution problem associated with the dynamics of rigid bodies systems with perfect bilateral and unilateral constraints. The initial condition is assumed to be compatible with the realization of the constraint: $v_0 \in V(q_0)$.

Problem III. Find $T > t_0$ and $q \in MMA([t_0, T[; Q)$ such that:

- $(q(t_0), \dot{q}^+(t_0)) = (q_0, v_0)$,
- $\forall t \in [t_0, T[, \quad q(t) \in A$,
- $R \stackrel{\text{def}}{=} } bD\dot{q}^+ - f(q(t), \dot{q}^+(t); t) dt \in -N^*(q(t))$,
- $\forall t \in]t_0, T[, \quad \dot{q}^+(t) = \mathcal{F}(q(t), \dot{q}^-(t))$.

Unilater

The equ
constitu

Yet, r
be done
Howeve
of class
any) of

Proposi
lem III.

$\forall t_1, t_2$

$$\frac{1}{2} \|\dot{q}^+(t)$$

Proof.

$$\left(\frac{\dot{q}^+}{\dot{q}^+} \right)$$

$$\left\langle \frac{\dot{q}^+}{\dot{q}^+} \right\rangle$$

Integrati

$$\frac{1}{2} \|\dot{q}^+$$

$$\int_{]t_1, t_2[} \langle \dot{q}^+ \rangle$$

Consider

D is (at

$$\frac{1}{2} \|\dot{q}^+$$

Therefor

The equation of motion is understood in sense of convention (1.8) and the impact constitutive equation is supposed to fulfill requirements (1.11) and (1.12).

Yet, no regularity assumption has been made on the mapping f . This will be done in the next section where well-posedness of problem III is studied. However, we can infer from Section 1.1.3 that f will be assumed to be at least of class C^1 . We can state an elementary property of any solution (if there are any) of problem III.

Proposition 11 (Energy inequality) *Let (T, q) be an arbitrary solution of problem III. Then, it satisfies:*

$$\forall t_1, t_2 \in [t_0, T[, \quad t_1 \leq t_2, \quad K(q(t_2), \dot{q}^+(t_2)) - K(q(t_1), \dot{q}^+(t_1)) = \frac{1}{2} \|\dot{q}^+(t_2)\|_{q(t_2)}^2 - \frac{1}{2} \|\dot{q}^+(t_1)\|_{q(t_1)}^2 \leq \int_{t_1}^{t_2} \langle f(q(s), \dot{q}^+(s); s), \dot{q}^+(s) \rangle_{q(s)} ds$$

Proof. We have the following equality between real measures:

$$\left(\frac{\dot{q}^+(t) + \dot{q}^-(t)}{2}, D\dot{q}^+ \right)_{q(t)} = \left\langle \frac{\dot{q}^+(t) + \dot{q}^-(t)}{2}, f(q(t), \dot{q}^+(t); t) \right\rangle_{q(t)} dt + \left\langle \frac{\dot{q}^+(t) + \dot{q}^-(t)}{2}, R \right\rangle_{q(t)}.$$

Integrating over $]t_1, t_2]$ and using proposition 41 of Appendix A, we get:

$$\frac{1}{2} \|\dot{q}^+(t_2)\|_{q(t_2)}^2 - \frac{1}{2} \|\dot{q}^+(t_1)\|_{q(t_1)}^2 = \int_{]t_1, t_2]} \left\langle \frac{\dot{q}^+(t) + \dot{q}^-(t)}{2}, f(q(t), \dot{q}^+(t); t) \right\rangle_{q(t)} dt + \int_{]t_1, t_2]} \left\langle \frac{\dot{q}^+ + \dot{q}^-}{2}, R \right\rangle_q.$$

Consider

$$D = \left\{ t \in]t_1, t_2]; \frac{\dot{q}^+(t) + \dot{q}^-(t)}{2} \neq \dot{q}^+(t) \right\}.$$

D is (at most) countable and therefore Lebesgue-negligible. We obtain:

$$\frac{1}{2} \|\dot{q}^+(t_2)\|_{q(t_2)}^2 - \frac{1}{2} \|\dot{q}^+(t_1)\|_{q(t_1)}^2 = \int_{t_1}^{t_2} \langle \dot{q}^+(t), f(q(t), \dot{q}^+(t); t) \rangle_{q(t)} dt + \int_{]t_1, t_2]} \left\langle \frac{\dot{q}^+ + \dot{q}^-}{2}, R \right\rangle_q.$$

Therefore, to prove proposition 11, there remains only to prove:

$$\int_{]t_1, t_2]} \left\langle \frac{\dot{q}^+ + \dot{q}^-}{2}, R \right\rangle_q \leq 0. \tag{1.14}$$

But, on one hand,

$$\int_{]t_1, t_2] \setminus D} \left\langle \frac{\dot{q}^+ + \dot{q}^-}{2}, R \right\rangle_q = \int_{]t_1, t_2] \setminus D} \langle \dot{q}^+, R \rangle_q = \int_{]t_1, t_2] \setminus D} \langle \dot{q}^-, R \rangle_q,$$

where the second integral is nonnegative by convention (1.8) whereas the third integral is nonpositive. As a consequence:

$$\int_{]t_1, t_2] \setminus D} \left\langle \frac{\dot{q}^+ + \dot{q}^-}{2}, R \right\rangle_q = 0. \tag{1.15}$$

On the other hand,

$$\begin{aligned} \int_D \left\langle \frac{\dot{q}^+(t) + \dot{q}^-(t)}{2}, R \right\rangle_{q(t)} &= \int_D \left(\frac{\dot{q}^+(t) + \dot{q}^-(t)}{2}, D\dot{q}^+ \right)_{q(t)}, \\ &= \frac{1}{2} \sum_{t \in D} \left(\|\dot{q}^+(t)\|_{q(t)}^2 - \|\dot{q}^-(t)\|_{q(t)}^2 \right), \\ &\leq 0, \end{aligned} \tag{1.16}$$

by virtue of formula (1.12). Bringing together formulae (1.15) and (1.16), we get inequality (1.14). \square

3.3 Well-posedness of the dynamics

To study the well-posedness of problem III, we need to state regularity assumptions on the data. Looking at those of Section 2.2.3, we could expect to be able to prove well-posedness of problem III under the assumption that the functions φ_i and the mapping f are of class C^2 and C^1 respectively. The following counter-example originally due to BRESSAN (1960) and SCHATZMAN (1978) shows that uniqueness does not hold in general even if the data are supposed to be of class C^∞ .

Counter-example 7. Consider a simple discrete mechanical system whose configuration space is \mathbb{R} equipped with its canonical structure of Riemannian manifold. This is the configuration space of a particle with unit mass constrained to move along a line. A fixed obstacle at the origin is taken into consideration. It gives rise to a unilateral constraint described by the single function:

$$\varphi_1(q) = q$$

Therefore, the admissible configuration set is $A = \mathbb{R}^-$. The impact constitutive equation is supposed to be elastic. Here, the geometry is so poor that this statement determines completely the impact constitutive equation. It is necessarily the canonical one with restitution coefficient $e \equiv 1$. The forces mapping f is

Unilatera

supposed
 $f(t)$. Th
correspo
find $T >$

Here $d\dot{q}$
tion with
assumpti

Then, it i
problem,
construct
ated evol
vanishing
First, c

where C

Define:

supposed not to depend on the state but only on time. It will be denoted by $f(t)$. The initial instant is $t_0 = 0$ and the initial state is $(q_0, v_0) = (0, 0)$. The corresponding problem III admits here the simple formulation: find $T > 0$ and $q \in MMA([0, T[; \mathbb{R})$ such that:

- $(q(0), \dot{q}^+(0)) = (0, 0)$,
- $\forall t \in [0, T[, \quad q(t) \leq 0$,
- $R \stackrel{\text{def}}{=} d\dot{q}^+ - f(t) dt$ is a nonpositive real measure such that:
 $\text{Supp } R \subset \{t \in [0, T[; q(t) = 0\}$,
- $\forall t \in]0, T[, \quad \begin{cases} q(t) \neq 0 & \Rightarrow \dot{q}^+(t) = \dot{q}^-(t) \\ q(t) = 0 & \Rightarrow \dot{q}^+(t) = -\dot{q}^-(t) \end{cases}$

Here $d\dot{q}^+$ is merely the classical Stieltjes measure associated with the function with locally bounded variation \dot{q}^+ . We investigate uniqueness under the assumption that f is of class C^∞ and nonnegative:

$$\forall t \in \mathbb{R}^+, \quad f(t) \geq 0.$$

Then, it is readily seen that the null function $\tilde{q} \equiv 0$ on \mathbb{R}^+ is a solution of that problem, whatever is the nonnegative C^∞ function f . Now, we are going to construct an explicit example of such a function f in such a way that the associated evolution problem III admits another solution, distinct from the identically vanishing one.

First, define a Massin function ρ by:

$$\rho \begin{cases} \mathbb{R} & \rightarrow & \mathbb{R} \\ x & \mapsto & \begin{cases} 0 & \text{if } x \in]-\infty, 0] \cup [1, +\infty[\\ C e^{\frac{1}{x(x-1)}} & \text{if } x \in]0, 1[\end{cases} \end{cases}$$

where C is a real constant which is chosen to get:

$$\int_{-\infty}^{+\infty} \rho(x) dx = 1.$$

Define:

$$T = \sum_{n=0}^{\infty} \frac{(n+5)^2}{(n+1)(n+2)(n+3)(n+4)},$$

and, for every $n \in \mathbb{N}$,

$$\begin{aligned} a_n &= \sum_{i=n}^{\infty} \frac{(i+5)^2}{(i+1)(i+2)(i+3)(i+4)}, \\ \delta_n &= \frac{n+5}{(n+1)(n+2)(n+4)} \quad \left(\text{i.e. } \delta_n = \frac{n+3}{n+5} (a_n - a_{n+1}) \right), \\ f_n &= \frac{1}{n!}, \\ v_n &= -\frac{1}{(n+3)!}. \end{aligned}$$

Now, the functions $f(t)$ and $v(t)$, from $[0, T[$ to \mathbb{R} , are defined by:

$$f(t) = \begin{cases} 0, & \text{if } t \in [a_{n+1}, a_{n+1} + \delta_n[\\ \frac{f_n}{2} \rho \left(\frac{t - a_{n+1} - \delta_n}{a_n - a_{n+1} - \delta_n} \right), & \text{if } t \in [a_{n+1} + \delta_n, a_n[\end{cases}$$

and:

$$v(t) = \begin{cases} v_{n+1}, & \text{if } t \in [a_{n+1}, a_{n+1} + \delta_n[\\ v_{n+1} + \frac{f_n}{2} \int_{a_{n+1} + \delta_n}^t \rho \left(\frac{s - a_{n+1} - \delta_n}{a_n - a_{n+1} - \delta_n} \right) ds, & \text{if } t \in [a_{n+1} + \delta_n, a_n[\end{cases}$$

Finally the function $q : [0, T[\rightarrow \mathbb{R}$ is defined by:

$$q(t) = \int_0^t v(s) ds.$$

The graph of the functions $f(t)$ and $q(t)$ is sketched on Figure 1.4. The reader will easily check that:

- $f(t)$ is a C^∞ nonnegative function on $[0, T[$,
- (T, q) is a solution of the considered evolution problem,
- the only instants at which $q(t) = 0$ are 0 and the a_n .

Therefore, q and \tilde{q} provide two solutions of the evolution problem. These two solutions do not coincide on any open subinterval of $[0, T[$. Therefore, uniqueness of solution for problem III cannot be asserted, even in the case

Unilateral

where the
the first to
then unique
one-degree
general co
mention to
the case v
MONTEI

Regular
tions φ_i

The p
An earlie

Proposit
analytic
that:

where the data are supposed to be of class C^∞ . PERCIVALE (1985, 1991) was the first to notice that, in the above example, if $f(t)$ is supposed to be *analytic*, then uniqueness of solution does hold. Recently, a complete discussion of the one-degree-of freedom problem was obtained by SCHATZMAN (1998). The general case is treated in BALLARD (2000) and is now recalled. Let us just mention that prior existence results had been obtained, but they were limited to the case where the unilateral constraint is represented by a single function (see MONTEIRO MARQUES (1993) and SCHATZMAN (1978)).

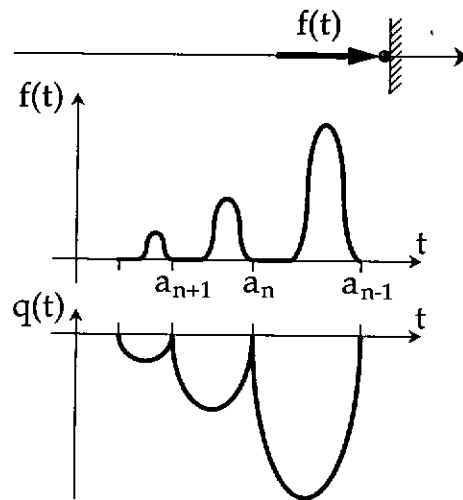

Figure 1.4. Bressan-Schatzman counterexample.

Regularity hypothesis V. The Riemannian configuration manifold, the functions φ_i and the mapping $f : TQ \times \mathbb{R} \rightarrow T^*Q$ are analytic.

The proof of the following proposition can be found in BALLARD (2000). An earlier proof can also be found in LÖTSTEDT (1982).

Proposition 12 Let $q_0 \in A$ and $v_0 \in V(q_0)$. Then, there exist $T_a > t_0$, an analytic curve $q_a : [t_0, T_a[\rightarrow Q$ and n analytic functions $\lambda_{ai} : [t_0, T_a[\rightarrow \mathbb{R}$ such that:

- $(q_a(0), \dot{q}_a^+(0)) = (q_0, v_0)$,
- $\forall t \in [t_0, T_a[$, $\frac{D}{dt} \dot{q}_a(t) = f(q_a(t), \dot{q}_a(t); t) + \sum_{i=1}^n \lambda_{ai}(t) d\varphi_i(q_a(t))$,
- $\forall t \in [t_0, T_a[$,
 $\forall i = 1, 2, \dots, n$, $\lambda_{ai}(t) \leq 0$, $\varphi_i(q_a(t)) \leq 0$, $\lambda_{ai}(t) \varphi_i(q_a(t)) = 0$.

Moreover, the solution of this evolution problem is unique in the sense that any other analytic solution $(T, q, \lambda_1, \dots, \lambda_n)$ is either a restriction or analytic extension of $(T_a, q_a, \lambda_{a1}, \dots, \lambda_{an})$.

Corollary 13 *There exists an analytic solution (T_a, q_a) for problem III.*

Proof. Consider the motion q_a furnished by proposition 12. It obviously satisfies the initial condition, the unilateral constraint and the equation of motion. The only thing which remains to prove is that it satisfies the impact constitutive equation. Since q_a is analytic and satisfies the unilateral constraint, we have:

$$\forall t \in]t_0, T_a[, \quad \dot{q}_a^-(t) = \dot{q}_a^+(t) \in V(q_a(t)) \cap (-V(q_a(t))),$$

and therefore,

$$\forall t \in]t_0, T_a[, \quad \dot{q}_a^+(t) = \dot{q}_a^-(t) = \mathcal{F}(q_a(t), \dot{q}_a^-(t)),$$

by proposition 10. □

Naturally, the analytic solution furnished by corollary 13 will cease to exist at the first instant of impact. This is the reason why we have considered the wider class *MMA* which contains motions which are not differentiable in the classical sense. Considering motions in *MMA* will allow to extend the solution beyond the first instant of impact. But, it must be made sure that admitting the wider class of solutions *MMA* will not introduce parasitic solutions. This is the aim of the following theorem.

Theorem 14 *Let (T_a, q_a) be the solution for problem III furnished by corollary 13, and (T, q) be an arbitrary solution for problem III. Then, there exists a real number T_0 ($t_0 < T_0 \leq \min\{T_a, T\}$) such that:*

$$q|_{[t_0, T_0[} \equiv q_a|_{[t_0, T_0[}.$$

In other terms, there is local uniqueness for problem III.

The proof of theorem 14 makes extensive use of the following corollary of Gronwall-Bellman lemma (lemma 4).

Unilatero

Lemma

function.

$\phi(t) = 0$
 real con

for a

then,

Proof.

t^{m+2} , w

After int

$\forall t$

Then, an

Proof of

Step 1.

We de

chart $\psi :$

$\psi(q)$ are

independ

small to

Such a cl

the funct

in the nat

and q are

Lemma 15 Let m be a nonnegative integer, and $\psi : [0, T] \rightarrow \mathbb{R}$ an integrable function. If $\phi : [0, T] \rightarrow \mathbb{R}$ is any absolutely continuous function such that $\phi(t) = o(t^{m+1})$ when t tends towards 0 and such that there exists a nonnegative real constant C such that:

$$\text{for almost all } t \in]0, T[, \quad t \frac{d}{dt} \phi(t) \leq (1 + m + Ct) \phi(t) + t^{m+2} \psi(t),$$

then,

$$\forall t \in [0, T], \quad \phi(t) \leq t^{m+1} e^{Ct} \int_0^t \psi(s) e^{-Cs} ds.$$

Proof. This is almost obvious. Dividing each member of the inequality by t^{m+2} , we obtain:

$$\text{for almost all } t \in]0, T[, \quad \frac{d}{dt} \left(\frac{\phi(t)}{t^{m+1}} \right) \leq C \frac{\phi(t)}{t^{m+1}} + \psi(t).$$

After integration, Gronwall-Bellman lemma yields:

$$\forall t \in]0, T[, \quad \frac{\phi(t)}{t^{m+1}} \leq \int_0^t \psi(s) ds + \int_0^t C e^{C(t-s)} \int_0^s \psi(\sigma) d\sigma ds.$$

Then, an integration by part gives the desired conclusion. □

Proof of theorem 14.

Step 1. Parametrization of the problem and notations.

We denote by $d_0 \leq d$ the number of elements of $J(q_0)$. Consider a local chart $\psi : U \subset Q \rightarrow \mathbb{R}^d$ on Q centered at q_0 such that the d_0 first components of $\psi(q)$ are $(\varphi_i(q))_{i \in J(q_0)}$. Such a chart exists since $(d\varphi_i(q_0))_{i \in J(q_0)}$ is linearly independent in $T_{q_0}^* Q$ by regularity hypothesis I. Next, choose $\alpha > 0$, sufficiently small to have, for all $t \in [t_0, t_0 + \alpha]$,

- $q_a(t) \in U, \quad q(t) \in U,$
- $\forall i \in J(q_0), \quad \frac{d}{dt} \varphi_i(q_a(t)) = \langle d\varphi_i(q_a(t)), \dot{q}_a(t) \rangle_{q_a(t)} \leq 0, \quad (1.17)$
- $\forall i \in \{1, 2, \dots, n\} \setminus J(q_0), \quad \varphi_i(q_a(t)) < 0, \quad \varphi_i(q(t)) < 0. \quad (1.18)$

Such a choice for α is possible because the functions $\varphi_i(q_a(t))$ are analytic and the functions $\varphi_i(q(t))$ are continuous. We denote by f_i the components of f in the natural basis (e^i) associated with the chart under consideration. Since q_a and q are local solutions for problem III, we have, for all $i \in \{1, 2, \dots, n\}$,

$$g_{ij}(q_a) \left(\ddot{q}_a^j + \Gamma_{kl}^j(q_a) \dot{q}_a^k \dot{q}_a^l \right) = f_i(q_a, \dot{q}_a; t) + \lambda_{ai}, \quad (1.19)$$

$$g_{ij}(q) \left(d\dot{q}^{+j} + \Gamma_{kl}^j(q) \dot{q}^{+k} \dot{q}^{+l} dt \right) = f_i(q, \dot{q}^+; t) dt + \mu_i, \quad (1.20)$$

where the λ_{ai} and μ_i are respectively d nonpositive analytic functions on $[t_0, t_0 + \alpha]$ and d nonpositive measures on $[t_0, t_0 + \alpha]$. Note incidentally that the λ_{ai} and μ_i vanish identically for $i > d_0$, by (1.18). We denote by $|\cdot|$ the standard euclidean norm on \mathbb{R}^d . Confusing (abusively) q and $\psi(q)$, we shall write:

$$|q|^2 = \sum_{i=1}^d (q^i)^2, \quad \text{and} \quad |\dot{q}^+|^2 = \sum_{i=1}^d (\dot{q}^{+i})^2.$$

Step 2. *There exist some positive real constants C_1 and C_2 such that the following estimate:*

$$\int_{t_0}^t \left(|q - q_a|^2(s) + |\dot{q}^+ - \dot{q}_a^+|^2(s) \right) ds \leq -C_1 \int_{t_0}^t e^{C_2(t-s)} \int_{t_0}^s \sum_{i=1}^{d_0} \lambda_{ai}(\sigma) \dot{q}^{+i}(\sigma) d\sigma ds. \quad (1.21)$$

holds for all $t \in [t_0, t_0 + \alpha]$.

By proposition 41 of Appendix A, we have:

$$d \left(\frac{1}{2} (\dot{q}^{+i} - \dot{q}_a^+)^i g_{ij}(q) (\dot{q}^{+j} - \dot{q}_a^+)^j \right) = \left(\frac{\dot{q}^{-i} + \dot{q}^{+i}}{2} - \dot{q}_a^+ \right) g_{ij}(q) \left(d\dot{q}^{+j} - \ddot{q}_a^+ dt + \Gamma_{kl}^j(q) \dot{q}^{+k} (\dot{q}^{+l} - \dot{q}_a^+)^l dt \right),$$

and, therefore, using equation of motion (1.20),

$$d \left(\frac{1}{2} (\dot{q}^{+i} - \dot{q}_a^+)^i g_{ij}(q) (\dot{q}^{+j} - \dot{q}_a^+)^j \right) = (\dot{q}^{+i} - \dot{q}_a^+)^i f_i(q, \dot{q}^+; t) dt - (\dot{q}^{+i} - \dot{q}_a^+)^i g_{ij}(q) \left(\ddot{q}_a^+ + \Gamma_{kl}^j(q) \dot{q}^{+k} \dot{q}_a^+ \right) dt + \sum_{k=1}^{d_0} \left(\frac{\dot{q}^{-k} + \dot{q}^{+k}}{2} - \dot{q}_a^+ \right) \mu_k.$$

But, each $\dot{q}_a^+ \mu_k$ is a nonnegative measure by (1.17), and,

$$\sum_{k=1}^{d_0} \frac{\dot{q}^{-k} + \dot{q}^{+k}}{2} \mu_k = \left\langle \frac{\dot{q}^- + \dot{q}^+}{2}, R \right\rangle_q$$

is a nonpositive real measure by proposition 11. Therefore,

$$d \left(\frac{1}{2} (\dot{q}^{+i} - \dot{q}_a^+)^i g_{ij}(q) (\dot{q}^{+j} - \dot{q}_a^+)^j \right) \leq \left[(\dot{q}^{+i} - \dot{q}_a^+)^i f_i(q, \dot{q}^+; t) - (\dot{q}^{+i} - \dot{q}_a^+)^i g_{ij}(q) \left(\ddot{q}_a^+ + \Gamma_{kl}^j(q) \dot{q}^{+k} \dot{q}_a^+ \right) \right] dt,$$

Unilatera

in the sen
we get:

$$\frac{1}{2} (\dot{q}^+ - \dot{q}_a^+)^2$$

The term
 \dot{q}^+ and s
 $\dot{q}^+ - \dot{q}_a^+$

But, each

where th
constant

$$|G_i(q)$$

Hence, v

$$\frac{1}{2} (\dot{q}^+ - \dot{q}_a^+)^2$$

Moreove
that for a

We obtai

$$|\dot{q}^+ - \dot{q}_a^+|^2$$

in the sense of ordering of real measures. Integrating over $]t_0, t[$ ($t \in [t_0, t_0 + \alpha]$), we get:

$$\frac{1}{2} (\dot{q}^{+i} - \dot{q}_a^i) g_{ij}(q) (\dot{q}^{+j} - \dot{q}_a^j) \leq \int_{t_0}^t \left[(\dot{q}^{+i} - \dot{q}_a^i) f_i(q, \dot{q}^+; s) - (\dot{q}^{+i} - \dot{q}_a^i) g_{ij}(q) \left(\ddot{q}_a^j + \Gamma_{kl}^j(q) \dot{q}^{+k} \dot{q}_a^l \right) \right] ds.$$

The term within the integral sign is an analytic function of the three variables q , \dot{q}^+ and s . Therefore, it is also an analytic function of the three variables $q - q_a$, $\dot{q}^+ - \dot{q}_a$ and s . It is written under the form:

$$(\dot{q}^{+i} - \dot{q}_a^i) F_i(q - q_a, \dot{q}^+ - \dot{q}_a; s).$$

But, each function F_i can be decomposed under the form:

$$F_i(q - q_a, \dot{q}^+ - \dot{q}_a; s) = F_i(0, 0; s) + G_i(q - q_a, \dot{q}^+ - \dot{q}_a; s),$$

where the G_i are analytic and $G_i(0, 0; s) \equiv 0$. Hence, there exists a positive constant M such that, for all $t \in [t_0, t_0 + \alpha]$,

$$|G_i(q(s) - q_a(s), \dot{q}^+(s) - \dot{q}_a(s); s)| \leq M \sqrt{|q(s) - q_a(s)|^2 + |\dot{q}^+(s) - \dot{q}_a(s)|^2}$$

Hence, we have proved:

$$\begin{aligned} \frac{1}{2} (\dot{q}^{+i} - \dot{q}_a^i) g_{ij}(q) (\dot{q}^{+j} - \dot{q}_a^j) \leq & \int_{t_0}^t \left\{ (\dot{q}^{+i} - \dot{q}_a^i) \left[f_i(q_a, \dot{q}_a; s) - g_{ij}(q_a) \left(\ddot{q}_a^j + \Gamma_{kl}^j(q_a) \dot{q}_a^k \dot{q}_a^l \right) \right] \right. \\ & \left. + Md |\dot{q}^+ - \dot{q}_a| \sqrt{|q - q_a|^2 + |\dot{q}^+ - \dot{q}_a|^2} \right\} ds. \end{aligned}$$

Moreover, by a compactness argument, there exists a positive constant m such that for all $t \in [t_0, t_0 + \alpha]$,

$$\frac{1}{2} (\dot{q}^{+i} - \dot{q}_a^i) g_{ij}(q) (\dot{q}^{+j} - \dot{q}_a^j) \geq m |\dot{q}^+ - \dot{q}_a|^2.$$

We obtain :

$$\begin{aligned} |\dot{q}^+ - \dot{q}_a|^2(t) \leq & \frac{Md}{m} \int_{t_0}^t \left(|q - q_a|^2(s) + |\dot{q}^+ - \dot{q}_a|^2(s) \right) ds \\ & - \frac{1}{m} \int_{t_0}^t \sum_{i=1}^{d_0} \lambda_{ai}(s) (\dot{q}^{+i} - \dot{q}_a^i) ds, \end{aligned}$$

where equation of motion (1.19) has been used. Note that, actually:

$$\forall i \in \{1, 2, \dots, d_0\}, \quad \lambda_{ai} \dot{q}_a^i \equiv 0,$$

and, so, by the analyticity of functions q_a^i and λ_{ai} :

$$\forall i \in \{1, 2, \dots, d_0\}, \quad \lambda_{ai} \dot{q}_a^i \equiv 0.$$

By use of Cauchy-Schwarz inequality, we get:

$$\begin{aligned} & |q - q_a|^2(t) + |\dot{q}^+ - \dot{q}_a|^2(t) \leq \\ & \left(\frac{Md}{m} + \alpha\right) \int_{t_0}^t \left(|q - q_a|^2(s) + |\dot{q}^+ - \dot{q}_a|^2(s)\right) ds - \frac{1}{m} \int_{t_0}^t \sum_{i=1}^{d_0} \lambda_{ai} \dot{q}^{+i} ds, \end{aligned}$$

Defining:

$$C_1 = \frac{1}{m}, \quad C_2 = \frac{Md}{m} + \alpha,$$

multiplying each term of the above inequality by $e^{-C_2 t}$ and integrating, we obtain estimate (1.21).

Step 3. Estimate (1.21) implies that the function $t \mapsto \sum_{i=1}^{d_0} \lambda_{ai}^i(t) \dot{q}^{+i}(t)$ vanishes identically on a right neighbourhood of t_0

Indeed, by estimate (1.21):

$$\forall t \in [t_0, t_0 + \alpha], \quad \int_{t_0}^t e^{-C_2 s} \int_{t_0}^s \sum_{i=1}^{d_0} \lambda_{ai}(\sigma) \dot{q}^{+i}(\sigma) d\sigma ds \leq 0,$$

which is, after integration by parts:

$$\int_{t_0}^t e^{-C_2 s} \sum_{i=1}^{d_0} \lambda_{ai}(s) q^i(s) ds \leq \int_{t_0}^t e^{-C_2 s} \int_{t_0}^s \sum_{i=1}^{d_0} q^i(\sigma) \dot{\lambda}_{ai}(\sigma) d\sigma ds. \quad (1.22)$$

But, since,

$$\forall i \in \{1, 2, \dots, d_0\}, \quad \forall s \in [t_0, t_0 + \alpha], \quad \lambda_{ai}(s) \leq 0 \text{ and } q^i(s) \leq 0,$$

the two members of inequality (1.22) are nonnegative and, therefore, the inequality is preserved when taking the absolute value of each member. We get:

$$\begin{aligned} \int_{t_0}^t e^{-C_2 s} \sum_{i=1}^{d_0} \lambda_{ai}(s) q^i(s) ds & \leq \int_{t_0}^t e^{-C_2 s} \int_{t_0}^s \sum_{i=1}^{d_0} |q^i(\sigma)| |\dot{\lambda}_{ai}(\sigma)| d\sigma ds, \\ & \leq \int_{t_0}^t \int_{t_0}^s e^{-C_2 \sigma} \sum_{i=1}^{d_0} |q^i(\sigma)| |\dot{\lambda}_{ai}(\sigma)| d\sigma ds. \end{aligned}$$

Define:

$$\begin{aligned} Q^i(s) &= -e^{-C_2(s+t_0)} q^i(s+t_0), \\ L^i(s) &= -\lambda_{ai}(s+t_0). \end{aligned}$$

With these notations, we obtain:

$$\forall t \in [0, \alpha], \quad \int_0^t \sum_{i=1}^{d_0} L^i(s) Q^i(s) ds \leq \int_0^t \int_0^s \sum_{i=1}^{d_0} |\dot{L}^i(s)| Q^i(s) d\sigma ds, \tag{1.23}$$

where the L^i are nonnegative real-analytic functions and the Q^i are nonnegative continuous functions which all vanish at $t = 0$ and are right-differentiable at $t = 0$. We are going to prove that inequality (1.23) implies that:

$$\exists \beta \in]0, \alpha], \quad \forall t \in [0, \beta], \quad \forall i \in \{1, 2, \dots, d_0\}, \quad L^i(t) Q^i(t) = 0.$$

The functions L^i being analytic nonnegative, there exist nonnegative integers $n_1 < n_2 < \dots < n_m$, a partition I_1, I_2, \dots, I_m of $\{1, 2, \dots, d_0\}$, and analytic nonnegative functions G^i such that:

$$\forall k \in \{1, 2, \dots, m\}, \quad \forall i \in I_k, \quad L^i(s) = s^{n_k} G^i(s),$$

with either $G^i(0) > 0$ or $G^i \equiv 0$. Inequality (1.23) may be rewritten as:

$$\begin{aligned} \int_0^t \sum_{k=1}^m \sum_{i \in I_k} \sigma^{n_k} G^i(\sigma) Q^i(\sigma) d\sigma &\leq \\ \int_0^t \int_0^s \sum_{k=1}^m \sum_{i \in I_k} n_k \sigma^{n_k-1} G^i(\sigma) Q^i(\sigma) d\sigma ds &+ \\ \int_0^t \int_0^s \sum_{k=1}^m \sum_{i \in I_k} \sigma^{n_k} |\dot{G}^i(\sigma)| Q^i(\sigma) d\sigma ds. \end{aligned}$$

But, by the analyticity of the functions G^i :

$$\exists \beta > 0, \quad \exists N > 0, \quad \forall i \in J(q_0), \quad \forall \sigma \in [0, \beta], \quad |\dot{G}^i(\sigma)| \leq N G^i(\sigma).$$

Therefore, for all $t \in [0, \beta]$,

$$\begin{aligned} \int_0^t \sum_{k=1}^m \sum_{i \in I_k} \sigma^{n_k} G^i(\sigma) Q^i(\sigma) d\sigma \leq \\ \int_0^t \int_0^s \sum_{k=1}^m \sum_{i \in I_k} n_k \sigma^{n_k-1} G^i(\sigma) Q^i(\sigma) d\sigma ds \\ + Nt \int_0^t \int_0^s \sum_{k=1}^m \sum_{i \in I_k} \sigma^{n_k-1} G^i(\sigma) Q^i(\sigma) d\sigma ds. \end{aligned}$$

Integrating by parts the left member of the inequality, we obtain:

$$\begin{aligned} t \int_0^t \sum_{k=1}^m \sum_{i \in I_k} \sigma^{n_k-1} G^i(\sigma) Q^i(\sigma) d\sigma \leq \\ \int_0^t \int_0^s \sum_{k=1}^m \sum_{i \in I_k} (n_k + 1) \sigma^{n_k-1} G^i(\sigma) Q^i(\sigma) d\sigma ds \\ + Nt \int_0^t \int_0^s \sum_{k=1}^m \sum_{i \in I_k} \sigma^{n_k-1} G^i(\sigma) Q^i(\sigma) d\sigma ds. \quad (1.24) \end{aligned}$$

Since each function $G^i(\sigma)Q^i(\sigma)/\sigma$ is bounded over $[0, \beta]$, there exists a nonnegative real constant H such that, for all $k \in \{1, 2, \dots, m\}$ and for all $t \in [0, \beta]$,

$$\int_0^t \int_0^s \sum_{i \in I_k} \sigma^{n_k-1} G^i(\sigma) Q^i(\sigma) d\sigma ds \leq Ht^{n_k+2}.$$

Since it can be assumed that $\beta < 1$, inequality (1.24) gives, for all $t \in [0, \beta]$,

$$\begin{aligned} t \int_0^t \sum_{i \in I_1} \sigma^{n_1-1} G^i(\sigma) Q^i(\sigma) d\sigma \leq \\ (1 + n_1 + Nt) \int_0^t \int_0^s \sum_{i \in I_1} \sigma^{n_1-1} G^i(\sigma) Q^i(\sigma) d\sigma ds + H_1 t^{n_2+2}, \end{aligned}$$

where H_1 is a non negative real constant. Applying lemma 15, we get:

$$\int_0^t \int_0^s \sum_{i \in I_1} \sigma^{n_1-1} G^i(\sigma) Q^i(\sigma) d\sigma ds = O(t^{n_2+2}).$$

Coming back to inequality (1.24), we get, for all $t \in [0, \beta]$,

$$t \int_0^t \sum_{k=1}^2 \sum_{i \in I_k} \sigma^{n_k-1} G^i(\sigma) Q^i(\sigma) d\sigma \leq (1 + n_2 + Nt) \int_0^t \int_0^s \sum_{k=1}^2 \sum_{i \in I_k} \sigma^{n_k-1} G^i(\sigma) Q^i(\sigma) d\sigma ds + H_2 t^{n_3+2}.$$

Applying once more lemma 15, we obtain:

$$\int_0^t \int_0^s \sum_{k=1}^2 \sum_{i \in I_k} \sigma^{n_k-1} G^i(\sigma) Q^i(\sigma) d\sigma ds = O(t^{n_3+2}).$$

Proceeding inductively, we obtain:

$$\int_0^t \int_0^s \sum_{k=1}^{m-1} \sum_{i \in I_k} \sigma^{n_k-1} G^i(\sigma) Q^i(\sigma) d\sigma ds = O(t^{n_m+2}).$$

But, by inequality (1.24), for all $t \in [0, \beta]$,

$$t \int_0^t \sum_{k=1}^m \sum_{i \in I_k} \sigma^{n_k-1} G^i(\sigma) Q^i(\sigma) d\sigma \leq (1 + n_m + Nt) \int_0^t \int_0^s \sum_{k=1}^m \sum_{i \in I_k} \sigma^{n_k-1} G^i(\sigma) Q^i(\sigma) d\sigma ds.$$

Using lemma 15 for the last time, we get:

$$\forall t \in [0, \beta], \int_0^t \int_0^s \sum_{k=1}^m \sum_{i \in I_k} \sigma^{n_k-1} G^i(\sigma) Q^i(\sigma) d\sigma ds = 0,$$

which implies:

$$\forall i \in \{1, 2, \dots, d_0\}, \quad \forall t \in [0, \beta], \quad G^i(t) Q^i(t) = 0,$$

which is nothing but:

$$\forall i \in \{1, 2, \dots, d_0\}, \quad \forall t \in [t_0, t_0 + \beta], \quad \lambda_{ai}(t) q^i(t) = 0.$$

But, the analyticity of the functions λ_{ai} implies:

$$\forall i \in \{1, 2, \dots, d_0\}, \quad \forall t \in [t_0, t_0 + \beta], \quad \lambda_{ai}(t) \dot{q}^i(t) = 0,$$

and the assertion of step 3 is proved.

Step 4. *Conclusion of the proof of local uniqueness.*

Bringing together the results of steps 2 and 3, we get:

$$\forall t \in [t_0, t_0 + \beta], \int_{t_0}^t (|q - q_a|^2(s) + |\dot{q}^+ - \dot{q}_a|^2(s)) ds \leq 0,$$

which yields the desired conclusion:

$$\forall t \in [t_0, t_0 + \beta], \quad q(t) = q_a(t).$$

□

Corollary 16 *There exists a unique maximal solution for problem III.*

It was noticed above that the analytical solution for problem III furnished by corollary 13 stops to exist at the first instant of impact. To overcome this fact, we have proved that local uniqueness still holds in the wider class of motion *MMA* which allows impacts. But, this does not guarantee that the maximal solution for problem III is not going to stop to exist at finite time for unphysical reasons. In other terms, we still do not know if the class *MMA* is wide enough. Actually, it is wide enough as shown by the following theorem which should be brought aside theorem 3.

Theorem 17 *The configuration manifold Q is assumed to be a complete Riemannian manifold and the mapping f is supposed to admit the following estimate:*

$$\forall (q, v) \in TQ, \quad \text{for almost all } t \in [t_0, +\infty[,$$

$$\|f(q, v; t)\|_q^* \leq l(t) (1 + d(q, q_0) + \|v\|_q),$$

where $d(\cdot, \cdot)$ is the Riemannian distance and $l(t)$, a (necessarily nonnegative) function of $L_{loc}^1(\mathbb{R}; \mathbb{R})$.

Then, the dynamics is eternal, that is, the maximal solution for problem III is defined on $[t_0, +\infty[$.

Proof. We proceed as for the proof of theorem 3. We assume that the maximal solution q is defined on $[t_0, T[$, with T finite and try to obtain a contradiction.

Step 1. *The function $t \mapsto \|\dot{q}^+(t)\|_{q(t)}$ is bounded over $[t_0, T[$:*

$$\exists V > 0, \quad \forall t \in [t_0, T[, \quad \|\dot{q}^+(t)\|_{q(t)} \leq V. \quad (1.25)$$

By proposition 11, we have:

$$\frac{1}{2} \|\dot{q}^+(t)\|_{q(t)}^2 \leq \frac{1}{2} \|v_0\|_{q_0}^2 + \int_{t_0}^t \|f(q(s), \dot{q}^+(s); s)\|_{q(s)}^* \|\dot{q}^+(s)\|_{q(s)} ds.$$

Unilateral

Applying

which yields

$$\|\dot{q}^+(t)$$

But,

therefore,

$$d(q(t), q_0)$$

$$\|v_0\|_{q_0}$$

By Gronw

$$d(q(t)$$

which yields

Step 2. *The*

By step

Since Q is

exists in T

be a local c

$(\varphi_i(q))_{i \in J}$

▪ $K \subset$

▪ $\forall q \in$

Applying lemma 5, we get:

$$\|\dot{q}^+(t)\|_{q(t)} \leq \|v_0\|_{q_0} + \int_{t_0}^t \|f(q(s), \dot{q}^+(s); s)\|_{q(s)}^* ds,$$

which yields, by virtue of the hypotheses of the theorem:

$$\|\dot{q}^+(t)\|_{q(t)} \leq \|v_0\|_{q_0} + \int_{t_0}^t l(s) \left(1 + d(q(s), q_0) + \|\dot{q}^+(s)\|_{q(s)}\right) ds.$$

But,

$$\forall t \in [t_0, T[, \quad d(q(t), q_0) \leq \int_{t_0}^t \|\dot{q}^+(s)\|_{q(s)} ds,$$

therefore,

$$\begin{aligned} d(q(t), q_0) + \|\dot{q}^+(t)\|_{q(t)} &\leq \\ &\|v_0\|_{q_0} + \int_0^t l(s) ds + \int_{t_0}^t (1 + l(s)) \left(d(q(s), q_0) + \|\dot{q}^+(s)\|_{q(s)}\right) ds. \end{aligned}$$

By Gronwall-Bellman lemma (lemma 4), we have, for all $t \in [t_0, T[$:

$$d(q(t), q_0) + \|\dot{q}^+(t)\|_{q(t)} \leq \left(\|v_0\|_{q_0} + \int_0^t l(s) ds\right) e^{\int_{t_0}^t (1+l(s)) ds},$$

which yields (1.25).

Step 2. The right velocity \dot{q}^+ has bounded variation over $[t_0, T[$:

$$\text{Var}(\dot{q}^+, [t_0, T[) < \infty. \tag{1.26}$$

By step 1, we have:

$$\forall s_1, s_2 \in [t_0, T[, \quad d(q(s_1), q(s_2)) \leq V |s_2 - s_1|.$$

Since Q is assumed to be complete, we deduce that:

$$q_T = \lim_{t \rightarrow T^-} q(t)$$

exists in TQ . We denote by d_T the number of elements of $J(q_T)$. Let (U, ψ) be a local chart on Q at q_T such that the d_T first components of $\psi(q)$ in \mathbb{R}^d are $(\varphi_i(q))_{i \in J(q_T)}$. Consider a compact neighbourhood K of q_T in Q such that:

- $K \subset U,$
- $\forall q \in K, \quad J(q) \subset J(q_T).$

Define:

$$t'_0 = \min \{t \in [t_0, T[; \forall s \in [t, T[, q(s) \in K\}.$$

Since $[t_0, t'_0]$ is compact, one has:

$$\text{Var}(\dot{q}^+; [t_0, t'_0]) < \infty,$$

therefore, it remains only to prove:

$$\text{Var}(\dot{q}^+;]t'_0, T]) < \infty.$$

Denote by λ^{\max} (resp. λ^{\min}) the maximum (resp. the minimum) of the greatest (resp. least) eigenvalue of the matrix $(g_{ij}(q))_{i,j=1,2,\dots,d}$ when q wanders in K . It is readily seen that:

$$\forall i \in \{1, 2, \dots, d\}, \quad \forall t \in [t'_0, T[, \quad \begin{aligned} |g_{ij}(q(t))\dot{q}^{+j}(t)| &\leq \sqrt{\lambda^{\max}}V, \\ |\dot{q}^{+i}(t)| &\leq \frac{V}{\sqrt{\lambda^{\min}}}. \end{aligned} \tag{1.27}$$

We denote by $B_q(0, V)$ the closed ball of T_qQ with radius V and centered at the origin. Considering the following compact subset K' of TQ :

$$K' = \bigcup_{q \in K} B_q(0, V),$$

we define the following nonnegative real constants:

$$F = \max_{\substack{(q,v;t) \in K' \times [t'_0, T], \\ i \in \{1, 2, \dots, d\}}} |f_i(q, v; t)|,$$

and:

$$G = \max_{\substack{i,j,k \in \{1, 2, \dots, d\}, \\ q \in K}} \left| \frac{\partial g_{ij}(q)}{\partial q^k} \right|.$$

Writing the equation of motion (1.9) in the local chart (U, ψ) , we obtain:

$$\forall i \in \{1, 2, \dots, d\}, \quad g_{ij}(q) \left(d\dot{q}^{+j} + \Gamma_{kl}^j(q)\dot{q}^{+k}\dot{q}^{+l} dt \right) = f_i(q, \dot{q}^+; t) dt + \lambda_i,$$

where the λ_i are d nonpositive real measures on $]t'_0; T[$. Expressing the Christoffel symbols in terms of the metric, we have:

$$g_{ij}(q)d\dot{q}^{+j} + \frac{\partial g_{ij}(q)}{\partial q^k}\dot{q}^{+j}\dot{q}^{+k}dt - \frac{1}{2}\frac{\partial g_{kl}(q)}{\partial q^i}\dot{q}^{+k}\dot{q}^{+l}dt = f_i(q, \dot{q}^+; t)dt + \lambda_i, \tag{1.28}$$

Unilatera

or, equiv

We dedu

\int_s

for all i
that the
is readily
Therefore
interval]
Step 3. (

By St

exists in

Take it as
and an ex
of proble

3.4

It is re
unique m
considera
side of in
 $t \in \mathbb{R}^+$, t
of q to $]t,$
is the foll

Proposit
lary 16. A
instant, s

or, equivalently,

$$d(g_{ij}(q)\dot{q}^{+j}) = \frac{1}{2} \frac{\partial g_{kl}(q)}{\partial q^i} \dot{q}^{+k} \dot{q}^{+l} dt + f_i(q, \dot{q}^+; t) dt + \lambda_i.$$

We deduce:

$$\begin{aligned} \int_{]s_1, s_2]} (-\lambda_i) &= g_{ij}(q(s_1))\dot{q}^{+j}(s_1) - g_{ij}(q(s_2))\dot{q}^{+j}(s_2) \\ &\quad + \int_{s_1}^{s_2} \left(f_i(q, \dot{q}^+; t) + \frac{1}{2} \frac{\partial g_{kl}(q)}{\partial q^i} \dot{q}^{+k} \dot{q}^{+l} \right) dt \\ &\leq 2\sqrt{\lambda^{\max} V} + \left(F + \frac{d^2 G V^2}{2\lambda^{\min}} \right) (s_2 - s_1), \end{aligned}$$

for all $i \in \{1, 2, \dots, d\}$ and all $s_1, s_2 \in]t'_0, T[$ with $s_1 < s_2$. There results that the λ_i are d bounded measures on $]t'_0, T[$. Thanks to equation (1.28), it is readily seen that the measures $d\dot{q}^{+i}$ are also bounded measures on $]t'_0, T[$. Therefore, the d functions $\dot{q}^{+i} :]t'_0, T[\rightarrow \mathbb{R}$ have bounded variation over the interval $]t'_0, T[$. Then, corollary 36 of Appendix A yields the desired result.

Step 3. Conclusion of the proof of theorem 17.

By Steps 1 and 2 and by proposition 38 of Appendix A,

$$(q_T, v_T^-) = \lim_{t \rightarrow T^-} (q(t), \dot{q}^+(t))$$

exists in TQ . Define:

$$v_T = \mathcal{F}(q_T, v_T^-)$$

Take it as a new initial condition at $t = T$. Then, theorem 13 furnishes $T' > T$ and an extension of q on $[T, T'[$ such that $q \in MMA([t_0, T']; Q)$ is a solution of problem III. But, this contradicts the definition of T . \square

3.4 Illustrative examples and comments

It is readily seen that the function q displayed in counter-example 6 is the unique maximal solution of problem III corresponding to the situation under consideration. This solution exhibits an accumulation of impacts on the left side of instant $t = 3$. However, as predicted by corollary 13, for each instant $t \in \mathbb{R}^+$, there exists a right neighbourhood $[t, t + \eta[$ of t , such that the restriction of q to $[t, t + \eta[$ is analytic. A straightforward and general consequence of this is the following.

Proposition 18 *Let q be the maximal solution of problem III furnished by corollary 16. Although infinitely many impacts can accumulate at the left of a given instant, such an accumulation of impacts can never occur at the right of any*

instant. Moreover, in the particular case where the impact constitutive equation is elastic, the instants of impact are isolated and therefore in finite number in any compact interval of time.

Proof. Since for each instant $t \in [t_0, T[$, there exists a right neighbourhood $[t, t + \eta[$ of t , such that the restriction of q to $[t, t + \eta[$ is analytic, we get the first part of the proposition. For the second part, let τ be an arbitrary instant in $]t_0, T[$ and consider the problem III associated with the initial condition $(q(\tau), -\dot{q}^-(\tau))$, the elastic constitutive impact equation and the force mapping $g(q, v; t)$ defined by:

$$g(q, v; t) = f(q, -v; \tau - t)$$

which is analytic. By theorem 14, there exists an analytic function $q_a : [0, T_a[\rightarrow Q$ which is a solution of this problem III. Any other solution of problem III coincides with q_a on a right neighbourhood of $t = 0$. Actually, as seen in the proof of local uniqueness (theorem 14), a little bit more is proved: any function $q' \in MMA([0, T[; Q)$ satisfying the initial condition, the unilateral constraint, the equation of motion (1.9) and the energy inequality (proposition 11) has to coincide with q_a on a right neighbourhood of $t = 0$. But, it is readily seen that the function defined by:

$$q'(t) = q(\tau - t), \quad t \in [0, \tau - t_0[$$

fulfill these requirements. Thus, q' can not have right accumulation of impacts at $t = \tau$ and, therefore, q can not have left accumulation of impacts at $t = \tau$ and the instants of impact are isolated. Of course, if q is the maximal solution defined on $[t_0, T[$, impacts can still accumulate at the left of T , as seen on simple examples. \square

The fact that infinitely many impacts can accumulate at the left of a given instant but not at the right is a specific feature of the analytical setting that is lost in the C^∞ setting as seen in counterexample 7. Actually, this counterexample shows that pathologies of nonuniqueness in the C^∞ setting are intimately connected to the possibility of right accumulations of impacts. The fact that the analytical setting prevents from such right accumulations is the thorough reason why we could prove uniqueness in this case.

We conclude this section by a come back to the double pendulum of example 4. The aim of the following example is to illustrate the generality of the above theory.

Example 8. Consider the double pendulum described in example 4 and add a rigid obstacle on the vertical coordinate axis as represented on Figure 1.5. This obstacle may be represented by two analytic functions whose expressions in

the global chart of Q described in example 4 are:

$$\begin{aligned} \varphi_1(q^1, q^2) &= -l_1 \sin q^1 \leq 0, \\ \varphi_2(q^1, q^2) &= -l_1 \sin q^1 - l_2 \sin q^2 \leq 0. \end{aligned}$$

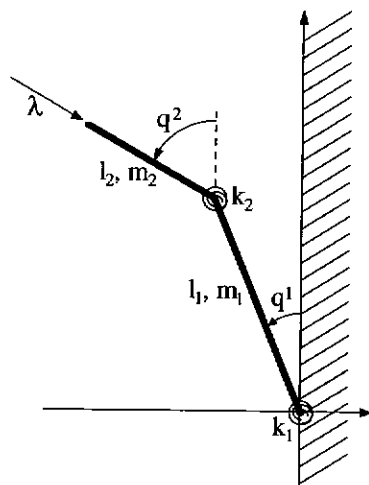

Figure 1.5. Double pendulum with obstacle.

It is readily seen that, except in the particular case where $l_1 = l_2$, these constraints are functionally independent, that is, they satisfy regularity hypothesis I. An arbitrary initial state (q_0, v_0) such that $v_0 \in V(q_0)$ is given at time $t_0 = 0$. To fix ideas, we adopt the canonical constitutive equation with arbitrary restitution coefficient $e(q, \dot{q}^-)$. Then, writing the evolution problem in the chart under consideration is straightforward. By corollary 16, we get a unique maximal solution for this evolution problem. By theorem 17, we can state that this maximal solution is defined all over \mathbb{R}^+ , that is, the dynamics is eternal.

4. Perfect non-holonomic bilateral constraints

In this section, we come back to simple discrete mechanical systems. Perfect holonomic bilateral constraints were defined to be constraints on the configurations of type:

$$\varphi_i(q) = 0.$$

Considering an arbitrary motion satisfying the constraint and differentiating with respect to time, gives:

$$\langle d\varphi_i(q), \dot{q} \rangle_q = 0.$$

Thus, the constraint may be viewed as acting on the velocity. There are practical situations where the constraint is given in this way. A typical occurrence is the "rolling without slipping". Thus, we are led to consider general constraints of type:

$$\langle \alpha_i(q), \dot{q} \rangle_q = 0,$$

where the $\alpha_i(q)$ are cotangent vector fields (we say also 1-form) on the configuration manifolds.

The reason that makes here desirable the study of non-holonomic constraints is that the "rolling without slipping" can be seen as a frictional bilateral constraint with a friction of infinite magnitude. Therefore, this section prepares the full discussion of frictional constraints in the sequel.

4.1 The geometric description

A *non-holonomic bilateral constraint* is a restriction on the admissible motions of the system which is expressed by means of a finite number n of smooth 1-form α_i defined on the configuration manifold:

$$\forall i \in \{1, 2, \dots, n\}, \quad \langle \alpha_i(q), \dot{q} \rangle_q = 0. \quad (1.29)$$

As in the case of holonomic constraints, the constraints are required to be independent in the following sense:

Regularity hypothesis I. For all q in Q , the $\alpha_i(q)$ ($i \in \{1, 2, \dots, n\}$) are linearly independent in T^*Q .

A straightforward consequence of this hypothesis is that the set E of all admissible velocities:

$$E = \left\{ (q, v) \in TQ ; \forall i \in \{1, 2, \dots, n\}, \quad \langle \alpha_i(q), v \rangle_q = 0 \right\}, \quad (1.30)$$

is a tangent subbundle of Q (that is, a vector bundle over Q which is also a submanifold of TQ) of dimension $2d - n$.

Of course, the terminology is a little bit confusing (but it is classical) since a non-holonomic constraint may turn out to be holonomic ('holonomic' is greek for 'integrable'). A trivial example is provided in the case $n = 1$ when the 1-form α_1 is *exact* (that is, there exists φ_1 such that $d\varphi_1 = \alpha_1$). In this case, the non-holonomic constraint is equivalent to the holonomic one: $\varphi_1(q) = \text{constant}$. The constant is determined by the initial configuration q_0 . The non-holonomic constraint defined by α_1 may turn out to be holonomic even in the case where α_1 is not exact. Indeed, even if α_1 is not exact, there may exist some real valued function $h(q)$ such that $h(q)\alpha_1(q)$ is exact. We shall say that the non-holonomic constraint defined by the α_i is holonomic if there exist (locally) n real-valued functions φ_i such that (1.29) is equivalent to:

$$\forall i \in \{1, 2, \dots, n\}, \quad \langle d\varphi_i(q), \dot{q} \rangle_q = 0.$$

Unilate

Decidin
or not,
for exa**Theore**
{1, 2, ·
defined
takes veHenc
the stud
Howeve
mediate
So, each
be integ

4.2

Here
tion for**Consti**
suppose
in any vHyp
such thNow
rigid bo
or holo
configu
with the**Proble**
such th

Deciding, in the general case, whether a non-holonomic constraint is holonomic or not, is a difficult issue. One answer is provided by Frobenius' theorem (see, for example, ABRAHAM & MARSDEN (1985), p. 93).

Theorem 19 (Frobenius) *The non-holonomic constraint defined by the α_i ($i \in \{1, 2, \dots, n\}$) is holonomic if and only if for any two vector fields X and Y defined on open sets of Q and which take values in E , the Lie bracket $[X, Y]$ takes values in E as well.*

Hence, the study of non-holonomic bilateral constraints is more general than the study of holonomic ones, since the former contains formally the latter. However, the handling of holonomic constraints is simpler since it allows immediately the elimination of the redundant parameters in any parametrization. So, each time a non-holonomic constraint turns out to be holonomic, it should be integrated.

4.2 Formulation of the dynamics

Here also, the realization of the constraints necessarily involves some reaction forces R which should be specified through a constitutive assumption.

Constitutive hypothesis II. The non-holonomic bilateral constraint (1.29) is supposed to be *perfect*, that is, the virtual power of the reaction forces R vanishes in any virtual velocity compatible with the bilateral constraint:

$$\forall (q, v) \in E, \quad \langle R, v \rangle_q = 0.$$

Hypotheses I and II imply that there exists n real-valued functions λ_i , unique, such that:

$$R(t) = \sum_{i=1}^n \lambda_i(t) \alpha_i(q).$$

Now, we formulate the evolution problem associated with the dynamics of rigid bodies systems with perfect bilateral constraints, either non-holonomic or holonomic (the holonomic constraint is included in the definition of the configuration manifold Q). The initial condition is assumed to be compatible with the realization of the constraint: $(q_0, v_0) \in E$.

Problem IV. Find $T > t_0$, $q \in C^2([t_0, T]; Q)$ and n functions $\lambda_i \in C^0([t_0, T]; \mathbb{R})$ such that:

- $(q(t_0), \dot{q}(t_0)) = (q_0, v_0),$
- $\forall t \in [t_0, T[, \quad (q(t), \dot{q}(t)) \in E,$
- $\forall t \in [t_0, T[, \quad \frac{D}{dt} \dot{q}(t) = f(q(t), \dot{q}(t), t) + \sum_{i=1}^n \lambda_i(t) \alpha_i(q(t)).$

4.3 Well-posedness of the dynamics

By similarity with that of Section 2.3, we state the following regularity hypothesis.

Regularity hypothesis III. The configuration manifold Q is of class C^2 , the mapping $f : TQ \times \mathbb{R} \rightarrow T^*Q$ and the 1-forms α_i are of class C^1 .

The fundamental reason why problem IV is well-posed, is, that it reduces to a (first order) ordinary differential equation on TE . To describe how this is realized, we need to introduce some new notations and definitions.

In Section 1.2, it has been stated briefly that the equation of motion:

$$\frac{D}{dt} \dot{q}(t) = \# \circ f(q(t), \dot{q}(t), t), \quad (1.31)$$

is a second order differential equation on the configuration manifold Q . We are going to express more precisely what is meant by that. Consider a local chart $\psi : U \rightarrow \mathbb{R}^d$. With ψ , we associate a natural local chart $\Psi : \Pi_Q^{-1}(U) \rightarrow \mathbb{R}^{2d}$ on TQ by:

$$\begin{aligned} \Psi(q, v) &= (q^1, \dots, q^d, v^1, \dots, v^d), \\ &= (\psi^1(q), \dots, \psi^d(q), \langle d\psi^1(q), v \rangle_q, \dots, \langle d\psi^d(q), v \rangle_q). \end{aligned}$$

Actually, $\Psi = T\psi$ is nothing but the classical tangent map of ψ (see, for example, ABRAHAM & MARSDEN (1985), p. 45). We find it convenient to write the basis of tangent spaces to TQ at points of $\Pi_Q^{-1}(U)$ by:

$$\left(\frac{\partial}{\partial q^1}, \dots, \frac{\partial}{\partial q^d}, \frac{\partial}{\partial v^1}, \dots, \frac{\partial}{\partial v^d} \right)$$

(this notation is standard and expresses the fact that tangents can be viewed as derivation operators, on real valued functions and reciprocally). It is easy to write equation (1.31) in the chart ψ as a first order differential equation:

$$\begin{aligned} \frac{d}{dt} q^i &= v^i, \\ \frac{d}{dt} v^i &= -\Gamma_{jk}^i(q) v^j v^k + g^{ij}(q) f_j(q, v; t). \end{aligned}$$

Hence, the solution of equation (1.31) is nothing but an integral curve (see ABRAHAM & MARSDEN (1985), Section 2.1) of the time-dependent vector field $\mathcal{G}(\cdot; t)$ defined on $\Pi_Q^{-1}(U)$ by:

$$\mathcal{G}(t) = v^i \frac{\partial}{\partial q^i} - \Gamma_{jk}^i(q) v^j v^k \frac{\partial}{\partial v^i} + g^{ij}(q) f_j(q, v; t) \frac{\partial}{\partial v^i}.$$

Unilater

Since th
 Q , we co
 Now, if
 defined

This last

and mot

Definitio
 time-dep
 different

Now,
 by formu
 by:

Recall th
 tion of v
 second ta
 field on
 vector fie
 Q .

Theorem
 dependen

Proof.
 $\Omega(t) = ($

where r
 orthogonal

Since the geodesic equations are independent of the choice of coordinates on Q , we conclude that $\mathcal{G}(\cdot; t)$ defines a global time-dependent vector field on TQ . Now, if $\Omega :]\alpha, \beta[\rightarrow TQ$ is any integral curve of $\mathcal{G}(\cdot; t)$ and ω is the curve on Q defined by $\omega = \Pi_Q \circ \Omega$, then it is readily seen that:

$$\frac{d}{dt}\omega = \Omega.$$

This last property is easily seen to be equivalent to the following property of \mathcal{G} :

$$\forall (q, v) \in TQ, \quad T\Pi_Q(\mathcal{G}(q, v; t)) = (q, v),$$

and motivates the following definition.

Definition 20 Let Q be a manifold and E any tangent subbundle of Q . A time-dependent vector field $\mathcal{X}(\cdot; t)$ on E is said to determine a second-order differential equation on Q if:

$$T\Pi_Q(\mathcal{X}(\cdot; t)) = id_E$$

Now, E will be the tangent subbundle of the configuration manifold defined by formula (1.30). We denote by E_q the fiber over $q \in Q$. We define a map P_E by:

$$P_E \begin{cases} TQ & \rightarrow E \\ (q, v) & \mapsto (q, \text{Proj}_q[v; E_q]) \end{cases}$$

Recall that $\text{Proj}_q[v; E_q]$ was defined in Section 2.2 to be the orthogonal projection of v on the subspace E_q of T_qQ . The tangent map TP_E of P_E maps the second tangent bundle TTQ of Q onto TE . Thus, $TP_E(\mathcal{G}(\cdot; t))$ is a C^1 vector field on E (we have used regularity hypothesis III). It is readily seen that the vector field $TP_E(\mathcal{G}(\cdot; t))$ determines a second-order differential equation on Q .

Theorem 21 Any solution of problem IV defines an integral curve of the time-dependent vector field $TP_E(\mathcal{G}(\cdot; t))$ on E and reciprocally.

Proof. Let $q(t)$ be an arbitrary solution of problem IV. We shall denote by $\Omega(t) = (q(t), \dot{q}(t))$ the corresponding curve in E . We have:

$$\frac{D}{dt}\dot{q}(t) = \# \circ f(q(t), \dot{q}(t), t) + r(t),$$

where $r : [t_0, T[\rightarrow TQ$ is such that, for all t , $r(t) = r^i(t) \partial/\partial q^i$ lies in the orthogonal complement of $E_{q(t)}$ in $T_{q(t)}Q$. As a result,

$$\frac{d}{dt}\Omega(t) = \mathcal{G}(\Omega(t); t) + \mathcal{R}(t),$$

where $\mathcal{R}(t)$ is the curve in TE which is expressed by $\mathcal{R}(t) = r^i(t)\partial/\partial v^i$ in any local chart. By $P_E(r(t)) = 0$, we get immediately $TP_E(\mathcal{R}(t)) = 0$. Moreover, since $\Omega(t)$ is in E for all t , we have:

$$\begin{aligned} \frac{d}{dt}\Omega(t) &= TP_E \frac{d}{dt}\Omega(t) \\ &= TP_E(\mathcal{G}(\Omega(t); t)) + TP_E(\mathcal{R}(t)) \\ &= TP_E(\mathcal{G}(\Omega(t); t)), \end{aligned}$$

and, therefore, the first part of the proposition. Reciprocally, let Ω be an integral curve of $TP_E(\mathcal{G}(\cdot; t))$. We define $q(t)$ by:

$$q(t) = \Pi_Q(\Omega(t))$$

Since $TP_E(\mathcal{G}(\cdot; t))$ determines a second-order differential equation on Q , we have:

$$(q(t), \dot{q}(t)) = \Omega(t) \in E.$$

Moreover, we easily have:

$$\forall t, \quad P_E \left(\frac{D}{dt}\dot{q}(t) - \sharp \circ f(q(t), \dot{q}(t), t) \right) = 0,$$

which yields the desired result. \square

Corollary 22 *Problem IV admits a unique maximal solution q_m . Moreover, if Q is of class C^p ($p \geq 2$), and f and the α_i are of class C^{p-1} then q_m is of class C^p . If Q , f and the α_i are analytic functions then so are q_m and the functions λ_i .*

Similarly to theorem 3, we have:

Theorem 23 *The configuration manifold Q is assumed to be a complete Riemannian manifold and the mapping f is supposed to admit the following estimate:*

$$\forall (q, v) \in T'Q, \quad \text{for almost all } t \in [t_0, +\infty[, \\ \|f(q, v; t)\|_q^* \leq l(t) \left(1 + d(q, q_0) + \|v\|_q \right),$$

where $d(\cdot, \cdot)$ is the Riemannian distance and $l(t)$, a (necessarily nonnegative) function of $L_{loc}^1(\mathbb{R}; \mathbb{R})$.

Then, the dynamics is eternal, that is, q_m is defined on $[t_0, +\infty[$.

Theorem 23 is proved exactly along the same lines as theorem 3.

4.4

Examp
neous b
remain
constrai
at the ce
the plan
constrai
 $Q = \mathcal{P}$
There is
configur
and som
the z -di
and $\phi =$

K

which p
The fore

where F
non-hol
real wor
need tw
consider

which a
charts, t
section,
of this s
to the ex
class C^1
time.

Given
is a sm
holonom

4.4 Illustrative example and comments

Example 9. In the usual three-dimensional space, consider a rigid homogeneous ball of radius R and mass M . The center of the ball is constrained to remain at distance R of a given fixed affine plane (perfect holonomic bilateral constraint). The ball is initially at rest and a prescribed punctual force applies at the center of the ball. Also, the ball is constrained to roll without slipping on the plane (perfect non-holonomic bilateral constraint). The holonomic bilateral constraint is taken into account by using the reduced configuration manifold $Q = \mathcal{P} \times \text{SO}3$ where \mathcal{P} is the affine plane containing the center of the ball. There is no global parametrization of that system. As a local chart at the initial configuration, we can use some Cartesian orthonormal coordinates (x, y) in \mathcal{P} and some Euler angles (ψ, θ, ϕ) (the ball is supposed to lie 'above the plane in the z -direction' and the initial configuration has Euler angle $\psi = 0, \theta = \pi/2$ and $\phi = 0$) in $\text{SO}3$. The kinetic energy in the considered chart is given by:

$$K(q, \dot{q}) = \frac{M}{2} (\dot{x}^2 + \dot{y}^2) + \frac{MR^2}{5} (\dot{\psi}^2 + \dot{\theta}^2 + \dot{\phi}^2 + 2 \cos \theta \dot{\psi} \dot{\phi}),$$

which provides immediately the components $g_{ij}(q)$ of the kinetic metric on Q . The force mapping $f(t)$ is given by:

$$f(t) = F_x(t) dx + F_y(t) dy,$$

where $F_x(t), F_y(t)$ are the components of the real world force along x, y . The non-holonomic constraint is obtained in the given chart, by writing that the real world velocity of the contact point must vanish. It is readily seen that we need two 1-forms α_1 and α_2 to express this. They are given in the chart under consideration by:

$$\begin{aligned} \alpha_1 &= dx - R \sin \psi d\theta + R \cos \psi \sin \theta d\phi, \\ \alpha_2 &= dy + R \cos \psi d\theta + R \sin \psi \sin \theta d\phi, \end{aligned}$$

which are clearly independent. Using a covering of the manifold Q by such charts, these definitions are easily globalized. Using the results of the present section, it is easy to form the evolution problem associated with the dynamics of this system. Straightforward application of corollary 22 allows to conclude to the existence of a unique maximal motion, provided $F_x(t)$ and $F_y(t)$ are of class C^1 . By corollary 23, we have that this maximal motion is defined for all time.

Given two arbitrary configuration q_i and q_f in Q , it can be proved that there is a smooth motion $q(t)$, starting at q_i , ending at q_f and satisfying the non-holonomic constraint at every instant:

$$\forall t, \quad \langle \alpha_1(q(t)), \dot{q}(t) \rangle_{q(t)} = \langle \alpha_2(q(t)), \dot{q}(t) \rangle_{q(t)} = 0.$$

This fact demonstrates that the non-holonomic constraint defined by α_1 and α_2 is not holonomic. An alternative way to see it would have been to apply Frobenius theorem (theorem 19).

To conclude this example, let us write the evolution problem in the parametrization described above. We have to find smooth functions $x(t)$, $y(t)$, $\psi(t)$, $\theta(t)$, $\phi(t)$, $\lambda_1(t)$ and $\lambda_2(t)$, satisfying the initial condition and such that:

$$\begin{aligned} M\ddot{x} &= F_x + \lambda_1, \\ M\ddot{y} &= F_y + \lambda_2, \\ \frac{2MR^2}{5} (\ddot{\psi} + \cos\theta \ddot{\phi} - \sin\theta \dot{\theta} \dot{\phi}) &= 0, \\ \frac{2MR^2}{5} (\ddot{\theta} + \sin\theta \dot{\psi} \dot{\phi}) &= -R \sin\psi \lambda_1 + R \cos\psi \lambda_2, \\ \frac{2MR^2}{5} (\ddot{\phi} + \cos\theta \ddot{\psi} - \sin\theta \dot{\psi} \dot{\theta}) &= R \cos\psi \sin\theta \lambda_1 + R \sin\psi \sin\theta \lambda_2, \\ \dot{x} - R \sin\psi \dot{\theta} + R \cos\psi \sin\theta \dot{\phi} &= 0, \\ \dot{y} + R \cos\psi \dot{\theta} + R \sin\psi \sin\theta \dot{\phi} &= 0, \end{aligned}$$

To solve this system, we can eliminate the unknown functions $\lambda_1(t)$ and $\lambda_2(t)$ in order to get a first order differential equation with unknown $(x, y, \psi, \theta, \phi, \dot{\psi}, \dot{\theta}, \dot{\phi})$. It turns out that this is nothing but particularizing the proof of theorem 21 to the given system with the particular chart under consideration. The intrinsic point-of-view has provided a valuable guide to perform this in a systematic way. Moreover, it has allowed to lighten the notations very much.

Remark 3. A comment similar to remark 2 can be made here. The dynamics of the constrained system depends only on the geometry of the tangent subbundle E and not on the particular choice of the 1-forms α_i used to define it.

5. Non-firm bilateral constraints

In Section 4, we have discussed general perfect bilateral constraints on simple discrete mechanical systems. They are described by means of a finite number n of linearly independent smooth 1-forms α_i defined on the configuration manifold. The reaction forces were seen to have general expression:

$$R(t) = \sum_{i=1}^n \lambda_i(t) \alpha_i(q),$$

where the λ_i are *a priori* unknown smooth real valued functions of time. Once the evolution problem associated with the dynamics is solved, they are uniquely

Unilater

determini
namics,
sense.

Definitio
value of

In so
bilateral

5.1

We an
definitio
independ
general e
by:

where (
constrain
is natura
and to re

Actually,
be conve
on time a
the gene
purpose.

Constitu
independ
force $R =$
 T_q^*Q def

$C(q, \dot{q})$

where:

determined. Actually, to write the evolution problem associated with the dynamics, we have implicitly assumed that the constraint is firm in the following sense.

Definition 24 A general perfect bilateral constraint is said to be firm if any value of the associated reaction force can be assumed by the system.

In some cases, it may turn to be physically relevant to deal with *non-firm* bilateral constraints. This is the object of this section.

5.1 Formulation of the dynamics

We are given an arbitrary simple discrete mechanical system according to definition 7 and a general perfect bilateral constraint defined by n linearly independent smooth 1-forms α_i defined on the configuration manifold Q . The general expression for the reaction force associated with that constraint is given by:

$$R = \sum_{i=1}^n \lambda_i \alpha_i(q), \quad (1.32)$$

where $(\lambda_1, \lambda_2, \dots, \lambda_n)$ is an arbitrary element of \mathbb{R}^n in the case where the constraint is assumed to be firm. To discuss the case of non-firm constraints, it is natural to introduce a closed convex subset C_0 of \mathbb{R}^n , containing the origin, and to require the following restriction for the reaction force:

$$(\lambda_1, \lambda_2, \dots, \lambda_n) \in C_0.$$

Actually, to get more generality and in view of discussing dry friction, it will be convenient to allow that the convex of admissible reaction forces can depend on time and also on the state. We state in the following constitutive hypothesis, the general form of the dependency that we allow. It will be enough for our purpose.

Constitutive hypothesis I. The bilateral constraint defined by the n linearly independent 1-forms α_i is non-firm in the sense that the associated reaction force $R = \sum_{i=1}^n \lambda_i \alpha_i(q)$ can not assume values out of the subset $C(q, \dot{q}; t)$ of T_q^*Q defined by:

$$C(q, \dot{q}; t) = \left\{ \sum_{i=1}^n \lambda_i \alpha_i(q); \right. \\ \left. (\lambda_1, \lambda_2, \dots, \lambda_n) \in M(q) \cdot \left[C_0 + \sum_{i=1}^m \mu_i(q, \dot{q}; t) C_i \right] \right\},$$

where:

- C_0 is a given closed convex subset of \mathbb{R}^n , possibly unbounded and containing the origin,
- the C_i ($i = 1, 2, \dots, m$) are given *bounded* closed convex subsets of \mathbb{R}^n , containing the origin,
- the $\mu_i : TQ \times \mathbb{R} \rightarrow \mathbb{R}^+$ are given functions whose regularity will be stated later on,
- $M(q)$ is a given invertible square real matrix of order n , which depends smoothly on q .

It is readily seen that $C(q, \dot{q}; t)$ is a closed convex subset of T_q^*Q which contains the origin.

Naturally, this formalism contains the case of firm constraints as a particular case: take $m = 0$ and $C_0 = \mathbb{R}^n$.

Of course, this restriction on the admissible reaction forces will not be compatible any more, in general, with the kinematical realization of the constraint:

$$\forall i \in \{1, 2, \dots, n\}, \quad \langle \alpha_i(q), \dot{q} \rangle_q = 0, \tag{1.33}$$

which, therefore, should be relaxed. But relaxing the constraint is equivalent to admit some dissipation of energy associated with the reaction force. The following constitutive hypothesis gives precise information on the way the constraint is relaxed.

Constitutive hypothesis II. The non-firm bilateral constraint obeys to the so-called *Principle of Maximal Dissipation*:

$$\forall \tilde{R} \in C(q, \dot{q}; t), \quad -\langle R, \dot{q} \rangle_q \geq -\langle \tilde{R}, \dot{q} \rangle_q.$$

In the particular case where $m = 0$ and $C_0 = \mathbb{R}^n$ (firm bilateral constraint), constitutive hypothesis II implies nothing but the realization (1.33) of the constraint. In the general case, constitutive hypothesis II specifies the way the constraint is relaxed. Hence, the general firm perfect bilateral constraint, as discussed in Section 4, appears as a particular case of non-firm bilateral constraints as discussed in this section. Constitutive hypothesis II can be given a synthetic formulation by use of elementary convex analysis and its notations (see Appendix B):

$$-\dot{q} \in \partial I_{C(q, \dot{q}; t)}(R),$$

where ∂I_C is the subdifferential (in the sense of the duality $(T_q Q, T_q^* Q)$) of the indicator function of the closed convex subset C of $T_q^* Q$. Introducing the support function $S_{C(q, \dot{q}; t)}$ of $C(q, \dot{q}; t)$ (that is, the conjugate or dual function

Unilatera

of $I_{C(q, \dot{q}; t)}$
Proposit

Now,
constrai

the evol
chanical
follows.

Proble

The r
larger th
example

5.2

Regular
mapping
are of cla
(in the s
locally B

Then,

Theore

Proof.
in a loca
if necess
Now, de

where th
transform

of $I_{C(q,\dot{q};t)}$ in the duality $(T_q Q, T_q^* Q)$, we have the equivalent formulation (see Proposition 48 of Appendix B).

$$R \in \partial S_{C(q,\dot{q};t)}(-\dot{q}).$$

Now, given any initial condition $(q_0, v_0) \in TQ$ compatible with the non-firm constraint:

$$-v_0 \in \text{Dom } S_{C(q_0, v_0; t_0)}, \tag{1.34}$$

the evolution problem associated with the dynamics of simple discrete mechanical systems subjected to non-firm bilateral constraints is formulated as follows.

Problem V. Find $T > t_0$ and $q \in W^{2,\infty}([t_0, T[; Q)$ such that:

- $(q(t_0), \dot{q}(t_0)) = (q_0, v_0)$,
- $b \frac{D}{dt} \dot{q}(t) - f(q(t), \dot{q}(t); t) \in \partial S_{C(q(t), \dot{q}(t); t)}(-\dot{q}(t))$.

The reason why we look for solutions in the Sobolev class $W^{2,\infty}$ which is larger than the usual class C^2 will be made clear later on (Section 5.2 and example 10).

5.2 Well-posedness of the dynamics

Regularity hypothesis III. The configuration manifold Q is of class C^2 , the mapping $f : TQ \times \mathbb{R} \rightarrow T^*Q$, the 1-forms α_i and the mapping $M : q \mapsto M(q)$ are of class C^1 . Also, the functions $\mu_i : TQ \times \mathbb{R} \rightarrow \mathbb{R}^+$ are locally lipschitzian (in the sense that the representative in a local chart at an arbitrary (q_0, v_0) is locally lipschitzian with respect to $(q, \dot{q}; t) \in \mathbb{R}^{2d+1}$).

Then, we can prove well-posedness for problem V.

Theorem 25 *There exists a solution (T, q) for problem V.*

Proof. First, we are going to write the evolution equation (actually, inclusion) in a local chart. Let (U, ψ) be a local chart on Q at q_0 . Also, taking U smaller if necessary, we can complete the $\alpha_i(q)$ so as to get a basis of T_q^*Q at each q . Now, define a new basis $(w^{i*}(q))$ of T_q^*Q by:

$$w^{i*}(q) = \sum_{j=1}^d M_{ji}(q) \alpha_j(q),$$

where the matrix $M(q)$, which has been defined as a real matrix of order n , is transformed into a matrix of order d by adding zeroes everywhere except on

the diagonal where we add some ones. Define a basis $(w_i(q))$ of T_qQ to be the dual basis of $(w^{i*}(q))$. If \dot{q} is any element of T_qQ , then we have:

$$\dot{q} = \eta^i w_i(q), \quad \text{with } \eta^i = A_{ij}(q) \dot{q}^j,$$

where $A(q)$ is an invertible real matrix of order d , depending smoothly on q . Its inverse matrix will be denoted by $B(q)$. Hence, the \mathbb{R}^{2d} -valued mapping $(q^1, \dots, q^d, \eta^1, \dots, \eta^d)$ defines a vector bundle local chart on TQ at (q_0, v_0) . We shall write:

$$f(q, \dot{q}; t) = f_i(q, \eta, t) w^{i*}(q),$$

where the f_i are C^1 functions defined on an open set of \mathbb{R}^{2d+1} . The C_i which have been defined as closed subsets of \mathbb{R}^n are now seen as closed subsets of \mathbb{R}^d . We denote by S_i their support functions which are, thus, defined on \mathbb{R}^d . We define some convex functions φ_i ($i = 0, 1, \dots, m$) on \mathbb{R}^{2d} by:

$$\varphi_i(q, \eta) = S_i(\eta).$$

We shall keep the same notation for the μ_i and their representatives in the chart (q, η) . With these notations, the evolution inclusion takes the following form in the chart under consideration, thanks to propositions 44 and 47 of Appendix B:

$$-G(q) \cdot \begin{pmatrix} \dot{q} \\ -\dot{\eta} \end{pmatrix} - F(q, \eta, t) \in \partial\varphi_0(q, -\eta) + \sum_{i=1}^m \mu_i(q, \eta, t) \partial\varphi_i(q, -\eta). \quad (1.35)$$

In evolution inclusion 1.35, we used the following notations.

$$G(q) = \begin{pmatrix} \text{Id} & 0 \\ 0 & {}^t B(q) \cdot g(q) \cdot B(q) \end{pmatrix},$$

where $g(q)$ is the real matrix of order d defined by the $g_{ij}(q)$. It is clear that the real matrix of order $2d$ $G(q)$ is symmetric positive definite for all q . Moreover, it is a C^1 function of the variable q . Also, we have denoted by $F(q, \eta, t)$ the element of \mathbb{R}^{2d} defined by:

$$F_i(q, \eta, t) = - \sum_{j=1}^d B_{ij}(q) \eta^j,$$

$$F_{d+i}(q, \eta, t) = f_i(q, \eta, t) + B_{ji}(q) g_{jk}(q) \left[\frac{\partial B_{kl}(q)}{\partial q^m} B_{mn}(q) \eta^l \eta^n + \Gamma_{lm}^k(q) B_{ln}(q) B_{mo}(q) \eta^n \eta^o \right],$$

for $i = 1, 2, \dots, d$. It is clear that the function F is of class C^1 . To express the initial condition, we introduce η_0 which is easily expressed in terms of q_0 and v_0 .

Unilatera

Next, we
 \mathbb{R}^d is co
 $(q_0, -\eta_0)$
 values in
 Find $(q,$

- $(q$
- for

-C

This evol
 in propo
 estimate
 $T > t_0$
 the solut
 of the p
 sequence
 function
 problem
 sequence
 prove ea

$\forall t \in$

where $|\cdot|$
 on N . T
 space C^0
 Appendi
 is bound
 reasoning
 u solves
 problem

Theorem
 (T_2, q_2)
 such that

Proof. \forall
 $T > t_0$ b

Next, we are given a positive real number R such that the closed ball $B(q_0, R) \subset \mathbb{R}^d$ is contained in $\psi(U)$. We denote by B the closed ball of \mathbb{R}^{2d} centered at $(q_0, -\eta_0)$ with radius R . Given a function $(\tilde{q}, -\tilde{\eta}) \in W^{1,\infty}(t_0, T; \mathbb{R}^{2d})$, taking values in B , consider the following evolution problem:

Find $(q, -\eta) \in W^{1,\infty}(t_0, T; \mathbb{R}^{2d})$ such that:

- $(q(t_0), -\eta(t_0)) = (q_0, -\eta_0)$,
- for a.e. $t \in [t_0, T[$,

$$-G(\tilde{q}) \cdot \begin{pmatrix} \dot{\tilde{q}} \\ -\dot{\tilde{\eta}} \end{pmatrix} - F(\tilde{q}, \tilde{\eta}, t) \in \partial\varphi_0(q, -\eta) + \sum_{i=1}^m \mu_i(\tilde{q}, \tilde{\eta}, t) \partial\varphi_i(q, -\eta).$$

This evolution problem falls exactly into the type of those which are studied in proposition 52 of Appendix B. Hence, it admits a unique solution. Using estimate (1.B.1) (proposition 52 of Appendix B), we can easily construct a $T > t_0$ depending only on R, G, F, φ_0 , the μ_i and the φ_i , which ensures that the solution of the above evolution problem takes values in B . In the sequel of the proof, we adopt the notation $u = (q, -\eta)$. We define by induction a sequence of such functions u . First, u_0 is the constant function $(q_0, -\eta_0)$. The function u_1 is defined to be the solution of the above well-posed evolution problem with the choice $(\tilde{q}, -\tilde{\eta}) = u_0$. Going on inductively, we have built a sequence u_N . By use of estimate (1.B.2) of proposition 52 of Appendix B, we prove easily by induction:

$$\forall t \in [t_0, T], \quad |u_{N+1}(t) - u_N(t)| \leq \frac{(Ct)^N}{N!} \max_{s \in [t_0, T]} |u_1(s) - u_0(s)|,$$

where $|\cdot|$ is the standard norm on \mathbb{R}^{2d} and C denotes a real constant independent on N . Therefore, the sequence u_N converges towards a limit u in the Banach space $C^0([t_0, T]; \mathbb{R}^{2d})$. Moreover, use of estimate (1.B.1) of proposition 52 of Appendix B together with the definition of T shows that the sequence $\|u_N\|_{L^\infty}$ is bounded. Thus, we have $u \in W^{1,\infty}(t_0, T; \mathbb{R}^{2d})$. Also, reproducing the reasoning of the proof of proposition 52 of Appendix B, we can conclude that u solves evolution inclusion (1.35) and so, we have constructed a solution for problem V. □

Theorem 26 *There is local uniqueness for problem V, that is, if (T_1, q_1) and (T_2, q_2) are two solutions of problem V, then, there exists $T_0 \leq \min\{T_1, T_2\}$ such that:*

$$q_1|_{[t_0, T_0]} \equiv q_2|_{[t_0, T_0]}$$

Proof. We stick to the notations of the proof of theorem 25. The real number $T > t_0$ being defined as in the above proof, define $T_0 = \min\{T, T_1, T_2\}$. The

two solutions q_1 and q_2 define two solutions $u_1 = (q_1, -\eta_1)$ and $u_2 = (q_2, -\eta_2)$ in $W^{1,\infty}(t_0, T_0; \mathbb{R}^{2d})$ of evolution inclusion (1.35). Use of estimate (1.B.2) of proposition 52 of Appendix B yields:

$$\forall t \in [t_0, T_0], \quad |u_2(t) - u_1(t)| \leq C \int_{t_0}^t |u_2(s) - u_1(s)| ds,$$

where C is a positive real constant. Now, use of Gronwall lemma (lemma 4) yields the claim. \square

Corollary 27 *There exists a unique maximal solution for problem V.*

Proposition 28 (Energy inequality) *Let (T, q) be an arbitrary solution of problem V. Then, we have:*

$$\forall t_1, t_2 \in [t_0, T], \quad t_1 \leq t_2, \quad K(q(t_2), \dot{q}(t_2)) - K(q(t_1), \dot{q}(t_1)) = \frac{1}{2} \|\dot{q}(t_2)\|_{q(t_2)}^2 - \frac{1}{2} \|\dot{q}(t_1)\|_{q(t_1)}^2 \leq \int_{t_1}^{t_2} \langle f(q(s), \dot{q}(s); s), \dot{q}(s) \rangle_{q(s)} ds$$

Proof. For all $w \in \partial S_{C(q(t), \dot{q}(t); t)}(-\dot{q}(t))$,

$$\langle w, \dot{q}(t) \rangle_{q(t)} \leq S_{C(q(t), \dot{q}(t); t)}(0) - S_{C(q(t), \dot{q}(t); t)}(-\dot{q}(t)) \leq 0,$$

since $S_{C(q(t), \dot{q}(t); t)}$ can only take nonnegative values. \square

Corollary 29 *The configuration manifold Q is assumed to be a complete Riemannian manifold and the mapping f is supposed to admit the following estimate:*

$$\forall (q, v) \in TQ, \quad \text{for almost all } t \in [t_0, +\infty[, \quad \|f(q, v; t)\|_q^* \leq l(t) (1 + d(q, q_0) + \|v\|_q),$$

where $d(\cdot, \cdot)$ is the Riemannian distance and $l(t)$, a (necessarily nonnegative) function of $L_{loc}^1(\mathbb{R}; \mathbb{R})$.

Then, the dynamics is eternal, that is, the maximal solution for problem V is defined on $[t_0, +\infty[$.

5.3 Illustrative examples and comments

Non-firm bilateral constraints have been introduced principally in view of discussing dry friction. This is postponed to next section. However, we shall provide here a simple example where a non-firm constraint appears naturally.

Unilate

Exam
provide
constra

Two
strained
and per
2-torus
measur

The for
defines
want to
has con
by the
present
evoluti
in the f
Find θ_1
 $t \in [0,$

By cor
solution

as initia
that the

$\dot{\theta}_1(t)$

$\dot{\theta}_1(t)$

Example 10. Consider the back wheel of a bicycle and its gear. We shall provide a simple model of their assembly in which appears naturally a non-firm constraint according to the above formalism.

Two homogeneous disks, with mass M_1, M_2 and radius R_1, R_2 are constrained to rotate around the same axis, passing through the centers of the disks and perpendicular to their common plane. The configuration manifold is the 2-torus and we shall use the global parametrization defined by the two angular measures (θ_1, θ_2) . The kinetic energy is given by:

$$K = \frac{1}{4} M_1 R_1^2 \dot{\theta}_1^2 + \frac{1}{4} M_2 R_2^2 \dot{\theta}_2^2$$

The forces is supposed to be a constant torque Γ_1 applied on the disk 1. This defines a simple discrete mechanical system according to definition 7. Next, we want to describe the fact that the relative velocity of disk 1 with respect to disk 2 has constant sign. To do this, introduce the *non-firm* bilateral constraint defined by the 1-form $\alpha_1 = d\theta_1 - d\theta_2$. Sticking to the notations of the beginning of the present section, choose $m = 0$, $C_0 = \mathbb{R}^-$ and $M(q) = \text{Id}$. The corresponding evolution problem V can be written in the parametrization under consideration in the following manner.

Find $\theta_1, \theta_2 \in W^{2,\infty}(0, T; \mathbb{R})$ and $\lambda \in L^\infty(0, T; \mathbb{R})$ such that, for almost every $t \in [0, T]$:

- $\frac{1}{2} M_1 R_1^2 \ddot{\theta}_1(t) = \Gamma_1 + \lambda(t)$,
- $\frac{1}{2} M_2 R_2^2 \ddot{\theta}_2(t) = -\lambda(t)$,
- $\lambda(t) \leq 0$,
- $\dot{\theta}_1(t) - \dot{\theta}_2(t) \leq 0$,
- $\lambda(t) (\dot{\theta}_1(t) - \dot{\theta}_2(t)) = 0$,
- + initial conditions.

By corollaries 27 and 29, we know that this evolution problem admits a unique solution whatever is $T > 0$. Next, choose:

$$\dot{\theta}_1(0) = -1 \text{ and } \dot{\theta}_2(0) = 0,$$

as initial conditions. Suppose, in addition, that $\Gamma_1 > 0$. Then, it is readily seen that the solution of the dynamics is given by:

$$\begin{aligned} \dot{\theta}_1(t) &= -1 + \frac{2\Gamma_1}{M_1 R_1^2} t, & \dot{\theta}_2(t) &= 0, & \text{if } 0 \leq t \leq \frac{M_1 R_1^2}{2\Gamma_1}, \\ \dot{\theta}_1(t) &= \dot{\theta}_2(t) = \frac{2\Gamma_1}{M_1 R_1^2 + M_2 R_2^2} \left(t - \frac{M_1 R_1^2}{2\Gamma_1} \right), & & \text{if } t \geq \frac{M_1 R_1^2}{2\Gamma_1}. \end{aligned}$$

The acceleration does not depend continuously on time. This example illustrates the fact that we can not require, in general, that the solution of problem V belongs to $C^2([0, T]; Q)$.

Also, this example explains the reason why we have allowed one of the C_i in the general theory, to be unbounded.

More generally, it is seen that the formalism of non-firm constraints can handle those cases where the constraints appears as inequalities applying on the velocity.

6. Bilateral constraints with dry friction

Usually, the dynamics of rigid bodies systems involving dry friction is formulated in terms of the *real world* reactions. However, this standard approach leads to two major difficulties.

- In case where the contact between two solids occur at more than two points, the real world reactions are generally not defined. The only reaction force which makes sense is the generalized reaction. With respect to this, the reader is referred to example 12.
- Such a formulation leads to situations where the dynamics is ill-posed. There may happen non-uniqueness of solutions and even non-existence (see LÖTSTEDT (1981)). As stated in the introduction, my opinion is that well-posedness should be a requirement for any theory in classical dynamics.

In this section, the formalism of non-firm constraints is applied to derive a general formulation of the dynamics of rigid bodies systems involving dry friction associated with a bilateral constraint. This formulation relies on the following principles. First, we consider a holonomic bilateral constraint. The associated reaction forces define the so-called 'normal reaction'. Next, we are given in addition a general non-holonomic bilateral constraint. The associated reaction forces define the 'tangential reaction'. This supplementary constraint is supposed to be non-firm and the tangential reaction is required to belong to a closed convex set depending on the magnitude of the normal reaction. Then, as for the general case of non-firm constraints, the flow rule is supposed to be governed by the Principle of Maximal Dissipation.

As illustrated by example 11, whenever we study systems of punctual particles, this new formulation encompass the usual formulation (for example, Coulomb friction law), since, in that case, the real world reactions are components of the generalized reaction.

Formulation and well-posedness of the dynamics are first derived. Next, we discuss in length, through many examples, how the theory is to be applied in practical situations.

6.1

Consid
First, we
single fu
in the su

The equa

where λ_1
problem
is a meas
S. It was

Then, $q(t)$

$$\frac{DQ}{dt} \dot{q}$$

To des
a non-fir
the magn
consider
constrain
Section 5

■ a b

■ an
on

■ a s

Define:

$$C(q, \dot{q}; t)$$

Then, fo
system s

6.1 Formulation of the dynamics

Consider a simple discrete mechanical system according to definition 7. First, we superimpose a perfect holonomic bilateral constraint described by a single function φ_1 as in Section 2. Hence, the motion is required to take place in the submanifold:

$$S = \{q \in Q ; \varphi_1(q) = 0\}.$$

The equation of motion was seen to be:

$${}^b \frac{D_Q}{dt} \dot{q}(t) = f(q(t), \dot{q}(t); t) + \lambda_1(t) d\varphi_1(q(t)),$$

where λ_1 is *a priori* unknown, but it is completely determined once the evolution problem has been solved. Physically, it could be said that $\|\lambda_1(t) d\varphi_1(q(t))\|_{q(t)}^*$ is a measure of 'how much the system is constrained' at instant t to remain in S . It was also noted in Section 2 that the equation of motion can be written as:

$${}^b \frac{D_S}{dt} \dot{q}(t) = \text{Proj}_{q(t)}^* [f(q(t), \dot{q}(t); t); T_{q(t)}^* S].$$

Then, $q(t)$ being the motion of the system, we have:

$${}^b \frac{D_Q}{dt} \dot{q}(t) = {}^b \frac{D_S}{dt} \dot{q}(t) + \text{Proj}_{q(t)}^* [f(q(t), \dot{q}(t); t); \mathbb{R} d\varphi_1(q(t))] + \lambda_1(t) d\varphi_1(q(t)).$$

To describe the physical phenomenon of dry friction, we shall superimpose a non-firm, non-holonomic bilateral constraint whose threshold depends on the magnitude $\|\lambda_1(t) d\varphi_1(q(t))\|_{q(t)}^*$ of the normal reaction. More precisely, consider a non-holonomic constraint described by n 1-forms $\alpha_{1j} \in T^*S$. This constraint will be supposed to be non-firm. According to the formalism of Section 5, we are given:

- a bounded closed convex subset C_1 of \mathbb{R}^n , containing the origin,
- an invertible square real matrix $M(q)$ of order n , which depends smoothly on q ,
- a smooth function $\kappa_1 : TQ \times \mathbb{R} \times \mathbb{R}^+ \rightarrow \mathbb{R}^+$.

Define:

$$C(q, \dot{q}; t; r) = \left\{ \sum_{i=1}^n \lambda_i \alpha_i(q) ; (\lambda_1, \lambda_2, \dots, \lambda_n) \in M(q) \cdot [\kappa_1(q, \dot{q}; t; r) C_1] \right\}$$

Then, following the formalism of Section 5, the equation of motion of the system subjected to the frictional bilateral constraint φ_1 is written as:

- $q(t) \in S,$
- $\mathfrak{b} \frac{D_S}{dt} \dot{q}(t) - \text{Proj}_{q(t)}^* \left[f(q(t), \dot{q}(t); t); T_{q(t)}^* S \right] \in \partial_S S_{C(q(t), \dot{q}(t); t; r(t))} (-\dot{q}(t)),$
- $\mathfrak{b} \frac{D_Q}{dt} \dot{q}(t) = \mathfrak{b} \frac{D_S}{dt} \dot{q}(t) + \text{Proj}_{q(t)}^* [f(q(t), \dot{q}(t); t); \mathbb{R} d\varphi_1(q(t))] + \lambda_1(t) d\varphi_1(q(t)),$
- $r(t) = \|\lambda_1(t) d\varphi_1(q(t))\|_{q(t)}^*,$

where the S in ∂_S recalls that the subdifferential is to be understood in the sense of the duality $(T_q S, T_q^* S)$.

Now, we are going to obtain a generalization to the case of a frictional bilateral constraint described by l smooth and functionally independent functions φ_i . The submanifold S containing the constrained motions is now defined by:

$$S = \{q \in Q; \forall i = 1, 2, \dots, l, \varphi_i(q) = 0\}.$$

The other data are as follows.

- α_i are n linearly independent 1-forms in T^*S ,
- C_0 is a given closed convex subset of \mathbb{R}^n , possibly unbounded and containing the origin,
- the C_i ($i = 1, 2, \dots, m$) are given *bounded* closed convex subsets of \mathbb{R}^n , containing the origin,
- $M(q)$ is a given invertible square real matrix of order n , which depends smoothly on $q \in S$,
- the $\kappa_i : TQ \times \mathbb{R} \times (\mathbb{R})^l \rightarrow \mathbb{R}^+$ are given functions whose regularity will be stated later on.

How these data are to be constructed in practical situations will be seen through the examples of Section 6.3. Next, we define:

$$C(q, \dot{q}; t; r) = \left\{ \sum_{i=1}^n \lambda_i \alpha_i(q); (\lambda_1, \lambda_2, \dots, \lambda_n) \in M(q) \cdot \left[C_0 + \sum_{i=1}^m \kappa_i(q, \dot{q}; t; r) C_i \right] \right\}.$$

Unilateral

The closed admissible

Now, given constraint

the evolution of mechanical system follows.

Problem ($i = 1, 2,$

• $(q$

• $q(t$

• $\mathfrak{b} \frac{D}{dt}$

• $\mathfrak{b} \frac{D}{dt}$

• r_n

6.2

Regular mapping are of class Lipschitzian

Theorem

Proof. V Then, core

First, $\psi_S(q) \in \mathbb{R}$

The closed convex subset $C(q, \dot{q}; t; r)$ of T_q^*S could be called 'the set of all admissible tangential reactions'.

Now, given any initial condition $(q_0, v_0) \in TQ$ compatible with the frictional constraint:

$$-v_0 \in \text{Dom } S_{C(q_0, v_0; t_0)} \subset T_{q_0}^*S,$$

the evolution problem associated with the dynamics of simple discrete mechanical systems subjected to frictional bilateral constraints is formulated as follows.

Problem VI. Find $T > t_0$, $q \in W^{2,\infty}([t_0, T[; Q)$ and $\lambda_i \in C^0([t_0, T[; \mathbb{R})$ ($i = 1, 2, \dots, l$) such that:

- $(q(t_0), \dot{q}(t_0)) = (q_0, v_0)$,
- $q(t) \in S, \quad \forall t \in [t_0, T[$,
- $b \frac{D_S}{dt} \dot{q}(t) - \text{Proj}_{q(t)}^* \left[f(q(t), \dot{q}(t); t); T_{q(t)}^*S \right] \in \partial_S S_{C(q(t), \dot{q}(t); t; r_n(t))}(-\dot{q}(t))$,
- $b \frac{D_Q}{dt} \dot{q}(t) = b \frac{D_S}{dt} \dot{q}(t) + \text{Proj}_{q(t)}^* \left[f(q(t), \dot{q}(t); t); \bigoplus_{i=1}^l \mathbb{R} d\varphi_i(q(t)) \right] + \sum_{i=1}^l \lambda_i(t) d\varphi_i(q(t)), \quad \text{for a.e. } t \in [t_0, T[$,
- $r_n(t) = (\lambda_1(t), \lambda_2(t), \dots, \lambda_l(t))$.

6.2 Well-posedness of the dynamics

Regularity hypothesis I. The configuration manifold Q is of class C^2 , the mapping $f : TQ \times \mathbb{R} \rightarrow T^*Q$, the 1-forms α_i and the mapping $M : q \mapsto M(q)$ are of class C^1 . Also, the functions $\kappa_i : TQ \times \mathbb{R} \times (\mathbb{R}^+)^l \rightarrow \mathbb{R}^+$ are locally lipschitzian.

Theorem 30 *There exists a unique maximal solution for problem VI.*

Proof. We are going to prove that problem VI reduces to a problem V on S . Then, corollary 27 will yield the claim.

First, consider an arbitrary chart (U_S, ψ_S) at q_0 on S . We shall denote $\psi_S(q) \in \mathbb{R}^{d-l}$ by $(q^{l+1}, q^{l+2}, \dots, q^d)$. Next, we construct a local chart at q_0 on:

$$S_{l-1} = \{q \in Q; \forall i = 1, 2, \dots, l-1, \varphi_i(q) = 0\},$$

by use of the flow of the vector field

$$\frac{\nabla\varphi_l(q)}{\|\nabla\varphi_l(q)\|_q^2}$$

on S_{l-1} . The supplementary coordinate is denoted by q^l and it is readily checked that:

$$q^l = \varphi_l(q).$$

Repeating that construction successively on $S_{l-2}, \dots, S_1, S_0 = Q$, we obtain a chart (U, ψ) at q_0 on Q such that:

- the l first coordinates of $\psi(q)$ are the $\varphi_i(q)$ ($i = 1, 2, \dots, l$).
- for all $q \in S$, the $\partial/\partial q^i$ ($i = 1, 2, \dots, l$) are orthogonal to the $\partial/\partial q^j$ ($j = l+1, l+2, \dots, d$).

As a consequence, the representative of the metric tensor in that chart satisfies:

$$\forall q \in S, \quad \forall i \in \{1, 2, \dots, l\}, \quad \forall j \in \{l+1, l+2, \dots, d\}, \\ g_{ij}(q) = g^{ij}(q) = 0.$$

Writing the evolution problem in the chart under consideration gives:

$$\lambda_i = g_{ij}(q)\Gamma_{kl}^j(q)\dot{q}^k\dot{q}^l - f_i(q, \dot{q}; t),$$

for $i = 1, 2, \dots, l$. Therefore, $r_n(t)$ is determined by $(q, \dot{q}; t) \in TS \times \mathbb{R}$. Moreover, the induced mapping $r_n : TS \times \mathbb{R} \rightarrow (\mathbb{R}^+)^l$ is clearly locally Lipschitzian. Defining:

$$\mu_i(q, \dot{q}; t) = \kappa_i(q, \dot{q}; t; r_n(q, \dot{q}; t)),$$

we see that the evolution problem reduces to a problem V on S . Thus, the existence and uniqueness of a maximal solution for problem VI is provided by corollary 27. \square

Proposition 31 *The configuration manifold Q is assumed to be a complete Riemannian manifold and the mapping f is supposed to admit the following estimate:*

$$\forall (q, v) \in TQ, \quad \text{for almost all } t \in [t_0, +\infty[, \\ \|f(q, v; t)\|_q^* \leq l(t) \left(1 + d(q, q_0) + \|v\|_q\right),$$

where $d(\cdot, \cdot)$ is the Riemannian distance and $l(\cdot)$ a nonnegative function in $L_{loc}^1(\mathbb{R}; \mathbb{R})$.

Then, the dynamics is eternal, that is, the maximal solution for problem VI is defined on $[t_0, +\infty[$.

Proof. If Q is complete, then so is S . Moreover, we have:

$$\forall (q, v; t) \in TS \times \mathbb{R}, \quad \|\text{Proj}_q^* [f(q, v; t); T_q^* S]\|_q^* \leq \|f(q, v; t)\|_q^*.$$

Therefore, use of corollary 29 in the proof of theorem 30 yields the claim. \square

6.3 Illustrative examples and comments

Our general formulation of dry friction relies on the Principle of Maximal Dissipation through the formalism of non-firm constraints. In some cases, it is the same that the usual formulation of Coulomb friction, as seen on next example.

Example 11. Consider a punctual particle of mass 1 moving in the usual Euclidean \mathbb{R}^3 . This particle is free of external forces but is constrained to move in a two-dimensional submanifold of \mathbb{R}^3 . In order to simplify the equations, we shall assume that this submanifold can be represented by the Cartesian equation:

$$z = s(x, y) \quad (\text{that is, } \varphi_1(x, y, z) = z - s(x, y)).$$

The associated 'normal reaction' has general expression:

$$R_N = \frac{\lambda}{\sqrt{1 + (\partial s / \partial x)^2 + (\partial s / \partial y)^2}} \left(-\frac{\partial s}{\partial x} dx - \frac{\partial s}{\partial y} dy + dz \right),$$

In order to express that this bilateral constraint is frictional, we shall superimpose a non-firm constraint of immobility on the constrained submanifold. So, we have to introduce two 1-form fields to express that the tangential velocity vanishes. It could be natural to use dx and dy , but to stick to our formalism of non-firm constraint, we project them on the orthogonal complement of

$$d\varphi_1 = -\frac{\partial s}{\partial x} dx - \frac{\partial s}{\partial y} dy + dz$$

to get:

$$\alpha_1 = \frac{1}{\sqrt{1 + (\partial s / \partial x)^2}} \left(dx + \frac{\partial s}{\partial x} dz \right),$$

$$\alpha_2 = \frac{1}{\sqrt{1 + (\partial s / \partial y)^2}} \left(dy + \frac{\partial s}{\partial y} dz \right).$$

These 1-form fields have been normalized for sake of simplicity (this normalization could also have been done by introducing appropriate matrix $M(q)$

in the definition of $C(q, R_N)$ below). Postulating the following convex set of admissible 'tangential reactions' associated with the non-firm constraint of immobility:

$$C(x, y, z, \lambda) = \left\{ \lambda_1 \alpha_1 + \lambda_2 \alpha_2 ; \sqrt{\lambda_1^2 + \lambda_2^2} \leq \mu |\lambda| \right\},$$

where μ is a positive real constant (the so-called Coulomb friction coefficient), it is now an easy matter to write the equation of motion in the parametrization (x, y, z) . Writing the corresponding evolution problem VI, the reader will check that one recovers the usual formulation of Coulomb friction. It is of interest to notice, that whenever the function s is not linear, some frictional dissipation can be activated during the motion even if the particle is free of external forces.

Many authors prefer to write directly the usual Coulomb friction law in any case rather than coming back to the Principle of Maximal Dissipation as we did. This method necessarily requires that the evolution problem should be written in terms of the 'real world reactions' instead of the 'generalized reaction' as in our formulation. At first glance, this makes it easier to identify the constitutive equations in practical situations. But, it should be stressed that the concept of 'real world reaction' is in general meaningless in the framework of rigid bodies system. Indeed, the whole theory relies on the rigid geometric description which determines the structure of the space of all virtual velocities. By duality, through the Virtual Power Principle, we obtain the representation of forces as linear forms on the space of virtual velocities. This is the most general representation of forces which is consistent with the geometric description of the system.

We are going to try to illustrate these general considerations by examining some more complicated examples.

Example 12. Consider a rigid four-foot table lying upon a plane floor. The extremity of each of the feet is supposed to be constrained to remain on the floor. This is a holonomic constraint which is described by *three* independent smooth functions. Some external forces are applied on the table. We aim at writing the evolution problem associated with the dynamics, with some dry friction between the table and the floor taken into account. In this example, the 'real world' reactions in each of the feet of the table are *undetermined* and we have actually no other choice than using the generalized reactions to express the dry friction.

We use the coordinates (x, y, z) of the 'center' of the table and Euler angles (ψ, θ, ϕ) to parametrize the system in such a way that the initial configuration is given by:

$$x_0 = y_0 = z_0 = 0, \quad \psi_0 = \phi_0 = 0, \quad \theta_0 = \frac{\pi}{2},$$

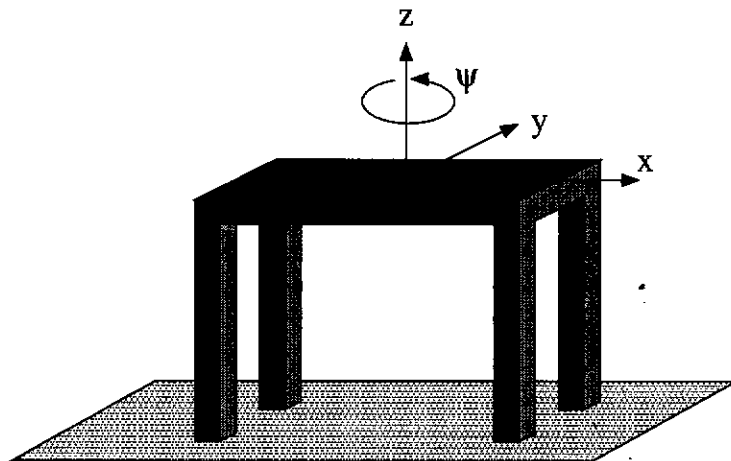

Figure 1.6. Four-feet table on a frictional floor.

and the holonomic constraint is described by:

$$z = 0, \quad \theta = \frac{\pi}{2}, \quad \phi = 0,$$

(see Figure 1.6). The associated reaction force (normal reaction) admits the general form:

$$R_N = R_z dz + R_\theta d\theta + R_\phi d\phi.$$

To describe the dry friction with the floor, we superimpose the non-holonomic constraint defined by the three 1-forms dx , dy and $d\psi$. The associated reaction force (tangential reaction) is written as:

$$R_T = R_x dx + R_y dy + R_\psi d\psi.$$

This non-holonomic constraint will be assumed to be non-firm with convex of admissible (tangential) reaction defined by:

$$C(R_N) = \left\{ R_x dx + R_y dy + R_\psi d\psi ; \right. \\ \left. (R_x, R_y, R_\psi) \in \kappa_1(|R_z|, |R_\theta|, |R_\phi|)C_1 \right\},$$

where C_1 is a given bounded closed convex subset of \mathbb{R}^3 , containing the origin and κ_1 an arbitrary smooth function taking positive values. It is then an easy matter to write the equation of motion of the system in the parametrization under consideration.

What we want to stress is that this is the most general description of the physical phenomenon of dry friction which is consistent with our choice for the geometric description of the table.

A general feature of this formulation is that, for each configuration q_0 and each given constant 'generalized' external forces f_0 , immobility will be the further motion of the system if and only if f_0 belongs to a given convex set. But, we have seen, in Section 1, that the 'generalized' forces f_0 are given, in general, in terms of some 'real world' forces distribution ϕ (notations of Section 1). It is easy to design experiments (for example, on the system of the above example), in which it could be observed that there exist two 'real world' forces distribution ϕ_1 and ϕ_2 consistent with the same generalized forces f_0 and such that ϕ_1 induces immobility of the system whereas ϕ_2 does not. In such a case, what is questionable is not our general formulation of dry friction, it is the geometric assumption of rigidity which is too rough to describe the physical phenomenon (dry friction) under consideration. In such a case, the only way to obtain a more realistic model is to refine the geometric description by adding some degrees-of-freedom. In the above example, this could be done by allowing that each foot of the table is connected to the table through a joint equipped with springs in such a way that some components of the generalized reaction can be interpreted in terms of real world reaction components.

Of course, in any case, there remains to identify the convex set C_1 and the function κ_1 which may turn out to be not so easy. But, once more this is the price we have to pay for the simplicity of the geometric description that we have adopted. Making that choice of simplicity requires to inject a lot of information which is not necessarily at hand in the constitutive equation. We could say that the geometric assumption that has been made is not in accordance with the physical phenomena we wish to describe.

In our formulation, the constitutive equation is completely determined by the data of the convex of admissible 'tangential generalized reaction' through the Principle of Maximal Dissipation. Of course, nothing forbids to use considerations based on 'real world reactions' to derive the convex set of admissible 'tangential generalized reaction' which should be postulated in one practical situation or the other. However, this method is far from working all the time as seen in next example.

Example 13. Consider a rigid homogeneous bar with length L and mass M which is constrained to move in a fixed plane. One of the extremities of the bar is constrained to remain on a fixed bar. We suppose that dry friction is associated to that bilateral constraint. We shall use the parametrization $q = (x, y, \theta)$ as represented on Figure 1.7. The kinetic energy in this parametrization is given

by:

and the

The hol

which d

To desc
which r
it invol
plement

The cor

where C
 κ_1 a fun

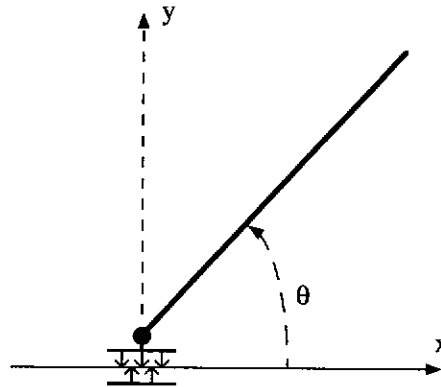

Figure 1.7. Rigid bar with frictional constraint at one extremity.

by:

$$K(q, \dot{q}) = \frac{M}{2} \left(\dot{x}^2 + \dot{y}^2 + \frac{L^2}{3} \dot{\theta}^2 - L \sin \theta \dot{x} \dot{\theta} + L \cos \theta \dot{y} \dot{\theta} \right),$$

and the external forces have general expression:

$$f(q, \dot{q}; t) = f_x(q, \dot{q}; t) dx + f_y(q, \dot{q}; t) dy + f_\theta(q, \dot{q}; t) d\theta.$$

The holonomic bilateral constraint is represented by the single function:

$$\varphi_1(x, y, \theta) = y,$$

which defines the 'normal' reaction as:

$$R_N dy$$

To describe dry friction, we superimpose a non-firm non-holonomic constraint which requires that \dot{x} should vanish. In the formalism of non-firm constraint, it involves the 1-form α_1 obtained by projection of dx on the orthogonal complement of dy :

$$\alpha_1 = dx + \frac{3 \cos \theta \sin \theta}{4 - 3 \sin^2 \theta} dy.$$

The convex of admissible tangential reaction has general form:

$$C(q, \dot{q}; t; R_N) = \{R_T \alpha_1 ; R_T \in \kappa_1(q, \dot{q}; t; |R_N|) C_1\},$$

where C_1 is a bounded closed convex subset of \mathbb{R} , containing the origin and κ_1 a function. To identify the constitutive data C_1 and κ_1 , a natural démarche

is to specify that the 'real world' reaction $R_x dx + R_y dy$ should belong to the Coulomb cone:

$$C = \{R_x dx + R_y dy ; |R_x| \leq \mu |R_y|\} \quad (1.36)$$

(where μ denotes the usual Coulomb friction coefficient) and to translate it in terms of the 'normal and tangential generalized reaction'. We obtain:

$$C(q, \dot{q}; t; R_N) = \left\{ R_T \alpha_1 ; |R_T| \leq \left| \frac{3 \cos \theta \sin \theta}{4 - 3 \sin^2 \theta} R_T + R_N \right| \right\}$$

which is *not convex in general* and prevents from applying the Principle of Maximal Dissipation. If we postulate Coulomb flow rule in such a case instead of the Principle of Maximal Dissipation, then we obtain an ill-posed evolution problem with possible multiple solutions or also no solutions at all, as it is well-known (see LÖTSTEDT (1981) and the references of that paper). In such a case, the only way to write the equation of motion which remains consistent with the initial geometric description is to stick to the above formalism of non-firm constraints. Of course, some structural effects are incorporated in the definition of the convex of admissible 'tangential' reaction and it is hard to see which convex set should be postulated in that situation. Moreover, it is also possible that we obtain unrealistic predictions, in which case the geometric description should be refined.

Now, we are going to discuss a last example which illustrates the interest of allowing the possibly unbounded convex set C_0 in the formalism of this section. It also demonstrates that some structural effects can play a role in the definition of the convex of admissible 'tangential' reactions.

Example 14. Consider the same system as in example 13, but suppose that, in addition, the free extremity of the bar is ideally constrained to remain on a fixed bar as on Figure 1.8. We keep the primitive parametrization $q = (x, y, \theta)$ as defined in example 13. The external forces have general form:

$$f(q, \dot{q}; t) = f_x(q, \dot{q}; t) dx + f_y(q, \dot{q}; t) dy + f_\theta(q, \dot{q}; t) d\theta.$$

The bilateral constraint associated with the 'bottom' fixed bar is still represented by:

$$\varphi_1(q) = y,$$

whereas the bilateral constraint associated with the 'top' bar is represented by:

$$\varphi_2(q) = y + L \sin \theta - d,$$

where d denotes the distance between the two fixed bars. The (normal) generalized reaction associated with that constraint has general expression:

$$\lambda_1 d\varphi_1(q) + \lambda_2 d\varphi_2(q).$$

Figure 1.
other.

Let us r
sociated

in which

Since n
have λ_1
tion ass
to say th
son is th
bodies d
sipation
two func
formulat
indicat
of the co
the Cou
the cons
We ar
of fricti
function
ciated w

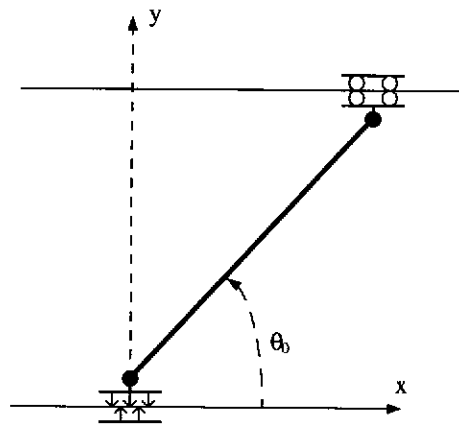

Figure 1.8. Rigid bar with frictional constraint at one extremity and perfect constraint at the other.

Let us note that we could equally have represented the bilateral constraint associated with the 'top' bar by the function:

$$\varphi_2'(q) = \theta - \theta_0,$$

in which case the normal generalized reaction would be expressed as:

$$\mu_1 d\varphi_1(q) + \mu_2 d\varphi_2'(q).$$

Since neither $(d\varphi_1(q), d\varphi_2(q))_q^* = 0$ nor $(d\varphi_1(q), d\varphi_2'(q))_q^* = 0$, we don't have $\lambda_1 = \mu_1$. In other words, we cannot *intrinsically define the normal reaction associated with one fixed bar or the other*. Actually, this is meaningless to say that one of the constraint is ideal and the other is frictional. The reason is that they are coupled by the kinetic metric. In the framework of rigid bodies dynamics, the only thing which can be expressed is that there is a dissipation mechanism associated with the bilateral constraint associated with the two functions φ_1 and φ_2 . We shall see that this does not contradict our general formulation through the non-firm constraint formalism. Actually, this is an indication that some structural effects are to be incorporated in the expression of the constitutive law associated with the dissipation mechanism. Therefore, the Coulomb friction law, which is local by nature, cannot be enough to build the constitutive law associated with such a dissipation mechanism.

We are going to write the equation of motion by applying the formalism of frictional bilateral constraint to the bilateral constraint defined by the two functions φ_1 and φ_2 . To express the non-firm non-holonomic constraint associated with the dissipation mechanism, we first project the 1-form dx onto the

orthogonal complement of the subspace containing the 'normal generalized' reaction:

$$\alpha_1 = dx - \frac{1}{2}L \sin \theta_0 d\theta,$$

We have now to postulate the constitutive law associated with the dissipation mechanism by defining a convex of admissible 'tangential generalized' reaction. One way to proceed is to make experiments to identify the set of values of (f_x, f_y, f_θ) are compatible with equilibrium. Once more, there may happen that different experimental ways of loading the system, which correspond to the same value of (f_x, f_y, f_θ) , give different outcomes of the experiment (equilibrium or not). In such a case, it is the simplicity of the geometric description which should be questioned and refined. Another way to identify the convex of admissible 'tangential generalized' reaction is to express that the 'real world' reaction at the bottom extremity of the bar belong to some Coulomb cone. This method should never be considered as systematic, since, fundamentally, it mixes two different geometric descriptions of the system (rigid and deformable). However, in some particular cases, this method can be a good guideline to identify the constitutive law corresponding to the dissipation mechanism. In the example under consideration, we denote by:

$$R_T \alpha_1 + R_{Ny} dy + R_{N\theta} d\theta$$

the 'generalized' reaction, by:

$$R_{x1} dx + R_{y1} dy$$

the 'real world' reaction associated with the top bar and by:

$$R_{y2} dy$$

the 'real world' reaction associated with the bottom bar. Assuming $\theta_0 \neq \pi/2$, we obtain easily:

$$\begin{aligned} R_{x1} &= R_T, \\ R_{y1} &= \frac{1}{2} \tan \theta_0 R_T + R_{Ny} - \frac{1}{L \cos \theta_0} R_{N\theta}, \\ R_{y2} &= -\frac{1}{2} \tan \theta_0 R_T + \frac{1}{L \cos \theta_0} R_{N\theta}. \end{aligned}$$

Expressing that the 'real world' reaction $R_{x1} dx + R_{y1} dy$ belongs to the Coulomb cone (1.36), we have:

$$|R_T| \leq \mu \left| \frac{1}{2} \tan \theta_0 R_T + R_{Ny} - \frac{1}{L \cos \theta_0} R_{N\theta} \right|. \quad (1.37)$$

Unilatera

In the cas

$C(R_N$

which is

$C(R_N$

where κ T
in the par

It is well-

In the
identify t
are to be
happen w
of the tan
situation,
of \mathbb{R} in the
dynamica
theoretica
of the sys
would be

One w
friction th
nism asso
associated
obeys to
systemati
well-pose
a deforma
other cas
is consist
local Cou
descriptio

In the case $\mu \tan \theta_0 < 2$, we easily identify:

$$C(R_{Ny}, R_{N\theta}) = \left\{ R_T \alpha_1 ; R_T, R_{Ny}, R_{N\theta} \text{ satisfies inequality (1.37)} \right\},$$

which is easily put under the form:

$$C(R_{Ny}, R_{N\theta}) = \left\{ R_T \alpha_1 ; R_T \in \kappa^-(R_{Ny}, R_{N\theta})[-1, 0] + \kappa^+(R_{Ny}, R_{N\theta})[0, 1] \right\},$$

where κ^- and κ^+ are positive Lipschitzian function. The equation of motion in the parametrization under consideration is:

$$\begin{aligned} M\ddot{x} &= f_x(x, \dot{x}; t) + R_T, \\ 0 &= f_y(x, \dot{x}; t) + R_{Ny}, \\ -\frac{ML}{2} \sin \theta_0 \ddot{x} &= f_\theta(x, \dot{x}; t) + R_{N\theta} - \frac{ML}{2} \sin \theta_0 R_T, \\ -\dot{x} &\in \partial I_{\kappa^-(R_{Ny}, R_{N\theta})[-1, 0] + \kappa^+(R_{Ny}, R_{N\theta})[0, 1]}(R_T). \end{aligned}$$

It is well-posed by virtue of theorem 30.

In the case $\mu \tan \theta_0 \geq 2$, inequality (1.37) does not allow any more to identify the convex of admissible tangential reaction. Some structural effects are to be incorporated in the definition of $C(q, \dot{q}; t)$. In this situation, there may happen what is often called 'dynamical locking': some arbitrary large values of the tangential reaction can be compatible with equilibrium. To model such a situation, it may turn out convenient to use some unbounded convex subset C_0 of \mathbb{R} in the definition of $C(q, \dot{q}; t)$. Let us underline that this situation of possible dynamical locking has to be postulated in the constitutive law. It can not be theoretically investigated in the framework of the simple geometric description of the system that has been adopted. The only way to lead this investigation would be to refine the geometric description.

One word to conclude and summarize this section. The point of view on dry friction that we have developed is the following: there is a dissipation mechanism associated with a bilateral constraint which depends on the reaction force associated with that constraint. The flow rule associated with this mechanism obeys to the Principle of Maximal Dissipation. This point of view allows a systematic and intrinsic formulation of the dynamics which is proved to be well-posed. In case where the system contains only punctual particles (or is a deformable body), we recover the usual local Coulomb friction law. In the other cases, we obtain the most general formulation of the dynamics which is consistent with the geometric description of the system. Trying to use the local Coulomb friction law in every case is not consistent with the geometric description of the system and produces numerous paradoxes, as is well-known.

7. On frictional unilateral constraints and related open problems

In this paper, we have extended the classical theory of the dynamics of simple discrete mechanical systems in two directions.

- In Section 3, we have discussed formulation and well-posedness of the dynamics of simple discrete mechanical systems submitted, in addition, to perfect unilateral constraints.
- In Section 4, we have discussed the same issues for simple discrete mechanical systems undergoing, in addition, non-holonomic bilateral constraints. Since a non-holonomic bilateral constraint can be viewed as a frictional bilateral constraint with infinitely large friction, the idea of non-holonomic constraint has been generalized to non-firm and frictional bilateral constraint. General and systematic formulation of the dynamics of such systems has been derived and well-posedness has been established.

Naturally, having in mind a general theory of the evolution of complex mechanisms, the question arises to take into account both unilateral constraints and frictional constraints. That is, we would like to be able to mix the two above theories. Since frictional bilateral constraint appears to be a generalization of non-holonomic bilateral constraint, we are going to handle the problem of associating unilateral constraints with non-holonomic constraints for sake of simplicity.

There are essentially two ways of associating non-holonomic bilateral constraints with unilateral constraints:

- the unconditional association means that the non-holonomic bilateral constraint is always active, no matter whether the unilateral constraint is active or not,
- the conditional association means that the non-holonomic constraint is active only when the unilateral constraint is active.

A typical occurrence of unconditional association is the rolling without slipping of a billiard ball on a billiard table with possible collisions with the edges of the table. An example of conditional association is the rolling without slipping of a ball on a wavy profile with possible takeoff.

The general theory of unconditional association can easily be derived by combining the contents of Sections 3 and 4. Systematic formulation and well-posedness would be obtained as well as the general conditions that should be satisfied by the impact constitutive equation. Even, it is possible to extend to the theory on unconditional association of unilateral constraints with frictional

Unilatera

bilateral
sufficien
solution
applicati
with obs
in each o

The g
cated. S
necessary

As a m
back in t
bodies sy
friction i
virtual re
actually
principle
rigid bod
structural
deformat
will be pr
realistic o

Append

In this s
space and
but only at
easy, proof

Bounded

In this s
RUDIN (19
A functi

where the s
 I . The prop
on E where
have locally
has locally
 $f^+(t)$. Th
for some t
the classica
subset of I .

bilateral constraints. The only difficulty, which is easily overcome, is to derive sufficient regularity assumptions on the data of problem VI to ensure that its solution is analytic on a right neighbourhood of every instant. An example of application of such a theory could be the dynamics of the double-pendulum with obstacle as in example 8 where we could take into account some friction in each of the ball-and-socket joints in addition.

The general theory of conditional association turns out to be more complicated. Some substantial adaptation of the proof of theorem 14 seems to be necessary.

As a matter of conclusion, let us underline the following remark which comes back in the paper as a *leitmotiv*. A complete theory of the dynamics of rigid bodies systems taking into account complicated phenomena such as impacts or friction is highly desirable in view of a lot of applications (granular dynamics, virtual reality, etc. . .). However, it turns out that it is the fact that bodies are actually deformable and not rigid that governs those physical phenomena. In principle, it does not prevent to derive a complete theory of the dynamics of rigid bodies including these phenomena, but, we have to keep in mind that the structural effects (those which physically rely on the fact that the bodies are deformable) are incorporated in the constitutive equations. As a result, there will be probably many situations where the theory will be of no use because no realistic constitutive equation will be at hand.

Appendix: The class of motion $MMA(I, Q)$

In this section, I is any interval of the real line, $(E, \|\cdot\|)$ a finite-dimensional normed vector space and Q a d -dimensional Hausdorff manifold. We do not aim at being systematic nor general, but only at stating definitions and elementary results needed in this paper. Since they are very easy, proofs are generally omitted.

Bounded variation of E -valued functions

In this section, we briefly recall standard results whose proofs may be found, for example, in RUDIN (1966) and MOREAU (1988b).

A function $f : I \rightarrow E$ is said to have *bounded variation* if

$$\text{Var}(f, I) \stackrel{\text{def}}{=} \sup \sum_{i=1}^n \|f(t_i) - f(t_{i-1})\| < \infty,$$

where the supremum is taken over all strictly increasing finite sequences $t_0 < t_1 < \dots < t_n$ in I . The property of having bounded variation does not depend on the particular choice of a norm on E whereas the real number $\text{Var}(f, I)$ depends on that choice. A function $f : I \rightarrow E$ is said to have *locally bounded variation* if it has bounded variation on any compact subinterval of I . If f has locally bounded variation, then it admits left and right limits at every $t \in \overset{\circ}{I}$ (notation $f^-(t)$, $f^+(t)$). The function f is continuous at every $t \in \overset{\circ}{I}$ (that is, $f^-(t) = f^+(t)$) except, maybe, for some t belonging to a (at most) countable subset of I . The function f is differentiable in the classical sense at every $t \in \overset{\circ}{I}$ except, maybe, for some t belonging to a Lebesgue-negligible subset of I . If $\psi : E \rightarrow E$ has class C^1 , then $\psi \circ f$ has locally bounded variation.

A E -valued measure on I is any real-valued linear functional μ on $C_c^0(I; E^*)$ satisfying the continuity property:

$$\forall a < b \in I, \quad \exists M_{a,b} \geq 0, \quad \forall \varphi \text{ with } \text{Supp } \varphi \subset [a, b],$$

$$|\mu(\varphi)| \leq M_{a,b} \max_{t \in I} \|\varphi(t)\|^*.$$

($(E^*, \|\cdot\|^*)$ denotes the dual space of E). The real number $\mu(\varphi)$ will also be denoted by:

$$\int_I \langle \varphi, \mu \rangle.$$

The support $\text{Supp } \mu$ of the measure μ is the complement of the union of all open subsets O of I such that:

$$\forall \varphi \in C_c^0(O; E^*), \quad \mu(\varphi) = 0.$$

For μ a E -valued measure on I , and φ a nonnegative function of $C_c^0(I, \mathbb{R})$, define:

$$|\mu|(\varphi) = \sup_{\substack{f \in C_c^0(I, E^*), \\ \|f(t)\| \leq \varphi(t)}} \mu(\varphi), \tag{1.A.1}$$

where the supremum is finite, thanks to the continuity properties included in the definition of measures. For arbitrary φ in $C_c^0(I, \mathbb{R})$, define $|\mu|(\varphi)$ by:

$$|\mu|(\varphi) = |\mu|(\langle \varphi \rangle^+) - |\mu|(\langle \varphi \rangle^-),$$

where $\langle x \rangle^\pm = \max\{\pm x, 0\}$ are the classical positive and negative parts. Then, $|\mu|$ is a real valued measure called the *modulus* measure of μ . We have $\text{Supp } |\mu| = \text{Supp } \mu$. Let χ_I the characteristic function of I . Define $\mu(\chi_I)$ by means of formula (1.A.1). If $\mu(\chi_I)$ is finite, then the measure μ is said *bounded*.

Let $f : I \rightarrow E$ be a function with locally bounded variation. Then, there exists a unique E -valued measure df on I such that:

$$\forall \varphi \in C_c^1(I, E^*), \quad \int_I \langle \varphi, df \rangle = - \int_I \left\langle \frac{d}{dt} \varphi, f \right\rangle.$$

The measure df is called the Stieltjes measure of f . Hence, the distributional derivative of a function with locally bounded variation is a measure. Reciprocally, if μ is a E -valued measure on I , then the E -valued function defined on I by:

$$t \mapsto \int_{[t_0, t]} \mu,$$

($t_0 \in I$) has locally bounded variation. A function with locally bounded variation has bounded variation if and only if its Stieltjes measure is bounded. If f has locally bounded variation, then, we have:

$$\int_{]a, b[} df = f^-(b) - f^+(a)$$

$$\int_{]a, b)} df = f^+(b) - f^+(a)$$

$$\int_{[a, b[} df = f^-(b) - f^-(a)$$

$$\int_{[a, b)} df = f^+(b) - f^-(a)$$

Unilate

If there

with dt

said to be

If $h \in I$

locally al

>From

bounded

have:

contin

solutely

Definition

exists a n

■ $q(\$

■ ψ

In that ca

mapping

Definition

condition:

From now

Definition

in any cha

It is possi

continuous

but we sha

variation o

requires a F

and from n

theorem, q

structure of

operator al

operator τ_t

Proposition

θ_{t_0} the map

If there exists $h \in L^1_{loc}(I, E)$ such that:

$$df = h dt,$$

with dt denoting the Lebesgue measure on I , then the function f with locally bounded variation is said to be *locally absolutely continuous*. A locally absolutely continuous function is continuous. If $h \in L^1(I, E)$, then f is said absolutely continuous. If $\psi : E \rightarrow E$ has class C^1 and f is locally absolutely continuous, then $\psi \circ f$ is locally absolutely continuous.

>From now on, E is assumed to be a Euclidean vector space. If $f, g : I \rightarrow E$ have locally bounded variation, then $(f, g) : t \mapsto (f(t), g(t))$ has also locally bounded variation and we have:

$$d(f, g) = \left(\frac{f^+ + f^-}{2}, dg \right) + \left(df, \frac{g^+ + g^-}{2} \right).$$

continuous curve on Q **Bounded variation of vector fields over a locally absolutely continuous curve on Q**

Definition 32 A curve $q : I \rightarrow Q$ is said *locally absolutely continuous* if, for all t in I , there exists a neighbourhood J of t in I and local chart (U, ψ) at $q(t)$ such that:

- $q(J) \subset U$,
- $\psi \circ q : J \rightarrow \mathbb{R}^d$ is *locally absolutely continuous*.

In that case, for any local chart (U, ψ) and any subinterval J of I such that $q(J) \subset U$, the mapping $\psi \circ q : J \rightarrow \mathbb{R}^d$ is *locally absolutely continuous*.

Definition 33 A vector field v over a curve $q : I \rightarrow Q$ is a mapping $v : I \rightarrow TQ$ satisfying the condition:

$$\forall t \in I, \quad \Pi_Q(v(t)) = q(t).$$

From now on, $q : I \rightarrow Q$ denotes a locally absolutely continuous curve.

Definition 34 A vector field v over q is said to have *locally bounded variation* if its components in any chart are real valued functions with locally bounded variation.

It is possible to define the concept of vector fields with bounded variation on an absolutely continuous curve by means of a locally finite covering by charts domain and partition of unity, but we shall not pursue in that direction. Indeed, though the definition of the concept of bounded variation of vector fields is possible on general manifolds, the definition of the variation itself requires a Riemannian structure on Q . So, we are going to particularize the definitions to that case and from now on, we assume that Q is equipped with a Riemannian structure. By Lebesgue's theorem, $q(t)$ admits a tangent vector $\dot{q}(t) \in T_{q(t)}Q$ for dt -almost all t in I . The Riemannian structure on Q and Caratheodory's theorem allow us to define classically a parallel translation operator along q , $\tau_{t,s} : T_{q(s)}Q \rightarrow T_{q(t)}Q$ (see, for example, CHAVEL (1993), p. 7). The operator $\tau_{t,s}$ is defined for all $(s, t) \in I^2$.

Proposition 35 Let t_0 be an arbitrary element of I and v a vector field over q . We denote by θ_{t_0} the mapping:

$$\theta_{t_0} \begin{cases} I & \rightarrow T_{q(t_0)}Q \\ s & \mapsto \tau_{t_0,s}(v(s)) \end{cases} \quad (1.A.2)$$

which takes values in the d -dimensional normed vector space $T_{q(t_0)}Q$. Then, v has locally bounded variation if and only if θ_{t_0} has locally bounded variation.

Proof. It is a consequence of the identity:

$$\frac{d}{dt}\theta_{t_0}(t) = \left[\frac{d}{dt}v^i(t) + \Gamma_{jk}^i(q(t))\dot{q}^j(t)v^k(t) \right] \tau_{t_0,t}(e_i(q(t))),$$

which holds in the sense of distributions in any local chart. □

Corollary 36 Let J be a bounded subinterval of I and (U, ψ) a local chart such that $q(J) \subset U$. Let v^i be the components in that chart of the vector field v over q with locally bounded variation. Then, θ_{t_0} has bounded variation over J if and only if each function v^i has bounded variation over J .

Definition 37 Let v be a vector field over q with locally bounded variation, J any subinterval of I and θ_{t_0} as in formula (1.A.2). The variation of v over J is, by definition:

$$\text{Var}(v(s); J) = \text{Var}(\tau_{t_0,s}(v(s)); J).$$

It belongs to $\mathbb{R} \cup \{+\infty\}$.

That $\text{Var}(v(s); J)$ does not depend on a particular choice of t_0 , relies on the identity:

$$\|\tau_{t_1,s_1}(v(s_1)) - \tau_{t_1,s_2}(v(s_2))\|_{q(t_1)} = \|\tau_{t_2,s_1}(v(s_1)) - \tau_{t_2,s_2}(v(s_2))\|_{q(t_2)},$$

that holds for all $s_1, s_2, t_1, t_2 \in I$.

Proposition 38 Let v be a vector field over q with locally bounded variation and J any subinterval of I . Then for all t_0 in $\overset{\circ}{J}$, the two one-sided limits $\lim_{t \rightarrow t_0^-} v(t)$ and $\lim_{t \rightarrow t_0^+} v(t)$ exist in TQ . They satisfy:

$$\Pi_Q \left(\lim_{t \rightarrow t_0^-} v(t) \right) = \Pi_Q \left(\lim_{t \rightarrow t_0^+} v(t) \right) = q(t_0),$$

and are denoted respectively by $v^-(t_0)$ and $v^+(t_0)$. They can be distinct only at points belonging to a countable subset of J . If $\text{Var}(v; J)$ is finite, such one-sided limits exist also at the two end-points of J , even if the end-points do not belong to J .

We denote by $C_c^0(I, q; TQ)$ the space of continuous vector fields over q with compact support (similar definition for $C_c^0(I, q; T^*Q)$). By definition, a vector valued measure over q is any linear functional μ on $C_c^0(I, q; T^*Q)$ enjoying the following continuity property:

$$\forall a < b \in I, \exists M_{a,b} \geq 0, \quad \forall \varphi \text{ with } \text{Supp } \varphi \subset [a, b],$$

$$|\mu(\varphi)| \leq M_{a,b} \max_{t \in I} \|\varphi(t)\|_{q(t)}^*.$$

The real number $\mu(\varphi)$ will also be denoted by $\int_I \langle \varphi(t), \mu \rangle_{q(t)}$. For μ being a vector valued measure over q , the definitions of $\text{Supp } \mu$ and $b\mu$ are straightforward.

Definition 39 Let v be a vector field over q with locally bounded variation and θ_{t_0} as in formula (1.A.2). Then, the linear form on $C_c^0(I, q; T^*Q)$ defined by:

$$\varphi^* \mapsto \int_I (\tau_{t_0,s}(\# \circ \varphi^*(s)), d\theta_{t_0})_{q(t_0)},$$

Unilater

turns out
over q , d
have:

Proposit
are also v

Proposit
the functi
I and we

d (

Definit

In this

Definit
locally ab
classical s

The fo

Proposit

Moreover,

Proof. U

Appen

In this a
analysis. V
results wh
train of ide

Basic co

We den
by $(E^*, \|\cdot\|$

turns out to be independent on the particular choice of t_0 and define a vector valued measure over q , denoted by Dv and called the covariant Stieltjes measure of v . In any local chart, we have:

$$Dv = \left[dv^i + \Gamma_{jk}^i(q(t))v^j(t)\dot{q}^k(t) dt \right] e_i(q(t)).$$

Proposition 40 Let v be a vector field over q with locally bounded variation. Then, v^- and v^+ are also vector fields over q with locally bounded variation and the following identities hold:

$$(v^+)^+ = v^+, \quad (v^+)^- = v^-, \quad (v^-)^+ = v^+, \quad (v^-)^- = v^-, \\ Dv^- = Dv^+ = Dv.$$

Proposition 41 Let v and w be two vector fields over q with locally bounded variation. Then, the function $t \mapsto (v(t), w(t))_{q(t)}$ is a real valued function with locally bounded variation over I and we have:

$$d(v(t), w(t))_{q(t)} = \left(\frac{v^-(t) + v^+(t)}{2}, Dw \right)_{q(t)} + \left(Dv, \frac{w^-(t) + w^+(t)}{2} \right)_{q(t)}.$$

Definition of the class MMA

In this section, Q is a d -dimensional Riemannian manifold.

Definition 42 We denote by $MMA(I; Q)$ (motions with measure acceleration) the set of all locally absolutely continuous motions $q : I \rightarrow Q$ such that the right velocity $\dot{q}^+(t)$ exists (in the classical sense) for all t in I and defines a vector field over q with locally bounded variation.

The following proposition ensures the consistency of our notations.

Proposition 43 Let q be in $MMA(I; Q)$. Then, $\dot{q}^+ : I \rightarrow TQ$ is right continuous:

$$\forall t \in \overset{\circ}{I}, \quad (\dot{q}^+(t))^+ = \dot{q}^+(t).$$

Moreover, $q(t)$ admits a left velocity vector at each instant and:

$$\forall t \in \overset{\circ}{I}, \quad \dot{q}^-(t) = (\dot{q}^+(t))^-.$$

Proof. Use the Mean Value Inequality in a local chart. □

Appendix: Some convex analysis

In this appendix, we do not aim at providing a systematic list of the main theorems in convex analysis. We just want to recall those that are needed in the paper and also to prove some technical results which, if they had been proved in the paper when needed, could have masked the logical train of ideas.

Basic convex analysis

We denote by $(E, \|\cdot\|)$ a finite-dimensional normed vector space. The dual will be denoted by $(E^*, \|\cdot\|^*)$. The bidual of E is systematically identified with E . We briefly recall some

standard definitions and results whose proofs may be found, for example, in ROCKAFELLAR (1970).

A function $\phi : E \rightarrow \mathbb{R} \cup \{+\infty\}$ is said *proper* if its domain:

$$\text{Dom } \phi \stackrel{\text{def}}{=} \{v \in E ; \phi(v) \neq +\infty\},$$

is non-void. A function $\phi : E \rightarrow \mathbb{R} \cup \{+\infty\}$ is said *lower-semi-continuous* if

$$\phi^{-1} (]-\infty, \lambda]) = \{v \in E ; \phi(v) \leq \lambda\}$$

is closed in E for all $\lambda \in \mathbb{R}$. If ϕ is convex, its domain is convex. If ϕ is lower-semi-continuous, its domain does not need to be closed. If C is any convex subset of E , then C is the domain of its indicator function I_C :

$$I_C(v) = \begin{cases} 0 & \text{if } v \in C \\ +\infty & \text{if } v \notin C \end{cases}$$

which is convex. It is lower-semi-continuous if and only if C is closed. A function $\phi : E \rightarrow \mathbb{R} \cup \{+\infty\}$ is said *positively homogeneous* if:

$$\forall \lambda \in \mathbb{R}^+, \forall v \in E \quad \phi(\lambda v) = \lambda \phi(v).$$

If $\phi : E \rightarrow \mathbb{R} \cup \{+\infty\}$ is a proper convex function, its conjugate (or dual) function $\phi^* : E^* \rightarrow \mathbb{R} \cup \{+\infty\}$ is defined by:

$$\phi^*(v^*) = \sup_{v \in E} \{ \langle v^*, v \rangle - \phi(v) \}.$$

It is a proper convex function which is, in addition, lower-semi-continuous. Identifying E with its bidual, the conjugacy is a one-to-one, involutive correspondence in the class of all proper lower-semi-continuous convex functions. Moreover, it maps proper, lower-semi-continuous, convex, positively homogeneous functions onto the class of indicator functions of non-void closed convex sets, and reciprocally. Let $\phi : E \rightarrow \mathbb{R} \cup \{+\infty\}$ be a proper convex function. For C being a closed convex subset of E , we define the *support function* S_C of C as being the conjugate function of the indicator function I_C of C . The following result is obvious.

Proposition 44 *Let C_1 and C_2 be two closed convex subsets of E . We have:*

$$S_{C_1+C_2} = S_{C_1} + S_{C_2}$$

Proposition 45 *Let C be a closed convex subset of E . Then, C is bounded if and only if its support function S_C does not take the value $+\infty$. In that case, S_C is L -Lipschitzian with:*

$$L = \max_{\|v\|^* = 1} S_C(v) = \max_{v \in E^* \setminus \{0\}} \frac{S_C(v)}{\|v\|^*} = \max_{v \in C} \|v\|$$

Definition 46 *The subdifferential $\partial\phi(v)$ of ϕ at point v is:*

$$\partial\phi(v) = \{v^* \in E^* ; \forall w \in E, \phi(w) \geq \phi(v) + \langle v^*, w - v \rangle\}.$$

It is a closed convex subset of E^ .*

Let ϕ and ψ be two proper, lower-semi-continuous, convex functions. We obviously have:

$$\partial\phi + \partial\psi \subset \partial(\phi + \psi),$$

Unilatera

but the eq
that one of

Propositio
E, then

Actually, it
necessarily

Propositio
We have:

Most of
We shall ne
continuous
p. 47).

Propositio
non-negativ

Then Φ is a

$\partial\phi$

Also, it is c
then Dom ϕ
possibly in

Propositio
space H . If

Note that in
not be lowe

Evolution

The syst
Hilbert spac
First, we
(1973), p. 5

Theorem 5
semi-contin
 $W^{1,\infty}(0, T$

but the equality does not hold in general. However, a sufficient condition to get the equality is that one of the two functions has domain E .

Proposition 47 *Let ϕ and ψ be two proper, lower-semi-continuous, convex functions. If $\text{Dom } \psi = E$, then*

$$\partial\phi + \partial\psi = \partial(\phi + \psi).$$

Actually, in the finite-dimensional case that we consider, a convex function with domain E is necessarily lower-semi-continuous and even more continuous.

Proposition 48 *Let $\phi : E \rightarrow \mathbb{R} \cup \{+\infty\}$ be a proper, convex, lower-semi-continuous function. We have:*

$$v^* \in \partial\phi(v) \iff v \in \partial\phi^*(v^*) \iff \phi(v) + \phi^*(v^*) = \langle v^*, v \rangle.$$

Most of the above definitions and results can be extended to the infinite-dimensional case. We shall need few results of this sort. In the following proposition, a proper convex lower-semi-continuous function is built on the space $L^2(0, T; E)$. The proof can be found in BREZIS (1973), p. 47).

Proposition 49 *Let ϕ be a proper, lower-semi-continuous, convex function on E and μ be a non-negative integrable function on $[0, T]$. For $u \in L^2(0, T; E)$, we define:*

$$\Phi(u) = \begin{cases} \int_0^T \mu(t)\phi(u(t)) dt & \text{if } \mu\phi(u) \in L^1(0, T; \mathbb{R}), \\ +\infty & \text{otherwise.} \end{cases}$$

Then Φ is a proper, lower-semi-continuous, convex function on $L^2(0, T; E)$. Moreover, we have:

$$\partial\Phi(u) = \{v \in L^2(0, T; E^*) ; v(t) \in \partial\mu(t)\phi(u(t)), \text{ for a.e. } t \in [0, T]\}.$$

Also, it is clear that, if, in addition, ϕ is positively homogeneous with domain E and $\mu \in L^2$, then $\text{Dom } \Phi = L^2(0, T; E)$. Proposition 47 holds true in the case where E is a Hilbert space, possibly infinite-dimensional (see BREZIS (1973), p. 41).

Proposition 50 *Let ϕ and ψ be two proper, lower-semi-continuous, convex functions on a Hilbert space H . If $\text{Dom } \psi = H$, then*

$$\partial\phi + \partial\psi = \partial(\phi + \psi).$$

Note that in the case where H is infinite-dimensional, a convex function with domain H needs not be lower-semi-continuous.

Evolution problems associated with subdifferentials

The systematic reference for this section is BREZIS (1973). In the sequel, for H being a Hilbert space, we shall systematically identify the dual of H with H .

First, we recall a well-known result whose proof is to be found, for example, in BREZIS (1973), p. 54.

Theorem 51 *Let H be a Hilbert space, $\varphi : H \rightarrow \mathbb{R} \cup \{+\infty\}$ be a convex, proper, lower-semi-continuous function, and u_0 be any element of $\text{Dom } \varphi$. Then, there exists a unique $u \in W^{1,\infty}(0, T; H)$ such that:*

- $u(0) = u_0,$
- $-\dot{u}(t) \in \partial\varphi(u(t)),$ for a.e. $t \in [0, T].$

Moreover,

- the solution u admits a right-derivative $\dot{u}^+(t),$ at all $t \in [0, T[$ and:

$$\forall t \in [0, T[, \quad \dot{u}^+(t) + \text{Proj}[0; \partial\varphi(u(t))] = 0,$$

- the function:

$$t \mapsto \|\text{Proj}[0; \partial\varphi(u(t))]\|_H = \min_{v \in \partial\varphi(u(t))} \|v\|_H$$

is non-increasing.

Now, we are going to derive a modified version of theorem 51 which is adapted to our needs. In the sequel, we denote by $(u, v) = {}^t u \cdot v$ the canonical scalar product of \mathbb{R}^n and by $|\cdot|$ the associated norm. The n^2 -dimensional space of real square matrices of order n is denoted by $\mathcal{M}_n(\mathbb{R}).$

We are given some data as follows.

- $\varphi_0 : \mathbb{R}^n \rightarrow \mathbb{R}^+ \cup \{+\infty\}$ is convex, proper, lower-semi-continuous and positively homogeneous.
- $\varphi_i : \mathbb{R}^n \rightarrow \mathbb{R}$ ($i = 1, 2, \dots, m$) are convex and positively homogeneous.
- $\mu_i \in W^{1,\infty}(0, T; \mathbb{R}^+)$ ($i = 1, 2, \dots, m$).
- $f \in W^{1,\infty}(0, T; \mathbb{R}^n).$
- $G \in W^{1,\infty}(0, T; \mathcal{M}_n(\mathbb{R}))$ is such that $G(t)$ is symmetric, positive definite, for all $t \in [0, T].$
- $u_0 \in \text{Dom } \varphi_0.$

By proposition 45, we have that the functions φ_i ($i = 1, 2, \dots, m$) are all L -Lipschitzian for some $L.$ We denote by $\lambda_G^{\min} > 0$ (respectively λ_G^{\max}) the minimum (respectively the maximum) of all the eigenvalues of $G(t)$ for t wandering in $[0, T].$

Proposition 52 *There exists a unique $u \in W^{1,\infty}(0, T; \mathbb{R}^n)$ such that:*

- $u(0) = u_0,$
- $-G(t) \cdot \dot{u}(t) - f(t) \in \partial\varphi_0(u(t)) + \sum_{i=1}^m \mu_i(t) \partial\varphi_i(u(t)),$ for a.e. $t \in [0, T].$

Moreover,

$$\|\dot{u}\|_{L^\infty} \leq \frac{\lambda_G^{\max}}{\lambda_G^{\min}} e^{\|\dot{G}\|_{L^\infty} T / \lambda_G^{\min}} \left\{ \min_{v \in \partial\varphi_0(u_0)} |v| + \|f\|_{L^\infty} + L \sum_{i=1}^m \|\mu_i\|_{L^\infty} + T \left\| \dot{f} \right\|_{L^\infty} + TL \sum_{i=1}^m \|\dot{\mu}_i\|_{L^\infty} \right\} \stackrel{(\text{def } C_1)}{=} C_1. \tag{1.B.1}$$

Finally, if u is the solution associated with the data (G, f, μ_i) and \bar{u} the one associated with the data $(\bar{G}, \bar{f}, \bar{\mu}_i),$ then, for all $t \in [0, T],$ the following estimate holds:

$$|\bar{u}(t) - u(t)| \leq e^{\|\dot{G}\|_{L^\infty} T / \lambda_G^{\min}} \left\{ \frac{C_1}{\lambda_G^{\min}} \int_0^t |\bar{G}(s) - G(s)|_{\mathcal{M}_n(\mathbb{R})} ds + \frac{L+1}{\lambda_G^{\min}} \int_0^t \left[|\bar{f}(s) - f(s)| + \sum_{i=1}^m |\bar{\mu}_i(s) - \mu_i(s)| \right] ds \right\}. \tag{1.B.2}$$

Unilater

Proof.
argument
To pro
As a cons

for all t
identically
To pro
following
successiv

for a.e.

- G

To see tha
 \mathbb{R}^n equip
 φ being d

It is obvie
theorem 5

where C_1
arbitrary i

where C_2

Applying
towards a
 $W^{1,\infty}(0,$
This yield
lution pro
properties

$-\int_0^T$

Proof. The proof of proposition 52 is derived from theorem 51 by means of very classical arguments.

To prove uniqueness of solution, consider two solutions u and \tilde{u} and define $\delta(t) = \tilde{u}(t) - u(t)$. As a consequence of the monotonicity of subdifferentials, we have easily:

$$\delta(t) \cdot G(t) \cdot \delta(t) \leq \frac{\|G\|_{L^\infty}}{\lambda_G^{\min}} \int_0^t \delta(s) \cdot G(s) \cdot \delta(s) \, ds,$$

for all $t \in [0, T]$. Applying the Gronwall lemma (lemma 4), we obtain that $\delta(t)$ vanishes identically. Therefore, the functions u and \tilde{u} coincide identically.

To prove existence, we define, for all $N \in \mathbb{N}$ an approximant u_N of the solution in the following way. First, we require $u_N(0) = 0$. Next, we define u_N on $[(k-1)T/2^N, kT/2^N]$ successively for $k = 1, 2, \dots, 2^N$ by:

$$\begin{aligned} &\text{for a.e. } t \in \left[\frac{(k-1)T}{2^N}, \frac{kT}{2^N} \right], \\ &-G \left(\frac{(k-1)T}{2^N} \right) \cdot \dot{u}_N(t) - f \left(\frac{(k-1)T}{2^N} \right) \in \partial\varphi_0(u_N(t)) + \sum_{i=1}^m \mu_i \left(\frac{(k-1)T}{2^N} \right) \partial\varphi_i(u_N(t)). \end{aligned}$$

To see that u_N is well-defined, it is enough to apply proposition 47 and theorem 51 with H being \mathbb{R}^n equipped with the scalar product induced by the matrix $G((k-1)T/2^N)$ and the function φ being defined by:

$$\varphi(v) = {}^t f \left(\frac{(k-1)T}{2^N} \right) \cdot v + \varphi_0(v) + \sum_{i=1}^m \mu_i \left(\frac{(k-1)T}{2^N} \right) \varphi_i(v).$$

It is obvious that, for all $N \in \mathbb{N}$, $u_N \in W^{1,\infty}(0, T; \mathbb{R}^n)$. Also, by use of the second part of theorem 51, we obtain, after a tedious but easy calculation:

$$\forall N \in \mathbb{N}, \quad \|\dot{u}_N\|_{L^\infty} \leq C_1, \tag{1.B.3}$$

where C_1 is the real constant defined in the statement of proposition 52. Now, we are given two arbitrary integers $M \geq N$. A standard but tedious calculation yields:

$$\forall t \in [0, T], \quad \frac{1}{2} |u_M(t) - u_N(t)|^2 \leq \frac{C_2}{2^N} \int_0^t |u_M(s) - u_N(s)| \, ds$$

where C_2 is a real constant which does not depend on M and N . Actually, we may take:

$$C_2 = \frac{T}{\lambda_G^{\min}} e^{\|G\|_{L^\infty} T / \lambda_G^{\min}} \left\{ \|f\|_{L^\infty} + L \sum_{i=1}^m \|\mu_i\|_{L^\infty} \right\}$$

Applying lemma 5, we obtain that the sequence u_N converges in the Banach space $C^0([0, T]; \mathbb{R}^n)$ towards a limit u . Coming back to uniform estimate (1.B.3), we can conclude that $u \in W^{1,\infty}(0, T; \mathbb{R}^n)$ and also that a subsequence of (\dot{u}_N) converges towards \dot{u} in L^∞ weak-*. This yields estimate (1.B.1), but there remains to prove that u is a solution of the considered evolution problem. Using the lower-semi-continuity of φ_0 , the Fatou lemma and the convergence properties of the sequence (u_N) , we easily establish that, for all $v \in L^1(0, T; \mathbb{R}^n)$,

$$-\int_0^T (G \cdot \dot{u} + f) \cdot (v - u) \leq \int_0^T \left\{ \varphi_0(v) - \varphi_0(u) + \sum_{i=1}^m \mu_i(t) (\varphi_i(v) - \varphi_i(u)) \right\}.$$

Next, there remains to use propositions 49 and 50 to deduce that, for almost every $t \in [0, T]$,

$$-G(t) \cdot \dot{u}(t) - f(t) \in \partial\varphi_0(u(t)) + \sum_{i=1}^m \mu_i(t) \partial\varphi_i(u(t))$$

and, so, that u solves the considered evolution problem.

To prove the last estimate of proposition 52, we take the sum of the inequalities:

$$-(G \cdot \dot{u} + f) \cdot (\bar{u} - u) \leq \varphi_0(\bar{u}) - \varphi_0(u) + \sum_{i=1}^m \mu_i (\varphi_i(\bar{u}) - \varphi_i(u)),$$

and

$$-(\bar{G} \cdot \dot{\bar{u}} + \bar{f}) \cdot (u - \bar{u}) \leq \varphi_0(u) - \varphi_0(\bar{u}) + \sum_{i=1}^m \mu_i (\varphi_i(u) - \varphi_i(\bar{u})).$$

We obtain:

$$\begin{aligned} (\dot{\bar{u}} - \dot{u}) \cdot \bar{G} \cdot (\bar{u} - u) &\leq (f - \bar{f}) \cdot (\bar{u} - u) + \sum_{i=1}^m (\mu_i - \bar{\mu}_i) (\varphi_i(\bar{u}) - \varphi_i(u)) \\ &\quad + \dot{u} \cdot (G - \bar{G}) \cdot (\bar{u} - u), \end{aligned}$$

which yields:

$$\begin{aligned} \frac{d}{dt} \left[\frac{1}{2} (\bar{u} - u) \cdot \bar{G} \cdot (\bar{u} - u) \right] &\leq \left[(L+1) \left(|\bar{f} - f| + \sum_{i=1}^m |\bar{\mu}_i - \mu_i| \right) \right. \\ &\quad \left. + C_1 |\bar{G} - G| + \|\dot{\bar{G}}\|_{L^\infty} |\bar{u} - u| \right] |\bar{u} - u|. \end{aligned}$$

To reach the desired conclusion, it is enough to integrate over $[0, t]$ and to apply successively lemma 5 and lemma 4. \square

References

- [1] R. ABRAHAM & J.E. MARSDEN (1985), *Foundations of Mechanics*, Addison-Wesley.
- [2] P. BALLARD (2000), The dynamics of discrete mechanical systems with perfect unilateral constraints, *Archive for Rational Mechanics and Analysis*, **154**, pp 199–274.
- [3] A. BRESSAN (1960), Incompatibilità dei Teoremi di Esistenza e di Unicità del Moto per un Tipo molto Comune e Regolare di Sistemi Meccanici, *Annali della Scuola Normale Superiore di Pisa*, Serie III, Vol. XIV, pp 333–348.
- [4] H. BREZIS (1973), *Opérateurs Maximaux Monotones et Semi-groupes de Contractions dans les Espaces de Hilbert*, North-Holland Publishing Company.
- [5] I. CHAVEL (1993), *Riemannian Geometry: a Modern Introduction*, Cambridge University Press.

- [6] E.A. CODDINGTON & N. LEVINSON (1955), *Theory of Ordinary Differential Equations*, McGraw-Hill Book Company.
- [7] P. LÖTSTEDT (1981), Coulomb Friction in Two-Dimensional Rigid Body Systems, *Z. Angew. Math. u. Mech.*, **61**, pp 605–615.
- [8] P. LÖTSTEDT (1982), Mechanical Systems of Rigid Bodies subject to Unilateral Constraints, *SIAM J. Appl. Math.*, **42**, no 2, pp 281–296.
- [9] M.D.P. MONTEIRO MARQUES (1993), *Differential Inclusions in Nonsmooth Mechanical Problems*, Birkhäuser Verlag, Basel-Boston-Berlin.
- [10] J.J. MOREAU (1983), Standard inelastic shocks and the dynamics of unilateral constraints, in *Unilateral problems in structural analysis* (G. Del Piero and F. Maceri Eds), Springer-Verlag, Wien, New-York, pp 173–221.
- [11] J.J. MOREAU (1988a), Unilateral contact and dry friction in finite freedom dynamics, in *Nonsmooth Mechanics and Applications*, CISM Courses and Lectures No 302 (J.J. Moreau and P.D. Panagiotopoulos Eds), Springer-Verlag, Wien, New-York, pp 1–82.
- [12] J.J. MOREAU (1988b), Bounded variation in time, in *Topics in Nonsmooth Mechanics* (J.J. Moreau, P.D. Panagiotopoulos, G. Strang, Eds.), Birkhäuser Verlag, Basel-Boston-Berlin, pp 1–74.
- [13] D. PERCIVALE (1985), Uniqueness in the Elastic Bounce Problem, I, *Journal of Differential Equations*, **56**, pp 206–215.
- [14] D. PERCIVALE (1991), Uniqueness in the Elastic Bounce Problem, II, *Journal of Differential Equations*, **90**, pp 304–315.
- [15] R.T. ROCKAFELLAR (1970), *Convex Analysis*, Princeton University Press.
- [16] W. RUDIN (1966), *Real and complex analysis*, McGraw-Hill.
- [17] M. SCHATZMAN (1978), A Class of Nonlinear Differential Equations of Second Order in Time, *Nonlinear Analysis, Theory, Methods & Applications*, **2**, No 2, pp 355–373.
- [18] M. SCHATZMAN (1998), Uniqueness and continuous dependence on data for one dimensional impact problems, *Mathematical and Computational Modelling*, **28**, No. 4–8, pp 1–18.

Chapter 5

Frictionless Unilateral Multibody Dynamics

5.1. Introduction

Granular materials dynamics is usually studied in the framework of the dynamics of a finite collection of rigid bodies submitted to non-penetration conditions. This chapter aims to describe the state-of-the-art of the mathematical formulation of such problems as well as the existence and uniqueness of solution. Since this subject has now reached some maturity in the *frictionless* situation (whereas, in my opinion, the handling of dry friction has not yet received complete understanding), the presentation is restricted to the idealized frictionless situation.

The formulation of the dynamics of rigid body systems can be traced to Lagrange's *Mécanique Analytique*. The corresponding evolution problem is a second-order ordinary differential equation in \mathbb{R}^n with initial conditions. Well-posedness (existence and uniqueness of solutions) of this evolution problem was proved by Cauchy at the beginning of the 19th century.

The handling of perfect bilateral constraints does not introduce supplementary mathematical difficulties and Cauchy's theorem still applies to prove that the corresponding evolution problem is well-posed.

The situation is rather different when we have to handle perfect *unilateral* constraints such as those arising with frictionless non-penetration conditions. Consistent formulation of the corresponding evolution problem was only obtained 25 years ago by Schatzman [SCH 78] and Moreau [MOR 83] who left the question of well-posedness

largely open. Substantial contributions on well-posedness were made by Lötstedt [LÖT 82], Percivale [PER 85], Monteiro Marques [MON 93], Schatzman [SCH 98] and Ballard [BAL 00].

A satisfactory theory with sufficient generality has now been reached. This has, as yet, only been presented in the framework of configuration manifolds, which can generate unnecessary difficulties (of vocabulary) for the readers who do not have a minimal training in differential geometry. This book provides the opportunity to present the main results in the usual language of non-smooth analytical dynamics, for the sake of clarity. The content of this chapter is the same as [BAL 01], but in a different language and with different notation.

Section 5.2 recalls the basics of the formulation and well-posedness of the dynamics of a collection of rigid bodies submitted to internal and external forces. This very standard material is joined in order to introduce notations and to fix the framework.

Section 5.3 deals with the handling of perfect bilateral constraints in this framework. This is also standard material, and is included for two reasons: (1) the handling of perfect bilateral constraints is classical matter which will serve as a guideline for the handling of perfect unilateral constraints; and (2) the dynamics of rigid bodies without constraints and the dynamics of rigid bodies with perfect bilateral constraints are seen to have the same mathematical structure, that of simple discrete mechanical systems. Therefore, the handling of unilateral constraints in the framework of rigid body systems with perfect bilateral constraints presents no supplementary difficulty with respect to the framework of rigid body systems without constraints.

Section 5.4 faces the handling of perfect *unilateral* constraints in simple discrete mechanical systems. The evolution problem is formulated along the lines of Moreau [MOR 83]. Well-posedness is investigated with aim of obtaining a theory with the same degree of generality and precision as that existing for perfect bilateral constraints. This material is essentially extracted from Ballard [BAL 00].

5.2. The dynamics of rigid body systems

5.2.1. The geometric description

Classical mechanics postulates the existence of a 3D oriented affine Euclidean space \mathcal{E} , sometimes called the (Galilean) *real world*, and of an absolute chronology represented (after the choice of an origin) by a real number denoted by t .

A solid is represented by its *real world reference configuration*, which is simply a possible geometric locus of all the material points of the solid in \mathcal{E} . A rigid solid is

a solid v
referenc

1) Th
configur
generic
and the
the trans
example,
rigid soli
configura

2) Th
contains
configura
configura
 q_1, q_2, \dots
rigid bar

3) The
to one poi
punctual p

A syste
of freedo
The gener
configurat
a time inte
motion at
The pair (c

5.2.2. Form

The ma
reference co
with any sta

$K(q_i)$

(Einstein su
explicitly sta
the assumpti

– the sup
contains at le

a solid which can only undergo transformations that are obtained from the real world reference configuration by *direct isometries*. There are three types of rigid solids:

1) The generic rigid solid: this is the case where the real world reference configuration contains three non-aligned points. Any real world configuration of a generic rigid solid is determined by the knowledge of the real world configuration and the data of a translation and a rotation. After the choice of coordinate frames, the translation and the rotation are determined by six real numbers q_1, q_2, \dots, q_6 (for example, the three components of the translation and three Euler angles). The generic rigid solid is said to have six degrees of freedom and $\mathbf{q} \in \mathbb{R}^6$ is called the generalized configuration.

2) The rigid bar: this is the case where the real world reference configuration contains only aligned points with at least two distinct points. Any real world configuration of a generic rigid solid is determined by the knowledge of the real world configuration and, after the choice of coordinate frames, the data of five real numbers q_1, q_2, \dots, q_5 (e.g. the three components of the translation and two Euler angles). The rigid bar has five degrees of freedom.

3) The punctual particle: this is the case where the real world configuration reduces to one point. The generalized configuration $\mathbf{q} \in \mathbb{R}^3$ reduces to the translation and the punctual particle only has three degrees of freedom.

A *system* will be a given finite collection of rigid solids. The number d of degrees of freedom of a system is, by definition, the sum of the freedom of each solid. The generalized configuration $\mathbf{q} \in \mathbb{R}^d$ is simply the ordered set of the generalized configurations of each solid of the system. A *motion* of the system is a mapping from a time interval I into $\mathbf{q} \in \mathbb{R}^d$, generally denoted by $\mathbf{q}(t)$. The time derivative of the motion at time t is denoted $\dot{\mathbf{q}}(t)$ and is called the *generalized velocity* of the system. The pair $(\mathbf{q}(t), \dot{\mathbf{q}}(t))$ is called the *state* of the system at instant t .

5.2.2. Formulation of the dynamics

The mass distribution is a bounded positive measure defined on the real world reference configuration of each solid of the system. It allows the traditional association with any state $(\mathbf{q}, \dot{\mathbf{q}})$ of the system, its *kinetic energy* $K(\mathbf{q}, \dot{\mathbf{q}})$ which takes the form:

$$K(\mathbf{q}, \dot{\mathbf{q}}) = \frac{1}{2} {}^t \dot{\mathbf{q}} \cdot \mathbf{M}(\mathbf{q}) \cdot \dot{\mathbf{q}} = \frac{1}{2} m_{ij}(\mathbf{q}) \dot{q}_j \dot{q}_i$$

(Einstein summation convention, which will always apply in the following unless explicitly stated), where the mass matrix $\mathbf{M}(\mathbf{q})$ is always positive symmetric. Under the assumption that:

- the support of the mass distribution of any generic rigid solid of the system contains at least three non-aligned points;

- the support of the mass distribution of any rigid bar of the system contains at least two distinct points; and
- the support of the mass distribution of any punctual particle of the system is non void,

it can be proven that the mass matrix $M(\mathbf{q})$ is also definite, which will be assumed in the following. Hence, the mass matrix $M(\mathbf{q})$ defines, for each $\mathbf{q} \in \mathbb{R}^d$, a scalar product on \mathbb{R}^d called the *kinetic metric*.

For an arbitrary motion $\mathbf{q}(t)$, the time derivative $dK(\mathbf{q}, \dot{\mathbf{q}})/dt$ is called the *power of acceleration* at instant t . Taking into account the above form of the kinetic energy, it is readily proven that:

$$\frac{d}{dt}K(\mathbf{q}, \dot{\mathbf{q}}) = \left(\frac{d}{dt} \frac{\partial}{\partial \dot{q}_i} K(\mathbf{q}, \dot{\mathbf{q}}) - \frac{\partial}{\partial q_i} K(\mathbf{q}, \dot{\mathbf{q}}) \right) \dot{q}_i.$$

If $\mathbf{v} \in \mathbb{R}^d$ is an arbitrary virtual velocity of the system, the expression:

$$\left(\frac{d}{dt} \frac{\partial}{\partial \dot{q}_i} K(\mathbf{q}, \dot{\mathbf{q}}) - \frac{\partial}{\partial q_i} K(\mathbf{q}, \dot{\mathbf{q}}) \right) v_i$$

is called the *virtual power of acceleration* of the system in the state $(\mathbf{q}, \dot{\mathbf{q}})$. Similarly, the modeling of internal and external forces passes through the *virtual power of internal and external forces*, which is a linear form on the space of virtual velocities:

$$f_i(\mathbf{q}, \dot{\mathbf{q}}; t) v_i.$$

This possibly depends upon the state $(\mathbf{q}, \dot{\mathbf{q}})$ of the system and on time t . The vector of \mathbb{R}^d with components

$$\frac{d}{dt} \frac{\partial}{\partial \dot{q}_i} K(\mathbf{q}, \dot{\mathbf{q}}) - \frac{\partial}{\partial q_i} K(\mathbf{q}, \dot{\mathbf{q}})$$

is called the *generalized acceleration* and the vector $\mathbf{f}(\mathbf{q}, \dot{\mathbf{q}}; t) \in \mathbb{R}^d$ with components $f_i(\mathbf{q}, \dot{\mathbf{q}}; t)$ is called the *generalized force*. The fundamental principle of classical mechanics asserts that the virtual power of acceleration equals the virtual power of forces in any virtual velocity, which gives Lagrange's equations of motion:

$$\forall t, \quad \forall i, \quad \frac{d}{dt} \frac{\partial}{\partial \dot{q}_i} K(\mathbf{q}, \dot{\mathbf{q}}) - \frac{\partial}{\partial q_i} K(\mathbf{q}, \dot{\mathbf{q}}) = f_i(\mathbf{q}, \dot{\mathbf{q}}; t). \tag{5.1}$$

Hence, we obtain the following evolution problem governing the dynamics of rigid body systems submitted to internal and external forces.

Problem 5.1. Find $T > 0$ and $\mathbf{q} \in C^2([0, T[; \mathbb{R}^d)$ such that:

- (q
- \forall t

Here,

5.2.3. We

To stu
we have t

Counter-

$$\frac{d^2}{dt^2}$$

(q(t) \in \mathbb{R}^d
two motio

To obta
paper, we s
the *regular*
physical m
to eliminat
stronger tha

Hypothesis
 \mathbb{R}^d are of c

Under th

Theorem 5.

More pre
0 ($T_m \in \mathbb{R}$
problem 5.1
case the dyn
granted.

$$\begin{aligned} - (\mathbf{q}(0), \dot{\mathbf{q}}(0)) &= (\mathbf{q}_0, \mathbf{v}_0), \\ - \forall t \in [0, T[, \forall i \in \{1, 2, \dots, d\}, \end{aligned}$$

$$m_{ij}(\mathbf{q})\ddot{q}_j + \frac{\partial m_{ij}}{\partial q_k} \dot{q}_j \dot{q}_k - \frac{1}{2} \frac{\partial m_{jk}}{\partial q_i} \dot{q}_j \dot{q}_k = f_i(\mathbf{q}, \dot{\mathbf{q}}; t).$$

Here, $(\mathbf{q}_0, \mathbf{v}_0)$ denotes an arbitrary given initial state of the system.

5.2.3. Well-posedness of the dynamics

To study the well-posedness (existence and uniqueness of solution) of problem 5.1, we have to specify regularity assumptions on \mathbf{M} and \mathbf{f} .

Counter-example 5.1. Consider the evolution equation

$$\frac{d^2}{dt^2} q(t) = 6 |q(t)|^{\frac{1}{3}}$$

$(q(t) \in \mathbb{R})$ with initial condition $(q(0), \dot{q}(0)) = (0, 0)$. It is readily checked that the two motions defined on \mathbb{R}^+ by $q(t) = 0$ and $q(t) = t^3$ provide two distinct solutions.

To obtain well-posedness, we are led to make further hypotheses. Throughout this paper, we shall distinguish two classes of hypotheses: the *constitutive* hypotheses and the *regularity* hypotheses. A constitutive hypothesis is an hypothesis which conveys physical meaning. A regularity hypothesis conveys no physical meaning and is stated to eliminate mathematical pathologies. The following regularity hypothesis is slightly stronger than necessary.

Hypothesis 5.1. (Regularity) The mappings $\mathbf{M} : \mathbb{R}^d \rightarrow \mathbb{R}^{d^2}$ and $\mathbf{f} : \mathbb{R}^d \times \mathbb{R}^d \times \mathbb{R}^+ \rightarrow \mathbb{R}^d$ are of class C^1 .

Under this regularity assumption, we have the following well-posedness result.

Theorem 5.1. (Cauchy) *There exists a unique maximal solution for problem 5.1.*

More precisely, theorem 5.1 states that there exists a solution of problem 5.1 $T_m > 0$ ($T_m \in \mathbb{R} \cup \{+\infty\}$) and $\mathbf{q}_m \in C^2([0, T_m[, \mathbb{R}^d)$ such that any other solution of problem 5.1 is a restriction of \mathbf{q}_m . Of course, we expect that $T_m = +\infty$, in which case the dynamics is said to be *eternal*. This situation can not generally be taken for granted.

Counter-example 5.2. Consider the evolution equation

$$\frac{d^2}{dt^2}q(t) = (\dot{q}(t))^2$$

($q \in \mathbb{R}$) with initial condition $(q(0), \dot{q}(0)) = (0, 1)$. It is readily checked that the maximal solution is defined on the interval $[0, 1[$.

In the usual cases encountered in mechanics, eternal dynamics is ensured by the following general sufficient condition.

Theorem 5.2. *The mapping M is assumed to satisfy:*

$$\exists \alpha > 0, \quad \forall \mathbf{q}, \mathbf{v} \in \mathbb{R}^d, \quad {}^t\mathbf{v} \cdot M(\mathbf{q}) \cdot \mathbf{v} \geq \alpha |\mathbf{v}|^2$$

where $|\cdot|$ denotes an arbitrary norm on \mathbb{R}^d . \mathbf{f} is assumed to fulfill the estimate:

$$|\mathbf{f}(\mathbf{q}, \mathbf{v}; t)| \leq l(t)(1 + |\mathbf{q}| + |\mathbf{v}|),$$

for all $\mathbf{q}, \mathbf{v} \in \mathbb{R}^d$ and almost all $t \in [0, +\infty[$, $l(t)$ being a (necessarily non-negative) function of $L^1_{loc}(\mathbb{R}^+; \mathbb{R})$.

The dynamics is then eternal: $T_m = +\infty$.

The proof of theorem 5.2 relies on Gronwall's lemma.

5.3. The dynamics of rigid body systems with perfect bilateral constraints

5.3.1. The geometric description

A constraint describes a type of force which is not taken into account by the force mapping \mathbf{f} . Indeed, it is possible to specify (partially) some forces by their kinematical effects. These kinematical effects generally leave the associated forces partially undetermined. We have to add phenomenological assumptions about the way the constraint acts, through a *constitutive law* of the constraint.

A (holonomic) *bilateral constraint* is a restriction on the admissible motions of the system which is expressed by means of a finite number n of smooth real-valued functions φ_j on \mathbb{R}^d , defining a set S of admissible configurations:

$$S = \left\{ \mathbf{q} \in \mathbb{R}^d ; \forall j \in \{1, 2, \dots, n\}, \quad \varphi_j(\mathbf{q}) = 0 \right\}. \tag{5.2}$$

The following hypothesis is usual in this framework.

Hypothe
for all \mathbf{q}

$\frac{d\mathbf{q}}{dt}$
 $\frac{d\mathbf{q}}{dt}$

are linear

A stra
hypothesi
possible to
the constr
there exist
subset of \mathbb{R}^d

$\psi(\mathbf{q})$

It is some
the sake of
to \mathbb{R}^{d-n} (t
configurati

If $\mathbf{q}(t)$

$\forall j \in$

In the follow

$T_{\mathbf{q}}S$

for the subs
constraint eq

$\frac{\partial \mathbf{q}}{\partial \tilde{q}_i}$
 $\frac{\partial \mathbf{q}}{\partial \tilde{q}_i}$

provides natu

5.3.2. Formu

The realiz
equation of m
the reaction fo

$\forall t, \forall$

Hypothesis 5.2. (Regularity) The functions φ_j are *functionally independent*, that is, for all $\mathbf{q} \in S$, the n vectors

$$\frac{d\varphi_j}{d\mathbf{q}}(\mathbf{q}) \quad (j \in \{1, 2, \dots, n\})$$

are linearly independent in \mathbb{R}^d .

A straightforward consequence (by use of the local inversion theorem) of this hypothesis is that S is locally diffeomorphic to \mathbb{R}^{d-n} . This means that it is always possible to find a new parameterization of the system by means of $d-n$ real variables: the constraint system has $d-n$ degrees of freedom. More precisely, at every $\mathbf{q} \in S$, there exists a diffeomorphism ψ defined on an open neighborhood of \mathbf{q} onto an open subset of \mathbb{R}^{d-n} . We shall use the notation:

$$\psi(\mathbf{q}) = \bar{\mathbf{q}} \in \mathbb{R}^{d-n} \quad (\mathbf{q} \in S). \quad (5.3)$$

It is sometimes said that $\bar{\mathbf{q}}$ defines a *reduced* parameterization of the system. For the sake of simplicity, we shall assume that ψ is actually a diffeomorphism from S to \mathbb{R}^{d-n} (the more general situation is more concisely expressed in the language of configuration manifolds; see [BAL 01]).

If $\mathbf{q}(t)$ is any arbitrary smooth motion in S , we obtain:

$$\forall j \in \{1, 2, \dots, n\}, \quad \frac{d\varphi_j}{d\mathbf{q}}(\mathbf{q}) \cdot \dot{\mathbf{q}} = 0 \quad \left(= \frac{\partial \varphi_j}{\partial q_i}(\mathbf{q}) \cdot \dot{q}_i \right).$$

In the following, we shall use the notation

$$T_{\mathbf{q}}S \stackrel{\text{def}}{=} \left\{ \mathbf{v}; \forall j \in \{1, 2, \dots, n\}, \frac{d\varphi_j}{d\mathbf{q}}(\mathbf{q}) \cdot \mathbf{v} = 0 \right\} \quad (\mathbf{q} \in S)$$

for the subspace of \mathbb{R}^d containing all the velocities at \mathbf{q} that are compatible with the constraint equation (5.2). Use of the natural basis:

$$\frac{\partial \mathbf{q}}{\partial \bar{q}_i} \quad (i = 1, 2, \dots, d-n), \quad (5.4)$$

provides natural identification of $T_{\mathbf{q}}S$ with \mathbb{R}^{d-n} .

5.3.2. Formulation of the dynamics

The realization of the constraint (5.2) necessarily involves a modification of the equation of motion (5.1). This is done by adding a corrective unknown term \mathbf{R} called the *reaction force* to the force mapping $f(\mathbf{q}, \dot{\mathbf{q}}; t)$, i.e.

$$\forall t, \quad \forall i, \quad \frac{d}{dt} \frac{\partial}{\partial \dot{q}_i} K(\mathbf{q}, \dot{\mathbf{q}}) - \frac{\partial}{\partial q_i} K(\mathbf{q}, \dot{\mathbf{q}}) = f_i(\mathbf{q}, \dot{\mathbf{q}}; t) + R_i(t).$$

We might expect \mathbf{R} to be determined by the geometric constraint (5.2). It does not work in general. We have to add phenomenological assumptions about the way the constraint acts. This is the *constitutive law* of the constraint.

Hypothesis 5.3. (Constitutive) The bilateral constraint (5.2) is supposed to be *perfect* (we also say synonymously *ideal*), that is, the power of the reaction force \mathbf{R} vanishes in any virtual velocity compatible with the bilateral constraint:

$$\begin{aligned} \forall \mathbf{v} \in T_{\mathbf{q}}S &= \left\{ \mathbf{v}; \forall j \in \{1, 2, \dots, n\}, \frac{d\varphi_j}{d\mathbf{q}}(\mathbf{q}) \cdot \mathbf{v} = 0 \right\}, \\ \mathbf{R} \cdot \mathbf{v} &= 0 \quad (= R_i v_i). \end{aligned}$$

Due to hypotheses 5.2 and 5.3, we can write:

$$\mathbf{R}(t) = \sum_{j=1}^n \lambda_j(t) \frac{d\varphi_j}{d\mathbf{q}}(\mathbf{q})$$

for some real-valued functions λ_j .

We now formulate the evolution problem associated with the dynamics of rigid bodies systems with perfect bilateral constraints. The initial condition is assumed to be compatible with the realization of the constraint: $\mathbf{q}_0 \in S$ and $\mathbf{v}_0 \in T_{\mathbf{q}_0}S$.

Problem 5.2. Find $T > 0$, $\mathbf{q} \in C^2([0, T[; \mathbb{R}^d)$ and n functions $\lambda_j \in C^0([0, T[; \mathbb{R})$ such that:

- $(\mathbf{q}(0), \dot{\mathbf{q}}(0)) = (\mathbf{q}_0, \mathbf{v}_0)$,
- $\forall t \in [0, T[$, $\mathbf{q}(t) \in S$,
- $\forall t \in [0, T[$, $\forall i \in \{1, 2, \dots, d\}$,

$$m_{ij}(\mathbf{q})\ddot{q}_j + \frac{\partial m_{ij}}{\partial q_k} \dot{q}_j \dot{q}_k - \frac{1}{2} \frac{\partial m_{jk}}{\partial q_i} \dot{q}_j \dot{q}_k = f_i(\mathbf{q}, \dot{\mathbf{q}}; t) + \sum_{j=1}^n \lambda_j(t) \frac{\partial \varphi_j}{\partial q_i}(\mathbf{q}).$$

This evolution problem can be reformulated in terms of the reduced parameterization $\tilde{\mathbf{q}}$. To do this, we define the *reduced kinetic energy* $\tilde{K}(\tilde{\mathbf{q}}, \dot{\tilde{\mathbf{q}}})$ by:

$$\tilde{K}(\tilde{\mathbf{q}}, \dot{\tilde{\mathbf{q}}}) = K(\mathbf{q}, \dot{\mathbf{q}});$$

where $\tilde{\mathbf{q}}$ and \mathbf{q} are connected by equation (5.3). This definition provides a *reduced mass matrix* $\tilde{\mathbf{M}}(\tilde{\mathbf{q}})$ which is a positive definite symmetric real matrix of order $d - n$. Similarly, we have a reduced force mapping defined by:

$$\tilde{\mathbf{f}}(\tilde{\mathbf{q}}, \dot{\tilde{\mathbf{q}}}; t) = \text{Proj}[\mathbf{f}(\mathbf{q}, \dot{\mathbf{q}}; t); T_{\mathbf{q}}S],$$

where Proj
product of

$$\tilde{\mathbf{f}}(\tilde{\mathbf{q}}, \dot{\tilde{\mathbf{q}}}; t)$$

Using
dynamics

Problem 5.2.

$$- (\tilde{\mathbf{q}}(0), \dot{\tilde{\mathbf{q}}}(0)) = (\tilde{\mathbf{q}}_0, \tilde{\mathbf{v}}_0)$$

$$- \forall t \in [0, T[$$

$$- \forall t \in [0, T[$$

Evolutio

Proposition
of problem
reciprocally

5.3.3. Well-

Problem
and 5.2 are
dynamics of

Hypothesis
 \mathbb{R}^d are of cla

Proposition

The analy

Regularity
would lead to

Example 5.1.
bar are const
bilateral cons
constraint wh
A constant fo
plane of the c
corresponding

where Proj denotes the orthogonal projection operator on $T_{\mathbf{q}}S$ (for the canonical scalar product of \mathbb{R}^d). Use of the natural basis equation(5.4) of $T_{\mathbf{q}}S$ enables us to write:

$$\tilde{\mathbf{f}}(\tilde{\mathbf{q}}, \dot{\tilde{\mathbf{q}}}; t) \in \mathbb{R}^{d-n}.$$

Using this notation and setting $\tilde{\mathbf{q}}_0 = \psi(\mathbf{q}_0)$, we have a natural formulation of the dynamics in terms of the reduced parameterization $\tilde{\mathbf{q}}$.

Problem 5.3. Find $T > 0$ and $\tilde{\mathbf{q}} \in C^2([0, T[; \mathbb{R}^{d-n})$ such that:

$$\begin{aligned} - (\tilde{\mathbf{q}}(0), \dot{\tilde{\mathbf{q}}}(0)) &= (\tilde{\mathbf{q}}_0, \tilde{\mathbf{v}}_0), \\ - \forall t \in [0, T[, \quad \forall i \in \{1, 2, \dots, d-n\}, \end{aligned}$$

$$\tilde{m}_{ij}(\tilde{\mathbf{q}})\ddot{\tilde{q}}_j + \frac{\partial \tilde{m}_{ij}}{\partial \tilde{q}_k} \dot{\tilde{q}}_j \dot{\tilde{q}}_k - \frac{1}{2} \frac{\partial \tilde{m}_{jk}}{\partial \tilde{q}_i} \dot{\tilde{q}}_j \dot{\tilde{q}}_k = \tilde{f}_i(\tilde{\mathbf{q}}, \dot{\tilde{\mathbf{q}}}; t).$$

Evolution problems 5.2 and 5.3 are connected by the following property.

Proposition 5.1. *Problems 5.2 and 5.3 are equivalent, that is, any solution $\mathbf{q}(t)$ of problem 5.2 provides a solution $\tilde{\mathbf{q}}(t)$ of problem 5.3 by equation (5.3), and reciprocally.*

5.3.3. Well-posedness of the dynamics

Problem 5.3 formally has the same structure as problem 5.1. Since problems 5.3 and 5.2 are equivalent, the results of Section 5.2.3 yield the well-posedness of the dynamics of rigid bodies systems with perfect bilateral constraints.

Hypothesis 5.4. (Regularity) The mappings $M : \mathbb{R}^d \rightarrow \mathbb{R}^{d^2}$ and $f : \mathbb{R}^d \times \mathbb{R}^d \times \mathbb{R}^+ \rightarrow \mathbb{R}^d$ are of class C^1 , and the functions φ_i are of class C^2 .

Proposition 5.2. *Problems 5.2 and 5.3 have a unique maximal solution q_m .*

The analysis of the eternity of the dynamics is provided by theorem 5.2.

Regularity hypothesis 5.2 could seem to be very restrictive. However, dropping it would lead to problems.

Example 5.1. Consider a rigid homogenous bar of length l . The two extremities of the bar are constrained to remain on a fixed circle of diameter l . The two corresponding bilateral constraints are assumed to be perfect. This is a simple occurrence of bilateral constraint which does not satisfy hypothesis 5.2. At the initial instant, the bar is at rest. A constant force is applied at the middle point of the bar. This force is directed in the plane of the circle but not along the bar. The reader will convince themselves that the corresponding evolution problem 5.2 admits no solution.

Since the modeling of a rigid body system with no constraint or with perfect bilateral constraint leads to the construction of mathematical structures of the same type, we state the following definition.

Definition 5.1. A simple discrete mechanical system is a triple $(d, \mathbf{M}, \mathbf{f})$ where:

- d is a positive integer, called the freedom of the system;
- \mathbf{M} is a smooth mapping from \mathbb{R}^d into the space of positive definite symmetric matrix of order d , called the mass matrix; and
- $\mathbf{f} : \mathbb{R}^d \times \mathbb{R}^d \times \mathbb{R}^+ \rightarrow \mathbb{R}^d$ is a smooth mapping referred to as the force mapping.

5.4. The dynamics of rigid body systems with perfect unilateral constraints

The consideration of elementary examples shows that the dynamics of rigid body systems can lead to some prediction of the motion where some bodies of the system *overlap* in the real world. Of course, this should not be allowed. Hence, very often, we have to add the statement of non-penetration conditions to a simple discrete mechanical system. This is a simple occurrence of unilateral constraint. In this section, we shall discuss the consideration of perfect unilateral constraints in simple discrete mechanical systems.

5.4.1. The geometric description

Consider a simple discrete mechanical system $(d, \mathbf{M}, \mathbf{f})$. A *unilateral constraint* is a restriction on the admissible motions of the system which is expressed by means of a finite number n of smooth real-valued functions φ_j on \mathbb{R}^d , so that the set of all admissible configurations A is given by:

$$A = \left\{ \mathbf{q} \in \mathbb{R}^d; \forall j \in \{1, 2, \dots, n\}, \varphi_j(\mathbf{q}) \leq 0 \right\}. \quad (5.5)$$

The set of all active constraints in the admissible configuration $\mathbf{q} \in A$ is defined by:

$$J(\mathbf{q}) = \left\{ j \in \{1, 2, \dots, n\}; \varphi_j(\mathbf{q}) = 0 \right\}.$$

The following hypothesis should be considered alongside regularity hypothesis 5.2 of section 5.3.1.

Hypothesis 5.5. (Regularity) The functions φ_j are *functionally independent*, that is, for all $\mathbf{q} \in A$, the vectors

$$\frac{d\varphi_j}{d\mathbf{q}}(\mathbf{q}) \quad (j \in J(\mathbf{q}))$$

are linearly independent in \mathbb{R}^d .

Consider a motion $\mathbf{q}(t)$ in A and assume that a right velocity $\dot{\mathbf{q}}^+(t) \in \mathbb{R}^d$ exists at instant t , then $\dot{\mathbf{q}}^+(t)$ necessarily belongs to the closed convex cone $V(\mathbf{q}(t))$ of \mathbb{R}^d defined by:

$$V(\mathbf{q}(t)) = \left\{ \mathbf{v} \in \mathbb{R}^d ; \forall j \in J(\mathbf{q}(t)), \frac{d\varphi_j}{dq}(\mathbf{q}(t)) \cdot \mathbf{v} \leq 0 \right\}.$$

$V(\mathbf{q})$ is called the cone of admissible right velocities at the configuration \mathbf{q} . In particular,

$$\mathbf{q} \in \overset{\circ}{A} \quad (\text{i.e. } J(\mathbf{q}) = \emptyset) \quad \implies \quad V(\mathbf{q}) = \mathbb{R}^d.$$

Similarly, if a left velocity $\dot{\mathbf{q}}^- \in \mathbb{R}^d$ exists, then $\dot{\mathbf{q}}^- \in -V(\mathbf{q})$.

5.4.2. Formulation of the dynamics

The formulation of the dynamics follows that of [MOR 83].

5.4.2.1. Equation of motion

As for bilateral constraints, the realization of the constraints induces some reaction effort \mathbf{R} . The following hypotheses are made.

Hypothesis 5.6. (Constitutive) The unilateral constraints are of type contact without adhesion:

$$\forall \mathbf{v} \in V(\mathbf{q}), \quad \mathbf{R} \cdot \mathbf{v} \geq 0.$$

Hypothesis 5.7. (Constitutive) The unilateral constraints are perfect:

$$\forall \mathbf{v} \in \left\{ \mathbf{v} \in \mathbb{R}^d ; \forall j \in J(\mathbf{q}), \frac{d\varphi_j}{dq}(\mathbf{q}) \cdot \mathbf{v} = 0 \right\}, \quad \mathbf{R} \cdot \mathbf{v} = 0.$$

As an easy consequence of constitutive hypotheses 5.6 and 5.7, we obtain:

$$\exists (\lambda_i)_{i=1,2,\dots,n} \in \mathbb{R}^n, \quad \mathbf{R} = \sum_{j=1}^n \lambda_j \frac{d\varphi_j}{dq}(\mathbf{q}), \quad \text{and} \quad \begin{cases} j \in J(\mathbf{q}) \Rightarrow \lambda_j \leq 0, \\ j \notin J(\mathbf{q}) \Rightarrow \lambda_j = 0. \end{cases}$$

The reaction effort $\mathbf{R} \in \mathbb{R}^d$ must therefore be such that:

$$-\mathbf{R} \in N(\mathbf{q}) \stackrel{\text{def}}{=} \left\{ \sum_{j=1}^n \lambda_j \frac{d\varphi_j}{dq}(\mathbf{q}) ; \forall j \in J(\mathbf{q}), \lambda_j \geq 0, \quad \forall j \notin J(\mathbf{q}), \lambda_j = 0 \right\}. \quad (5.6)$$

$N(\mathbf{q})$ is a closed convex cone of \mathbb{R}^d and it is the polar cone of $V(\mathbf{q})$ (for the canonical Euclidean structure of \mathbb{R}^d).

Now, consider a motion $\mathbf{q}(t)$ starting at $\mathbf{q}_0 \in \overset{\circ}{A}$ at time t_0 with velocity \mathbf{v}_0 . Assumed to be continuous, $\mathbf{q}(t)$ remains in $\overset{\circ}{A}$ on a right neighborhood of t_0 . By equation (5.6), the reaction effort \mathbf{R} vanishes as long as $\mathbf{q}(t)$ is in $\overset{\circ}{A}$ and the motion is governed by the ordinary differential equation:

$$\begin{cases} m_{ij}(\mathbf{q})\ddot{q}_j + \frac{\partial m_{ij}}{\partial q_k} \dot{q}_j \dot{q}_k - \frac{1}{2} \frac{\partial m_{jk}}{\partial q_i} \dot{q}_j \dot{q}_k = f_i(\mathbf{q}, \dot{\mathbf{q}}; t), & \forall i = 1, 2, \dots, d, \\ (\mathbf{q}(t_0), \dot{\mathbf{q}}(t_0)) = (\mathbf{q}_0, \mathbf{v}_0). \end{cases}$$

Suppose that the solution of this Cauchy problem meets ∂A at some instant greater than t_0 . Denote by T the smallest of these instants. The motion admits a left velocity vector \mathbf{v}_T^- at time T . Of course, it may occur that: $\mathbf{v}_T^- \notin V(\mathbf{q}(T))$. In this case, no differentiable extension of the motion can exist in A for t greater than T . The requirement of differentiability has to be dropped. An instant such as T is called an instant of *impact*.

However, we are still going to require the existence of a right velocity vector $\dot{\mathbf{q}}^+(t) \in V(\mathbf{q}(t))$ at every instant t . The right velocity does not need to be a continuous function of time and the equation of motion

$$m_{ij}(\mathbf{q})\ddot{q}_j + \frac{\partial m_{ij}}{\partial q_k} \dot{q}_j \dot{q}_k - \frac{1}{2} \frac{\partial m_{jk}}{\partial q_i} \dot{q}_j \dot{q}_k = f_i(\mathbf{q}, \dot{\mathbf{q}}; t) + R_i, \quad \forall i = 1, 2, \dots, d,$$

should be understood in the sense of Schwartz's distribution. Hence, the reaction force \mathbf{R} appears to be a distribution submitted to inequality restrictions. Since it is well known that a positive distribution (i.e. taking positive values on positive C^∞ compactly supported functions) is necessarily a measure, we shall require \mathbf{R} to be a *vector valued measure* rather than a general distribution. As a consequence, $\ddot{\mathbf{q}}$ must also be a measure, and the velocity $\dot{\mathbf{q}}$ can be identified with a function with locally bounded variation. Since functions with locally bounded variation are locally integrable and admit left and right limits at every point, it turns out that the motion $\mathbf{q}(t)$ can be identified with a locally absolutely continuous function admitting left and right derivatives (in the classical sense) $\dot{\mathbf{q}}^-(t)$ and $\dot{\mathbf{q}}^+(t)$ at every instant.

We denote by $MMA(I; \mathbb{R}^d)$ (motions with measure acceleration) the set of all absolutely continuous motions $q(t)$ from a real interval I to \mathbb{R}^d whose second distributional derivative is a measure. We now have to give a precise meaning to equation (5.6) with \mathbf{R} being a vector valued measure.

5.4.2.1.1. Convention

We shall write:

$$\mathbf{R} \in -N(\mathbf{q}(t))$$

to mean th

$$\mathbf{R} = \sum_{j=1}^n$$

Using t

A straight
is, a discont
 $J(\mathbf{q}(t)) \neq 0$

Definition 5
exactly one
multiple.

5.4.2.2. The

We begin
defined by

- $d = 1,$
- $M(q) \equiv$
- $f(q, \dot{q}; t)$

We consider
that the admitt
initial state (q
of motion (5.
the left veloci
is compatible

The reason
interaction of
determined.

to mean there exist n non-positive real measures λ_j such that:

$$\mathbf{R} = \sum_{j=1}^n \lambda_j \frac{d\varphi_j}{d\mathbf{q}}(\mathbf{q}(t)) \quad \text{and} \quad \forall j = 1, \dots, n, \quad \text{Supp } \lambda_j \subset \{t; \varphi_j(\mathbf{q}(t)) = 0\}. \quad (5.7)$$

Using this convention, the final form of the equation of motion is:

$$m_{ij}(\mathbf{q})\ddot{q}_j + \frac{\partial m_{ij}}{\partial q_k} \dot{q}_j \dot{q}_k - \frac{1}{2} \frac{\partial m_{jk}}{\partial q_i} \dot{q}_j \dot{q}_k = f_i(\mathbf{q}, \dot{\mathbf{q}}; t) + R_i, \quad (5.8)$$

$$\forall i = 1, 2, \dots, d, \quad \mathbf{R} \in -N(\mathbf{q}(t))$$

A straightforward consequence of the equation of motion is that an impact (that is, a discontinuity of the right velocity $\dot{\mathbf{q}}^+$) can only occur at an instant t such that $J(\mathbf{q}(t)) \neq \emptyset$. This fact is a justification for the following definition.

Definition 5.2. An impact occurring at time t is said to be *simple* if $J(\mathbf{q}(t))$ contains exactly one element. If $J(\mathbf{q}(t))$ contains at least two elements, the impact is said to be *multiple*.

5.4.2.2. The impact constitutive equation

We begin this section with an example. Consider the simple mechanical system defined by

$$\begin{aligned} -d &= 1, \\ -M(q) &\equiv 1, \\ -f(q, \dot{q}; t) &\equiv 0. \end{aligned}$$

We consider the unilateral constraint represented by the single function $\varphi_1(q) = q$ so that the admissible configuration set A is \mathbb{R}^- . At initial time $t_0 = 0$, we consider an initial state (q_0, v_0) such that $q_0 < 0$ and $v_0 > 0$. It is readily seen from the equation of motion (5.8) that an impact necessarily occurs at time $t = -q_0/v_0$. At this time, the left velocity is v_0 . However, the right velocity can take any negative value which is compatible with the equation of motion.

The reason for this indetermination lies in the phenomenological nature of the interaction of the system with the obstacle. This missing information must be determined.

Hypothesis 5.8. (Constitutive) The interaction of the system with the obstacle at time t is completely determined by the current configuration $\mathbf{q}(t)$ and the current left velocity $\dot{\mathbf{q}}^-(t)$. In other terms, we postulate the existence of a mapping $\mathcal{F} : \mathbb{R}^d \times \mathbb{R}^d \rightarrow \mathbb{R}^d$ describing the interaction of the system with the obstacle during an impact:

$$\forall t, \quad \dot{\mathbf{q}}^+(t) = \mathcal{F}(\mathbf{q}(t), \dot{\mathbf{q}}^-(t)). \tag{5.9}$$

To ensure compatibility with the equation of motion (5.8), the mapping \mathcal{F} should satisfy:

$$\forall \mathbf{q} \in A, \quad \forall \mathbf{v}^- \in -V(\mathbf{q}), \quad \begin{aligned} \mathcal{F}(\mathbf{q}, \mathbf{v}^-) &\in V(\mathbf{q}), \\ \mathcal{F}(\mathbf{q}, \mathbf{v}^-) - \mathbf{v}^- &\in -\mathbf{M}^{-1}(\mathbf{q}) \cdot N(\mathbf{q}). \end{aligned} \tag{5.10}$$

Moreover, we add the assumption that the kinetic energy of the system cannot increase during an impact, i.e.

$$\forall \mathbf{q} \in A, \quad \forall \mathbf{v}^- \in -V(\mathbf{q}), \quad K(\mathbf{q}, \mathcal{F}(\mathbf{q}, \mathbf{v}^-)) \leq K(\mathbf{q}, \mathbf{v}^-). \tag{5.11}$$

Let us comment on hypothesis 5.8. When two solids collide, their bouncing is actually governed by the propagation of deformation waves in each the two solids. However, from the very beginning, we have adopted the simple framework in which each solid is assumed to be rigid, i.e. for the sake of simplicity, we have chosen not to consider any phenomena relying on the deformation of the solids. We therefore cannot expect the theory to be able to predict the outcome of an impact experiment.

The aim of constitutive hypothesis 5.8 is to introduce to the theory the information which is missing. Of course, in practical situations, we have to identify the unknown mapping \mathcal{F} . This can be done either by means of experiments or by use of a refined theory. For example, the theory of elastodynamics could be used to predict the outcome of an impact in every impact configuration. The result would be an identification of the mapping \mathcal{F} . In any case, a very large amount of work is required to obtain a precise identification of \mathcal{F} . This is the price we have to pay to describe sophisticated physical phenomena in a very simple framework. This issue is actually faced in any mechanical theory (e.g. the theory of elasticity). Naturally, in each mechanical theory, the question arises of what amount of lacking constitutive information should be introduced. Most of the time, well-posedness of the resulting evolution problem serves as a guideline to state the constitutive hypotheses.

Definition 5.3. Equation (5.9) with mapping \mathcal{F} satisfying both requirements (5.10) and (5.11) is called the *impact constitutive equation*. An impact constitutive equation which ensures the conservation of kinetic energy during an impact is called *elastic*:

$$\forall \mathbf{q} \in A, \quad \forall \mathbf{v}^- \in -V(\mathbf{q}), \quad K(\mathbf{q}, \mathcal{F}(\mathbf{q}, \mathbf{v}^-)) = K(\mathbf{q}, \mathbf{v}^-).$$

There
Example
defined by

$$\mathcal{F}(\mathbf{q}$$

where Pro
product of
and (5.11)
impact cor
traditional

The rea
in situatio
constraint i
must be th
(5.11)). Ho
equation ha
is provided
Figure 5.1a
of the cano

The foll
ments (5.10

Proposition
(5.11). We th

$$\forall \mathbf{q} \in$$

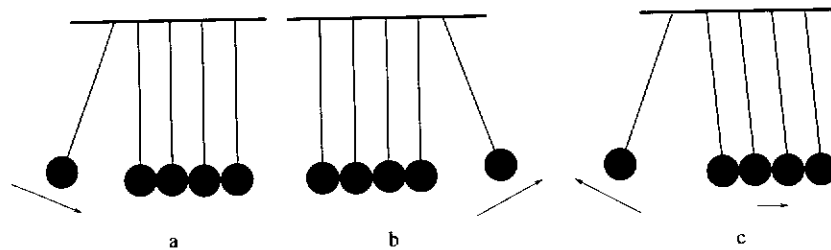

Figure 5.1. Newton's cradle

There always exist many mappings \mathcal{F} satisfying requirements (5.10) and (5.11).

Example 5.2. Let $e : \mathbb{R}^d \times \mathbb{R}^d \rightarrow [0, 1]$ be an arbitrary function. The mapping \mathcal{F} , defined by

$$\mathcal{F}(\mathbf{q}, \mathbf{v}^-) = \text{Proj}_{M(\mathbf{q})} \left[\mathbf{v}^-; V(\mathbf{q}) \right] - e(\mathbf{q}, \mathbf{v}^-) \text{Proj}_{M(\mathbf{q})} \left[\mathbf{v}^-; M^{-1}(\mathbf{q}) \cdot N(\mathbf{q}) \right] \quad (5.12)$$

where $\text{Proj}_{M(\mathbf{q})}$ denotes the orthogonal projection operator (in the sense of the scalar product of \mathbb{R}^d defined by the matrix $M(\mathbf{q})$) is easily seen to satisfy requirements (5.10) and (5.11). The associated impact constitutive equation is often called the *canonical* impact constitutive equation. It is elastic if and only if $e \equiv 1$. The function e is traditionally called the *restitution* coefficient.

The reason for distinguishing the canonical impact constitutive equation is that in situations where only simple impacts can occur (for example, if the unilateral constraint is represented by a single function φ_1), then the impact constitutive equation must be the canonical one (it is a simple consequence of requirements (5.10) and (5.11)). However, in the case of multiple impacts, the canonical impact constitutive equation has no specific physical relevance. A simple occurrence of multiple impact is provided by Newton's cradle. The principle of the experiment is depicted in Figure 5.1a and its outcome in Figure 5.1b. It should be compared with the prediction of the canonical elastic impact constitutive equation, depicted in Figure 5.1c.

The following proposition is a straightforward and useful consequence of requirements (5.10) and (5.11).

Proposition 5.3. Let \mathcal{F} be a constitutive mapping satisfying requirements (5.10) and (5.11). We then have:

$$\forall \mathbf{q} \in A, \quad \forall \mathbf{v}^- \in V(\mathbf{q}) \cap (-V(\mathbf{q})), \quad \mathcal{F}(\mathbf{q}, \mathbf{v}^-) = \mathbf{v}^-.$$

We conclude this section by a comment on requirement (5.11). At first glance, it could seem to be unnecessary. The following counter-example proves that, if it was omitted, uniqueness of solution for the resulting evolution problem would surely not hold.

Counter-example 5.3. Consider the simple mechanical system defined by:

- $d = 1,$
- $M(q) \equiv 1,$
- $f(q, \dot{q}; t) \equiv 2.$

We consider the unilateral constraint represented by the single function $\varphi_1(q) = q$. Thus, $A = \mathbb{R}^-$. The impact constitutive equation is given by equation (5.12) where the restitution coefficient is assumed to be the constant $1/2$ i.e. $e(q, \dot{q}^-) \equiv 1/2$. This mechanical system is a formal description of the physical occurrence of a single particle subjected to gravity and bouncing on the floor. Consider the initial instant $t_0 = 0$ and the initial state $(q_0, v_0) = (-1, 0)$. It is readily seen that the function $q : \mathbb{R}^+ \rightarrow \mathbb{R}^-$ defined by:

$$\begin{aligned} \forall t \in [0, 1], & \quad q(t) = t^2 - 1, \\ \forall t \in [3 - \frac{1}{2^{n-1}}, 3 - \frac{1}{2^n}], & \quad q(t) = t^2 + (-6 + \frac{3}{2^n})t + (3 - \frac{1}{2^{n-1}})(3 - \frac{1}{2^n}), \\ \forall t \in [3, +\infty[, & \quad q(t) = 0, \end{aligned}$$

$n \in \mathbb{N}$, belongs to $MMA(\mathbb{R}^+; \mathbb{R}^-)$ and satisfies:

- the initial condition,
- the equation of motion (5.8) (with $f(q, \dot{q}; t) \equiv 2$),
- the impact constitutive equation (5.12) (with $e(q, \dot{q}) \equiv 1/2$).

This motion is depicted in Figure 5.2. Note that it exhibits an infinite number of impacts on a compact time subinterval. It could easily be proven that no motion, defined on $[0, +\infty[$ with a finite number of impacts on every compact interval, can exist.

Now, we shall analyze what happens when the flow of time is reversed. Define q' by:

$$q' \begin{cases} [0, 4] & \rightarrow \mathbb{R}^- \\ t & \mapsto q(4-t) \end{cases}$$

Considering the initial state $(q_0, v_0) = (0, 0)$ at $t_0 = 0$, it is easily seen that q' satisfies:

- the initial condition,
- the equation of motion (5.8) (with $f(q, \dot{q}; t) \equiv 2$),

Figure

- the i

Howev
of motion
cannot exp
equation
greater tha
coefficient

5.4.2.3. T

We no
body syste
assumed to
 $V(q_0)$.

Problem 5

$\lambda_j \in \mathcal{M}([0$

- $(q(0)$

- $\forall t \in$

- $\forall t \in$

m_{ij}

- $\forall j =$

- $\forall t \in [$

The impact

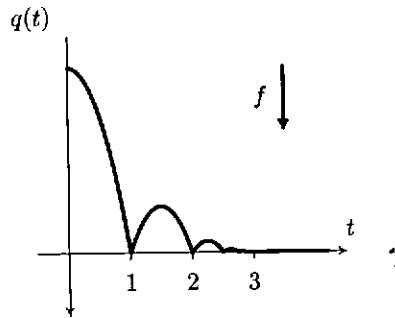

Figure 5.2. Motion of a punctual particle subjected to gravity and bouncing on the floor

– the impact constitutive equation (5.12) (with $e(q, \dot{q}) \equiv 2$).

However, $q'' \equiv 0$ is also seen to satisfy the same initial condition, the equation of motion and impact constitutive equation. This example demonstrates that we cannot expect uniqueness of solution when adopting the canonical impact constitutive equation (5.12) with restitution coefficient $e \equiv 2$ (or any real number strictly greater than 1). However, the canonical impact constitutive equation with restitution coefficient strictly greater than 1 violates requirement (5.11).

5.4.2.3. The evolution problem

We now formulate the evolution problem associated with the dynamics of rigid body systems with perfect bilateral and unilateral constraints. The initial condition is assumed to be compatible with the realization of the constraint: $\mathbf{q}_0 \in A$ and $\mathbf{v}_0 \in V(\mathbf{q}_0)$.

Problem 5.4. Find $T > 0$, $\mathbf{q} \in MMA([0, T[; \mathbb{R}^d)$ and n non-positive measures $\lambda_j \in \mathcal{M}([0, T[; \mathbb{R})$ such that:

- $(\mathbf{q}(0), \dot{\mathbf{q}}^+(0)) = (\mathbf{q}_0, \mathbf{v}_0)$,
- $\forall t \in [0, T[$, $\mathbf{q}(t) \in A$,
- $\forall t \in [0, T[$, $\forall i \in \{1, 2, \dots, d\}$,

$$m_{ij}(\mathbf{q})\ddot{q}_j + \frac{\partial m_{ij}}{\partial q_k} \dot{q}_j \dot{q}_k - \frac{1}{2} \frac{\partial m_{jk}}{\partial q_i} \dot{q}_j \dot{q}_k = f_i(\mathbf{q}, \dot{\mathbf{q}}; t) + \sum_{j=1}^n \lambda_j \frac{\partial \varphi_j}{\partial q_i}(\mathbf{q}),$$

- $\forall j = 1, 2, \dots, n$, $\text{Supp } \lambda_j \subset \{t \in [0, T[; \varphi_j(q(t)) = 0\}$,
- $\forall t \in]0, T[$, $\dot{\mathbf{q}}^+(t) = \mathcal{F}(\mathbf{q}(t), \dot{\mathbf{q}}^-(t))$.

The impact constitutive equation is assumed to fulfill requirements (5.10) and (5.11).

However, no regularity assumption has been made on the mapping f . This will be done in the following section where well-posedness of problem 5.4 is studied. However, we can infer from section 5.2.3 that f will be assumed to be at least of class C^1 . We can state an elementary property of any solution (if there are any) of problem 5.4.

Proposition 5.4. (Energy inequality.) Any solution (T, \mathbf{q}) of problem 5.4 satisfies:

$$\forall t_1, t_2 \in [0, T], \quad t_1 \leq t_2,$$

$$K(\mathbf{q}(t_2), \dot{\mathbf{q}}^+(t_2)) - K(\mathbf{q}(t_1), \dot{\mathbf{q}}^+(t_1)) \leq \int_{t_1}^{t_2} \mathbf{f}(\mathbf{q}(s), \dot{\mathbf{q}}^+(s); s) \cdot \dot{\mathbf{q}}^+(s) ds$$

Naturally, the proof of proposition 5.4 (which can be found in [BAL 01]) relies strongly on requirement (5.11).

5.4.3. Well-posedness of the dynamics

To study the well-posedness of problem 5.4, we need to impose regularity assumptions on the data. Looking at those of section 5.3.3, we could expect to be able to prove well-posedness of problem 5.4 under the assumption that the functions φ_j and the mapping f are of class C^2 and C^1 , respectively. The following counter-example (originally due to Bressan [BRE 60] and Schatzman [SCH 78]) shows that uniqueness does not generally hold even if the data are assumed to be of class C^∞ .

Counter-example 5.4. Consider a simple discrete mechanical system such that:

- $d = 1$,
- $M(q) \equiv 1$,
- the force mapping f is assumed to be independent of the current state but only on time, denoted by $f(t)$.

This is the simple discrete mechanical system defined by a particle with unit mass constrained to move along a line submitted to a prescribed force. A fixed obstacle at the origin is taken into consideration. It leads to a unilateral constraint described by the single function:

$$\varphi_1(q) = q.$$

The admissible configuration set is therefore $A = \mathbb{R}^-$. The impact constitutive equation is assumed to be elastic. Here, the geometry is so poor that this statement determines completely the impact constitutive equation. It is necessarily the canonical one with restitution coefficient $e \equiv 1$. The initial state is $(q_0, v_0) = (0, 0)$. The corresponding problem 5.4 yields the following simple formulation.

Find $T > 0$ and $q \in MMA([0, T[; \mathbb{R})$ such that:

- $(q(0)$
 - $\forall t \in$
 - $R \stackrel{\text{def}}{=}$

 - $\forall t \in$

 We inv
 negative:

 $\forall t \in$

 It is then re
 whatever th
 a function
 solution, di

 First, de

 $\rho \left\{ \right.$

 where C is

 $T =$

 and, for ever

 $a_n = \sum_{i=0}^{\infty}$

 $\delta_n = \frac{1}{(n}$

 $f_n = \frac{1}{n!}$

 $v_n = -$

$$\begin{aligned}
 & - (q(0), \dot{q}^+(0)) = (0, 0), \\
 & - \forall t \in [0, T[, \quad q(t) \leq 0, \\
 & - R \stackrel{\text{def}}{=} \frac{d\dot{q}^+}{dt} - f(t) \text{ is a non-positive real measure such that:}
 \end{aligned}$$

$$\text{Supp } R \subset \{t \in [0, T[; q(t) = 0\},$$

$$- \forall t \in]0, T[,$$

$$\begin{cases} q(t) \neq 0 & \Rightarrow \dot{q}^+(t) = \dot{q}^-(t) \\ q(t) = 0 & \Rightarrow \dot{q}^+(t) = -\dot{q}^-(t). \end{cases}$$

We investigate uniqueness under the assumption that f is of class C^∞ and non-negative:

$$\forall t \in \mathbb{R}^+, \quad f(t) \geq 0.$$

It is then readily seen that the null function $\tilde{q} \equiv 0$ on \mathbb{R}^+ is a solution of that problem, whatever the non-negative C^∞ function f . We now construct an explicit example of a function f in such a way that the associated evolution problem 5.4 yields another solution, distinct from the identically vanishing solution.

First, define a Massin function ρ by:

$$\rho \begin{cases} \mathbb{R} \rightarrow \mathbb{R} \\ x \mapsto \begin{cases} 0 & \text{if } x \in]-\infty, 0] \cup [1, +\infty[\\ C e^{\frac{1}{x(x-1)}} & \text{if } x \in]0, 1[\end{cases} \end{cases}$$

where C is a real constant chosen to obtain $\int_{-\infty}^{+\infty} \rho(x) dx = 1$. Define

$$T = \sum_{n=0}^{\infty} \frac{(n+5)^2}{(n+1)(n+2)(n+3)(n+4)}$$

and, for every $n \in \mathbb{N}$,

$$a_n = \sum_{i=n}^{\infty} \frac{(i+5)^2}{(i+1)(i+2)(i+3)(i+4)},$$

$$\delta_n = \frac{n+5}{(n+1)(n+2)(n+4)} \quad \left(\text{i.e. } \delta_n = \frac{n+3}{n+5} (a_n - a_{n+1}) < a_n - a_{n+1} \right),$$

$$f_n = \frac{1}{n!},$$

$$v_n = -\frac{1}{(n+3)!}.$$

Now, the functions $f(t)$ and $v(t)$ from $[0, T[$ to \mathbb{R} are defined by

$$f(0) = 0$$

$$f(t) = \begin{cases} 0, & \text{if } t \in [a_{n+1}, a_{n+1} + \delta_n[\\ \frac{f_n}{2} \rho \left(\frac{t - a_{n+1} - \delta_n}{a_n - a_{n+1} - \delta_n} \right), & \text{if } t \in [a_{n+1} + \delta_n, a_n[\end{cases}$$

and

$$v(0) = 0,$$

$$v(t) = \begin{cases} v_{n+1}, & \text{if } t \in [a_{n+1}, a_{n+1} + \delta_n[\\ v_{n+1} + \frac{f_n}{2} \int_{a_{n+1} + \delta_n}^t \rho \left(\frac{s - a_{n+1} - \delta_n}{a_n - a_{n+1} - \delta_n} \right) ds, & \text{if } t \in [a_{n+1} + \delta_n, a_n[\end{cases}$$

Finally, the function $q : [0, T[\rightarrow \mathbb{R}$ is defined by:

$$q(t) = \int_0^t v(s) ds.$$

The graph of the functions $f(t)$ and $q(t)$ is depicted in Figure 5.3. The reader will easily check that:

- $f(t)$ is a C^∞ non-negative function on $[0, T[$,
- (T, q) is a solution of the considered evolution problem,
- the only instants at which $q(t) = 0$ are 0 and the a_n .

Therefore, q and $\tilde{q} \equiv 0$ provide two solutions of the evolution problem. These two solutions do not coincide on any open subinterval of $[0, T[$. Therefore, uniqueness of solution for problem 5.4 cannot be asserted, even in the case where the data are supposed to be of class C^∞ . Percivale [PER 85] was the first to notice that, in the above example, if $f(t)$ is assumed to be *analytic*, then uniqueness of solution does hold.

Recently, a complete discussion of the one-degree-of-freedom problem was obtained by Schatzman [SCH 98]. The general case is treated in [BAL 00] and is now recalled. Let us mention that prior existence results had been obtained, but they were limited to restricted cases such as where A is convex or where the unilateral constraint is represented by a single function [MON 93, SCH 78].

Hypothesis
and the fur

In this

Proposition
curve $q_a :$

- $(q_a(0$
- $\forall t \in$

$m_{ij}(q_a)\ddot{q}_a$

- $\forall t \in$

Moreover
any other
extension of

Proof. A de
to look for
each coeffic
be found in

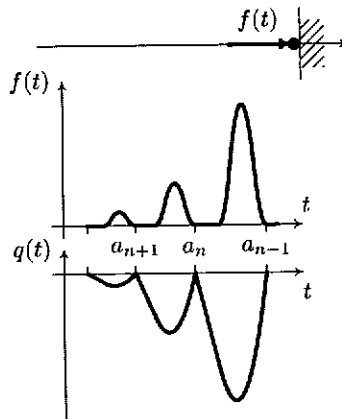

Figure 5.3. Bressan-Schatzman counter-example

Hypothesis 5.9. (Regularity) The mappings $M : \mathbb{R}^d \rightarrow \mathbb{R}^{d^2}$, $f : \mathbb{R}^d \times \mathbb{R}^d \times \mathbb{R}^+ \rightarrow \mathbb{R}^d$ and the functions φ_j are analytic.

In this framework, we have the following property.

Proposition 5.5. Let $\mathbf{q}_0 \in A$ and $\mathbf{v}_0 \in V(\mathbf{q}_0)$. Then, there exist $T_a > 0$, an analytic curve $\mathbf{q}_a : [0, T_a[\rightarrow \mathbb{R}^d$ and n analytic functions $\lambda_{ai} : [0, T_a[\rightarrow \mathbb{R}$ such that:

$$\begin{aligned} & - (\mathbf{q}_a(0), \dot{\mathbf{q}}_a^+(0)) = (\mathbf{q}_0, \mathbf{v}_0), \\ & - \forall t \in [0, T[, \quad \forall i \in \{1, 2, \dots, d\}, \end{aligned}$$

$$m_{ij}(\mathbf{q}_a) \ddot{q}_{aj} + \frac{\partial m_{ij}}{\partial q_k} \dot{q}_{aj} \dot{q}_{ak} - \frac{1}{2} \frac{\partial m_{jk}}{\partial q_i} \dot{q}_{aj} \dot{q}_{ak} = f_i(\mathbf{q}_a, \dot{\mathbf{q}}_a; t) + \sum_{j=1}^n \lambda_{aj}(t) \frac{\partial \varphi_j}{\partial q_i}(\mathbf{q}_a),$$

$$- \forall t \in [0, T_a[, \quad \forall i = 1, 2, \dots, n,$$

$$\lambda_{ai}(t) \leq 0; \quad \varphi_i(\mathbf{q}_a(t)) \leq 0, \quad \lambda_{ai}(t) \varphi_i(\mathbf{q}_a(t)) = 0.$$

Moreover, the solution of this evolution problem is unique in the sense that any other analytic solution $(T, \mathbf{q}, \lambda_1, \dots, \lambda_n)$ is either a restriction or an analytic extension of $(T_a, \mathbf{q}_a, \lambda_{a1}, \dots, \lambda_{an})$.

Proof. A detailed proof of proposition 5.5 can be found in [BAL 00]. The strategy is to look for a solution in the form of a power series in time. It can then be proven that each coefficient solves a well-posed variational inequality. An earlier proof can also be found in [LÖT 82]. \square

Corollary 5.1. *There exists an analytic solution (T_a, \mathbf{q}_a) for problem 5.4.*

Proof. Consider the motion \mathbf{q}_a furnished by proposition 5.5. It obviously satisfies the initial condition, the unilateral constraint and the equation of motion. The only thing which remains to be proven is that it satisfies the impact constitutive equation. Since \mathbf{q}_a is analytic and satisfies the unilateral constraint, we have:

$$\forall t \in]0, T_a[, \quad \dot{\mathbf{q}}_a^-(t) = \dot{\mathbf{q}}_a^+(t) \in V(\mathbf{q}_a(t)) \cap (-V(\mathbf{q}_a(t)))$$

and therefore

$$\forall t \in]0, T_a[, \quad \dot{\mathbf{q}}_a^+(t) = \dot{\mathbf{q}}_a^-(t) = \mathcal{F}(\mathbf{q}_a(t), \dot{\mathbf{q}}_a^-(t))$$

by proposition 5.3. \square

Naturally, the analytic solution furnished by corollary 5.1 will cease to exist at the first instant of impact. This is the reason why we have considered the wider class MMA which contain motions which are not differentiable in the classical sense. Considering motions in MMA will allow the extension of the solution beyond the first instant of impact. However, it must be ensured that admitting the wider class of solutions MMA will not introduce parasitic solutions. This is the aim of the following theorem.

Theorem 5.3. *Let (T_a, \mathbf{q}_a) be the solution for problem 5.4 furnished by corollary 5.1, and (T, \mathbf{q}) be an arbitrary solution for problem 5.4. Then, there exists a real number T_0 ($0 < T_0 \leq \min\{T_a, T\}$) such that:*

$$\mathbf{q}|_{]0, T_0[} \equiv \mathbf{q}_a|_{]0, T_0[}$$

In other terms, there is local uniqueness for problem 5.4.

Local uniqueness is the difficult part in the study of well-posedness of problem 5.4. A detailed proof of local uniqueness theorem 5.3 can be found in [BAL 00]. It is written in the framework of the canonical impact constitutive equation (5.12). However, careful examination of the proof shows that the canonical impact constitutive equation is only used through the energy inequality (proposition 5.4). Since the energy inequality holds for any impact constitutive equation satisfying requirements (5.10) and (5.11), so does local uniqueness.

Corollary 5.2. *There exists a unique maximal solution for problem 5.4.*

It was
corollary 5
we have pr
which allo
problem 5.
In other te
it is wide
alongside t

Theorem 5

$\exists \alpha >$
where $|\cdot|$

$|\mathbf{f}(\mathbf{q}, \mathbf{v})|$
for all \mathbf{q}, \mathbf{v}
function of

Then, the
defined on

For a d
constitutive

5.4.3.1. Co

It is read
maximal so
This solutio
However, a
neighborho
Straightforw

Proposition
corollary 5.

Proposition
corollary 5.
a given inst
instant. Mo
elastic, the
compact inte

It was noticed above that the analytical solution for problem 5.4 furnished by corollary 5.1 ceases to exist at the first instant of impact. To overcome this fact, we have proved that local uniqueness still holds in the wider class of motion *MMA* which allows impacts. However, this does not guarantee that the maximal solution for problem 5.4 is not going to cease to exist at a finite time for non-physical reasons. In other terms, we still do not know if the class *MMA* is wide enough. Actually, it is wide enough as shown by the following theorem which should be considered alongside theorem 5.2.

Theorem 5.4. *The mapping M is assumed to satisfy:*

$$\exists \alpha > 0, \quad \forall \mathbf{q}, \mathbf{v} \in \mathbb{R}^d, \quad {}^t\mathbf{v} \cdot M(\mathbf{q}) \cdot \mathbf{v} \geq \alpha |\mathbf{v}|^2$$

where $|\cdot|$ denotes an arbitrary norm on \mathbb{R}^d and \mathbf{f} is assumed to fulfill the estimate:

$$|\mathbf{f}(\mathbf{q}, \mathbf{v}; t)| \leq l(t)(1 + |\mathbf{q}| + |\mathbf{v}|)$$

for all $\mathbf{q}, \mathbf{v} \in \mathbb{R}^d$ and almost all $t \in [0, +\infty[$, $l(t)$ being a necessarily non-negative function of $L^1_{loc}(\mathbb{R}^+; \mathbb{R})$.

Then, the dynamics is eternal, that is, the maximal solution for problem 5.4 is defined on $[0, +\infty[$.

For a detailed proof, the reader is referred to [BAL 00]. Here also, the impact constitutive equation is only used through the energy inequality.

5.4.3.1. Comments

It is readily seen that the function q displayed in counter-example 5.3 is the unique maximal solution of problem 5.4 corresponding to the situation under consideration. This solution exhibits an accumulation of impacts on the *left* side of instant $t = 3$. However, as predicted by corollary 5.1, for each instant $t \in \mathbb{R}^+$, there exists a right neighborhood $[t, t + \eta[$ of t , such that the restriction of q to $[t, t + \eta[$ is analytic. Straightforward and general consequences of this are the following.

Proposition 5.6. *Let \mathbf{q} be the maximal solution of problem 5.4 furnished by corollary 5.2. Then, the singular parts of the measures $\dot{\mathbf{q}}$ and \mathbf{R} are purely atomic.*

Proposition 5.7. *Let \mathbf{q} be the maximal solution of problem 5.4 furnished by corollary 5.2. Although an infinite number of impacts can accumulate at the left of a given instant, such an accumulation of impacts can never occur at the right of any instant. Moreover, in the particular case where the impact constitutive equation is elastic, the instants of impact are isolated and therefore in a finite number in any compact interval of time.*

Proof. Since for each instant $t \in [0, T[$, there exists a right neighborhood $[t, t + \eta[$ of t such that the restriction of \mathbf{q} to $[t, t + \eta[$ is analytic, we obtain the first part of the proposition. For the second part, let τ be an arbitrary instant in $]0, T[$ and consider the problem 5.4 associated with the initial condition $(\mathbf{q}(\tau), -\dot{\mathbf{q}}^-(\tau))$, the elastic constitutive impact equation and the effort mapping $\mathbf{g}(\mathbf{q}, \mathbf{v}; t)$ defined by:

$$\mathbf{g}(\mathbf{q}, \mathbf{v}; t) = \mathbf{f}(\mathbf{q}, -\mathbf{v}; \tau - t)$$

which is analytic. By theorem 5.3, there exists an analytic function $\mathbf{q}_a : [0, T_a[\rightarrow \mathbb{R}^d$ which is a solution of problem 5.4. Any other solution of problem 5.4 coincides with \mathbf{q}_a on a right neighborhood of $t = 0$. Actually, as seen in the proof of local uniqueness (theorem 5.3), a little bit more is proven. Any function $\mathbf{q}' \in MMA([0, T[; \mathbb{R}^d)$ satisfying the initial condition, the unilateral constraint, the equation of motion (5.8) and the energy inequality proposition 5.4) has to coincide with \mathbf{q}_a on a right neighborhood of $t = 0$. However, it is readily seen that the function defined by

$$\mathbf{q}'(t) = \mathbf{q}(\tau - t), \quad t \in [0, \tau - t_0[$$

fulfills these requirements. Thus, \mathbf{q}' cannot have right accumulation of impacts at $t = \tau$, therefore \mathbf{q} cannot have left accumulation of impacts at $t = \tau$ and the instants of impact are isolated. Of course, if \mathbf{q} is the maximal solution defined on $[0, T[$, impacts can still accumulate at the left of T , as seen in simple examples. \square

The fact that infinitely many impacts can accumulate at the left of a given instant but not at the right is a specific feature of the analytical setting that is lost in the C^∞ setting as seen in counter-example 5.4. Actually, this counter-example shows that pathologies of non-uniqueness in the C^∞ setting are intimately connected to the possibility of right accumulations of impacts. The fact that the analytical setting prevents such right accumulations is the reason why we could prove uniqueness in this case.

5.5. Bibliography.

- [BAL 00] BALLARD P., "The dynamics of discrete mechanical systems with perfect unilateral constraints". *Archive for Rational Mechanics and Analysis*, vol. 154, 199–274, 2000.
- [BAL 01] BALLARD P., "Formulation and well-posedness of the dynamics of rigid-body systems with perfect unilateral constraints". *Philosophical Transactions of the Royal Society of London, A*, vol. 359, 2327–2346, 2001.
- [BRE 60] BRESSAN A., "Incompatibilità dei Teoremi di Esistenza e di Unicità del Moto per un Tipo molto Comune e Regolare di Sistemi Meccanici". *Annali della Scuola Normale Superiore di Pisa, Serie III*, vol. XIV, 333–348, 1960.

[LÖT 82]
constrai[MON 93]
Proble[MOR 83]
Constra
Analysis[PER 85]
Differen[SCH 78]
time". A[SCH 98]
dimensi
1–18, 19

- [LÖT 82] LÖTSTEDT P., "Mechanical systems of rigid bodies subject to unilateral constraints". *SIAM Journal of Applied Mathematics*, vol. 42(2), 281–296, 1982.
- [MON 93] MONTEIRO MARQUES M. D. P., *Differential Inclusions in Nonsmooth Mechanical Problems*. Birkhäuser, Basel, Boston, Berlin, 1993.
- [MOR 83] MOREAU J. J., "Standard Inelastic Shocks and the Dynamics of Unilateral Constraints". In DEL PIERO G., MACERI F. (eds), *Unilateral Problems in Structural Analysis*, Springer-Verlag, 173–221, 1983.
- [PER 85] PERCIVALE D., "Uniqueness in the elastic bounce problem, I". *Journal of Differential Equations*, vol. 56, 206–215, 1985.
- [SCH 78] SCHATZMAN M., "A class of nonlinear differential equations of second order in time". *Nonlinear Analysis, Theory, Methods & Applications*, vol. 2(2), 355–373, 1978.
- [SCH 98] SCHATZMAN M., "Uniqueness and continuous dependence on data for one dimensional impact problems". *Mathematical and Computational Modelling*, vol. 28(4–8), 1–18, 1998.

EXISTENCE AND UNIQUENESS FOR DYNAMICAL UNILATERAL CONTACT WITH COULOMB FRICTION: A MODEL PROBLEM

PATRICK BALLARD¹ AND STÉPHANIE BASSEVILLE¹

Abstract. A simple dynamical problem involving unilateral contact and dry friction of Coulomb type is considered as an archetype. We are concerned with the existence and uniqueness of solutions of the system with Cauchy data. In the frictionless case, it is known [Schatzman, *Nonlinear Anal. Theory, Methods Appl.* **2** (1978) 355–373] that pathologies of non-uniqueness can exist, even if all the data are of class C^∞ . However, uniqueness is recovered provided that the data are analytic [Ballard, *Arch. Rational Mech. Anal.* **154** (2000) 199–274]. Under this analyticity hypothesis, we prove the existence and uniqueness of solutions for the dynamical problem with unilateral contact and Coulomb friction, extending [Ballard, *Arch. Rational Mech. Anal.* **154** (2000) 199–274] to the case where Coulomb friction is added to unilateral contact.

Mathematics Subject Classification. 34A60, 49J52, 70F40.

Received: May 24, 2004. Revised: November 4, 2004.

1. DESCRIPTION OF THE PROBLEM

At the time being, dynamics involving unilateral contact and Coulomb friction has been mainly studied in the framework of systems with finite number of degrees of freedom. In this paper, we are concerned with the questions of existence and uniqueness of solutions for the associated evolution problem. In order to make clear the structure of our existence and uniqueness proof, we shall consider only the simple system introduced by Klarbring [4]. However, the reader should have in mind that the proof presented here can be adapted to a far more general situation. The most general situation in finite d.o.f. dynamics with unilateral contact and Coulomb friction, which is covered by our approach, will be described in a next publication.

Klarbring's system refers to the following situation. Let $n \geq 2$ be some integer. A punctual particle of unit mass in \mathbb{R}^n evolves in a quadratic well of potential elastic energy, described by a symmetric positive definite stiffness matrix K , and is subjected to an external force $F(t)$, depending only on time. Moreover, the particle is constrained to remain in a half-space, and, at contact, Coulomb friction takes place. For $X \in \mathbb{R}^n$, we denote by X_N its first component ("normal component") and by X_T the vector of \mathbb{R}^{n-1} formed by the $n - 1$ last components of X ("tangential component"). The symmetric positive definite stiffness matrix K will be written as:

$$K = \begin{pmatrix} k_N & {}^tW \\ W & K_T \end{pmatrix},$$

Keywords and phrases. Unilateral dynamics with friction, existence and uniqueness.

¹ Laboratoire de Mécanique et d'Acoustique, 31, Chemin Joseph Aiguier, 13402 Marseille Cedex 20, France.

ballard@lma.cnrs-mrs.fr

© EDP Sciences, SMAI 2005

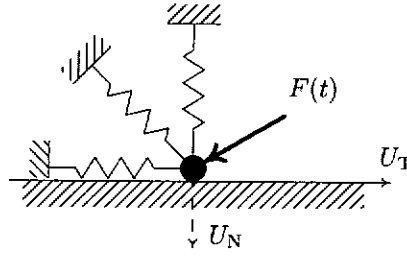

FIGURE 1. Klarbring's system.

where $k_N \in \mathbb{R}$, $W \in \mathbb{R}^{n-1}$ and K_T is a symmetric positive definite real matrix of order $n-1$. The two following statements are equivalent.

- (i) The matrix K is positive definite.
- (ii) The matrix K_T is positive definite and $k_N > {}^tW \cdot K_T^{-1} \cdot W$.

The term W couples the normal and tangential degrees of freedom and is a source of difficulty in the analysis of the system.

We denote by $MMA([0, T]; \mathbb{R}^n)$ (motions with measure acceleration) the vector space of those integrable functions of $[0, T]$ into \mathbb{R}^n whose second derivative in the sense of distributions is a measure. It is nothing but the space of integrals of functions of bounded variation over $[0, T]$. Functions U in MMA are continuous and admit left and right derivatives (in the classical sense) \dot{U}^- , \dot{U}^+ , at any point, both being functions of bounded variation. We recall that a function of bounded variation, being uniform limit of a sequence of step functions, is universally integrable (integrable with respect to any measure). The evolution problem is formulated along the lines of Moreau [6, 8] and in the sequel, the term "unilateral problem" will refer to the following evolution problem:

Problem \mathcal{P}_u . Find $U \in MMA([0, T]; \mathbb{R}^n)$ and $R \in \mathcal{M}([0, T]; \mathbb{R}^n)$ such that:

- $U(0) = U_0$; $\dot{U}^+(0) = V_0$ (initial condition);
- $\ddot{U} + K \cdot U = F + R$, in $[0, T]$ (motion equation);
- $U_N \leq 0$, $R_N \leq 0$, $U_N R_N = 0$ (unilateral contact);
- $\int_{[0, T]} [R_T \cdot (V - \dot{U}_T^+) - \mu R_N (|V| - |\dot{U}_T^+|)] \geq 0$, $\forall V \in C^0([0, T]; \mathbb{R}^{n-1})$ (Coulomb friction);
- $U_N(t) = 0 \implies \dot{U}_N^+(t) = -e \dot{U}_N^-(t)$, in $]0, T[$ (impact law),

where F denotes a given integrable function of $[0, T]$ into \mathbb{R}^n (external force), μ a given nonnegative real constant (friction coefficient), $e \in [0, 1]$ a real constant (restitution coefficient) and (U_0, V_0) some initial condition, assumed to be compatible with the unilateral constraint:

$$U_{0N} \leq 0 \quad \text{and:} \quad U_{0N} = 0 \implies V_{0N} \leq 0.$$

Our goal is to investigate the existence and uniqueness of a solution of problem \mathcal{P}_u .

2. REVIEW OF EXISTING RESULTS AND CONTENT

Well-posedness of the dynamics of discrete systems with unilateral constraints (without friction) seems to have been first investigated by Schatzman in [11], where she proved an existence result by a penalization

technique in the case of the elastic impact law $e = 1$. She also gave a striking counter-example showing that, even in the case where the data have regularity C^∞ , one cannot expect uniqueness of solution, in general. A major remark was, then, made by Percivale in [10] who noticed that, in the case of the (necessarily frictionless) one-degree-of-freedom problem with external force depending only on time, uniqueness of solution is recovered provided the external force is assumed to be an *analytic* function of time (instead of C^∞). Later, Schatzman [12] provided a generalization of this uniqueness result under analyticity assumption, still for the one-degree-of-freedom problem, but in the more general case where the external force is allowed to depend not only on time but also on current position and velocity. However, her proof was specific to the one-degree-of-freedom problem. A simpler proof was given by Ballard [1] who was, then, able to extend the result to the general case of an arbitrary number of degrees of freedom and unilateral constraints. But his result was restricted to the frictionless situation.

The case of dry friction has been considered by Monteiro Marques in [5]. He considered a case with a single smooth unilateral constraint and inelastic impact law $e = 0$ which contains Klarbring's system (provided $e = 0$). Using a time-stepping algorithm introduced by Moreau [7, 8] (which is, roughly speaking, an adaptation of the implicit Euler scheme to the non-smooth situation under consideration) to build a sequence of approximants, Monteiro Marques was able to pass to the limit by extraction of a subsequence using a compactness argument, to prove an existence result which applies to Klarbring's system in the case $e = 0$ and $F \in L^1$. However, note that Klarbring's system, in the particular case $W = 0$ and $F_T \equiv 0$, reduces to a one-degree-of-freedom system in which Coulomb friction plays no role, and, Schatzman's counter-example [11] can be readily adapted to this particular case of Klarbring's system, demonstrating that one cannot expect uniqueness in general, even in the case where the external force is assumed to have C^∞ regularity. Therefore, our purpose, here, is to adapt the technique of Ballard [1] to the situation where Coulomb friction is involved, to prove the uniqueness of a solution under the assumption that F is an *analytic* function of time.

In the frictionless situation, Ballard's uniqueness proof relied on the fact that the associated bilateral problem is governed by an ordinary differential equation, whose solution is analytic provided the data of the problem are analytic. In the situation under consideration, the associated bilateral problem is governed by a differential inclusion (multivocal differential equation) because of Coulomb friction. The Cauchy problem associated with the bilateral problem is studied in Section 3. First, the existence and uniqueness of a solution is proved by use of standard monotonicity techniques in Section 3.1. Then, it is proved in Section 3.2 that the restriction of the solution on some right-neighbourhood of the time origin is analytic, provided the external force is analytic. The analysis of the bilateral problem, as performed in Section 3, is used in Section 4.1 to build a local analytic solution of the unilateral problem with analytic external force. Then, to obtain well-posedness for the unilateral problem, there remains only to prove that there cannot exist any other local solution in MMA , different from the local analytic one. This is performed in Section 4.2 by adapting Ballard's strategy [1] to the situation under consideration.

3. THE BILATERAL PROBLEM

In the sequel, the "bilateral problem" will refer to the evolution problem we obtain when the unilateral constraint is replaced by a bilateral constraint. More precisely, this is the following evolution problem.

Problem \mathcal{P}_b . Find $U \in MMA([0, T]; \mathbb{R}^n)$ and $R \in \mathcal{M}([0, T]; \mathbb{R}^n)$ such that:

- $U(0) = U_0; \quad \dot{U}^+(0) = V_0 \quad$ (initial condition);
- $\ddot{U} + K \cdot U = F + R, \quad$ in $[0, T] \quad$ (motion equation);
- $U_N \equiv 0 \quad$ (bilateral contact);
- $\int_{[0, T]} \left[R_T \cdot (V - \dot{U}_T^+) + \mu |R_N| (|V| - |\dot{U}_T^+|) \right] \geq 0, \quad \forall V \in C^0([0, T]; \mathbb{R}^{n-1}) \quad$ (Coulomb friction),

where F denotes some given integrable function ($F \in L^1([0, T]; \mathbb{R})$) and (U_0, V_0) some initial condition, assumed to be compatible with the bilateral constraint:

$$U_{0N} = 0 \quad \text{and} \quad V_{0N} = 0.$$

Actually, the first component of the motion equation:

$$R_N = W \cdot U_T - F_N,$$

shows that the measure R_N is necessarily absolutely continuous with respect to the Lebesgue measure. Since the Coulomb friction law implies the following inequality between measures:

$$|R_T| \leq \mu |R_N|,$$

we infer that the measure R_T is also absolutely continuous with respect to the Lebesgue measure. As a result, any solution $(U, R) \in MMA \times \mathcal{M}$ of problem \mathcal{P}_b belongs, actually, to $W^{2,1} \times L^1$. For \mathcal{C} being a nonempty closed convex subset of \mathbb{R}^{n-1} , we denote by $\partial S_{\mathcal{C}}$ the subdifferential of its support function $S_{\mathcal{C}}$. In the sequel, \mathcal{B} will be the closed unit ball of Euclidean \mathbb{R}^{n-1} . Using these notations, we have the following equivalent formulation for problem \mathcal{P}_b .

Problem \mathcal{P}_b . Find $U_T \in W^{2,1}([0, T]; \mathbb{R}^{n-1})$ such that:

- $U_T(0) = U_{0T}; \quad \dot{U}_T(0) = V_{0T} \quad (\text{initial condition});$
- $\ddot{U}_T(t) + K_T \cdot U_T(t) - F_T(t) \in \partial S_{\mu|F_N(t) - W \cdot U_T(t)|\mathcal{B}}[-\dot{U}_T(t)], \quad \text{for a.a. } t \in [0, T].$

3.1. The bilateral problem with integrable force

In this section, we prove the existence and uniqueness of a solution of problem \mathcal{P}_b by monotonicity techniques.

Proposition 3.1. *Let $r \in \mathbb{R}^+$ and $F_T \in L^1([0, T]; \mathbb{R}^{n-1})$. Then, there exists a unique $U_T \in W^{2,1}([0, T]; \mathbb{R}^{n-1})$ such that:*

- $U_T(0) = U_{0T}; \quad \dot{U}_T(0) = V_{0T} \quad (\text{initial condition});$
- $\ddot{U}_T(t) + K_T \cdot U_T(t) - F_T(t) \in \partial S_{r\mathcal{B}}[-\dot{U}_T(t)], \quad \text{for a.a. } t \in [0, T].$

Proof.

Uniqueness. Straightforward by monotonicity of the subdifferential.

Existence. We shall use a Caratheodory type construction, implicit with respect to the subdifferential term. Let V_T^n be the sequence of functions in $W^{1,1}([0, T]; \mathbb{R}^{n-1})$ defined by:

$$V_T^0 \equiv V_{0T},$$

and by the following induction. Given the function $V_T^n \in W^{1,1}([0, T]; \mathbb{R}^{n-1})$, the function V_T^{n+1} is defined to be the unique solution in $W^{1,1}([0, T]; \mathbb{R}^{n-1})$, provided by Proposition 3.4, p. 69 of [2], of the evolution problem:

- $V_T^{n+1}(0) = V_{0T};$
- $\dot{V}_T^{n+1}(t) + K_T \cdot \left(U_{0T} + \int_0^t V_T^n(s) ds \right) - F_T(t) \in \partial S_{r\mathcal{B}}[-V_T^{n+1}(t)], \quad \text{for a.a. } t.$

By monotonicity of the subdifferential, it is easily seen that, for all $t \in [0, T]$:

$$\frac{1}{2}|V_{\mathbb{T}}^{n+1}(t) - V_{\mathbb{T}}^n(t)|^2 + \int_0^t [V_{\mathbb{T}}^{n+1}(s) - V_{\mathbb{T}}^n(s)] \cdot K_{\mathbb{T}} \cdot \int_0^s [V_{\mathbb{T}}^n(\sigma) - V_{\mathbb{T}}^{n-1}(\sigma)] \leq 0,$$

where $|\cdot|$ denotes the Euclidean norm in \mathbb{R}^{n-1} . Using the same notation for the associated matrix norm, we get:

$$\frac{1}{2}|V_{\mathbb{T}}^{n+1}(t) - V_{\mathbb{T}}^n(t)|^2 \leq |K_{\mathbb{T}}| \int_0^t |V_{\mathbb{T}}^{n+1}(s) - V_{\mathbb{T}}^n(s)| \int_0^s |V_{\mathbb{T}}^n(\sigma) - V_{\mathbb{T}}^{n-1}(\sigma)|,$$

and, by Lemma A.5, p. 157 of [2]:

$$\begin{aligned} |V_{\mathbb{T}}^{n+1}(t) - V_{\mathbb{T}}^n(t)| &\leq |K_{\mathbb{T}}| \int_0^t \int_0^s |V_{\mathbb{T}}^n(\sigma) - V_{\mathbb{T}}^{n-1}(\sigma)|, \\ &\leq |K_{\mathbb{T}}| T \int_0^t |V_{\mathbb{T}}^n(s) - V_{\mathbb{T}}^{n-1}(s)|, \\ &\leq \frac{(|K_{\mathbb{T}}| T t)^n}{n!} \|V_{\mathbb{T}}^1 - V_{\mathbb{T}}^0\|_{C^0}, \end{aligned}$$

for all $t \in [0, T]$. As a consequence, the sequence $(V_{\mathbb{T}}^n)_{n \in \mathbb{N}}$ converges, uniformly on $[0, T]$, towards some limit $V_{\mathbb{T}} \in C^0([0, T]; \mathbb{R}^{n-1})$. Now, let $W_{\mathbb{T}} \in W^{1,1}([0, T]; \mathbb{R}^{n-1})$ be the solution of the evolution problem:

- $W_{\mathbb{T}}(0) = V_{0\mathbb{T}}$;
- $\dot{W}_{\mathbb{T}}(t) + K_{\mathbb{T}} \cdot \left(U_{0\mathbb{T}} + \int_0^t V_{\mathbb{T}}(s) ds \right) - F_{\mathbb{T}}(t) \in \partial S_{r\mathcal{B}}[-W_{\mathbb{T}}(t)],$ for a.a. t .

Now, taking the difference of this differential inclusion with the one defining $V_{\mathbb{T}}^n$, multiplying by $W_{\mathbb{T}} - V_{\mathbb{T}}^n$ and integrating, we get, thanks to the monotonicity of the subdifferential and to Lemma A.5, p. 157 of [2]:

$$|W_{\mathbb{T}}(t) - V_{\mathbb{T}}^n(t)| \leq |K_{\mathbb{T}}| T \int_0^t |V_{\mathbb{T}}(s) - V_{\mathbb{T}}^{n-1}(s)|,$$

for all $t \in [0, T]$, which shows that the sequence $(V_{\mathbb{T}}^n)_{n \in \mathbb{N}}$ converges, uniformly on $[0, T]$, towards $W_{\mathbb{T}}$. Hence, $V_{\mathbb{T}} = W_{\mathbb{T}} \in W^{1,1}$ and we have:

- $V_{\mathbb{T}}(0) = V_{0\mathbb{T}}$;
- $\dot{V}_{\mathbb{T}}(t) + K_{\mathbb{T}} \cdot \left(U_{0\mathbb{T}} + \int_0^t V_{\mathbb{T}}(s) ds \right) - F_{\mathbb{T}}(t) \in \partial S_{r\mathcal{B}}[-V_{\mathbb{T}}(t)],$ for a.a. t .

Setting:

$$U_{\mathbb{T}}(t) = U_{0\mathbb{T}} + \int_0^t V_{\mathbb{T}}(s) ds,$$

we see that $U_{\mathbb{T}} \in W^{2,1}([0, T]; \mathbb{R}^{n-1})$ and provides the solution we sought. \square

Proposition 3.2. *Let $r \in L^1([0, T]; \mathbb{R})$ be a nonnegative integrable function and assume $F_{\mathbb{T}} \in L^1([0, T]; \mathbb{R}^{n-1})$. Then, there exists a unique $U_{\mathbb{T}} \in W^{2,1}([0, T]; \mathbb{R}^{n-1})$ such that:*

- $U_{\mathbb{T}}(0) = U_{0\mathbb{T}}; \quad \dot{U}_{\mathbb{T}}(0) = V_{0\mathbb{T}} \quad (\text{initial condition});$
- $\ddot{U}_{\mathbb{T}}(t) + K_{\mathbb{T}} \cdot U_{\mathbb{T}}(t) - F_{\mathbb{T}}(t) \in \partial S_{r(t), \mathcal{B}}[-\dot{U}_{\mathbb{T}}(t)],$ for a.a. $t \in [0, T]$.

Proof.

Uniqueness. Straightforward by monotonicity of the subdifferential.

Existence. Let $(r^n)_{n \in \mathbb{N}}$ be a sequence of nonnegative step functions on $[0, T]$, converging towards r in $L^1([0, T]; \mathbb{R})$. By Proposition 3.1, there exists a unique solution $U_T^n \in W^{2,1}([0, T]; \mathbb{R}^{n-1})$ of:

$$\begin{aligned} & \bullet \quad U_T^n(0) = U_{0T}; \quad \dot{U}_T^n(0) = V_{0T} \quad (\text{initial condition}); \\ & \bullet \quad \ddot{U}_T^n(t) + K_T \cdot U_T^n(t) - F_T(t) \in \partial S_{r^n(t)\mathcal{B}}[-\dot{U}_T^n(t)], \quad \text{for a.a. } t \in [0, T]. \end{aligned} \quad (1)$$

Step 1. The sequences $(U_T^n)_{n \in \mathbb{N}}$ and $(\dot{U}_T^n)_{n \in \mathbb{N}}$ are Cauchy sequences in C^0 and, then, converge towards some limits U_T and \dot{U}_T in C^0 .

Indeed:

$$\begin{aligned} \frac{1}{2} \left| \dot{U}_T^{n+p}(t) - \dot{U}_T^n(t) \right|^2 + \frac{1}{2} \left[U_T^{n+p}(t) - U_T^n(t) \right] \cdot K_T \cdot \left[U_T^{n+p}(t) - U_T^n(t) \right] &\leq - \int_0^t (r^{n+p} - r^n) \left(\left| \dot{U}_T^{n+p} \right| - \left| \dot{U}_T^n \right| \right), \\ &\leq \int_0^t |r^{n+p} - r^n| \cdot \left| \dot{U}_T^{n+p} - \dot{U}_T^n(t) \right|. \end{aligned}$$

The conclusion follows by use of Lemma A.5, p. 157 of [2].

Step 2. $\dot{U}_T \in W^{1,1}$.

Pick $0 \leq t_1 \leq t_2 \leq t$. Multiplying differential inclusion (1) by $\dot{U}_T^n(s) - \dot{U}_T^n(t_1)$ and integrating over $[t_1, t]$, we get:

$$\begin{aligned} \frac{1}{2} \left| \dot{U}_T^n(t) - \dot{U}_T^n(t_1) \right|^2 + \frac{1}{2} \left| U_T^n(t) - U_T^n(t_1) - (t - t_1) \dot{U}_T^n(t_1) \right|_{K_T}^2 \\ \leq \int_{t_1}^t \left| F_T(s) - K_T \cdot \left[U_T^n(t_1) + (s - t_1) \dot{U}_T^n(t_1) \right] \right| \cdot \left| \dot{U}_T^n(s) - \dot{U}_T^n(t_1) \right| ds + \int_{t_1}^t r^n(s) \left| \dot{U}_T^n(s) - \dot{U}_T^n(t_1) \right| ds, \end{aligned}$$

where $|\cdot|_{K_T}$ denotes the norm on \mathbb{R}^{n-1} which is associated with the scalar product defined by the symmetric positive definite matrix K_T . Using, once more, Lemma A.5, p. 157 of [2], we obtain:

$$\left| \dot{U}_T^n(t_2) - \dot{U}_T^n(t_1) \right| \leq \int_{t_1}^{t_2} \left[|F_T(s)| + r^n(s) + M \right] ds, \quad (2)$$

where M is some real constant, independent on t_1 , t_2 and n . Taking the limit $n \rightarrow \infty$, we get:

$$\left| \dot{U}_T(t_2) - \dot{U}_T(t_1) \right| \leq \int_{t_1}^{t_2} \left[|F_T(s)| + r(s) + M \right] ds,$$

which shows that \dot{U}_T is absolutely continuous.

Step 3. U_T is a solution of the evolution problem under consideration.

Inequality (2) gives:

$$\|\dot{U}_T^n\|_{L^1} \leq MT + \|r^n\|_{L^1} + \|F_T\|_{L^1} \leq M',$$

where M' is a real constant independent of n . Therefore, extracting a subsequence if necessary, the sequence $(\dot{U}_T^n)_{n \in \mathbb{N}}$ converges in $\mathcal{M}([0, T]; \mathbb{R}^{n-1})$ weak-*. Its limit is necessarily \dot{U}_T . Now, U_T^n being a solution of evolution

problem (1), we have:

$$\forall V \in C^0([0, T]; \mathbb{R}^{n-1}),$$

$$\int_0^T r^n(s) |V(s)| ds \geq \int_0^T r^n(s) |\dot{U}_T^n(s)| ds + \int_0^T \left[\ddot{U}_T^n(s) + K_T \cdot U_T^n(s) - F_T(s) \right] \left[V(s) + \dot{U}_T^n(s) \right] ds.$$

Thanks to the convergence properties of all the sequences involved, we can take the limit as $n \rightarrow \infty$ in this inequality. We deduce that U_T is a solution of the evolution problem under consideration. \square

Proposition 3.3. *Let $W \in \mathbb{R}^{n-1}$, $F_N \in L^1([0, T]; \mathbb{R})$ and $F_T \in L^1([0, T]; \mathbb{R}^{n-1})$. Then, there exists a unique $U_T \in W^{2,1}([0, T]; \mathbb{R}^{n-1})$ such that:*

- $U_T(0) = U_{0T}$; $\dot{U}_T(0) = V_{0T}$ (initial condition);
- $\ddot{U}_T(t) + K_T \cdot U_T(t) - F_T(t) \in \partial S_{\mu|F_N(t)-W \cdot U_T(t), \mathcal{B}}[-\dot{U}_T(t)]$, for a.a. $t \in [0, T]$.

Proof.

Uniqueness. If U_T^1 and U_T^2 denote two solutions, then we have:

$$\begin{aligned} \frac{1}{2} \left| \dot{U}_T^1(t) - \dot{U}_T^2(t) \right|^2 + \frac{1}{2} \left| U_T^1(t) - U_T^2(t) \right|_{K_T}^2 &\leq \mu \int_0^t \left| W \cdot U_T^1(s) - W \cdot U_T^2(s) \right| \cdot \left| \dot{U}_T^1(s) - \dot{U}_T^2(s) \right| ds, \\ &\leq \frac{\mu |W|}{2} \int_0^t \left(\left| \dot{U}_T^1(s) - \dot{U}_T^2(s) \right|^2 + \left| U_T^1(s) - U_T^2(s) \right|^2 \right) ds, \end{aligned}$$

and, therefore, $U_T^1 \equiv U_T^2$, by Gronwall's lemma.

Existence. Let U_T^n be the sequence of functions in $W^{2,1}([0, T]; \mathbb{R}^{n-1})$ defined by:

$$U_T^0(t) = U_{0T} + V_{0T} t,$$

and by the following induction: knowing the function $U_T^n \in W^{2,1}([0, T]; \mathbb{R}^{n-1})$, U_T^{n+1} is the unique solution in $W^{2,1}([0, T]; \mathbb{R}^{n-1})$, provided by Proposition 3.2, of the evolution problem:

- $U_T^{n+1}(0) = U_{0T}$; $\dot{U}_T^{n+1}(0) = V_{0T}$ (initial condition);
- $\ddot{U}_T^{n+1}(t) + K_T \cdot U_T^{n+1}(t) - F_T(t) \in \partial S_{\mu|F_N(t)-W \cdot U_T^n(t), \mathcal{B}}[-\dot{U}_T^{n+1}(t)]$, for a.a. t .

First, we get:

$$\frac{1}{2} \left| \dot{U}_T^{n+1}(t) - \dot{U}_T^n(t) \right|^2 + \frac{1}{2} \left| U_T^{n+1}(t) - U_T^n(t) \right|_{K_T}^2 \leq \mu |W| \int_0^t \left| U_T^n(s) - U_T^{n-1}(s) \right| \cdot \left| \dot{U}_T^{n+1}(s) - \dot{U}_T^n(s) \right| ds, \quad (3)$$

and then, by Lemma A.5, p. 157 of [2]:

$$\left| U_T^{n+1}(t) - U_T^n(t) \right| \leq C \int_0^t \left| U_T^n(s) - U_T^{n-1}(s) \right| ds,$$

where C is a real constant independent of t and n . Reusing the argument in the proof of Proposition 3.1, we obtain first the uniform convergence of the sequence $(U_T^n)_{n \in \mathbb{N}}$, and then, coming back to inequality (3), the uniform convergence of the sequence $(\dot{U}_T^n)_{n \in \mathbb{N}}$. Then, it can be shown, exactly as in the proof of Proposition 3.1, that this limit provides the solution we sought. \square

3.2. The bilateral problem with analytic force

The aim of this section is to prove that, if the external force F is not only integrable but *analytic*, then the solution of the bilateral problem \mathcal{P}_b provided by Proposition 3.3 is *analytic* on some right-neighbourhood of $t = 0$.

Lemma 3.4. *Let n be a positive integer, \mathcal{O} a neighbourhood of $(0, 0)$ in $\mathbb{R}^n \times \mathbb{R}$, $G : \mathcal{O} \rightarrow \mathbb{R}^n$ an analytic function and A a real square matrix of order n without any eigenvalue in $\mathbb{N} \setminus \{0\}$. Then, there exist $\eta > 0$ and an analytic function $X : [0, \eta[\rightarrow \mathbb{R}^n$ which is a solution of the Cauchy problem:*

- $X(0) = 0$;
- $\dot{X}(t) = \frac{1}{t} A \cdot X(t) + G(X(t), t), \quad \forall t \in]0, \eta[.$

Moreover, any other analytic solution of this Cauchy problem is, either a restriction, or an analytic extension of $X(t)$.

Proof. For the sake of clarity, the proof is presented only in the particular case $n = 1$. For $|X| < r$ and $|t| < r$, we can write:

$$G(X, t) = \sum_{i,j=0}^{\infty} g_{ij} X^i t^j.$$

Then, for $|X| < r$ and $|t| < r$, set:

$$\tilde{G}(X, t) = \sum_{i,j=0}^{\infty} |g_{ij}| X^i t^j,$$

and consider the Cauchy problem:

- $\tilde{X}(0) = 0$;
- $\frac{d}{dt} \tilde{X}(t) = \tilde{G}(\tilde{X}(t), t), \quad \forall t,$

that admits a unique local solution \tilde{X} which, moreover, is analytic (Th. 1, p. 214 of [3]). This solution can be expanded in a power series:

$$\tilde{X}(t) = \sum_{i=1}^{\infty} \tilde{x}_i t^i,$$

which converges in a neighbourhood of $t = 0$. The coefficients \tilde{x}_i are inductively computed by substituting the power series expansion into the differential equation. This procedure gives, for all $k \in \mathbb{N}$:

$$(k+1)\tilde{x}_{k+1} = P_{k+1}(\tilde{x}_1, \tilde{x}_2, \dots, \tilde{x}_k; |g_{ij}|), \quad (4)$$

where P_{k+1} is a polynomial with integer coefficients, and arguments $\tilde{x}_1, \tilde{x}_2, \dots, \tilde{x}_k$ and a finite number of $|g_{ij}|$. An induction argument based on equation (4) shows that all the \tilde{x}_i are uniquely determined and satisfy in addition:

$$\forall k \in \mathbb{N}, \quad \tilde{x}_{k+1} \geq 0.$$

Note that all the polynomials P_{k+1} have the property:

$$\forall \alpha \geq 1, \quad \forall \tilde{x}_i \in \mathbb{R}, \quad \left| P_{k+1}(\alpha \tilde{x}_1, \alpha^2 \tilde{x}_2, \dots, \alpha^k \tilde{x}_k; |g_{ij}|) \right| \leq \alpha^k P_{k+1}(|\tilde{x}_1|, |\tilde{x}_2|, \dots, |\tilde{x}_k|; |g_{ij}|). \quad (5)$$

Now, let us come back to the Cauchy problem:

- $X(0) = 0$;
- $\dot{X}(t) = \frac{1}{t} A X(t) + G(X(t), t)$,

and search a solution as a formal power series:

$$X(t) = \sum_{i=1}^{\infty} x_i t^i.$$

Substituting this expression into the differential equation, we obtain, for all $k \in \mathbb{N}$:

$$(k+1-A)x_{k+1} = P_{k+1}(x_1, x_2, \dots, x_k; g_{ij}). \quad (6)$$

Set:

$$\alpha = \sup_{k \in \mathbb{N}} \left\{ \frac{k+1}{k+1-A} \right\} \quad (\alpha \geq 1),$$

which is finite, since, by hypothesis, A is not a positive integer. By virtue of the induction equation (6), we have, for all $k \in \mathbb{N}$:

$$|x_{k+1}| \leq \frac{\alpha}{k+1} P_{k+1}(|x_1|, |x_2|, \dots, |x_k|; |g_{ij}|).$$

By induction based on property (5), we get:

$$\forall k \in \mathbb{N}, \quad |x_{k+1}| \leq \alpha^{k+1} \tilde{x}_{k+1},$$

which proves that the convergence radius of the power series $\sum_{i \geq 1} x_i t^i$ is positive and, thus, gives the desired conclusion.

In the case where n is arbitrary, the argument is similar, using the maximum norm on \mathbb{R}^n instead of the absolute value; the constant α is then defined by:

$$\alpha = \sup_{k \in \mathbb{N}} \left\{ (k+1) \left\| [(k+1)I - A]^{-1} \right\|_{\infty} \right\} \quad (\alpha \geq 1),$$

where I is the identity matrix and $\|\cdot\|_{\infty}$ denotes the matrix norm associated with the maximum norm on \mathbb{R}^n . \square

Proposition 3.5. *Let $F_N : [0, T] \rightarrow \mathbb{R}$ and $F_T : [0, T] \rightarrow \mathbb{R}^{n-1}$ be two analytic functions. Then, there exists $\eta > 0$ such that the restriction to $[0, \eta]$ of $U_T \in W^{2,1}$, provided by Proposition 3.3, is analytic.*

Proof. By the assumed analyticity of functions $F_N(t)$ and $F_T(t)$, there exists $\eta > 0$ such that, necessarily, one of the following three cases occurs.

Case 1. $V_{0T} \neq 0$.

Case 2. $V_{0T} = 0$ and $\forall t \in]0, \eta[$, $|F_T(t) - K_T \cdot U_{0T}| \leq \mu |F_N(t) - W \cdot U_{0T}|$.

Case 3. $V_{0T} = 0$ and $\forall t \in]0, \eta[$, $|F_T(t) - K_T \cdot U_{0T}| > \mu |F_N(t) - W \cdot U_{0T}|$.

Thus, we are going to prove that the conclusion is reached in any of these cases.

Case 1. $V_{0T} \neq 0$.

Let \mathcal{O} be an open neighbourhood of V_{0T} in \mathbb{R}^{n-1} which does not contain 0. Then, the function:

$$\begin{cases} \mathcal{O} \rightarrow \mathbb{R}^{n-1} \\ V \mapsto \frac{V}{|V|} \end{cases}$$

is analytic. Cauchy-Lipschitz' theorem provides a solution $U_T \in C^2([0, \alpha[; \mathbb{R}^{n-1})$ of the Cauchy problem:

$$\begin{aligned} & \bullet \quad U_T(0) = U_{0T}; \quad \dot{U}_T(0) = V_{0T}; \\ & \bullet \quad \ddot{U}_T(t) + K_T \cdot U_T(t) + \mu |F_N(t) - W \cdot U_T(t)| \frac{\dot{U}_T(t)}{|\dot{U}_T(t)|} = F_T(t); \\ & \bullet \quad \dot{U}_T(t) \in \mathcal{O}. \end{aligned} \tag{7}$$

Now, seeking a solution of (7) as a formal power series:

$$U_T(t) = \sum_{k=0}^{\infty} \lambda_k t^k,$$

and substituting into (7), we have necessarily:

$$\lambda_0 = U_{0T}, \quad \lambda_1 = V_{0T}$$

and then:

$$\lambda_2 = \frac{1}{2} \left\{ F_T(0) - K_T \cdot U_{0T} - |F_N(0) - W \cdot U_{0T}| \frac{V_{0T}}{|V_{0T}|} \right\}.$$

Replacing the term $|F_N(t) - W \cdot U_T(t)|$, in (7), by $\pm [F_N(t) - W \cdot U_T(t)]$ according to the sign of the first nonzero term of the formal power series expansion of $[F_N(t) - W \cdot U_T(t)]$, it is readily seen, by induction, that the sequence $(\lambda_n)_{n \in \mathbb{N}}$ is uniquely determined. Only two cases are possible.

Case 1.1. $\forall n \in \mathbb{N}$, $\frac{F_N^{(n)}(0)}{n!} = W \cdot \lambda_n$,

in which case the solution of the Cauchy problem:

$$\begin{aligned} & \bullet \quad U_T(0) = U_{0T}; \quad \dot{U}_T(0) = V_{0T}; \\ & \bullet \quad \ddot{U}_T(t) + K_T \cdot U_T(t) = F_T(t); \\ & \bullet \quad \dot{U}_T(t) \in \mathcal{O}, \end{aligned}$$

which is analytic by Theorem 1, p. 214 of [3], has the λ_n as coefficients of its power series expansion at 0. Hence, the λ_n are the coefficients of the power series expansion at 0 of a certain analytic function defined on a right-neighbourhood of 0 and which solves problem (7) and therefore the Cauchy problem of Proposition 3.3.

Case 1.2. $\forall n \in \{0, 1, \dots, n_0 - 1\}$, $\frac{F_N^{(n)}(0)}{n!} = W \cdot \lambda_n$, and $\frac{F_N^{(n_0)}(0)}{n_0!} \neq W \cdot \lambda_{n_0}$,

in which case the analytic solution of the Cauchy problem:

$$\begin{aligned} & \bullet \quad U_T(0) = U_{0T}; \quad \dot{U}_T(0) = V_{0T}; \\ & \bullet \quad \ddot{U}_T(t) + K_T \cdot U_T(t) + \mu \operatorname{sgn} \left[\frac{F_N^{(n_0)}(0)}{n_0!} - W \cdot \lambda_{n_0} \right] [F_N(t) - W \cdot U_T(t)] \frac{\dot{U}_T(t)}{|\dot{U}_T(t)|} = F_T(t); \\ & \bullet \quad \dot{U}_T(t) \in \mathcal{O}, \end{aligned}$$

is a solution of problem (7) on a right-neighbourhood of $t = 0$ and therefore solves the Cauchy problem of Proposition 3.3.

Case 2. $V_{0T} = 0$ and $\forall t \in]0, \eta[$, $|F_T(t) - K_T \cdot U_{0T}| \leq \mu |F_N(t) - W \cdot U_{0T}|$.

In this case, it is readily checked that the constant function $U_T \equiv U_{0T}$ on $[0, \eta[$ (which is analytic) provides a solution on $[0, \eta[$ of the Cauchy problem of Proposition 3.3.

Case 3. $V_{0T} = 0$ and $\forall t \in]0, \eta[, |F_T(t) - K_T \cdot U_{0T}| > \mu |F_N(t) - W \cdot U_{0T}|$.

This case is the most tricky to examine. Our technique will consist to transform problem (7) into a form on which Lemma 3.4 applies.

By the assumed analyticity of functions $F_N(t)$ and $F_T(t)$, together with the hypothesis of case 3, we know that there exist two integers n_0 and $n_1 \geq n_0$ such that:

$$\begin{aligned} F_T(t) - K_T \cdot U_{0T} &\sim \alpha t^{n_0}, \quad \alpha \in \mathbb{R}^{n-1} \setminus \{0\}, \\ F_N(t) - W \cdot U_{0T} &\sim \beta t^{n_1}, \quad \beta \in \mathbb{R} \setminus \{0\}, \end{aligned}$$

when t goes to 0 (in case where $F_N(t) \equiv W \cdot U_{0T}$, just set $n_1 = +\infty$ in the sequel). Let us look for a formal power series solution of problem (7). It is readily checked that the first nonzero term of the formal power series associated to $U_T - U_{0T}$ can be written:

$$\gamma t^{n_0+2},$$

where γ must satisfy the equation:

$$(n_0 + 2)(n_0 + 1)\gamma + \mu \delta_{n_0}^{n_1} |\beta| \frac{\gamma}{|\gamma|} = \alpha. \quad (8)$$

Here, $\delta_{n_0}^{n_1}$ denotes the Kronecker index (which equals 1, if $n_0 = n_1$, and 0, otherwise). The solution of equation (8) is:

$$\gamma = \frac{|\alpha| - \mu \delta_{n_0}^{n_1} |\beta|}{(n_0 + 2)(n_0 + 1)} \cdot \frac{\alpha}{|\alpha|}.$$

Then, we define new unknown functions, for $t > 0$, by:

$$\begin{aligned} \tilde{U}_T &= \frac{U_T - U_{0T}}{t^{n_0+1}}, \\ \tilde{V}_T &= \frac{\dot{U}_T}{(n_0 + 2)t^{n_0+1}} - \gamma. \end{aligned}$$

Hence, for $t > 0$, the functions \tilde{U}_T and \tilde{V}_T are related by the differential equation:

$$\frac{d}{dt} \tilde{U}_T = -\frac{n_0 + 1}{t} \tilde{U}_T + (n_0 + 2)(\tilde{V}_T + \gamma).$$

Now, there remains to write the differential equation in problem (7) in terms of the new unknown functions \tilde{U}_T and \tilde{V}_T . We get:

$$\frac{d}{dt} \tilde{V}_T = -\frac{n_0 + 1}{t} (\tilde{V}_T + \gamma) - \frac{1}{n_0 + 2} K_T \cdot \tilde{U}_T + \frac{F_T - K_T \cdot U_{0T}}{(n_0 + 2)t^{n_0+1}} - \frac{\mu}{n_0 + 2} \left| \frac{F_N - W \cdot U_{0T}}{t^{n_0+1}} - W \cdot \tilde{U}_T \right| \frac{\gamma + \tilde{V}_T}{|\gamma + \tilde{V}_T|},$$

which is, using definition (8) of γ , nothing but:

$$\begin{aligned} \frac{d}{dt} \tilde{V}_T &= -\frac{n_0 + 1}{t} \tilde{V}_T - \frac{1}{n_0 + 2} K_T \cdot \tilde{U}_T + \frac{F_T - K_T \cdot U_{0T} - \alpha t^{n_0}}{(n_0 + 2)t^{n_0+1}} \\ &\quad + \frac{\mu \delta_{n_0}^{n_1} |\beta|}{(n_0 + 2)t} \cdot \frac{\gamma}{|\gamma|} - \frac{\mu}{n_0 + 2} \left| \frac{F_N - W \cdot U_{0T}}{t^{n_0+1}} - W \cdot \tilde{U}_T \right| \frac{\gamma + \tilde{V}_T}{|\gamma + \tilde{V}_T|}. \end{aligned}$$

Now, it is readily seen that the Cauchy problem:

- $\tilde{U}_T(0) = 0; \quad \tilde{V}_T(0) = 0;$
- $\frac{d}{dt} \tilde{U}_T = -\frac{n_0+1}{t} \tilde{U}_T + (n_0+2)(\gamma + \tilde{V}_T);$
- $\frac{d}{dt} \tilde{V}_T = -\frac{n_0+1}{t} \tilde{V}_T - \frac{1}{n_0+2} K_T \cdot \tilde{U}_T + \frac{F_T - K_T \cdot U_{0T} - \alpha t^{n_0}}{(n_0+2)t^{n_0+1}}$
 $+ \frac{\mu \delta_{n_0}^{n_1} |\beta|}{(n_0+2)t} \frac{\gamma}{|\gamma|} - \frac{\mu}{n_0+2} \left| \frac{F_N - W \cdot U_{0T}}{t^{n_0+1}} - W \cdot \tilde{U}_T \right| \frac{\gamma + \tilde{V}_T}{|\gamma + \tilde{V}_T|},$

has a unique formal power series solution. Let sign equal -1 or $+1$ according to the sign of the first nonzero term in the formal power series expansion of:

$$F_N - W \cdot U_{0T} - t^{n_0+1} W \cdot \tilde{U}_T.$$

It is easily checked that, in the particular case $n_1 = n_0$, we have:

$$\text{sign} = \text{sgn}(\beta),$$

so that the function \tilde{G} defined by:

$$\tilde{G}(\tilde{U}_T, \tilde{V}_T, t) = \frac{F_T - K_T \cdot U_{0T} - \alpha t^{n_0}}{(n_0+2)t^{n_0+1}} + \frac{\mu \delta_{n_0}^{n_1} |\beta|}{(n_0+2)t} \frac{\gamma}{|\gamma|} - \frac{\mu \text{sign}}{n_0+2} \left[\frac{F_N - W \cdot U_{0T}}{t^{n_0+1}} - W \cdot \tilde{U}_T \right] \frac{\gamma + \tilde{V}_T}{|\gamma + \tilde{V}_T|},$$

is analytic on some neighbourhood of $(0, 0, 0)$. Then, Lemma 3.4 provides a local analytic solution $(\tilde{U}_T, \tilde{V}_T)$ of the problem:

- $\tilde{U}_T(0) = 0; \quad \tilde{V}_T(0) = 0;$
- $\frac{d}{dt} \tilde{U}_T = -\frac{n_0+1}{t} \tilde{U}_T + (n_0+2)(\gamma + \tilde{V}_T);$
- $\frac{d}{dt} \tilde{V}_T = -\frac{n_0+1}{t} \tilde{V}_T - \frac{1}{n_0+2} K_T \cdot \tilde{U}_T + \tilde{G}(\tilde{U}_T, \tilde{V}_T, t).$

Setting:

$$U_T(t) = U_{0T} + t^{n_0+1} \tilde{U}_T(t),$$

the function U_T is analytic on a right-neighbourhood of 0 and:

$$\dot{U}_T(t) = (n_0+2)t^{n_0+1}(\gamma + \tilde{V}_T(t)).$$

Rewinding the argument, it is readily seen that U_T is a solution of problem (7) and therefore, of the evolution problem of Proposition 3.3. \square

4. THE UNILATERAL PROBLEM WITH ANALYTIC FORCE

4.1. Existence of a local analytic solution

The result announced in the title of this section is the following.

Theorem 4.1. *Let $F : [0, T] \rightarrow \mathbb{R}^n$ be an analytic function. Then, there exist $T_a > 0$ and analytic functions $U_a : [0, T_a[\rightarrow \mathbb{R}^n$ and $R_{aN} : [0, T_a[\rightarrow \mathbb{R}$, solution of the problem:*

- $U_a(0) = U_0; \quad \dot{U}_a(0) = V_0;$
- $\ddot{U}_{aN} + k_N U_{aN} + W \cdot U_{aT} = F_N + R_{aN}, \quad \text{in } [0, T_a[;$
- $\ddot{U}_{aT} + K_T \cdot U_{aT} + W U_{aN} - F_T \in \partial S_{-\mu R_{aN}, \mathcal{B}}[-\dot{U}_{aT}], \quad \text{in } [0, T_a[;$
- $U_{aN} \leq 0, \quad R_{aN} \leq 0, \quad U_{aN} R_{aN} \equiv 0.$

Moreover, any other analytic solution of this evolution problem is, either a restriction, or an analytic extension of this solution.

Proof. If we do not have $U_{0N} = V_{0N} = 0$, Theorem 4.1 is obvious, so we concentrate on the case $U_{0N} = V_{0N} = 0$. Denoting by:

$$F(t) = \sum_{i=0}^{\infty} f_i t^i$$

the power series expansion of F at $t = 0$, we shall look for a formal power series solution given by:

$$U_a = \sum_{i=2}^{\infty} u_i t^i, \quad R_{aN} = \sum_{i=0}^{\infty} r_i t^i.$$

The first terms of these two formal series must satisfy:

- $2u_{2N} = f_{0N} + r_0;$
- $u_{2N} \leq 0, \quad r_0 \leq 0, \quad u_{2N} r_0 = 0.$

This system determines uniquely the couple (u_{2N}, r_0) . If this couple does not vanish, we stop. Otherwise, we continue the induction until, perhaps, a couple $(u_{(i+2)N}, r_i)$ becomes distinct from $(0, 0)$. At rank i , the problem to be solved is:

- $i(i+1)u_{(i+1)T} + K_T u_{(i-1)T} + W u_{(i-1)N} = f_{(i-1)T};$
- $(i+1)(i+2)u_{(i+2)N} + k_N u_{iN} + W \cdot u_{iT} = f_i + r_i;$
- $u_{(i+2)N} \leq 0, \quad r_i \leq 0, \quad u_{(i+2)N} r_i = 0.$

The two following cases have to be considered.

Case 1. The induction does not stop because all the couples $(u_{(i+2)N}, r_i)$ vanish.

Then, Theorem 1, p. 214 of [3] provides an analytic solution $u_a : [0, T_a[\rightarrow \mathbb{R}^n$ of the problem:

- $U_a(0) = U_0; \quad \dot{U}_a(0) = V_0;$
- $\ddot{U}_a + K \cdot U_a = F, \quad \text{in } [0, T_a[.$

This solution, associated with the choice $R_{aN} \equiv 0$ provides the sought analytic solution of the evolution problem under consideration.

Case 2. The induction stops at rank n_0 because $u_{(n_0+2)N} < 0$.

Then, Theorem 1, p. 214 of [3] provides an analytic solution $U_a : [0, T_a[\rightarrow \mathbb{R}^n$ of the problem:

- $U_a(0) = U_0; \quad \dot{U}_a(0) = V_0;$
- $\ddot{U}_a + K \cdot U_a = F, \quad \text{in } [0, T_a[.$

Restricting, if necessary, the time interval on which U_a is defined, we have:

$$\forall t \in]0, T_a[, \quad U_{aN}(t) < 0,$$

and this solution, associated with the choice $R_{aN} \equiv 0$ provides the sought analytic solution of the evolution problem under consideration.

Case 3. The induction stops at rank n_0 because $r_{n_0} < 0$.

Propositions 3.3 and 3.5 provide an analytic solution $U_{aT} :]0, T_a[\rightarrow \mathbb{R}^{n-1}$ of the problem:

- $U_{aT}(0) = 0; \quad \dot{U}_{aT}(0) = 0;$
- $\ddot{U}_{aT}(t) + K_T \cdot U_{aT}(t) - F_T(t) \in \partial S_{\mu|F_N(t) - W \cdot U_{aT}(t)|.B}[-\dot{U}_{aT}(t)]; \quad \forall t \in]0, T_a[.$

Restricting, if necessary, the time interval on which U_{aT} is defined, we have:

$$\forall t \in]0, T_a[, \quad W \cdot U_{aT}(t) - F_N(t) < 0,$$

and this function, associated with the choices:

$$U_{aN} \equiv 0, \quad R_{aN} \equiv W \cdot U_{aT} - F_N,$$

provides the sought analytic solution of the evolution problem under consideration.

The uniqueness part of the theorem comes from the fact that the induction (finite or infinite) determines the status (active contact or not) of the system on a right-neighbourhood of $t = 0$, and uniqueness at fixed status holds either by virtue of Theorem 1, p. 214 of [3], or by virtue of Propositions 3.3 and 3.5. \square

4.2. Local uniqueness for the unilateral problem with analytic force

The result announced in the title of this section is the following.

Theorem 4.2. *Let $F :]0, T[\rightarrow \mathbb{R}^n$ be an analytic function, $U_a :]0, T_a[\rightarrow \mathbb{R}^n$, the local analytic solution of problem \mathcal{P}_u provided by Theorem 4.1 and $U \in MMA(]0, T[; \mathbb{R}^n)$, an arbitrary solution of problem \mathcal{P}_u . Then, U_a and U are identically equal on some right-neighbourhood of $t = 0$:*

$$\exists T' \leq T_a, \quad \forall t \in]0, T'[, \quad U_a(t) = U(t).$$

Proof.

Step 1. For all $t \in]0, T_a[$, the following estimate holds:

$$|\dot{U}_T^+ - \dot{U}_{aT}|(t) + |U_T - U_{aT}|(t) \leq C_1 \int_{]0, t[} |R_N - R_{aN}| + C_2 \int_0^t |U_N - U_{aN}|,$$

for some real constants C_1 and C_2 depending only on K and μ .

We start with:

$$\ddot{U}_T - \ddot{U}_{aT} + K_T \cdot (U_T - U_{aT}) + (U_N - U_{aN})W = R_T - R_{aT}.$$

We multiply by $\dot{U}_T^+ - \dot{U}_{aT}$ and integrate over $[0, t]$. The Coulomb friction law gives:

$$\begin{aligned} \int_{]0, t[} (R_T - R_{aT}) \cdot (\dot{U}_T^+ - \dot{U}_{aT}) &\leq \mu \int_{]0, t[} (R_N - R_{aN}) (|\dot{U}_T^+| - |\dot{U}_{aT}|), \\ &\leq \mu \int_{]0, t[} |R_N - R_{aN}| |\dot{U}_T^+ - \dot{U}_{aT}|. \end{aligned}$$

Moreover:

$$\int_{[0,t]} \ddot{U}_T \cdot \dot{U}_T^+ \geq \frac{1}{2} |\dot{U}_T^+|^2(t) - \frac{1}{2} |V_{0T}|^2,$$

(by use of [9], p. 44), which leads to:

$$\int_{[0,t]} (\ddot{U}_T - \ddot{U}_{aT}) \cdot (\dot{U}_T^+ - \dot{U}_{aT}) \geq \frac{1}{2} |\dot{U}_T^+ - \dot{U}_{aT}|^2(t).$$

Putting everything together, we get, for all $t \in [0, T_a[$:

$$\frac{1}{2} |\dot{U}_T^+ - \dot{U}_{aT}|^2(t) + \frac{1}{2} |U_T - U_{aT}|_{K_T}^2(t) \leq \mu \int_{[0,t]} |R_N - R_{aN}| |\dot{U}_T^+ - \dot{U}_{aT}| + |W| \int_0^t |U_N - U_{aN}| |\dot{U}_T^+ - \dot{U}_{aT}|.$$

Then, Lemma A.5, p. 157 of [2] gives the estimate we looked for:

$$|\dot{U}_T^+ - \dot{U}_{aT}|(t) + |U_T - U_{aT}|_{K_T}(t) \leq \mu\sqrt{2} \int_{[0,t]} |R_N - R_{aN}| + |W|\sqrt{2} \int_0^t |U_N - U_{aN}|.$$

Step 2. For all $t \in [0, T_a[$, the following estimate holds:

$$|\dot{U}_N^+ - \dot{U}_{aN}|(t) + |U_N - U_{aN}|(t) \leq C_3 \int_0^t |U_T - U_{aT}| + C_4 \int_0^t |R_{aN}|.$$

for some real constants C_3 et C_4 depending only on K .

We start with:

$$\ddot{U}_N - \ddot{U}_{aN} + k_N(U_N - U_{aN}) + W \cdot (U_T - U_{aT}) = R_N - R_{aN}.$$

We multiply by $(\dot{U}_N^+ + \dot{U}_N^-)/2 - \dot{U}_{aN}$ and integrate over $[0, t]$. We get:

$$\frac{1}{2} |\dot{U}_N^+ - \dot{U}_{aN}|^2(t) + \frac{k_N}{2} |U_N - U_{aN}|^2(t) = \int_{[0,t]} (R_N - R_{aN}) ((\dot{U}_N^+ + \dot{U}_N^-)/2 - \dot{U}_{aN}) - \int_0^t (\dot{U}_N^+ - \dot{U}_{aN}) W \cdot (U_T - U_{aT}). \quad (9)$$

But, note the two following remarks.

- (1) Restricting, if necessary, the time interval we work on:

$$R_N \dot{U}_{aN} \geq 0,$$

because, if $U_{0N} < 0$, then R_N must vanish on a right neighbourhood of $t = 0$, and, if $U_{0N} = 0$, then the nonpositive analytic function U_{aN} must be nonincreasing on a right neighbourhood of $t = 0$.

- (2) The measure defined by:

$$R_N(\dot{U}_N^+ + \dot{U}_N^-) \leq 0,$$

is nonpositive. Indeed, let D be the countable subset of $[0, T]$ of those instants t at which the normal velocity is discontinuous: $\dot{U}_N^+(t) \neq \dot{U}_N^-(t)$. On $[0, T] \setminus D$, the measure $R_N(\dot{U}_N^+ + \dot{U}_N^-)$ equals $R_N \dot{U}_N^-$ which is nonpositive, thanks to the unilateral contact condition (actually, the measure $R_N \dot{U}_N^-$ vanishes identically on $[0, T] \setminus D$). Moreover, at each instant $t \in D$, the measure $R_N(\dot{U}_N^+ + \dot{U}_N^-)$ has an atom given by:

$$|\dot{U}_N^+|^2 - |\dot{U}_N^-|^2 = (e^2 - 1) |\dot{U}_N^-|^2 \leq 0,$$

thanks to the equation of motion and the impact law.

Taking these two remarks into account in (9), we obtain:

$$\int_{[0,t]} (R_N - R_{aN}) ((\dot{U}_N^+ + \dot{U}_N^-)/2 - \dot{U}_{aN}) \leq - \int_0^t R_{aN} (\dot{U}_N^+ - \dot{U}_{aN}),$$

and then:

$$\frac{1}{2} |\dot{U}_N^+ - \dot{U}_{aN}|^2(t) + \frac{k_N}{2} |U_N - U_{aN}|^2(t) \leq |W| \int_0^t |U_T - U_{aT}| |\dot{U}_N^+ - \dot{U}_{aN}| + \int_0^t |R_{aN}| |\dot{U}_N^+ - \dot{U}_{aN}|.$$

Lemma A.5, p. 157 of [2] allows us to obtain the desired estimate:

$$|\dot{U}_N^+ - \dot{U}_{aN}|(t) + |U_N - U_{aN}|(t) \leq \frac{k_N + 1}{k_N} |W| \sqrt{2} \int_0^t |U_T - U_{aT}| + \frac{k_N + 1}{k_N} \sqrt{2} \int_0^t |R_{aN}|.$$

Step 3. For all $t \in [0, T_a]$, the following estimate holds:

$$\int_{[0,t]} |R_N - R_{aN}| \leq |\dot{U}_N^+ - \dot{U}_{aN}|(t) + C_5 \int_0^t |U_N - U_{aN}| + C_6 \int_0^t |U_T - U_{aT}| + 2 \int_0^t |R_{aN}|,$$

for some real constants C_5 and C_6 depending only on K .

Since R_N is a nonpositive measure:

$$\int_{[0,t]} |R_N - R_{aN}| \leq - \int_{[0,t]} R_N + \int_0^t |R_{aN}|.$$

Also, we have:

$$\begin{aligned} - \int_{[0,t]} R_N &= - \int_{[0,t]} (\ddot{U}_N - \ddot{U}_{aN}) - \int_0^t k_N (U_N - U_{aN}) + W \cdot (U_T - U_{aT}) + R_{aN}, \\ &\leq |\dot{U}_N^+ - \dot{U}_{aN}|(t) + k_N \int_0^t |U_N - U_{aN}| + |W| \int_0^t |U_T - U_{aT}| + \int_0^t |R_{aN}|. \end{aligned}$$

Putting everything together, we get the estimate that we looked for, with $C_5 = k_N$ and $C_6 = |W|$.

Step 4. For all $t \in [0, T_a]$, the following estimate holds:

$$|\dot{U}_T^+ - \dot{U}_{aT}|(t) + |U_T - U_{aT}|(t) \leq C \int_0^t |R_{aN}|,$$

for some real constant C depending only on K , μ and T_a .

Putting together steps 1, 2 and 3, the function:

$$\phi(t) \stackrel{\text{def}}{=} |\dot{U}_T^+ - \dot{U}_{aT}|(t) + |U_T - U_{aT}|(t)$$

satisfies the estimate:

$$\phi(t) \leq C_7 \int_0^t \phi + C_8 \int_0^t |R_{aN}|,$$

for some real constants C_7 et C_8 depending only on K , μ and T_a . By Gronwall's lemma, we get:

$$\begin{aligned}\phi(t) &\leq C_8 \int_0^t |R_{aN}| + C_7 C_8 \int_0^t e^{C_7(t-s)} \int_0^s |R_{aN}|, \\ &\leq C_8 (1 + C_7 T_a e^{C_7 T_a}) \int_0^t |R_{aN}|\end{aligned}$$

which is the estimate that we sought.

Step 5. Conclusion.

The function R_{aN} being analytic, only the two following cases are possible.

- (1) $R_{aN} \equiv 0$. In such a case, step 4 gives $U_T \equiv U_{aT}$ and step 2, $U_N \equiv U_{aN}$. The sought conclusion holds true.
- (2) $\forall t \in]0, T_a]$, $R_{aN}(t) < 0$. Then, the function U_{aN} vanishes identically. Since the uniqueness of solution has already been proved for the bilateral problem, it is enough to prove $U_N \equiv 0$ to reach the desired conclusion. So, let us concentrate on this goal. Taking T_a smaller, if necessary, we have:

$$\forall t \in]0, T_a], \quad -R_{aN}(t) - C|W| \int_0^t |R_{aN}| > 0.$$

Multiplying the equation:

$$\ddot{U}_N + k_N U_N = R_N - R_{aN} - W \cdot (U_T - U_{aT}),$$

by $(\dot{U}_N^+ + \dot{U}_N^-)/2$ and integrating over $[0, t]$, we obtain:

$$\frac{1}{2} |\dot{U}_N^+|^2(t) + \frac{k_N}{2} |U_N|^2(t) = \int_{[0,t]} R_N \frac{\dot{U}_N^+ + \dot{U}_N^-}{2} - \int_0^t (R_{aN} + W \cdot (U_T - U_{aT})) \dot{U}_N^+.$$

Since $R_N(\dot{U}_N^+ + \dot{U}_N^-)$ is a nonpositive measure, we have:

$$\int_0^t (R_{aN} + W \cdot (U_T - U_{aT})) \dot{U}_N^+ \leq 0.$$

Applying an integration by parts, we get:

$$(R_{aN} + W \cdot (U_T - U_{aT})) U_N \leq \int_0^t (\dot{R}_{aN} + W \cdot (\dot{U}_T^+ - \dot{U}_{aT})) U_N,$$

and, therefore, by step 4:

$$0 \leq \left\{ |R_{aN}|(t) - C|W| \int_0^t |R_{aN}| \right\} |U_N|(t) \leq \int_0^t \left\{ |\dot{R}_{aN}|(s) + C|W| \int_0^s |R_{aN}| \right\} |U_N|(s).$$

Denoting by $m \in \mathbb{N}$ the order of the first nonzero term in the power series expansion at 0 of the analytic function R_{aN} , we get the estimate:

$$\forall t \in]0, T_a[, \quad |\dot{R}_{aN}|(t) \leq \frac{m + \tilde{D}t}{t} |R_{aN}|(t),$$

for some nonnegative real constant \tilde{D} . We deduce that the following estimate holds:

$$\forall t \in]0, T_a[, \quad \left| \dot{R}_{aN}(t) + C|W| \int_0^t |R_{aN}| \right| \leq \frac{m + Dt}{t} \left| |R_{aN}|(t) - C|W| \int_0^t |R_{aN}| \right|,$$

for some nonnegative real constant D . Substituting this estimate into the previous inequality, we get:

$$t\psi(t) \leq (m + Dt) \int_0^t \psi.$$

where we have set:

$$\psi(t) \stackrel{\text{def}}{=} \left\{ |R_{aN}|(t) - C|W| \int_0^t |R_{aN}| \right\} \frac{|U_N|(t)}{t},$$

which is a continuous function, even at $t = 0$ (more precisely $\psi(t) = o(t^m)$ when $t \rightarrow 0$). Then, we see that:

$$\forall t \in]0, T_a[, \quad \frac{d}{dt} \left\{ \frac{e^{-Dt}}{t^m} \int_0^t \psi \right\} \leq 0,$$

which implies that this nonnegative function which vanishes at $t = 0$ is nonincreasing. Therefore:

$$\psi \equiv 0,$$

and, then:

$$U_N \equiv 0,$$

which is nothing but the desired conclusion. \square

4.3. Well-posedness of the unilateral problem with analytic force

Corollary 4.3. *If $F : [0, T] \rightarrow \mathbb{R}^n$ is analytic (or piecewise analytic), then, problem \mathcal{P}_u admits a unique solution in $MMA([0, T]; \mathbb{R}^n)$.*

Proof. Using the local existence of solution for problem \mathcal{P}_u provided by Theorem 4.1, and the local uniqueness in MMA , provided by Theorem 4.2, we get a maximal solution U which is defined either on a subinterval $[0, \eta[$, for some $\eta \in]0, T]$, or on $[0, T]$. We have to prove that it is defined on $[0, T]$. To reach this conclusion, it is enough to prove that, if the maximal solution were defined only on a subinterval $[0, \eta[$, then, the total variation of the right-velocity \dot{U}^+ over $[0, \eta]$ is finite, for, in such a case, it would be possible to extend U beyond $[0, \eta[$ and obtain a contradiction. So, suppose that the maximal solution is only defined on $[0, \eta[$.

First, we have already noticed that $R_N(\dot{U}_N^+ + \dot{U}_N^-)$ is a nonpositive measure, thanks to the contact condition, the equation of motion and the impact law. Also, by the Coulomb friction law, $R_T \cdot \dot{U}_T^+$ is a nonpositive measure. Let D be the countable subset of those instants $t \in [0, \eta[$ at which the tangential velocity is discontinuous: $\dot{U}_T^+(t) \neq \dot{U}_T^-(t)$. On $[0, \eta[\setminus D$, the measure $R_T \cdot (\dot{U}_T^+ + \dot{U}_T^-)$ equals $R_T \cdot \dot{U}_T^+$ which is nonpositive. At each instant $t \in D$, making use of the equation of motion together with the Coulomb friction law, it is readily checked that the measure $R_T \cdot (\dot{U}_T^+ + \dot{U}_T^-)$ has a negative atom. Finally, $R \cdot (\dot{U}^+ + \dot{U}^-)$ is a nonnegative measure. So, multiplying the equation of motion:

$$\ddot{U} + K \cdot U = F + R,$$

by $(\dot{U}^+ + \dot{U}^-)/2$, and integrating over $]0, t]$ ($t \in]0, \eta[$), we get the energy inequality:

$$\frac{1}{2} |\dot{U}^+|^2(t) + \frac{1}{2} |U|_K^2(t) \leq \frac{1}{2} |V_0|^2 + \frac{1}{2} |U_0|_K^2 + \int_0^t F \cdot \dot{U}^+.$$

Applying Lemma A.5, p. 157 of [2]:

$$|\dot{U}^+|(t) \leq |U_0|_K + |V_0| + \int_0^T |F|,$$

we find that the right-velocity \dot{U}^+ is bounded over the interval $[0, \eta]$. Next, integrating the first component of the equation of motion over $[0, t]$ ($t \in]0, \eta[$), we get:

$$\int_{[0,t]} R_N = \dot{U}_N^+(t) - V_{0N} + \int_0^t (k_N U_N + W \cdot U_T) - \int_0^t F_N,$$

which, since the right-velocity \dot{U}^+ is bounded over $[0, \eta]$ and since R_N is a nonpositive measure, shows:

$$\int_{[0,\eta]} |R_N| < \infty.$$

But, Coulomb friction law implies:

$$|R_T| \leq \mu |R_N|,$$

and therefore:

$$\int_{[0,\eta]} |R| < \infty.$$

Coming back to the equation of motion, we obtain:

$$\int_{[0,\eta]} |\ddot{U}| < \infty,$$

which is the desired conclusion. □

Acknowledgements. We are thankful to Alain Léger for valuable discussions and constant support during this work.

REFERENCES

- [1] P. Ballard, The dynamics of discrete mechanical systems with perfect unilateral constraints. *Arch. Rational Mech. Anal.* **154** (2000) 199–274.
- [2] H. Brezis, *Opérateurs Maximaux Monotones et Semi-groupes de Contractions dans les Espaces de Hilbert*. North-Holland Publishing Company (1973).
- [3] H. Cartan, *Théorie Élémentaire des Fonctions Analytiques d'une ou plusieurs Variables Complexes*. Hermann, Paris (1961).
- [4] A. Klarbring, *Ingenieur-Archiv* **60** (1990) 529–541.
- [5] M.D.P. Monteiro Marques, *Differential Inclusions in Nonsmooth Mechanical Problems*. Birkhäuser, Basel-Boston-Berlin (1993).
- [6] J.J. Moreau, Standard inelastic shocks and the dynamics of unilateral constraints, in *Unilateral problems in structural analysis*. G. Del Piero and F. Maceri Eds., Springer-Verlag, Wien-New-York (1983) 173–221.
- [7] J.J. Moreau, Dynamique de systèmes liaisons unilatérales avec frottement sec éventuel : essais numériques. *Note Technique* No 85-1 (1985), LMGMCM, Montpellier.
- [8] J.J. Moreau, Unilateral contact and dry friction in finite freedom dynamics, in *Nonsmooth Mechanics and Applications*, CISM Courses and Lectures No 302, J.J. Moreau and P.D. Panagiotopoulos Eds., Springer-Verlag, Wien-New-York (1988) 1–82.
- [9] J.J. Moreau, Bounded variation in time, in *Topics in Non-smooth Mechanics*, J.J. Moreau, P.D. Panagiotopoulos, G. Strang, Eds., Birkhäuser Verlag, Basel-Boston-Berlin (1988) 1–74.
- [10] D. Percivale, Uniqueness in the elastic bounce problem, I. *J. Differ. Equations* **56** (1985) 206–215.
- [11] M. Schatzman, A class of nonlinear differential equations of second order in time. *Nonlinear Anal. Theory, Methods Appl.* **2** (1978) 355–373.
- [12] M. Schatzman, Uniqueness and continuous dependence on data for one dimensional impact problems. *Math. Comput. Modelling* **28** (1998) 1–18.

*Frictional contact problems for
thin elastic structures and
weak solutions of sweeping process*

PATRICK BALLARD

Abstract

The linearized equilibrium equations for straight elastic strings, beams, membranes or plates do not couple tangential and normal components. In the quasi-static evolution occurring above a fixed rigid obstacle with Coulomb dry friction, the normal displacement is governed by a variational inequality whereas the tangential displacement is seen to obey a sweeping process, the theory of which was extensively developed by Moreau in the 70s. In some cases, the underlying moving convex set has bounded retraction and, in these cases, the sweeping process can be solved by directly applying Moreau's results. However, in many other cases, the bounded retraction condition is not fulfilled and this is seen to be connected to the possible event of moving velocity discontinuities. In such a case, there are no strong solutions and we have to cope with weak solutions of the underlying sweeping process.

1. Motivation and outline

1.1. Background

The frictionless equilibrium of linearly elastic strings and beams (or membranes and plates) above a fixed rigid obstacle provides an archetypical example of variational inequality, the theory of which was extensively developed in the seventies. This paper deals with the situation where Coulomb dry friction between the elastic structure and the obstacle should be assumed to occur in addition. More specifically, it is proposed to focus here on cases where the linearized equilibrium equation can be used and consider the quasi-static evolution problem given by the usual Coulomb friction law. Surprisingly, this seems to be the first time this class of problems has been

investigated. One specific (and comfortable) feature of these problems is the fact that the linearized equilibrium equations do not couple the normal and tangential components of the displacement. The problem that governs the normal displacement is therefore the same as that arising in the frictionless situation, that is a variational inequality at every instant. Solving this variational inequality at every instant gives the normal component of the reaction force exerted by the obstacle and therefore gives the threshold for the friction law, which generally depends on the time and the position. The evolution problem that governs the tangential displacement is shown to provide an archetypical example of sweeping process in a Hilbert space, the theory of which was developed in the seventies by Moreau [10] with a view to applying it to elastoplastic systems.

The fact that the linearized equilibrium equations do not couple the normal and tangential components of the displacement give to the situation under consideration some similarity with perfect plasticity. And, the moving tangential velocity discontinuities that will be exhibited in this paper should certainly be brought aside the velocity discontinuities that are well known to spontaneously occur in perfect plasticity [11].

This uncoupling is a specific feature of the straight thin elastic structures that are the only ones considered in this paper. The situation is rather different in the more usual situation where a *massive* elastic body is considered. Indeed, in that case, the linearized equilibrium equations couple normal and tangential components so that monotonicity is lost. This raises important mathematical difficulties in the analysis. An existence result for the corresponding evolution problem (quasi-static contact problem in linear elasticity with Coulomb friction) was obtained only in 2000 by Andersson [2] using the approach developed in the pioneering work of Jarušek [7]. Very few is known about uniqueness, but the lack of monotony makes the situation tricky [3]. For a recent survey on the analysis of frictional contact problems for massive bodies, the reader is referred to [6].

1.2. The basic evolution problem

Let us consider a straight elastic string which is uniformly tensed in its reference configuration, and an orthonormal basis $(\mathbf{e}_x, \mathbf{e}_y)$ with \mathbf{e}_x chosen along the direction of the string. A fixed rigid obstacle is described by the function $y = \psi(x)$. The string is loaded with a given body force $f \mathbf{e}_x + g \mathbf{e}_y$ and displacements $u_0^p \mathbf{e}_x + v_0^p \mathbf{e}_y$, $u_1^p \mathbf{e}_x + v_1^p \mathbf{e}_y$ are prescribed at extremities $x = 0, 1$. Let $u \mathbf{e}_x + v \mathbf{e}_y$ denote the displacement field in the string and $r \mathbf{e}_x + s \mathbf{e}_y$ denote the reaction force exerted by the obstacle on the string. Assuming that the linearized equilibrium equations can be used, the quasi-static evolution of that string above the obstacle with unilateral contact condition and Coulomb dry friction during the time interval $[t_0, T]$

is governed by:

$$\left\{ \begin{array}{ll} u'' + f + r = 0, & \text{in }]0, 1[\times [t_0, T], \\ r(\hat{u} - \dot{u}) + \mu s(|\hat{u}| - |\dot{u}|) \geq 0, \quad \forall \hat{u} \in \mathbb{R}, & \text{in }]0, 1[\times [t_0, T], \\ u(0) = u_0^P, \quad u(1) = u_1^P, & \text{on } [t_0, T], \\ v'' + g + s = 0, & \text{in }]0, 1[, \\ v - \psi \geq 0, \quad s \geq 0, \quad s(v - \psi) \equiv 0, & \text{in }]0, 1[\times [t_0, T], \\ v(0) = v_0^P, \quad v(1) = v_1^P, & \text{on } [t_0, T]. \end{array} \right. \quad (1)$$

where μ is the friction coefficient, which is assumed to be given.

The last three lines of system (1) govern the normal component v of the displacement, and are not coupled with the other equations of system (1). Therefore, at every instant, v obeys the same variational inequality as that governing the more usual frictionless situation. Assuming that this problem has been solved, the normal component s of the reaction is now supposed to be given in the study of the tangential problem, that is, the first three lines of system (1). It is necessary of course to know what regularity s can be expected to show, and this question requires detailed analysis of the normal problem governed by the variational inequality. As we will see, the regularity of s is crucial to the analysis of the tangential problem.

Introducing for every $t \in [t_0, T]$ the closed convex subset of $H^1(0, 1; \mathbb{R})$ defined by:

$$\mathcal{C}(t) = \left\{ u \in H^1 \mid u(x=0) = u_0^P, \quad u(x=1) = u_1^P, \right. \\ \left. \text{and } \forall \varphi \in H_0^1, \quad \langle u'' + f, \varphi \rangle_{H^{-1}, H_0^1} \leq \langle \mu s, |\varphi| \rangle_{H^{-1}, H_0^1} \right\}, \quad (2)$$

and equipping H^1 with the scalar product:

$$(\varphi \mid \psi)_{H^1} = \int_0^1 \overline{\varphi}'(x) \overline{\psi}'(x) \, dx + \varphi(0) \psi(0) + \varphi(1) \psi(1),$$

taking:

$$\overline{\varphi}(x) = \varphi(x) - \varphi(0) - x(\varphi(1) - \varphi(0)) \in H_0^1,$$

the evolution problem that governs the tangential displacement u can be written in the following concise form:

$$-\dot{u}(t) \in \partial I_{\mathcal{C}(t)}[u(t)]$$

after eliminating the unknown reaction force r (see section 4 for details). In this differential inclusion, $I_{\mathcal{C}(t)}[\cdot]$ denotes the indicatrix function of $\mathcal{C}(t)$ (which equals 0 at any point of $\mathcal{C}(t)$ and $+\infty$ elsewhere), and $\partial I_{\mathcal{C}(t)}[\cdot]$ its subdifferential in the sense of the above scalar product in H^1 , that is, the cone of all the outward normal to $\mathcal{C}(t)$ (which is empty at any point not belonging to $\mathcal{C}(t)$, and reduces to $\{0\}$ at an interior point, if any).

1.3. Weak solutions of sweeping process

Let H be a Hilbert space and $\mathcal{C}(t)$ a set-valued mapping defined on a time interval $[t_0, T]$ and whose values are closed convex and nonempty. A sweeping process is the evolution problem defined by:

$$\begin{cases} -\dot{u}(t) \in \partial I_{\mathcal{C}(t)}[u(t)], & \text{in } [t_0, T], \\ u(t_0) = u_0, \end{cases}$$

with the given initial condition $u_0 \in \mathcal{C}(t_0)$. This abstract evolution problem was introduced and studied by Jean Jacques Moreau [10] with a view to using it in the analysis of elastoplastic systems. In kinematic terms, $\mathcal{C}(t)$ is a moving convex set and $u(t)$ a point in that set ($u(t) \in \mathcal{C}(t)$ since $\partial I_{\mathcal{C}(t)}[\cdot]$ is empty at any point which does not belong to $\mathcal{C}(t)$). The evolution problem under consideration therefore has a geometrical interpretation which is especially clear if $\mathcal{C}(t)$ has a non-empty interior. Indeed, whenever $u(t)$ is an interior point, $\partial I_{\mathcal{C}(t)}[u(t)]$ reduces to $\{0\}$ and the point $u(t)$ must remain at rest until meeting the boundary of $\mathcal{C}(t)$. It, then, proceeds in an inward normal direction, as if it were pushed by the boundary so as to go on belonging to $\mathcal{C}(t)$. The name of ‘‘sweeping process’’, which was coined by Jean Jacques Moreau, refers to this vivid mechanical interpretation.

To discuss the existence of solutions to the sweeping process, some regularity assumptions about the set-valued mapping $\mathcal{C}(t)$ must be made. Actually, regularity is needed only when the set retracts, thus effectively sweeping the point $u(t)$. Jean Jacques Moreau defined and extensively studied the class of set-valued mappings $\mathcal{C}(t)$ *with bounded retraction* (see [9] or appendix A). In particular, set-valued mappings $\mathcal{C}(t)$ with bounded retraction admit a left limit $\mathcal{C}(t-)$, in the sense of Kuratowski (see appendix A), at any $t \in]t_0, T]$ and a right limit $\mathcal{C}(t+)$ at any $t \in [t_0, T[$.

Taking an arbitrary subdivision P (finite partition into intervals of any sort) of $[t_0, T]$ and denoting by I_i the corresponding intervals (which are indexed according to their successive order) with origin t_i (left extremity, which does not necessarily belong to I_i), one can build the piecewise constant set-valued mapping \mathcal{C}_P with closed convex values by using the definition:

$$\mathcal{C}_P(I_i) = \mathcal{C}_i = \begin{cases} \mathcal{C}(t_i) & \text{if } t_i \in I_i, \\ \mathcal{C}(t_{i+}) & \text{if } t_i \notin I_i. \end{cases}$$

Given the initial condition $u_0 \in \mathcal{C}(t_0)$, the ‘‘catching-up algorithm’’ is based on the inductive projections:

$$u_{i+1} = \text{proj}(u_i, \mathcal{C}_{i+1}),$$

to build a step function $u_P : [t_0, T] \rightarrow H$, defined by:

$$u_P(I_i) = u_i.$$

This is simply a version of the implicit Euler algorithm for ordinary differential equations adapted to the differential inclusion involved. Assuming

that $\mathcal{C}(t)$ has bounded retraction, Moreau [10] proved that the net u_P (P covering all the subdivisions of $[t_0, T]$) converges *strongly in H* , uniformly on $t \in [t_0, T]$, towards a function $u : [t_0, T] \rightarrow H$ which Moreau calls a *weak solution* of the sweeping process. He then proved that this weak solution $u : [t_0, T] \rightarrow H$ has bounded variation and solves the sweeping process in the sense of “differential measures” (see [10] or appendix B). If $\mathcal{C}(t)$ has not only bounded retraction, but absolutely continuous retraction, it turns out that the weak solution $u : [t_0, T] \rightarrow H$ is absolutely continuous and is a strong solution of the sweeping process, that is:

$$-\dot{u}(t) \in \partial I_{\mathcal{C}(t)}[u(t)], \quad \text{for a. a. } t \in [t_0, T].$$

The quasi-static evolution of the elastic string above the rigid obstacle when Coulomb friction is taken into account provides some natural examples of sweeping processes in the Hilbert space $H = H^1$. Some of these examples will be given in this paper, in cases where the underlying sweeping process has bounded retraction and Moreau’s theory provides a unique weak solution which is also a solution in the sense of differential measures. In some of these examples, this solution turns out to be also a strong solution but this is not always the case. More interestingly, it is easy to design an evolution problem for the elastic string where the underlying sweeping process turns out *not* to have bounded retraction. Sticking to the standpoint of the numerical computations, such examples require an extension of the definition of weak solutions for sweeping processes to a more general class of set-valued mappings $\mathcal{C}(t)$ than that of bounded retraction. Since the catching-up algorithm requires the existence of a right limit $\mathcal{C}(t+)$ in the sense of Kuratowski, it turns out that the class of $\mathcal{C}(t)$ which is suitable for defining weak solutions of sweeping processes in general, seems to be the class of so-called *Wijsman-regulated* set-valued mappings which is exactly the class of those $\mathcal{C}(t)$ with closed convex values that admit a left limit $\mathcal{C}(t-)$, in the sense of Kuratowski, at any $t \in]t_0, T]$ and a right limit $\mathcal{C}(t+)$ at any $t \in [t_0, T[$. Wijsman-regulated $\mathcal{C}(t)$ are also characterized by the condition that for every $x \in H$, the function:

$$t \mapsto \text{proj}[x; \mathcal{C}(t)]$$

is regulated (that is, is the uniform limit of a sequence of step functions, or, equivalently, admits a left and a right limit at every t). The name given to this class of set-valued mappings originates from the fact that the class of all closed non-empty subsets of H can be equipped with a complete metrizable topology called the Wijsman topology. This is the weakest topology generated by the set functions $C \rightarrow d(x, C)$ when x covers H (here $d(x, C)$ denotes the distance of the point x to the set C). Wijsman-regulated $\mathcal{C}(t)$ are exactly those set-valued mappings that are regulated in the sense defined by the Wijsman topology on the class of all closed non-empty subsets in H .

Weak solutions of sweeping processes associated with Wijsman-regulated $\mathcal{C}(t)$, when they exist, are proved to enjoy the same general properties as

those established by Moreau in the case of weak solutions of sweeping processes based on $\mathcal{C}(t)$ with bounded retraction. Some examples of weak solutions of sweeping processes based on Wijsman-regulated $\mathcal{C}(t)$ that do not have bounded retraction are displayed in this paper. As we will see, these weak solutions do not necessarily have bounded variation. Examples will also be given of sweeping processes based on Wijsman-regulated $\mathcal{C}(t)$ that do not have any weak solution at all.

1.4. Frictional contact problems for the elastic string

Recalling that the tangential displacement of elastic strings obeys a sweeping process based on the set-valued mapping (2), a sufficient condition for $\mathcal{C}(t)$ to have bounded retraction is proved to be:

$$\begin{aligned} u_0^p, u_1^p &\in BV([t_0, T]; \mathbb{R}), \\ f &\in BV([t_0, T]; H^{-1}), \\ s &\in BV([t_0, T]; \mathcal{M}). \end{aligned} \tag{3}$$

Here, BV stands for ‘‘Bounded Variation’’ and \mathcal{M} denotes the Banach space of the Radon measures on $[0, 1]$, that is, the topological dual of $C^0([0, 1]; \mathbb{R})$. The first two lines in (3) give regularity assumptions about the data involved in the evolution problem, but the last line refers to the regularity of the solution of the normal problem governed by the variational inequality and therefore can not be controlled directly. It may occur that these regularity conditions are met and a detailed example is discussed in section 4.3. In such a case, Moreau’s results provide a unique solution:

$$u \in BV([t_0, T]; H^1),$$

and if the regularity that is met with the data is not only that of functions with ‘‘bounded variation’’ in time, but that of ‘‘absolutely continuous’’ functions, then the same will be true of u which is a strong solution of the sweeping process. In such a circumstance, the tangential velocity \dot{u} will belong to $H^1(0, 1; \mathbb{R})$, at almost all value of $t \in [t_0, T]$, and will therefore be spatially continuous.

However, it may occur that the condition $s \in BV([t_0, T]; \mathcal{M})$ is not fulfilled. A simple example of this occurrence is that of a string with a reference configuration lying on a rectilinear rigid obstacle (see figure 2). The data of the evolution problem are defined by $u_0^p = v_0^p = v_1^p \equiv 0$, u_1^p is the function which takes the value 0 at $t = 0$ and 1 at every $t > 0$, and $f = \delta_{x=1/2-t}$, $g \equiv 0$ (the body force is a ‘‘moving transverse punctual force’’). The unique solution of the normal problem is given by $v \equiv 0$, which entails $s \equiv -f$. Since for all $t_1 < t_2 \in]0, 1[$:

$$\|\delta_{t_2} - \delta_{t_1}\|_{\mathcal{M}} = 2,$$

the normal reaction $s : [t_0, T] \rightarrow \mathcal{M}$ is neither a function with bounded variation nor a continuous function. Assuming for the sake of conveniency

that $\mu > 2$, it will still be possible to arbitrarily subdivide the time interval $[0, 1/3]$ and to perform the successive projections of Moreau's catching-up algorithm. It then can be seen that the corresponding approximating step functions u_P converge strongly in H^1 , uniformly with respect to $t \in [0, 1/3]$, towards the function:

$$u(x, t) = \begin{cases} 0, & \text{if } 0 \leq x \leq 1/2 - t, \\ \frac{x + t - 1/2}{t + 1/2}, & \text{if } 1/2 - t \leq x \leq 1. \end{cases}$$

The graph of this function together with that of the velocity \dot{u} is plotted in figure 3. The velocity can be seen to show a moving discontinuity, and it therefore does not belong to H^1 at any t . Consequently, the underlying $\mathcal{C}(t)$ does not have bounded retraction. However, it is Wijsman-regulated and the function u is a weak solution of the underlying sweeping process (in the sense of the definition 9 in appendix B). It is worth noting that since the velocity is discontinuous, its value at the point of the string just below the load is not defined. One therefore cannot check if the Coulomb friction law is satisfied by the solution in the strong sense (that is, pointwise). The picture looks like that of perfect plasticity [11] where the spontaneous occurrence of velocity discontinuities imposes to cope with weak solutions only. Extending Moreau's definition of weak solutions for sweeping processes to the case of Wijsman-regulated set-valued mappings leads to the appropriate definition of what should be called a weak solution of the frictional contact problem. This definition sticks to the standpoint of computational approximations. Another approach would consist in using a regularization procedure. A natural regularization method which could be used in the example under consideration would consist in "spreading out" the moving load a little bit by performing a spatial convolution. For example, the Dirac measure at x can be approximated by the function taking the value $1/(2\varepsilon)$ at $]x - \varepsilon, x + \varepsilon[$ and 0 elsewhere. This suffices for the underlying $\mathcal{C}_\varepsilon(t)$ to have bounded retraction. The unique solution u_ε of the corresponding sweeping process is given explicitly in section 4.4. It can therefore be seen that u_ε converges strongly in H^1 uniformly with respect to $t \in [0, 1/3]$, towards the previously calculated weak solution u .

1.5. Replacing the string by a beam

Replacing the string by an elastic beam in the evolution problem (1) requires changing only the last three lines governing the normal displacement v , whereas the tangential problems governed by the first three lines remains unchanged. In particular, the equilibrium equation satisfied by v is now an equation of order 4. The normal component s of the reaction force, which is now obtained after solving a variational inequality associated with the *biharmonic operator*, is therefore seen to be possibly a "moving Dirac measure" even in case where all the data of the normal problem are C^∞ in

space and time. This means that moving tangential velocity discontinuities should be generically be expected to occur in the case of the beam, and the underlying sweeping process should be expected to admit only weak solutions even when arbitrarily smooth data are involved.

In this paper, it is proved that it suffices to require that the data:

$$\begin{aligned} u_0^P, u_1^P, v_0^P, v_1^P &: [t_0, T] \rightarrow \mathbb{R}, \\ f, g &: [t_0, T] \rightarrow H^{-1}, \end{aligned}$$

should be *regulated* functions (that is, are the uniform limit of a sequence of step functions, or, equivalently, admit a left and a right limit at every t) to ensure that the moving set $\mathcal{C}(t)$ associated with the sweeping process governing the tangential problem will be Wijsman-regulated, so as to be able to speak about possible weak solutions. This claim which relies on regularity analysis on the variational inequalities associated with the harmonic and biharmonic operators, holds true for string as well as for beams.

However, these regularity assumptions are too weak to systematically ensure the existence of a weak solution to the underlying sweeping process. An example is provided that shows in particular that sweeping processes based on Wijsman-regulated set-valued mappings need not have weak solutions. The question as to what regularity assumptions about the data should be required to ensure the existence of a weak solution to the frictional contact problem is left open in this paper.

2. Statement of the evolution problem for an elastic string

The orthonormal basis $(\mathbf{e}_x, \mathbf{e}_y)$ will be used here in the affine Euclidean plane. Let us consider a string having the segment $[0, 1] \times \{0\}$ as its reference configuration. This configuration undergoes some homogeneous tension $T_0 > 0$ and is an equilibrium configuration when the string is free of body forces.

Next, let us consider the given external body force:

$$f \mathbf{e}_x + g \mathbf{e}_y.$$

Taking:

$$u \mathbf{e}_x + v \mathbf{e}_y,$$

to denote the displacement field in the string, the *linearized* equations that governs the equilibrium of the string, which is assumed to be elastic with stiffness k , will read as follows:

$$\left\{ \begin{array}{ll} k u'' + f = 0, & \text{in }]0, 1[, \\ u(0) = u_0^P, & u(1) = u_1^P, \\ T_0 v'' + g = 0, & \text{in }]0, 1[, \\ v(0) = v_0^P, & v(1) = v_1^P, \end{array} \right.$$

where $u_0^p \mathbf{e}_x + v_0^p \mathbf{e}_y$ and $u_1^p \mathbf{e}_x + v_1^p \mathbf{e}_y$ are the prescribed displacements at both ends $x = 0$ and $x = 1$.

A fixed rigid obstacle is also considered and described by the function:

$$y = \psi(x).$$

The reaction force possibly exerted by this obstacle on the string will be written:

$$r \mathbf{e}_x + s \mathbf{e}_y.$$

In the above expression, r and s are respectively the tangential and normal components of the reaction force with respect to *reference* configuration. It should be underlined here that, in the *linearized* framework that has been adopted here, r and s cannot be distinguished in this approximation from the tangential and normal components of the reaction force with respect to the *deformed* configuration, since the difference is of higher order.

Assuming that the contact between the string and the obstacle obeys the dry friction Coulomb law with a friction coefficient denoted by μ , the equations that govern the quasi-static evolution of the elastic string above the obstacle read formally as follows:

$$\left\{ \begin{array}{ll} k u'' + f + r = 0, & \text{in }]0, 1[\times [t_0, T], \\ r(\hat{u} - \dot{u}) + \mu s(|\hat{u}| - |\dot{u}|) \geq 0, \quad \forall \hat{u} \in \mathbb{R}, & \text{in }]0, 1[\times [t_0, T], \\ u(0) = u_0^p, \quad u(1) = u_1^p, & \text{on } [t_0, T], \\ T_0 v'' + g + s = 0, & \text{in }]0, 1[, \\ v - \psi \geq 0, \quad s \geq 0, \quad s(v - \psi) \equiv 0, & \text{in }]0, 1[\times [t_0, T], \\ v(0) = v_0^p, \quad v(1) = v_1^p, & \text{on } [t_0, T]. \end{array} \right.$$

It can be easily checked that the pointwise weak formulation of the Coulomb law used here is equivalent to the usual pointwise formulation. It is worth noting that the equations that govern the transverse component v of the displacement are not coupled with the ones that govern the tangential component.

By changing the value μ of the friction coefficient, one can always suppose $T_0 = k = 1$. This choice will be made systematically in what follows.

3. Analysis of the “normal problem” for the string

The problem that governs the transverse component v of the displacement will be solved first. This problem is the same as that arising in the more usual frictionless situation. At every instant, the problem is classically governed by a variational inequality, which is solved using standard tools (see for example [8]). The purpose of the following theorem is to express how the regularity of the dependance of the data on time can be transferred

to the solution, in order to obtain some information on the regularity of the normal component $s(t)$ of the reaction force as it will be used as input data in the analysis of the “tangential problem”.

Theorem 1. *Let us assume that $\psi \in H^1(0, 1; \mathbb{R})$, $g : [t_0, T] \rightarrow H^{-1}$ and that the functions $v_0^P, v_1^P : [t_0, T] \rightarrow \mathbb{R}$ satisfy the strong compatibility condition:*

$$\inf_{t \in [t_0, T]} v_0^P(t) > \psi(0), \quad \inf_{t \in [t_0, T]} v_1^P(t) > \psi(1), \quad (4)$$

Setting:

$$K(t) = \left\{ \varphi \in H^1(0, 1; \mathbb{R}) \mid \varphi(0) = v_0^P(t), \quad \varphi(1) = v_1^P(t), \right. \\ \left. \forall x \in]0, 1[, \quad \varphi(x) \geq \psi(x) \right\},$$

there exists a unique function $v : [t_0, T] \rightarrow H^1(0, 1; \mathbb{R})$ such that:

- $\forall t \in [t_0, T], \quad v(t) \in K(t),$
- $\forall t \in [t_0, T], \quad \forall \varphi \in K(t), \quad \int_0^1 v'(\varphi' - v') \geq \langle g, \varphi - v \rangle_{H^{-1}, H_0^1}.$

Moreover, if $v_0^P, v_1^P : [t_0, T] \rightarrow \mathbb{R}$ and $g : [t_0, T] \rightarrow H^{-1}$ are regulated (with bounded variation, absolutely continuous, and Lipschitz-continuous, respectively), then the same is true of the function $v : [t_0, T] \rightarrow H^1$, and therefore of the function $-v'' - g \stackrel{\text{def}}{=} s : [t_0, T] \rightarrow H^{-1}$.

Also, for every $t \in [t_0, T]$, $s(t)$ is a positive measure with support contained in $[\alpha, \beta] \subset]0, 1[$ (α, β independent of t), and its total mass is a bounded function of t .

Proof.

Step 1. *Existence of $v(t)$.*

For every $t \in [t_0, T]$, we take $w(\cdot, t) \in H^1(0, 1; \mathbb{R})$ to denote the solution of the linear problem:

$$\begin{cases} w'' + g = 0, & \text{in }]0, 1[, \\ w(0) = v_0^P, \quad w(1) = v_1^P. \end{cases}$$

It can be readily checked that if $v_0^P, v_1^P : [t_0, T] \rightarrow \mathbb{R}$ and $g : [t_0, T] \rightarrow H^{-1}$ are regulated (with bounded variation, absolutely continuous, and Lipschitz-continuous, respectively), then the same will be true of the function $w : [t_0, T] \rightarrow H^1$.

Let us then proceed by changing the unknown function:

$$\bar{v}(x, t) = v(x, t) - w(x, t).$$

Setting:

$$\bar{K}(t) = \left\{ \varphi \in H_0^1 \mid \forall x \in]0, 1[, \quad \varphi(x) \geq \psi(x) - w(x, t) \right\},$$

it is now required to prove the existence of a unique function $\bar{v} : [t_0, T] \rightarrow H_0^1(0, 1; \mathbb{R})$, having the required regularity in time and satisfying:

- $\forall t \in [t_0, T], \quad \bar{v}(t) \in \bar{K}(t),$
- $\forall t \in [t_0, T], \quad \forall \varphi \in \bar{K}(t), \quad \int_0^1 \bar{v}'(\varphi' - \bar{v}') \geq 0.$

For every $t \in [t_0, T]$, the use of the Lions-Stampacchia theorem [8] associated with the Poincaré inequality gives a unique $\bar{v}(t) \in \bar{K}(t)$.

Step 2. *Properties of the function $s : [t_0, T] \rightarrow H^{-1}$.*

It is deduced from the variational inequality satisfied by $\bar{v}(t)$ that at every t , the distribution $s(t) = -\bar{v}''(t)$ is *non-negative* (i.e., it takes a non-negative value at every C^∞ compactly supported non-negative test function). This classically entails that the distribution $s(t)$ is actually a measure.

Since w is a regulated function on $[t_0, T]$ into $H^1 \subset C^0$, given the compactness of the sets $\{0\} \times [t_0, T]$, $\{1\} \times [t_0, T]$ and the conditions (4), one can find $\alpha, \beta \in]0, 1[$ such that:

$$\begin{aligned} \forall x \in [0, \alpha], \quad \forall t \in [t_0, T], \quad \psi(x) - w(x, t) < 0, \\ \forall x \in [\beta, 1], \quad \forall t \in [t_0, T], \quad \psi(x) - w(x, t) < 0. \end{aligned} \quad (5)$$

The support of the measure $s(t)$ is therefore contained in $[\alpha, \beta]$.

It now remains only to be proved that the total mass of this measure is bounded with respect to t . Take $s = -\bar{v}''$ to denote the measure $s(t)$ at an arbitrarily fixed t . For any compact subset $K \in]0, 1[$, there exists a nonnegative function $\xi \in C_0^\infty(]0, 1[)$, which is identically 1 in K . For this function:

$$s(K) \leq \int \xi \, ds \leq \|\xi'\|_{L^2} \|\bar{v}'\|_{L^2}.$$

Since:

$$\int_0^1 (\bar{v}')^2 = \int_{[0,1]} (\psi - w) \, ds \leq \left\| \langle \psi - w \rangle^+ \right\|_{L^\infty} s(\text{supp } \langle \psi - w \rangle^+),$$

where $\langle x \rangle^+ = \max\{x, 0\}$, adopting $K_1 = \text{supp } \langle \psi - w \rangle^+$ gives:

$$\int_0^1 (\bar{v}')^2 \leq \left\| \langle \psi - w \rangle^+ \right\|_{L^\infty} \|\xi_1'\|_{L^2} \|\bar{v}'\|_{L^2},$$

that is:

$$\|\bar{v}'\|_{L^2} \leq \left\| \langle \psi - w \rangle^+ \right\|_{L^\infty} \|\xi_1'\|_{L^2}.$$

It then suffices to take $K_2 = [\alpha, \beta]$ to obtain the required estimate of the total mass of the non-negative measure s :

$$s(]0, 1[) = s([\alpha, \beta]) \leq \|\xi_1'\|_{L^2} \|\xi_2'\|_{L^2} \left\| \langle \psi - w \rangle^+ \right\|_{L^\infty},$$

since:

$$\|w(t)\|_{L^\infty} \leq C \left\{ |v_0^p(t)| + |v_1^p(t)| + \|g(t)\|_{H^{-1}} \right\},$$

and since any regulated function is bounded.

Step 3. *Regularity of the function $\bar{v} : [t_0, T] \rightarrow H_0^1(0, 1; \mathbb{R})$.*

The claimed regularity of the dependence of the solution on t will be ensured if there exists a constant C which is independent of $t_1, t_2 \in [t_0, T]$, and such that:

$$\|\bar{v}(t_2) - \bar{v}(t_1)\|_{H_0^1} \leq C \|w(t_2) - w(t_1)\|_{H^1}. \quad (6)$$

Taking arbitrary $t_1, t_2 \in [t_0, T]$ and recalling (5), we set:

$$\begin{aligned} \bar{\psi}_i(\lambda\alpha) &= \lambda[\psi(\alpha) - w(\alpha, t_i)] \\ \bar{\psi}_i(\lambda\alpha + (1-\lambda)\beta) &= \psi(\lambda\alpha + (1-\lambda)\beta) - w(\lambda\alpha + (1-\lambda)\beta, t_i), \\ \bar{\psi}_i(\lambda\beta + (1-\lambda)\alpha) &= \lambda[\psi(\beta) - w(\beta, t_i)], \end{aligned}$$

for all $\lambda \in [0, 1]$ and $i \in \{1, 2\}$. The functions $\bar{\psi}_i$ defined in this way belong to H_0^1 and satisfy:

$$\|\bar{\psi}'_2 - \bar{\psi}'_1\|_{L^2} \leq C \|w(t_2) - w(t_1)\|_{H^1},$$

where C is a real constant which is independent of t_1, t_2 . Moreover, the functions $\bar{\psi}_i \in H_0^1$ differ from $\psi(\cdot) - w(\cdot, t_i)$ only at those x where $\psi(x) - w(x, t_i) < 0$. Also, the two functions $\bar{\psi}_i$ are concave, since their second derivatives are non-positive measures. As they vanish at both ends, these functions are non-negative. Therefore, the function $\bar{v}(t_i)$ which solves the obstacle problem associated with $\psi - w(t_i)$, is also the solution of the obstacle problem associated with $\bar{\psi}_i$. From the variational inequalities satisfied by $\bar{v}(t_1)$ and $\bar{v}(t_2)$ respectively, it is deduced that:

$$\begin{aligned} \int_0^1 \bar{v}'(t_1) [\bar{v}'(t_2) - \bar{\psi}'_2 + \bar{\psi}'_1 - \bar{v}'(t_1)] &\geq 0, \\ \int_0^1 \bar{v}'(t_2) [\bar{v}'(t_1) - \bar{\psi}'_1 + \bar{\psi}'_2 - \bar{v}'(t_2)] &\geq 0. \end{aligned}$$

Taking the sum of these two inequalities, we obtain:

$$\int_0^1 [\bar{v}'(t_2) - \bar{v}'(t_1)]^2 \leq \int_0^1 [\bar{v}'(t_2) - \bar{v}'(t_1)] [\bar{\psi}'_2 - \bar{\psi}'_1],$$

and therefore reach the desired conclusion (6) by Cauchy-Schwarz inequality.

4. Analysis of the “tangential problem”

4.1. Structure of the evolution problem

Once the transverse problem has been solved, the function $s : [t_0, T] \rightarrow \mathcal{M}$ becomes part of the input data in the study on the tangential problem. It is now proposed to examine the structure of the corresponding evolution problem.

After eliminating the unknown r , the problem now consists in finding $u : [t_0, T] \rightarrow H^1$ such that:

- $u(x, t = 0) = u_0(x)$,
- $u(x = 0, t) = u_0^p(t)$, $u(x = 1, t) = u_1^p(t)$,
- $\forall \varphi \in \{\dot{u}\} + H_0^1$, $\left\langle u'' + f, \varphi - \dot{u} \right\rangle_{H^{-1}, H_0^1} \leq \left\langle \mu s, |\varphi| - |\dot{u}| \right\rangle_{H^{-1}, H_0^1}$.

For $\varphi \in H^1(0, 1; \mathbb{R})$, set:

$$\overline{\varphi}(x) = \varphi(x) - \varphi(0) - x(\varphi(1) - \varphi(0)) \in H_0^1.$$

The isomorphism:

$$\begin{cases} H^1 \rightarrow H_0^1 \times \mathbb{R} \times \mathbb{R} \\ \varphi \mapsto (\overline{\varphi}, \varphi(0), \varphi(1)) \end{cases}$$

together with the Poincaré inequality can then be used to endow H^1 with the scalar product defined by:

$$(\varphi | \psi)_{H^1} = \int_0^1 \overline{\varphi}'(x) \overline{\psi}'(x) dx + \varphi(0) \psi(0) + \varphi(1) \psi(1). \quad (7)$$

Let us consider the function $\Phi : H^1 \rightarrow \mathbb{R}$ defined by:

$$\Phi(\varphi) = \left\langle \mu s, |\varphi| \right\rangle_{H^{-1}, H_0^1} - \left\langle f, \overline{\varphi} \right\rangle_{H^{-1}, H_0^1} - u_0^p \varphi(0) - u_1^p \varphi(1).$$

This definition is meaningful since it was noted in the proof of theorem 1 that $\text{supp } s \subset [\alpha, \beta] \subset]0, 1[$. The function Φ is clearly convex and continuous on H^1 . With these notations, the evolution inequality can be rewritten as follows:

$$\begin{aligned} \forall \varphi \in H^1, \\ \left\langle u'', \overline{\varphi} - \dot{u} \right\rangle_{H^{-1}, H_0^1} - u(0)(\varphi(0) - \dot{u}(0)) - u(1)(\varphi(1) - \dot{u}(1)) \\ \leq \Phi(\varphi) - \Phi(\dot{u}), \end{aligned}$$

that is, since $u'' = \bar{u}''$:

$$\begin{aligned} \forall \varphi \in H^1, \\ - \int_0^1 \bar{u}' (\bar{\varphi}' - \dot{\bar{u}}') - u(0)(\varphi(0) - \dot{u}(0)) - u(1)(\varphi(1) - \dot{u}(1)) \\ \leq \Phi(\varphi) - \Phi(\dot{u}), \end{aligned}$$

which, in terms of the subdifferential of the function Φ , simply amounts to:

$$-u(t) \in \partial\Phi[\dot{u}(t)],$$

where the subdifferential is understood in the sense of the scalar product (7). Since Φ is positively homogeneous of degree 1, the conjugate function Φ^* is the indicatrix (in the sense of convex analysis) function of some closed convex set $-\mathcal{C}(t)$. It can then be easily calculated that:

$$\begin{aligned} \mathcal{C}(t) &= \left\{ u \in H^1 \mid \forall \varphi \in H^1, \int_0^1 \bar{u}' \bar{\varphi}' + u(0)\varphi(0) + u(1)\varphi(1) + \Phi(\varphi) \geq 0 \right\}, \\ &= \left\{ u \in H^1 \mid u(x=0) = u_0^p, \quad u(x=1) = u_1^p, \right. \\ &\quad \left. \text{and } \forall \varphi \in H_0^1, \quad \left\langle u'' + f, \varphi \right\rangle_{H^{-1}, H_0^1} \leq \left\langle \mu s, |\varphi| \right\rangle_{H^{-1}, H_0^1} \right\}, \end{aligned}$$

and the problem to be solved is equivalent to that of finding $u : [t_0, T] \rightarrow H^1$ such that:

- $u(t_0) = u_0$,
- $-\dot{u}(t) \in \partial I_{\mathcal{C}(t)}[u(t)], \quad \text{for a.a. } t \in [t_0, T],$

where the subdifferential should be understood with respect to the scalar product (7). The tangential problem therefore obeys a sweeping process (see appendix B) in the Hilbert space H^1 .

4.2. Existence and uniqueness of strong solutions

In this section, it is established that the sweeping process that governs the tangential problem can be solved, in some restrictive circumstances, using the results obtained by Moreau (cf [10] or appendix B).

Theorem 2. *Let $f, s : [t_0, T] \rightarrow H^{-1}$, and $u_0^p, u_1^p : [t_0, T] \rightarrow \mathbb{R}$. Let us assume that for every $t \in [t_0, T]$, $s(t)$ is a nonnegative measure with support contained in some fixed compact interval $[\alpha, \beta] \subset]0, 1[$, and let us consider the set-valued mapping defined by:*

$$\begin{aligned} \mathcal{C}(t) &= \left\{ u \in H^1 \mid u(x=0) = u_0^p, \quad u(x=1) = u_1^p, \right. \\ &\quad \left. \text{and } \forall \varphi \in H_0^1, \quad \left\langle u'' + f, \varphi \right\rangle_{H^{-1}, H_0^1} \leq \left\langle \mu s, |\varphi| \right\rangle_{H^{-1}, H_0^1} \right\}, \end{aligned}$$

Some initial condition $u_0 \in \mathcal{C}(0)$ is also given.

If the functions $u_0^p, u_1^p : [t_0, T] \rightarrow \mathbb{R}$, $f : [t_0, T] \rightarrow H^{-1}$, $s : [t_0, T] \rightarrow \mathcal{M}$ have bounded variation and are right-continuous at every $t \in [t_0, T[$, then the set-valued mapping $\mathcal{C}(t)$ has bounded retraction, and there exists a unique weak solution $u \in BV([t_0, T]; H^1)$ of the sweeping process based on $\mathcal{C}(t)$ which agrees with the initial condition u_0 . This weak solution is also the unique solution in the sense of “differential measures”, which is right-continuous at every $t \in [t_0, T[$ (see appendix B).

If, in addition, the functions $u_0^p, u_1^p : [t_0, T] \rightarrow \mathbb{R}$, $f : [t_0, T] \rightarrow H^{-1}$, $s : [t_0, T] \rightarrow \mathcal{M}$ are absolutely continuous (respectively Lipschitz-continuous), then the set-valued mapping $\mathcal{C}(t)$ has absolutely continuous (respectively Lipschitz-continuous) retraction, the solution $u : [t_0, T] \rightarrow H^1$ is absolutely continuous (respectively Lipschitz-continuous) and is the unique strong solution of the sweeping process in the sense:

- $u(t_0) = u_0$,
- $-\dot{u}(t) \in \partial I_{\mathcal{C}(t)}[u(t)]$, for a.a. $t \in [t_0, T]$.

Proof. Taking $e(\cdot, \cdot)$ to denote the “excess” (see Appendix A) associated with the scalar product (7) on H^1 , in order to prove all the claims about the retraction of $\mathcal{C}(t)$, it suffices to prove that, at all $t_1 \leq t_2 \in [t_0, T]$:

$$e(\mathcal{C}(t_1), \mathcal{C}(t_2)) \leq C \left\{ |u_0^p(t_2) - u_0^p(t_1)| + |u_1^p(t_2) - u_1^p(t_1)| \right. \\ \left. + \|f(t_2) - f(t_1)\|_{H^{-1}} + \|\mu s(t_2) - \mu s(t_1)\|_{\mathcal{M}} \right\},$$

for some real constant independent of t_1, t_2 . We take w_i ($i = 1, 2$) to denote the unique solution in H^1 of the linear problem:

$$\begin{cases} w_i'' + f(t_i) = 0, \\ w_i(0) = u_0^p(t_i), \quad w_i(1) = u_1^p(t_i), \end{cases}$$

$s_i = \mu s(t_i)$, and

$$\bar{\mathcal{C}}_i = \left\{ u \in H_0^1 \mid \forall \varphi \in H_0^1, \quad \langle u'', \varphi \rangle_{H^{-1}, H_0^1} \leq \langle s_i, |\varphi| \rangle_{H^{-1}, H_0^1} \right\},$$

so that, according to these notations:

$$\mathcal{C}(t_i) = \{w_i\} + \bar{\mathcal{C}}_i.$$

Since the “excess” obeys a triangle inequality (see proposition 2 in Appendix A):

$$e(\mathcal{C}(t_1), \mathcal{C}(t_2)) \leq \|w_2 - w_1\|_{H^1} + e(\bar{\mathcal{C}}_1, \bar{\mathcal{C}}_2).$$

The desired inequality will therefore be proved provided:

$$e(\bar{\mathcal{C}}_1, \bar{\mathcal{C}}_2) \leq C \|s_2 - s_1\|_{\mathcal{M}},$$

that is, arbitrarily choosing some $\bar{u}_1 \in \bar{\mathcal{C}}_1$:

$$d(\bar{u}_1, \bar{\mathcal{C}}_2) \leq C \|s_2 - s_1\|_{\mathcal{M}},$$

or:

$$\inf_{\bar{v} \in \bar{\mathcal{C}}_2} \|\bar{u}'_1 - \bar{v}'\|_{L^2} \leq C \|s_2 - s_1\|_{\mathcal{M}}. \quad (8)$$

Since $\bar{u}_1 \in \bar{\mathcal{C}}_1$, \bar{u}'_1 is a measure with support contained in $[\alpha, \beta]$ and we take \bar{v}_0 to denote the unique function in H_0^1 such that:

$$\bar{v}_0'' = \inf \left\{ \sup \{ \bar{u}'_1, 0 \}, s_2 \right\} + \sup \left\{ \inf \{ \bar{u}'_1, 0 \}, -s_2 \right\},$$

where the “inf” and “sup” should be understood with respect to the partial order in the space of measures. From:

$$-s_2 \leq \bar{v}_0'' \leq s_2,$$

we get $\bar{v}_0 \in \bar{\mathcal{C}}_2$, and:

$$-|s_2 - s_1| \leq \bar{v}_0'' - \bar{u}'_1 \leq |s_2 - s_1|,$$

gives:

$$\|\bar{v}_0'' - \bar{u}'_1\|_{\mathcal{M}} = \|\bar{v}_0'' - \bar{u}'_1\|_{\mathcal{M}} \leq \| |s_2 - s_1| \|_{\mathcal{M}} = \|s_2 - s_1\|_{\mathcal{M}}.$$

Since the imbedding of \mathcal{M} in H^{-1} is continuous (in dimension one):

$$\|\bar{u}'_1 - \bar{v}_0'\|_{L^2} \leq C \|s_2 - s_1\|_{\mathcal{M}},$$

for a constant C which is independent of \bar{v}_0 and \bar{u}_1 . The desired conclusion (8) has now been reached.

Theorem 2 is now a straightforward consequence of Moreau’s results (theorems 8 and 10) as regards the solvability of sweeping processes based on set-valued mappings with bounded retraction.

4.3. An example of an explicit solution

Let us consider the case of the evolution of a string above a fixed rigid wedge-shaped obstacle.

At instant $t = 0$, the middle of the string undergoes grazing contact with the top of the obstacle. Between instants $t = 0$ and $t = 1$, a “vertical” displacement of amplitude $y = -1/4$ is imposed on both ends of the string. Then, between instants $t = 1$ and $t = 2$, a right “horizontal” displacement of the extremities of the string is prescribed at a constant speed (see figure 1).

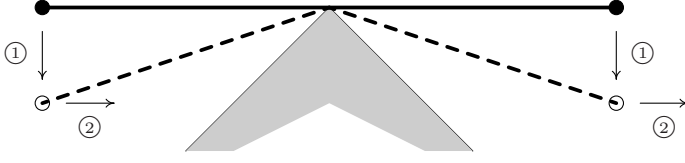

Fig. 1. Elastic string in frictional contact with a wedge-shaped obstacle.

More specifically, this amounts to studying the quasi-static evolution problem for the string associated with the data: $\psi(x) = -|x - 1/2|$, and:

$$\begin{aligned} u_0^P(t) &= 0, & v_0^P(t) &= -\frac{t}{4}, & \text{pour } 0 \leq t \leq 1, \\ u_1^P(t) &= 0, & v_1^P(t) &= -\frac{t}{4}, \\ u_0^P(t) &= \frac{t-1}{4}, & v_0^P(t) &= -\frac{1}{4}, & \text{pour } 1 \leq t \leq 2, \\ u_1^P(t) &= \frac{t-1}{4}, & v_1^P(t) &= -\frac{1}{4}, \end{aligned}$$

It is easily checked that the unique solution of this evolution problem is given by:

$$\begin{aligned} v(x, t) &= -\frac{t}{2} \left| x - \frac{1}{2} \right|, & u(x, t) &= 0, \\ s &= t \delta_{x=1/2}, & r &= 0, \end{aligned}$$

at $0 \leq t \leq 1$,

$$\begin{aligned} v(x, t) &= -\frac{1}{2} \left| x - \frac{1}{2} \right|, & u(x, t) &= \frac{t-1}{2} \left| x - \frac{1}{2} \right|, \\ s &= \delta_{x=1/2}, & r &= (1-t) \delta_{x=1/2}, \end{aligned}$$

at $1 \leq t \leq \min(2, 1 + \mu)$, and in the case $\mu < 1$:

$$\begin{aligned} v(x, t) &= -\frac{1}{2} \left| x - \frac{1}{2} \right|, & u(x, t) &= \frac{1}{4} (t-1-\mu) + \frac{\mu}{2} \left| x - \frac{1}{2} \right|, \\ s &= \delta_{x=1/2}, & r &= -\mu \delta_{x=1/2}, \end{aligned}$$

at $1 + \mu \leq t \leq 2$. Thanks to theorem 2, the underlying set-valued mapping $\mathcal{C}(t)$ has absolutely continuous (and even Lipschitz-continuous) retraction, and u is a strong solution of the underlying sweeping process.

Since dry friction is rate-independent, it is natural to attempt to concentrate the episodes of motion prescribed on extremities of the string during

the isolated instants $t = 0, 1$. Setting $u_0^p(0) = u_1^p(0) = v_0^p(0) = v_1^p(0) = 0$, this amounts to considering the following data:

$$\begin{aligned} u_0^p(t) &= 0, & v_0^p(t) &= -\frac{1}{4}, & \text{for } 0 < t < 1, \\ u_1^p(t) &= 0, & v_1^p(t) &= -\frac{1}{4}, \\ u_0^p(t) &= \frac{1}{4}, & v_0^p(t) &= -\frac{1}{4}, & \text{for } 1 \leq t \leq 2. \\ u_1^p(t) &= \frac{1}{4}, & v_1^p(t) &= -\frac{1}{4}, \end{aligned}$$

The motion of the string is now given by:

$$\begin{aligned} v(x, t) &= -\frac{1}{2}\left|x - \frac{1}{2}\right|, & u(x, t) &= 0, \\ s &= \delta_{x=1/2}, & r &= 0, \end{aligned}$$

at $0 < t < 1$, and then, in the case where $\mu \leq 1$, by:

$$\begin{aligned} v(x, t) &= -\frac{1}{2}\left|x - \frac{1}{2}\right|, & u(x, t) &= \frac{1}{2}\left|x - \frac{1}{2}\right|, \\ s &= \delta_{x=1/2}, & r &= -\delta_{x=1/2}, \end{aligned}$$

at $1 \leq t \leq 2$, and, in the case where $\mu \geq 1$, by:

$$\begin{aligned} v(x, t) &= -\frac{1}{2}\left|x - \frac{1}{2}\right|, & u(x, t) &= \frac{1}{4}(1 - \mu) + \frac{\mu}{2}\left|x - \frac{1}{2}\right|, \\ s &= \delta_{x=1/2}, & r &= -\mu \delta_{x=1/2}, \end{aligned}$$

for $1 \leq t \leq 2$. In this situation, the moving set $\mathcal{C}(t)$ moves only by translation, but this translation involves two steps. The set-valued mapping $\mathcal{C}(t)$ has right-continuous retraction, the retraction is no longer absolutely continuous, and the function u is a solution of the sweeping process only in the sense of differential measures (see definition 10).

4.4. Another example that eludes the theory

Let us consider the example of a string tightly stretched just above a rigid rectilinear ground. First, a punctual downward force of unit amplitude is applied to the middle of the string. Assuming that the friction coefficient is large (greater than 2), a right displacement of unit amplitude is prescribed on the right extremity of the string. The punctual force then starts to move to the left at a constant speed (see figure 2).

More specifically, this amounts to studying the quasi-static evolution problem for the string associated with the following data: $\psi \equiv 0$, $u_0^p = v_0^p = v_1^p \equiv 0$ and u_1^p is the function which takes the value 0 at $t = 0$ and 1 at every $t > 0$. In addition, the body force:

$$f = \delta_{x=1/2-t},$$

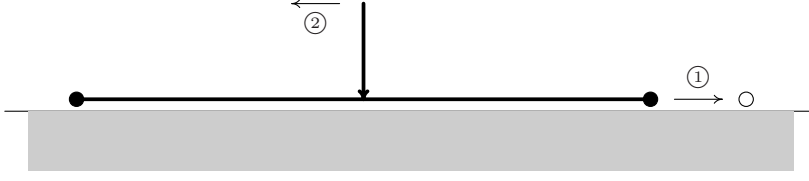

Fig. 2. Frictional contact between an elastic string and a rigid floor.

has to be taken into account. The unique solution of the transverse problem is given by $v \equiv 0$, which entails $s \equiv -f$. Since at all $t_1 < t_2 \in]0, 1[$:

$$\begin{aligned} \|\delta_{t_2} - \delta_{t_1}\|_{\mathcal{M}} &= 2, \\ \|\delta_{t_2} - \delta_{t_1}\|_{H^{-1}} &= \sqrt{t_2 - t_1} \sqrt{1 - (t_2 - t_1)}, \end{aligned}$$

we have the following regularity for s :

$$\begin{aligned} s &\notin BV([0, 1/3]; \mathcal{M}), & s &\notin BV([0, 1/3]; H^{-1}), \\ s &\notin C^0([0, 1/3]; \mathcal{M}), & s &\in C^0([0, 1/3]; H^{-1}). \end{aligned}$$

This regularity is not sufficiently strong to be able to use theorem 2 to solve the underlying sweeping process by means of Moreau's results. However, it is still possible to consider subdividing of $[t_0, T]$, performing the successive projections of the catching-up algorithm, and then attempting to take a limit as the size of the largest interval of the subdivision tends to zero. In the example under consideration, strong convergence in H^1 , occurring uniformly with respect to time, is obtained, giving the following weak solution (in line with definition 9) of the sweeping process:

$$u(x, t) = \begin{cases} 0, & \text{if } 0 \leq x \leq 1/2 - t, \\ \frac{x + t - 1/2}{t + 1/2}, & \text{if } 1/2 - t \leq x \leq 1. \end{cases}$$

However, the associated velocity:

$$\dot{u}(x, t) = \begin{cases} 0, & \text{if } 0 \leq x < 1/2 - t, \\ \frac{1 - x}{(t + 1/2)^2}, & \text{if } 1/2 - t < x \leq 1, \end{cases}$$

shows spatial discontinuity just below the load (see figure 3). Therefore, this weak solution does not belong to $BV([0, 1/3]; H^1)$, and the underlying set-valued mapping $\mathcal{C}(t)$ cannot have bounded retraction in the Hilbert space H^1 (see theorem 8). Note, incidentally, that the value of the velocity just below the load is not defined, so that pointwise formulation of the Coulomb law cannot be checked in this problem.

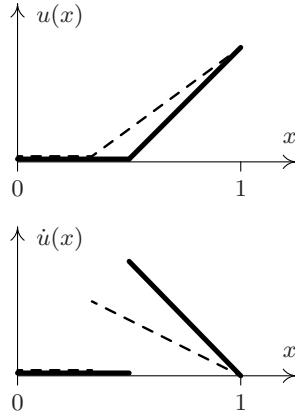

Fig. 3. Longitudinal displacement and velocity at the initial instant as well as at some later instant (dashed lines).

The concept of the weak solution corresponds to subdividing the time interval and introducing the discrete locations of the load associated with the subdivisions. Another way of proceeding would be to “spread” out the load a little bit, by means of a spatial convolution with an approximation of the identity. This is enough to make the underlying set-valued mapping have absolutely continuous (and even Lipschitz-continuous) retraction, and thus to ensure the existence of a strong solution, with a spatially continuous velocity field, in particular. This naturally raises the question as to the existence of a limit, as the regularization tends to identity and the possibility that this limit may coincide with the weak solution, that is the limit of the solutions of the time-discretized problems.

As an example, let us look at the load, which is homogeneous over the spatial interval $[1/2 - t - \varepsilon, 1/2 - t + \varepsilon]$, and of amplitude $1/(2\varepsilon)$, where $0 < \varepsilon < 1/6$. It can be easily confirmed that the strong solution of the underlying sweeping process is:

$$u_\varepsilon(x, t) = \begin{cases} 0, & \text{if } 0 \leq x \leq x_\varepsilon(t), \\ \frac{\mu}{4\varepsilon}(x - x_\varepsilon(t))^2, & \text{if } x_\varepsilon(t) \leq x \leq \frac{1}{2} - t + \varepsilon, \\ 1 + \frac{\mu}{2\varepsilon}\left(\frac{1}{2} - t + \varepsilon - x_\varepsilon(t)\right)(x - 1), & \text{if } \frac{1}{2} - t + \varepsilon \leq x \leq 1. \end{cases}$$

where:

$$x_\varepsilon(t) = 1 - \sqrt{\left(\frac{1}{2} + t - \varepsilon\right)^2 + \frac{4\varepsilon}{\mu}} \in \left[\frac{1}{2} - t - \varepsilon, \frac{1}{2} - t + \varepsilon\right].$$

It is worth noting in this example that u_ε converges towards u as ε tends to 0, in a strong sense: strong convergence in H^1 , uniformly with respect to $t \in [0, 1/3]$.

The solution u_ε provides an explanation of a surprising feature of the solution u of the non-regularized problem: although the friction coefficient chosen was large enough to prevent any slipping, the elastic energy associated with u decreases with respect to time. This fact can be explained as follows. The solution u_ε of the regularized problem always shows some slipping, and it can be checked that the accumulated dissipation (the time integral of the power of the friction force) tends, as $\varepsilon \rightarrow 0$, not towards zero, but towards some finite value. It is therefore logical that the weak solution u of the “limit” problem should keep some memory of this dissipation, although showing no slipping itself.

4.5. Weak solutions

In this section, it is proved, after adopting some fairly general regularity hypotheses about the data involved in the frictional problem, that the set-valued mapping of the underlying sweeping process is Wijsman-regulated. This enables us to state the problem of the possible existence of a weak solution of the frictional contact problem. However, the question of existence of such a weak solution is left open at the moment.

More specifically, it is proposed to prove that the regularity obtained for the function $s(t)$ by solving the normal problem yields a Wijsman-regulated set-valued mapping $\mathcal{C}(t)$.

Proposition 1. *Let $f, s : [t_0, T] \rightarrow H^{-1}$, as well as $u_0^p, u_1^p : [t_0, T] \rightarrow \mathbb{R}$. Let us assume that for every $t \in [t_0, T]$, $s(t)$ is a non-negative measure having a support which is contained in a fixed compact interval $[\alpha, \beta] \subset]0, 1[$, and a total mass bounded independently of t . Let us consider the set-valued mapping defined by:*

$$\mathcal{C}(t) = \left\{ u \in H^1 \mid u(x=0) = u_0^p, \quad u(x=1) = u_1^p, \right. \\ \left. \text{and } \forall \varphi \in H_0^1, \quad \left\langle u'' + f, \varphi \right\rangle_{H^{-1}, H_0^1} \leq \left\langle \mu s, |\varphi| \right\rangle_{H^{-1}, H_0^1} \right\},$$

If the functions $f, s : [t_0, T] \rightarrow H^{-1}$, $u_0^p, u_1^p : [t_0, T] \rightarrow \mathbb{R}$ are regulated, then the set-valued mapping $\mathcal{C}(t)$ is Wijsman-regulated.

Proof. As in the proof of theorem 2, $w(t)$ is defined as the unique solution (at fixed t) of the linear problem:

$$\begin{cases} w'' + f(t) = 0, \\ w(0) = u_0^p(t), \quad w(1) = u_1^p(t), \end{cases}$$

and:

$$\bar{\mathcal{C}}(t) = \left\{ u \in H_0^1 \mid \forall \varphi \in H_0^1, \quad \int_0^1 u' \varphi' \leq \left\langle s(t), |\varphi| \right\rangle_{H^{-1}, H_0^1} \right\}.$$

According to these notations:

$$\mathcal{C}(t) = \{w(t)\} + \bar{\mathcal{C}}(t).$$

It should be clear that if the three functions $f : [t_0, T] \rightarrow H^{-1}$, $u_0^p, u_1^p : [t_0, T] \rightarrow \mathbb{R}$ are regulated, then the same will be true of the function $w : [t_0, T] \rightarrow H^1$. Setting:

$$\begin{aligned} \bar{\mathcal{C}}_n &= \left\{ u \in H_0^1 \mid \forall \varphi \in H_0^1, \int_0^1 u' \varphi' \leq \langle s_n, |\varphi| \rangle_{H^{-1}, H_0^1} \right\}, \\ \bar{\mathcal{C}} &= \left\{ u \in H_0^1 \mid \forall \varphi \in H_0^1, \int_0^1 u' \varphi' \leq \langle s, |\varphi| \rangle_{H^{-1}, H_0^1} \right\}, \end{aligned}$$

(where s_n and s are non-negative measures with their support in $[\alpha, \beta]$, having a total mass which is bounded independently of n) and taking into account theorem 4, it is now necessary to prove that if the sequence (s_n) converges strongly towards s in H^{-1} , then $\lim_{n \rightarrow \infty} \bar{\mathcal{C}}_n = \bar{\mathcal{C}}$, in the sense of Kuratowski.

Choosing $u \in \limsup_{n \rightarrow \infty} \bar{\mathcal{C}}_n$ arbitrarily, there exists a subsequence of (s_n) , which is still denoted by (s_n) , and a sequence (u_n) in H_0^1 such that (u_n') converges strongly towards u' in L^2 and:

$$\forall \varphi \in H_0^1, \quad \forall n \in \mathbb{N}, \quad \int_0^1 u_n' \varphi' \leq \langle s_n, |\varphi| \rangle_{H^{-1}, H_0^1}.$$

If n tends to infinity, it can be seen that $u \in \bar{\mathcal{C}}$, and, hence $\limsup_{n \rightarrow \infty} \bar{\mathcal{C}}_n \subset \bar{\mathcal{C}}$.

Now let us take arbitrary $u \in \bar{\mathcal{C}}$. Noting that u'' is a measure with support in $[\alpha, \beta]$, set:

$$\bar{u}_n'' = \inf \left\{ \sup \{ \bar{u}'', 0 \}, s_n \right\} + \sup \left\{ \inf \{ \bar{u}'', 0 \}, -s_n \right\},$$

where the *infimum* and *supremum* should be understood in terms of the partial ordering in the space of measures. As:

$$-s_n \leq \bar{u}_n'' \leq s_n,$$

we obtain $\bar{u}_n \in \bar{\mathcal{C}}_n$. Now, remember that a sequence (f_n) in the dual space X' of a Banach space X converges weakly-star towards f if and only if $\|f_n\|$ is bounded, and if $\langle f_n, x \rangle \rightarrow \langle f, x \rangle$ for every x in a dense subset of X (see [13], theorem 10, p.125). Since the total mass of s_n is bounded and since the restrictions of functions in H_0^1 to the interval $[\alpha, \beta]$ are dense in $C^0([\alpha, \beta])$, it is deduced that the strong convergence of s_n towards s in H^{-1} entails the weak-star convergence of s_n towards s in $\mathcal{M}([\alpha, \beta])$. From the definition of \bar{u}_n'' in terms of $u \in \bar{\mathcal{C}}$, then we have the weak-star convergence of u_n'' towards u'' in $\mathcal{M}([\alpha, \beta])$. First, this entails pointwise convergence almost everywhere of \bar{u}_n' towards \bar{u}' , and then, by dominated convergence, strong convergence in L^2 of \bar{u}_n' towards \bar{u}' . Hence, $u \in \liminf_{n \rightarrow \infty} \bar{\mathcal{C}}_n$.

Upon combining all these elements, we obtain:

$$\limsup_{n \rightarrow \infty} \bar{\mathcal{C}}_n \subset \bar{\mathcal{C}} \subset \liminf_{n \rightarrow \infty} \bar{\mathcal{C}}_n,$$

which is the conclusion we were looking for.

5. Replacing the string by a beam

Let us consider a straight beam, which is simply supported at both ends, and has as its initial configuration the segment $[0, 1] \times \{0\}$. The linearized equations that govern the equilibrium of the beam, which is assumed to be elastic, read as follows:

$$\left\{ \begin{array}{ll} k u'' + f = 0, & \text{dans }]0, 1[, \\ u(0) = u_0^P, \quad u(1) = u_1^P, & \\ l v'''' - g = 0, & \text{dans }]0, 1[, \\ v(0) = v_0^P, \quad v(1) = v_1^P, & \\ v''(0) = v''(1) = 0, & \end{array} \right.$$

where the traction stiffness k and the flexion stiffness l will equal 1 in what follows by choosing appropriately the unit, and $u_0^P \mathbf{e}_x + v_0^P \mathbf{e}_y$ and $u_1^P \mathbf{e}_x + v_1^P \mathbf{e}_y$ are the prescribed displacements at extremities $x = 0$ and $x = 1$, respectively.

The equations governing the quasi-static evolution of the beam above a fixed rigid obstacle of equation $y = \psi(x)$ with Coulomb dry friction of coefficient denoted by μ , can be written as follows:

$$\left\{ \begin{array}{ll} u'' + f + r = 0, & \text{dans }]0, 1[\times [t_0, T], \\ r(\hat{u} - \dot{u}) + \mu s(|\hat{u}| - |\dot{u}|) \geq 0, \quad \forall \hat{u} \in \mathbb{R}, & \text{dans }]0, 1[\times [t_0, T], \\ u(0) = u_0^P, \quad u(1) = u_1^P, & \text{sur } [t_0, T], \\ v'''' - g - s = 0, & \text{dans }]0, 1[, \\ v - \psi \geq 0, \quad s \geq 0, \quad s(v - \psi) \equiv 0, & \text{dans }]0, 1[\times [t_0, T], \\ v(0) = v_0^P, \quad v(1) = v_1^P, & \text{sur } [t_0, T], \\ v''(0) = v''(1) = 0, & \text{sur } [t_0, T]. \end{array} \right.$$

The equations governing the normal component v of the displacement are still uncoupled with those governing the tangential component.

5.1. Another example

It could seem at first sight that the case of the beam brings nothing more compared to the case of the string, except that the order of the differential operator in the variational inequality that governs the normal displacement is 4 instead of 2, whereas the problems governing the tangential displacement remains formally the same in both cases.

This is true, but the fact that the operator governing the normal displacement is now of order 4 has some important effects. In particular, one can expect the solutions of the underlying sweeping process to be weak solutions, even when arbitrarily smooth data are available. This can be con-

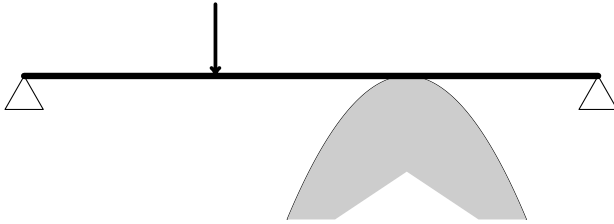

Fig. 4. Frictional contact of a simply supported beam.

firmed by analysing the problem with the geometry shown in figure 4. In the initial configuration, the beam undergoes grazing contact with a smooth obstacle. The amplitude of the force is made to increase gradually with time t . It can easily be checked that the contact zone in the solution reduces to a single point provided the amplitude of the force is small enough, and that this punctual contact zone is associated with a point on the obstacle that moves to the left of the figure with time. Consequently, the normal reaction s is a Dirac measure whose support moves with time as in the example given in figure 2. This fact will be true even in cases where the external force is “spread out” a little bit so as to be as smooth as desired. Therefore, one cannot expect to obtain:

$$s \in BV([t_0, T]; \mathcal{M}),$$

by requiring the data to be smooth. The tangential problem will therefore generally have only weak solutions, even with smooth data.

5.2. About weak solutions

In this section, the regularity that can be expected to occur with the function $s(t)$, and therefore with the set-valued mapping $\mathcal{C}(t)$ will be analysed in the case of beams, where the variational inequality is associated

with the biharmonic operator instead of the harmonic one. It is worth noting that under the same regularity assumptions about the data, the function $s(t)$ shows the same regularity here as in theorem 1. This is stated in the following theorem, in which brings together several regularity results are combined that are known for variational inequalities associated with the biharmonic operator.

Once theorem 3 has been proved, proposition 1 ensures that the underlying set-valued mapping $\mathcal{C}(t)$ is Wijsman-regulated, provided the data $f, g : [t_0, T] \rightarrow H^{-1}$, $u_0^p, v_0^p, u_1^p, v_1^p : [t_0, T] \rightarrow \mathbb{R}$ are regulated functions.

Theorem 3. *Let us assume that $\psi \in H^3(0, 1; \mathbb{R})$, $g : [t_0, T] \rightarrow H^{-1}$ and that the functions $v_0^p, v_1^p : [t_0, T] \rightarrow \mathbb{R}$ satisfy the strong compatibility condition:*

$$\inf_{t \in [t_0, T]} v_0^p(t) > \psi(0), \quad \inf_{t \in [t_0, T]} v_1^p(t) > \psi(1).$$

Setting:

$$K(t) = \left\{ \hat{v} \in H^2(0, 1; \mathbb{R}) \mid \hat{v}(0) = v_0^p(t), \quad \hat{v}(1) = v_1^p(t), \right. \\ \left. \forall x \in]0, 1[, \quad \hat{v}(x) \geq \psi(x) \right\},$$

then there exists a unique function $v : [t_0, T] \rightarrow H^2(0, 1; \mathbb{R})$ such that:

- $\forall t \in [t_0, T], \quad v(t) \in K(t),$
- $\forall t \in [t_0, T], \quad \forall \hat{v} \in K(t), \quad \int_0^1 v''(\hat{v}'' - v'') \geq \left\langle g, \hat{v} - v \right\rangle_{H^{-1}, H_0^1}.$

Moreover, if $v_0^p, v_1^p : [t_0, T] \rightarrow \mathbb{R}$ and $g : [t_0, T] \rightarrow H^{-1}$ are regulated, then, the same will be true of the function $v : [t_0, T] \rightarrow H^3$, and therefore, of the function $v'''' - g \stackrel{\text{def}}{=} s : [t_0, T] \rightarrow H^{-1}$.

Also, for every $t \in [t_0, T]$, $s(t)$ is a non-negative measure with support contained in $[\alpha, \beta] \subset]0, 1[$ (α, β are independent of t), whose total mass is a bounded function of t .

Proof. This additional regularity (H^3 instead of H^2) shown by the solutions of the obstacle problem associated with the biharmonic operator is a well-known fact. Here we reproduce the proof by penalization displayed in [8], p.270 (the reader will find there the bibliography references on the subject), because it can readily be transposed to higher space dimensions and in particular, to the case of the plate. To prove that the mapping $v : [t_0, T] \rightarrow H^3$ thus defined, is regulated, we shall use the fact that a mapping with values in a complete metric space is regulated if and only if it admits a left limit and a right limit at every point. Thus, the problem is made to focus on the stability of the solution to the biharmonic obstacle problem with respect to the data. This stability problem was studied by Adams [1], whose results are very similar to those needed here. Our method of proof is on very similar lines to those used in [1].

Step 1. *Existence and uniqueness of the function $v : [t_0, T] \rightarrow H^2$.*

At every $t \in [t_0, T]$, we take $w(\cdot, t) \in H^2(0, 1; \mathbb{R})$ to denote the solution of the linear problem:

$$\begin{cases} w'''' - g = 0, & \text{dans }]0, 1[, \\ w(0) = v_0^p, & w(1) = v_1^p, \\ w''(0) = w''(1) = 0. \end{cases}$$

It should be clear that actually, $w(\cdot, t) \in H^3(0, 1; \mathbb{R})$ and that the linear mapping:

$$\begin{cases} \mathbb{R} \times \mathbb{R} \times H^{-1} \rightarrow H^3 \\ (v_0^p(t), v_1^p(t), g(t)) \mapsto w(t) \end{cases}$$

is continuous. In particular, if the data are regulated functions of the variable t , then the same will be true of the function $w : [t_0, T] \rightarrow H^3$. Next, we proceed with changing the unknown function:

$$\bar{v}(x, t) = v(x, t) - w(x, t),$$

and set:

$$\bar{K}(t) = \left\{ \hat{v} \in H_0^1 \cap H^2 \mid \forall x \in]0, 1[, \hat{v}(x) \geq \psi(x) - w(t, x) \right\},$$

By the Lions-Stampacchia theorem, there exists a unique $\bar{v}(t) \in \bar{K}(t)$ such that:

$$\forall \hat{v} \in \bar{K}(t), \int_0^1 \bar{v}'' (\hat{v}'' - \bar{v}'') \geq 0, \quad (9)$$

provided that the bilinear form $(v, w) \rightarrow \int_0^1 v'' w''$ is coercive on the Hilbert space $H_0^1 \cap H^2$ equipped with the norm:

$$\|v\|_{H_0^1 \cap H^2} = \sqrt{\|v'\|_{L_2}^2 + \|v''\|_{L_2}^2}.$$

Take $v \in H_0^1 \cap H^2 \subset C^1$. There exists $x_0 \in]0, 1[$ such that $v'(x_0) = 0$. We obtain:

$$[v'(x)]^2 = 2 \int_{x_0}^x v' v'' \leq 2 \sqrt{\int_0^1 v'^2} \sqrt{\int_0^1 v''^2},$$

which entails:

$$\sqrt{\int_0^1 v'^2} \leq 2 \sqrt{\int_0^1 v''^2}, \quad (10)$$

(this is in fact the desired coerciveness) and therefore, the existence of a unique $\bar{v}(t) \in \bar{K}(t)$ solving the variational inequality.

It is now proposed to prove that it is always possible to reduce the problem to the case where the obstacle is described by a function which vanishes at the extremities $x = 0, 1$. The function $\bar{\psi}(x)$ will be constructed

as in the proof of theorem 1. Since $w : [t_0, T] \rightarrow H^3$ is regulated, by the conditions pertaining in (4), one can find $\alpha, \beta \in]0, 1[$ such that:

$$\begin{aligned} \forall x \in [0, \alpha], \quad \forall t \in [t_0, T], \quad \psi(x) - w(x, t) < 0, \\ \forall x \in [\beta, 1], \quad \forall t \in [t_0, T], \quad \psi(x) - w(x, t) < 0. \end{aligned}$$

The function $\bar{\psi}(x, t)$ can then be defined by:

$$\begin{aligned} \bar{\psi}(\lambda\alpha, t) &= [\lambda^3 - 3\lambda^2 + 3\lambda] [\psi(\alpha) - w(\alpha, t)] \\ &\quad - [\lambda^3 - 3\lambda^2 + 2\lambda] \left[\psi'(\alpha) - \frac{\partial w}{\partial x}(\alpha, t) \right] \alpha \\ &\quad + [\lambda^3 - 2\lambda^2 + \lambda] \left[\psi''(\alpha) - \frac{\partial^2 w}{\partial x^2}(\alpha, t) \right] \frac{\alpha^2}{2}, \\ \bar{\psi}(\lambda\alpha + (1-\lambda)\beta, t) &= \psi(\lambda\alpha + (1-\lambda)\beta) - w(\lambda\alpha + (1-\lambda)\beta, t), \\ \bar{\psi}(\lambda\beta + (1-\lambda), t) &= [\lambda^3 - 3\lambda^2 + 3\lambda] [\psi(\beta) - w(\beta, t)] \\ &\quad - [\lambda^3 - 3\lambda^2 + 2\lambda] \left[\psi'(\beta) - \frac{\partial w}{\partial x}(\beta, t) \right] (1-\beta) \\ &\quad + [\lambda^3 - 2\lambda^2 + \lambda] \left[\psi''(\beta) - \frac{\partial^2 w}{\partial x^2}(\beta, t) \right] \frac{(1-\beta)^2}{2}, \end{aligned}$$

for every $\lambda \in [0, 1]$. It can be readily checked that $\bar{\psi}(t) \in H_0^1 \cap H^3$ and that:

$$\|\bar{\psi}(t)\|_{H^3} \leq C \|\psi - w(t)\|_{H^3}, \quad (11)$$

for a real constant C which depends only on α and β (and is therefore independent of t and $w(t)$). Moreover, \bar{v}'' is convex and vanishes at extremities $x = 0, 1$. It is therefore non-positive, and $\bar{v}(t)$ is a concave function of x . Hence, it is non-negative. Since the function $\bar{\psi}(\cdot, t)$ differs from $\psi(\cdot) - w(\cdot, t)$ only at those values of x where the latter is negative, this entails that \bar{v} , which solves the obstacle problem associated with $\psi - w$, also solves the obstacle problem associated with $\bar{\psi}$.

Step 2. H^3 regularity of the solution at every instant.

In step 2, an arbitrary t in $[t_0, T]$ is fixed once for all.

Define $\bar{g} = \bar{\psi}'''' \in H^{-1}$ to be able to proceed with changing the unknown function:

$$\bar{v} = \bar{v} - \bar{\psi},$$

so that, setting:

$$\bar{K} = \left\{ \hat{v} \in H_0^1 \cap H^2 \mid \forall x \in]0, 1[, \quad \hat{v}(x) \geq 0 \right\},$$

one obtains $\bar{v} \in \bar{K}$ and:

$$\forall \hat{v} \in \bar{K}, \quad \int_0^1 \bar{v}'' (\hat{v}'' - \bar{v}'') \geq \langle \bar{g}, \hat{v} - \bar{v} \rangle_{H^{-1}, H_0^1}.$$

As in [8], p.270, for every $\varepsilon > 0$, the penalized function p_ε is defined as the unique solution in $H^2(0, 1; \mathbb{R})$ of the linear boundary problem:

$$\begin{cases} p_\varepsilon - \varepsilon p_\varepsilon'' = \bar{v}, & \text{in }]0, 1[, \\ p_\varepsilon(0) = p_\varepsilon(1) = 0. \end{cases}$$

It can be readily seen that:

- $p_\varepsilon \in H^4(0, 1; \mathbb{R})$,
- $p_\varepsilon''(0) = p_\varepsilon''(1) = 0$.

Moreover, if $p_\varepsilon(x_0) = \min_{[0,1]} p_\varepsilon$ for some $x_0 \in]0, 1[$, then $p_\varepsilon''(x_0) \geq 0$, and therefore $p_\varepsilon(x_0) \geq \bar{v}(x_0) \geq 0$. This entails:

$$\forall \varepsilon > 0, \quad p_\varepsilon \in \bar{K}.$$

But, for all $\hat{v} \in \bar{K}$:

$$\int_0^1 \hat{v}''(\hat{v}'' - \bar{v}'') \geq \int_0^1 \bar{v}''(\hat{v}'' - \bar{v}'') \geq \langle \bar{g}, \hat{v} - \bar{v} \rangle_{H^{-1}, H_0^1}.$$

Applying this inequality to the case $\hat{v} = p_\varepsilon$, one gets:

$$\int_0^1 p_\varepsilon'''' p_\varepsilon'' \geq \langle \bar{g}, p_\varepsilon'' \rangle_{H^{-1}, H_0^1}.$$

But $\bar{g} = -G'$ for some $G \in L^2$ and one obtains:

$$\int_0^1 p_\varepsilon'''' p_\varepsilon'' \geq \int_0^1 G p_\varepsilon''',$$

that is:

$$\int_0^1 (p_\varepsilon''')^2 \leq - \int_0^1 G p_\varepsilon''',$$

and as a result:

$$\|p_\varepsilon'''\|_{L^2} \leq \|G\|_{L^2} = \|\bar{g}\|_{H^{-1}}.$$

By Poincaré inequality:

$$\|p_\varepsilon''\|_{L^2} \leq C \|p_\varepsilon'''\|_{L^2},$$

for a constant C independent of ε . Recalling $p_\varepsilon \in H_0^1 \cap H^2$ and inequality (10), one gets:

$$\forall \varepsilon > 0, \quad \|p_\varepsilon\|_{H^3} \leq C \|\bar{g}\|_{H^{-1}}, \quad (12)$$

for a constant C independent of ε , as well as of \bar{g} . This inequality gives $\|p_\varepsilon''\|_{L^2} \leq C \|\bar{g}\|_{H^{-1}}$, first, and $\|p_\varepsilon - \bar{v}\|_{L^2} \leq C\varepsilon \|\bar{g}\|_{H^{-1}}$, then, which shows that p_ε tends towards \bar{v} strongly in L^2 , as ε tends to $0+$. Also, by virtue of (12), there exists a subsequence converging weakly in H^3 . Since weak

convergence in H^3 is in particular strong convergence in L^2 , the limit must be \bar{v} , which therefore belongs to H^3 .

Step 3. *Regularity of the dependance of the solution on time.*

Since a function with values in a complete metric space is regulated if and only if it admits a left limit and a right limit at every point, it suffices to prove the following stability result:

$$\lim_{n \rightarrow +\infty} \|w - w_n\|_{H^3} = 0 \quad \implies \quad \lim_{n \rightarrow +\infty} \|\bar{v} - \bar{v}_n\|_{H^3} = 0,$$

where \bar{v} (respectively \bar{v}_n) is the solution of inequality (9) involving the data w (respectively w_n).

The proof of this stability result is largely inspired by Adams' technique [1].

Denote $s_n = \bar{v}_n''''$ (respectively $s = \bar{v}''''$). These distributions are non-negative (that is, they take non-negative values at every C^∞ test-function with compact support), and they are therefore some measures. A double integration by parts yields:

$$\int_0^1 (\bar{v}'' - \bar{v}_n'')^2 = \int_0^1 (\bar{v} - \bar{v}_n) d(s - s_n) \leq \int_0^1 (w_n - w) d(s - s_n),$$

since $\bar{v}_n = \psi - w_n$ on $\text{supp } s_n$ ($\bar{v} = \psi - w$ on $\text{supp } s$) and $\bar{v}_n \geq \psi - w_n$ on $[0, 1]$ ($\bar{v} \geq \psi - w$ on $[0, 1]$). This entails:

$$\lim_{n \rightarrow +\infty} \|\bar{v} - \bar{v}_n\|_{H^2} = 0, \quad (13)$$

provided the total mass of the nonnegative measure $s_n = \bar{v}_n''''$ is bounded independently of n . To prove this, take $[\alpha, \beta] \subset]0, 1[$ such that $\psi - w_n < 0$ on $]0, 1[\setminus [\alpha, \beta]$. Since $\bar{v}_n \geq 0$, $\text{supp } s_n \subset [\alpha, \beta]$. Moreover, for every compact set $K \in]0, 1[$, one can find a non-negative function $\xi \in C_0^\infty(]0, 1[)$, which equals 1 identically on K . This entails:

$$s_n(K) \leq \int \xi ds_n \leq \|\xi''\|_{L^2} \|\bar{v}_n''\|_{L^2}.$$

Since:

$$\int_0^1 (\bar{v}_n'')^2 = \int_{[0,1]} (\psi - w_n) ds_n \leq \|\langle \psi - w_n \rangle^+\|_{L^\infty} s_n(\text{supp } \langle \psi - w_n \rangle^+),$$

where $\langle x \rangle^+ = \max\{x, 0\}$, the choice $K = \text{supp } \langle \psi - w_n \rangle^+$ gives:

$$\int_0^1 (\bar{v}_n'')^2 \leq \|\langle \psi - w_n \rangle^+\|_{L^\infty} \|\xi_1''\|_{L^2} \|\bar{v}_n''\|_{L^2},$$

that is:

$$\|\bar{v}_n''\|_{L^2} \leq \|\langle \psi - w_n \rangle^+\|_{L^\infty} \|\xi_1''\|_{L^2}.$$

It then suffices to set $K = [\alpha, \beta]$ to obtain the desired estimate of the total mass of the non-negative measure s_n :

$$s_n(]0, 1[) = s_n([\alpha, \beta]) \leq \|\xi_1''\|_{L^2} \|\xi_2''\|_{L^2} \left\| \langle \psi - w_n \rangle^+ \right\|_{L^\infty}. \quad (14)$$

Next, from inequalities (11) and (12):

$$\|\bar{v}_n\|_{H^3} \leq C,$$

for some real constant C independent of n . Consequently, there exists a subsequence of (\bar{v}_n) converging weakly in H^3 . But in view of (13), this weak limit must be \bar{v} . Recalling that the weak topology of a closed ball in a separable Hilbert space is metrizable, and that a sequence with values in a compact metric space having a unique cluster value must converge towards it, it can be deduced that the whole sequence \bar{v}_n converges weakly towards \bar{v} in H^3 . It is now proposed to prove that this convergence is actually strong. One has:

$$\int_0^1 (\bar{v}_n''' - \bar{v}''')^2 = - \int_0^1 (\bar{v}_n'' - \bar{v}'') (ds_n - ds).$$

But, since $\bar{v}_n''(0) = \bar{v}''(0) = 0$ and the sequence \bar{v}_n converges weakly towards \bar{v} in H^3 , the sequence $\bar{v}_n'' - \bar{v}''$ must converge pointwise towards 0 and be bounded by a constant C which is independent of x and n . By Egoroff's theorem, there exists a measurable subset M of $[0, 1]$ such that the sequence $\bar{v}_n'' - \bar{v}''$ converges towards 0 uniformly on $[0, 1] \setminus M$, where $s(M)$ is as small as desired. Thus:

$$\int_{[0,1] \setminus M} |\bar{v}_n'' - \bar{v}''| (ds_n + ds) \leq \varepsilon [s([0, 1]) + s_n([0, 1])],$$

which is controlled by estimate (14). Moreover:

$$\int_M |\bar{v}_n'' - \bar{v}''| (ds_n + ds) \leq [\|\bar{v}_n''\|_{L^\infty} + \|\bar{v}''\|_{L^\infty}] [s(M) + s_n(M)].$$

Since $\|\bar{v}_n''\|_{L^\infty}$ is bounded, the desired conclusion will be reached as soon as:

$$\lim_{n \rightarrow +\infty} s_n(M) = s(M),$$

has been proved. But, it suffices to establish that for all functions $\xi \in C_0^\infty(]0, 1[)$, one has:

$$\lim_{n \rightarrow +\infty} \int_{]0,1[} \xi ds_n = \int_{]0,1[} \xi ds.$$

And, since:

$$\int_{]0,1[} \xi ds_n = - \int_0^1 \xi' \bar{v}_n''',$$

this is a consequence of the weak convergence in H^3 of \bar{v}_n towards \bar{v} .

6. Existence of weak solutions and related open problems

The following example is presented to show that with the regularity that was proved above of the friction threshold s (theorem 1 and 3), there may exist no weak solution to the frictional quasi-static problem. Incidentally, this example shows that a sweeping process associated with an arbitrary Wijsman-regulated set-valued mapping needs not have any weak solution.

Example. Let us consider the initial condition defined by $u_0(x) = 1 - 2|x - 1/2|$ with $x \in]0, 1[$. The displacements prescribed at the extremities, as well as the body forces are assumed to vanish identically $u_0^p \equiv u_1^p \equiv 0$, $f \equiv 0$. Assuming that the friction coefficient is larger than 2 in order to prevent any slipping, the measure $s(t)$ will be assumed to be a “moving Dirac measure” $\delta_{p(t)}$ at position $x = p(t)$. The position $p(t)$ will be an oscillating function around $x = 1/2$, which is continuous but shows unbounded variation. To define the function $p(t)$, take a sequence α_n in $]0, 1/4[$ converging towards 0, such that $\sum_{n=0}^{\infty} \alpha_n = \infty$. Then set:

$$p(0) = 1/2,$$

$$p(t) = \begin{cases} 1/2 + (-1)^n 2^{2n+2} \alpha_n |t - 1/2^{2n+2}| & \text{if } t \in [1/2^{2n+2}, 1/2^{2n+1}], \\ 1/2 + (-1)^n 2^{2n+1} \alpha_n |t - 1/2^{2n}| & \text{if } t \in [1/2^{2n+1}, 1/2^{2n}]. \end{cases}$$

It can be readily checked that the support of the measure $\delta_{p(t)}$ is contained in $[1/4, 3/4]$, its total mass equals 1, and $\delta_{p(t)} \in C^0([0, 1]; H^{-1})$. From proposition 1, it follows that the set-valued mapping $\mathcal{C}(t)$ associated with the underlying sweeping process is Wijsman-regulated.

Next, set:

$$s_n(t) = \begin{cases} \delta_{1/2} & \text{if } t \in [0, 1/2^{2n}], \\ s(t) & \text{if } t \in [1/2^{2n}, 1], \end{cases}$$

so that the sweeping process based on the associated $\mathcal{C}_n(t)$ admits a weak solution $u_n(t)$, which can be explicitly computed. It can easily be checked that, for all $m \leq n$:

$$\forall t \geq \frac{1}{2^{2m}}, \quad \forall x \in [0, 1], \quad 0 \leq u_n(x, t) \leq \frac{3}{2} \prod_{k=m}^n \left(\frac{1 - 2\alpha_k}{1 + 2\alpha_k} \right)^2.$$

This estimate entails:

$$\lim_{n \rightarrow \infty} u_n(t) = 0,$$

at all $t \in]0, 1]$. If we go back to the sweeping process based on $\mathcal{C}(t)$, and taking $u_P(t)$ to denote the piecewise constant function associated with a given subdivision P by use of the catching-up algorithm, it can be readily checked that the net $u_P(t)$ converges *pointwise* towards the function:

$$u(t) = \begin{cases} u_0 & \text{if } t = 0, \\ 0 & \text{if } t \in]0, 1]. \end{cases}$$

The convergence cannot be uniform on $[0, 1]$, because otherwise, the limit would be right-continuous at 0, in view of proposition 11. The sweeping process based on $\mathcal{C}(t)$, which was found above to be Wijsman-regulated, therefore does not have any weak solution in the sense of definition 9.

It might seem that pointwise convergence of the net $u_P(t)$ could be allowed by weakening the definition of a weak solution. However, one can model a rigid motion of a segment $\mathcal{C}(t)$ in \mathbb{R}^2 such that $\mathcal{C}(t)$ is Wijsman-regulated and the corresponding net $u_P(t)$ does not converge even pointwise. Our definition 9 of weak solutions of sweeping processes by Wijsman-regulated set-valued mapping therefore seems to be appropriate. However, since a weak solution does not necessarily exist, some problems still remain to be solved.

Open problem 1. Find regularity assumptions about $s(t)$ compatible with a “moving Dirac measure”, where the existence of a weak solution to the underlying sweeping process could be proved. Of course, the regularity assumptions will have to be weak enough to be ensured by requiring that the data involved in the “normal problem” show some regularity.

Open problem 2. In cases where regularizing $s(t)$ by performing spatial convolution with a mollifier gives a set-valued mapping $\mathcal{C}(t)$ with bounded retraction, is it true that the corresponding solutions of the associated sweeping processes converge uniformly with t towards a limit ? If so and a weak solution of the sweeping process based on $\mathcal{C}(t)$ does exist, are both limits necessarily equal ?

Open problem 3. In cases where the sweeping process based on $\mathcal{C}(t)$ admits a weak solution $u(t)$, is it true that \dot{u} is a function of bounded variation of x at every t ?

Appendix A: set-valued mappings that are of bounded retraction or Wijsman-regulated

Let E be an arbitrary metric space whose distance function is denoted by d .

Definition 1. The *excess* of a subset A of E over a subset B is defined as:

$$e(A, B) = \sup_{a \in A} \inf_{b \in B} d(a, b),$$

where the supremum should be understood with respect to the order on $[0, +\infty]$, so that:

$$\begin{aligned} \forall B \in \mathcal{P}(E), \quad e(\emptyset, B) &= 0, \\ \forall A \in \mathcal{P}(E) \setminus \{\emptyset\}, \quad e(A, \emptyset) &= +\infty. \end{aligned}$$

The Hausdorff “distance” between the two subsets A and B of E is defined by:

$$h(A, B) = \max\{e(A, B), e(B, A)\} \in [0, +\infty].$$

A key fact, which is recalled in the following proposition, is that the excess gives rise to a triangular inequality.

Proposition 2. For all $A, B, C \subset E$, we have:

- (i) $e(A, B) = 0 \iff A \subset \overline{B}$,
- (ii) $h(A, B) = 0 \iff \overline{A} = \overline{B}$,
- (iii) $e(A, C) \leq e(A, B) + e(B, C)$,
- (iv) $h(A, C) \leq h(A, B) + h(B, C)$.

The class of all non-empty closed bounded subsets of E equipped with the Hausdorff distance is a metric space. Hence, the Hausdorff distance defines a notion of limit for sequences $C_n : \mathbb{N} \rightarrow \mathcal{P}(E)$ of subsets of E .

Definition 2. A sequence $C_n : \mathbb{N} \rightarrow \mathcal{P}(E)$ of subsets of E will be said to *converge in the sense of Hausdorff* towards a closed subset $L \subset E$ if:

$$\lim_{n \rightarrow \infty} h(C_n, L) = 0.$$

In practice, convergence in the sense of Hausdorff is often too strong as seen in the following example.

Example. In Euclidean \mathbb{R}^2 , let us consider the sequence $C_n : \mathbb{N} \rightarrow \mathcal{P}(\mathbb{R}^2)$ defined by:

$$C_n = \left\{ (x, y) \in \mathbb{R}^2 \mid y \geq \frac{x^2}{n+1} \right\},$$

and take Π^+ to denote the closed half-space $y \geq 0$. As:

$$\forall n \in \mathbb{N}, \quad h(C_n, \Pi^+) = +\infty,$$

the sequence C_n does not converge in the sense of Hausdorff towards Π^+ .

Definition 3. Let $C_n : \mathbb{N} \rightarrow \mathcal{P}(E)$ be a sequence of subsets of E . The two closed sets (possibly empty) defined by:

$$\begin{aligned}\liminf_{n \rightarrow \infty} C_n &= \left\{ x \in E \mid \limsup_{n \rightarrow \infty} d(x, C_n) = 0 \right\}, \\ \limsup_{n \rightarrow \infty} C_n &= \left\{ x \in E \mid \liminf_{n \rightarrow \infty} d(x, C_n) = 0 \right\},\end{aligned}$$

always satisfy:

$$\liminf_{n \rightarrow \infty} C_n \subset \limsup_{n \rightarrow \infty} C_n.$$

When these two sets equal a set L (necessarily closed), it will be said that the sequence C_n *converges in the sense of Kuratowski* towards L , which will be written:

$$\lim_{n \rightarrow \infty} C_n = L.$$

Definition 4. A sequence $C_n : \mathbb{N} \rightarrow \mathcal{P}(E)$ of subsets of E will be said to *converge in the sense of Wijsman* towards a closed set $L \subset E$ if:

$$\forall x \in E, \quad \lim_{n \rightarrow \infty} d(x, C_n) = d(x, L).$$

The interest of convergence in the sense of Wijsman is that it is induced by a natural topology in the class of all nonempty closed subsets of E : the weak topology generated by the family of functions $d(x, \cdot)$, when x covers E , which is called *Wijsman's topology*.

Theorem 4 (Beer, [4]). *Let (E, d) be a complete separable metric space, then the class of nonempty closed subsets of E equipped with Wijsman's topology is separable, and there is a complete metric compatible with the topology.*

A link between convergence in the sense of Hausdorff and convergence in the sense of Kuratowski is provided by the following proposition (a proof of which can be found in [9]).

Proposition 3. *Let $C_n : \mathbb{N} \rightarrow \mathcal{P}(E)$ be a sequence of subsets of E , and L a closed set. If C_n converges towards L in the sense of Hausdorff, then C_n converges towards L in the sense of Kuratowski:*

$$\lim_{n \rightarrow \infty} h(C_n, L) = 0 \quad \implies \quad \lim_{n \rightarrow \infty} C_n = L.$$

If all the C_n are contained in a fixed compact set $K \subset E$ ($\forall n \in \mathbb{N}, C_n \subset K$), then the converse is true.

A link between convergence in the sense of Kuratowski and convergence in the sense of Wijsman is provided by the following proposition.

Proposition 4. *Let $C_n : \mathbb{N} \rightarrow \mathcal{P}(E)$ be a sequence of subsets of E , and L a closed set. If C_n converges towards L in the sense of Wijsman, then C_n will converge towards L in the sense of Kuratowski.*

Proof. This is a straightforward consequence of the following two simple statements:

$$\forall x \in E, \quad d(x, L) \geq \limsup_{n \rightarrow \infty} d(x, C_n) \quad \Longrightarrow \quad L \subset \liminf_{n \rightarrow \infty} C_n,$$

$$\forall x \in E, \quad d(x, L) \leq \liminf_{n \rightarrow \infty} d(x, C_n) \quad \Longrightarrow \quad L \supset \limsup_{n \rightarrow \infty} C_n.$$

Definition 5 (Moreau, [9]). A set-valued mapping $C : [t_0, T] \rightarrow \mathcal{P}(E)$ will be said to have *bounded retraction* if:

$$\text{ret}(C; t_0, T) \stackrel{\text{def}}{=} \sup \sum_{i=1}^n e(C(t_{i-1}), C(t_i)) < \infty,$$

where the supremum is taken over all the finite sequences $t_0 \leq t_1 \leq t_2 \leq \dots \leq t_n = T$. The function $t \mapsto \text{ret}(C; t_0, t)$ thus defined is non-decreasing.

Theorem 5 (Moreau, [9]). Let $C : [t_0, T] \rightarrow \mathcal{P}(E)$ be a set-valued mapping with bounded retraction. Then, $C(t)$ admits a left limit $C(t-)$ in the sense of Kuratowski at every $t \in]t_0, T]$, and a right limit $C(t+)$, at every $t \in [t_0, T[$.

Definition 6. A set-valued mapping $C : [t_0, T] \rightarrow \mathcal{P}(E)$ will be said to have *absolutely continuous retraction* if, for all $\varepsilon > 0$, some $\eta > 0$ can be found such that for all finite collection $]\sigma_i, \tau_i[\subset [t_0, T]$ of non-overlapping open intervals, the following statement:

$$\sum_i (\tau_i - \sigma_i) < \eta \quad \Longrightarrow \quad \sum_i e(C(\sigma_i), C(\tau_i)) < \varepsilon,$$

holds true, and to show *Lipschitz-continuous retraction* if there exists $L \geq 0$ such that:

$$\forall s \leq t \in [t_0, T], \quad e(C(s), C(t)) \leq L(t - s).$$

The following proposition accounts for the terminology used here.

Proposition 5 (Moreau, [9]). Let $C : [t_0, T] \rightarrow \mathcal{P}(E)$ be a set-valued mapping. The following two claims are then equivalent.

- (i) C has absolutely continuous (respectively Lipschitz-continuous) retraction.
- (ii) C has bounded retraction and the non-decreasing real-valued function $\tau \mapsto \text{ret}(C; t_0, \tau)$ is absolutely continuous (resp. Lipschitz-continuous).

On similar lines, we have the following proposition.

Proposition 6 (Moreau, [9]). Let $C : [t_0, T] \rightarrow \mathcal{P}(E)$ be a set-valued mapping with bounded retraction. The following three claims are then equivalent.

- (i) C has right-continuous retraction at $t \in [t_0, T[$ (i.e., the real-valued function $\tau \mapsto \text{ret}(C; t_0, \tau)$ is right-continuous at t).

- (ii) $\lim_{\tau \rightarrow t+} e(C(t), C(\tau)) = 0$.
 (iii) $C(t) \subset C(t+)$.

Classically, a function $f : [t_0, T] \rightarrow E$ is said to be *regulated* if there is a sequence of step functions converging towards f *uniformly* with regard to $t \in [t_0, T]$. In the specific case where the metric space is *complete*, a function $f : [t_0, T] \rightarrow E$ is regulated if and only if it admits a left limit $f(t-)$ at every $t \in]t_0, T[$ and a right limit $f(t+)$ at every $t \in [t_0, T[$.

Definition 7. A set-valued mapping $C : [t_0, T] \rightarrow \mathcal{P}(E)$ with non-empty closed values, will be said to be *Wijsman-regulated*, if it is regulated as a mapping with values in the class of nonempty closed subsets of E equipped with Wijsman's topology.

In what follows, only the specific case where the metric space (E, d) is a separable Hilbert space H will be considered. The scalar product will be denoted by $(\cdot | \cdot)$, the norm by $\|\cdot\|$ and the closed ball with center c and radius r by $B(c, r)$. The notation $\mathcal{C}(H)$ will stand for the class consisting of the non-empty closed convex subsets of H .

Theorem 6. Let $C_n : \mathbb{N} \rightarrow \mathcal{C}(H)$ be a sequence of nonempty closed convex subsets of H . If this sequence has a non-empty limit L in the sense of Kuratowski, then L is convex, and the following statement holds true:

$$\forall x \in H, \quad \lim_{n \rightarrow \infty} \text{proj}[x, C_n] = \text{proj}[x, L].$$

Proof. Fix $x \in H$ arbitrary and set:

$$\begin{aligned} x_n &= \text{proj}[x, C_n], \\ l &= \text{proj}[x, L]. \end{aligned}$$

It has to be proved that the sequence (x_n) converges strongly towards l . Let $c \in L$ be arbitrary. The definition of $\lim_{n \rightarrow \infty} C_n$ (convergence in the sense of Kuratowski) gives:

$$\forall m \in \mathbb{N}, \quad \exists N_{c,m} \in \mathbb{N}, \quad \forall n \geq N_{c,m}, \quad d(c, C_n) < \frac{1}{m+1}. \quad (15)$$

Setting $c = l$, $m = 0$, and removing finitely many terms of the sequence if necessary, we obtain:

$$d(l, C_n) < 1.$$

Hence, the sequence (x_n) takes values in the closed ball having center x and radius $1 + 2\|l - x\|$. Therefore, a subsequence, still denoted by (x_n) , converges weakly towards $\tilde{l} \in B(x, 1 + 2\|l - x\|)$.

Next, fix $c \in L$ et $m \in \mathbb{N}$ arbitrarily. From statement (15), we can find $N \in \mathbb{N}$ such that:

$$\forall n \geq N, \quad \exists b_n \in B(0, 1), \quad c + \frac{b_n}{m+1} \in C_n.$$

With $n \geq N$, we obtain:

$$\left(x - x_n \mid c + \frac{b_n}{m+1} - x_n\right) \leq 0,$$

and, therefore:

$$(x - x_n \mid c - x_n) \leq \frac{1 + 2\|l - x\|}{m+1}.$$

Taking the infimum limit $n \rightarrow \infty$ in this inequality, one obtains:

$$(x - \tilde{l} \mid c) - (x \mid \tilde{l}) + \liminf_{n \rightarrow \infty} \|x_n\|^2 \leq \frac{1 + 2\|l - x\|}{m+1},$$

and therefore:

$$\forall m \in \mathbb{N}, \quad \forall c \in L, \quad (x - \tilde{l} \mid c - \tilde{l})_H \leq \frac{1 + \|l - x\|}{m+1},$$

which gives:

$$\tilde{l} = l,$$

because of the uniqueness of the projection of a point onto a closed convex subset of a Hilbert space. Reminding that the weak topology in a closed ball of a separable Hilbert space is metrizable, and that a sequence in a compact metric space that has a unique cluster value converges towards it, it has been actually proved that the whole sequence converges weakly towards l (with no need to extract any subsequences).

Finally, since $\|x - x_n\| = d(x, C_n)$, setting $c = l$ in statement (15) gives:

$$\forall m \in \mathbb{N}, \quad \exists N_m \in \mathbb{N}, \quad \forall n \geq N_m, \quad \|x - x_n\| \leq \|x - l\| + \frac{1}{m+1},$$

and therefore:

$$\limsup_{n \rightarrow \infty} \|x - x_n\| \leq \|x - l\|,$$

which suffices to ensure that the weak convergence of the sequence (x_n) is actually a strong convergence.

Corollary 1. *Let $C_n : \mathbb{N} \rightarrow \mathcal{C}(H)$ be a sequence of non-empty closed convex subsets of H , and $L \in \mathcal{C}(H)$. The following three statements are then equivalent.*

- (i) $\lim_{n \rightarrow \infty} C_n = L$,
- (ii) $\forall x \in H, \quad \lim_{n \rightarrow \infty} d(x, C_n) = d(x, L)$,
- (iii) $\forall x \in H, \quad \lim_{n \rightarrow \infty} \text{proj}[x, C_n] = \text{proj}[x, L]$.

Proof. The identity:

$$d(x, C_n) = d\left(x, \text{proj}[x, C_n]\right),$$

gives (iii) \Rightarrow (ii), proposition 4, (ii) \Rightarrow (i), and finally, theorem 6 is exactly (i) \Rightarrow (iii).

In particular, with sequences of non-empty closed convex subsets in a separable Hilbert space, convergence in the sense of Kuratowski and in the sense of Wijsman is the same. In the specific case of finite-dimensional Hilbert spaces, this fact was first proved by Wijsman in 1966 (see [12]) for sequences of non-empty closed subsets which are not necessarily convex. Corollary 1 is simply a particular case of more general extensions of Wijsman's theorem to infinite dimensions which were reviewed in [5] in 1994. The aim of the following example is to show that in an infinite-dimensional Hilbert space, the additional assumption of convexity cannot be relaxed.

Example. Take e_n to denote the vectors of the canonical basis of l^2 . For all $n \in \mathbb{N}$, set:

$$C_n = \{2e_0, e_n\}, \quad L = \{2e_0\}.$$

It can be readily checked that:

$$\lim_{n \rightarrow \infty} C_n = L,$$

but:

$$d(0, C_n) = 1, \quad d(0, L) = 2.$$

Proposition 7. Let $C : [t_0, T] \rightarrow \mathcal{C}(H)$ be an arbitrary set-valued mapping with non-empty closed convex values. The following three statements are then equivalent.

- (i) C is Wijsman-regulated.
- (ii) C admits a non-empty left limit in the sense of Kuratowski (notation $C(t-)$) at every $t \in]t_0, T]$ and a non-empty right limit (notation $C(t+)$) at every $t \in [t_0, T[$.
- (iii) For all $x \in H$, the mapping:

$$\begin{cases} [t_0, T] \rightarrow H \\ t \mapsto \text{proj}[x, C(t)] \end{cases}$$

is regulated.

Proof. This is straightforward consequence of theorem 4 and corollary 1.

We are now able to list some classes of Wijsman-regulated set-valued mappings.

Proposition 8. Let $C : [t_0, T] \rightarrow \mathcal{C}(H)$ a set-valued mapping with bounded retraction the values $C(t)$ of which are non-empty closed convex, at all $t \in [t_0, T]$. Then C is Wijsman-regulated.

Proof. This is straightforward consequence of theorem 5 and proposition 7.

Hence, in the case of set-valued mappings with non-empty closed convex values in a Hilbert space, the class consisting of the Wijsman-regulated set-valued mappings contains that consisting of the set-valued mappings with bounded retraction. Another important class of Wijsman-regulated set-valued mappings is that of those set-valued mappings that are regulated in the sense of Hausdorff distance.

Theorem 7. *A set-valued mapping $C : [t_0, T] \rightarrow \mathcal{C}(H)$ is said to be regulated in the sense of the Hausdorff distance if there exists a sequence $C_n : [t_0, T] \rightarrow \mathcal{P}(H)$ of piecewise constant set-valued mappings such that the sequence of real-valued functions $t \mapsto h(C_n(t), C(t))$ converges uniformly towards 0.*

Any set-valued mapping $C : [t_0, T] \rightarrow \mathcal{C}(H)$ which is regulated in the sense of the Hausdorff distance is Wijsman-regulated. Moreover, in those cases where the values of C are contained in a fixed compact subset $K \subset H$ ($\forall t \in [t_0, T], C(t) \subset K$), then the converse is true.

Proof.

Necessary condition.

Let us consider a set-valued mapping $C : [t_0, T] \rightarrow \mathcal{C}(H)$ which is regulated in the sense of the Hausdorff distance. Based on proposition 7, the conclusion targeted will be reached if at an arbitrary $t \in [t_0, T[$, it can be proved that $\liminf_{\tau \rightarrow t+} C(\tau) \neq \emptyset$ and $\liminf_{\tau \rightarrow t+} C(\tau) = \limsup_{\tau \rightarrow t+} C(\tau)$.

- First let us prove that the infimum limit is non-empty. There exists a piecewise constant set-valued mapping C_{n_0} such that:

$$\forall t \in [t_0, T], \quad h(C_{n_0}(t), C(t)) \leq \frac{1}{2},$$

and a finite collection $\{a_k\}$ of elements of H such that all the $C_{n_0}(t)$ contain at least one of the a_k . Let B be a closed ball with center a_0 and a radius larger than 2 plus the maximum of the distance from a_0 to one of the a_k . Then, for all $n \in \mathbb{N}$, there exists a piecewise constant set-valued mapping $C_n : [t_0, T] \rightarrow \mathcal{P}(H)$ such that:

$$\forall t \in [t_0, T], \quad h(C_n(t), C(t)) \leq \frac{1}{n+1}, \quad \text{and} \quad B \cap C_n(t) \neq \emptyset.$$

This entails:

$$\forall n \in \mathbb{N}, \quad \exists x_n \in B, \quad \exists \eta_n > 0,$$

$$\forall \tau \in]t, t + \eta_n[, \quad d(x_n, C(\tau)) < \frac{1}{n+1}.$$

One can then extract a subsequence, which is still written (x_n) , that converges weakly towards $l \in B$. It is now proposed to prove that:

$$l \in \liminf_{\tau \rightarrow t+} C(\tau),$$

that is:

$$\lim_{\tau \rightarrow t^+} d(l, C(\tau)) = 0.$$

Fix $m \in \mathbb{N}$. Based on Mazur's theorem, there exists a convex combination c_m of the x_n such that $d(l, c_m) < 1/(m+1)$. Since all the x_n in that convex combination can be chosen with arbitrarily large ranks, one can assume:

$$\exists \eta > 0, \quad \forall \tau \in]t, t + \eta[, \quad d(x_n, C(\tau)) < \frac{1}{m+1},$$

for all the x_n in that convex combination. In addition, the convexity of $C(\tau) + B(0, 1/(m+1))$ entails:

$$\forall \tau \in]t, t + \eta[, \quad d(c_m, C(\tau)) < \frac{1}{m+1},$$

and the conclusion targeted is reached, since: $d(l, C(\tau)) \leq d(l, c_m) + d(c_m, C(\tau))$.

- It still remains to be proved that the infimum limit equals the supremum limit. Let $h \in \limsup_{\tau \rightarrow t^+} C(\tau)$, and $\varepsilon > 0$. Since $C(t)$ is regulated in the sense of Hausdorff distance, one can find a set $C_m \subset H$ and a real number $\eta > 0$ such that:

$$\forall \tau \in]t, t + \eta[, \quad h(C_m, C(\tau)) < \frac{\varepsilon}{3}.$$

Since $h \in \limsup_{\tau \rightarrow t^+} C(\tau)$,

$$\exists \tau' \in]t, t + \eta[, \quad d(h, C(\tau')) < \frac{\varepsilon}{3}.$$

Therefore, for all $\tau \in]t, t + \eta[$,

$$d(h, C(\tau)) \leq d(h, C(\tau')) + h(C(\tau'), C_m) + h(C_m, C(\tau)) < \varepsilon,$$

which proves that $h \in \liminf_{\tau \rightarrow t^+} C(\tau)$.

Sufficient condition.

Let $C(t)$ be a Wijsman-regulated set-valued mapping with values contained in a fixed compact set. By using of both propositions 7 and 3, this set-valued mapping admits left and right limits in the sense of Hausdorff at every t . Therefore, choosing $n \in \mathbb{N}$ and $t \in [t_0, T]$ arbitrarily, one obtains:

$$\begin{aligned} \exists \eta_t > 0, \quad & \forall \tau \in]t - \eta_t, t[, \quad h(C(\tau), C(t-)) < 1/(n+1), \\ & \forall \tau \in]t, t + \eta_t[, \quad h(C(\tau), C(t+)) < 1/(n+1). \end{aligned}$$

From the open sets $]t - \eta_t, t + \eta_t[$ defining a covering of the compact $[t_0, T]$, a finite subcovering defined by $t_0 < t_1 < t_2 < \dots < t_n = T$ can be extracted. Let us define a piecewise constant set-valued mapping C_n by:

$$\forall i, \quad C_n(t_i) = C(t_i), \quad \text{et} \quad \forall i, \quad \forall \tau \in]t_{i-1}, t_i[, \quad C_n(\tau) = C\left(\frac{t_{i-1} + t_i}{2}\right).$$

From this definition, for all $\tau \in]t_{i-1}, t_i[$, one obtains:

$$\begin{aligned} h(C_n(\tau), C(\tau)) & \\ & \leq h(C(\tau), C(t_i-)) + h(C(t_i-), C_n(t_i-)) + h(C_n(t_i-), C_n(\tau)), \\ & < \frac{1}{n+1} + \frac{1}{n+1} + 0 = \frac{2}{n+1}, \end{aligned}$$

which shows that $C(t)$ is regulated in the sense of the Hausdorff distance.

Corollary 2. *Every set-valued mapping $C : [t_0, T] \rightarrow \mathcal{C}(H)$ which is continuous in the sense of the Hausdorff distance:*

$$\forall \varepsilon > 0, \quad \exists \eta > 0, \quad \forall \tau \in]t - \eta, t + \eta[, \quad h(C(\tau), C(t)) < \varepsilon,$$

is Wijsman-regulated.

Another class of Wijsman-regulated set-valued mappings is provided by the class of *non-increasing* set-valued mappings with non-empty closed convex values.

Proposition 9. *Let $C : [t_0, T] \rightarrow \mathcal{C}(H)$ be a set-valued mapping with non-empty closed convex values, which is assumed to be non-increasing in the sense:*

$$\forall t_1, t_2 \in [t_0, T], \quad t_1 \leq t_2 \quad \implies \quad C(t_2) \subset C(t_1).$$

Then $C(t)$ is Wijsman-regulated.

Proof. It can be readily checked that:

$$\begin{aligned} \limsup_{\tau \rightarrow t-} C(\tau) & \subset \bigcap_{\tau \in [t_0, t[} C(\tau) \subset \liminf_{\tau \rightarrow t-} C(\tau), \\ \limsup_{\tau \rightarrow t+} C(\tau) & \subset \overline{\bigcup_{\tau \in]t, T]} C(\tau)} \subset \liminf_{\tau \rightarrow t+} C(\tau), \end{aligned}$$

which shows that C admits the left and right limits:

$$\begin{aligned} C(t-) & = \bigcap_{\tau \in [t_0, t[} C(\tau), \\ C(t+) & = \overline{\bigcup_{\tau \in]t, T]} C(\tau)}, \end{aligned}$$

which are non-empty since they contain $C(T)$. Proposition 7 now yields the conclusion targeted.

Appendix B: weak solutions of sweeping processes

In this appendix, H is a separable Hilbert space, and all the set-valued mappings $C : [t_0, T] \rightarrow \mathcal{C}(H)$ will be assumed to take only non-empty closed convex values.

Given a closed convex subset K of H , ∂I_K will denote the subdifferential of the indicatrix function (in the sense of convex analysis) of K . Hence, $\partial I_K(x)$ is the cone of all the outward normals to K at x . It will be empty if $x \notin K$ and reduces to $\{0\}$ at any interior point x of K . Given a set-valued mapping $C : [t_0, T] \rightarrow \mathcal{C}(H)$ with non-empty closed convex values, we will use the term ‘‘sweeping process’’ to refer to the evolution problem consisting of finding a function $u : [t_0, T] \rightarrow H$ such that:

- $u(t_0) = u_0$,
- $-\dot{u}(t) \in \partial I_{C(t)}[u(t)], \quad \forall t \in [t_0, T],$

where u_0 denotes a given initial condition. This evolution problem has a clear geometrical interpretation in kinematic terms when $C(t)$ has a non-empty interior. As long as the point $u(t)$ is an interior point in the moving convex set $C(t)$, it will remain at rest. When, by the evolution of $C(t)$, the point $u(t)$ meets the boundary of $C(t)$ at some instant t , it proceeds in an inward normal direction, so as to go on belonging to $C(t)$, exactly as if it was being pushed by the boundary of the moving convex set.

A definition of weak solutions of sweeping processes was first proposed by Moreau [10] in the case of set-valued mappings with bounded retraction. He proved their existence before showing that they are actually strong solutions in some sense. In the problems analysed in the present paper, some sweeping processes appear that have weak solutions that are not strong solutions. Of course, the underlying set-valued mappings do not have bounded retraction. Thus, one is led to extend Moreau’s definition of weak solutions of sweeping processes to a larger class of set-valued mappings than that showing bounded retraction. Since these set-valued mappings must have a right limit $C(t+)$ in the sense of Kuratowski, at every t , one is naturally led to consider the larger class consisting of all the Wijsman-regulated set-valued mappings.

In this Appendix, we first define weak solutions of sweeping processes based on Wijsman-regulated set-valued mappings, and these weak solutions, when they exist, are proved to enjoy the same general properties as those of the weak solutions of sweeping processes based on set-valued mappings with bounded retraction. Moreau’s [10] existence results obtained in the case of set-valued mappings with bounded retraction are then briefly recalled without going into the proofs.

Definition 8. We define P as a *subdivision* of the real interval $[t_0, T]$ (notation $P \in \text{subd}([t_0, T])$) if it is a finite partition of $[t_0, T]$ into intervals of any sort (some of them possibly reduced to single points).

A $P' \in \text{subd}([t_0, T])$ will be said to be a *refinement* of $P \in \text{subd}([t_0, T])$ (notation $P' \succ P$) if every interval of P' is contained in an interval of P .

A mapping defined on $[t_0, T]$ will be said to be *piecewise constant* if it is constant in every interval of some $P \in \text{subd}([t_0, T])$.

Definition 9. Let $C : [t_0, T] \rightarrow \mathcal{C}(H)$ be a Wijsman-regulated set-valued mapping taking non-empty closed convex values. For $P \in \text{subd}([t_0, T])$, I_0, I_1, I_2, \dots will denote the ordered sequence of the corresponding intervals, and t_i the origin (left extremity) of I_i . We will also take C_P to denote the piecewise constant set-valued mapping with non-empty closed convex values defined by:

$$C_P(I_i) = C_i = \begin{cases} C(t_i) & \text{if } t_i \in I_i, \\ C(t_{i+}) & \text{if } t_i \notin I_i. \end{cases}$$

Given the initial value $a \in C(t_0)$, set inductively (“catching-up” algorithm):

$$\begin{aligned} u_0 &= a, \\ u_{i+1} &= \text{proj}(u_i, C_{i+1}), \end{aligned}$$

to define the piecewise constant function $u_P : [t_0, T] \rightarrow H$ by:

$$u_P(I_i) = u_i.$$

When the net (u_P) converges uniformly in $[t_0, T]$, towards some limit $u : [t_0, T] \rightarrow H$ in the sense:

$$\begin{aligned} \forall \varepsilon > 0, \quad \exists P \in \text{subd}([t_0, T]), \quad \forall P' \succ P, \\ \forall t \in [t_0, T], \quad \|u_{P'}(t) - u(t)\| \leq \varepsilon, \end{aligned}$$

the function $u : [t_0, T] \rightarrow H$ will be said to be a *weak solution of the sweeping process* based on the set-valued mapping $C(t)$, starting at initial condition a .

Proposition 10. Let $C : [t_0, T] \rightarrow \mathcal{C}(H)$ be a Wijsman-regulated set-valued mapping, and u, u' be two weak solutions of the associated sweeping process. Then, the real-valued function:

$$\begin{cases} [t_0, T] \rightarrow \mathbb{R}^+ \\ t \mapsto \|u(t) - u'(t)\| \end{cases}$$

is non-increasing.

Proof. If u and u' start at initial values a and a' , these functions are the limits of (generalized) sequences u_P and u'_P of the piecewise constant functions inductively defined from these initial data. As the successive values of u_P and u'_P are obtained by performing projections onto the convex sets C_i , the contraction property of such projections entails that:

$$\forall P \in \text{subd}([t_0, T]), \quad \forall s \leq t, \quad \|u_P(t) - u'_P(t)\| \leq \|u_P(s) - u'_P(s)\|.$$

It then suffices to go to the limit of the two members of this inequality to obtain the conclusion required.

Proposition 11. *Let $u : [t_0, T] \rightarrow H$ be weak solution of the sweeping process based on the set-valued mapping $C(t)$, which is assumed to be Wijsman-regulated. Then u admits a left limit $u(t-)$ and a right limit $u(t+)$ at every $t \in [t_0, T]$ (with appropriate adjustments at t_0 and T) and:*

$$\begin{aligned} \forall t \in [t_0, T], \quad & u(t) \in C(t), \\ \forall t \in]t_0, T], \quad & u(t) = \text{proj}(u(t-), C(t)), \\ \forall t \in [t_0, T[, \quad & u(t+) = \text{proj}(u(t), C(t+)). \end{aligned}$$

Proof. The existence of $u(t-)$ and $u(t+)$ is ensured by the fact that u is regulated.

At an arbitrary $t \in [t_0, T]$, we take \mathcal{P} to denote the set of all subdivisions in $\text{subd}([t_0, T])$ containing $\{t\}$. Based on the definition of C_P :

$$\forall P \in \mathcal{P}, \quad C_P(t) = C(t),$$

and therefore, based on the definition of u_P :

$$\forall P \in \mathcal{P}, \quad u_P(t) = \text{proj}[u_P(t-), C(t)],$$

which entails:

$$\forall P \in \mathcal{P}, \quad u_P(t) \in C(t).$$

Taking a limit with respect to $P \in \mathcal{P}$, it can be readily seen that $u(t) \in C(t)$.

As the convergence of the net u_P , $P \in \mathcal{P}$, is uniform with t , the following commutation of limits holds:

$$u(t-) = \lim_{P \in \mathcal{P}} u_P(t-),$$

and therefore:

$$u(t) = \text{proj}(u(t-), C(t)).$$

Likewise:

$$\forall P \in \mathcal{P}, \quad u_P(t+) = \text{proj}(u_P(t), C(t+)),$$

and the last statement in the proposition can be proved in the same way.

The two following propositions display the local character of the concept of weak solutions.

Proposition 12. *Let $u : [t_0, T] \rightarrow H$ be a weak solution of the sweeping process based on $C(t)$. Let $[t'_0, T']$ be a subinterval of $[t_0, T]$. Then $u|_{[t'_0, T']}$ will be a weak solution of the sweeping process based on $C|_{[t'_0, T']}$.*

Proposition 13. *Let I_0, I_1, I_2, \dots be a subdivision of $[t_0, T]$ into intervals containing their respective origins t_0, t_1, t_2, \dots , and $u : [t_0, T] \rightarrow H$ a function such that:*

- (i) *For all i , $u|_{I_i}$ is a weak solution of the sweeping process based on $C|_{I_i}$ (which entails the existence of $u(t_i-)$ for $i > 0$).*

(ii) For $i > 0$:

$$u(t_i) = \text{proj} (u(t_i-), C(t_i)).$$

Then u is a weak solution of the sweeping process based on C in $[t_0, T]$.

The following theorem is due to Moreau. It claims that provided the set-valued mapping has bounded retraction, the corresponding sweeping process admits a weak solution starting from any arbitrary initial condition.

Theorem 8 (Moreau, [10]). *Let $C : [t_0, T] \rightarrow \mathcal{C}(H)$ be a set-valued mapping with non-empty closed convex values, which is assumed to have bounded retraction. Then there exists a weak solution u of the sweeping process starting at any given initial condition $a \in C(t_0)$. This weak solution is such that:*

$$\forall s \leq t \in [t_0, T], \quad \|u(t) - u(s)\| \leq \text{ret}(C; s, t).$$

In particular, the function u has bounded variation. If, in addition, $C(t)$ has right-continuous (respectively absolutely continuous, respectively Lipschitz-continuous) retraction, then the weak solution u is right-continuous (respectively absolutely continuous, respectively Lipschitz-continuous).

This weak solution depends continuously on the data (the set-valued mapping $C(t)$ and the initial condition) involved in the sweeping process in the sense displayed by the following theorem.

Theorem 9 (Moreau, [10]). *Let $C, C' : [t_0, T] \rightarrow \mathcal{C}(H)$ be two set-valued mappings with non-empty closed convex values and bounded retraction. Then every pair (u, u') of weak solutions of the associated sweeping processes will satisfy the estimate:*

$$\begin{aligned} \forall t \in [t_0, T], \quad & \|u(t) - u'(t)\|^2 - \|u(t_0) - u'(t_0)\|^2 \\ & \leq \left[\sup_{\tau \in [t_0, t]} h(C(\tau), C(\tau')) \right] \left[\text{ret}(C; t_0, t) + \text{ret}(C'; t_0, t) \right]. \end{aligned}$$

Theorem 9 can be used to obtain an estimate of the error occurring when the catching-up algorithm is used to approximate the weak solution of a sweeping process with bounded retraction.

Proposition 14 (Moreau, [10]). *Let $C : [t_0, T] \rightarrow \mathcal{C}(H)$ be a set-valued mapping with non-empty closed convex values and bounded retraction. Consider an arbitrary subdivision $P \in \text{subd}([t_0, T])$ of the interval $[t_0, T]$, let I_0, I_1, I_2, \dots be the corresponding finite sequence of intervals, and μ be some majorant of $\text{ret}(C; s, t)$, for arbitrary $[s, t] \in I_i$. Still denoting by u_P the piecewise constant function provided by the catching-up algorithm, one has:*

$$\|u(t) - u_P(t)\| \leq 2\sqrt{\mu \text{ret}(C; t_0, t)}.$$

With any function $u \in BV([t_0, T], H)$, it is classically associated its *differential measure* or *Stieltjes measure* $du \in \mathcal{M}([t_0, T], H)$. It satisfies in particular:

$$\int_{]s,t]} du = u(t+) - u(s+).$$

Definition 10 (Moreau, [10]). Let $C : [t_0, T] \rightarrow \mathcal{C}(H)$ be a set-valued mapping whose values are nonempty closed and convex. The function $u \in BV([t_0, T], H)$ will be said to be a solution of the sweeping process in the sense of “differential measures” if there exists (non uniquely) a non-negative real measure μ , as well as a function $u' \in \mathcal{L}_{\text{loc}}^1([t_0, T]; H)$ such that $du = u'\mu$ and:

$$\forall t \in [t_0, T], \quad -u'(t) \in \partial I_{C(t)}[u(t)].$$

Proposition 15 (Moreau, [10]). Let $C : [t_0, T] \rightarrow \mathcal{C}(H)$ be a set-valued mapping with nonempty closed convex values, and $u_1, u_2 \in BV([t_0, T], H)$ be two solutions in the sense of differential measures of the associated sweeping process. These two solutions are assumed to be both right-continuous, and to agree with the same initial condition $u_1(t_0) = u_2(t_0) = a$. Then:

$$\forall t \in [t_0, T], \quad u_1(t) = u_2(t).$$

Theorem 10 (Moreau, [10]). Let $C : [t_0, T] \rightarrow \mathcal{C}(H)$ be a set-valued mapping with non-empty closed convex values and which is assumed to have bounded right-continuous retraction. Then every weak solution of the associated sweeping process (which is a function with bounded variation by virtue of theorem 8 and right-continuous by virtue of propositions 6 and 11) will also be a solution in the sense of differential measures.

If, in addition, $C : [t_0, T] \rightarrow \mathcal{C}(H)$ is assumed to show absolutely continuous retraction, then every weak solution will be a strong solution in the sense:

$$\text{for a.a. } t \in [t_0, T], \quad -u'(t) \in \partial I_{C(t)}[u(t)].$$

References

1. D.R. ADAMS, The Biharmonic Obstacle Problem with Varying Obstacles and a Related Maximal Operator. *Operator Theory*, **110**, (1999) pp 1–12.
2. L.E. ANDERSSON, Existence result for quasistatic contact problem with Coulomb friction, *Applied Mathematics and Optimization*, **42**, (2000) pp 169–202.
3. P. BALLARD, A counter-example to uniqueness in quasi-static elastic contact problems with friction, *International Journal of Engineering Science*, **37**, (1999) pp 163–178.
4. G. BEER, A Polish topology for the closed subsets of a Polish space, *Proceedings of the American Mathematical Society*, **113**, (1991) pp 1123–1133.
5. G. BEER, Wijsman convergence: a survey, *Set-Valued Analysis*, **2**, pp 77–94. **113**, (1994) pp 1123–1133.

6. C. ECK, J. JARUŠEK and M. KRBEČ, *Unilateral Contact Problems in Mechanics. Variational Methods and Existence Theorems*. Monographs & Textbooks in Pure & Appl. Math. No. 270 (ISBN 1-57444-629-0). Chapman & Hall/CRC (Taylor & Francis Group), Boca Raton London New York Singapore (2005).
7. J. JARUŠEK, Contact Problems with Bounded Friction. *Czechoslovak Mathematical Journal*, **33**, 108 (1983), pp. 237–261.
8. D. KINDERLEHRER & G. STAMPACCHIA, *An Introduction to Variational Inequalities and their Applications* (Academic Press, New York, 1980).
9. J.J. MOREAU, Multiapplications à rétraction finie, *Annali della Scuola Normale Superiore di Pisa*, **1**, (1974) pp 169–203.
10. J.J. MOREAU, Evolution problem associated with a moving convex set in a Hilbert space, *Journal of Differential Equations*, **26**, (1977) pp 347–374.
11. P.M. SUQUET, Discontinuities and plasticity. In *Nonsmooth mechanics and applications* (J.J. Moreau & P.D. Panagiotopoulos Eds), CISM Courses No 302, Springer, (1988) pp 279–341.
12. R.T. ROCKFELLAR & R.J-B. WETS, *Variational Analysis* (Springer-Verlag Berlin Heidelberg New York, 1998).
13. K. YOSIDA (1980), *Functional Analysis*, Sixth Edition, Springer-Verlag Berlin Heidelberg New York.

Laboratoire de Mécanique et d'Acoustique,
31, chemin Joseph Aiguier,
13402 Marseille Cedex 20, FRANCE.
ballard@lma.cnrs-mrs.fr

Indentation of an elastic half-space by a rigid flat punch as a model problem for analysing contact problems with Coulomb friction

Patrick BALLARD · Jiří JARUŠEK

Received: date / Accepted: date

Abstract One important problem which still remains to be solved today is the uniqueness of the solution of contact problems in linearized elastostatics with small Coulomb friction. This difficult question is addressed here in the case of the indentation of a two-dimensional elastic half-space by a rigid flat punch of finite width, which has been previously studied by Spence [10]. It is proved that all the solutions have the same simple structure, involving active contact everywhere below the punch and a sticking interval surrounded by two inward slipping intervals. All these solutions show the same local asymptotics for surface traction and displacement at a border between a sticking and a slipping zone. These asymptotics describe (soft) singularities, which are universal (they hold with any geometry) and are explicitly given. It is also proved that in cases where the friction coefficient is small enough, the sticking intervals present in two distinct solutions, if two distinct solutions exist, cannot overlap.

Keywords elasticity · contact · friction · uniqueness · singularity

PACS 46.25 · 46.55 · 62.20

Mathematics Subject Classification (2000) 74B05 · 74M10 · 74M15

P. Ballard
CNRS - Laboratoire de Mécanique et d'Acoustique,
31, chemin Joseph Aiguier, 13402 Marseille Cedex 20, France.
Tel.: +33-4-91164059
Fax: +123-45-91164481
E-mail: ballard@lma.cnrs-mrs.fr

J. Jarušek
Mathematical Institute, Academy of Sciences of the Czech Republic,
Žitná 25, 115 67 Praha 1, Czech Republic.
E-mail: jarusek@math.cas.cz

1 Background and motivation

The general contact problem in the theory of linear elasticity reads formally as follows.

$$\left\{ \begin{array}{ll} \operatorname{div} \boldsymbol{\sigma}(\mathbf{u}) + \mathbf{f}^p = \mathbf{0}, & \text{in } \Omega, \\ \mathbf{u} = \mathbf{u}^p, & \text{on } \Gamma_u, \\ \mathbf{t} \stackrel{\text{def}}{=} \boldsymbol{\sigma} \cdot \mathbf{n} = \mathbf{t}^p, & \text{on } \Gamma_t, \\ \begin{array}{l} u_n - g^p \leq 0, \quad t_n \leq 0, \quad (u_n - g^p)t_n = 0, \\ \text{and "tangential boundary conditions"} \end{array} & \text{on } \Gamma_c, \end{array} \right. \quad (1)$$

where Ω denotes some smooth bounded open set in \mathbb{R}^2 or \mathbb{R}^3 , $\Gamma_u \cup \Gamma_t \cup \Gamma_c = \partial\Omega$ denotes a splitting of the boundary into three disjoint parts, and \mathbf{n} is the outward unit normal. As usual, \mathbf{u} is the (unknown) displacement, $\boldsymbol{\sigma}(\mathbf{u})$ is the Cauchy stress which is associated with this displacement by the linear elastic constitutive law, and $\mathbf{t} = \boldsymbol{\sigma} \cdot \mathbf{n}$ denotes the surface tractions. For any vector field \mathbf{v} defined on part of the boundary, we will write $\mathbf{v} = v_n \mathbf{n} + \mathbf{v}_t$, its splitting into normal and tangential parts. The loading conditions are defined by \mathbf{u}^p (the surface displacement prescribed on Γ_u), \mathbf{t}^p (the surface tractions prescribed on Γ_t), \mathbf{f}^p (the prescribed body forces), and g^p (the initial gap with the obstacle).

The simplest tangential boundary condition on Γ_c is the frictionless one:

$$\mathbf{t}_t = \mathbf{0}, \quad \text{on } \Gamma_c,$$

in which case, problem (1) reduces to the so-called Signorini problem. Providing a variational formulation under the form of an inequality, Fichera proved in 1964 the existence and uniqueness of the solution of the Signorini problem under appropriate regularity assumptions about the data. While the general theory of variational inequalities was rapidly developing during the subsequent years, making it possible to solve a wide class of so-called free boundary problems, the question as to how to solve problem (1) with more general tangential boundary conditions emerged [1], focusing in particular on the Coulomb friction law:

$$|\mathbf{t}_t| \leq -\mathcal{F}t_n, \quad \text{and,} \quad \left\{ \begin{array}{ll} |\mathbf{t}_t| < -\mathcal{F}t_n & \Rightarrow \quad \dot{\mathbf{u}}_t = \mathbf{0}, \\ |\mathbf{t}_t| = -\mathcal{F}t_n & \Rightarrow \quad \mathbf{t}_t = -\lambda \dot{\mathbf{u}}_t \quad \text{with } \lambda \in \mathbb{R}^+, \end{array} \right.$$

or equivalently:

$$\forall \mathbf{v}, \quad \mathbf{t}_t \cdot (\mathbf{v} - \dot{\mathbf{u}}_t) - \mathcal{F}t_n(|\mathbf{v}| - |\dot{\mathbf{u}}_t|) \geq 0. \quad (2)$$

Here, $\mathcal{F} > 0$ is a given friction coefficient and the dot refers to a time-derivative. Due to this time-derivative, the corresponding problem (1) becomes an *evolution* problem, which is sometimes called the Signorini problem with quasi-static Coulomb friction. This was a very challenging problem and, many efforts were first devoted to the situation where the tangential velocity in the friction law is replaced by the tangential displacement:

$$\forall \mathbf{v}, \quad \mathbf{t}_t \cdot (\mathbf{v} - \mathbf{u}_t) - \mathcal{F}t_n(|\mathbf{v}| - |\mathbf{u}_t|) \geq 0. \quad (3)$$

Law (2) is called the “quasistatic” Coulomb friction law (or merely Coulomb friction law), while law (3) is usually called the “static Coulomb friction law”, although it may not be a particularly appropriate term. The reason for studying the contact problem with static

Coulomb friction law is that this is formally the problem that arises at each time step when a time-discretization procedure is introduced into the analysis of the contact problem with quasi-static Coulomb friction [2]. Also, in the case of some problems such as that considered by Spence in [10], which will be dealt with below, consideration of the static law (3) makes it possible to solve problem (1) with the true friction law (2) simply by multiplying the static solution by an increasing function of time.

It was recognized very early [1] that by replacing the threshold $\mathcal{F}t_n$ by a given function G , the corresponding problem (the so-called contact problem with given friction) can be solved using standard optimization techniques that provide the existence and uniqueness of the solution under appropriate regularity hypothesis about the data. The contact problem with given friction is naturally not physically very relevant since friction can occur even in some part of the boundary where there is no active contact with the obstacle. But since $\mathcal{F}t_n$ can be calculated from the solution of the contact problem with given friction, one naturally tends to use a fixed point strategy. Since no contraction properties appear naturally in the analysis, the fixed point theorem to apply should be that of Schauder or Tikhonov. But this requires proving technical regularity results of the solution, to satisfy the compactness requirements. These results were obtained first in the case of an infinite strip by Nečas, Jarušek and Haslinger in [8] using a shift technique and then extended to a body of arbitrary shape by Jarušek in [5]. As a consequence, the existence of a solution (solvability) was proved, provided that the friction coefficient was small enough $\mathcal{F} < \mathcal{F}_c$.

Looking at the spatially discretized counterpart of the problem (where the frictional contact conditions are prescribed only at the nodes which are candidates for contact), Brouwer's theorem yields unconditional solvability, whereas uniqueness is proved only with small friction coefficients $\mathcal{F} < \mathcal{F}_c$, thanks to some contraction property that can be easily established in this finite-dimensional setting. The fact that the uniqueness of solutions to the discretized problem can be lost for large friction coefficients \mathcal{F} was first observed in [6]. A similar example for an elastic continuum was displayed in [4], where the author shows that uniqueness cannot be expected either in the case of a continuum with large friction coefficient.

The fixed point strategy, applied to the discretized problem, is of common practice for computational purposes. However, all the estimations of a critical friction coefficient \mathcal{F}_c , below which the existence and uniqueness of a fixed point in the discretized problem are ensured tend towards zero when the thickness of the spatial discretization goes to zero. There is therefore no theoretical justification at the moment for using this fixed point strategy for computing approximate solutions. This question is closely connected with the existence of a critical friction coefficient \mathcal{F}_c for the *continuum* problem, below which the uniqueness of the fixed point could be ensured.

This is still an open question today, and it can be rephrased as follows. For given geometry and material, can multiple solutions be constructed with arbitrarily small friction coefficients or not ?

The issue involved here goes far beyond the theoretical justification of using the fixed point strategy for computational purposes. It is of common experience that when elasticity is combined with large friction, vibrations (noise) can be excited with loads that vary arbitrarily slowly in time. It therefore seems likely that the quasi-static analysis of such problems is physically relevant only for those friction coefficients \mathcal{F} that are small enough. The question arises as to how define a critical friction coefficient \mathcal{F}_c below which the quasi-static analysis makes sense. Since such a critical friction coefficient \mathcal{F}_c naturally appears in Jarušek's analysis [5] of the existence of a fixed point, many efforts were subsequently made by Eck and Jarušek [2] to obtain explicit values of \mathcal{F}_c . However, it is not known whether their bound can be improved or not. In addition, the definition of a critical friction coefficient \mathcal{F}_c

for quasi-static analysis in terms of solvability is very difficult to handle in practice (it is even not known whether non-solvability can be met in the case of a continuum problem). A definition in terms of the loss of uniqueness would be far easier to handle.

Therefore, the question of uniqueness of solutions to the contact problem with static Coulomb friction with an arbitrarily small coefficient is of great theoretical and practical importance. The aim of this study was to obtain new insights on this difficult problem by carefully investigating a problem with a simple geometry for which harmonic analysis makes possible deeper investigation.

2 Outline

2.1 A particular geometry: the elastic half-space

In this paper, the analysis is restricted to the case of a particular geometry, that of an isotropic linearly elastic half-space. All the displacement fields under consideration will have a zero component along a direction z orthogonal to the normal to the boundary, and will not depend on z . Thus, all the problems under consideration will actually be two-dimensional ones.

The Poisson ratio of the elastic material is given by $\nu \in]-1, 1/2[$ and the force unit is chosen so that the Young modulus $E = 1$. Taking x to denote the space variable along the boundary and $y > 0$ to be the depth in the half-space, the linear operator expressing the surface displacement (u_x, u_y) in terms of the surface traction (t_x, t_y) is proved in section 3.1 to be:

$$\begin{aligned} \frac{1}{2(1-\nu^2)} \frac{d}{dx} u_x &= -\frac{1}{\pi} \text{pv} \frac{1}{x} * t_x - \frac{1-2\nu}{2(1-\nu)} t_y, \\ \frac{1}{2(1-\nu^2)} \frac{d}{dx} u_y &= -\frac{1}{\pi} \text{pv} \frac{1}{x} * t_y + \frac{1-2\nu}{2(1-\nu)} t_x, \end{aligned}$$

where $\text{pv}1/x$ denotes the distributional derivative of the locally integrable function $\log|x|$ (see appendix A), and $*$ is the spatial convolution. In section 3.2, it is proved that this operator defines a symmetric bilinear form on $H^{-1/2}(-1, 1[; \mathbb{R}) \times H^{-1/2}(-1, 1[; \mathbb{R})$ which is a scalar product on that Hilbert space, which induces a norm that is equivalent to that of $H^{-1/2} \times H^{-1/2}$. Since the solutions of elastic problems in the two-dimensional half-space are generally of unbounded elastic energy, this scalar product on $H^{-1/2} \times H^{-1/2}$ plays the same role in the case of the half-space as the elastic energy bilinear form in the case of a bounded body.

2.2 A Signorini problem in the half-space

The *frictionless* indentation of the half-space by a rigid flat punch is studied first. The length unit is chosen so that the width of the punch is 2. Looking for a solution involving a surface traction distribution that is an integrable function (the most general case should be a Radon

measure), the problem consists in finding $t_y, u'_y \in L^1(-1, 1; \mathbb{R})$ such that:

- $\frac{1}{2(1-\nu^2)} u'_y = -\frac{1}{\pi} \text{pv} \frac{1}{x} * t_y, \quad \text{in }]-1, 1[,$
- $t_y(x) \geq 0, \quad \text{for a.a. } x \in]-1, 1[,$
- $t_y(x) \left[\int_0^x u'_y - \min_{x \in [-1, 1]} \int_0^x u'_y \right] = 0, \quad \text{for a.a. } x \in]-1, 1[,$
- $\int_{-1}^1 t_y = F,$

where the total force F exerted on the punch is assumed to be given. In the first line, the convolution product is defined after extending t_y by zero outside $]-1, 1[$.

Note that the normal displacement u_y appears in these equations only via its derivative u'_y . The total displacement of the punch is undefined and the problem must be parametrized by the total force F and *cannot* be parametrized by the displacement. This can be explained by taking a similar contact problem, where the half-space is replaced by a half-disk of radius $R > 1$ whose the whole curved part of the boundary is clamped. In that situation, the displacement of the punch is well defined and is seen to tend to infinity like $\log R$ as R tends to infinity. This result is intimately connected with the fact that the stress field in the half-space is not square-integrable, so that the elastic energy, and therefore the displacement of the punch, are morally infinite in the case of the half-space.

In section 4, it is proved that this problem admits a unique solution, which is explicitly given by the well-known expression:

$$t_y(x) = \frac{F}{\pi\sqrt{1-x^2}}, \quad u'_y(x) = 0,$$

which means, in particular, that the contact is active everywhere below the punch. The tangential displacement below the punch can be explicitly computed from the Neumann-Dirichlet operator. It is seen to be *inwards*.

The surface traction distribution is not only in $L^1(-1, 1; \mathbb{R})$, but in $L^p(-1, 1; \mathbb{R})$ for all $p \in [1, 2[$. However, it is not square integrable.

2.3 A contact problem with static Coulomb friction in the half-space

Given a friction coefficient $\mathcal{F} > 0$, it is now proposed to handle *static* Coulomb friction in the above problem. Introducing the notations:

$$\begin{aligned} u &= \frac{1}{2(1-\nu^2)} u_y, & p &= t_y, \\ v &= \frac{1}{2(1-\nu^2)} u_x, & q &= t_x, \\ \gamma &= \frac{1-2\nu}{2(1-\nu)} \in]0, 3/4[, \end{aligned}$$

the problem is now to find $p, q \in L^1(-1, 1; \mathbb{R})$ and $u, v \in W^{1,1}(-1, 1; \mathbb{R})$ satisfying:

- $-\frac{1}{\pi} p v \frac{1}{x} * p + \gamma q = u', \quad \text{in }]-1, 1[,$
- $-\frac{1}{\pi} p v \frac{1}{x} * q - \gamma p = v', \quad \text{in }]-1, 1[,$
- $p(x) \geq 0, \quad u(x) \geq 0, \quad p(x) u(x) = 0, \quad \text{for a.a. } x \in]-1, 1[,$
- $|q(x)| \leq \mathcal{F} p(x), \quad v(x) q(x) \leq 0, \quad \left[\mathcal{F} p(x) - |q(x)| \right] v(x) = 0, \quad \text{a.e.}$
- $\int_{-1}^1 p(t) dt = P, \quad \int_{-1}^1 q(t) dt = Q,$

where P, Q are two given real numbers such that $-\mathcal{F}P < Q < \mathcal{F}P$.

In what follows, we will refer to this contact problem with (static) Coulomb friction as ‘problem \mathcal{P} ’.

The particular case where $Q = 0$ was studied by Spence [10], who constructed a quasi explicit solution. Spence’s solution involves active contact everywhere below the punch ($u \equiv 0$) and shows the presence of a centered sticking interval (where $v \equiv 0$) surrounded by two inward slipping intervals. Since no uniqueness result is available for this problem, one cannot rule out *a priori* the possibility that unsymmetric solutions or solutions with non connected sticking zones may exist.

2.4 Some properties satisfied by any solution of problem \mathcal{P}

Actually, it is proved in section 6 that *any* solution of problem \mathcal{P} achieves active contact everywhere below the punch and involves a sticking interval surrounded by two inward slipping intervals. More precisely, any solution of problem \mathcal{P} is such that $u \equiv 0$ on $]-1, 1[$ and there exist $-1 < a < b < 1$ such that $v > 0$ on $]-1, a[$, $v \equiv 0$ on $[a, b]$, and $v < 0$ on $]b, 1[$.

In particular, no solutions with fine combinations of slipping and sticking zones can exist.

In addition, some asymptotics prove to hold true for any solution of problem \mathcal{P} , at $x = -1, 1$ (the edges of the punch), as well as $x = a, b$ (the border between a slipping and a sticking zone). Thanks to the elliptic nature of the equations of elastostatics, these asymptotics do not apply only to the particular geometry under consideration but they are *universal*. In particular, they contain a local description of the displacement field and the surface traction distribution on each side of a smooth boundary between a slipping zone and a sticking zone, in the case of an *arbitrary* geometry.

These asymptotics read as follows at $x = -1, 1$.

$$p(x) \sim \frac{C_{-1}}{(1+x)^{1/2-\alpha}}, \quad q(x) \sim -\frac{\mathcal{F}C_{-1}}{(1+x)^{1/2-\alpha}}, \quad v'(x) \sim -\frac{\gamma(1+\mathcal{F}^2)C_{-1}}{(1+x)^{1/2-\alpha}}, \quad \text{as } x \rightarrow -1+,$$

$$p(x) \sim \frac{C_1}{(1-x)^{1/2-\alpha}}, \quad q(x) \sim \frac{\mathcal{F}C_1}{(1-x)^{1/2-\alpha}}, \quad v'(x) \sim -\frac{\gamma(1+\mathcal{F}^2)C_1}{(1-x)^{1/2-\alpha}}, \quad \text{as } x \rightarrow 1-,$$

where:

$$\alpha = \frac{1}{\pi} \arctan \gamma \mathcal{F} \in]0, 1/2[,$$

and C_{-1}, C_1 are two positive constants. The following asymptotic estimates also hold true at a and b :

$$\begin{aligned}
v'(x) &\sim -C_a \sin \pi \alpha \frac{1-\gamma^2}{\gamma} (a-x)^{1/2-\alpha}, & \text{as } x \rightarrow a-, \\
p(x) - p(a) &\sim -C_a \sin \pi \alpha (a-x)^{1/2-\alpha} & \text{as } x \rightarrow a-, \\
p(x) + q(x)/\mathcal{F} &\sim C_a (x-a)^{1/2-\alpha}, & \text{as } x \rightarrow a+, \\
p(x) - q(x)/\mathcal{F} &\sim C_b (b-x)^{1/2-\alpha}, & \text{as } x \rightarrow b-, \\
v'(x) &\sim -C_b \sin \pi \alpha \frac{1-\gamma^2}{\gamma} (x-b)^{1/2-\alpha}, & \text{as } x \rightarrow b+, \\
p(x) - p(b) &\sim -C_b \sin \pi \alpha (x-b)^{1/2-\alpha}, & \text{as } x \rightarrow b+,
\end{aligned}$$

where C_a and C_b are two positive constants. In addition, $p(x)$ admits a negative right-derivative at $x = a$ and a positive left-derivative at $x = b$. The normal component p of the surface traction has therefore a local maximum at $x = a, b$.

Since it can be proved in addition that the restrictions of the functions p, q, v to each of the open intervals $] -1, a[,] a, b[,] b, 1[$ are C^∞ , these estimates show that all the solutions of problem \mathcal{P} show the same Sobolev and Hölder regularity which can be read explicitly from the asymptotics.

2.5 Discussion about the uniqueness of the solution

In section 7, it is proved that there exists $\mathcal{F}_c > 0$, depending only on the Poisson ratio, such that whenever $\mathcal{F} < \mathcal{F}_c$, the sticking intervals $[a, b]$ and $[\bar{a}, \bar{b}]$ in two distinct solutions of problem \mathcal{P} cannot *overlap*, that is, either $b < \bar{a}$, or $a > \bar{b}$. Consequently, the number of solutions is at most countable.

When there exist multiple solutions, one cannot therefore move continuously from one to another. This seems to suggest that some kind of uniqueness of the solution should hold true, under some condition $\mathcal{F} < \mathcal{F}_c$. We hope to further elucidate this difficult but important question in the close future.

3 The Neumann-Dirichlet operator of the two-dimensional elastic half-space

3.1 The explicit expression for the Neumann-Dirichlet operator

Let us consider an isotropic homogeneous linearly elastic half-space. Some orthonormal Cartesian coordinate system (x, y, z) is chosen so that the half-space is defined by: $y > 0$. Since only the plane strain situation will be considered here, it is convenient to take:

$$\Omega = \left\{ (x, y) \in \mathbb{R}^2 ; y > 0 \right\},$$

to denote a corresponding two-dimensional ‘‘slice’’ of the half-space. The Poisson ratio of the elastic material is written $\nu \in] -1, 1/2[$. The units will always be chosen so that the Young modulus $E = 1$.

The task in this section is to find a fundamental solution to the Neumann problem in this half-space, restricted to the plane strain framework. In other words, it is proposed to obtain

the z -independent displacement and stress field in the half-space in the case where the load is some homogeneous force (F_x, F_y) concentrated along the line $x = y = 0$ of the boundary. This can be done using the Fourier transform with respect to the variable x . As usual, \mathbf{u} is taken to denote the displacement, $\boldsymbol{\varepsilon}(\mathbf{u})$ to denote the associated linearized strain tensor, and $\boldsymbol{\sigma}(\mathbf{u})$ to denote the corresponding Cauchy stress tensor.

Theorem 1 *Let $(F_x, F_y) \in \mathbb{R}^2$ be arbitrary. All the tempered distributions $\mathbf{u} \in \mathcal{S}'(\overline{\Omega}; \mathbb{R}^2)$ such that:*

$$\forall \boldsymbol{\varphi} \in C_c^\infty(\overline{\Omega}; \mathbb{R}^2), \quad \left\langle \boldsymbol{\sigma}_{ij}(\mathbf{u}), \boldsymbol{\varepsilon}_{ji}(\boldsymbol{\varphi}) \right\rangle_{\mathcal{S}', \mathcal{S}} = F_x \varphi_x(0, 0) + F_y \varphi_y(0, 0),$$

$(C_c^\infty(\overline{\Omega}; \mathbb{R}^2))$ stands, as usual, for the space of C^∞ test-functions compactly supported in the closed half-space $\overline{\Omega}$ are given by:

$$\begin{aligned} u_x &= F_x U_{xx}^0(x, y) + F_y U_{xy}^0(x, y) + D_x - \Omega y + (1 - \nu^2) \Sigma x, \\ u_y &= F_x U_{yx}^0(x, y) + F_y U_{yy}^0(x, y) + D_y + \Omega x - \nu(1 + \nu) \Sigma y, \end{aligned}$$

where D_x, D_y, Ω, Σ are four arbitrary real constants, and $U_{xx}^0, U_{xy}^0, U_{yx}^0, U_{yy}^0$ are the four functions in $C^\infty(\Omega; \mathbb{R})$ defined by:

$$\begin{aligned} U_{xx}^0 &= -\frac{1 - \nu^2}{\pi} \log(x^2 + y^2) - \frac{1 + \nu}{\pi} \cdot \frac{y^2}{x^2 + y^2}, \\ U_{xy}^0 &= -\frac{(1 - 2\nu)(1 + \nu)}{\pi} \arctan \frac{x}{y} + \frac{1 + \nu}{\pi} \cdot \frac{xy}{x^2 + y^2}, \\ U_{yx}^0 &= +\frac{(1 - 2\nu)(1 + \nu)}{\pi} \arctan \frac{x}{y} + \frac{1 + \nu}{\pi} \cdot \frac{xy}{x^2 + y^2}, \\ U_{yy}^0 &= -\frac{1 - \nu^2}{\pi} \log(x^2 + y^2) + \frac{1 + \nu}{\pi} \cdot \frac{y^2}{x^2 + y^2}. \end{aligned}$$

The corresponding Cauchy stress field is then given by the three functions in $C^\infty(\Omega; \mathbb{R})$ defined by:

$$\begin{aligned} \sigma_{xx}(\mathbf{u}) &= -\frac{2F_x}{\pi} \cdot \frac{x^3}{(x^2 + y^2)^2} - \frac{2F_y}{\pi} \cdot \frac{x^2 y}{(x^2 + y^2)^2} + \Sigma, \\ \sigma_{xy}(\mathbf{u}) &= -\frac{2F_x}{\pi} \cdot \frac{x^2 y}{(x^2 + y^2)^2} - \frac{2F_y}{\pi} \cdot \frac{xy^2}{(x^2 + y^2)^2}, \\ \sigma_{yy}(\mathbf{u}) &= -\frac{2F_x}{\pi} \cdot \frac{xy^2}{(x^2 + y^2)^2} - \frac{2F_y}{\pi} \cdot \frac{y^3}{(x^2 + y^2)^2}. \end{aligned}$$

In particular, we can prescribe the supplementary condition: $\lim_{\infty} \boldsymbol{\sigma}(\mathbf{u}) = \mathbf{0}$, which imposes $\Sigma = 0$ and determines $\boldsymbol{\sigma}(\mathbf{u})$ uniquely. The arbitrariness still remaining in \mathbf{u} , because of the three constants D_x, D_y, Ω , can be interpreted as some arbitrary (linearized) rigid displacement.

Proof Perform a Fourier transform with respect to x , then solve the ordinary differential equation with respect to y , and, lastly, perform the inverse Fourier transform. \square

The explicit knowledge of the fundamental solution makes it possible to solve by convolution the Neumann problem with arbitrary, compactly supported, surface traction distributions (t_x, t_y) :

$$\begin{aligned} u_x &= t_x * U_{xx}^0(x, y) + t_y * U_{xy}^0(x, y) + D_x - \Omega y, \\ u_y &= t_x * U_{yx}^0(x, y) + t_y * U_{yy}^0(x, y) + D_y + \Omega x, \end{aligned}$$

where the supplementary condition: $\lim_{\infty} \boldsymbol{\sigma}(\mathbf{u}) = \mathbf{0}$ is imposed. The stress field is therefore uniquely determined. It is in $C^\infty(\Omega; \mathbb{R}^3)$, but it is generally not square-integrable. Consequently, no energy can be associated with that solution. Also, it can be seen that the displacement field is infinite at infinity, and, we cannot superimpose any conditions such as: $\lim_{\infty} \mathbf{u} = \mathbf{0}$, in order to set the arbitrary rigid displacement. The only possible solution here consists in superimposing the condition:

$$\mathbf{u} = O(\log(x^2 + y^2)), \quad \text{as } x^2 + y^2 \rightarrow \infty,$$

to set $\Omega = 0$, which will always be assumed to be the case from now on. In this case, the surface displacement (\bar{u}_x, \bar{u}_y) must be:

$$\begin{aligned} \bar{u}_x &= -\frac{2(1-\nu^2)}{\pi} \log|x| * t_x - \frac{(1-2\nu)(1+\nu)}{2} \operatorname{sgn}(x) * t_y + D_x, \\ \bar{u}_y &= +\frac{(1-2\nu)(1+\nu)}{2} \operatorname{sgn}(x) * t_x - \frac{2(1-\nu^2)}{\pi} \log|x| * t_y + D_y. \end{aligned}$$

To eliminate the arbitrary constants D_x, D_y , it is convenient to take a derivative with respect to x . Making use of the results given at the beginning of appendix A, we obtain the following theorem, which explicitly gives the Neumann-Dirichlet operator for the isotropic homogeneous linearly elastic two-dimensional half-space.

Theorem 2 (N.I. Muskhelishvili) *With arbitrary*

$$t_x, t_y \in L^{1+}(-1, 1; \mathbb{R}) \stackrel{\text{def}}{=} \bigcup_{p \in]1, \infty[} L^p(-1, 1; \mathbb{R}),$$

let us consider the Neumann problem in the isotropic homogeneous elastic two-dimensional half-space involving:

- surface tractions (t_x, t_y) ,
- no body forces,
- the following conditions at infinity:

$$\lim_{\infty} \boldsymbol{\sigma}(\mathbf{u}) = \mathbf{0}, \quad \mathbf{u} = O(\log(x^2 + y^2)), \quad \text{as } x^2 + y^2 \rightarrow \infty.$$

The surface displacement $(\bar{u}_x(x), \bar{u}_y(x))$ is therefore given by:

$$\begin{aligned} \frac{1}{2(1-\nu^2)} \frac{d}{dx} \bar{u}_x &= \frac{1}{\pi} \oint_{-1}^1 \frac{t_x(t)}{t-x} dt - \frac{1-2\nu}{2(1-\nu)} t_y(x), \\ \frac{1}{2(1-\nu^2)} \frac{d}{dx} \bar{u}_y &= \frac{1}{\pi} \oint_{-1}^1 \frac{t_y(t)}{t-x} dt + \frac{1-2\nu}{2(1-\nu)} t_x(x). \end{aligned}$$

In what follows, the following notation will be used:

$$\gamma = \frac{1-2\nu}{2(1-\nu)} \in]0, 3/4[.$$

3.2 Analysis of the Neumann-Dirichlet operator

This section is devoted to proving that the Neumann-Dirichlet operator, an explicit expression for which is given by theorem 2, defines a scalar product in the Hilbert space $H^{-1/2}(-1, 1[)$.

With $\Omega =]-1, 1[$ or $\Omega = \mathbb{R}$, $H^{1/2}(\Omega)$ will denote the space of functions $f \in L^2(\Omega)$ such that:

$$\int_{\Omega \times \Omega} \left| \frac{f(x) - f(y)}{x - y} \right|^2 < \infty,$$

endowed with the norm:

$$\|f\|_{H^{1/2}} = \left(\|f\|_{L^2} + \int_{\Omega \times \Omega} \left| \frac{f(x) - f(y)}{x - y} \right|^2 \right)^{1/2}, \quad (4)$$

which makes it a Hilbert space.

Since $C_c^\infty(\Omega)$ is dense in $H^{1/2}(\Omega)$, the space $H^{-1/2}(\Omega)$ is defined as the topological dual of $H^{1/2}(\Omega)$, so that $H^{-1/2}(\Omega)$ is a space of distributions. This makes it possible to extend a distribution $f \in H^{-1/2}(-1, 1[)$ by 0 and obtain a distribution $\bar{f} \in H^{-1/2}(\mathbb{R})$. This is the distribution $\bar{f} \in H^{-1/2}(\mathbb{R})$ defined by:

$$\langle \bar{f}, \varphi \rangle_{H^{-1/2}(\mathbb{R}), H^{1/2}(\mathbb{R})} = \langle f, \varphi|_{]-1, 1[} \rangle_{H^{-1/2}(-1, 1[), H^{1/2}(-1, 1[)}.$$

The Fourier transform of a tempered distribution $f \in \mathcal{S}'(\mathbb{R})$ is denoted by $\hat{f} = \mathcal{F}[f]$, so that in the case of smooth functions, it reduces to definition (14). In the case of a distribution $f \in H^{-1/2}(-1, 1[)$, \hat{f} stands for the Fourier transform of its extension to \mathbb{R} by 0. This is a C^∞ function (the Fourier transform of a compactly supported distribution).

With $f \in H^{-1/2}(\Omega)$, the expression:

$$\left(\int_{\mathbb{R}} \frac{|\hat{f}(t)|^2}{\sqrt{1+t^2}} dt \right)^{1/2},$$

defines a norm and this norm is equivalent to that of $H^{-1/2}(\Omega)$.

We recall the following definitions (see appendix A):

$$\text{pv} \frac{1}{x} = \frac{d}{dx} (\log|x|), \quad \text{fp} \frac{1}{|x|} = \frac{d}{dx} (\text{sgn}(x) \log|x|).$$

The extension of some $f \in H^{-1/2}(-1, 1[)$ by 0 to \mathbb{R} is in $H^{-1/2}(\mathbb{R})$, and therefore, $f * \text{pv}1/x$ also (take the Fourier transform and use corollary 2 of appendix A). Therefore, $f * \log|x|$ is in $H_{\text{loc}}^{1/2}(\mathbb{R})$ and the duality product:

$$\langle f, g * \log|x| \rangle_{H^{-1/2}, H^{1/2}},$$

is well-defined for all $f, g \in H^{-1/2}(-1, 1[)$. The same applies to:

$$\langle f, g * \text{sgn}(x) \rangle_{H^{-1/2}, H^{1/2}}.$$

With $f \in H^{-1/2}(-1, 1]$, \hat{f} is a C^∞ function and $|\hat{f}(t)|^2/\sqrt{1+t^2}$ is integrable. Therefore, taking $\varphi \in C_c^\infty(\mathbb{R})$ such that $\varphi = 1$ in a neighbourhood of 0, one can define:

$$\left\langle \text{fp} \frac{1}{|x|}, |\hat{f}(x)|^2 \right\rangle \stackrel{\text{def}}{=} \left\langle \text{fp} \frac{1}{|x|}, |\hat{f}(x)|^2 \varphi(x) \right\rangle_{\mathcal{D}', \mathcal{D}} + \int_{-\infty}^{+\infty} \frac{|\hat{f}(x)|^2}{|x|} [1 - \varphi(x)] dx,$$

and the result does not depend on φ .

Proposition 1 For all $f, g \in H^{-1/2}(-1, 1]$:

$$\begin{aligned} -\frac{1}{\pi} \left\langle f, g * \log|x| \right\rangle_{H^{-1/2}, H^{1/2}} &= \left\langle \text{fp} \frac{1}{|x|}, \hat{f}(x) \bar{\hat{g}}(x) \right\rangle + \frac{\Gamma_{\text{Eul}}}{\pi} \hat{f}(0) \bar{\hat{g}}(0), \\ \left\langle f, g * \text{sgn}(x) \right\rangle_{H^{-1/2}, H^{1/2}} &= -2i \left\langle \text{pv} \frac{1}{x}, \hat{f}(x) \bar{\hat{g}}(x) \right\rangle, \end{aligned}$$

where $\Gamma_{\text{Eul}} = \lim_{n \rightarrow \infty} \left(\sum_{k=1}^n \frac{1}{k} - \log n \right)$ is Euler's constant.

Proof This is an immediate consequence of the explicit knowledge of the Fourier transforms $\mathcal{F}[\log|x|]$ and $\mathcal{F}[\text{pv}1/x]$ displayed in proposition 6 and corollary 2 of appendix A. \square

Theorem 3 The symmetric bilinear form on $H^{-1/2}(-1, 1] \times H^{-1/2}(-1, 1]$:

$$b(f, g) = -\frac{1}{\pi} \left\langle f, g * \log|x| \right\rangle_{H^{-1/2}, H^{1/2}},$$

is a scalar product that induces a norm equivalent to that of $H^{-1/2}(-1, 1]$.

Proof Set:

$$\mathcal{H} = \left\{ f \in \mathcal{S}'(\mathbb{R}) \mid \text{supp } f \subset [-1, 1] \quad \text{and} \quad \frac{\hat{f}(x)}{\sqrt{|x|}} \in L^2 \right\},$$

Step 1. \mathcal{H} endowed with its natural norm is a Hilbert space.

Let us consider an arbitrary Cauchy sequence (f_n) in \mathcal{H} . The sequence $(\hat{f}_n(x)/\sqrt{|x|})$ converges strongly in $L^2(\mathbb{R})$ towards some limit g . Since $\sqrt{|x|}g \in \mathcal{S}'$, then $\sqrt{|x|}g = \hat{f}$ with some $f \in \mathcal{S}'$. Furthermore, extracting a subsequence if necessary, we have:

- $\lim_{n \rightarrow \infty} \hat{f}_n(x) = f(x)$, for almost all $x \in \mathbb{R}$,
- $|\hat{f}_n(x)| \leq \sqrt{|x|}h(x)$, for some $h \in L^2$.

Using the Plancherel formula and the dominated convergence theorem, one obtains:

$$\forall \varphi \in \mathcal{D}(\mathbb{R}), \quad \text{Supp } \varphi \cap [-1, 1], \quad \langle f, \varphi \rangle_{\mathcal{D}', \mathcal{D}} = 0,$$

and, hence, $\text{Supp } f \subset [-1, 1]$. Since $\hat{f}/\sqrt{|x|} \in L^2$, $f \in \mathcal{H}$ and the sequence (f_n) converges towards f in \mathcal{H} .

Step 2. One has:

$$\mathcal{H} = \left\{ f \in H^{-1/2}(-1, 1] \mid \langle f, 1 \rangle_{H^{-1/2}, H^{1/2}} = 0 \right\},$$

and its norm is equivalent to that induced by $H^{-1/2}(-1, 1]$.

Pick $f \in \mathcal{H}$. As:

$$\int_{-\infty}^{+\infty} \frac{|\hat{f}(x)|^2}{\sqrt{1+x^2}} dx \leq \int_{-\infty}^{+\infty} \frac{|\hat{f}(x)|^2}{|x|} dx, \quad (5)$$

one has $f \in H^{-1/2}(-1, 1]$. Since f is a compactly supported distribution, \hat{f} is a C^∞ function. Thus, as $|\hat{f}(x)|^2/|x|$ is integrable, one must have $\hat{f}(0) = 0$. But:

$$\hat{f}(0) = \frac{1}{\sqrt{2\pi}} \langle f, 1 \rangle_{H^{-1/2}, H^{1/2}}.$$

Reciprocally, if $f \in H^{-1/2}(-1, 1]$ with $\langle f, 1 \rangle = 0$, then $\hat{f}(x)/\sqrt{|x|}$ is square integrable and $f \in \mathcal{H}$. Hence, \mathcal{H} is identified with a close subspace of $H^{-1/2}(-1, 1]$. The equivalence of norms is now a straightforward consequence of (5) and the open mapping theorem.

Step 3. Conclusion.

The function $1/\sqrt{1-x^2}$ clearly defines an element of $H^{-1/2}(-1, 1]$. The derivative of $1/\sqrt{1-x^2} * \log|x|$ is the function $1/\sqrt{1-x^2} * \text{pv}1/x$ which vanishes identically over $]-1, 1[$ by virtue of theorem 12 of appendix A. This gives:

$$\frac{1}{\sqrt{1-x^2}} * \log|x| \equiv \int_{-1}^1 \frac{\log|x|}{\sqrt{1-x^2}} dx = -\pi \log 2,$$

on $]-1, 1[$. Set:

$$b(f, g) = -\frac{1}{\pi} \langle f, g * \log|x| \rangle_{H^{-1/2}, H^{1/2}},$$

which is a symmetric bilinear form by virtue of proposition 1. Introducing the decomposition:

$$f = \underbrace{f - \frac{\langle f, 1 \rangle}{\pi\sqrt{1-x^2}}}_{\in \mathcal{H}} + \frac{\langle f, 1 \rangle}{\pi\sqrt{1-x^2}},$$

one obtains

$$b(f, f) = b\left(f - \frac{\langle f, 1 \rangle}{\pi\sqrt{1-x^2}}, f - \frac{\langle f, 1 \rangle}{\pi\sqrt{1-x^2}}\right) + \log 2 \langle f, 1 \rangle_{H^{-1/2}, H^{1/2}}^2.$$

Combining proposition 1 and step 2, it can be readily seen that the restriction of b to $\mathcal{H} \times \mathcal{H}$ is simply the scalar product of \mathcal{H} . This yields the announced result. \square

The following result plays the same role as Korn's inequality in the situation under consideration.

Theorem 4 On $H^{-1/2}(-1, 1] \times H^{-1/2}(-1, 1]$, the symmetric bilinear form:

$$\begin{aligned} a[(p_1, q_1), (p_2, q_2)] \stackrel{\text{def}}{=} & -\frac{1}{\pi} \langle p_1, p_2 * \log|x| \rangle_{H^{-1/2}, H^{1/2}} + \frac{\gamma}{2} \langle p_1, q_2 * \text{sgn}(x) \rangle_{H^{-1/2}, H^{1/2}} \\ & - \frac{\gamma}{2} \langle q_1, p_2 * \text{sgn}(x) \rangle_{H^{-1/2}, H^{1/2}} - \frac{1}{\pi} \langle q_1, q_2 * \log|x| \rangle_{H^{-1/2}, H^{1/2}}, \end{aligned}$$

is continuous and coercive. Hence, this is a scalar product inducing a norm which is equivalent to that of $H^{-1/2}(-1, 1] \times H^{-1/2}(-1, 1]$.

Proof Applying proposition 1, one obtains:

$$a[(p, q), (p, q)] = \left\langle \text{fp} \frac{1}{|x|}, |\hat{p}|^2 + |\hat{q}|^2 \right\rangle + \frac{\Gamma_{\text{Eul}}}{\pi} \left(|\hat{p}(0)|^2 + |\hat{q}(0)|^2 \right) - \gamma \left\langle \text{pv} \frac{1}{x}, i\hat{p}\bar{\hat{q}} - i\bar{\hat{p}}\hat{q} \right\rangle.$$

But, for all $\varphi \in C_c^\infty(\mathbb{R})$:

$$\begin{aligned} \left\langle \text{pv} \frac{1}{x}, \varphi \right\rangle_{\mathcal{D}', \mathcal{D}} &= \lim_{\varepsilon \rightarrow \infty} \int_{-\infty}^{+\infty} \frac{t \varphi(t)}{t^2 + \varepsilon^2} dt, \\ \left\langle \text{fp} \frac{1}{|x|}, \varphi \right\rangle_{\mathcal{D}', \mathcal{D}} &= \lim_{\varepsilon \rightarrow \infty} \int_{-\infty}^{+\infty} \frac{|t| \varphi(t)}{t^2 + \varepsilon^2} dt, \end{aligned}$$

which entails:

$$\left| \left\langle \text{pv} \frac{1}{x}, i\hat{p}\bar{\hat{q}} - i\bar{\hat{p}}\hat{q} \right\rangle \right| \leq \left\langle \text{fp} \frac{1}{|x|}, 2|\hat{p}||\hat{q}| \right\rangle \leq \left\langle \text{fp} \frac{1}{|x|}, |\hat{p}|^2 + |\hat{q}|^2 \right\rangle.$$

Putting everything together, we obtain:

$$\begin{aligned} (1 - \gamma) \left\langle \text{fp} \frac{1}{|x|}, |\hat{p}|^2 + |\hat{q}|^2 \right\rangle + \frac{\Gamma_{\text{Eul}}}{\pi} \left(|\hat{p}(0)|^2 + |\hat{q}(0)|^2 \right) &\leq \\ a[(p, q), (p, q)] & \\ \leq (1 + \gamma) \left\langle \text{fp} \frac{1}{|x|}, |\hat{p}|^2 + |\hat{q}|^2 \right\rangle + \frac{\Gamma_{\text{Eul}}}{\pi} \left(|\hat{p}(0)|^2 + |\hat{q}(0)|^2 \right), & \end{aligned}$$

which, by virtue of proposition 1, gives:

$$\begin{aligned} (1 - \gamma) \left(-\frac{1}{\pi} \langle p, p * \log |x| \rangle_{H^{-1/2}, H^{1/2}} - \frac{1}{\pi} \langle q, q * \log |x| \rangle_{H^{-1/2}, H^{1/2}} \right) &\leq \\ a[(p, q), (p, q)] & \\ \leq (1 + \gamma) \left(-\frac{1}{\pi} \langle p, p * \log |x| \rangle_{H^{-1/2}, H^{1/2}} - \frac{1}{\pi} \langle q, q * \log |x| \rangle_{H^{-1/2}, H^{1/2}} \right), & \end{aligned}$$

and the conclusion we were looking for now follows from theorem 3. \square

4 Frictionless indentation of the two-dimensional half-space by a rigid flat punch

Let us consider the problem of the frictionless indentation of the two-dimensional half-space dealt with in the previous subsection by a rigid flat punch with a finite width (see figure 1). The units are assumed to have been chosen in such a way that the width of the punch is equal to 2 and the Young modulus is equal to 1. Using the explicit knowledge of the Neumann-Dirichlet operator of the half-space (theorem 2) and given the total force $F \geq 0$ exerted on the punch, the problem is that of finding $t_y, u'_y \in L^{1+}(-1, 1; \mathbb{R})$ such that:

- $\frac{1}{\pi} \oint_{-1}^1 \frac{t_y(t)}{t-x} dt = \frac{1}{2(1-\nu^2)} u'_y(x),$ for a.a. $x \in]-1, 1[$,
- $t_y(x) \geq 0, \quad t_y(x) \left\{ \int_0^x u'_y(t) dt - \min_{x \in [-1,1]} \int_0^x u'_y(t) dt \right\} = 0,$ for a.a. $x \in]-1, 1[$,
- $\int_{-1}^1 t_y(t) dt = F.$

The following theorem provides a *unique* explicit solution to this problem. This solution was apparently first obtained by Muskhelishvili.

Theorem 5 *There exists a unique pair of functions $t_y, u'_y \in L^{1+}(-1, 1; \mathbb{R})$ satisfying:*

- $\frac{1}{\pi} \oint_{-1}^1 \frac{t_y(t)}{t-x} dt = \frac{1}{2(1-\nu^2)} u'_y(x),$ for a.a. $x \in]-1, 1[$,
- $t_y(x) \geq 0, \quad \int_0^x u'_y(t) dt \geq 0, \quad t_y(x) \int_0^x u'_y(t) dt = 0,$ for a.a. $x \in]-1, 1[$,
- $\int_{-1}^1 t_y(t) dt = F.$

These functions are given by:

$$t_y(x) = \frac{F}{\pi\sqrt{1-x^2}}, \quad u'_y(x) = 0.$$

Proof The Hilbert space $H^{-1/2}(]-1, 1[)$ is endowed with the scalar product:

$$b(f, g) = -\frac{1}{\pi} \left\langle f, g * \log|x| \right\rangle_{H^{-1/2}, H^{1/2}},$$

thanks to theorem 3. Let us take:

$$K = \left\{ f \in H^{-1/2}(]-1, 1[) \mid \langle f, 1 \rangle_{H^{-1/2}, H^{1/2}} = F, \right. \\ \left. \text{and } \forall \varphi \in H^{1/2}(]-1, 1[), \varphi \geq 0, \langle f, \varphi \rangle \geq 0 \right\},$$

which is clearly nonempty closed and convex. Any solution of the problem under consideration will solve the variational inequality:

$$\forall p \in K, \quad b(t_y, t_y - p) \leq 0,$$

that is, is a projection of 0 onto K . This proves the existence and uniqueness of the solution $t_y \in H^{-1/2}(]-1, 1[)$.

The explicit solution is provided by theorem 12, and this solution is seen to belong not only to $H^{-1/2}(]-1, 1[)$ but also to L^{1+} . \square

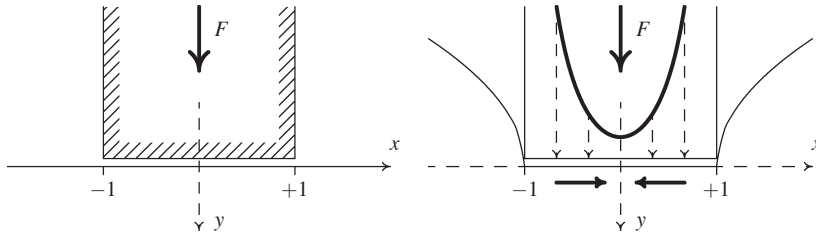

Fig. 1 Frictionless indentation of the elastic half-space by a rigid flat punch.

Remark 1 Note that $t_y \notin L^2$. The surface displacement can be calculated (modulo some arbitrary additive constants) using theorem 2.

$$\bar{u}_x(x) = \begin{cases} -\frac{(1-2\nu)(1+\nu)F}{\pi} \arcsin(x), & \text{if } |x| < 1, \\ -\frac{(1-2\nu)(1+\nu)F}{2} \operatorname{sgn}(x) & \text{if } |x| > 1. \end{cases}$$

$$\bar{u}_y(x) = \begin{cases} 0, & \text{if } |x| < 1, \\ -\frac{2(1-\nu^2)F}{\pi} \log(|x| + \sqrt{x^2-1}), & \text{if } |x| > 1. \end{cases}$$

It can be seen that the surface normal displacement is infinite at infinity, which means that the total displacement of the rigid punch is undefined. This is consistent with the fact that since the stress field is not square-integrable, no energy can be associated with that solution. The problem must be parametrized by the total force exerted on the punch, and not by the total displacement of the punch. Note also that the tangential displacement is directed *inwards*.

5 Formulation of the indentation problem with Coulomb friction

We recall the notation:

$$\gamma = \frac{1-2\nu}{2(1-\nu)} \in]0, 3/4[.$$

It is also convenient to set:

$$u(x) = \frac{1}{2(1-\nu^2)} u_y(x), \quad v(x) = \frac{1}{2(1-\nu^2)} u_x(x),$$

and, $p = t_y$ and $q = t_x$, for the sake of consistency of notations. Given the friction coefficient $\mathcal{F} \geq 0$, the total normal force $P > 0$ and the total tangential force $Q \in]-\mathcal{F}P, \mathcal{F}P[$, the

problem consists now in finding $p, q \in L^{1+}(-1, 1; \mathbb{R})$ and $u, v \in W^{1,1}(-1, 1; \mathbb{R})$ satisfying:

- $\int_{-1}^1 p(t) dt = P, \quad \int_{-1}^1 q(t) dt = Q,$
- $\frac{1}{\pi} \oint_{-1}^1 \frac{p(t)}{t-x} dt + \gamma q(x) = u'(x), \quad \text{for a.a. } x \in]-1, 1[,$
- $\frac{1}{\pi} \oint_{-1}^1 \frac{q(t)}{t-x} dt - \gamma p(x) = v'(x), \quad \text{for a.a. } x \in]-1, 1[,$
- $p(x) \geq 0, \quad u(x) \geq 0, \quad p(x)u(x) = 0, \quad \text{for a.a. } x \in]-1, 1[,$
- $|q(x)| \leq \mathcal{F}p(x), \quad v(x)q(x) \leq 0, \quad \left[\mathcal{F}p(x) - |q(x)| \right] v(x) = 0, \quad \text{a.e.}$

In what follows, we will refer to this contact problem with (static) Coulomb friction as ‘problem \mathcal{P} ’.

6 Qualitative analysis of an arbitrary solution

Proposition 2 *Any solution of problem \mathcal{P} must achieve active contact everywhere:*

$$\forall x \in]-1, 1[, \quad u(x) = 0.$$

Proof Let us assume that $u(x_0) > 0$ for some $x_0 \in]-1, 1[$. Let us take $]a, b[$ to denote the connected component of the nonempty open set $\{x \in]-1, 1[\mid u(x) > 0\}$ which contains x_0 . Based on $p(x)u(x) \equiv 0$ and $|q(x)| \leq \mathcal{F}p(x)$, it can be seen that p and q must vanish identically over $]a, b[$. Therefore:

$$\text{for a.a. } x \in]a, b[, \quad u'(x) = \frac{1}{\pi} \oint_{-1}^1 \frac{p(t)}{t-x} dt.$$

Since $\int_{-1}^1 p(t) dt = P > 0$, the circumstance $]a, b[=]-1, 1[$ can be ruled out. Only the following three cases can therefore occur.

- If $a = -1$, then:

$$\text{for a.a. } x \in]-1, b[, \quad u'(x) = \frac{1}{\pi} \int_b^1 \frac{p(t)}{t-x} dt \geq 0.$$

Therefore, u is nondecreasing over $] -1, b[$. Since, in addition, it is nonnegative and $u(b) = 0$, the function u must vanish identically over $] -1, b[$. However, this is in contradiction with the definition of b .

- If $b = 1$, then:

$$\text{for a.a. } x \in]-1, b[, \quad u'(x) = \frac{1}{\pi} \int_{-1}^a \frac{p(t)}{t-x} dt \leq 0.$$

Therefore, u is nonincreasing over $]a, 1[$. Since, in addition, it is nonnegative and $u(a) = 0$, the function u must vanish identically over $]a, 1[$. However, this is in contradiction with the definition of a .

- If $-1 < a < x_0 < b < 1$, then:

$$\text{for a.a. } x \in]a, b[, \quad u'(x) = \frac{1}{\pi} \int_{-1}^a \frac{p(t)}{t-x} dt + \frac{1}{\pi} \int_b^1 \frac{p(t)}{t-x} dt.$$

Since $p \geq 0$, the two integrals, and therefore $u'(x)$, are nondecreasing functions of $x \in]a, b[$. The restriction of u to $]a, b[$ must therefore be convex. Since $u(a) = u(b) = 0$, it must vanish identically over $]a, b[$. However, this is in contradiction with the existence of x_0 . \square

Proposition 3 Any slipping zone associated with a solution of problem \mathcal{P} must reach the edge of the punch. More specifically:

- if $]a, b[$ is a connected component of the open set $\{x \in]-1, 1[\mid v(x) < 0\}$, then $b = 1$.
- if $]a, b[$ is a connected component of the open set $\{x \in]-1, 1[\mid v(x) > 0\}$, then $a = -1$.

In addition, the restriction of $v(x)$ to one of these intervals must be a non-increasing function of x .

Proof Let $]a, b[$ be a connected component of the open set $\{x \in]-1, 1[\mid v(x) < 0\}$. Let $e(x) = p(x) - q(x)/\mathcal{F}$ so that e is a nonnegative function, vanishing identically over $]a, b[$. Then:

$$\begin{aligned} p(x) + \frac{1}{\gamma \mathcal{F}} \frac{1}{\pi} \oint_{-1}^1 \frac{p(t)}{t-x} dt &= e(x), \\ \gamma \mathcal{F}^2 e(x) - \frac{\mathcal{F}}{\pi} \oint_{-1}^1 \frac{e(t)}{t-x} dt - \gamma(1 + \mathcal{F}^2)p(x) &= v'(x), \end{aligned}$$

for almost all $x \in]-1, 1[$. Let:

$$\alpha = -\frac{1}{\pi} \arctan \gamma \mathcal{F} \in]-1/2, 0[.$$

Applying Söhngen's theorem 13 to the first equation gives:

$$\begin{aligned} p(x) &= \frac{\gamma^2 \mathcal{F}^2}{1 + \gamma^2 \mathcal{F}^2} e(x) \\ &- \frac{\gamma \mathcal{F}}{1 + \gamma^2 \mathcal{F}^2} \frac{1}{(1+x)^{1/2-\alpha} (1-x)^{1/2+\alpha}} \frac{1}{\pi} \oint_{-1}^1 \frac{(1+t)^{1/2-\alpha} (1-t)^{1/2+\alpha} e(t)}{t-x} dt \\ &+ \frac{\cos \alpha \pi}{\pi} \frac{P}{(1+x)^{1/2-\alpha} (1-x)^{1/2+\alpha}}, \end{aligned}$$

in $] -1, 1[$. Using the second equation then yields:

$$\begin{aligned} \frac{(1+x)^{1/2-\alpha} (1-x)^{1/2+\alpha} v'(x)}{\mathcal{F}} &= -\frac{\gamma(1 + \mathcal{F}^2)}{\mathcal{F}} \frac{P \cos \alpha \pi}{\pi} \\ &+ \frac{1}{\pi} \int_{-1}^1 \frac{(1+t)^{1/2-\alpha} (1-t)^{1/2+\alpha} - (1+x)^{1/2-\alpha} (1-x)^{1/2+\alpha}}{t-x} e(t) dt \\ &- \frac{1 - \gamma^2}{1 + \gamma^2 \mathcal{F}^2} \frac{1}{\pi} \oint_{-1}^1 \frac{(1+t)^{1/2-\alpha} (1-t)^{1/2+\alpha} e(t)}{t-x} dt, \quad (6) \end{aligned}$$

for almost all $x \in]a, b[$. Note also that:

$$\frac{d}{dx}(1+x)^{1/2-\alpha}(1-x)^{1/2+\alpha} = \left(\frac{1}{2}-\alpha\right)\left(\frac{1-x}{1+x}\right)^{1/2+\alpha} - \left(\frac{1}{2}+\alpha\right)\left(\frac{1+x}{1-x}\right)^{1/2-\alpha}.$$

The derivative of $(1+x)^{1/2-\alpha}(1-x)^{1/2+\alpha}$, which is the sum of two nonincreasing functions, is therefore nonincreasing over $] -1, 1[$. Since, in addition, function e is nonnegative, then, for almost all $t \in] -1, 1[$, the function:

$$x \mapsto \frac{(1+t)^{1/2-\alpha}(1-t)^{1/2+\alpha} - (1+x)^{1/2-\alpha}(1-x)^{1/2+\alpha}}{t-x} e(t)$$

is nonincreasing. Going back to (6), it can be seen that the function:

$$x \mapsto (1+x)^{1/2-\alpha}(1-x)^{1/2+\alpha} v'(x)$$

is nonincreasing over $]a, b[$.

Let us now assume that $b \neq 1$. Then $v(b) = 0$ since v is continuous. As $(1+x)^{1/2-\alpha}(1-x)^{1/2+\alpha} v'(x)$ admits a limit in $\overline{\mathbb{R}}$ as $x \rightarrow b-$, the same is true in the case of $v'(x)$. This limit must necessarily be in $[0, +\infty]$. Consequently, the function $(1+x)^{1/2-\alpha}(1-x)^{1/2+\alpha} v'(x)$ is nonnegative and therefore, v is nondecreasing over $]a, b[$. This entails that $a = -1$ (otherwise $v(a) = 0$, and this would be contradictory). Hence, for almost all $x \in] -1, b[$:

$$v'(x) = -\gamma(1 + \mathcal{F}^2) p(x) - \frac{\mathcal{F}}{\pi} \int_b^1 \frac{e(t)}{t-x} dt \leq 0.$$

But, this also leads to a contradiction.

Therefore, necessarily, $b = 1$. This entails that $a \neq -1$, otherwise $q \equiv \mathcal{F}p$, which would be contradictory with:

$$\int_{-1}^1 p(t) dt = P, \quad \int_{-1}^1 q(t) dt = Q,$$

where $Q \in]-\mathcal{F}P, \mathcal{F}P[$. Since v is continuous, $v(a) = 0$ and the limit of $v'(x)$ as $x \rightarrow a+$ must be in $[-\infty, 0]$. As the function $(1+x)^{1/2-\alpha}(1-x)^{1/2+\alpha} v'(x)$ is nonincreasing over $]a, b[$, it must be nonnegative and therefore, v is nondecreasing over $]a, b[$.

The other claim in the proposition can be proved on exactly the same lines. \square

Proposition 4 *The sticking zone $\{x \in] -1, 1[\mid v(x) = 0\}$ is a nonempty interval which does not reduce to a singleton.*

Proof If the set $\{x \in] -1, 1[\mid v(x) = 0\}$ was empty, then the continuous function $v(x)$ would have constant sign. This would entail either $q \equiv \mathcal{F}p$ or $q \equiv -\mathcal{F}p$. But this would be contradictory with:

$$\int_{-1}^1 p(t) dt = P, \quad \int_{-1}^1 q(t) dt = Q,$$

with $Q \in]-\mathcal{F}P, \mathcal{F}P[$. Hence, the sticking zone is nonempty.

If the sticking zone was not connected, then there would exist a slipping interval that would not reach one edge of the punch, which would be contradictory with proposition 3.

The sticking zone is therefore a nonempty interval. If it was reduced to a singleton $\{x_0\}$ ($x_0 \in] -1, 1[$), then by virtue of proposition 3, we would have:

$$\begin{aligned} \forall x \in] -1, x_0[, \quad v(x) &> 0, \\ \forall x \in] x_0, 1[, \quad v(x) &< 0, \end{aligned}$$

and therefore:

$$q(x) = \mathcal{F} \operatorname{sgn}(x - x_0) p(x).$$

Since the contact is active everywhere below the punch, based on proposition 2, this entails:

$$\text{for almost all } x \in]-1, 1[, \quad \operatorname{sgn}(x - x_0) p(x) + \frac{1}{\gamma \mathcal{F}} \frac{1}{\pi} \oint_{-1}^1 \frac{p(t)}{t - x} dt = 0.$$

From theorem 14 in appendix A, one obtains:

$$p(x) = \frac{C^{\text{te}}}{|x - x_0|^{2\alpha} (1 - x^2)^{1/2 - \alpha}},$$

where:

$$\alpha = \frac{1}{\pi} \arctan \gamma \mathcal{F} \in]0, 1/2[,$$

and C^{te} is a positive constant. Then, one calculates:

$$\begin{aligned} v'(x) &= \frac{\mathcal{F}}{\pi} \oint_{-1}^1 \frac{\operatorname{sgn}(t - x_0) p(t)}{t - x} dt - \gamma p(x), \\ &= \frac{\mathcal{F} C^{\text{te}}}{\pi} \oint_{-1}^1 \frac{\operatorname{sgn}(t - x_0) dt}{|t - x_0|^{2\alpha} (1 - t^2)^{1/2 - \alpha} (t - x)} - \frac{\gamma C^{\text{te}}}{|x - x_0|^{2\alpha} (1 - x^2)^{1/2 - \alpha}}, \end{aligned}$$

which, based on proposition 8, gives the following asymptotics:

$$v'(x) \sim \left(\frac{1}{\gamma} - \gamma \right) \frac{C^{\text{te}}}{|x - x_0|^{2\alpha} (1 - x^2)^{1/2 - \alpha}}, \quad \text{as } x \rightarrow x_0.$$

However, these asymptotics are not consistent with the known sign of the function v in a neighbourhood of x_0 . The sticking zone cannot therefore be reduced to a single point. \square

Proposition 5 *The sticking zone does not reach the edge of the punch:*

$$\{x \in]-1, 1[\mid v(x) = 0\} = [a, b],$$

where $-1 < a < b < 1$.

Proof Let us assume that $a = -1$. Then, for almost all $x \in]-1, 1[$:

$$p(x) + iq(x) + \frac{i}{\gamma} \frac{1}{\pi} \oint_{-1}^1 \frac{p(t) + iq(t)}{t - x} dt = -\frac{1}{\gamma} v'(x).$$

Based on theorem 13, this entails:

$$\begin{aligned} p(x) + iq(x) &= \frac{e^{\frac{i}{2\pi} \log \frac{1+\gamma}{1-\gamma} \log \frac{1+x}{1-x}}}{\sqrt{1-x^2}} \left\{ (P + iQ) \frac{\cosh \log \sqrt{\frac{1+\gamma}{1-\gamma}}}{\pi} \right. \\ &\quad \left. - \frac{i}{1-\gamma^2} \frac{1}{\pi} \oint_{-1}^1 \frac{\sqrt{1-t^2} e^{-\frac{i}{2\pi} \log \frac{1+\gamma}{1-\gamma} \log \frac{1+t}{1-t}} v'(t)}{t-x} dt \right\} + \underbrace{\frac{\gamma}{1-\gamma^2} v'(x)}_{\equiv 0 \text{ on }]-1, b[}. \end{aligned}$$

Then, the only way for p to be nonnegative over $] -1, b[$ is to vanish identically over this interval. But in this case:

$$P = \int_b^1 p(t) dt = \frac{1}{\mathcal{F}} \int_b^1 q(t) dt = \frac{Q}{\mathcal{F}} \in] -P, P[,$$

which is absurd. Therefore $a > -1$. The fact $b < 1$ can be proved on exactly the same lines. \square

By combining propositions 2, 3, 4 and 5, we can prove the following theorem.

Theorem 6 *Any solution of problem \mathcal{P} must achieve active contact everywhere below the punch ($u \equiv 0$) and must have a sticking interval $[a, b]$ ($-1 < a < b < 1$) surrounded by two inward slipping zones:*

$$\begin{aligned} \{x \in] -1, 1[\mid v(x) > 0\} &=] -1, a[, \\ \{x \in] -1, 1[\mid v(x) = 0\} &= [a, b], \\ \{x \in] -1, 1[\mid v(x) < 0\} &=] b, 1[. \end{aligned}$$

In addition, the tangential displacement $v(x)$ must be a non-increasing function of $x \in] -1, 1[$.

The next theorem give asymptotic estimates that must satisfy any solution.

Theorem 7 *For any solution of problem \mathcal{P} , the functions p, q, v' are continuous in $] -1, 1[$ and their restrictions to each of the open intervals $] -1, a[$, $] a, b[$ and $] b, 1[$ are C^∞ . In addition, they satisfy the following asymptotic estimates at the bounds of the intervals:*

$$\begin{aligned} p(x) &\sim \frac{C_{-1}}{(1+x)^{1/2-\alpha}}, & q(x) &\sim -\frac{\mathcal{F}C_{-1}}{(1+x)^{1/2-\alpha}}, & v'(x) &\sim -\frac{\gamma(1+\mathcal{F}^2)C_{-1}}{(1+x)^{1/2-\alpha}}, & \text{as } x &\rightarrow -1+, \\ p(x) &\sim \frac{C_1}{(1-x)^{1/2-\alpha}}, & q(x) &\sim \frac{\mathcal{F}C_1}{(1-x)^{1/2-\alpha}}, & v'(x) &\sim -\frac{\gamma(1+\mathcal{F}^2)C_1}{(1-x)^{1/2-\alpha}}, & \text{as } x &\rightarrow 1-, \end{aligned}$$

where:

$$\alpha = \frac{1}{\pi} \arctan \gamma \mathcal{F} \in] 0, 1/2[,$$

and C_{-1}, C_1 are two positive constants. Also, the following asymptotic estimates holds true at a and b :

$$\begin{aligned} v'(x) &\sim -C_a \sin \pi \alpha \frac{1-\gamma^2}{\gamma} (a-x)^{1/2-\alpha}, & \text{as } x &\rightarrow a-, \\ p(x) - p(a) &\sim -C_a \sin \pi \alpha (a-x)^{1/2-\alpha} & \text{as } x &\rightarrow a-, \\ p(x) + q(x)/\mathcal{F} &\sim C_a (x-a)^{1/2-\alpha}, & \text{as } x &\rightarrow a+, \\ p(x) - q(x)/\mathcal{F} &\sim C_b (b-x)^{1/2-\alpha}, & \text{as } x &\rightarrow b-, \\ v'(x) &\sim -C_b \sin \pi \alpha \frac{1-\gamma^2}{\gamma} (x-b)^{1/2-\alpha}, & \text{as } x &\rightarrow b+, \\ p(x) - p(b) &\sim -C_b \sin \pi \alpha (x-b)^{1/2-\alpha}, & \text{as } x &\rightarrow b+, \end{aligned}$$

where C_a, C_b are two positive constants. In addition, $p(x)$ admits a negative right-derivative at $x = a$ and a positive left-derivative at $x = b$.

Proof

Step 1. *Estimates at the bounds* $x = -1, 1$.

Based on theorem 6, we can write:

$$\frac{1}{\pi} \oint_{-1}^1 \frac{p(t)}{t-x} dt - \gamma \mathcal{F} p(x) = -\gamma \mathcal{F} e(x),$$

for almost all $x \in]-1, 1[$, where $e = p + q/\mathcal{F}$ is a nonnegative function vanishing identically over $] -1, a[$. Based on theorem 13 in appendix A, we therefore obtain:

$$p(x) = \frac{\cos \pi \alpha}{\pi} \frac{P}{(1+x)^{1/2-\alpha}(1-x)^{1/2+\alpha}} + \frac{\cos \pi \alpha \sin \pi \alpha}{\pi} \int_a^1 \frac{(1+t)^{1/2-\alpha}(1-t)^{1/2+\alpha}}{(1+x)^{1/2-\alpha}(1-x)^{1/2+\alpha}} \frac{e(t)}{t-x} dt, \quad (7)$$

for almost all $x \in]-1, a[$, where:

$$\alpha = \frac{1}{\pi} \arctan \gamma \mathcal{F}.$$

Thus,

$$p(x) = \frac{\cos \pi \alpha}{\pi} \frac{P + d(x)}{(1+x)^{1/2-\alpha}(1-x)^{1/2+\alpha}},$$

where $d(x)$ is a nonnegative, nondecreasing function of $x \in]-1, a[$. Hence, d must have a limit $d(-1+) \geq 0$ as $x \rightarrow -1+$. Setting $C_{-1} = (P + d(-1+)) \cos \pi \alpha / (\pi 2^{1/2+\alpha})$, it can be readily seen that the validity of the asymptotic estimate for $p(x)$ as $x \rightarrow -1+$ is proved. Since $q(x) = -\mathcal{F} p(x)$ in $] -1, a[$, the asymptotic estimate for $q(x)$ as $x \rightarrow -1+$ can be readily deduced, and the one for $v'(x)$ is now a straightforward consequence of:

$$\frac{1}{\pi} \oint_{-1}^1 \frac{q(t)}{t-x} dt - \gamma p(x) = v'(x),$$

and proposition 8 in appendix A. Going back to formula (7), it can be seen that the restriction of p to the interval $] -1, a[$ is C^∞ , and the same holds true for q . From the above expression for v' in terms of p and q , it can be seen that the same regularity holds true for the restriction of v' to $] -1, a[$ based on proposition 7 in appendix A.

The asymptotic estimates for $x \rightarrow 1-$ can be proved on exactly the same lines.

Step 2. *Estimates at* $x = a, b$.

Focusing first on the left extremity $x = a$ of the sticking zone, let $e(x) = p(x) + q(x)/\mathcal{F}$ as in step 1, so that $e(x)$ is a nonnegative function that vanishes identically over $] -1, a[$. From:

$$\frac{1}{\pi} \oint_{-1}^1 \frac{p(t)}{t-x} dt = \tan \pi \alpha (p(x) - e(x)),$$

and theorem 13 in appendix A, we obtain:

$$p(x) = \sin^2 \pi \alpha e(x) + \frac{\cos \pi \alpha \sin \pi \alpha}{\pi} \int_a^1 \frac{(1+t)^{1/2-\alpha}(1-t)^{1/2+\alpha}}{(1+x)^{1/2-\alpha}(1-x)^{1/2+\alpha}} \frac{e(t)}{t-x} dt + \frac{\cos \pi \alpha}{\pi} \frac{P}{(1+x)^{1/2-\alpha}(1-x)^{1/2+\alpha}}, \quad (8)$$

for almost all $x \in]-1, 1[$. Consequently:

$$\begin{aligned} (1 - \gamma^2)p(x) - \gamma v'(x) &= p(x) + \tan^2 \pi \alpha (p(x) - e(x)) - \frac{\tan \pi \alpha}{\pi} \oint_{-1}^1 \frac{e(t)}{t-x} dt, \\ &= \frac{\tan \pi \alpha}{\pi} \int_a^1 \frac{(1+t)^{1/2-\alpha}(1-t)^{1/2+\alpha}}{(1+x)^{1/2-\alpha}(1-x)^{1/2+\alpha}} \frac{e(t)}{t-x} dt - \frac{\tan \pi \alpha}{\pi} \oint_{-1}^1 \frac{e(t)}{t-x} dt \\ &\quad + \frac{1}{\pi \cos \pi \alpha} \frac{P}{(1+x)^{1/2-\alpha}(1-x)^{1/2+\alpha}}. \end{aligned}$$

Setting:

$$K(x, t) = \frac{(1+t)^{1/2-\alpha}(1-t)^{1/2+\alpha} - (1+x)^{1/2-\alpha}(1-x)^{1/2+\alpha}}{t-x},$$

it has been proved that:

$$(1 - \gamma^2)p(x) = \gamma v'(x) + \frac{\tan \pi \alpha}{\pi} \frac{1}{(1+x)^{1/2-\alpha}(1-x)^{1/2+\alpha}} \int_{-1}^1 K(x, t) e(t) dt + \frac{1}{\pi \cos \pi \alpha} \frac{P}{(1+x)^{1/2-\alpha}(1-x)^{1/2+\alpha}}. \quad (9)$$

Next, let:

$$\begin{aligned} \tilde{p}(x) &= p(x) (1+x)^{1/2-\alpha} (1-x)^{1/2+\alpha}, \\ \tilde{e}(x) &= e(x) (1+x)^{1/2-\alpha} (1-x)^{1/2+\alpha}, \\ \tilde{w}(x) &= v'(x) (1+x)^{1/2-\alpha} (1-x)^{1/2+\alpha}, \end{aligned}$$

so that formulae (8) and (9) now read as follows:

$$\tilde{p}(x) = \sin^2 \pi \alpha \tilde{e}(x) + \frac{\cos \pi \alpha \sin \pi \alpha}{\pi} \oint_a^1 \frac{\tilde{e}(t)}{t-x} dt + \frac{P \cos \pi \alpha}{\pi}, \quad (10)$$

$$(1 - \gamma^2)\tilde{p}(x) = \gamma \tilde{w}(x) + \frac{\tan \pi \alpha}{\pi} \int_a^1 \frac{K(x, t)}{(1+t)^{1/2-\alpha}(1-t)^{1/2+\alpha}} \tilde{e}(t) dt + \frac{P}{\pi \cos \pi \alpha}. \quad (11)$$

Since \tilde{w} vanishes identically over $]a, b[$, formula (11) entails that \tilde{p} , and therefore p , is C^∞ in $]a, b[$, admits a right-limit as $x \rightarrow a+$ and is C^1 in $[a, b[$. Since, because of the concavity of $(1+x)^{1/2-\alpha}(1-x)^{1/2+\alpha}$, $\partial K(x, t)/\partial x$ is negative, so is the right-derivative of p at $x = a$.

By formula (10) and theorem 13 of appendix A, one gets, for almost all $x \in]a, 1[$:

$$\begin{aligned} \tilde{e}(x) &= \tilde{p}(x) - (P \cos \pi \alpha)/\pi - \frac{\cot \pi \alpha}{\pi} \oint_a^1 \frac{(t-a)^{1/2+\alpha}(1-t)^{1/2-\alpha}}{(x-a)^{1/2+\alpha}(1-x)^{1/2-\alpha}} \frac{\tilde{p}(t) - (P \cos \pi \alpha)/\pi}{t-x} dt \\ &\quad + \frac{C}{(x-a)^{1/2+\alpha}(1-x)^{1/2-\alpha}}, \\ &= \tilde{p}(x) - (P \cos \pi \alpha)/\pi - \frac{\cot \pi \alpha}{\pi} \oint_a^1 \left(\frac{1-t}{t-a} \times \frac{x-a}{1-x} \right)^{1/2-\alpha} \frac{\tilde{p}(t) - (P \cos \pi \alpha)/\pi}{t-x} dt \\ &\quad + \frac{C'}{(x-a)^{1/2+\alpha}(1-x)^{1/2-\alpha}}, \end{aligned}$$

As \tilde{p} belongs to class C^1 in $[a, b[$, the Cauchy principal value integral in the latter expression admits a finite limit as $x \rightarrow a+$, based on proposition 8 (if $\tilde{p}(a+) - (P \cos \pi \alpha)/\pi \neq 0$) or proposition 7 (if $\tilde{p}(a+) - (P \cos \pi \alpha)/\pi = 0$). But as $\tilde{e} \leq 2\tilde{p}$, the function $\tilde{e}(x)$ must be bounded in a right-neighbourhood of a . Therefore $C' = 0$ and it has been proved that:

$$\tilde{e}(x) = \tilde{p}(x) - (P \cos \pi \alpha)/\pi - \frac{\cot \pi \alpha}{\pi} \oint_a^1 \left(\frac{1-t}{t-a} \times \frac{x-a}{1-x} \right)^{1/2-\alpha} \frac{\tilde{p}(t) - (P \cos \pi \alpha)/\pi}{t-x} dt, \quad (12)$$

for almost all $x \in]a, 1[$. Since it was noted above that the Cauchy principal value integral admits a finite limit as $x \rightarrow a+$, the same is true in the case of the function $\tilde{e}(x)$ and therefore, in that of $e(x)$. If this limit was not zero, then formula (10) together with proposition 8 in appendix A imply that $\tilde{p}(x)$ would show a logarithmic singularity at the right of a , which has been ruled out. Therefore $\tilde{e}(a+) = 0$. Going back to expression (12), it can also be seen, from proposition 7 in appendix A, that $\tilde{e}(x)$ satisfies a Hölder condition in a right-neighbourhood of a . But, expression (10) entails that \tilde{p} is continuous at $x = a$ and:

$$\tilde{p}(a) - \frac{P \cos \pi \alpha}{\pi} > 0, \quad (13)$$

since $\tilde{e}(x)$ is nonnegative, continuous on $]b, 1[$ and cannot vanish identically over this interval. As:

$$1 - \frac{\cot \pi \alpha}{\pi} \oint_a^1 \left(\frac{1-t}{t-a} \times \frac{x-a}{1-x} \right)^{1/2-\alpha} \frac{dt}{t-x} = \frac{1}{\sin \pi \alpha} \left(\frac{x-a}{1-x} \right)^{1/2-\alpha},$$

for $x \in]a, 1[$ (which can be checked, for example, from theorem 13 in appendix A), then (12) and (13) entail:

$$e(x) \sim C_a (x-a)^{1/2-\alpha}, \quad \text{as } x \rightarrow a+,$$

for some positive constant C_a . Examining the distributional derivative of expression (10) locally in the light of proposition 8 in appendix A gives:

$$p(x) - p(a) \sim -C_a \sin \pi \alpha (a-x)^{1/2-\alpha}, \quad \text{as } x \rightarrow a-,$$

and, finally, expression (11) yields:

$$v'(x) \sim -C_a \sin \pi \alpha \frac{1-\gamma^2}{\gamma} (a-x)^{1/2-\alpha}, \quad \text{as } x \rightarrow a-.$$

Therefore, all the announced asymptotic estimates around $x = a$ have been proved to be valid. Those around $x = b$ could be proved along the same lines. \square

The above theorem makes it possible to read the Sobolev and Hölder regularity of any solution.

Corollary 1 For any solution of problem \mathcal{P} , the functions p, q, v' belong to $L^{2/(1-2\alpha)-}$, and locally satisfy a Hölder condition of exponent $1/2 - \alpha$, where:

$$\alpha = \frac{1}{\pi} \arctan \gamma \mathcal{F} \in]0, 1/2[.$$

It is worth noting that friction has a regularizing effect on the singularities at the edges of the punch: the larger the friction coefficient \mathcal{F} becomes, the weaker the singularities will be. In particular, the surface traction are in L^2 provided the friction coefficient \mathcal{F} is positive, whereas, as seen in section 4, in the frictionless situation, the singularities at the edges are not square-integrable.

7 Investigations on the uniqueness

In section 6, it was proved that, for any solution, there exist $-1 < a < b < 1$ such that the sticking zone is exactly the interval $[a, b]$.

We are not yet able to prove that such a solution is unique, even with a sufficiently small friction coefficient \mathcal{F} . However, we are going to prove the existence of some constant $\mathcal{F}_c > 0$, depending only on the Poisson ratio ν , such that, provided $\mathcal{F} < \mathcal{F}_c$, the sticking intervals $[a, b], [\bar{a}, \bar{b}]$ of two distinct solutions *cannot overlap*, that is:

$$b \leq \bar{a}, \quad \text{or} \quad \bar{b} \leq a.$$

This means, in particular, that the number of solutions is at most countable, for $\mathcal{F} < \mathcal{F}_c$.

Theorem 8 *Let us assume that $\mathcal{F} < \mathcal{F}_c$, where \mathcal{F}_c stands for a positive constant depending only on ν . Then, the sticking intervals $[a, b], [\bar{a}, \bar{b}]$ of two distinct solutions cannot overlap.*

Proof Let us consider two distinct solutions of problem \mathcal{P} involving sticking intervals $[a, b]$ and $[\bar{a}, \bar{b}]$. We are going to assume that these intervals *overlap*, that is, without loss of generality:

$$l \stackrel{\text{def}}{=} b - \bar{a} \geq 0,$$

and try to find a constant \mathcal{F}_c , depending only on ν , so that a contradiction is reached whenever $\mathcal{F} < \mathcal{F}_c$.

Introducing the bilinear form of theorem 4, it can be readily seen that:

$$a[(p, q) - (\bar{p}, \bar{q}), (p, q) - (\bar{p}, \bar{q})] \leq \mathcal{F} \int_{-1}^1 [p(x) - \bar{p}(x)] [|v(x)| - |\bar{v}(x)|] dx.$$

We take c to denote the mid-point between \bar{a} and b . From theorem 6, it can be stated that v and \bar{v} are nonnegative over $]-1, c[$ and nonpositive over $]c, 1[$. Therefore:

$$\begin{aligned} a[(p, q) - (\bar{p}, \bar{q}), (p, q) - (\bar{p}, \bar{q})] &\leq \mathcal{F} \int_{-1}^c [p(x) - \bar{p}(x)] [v(x) - \bar{v}(x)] dx \\ &\quad - \mathcal{F} \int_c^1 [p(x) - \bar{p}(x)] [v(x) - \bar{v}(x)] dx, \\ &= \mathcal{F} \left\langle p - \bar{p}, \text{sgn}(x) * [\text{sgn}(c - x)(v' - \bar{v}')] \right\rangle_{H^{-1/2}, H^{1/2}}, \\ &\leq C \mathcal{F} \|p - \bar{p}\|_{H^{-1/2}} \|v' - \bar{v}'\|_{H^{-1/2}}, \end{aligned}$$

with some universal constant C . Now, theorem 4 entails:

$$\begin{aligned} \|p - \bar{p}\|_{H^{-1/2}} &\leq C_1 a[(p, q) - (\bar{p}, \bar{q}), (p, q) - (\bar{p}, \bar{q})], \\ \|v' - \bar{v}'\|_{H^{-1/2}} &\leq C_2 a[(p, q) - (\bar{p}, \bar{q}), (p, q) - (\bar{p}, \bar{q})], \end{aligned}$$

with some positive constants C_1 and C_2 depending only on the Poisson ratio ν . But, as $a[(p, q) - (\bar{p}, \bar{q}), (p, q) - (\bar{p}, \bar{q})] > 0$ with two *distinct* solutions, a contradiction arises whenever $CC_1C_2\mathcal{F} < 1$. \square

Appendix A: Cauchy principal values and Hilbert transform

A.1. The distribution $\log|x|$ and its Fourier transform

Since the function $f(x) = \log|x|$ is locally integrable, it defines a distribution on \mathbb{R} . Its distributional derivative cannot be the function $g(x) = 1/x$ which does not define any distribution, because it is not locally integrable. The distributional derivative of $f(x) = \log|x|$ is defined by the identity:

$$\forall \varphi \in C_c^\infty(\mathbb{R}; \mathbb{R}), \quad - \int_{-\infty}^{\infty} \varphi'(x) \log|x| dx = \lim_{\varepsilon \rightarrow 0^+} \int_{-\infty}^{-\varepsilon} + \int_{\varepsilon}^{\infty} \frac{\varphi(x)}{x} dx,$$

(C_c^∞ stands for the space of C^∞ compatly supported test-functions), where the limit exists, thanks to the differentiability of φ at 0. Thus, in the sense of distributions, we have:

$$\frac{d}{dx} \log|x| = \text{pv} \frac{1}{x},$$

where $\text{pv} 1/x$ is the distribution on \mathbb{R} defined by:

$$\forall \varphi \in C_c^\infty(\mathbb{R}; \mathbb{R}), \quad \left\langle \text{pv} \frac{1}{x}, \varphi \right\rangle = \lim_{\varepsilon \rightarrow 0^+} \int_{-\infty}^{-\varepsilon} + \int_{\varepsilon}^{\infty} \frac{\varphi(x)}{x} dx.$$

The distribution $\text{pv} 1/x$ is a tempered distribution which is not a function or even a measure. We adopt the notation:

$$\oint_{-\infty}^{\infty} \frac{\varphi(x)}{x} dx \stackrel{\text{def}}{=} \lim_{\varepsilon \rightarrow 0^+} \int_{-\infty}^{-\varepsilon} + \int_{\varepsilon}^{\infty} \frac{\varphi(x)}{x} dx,$$

and shall speak of integrals in the sense of Cauchy principal value.

With $f \in L^1 \cap L^2$, the following definition:

$$\mathcal{F}[f] \stackrel{\text{def}}{=} \frac{1}{\sqrt{2\pi}} \int_{-\infty}^{+\infty} f(t) e^{ixt} dt, \quad (14)$$

is adopted for the Fourier transform, which can be extended, as usual, to all the tempered distributions.

Proposition 6 *The Fourier transform of the tempered distribution $\log|t|$ is given by:*

$$\mathcal{F}[\log|t|] = -\frac{\sqrt{2\pi}}{2} \text{fp} \frac{1}{|x|} - \frac{\Gamma_{\text{Eul}}}{\sqrt{2\pi}} \delta,$$

where:

- $\Gamma_{\text{Eul}} = \lim_{n \rightarrow \infty} \left(\sum_{k=1}^n \frac{1}{k} - \log n \right)$ is Euler's constant,
- $\text{fp} \frac{1}{|x|} = \frac{d}{dx} (\text{sgn}(x) \log|x|)$,
- δ is Dirac measure at $x = 0$.

Proof Fix $a \in]0, \infty[$. A direct calculation of residue gives:

$$\begin{aligned}\mathcal{F}\left[\frac{a}{a^2+t^2}\right] &= \frac{1}{\sqrt{2\pi}} \int_{-\infty}^{+\infty} \frac{a e^{ixt}}{a^2+t^2} dt = \frac{\sqrt{2\pi}}{2} e^{-a|x|}, \\ \mathcal{F}\left[\frac{t}{a^2+t^2}\right] &= \frac{1}{\sqrt{2\pi}} \int_{-\infty}^{+\infty} \frac{t e^{ixt}}{a^2+t^2} dt = \frac{i\sqrt{2\pi}}{2} \operatorname{sgn}(x) e^{-a|x|}.\end{aligned}\quad (15)$$

From:

$$\frac{d}{dx} \log(a^2+x^2) = \frac{2x}{a^2+x^2},$$

we obtain:

$$-ix \mathcal{F}[\log(a^2+t^2)] = 2\mathcal{F}\left[\frac{t}{a^2+t^2}\right] = i\sqrt{2\pi} \operatorname{sgn}(x) e^{-a|x|},$$

which entails:

$$\mathcal{F}[\log(a^2+t^2)] = -\sqrt{2\pi} e^{-a|x|} \operatorname{fp} \frac{1}{|x|} + C \delta,$$

where C is some complex constant, and the distribution $\operatorname{fp} 1/|x|$ is defined by:

$$\left\langle \operatorname{fp} \frac{1}{|x|}, \varphi \right\rangle_{\mathcal{D}', \mathcal{D}} = - \int_{-\infty}^{+\infty} \operatorname{sgn}(t) \log|t| \varphi'(t) dt.$$

Then, using Plancherel's formula together with (15), we obtain:

$$\underbrace{\int_{-\infty}^{+\infty} \frac{\varepsilon \log(a^2+t^2)}{\varepsilon^2+t^2} dt}_{2\pi \log(a+\varepsilon)} = \frac{\sqrt{2\pi}}{2} C - \pi \underbrace{\int_{-\infty}^{+\infty} \log|x|(a+\varepsilon) e^{(a+\varepsilon)|x|} dx}_{-2\Gamma_{\text{Eul}} - 2\log(a+\varepsilon)},$$

where the values of the integrals are formulae 4.295.7 and 4.331.1 of [3]. The latter identity gives:

$$C = -\frac{2\Gamma_{\text{Eul}}}{\sqrt{2\pi}},$$

and therefore:

$$\mathcal{F}[\log(a^2+t^2)] = -\sqrt{2\pi} e^{-a|x|} \operatorname{fp} \frac{1}{|x|} - \frac{2\Gamma_{\text{Eul}}}{\sqrt{2\pi}} \delta.$$

Taking the limit $a \rightarrow 0+$, the result announced has been proved. \square

Corollary 2 *The Fourier transform of $\operatorname{pv} 1/x$ is given by:*

$$\mathcal{F}\left[\operatorname{pv} \frac{1}{t}\right] = \frac{i\sqrt{2\pi}}{2} \operatorname{sgn}(x).$$

A.2. L^p theory of the Hilbert transform

If T is an arbitrary, compactly supported distribution on \mathbb{R} , the convolution

$$T * \text{pv} \frac{1}{x},$$

is well defined in the sense of distributions. However, in the case where T is some integrable function, we cannot assert that this convolution product is a function. The fact that this is true of functions $T \in L^p$, with $p \in]1, \infty[$, is the main result of the Hilbert transform theory. In this section, some key facts are briefly recalled. For the proofs, the readers are referred to a textbook in harmonic analysis such as [11].

Theorem 9 (M. Riesz) *Let $p \in]1, \infty[$ and $f \in L^p(\mathbb{R}; \mathbb{R})$. Then:*

(i) *For almost all $x \in \mathbb{R}$,*

$$\oint_{-\infty}^{\infty} \frac{f(t)}{t-x} dt = \lim_{\varepsilon \rightarrow 0^+} \int_{-\infty}^{x-\varepsilon} + \int_{x+\varepsilon}^{\infty} \frac{f(t)}{t-x} dt,$$

exists and is finite.

(ii) *The function g , defined for almost all $x \in \mathbb{R}$, by:*

$$g(x) = \frac{1}{\pi} \oint_{-\infty}^{\infty} \frac{f(t)}{t-x} dt,$$

is in $L^p(\mathbb{R}; \mathbb{R})$. We take $g = \mathcal{H}[f]$ to denote this expression and call it the Hilbert transform of f .

(iii) *The Hilbert transform $\mathcal{H} : L^p \rightarrow L^p$ is linear continuous.*

(iv) *The following identity holds:*

$$\mathcal{H}[\mathcal{H}[f]] = -f,$$

which shows that the Hilbert transform is an isomorphism of $L^p(\mathbb{R}; \mathbb{R})$.

Of course, for all $f \in L^p(\mathbb{R}; \mathbb{R})$ ($p \in]1, \infty[$), we have:

$$f * \text{pv} \frac{1}{x} = -\pi \mathcal{H}[f].$$

Theorem 9 was first known in the case $p = 2$, where an easy proof based on Plancherel's formula and corollary 2 can be worked out. This is the generalization of this result to $p \in]1, \infty[$ which was achieved by Marcel Riesz.

The L^p theory of the Hilbert transform is closely related to the study of some class of holomorphic functions defined in the open upper-half plane:

$$\Pi^+ = \left\{ z \in \mathbb{C}; \Im(z) > 0 \right\},$$

as seen in the next theorem.

Theorem 10 (M. Riesz)

(i) Let $p \in]1, \infty[$ and $f \in L^p(\mathbb{R}; \mathbb{R})$. Then, the function $\Phi : \Pi^+ \rightarrow \mathbb{C}$ defined by:

$$\Phi(z) = \frac{1}{\pi} \int_{-\infty}^{\infty} \frac{f(t)}{t-z} dt,$$

is holomorphic in Π^+ and satisfies:

$$\exists K \in \mathbb{R}, \quad \forall y > 0, \quad \int_{-\infty}^{\infty} |\Phi(x+iy)|^p dx < K. \quad (16)$$

In addition, $\Phi(x+iy)$ converges, as $y \rightarrow 0+$, in $L^p(\mathbb{R}; \mathbb{R})$, but also for almost all $x \in \mathbb{R}$, towards the limit:

$$\Phi(x+i0) = \mathcal{H}[f](x) + if(x).$$

(ii) Reciprocally, if Φ is some holomorphic function in Π^+ satisfying the condition:

$$\exists K \in \mathbb{R}, \quad \forall y > 0, \quad \int_{-\infty}^{\infty} |\Phi(x+iy)|^p dx < K,$$

then, $\Phi(x+iy)$ converges, as $y \rightarrow 0+$, in $L^p(\mathbb{R}; \mathbb{R})$, but also for almost all $x \in \mathbb{R}$, towards some limit $\Phi(x+i0)$, which satisfies in addition:

$$\Re\{\Phi(x+i0)\} = \mathcal{H}\left[\Im\{\Phi(x+i0)\}\right].$$

Condition (16) defines a Banach space of holomorphic functions in Π^+ named $\mathcal{H}^p(\Pi^+)$ after Hardy. Theorem 10 states that functions in $\mathcal{H}^p(\Pi^+)$ have a trace on the real line, belonging to $L^p(\mathbb{R}; \mathbb{R})$ and with real and imaginary parts conjugated by the Hilbert transform. Theorem 10 provides a convenient means of identifying the Hilbert transform of some function in L^p : we will try to find a function $\Phi \in \mathcal{H}^p$ having a trace on the real line with imaginary part coinciding with the given function. Then, the real part of the trace on the real line will provide the Hilbert transform we are looking for. Therefore, theorem 10 is the key to solving the class of singular integral equations examined in section A.3.

Theorem 11 (M. Riesz)

(i) Let $f_1 \in L^{p_1}(\mathbb{R}; \mathbb{R})$ and $f_2 \in L^{p_2}(\mathbb{R}; \mathbb{R})$, with $\frac{1}{p_1} + \frac{1}{p_2} = 1$. Then:

$$\begin{aligned} \int_{-\infty}^{\infty} \mathcal{H}[f_1] \mathcal{H}[f_2] &= \int_{-\infty}^{\infty} f_1 f_2, \\ \int_{-\infty}^{\infty} \mathcal{H}[f_1] f_2 &= - \int_{-\infty}^{\infty} f_1 \mathcal{H}[f_2]. \end{aligned}$$

In particular, the Hilbert transform is an isometry of L^2 .

(ii) Let $f_1 \in L^{p_1}(\mathbb{R}; \mathbb{R})$ and $f_2 \in L^{p_2}(\mathbb{R}; \mathbb{R})$, with $\frac{1}{p_1} + \frac{1}{p_2} < 1$. Then:

$$\mathcal{H}[\mathcal{H}[f_1] f_2 + f_1 \mathcal{H}[f_2]] = \mathcal{H}[f_1] \mathcal{H}[f_2] - f_1 f_2.$$

Proof of theorems 9, 10 and 11 (i) can be found, for example, in [11]. Proof of theorem 11 (ii) can be found in [12]. Theorem 11 (i) can be regarded as a statement concerning the exchange of order between an ordinary integral and a Cauchy integral whereas theorem 11 (ii) is a statement concerning the exchange of order between two Cauchy integrals as shown in the following corollary.

Corollary 3

(i) Let $f_1 \in L^{p_1}(\mathbb{R}; \mathbb{R})$ and $f_2 \in L^{p_2}(\mathbb{R}; \mathbb{R})$, where $\frac{1}{p_1} + \frac{1}{p_2} = 1$. Then:

$$\int_{-\infty}^{\infty} f_1(x) \oint_{-\infty}^{\infty} \frac{f_2(y)}{y-x} dy dx = \int_{-\infty}^{\infty} f_2(y) \oint_{-\infty}^{\infty} \frac{f_1(x)}{y-x} dx dy.$$

(ii) Let $f_1 \in L^{p_1}(\mathbb{R}; \mathbb{R})$ and $f_2 \in L^{p_2}(\mathbb{R}; \mathbb{R})$, where $\frac{1}{p_1} + \frac{1}{p_2} < 1$. Then, for almost all $x_0 \in \mathbb{R}$:

$$\begin{aligned} \oint_{-\infty}^{\infty} \frac{f_1(x)}{x-x_0} \oint_{-\infty}^{\infty} \frac{f_2(y)}{y-x} dy dx = \\ \oint_{-\infty}^{\infty} f_2(y) \oint_{-\infty}^{\infty} \frac{f_1(x)}{(x-x_0)(y-x)} dx dy - \pi^2 f_1(x_0) f_2(x_0). \end{aligned}$$

Theorem 11 (ii), or its explicit form, corollary 3 (ii), is generally referred to as the Poincaré-Bertrand-Tricomi Lemma.

If $f \in L^p(\mathbb{R}; \mathbb{R})$ is continuous, its Hilbert transform $\mathcal{H}[f]$ is not necessarily continuous. However, the following result holds.

Proposition 7 (Plemelj-Privalov) Let $f : \mathbb{R} \rightarrow \mathbb{R}$ be a continuous function with compact support. Assuming that f belongs to the Hölder space $C^{0,\alpha}$, for some $\alpha \in]0, 1[$, then $\mathcal{H}[f]$ is locally in $C^{0,\alpha}$. In addition, for all $\alpha \in]0, 1[$, there exists a real constant M_α such that for all continuous function $f : \mathbb{R} \rightarrow \mathbb{R}$, with support in $[-1, 1]$ belonging to $C^{0,\alpha}([-1, 1]; \mathbb{R})$, the continuity property:

$$\|\mathcal{H}[f]\|_{C^{0,\alpha}([-1,1]; \mathbb{R})} \leq M_\alpha \|f\|_{C^{0,\alpha}([-1,1]; \mathbb{R})},$$

holds true.

Proof of proposition 7 can be found in [7]. We end this subsection by giving asymptotic estimates for the finite Hilbert transform.

Proposition 8 Let $f \in L^p(-1, 1; \mathbb{R})$, with $p \in]1, \infty[$. Assuming that f can be written:

$$f(x) = \frac{A}{(1-x)^\alpha} + g(x),$$

where $A \in \mathbb{R}$, $\alpha \in [0, 1[$ and g is some function vanishing at $x = 1$ and satisfying some Hölder condition in a left-neighbourhood of $x = 1$. Then:

(i) if $\alpha = 0$, then we have:

$$\begin{aligned} \frac{1}{\pi} \oint_{-1}^1 \frac{f(t)}{t-x} dt &= \frac{A}{\pi} \log(1-x) + O(1) & \text{as } x \rightarrow 1-, \\ \frac{1}{\pi} \int_{-1}^1 \frac{f(t)}{t-x} dt &= \frac{A}{\pi} \log(x-1) + O(1) & \text{as } x \rightarrow 1+. \end{aligned}$$

(ii) if $\alpha \in]0, 1[$, then we have:

$$\begin{aligned} \frac{1}{\pi} \oint_{-1}^1 \frac{f(t)}{t-x} dt &= -\frac{A \cot \pi \alpha}{(1-x)^\alpha} + O(1) & \text{as } x \rightarrow 1-, \\ \frac{1}{\pi} \int_{-1}^1 \frac{f(t)}{t-x} dt &= -\frac{A}{(x-1)^\alpha \sin \pi \alpha} + O(1) & \text{as } x \rightarrow 1+. \end{aligned}$$

Proof of proposition 8 can be found in [12].

A.3. L^p theory of some class of singular integral equations

Singular integral equations involving the Hilbert transform on the full real line can be easily solved using the inversion formula:

$$\mathcal{H}[\mathcal{H}[f]] = -f.$$

However, we will deal here, with singular integral equations that are given not on the full real line \mathbb{R} , but only on the finite interval $] -1, 1[$. We consider three classes of such singular integral equations with unknown $f(x)$.

- The equation of the first kind (which is sometimes called the “airfoil equation”):

$$\text{for a.a. } x \in] -1, 1[, \quad \frac{1}{\pi} \oint_{-1}^1 \frac{f(t)}{t-x} dt = g(x).$$

- The equation of the second kind:

$$\text{for a.a. } x \in] -1, 1[, \quad f(x) - \frac{\lambda}{\pi} \oint_{-1}^1 \frac{f(t)}{t-x} dt = g(x).$$

- The Carleman equation:

$$\text{for a.a. } x \in] -1, 1[, \quad a(x)f(x) - \frac{\lambda}{\pi} \oint_{-1}^1 \frac{f(t)}{t-x} dt = g(x).$$

Optimal L^p theory of the equations of the first and second kind was obtained by Söhngen [9]. In what follows, we will use the notation:

$$L^{1+}(-1, 1; \mathbb{R}) = \bigcup_{p \in]1, \infty[} L^p(-1, 1; \mathbb{R}).$$

Theorem 12 (H. Söhngen) *Let $g \in L^{1+}(-1, 1; \mathbb{R})$ be given. Then, all the solutions $f \in L^{1+}(-1, 1; \mathbb{R})$ of the singular integral equation:*

$$\text{for a.a. } x \in] -1, 1[, \quad \frac{1}{\pi} \oint_{-1}^1 \frac{f(t)}{t-x} dt = g(x),$$

are given by:

$$f(x) = -\frac{1}{\pi} \oint_{-1}^1 \sqrt{\frac{1-t^2}{1-x^2}} \frac{g(t)}{t-x} dt + \frac{C}{\pi} \frac{1}{\sqrt{1-x^2}},$$

where:

$$C = \int_{-1}^1 f(t) dt$$

plays the role of an arbitrary constant.

Theorem 13 (H. Söhngen) Let $g \in L^{1+}(-1, 1; \mathbb{R})$ and $\lambda \in \mathbb{R} \setminus \{0\}$. Let:

$$\alpha \stackrel{\text{def}}{=} \frac{1}{\pi} \arctan \frac{1}{\lambda} \quad (\in]-1/2, 1/2[).$$

Then, all the solutions $f \in L^{1+}(-1, 1; \mathbb{R})$ of the singular integral equation:

$$\text{for a.a. } x \in]-1, 1[, \quad f(x) - \frac{\lambda}{\pi} \oint_{-1}^1 \frac{f(t)}{t-x} dt = g(x),$$

are given by:

$$f(x) = \frac{g(x)}{1+\lambda^2} + \frac{\lambda}{1+\lambda^2} \frac{1}{\pi} \oint_{-1}^1 \frac{(1+t)^{\frac{1}{2}-\alpha}(1-t)^{\frac{1}{2}+\alpha}}{(1+x)^{\frac{1}{2}-\alpha}(1-x)^{\frac{1}{2}+\alpha}} \cdot \frac{g(t)}{t-x} dt \\ + \frac{C \cos \pi \alpha}{\pi} \cdot \frac{1}{(1+x)^{\frac{1}{2}-\alpha}(1-x)^{\frac{1}{2}+\alpha}},$$

where:

$$C = \int_{-1}^1 f(t) dt$$

plays the role of an arbitrary constant.

A similar theorem to theorem 13, but for the Carleman equation is proved in [12]. This theorem is restricted to the case where $g \in L^\infty(-1, 1; \mathbb{R})$ and $a(x)$ is Lipschitz-continuous in $[-1, 1]$. The kernel (the vector space of solutions to the homogeneous equation) can be seen to have dimension 1, as in theorems 12 and 13. It seems highly plausible that this result could be extended to the case $g \in L^{1+}(-1, 1; \mathbb{R})$ by adapting Söhngen's technique [9]. However, this is not the extension required in this paper. What is required is to relax the hypothesis that $a(x)$ is Lipschitz-continuous in $[-1, 1]$ into the weaker hypothesis that $a(x)$ is *piecewise* Lipschitz-continuous in $[-1, 1]$. Surprisingly, if the kernel is still finite-dimensional in that case, it needs not to have dimension 1 in this extended case. Since, as far as we know, this extension of the Carleman equation has not been studied so far, we enclose the full proof of this result. This proof is restricted to the case where $g \in L^\infty(-1, 1; \mathbb{R})$, which suffices for the present purposes, but it could certainly be extended to the case where $g \in L^{1+}(-1, 1; \mathbb{R})$ by adapting Söhngen's technique [9].

Theorem 14 Let $g \in L^\infty(-1, 1; \mathbb{R})$, $\lambda \in \mathbb{R} \setminus \{0\}$ and $a : [-1, 1] \rightarrow \mathbb{R}$ be some *piecewise Lipschitz-continuous function*. Take:

$$\theta(x) = \begin{cases} \arctan \frac{\lambda}{a(x)}, & \text{if } x \in [-1, 1], \\ 0, & \text{if } |x| > 1. \end{cases}$$

The function $\theta(x)$ is *piecewise Lipschitz-continuous* in $[-1, 1]$ and we take:

$$-1 = \bar{x}_1 < \bar{x}_2 < \dots < \bar{x}_m = 1,$$

to denote all its discontinuity points, and:

$$-1 < x_1 < x_2 < \dots < x_n = 1,$$

to denote all the discontinuity points \tilde{x}_i which satisfy in addition the condition:

$$\theta(\tilde{x}_i - 0) > \theta(\tilde{x}_i + 0).$$

Then, all the solutions $f \in L^{1+}(-1, 1; \mathbb{R})$ of the singular integral equation:

$$\text{for a.a. } x \in]-1, 1[, \quad a(x)f(x) - \frac{\lambda}{\pi} \oint_{-1}^1 \frac{f(t)}{t-x} dt = g(x),$$

are given by:

$$f(x) = \frac{a(x)g(x)}{a^2(x) + \lambda^2} + \frac{\lambda e^{\tau(x)}}{\sqrt{a^2(x) + \lambda^2}} \frac{1}{\pi} \oint_{-1}^1 \frac{g(t) e^{-\tau(t)}}{\sqrt{a^2(t) + \lambda^2}} \cdot \frac{dt}{t-x} + \frac{P(x) e^{\tau(x)}}{\prod_{i=1}^n (x_i - x) \sqrt{a^2(x) + \lambda^2}},$$

where:

$$\tau(x) = \frac{1}{\pi} \oint_{-1}^1 \frac{\theta(t)}{t-x} dt,$$

and, $P \in \mathbb{R}_{n-1}[X]$ is some arbitrary real polynomial the degree of which is at most $n-1$.

Proof With $i \in \{1, 2, \dots, m\}$, we adopt the notation:

$$\alpha_i = \frac{1}{\pi} \theta(\tilde{x}_i - 0), \quad \beta_i = \frac{1}{\pi} \theta(\tilde{x}_i + 0).$$

Step 1. The following identity holds, for almost all $x \in]-1, 1[$:

$$\frac{1}{\pi} \oint_{-1}^1 \frac{e^{\tau(t)}}{\sqrt{a^2(t) + \lambda^2}} \cdot \frac{dt}{t-x} = \frac{1}{\lambda} \left\{ \frac{a(x) e^{\tau(x)}}{\sqrt{a^2(x) + \lambda^2}} - \text{sgn}(\lambda) \right\}.$$

First, note that, by virtue of proposition 7, the functions $\tau(x)$ and $e^{\tau(x)}$ are continuous in each interval $]\tilde{x}_i, \tilde{x}_{i+1}[$. In addition, proposition 8 gives the estimates:

$$e^{\tau(x)} = O(|x - \tilde{x}_i|^{\alpha_i - \beta_i}), \quad \text{as } x \rightarrow \tilde{x}_i.$$

In particular:

$$e^{\tau(x)} \in L^{1+}(-1, 1; \mathbb{R}).$$

Now, with $z \in \Pi^+ = \{z \in \mathbb{C}; \Im(z) > 0\}$, take:

$$\tau(z) = \frac{1}{\pi} \int_{-1}^1 \frac{\theta(t)}{t-z} dt,$$

$$\Phi(z) = e^{\tau(z)} - 1.$$

Then, upon applying theorem 10 to the function $\tau(z)$, it can be seen that $\Phi(x + iy)$ converges, as $y \rightarrow 0+$, for almost all $x \in \mathbb{R}$, towards:

$$\Phi(x + i0) = \begin{cases} e^{\left\{ \frac{1}{\pi} \oint_{-1}^1 \frac{\theta(t)}{t-x} dt + i\theta(x) \right\}} - 1, & \text{if } |x| < 1, \\ e^{\left\{ \frac{1}{\pi} \int_{-1}^1 \frac{\theta(t)}{t-x} dt \right\}} - 1, & \text{if } |x| > 1. \end{cases}$$

The restriction of $\Phi(x+i0)$ to $] -1, 1[$ is obviously in $L^{1+}(-1, 1; \mathbb{R})$. In addition:

$$\Phi(x+i0) \sim -\frac{M}{\pi x}, \quad \text{as } |x| \rightarrow \infty,$$

where $M = \int_{-1}^1 \theta(t) dt > 0$, since $\theta(x)$ is positive in $] -1, 1[$. As a result, $\Phi(x+i0)$ belongs to $L^p(\mathbb{R}; \mathbb{R})$ for some $p \in]1, \infty[$, and from theorem 10, we deduce that, for almost all $x \in] -1, 1[$:

$$e^{\tau(x)} \cos \theta(x) - 1 = \frac{1}{\pi} \oint_{-1}^1 \frac{e^{\tau(t)} \sin \theta(t)}{t-x} dt.$$

Since:

$$\cos \theta(x) = \frac{\operatorname{sgn}(\lambda) a(x)}{\sqrt{a^2(x) + \lambda^2}} \quad \text{and} \quad \sin \theta(x) = \frac{|\lambda|}{\sqrt{a^2(x) + \lambda^2}},$$

the claimed identity is proved.

Step 2. The function defined by:

$$\frac{e^{\tau(x)}}{(1-x)\sqrt{a^2(x) + \lambda^2}},$$

belongs to $L^{1+}(-1, 1; \mathbb{R})$ and solves the homogeneous equation.

It has already been seen in step 1 that $e^{\tau(x)} \in L^{1+}(-1, 1; \mathbb{R})$. In addition:

$$e^{\tau(x)} = O((1-x)^{\alpha_m}), \quad \text{as } x \rightarrow 1-,$$

where $\alpha_m \in]0, 1[$. Therefore:

$$\frac{e^{\tau(x)}}{(1-x)\sqrt{a^2(x) + \lambda^2}} \in L^{1+}(-1, 1; \mathbb{R}),$$

Now replacing $\theta(x)$ by $\theta(x) - \pi$, and therefore $\tau(x)$ by $\tau(x) - \log \frac{1-x}{1+x}$ in the proof of step 1, we obtain the identity:

$$\frac{1}{\pi} \oint_{-1}^1 \frac{1+t}{1-t} \cdot \frac{e^{\tau(t)}}{\sqrt{a^2(t) + \lambda^2}} \cdot \frac{dt}{t-x} = \frac{1}{\lambda} \left\{ \frac{1+x}{1-x} \cdot \frac{a(x) e^{\tau(x)}}{\sqrt{a^2(x) + \lambda^2}} + \operatorname{sgn}(\lambda) \right\}, \quad (17)$$

for almost all $x \in] -1, 1[$. Taking the half-sum of this identity and that in step 1, it can be readily seen that:

$$\frac{e^{\tau(x)}}{(1-x)\sqrt{a^2(x) + \lambda^2}},$$

solves the homogeneous equation.

Step 3. Let $P \in \mathbb{R}_{n-1}[X]$ be some arbitrary real polynomial the degree of which is at most $n-1$. Then the function defined by:

$$\frac{P(x) e^{\tau(x)}}{\prod_{i=1}^n (x_i - x) \sqrt{a^2(x) + \lambda^2}},$$

belongs to $L^{1+}(-1, 1; \mathbb{R})$ and solves the homogeneous equation.

From the estimates:

$$e^{\tau(x)} = O(|x - x_i|^{\alpha_i - \beta_i}), \quad \text{as } x \rightarrow x_i,$$

where $\alpha_i - \beta_i \in]0, 1[$, we readily obtain:

$$\frac{P(x) e^{\tau(x)}}{\prod_{i=1}^n (x_i - x) \sqrt{a^2(x) + \lambda^2}} \in L^{1+}(-1, 1; \mathbb{R}).$$

Since the case where $n = 1$ was dealt with in step 2, presumably $n \geq 2$. In view of step 2, we get:

$$\begin{aligned} & \frac{a(x) e^{\tau(x)}}{(1-x) \sqrt{a^2(x) + \lambda^2}} \\ &= \frac{\lambda}{\pi} \oint_{-1}^1 \frac{(x_{n-1} - t) e^{\tau(t)}}{(x_{n-1} - t)(1-t) \sqrt{a^2(t) + \lambda^2}} \cdot \frac{dt}{t-x}, \\ &= (x_{n-1} - x) \frac{\lambda}{\pi} \oint_{-1}^1 \frac{e^{\tau(t)}}{(x_{n-1} - t)(1-t) \sqrt{a^2(t) + \lambda^2}} \cdot \frac{dt}{t-x} \\ &\quad - \frac{\lambda}{\pi} \int_{-1}^1 \frac{e^{\tau(t)}}{(x_{n-1} - t)(1-t) \sqrt{a^2(t) + \lambda^2}} dt. \end{aligned}$$

Hence:

$$\begin{aligned} & \frac{a(x) e^{\tau(x)}}{(x_{n-1} - x)(1-x) \sqrt{a^2(x) + \lambda^2}} \\ &\quad - \frac{\lambda}{\pi} \oint_{-1}^1 \frac{e^{\tau(t)}}{(x_{n-1} - t)(1-t) \sqrt{a^2(t) + \lambda^2}} \cdot \frac{dt}{t-x} \\ &\quad = \frac{1}{(x_{n-1} - x)} \cdot \frac{\lambda}{\pi} \int_{-1}^1 \frac{e^{\tau(t)}}{(x_{n-1} - t)(1-t) \sqrt{a^2(t) + \lambda^2}} dt. \end{aligned}$$

But since the first member of this equality belongs to $L^{1+}(-1, 1; \mathbb{R})$, we obtain:

$$\int_{-1}^1 \frac{e^{\tau(t)}}{(x_{n-1} - t)(1-t) \sqrt{a^2(t) + \lambda^2}} dt = 0,$$

and the fact that:

$$\frac{e^{\tau(x)}}{(x_{n-1} - x)(1-x) \sqrt{a^2(x) + \lambda^2}},$$

solves the homogeneous equation. By finite induction, it is proved that each function:

$$\frac{e^{\tau(x)}}{\prod_{i=j}^n (x_i - x) \sqrt{a^2(x) + \lambda^2}},$$

with $j \in \{1, 2, \dots, n\}$, solves the homogeneous equation. Now any polynomial $P \in \mathbb{R}_{n-1}[X]$ can be uniquely decomposed into:

$$P(x) = \sum_{j=1}^{n-1} c_j \prod_{k=1}^j (x_k - x),$$

and so:

$$\frac{P(x)e^{\tau(x)}}{\prod_{i=1}^n(x_i-x)\sqrt{a^2(x)+\lambda^2}} = \sum_{j=1}^{n-1} \frac{c_j e^{\tau(x)}}{\prod_{i=j+1}^n(x_i-x)\sqrt{a^2(x)+\lambda^2}},$$

indeed solves the homogeneous equation.

Step 4. Any solution in $L^1(-1, 1; \mathbb{R})$ of the homogeneous equation has the form:

$$\frac{P(x)e^{\tau(x)}}{\prod_{i=1}^n(x_i-x)\sqrt{a^2(x)+\lambda^2}},$$

where $P \in \mathbb{R}_{n-1}[X]$ denotes some arbitrary real polynomial, the degree of which is at most $n-1$.

Apply identity (17) to $-\lambda$ instead of λ . Since:

$$\arctan_{]0, \pi[} \left(\frac{-\lambda}{a(x)} \right) = \pi - \arctan_{]0, \pi[} \left(\frac{\lambda}{a(x)} \right),$$

we have to replace $\tau(x)$ by $\log \frac{1-x}{1+x} - \tau(x)$ in identity 17 and we obtain:

$$\frac{1}{\pi} \oint_{-1}^1 \frac{e^{-\tau(t)}}{\sqrt{a^2(t)+\lambda^2}} \cdot \frac{dt}{t-x} = -\frac{1}{\lambda} \left\{ \frac{a(x)e^{-\tau(x)}}{\sqrt{a^2(x)+\lambda^2}} - \operatorname{sgn}(\lambda) \right\}, \quad (18)$$

for almost all $x \in]-1, 1[$, and then:

$$\frac{1}{\pi} \oint_{-1}^1 \frac{t e^{-\tau(t)}}{\sqrt{a^2(t)+\lambda^2}} \cdot \frac{dt}{t-x} = -\frac{x}{\lambda} \cdot \frac{a(x)e^{-\tau(x)}}{\sqrt{a^2(x)+\lambda^2}} + Q_1(x),$$

where Q_1 denotes some real polynomial of degree 1 at most. With $P \in \mathbb{R}[X]$, an arbitrary polynomial, we obtain by induction:

$$\frac{1}{\pi} \oint_{-1}^1 \frac{P(t)e^{-\tau(t)}}{\sqrt{a^2(t)+\lambda^2}} \cdot \frac{dt}{t-x} = -\frac{P(x)}{\lambda} \cdot \frac{a(x)e^{-\tau(x)}}{\sqrt{a^2(x)+\lambda^2}} + Q(x), \quad (19)$$

where $Q \in \mathbb{R}[X]$ is some polynomial, the degree of which is no greater than that of P .

Now let $f \in L^1(-1, 1; \mathbb{R})$ be some arbitrary solution of the homogeneous equation:

$$a(x)f(x) = \frac{\lambda}{\pi} \oint_{-1}^1 \frac{f(t)}{t-x} dt.$$

Noting that $e^{-\tau(x)} \prod_{i=1}^n(x_i-x)$ is in $L^\infty(-1, 1; \mathbb{R})$, we have:

$$\begin{aligned} \frac{1}{\pi} \oint_{-1}^1 \frac{\prod_{i=1}^n(x_i-t)a(t)e^{-\tau(t)}}{\sqrt{a^2(t)+\lambda^2}} \cdot \frac{f(t)}{t-x} dt \\ = \frac{\lambda}{\pi^2} \oint_{-1}^1 \frac{\prod_{i=1}^n(x_i-t)e^{-\tau(t)}}{\sqrt{a^2(t)+\lambda^2}} \cdot \frac{1}{t-x} \oint_{-1}^1 \frac{f(s)}{s-t} ds dt. \end{aligned}$$

Now using the Poincaré-Bertrand-Tricomi Lemma (theorem 11 (ii)), and then equality (19), we calculate:

$$\begin{aligned}
& \frac{1}{\pi} \oint_{-1}^1 \frac{\prod_{i=1}^n (x_i - t) a(t) e^{-\tau(t)}}{\sqrt{a^2(t) + \lambda^2}} \cdot \frac{f(t)}{t-x} dt \\
&= \frac{\lambda}{\pi^2} \oint_{-1}^1 \frac{f(s)}{s-x} \left\{ \oint_{-1}^1 \frac{\prod_{i=1}^n (x_i - t) e^{-\tau(t)}}{\sqrt{a^2(t) + \lambda^2}} \cdot \frac{dt}{t-x} \right. \\
&\quad \left. - \oint_{-1}^1 \frac{\prod_{i=1}^n (x_i - t) e^{-\tau(t)}}{\sqrt{a^2(t) + \lambda^2}} \cdot \frac{dt}{t-s} \right\} ds - \lambda f(x) \frac{\prod_{i=1}^n (x_i - x) e^{-\tau(x)}}{\sqrt{a^2(x) + \lambda^2}}, \\
&= \frac{1}{\pi} \oint_{-1}^1 \frac{f(s)}{s-x} \left\{ \frac{a(s) \prod_{i=1}^n (x_i - s) e^{-\tau(s)}}{\sqrt{a^2(s) + \lambda^2}} - \frac{a(x) \prod_{i=1}^n (x_i - x) e^{-\tau(x)}}{\sqrt{a^2(x) + \lambda^2}} \right\} ds \\
&\quad - \frac{\lambda}{\pi} \int_{-1}^1 f(s) \frac{Q(s) - Q(x)}{s-x} ds - \lambda f(x) \frac{\prod_{i=1}^n (x_i - x) e^{-\tau(x)}}{\sqrt{a^2(x) + \lambda^2}}.
\end{aligned}$$

Taking:

$$P(x) = -\frac{\lambda^2}{\pi} \int_{-1}^1 f(s) \frac{Q(s) - Q(x)}{s-x} ds,$$

(P is a real polynomial, the degree of which is at most $n-1$), we obtain:

$$\lambda \frac{\prod_{i=1}^n (x_i - x) e^{-\tau(x)}}{\sqrt{a^2(x) + \lambda^2}} f(x) + \frac{a^2(x)}{\lambda} \frac{\prod_{i=1}^n (x_i - x) e^{-\tau(x)}}{\sqrt{a^2(x) + \lambda^2}} f(x) = \frac{1}{\lambda} P(x),$$

that is:

$$f(x) = \frac{P(x) e^{\tau(x)}}{\prod_{i=1}^n (x_i - x) \sqrt{a^2(x) + \lambda^2}},$$

which is exactly the conclusion we wanted to obtain.

Step 5. The function defined by:

$$\frac{a(x) g(x)}{a^2(x) + \lambda^2} + \frac{\lambda e^{\tau(x)}}{\sqrt{a^2(x) + \lambda^2}} \frac{1}{\pi} \oint_{-1}^1 \frac{g(t) e^{-\tau(t)}}{\sqrt{a^2(t) + \lambda^2}} \cdot \frac{dt}{t-x},$$

belongs to $L^1(-1, 1; \mathbb{R})$ and solves the non-homogeneous equation.

Noting, as previously, that $e^{-\tau(x)} \prod_{i=1}^n (x_i - x)$ is in $L^\infty(-1, 1; \mathbb{R})$, let:

$$f(x) = \frac{a(x) g(x)}{a^2(x) + \lambda^2} + \frac{\lambda e^{\tau(x)}}{\sqrt{a^2(x) + \lambda^2}} \frac{1}{\pi} \oint_{-1}^1 \frac{\prod_{i=1}^n (x_i - t)}{\prod_{i=1}^n (x_i - x)} \cdot \frac{g(t) e^{-\tau(t)}}{\sqrt{a^2(t) + \lambda^2}} \cdot \frac{dt}{t-x}.$$

It is obvious that $f \in L^1(-1, 1; \mathbb{R})$. A simple calculation based on the use of the Poincaré-Bertrand-Tricomi Lemma (theorem 11 (ii)) yields:

$$\begin{aligned}
\frac{1}{\pi} \oint_{-1}^1 \frac{f(t)}{t-x} dt &= -\frac{\lambda g(x)}{a^2(x) + \lambda^2} + \frac{1}{\pi} \oint_{-1}^1 \frac{a(t) g(t)}{a^2(t) + \lambda^2} \cdot \frac{dt}{t-x} + \\
&\frac{\lambda}{\pi^2} \oint_{-1}^1 \frac{g(s) \prod_{i=1}^n (x_i - s) e^{-\tau(s)}}{\sqrt{a^2(s) + \lambda^2}} \cdot \frac{1}{s-x} \left\{ \oint_{-1}^1 \frac{e^{\tau(t)}}{\prod_{i=1}^n (x_i - t) \sqrt{a^2(t) + \lambda^2}} \cdot \frac{dt}{t-x} \right. \\
&\quad \left. - \oint_{-1}^1 \frac{e^{\tau(t)}}{\prod_{i=1}^n (x_i - t) \sqrt{a^2(t) + \lambda^2}} \cdot \frac{dt}{t-s} \right\} ds.
\end{aligned}$$

Based on step 3, we then obtain:

$$\begin{aligned} & \frac{1}{\pi} \oint_{-1}^1 \frac{f(t)}{t-x} dt \\ &= -\frac{\lambda g(x)}{a^2(x) + \lambda^2} + \frac{1}{\pi} \oint_{-1}^1 \frac{a(t)g(t)}{a^2(t) + \lambda^2} \cdot \frac{dt}{t-x} \\ &+ \frac{1}{\pi} \oint_{-1}^1 \frac{g(s) \prod_{i=1}^n (x_i - s) e^{-\tau(s)}}{(s-x) \sqrt{a^2(s) + \lambda^2}} \left\{ \frac{a(x) e^{\tau(x)}}{\prod_{i=1}^n (x_i - x) \sqrt{a^2(x) + \lambda^2}} \right. \\ &\quad \left. - \frac{a(s) e^{\tau(s)}}{\prod_{i=1}^n (x_i - s) \sqrt{a^2(s) + \lambda^2}} \right\} ds, \\ &= \frac{1}{\lambda} \{a(x)f(x) - g(x)\}, \end{aligned}$$

which shows that f in fact solves the equation under consideration. In the end, after performing some easy calculations on the definition of f , it is established that:

$$\begin{aligned} f(x) = & \frac{a(x)g(x)}{a^2(x) + \lambda^2} + \frac{\lambda e^{\tau(x)}}{\sqrt{a^2(x) + \lambda^2}} \frac{1}{\pi} \oint_{-1}^1 \frac{g(t) e^{-\tau(t)}}{\sqrt{a^2(t) + \lambda^2}} \cdot \frac{dt}{t-x} \\ & + \frac{P(x) e^{\tau(x)}}{\prod_{i=1}^n (x_i - x) \sqrt{a^2(x) + \lambda^2}}, \end{aligned}$$

where $P \in \mathbb{R}_{n-1}[X]$ is some real polynomial, the degree of which is no greater than $n-1$. This identity implies on the one hand, that the function:

$$\frac{a(x)g(x)}{a^2(x) + \lambda^2} + \frac{\lambda e^{\tau(x)}}{\sqrt{a^2(x) + \lambda^2}} \frac{1}{\pi} \oint_{-1}^1 \frac{g(t) e^{-\tau(t)}}{\sqrt{a^2(t) + \lambda^2}} \cdot \frac{dt}{t-x},$$

belongs to $L^1(-1, 1; \mathbb{R})$, and on the other hand, that it solves the non-homogeneous equation. \square

References

1. G. DUVAUT & J.L. LIONS, *Les Inéquations en Mécanique et en Physique* (Dunod, Paris, 1972).
2. C. ECK, J. JARUŠEK and M. KRBEČ, *Unilateral Contact Problems in Mechanics. Variational Methods and Existence Theorems*. Monographs & Textbooks in Pure & Appl. Math. No. 270 (ISBN 1-57444-629-0). Chapman & Hall/CRC (Taylor & Francis Group), Boca Raton London New York Singapore (2005).
3. I.S. GRADSHTEYN & I.M. RYZHIK, *Table of Integrals, Series and Products* (Corrected and enlarged edition, Academic Press, London, 1965).
4. P. HILD, Non-unique slipping in the Coulomb friction model in two-dimensional linear elasticity, *The Quarterly Journal of Mechanics and Applied Mathematics*, **57** (2), pp. 225–235 (2004).
5. J. JARUŠEK, Contact Problems with Bounded Friction. *Czechoslovak Mathematical Journal*, **33**, 108, pp. 237–261 (1983).
6. A. KLARBRING, Example of non-uniqueness and non-existence of solutions to quasistatic contact problems. *Ingenieur Archiv*, **60**, pp. 529–541 (1990).
7. N.I. MUSKHELISHVILI, *Singular Integral Equations*, (Moscow, 1946, english translation: P. Noordhoff N.V., Groningen, 1953).
8. J. NEČAS, J. JARUŠEK & J. HASLINGER, On the solution of the variational inequality to the Signorini problem with small friction. *Bollettino dell'Unione Matematica Italiana*, **5** (17-B), pp. 796–811 (1980).
9. H. SÖHNGEN, Zur Theorie der Endlichen Hilbert-Transformation. *Mathematik Zeitschrift*, **60**, pp. 31–51 (1954).
10. D.A. SPENCE, An Eigenvalue Problem for Elastic Contact with Finite Friction. *Proceedings of the Cambridge Philosophical Society*, **73**, pp. 249–268 (1973).
11. E.C. TITCHMARSH, *Introduction to the Theory of Fourier Integrals*. Oxford University Press (1937).
12. F.G. TRICOMI, *Integral Equations*. Interscience Publishers, New York (1957).