



HAL
open science

Selective anchoring of cyclic thionocarbamates on ketohehexoses

Ana Catarina Simão

► **To cite this version:**

Ana Catarina Simão. Selective anchoring of cyclic thionocarbamates on ketohehexoses. Chemical Sciences. Université d'Orléans; Université de Lisbonne, 2009. English. NNT : . tel-00471602v1

HAL Id: tel-00471602

<https://theses.hal.science/tel-00471602v1>

Submitted on 8 Apr 2010 (v1), last revised 6 Apr 2011 (v2)

HAL is a multi-disciplinary open access archive for the deposit and dissemination of scientific research documents, whether they are published or not. The documents may come from teaching and research institutions in France or abroad, or from public or private research centers.

L'archive ouverte pluridisciplinaire **HAL**, est destinée au dépôt et à la diffusion de documents scientifiques de niveau recherche, publiés ou non, émanant des établissements d'enseignement et de recherche français ou étrangers, des laboratoires publics ou privés.



ÉCOLE DOCTORALE SCIENCES ET TECHNOLOGIE

**Institut de Chimie Organique et Analytique – UMR 6005
DQB/CQB – Faculdade de Ciências da Universidade de Lisboa**

THÈSE EN COTUTELLE INTERNATIONALE présentée par :

Ana Catarina SIMÃO

soutenue le : 18 Décembre 2009

pour obtenir le grade de :
**Docteur de l'université d'Orléans
et de l'Université de Lisbonne**

Discipline : Chimie Organique

**ANCRAGES SELECTIFS SUR CETOHEXOSES DE
THONOCARBAMATES CYCLIQUES**

THÈSE dirigée par :

**Mme. Amélia P. RAUTER
M. Patrick ROLLIN**

Professeur, Université de Lisbonne
Professeur, Université d'Orléans

RAPPORTEURS :

**Mme. Isabel ISMAEL
M. David GUEYRARD**

Professeur, Université da Beira Interior
HDR, Université Claude Bernard - Lyon 1

JURY :

M. Sergio CASTILLON

Professeur, Université Rovira i Virgili - Tarragona
Président du jury

Mme. Isabel ISMAEL

Professeur, Université da Beira Interior

M. David GUEYRARD

HDR, Université Claude Bernard - Lyon 1

M. Arnaud TATIBOUET

Professeur, Université d'Orléans

Mme. Amélia P. RAUTER

Professeur, Université de Lisbonne

M. Patrick ROLLIN

Professeur, Université d'Orléans

M. Jorge JUSTINO

Professeur, Université de Santarém



ÉCOLE DOCTORALE SCIENCES ET TECHNOLOGIE

**Institut de Chimie Organique et Analytique – UMR 6005
DQB/CQB – Faculdade de Ciências da Universidade de Lisboa**

THÈSE EN COTUTELLE INTERNATIONALE présentée par :

Ana Catarina SIMÃO

soutenue le : 18 Décembre 2009

pour obtenir le grade de :

**Docteur de l'université d'Orléans
et de l'Université de Lisbonne**

Discipline : Chimie Organique

**SELECTIVE ANCHORING OF CYCLIC THIONOCARBAMATES ON
KETOHEXOSES**

THÈSE dirigée par :

**Mme. Amélia P. RAUTER
M. Patrick ROLLIN**

Professeur, Université de Lisbonne
Professeur, Université d'Orléans

RAPPORTEURS :

**Mme. Isabel ISMAEL
M. David GUEYRARD**

Professeur, Université da Beira Interior
HDR, Université Claude Bernard - Lyon 1

JURY :

M. Sergio CASTILLON

Professeur, Université Rovira i Virgili - Tarragona
Président du jury

**Mme. Isabel ISMAEL
M. David GUEYRARD**

Professeur, Université da Beira Interior
HDR, Université Claude Bernard - Lyon 1

**M. Arnaud TATIBOUET
Mme. Amélia P. RAUTER
M. Patrick ROLLIN
M. Jorge JUSTINO**

Professeur, Université d'Orléans
Professeur, Université de Lisbonne
Professeur, Université d'Orléans
Professeur, Université de Santarém

ACKNOWLEDGEMENTS

First of all, I would like to express my sincerely gratitude to my supervisors, Prof. Amélia Pilar Rauter and Prof. Patrick Rollin, for giving me the opportunity to develop this interesting subject of research. Thank you for your excellent supervision, stimulation, encouragement and support they were essential for the accomplishment of this project.

I would also like to thank to Fundação para a Ciência e Tecnologia for the PhD grant SFRH/BD/25891/2005.

In a particular, I want to show my deep gratitude to Prof. Arnaud Tatibouët, for all knowledge transmitted, good advices, availability, patience, sympathy and friendship. It was very important to me and encouraging all along this project.

I want to express my grateful thanks to Prof. Jorge Justino for his great interest, motivation and availability to test my compounds for biological activity. I also want to thank Filipa Vinagre for the antimicrobial activity tests and Margarida Goulart for cytotoxicity tests.

I wish to express my gratitude to Professor Olivier Martin for having accepted me in ICOA, the institute he directs.

I also extend my warmest thanks to Prof. Isabel Ismael from University of Beira Interior and Dr. David Gueyrard from University Claude Bernard - Lyon 1 for having kindly accepted to judge this work. Moreover I would like to thank Professor Sergio Castellón from University of Rovira i Virgili - Tarragona for giving me the honor of participating in this PhD jury.

To all of ICOA, thank you for your kindness and companionship that make the lab a pleasant and enjoyable place to work. Among them I would like to thank in particular Labo 1: Sandy, Deimas, Sophie, Sandrine, Ana Cristina, Jola, Estelle, Charlotte, Sara, Claudia, Andreia, Filipa, Joana, Séb, Julie, Benita, Vilija, Anthony, Balla and Leo. But also from others labs: Nick-Nick, grand Mathieu, Abdel, Mimi, petit Mathieu, Matteo, Aude, Aurélien, Cleo, Jérôme, Monika, Alexis, Fred, Joana, Stéphane, Catherine, Vincent, Julie Broggi, Mathilde, and the effective personnel Marie Madeleine, Jean-Marie, Nathalie et Yan. From portuguese lab I want to thank Susana, Nuno, Filipa, João, Caio, Ana Catarina, Salta and Rui.

To my friends, Paula, Mi, Pat, Paulo, Tiago, Raposo, Fernando e Carla I want to thank them for their friendship, patience and support during this PhD.

At last but no less important I want to express my biggest gratitude to my family. Muito obrigada aos meus pais e mano, por me terem apoiado nesta decisão tão importante pela sua compreensão, encorajamento nos momentos mais difíceis e por todos os sacrifícios que fizeram para que eu chegasse até aqui. Sem esquecer os meus avós, padrinhos e priminha que também acreditaram em mim e estiveram sempre presentes não só nesta etapa como ao longo de todos os momentos importantes da minha vida. São vocês que me dão força para enfrentar todas as dificuldades e lutar pelos meus objectivos.

En fin un grand merci à Ugo pour son soutien inconditionnel, patience, bon humour... entre autres, mais aussi à ma nouvelle famille Christine, Gérard (et Dudune).

*Esta tese é dedicada às pessoas mais importantes da minha vida
Mommy, Pappy, Micas, Vó, Vô, Madrinha, Padrinho, Patty e Ugo.*

Pela sua amizade, amor, paciência, atenção, carinho e dedicação...

“The productive scientist must be a traditionalist who enjoys playing intricate games by preestablished rules in order to be a successful innovator who discovers new rules and new pieces with which to play them.”

Thomas S. Kuhn in *The Essential Tension*
(University of Chicago Press, 1977)

ABBREVIATIONS LIST

A			
Å	Angstrom	Im ₂ CS	diimidazolyl thione
Ac	acetyl	IR	Infra red
Ac ₂ O	acetic anhydride		
AcOH	acetic acid		
B		J	
Bn	benzyl	<i>J</i>	coupling constant
BnBr	benzyl bromide		
BzCl	benzoyl chloride		
Boc	<i>tert</i> -butoxycarbonyl		
BPSE	1,2-bis-(phenylsulfonyl)ethylene		
C		M	
°C	Celsius degree(s)	m	multiplet
¹³ C	NMR carbon spectrum	M	molar (g.dm ⁻³)
cm ⁻¹	wave number	<i>m</i> -CPBA	<i>meta</i> -chloroperbenzoic acid
CORREL	NMR correlation ¹ H- ¹³ C	Me	methyl
COSY	NMR correlation ¹ H- ¹ H	MHz	Megahertz
CSA	camphosulfonic acid	min	minute(s)
δ	chemical shift in ppm	mL	millilitre(s)
D		mmol	millimol
d	doublet	MS	mass spectroscopy
dd	doublet doublet	MsCl	mesyl chloride
ddd	doublet doublet doublet	MW	molecular weight
dt	doublet triplet	m/z	mass under charge
DCC	<i>N</i> -dicyclohexylcarbodiimide		
DCM	dichloromethane		
DDQ	2,3-dichloro-5,6-dicyanobenzoquinone		
DIEA	diisopropylamine		
DMAP	4-(<i>N,N</i> -dimethylamino)pyridine		
DMF	dimethylformamide		
DMP	2,2-dimethoxypropane		
DMSO	dimethylsulfoxide		
E			
EA	ethyl acetate		
eq.	equivalent(s)		
Et	ethyl		
G			
g	gram(s)		
GLUT5	protein transporter specific for fructose transport		
H			
h	hour(s)		
¹ H	NMR proton spectrum		
Hz	Hertz		
			I
			diimidazolyl thione
			Infra red
			J
			coupling constant
			M
			multiplet
			molar (g.dm ⁻³)
			<i>meta</i> -chloroperbenzoic acid
			methyl
			Megahertz
			minute(s)
			millilitre(s)
			millimol
			mass spectroscopy
			mesyl chloride
			molecular weight
			mass under charge
			N
			<i>N</i> -bromosuccinimide
			Nuclear Magnetic Resonance
			Nuclear Overhauser Effect Spectroscopy
			nucleophile
			O
			1,3-oxazoline-2-thione
			1,3-oxazolidin-2-one
			1,3-oxazolidine-2-thione
			P
			pyridinium chlorochromate
			pyridinium dichromate
			palladium under carbon
			petroleum ether
			phenyl
			parts per million
			<i>para</i> -toluene sulfonic acid
			R
			retention factor
			room temperature
			S
			singlet
			T
			<i>tert</i> -butyl

TBDMSCl	tert-butyldimethylsilyl chloride		
TFA	trifluoroacetic acid		U
Tf ₂ O	trifluoromethanesulfonic anhydride	UV	ultraviolet
TLC	thin layer chromatography		
THF	tetrahydrofuran		V
TMS	trimethylsilyl	ν	wave number
TsCl	4-toluenesulfonyl chloride		

TABLE OF CONTENTS

ACKNOWLEDGEMENTS	1
ABBREVIATIONS LIST	9
TABLE OF CONTENTS	11

CHAPTER I – Ketoses ...ever since until nowadays

1. A KETOSE	17
2. THE 2-KETOHEXOSE (HEX-2-ULOSE) FAMILY	18
2.1. D-Fructose	18
2.2. D- Psicose.....	20
2.3. D-Tagatose.....	21
2.4. L-Sorbose	23
3. SOME KETOHEXOSE CHEMISTRY	23
3.1. Ketoses as intermediate synthetic tools	25
3.1.1. Exocyclic vinyl ethers.....	25
3.1.2. 5-C-Methyl ketohexoses.....	26
3.1.3. 1-Deoxy-D-ketohexoses.....	27
3.1.4. 2-C-(Hydroxymethyl)aldoses.....	28
3.1.5. Di-D-Fructose dianhydrides (DFAs).....	29
3.1.6. 1,5-Anhydro-D-fructose	31
3.1.7. Iminosugars	32
3.1.8. Nucleoside analogues	33
3.1.9. Glucose and fructose transporters, GLUT5. Potential insecticides.....	36
PhD Objectives.	36
a) First Part of the Project	36
b) Biological applications of the project	42

CHAPTER II – 3,4-Fused thionocarbamates in pyranose form

1. SYNTHESIS OF 3,4-FUSED THIONOCARBAMATES STARTING FROM D-FRUCTOSE	47
1.1. Choosing the pathway.....	47
1.2. Condensation with HSCN. Zemplén versus Willems-Vandenberghe reaction.....	49
1.3. Synthesis of a 3,4-fused OZT	52
1.3.1. Preparation of the α -hydroxyketone.....	52
1.3.3. Synthesis of the OZT – the Willems-Vandenberghe reaction.....	54
1.3.4. Deprotection assays.....	57
1.4. Synthesis of a 3,4-fused OZO	60
1.4.1. A list of methods.....	61
a) Direct oxidative desulfurization	61
b) After nitrogen protection.....	62
c) <i>Via S</i> -alkylation.....	62
1.4.2. Chosen method: <i>via S</i> -alkylation	63

1.4.3. Oxidation.....	64
1.5. Synthesis of 3,4-fused OXTs	66
1.5.1. Previous studies	66
1.5.2. S-Alkylation. A surprising result.....	67
1.5.3. OXT formation through OZT dehydration.....	68
1.6. Conclusion.....	70

CHAPTER III – 4,5-Fused OZT in pyranose form

1. SYNTHESIS OF 4,5-FUSED OZTs ON β -D-FRUCTO AND β -D-PSICOPYRANOSE

DERIVATIVES	75
1.1. Choice of the pathway	75
1.1.1. Preparation of α -hydroxyketone	75
a) Selective oxidation	76
1.2. Condensation with a thiocarbonyl source - CS ₂ or CSeCl ₂	78
1.2.1. Glycosylamines	79
1.2.2. Saccharidic templates bearing an amino group.....	80
a) Aldoses	81
b) Ketoses.....	82
1.2.3. Saccharidic thionocarbamates <i>via</i> aziridine or epoxide.....	84
1.3. 4,5-Fused OZT in β -D-fructopyranose.....	85
1.3.1. First Approach.....	85
a) Structural protection.....	85
b) Iodination and azide Formation	86
c) OZT Formation	87
1.3.2. Second approach	88
a) Selective tosylation.....	89
b) Selective iodination.....	89
c) OZT formation	90
1.4. Fused OZT in β -D-psicopyranose	91
1.4.1. D-Fructose similar approach	91
a) From D-fructo to D-psico series.....	91
b) Iodination	92
c) Azido and OZT formation	93
1.5. Deprotection assays	93
1.5.1. Hydrochloric acid conditions.....	94
a) D-Fructose	94
b) D-Psicose	94
1.5.2. An original reagent, Sc(OTf) ₃	95
1.2.3. Trifluoroacetic acid conditions.....	95
1.6. Selective Iodination.....	96
1.6.1. Diol derivatives	99
1.6.2. Triol derivatives	101
a) Ketoses	101
b) Aldohexoses.....	103
1.7. Conclusion.....	105

CHAPTER IV – Spiro-thionocarbamates in pyranose form

1. SYNTHESIS OF SPIRO OZTs and OZOs IN 3,4,5-tri-O-BENZYLATED β-D-FRUCTO- AND β-D-PSICOPYRANO- DERIVATIVES	111
1.1. Choice of the pathway.....	111
1.1.1. Condensation with HSCN.....	111
1.1.2. Condensation with trimethylsilyl reagents.....	116
a) TMSN ₃	116
b) TMSNCS.....	117
c) TMSCN.....	117
1.2. Synthesis of <i>spiro</i> -OZTs.....	118
1.2.1. Ketose protection.....	118
1.2.2. OZT formation - HSCN.....	119
1.2.3. OZT formation - TMSNCS.....	120
1.2.4. Comparison of methods.....	122
1.3. Synthesis of <i>spiro</i> -OZOs.....	123
1.3.1. S-alkylation.....	123
1.3.2. Oxidation.....	124
1.3.3. Deprotection assays.....	124
1.4. Conclusion.....	125
2. SYNTHESIS OF SPIRO OZTs IN 3-O-BENZYLATED β-D-FRUCTO- AND β-D- PSICOPYRANO AND -FURANO DERIVATIVES	127
2.1. Synthesis of <i>spiro</i> -OZTs in D-fructo series.....	127
2.1.1. Choice of the pathway.....	127
2.1.2. Synthesis of <i>spiro</i> -OZTs.....	127
2.1.2. Isolation of the products.....	128
a) By protection.....	128
b) By S-alkylation.....	129
2.1.3. An unexpected OZT.....	130
2.2. Synthesis of <i>spiro</i> -OZTs in D-psico series.....	131
2.3. Conclusion.....	132

CHAPTER V – 2,3-Fused and spiro-thionocarbamates in furanose form

1. SYNTHESIS OF SPIRO- AND FUSED OZTs BUILT ON D-TAGATO AND D- PSICOFURANO FRAMES	135
1.1. Preparation of D-tagatose.....	135
1.1.1. From D-fructose to D-tagatose series.....	135
a) Epoxide formation.....	136
b) Epoxide opening.....	137
1.2. Conversion of D-tagatose into an OZT.....	139
1.3. D-Tagatose and D-psicose – OZT Selective formation on furanose form.....	140
1.3.1. From pyrano to furano form.....	140
a) D-Tagatose.....	140
b) D-Psicose.....	141
1.3.2. O-Benzylation.....	142

1.3.3. Isopropylidene selective cleavage	142
1.3.4. OZT formation.....	143
a) Two-step reaction - HSCN	143
b) One-step reaction - TMSNCS	144
1.4. Synthesis of OZO.....	146
1.4.1. S-Alkylation.....	146
1.4.2. Oxidation.....	147
1.5. Conclusion.....	147

CHAPTER VI – Biological Screening
--

1. GLUT5 POTENTIAL INHIBITORS	151
1.1. Role of D-fructose in human life	151
a) Sugars in Life.....	151
b) Diabetes	151
c) Sugars in human body. GLUTs.	153
d) GLUT5.....	155
1.2. PhD project.....	156
1.2.1. Objectives	156
1.2.2. Previous works.....	157
1.2.3. PhD prospects.....	159
2. POTENTIAL ANTIMICROBIAL AGENTS	160
2.1. Biological activity of thionocarbamates	160
2.2. Antimicrobial activity	162
2.2.1. Methodology for susceptibility testing.....	162
2.2.2. Antimicrobial activity results.....	162
a) Fused OZTs	163
b) <i>Spiro</i> OZTs and OZOs	164
c) D-Tagato OZTs and OZOs	166
2.3. Cytotoxicity measurements	167
2.3.1. Methodology for measuring cytotoxicity	167
2.3.2. Cytotoxicity results	168
2.4. Conclusion.....	168
GENERAL CONCLUSION.....	173
EXPERIMENTAL PART.....	177
General procedures.....	177
Compounds description.....	187
BIBLIOGRAPHIC SUPPORT	239

CHAPTER I

*Ketoses...ever since until
nowadays*

1. A KETOSE

A ketose ?

What is it ? Where can we find it ? And what we can do with it?

A ketose is a monosaccharide which contains a ketone function in its structure. The first example, fructose exists in abundance in fruits, honey, vegetables... and has found many applications mainly in fine chemistry and is currently being developed especially in view of its use as raw material. It has applications in several areas, such as food, medicine, cosmetics and pharmaceuticals.

Just as a reminder, monosaccharides are classified according to three different characteristics: the placement of the carbonyl group, the number of carbon atoms in the chain, and its chiral handedness. When the carbonyl group is an aldehyde, the monosaccharide is called aldose. When the carbonyl group is a ketone, the monosaccharide is called ketose, a less common class of sugars. Monosaccharides with three carbon atoms are called trioses, those with four are called tetroses, five are called pentoses, six are hexoses, and so on... These two systems of classification are usually combined: for example, ribose is an aldopentose (five-carbon aldehyde), and fructose is a ketohexose (six-carbon ketone) (Figure 1).

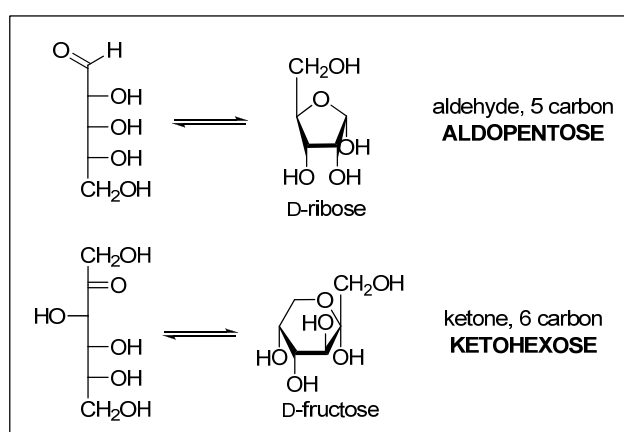

Figure 1

2. THE 2-KETOHEXOSE (HEX-2-ULOSE) FAMILY

The 2-ketohexose family is formed of eight molecules, D-fructose and its epimers, D-psicose, D-tagatose and L-sorbose (Figure 2) and their respective enantiomers.

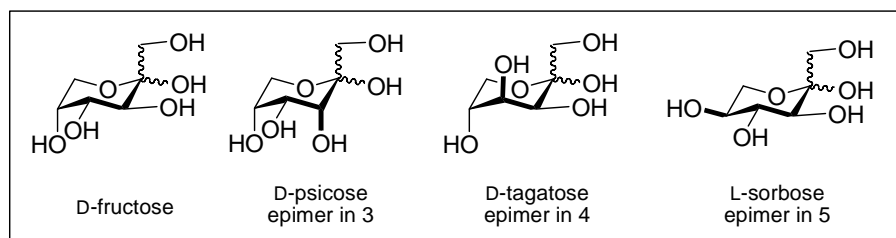

Figure 2

The above four members of this family being the topic of discussion in this PhD thesis, a brief description of each of them seems to be appropriate.

2.1. D-Fructose

D-Fructose - *D-arabino*-hex-2-ulose - is also known as levulose (or “laevulose” - an older common name) thanks to its levorotatory property. It is the most important and the most exploited of all ketoses. This simple sugar can be found in many foods and along with D-glucose and D-galactose is one of the three essential dietary monosaccharides. D-Fructose is accessible in fruits, vegetables and honey,¹ is responsible for the intense sweetness of these natural food and hence the source of its name. In nature it can exist mainly in two forms, either as a free monosaccharide or bound to D-glucose as in sucrose (disaccharide).

It is the sweetest of all naturally occurring carbohydrates and its sweetening power is 173% higher than that of sucrose², the reference sugar. For this reason using D-fructose, to reach the same degree of sweetness a smaller amount is necessary which makes it less expensive, profitable, attractive and explains its commercial uses in foods and beverages. In addition it has little effect on measured blood glucose levels making it recommended in some diets. It can also

¹ K. P. C. Vollhardt, N. E. Schore *Organic Chemistry – Structure and Function*, W.H. Freeman and Company, New York, 2003, 4th Edition, p. 1056.

² (a) L. M. Hanover, J. S. White *Am. J. Clin. Nutr.* **1993**, *58*, 724; (b) A. E. Benders *Dictionary of Nutrition and Food Technology* **1990**, Butterworths, Boston.

enhance other flavours in the system^{2a} and can also exhibit a sweetness synergy effect when used in combination with other sweeteners.³

When in solution, D-fructose forms different cyclic structures in equilibrium. In water at 25°C, different tautomeric forms can be observed, however, there is a predominant form, the β-D-fructopyranose (73%) followed by β-D-fructofuranose (20%)⁴ (Figure 3).

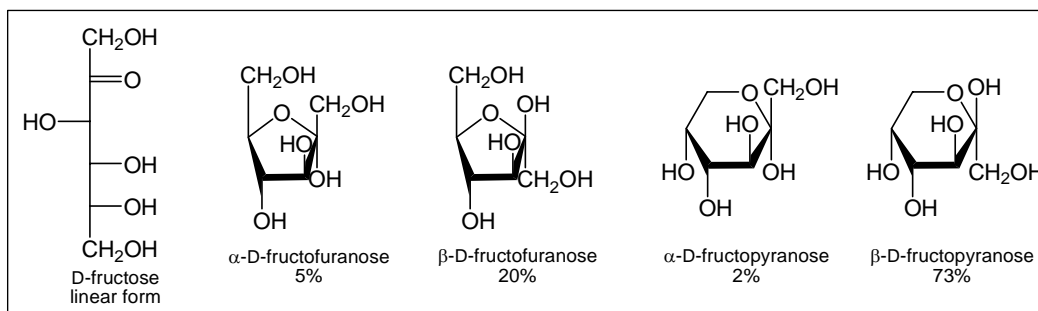

Figure 3

Just for curiosity, it is the 5-membered ring form of D-fructose that is the sweetest; the 6-membered ring form tastes about the same as typical table sugar. Unfortunately, warming fructose leads to formation of the pyranose form⁵.

Just out of curiosity

It is known that every cell in the body can metabolize D-glucose but on the other hand, D-fructose is almost entirely metabolized in the liver. In United States a team of researchers observed that the liver of rats on a high fructose diet looked like the liver of alcoholics, plugged with fat and cirrhotic.⁶ However this cannot be entirely true as a few other tissues (*e.g.* sperm cells and some intestinal cells) do use D-fructose directly, though in less metabolically significant amounts.

³ L. O. Nabors *American Sweeteners* 2001, 374.

⁴ F. W. Lichtenthaler *Carbohydr. Res.* 1998, 313, 69.

⁵ http://www.medbio.info/Horn/Time%201-2/carbohydrate_metabolism.htm

⁶ L. Forristal *The Murky World of High-Fructose Corn Syrup* 2001, Weston A. Price Foundation. <http://www.westonaprice.org/motherlinda/hfcs.html> it's a magazine.

2.2. D-Psicose

D-Psicose - *D-ribo*-hex-2-ulose or D-allulose - is the C-3 epimer of D-fructose. In water at 27°C, all tautomeric forms are in equilibrium and α -D-psicofuranose is the predominant form (39%)⁷ (Figure 4).

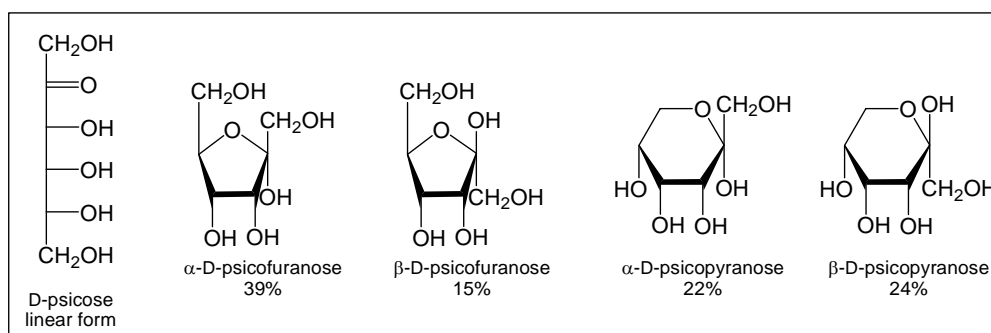

Figure 4

D-Psicose is an ultralow-energy monosaccharide : with the same amount as sucrose, it liberates only 0.3% of the equivalent metabolic energy. It is known as a "rare sugar" because it is scarcely found in nature, and even when it occurs, it is in small amounts. The presence of D-psicose can also be detected in some agricultural products or in commercially prepared carbohydrate complexes but always in small quantities. First described by Steiger and Reichstein⁸ in 1936, this ketose can also be isolated from *psicofuranine*,⁹ a nucleoside antibiotic which has good antibacterial activity *in vivo* and antitumor activity, but shows no activity *in vitro* when assayed by conventional methods¹⁰ (Figure 5).

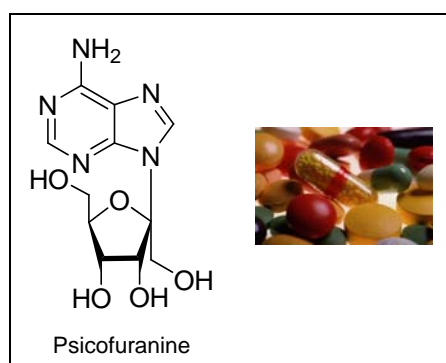

Figure 5

⁷ S. C. Köpper, S. Freimund *Helv. Chim. Acta* **2003**, *86*, 827.

⁸ M. Steiger, T. Reichstein *Helv. Chim. Acta* **1936**, *19*, 187.

⁹ V. K. Srivastava, L. M. Lerner *J. Org. Chem.* **1979**, *44*, 3368.

¹⁰ L. J. Hanka *J. Bacteriol.* **1960**, *80*, 30 and references cited therein.

Recently, rare sugars have attracted much attention because of their countless applications¹¹. D- Psicose might be an excellent sucrose substitute for food products due to its sweet taste, easy processing, and functional properties.^{11, 12} Actually, research studies are being conducted in order to know how it can be used in diets to help fighting hyperglycemia, diabetes mellitus and arteriosclerosis diseases. Moreover, it has been shown to have a large number of chemotherapeutical properties¹³.

2.3. D-Tagatose

D-Tagatose - *D-lyxo-hex-2-ulose* or *D-galactulose* - is a low caloric carbohydrate sweetener. Epimer at C-4 of D-fructose, it is a naturally occurring monosaccharide, e.g. in *Sterculia setigera* (Arabian gum).¹⁴ D-Tagatose was discovered in 1926 by an American engineer, G. Levin, during his studies on chirality. While searching through various left-handed sugars, he was faced to D-tagatose which is structurally close to L-fructose.

D-Tagatose can be found in small amounts in dairy products. It can be produced commercially from lactose in a two-step process: first the lactose is enzymatically hydrolyzed by *Aspergillus oryzae* lactase to D-glucose and D-galactose, then the latter undergoes isomerization into D-tagatose under alkaline conditions (calcium hydroxide). After purification of the resulting mixture through neutralization, ion exchange chromatography and recrystallization,¹⁵ white crystals are produced which are more than 99% pure with perfect taste and appearance of sugar. D-Tagatose can also be bio-manufactured from D-galactose via enzymatic processes involving for example, L-arabinose isomerase.¹⁴

In water at 27°C, all tautomeric forms are in equilibrium and α -D-tagatopyranose is the predominant form (79%)⁷ (Figure 6).

¹¹ K. Muraio, X. Yu, W.M. Cao, H. Imachi, K. Chen, T. Muraoka, N. Kitanaka, J. Li, R.A.M. Ahmed, K. Matsumoto, T. Nishiuchi, M. Tokuda, T. Ishida *Life Sci* **2007**, *81*, 592 and references cited therein.

¹² Y. Sun, S. Hayakawa, M. Ogawa, K. Fukada, K. Izumori *J. Agric. Food. Chem.* **2008**, *56* (12), 4789.

¹³ (a) M. K. Takada, F. Yamaguchi, Y. Nakanose, Y. Watanabe, N. Hatano, I. Tsukamoto, M. Nagata, K. Izumori. M. Tokuda *J. Biosci. Bioeng.* **2005**, *100*, 511; (b) B. T. Menavuvu, W. Poonperm, K. Leang, N. Noguchi, H. Okada, K. Morimoto, T. B. Granstrom, G. Takada, K. Izumori *J. Biosci. Bioeng.* **2006**, *101*, 340.

¹⁴ D. Oh *Appl Microbiol Biotechnol* **2007**, *76*, 1.

¹⁵ *FAO Monograph* **2006**, *1*, www.fao.org.

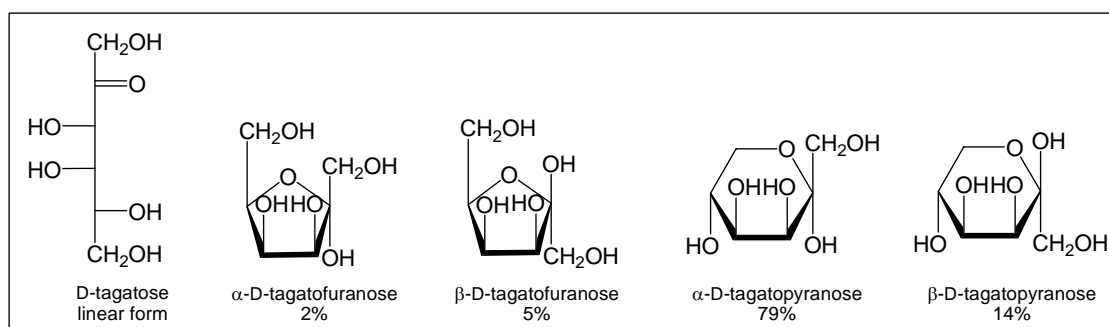

Figure 6

Since it is differently metabolized from sucrose, it has a minimal effect on blood glucose and insulin levels. It has shown anti-hyperglycemic properties and is therefore useful in the treatment of diabetes.¹⁶ Its sweetness is about 75-92% higher^{14, 17} but with only 38% of the calories comparing to sucrose (in equal weight). It has also been approved as a tooth friendly ingredient.¹⁴

Just out of curiosity

During the past decade, a continuous growing interest on D-tagatose has been observed. Notably, the fact that D-tagatose was approved by the FDA (U.S. Food and Drug Administration) in 1999 as a low-calorie sugar substitute (1.5 kcal/g as against 4 kcal/g) and also in 2001 “Generally Recognized as Safe” (GRAS) by the FAO/WHO¹⁷ and in 2003 as food additive.¹⁶ Nowadays, it has applications in the food industry as a sweetener, flavour enhancer, humectant, texture agent, thickener, etc...^{14, 15}

However this rare sugar of easy access (inexpensive production) is not only attractive for food and beverage markets but also for pharmaceutical markets.^{14, 18, 19} In 2004, Australian researchers revealed the effects of D-tagatose on blood glucose and insulin responses, animal studies in rats confirmed the hypoglycaemic properties of the product, triggering its development as an anti-diabetic agent in humans.¹⁹ In United States a pharmaceutical company has already developed a new product with a view to including it in the treatment of intestine cancer taking into account its restorative properties on the intestinal flora. The non absorbed D-tagatose (nearly 75% of the total amount) acts as a prebiotic.¹⁹ But this is not the only

¹⁶ N. A. Jones, S. F. Jenkinson, R. Soengas, M. Fanejord, M. R. Wormald, R. A. Dwek, G. P. Kiran, R. Devendar, G. Takata, K. Morimoto, K. Izumoric, G. W. J. Fleet *Tetrahedron: Asymmetry* **2007**, *18*, 774.

¹⁷ Agency Response Letter GRAS Notice No. GRN 000078.

¹⁸ T. W. Donner, J. F. Wilber, D. Ostrowski *Diabetes, Obesity and Metabolism* **1999**, *1* (5), 285.

¹⁹ Y. Lu, G. V. Levin, T. W. Donner *Diabetes, Obesity and Metabolism* **2008**, *10*, 109.

application: another product based on D-tagatose, targeting the treatment of type 2 diabetes is also in phase 3 of testing.¹⁹ The first efficacy studies in humans confirm that orally taken D-tagatose leads to very low insulin and glycemic responses, both in normal and in diabetic patients. Besides, considerable increases on HDL cholesterol and antioxidant properties were also observed. In addition, these studies also highlight the significant benefits of the product on obesity, unlike other anti-diabetic such as sulfonylureas or thiazolidinediones which lead to weight gain.^{14, 19} The standard toxicity studies in animals and potential genotoxicity, embryotoxicity and teratogenicity studies demonstrate that the product may be considered risk-free.

2.4. L-Sorbose

L-Sorbose - a white crystalline sugar – is the C-5 epimer of D-fructose. It is the most readily large-scale available L-sugar as part of the commercial preparation of vitamin C (L-ascorbic acid).

In water at 27°C, all tautomeric forms are in equilibrium and α -D-sorbopyranose is the largely predominant form (98%)⁴ (Figure 7).

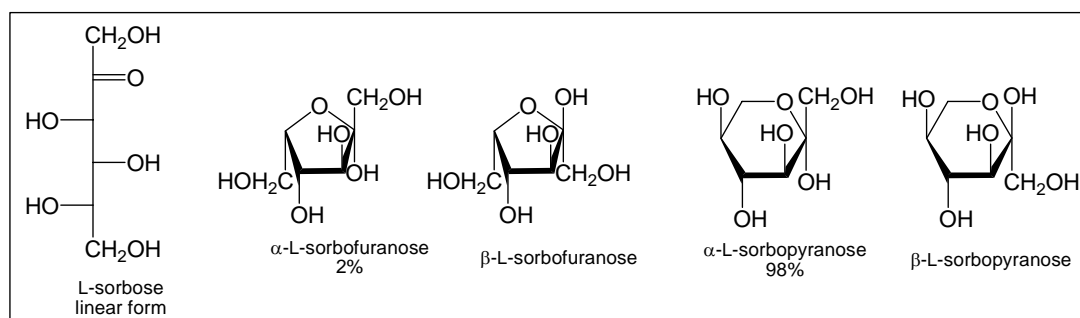

Figure 7

3. SOME KETOHEXOSE CHEMISTRY

On a general point of view, carbohydrates are implicated in a large number of biological pathways and thus have been the subject of numerous researches. Besides those intense studies, working on this topic is not as simple as it could be thought. Of the number of reasons, in water (in solution), one monosaccharide exist as a complex mixture in equilibrium, of different

isomers (α -, β -pyrano or furano and acyclic forms) which requires from organic chemists challenging and ingenious approaches to solve or simplify this complexity.

Rare sugars like ketoses have seen light for their uses as healthy alternative foodstuff.²⁰ The recent discovery of several beneficial healthy properties has potentiated the application of rare sugars in pharmaceutical industry for the treatment of different diseases, such as diabetes and obesity.

Consequently, many attempts to find more effective synthetic accesses to these rare sugars and/or new potential sugar compounds are currently under investigation. However for large scale production it is predicted that biotechnological approaches might be more economically efficient and environmentally friendly.¹⁶

In this part of the chapter, we shall present some recent reports on ketose chemistry: how to synthesis these rare sugars and derivatives, their application as chiral auxiliaries²¹ and as synthons in the synthesis of natural compounds²², nucleosides²³ and iminosugar analogues²⁴. The kind of molecules synthesized goes from cyclic to acyclic structures, simple to more complex. The purposes are diverse but mainly with a wide range of applications in the biological treatment of various diseases, namely cancer, diabetes, HIV, herpes...

²⁰ (a) G. V. Levin, *J. Med. Food* **2002**, *5*, 23; (b) Y. X. Sun, S. Hayakawa, M. Ogawa, K. Izumori *Food Control* **2007**, *18*, 220; (c) Y. X. Sun, S. Hayakawa, H. H. Jiang, M. Ogawa, K. Izumori, *Biosci., Biotechnol., Biochem.* **2006**, *70*, 2859.

²¹ (a) Y. Nagao, S. Yamada, T. Kumagai, M. Ochiai, E. Fujita *J. Chem. Soc. Chem. Commun.* **1985**, 1418 ; (b) C. N. Hsiao, L. Liu, M. J. Miller, *J. Org. Chem.* **1987**, *52*, 2201; (c) F. Kazmierczak, P. Helquist *J. Org. Chem.* **1989**, *54*, 3988; (d) T. H. Yan, H. C. Lee, C. W. Tan *Tetrahedron Lett.* **1993**, *34*, 3559; (e) T. H. Yan, C. W. Tan, H. C. Lee, T. Y. Huang *J. Am. Chem. Soc.* **1993**, *115*, 2613; (f) C. N. Hsiao, L. Liu, M. J. Miller *J. Org. Chem.* **1995**, *60*, 3301; (g) D. W. Su, Y. C. Wang, T. H. Yan, *Tetrahedron Lett.* **1999**, *40*, 4197; (h) N. R. Guz, A. J. Phillips *Org. Lett.* **2002**, *4*, 2253; (i) F. Velazquez, H. F. Olivo *Curr. Org. Chem.* **2002**, *6*, 1 and references citer therein.

²² (a) J. M. Garcia Fernandez, C. Ortiz Mellet, J. Fuentes *J. Org. Chem.* **1993**, *58*, 5192; (b) J. G. Fernandez-Bolanos, E. Zafra, O. Lopez, I. Robina and J. Fuentes, *Tetrahedron: Asymmetry* **1999**, *10*, 3011; (c) J. Fuentes Mota, J. L. Jimenez Blanco, C. Ortiz Mellet, J. M. Garcia Fernandez *Carbohydr. Res.* **1994**, *257*, 127; (d) C. Gasch, M. Angeles Pradera, B. A. B. Salameh, J. L. Molina, J. Fuentes *Tetrahedron: Asymmetry* **2001**, *12*, 1267.

²³ (a) R. Ranganathan *Tetrahedron Lett.* **1975**, *13*, 1185; (b) R. Ranganathan *Tetrahedron Lett.* **1977**, *15*, 1291; (c) B. Rayner, C. Tapiero, J. L. Imbach *J. Heterocyclic Chem.* **1982**, *19*, 593; (d) G. Gosselin, M. C. Bergogne, J. De Rudder, E. De Clerq, J. L. Imbach *J. Med. Chem.* **1986**, *29*, 203; (e) A. Grouiller, G. Mackenzie, B. Najib, G. Shaw and D. Ewig *J. Chem. Soc., Chem. Commun.* **1988**, 671; (f) G. Gosselin, M. C. Bergogne, J. L. Imbach *Nucleosides Nucleotides* **1990**, *9*, 81.

²⁴ (a) J. L. Jimenez Blanco, V. M. Diaz Perez, C. Ortiz Mellet, J. Fuentes, J. M. Garcia Fernandez, J. C. Diaz Arribas, F. J. Cañada *J. Chem. Soc., Chem. Commun.* **1997**, 1969 and references cited therein; (b) V. M. Diaz Perez, M. I. Garcia Moreno, C. Ortiz Mellet, J. Fuentes, J. C. Diaz Arribas, F. J. Cañada, J. M. Garcia Fernandez *J. Org. Chem.* **2000**, *65*, 136; (c) S. Silva *PhD Thesis*, University of Lisbon and University of Orléans **2009**.

3.1. Ketoses as intermediate synthetic tools

3.1.1. Exocyclic vinyl ethers²⁵

Exocyclic vinyl ether derivatives of sugars are reported in literature as intermediates in various metabolic and biosynthetic pathways and for their potential as synthetic intermediates, for example in the synthesis of enzyme inhibitors, biologically relevant compounds or as monomers for polymerization. Throughout the years, numerous researches have been developed in this area with sugars but most of them with aldoses, the ketose family still remaining scarcely explored.

Latest studies proposed that the biosynthesis of the carbocyclic moiety of natural products such as neplanocin A (a novel cyclopentenyl analogue of adenosine, naturally occurring antibiotic which exhibits significant antitumor activity against leukemia in mice)²⁶ and aristeromycin (an inhibitor of purine biosynthesis, carboxylic nucleoside antibiotic which exhibits a variety of biological activities²⁷) involved a key intramolecular aldol condensation. As a result Bechor and Albeck proposed that these molecules may engage a common exocyclic vinyl derivative of fructose-6-phosphate (Scheme 1).

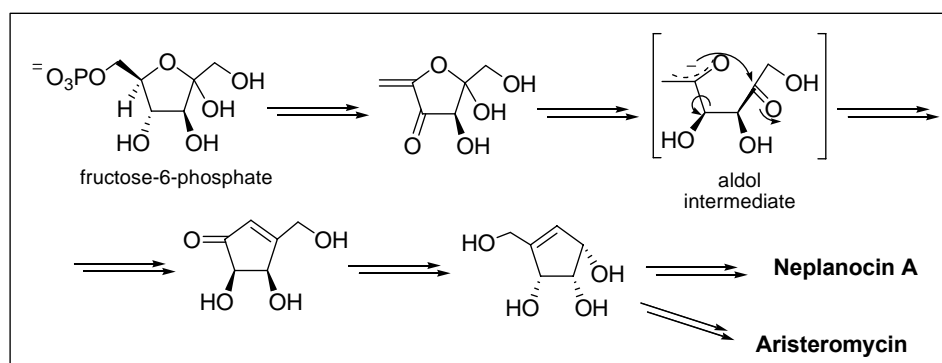

Scheme 1

Consequently, the synthetic strategy relied on two different reactions: a β -elimination or a reductive elimination. However there are some important aspects that should be taken into account like locking the ketohexose sugar in its furano form, the choice of a suitable protection for hydroxyl groups and an adequate leaving group at the C-6 primary position.

²⁵ Y. Bechor, A. Albeck *Tetrahedron* **2008**, *64*, 2080 and references cited therein.

²⁶ R. T. Borchardt, B. T. Keller, U. Patel-Thombre *J. Biol. Chem.* **1984**, *259*, 4353.

²⁷ R. J. Parry, Y. Jiang *Tetrahedron Lett.* **1994**, *35*, 9665.

Another example starting with D-tagatose is the synthesis of angustmycin A, a nucleoside antibiotic which shows antimicrobial and antitumor activity²⁸ (Scheme 2).

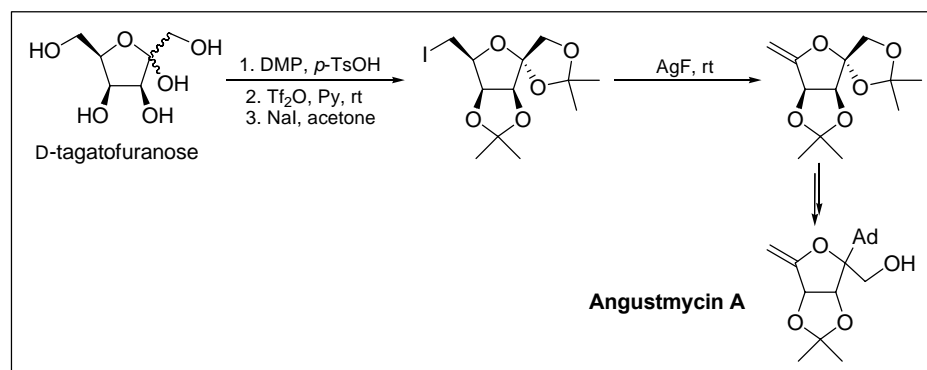

Scheme 2

3.1.2. 5-C-Methyl ketohexoses²⁹

DC-SIGN (dendritic cell-specific intercellular adhesion molecule-3-grabbing non-integrin) protein, also known as CD209 (cluster of differentiation 209) is a C-type lectin receptor present on both macrophages and dendritic cells. It binds various microorganisms by recognizing high-mannose-containing glycoproteins and functions especially as receptor for several viruses such as HIV and hepatitis C. Together with other C-type lectins, it is involved in recognition of tumors by dendritic cells and is a potential engineering target for a cancer vaccine.

The 2-C-methyl-branched mannose is the first example of a small molecule that binds to a DC-SIGN receptor. From this viewpoint and due to all the promising advantages and applications of rare sugars, many attempts for finding more effective syntheses and also 'new' monosaccharidic compounds have been made.

Even today, the use of enzymes in organic synthesis transformations is limited because of substrate specificity. However, the evolution and discovery of new enzymes seems to open new horizons for this type of biotechnological process. For instance the procedures developed

²⁸ E. J. Prisbe, J. Smejkal, J. P. H. Verheyden, J. G. Moffatt *J. Org. Chem.* **1976**, *41*, 1836.

²⁹ N. A. Jones, D. Rao, A. Yoshihara, P. Gullapalli, K. Morimoto, G. Takata, S. J. Hunter, M. R. Wormald, R. Dwek, K. Izumori, G. W. J. Fleet *Tetrahedron:Asymmetry* **2008**, *19*, 1904 and references cited therein.

by Izumori³⁰ allow the isomerization of all 16 aldohexoses and 8 ketohexoses in water under environmentally friendly conditions.

Herein is presented just an example, the preparation starting from D-fructose of 5-C-methyl-D-psicose *via* 5-C-methyl-D-fructose through a combination of chemical and biotechnological steps (Scheme 3).

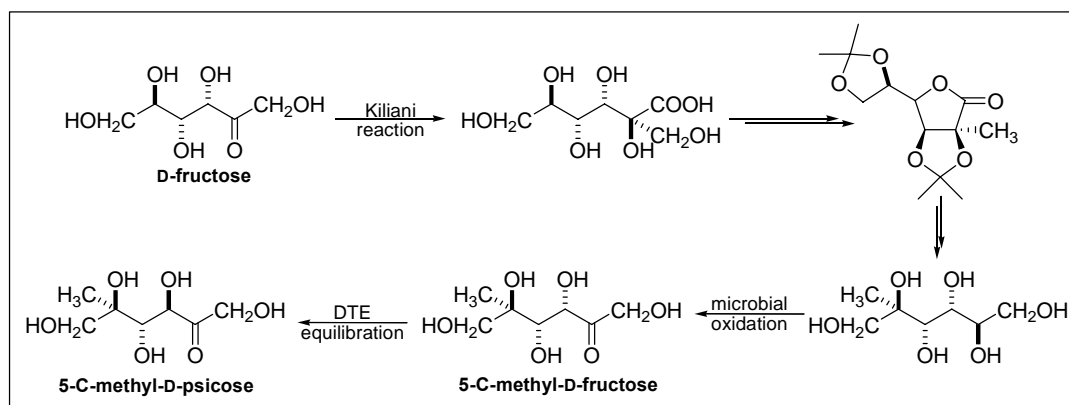

Scheme 3

This synthesis depends greatly on the efficiency of the Kiliani reaction on the starting material. It is well established that D-tagatose-3-epimerase (DTE) owns a capacity to equilibrate methyl ketohexoses derivatives between the D-fructo and D-psico series. Such procedures open the way to new C-branched monosaccharides, allowing evaluation of their potential biological activity. These reactions were also applied with success to other members of the ketose family.

3.1.3. 1-Deoxy-D-ketohexoses³¹

Rare monosaccharides, like ketoses, seem to be owners of interesting biological activity. D-Tagatose is an anti-hyperglycemic agent and therefore useful in the treatment of diabetes. D-Psicose, readily available from D-fructose by the action of DTE enzyme, has a considerable number of chemotherapeutic properties. And both of them seem to be attractive as healthy food substitutes.

³⁰ (a) K. Izumori *J. Biotech.* **2006**, *124*, 717; (b) T. B. Granstrom, G. Takata, M. Tokuda, K. Izumori *J. Biosci. Bioeng.* **2004**, *97*, 89; (c) K. Morimoto, C. S. Park, M. Ozaki, K. Takeshita, T. Shimonishi, T. B. Granstrom, G. Takata, M. Tokuda, K. Izumori *Enzyme Microb. Technol.* **2006**, *38*, 855.

³¹ N. A. Jones, S. F. Jenkinson, R. Soengas, M. Fanefjord, M. R. Wormald, R. A. Dwek, G. P. Kiran, R. Devendar, G. Takata, K. Morimoto, K. Izumori, G. W. J. Fleet *Tetrahedron:Asymmetry* **2007**, *18*, 774.

Until now, scarce attention has been given to the synthesis of deoxyketohexoses. The objective of the reported syntheses was to explore the deoxyketohexoses abilities for biological applications. Such new compounds might have potential applications in food chemistry as well. If they reveal interesting characteristics they might be prepared on a large scale by the biotechnological Izumori's procedures.

The synthetic pathway is quite simple, each diastereomeric D-ketohexose is obtained by methyl lithium addition to a suitably protected lactone of an aldonic acid (Scheme 4).

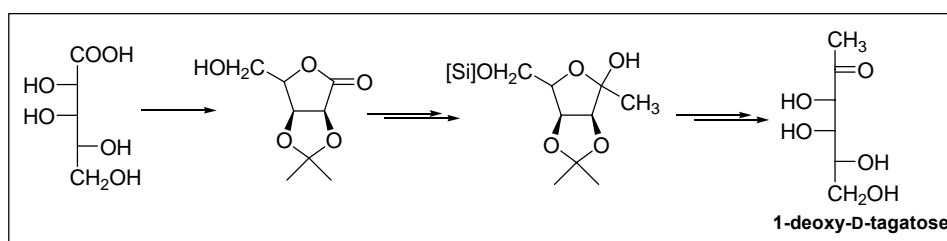

Scheme 4

For example 1-deoxy-D-tagatose is prepared from D-lyxonic acid. All other D- and L-ketohexoses can also be synthesized by the same method starting from the appropriate lactone.

3.1.4. 2-C-(Hydroxymethyl)aldoses³²

The Bílik reaction corresponds to the reciprocal interconversion of C-2-epimeric aldoses under molybdic acid catalysis. Taking into account its easiness, this reaction is commonly used to synthesise quite a few rare aldoses on a large scale.

It was reported in the middle of the 90s that submitting 2-C-(hydroxymethyl)-D-fructose to those conditions led to remarkable structural modifications. The treatment with this catalyst induces highly stereospecific carbon-skeleton rearrangements to give equilibrium mixtures containing 2-C-(hydroxymethyl)-D-ribose or D-hamamelose. Later, new improvements were brought and the same kind of reaction was applied in other ketose series giving analogous results (A) (B), with the sole exception of D-psicose (Scheme 5).

³² Z. Hricovíniová-Bíliková, M. Hricovíni, M. Petrušová, A. S. Serianni, L. Petruš *Carbohydr. Res.* **1999**, 319, 38.

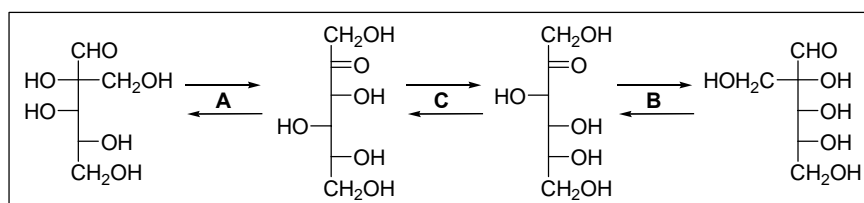

Scheme 5

The reaction mechanism seems to be similar to that described for aldoses, the carbon atoms exchange with their substituents is mediated by a tetradentate dimolybdate complex involving four neighbouring hydroxyl groups. This complex promotes the formation of a new C-1–C-3 bond while simultaneously breaking the C-2–C-3 bond, thereby causing epimerization with concomitant C-1–C-2 transposition.

Curiously, when boric acid is added in the reaction mixture in L-sorbose and D-fructose series, the equilibrium is considerably changed in 2-C-(hydroxymethyl)-pentoses. Furthermore, these two ketoses also undertake a competitive secondary isomerization process although in small quantity (C).

3.1.5. Di-D-fructose dianhydrides (DFAs)³³

Difructose dianhydrides (DFAs), a single class of spiroketal disaccharides (condensation of two fructose molecules, with formation of two reciprocal glycosidic linkages) comes from thermal and/or acidic activation of sucrose- and/or D-fructose-rich materials. Until their presence was detected in food materials (caramels or chicory) in substantial amount they were just considered as laboratory curiosity. This discovery has completely changed DFA chemistry, by exhaustive and meticulous research which revealed the biological (beneficial prebiotic nutritional functions), nutritional (low-caloric sweeteners) and technological importance of this family of compounds. However, the complexity of the formed DFA mixtures - up to 14 diastereomeric spiroketal cores - makes the evaluation of their individual characteristics a tricky challenge (Figure 8).

³³ M. I. García-Moreno, J. M. Benito, C. Ortiz Mellet, J. M. García Fernández *Molecules* **2008**, *13*, 1640 and references cited therein.

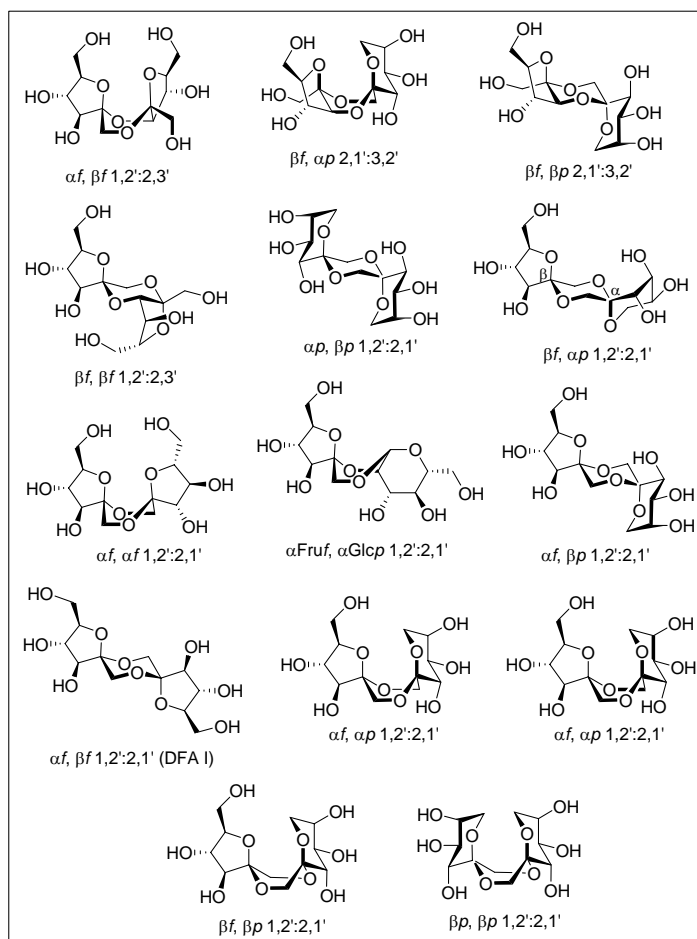
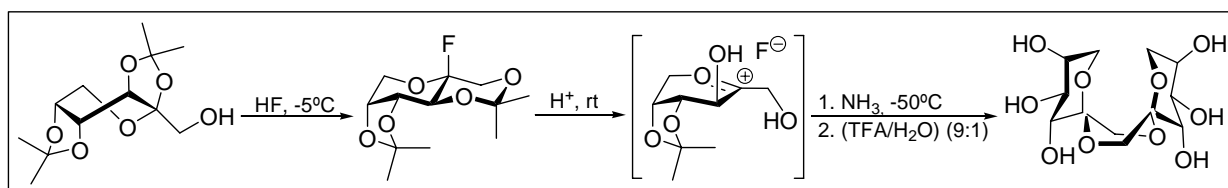

Figure 8

Improvement of standard methodologies to get access to each individual, isolated and pure compound is fundamental in order to understand their biological role and to develop new applications. With this purpose chemical and enzymatic syntheses have been used as complementary strategies to obtain these compounds and study their properties. For example, they can be chemically synthesised by protic acid activation starting from either unprotected, ring-size blocked (Scheme 6), or conformationally controlled D-fructose precursors and even *via* the intramolecular aglycon delivery methodology.



Scheme 6

Actually with all the knowledge acquired about DFAs more attractive perspectives can be considered in terms of food processing for enhancement of biological functions.

3.1.6. 1,5-Anhydro-D-fructose³⁴

1,5-Anhydro-D-fructose (Figure 9), was synthesized for the first time in 1980 by Lichtenthaler from 1,5-anhydro-2,3,4,6-tetra-*O*-benzoyl-D-*arabino*-hex-1-enitol *via* two different routes.

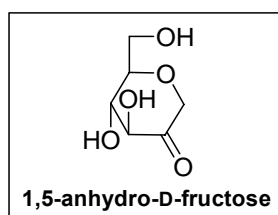
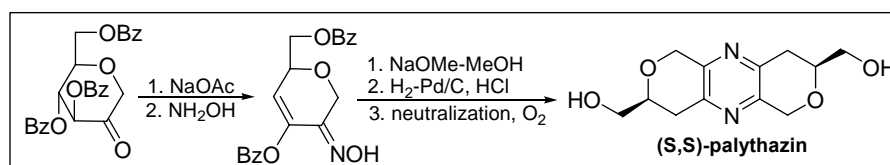

Figure 9

It is an attractive chiral building block, with the different functional groups which are ready for selective modifications. It possesses a prochiral center together with a permanent pyrano form due to the lack of an anomeric carbon atom, which makes it a potential chiral building block for the synthesis of high-value and potentially biologically active compounds.

However its chemical synthesis - fastidious and low yielding - only gives access to limited quantities. Fortunately, the identification and isolation of the starch-degrading enzyme α -(1 \rightarrow 4)-*glucan lyase* has facilitated its production.

Therefore, 1,5-anhydro-D-fructose can be used as a chiral starting material for the preparation of potential glycosidase inhibitors or natural products, *e.g.* (S,S)-palythazin (Scheme 7).



Scheme 7

³⁴ S. M. Andersen, I. Lundt, J. Marcussen, S. Yu *Carbohydr. Res.* **2002**, 337, 873 and references cited therein.

As it was presented 1,5-anhydro-D-fructose is considered a valuable chiral building block to prepared biologically active fine and as well bulk chemicals with potential applications in the food and pharmaceutical industry.

3.1.7. Iminosugars

Azasugars or better “iminosugars” (carbohydrate mimics with a nitrogen replacing the ring oxygen) represent the most important class of glycosyl hydrolase inhibitors^{35, 36, 37}. Thanks to their inhibition potencies they are a high promise as probes for structure and useful biological tools for studies on glycoconjugate functions, targeting and turnover^{24a}. Furthermore these compounds have also applications as chemotherapeutic agents for the treatment of cancer, diabetes and inflammation or viral replication^{35, 24a} and rare diseases. Actually there are many available iminosugars but the problem is the lack of specificity.^{24a} Recently however, two imino-sugar based drugs have been released on the market. In 1996, Glyset™ for handling with type II diabetes complications and in 2003 Zavesca™ for the treatment of Gaucher’s disease, a harsh lysosomal storage disorder.³⁷

Starting with D-fructose, natural glycosidase inhibitors, DMDP and DGDP, *via* intramolecular delivery of benzyl protection have been prepared.³⁶ Further modifications of the inhibitors demonstrated that remarkable specificities in enzyme inhibition can be achieved upon modifications on the nature of the sp²-hybridized endocyclic ring nitrogen (Scheme 8).³⁵

³⁵ M. I. Garcia-Moreno, D. Rodriguez-Lucena, C. Ortiz Mellet, J. M. Garcia Fernandez *J. Org. Chem.* **2004**, *69*, 3578;

³⁶ M. I. Garcia-Moreno, M. Aguilar, C. Ortiz Mellet, J. M. Garcia Fernandez *Org. Lett.* **2006**, *8*, 297.

³⁷ P. Compain, O. R. Martin *Iminosugars: from synthesis to therapeutical applications*, Wiley, **2007**.

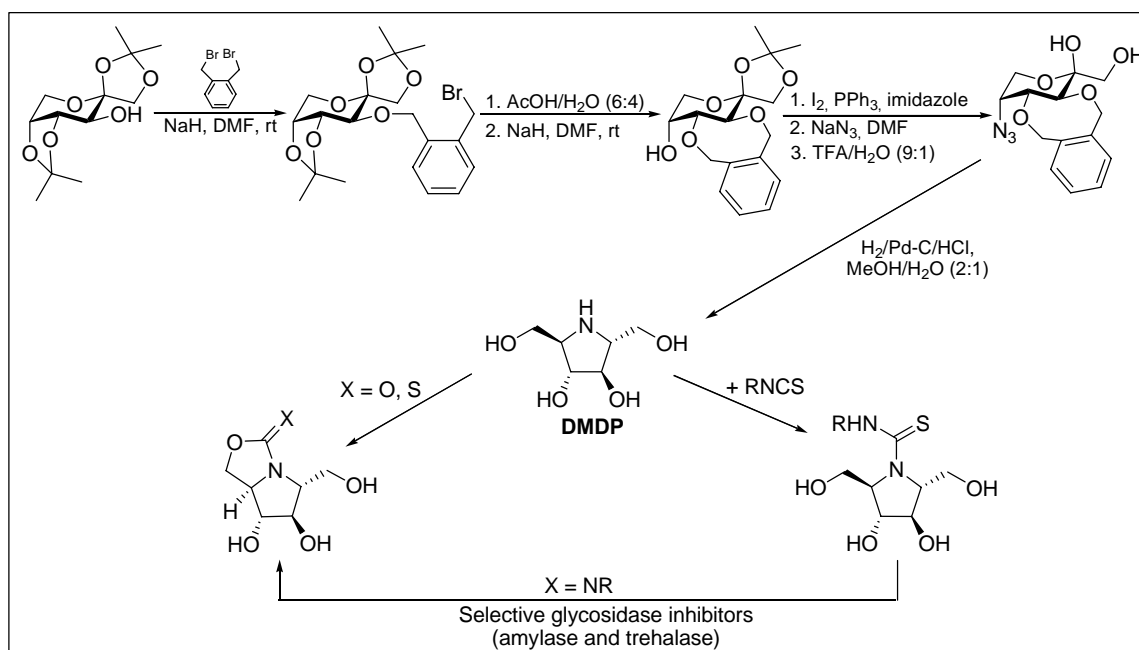

Scheme 8

Starting also from D-fructose a highly stereocontrolled preparation of a DMDP analogue, has been described and used as source of chirality in the preparation of protected derivatives of hyacinthacines, another well-known family of glycosidase inhibitors³⁸ (Scheme 9).

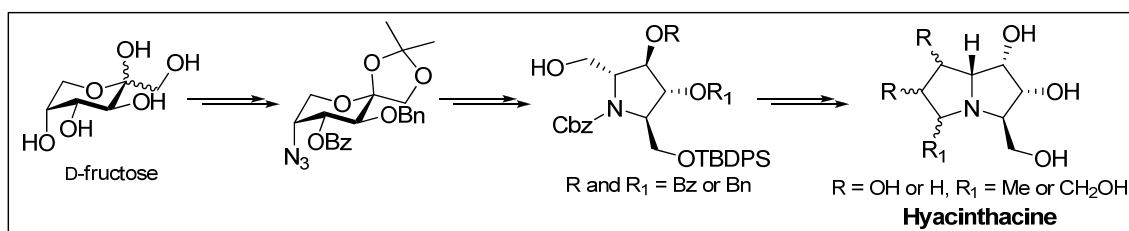

Scheme 9

3.1.8. Nucleoside analogues

Over recent years, synthetic base-modified nucleosides and nucleotides have proven their important impact in various therapeutical fields. Their biological properties have found application as antiviral tools against hepatitis virus (HBV), herpes virus (VZV) and human

³⁸ I. Izquierdo, M. T. Plaza, V. Yáñez *Tetrahedron* **2007**, *63*, 1440 and references cited therein.

immunodeficiency (HIV).³⁹ Many of those compounds exhibit antiproliferative, antibiotic and antifungal activities and some have been used as probes for DNA damages⁴⁰ as well as in the anti-sense approach and DNA-probe technology with fluorescence properties.⁴¹

It is believed that introducing diversity either onto the carbohydrate or onto the heterocyclic moiety of nucleosides, in methylated bases of the bacteria world, in RNA duplexes⁴² or in new antibiotic analogues⁴³ leads to gifted molecules with therapeutical potential (antiviral and anti-cancer agents).⁴⁴

Two general methods for nucleoside preparation have been reported in literature: one is using a glycosylation procedure which may lead to anomeric selectivity problems,⁴⁵ the other is based on a multistep process to construct the base from the sugar template.⁴⁶

Methods for the synthesis of nucleoside analogues based on saccharidic 1,3-oxazolidine-2-thiones (OZT) have slightly been described. In 1975, Ranganathan developed the synthesis of 9- β -D-arabinofuranosyl-adenine from a D-arabino OZT derivative.⁴⁷ A few years later, Imbach obtained nucleoside analogues from D-ribose⁴⁸ as well as from α - and β -D-xylose⁴⁹ and β -D-arabinose⁵⁰. Grouiller has also applied this method for the preparation of nucleosides derived from β -D-fructose.⁵¹

³⁹ (a) L. Agrofoglio, S. R. Challand, *Acyclic, carbocyclic and L-nucleosides*, Kluwer, London, **1998**; (b) R. F. Rando, N. Nguyen-Ba, *Drug Discov. Today* **2000**, *5*, 465; (c) C. McGuigan, C. J. Yarnold, G. Jones, S. Velazquez, H. Barucki, A. Brancale, G. Andrei, R. Snoeck, E. De Clercq, J. Balzarini, *J. Med. Chem.* **1999**, *42*, 4479.

⁴⁰ (a) E. A. Harwood, P. B. Hopkins, S. T. Sigurdsson *J. Org. Chem.* **2000**, *65*, 2959; (b) M. Kotera, Y. Roupioz, E. Defrancq, A.-G. Bourdat, J. Garcia, C. Coulombeau, J. Lhomme *Chem. Eur. J.* **2000**, *6*, 4163.

⁴¹ E. Trévisiol, E. Defrancq, J. Lhomme, A. Laayoun, P. Cros *Eur. J. Org. Chem.* **2000**, 211.

⁴² J. A. M. Gimenez, G. T. Saez, R. T. Tabraes *J. Theor. Biol.* **1998**, *194*, 485.

⁴³ (a) A. Rösler, W. Pfeleiderer *Helv. Chim. Acta* **1997**, *80*, 1869; (b) O. Jungmann, W. Pfeleiderer, *Tetrahedron Lett.* **1996**, *37*, 8355; (c) H. Sugimura, K. Osumi, Y. Kodaka, K. Sujino *J. Org. Chem.* **1994**, *59*, 7653; (d) Y. Saito, M. Nakamura, T. Ohno, C. Chaicharoenpong, E. Ichikawa, S. Yamamura, K. Kato, K. Umezawa *J. Chem. Soc., Perkin Trans. I* **2001**, 198; (e) E. R. Kandimalla, D. Yu, Q. Zhao, S. Agrawal *Bioorg. Med. Chem.* **2001**, *9*, 807; (f) D. R. Sauer, S. W. Schneller *Synthesis* **1991**, 747; (g) A. Al Mourabit, M. Beckmann, C. Poupat, A. Ahond, P. Potier, *Tetrahedron: Asymmetry* **1996**, *7*, 3455; (h) D. Lengeler, K. Weisz *Tetrahedron Lett.* **2001**, *42*, 1479; (i) O. Jungmann, W. Pfeleiderer *Tetrahedron Lett.* **1996**, *37*, 8355; (j) A. Rosler, W. Pfeleiderer *Helv. Chim. Acta* **1997**, *80*, 1869; (k) Z. Wang, C. Rizzo *Org. Lett.* **2000**, *2*, 227; (l) E. S. H. El Ashry, L. F. Awad, M. Winkler *J. Chem. Soc., Perkin Trans. I* **2000**, 829, (m) D. Loakes, M. -J. Guo, J.-C. Yang, D. M. Brown *Helv. Chim. Acta* **2000**, *83*, 1693; (n) R. Bertolini, J. Hunziker *Helv. Chim. Acta* **2000**, *83*, 1962; (o) W. Wu, D. E. Bergstrom *J. Org. Chem.* **2003**, *68*, 3860.

⁴⁴ N. Kifli, T. T. Htar, E. De Clercq, J. Balzarini, C. Simons *Bioorg. Med. Chem.* **2004**, *12*, 3247.

⁴⁵ (a) O. Jungmann, W. Pfeleiderer *Tetrahedron Lett.* **1996**, *37*, 8355; (c) H. Sugimura, K. Osumi, Y. Kodaka, K. Sujino *J. Org. Chem.* **1994**, *59*, 7653.

⁴⁶ (a) J. Girniene, D. Gueyrard, A. Tatibouët, A. Sackus, P. Rollin *Tetrahedron Lett.* **2001**, *42*, 2977; (b) N. S. Mourier, A. Eleuteri, S. Hurwitz, P. M. Tharnish, R. F. Schinazi *Bioorg. Med. Chem.* **1999**, *7*, 2759.

⁴⁷ R. Ranganathan *Tetrahedron Lett.* **1975**, *13*, 1185.

⁴⁸ B. Rayner, C. Tapiero, J. L. Imbach *J. Heterocyclic Chem.* **1982**, *19*, 593.

⁴⁹ G. Gosselin, M. C. Bergogne, E. De Clercq, J. L. Imbach *J. Med. Chem.* **1986**, *29*, 203.

⁵⁰ G. Gosselin, M. C. Bergogne, J. L. Imbach *Nucleosides Nucleotides* **1990**, *9*, 81.

⁵¹ A. Grouiller, G. Mackenzie, B. Najib, G. Shaw, D. Ewig *J. Chem. Soc., Chem. Commun.* **1988**, 671.

Recently, the approach developed in our laboratory involved this thionocarbamate moiety / a sugar derived 1,3-oxazolidine-2-thione (OZT) and anthranilic acid. Application of the process led to new homochiral quinazolinone derivatives and conducts to the synthesis of new base-modified "artificial nucleosides"^{46a, 52} (Scheme 10).

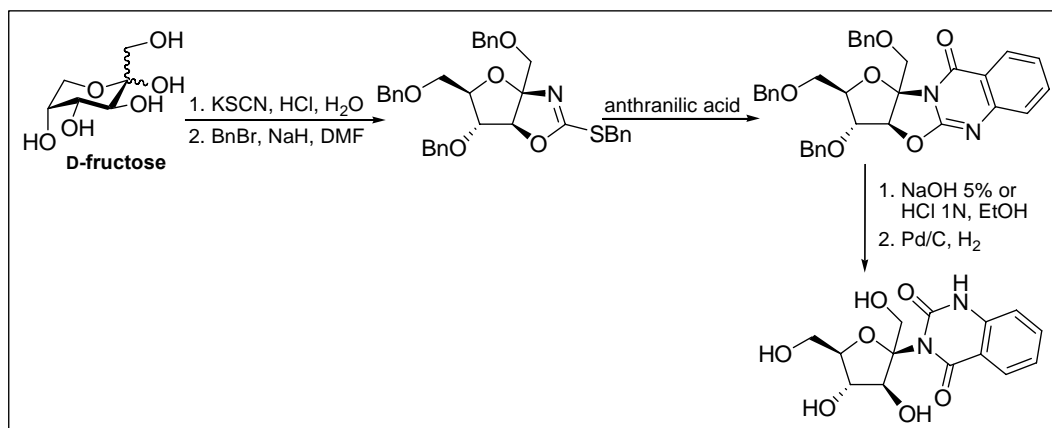

Scheme 10

In summary, starting from natural carbohydrates, a short, simple and original synthetic pathway through OZT derivatives for the preparation of based-modified nucleosides has been disclosed. This pathway has also been extended with success to diverse aldose and ketose series.^{46a}

Another example of original nucleoside bearing modifications on the sugar ring was reported by Kifli.⁴⁴ It refers to a nucleoside with a fused-OZT moiety in the sugar ring. This molecule could be a zidovudine (AZT) or stavudine (d4T) analogue, which are antiviral and anticancer agent analogues⁵³ (Figure 10).

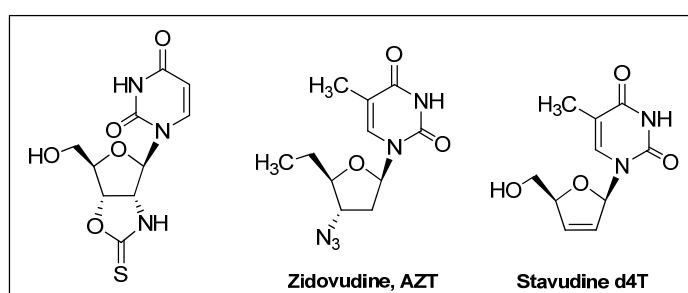

Figure 10

⁵² J. Girniene, G. Apremont, A. Tatibouët, A. Sackus, P. Rollin *Tetrahedron* **2004**, *60*, 2609.

⁵³ (a) T. S. Mansour, R. Storer, *Curr. Pharm. Des.* **1997**, *3*, 227; (b) E. Ichikawa; K. Kato, *Curr. Med. Chem.* **2001**, *8*, 385.

In general OZT moieties onto carbohydrate scaffolds are very useful structures. The synthesis of saccharidic OZTs is an attractive challenge from a chemical point of view but also because of the growing interest aroused by their biological properties. OZTs have shown potential uses as chiral intermediates²¹ in various synthetic transformations as synthons in the synthesis of iminosugars,²³ as precursors to nucleosides,²³ as mimics of ketohexose conformations to inhibit the fructose transporter, GLUT5^{21, 23d, 23e, 54} or as potential biological agents.^{21,24c, 55}

These two last applications constitute the biological challenge of this PhD.

3.1.9. Glucose and fructose transporters, GLUT5. Potential insecticides.

PhD Objectives.

a) First Part of the Project

The aim of the project is the development a selective inhibitor of a fructose-transporter (protein GLUT 5, a facilitative transporter). Therefore we needed to build up a library of potential GLUT5 inhibitors based on structural modulation of ketohexose structures. We would then expect to extract information of the structure-activity relationship to improve our understanding of the interactions with the protein. For the leading inhibitors further transformation could be made in order to develop novel biochemical tools bearing a photo-affinity label and / or a biochemical tag. This new sensor would be a precious tool in defining the tissue specific patterns of expression of the GLUTs, their response to alterations in diet and hormonal regulation and to disease states.

However, designing an inhibitor of D-fructose transporters is not so simple ! In early studies it was decided to compare the influence of various factors in the recognition process. These studies required investigation of the positions around D-fructose structure by the synthesis of molecules in which each position was substituted in order to determine the

⁵⁴ J. Girmiene, A. Tatibouët, A. Sackus, J. Yang, G. D. Holman, P. Rollin *Carbohydr. Res.* **2003**, 338, 711.

⁵⁵ (a) G. Li, X. Qian, J. Cui, Q. Huang, R. Zhang, H. Guan *J. Agric. Food Chem.* **2006**, 54, 125; (b) A. P. Rauter, M. Padilha, J. A. Figueiredo, M. I. Ismael, J. Justino, H. Ferreira, M. J. Ferreira, C. Rajendran, R. Wikkins, P. Vaz, M. J. Calhorda *J. Carbohydr. Chem.* **2005**, 24, 275; (c) S. Bondock, W. Khalifa, A. A. Fadda *Eur. J. Med.Chem.* **2007**, 42, 948; (d) J. W. Chien, M. L. Kucia, R. A. Salata *Clinical Infectious Diseases*, **2000**, 30, 146; (e) D. J. Diekema, R. N. Jones *Drugs* **2000**, 59, 7.

importance of each of the hydroxyl groups in the binding and interaction with GLUT5. Firstly, some studies were investigated using bulky groups. It was concluded that both ring forms (pyrano and furano) were tolerated,⁵⁶ thus increasing the difficulty in finding efficient inhibitors (Scheme 11).

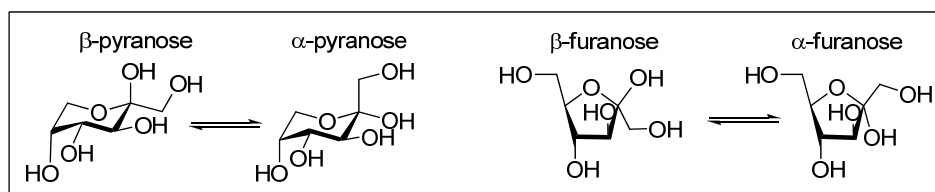

Scheme 11

Two sites, O-2 (pyrano and furano) and O-6 (furano) could be modified and addressed a visualization of important interactions with the protein. These interactions may occur because D-fructofuranose is a relatively symmetrical molecule and for that reason, the binding site can either arise in anomeric position or on the other side of the molecule. Hence D-fructopyranose appears to present to GLUT5 transporter by hydroxyl 3, 4, 5 recognition (Figure 11).

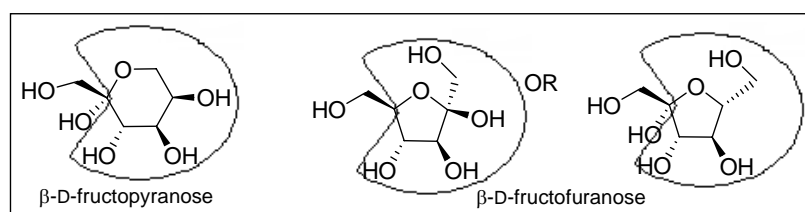

Figure 11

With the aim to explore this model of interaction, Girniene-Rousseau *et al.*⁵⁴ have started to develop a method using OZTs moieties to block the D-fructose structure and analogues (Figure 12). The OZT structures can be regarded as analogues of D-fructose in pentose series (derived from D- and L-arabinose, D-ribose and D-xylose), as well as in ketohexose series (derived from D-fructose and L-sorbose).

⁵⁶ (a) A. Tatibouët, J. Yang, C. Morin, G. D. Holman *Bioorg. Med. Chem.* **2000**, *8*, 1825; (b) J. Yang, J. Dowden, A. Tatibouët, Y. Hatanaka, G. D. Holman *Biochem. J.* **2002**, *367*, 533.

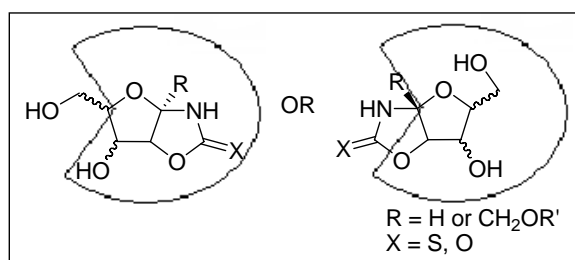
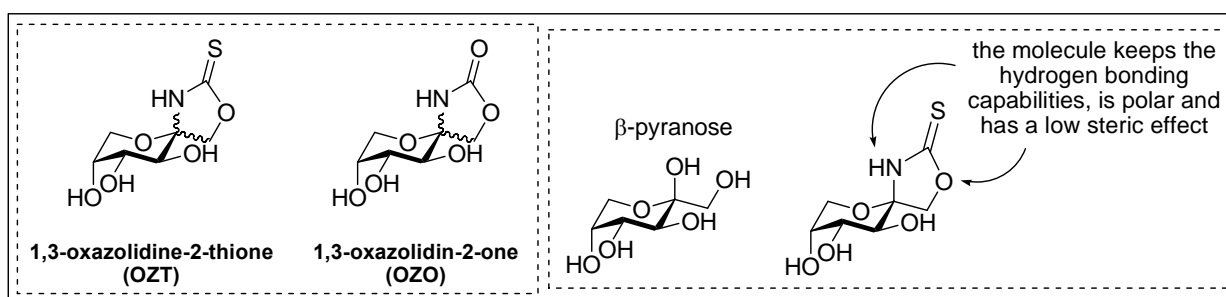

Figure 12

These first studies have put in evidence that pentose-derived OZTs were not recognized by the protein transporter. Only ketohexose-derived OZTs expressed some inhibition of GLUT5. These inhibition constants showed to be more effective with L-sorbo than for D-fructo derivatives. The oxygenated compounds, 1,3-oxazolidin-2-ones (OZO) were also observed to be better inhibitors than their thio-analogues (OZTs) and even better than D-fructose itself. Above all, these studies only address the furano isomer: nothing has been previously explored on pyrano structures.

Taking into account the results obtained in our laboratory it was decided that in this PhD the approach would follow the same guidelines: designing a molecule that mimics perfectly the ketohexose - either in α - and β -pyrano or α - and β -furano forms - but avoiding tautomeric problems. 1,3-Oxazolidine-2-thione (OZT) and 1,3-oxazolidin-2-one (OZO) were chosen as cyclic structures able to maintain the geometry and the interaction capability of the original ketohexose structures (Scheme 12). These new molecules (derived from all ketohexoses) would map the recognition pattern for each GLUTs of Class II, in testing only one tautomeric form of a ketohexose at a time.



Scheme 12

According to the chemistry developed in the laboratory, OZT was preferentially chosen. This structure provides a flexible chemistry and offers a number of advantages compared to their OZO analogues^{57, 58}, furthermore, they can easily be converted into their parent 2-oxo⁵⁹. Previous studies conducted in the laboratory have already shown the chemical potential of this synthon.⁵⁷

Anchoring an OZT on a saccharidic backbone can follow two main different pathways.⁶⁰ The most important is the condensation of an β -aminoalcohol with a thiocarbonyl source. This method implies control of different parameters from the saccharidic frame,^{22, 24a, 24b, 61} for example, requirement of a 1,2-*cis* relationship between alcohol and amine, and the thermodynamic force imposed by the monosaccharide to create the OZT. When these parameters are satisfied the formation of 1,3-oxazine-2-thiones becomes possible (Scheme 13).

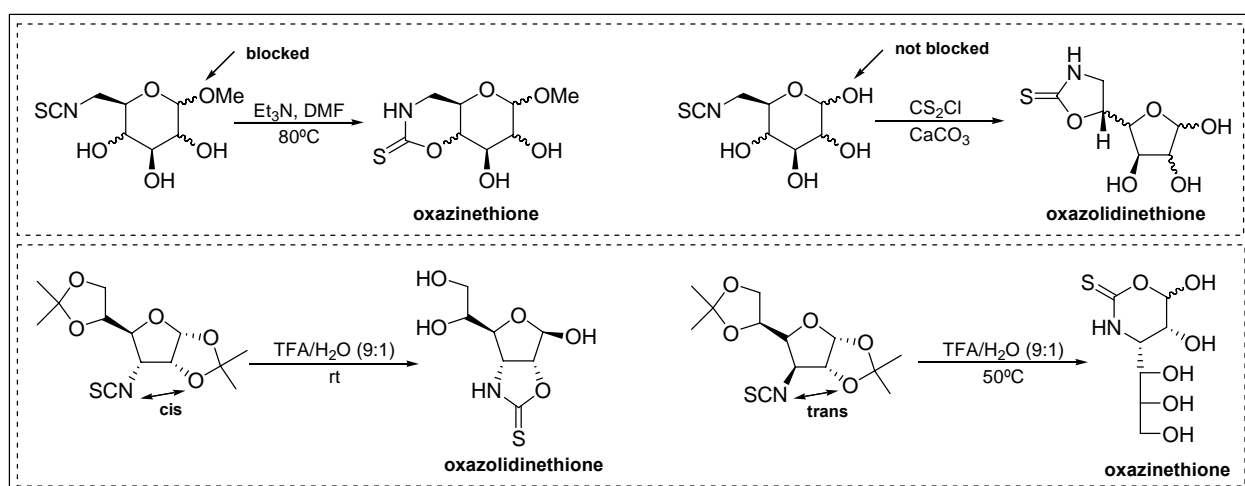

Scheme 13

⁵⁷ (a) O. Leoni, R. Bernardi, D. Gueyrard, P. Rollin, S. Palmieri *Tetrahedron: Asymmetry* **1999**, *10*, 4775; (b) D. Gueyrard, V. Grumel, O. Leoni, S. Palmieri, P. Rollin *Heterocycles* **2000**, *52*, 827.

⁵⁸ (a) E. Fujita, Y. Nagao *Adv. Heterocycl. Chem.* **1989**, *45*, 1; (b) P. Kocienski, M. Stocks, D. Donald, M. Perry *Synlett* **1990**, *1*, 38; (c) R. C. D. Brown, P. Kocienski *Synlett* **1994**, *6*, 415; (d) M. T. Crimmins, B. W. King, E. A. Tabet *J. Am. Chem. Soc.* **1997**, *119*, 7883; (e) M. T. Crimmins, B. W. King, *J. Am. Chem. Soc.* **1998**, *120*, 9084; (f) M. T. Crimmins, E. A. Tabet *J. Am. Chem. Soc.* **2000**, *122*, 5473; (g) Y. C. Wang, D. W. Su, C. M. Lin, H. L. Tseng, C. L. Li, T. H. Yan *Tetrahedron Lett.* **1999**, *40*, 3577; (h) Y. Nagao, M. Yagi, T. Ikedo, E. Fujita *Tetrahedron Lett.* **1982**, *23*, 201; (i) Y. Nagao, T. Kumagai, S. Yamada, E. Fujita, Y. Inoue, Y. Nagase, T. Abe *J. Chem. Soc. Perkin Trans 1* **1985**, 2361.

⁵⁹ (a) K. A. Jorgesen, A. B. Ghattas, S. O. Lawesson *Tetrahedron* **1982**, *38*, 1163; (b) R. Masuda, M. Hojo, T. Ichi, S. Sasano, T. Kobayashi, C. Kuroda *Tetrahedron Lett.* **1991**, *32*, 1195; (c) M. Moreno-Mañas, I. Padros *J. Heterocycl. Chem.* **1993**, *30*, 1235; (d) A. Corsaro, V. Pistrà *Tetrahedron* **1998**, *54*, 15027.

⁶⁰ For a general survey, cf. A. C. Simão, J. Rousseau, S. Silva, A. P. Rauter, A. Tatibouët, P. Rollin *Thionocarbamates on carbohydrate scaffolds – from synthesis to bioactivity in Specialist Periodical Reports – Carbohydr. Chem.* **2009**, *35*, 127.

⁶¹ (a) J. M. Garcia Fernandez, C. Ortiz Mellet *Sulfur Reports* **1996**, *19*, 61; (b) J. M. Garcia Fernandez, C. Ortiz Mellet, *Adv. Carbohydr. Chem. Biochem.* **2000**, *55*, 35.

The second method is the oldest one but curiously the least used. It results from the condensation of thiocyanic acid (generated *in situ* from potassium thiocyanate and hydrochloric acid) on an anomeric-free sugar to give essentially the thermodynamically more stable OZT.

In most cases, the reaction of thiocyanic acid with aldoses produces furano bicyclic compounds. This method directly generates OZT moieties under perfect stereochemical control from aldoses without preliminary protections (Scheme 14).

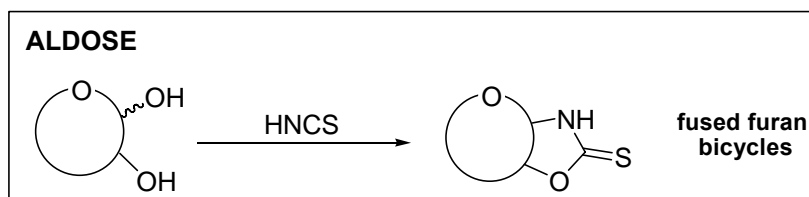

Scheme 14

Under the same conditions, ketohexoses behave differently and in a much more complicated way. The major problem lies in the capricious ketose chemistry: under acidic conditions, a complex equilibrium settles between tautomeric forms, resulting in a lack of selectivity and therefore frequently leading to the formation of mixtures of both straight-chain and cyclic structures. Indeed, it is possible to predict up to ten different structural types: fused bicyclic structures in furano and pyrano forms, spiro-epimers (α/β mixtures), acyclic chain or even spiro-bis-OZT (Scheme 15).

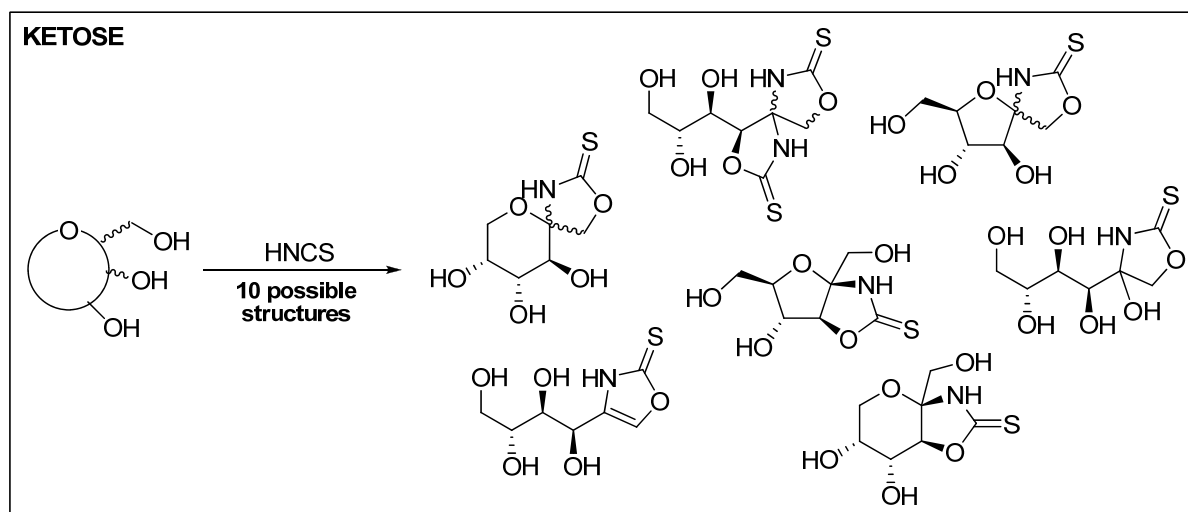

Scheme 15

The reaction results into a mixture of compounds difficult to separate chromatographically. With a view to managing the selective synthesis of OZT moieties, one of

the main objective developed in our laboratory consisted in the selective protection of the different hydroxyl groups of the ketose. With this purpose in mind, we have considered three options: controlling the reaction conditions, purification aspects by selective protections (post-functionalization) of the OH groups or a pre-reaction protection to enhance the selectivity in OZT formation.

In 2001, Fuentes *et al.* reported a new pathway for the synthesis of spirothionocarbamates.^{22d} This modified procedure consists of the reaction of sugars with trimethylsilyl azide (TMSN₃), isothiocyanate (TMSNCS) or cyanide (TMSCN). The mechanism is simple after nucleophilic attack in the anomeric position the isothiocyanate formed (with TMNCS) undergoes spontaneous cyclization (Scheme 16). However it cannot be considered a preparative method once yields are very low.

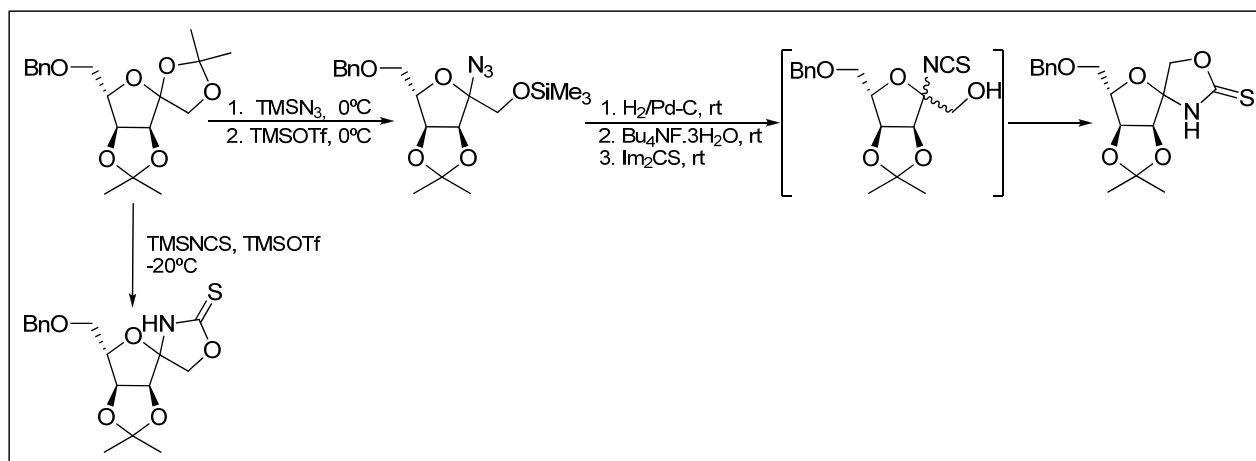

Scheme 16

All of these synthetic pathways will be described in more details along this PhD work. The choice of each method was carried out according to the type of targeted molecule.

Numerous different structures bearing the OZT or the OZO moieties could be produced from D-fructose itself. When locking is effected at the anomeric carbon, spiro-structures (furan- or pyrano-) as well as fused ones should be attained. On the other hand when locking is effected on the saccharidic backbone, only fused bicyclic structures should be obtained (Figure 13).

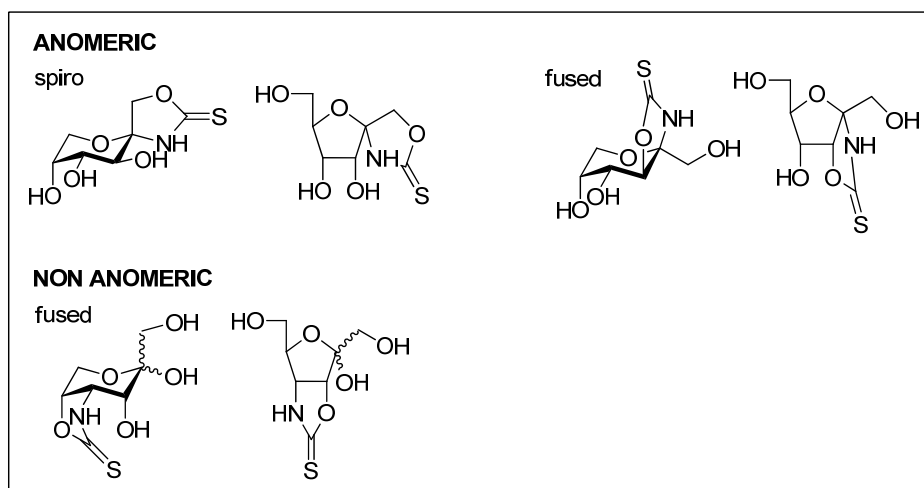

Figure 13

Applying to D-fructose and its epimers D-psicose, D-tagatose and L-sorbose, the glycochemical methodologies currently developed in our laboratory, we could give access to a panel of diverse compounds which constitute our library of potential inhibitors.

b) Biological applications of the project

The second part of this project is run in common with our partner, G. Holman (University of Bath). It concerns the fructose transport assays on Chinese hamster ovary (CHO) cells expressing GLUT5,^{56, 62} measuring inhibition of D-[¹⁴C-U]-fructose uptake by using scintillation counting.⁵⁶ This screening technique is to be applied on all our library of compounds in order to define the leading ligands to GLUT5. Among all leading compounds, transport assays against other GLUT should then be applied. The combined results would give a complete map of interaction between synthesized drugs and GLUTs. An in-depth understanding of the recognition site of GLUT5 should be the first result of this approach; further studies would be enlightened by the finding of inhibitors both selective and specific to GLUT5 (also to Class II family).

In addition, the potential of these molecules as biological agents should be explored. It is reported in the literature that some OZTs exhibit biological properties such as effective antifertility action in rats⁶³ or herbicidal activity⁶⁴ (Figure 14).

⁶² A. Tatibouët, M. Lefoix, J. Nadolny, O. R. Martin, P. Rollin, J. Yang, G. D. Holman *Carbohydr. Res.* **2001**, 333, 327.

⁶³ G. A. Youngdale, G. W. Duncan, D. E. Emmert, D. Lednicer *J. Med. Chem.* **1966**, 9, 155.

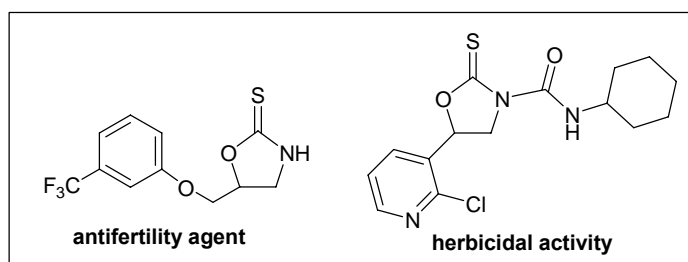

Figure 14

It was also observed that other molecules which contained in their skeletons an OZT or similar heterocyclic moieties could be used as insecticide^{Erreur! Signet non défini.b}, antifungal^{Erreur! Signet non défini.c}, antimicrobial^{Erreur! Signet non défini.c} and antibacterial agents^{Erreur! Signet non défini.d, Erreur! Signet non défini.e} (Figure 15).

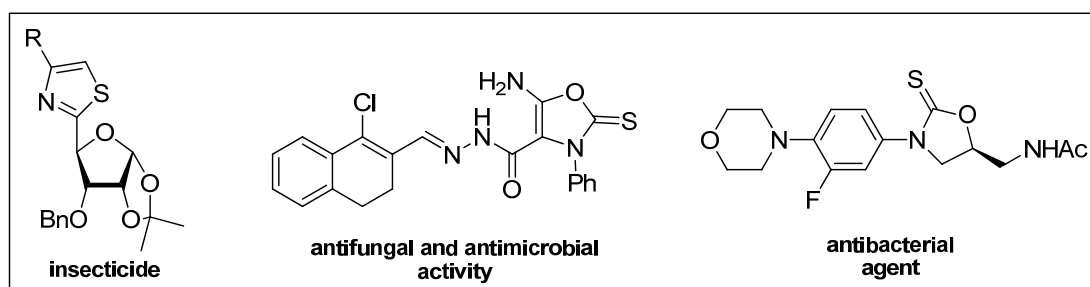

Figure 15

The search for D-fructose mimics aiming at developing new inhibitors selective for a protein carrier and potential bio-active agents has enabled us to improve some of the chemistry of D-fructose and its epimers. We have enlarged the ketose chemistry in order to have access to these new structures. However this is a long, laborious and audacious project that can not be completed in just 4 years of research. Herein we have done the first steps. We have synthesised a panel of molecules, potential inhibitors that are going to be tested. Only later, this kind of biochemical tools and application can be done and used.

⁶⁴ G. Li, X. Quian, J. Cui, Q. Huang, R. Zhang, H. Guan *J. Agric. Food Chem.* **2006**, *54*, 125.

CHAPTER II

3,4-Fused thionocarbamates in pyranose form

1. SYNTHESIS OF 3,4-FUSED THIONOCARBAMATES STARTING FROM D-FRUCTOSE

In this chapter, the synthesis of 3,4-fused thionocarbamates starting from D-fructose is described and their chemistry explored. The OZT **1** has been prepared as well as the 1,3-oxazolidin-2-one (OZO) **2** and the 1,3-oxazoline-2-thione (OXT) **3** (Scheme 17). For both cases, the OZT moiety was the material of choice to access these structures,⁶⁵ thanks to Rollin's group experience.^{5721, 46a, 52, 54} Erreur ! Signet non défini., 62, 66

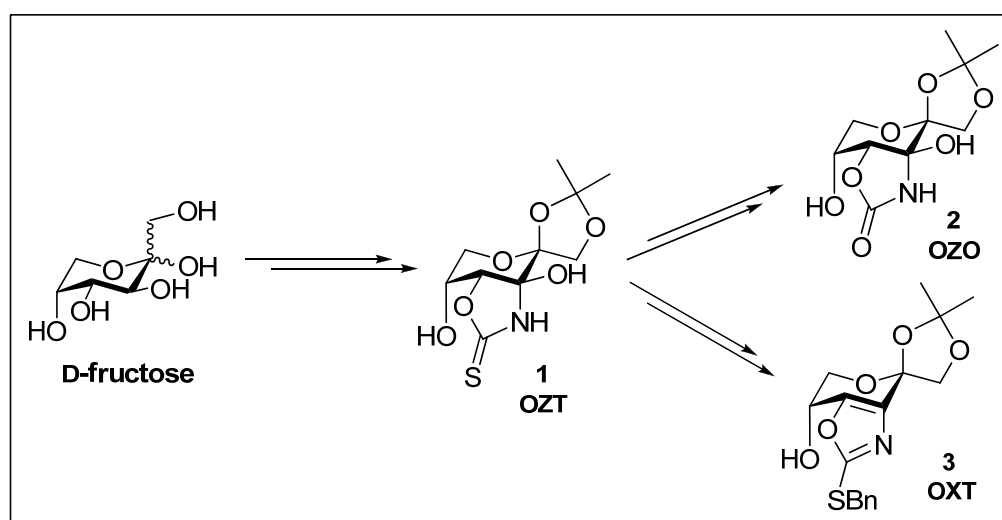

Scheme 17

1.1. Choosing the pathway

As was stated in the introduction (Chapter I - 3.1.9.) there are two main routes for the synthesis of thionocarbamates: condensation with a thiocarbonyl source or with thiocyanic acid. Each approach possesses its own characteristics and is especially suitable depending on the formation of a specific structure. It has to be mentioned that reacting trimethylsilyl

⁶⁵ (a) M. T. Crimmins, B. W. King, W. J. Zuercher, A. L. Choy, *J. Org. Chem.* **2000**, *65*, 8499 ; (b) M. T. Crimmins, W. J. Zuercher *Org. Lett.* **2000**, *2*, 1065; (c) M. T. Crimmins, E. A. Tabet *J. Org. Chem.* **2001**, *66*, 4012; (d) T. K. Chakraborty, S. Jayaprakash, P. Laxman, *Tetrahedron* **2001**, *57*, 9461; (e) M. T. Crimmins, J. D. Katz, D. G. Washburn, S. P. Allwein, L. F. McAtee *J. Am. Chem. Soc.* **2002**, *124*, 5661.

⁶⁶ (a) N. Leconte, S. Silva, A. Tatibouët, A. P. Rauter, P. Rollin *Synlett* **2006**, *2*, 301; (b) S. Silva, A. C. Simão, A. Tatibouët, P. Rollin, A. P. Rauter *Tetrahedron Lett.* **2008**, *49*, 682; (c) A. Tatibouët, A. C. Simão, P. Rollin *Lett. Org. Chem.* **2005**, *2*, 47.

isothiocyanate at the anomeric position still cannot be considered a convincing method because of low yields.

For our purpose, we planned to prepare a fused OZT starting with 1,2:4,5-di-*O*-isopropylidene- β -D-fructopyranose **4**. The direct methods involving condensation of thiocyanic acid with unprotected sugars^{23, 54, 67} or with trimethylsilyl reagents^{22d} can not be used. Both are devoted to the synthesis of OZTs involving the anomeric carbon, i.e. 2,3-fused **5** (first method only) and spiro OZTs **6** (Scheme 18). These methodologies will be discussed later in Chapter IV.

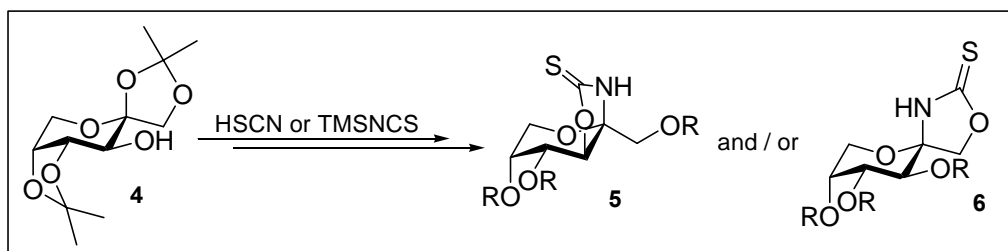

Scheme 18

Therefore the procedure that seemed to be the most appropriate was the condensation of a β -aminoalcohol with a thiocarbonyl source.^{22a, 24a, 24b, 68} However, it was also observed that it might not be a good pathway since the starting material configurations are kept. No matter the route chosen to form the amine substituent, it will be always placed in a 1,2-*trans* relationship with the alcohol,^{66, 69} **8** and **10** (Scheme 19). This *trans* configuration obstructs the OZT formation, due to its intrinsic geometry and to the rigidity of the sugar backbone which are strong enough to hamper the condensation.

⁶⁷ (a) G. Zemplén, A. Gerecs, M. Rados, *Ber.* **1936**, 39, 748; (b) G. Zemplén, A. Gerecs, E. Illés, *Ber.* **1938**, 71, 590; (c) W. H. Bromund, R. M. Herbst *J. Org. Chem.* **1945**, 10, 267; (d) A. Wickstrom, J. K. Wold *Acta Chem. Scand.* **1959**, 13, 1129; (e) J. C. Jochims, A. Seeliger, G. Taigel *Chem. Ber.* **1967**, 100, 845; (f) M. Avalos, R. Babiano, P. Cintas, J. L. Jiménez, J. C. Palacios, C. Valencia *Tetrahedron* **1993**, 49, 2676.

⁶⁸ (a) J. G. Fernandez-Bolanos, E. Zafra, I. Robina, J. Fuentes *Carbohydr. Lett.* **1999**, 3, 239; (b) I. Maya, O. Lopez, J. G. Fernandez-Bolanos, I. Robina, J. Fuentes *Tetrahedron Lett.* **2001**, 42, 5413; (c) O. Lopez, I. Maya, J. Fuentes, J. G. Fernandez-Bolanos *Tetrahedron* **2004**, 60, 61; (d) B. Paizs, I. Pinter, I. G. Csizmadia *Theochem* **1998**, 455, 267; (e) J. M. Garcia Fernandez, C. Ortiz Mellet, J. Fuentes *Tetrahedron Lett.* **1992**, 33, 3931; (f) J. M. Garcia Fernandez, C. Ortiz Mellet, J. L. Jimenez Blanco, J. Fuentes *J. Org. Chem.* **1994**, 59, 5565; (g) O. Lopez, E. Zafra, I. Maya, J. Fuentes, M. J. Dianez, M. D. Estrada, S. Perez-Garrido, J. G. Fernandez-Bolanos *Tetrahedron* **2008**, 64, 11789; (h) J. M. Garcia Fernandez, C. Ortiz Mellet, J. L. Jimenez Blanco, J. Fuentes Mota, A. Gabelle, A. Coste-Sarguet, J. Defaye *Carbohydr. Res.* **1995**, 268, 57; (i) J. M. Benito, C. Ortiz Mellet, J. M. Garcia Fernandez *Carbohydr. Res.* **2000**, 323, 218.

⁶⁹ T. Elbert, M. Cerny *Coll. Czech. Chem. Commun.* **1985**, 50, 2000.

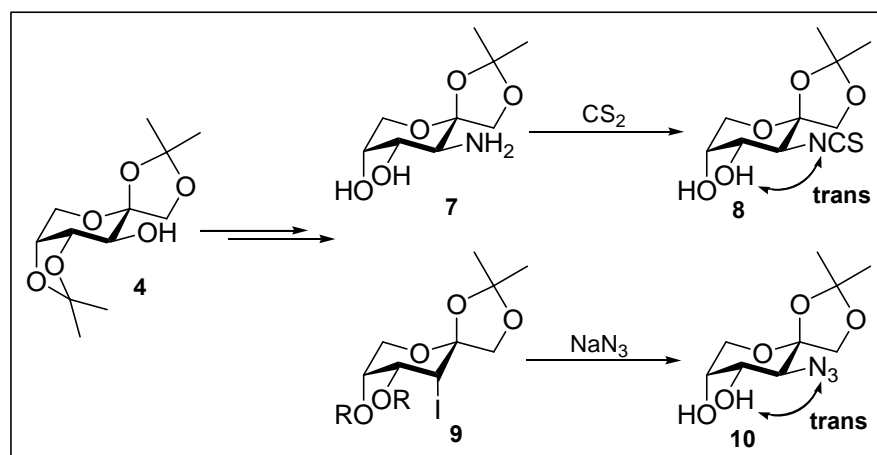

Scheme 19

So, how to achieve the formation of this 3,4-fused OZT ? modifying the configuration ?

A shorter solution was brought by using condensation of thiocyanic acid - not with a free sugar like in Zemplén's method^{67a, 67b} but with an α -hydroxyketone according to Willems and Vandenberghe.⁷⁰

A brief introduction about this methodology seems to be important.

1.2. Condensation with HSCN. Zemplén vs Willems-Vandenberghe reaction.

The first method developed for anchoring an OZT onto a saccharidic backbone was originally reported by Zemplén^{67a, 67b} in 1936 (it will be described in more details in Chapter IV 1.1.; herein we will only illustrate some general conclusions). It was based on the condensation of *O*-unprotected sugars with thiocyanic acid (generated *in situ* from potassium thiocyanate and a protic acid) in anomeric position. Since then, several groups of researchers^{23, 54, 67c, 67d, 67e, 67f} proved to be interested in this issue and therefore different theories were appointed. After a controversy surrounding which thionocarbamate structures were obtained, ideas were finally clear. In both sugars series, aldose and ketose produced bicyclic fused-OZT type structures. Thus, for aldoses most of the products obtained possess furano backbones,^{23, 54, 67d, 67f} the thermodynamically more stable entities. For ketoses, things are much more complicated due to

⁷⁰ J. F. Willems, A. Vandenberghe *Bull. Soc. Chim. Belg.* **1961**, 70, 745.

the numerous possibilities offered by their chemistry. In fact, as already pointed out previously up to 10 different compounds (fused, spiro OZTs in furano or pyrano forms as well as acyclic structures and OXT) can be expected (Chapter I – 3.1.9.).

In 1961, Willems and Vandenberghe⁷⁰ described a similar process, involving condensation of HSCN with simple hydroxyacetones, and leading to OXT moieties instead of OZT moieties (Scheme 20). A possible thione-thiol tautomeric equilibrium could exist between the OXT **15** and the oxazole **16**. Surprisingly, in literature^{70, 71} this kind of reaction has been little investigated.

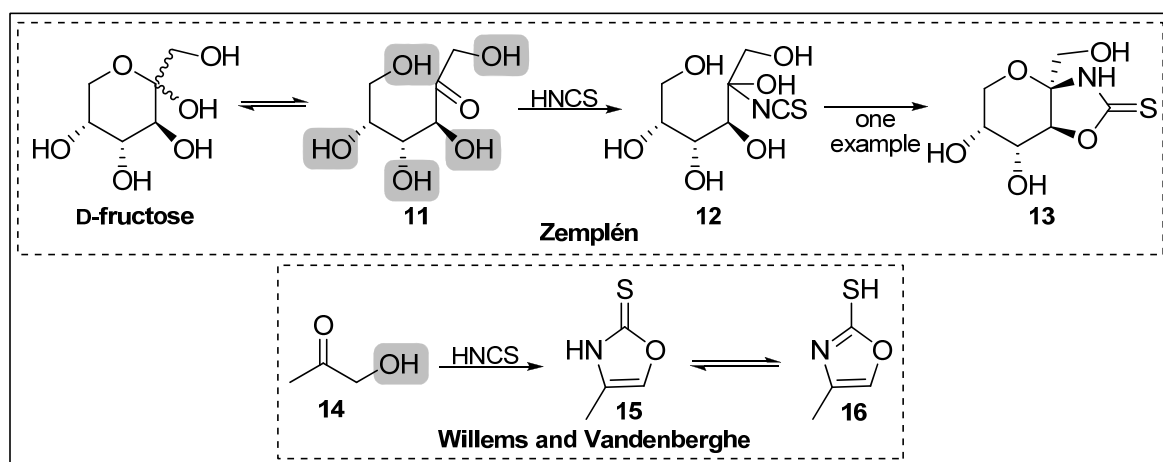

Scheme 20

Consequently, in our laboratory, Leconte^{66a} has explored this reaction. His first assays were performed with 1,3-hydroxyacetone and L-erythrulose, for which the formation of chiral spiro-bis-OZTs **19** was observed. Hence he decided to use substrates with only one α -hydroxyl and thereby only OXT structures **20** resulted (Scheme 21).

⁷¹ (a) G. Lacasse, J. M. Mucowki *Can. J. Chem.* **1972**, *50*, 3082; (b) R. Gompper, H. Herlinger *Chem. Ber.* **1956**, *89*, 1762.

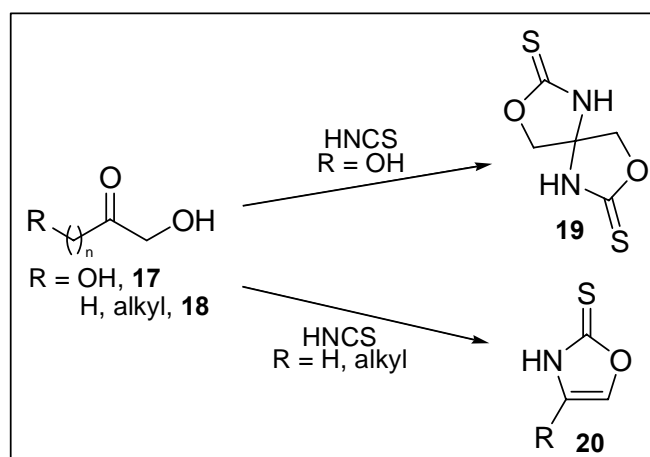

Scheme 21

This topic was later extended to aldose templates by Dr. Silva.^{66b} It was attempted to determine whether the sugar ring and protective groups influence or not the formation of either an OZT or an OXT. Some experiments were done in D-arabino and D-xyllo series in furano forms and in D-gluco series in pyrano form. Considering anterior results, the only reaction expected was the exclusive formation of OXTs, without bis-OZTs (just one α -hydroxyl group present in each substrate). However, the only molecules produced were hydrated OXTs **22** (Scheme 22). No water elimination to form OXTs **23** was observed.

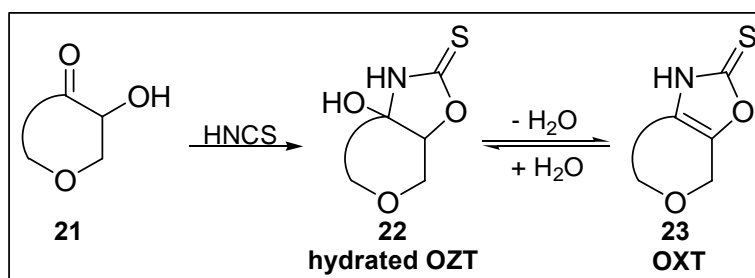

Scheme 22

Thus taking into account the results obtained by Dr. Silva and considering the targeted 3,4-fused OZT, the reaction of Willems and Vandenberghe was chosen as the key-step for this synthesis. This pathway will also allow to check whether the results previously obtained in aldose series could be extended to other carbohydrate series.

1.3. Synthesis of a 3,4-fused OZT

For the reasons explained above, the pathway to be followed in order to synthesize the 3,4-fused OZT is : introduction of a keto group in position 3 then condensation with thiocyanic acid (Scheme 23).

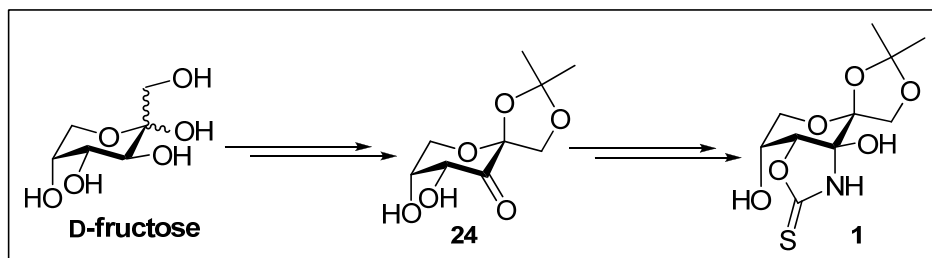

Scheme 23

1.3.1. Preparation of the α -hydroxyketone

The first step of this pathway consisted in protecting C-1,2 and C-4,5 hydroxyl groups of D-fructose in order to functionalize position C-3 without any problem. This standard reaction was carried out in acetone, which acted both as reagent and solvent, and using sulfuric acid as catalyst. Compound 4 was easily isolated after recrystallization with an acceptable yield according to literature⁷² (Scheme 24).

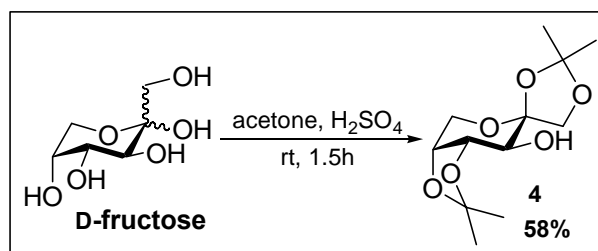

Scheme 24

Oxidation of secondary alcohols into ketones represents an important transformation in organic chemistry. The list of reagents able to carry out this conversion is considerable. Among

⁷² (a) J. Kang, G. J. Lim, S. K. Yoon, M. Y. Kim *J. Org. Chem.* **1995**, *60*, 564; (b) N. Nieto, P. Molas, J. Benet-Buchholz, A. Vida-Ferran *J. Org. Chem.* **2005**, *70*, 10143.

them chromium oxides under acidic or non-acidic conditions, methyl sulfoxide-based reagents, ruthenium oxide⁷³ and hypervalent iodine are mostly used.

For this C-3 oxidation we decided to compare two chromium reagents: pyridinium chlorochromate (PCC) and pyridinium dichromate (PDC) (Scheme 25). The best result was observed with PDC, with a quantitative yield. The protected fructopyranose **4** was readily oxidized to afford the uloside **25**. Furthermore, this reaction is much faster and cleaner than with PCC (Table 1).

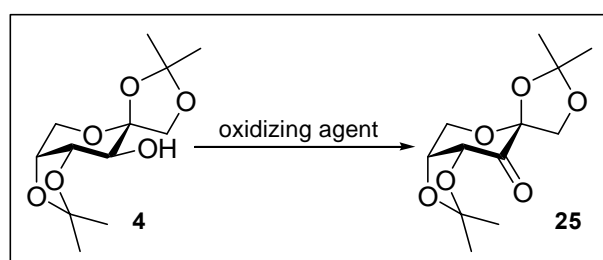

Scheme 25

Table 1

OXIDIZING AGENT	SOLV.	EQUIV.	TEMP. (°C)	TIME (h)	YIELD (%)
PCC	DCM	2	40	72	79
PDC	DCM	2 + Ac ₂ O	40	2	100

The next step involved regioselective hydrolysis of the 4,5-*O*-isopropylidene group. This can be achieved, for example, by using 2,3-dichloro-5,6-dicyanobenzoquinone (DDQ) in solution,⁷⁴ however a more practical alternative method has been reported in literature.^{79a, 73} A simple 8:2 acetic acid/water mixture can also be very efficient (Scheme 26). In addition, an easy workup - evaporation and co-evaporation of the solvents with toluene - make this procedure very attractive.

The selective 4,5-deprotection is possible because the vicinity of the 1,2-*O*-isopropylidene protection to the anomeric position hampered its hydrolysis.

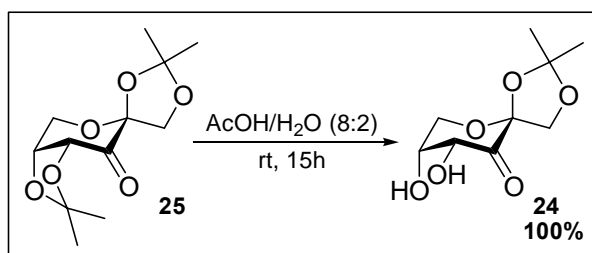

Scheme 26

⁷³ P. E. Moris, D. E. Kiely *J. Org. Chem.* **1987**, *52*, 1149 and references cited herein.

⁷⁴ X.-Y. Wu, X. She, Y. Shi *J. Am. Chem. Soc.* **2002**, *124*, 8792.

The stable α -hydroxyketone **24** is thus rather easily obtained in good yields.

1.3.3. Synthesis of the OZT – the Willems-Vanderberghe reaction

The key-step was the OZT formation through a Willems-Vanderberghe reaction, by condensing thiocyanic acid generated *in situ* with the α -hydroxyketone **24** (Scheme 27).

The solvent was chosen taking into account the results of Silva's investigations^{66b} (Table 2). From that, the best conditions established involved a 1:1 THF/DMF mixture: however in such conditions, our substrate was converted in only 31% yield. The best results were obtained in pure DMF with 59% isolated yield of OZT **1**. Changing to a protic solvent as ethanol resulted in a moderate yield of a closely related analogue of **1**, the ethyl acetal **26**.

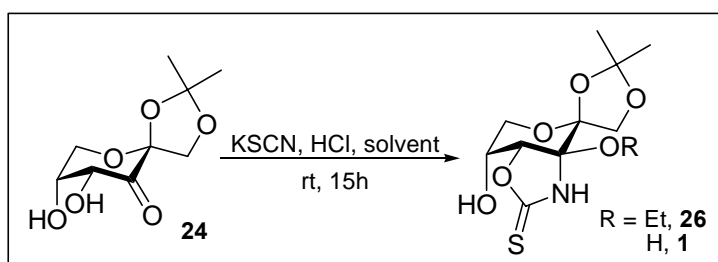

Scheme 27

Table 2

SOLVENT	R	YIELD
EtOH	Et, 26	35%
THF/DMF	H, 1	31%
DMF	H, 1	59%

As expected from Dr. Silva's previous observations in aldose series,⁷⁸ we have obtained a hydrated-OXT. In position C-3 stands a hydroxyl or an ethoxy group, depending on the solvent used.

How does it happen ?

When performing the reaction in an aprotic solvent like DMF, the medium does not interfere in OZT formation. The reaction occurs under acidic conditions : the carbonyl group of **24** can first be protonated to the oxonium ion **27** which further reacts with thiocyanic acid to form an isothiocyanate **28**. This intermediate undergoes spontaneous attack of the OH-4 to produce OZT **1** (Scheme 28).

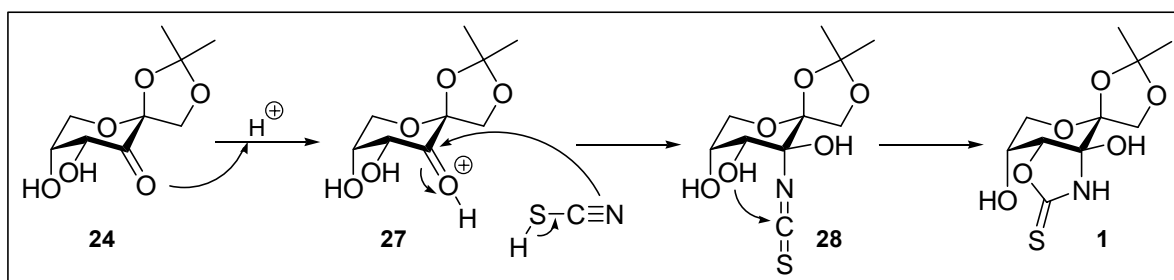

Scheme 28

A protic solvent like ethanol gets involved in the reaction, so that a different mechanism takes over. Herein, we propose two different hypotheses for the formation of compound 26 (Scheme 29). In a first hypothesis, the initial steps are similar and compound 1 is formed, then H₂O elimination and subsequent EtOH addition afford compound 26. The second hypothesis claims oxonium ion formation followed by EtOH addition to give hemiacetal 29. Then H₂O elimination occurs to give another oxonium ion, which undergoes HSCN addition to give the isothiocyanate 30. Finally spontaneous cyclization affords OZT 26.

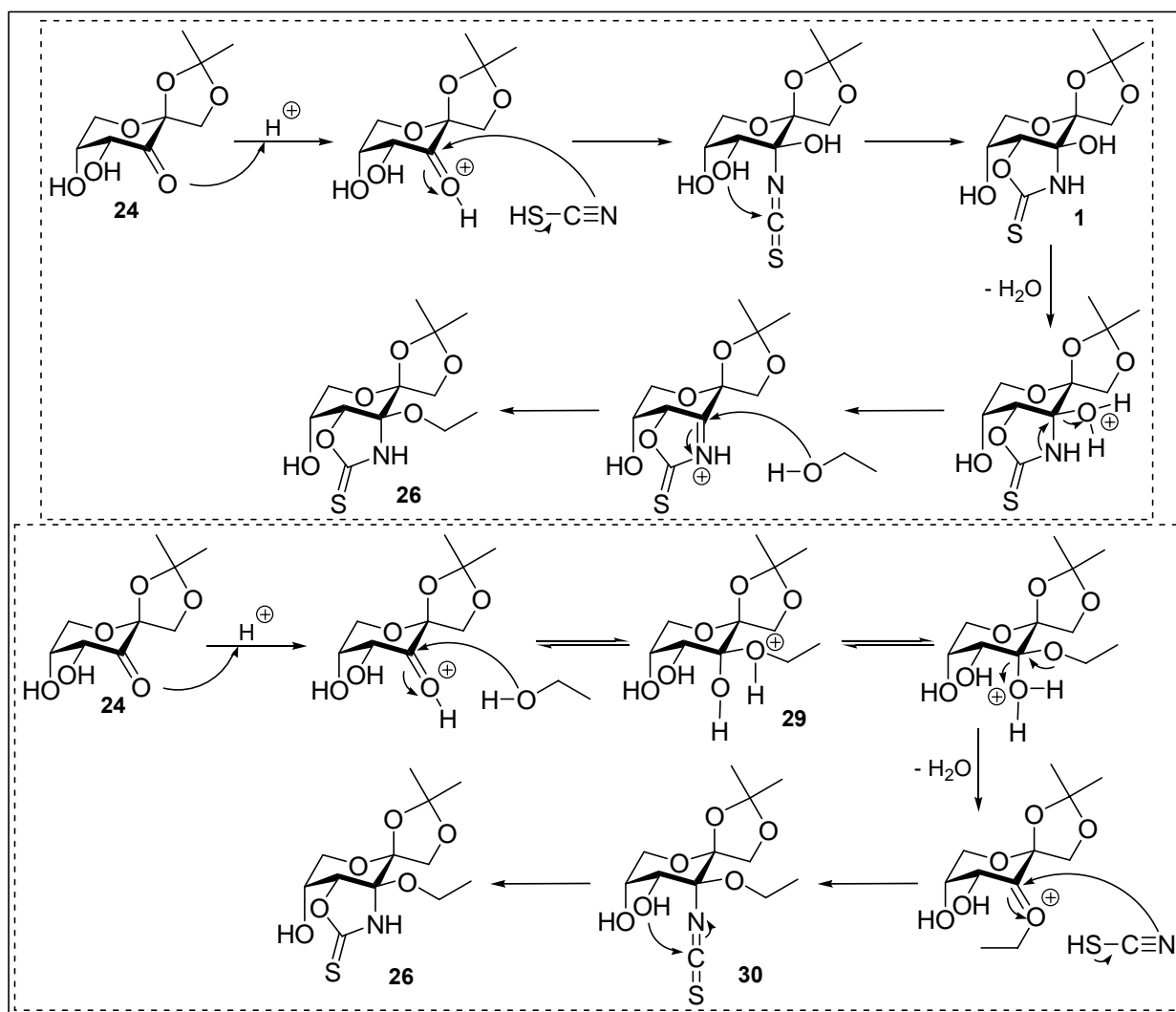

Scheme 29

In the reaction performed with ethanol, detection of a small amount of 1 was not surprising when considering the mechanism illustrated above.^{66b}

The yields obtained range from moderate to reasonable, but they never reach the values reported by Silva *et al.* in aldose series. We can postulate that, even if the cyclization of the isothiocyanate in OZT occurs spontaneously, the fused ring system associates a 5-membered ring to a 6-membered sugar ring which is a disfavored situation (the fusion of two 5-membered rings is usually preferred) (Figure 16). Furthermore the saccharidic backbone being rather rigid, this does not particularly support the OZT formation.

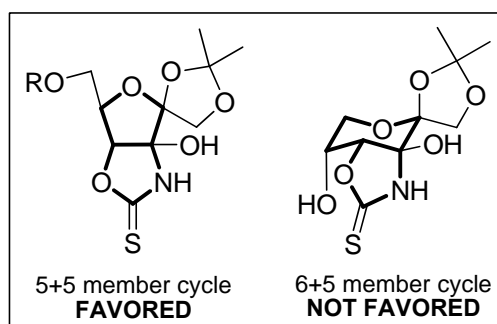

Figure 16

This can be considered an original approach for the synthesis from carbohydrate-based α -hydroxyketones of OZTs anchored onto saccharidic backbones.

In terms of manipulation and purification (column chromatography) it can be stated that OZTs are easy to handle as they strongly absorb UV light (λ_{\max} in 280-300 nm range), making their detection straightforward.^{65a}

1.3.4. Deprotection assays

The last step of this pathway was the deprotection of the target molecules (Scheme 30): however these unprotected OZTs are not stable and thus rather difficult to isolate.

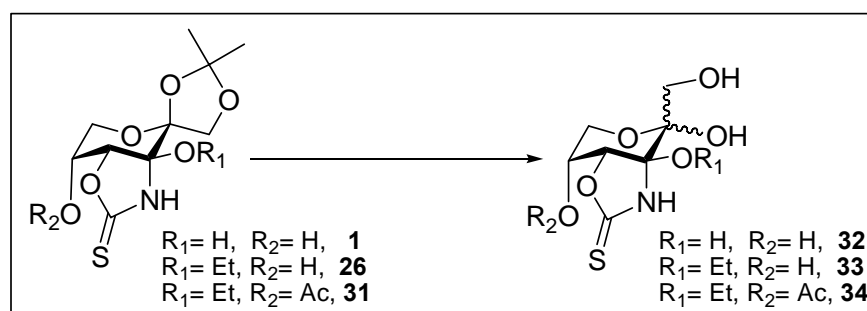

Scheme 30

In order to remove the isopropylidene group several attempts were made in aqueous acidic conditions (Table 3).

Table 3

R1	R2	R3	CONDITIONS	RESULTS
H	H	H	AcOH/H ₂ O (8:2), rt, 15 h	starting material
H	H	H	AcOH/H ₂ O (8:2), 50°C, 15 h	degradation
Et	H	H	TFA/H ₂ O (9:1), rt, 15 h	traces
Et	H	H	2M HCl, THF, rt, 15 h	degradation
Et	Ac	H	2M HCl, THF, rt, 15 h	degradation

The first trials were performed under TLC monitoring with standard 80% aqueous acetic acid: at room temperature no reaction was observed; increasing the temperature to 50°C only resulted in total degradation of the starting material.

Since those first assays did not afford the desired unprotected product **32**, the latter molecule was regarded as very sensitive. It was thus decided to work rather with the ethyl protected substrate **26**. After disappointing attempts with 80% aqueous AcOH, much harsher conditions were applied, using 90% aqueous trifluoroacetic acid at room temperature. In that case, only traces of the expected compound **33** could be detected.

Finally, 2M hydrochloric acid was applied with a view to obtaining a larger amount of **33**, but unfortunately, only degradation was observed. An ultimate assay was performed involving a protected substrate **31** bearing an acetyl group on position C-5 : to our disappointingment however, degradation also occurred in that case.

Meanwhile, a more unusual deprotection with Bi(OTf)₃.xH₂O was experienced. In this case the expected final molecule **36** would be more stable because of the acetyl protecting groups (Scheme 30). This method has been recently reported by Zhang and coll⁷⁵ as a facile one-pot procedure for the conversion of acetonides into diacetates, and it was applied to our case : unfortunately OZT **35** could not be transformed into the expected derivative **36**.

⁷⁵ Q.-P. Wu, M.-X. Zhou, X.-D. Xi, D. Song, Y. Wang, H.-X. Liu, Y.-Z. Li, Q.-S. Zhang *Tetrahedron Lett.* **2008**, *49*, 2714-2718.

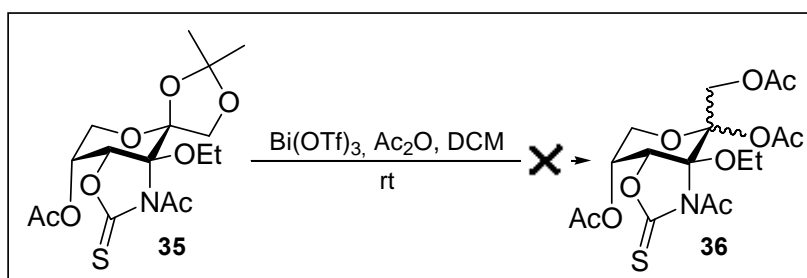

Scheme 31

Taking into account all the de-acetonation tests conducted, we had to admit that the best result was obtained with 9:1 TFA/H₂O at room temperature : no more starting material was detected by TLC after overnight reaction, but only traces of the desired compound could be isolated from degradation products.

Therefore it can be assumed that aqueous TFA solution could be an appropriate hydrolytic system provided that the concentration is carefully established. This assumption is actually supported by literature: Izquierdo³⁸ reported the use of 60% aqueous TFA for isopropylidene cleavage. The structures reported were similar to ours, bearing isopropylidene groups at the anomeric carbon of a ketose. So we decided to apply these conditions to our substrates **1** and **26** (Scheme 32).

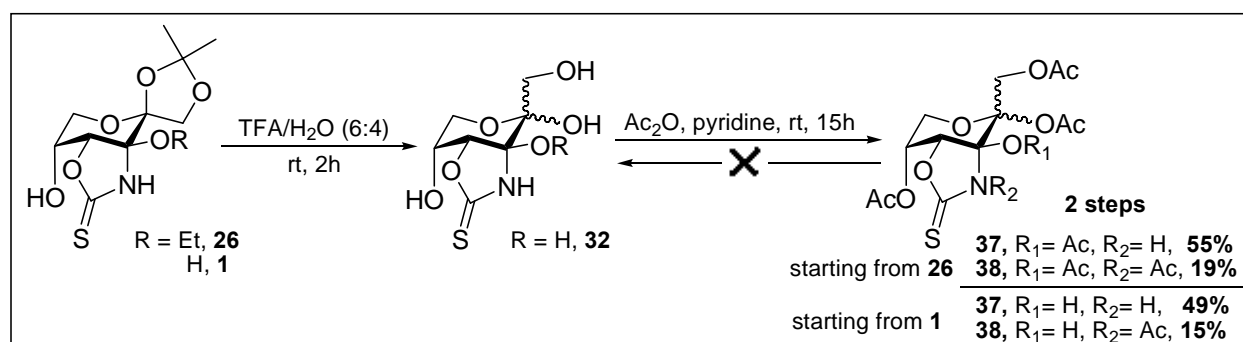

Scheme 32

As can be observed, a more diluted aqueous TFA and a shorter reaction time bring a solution to our deprotection problems, most of the degradation being avoided. However for **26** the ethyl group cleavage was also observed, leading to only one kind of structure.

The hydrolysis product was not isolated but immediately submitted to peracetylation without any preliminary treatment: with this approach we could assure stabilization and better purification and characterization of the targeted product. Not only 5-*O*-protection was obtained but also *N*-acetylation, although in a lower proportion. The overall yields were about 64-74%. This protective group was chosen as de-*O*-acetylation is a usually simple, mild and clean process that can supersede many specific purification methods (Scheme 32

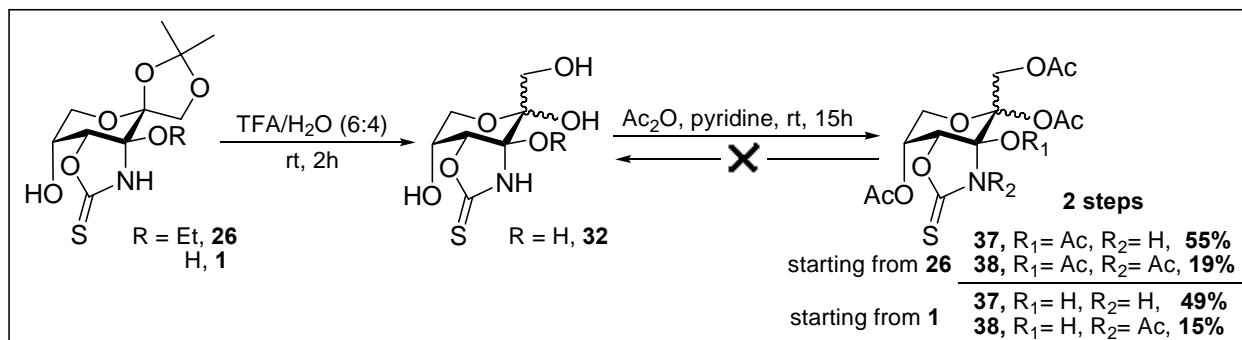

Scheme 32).

Final de-*O*-acetylation was performed in standard Zemplén conditions - sodium methoxide or ammonia in methanol. However this proved to be fruitless because only degradation of the compounds was observed. Therefore in spite of all attempts and due to its instability, the final compound could not be isolated.

1.4. Synthesis of a 3,4-fused OZO

Chiral 1,3-oxazolidin-2-ones (OZO) are a family of molecules that has been the subject of impressive studies for various applications, such as medicinal chemistry⁷⁶ and stereocontrolled synthesis.⁷⁷ In this latter aspect, OZO and OZTs have shared the same applications especially in aldol condensations, albeit with different properties. Thus it seemed an interesting aspect to explore the oxidative desulfurization of the OZTs to produce OZO.

⁷⁶ (a) G. A. Ellestad, D. B. Cosulich, R. W. Broschard, J. H. Martin, M. P. Kunstmann, G. O. Morton, J. E. Lancaster, W. Fulmor, F. M. Lovell *J. Am. Chem. Soc.* **1978**, *100*, 2515; (b) J. Shimada, F. Suzuki, H. Nonaka, A. Karasawa, H. Mizumoto, T. Ohno, K. Kubo, A. Ishii *J. Med. Chem.* **1991**, *34*, 469; (c) C.-H. Park, D. R. Brittelli, C.L.-J. Wang, F. D. Marsh, W. A. Gregory, M. A. Wuonola, R. J. McRipley, V. S. Eberly, A. M. Slee, M. Forbes *J. Med. Chem.* **1992**, *35*, 1156.

⁷⁷ (a) D. A. Evans, J. Bartroli, T. L. Shih *J. Am. Chem. Soc.* **1981**, *103*, 2127; (b) D. A. Evans, A. E. Weber *J. Am. Chem. Soc.* **1986**, *108*, 6757.

1.4.1. A list of methods

Oxidative desulfurization is a type of transformation that can be achieved by direct or indirect procedures using a wide range of reagents and conditions.⁷⁸ Herein we are going to do a succinct report on what has been performed in our laboratory.

a) Direct oxidative desulfurization

Pistara⁷⁹ reported a variety of methods that allow the transformation of a thiocarbonyl group into a carbonyl group through the use of various organic or inorganic reagents.

These methods were tested in our laboratory first with simple OZTs⁸⁰ then with OZTs anchored onto saccharidic backbones⁸¹ but all assays were disappointing (Scheme 33).

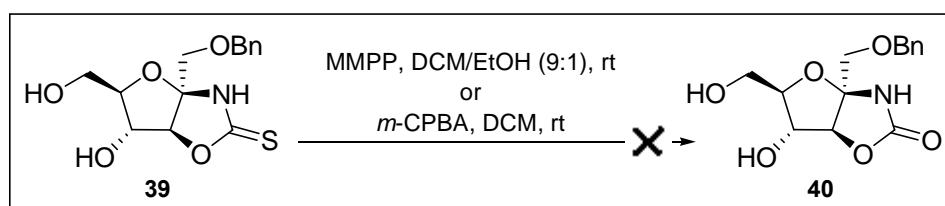

Scheme 33

The attempts to replace the sulfur atom by an oxygen atom on a partly-protected model OZT derived from D-fructose did not lead to the corresponding OZO (Scheme 33). This approach of direct oxidative desulfurization by smooth methods confirms the reluctance of the thionocarbamate function. In our laboratory we thought that the N-H bond needed to be masked in order to perform the oxidative transformation.

⁷⁸ K. Bahrami, M. M. Khodaei, Y. Tirandaz *Synthesis* **2009**, 3, 369 and references cited therein.

⁷⁹ A. Corsaro, V. Pistara *Tetrahedron* **1998**, 54, 15027.

⁸⁰ D. Gueyrard *PhD Thesis*, Université d'Orléans **2000**.

⁸¹ J. Girniene *PhD Thesis*, Université d'Orléans **2003**.

b) After nitrogen protection

Indeed, the transformation was achieved after prior protection of the nitrogen atom. Gueyrard *et al.*^{57b, 80} described the use of *meta*-chloroperoxybenzoic acid to produce OZOs with excellent yields. Later, Girniene-Rousseau *et al.*⁸¹ tested this synthetic route and verified that N-protection of the thionocarbamate was also needed. Consequently applying this approach, she performed S to O transformations (such as **41** to **42**, Scheme 34) with good results.

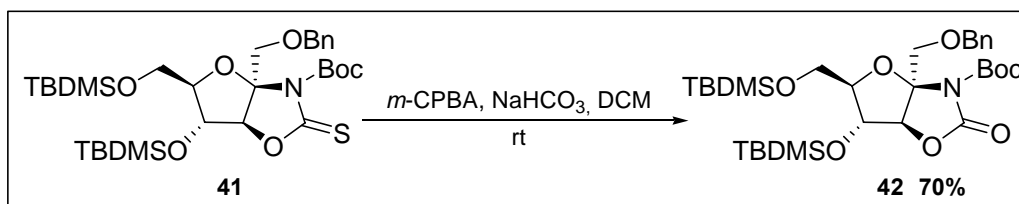

Scheme 34

This synthetic route gives OZOs in only three steps with good yields. However, it is important to notice that these structures still needed an additional deprotection reaction to generate the OZOs.

c) Via S-alkylation

Another method of oxidative desulfurization has also been performed after preliminary S-alkylation.

Chemoselective S-alkylations were reported on some simple OZTs,^{57b} taking advantage of the smooth electrophilic character of various haloalkanes. Preferential alkylation at the sulfur atom was achieved in good yields to form enantiopure S-alkylthiooxazolines.

Coxon⁸² and Toth⁸³ reported that reaction of chloromethane or *p*-chlorobenzyl chloride with saccharidic OZTs also lead to the corresponding 2-alkylsulfanyloxazolines.

⁸² R. M. Davidson, G. D. Byrd, E. White, S. A. Margolis, B. Coxon *Magn. Res. Chem.* **1986**, *24*, 929.

⁸³ P. Meszaros, I. Pinter, J. Kovacs, G. Toth *Carbohydr. Res.* **1994**, *258*, 287.

Girniene-Rousseau *et al.*^{46a} applied the standard alkylation conditions – NaH then benzyl bromide in DMF - to the non-protected saccharidic OZT **39**, obtaining a *per*-alkylated derivative **43** (Scheme 35).

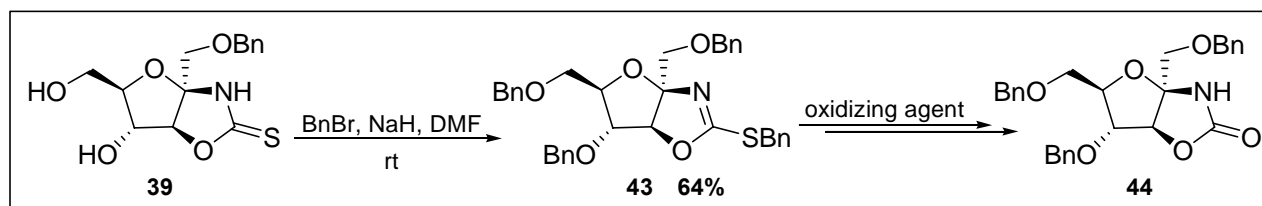

Scheme 35

We hypothesized that under oxidizing conditions the benzylsulfanyl substituent might be converted into better leaving groups, thus facilitating further hydrolysis to the OZO **44**.

1.4.2. Chosen method: via *S*-alkylation

In our synthesis, we decided to use the *S*-alkylated intermediate method, in which some changes were introduced comparing to Girniene-Rousseau's procedure⁸¹. Concerning *S*-benzylation, she observed large variations in yields, which means some degradation occurs in the presence of excess NaH. Besides, Fujita⁸⁴ reported that in the presence of excess BnBr or under heating, *S*-benzylated compounds could suffer a rearrangement leading to *N*-benzylated products. Taking into account these assumptions, the following conditions were fixed: NaHCO₃ as much weaker base than NaH and reaction performed at room temperature.

Following those parameters, we obtained the *S*-benzylated compound **45** in good yield as compared with literature data^{46a, 52b 85} (Scheme 36).

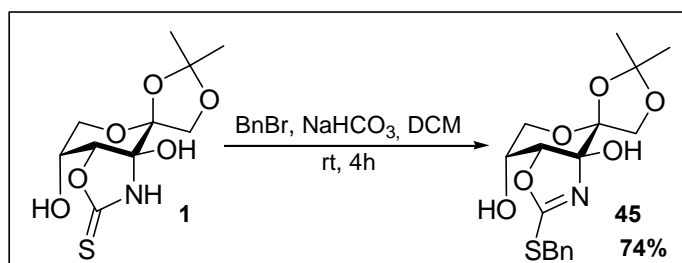

Scheme 36

⁸⁴ Y. Nagao, K. Inoue, M. Yamaki, M. Shiro, S. Takagi, E. Fujita *Chem. Pharm. Bull.* **1988**, *36*, 4293.

⁸⁵ S. Silva *PhD Thesis*, University of Lisbon and University of Orléans **2009**.

Moreover, neither *N*-benzylation nor *O*-benzylation were observed, even in the presence of BnBr in excess.

1.4.3. Oxidation

The oxidizing agent was chosen based on previous results obtained in our laboratory.^{55, 57b, 93} Even if the synthetic pathways were different – *N*-protection method⁵⁵ or *S*-alkylation⁹³ – both used *m*-CPBA as the oxidant.

Normally, with an excess of *m*-CPBA, the sulfur function would be oxidized to an unstable sulfoxide or sulfone derivative. This intermediate should be sensitive to a nucleophilic attack of the remaining water in the medium, leading to the formation of an OZO through the expulsion of a sulfur-containing moiety. However in our case, the expected OZO **2** was not detected (Scheme 37).

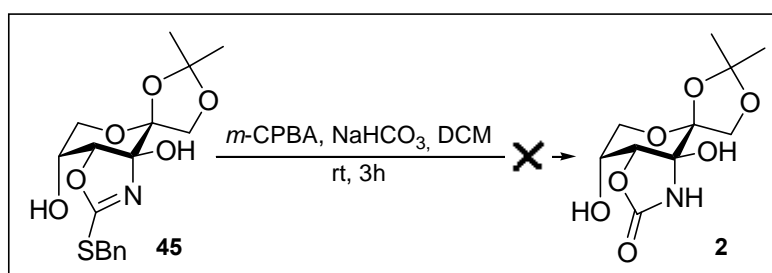

Scheme 37

Fearing that the targeted OZO **2** would cause purification problems, due to its strong polarity and lower stability compared to the corresponding OZT, we decided to protect the starting molecule. In standard conditions, **45** was acetylated in 93% overall yield as a mixture of 5-*O*-acetylated derivative **46** (76%) and 3,5-di-*O*-acetylated derivative **47** (17%).

Once again oxidation conditions were applied to **46** but even after 24 h at room temperature no transformation was noted. Refluxing the mixture during 24 h did not bring any improvement and the starting material was totally recovered (Scheme38).

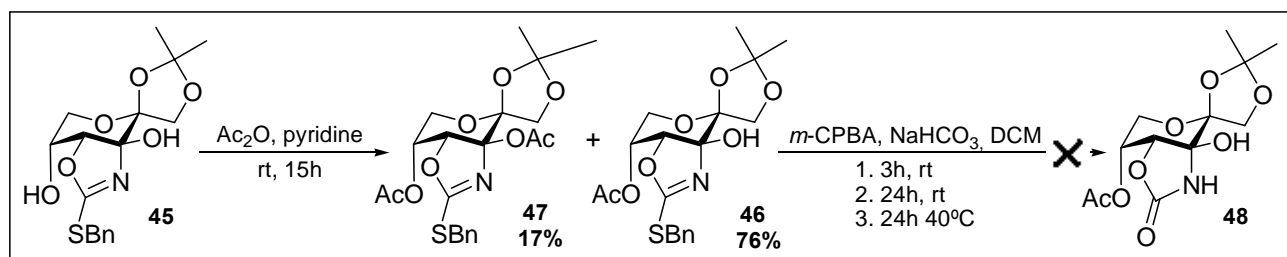

Scheme 38

Taking into account the results reported above, we searched for an alternative reagent that could be efficient in this transformation. The oxidizing capacity of hydrogen peroxide is known for being so strong that it is considered as a highly reactive oxygen species. Moreover it is an eco-friendly reagent, its manipulation and storage is quite secure and it can be considered a low cost reagent. Indeed, hydrogen peroxide gave good results, with 72% and 81% yields of OZOs **2** and **48**, respectively (Scheme 39). Despite of its high polarity OZO **2** could also be isolated in good yield.

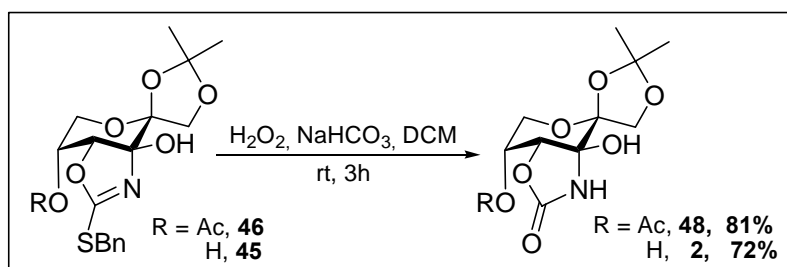

Scheme 39

Tirandaz recently reported a direct oxidative desulfurization of thioamides into amides using H_2O_2 in the presence of zirconium tetrachloride with good results.⁸⁶ However, Tirandaz conditions were not tested, the present part of our project having been completed at the beginning of the PhD.

The structure of the *S*-benzylated and OZO compounds was ascertained by ^{13}C NMR experiments. The chemical shifts for quaternary carbons vary from ca 188 ppm (C=S in OZT **1**) to ca 161 ppm (C-SBn in **45** and **46**) and ca 155 ppm (C=O in OZOs **2** and **48**) (Table 4).

Table 4

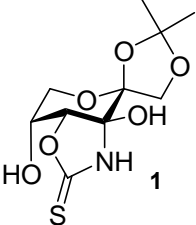
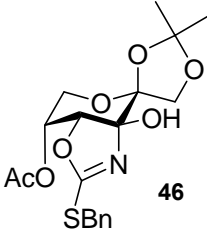
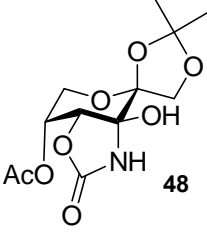
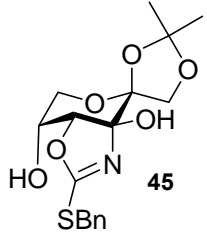
COMPOUND	C=S (ppm)	COMPOUND	C-SBn (ppm)	COMPOUND	C=O (ppm)
	188.2		160.8		171.1
				160.9	

On a more practical aspect, comparing a thiono-derivative with its oxo analogue, one can observe that beyond its higher polarity, an OZO also has a much weaker absorption in UV. Those aspects importantly interfere with the detection and purification of our compounds.

1.5. Synthesis of 3,4-fused OXTs

1.5.1. Previous studies

As was mentioned before in this chapter (1.1. and 1.2.) that reacting an α -hydroxyketone with HSCN would generally produce the hydrated form of an OXT.

While working on acyclic ketols, Silva *et al.* noticed the formation of OXTs without a trace of hydrated form.⁸⁵ So the question was: “is it possible to control this reaction in order to obtain selectively either the hydrated form or the aromatic form ?” and further: “is it possible to eliminate water in order to convert an hydrated form into the related OXT ?”

In the course of their study on dehydration of fused OZT on carbohydrate scaffolds, Silva *et al.*⁸⁵ realized that two major parameters were those she should pay attention to: a) protection of the thiocarboxamido system to improve stability of the substrate b) protection of the free hydroxyl groups to avoid side-reactions.

After *S*-benzylation of the hydrated OXT, mesyl chloride⁸⁶ was first successfully applied as dehydrating agent on simple structures. But when trying more complex hydrated OXTs anchored to saccharidic backbones, no elimination was observed and the starting material was always recovered (Scheme 40). This lack of reactivity could be attributed to steric hindrance to access the hydroxyl group.

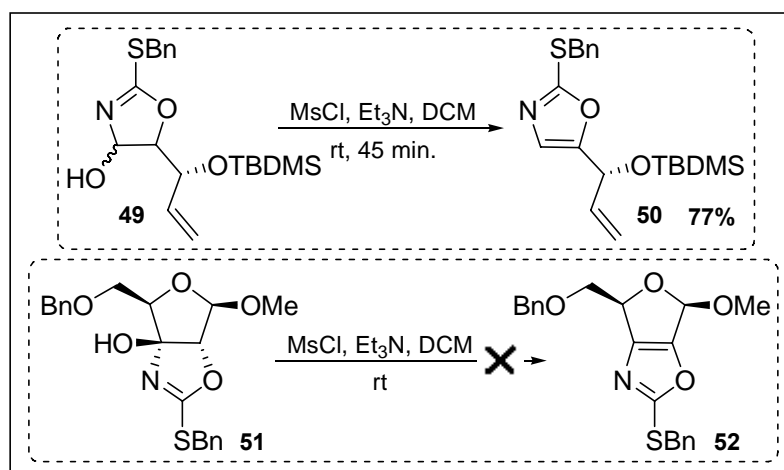

Scheme 40

With the purpose of forcing the reaction conditions, a more powerful electrophilic reagent like triflic anhydride⁸⁷ was used and hydrated OZT forms underwent smooth dehydration.

1.5.2. *S*-Alkylation. A surprising result.

In this chapter, *S*-alkylation has already been explored in the course of OZO preparation (chapter II – 1.4.2.) (Scheme 33). Although the yield was satisfactory, however we wanted to

⁸⁶ (a) A. Padwa, H. Zhang *J. Org. Chem.* **2007**, *72*, 2570. (b) J. Reeves *Org. Lett.* **2007**, *9*, 1879.

⁸⁷ (a) V. Justribo, S. C. Pellegrinet, M. I. Colombo *J. Org. Chem.* **2007**, *72*, 3702. (b) I. L. Baraznenok, V. G. Nenajdenko, E. S. Balenkova *Tetrahedron* **2000**, *56*, 3077.

improve it and thus decided to use the conditions previously established by Girniene-Rousseau^{46a, 52b} and Silva^{24c} - a stronger base - even though it can cause some degradation.

The result still was good, albeit with a slightly lower 74% yield and no trace of *O*- or *N*-benzylation (Scheme 33). Surprisingly, minor amounts of the 2-benzylsulfanyloxazole **3** were detected (Scheme 41).

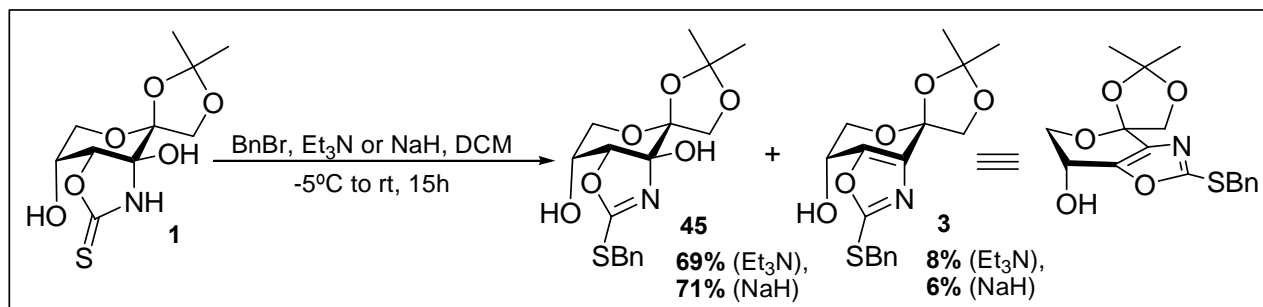

Scheme 41

Silva *et al.*⁸⁵ has applied benzylation in aldose series under the same conditions to similar structures (fused OZTs on pyrano frameworks), however an oxazole formation was never reported.

It can be supposed that the elimination observed is induced by the base : both triethylamine and NaH are stronger than NaHCO₃, and able to extrude the H-4 proton, forming a C-4 carbanion which expels the hydroxide ion from C-3 in a *syn* process (Scheme 42).

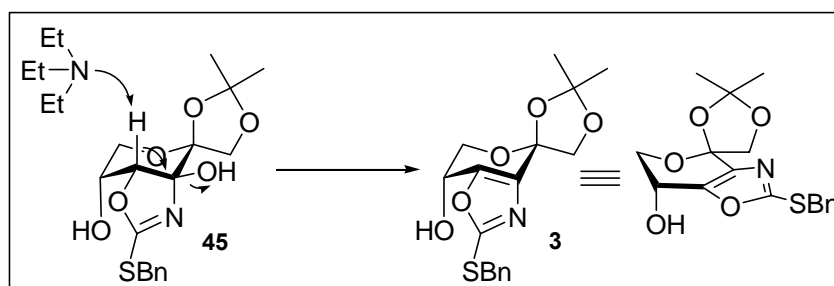

Scheme 42

1.5.3. OXT formation through OZT dehydration

Having in mind Silva's considerations, we decided that it would be safer to firstly protect the free hydroxyl at C-5. Initially, we tried *O*-silylation with *tert*-butyldimethylsilyl

chloride but even at reflux for over 24 h no silylation occurred. That could be mostly due to the protective group size and to hindrance at the C-5 position. Next benzoylation (benzoyl chloride in pyridine with a catalytic amount of DMAP) was tested, but the starting material **45** was completely recovered. We then turned to our acetylated derivative **46**, which had been previously prepared for the OZO study.

Submitting **46** to Tf₂O dehydration conditions in the presence of *N,N*-diisopropylethylamine (DIEA) at low temperature led as expected to the alkylsulfanyloxazole **53** in 70% yield (Scheme 43).

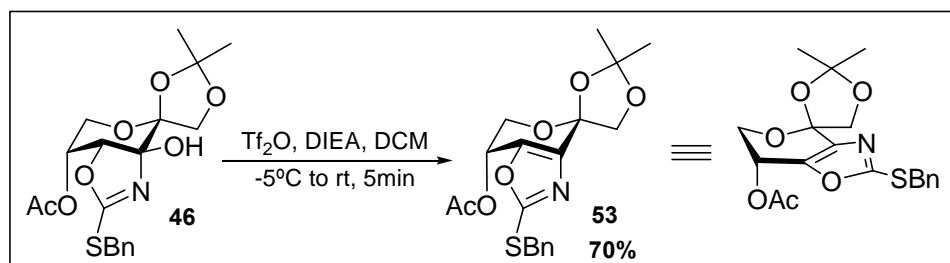

Scheme 43

This reaction must be carefully monitored once it takes place in only 5 minutes: after 15 minutes, complete degradation of the product was observed.

The structure of the OXTs was determined by ¹H and ¹³C NMR experiments. The chemical shifts of C-3 and C-4 in OZTs **1** and **46** are close to 82-88 ppm and 62-64 ppm, respectively; the values for C-3 and C-4 in oxazoles **3** and **53** are ca 135-136 ppm (Table 5).

Table 5

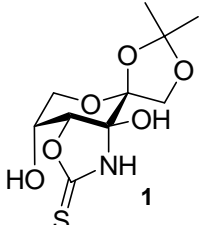
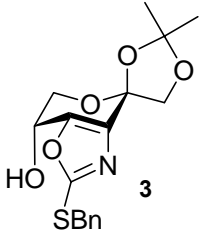
COMPOUND	¹³ C C-3	¹³ C C-4	COMPOUND	¹³ C C-3	¹³ C C-4
	88.0	62.1		135.5	136.2

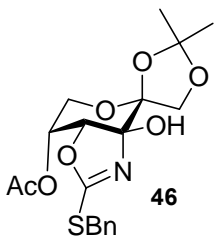
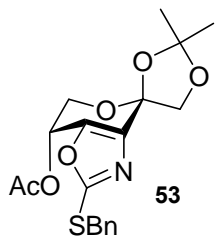
 <p>46</p>	81.3	65.4	 <p>53</p>	137.7	143.6
---	------	------	--	-------	-------

1.6. Conclusion

In this chapter, we have focused our attention on the synthesis from D-fructose of 3,4-fused thionocarbamates on saccharidic backbones (Scheme 44).

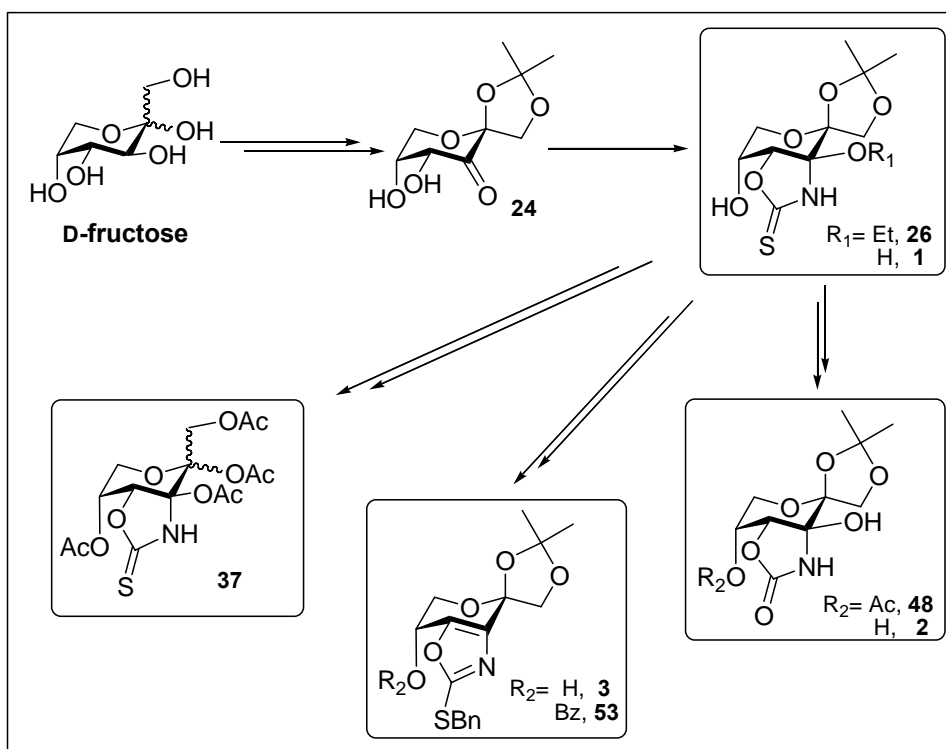

Scheme 44

From the results obtained, we can put forward some preliminary assumptions:

- ☑ Condensation of an α -hydroxyketone anchored onto a sugar scaffold with HSCN favors the formation of fused hydrated OXTs instead of OXTs (as previously observed by Silva in aldose series), while the opposite was observed for acyclic structures.

- ☑ The 3,4-fused OZT that we have prepared have shown some sensitivity and instability. Complete deprotection could not be achieved neither under acidic nor basic conditions.

- ☑ The S-alkylation method allowed us to obtain saccharidic chiral OZO in good yields in only two steps from OZTs. This is a shorter route compared to Girniene-Rousseau's method.

- ☑ In partnership with Silva was developed a novel family of molecules, hydrated OXTs and OZO fused in aldose and ketose series; those have scarcely appeared in literature, at least to our knowledge.

- ☑ The dehydration method allowed us to obtain saccharidic oxazoles in only two steps from OZTs. However, the thiono group should be masked in order to have good results. OXTs anchored onto carbohydrate backbones constitute an attractive subject that has not yet been much explored in literature.

- ☑ All of these compounds, hydrated OXT, OZO and OXT analogues, are strictly related to enantiomerically pure OZO, the importance of which has already been repeatedly mentioned.

Some of these molecules have been submitted to biological testing (Chapter VI).

CHAPTER III

4,5-Fused OZTs in pyranose form

1. SYNTHESIS OF 4,5-FUSED OZTs ON β -D-FRUCTO AND β -D-PSICOPYRANOSE DERIVATIVES

In the previous chapter we have studied the synthesis of different 3,4-fused thionocarbamates, OZTs, OZOes and OXTs. Herein we are going to describe the synthesis of 4,5-fused OZTs on D-fructose and D-psicose series starting from D-fructose (Scheme 45).

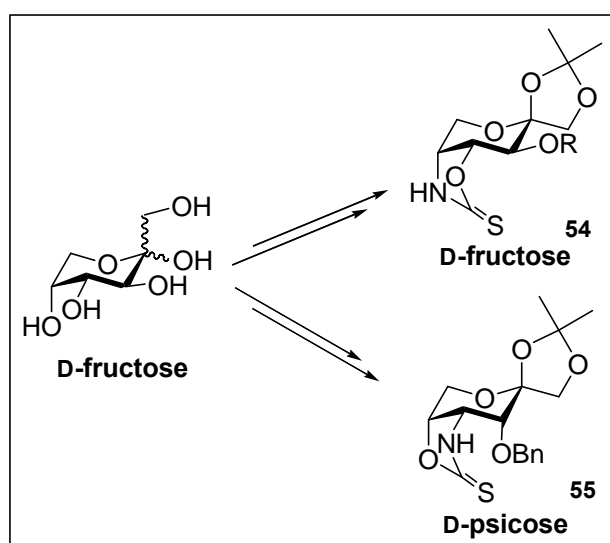

Scheme 45

1.1. Choice of the pathway

Since the purpose of this chapter was the synthesis of fused OZT moieties, the pathway developed in Chapter II was explored, *via* the key-step reaction of Willems and Vandenberghe⁷⁰, *i.e.*, condensation of thiocyanic acid with an α -hydroxy keto sugar.

1.1.1. Preparation of α -hydroxyketone

We were keen to develop a short access to an α -hydroxyketone, starting from the fructopyrano derivative **57** (Scheme 2). The di-*O*-isopropylidene-D-fructopyranose **4** was synthesized following Kim's^{79a} procedure. Benzylation of the free hydroxyl under standard

conditions⁸⁸ then selective 4,5-*O*-isopropylidene hydrolysis using 80% aqueous acetic acid at room temperature^{79a, 82} afforded **57** in good overall yield (Scheme 46). The reaction time of this regioselective deprotection could be improved from 15 h to 3 h by carrying out the reaction at 60°C.

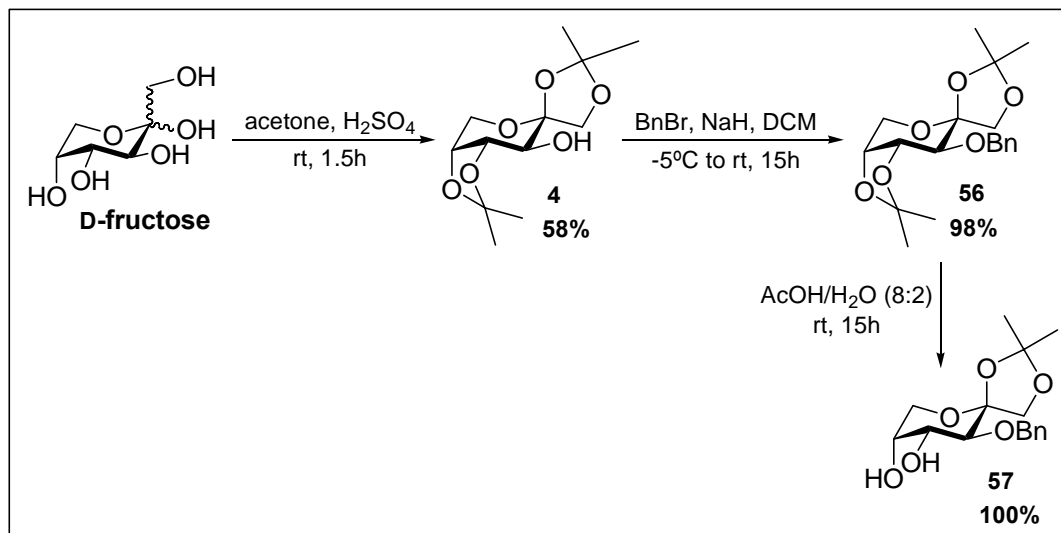

Scheme 46

a) Selective oxidation

In 1985, David⁸⁹ has shown the benefit of organotin derivatives of alcohols in regioselective reactions, leading to indirect oxidation, acylation and alkylation. The possibility of introducing dibutylstannylene acetals from diols enabled a huge advance in carbohydrate chemistry.⁹⁰

Produced by reaction of a diol **58** with dibutyltin oxide, stannylene ketals are very sensitive to brominolysis and may lead to α -hydroxycarbonyl compounds **59** at the speed of titration⁹¹ (Scheme 47).

⁸⁸ E. J. Enholm, A. Bhardawaj *Tetrahedron Lett.* **2003**, *44*, 3763.

⁸⁹ S. David, S. Hanessian, *Tetrahedron* **1985**, *41*, 643.

⁹⁰ (a) P. B. Alper, M. Hendrix, P. Sears, C. H. Wong *J. Am. Chem. Soc.* **1998**, *120*, 1965; (b) A. B. C. Simas, K. C. Pais, A. A. T. Silva *J. Org. Chem.* **2003**, *68*, 5426.

⁹¹ S. Cossu, O. De Lucchi, D. Fabbri, G. Licini, L. Pasquato *Org. Prep. Proc. Int.* **1991**, *23*, 573.

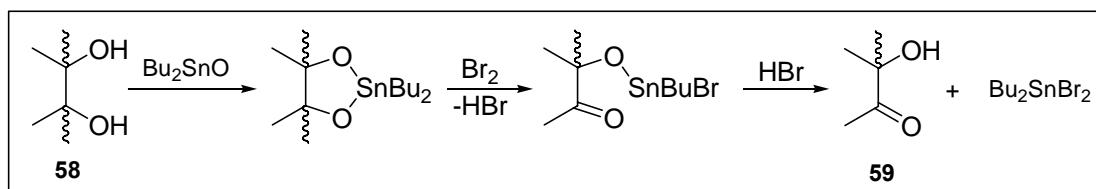

Scheme 47

Herein an example of a successful mono-oxidation of a partially protected D-gluco diol, **60** through treatment with Bu_2SnO followed by brominolysis.^{89, 92} Oxidation takes place on the secondary hydroxyl group in good yield (Scheme 48).

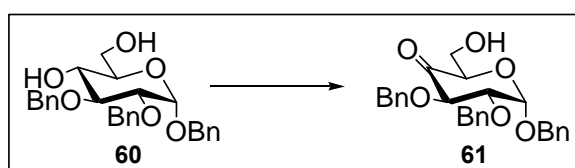

Scheme 48

In 1989, Tsuda⁹³ reported the mono-oxidation of non protected glycosides. He compared two systems - $\text{Bu}_2\text{SnO}-\text{Br}_2$ and $(\text{Bu}_3\text{Sn})_2\text{O}-\text{Br}_2$ - concluding that the second one was better in terms of yield and selectivity. In our case, the optimised conditions for smooth oxidation of glycosides involved an excess of $(\text{Bu}_3\text{Sn})_2\text{O}$ in the presence of 3\AA molecular sieves in refluxing chloroform, followed by *in situ* bromolysis of the cooled mixture.

All of these procedures were used for selective oxidation of a secondary OH to the detriment of a primary OH, either on protected or non-protected glycosides. However our objective is the oxidation of a secondary alcohol in the presence of another secondary alcohol.

In 1993, Grindley⁹⁴ described that dibutylstannylene ketals could suffer regiospecific oxidations using *N*-bromosuccinimide (NBS) with good results. This method improved the conversion of carbohydrate diols into α -hydroxyketones. This has been experimented both on terminal (anchored) and internal (secondary) diols in furano and pyrano structures.

⁹² D. David, A. Thieffry *J. Chem. Soc. Perkin Trans. I* **1979**, 1568.

⁹³ Y. Tsuda, M. Hanajima, M. Naohisa, Y. Okund, K. Kanemitsu *Chem. Pharm. Bull.* **1989**, 37, 2344.

⁹⁴ X. Kong, T. B. Grindley *J. Carbohydr. Chem.* **1993**, 12, 557.

However in our case, when submitting diol **57** to the above conditions, no oxidation was observed, the starting material being recovered unchanged (Scheme 49).

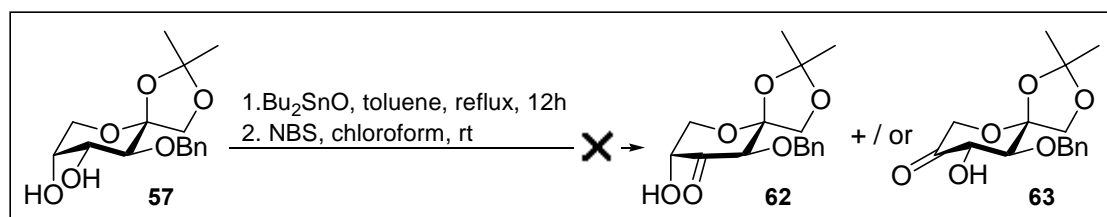

Scheme 49

This lack of reactivity might be attributed to non-stannylation of the diol, so that brominolysis could not take place.

As direct formation of an α -hydroxyketone through regioselective oxidation could not be achieved, another way had to be considered.

Since the target was a fused-OZT, we moved to the preparation of a fused bicycle using the condensation of a β -aminoalcohol with a thiocarbonyl source (Scheme 50).

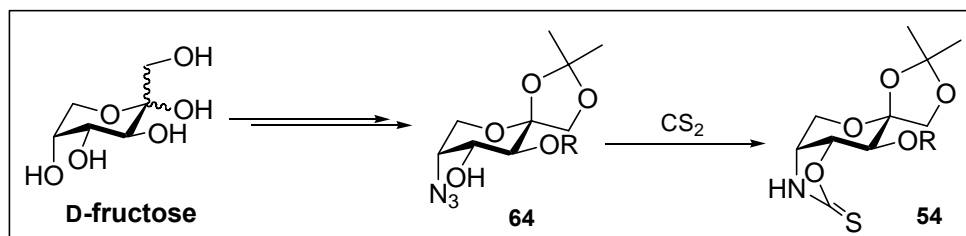

Scheme 50

Thus a brief survey of the methodologies involved seems pertinent.

1.2. Condensation with a thiocarbonyl source - CS_2 or CSCl_2

In glycochemistry, the best known method for the synthesis of cyclic thionocarbamates on saccharidic backbones uses amino-sugars as precursors. The first steps are related to the introduction of the amine function on the partial or unprotected saccharidic structure. The

reaction generally takes place *via* an isothiocyanate intermediate which is formed from carbon disulfide or thiophosgene to give the desired OZTs or 1,3-oxazine-2-thiones.

The capacity and facility with which this process can occur depends on the size and natural strain of the saccharidic ring.

Herein are described some crucial rules compiled from literature: a) five-member thionocarbamates are preferred against six-membered counterparts b) furanic systems are more pre-arranged to receive bicyclic derivatives than their pyranic tautomers c) the relative arrangement of both reacting groups is extremely important: e.g. *trans*-diaxial-arranged isothiocyanate and hydroxyl groups in a conformationally rigid pyrano ring do not cyclize to give a saccharidic thionocarbamate.^{75a}

In literature can be found an exhaustive list with examples of this methodology applied to aldoses and ketoses, distinguishing the location of the amine function, either on the anomeric carbon, or on the carbon skeleton (C-2, C-3, C-5, C-6 and C-1 for ketoses). Here we are going to illustrate some of them.

1.2.1. Glycosylamines

In the course of studies on *O*-unprotected glycosylthioureas, while introducing an isothiocyanate function at the anomeric position of some aldose series, Fuentes reported important results.^{74a, 74b, 74c} The traditional method consisted of reacting glycosamines with thiophosgene in a buffered medium to obtain isothiocyanates, which were engaged with assorted amines to form the required thioureas. However, in β -D-gluco and β -D-galacto series, the presence of a mixture of two compounds in equilibrium was detected: the desired isothiocyanate **66** and more surprisingly, the cyclic thionocarbamate **67** (Scheme 51). It was thus shown that a *trans*-fused OZT can be formed on a pyranosidic ring.

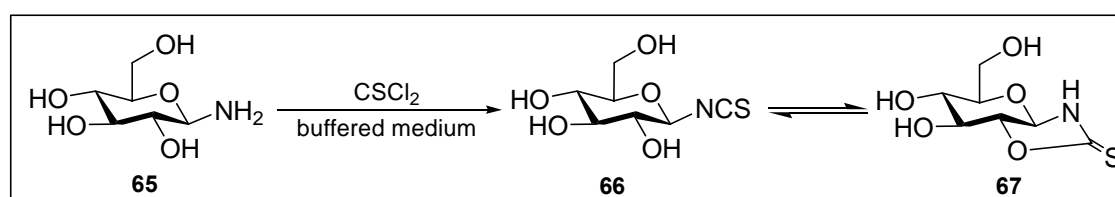

Scheme 51

The above results seem to be in contradiction with the assumptions outlined for the synthesis of D-fructopyrano-based OZTs in Chapter II 1.1. However, these cases are different: the saccharidic structures are less rigid, thus OZTs could be formed – remaining however in equilibrium with the isothiocyanate. The existence of similar *trans*-fused pyrano-carbamates, are reported in the literature.^{74d, 95}

In β -D-mannose series, only the *cis*-OZT **69** was isolated (Scheme 52). No signal in the NMR spectrum accounts for the presence of isothiocyanate.

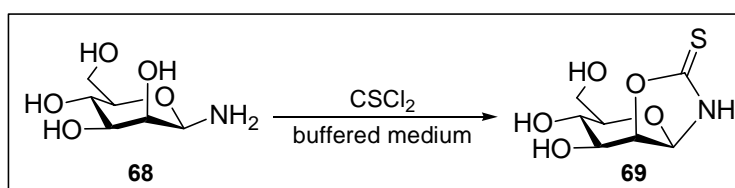

Scheme 52

This differential behavior is due to aldose initial configuration. In the first two series (D-Glc and D-Gal), hydroxyl groups (at anomeric position and C-2) are in *trans*-relationship while they are in *cis*-relationship in β -D-mannose. On the opposite to the *cis* relation, the formation of the OZT ring with the *trans* configuration is not so favorable which explains the observed equilibrium. These results agree with the fact that bicyclic compounds can be formed either in a 5 + 5 or 6 + 5 ring fusion, nevertheless in both cases *cis* isomers are clearly more stable than *trans*.^{74d}

1.2.2. Saccharidic templates bearing an amino group

The OZT formation starting from an amine generally arises in a similar way regardless of whether the amino group stands at the anomeric carbon or on the skeleton. The isothiocyanate is preliminary formed from CS₂ or thiophosgene, and then by spontaneous cyclization or base-induced reaction (from β - and/or γ -hydroxyl groups nearby) different enantiopure OZTs or oxazinethiones can be prepared.

Several studies have resulted in diversified positioning of thionocarbamate structures in a selective manner on saccharide backbones.^{22, 24a, 24b, 74a, 74e, 74f, 74g, 74h, 74i}

Hereafter, some examples from aldose and ketose families are described.

⁹⁵ B. Paizs, I. Pinter, J. Kovacs, W. Viviani, A. Mansura, P. Friant-Michel, I. G. Csizmadia *Theochem* **1997**, *41*, 395-396.

a) Aldoses

C-2

The synthesis of *cis*-fused OZTs was recently published starting from 2-amino-2-deoxy-D-glucose and D-mannose using the same method previously described for glycosylamines: thiophosgene in buffered medium^{74g} (Scheme 53).

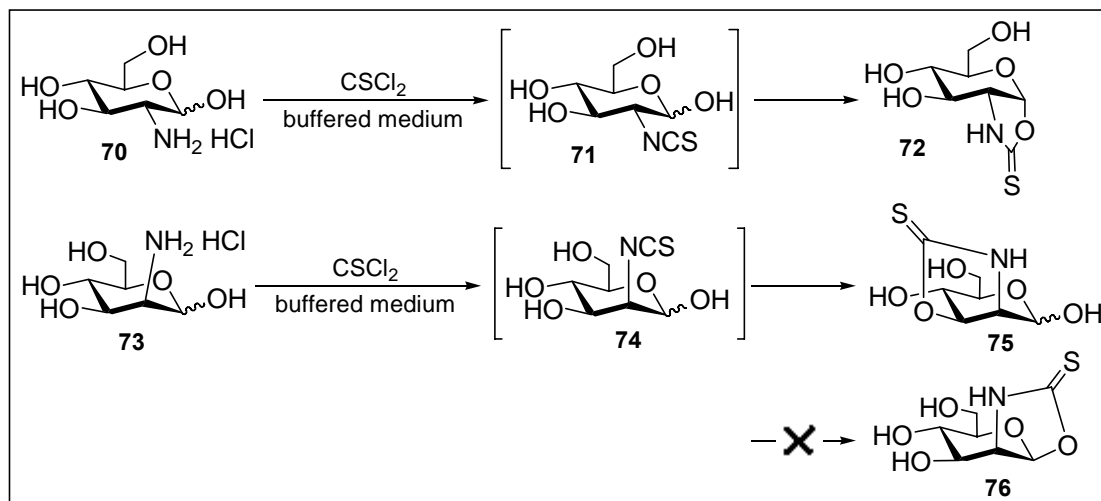

Scheme 53

Following the general rules, in these cases, the formation of OZTs forced the anomeric position to adopt a *cis* relationship; no equilibrium involving isothiocyanate was observed.

74a,74b,74c

In the D-manno series, a specific point was observed - the formation of 2,3-*cis*-fused OZT **75**, rather than the 1,2-*cis* regioisomer **76**. This is most likely due to the fact that **74** is expected to be in higher proportion as an α -isomer, which leads to the formation of a *trans* structure that is less favorable. Simultaneously there is the reduced nucleophilicity of the hydroxyl group in the anomeric position.

C-6

The construction of thionocarbamate on the side chain of the sugar ring has been explored for example with an 7-amino-6,7-dideoxy- α -heptopyranoside, related to the D-glucose

series.⁷⁴ⁱ The amino-alcohol was prepared through cyanide anion displacement from a 6-iodo-D-glucopyranose derivative, followed by nitrile reduction. Further condensation with thiophosgene yielded the isothiocyanate **78**. Under acidic conditions the isopropylidene acetal was removed, allowing rearrangement to the pyranose **80**. This unprotected isothiocyanate seems to be stable in the absence of base. Final treatment of **80** with triethylamine in DMF at 80°C forced the sugar ring to return to a furano form and afforded 1,3-oxazine-2-thione **81**. Inversion of the steps - first basic conditions yielding **79**, then acidic hydrolysis - gave the same results. (Scheme 54)

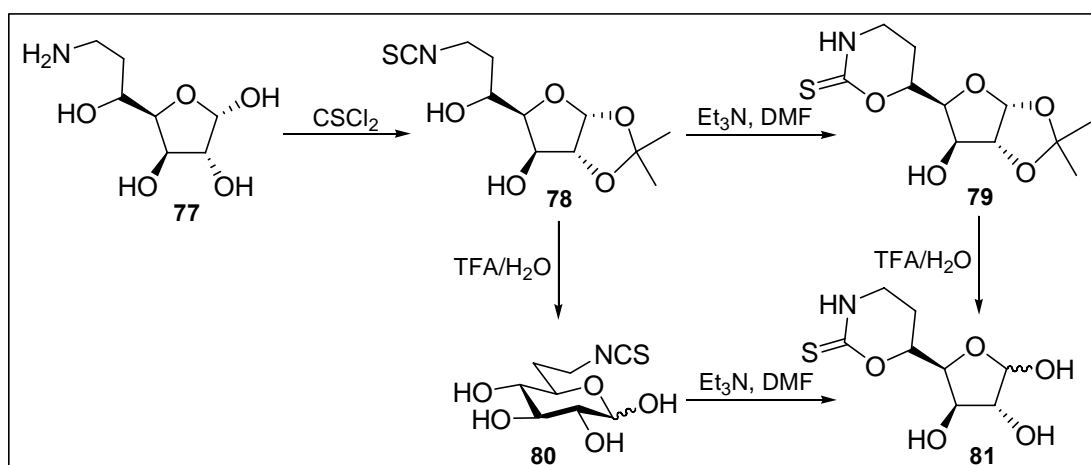

Scheme 54

As we can see the same thionocarbamate can be prepared by two different pathways: a) condensation with thiophosgene then subsequent deprotection, or b) deprotection followed by base-induced intramolecular annulation of the isothiocyanate.

b) Ketoses

C-1

In ketose series, thionocarbamate synthesis has always been more complicated than for aldoses. For example, reacting 1-amino-1-deoxy-D-fructose with CS_2 leads to an intermediate isothiocyanate which undergoes cyclization to two *spiro*-OZTs, in β -pyrano- (**85**) and β -furano- (**86**) forms⁹⁶ (Scheme 11).

⁹⁶ J. G. Fernandez-Bolanos, A. B. Lopez, J. Fuentes *Carbohydr. Res.* **1990**, *199*, 239.

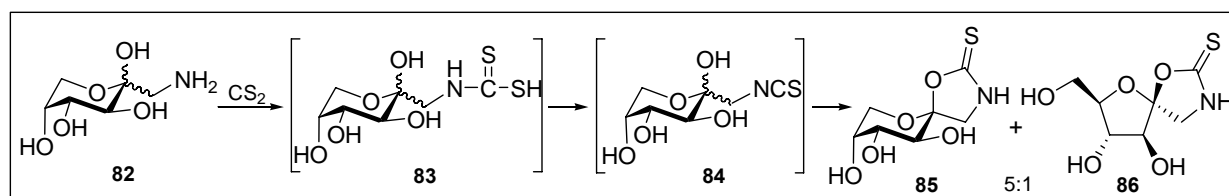

Scheme 55

Under acidic conditions, the formation of a *spiro*-OZT mixture is due to total deprotection of the starting D-fructo derivative.^{22c} Nevertheless if the reaction time is longer or the temperature higher, further isomerisation can occur and an open-chain dithiocarbamate can be formed. Actually, this was already reported by Jochims who obtained dithiocarbamates instead of OZTs thanks to excess triethylamine, which induced dithiocarbamate cyclization *via* D-fructo carbonyl group.

The dithiocarbamate cyclization to give 1,3-thiazolidine-2-thiones or conversion to the corresponding isothiocyanate to afford OZT depends on the reaction conditions. In the presence of Et₃N excess at 5°C it leads to a 5R/5S diastereoisomeric mixture of open-chain 1,3-thiazolidine-2-thiones as reported by Jochims (Scheme 56).⁹⁷ To obtain the OZT more severe conditions in the absence of base are required (Scheme 55).

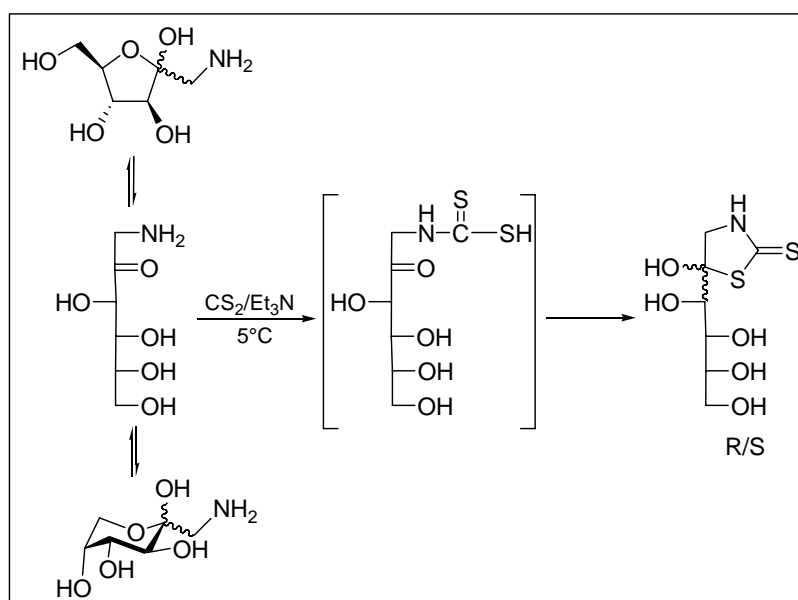

Scheme 56

⁹⁷ J. C. Jochims *Chem. Ber.* **1975**, *108*, 2320.

1.2.3. Saccharidic thionocarbamates *via* aziridine or epoxide

In 2008, Tardy *et al.*⁹⁸ reported an atypical method for the synthesis of *spiro*-OZTs at C-3 position in D-fructo and D-glucos series. These syntheses were realized *via* epoxide or aziridine intermediates - the key intermediates for preparing *exo* or *endo*-structures (Scheme 57). Both approaches start from a simple uloside, obtained by oxidation of a protected sugar.

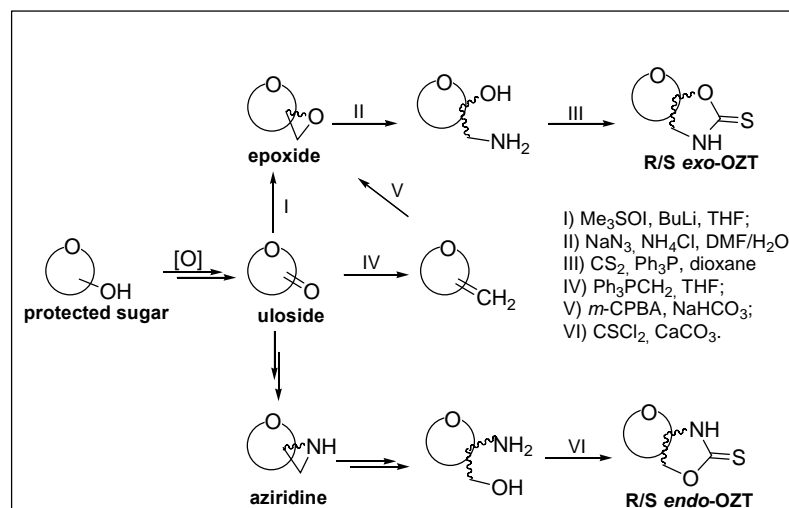

Scheme 57

The first step in *exo*-OZTs synthetic sequence was the epoxidation, which afforded two epimers but could be stereoselectively controlled depending on the conditions used. The two-step sequence, Wittig methylenation and stereoselective epoxidation, allowed better yields and improved stereoselectivity. On both templates, the (3*S*)-epoxides showed easier to synthesize with good stereoselectivity compared to the epimeric counterparts. Nonetheless, the (3*R*)-epoxide in D-fructo series was obtained in reasonable yield and good stereoselectivity. Next step involved the introduction of a nitrogen: the epoxide rings were regioselectively opened by sodium azide under protic conditions to afford the azido-alcohols. Cyclization to the OZT moiety was performed following a one-pot protocol: the modified Staudinger condensation with spontaneous cyclization of the intermediate hydroxylated isothiocyanate.

The *endo*-OZTs could be prepared *via* a similar sequence using an aziridine key structure. Cyanohydrin formation from ketones was investigated under kinetic and

⁹⁸ S. Tardy, J. L. Vicente, A. Tatibouët, G. Dujardin, P. Rollin *Synthesis* **2008**, 3108.

thermodynamic conditions, obtaining (*R*)- and (*S*)-cyanohydrin with excellent yields. Aziridines were synthesized in two steps: *O*-tosylation followed by hydride reduction of the cyano group with spontaneous intramolecular cyclization. As expected, direct acetolysis of aziridines failed: the ring-opening of a spiro-aziridine often requires strong activation *via* *N*-sulfonylation. After obtaining epimeric β -amino alcohols precursors, the last step is the formation of OZT by condensation with thiophosgene under basic conditions.

Exo-OZTs can also be obtained *via* a cyanohydrin from the 3-keto sugar albeit without stereoselectivity. Reduction of the nitrile by LiAlH_4 led to the corresponding amino-alcohol, which was further condensed with thiophosgene to afford the (*3R*)-*spiro*-OZT in *ca.* 30% overall yield. Despite being a shorter pathway, the last two steps gave disappointing yields.

1.3. 4,5-Fused OZT in β -D-fructopyranose

As mentioned before (Chapter 1.1.) condensation of a β -amino-alcohol with a thiocarbonyl source was the chosen pathway for the preparation of 4,5-fused OZTs.

1.3.1. First Approach

a) Structural protection

This approach first involved protection steps in order to functionalize selectively position C-5 and introduce the azide moiety. With respect to D-fructose structure, it was needed to select an efficient selective protection of OH-3 and OH-4. In the extensive list of hydroxyl protective groups, benzyl ethers are very popular. At an early stage, benzylation of OH-3 is straightforward; in contrast regioselective benzylation of equatorial OH-4 over axial OH-5 is much more tricky. Alternatively the fastidious multistep process described by Tatibouët can be envisaged.⁶² Recently, Garcia Fernandez³⁶ reported the use of xylylene bis-ethers, which offer several advantages and can be easily removed by catalytic hydrogenolysis under mild conditions.

However our first approach was based on a synthesis previously developed in our laboratory⁶² which involved OH-4 selective benzylation. It is important to refer that this kind of protection, as 4-*O*-acylation and silylation, has already been reported in literature.⁹⁹

The 3-position of **4** was *O*-benzoylated before partial de-acetonation^{79a, 82} to afford **88**. Finally, OH-4 was regioselectively *O*-benzoyled; after optimization, this protection-deprotection sequence was performed with excellent yields (Scheme 58).

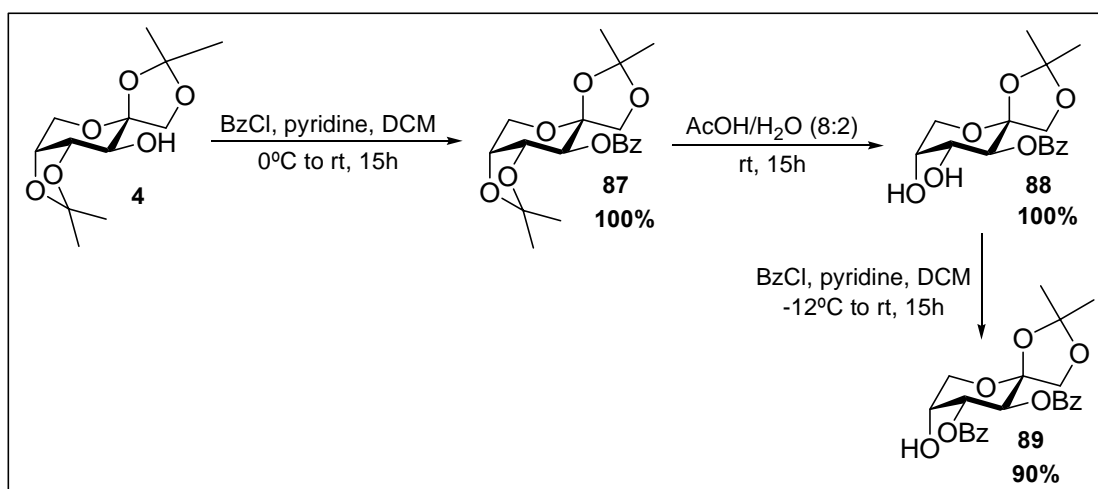

Scheme 58

b) Iodination and azide Formation

Iodination of position C-5 was effected following Garegg's conditions:¹⁰⁰ iodine, triphenylphosphine and imidazole in refluxing toluene for 4 h. Treatment with sodium azide provided a good yield product **91** after "ping-pong" nucleophilic inversions of D-fructo to L-sorbo and return to D-fructo. Last step involved de-*O*-benzylation at *O*-3 and *O*-4 using Zemplén's conditions (Scheme 59).

⁹⁹ (a) F. W. Lichtenthaler, W. Doleschal, S. Hahn *Liebigs Ann. Chem.* **1985**, 2454; (b) Y. Takagi, G.-J. Lim, T. Tsuchiya, S. Umezawa *J. Chem. Soc., Perkin Trans. 1* **1992**, 657.

¹⁰⁰ P. J. Garegg, B. Samuelsson *J. Chem. Soc., Chem. Commun.* **1979**, 978.

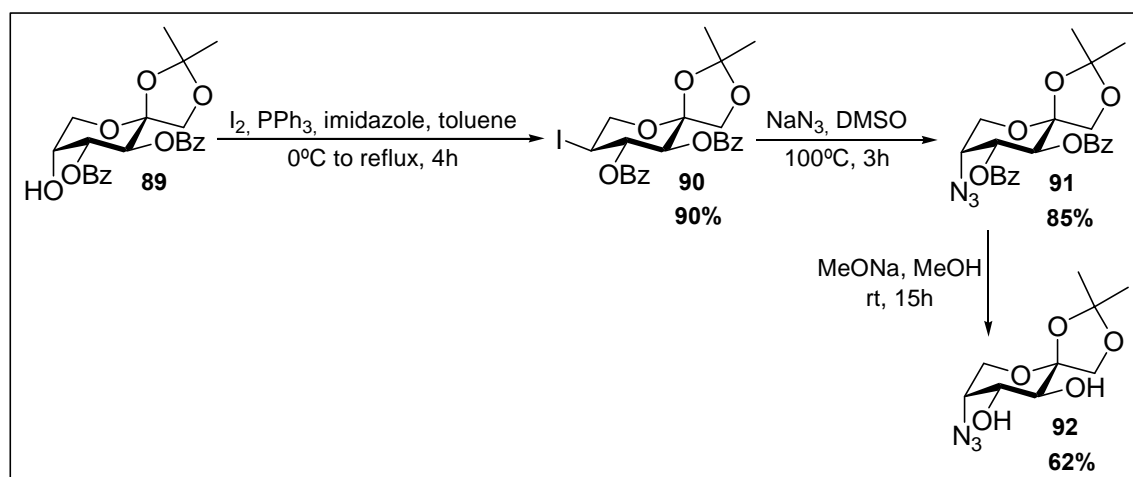

Scheme 59

c) OZT Formation

For the synthesis of OZT **93**, we have applied the Staudinger-aza-Wittig sequence which was previously developed by Defaye, Garcia-Fernandez and Ortiz-Mellet¹⁰¹ and further applied in our laboratory by Tardy *et al.*¹⁰² In the presence of CS₂ and PPh₃, the β-azidoalcohol is converted into an isothiocyanate, which undergoes a spontaneous attack of the free OH-4 and directly leads to the 4,5-fused OZT (Scheme 60).

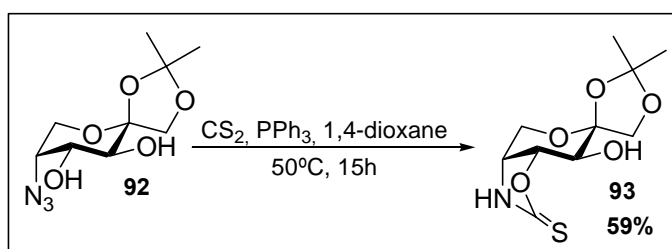

Scheme 60

In this reaction the intermediary isothiocyanate is not obtained through the conventional method (condensation of CS₂ or thiophosgene onto an amine resulting from azide reduction). This strategy avoids to handle amines which are known for being frequently difficult to purify

¹⁰¹ (a) M. I. Garcia-Moreno, P. Diaz-Perez, J. M. Benito, C. Ortiz Mellet, J. Defaye, J. M. Garcia Fernandez *Carbohydr. Res.* **2002**, 337, 2329; (b) T. Isoda, K. Hayashi, S. Tamai, T. Kumagai, Y. Nagao *Chem. Pharm. Bull.* **2006**, 54, 1616.

¹⁰² S. Tardy *PhD Thesis*, University of Orléans **2007**.

by silica gel chromatography: a) amino group introduced *via* an azide precursor, b) isothiocyanate formation and c) OZT cyclisation - three reactions in a one-pot procedure.

The yield of 59% is acceptable because (as reported in literature)^{101a} secondary sugar azides afford lower isothiocyanation yields than primary azides. And even if there is spontaneous cyclization of the isothiocyanate into OZT, the rigidity of the D-fructo backbone hampers its formation. Moreover it was mentioned before (Chapter II 1.3.3.) that formation of a 5 + 6 bicyclic system is not so favored. In order to improve the yield, this reaction was carried out in a sealed tube because of CS₂ high volatility.

The mechanism of the reaction is not completely established. Actually, Garcia Fernandez and co-workers^{101a} proposed a double route: one *via* an iminophosphorane and the other *via* a phosphazide. Both intermediates suffer a rearrangement to form the isothiocyanate, which cyclizes to give the OZT **93** (Scheme 61).

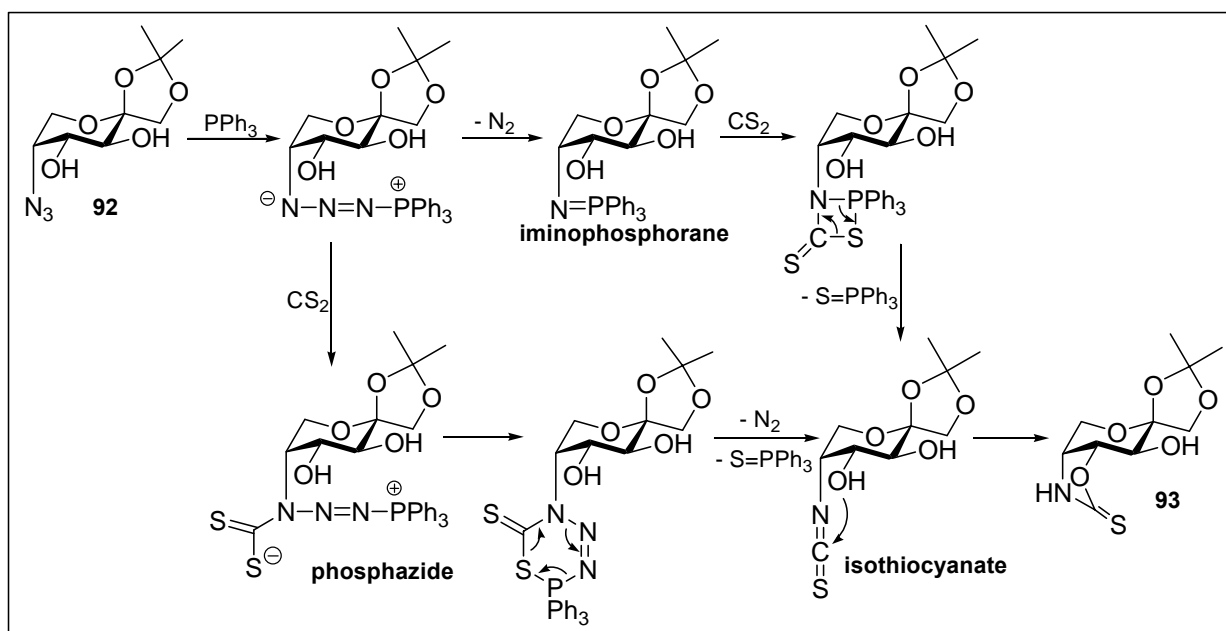

Scheme 61

1.3.2. Second approach

Our first approach involved a sequence of eight steps – among which five corresponding to protection and deprotection reactions. With the intention of improving this pathway by reducing the number of steps it was decided to try selective functionalization at position C-5.

a) Selective tosylation

Our first attempts focused on tosylation, as OH-5 must be selectively activated by a good leaving group. The main objective was to directly synthesize the azido precursor which would avoid two steps (selective benzoyl protection and benzoyl cleavage) in the preceding pathway. Tosylation was achieved with tosyl chloride and Et₃N in mild conditions. Only regioisomeric mono-tosylated compounds **94** and **95** were isolated and no trace of di-tosylation was detected (Scheme 62).

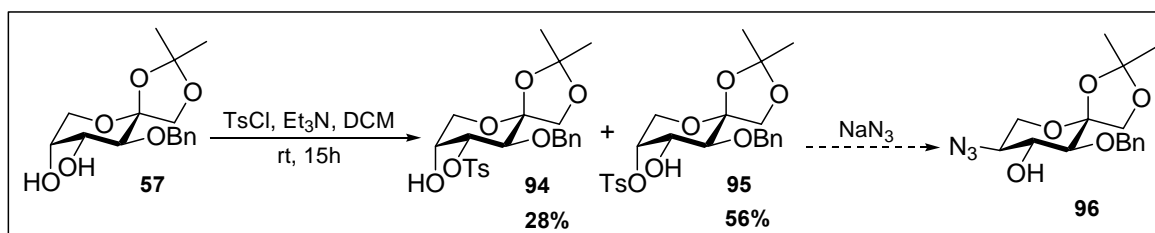

Scheme 62

Sulfonylation at O-5 was preferred as expected probably because the tosyl group can be considered relatively bulky and therefore more easily to enter the 5-position, which offers an easier access.

b) Selective iodination

Selective tosylation was not further explored because meanwhile selective iodination had been tested with stimulating results. In the beginning only traces of the iodinated compound were obtained together with elimination products, but after optimization studies under Garegg conditions,¹⁰⁰ excellent results were achieved, the 5-iodo-derivative **97** being isolated in 94% of yield. Selective iodination was thus achieved with inversion of the C-5 configuration (Scheme 63).

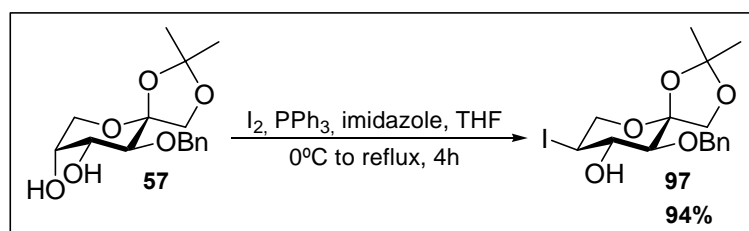

Scheme 63

At the end of this chapter a full recount is made on the selective iodination optimizations and studies on some other diol and triol moieties in ketose and aldose series (1.6.).

c) OZI formation

As reactions were optimized, we have prepared an assortment of 4,5-fused OZT with different substituents in C-3 in a view of future biological tests.

The first steps of the sequence were dedicated to preliminary protection. Compounds 95, 88 and 98 were prepared with excellent yields. Selective iodination in C-5 took place with good results for all substrates: 94% for 97 and 70% for 99. It has to be emphasized that compound 98 is a triol which was also successfully submitted to the selective iodination in 65% yield. Further azidation was also achieved in good yields, 62-92%. The last OZT formation step followed the same CS₂ protocol which afforded moderate yields (53-62%) albeit completely acceptable for the reasons explained above (Scheme 64).

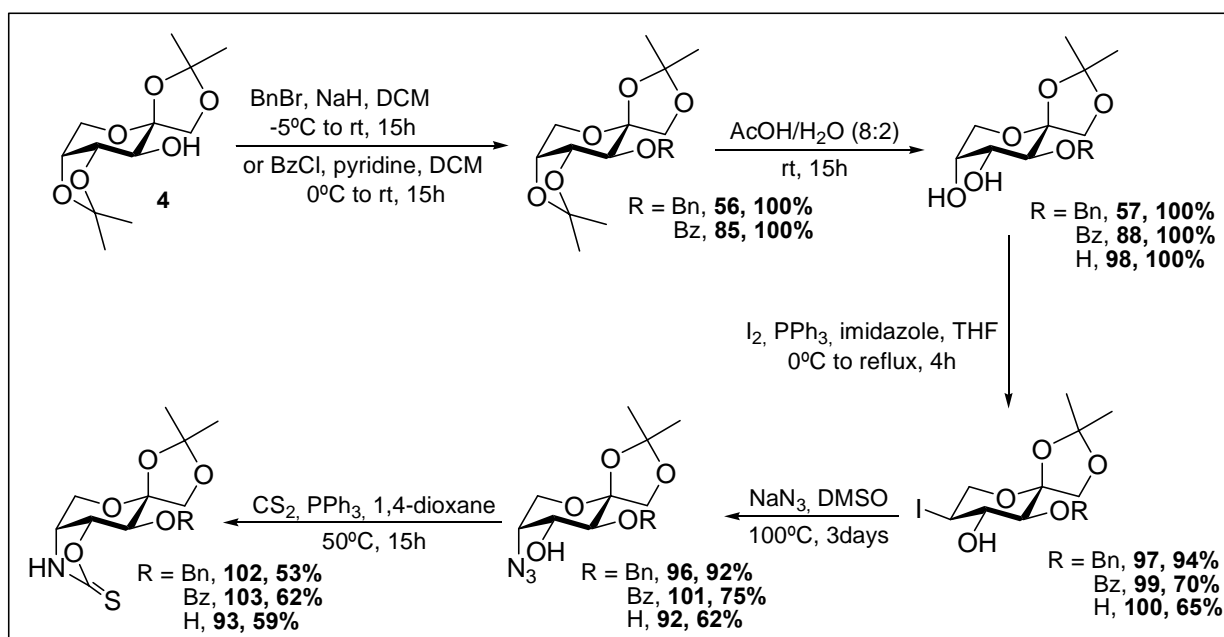

Comparing the first and second approach the number of steps (and time consumption) was reduced, from 7 to 4 in some cases. This novel and more original pathway has allowed the development of an innovative methodology that can be attractive in other fields of carbohydrate chemistry.

1.4. Fused OZT in β -D-psicopyranose

1.4.1. D-Fructose similar approach

As the synthesis of the 4,5-OZT in D-fructo series proved successful it was encouraging to apply a similar pathway in D-psico series.

a) From D-fructo to D-psico series

D-Psicose is a "rare sugar", therefore it is much easier (and cheaper) to synthesize it from its C-3 epimer, D-fructose. This transformation is simple: in order to invert the stereochemistry an oxidation-reduction sequence was required. Oxidation was realized with PDC, a reaction already presented in Chapter II 1.3.1., to give uloside **25**. This step was followed by

stereoselective reduction under classical conditions. The compound **104** was easily obtained with 89% yield (Scheme 65).

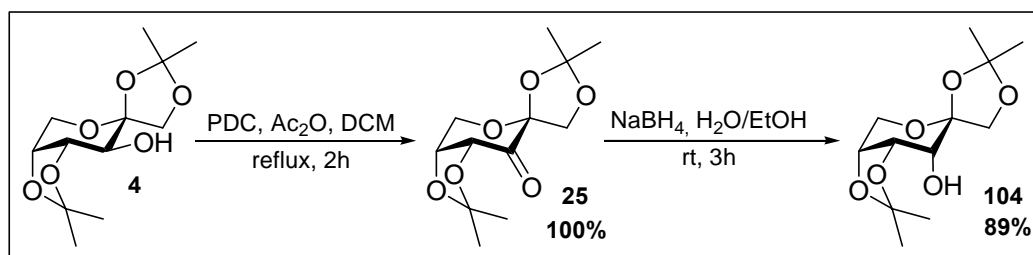

Scheme 65

Position OH-3 was *O*-benzylated following standard conditions then OH-4,5 selective deprotection was effected. Both **105** and **106** were obtained in qualitative yield (Scheme 66).

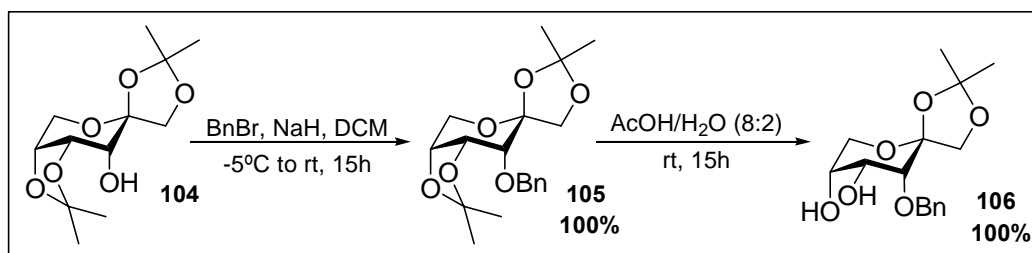

Scheme 66

b) Iodination

Similarly as before in D-fructo series, modified Garegg conditions were directly applied to the diol **106**. Selective iodination was successfully achieved with a reasonable yield, 56%. Instead of C-5 functionalization, the iodine introduction was observed in that case on C-4 and with both configuration and conformation inversion in product **107** (Scheme 67).

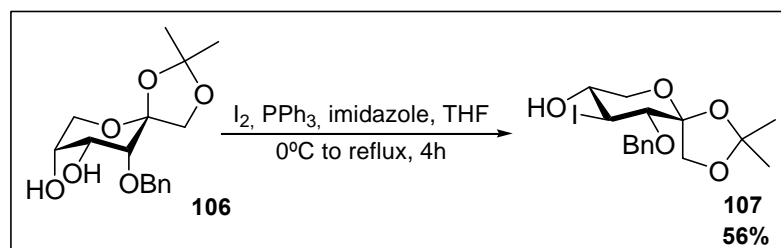

Scheme 67

An issue at the end of this chapter is dedicated to selective iodination, and this different behavior, between D-fructo and D-psico series will be discussed.

c) Azido and OZT formation

Finally to obtain the OZT there was an intermediary “passage” through the azido derivative followed by isothiocyanate formation and cyclization to give OZT **55**. The reactions applied have been precedently optimized in D-fructo series and yields were in accordance with previous results (Scheme 68).

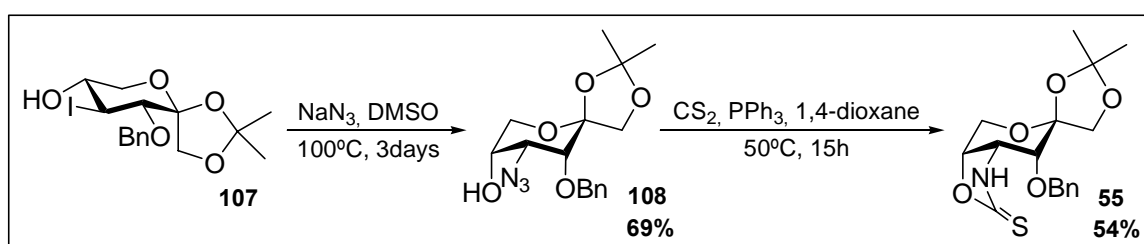

Scheme 68

This pathway enabled the synthesis of a 4,5-fused OZT in D-psico series, which will allow a comparison between the two series in biological tests. In addition it was also an opportunity to observe the behavior and to investigate the relatively unexplored chemistry of D-psicose.

1.5. Deprotection assays

As mentioned in introduction one of our objectives is the development of a library of OZTs to be tested as potential GLUT5 inhibitors (Chapter VII). The inhibition capacity is quantified by the interaction of the hydroxyl groups of the molecule and the protein. Therefore, unmasking the hydroxyl groups in our molecules is crucial.

1.5.1. Hydrochloric acid conditions

a) D-Fructose

For the OH-1,2 deprotection we have first tried 2M aqueous HCl at room temperature. After 15 h the 1,2-*O*-isopropylidene hydrolysis was observed: however the expected pyranose **109** was not obtained, but instead an open-chain ketose was isolated. This disubstituted chiral OZT **110** was formed in 70% yield (Scheme 69).

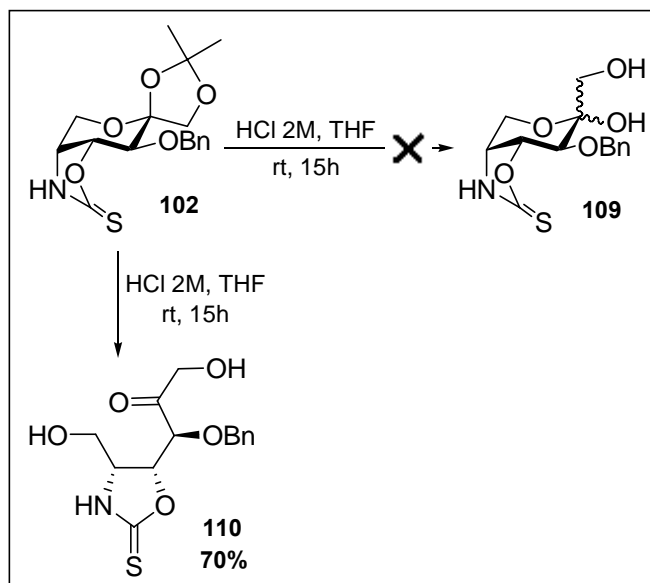

Scheme 69

b) D-Psicose

When the same conditions were applied to the D-psicose 4,5-fused OZT **55**, a similar result was obtained. The opening of the sugar ring was observed which gave place to the OZT **111** in 79% yield (Scheme 70).

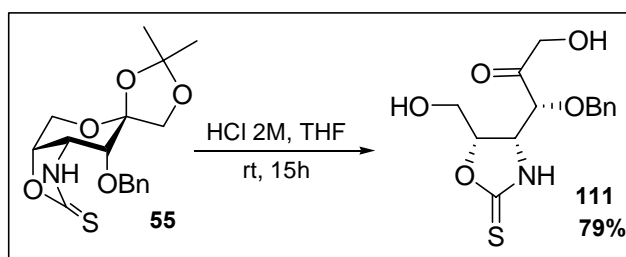

Scheme 70

It can be deduced that 2M aqueous HCl might be too strong a medium, which allows deprotection at the anomeric carbon but prevents re-cyclization to the pyrano hemi-ketal. In other respects, it can be noted that these 4,5-OZTs are less sensitive than the 3,4-fused OZTs as less degradation was observed (Chapter II 1.2.4.).

1.5.2. An original reagent, Sc(OTf)₃

With the same goal of deprotecting C-1,2 positions, another type of reagent was tested, scandium (III) triflate.¹⁰³ From the literature, this kind of reagent seemed to be more adequate for a selective hydrolysis of terminal isopropylidene. We have experimented Sc(OTf)₃ but under the conditions tested, no isopropylidene cleavage was observed. (Scheme 71).

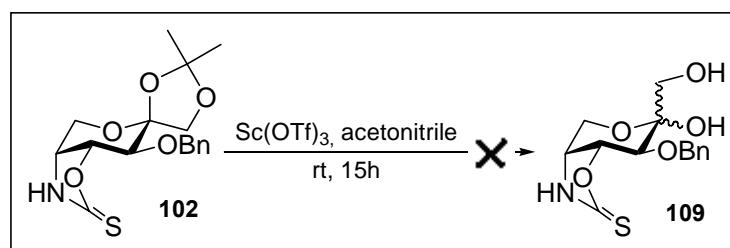

Scheme 71

1.2.3. Trifluoroacetic acid conditions

From the literature³⁸ and the encouraging results obtained for the 3,4-fused OZT in chapter II (1.3.4.), in using 6:4 aqueous TFA for C-1,2 isopropylidene cleavage, we decided to try the same conditions on these substrates.

¹⁰³ J. S. Yadav, B. V. S. Reddy, K. S. Reddy *Chem. Lett.* **2001**, 430.

It was really difficult to purify the mixture obtained, so the deprotected mixture was directly peracetylated. The di-*O*-acetylated compound **113** was obtained with good yield after the two-step reaction. No trace of the acyclic form was observed. Zemplén de-*O*-acetylation was finally applied but only degradation was observed (Scheme 72).

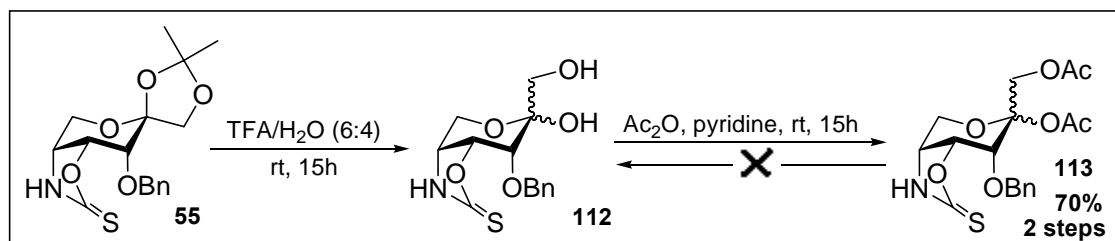

Scheme 72

In conclusion final compounds **109** and **112** could not be isolated under acidic and basic conditions, due to their instability, but the acyclic derivatives **110** and **111** could be obtained in quite good yields and will be submitted to biological tests (Chapter VI).

1.6. Selective Iodination

Iodination is a classical reaction commonly used in organic synthesis. The replacement of a hydroxyl group by iodine has been widely used in carbohydrate chemistry and it has aroused many interest in the last decades.¹⁰⁴

Deoxyhalogeno sugars - especially deoxyiodo - are very useful intermediates in many syntheses,^{105,38} of azido-, amino- and thio-deoxy derivatives by substitution,¹⁰⁵ or deoxy sugars by reduction, which allows the preparation of natural compounds of biological importance such as antibiotic substances, cardiac glycosides, and bacterial antigens.¹⁰⁶ Their capacity to create radicals allows its applications in the synthesis of some natural compounds.¹⁰⁵ These versatile precursors can also be used in the conception of carbafuranosides which are analogues of biologically important products.¹⁰⁷ The one-step conversion of diols into olefins, has attracted

¹⁰⁴ (a) E. Barnett *Adv. Carbohydr. Chem.* **1967**, 22, 177; (b) W. A. Szarek *Adv. Carbohydr. Chem.* **1973**, 28, 225; (c) R. S. Tipson, A. Cohen *Carbohydr. Res.* **1965**, 1, 338; (d) Z. Liu, B. Classon *J. Org. Chem.* **1990**, 55, 4273.

¹⁰⁵ B. Rondot, T. Durand, J.-C. Rossi, P. Rollin *Carbohydr. Res.* **1994**, 261, 149.

¹⁰⁶ P. J. Garegg, B. Samuelsson *J. Chem. Soc. Perkin Trans. I* **1980**, 2866.

¹⁰⁷ J. Desire, J. Prandi *Eur. J. Org. Chem.* **2000**, 3075.

the attention of a number of chemists and several methodologies were developed.^{100,104d,106,108} This kind of modifications unlocks the potential of structural alterations in important biological compounds, like modified aminoglycoside antibiotics, nucleosides or nucleosides analogues.¹⁰⁹

In addition, deoxyiodo sugars also have biological interest as themselves, for example in SPECT medical imaging they are tracers of glucose transport.¹¹⁰ Or, once iodine is a heavy element (quite radio-opaque) certain organic compounds (iodine-substituted) are thus used in medicine as X-ray radio contrast agents for intravenous injection, and X-ray urology.¹¹¹

For a long time iodination has been being exhaustively studied and many conditions and reagents have been tested.

There are mainly two different pathways to perform iodination: a) by a two-step reaction, where in general sulfonate esters *e.g.*, mesylate, tosylate or triflate, are used,¹¹² as good leaving groups or b) by a one step reaction which means directly from the hydroxyl group (Scheme 73). In these case a phosphorus-based reagent¹¹³ such as commonly PPh₃. The iodine sources are various, like *N*-iodosuccinimide,¹¹⁴ tetraiodomethane,^{112a} imidazole and I₂ or tri-iodoimidazole.^{100, 106}

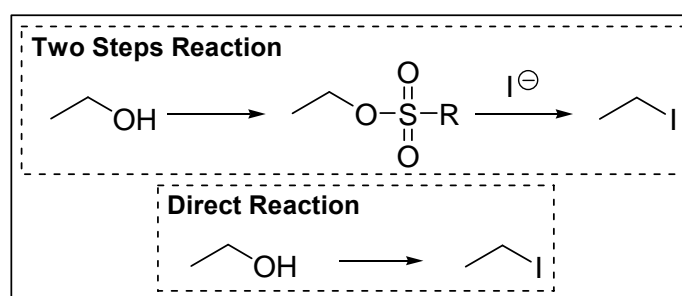

Scheme 73

¹⁰⁸ (a) P. J. Garegg, B. Samuelsson *Synthesis* **1979**, 469; (b) P. J. Garegg, B. Samuelsson *Synthesis* **1979**, 813; (c) F. W. Lichtenthaler, W. Doleschal, S. Hahn *Liebigs Ann. Chem.* **1985**, 2454.

¹⁰⁹ K. Augustyns, F. Vandendriessche, A. V. Aerschot, R. Busson, C. Urbanke, P. Herdewijn *Nucleic Acids Res.* **1992**, *20*, 4711.

¹¹⁰ C. Morin *Tetrahedron Lett.* **2006**, *47*, 5055 and references cited therein.

¹¹¹ A. L. Raymond, E. F. Schroeder *J. Amer. Chem. Soc.* **1948**, *60*, 2785.

¹¹² (a) R. W. Binkley, D. G. Hebermann *J. Org. Chem.* **1978**, *43*, 3244; (b) R. S. Tipson *Adv. Carbohydr. Chem.* **1953**, *8*, 107; (c) P. R. Skaanderup, C. S. Poulsen, L. Hyldtoft, M. R. Jorgensen, R. Madsen *Synthesis* **2002**, *12*, 1721.

¹¹³ (a) S. R. Landauer, H. N. Rydon *J. Chem. Soc.* **1953**, 2224; (b) H. N. Rydon, B. L. Tonge *J. Chem. Soc.* **1956**, 3043.

¹¹⁴ S. Hanessian, M. M. Ponpipom, P. Lavallée *Carbohydr. Res.* **1972**, *24*, 45.

The list of methodologies is extended but the most currently used and well known was developed in 1979 by Garegg and Samuelsson.^{100, 106}

The authors described the synthesis of deoxyiodo sugars from a three-reagent system: PPh_3 , imidazole and I_2 or tri-iodoimidazole, which gave better yields, in refluxing toluene. The first conversions were done with primary and secondary hydroxyl groups on protected structures (Scheme 74).^{100, 106}

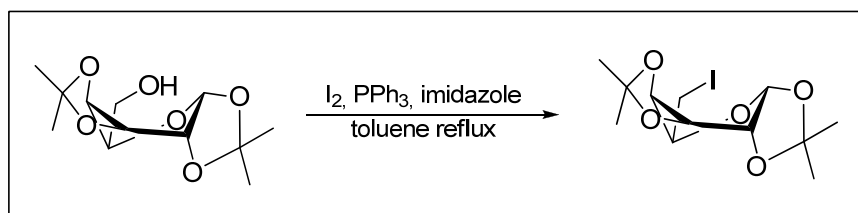

Scheme 74

Later they improved the reaction conditions by changing the solvent to a mixture of toluene and acetonitrile (2:1), in which selective primary iodination on unprotected structures could be achieved (Scheme 75).¹¹⁵

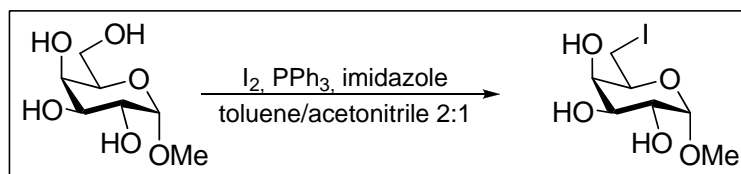

Scheme 75

If Garegg's conditions were applied to unprotected vicinal diols, iodine substitution it was not observed but instead an elimination took place to form an olefin (Scheme 76).^{108a, 108b}

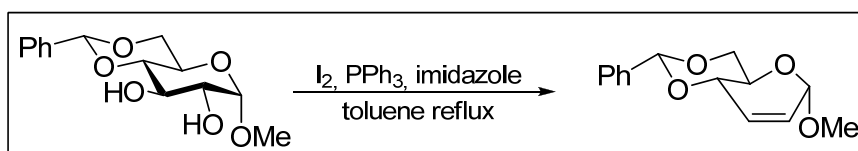

Scheme 76

¹¹⁵ P. J. Garegg, B. Samuelsson *J. Chem. Soc. Perkin Trans. I* **1982**, 681.

All of these methodologies provide efficient iodination. The substitution proceeds with clean inversion of chiral secondary hydroxyl and there is selective iodination of primary hydroxyl over the secondary. Furthermore, the iodination of the secondary is only possible onto protected structures.

During optimization of our synthetic pathway for the preparation of 4,5-fused OZT we have tried selective iodination with good results (1.3.2. b) and 1.4.1. b)). As far as we know, selective iodination of secondary polyhydroxylated unprotected structures is unprecedented. This is an important improvement over the original conditions developed by Garegg and Samuelsson.

1.6.1. Diol derivatives

Initially we focused our attention on two vicinal diol structures **55** and **106** in D-fructo and D-psico series (Scheme 77).

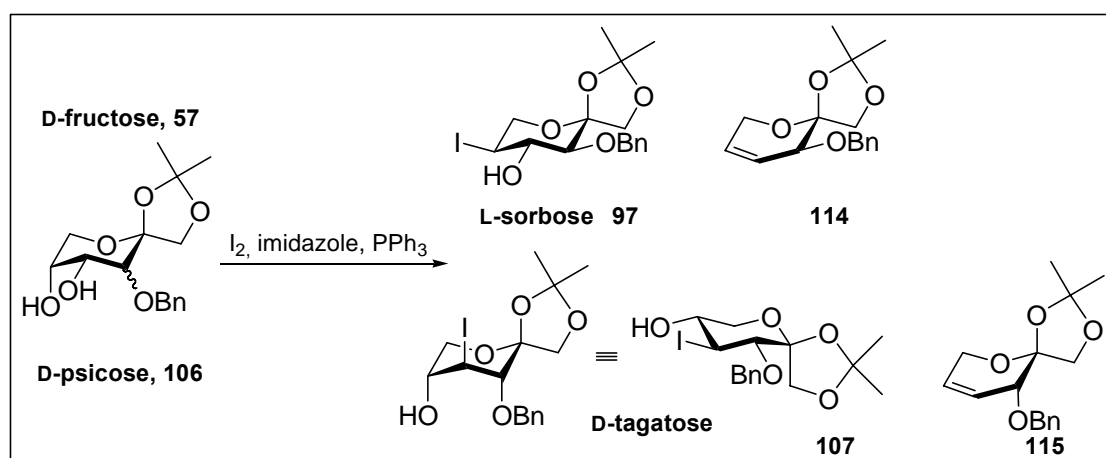

Scheme 77

At first, we decided to apply the conditions developed by Garegg and Samuelsson¹⁰⁰ and as expected, the major product was an olefin, **114** or **115**. But more surprising was the unprecedented formation of a mono-iodinated compound. Taking into account this result we have concentrated our efforts to optimize this reaction in order to improve the synthesis of the iodinated derivatives. An optimization study was carried out involving several parameters: solvent, temperature, reaction time and equivalent number of iodine (Table 6).

Table 6

PRODUCT	SOLVENT	I ₂ (eq.)	TEMPERATURE (C°)	TIME (h)	D-FRUCTOSE		D-PSICOSE	
					97 (%)	114 (%)	107 (%)	115 (%)
57 /106	toluene	1.4	100-110	1	40	54	8	67
57 /106	toluene	1.4	rt	24	-	-	-	-
57 /106	THF	1.4	rt	15	7	-	-	-
57 /106	THF	1.0	reflux	4	94	-	56	-
57 /106	1,4-dioxane	1.0	60-70	72	67	-	43	-

When Garegg's conditions were applied, *i.e.*, excess I₂ in refluxing toluene, the olefin was obtained in reasonable yields. To avoid this product, our first modification was to decrease the temperature but no reaction (and no degradation) was detected. Consequently, it was decided to replace toluene by THF for solubility problems. But most importantly, the number of I₂ equivalents was also reduced to one equivalent and this must be precise otherwise olefins will be formed too. At room temperature no conversion was detected, thus the reaction was placed under THF reflux. As a result, the iodinated derivatives **97** and **107** were isolated in good yields, 94% and 56%, respectively. Replacing THF by 1,4-dioxane did not improve the reaction yields.

In both series, the reaction leads to iodination with inversion of the configuration, but not at the same position. It was observed in D-fructo series that iodination occurred at C-5 yielding **97**. Quite surprisingly, in D-psico series iodination occurred at C-4 yielding **107** (Scheme 77).

How to explain this behavior ?

A plausible mechanism could be hypothesized (Scheme 78). It is known that during the iodination mechanism an oxyphosphonium intermediate is formed. But in our case, the vicinal alcohol might chelate the phosphorus atom: thus, in the D-fructo case, a tautomeric equilibrium between intermediates **116** and **117** can exist. The nucleophilic attack of iodine then would be on the C-5 position to generate the thermodynamic iodo L-sorbopyranose **97**. All substituents are in equatorial position, which is the most stable situation.

In the D-psico case, a similar equilibrium can be postulated together with a conformational equilibrium between **117** and **118**. Consequently iodine would be introduced at

C-4 with inversion of both configuration and conformation, leading to a D-tagatopyrano unit. Once again all substituents are in the favored equatorial position.

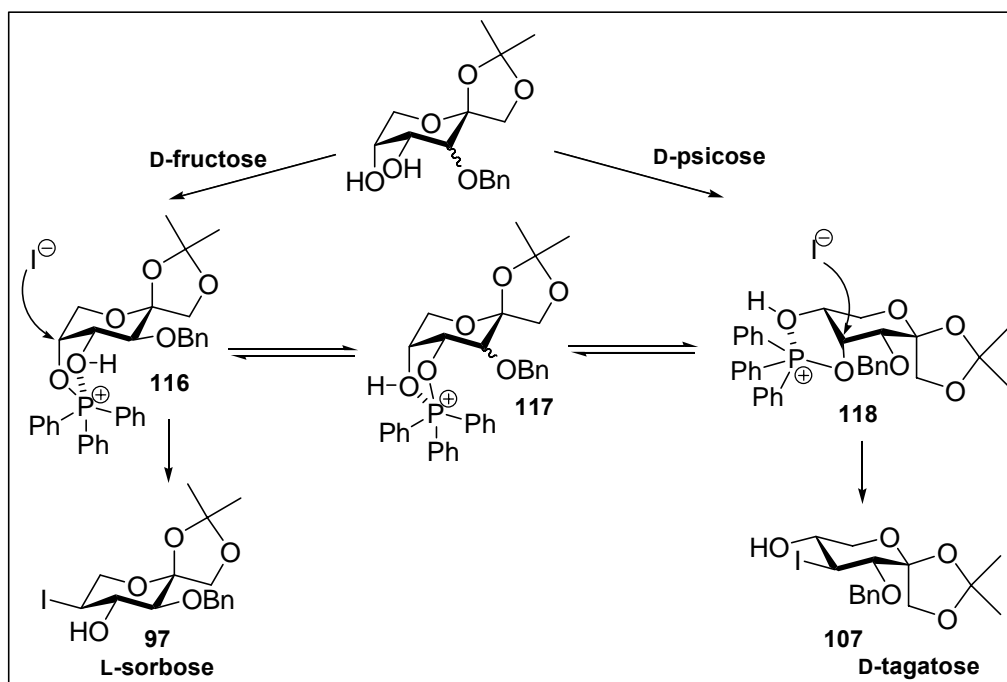

Scheme 78

Both structures were characterized by NMR analysis. The ^1H - ^{13}C correlation allowed us to ascertain the structures correctly once the ^{13}C chemical shift of C-I is well defined, therefore clearly locating the iodine atom in the molecule.

1.6.2. Triol derivatives

a) Ketoses

The interesting results obtained for diols prompted us to continue and try selective iodination on triol structures. This study was applied in D-fructo and D-psico series (Scheme 79).

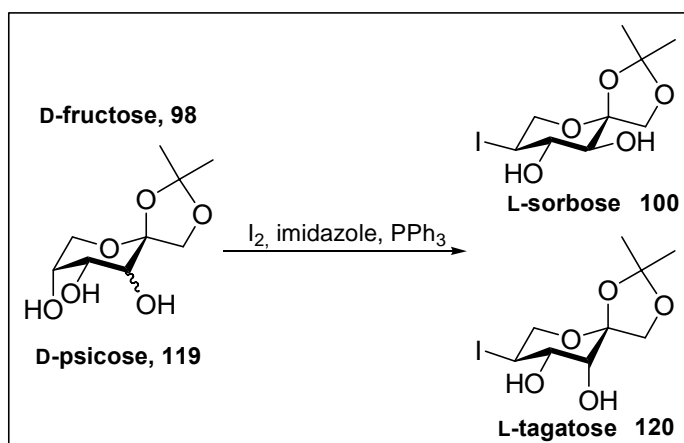

Scheme 79

Similarly to the study of diols an optimization was carried out (Table 7).

Table 7

PRODUCT	SOLVENT	I ₂ (eq.)	TEMPERATURE (C°)	TIME (h)	D-FRUCTOSE	D-PSICOSE
					100 (%)	120 (%)
98 /119	THF	1.0	reflux	4	21	20
98 /119	THF	1.0	reflux	72	15	11
98 /119	1,4-dioxane	1.0	100	4	38	39
98 /119	1,4-dioxane	1.0	100	72	27	21
98 /119	1,4-dioxane	1.0	100	120	39	31
98 /119 (1g)	1,4-dioxane	1.0	100	4	65	63

The first tests were applied using the conditions previously developed for diols. Some selectivity was observed but only with low yields. The reaction was then carried out for 72 h but without noticeable improvement. Since the reaction was not complete, it was decided to force the conditions, and the solvent was changed for 1,4-dioxane in order to increase the temperature. The amelioration was significant but starting material still remained in the mixture, even after extending the reaction time. However, if the reaction was performed on larger scale (*ca.* 1g starting material), the reaction yields for **100** and **120** increased to 63% and 65%, respectively. This might be due to the concentration of the starting material. We have thus

optimized the conditions to obtain good yields of a selectively iodinated ketose. It can also be pointed out that no olefin formation is detected.

In comparison with the study on diols, it was interesting to observe that whatever the sugar series - D-fructo or D-psico - only position C-5 is selectively iodinated.

We might propose in these cases that complexation was not the main aspect for the reactivity. Instead, if we assume the 5-OH having a stronger reactivity to form the oxyphosphonium intermediate **121-122**, intramolecular hydrogen bonds that could be formed between OH-3 and OH-4 might hampered any equilibrium. Then iodine attacks position C-5 and the iodinated derivative in L-tagato series is obtained. In order to ascertain the conformation, these molecules were acetylated.

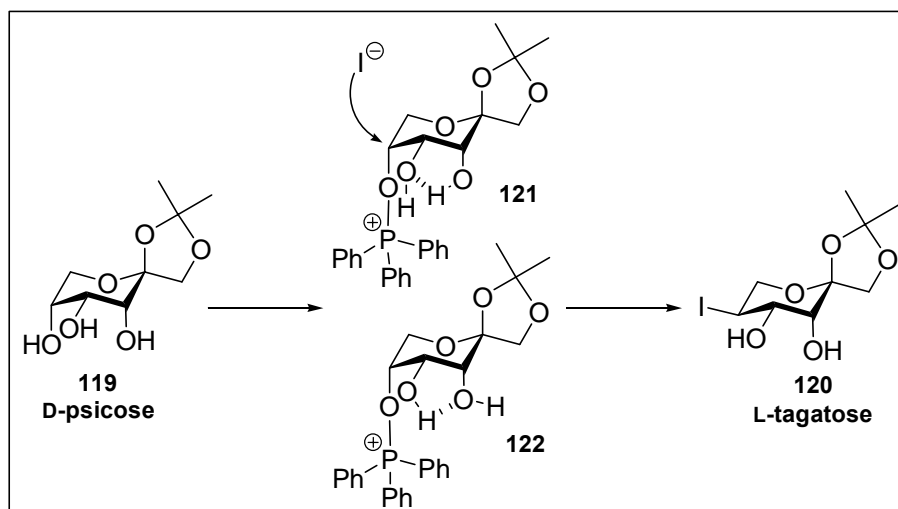

Scheme 80

b) Aldohexoses

In order to experience the efficacy of this method it was decided to also test it on aldoses and therefore it was applied in D-gluco, D-manno and D-galacto series.

The triol substrates were prepared from methyl β -D-pyranosides, in which the primary hydroxyl was selectively O-silylated under standard conditions to afford 6-O-silylated derivatives **123**, **124** and **125** in good yield (Scheme 81).

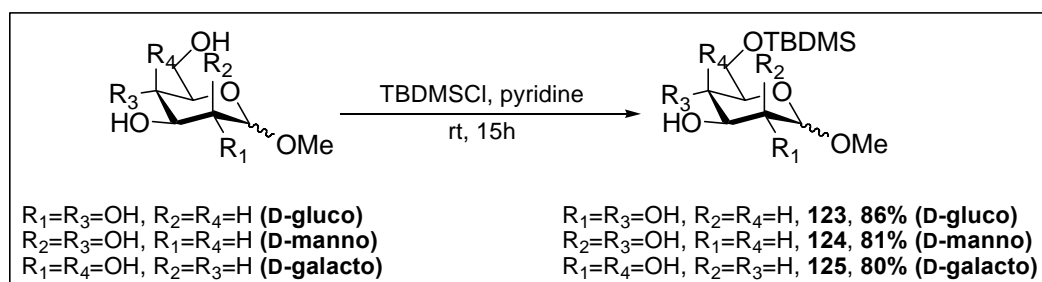

Scheme 81

Then the conditions for selective iodination were applied (Scheme 82 and Table 8).

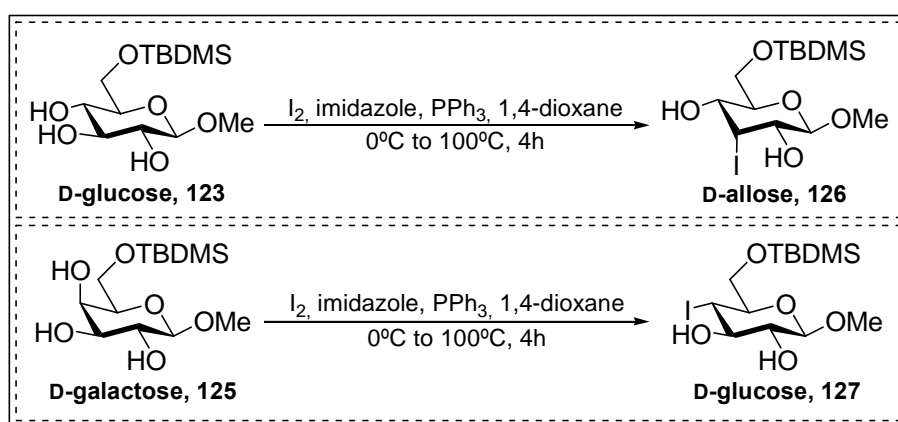

Scheme 82

Table 8

STARTING MATERIAL	PRODUCT
D-glucose, 123	D-allose, 126 45%
D-mannose, 124	D-mannose, no selectivity
D-galactose, 125	D-glucose, 127 42%

The conditions used were the same as for triol derivatives: I_2 (1.0 eq.) in 1,4-dioxane at 100°C for 4 h. Selective iodination was observed in D-gluco and D-galacto series but high reactivity was detected in D-mannose series. The yields are acceptable about 42 and 45% for **126** and **127**, respectively. We thought that these results could be increased if the reaction has been done on a higher scale. The selectivity can be explained taking into account the stability of the final compounds. As previously stated the reaction occurs with inversion of the configuration at the iodinated position.

When it was decided to test selective iodination in D-gluco series it was not expected that it occurs once all substituent are already in equatorial position. And if that happened to it was attended in position C-2 since it known for being the most reactive, for example, in glycosylation reactions or selective O-silylation. However, regarding literature it can be observed a similar behaviour when working with other halogen elements like bromine or chlorine.¹¹⁶ Under our conditions, the D-mannopyranoside **124** gave an intractable mixture of compounds. The D-galacto derivative **125** behaved as expected, iodination occurring at C-4 and all substituents being equatorial. The iodinated compound **127** belongs to the D-gluco series.

1.7. Conclusion

In this Chapter III we have focused our attention on the synthesis of 4,5-fused OZTs in D-fructo and D-psico series starting from D-fructose itself (Scheme 83).

¹¹⁶ M.-K. Chung, G. Orlova, J. D. Goddard, M. Schlaf, R. Harris, T. J. Beveridge, G. White, F. R. Hallett *J. Am. Chem. Soc.* **2002**, *124*, 10508.

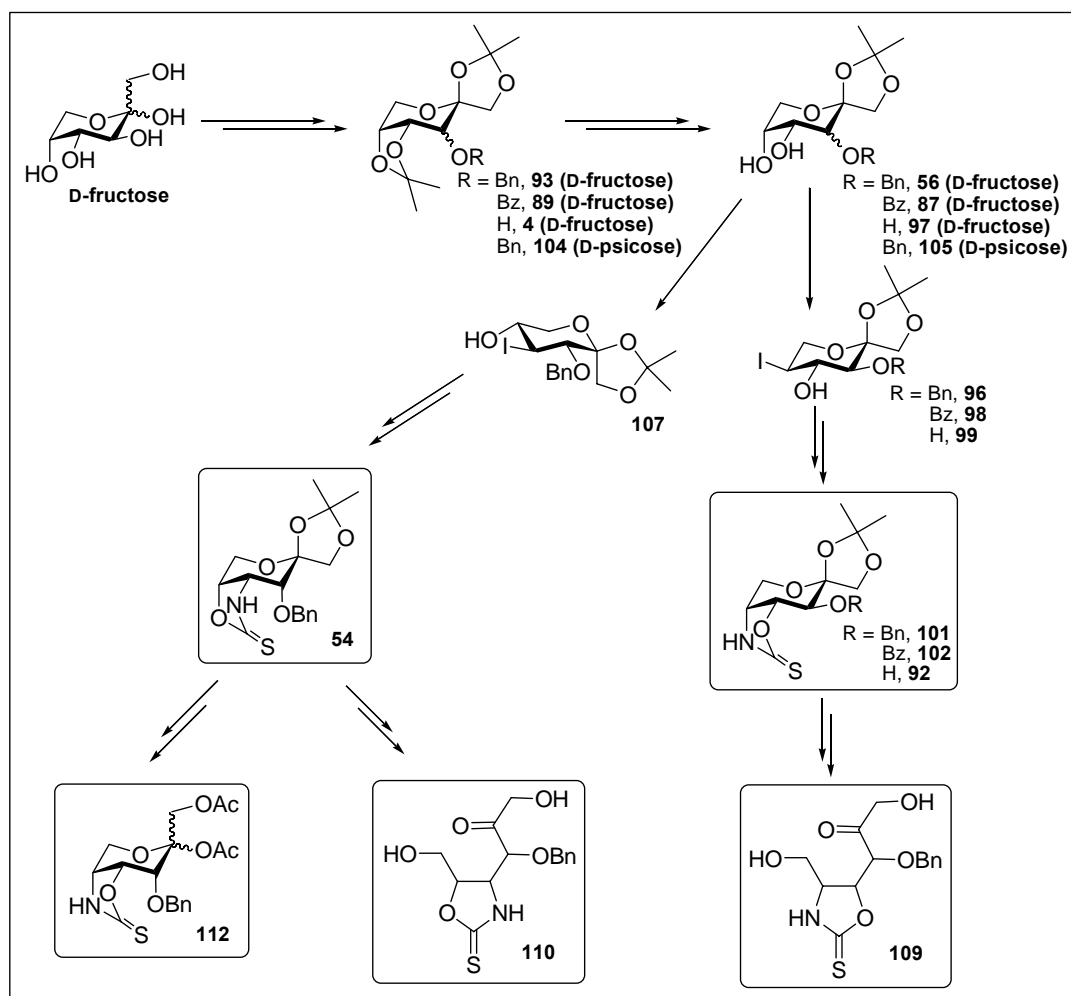

Scheme 83

Taking into account the results obtained we can put forward some preliminary assumptions:

- ☑ A novel and original synthetic pathway for 4,5-OZTs preparation was developed using selective iodination. In some cases we succeeded in reducing the number of steps from seven to just four.
- ☑ Functionalization and epimerization of C-5 and C-4 in D-fructo and D-psico series, respectively, was explored *via* Garegg's methodologies.
- ☑ In some cases, fused OZTs are very sensitive molecules. Complete deprotection of cyclic structures could not be achieved neither under acidic nor basic conditions. In special acidic

conditions the decyclization of the saccharidic backbone was observed, maybe due to the steric effect of the cyclic thionocarbamate.

- ☑ Some of the chemistry of D-psicose, a “rare sugar”, which has not yet been much explored in literature has been further developed.

Some of these molecules have been submitted to biological tests (Chapter VI).

On a more specific point, regarding the selective iodination, it can be assumed that:

- ☑ Regio and stereoselective iodination on diol and triol carbohydrate templates have been achieved.
- ☑ The yields of conversion are good to satisfactory depending of the kind of derivative and sugar series that we are working on.
- ☑ This selectivity can be applied to different sugar families: ketoses and aldoses, but no clear rule could be extracted except the choice of the thermodynamic pathway.
- ☑ It is a shortened access to OZTs which can be useful for iminosugars preparation once those can be prepared from azido compounds similar to ours.

CHAPTER IV

Spiro-thionocarbamates in pyranose form

1. SYNTHESIS OF *SPIRO* OZTs and OZOs IN 3,4,5-tri-*O*-BENZYLATED β -D-FRUCTO- AND β -D-PSICOPYRANO- DERIVATIVES

In the last two chapters, the synthesis of fused thionocarbamates was described. Herein we report the preparation of *spiro*-OZTs and OZOs in D-fructo and D-psico series (Scheme 84). In these approaches we will compare two different methods we have used and improved.

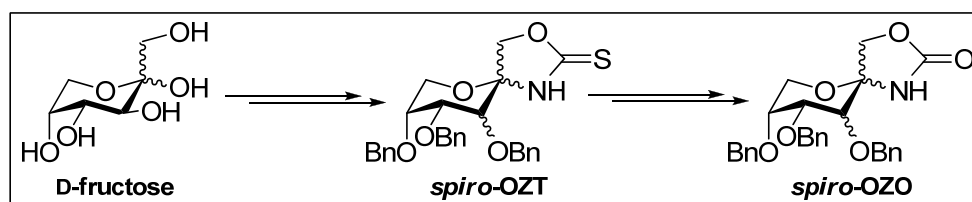

Scheme 84

1.1. Choice of the pathway

The purpose of this chapter is the preparation of *spiro*-OZTs. Considering the different processes discussed in the previous chapters, the appropriate method seems to be the condensation with thiocyanic acid. Another approach with the use of trimethylsilyl isothiocyanate has more recently been reported in the literature.^{22d} Between the two approaches, the first one involves several steps to be efficient; the reaction using TMSNCS is more direct but has not shown significant reactivity, low yields (about 10%) being observed. Those two procedures are going to be developed in this chapter and therefore a brief description of both seems to be appropriate.

1.1.1. Condensation with HSCN

Preparation of carbohydrate-derived thionocarbamates by condensation of HSCN on *O*-unprotected sugars was initially described by Zemplén. The reaction implies the anomeric position and the neighboring hydroxyl group able to cyclize intramolecularly with the transient isothiocyanate. The condensation gives the thermodynamically most stable OZT. Curiously, this pioneering method has been no so well studied. The first assays were performed in two

standard sugar families, an aldose^{73a} (D-glucose) and a ketose^{73b} (D-fructose), and the products obtained were believed to be OZTs fused on pyrano backbones (Figure 17).

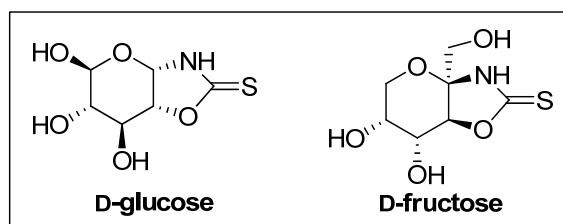

Figure 17

Ten years later, Herbst and Bromund explored other aldose series (D-galactose, D-xylose and L-arabinose) and came to similar structural conclusions (Figure 18).^{73c}

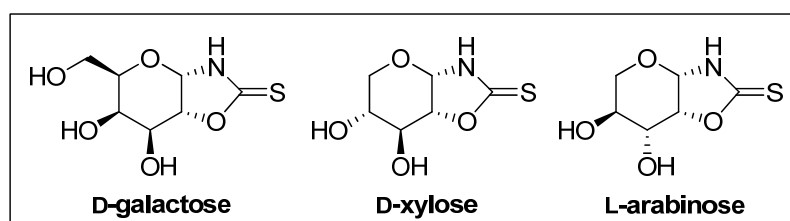

Figure 18

However, structural determination was not completely accepted and it was an issue of contentious discussions for some time. In 1959, Wickstrom and Wold decided to reconsider the studies previously carried out.^{73d} Characterization tests such as periodate oxidation, IR and UV spectral measurements were performed to confirm and correct the structures previously postulated. Therefore it was demonstrated that the structures obtained were indeed fused bicyclic OZTs: those arising from aldoses were in furano form while those from ketoses were in pyrano form (Figure 19). This conclusion was additionally confirmed by the first NMR analysis of OZT moieties performed by Jochims.^{73e}

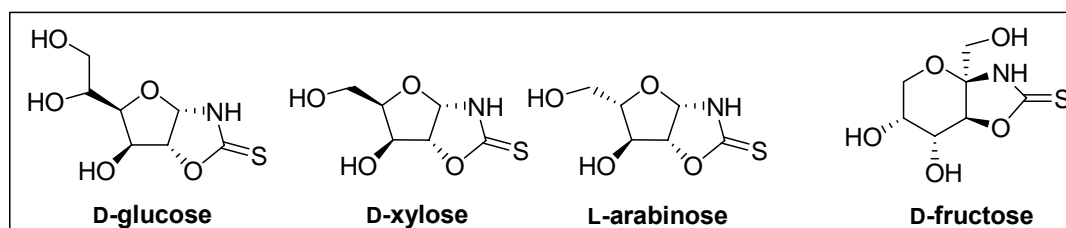

Figure 19

In 1975, Ranganathan reported about nucleosides using D-arabinofurano-derived OZTs as precursors.^{23a, 23b} In the same lines, Imbach worked with D-xylo-derived bicyclic OZTs.^{23c, 23d, 23e} Valencia strengthened later this hypothesis:^{73f} aldo-series originated mostly bicyclic OZTs on furano frames, contrary to the first erroneous interpretations of Zemplén.^{73a, 73b} But if there is a consensus about the structure obtained with aldoses, the same cannot be said for ketoses. As it was argued by Zemplén, Wickstrom and Wold, the condensation of HSCN with ketoses leads to the formation of pyrano structures. In 1988, Grouiller *et al.* raised a controversy by defending the formation of a mixture of fused pyrano and furano OZTs (Figure 20).^{23e}

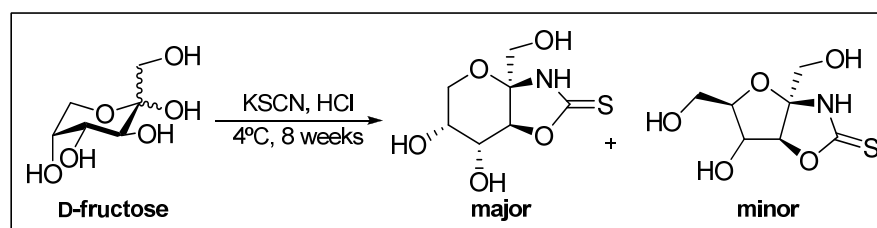
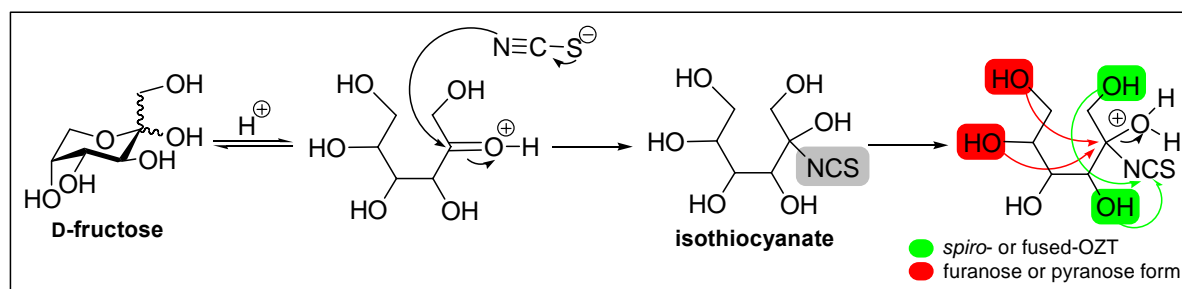

Figure 20

In recent years, the OZT subject aroused the interest of our laboratory and several studies were developed in diverse sugar families. In aldose series, Girniene-Rousseau *et al.*^{46a, 52, 55} agreed with the assumptions previously proposed, essentially concluding that this is the only method which can lead directly to OZTs without preliminary protection of the sugar.

When submitted to HSCN condensation, ketoses behave differently. A major problem lies in the lack of chemical selectivity, probably due to the complexity of the tautomeric equilibria and the predisposition of ketoses to form tertiary oxocarbenium ions under acidic conditions. This often leads to the formation of cyclic and open forms mixtures but also inevitably to degradation.^{22c} The reaction mechanism is probably similar to that of aldoses, certainly involving initial formation of an intermediate anomeric isothiocyanate, which will subsequently undergo nucleophilic attack of an α -hydroxyl. The first stage is reversible and leads to the formation of the thermodynamically most stable (Scheme 85).^{61a}



Scheme 85 : The green arrows represent the formation of *spiro*- or fused-OZTs and the red illustrate the attack of OH-5 or OH-6 that could lead to the formation of furano- or pyrano-rings - acyclic structures might also be formed.

From that point, Tatibouët presented a hypothesis that reflects well this complicated ketose chemistry.^{66c} Indeed, it is possible to predict ten different compounds: fused bicyclic structures in furano and pyrano forms, *spiro*-epimers (α/β mixtures), acyclic chain or even *spiro*-bis-OZT (Scheme 86).

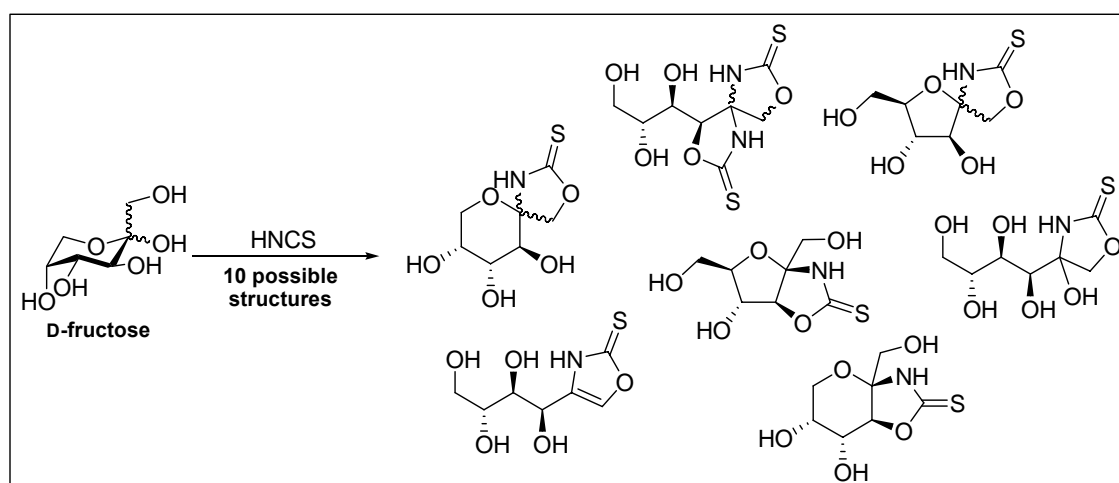

Scheme 86

It has to be mentioned that this statement is supported by previously reported observations by Lichtenthaler: D-fructose reacts with cyanic acid to form four different OZO structures: a furan-fused and three *spiro* derivatives.¹¹⁷

Therefore a complex mixture was attained which did not allow easy separation. In order to solve this problem and understand better the behavior of ketoses, Girniene-Rousseau *et al.*⁵⁵ developed a procedure to facilitate isolation of different products based on Grouiller's results.^{23e}

¹¹⁷ F. W. Lichtenthaler, J. Klotz, F.-J. Flath *Liebigs Ann. Chem.* **1995**, 2069.

Subsequent O-silylation of hydroxyls allowed final isolation in D-fructo series of a fused furano OZT **128** (Scheme 87) and similar results were obtained in the L-sorbo series.

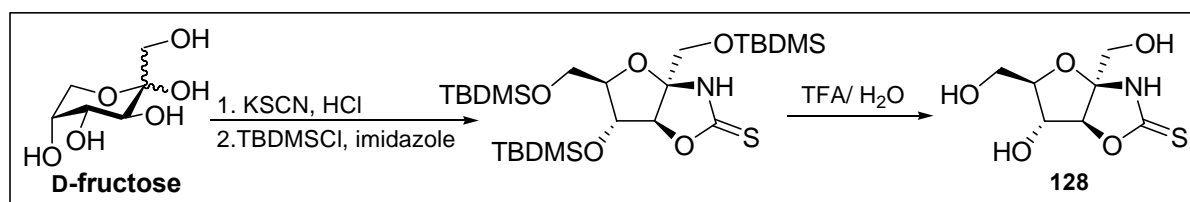

Scheme 87

In 2006, Leconte reported the detection of traces of a D-fructose-derived open chain OXT **129** (Scheme 88).^{66a}

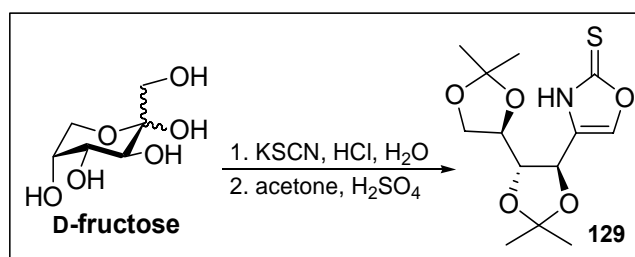

Scheme 88

With a view to increasing the selectivity in OZT construction, *i.e.*, reducing the number of products that can be formed, two routes have been developed in our laboratory: a) targeted preparation of OZTs using selective preliminary protection of the ketose or b) selective subsequent protection of the OZT formed. This methodology proved efficient in selective synthesis of OZTs on ketohexose templates. Until now it was already possible to isolate seven of the ten possible compounds: fused bicyclic structures in furano and pyrano forms, *spiro*-epimers (α/β mixtures), and OXT in acyclic chain.

Herein, our objective was to improve these selective pre- and post-protections in order to increase chemical yields.

From this standpoint, and as a parallel to the HSCN method, we called for a recently described and not much explored TMSNCS methodology,^{22d} which might allow a one-step conversion.

1.1.2. Condensation with trimethylsilyl reagents^{22d}

In 2001, Fuentes reported an unconventional pathway for the synthesis of *spiro* thionocarbamates. The key-step of the method involves reaction of sugars with trimethylsilyl azide (TMSN₃), isothiocyanate (TMSNCS) or cyanide (TMSCN). The mechanism is similar to the one postulated for the condensation with HSCN: after nucleophilic attack at the anomeric position, the isothiocyanate formed undergoes spontaneous cyclization.

a) TMSN₃

To synthesize a *spiro*-D-fructopyrano derivative, TMSN₃ was used in the presence of a Lewis acid, TMSOTf. The initially formed azide is hydrogenated into an amine **130**, which is subsequently condensed with a thiocarbonyl donor (Im₂CS) to furnish the isothiocyanate **131**. Spontaneous cyclization selectively affords in good yield the β-anomer **132** (α:β)=(1:9) (Scheme 89).

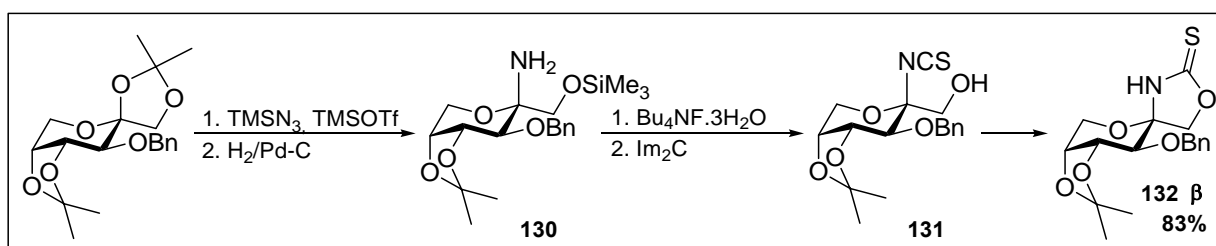

Scheme 89

The same pathway was used in D-psicofurano series: in this case, the isomeric mixture is obtained in *ca* 80% yield but the stereoselectivity (α:β)=(8:2) is in favor of the α anomer **133** (Scheme 90).

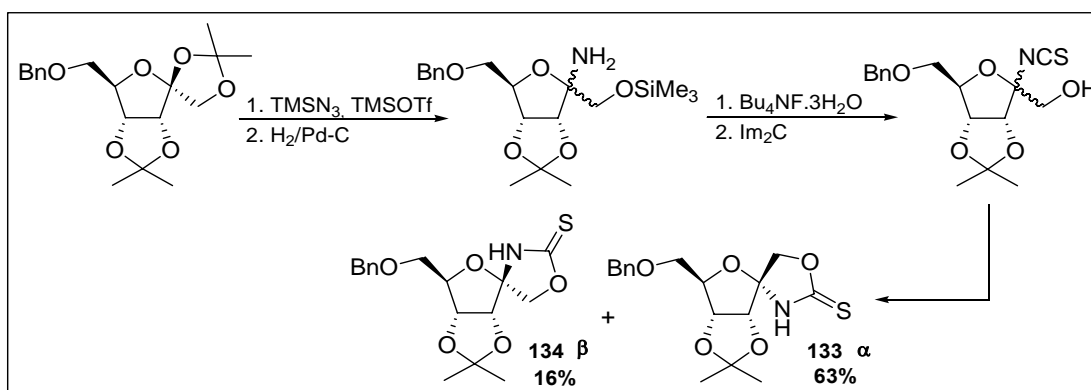

Scheme 90

b) TMSNCS

The use of TMSNCS should allow direct introduction of the isothiocyanate function at the anomeric position, followed by a spontaneous cyclization which reduces OZT formation to a one-step process. This innovative approach unfortunately requires to be optimized, since it produces the *spiro*-OZT **135** in only 10% yield (Scheme 91).

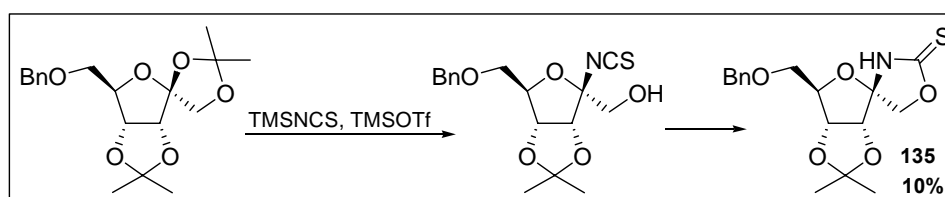

Scheme 91

c) TMSCN

Using TMSCN allows to add an extra carbon atom and therefore renders possible the synthesis of six-membered ring thionocarbamates. Some examples in D-fructo and D-psico series could be found in the literature.^{22d} The first step involves introduction of the CN group at the anomeric position to afford hydroxy-nitriles **136** and **137**; subsequent nitrile reduction then condensation with thiophosgene selectively gives the isothiocyanate **138**. In this case cyclization to the 1,3-oxazine-2-thione does not occur spontaneously, it must be induced by a base to obtain **139** in good yield (Scheme 92).

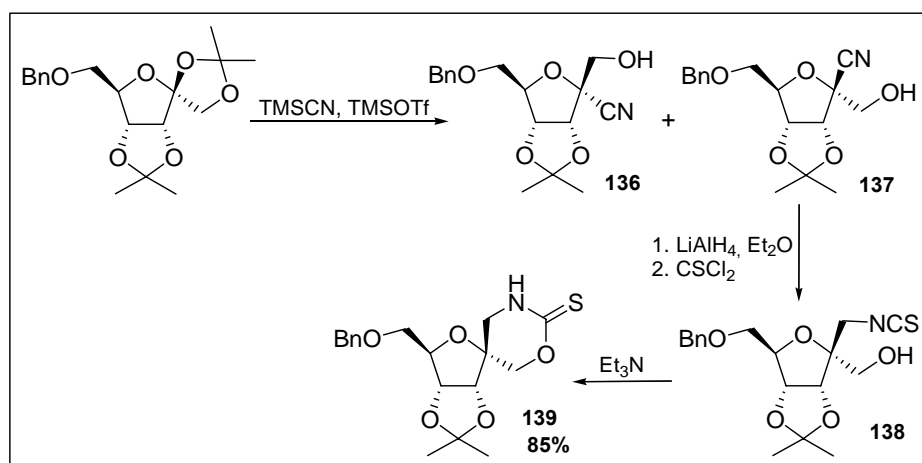

Scheme 92

1.2. Synthesis of *spiro*-OZTs

As mentioned at the beginning of this chapter, our objective was the synthesis of *spiro*-OZTs using either the HSCN or the TMSNCS method. In order to avoid the formation of a complex mixtures of different compounds (see § 1.1.1.), we first had to properly protect our ketose moieties. Once we wanted to prepare *spiro*-OZT OH-3, OH-4 and OH-5 could be protected with a stable protective group and different from the one at the anomeric position.

1.2.1. Ketose protection

Benzyl ethers are among the most popular protecting groups used in glycochemistry. They can be easily introduced by treatment of an alcohol with benzyl halides in the presence of a base. Such standard conditions (BnBr, NaH) were previously applied, Chapter III 1.1.1., with excellent results.

However, performing a triple *O*-benzylation under these conditions was not so effective. Actually, a mixture of several compounds was obtained, including mono-, bis- and tris-protected pyrano systems, the column chromatography of which proved tedious. Terashima has reported improved conditions to realize this reaction by using benzyl chloride (acting both as reagent and solvent), and potassium hydroxide (KOH) at 130°C for 3 h.¹¹⁸ Full protection of triols provided the tri-*O*-benzylated compounds **140** and **141** in excellent yields (Scheme 93).

¹¹⁸ N. Nakajima, M. Matsumoto, M. Kirihara, M. Hashimoto, T. Katoh, S. Terashima *Tetrahedron* **1996**, 52, 1177.

Previously mentioned triols **98** and **119** were prepared following the steps described in Chapter III 1.3.2. and 1.4.1.

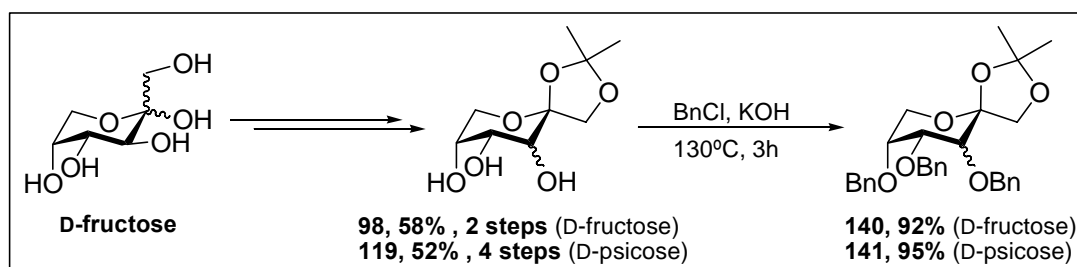

Scheme 93

At this stage the ketoses were ready to undergo condensation with HSCN and TMSNCS to give *spiro*-OZTs without any complex mixture formation.

1.2.2. OZT formation - HSCN

The first method experienced was the condensation with HSCN; once it is a broadly exploited procedure in our laboratory.

The reaction took place in two stages: a) cleavage of isopropylidene group under acidic conditions b) condensation with HSCN followed by spontaneous cyclization to give *spiro*-OZTs **144** and **145**. This two-step reaction is a simple process since intermediates **142** and **143** were not isolated and immediately engaged in the following transformation.

The result was a non selective conversion leading to α : β mixtures of *spiro*-OZTs **144** and **145** and open-chain OZTs **146** and **147** (Scheme 94).

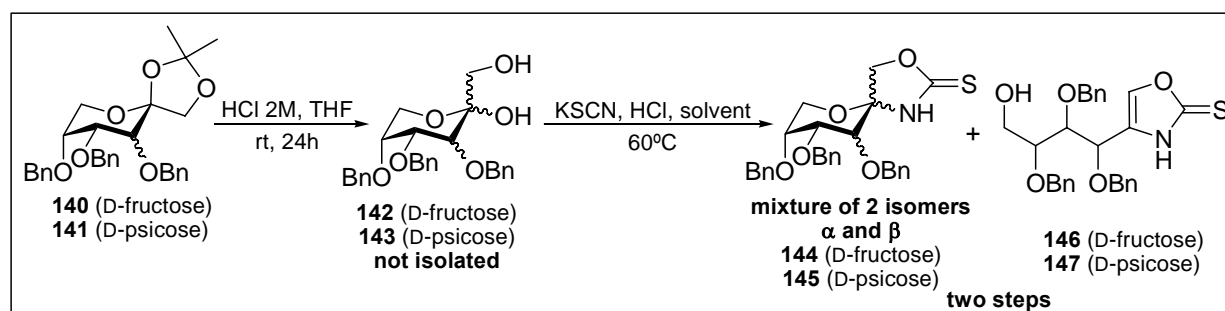

Scheme 94

In order to improve the yields, various solvents were tested. This optimization was done taking into account a study developed by Silva *et al.*^{66b} about the choice of adequate solvent-acid couple for the synthesis of simple OXTs and OZTs.

Table 9

PRODUCT	SOLVENT	TEMPERATURE (°C)	D-FRUCTOSE		D-PSICOSE	
			144	146	145	147
140 / 141	THF	60	52% ($\alpha:\beta$)=(6:4)	-	68% ($\alpha:\beta$)=(5:5)	-
140 / 141 (0.2g)	EtOH	60	78% ($\alpha:\beta$)=(5:5)	-	70% ($\alpha:\beta$)=(5:5)	-
140 / 141 (6g)	EtOH	60	62% ($\alpha:\beta$)=(5:5)	20%	56% ($\alpha:\beta$)=(5:5)	15%

The best results in D-fructo and D-psico series were obtained with ethanol (Table 1). The anomeric ratio established after deprotection correlated well with the 5:5 $\alpha:\beta$ -ratio obtained for **142** and **143**; for both cases it was not possible to separate the anomers. As can be seen, a low yield of acyclic compounds **146** and **147** could be obtained, albeit in one assay only. The above OZT preparation could be scaled up to 6g starting material.

1.2.3. OZT formation - TMSNCS

TMSNCS is used in a one-pot procedure and stereoselectivity at the anomeric position can be observed. Such selectivity could be explained by the fact that the ketopyrano precursors were already in β form (Scheme 95).

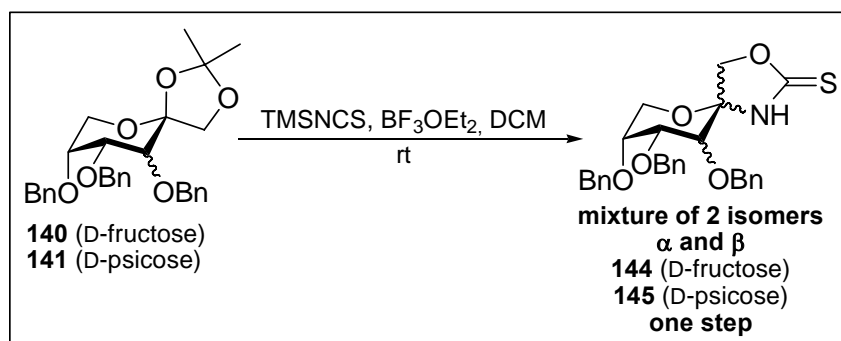

Scheme 95

We first applied the conditions developed by Fuentes, namely TMSNCS, TMSOTf at room temperature.^{22d} As expected, only traces of the desired compound were detected. Changing the Lewis acid from TMSOTf to BF₃.OEt₂ at 0°C mostly resulted in degradation, whereas working at -78°C froze the reactivity. Increasing the number of TMSNCS equivalents proved to be more effective. The conditions optimized in D-fructo series - TMSNCS (3.0 eq), BF₃.OEt₂ (1.0 eq) at room temperature - were subsequently applied to the D-psico series. Major formation of the β anomer was observed for the D-fructo OZT **144** (66% yield, α:β=1:9) and the D-psico OZT **145** (47% yield, α:β=2:8) (Table 10).

Table 10

PRODUCT	SOLVENT	REAGENTS	TEMPERATURE	D-FRUCTOSE	D-PSICOSE
				144	145
140	DCM + tamis	TMSNCS (3eq) TMSOTf (1eq)	- 78°C to rt	traces	-
140	DCM + tamis	TMSNCS (1eq) BF ₃ OEt ₂ (1eq)	0°C to rt	traces and degradation	-
140	DCM + tamis	TMSNCS (1eq) BF ₃ OEt ₂ (1eq)	- 78°C to rt	traces	-
140 / 141	DCM + tamis	TMSNCS (3eq) BF₃OEt₂ (1eq)	- 78°C to rt	66% (α:β)=(1:9)	47% (α:β)=(2:8)

1.2.4. Comparison of methods

It can be noted that both methods are efficient for the synthesis of *spiro*-OZTs. Despite of slightly superior yields obtained with the HSCN condensation, the use of TMSNCS brings the advantages of a one-step procedure and better stereoselectivity in favor of the β -anomers.

Table 11

	D-FRUCTOSE	D-PSICOSE
METHOD	144	145
HSCN	78% (α : β)=(5:5)	70% (α : β)=(5:5)
TMSNCS	66% (α : β)=(1:9)	47% (α : β)=(2:8)

In either D-fructo or D-psico series, separation of the anomeric forms was challenging: only traces of both α isomers **148** and **149** could be isolated for characterization (Figure 21). This separation was only possible through a very slow and meticulous silica gel column chromatography.

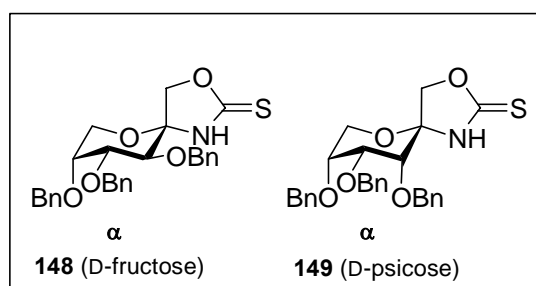

Figure 21

These structures were determined by NOESY experiments which showed the constant coupling of long distance between the H-1 and H-6. Furthermore the C-2 chemical shifts are about 92.6 ppm for both **148** and **149** which is characteristic of α structures.

1.3. Synthesis of *spiro*-OZOs

Notwithstanding our main concern - OZT syntheses – we had to take into consideration the importance of OZOs in the literature^{84, 85} and it seemed therefore quite interesting to study the oxidative desulfurization of OZTs **144** and **145**, to be able to introduce some biological comparison between both structures.

Oxidative desulfurization can be achieved by three different routes, which have already been introduced in Chapter II 2.1.4.: 1) direct oxidation 2) oxidation after *N*-protection or 3) oxidation after *S*-alkylation.

1.3.1. *S*-alkylation

Since *S*-alkylation had given good results when applied to 3,4-fused OZT, the same procedure was adopted. Compounds **144** and **145** were *S*-benzylated using BnBr and NaHCO₃ as base in DCM at room temperature (Scheme 96). The results were excellent: indeed the 90% yields obtained were better than reported in literature,^{24c, 46a, 52b} but more surprisingly this procedure allowed easy column chromatography separation of spiro-epimers. In D-fructo series **150** and **152** were obtained with 48% and 43% yields, and in D-psico series **151** and **153** were obtained with 43% and 47% yields.

Tatibouët initially tried to perform separation of stereoisomers *via N*-acetylation in D-fructo series but without good results.¹¹⁹ Only 9% and 16% yields were respectively obtained for α and β isomers.

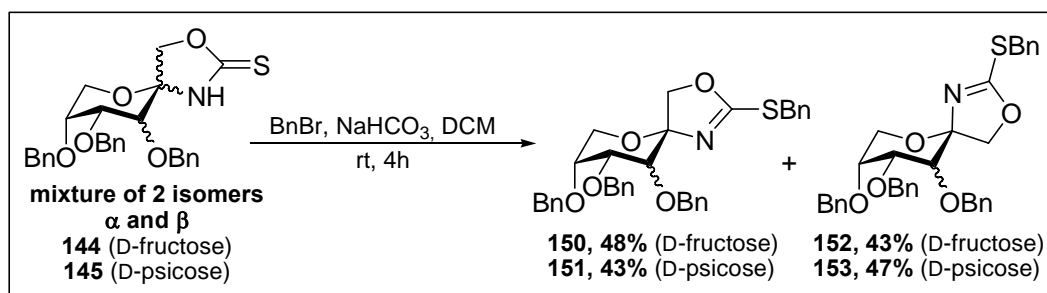

Scheme 96

¹¹⁹ A. Tatibouët, S. Lawrence, P. Rollin, G. D. Holman *Synlett* **2004**, *11*, 1945.

1.3.2. Oxidation

The oxidizing reagent chosen was 77% *m*-CPBA, which is currently used in our laboratory to perform this kind of transformation. OZOs **154**, **155**, **156** and **157** were obtained with acceptable yields - 65% and 64% in D-fructo series; 69% and 52% in D-psico series (Scheme 97).

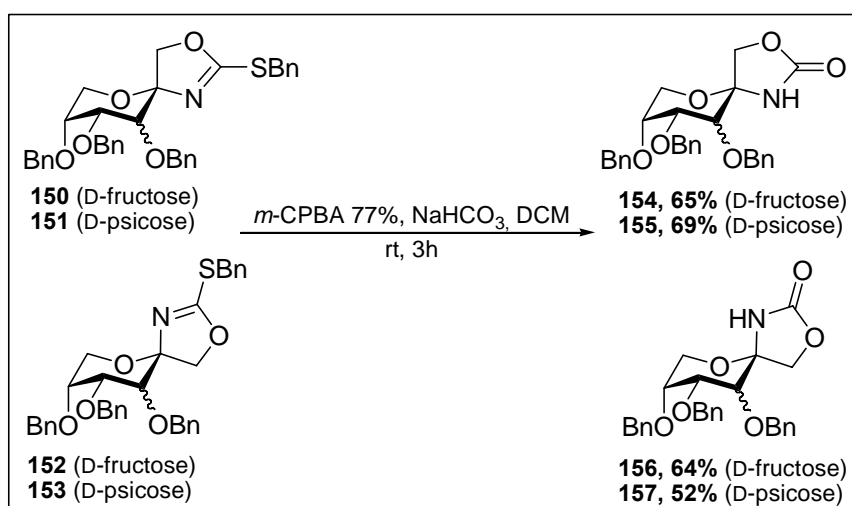

Scheme 97

In Chapter II 1.4.3., we have observed that oxidation with *m*-CPBA was not as efficient as with H₂O₂. However due to lack of time, no test was effected with this reagent.

1.3.3. Deprotection assays

The complete deprotection of the OZO was effected by catalytic (10% Pd/C) hydrogenolysis (Scheme 98). The unprotected α -isomers **158** and **159** were obtained with low yields - 25% and 34% respectively – but the results were better for β isomers **157** and **161**, with 68% and 56% yields, respectively. Nevertheless those yields were lower than what can be expected in such de-*O*-benzylation processes. This could be due to the presence of several benzyl groups: indeed tri-, di- and mono-benzylated compounds were detected on TLC after four days reaction.

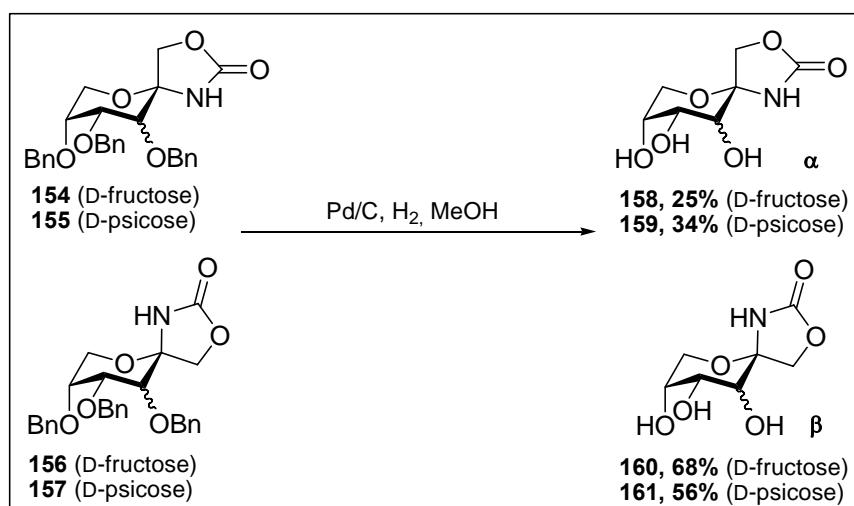

Scheme 98

In order to improve the yields and to accelerate the reaction, a catalytic amount of AcOH can be added, as reported in the literature.¹²⁰

Py & coll. described good results with using boron trichloride in DCM for the deprotection of benzyloxy-substituted nitrones.¹²¹ However when applied to our OZO with varying reaction time and temperature, those conditions failed to bring improvement in de-O-benylation.

1.4. Conclusion

In this part of chapter IV we have focused our attention on the synthesis of *spiro*-pyrano OZTs and OZOs in D-fructo and D-psico series starting from tri-O-benzylated compounds (Scheme 99).

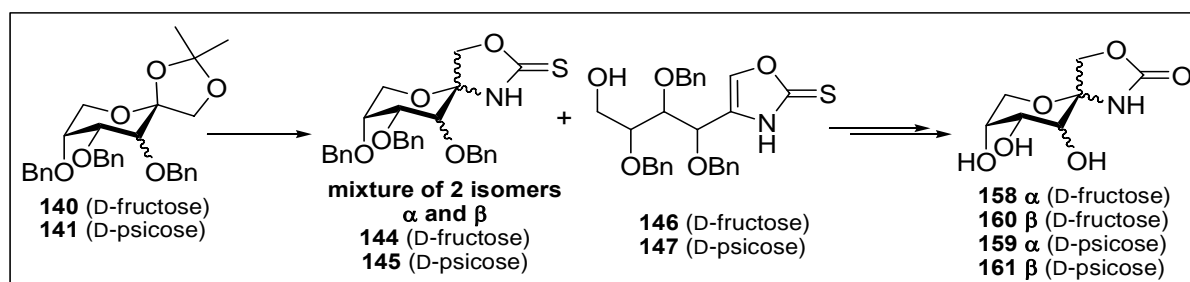

Scheme 99

¹²⁰ C. A. Centrone, T. L. Lowary *J. Org. Chem.* **2002**, *67*, 8862.

¹²¹ S. Desvergnès, Y. Vallée, S. Py *Org. Lett.* **2008**, *10*, 2967.

From the results obtained, we can report some preliminary statements:

- ☑ The purpose of pre-selective protection in order to control the products formed was efficient by 3,4,5-*O*-benzylation it were only obtained *spiro*-OZTs.
- ☑ Both methods for *spiro*-OZT preparation were effective using either HSCN or TMSNCS.
- ☑ An original and attractive procedure for direct synthesis of *spiro*-OZTs using TMSNCS has been improved from 10% (literature) to 47-66% of yield.
- ☑ Stereoselectivity at the anomeric position can be controlled depending on the type of reaction performed. The β -isomer is preferentially formed with TMSNCS .
- ☑ *Spiro*-OZTs have been prepared in good yields, but separation of isomers is rather difficult; nevertheless small amounts of β -isomers in D-fructo and D-psico series were obtained for characterization.
- ☑ S-alkylation was performed with excellent yields. Furthermore it has allowed perfect separation of the α - and β -anomers by simple silica gel column chromatography.
- ☑ *Spiro*-OZO were also prepared by a reaction sequence that allowed the preparation of each isomer separately in acceptable yields.
- ☑ The de-*O*-benzylation of the α -isomer was difficult to perform, whereas with the β -isomer acceptable yields were obtained.

Some of these molecules were submitted to biological tests (Chapter VI).

2. SYNTHESIS OF *SPIRO* OZTs IN 3-O-BENZYLATED β -D-FRUCTO- AND β -D-PSICOPYRANO AND -FURANO DERIVATIVES

Using a 3,4,5-*O*-protection of the starting material allowed selective preparation of *spiro*-OZTs in pyrano form. Once that early studies developed in our laboratory have revealed that *spiro*-OZTs in furanose form bearing a benzyl group show improved biological properties, ^{Erreur!} Signet non défini. we wanted to develop a specific approach to *spiro*-OZTs anchored on such frames.

2.1. Synthesis of *spiro*-OZTs in D-fructo series

Unlike D-psicose, D-fructose is readily available and cheap; among ketohexoses, it is also by far the one whose chemistry is the best documented. Therefore our experiments were first optimized in D-fructo series then applied in the D-psico series.

2.1.1. Choice of the pathway

With the purpose of preparing *spiro*-OZTs in furano form, we have chosen a pre-selective protection approach and subsequent OZT formation, which reduced the number of products to four OZTs, instead of a mixture of ten.

2.1.2. Synthesis of *spiro*-OZTs

The starting 3-*O*-benzylated D-fructo derivative **57** was prepared following the sequence described in Chapter III 1.1.1. and we have applied a similar approach as that previously used for the tri-*O*-benzylated derivatives. A two-step protocol involved isopropylidene acid hydrolysis to yield the intermediate **162**, which was then condensed with thiocyanic acid. A one-step protocol using TsOH and HSCN also gave the OZTs, but both methods resulted, as expected, in a mixture of four products: both α - and β -isomers of *spiro*-OZTs in furano and pyrano form (Scheme 100). In the present case, it was quite difficult to estimate the isomeric ratio of the compounds; the separation of such a complex mixture was rather tricky.

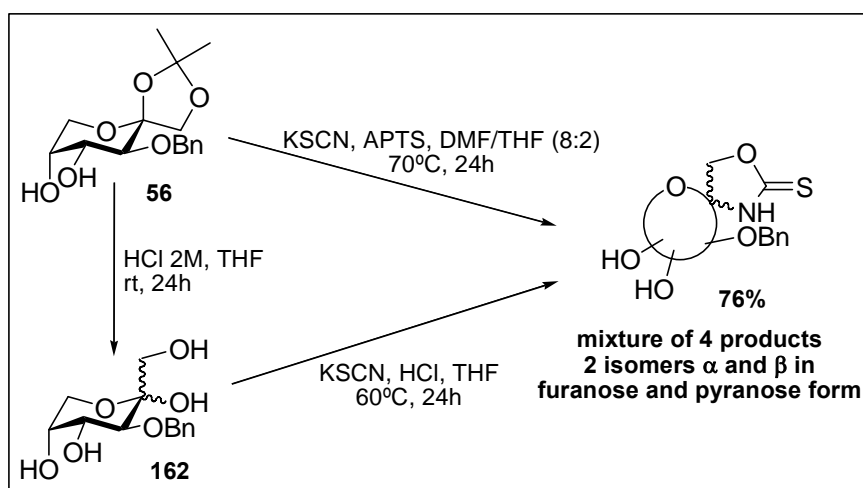

Scheme 100

2.1.2. Isolation of the products

In order to purify the mixtures of OZTs, some chemical modifications were required. Those were performed through selective protections and / or functionalization.

a) By protection

Several protecting groups were tested to separate furano- from pyrano-*spiro*-OZTs (Scheme 101).

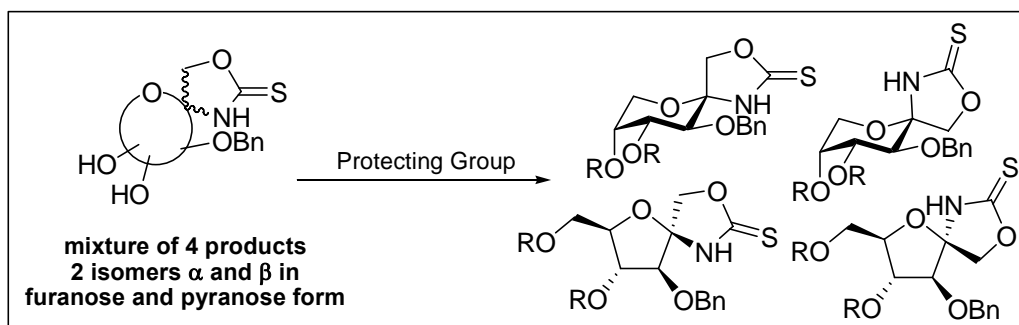

Scheme 101

First attempt to separate the OZTs involved acetylation using Ac_2O but only a mixture of fully acetylated compounds was obtained. Insertion of an isopropylidene group was then experimented. The purpose was simultaneous protection of OH-4 and OH-5 in the pyranose structures, with a view to inducing a chromatographic difference between the two ring forms. Two procedures were tested: acetone-dimethoxypropane with CSA and acetone/sulfuric acid.

The best results with the first procedure were 6% and 27% yields of isolated α - and β -pyranose forms **163** and **164**, while in both attempts unseparated α : β mixtures were respectively obtained in 11% and 24% yields. In other respect, the second procedure allowed isolation in 16% yield of the unprotected furano OZT. Other protection attempts were performed with TBDMSCl: complex mixtures of mono- and di-*O*-silylated α and β , pyranose and furano forms were obtained, therefore the idea was to selectively protect the primary hydroxyl of furano forms. Using just one equivalent of TBDMSCl, mono-*O*-silylated α - and β -furano-OZT were obtained in 10% yield (Table 12).

Table 12

R	CONDITIONS	RESULTS
Ac	Ac ₂ O, pyridine, rt, 15h	mixture of the acetylated products α and β in pyranose and furanose forms
isopropylidene	acetone, H ₂ SO ₄ , rt, 15h	<i>α-pyranose 163=6% β-pyranose 164=27%</i> <i>mixture pyranose α and β 11%</i> <i>furanose α and β not isolated</i>
	dimethoxypropane, CSA, acetone, rt, 15h	pyranose α =5% pyranose β =9% mixture pyranose α and β 24% furanose α and β not protected 18%
TBDMS	TBDMSCl (3.0eq), imidazole, THF, rt, 15h	mixture of products mono and di-silylated α and β in pyranose and furanose forms
	TBDMSCl (1.0eq), imidazole, THF, rt, 15h	furanose α and β mono-silylated 10%

The separation of *spiro*-OZTs in both furano- and pyrano- forms could be achieved albeit with not very encouraging results. Nonetheless the isolated compounds are interesting for characterization and for biological testing (Chapter VI).

b) By S-alkylation

Previously, for the tri-*O*-benzylated compounds, it was observed that isomers separation was possible using an *S*-functionalization. After application of nearly quantitative *S*-benzylation

to, effective separation of the epimers **165** and **166** was performed with 52% and 47% yield, respectively (Scheme 102).

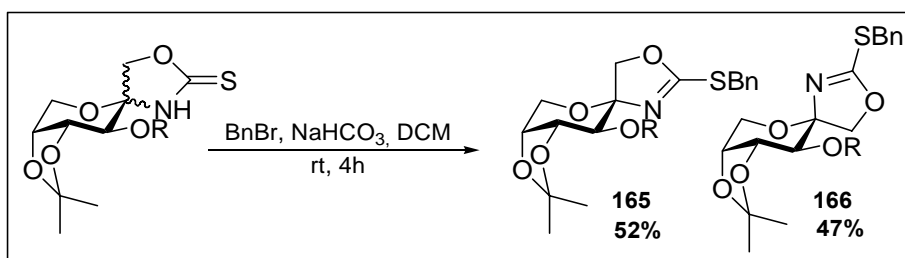

Scheme 102

From that point, we decided to perform *S*-benzylation on the mixture of four products, in order to check whether a separation of the alkylated products would be facilitated (Scheme 103). Unfortunately, no clean separation of the *S*-alkylated mixture was achieved.

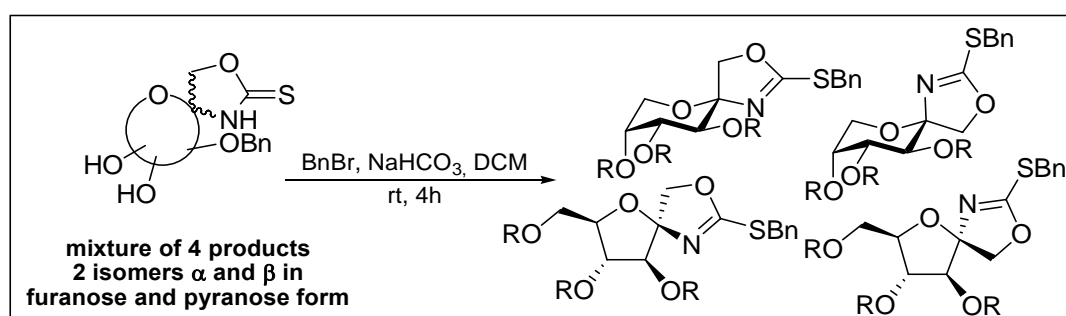

Scheme 103

2.1.3. An unexpected OZT

An alternative procedure to prepare *spiro*-OZTs **163** and **164** would be starting from the protected di-*O*-isopropylidene **56** and using the TMSNCS approach. Accordingly, an experiment with TMSNCS was made and led to an unexpected result. Instead of obtaining a clean conversion to the α : β *spiro*-OZTs, numerous compounds were formed, as indicated by TLC monitoring. Among those products, we were able to identify a minor (4% yield) OZT connected to an open-chain **167** (Scheme 104).

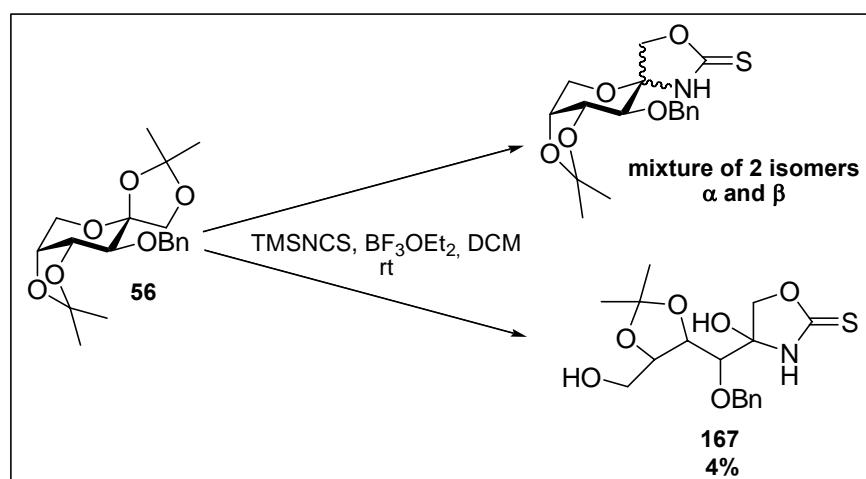

Scheme 104

2.2. Synthesis of *spiro*-OZTs in D-psico series

Although not exceptional, the results obtained in D-fructo series contributed to a better understanding of ketose behavior. Altogether, the synthesis and characterization of interesting new OZTs allowed to enrich our library of thionocarbamates. On another hand, D-psico derivatives have not been much explored yet and that called for further experiments in the D-psico series.

A similar approach was considered and analogous results were achieved (Scheme 105). Condensation with HSCN led to the formation of a four-compound mixture containing α- and β-isomers in furano and pyrano forms. Subsequent isopropylidene protection was performed and both α- and β-*spiro*-OZTs isomers in pyrano form were obtained in 31% yield. The furano unprotected compounds were not isolated.

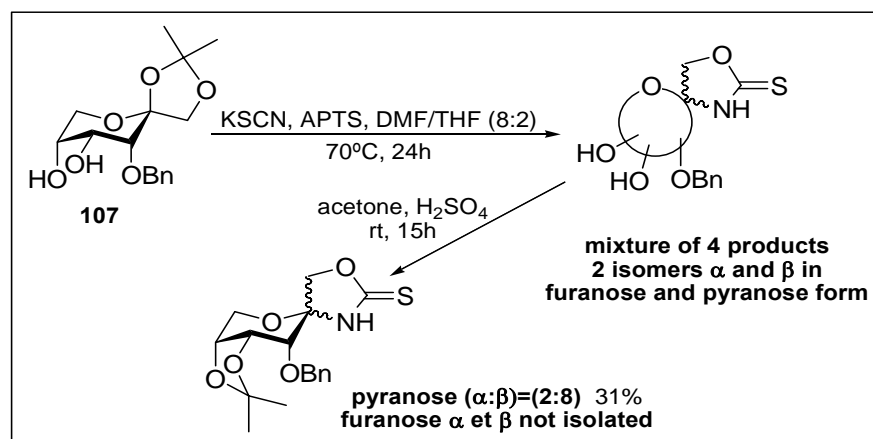

Scheme 105

2.3. Conclusion

In this part of the Chapter IV we have focused our attention on the synthesis from 3-O-benzylated precursors of *spiro*-OZTs in furano and pyrano forms in the D-fructo and D-psico series (Scheme 106).

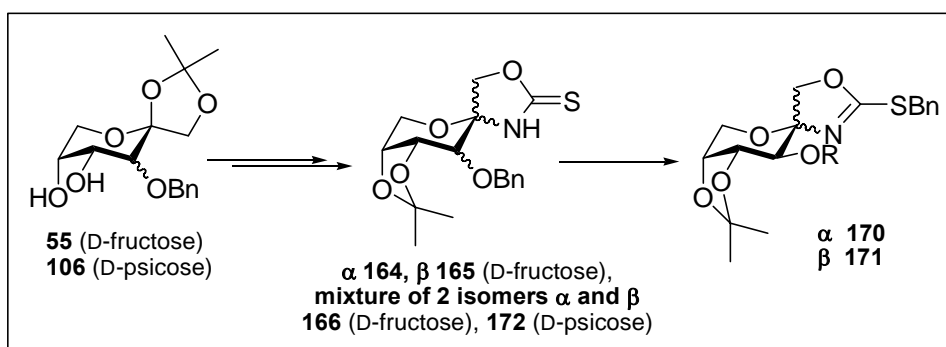

Scheme 106

From the results obtained, we can put forward some preliminary statements:

- ☑ Starting with a 3-O-benzylated precursor, both pyrano and furano *spiro*-OZTs could be prepared.
- ☑ In both series, the effective isolation of the *spiro*-OZTs proved to be rather complicated especially with the furano forms.
- ☑ Once again S-alkylation proved to be an excellent method for the separation of *spiro*-OZT isomers but was only effective on pyrano entities.

Some of these molecules were submitted to biological tests (Chapter VI).

CHAPTER V

2,3-Fused and spiro thionocarbamates in furanose form

1. SYNTHESIS OF *SPIRO*- AND FUSED OZTs BUILT ON D-TAGATO AND D-PSICOFURANO FRAMES

In this chapter we are going to illustrate the thionocarbamate chemistry of another ketose - D-tagatose. This sugar is a C-4 epimer of D-fructose, whose chemistry has not been much explored according to the literature. Furthermore a chemical comparison with D-psicose in furano form will be reported.

1.1. Preparation of D-tagatose

D-Tagatose is currently manufactured, but even if its commercial production is already well developed (and on a large scale) it remains extremely expensive: the cost of 1g D-tagatose is ca 200€, while the cost of 100g of D-fructose is around 15€ ! Taking into account this huge difference of price, it looked interesting to prepare D-tagatose from its cheap C-4 epimer.

1.1.1. From D-fructose to D-tagatose series

In Chapter III 1.4.1. we reported the conversion of D-fructose into D-psicose through a simple inversion of the C-3 configuration via an oxidation-reduction sequence.

However, due to the conformational characteristics of D-tagatose, this type of transformation seems to be more tricky in this case, the selective access to C-4 being more complicated. Transposition of the D-psicose synthetic pathway to D-tagatose would require several protection/deprotection steps, which would make the procedure difficult and not very productive (Scheme 107). Furthermore selective oxidation was already tried without success, Chapter III 1.1.

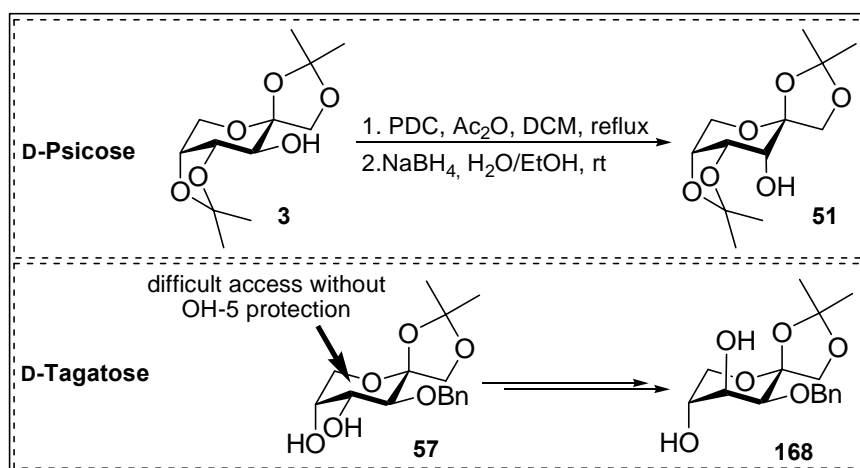

Scheme 107

Another possible pathway already described by Miethchen¹²² could be a non-conventional acetalation/epimerization procedure involving a D-fructopyrano triol derivative, **98**. In the presence of chloral and DCC, cyclic acetals are formed with simultaneous inversion of the configuration at C-4. The major drawback of the reaction sequence is the moderate overall yield (ca 30%) for **169**; however this can be considered acceptable for such a straightforward synthesis (Scheme 108).

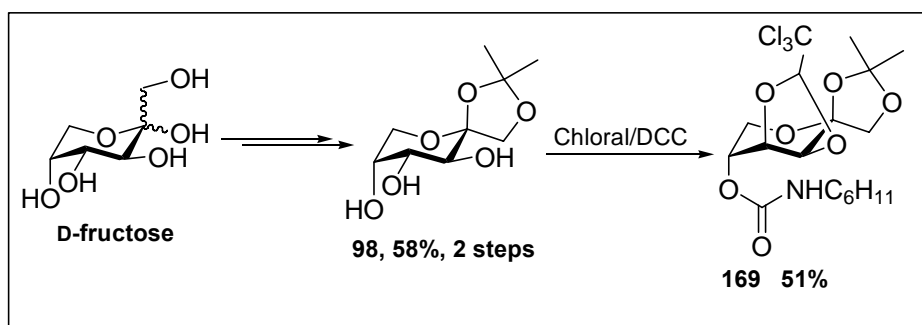

Scheme 108

a) Epoxide formation

Therefore we decided to explore a different route and use the chemistry already developed in the previous chapter, using an epoxide as intermediate. This can be achieved following diverse approaches: however, the choice was put on an iodo intermediate because of the satisfactory procedure previously developed in Chapter III 1.3.2.

¹²² M. Franck, R. Miethchen, D. Degenring *Carbohydr. Res.* **1999**, 318, 167.

The reaction was a standard base-catalyzed cyclization of iodohydrin **97** to give the 4,5-epoxide **170** with excellent yield (Scheme 84).¹²³

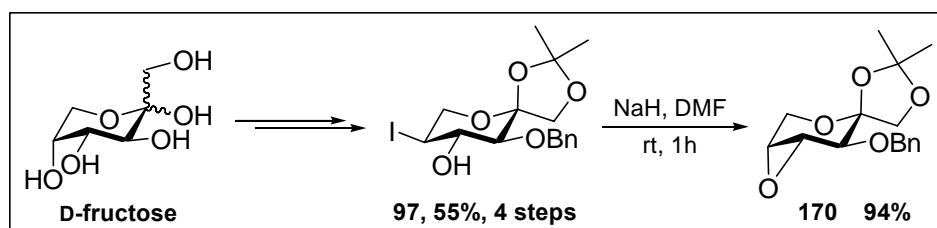

b) Epoxide opening

In general, the nucleophilic opening of such juxtacyclic epoxides occurs regioselectively under stereoelectronic control, the axial attack taking place preferentially to produce the *trans*-diaxial product (Fürst-Plattner rule). Nucleophiles are expected to attack **170** at C-4, causing the breaking of a C-O bond and leading to *trans*-diaxial compounds **171-173**. Unfortunately in this case, the epoxide underwent opposite opening to afford the *trans*-diequatorial product, a L-sorbo derivative.

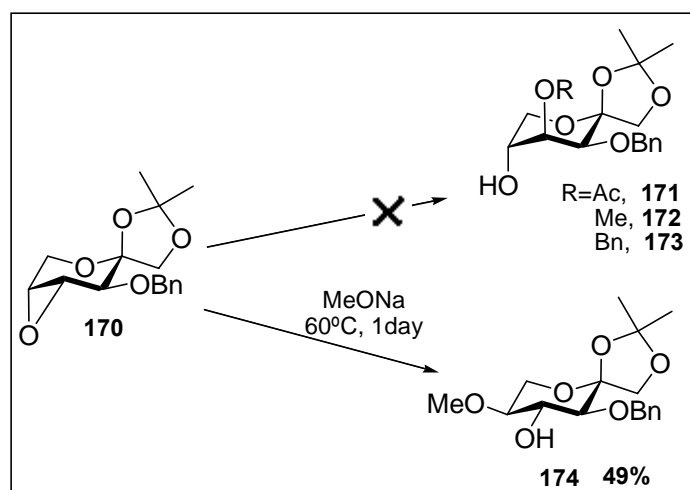

The nucleophilic ring cleavage of epoxide **170** was therefore investigated in miscellaneous (basic or acid) conditions, however in most cases no reaction occurred, the

¹²³ (a) K. Krohn, D. Gehle, U. Flörke *Eur. J. Org. Chem.* **2005**, 4557; (b) M. Samadi, C. Munoz-Letelier, S. Poigny, M. Guyot *Tetrahedron Lett.* **2000**, *41*, 3349.

starting material **170**, always being entirely recovered. Only MeONa in methanol solution at 60°C effected epoxide opening to give a moderate yield of the L-sorbopyrano compound **174**. The attack and inversion at C-5 might be favored by the stability of the resulting all-equatorial system: indeed a similar result was obtained in previous iodination studies (Chapter III 1.6.1. and 1.6.2.).

Table 13

	REACTIFS	RESULTS
BASIC CONDITIONS	AcONa, rt, 2 days AcONa, 60°C, 2 days AcONa, 100°C, 4 days	starting material, 170
	MeONa, rt, 2 days MeONa, 60°C, 1 day	starting material, 170 5-OMe (L-sorbose) 174=49%
ACIDIC CONDITIONS	BnOH, BF ₃ OEt ₂ , rt, 2 days BnOH, BF ₃ OEt ₂ , 60°C, 2 days BnOH, BF ₃ OEt ₂ , 100°C, 4 days	starting material, 170

This regioselective inversion could also be induced by the epoxide geometry, which after minimization (Figure 1) showed that both position C-4 and C-5 are quite similar for the nucleophilic approach. The main difference comes from the benzyl substituent which could hamper the attack in C-4 and thus favor the “anti- Fürst-Plattner” nucleophilic opening.

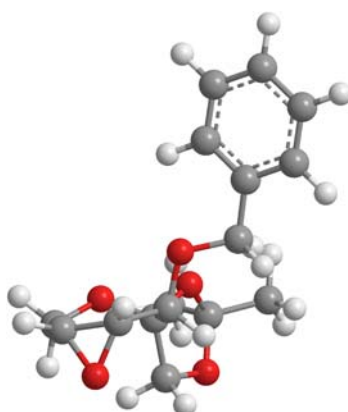

Figure 22

1.2. Conversion of D-tagatose into an OZT

Since it did not seem feasible to synthesize D-tagatose from D-fructose using the epoxide-way, we had to turn to commercially available D-tagatose for OZT synthesis.

Few experiments involving unprotected D-tagatose have been reported. As previously described in Chapter IV 1.1.1., reacting HSCN with an unprotected ketose can result in the formation of ten different OZTs.¹²³ Surprisingly however, applying the standard conditions previously used in other ketohexose series, only acyclic bis-OZTs **175** and **176** were isolated in 61% overall yield and no other thionocarbamate was detected (Scheme 111). Fortunately, the two spiro-epimers could be isolated separately, but the configuration of the newly formed stereogenic carbon could not be established for lack of crystallinity of both epimers.



Scheme 111

The same reaction was subsequently performed with a reduced quantity of KSCN in order to avoid the formation of bis-OZTs: as expected, a mixture of several products was obtained (Scheme 112). A post-protection reaction was thus needed to try and separate the compounds. The TBDMS bulky group was chosen to accomplish selective protection, which might facilitate separation. Only 2,3-fused cyclic thionocarbamates in furano and pyrano form were isolated in 53% overall yield for a two step sequence. Three molecules **177-179** isolated in 20%, 22% and 11% yield, respectively were characterized. No spiro or acyclic structure could be detected. Curiously, compound **177** was shown to be a 2,3-fused OZO, indicating that a sulfur/oxygen exchange had occurred, probably resulting from an hydrolysis. The structure of compound **177** was easily assigned by ¹³C NMR analysis, the chemical shift for C=O being 157.6 ppm in accordance with literature data. The structure of the pyrano compound **179** was

established from the high coupling constant between the *trans*-equatorial H-4 and H-5 ($J_{45}=7.2\text{Hz}$).

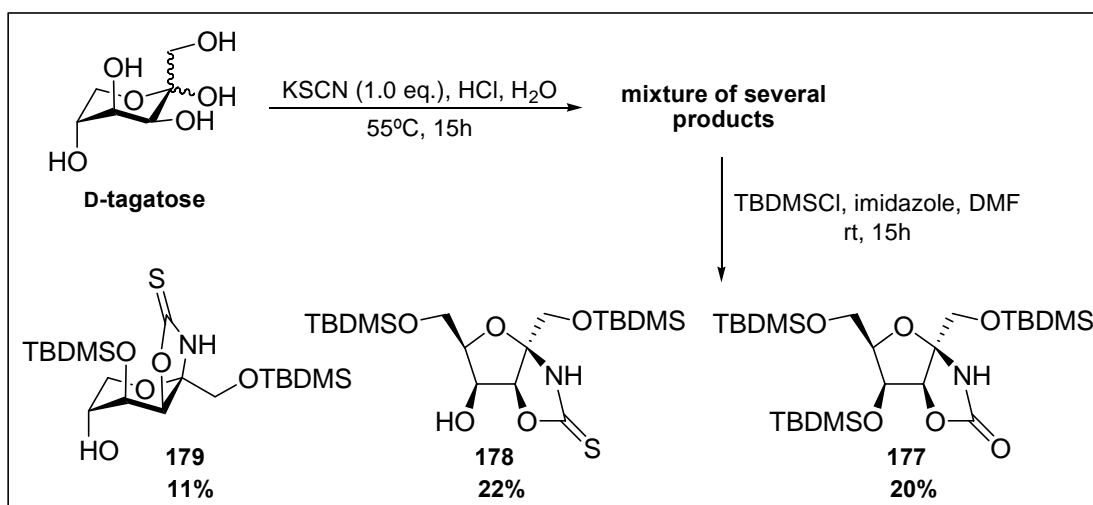

Scheme 112

1.3. D-Tagatose and D-psicose – OZT Selective Formation on Furanose Form

After some assays with unprotected D-tagatose the selective synthesis of some *spiro*-OZTs was then considered, implying pre-protection reactions: the reactivity of D-tagatose and D-psicose both in furano form will be compared.

1.3.1. From pyrano to furano form

a) D-Tagatose

The protection of D-tagatose with isopropylidene groups leads to a furano form, which is induced by the structural relationship of hydroxyls. Both isomers α and β were obtained even if in different proportions (Scheme 113).

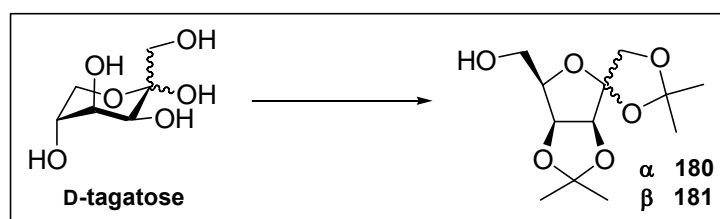

Scheme 113

This protection was performed under acid catalysis using two different reagents. Standard conditions involved acetone with a catalytic amount of H_2SO_4 , as previously used for D-fructose protection (Chapter II 1.3.1.): a mixture of two separable isomers was obtained: α **180** in 67% and β **181** as traces (2.4 %). The second method used 2,2-dimethoxypropane with PTSA catalysis in a 4:5 toluene-DCM mixture at 60-65°C for 18h. In this case only the α isomer was produced in 83% yield and both results were in accordance with literature.¹²⁴ Although better in yield, the second procedure is more susceptible, because of reaction parameters which have to be scrupulously respected to avoid significant yield reductions.^{130b}

Table 14

PRODUCT	CONDITIONS	RESULTS
D-tagatose	H_2SO_4 , acetone, rt, 15h	α 180 = 67% β 181 = 2.4%
D-tagatose	2,2-dimethoxypropane, PTSA Toluene-DCM (4:5), 60-65°C, 18h	α 180 = 83%

b) D-Psicose

The relationship between D-tagatose and D-psicose in terms of configuration is quite obvious: positions 3 and 4 are stereochemically inverted. With this in mind, D-psicose could be protected similarly to D-tagatose as a 1,2;3,4-di-O-isopropylideneketofurano derivative.

More specifically, the passage of D-psicose from pyrano to furano form was performed to give the thermodynamically more stable molecule. Treatment of **104** (obtained following the sequence previously described in Chapter III 1.4.1) with 2,2-dimethoxypropane in acetone in the

¹²⁴ (a) I. Izquierdo Cubero, M. T. P. López-Espinosa *Carbohydr. Chem.* **1986**, *5*, 299; (b) Y. Bechor, A. Albeck *Tetrahedron* **2008**, *64*, 2080.

presence of catalytic perchloric acid gave the β D-psicofurano derivative **182** in 74% yield (Scheme 114).¹²⁵

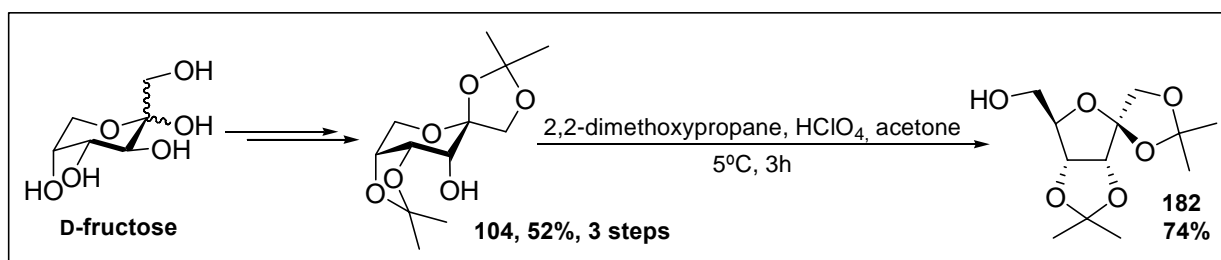

1.3.2. O-Benzylation

In both ketose series, the primary alcohol was protected as a benzyl ether using standard conditions (see Chapter III 1.1.1.). The D-tagato derivative **183** (α isomer) was obtained in 77% yield and D-psico derivative **184** (β isomer) in 83% yield (Scheme 115).

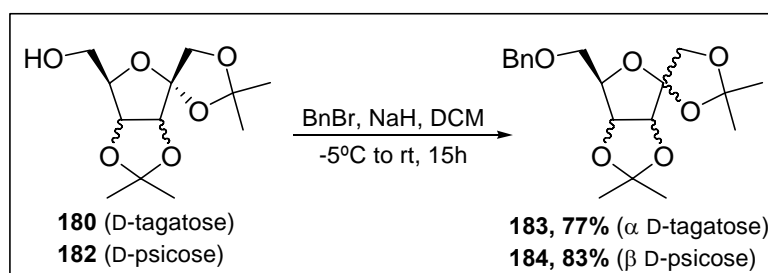

1.3.3. Isopropylidene selective cleavage

Selective 3,4-O-isopropylidene cleavage in D-psico series was experimented but without success: even after 15h at 60°C, the starting material was completely recovered. Whereas this kind of deprotection can easily be performed in pyrano derivatives as mentioned in Chapters II 1.3.2. and III 1.1.1, the furano derivative **184** showed a different behaviour, no selective deprotection being observed.

¹²⁵ S. Mio, Y. Kumagawa, S. Sugai *Tetrahedron* **1991**, *47*, 2133.

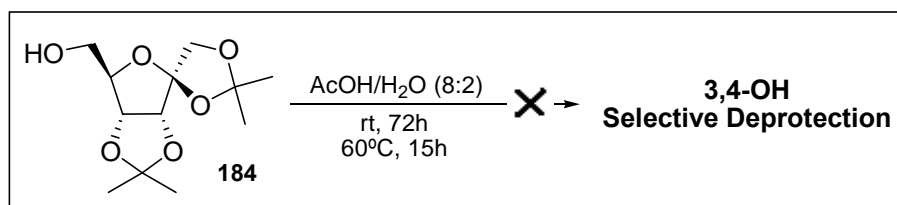

Scheme 116

1.3.4. OZT formation

The selective formation of thionocarbamates will be focused on the preparation of *spiro*- and fused-OZTs at the anomeric position. As mentioned in Chapter IV, two methods will be experimented: a) condensation with HSCN and b) condensation with TMSNCS.

a) Two-step reaction - HSCN

First assays were realized in D-psico series. Compound **184** was subjected to a complete deprotection of ketal groups under acidic conditions (2M HCl). In the presence of HSCN, an untractable mixture of OZTs was produced. By ^1H NMR analysis in DMSO- d_6 , it was possible to observe the presence of three different OZTs: these molecules were most likely the expected *spiro*- and 2,3-fused OZTs in furano form. Separation of the products was attempted through acetylation but without satisfactory results (Scheme 117).

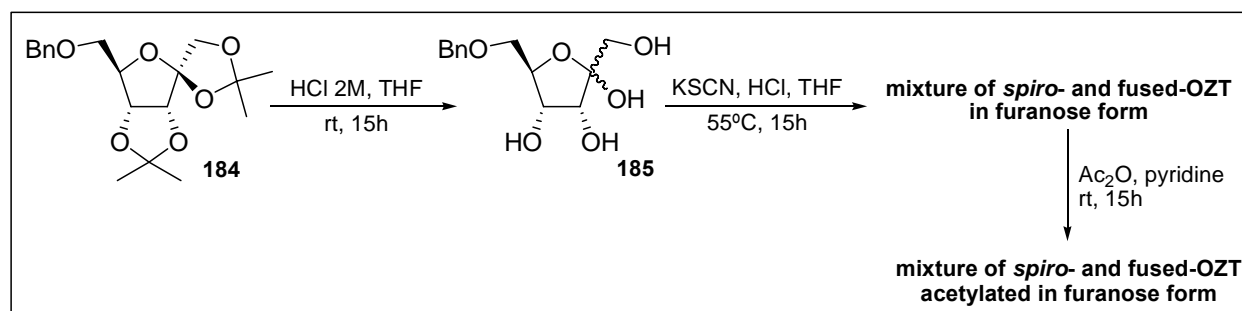

Scheme 117

A second attempt was performed with slightly modified conditions. The two consecutive reactions were carried out in aqueous medium, first effecting deprotection with a 60% TFA solution then condensation with HSCN. For both ketose series, a similar mixture of three compounds was obtained as previously noted. Those mixtures were obtained in good to

excellent yields and a major compound was clearly formed, which was supposed to be the 2,3-fused OZT (**188** or **190**) – however this could not be purified (Scheme 118).

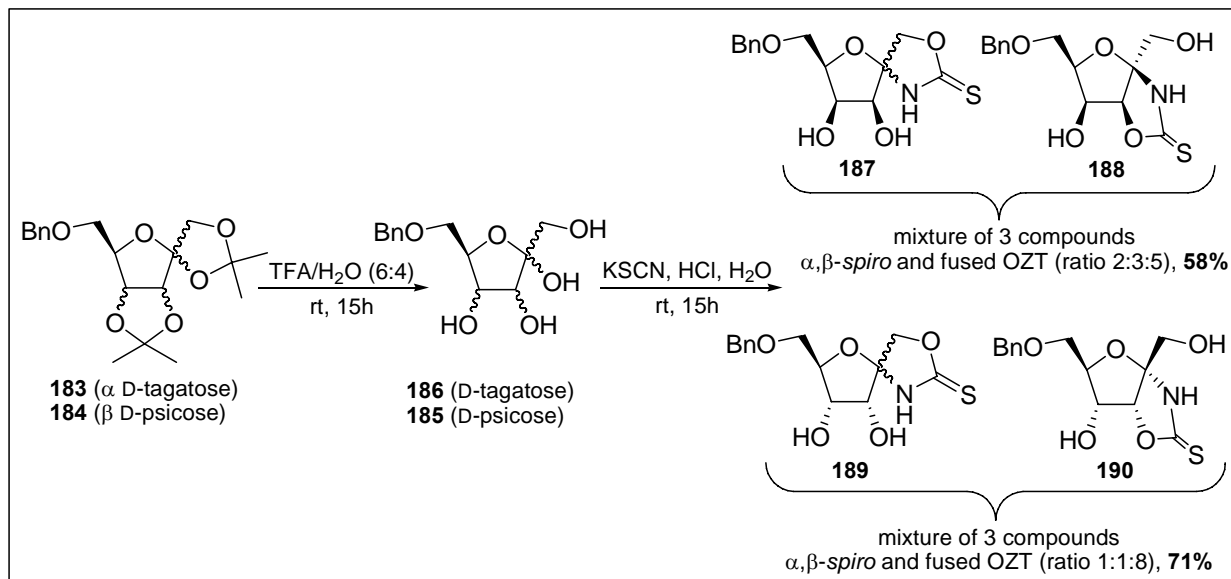

Scheme 118

b) One-step reaction - TMSNCS

The complex results obtained with the two-step reaction drove us to use the one-step approach. Under the TMSNCS/BF₃.Et₂O conditions, the expected *spiro* derivatives were obtained - the OZT but also an unexpected OZO. In the D-tagato series, the formation of an anhydrosugar **194** was also observed and, as previously observed, benzyl group migration led to the di-*O*-benzylated compound **195**. Those secondary reactions took place through the activation of the ketose molecule with the Lewis acid (Scheme 119).

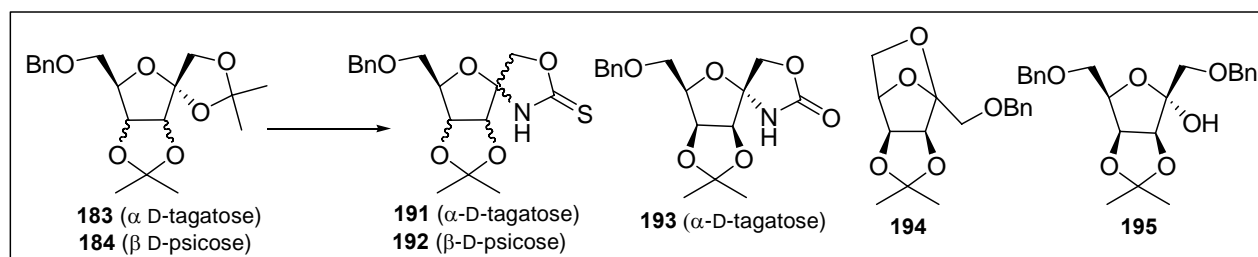

Scheme 119

With the D-tagato derivative **183**, a direct trial with KSCN gave only the starting material. A second assay with TMSNCS gave a mixture of two unseparable *spiro*-structures - the OZT **191** and the OZO **193**. For both compounds only the α anomer was observed. This result corroborates those reported in Chapter IV 1.2.3., when the OZT formation with TMSNCS reagent allowed to control the anomeric configuration. In an attempt to improve the performance of the OZT formation the number of equivalents of TMSNCS was increased, resulting in selective formation of the α -*spiro*-OZT **191** with a lower yield but without the formation of the OZO. Another molecule **195**, resulting from an intermolecular benzylation reaction was also isolated as side-product (Table 15). The conditions using 3 equivalents of TMSNCS were also applied in D-psico series. In this case, the selective formation of the β OZT **192** in 57% of yield was observed, without any side-product resulting from the benzyl migration.

Table 15

PRODUCT	CONDITIONS	RESULTS
183	KSCN, PTSA, (DMF/THF) (8:2) 70°C, 2 days	starting material, 183
183	TMSNCS (3.0 eq.), BF ₃ OEt ₂ (1.0 eq.), DCM, tamis, -78°C to rt, 15h	mixture of 2 α - <i>spiro</i> (OZT:OZO)=(7:3), 191+193 =56% 194 =21%
183	TMSNCS (5.0 eq.), BF ₃ OEt ₂ (1.0 eq.), DCM, tamis, -78°C to rt, 15h	isomer α 191 =42% 195 =13%
184	TMSNCS (3.0 eq.), BF ₃ OEt ₂ (1.0 eq.), DCM, tamis, -78°C to rt, 15h	isomer β 192 =57%

Herein we propose a mechanism for the formation of both secondary products, **194** and **195** (Scheme 120). By action of BF₃OEt₂ there is isopropylidene cleavage in **196**. The O-6 attacks the C-1 to produce the intermediary **197**. By migration of benzyl group from O-6 to O-1 compound **194** is formed. In the other hand it can happens that O-1 takes the benzyl group from intermediate **197** and **195** is obtained. In the two cases only one secondary product was observed at a time but probably both were present however it were not isolated.

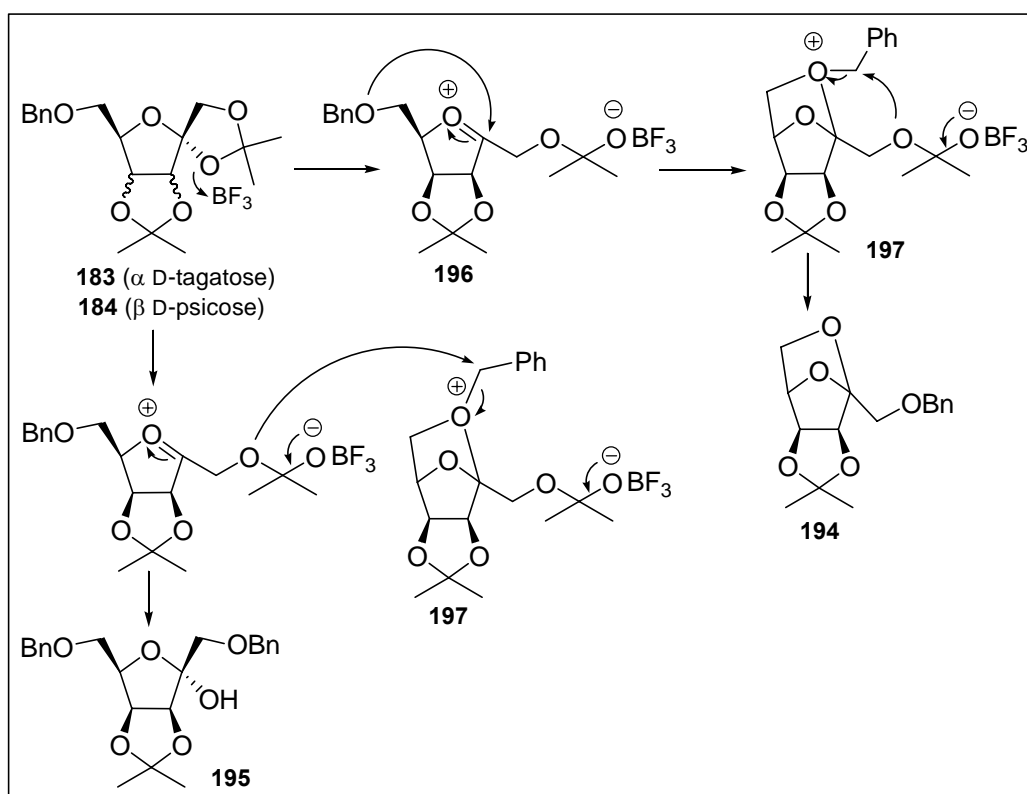

Scheme 120

1.4. Synthesis of OZO

In the D-tagato series, a *spiro*-OZO was obtained as side-product in the synthesis of OZTs: however the compound only appeared in mixtures. In order to prepare pure OZO, *S*-alkylation of the OZT, followed by oxidative desulfurization had to be performed

1.4.1. *S*-Alkylation

The reaction was performed as previously described with BnBr in the presence of NaHCO₃ to afford compound **198** in 83% yield (Scheme 121).

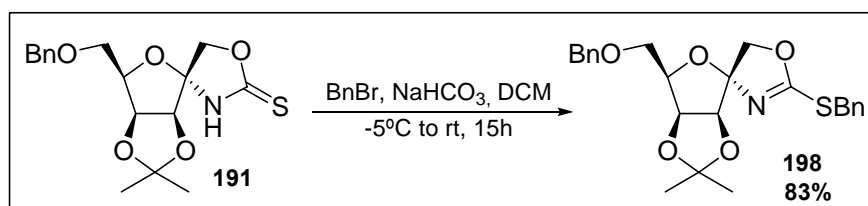

Scheme 121

1.4.2. Oxidation

To perform the oxidation, the same conditions used for preparing *spiro*-OZO in D-fructo and D-psicopyrano series were applied (Chapter IV 1.3.2.). Unfortunately this reaction could not be performed due to a lack of time (Scheme 122).

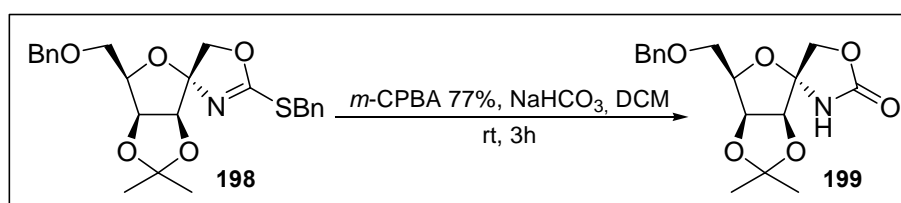

Scheme 122

1.5. Conclusion

In this Chapter V we have focused on thionocarbamates derived from D-tagatose and D-psicose (Scheme 123).

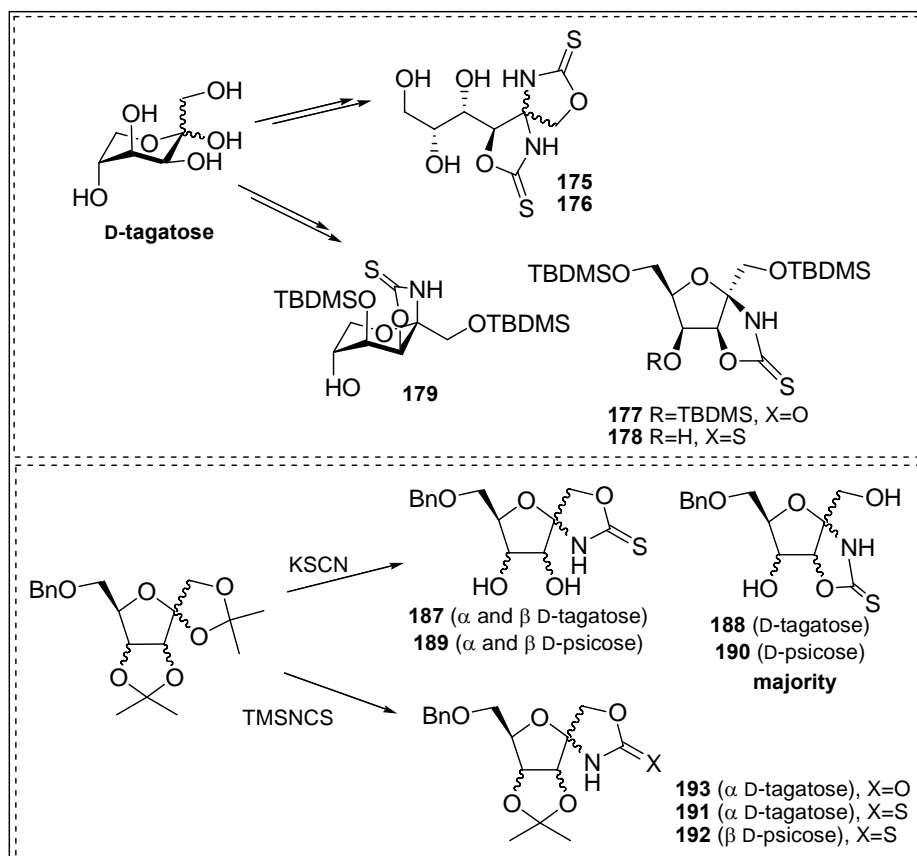

Scheme 123

Considering the results obtained we can put forward some preliminary assumptions:

- ☑ The synthesis of D-tagatose via C-5 epimerization of D-fructose was not efficient. The best approach seems to be from the literature but the overall yield is still quite low.

- ☑ The epoxide opening under basic or acidic conditions was not an efficient transformation. Nonetheless, the reaction was regioselective with the formation of the L-sorbopyrano derivative.

- ☑ In comparison with other unprotected ketoses, D-tagatose appears more susceptible to the number of equivalents of thiocyanic acid.

- ☑ When the same reaction was realized on protected derivatives with KSCN, the 2,3-fused OZT was formed preferentially while with TMSNCS, *spiro* structures are mainly formed.

- ☑ The separation of this mixture of three compounds, specially fused and spiro-OZTs, was more difficult than in other ketose series.

CHAPTER VI

Biological screening

1. GLUT5 POTENTIAL INHIBITORS

1.1. Role of D-fructose in human life

a) Sugars in Life

Human beings are born with an instinctive predilection for sweetness. Still in maternal uterus the foetus is hitherto surrounded by a sweet amniotic fluid. After birth, the majority of children are fed with breast or commercial milk which contains lactose (sugar milk). So it is not shocking that this appetite for sweet continues until grown-up age.

In the past, humans used to consume about 16-24g D-fructose per day, essentially as fruits and honey obtained from agricultural activities. But nowadays, with modernization and specialization in agriculture and food manufacturing processes, consumption patterns have changed. It was recently disclosed that these numbers have increased to 8-100g being ~80g the average of fructose daily consumption.¹²⁶

It is known that sugars have been added, since a long time, to boost the sweetness of foods during their preparation, production, and preservation. In addition, they add a wide variety of other favorable qualities to food their biological, sensory, physical and chemical properties. The principal type of sugar used in formulation of food and beverage products is the high fructose corn syrup (HFCS) because fructose is the sweetest of all natural sugars and besides it is low cost source. Recent studies revealed a straight connection between increases in fructose consumption and increases in obesity and type 2 diabetes incidences. A diet with high levels of fructose may possibly lead to the development of "metabolic syndrome", which anticipates the beginning of type 2 diabetes and is a group of symptoms associated with insulin resistance, including dyslipidemia, hypertension, cancer, impaired glucose homeostasis, increased body fat, high blood pressure and coronary artery disease.^{126, 127}

b) Diabetes

Diabetes mellitus is a chronic metabolic disorder. Unlike type 1 diabetes, which appears in childhood and results from an inadequate secretion of insulin, type 2 diabetes comes after

¹²⁶ V. Douard, R. P. Ferraris *Am. J. Physiol. Endocrinol. Metab.* **2008**, 295, 227 and references cited therein.

¹²⁷ J. L. Evans, J. F. Youngren, I. D. Goldfine *Trends in Endocrinology and Metabolism* **2004**, 15.

years while secreted insulin did not sufficiently act on the body tissue to lower blood glucose levels. This pathogenesis is complex, and involves progressive development of insulin resistance and a relative deficiency in insulin secretion, leading to hyperglycemia. The disease is largely associated with obesity, a major cause of insulin resistance.¹²⁸ About 75-80% of type 2 diabetics are obese and 20-25% of obesities become diabetics.

To date several oral drugs and insulin are the current available therapies.^{128, 129} The two major pharmacological approaches are bisguanides and thiazolidinediones but even though successful, they are often associated with undesirable side effects. A potential new advance is the use of antioxidants however, combined innovative pharmaceutical and non-pharmaceutical strategies are desirable.¹²⁷ Diabetes incidence is increasing at an alarming rate and has reached epidemic proportions. According to World Health Organizations (WHO) reports, if it continues to grow as actually in 2030 there will be about 366 millions of patients being more than 90% type 2 diabetes (Figure 23). Furthermore, and always according to WHO, deaths are projected to increase more than 50% over the next decade if appropriate measures are not taken as quick as possible.

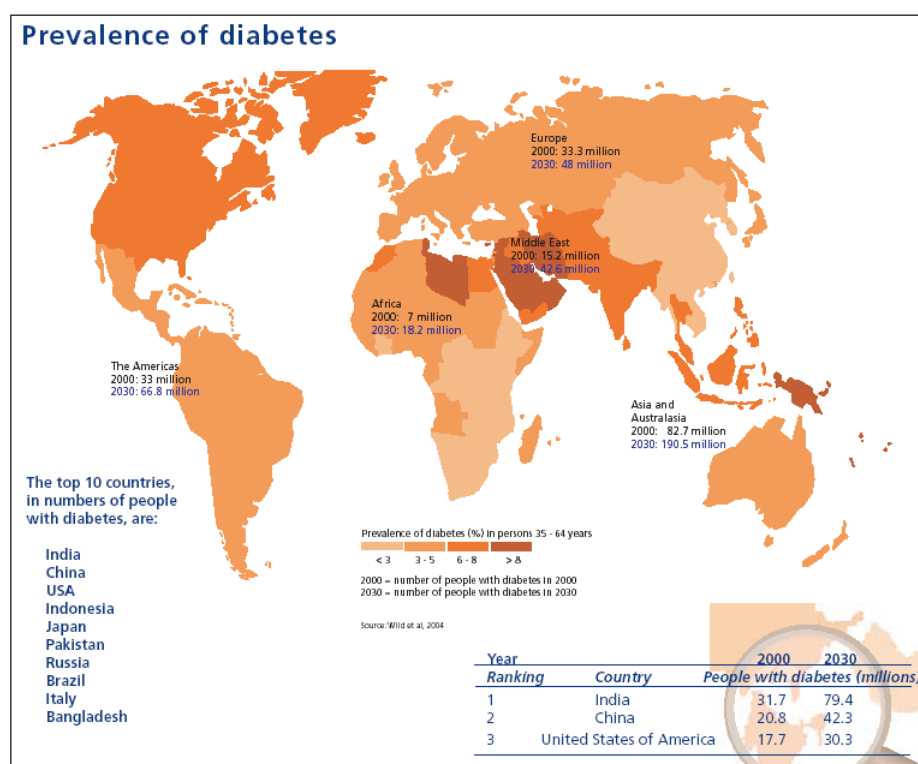

Figure 23

¹²⁸ Zhang, D. E. Moller *Current Opinion in Chemical Biology* **2000**, *4*, 461.

¹²⁹ A. Oku, K. Ueta, M. Nawano, K. Arakawa, T. Kano-Ishihara, M. Matsumoto, A. Saito, K. Tsujihara, M. Anai, T. Asano *Eur. J. Pharmacol.* **2000**, *391*, 183.

These diseases underlie many costly health problems in most developed countries. Managing the long-term complications of the disease, like cardiovascular complications among others, will have a serious impact on public health budgets.¹³⁰

Our detailed knowledge of the symptoms of the disease (peripheral insulin resistance, early hyperinsulinemia, late hypoinsulinemia, intolerance to glucose, hyperglycemia, frequent infections, hypertension and cardiac failure) is in sharp contrast with the poor information that is available on its biochemical, cell biological and genetic background. Poor regulation of glucose intake and disposal has a strong polygenic background but the influences of dietary factors and sedentary lifestyle on the aetiology of the disease are gradually being more fully appreciated and understood. An important interdisciplinary study at this stage would be very helpful and would bring an integrated approach to this multi-factorial problem. Only with this kind of inter-cooperation it would be possible to improve better understanding on basis disposal of excess amounts of fat, fructose and glucose, with the aim of taking appropriated measures of prevention and treatment to a long term battle against these diseases.

c) Sugars in human body. GLUTs.

Sugars are the major source of calories at all stages of life and they are essential for supplying our metabolic needs. They are abundant components of diet and can vary from simple to complex carbohydrates. For example, sucrose is broken down in the intestine to produce both glucose and fructose. These sugars are absorbed into the blood stream and act as a supply of nutrient for tissue metabolism. Sugar disposal occurs via uptake into selective tissues that use specialized membrane transporters called GLUTs.

Glucose transporters (GLUT or SLC2A family) are a family of transmembrane proteins found in most mammalian cells which are responsible for glucose homeostasis by facilitating the transmembrane passage of monosaccharides.¹³¹ Since the discovery of the glucose transporters GLUTs 1-5 in the early 80/90s it has generally been assumed that these isoforms alone controlled mammalian glucose homeostasis. However, the project of sequencing of human genome has recently disturbed this notion. It is now believed that there are 8 more un-

¹³⁰ B. L. Mylari, S. J. Armento, D. A. Beebe, E. L. Conn, J. B. Coutcher, M. S. Dina, M. T. O’Gorman, M. C. Linhares, W. H. Martin, P. J. Oates, D. A. Tess, G. J. Withbroe, W. J. Zembrowski *J. Med. Chem.* **2005**, *48*, 6326.

¹³¹ G. W. Gould, G. D. Holman *Biochem. J.* **1993** *295*, 329.

characterised isoforms, which makes a total of 13 GLUTs. Therefore these protein transporters were divided into three subfamilies namely Class I (GLUT 1-4), Class II (GLUT 5, 7, 9 and 11) and Class III (GLUT 6, 8, 10 and 12 and the myo-inositol transporter HMIT 1).¹³²

We would like to utilize this recent human genome data in post-genomic approaches aimed at understanding the functional roles of the new transporters, their substrates preference tissue distribution, and how they complement and add to the functionality of GLUTs 1-5. At the moment research must be focused on the molecular function: substrate specificity, affinity, regulation of subcellular localization and mechanism of cellular trafficking. An integrated process starting with pharmacomodulation of inhibitors of transporters to the development of biochemical tool with high selectivity and affinity for a specific GLUT is the first step toward understanding the physiological regulation between GLUTs and glucose homeostasis. In this project, we want to focus our attention on the Class II transporters, in particularly GLUT5, due to its specificity to the transport of D-fructose, which is the second sugar - after D-glucose - most present in human diet. So far it is known that GLUT5 is localized in the mucosal surface in small intestine but also expressed in skeletal muscle¹³³, testis, kidney, fat tissue, and brain¹³⁴ (Figure 24).

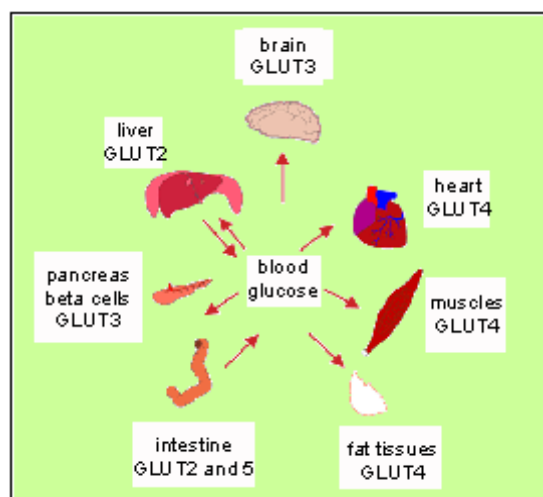

Figure 24

¹³² (a) M. Uldry, B. Thorens *Eur. J. Physiol.* **2004**, 447, 480; (b) E. M. Wright, M. G. Martin, E. Turk *Best Practice Research Clinical Gastroenterology*, **2003**, 17, 943; (c) I. Stuart Wood, P. Trayhurn *British J. Nutrition*, **2003**, 89, 3; (d) H. G. Joost, B. Thorens *Mol. Memb. Biol.* **2001**, 18, 247.

¹³³ H. S. Hundal, F. Darakhshan, S. Kristiansen, S. J. Blakemore, E. A. Richter *Adv. Exp. Med. Biol.* **1998**, 441, 35.

¹³⁴ V. Douard, R. P. Ferraris *Am. J. Physiol. Endocrinol. Metab.* **2008**, 295 (2), 227.

Although some digestion occurs in the mouth and stomach, disaccharides and oligosaccharides from any food source remain relatively undigested, for the most part, until entering in the small intestine where the appropriate enzymes break them down into the respective monosaccharides. Absorbed monosaccharides pass through the small intestine into the portal circulation and are transported to the liver, where glucose, galactose, and fructose are phosphorylated. Fructose absorption mechanism in the small intestine is still not completely understood. Some facts propose either active transport, because fructose uptake was observed to occur against a concentration gradient¹³⁵ or by facilitated transport involving GLUT5 (fructose specific) or GLUT2 (in competition with glucose and galactose) protein transporter¹³⁶ (Figure 25).

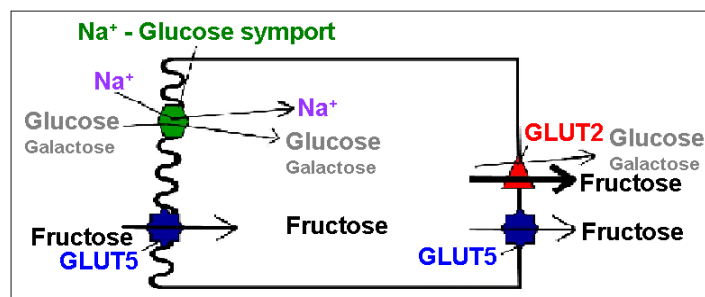

Figure 25

d) GLUT5

Studies have shown that the greatest absorption rate occurs when glucose and fructose are administered in equal quantities¹³⁷. It appears that the GLUT5 transfer rate may be saturated at low levels and absorption is increased through joint absorption with glucose¹³⁸ (glucose-dependent co-transport phenomenon). In addition, fructose transfer activity increases with dietary fructose intake. A GLUT5 insufficiency can generate an excess of fructose carried into the lower intestine¹³⁶ which provide nutrients for the existing gut flora, and may cause some illness.

¹³⁵ M. H. Stipanuk *Biochemical, Physiological, and Molecular Aspects of Human Nutrition* 2006, W. B. Saunders, Philadelphia, PA. 2nd Edition.

¹³⁶ A. E. Buchs, S. Sasson, H. G. Joost, E. Cerasi *Endocrinology* 1998, 139 (3), 827.

¹³⁷ T. Fujisawa, J. Riby, N. Kretchmer *Gastroenterology* 1991, 101, 360.

¹³⁸ K. Ushijima, T. Fujisawa, J. Riby, N. Kretchmer *Journal of Nutrition* 1991, 125, 2156.

GLUT5 is found in many tissues, its expression levels and activity are clearly regulated under normal conditions and are altered under pathological conditions (diabetes, hypertension, obesity, and inflammation). It also seemed to be induced during carcinogenesis, particularly in the mammary glands.¹²⁶ The increasing importance of fructose in human nutrition and disease calls for additional studies that hopefully will increase our understanding of the role of the fructose transporter GLUT5 in health and disease. Despite the importance of dietary fructose in the development of diabetes, and that of GLUT5 in fructose transport, very few studies have investigated the link between diabetes and GLUT5 in these insulin-sensitive organ systems. The abundance and the specificity of GLUT5 suggest that it plays a metabolic important role which is imperfectly understood. The comprehension of the structure and function of this transmembrane protein is indeed crucial.¹³⁹ This involves utilization of chemical biology approaches for the design and chemical synthesis of sugar analogues and inhibitors of the GLUT proteins. Thus, specific inhibitors of this protein are reagents of choice to develop chemical probes.¹⁴⁰ We wanted to focus on fructose specific transporters of Class II.

1.2. PhD project

1.2.1. Objectives

This part of the project dedicated to biological tests was in charge of our partner Dr. G. Holman at the University of Bath. The library of compounds synthesized is going to be submitted to a screening to determine the potential GLUT5 inhibitors. The inhibition rate will be defined by measuring inhibition of D-[¹⁴C-U]-fructose uptake by using scintillation counting^{75a} of Chinese hamster ovary (CHO) cells.^{62, 75a} The results will give a entire knowledge of interaction between synthesized compounds and GLUT5 which will allow a detailed understanding of the recognition site of GLUT5. Furthermore it will determine which inhibitors will be selective and specific to GLUT5 (also to Class II family) and will allow us to prepare photoaffinity labels which will track *in vitro* and *in vivo* the localization and physiological behavior of GLUT5 (Class II).¹⁴¹

¹³⁹ (a) M. I. Borges-Walmsley, A. R. Walmsley *Trends Microbiol.* **2001**, *2*, 71; (b) V. H. L. Lee *Eur. J. Pharm. Sci.* **2000**, *11*, S41.

¹⁴⁰ M. Hashimoto, J. Yang, G. D. Holman *ChemBioChem.* **2001**, *2*, 52.

¹⁴¹ G. Dorman, G. D. Prestwich *Trends Biotechnol.* **2000**, *18*, 64.

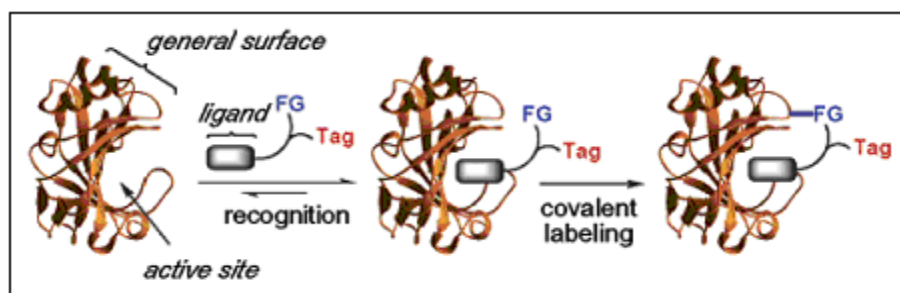

Figure 26

The bio-chemical device should be composed of three different components: (1) the recognition domain of GLUTs (the structure proposed is based on previous results), (2) on a selected position, a photoreactive structure, (3) a long spacer toward the last part of the biochemical tool like biotin or a fluorescent tag (Figure 26).^{75b, 142}

1.2.2. Previous works

First studies to find potential inhibitors of GLUT5 started with Dr. G. Holman & coll. by blocking all the hydroxyl groups, one at a time, of D-fructose in both ring forms with allylic ethers.^{56a} At the end, it was concluded that both furano and pyrano forms were tolerated and the two sites O-2 (furanose and pyranose) and O-6 (furanose) could be altered to give informations about the interaction with the protein. Furthermore, postulating that D-fructose is a quasi-symmetrical molecule, they deduced that the binding site could be on both sides of the molecule, the anomeric and the opposite side, which means 3, 4, 5-OH for D-fructopyranose and 1, 2, 3-OH or 3, 4, 6-OH for D-fructofuranose (Figure 27).

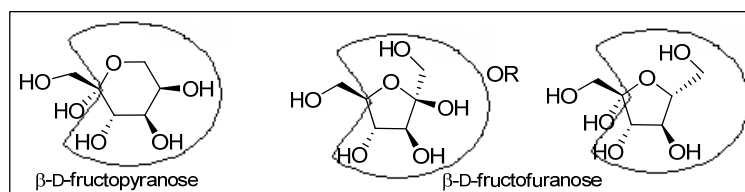

Figure 27

¹⁴² M. Hashimoto, Y. Hatanaka, J. Yang, J. Dhesi, G. D. Holman *Carbohydr. Res.* **2001**, *331*, 119.

In order to investigate this model of interaction Rollin & coll. developed a second approach involving thionocarbamate moieties. OZTs and OZO were the structures of choice to block the D-fructose skeleton. Erreur ! Signet non défini.

To better understand the recognition process and determine the importance of each of hydroxyl groups in the binding and interaction with GLUT5 a study was made involving diverse parameters like sugar family (aldoses or ketoses) and series (configuration of different hydroxylated sites), nature of the group at C-1 (allyl or benzyl) and type of thionocarbamate (OZT or OZO) (Figure 28).

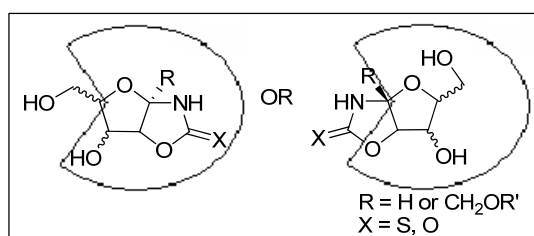
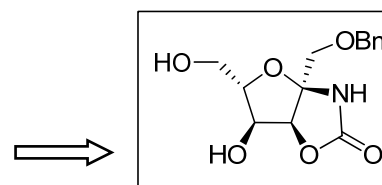

Figure 28

The results highlighted that aldopentose OZT derivatives were not recognized by the protein transporter and ketohexose OZT and OZO derivatives presented some inhibition. Moreover, L-sorbo OZO derivatives, with C-1 benzyl group expressed better inhibition constants (K_i) than OZTs, with 1-O-allyl, in D-fructose series than D-fructose itself (Table 16).

Table 16

<i>D-fructose</i>		<i>15.5 ± 2.9</i>	
OZT	K_i [mM]	OZO	K_i [mM]
D-fructo	24.9 ± 3.2	<i>D-fructo</i>	11.9 ± 3.4
D-fructo-Bn	32.6 ± 3.6	<i>D-fructo-Bn</i>	8.5 ± 1.7
D-fructo-All	20.8 ± 3.8	-	-
L-sorbo	17.4 ± 6.7	<i>L-sorbo</i>	7.2 ± 1.0
<i>L-sorbo-Bn</i>	12.4 ± 1.5	<i>L-sorbo-Bn</i>	3.1 ± 0.5
<i>L-sorbo-All</i>	14.5 ± 2.1	-	-



Those studies allowed a better comprehension of the interaction model. It is understood that the C-1 arm in ketoses is important to obtain some inhibition, however this can be substituted and when it is it presents even better results. The fact that C-1 can carry bulky

groups means that the binding site could be on the opposite side of the anomeric position, in C-4 and C-6, as previously postulated (Figure 29).

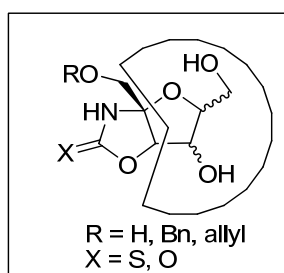

Figure 29

1.2.3. PhD prospects

In this PhD we have synthesized various molecules that compose a library of potential GLUT5 inhibitors. Among them stands a wide range of thionocarbamates: OZTs, OZO and OXTs. Those were prepared in different ketose series, as fused or spiro structures, in cyclic or even acyclic frameworks and in furano, but mostly in pyrano form.

In the previous studies the structures of choice which gave the best results were OZTs and OZO in furano form. This PhD gave the possibility to go more deeply by enlarging it to other ketose family members and specially focus on pyrano forms that have not been tested. However to date, this biological screening has not yet been realized. Nonetheless, taking into account preceding studies and the interaction models proposed it can be predicted that some of the molecules could be promising inhibitors. Some examples of the molecules synthesized in furano and pyrano forms are presented in Figure 30.

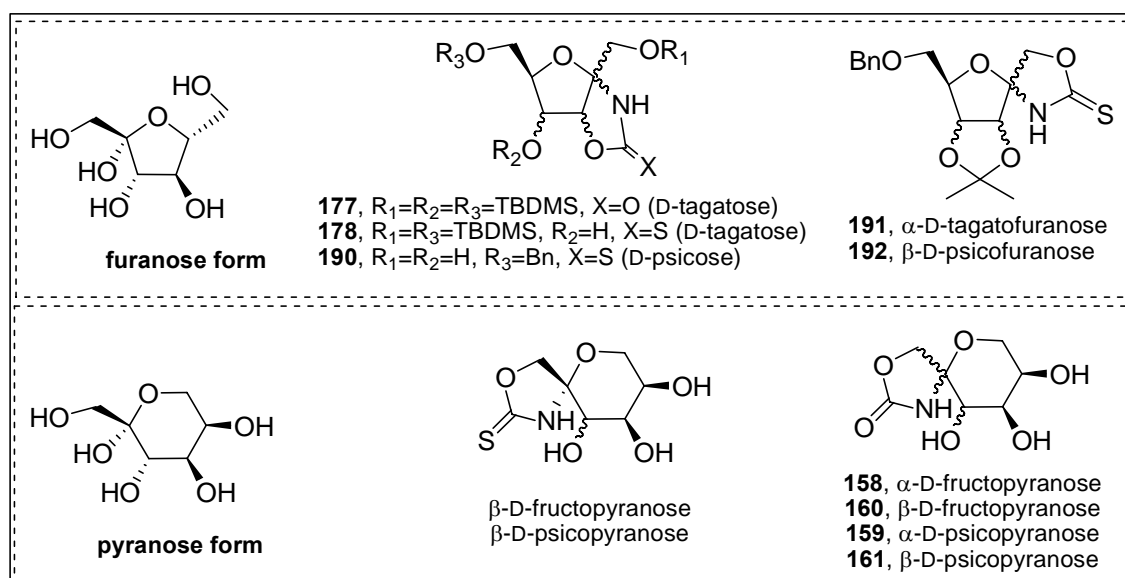

Figure 30

2. POTENTIAL ANTIMICROBIAL AGENTS

2.1. Biological activity of thionocarbamates

For some decades oxazolidinethione chemistry has received considerable attention once those derivatives exhibit high potentials of biological activities, like antithyroid,¹⁴³ antifertility,^{63, 144} inhibition of dopamine β -hydroxylase,¹⁴⁵ antibacterial,¹⁴⁶ and insecticidal¹⁴⁷ and herbicidal^{Erreur ! Signet non défini.a} activities (Figure 31).

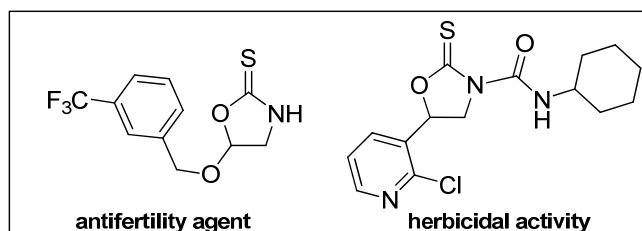

Figure 31

¹⁴³ M. G. Ettliger *J. Am. Chem. Soc.* **1950**, *72*, 4792; (b) H. J. Eichel, R. J. Meyer, P. F. Buzzi *J. Med. Chem.* **1967**, *10*, 942.

¹⁴⁴ D. Lednicer, D. E. Emmert *J. Med. Chem.* **1968**, *11*, 1258.

¹⁴⁵ G. A. Johnson, E. G. Kim, S. J. Boukma, D. Lednicer, G. A. Youngdale *J. Med. Chem.* **1972**, *15*, 327.

¹⁴⁶ P. Seneci, M. Caspani, F. Ripamonti, R. Ciabatti *J. Chem. Soc., Perkin Trans. 1* **1994**, *16*, 2345.

¹⁴⁷ N. Gandhi, B. K. Srivastava, V. B. Lohray, B. B.; Lohray *Tetrahedron Lett.* **2004**, *45*, 6269-6272.

Closely related molecules, instead of bearing an OZT in their structure do have similar heterocycles and present interesting biological activities. For example, thiazoles and derivatives have attracted interest over the years thanks to their diverse biological activities like antifungal, antimicrobial and insecticidal.^{Erreur ! Signet non défini.}^b, ^{Erreur ! Signet non défini.}^c Application was recently found in drug development for the treatment of allergies, hypertension, inflammation, schizophrenia, HIV infections, cancer among others (Figure 32).^{Erreur ! Signet non défini.}^c

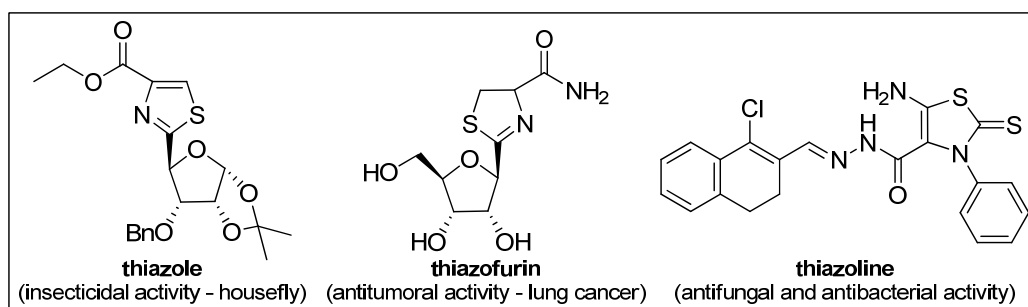

Figure 32

1,3-Oxazolidin-2-ones constitute a new chemical class of synthetic antimicrobial agents, presenting a special mechanism for protein synthesis inhibition that normally displays bacteriostatic activity against many important human pathogens. Linezolid is a molecule holding an OZO heterocycle belonging to a new class of antibiotics which has enhanced activity against Gram-positive aerobic, some Gram-negative and anaerobic microorganisms. Actually it is commercialized under the name Zyvox™ to treat serious infections due to resistant Gram-positive organisms like community-acquired pneumonia, nosocomial pneumonia, and uncomplicated and complicated skin and soft-tissue infections (Figure 33).¹⁴⁸

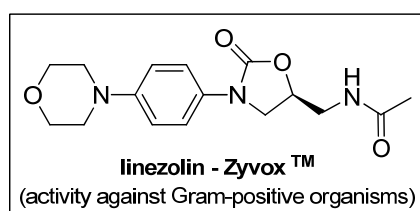

Figure 33

¹⁴⁸ (a) J. F. Plouffe *Clinical Infectious Diseases* **2000**, *31*, S144; (b) D. J. Diekema, R. N. Jones *Drugs* **2000**, *59*, 7; (c) J. W. Chien, M. L. Kucia, R. A. Salata *Clinical Infectious Diseases* **2000**, *30*, 146.

2.2. Antimicrobial activity

The strongly diversified panel of molecules synthesized was tested as potential antimicrobial agents in partnership with Pr. Jorge Justino in Escola Superior Agrária of Instituto Politécnico de Santarém.

2.2.1. Methodology for susceptibility testing

The antimicrobial activity of 19 compounds was screened using the paper disk diffusion method.¹⁴⁹ The microorganisms used in the tests belong to the American Type Culture Collection (ATCC) and Centraalbureau voor Schimmelcultures (CBS) collections, from United States and The Netherlands, respectively. Some fungi tests were from Escola Superior Agrária of Instituto Politécnico de Santarém. With respect to fungi, the yeast *Candida albicans* (ATCC 10231) and the following filamentous fungi were used: *Botrytis spp.*, *Pyricularia oryzae* (CBS 433.70) and *Rhizopus spp.*. Regarding bacteria, tests were carried out with pathogens *Bacillus cereus* (ATCC 11778), *Bacillus subtilis* (ATCC 6633), *Enterococcus faecalis* (ATCC 29212) and *Staphylococcus aureus* (ATCC 25923). The culture medium and incubation temperature used for fungal growth was potato dextrose agar and 25°C, whereas for bacteria, nutrient agar incubated at 37°C was used. Paper disks of 6.4 mm were placed on the agar and the solution of each substance (300 µg) in DMSO (15 µL) was applied on each disk. Chloramphenicol and actidione were used as antimicrobial controls for bacteria and fungi, respectively. After incubation, the nearest diameter of the inhibition zone was measured. At least two replicates were made.

2.2.2. Antimicrobial activity results

The results for compounds exhibiting antimicrobial activity are presented in Table 17, 3 and Table 19: they are expressed in terms of average diameter of inhibition (Ø) in mm for the active compounds (300 µg). For comparison purposes, the control substances (chloramphenicol or actidione) are also shown for doses of 30 µg and 300 µg. Zones less than 10

¹⁴⁹ (a) A. W. Bauer, W. M. Kirby, J. C. Sherris, M. Turck *The American Journal of Clinical Pathology* **1966**, *45*, 493; (b) CLSI, *Performance standards for antimicrobial disk susceptibility tests* **2006**, 9th edition, M2-A9, Clinical and Laboratory Standards Institute, USA; (c) F. V. M. Silva, M. Goulart, J. Justino, A. Neves, F. Santos, J. Caio, S. Lucas, A. Newton, D. Sacoto, E. Barbosa, M. S. Santos, A. P. Rauter *Bioorg. Med. Chem.* **2008**, *16*, 4083.

mm in diameter and uniform growth in the dish were considered indicative of weak antimicrobial activity, 10-15mm moderate activity, more than 15 mm strong activity.

a) Fused OZTs

Table 1 showed results for OZTs fused to the ketose backbone leading to cyclic and acyclic structures. 4,5-Fused OZTs (**96**, **106**, **107** and **55**) have shown more antimicrobial activity than 3,4-fused OZTs (**2**). A further analysis show that cyclic 4,5-fused OZT with a protective group in position C-3 (**106**, **107** and **55**) expressed an overall better activity results than the unprotected D-fructose **96**. The presence of a benzyl group in place of a benzoyl group did not significantly affect the activity. These compounds (**106** and **107**) expressed interesting antifungal activity for *Candida albicans* and a slight bactericidal activity against *Bacillus cereus* and *Bacillus subtilis*. Comparing D-fructose (**96**, **106** and **107**) and the only member of the cyclic D-psicose series (**55**), the latter showed a better antimicrobial activity. The fact that this compound exhibits a greater activity could be due either to a different configuration at the C-3 or to the localization of nitrogen atom. This compound **55** showed a large spectrum of activity with a stronger bacterial activity. Furthermore it expressed excellent antifungal activity against *Pyricularia oryzae*, which is considered in international listings as a bioterrorism agent.

From comparing cyclic (**2**, **106**, **107**, **96** and **55**) and acyclic (**114** and **115**) structures, it can be said that cyclic structures gave better results. Once again D-psicose series (**115**) showed superior activity as compared to D-fructose (**114**).

In general this family of compounds has presented better bactericidal than fungicidal activity (Table 17).

Table 17

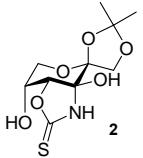
	FUNGI				BACTERIA			
	<i>Botrytis spp.</i>	<i>Candida albicans</i>	<i>Pyricularia oryzae</i>	<i>Rhizopus spp.</i>	<i>Bacillus cereus</i>	<i>Bacillus subtilis</i>	<i>Enterococcus faecalis</i>	<i>Staphylococcus aureus</i>
 <chem>CC1(C)OC2C(C1)OC(=O)NC2O</chem> 2	-	-	-	-	8-10	8-10	8-10	8-10

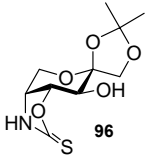
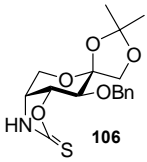
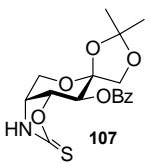
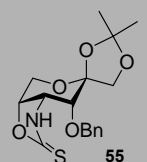
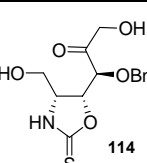
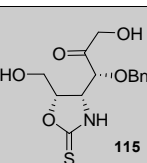
C O M P O U N D S	 96	-	-	-	-	8-10	8-10	8-10	8-10
	 106	< 6.4	11	< 6.4	< 6.4	11	14	< 6.4	11
	 107	10	9	< 6.4	< 6.4	9	10	< 6.4	< 6.4
	 55	8	8	25	8	19	19	19	19
	 114	< 6.4	< 6.4	8	< 6.4	13	15	< 6.4	< 6.4
	 115	< 6.4	9	7	< 6.4	9	12	10	9
C O N T R O L	I (30 µg)	< 6.4	< 6.4	40	11	24	30	26	27
	II (300 µg)	20	15	70	19	45	46	43	41

The measurements are expressed in terms of average diameter of inhibition (Ø) in mm.

b) *Spiro* OZTs and OZOs

The second family of molecules tested is composed of the *spiro* derivatives. In an overall view, *spiro* structures did not seem to present any significant antimicrobial activity. The results were similar for both protected (148, 154, 156, 155 and 157) and unprotected structures (158 and

159). Spiro-OZT **148** showed no antimicrobial activity against any of the microbes tested. Herein, D-psicose series (**155**, **157** and **159**) do not present better results than D-fructose (**154**, **156** and **158**) like previously observed for fused-OZTs. Comparing α (**154** and **153**) and β (**156** and **157**) spiro-OZO, α isomer showed to have better activity. Unexpectedly, compound **164**, a β spiro-OZT protected with an isopropylidene group instead of benzyl groups, presented a large spectrum of activity with extraordinary activity against *Candida albicans*, twice higher than the control (Table 3). This fungus is considered as a causal agent of opportunistic oral and genital infections in humans. Moreover systemic fungal infections have emerged as important causes of morbidity and mortality in immuno-compromised patients - AIDS, cancer chemotherapy, organ or bone marrow transplantation – a reason why *Candida albicans* has aroused great interest of research in health and medicine fields.

Table 18

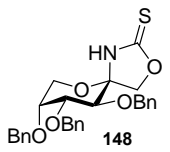
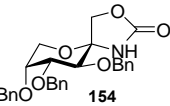
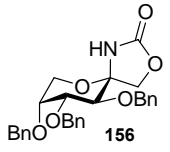
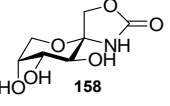
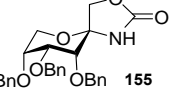
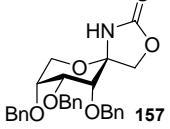
		FUNGI				BACTERIA			
		<i>Botrytis</i> <i>spp.</i>	<i>Candida</i> <i>albicans</i>	<i>Pyricularia</i> <i>oryzae</i>	<i>Rhizopus</i> <i>spp.</i>	<i>Bacillus</i> <i>cereus</i>	<i>Bacillus</i> <i>subtilis</i>	<i>Enterococcus</i> <i>faecalis</i>	<i>Staphylococcus</i> <i>Aureus</i>
COMPOUNDS	 148	-	-	-	-	-	-	-	-
	 154	8-10	8-10	8-10	8-10	-	-	-	-
	 156	-	-	-	-	-	-	-	-
	 158	< 6.4	< 6.4	< 6.4	< 6.4	< 6.4	8	15	< 6.4
	 155	-	-	-	-	-	-	-	-
	 157	-	-	-	-	-	-	-	-

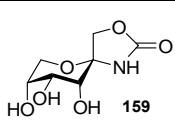
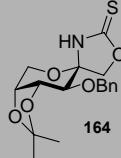
		-	-	-	-	8-10	8-10	8-10	8-10
		< 6.4	37	< 6.4	10	9	10	< 6.4	9
C O N T R O L	I (30 µg)	< 6.4	< 6.4	40	11	24	30	26	27
	II (300 µg)	20	15	70	19	45	46	43	41

The measurements are expressed in terms of average diameter of inhibition (\varnothing) in mm.

c) D-Tagato OZTs and OZOs

The last family is dedicated to D-tagato derivatives. The acyclic bis-OZT **175** presented some weak to moderated antimicrobial activity. The 2,3-fused OZTs both in furano (**178**) and pyrano (**179**) form did not showed significant results. However 2,3-fused OZO **177** expressed some antibacterial activity for *Bacillus cereus* and *Bacillus subtilis*. On the overview this small family of derivitaves did not show effective antimicrobial activities.

Table 19

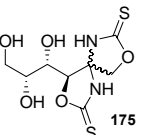
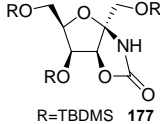
		FUNGI				BACTERIA			
		<i>Botrytis spp.</i>	<i>Candida albicans</i>	<i>Pyricularia oryzae</i>	<i>Rhizopus spp.</i>	<i>Bacillus cereus</i>	<i>Bacillus subtilis</i>	<i>Enterococcus faecalis</i>	<i>Staphylococcus Aureus</i>
C O M P O U N		< 6.4	9	< 6.4	< 6.4	< 6.4	9	12	< 6.4
		-	-	-	-	-	-	-	-

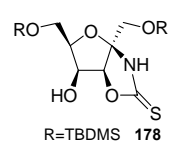
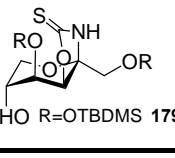
D S	 R=TBDMMS 178	< 6.4	< 6.4	< 6.4	< 6.4	10	17	< 6.4	11
	 HO R=OTBDMMS 179	8-10	8-10	8-10	8-10	-	-	-	-
C O N T R O L	I (30 µg)	< 6.4	< 6.4	40	11	24	30	26	27
	II (300 µg)	20	15	70	19	45	46	43	41

The measurements are expressed in terms of average diameter of inhibition (Ø) in mm.

2.3. Cytotoxicity measurements

As some of our molecules have shown interesting antimicrobial activities, it is pertinent to also test their cytotoxicity. This study was also developed in partnership with Pr. Jorge Justino in Escola Superior Agrária of Instituto Politécnico de Santarém.

2.3.1. Methodology for measuring cytotoxicity

Acute cytotoxicity measurements were performed by the MTT method.¹⁵⁰ The 3-(4,5-dimethylthiazol-2-yl)-2,5-diphenyltetrazolium bromide (MTT) assay was used to quantify metabolically viable cells in all samples. Adherent cells (A549 human lung fibroblasts, 100 µL of 5x10⁴ cells per mL cell suspension) were seeded onto 96-well plates, allowed to attach for 24 h and exposed to the test compound for the following 24 h. Positive control (hydrogen peroxide) and negative control (pure solvent) were also included. At 48 h of culture MTT was added to the cells at a final concentration of 0.5 mg/mL, followed by an incubation period of 3 h to allow the formazan crystals to form. After incubation, medium was removed, cells were washed twice to remove traces of medium and un-metabolized MTT, and DMSO (100 µL) was added to each

¹⁵⁰ (a) R. L. Freshney *Culture of Animal Cells: A Manual of Basic Techniques* 2000 Wiley-Liss: New York; (b) J. A. Plumb, R. Milroy, S. B. Kaye *Cancer Res.* 1989, 49, 4435.

well. Solubilization of formazan crystals was performed by gentle shaking in a 96-well plate shaker for 20 min at room temperature. Absorbance of each well was quantified at 540 nm using 620 nm as reference wavelength on a scanning multiwell spectrophotometer (automated microplate reader).

2.3.2. Cytotoxicity results

The cytotoxicity tests were performed in the family of molecules that showed the best results for antimicrobial activity: fused-OZTs. Five compounds were tested but unfortunately all proved to be relatively toxic to human lung fibroblasts cells (Table 20).

Table 20

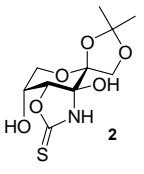
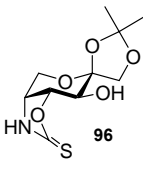
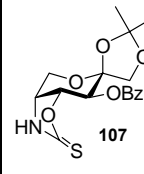
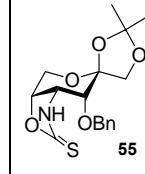
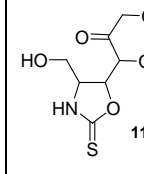
COMPOUND	 2	 96	 107	 55	 114
IC50 (mg/mL)	0,027	0,029	0,071	0,007	0,003
CONTROL	DMSO	0,449			
	H₂O₂	0,002			

2.4. Conclusion

This Chapter was dedicated to the biological screening of our thionocarbamate library.

Taking into account the results obtained we can put forward some preliminary assumptions:

- In general protected and fused molecules presented better antimicrobial activities as well as OZTs compared to OZOs.
- The tested molecules exhibited stronger antibacterial activity than antifungal activity.

- ☑ Compound **54** showed a great activity regarding *Pyricularia oryzae* ($\varnothing = 25$ mm) and a large spectrum of action which will prompt us to continue some pharmacomodulation studies.

- ☑ Compound **164** presented an impressive selectivity of action against *Candida albicans* ($\varnothing = 37$ mm), much better than the control and also a large spectrum of activity. Several studies of pharmacomodulation will shortly be developed on this compound.

- ☑ The cytotoxicity tests showed that the compounds were relatively toxic so the next step is to modulate them with a view to lowering their toxicity without a change in activity. A positive aspect is that the cytotoxicity is not directly correlated to the antimicrobial activity.

- ☑ Future structural modification and biological evaluation will be carried out to explore the full potential of this novel class of antimicrobial compounds.

GENERAL

CONCLUSION

GENERAL CONCLUSION

This PhD work allowed the exploration of ketoses chemistry, focused on D-psicose and D-tagatose series which are two 'rare sugars' which have not been much explored in literature. Furthermore some aspects of cyclic thionocarbamate chemistry were investigated and have shown simplified synthesis of various molecules which were submitted to preliminary biological screening.

In Chapter II the preparation of fused bicyclic structures was studied by condensation of an α -hydroxyketone with thiocyanic acid. This procedure favors the formation of hydrated-OZTs over the expected OXTs. Both oxidized and dehydrated analogues were obtained *via* an S-alkylation. The benzylsulfanyl derivatives were easily oxidized with H₂O₂ to the corresponding OZO. This is an improved procedure over the previous N-protection methods. The dehydration was obtained by reacting the hydroxyl of the S-benzylated derivatives with Tf₂O-Et₃N in good yields. All of these structures make a new family of molecules littlely described in literature.

Chapter III was dedicated to the synthesis of 4,5-fused OZT *via* condensation with a thiocarbonyl source. First, for D-fructose series a previous functionalization method was improved by the development of a selective iodination of on polyhydroxylated structures. After optimization of the protocol, the method was also applied with success to D-psicose series. The improvement allowed to reduce the time and number of steps in synthetic pathways. In fact a study in ketoses diols and triols derivatives was performed and it was observed that this methodology can also be extended with good results to some aldohexoses series. Some general rule could be proposed such as the introduction of the iodine was correlated to formation of the thermodynamically most stable compound but in some cases, this simple rule could not be applied.

In Chapter IV we concentrated our efforts toward the synthesis of *spiro*-OZTs (thus protecting the 3,4&5 hydroxyls of D-psicose and D-fructose series) following two different pathways: a) deprotection of the anomeric position, followed by condensation with thiocyanic acid or b) a one-pot procedure using trimethylsilyl isothiocyanate reagent. This last method was

greatly optimized: *spiro*-OZTs in both D-fructose and D-psicose series were obtained in only one step with controlled stereoselectivity at the anomeric position in favor of the β form with good yields. Separation of stereoisomers α and β of structures in pyranose form was performed *via* an S-alkylation with impressive and unexpected efficiencies in both series. We were unable to separate the *spiro*-OZT, but the benzylsulfanyl derivatives allowed us after selective oxidation with *m*-CPBA to obtain each α and β OZOs.

When the synthesis of *spiro*-OZT was performed using partially protected sugar frameworks, complex mixtures were obtained. The purification of each molecule by post-protection reaction was re-studied and in some cases these methods have been improved and therefore their yields. However the best method to obtain pure compounds remains the S-alkylation of the OZTs.

In Chapter V the chemistry of D-tagatose was explored. Some assays with the unprotected sugar were done and have shown that depending on the equivalent of thiocyanic acid, bis- and fused-OZTs were fairly obtained. D-tagatose is much more sensible than D-fructose or L-sorbose to the number of equivalent of HSCN. Latter two different pathways previously used for the synthesis of *spiro*-OZT were performed. When condensation with HSCN is applied to partial protected ketose in furanose form 2,3-fused OZTs are majority formed and *spiro*-OZTs merely in some traces. In the other hand, when TMSNCS method is employed only *spiro*-OZTs and OZOs are detected. In order to compare the two series of ketoses the same reaction were applied to D-psicose series in furanose form.

Finally, the Chapter VI describes the biological tests that were performed on this panel of compounds. It was planned to test these molecules as potential inhibitors of GLUT5, a protein transporter specific to D-fructose transport. The aim was to find selective inhibitors for the development of the novel biochemical tools. This type of sensor would be very useful to determine the standard tissue-specificity of GLUT5 expression, their response to changes in diet, hormonal regulation and to diseases states, in order to better understand some metabolic disorder likes type 2 diabetes and obesity. Unfortunately these tests have not been made yet.

For antimicrobial screening several compounds presented a certain and interesting activity, in general stronger for bacteria. Among the molecules tested, two of them, **54** and **165**, have shown a large spectrum of activities together with excellent results for a specific fungus.

Compound **54** expressed excellent antifungal activity against *pyricularia oryzae*, considered as an agent of bioterrorism in international listings and **165** for *candida albicans* known as a causal agent of opportunistic infections in humans that lately has concentrated large attention from health and medicine fields once systemic fungal infections have appeared as main reason of morbidity and mortality in immuno-compromised patients. The next step from these results would be to modulate the leading compounds in order to reduce their quite high toxicities and still maintaining or improving their specific activities.

As could be seen in this PhD we have worked with three of the four ketoses: D-fructose, D-psicose and D-tagatose. But L-sorbose was not forgotten in this project. Some of its chemistry was started however due to lack of time final OZT or OXT compounds were not obtained (Scheme 124). Therefore it was decided to avoid the description in this manuscript of the chemical steps studied toward these objectives. They could be shortly overviewed in the following scheme:

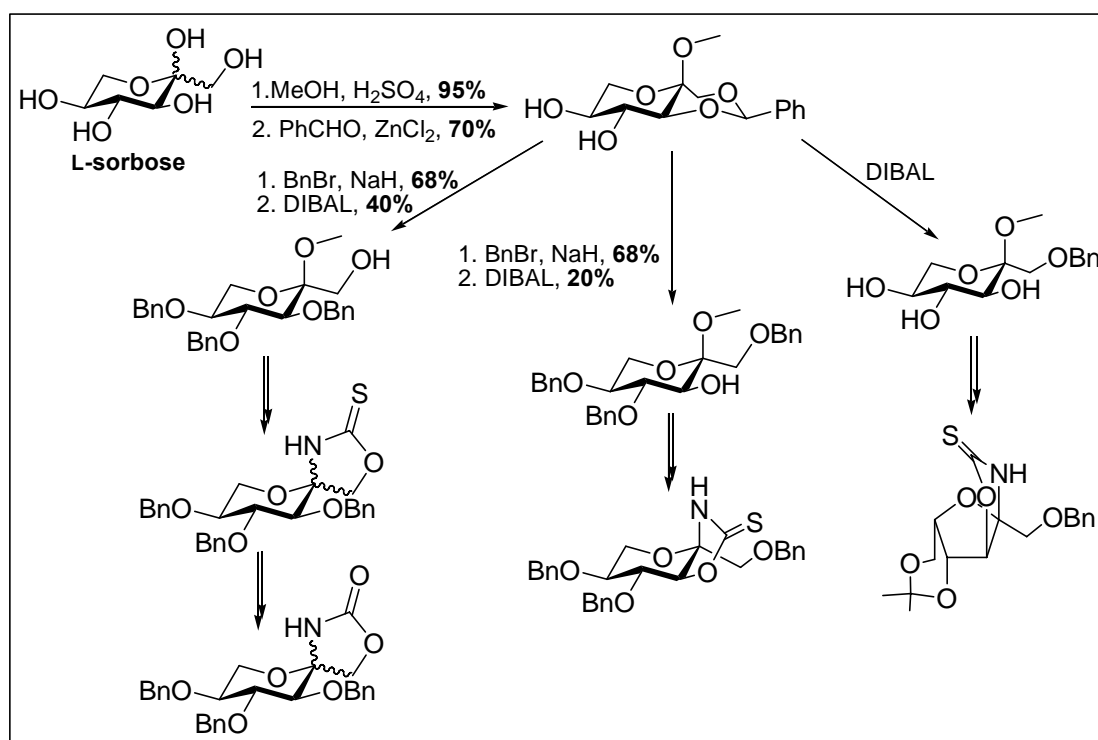

Scheme 124

EXPERIMENTAL PART

General procedures

1. GENERAL METHODS

In this PhD work, reactions requiring anhydrous conditions were performed in blazed or oven-dried glassware with anhydrous solvents under inert atmosphere (argon). The solvents and reagents were purchased from Acros Organics, Aldrich, Fluka or Merck and distilled following the procedures described by D. D. Perrin, W. L. F. Armarego and D. R. Perrin, *Purification of Laboratory Chemicals*, Pergamon, Oxford, 1986.

The methods used are as follows:

- ↻ DCM was distilled in the presence of CaH₂;
- ↻ THF was distilled in the presence of sodium/benzophenone;
- ↻ Toluene was distilled in the presence of CaH₂;
- ↻ DMF (HPLC), DMSO (HPLC) and 1,4-dioxane were dried over molecular sieves 4 Å;
- ↻ MeOH (HPLC) was dried over molecular sieves 3 Å;
- ↻ Chloroform (HPLC) and cyclohexane (HPLC) were used without further purification.

The reactions were monitored by TLC on Silica Gel 60F-254 precoated plates (Merck). Visualization of the compounds was made by UV light (254 nm) and revelation was done either by immersion in a 10% solution of concentrated sulfuric acid in ethanol followed by heating or by contact with dispersed iodine in silica gel.

Flash column chromatography was carried out using Silica gel 60N (spherical, neutral, 40-63µm) (Merck) under nitrogen pressure.

NMR spectra were recorded on 400MHz Bruker Avance2 or 250 MHz Bruker Avance DPX250 spectrometers using TMS as the internal standard. Chemical shifts are reported in parts per million (ppm, δ units). Coupling constants (J) are reported and expressed in hertz (Hz), splitting patterns are designated as: br (broad), s (singlet), d (doublet), dd (double doublet), q (quartet), dt (double triplet), td (triple doublet), ddd (double double doublet), m (multiplet) and t (triplet).

Mass spectra were recorded on Perkin Elmer Sciex API 300 for negative (ISN) and positive (ISP) electrospray ionization.

High resolution mass spectra (HRMS) were recorded with a TOF spectrometer in electrospray ionisation (ESI) mode or in chemical ionisation (CI) mode.

IR spectra were reported on Thermo-Nicolet AVATAR 320 AEK0200713. Melting points were measured using a Buchi 510 capillary apparatus and are uncorrected.

Optical rotations were measured at 20°C with a Perkin Elmer 341 polarimeter (path length 1 dm).

2. GENERAL PROCEDURES

2.1. Protection reactions

2.1.1. Isopropylidene ketal formation

a) Method using acetone

A suspension of D-fructose (20 g, 0.11 mol) in dry acetone (0.4 L) was cooled (ice-salt bath) to 0°C. Then 98% sulfuric acid (1.5 mL) was added dropwise. When addition was completed the reaction mixture was stirred at room temperature until the starting material was entirely dissolved. At this time the reaction mixture was again cooled to 0°C and triethylamine was added slowly until basic pH. The crystals formed were filtered and the filtrate was concentrated. The solid in the bottom of the flash was dissolved in AcOEt. In a separating funnel, the organic layers were washed with water, brine and finally dried over MgSO₄, filtered, and concentrated. The residue was purified by recrystallisation or by silica gel column chromatography.

b) Method using dimethoxypropane

To a 0.2M suspension of the starting material in dry acetone was added 2,2-dimethoxypropane in large excess and the chosen acid. The reaction mixture was stirred at room temperature until protection was complete. To eliminate de traces of acid the reaction mixture was made neutral with sodium hydrogen carbonate, filtered and the filtrate concentrated under reduced pressure. The residue was purified by silica gel column chromatography.

c) Method used for tagatose

To a 0.2M suspension of the starting material in a dry mixture of toluene/DCM (4:6) was added *p*-toluenesulfonic acid (0.03 eq.). The reaction mixture heated until reflux was reached (60-65°C), then 2,2-dimethoxypropane (4.0 eq.) was added and reflux was maintained until complete protection. After cooling to room temperature the reaction mixture was diluted with AcOEt, washed with water, brine, dried over MgSO₄, filtered and concentrated under reduced pressure. The residue was purified by silica gel column chromatography.

2.1.2. Acetylation

To a 0.4M solution of the starting material in pyridine (first dried over KOH) was added acetic anhydride (0.5 mL of pyridine). The reaction mixture was stirred at room temperature until acetylation was complete. The solvents were evaporated and co-evaporated with toluene under reduced pressure. The residue was purified by silica gel column chromatography.

2.1.3. Benzylation

a) Method for mono-O-benzylation

To a 0.2M solution of the starting material in dry DCM was added a chosen base. The mixture was cooled to 0°C and benzyl bromide was added dropwise. The reaction mixture was allowed to reach room temperature and stirred until benzylation was complete. In order to eliminate traces of benzyl bromide the reaction mixture was first diluted in a 1M aqueous solution of sodium hydroxide. Then the resulting solution was extracted with DCM, washed with water, then brine, dried over MgSO₄, filtered and concentrated under reduced pressure. The residue was purified by silica gel column chromatography.

b) Method for tri-O-benzylation

To the starting “triol”, benzyl chloride (16.0 eq.) was added followed by potassium hydroxide (19.5 eq.). The reaction mixture was stirred under reflux until complete protection. After cooling to room temperature the reaction mixture was diluted with chloroform, washed with water, brine, then dried over Na₂SO₄, filtered and concentrated under reduced pressure. The residue was purified by silica gel column chromatography.

2.1.4. Benzoylation

a) Benzoylation at O-3

A 0.8 M solution of the starting material in dry pyridine was cooled to 0°C. Then benzoyl chloride (1.2 eq.) was added dropwise. When addition was completed the reaction mixture was stirred at room temperature until the starting material was entirely esterified. Pyridine was evaporated and co-evaporated with toluene under reduced pressure. The crude was dissolved in AcOEt, washed with water, brine, dried over MgSO₄, filtered and concentrated under reduced pressure. The residue was purified by silica gel column chromatography.

b) Benzoylation at O-4

A 0.3 M solution of the starting material in a dry DCM/pyridine 8:2 mixture was cooled to -12°C (using crushed ice-salt bath). Then a 3.5 M solution of benzoyl chloride (1.3 eq.) in dry 6:4 DCM/pyridine was slowly added without temperature exceeding 0°C. When addition was completed DMAP (catalytic amount) was added and the reaction mixture was stirred at room temperature until esterification was complete. The reaction mixture was diluted in DCM, washed with 1M hydrochloric acid, then 1M NaOH and brine, dried over MgSO₄, filtered and concentrated under reduced pressure. The residue was purified by silica gel column chromatography.

2.1.5. Formation of *tert*-butyldimethylsilyl ethers

To a 0.5M solution of the starting material in dry pyridine or in dry DMF containing imidazole (2.2 eq.) was added *tert*-butyldimethylsilyl chloride. The reaction mixture was stirred at room temperature until *O*-silylation was complete. The solvent was evaporated and co-

evaporated with toluene under reduced pressure. The residue was purified by silica gel column chromatography.

2.1.6. Methyl glycosidation

To a 0.3M solution of the starting material in dry MeOH was added sulfuric acid 98% (0.3 eq.). The reaction mixture was stirred at room temperature until glycosidation was complete. Solid K_2CO_3 in excess was added to neutralize the reaction mixture, which was further filtered and concentrated under reduced pressure. The residue was purified by silica gel column chromatography.

2.1.7. Benzylidene acetal formation

To a 2.5M solution of the starting material in dry DMF was added benzaldehyde (5.0 eq.) and zinc chloride (1.5 eq.). The reaction mixture was stirred at room temperature until protection was complete. It was then diluted with AcOEt, washed with water, brine, dried over $MgSO_4$, filtered and concentrated under reduced pressure. The residue was purified by silica gel column chromatography.

2.2. Deprotection reactions

2.2.1. 4,5-Isopropylidene cleavage

A 0.4M suspension of the starting material in 80% aqueous acetic acid was stirred at room temperature until deprotection was complete. The solvents were evaporated and co-evaporated with toluene under reduced pressure. The desired compound was obtained pure without requiring any further purification.

2.2.2. Cleavage of benzoyl groups

To a 0.1M solution of the starting material in dry MeOH was added a 0.5M methanol solution of MeONa until basic pH. The reaction mixture was stirred at room temperature until deprotection was complete. The solvent was evaporated and co-evaporated with toluene under reduced pressure. The residue was purified by silica gel column chromatography.

2.2.3. Cleavage of benzyl groups

To a 0.2M solution of the starting material in dry MeOH was added Pd/C (10%) (equal mass of starting material). The reaction mixture was stirred at room temperature under hydrogen atmosphere until deprotection was complete. The catalyst was then removed using Celite® filtration and the filtrate concentrated under reduced pressure. The residue was purified by silica gel column chromatography.

2.2.4. 1,2-Isopropylidene cleavage

a) Without ring opening

A 0.3M solution of the starting material in 60% aqueous trifluoroacetic acid was stirred at room temperature until deprotection was complete. The solvents were evaporated and co-evaporated with toluene under reduced pressure. The desired compound was obtained without requiring any further purification.

b) With ring opening

To a 0.3M solution of the starting material in THF was added 2M hydrochloric acid (equal volume of the solvent). The reaction mixture was stirred at room temperature until deprotection was complete. The organic layer was then extracted with AcOEt, washed with water, brine, dried over MgSO₄, filtered and concentrated under reduced pressure. The residue was purified by silica gel column chromatography.

2.3. Functionalization reactions

2.3.1. Oxidation

a) With PCC

To a 0.3 M solution of the starting material in dry DCM was added PCC (2.0 eq.). The reaction mixture was stirred under reflux until the oxidation was complete. After cooling to room temperature a small amount of silica was added to the mixture, and the solvent removed under reduced pressure. The residue was purified by silica gel column chromatography. In case the final product is not pure enough, an extraction with AcOEt can be effected.

b) With PDC

To 0.3M solution of the starting material in dry DCM was added PDC (1.1 eq.) and acetic anhydride (3.0 eq.). The reaction mixture was stirred under reflux until the oxidation was complete. After cooling to room temperature a small amount of silica was added to the mixture, and the solvent removed under reduce pressure. The residue was purified by silica gel column chromatography. In case the final product it is not pure enough, an extraction with AcOEt can be effected.

2.3.2. Iodination

To a 0.5M solution of the starting material in the chosen dry solvent was added imidazole (3.0 eq.) and triphenylphosphine (1.5 eq.). After cooling to 0°C iodine (1.0 eq.) was added. The reaction was then stirred at 60-70°C until the iodination was complete. The solvent was evaporated and co-evaporated under reduced pressure with toluene. The residue was purified by silica gel column chromatography.

2.3.3. Elimination

To a 0.2M solution of the starting material in dry toluene was added imidazole (3.0 eq.) and triphenylphosphine (1.5 eq.). After cooling to 0°C iodine (1.4 eq.) was added. The reaction was then stirred under reflux until elimination was complete. The solvent was evaporated and co-evaporated with toluene under reduced pressure. The residue was purified by silica gel column chromatography.

2.3.4. Azide formation

To a 0.3M solution of the starting material in DMSO was added sodium azide (3.0 eq.). The reaction mixture was stirred at 100°C until azide formation was complete. After cooling to room temperature, water was added and the solution was extracted with AcOEt. The combined organic layers were washed with water, brine, dried over MgSO₄, filtered and concentrated. The residue was purified by silica gel column chromatography.

2.3.5. S-Benzylolation

To a 0.3M solution of the starting material in dry DMF was added sodium hydride (60% in mineral oil, 4.0 eq.). The mixture was cooled to 0°C and benzyl bromide (4.0 eq.) was added dropwise. The reaction mixture was allowed to reach room temperature and stirred until benzylolation was complete. In order to eliminate traces of benzyl bromide, the reaction mixture was first washed with 1M aqueous NaOH, then extracted with AcOEt, washed with water, brine, dried over MgSO₄, filtered and concentrated under reduced pressure. The residue was purified by silica gel column chromatography.

2.3.6. Epoxide formation

A 0.2M solution of the starting material in dry DMF was cooled to 0°C, then sodium hydride (60% in mineral oil, 3.0 eq.) was added and the mixture was stirred at room temperature until conversion was complete. The reaction mixture was then diluted with AcOEt, washed with water, brine, dried over MgSO₄, filtered and concentrated under reduced pressure. The residue was purified by silica gel column chromatography.

2.3.7. Epoxide cleavage

To a 0.2M solution of the starting material in dry MeOH was added a 0.5M methanol solution of MeONa until basic pH. The reaction mixture was stirred at 60°C until epoxide cleavage was complete. The solvent was evaporated and co-evaporated with toluene under reduced pressure. The residue was purified by silica gel column chromatography.

2.4. Synthesis of OZTs

2.4.1. Condensation with thiocyanic Acid

To a 0.3M solution of the starting material in the chosen solvent was added potassium isothiocyanate (4.0 eq.). The reaction was cooled to 0°C and 37% hydrochloric acid (2.0 eq.) was added dropwise. The reaction mixture was stirred under reflux or at room temperature until complete consumption of the starting material. After cooling to room temperature, if necessary, crushed ice was added and the solution was extracted with AcOEt. The combined organic layers were washed with water, brine, dried over MgSO₄, filtered and concentrated. The residue was purified by silica gel column chromatography.

2.4.2. Condensation with a thiocarbonyl source: CS₂

To a 0.3M solution of the starting material in dry 1,4-dioxane were added triphenylphosphine (1.1 eq.) and carbon disulfide (20 eq.). The reaction mixture was stirred at 50°C until complete consumption of the starting material. After cooling to room temperature, the solvent was evaporated under reduced pressure. The residue was purified by silica gel column chromatography.

2.4.3. Using trimethylsilyl isothiocyanate

To a 0.2M solution of the starting material in DCM (with 4Å molecular sieves) was added trimethylsilyl isothiocyanate (3.0 eq.). After cooling to -78°C, boron trifluoride etherate (1.0 eq.) was added. The reaction mixture was stirred at room temperature until complete consumption of the starting material. Saturated aqueous sodium hydrogen carbonate was then added and the organic phase was extracted with DCM, washed with water, brine, dried over MgSO₄, filtered and concentrated. The residue was purified by silica gel column chromatography.

2.5. Synthesis of OZOs

2.5.1. Oxydation

a) With hydrogen peroxide

To a 0.1M solution of the starting material in DCM was added sodium hydrogenocarbonate (2.0 eq.) and 30% hydrogen peroxide (5.0 eq.). The reaction mixture was stirred at room temperature until oxidation was complete. The residue was concentrated under reduced pressure and purified by silica gel column chromatography.

b) With *m*-chloroperbenzoic acid

To a 0.2M solution of the starting material in DCM was added sodium hydrogenocarbonate (3.0 eq.) and *m*-chloroperbenzoic acid 77% (3.0 eq.). The reaction mixture was stirred at room temperature until oxidation was complete. Then it was washed with a

saturated solution of sodium metabisulfite and a 0.5M solution of sodium hydrogen carbonate. The organic layer was extracted with DCM washed with water, brine, dried over MgSO_4 , filtered and concentrated. The residue was purified by silica gel column chromatography.

2.6. Synthesis of OXTs

2.6.1. Dehydration

A 0.03 M solution of the starting material in dry DCM was cooled to -5°C and DIPEA (4.0 eq.) was added. After stirring for 30 min. at -5°C triflic anhydride (2.0 eq.) was introduced. The reaction mixture was stirred at room temperature until dehydration was complete. Then crushed ice was added and the solution was extracted with DCM. The combined organic layers were washed with water, brine, dried over MgSO_4 , filtered and concentrated. The residue was purified by silica gel column chromatography.

EXPERIMENTAL PART

Compounds description

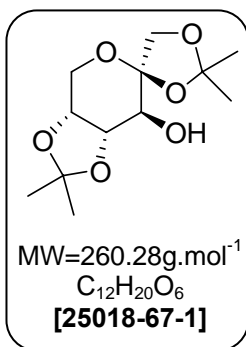
1,2:4,5-Di-O-isopropylidene-β-D-fructopyranose (4)

Starting with **D-fructose** (15.0 g, 83.8 mmol) and after using G.P. 2.1.1.a) (reaction time 1.5h) the product was crystallized with PE/EA (8:2) to give **4** (12.5 g, 48.0 mmol, 58%) as a colorless solid.

¹H NMR (250MHz, CDCl₃) δ: 1.37 (s, 3H, **CH**₃); 1.45 (s, 3H, **CH**₃); 1.52 (s, 3H, **CH**₃); 1.54 (s, 3H, **CH**₃); 2.03 (d, 1H, *J*_{OH-3}=8.3Hz, **OH**); 3.67 (t, 1H, *J*₃₋₄=7.1Hz, **H-3**); 3.98 (d, 1H, *J*_{1a-1b}=9.0Hz, **H-1a**); 4.01 (d, 1H, *J*_{6a-6b}=13.3Hz, **H-6a**); 4.09-4.23 (m, 3H, **H-4**, **H-5**, **H-6b**); 4.19 (d, 1H, *J*_{1b-1a}=9.0Hz, **H-1b**).

Yield=58%

Rf=0.63 PE/EA(5:5)

¹³C NMR (62.89MHz, CDCl₃) δ: 24.3, 24.6, 24.7, 26.2 (**CH**₃); 59.1 (**C-6**); 68.7 (**C-3**); 70.6 (**C-1**); 71.6 (**C-5**); 75.6 (**C-4**); 102.8 (**C-2**); 107.7, 110.2 (**Cq-isop**).

J. Kang, G. J. Lim, S. K. Yoon, M. Y. Kim *J. Org. Chem.* **1995**, *60*, 564; G. D. K. Kumar, S. Baskaran *J. Org. Chem.* **2005**, *70*, 4520.

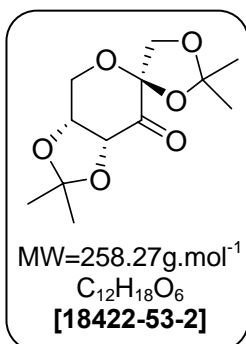
1,2:4,5-Di-O-isopropylidene-β-D-erythro-hexo-2,3-diulo-2,6-pyranose (25)

Starting with **4** (1.5 g, 5.8 mmol) and using G.P. 2.3.1. a) (reaction time 3 days) the residue was chromatographed with PE/EA (8:2) to give **25** (1.2 g, 4.6 mmol, 79%) as a colorless solid.

Starting with **4** (3.5 g, 13.5 mmol) and using G.P. 2.3.1. b) (reaction time 2h) the residue was chromatographed with PE/EA (8:2) to give **25** (3.4 g, 13.3 mmol, 99%) as a colorless solid.

Yield= 99%

Rf=0.59 PE/EA(7:3)

¹H NMR (250MHz, CDCl₃) δ: 1.38 (s, 6H, **CH**₃); 1.44 (s, 3H, **CH**₃); 1.53 (s, 3H, **CH**₃); 3.97 (d, 1H, *J*_{1a-1b}=9.5Hz, **H-1a**); 4.10 (d, 1H, *J*_{6a-6b}=13.5Hz, **H-6a**); 4.37 (d, 1H, *J*_{6b-5}=2.2Hz, *J*_{6b-6a}=13.5Hz, **H-6b**); 4.52 (ddd, 1H, *J*_{5-6a}=1.0Hz, *J*_{5-6b}=2.2Hz, *J*₅₋₄=5.5Hz, **H-5**); 4.59 (d, 1H, *J*_{1b-1a}=9.5Hz, **H-1b**); 4.71 (d, 1H, *J*₄₋₅=5.5Hz, **H-4**).

¹³C NMR (62.89MHz, CDCl₃) δ: 26.2, 26.7, 27.3 (**CH**₃); 60.2 (**C-6**); 70.1 (**C-1**); 76.0 (**C-4**); 78.1 (**C-5**); 104.3 (**C-2**); 110.8, 114.0 (**Cq-isop**); 197.1 (**C-3**).

J. Kang, G. J. Lim, S. K. Yoon, M. Y. Kim *J. Org. Chem.* **1995**, *60*, 564; J.-C. Lee, S. W. Chang, C.-C. Liao, F.-C. Chi, C.-S. Chen, Y.-S. Wen, C.-C. Wang, S. S. Kulkareni, R. Puranik, Y.-H. Liu, S.-C. Hung *Chem. Eur. J.* **2004**, *10*, 399.

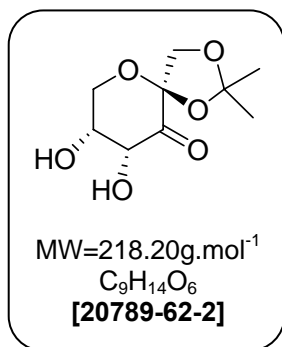
1,2-O-isopropylidene- β -D-erythro-hexo-2,3-diulo-2,6-pyranose (24)

Starting with **25** (2.5 g, 9.6 mmol) and using G.P. 2.2.1. (reaction time 15h) the compound **24** (2.5 g, 11.5 mmol, 99%) was obtained as a colorless solid.

¹H NMR (250MHz, CDCl₃) δ : 1.39 (s, 3H, CH₃); 1.55 (s, 3H, CH₃); 2.65 (brs, 1H, OH-4); 3.62 (brs, 1H, OH-5); 3.99 (dd, 1H, $J_{6a-5}=2.0\text{Hz}$, $J_{6a-6b}=12.8\text{Hz}$, H-6a) 4.00 (d, 1H, $J_{1a-1b}=9.5\text{Hz}$, H-1a); 4.33 (dd, 1H, $J_{6b-5}=1.3\text{Hz}$, $J_{6b-6a}=12.8\text{Hz}$, H-6b); 4.38-4.41 (m, 1H, H-5); 4.68 (d, 1H, $J_{1b-1a}=9.5\text{Hz}$, H-1b); 4.73 (d, 1H, $J_{4-5}=4.0\text{Hz}$, H-4).

Yield= 100%

Rf=0.47 PE/EA(7:3)

¹³C NMR (62.89MHz, CDCl₃) δ : 26.3 (CH₃); 26.5 (CH₃); 63.4 (C-6); 69.7 (C-1); 73.6 (C-4); 74.3 (C-5); 104.4 (C-2); 113.7 (Cq-isop); 199.1 (C=O).

J. Kang, G. J. Lim, S. K. Yoon, M. Y. Kim *J. Org. Chem.* **1995**, 60, 564; X.-Y. Wu, X. She, Y. Shi *J. Am. Chem. Soc.* **2002**, 124, 8792.

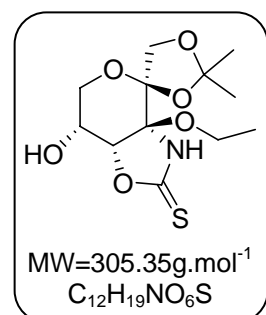
4,5-Dihydro[3-O-ethyl-1,2-O-isopropylidene- β -D-fructopyranoso][3,4-d]-1,3-oxazolidine-2-thione (26)

Starting with **24** (0.40 g, 1.8 mmol) and using G.P. 2.4.1. with ethanol as solvent and at reflux (reaction time 15h) the compound **26** was obtained after column chromatography on silica gel with a mixture of PE/EA (8:2) as an orange oil (0.20 g, 0.65 mmol, 35%).

¹H NMR (400MHz, CDCl₃) δ : 1.26 (t, 3H, $J=7.2\text{Hz}$, CH₂-CH₃); 1.39 (s, 3H, CH₃-isop); 1.51 (s, 3H, CH₃-isop); 2.87 (brs, 1H, OH); 3.56-3.64 (m, 3H, H-6a, CH₂-CH₃); 3.99 (d, 1H, $J_{1a-1b}=8.8\text{Hz}$, H-1a); 4.04 (dd, 1H, $J_{6b-5}=5.6\text{Hz}$, $J_{6b-6a}=10.4\text{Hz}$, H-6b); 4.20 (d, 1H, $J_{1b-1a}=8.8\text{Hz}$, H-1b); 4.58-4.63 (m, 1H, H-5); 5.01 (d, 1H, $J_{4-5}=3.6\text{Hz}$, H-4); 8.80 (s, 1H, NH).

Yield=35%

Rf=0.55 PE/EA(5:5)

$[\alpha]_D^{20} = -2$ (c=0.45

CHCl₃)

¹³C NMR (100MHz, CDCl₃) δ : 15.1 (CH₂-CH₃); 25.6, 26.9 (CH₃-isop); 58.7 (CH₂-CH₃); 62.5 (C-6); 64.1 (C-5); 71.2 (C-1); 83.0 (C-4); 91.5 (C-3); 103.2 (C-2); 113.7 (Cq-isop); 189.6 (C=S).

HRMS: Calculated for C₁₂H₁₉NO₆S [M+H]⁺ 306.1019, found: 306.1011.

IR: (neat) ν (cm⁻¹): 3177 (OH); 2984 (CH); 1484, 1256, 1015 (N-CS-O).

4,5-Dihydro[1,2-*O*-isopropylidene- β -D-fructopyranoso][3,4-*d*]-1,3-oxazolidine-2-thione (1)

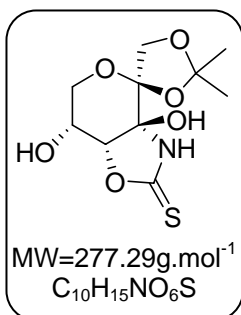

Yield=59%

Rf=0.50 PE/EA(2:8)

mp=163-167°C

[α]_D²⁰ = +5 (c=0.14 MeOH)

Starting with **24** (0.4 g, 1.8 mmol) and using G.P. 2.4.1. with DMF as solvent and at room temperature (reaction time 15h) the compound **1** was obtained after column chromatography on silica gel with a mixture of PE/EA (5:5) as a cream-colored solid (0.30 g, 1.15 mmol, 59%).

¹H NMR (250MHz, DMSO) δ : 1.30 (s, 3H, **CH**₃); 1.40 (s, 3H, **CH**₃); 3.16 (d, 1H, $J_{6a-6b}=J_{6a-5}=5.3$ Hz, **H-6a**); 3.72 (d, $J_{1a-1b}=9.4$ Hz, **H-1a**); 3.73 (dd, $J_{6b-5}=5.3$ Hz, $J_{6b-6a}=9.5$ Hz, **H-6b**); 4.15 (d, 1H, $J_{1b-1a}=9.4$ Hz, **H-1b**); 4.33-4.44 (m, 1H, **H-5**); 4.62 (d, 1H, $J_{4-5}=3.3$ Hz, **H-4**); 5.47 (d, 1H, $J_{OH-5}=6.0$ Hz, **OH-5**); 7.08 (s, 1H, **OH-3**); 10.65 (s, 1H, **NH**).

¹³C NMR (62.89MHz, DMSO) δ : 25.7, 26.7 (**CH**₃); 62.0 (**C-6**); 62.1 (**C-4**); 70.5 (**C-1**); 87.3 (**C-5**); 88.0 (**C-3**); 103.2 (**C-2**); 112.1 (**Cq-isop**); 188.2 (**C=S**).

HRMS: Calculated for C₁₀H₁₅NO₆S [M+H]⁺ 278.0707, found: 278.0698.

IR: (neat) ν (cm⁻¹): 3477 (**OH**); 3209 (**NH**); 2994 (**CH**), 1489, 1372, 1012 (**N-CS-O**).

4,5-Dihydro[5-*O*-acetyl-3-*O*-ethyl-1,2-*O*-isopropylidene- β -D-fructopyranoso]-[3,4-*d*]-1,3-oxazolidine-2-thione (31)

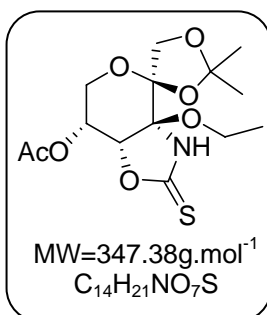

Yield=67%

Rf=0.28 PE/EA(8:2)

[α]_D²⁰ = +15 (c=0.22 CHCl₃)

Starting with **26** (0.2 g, 0.7 mmol) and using G.P. 2.1.2. (reaction time 15h) the compound **31** was obtained after column chromatography on silica gel with a mixture of PE/EA (8:2) as a cream colored oil (0.16 g, 0.5 mmol, 67%).

¹H NMR (400MHz, CDCl₃) δ : 1.27 (t, 3H, **CH**₂-**CH**₃); 1.39 (s, 3H, **CH**₃-**isop**); 1.52 (s, 3H, **CH**₃-**isop**); 2.14 (s, 3H, **O-CO-CH**₃), 3.53-3.64 (m, 2H, **CH**₂-**CH**₃); 3.75 (dd, 1H, $J_{6a-5}=8.8$ Hz, $J_{6a-6b}=10.6$ Hz, **H-6a**); 4.01 (d, 1H, $J_{1a-1b}=8.8$ Hz, **H-1a**); 4.05 (dd, 1H, $J_{6b-5}=5.6$ Hz, $J_{6b-6a}=10.6$ Hz, **H-6b**); 4.15 (d, 1H, $J_{1b-1a}=8.8$ Hz, **H-1b**); 5.12 (d, 1H, $J_{4-5}=4.4$ Hz, **H-4**); 5.62 (ddd, 1H, $J_{5-4}=4.4$ Hz, $J_{5-6b}=5.6$ Hz, $J_{5-6a}=8.8$ Hz, **H-5**); 8.42 (s, 1H, **NH**).

¹³C NMR (100MHz, CDCl₃) δ : 15.1 (**CH**₂-**CH**₃); 19.6 (**O-CO-CH**₃); 24.6, 26.0 (**CH**₃-**isop**); 57.9 (**CH**₂-**CH**₃); 58.9 (**C-6**); 64.2 (**C-5**); 70.2 (**C-1**); 79.3 (**C-4**); 90.6 (**C-3**); 102.3 (**C-2**); 113.2 (**Cq-isop**); 169.4 (**C=O**); 188.7 (**C=S**).

MS: (IS⁺) m/z: 348 (M+H)⁺; 370 (M+Na)⁺.

IR: (neat) ν (cm⁻¹): 2987, 2942 (**CH**); 1752 (**C=O**); 1483, 1255, 1015 (**N-CS-O**).

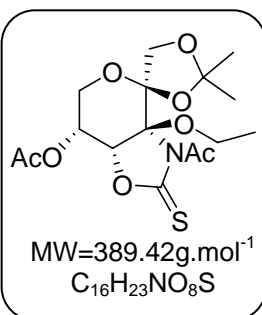
4,5-Dihydro[5-O-acetyl-3-O-ethyl-1,2-O-isopropylidene-β-D-fructopyranoso][3,4-d]-1,3-oxazolidine-2-thione (35)

Yield=23%

R_f=0.46 PE/EA(8:2)[α]_D²⁰ = +45 (c=0.24CHCl₃)

The compound **35** was a side product of the synthesis of compound **31**. Compound **35** was obtained after column chromatography on silica gel with a mixture of PE/EA (9:1) as a cream oil (60 mg, 0.15 mmol, 23%).

¹H NMR (400MHz, CDCl₃) δ: 1.22-1.26 (m, 6H, CH₂-CH₃, O-CO-CH₃); 1.35 (s, 3H, CH₃-isop); 1.51 (s, 3H, CH₃-isop); 2.78 (s, 3H, N-CO-CH₃); 3.42-3.50 (m, 1H, CH₂-CH_{3a}); 3.56-3.63 (m, 1H, CH₂-CH_{3b}); 3.65 (dd, 1H, J_{6a-6b}=11.0Hz, J_{6a-5}=9.4Hz, H-6a); 3.75 (d, 1H, J_{1a-1b}=9.8Hz, H-1a); 4.05 (dd, J_{6b-6a}=11.0Hz, J_{6b-5}=5.6Hz, H-6b); 4.44 (d, 1H, J_{1b-1a}=9.8Hz, H-1b); 5.07 (d, 1H, J₄₋₅=5.6Hz, H-4); 5.69 (ddd, 1H, J₅₋₄=J_{5-6b}=5.6Hz, J_{5-6a}=9.4Hz, H-5).

¹³C NMR (100MHz, CDCl₃) δ: 14.8 (CH₂-CH₃); 19.9 (O-CO-CH₃); 24.8, 27.6 (CH₃-isop); 36.9 (N-CO-CH₃); 59.7 (CH₂-CH₃); 60.5 (C-6); 65.3 (C-5); 71.1 (C-1); 79.5 (C-4); 91.6 (C-3); 100.2 (C-2); 111.8 (Cq-isop); 156.0, 157.4 (C=O); 188.7 (C=S).

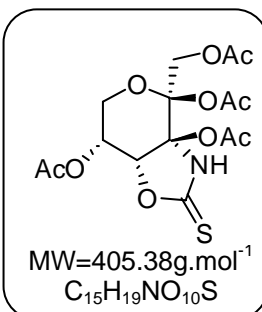
MS: (IS+) m/z: 412 (M+Na)⁺.IR: (neat) ν (cm⁻¹): 2985 (CH); 1754 (C=O); 1473, 1245, 1023 (N-CS-O).**4,5-Dihydro[1,2,3,5-tetra-O-acetyl-β-D-fructopyranoso][3,4-d]-1,3-oxazoline-2-thione (37)**

Yield=55%

R_f=0.28 PE/EA(8:2)[α]_D²⁰ = +19 (c=0.21CHCl₃)

Starting with **26** (0.5 g, 1.64 mmol) and using G.P. 2.2.4. a) (reaction time 2h) the compound **32** was obtained and immediately used for the next reaction without further purification. Starting with **32** and using G.P. 2.1.2. (reaction time 15h) the compound **37** was obtained after column chromatography on silica gel with a mixture of PE/EA (8:2) as a brown oil (0.33 g, 0.91 mmol, 55%).

Starting with **1** (0.5 g, 1.80 mmol) and using G.P. 2.2.4. a) (reaction time 2h) the compound **32** was obtained and immediately used for the next reaction without further purification. Starting with **32** and using G.P. 2.1.2. (reaction time 15h) the compound **37** was obtained after column chromatography on silica gel with a mixture of PE/EA (8:2) as a brown oil (0.32 g, 0.88 mmol, 49%).

¹H NMR (400MHz, CDCl₃) δ: 2.09 (s, 6H, O-CO-CH₃); 2.15 (s, 3H, O-CO-CH₃); 2.17 (s, 3H, O-CO-CH₃); 4.28 (dd, 1H, J_{6a-5}=4.4Hz, J_{6a-6b}=12.0Hz, H-6a); 4.39-4.48 (m, 2H, H-5, H-6b); 4.55 (d, 1H, J_{1a-1b}=12.4, H-1a); 4.82 (d, 1H, J_{1b-1a}=12.4Hz, H-1b); 5.24 (d, 1H, J₄₋₅=6.4Hz, H-4); 8.15 (brs, 1H, NH).

¹³C NMR (100MHz, CDCl₃) δ: 20.7, 20.8, 21.5, 21.6 (O-CO-CH₃); 61.5 (C-1); 61.9 (C-6); 80.2 (C-5); 87.8 (C-4); 101.9 (C-2); 108.6 (C-3); 168.8, 169.8, 169.9, 170.4 (C=O); 189.2 (C=S).

HRMS: Calculated for C₁₅H₁₉NO₁₀S [M+Na]⁺ 428.0627, found: 428.0643.IR: (neat) ν (cm⁻¹): 2928 (CH); 1741 (C=O); 1775, 1369, 1042 (N-CS-O).

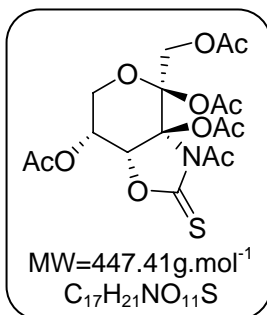
4,5-Dihydro[*N*-acetyl-1,2,3,5-tetra-*O*-acetyl- β -D-fructopyranoso][3,4-*d*]-1,3-oxazoline-2-thione (38)**Yield**=19%**R_f**=0.45 PE/EA(8:2)**[α]_D²⁰**=+30 (c=0.46
CHCl₃)

The compound **38** was a side product of the synthesis of compound **37** using both procedures. Compound **38** was obtained after column chromatography on silica gel with a mixture of PE/EA (9:1) as a brown oil (0.14 g, 0.31 mmol, 19%) starting from **26** and (0.11 g, 0.25 mmol, 15%) from **1**.

¹H NMR (400MHz, CDCl₃) δ : 2.08 (s, 3H, **O-CO-CH₃**); 2.10 (s, 6H, **O-CO-CH₃**); 2.16 (s, 3H, **O-CO-CH₃**); 2.78 (s, 3H, **N-CO-CH₃**); 4.30 (dd, 1H, $J_{6a-5}=4.0\text{Hz}$, $J_{6a-6b}=12.2$. **H-6a**); 4.42 (dd, 1H, $J_{6b-5}=4.6\text{Hz}$, $J_{6b-6a}=12.2$. **H-6b**); 4.58 (dd, 1H, $J_{5-6a}=4.6\text{Hz}$, $J_{5-4}=5.6$ **H-5**); 4.74 (d, 1H, $J_{1a-1b}=12.0\text{Hz}$, **H-1a**); 5.09 (d, 1H, $J_{1b-1a}=12.0\text{Hz}$, **H-1b**); 5.15 (d, 1H, $J_{4-5}=5.6\text{Hz}$, **H-4**).

¹³C NMR (100MHz, CDCl₃) δ : 20.7, 20.8, 21.1, 21.7 (**O-CO-CH₃**); 27.0 (**N-CO-CH₃**); 60.4 (**C-1**); 62.1 (**C-6**); 80.5 (**C-5**); 84.0 (**C-4**); 102.8 (**C-2**); 108.6 (**C-3**); 167.0, 168.6, 169.9, 170.2, 170.3 (**C=O**); 185.3 (**C=S**).

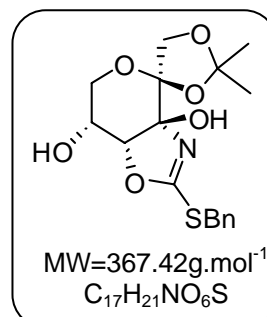
HRMS: Calculated for C₁₇H₂₁NO₁₁S [M+Na]⁺ 470.0733, found: 470.0751.**IR**: (neat) ν (cm⁻¹): 2885 (**CH**); 1722 (**C=O**); 1453, 1370, 1057 (**N-CS-O**).**2-Benzylsulfanyl-4,5-dihydro[1,2-*O*-isopropylidene- β -D-fructopyranoso][3,4-*d*]-1,3-oxazoline (45)****Yield**=74%**R_f**=0.48 PE/EA(3:7)**[α]_D²⁰**=-74 (c=0.23
CHCl₃)

Starting with **1** (0.2 g, 0.72 mmol) and using G.P. 2.3.6. with sodium hydrogen carbonate (4.0 eq.) as base and adding BnBr (4.0 eq.) (reaction time 4h) the compound **45** was obtained after column chromatography on silica gel with a mixture of PE/EA (5:5) as a colorless oil (0.2 g, 0.54 mmol, 74%).

Starting with **1** (0.3 g, 1.08 mmol) and using G.P. 1.1.3. a), with NaH (60% in mineral oil) (4.0 eq.) and adding BnBr (4.0 eq.), or triethylamine (1.2 eq.) then addition of BnBr (2.5 eq.), (reaction time 4h), the compound **45** was obtained after column chromatography on silica gel with a mixture of PE/EA (5:5) as a colorless oil (0.28 g, 0.76 mmol, 71%) or (0.27 g, 0.73 mmol, 69%) respectively.

¹H NMR (400MHz, CDCl₃) δ : 1.46 (s, 3H, **CH₃**); 1.47 (s, 3H, **CH₃**); 3.63 (d, $J_{1a-1b}=9.4\text{Hz}$, **H-1a**); 3.91 (d, 1H, $J_{7a-7b}=10.8\text{Hz}$, **H-7a**); 3.94 (d, 1H, $J_{7b-7a}=10.8\text{Hz}$, **H-7b**); 4.06 (d, 1H, $J_{6a-6b}=13.8\text{Hz}$, **H-6a**); 4.18 (d, 1H, $J_{4-5}=2.0\text{Hz}$, **H-4**); 4.22 (dd, $J_{6b-6a}=13.8\text{Hz}$, **H-6b**); 4.25 (d, 1H, $J_{1b-1a}=9.4\text{Hz}$, **H-1b**); 4.51 (dd, 1H, $J_{5-4}=2.0\text{Hz}$, $J_{5-6}=3.6\text{Hz}$, **H-5**); 7.24-7.36 (m, 5H, **Ph**).

¹³C NMR (100MHz, CDCl₃) δ : 25.3, 25.4 (**CH₃**); 34.5 (**C-7**); 62.4 (**C-6**); 64.1 (**C-4**); 69.5 (**C-1**); 76.4 (**C-5**); 81.6 (**C-3**); 106.6 (**C-2**); 111.5 (**Cq-isop**); 126.4, 127.6, 128.0 (**CH-Ph**); 136.1 (**Cq-Ph**); 160.9 (**C-SBn**).

HRMS: Calculated: 368.1168; Found: 368.1155.**IR**: (neat) ν (cm⁻¹): 3394 (**OH**); 2988, 2928 (**CH**), 1618, 1064, 699 (**N-C-S-O**); 1495, 1454 (**Ph**).

2-Benzylsulfanyl-4,5-dihydro[5-O-acetyl-1,2-O-isopropylidene-β-D-fructopyranoso][3,4-d]-1,3-oxazoline (47)

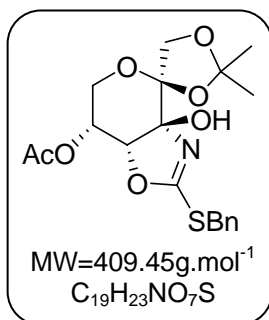

Yield=76%

R_f=0.24 PE/EA(8:2)

[α]_D²⁰ = +41 (c=0.13
CHCl₃)

Starting with **45** (0.13 g, 0.35 mmol) and using G.P. 2.1.2. (reaction time 15h) the compound **47** was obtained after column chromatography on silica gel with a mixture of PE/EA (8:2) as a colorless oil (0.11 g, 0.27 mmol, 76%).

¹H NMR (400MHz, CDCl₃) δ: 1.47 (s, 6H, CH₃-isop); 2.11 (s, 3H, O-CO-CH₃); 2.72 (s, 1H, OH); 3.60 (d, 1H, J_{1a-1b}=9.2Hz, H-1a); 3.92 (dd, 1H, J_{6a-6b}=12.4Hz, H-6a); 4.00 (d, 1H, J_{6b-6a}=12.4Hz, H-6b); 4.06 (d, 1H, J_{7a-7b}=14.0Hz, H-7a); 4.23 (d, 1H, J_{7b-7a}=14.0Hz, H-7b); 4.31 (d, 1H, J_{1b-1a}=9.2Hz, H-1b); 4.55 (t, 1H, J₅₋₄=2.0Hz, H-5); 5.29 (d, 1H, J₄₋₅=2.0Hz, H-4); 7.22-7.37 (m, 5H, Ph).

¹³C NMR (100MHz, CDCl₃) δ: 21.1 (O-CO-CH₃); 26.3, 26.4 (CH₃-isop); 35.4 (C-7); 65.0 (C-6); 65.5 (C-4); 70.5 (C-1); 76.0 (C-5); 81.3 (C-3); 108.0 (C-2); 112.6 (Cq-isop); 127.4, 128.5, 129.0 (CH-Ph); 137.2 (Cq-Ph); 160.8 (C-SBn); 171.0 (C=O).

HRMS: Calculated for C₁₉H₂₃NO₇S [M+H]⁺ 410.1273, found: 410.1268.

IR: (neat) ν (cm⁻¹): 3453 (OH); 2990, 2928 (CH); 1745 (C=O); 1621, 1063, 987 (N=CS-O); 1496, 1454 (Ph).

2-Benzylsulfanyl-4,5-dihydro[3,5-di-O-acetyl-4-deoxy-1,2-O-isopropylidene-β-D-fructopyranoso][3,4-d]-1,3-oxazoline (46)

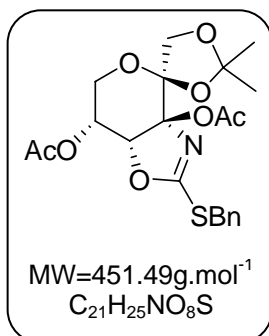

Yield=17%

R_f=0.34 PE/EA(8:2)

[α]_D²⁰ = -180 (c=0.3
CHCl₃)

The compound **46** is a side product of the synthesis of compound **47**. Compound **46** was obtained after column chromatography on silica gel with a mixture of PE/EA (9:1) as a yellow oil (0.03 g, 0.07 mmol, 17%).

¹H NMR (400MHz, CDCl₃) δ: 1.40 (s, 3H, CH₃-isop); 1.44 (s, 3H, CH₃-isop); 2.07 (s, 3H, O-CO-CH₃); 2.11 (s, 3H, O-CO-CH₃); 3.61 (d, 1H, J_{1a-1b}=9.3Hz, H-1a); 3.93 (dd, 1H, J_{6a-5}=2.5Hz, J_{6a-6b}=12.5Hz, H-6a); 4.05-4.11 (m, 2H, H-6b, H-7a); 4.26 (d, 1H, J_{7b-7a}=14.0Hz, H-7b); 4.35 (d, 1H, J_{1b-1a}=9.3Hz, H-1b); 4.66 (t, 1H, J₅₋₄=2.3Hz, H-5); 6.23 (d, 1H, J₄₋₅=2.3Hz, H-4); 7.24-7.39 (m, 5H, Ph).

¹³C NMR (100MHz, CDCl₃) δ: 21.1, 22.8 (O-CO-CH₃); 25.7, 29.8 (CH₃-isop); 35.6 (C-7); 64.4 (C-6); 65.1 (C-4); 71.2 (C-1); 75.6 (C-5); 88.3 (C-3); 108.0 (C-2); 112.7 (Cq-isop); 127.5, 128.6, 129.0 (CH-Ph); 137.2 (Cq-Ph); 167.9 (C-S); 170.2 (C=O).

HRMS: Calculated for C₂₁H₂₅NO₈S [M+H]⁺ 452.1379, found: 452.1394.

IR: (neat) ν (cm⁻¹): 2991, 2927 (CH); 1749 (C=O); 1627, 1080, 698 (N=C-S-O); 1495, 1454 (Ph); 876, 845 (CH₃).

4,5-Dihydro[3,5-di-O-acetyl-1,2-O-isopropylidene-β-D-fructopyranoso][3,4-d]-1,3-oxazoline-2-one (48)

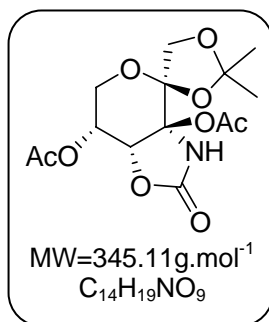

Starting with **46** (50 mg, 0.11 mmol) and using G.P. 2.5.1. a) (reaction time 3h) the compound **48** was obtained after column chromatography on silica gel with a mixture of PE/EA (9:1) as a colorless oil (31 mg, 0.09 mmol, 81%).

¹H NMR (400MHz, CDCl₃) δ: 1.40 (s, 3H, CH₃-isop); 1.42 (s, 3H, CH₃-isop); 2.07 (s, 3H, O-CO-CH₃); 2.11 (s, 3H, O-CO-CH₃); 3.83-3.88 (m, 1H, H-6a); 3.94-4.02 (m, 2H, H-1a, H-4); 4.27 (d, 1H, J_{1a-1b}=9.2Hz, H-1b); 4.42 (d, 1H, J_{6a-6b}=10.0Hz, H-6b); 4.55-4.60 (m, 1H, H-5), 7.41 (brs, 1H, NH).

Yield=81%

R_f=0.30 PE/EA(8:2)

[α]_D²⁰ = -150 (c=0.16
CHCl₃)

¹³C NMR (100MHz, CDCl₃) δ: 21.0, 21.3 (O-CO-CH₃); 26.0, 26.3 (isop-CH₃); 65.1 (C-6); 70.2 (C-4); 74.6 (C-1); 80.4 (C-5); 86.4 (C-3); 107.6 (C-2); 113.5 (Cq-isop); 170.2, 171.1 (O-C=O-CH₃); 178.0 (C=O).

IR: (neat) ν (cm⁻¹): 3255 (OH); 2933, 2842 (CH); 1685 (C=O).

4,5-Dihydro[1,2-O-isopropylidene-β-D-fructopyranoso][3,4-d]-1,3-oxazoline-2-one (2)

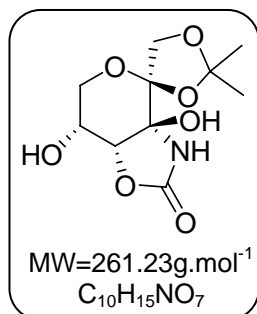

Starting with **45** (16 mg, 0.04 mmol) and using G.P. 2.5.1. a) (reaction time 3h) the compound **2** was obtained after column chromatography on silica gel with a mixture of PE/EA (1:9) as a colorless oil (8 mg, 0.03 mmol, 72%).

¹H NMR (400MHz, CDCl₃) δ: 1.46 (s, 6H, CH₃-isop); 2.01 (brs, 2H, OH); 3.88-3.94 (m, 3H, H-1a, H-6a, H-6b); 4.23 (brs, 1H, H-4); 4.37 (d, 1H, J_{1b-1a}=9.3Hz, H-1b); 4.59 (m, 1H, H-5); 7.25 (brs, 1H, NH).

Yield=72%

R_f=0.30 PE/EA(2:8)

[α]_D²⁰ = -50 (c=0.12
MeOH)

¹³C NMR (100MHz, CDCl₃) δ: 25.1, 25.2 (CH₃); 62.0 (C-6); 63.4 (C-4); 69.1 (C-1); 76.5 (C-5); 99.1 (C-3); 106.3 (C-2); 112.2 (Cq-isop); 168.4 (C=O).

MS: (IS+) m/z: 279 (M+NH₄)⁺; 284 (M+Na)⁺.

IR: (neat) ν (cm⁻¹): 3268 (OH); 2923, 2853 (CH); 1686 (C=O).

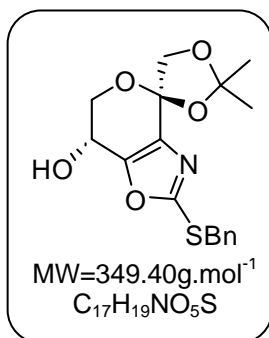
2-Benzylsulfanyl[3,4-dideoxy-1,2-O-isopropylidene-β-D-glycero-pyranoso][3,4-d]-1,3-oxazole (3)

Yield=8%

R_f=0.54 PE/EA(5:5)[α]_D²⁰ = +0.4 (c=0.05
CHCl₃)

The compound **3** was a side product of the synthesis of compound **45**. Compound **3** was obtained (with triethylamine (1.2 eq.) or NaH (60% in mineral oil) (4.0 eq.) as base and adding BnBr (4.0 eq.) or (2.5 eq.) respectively) after column chromatography on silica gel with a mixture of PE/EA (8:2) as a orange oil (20 mg, 0.06 mmol, 8%) or (15 mg, 0.04 mmol, 6%) respectively to the base used.

¹H NMR (400MHz, CDCl₃) δ: 1.52 (s, 3H, CH₃-isop); 1.56 (s, 3H, CH₃-isop); 2.08 (brs, 1H, OH); 4.03 (d, 1H, J_{6a-6b}=12.8Hz, H-6a); 4.18 (d, 1H, J_{1a-1b}=9.2Hz, H-1a); 4.30 (dd, 1H, J_{6b-5}=2.8Hz, J_{6b-6a}=12.8Hz, H-6a); 4.40 (s, 2H, H-7); 4.44 (d, 1H, J_{1b-1a}=9.2Hz, H-1b); 4.56-4.58 (m, 1H, H-5); 7.26-7.41 (m, 5H, Ph).

¹³C NMR (100MHz, CDCl₃) δ: 26.4, 27.1 (isop-CH₃); 36.9 (C-7); 61.4 (C-5); 67.6 (C-6); 72.7 (C-1); 101.4 (C-2); 112.4 (Cq-isop); 128.0, 128.8, 129.3 (CH-Ph); 135.5 (C-3); 136.2 (Cq-Ph); 148.8 (C-4); 161.9 (C-SBn).

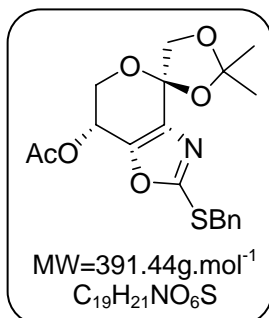
MS: (IS+) m/z: 372 (M+Na)⁺.IR: (neat) ν (cm⁻¹): 3329 (OH); 2988, 2932 (CH); 1062, 698 (N=CS-O); 1479, 1454 (Ph).**2-Benzylsulfanyl[5-O-acetyl-3,4-dideoxy-1,2-O-isopropylidene-β-D-glycero-pyranoso][3,4-d]-1,3-oxazole (53)**

Starting with **46** (50 mg, 0.18 mmol) and using G.P. 2.6.1. (reaction time 5 min.) the compound **53** was obtained after column chromatography on silica gel with a mixture of PE/EA (9:1) as a colorless oil (33 mg, 0.08 mmol, 70%).

¹H NMR (250MHz, CDCl₃) δ: 1.46 (s, 3H, CH₃-isop); 1.50 (s, 3H, CH₃-isop); 2.04 (s, 3H, O-CO-CH₃); 3.96-4.10 (m, 2H, H-5, H-6a); 4.14 (d, 1H, J_{1a-1b}=9.2Hz, H-1a); 4.27 (dd, 1H, J_{6b-5}=2.8Hz, J_{6b-6a}=13.3Hz, H-6b); 4.33 (s, 2H, H-7); 4.39 (d, 1H, J_{1b-1a}=9.2Hz, H-1b); 7.23-7.40 (m, 5H, Ph).

Yield=70%

R_f=0.33 PE/EA(8:2)[α]_D²⁰ = +20 (c=0.21
CHCl₃)

¹³C NMR (62.89MHz, CDCl₃) δ: 21.6 (O-CO-CH₃); 25.3, 26.0 (CH₃-isop); 30.1 (C-7); 62.2 (C-5); 64.6 (C-6); 72.9 (C-1); 105.2 (C-2); 112.6 (Cq-isop); 128.7, 129.2, 129.3 (CH-Ph); 133.7 (C-3); 135.4 (Cq-Ph); 143.6 (C-4); 162.7 (C-S); 177.0 (C=O).

IR: (neat) ν (cm⁻¹): 3330 (OH); 2987, 2933 (CH); 1062, 699 (N=CS-O); 1489, 1454 (Ph).

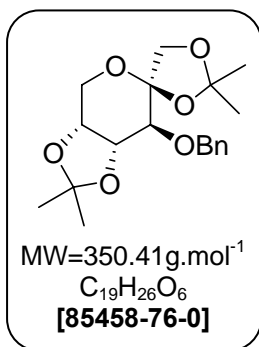
3-O-benzyl-1,2:4,5-di-O-isopropylidene-β-D-fructopyranose (56)

Yield= 98%
Rf=0.8 PE/EA(7:3)

Starting with **4** (3 g, 11.5 mmol) using G.P. 2.1.3. a), DMF as solvent and NaH (60% in mineral oil) as base, the compound **56** was obtained after column chromatography on silica gel with a mixture of PE/EA (9:1) as colorless oil (3.96 g, 11.3 mmol, 98%).

¹H NMR (400MHz, CDCl₃) δ: 1.30 (s, 3H, CH₃); 1.34 (s, 3H, CH₃); 1.42 (s, 3H, CH₃); 1.46 (s, 3H, CH₃); 3.42 (d, 1H, J₃₋₄=7.0Hz, H-3); 3.80 (d, 1H, J_{1a-1b}=8.4Hz, H-1a); 3.91 (d, 1H, J_{6a-6b}=13.2Hz, H-6a); 4.00 (d, 1H, J_{1b-1a}=8.4Hz, H-1b); 4.06 (dd, 1H, J_{6b-5}=2.4Hz, J_{6b-6a}=13.2Hz, H-6b); 4.14 (dd, 1H, J_{5, 6b}=2.4Hz, J₅₋₄=5.8Hz, H-5); 4.31 (dd, 1H, J₄₋₅=5.8Hz, J₄₋₃=7.0Hz, H-4); 4.58 (d, 1H, J_{7a-7b}=11.8Hz, H-7a); 4.89 (d, 1H, J_{7b-7a}=11.8Hz, H-7b); 7.17-7.30 (m, 5H, Ph).

¹³C NMR (100MHz, CDCl₃) δ: 25.2, 25.3, 26.0, 27.3 (CH₃); 59.3 (C-6); 71.0 (C-1); 72.1 (C-7); 72.9 (C-5); 75.1 (C-3); 76.9 (C-4); 103.3 (C-2); 108.1, 111.3 (Cq-isop); 126.7, 126.8, 126.9, 127.4, 127.5 (CH-Ph); 137.3 (Cq-Ph).

J. Kang, G. J. Lim, S. K. Yoon, M. Y. Kim *J. Org. Chem.* **1996**, *60*, 564.

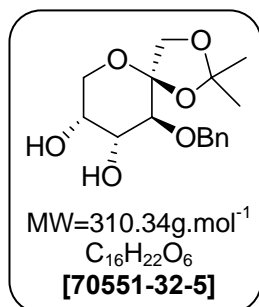
3-O-benzyl-1,2-O-isopropylidene-β-D-fructopyranose (57)

Yield=100%
Rf=0.43 PE/EA(5:5)

Starting with **56** (4.7 g, 13.4 mmol) and using G.P. 2.2.1. (reaction time 15h) the compound **57** was obtained as a colorless solid (4.14 g, 13.3 mmol, 100%).

¹H NMR (250MHz, CDCl₃) δ: 1.43 (s, 3H, CH₃); 1.49 (s, 3H, CH₃); 2.43 (brs, 1H, OH); 2.51 (brs, 1H, OH); 3.68 (d, 1H, J_{1a-1b}=9.3Hz, H-1a); 3.77 (d, 1H, J_{6a-5}=1.8Hz, J_{6a-6b}=13.0Hz, H-6a); 3.94-4.07 (m, 5H, H-1b, H-3, H-4, H-5, H-6b); 4.75 (d, J_{7a-7b}=11.5Hz, H-7a); 4.81 (d, 1H, J_{7b-7a}=11.5Hz, H-7b); 7.33-7.38 (m, 5H, Ph).

¹³C NMR (62.89MHz, CDCl₃) δ: 26.3, 27.0 (CH₃); 63.7 (C-6); 69.8, 71.5, 72.0 (C-3); (C-4); (C-5); 75.5 (C-7); 77.1 (C-1); 105.7 (C-2); 112.1 (Cq-isop); 128.1, 128.2, 128.8 (CH-Ph); 138.0 (Cq-Ph).

J. Kang, G. J. Lim, S. K. Yoon, M. Y. Kim *J. Org. Chem.* **1996**, *60*, 564.

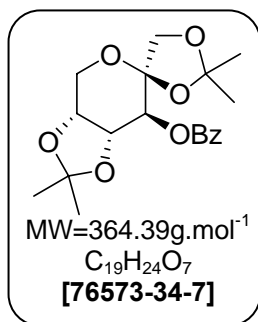
3-O-benzoyl-1,2:4,5-di-O-isopropylidene-β-D-fructopyranose (85)

Yield=100%

Rf=0.8 PE/EA(7:3)

Starting with **4** (2.5 g, 9.6 mmol) and using G.P. 2.1.4. a) (reaction time 15h) compound **85** was obtained after column chromatography on silica gel with a mixture of PE/EA (9:1) as colourless oil (3.48 g, 9.55 mmol, 100%).

¹H NMR (250MHz, CDCl₃) δ: 1.37 (s, 3H, CH₃); 1.41 (s, 3H, CH₃); 1.51 (s, 3H, CH₃); 1.61 (s, 3H, CH₃); 3.90 (d, 1H, J_{1a-1b}=9.2Hz, H-1a); 4.01 (d, 1H, J_{1b-1a}=9.2Hz, H-1b); 4.14 (d, 1H, J_{6a-6b}=13.2Hz, H-6a); 4.21 (dd, 1H, J_{6b-5}=5.4Hz, J_{6a-6b}=13.2Hz, H-6b); 4.29 (dd, 1H, J₅₋₄=5.1Hz, H-5); 4.46 (dd, 1H, J₄₋₅=5.1Hz, J₄₋₃=7.8Hz, H-4); 5.39 (d, 1H, J₄₋₃=7.8Hz, H-3); 7.42-7.47 (m, 2H, *m*-Ph); 7.54-7.60 (m, 1H, *p*-Ph); 8.08-8.11 (m, 2H, *o*-Ph).

¹³C NMR (62.89MHz, CDCl₃) δ: 26.3, 26.5, 26.6, 28.0 (CH₃); 60.6 (C-6); 70.7 (C-1); 71.8 (C-5); 73.9 (C-3); 75.2 (C-4); 104.0 (C-2); 109.8 (Cq-isop); 112.3 (Cq-isop); 128.6, 129.6, 130.0 (CH-Ph); 133.5 (Cq-Ph); 166.1 (C=O).

F. W. Lichtenthaler, W. Doleschal, S. Hahn *Liebigs Ann. Chem.* **1985**, 2454; H. Tian, S. She, Y. Shi *Org. Lett.* **2001**, 35, 715.

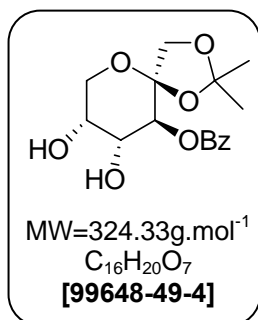
3-O-benzoyl-1,2-O-isopropylidene-β-D-fructopyranose (88)

Yield=100%

Rf=0.43 PE/EA(5:5)

Starting with **85** (2.8 g, 7.68 mmol) and using G.P. 2.2.1. (reaction time 15h) the compound **88** was obtained as a colorless oil (2.48 g, 7.65 mmol, 100%).

¹H NMR (400MHz, CDCl₃) δ: 1.47 (s, 3H, CH₃); 1.52 (s, 3H, CH₃); 2.74 (brs, 1H, OH); 3.89 (dd, 1H, J_{6a-5}=1.6Hz, J_{6a-6b}=12.8Hz, H-6a); 3.96 (d, 1H, J_{1a-1b}=9.2Hz, H-1a); 4.04-4.09 (m, 3H, H1b, H-5, H-6b); 4.14 (dd, 1H, J₄₋₃=9.6Hz, J₄₋₅=3.6Hz, H-4); 5.40 (d, 1H, J₃₋₄=9.6Hz, H-3); 7.46 (t, 2H, J_{m-o}=7.4Hz, J_{m-p}=7.6Hz, *m*-Ph); 7.59 (t, 1H, J_{p-m}=7.6Hz, *p*-Ph); 8.09 (d, 2H, J_{o-m}=7.4Hz, *o*-Ph).

¹³C NMR (100MHz, CDCl₃) δ: 25.5, 25.6 (CH₃); 63.1 (C-6); 68.8 (C-5); 69.4 (C-4); 70.3 (C-3); 71.1 (C-1); 103.6 (C-2); 111.3 (Cq-isop); 127.7 (*m*-Ph); 128.4 (Cq-Ph); 129.1 (*o*-Ph); 132.8 (*p*-Ph); 166.7 (C=O).

F. W. Lichtenthaler, W. Doleschal, S. Hahn *Liebigs Ann. Chem.* **1985**, 2454; H. Tian, S. She, Y. Shi *Org. Lett.* **2001**, 35, 715.

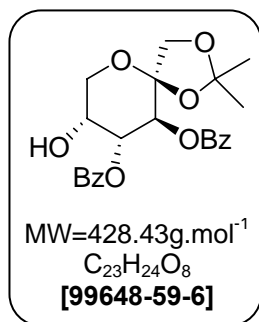
3,4-Di-O-benzoyl-1,2-O-isopropylidene-β-D-fructopyranose (89)

Yield=90%
Rf=0.6 PE/EA(5:5)

Starting with **88** (2 g, 6.17 mmol) and using G.P. 2.1.4. b) (reaction time 15h) the compound **89** was obtained after column chromatography on silica gel with a mixture of PE/EA (7:3) as a colorless solid (2.38 g, 5.56 mmol, 90%).

¹H NMR (400MHz, CDCl₃) δ: 1.41 (s, 3H, CH₃); 1.52 (s, 3H, CH₃); 2.24 (brs, 1H, OH); 3.90 (dd, 1H, J_{6a-5}=2.0Hz, J_{6a-6b}=12.8Hz, H-6a); 3.98 (d, 1H, J_{1a-1b}=9.2Hz, H-1a); 4.08 (d, 1H, J_{1b-1a}=9.2Hz, H-1b); 4.19 (d, 1H, J_{6b-6a}=12.8Hz, H-6b); 4.33 (m, 1H, H-5); 5.62 (dd, 1H, J₄₋₅=3.2Hz, J₄₋₃=10.4Hz, H-4); 5.87 (d, 1H, J₃₋₄=10.4Hz, H-3); 7.31-7.36 (m, 4H, H-*m*-Ph); 7.45-7.50 (m, 2H, H-*p*-Ph); 7.91 (d, 2H, J_{*o-m*}=8.8Hz, H-*o*-Ph); 7.97 (d, 2H, J_{*o-m*}=8.4Hz, H-*o*-Ph).

¹³C NMR (100MHz, CDCl₃) δ: 26.4, 26.7 (CH₃); 64.2 (C-6); 67.3 (C-3); 68.4 (C-5); 72.1 (C-1); 72.9 (C-4); 105.0 (C-2); 112.5 (Cq-isop); 128.6 (CH-*m*Ph); 129.2 (Cq-Ph); 129.9 (CH-*o*Ph); 133.5 (CH-*p*Ph); 165.8, 166.2 (C=O).

A. Tatibouët, M. Lefoix, J. Nadolny, O. R. Martin, P. Rollin, J. Yang, G. D. Holman *Carbohydr. Res.* **2001**, 333, 327.

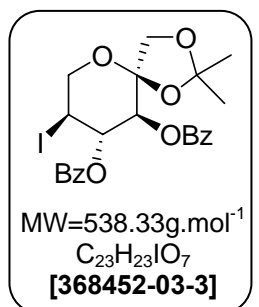
3,4-Di-O-benzoyl-5-deoxy-5-iodo-1,2-O-isopropylidene-α-L-sorbopyranose (90)

Yield=90%
Rf=0.6 PE/EA(8:2)

Starting with **89** (2 g, 4.67 mmol) using G.P. 2.3.3. (reaction time 4h) with dry tetrahydrofuran. The compound **90** was obtained after column chromatography on silica gel with a mixture of PE/EA (95:5) as a yellow solid (2.26 g, 4.20 mmol, 90%).

¹H NMR (400MHz, CDCl₃) δ: 1.41 (s, 3H, CH₃); 1.54 (s, 3H, CH₃); 3.94-4.10 (dd, 1H, J_{6a, 6b}=12.8Hz, J_{6a, 5}=2.0Hz, H-6a); 3.99 (d, 1H, J_{1a-1b}=9.4Hz, H-1a); 4.16-4.34 (m, 2H, J_{6b, 6a}=12.8Hz, H-5, H-6b); 5.40 (d, J₃₋₄=9.7Hz, H-3); 5.96 (dd, 1H, J₄₋₅=10.1Hz, H-4); 7.31-7.36 (m, 4H, *m*-Ph); 7.45-7.50 (m, 2H, *p*-Ph); 7.91 (d, 2H, *o*-Ph); 7.97 (d, 2H, *o*-Ph).

¹³C NMR (100MHz, CDCl₃) δ: 26.1, 26.7 (CH₃); 22.0 (C-5); 65.9 (C-6); 71.0 (C-3); 71.8 (C-1); 74.3 (C-4); 104.6 (C-2); 112.8 (Cq-isop); 128.6 (*m*-Ph); 129.2 (Cq-Ph); 129.9 (*o*-Ph); 133.5 (*p*-Ph); 165.8, 166.2 (C=O).

A. Tatibouët, M. Lefoix, J. Nadolny, O. R. Martin, P. Rollin, J. Yang, G. D. Holman *Carbohydr. Res.* **2001**, 333, 327.

5-Azido-3,4-di-O-benzoyl-5-deoxy-1,2-O-isopropylidene-β-D-fructopyranose (91)

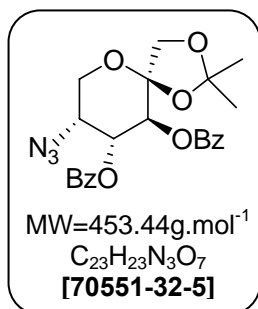

Yield=85%

Rf=0.33 PE/EA(9:1)

Starting with **90** (2 g, 3.72 mmol) and using G.P. 2.3.6. (reaction time 3h) the compound **91** was obtained after column chromatography on silica gel with a mixture of PE/EA (9:1) as a colorless solid (1.43 g, 3.15 mmol, 85%).

¹H NMR (250MHz, CDCl₃) δ: 1.44 (s, 3H, CH₃); 1.53 (s, 3H, CH₃); 3.88 (dd, 1H, J_{6a-5}=1.5Hz, J_{6a-6b}=12.8Hz, H-6a); 4.03 (d, 1H, J_{1a-1b}=9.3Hz, H-1a); 4.10 (d, 1H, J_{1b-1a}=9.3Hz, H-1b); 4.24 (dd, 1H, J_{6b-5}=1.5Hz, J_{6b-6a}=12.8Hz, H-6b); 4.31-4.32 (m, 1H, H-5); 5.79 (dd, 1H, J₄₋₅=3.5Hz, J₄₋₃=10.4Hz, H-4); 5.88 (d, 1H, J₃₋₄=10.4Hz, H-3); 7.30-7.38 (m, 4H, H-*m*-Ph); 7.43-7.51 (m, 2H, H-*p*-Ph); 7.94-8.03 (m, 4H, H-*o*-Ph).

¹³C NMR (62.89MHz, CDCl₃) δ: 26.2, 26.5 (CH₃); 60.2 (C-5); 62.1 (C-6); 67.2 (C-3); 71.8 (C-4); 71.9 (C-1); 104.8 (C-2); 112.5 (Cq-isop); 128.4 (CH-*m*Ph); 128.6, 128.9 (Cq-Ph); 129.7, 129.9 (CH-*o*Ph); 133.5, 133.5 (CH-*p*Ph); 165.7, 165.8 (C=O).

A. Tatibouët, M. Lefoix, J. Nadolny, O. R. Martin, P. Rollin, J. Yang, G. D. Holman *Carbohydr. Res.* **2001**, 333, 327.

5-Azido-5-deoxy-1,2-O-isopropylidene-β-D-fructopyranose (92)

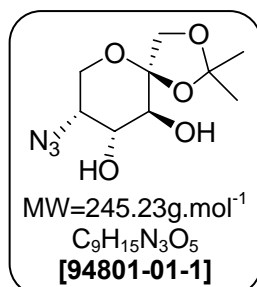

Yield=81%

Rf=0.22 PE/EA(3:7)

Starting with **90** (1.5 g, 3.31 mmol) and using G.P. 2.2.2. (reaction time 15h) the compound **92** was obtained after column chromatography on silica gel with a mixture of PE/EA (3:7) as a colorless solid (0.66 g, 2.69 mmol, 81%).

Starting with **100** (0.5 g, 1.51 mmol) and using G.P. 2.3.6. (reaction time 3 days) the compound **92** was obtained after column chromatography on silica gel with a mixture of PE/EA (3:7) as a colorless solid (0.23 g, 0.94 mmol, 62%).

¹H NMR (400MHz, CDCl₃) δ: 1.45 (s, 3H, CH₃); 1.49 (s, 3H, CH₃); 2.73 (brs, 1H, OH); 3.64 (brs, 1H, OH); 3.73 (brs, 1H, H-3); 3.77 (dd, 1H, J_{6a-5}=1.2Hz, J_{6a-6b}=12.4Hz, H-6a); 3.94-3.96 (m, 2H, H-5, H-6b); 3.97-3.99 (m, 1H, H-4); 4.01 (d, 1H, J_{1a-1b}=9.0Hz, H-1a); 4.19 (d, 1H, J_{1b-1a}=9.0Hz, H-1b).

¹³C NMR (100MHz, CDCl₃) δ: 26.3, 26.5 (CH₃); 61.9 (C-5); 62.1 (C-6); 69.4 (C-3); 72.0 (C-1); 72.1 (C-4); 105.7 (C-2); 112.3 (Cq-isop).

A. Tatibouët, M. Lefoix, J. Nadolny, O. R. Martin, P. Rollin, J. Yang, G. D. Holman *Carbohydr. Res.* **2001**, 333, 327.

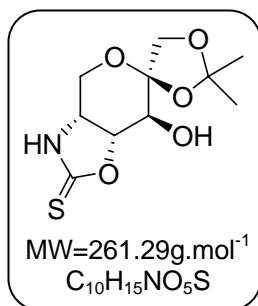
4,5-Dihydro-[5-deoxy-1,2-O-isopropylidene-β-D-fructopyranoso][4,5-d]-1,3-oxazoline-2-thione (93)

Starting with **92** (0.5 g, 2.04 mmol) and using G.P. 2.4.2. (reaction time 15h) the compound **93** was obtained after column chromatography on silica gel with a mixture of PE/EA (6:4) as a colorless solid (0.31 g, 1.19 mmol, 59%).

¹H NMR (400MHz, CDCl₃) δ: 1.43 (s, 3H, CH₃); 1.49 (s, 3H, CH₃); 2.73 (d, 1H, J_{OH-3}=4.8Hz); 3.79 (d, 1H, J_{6a-6b}=13.2Hz, H-6a); 3.79 (t, 1H, J₃₋₄=5.2Hz, H-3); 3.98 (d, 1H, J_{1a-1b}=9.2Hz, H-1a); 4.11-4.19 (m, 3H, H-1b, H-5, H-6b); 5.00 (dd, 1H, J₄₋₃=5.2Hz, J₄₋₅=8.0Hz, H-4); 7.20 (brs, 1H, NH).

Yield=59%

Rf=0.2 PE/EA(6:4) ¹³C NMR (100MHz, CDCl₃) δ: 26.1, 26.5 (CH₃); 55.2 (C-5); 60.3 (C-6); 68.3 (C-3); 73.1 (C-1); 82.0 (C-4); 103.3 (C-2); 112.3 (Cq-isop); 175.1 (C=S).

[α]_D²⁰ = -186 (c=0.27
MeOH)

HRMS: Calculated for C₁₀H₁₅NO₅S [M+H]⁺ 262.0749, found: 262.0743.

IR: (neat) ν (cm⁻¹): 3438 (OH); 3265 (NH); 2987 (CH); 1492, 1226, 1060 (N-CS-O).

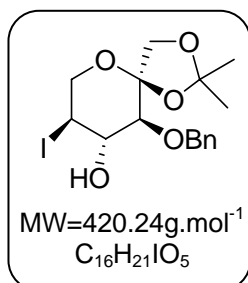
3-O-benzyl-5-deoxy-5-iodo-1,2-O-isopropylidene-α-L-sorbopyranose (97)

Starting with **57** (1 g, 3.22 mmol) and using G.P. 2.3.3. (reaction time 4h) with dry tetrahydrofuran as solvent the compound **97** was obtained after column chromatography on silica gel with a mixture of PE/EA (9:1) as yellow solid (1.27 g, 3.02 mmol, 94%).

¹H NMR (250MHz, CDCl₃) δ: 1.42 (s, 3H, CH₃); 1.49 (s, 3H, CH₃); 2.60 (brs, 1H, OH); 3.44 (d, 1H, J₃₋₄=8.8Hz, H-3); 3.84 (dd, 1H, J_{6a-6b}=14.7Hz, J_{6a-5}=4.4Hz, H-6a); 3.85 (d, 1H, J_{1a-1b}=8.5Hz, H-1a), 3.96 (dd, 1H, J_{6b-6a}=14.7Hz, J_{6b-5}=4.4Hz, H-6b); 3.98 (d, 1H, J_{1b-1a}=8.5Hz, H-1b); 4.03 (s, 1H, H-4); 4.07 (s, 1H, H-5); 4.72 (d, 1H, J_{7a-7b}=11.6Hz, H-7a); 4.91 (d, 1H, J_{7b-7a}=11.6Hz, H-7b); 7.28-7.37 (m, 5H, Ph).

Yield=94%

Rf=0.26 PE/EA(9:1)

mp=123-125°C

[α]_D²⁰ = +51 (c=0.14

CHCl₃)

¹³C NMR (62.89MHz, CDCl₃) δ: 26.2, 27.2 (CH₃); 30.5(C-5); 65.5 (C-6); 71.9 (C-1); 75.6 (C-7); 76.7 (C-4); 79.6 (C-3); 105.8 (C-2); 112.6 (Cq-isop); 128.1, 128.2, 128.7 (CH-Ph); 137.8 (Cq-Ph).

HRMS: Calculated for C₂₁H₂₅NO₅S [M+Na]⁺ 443.0331, found: 443.0334.

IR: (neat) ν (cm⁻¹): 3429 (OH); 2921, 2851 (CH); 1455, 1373 (Ph).

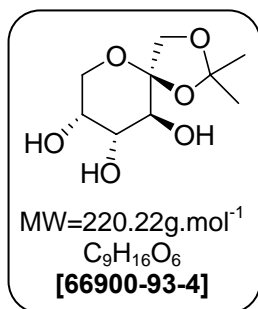
1,2-O-isopropylidene- β -D-fructopyranose (98)

Starting with **4** (3 g, 11.5 mmol) and using G.P. 2.2.1. (reaction time 15h) the compound **98** was obtained as a colorless solid (2.52 g, 11.5 mmol, 100%).

¹H NMR (400MHz, DMSO-d₆) δ : 1.31 (s, 3H, CH₃); 1.37 (s, 3H, CH₃); 3.46-3.50 (m, 3H, H-3, H-4, H-6b); 3.68 (brs, 1H, H-5); 3.71 (d, 1H, J_{6b-6a}=10.8Hz, H-6b); 3.73 (d, 1H, J_{1a-1b}=8.4Hz, H1-a); 4.01 (d, 1H, J_{1b-1a}=8.4Hz, H1-b); 4.56 (d, 1H, OH-5); 4.64 (d, 1H, OH-3); 4.76 (d, 1H, OH-4).

¹³C NMR (100MHz, DMSO-d₆) δ : 26.2, 27.0 (CH₃); 64.5 (C-6); 67.4 (C-4); 68.9 (C-5); 70.3 (C-1); 71.1 (C-3); 106.4 (C-2); 110.6 (Cq-isop).

Yield=100%

Rf=0.15 PE/EA(5:5)

mp=98-103°C

[α]_D²⁰ = -145 (c=0.43 MeOH) MS: (IS+) m/z: 243 (M+Na)⁺

IR: (neat) ν (cm⁻¹): 3344 (OH); 2988, 2938, 2897 (CH).

E. Kaji, E. Kurimoto, R. Saiga, A. Matsuura, K. Harada, T. Nishino *Heterocycles* **2005**, 66, 453.

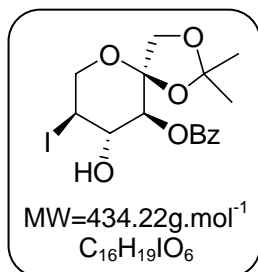
3-O-benzoyl-5-deoxy-5-iodo-1,2-O-isopropylidene- α -L-sorbopyranose (99)

Starting with **88** (1 g, 3.08 mmol) using G.P. 2.3.3. and tetrahydrofuran as solvent the compound **99** was obtained after column chromatography on silica gel with a mixture of PE/EA (95:5) as cream solid (0.94 g, 2.16 mmol, 70%).

¹H NMR (400MHz, CDCl₃) δ : 1.43 (s, 3H, CH₃); 1.51 (s, 3H, CH₃); 2.69 (d, J_{OH-4}=4.4Hz, 1H, OH); 3.92 (d, 1H, J_{1a-1b}=9.2Hz, H-1a); 3.93 (dd, 1H, J_{6a-5}=5.0Hz, J_{6a-6b}=11.2Hz, H-6a); 3.97 (d, 1H, J_{1b-1a}=9.2Hz, H-1b); 4.04-4.09 (m, 1H, H-5); 4.14 (dd, 1H, J_{6b-6a}=11.2Hz, H-6b); 4.15-4.22 (m, 1H, H-4); 5.16 (d, 1H, J₃₋₄=9.6Hz, H-3); 7.46 (t, 2H, m-Ph); 7.59 (t, 1H, p-Ph); 8.09 (d, 2H, o-Ph).

¹³C NMR (100MHz, CDCl₃) δ : 26.3, 26.8 (CH₃); 29.3 (C-5); 65.8 (C-6); 72.0 (C-1); 72.3 (C-3); 74.5 (C-4); 104.8 (C-2); 112.7 (Cq-isop); 128.7 (CH-mPh); 129.2 (CH-oPh); 130.1 (CH-pPh); 133.8 (Cq-Ph); 166.4 (C=O).

Yield=70%

Rf=0.28 PE/EA(9:1)

mp=148-151°C

[α]_D²⁰ = -136 (c=0.75 CHCl₃)

HRMS: Calculated for C₁₆H₁₉IO₆ [M+Na]⁺ 457.0124, found: 457.0133.

IR: (neat) ν (cm⁻¹): 3537 (OH); 2993, 2944 (CH); 1708 (C=O); 1600, 1454 (Ph).

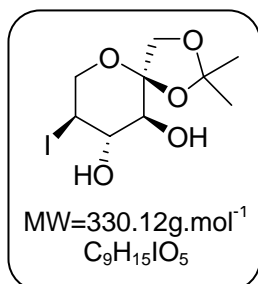
5-Deoxy-5-iodo-1,2-O-isopropylidene- α -L-sorbopyranose (100)**Yield**=65%**Rf**=0.27 PE/EA(5:5)**mp**=82-85°C**[α]_D²⁰** =-11 (c=0.51
MeOH)

Starting with **98** (1 g, 4.54 mmol) using G.P. 2.3.3. (reaction time 4h) and 1,4-dioxane as solvent the compound **100** was obtained after column chromatography on silica gel with a mixture of PE/EA (6:4) as cream solid (0.97 g, 2.94 mmol, 65%).

¹H NMR (400MHz, CDCl₃) δ : 1.46 (s, 3H, **CH**₃); 1.51 (s, 3H, **CH**₃); 2.10 (d, 1H, J_{OH-3} =9.6Hz, **OH-3**); 2.80 (d, 1H, J_{OH-4} =1.8Hz **OH-4**); 3.44 (t, 1H, J_{3-4} =9.0Hz, **H-3**); 3.81 (dt, 1H, J_{4-OH} =1.8Hz, J_{4-3} =9.0Hz, **H-4**); 3.97 (dd, 1H, J_{6a-5} =4.6Hz, J_{6a-6b} =10.8Hz, **H-6a**); 3.93-3.97 (m, 1H, **H-5**); 3.98 (d, 1H, J_{1a-1b} =8.8Hz, **H-1a**); 4.04 (d, 1H, J_{6b-6a} =10.8Hz, **H-6b**); 4.18 (d, 1H, J_{1b-1a} =8.8Hz, **H-1b**).

¹³C NMR (100MHz, CDCl₃) δ : 26.4, 26.7 (**CH**₃); 28.2 (**C-5**); 66.0 (**C-6**); 72.1 (**C-1**); 72.9 (**C-3**); 77.0 (**C-4**); 105.7 (**C-2**); 112.6 (**Cq-isop**).

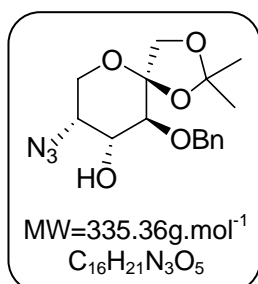
MS: (IS+) m/z: 413 (M+CH₃COOH+Na)⁺.**IR**: (neat) ν (cm⁻¹): 3556 (**OH**); 2999 (**CH**).**5-Azido-3-O-benzyl-5-deoxy-1,2-O-isopropylidene- β -D-fructopyranose (96)****Yield**=92%**Rf**=0.24 PE/EA(9:1)**mp**=107-109°C**[α]_D²⁰** =-117 (c=0.25
CHCl₃)

Starting with **97** (1 g, 2.38 mmol) and using G.P. 2.3.6. (reaction time 3 days) the compound **96** was obtained after column chromatography on silica gel with a mixture of PE/EA (9:1) as colorless solid (0.73 g, 2.17 mmol, 92%).

¹H NMR (400MHz, CDCl₃) δ : 1.42 (s, 3H, **CH**₃); 1.48 (s, 3H, **CH**₃); 2.31 (d, 1H, J_{OH-4} =5.2Hz, **OH**); 3.67 (d, 1H, J_{3-4} =9.6Hz, **H-3**); 3.74 (dd, 1H, J_{6a-6b} =12.4Hz, J_{6a-5} =1.6Hz, **H-6a**); 3.93-3.95 (m, 1H, **H-5**); 3.96 (d, 1H, J_{1a-1b} =8.6Hz, **H-1a**), 3.99 (dd, 1H, J_{6b-6a} =12.6Hz, J_{6b-5} =1.6Hz, **H-6b**); 4.03 (d, 1H, J_{1b-1a} =8.6Hz, **H-1b**); 4.19 (ddd, 1H, J_{4-3} =4.4Hz, J_{4-OH} =5.2Hz, J_{4-5} =9.6Hz, **H-4**); 4.75 (d, 1H, J_{7a-7b} =11.6Hz, **H-7a**); 4.84 (d, 1H, J_{7b-7a} =11.6Hz, **H-7b**); 7.32-7.38 (m, 5H, **Ph**).

¹³C NMR (100MHz, CDCl₃) δ : 26.2, 27.0 (**CH**₃); 61.9 (**C-6**); 62.4 (**C-5**); 71.7 (**C-4**); 72.0 (**C-1**); 73.0 (**C-3**); 75.8 (**C-7**); 105.7 (**C-2**); 112.3 (**Cq-isop**); 128.1, 128.3, 128.8 (**CH-Ph**); 137.8 (**Cq-Ph**).

HRMS: Calculated for C₁₆H₂₁N₃O₅ [M+Na]⁺ 358.1379, found: 358.1377.**IR**: (neat) ν (cm⁻¹): 3541 (**OH**); 2993, 2909 (**CH**); 2119 (**N**₃); 1457, 1371 (**Ph**).

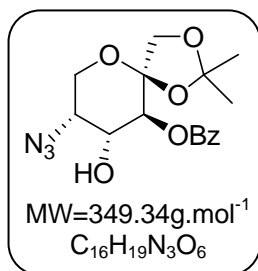
5-Azido-3-O-benzoyl-5-deoxy-1,2-O-isopropylidene- β -D-fructopyranose (101)**Yield**=75%**R_f**=0.22 PE/EA(9:1)**[α]_D²⁰**=-63 (c=0.86
CHCl₃)

Starting with **99** (1 g, 2.30 mmol) and using G.P. 2.3.6. (reaction time 3 days) the compound **101** was obtained after column chromatography on silica gel with a mixture of PE/EA (9:1) as colorless oil (0.60 g, 1.72 mmol, 75%).

¹H NMR (250MHz, CDCl₃) δ : 1.42 (s, 3H, CH₃); 1.49 (s, 3H, CH₃); 3.72-3.80 (m 1H, H-6); 3.93-4.08 (m, 4H, H-1a, H-4, H-5, H6b); 4.20 (d, 1H, J_{1b-1a}=8.8Hz, H-1b); 5.43 (dd, 1H, J₄₋₃=3.8Hz, J₄₋₅=10.0Hz, H-3); 7.41-7.47 (m, 3H, Ph); 7.53-7.60 (m, 2H, Ph).

¹³C NMR (62.89MHz, CDCl₃) δ : 26.4, 26.6 (CH₃); 60.7 (C-4); 62.3 (C-6); 67.5 (C-5); 72.1 (C-1); 74.1 (C-3); 106.2 (C-2); 112.6 (Cq-isop); 128.6, 128.7, 130.1 (CH-Ph); 133.8 (Cq-Ph); 1166.7 (C=O).

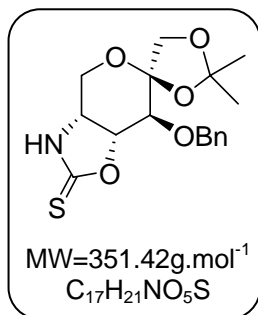
HRMS: Calculated for C₁₆H₁₉N₃O₆ [M+Na]⁺ 372.1172, found: 372.1177.**IR**: (neat) ν (cm⁻¹): 3459 (OH); 2989 (CH); 2104 (N₃); 1717 (C=O); 1602, 1453 (Ph).**4,5-Dihydro-{3-O-benzyl-5-deoxy-1,2-O-isopropylidene- β -D-fructopyranoso}[4,5-d]-1,3-oxazoline-2-thione (102)****Yield**=53%**R_f**=0.22 PE/EA(7:3)**[α]_D²⁰**=-153 (c=0.32
CHCl₃)

Starting with **96** (0.5 g, 1.49 mmol) using G.P. 2.4.2. (reaction time 15h) the compound **102** was obtained after column chromatography on silica gel with a mixture of PE/EA (7:3) as cream oil (0.28 g, 7.97 mmol, 53%).

¹H NMR (400MHz, CDCl₃) δ : 1.42 (s, 3H, CH₃); 1.48 (s, 3H, CH₃); 3.65 (d, 1H, J₃₋₄=6.4Hz, H-3); 3.87 (d, 1H, J_{6a-6b}=13.4Hz, H-6a); 3.86 (d, 1H, J_{1a-1b}=8.8Hz, H-1a); 4.03 (d, 1H, J_{1b-1a}=8.8Hz, H-1b); 4.09 (dd, 1H, J_{6b-5}=2.6Hz, J_{6b-6a}=13.4Hz H-6b); 4.22 (dd, 1H, J_{5-6b}=2.6Hz, J₅₋₄=8.0Hz, H-5); 4.70 (d, 1H, J_{7a-7b}=11.6Hz, H-7a); 4.92 (d, 1H, J_{7b-7a}=11.6Hz, H-7a); 5.07 (dd, 1H, J₄₋₃=6.8Hz, J₄₋₅=8.0Hz, H-4); 7.27-7.40 (m, 5H, Ph); 8.46 (brs, 1H, NH).

¹³C NMR (100MHz, CDCl₃) δ : 26.0, 26.7 (CH₃); 56.3 (C-5); 58.9 (C-6); 72.1 (C-1); 73.8 (C-7); 74.1 (C-3); 83.8 (C-4); 103.5 (C-2); 112.7 (Cq-isop); 128.1, 128.3, 128.5 (CH-Ph); 137.1 (Cq-Ph); 189.6 (C=S).

MS: (IS+) m/z: 374 (M+Na)⁺**IR**: (neat) ν (cm⁻¹): 2989, 2934 (CH); 1497, 1312, 1072 (N-CS-O); 1454 (Ph).

4,5-Dihydro-[3-*O*-benzoyl-5-deoxy-1,2-*O*-isopropylidene- β -D-fructopyranoso][4,5-d]-1,3-oxazoline-2-thione (103)

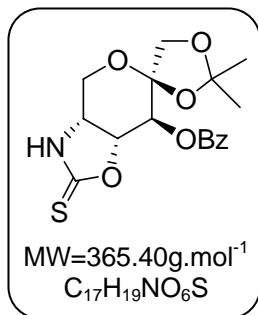

Starting with **101** (0.5 g, 1.43 mmol) and using G.P. 2.4.2. (reaction time 15h) the compound **103** was obtained after column chromatography on silica gel with a mixture of PE/EA (:) as cream oil (0.32 g, 0.88 mmol, 62%).

¹H NMR (250MHz, CDCl₃) δ : 1.38 (s, 3H, CH₃); 1.49 (s, 3H, CH₃); 3.93-4.16 (m, 4H, H-1, H-6); 5.15 (t, 1H, J₄₋₃=7.5Hz, H-4); 5.26-5.35 (m, 1H, H-5); 5.52 (d, 1H, J₃₋₄=7.5Hz, H-3); 7.34-7.66 (m, 3H, Ph); 7.97-8.09 (m, 2H, Ph); 8.23 (brs, 1H, NH).

Yield=62%
Rf=0.59 PE/EA(7:3)
[α]_D²⁰ = -137 (c=0.39
CHCl₃)

¹³C NMR (62.89MHz, CDCl₃) δ : 26.1, 26.4 (CH₃); 55.8 (C-5); 59.2 (C-6); 68.8 (C-3); 72.3 (C-1); 80.6 (C-4); 105.3 (C-2); 112.6 (Cq-isop); 128.7, 130.0, 130.1, 130.6 (CH-Ph); 133.8 (Cq-Ph); 168.3 (C=O); 189.9(C=S).

MS: (IS+) m/z: 388 (M+Na)⁺

IR: (neat) ν (cm⁻¹): 2989 (CH); 1722 (C=O); 1506, 1316, 1067 (N-CS-O); 1453 (Ph).

1,2:4,5-Di-*O*-isopropylidene- β -D-psicopyranose (104)

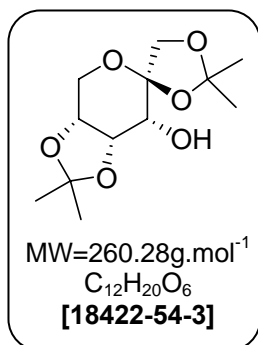

Starting with **25** (5 g, 19.3 mmol) and using G.P. 2.3.2. (reaction time 3h) the compound **104** was obtained after column chromatography on silica gel with a mixture of PE/EA (7:3) as colorless solid (4.92 g, 18.9 mmol, 98%).

¹H NMR (250MHz, CDCl₃) δ : 1.38 (s, 3H, CH₃); 1.41 (s, 3H, CH₃); 1.50 (s, 3H, CH₃); 1.56 (s, 3H, CH₃); 2.36 (d, 1H, J_{OH-3}=6.5Hz, OH); 3.75 (dd, 1H, J_{3-OH}=6.5Hz, J₃₋₄=4.0Hz, H-3); 4.00 (m, 2H, H-6a, H-6b); 4.04 (d, 1H, J_{1a-1b}=9.5Hz, H-1a); 4.21-4.25 (m, 1H, H-5); 4.26 (d, 1H, J_{1b-1a}=9.5Hz, H-1b); 4.45 (dd, 1H, J₄₋₃=4.0Hz, J₄₋₅=6.8Hz, H-4).

Yield=98%
Rf=0.24 PE/EA(7:3)

¹³C NMR (62.89MHz, CDCl₃) δ : 25.2, 26.1, 26.3, 26.6 (CH₃); 61.3 (C-6); 68.9 (C-3); 71.9 (C-5); 72.2 (C-4); 73.1 (C-1); 105.0 (C-2); 109.5 (Cq-isop); 111.2 (Cq-isop).

J. Kang, G. J. Lim, S. K. Yoon, M. Y. Kim *J. Org. Chem.* **1996**, *60*, 564.

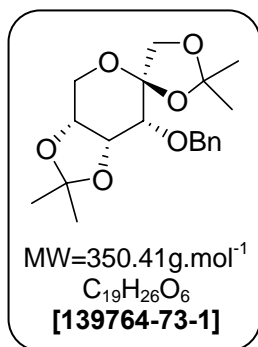
3-O-benzyl-1,2:4,5-di-O-isopropylidene-β-D-psicopyranose (105)

Starting with **104** (5 g, 19.2 mmol) using G.P. 2.1.3. a) (reaction time 15h), dry DMF as solvent and NaH (60% in mineral oil) (1.5 eq.) as base the compound **105** was obtained after column chromatography on silica gel with a mixture of PE/EA (9:1) as colorless oil (6.70 g, 19.1 mmol, 100%).

¹H NMR (400MHz, CDCl₃) δ: 1.32 (s, 3H, CH₃); 1.48 (s, 3H, CH₃); 1.49 (s, 3H, CH₃); 1.51 (s, 3H, CH₃); 3.66-3.73 (m, 3H, H-5, H-6a, H-6b); 3.95 (d, 1H, J_{1a-1b}=9.0Hz, H-1a); 4.21 (d, 1H, J₃₋₄=7.6Hz, H-3); 4.44 (dd, 1H, J₄₋₃=7.6Hz, J₄₋₅=2.4Hz, H-4); 4.48 (d, 1H, J_{1b-1a}=9.0Hz, H-1b); 4.73 (d, 1H, J_{7a-7b}=12.0Hz, H-7a); 4.86 (d, 1H, J_{7b-7a}=12.0Hz, H-7b); 7.28-7.41 (m, 5H, Ph).

Yield=100%

Rf=0.57 PE/EA(7:3)

¹³C NMR (100MHz, CDCl₃) δ: 25.1, 26.3 (CH₃); 26.4 (CH₃); 26.8 (CH₃); 62.7 (C-6); 72.0 (C-1); 73.2 (C-5); 73.7 (C-7); 74.1 (C-3); 74.9 (C-4); 106.1 (C-2); 109.5 (Cq-isop); 110.2 (Cq-isop); 128.1, 128.3, 128.6 (CH-Ph); 137.8 (Cq-Ph).

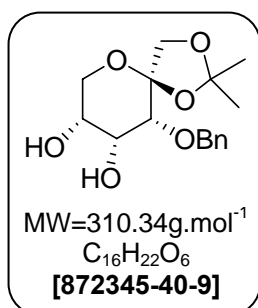
3-O-benzyl-1,2-O-isopropylidene-β-D-psicopyranose (106)

Starting with **105** (5 g, 14.3 mmol) and using G.P. 2.2.1. (reaction time 15h) the compound **106** was obtained as colorless solid (4.41 g, 14.2 mmol, 100%).

¹H NMR (250MHz, CDCl₃) δ: 1.33 (s, 3H, CH₃); 1.46 (s, 3H, CH₃); 2.95 (d, 1H, J_{OH}=9.0Hz, OH); 3.31 (d, 1H, J_{OH}=11.8Hz, OH); 3.66-3.97 (m, 6H, J_{1a-1b}=9.3Hz, H-1a, H-3, H-4, H-5, H-6a, H-6b); 4.04 (d, 1H, J_{1b-1a}=9.0Hz, H-1b); 4.67 (d, J_{7a-7b}=11.3Hz, H-7a); 4.85 (d, 1H, J_{7b-7a}=11.3Hz, H-7b); 7.26-7.39 (m, 5H, Ph).

Yield=100%

Rf=0.42 PE/EA(5:5)

¹³C NMR (62.89MHz, CDCl₃) δ: 26.4, 26.9 (CH₃); 65.5 (C-6); 65.5, 67.5, 81.2 (C-3), (C-4), (C-5); 73.5 (C-1); 76.2 (C-7); 105.0 (C-2); 112.2 (Cq-isop); 128.2, 128.5, 128.8 (CH-Ph); 137.2 (Cq-Ph).

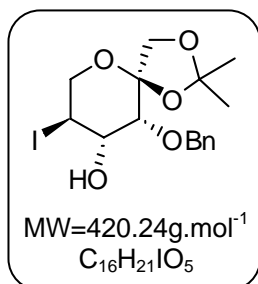
3-O-benzyl-5-deoxy-5-iodo-1,2-O-isopropylidene-β-L-tagatopyranose (107)

Yield=56%
Rf=0.22 PE/EA(8:2)
mp=98-101°C
[α]_D²⁰ =+21 (c=0.54
CHCl₃)

Starting with **106** (1 g, 3.22 mmol) using G.P. 2.3.3. (reaction time 4h) and dry tetrahydrofuran as solvent the compound **107** was obtained after column chromatography on silica gel with a mixture of PE/EA (8:2) as cream solid (0.76 g, 1.81 mmol, 56%).

¹H NMR (250MHz, CDCl₃) δ: 1.42 (s, 3H, **CH**₃); 1.53 (s, 3H, **CH**₃); 2.86 (d, 1H, *J*_{OH}=6.3Hz, **OH**); 3.45 (dd, 1H, *J*_{6a-5}=7.0Hz, *J*_{6a-6b}=12.3Hz, **H-6a**); 3.76 (d, 1H, *J*₃₋₄=7.8Hz, **H-3**); 3.91-4.00 (m, 1H, **H-5**); 4.04 (d, 1H, *J*_{1a-1b}=9.1Hz, **H-1a**); 4.09-4.13 (m, 1H, **H-4**); 4.14 (d, 1H, *J*_{1b-1a}=9.1Hz, **H-1b**); 4.24 (dd, 1H, *J*_{6b-5}=3.8Hz, *J*_{6b-6a}=12.3Hz, **H-6b**); 4.77 (d, 1H, *J*_{7a-7b}=10.8Hz, **H-7a**); 4.82 (d, 1H, *J*_{7b-7a}=10.8Hz, **H-7b**); 7.27-7.38 (m, 5H, **Ph**).

¹³C NMR (62.89MHz, CDCl₃) δ: 26.2, 27.1 (**CH**₃); 64.6 (**C-6**); 67.5 (**C-4**); 69.2 (**C-1**); 71.2 (**C-5**); 74.7 (**C-7**); 79.7 (**C-3**); 105.6 (**C-2**); 112.4 (**Cq-isop**); 128.3, 128.4, 128.5, 128.7, 129.0 (**CH-Ph**); 137.0 (**Cq-Ph**).

HRMS: Calculated for C₁₆H₂₁IO₅ [M+Na]⁺ 443.0331, found: 443.0334.

IR: (neat) ν (cm⁻¹): 3543, 3449 (**OH**); 2987, 2921 (**CH**); 1497, 1453, 1407 (**Ph**).

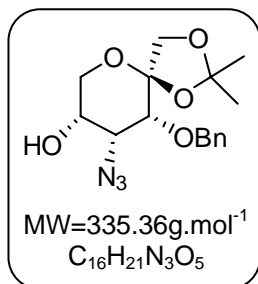
3-O-benzyl-4-deoxy-4-iodo-1,2-O-isopropylidene-β-D-psicopyranose (108)

Yield=69%
Rf=0.20 PE/EA(9:1)
mp=118-121°C
[α]_D²⁰ =-13 (c=0.52
CHCl₃)

Starting with **107** (1 g, 2.38 mmol) using G.P. 2.3.5. (reaction time 3 days) the compound **108** was obtained after column chromatography on silica gel with a mixture of PE/EA (9:1) as colorless solid (0.55 g, 1.64 mmol, 69%).

¹H NMR (250MHz, CDCl₃) δ: 1.36 (s, 3H, **CH**₃); 1.47 (s, 3H, **CH**₃); 2.52 (d, 1H, *J*_{OH}=7.0Hz, **OH**); 3.68-3.73 (m, 1H, **H-3**); 3.74 (d, 1H, *J*_{6a-6b}=12.8Hz, **H-6a**); 3.84 (d, 1H, *J*_{1a-1b}=9.3Hz, **H-1a**); 3.87-3.91 (m, 1H, **H-4**); 4.01-4.06 (m, 3H, *J*_{1b-1a}=9.3Hz, **H-1b**, **H-5**, **H-6b**); 4.71 (d, 1H, *J*_{7a-7b}=11.5Hz, **H-7a**); 4.81 (d, 1H, *J*_{7b-7a}=11.5Hz, **H-7b**); 7.25-7.40 (m, 5H, **Ph**).

¹³C NMR (62.89MHz, CDCl₃) δ: 26.3, 26.8 (**CH**₃); 56.1 (**C-6**); 62.2 (**C-4**); 72.1 (**C-5**); 72.8 (**C-1**); 75.6 (**C-7**); 79.4 (**C-3**); 105.1 (**C-2**); 112.4 (**Cq-isop**); 128.3, 128.4, 128.8 (**CH-Ph**); 137.4 (**Cq-Ph**).

HRMS: Calculated for C₁₆H₂₁N₃O₅ [M+Na]⁺ 358.1379, found: 358.1384.

IR: (neat) ν (cm⁻¹): 3514 (**OH**); 2980 (**CH**); 2086 (**N**₃); 1454, 1377 (**Ph**).

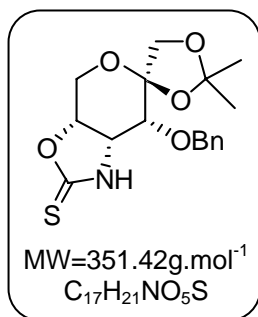
4,5-Dihydro-{3-O-benzyl-4-deoxy-1,2-O-isopropylidene-β-D-psicopyranoso}[4,5-d]-1,3-oxazoline-2-thione (55)

Yield=54%

Rf=0.28 PE/EA(7:3)

mp=147-158°C

[α]_D²⁰ = -110 (c=0.14
CHCl₃)

Starting with **108** (1 g, 2.98 mmol) and using G.P. 2.4.2. (reaction time 15h) the compound **55** was obtained after column chromatography on silica gel with a mixture of PE/EA (8:2) as colorless solid (0.57 g, 1.62 mmol, 54%).

¹H NMR (400MHz, CDCl₃) δ: 1.33 (s, 6H, CH₃); 1.46 (s, 3H, CH₃); 3.83 (t, 1H, J_{6a-6b}=10.1Hz, H-6a); 3.91 (d, 1H, J_{1a-1b}=9.6Hz, H-1a); 4.05 (d, 1H, J_{1b-1a}=9.6Hz, H-1b); 4.09 (d, 1H, J_{6b-6a}=10.1Hz, H-6b); 4.06-4.10 (m, 1H, H-3); 4.22 (ddd, 1H, J₅₋₄=2.0Hz, J₅₋₆=4.4Hz, H-5); 4.59 (d, 1H, J_{7a-7b}=11.6Hz, H-7a); 4.69 (dd, 1H, J₄₋₅=2.0Hz, H-4); 4.89 (d, 1H, J_{7b-7a}=11.6Hz, H-7b); 7.32-7.39 (m, 5H, Ph); 7.71 (brs, 1H, NH).

¹³C NMR (100MHz, CDCl₃) δ: 26.2, 26.7 (CH₃); 53.2 (C-5); 63.5 (C-6); 73.5 (C-1); 73.6 (C-7); 76.7 (C-3); 86.8 (C-4); 105.2 (C-2); 113.1 (Cq-isop); 128.3, 128.4, 128.7 (CH-Ph); 136.8 (Cq-Ph); 192.0 (C=S).

HRMS: Calculated for C₁₇H₂₁NO₅S [M+Na]⁺ 374.1038, found: 374.1051.

IR: (neat) ν (cm⁻¹): 2906 (CH); 1501 (Ph); 1471, 1336, 1009 (N-CS-O).

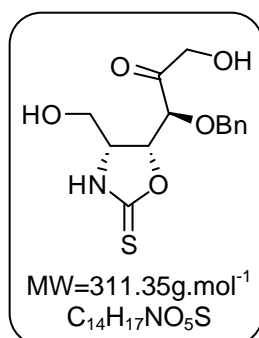
(4R,5R) 5-[(1S)-1-Benzloxy-2-oxo-3-hydroxypropyl]-4,5-dihydro-4-hydroxymethyl-1,3-oxazoline-2-thione (110)

Starting with **102** (0.5 g, 1.42 mmol) and using G.P. 2.2.4. b) (reaction time 15h) the compound **110** was obtained after column chromatography on silica gel with a mixture of PE/EA (7:3) as brown solid (0.31 g, 0.99 mmol, 70%).

¹H NMR (400MHz, CDCl₃) δ: 3.46-3.53 (m, 2H, H-6a, H-6b); 3.69 (m, 2H, H-3, H-1a); 3.98 (dd, 1H, J_{1b-1a}=13.2Hz, H-1b); 4.06-4.11 (m, 1H, H-5); 4.67 (d, 1H, J_{7a-7b}=11.6Hz, H-7a); 4.79 (d, 1H, J_{7b-7a}=11.6Hz), 5.05 (dd, J₄₋₃=5.6Hz, J₄₋₃=8.4Hz, H-4), 7.24-7.33 (m, 5H, Ph), 7.84 (brs, 1H, NH).

Yield=70%

Rf=0.12 PE/EA(5:5)

mp=58-61°C

¹³C NMR (100MHz, CDCl₃) δ: 59.0 (C-5); 63.5 (C-6); 65.5 (C-1); 74.2 (C-7); 82.0 (C-3); 95.7 (C-4); 128.8, 128.9 (CH-Ph); 135.3 (Cq-Ph); 190.0 (C=S); 203.0 (C=O).

MS: (IS+) m/z: 334 (M+Na)⁺.

IR: (neat) ν (cm⁻¹): 3306 (OH); 1727 (C=O); 1520, 1074 (N-CS-O); 1455 (Ph).

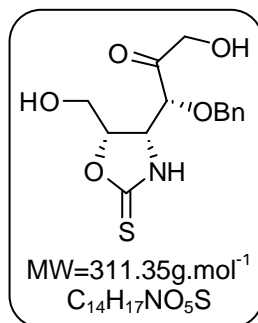
(4R,5R) 4-[(1S)-1-Benzyloxy-2-oxo-3-hydroxypropyl]-4,5-dihydro-5-hydroxymethyl-1,3-oxazoline-2-thione (111)

Yield=79%

Rf=0.10 PE/EA(5:5)

mp=69-72°C

Starting with **55** (0.5 g, 1.42 mmol) and using G.P. 2.2.4.b) (reaction time 15h) the compound **111** was obtained after column chromatography on silica gel with a mixture of PE/EA (7:3) as brown solid (0.35 g, 1.12 mmol, 79%).

¹H NMR (400MHz, DMSO) δ: 3.28-3.31 (m, 1H, **H-6a**); 3.37-3.42 (m, 1H, **H-6b**); 3.82-3.85 (m, 1H, **H-5**); 4.31 (ddd, 2H, *J*_{1a-1b}=*J*_{1b-1a}=13.4Hz, **H-1a**, **H-1b**); 4.60 (d, 1H, *J*_{7a-7b}=11.3Hz, **H-7a**); 4.65 (d, 1H, *J*₃₋₄=3.4Hz, **H-3**); 4.66 (d, 1H, *J*_{7b-7a}=11.3Hz, **H-7b**); 5.04 (dd, 1H, *J*₄₋₃=3.4Hz, *J*₄₋₅=5.2Hz, **H-4**); 5.15 (t, 1H, *J*_{OH-6}=5.6Hz, **OH-6**); 5.21 (t, 1H, *J*_{OH-1}=5.6Hz, **OH-1**); 7.29-7.40 (m, 5H, **Ph**); 10.07 (s, 1H, **NH**).

¹³C NMR (100MHz, DMSO) δ: 58.4 (**C-5**); 61.2 (**C-6**); 66.8 (**C-1**); 73.1 (**C-7**); 81.7 (**C-3**); 82.4 (**C-4**); 127.8, 127.9, 128.3 (**CH-Ph**); 137.4 (**Cq-Ph**); 187.4 (**C=O**); 208.0 (**C=S**).

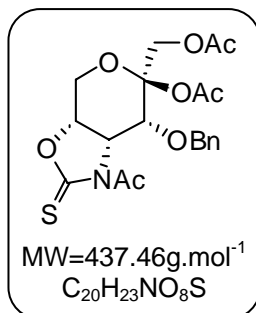
MS: (IS+) m/z: 334 (M+Na)⁺IR: (neat) ν (cm⁻¹): 3307 (**OH**); 2918, 2850 (**CH**); 1716 (**C=O**); 1461, 1376, 1048 (**N-CS-O**).**4,5-Dihydro-[N-acetyl-1,2-di-O-acetyl-3-O-benzyl-4-deoxy-β-D-psicopyranoso][4,5-d]-1,3-oxazoline-2-thione (113)**

Yield=70%

Rf=0.34 PE/EA(8:2)

[α]_D²⁰ = -39 (c=0.46
CHCl₃)

Starting with **55** (0.5 g, 1.42 mmol) and using G.P. 2.2.4. a) (reaction time 15h) the compound **112** was obtained and immediately used for the next reaction without further purification.

Starting with **112** and using G.P. 2.1.2. (reaction time 15h) the compound **113** was obtained after column chromatography on silica gel with a mixture of PE/EA (9:1) as a brown oil (0.43 g, 0.98 mmol, 70%).

¹H NMR (400MHz, CDCl₃) δ: 1.30 (s, 3H, **O-CO-CH₃**); 1.31 (s, 3H, **O-CO-CH₃**); 1.40 (s, 3H, **N-CO-CH₃**); 3.60 (dd, 1H, *J*_{6a-5}=6.8Hz, *J*_{6a-6b}=10.4Hz **H-6a**); 3.72 (dd, 1H, *J*_{6b-5}=5.2Hz, *J*_{6b-6a}=10.4Hz **H-6b**); 3.97 (d, 1H, *J*_{1a-1b}=9.6Hz, **H-1a**); 4.09 (ddd, 1H, *J*₅₋₄=4.0Hz, *J*_{5-6b}=5.2Hz, *J*_{5-6a}=6.8Hz, **H-5**); 4.18 (d, 1H, *J*_{1b-1a}=9.6Hz, **H-1b**); 4.41-4.57 (m, 3H, **H-3**, **H-7**); 4.70 (1H, dd, *J*₄₋₅=4.0Hz, *J*₄₋₃=5.5Hz, **H-4**); 7.16-7.28 (m, 5H, **Ph**).

¹³C NMR (100MHz, CDCl₃) δ: 25.0 (**N-CO-CH₃**), 26.1, 26.5 (**O-CO-CH₃**); 68.0 (**C-6**); 69.3 (**C-1**); 73.3 (**C-7**); 78.4 (**C-5**); 80.2 (**C-4**); 85.2 (**C-3**); 100.0 (**C-2**); 112.6 (**Cq-isop**); 127.6, 127.7, 128.3 (**CH-Ph**); 138.3 (**Cq-Ph**); 189.2 (**C=S**).

MS: (IS+) m/z: 460 (M+Na)⁺IR: (neat) ν (cm⁻¹): 2927 (**CH**); 1740 (**C=O**); 1776, 1370, 1041 (**N-CS-O**).

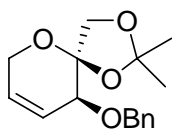
3-O-benzyl-4,5-dideoxy-1,2-O-isopropylidene-β-L-glycerohex-4-en-2-ulose (114)

MW=276.33g.mol⁻¹
C₁₆H₂₀O₄
[132369-48-3]

Yield=54%

Rf=0.68 PE/EA(8:2)

Starting with **57** (0.5 g, 1.61 mmol) and using G.P. 2.3.4. (reaction time 1h) the compound **114** was obtained after column chromatography on silica gel with a mixture of PE/EA (95:5) as orange oil (0.24 g, 0.87 mmol, 54%).

¹H NMR (250MHz, CDCl₃) δ: 1.46 (s, 3H, CH₃); 1.54 (s, 3H, CH₃); 3.90 (d 1H, J_{1a-1b}=8.5Hz, H-1a); 4.04 (d, 1H, J_{1b-1a}=8.5Hz, H-1b); 4.06-4.13 (m, 2H, H-3, H-6a); 4.40 (dd, 1H, J_{6b-5}=3.8z H-6b); 4.57 (d, 1H, J_{7a-7b}=12.0Hz, H-7a); 4.79 (d, 1H, J_{7b-7a}=12.0Hz, H-7b); 5.83-5.93 (m, 2H, H-4, H-5); 7.26-7.38 (m, 5H, Ph).

¹³C NMR (62.89MHz, CDCl₃) δ: 26.1, 27.4 (CH₃); 61.7 (C-6); 70.4 (C-3); 71.2 (C-7); 72.1 (C-1); 102.5 (C-2); 112.1 (Cq-isop); 123.8, 127.7 (C-4), (C-5); 127.9, 128.0, 128.5 (CH-Ph); 138.1 (Cq-Ph).

I. Izquierdo, M. T. P. López-Espinosa, *Anales de Química* **1990**, 86 (5), 554.

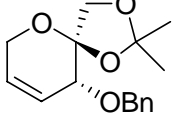
3-O-benzyl-4,5-dideoxy-1,2-O-isopropylidene-β-D-glycerohex-4-en-2-ulose (115)

MW=276.33g.mol⁻¹
C₁₆H₂₀O₄

Yield=67%

Rf=0.67 PE/EA(8:2)

[α]_D²⁰ = -240 (c=5.53

CHCl₃)

Starting with **106** (0.5 g, 1.61 mmol) and using G.P. 2.3.4. (reaction time 1h) the compound **115** was obtained after column chromatography on silica gel with a mixture of PE/EA (95:5) as orange oil (0.30 g, 1.09 mmol, 67%).

¹H NMR (250MHz, CDCl₃) δ: 1.38 (s, 3H, CH₃); 1.53 (s, 3H, CH₃); 3.78 (dd, 1H, J₃₋₅=1.8Hz, J₃₋₄=4.3Hz, H-3); 4.13 (s, 2H, H-1); 4.21-4.30 (m, 1H, H-6a); 4.39 (ddd, 1H, J_{6b-4}=J_{6b-5}=2.0Hz, J_{6b-6a}=17.3Hz, H-6b); 4.56 (d, 1H, J_{7a-7b}=11.8Hz, H-7a); 4.66 (d, 1H, J_{7b-7a}=11.8Hz, H-7b); 5.98 (ddt, 1H, J_{4-6b}=2.0Hz, J₄₋₃=4.3Hz, J₄₋₅=10.3Hz, H-4); 6.09 (ddd, 1H, J_{5-6a}=J_{5-6b}=2.0Hz, J₅₋₃=1.8Hz, J₅₋₄=10.3Hz, H-5); 7.24-7.38 (m, 5H, Ph).

¹³C NMR (62.89MHz, CDCl₃) δ: 26.3, 27.1 (CH₃); 61.7 (C-6); 70.3 (C-7); 71.9 (C-3); 72.9 (C-1); 103.9 (C-2); 111.9 (Cq-isop); 122.2 (C-4); 127.8, 127.9, 128.9 (CH-Ph); 131.0 (C-5); 138.3 (Cq-Ph).

MS: (IS+) m/z: 299 (M+Na)⁺

IR: (neat) ν (cm⁻¹): 2934, 2884 (CH); 1496, 1454 (Ph).

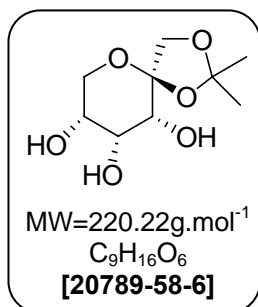
1,2-Di-O-isopropylidene- β -D-psicopyranose (119)

Starting with **104** (5 g, 19.2 mmol) and using G.P. 2.2.1. (reaction time 15h) the compound **119** was obtained as colorless solid (4.21 g, 19.1 mmol, 100%).

¹H NMR (250MHz, DMSO-d₆) δ : 1.29 (s, 3H, CH₃); 1.38 (s, 3H, CH₃); 3.46 (d, 1H, $J_{3-4}=7.6$ Hz, H-3); 3.60-3.72 (m, 4H, H-4, H-5, H-6a, H6b); 3.88 (d, 1H, $J_{1a-1b}=9.1$ Hz, H-1a); 3.96 (d, 1H, $J_{1b-1a}=9.1$ Hz, H-1b); 4.89 (d, 1H, $J_{OH-4}=5.8$ Hz, OH-4); 5.01 (d, 1H, $J_{OH-3}=8.0$ Hz, OH-3); 5.12 (d, 1H, $J_{OH-5}=5.3$ Hz, OH-5).

Yield=100%

Rf=0.18 PE/EA(5:5)

mp=159-162°C

$[\alpha]_D^{20} = -124$ (c=0.53

MeOH)

¹³C NMR (62.89MHz, DMSO-d₆) δ : 26.3, 26.9 (CH₃); 64.8 (C-6); 66.4 (C-4); 68.5 (C-5); 72.0 (C-1); 72.9 (C-3); 105.8 (C-2); 110.6 (Cq-isop).

MS: (IS+) m/z: 243 (M+Na)⁺

IR: (neat) ν (cm⁻¹): 3391, 3293 (OH); 2932, 2890 (CH).

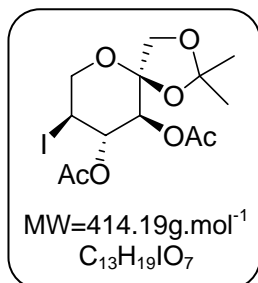
3,4-Di-O-acetyl-5-deoxy-5-iodo-1,2-O-isopropylidene- α -L-sorbopyranose (100a)

Starting with **100** (0.5 g, 1.51 mmol) and using G.P. 2.1.2. (reaction time 15h) the compound **100a** was obtained after column chromatography on silica gel with a mixture of PE/EA (95:5) as cream solid (0.60 g, 1.45 mmol, 95%).

¹H NMR (250MHz, DMSO-d₆) δ : 1.43 (s, 3H, CH₃-isop); 1.49 (s, 3H, CH₃-isop); 2.06 (s, 3H, O-CO-CH₃); 2.08 (s, 3H, O-CO-CH₃); 3.84 (d, 1H, $J_{1a-1b}=9.3$ Hz, H-1a); 3.89-4.04 (m, 3H, H1-b, H5, H-6a); 4.12 (d, 1H, $J_{6b-6a}=10.3$ Hz, H6-b); 4.97 (d, 1H, $J_{3-4}=9.7$ Hz H-3); 5.48 (d, 1H, $J_{4-3}=9.7$ Hz H-4).

Yield=95%

Rf=0.63 PE/EA(8:2)

mp=95-98°C

$[\alpha]_D^{20} = +6$ (c=0.18

CHCl₃)

¹³C NMR (62.89MHz, DMSO-d₆) δ : 20.8, 21.0 (O-CO-CH₃); 22.3 (C-5); 26.1, 26.2 (CH₃-isop); 65.8 (C-6); 70.7 (C-3); 71.9 (C-1); 74.0 (C-4); 104.2 (C-2); 112.9 (Cq-isop); 169.5, 130.3 (C=O).

HRMS: Calculated for C₁₃H₁₉IO₇ [M+Na]⁺ 437.0073, found: 437.0063.

IR: (neat) ν (cm⁻¹): 2985 (CH); 1741 (C=O); 906 (CH₃).

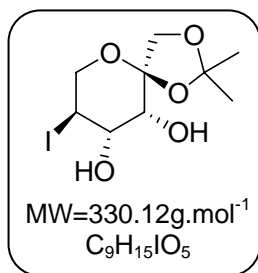
5-Deoxy-5-iodo-1,2-O-isopropylidene- α -L-tagatopyranose (120)**Yield**=63%**Rf**=0.26 PE/EA(5:5)**mp**=155-158°C**[α]_D²⁰** = -13 (c=0.45
MeOH)

Starting with **119** (1 g, 4.54 mmol) using G.P. 2.3.3. (reaction time 4h) and 1,4-dioxane as solvent the compound **120** was obtained after column chromatography on silica gel with a mixture of PE/EA (6:4) as cream solid (0.94 g, 2.85 mmol, 63%).

¹H NMR (400MHz, CDCl₃) δ : 1.40 (s, 3H, CH₃); 1.50 (s, 3H, CH₃); 2.44 (d, 1H, J_{OH-3} =3.6Hz, OH-3); 2.54 (d, 1H, J_{OH-4} =4.4Hz, OH-4); 3.83 (t, 1H, J_{3-4} =3.0Hz, H-3); 3.94 (d, 1H, J_{6a-5} =5.2Hz, J_{6a-6b} =11.2Hz, H-6a); 4.01-4.05 (m, 1H, H-4); 4.04 (d, 1H, J_{1a-1b} =9.4Hz, H-1a); 4.09 (d, 1H, J_{6b-6a} =11.2Hz, H-6b); 4.12 (d, 1H, J_{1b-1a} =9.4Hz, H-1b); 4.22-4.27 (m, 1H, H-5).

¹³C NMR (100MHz, CDCl₃) δ : 26.5, 26.8 (CH₃); 29.7 (C-5); 65.9 (C-6); 68.3 (C-1); 73.4 (C-3); 73.6 (C-4); 96.0 (C-2); 112.6 (Cq-isop).

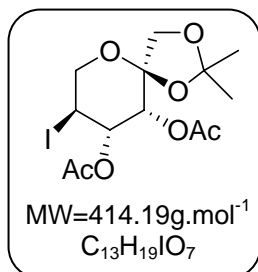
MS: (IS+) m/z: 413 (M+CH₃COOH+Na)⁺**IR**: (neat) ν (cm⁻¹): 3556 (OH); 3377, 3243, 3129 (CH).**3,4-Di-O-acetyl-5-deoxy-5-iodo-1,2-O-isopropylidene- α -L-tagatopyranose (120a)****Yield**=93%**Rf**=0.64 PE/EA(8:2)**mp**=106-109°C**[α]_D²⁰** = -26 (c=0.17
CHCl₃)

Starting with **120** (0.5 g, 1.51 mmol) and using G.P. 2.1.2. (reaction time 15h) the compound **120a** was obtained after column chromatography on silica gel with a mixture of PE/EA (95:5) as cream solid (0.58 g, 1.40 mmol, 95%).

¹H NMR (400MHz, CDCl₃) δ : 1.41 (s, 3H, CH₃-isop); 1.49 (s, 3H, CH₃-isop); 2.04 (s, 3H, O-CO-CH₃); 2.12 (s, 3H, O-CO-CH₃); 3.78 (d, 1H, J_{1a-1b} =9.2Hz, H-1a); 3.93 (d, 1H, J_{1b-1a} =9.2Hz, H-1b); 4.08 (dd, 1H, J_{6a-6b} =10.4Hz, J_{6a-5} =3.6Hz, H-6a); 4.14-4.23 (m, 2H, H-5, H-6b); 5.17 (d, 1H, J_{3-4} =3.2Hz, H-3); 5.35 (dd, 1H, J_{4-3} =3.2Hz, J_{4-5} =10.8Hz, H-4).

¹³C NMR (100MHz, CDCl₃) δ : 20.8 (O-CO-CH₃); 21.2 (C-5); 26.4, 26.9 (CH₃-isop); 66.6 (C-6); 72.2 (C-3); 72.7 (C-4); 73.4 (C-1); 103.9 (C-2); 113.6 (Cq-isop); 169.5, 169.9 (C=O).

HRMS: Calculated for C₁₃H₁₉I O₅ [M+Na]⁺ 437.0073, found: 437.0090**IR**: (neat) ν (cm⁻¹): 2988 (CH); 1752 (C=O); 917 (CH₃).

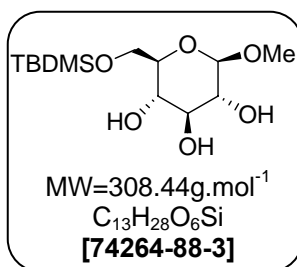
Methyl 6-*O*-*tert*-butyldimethylsilyl- β -D-glucopyranoside (**123**)

Yield=86%
Rf=0.69 PE/EA(2:8)

Starting with **methyl- β -glucopyranoside** (1.0 g, 4.92 mmol) using G.P. 2.1.5. (reaction time 15h), pyridine (in KOH) and *tert*-butyldimethylsilyl chloride (1.1. eq.) the compound **123** was obtained after column chromatography on silica gel with a mixture of PE/EA (2:8) as colorless solid (1.31 g, 4.25 mmol, 86%).

¹H NMR (400MHz, CDCl₃) δ : 0.08 (s, 6H, Si(CH₃)₂); 0.89 (s, 9H, C(CH₃)₃); 3.29-3.35 (m, 2H, H-2, H-5); 3.44 (t, 1H, J₄₋₅=9.2Hz, H-4); 3.51-3.54 (m, 4H, OMe, H-3); 3.82 (dd, 1H, J_{6a-5}=5.4Hz, J_{6a-6b}=10.8Hz, H-6a); 3.89 (dd, 1H, J_{6b-5}=4.0Hz, J_{6b-6a}=10.8Hz, H-6b); 4.18 (d, 1H, J₁₋₂=7.6Hz, H-1); 4.22 (brs, 1H, OH-3, OH-4); 4.78 (brs, 1H, OH-2).

¹³C NMR (100MHz, CDCl₃) δ : -5.3 (Si(CH₃)₂); 18.4 (Cq-C(CH₃)₃); 26.0 (C(CH₃)₃); 57.0 (OMe); 64.1 (C-6); 71.8 (C-2); 73.5 (C-4); 75.4 (C-3); 76.6 (C-5); 103.5 (C-1).

M. Chung, G. Orlova, J. D. Goddard, M. Schlaf, R. Harris, T. J. Beveridge, G. White, F. R. Hallet *J. Am. Chem. Soc.* **2002**, *124*, 10508.

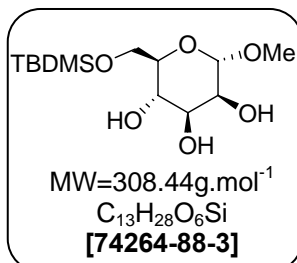
Methyl 6-*O*-*tert*-butyldimethylsilyl- β -D-mannopyranoside (**124**)

Yield=81%
Rf=0.68 PE/EA(2:8)

Starting with **methyl- β -mannopyranoside** (1 g, 4.92 mmol) using G.P. 2.1.5. (reaction time 15h), pyridine (in KOH) and *tert*-butyldimethylsilyl chloride (1.1. eq.) the compound **124** was obtained after column chromatography on silica gel with a mixture of PE/EA (2:8) as colorless solid (1.23 g, 3.99 mmol, 81%).

¹H NMR (400MHz, CDCl₃) δ : 0.07 (s, 6H, Si(CH₃)₂); 0.88 (s, 9H, C(CH₃)₃); 3.33 (s, 3H, OMe); 3.49-3.54 (m, 1H, H-5); 3.66 (t, 1H, J₄₋₃=9.3Hz, H-4); 3.75 (dd, 1H, J₃₋₂=3.2Hz, J₃₋₄=9.3Hz, H-3); 3.79 (dd, 1H, J_{6a-5}=6.0Hz, J_{6a-6b}=10.8Hz, H-6a); 3.86-3.87 (m, 1H, H-2); 3.90 (dd, 1H, J_{6b-5}=4.0Hz, J_{6b-6a}=10.8Hz, H-6b); 4.12 (brs, 3H, OH); 4.66 (s, 1H, H-1).

¹³C NMR (100MHz, CDCl₃) δ : -5.2 (Si(CH₃)₂); 18.4 (Cq-C(CH₃)₃); 26.0 (C(CH₃)₃); 54.8 (OMe); 64.3 (C-6); 69.4 (C-2); 70.6 (C-5); 71.8 (C-3); 71.9 (C-4); 100.9 (C-1).

M. Chung, G. Orlova, J. D. Goddard, M. Schlaf, R. Harris, T. J. Beveridge, G. White, F. R. Hallet *J. Am. Chem. Soc.* **2002**, *124*, 10508.

Methyl 6-O-*tert*-butyldimethylsilyl- β -D-galactopyranoside (125)

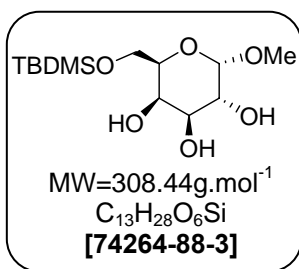

Yield=80%

Rf=0.69 PE/EA(2:8)

Starting with **methyl- β -galactopyranoside** (1 g, 4.92 mmol) using G.P. 2.1.5. (reaction time 15h), pyridine (in KOH) and *tert*-butyldimethylsilyl chloride (1.1. eq.) the compound **125** was obtained after column chromatography on silica gel with a mixture of PE/EA (2:8) as colorless solid (1.21 g, 3.92 mmol, 80%).

¹H NMR (400MHz, MeOD) δ : 0.10 (s, 6H, Si(CH₃)₂); 0.92 (s, 9H, C(CH₃)₃); 3.39 (s, 3H, OMe); 3.69 (dd, 1H, J₃₋₄=3.3Hz, J₃₋₂=9.7Hz H-3); 3.74-3.83 (m, 4H, H-2, H-5, H-6a, H-6b); 3.88 (d, 1H, J₄₋₃=3.3Hz, H-4); 4.68 (d, 1H, J₁₋₂=3.9Hz, H-1).

¹³C NMR (100MHz, MeOD) δ : -5.2 (Si(CH₃)₂); 19.2 (Cq-C(CH₃)₃); 26.4 (C(CH₃)₃); 55.6 (OMe); 63.9 (C-6); 70.3 (C-2); 70.8 (C-4); 71.7 (C-3); 72.4 (C-5); 101.5 (C-1).

M. Chung, G. Orlova, J. D. Goddard, M. Schlaf, R. Harris, T. J. Beveridge, G. White, F. R. Hallet *J. Am. Chem. Soc.* **2002**, *124*, 10508.

Methyl 6-O-*tert*-butyldimethylsilyl-3-deoxy-3-iodo- β -D-allopyranoside (126)

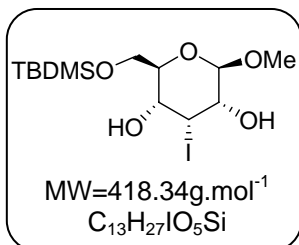

Yield=45%

Rf=0.7 PE/EA(7:3)

mp=152-155°C

[α]_D²⁰ = +9 (c=0.87
MeOH)

Starting with **123** (0.5 g, 1.62 mmol) using G.P. 2.3.3. (reaction time 4h) and 1,4-dioxane as solvent the compound **126** was obtained after column chromatography on silica gel with a mixture of PE/EA (9:1) as cream solid (0.31 g, 0.74 mmol, 45%).

¹H NMR (400MHz, CDCl₃) δ : 0.09 (s, 6H, Si(CH₃)₂); 0.89 (s, 9H, C(CH₃)₃); 2.85 (d, 1H, J_{OH-2}=2.8Hz, OH-2); 3.36 (ddd, 1H, J₅₋₄=4.8Hz, J_{5-6a}=6.3Hz, J_{5-6b}=8.8Hz, H-5); 3.54 (s, 3H, OMe); 3.59 (ddd, 1H, J₂₋₃=2.6Hz, J₂₋₁=7.4Hz, H-2); 3.65 (d, 1H, J_{OH-4}=1.6Hz, OH-4); 3.79-3.85 (m, 1H, H-4); 3.82 (d, 1H, J_{6a-6b}=10.2Hz, H-6a); 3.90 (dd, 1H, J_{6b-6a}=10.2, H-6b); 3.91-3.95 (m, 1H, H-3); 4.18 (d, 1H, J₁₋₂=7.4Hz, H-1).

¹³C NMR (100MHz, CDCl₃) δ : -5.3 (Si(CH₃)₂); 18.3 (Cq-C(CH₃)₃); 25.9 (C(CH₃)₃); 38.3 (C-3); 57.2 (OMe); 64.8 (C-6); 74.8 (C-2), (C-4); 76.6 (C-5); 103.8 (C-1).

MS: (IS+) m/z: 469 (M+K)⁺.

IR: (neat) ν (cm⁻¹): 3248 (OH); 2918, 2847 (CH); 1283 [Si(CH₃)₂].

Methyl 2,3-di-O-acetyl-6-O-tert-butyldimethylsilyl-4-deoxy-4-iodo- β -D-glucopyranoside (127a)

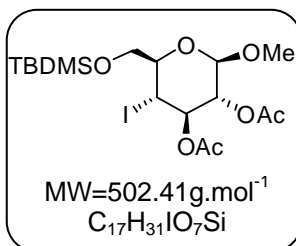

Starting with **125** (0.5 g, 1.62 mmol) using G.P. 2.3.3. (reaction time 4h) and 1,4-dioxane as solvent the compound **127** was obtained after column chromatography on silica gel with a mixture of PE/EA (9:1) as cream solid (0.28 g, 0.67 mmol, 42%).

Starting with **127** (0.2 g, 0.48 mmol) and using G.P. 2.1.2. (reaction time 15h) the compound **127a** was obtained after column chromatography on silica gel with a mixture of PE/EA (95:5) as cream solid (0.22 g, 0.44 mmol, 93%).

Yield=93%

Rf=0.62 PE/EA(8:2)

mp=93-96°C

$[\alpha]_D^{20}$ =+58 (c=0.23
MeOH)

¹H NMR (400MHz, CDCl₃) δ : 0.09 (s, 3H, Si(CH₃)₂); 0.10 (s, 3H, Si(CH₃)₂); 0.92 (s, 9H, C(CH₃)₃); 2.06 (s, 3H, O-CO-CH₃); 2.10 (s, 3H, O-CO-CH₃); 3.39 (s, 3H, OMe); 3.95-4.04 (m, 4H, H-4, H-5, H-6a, H-6b); 4.78 (dd, 1H, J₂₋₁=3.6Hz, J₂₋₃=10.0Hz, H-2); 4.95 (d, 1H, J₁₋₂=3.6Hz, H-1); 5.61 (t, 1H, J₃₋₂=J₃₋₄=10.0Hz, H-3).

¹³C NMR (100MHz, CDCl₃) δ : -5.2, -5.0 (Si(CH₃)₂); 18.5 (Cq-C(CH₃)₃); 20.9, 21.1 (O-CO-CH₃); 25.6 (C-4); 26.1 (C(CH₃)₃); 55.5 (OMe); 64.3 (C-6); 71.9 (C-2); 72.6 (C-3); 72.9 (C-5); 97.3 (C-1); 169.6, 170.3 (C=O).

MS: (IS+) m/z: 469 (M+K)⁺.

IR: (neat) ν (cm⁻¹): 2932 (CH); 1755 (C=O); 1218 [Si(CH₃)₂].

3,4,5-Tri-O-benzyl-1,2-O-isopropylidene- β -D-fructopyranose (140)

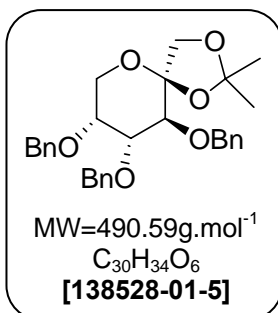

Starting with **98** (5 g, 22.7 mmol) and using G.P. 2.1.3. b) (reaction time 3h) the compound **140** was obtained after column chromatography on silica gel with a mixture of cyclohexane/EA (85:15) as colorless oil (10.2 g, 20.8 mmol, 92%).

¹H NMR (400MHz, CDCl₃) δ : 1.43 (s, 3H, CH₃); 1.48 (s, 3H, CH₃); 3.74-3.83 (m, 3H, H-6a, H-6b, H-5); 3.90-3.96 (m, 2H, H-3, H-4); 3.96 (d, 1H, J_{1a-1b}=8.4Hz, H-1a); 4.00 (d, 1H, J_{1b-1a}=8.4Hz, H-1b); 4.57-4.78 (m, 5H, CH₂Ph); 5.04 (d, 1H, J=11.6Hz, CH₂Ph); 7.27-7.41 (m, 15H, Ph).

Yield=92%

Rf=0.61 PE/EA(9:1)

$[\alpha]_D^{20}$ =-69 (c=0.34
CHCl₃)

¹³C NMR (100MHz, CDCl₃) δ : 26.4, 27.3 (CH₃); 61.5 (C-6); 71.5, 71.9 (CH₂Ph); 72.2 (C-1); 73.5 (C-5); 75.1 (C-4); 75.5 (CH₂Ph); 80.2 (C-3); 106.0 (C-2); 112.0 (Cq-isop); 127.6, 127.7, 127.8, 128.0, 128.4, 128.5 (CH-Ph) 138.4, 138.6, 138.7 (Cq-Ph).

MS: (IS+) m/z: 513 (M+Na)⁺

IR: (neat) ν (cm⁻¹): 2987, 2932 (CH); 1496, 1454 (Ph).

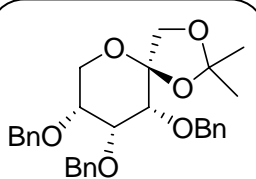
3,4,5-Tri-O-benzyl-1,2-O-isopropylidene-β-D-psicopyranose (141)

MW=490.59g.mol⁻¹
C₃₀H₃₄O₆
[153289-45-3]

Yield=95%

Rf=0.60 PE/EA(9:1)

[α]_D²⁰ = -21 (c=0.57
CHCl₃)

Starting with **119** (5 g, 22.7 mmol) and using G.P. 2.1.3. b) (reaction time 3h) the compound **141** was obtained after column chromatography on silica gel with a mixture of cyclohexane/EA (85:15) as colorless oil (10.6 g, 21.6 mmol, 95%).

¹H NMR (400MHz, CDCl₃) δ: 1.38 (s, 3H, CH₃); 1.52 (s, 3H, CH₃); 3.52 (dd, 1H, J₅₋₄=2.8Hz, J₅₋₆=7.2Hz, H-5); 3.55 (d, 1H, J₃₋₄=2.0Hz, H-3); 3.78 (d, 1H, J_{6a-6b}=11.4Hz, H-6a); 3.83 (d, 1H, J_{6b-6a}=11.4Hz, H-6b); 4.03 (t, 1H, J₄₋₅=2.8Hz, H-4); 4.17 (d, 1H, J_{1a-1b}=10.0Hz, H-1a); 4.21 (d, 1H, J_{1b-1a}=10.0Hz, H-1b); 4.50 (d, 1H, J=12.2Hz, CH₂Ph); 4.53 (d, 1H, J=12.2Hz, CH₂Ph); 4.68 (d, 1H, J=12.0Hz, CH₂Ph); 4.74-4.83 (m, 3H, CH₂Ph); 7.25-7.37 (m, 15H, Ph).

¹³C NMR (100MHz, CDCl₃) δ: 25.9, 27.6 (CH₃); 62.0 (C-6); 68.6 (C-1); 71.6, 73.6, 73.9 (C-7); 75.6 (C-4); 77.5 (C-3); 106.1 (C-2); 110.4 (Cq-isop); 127.6, 127.7, 127.8, 127.9, 128.4, 128.5 (Ph); 138.1, 138.5, 138.8 (Cq-Ph).

MS: (IS+) m/z: 513 (M+Na)⁺

IR: (neat) ν (cm⁻¹): 2986, 2985 (CH); 1496, 1454 (Ph).

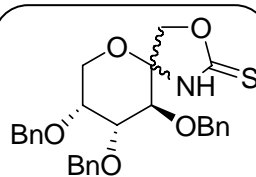
3,4,5-Tri-O-benzyl-2-N,1-O-thiocarbonyl-α-D-fructopyranosylamine (148)

MW=491.60g.mol⁻¹
C₂₈H₂₉O₅S
[785803-51-2]

Yield=78%

Rf=0.50 PE/EA(7:3)

Starting with **140** (6 g, 12.2 mmol) and using G.P. 2.2.4. b) (reaction time 24h) the mixture **142** was obtained without further purification. Starting with **142** using G.P. 2.4.1. (reaction time 24h) and ethanol as solvent the mixture **144** was obtained after column chromatography on silica gel with a mixture of PE/EA (9:1) as a yellow oil (4.69 g, 9.54 mmol, 78%).

Starting with **140** (1 g, 2.04 mmol) and using G.P. 2.4.3. (reaction time 15h) the compound **144** was obtained after column chromatography on silica gel with a mixture of PE/EA (9:1) as a yellow oil (0.66 g, 1.34 mmol, 66%).

Some traces of the **148** were isolated:

¹H NMR (400MHz, CDCl₃) δ: 3.47-3.52 (m, 2H, H-3, H-5); 3.73-3.78 (m, 2H, H-6); 4.05 (s, 1H, CH-4); 4.42-4.68 (m, 6H, H-1, CH₂Ph); 4.77 (d, 1H, J=11.4Hz, CH₂Ph); 4.85 (d, 1H, J=11.4Hz, CH₂Ph); 7.26-7.35 (m, 15H, Ph); 8.80 (brs, 1H, NH).

¹³C NMR (100MHz, CDCl₃) δ: 60.5 (C-6); 71.5 (C-1); 72.6 (CH₂Ph); 74.2 (C-4); 74.5 (C-5); 74.6 (CH₂Ph), (CH₂Ph); 75.7 (C-3); 92.6 (C-2); 127.4, 127.7, 127.8, 127.9, 128.1, 128.3, 128.5 (CH-Ph); 137.2, 137.7, 138.2 (Cq-Ph); 190.2 (C=S).

[α]_D²⁰ = -7 (c=2.64
CHCl₃)

HRMS: Calculated for C₂₈H₂₉O₅S [M+H]⁺ 492.1845, found: 492.1863.

IR: (neat) ν (cm⁻¹): 2885 (CH); 1494, 1322, 1047 (N-CS-O); 1454 (Ph).

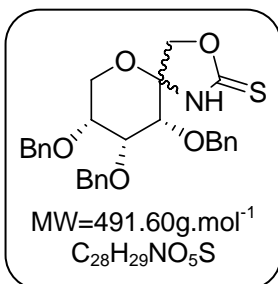
3,4,5-Tri-O-benzyl-2-N,1-O-thiocarbonyl- α -D-psicopyranosylamine (149)

Yield=70%
Rf=0.49 PE/EA(7:3)

Starting with **141** (6 g, 12.2 mmol) and using G.P. 2.2.4. b) (reaction time 24h) the mixture **143** was obtained without further purification. Starting with **143** using G.P. 2.4.1. (reaction time 24h) and ethanol as solvent the compound **145** was obtained after column chromatography on silica gel with a mixture of PE/EA (9:1) as a yellow oil (4.21 g, 8.56 mmol, 70%).

Starting with **141** (1 g, 2.04 mmol) and using G.P. 2.4.3. (reaction time 15h) the compound **145** was obtained after column chromatography on silica gel with a mixture of PE/EA (9:1) as a yellow oil (0.47 g, 0.96 mmol, 47%).

Some traces of the **149** were isolated:

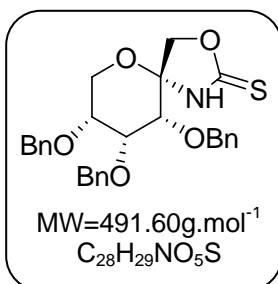

[α]_D²⁰ = -11 (c=0.54
CHCl₃)

¹H NMR (400MHz, CDCl₃) δ : 3.43 (d, 1H, J_{3-4} =2.4Hz, **H-3**); 3.47 (ddd, 1H, J_{5-6a} =2.0Hz, J_{5-4} =5.2Hz, J_{5-6b} =10.0Hz, **H-5**); 3.71-3.82 (m, 2H, **H-6**); 4.06 (brs, 1H, **H-4**); 4.49 (d, 2H, J_{1a-1b} =3.6Hz, **H-1a**, **H-1b**); 4.54-4.57 (m, 3H, **CH₂Ph**); 4.69 (d, 1H, J =11.8Hz, **CH₂Ph**); 4.79 (d, 1H, J =11.8Hz, **CH₂Ph**); 4.87 (d, 1H, J =11.2Hz, **CH₂Ph**); 7.25-7.35 (m, 15H, **Ph**); 8.22 (brs, 1H, **NH**).

¹³C NMR (100MHz, CDCl₃) δ : 60.7 (**C-6**); 71.7 (**C-1**); 72.6 (**CH₂Ph**); 74.2 (**C-4**); 74.3 (**C-5**); 74.7 (**CH₂Ph**), (**CH₂Ph**); 75.7 (**C-3**); 92.6 (**C-2**); 127.6, 127.9, 128.0, 128.1, 128.3, 128.5, 128.7 (**CH-Ph**); 137.1, 137.7, 138.2 (**Cq-Ph**); 190.4 (**C=S**).

MS: (IS+) m/z: 514 (M+Na)⁺

IR: (neat) ν (cm⁻¹): 2886 (**CH**); 1494, 1321, 1046 (**N-CS-O**); 1454 (**Ph**).

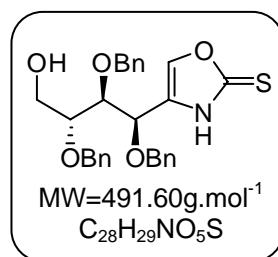
4-((1R,2S,3R)-4-hydroxy-1,2,3-tribenzyloxybutyl)[1,3]oxazole-2-thione (146)

Yield=20%
Rf=0.31 PE/EA(8:2)
mp=103-105°C
[α]_D²⁰ = +25 (c=0.56
CHCl₃)

The compound **146** was a side product of the synthesis of compound **144** when using G.P. 2.4.1.. Compound **146** was obtained after column chromatography on silica gel with a mixture of PE/EA (85:15) as a yellow solid (1.20 g, 2.44 mmol, 20%).

¹H NMR (400MHz, CDCl₃) δ : 3.52-3.53 (m, 1H, **H-5**); 3.70-3.75 (m, 1H, **H-6a**); 3.77-3.81 (m, 1H, **H-4**); 3.86-3.88 (m, 1H, **H-6b**); 4.27 (d, 1H, J =11.6Hz, **CH₂Ph**); 4.41-4.62 (m, 5H, **H-3**, **CH₂Ph**); 4.79 (d, 1H, J =12.0Hz, **CH₂Ph**); 6.40 (s, 1H, **H-1**); 7.22-7.36 (m, 15H, **Ph**); 9.89 (brs, 1H, **NH**).

¹³C NMR (100MHz, CDCl₃) δ : 60.2 (**C-6**); 71.1 (**C-3**); 71.7, 72.7, 72.9 (**CH₂Ph**); 77.1 (**C-5**); 79.1 (**C-4**); 110.6 (**C-2**); 127.6, 127.9, 128.0, 128.2, 128.3, 128.5, 128.6, 128.9 (**CH-Ph**); 136.5 (**C-1**); 137.3, 137.6, 137.8 (**Cq-Ph**); 171.1 (**C=S**).

MS: (IS+) m/z: 492(M+H)⁺; 514 (M+Na)⁺

IR: (neat) ν (cm⁻¹): 3271 (**OH**); 3029, 2923 (**CH**); 1627 (**C=C**); 1514, 1306, 1080 (**N-CS-O**); 1453 (**Ph**).

4-((1S,2S,3R)-4-hydroxy-1,2,3-tribenzyloxybutyl)[1,3]oxazole-2-thione (147)

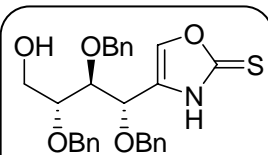

MW=491.60g.mol⁻¹
C₂₈H₂₉NO₅S

Yield=15%

R_f=0.30 PE/EA(8:2)

mp=115-118°C

[α]_D²⁰=+32 (c=1.1

CHCl₃)

The compound **147** was a side product of the synthesis of compound **145** when using G.P. 2.4.1.. Compound **147** was obtained after column chromatography on silica gel with a mixture of PE/EA (85:15) as a yellow solid (0.90 g, 1.83 mmol, 15%).

¹H NMR (400MHz, CDCl₃) δ: 3.23-3.26 (m, 1H, **H-5**); 3.69 (dd, 1H, *J*_{6a-5}=2.4Hz, *J*_{6a-6b}=12.0Hz **H-6a**); 3.80 (dd, 1H, *J*_{6b-5}=3.6Hz, *J*_{6b-6a}=12.0Hz, **H-6b**); 4.08 (dd, 1H, *J*₄₋₃=3.2Hz, *J*₄₋₅=8.0Hz, **H-4**); 4.31 (d, 2H, *J*=12.0Hz, **CH₂Ph**); 4.47 (d, 1H, *J*₃₋₄=3.2Hz, **H-3**); 4.54 (d, 1H, *J*=11.8Hz, **CH₂Ph**); 4.58 (d, 1H, *J*=11.8Hz, **CH₂Ph**); 4.75 (d, 1H, *J*=11.2Hz, **CH₂Ph**); 4.81 (d, 1H, *J*=11.2Hz, **CH₂Ph**); 6.50 (s, 1H, **H-1**); 7.25-7.38 (m, 15H, **Ph**); 10.0 (brs, 1H, **NH**).

¹³C NMR (100MHz, CDCl₃) δ: 59.4 (**C-6**); 70.9 (**C-3**); 71.1, 71.4, 75.5 (**CH₂Ph**); 77.6 (**C-5**); 79.0 (**C-4**); 127.1 (**C-2**); 128.0, 128.2, 128.3, 128.4, 128.7, 128.8 (**CH-Ph**); 135.4 (**C-1**); 136.7, 137.3, 137.4 (**Cq-Ph**); 179.3 (**C=S**).

HRMS: Calculated for C₂₈H₂₉NO₅ [M+H]⁺ 492.1845, found: 492.1833.

IR: (neat) ν (cm⁻¹): 3030, 2874 (**CH**); 1501, 1453 (**Ph**); 1471, 1028, 1027 (**N-CS-O**).

(5S,8R,9R,10S) 8,9,10-Tribenzyloxy-2-benzylsulfanyl-1,2-dehydro-1-aza-3,6-dioxaspiro[4,5]decane (150)

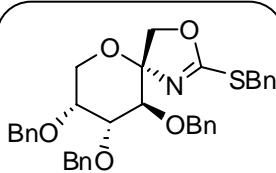

MW=581.72g.mol⁻¹
C₃₅H₃₅NO₅S

Yield=43%

R_f=0.21 PE/EA(8:2)

[α]_D²⁰=-16 (c=1.02

CHCl₃)

Starting with **144** (1 g, 2.03 mmol) using G.P. 2.3.6. (reaction time 3h), sodium hydrogen carbonate (4.0 eq.) as base and benzyl bromide (4.0 eq.) the compound **150** was obtained after column chromatography on silica gel with a mixture of PE/EA (9:1) as cream oil (0.57 g, 0.98 mmol, 48%).

¹H NMR (250MHz, CDCl₃) δ: 3.33 (d, 1H, *J*_{6a-6b}=12.8Hz, **H-6a**); 3.42 (d, 1H, *J*₅₋₆=2.5Hz, *J*₄₋₃=9.3Hz, **H-4**); 3.67-3.82 (m, 1H, **H-5**); 4.09 (dd, 1H, *J*_{6b-5}=2.8Hz, *J*_{6b-6a}=12.3Hz, **H-6b**); 4.16-4.27 (m, 3H, **H-1**, **H-3**, **SCH₂Ph**); 4.37 (d, 1H, *J*=13.5Hz, **SCH₂Ph**); 4.45-4.50 (m, 2H, **H-1b**, **CH₂Ph**); 4.63-4.83 (m, 5H, **CH₂Ph**); 7.16-7.43 (m, 20H, **Ph**).

¹³C NMR (62.89MHz, CDCl₃) δ: 36.8 (**SCH₂Ph**); 60.6 (**C-6**); 71.2 (**C-5**); 73.6 (**CH₂Ph**), (**C-1**); 73.7 (**CH₂Ph**); 74.0 (**CH₂Ph**); 78.8 (**C-4**); 79.6 (**C-3**); 93.3 (**C-2**); 127.8, 128.6, 128.0, 128.9 (**CH-Ph**); 135.6 (**Cq-SBn**); 137.4, 137.9, 138.5 (**Cq-Ph**); 177.7 (**C-S**).

MS: (IS+) m/z: 582 (M+H)⁺; 604 (M+Na)⁺

IR: (neat) ν (cm⁻¹): 3029, 2883 (**CH**); 1589, 1095, 698 (**N-CS-O**); 1494, 1454 (**Ph**).

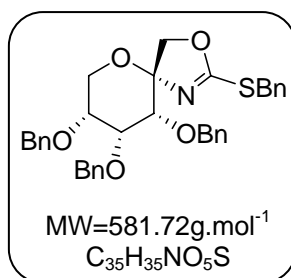
(5S,8R,9R,10R) 8,9,10-Tribenzyloxy-2-benzylsulfanyl-1,2-dehydro-1-aza-3,6-dioxaspiro[4,5]decane (151)

Yield=43%
Rf=0.21 PE/EA(8:2)
[α]_D²⁰ = -16 (c=1.02
CHCl₃)

Starting with **145** (1 g, 2.03 mmol) using G.P. 2.3.6. (reaction time 3h), sodium hydrogen carbonate (4.0 eq.) as base and benzyl bromide (4.0 eq.) the compound **151** was obtained after column chromatography on silica gel with a mixture of PE/EA (9:1) as cream oil (0.51 g, 0.88 mmol, 43%).

¹H NMR (400MHz, CDCl₃) δ: 3.33 (d, 1H, *J*_{6a-6b}=12.6Hz, **H-6a**); 3.42 (d, 1H, *J*₄₋₅=3.2Hz, *J*₄₋₃=9.4Hz, **H-4**); 4.07 (dd, 1H, *J*_{6b-5}=3.2Hz, *J*_{6b-6a}=12.6Hz, **H-6b**); 4.18 (d, 1H, *J*₃₋₄=9.4Hz, **H-3**); 4.23 (d, 1H, *J*_{1a-1b}=8.8Hz, **H-1a**); 4.25 (d, 1H, *J*=13.2Hz, **SCH₂Ph**); 4.36 (d, 1H, *J*=13.2Hz, **SCH₂Ph**); 4.47 (d, 1H, *J*=12.4Hz, **CH₂Ph**); 4.48 (d, 1H, *J*_{1b-1a}=8.8Hz, **H-1b**); 4.63 (d, 2H, **CH₂Ph**); 4.67 (d, 2H, *J*=12.4Hz, **CH₂Ph**); 4.80 (d, 1H, *J*_{7b-7a}=12.4, **H-7b**); 7.17-7.42 (m, 20H, **Ph**).

¹³C NMR (100MHz, CDCl₃) δ: 36.5 (**SCH₂Ph**); 62.0 (**C-6**); 71.2, 72.2 (**CH₂Ph**); 72.3 (**C-5**); 73.0 (**C-1**); 75.2 (**CH₂Ph**); 78.4 (**C-4**); 78.9 (**C-3**); 90.1 (**C-2**); 127.6, 127.7, 128.0, 128.2, 128.3, 128.4, 128.5, 129.2 (**CH-Ph**); 136.4 (**Cq-SBn**); 138.1, 138.3, 138.4 (**Cq-Ph**); 170.6 (**C-S**).

HRMS: Calculated for C₃₅H₃₅NO₅S [M+H]⁺ 582.2314, found: 582.2308.

IR: (neat) ν (cm⁻¹): 3030, 2884 (**CH**); 1589, 1090, 696 (**N-CS-O**); 1495, 1453 (**Ph**).

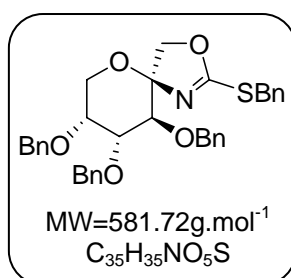
(5R,8R,9R,10S) 8,9,10-Tribenzyloxy-2-benzylsulfanyl-1,2-dehydro-1-aza-3,6-dioxaspiro[4,5]decane (152)

Yield=43%
Rf=0.21 PE/EA(8:2)
[α]_D²⁰ = -16 (c=1.02
CHCl₃)

Starting with **144** (1 g, 2.03 mmol) using G.P. 2.3.6. (reaction time 3h), sodium hydrogen carbonate (4.0 eq.) as base and benzyl bromide (4.0 eq.) the compound **152** was obtained after column chromatography on silica gel with a mixture of PE/EA (8:2) as cream oil (0.51 g, 0.88 mmol, 43%).

¹H NMR (250MHz, CDCl₃) δ: 3.77 (d, 1H, *J*_{6a-5}=1.8Hz, *J*_{6a-6b}=12.5Hz, **H-6a**); 3.84-3.85 (m, 1H, **H-4**); 3.96-4.02 (m, 2H, **H-3**, **H-5**); 4.12 (s, 2H, **H-1**); 4.12-4.17 (m, 1H, **H-6b**); 4.23 (d, 1H, *J*=13.7Hz, **SCH₂Ph**); 4.30 (d, 1H, *J*=13.7Hz, **SCH₂Ph**); 4.63 (s, 2H, **CH₂Ph**); 4.69-4.81 (m, 3H, **CH₂Ph**); 5.03 (d, 1H, *J*=11.8Hz, **CH₂Ph**); 7.22-7.42 (m, 20H, **Ph**).

¹³C NMR (62.89MHz, CDCl₃) δ: 38.2 (**SCH₂Ph**); 62.3 (**C-6**); 71.9, 72.4 (**CH₂Ph**); 72.7 (**C-1**); 73.9 (**C-5**); 74.3 (**CH₂Ph**); 78.3 (**C-3**); 80.3 (**C-4**); 102.3 (**C-2**); 127.7, 127.9, 128.0, 128.2, 128.4, 128.7 (**CH-Ph**); 136.4 (**Cq-SBn**); 137.3, 137.6, 137.9 (**Cq-Ph**); 177.2 (**C-S**).

MS: (IS⁺) m/z: 604 (M+Na)⁺.

IR: (neat) ν (cm⁻¹): 3030, 2921 (**CH**); 1600, 1091, 697 (**N=CS-O**); 1495, 1453 (**Ph**).

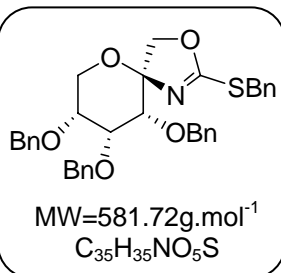
(5R,8R,9R,10R) 8,9,10-Tribenzyloxy-2-benzylsulfanyl-1,2-dehydro-1-aza-3,6-dioxaspiro[4,5]decane (153)

Yield=43%

Rf=0.21 PE/EA(8:2)

[α]_D²⁰ = -16 (c=1.02
CHCl₃)

Starting with **145** (1 g, 2.03 mmol) using G.P. 2.3.6. (reaction time 3h), sodium hydrogen carbonate (4.0 eq.) as base and benzyl bromide (4.0 eq.) the compound **153** was obtained after column chromatography on silica gel with a mixture of PE/EA (8:2) as cream oil (0.56 g, 0.96 mmol, 47%).

¹H NMR (400MHz, CDCl₃) δ: 3.77 (dd, 1H, *J*_{6a-5}=2.0Hz, *J*_{6a-6b}=12.2Hz, **H-6a**); 3.86 (brs, 1H, **H-5**); 3.98 (d, 1H, *J*_{6b-6a}=12.2Hz, **H-6b**); 4.00 (d, 1H, *J*₃₋₄=9.6Hz, **H-3**); 4.12 (s, 2H, **SCH₂Ph**); 4.15 (dd, 1H, *J*₄₋₅=3.2Hz, *J*₄₋₃=9.6Hz, **H-4**); 4.24 (d, 1H, *J*_{1a-1b}=13.6Hz, **H-1a**); 4.29 (d, 1H, *J*_{1b-1a}=13.6Hz, **H-1b**); 4.62 (d, 1H, *J*=12.0Hz, **CH₂Ph**); 4.65 (d, 1H, *J*=12.0Hz, **CH₂Ph**); 4.72 (d, 2H, *J*=11.8Hz, **CH₂Ph**); 4.73 (d, 1H, *J*=12.4Hz, **CH₂Ph**); 4.78 (d, 1H, *J*=12.4, **CH₂Ph**); 5.03 (d, 1H, *J*=12.4Hz, **CH₂Ph**); 7.22-7.41 (m, 20H, **Ph**).

¹³C NMR (100MHz, CDCl₃) δ: 36.4 (**SCH₂Ph**); 63.0 (**C-6**); 71.9, 72.3 (**CH₂Ph**); 73.9 (**C-5**); 75.1 (**CH₂Ph**); 76.6 (**C-1**); 77.4 (**C-3**); 80.5 (**C-4**); 102.7 (**C-2**); 127.8, 127.9, 128.1, 128.5, 128.6, 129.1 (**CH-Ph**); 137.2 (**Cq-SBn**); 138.5, 138.6, 138.4 (**Cq-Ph**); 169.6 (**C-S**).

HRMS: Calculated for C₃₅H₃₅NO₅S [M+H]⁺ 582.2314, found: 582.2308.

IR: (neat) ν (cm⁻¹): 3030, 2921 (**CH**); 1600, 1091, 697 (**N=CS-O**); 1495, 1453 (**Ph**).

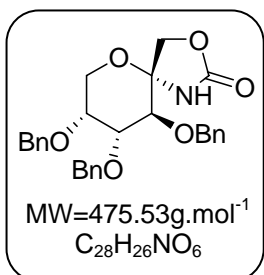
3,4,5-Tri-O-benzyl-2-N,1-O-carbonyl-β-D-fructopyranosylamine (154)

Yield=65%

Rf=0.36 PE/EA(6:4)

[α]_D²⁰ = +52 (c=0.19
CHCl₃)

Starting with **150** (1 g, 1.72 mmol) and using G.P. 2.5.1. b) the compound **154** was obtained after column chromatography on silica gel with a mixture of PE/EA (8:2) as colorless oil (0.53 g, 1.11 mmol, 65%).

¹H NMR (250MHz, CDCl₃) δ: 3.51 (d, 1H, *J*₃₋₄=3.6Hz, **H-3**); 3.71-3.72 (m, 1H, **H-4**); 3.83-3.88 (m, 1H, **H-4**); 3.88 (s, 2H, **H-1**); 4.02 (d, 1H, *J*_{6a-6b}=10.0Hz, **H-6a**); 4.15 (d, 1H, *J*_{6b-6a}=10.0Hz, **H-6b**); 4.27 (d, 1H, *J*=12.0Hz, **CH₂Ph**); 4.43 (d, 1H, *J*=12.0Hz, **CH₂Ph**); 4.48 (d, 1H, *J*=12.0Hz, **CH₂Ph**); 4.55 (d, 1H, *J*=12.0Hz, **CH₂Ph**); 4.58 (d, 1H, *J*=12.0Hz, **CH₂Ph**); 4.79 (d, 1H, *J*=12.0Hz, **CH₂Ph**); 6.79 (s, 1H, **NH**); 7.07-7.09 (m, 2H, **Ph**); 7.23-7.40 (m, 13H, **Ph**).

¹³C NMR (62.89MHz, CDCl₃) δ: 60.5 (**C-6**); 71.6 (**C-5**); 72.0 (**CH₂Ph**); 72.4 (**C-4**); 73.8 (**C-1**); 74.0, 74.2 (**CH₂Ph**); 77.8 (**C-3**); 92.1 (**C-2**); 127.8, 128.5, 128.8, 128.9 (**CH-Ph**); 137.4, 137.6, 138.1 (**Cq-Ph**); 161.5 (**C=O**).

HRMS: Calculated for C₂₈H₂₆NO₆ [M+H]⁺ 476.2073, found: 476.2083.

IR: (neat) ν (cm⁻¹): 3031, 2874 (**CH**); 1760 (**C=O**); 1496, 1454 (**Ph**).

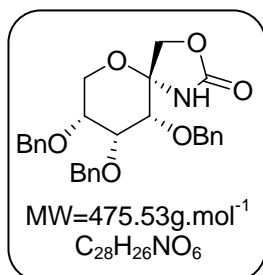
3,4,5, Tri-O-benzyl-2-N,1-O-carbonyl- α -D-psicopyranosylamine (155)

Yield=69%

Rf=0.35 PE/EA(6:4)

[α]_D²⁰ = +25 (c=0.59
CHCl₃)

Starting with **151** (1 g, 1.72 mmol) and using G.P. 2.5.1. b) the compound **155** was obtained after column chromatography on silica gel with a mixture of PE/EA (8:2) as colorless oil (0.53 g, 1.11 mmol, 65%).

¹H NMR (400MHz, CDCl₃) δ : 3.64 (d, 1H, J_{6a-6b} =10.8Hz, **H-6a**); 3.78-3.85 (m, 4H, **H-3**, **H-4**, **H-5**, **H-6b**); 4.09 (d, 1H, J_{1a-1b} =9.6Hz, **H-1a**); 4.20 (d, 1H, J_{1b-1a} =9.6Hz, **H-1b**); 4.55-4.67 (m, 5H, **CH₂Ph**); 4.85 (d, 1H, J =11.6Hz, **CH₂Ph**); 7.24-7.34 (m, 15H, **Ph**); 8.40 (brs, 1H, **NH**).

¹³C NMR (62.89MHz, CDCl₃) δ : 62.2 (**C-6**); 71.9 (**C-5**); 72.6 (**C-4**); 72.7 **CH₂Ph**; 72.8 (**C-1**); 73.9 **CH₂Ph**; 75.7 **CH₂Ph**; 78.5 (**C-3**); 90.3 (**C-2**); 127.8, 127.9, 128.0, 128.2, 128.5 (**CH-Ph**); 137.6, 137.9, 138.0 (**Cq-Ph**); 159.9 (**C=O**).

HRMS: Calculated for C₂₈H₂₆NO₆ [M+H]⁺ 476.2073, found: 476.2073.

IR: (neat) ν (cm⁻¹): 3031, 2874 (**CH**); 1756 (**C=O**); 1496, 1454 (**Ph**).

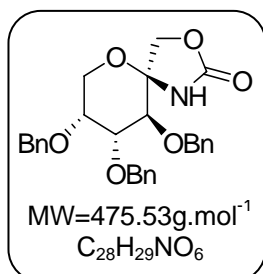
3,4,5, Tri-O-benzyl-2-N,1-O-carbonyl- β -D-fructopyranosylamine (156)

Yield=43%

Rf=0.47 PE/EA(6:4)

[α]_D²⁰ = -39 (c=1.13
CHCl₃)

Starting with **152** (1 g, 1.72 mmol) and using G.P. 2.5.1. b) the compound **156** was obtained after column chromatography on silica gel with a mixture of PE/EA (7:3) as colorless oil (0.52 g, 1.09 mmol, 64%).

¹H NMR (400MHz, CDCl₃) δ : 3.62 (dd, 1H, J_{6a-5} =3.3Hz, J_{6a-6b} =13.5Hz, **H-6a**); 3.80-3.83 (m, 4H, **H-3**, **H-4**, **H-5**, **H-6b**); 4.38 (d, 1H, J_{1a-1b} =9.8Hz, **H-1a**); 4.22 (d, 1H, J_{1b-1a} =9.8Hz, **H-1b**); 4.51-4.66 (m, 5H, **CH₂Ph**); 4.83 (d, 1H, J =11.8Hz, **CH₂Ph**); 7.26-7.30 (m, 15H, **Ph**); 8.19 (s, 1H, **NH**).

¹³C NMR (62.89MHz, CDCl₃) δ : 61.9 (**C-6**); 71.4 (**C-5**); 71.9 (**CH₂Ph**); 72.5 (**C-4**); 72.8 (**C-7**); 73.9 (**C-1**); 74.9 (**C-7**); 76.1 (**C-4**); 101.3 (**C-2**); 127.9, 128.0, 128.4, 128.6, 128.7 (**CH-Ph**); 137.5, 137.8, 138.0 (**Cq-Ph**); 159.6 (**C=O**).

HRMS: Calculated for C₂₈H₂₆NO₆ [M+H]⁺ 476.2073, found: 476.2092.

IR: (neat) ν (cm⁻¹): 2872 (**CH**); 1752 (**C=O**); 1496, 1454 (**Ph**).

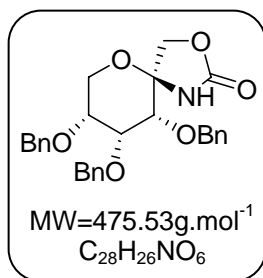
3,4,5-Tri-O-benzyl-2-N,1-O-carbonyl-β-D-psiopyranosylamine (157)

Yield=52%

Rf=0.48 PE/EA(6:4)

[α]_D²⁰ = -16 (c=2.73CHCl₃)

Starting with **153** (1 g, 1.72 mmol) and using G.P. 2.5.1. b) the compound **157** was obtained after column chromatography on silica gel with a mixture of petroleum ether/ethyl acetate (7:3) as colorless oil (0.43 g, 0.90 mmol, 52%).

¹H NMR (400MHz, CDCl₃) δ: 3.50 (d, 1H, J₃₋₄=4.0Hz, **H-3**); 3.71 (dd, 1H, J_{6a-6b}=10.8Hz, **H-6a**); 3.83-3.90 (m, 3H, **H-4**, **H-5**, **H-6b**); 4.00 (d, 1H, J_{1a-1b}=10.0Hz, **H-1a**); 4.14 (d, 1H, J_{1b-1a}=10.0Hz, **H-1b**); 4.26 (d, 1H, J_{7a-7b}=12.0Hz, **CH₂Ph**); 4.43 (d, 1H, J_{7b-7a}=12.0Hz, **CH₂Ph**); 4.47 (d, 1H, J_{7a-7b}=12.0Hz, **CH₂Ph**); 4.56 (d, H, J_{7b-7a}=12.0Hz, **CH₂Ph**); 4.79 (d, 1H, J_{7b-7a}=11.6Hz, **CH₂Ph**); 6.74 (brs, 1H, **NH**); 7.06-7.08 (m, 2H, **Ph**); 7.27-7.37 (m, 13H, **Ph**);

¹³C NMR (100MHz, CDCl₃) δ: 59.1 (**C-6**); 71.4 (**C-5**); 71.9 (**CH₂Ph**); 72.4 (**C-4**); 73.0 (**CH₂Ph**); 73.8 (**C-1**); 74.0 (**CH₂Ph**); 77.4 (**C-3**); 102.0 (**C-2**); 127.7, 128.1, 128.3, 128.4, 128.6, 128.8 (**CH-Ph**); 136.5, 137.4, 137.9 (**Cq-Ph**); 157.5 (**C=O**).

HRMS: Calculated for C₂₈H₂₆NO₆ [M+H]⁺ 476.2073, found: 476.2083.

IR: (neat) ν (cm⁻¹): 3031, 2874 (**CH**); 1753 (**C=O**); 1496, 1454 (**Ph**).

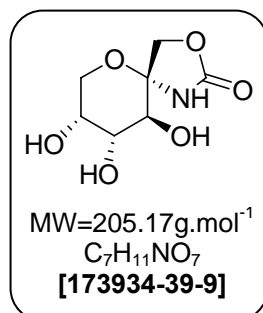
2-N,1-O-carbonyl-α-D-fructopyranosylamine (158)

Yield=25%

Rf=0.3 EA

Starting with **154** (0.5 g, 1.05 mmol) and using G.P. 2.2.3. the compound **158** was obtained after column chromatography on silica gel with EA as colorless oil (53 mg, 0.26 mmol, 25%).

¹H NMR (400MHz, MeOD) δ: 3.66 (dd, 1H, J₄₋₅=3.2Hz, J₄₋₃=9.6Hz, **H-4**); 3.71-3.74 (m, 3H, **H-3**, **H-6a**, **H-6b**); 3.85-3.87 (m, 1H, **H-5**); 4.21 (d, 1H, J_{1a-1b}=9.6Hz, **H-1a**); 4.44 (d, 1H, J_{1b-1a}=9.6Hz, **H-1b**).

¹³C NMR (100MHz, MeOD) δ: 66.0 (**C-6**); 69.9 (**C-3**); 70.3 (**C-5**); 71.9 (**C-4**); 73.4 (**C-1**); 92.4 (**C-2**); 162.1 (**C=O**).

F. W. Lichtenthaler, J. Klotz, F. Flath *Liebigs Ann.* **1995**, 2069.

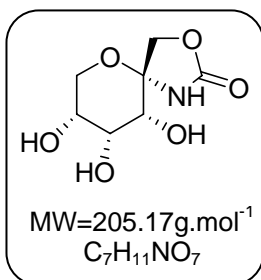
2-N,1-O-carbonyl- α -D-psicopyranosylamine (159)

Yield=25%
Rf=0.3 EA

Starting with **155** (0.5 g, 1.05 mmol) and using G.P. 2.2.3. the compound **159** was obtained after column chromatography on silica gel with EA as colorless oil (73 mg, 0.36 mmol, 34%).

¹H NMR (250MHz, MeOD) δ : 3.65 (dd, 1H, $J_{4-5}=3.0\text{Hz}$, $J_{4-3}=9.8\text{Hz}$, **H-4**); 3.71-3.74 (m, 3H, **H-3**, **H-6a**, **H6b**); 3.85-3.88 (m, 1H, **H-5**); 4.20 (d, 1H, $J_{1a-1b}=9.5\text{Hz}$, **H-1a**); 4.44 (d, 1H, $J_{1b-1a}=9.5\text{Hz}$, **H-1b**).

¹³C NMR (62.89MHz, MeOD) δ : 66.1 (**C-6**); 69.9 (**C-3**); 70.4 (**C-5**); 71.9 (**C-4**); 74.3 (**C-1**); 92.8 (**C-2**); 161.0 (**C=O**).

IR: (neat) ν (cm⁻¹): 3339 (**OH**); 2962 (**CH**); 1636 (**C=O**).

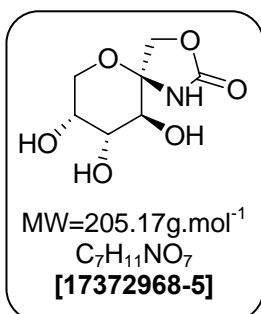
2-N,1-O-carbonyl- β -D-fructopyranosylamine (160)

Yield=25%
Rf=0.3 EA

Starting with **156** (0.5 g, 1.05 mmol) and using G.P. 2.2.3. the compound **160** was obtained after column chromatography on silica gel with EA as colorless oil (0.15 g, 0.73 mmol, 68%).

¹H NMR (250MHz, MeOD) δ : 3.74-3.80 (m, 2H, **H-3**, **H-4**); 3.81-3.89 (m, 3H, **H-5**, **H-6a**, **H6b**); 4.06 (d, 1H, $J_{1a-1b}=9.4\text{Hz}$, **H-1a**); 4.10 (d, 1H, $J_{1b-1a}=9.4\text{Hz}$, **H-1b**).

¹³C NMR (62.89MHz, MeOD) δ : 63.0 (**C-6**); 72.8 (**C-1**); 74.1 (**C-5**); 77.0, 80.2 (**C-3**), (**C-4**); 101.3 (**C-2**); 163.0 (**C=O**).

F. W. Lichtenhaler, J. Klotz, F. Flath *Liebigs Ann.* **1995**, 2069.

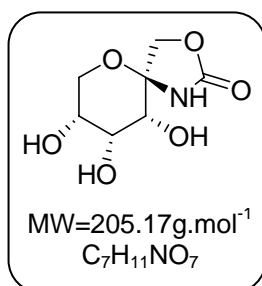
2-N,1-O-carbonyl-β-D-psicopyranosylamine (161)**Yield=56%****Rf=0.3 EA**

Starting with **157** (0.5 g, 1.05 mmol) and using G.P. 2.2.3. the compound **161** was obtained after column chromatography on silica gel with EA as colorless oil (0.12 g, 0.58 mmol, 56%).

¹H NMR (400MHz, MeOD) δ: 3.75-3.79 (m, 2H, **H-3**, **H-4**); 3.81-3.90 (m, 3H, **H-5**, **H-6a**, **H6b**); 4.05 (d, 1H, *J*_{1a-1b}=9.6Hz, **H-1a**); 4.09 (d, 1H, *J*_{1b-1a}=9.6Hz, **H-1b**).

¹³C NMR (100MHz, MeOD) δ: 62.8 (**C-6**); 72.9 (**C-1**); 74.3 (**C-5**); 76.9, 80.0 (**C-3**), (**C-4**); 101.9 (**C-2**); 162.8 (**C=O**).

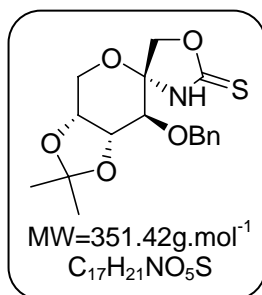
3-O-benzyl-4,5-O-isopropylidene-2-N,1-O-thiocarbonyl-α-D-fructopyranosylamine (163)**Yield=27%****Rf=0.33 PE/EA(8:2)****mp=60-63°C****[α]_D²⁰ = -130 (c=0.22 CHCl₃)**

Starting with **56** (1 g, 2.85 mmol) and using G.P. 2.2.4. b) (reaction time 24h) a mixture of four compounds is obtained. Without further purification and using G.P. 2.4.1. (reaction time 24h) a mixture of OZTs is obtained. Finally this mixture and using G.P. 2.1.1.a) (reaction time 15h) the compound **163** was obtained after column chromatography on silica gel with a mixture of PE/EA (9:1) as a cream solid (0.27 g, 0.77 mmol, 27%).

¹H NMR (400MHz, CDCl₃) δ: 1.38 (s, 3H, **CH₃**); 1.58 (s, 3H, **CH₃**); 3.78 (dd, 1H, *J*_{6a-5}=3.2Hz, *J*_{6a-6b}=12.8Hz, **H-6a**); 3.87 (d, 1H, *J*₃₋₄=3.6Hz, **H-3**); 3.97 (dd, 1H, *J*_{6b-5}=3.2Hz, *J*_{6b-6a}=12.8Hz, **H-6b**); 4.31 (td, 1H, *J*₅₋₆=3.2Hz *J*₅₋₄=6.8Hz, **H-5**); 4.44 (d, 1H, *J*_{1a-1b}=10.6Hz, **H-1a**); 4.47 (dd, 1H, *J*₄₋₃=3.6Hz, *J*₄₋₅=6.8Hz, **H-4**); 4.52 (d, 1H, *J*_{1b-1a}=10.6Hz, **H-1b**); 4.60 (d, 1H, *J*_{7a-7b}=11.8Hz, **H-7a**); 4.76 (d, 1H, *J*_{7b-7a}=11.8Hz, **H-7b**); 7.29-7.43 (m, 5H, **Ph**).

¹³C NMR (100MHz, CDCl₃) δ: 25.0, 27.1 (**CH₃**); 62.7 (**C-6**); 75.1 (**C-3**); 70.9 (**C-5**); 79.0 (**C-1**); 71.3 (**C-4**); 73.8 (**C-7**); 90.6 (**C-2**); 110.7 (**Cq-isop**); 128.3, 128.9, 129.0 (**CH-Ph**); 136.3 (**Cq-Ph**); 189.7 (**C=S**).

MS: (IS+) m/z: 374 (M+Na)⁺**IR: (neat) ν (cm⁻¹): 2983, 2935 (**CH**); 1495, 1454 (**Ph**); 1066, 698 (**N-CS-O**).**

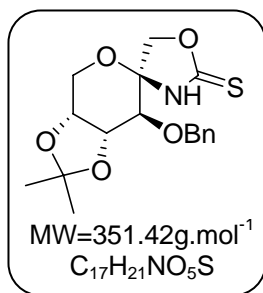
3-O-benzyl-4,5-O-isopropylidene-2-N,1-O-thiocarbonyl-β-D-fructopyranosylamine (164)

Yield=6%

Rf=0.29 PE/EA(6:4)

mp=65-68°C

[α]_D²⁰ = -116 (c=0.30
CHCl₃)

Starting with **56** (1 g, 2,85 mmol) and using G.P. 2.2.4. b) (reaction time 24h) a mixture of four compounds is obtained. Without further purification and using G.P. 2.4.1. (reaction time 24h) a mixture of OZTs is obtained. Finally this mixture and using G.P. 2.1.1.a) (reaction time 15h) the compound **164** was obtained after column chromatography on silica gel with a mixture of PE/EA (8:2) as a cream solid (60 mg, 0.17 mmol, 6%).

¹H NMR (400MHz, CDCl₃) δ: 1.33 (s, 3H, CH₃); 1.47 (s, 3H, CH₃); 3.70 (d, 1H, J₃₋₄=5.2Hz, H-3); 3.91 (d, 1H, J_{6a-6b}=13.3Hz, H-6a); 4.06 (dd, 1H, J_{6b-5}=2.0Hz, J_{6b-6a}=13.5Hz, H-6b); 4.23 (dd, 1H, J₅₋₆=1.6Hz J₅₋₄=6.8Hz, H-5); 4.42 (d, 1H, J_{1a-1b}=9.9Hz, H-1a); 4.42 (dd, 1H, J₄₋₃=5.0Hz, J₄₋₅=6.8Hz, H-4); 4.46 (d, 1H, J_{1b-1a}=9.9Hz, H-1b); 4.68 (d, 1H, J_{7a-7b}=12.0Hz, H-7a); 4.77 (d, 1H, J_{7b-7a}=12.0Hz, H-7b); 7.29-7.36 (m, 5H, Ph), 9.13 (brs, 1H, NH).

¹³C NMR (100MHz, CDCl₃) δ: 25.3, 27.0 (CH₃); 63.3 (C-6); 75.3 (C-3); 72.4 (C-5); 73.6 (C-4), (C-7); 80.3 (C-1); 91.4 (C-2); 110.1 (Cq-isop); 128.3, 128.5, 128.8 (CH-Ph); 136.7 (Cq-Ph); 190.0 (C=S).

HRMS: Calculated for C₁₇H₂₁NO₅S [M+H]⁺ 352.1219, found: 352.1210.

IR: (neat) ν (cm⁻¹): 2984, 2934 (CH); 1485, 1454 (Ph); 1067, 698 (N-CS-O).

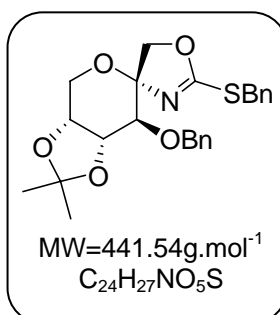
(5S,8R,9R,10S) 8,9-(Isopropylidenedioxy)-10-benzyloxy-2-benzylsulfanyl-1,2-dehydro-1-aza-3,6-dioxaspiro[4,5]decane (165)

Yield=52%

Rf=0.29 PE/EA(8:2)

mp=73-76°C

[α]_D²⁰ = 0.6 (c=0.24
CHCl₃)

Starting with the mixture of the two OZTs **163** and **164** (50mg g, 0.14 mmol) using G.P. 2.3.6. (reaction time 4h), sodium hydrogen carbonate (4.0 eq.) as base and benzyl bromide (4.0 eq.) the compound **165** was obtained after column chromatography on silica gel with a mixture of PE/EA (9:1) as cream solid (32 g, 0.07 mmol, 52%).

¹H NMR (400MHz, CDCl₃) δ: 1.36 (s, 6H, CH₃); 1.50 (s, 3H, CH₃); 3.83 (d, 1H, J₃₋₄=8.0Hz, H-3); 3.87 (dd, 1H, J_{6a-5}=4.8Hz, J_{6a-6b}=12.8Hz H-6a); 4.07-4.14 (m, 2H, J_{6b-5}=5.2Hz, J_{6b-6a}=12.8Hz, H-4, H-6b); 4.18 (d, 1H, J_{1a-1b}=9.2Hz, H-1a); 4.23-4.32 (m, 3H, H-5, H8); 4.47 (d, 1H, J_{1b-1a}=9.2Hz, H-1b); 4.57 (d, 1H, J_{7a-7b}=11.6Hz, H-7a); 4.72 (d, 1H, J_{7b-7a}=11.6Hz, H-7b); 7.22-7.38 (m, 5H, Ph).

¹³C NMR (100MHz, CDCl₃) δ: 25.9, 27.8 (CH₃); 36.6 (C-8); 62.1 (C-6); 72.2 (C-5); 73.0 (C-1); 74.1 (C-7); 76.6 (C-4); 79.7 (C-3); 102.1 (C-2); 110.2 (Cq-isop); 127.7, 127.8, 128.1, 128.4, 128.7, 129.2 (CH-Ph); 136.4 (Cq-SBn); 138.1 (Cq-Ph); 170.5 (C-SBn).

MS: (IS+) m/z: 442(M+H)⁺; 464 (M+Na)⁺

IR: (neat) ν (cm⁻¹): 2923, 2880 (CH); 1607, 1081, 697 (N-CS-O); 1494, 1454 (Ph).

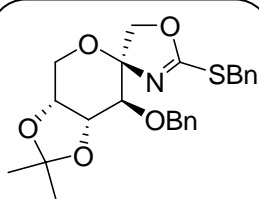
(5R,8R,9R,10S) 8,9-(Isopropylidenedioxy)-10-benzyloxy-2-benzylsulfanyl-1,2-dehydro-1-aza-3,6-dioxaspiro[4,5]decane (166)

MW=441.54g.mol⁻¹
C₂₄H₂₇NO₅S

Yield=47%

Rf=0.32 PE/EA(8:2)

mp=85-88°C

Starting with the mixture of the two OZTs **163** and **164** (50mg g, 0.14 mmol) using G.P. 2.3.6. (reaction time 4h), sodium hydrogen carbonate (4.0 eq.) as base and benzyl bromide (4.0 eq.) the compound **166** was obtained after column chromatography on silica gel with a mixture of PE/EA (9:1) as cream solid (29 g, 0.07 mmol, 47%).

¹H NMR (400MHz, CDCl₃) δ: 1.36 (s, 6H, CH₃); 1.51 (s, 3H, CH₃); 3.81 (dd, 1H, J_{6a-5}=2.4Hz, J_{6a-6b}=13.6Hz H-6a); 3.94-4.05 (m, 4H, H-1, H-3, H-6b); 4.11 (s, 2H, H-8); 4.20 (dd, 1H, J_{5-6b}=1.6Hz, J₅₋₄=6.2Hz, H-5); 4.31 (t, 1H, J₄₋₅=6.2Hz, H-4); 4.64 (d, 1H, J_{7a-7b}=11.2Hz, H-7a); 4.81 (d, 1H, J_{7b-7a}=11.2Hz, H-7b); 6.14 (s, 1H, NH); 7.23-7.40 (m, 10H, Ph).

¹³C NMR (100MHz, CDCl₃) δ: 25.9 (CH₃); 27.5 (CH₃); 34.4 (C-8); 62.0 (C-6); 72.7 (C-5); 74.0 (C-3); 74.7 (C-4); 75.1 (C-1); 89.3 (C-2); 110.0 (Cq-isop); 127.4, 128.5, 128.8, 129.0 (CH-Ph); 136.9 (Cq-SBn); 138.0 (Cq-isop); 166.4 (C-S).

HRMS: Calculated for C₂₄H₂₇NO₅S [M+H]⁺ 442.1688, found: 442.1678.

IR: (neat) ν (cm⁻¹): 3030, 2886 (CH); 1694, 1093, 697 (N-CS-O); 1495, 1454 (Ph).

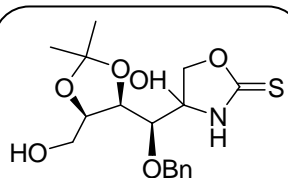
4-Hydroxy-4-((1S,2R,3R)-4-hydroxy-1,2-isopropylidenedioxy-3-benzyloxybutyl)-[1,3]-oxazoline-2-thione (167)

MW=369.43g.mol⁻¹
C₁₇H₂₃NO₃S

Yield=4%

Rf=0.28 PE/EA(7:3)

[α]_D²⁰ = -70 (c=0.40
CHCl₃)

Starting with **56** (0.3 g, 0.86 mmol) and using G.P. 2.4.3. (reaction time 15h) the compound **167** was obtained after column chromatography on silica gel with a mixture of PE/EA (8:2) as a colorless oil (13 mg, 0.03 mmol, 4%).

¹H NMR (400MHz, CDCl₃) δ: 1.35 (s, 6H, CH₃); 1.49 (s, 3H, CH₃); 1.68 (brs, 1H, OH); 1.94 (brs, 1H, OH); 3.28 (dd, 1H, J_{6a-5}=1.6Hz, J_{6a-6b}=13.6Hz, H-6a); 3.70-3.81 (m, 3H, H-1, H-6b); 4.15 (dd, 1H, J_{5,6a}=1.6Hz, J₅₋₄=7.6Hz, H-5); 4.26 (s, 2H, CH₂Ph); 4.61 (d, 1H, J₃₋₄=2.0Hz, H-3); 4.66 (dd, 1H, J₄₋₃=2.0Hz, J₄₋₅=7.6Hz, H-4); 7.26-7.40 (m, 5H, Ph).

¹³C NMR (100MHz, CDCl₃) δ: 24.3, 26.1 (CH₃); 36.5 (CH₂Ph); 61.6 (C-6); 66.6 (C-1); 69.7 (C-4); 70.3 (C-5); 75.5 (C-3); 99.3 (C-2); 109.6 (Cq-isop); 128.0, 128.8, 129.2 (CH-Ph); 136.3 (Cq-Ph); 170.1 (C=S).

MS: (IS+) m/z: 392 (M+Na)⁺

IR: (neat) ν (cm⁻¹): 3342 (OH); 3029, 2943 (CH); 1495, 1314, 1065, (N-CS-O); 1453 (Ph).

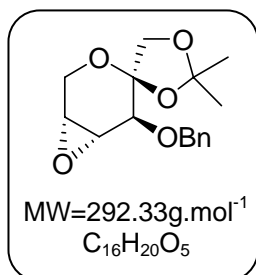
4,5-Anhydro-3-O-benzyl-1,2-O-isopropylidene- β -D-fructopyranose (170)

Yield=94%

Rf=0.26 PE/EA(8:2)

[α]_D²⁰ = +20 (c=0.34
CHCl₃)

Starting with **97** (1 g, 2.38 mmol) and using G.P. 2.3.7. (reaction time 1h) the compound **170** was obtained after column chromatography on silica gel with a mixture of PE/EA (8:2) as colorless oil (0.65 g, 2.22 mmol, 94%).

¹H NMR (400MHz, CDCl₃) δ : 1.44 (s, 3H, CH₃); 1.52 (s, 3H, CH₃); 3.22 (d, 1H, $J_{5-4}=4.0$ Hz, H-5); 3.38 (d, 1H, $J_{4-5}=4.0$ Hz, H-4); 3.48 (s, 1H, H-3); 3.83 (d, 1H, $J_{1a-1b}=8.6$ Hz, H-1a); 3.86 (d, 1H, $J_{1b-1a}=8.6$ Hz, H-1b); 4.00 (d, 1H, $J_{6a-6b}=13.2$ Hz, H-6a); 4.16 (d, 1H, $J_{6b-5}=1.0$ Hz, $J_{6b-6a}=13.2$ Hz, H-6b); 4.61 (d, 1H, $J=11.8$ Hz, CH₂Ph); 4.88 (d, 1H, $J=11.8$ Hz, CH₂Ph); 7.26-7.39 (m, 5H, Ph).

¹³C NMR (100MHz, CDCl₃) δ : 25.9, 27.2 (CH₃); 49.9 (C-5); 52.2 (C-4); 59.1 (C-6); 70.4 (C-3); 72.0 (C-1), (CH₂Ph); 101.0 (C-2); 112.6 (Cq-isop); 128.2, 128.3, 128.7 (CH-Ph); 137.1 (C-8).

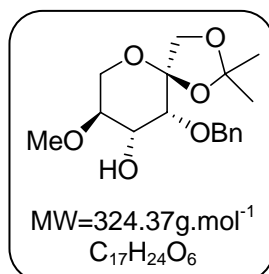
MS: (IS+) m/z: 315 (M+Na)⁺3-O-benzyl-1,2-O-isopropylidene-5-O-methyl- β -D-fructopyranose (174)

Yield=29%

Rf=0.34 PE/EA(5:5)

[α]_D²⁰ = -123 (c=0.22
CHCl₃)

Starting with **170** (0.5 g, 1.71 mmol) and using G.P. 2.3.7. (reaction time 24h) the compound **174** was obtained after column chromatography on silica gel with a mixture of PE/EA (7:3) as colorless oil (0.27 g, 0.83 mmol, 49%).

¹H NMR (400MHz, CDCl₃) δ : 1.38 (s, 3H, CH₃); 1.45 (s, 3H, CH₃); 3.24 (ddd, 1H, $J_{5-6b}=5.6$ Hz, $J_{5-4}=9.2$ Hz, $J_{5-6a}=10.8$ Hz, H-5); 3.29 (d, 1H, $J_{3-4}=9.6$ Hz, H-3); 3.45 (s, 3H, OCH₃); 3.56 (t, 1H, $J_{6a-5}=10.8$ Hz, H-6a); 3.79 (dd, 1H, $J_{6b-5}=5.6$ Hz, H-6b); 3.82 (d, 1H, $J_{1a-1b}=8.6$ Hz, H-1a); 3.89-3.94 (m, 1H, $J_{4-5}=9.2$ Hz, H-4); 3.94 (d, 1H, $J_{1b-1a}=8.6$ Hz); 4.69 (d, 1H, $J=11.6$ Hz, CH₂Ph); 4.92 (d, 1H, $J=11.6$ Hz, CH₂Ph); 7.24-7.35 (m, 5H, Ph).

¹³C NMR (100MHz, CDCl₃) δ : 26.2, 27.2 (CH₃); 58.6 (OCH₃); 60.5 (C-6); 71.8 (C-1); 75.0 (C-4); 75.1 (CH₂Ph); 78.0 (C-3); 79.8 (C-5); 105.0 (C-2); 112.3 (Cq-isop); 127.9, 128.0, 128.6 (CH-Ph); 138.2 (Cq-Ph).

MS: (IS+) m/z: 347 (M+Na)⁺

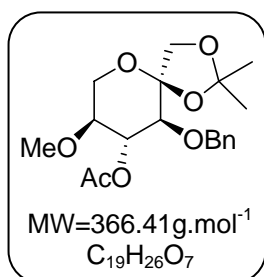
4-O-acetyl-3-O-benzyl-1,2-O-isopropylidene-5-O-methyl-β-D-fructopyranose (174a)

Yield=95%

Rf=0.31 PE/EA(8:2)

[α]_D²⁰ = -48 (c=0.53
CHCl₃)

Starting with **174** (0.2 g, 0.62 mmol) and using G.P. 2.2.1. (reaction time 15h) the compound **174a** was obtained after column chromatography on silica gel with a mixture of PE/EA (9:1) as colorless oil (0.22 g, 0.60 mmol, 95%).

¹H NMR (400MHz, CDCl₃) δ: 1.38 (s, 3H, CH₃); 1.47 (s, 3H, CH₃); 2.03 (s, 3H, O-CO-CH₃); 3.33-3.39 (m, 4H, OCH₃, H-5); 3.34 (d, 1H, J₃₋₄=9.6Hz, H-3); 3.70 (t, 1H, J_{6a-5}=J_{6a-6b}=10.8Hz, H-6a); 3.81-3.86 (m, 2H, J_{1a-1b}=8.4Hz, H-1a, H-6b); 3.93 (d, 1H, J_{1b-1a}=8.4Hz, H-1b); 4.58 (d, 1H, J_{7a-7b}=11.6Hz, H-7a); 4.73 (d, 1H, J_{7b-7a}=11.6Hz, H-7b); 5.41 (t, 1H, J₄₋₃=9.6Hz, H-4) 7.26-7.35 (m, 5H, Ph).

¹³C NMR (100MHz, CDCl₃) δ: 21.3 (O-CO-CH₃); 26.1, 27.1 (CH₃); 58.5 (OCH₃); 60.8 (C-6); 71.7 (C-1); 74.7 (C-7); 75.0 (C-4); 76.9 (C-3); 78.2 (C-5); 105.1 (C-2); 112.6 (Cq-isop); 127.7, 127.9, 128.6 (CH-Ph); 137.9 (Cq-Ph); 170.0 (C=O).

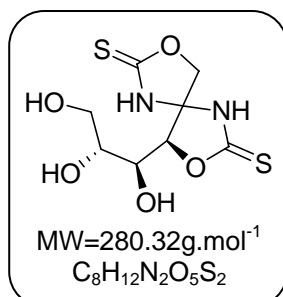
MS: (IS+) m/z: 389 (M+Na)⁺.IR: (neat) ν (cm⁻¹): 2987, 2934, 2890 (CH); 1742 (C=O).**(4R)-4-[(1S,2R)-1,2,3-trihydroxypropyl]-3,8-dioxa-1,6-diazaspiro[4.4]nonane-2,7-dithione (175)**

Yield=33%

Rf=0.23 PE/EA(4:6)

mp=157-160°C

[α]_D²⁰ = +23 (c=0.14
MeOH)

Starting with **D-tagatose** (0.3 g, 1.66 mmol) using G.P. 2.4.1. (reaction time 15h) and potassium thiocyanate (2.0 eq.) the compound **175** was obtained after column chromatography on silica gel with a mixture of PE/EA (4:6) as colorless solid (0.15 g, 0.54 mmol, 33%).

¹H NMR (400MHz, DMSO) δ: 3.35-3.48 (m, 2H, H-6a, H-6b); 3.58 (dd, 1H, J₅₋₄=6.4Hz, J₅₋₆=13.6Hz, H-5); 3.93 (t, 1H, J₄₋₃=9.6Hz, H-4); 4.61 (d, 1H, J_{1a-1b}=10.4Hz, H-1a); 4.66 (d, 1H, J_{1b-1a}=10.4Hz, H-1b); 4.67-4.70 (m, 2H, H-3, OH-6); 4.75 (d, 1H, J_{OH-4}=8.8Hz, OH-4); 4.90 (d, 1H, J_{OH-5}=5.6Hz, OH-5); 10.94 (s, 1H, NH); 11.00 (s, 1H, NH).

¹³C NMR (100MHz, DMSO) δ: 61.3 (C-6); 66.5 (C-4); 69.8 (C-5); 75.9 (C-1); 84.4 (C-2); 82.5 (C-3); 186.7, 187.8 (C=S).

HRMS: Calculated for C₈H₁₂N₂O₅S₂ [M+Na]⁺ 303.0085, found: 303.0092.IR: (neat) ν (cm⁻¹): 3214 (OH); 2923 (CH); 1471, 1372, 1081 (N-CS-O).

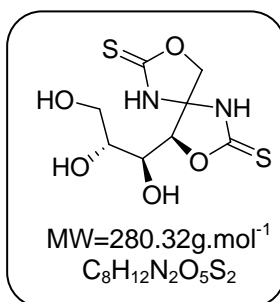
(4R)-4-[(1S,2R)-1,2,3-trihydroxypropyl]-3,8-dioxa-1,6-diazaspiro[4.4]nonane-2,7-dithione (176)

The compound **176** was obtained together with compound **175** as a colorless solid (0.13 mg, 0.05 mmol, 28%).

¹H NMR (400MHz, DMSO) δ: 3.72-3.85 (m, 3H, **H-5**, **H-6**); 3.98-4.04 (m, 3H, **H-1**, **H-4**); 4.64 (s, 1H, **H-3**); 4.72 (s, 1H, **OH**); 5.18 (d, 1H, **OH**); 5.36 (d, 1H, **OH**); 10.96 (s, 1H, **NH**); 11.00 (s, 1H, **NH**).

MS: (IS+) m/z: 303 (M+Na)⁺.

Yield=28%

Rf=0.23 PE/EA(5:5) IR: (neat) ν (cm⁻¹): 3225 (**OH**); 2943 (**CH**); 1475, 1354, 1071 (**N-CS-O**).

mp=160-163°C

[α]_D²⁰ = +4 (c=0.13

MeOH)

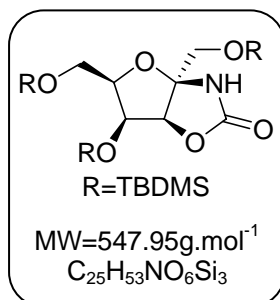
1,4,6-tri-O-tert-butyldimethylsilyl-2,N-3,O-carbonyl-β-D-fructofuranosylamine (177)

Starting with **D-tagatose** (0.3 g, 1.66 mmol) using G.P. 2.4.1. (reaction time 15h) and potassium thiocyanate (1.0 eq.) the compound **177** was obtained after column chromatography on silica gel with a mixture of PE/EA (9:1) as colorless solid (0.18 g, 0.33 mmol, 20%).

¹H NMR (400MHz, CDCl₃) δ: 0.05-0.12 (m, 18H, **Si(CH₃)₂**); 0.89-0.93 (m, 27H, **C(CH₃)₃**); 3.53 (dd, 1H, J_{6a-5}=1.6Hz, J_{6a-6b}=13.0Hz, **H-6a**); 3.60 (d, 1H, J_{1a-1b}=10.8Hz, **H-1a**); 3.63 (d, 1H, J_{1b-1a}=10.8Hz, **H-1b**); 3.80-3.84 (m, 1H, **H-4**, **H-5**); 3.99 (dd, 1H, J_{6b-5}=4.4Hz, J_{6b-6a}=13.0Hz, **H-6b**); 4.55 (d, 1H, J₃₋₄=2.8Hz, **H-3**); 5.24 (brs, 1H, **NH**).

Yield=20%

Rf=0.25 PE/EA(8:2)

mp=123-126°C

[α]_D²⁰ = -65 (c=0.14

CHCl₃)

¹³C NMR (100MHz, CDCl₃) δ: -5.5, -5.4, -4.7, -4.6, -4.5, -4.4 (**Si(CH₃)₂**); 17.8, 18.0, 18.2 (**t-CH₃**); 25.7, 25.8 (**C(CH₃)₃**); 65.1 (**C-1**); 66.8 (**C-6**); 70.0, 71.7 (**C-4**), (**C-5**); 78.2 (**C-3**); 89.1 (**C-2**); 157.6 (**C=O**).

HRMS: Calculated for C₂₅H₅₃NO₆Si₃ [M+H]⁺ 548.3259, found: 548.3261.

IR: (neat) ν (cm⁻¹): 2929, 2886 (**CH**); 1773, 1739 (**C=O**); 1388 (**C(CH₃)₃**); 125 (**Si(CH₃)₂**); 678 (**Si-C**).

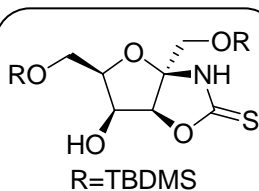
1,6-di-*O*-*tert*-butyldimethylsilyl-2,*N*-3,*O*-thiocarbonyl- β -D-fructofuranosylamine (178)

MW=449.75g.mol⁻¹
C₁₉H₃₉NO₅SSi₂

Yield=22%

R_f=0.28 PE/EA(8:2)

mp=63-66°C

[α]_D²⁰ = -78 (c=0.14
CHCl₃)

Starting with **D-tagatose** (0.3 g, 1.66 mmol) using G.P. 2.4.1. (reaction time 15h) and potassium thiocyanate (1.0 eq.) the compound **178** was obtained after column chromatography on silica gel with a mixture of PE/EA (9:1) as colorless solid (0.16 g, 0.36 mmol, 22%).

¹H NMR (400MHz, CDCl₃) δ : -0.01-0.02 (m, 12H, Si(CH₃)₂); 0.80-0.82 (m, 18H, C(CH₃)₃); 2.16 (d, 1H, *J*_{OH-4}=7.6Hz, OH-4); 3.59 (dd, 1H, *J*_{6a-5}=2.0Hz, *J*_{6a-6b}=12.8Hz, H-6a); 3.65 (d, 1H, *J*_{1a-1b}=11.0Hz, H-1a); 3.68 (d, 1H, *J*_{1b-1a}=11.0Hz, H-1b); 3.73-3.77 (m, 1H, H-4); 3.79-3.83 (m, 1H, H-5); 3.89 (dd, 1H, *J*_{6b-5}=5.2Hz, *J*_{6b-6a}=12.8Hz, H-6b); 4.89 (d, 1H, *J*₃₋₄=3.2Hz, H-3); 7.23 (brs, 1H, NH).

¹³C NMR (100MHz, CDCl₃) δ : -5.3, -5.2, -4.5, -4.4 (Si(CH₃)₂); 18.1, 18.3 (t-CH₃); 25.8, 25.9 (C(CH₃)₃); 64.3 (C-1); 67.9 (C-6); 70.4 (C-5); 71.8 (C-4); 82.3 (C-3); 93.0 (C-2); 189.6 (C=S).

HRMS: Calculated for C₁₉H₃₉NO₅Si₂ [M+H]⁺ 450.2166, found: 450.2170.

IR: (neat) ν (cm⁻¹): 2930, 2857 (CH); 1463, 1390 (N-C=S-O); 1360 (C(CH₃)₃); 1254 (Si(CH₃)₂); 678 (Si-C).

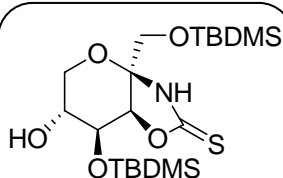
1,4-di-*O*-*tert*-butyldimethylsilyl-2,*N*-3,*O*-thiocarbonyl- β -D-fructopyranosylamine (179)

MW=449.75g.mol⁻¹
C₁₉H₃₉NO₅SSi₂

Yield=11%

R_f=0.23 PE/EA(8:2)

mp=154-157°C

[α]_D²⁰ = -81 (c=0.10

CHCl₃)

Starting with **D-tagatose** (0.3 g, 1.66 mmol) using G.P. 2.4.1. (reaction time 15h) and potassium thiocyanate (1.0 eq.) the compound **179** was obtained after column chromatography on silica gel with a mixture of PE/EA (9:1) as colorless solid (40 mg, 0.18 mmol, 11%).

¹H NMR (400MHz, CDCl₃) δ : 0.07-0.15 (m, 12H, Si(CH₃)₂); 0.90 (m, 9H, C(CH₃)₃); 0.94 (m, 9H, C(CH₃)₃); 2.13 (d, 1H, *J*_{OH-5}=3.2Hz, OH-5); 3.71 (d, 1H, *J*_{1a-1b}=10.8Hz, H-1a); 3.75 (d, 1H, *J*_{1b-1a}=10.8Hz, H-1b); 3.78 (dd, 1H, *J*_{6a-5}=2.0Hz, *J*_{6a-6b}=13.0Hz, H-6a); 3.89 (dd, 1H, *J*₄₋₃=2.8Hz, *J*₄₋₅=7.2Hz, H-4); 3.95-3.98 (m, 1H, H-5); 4.06 (dd, 1H, *J*_{6b-5}=5.6Hz, *J*_{6b-6a}=13.0Hz, H-6b); 4.85 (d, 1H, *J*₃₋₄=2.8Hz, H-3); 7.01 (brs, 1H, NH).

¹³C NMR (100MHz, CDCl₃) δ : -5.2, -4.5, -4.4 (Si(CH₃)₂); 18.2, 18.4 (t-CH₃); 25.9 (C(CH₃)₃); 64.6 (C-1); 66.6 (C-6); 69.3 (C-5); 72.2 (C-4); 83.6 (C-3); 93.0 (C-2); 190.0 (C=S).

HRMS: Calculated for C₁₉H₃₉NO₅Si₂ [M+H]⁺ 450.2166, found: 450.2179.

IR: (neat) ν (cm⁻¹): 3357 (OH); 2929, 2856 (CH); 1462, 1223, 1051 (N-C=S-O); 1361 (C(CH₃)₃); 1256 (Si(CH₃)₂); 669 (Si-C).

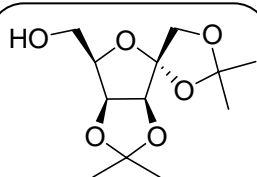
1,2:3,4-Di-O-isopropylidene- α -D-tagatofuranose (180)

MW=260.28g.mol⁻¹
C₁₂H₂₀O₆
[59686-31-6]

Yield=83%
Rf=0.23 PE/EA(7:3)
[α]_D²⁰=+50 (c=0.1
CHCl₃)

Starting with **D-tagatose** (1 g, 5.55 mmol) using G.P. 2.1.1. a) (reaction time 15h) and camphorsulfonic acid (1.0 eq.) the compound **180** was obtained after column chromatography on silica gel with a mixture of PE/EA (8:2) as colorless solid (0.97 g, 3.72 mmol, 67%).

Starting with **D-tagatose** (1 g, 5.55 mmol) using G.P. 2.1.1. b) (reaction time 18h) the compound **193** was obtained after column chromatography on silica gel with a mixture of PE/EA (8:2) as colorless solid (1.20 mg, 4.61 mmol, 83%).

¹H NMR (400MHz, CDCl₃) δ : 1.30 (s, 3H, CH₃); 1.39 (s, 3H, CH₃); 1.42 (s, 3H, CH₃); 1.46 (s, 3H, CH₃); 2.38 (brs, 1H, OH-6); 3.85-3.94 (m, 2H, H-6); 4.04-4.08 (m, 1H, H-5); 4.06 (d, 1H, J_{1a-1b}=10.2Hz, H-1a); 4.26 (d, 1H, J_{1b-1a}=10.2Hz, H-1b); 4.62 (d, 1H, J₃₋₄=5.8Hz, H-3); 4.83 (dd, 1H, J₄₋₅=4.0Hz, J₄₋₃=5.8Hz, H-4).

¹³C NMR (100MHz, CDCl₃) δ : 24.8, 26.0, 26.5 (CH₃); 61.1 (C-6); 69.3 (C-1); 79.0 (C-5); 80.5 (C-4); 85.5 (C-3); 111.8, 111.9 (Cq-isop); 113.0 (C-2).

Y. Bechor, A. Albeck *Tetrahedron* **2008**, *64*, 2080.

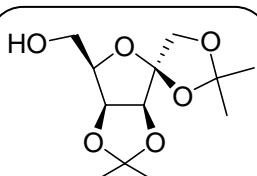
1,2:3,4-Di-O-isopropylidene- β -D-tagatofuranose (181)

MW=260.28g.mol⁻¹
C₁₂H₂₀O₆

Yield=2.4%
Rf=0.28 PE/EA(7:3)
mp=117-119°C
[α]_D²⁰=+66 (c=0.27
CHCl₃)

Starting with **D-tagatose** (1 g, 5.55 mmol) using G.P. 2.1.1. a) (reaction time 15h) the compound **181** was obtained after column chromatography on silica gel with a mixture of PE/EA (8:2) as colorless solid (34 mg, 0.13 mmol, 2.4%).

¹H NMR (400MHz, CDCl₃) δ : 1.36 (s, 3H, CH₃); 1.40 (s, 3H, CH₃); 1.46 (s, 3H, CH₃); 1.53 (s, 3H, CH₃); 3.28 (d, 1H, J_{OH-6}=9.0Hz, OH-6); 3.68-3.83 (m, 2H, H-6); 3.95-4.03 (m, 1H, H-3); 4.01 (d, 1H, J_{1a-1b}=9.5Hz, H-1a); 4.12-4.16 (m, 1H, H-1b, H-5); 4.27-4.31 (m, 1H, H-4).

¹³C NMR (100MHz, CDCl₃) δ : 25.6, 26.8, 26.9, 27.5 (CH₃); 64.5 (C-6); 67.8 (C-1); 73.4 (C-5); 76.5 (C-4); 76.6 (C-3); 102.8 (C-2), 110.2, 112.4 (Cq-isop).

HRMS: Calculated for C₁₂H₂₀O₆ [M+Na]⁺ 283.1158, found: 283.1164.

IR: (neat) ν (cm⁻¹): 3511 (OH); 2988, 2951 (CH).

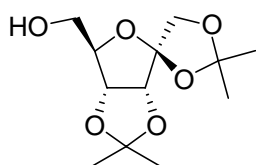
1,2:3,4-Di-O-isopropylidene- β -D-psico furanose (182)

MW=260.28g.mol⁻¹
C₁₂H₂₀O₆
[34626-95-4]

Yield=74%

R_f=0.46 PE/EA(8:2)

Starting with **104** (2 g, 7.68 mmol) using G.P. 2.1.1. b) (reaction time 3h) and add perchloric acid (0.17 eq.) at 5°C the compound **182** was obtained after column chromatography on silica gel with a mixture of PE/EA (7:3) as colorless oil (1.48 g, 5.69 mmol, 95%).

¹H NMR (250MHz, CDCl₃) δ : 1.33 (s, 6H, CH₃); 1.40 (s, 3H, CH₃); 1.44 (s, 3H, CH₃); 1.50 (s, 3H, CH₃); 3.33 (dd, 1H, $J_{6a-OH}=4.3\text{Hz}$, $J_{6a-5}=8.5\text{Hz}$ H-6a); 3.59-3.74 (m, 2H, H-6b, OH); 4.05 (d, 1H, $J_{1a-1b}=9.8\text{Hz}$, H-1a); 4.26 (t, 1H, $J_{5-6b}=3.8\text{Hz}$, H-5); 4.32 (d, 1H, $J_{1b-1a}=9.8\text{Hz}$, H-1b); 4.64 (d, 1H, $J_{3-4}=6.0\text{Hz}$, H-3); 4.88 (dd, 1H, $J_{4-5}=1.0\text{Hz}$, $J_{4-3}=6.0\text{Hz}$, H-4).

¹³C NMR (62.89MHz, CDCl₃) δ : 24.5, 25.8, 25.9, 26.0 (CH₃); 63.3 (C-6); 69.5 (C-1); 86.2 (C-5); 85.3 (C-3); 81.4 (C-4); 111.2, 111.9 (Cq-isop); 113.1 (C-2).

S.Mio, Y.Kumagawa, S. Sugai *Tetrahedron* **1991**, 47, 2133.

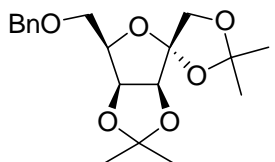
6-O-benzyl-1,2:3,4-di-O-isopropylidene- α -D-tagatofuranose (183)

MW=350.41g.mol⁻¹
C₁₉H₂₆O₆

Yield=77%

R_f=0.55 PE/EA(7:3)

Starting with **180** (1 g, 3.84 mmol) using G.P. 2.1.3. a) (reaction time 15h), (reaction time 15h), dichloromethane as solvent, sodium hydride (60% in mineral oil) (1.5 eq.) as base and benzyl bromide (1.5 eq.) the compound **183** was obtained after column chromatography on silica gel with a mixture of PE/EA (9:1) as colorless oil (1.04 g, 2.97 mmol, 77%).

¹H NMR (400MHz, CDCl₃) δ : 1.21 (s, 6H, CH₃); 1.30 (s, 3H, CH₃); 1.31 (s, 3H, CH₃); 1.40 (s, 3H, CH₃); 3.60 (dd, 1H, $J_{6a-5}=6.4\text{Hz}$, $J_{6a-6b}=10.4\text{Hz}$, H-6a); 3.73 (dd, 1H, $J_{6b-5}=5.2\text{Hz}$, $J_{6b-6a}=10.4\text{Hz}$, H-6b); 3.97 (d, 1H, $J_{1a-1b}=9.6\text{Hz}$, H-1a); 4.07-4.11 (m, 1H, H-5); 4.18 (d, 1H, $J_{1b-1a}=9.6\text{Hz}$, H-1b); 4.46 (d, 1H, $J=12.0\text{Hz}$, CH₂Ph); 4.50 (d, 1H, $J_{3-4}=5.8\text{Hz}$, H-3); 4.55 (d, 1H, $J=12.0\text{Hz}$, CH₂Ph); 4.70 (dd, 1H, $J_{4-5}=3.8\text{Hz}$, $J_{4-3}=5.8\text{Hz}$, H-4); 7.16-7.28 (m, 5H, Ph).

¹³C NMR (100MHz, CDCl₃) δ : 26.0, 26.1, 26.5, 26.6 (CH₃); 68.0 (C-6); 69.3 (C-1); 73.3 (CH₂Ph); 78.4 (C-5); 80.2 (C-4); 85.2 (C-3); 111.6, 111.9 (Cq-isop); 112.7 (C-2); 127.6, 127.7, 128.3 (CH-Ph); 138.3 (C-8).

MS: (IS+) m/z : 373 (M+Na)⁺

IR: (neat) ν (cm⁻¹): 2985, 2937 (CH); 1455 (Ph).

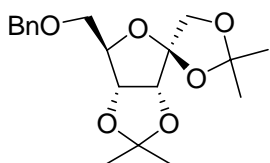
6-benzyl-1,2:3,4-Di-O-isopropylidene-β-D-psicofuranose (184)

MW=350.41g.mol⁻¹
C₁₉H₂₆O₆
[71020-96-7]

Yield=83%

Rf=0.42 PE/EA(8:2)

Starting with **182** (2 g, 7.68 mmol) using G.P. 2.3.9. (reaction time 15h), dichloromethane as solvent, sodium hydride (60% in mineral oil) (1.5 eq.) as base and benzyl bromide (1.5 eq.) the compound **184** was obtained after column chromatography on silica gel with a mixture of PE/EA (9:1) as colorless oil (2.23 g, 6.36 mmol, 83%).

¹H NMR (400MHz, CDCl₃) δ: 1.31 (s, 6H, CH₃); 1.36 (s, 3H, CH₃); 1.42 (s, 3H, CH₃); 1.44 (s, 3H, CH₃); 3.52 (dd, 1H, J_{6a-5}=8.4Hz, J_{6a-6b}=9.6Hz, H-6a); 3.57 (dd, 1H, J_{6b-5}=6.4Hz, J_{6b-6a}=9.6Hz, H-6b); 4.04 (d, 1H, J_{1a-1b}=9.6Hz, H-1a); 4.28 (d, 1H, J_{1b-1a}=9.6Hz, H-1b); 4.27-4.31 (m, 1H, H-5); 4.53 (d, 1H, J=12.0Hz, CH₂Ph); 4.58 (d, 1H, J=12.0Hz, CH₂Ph); 4.59 (d, 1H, J₃₋₄=5.8Hz, H-3); 4.75 (dd, 1H, J₄₋₃=5.8Hz, H-4); 7.25-7.40 (m, 5H, Ph).

¹³C NMR (100MHz, CDCl₃) δ: 25.3, 26.5, 26.6, (CH₃); 70.0 (C-1); 71.0 (C-6); 73.5 (CH₂Ph); 82.7 (C-4); 84.0 (C-5); 85.3 (C-3); 111.6, 112.7 (Cq-isop); 113.7 (C-2); 127.8, 128.5, 128.9, 129.2 (CH-Ph); 138.2 (C-8).

S.Mio, Y.Kumagawa, S. Sugai *Tetrahedron* **1991**, 47, 2133.

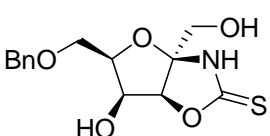
6-O-benzyl-2,N-3,O-thiocarbonyl-β-D-tagatofuranosylamine (288)

MW=311.35g.mol⁻¹
C₁₄H₁₇NO₅S

Yield=30%

Rf=0.23 PE/EA(6:4)

Starting with **183** (0.5 g, 1.42 mmol) and using G.P. 2.2.4. a) (reaction time 15h) the mixture **186** was obtained without further purification. Starting with **186** using G.P. 2.4.1. (reaction time 15h) and water as solvent the compound **188** was obtained after column chromatography on silica gel with a mixture of PE/EA (4:6) as a cream oil (0.13 g, 0.42 mmol, 30%). This fused OZT was obtained as the major compound in a mixture with two *spiro*-OZTs.

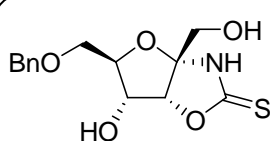
6-O-benzyl-2,N-3,O-thiocarbonyl-β-D-psicofuranosylamine (190)

MW=311.35g.mol⁻¹
C₁₄H₁₇NO₅S

Yield=57%

Rf=0.59 PE/EA(7:3)

Starting with **184** (0.5 g, 1.42 mmol) and using G.P. 2.2.4. a) (reaction time 15h) the mixture **185** was obtained without further purification. Starting with **185** using G.P. 2.4.1. (reaction time 15h) and water as solvent the compound **190** was obtained after column chromatography on silica gel with a mixture of PE/EA (4:6) as a cream oil (0.25 g, 0.80 mmol, 57%).

¹H NMR (250MHz, CDCl₃) δ: 3.61-3.64 (m, 1H, **H-6a**); 3.73-3.80 (m, 3H, **H-6b**, **H-1**); 3.92-3.95 (m, 1H, **H-3**); 4.11-4.15 (m, 1H, **H-4**); 4.53 (s, 2H, **CH₂Ph**); 5.06-5.08 (m, 1H, **H-5**); 7.52-7.34 (m, 5H, Ph); 8.68 (brs, 1H, NH).

¹³C NMR (62.89MHz, CDCl₃) δ: 61.4 (**C-1**); 67.5 (**C-6**); 70.8 (**C-4**); 72.9 (**CH₂Ph**); 78.8 (**C-3**); 84.9 (**C-5**); 98.3 (**C-2**); 127.2, 127.3, 127.7 (**CH-Ph**); 136.3 (**Cq-Ph**); 127.9, 128.1, 128.6 (**CH-Ph**); 137.9 (**Cq-Ph**); 188.7 (**C=S**).

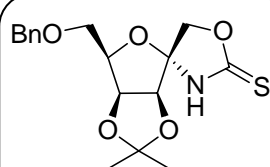
6-O-benzyl-2,N-3,O-thiocarbonyl-α-D-tagatofuranosylamine (191)

MW=351.42g.mol⁻¹
C₁₇H₂₁NO₅S

Yield=39%

Rf=0.28 PE/EA(8:2)

Starting with **183** (0.3 g, 0.86 mmol) using G.P. 2.4.3. (reaction time 15h) and trimethylsilyl thiocyanate (3.0 eq.) the compound **191** was obtained after column chromatography on silica gel with a mixture of PE/EA (9:1) as a colorless oil (0.12 g, 0.34 mmol, 39%).

¹H NMR (250MHz, CDCl₃) δ: 1.32 (s, 3H, **CH₃**); 1.35 (s, 3H, **CH₃**); 3.62 (dd, 1H, *J*_{6a-5}=7.0Hz, *J*_{6b-6a}=10.5Hz, **H-6a**); 3.76 (dd, 1H, *J*_{6b-5}=5.0Hz, *J*_{6b-6a}=10.5Hz, **H-6b**); 3.84 (d, 1H, *J*_{1a-1b}=12.5Hz, **H-1a**); 3.96 (d, 1H, *J*_{1b-1a}=12.5Hz, **H-1b**); 4.18-4.25 (m, 1H, **H-5**); 4.48-4.63 (m, 3H, **H-3**, **CH₂Ph**); 4.74-4.78 (dd, 1H, *J*₄₋₃=4.0Hz, *J*₄₋₅=6.0Hz, **H-4**); 7.24-7.33 (m, 5H, Ph); 8.85 (brs, 1H, NH).

IR: (neat) ν (cm⁻¹): 2925 (**CH**); 1453 (**Ph**); 1088, 698 (**N-CS-O**).

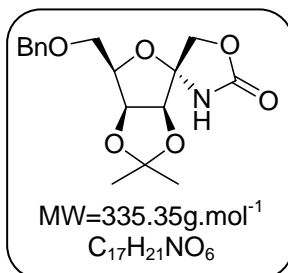
6-O-benzyl-2,N-3,O-carbonyl- α -D-tagatofuranosylamine (193)

Yield=17%

Rf=0.28 PE/EA(8:2)

Starting with **183** (0.3 g, 0.86 mmol) using G.P. 2.4.3. (reaction time 15h) and trimethyl silyl thiocyanate (3.0 eq.) the compound **193** was obtained after column chromatography on silica gel with a mixture of PE/EA (9:1) as a colorless oil (49 mg, 0.15 mmol, 17%).

¹H NMR (400MHz, CDCl₃) δ : 1.28 (s, 3H, CH₃); 1.38 (s, 3H, CH₃); 3.65-3.70 (m, 1H, H-6a); 3.76 (dd, 1H, $J_{6b-5}=4.4\text{Hz}$, $J_{6b-6a}=10.8\text{Hz}$, H-6b); 4.05 (m, 1H, H-5); 4.36 (d, 1H, $J_{1a-1b}=10.4\text{Hz}$, H-1a); 4.51-4.58 (m, 2H, CH₂Ph); 4.62-4.68 (m, 4H, H-1b, H-3, CH₂-Ph); 4.77-4.80 (m, 1H, H-4); 7.26-7.36 (m, 5H, Ph); 7.97 (s, 1H, NH).

¹³C NMR (100MHz, CDCl₃) δ : 24.9, 26.0 (CH₃); 67.9 (C-6); 70.8 (C-1); 73.7 (CH₂Ph); 79.2 (C-5); 80.3 (C-4); 84.9 (C-3); 98.9 (C-2); 113.6 (Cq-isop); 127.9, 128.1, 128.6 (CH-Ph); 137.9(Cq-Ph); 159.5 (C=O).

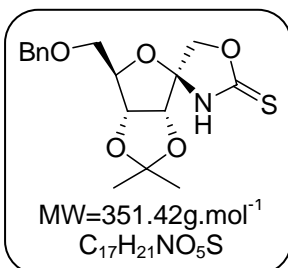
6-O-benzyl-2,N-3,O-thiocarbonyl- β -D-psicofuranosylamine (192)

Yield=42%

Rf=0.28 PE/EA(8:2)

Starting with **184** (0.3 g, 0.86 mmol) using G.P. 2.4.3. (reaction time 15h) and trimethyl silyl thiocyanate (5.0 eq.) the compound **192** was obtained after column chromatography on silica gel with a mixture of PE/EA (9:1) as a colorless oil (0.13 g, 0.37 mmol, 42%).

¹H NMR (400MHz, CDCl₃) δ : 1.33 (s, 3H, CH₃); 1.46 (s, 3H, CH₃); 3.54-3.73 (m, 2H, H-6); 4.12-4.34 (m, 3H, H-1, H-5); 4.49-4.54 (m, 1H, CH₂Ph); 4.59-4.97 (m, 2H, H-3, CH₂Ph); 4.81 (dd, 1H, $J_{4-3}=6.0\text{Hz}$, $J_{4-5}=10.4\text{Hz}$, H-4); 6.56 (brs, 1H, NH), 7.26-7.36 (m, 5H, Ph).

¹³C NMR (100MHz, CDCl₃) δ : 25.3, 26.6 (CH₃); 70.9 (C-6); 73.5 (CH₂Ph); 74.0 (C-1); 83.6 (C-4); 84.1 (C-5); 85.7 (C-3); 109.7 (C-2); 112.8 (Cq-isop); 127.9, 128.5, 128.7, 129.0 (CH-Ph); 138.3 (Cq-Ph); 191.4 (C=S).

IR: (neat) ν (cm⁻¹): 2926, 2855 (CH); 1592, 1045, 698 (N-CS-O); 1495, 1454 (Ph).

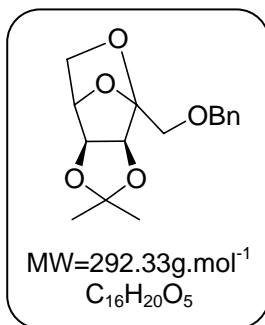
2,6-Anhydro-β-1-O-benzyl-3,4-O-isopropylidene-D-tagatofuranoside (194)

Yield=21%

Rf=0.33 PE/EA(8:2)

The compound **194** was a side product of the synthesis of compounds **191** and **193**. Compound **194** was obtained after column chromatography on silica gel with a mixture of PE/EA (9:1) as a colorless oil (62 mg, 0.15 mmol, 21%).

¹H NMR (400MHz, CDCl₃) δ: 1.31 (s, 3H, CH₃); 1.41 (s, 3H, CH₃); 3.65 (dd, 1H, J_{6a-5}=6.4Hz, J_{6a-6b}=10.4Hz, H-6a); 3.79 (dd, 1H, J_{6b-5}=4.8Hz, J_{6b-6a}=10.4Hz, H-6b); 3.87 (d, 1H, J_{1a-1b}=12.4Hz, H-1a); 3.98 (d, 1H, J_{1b-1a}=12.4Hz, H-1b); 4.22-4.26 (m, 1H, H-5); 4.53 (d, 1H, J=12.2Hz, CH₂Ph); 4.59 (d, 1H, J₃₋₄=6.0Hz, H-3); 4.63 (d, 1H, J=12.2Hz, CH₂Ph); 4.79 (dd, 1H, J₄₋₅=4.0Hz, J₄₋₃=6.0Hz, H-4); 7.26-7.36 (m, 5H, Ph).

¹³C NMR (100MHz, CDCl₃) δ: 24.9, 26.1 (CH₃); 60.0 (C-1); 68.0 (C-6); 73.5 (C-7); 78.3 (C-5); 80.5 (C-4); 83.4 (C-3); 104.3 (C-2); 113.1 (Cq-isop); 127.7, 127.9, 128.5 (CH-Ph); 138.3(Cq-Ph).

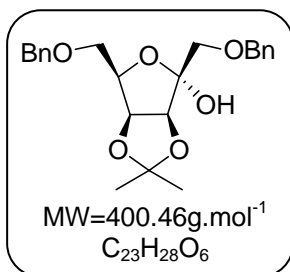
MS: (IS+) m/z: 310 (M+NH₄)⁺; 315 (M+Na)⁺IR: (neat) ν (cm⁻¹): 2936 (CH); 1454 (Ph).**1,2-Di-O-benzyl-3,4-O-isopropylidene-α-D-tagatofuranose (195)**

Yield=13%

Rf=0.35 PE/EA(8:2)

The compound **195** was a side product of the synthesis of compound **191**. Compound **195** was obtained after column chromatography on silica gel with a mixture of PE/EA (9:1) as a colorless oil (45 mg, 0.11 mmol, 13%).

¹H NMR (250MHz, CDCl₃) δ: 1.31 (s, 3H, CH₃); 1.40 (s, 3H, CH₃); 3.64-3.71 (m, 1H, H-6a); 3.80 (dd, 1H, J_{6a-5}=4.5Hz, J_{6a-6b}=10.5Hz, H-6b); 4.22 (s, 2H, CH₂Ph); 4.32 (d, 1H, J_{1a-1b}=10.3Hz, H-1a); 4.33-4.37 (m, 1H, H-5); 4.52-4.54 (m, 3H, H-1b, H-3, CH₂Ph); 4.67 (d, 1H, J=12.5Hz, CH₂Ph); 4.88 (dd, 1H, J₄₋₃=3.8Hz, J₄₋₅=6.0Hz, H-4); 7.25-7.36 (m, 10H, Ph).

¹³C NMR (62.89MHz, CDCl₃) δ: 26.2, 25.1 (CH₃); 36.4 (CH₂Ph); 68.2 (C-6); 73.2 (C-1); 73.6 (CH₂Ph); 72.7 (C-5); 81.2 (C-4); 85.3 (C-3); 108.3 (C-2); 112.7 (Cq-isop); 127.8, 128.0, 128.5, 128.7, 129.2 (CH-Ph); 136.9, 138.2 (Cq-Ph).

MS: (IS+) m/z: 423 (M+Na)⁺.IR: (neat) ν (cm⁻¹): 2932 (CH); 1495, 1454 (Ph).

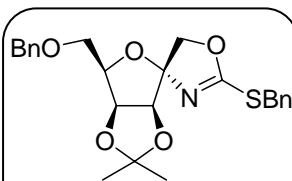
(5*S*,7*R*,8*R*,9*S*) 7-Benzyloxymethyl-2-benzylsulfanyl-1,2-dehydro-8,9-(isopropylidenedioxy)-1-aza-3,6-dioxaspiro[4,5]nonane (198)

MW=441.54g.mol⁻¹
C₂₄H₂₇NO₅S

Yield=83%
R_f=0.32 PE/EA(8:2)

Starting with **195** (0.1 g, 0.28 mmol) using G.P. 2.4.3. (reaction time 15h) and trimethyl silyl thiocyanate (5.0 eq.) the compound **198** was obtained after column chromatography on silica gel with a mixture of PE/EA (9:1) as a colorless oil (0.10 g, 0.23 mmol, 83%).

¹H NMR (250MHz, CDCl₃) δ: 1.31 (s, 3H, **CH**₃); 1.40 (s, 3H, **CH**₃); 3.68 (dd, 1H, *J*_{6a-5}=4.8Hz, *J*_{6a-6b}=6.8Hz, **H-6a**); 3.79 (dd, 1H, *J*_{6b-5}=2.8Hz, *J*_{6b-6a}=6.8Hz, **H-6b**); 4.22 (s, 2H, **CH**₂**Ph**); 4.33 (d, 1H, *J*_{1a-1b}=6.5Hz, **H-1a**); 4.36-4.38 (m, 1H, **H-5**); 4.53-4.59 (m, 3H, **H-1b**, **H-3**, **CH**₂**Ph**); 4.67 (d, 1H, *J*=7.8Hz, **CH**₂**Ph**); 4.89-4.91 (m, 1H, **H-4**); 7.26-7.37 (m, 10H, **Ph**).

¹³C NMR (62.89MHz, CDCl₃) δ: 25.1, 26.2 (**CH**₃); 36.4 (**SCH**₂**Ph**); 68.2 (**C-6**); 73.2 (**C-1**); 73.6 (**C-7**); 78.7 (**C-5**); 81.2 (**C-4**); 85.5 (**C-3**); 108.4 (**C-2**); 112.7 (**Cq-isop**); 127.8, 128.0, 128.5, 128.7, 129.2 (**CH-Ph**); 138.2 (**Cq-Ph**); 163.5 (**Cq-SBn**).

MS: (IS+) *m/z*: 442 (M+H)⁺; 464 (M+Na)⁺

IR: (neat) *v* (cm⁻¹): 2921, 2851 (**CH**); 1592, 1049, 698 (**N-CS-O**); 1496, 1454 (**Ph**).

BIBLIOGRAPHIC

SUPPORT

- ¹ K. P. C. Vollhardt, N. E. Schore *Organic Chemistry – Structure and Function*, W.H. Freeman and Company, New York, **2003**, 4th Edition, p. 1056.
- ² (a) L. M. Hanover, J. S. White *Am. J. Clin. Nutr.* **1993**, *58*, 724; (b) A. E. Benders *Dictionary of Nutrition and Food Technology* **1990**, Butterworths, Boston.
- ³ L. O. Nabors *American Sweeteners* **2001**, 374.
- ⁴ F. W. Lichtenthaler *Carbohydr. Res.* **1998**, *313*, 69.
- ⁵ [http://www.medbio.info/Horn/Time%201-2/carbohydrate metabolism.htm](http://www.medbio.info/Horn/Time%201-2/carbohydrate%20metabolism.htm)
- ⁶ L. Forristal *The Murky World of High-Fructose Corn Syrup* **2001**, Weston A. Price Foundation. <http://www.westonaprice.org/motherlinda/hfcs.html> it's a magazine.
- ⁷ S. C. Köpper, S. Freimund *Helv. Chim. Acta* **2003**, *86*, 827.
- ⁸ M. Steiger, T. Reichstein *Helv. Chim. Acta* **1936**, *19*, 187.
- ⁹ V. K. Srivastava, L. M. Lerner *J. Org. Chem.* **1979**, *44*, 3368.
- ¹⁰ L. J. Hanka *J. Bacteriol.* **1960**, *80*, 30 and references cited therein.
- ¹¹ K. Muraio, X. Yu, W.M. Cao, H. Imachi, K. Chen, T. Muraoka, N. Kitanaka, J. Li, R.A.M. Ahmed, K. Matsumoto, T. Nishiuchi, M. Tokuda, T. Ishida *Life Sci* **2007**, *81*, 592 and references cited therein.
- ¹² Y. Sun, S. Hayakawa, M. Ogawa, K. Fukada, K. Izumori *J. Agric. Food. Chem.* **2008**, *56* (12), 4789.
- ¹³ (a) M. K. Takada, F. Yamaguchi, Y. Nakanose, Y. Watanabe, N. Hatano, I. Tsukamoto, M. Nagata, K. Izumori, M. Tokuda *J. Biosci. Bioeng.* **2005**, *100*, 511; (b) B. T. Menavuvu, W. Poonperm, K. Leang, N. Noguchi, H. Okada, K. Morimoto, T. B. Granstrom, G. Takada, K. Izumori *J. Biosci. Bioeng.* **2006**, *101*, 340.
- ¹⁴ D. Oh *Appl Microbiol Biotechnol* **2007**, *76*, 1.
- ¹⁵ *FAO Monograph* **2006**, 1, www.fao.org.
- ¹⁶ N. A. Jones, S. F. Jenkinson, R. Soengas, M. Fanefjord, M. R. Wormald, R. A. Dwek, G. P. Kiran, R. Devendar, G. Takata, K. Morimoto, K. Izumori, G. W. J. Fleet *Tetrahedron: Asymmetry* **2007**, *18*, 774.
- ¹⁷ Agency Response Letter GRAS Notice No. GRN 000078.
- ¹⁸ T. W. Donner, J. F. Wilber, D. Ostrowski *Diabetes, Obesity and Metabolism* **1999**, *1* (5), 285.
- ¹⁹ Y. Lu, G. V. Levin, T. W. Donner *Diabetes, Obesity and Metabolism* **2008**, *10*, 109.
- ²⁰ (a) G. V. Levin, *J. Med. Food* **2002**, *5*, 23; (b) Y. X. Sun, S. Hayakawa, M. Ogawa, K. Izumori *Food Control* **2007**, *18*, 220; (c) Y. X. Sun, S. Hayakawa, H. H. Jiang, M. Ogawa, K. Izumori, *Biosci., Biotechnol., Biochem.* **2006**, *70*, 2859.
- ²¹ (a) Y. Nagao, S. Yamada, T. Kumagai, M. Ochiai, E. Fujita *J. Chem. Soc. Chem. Commun.* **1985**, 1418; (b) C. N. Hsiao, L. Liu, M. J. Miller, *J. Org. Chem.* **1987**, *52*, 2201; (c) F. Kazmierczak, P. Helquist *J. Org. Chem.* **1989**, *54*, 3988; (d) T. H. Yan, H. C. Lee, C. W. Tan *Tetrahedron Lett.* **1993**, *34*, 3559; (e) T. H. Yan, C. W. Tan, H. C. Lee, T. Y. Huang *J. Am. Chem. Soc.* **1993**, *115*, 2613; (f) C. N. Hsiao, L. Liu, M. J. Miller *J. Org. Chem.* **1995**, *60*, 3301; (g) D. W. Su, Y. C. Wang, T. H. Yan, *Tetrahedron Lett.* **1999**, *40*, 4197; (h) N. R. Guz, A. J. Phillips *Org. Lett.* **2002**, *4*, 2253; (i) F. Velazquez, H. F. Olivo *Curr. Org. Chem.* **2002**, *6*, 1 and references cited therein.
- (a) O. Leoni, R. Bernardi, D. Gueyrard, P. Rollin, S. Palmieri *Tetrahedron: Asymmetry* **1999**, *10*, 4775; (b) D. Gueyrard, V. Grumel, O. Leoni, S. Palmieri, P. Rollin *Heterocycles* **2000**, *52*, 827.
- ²² (a) J. M. Garcia Fernandez, C. Ortiz Mellet, J. Fuentes *J. Org. Chem.* **1993**, *58*, 5192; (b) J. G. Fernandez-Bolanos, E. Zafra, O. Lopez, I. Robina and J. Fuentes, *Tetrahedron: Asymmetry* **1999**, *10*, 3011; (c) J. Fuentes Mota, J. L. Jimenez Blanco, C. Ortiz Mellet, J. M. Garcia Fernandez *Carbohydr. Res.* **1994**, *257*, 127; (d) C. Gasch, M. Angeles Pradera, B. A. B. Salameh, J. L. Molina, J. Fuentes *Tetrahedron: Asymmetry* **2001**, *12*, 1267.

- ²³ (a) R. Ranganathan *Tetrahedron Lett.* **1975**, *13*, 1185; (b) R. Ranganathan *Tetrahedron Lett.* **1977**, *15*, 1291; (c) B. Rayner, C. Tapiero, J. L. Imbach *J. Heterocyclic Chem.* **1982**, *19*, 593; (d) G. Gosselin, M. C. Bergogne, J. De Rudder, E. De Clercq, J. L. Imbach *J. Med. Chem.* **1986**, *29*, 203; (e) A. Grouiller, G. Mackenzie, B. Najib, G. Shaw and D. Ewig *J. Chem. Soc., Chem. Commun.* **1988**, 671; (f) G. Gosselin, M. C. Bergogne, J. L. Imbach *Nucleosides Nucleotides* **1990**, *9*, 81.
- ²⁴ (a) J. L. Jimenez Blanco, V. M. Diaz Perez, C. Ortiz Mellet, J. Fuentes, J. M. Garcia Fernandez, J. C. Diaz Arribas, F. J. Cañada *J. Chem. Soc., Chem. Commun.* **1997**, 1969 and references cited therein; (b) V. M. Diaz Perez, M. I. Garcia Moreno, C. Ortiz Mellet, J. Fuentes, J. C. Diaz Arribas, F. J. Cañada, J. M. Garcia Fernandez *J. Org. Chem.* **2000**, *65*, 136; (c) S. Silva *PhD Thesis*, University of Lisbon and University of Orléans **2009**.
- ²⁵ Y. Bechor, A. Albeck *Tetrahedron* **2008**, *64*, 2080 and references cited therein.
- ²⁶ R. T. Borchardt, B. T. Keller, U. Patel-Thombre *J. Biol. Chem.* **1984**, *259*, 4353.
- ²⁷ R. J. Parry, Y. Jiang *Tetrahedron Lett.* **1994**, *35*, 9665.
- ²⁸ E. J. Prisbe, J. Smejkal, J. P. H. Verheyden, J. G. Moffatt *J. Org. Chem.* **1976**, *41*, 1836.
- ²⁹ N. A. Jones, D. Rao, A. Yoshihara, P. Gullapalli, K. Morimoto, G. Takata, S. J. Hunter, M. R. Wormald, R. Dwek, K. Izumori, G. W. J. Fleet *Tetrahedron:Asymmetry* **2008**, *19*, 1904 and references cited therein.
- ³⁰ (a) K. Izumori *J. Biotech.* **2006**, *124*, 717; (b) T. B. Granstrom, G. Takata, M. Tokuda, K. Izumori *J. Biosci. Bioeng.* **2004**, *97*, 89; (c) K. Morimoto, C. S. Park, M. Ozaki, K. Takeshita, T. Shimonishi, T. B. Granstrom, G. Takata, M. Tokuda, K. Izumori *Enzyme Microb. Technol.* **2006**, *38*, 855.
- ³¹ N. A. Jones, S. F. Jenkinson, R. Soengas, M. Fanefjord, M. R. Wormald, R. A. Dwek, G. P. Kiran, R. Devendar, G. Takata, K. Morimoto, K. Izumori, G. W. J. Fleet *Tetrahedron:Asymmetry* **2007**, *18*, 774.
- ³² Z. Hricovíniová-Bíliková, M. Hricovíni, M. Petrušová, A. S. Serianni, L. Petruš *Carbohydr. Res.* **1999**, *319*, 38.
- ³³ M. I. García-Moreno, J. M. Benito, C. Ortiz Mellet, J. M. García Fernández *Molecules* **2008**, *13*, 1640 and references cited therein.
- ³⁴ S. M. Andersen, I. Lundt, J. Marcussen, S. Yu *Carbohydr. Res.* **2002**, *337*, 873 and references cited therein.
- ³⁵ M. I. Garcia-Moreno, D. Rodriguez-Lucena, C. Ortiz Mellet, J. M. Garcia Fernandez *J. Org. Chem.* **2004**, *69*, 3578;
- ³⁶ M. I. Garcia-Moreno, M. Aguilar, C. Ortiz Mellet, J. M. Garcia Fernandez *Org. Lett.* **2006**, *8*, 297.
- ³⁷ P. Compain, O. R. Martin *Iminosugars: from synthesis to therapeutical applications*, Wiley, **2007**.
- ³⁸ I. Izquierdo, M. T. Plaza, V. Yáñez *Tetrahedron* **2007**, *63*, 1440 and references cited therein.
- ³⁹ (a) L. Agrofoglio, S. R. Challand, *Acyclic, carbocyclic and L-nucleosides*, Kluwer, London, **1998**; (b) R. F. Rando, N. Nguyen-Ba, *Drug Discov. Today* **2000**, *5*, 465; (c) C. McGuigan, C. J. Yarnold, G. Jones, S. Velazquez, H. Barucki, A. Brancale, G. Andrei, R. Snoeck, E. De Clercq, J. Balzarini, *J. Med. Chem.* **1999**, *42*, 4479.
- ⁴⁰ (a) E. A. Harwood, P. B. Hopkins, S. T. Sigurdsson *J. Org. Chem.* **2000**, *65*, 2959; (b) M. Kotera, Y. Roupioz, E. Defrancq, A.-G. Bourdat, J. Garcia, C. Coulombeau, J. Lhomme *Chem. Eur. J.* **2000**, *6*, 4163.
- ⁴¹ E. Trévisiol, E. Defrancq, J. Lhomme, A. Laayoun, P. Cros *Eur. J. Org. Chem.* **2000**, 211.
- ⁴² J. A. M. Gimenez, G. T. Saez, R. T. Tabraes *J. Theor. Biol.* **1998**, *194*, 485.
- ⁴³ (a) A. Rösler, W. Pfeleiderer *Helv. Chim. Acta* **1997**, *80*, 1869; (b) O. Jungmann, W. Pfeleiderer, *Tetrahedron Lett.* **1996**, *37*, 8355; (c) H. Sugimura, K. Osumi, Y. Kodaka, K. Sujino *J. Org. Chem.* **1994**, *59*, 7653; (d) Y. Saito, M. Nakamura, T. Ohno, C. Chaicharoenpong, E. Ichikawa, S. Yamamura, K. Kato, K. Umezawa *J. Chem. Soc., Perkin Trans. I* **2001**, 198; (e) E. R. Kandimalla,

- D. Yu, Q. Zhao, S. Agrawal *Bioorg. Med. Chem.* **2001**, *9*, 807; (f) D. R. Sauer, S. W. Schneller *Synthesis* **1991**, 747; (g) A. Al Mourabit, M. Beckmann, C. Poupat, A. Ahond, P. Potier, *Tetrahedron: Asymmetry* **1996**, *7*, 3455; (h) D. Lengeler, K. Weisz *Tetrahedron Lett.* **2001**, *42*, 1479; (i) O. Jungmann, W. Pfeleiderer *Tetrahedron Lett.* **1996**, *37*, 8355; (j) A. Rosler, W. Pfeleiderer *Helv. Chim. Acta* **1997**, *80*, 1869; (k) Z. Wang, C. Rizzo *Org. Lett.* **2000**, *2*, 227; (l) E. S. H. El Ashry, L. F. Awad, M. Winkler *J. Chem. Soc., Perkin Trans. I* **2000**, 829, (m) D. Loakes, M. -J. Guo, J.-C. Yang, D. M. Brown *Helv. Chim. Acta* **2000**, *83*, 1693; (n) R. Bertolini, J. Hunziker *Helv. Chim. Acta* **2000**, *83*, 1962; (o) W. Wu, D. E. Bergstrom *J. Org. Chem.* **2003**, *68*, 3860.
- ⁴⁴ N. Kifli, T. T. Htar, E. De Clercq, J. Balzarini, C. Simons *Bioorg. Med. Chem.* **2004**, *12*, 3247.
- ⁴⁵ (a) O. Jungmann, W. Pfeleiderer *Tetrahedron Lett.* **1996**, *37*, 8355; (c) H. Sugimura, K. Osumi, Y. Kodaka, K. Sujino *J. Org. Chem.* **1994**, *59*, 7653.
- ⁴⁶ (a) J. Girniene, D. Gueyrard, A. Tatibouët, A. Sackus, P. Rollin *Tetrahedron Lett.* **2001**, *42*, 2977; (b) N. S. Mourier, A. Eleuteri, S. Hurwitz, P. M. Tharnish, R. F. Schinazi *Bioorg. Med. Chem.* **1999**, *7*, 2759.
- ⁴⁷ R. Ranganathan *Tetrahedron Lett.* **1975**, *13*, 1185.
- ⁴⁸ B. Rayner, C. Tapiero, J. L. Imbach *J. Heterocyclic Chem.* **1982**, *19*, 593.
- ⁴⁹ G. Gosselin, M. C. Bergogne, E. De Clercq, J. L. Imbach *J. Med. Chem.* **1986**, *29*, 203.
- ⁵⁰ G. Gosselin, M. C. Bergogne, J. L. Imbach *Nucleosides Nucleotides* **1990**, *9*, 81.
- ⁵¹ A. Grouiller, G. Mackenzie, B. Najib, G. Shaw, D. Ewig *J. Chem. Soc., Chem. Commun.* **1988**, 671.
- ⁵² J. Girniene, G. Apremont, A. Tatibouët, A. Sackus, P. Rollin *Tetrahedron* **2004**, *60*, 2609.
- ⁵³ (a) T. S. Mansour, R. Storer, *Curr. Pharm. Des.* **1997**, *3*, 227; (b) E. Ichikawa; K. Kato, *Curr. Med. Chem.* **2001**, *8*, 385.
- ⁵⁴ J. Girniene, A. Tatibouët, A. Sackus, J. Yang, G. D. Holman, P. Rollin *Carbohydr. Res.* **2003**, 338, 711.
- ⁵⁵ (a) G. Li, X. Qian, J. Cui, Q. Huang, R. Zhang, H. Guan *J. Agric. Food Chem.* **2006**, *54*, 125; (b) A. P. Rauter, M. Padilha, J. A. Figueiredo, M. I. Ismael, J. Justino, H. Ferreira, M. J. Ferreira, C. Rajendran, R. Wikkins, P. Vaz, M. J. Calhorda *J. Carbohydr. Chem.* **2005**, *24*, 275; (c) S. Bondock, W. Khalifa, A. A. Fadda *Eur. J. Med. Chem.* **2007**, *42*, 948; (d) J. W. Chien, M. L. Kucia, R. A. Salata *Clinical Infectious Diseases*, **2000**, *30*, 146; (e) D. J. Diekema, R. N. Jones *Drugs* **2000**, *59*, 7.
- ⁵⁶ (a) A. Tatibouët, J. Yang, C. Morin, G. D. Holman *Bioorg. Med. Chem.* **2000**, *8*, 1825; (b) J. Yang, J. Dowden, A. Tatibouët, Y. Hatanaka, G. D. Holman *Biochem. J.* **2002**, *367*, 533.
- ⁵⁷ (a) O. Leoni, R. Bernardi, D. Gueyrard, P. Rollin, S. Palmieri *Tetrahedron: Asymmetry* **1999**, *10*, 4775; (b) D. Gueyrard, V. Grumel, O. Leoni, S. Palmieri, P. Rollin *Heterocycles* **2000**, *52*, 827.
- ⁵⁸ (a) E. Fujita, Y. Nagao *Adv. Heterocycl. Chem.* **1989**, *45*, 1; (b) P. Kocienski, M. Stocks, D. Donald, M. Perry *Synlett* **1990**, *1*, 38; (c) R. C. D. Brown, P. Kocienski *Synlett* **1994**, *6*, 415; (d) M. T. Crimmins, B. W. King, E. A. Tabet *J. Am. Chem. Soc.* **1997**, *119*, 7883; (e) M. T. Crimmins, B. W. King, *J. Am. Chem. Soc.* **1998**, *120*, 9084; (f) M. T. Crimmins, E. A. Tabet *J. Am. Chem. Soc.* **2000**, *122*, 5473; (g) Y. C. Wang, D. W. Su, C. M. Lin, H. L. Tseng, C. L. Li, T. H. Yan *Tetrahedron Lett.* **1999**, *40*, 3577; (h) Y. Nagao, M. Yagi, T. Ikedo, E. Fujita *Tetrahedron Lett.* **1982**, *23*, 201; (i) Y. Nagao, T. Kumagai, S. Yamada, E. Fujita, Y. Inoue, Y. Nagase, T. Abe *J. Chem. Soc. Perkin Trans 1* **1985**, 2361.
- ⁵⁹ (a) K. A. Jorgesen, A. B. Ghattas, S. O. Lawesson *Tetrahedron* **1982**, *38*, 1163; (b) R. Masuda, M. Hojo, T. Ichi, S. Sasano, T. Kobayashi, C. Kuroda *Tetrahedron Lett.* **1991**, *32*, 1195; (c) M. Moreno-Mañas, I. Padros *J. Heterocycl. Chem.* **1993**, *30*, 1235; (d) A. Corsaro, V. Pistrà *Tetrahedron* **1998**, *54*, 15027.
- ⁶⁰ For a general survey, cf. A. C. Simão, J. Rousseau, S. Silva, A. P. Rauter, A. Tatibouët, P. Rollin *Thionocarbamates on carbohydrate scaffolds – from synthesis to bioactivity in Specialist Periodical Reports – Carbohydr. Chem.* **2009**, *35*, 127.

- ⁶¹ (a) J. M. Garcia Fernandez, C. Ortiz Mellet *Sulfur Reports* **1996**, *19*, 61; (b) J. M. Garcia Fernandez, C. Ortiz Mellet, *Adv. Carbohydr. Chem. Biochem.* **2000**, *55*, 35.
- ⁶² A. Tatibouët, M. Lefoix, J. Nadolny, O. R. Martin, P. Rollin, J. Yang, G. D. Holman *Carbohydr. Res.* **2001**, *333*, 327.
- ⁶³ G. A. Youngdale, G. W. Duncan, D. E. Emmert, D. Lednicer *J. Med. Chem.* **1966**, *9*, 155.
- ⁶⁴ G. Li, X. Quian, J. Cui, Q. Huang, R. Zhang, H. Guan *J. Agric. Food Chem.* **2006**, *54*, 125.
- ⁶⁵ (a) M. T. Crimmins, B. W. King, W. J. Zuercher, A. L. Choy, *J. Org. Chem.* **2000**, *65*, 8499 ; (b) M. T. Crimmins, W. J. Zuercher *Org. Lett.* **2000**, *2*, 1065; (c) M. T. Crimmins, E. A. Tabet *J. Org. Chem.* **2001**, *66*, 4012; (d) T. K. Chakraborty, S. Jayaprakash, P. Laxman, *Tetrahedron* **2001**, *57*, 9461; (e) M. T. Crimmins, J. D. Katz, D. G. Washburn, S. P. Allwein, L. F. McAtee *J. Am. Chem. Soc.* **2002**, *124*, 5661.
- ⁶⁶ (a) N. Leconte, S. Silva, A. Tatibouët, A. P. Rauter, P. Rollin *Synlett* **2006**, *2*, 301; (b) S. Silva, A. C. Simão, A. Tatibouët, P. Rollin, A. P. Rauter *Tetrahedron Lett.* **2008**, *49*, 682; (c) A. Tatibouët, A. C. Simão, P. Rollin *Lett. Org. Chem.* **2005**, *2*, 47.
- ⁶⁷ (a) G. Zemplén, A. Gerecs, M. Rados, *Ber.* **1936**, *39*, 748; (b) G. Zemplén, A. Gerecs, E. Illés, *Ber.* **1938**, *71*, 590; (c) W. H. Bromund, R. M. Herbst *J. Org. Chem.* **1945**, *10*, 267; (d) A. Wickstrom, J. K. Wold *Acta Chem. Scand.* **1959**, *13*, 1129; (e) J. C. Jochims, A. Seeliger, G. Taigel *Chem. Ber.* **1967**, *100*, 845; (f) M. Avalos, R. Babiano, P. Cintas, J. L. Jiménez, J. C. Palacios, C. Valencia *Tetrahedron* **1993**, *49*, 2676.
- ⁶⁸ (a) J. G. Fernandez-Bolanos, E. Zafra, I. Robina, J. Fuentes *Carbohydr. Lett.* **1999**, *3*, 239; (b) I. Maya, O. Lopez, J. G. Fernandez-Bolanos, I. Robina, J. Fuentes *Tetrahedron Lett.* **2001**, *42*, 5413; (c) O. Lopez, I. Maya, J. Fuentes, J. G. Fernandez-Bolanos *Tetrahedron* **2004**, *60*, 61; (d) B. Paizs, I. Pinter, I. G. Csizmadia *Theochem* **1998**, *455*, 267; (e) J. M. Garcia Fernandez, C. Ortiz Mellet, J. Fuentes *Tetrahedron Lett.* **1992**, *33*, 3931; (f) J. M. Garcia Fernandez, C. Ortiz Mellet, J. L. Jimenez Blanco, J. Fuentes *J. Org. Chem.* **1994**, *59*, 5565; (g) O. Lopez, E. Zafra, I. Maya, J. Fuentes, M. J. Dianez, M. D. Estrada, S. Perez-Garrido, J. G. Fernandez-Bolanos *Tetrahedron* **2008**, *64*, 11789; (h) J. M. Garcia Fernandez, C. Ortiz Mellet, J. L. Jimenez Blanco, J. Fuentes Mota, A. Gadelle, A. Coste-Sarguet, J. Defaye *Carbohydr. Res.* **1995**, *268*, 57; (i) J. M. Benito, C. Ortiz Mellet, J. M. Garcia Fernandez *Carbohydr. Res.* **2000**, *323*, 218.
- ⁶⁹ T. Elbert, M. Cerny *Collect. Czech. Chem. Commun.* **1985**, *50*, 2000.
- ⁷⁰ J. F. Willems, A. Vandenberghe *Bull. Soc. Chim. Belg.* **1961**, *70*, 745.
- ⁷¹ (a) G. Lacasse, J. M. Mucocki *Can. J. Chem.* **1972**, *50*, 3082; (b) R. Gompper, H. Herlinger *Chem. Ber.* **1956**, *89*, 1762.
- ⁷² (a) J. Kang, G. J. Lim, S. K. Yoon, M. Y. Kim *J. Org. Chem.* **1995**, *60*, 564; (b) N. Nieto, P. Molas, J. Benet-Buchholz, A. Vida-Ferran *J. Org. Chem.* **2005**, *70*, 10143.
- ⁷³ P. E. Moris, D. E. Kiely *J. Org. Chem.* **1987**, *52*, 1149 and references cited herein.
- ⁷⁴ X.-Y. Wu, X. She, Y. Shi *J. Am. Chem. Soc.* **2002**, *124*, 8792.
- ⁷⁵ Q.-P. Wu, M.-X. Zhou, X.-D. Xi, D. Song, Y. Wang, H.-X. Liu, Y.-Z. Li, Q.-S. Zhang *Tetrahedron Lett.* **2008**, *49*, 2714-2718.
- ⁷⁶ (a) G. A. Ellestad, D. B. Cosulich, R. W. Broschard, J. H. Martin, M. P. Kunstmann, G. O. Morton, J. E. Lancaster, W. Fulmor, F. M. Lovell *J. Am. Chem. Soc.* **1978**, *100*, 2515; (b) J. Shimada, F. Suzuki, H. Nonaka, A. Karasawa, H. Mizumoto, T. Ohno, K. Kubo, A. Ishii *J. Med. Chem.* **1991**, *34*, 469; (c) C.-H. Park, D. R. Brittelli, C.L.-J. Wang, F. D. Marsh, W. A. Gregory, M. A. Wuonola, R. J. McRipley, V. S. Eberly, A. M. Slee, M. Forbes *J. Med. Chem.* **1992**, *35*, 1156.
- ⁷⁷ (a) D. A. Evans, J. Bartroli, T. L. Shih *J. Am. Chem. Soc.* **1981**, *103*, 2127; (b) D. A. Evans, A. E. Weber *J. Am. Chem. Soc.* **1986**, *108*, 6757.
- ⁷⁸ K. Bahrami, M. M. Khodaei, Y. Tirandaz *Synthesis* **2009**, *3*, 369 and references cited therein.
- ⁷⁹ A. Corsaro, V. Pistara *Tetrahedron* **1998**, *54*, 15027.
- ⁸⁰ D. Gueyrard *PhD Thesis*, Université d'Orléans **2000**.

- ⁸¹ J. Girniene *PhD Thesis*, Université d'Orléans **2003**.
- ⁸² R. M. Davidson, G. D. Byrd, E. White, S. A. Margolis, B. Coxon *Magn. Res. Chem.* **1986**, *24*, 929.
- ⁸³ P. Meszaros, I. Pinter, J. Kovacs, G. Toth *Carbohydr. Res.* **1994**, *258*, 287.
- ⁸⁴ Y. Nagao, K. Inoue, M. Yamaki, M. Shiro, S. Takagi, E. Fujita *Chem. Pharm. Bull.* **1988**, *36*, 4293.
- ⁸⁵ S. Silva *PhD Thesis*, University of Lisbon and University of Orléans **2009**.
- ⁸⁶ (a) A. Padwa, H. Zhang *J. Org. Chem.* **2007**, *72*, 2570. (b) J. Reeves *Org. Lett.* **2007**, *9*, 1879.
- ⁸⁷ (a) V. Justribo, S. C. Pellegrinet, M. I. Colombo *J. Org. Chem.* **2007**, *72*, 3702. (b) I. L. Baraznenok, V. G. Nenajdenko, E. S. Balenkova *Tetrahedron* **2000**, *56*, 3077.
- ⁸⁸ E. J. Enholm, A. Bhardawaj *Tetrahedron Lett.* **2003**, *44*, 3763.
- ⁸⁹ S. David, S. Hanessian, *Tetrahedron* **1985**, *41*, 643.
- ⁹⁰ (a) P. B. Alper, M. Hendrix, P. Sears, C. H. Wong *J. Am. Chem. Soc.* **1998**, *120*, 1965; (b) A. B. C. Simas, K. C. Pais, A. A. T. Silva *J. Org. Chem.* **2003**, *68*, 5426.
- ⁹¹ S. Cossu, O. De Lucchi, D. Fabbri, G. Licini, L. Pasquato *Org. Prep. Proc. Int.* **1991**, *23*, 573.
- ⁹² D. Serge, A. Thieffry *J. Chem. Soc. Perkin Trans. I* **1979**, 1568.
- ⁹³ Y. Tsuda, M. Hanajima, M. Naohisa, Y. Okund, K. Kanemitsu *Chem. Pharm. Bull.* **1989**, *37*, 2344.
- ⁹⁴ X. Kong, T. B. Grindley *J. Carbohydr. Chem.* **1993**, *12*, 557.
- ⁹⁵ B. Paizs, I. Pinter, J. Kovacs, W. Viviani, A. Mansura, P. Friant-Michel, I. G. Csizmadia *Theochem* **1997**, *41*, 395-396.
- ⁹⁶ J. G. Fernandez-Bolanos, A. B. Lopez, J. Fuentes *Carbohydr. Res.* **1990**, *199*, 239.
- ⁹⁷ J. C. Jochims *Chem. Ber.* **1975**, *108*, 2320.
- ⁹⁸ S. Tardy, J. Lobo Vicente, A. Tatibouët, G. Dujardin, P. Rollin *Synthesis* **2008**, 3108.
- ⁹⁹ (a) F. W. Lichtenthaler, W. Doleschal, S. Hahn *Liebigs Ann. Chem.* **1985**, 2454; (b) Y. Takagi, G.-J. Lim, T. Tsuchiya, S. Umezawa *J. Chem. Soc., Perkin Trans. 1* **1992**, 657.
- ¹⁰⁰ P. J. Garegg, B. Samuelsson *J. Chem. Soc., Chem. Commun.* **1979**, 978.
- ¹⁰¹ (a) M. I. Garcia-Moreno, P. Diaz-Perez, J. M. Benito, C. Ortiz Mellet, J. Defaye, J. M. Garcia Fernandez *Carbohydr. Res.* **2002**, *337*, 2329; (b) T. Isoda, K. Hayashi, S. Tamai, T. Kumagai, Y. Nagao *Chem. Pharm. Bull.* **2006**, *54*, 1616.
- ¹⁰² S. Tardy *PhD Thesis*, University of Orléans **2007**.
- ¹⁰³ J. S. Yadav, B. V. S. Reddy, K. S. Reddy *Chem. Lett.* **2001**, 430.
- ¹⁰⁴ (a) E. Barnett *Adv. Carbohydr. Chem.* **1967**, *22*, 177; (b) W. A. Szarek *Adv. Carbohydr. Chem.* **1973**, *28*, 225; (c) R. S. Tipson, A. Cohen *Carbohydr. Res.* **1965**, *1*, 338; (d) Z. Liu, B. Classon *J. Org. Chem.* **1990**, *55*, 4273.
- ¹⁰⁵ B. Rondot, T. Durand, J.-C. Rossi, P. Rollin *Carbohydr. Res.* **1994**, *261*, 149.
- ¹⁰⁶ P. J. Garegg, B. Samuelsson *J. Chem. Soc. Perkin Trans. I* **1980**, 2866.
- ¹⁰⁷ J. Desire, J. Prandi *Eur. J. Org. Chem.* **2000**, 3075.
- ¹⁰⁸ (a) P. J. Garegg, B. Samuelsson *Synthesis* **1979**, 469; (b) P. J. Garegg, B. Samuelsson *Synthesis* **1979**, 813; (c) F. W. Lichtenthaler, W. Doleschal, S. Hahn *Liebigs Ann. Chem.* **1985**, 2454.
- ¹⁰⁹ K. Augustyns, F. Vandendriessche, A. V. Aerschot, R. Busson, C. Urbanke, P. Herdewijn *Nucleic Acids Res.* **1992**, *20*, 4711.
- ¹¹⁰ C. Morin *Tetrahedron Lett.* **2006**, *47*, 5055 and references cited therein.
- ¹¹¹ A. L. Raymond, E. F. Schroeder *J. Amer. Chem. Soc.* **1948**, *60*, 2785.
- ¹¹² (a) R. W. Binkley, D. G. Hebermann *J. Org. Chem.* **1978**, *43*, 3244; (b) R. S. Tipson *Adv. Carbohydr. Chem.* **1953**, *8*, 107; (c) P. R. Skaanderup, C. S. Poulsen, L. Hyltdoft, M. R. Jorgensen, R. Madsen *Synthesis* **2002**, *12*, 1721.
- ¹¹³ (a) S. R. Landauer, H. N. Rydon *J. Chem. Soc.* **1953**, 2224; (b) H. N. Rydon, B. L. Tonge *J. Chem. Soc.* **1956**, 3043.
- ¹¹⁴ S. Hanessian, M. M. Ponpipom, P. Lavallée *Carbohydr. Res.* **1972**, *24*, 45.
- ¹¹⁵ P. J. Garegg, B. Samuelsson *J. Chem. Soc. Perkin Trans. I* **1982**, 681.

- ¹¹⁶ M.-K. Chung, G. Orlova, J. D. Goddard, M. Schlaf, R. Harris, T. J. Beveridge, G. White, F. R. Hallett *J. Am. Chem. Soc.* **2002**, *124*, 10508.
- ¹¹⁷ F. W. Lichtenthaler, J. Klotz, F.-J. Flath *Liebigs Ann. Chem.* **1995**, 2069.
- ¹¹⁸ N. Nakajima, M. Matsumoto, M. Kirihara, M. Hashimoto, T. Katoh, S. Terashima *Tetrahedron* **1996**, *52*, 1177.
- ¹¹⁹ A. Tatibouët, S. Lawrence, P. Rollin, G. D. Holman *Synlett* **2004**, *11*, 1945.
- ¹²⁰ C. A. Centrone, T. L. Lowary *J. Org. Chem.* **2002**, *67*, 8862.
- ¹²¹ S. Desvergnès, Y. Vallée, S. Py *Org. Lett.* **2008**, *10*, 2967.
- ¹²² M. Franck, R. Miethchen, D. Degenring *Carbohydr. Res.* **1999**, *318*, 167.
- ¹²³ (a) K. Krohn, D. Gehle, U. Flörke *Eur. J. Org. Chem.* **2005**, 4557; (b) M. Samadi, C. Munoz-Letelier, S. Poigny, M. Guyot *Tetrahedron Lett.* **2000**, *41*, 3349.
- ¹²⁴ (a) I. Izquierdo Cubero, M. T. P. López-Espinosa *Carbohydr. Chem.* **1986**, *5*, 299; (b) Y. Bechor, A. Albeck *Tetrahedron* **2008**, *64*, 2080.
- ¹²⁵ S. Mio, Y. Kumagawa, S. Sugai *Tetrahedron* **1991**, *47*, 2133.
- ¹²⁶ V. Douard, R. P. Ferraris *Am. J. Physiol. Endocrinol. Metab.* **2008**, *295*, 227 and references cited therein.
- ¹²⁷ J. L. Evans, J. F. Youngren, I. D. Goldfine *Trends in Endocrinology and Metabolism* **2004**, *15*.
- ¹²⁸ Zhang, D. E. Moller *Current Opinion in Chemical Biology* **2000**, *4*, 461.
- ¹²⁹ A. Oku, K. Ueta, M. Nawano, K. Arakawa, T. Kano-Ishihara, M. Matsumoto, A. Saito, K. Tsujihara, M. Anai, T. Asano *Eur. J. Pharmacol.* **2000**, *391*, 183.
- ¹³⁰ B. L. Mylari, S. J. Armento, D. A. Beebe, E. L. Conn, J. B. Coutcher, M. S. Dina, M. T. O’Gorman, M. C. Linhares, W. H. Martin, P. J. Oates, D. A. Tess, G. J. Withbroe, W. J. Zembrowski *J. Med. Chem.* **2005**, *48*, 6326.
- ¹³¹ G. W. Gould, G. D. Holman *Biochem. J.* **1993** *295*, 329.
- ¹³² (a) M. Uldry, B. Thorens *Eur. J. Physiol.* **2004**, *447*, 480; (b) E. M. Wright, M. G. Martin, E. Turk *Best Practice Research Clinical Gastroenterology*, **2003**, *17*, 943; (c) I. Stuart Wood, P. Trayhurn *British J. Nutrition*, **2003**, *89*, 3; (d) H. G. Joost, B. Thorens *Mol. Memb. Biol.* **2001**, *18*, 247.
- ¹³³ H. S. Hundal, F. Darakhshan, S. Kristiansen, S. J. Blakemore, E. A. Richter *Adv. Exp. Med. Biol.* **1998**, *441*, 35.
- ¹³⁴ V. Douard, R. P. Ferraris *Am. J. Physiol. Endocrinol. Metab.* **2008**, *295* (2), 227.
- ¹³⁵ M. H. Stipanuk *Biochemical, Physiological, and Molecular Aspects of Human Nutrition* **2006**, W. B. Saunders, Philadelphia, PA. 2nd Edition.
- ¹³⁶ A. E. Buchs, S. Sasson, H. G. Joost, E. Cerasi *Endocrinology* **1998**, *139* (3), 827.
- ¹³⁷ T. Fujisawa, J. Riby, N. Kretchmer *Gastroenterology* **1991**, *101*, 360.
- ¹³⁸ K. Ushijima, T. Fujisawa, J. Riby, N. Kretchmer *Journal of Nutrition* **1991**, *125*, 2156.
- ¹³⁹ (a) M. I. Borges-Walmsley, A. R. Walmsley *Trends Microbiol.* **2001**, *2*, 71; (b) V. H. L. Lee *Eur. J. Pharm. Sci.* **2000**, *11*, S41.
- ¹⁴⁰ M. Hashimoto, J. Yang, G. D. Holman *ChemBioChem.* **2001**, *2*, 52.
- ¹⁴¹ G. Dorman, G. D. Prestwich *Trends Biotechnol.* **2000**, *18*, 64.
- ¹⁴² M. Hashimoto, Y. Hatanaka, J. Yang, J. Dhesi, G. D. Holman *Carbohydr. Res.* **2001**, *331*, 119.
- ¹⁴³ M. G. Ettliger *J. Am. Chem. Soc.* **1950**, *72*, 4792; (b) H. J. Eichel, R. J. Meyer, P. F. Buzzi *J. Med. Chem.* **1967**, *10*, 942.
- ¹⁴⁴ D. Lednicer, D. E. Emmert *J. Med. Chem.* **1968**, *11*, 1258.
- ¹⁴⁵ G. A. Johnson, E. G. Kim, S. J. Boukma, D. Lednicer, G. A. Youngdale *J. Med. Chem.* **1972**, *15*, 327.
- ¹⁴⁶ P. Seneci, M. Caspani, F. Ripamonti, R. Ciabatti *J. Chem. Soc., Perkin Trans. 1* **1994**, *16*, 2345.
- ¹⁴⁷ N. Gandhi, B. K. Srivastava, V. B. Lohray, B. B.; Lohray *Tetrahedron Lett.* **2004**, *45*, 6269-6272.
- ¹⁴⁸ (a) J. F. Plouffe *Clinical Infectious Diseases* **2000**, *31*, S144; (b) D. J. Diekema, R. N. Jones *Drugs* **2000**, *59*, 7; (c) J. W. Chien, M. L. Kucia, R. A. Salata *Clinical Infectious Diseases* **2000**, *30*, 146.

- ¹⁵⁰ (a) A. W. Bauer, W. M. Kirby, J. C. Sherris, M. Turck *The American Journal of Clinical Pathology* **1966**, *45*, 493; (b) CLSI, *Performance standards for antimicrobial disk susceptibility tests* **2006**, 9th edition, M2-A9, Clinical and Laboratory Standards Institute, USA; (c) F. V. M. Silva, M. Goulart, J. Justino, A. Neves, F. Santos, J. Caio, S. Lucas, A. Newton, D. Sacoto, E. Barbosa, M. S. Santos, A. P. Rauter *Bioorg. Med. Chem.* **2008**, *16*, 4083.
- ¹⁵¹ (a) R. L. Freshney *Culture of Animal Cells: A Manual of Basic Techniques* **2000** Wiley-Liss: New York; (b) J. A. Plumb, R. Milroy, S. B. Kaye *Cancer Res.* **1989**, *49*, 4435.

LIGAÇÃO SELECTIVA DE TIONOCARBAMATOS CÍCLICOS EM CETOHEXOSES

Uma simples reacção como a condensação de ácido tiociânico com uma cetohexose pode levar à formação de 10 oxazolidinetionas (OZTs) ou oxazolinetionas (OXTs) diferentes. A questão é “como lidar com esta química tão complexa?” O controlo cuidadoso das condições de reacção associado a sequências de purificação incluindo protecções selectivas e diversas funcionalizações podem certamente ser úteis. Um jogo químico subtil e estimulante foi desenvolvido entre pré- e pós-protecções selectivas e reacções originais de funcionalização. Neste trabalho de doutoramento, dedicámo-nos a estudar novas tácticas de síntese e de purificação para aceder a OZTs e oxazolidinonas (OZO) ligadas a cetohexose. Estes trabalhos foram aplicados à série D-fructo e seus epímeros, D-psico e D-tagato, cuja química tem sido pouco explorada em comparação com outras séries de monossacarídeos. Deste modo foi possível um melhor controlo das abordagens químicas para aceder a estes tionocarbamatos sacarídicos e assim valorizar estas moléculas para as quais o interesse tanto do ponto de vista biológico como químico é importante. Nestes estudos, foi desenvolvida uma biblioteca de formas tautoméricas fixas de compostos híbridos que foram submetidos a testes biológicos. Assim, este grupo de compostos foi objecto de testes antimicrobianos cujos resultados foram muito interessantes. Além disso, os melhores inibidores de GLUT5 serão utilizados no desenvolvimento de novas ferramentas bioquímicas para uma melhor compreensão dos papéis desempenhados por este transportador de D-frutose em relação à diabetes tipo 2 e à obesidade.

Oxazolidinetionas; oxazolidinonas; cetohexoses; D-fructose; D-psicose; D-tagatose; tionocarbamatos

Ana Catarina SIMÃO

ANCRAGES SELECTIFS SUR CETOHEXOSES DE THIONOCARBAMATES CYCLIQUES

Une réaction simple de condensation de l'acide thiocyanique avec un cétohexose peut conduire à la formation d'une dizaine de 10 oxazolidinethiones (OZTs) ou oxazolinethiones (OXTs) distinctes. La question que nous nous sommes posée a été "comment gérer une chimie aussi complexe?" Un contrôle attentif des conditions de réaction, associé à des séquences de purification comportant des protections sélectives et diverses fonctionnalisations, peuvent certainement être utiles. Un jeu chimique subtil et stimulant a été développé entre des pré- et post-protections sélectives et des réactions originales de fonctionnalisation. Dans ce travail de thèse, nous avons mis à l'étude de nouvelles tactiques de synthèse et de purification pour accéder à des OZTs et des oxazolidinones (OZO) ancrées sur des charpentes des cétohexoses. Ces travaux ont été mis en application notamment en série D-fructo et dans les séries épimères D-psico et D-tagato dont la chimie ont été peu explorée en comparaison d'autres séries monosaccharidiques. Nous avons ainsi mieux maîtrisé les approches chimiques permettant d'accéder à ces thionocarbamates saccharidiques et ainsi de valoriser ces molécules dont l'intérêt d'un point de vue biologique et chimique est important. Dans ces études, nous avons élaboré une bibliothèque de formes tautomères fixes de composés hybrides qui ont été soumis à des essais biologiques. Ainsi, ce groupe de composés a fait l'objet de tests antimicrobiens, livrant des résultats très intéressants. Par ailleurs, les meilleurs inhibiteurs de GLUT5 seront utilisés dans le développement de nouveaux outils biochimiques pour une meilleure compréhension des rôles joués par ce transporteur du D-fructose en relation au le diabète de type 2 et de l'obésité.

Oxazolidinethiones; oxazolidinones; cétohexoses; D-fructose; D-psicose; D-tagatose; thionocarbamates

SELECTIVE ANCHORING OF CYCLIC THIONOCARBAMATES ON KETOHEXOSES

A simple condensation reaction of thiocyanic acid with a ketohexose can provide a library of up to 10 different molecules composed of oxazolidinethiones (OZTs) or oxazolinethiones (OXTs). The question arising is "how to manage such a complex chemistry?" Careful control of the reaction conditions associated with purification sequences (involving selective protection or functionalization) can certainly help. A subtle and challenging chemical game could be played between selective pre- and post-protections and original functionalizing reactions. In this PhD work, we disclose the development of new chemical and purification tactics to access OZTs and oxazolidinones (OZO) anchored onto ketohexose scaffolds, namely D-fructo and its epimers D-psico, D-tagato, whose chemistry has been poorly investigated in comparison with other monosaccharidic systems. Furthermore we have improved our understanding about saccharidic thionocarbamates chemistry for a better valorization from both chemical and biological point of view. We have generated a library of fixed tautomeric forms of hybrid compounds to be submitted to biological tests. This panel of compounds was subjected to antimicrobial screening and some molecules have shown very efficient effects. Moreover, the leading inhibitors of GLUT5 will be used in the development of biochemical tools for a better comprehension of the role of this D-fructose transporter in relation to type 2 diabetes and obesity.

oxazolidinethiones; oxazolidinones; ketohexoses; D-fructose; D-psicose; D-tagatose; thionocarbamates



ICOA – Institut de Chimie Organique et Analytique
UMR 6005 - UFR Sciences - BP 6759 - rue de Chartres
45067 Orléans Cedex 2t6

