



**HAL**  
open science

# Localization in Wireless Sensor Networks: Communication Protocols and Energy Efficiency

Sadaf Tanvir

► **To cite this version:**

Sadaf Tanvir. Localization in Wireless Sensor Networks: Communication Protocols and Energy Efficiency. Networking and Internet Architecture [cs.NI]. Université de Grenoble, 2010. English. NNT : . tel-00473480

**HAL Id: tel-00473480**

**<https://theses.hal.science/tel-00473480>**

Submitted on 15 Apr 2010

**HAL** is a multi-disciplinary open access archive for the deposit and dissemination of scientific research documents, whether they are published or not. The documents may come from teaching and research institutions in France or abroad, or from public or private research centers.

L'archive ouverte pluridisciplinaire **HAL**, est destinée au dépôt et à la diffusion de documents scientifiques de niveau recherche, publiés ou non, émanant des établissements d'enseignement et de recherche français ou étrangers, des laboratoires publics ou privés.

# UNIVERSITE DE GRENOBLE

No attribué par la bibliothèque

--	--	--	--	--	--	--	--	--	--

## THÈSE

pour obtenir le grade de

**DOCTEUR DE UDG**

Spécialité : Informatique : Systèmes et Logiciels

préparée au laboratoire LIG

dans le cadre de l'École Doctorale

**Mathématiques, Sciences et Technologies de l'Information**

présentée et soutenue publiquement par

Sadaf TANVIR

25 Mars 2010

## **Localisation dans les Réseaux de Capteurs - Protocoles de Communication et Efficacité Energetique**

-----  
Directeur de thèse: M. Andrzej Duda

Co-encadrant: M. Benoît Ponsard

### **JURY**

President: M. Jacques Mossière

Rapporteur: M. Congduc Pham

Rapporteur: M. Fabrice Valois

Examineur: M. Guillaume Chelius

Directeur de thèse: M. Andrzej Duda

Co-encadrant: M. Benoît Ponsard

To my father late M. Ashraf Tanvir

## Acknowledgements

First of all, I would like to thank Almighty Allah, the most benevolent, the most merciful who's favors enabled me to reach up to here in life. As said in the Holy Qur'an "If ye would count up the favors of Allah, never would ye be able to number them: for Allah is Oft-Forgiving, Most Merciful" (verse 18, sura 16) I find my self deeply in debt to His blessings which I will never be able to pay off.

I express my sincere gratitude to my parents, my mother who has always facilitated me during my academic pursuits and my father who is no longer in this world but who's constant encouragement and guidance has brought me to this achievement. May his soul rest in peace (Ameen)

I am thankful to my thesis co-advisor, M. Benoit Ponsard for taking me as his student and giving me the opportunity to do research. He has seen me going through both happy and sad phases during these three years and has always been a source of motivation for me. I have learned a lot from him.

I am equally grateful to my thesis advisor Prof. Andrzej Duda for his valuable guidance and patience during my research work.

Thanks to my husband for his help, cooperation and patience specially during the last months of my thesis when he was himself busy in finalizing his research. I am specially thankful to our son Ibrahim who joined us in the third year of our thesis but has always been a well-behaved baby.

This work could not have been possible without a conducive and friendly environment. I am thankful to all of my friends and colleagues who made our stay in Grenoble a memorable experience.

Sadaf Tanvir

## **Abstract**

This thesis deals with localization and energy consumption in Wireless Sensor Networks (WSN). Localization in WSN can be seen as a distributed process with three main steps 1) internode information exchange to estimate distance between unlocalized nodes and reference nodes, 2) node's position estimation and refinement, 3) propagation of localization process network wide. Communication cost is the major source of energy consumption during localization process in WSN. The scope of this thesis is to study the energy consumption in communication in step 1 and 3 of the localization process. Carrying out WSN localization is a cooperative process throughout the whole network. There are many ways of organizing this cooperation. We propose three such possibilities in the form of our contributed protocols. Cooperation among distributed nodes generates many radio transmissions. Radio broadcasting is often seen as a drawback in WSN because of overhearing. Here we turn this drawback into a key feature to improve energy consumption during localization. We analyze our protocols' convergence condition, propagation, speed and communication cost with a simulation tool. We show that one of our approaches which takes the most benefit from overhearing, outperforms the other two both in terms of convergence speed and communication cost.



# Contents

<b>1</b>	<b>Introduction</b>	<b>2</b>
1.1	Motivation and Objectives . . . . .	3
1.1.1	Thesis Outline . . . . .	4
<b>2</b>	<b>Localization in WSNs</b>	<b>7</b>
2.1	A Sensor node . . . . .	7
2.1.1	Sensor node Hardware . . . . .	7
2.1.2	Sensor node Software . . . . .	10
2.2	The Process of Localization . . . . .	10
2.2.1	Global Positioning System . . . . .	11
2.3	Coordinate Systems . . . . .	12
2.4	Taxonomy of Localization Process . . . . .	13
2.4.1	Exogenous Approach . . . . .	13
2.4.2	Endogenous Approach . . . . .	14
2.5	The Localization Process . . . . .	14
2.5.1	Classification of 1-hop Measurement Techniques . . . . .	16
2.5.2	Local Process . . . . .	21
2.5.3	Global Process . . . . .	22
2.5.4	Position Refinement . . . . .	32
2.5.5	Medium Access Control (MAC) . . . . .	32
2.6	Energy in a Sensor Network . . . . .	33
2.6.1	Energy Consumption at Microcontroller level . . . . .	34
2.6.2	Energy Consumption at Communication level . . . . .	34
2.6.3	Energy consumption at computation vs. communication level . . . . .	35
2.6.4	Energy Efficient Communication for WSNs . . . . .	35
2.6.5	Energy Efficient Localization in WSNs . . . . .	35
2.7	Conclusion . . . . .	36
<b>3</b>	<b>Beacon Based Localization Protocol</b>	<b>40</b>
3.1	Introduction . . . . .	40
3.2	Assumptions . . . . .	40
3.3	The Radio Communication Model . . . . .	41
3.4	MAC protocol . . . . .	41
3.5	Communication Energy Model . . . . .	41
3.6	1-hop Measurement Phase . . . . .	42
3.7	Local Process Phase . . . . .	43
3.8	Two Way Ranging (TWR) Implementation . . . . .	43
3.9	BBLP's Implementation . . . . .	44

3.9.1	OPNET . . . . .	44
3.9.2	BBLP's Implementation Details . . . . .	44
3.10	Performance Evaluation . . . . .	49
3.10.1	Network Generation . . . . .	52
3.10.2	Protocol's Convergence . . . . .	52
3.10.3	State Change Delay of Nodes across the Network . . . . .	58
3.10.4	Isotropic Propagation of the Process . . . . .	59
3.10.5	Protocol's Propagation Time . . . . .	59
3.10.6	Protocol's Convergence Speed vs. Packet Interarrival Rate . . . . .	61
3.10.7	Communication Cost . . . . .	63
3.10.8	Effect of Additional Anchor Nodes . . . . .	70
3.11	Conclusion . . . . .	73
<b>4</b>	<b>Continuous Ranging Localization Protocol</b>	<b>75</b>
4.1	Introduction . . . . .	75
4.2	1-hop Measurement Phase . . . . .	75
4.3	Local Process Phase . . . . .	76
4.4	CRLP's Implementation . . . . .	76
4.5	Performance Evaluation . . . . .	77
4.5.1	Protocol's Convergence . . . . .	77
4.5.2	State Change Delay of Nodes across the Network . . . . .	77
4.5.3	Isotropic Propagation . . . . .	78
4.5.4	Protocol's Propagation Time . . . . .	80
4.5.5	Protocol's Convergence Speed vs. Interarrival Rate . . . . .	80
4.5.6	Communication Cost . . . . .	81
4.5.7	Effect of Additional Anchor Nodes . . . . .	88
4.6	Conclusion . . . . .	91
<b>5</b>	<b>Optimized Beacon Protocol</b>	<b>93</b>
5.1	Introduction . . . . .	93
5.2	1-hop Measurement Phase . . . . .	93
5.3	Local Process Phase . . . . .	94
5.4	OBP's Implementation . . . . .	94
5.5	Performance Evaluation . . . . .	94
5.5.1	Protocol's Convergence . . . . .	94
5.5.2	State Change Delay of Nodes across the Network . . . . .	96
5.5.3	Effect of Delay $\Delta t$ . . . . .	96
5.5.4	Isotropic Propagation of the Process . . . . .	98
5.5.5	Protocol's Propagation Time . . . . .	98
5.5.6	Protocol's Convergence Speed vs. Packet Interarrival Rate . . . . .	98
5.5.7	Communication Cost . . . . .	98
5.6	Conclusion . . . . .	108
<b>6</b>	<b>Conclusions</b>	<b>112</b>
6.1	Future Directions and Perspectives . . . . .	113
	<b>Appendices</b>	<b>114</b>
<b>A</b>		<b>115</b>



<b>B</b>	<b>120</b>
<b>C</b>	<b>124</b>
<b>D</b>	<b>130</b>
<b>Glossary</b>	<b>131</b>

# List of Figures

2.1	WSN430 of Worldsens . . . . .	7
2.2	Hardware Components of a sensor node [31]. . . . .	8
2.3	WSN monitoring seismic activity [75]. . . . .	9
2.4	Localization using GPS . . . . .	12
2.5	Localization Block Diagram . . . . .	15
2.6	AoA Technique . . . . .	17
2.7	Distance estimation using TDoA technique . . . . .	18
2.8	UN located at the intersection of hyperbolas . . . . .	19
2.9	Principle of Two Way Ranging . . . . .	20
2.10	Symmetric Double Sided Two Way Ranging . . . . .	21
2.11	DV-hop correction factor [46] . . . . .	23
2.12	Ill-connected node [60] . . . . .	24
2.13	Regular mesh of reference nodes[27] . . . . .	25
2.14	APIT Overview[21] . . . . .	26
2.15	Localization through trilateration . . . . .	27
2.16	Localization through triangulation . . . . .	29
2.17	Localization through Min-max [63] . . . . .	30
2.18	<i>Euclidean</i> Propagation Method [35]. . . . .	31
2.19	Sensor Node's Energy Consuming Components . . . . .	33
3.1	State transition Diagram for Our MAC protocol . . . . .	42
3.2	Two Way Ranging using Beacon Messages . . . . .	42
3.3	OPNET's Sensor Network . . . . .	45
3.4	OPNET Node Model for BBLP . . . . .	45
3.5	Sensor Node's State Control Module for BBLP . . . . .	46
3.6	BBLP's Source Attributes . . . . .	47
3.7	BBLP: Packet Format . . . . .	48
3.8	BBLP using random delays . . . . .	49
3.9	TWR in OPNET: $AN_1$ unicasts ACK to $UN_1$ instead of a BP . . . . .	50
3.10	TWR in OPNET contd. $AN_3$ replies to the latest RP by $UN_1$ . . . . .	51
3.11	TWR with two UNs in OPNET: Ranging initiated by $UN_1$ . . . . .	53
3.12	TWR with two UNs in OPNET contd.: Ranging initiated by $UN_2$ however $AN_2$ was waiting to reply to $UN_1$ . . . . .	54
3.13	TWR with two UNs in OPNET contd.: Ranging for $UN_2$ gets completed . . . . .	55
3.14	BBLP: Phase Transition . . . . .	57
3.15	BBLP: Critical Node Degree . . . . .	57
3.16	BBLP: Mean Node Degree vs. State Change Delay of Last Node . . . . .	58
3.17	BBLP: Propagation speed . . . . .	59
3.18	BBLP: Isotropic Propagation . . . . .	60

3.19	BBLP: Propagation Time . . . . .	61
3.20	BBLP: Propagation Time near Critical Node Degree . . . . .	62
3.21	BBLP: Convergence Speed vs. Packet Interarrival Rate . . . . .	62
3.22	BBLP: No. of All Transmitted Packets . . . . .	63
3.23	BBLP: No. of Received Packets . . . . .	64
3.24	BBLP: Mean Node Degree vs. No. of Transmitted Packets . . . . .	69
3.25	BBLP: Mean Node Degree vs. No. of Received Packets . . . . .	69
3.26	BBLP: Increase in Propagation Time with Large Node Degree . . . . .	70
3.27	BBLP: Placement of Additional ANs Across the Network . . . . .	71
3.28	BBLP: Effect of Additional ANs on Protocol's Convergence Speed . . . . .	71
3.29	BBLP: State Change Delay in the Presence of Additional ANs . . . . .	72
4.1	Two Way Ranging using Range Messages . . . . .	76
4.2	BBLP vs. CRLP: Phase Transition . . . . .	77
4.3	BBLP vs. CRLP: State Change Delay of Nodes across the Network . . . . .	78
4.4	BBLP vs. CRLP: Propagation Time . . . . .	78
4.5	CRLP: Isotropic Propagation . . . . .	79
4.6	BBLP vs. CRLP: Propagation Time near the critical node degree . . . . .	80
4.7	BBLP vs. CRLP: Convergence Speed vs. Interarrival Rate . . . . .	81
4.8	CRLP: Transmitted Packets across the Network . . . . .	82
4.9	CRLP: Received Packets across the Network . . . . .	83
4.10	BBLP vs. CRLP: Transmissions from Node Perspective . . . . .	86
4.11	BBLP vs. CRLP: Receptions from Node Perspective . . . . .	87
4.12	BBLP vs. CRLP: Transmissions from Network Perspective . . . . .	87
4.13	BBLP vs. CRLP: Receptions from Network Perspective . . . . .	87
4.14	BBLP vs. CRLP: Mean Node Degree vs. No. of Transmitted Packets . . . . .	88
4.15	BBLP vs. CRLP: Mean Node Degree vs. No. of Received Packets . . . . .	89
4.16	BBLP vs. CRLP: Effect of Additional ANs on Protocol's Convergence Speed . . . . .	89
4.17	CRLP: State Change Delay in the Presence of Additional ANs . . . . .	90
5.1	Two Way Ranging in Optimized Beacon Protocol . . . . .	94
5.2	BBLP vs. CRLP vs. OBP: Phase Transition . . . . .	95
5.3	OBP: Critical Node Degree for Large Networks . . . . .	95
5.4	BBLP vs. CRLP vs. OBP: State Change Delay of Nodes Across the Network . . . . .	96
5.5	OBP: Delay vs. % of localized nodes . . . . .	97
5.6	OBP: Delay vs. OBP's Propagation Time . . . . .	97
5.7	OBP: Isotropic Propagation . . . . .	99
5.8	BBLP vs. CRLP vs. OBP: Propagation Time . . . . .	100
5.9	BBLP vs. CRLP vs. OBP: Propagation Time near critical node degree . . . . .	100
5.10	BBLP vs. CRLP vs. OBP: Convergence Speed vs. Interarrival Rate . . . . .	101
5.11	OBP: No. of Transmitted Packets . . . . .	102
5.12	OBP: No. of Received Messages . . . . .	103
5.13	BBLP vs. CRLP vs. OBP: Transmissions from Node Perspective . . . . .	106
5.14	BBLP vs. CRLP vs. OBP: Receptions from Node Perspective . . . . .	106
5.15	BBLP vs. CRLP vs. OBP: Transmissions from Network Perspective . . . . .	106
5.16	BBLP vs. CRLP vs. OBP: Receptions from Network Perspective . . . . .	107
5.17	BBLP vs. CRLP vs. OBP: Mean Node Degree vs. No. of Transmitted Packets . . . . .	107
5.18	BBLP vs. CRLP vs. OBP: Mean Node Degree vs. No. of Received Packets . . . . .	108
5.19	BBLP vs. CRLP vs. OBP: Effect of Additional ANs on Convergence Speed . . . . .	109
5.20	OBP: Effect of Additional ANs on State Change Delay of Nodes . . . . .	110

A.1	BBLP: Flow Chart . . . . .	115
A.2	BBLP: Flow Chart contd. . . . .	116
A.3	BBLP: Flow Chart contd. . . . .	117
A.4	BBLP: Flow Chart contd. . . . .	118
A.5	BBLP: Finite State Machine . . . . .	119
B.1	CRLP: Flow Chart . . . . .	120
B.2	CRLP: Flow Chart contd. . . . .	121
B.3	CRLP: Flow Chart contd. . . . .	122
B.4	CRLP: Finite State Machine . . . . .	123
C.1	OBP: FFlow Chart . . . . .	124
C.2	OBP: FFlow Chart Cond. . . . .	125
C.3	OBP: FFlow Chart Cond. . . . .	126
C.4	OBP: FFlow Chart Cond. . . . .	127
C.5	OBP: FFlow Chart Cond. . . . .	128
C.6	OBP: Finite State Machine . . . . .	129

# List of Tables

2.1	Power Consumption: Computation vs. Communication . . . . .	36
3.1	Mean Tx Packet count for each Packet Category under BBLP . . . . .	64
3.2	Mean Rx Packet count for each Packet Category under BBLP . . . . .	65
3.3	Mean Rx Packet count for each Packet Category under BBLP . . . . .	65
3.4	Required and Overhead Packets from a Single Node's Perspective under BBLP	66
3.5	Required and Overhead Packets from Entire Network's Perspective under BBLP	67
3.6	Required and Overhead Mean Packet Count from a Single Node's Perspective under BBLP . . . . .	67
3.7	Required and Overhead Mean Packet Count from Whole Network's Perspective under BBLP . . . . .	67
3.8	Required and Overhead Mean Packet Count from a Single Node's Perspective under BBLP(without border nodes) . . . . .	67
3.9	Required and Overhead Mean Packet Count from Whole Network's Perspective under BBLP(without border nodes) . . . . .	68
3.10	Required and Overhead Mean Packet Count from a Single Node's Perspective under BBLP(Strip 100-125m) . . . . .	68
3.11	Required and Overhead Mean Packet Count from Whole Network's Perspective under BBLP(Strip 100-125m) . . . . .	68
4.1	Mean Tx Packet count for each Packet Category under CRLP . . . . .	82
4.2	Mean Rx Packet count for each Packet Category under CRLP . . . . .	83
4.3	Mean Rx Packet count for each Packet Category under CRLP . . . . .	83
4.4	Required and Overhead Packets from a Single Node's Perspective under CRLP	84
4.5	Required and Overhead Packets from Entire Network's Perspective under CRLP	84
4.6	Required and Overhead Mean Packet Count from a Single Node's Perspective under CRLP . . . . .	85
4.7	Required and Overhead Mean Packet Count from Whole Network's Perspective under CRLP . . . . .	85
4.8	Required and Overhead Mean Packet Count from a Single Node's Perspective under CRLP(without border nodes) . . . . .	85
4.9	Required and Overhead Mean Packet Count from Whole Network's Perspective under CRLP(without border nodes) . . . . .	85
4.10	Required and Overhead Mean Packet Count from a Single Node's Perspective under CRLP(Strip 100-125m) . . . . .	86
4.11	Required and Overhead Mean Packet Count from Whole Network's Perspective under CRLP(Strip 100-125m) . . . . .	86
5.1	Mean Tx Packet count for each Packet Category under OBP . . . . .	102

5.2	Mean Rx Packet count for each Packet Category under OBP . . . . .	102
5.3	Mean Rx Packet count for each Packet Category under OBP . . . . .	103
5.4	Required and Overhead Packets from a Single Node's Perspective under OBP	103
5.5	Required and Overhead Packets from Entire Network's Perspective under OBP	104
5.6	Required and Overhead Mean Packet Count from a Single Node's Perspective under OBP . . . . .	104
5.7	Required and Overhead Mean Packet Count from Whole Network's Perspective under OBP . . . . .	104
5.8	Required and Overhead Mean Packet Count from a Single Node's Perspective under OBP(without border nodes) . . . . .	104
5.9	Required and Overhead Mean Packet Count from Whole Network's Perspective under OBP(without border nodes) . . . . .	105
5.10	Required and Overhead Mean Packet Count from a Single Node's Perspective under OBP(Strip 100-125m) . . . . .	105
5.11	Required and Overhead Mean Packet Count from Whole Network's Perspective under OBP((Strip 100-125m) . . . . .	105



# Chapter 1

## Introduction

Today's world is a witness of effective progress in realizing the dream of Ambient Intelligence. Ambient Intelligence or equilaterally pervasive computing is a concept based on environments that are capable of interacting intelligently with human beings. The main idea is to group computing, telecommunication and electronic devices available in an environment in such a way that the environment becomes a helper for human beings in carrying out their desired tasks. The vision of ambient intelligence was conceived in late 90's. Later on, funding and research efforts concretized the idea so that now, we are aware of various technologies involved with this concept. Small and inexpensive sensors nodes are one such required technology.

These sensor nodes are normally deployed in a large number in the region from whom we are interested in getting information. These nodes are either deployed by hand or sprinkled from an air plane. They sense the required information and send it to a sink. The humans can retrieve this information from the sink. This sink may also be a source of connecting a collection of sensors to another network.

The reason behind sensor node's becoming an inevitable device for Ambient Intelligence is the advancement in its enabling technologies. A sensor node essentially consists of three parts: the computation part, communication part and the sensing part. Advancements in the field of Micro Electromechanical Systems (MEMS) have enabled commercial production of cheap and small sized microcontroller and memory chips which consume little energy. These chips have made sensor nodes a reality. Besides, in recent years, the radio transceiver required by sensor nodes for communicating with other devices has also become energy efficient. Similarly, the sensing part of sensor node can be energy efficient as well depending on the application for which the sensor nodes are being deployed. Nonetheless, the small size of nodes requires them to use as little energy as possible out of the total available energy or possibly possess a mechanism of scavenging energy. As a result, the sensor nodes deployed in an environment spend most of their time in inactive/sleep mode and wake up for a very small period to perform their duty in order to live as long as possible.

Many applications have been envisioned for WSNs. Some of the most common ones that are repeatedly referred in the literature are: disaster relief operations where the deployed WSN can inform about accessible regions of a disaster struck area to save lives, environmental and habitat monitoring like measuring pollution in a certain area or observing plant or animal species, designing intelligent buildings which can monitor and control their temperature, humidity and optimize the use of electricity, big machine surveillance where human beings can not reach certain parts of machinery, precision agriculture in which WSNs are deployed



## 1.1 Motivation and Objectives

for precise use of irrigation water and fertilizer, livestock monitoring to observe the health of animals, medicine and health care that may use WSNs for the surveillance of elderly people and monitor drug usage, logistics to keep track of goods during their transport and in traffic monitoring and control.

While performing the desired task of sensing and sending the required environmental data to the base station, a node should be able to communicate with other nodes in its vicinity and collaborate with its neighboring nodes hence forming a network of sensors generally called Wireless Sensor Network (WSN). One of the most important operations of a WSN is its ability to *Self Organize*. The process by which nodes of a WSN know their position with respect to one another is called *localization*. This position can either be relative to a coordinate system defined by some nodes who know their positions *a priori* or to the global coordinate system like GPS. The difficulty is that nodes of a WSN cannot make use of GPS because: 1) of the huge size, 2) high cost, 3) high power consumption of receiver and 4) hindrance caused in reception of GPS signals because of obstacles. Hence, one possible way is that we allow a few nodes (also referred to as *Anchor nodes*) in the literature to make use of GPS and know their position in advance and then help other nodes to localize themselves.

## 1.1 Motivation and Objectives

Sensor nodes in a WSN need to be aware of their positions in order to collaborate effectively. Each node's position information obtained along with the required data can help human beings in a variety of ways. It can enable better interpretation of sensed data by identifying where the data came from. It can aid in determining quality of network coverage. It can help in applications like Geographic Routing or Target movement Monitoring.

However, since the network comprises of a large number of nodes, the process of localization should be carried out distributed by the nodes themselves instead of being executed on a central system and should start automatically right after network's deployment. The challenges while performing this task are that the localization process should converge, it should converge as quickly as possible, nodes should use as little energy as possible and the resulting node position estimates should be of desirable accuracy.

Generally, wireless sensor nodes can communicate using either radio frequency transmission or ultrasound waves. We see many propositions in literature that suggest the use of ultrasound in WSNs. However, its large, energy consuming speaker and short range makes it hard to be used in cheap and energy constrained sensor nodes. Radio Frequency(RF) on the other hand is the most appropriate choice in this regard since it provides long communication range and does not require additional hardware. Communication for localization is carried out by the node's transceiver. Studies have shown that if we compare the computation aspect of a sensor node to its communication aspect to see which operation is more energy consuming, it is the communication aspect that draws most of a sensor node's energy. Therefore, communication among sensor nodes needs to be minimized.

Although, the use of one way time of flight of radio signal for the purpose of localization is possible, its use in WSN has always been considered inappropriate because of the tight synchronization required among transmitter and the receiver. However, radio signal's two way time of flight can relieve the cheap sensor nodes from the burden of synchronization. Recently, this method has been standardized in the IEEE 802.15.4a document.

In this dissertation, we deal with localization in WSNs based on the use of two way time of flight of radio signal for calculating internode distances. We aim at reducing energy consumed

## 1.1 Motivation and Objectives

by nodes during the process of localization particularly in the form of radio communication.

### 1.1.1 Thesis Outline

Next chapter of this dissertation describes the state of the art in which we mainly overview the localization process. We propose our own localization model for WSNs to better elaborate our area of contribution. We then review the various proposals present in the literature for localizing wireless sensor networks. We describe our contributions in chapter 3, 4 and 5 which are three protocols based on two way ranging distance estimation technique. We compare them with one another in terms of convergence condition, convergence speed and communication cost. Chapter 6 concludes this dissertation with possible directions for future work.

## Part I

# Context and State of the Art

## 1.1 Motivation and Objectives

## Chapter 2

# Localization in WSNs

### 2.1 A Sensor node

A WSN is made up of large number of small sensor nodes also called *nodes*. These nodes are deployed randomly and are supposed to have a way of *self organising* them to form a WSN. Figure 2.1 depicts a sensor node developed by Worldsens [77] and is named as WSN430. At present, there are many research groups and companies involved in manufacturing of sensor nodes. [69] contains a list of all known sensor node platforms. Firefly [18], Imote2, Telos and WeBee are just to name a few.



Figure 2.1: WSN430 of Worldsens

A sensor node consists of two main components: A hardware component and a software component. The hardware component consists of a microcontroller, memory chip, communication device, sensor/actuator and power supply. The software component constitutes an operating system and programs to collect the desired data [31]. Figure 2.2 shows the main hardware components of a typical sensor node.

#### 2.1.1 Sensor node Hardware

##### 2.1.1.1 Microcontroller

Microcontrollers that are used in sensor nodes have been specially designed for small inexpensive and energy constrained sensor nodes. They process the gathered data and interact with the communication device and sensor/actuator part to carry out node's duties. Typical

## 2.1 A Sensor node

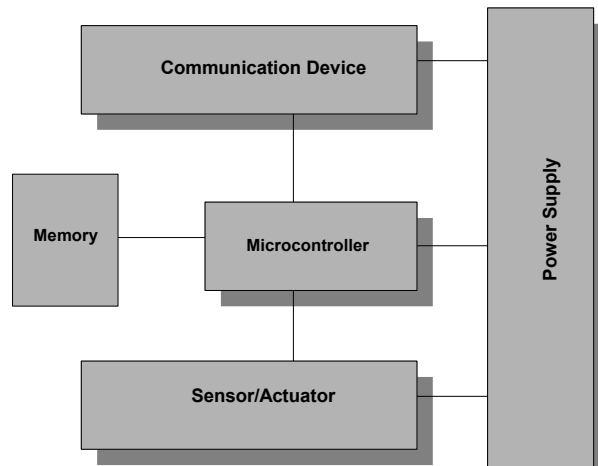

Figure 2.2: Hardware Components of a sensor node [31].

examples of these microcontrollers include Texas Instrument's MSP 430 and ARM's 32 bit chipsets.

### 2.1.1.2 Memory

A sensor node requires both volatile memory and non-volatile memory to carry out its operations. The former one also known as Random Access Memory (RAM) is used to store the gathered data before sending it elsewhere and for storing communication packets from other nodes. The later one also called Read only memory (ROM) or more specifically the flash memory is used to store the program code and the operating system.

### 2.1.1.3 Communication Device

A wireless sensor node needs to connect itself to its peers. These peers can be other sensor nodes like itself or a sink/base station to which it sends the environment data. At present, most nodes use radio frequency as a communication medium between themselves and their counterparts. This internode communication through radio frequency is done by a special device called the *transceiver*.

Although most nodes use radio waves as their medium of communication but some nodes also use nonradio frequency medium for wireless communication. Typical example of communication through nonradio frequency mediums include optical communication and ultrasound. [29] has suggested to make nodes communicate with one another using optical links between them. The authors of this suggestion see the benefit of using very small energy required to send and receive data as light beams. Furthermore, the form factor of nodes equipped with optical communication device is much less than their transceiver based counterparts. On the other hand, this form of communication requires the Line of Sight (LOS) between the sender and the receiver and its performance varies with weather conditions. That's why it is not a preferred choice of communication among the WSN community.

WSNs can be used for monitoring in mediums like water where radio or optical communication are not good options because of their difficulty in propagation. In such a case, ultrasonic waves are used.

## 2.1 A Sensor node

Ultrasound is also used as a mechanism of estimating internode distance. Its details are explained later in this chapter [31].

### 2.1.1.4 Sensor/Actuator

The sensing part of a node is what makes it communicate with its physical environment. Presently, many prototype WSNs are being used for getting desirable information from the environment. To quote a few examples, at Pinjar, Western Australia, WSN is being used for soil moisture monitoring [9]. [75] presents work on seismic monitoring of the Reventador volcano in Ecuador. Figure 2.3 shows the data reported by the WSN. [39] deploys a sensor network for observing the seabirds' nesting near the coast of Maine, USA.

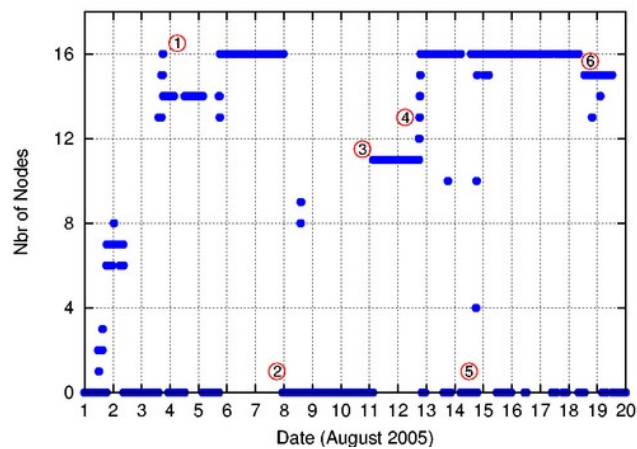

Figure 2.3: WSN monitoring seismic activity [75].

While sensors in a node report about the events taking place in the environment, actuators react upon the reports sent by the sensor part. Although most of the sensor node platforms consists of only the sensing part and not actuator, [49] have gone a step further and have presented the idea of Wireless Sensor and Actuator networks (WSAN). They target to use WSNs in a mobile environment like that of parking lots. Their objective is to use the sensors for sensing vacancy information in a parking lot. This information is communicated to all sensors in the network. The sensor and actuator nodes located at the entrance of a parking lot actuate upon the vacancy information and display it to the user.

### 2.1.1.5 Power Supply

Since the sensor nodes are required to operate unattended for many months/years, they normally use batteries instead of the AC current as a source of power supply. Batteries used by sensor nodes should be cheap, light weight, small and should have a low discharge rate.

#### 2.1.1.5.1 Energy management

Stringent power constraints of sensor nodes demand them to spend most of their time sleeping and wake-up for a very brief period to perform their duties in order to save energy. For this reason, the various sensor node operations like data gathering, data communication to sink

## 2.2 The Process of Localization

node or communication with other nodes is designed to use as little energy as possible. This makes a sensor node and its hardware components operate in various states resulting in variable energy usage. A sensor node's power supply should bear these changing energy usage patterns. Details about energy management are discussed in the last part of this chapter.

In many cases, sensor nodes also have a mechanism of replenishing their used up energy. Some of the ways of scavenging it from the environment are: photovoltaic cells, vibrations, temperature gradient, pressure variations and flow of air/liquid [31].

### 2.1.2 Sensor node Software

Commonly used operating systems for sensor nodes include TinyOS [70], contiki [11] and Nano-RK [69]. TinyOS is the first known attempt to create an operating system dedicated for sensor nodes keeping in view their peculiar characteristics. It was initially conceived to be employed in the *Smartdust* nodes in a joint project of University of California, Berkeley and Intel Research but later on became a great success for most other sensor nodes as well. Presently, it is an open source operating system supported by a huge developer community. TinyOS has a component based architecture that in addition to many other advantages helps in reducing the code size to be stored in the limited memory of sensor nodes.

Contiki is another open source operating system for sensor nodes. Its typical configuration uses 2K of RAM and 40K of ROM. It has an event-driven kernel which dynamically loads and unloads the application programs on runtime. It has been ported on multiple platforms [72]

Nano-Rk is a real-time operating system developed at Carnegie Mellon University. The term "Nano" implies that it consumes a very small amount of memory i.e. 2K of RAM and 18K of flash. "RK" stands for Resource Kernel. Its resource kernel provides a mechanism for managing sensor node's energy by creating a virtual budget for node's resources. It has been designed for FireFly [18] sensor networking platform but can be used by others as well [43].

In short, the above description highlights the fact that the most critical resource in a sensor node is its energy. Its use has to be optimized both in the hardware components of the node and its software part. In the next section, we will describe the process of localization and concepts related to it.

## 2.2 The Process of Localization

The term *Localization* refers to the process by which an object finds its position. History of localization dates back to ancient times when human beings were interested in finding the location of their ships/crafts in oceans. This process is more appropriately called *Navigation*. Sailors belonging to different nations used different ways of navigation. Polynesians used direction of ocean winds and tides and positions of sun, planets, constellations and stars to navigate. Vikings are reported to use coastal lines and a tool called sun compass to know their direction as near North Pole, the sun never sets in summer season making it impossible to use celestial navigation. Ancient Greeks were the first ones to use maps with latitudes and longitudes to calculate position. These advancements led the Arabs and Europeans sailors know how to navigate using a magnetic compass and clock. Progress in the field of aviation and the use of aeroplanes gave birth to air navigation. Later on, the launch of sputnik 1 introduced the possibility of using satellites for navigation. The development of *Transit* system is the first example of its use. Transit also called NAVSAT (Navy Navigation Satellite System) was the first operational satellite navigation system. Developments in this area continued and at present navigation have been revolutionized by the development of Global Positioning System (GPS).



## 2.2 The Process of Localization

### 2.2.1 Global Positioning System

Global positioning system is the Global Navigation Satellite System (GNSS) developed by United States Department of Defense. It became operational in 1995 and since 2000 is fully available for use to anyone having a GPS receiver. It is made up of three major segments:

- Space Segment (SS)
- Control Segment (CS)
- User Segment (US)

The space segment consists of the orbiting satellites and space vehicles. The control segment control and monitors the satellites and their flight paths from control stations located on earth. The user segment consists of the GPS receiver commercially available for use to the users.

GPS system consists of 24 to 32 satellites. GPS satellites are orbiting the Earth at an altitude of 11,000 miles. Each satellite periodically transmits messages containing the time when the message is emitted from the satellite i.e. “time stamp”, satellite’s precise orbital information called “ephemeris” and information about all other GPS satellites, their orbits and positions called “Almanac”. A GPS receiver stores and periodically updates this information.

Figure 2.4 shows how a GPS receiver estimates its position on earth. In order to estimate position, the receiver needs the position of three satellites and its distance from them. The receiver gets satellites’ position from the almanac stored in it. In order to estimate the distance from each satellite, the receiver uses periodic radio signals that it receives from satellites in its view. It uses each signal’s travel delay required to reach it in order to estimate its distance from each satellite by using the technique called “Time difference of arrival (TDoA)”. These estimated distances are then used to calculate the receiver’s location on earth using “trilateration”. The estimated position suffers from satellites’ ephemeris and clock errors, atmospheric effects and multipath effects. Therefore, additional signals from other visible satellites are also used to improve receiver’s position accuracy. Once a receiver knows its position, it is represented in terms of latitude, longitude, and altitude in case WGS84 coordinate system is used and as zone and grid position in meters if UTM coordinate system is used. Section 2.5 of this dissertation discuss TDoA and trilateration, position accuracy and coordinate system in detail.

GPS is presently the most accurate system of providing user location. It is being used world wide in various civil applications like air, marine and ground transportation systems and mobile phone operations like precise time synchronization required for cellular network protocols. Considering the importance of such a location providing system, many countries have proposed their own navigation system. These include “Galileo”, a global navigation system being developed by European Union planned to be operational by 2013, “Beidou” proposed by China which is a regional system and IRNSS proposed by India which is also a regional system covering Asia and Indian Ocean only.

GPS or GPS-like navigation system is a good option for localizing a wireless object that has a reasonable size, computation and communication capabilities. However, it is not an option for nodes of a wireless sensor network because of two main reasons:

- it will consume considerable energy on nodes
- it demands line of sight which is not always available for nodes especially if they are deployed under foliage or any other radio wave obstacle

In the next section, we describe the different coordinate systems that can be used for localizing a wireless sensor network.

## 2.3 Coordinate Systems

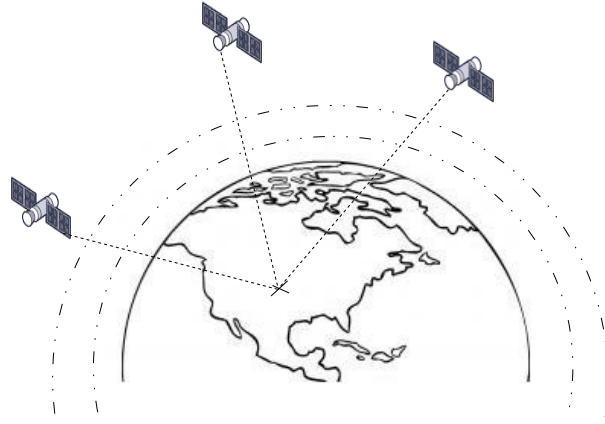

Figure 2.4: Localization using GPS

## 2.3 Coordinate Systems

In order to find the position of any object on earth, we need to have a coordinate system. Many coordinate systems for earth have been defined up to now but the standard one being used since more than two decades is the “WGS84”. WGS84 stands for World Geodetic System that was standardized in 1984. As mentioned previously, it is the same coordinate system that is used by the GPS.

In fact, WGS84 belongs to the family of geodetic coordinate systems which use different ways to model the shape and size of the earth since earth is not a perfect sphere. As shape of the earth resembles an ellipsoid, they use either the Clarke’s ellipsoid model or the International ellipsoid model as the earth’s representation. WGS84 uses the reference ellipsoid that has been described in the Earth’s Gravitational Model 96(EGM96). WGS84 is geocentric with an error of less than a meter. It uses latitude, longitude and altitude to represent the position of an object.

Another important global coordinate system that is being accepted and used more widely is the Universal Transverse Mercator/Universal Polar Stereographic (UTM/UPS). It is different from the previous global coordinate systems in the way they represent location of an object on earth. The previous systems locate an object using three dimensions whereas the UTM uses two dimensions to show an object’s position using a grid. The system uses a series of sixty zones, each of which is based on a specifically defined secant transverse Mercator projection. It uses the WGS84 ellipsoid as the underlying model of the Earth. In the UTM coordinate system, the location is represented by the zone and the easting and northing coordinate pair. In order to locate an object in Polar Regions, the UPS is used in conjunction with the UTM since poles are not covered by the UTM grid.

Any type of global coordinate system is also called the “Absolute coordinate system” since in this system, the position of an object remains the same with respect to any other object. The absolute coordinate system can be used for localizing a wireless sensor network. It suffices to have a few anchor nodes in the network that are already aware of their locations either by manual configuration of their coordinates or through the use of GPS. These anchor nodes then help the unlocalized nodes in finding their respective positions. In this way, the

## 2.4 Taxonomy of Localization Process

whole network will be aligned to the global absolute coordinate system.

However, some researchers have realized that many WSN applications do not require nodes to have precise positions. In such cases, it is appropriate to have a rough estimate of a node's location or to have information that it is located in the vicinity of which nodes. Such a coordinate system is called a "Relative/ Virtual Coordinate System" which is native to the network itself [73], [27] [3]. Anchor nodes in a WSN can rotate, translate or scale the relative coordinate system afterwards to make it coincide with the absolute coordinate system if needed [63].

## 2.4 Taxonomy of Localization Process

Literature about WSN localization can be classified in two main categories:

- Exogenous Approach
- Endogenous Approach

### 2.4.1 Exogenous Approach

Exogenous approach relies on a certain external infrastructure which calculates the positions of nodes and maintains them. Initial works in object localization consisted of exogenous approaches consisting of famous approaches: Active badge [74], Active bat [20] and RADAR [2]

#### 2.4.1.1 Active badge

It is an indoor localization system designed to locate people. It was introduced in 1992. The system works as follows: Each person to be located wears an infra red badge with 6 meters range. The whole indoor area where localization is to be performed is divided into many cells and each cell is equipped with a sensor. The purpose of this sensor is to collect the infra red signal emitted by *Active Badges* worn by people. These Active badges emit signal containing an ID every 10 seconds or on demand. The information collected by room level sensor is then transferred to the central server by a wired network. Active badge faces the following problems: its performance degrades in the presence of white light or florescent light and dead spots (areas in a room where infrared reception is not good), its cell sizes have to be small to cater for the limited range of infra red signal, a limited range of infra red signal demands large rooms to have more than one sensor and scalability issue since it is dependent on an infrastructure.

#### 2.4.1.2 Active bat

Introduced in 1999, in this system, each user or object carries an active bat tag. This tag is capable of emitting ultrasonic waves and short range radio waves. The array of ultrasonic receivers is mounted on the ceiling. They measure the time difference of arrival of the ultrasonic wave with respect to the radio wave by neglecting the time of flight of the radio wave. A Radio Frequency (RF) base station coordinates RF and ultrasonic transmissions so that interference from nearby nodes may be avoided. This time is then converted into distance and then trilateration is performed to get the position of each user/object. This method gives much higher accuracy than Active Badge of 9 cm 95% of time. However, it faces the issues of deployment difficulty of ultrasonic receivers on the ceilings, low scalability because of infrastructure dependence; it is costly, has limited range and is sensitive to ambient conditions because of the use of ultrasonic waves.

## 2.5 The Localization Process

### 2.4.1.3 RADAR

The previous systems that have been discussed above were developed by AT&T. RADAR is a system that has been developed by Microsoft Research group in 2000. It is based on IEEE 802.11 technology that is used in homes these days. It makes use of the infrastructure already deployed for the wireless LANs and use the base stations to measure received Signal Strength (RSS) and signal to noise ratio to get location information. It can localize objects based on lateration or on scene analysis. The system gives an accuracy of 4.3m 50% of time with lateration and of 3m 50% of time with scene analysis. However, in addition to the infrastructure requirement, its downsides are that: the scene analysis must have its database constructed in case of rapid environment change and it requires all devices to have the 802.11 Network Interface Card.

These initially proposed exogenous schemes were targeted to localize objects and people. They did not match well for localizing WSNs because of WSN's peculiar characteristics specially the decentralized nature in which it is much more desirable that every node calculates its position by itself.

### 2.4.2 Endogenous Approach

In Endogenous approach, the nodes may make use of external infrastructure like the constellation of GPS satellites but they calculate and maintain position by themselves. Most of the WSN localization techniques belong to this class.

#### 2.4.2.1 Cricket

Initial work belonging to endogenous localization is the CRICKET system [52]. It was developed in 2000 to complement the previous Active bat system. Its goal was to allow applications running on user devices to learn their physical location. It uses the same ranging technique as active bat but the devices to be localized perform location calculations by themselves which makes the system decentralized and more scalable with respect to the previously proposed systems Active Badge, Active Bat and RADAR. The object's location becomes more private in CRICKET as compared to other systems discussed above. CRICKET can pinpoint objects location in 4x4 feet area almost 100% of time. Its issues include: higher power consumption due to increased computation at node level, limited range and large sensibility to ambient conditions and scalability. Other endogenous localization approaches are categorized as range based and range free and are explained later.

## 2.5 The Localization Process

Extensive study of literature related to localization in WSNs highlights the fact that the endogenous process of sensor node localization takes place in various steps. Most of the localization approaches are proposed independently but they share similarities. [35] has defined the WSN localization in three steps which are as follows:

- estimate the distance between unlocalized nodes and anchor nodes
- use this distance to have an initial estimate of a node's position
- refine this initial estimate by making use of additional internode communication

We fully agree with the generalized three-phase approach deduced above but we classify the process in a slightly different way. Our localization model is shown in figure 2.5 which is

## 2.5 The Localization Process

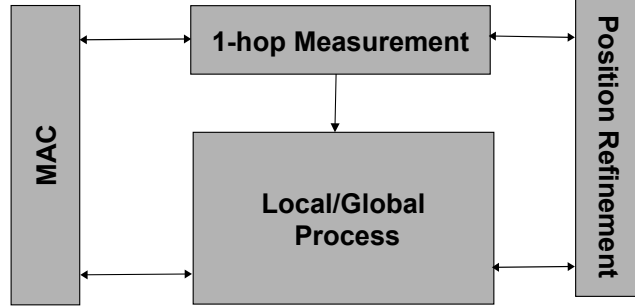

Figure 2.5: Localization Block Diagram

inspired by [13]. The various elements of our conceived localization process are represented in blocks. The process starts by the distance estimation phase between an unlocalized node and the anchor node. We consider that if an unlocalized node wants to have distance estimate with an anchor node located at multiple hops, the unlocalized node  $a$  will communicate with its 1-hop neighbor node which in turn will convey  $a$ 's message to its own one hop neighbor node and so on until the  $a$ 's query reaches the anchor node. We use the notion of 1-hop to highlight the fact that only one hop communication is best suited in WSN localization considering the energy consumption and network congestion issues. The outcome of 1-hop measurement phase is that node  $a$  has got all the raw data that it needs to estimate its distance to the anchor nodes.

The second step of our localization model uses this accumulated raw data to calculate the distance. This is done in the step named as “local process” in the figure 2.5. The phase is named as “local process” because its operations are carried out in the node locally, inside itself. The unlocalized node performs two operations in the local process phase. Firstly, it estimates its distance to the anchor nodes and secondly, it performs computations to have an initial estimate of its position.

After having an initial estimate of the node's position, the node helps its neighboring nodes in localization. This *help* may vary from one localization technique to another but it results is a global process that is carried out across the whole network. In other words, there is the aspect of internode communication that is an important element in the “Global process” phase of our localization process.

The two vertical blocks of fig 2.5 highlight the importance of MAC level message exchange and position refinement in our localization process concept.

Since the 1-hop measurement phase involves distance estimation, it needs to exchange range messages and the global process spreads the localization process network wide which also is based on message exchange, both these phases make use of the wireless medium access control layer.

Position refinement block deals with improving the initial node position estimates. Depending on the proposed localization technique in literature, some proposals attempt to do it in the 1-hop measurement phase while others prefer to do it in the global process phase.

In the following subsections, we describe the blocks of our localization process in detail. For the rest of this dissertation, we assume node localization in two dimensional space. Later in this document we use AN as the abbreviation for anchor nodes, UN for the unlocalized

## 2.5 The Localization Process

nodes and LNs for the unlocalized nodes which have changed their state from unlocalized to localized node.

### 2.5.1 Classification of 1-hop Measurement Techniques

Broadly speaking, there are two ways of getting 1-hop measurement:

- Range-Free Method
- Range-Based Method

#### 2.5.1.1 Range-Free Method

Range free method of estimating internode distance is also referred as *connectivity based* method in which the sensor nodes make use of topology information of nodes to know where they are located. Localization approaches using range free method yield coarse grained position estimates. Some well known range free methods are explained in section 2.5.2.

#### 2.5.1.2 Range-Based Method

Range based methods are also known as *distance based* method and gives fine grained location estimates. There are many ways of estimating distance among nodes. Some of them are explained below:

##### 2.5.1.2.1 Angle of Arrival (AoA) Measurements

One of the ways of estimating distance between a UN and ANs is the angle of arrival (AoA) or direction of arrival (DoA) technique. This technique makes use of a signal's angle between line of sight of a UN and at least two ANs as shown in figure 2.6. It requires highly directional antennas for the communicating nodes. In figure 2.6, a UN receives two signals from  $AN_1$  and  $AN_2$  and estimates its interior angle  $\beta$  with these two anchor nodes. It receives the relevant information from the two ANs. At the end of 1-hop measurement phase, a UN has the collected the following data:

Node IDs	Angle
$AN_1$	$\alpha$
$AN_2$	$\gamma$
UN	$\beta$

This data is then used in triangulation to estimate UN's position. Triangulation is explained later.

Keeping in view the use of highly directional antennas, it is an expensive demand for cheap sensor nodes. Hence, AoA technique is not a preferred choice for ranging in WSN community.

##### 2.5.1.2.2 Received Signal Strength Indicator (RSSI)

Distance between two communicating nodes can be computed by measuring the received signal strength  $P_{rcvd}$  of the radio signal at the receiver. For this, we should know the signal's transmitted power  $P_{tx}$ , the path loss model and the path loss co-efficient  $\alpha$ . The path loss

## 2.5 The Localization Process

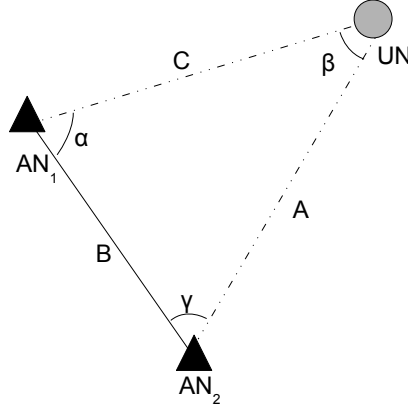

Figure 2.6: AoA Technique

models for radio waves have been standardized by the ITU both for indoor and outdoor environments [55], [54].

$$P_{rcvd} = c \frac{P_{tx}}{d^\alpha} \Leftrightarrow d = \sqrt[\alpha]{\frac{cP_{tx}}{P_{rcvd}}} \quad (2.1)$$

Using RSSI the 1-hop measurement phase results in the accumulation of following information at the sensor node

AN IDs	AN coordinates	RSSI (mW/dBm)
$AN_1$	$AN_1(x_1, y_1)$	$X_1$
$AN_2$	$AN_2(x_2, y_2)$	$X_2$
$AN_3$	$AN_3(x_3, y_3)$	$X_3$

This information is used to estimate distance between the communicating nodes. The attractive features of this approach are that it does not involve extra communication among nodes for localization purposes because simple data transmission signals can serve the purpose. Secondly, no additional hardware is needed to support RSSI. Due to these properties, it has been a favorite choice for many researchers cite [5], [62], [2]. But presently, we know that RSSI suffers from various drawbacks like: error introduction due to multipath fading and environment mobility, impossibility of calibrating cheap radio transceivers which result in same signal strength values giving different RSSI values. Furthermore, cheap sensor node transmitter also exhibit difference in intended transmission power and the actual emitted power. These issues make RSSI yield results with  $\pm 50\%$  errors [31].

### 2.5.1.2.3 Time Difference of Arrival(TDoA)

TDoA uses time difference of arrival of a signal at multiple receivers as shown in the figure 2.7. It is the same technique that is used by GPS receivers to calculate their position on earth. The time difference of arrival between a pair of receivers  $R_i$  and  $R_j$  is given by:

## 2.5 The Localization Process

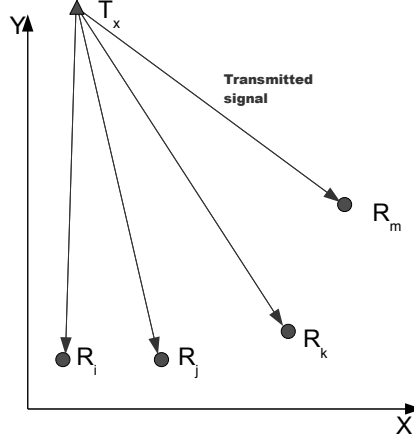

Figure 2.7: Distance estimation using TDoA technique

$$\Delta t_{ij} \triangleq t_i - t_j = \frac{1}{c} (\|\mathbf{r}_i - \mathbf{r}_t\| - \|\mathbf{r}_j - \mathbf{r}_t\|), i \neq j \quad (2.2)$$

where  $t_i$  and  $t_j$  are the time when the signal is received at receivers  $R_i$  and  $R_j$  respectively,  $c$  is signal's propagation speed and  $\|\cdot\|$  is the euclidean norm. A general method of estimating TDoA of a signal of two receivers  $R_i$  and  $R_j$  is to integrate their lag product over a considerable time period  $T$  [40]

$$\rho_{i,j}(\tau) = \frac{1}{T} \int_0^T s_i(t) s_j(t - \tau) dt \quad (2.3)$$

At the end of 1-hop measurement phase, a sensor node has the following data:

AN IDs	AN coordinates	Time
$AN_1$	$AN_1(x_1, y_1)$	$T_1$
$AN_2$	$AN_2(x_2, y_2)$	$T_2$
$AN_3$	$AN_3(x_3, y_3)$	$T_3$

As shown in the figure 2.8, according to equation 2.3, this technique ends up in creating hyperbolas. The receivers (which are ANs in the figure) are the foci of one of the sheets of these hyperbolas and UN is located at their intersection.

### 2.5.1.2.4 Time of Arrival (ToA)

Distance between two nodes can be obtained by recording the propagation delay of a signal between them. Time of Arrival distance measurement technique is also known as Time of Flight (ToF) technique. This technique is used in the GPS satellites to measure their distance from earth. This technique is also used in aircraft radio-altimeters which emit an RF signal and note the time required for it to reflect back to determine aircraft's altitude.



## 2.5 The Localization Process

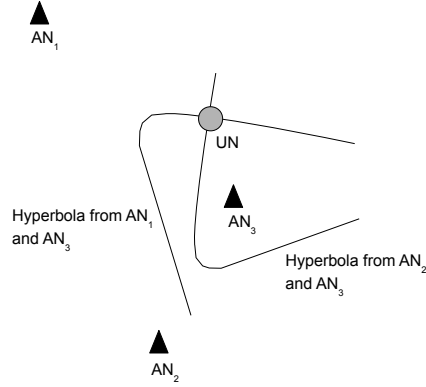

Figure 2.8: UN located at the intersection of hyperbolas

In sensor nodes, this technique can make use of two transmission mediums of different propagation speeds to avoid accurate clock synchronization among the transmitter and receiver. Normally, radio signal with the ultrasound signal are used in combination. The signal speeds differ from one another in about 6 orders of magnitude. It works as follows: the sender transmits the two signals, the radio signal and the ultrasound signal at the same time. The receiver records the time of reception of the radio signal and considers it a reference to observe the arrival of ultrasound signal. Since the propagation delay of radio signal is negligible, this difference of arrivals between two signals can be used to estimate the distance between the sender and the receiver. This mechanism is used in cricket and AHLoS. Its downsides are: the use of ultrasonic transducer mounted on a cheap sensor node that is large in size, short ranged and costly in terms of energy.

### 2.5.1.2.5 Radio Frequency Time of Flight (RF TOF) based Ranging

One way to estimate range between two nodes is to measure the time of flight of a radio signal among them. This time of flight is measured at the physical layer. For such a range signal, messages are exchanged among nodes at the MAC layer. Multiplying the signal propagation time with the speed of light gives us the required range. In case the two nodes have synchronized clocks, only one message is enough to know range. Unfortunately, this is not the case in cheap sensor nodes. Hence they exchange two messages fig 2.9. This mechanism of using RF TOF with two messages is known as the Two Way Ranging (TWR) technique. Since the clocks of two nodes are not synchronized, node A takes its own clock as reference. It starts the session and sends a range request message at time  $T_r$ . Node B receives the message and sends its acknowledgment message after a response delay  $\Delta T$ . Node A receives this acknowledgment message at time instant  $T_a$ . It subtracts the response delay  $\Delta T$  from the signal's propagation time and divides the resulting value by 2 to get one way signal's propagation time. The response delay can either be a fixed value known to node A before hand or node B measures it and sends it back to the node A.

RF TOF based TWR is considered to be a good option for WSNs because it does not involve hardware overhead. The same transceiver used for data communication can be used

## 2.5 The Localization Process

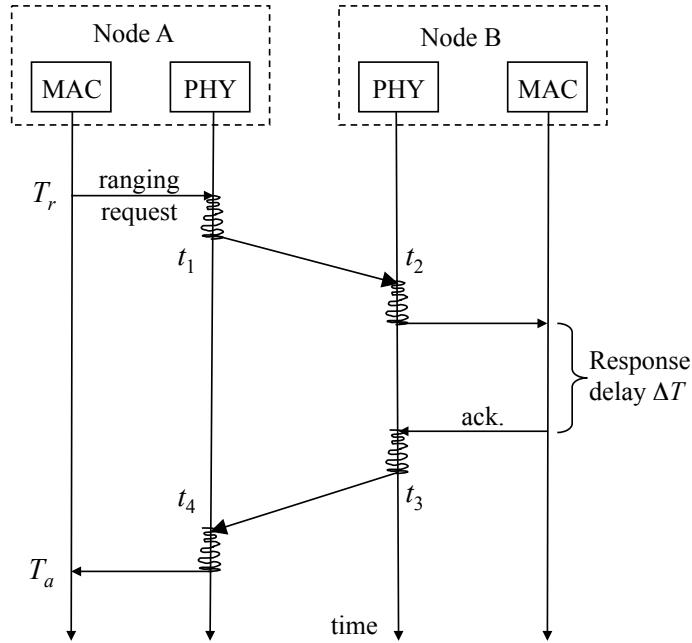

Figure 2.9: Principle of Two Way Ranging

for ranging. Many attempts [36], [30] have been made to study the feasibility of ToA approach in WSNs. Initially, the usage of this technique as a way of estimating internode distance was considered skeptical because of the significant error introduced due to node's clock drift and interference from other signals, noise, or MP propagation during signal's flight in the medium. These issues can be tackled by performing RF TOF Ranging with the Ultra Wide Band (UWB) technology. When a signal is sent on a wide band, it does not suffer from the above mentioned issues. This advancement has been recently standardized by IEEE's 802.15.4a standard that presents a ToF based ranging for sensor nodes.

### *Ultra Wide Band(UWB) Technology*

Ultra-Wideband (UWB) technology has been around since the 1980s, but it has been mainly used in military applications [67]. It is substantially different from the conventional technique of radio communication. In fact there are two main differences: First, the bandwidth of UWB systems, as defined by the Federal Communications Commission (FCC) in [47], is more than 25% of a center frequency. Second, UWB is typically implemented in a carrier less fashion. Federal Communications Commission (FCC) has mandated that UWB radio transmissions can legally operate in the range from 3.1 GHz up to 10.6 GHz, at a limited transmit power of -41dBm/MHz.

The difference between UWB and the traditional "narrowband" systems is that these systems use Radio Frequency (RF) carriers to move the signal in the frequency domain from baseband to the actual carrier frequency where the system is allowed to operate. Conversely, UWB implementations can directly modulate an "impulse" that has a very sharp rise and fall time, thus resulting in a waveform that occupies several GHz of bandwidth.

Generally, there are two methods for generating a UWB waveform e.g. impulse radio(IR) or chirped signal(CS)

Using a UWB transceiver for ranging and data communication in sensor nodes is practical

## 2.5 The Localization Process

because 1)it uses nominal power to generate range pulses 2) the transceiver chip is very small sized hence is low cost. Besides these features, it can also penetrate obstacles which normal narrowband radio signals cannot hence making accurate location estimation possible in congested obstacle rich in-door environment.

*IEEE's 802.15.4 standard*

The possibility of implementing TWR based on UWB has been standardized in IEEE's 802.15.4a 2007 draft.

In cheap sensor nodes, it is difficult to calibrate each node's clock precisely to a predefined frequency. Hence two node's clock often do not have same oscillator frequencies and each clock's frequency changes with time and environmental effects resulting in timing difference among nodes. This clock drift among nodes affects distance measured through TWR. The clock drift values of a node's clock are normally known beforehand and represented in parts per million (ppm). To cope for such errors, annex D1 of 802.15.4a2007 defines a feasible scheme of implementing TWR.

A simple way to avoid the drawback of clock drift is to perform the ranging measurement twice and symmetrical. The first ranging measurement is calculated based on a round trip from node 1 to node 2 and back to node 1. The second measurement is calculated based on a round trip from node 2 to node 1 and back to node 2. This double-sided ranging measurement zeroes out the errors of the first order due to the clock drift. It can be illustrated as in fig 2.10. The SDS-TWR approach provides the required time resolution of one ns using a standard quality crystal of 40 ppm.

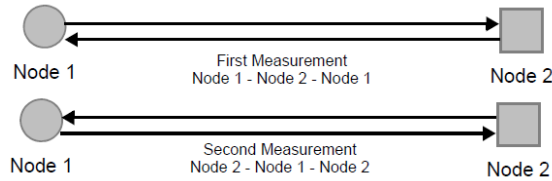

Figure 2.10: Symmetric Double Sided Two Way Ranging

Besides, [78] have proposed an enhancement to the SDS-TWR for nodes who have unequal reply time. [17] propose a Symmetric Multi-Way Ranging (SMWR) method for distance estimation. As claimed, this technique is both energy efficient and is able to combat timing drift.

### 2.5.2 Local Process

The local process phase of localization is made up of two parts:

- Distance estimation
- Initial position estimate

#### 2.5.2.1 Distance Estimation

Once a node has any form of raw information mentioned in section 2.5.1.2, it uses this information to estimate its distance from the anchor nodes which makes up our local process.

## 2.5 The Localization Process

We call this the “local process” because it is carried out in the form of computations locally inside the sensor node and does not involve communication with other nodes.

### 2.5.2.2 Initial position estimate

In this sub phase, the estimated distance is used to compute a node’s coordinates. These coordinates are the initial estimate of node’s position because during the ranging phase, the measurements are contaminated by error arising from multiple sources. These sources include imprecision in the directionality of antennas in case of AoA, calibration of the cheap transceivers and mobile environment in case of RSSI, clock drifts, multipath and diffraction in case of TDoA and ToA. Sensor nodes need to communicate among themselves to reduce these errors. This internode communication carried out to achieve refined position estimates belongs to the global process of our localization model 2.5.

### 2.5.3 Global Process

In the global process, sensor nodes who have computed their initial position estimates help other sensor nodes in getting localized and result in a network wide localization activity. This help can be in different ways depending on the proposed localization scheme. In case of range free localization schemes, the local and global process is very hard to be separated from one another. For this reason, in the following part of this section, we discuss the prominent range free localization approaches and discuss their local and global process together.

#### 2.5.3.1 DV(Distance Vector)-hop

One of the famous range free method of WSN localization is the DV-hop method proposed in [46]. It is similar to the distance vector routing scheme and is executed in two steps: in the first step the anchor nodes deployed in the network broadcast their coordinates to their 1-hop neighboring nodes. The broadcast messages also contain a *hop count* field. Initially this hop count field contains 0. The neighboring nodes rebroadcast these messages after incrementing the hop count field. Each node stores the least number of hops from every anchor in an anchor table. When one AN receives broadcast message of another AN, it estimates its distance from that AN by using coordinates of that AN and divides this distance by the hop count value to get the average distance in meters of one hop.

$$HopSize_i = \frac{\sum \sqrt{(X_i - X_j)^2 + (Y_i - Y_j)^2}}{\sum h_j}, i \neq j \quad (2.4)$$

here  $X_j$  and  $Y_j$  are the coordinates of AN j and  $h_j$  is the distance in hops between AN i and j.

For example, in figure 2.11,  $AN_1$  has coordinates of both  $AN_2$  and  $AN_3$ . With the help of these coordinates, it calculates its distance from  $AN_2=30m$  and  $AN_3=100m$ .  $AN_1$  also knows that  $AN_2$  is located at 2 hops from itself and  $AN_3$  at 5 hops. It calculates the correction as  $\frac{30+100}{2+5} = 18.5$ . It is the average size of one hop.  $AN_2$  and  $AN_3$  computes the average hop size in the same way. These correction values are then broadcasted in the network through controlled flooding. It ensures that each node only has the correction factor of its nearest AN. The UN in figure 2.11 gets correction factor of  $AN_1$  and multiplies it with its path length to  $AN_1$  ( $2 \times 18.5$ ),  $AN_2$  ( $2 \times 18.5$ ) and  $AN_3$  ( $3 \times 18.5$ ) to get its distance in meters from them. These distances are then used to estimate UN’s position.

## 2.5 The Localization Process

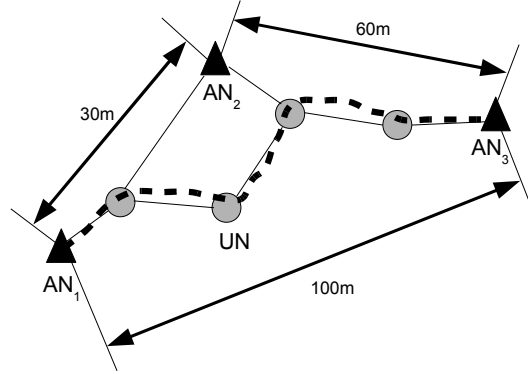

Figure 2.11: DV-hop correction factor [46]

### 2.5.3.2 Hop-TERRAIN

Another localization approach that uses the same idea of number of hops among nodes to estimate distances among them is the HOP-TERRAIN approach proposed in [60]. It has been proposed independently but resembles the DV-hop approach. The HOP-TERRAIN consists of two phases. In the first phase, the nodes get average distance from the anchor nodes in the same way as DV-hop to get their initial position estimate. In the second phase, the initial node position estimate is refined in iterative process. Refinement is a distributed process in which a node exchanges information only with 1-hop neighbors. In this process, a node broadcasts its position estimate, receives position estimates of its neighbors and range estimates between itself and them. It then applies the least squares method to refine its position. It repeatedly does it until the position refinement becomes small. Many factors that influence the convergence of node position refinement process include: initial node position estimate in first phase of HOP-TERRAIN, the magnitude of error in ranging process, the percentage of Anchor nodes in the network and the mean node degree of the network. In order to mitigate the effect of ranging error, each node participating in refinement chooses a confidence weight value for its own position estimate. The Anchor nodes are highly confident about the purity of their positions and hence choose a weight value close to 1. The nodes that become localized with the help of fewer neighbors choose a low weight value close to 0. Now, instead of solving the least square equations of  $Ax=B$ , the approach solves  $wAx=wb$  where  $w$  is the vector of confidence weights. refinement goes on periodically. The incoming information is accumulated but is not processed immediately. The anchor nodes start by broadcasting their position with maximum confidence weight. The newly localized nodes broadcast with least value of confidence weight (0.1) and may increase it at each iteration. After performing the least squares computation, a node sets its confidence weight to the average of the confidence weight of its neighbors. number of refinement iterations is set to a maximum value to terminate the process. The refinement step may fail because of too few

## 2.5 The Localization Process

neighbors or because of the possibility that new position is very close to previous one leading almost no improvement in the position. The approach checks if the node's position lies in the convex region of shortest path between it and the anchor nodes plus the transmission range. In case it not true, node position is set to its initial estimate obtained from the HOP-TERRAIN phase. A residue check is made to see the difference between measured inter node range and the estimated range. The position is accepted if residue is small. In case, when two neighboring nodes having same number of hops from the anchors are assigned same position estimates, one of the two equations is dropped from the least square step to get better position. This inclusion of weights improves the convergence of refinement process and accuracy of node positions. The authors identified that in many topologies, the refinement did not converge due to ill connection of nodes e.g. a node not connected to three other nodes. To avoid this problem, they have introduced the idea of *sound node*. A node is a sound node if it is connected to the three anchor nodes through paths that are disjoint. HOP-TERRAIN records the IDs of sound neighbors on path to each anchor node. In fig 2.12, node 3 is sound but 4 is not. When these IDs count reach 3, the node now becomes a sound node. Its ID can then used by its neighbors to become sound. This technique helps in the convergence of position refinement process in hard to localize network topologies.

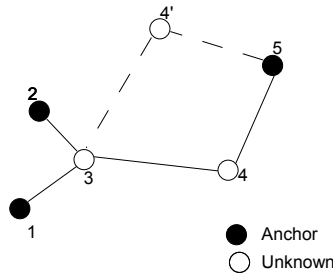

Figure 2.12: Ill-connected node [60]

### 2.5.3.3 Centroid Scheme

Centroid Scheme has been presented in [27]. It considers multiple reference nodes (ANs) deployed in WSN with large overlapping coverage area (labelled  $R_1$  to  $R_n$ ). These anchor nodes are placed at known positions as a regular mesh and they transmit their positions regularly by sending periodic beacon signals fig 2.13. The authors assume that these beacon signals do not collide with one another. They define the connectivity metric as:

$$CM_i = \frac{N_{recv}(i, t)}{N_{sent}(i, t)} * 100 \quad (2.5)$$

where  $N_{sent}$  and  $N_{recv}$  are the number of beacons sent and received by  $R_i$  in time  $t$ . A UN estimates this metric and infers its existence near the ANs with whom the connectivity metric exceeds a certain defined threshold  $CM_{thresh}$  (e.g. 90%). The UN then localizes itself in the region defined by the centroid of these reference nodes  $R_{i1}, R_{i2} \dots R_{ik}$  using the following formula:

## 2.5 The Localization Process

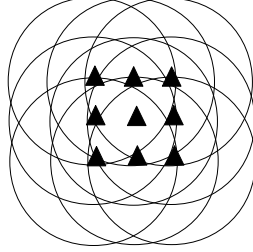

Figure 2.13: Regular mesh of reference nodes[27]

$$(\mathbf{X}_{est}, \mathbf{Y}_{est}) = \left( \frac{\mathbf{X}_{i1} + \dots + \mathbf{X}_{ik}}{k}, \frac{\mathbf{Y}_{i1} + \dots + \mathbf{Y}_{ik}}{k} \right) \quad (2.6)$$

here  $\mathbf{X}_{est}, \mathbf{Y}_{est}$  are the estimated x and y coordinates of the UN.

### 2.5.3.4 Approximate point in Triangulation

[21] presents an *area based* sensor network localization scheme. This scheme works in six steps: 1) UNs hear the beaconing ANs. These ANs are located at the vertices of triangles. A UN stores each AN's ID, its location and signal strengths in a table 2) Each UN exchanges the anchor tables with its 1-hop neighbors once during the execution of the process. These tables are merged in each node to maintain the neighborhood state 3) Each UN is located in the region where many triangles overlap as shown in figure 2.14. Therefore, it performs a Point In Triangulation test (PIT) to narrow down the probable area where it resides. In this test, the UN checks whether it lies outside or inside a certain triangle. 4) Using the high node degree of a WSN, a UN repeatedly performs Approximate PIT test (APIT) in which it considers the information given to it by its neighbors who share the common anchor nodes to decide whether it is inside or outside of a triangle. 5) The results of APIT test are aggregated through a grid SCAN algorithm. In this algorithm, a grid is used to specify the area in which a UN is likely to reside. These APIT tests are repeated with all audible ANs until all combinations are exhausted or the UN has achieved its required accuracy. 6) Finally, each node calculates a center of gravity (COG) of the overlapping area of triangles in which it resides to determine its position.

### 2.5.3.5 Amorphous positioning

Amorphous positioning is another range free localization scheme described in [42]. In one aspect, it is similar to the DV-hop approach because it also uses the hop count values of each UN to the anchor node. It consists of two parts: 1) The first part constitutes *Gradient* propagation in which the seed nodes(ANs) propagate their location information including the hop count field so that UNs can estimate their distances from them. 2) These distances are then used in multilateration to estimate a UN's position.

In this scheme, the maximum physical distance of a communication hop  $r$  is fixed. The authors consider that the sensor nodes are placed according to a uniform random distribution

## 2.5 The Localization Process

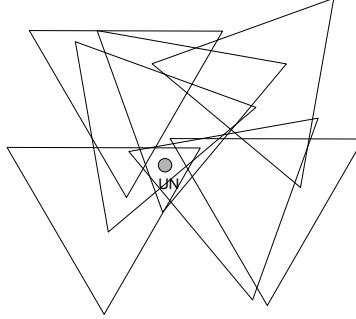

Figure 2.14: APIT Overview[21]

on a square unit plane. and use the Kleinrock and Slivester formula:

$$d_{hop} = r(1 + e^{-n_{local}} - \int_{-1}^1 e^{-\frac{n_{local}}{\pi} (\arccost-t\sqrt{1-t^2})} dt) \quad (2.7)$$

which develops a relationship between the distance covered in one hop  $d_{hop}$  and the parameters of random distribution. Equation 2.7 shows that  $d_{hop}$  depends only on the expected local neighborhood  $n_{local}$  of a node and not on the number of sensors in the network keeping the node density constant. If the local neighborhood  $n_{local}$  is sparse, the per hop distance covered is small and the network is disconnected but when  $n_{local}$  increases, it increases the  $d_{hop}$  and the probability of network connectivity. They show that increasing the value of  $n_{local}$  beyond 15 has diminishing returns.

The two localization schemes Multidimensional Scaling (MDS) and Semidefinite Programming (SDP) described below belong to the centralized range free approaches. They are mentioned here for the sake of completeness

### 2.5.3.6 Multidimensional Scaling (MDS)

Multidimensional scaling is a statistical technique of data visualization which is used to see similarities and difference in the data. [66] have used it in WSN localization. It is a centralized location computation technique in which, the first step comprises of distance estimation based on hop count values between all pairs of nodes in a WSN. These values are used to generate a distance matrix for MDS. It includes hop count values between one hop neighbors as well as between nodes that are located at the opposite edges of the network. In the second step, MDS technique is applied to this matrix to get relative coordinates of all nodes. These relative coordinates are then aligned to the absolute coordinate system. Authors have augmented their work in [65] by dividing the WSN area and performing the same operation in individual regions. The nodes that are located on the borders of these regions belonging to more than one region are then used to stitch the locally generated maps into one large map spanning the entire WSN.

### 2.5.3.7 Semidefinite Programming (SDP)

[14] has viewed the node localization problem as a convex optimization problem and has solved it using the semidefinite programming (SDP) algorithms. In this approach, authors



## 2.5 The Localization Process

try to minimize the non-linear objective function:

$$\text{Minimize } \mathbf{c}^T \mathbf{x} \quad (2.8)$$

$$\text{Subject to : } \mathbf{F}(x) = \mathbf{F}_0 + \mathbf{x}_1 \mathbf{F}_1 + \dots + \mathbf{x}_n \mathbf{F}_n \quad (2.9)$$

$$\mathbf{A} \mathbf{x} < b \quad (2.10)$$

$$\mathbf{F}_i = \mathbf{F}_i^T \quad (2.11)$$

where A,b,c and F are known. In the above equations,  $\mathbf{x} = [\mathbf{x}_1, \mathbf{x}_2, \dots, \mathbf{x}_n]^T$  and  $\mathbf{x}_i$  is the coordinate vector of a node  $i$  i.e.  $\mathbf{x}_i = [x_i, y_i]$ . The relationship between any two nodes is represented by a *radial constraint* on the location of nodes.  $\|\mathbf{x}_i - \mathbf{x}_j\| \leq R$  where R is the transmission range of nodes. One possible way to get node coordinates is to set elements of  $\mathbf{c}$  corresponding to  $x$  and  $y$  to be 1 and -1 and all other elements of  $\mathbf{c}$  to be 0 hence making the problem a constrained maximization(or minimization) problem. It is then possible to get a upper or a lower bound on the  $x_i$ (or  $y_i$ ) satisfying the radial constraints. Hence, we can have node's coordinates bounded by a box. [40] Range based propositions of MDS and SDP are also available [26], [14].

When range based strategies are employed for distance calculation, the following techniques are used to convert this distance into initial node location estimates:

### 2.5.3.8 Trilateration

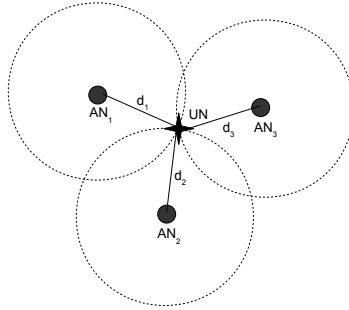

Figure 2.15: Localization through trilateration

Trilateration process is based on the fact that if we have accurate distances  $d_1$ ,  $d_2$  and  $d_3$  of a UN from three different anchor nodes  $AN_1$ ,  $AN_2$  and  $AN_3$ , UN's position can be calculated at the intersection of the three circles as shown in figure 2.15.

#### 2.5.3.8.1 Basics of lateration

Considering that by using any ranging method described above, we have perfect distance estimates to the three anchor nodes. Assume that the anchor nodes are located at  $(x_i, y_i)$ ,  $i = 1, \dots, 3$ , the Euclidean Distance between a UN and the three ANs can be represented as

## 2.5 The Localization Process

$$(x_i - x_{UN})^2 + (y_i - y_{UN})^2 = r_i^2 \quad (2.12)$$

where  $x_{UN}$  and  $y_{UN}$  are the coordinates of a UN. In order to solve this equation for  $x_{UN}$  and  $y_{UN}$ , it is convenient to write it as a linear equation in  $x_{UN}$  and  $y_{UN}$ . This can be done in two ways: either using the Taylor series or using a linearization tool.

### Taylor Series

A simple method to linearize a non-linear equation is to use Taylor series first order approximation. Given a differentiable function  $f(x, y)$  with real values, we can approximate  $f(x, y)$  for  $(x, y)$  close to  $(a, b)$  by the formula

$$f(x, y) \approx f(a, b) + \frac{\delta f}{\delta x}(a, b)(x - a) + \frac{\delta f}{\delta y}(a, b)(y - b) \quad (2.13)$$

### Linearization Tool

Another most commonly used method of linearizing a system of non-linear equations is the following: consider equation 2.12: if we subtract the third equation for  $i=3$  from the other two equations for  $i=1,2$  we get the following:

$$(x_1 - x_{UN})^2 - (x_3 - x_{UN})^2 + (y_1 - y_{UN})^2 - (y_3 - y_{UN})^2 = r_1^2 - r_3^2 \quad (2.14)$$

$$(x_2 - x_{UN})^2 - (x_3 - x_{UN})^2 + (y_2 - y_{UN})^2 - (y_3 - y_{UN})^2 = r_2^2 - r_3^2 \quad (2.15)$$

Rearranging equations(2.14)and(2.15) , we get

$$2(x_3 - x_1)x_{UN} + 2(y_3 - y_1)y_{UN} = (r_1^2 - r_3^2) - (x_1^2 - x_3^2) - (y_1^2 - y_3^2) \quad (2.16)$$

$$2(x_3 - x_2)x_{UN} + 2(y_3 - y_2)y_{UN} = (r_2^2 - r_3^2) - (x_2^2 - x_3^2) - (y_2^2 - y_3^2) \quad (2.17)$$

$$(2.18)$$

Equations(2.16) and(2.17) can be written in the form of a matrix

$$2 \begin{bmatrix} x_3 - x_1 & y_3 - y_1 \\ x_3 - x_2 & y_3 - y_2 \end{bmatrix} \begin{bmatrix} x_{UN} \\ y_{UN} \end{bmatrix} = \begin{bmatrix} (r_1^2 - r_3^2) - (x_1^2 - x_3^2) - (y_1^2 - y_3^2) \\ (r_2^2 - r_3^2) - (x_2^2 - x_3^2) - (y_2^2 - y_3^2) \end{bmatrix} \quad (2.19)$$

In equation(2.19), the matrices apart from  $x_{UN}, y_{UN}$  contain known values. The system of equations can now be solved to get the coordinates of the unlocalized node.

At the end, an additional check is performed to calculate the residue between the measured distances  $d_i$  and the estimated distances  $\hat{d}_i$ . The coordinates are accepted if this residue value is small.

$$residue = \frac{\sum_{i=1}^n \sqrt{(x_i - \hat{x})^2 + (y_i - \hat{y})^2} - d_i}{n} \quad (2.20)$$

## 2.5 The Localization Process

### 2.5.3.9 Triangulation

Triangulation is a position estimation technique in which a UN knows its angle  $\beta$  from two anchor nodes  $AN_1$  and  $AN_2$  as shown in figure 2.16 and the two anchor nodes know angles  $\alpha$  and  $\gamma$ . The distance between the two anchor nodes  $AN_1$  and  $AN_2$  is also known. A UN can then estimate its position by using sine or cosine rules.

$$\text{Sines Rule } \frac{A}{\sin\alpha} = \frac{B}{\sin\beta} = \frac{C}{\sin\gamma} \quad (2.21)$$

$$\text{Cosines Rule } C^2 = A^2 + B^2 - 2AB\cos(\gamma) \quad (2.22)$$

$$B^2 = A^2 + C^2 - 2AC\cos(\beta) \quad (2.23)$$

$$A^2 = B^2 + C^2 - 2BC\cos(\alpha) \quad (2.24)$$

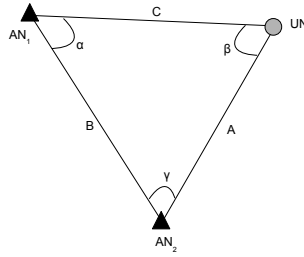

Figure 2.16: Localization through triangulation

### 2.5.3.10 Min-max

Lateration proves to be an expensive technique for energy constrained sensor nodes as it demands a lot of floating point computations. A relatively cheap way of estimating node's initial position is proposed by [63]. This technique is called the *Min-max* technique for node localization. It is based on the idea of applying the distance from the anchor nodes as a constraint on an unlocalized node's  $x$  and  $y$  coordinates. In order to estimate a node's location, min-max uses anchor node's coordinates and their distances from the UN to create a bounding box. Each anchor node has an associated bounding box. This box localizes the area where the UN is likely to be present. The UN is located at the center of the intersection of all bounding boxes. An example is presented in figure 2.17 showing the creation of a bounding box: Figure 2.17 In this example, distance of the  $UN_1$  from the anchor nodes  $AN_1$  and  $AN_2$  are used to bound the  $x$  coordinate of the  $UN_1$ . Let the distance between  $UN_1$  and  $AN_1$  be  $a_1$ , then the  $x$  coordinate of the  $UN_1$  is bounded from the left and right side by the  $x$  coordinate of  $AN_1$ ,  $(x_{AN_1} - a_1)$  and  $(x_{AN_1} + a_1)$ . In the same way,  $UN_1$  is located

## 2.5 The Localization Process

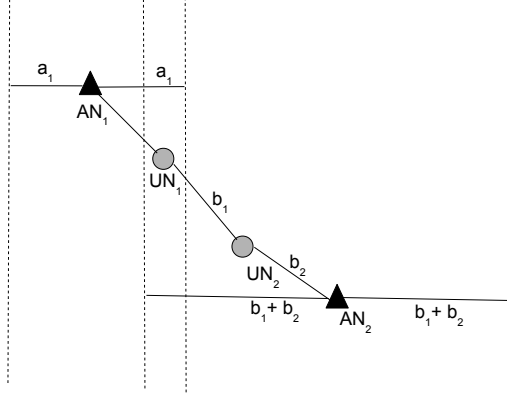

Figure 2.17: Localization through Min-max [63]

at two hops from  $AN_2$ .  $AN_2$  bounds the x coordinates of  $UN_1$  by  $(x_{AN_2} - (b_1 + b_2))$  and  $(x_{AN_2} + (b_1 + b_2))$ . In this way, the tightest right and left hand side bounds are obtained from each anchor node. The same process is repeated for  $y$  coordinates. The  $UN_1$  also receives coordinates of the anchors nodes and finally a bounding box is created in such a way that it encloses the  $UN_1$  [63]. The intersection of the bounded boxes is obtained by taking the maximum of the entire minimum valued coordinates and the minimum of all the maximums. The final  $UN_1$ 's position is the average of both corners. Normally, a residue is calculated in the same way as lateration and the coordinates are accepted if the residue is small [35].

The global process for some prominent range based localization schemes is discussed below:

### 2.5.3.11 Euclidean propagation method

In [46], besides presenting the DV-hop approach, the authors have also presented a range based way of localizing sensor nodes. This method is based on dissemination of the actual *Euclidean* distance between a nodes. A  $UN_1$  needs to be connected to two nodes who have already been localized (LNs) and one anchor node (fig 2.18). The two LNs,  $LN_1$  and  $LN_2$  know their distances to the AN a and b. These LNs should be the neighbors of each other as well so they also know the distance f among themselves. Hence the three sides of triangle fab are known.  $UN_1$  knows the three sides of triangle fce. Using these triangles and solving for the euclidean distance of  $UN_1$  from AN, it can have two possible values  $d_1$  and  $d_2$ .

To resolve this ambiguity, the authors present two ways: One way is to have at least one another neighbor of  $UN_1$  let's say  $LN_3$  that is a neighbor of AN and any one of the two LNs as well. Then a voting procedure is used for accepting one of the two distances values since the correct distance will belong to the two pairs  $LN_1, LN_3$  and  $LN_2, LN_3$ . Involving more

## 2.5 The Localization Process

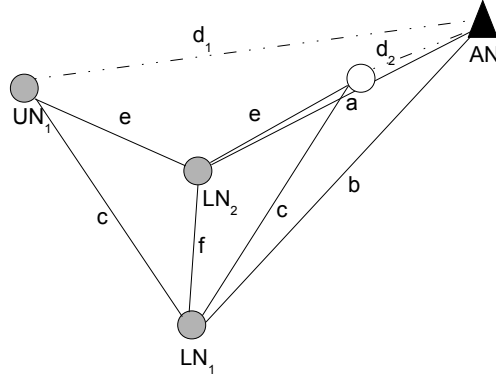

Figure 2.18: *Euclidean Propagation Method* [35]

neighbors in the voting process will yield more accurate results. Second way is to have a node (again assuming  $LN_3$ ) which is a neighbor of both the LNs. Considering the line joining the two LNs, the AN and  $LN_3$  can either lie on the same side of this line or the opposite side. Similarly we can judge if the  $UN_1$  and  $LN_3$  lie on the same side or not and hence we can find if the  $UN_1$  and AN lie on the same side or not and choose the appropriate distance.

### 2.5.3.12 Collaborative Multilateration

In this approach [63], the authors have addressed localization issues arising from the topology of a sensor network. They introduce the idea of a node being uniquely localizable if it jointly satisfies the following conditions: 1) it is connected to three nodes which are uniquely localizable 2) it uses at least one anchor node not collinear with other anchor nodes 3) if two unlocalized nodes are linked together, they should have at least one link to a different node from the nodes being used by the other unlocalized node. Collaborative multilateration works in three steps: 1) First step creates collaborative sub-trees by selecting nodes in the network that fulfill the criteria of solution uniqueness. It is in this step that nodes estimate their distance from the anchor nodes. The distance estimation phase of this approach makes use of three sub phases. The first subphase constitutes of the distance estimation of the nodes which are located in 1-hop neighborhood of the anchor nodes. In the second subphase, the nodes not directly connected to the anchor nodes estimate their distances from the anchor nodes by using the intermediate nodes which are located between them and the anchor nodes. These intermediate nodes have to be uniquely localizable. The anchor nodes broadcast their coordinates to the neighboring UNs. The UNs receiving these broadcast messages measure their distance from the anchor nodes through ToA using radio and ultrasound signals and forward these messages. At each forward, the UN adds the measured path length to the incoming path length. Also, if a UN receives broadcast of the same anchor node more than once, it forwards the one who has less path length. It then creates an overdetermined system

## 2.5 The Localization Process

of non-linear equations presented in section 2.5.3.8.1 in  $n$  variables. 2) In the second step initial node position estimates are made. 3) Third phase involves the following tasks: a) It uses the initial position estimates of uniquely localizable nodes to help in position estimation of nodes that could not participate in the creation of collaborative sub-trees b) it refines the initial position estimates. An unlocalized node when attached to many nodes that have recently been localized can suffer. The reason being the exchange of improvements in position estimates can cause a certain group of nodes to coverage to their local minimum but that will be erroneous with respect to whole network. For this reason, the authors propose to carryout position refinement iterations in a defined in sequence consistent way across the network so that it creates a gradient of location information flow and each node computes its global minimum locally. The authors propose one method of maintaining this consistency by using distributed depth first search method to make two iterations across the network to visit the nodes and maintain a time interval between two iterations. This time interval serves as a delay in which nodes have to reestimate and broadcast their positions.

Coming back to our classification model for the localization process, in the following two subsections, we discuss the two supporting blocks of the process which are a node's position refinement and the medium access control layer.

### 2.5.4 Position Refinement

Of all the distance measurement techniques that we mentioned in section 2.5.1.2 of this chapter, all of them are affected by reflection, refraction, diffraction, absorption, scattering and multipath fading faced by the electromagnetic waves. These factors introduce errors in the signal when it reaches the receiver. Referring to the *Position Refinement* block of the diagram 2.5, deals with reduction of errors arising in the localization process.

#### *Kinds of errors in node localization*

Considering the block diagram once again, errors are introduced in two blocks: the 1-hop measurement block and the local/global process block. [38] classifies the two errors as 1) Edge error: this is the error in distance measurements owing itself to various physical phenomena described above 2) Vertex errors: this is the error in neighboring nodes, since their location information may contain error, especially for non-anchor neighbors. For anchor nodes, the vertex error is zero.

Besides these two sources of errors, local/global process block also introduces errors in node positions as highlighted in by some researchers working on distributed sensor node localization. They claim that significant amount of error is introduced in node positions by the 1) placement of anchor nodes in the network 2) their percentage and 3) the mean node degree of the network. [4] investigates the impact of anchor node placement on the accuracy of position estimates. It shows that when hop count based localization approaches are considered 1) placing the anchor nodes near network boundaries improves node position estimates 2) increasing number of anchor nodes in the network increases position accuracy of nodes and 3) using enough number of randomly placed anchor nodes we can get comparable position accuracy as with the anchor placement around network boundaries.

[60], [63] and [42] shows the impact of node degree on localization accuracy up to a certain threshold value of node degree.

### 2.5.5 Medium Access Control (MAC)

The whole process of localization is carried out by exchanging messages among the nodes at MAC level. It enables I-hop measurement among nodes, the global process and the position refinement process for each sensor node. This thesis is aimed at analyzing localization

## 2.6 Energy in a Sensor Network

protocols for WSNs that at MAC level message exchange since MAC level is considered to be the most energy consuming level for a sensor node. Details about sources of energy dissipation at MAC level are explained in section 2.6.2.

## 2.6 Energy in a Sensor Network

It is a well known fact that the biggest challenge for a WSN is to remain operational as long as possible. The amount of available energy in a sensor network defines its lifetime. Presently, a sensor network's *lifetime* has many definitions. Some of which are listed below:

- Time to first node death  
One way to define it is to note the time of death for the first node of a WSN which happens when the node has no more energy.
- Network half life  
Another idea is to note when 50% nodes of a network fail
- Time to partition  
or to see how much time it takes so that a network becomes partitioned into two or more parts because of the death of nodes.
- Time to loss coverage  
to see if a point in observed region is not covered by a sensor node any more.
- Time to failure of first event notification  
a node may be unable to report an event either because it is dead or it has been disconnected from the sink [31]

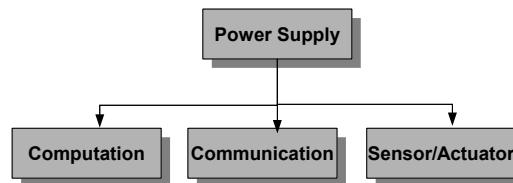

Figure 2.19: Sensor Node's Energy Consuming Components

Energy consumption in sensor nodes is often viewed at three levels: the computation level, the communication level and the sensor/Actuator level 2.19. We are interested in the computation and communication level hence will discuss about these two levels. Computation level is the microprocessor level where a node performs various operational functional and processes data in one way or another to perform its job and make its operations efficient. Communication is the Medium Access Control (MAC) layer and the physical layer where a node spends substantial amount of its energy in listening and transmitting and receiving information.

While a node can have its energy in the form of batteries which may be non rechargeable/rechargeable, [53], [57], [58] and many others have proposed mechanisms for scavenging

## 2.6 Energy in a Sensor Network

energy from the environment since replacing batteries is not always feasible in WSNs. These works propose the use of solar cells, temperature gradient, vibrations and flow of air/liquid as a mechanism of harvesting energy from environment.

### 2.6.1 Energy Consumption at Microcontroller level

A sensor node is required to perform many operations that consume energy at the microcontroller level. Microcontroller's main functions include: data acquisition from sensor part of the node and process it. In a WSN, it is often the case that all data from all nodes needs not to arrive at the sink when demanded. It is more desirable to reduce network traffic and facilitate the sink by aggregating the sensed data e.g. taking its mean or the maximum value. In order to do this, microcontrollers of nodes that are located on path towards the sink may perform this aggregation task. This in-network processing incurs computational load on these nodes. Also, in an effort to transmit less information in the network as compared to the gathered information, the spatially and temporally correlated data can be compressed before its transportation in the network [51], [79]. This is costly in terms of microcontroller computations [76].

In a WSN, generally, events of interest do not arrive often, hence in order to save energy, its preferable for a node to stay in inactive mode and be active only when an event occurs. Microcontroller performs these power management functions by switching to various operational states which is energy consuming. Most microcontroller implement various operational states and the number of these states along with power consumption in each state also vary with manufacturer [31]. In addition, a microcontroller has to manage the layers of communication stack.

### 2.6.2 Energy Consumption at Communication level

WSN shares a common wireless channel for all sensor nodes. MAC layer is there to arbitrate access to this channel among the various communicating nodes. MAC for WSNs is different from traditional MAC for other wireless networks because in WSN MAC its energy consumption is given premier importance as compared to the network's throughput, fairness among nodes, and reduction in end-to-end communication delay.

Studies [81] have identified multiples sources of energy dissipation at the MAC layer, the most important being the following:

*Idle Listening:* is a node's transceiver state in which it listening to the wireless channel but it doesn't know when it will receive data useful for itself. A node wastes considerable amount of energy in this state.

*Collisions:* may occur if a node is in the transmission range of other nodes and two or more of them transmit data at the same time. In such a case, node's both transmitted and received energy is wasted.

*Overhearing:* If a node receives data destined to other nodes in its neighborhood, it spends its reception energy uselessly in hearing irrelevant data.

*Protocol overhead:* is the energy spent by a node to send and receive a communication protocols control frames e.g. the RTS/CTS frames used in 802.11 and beacon and preambles frames used in some WSN oriented MAC protocols [24], [1]. They do not carry any data although their transmission and reception consumes energy.

Communication channel in a WSN remain idle most of the time because of the nature of its operation. Most often it generates low traffic load. In such a situation, keeping the sensor nodes awake in the state of idle listening results in significant amount of energy wastage.



## 2.6 Energy in a Sensor Network

Therefore, sensor nodes should stay asleep when there is nothing to transmit or receive but wake up when they need to transmit data or when another node has sent data to them.

### 2.6.3 Energy consumption at computation vs. communication level

Studies reported in [31] make it evident that communication in a WSN is more energy consuming than the computation. Table 2.1 shows energy consumption of chipcon CC2500's transceiver [10] and MSP430C11x1 microcontroller [68]. In Mica2 nodes, communicating one bit is equal to processing several hundreds of instructions [34]. Therefore, it's wise to limit communication. Depending on the type of computation, the energy consumed in it can be significant but it will still be less than the communication energy. Hence, it is preferred to keep the node's transceiver asleep most of the time and perform in-network processing and data aggregation to spend more energy in computation than in communication.

### 2.6.4 Energy Efficient Communication for WSNs

Many MAC protocols have been designed for WSNs and they take into account the energy wasted during idle listening, collisions, and overhearing. Most contention based MAC protocols aim at reducing *Duty Cycle* which is the ratio between active to sleep period of nodes. In this regard, [23] and [15] and [50] propose the transmission of a short frame called *Preamble* preceding the data. The idea is to keep the receiver node's radio asleep most of the time. Transmitter node sends a preamble preceding the actual data. The receiver nodes periodically wake up to sample the incoming data. They stay awake to listen to the data only if they hear a preamble. In order to cater for the wakeup time of all intended receivers, the preamble length is set to be equal to the *check Interval* which is period between two consecutive wake ups at the receiver. Use of preamble reduces the idle listening cost by a factor of 10 [34]. Another approach WiseMAC(Wireless Sensor MAC) [16] further improves the idea of preamble sampling by reducing the length of preamble. It considers that each node is aware of its neighbor's wakeup time hence a transmitter node transmits data near the wakeup time of intended receivers with eventually short preambles.

MAC protocols like S-MAC [81] and T-MAC [71] address the idle listening problem by synchronizing the nodes to a common active/sleep period. Node synchronization increases the probability of collision which they address by using the RTS/CTS (Request to Send/Clear to Send) handshake mechanism of reserving the channel by the communicating nodes. Use of RTS/CTS also helps other nodes to avoid overhearing by turning off their radio during irrelevant communication. Besides, S-MAC also has the ability to reduce protocol overhead (RTS/CTS). In case a node has a large message to transmit, it is broken down into fragments. Instead of reserving the channel for each fragment, a node reserves it once has obtained it. The node then transmits all the fragments of the large message and receives ACKs for each of these fragments in one allocation.

### 2.6.5 Energy Efficient Localization in WSNs

Energy efficient localization involves saving node's energy at both at computation and communication level. Out of the various WSN localization schemes presented in this chapter, schemes like MDS [26] and SDP [14] can be ruled out since they involve huge computation and communication. For the remaining localization approaches, their energy consumption has been evaluated individually in DV-hop [46], Collaborative multilateration [63] and APIT [22]. APIT [22] also compares their energy consumption with centroid [27], DV-hop and amorphous scheme [42] and argue that centroid and their proposal is more communication efficient

## 2.7 Conclusion

than the other two. In terms of computation cost, [56] proposes to reduce the burden of performing computationally intensive floating point operations for node position by distributing the task among all participating nodes.

In short, all these works either come up with a localization scheme and then evaluate it or compare the already existing ones. However, very few of them have been conceived as energy efficient localization approaches.

Table 2.1: Power Consumption: Computation vs. Communication

Radio(Sleep)	$3\mu\text{W}$
Radio(Idle)	5.8mW
Radio(Tx)	83mW
Radio(Rx)	56.55mW
Microcontroller(Active)	0.3mW
Microcontroller(Sleep)	$2\mu\text{W}$

## 2.7 Conclusion

We view localization in WSNs as a three faceted paradigm and these facets are firstly, its 1-hop measurement phase, secondly energy consumption involved in node position computation and thirdly energy consumption in communication.

Regarding the 1-hop measurement phase, if we recapitulate the various range based techniques mentioned in this chapter, initial works in this field have come up with ways to estimate internode distances which are now considered unrealistic for large scale operational deployments. e.g. use of propagation delay of two types of signal i.e. sound and radio, AoA techniques which require antenna arrays mounted on cheap sensor nodes or the use of RSSI for ranging which is an unreliable technique. Presently, much larger WSNs are being envisioned and taking this fact in account, none of the above mentioned ways cater for today's demands for a WSN. At the present time, the only suitable candidate for ranging in sensor nodes is the ranging based on UWB signals. It is suitable both in terms of financial cost and its accuracy.

Considering the computation aspect in the local process and position refinement, use of node's precious energy and finding ways for optimizing this use is itself a separate research area.

Energy consumption in communication involves message exchange in both 1-hop measurement phase and the global process phase. Very few distributed WSN localization techniques with a focus on computation and communication efficiency exist presently. Out of the computation and communication aspect in energy consumption, we are interested in the communication aspect.

This thesis considers the first and third facet of localization paradigm. We propose localization protocols that make use of TWR for finding internode distance. Then, we evaluate these protocols in terms of their communication cost.

While considering communication efficient localization in WSNs, an important point to keep in mind is that localization is mainly a start up process. It is carried out right after the WSN is deployed and is supposed to last for a very small time as compared to the network's life. During this very small time, nodes stay in their active part of the active/sleep schedule defined by the energy efficient MAC layer. Hence, the main target in making a localization

## 2.7 Conclusion

protocol communication efficient is to make it exchange as little number of messages as possible while localizing maximum nodes in the network.

As our first contribution, we present a protocol of WSN localization which we call the *beacon* protocol. We evaluate it in terms of its convergence latency and communication cost. Our second contribution is the *Continuous Ranging* protocol. We compare it with the beacon protocol to see which one is more efficient in terms of convergence and message exchange. The study of these two protocols leads us to conceive the *Optimized Beacon Protocol* that gets rid of shortcomings of the two previous protocols and has the positive aspects of the two of them. We compare the three protocols and this comparison concludes our work.

## 2.7 Conclusion

# Part II

## Contributions

## 2.7 Conclusion

## Chapter 3

# Beacon Based Localization Protocol

### 3.1 Introduction

Chapter 3 of this dissertation describes our first contribution which is the beacon based localization protocol (BBLP) in a stationary WSN. In order to initiate the localization process, we suppose that three non collinear anchor nodes are present in a network and are placed in such a way that they have overlapping communication ranges. This enables the unlocalized nodes which are in this overlapping area to localize them.

### 3.2 Assumptions

Considering the WSN localization problem according to the block diagram in the previous chapter, it is important to highlight our assumptions. Firstly, all of our contributions assume that all of our nodes are equipped with UWB enabled transceivers and they can perform ranging among nodes by exchanging ranging and ACK messages through TWR technique in the 1-hop measurement phase. Secondly, we assume that once the node has distances and coordinates of three anchor or localized nodes, it can use them in its local process to perform calculations for trilateration to get its position. We do not consider these trilateration calculations since we target to work on communication. Thirdly, we do not take into account node's position refinement because it makes the problem complex since it involves additional communication and computation. For us, position refinement phase can be studied after having a low communication cost basic localization algorithm.

Hence, our contribution areas according to the localization block diagram are the MAC block and the global process part of the local/global process block. Although, node localization is an application level process but to execute it, we need to exchange messages at the MAC layer. That's why we have categorized localization related communication as the MAC block in the Localization block diagram. We have also studied the way in which localization process propagates across the network. This network wide propagation is represented by the global process phase in the block diagram.

### 3.3 The Radio Communication Model

## 3.3 The Radio Communication Model

We use Unit Disk Graphs model of communication for our work. In this model, it is assumed that all nodes are homogeneous and equipped with omni directional antennas. Node locations are modeled as Euclidean points, and the area within which a signal from one node can be received by another node is modeled as a circle. This circle's radius is given by the transmission range  $r$  of the node. If all nodes have transmitters of equal power, these circles are all equal.

We are aware of the fact that a disk graph may not accurately model the communication of a WSN since transmission ranges of sensor nodes may not form circles in reality and that some new more practical models have been recently proposed like *quasi unit disk graph* [33] and *mutual inclusion graph* [37]. However, we have followed the convention of using disk graph because of its theoretical simplicity. We also assume that all of our wireless links among nodes are symmetric and bidirectional.

## 3.4 MAC protocol

For all of our proposed protocols, we have used a simple MAC which we can call a variant of conventional ALOHA protocol.

In the pure ALOHA protocol, when a node has data to send, it sends it immediately without sensing any on going transmission on the channel. It waits for a round trip time and if it doesn't receive an ACK, it computes a random value  $k$  for backoff and delays its future transmission for  $k$  [8]. Compared to ALOHA, our MAC is a bit different. It is represented in the following figure 3.1. In our case, whenever a node has a message to transmit, it senses the channel at that instant. At that particular instant, if the channel is free, the node transmits. Otherwise, it waits and at the same time continues to sense the channel until the instant when the channel becomes idle. The moment its idle, the node transmits. If while waiting for the channel to be idle, a node has created other messages to transmit, it queues all these messages and then transmit them when it gets the free channel. We believe that such a MAC layer is acceptable because of two reasons: 1) each node generates a very low network load as compared to other WSN applications and 2) all localization messages are very short and of same duration therefore they are not likely to cause collisions. Implementation section of the next chapter discusses this in detail.

## 3.5 Communication Energy Model

As described in the previous chapter, most of sensor node's energy is consumed by its transceiver while the microcontroller uses only a fraction of it. Our communication energy model is based on table 2.1 of this thesis. We can make two observations from this table; first is that the transceiver in its transmit mode uses 277 times more energy than the microcontroller in its active mode with low power consumption (1 MHz, 2.2V cf. [68]). Secondly, if we see the power consumption in various states of a transceiver, the most energy consuming states are the transmission and reception as compared to its other two states(idle and sleep).

A commercial UWB transceiver [44] claiming itself to be low power uses 108mW for transmission and 118mW for reception of data. Therefore, we aim at minimizing energy consumption in a localization process by reducing the number of transmitted and received messages.

### 3.6 1-hop Measurement Phase

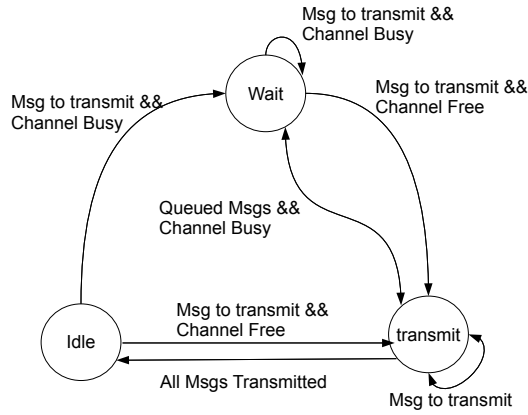

Figure 3.1: State transition Diagram for Our MAC protocol

### 3.6 1-hop Measurement Phase

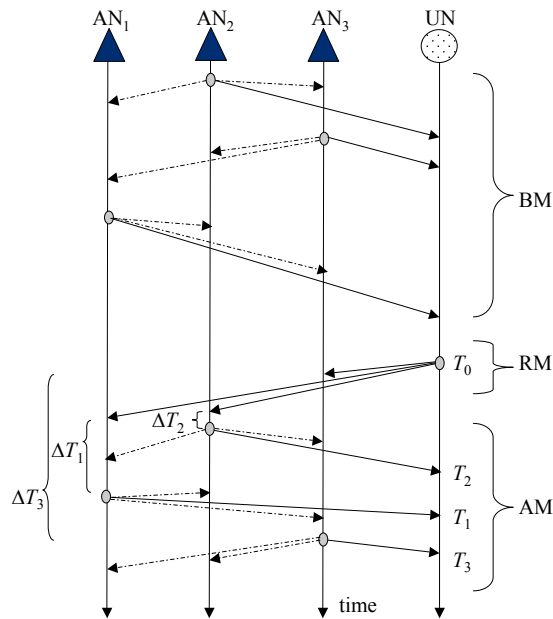

Figure 3.2: Two Way Ranging using Beacon Messages

Figure 3.2 shows the 1-hop measurement process carried out at one UN. This UN is located in the vicinity of the three ANs:  $AN_1, AN_2$  and  $AN_3$ . The ANs broadcast beacon messages (BM). Upon receiving at least one BM from each AN, a UN knows that it has three nodes in its vicinity that can answer its request for getting localized. Hence the UN broadcasts its Range message (RM) which makes the first step of TWR process. This RM is received by the ANs and upon receiving it, they schedule their Acknowledgment messages



### 3.7 Local Process Phase

(AM).  $\Delta T_1, \Delta T_2$  and  $\Delta T_3$  in the figure show the delay in each AN for receiving the RM, decoding it and scheduling its AM. The ANs unicast AMs upon their scheduled instants which are received by the UN at time  $T_1, T_2$  and  $T_3$  as shown in the figure. This reception constitutes the second step of TWR.

### 3.7 Local Process Phase

The ranging process enables the UN to estimate its distance from the three ANs. AMs also contain ANs' coordinates which are used by the UN to estimate its location through trilateration.

Once a UN becomes an LN, it starts transmitting beacon messages to help its unlocalized neighbors in getting localized. The ranging process is iterated across the network until most/all nodes of the network are localized.

Considering this protocol as the foundation of our work, we are interested in answering the following questions:

- What are convergence conditions to achieve the network wide localization?
- How the localization process in a WSN should start and terminate?
- How to astutely take advantage of the broadcast nature of radio communication?
- How to organize the cooperation between nodes to reduce the number of exchanged messages and so energy consumption?

### 3.8 Two Way Ranging (TWR) Implementation

The basic concept of TWR process has already been explained in section 2.5.1.2.5 of the previous chapter. Implementing the TWR process among sensor nodes involve three main issues to be addressed. The first one deals with segregating the ranging operation among layers. [12] classifies it in the following way:

- Since radio signal's speed is very fast, the message time stamping process is implemented in the physical layer. [59] describes the standardized physical layer mechanism used for the purpose of ranging in 802.15.4a
- The conducting process for exchanging range messages needs to be rapid and is implemented in the MAC layer
- Afterwards, the local process phase of position estimation which is less time critical is carried out above the MAC layer

The second issue deals with the circuit and logic delays involved in signal's creation and emission into the medium. [12] also proposes calibration constants that can be applied to correct errors incurred on the time instant values due to these delays.

The third issue deals with the measurement errors introduced by multipath signal propagation, sensor node's low clock resolution and clock tolerances. While UWB can resolve signal's multipath components [28], IEEE's standard [24] proposes an improved ranging mechanism: "Symmetric Double Sided-Two Way Ranging" that reduces the error margin of clocks with as low as 80ppm tolerance. This mechanism is already explained in chapter 2 of this dissertation.

### 3.9 BBLP's Implementation

## 3.9 BBLP's Implementation

BBLP works as a conducting process for performing the ranging operation at physical layer. It focuses on the MAC layer message exchange involved in TWR. For the purpose of simplicity and clarity, we do not deal with any sort of error introducing factors and delays mentioned in section 3.8.

Since BBLP is conceived to be executed across a dense WSN, one of the potential problems in its implementation is the high node degree that is likely to cause message collisions. In order to handle collisions, one way is to synchronize their exchange among nodes so that one communication can not interfere with another one. The second way is to randomize the message exchange. Since message synchronization has additional energy consumption overhead on sensor nodes, we consider message randomization a more suitable way to handle the collision problem. Randomization of message exchange works well if the network has low traffic load which is the case in WSNs.

The broadcast of BMs either by AN or LN, the broadcast of RMs by UNs upon hearing the BM and ACK to RMs by each AN/LN all are poisson processes. Details of message scheduling, creation and destruction are described in the subsection "BBLP's Implementation Details".

We use OPNET modeler's wireless module [48] to implement and study all of our protocols.

### 3.9.1 OPNET

OPNET is a discrete event simulator with an organized hierarchical strategy to implement a network. This hierarchy is defined as following: its highest level is the network level where the modeler places all nodes to create a network (fig 3.3). Each node is made up of modules which manage message creation, their access to the channel, transmission in the radio medium, reception by the nodes and node's processing involved on these messages. Figure 3.4 shows various modules of a sensor node. These modules are connected to one another either by packet streams or by information wires that communicate small information of one module to the other.

All modules except radio\_tx, radio\_rx and the antenna are implemented as a state machine. As an example, OPNET's state transition diagram for one of the node's module called "State Control" module is shown in figure 3.5. The radio\_tx, radio\_rx and ant\_x make the transceiver of node.

### 3.9.2 BBLP's Implementation Details

In this subsection, we explain the radio pipeline, message scheduling and generation, their management and destruction by a node.

#### 3.9.2.1 Radio pipeline

In OPNET the wireless channel is modelled using a 14 staged radio pipeline. These stages are executed among each pair of transmitter and receiver. Six of the pipeline stages belong to the transmitter side. They are: receiver group, transmission delay, link closure, channel match, tx antenna gain, propagation delay. Receiver group models the broadcast nature of radio by implementing multiple radio links between the transmitter channel and the receiver channels. Transmission delay calculates the amount of time required to transmit the entire message. Link closure determines if communication among two nodes is possible i.e. whether they

### 3.9 BBLP's Implementation

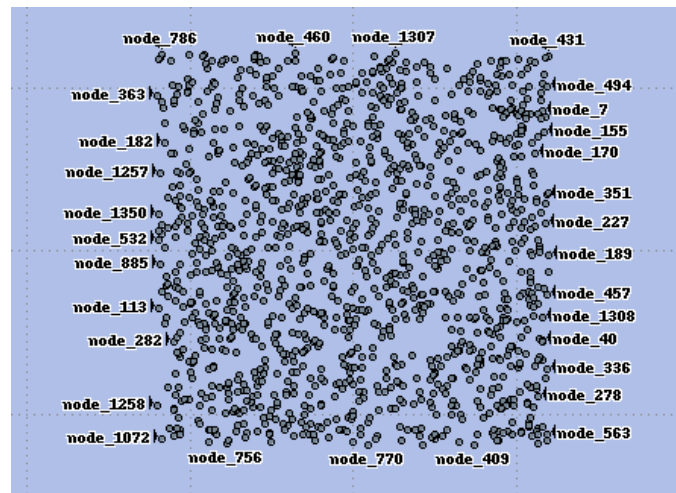

Figure 3.3: OPNET's Sensor Network

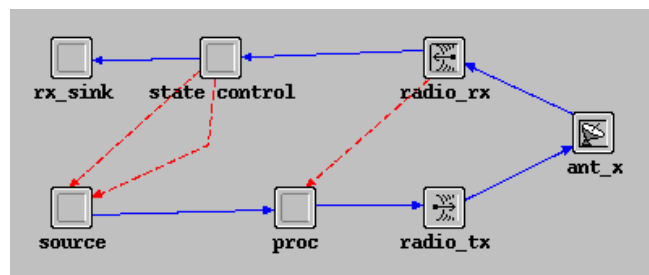

Figure 3.4: OPNET Node Model for BBLP

### 3.9 BBLP's Implementation

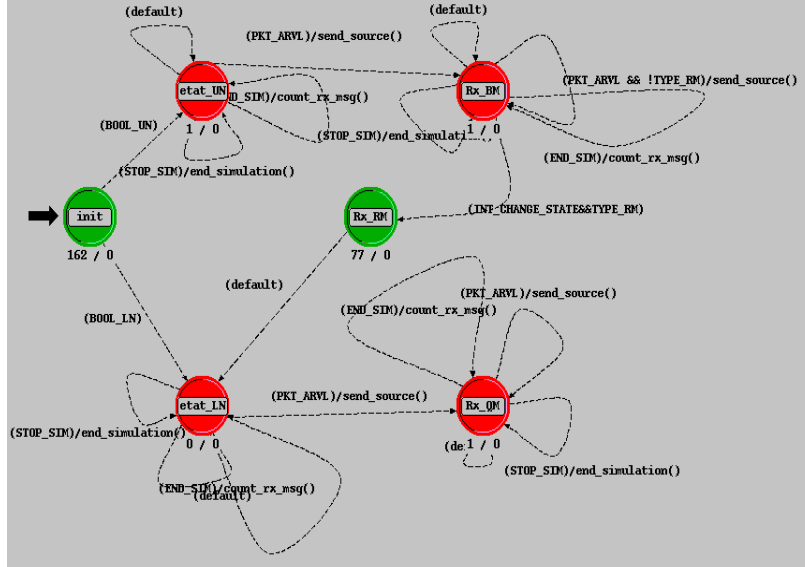

Figure 3.5: Sensor Node's State Control Module for BBLP

are in range of one another. Channel match's function is to classify the transmission with respect to the receiver channel; tx antenna gain computes the gain provided by transmitter's associated antenna based on the direction of vector from transmitter to receiver. Propagation delay defines the speed of propagation of the signal.

Rest of the stages belong to the receiver side: rx antenna gain, received power interference noise, background noise, signal-to-noise ratio, bit error rate, error allocation, error correction. Rx antenna gain serves the same purpose as of tx antenna gain but on receiver side. Received power interference noise takes care of interactions between transmissions that arrive simultaneously at the receiver channel. Background noise models all noise sources other than simultaneous transmissions. Signal-to-noise ratio computes the current average power SNR result of the arriving message. The function of the stage named "bit error rate" is that, based on SNR value, it derives the probability of bit errors during the past interval of constant SNR. Error allocation stage's purpose is to estimate the number of bit errors in a message segment where the BER probability is calculated and constant. Error correction stage checks whether or not the arriving message can be accepted and forwarded via channel's corresponding output stream to one of the modules in the receiver node [48].

For implementing the BBLP, we have modified two pipeline stages that are "link closure" and "propagation delay". We have modified link closure so that it takes our supplied transmission range in meters as the maximum range limit among nodes and occludes the communication path among nodes beyond our supplied value. We have changed the signal's propagation speed from the speed of radio signal to the speed of sound. This modification helps us to measure all time instants in seconds instead of nanoseconds and helps to focus on the behaviour and number of message exchange among nodes and across the network.

### 3.9 BBLP's Implementation

#### 3.9.2.2 Source

The source, proc, state control and sink modules of node model have their specific attributes. We consider the attributes of source module worth mentioning (fig 3.6). OPNET calls messages as *Packets* hence throughout the rest of this dissertation we will use the term "packet" to refer to our message. Three of these attributes are highlighted to show the information regarding packets generated by the source. They are packet format, packet interarrival time and packet size. It shows that 1) we use ALOHA packet 2) all of our packets, whether BM, RM or AM are scheduled according to the same poisson process. Figure also shows the packet's exponential interarrival time of 5 sec. 3) the packet size is constant and of 78 bits only.

The average packet arrival rate of 5 sec, the constant and very small packet size of 78 bits and the available bandwidth of 1Mbps (according to OPNET's default radio pipeline specifications) make the network load very low. Hence, we can safely state that the network has very less probability to face collisions. Source module is responsible for scheduling and generating the three types of packets.

Attribute	Value
name	source
process model	hello_start_opti_source_sa...
icon name	processor
Packet Format	ver1_aloha_sensor_msg_format
Packet Interarrival Time	exponential (5)
Packet Size	constant (78)
Start Time	10.0
Stop Time	Infinity

Figure 3.6: BBLP's Source Attributes

#### 3.9.2.3 Proc

Proc module constitutes the MAC layer for BBLP protocol. Its details have already been presented in the chapter 3 of this dissertation.

#### 3.9.2.4 State Control

State Control module of the node model handles the packet processing involved after a node whether UN or LN/AN receives a packet. State Control decodes and analyses the contents of the packet. If a UN has received a BP, it informs the source module about it that the BP count is enough to start scheduling RP. If a LN/AN receives RP, State Control informs Source module to schedule unicast AP for demanding UN. This information is passed on through a "Statistic Wire" which is a way of communicating small information among modules in OPNET. When a UN has received one AP from three different LNs/ANs, State Control changes the state of the node to LN.

#### 3.9.2.5 rx\_sink

Packets that have been processed are destroyed by the rx\_sink.

## 3.9 BBLP's Implementation

### 3.9.2.6 Packet Format

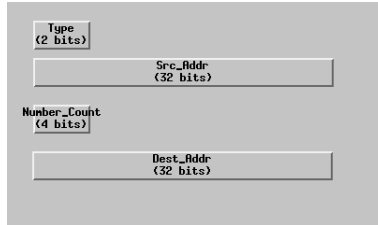

Figure 3.7: BBLP: Packet Format

Figure 3.7 shows the packet format for BBLP. The first field *type* corresponds to the type of the packet whether BP, RP or ACK packet. The *source* and *destination* fields identify the transmitter and receiver nodes, the *number\_count* field correspond to the number of times a packet is retransmitted which is mostly used for RPs.

Fig 3.8 further elaborates the implementation of BBLP. In BBLP, although all packets BP, RP and ACK are transmitted after a random delay, the figure only highlights the random delays involved before the transmission of RP and ACK packets for the purpose of clarity. These random delays represent the poisson processes. We are aware of the fact that using random delays increases the response delay of sending ACK packet in AN/LN. Nonetheless, we have opted for this mechanism because of its capability of avoiding packet collisions. Furthermore, the response delay in AN/LN can be reduced by fixing it to a small constant value instead of a random value. The reason for not doing it is that if the loop back delay is a fixed constant value, the AN sending ACK packets to more than one UN may send them simultaneously resulting in probable packet collisions.

BBLP starts off when the three ANs schedule and generate their BPs as shown in figure 3.9 and 3.10. The UNs are only able to receive packets at this stage. The BPs are broadcast in the network using the MAC implemented in the proc module and received by UNs in the neighborhood. In each node, whether LN or UN, the operations to be carried out after a packet's reception are implemented in "State Control" module. Hence, upon receiving a BP, UN goes to the state control module. In this module, it checks if it already has an entry for the AN whose BP it has received in its "neighbor AN/LN" table. If not, it stores this AN's ID in its table. The moment a UN has received one BP from each of the three ANs, it signals its source module to start scheduling RPs. The UN broadcasts its RP on the scheduled instant and starts scheduling next RP. The ANs which received UN's RP now move to their state control module and store the RPs in a queue. The ANs, then start scheduling ACK packet instead of a BP. In such a situation, the UN is scheduling its RP and ANs are scheduling their ACK. In an ideal case, the UN may receive each ACK from three ANs before it rebroadcasts its second RP. If this is the case, UN's 1-hop measurement phase is successfully completed and it can now enter into the local process phase of distance estimation with each AN and position calculation through trilateration. However, this is not always the case. It may happen that a UN has received ACK from only two ANs before it broadcasts its second RP. In such a case, the remaining AN who has not yet replied to the UN store UN's second broadcast RP in the queue and on its scheduled instant for unicasting ACK, it searches its stored RP queue and reply to the latest(second) RP of that UN and not the first one. This way, the long loop back delay between RP and ACK packet is decreased

### 3.10 Performance Evaluation

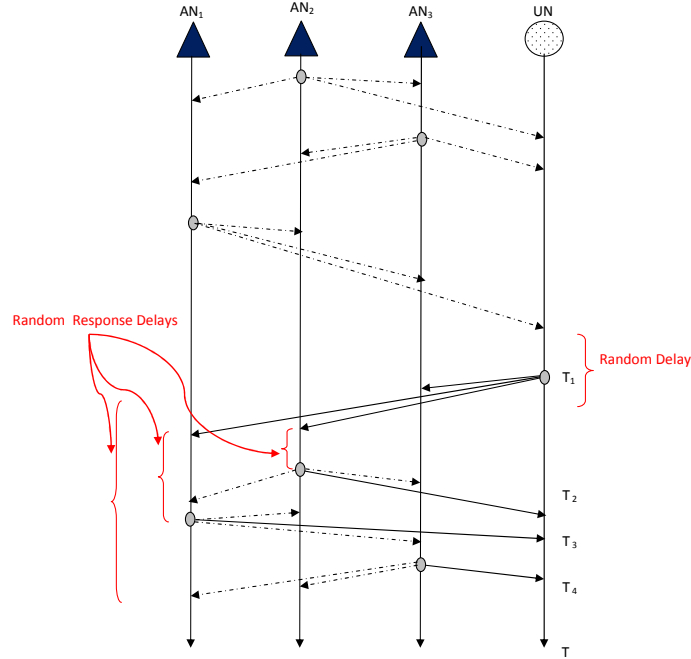

Figure 3.8: BBLP using random delays

to as low as possible (fig 3.10). Each AN only sends one ACK packet to a demanding UN and then starts scheduling and generating BPs as usual. All processed packets are discarded by the sink module. UN with an ACK from three different ANs becomes LN and informs its source module to start schedule and generate BPs. It performs the same role as that of a AN. The same process reiterates across the network until all connected nodes in the network are localized.

#### 3.9.2.7 Trace Files

We generate four trace files of our interest. 1) `changet_vs_distance.txt`: in this file we note the time instant of state change of each node vs. node's distance from the centroid of ANs deployed in the network's center. 2) `txmsg_vs_distance.txt`: in this file we note the number of transmitted packets by each node both as UN and LN. It includes all the three types of packets. 3) `rxmsg_vs_distance.txt`: in this file we store the number of received packets by each node both as UN and LN 4) `percotime_vs_range`: in this file we store the network's status whether it is localized or not, the time to localize the entire network by recording the time to change state of the last localized node and the total number of localized nodes in the network.

### 3.10 Performance Evaluation

One of the reasons of using random delays to model our protocol is that it is the simplest system to analyse theoretically. We are interested in analytically modelling the state change delay of a UN to LN. However, we have observed that it is not trivial since the trilateration process involves many independent identically distributed random delays. If a network only

### 3.10 Performance Evaluation

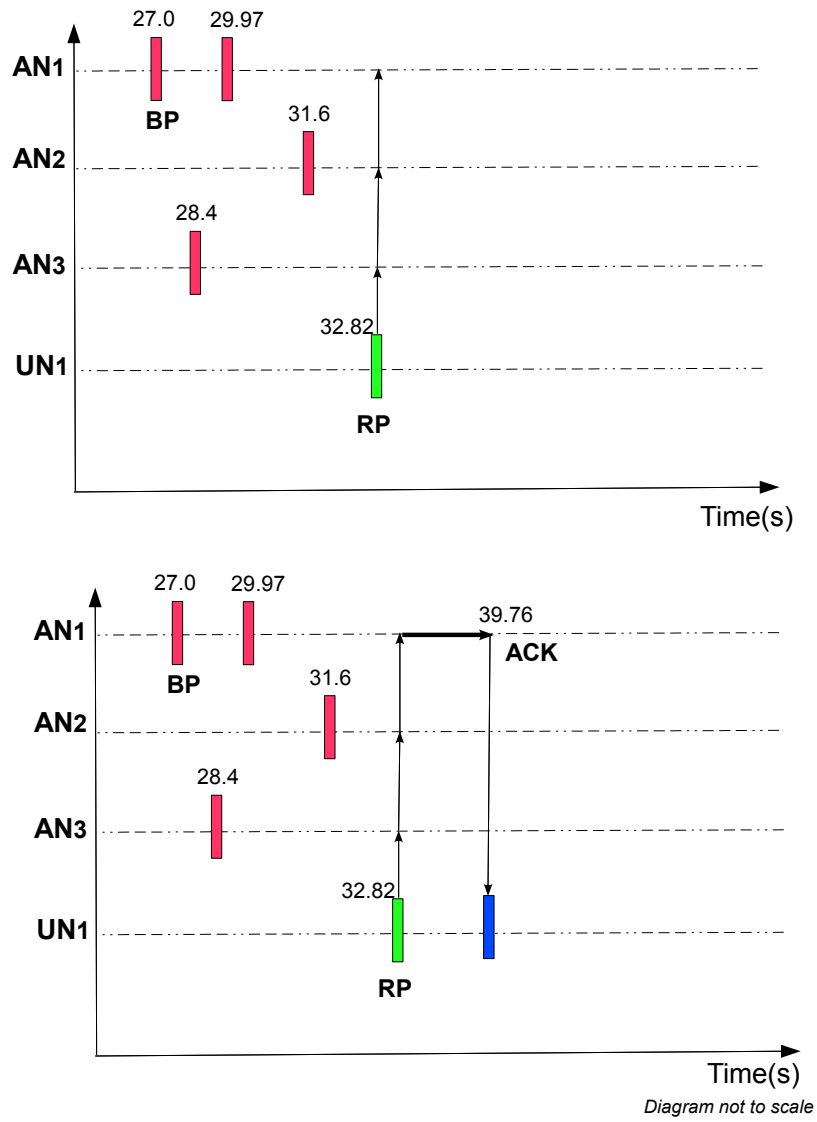

Figure 3.9: TWR in OPNET:  $AN_1$  unicasts ACK to  $UN_1$  instead of a BP



### 3.10 Performance Evaluation

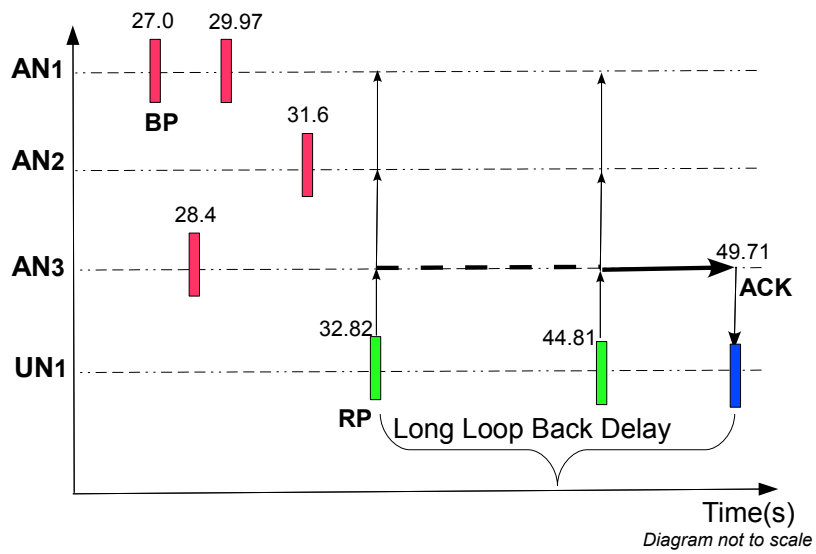
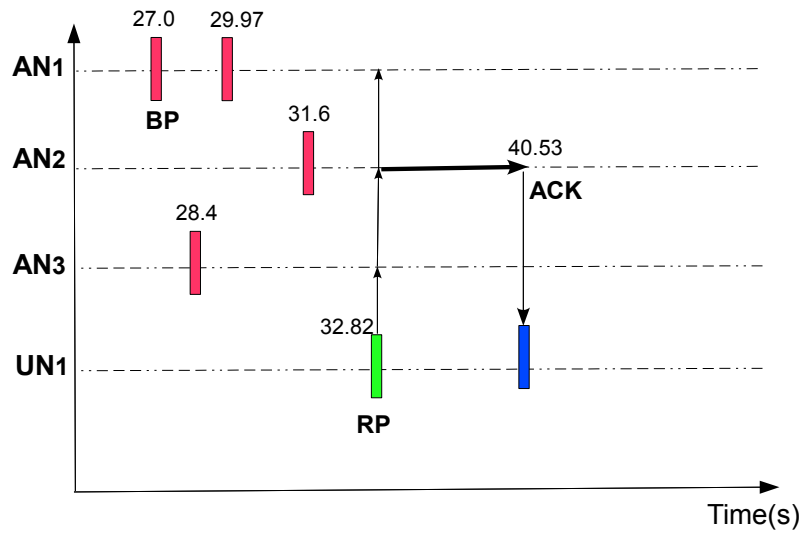

Figure 3.10: TWR in OPNET contd.  $AN_3$  replies to the latest RP by  $UN_1$

### 3.10 Performance Evaluation

contains one UN, we may derive an expression for its state change delay. However, since a WSN has numerous UNs, finding a generic expression for any UN's state change delay is a complex problem. Figure 3.11, 3.12 and 3.13 show the involved intricacy of this process with two unlocalized nodes in a network. The BPs broadcast by the three ANs are heard by the two UNs. The two UNs start scheduling their RPs at the same time. Out of the two,  $UN_1$  is the first one to transmit its RP to start the ranging process.  $AN_1$  unicasts its ACK packet to  $UN_1$ . Hence, ranging with  $UN_2$  is delayed because of ranging with  $UN_1$  which would not have been the case if there were only  $UN_1$ . This delay is complex to model analytically. During this thesis, we collaborated with mathematicians in this regard. However, this issue remains unanswered till the date of writing this thesis. Hence, we have chosen to study the behavior of our protocol through simulations.

#### 3.10.1 Network Generation

We characterize the performance of our protocol as a function of various sensor network and node parameters like node degree, network size and node's packet interarrival time. If we consider

$$\rho = \frac{N}{L^2} \quad (3.1)$$

as the density of network and  $R$  as the node's transmission range in which it can detect other nodes, the mean number of neighbors per node (also called the average node degree) is

$$\eta = \rho\pi R^2 \quad (3.2)$$

This node degree is for the nodes located in the interior of the network. For nodes located at network borders, mean node degree value will be small (Note that some authors [61] add 1 to eq. 3.2 to account for the node itself). Since network connectivity increases either by increasing node density or node degree, we keep node density constant throughout our work and control network's connectivity through node degree. We vary node degree by varying the transmission range of nodes. Throughout our work, when we need a larger network, we increase the network size by increasing the area occupied by the network and the number of nodes placed in it in such a way that node density remains the same (0.015) for large or small networks. We place  $N$  sensor nodes in a square of size  $L \times L$   $m^2$  according to the uniform random distribution. The packet interarrival time for all types of packets in all our protocols is set to 5 sec unless stated otherwise.

In the following subsections, we explain the answers that we have obtained for questions mentioned in section 3.7 of this chapter.

#### 3.10.2 Protocol's Convergence

To answer our first question about convergence condition of this network wide localization protocol, we observed the relationship between percentage of nodes that changed their state across the network with respect to the mean node degree. Fig 3.14 shows this relationship. The curve shows that as we start with a mean node degree value of around 5, with the propagation of BBLP, the percentage of nodes who change their state to LNs in the network is very small. As we continue to increase the node degree, the percentage of LNs starts to increase. From node degree of 9 onwards, this percentage increases sharply. Around node degree of 10.5, almost 50% of nodes in the network have become LNs. The LN percentage continues to increase with further increase in the node degree until at 14 almost 99% of nodes have localized themselves. Since most of the network nodes become localized at node degree of 14, any further increase in node degree is useless for the convergence of BBLP.

### 3.10 Performance Evaluation

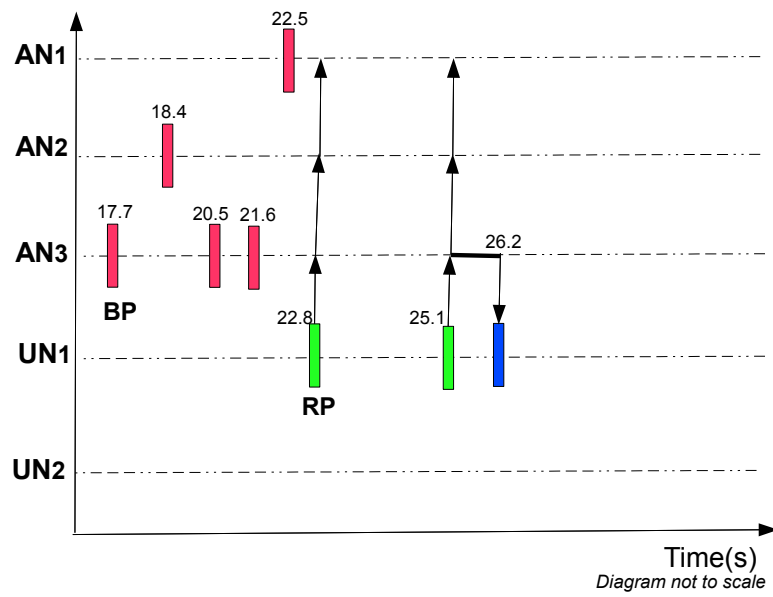
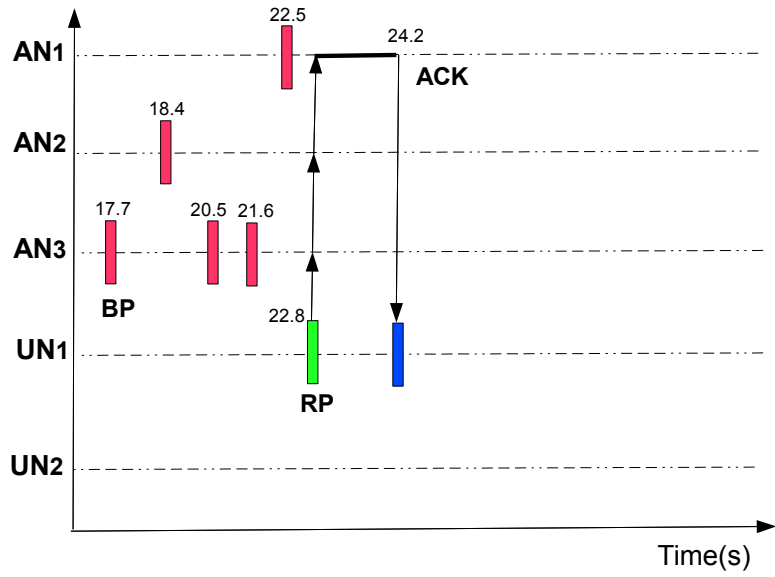

Figure 3.11: TWR with two UNs in OPNET: Ranging initiated by UN<sub>1</sub>

### 3.10 Performance Evaluation

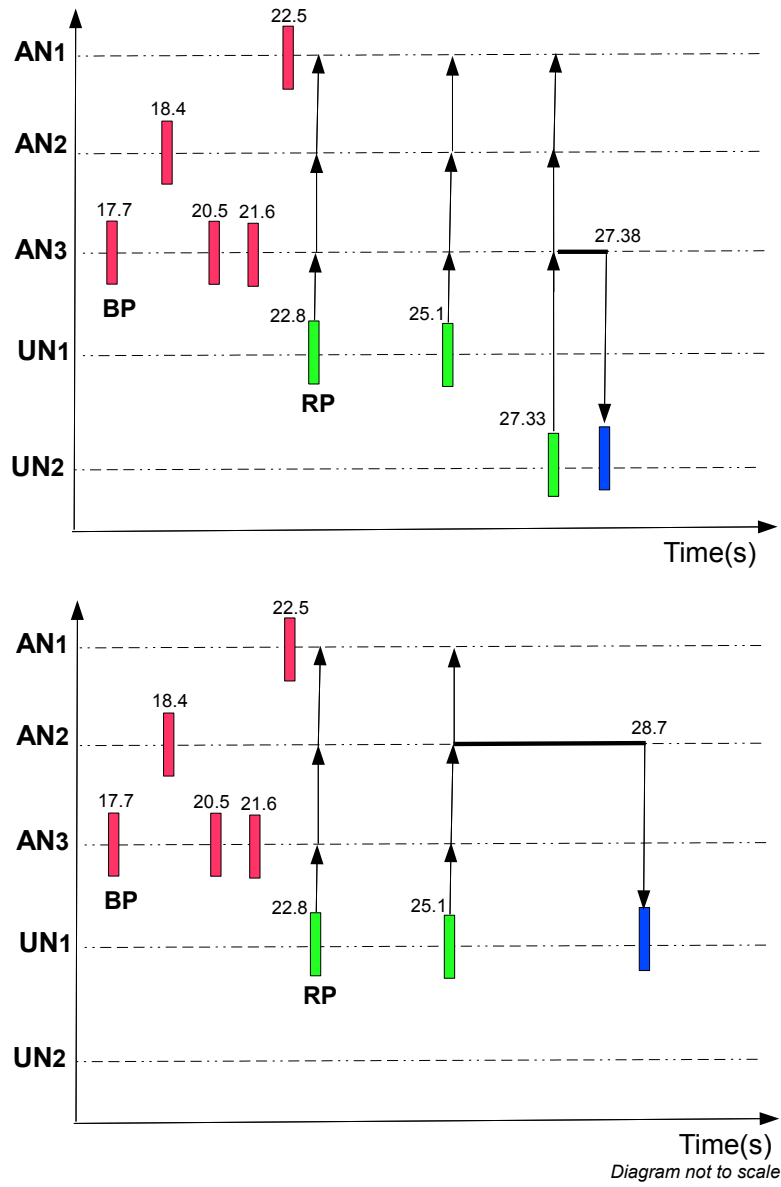

Figure 3.12: TWR with two UNs in OPNET contd.: Ranging initiated by  $UN_2$  however  $AN_2$  was waiting to reply to  $UN_1$

### 3.10 Performance Evaluation

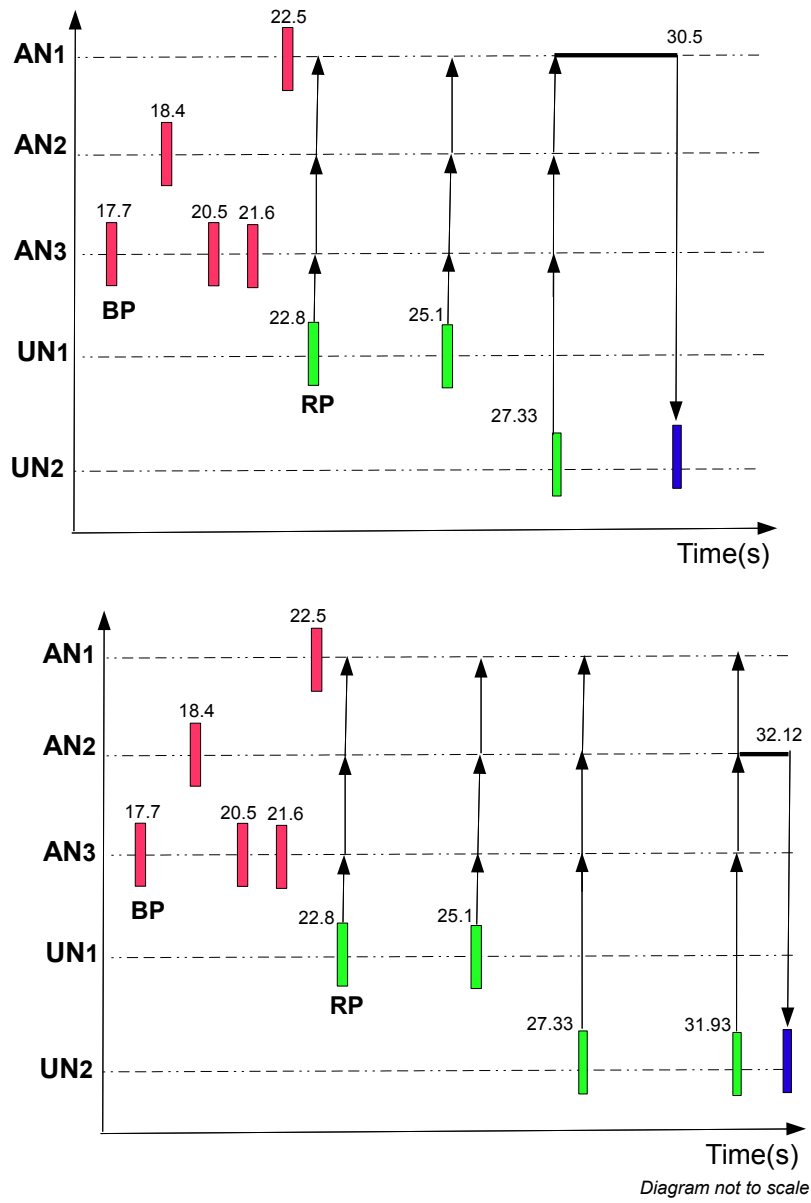

Figure 3.13: TWR with two UNs in OPNET contd.: Ranging for  $UN_2$  gets completed

## 3.10 Performance Evaluation

### 3.10.2.1 Discussion

To visualize the propagation behavior of BBLP, consider a small mean node degree of 5. The localization activity starts from the AN nucleus but is unable to progress outwards because in order to perform trilateration, each unlocalized node in the network needs to have ACK from three LNs/ANs. In other words, each node of the network needs to be connected to at least three other nodes. This need of 3-connectivity is not met with node degree of 5. Hence, with such a low node degree value, localization process can reach only a few nodes situated close to the AN nucleus and we observe cessation in its further propagation. As the node degree increases, it increases the probability of having 3-connectivity for all nodes of the network. As a result, the cluster of nodes surrounding the AN nucleus that change their state to LNs increases in size. The network begins to have small individual clusters of 3-connected nodes. Some of them are connected to the central cluster with AN nucleus which eventually increases the percentage of localized nodes in the network. However, most of these individual clusters remain isolated, as with insufficient node degree, the network does not have enough links to merge all clusters to the central cluster. Further increase in node degree increases the size of these small clusters so that boundaries of isolated clusters come close to one another which eventually join together to make one giant 3-connected cluster. Now the localization process can easily progress outwards and propagate towards network boundaries changing the state of all nodes in the network. Once, the network has sufficient node degree for 3-connectivity/BBLP convergence, any further increase in the node degree only increases the number of connections in the giant component.

#### 3.10.2.1.1 Phase Transition

When wireless networks are modeled as random graphs, there are many network wide properties which exhibit a *phase transition* behavior. This behavior involves the presence of a certain critical threshold value. Below this threshold value, the network wide property is unlikely to exist. Whereas, the moment this threshold is surmounted, the particular global property arises with high probability. [32] has studied some of these properties. These properties include probabilistic flooding, 1-connectivity and sensor network coordination phenomena in wireless networks. BBLP's propagation across the network also shows network's phase transition from unlocalized to localized state. If we consider the threshold of this phase transition to be localization of 50% of the network, this critical value is met at node degree of around 11(fig 3.14).

The need of a critical node degree threshold for BBLP's propagation is of particular importance from the point of view of node's power consumption. Ever since the beginning of research work in wireless networks, researchers have been interested in estimating the *adequate* amount of power required for 1-connectivity. The term "adequate" here refers to the amount of "just enough" transmit power required by nodes so that the whole network becomes 1-connected. If we take a look at previous works in this regard, [19] has statistically derived an expression for critical power required for asymptotic connectivity in wireless networks. [41] has presented a method to calculate node's minimum transmission range while maintaining 1-connectivity of the network. Besides these works, [80] and [7] have independently studied the relationship between  $k$ -connectivity of the network vs. the mean node degree required to achieve it. The phase transition curve for the convergence of BBLP answers similar question about the required node degree for trilateration based localization protocol i.e. how many neighbors does a node need to be connected to in order to have a 3-connected network?

In order to further investigate the phase transition behavior of BBLP, we observed the same relationship for large sized networks. Fig 3.15 shows the BBLP's phase transitions

### 3.10 Performance Evaluation

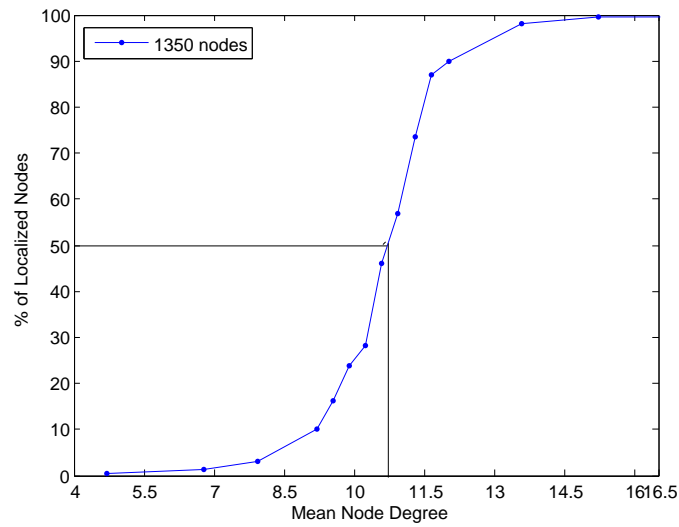

Figure 3.14: BBLP: Phase Transition

curves with increasing network sizes. These curves show that the critical node degree threshold almost remains the same (between 10.5 and 11) whatever the network size may be. Based on these results, we are able to predict the node degree required for localizing  $x$  percentage of nodes during practical deployment of a WSN hence economically using node's precious energy.

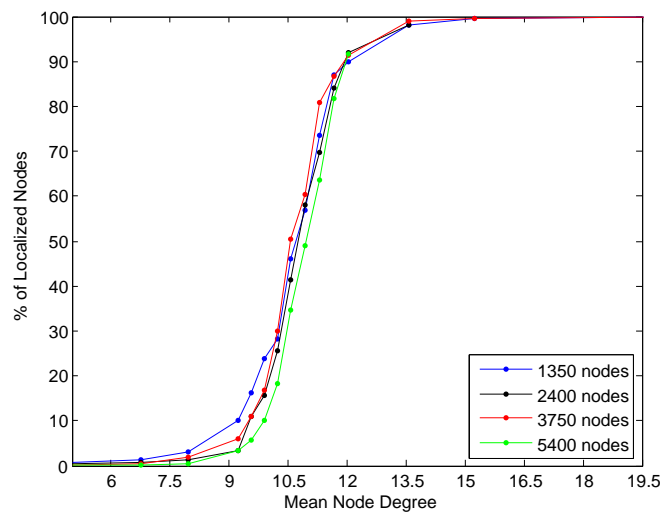

Figure 3.15: BBLP: Critical Node Degree

## 3.10 Performance Evaluation

### 3.10.3 State Change Delay of Nodes across the Network

Results presented in the previous section on protocol's convergence condition indicate the need of mean node degree to be higher than the critical threshold value between (10.5 and 11). Now, we are interested in observing the nature of relationship between mean node degree above the threshold vs. state change delay of the last node in the network (figure 3.16). We take the same network of 1350 nodes and vary node degrees from 12 to 29. We stop at the value of 29 because any further increase in the node degree reduces the number of network hops and the propagation behavior of the protocol remains no longer visible. We observe that the maximum state change delay i.e. the state change delay of the latest node exponentially decreases with increase in the node degree and reaches a stable value for node degree of 22 and above. The reason being, node degree of 14 has already 3-connectivity which is enough to enable BBLP propagation. Further increase in the node degree increase the number of links among already 3-connected nodes which further reduces the time for localization of the network.

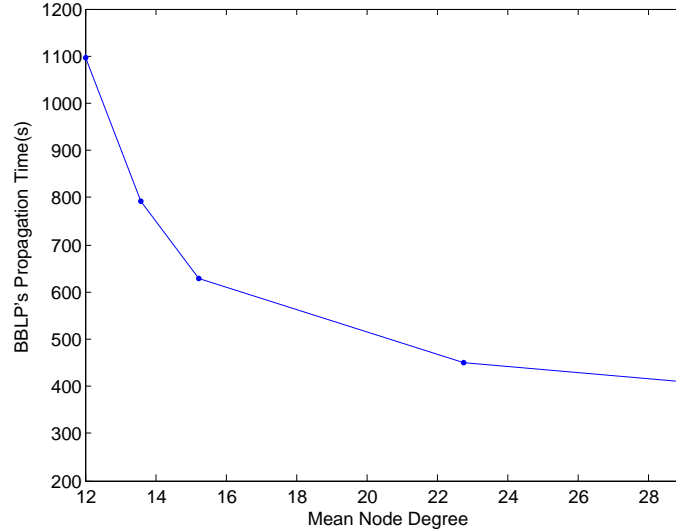

Figure 3.16: BBLP: Mean Node Degree vs. State Change Delay of Last Node

Now that we are aware of the mean node degree required for localizing almost 100% of nodes in minimum amount of time, we take node degree of 29 in the same 1350 node network and observe the nature of relationship between the state change delay of nodes vs. increasing distances from the AN nucleus (Figure 3.17). In this figure, each point is an average of all nodes located at a particular distance from the AN nucleus and is averaged over 10 different random placements of nodes with 25 different simulation seeds for each random placement.

Figure shows that for the first hop of the network in which UNs are placed inside the overlapping transmission range of the three ANs, the state change delay of all nodes occur more or less at the same time. The reason is: all of them hear the BPs broadcast by the ANs at the same time and as a consequence, start scheduling their RPs. As a result, the ANs unicast their APs one after the other for all the demanding UNs which make them change their state more or less concurrently. However, as we move away from the AN nucleus, the UNs in the network have to wait for the BPs. They can only start ranging after hearing a BP from three different ANs/LNs. This delay increase the state change delay of nodes



### 3.10 Performance Evaluation

located outside the AN nucleus. The figure shows that this increase is linear with respect to increase in distance from the AN nucleus. The dispersion of points at the end of the graph shows the border effect since nodes located near the network boundaries do not have the same neighborhood as that of nodes located inside the network. Linear increase in the state change delay of nodes clearly indicates that the propagation speed of the process remains constant throughout the network.

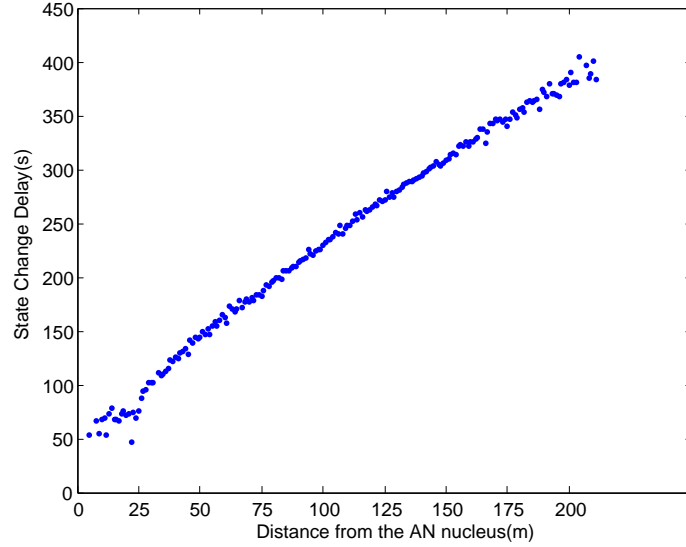

Figure 3.17: BBLP: Propagation speed

#### 3.10.4 Isotropic Propagation of the Process

The linear increase in nodes' state change delay with increasing distance from the AN nucleus indicate that BBLP propagates across the network isotropically. However, further evidence is needed to prove it. In this subsection, we explain the isotropic propagation of BBLP. In the trace file `changet_vs_distance`, we have the x and y coordinates of all nodes of the network along with their state change delay and distance from the AN nucleus. We consider a network of 1350 nodes with mean node degree of 29. We take a strip of network area i.e. 100-125m which is right in the middle of the network and note the angles made by nodes situated in this region with respect to the AN nucleus. We divide the network into 12 parts based on angles (fig 3.18) and we plot the histograms for state change delay of all nodes located in each part. Figure shows that the state change delay histograms in all directions of the AN nucleus are almost the same as is the case with mean state change delay in each section. This shows that the localization process progresses across the network in the form of a *wave* that has no particular direction.

#### 3.10.5 Protocol's Propagation Time

In this subsection, we investigate the propagation time of BBLP vs. mean node degree. Section 3.10.3 of this chapter discusses about the exponential decrease in state change delay of latest node in the network with respect to increase in node degree from 12 to 29. Here,

### 3.10 Performance Evaluation

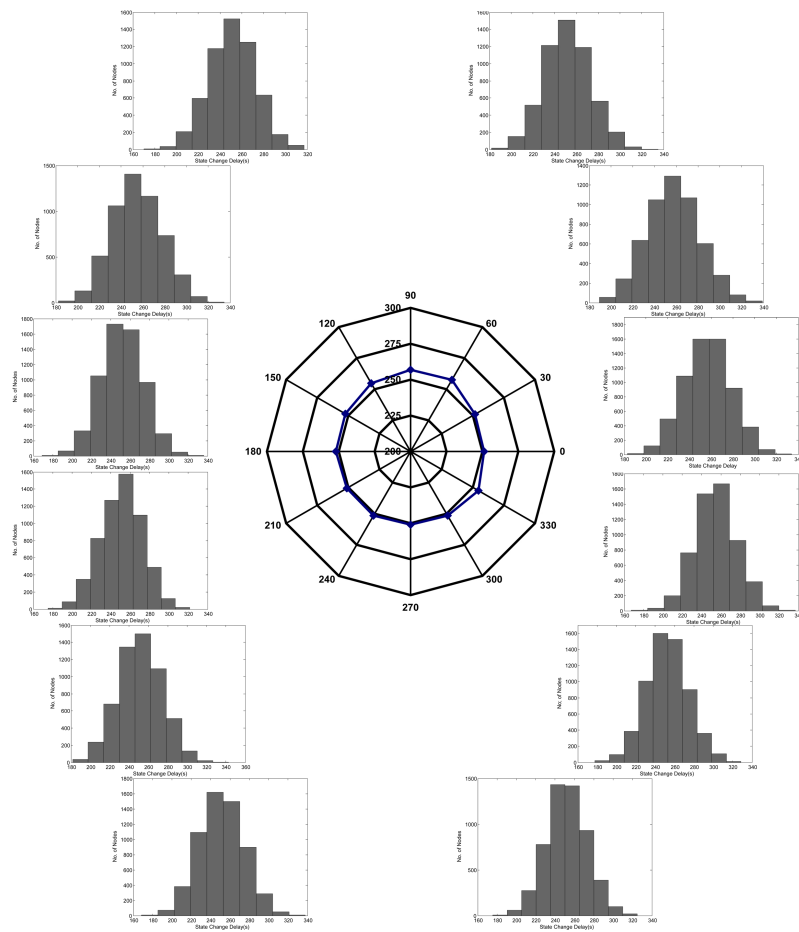

Figure 3.18: BBLP: Isotropic Propagation

### 3.10 Performance Evaluation

we are interested in observing the protocol's maximum propagation time before the node degree value of 12. In order to clarify the term "propagation time", it is the time that BBLP takes to spread across the network until it localizes the last node of the network. Hence it is the same as state change delay of the latest node. We consider a network with 1350 nodes (Figure 3.19). Each point in the figure is an average of 10 random placements with 25 different simulation seeds.

The figure shows that with a small node degree, the propagation time is small since only a few nodes surrounding the AN nucleus become localized. However, it starts to increase with increase in the node degree. It reaches its maximum value near the critical node degree. Fig 3.20 shows this for clarity. This behavior of the protocol's propagation time indicates that BBLP spends considerable amount of time propagating the information across links which are barely enough to localize 50% of the network near the critical node degree. This is the point where UNs have to wait the most for getting localized. However, as the node degree increases, the existences of more links than for the previous node degree, the waiting UNs are finally served. Once this critical node degree value is surmounted, BBLP's propagation time starts to decrease. This is because of the increase in the average node degree which starts to render sufficient 3-connectivity required for trilateration. This increases the rate of flow of localization wave. It was this part of the curve that we observed in section 3.10.3 of this chapter.

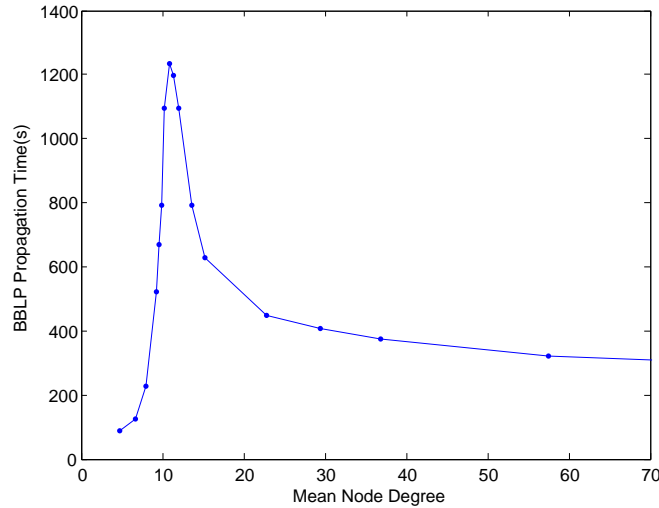

Figure 3.19: BBLP: Propagation Time

#### 3.10.6 Protocol's Convergence Speed vs. Packet Interarrival Rate

Section 3.10.3 of this chapter demonstrates that throughout the propagation of BBLP across the network, its speed remains constant. In this subsection, we present our observation on the relationship between convergence speed of the protocol vs. packet interarrival rate. We consider a 1350 node network with mean node degree of 29. We repeat simulations for increasing packet interarrival rates i.e. 1, 2.5, 5, 10, 20 and 50 sec. An obvious outcome is that BBLP's maximum propagation time increases linearly with increase in packet interarrival rate. Figure 3.21 shows the relationship between BBLP's convergence speed which decreases

### 3.10 Performance Evaluation

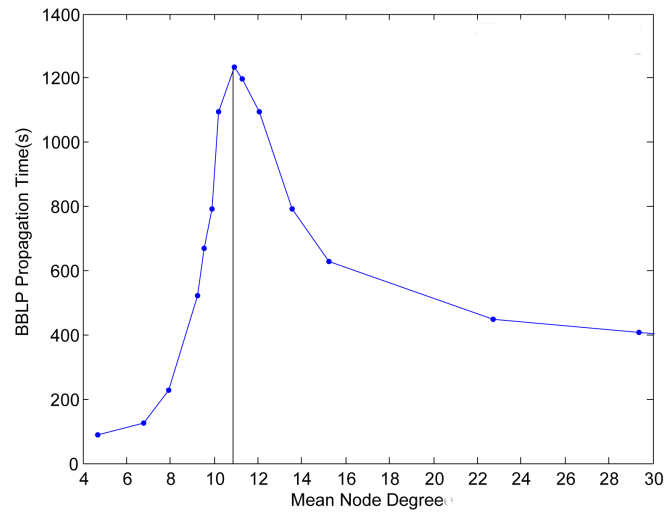

Figure 3.20: BBLP: Propagation Time near Critical Node Degree

exponentially with increase in the packet interarrival rate. We have used the following negative exponential function to fit this curve :

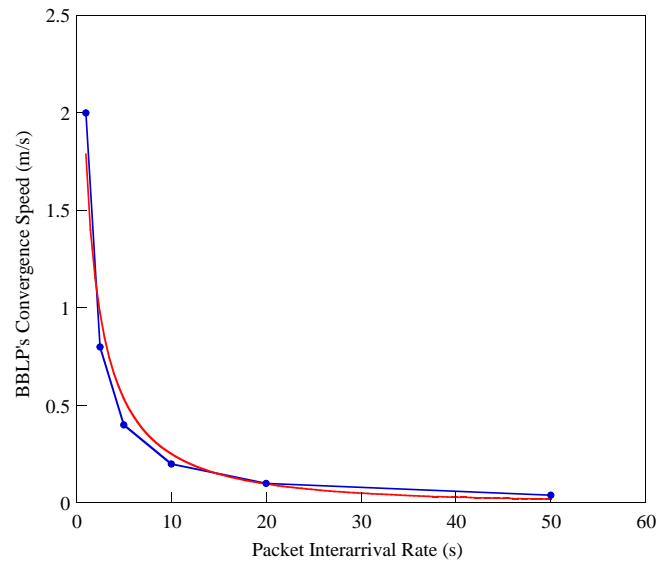

Figure 3.21: BBLP: Convergence Speed vs. Packet Interarrival Rate

$$y = ae^{-(x/b)^c} \quad (3.3)$$

where  $a$  is the coefficient,  $b$  is the characteristic parameter and  $c$  controls the stretch of the curve around its groove.

## 3.10 Performance Evaluation

### 3.10.7 Communication Cost

The fundamental motivation behind this work is to address the energy consumption involved in communication during the process of localization. Therefore, considering BBLP as the foundation of our work, we present a detailed analysis on the communication involved in its propagation across the network.

In this regard, we have addressed three aspects of communication across the network. The first one is, the pattern of each type of packet transmission and reception as we progressively move away from the AN nucleus. The second aspect is to count the total number of packets transmitted and received in the network and classify them as *Required* and *Overhead* packets from two perspectives: a single node's perspective and the whole network's perspective. The third one is to analyse the number of transmitted and received packets with respect to increase in the mean node degree.

#### 3.10.7.1 Number of Transmitted Packets vs. Distance from AN nucleus

In this subsection, we describe the pattern of all types of transmitted packets in detail. We consider a 1350 node network with the transmission range of nodes as 25m making a mean node degree of approximately 29. The packet interarrival time for the three types of packets is set to 5 sec. The BBLP protocol starts its execution 10s after the start of simulation and we terminate the simulation on two conditions: 1)all nodes of the network have been localized 2)in case all nodes have not been localized, the maximum simulation duration(1000sec) is reached.

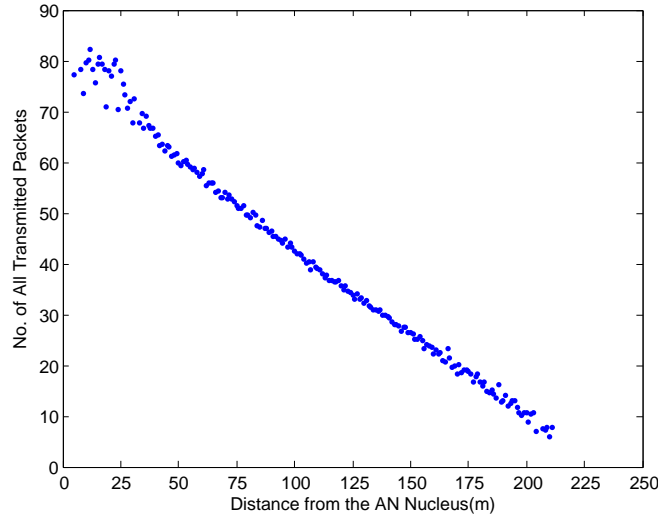

Figure 3.22: BBLP: No. of All Transmitted Packets

Figure 3.22 shows the number of transmitted packets vs. distance from the AN nucleus. In this figure, each point is an average of 10 different random placements with 25 different simulation seeds. We average the number of transmitted packets by nodes which are located at the same distance from the AN nucleus in all directions. Figure shows that the transmissions are highest in the vicinity of AN nucleus. This is because; the localization activity starts from here. Even though the localization wave moves forward, the localized nodes that remain behind continue to broadcast BPs till the end of simulation or until all nodes have

### 3.10 Performance Evaluation

changed state. As we move away from the AN nucleus, the newly localized nodes get less time to broadcast BPs as compared to the ones near the AN nucleus. Hence, there is a descent in the total number of transmitted packets with an increase in distance from the network center. The linear nature of decrease is due to the linear increase in the state change delay. We see some spreading in the first hop of the network which is due to the presence of non-uniform neighborhood for the unlocalized nodes located there. In the first hop, on one side of the unlocalized nodes, they have a permanent AN nucleus which does not demand for getting localized. However, once the unlocalized nodes become localized and broadcast BPs, they have to send ACKs to the demanding UNs on the other side. We see a different pattern of number of transmitted packets in the first hop since initially, the "localization wave" needs some area to start progressing smoothly. In order to explain it further, we consider two regions of the network: the first hop and the fifth hop(i.e. 100-125m) which is right in the middle of the network. Table 3.1 shows the average number of all packets transmitted in the first and fifth hop. Table values show that nodes in the first hop transmit more ACKs than the fifth hop. Since in the fifth hop, the isotropically propagating wave smoothly progresses outwards. Table also shows that first hop UNs send more RPs than the fifth hop UNs. This is because they receive BPs from the three ANs simultaneously. Hence, they start scheduling their RPs. Since the number of serving nodes is less than demanding nodes in this region; UNs have to broadcast more RPs.

Table 3.1: Mean Tx Packet count for each Packet Category under BBLP

1st Hop			5th Hop		
BP	RP	ACK	BP	RP	ACK
46	10	21	15	6	15

#### 3.10.7.2 Number of Received Packets vs. Distance from AN nucleus

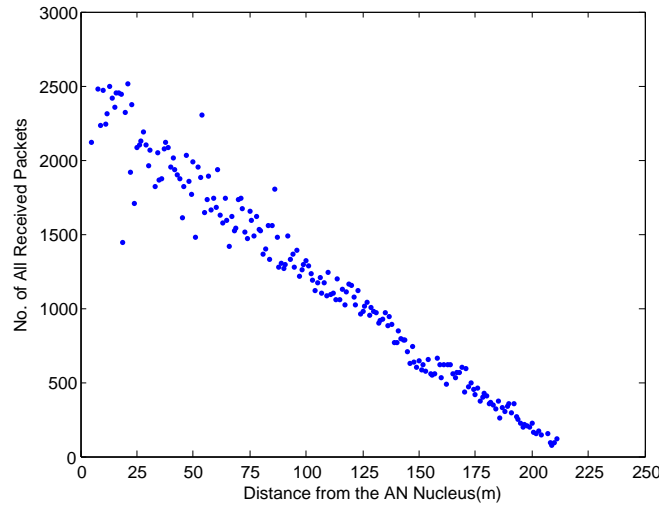

Figure 3.23: BBLP: No. of Received Packets

In this subsection, we present the network wide pattern for the total number of received

### 3.10 Performance Evaluation

packets vs. distance from the AN nucleus considering the same network parameters as for the number of transmitted packets in the previous subsection. Figure 3.23 shows the total number of received packets by all nodes of the network. We observe that the order of magnitude of the total number of received packets is more than 10 times than the number of transmitted packets. This is due to the wireless nature of the medium. Besides, the total number of received packets presented here include all types of packets BP, RPs and ACKs whether they are needed by a node for getting localized or not. We classify the received packets in the following categories:

- BPs received by a UN(A)
- ACKs received by a UN that were destined to it(B)
- RPs broadcast by other UNs received by a UN(C)
- ACKs received by a UN that were destined for other UNs(D)
- BPs received by a LN(E)
- RPs received by a LN(F)
- ACKs received by a LN(G)

Table 3.2: Mean Rx Packet count for each Packet Category under BBLP

1st Hop						
A	B	C	D	E	F	G
14	3	162	61	1399	106	606

Table 3.3: Mean Rx Packet count for each Packet Category under BBLP

Fifth Hop						
A	B	C	D	E	F	G
15	3	125	49	451	57	408

Table 3.2 and 3.3 present the individual count for each category of packets for the first and fifth hop of the network. Table values show that the number of BPs received by a node that has not yet changed its state is almost the same in both first and fifth hop. The number of ACKs received by a UN should be 3 which is the case in both regions. We see that the number of RPs received by a UN in first hop is more than the RPs received by UN in fifth hop. This is due to the simultaneous reception of BPs broadcast by ANs in first hop as already explained in the previous section. Consequently, the number of ACKs received by a UN is more in the first than the fifth hop. The huge number of BPs received by the first hop nodes who have changed their state to LNs is due to the largest amount of time that nodes of this region possess before the BBLP propagation terminates. More number of RPs and ACKs received by LNs in first hop than the fifth hop is due to the initiation of localization process as explained in the previous section.

#### 3.10.7.3 Required and Overhead Packets

In the previous two subsections, we have presented results on the total number of transmitted and received packets across the whole network. The classification of received packets in the

### 3.10 Performance Evaluation

previous section indicates that a node does not need all types of packets in the two of its states i.e. unlocalized and localized.

To further elaborate this point, we first consider the transmission of packets. A node in unlocalized state needs to transmit RPs in order to get localized. However, once the node has localized itself, it does not need to transmit BPs and ACKs to other UNs. Similarly, for the reception of packets, consider the packet classification mentioned in the previous section. In order to get localized, a node needs to receive BPs from its neighboring ANs/LNs and the ACKs destined to it for getting localized. However, being an unlocalized node, it does not need to receive RPs broadcast by other UNs or ACKs that were destined for other UNs. In the same way, when the node has changed its state to localized, it does not need to receive BPs, RPs or ACKs.

Based on this idea, we classify both the transmitted and received packets as either *Required* or *Overhead* packets for the two states of the nodes.

#### 3.10.7.4 Two Perspectives of Communication Cost

The concept of Required and Overhead packets can be viewed from two perspectives in network-wide propagation protocols. One is the single *Node's Perspective* in which we classify the communication carried out in the network as *Required* or *Overhead* from the point of view localizing a single node. Another way of considering this communication cost is from the whole *Network's Perspective*. Network's perspective deals with the communication cost incurred for localizing the whole network and classify the packets as required and overhead from the point of view of the whole network. Table 3.4 and 3.5 classify both transmitted and received packets as required and overhead from these two perspectives for the two state of nodes.

Table 3.4: Required and Overhead Packets from a Single Node's Perspective under BBLP

	Unlocalized Node	Localized Node
Tx Packets	Required: RP Overhead:None	Required:None Overhead:BP, AP
Rx Packets	Required:1) BP 2) AP for it Overhead:1)AP for others 2)RP for LNs	Required: None Overhead: BP, RP, AP

According to table 3.4 the RPs transmitted by a UN are required packets whereas the BPs and ACKs transmitted by a LN are overhead packets since their transmission is of no use to the already localized nodes. Similarly, a UN need to receive BPs and ACKs whereas a LN does not need to receive any packet.

Table 3.5 on the other hand shows that BPs and ACKs transmitted by the LNs are required packets since they help in disseminating the process of localization network wide. Table also indicates that a RP received by LN is a required packet for the same reason of helping a node in the network in getting localized.

Based on this classification, we have noted the communication cost of the same network as of subsection 3.10.7.1 of this chapter. Table 3.6 and 3.7 show these values.

According to these tables, in terms of required transmissions network perspective is 6 times more costly than the node perspective. On the other hand, network perspective has no transmission overhead as compared to the node perspective. Similarly, in terms of required reception, network perspective is 4 times more costly than the node perspective whereas for overhead reception, the two perspectives have more or less the same cost.



### 3.10 Performance Evaluation

Table 3.5: Required and Overhead Packets from Entire Network’s Perspective under BBLP

	Unlocalized Node	Localized Node
Tx Packets	Required: RP Overhead:None	Required:BP, AP Overhead:None
Rx Packets	Required:1)BP 2)APs for it Overhead: 1)AP for others 2) RM for LNs	Required: RP Overhead: BP, AP

Table 3.6: Required and Overhead Mean Packet Count from a Single Node’s Perspective under BBLP

	Unlocalized Node	Localized Node
Tx Packets	Required: 6 Overhead:None	Required:None Overhead:33
Rx Packets	Required:18 Overhead:167	Required: None Overhead:970

Table 3.7: Required and Overhead Mean Packet Count from Whole Network’s Perspective under BBLP

	Unlocalized Node	Localized Node
Tx Packets	Required: 6 Overhead:None	Required: 33 Overhead:None
Rx Packets	Required: 18 Overhead: 167	Required: 50 Overhead:920

#### 3.10.7.5 The Border Effect

In this subsection, we present communication cost incurred by BBLP propagation excluding the border areas of the network. Border effect [6] is a well known problem in wireless networks community which is the problem of non-uniform neighborhood near the corners of the network. In the case of BBLP protocol’s propagation, we have already observed that its propagation in the first hop is not similar to the rest of the network. Its propagation near the network boundaries also undergoes the border effect as depicted in subsection 3.10.3 of this chapter. In order to observe its communication cost without the border effect, we consider the network after excluding boundary nodes (table 3.8 and 3.9). To observe this cost right in the middle region of the network, we consider a strip of the network area between 100 and 125m i.e. the fifth hop of network(table 3.10 and 3.11).

Table 3.8: Required and Overhead Mean Packet Count from a Single Node’s Perspective under BBLP(without border nodes)

	Unlocalized Node	Localized Node
Tx Packets	Required: 6 Overhead:None	Required:None Overhead:32
Rx Packets	Required:18 Overhead:172	Required: None Overhead:901

In both the two cases i.e. network without borders and a strip of network area, we observe more or less similar numerical values for transmitted and received packets both in

### 3.10 Performance Evaluation

Table 3.9: Required and Overhead Mean Packet Count from Whole Network's Perspective under BBLP(without border nodes)

	Unlocalized Node	Localized Node
Tx Packets	Required: 6 Overhead:None	Required: 32 Overhead:None
Rx Packets	Required:18 Overhead: 172	Required: 51 Overhead: 850

Table 3.10: Required and Overhead Mean Packet Count from a Single Node's Perspective under BBLP(Strip 100-125m)

	Unlocalized Node	Localized Node
Tx Packets	Required:6 Overhead:None	Required:None Overhead:31
Rx Packets	Required:19 Overhead:175	Required: None Overhead:917

Table 3.11: Required and Overhead Mean Packet Count from Whole Network's Perspective under BBLP(Strip 100-125m)

	Unlocalized Node	Localized Node
Tx Packets	Required: 6 Overhead:None	Required: 31 Overhead:None
Rx Packets	Required: 19 Overhead: 175	Required: 57 Overhead: 860

node and network's perspective. Hence, we can state that the network border does not have a significant effect on the communication cost values reported in the previous subsection of this chapter.

#### 3.10.7.6 Communication Cost vs. Mean Node Degree

In this subsection, we deal with the third aspect of communication cost which is its behavior with increase in the mean node degree. It is obvious from the result presented in section 3.10.5 of this chapter that the number of packets transmitted and received across the network should increase with increase in the mean node degree. The reason is the availability of more connections among nodes and the feasibility of localization wave to progress outward. We consider a 1350 node network. Figure 3.24 and 3.25 show this relationship. We see that as we increase the mean node degree of the network, the number of transmitted packets by nodes increase following the same pattern as that of the propagation time reported in section 3.10.5 of this chapter. These packets reach their maximum count near the node degree 14 where most nodes of the network possess 3-connectivity required for trilateration and afterwards start to decrease as is the case with BBLP's propagation time. Thereafter, their number continues to be the same with any further increase in the node degree up to around 100. However, after the value 100, any further increase in the mean node degree increases the number of transmitted packets by nodes. This is because, as we increase the size of neighborhood, more and more UNs receive the BPs broadcast by the ANs/LNs at the same time. As a result, all UNs in the neighborhood of these ANs/LNs start scheduling their RPs simultaneously. These RPs are then broadcast at more or less the same time.

### 3.10 Performance Evaluation

The ANs/LNs receive them at the same time and hence schedule their ACKs for each of the demanding node at the same time. Since the ANs/LNs can only reply the demanding UNs one after the other, before the ANs/LNs can unicast scheduled ACK for one demanding node, that demanding node broadcasts another RP. Since there are multiple demanding nodes at the same time, they all rebroadcast their RPs until they get one ACK from three different LNs/ANs. This process continues and results in increase in the number of transmitted and received packets in the network. Note that this phenomenon eventually increases BBLP's propagation time for a node degree of 100 onwards as shown in figure 3.26.

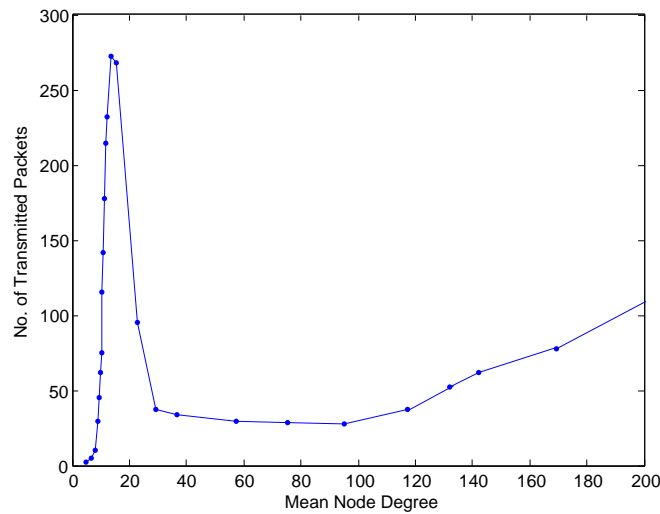

Figure 3.24: BBLP: Mean Node Degree vs. No. of Transmitted Packets

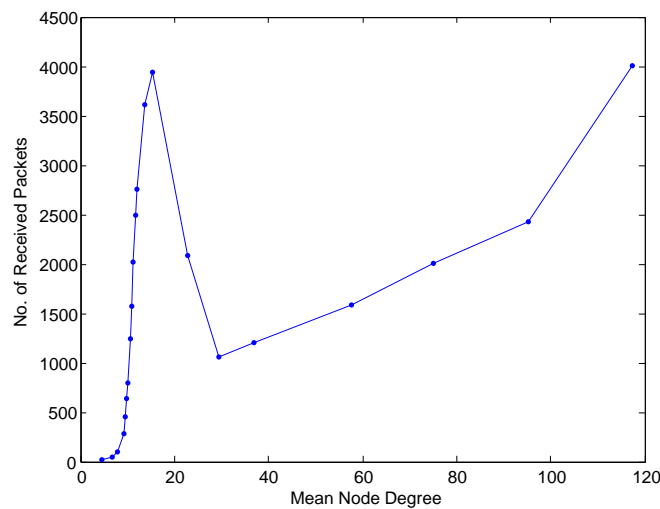

Figure 3.25: BBLP: Mean Node Degree vs. No. of Received Packets

### 3.10 Performance Evaluation

#### 3.10.8 Effect of Additional Anchor Nodes

Researchers working on anchor based WSN localization have always been interested in the effect of number and placement of anchor nodes in the network. Works in this regard forming a non-exhaustive list include: [62], [61], [38], [4] and [45]. All of these works have focused on reducing the position error introduced by placement and percentage of anchor nodes in the network.

Since localization error management is not the scope of this dissertation, we are interested in observing the speed of TWR based BBLP protocol by placing more anchor nodes in the network. An intuitive question that arises here is: how do we place these anchor nodes and how many should we place in the network. As we are interested in propagation of BBLP once the wave has been generated by the AN nucleus, we do not want to place the additional ANs randomly as by placing them in such way they might create additional nuclei and eventually more waves in the network.

Hence, the number of additional anchor nodes should be very small as compared to the unlocalized nodes. We have decided to add 1-2% additional ANs. We consider a 1350 node network with each node's transmission range as 25m making approximately 8 hop network. We choose to place additional ANs at each network hop starting from the 1st up to 5th hop as shown in figure 3.27. By doing this way, we manage to avoid creating probable more nuclei and focus on the increase in propagation speed of already created wave by introduction of individual ANs along wave's dissemination path.

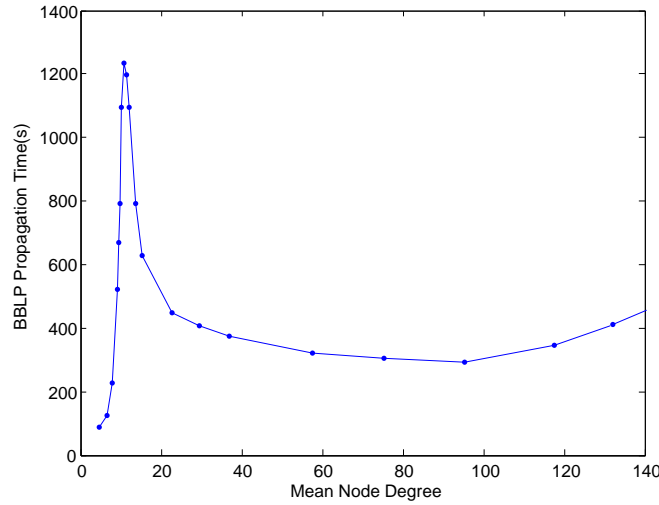

Figure 3.26: BBLP: Increase in Propagation Time with Large Node Degree

Figure 3.28 shows the relationship between convergence speed of BBLP vs. additional anchor nodes placed along 1 to 5th network hop. 0 on the x-axis indicates that we only have the original AN nucleus in the network. We have carried out these simulations in the following way: in the first set of simulations, we have placed additional 4 ANs on the periphery of first hop. In the second set, we have placed more ANs on the borders of 2nd and 3rd hop as well. In the third set, we have placed additional ANs along the borders of fourth and fifth hop in addition to the ANs on previous hops. Each point in the reported figure corresponds to an average of speed on 10 different random placements with 25 different simulation seeds. In the figure, we see that by placing more ANs in the 1st hop, the speed of

### 3.10 Performance Evaluation

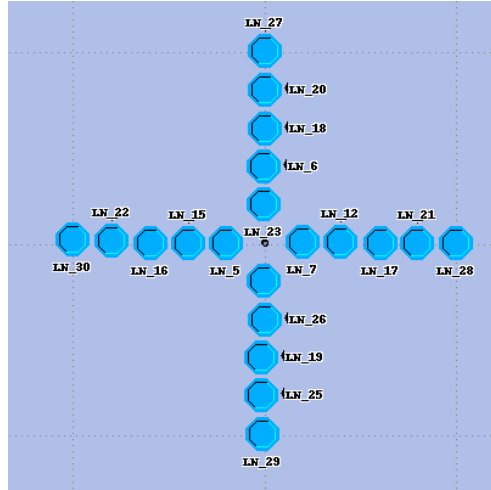

Figure 3.27: BBLP: Placement of Additional ANs Across the Network

the BBLP propagation increases by 19%. However, afterwards, with addition of more ANs, there is a nominal increase in speed and it stays constant with further addition of anchors up to fifth hop. One of the possible reason for initial 19% increase in BBLP's propagation speed can be due to the fact that more ANs placed in the communication range of the AN nucleus facilitate the generation and initial propagation of wave while ANs placed along 2-5th hop only help the wave in maintaining its speed.

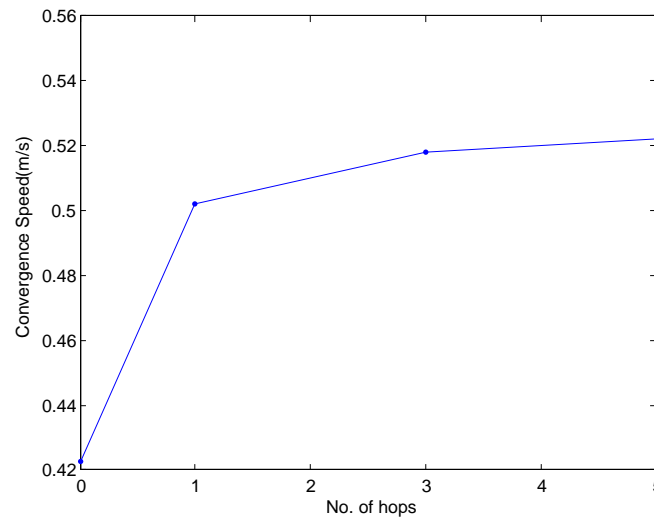

Figure 3.28: BBLP: Effect of Additional ANs on Protocol's Convergence Speed

In order to verify this reasoning, we have carried out simulations with additional ANs on

### 3.10 Performance Evaluation

second and third network hop only and not on the first hop. We observe similar increase in the convergence speed. The same increase in speed is observed if we place ANs on second, third, fourth and fifth hop and no ANs on the first hop.

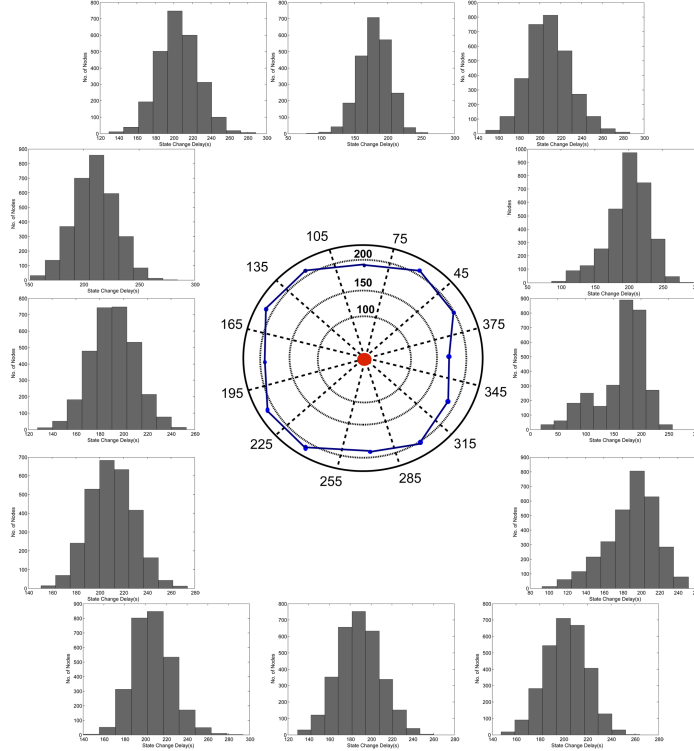

Figure 3.29: BBLP: State Change Delay in the Presence of Additional ANs

The convergence speed of the process increases if we place more ANs on the first hop only and on the second hop only. However, if we place ANs on third hop only, fourth hop only and fifth hop only, there is no increase in the convergence speed.

Based on these results, we make the following conclusions: firstly, that there is a maximum limit of increase in the speed of one BBLP propagation wave that can not be crossed by adding more ANs in the network. Secondly, adding 4 more ANs on the periphery of first or second network hop results in the same increase as by placing 8(second and third hops) or 16(second, third, fourth and fifth hops) more ANs in the network.

In section 3.10.4 of this chapter, we have already presented results on isotropic nature of BBLP's propagation. In this subsection, we want to observe the state change delay of nodes located in the vicinity of additional ANs and the ones that are not. In other words, we want to investigate if the increase in convergence speed of the protocol is higher near the additional ANs or is it the same throughout the network. We divide the network into sections based on

### 3.11 Conclusion

node position angles with respect to the network's origin as we did in section 3.10.4 of this chapter, but in a slightly different way. Here, we consider the network sections in such a way that two horizontal and vertical sections also include additional individual ANs (figure 3.29). Figure shows state change delays of nodes for additional ANs from first to fifth hop of the network. It indicates that state change delay of nodes that are located inside the network sections with additional ANs are the same as the ones located outside these sections. This is because additional ANs provide help to the unlocalized neighborhood but this help does not result in significant increase in the propagation of BBLP inside these sections.

### 3.11 Conclusion

In this chapter, we have proposed two way ranging based localization protocol for sensor networks. We have studied its convergence condition and have found that it undergoes a phase transition. The protocol can propagate in the network only if the node is above a critical threshold value and this critical threshold value remains the same whether the network is large or small. This fact is helpful in predicting the required node degree before network deployment hence enables in spending only the required amount of energy in radio communication. The protocol propagates isotropically across the network and has a constant progress speed. We have analyzed the communication cost incurred by this protocol from a single node and the whole network's perspective. Our study shows that network's perspective is 6 times more costly in terms of required transmissions and 4 times more costly in terms of required reception. We have observed the effect of placing additional ANs in the network on protocol's propagation speed and have found that there is a limit for the increase in this speed which can not be surpassed by adding more ANs in the network.

### 3.11 Conclusion



## Chapter 4

# Continuous Ranging Localization Protocol

### 4.1 Introduction

The proposed Beacon Based Localization Protocol in previous chapter has the advantage of letting ANs/LNs inform about their presence so that the UNs may start the ranging process. BBLP also enables the addition and quick localization of new nodes in a WSN. On the other side, BBLP is communication costly since the localized nodes broadcast BPs continuously even after the network is localized, keeping in view the fact that the need of adding new nodes in the network does not arise very often. Considering this issue, we are interested in making our localization protocol *demand based*. In other words, instead of every localized node informing about its presence through BPs, it should be every unlocalized node that should demand for getting localized by broadcasting HELLO packets.

The idea of using HELLO packets by a node for informing neighbors about its presence was first proposed in OSPF version 2 [25]. Here, our intention is to use HELLO packets for carrying out the first step of the two way ranging process.

Chapter 4 of this dissertation describes our second contribution which is the continuous ranging localization protocol(CRLP). From network's point of view, we consider the same assumption of three non-collinear anchor nodes placed with overlapping communication ranges in the network's center for initiating the localization process as we did for the Beacon based Localization Protocol.

### 4.2 1-hop Measurement Phase

Figure 4.1 shows the 1-hop measurement process carried out at one UN. This UN is located in the vicinity of the three ANs:  $AN_1$ ,  $AN_2$  and  $AN_3$ . The Two Way Ranging process is started by the UN who broadcasts a HELLO packet which is also a RP. This RP is received by the three ANs located in the neighborhood. Upon its reception, the ANs schedule their ACKs for the demanding UN.  $\Delta T_1, \Delta T_2$  and  $\Delta T_3$  in the figure indicates the delay in each AN for receiving the RP, decoding it and scheduling its ACK. The ANs unicast their ACKs upon their scheduled instants which are received by the UN at time  $T_1, T_2$  and  $T_3$  as shown in the figure. This reception constitutes the second step of TWR.

### 4.3 Local Process Phase

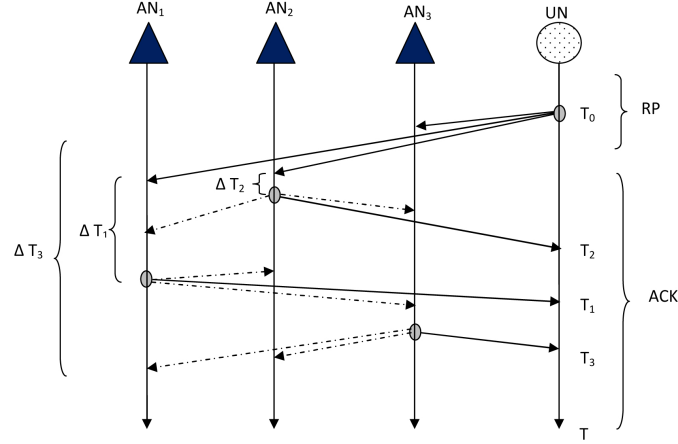

Figure 4.1: Two Way Ranging using Range Messages

### 4.3 Local Process Phase

This ranging process enables the UN to estimate its distance from the three ANs. ACKs contain ANs' coordinates which are used by the UN to estimate its localization through trilateration.

Once a UN becomes a LN, it remains silent and only responds to its unlocalized neighbors ranging packets for helping them in getting localized. In this way, the moment a node arrives in the network; it can start its localization process. In addition, the anchor/localized nodes are relieved from heavy BP broadcast.

It is evident that in the case of CRLP, the nodes may have to broadcast many RPs in order to get localized. Considering the BBLP protocol and the CRLP protocol, we are interested in investigating the following questions:

- What is the convergence condition for CRLP?
- What is the nature of its convergence speed (linear/logarithmic)
- What is the nature of its propagation (isotropic/direction dependent)?
- Which of the two protocols among BBLP and CRLP, is the most communication efficient way of TWR based WSN localization?

### 4.4 CRLP's Implementation

OPNET's implementation of CRLP is very much similar to the BBLP's implementation. Like BBLP, CRLP also is a conduction process that is carried for performing the ranging process at the physical layer. We use the same type of random delays for arrival and service of the two types (RPs and ACKs) of packets. For the purpose of simplicity do not deal with errors in the position estimation process.

CRLP has the same modules: source, proc, state\_control and sink, except that the source and state\_control modules have been modified according to the functionality of CRLP. It has the same packet format and generates same trace files.

## 4.5 Performance Evaluation

### 4.5 Performance Evaluation

In order to answer our questions listed in section 4.3 of this chapter, we consider the same network generation principle as for the BBLP protocol.

#### 4.5.1 Protocol's Convergence

To answer our first question about the convergence condition of CRLP, we plot the same relationship between the network's mean node degree vs. the percentage of localized nodes as we did for the BBLP. Fig 4.2 shows this relationship for BBLP as well as for CRLP. We can see that the phase transition curve for the two protocols overlap completely. This shows that the convergence of CRLP can be characterized with the same phenomenon that governs the convergence of the BBLP.

The convergence condition for CRLP can be explained as follows: CRLP is a trilateration based localization protocol. Even though, the two way ranging process in this protocol is initiated by the UNs, the nodes still need three ACKs from three different ANs/LNs to localize themselves. Hence, it needs to have same node degree as for the BBLP in order to propagate across the network. In other words, the same process of creation and expansion of 3-connected clusters exist with the increase in the node degree in this protocol as well.

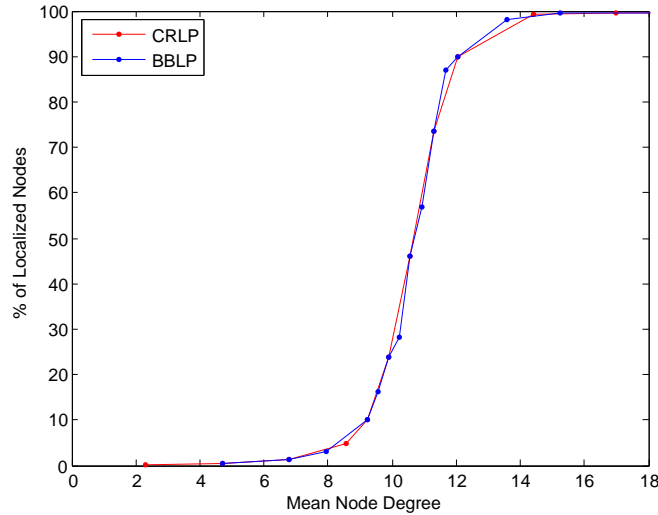

Figure 4.2: BBLP vs. CRLP: Phase Transition

#### 4.5.2 State Change Delay of Nodes across the Network

CRLP's convergence indicates the similar need of mean node degree to be higher than the critical threshold value as is the case with BBLP. Hence, we take node degree of 29 (tx range 25m in a 1350 node network) and plot the same relationship between state change delay of nodes vs. increasing distance from the AN nucleus as we did for BBLP (Fig 4.3).

It is evident that the state change delay of nodes with respect to their distance from the AN nucleus follows the same pattern for the CRLP as it has for the BBLP except that CRLP's propagation is relatively speedy. Hence, we can state that the propagation speed of CRLP also remains constant throughout the network. In the first hop of the network, unlocalized

## 4.5 Performance Evaluation

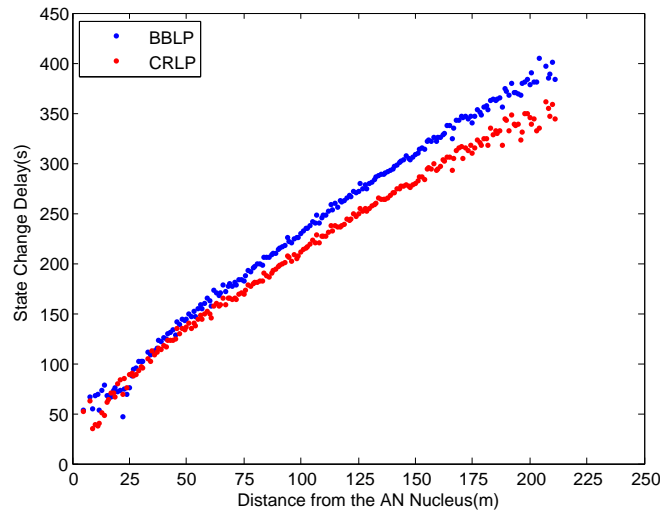

Figure 4.3: BBLP vs. CRLP: State Change Delay of Nodes across the Network

nodes under CRLP start changing their state quickly as compared to BBLP since they do not have to wait for three BPs from three different ANs.

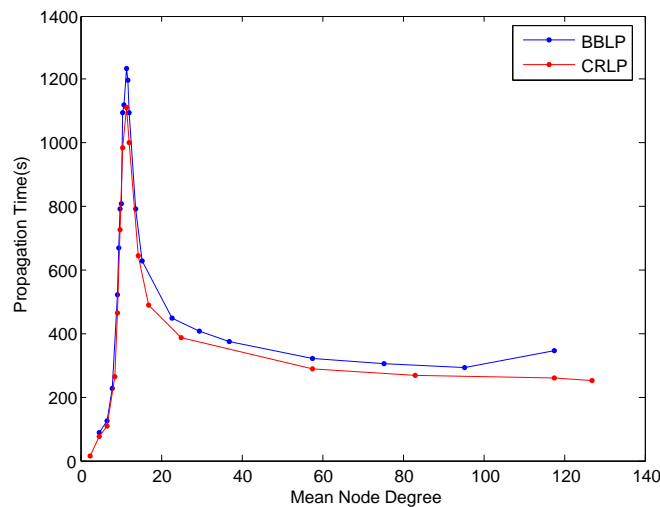

Figure 4.4: BBLP vs. CRLP: Propagation Time

### 4.5.3 Isotropic Propagation

To verify if CRLP also propagates across the network equally in all directions, we consider the same network of 1350 nodes with each node's transmission range to be 25m and plot histograms of state change delays for 12 parts of the network strip (100-125m). Figure 4.5 shows the mean values of delay in the 12 sections along with histograms which are similar to one another.

## 4.5 Performance Evaluation

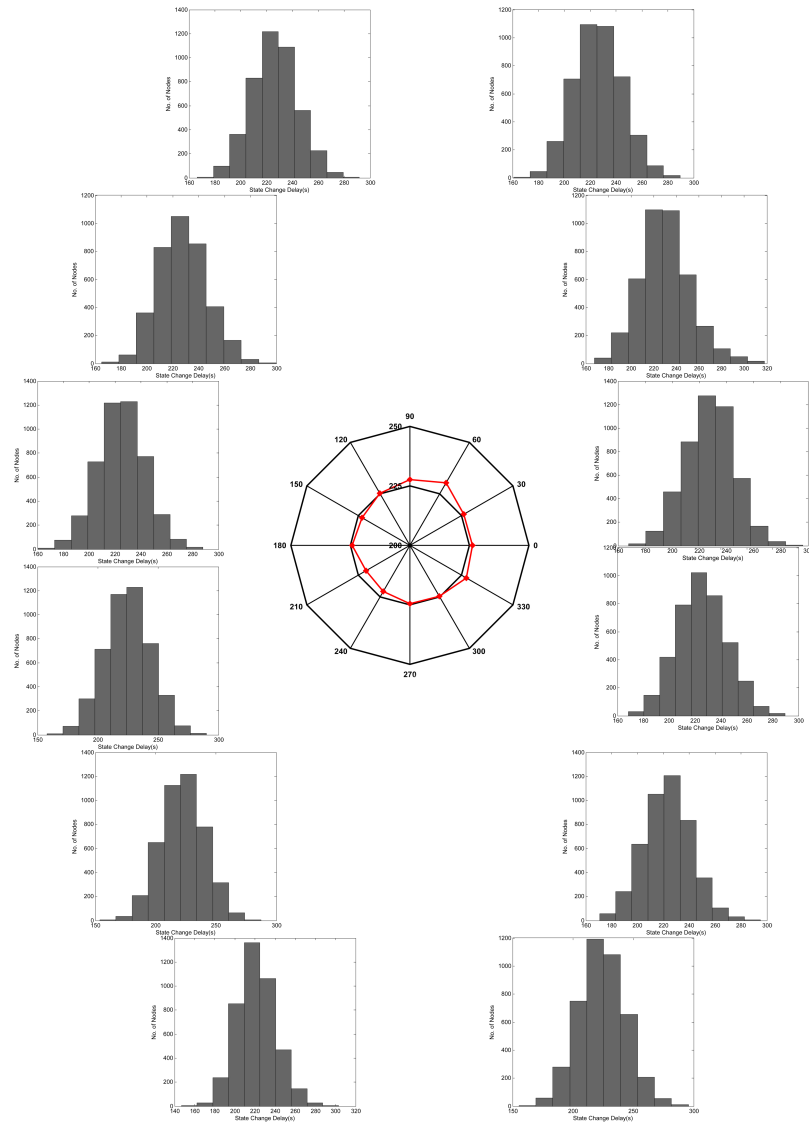

Figure 4.5: CRLP: Isotropic Propagation

## 4.5 Performance Evaluation

Therefore, we can state that, CRLP also propagates isotropically across the network in the form of a *localization wave*. However, there is a difference in the state of network after the two protocol's waves have passed through it. In the case of BBLP, the localization wave leaves behind LNs who broadcast BPs endlessly whereas the CRLP wave leaves behind LNs who have the task of only listening and responding to the RPs broadcast by newly added UN(s).

### 4.5.4 Protocol's Propagation Time

Figure 4.4 shows the propagation time for both BBLP and CRLP with increase in the node degree. In this figure, each point is an average of 10 different random placements. We can see that the propagation time for CRLP follows exactly the same shape of the curve as for the BBLP except that its maximum propagation time is a little less than the BBLP (fig 4.6). CRLP like BBLP undergoes the phenomenon of merging of small isolated clusters into a single 3-connected cluster with increase in node degree. A node degree larger than the critical threshold makes it easy for CRLP to propagate because of enough links for 3-connectedness. For the last part of the two curves in figure 4.4, we observe a difference in behavior of the two protocols. BBLP's propagation time starts to rise after a node degree of 100 whereas CRLP's propagation time remains as constant as it was for the previous node degrees above 29. This behaviour is related to the number of transmitted packets at such a high node degree and is explained in subsection 4.5.6.6 of this chapter.

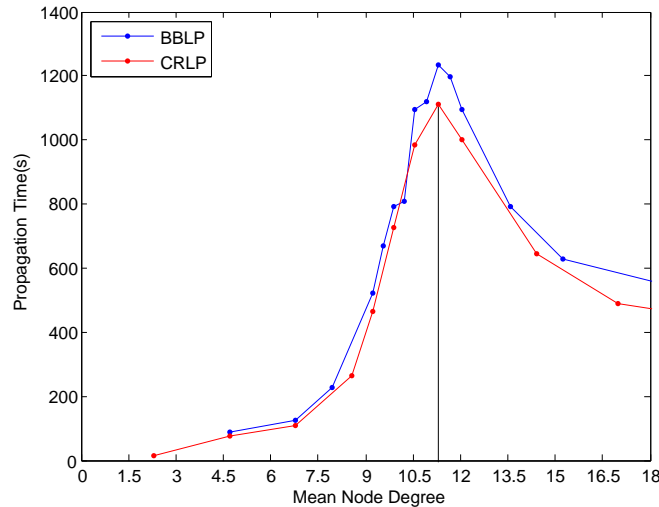

Figure 4.6: BBLP vs. CRLP: Propagation Time near the critical node degree

### 4.5.5 Protocol's Convergence Speed vs. Interarrival Rate

In this subsection, we present a comparison between the convergence speed vs. packet interarrival rate for the two protocols. Figure 4.7 shows that there is no difference in this relationship for the two protocols. The exponential decay function for BBLP also represents this curve for CRLP.

$$y = ae^{-(x/b)^c} \quad (4.1)$$

## 4.5 Performance Evaluation

where  $a$  is the coefficient,  $b$  is the characteristic parameter and  $c$  controls the stretch of the curve around its groove.

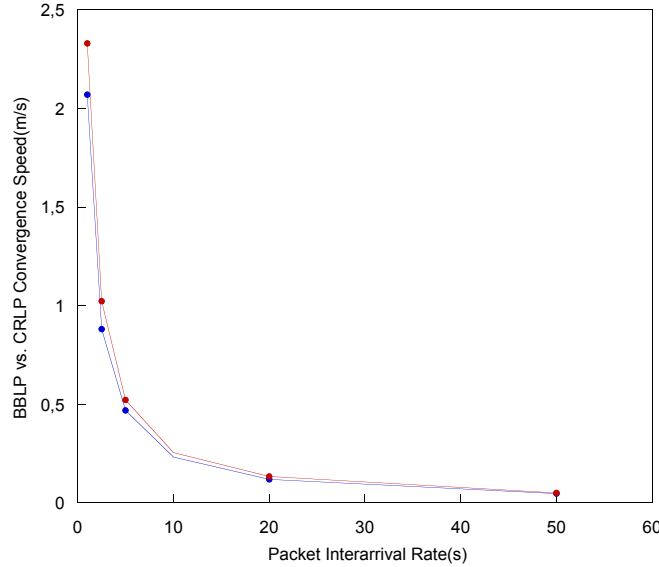

Figure 4.7: BBLP vs. CRLP: Convergence Speed vs. Interarrival Rate

### 4.5.6 Communication Cost

In this subsection, we present our results for communication cost of Continuous Ranging Localization Protocol and compare them with the Beacon Based Localization Protocol. First, we present the overall pattern of transmitted and received packets across the network. Secondly, we classify the packets as *Required* and *Overhead* and count them from a single node and whole network's perspective. We then compare the costs for node and network's perspective of CRLP vs. that of BBLP. Finally, we observe the behavior of number of transmitted and received packets vs. mean node degree.

#### 4.5.6.1 Number of Transmitted Packets vs. Distance from AN Nucleus

We consider a 1350 node network as we did for BBLP with transmission range of nodes to be 25m making approximately 8 hop network. The packet interarrival time for the two types of packets is set to 5 secs. The CRLP starts its execution 10sec after the start of simulation. Simulation is terminated either when all nodes have changed their state or the maximum simulation duration is reached. Figure 4.8 shows the overall pattern of the number of transmitted packets vs. distance from the AN nucleus for a network in which all nodes change their state due to CRLP's propagation. Each point in the figure is the average of packets transmitted by nodes located at a specific distance from the AN nucleus in all directions. This average is made on 10 different uniform random placements with 25 different simulation seeds for each placement.

We observe that this pattern is different from the pattern of transmitted packets under BBLP. In the case of CRLP, nodes that are located at large distance from the AN nucleus transmit more packets since the TWR process is initiated by the unlocalized nodes. However,

## 4.5 Performance Evaluation

the unlocalized nodes do not know if they have enough ANs/LNs in the neighborhood to answer their request. As a result, nodes located in the eighth hop transmit more range packets than the ones located in the first hop.

The maximum number of packets transmitted by nodes remains the same (around 80) for both BBLP and CRLP. This result shows that in terms of communication cost, CRLP is not better than the BBLP. If the localized nodes under BBLP spend energy in broadcasting BPs continuously, nodes under CRLP spend almost equal amount of energy in broadcasting RPs repeatedly until they are answered. In the end, the communication cost incurred on nodes in localized state in case of BBLP is equalized on nodes in unlocalized state in the case of CRLP.

Table 4.1: Mean Tx Packet count for each Packet Category under CRLP

Fifth Hop		Seventh Hop	
RP	ACK	RP	ACK
45	15	58	10

We observe that in the case of CRLP, the pattern of transmitted packets is smooth from 2-6 hop of the network whereas the packets transmitted in the first hop and in seventh and eighth hop suffer irregularity. On the other hand, the overall pattern of transmitted packets for BBLP starts to be smooth from the second hop and remains smooth till the end of the network. This difference is because of the presence of BPs that organize the scheduling and transmission of the three types of packets in BBLP propagation. On the contrary, CRLP has no such mechanism of organizing the packet transmission pattern. The smoothness in its packet transmission pattern from 2-6th hop is due to the steady flow of localization wave which is not the case at the borders. Table 4.1 shows individual count of RPs and ACKs in fifth hop where localization flow is smooth vs. seventh hop which suffers irregularity. Table values show that nodes in the seventh hop transmit less ACKs as compared to the nodes in fifth hop. The reason is that nodes of the seventh hop get little time to respond to RPs of their demanding neighbors before the whole network is localized.

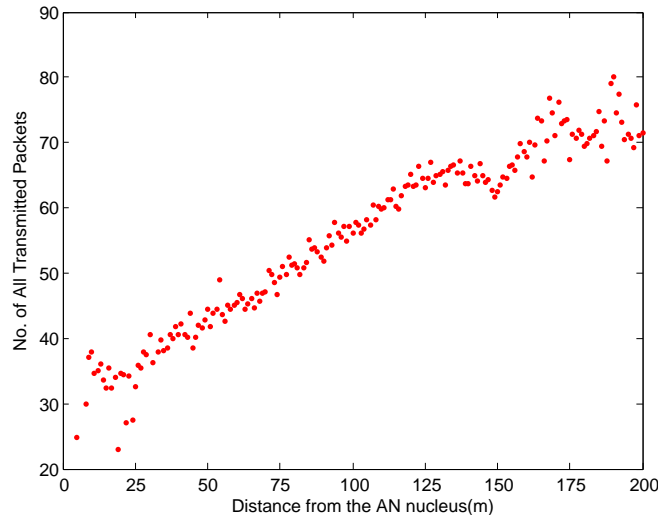

Figure 4.8: CRLP: Transmitted Packets across the Network



## 4.5 Performance Evaluation

### 4.5.6.2 Number of Received Packets vs. Distance from AN Nucleus

Table 4.2: Mean Rx Packet count for each Packet Category under CRLP

Fifth Hop				
A	B	C	D	E
1287	3	46	415	55

Table 4.3: Mean Rx Packet count for each Packet Category under CRLP

Seventh Hop				
A	B	C	D	E
1357	3	38	242	28

In this subsection, we present the overall pattern of the received packets vs. distance from the AN nucleus under CRLP protocol. We consider the same network parameters as for the number of transmitted packets in the previous section. Figure 4.9 shows this pattern. We see almost the same number of received packets under CRLP as in the BBLP propagation. The number of received packets shown here include the two types of received packets RPs or ACKs in any of the two states of a node whether they are needed by the node or not. We classify the packets in the following way:

- RPs received by a UN(A)
- ACKs received by a UN destined to it(B)
- ACKs received by a UN for other UNs(C)
- RPs received by a LN(D)
- ACKs received by a LN(E)

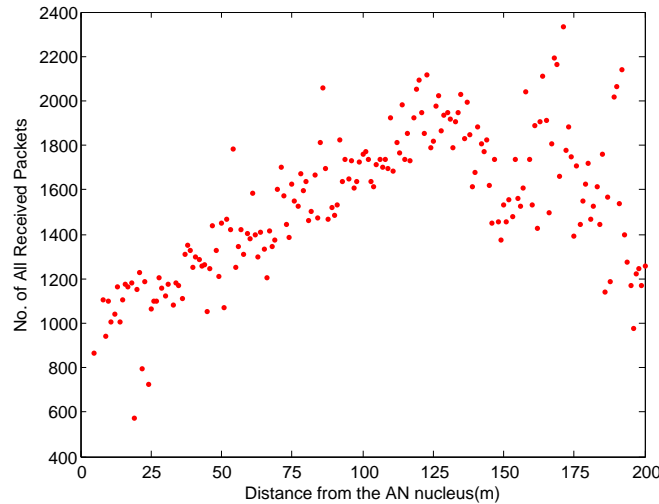

Figure 4.9: CRLP: Received Packets across the Network

## 4.5 Performance Evaluation

Table 4.2 and 4.3 show the individual count for the number of received packets in fifth and seventh hop of the network. Due to the non availability of localization wave, the unlocalized nodes in the seventh hop receive 17% less ACKs destined to other UNs Nodes. Similarly, localized nodes in the seventh hop receive approximately 42% less RPs and 50% less ACKs destined for other UNs due to the probable termination of the localization process in near future.

### 4.5.6.3 Required and Overhead Packets

In this subsection, we classify the packets transmitted and received by a node as either *Required* for getting localized or as a communication *Overhead* from the two perspectives as described in the previous chapter of this dissertation. Table 3.4 and 4.5 shows this classification from a single node's localization perspective and a whole network's localization perspective. Table 4.4 shows that from a node's perspective, it needs to transmit RPs and receive Acknowledgement Packets(APs) destined to it. APs transmitted to other UNs are a communication overhead. From packet reception point of view, APs destined to other demanding UNs, RPs destined for ANs/LNs in both unlocalized and localized state are a communication overhead.

On the other hand, if we consider the communication needed for whole network's localization (table 3.5), the ACKs transmitted by a LN are considered as required packets. In the same way, the RPs received by a LN are meant to help in whole network's localization. Hence, they are considered as required as well.

Table 4.4: Required and Overhead Packets from a Single Node's Perspective under CRLP

	Unlocalized Node	Localized Node
Tx Packets	Required: RP Overhead:None	Required:None Overhead:AP
Rx Packets	Required:AP for it Overhead:1)AP for others 2)RP for LNs	Required: None Overhead: RP, AP

Table 4.5: Required and Overhead Packets from Entire Network's Perspective under CRLP

	Unlocalized Node	Localized Node
Tx Packets	Required: RP Overhead:None	Required:AP Overhead:None
Rx Packets	Required:APs for it Overhead: 1)AP for others 2) RP for LNs	Required: RP Overhead: AP

Table 4.6 and 4.7 show the mean packet count for classified required and overhead packets from the two perspectives for the same network considered in section 4.5.6.1 of this chapter. According to these tables, in terms of required transmissions, network perspective is 33% more costly than the node perspective. On the other hand, network perspective has no transmission overhead as compared to the node perspective. Similarly, in terms of required reception, network perspective is 18 times more costly than the node perspective whereas for overhead reception the two perspectives have more or less the same cost.

## 4.5 Performance Evaluation

Table 4.6: Required and Overhead Mean Packet Count from a Single Node's Perspective under CRLP

	Unlocalized Node	Localized Node
Tx Packets	Required: 40 Overhead:None	Required:None Overhead: 13
Rx Packets	Required:3 Overhead:1030	Required:None Overhead:401

Table 4.7: Required and Overhead Mean Packet Count from Whole Network's Perspective under CRLP

	Unlocalized Node	Localized Node
Tx Packets	Required: 40 Overhead:None	Required: 13 Overhead:None
Rx Packets	Required: 3 Overhead:1030	Required:51 Overhead:350

### 4.5.6.4 The Border Effect

Tables 4.8 and 4.9 present the communication cost as described in the previous subsection excluding border nodes from the first, seventh and eighth hop. We have also noted this cost for the network strip of 100-125m located in the middle of the network. Table 4.10 and 4.11 show these values. It is evident that there is no significant difference in the communication cost values with and without border nodes or for nodes located in the network strip.

Table 4.8: Required and Overhead Mean Packet Count from a Single Node's Perspective under CRLP(without border nodes)

	Unlocalized Node	Localized Node
Tx Packets	Required: 45 Overhead:None	Required:None Overhead:15
Rx Packets	Required:3 Overhead:1334	Required: None Overhead:471

Table 4.9: Required and Overhead Mean Packet Count from Whole Network's Perspective under CRLP(without border nodes)

	Unlocalized Node	Localized Node
Tx Packets	Required: 45 Overhead:None	Required: 15 Overhead:None
Rx Packets	Required: 3 Overhead: 1334	Required:56 Overhead:415

### 4.5.6.5 BBLP vs. CRLP: Communication Cost

In this subsection, we present a comparison between the communication cost incurred by BBLP vs. CRLP. Figure 4.10, 4.11, 4.12 and 4.13 present this comparison for transmitted and received packets from node and network's perspective. Fig 4.10 and 4.11 show that in terms of

## 4.5 Performance Evaluation

Table 4.10: Required and Overhead Mean Packet Count from a Single Node's Perspective under CRLP(Strip 100-125m)

	Unlocalized Node	Localized Node
Tx Packets	Required: 9 Overhead:None	Required:None Overhead:3
Rx Packets	Required:1 Overhead:275	Required:None Overhead:97

Table 4.11: Required and Overhead Mean Packet Count from Whole Network's Perspective under CRLP(Strip 100-125m)

	Unlocalized Node	Localized Node
Tx Packets	Required: 9 Overhead:None	Required: 3 Overhead:None
Rx Packets	Required: 1 Overhead: 275	Required: 12 Overhead:85

required transmissions BBLP is 7 times less costly than CRLP whereas it has a transmission overhead of more than 2 times as compared to the CRLP. In terms of required receptions, CRLP outperforms BBLP since it requires 6 times less packets than BBLP. For overhead receptions, both of them incur equally significant cost on the nodes. Fig 4.12 and 4.13 show that from network's perspective, the two protocols give more or less comparable performance for both required an overhead transmitted and received packets.

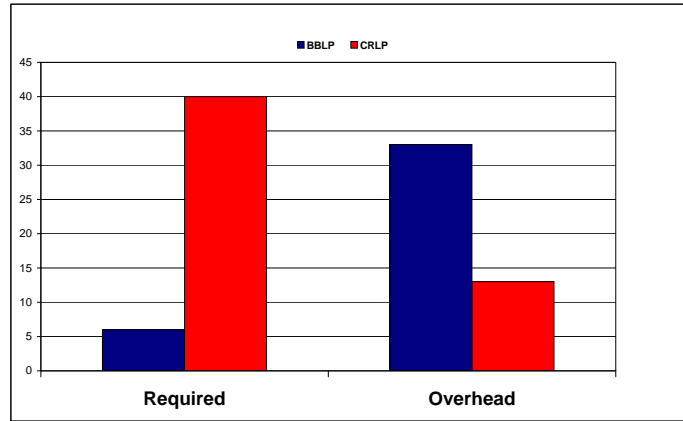

Figure 4.10: BBLP vs. CRLP: Transmissions from Node Perspective

### 4.5.6.6 Communication Cost vs. Mean Node Degree

In this subsection, we compare the transmission and reception cost vs. increase in the mean node degree for BBLP and CRLP. Figure 4.14 shows a different behaviour of transmitted packets across the network for the two protocols. In the case of BBLP, initial increase in the number of transmitted packets with increase in the node degree and then the maximum peak near the critical node degree is due to the phenomenon of phase transition as explained in the previous chapter of this dissertation. An important point to note here is that the peak of

## 4.5 Performance Evaluation

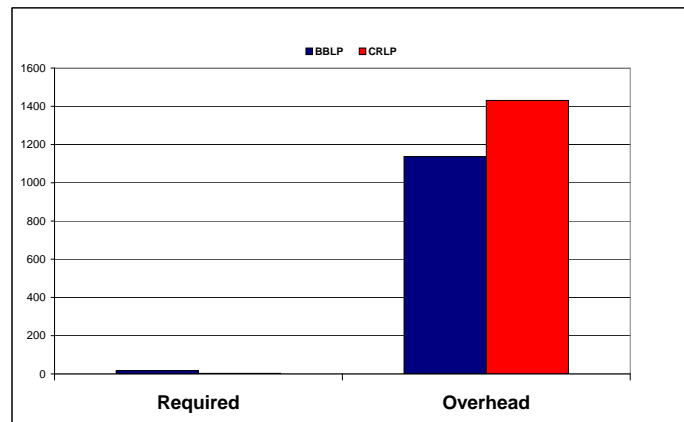

Figure 4.11: BBLP vs. CRLP: Receptions from Node Perspective

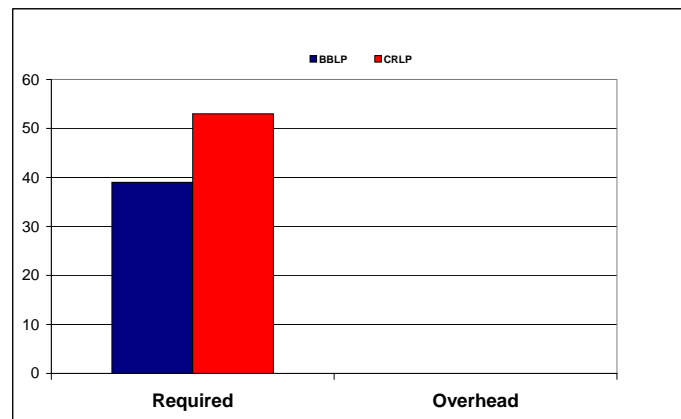

Figure 4.12: BBLP vs. CRLP: Transmissions from Network Perspective

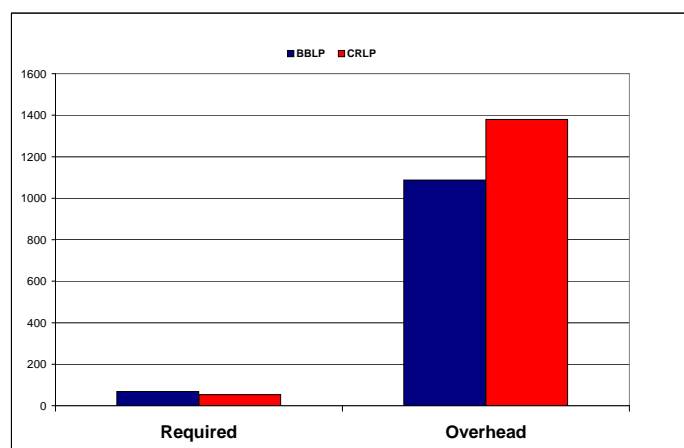

Figure 4.13: BBLP vs. CRLP: Receptions from Network Perspective

## 4.5 Performance Evaluation

transmitted packet count in BBLP is not at 10.5-11 but at node degree of 14. It shows that under BBLP, even after the critical threshold node degree, the whole network has to put in considerable effort for getting localized. After the node degree of 14, the packet count starts to drop and starts to be stable at node degree of 29 onwards.

In the case of CRLP, we observe maximum number of transmitted packets for initial small node degrees. This huge amount represents the struggle of UNs to get localized until the maximum simulation duration(1000sec). However, with increase in the node degree, this number starts to drop near node degree of 9. It steadily drops until node degree of 14 and finally becomes stable at node degree 25. This behavior shows that under CRLP, nodes spend less energy in communication in the vicinity of critical threshold node degree.

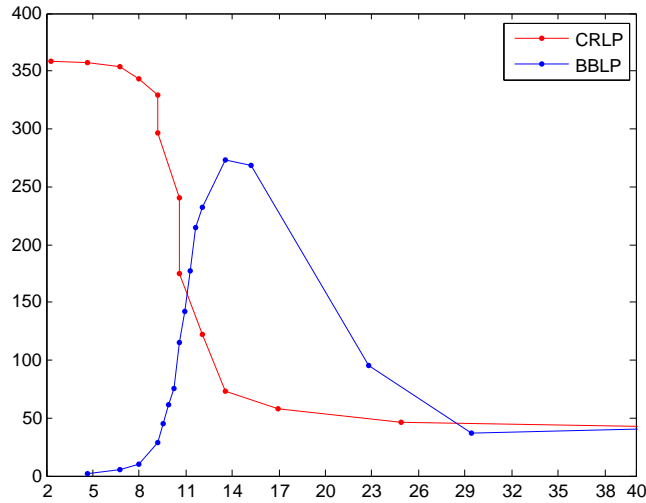

Figure 4.14: BBLP vs. CRLP: Mean Node Degree vs. No. of Transmitted Packets

Figure 4.15 shows the behavior of total received packet count vs. increase in the node degree for the two protocols. Since in the CRLP, the network receives maximum transmitted packets at a node degree less than for the node degree in the case of BBLP, we observe that the maximum receive packet count for CRLP is less than that of the BBLP near the critical threshold region. This count starts to rise more sharply in the case of CRLP for node degree values above 25 due to the inherent huge transmission of RPs by UNs.

### 4.5.7 Effect of Additional Anchor Nodes

In this subsection, we explain the effect of adding more anchor nodes in the network on the convergence speed of the Continuous Ranging Localization Protocol. We consider the same placement of additional anchor nodes that we used for the BBLP. Figure 4.16 shows the comparison between increase in speed of propagation of BBLP vs. CRLP. In this figure, each point represents an average of 250 simulation runs. Initially, we have no anchor nodes but only the AN nucleus, then anchor nodes placed at first hop, then anchor nodes placed at first, second and third hop and finally, anchor nodes placed at first, second, third, fourth and fifth hop.

We have already observed that BBLP's convergence speed has a maximum limit that can not be surpassed by adding more anchor nodes. However, in the case of CRLP, the

## 4.5 Performance Evaluation

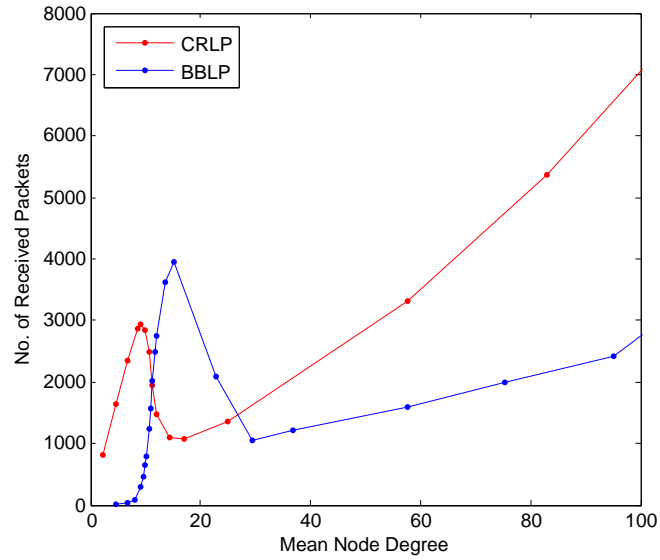

Figure 4.15: BBLP vs. CRLP: Mean Node Degree vs. No. of Received Packets

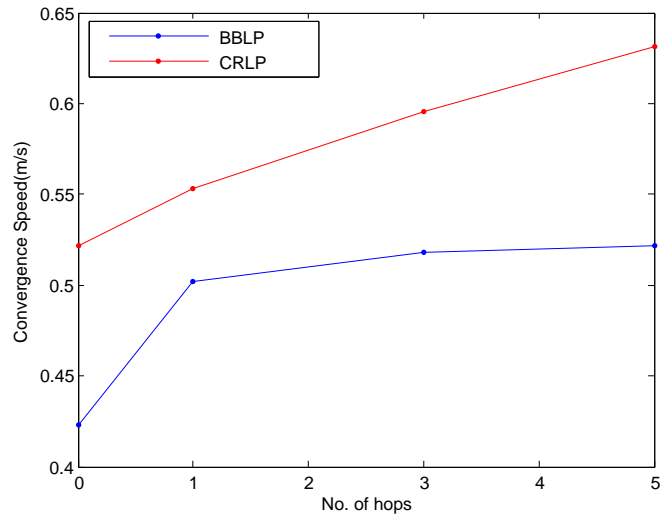

Figure 4.16: BBLP vs. CRLP: Effect of Additional ANs on Protocol's Convergence Speed

## 4.5 Performance Evaluation

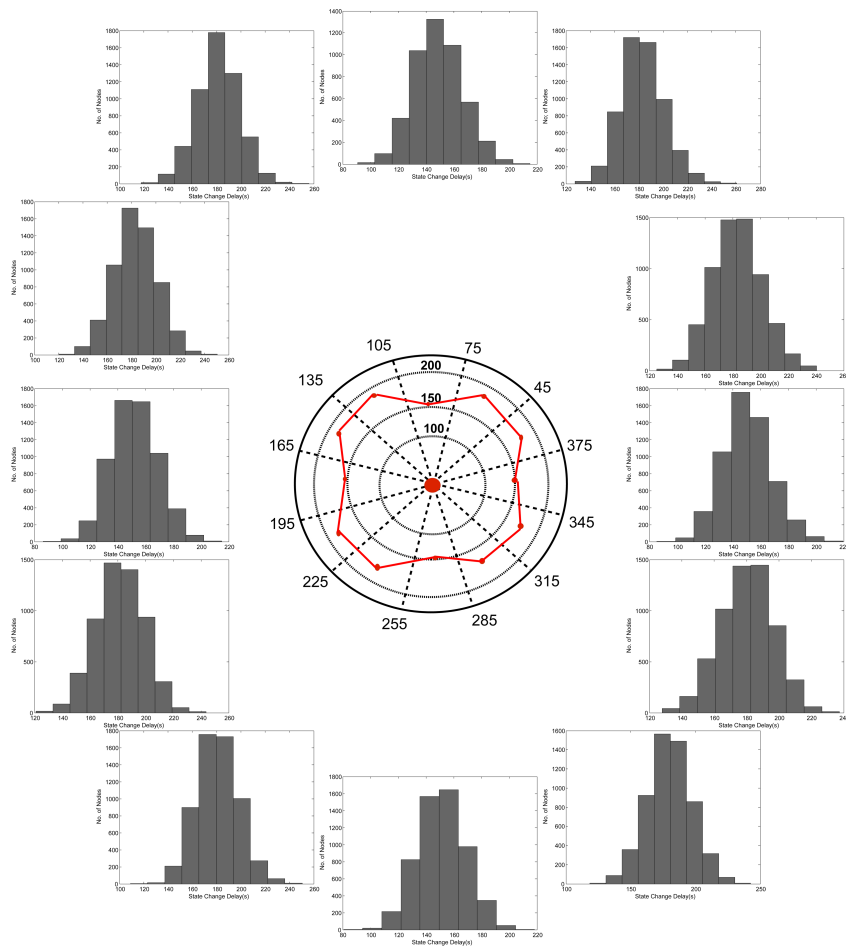

Figure 4.17: CRLP: State Change Delay in the Presence of Additional ANs



## 4.6 Conclusion

convergence speed of the protocol increases by adding more anchor nodes in the network. We ask the same question once again i.e. whether this increase is only in the network sections with additional anchor nodes or is it isotropic throughout the network. To get an answer, we observe the state change delay of nodes in sections of the network with additional anchor nodes and sections without them. We plot the same diagram for the CRLP as we did for the BBLP (fig 4.17) for a network with additional ANs located on 1-5th hop. It shows that mean value of state change delays of nodes is 17% less in network sections with anchor nodes as compared to the ones without anchor nodes. This is because, in the case of CRLP, we always have demanding UNs in the network. Additional anchor nodes reply to the demanding UNs before the actual wave can reach them hence reducing the required ACK count to two which is obtained relatively earlier resulting in quick state change delay of nodes.

## 4.6 Conclusion

In this chapter, we have proposed a demand based localization protocol *CRLP* in which the unlocalized nodes initiate the two way ranging process. We have observed that it shares many similarities with our previously proposed BBLP protocol. CRLP's convergence condition, nature of convergence speed and its propagation is the same as that of the BBLP protocol. However, in terms of communication cost, nodes transmit the same number of packets across the network for the propagation of both BBLP and CRLP. From the point of view of a single node, CRLP requires more transmissions and fewer receptions than BBLP. We have observed that for CRLP, the maximum transmit packet count in the network decreases near the critical threshold region contrary to the BBLP. The maximum receive packet count for CRLP is 4 times more than the BBLP. We have also seen that by placing more anchor nodes in the network, the state change delay increases by 17% for nodes located in the network sections with the additional anchor nodes.

## 4.6 Conclusion

## Chapter 5

# Optimized Beacon Protocol

### 5.1 Introduction

Chapter 5 of this dissertation describes our third contribution which we call the Optimized Beacon Protocol (OBP) for localization in stationary sensor networks. The Beacon Based and the Continuous Ranging Localization Protocol both have the drawback of inducing significant communication on nodes. In the Optimized Beacon Protocol, we address this issue by taking advantage of the broadcast nature of radio communication. Like the Beacon Based and Continuous Ranging Localization Protocol, this protocol is also based on two way ranging distance estimation technique along with the same prerequisite of having the AN nucleus in the center of the network for initiating the propagation process.

### 5.2 1-hop Measurement Phase

In the Optimized Beacon Protocol, the process of localization is initiated by the unlocalized nodes after overhearing a range packet (RP) from a neighboring unlocalized node. The idea is to interpret the reception of the RP as a signal that the localization wave approaches so a node can start localization as in the CRLP. However, the node needs to wait for some delay to be sure that three ANs/LNs are in its neighborhood when it starts ranging. Since, in the beginning, someone has to send RPs, we deploy a starter node at the centroid of the three anchor nodes whose only purpose is to initiate the network wide localization process. The unlocalized nodes in the neighborhood overhear RPs sent by the starter node. These RPs serve as a *trigger* for the unlocalized nodes and they wait for a certain delay  $\Delta t$ . This delay ensures that the starter node will have changed its state to localized in the near future. When this delay expires, these unlocalized nodes start their ranging process. They get ACKs from the ANs/LNs and change their state. The same process is then iterated network wide. In this way, we get rid of continuous emission of Beacon Packets sent by localized nodes in the case of BBLP and the continuous emission of Range Packets in the case of Continuous Ranging Localization Protocol. Furthermore, in the OBP, we can restrict node communication to a maximum allowed budget both in the unlocalized state to send RPs and in the localized state to send ACKs after which the node stops taking part in the localization process. Newly added nodes can start transmitting RPs after a default  $\Delta t$ . Figure 5.1 shows the TWR process being carried out among two unlocalized nodes.

### 5.3 Local Process Phase

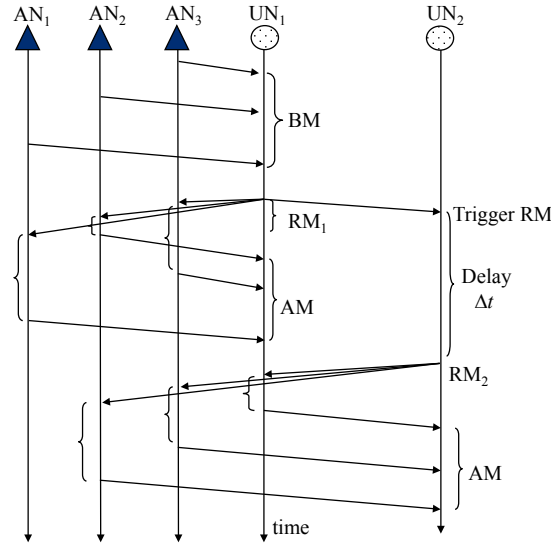

Figure 5.1: Two Way Ranging in Optimized Beacon Protocol

### 5.3 Local Process Phase

The unlocalized node estimates its position using distances from three ANs/LNs through trilateration. The Optimized Beacon Protocol makes addition of new nodes much more communication efficient than our two previously proposed protocols. In the following subsections, we observe the same aspects of convergence condition, convergence speed, nature of propagation and communication cost for the optimized beacon protocol.

### 5.4 OBP's Implementation

OBP's implementation in OPNET follows the same underlying use of random delays implemented in the same modules and generates the same trace files. As for the two previous protocols, we do not address the issue of errors in node's position estimation.

### 5.5 Performance Evaluation

We use the same network generation principles that we considered for the BBLP and CRLP.

#### 5.5.1 Protocol's Convergence

In this subsection, we present the convergence of OBP and compare it with BBLP and CRLP. Figure 5.2 shows the curves for a network with 1350 nodes. For the Optimized Beacon Protocol, we have restricted the unlocalized nodes to send at most 20 RPs and the localized nodes to send a maximum of 20 ACKs. The  $\Delta t$  is 10.0s. We can see that while the critical node degree needed for BBLP and CRLP is exactly the same, it is slightly larger for the OBP. This is due to the communication restriction applied on localized nodes to send a limited number of ACKs. A natural question that arises here is: how does this critical node degree value vary with increase in network size. In order to investigate it, we observed

## 5.5 Performance Evaluation

the convergence of OBP on large networks with 2400 and 3750 nodes with same  $\Delta t$  and communication parameters. Figure 5.3 shows the curves. We can see that the critical node degree for 2400 node network is larger than that for 1350 node network. However, for 3750 node network, it is the same as that for 2400 node network. In other words, the critical node degree value approaches a single finite point with increase in the network size. Since this is one of the basic characteristic of a percolating system [64], we can conclude that the propagation of OBP across the network is also a percolating process.

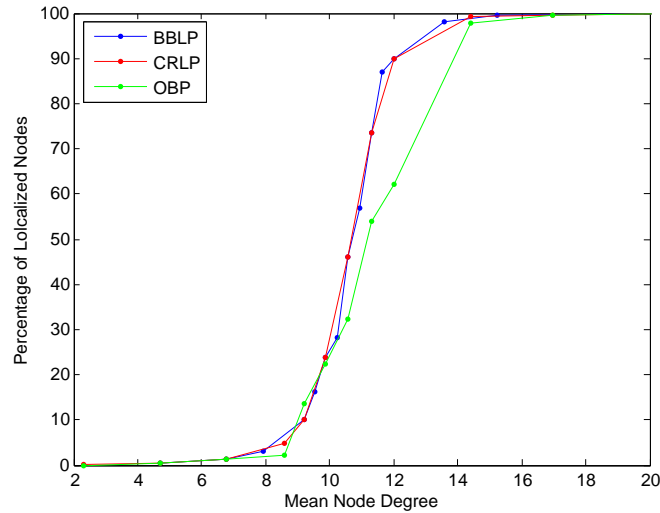

Figure 5.2: BBLP vs. CRLP vs. OBP: Phase Transition

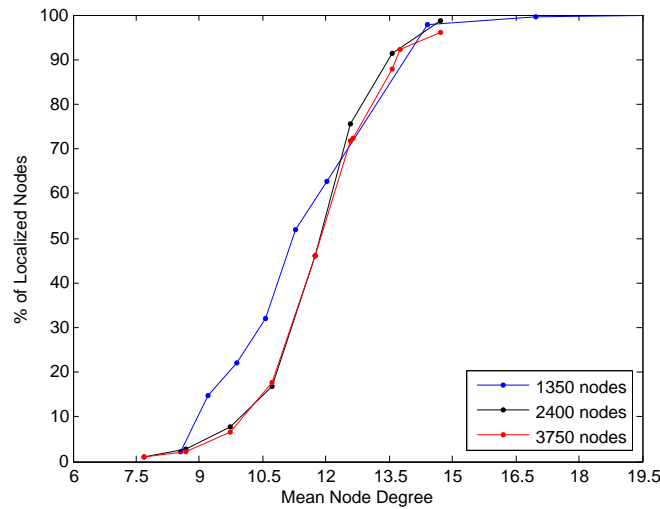

Figure 5.3: OBP: Critical Node Degree for Large Networks

## 5.5 Performance Evaluation

### 5.5.2 State Change Delay of Nodes across the Network

In order to observe the state change delay of nodes with respect to increase in distance from the AN nucleus, we consider a 1350 node network with transmission range of nodes set to 25m. The node degree is 29 which is well above the critical threshold value. For the OBP, we allow each UN to transmit 5 RPs and a LN 15 ACKs. The UNs wait for  $\Delta t$  10.0s after overhearing a RP. Our parameters result in localization of the whole network. Figure 5.4 shows the curves for the three protocols with same simulation parameters. It is evident that the propagation delay for the optimized beacon protocol is around 3.3 times faster than the BBLP and 2.9 time faster than CRLP. Its state change delay also increases linearly with increase in distance from the AN nucleus. We can observe a slight difference in the behaviour of first hop nodes and other nodes of the network as is there for the BBLP. This is due to the starter node's RP that is heard simultaneously by all unlocalized nodes of the first hop and as a result after waiting for  $\Delta t$  10.0 s they start scheduling their RPs at the same time. The curve for OBP is much finer than the other two curves. This is because of  $\Delta t$  that ensures the availability of enough LNs in the neighbors with whom a UN can perform ranging rapidly. The propagation speed of OBP also remains constant throughout the network.

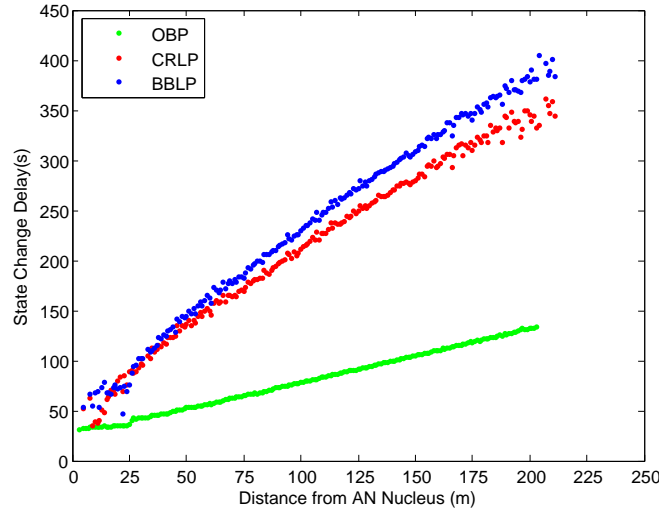

Figure 5.4: BBLP vs. CRLP vs. OBP: State Change Delay of Nodes Across the Network

### 5.5.3 Effect of Delay $\Delta t$

We are interested in observing the effect of  $\Delta t$  on the percentage of nodes who change their state from unlocalized to localized and on OBP's propagation time. Figure 5.5 and 5.6 show the results. These results are based on a network of 1350 nodes with node degree of 29. Ideally speaking, with such a high node degree, each UN needs to transmit only one RP. Nonetheless, for both figures, we set each UN to transmit 2 RPs and a LN can transmit 15 ACKs at maximum.

If we compare the results in the previous section ( OBP parameters: 5 RPs, 15 ACKs,  $\Delta t$  =10s) with the results presented in figure 5.5, we can see that there is a trade-off between delay and communication cost. In figure 5.5, for maximum RPs = 2 and  $\Delta t$  = 20sec we get

## 5.5 Performance Evaluation

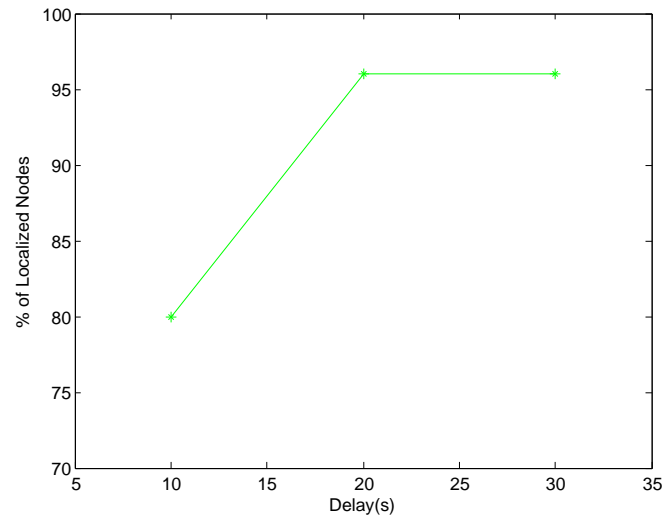

Figure 5.5: OBP: Delay vs. % of localized nodes

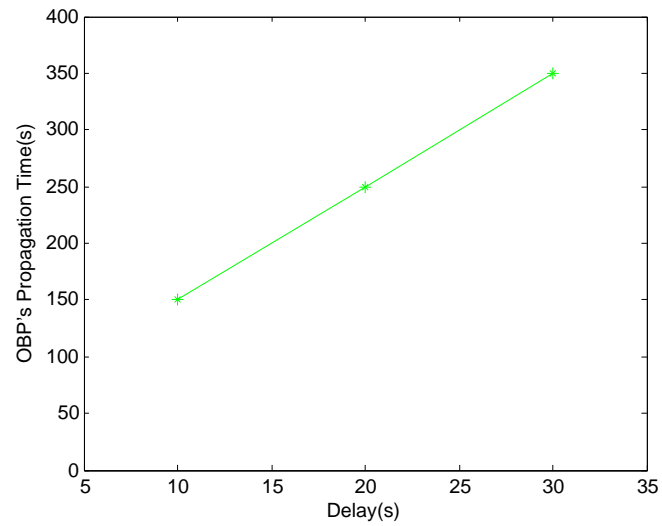

Figure 5.6: OBP: Delay vs. OBP's Propagation Time

## 5.5 Performance Evaluation

95% localization of the network. However, for maximum RPs = 5 and  $\Delta t = 10\text{sec}$  we get 100% localization of the network. Hence, in principle, we can tune either of the two parameters:  $\Delta t$  or the number of allowed packets to be transmitted by a node to get maximum localized nodes depending on our need for latency or cost.

### 5.5.4 Isotropic Propagation of the Process

We consider the same network parameters for OBP as mentioned in the previous subsection 5.5.2 of this chapter and isolate the network region of 100-125m. We then divide this region into 12 parts and plot the mean values of state change delays of nodes in each of these parts along with their histograms (figure 5.7). We can observe that these histograms are similar to one another and the mean values of all parts are also the same. Hence, we can state that OBP also propagates isotropically across the network in the form of a wave except that in the case of OBP, the localization activity area is reduced. During the propagation of OBP, as the localization wave moves forward, it leaves behind inactive localized nodes. The localization activity is only carried out at the anterior end of the wave where the UNs have overheard RPs from other demanding UNs.

### 5.5.5 Protocol's Propagation Time

In this subsection, we present the relationship between OBP's propagation time vs. increase in the mean node degree and compare it with the other two protocols. Figure 5.8 shows the relationship. We can observe that in the beginning, the propagation time for OBP increases with increase in the mean node degree as is the case with the other two protocols. However, at the critical node degree the maximum peak for the propagation time of OBP is around 4 times less the other two protocols. A closer look at the peak in figure 5.9 shows that for the OBP, this peak is not pointed as is the case with the other two protocols. This is because of the utilization of overhearing implemented in the OBP. Nodes due to overhearing spend less time and less energy in merging the central 3-connected cluster with neighboring small and isolated 3-connected clusters. Afterwards, with further increase in the node degree, the propagation time of OBP decreases and then becomes stable as is the case in the other two protocols.

### 5.5.6 Protocol's Convergence Speed vs. Packet Interarrival Rate

In this subsection, we present the comparison of convergence speed vs. packet interarrival rate for the three protocols. Figure 5.10 shows these curves. We can see that while this relationship remains the same for BBLP and CRLP, for the OBP the increase in speed is more rapid as compared to the other two protocols.

### 5.5.7 Communication Cost

In this subsection, we present our results for communication cost of Optimized Beacon Protocol and compare them with the Beacon Based Localization Protocol and Continuous Ranging Localization Protocol. Like in the previous chapters, first, we present the overall pattern of transmitted and received packets under OBP across the network. Then, we classify the packets as *Required* and *Overhead* and count them from a single node and whole network's perspective. We then compare the costs for node and network's perspective of OBP vs. BBLP and CRLP. Finally, we observe the behavior of number of transmitted and received packets vs. mean node degree under the three protocols.



## 5.5 Performance Evaluation

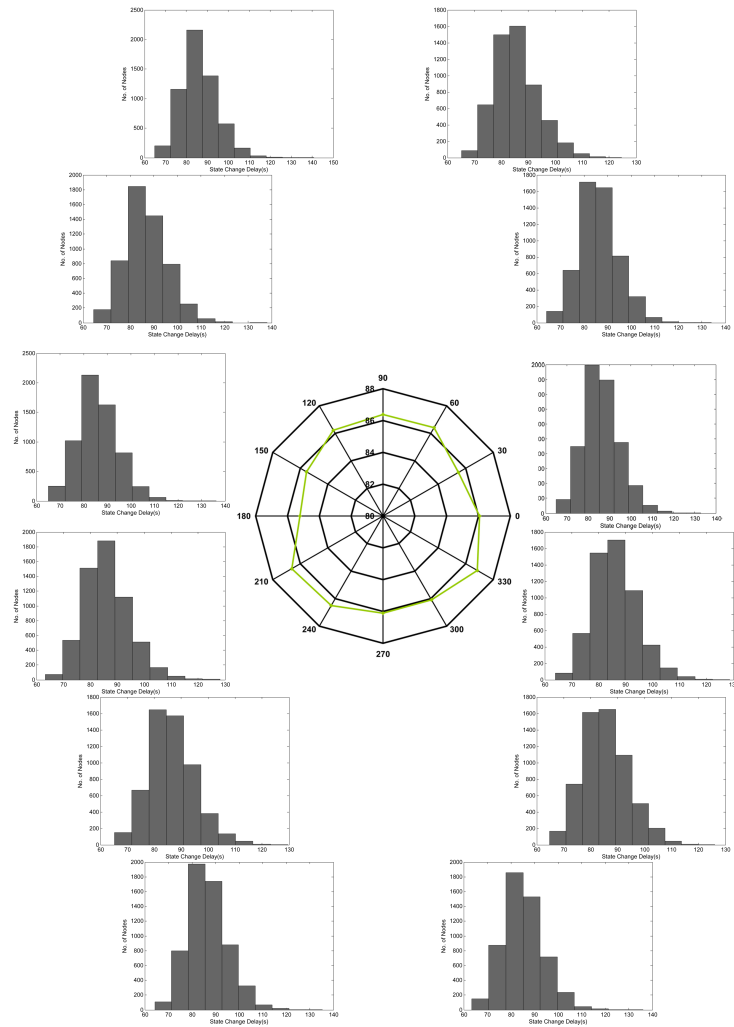

Figure 5.7: OBP: Isotropic Propagation

## 5.5 Performance Evaluation

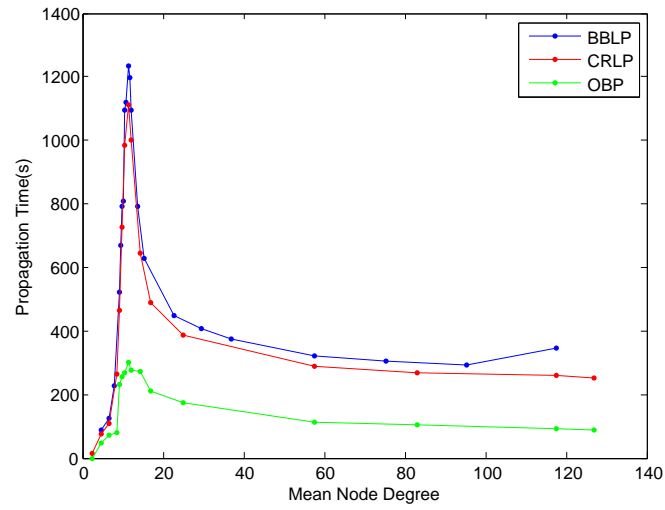

Figure 5.8: BBLP vs. CRLP vs. OBP: Propagation Time

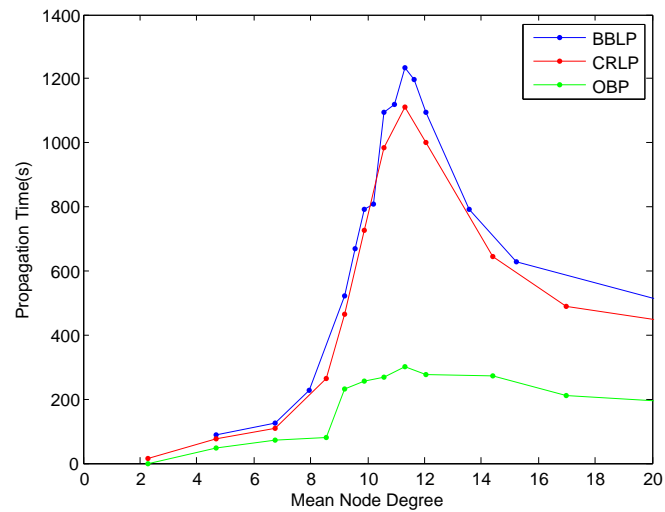

Figure 5.9: BBLP vs. CRLP vs. OBP: Propagation Time near critical node degree

## 5.5 Performance Evaluation

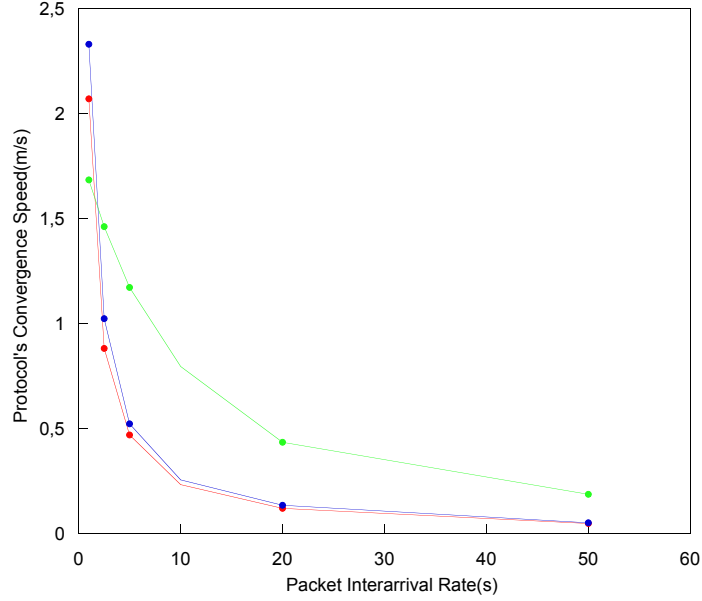

Figure 5.10: BBLP vs. CRLP vs. OBP: Convergence Speed vs. Interarrival Rate

### 5.5.7.1 Number of Transmitted Packets vs. Distance from AN nucleus

We consider a 1350 node network as we did for the previous two protocols with transmission range of nodes to be 25m making approximately 8 hop network. The packet interarrival time for the two types of packets is set to 5 secs. We allow each UN to transmit 5 RPs and a LN 15 ACKs. The UNs wait for  $\Delta t$  10.0s after overhearing a RP. The OBP starts its execution 10sec after the start of simulation. Simulation is terminated either when all nodes have changed their state or the maximum simulation duration is reached. Figure 5.11 shows the overall pattern of the number of transmitted packets vs. distance from the AN nucleus for a network in which all nodes change their state due to OBP's propagation. Each point in the figure is the average of packets transmitted by nodes located at a specific distance from the AN nucleus in all directions. This average is made on 10 different uniform random placements with 25 different simulation seeds for each placement.

We can observe that the maximum number of packets transmitted by nodes under OBP is 6 times less than that for the previous two protocols. Under OBP, maximum packets are transmitted near the AN nucleus because ANs/LNs have to answer large number of RPs by unlocalized nodes who overheard started node's RP simultaneously. This count remains more or less the same up to sixth hop because of the smooth flow of localization wave. After the sixth hop, this count starts to decrease because of the probable termination of the process. In order to see the number of RPs and ACKs making up the total count, table 5.1 further elaborates our results. It shows individual packet count for OBP in fifth and seventh hop of the network. It is evident that with such network parameters, it suffices for a UN to transmit only 1 RP in order to get localized.

## 5.5 Performance Evaluation

Table 5.1: Mean Tx Packet count for each Packet Category under OBP

Fifth Hop		Seventh Hop	
RP	ACK	RP	ACK
1	10	1	7

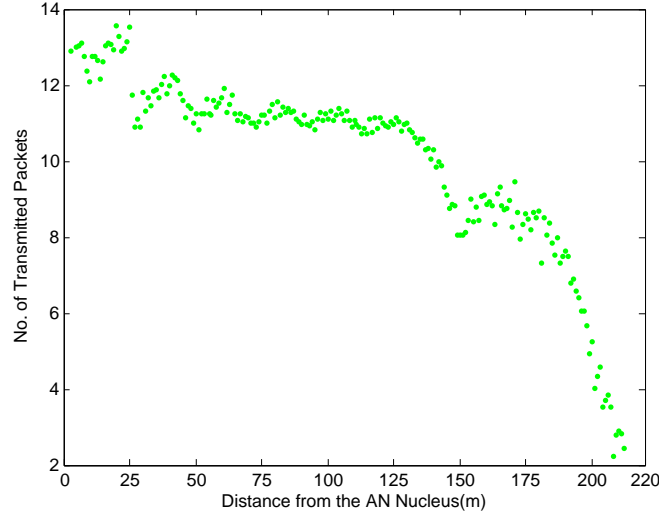

Figure 5.11: OBP: No. of Transmitted Packets

### 5.5.7.2 Number of Received Packets vs. Distance from AN nucleus

Figure 5.12 shows the overall pattern of the number of received packets vs. distance from the AN nucleus considering the same network parameters as for the number of transmitted packets. As for the transmitted packets, the number of received packets under OBP is 6 times less than the other two protocols. The received packet count presented here can be classified as:

- RPs received by a UN(A)
- ACKs received by a UN destined to it(B)
- ACKs received by a UN for other UNs(C)
- RPs received by a LN(D)
- ACKs received by a LN(E)

Table 5.2 and 5.3 shows the individual count for the above mentioned classification in fifth and seventh hop.

Table 5.2: Mean Rx Packet count for each Packet Category under OBP

Fifth Hop				
A	B	C	D	E
25	3	138	20	142

## 5.5 Performance Evaluation

Table 5.3: Mean Rx Packet count for each Packet Category under OBP

Seventh Hop				
A	B	C	D	E
21	3	130	18	98

We can observe the comparatively less number of ACKs received by a LN in the seventh hop since the process is about to terminate.

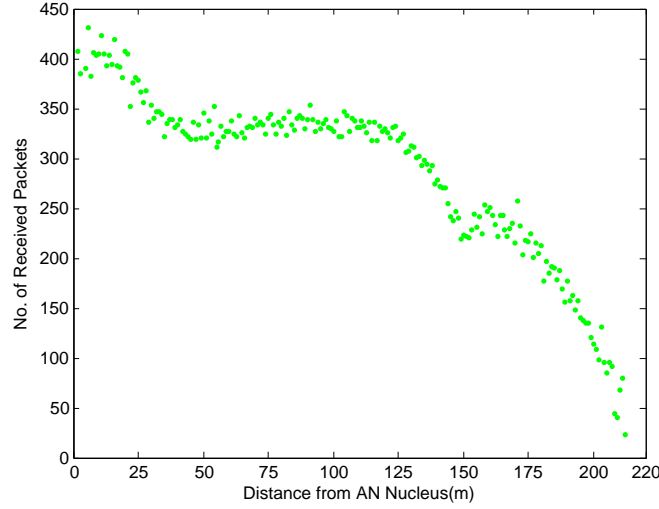

Figure 5.12: OBP: No. of Received Messages

### 5.5.7.3 Required and Overhead Packets

In this subsection, we classify the packets as *Required* and *Overhead* from a single node's perspective and the whole network's perspective as we did for the other two protocols. Tables 5.4 and 5.5 show this classification. This classification is almost the same as that of the CRLP protocol except that an unlocalized node needs to overhear a RP that triggers it to start its ranging process both in node and network's perspective.

Table 5.4: Required and Overhead Packets from a Single Node's Perspective under OBP

	Unlocalized Node	Localized Node
Tx Packets	Required: RP Overhead:None	Required:None Overhead:AP
Rx Packets	Required:1) Trigger RP 2) AP for it Overhead:1)AP for others 2)RP for LNs	Required: None Overhead: RP, AP

Based on this classification, tables 5.6 and 5.7 show the values obtained for each category of packets. Table values show that in terms of required transmissions, network perspective is 10 times more costly than the node perspective while it has no transmission overhead as

## 5.5 Performance Evaluation

Table 5.5: Required and Overhead Packets from Entire Network’s Perspective under OBP

	Unlocalized Node	Localized Node
Tx Packets	Required: RP Overhead:None	Required: AP Overhead:None
Rx Packets	Required:1) Trigger RP 2)APs for it Overhead: 1)AP for others 2) RP for LNs	Required: RP Overhead: AP

compared to the node perspective. In terms of required receptions, network’s perspective is 5 times more costly than the node perspective whereas reception overhead for the two perspectives is more or less the same.

Table 5.6: Required and Overhead Mean Packet Count from a Single Node’s Perspective under OBP

	Unlocalized Node	Localized Node
Tx Packets	Required: 1 Overhead:None	Required:None Overhead:9
Rx Packets	Required:4 Overhead:140	Required: None Overhead: 137

Table 5.7: Required and Overhead Mean Packet Count from Whole Network’s Perspective under OBP

	Unlocalized Node	Localized Node
Tx Packets	Required: 1 Overhead:None	Required: 9 Overhead:None
Rx Packets	Required:4 Overhead:140	Required: 20 Overhead: 117

### 5.5.7.4 The Border Effect

Tables 5.8 and 5.9 present the communication cost as described in the previous subsection excluding border nodes from the first, seventh and eighth hop. We have also noted this cost for the network strip of 100-125m located in the middle of the network. Table 5.10 and 5.11 show these values. It is evident that there is no significant difference in the communication cost values with and without border nodes or for nodes located in the network strip.

Table 5.8: Required and Overhead Mean Packet Count from a Single Node’s Perspective under OBP(without border nodes)

	Unlocalized Node	Localized Node
Tx Packets	Required: 1 Overhead:None	Required:None Overhead:9
Rx Packets	Required:4 Overhead:146	Required: None Overhead:131

## 5.5 Performance Evaluation

Table 5.9: Required and Overhead Mean Packet Count from Whole Network's Perspective under OBP(without border nodes)

	Unlocalized Node	Localized Node
Tx Packets	Required:1 Overhead:None	Required:9 Overhead:None
Rx Packets	Required: 4 Overhead: 146	Required:16 Overhead:115

Table 5.10: Required and Overhead Mean Packet Count from a Single Node's Perspective under OBP(Strip 100-125m)

	Unlocalized Node	Localized Node
Tx Packets	Required: 1 Overhead:None	Required:None Overhead:8
Rx Packets	Required: 4 Overhead:163	Required:None Overhead:162

Table 5.11: Required and Overhead Mean Packet Count from Whole Network's Perspective under OBP((Strip 100-125m)

	Unlocalized Node	Localized Node
Tx Packets	Required:1 Overhead:None	Required: 8 Overhead:None
Rx Packets	Required: 4 Overhead: 163	Required:14 Overhead:148

### 5.5.7.5 Comparison of BBLP, CRLP and OBP Communication Cost

In this subsection, we present a comparison between the communication cost incurred by OBP vs. BBLP and CRLP. Figure 5.13, 5.14, 5.15 and 5.16 present this comparison for transmitted and received packets from node and network's perspective. In all the following categories, we consider the most expensive protocol and compare OBP with it. These figures show that from node's perspective, in terms of required transmissions, OBP is 10 times less costly than the CRLP. For overhead transmissions, it is 3.5 times less costly than the most expensive BBLP. In the case of required receptions, the three protocols have almost the same requirement because they are all based on trilateration. For overhead receptions, OBP is 5 times less costly than the most expensive CRLP.

From network's perspective, OBP's required transmission cost is 5 times less than the most expensive protocol in this category which is CRLP. In terms of required receptions, OBP is 3 times less costly than the most expensive protocol which is BBLP in this category. In terms of overhead receptions, OBP is 5.5 times less costly than the most expensive CRLP.

### 5.5.7.6 Communication Cost vs. Mean Node Degree

In this subsection, we compare the transmission and reception cost vs. increase in the mean node degree for the three protocols considering the same network and OBP parameters as mentioned in section 5.5.7.1 of this chapter. Figure 5.17 and 5.18 show this behaviour. We can observe that the maximum transmitted packet count under OBP near the critical threshold value is around 9 times less than both the other two protocols. With increase in the mean

## 5.5 Performance Evaluation

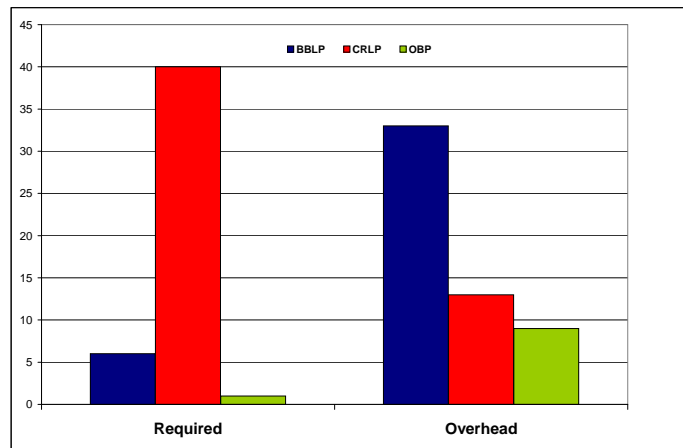

Figure 5.13: BBLP vs. CRLP vs. OBP: Transmissions from Node Perspective

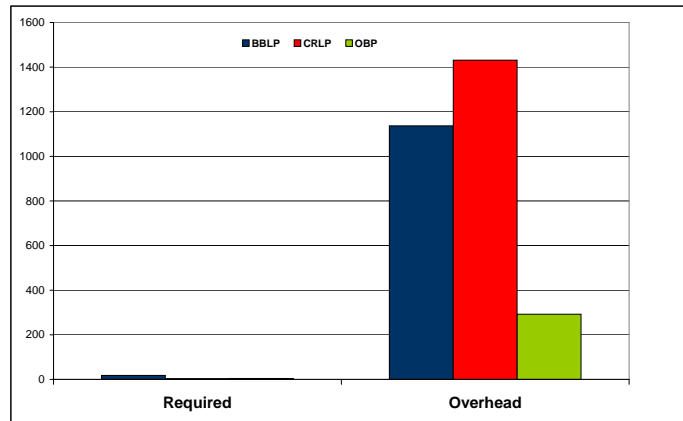

Figure 5.14: BBLP vs. CRLP vs. OBP: Receptions from Node Perspective

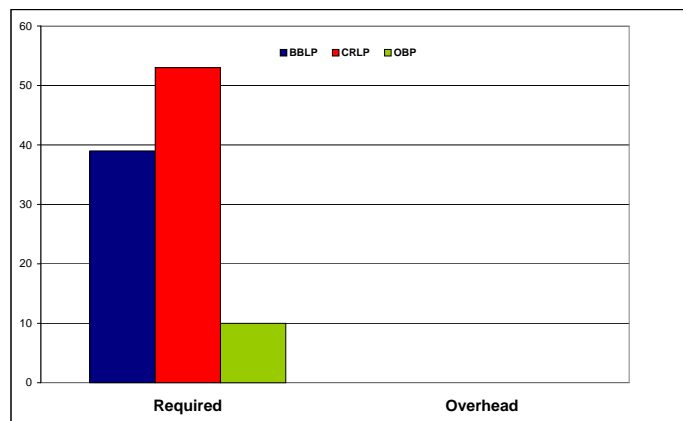

Figure 5.15: BBLP vs. CRLP vs. OBP: Transmissions from Network Perspective



## 5.5 Performance Evaluation

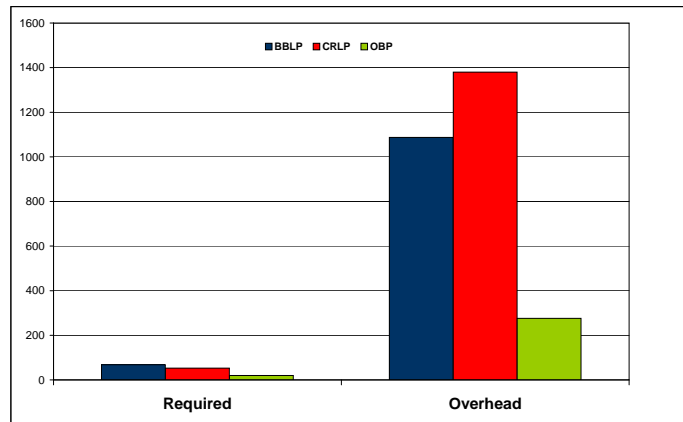

Figure 5.16: BBLP vs. CRLP vs. OBP: Receptions from Network Perspective

node degree, this count becomes stable and remains stable even for high node degree value after 100 as compared to the BBLP. This is because even if nodes have a large neighborhood, the localization activity is carried out in the vicinity of the wave. The serving of RPs through ACKs by LNs never slows down because there are always enough LNs to respond.

Figure 5.18 shows the number of received packets vs. increase in the mean node degree. We can observe that the receive packet count for OBP is approximately 10 orders of magnitude less than both the BBLP and CRLP near the critical node degree value.

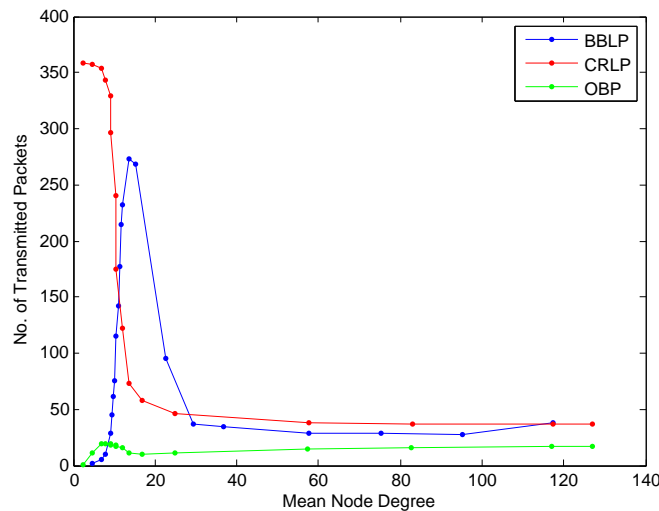

Figure 5.17: BBLP vs. CRLP vs. OBP: Mean Node Degree vs. No. of Transmitted Packets

### 5.5.7.7 Effect of Additional Anchor Nodes

In this subsection, we explain the effect of adding more anchor nodes in the network on the convergence speed of the Optimized Beacon Protocol. We consider the same placement of

## 5.6 Conclusion

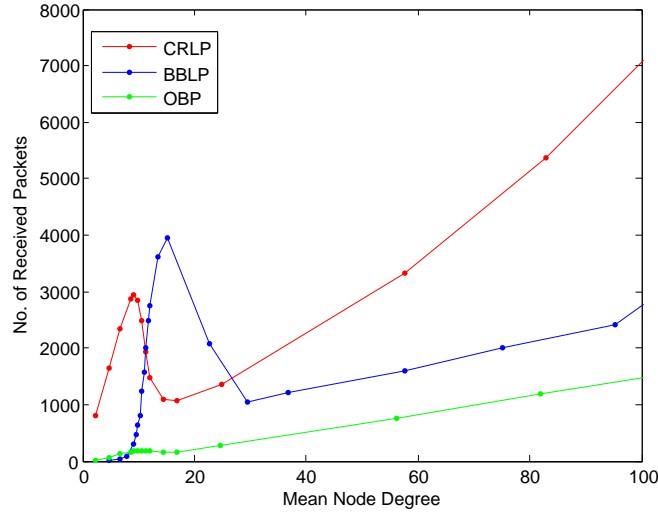

Figure 5.18: BBLP vs. CRLP vs. OBP: Mean Node Degree vs. No. of Received Packets

additional anchor nodes and the network parameters that we used for the BBLP and CRLP. Figure 5.19 shows the comparison between increase in speed of propagation of OBP vs. BBLP and CRLP. In the figure, initially, we have no anchor nodes but only the AN nucleus, then anchor nodes placed at first hop, then anchor nodes placed at first, second and third hop and finally, anchor nodes placed at first, second, third, fourth and fifth hop. Each point in the figure represents an average of 250 simulation runs.

We can observe two aspects in this figure. First is that the convergence speed of OBP is 2.4 times faster than the CRLP and 3 times faster than the BBLP. Secondly, the addition of more anchor nodes has no effect on the convergence of OBP and its speed remains constant. This is understandable because with a network degree of 29, in the vicinity of localization wave, the  $\Delta t$  of 10.0s enables the availability of enough localized nodes for answering RPs by UNs. Hence, adding more ANs has no effect on the convergence speed of the process. Figure 5.20 shows the state change delay of nodes in the network with additional anchor nodes on first, second, third, fourth and fifth hop. It is evident that the propagation of OBP remains isotropic as was the case without additional anchor nodes presented in section 5.5.4 of this chapter.

## 5.6 Conclusion

In this chapter, we have proposed an improved and communication efficient localization protocol *OBP* which benefits from the phenomenon of *Overhearing* to get rid of the shortcomings of our two previous protocols. We have observed that by adding communication restrictions on nodes, there is only a slight increase in the critical node degree required for protocol's propagation but a significant gain in communication cost. This improved protocol is 6 times less costly than our two previous protocols. Its propagation across the network is isotropic and its speed remains constant like the other two protocols but it is better than the other two protocols in terms of convergence speed and propagation time near the critical node degree. We have also observed that there is no effect of adding additional anchor nodes on

## 5.6 Conclusion

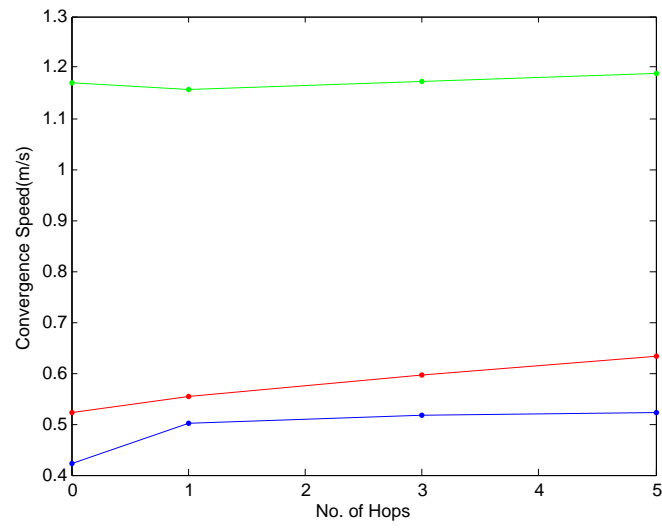

Figure 5.19: BBLP vs. CRLP vs. OBP: Effect of Additional ANs on Convergence Speed

the propagation of OBP.

## 5.6 Conclusion

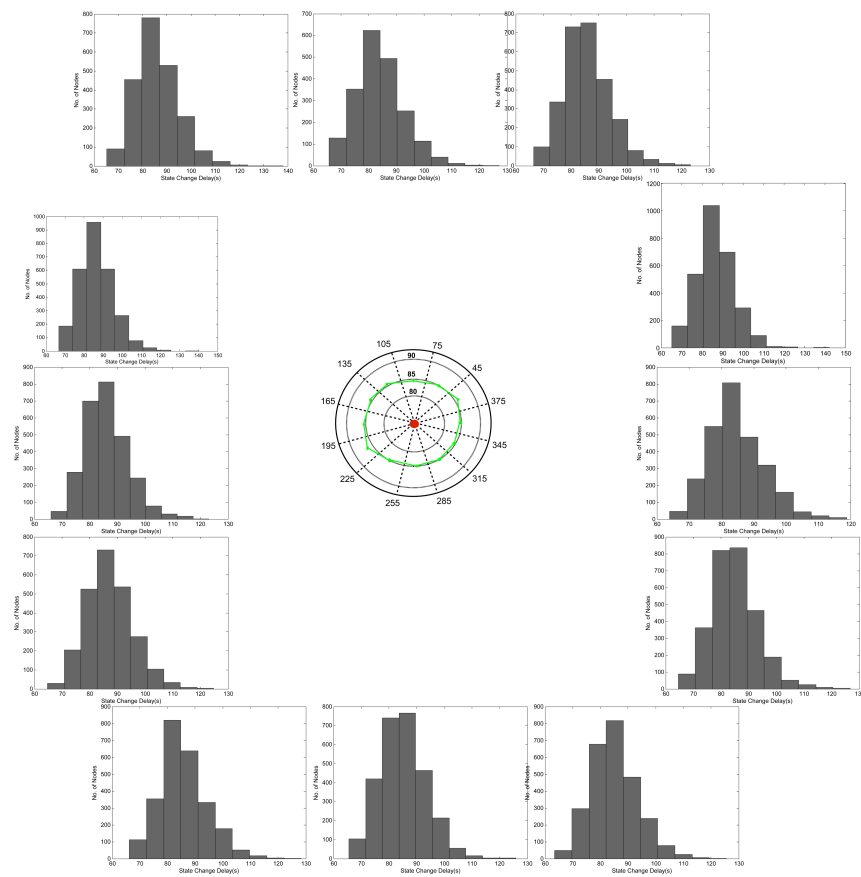

Figure 5.20: OBP: Effect of Additional ANs on State Change Delay of Nodes

## 5.6 Conclusion

## Chapter 6

# Conclusions

Limited energy possessed by wireless sensor nodes is a major hindrance in their large scale deployment. Localization process of a wireless sensor network also suffers from this constraint. Localization of wireless sensor networks is an active research area by itself even though a lot of work has been done in it in the past decade.

This thesis deals with a two faceted problem: localization and energy consumption in WSNs localization. Localization in WSNs has three aspect and these are firstly, its 1-hop measurement phase, secondly energy consumption involved in node position computation and thirdly energy consumption in communication. Even though, the various steps of localization process have been identified in the literature, we present our own model for the process of localization to better elaborate our area of contribution.

Considering the 1-hop measurement phase, the standardization of UWB based ranging process in 802.15.4a has opened a new domain in this research area. Now, the use of Radio Frequency Time of Flight (RF ToF) for ranging which was once thought to be skeptical is being considered as a good option for WSNs. It is one of the basic motivations behind carrying out this work.

In this thesis, we deal with the wireless sensor network localization from the aspect of energy consumption in communication considering RF ToF based Two Way Ranging Process. In our work, we have investigated the possible ways of commencement of the network wide localization process; whether it should be initiated by an unlocalized node of the network or the localized node. We have studied how it should terminate for the nodes present in the network in such a way that adding and localizing new nodes remains possible. We have observed various ways to organize cooperation among the nodes. We have investigated if it is possible to take advantage of the broadcast nature of the radio medium to reduce the localization related communication cost incurred on energy constrained sensor nodes.

We have observed that all the three of our proposed localization protocols when propagate across the network; it can be explained as a phase transition behavior. This behavior enables us to predict the number of neighbors needed by each node for the propagation of our protocols allowing the nodes to spend only required amount of transmission power.

We have classified localization related communication into two perspectives: a single node's

## 6.1 Future Directions and Perspectives

perspective and the whole network's perspective. A single node's perspective is a selfish way of communication which does not enable network's localization. Whereas, network's perspective is the communication needed for whole network's localization. We have observed the communication cost for the three of our proposals from these two perspectives.

### 6.1 Future Directions and Perspectives

Our present work has highlighted many directions for future research. One of them is the use of more realistic radio communication model instead of the typical unit disk graph model like quasi unit disk graph and observe communication efficiency of our proposed protocols.

While most works on localization aim at reducing errors in estimated node positions, we have not dealt with this issue in our present work in an effort to focus on the basic communication cost for network wide localization. Another direction is to incorporate error management in the three of protocols and observe the resultant energy usage among nodes.

In this work, we have studied the effect of additional anchor nodes on the convergence speed of the three protocols using only one pattern of their placement. However, much remains to be done with number and placement of additional anchor nodes vs. node position accuracy.

It's a well known fact that position related computations are costly for energy limited sensor nodes. In this regard, a direction of research is to address the computation cost incurred on nodes while estimating their positions during the execution of our tri-multilateration protocols and study the cost/accuracy trade-off.

Our work has paved way for testbed implementation and study of the three protocols using commercially available modules with ranging enabled transceivers.

Still another direction of future work is to use and enhance the present work for the purpose of geographic routing and study the communication cost/accuracy trade-offs for this particular application.

# Appendices



# Appendix A

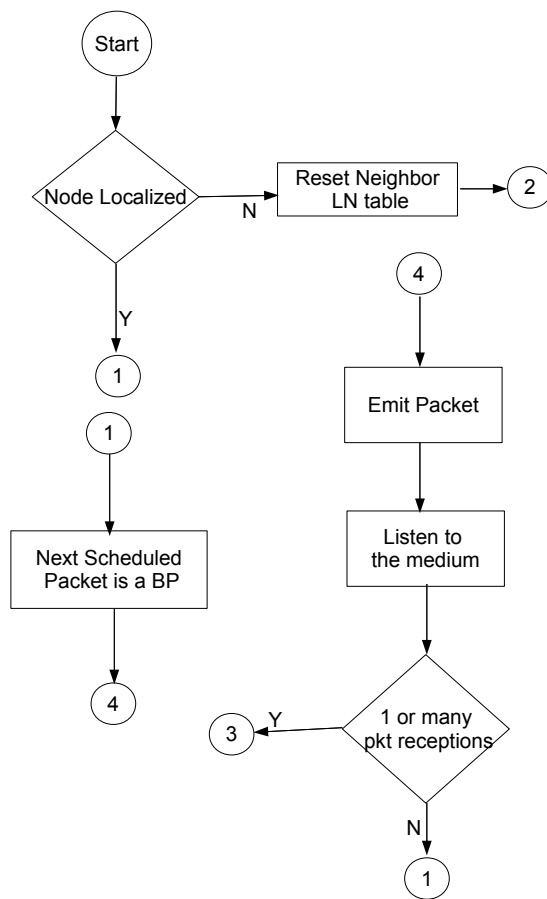

Figure A.1: BBLP: Flow Chart

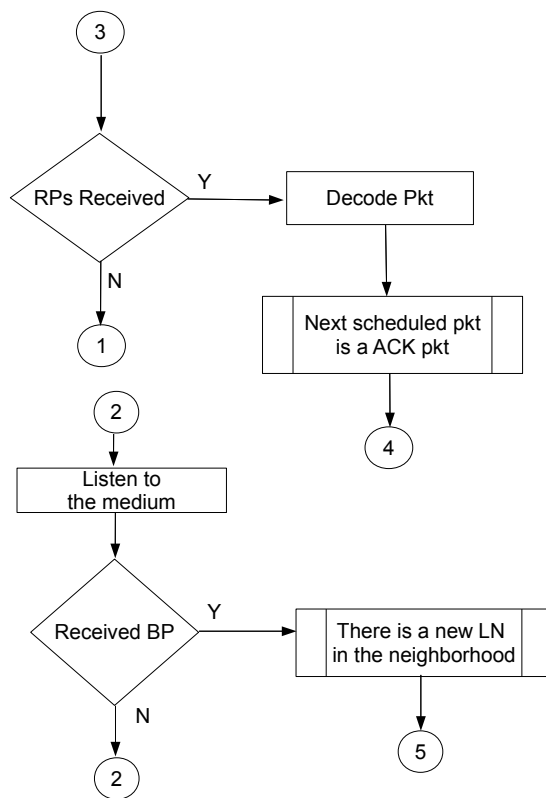

Figure A.2: BBLP: Flow Chart contd.

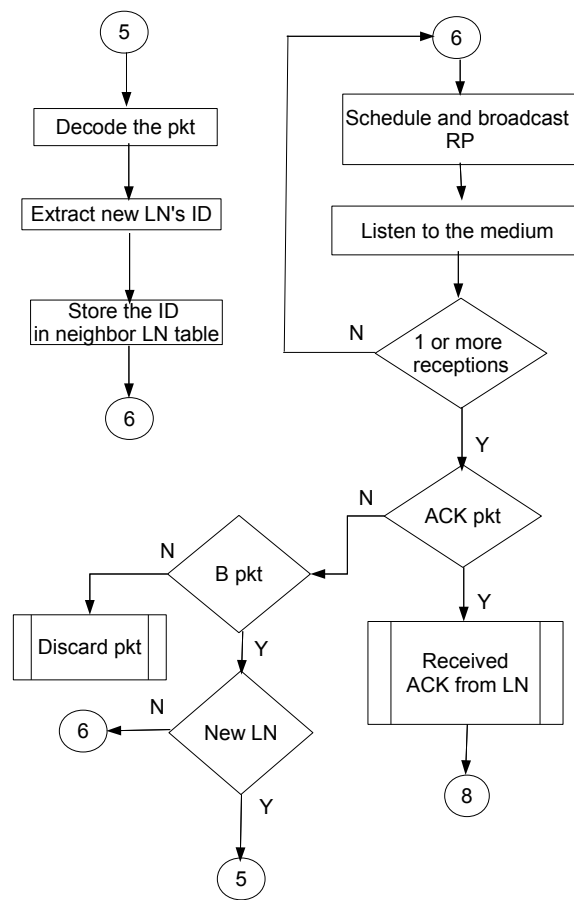

Figure A.3: BBLP: Flow Chart contd.

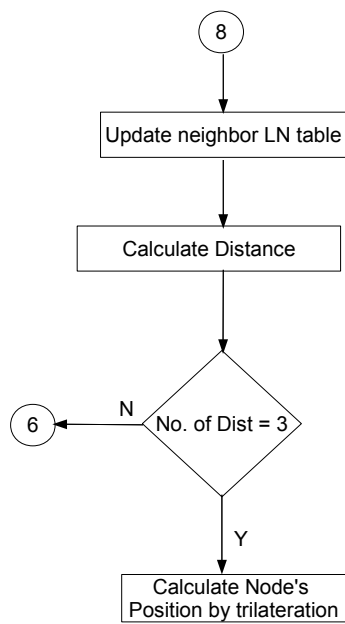

Figure A.4: BBLP: Flow Chart contd.

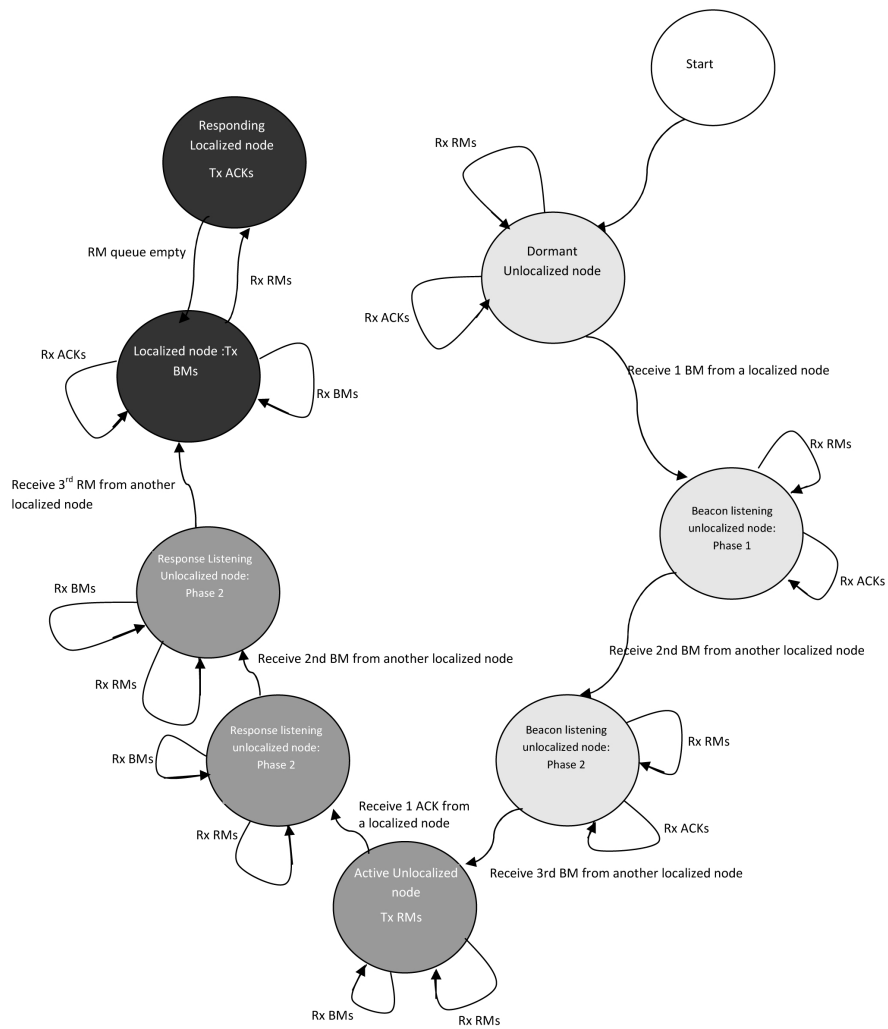

Figure A.5: BBLP: Finite State Machine

# Appendix B

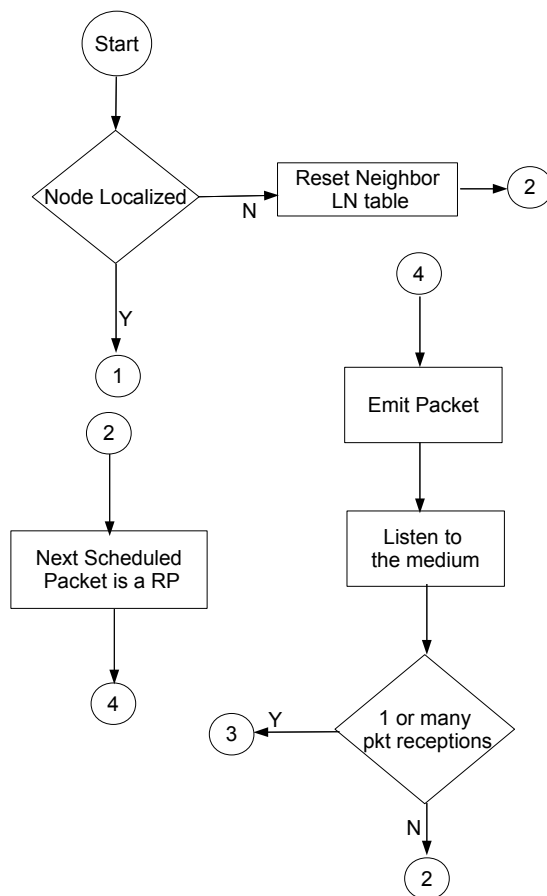

Figure B.1: CRLP: Flow Chart

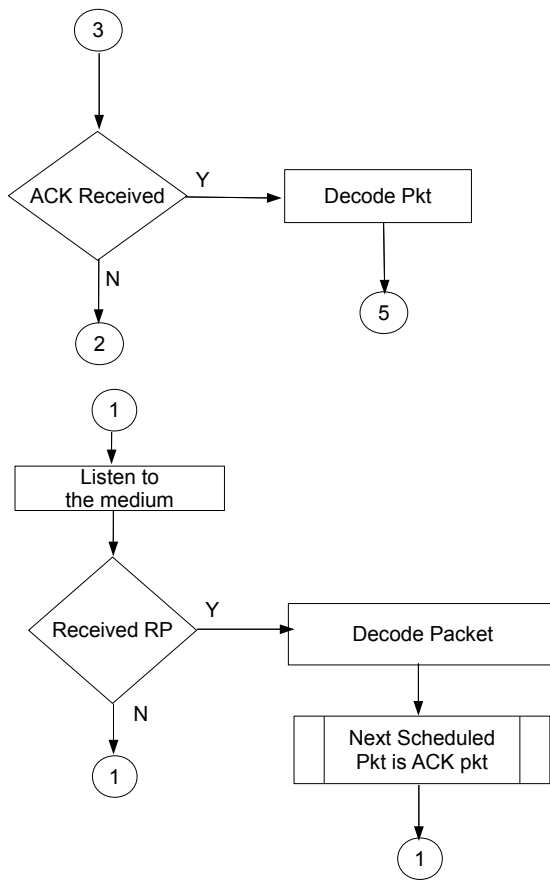

Figure B.2: CRLP: Flow Chart contd.

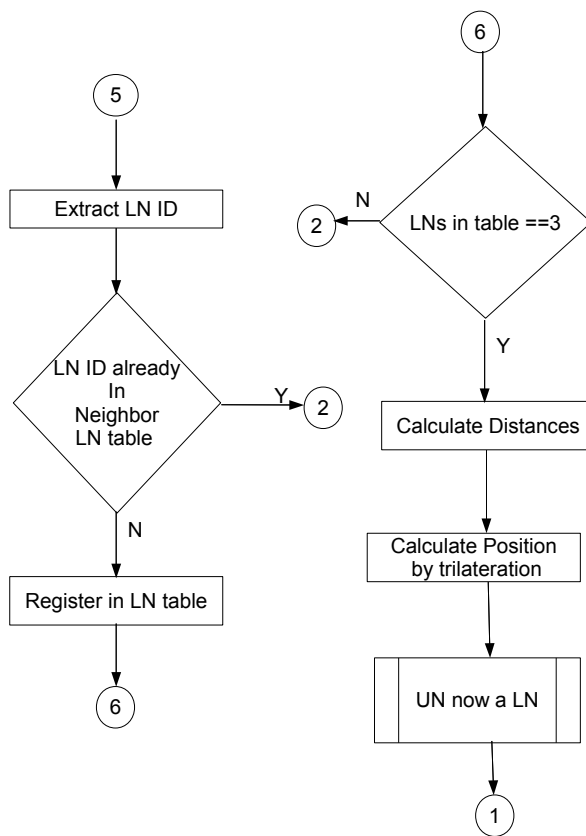

Figure B.3: CRLP: Flow Chart contd.



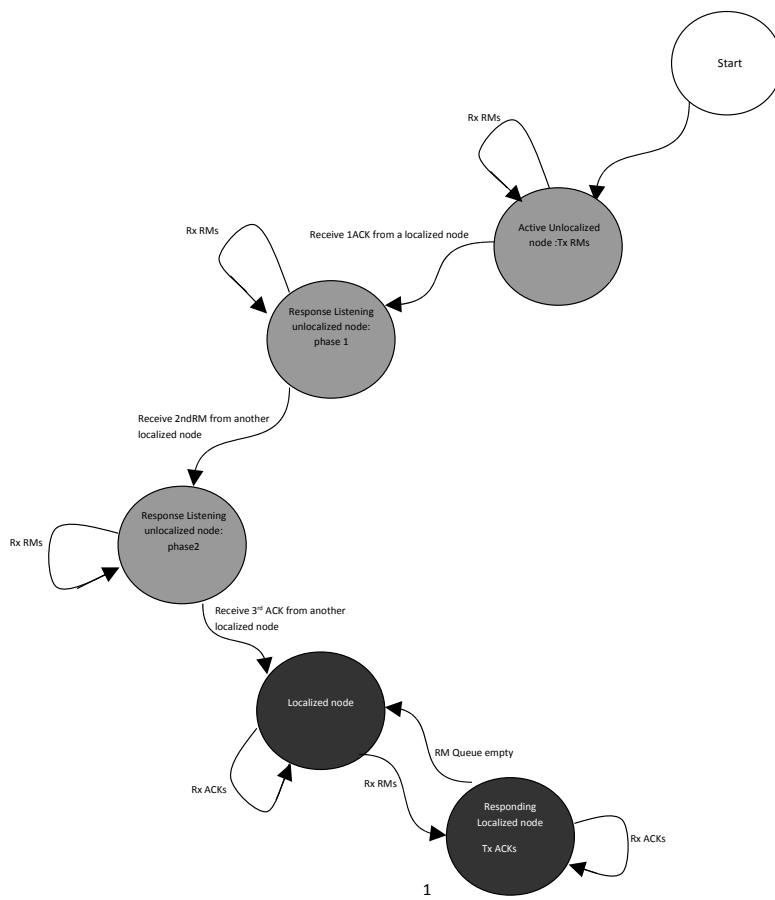

Figure B.4: CRLP: Finite State Machine

# Appendix C

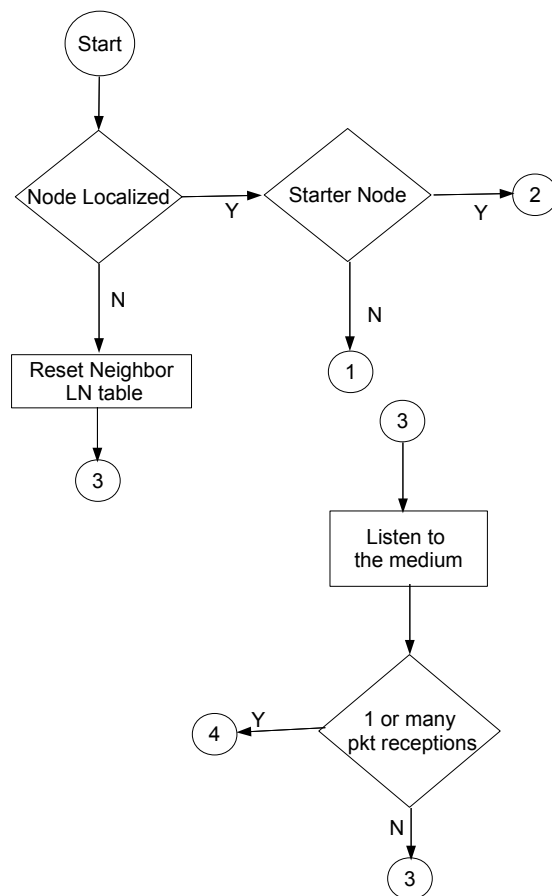

Figure C.1: OBP: FFlow Chart

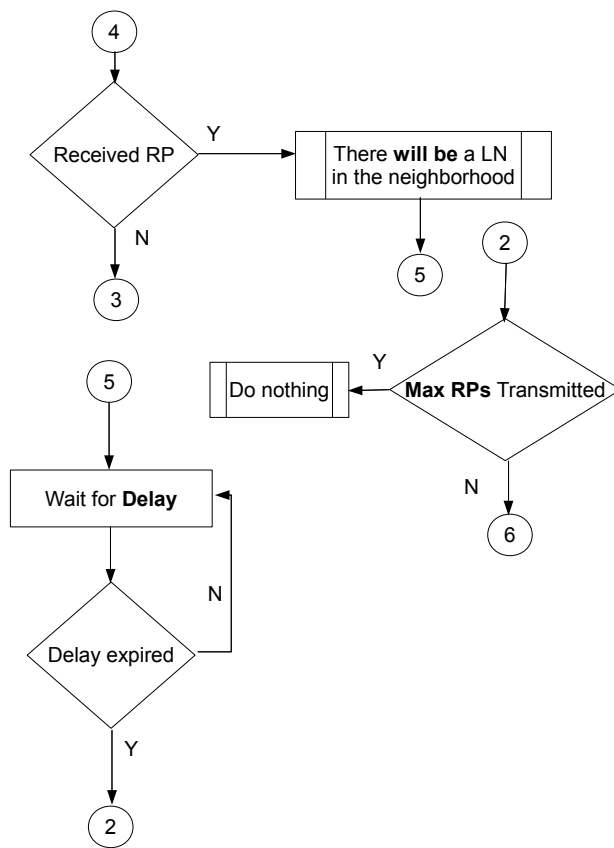

Figure C.2: OBP: FLOW Chart Cond.

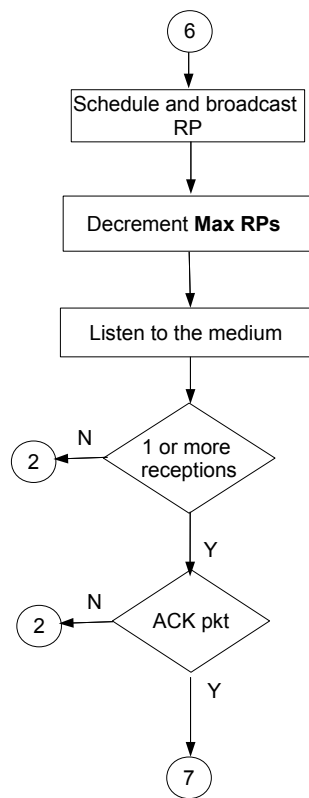

Figure C.3: OBP: FLOW Chart Cond.

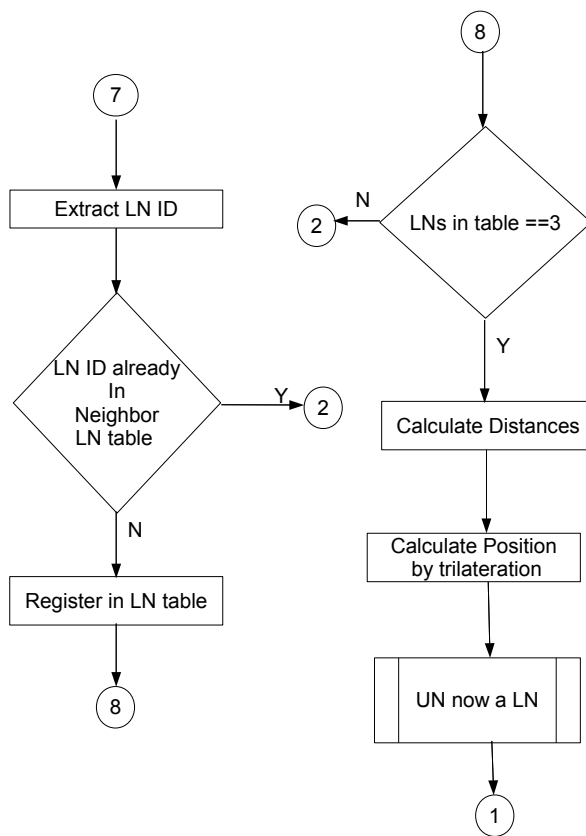

Figure C.4: OBP: FLOW Chart Cond.

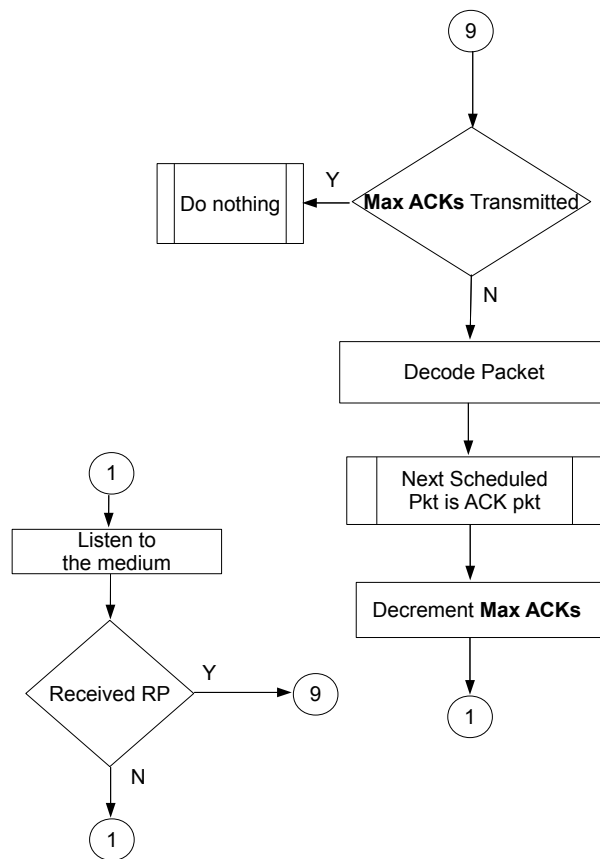

Figure C.5: OBP: FLOW Chart Cond.

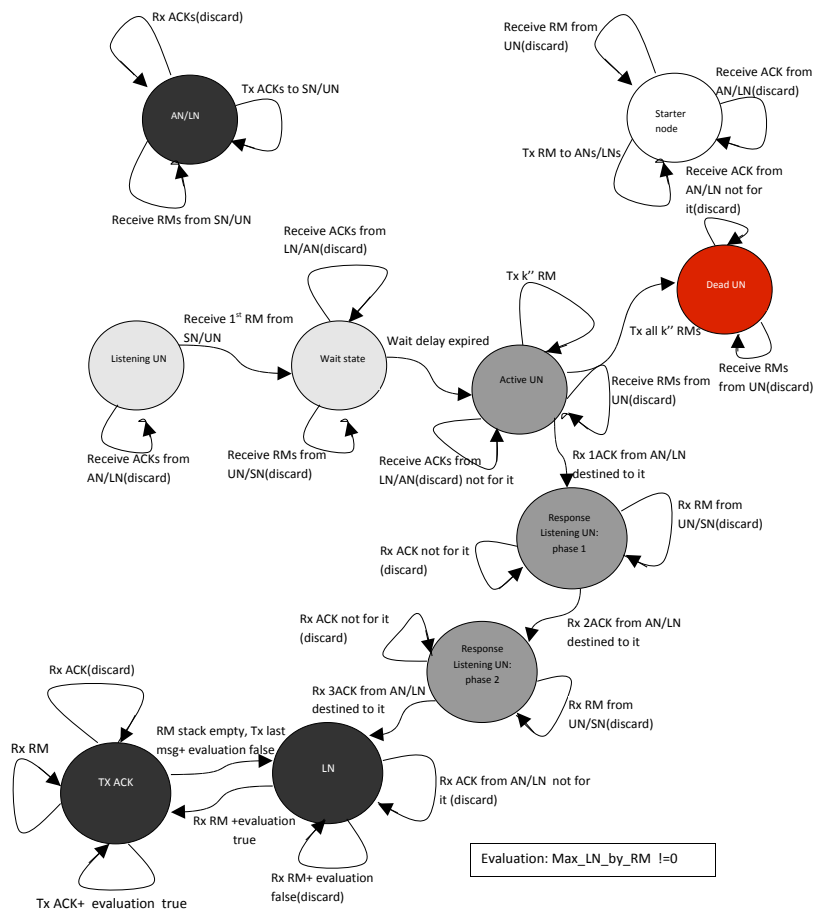

Figure C.6: OBP: Finite State Machine

# Appendix D

## Author Publications

- Sadaf Tanvir, Benoit Ponsard. Percolation of Localization in WSNs. AEP9, 9th Performance Evaluation Workshop. Aussois, France, June 1-4, 2008.
- Sadaf Tanvir, Eryk Schiller, Benoit Ponsard and Andrzej Duda. Propagation Protocols for Network-wide Localization Based on Two-Way Ranging. In Proceedings of IEEE WCNC (Wireless Communications and Networking Conference). Sydney, Australia, April 18-21, 2010.



# Glossary

AM	Acknowledgement Message, 42
AN	Anchor Node, 22
AoA	Angle of Arrival, 22
AP	ACK Packet, 47
BBLP	Beacon Based Localization Protocol, 40
BER	Bit Error Rate, 46
BM	Beacon Message, 42
BP	Beacon Packet, 47
CRLP	Continuous Ranging Localization Protocol, 75
LN	Localized Node, 15
MAC	Medium Access Control, 15
OBP	Optimized Beacon Protocol, 93
RM	Range Message, 42
RP	Range Packet, 47
RSSI	Received Signal Strength Indicator, 22
SDS-TWR	Symmetric Double Sided Two Way Ranging, 21
SNR	Signal to Noise Ratio, 46
TDoA	Time Difference of Arrival, 22
ToA	Time of Arrival, 22
TWR	Two Way Ranging, 21
UN	Unlocalized Node, 15
UWB	Ultra Wide Band, 19

# Bibliography

- [1] Abdelmalik Bachir. *Allongement de la durée de vie des réseaux sans fil de capteurs par l'optimisation des protocoles de routage et d'accès au canal*. PhD thesis, Grenoble Institute of Technology, 2007.
- [2] P. Bahl and V. N. Padmanabhan. RADAR: An In-building RF-based User Location and Tracking System. In *Proceedings of IEEE INFOCOM 2000*, volume 2, pages 775–784, Tel-Aviv, Israel, 2000.
- [3] F. Benbadis, T. Friedman, M. Dias de Amorim, and S. Fdida. GPS-Free-Free Positioning System for Sensor Networks. In *Proceedings of WOCN Conference*, 2005.
- [4] F. Benbadis, K. Obraczka, J. Cortes, and A. Brandwajn. Exploring landmark placement strategies for self-localization in wireless sensor networks. In *IEEE 18th International Symposium on Personal, Indoor and Mobile Radio Communications, 2007. PIMRC 2007.*, 2007.
- [5] P. Bergamo and G. Mazzini. Localization in Sensor Networks with Fading and Mobility. In *Proceedings of 13th IEEE International Symposium on Personal, Indoor and Mobile Radio Communications(PIMRC02)*, volume 2, pages 750–754, Sept. 2002.
- [6] C. Bettstetter and O. Krause. On border effects in modeling and simulation of wireless ad hoc networks. In *in Proc. IEEE Intern. Conf. on Mobile and Wireless Comm. Netw. (MWCN)*, Aug. 2001.
- [7] Christian Bettstetter. On the minimum node degree and connectivity of a wireless multihop network. In *MobiHoc '02: Proceedings of the 3rd ACM international symposium on Mobile ad hoc networking & computing*, pages 80–91, New York, NY, USA, 2002. ACM Press.
- [8] Azzedine Boukerche. *Handbook of algorithms for wireless networking and mobile computing*. Chapman and Hall/CRC Taylor and Francis Group, 2006.
- [9] Rachel Cardell-Oliver, Mark Kranz, Keith Smettem, and Kevin Mayer. A reactive soil moisture sensor network: Design and field evaluation. *IJDSN*, 1(2):149–162, 2005.
- [10] Chipcon Corporation. CC2500 Low-Cost Low-Power 2.4 GHz RF Transceiver Data Sheet 2008. <http://focus.ti.com.cn/cn/lit/ds/swrs040c/swrs040c.pdf>.

## BIBLIOGRAPHY

- [11] contiki. <http://www.sics.se/contiki/>.
- [12] Joe Decuir. Two Way Time Transfer Based Ranging. Contribution to the IEEE 802.15.4a Ranging Subcommittee, October 2004.
- [13] Benoit Denis. *Exploitation des Capacités de Radiolocalisation des Transmissions Ultra-Large Bande dans les Réseaux Sans-Fil*. PhD thesis, Institut National des Sciences Appliquées de Rennes, 2005.
- [14] L. Doherty, K. S. J. Pister, and El. Convex position estimation in wireless sensor networks. In *INFOCOM 2001. Twentieth Annual Joint Conference of the IEEE Computer and Communications Societies. Proceedings. IEEE*, volume 3, pages 1655–1663 vol.3, 2001.
- [15] A. El-Hoiydi. Aloha with preamble sampling for sporadic traffic in ad hoc wireless sensor networks. In *In Proceedings of IEEE ICC*, April 2002.
- [16] A. El-Hoiydi, J.-D. Decotignie, C. Enz, and E. Le Roux. Poster abstract: wisemac, an ultra low power mac protocol for the wisenet wireless sensor network. In *SenSys '03: Proceedings of the 1st international conference on Embedded networked sensor systems*, pages 302–303, New York, NY, USA, 2003. ACM.
- [17] Shin F.C.P., Lin Zhiwei, and Lee Jian Xing. Symmetric multi-way ranging for wireless sensor network. In *IEEE 18th International Symposium on Personal, Indoor and Mobile Radio Communications, PIMRC*, pages 1–5, September 2007.
- [18] FireFly. <http://www.ece.cmu.edu/firefly/index.html>.
- [19] P. Gupta and P.R. Kumar. Critical power for asymptotic connectivity. In *Decision and Control, 1998. Proceedings of the 37th IEEE Conference on*, volume 1, pages 1106–1110 vol.1, 1998.
- [20] Andy Harter, Andy Hopper, Pete Steggles, Andy Ward, and Paul Webster. The anatomy of a context-aware application. In *In Mobile Computing and Networking*, pages 59–68. ACM Press, 1999.
- [21] Tian He, Chengdu Huang, Brian M. Blum, John A. Stankovic, and Tarek Abdelzaher. Range-free localization schemes for large scale sensor networks. In *MOBICOM*, pages 81–95, 2003.
- [22] Tian He, Chengdu Huang, Brian M. Blum, John A. Stankovic, and Tarek Abdelzaher. Range-free localization schemes for large scale sensor networks. In *MobiCom '03: Proceedings of the 9th annual international conference on Mobile computing and networking*, pages 81–95, New York, NY, USA, 2003. ACM Press.
- [23] Jason L. Hill and David E. Culler. Mica: A wireless platform for deeply embedded networks. *IEEE Micro*, 22(6):12–24, 2002.
- [24] IEEE 802.15.4a-2007. <http://standards.ieee.org/getieee802/download/802.15.4a-2007.pdf>.
- [25] J. Moy. OSPF. Open Shortest Path First,1994. RFC 1583.

## BIBLIOGRAPHY

- [26] Xiang Ji. Sensor positioning in wireless ad-hoc sensor networks with multidimensional scaling. In *INFOCOM*, 2004.
- [27] Nirupama Bulusu John, John Heidemann, and Deborah Estrin. Gps-less low cost outdoor localization for very small devices. *IEEE Personal Communications Magazine*, 7:28–34, 2000.
- [28] Damien Bruno Jourdan. *Wireless Sensor Network Planning with Applications to UWB Localization in GPS-Denied ENvironments*. PhD thesis, Massachusetts Institute of Technology, 2006.
- [29] Joseph M. Kahn, Randy H. Katz, and Kristofer S. J. Pister. Next century challenges: Mobile networking for "smart dust". In *MOBICOM*, pages 271–278, 1999.
- [30] T.C. Karalar and J. Rabaey. An RF ToF Based Ranging Implementation for Sensor Networks. In *Proceedings of IEEE International Conference on Communications (ICC'06)*, volume 7, pages 3347–3352, Istanbul, Turkey, June 2006.
- [31] H Karl and A Willig. *Protocols and Architectures for Wireless Sensor Networks*. John Wiley and Sons, Ltd, 2006.
- [32] B. Krishnamachari, S.B. Wicker, and R. Bejar. Phase transition phenomena in wireless ad hoc networks. In *Global Telecommunications Conference, 2001. GLOBECOM '01. IEEE*, volume 5, pages 2921–2925 vol.5, 2001.
- [33] Fabian Kuhn, Roger Wattenhofer, and Aaron Zollinger. Ad hoc networks beyond unit disk graphs. *Wireless Networks*, 14(5):715–729, 2008.
- [34] Koen Langendoen and Gertjan Halkes. Energy-efficient medium access control. In Richard Zurawski, editor, *Embedded Systems Handbook*, chapter 34. CRC press, 2005.
- [35] Koen Langendoen and Niels Reijers. Distributed localization in wireless sensor networks: a quantitative comparison. *Comput. Networks*, 43(4):499–518, November 2003.
- [36] Steven Lanzisera, David T. Lin, and Kristofer S.J. Pister. RF Time of Flight Ranging for Wireless Sensor Network Localization. In *Proceedings of Workshop on Intelligent Solutions in Embedded Systems (WISES'06)*, Vienna, Austria, June 2006.
- [37] Xiang-Yang Li, Wen-Zhan Song, and Yu Wang 0003. Efficient topology control for ad-hoc wireless networks with non-uniform transmission ranges. *Wireless Networks*, 11(3):255–264, 2005.
- [38] Juan Liu, Ying Zhang, and Feng Zao. Robust Distributed Node Localization with Error Management. In *Proceedings of the 7th ACM International Symposium on Mobile Ad Hoc Networking and Computing (MobiHoc'06)*, pages 250–261, Florence, Italy, May 22–25 2006.
- [39] Alan M. Mainwaring, David E. Culler, Joseph Polastre, Robert Szewczyk, and John Anderson. Wireless sensor networks for habitat monitoring. In *WSNA*, pages 88–97, 2002.

## BIBLIOGRAPHY

- [40] Guoqiang Mao, Baris Fidan, and Brian D. O. Anderson. Wireless Sensor Network Localization Techniques. *Computer Networks*, 51(10):2529–2553, July 2007.
- [41] Miguel Sánchez and Pietro Manzoni and Zygmunt J. Haas. Determination of critical transmission range in ad-hoc networks. In *in proceedings of Multiaccess, Mobility and Teletraffic for Wireless Communication*, 1999.
- [42] Radhika Nagpal, Howard E. Shrobe, and Jonathan Bachrach. Organizing a global coordinate system from local information on an ad hoc sensor network. In *IPSN*, pages 333–348, 2003.
- [43] Nano-RK: A Wireless Sensor Networking Real-Time Operating System. <http://www.nano-rk.org/>.
- [44] Nanotron Technologies. nanoLOC TRX Fact Sheet 2007. [http://www.nanotron.com/EN/pdf/Factsheet\\_nanoLOC-NA5TR1.pdf](http://www.nanotron.com/EN/pdf/Factsheet_nanoLOC-NA5TR1.pdf).
- [45] Sarfaraz Nawaz and Sanjay Jha. Collaborative localization for wireless sensor networks. In *The 18th Annual IEEE International Symposium on Personal, Indoor and Mobile Radio Communication(PIMRC'07)*, 2007.
- [46] Dragos Niculescu and Badri Nath. Ad hoc positioning system (aps. In *In GLOBECOM*, pages 2926–2931, 2001.
- [47] FCC Notice of Proposed Rule Making. Revision of Part 15 of the Commission’s Rules Regarding Ultrawideband Transmission Systems,. ET-Docket 98-153.
- [48] OPNET Technologies, Inc. <http://www.opnet.com>.
- [49] Michal Piorkowski, Matthias Grossglauser, and Aristidis Papaioannou. Mobile User Navigation Supported by WSA: Full-fledge Demo of the Smart-Park System. 2006.
- [50] Joseph Polastre, Jason L. Hill, and David E. Culler. Versatile low power media access for wireless sensor networks. In *SenSys*, pages 95–107, 2004.
- [51] Ramchandran K Pradhan S S, Kusuma J. Distributed Compression in a Dense Microsensor Network. *IEEE Signal Processing Magazine*, 2002.
- [52] Nissanka Bodhi Priyantha, Anit Chakraborty, and Hari Balakrishnan. The Cricket Location-Support System. In *6th ACM MOBICOM*, Boston, MA, August 2000.
- [53] J. M. Rabaey, M. J. Ammer, J. L. da Silva, D. Patel, and S. Roundy. Picoradio supports ad hoc ultra low power wireless networking. *IEEE Computer*, 33(7), 2000.
- [54] ITU-R Recommendations. Propagation data and prediction methods for the planning of indoor radio communication systems and the radio local area networks in the frequency range 900 mhz to 100 ghz. 2001.
- [55] ITU-R Recommendations. Propagation data and prediction methods required for the design of terrestrial line-of-sight systems. 2001.

## BIBLIOGRAPHY

- [56] Frank Reichenbach, Alexander Born, Dirk Timmermann, and Ralf Bill. Splitting the linear least squares problem for precise localization in geosensor networks. In *GIScience*, pages 321–337, 2006.
- [57] S. Roundy. Energy scavenging for wireless sensor networks. *Kluwer Academic Publishers*, 2003.
- [58] S. Roundy, D. Steingart, L. Frechette, P. Wright, and J. Rabaey. Power Sources for Wireless Sensor Networks In H. Karl, A. Willig, and A. Wolisz, editors, Proceedings of 1st European Workshop on Wireless Sensor Networks (EWSN). *LNCS, Springer*, 2920:1–17, January 2004.
- [59] Z. Sahinoglu and S. Gezici. Ranging in the IEEE 802.15.4a Standard. In *Proceedings of the IEEE Annual Wireless and Microwave Technology Conference (WAMICON'06)*, pages 1–5, Clearwater Beach, Florida, December 2006.
- [60] Chris Savarese, Jan M. Rabaey, and Koen Langendoen. Robust positioning algorithms for distributed ad-hoc wireless sensor networks. In *Proceedings of the General Track: 2002 USENIX Annual Technical Conference*, pages 317–327, Berkeley, CA, USA, 2002. USENIX Association.
- [61] Andreas Savvides, Wendy L. Garber, Randolph L. Moses, and Mani B. Srivastava. An analysis of error inducing parameters in multihop sensor node localization. *IEEE Transactions on Mobile Computing*, 4:567–577, 2005.
- [62] Andreas Savvides, Chih-Chieh Han, and Mani B. Srivastava. Dynamic Fine-Grained Localization in Ad-Hoc Networks of Sensors. In *Proceedings of the 7th Annual International Conference on Mobile Computing and Networking (MobiCom'01)*, pages 166–179, Rome, Italy, 2001. ACM.
- [63] Andreas Savvides, Heemin Park, and Mani B. Srivastava. The N-hop Multilateration Primitive For Node Localization Problems. *Mobile Networks and Applications journal*, 8, number 4:443–451, August 2003.
- [64] Eryk Schiller, Paul Starzetz, Franck Rousseau, and Andrzej Duda. Binary waypoint geographical routing in wireless mesh networks. In *MSWiM '08: Proceedings of the 11th international symposium on Modeling, analysis and simulation of wireless and mobile systems*, pages 252–259, New York, NY, USA, 2008. ACM.
- [65] Yi Shang and Wheeler Ruml. Improved mds-based localization. In *IN PROCEEDINGS OF IEEE INFOCOM '04, HONG KONG*, pages 2640–2651, 2004.
- [66] Yi Shang, Wheeler Ruml, Ying Zhang, and Markus Fromherz. Localization from connectivity in sensor networks. *IEEE Transactions on Parallel and Distributed Systems*, 15(11):961–974, 2004.
- [67] J. D. Taylor. *Introduction to Ultra-wideband Radar Systems*. CRC Press, 1995.

## BIBLIOGRAPHY

- [68] Texas Instruments. MSP430C11x1, MSP430F11x1A Mixed Signal Microcontroller Data Sheet 2008. <http://focus.ti.com/lit/ds/symlink/msp430c1101.pdf>.
- [69] The Sensor Network Museum. <http://www.snm.ethz.ch/Main/HomePage>.
- [70] TinyOS. <http://www.tinyos.net/>.
- [71] Tijs van Dam and Koen Langendoen. An adaptive energy-efficient mac protocol for wireless sensor networks. In *SenSys '03: Proceedings of the 1st international conference on Embedded networked sensor systems*, pages 171–180, New York, NY, USA, 2003. ACM.
- [72] Thiemo Voigt, Joakim Eriksson, Finne Niclas, and Adam Dunkels. Runtime dynamic linking for reprogramming wireless sensor networks. In *Proceedings of Proceedings of the Fourth ACM Conference on Embedded Networked Sensor Systems (SenSys 2006)*, page 14, Boulder, Colorado, USA, 2006.
- [73] A. Wadaa, S. Olariu, L. Wilson, M. Eltoweissy, and K. Jones. On providing anonymity in wireless sensor networks. In *In Proceedings of the 10th International Conference on Parallel and Distributed Systems (ICPADS-2004)*, pages 411–418, 2004.
- [74] Roy Want, Veronica Falcao, and Jon Gibbons. The active badge location system. *ACM Transactions on Information Systems*, 10:91–102, 1992.
- [75] Geoff Werner-Allen, Konrad Lorincz, Jeff Johnson, Jonathan Lees, and Matt Welsh. Fidelity and yield in a volcano monitoring sensor network. In *OSDI '06: Proceedings of the 7th USENIX Symposium on Operating Systems Design and Implementation*, pages 27–27, Berkeley, CA, USA, 2006. USENIX Association.
- [76] Jon S. Wilson. *Sensor Technology Handbook*. Elsevier, 2005.
- [77] Worldsens. <http://worldsens.citi.insa-lyon.fr/>.
- [78] Lee Jian Xing, Lin Zhiwei, and Francois Chin Po Shin. Symmetric double side two way ranging with unequal reply time. In *IEEE 66th Vehicular Technology Conference*, pages 1980–1983, October 2007.
- [79] Cheng S Xiong Z, Liveris A. Distributed Source Coding for Sensor Networks. *IEEE Signal Processing Magazine (Special Issue on Signal Processing for Networks)*, Sept. 2004.
- [80] Feng Xue and P. R. Kumar. The number of neighbors needed for connectivity of wireless networks. *Wireless Networks*, 10:169–181, 2002.
- [81] Wei Ye, John Heidemann, and Deborah Estrin. An Energy-Efficient MAC Protocol for Wireless Sensor Networks. In *21st IEEE Conference on Computer Communications (IEEE INFOCOM 2002)*, volume 3, pages 1567–1576, New York, NY, USA, June 2002.