



HAL
open science

Effets des acides gras Oméga-3 sur la Cardioprotection: Etude des acides gras oméga-3 chez le rat et chez des patients porteurs d'un défibrillateur automatique implantable

Sabrina Zeghichi

► **To cite this version:**

Sabrina Zeghichi. Effets des acides gras Oméga-3 sur la Cardioprotection: Etude des acides gras oméga-3 chez le rat et chez des patients porteurs d'un défibrillateur automatique implantable. Sciences du Vivant [q-bio]. Université Joseph-Fourier - Grenoble I, 2009. Français. NNT: . tel-00473608v1

HAL Id: tel-00473608

<https://theses.hal.science/tel-00473608v1>

Submitted on 15 Apr 2010 (v1), last revised 24 Apr 2010 (v2)

HAL is a multi-disciplinary open access archive for the deposit and dissemination of scientific research documents, whether they are published or not. The documents may come from teaching and research institutions in France or abroad, or from public or private research centers.

L'archive ouverte pluridisciplinaire **HAL**, est destinée au dépôt et à la diffusion de documents scientifiques de niveau recherche, publiés ou non, émanant des établissements d'enseignement et de recherche français ou étrangers, des laboratoires publics ou privés.

UNIVERSITE JOSEPH FOURIER-GRENOBLE 1

Ecole Doctorale Chimie et Sciences du Vivant

N°

THESE

Pour obtenir le grade de

DOCTEUR DE L'UNIVERSITE JOSEPH FOURIER

Spécialité : Physiologie, Physiopathologie et Pharmacologie

Présentée et soutenue publiquement par

Sabrina ZEGHICHI HAMRI

le 26 Mars 2009

Effets des acides gras Oméga-3 sur la Cardioprotection: Etude des acides gras oméga-3 chez le rat et chez des patients porteurs d'un défibrillateur automatique implantable

Directeur de thèse : Pr. Joël de Leiris

Composition du jury

Mme Danièle Feuvray	Professeur, Université Paris sud XI-Orsay, France	Rapporteur
M. Luc Rochette	Professeur, Université of Dijon, France	Rapporteur
M. Jean-Yves Le Heuzey	Professeur, Hôpital Européen George Pampidou, France	Examineur
M. François Boucher	Professeur, Université Joseph Fourier Grenoble, France	Président
M. Joël de Leiris	Professeur, Université Joseph Fourier Grenoble, France	Directeur
M. Mohamed Chibane	Professeur, University of Béjaia, Algerie	Membre Invité
M. Pascal Defaye	Docteur, Grenoble University Hospital, France	Membre Invité
M. Michel de Lorgeril	Docteur, University Joseph Fourier Grenoble, France	Co-directeur

Thèse préparée au sein du laboratoire Cœur et Nutrition. Université Joseph Fourier, Grenoble 1.

Abstract

Although the Mediterranean diet (MED) is considered the optimal diet to prevent coronary heart disease (CHD), it is still unknown whether adoption of MED may result in improved myocardial resistance to ischemia-reperfusion injury and may potentially prevent ventricular arrhythmias. Accordingly, the first experimental study was carried out to investigate whether a diet low in saturated fats and omega-6 fatty acids ($\omega 6$) but rich in plant and marine omega-3 fatty acids ($\omega 3$), a typical MED fatty acid profile, may result in smaller infarct size and better left ventricular function (LVF) recovery in a rat model of regional ischemia-reperfusion. Results demonstrate a great accumulation of $\omega 3$ and a parallel decrease of arachidonic acid in plasma, cell membranes and cardiac mitochondria. Also, the MED rats developed smaller infarct size compared with the control groups ($p < 0.01$) while LVF recovery was not different in the three groups. The second epidemiologic study was carried out to determine whether $\omega 3$ have beneficial antiarrhythmic effects in patients at high risk for fatal ventricular arrhythmias. Two hundred thirty eight patients with implantable cardioverter defibrillators (ICDs) were included at Grenoble University Hospital. The primary end point was time to first ICD event for ventricular tachycardia or fibrillation (VT or VF) or death from cardiac cause. Red blood cells fatty acids was analyzed and the Omega-3 Index was calculated from eicosapentaenoic acid and docosahexaenoic acid. Results did not show significant differences neither in individual omega-3 fatty acids (ALA, EPA and DHA) nor in omega-3 index between quartiles. However, it comes into view that the RBC omega-3 index in these patients (8.6 ± 1.59 to $8,8 \pm 1.76$) was already at levels that have been previously reported to be cardioprotective.

Key words: *Omega-3 fatty acids, Mediterranean diet, myocardial infarct, arrhythmia, Omega-3 index.*

Résumé

Bien que le régime méditerranéen (MED) soit considéré comme le meilleur régime alimentaire pour prévenir les maladies cardiaques, on ignore toujours si l'adoption de MED résulte en une amélioration de la résistance du myocarde à l'ischémie et la reperfusion et en une prévention des arythmies ventriculaires. En conséquence, nous avons mené deux études : (1) vérifier si un profil lipidique de type MED; faible en gras saturés et en acides gras oméga-6 ($\omega 6$) et riche en acides gras oméga-3 ($\omega 3$) d'origines végétale et marine; peut réduire la taille d'infarctus et une meilleure récupération de la fonction ventriculaire gauche (FVG) dans un modèle de rat. Les rats MED ont été comparés avec des rats recevant des régimes riches en acides gras saturés ou en acides gras $\omega 6$. Les résultats montrent une grande accumulation des $\omega 3$ et une diminution de l'acide arachidonique dans le plasma, les membranes des cellules cardiaques et dans les mitochondries. Pareillement, les rats MED avaient une taille infarctus plus réduite par rapport aux deux autres groupes, tandis que FVG récupération n'était pas différente dans les trois groupes. La deuxième étude épidémiologique a été menée au Centre Hospitalier Universitaire de Grenoble pour déterminer une éventuelle corrélation entre les oméga-3 et la survenue de complications rythmiques. Deux cent trente huit patients porteurs de défibrillateurs automatiques implantables (DEF) ont été inclus. La composition en acides gras des globules rouges a été analysé et l'index oméga-3 a été calculée à partir de l'acide eicosapentaénoïque et acide docosahexaénoïque. Aucune différence significative entre les acides gras oméga-3 (ALA, EPA et DHA) ou l'index oméga-3 et la survenue d'événements n'a été observée entre quartiles. Néanmoins, l'index oméga-3 chez ces patients était déjà à des niveaux qui ont été démontrés avoir un pouvoir cardioprotecteur (8.6 ± 1.59 à $8,8 \pm 1.76$).

Mots clés: *Acides gras oméga 3, diète méditerranéenne, infarctus du myocarde, arythmies, Indice Omega-3.*

ACKNOWLEDGEMENTS

I would like to express my sincere gratitude to my supervisor, Professor Joel de Leiris as well as my co-supervisors Doctor Michel de Lorgeril and Dr. Pascal Defay for their valuable scientific advice, encouragement, and guidance throughout this study, without which, the completion of this work would have been unattainable.

I gratefully acknowledge Professor Danielle Feuvray from the University of Paris sud XI-Orsay and Professor Luc Rochette from the University of Dijon for being a part of my PhD committee. I sincerely thank as well Professor Jean-Yves Le Heuzey from the European Hospital George Pampidou. I would like to thank them immensely for their valuable time and suggestions. I do feel privileged to have them in my PhD jury.

Special thanks go to my supervisor in Algeria Pr Mohamed Chibane the dean of the faculty of Biology, University of Bejaia for his continuous support.

I would like to thank the Departement of Cardiology at Grenoble University Hospital (Pr J Machecourt and Pr G Vanzetto), the Department of Integrated Biology CHU (DBI) (Pr A. Favier, Dr F. Laporte and Dr MT. Foulon), the Centre of Clinical Investigation (Pr JL. Bosson and and JL. Quessada), and the laboratory “Coeur & Nutrition” (Pr Joel de Leiris, Pr François Boucher and Patricia Loiacono) for their good reception and for offering me all facilities to accomplish my thesis. Special thanks go to Pr Mohamed Chibane and the University of Bejaia for the facilities to complete my thesis.

Exceptional thanks go to Patricia Salen for her assistance and guidance in realizing this work, and also for her continual friendship and endless moral support during my stay in France.

I am indebted to many people for the completion of this work. My great appreciation is expressed to JL. Quessada from the Centre of Clinical Investigation, all staff and nurses of the Departement of Cardiology at Grenoble University Hospital and

the whole technical team of the DBI for their valuable technical support in realizing this work.

Special appreciation to Dr Artemis Simopoulos President of The Center for Genetic, Nutrition and Health, Washington D.C., Dr Tina Kallithraka from the National Agricultural Research Foundation, Athens, and Anastasia Konstantinidi from the Mediterranean Institute of Chania, Crete, for their continual encouragement during my studies.

Special thanks go to Annabelle Guiraud, Benhalima Afef, Delphine Serrano, Natasha Pellet, Marie Thèrese, Andry Rokotovao, Marie C. Toufekstian, Marie Gabrielle Jouan, Nadia Bendoucha, Salima Bendeffou, Alexandra Zirmi, Nedjma Rajah and Ghania Chabane, Sabira Guehlouz, Naima Guesri, Amel Benamor, Fathia Yahiaoui, Josette Bouget, Michelle and Jean Pierre Riffard, Celine Zitouni, Jessica Escoffier, and all my friends for their cooperation and endless friendship.

Special gratitude to every member of my family in law, particular thanks and appreciation are considered to Mrs Aicha and M. Youcef Terfaia and their Children Oualid, Dilanda and Khalil.

My acknowledgements cannot be completed without mentioning the continued moral support of my parents and my brothers. To them, my sincere respect, love, gratitude and special thanks.

To all these people I would like to express my deepest gratitude.

To my Dear Father Lakhdar Zeghichi

To my Dear Mother

To my Dear Brothers

To my Dear husband and my daughter Basmala-Imane

TABLE OF CONTENTS

Abstract
Acknowledgements
Table of Contents

INTRODUCTION

LITERATURE REVIEW

Chapter I. Nutrition and dietary lipids.....13

1.1. Dietary lipids and essential fatty acids (EFA).....14

1.2. Structure and taxonomy.....15

 1.2.1. Saturated fatty acids (SFA).....16

 1.2.2. Monounsaturated fatty acids (MUFA).....16

 1.2.3. Polyunsaturated fatty acids (PUFA).....16

 1.2.4. *Trans* fatty acids.....18

1.3. Essential fatty acids (EFA).....18

1.4. Dietary sources of essential fatty acids.....21

1.5. Ratio of omega-6 to omega-3 PUFA.....22

1.6. Alpha-linolenic acid (ALA).....25

1.7. Metabolism of essential fatty acids.....26

1.8. Biological effects of omega-3 PUFA and their metabolites.....29

 1.8.1. Cell membrane fluidity.....29

 1.8.2. Eicosanoid Synthesis.....30

 1.8.3. Regulation of Gene Expression.....32

 1.8.4. Second messenger action.....33

 1.8.5. Antibiotic-like actions.....34

 1.8.6. Vision.....34

 1.8.7. Nervous System.....34

1.9. Recommended Dietary Intakes EFA.....35

Chapter II. Heart anatomy and physiology.....	37
2.1. Heart anatomy.....	38
2.1.1. The Wall and Coverings of the Heart.....	38
2.2.1. Heart chambers.....	39
2.2. Internal conduction (Stimulation) system.....	40
2.3. Pumping Action of the Heart.....	42
2.4. Myocardium and mechanism of contraction and contractile function.....	43
2.5. Energetic metabolism of myocardium.....	43
2.6. Myocardial ischemia and reperfusion.....	46
Chapter III. Omega-3 PUFA and coronary heart disease.....	49
3.1. Lipid lowering effects.....	50
3.2. Anti-inflammatory and antithrombotic effects.....	51
3.3. Omega-3 PUFA and atherosclerosis.....	53
3.4. Omega-3 PUFA and Blood pressure (BP).....	56
3.5. Omega-3 fatty acids and reduction of sudden death.....	56
3.5.1. Epidemiologic Studies.....	58
3.5.2. Interventional Studies.....	62
3.6. Omega3 fatty acids and reduction of arrhythmias.....	68
3.6.1. Ventricular tachycardia and fibrillation.....	68
3.6.2. Evidence in Atrial Fibrillation (AF).....	72
3.7. Experimental studies of Omega-3 PUFA on arrhythmias and electrophysiology.....	73
3.8. Potential mechanisms of anti-arrhythmic effects.....	78
3.8.1. Effect of (ω -3) PUFA on membrane phospholipids.....	78
3.8.2. Direct effects of ω -3 PUFA on FFA composition and the myocardium.....	80
3.8.3. Effects of ω -3 PUFA on ion channels, exchangers and intracellular calcium.....	82
3.8.4. Effects of ω -3 PUFA on enzymes and receptors.....	86
3.8.5. Effects of ω -3 PUFA on myocardial mitochondria.....	88
Chapter VI. What is an Implantable Cardioverter Defibrillator?.....	90
4.1. Historical Background of CID.....	91
4.2. Definition of ICD.....	92
4.3. How do ICDs Work?.....	94
4.4. Benefits of ICD therapy.....	96
4.5. When is ICD therapy the right choice?.....	100
4.5.1. Secondary prevention of sudden cardiac death.....	100

4.5.1.1.	Implantable cardioverter-defibrillator therapy for cardiac arrest and sustained ventricular tachycardia.....	101
4.5.1.2.	Coronary Artery Disease.....	101
4.5.1.3.	Nonischemic Dilated Cardiomyopathy.....	101
4.5.1.4.	Hypertrophic Cardiomyopathy.....	101
4.5.1.5.	Arrhythmogenic Right Ventricular Dysplasia/ Cardiomyopathy.....	102
4.5.1.6.	Genetic Arrhythmia Syndromes.....	102
4.5.1.7.	Syncope With Inducible Sustained Ventricular Tachycardia.....	102
4.5.2.	Primary Prevention of Sudden Cardiac Death.....	103
4.5.3.	Advanced Heart Failure and Cardiac Transplantation.....	103
4.6.	Follow-Up Procedures.....	104
4.7.	Cost-effectiveness of ICD therapy.....	106
4.8.	Omega-3 PUFA and arrhythmia risk in patients with an implantable defibrillator.....	107

MATERIAL AND METHODS

PART I. Modulation of myocardial resistance to ischemia-reperfusion injury by dietary saturated and polyunsaturated fatty acids. *Insights into the concept of Mediterranean omega-3 preconditioning.*

I.	Animals.....	109
II.	Cardiac experiments: ex vivo isolated perfused heart model.....	111
	2.1. Anesthesia and heart isolation.....	111
	2.2. Isolated perfused heart model.....	112
	2.3. Intra-ventricular balloon.....	113
	2.4. Evaluation of hemodynamic variables.....	114
	2.5. Regional Ischemia/Reperfusion Protocol.....	114
	2.6. Histoenzymology coloration.....	115
III.	Samples Preparation.....	116
	3.1. Preparation of blood samples.....	116
	3.2. Mitochondria preparation.....	116
IV.	Determination of proteins.....	119
V.	Determination of fatty acid profile.....	119

VI. Fatty acid analyses of plasma and erythrocytes.....	121
6.1. Total lipids extraction.....	121
6.2. Total lipid saponification and fatty acid methylation.....	122
6.3. Extraction of methylated fatty acids and GC.....	122
6.4. Standard mixture analyses.....	123
6.4.1. Fatty acid methylation.....	123
6.4.2. Extraction of methylated fatty acids and GC.....	123
6.4.3. Peaks identification and expression of results.....	123
6.5. Fatty acid composition of mitochondrial phospholipids.....	124
6.5.1. Separation of phospholipids.....	127
6.5.2. Quantitative analysis of mitochondrial phospholipids.....	127
VII. Blood fatty acids analysis.....	132
7.1. Total Cholesterol (TC).....	132
7.2. HDL-cholesterol.....	132
7.3. Triglycerides.....	133
VIII. Statistics.....	133

PART II. Plant and Marine Omega-3 fatty acids and ventricular arrhythmias in French patients with Implantable Cardioverter Defibrillators “the Grenoble city Omegadef Study”

I. Clinical research in France.....	135
II. Study design.....	136
III. Laboratory methods.....	137
3.1.1. Blood analysis and fatty acid determination.....	137
3.1.2. Omega-3 index determination.....	137
IV. Statistical analysis.....	139
4.1.1. Descriptive analysis.....	139
4.1.2. Inferential analysis.....	140
V. Consent.....	140
VI. Report form.....	141

RESULTS AND DISCUSSION

PART I. Modulation of myocardial resistance to ischemia-reperfusion injury by dietary saturated and polyunsaturated fatty acids. *Insights into the concept of Mediterranean omega-3 preconditioning.*

I. Results.....	158
1.1. Food consumption and energy supply.....	158
1.2. Blood lipids and fatty acid profile.....	160
1.3. Cardiac experiments.....	163
II. Discussion.....	167
2.1. Clinical implication.....	167
2.2. The potential importance of ω -3 in myocardial resistance to ischemia-reperfusion.....	168
2.3. MED fatty acid profile and hemodynamics.....	170
2.4. Limitations of the study.....	171

PART II. Plant and Marine Omega-3 fatty acids and ventricular arrhythmias in French patients with Implantable Cardioverter Defibrillators “the Grenoble city Omegadef Study”

I. Results.....	174
1.1. Baseline clinical characteristics.....	174
1.2. Deaths and number of events.....	178
1.3. Hazard Ratios for studied parameters.....	178
1.4. Omega-3 fatty acids and Recurrence.....	180
1.5. Trans fatty acids and Recurrence.....	180
II. Discussion.....	185

CONCLUSION

BIBLIOGRAPHY

List of Figures

List of Tables

Abbreviations

INTRODUCTION

Introduction

Dietary fats play an important role in coronary heart disease (CHD) (de Lorgeril et al., 1994; de Lorgeril et al., 1999; Fiaccavento et al., 2006; GISSI; 1999). Beyond their well-known effects on atherosclerosis, thrombosis and the risk of cardiac death (de Lorgeril et al., 1994; de Lorgeril et al., 1999; Fiaccavento et al., 2006; GISSI; 1999), it is still unclear whether specific dietary fatty acid profiles modulate the myocardial resistance to ischemia and reperfusion injury. This is a critical issue because myocardial resistance to ischemia-reperfusion is a major determinant of myocardial infarct size which in turn is a causal factor in the development of CHD complications such as heart failure and malignant ventricular arrhythmias. For instance, it is still unknown whether dietary fatty acid profiles associated with the Mediterranean diets (de Lorgeril et al., 1994; de Lorgeril et al., 1999) result in smaller infarct size after ischemia-reperfusion. As the Mediterranean diet (MED) was shown to be very protective against CHD complications (de Lorgeril et al., 1994; de Lorgeril et al., 1999, Trichopoulou et al., 2003; Knoops et al., 2004), it is important to understand by which mechanism(s) MED is protective. There are several fat and non fat components in MED (de Lorgeril et al., 1994; de Lorgeril et al., 1999, Trichopoulou et al., 2003; Knoops et al., 2004). It is, however, believed that typical MED dietary fatty acid profiles might be critical in the MED-induced cardioprotection. Depending of the geographic area, there are several MED fatty acid profiles. The most common one is low in both animal and plant saturated fats, low in *trans* fatty acids and plant omega-6 fatty acids (ω -6) but rich in both plant and marine omega-3 fatty acids (ω -3) (de Lorgeril et al., 1994; de Lorgeril et al., 1999).

Two studies were carried to study the effect of omega-3 fatty acids on cardioprotection. The main aim of the first experimental study was therefore to investigate the effect of that specific MED fatty acid profiles on both infarct size and left ventricular function recovery in a rat model of regional ischemia-reperfusion. For that purpose, we used an isolated heart model which allows studying the response of the myocardium itself, independent from other organs, from neurological brain-heart connections and from blood components such as circulating cells, platelets, hormones or cytokines which are all potentially influenced by dietary fats. Although the *biological milieu* is both influenced by dietary fats and can by itself influence the myocardial response to ischemia-reperfusion, the isolated heart model was preferred to an *in vivo* model in order to specifically study the myocardial response independently from the *biological milieu*.

To evaluate the effects of MED, we used two comparison groups: the first one received palm oil (rich in saturated fats but poor in ω -6 and ω -3 and named PO) and the second one received sunflower oil (low in saturated fats and ω -3 but extremely rich in ω -6 and named SO) in addition to the usual low fat chow diet. We thus compared three diets with similar energy and fat intake but very different fatty acid profiles. The effects of the three diets were examined by analyzing the fatty acid composition of plasma, erythrocyte cell membranes and phospholipids of cardiac mitochondria. We used erythrocytes because of their short half-life (compatible with dietary protocols in animals) and because they are known to reflect the fatty acid composition of cardiac cell membrane (Harris *et al.*, 2004). We evaluated the fatty acid composition of the main phospholipids of cardiac mitochondria because mitochondria phospholipids are thought to play a central role in the myocardial resistance to ischemia-reperfusion (Das *et al.*, 2008; Uchiyama *et al.*, 2004; Murphy and Steenbergen, 2008; Gustafsson and Gottlieb, 2008; Pepe and McLennan; 2002).

The second epidemiologic study was carried out at Grenoble University Hospital from June 2004 until July 2007. The main objective of this study was to determine whether omega-3 PUFA have beneficial antiarrhythmic in patients at high risk for fatal ventricular arrhythmias. The omega-3 fatty acids have been widely reported to have impressive protective effects on CHD. Numerous epidemiological studies and clinical trials have supported this issue (GISSI, 1999; Marchioli *et al.*, 2002; Albert *et al.*, 1998 and 2002; Siscovick *et al.*, 1995 and 2000; Burr *et al.*, 1989; de Lorgeril *et al.*, 1994 and 1999, Mozaffarian *et al.*, 2003). Likewise, the beneficial antiarrhythmic effects of ω -3 fatty acids were reported in animal and laboratory studies (McLennan *et al.*, 1988 and 1992 and 1993; Billman *et al.*, 1994 and 1997 and 1999; Kang *et al.*, 1994; 1995 and 1996; Xiao *et al.*, 1995, 1997, and 2001; Leaf *et al.*, 2003). Two hundred thirty eight patients with implantable cardioverter defibrillators (ICDs) were included. The research protocol was approved by the regional Consultative Committee for the Protection of Persons in Medical Research (CCPPRB) in accordance with “Huriet-Sérusclat” law and a written fully informed consent was obtained from all participants before inclusion. All subjects underwent provided blood samples for lipid profile analysis, and answered a questionnaire concerning their medication and their usual ω -3 fatty acid intakes notably fish consumption. The relevant end point was defined as an appropriate ICD intervention, ie, shock or antitachycardia pacing (ATP), for spontaneous ventricular tachyarrhythmias (VT or VF), or death from cardiac cause. These patients were followed for at least 12 months.

LITERATURE REVIEW

Chapter I

Nutrition and Dietary lipids



1.1. Dietary lipids and essential fatty acids (EFA)

Hippocrates' famous quote "let Food be your Medicine" originally extended far beyond the modern meaning of the words "food" and "Medicine" (Hippocrates 480 BC). Nutrition is a major and broad scientific field, advances in which are based on many disciplines, such as human physiology (absorption, digestion, excretion, and metabolism of nutrients), biochemistry, endocrinology and metabolism, food science, food composition, biotechnology and most importantly genetics. In Hippocrates' concept, "Diatia" referred to food, exercise and lifestyle changes consistent with good health (Simopoulos, 1995).

Through the process of nutrition, the body breaks down food into simple building blocks, and then recombines them into living human tissue. The cells within our bodies draw much of the energy for this transformation from the nutrients that we call essential. These nutrients are crucial to our well-being and we must get them from outside sources: **Our food**. From the nutrients we ingest, our body creates and maintains every eyelash, hormone, blood cell, and toenail in the human anatomy (Berry and Gapaul, 1982). Furthermore, nutrients are necessary for the immune response to pathogens so that cells can divide and produce antibodies and cytokines (Nieman, 2001). Research is defining the mechanism by which nutrients influence gene expression. Nutrients regulate the activity of enzymes involved in their own metabolism by specifically affecting enzyme activity or the enzyme gene expression. This nutritional regulation occurs both by macro- and micro-nutrients (De Caterina *et al.*, 2001, Simopoulos, 1995).

Lipids are important nutrients which can be classified broadly as "structural" or "storage". In man, the first ones are mainly the phospholipids and cholesterol; the second are those that provide a long-term reservoir of energy in the adipose tissue. They are also required by the body to regulate membrane functions such as activities of membrane bound enzymes, receptors, ion channels, etc. (Berry and Gapaul, 1982; Clandinin *et al.*, 1994).

Lipids in the form of phospholipids are found in cell membranes and are necessary for the production of various hormones (prostaglandins, leukotriens, thromboxans) and vitamins (fat soluble vitamins), within the body. They are present in the food as the stored energy supplies of the plant or animal product that we eat. Fats may be both good and bad for health. Internal fat protects and cushions the body organs. Subcutaneous layers of fat help to insulate the body against heat loss through its surface. If too much fat is deposited, however, an individual may

become overweight, thus, placing extra strain on the heart, muscles, and bones as well as causing some emotional distress (Berry and Gapaul, 1982; Clandinin et al., 1994; Simopoulos and Pavlou, 2001).

1.2. Structure and taxonomy

Lipids are composed of fatty acids of different chain lengths and degrees of saturation as well as different configurations. The degree of unsaturation among lipids is of great interest to lipid researchers because of its effect on health. The most significant characteristic of dietary lipids is the content of different types of fatty acids. Fatty acids are classified into three families, saturated fatty acids (SFA), monounsaturated fatty acids (MUFA) and polyunsaturated fatty acids (PUFA). These designations refer to the type of bonds that hold their carbon atom chains together (Table 1).

Table 1. Structure and taxonomy of fatty acids (Williams, 1997; Simopoulos and Robinson, 1998).

Structure	Taxonomy	Common name
C4:0	Butanoic acid	Butyric acid
C6:0	Hexanoic acid	Caproic acid
C8:0	Octanoic acid	Caprylic acid
C10:0	Decanoic acid	Capric acid
C12:0	Didecanoic acid	Lauric acid
C14:0	Tetradecanoic acid	Myristic acid
C16:0	Hexadecanoic acid	Palmitic acid
C16:1 ω-7	<i>Cis</i> -9 hexadecaenoic acid	Palmitoleic acid
C18:0	Octadecanoic acid	Stearic acid
C18:1 ω-9	<i>Cis</i> -9 octadecaenoic acid	Oleic acid (OA)
C18:2 ω-6	<i>Cis</i> -9,12 octadecadienoic acid	Linoleic acid (LA)
C18:3 ω-6	<i>Cis</i> -6,9,12 octadecatrienoic acid	γ -linolenic acid (GLA)
C18:3 ω-3	<i>Cis</i> -9,12,15 octadecatrienoic acid	α -linolenic acid (ALA)
C20:0	Eicosanoic acid	Arachidic acid
C20:4 ω-6	<i>Cis</i> -5,8,11,14 eicosatetraenoic acid	Arachidonic acid (AA)
C20:5 ω-3	<i>Cis</i> -5,8,11,14,17 eicosapentaenoic acid	Timnodonic acid (EPA)
C22:0	Docosanoic acid	Behenic acid
C22:5 ω-3	<i>Cis</i> -7,10,13,16,19 docosapentaenoic acid	Lupanodonic acid (DPA)
C22:6 ω-3	<i>Cis</i> -4,7,10,13,16,19 docosahexaenoic acid	Cervonic acid (DHA)
C24:0	Tetracosanoic acid	Lignoceric acid

1.2.1. Saturated fatty acids (SFA)

These fatty acids have single bonds between all the carbon atoms (Figure 1). A “saturated” fat or oil is one that contains a significant amount of saturated fatty acids. Most saturated fats are solid or semi solid at room temperature. The exceptions are the tropical oils; palm oil, palm kernel oil and coconut oil. Found in meat, dairy products, and in some tropical oils, saturated fats are the main dietary culprit in raising blood cholesterol and in increasing the risk of coronary artery disease, diabetes, and obesity (Simopoulos and Robinson, 1998).

1.2.2. Monounsaturated fatty acids (MUFA)

These fatty acids have one (mono= single) double bond in the fatty acid chain (Figure 1). The MUFA content of our diet is accounted for by oleic acid, the predominant component of olive oil. Olive oil and canola oil contain high amounts of monounsaturated fatty acids, 80% and 70% respectively. Monounsaturated oils are liquid at room temperature, but may become cloudy or semi solid in the refrigerator. Monounsaturated fatty acids help protect the cardiovascular system, they also reduce the risk of certain metabolic disorders such as insulin resistance and diabetes, and are linked with the lower rate of cancer (Simopoulos and Robinson, 1998). Roche *et al.* (1998) have shown the beneficial effects of olive oil, a good source of monounsaturated fatty acids in the Mediterranean diet. They demonstrated that the isoenergetic substitution of saturated fatty acids by monounsaturated fatty acids reduces plasma cholesterol and reduces the degree of postprandial factor VII activation.

1.2.3 Polyunsaturated fatty acids (PUFA)

Polyunsaturated fatty acids are fatty acids that have two or more (poly= many) double bonds (Figure 1). All polyunsaturated oils are liquid at room temperature and remain liquid in the refrigerator. Flaxseed oil and fish oil are the most highly unsaturated of all oils (Simopoulos and Robinson, 1998). PUFA consist of two families of fatty acids, omega-6 (ω -6) and omega-3 (ω -3). Both ω -3 and ω -6 fatty acids are called **Essential Fatty Acids (EFA)**.

Most vertebrates are capable of synthesizing either SFA or MUFA, but they cannot produce PUFA.

The most commonly used fats and oils are presented in Table 1. Lipids are greasy to the touch and insoluble in water but soluble in alcohol, ether, and other organic solvents. Despite their differences in structure, all fats contain the same amount of energy (9 kcal/g or 37 kJ/g).

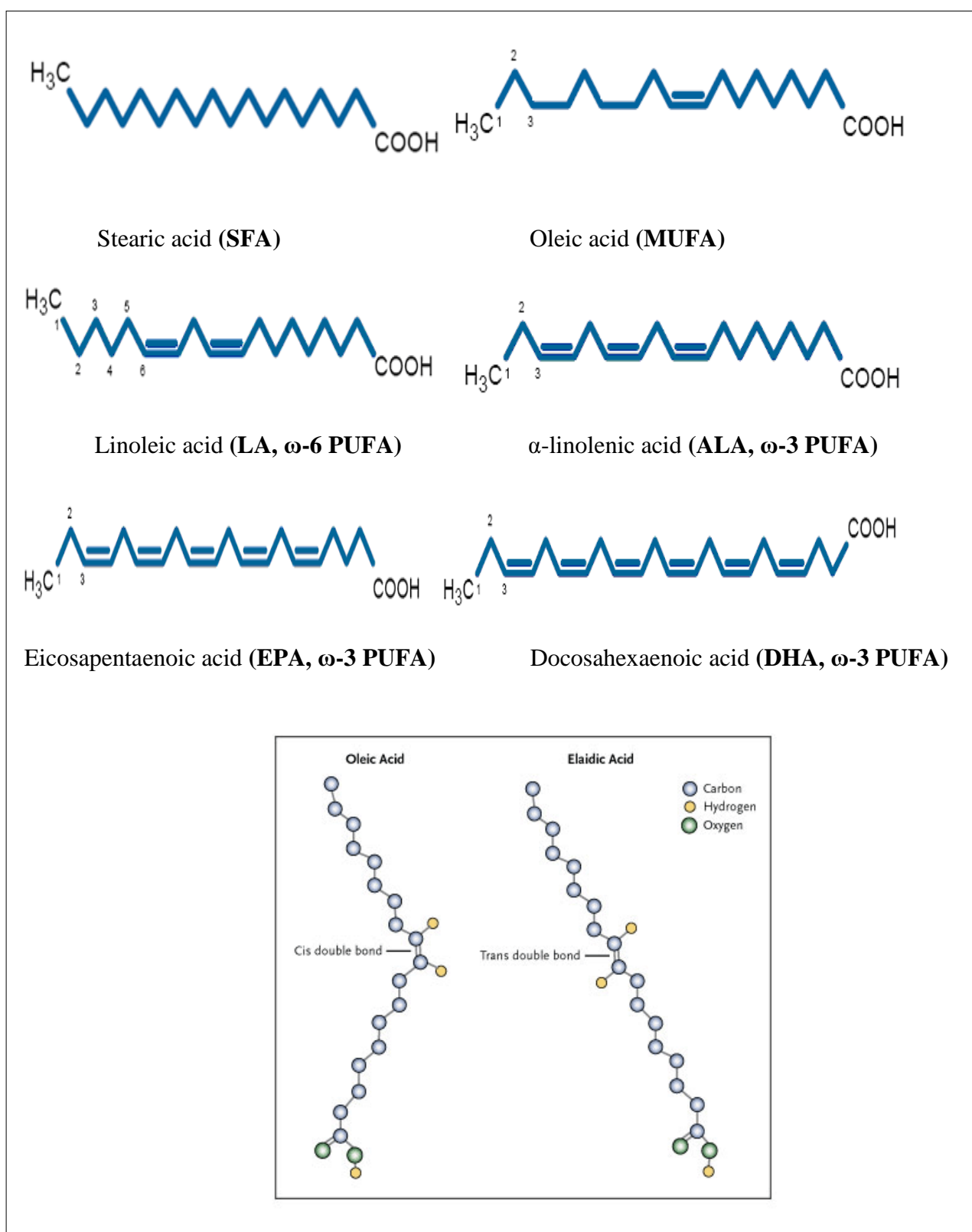

Figure 1: Saturated fatty acids (SA), Monounsaturated fatty acids (MUFA), Polyunsaturated fatty acids (PUFA), and *Trans* fatty acids.

1.2.4. *Trans* fatty acids

Cis and *trans* describe the typical configurations of hydrogen atoms or groups attached to the carbon atoms involved in double bonds. In the *cis* configuration, they are located on the same side of the plane containing the carbon to carbon double bond. During the hydrogenation process, a hydrogen atom moves to the opposite side of the plane containing the double bond. This new configuration is referred to as *trans* (Colate, 1992; Simopoulos and Robinson, 1998). Though most naturally occurring fatty acids are *cis*, small quantities of *trans* fatty acids do occur naturally in ruminant fats and dairy products. Hydrogenated oils are the major source of *trans* fatty acids (shortening, stick margarine, most deep-fat fried foods, and commercially prepared cookies, doughnuts, pastries, potato chips, cakes, and crackers) (Colate, 1992; Simopoulos and Robinson, 1998).

Since the discovery of catalytic hydrogenation by Sabatier and Senderens in 1897 and its application to the hardening of edible oils, partially hydrogenated vegetable oils have become a major food fat in many countries (Holman, 1985). The hydrogenation of oils rich in ω -6 fatty acids to form margarines has led to increased amounts of *trans* fatty acids in the food supply (Simopoulos, 1997). Hydrogenation also reduces the essential fatty acid content in oil, both ω -6 and ω -3. Untreated soybean, for example, contains 7% omega-3 fatty acids, when partially hydrogenated this content drops to 3% (Sanders, 1985). Furthermore, the frying of oils causes some of the *cis* bonds to be converted to *trans* bonds (Simopoulos and Robinson, 1998).

The Food and Drug Administration (FDA) ruled that the nutrition labels for all conventional foods and supplements must indicate the content of *trans* fatty acids (The Food and Drug Administration, 2005). The Dietary Guidelines Advisory Committee recommends that the consumption of *trans* fatty acids be kept below 1 % of total energy intake (Dietary Guidelines Advisory Committee, 2005).

The relation between the intake of *trans* fats and the incidence of CHD was reported in many studies. *Trans* fatty acids raise levels of low-density lipoprotein (LDL) cholesterol and reduce levels of high-density lipoprotein (HDL) cholesterol, increase the ratio of total cholesterol to HDL cholesterol, a powerful predictor of the risk of CHD; increase the blood levels of triglycerides compared with the intake of other fats, and increase levels of Lp(a) lipoprotein, each of which may further raise the risk of CHD (Stampfer et al., 1991; Ascherio et al., 1999; Mauger et al., 2003; Mensink et al., 2003).

Trans fats appear to increase the risk of CHD more than any other macronutrient, conferring a substantially increased risk at low levels of consumption (1 to 3 % of total energy intake) (Ascherio et al., 1999; Pietinen et al., 1997; Oomen et al., 2001; Oh et al., 2005). In a large case-control study, levels of *trans* fatty acids in erythrocyte membranes were associated with an increase in the risk of sudden cardiac death after adjustment for other risk factors (Lemaitre et al., 2002). Recent data indicates that *trans* fats may also cause endothelial dysfunction and promote inflammation (Lopez-Garcia et al., 2005; Mozaffarian^b et al., 2004; Han Baer et al., 2002; Baer et al., 2004; de Roos et al., 2001).

1.2. Essential fatty acids (EFA)

Essential Fatty Acids (EFA) are necessary fats that humans cannot synthesize, and must be obtained through diet. EFA are long-chain polyunsaturated fatty acids derived from linolenic, linoleic, and oleic acids. There are two families of EFA: Omega-3 (ω -3) and Omega-6 (ω -6). The number following "*Omega-*" represents the position of the first double bond, counting from the terminal methyl group on the molecule. ω -3 fatty acids have their first double bond between the 3rd and the 4th carbon atom from the methyl end of the molecule, whereas in ω -6 fatty acids the double bond is between the 6th and 7th carbon atom (Figure 2). ω -9 fatty acids are necessary yet "non-essential" because the body can manufacture a modest amount on its own. Humans can easily make SFA acids or MUFA with a double bond at the ω -9 position, but do not have the enzymes necessary to introduce a double bond at the ω -3 or ω -6 position (Das, 1991; Nair et al., 1997).

The basic of ω -3 fatty acids is α -linolenic acid (ALA; 18:3 ω -3) and the basic of ω -6 fatty acids is linoleic acid (LA; 18:2 ω -6) whereas ω -9 is derived from oleic Acid (OA; 18:1 ω -9). Some of the functions of the EFAs require the conversion of LA and ALA to longer chain metabolites (Figure 2). These later are of major importance in the brain, retina, liver, kidney, adrenal glands and gonads. Both fatty acid families are plentiful in nature. LA is found in the seeds of most plants with the exception of coconut, cocoa, and palm. ALA is found in the chloroplast of green leafy vegetables instead of the seeds, with the exception of flaxseed, and rapeseed oils. Walnuts are also rich in ALA. Edible green leafy vegetables contain more ALA than any other edible green leafy vegetable (Crawford, 1985; Simopoulos^b, 1996, Ollis et al., 1999, Zeghichi et al., 2003).

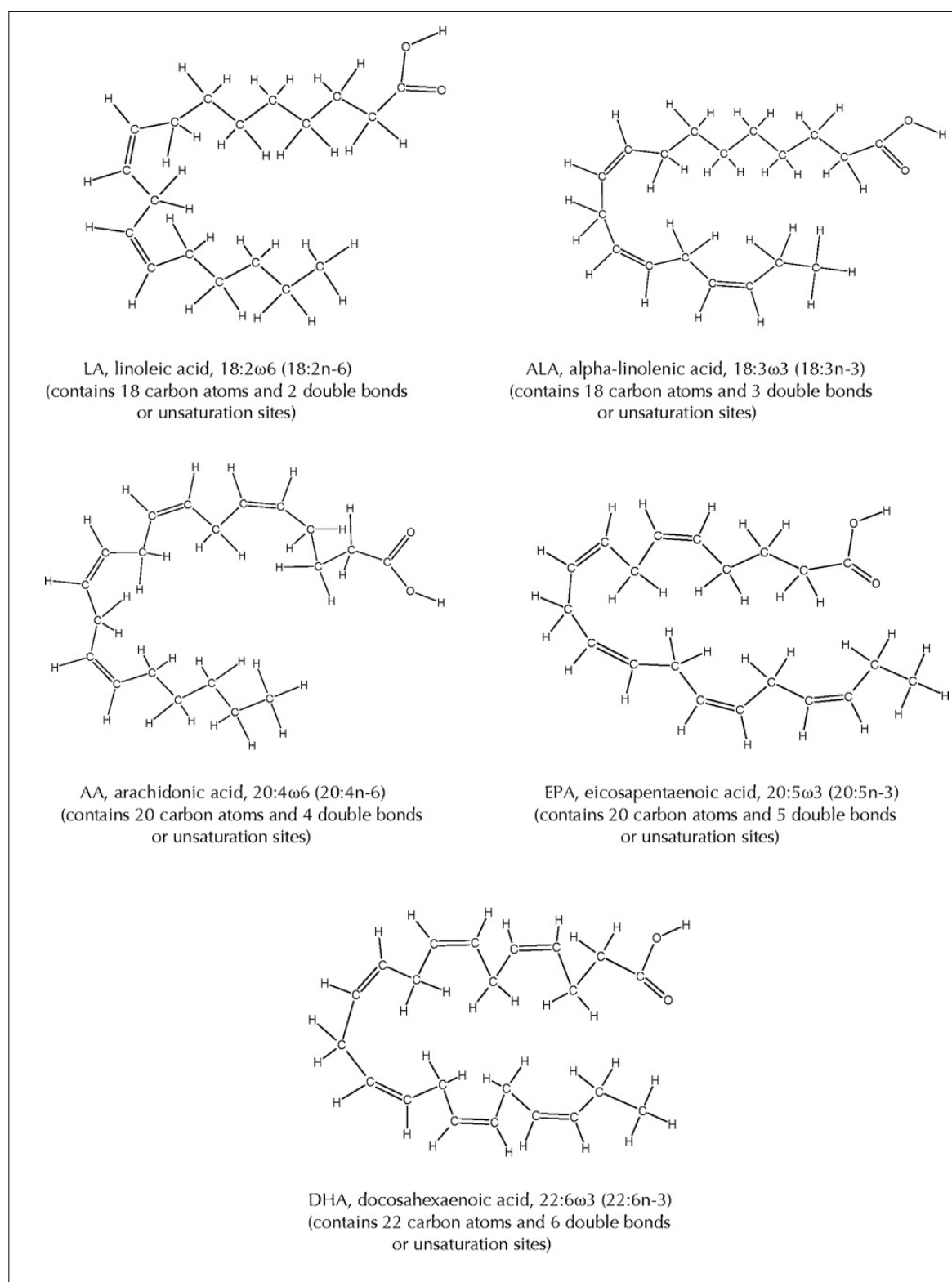

Figure 2: Polyunsaturated fatty acids (PUFA) derived from ALA and LA (Nair et al., 1997).

1.3. Dietary sources of essential fatty acids

Essential fatty acids (EFA) are abundant in many foods, including nuts, seeds, fish, and oils (Table 2). Physicians agree that the best way to incorporate EFA in the diet is to get them from foods. ALA is highly sensitive to oxidation; a high intake of ALA should be balanced with a high intake of antioxidants found in vegetables and fruits, to protect it from oxidation (Shekelle et al., 1985; Norell et al., 1986; Dolecek, 1992).

On the other hand, fish or fish oil supplements rich in EPA and DHA are the main source of long chain ω -3 PUFA. Mackerel, herring, salmon and trout are among the richest sources of EPA and DHA (Figure 3). EPA and DHA are ω -3 PUFA commonly found in the oils of marine fish, marine mammals, and phytoplankton. Human milk is particularly rich in EFAs and GLA, AA, EPA, and DHA (Simopoulos and Robinson, 1998; Simopoulos^a, 1996, Rose and Connolly, 1999; Budowski and Crawford, 1985). Canola oil, flaxseed oil, linseed and rapeseed oils, walnuts and leafy green vegetables such as *Portulaca oleracea*, *Cichorium spinosum* and *Corchorus olitorius* are rich sources of EFA.

Table 2: Content of ω -3 and ω -6 PUFA in nuts and in seeds and in Oils (Calder, 2004).

	Omega-3 (g/100g)	Omega-6 (g/100g)
Walnuts	5.5	28
Hazelnuts	trace	4
Cashews	trace	8
Almonds	trace	10
Brazils	trace	23
Flax / Linseeds	15-25	6
Pumpkin seeds	7-10	20
Sunflower seeds	trace	30
Sesame seeds	trace	25
Pine nuts	1	25
Flax / Linseed oil	58	74
Flax / Linseeds	15-30	68
Walnut oil	11.5	63
Canola / Rapeseed oil	7	58
Soybean oil	7	51
Wheat germ oil	5	50

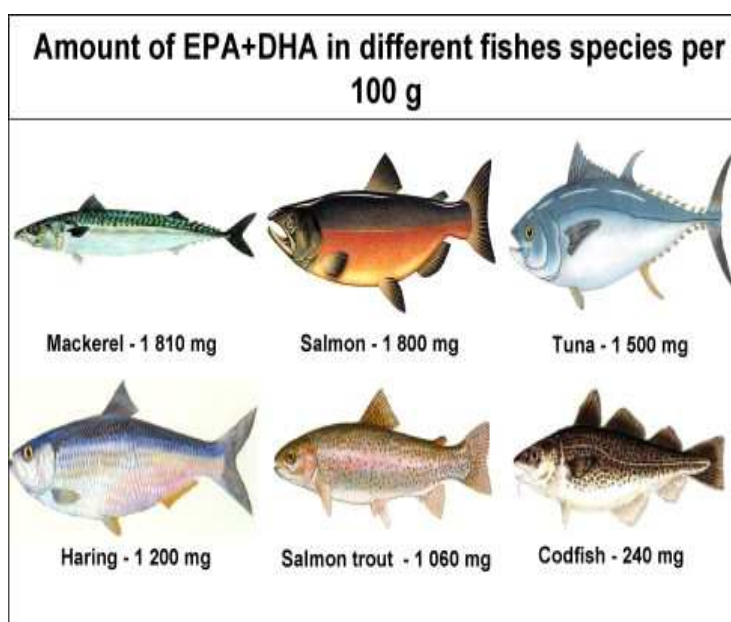

Figure 3: Content of ω -3 PUFA in Fish (g/100 g of fresh uncooked fish) (Feskens et al., 1993; Calder, 2004).

1.4. Ratio of omega-6 to omega-3 PUFA

Because of the increased amounts of ω -6 fatty acids in our diets, the eicosanoid metabolic products from AA, specifically prostaglandins, thromboxanes, leukotrienes, hydroxy fatty acids, and lipoxins, are formed in larger quantities than those formed from ω -3 fatty acids, specifically EPA (Simopoulos, 1991). The eicosanoids from AA are biologically active in very small quantities and, if they are formed in large amounts, they contribute to the formation of thrombus and atheromas; to allergic and inflammatory disorders, particularly in susceptible people (Simopoulos, 2006). Thus, a diet rich in ω -6 fatty acids shifts the physiological state to one that is prothrombotic and proaggregatory, with increases in blood viscosity, vasospasm, and vasoconstriction and decreases in bleeding time. Bleeding time is decreased in groups of patients with hypercholesterolemia, hyperlipoproteinemia, myocardial infarction, other forms of atherosclerotic disease, and diabetes (Simopoulos, 2006).

Cleland et al. (1992) showed that LA inhibits EPA incorporation from dietary fish oil supplements in human subjects. Thirty healthy male subjects were randomly allocated into one of two treatment groups. One group was on a high LA and low saturated fatty acid diet, whereas the other group was on a low LA and low saturated fat diet. The difference in the low LA and low saturated fatty acid diet was made up with monounsaturated fatty acids (olive oil). After a 3-week run-in period, the subjects consumed a fish oil supplement containing

1.6 g EPA and 0.32 g DHA per day. After 4 weeks of fish oil supplementation, the incorporation of EPA in neutrophil membrane phospholipids was highest in the lowest LA group, indicating that the ingestion of ω -6 fatty acids within the diet is an important determinant of EPA incorporation into neutrophil membranes. This study also showed that monounsaturated fatty acids (olive oil) do not interfere with EPA incorporation.

Ambring et al. (2006) studied the ratio of serum phospholipid ω -6 to ω -3 fatty acids, the number of leukocytes and platelets, and vascular endothelial growth factor (VEGF) in healthy subjects on an ordinary Swedish diet and on a Mediterranean-inspired diet in healthy subjects. This study clearly showed that the plasma ratio of ω -6/ ω -3 fatty acids was substantially lowered after the Mediterranean diet versus the Swedish diet. The ω -6/ ω -3 ratio was 4.72 ± 0.19 on the Swedish diet and 2.60 ± 0.19 on the Mediterranean diet ($P < 0.0001$). There was no change in C-reactive protein (CRP) or interleukine-6 (IL-6), but the total number of leukocytes was 10% lower after the Mediterranean diet, the total number of platelets was 15% lower after the Mediterranean diet, and so was the serum VEGF, 206 ± 25 pg/ml versus 237 ± 30 on the Swedish diet ($P = 0.0014$). The authors concluded that a "Mediterranean-inspired diet" reduces the number of platelets and leukocytes and VEGF concentrations in healthy subjects. This may be linked to higher serum concentrations of ω -3 fatty acids, which promote a favorable composition of phospholipids (Ambring et al., 2006). The higher the ratio of ω -6/ ω -3 fatty acids in platelet phospholipids, the higher the death rate from cardiovascular disease (Simopoulos, 2006). Excessive amounts of ω -6 PUFA and a very high ω -6/ ω -3 ratio, as is found in today's Western diets, promote the pathogenesis of many diseases, including cardiovascular disease, cancer, and inflammatory and autoimmune diseases, whereas increased levels of ω -3 PUFA (a lower ω -6/ ω -3 ratio), exert suppressive effects (Simopoulos and Cleland, 2003). In the secondary prevention of cardiovascular disease, a ratio of 4/1 was associated with a 70% decrease in total mortality (de Lorgeril et al., 1994). A ratio of 2.5/1 reduced rectal cell proliferation in patients with colorectal cancer, whereas a ratio of 4/1 with the same amount of ω -3 PUFA had no effect. The lower ω -6/ ω -3 ratio in women with breast cancer was associated with decreased risk (Simopoulos and Cleland, 2003). A ratio of 2-3/1 suppressed inflammation in patients with rheumatoid arthritis, and a ratio of 5/1 had a beneficial effect on patients with asthma, whereas a ratio of 10/1 had adverse consequences. These studies indicate that the optimal ratio may vary with the disease under consideration (Simopoulos and Cleland, 2003). The relative amounts of dietary ω -6 and ω -3 fatty acids may play a vital role in preserving skeletal integrity of old age (Weiss et al., 2005).

A wealth of new studies, both in humans and animals, show that optimal health comes from eating a balance of ω -6 to ω -3 fatty acids that has a ratio of ω 6/ ω 3= 4/1 or less (Simopoulos, 2006). The typical western diet contains from 14 to 20 times more ω -6 than ω -3 fatty acids, upsetting a critical balance. A more balanced ratio can be reached by limiting the intake of oils such as corn, safflower, sunflower, and soybean oils, which contain relatively high amounts of ω -6 fatty acids, and by eating more food rich in ω -3 fatty acids such as fish, canola oil for cooking and walnuts (Simopoulos, 2006).

Modern agriculture, with its emphasis on production, has decreased the ω -3 fatty acids content in many foods; in green leafy vegetables, animal meat, eggs and even fish (Salem et al., 1996). In contrast, in the Mediterranean countries where there is high intake of olive oil, the rate of death due to coronary heart disease is low. Olive oil is very low in ω -6 fatty acids (it contains about 6% to 8% ω -6 and 0.3% to 1.3% ω -3), which gives it a favorable ratio ω -6 to ω -3 fatty acids (Kallithraka et al., 2000; Zeghichi et al. 2007); in addition, it is rich in antioxidants.

The Mediterranean diet has gained enormous popularity lately (La Vecchia et al., 1988; Katan et al., 1995), mainly because it is associated with lower death rates from coronary heart disease (Katan et al., 1995) and certain types of cancer (Buzina et al., 1991). Linolenic acid from eating wild plants walnuts and figs contributes to the increased content of the ω -3 fatty acids in the diet of Crete (Simopoulos and Sidossis, 2000). The Lyon Diet Heart Study clearly showed that in the secondary prevention of coronary heart disease the adoption of a modified Cretan Mediterranean-type diet reduced the incidence of sudden death significantly (by 50-70% at 5 years follow up) (de Lorgeril and Salen, 2000). This study was based on high intake of canola oil that is high in linolenic acid. The experimental modified diet was a low saturated and polyunsaturated fat, non-strict vegetarian diet rich in oleic acid, ω -3 fatty acids, fibers, vitamins of the group B and various antioxidants including vitamin C, E, trace elements and flavonoids (de Lorgeril and Salen, 2000). de Lorgeril and Salen concluded that any dietary pattern combining high intake of natural antioxidants, low intake of saturated fatty acids, high intake of oleic acid, low intake of ω -6 fatty acids and high intake of ω -3 fatty acids would logically result in highly cardioprotective effect (de Lorgeril and Salen, 2000).

1.5. Alpha-linolenic acid (ALA)

Most studies were carried out on fish oils (EPA and DHA). However, α -linolenic acid (ALA), found in green leafy vegetables, flaxseed, rapeseed and walnuts, desaturates and elongates in the human body to EPA and DHA and, by itself, may have beneficial effects on health and on the control of chronic diseases (Simopoulos; 1999). Indu and Ghafoorunissa (1992) were able to show antithrombotic effects by reducing the ratio of ω -6 to ω -3 fatty acids with ALA-rich vegetable oils. They have shown that a ratio of 4 (15 g LA: 3.7 g LNA) is appropriate for conversion Indu and Ghafoorunissa (1992). The supplementation with ALA increased the long chain ω -3 PUFA in plasma and platelet phospholipids and decreased the platelet aggregation. ALA intake is associated with inhibitory effects on the clotting activity of platelets, on their response to thrombin (Renaud *et al.*, 1986, Renaud and de Lorgeril, 1989) and on the regulation of arachidonic acid metabolism (Budowski and Crawford, 1985). One more advantage of the consumption of α -linolenic acid over ω -3 fatty acids from fish is that the problem of insufficient vitamin E intake does not exist with a high intake of ALA from plant sources (Simopoulos, 1999).

A study comparing the fatty acid composition of serum cholesterol esters in subjects in Crete- *Greece*, and Zutphen- *The Netherlands*, reported that Cretans had higher concentrations of 18:1 ω -9, much lower concentrations of linoleic acid and unexpectedly high concentrations of ALA (Sandker *et al.*, 1993). α -linolenic acid in the Cretan diet comes from purslane, walnuts, and other wild green leafy plants. Similarly, the population of Kohama Island- *Japan*, which has the longest life expectancy in the world and the lowest coronary heart disease mortality rate, has high concentrations of plasma ALA (Kagawa *et al.*, 1982). In Japan, the dietary sources of ALA are mainly canola and soybean oils. Thus, the two populations documented to have the greatest life expectancies in the world (Japanese and Cretans) both appear to have high intakes of α -linolenic acid. The dietary ratio of LA to ALA in the de Lorgeril trial was 4:1 (de Lorgeril *et al.*, 1998; de Lorgeril *et al.*, 2000).

1.6. Metabolism of essential fatty acids

Both ALA and LA are metabolized to very longer chain fatty acids (VLC-PUFA), of 20 and 22 carbon atoms, largely in the liver; ALA is converted to eicosapentaenoic acid (EPA), and then to docosahexaenoic acid (DHA), while LA is the metabolic precursor of arachidonic acid (AA). These events, which are summarized in Figure 3, involve increases in chain length and the degree of unsaturation by adding extra double bonds to the carboxyl end of the fatty acid molecule.

LA is converted to Gamma-linolenic acid (GLA, 18:3 ω -6) by the action of the enzyme delta-6 desaturase (Δ -6 desaturase), and GLA is elongated to form dihomo-GLA (DGLA, 20:3 ω -6), the precursor of the 1 series of prostaglandins (PGs). DGLA can also be converted to arachidonic acid (AA, 20:4 ω -6) by the action of the enzyme Δ -5 desaturase. AA forms the precursor of 2 series of prostaglandins, thromboxanes and the 4 series of leukotrienes. ALA is converted to eicosapentaenoic acid (EPA, 20:5, ω -3) by Δ -6 desaturase and Δ -5 desaturase. EPA forms the precursor of the 3 series of prostaglandins and the 5 series of leukotrienes. LA, GLA, DGLA, AA, ALA, EPA and docosahexaenoic acid (DHA, 22:6 ω -3) are all PUFA, but only LA and ALA are EFAs (Figures 4 and 5). AA and EPA also give rise to their respective hydroxy acids, which in turn are converted to their respective leukotrienes (LTs). EPA and DHA are precursors of the 3-series of prostanoids and leukotrienes of the 5-series (Figure 5), they may play an important role in the prevention and treatment of coronary heart disease, hypertension, diabetes, arthritis, other inflammatory and auto-immune disorders, and cancer, whereas AA is the precursor of the 2-series of prostaglandins and thromboxanes and the leukotrienes of the 4-series (Figure 6) which have pro-inflammatory action, and are known to be involved in various pathological processes (Leaf and Weber, 1988; Simopoulos, 1991; Connor and Connor, 1997, Das, 2006).

Competition exists between ω -3 and ω -6 fatty acids for the Δ -5 and Δ -6 desaturases; but the ω -3 fatty acids have greater affinity for these enzymes (de Gomez and Brenner, 1975). However, increased amounts of ω -6 fatty acids in the diet, interfere or slow down the metabolism of ALA to EPA and DHA (Simopoulos^a, 1996). Δ -6 desaturase may decrease with age (de Gomez and Brenner, 1975).

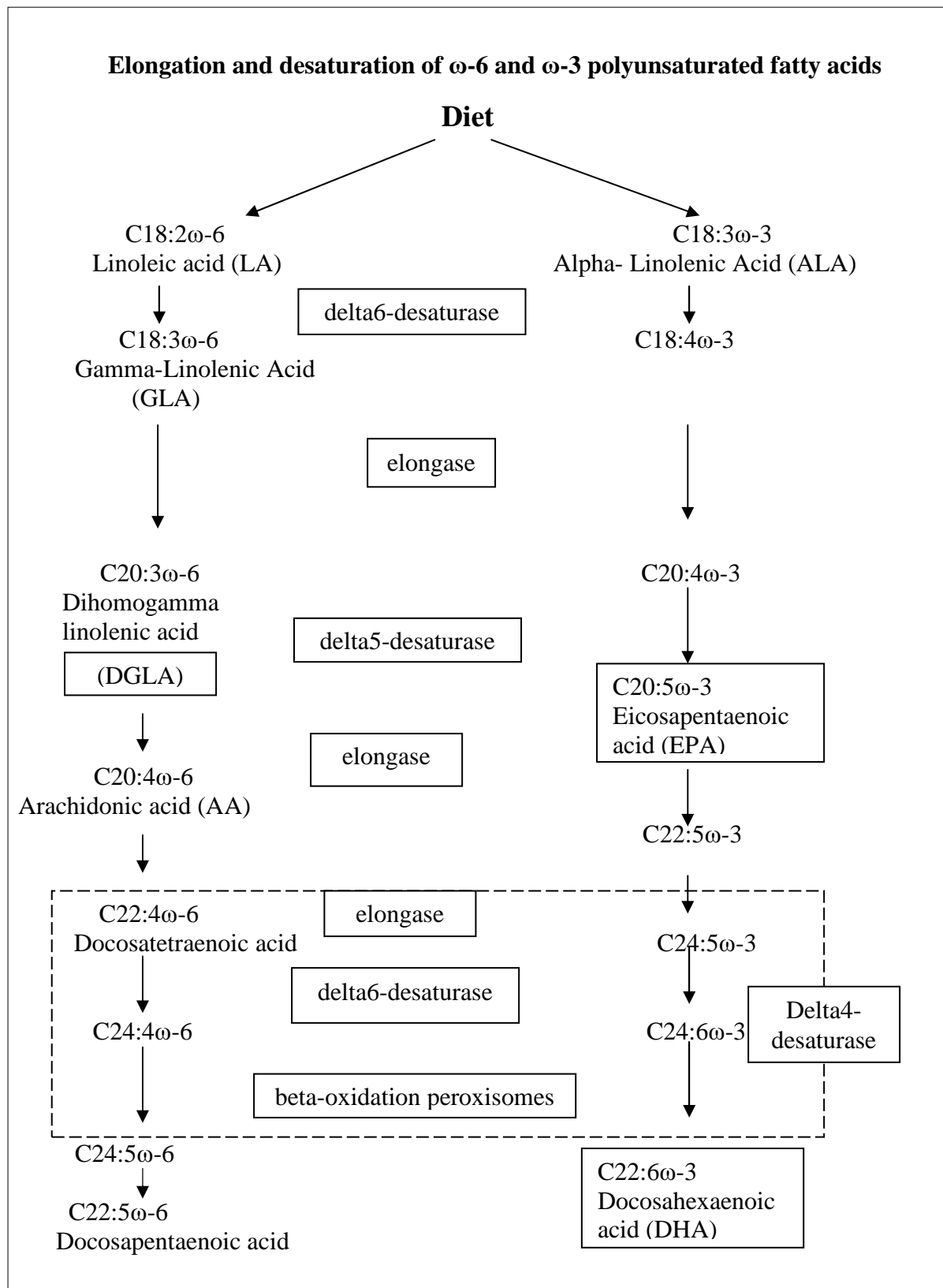

Figure 4: Metabolism of essential fatty acids (Simopoulos^a, 1996).

Mantzioris *et al.* (1994) have shown that the feeding of a low LA-containing diet to human volunteers, thus reducing the enzymatic competition, did allow effective conversion of ALA to EPA with a corresponding elevation in the tissue DHA levels. In rats, incremental elevations in LA intake did produce corresponding increases in liver AA (Lands *et al.*, 1990; Marangoni *et al.*, 1992), but the enhanced bioavailability of LA can result in the displacement of AA, which can result in a reduction in the biosynthesis of AA-derived eicosanoids (Galli *et al.*, 1981; Croft *et al.*, 1984; Tremoli *et al.*, 1986).

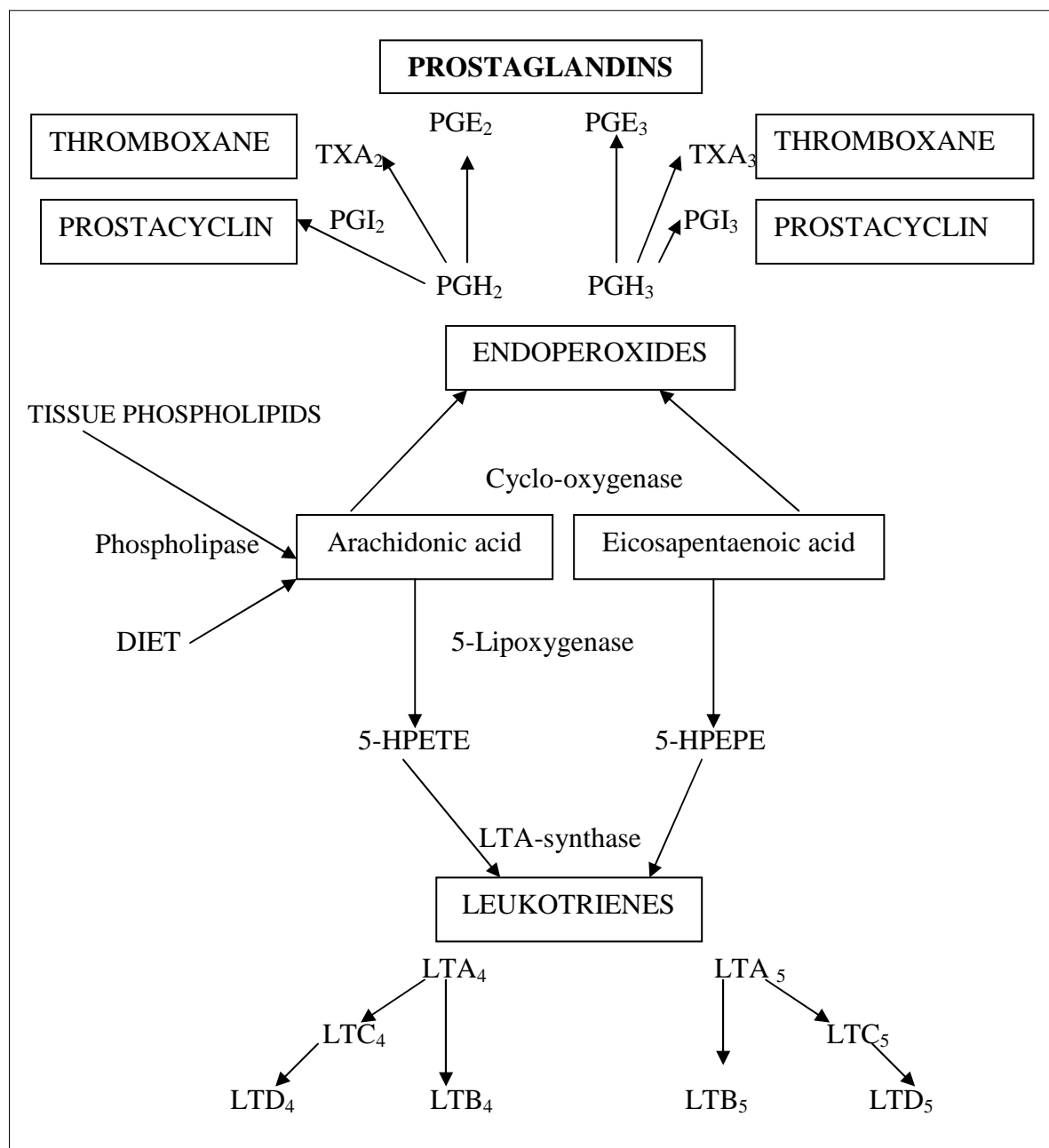

Figure 5: Oxidative metabolism of AA and EPA (Simopoulos^a, 1996).

1.7. Biological effects of omega-3 PUFA and their metabolites

The long-chain ω -3 PUFA are major structural components of membrane phospholipids of tissues throughout the body and in addition, they influence membrane fluidity and ion transports. These fatty acids are especially rich in the myocardium, retina, brain and spermatozoa, and are essential for proper functioning of these tissues and growth, being important modulators of many physiological processes (Connor, 2000). Fatty acid analyses of serum and plasma, as well as blood cell membrane (including red blood cell, platelets or granulocytes) phospholipid levels are commonly used as indicators of ω -3 PUFA intake and their physiological status. An increased intake of fish ω -3 PUFA will result in a corresponding increase in blood and cellular levels of these fatty acids, as evident from both animal and human studies (Holub, 1989; McLennan, 2001; Christensen *et al.*, 1999; Harris and von Schacky, 2004). In particular, the fatty acid composition of myocardial membrane phospholipid is sensitive to the type of fatty acid consumed in the diet. Indeed, the myocardium and the myocardial membrane phospholipids are rich in ω -3 PUFA after feeding fish oils (McLennan, 2001; Nair *et al.*, 1997; Nair *et al.*, 1999; Harris and von Schacky, 2004).

1.8.1. Cell membrane fluidity

Cell membrane fluidity is determined by its lipid composition. Increased incorporation of saturated fatty acids and cholesterol into the cell membranes render the membrane more rigid. In contrast, PUFA are rapidly incorporated into animal and human tissues. These PUFA are particularly incorporated into membrane phospholipids (Ruthing and Meckling-Gill, 1999). Omega-3 PUFA reduce the presence of saturated fatty acids in membranes particularly in lipid rafts and calveolae (Garattini, 2007). This results in remodeling of the bilayer and influences the presence and function of proteins (Ma *et al.*, 2004). As a result, omega-3 PUFA can alter the basic properties of cell membranes, including fluidity, elastic compressibility and ion permeability (Stillwell and Wassal, 2003).

Studies suggested that the number of receptors and their affinity to their respective hormones, growth factors or proteins depends on the fluidity of the cell membrane. For instance, increase in the rigidity of the cell membrane reduces the number of insulin receptors and their affinity to insulin. This, in turn, causes insulin resistance. On the other hand, increase in cell membrane fluidity due to increase in the unsaturated fatty acid content in the membrane phospholipids, increases the number of insulin receptors on the membrane and their affinity to

insulin and thus, decrease in insulin resistance (Holub, 1989; McLennan, 2001; Christensen et al., 1999). This has important therapeutic implications in diabetes mellitus.

The growth of brain during the perinatal period and adolescence depends on the availability of ω -3 and ω -6 fatty acids and various growth factors (Nair et al., 1999; Nair et al., 1997; Calderon and Kim; 2004). It is likely that decrease in the availability of ω -3 and ω -6 fatty acids during this critical period of growth may impair brain growth and the development of appropriate synaptic connections. This, in turn, may lead to several developmental disorders of the brain and neuropsychological conditions such as dementia, depression, schizophrenia, Alzheimer's disease, and neurodegenerative diseases (Huntington's disease, Parkinson's disease, spinocerebellar degeneration, etc).

1.8.2. Eicosanoid Synthesis

Omega-6 and ω -3 fatty acids are the parent fatty acids for the production of eicosanoids. Eicosanoids derived from ω -6 fatty acids have opposing metabolic properties to those derived from ω -3 fatty acids. A balanced intake of both ω -6 and ω -3 fatty acids is essential for health. Because EPA is biologically more active than ALA and high amounts of LA decrease the conversion of ALA to EPA, the optimal intake of LA relative to ALA is crucial for normal metabolism. The predominant ω -6 fatty acid is arachidonic acid. Products of arachidonic acid metabolism, including prostaglandins, leukotrienes, lipoxins, and epoxygenase products, are important regulators of cellular functions; many of these products have atherogenic and prothrombotic effects. Eicosanoids are potent chemical messengers derived from 20-carbon PUFA that play critical roles in immune and inflammatory responses. During an inflammatory response, DGLA, AA and EPA in cell membranes can be metabolized by enzymes known as cyclooxygenases (COX) and lipoxygenases (LPX) to form prostaglandins and leukotrienes, respectively (Figure 6). It is likely that under physiological conditions, COX enzymes are utilized for the formation of beneficial eicosanoids such as PGE1, PGI2, and LXs in various tissues such that inflammation is prevented. Failure to produce adequate amounts of these eicosanoids or interference with their action, and a simultaneous increase in the production of pro-inflammatory PGs, TXs, and LTs, and cytokines, could lead to initiation and persistence of inflammation and tissue damage (Robinson and Stone, 2006; Das, 2006).

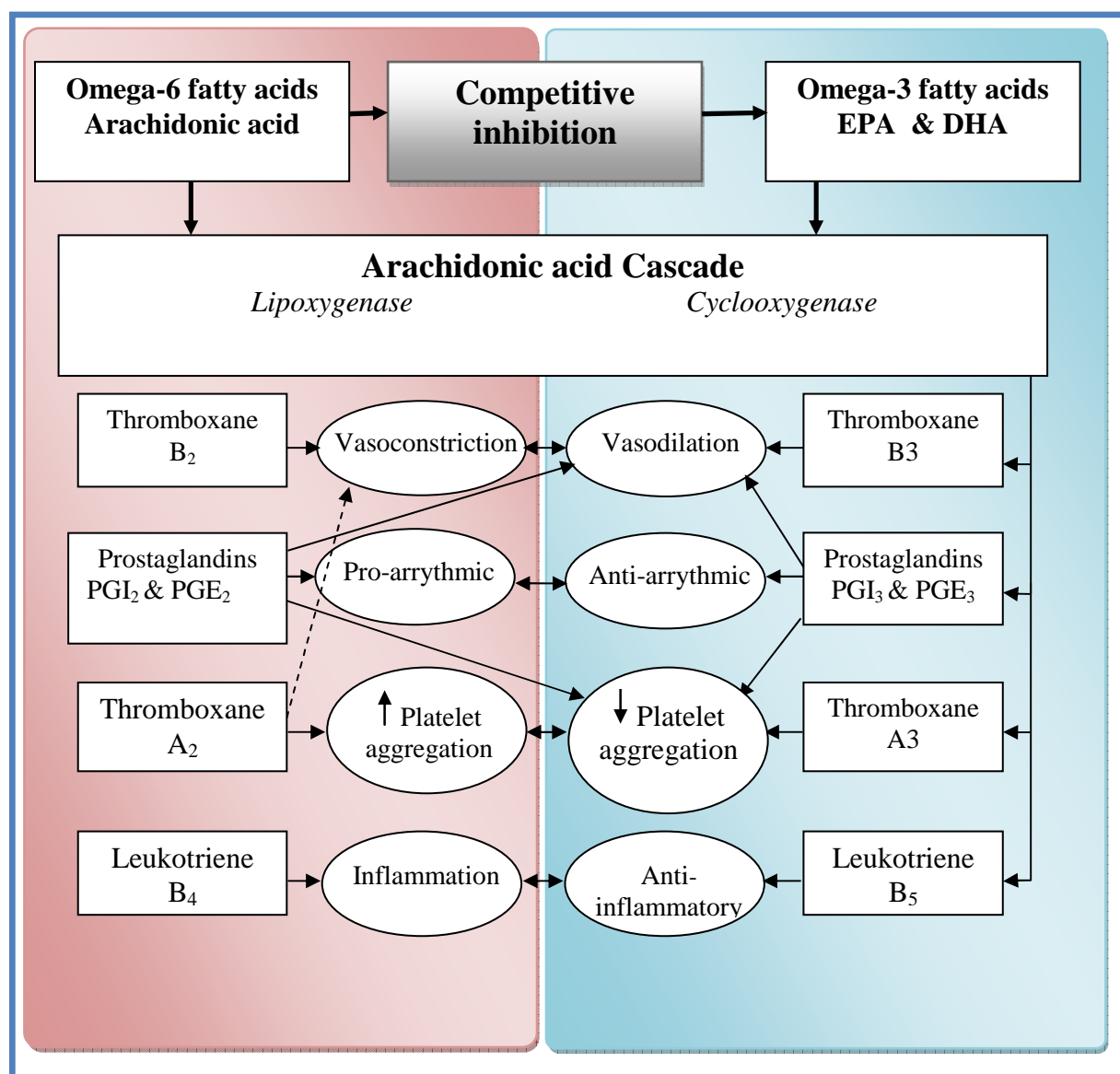

Figure 6. Opposing effects of ω -6 and ω -3 fatty acids on the arachidonic acid cascade. (Robinson and Stone, 2006).

In those who consume typical Western diets, the amount of AA in cell membranes is much greater than the amount of EPA, resulting in the formation of more eicosanoids derived from AA than EPA. However, increasing ω -3 fatty acid intake increases the EPA content of cell membranes, resulting in higher proportions of eicosanoids derived from EPA. Physiological responses to AA-derived eicosanoids differ from responses to EPA-derived eicosanoids. In general, eicosanoids derived from EPA are less potent inducers of inflammation, blood vessel constriction, and coagulation than eicosanoids derived from AA (Kris-Etherton and Harris, 2002; Calder, 2002; Robinson and Stone, 2006).

1.8.3. Regulation of Gene Expression

Nutrients, like hormones, influence and control gene expression (Rucker and Tinker; 1986; De Caterina et al., 2001). PUFA are not only utilized as energy sources or fuel for the organism and structural components of cells, but serve as important mediators of gene expression (Simopoulos^a, 1996). The results of cell culture and animal studies indicate that ω -6 and ω -3 fatty acids can modulate the expression of a number of genes, including those involved with fatty acid metabolism and inflammation. Although the mechanisms require further clarification, ω -6 and ω -3 fatty acids may regulate gene expression by interacting with specific transcription factors (Table 3) (Sampath and Ntambi, 2004; Simopoulos, 1999).

Omega-3 fatty acids from menhaden oil have been shown to lower the enzyme fatty acid synthetase in the liver by decreasing fatty acid synthase mRNA (Clarke and Armstrong, 1988). Other studies have demonstrated that fatty acids, whether released from membrane phospholipids by cellular phospholipases or made available to the cell from the diet or other aspects of the extracellular environment, are important cell-signaling molecules (Simopoulos, 1999). They can act as second messengers or substitute for classic second messengers of the inositide phospholipid and cyclic AMP signal transduction pathways (Graber et al., 1994). They can also act as modulator molecules mediating responses of the cell to extra-cellular signals (Graber et al., 1994). It has also been shown that fatty acids rapidly and directly alter the transcription of specific genes (Clarke and Jump, 1994). Omega-3 fatty acids DHA are essential for the normal growth and development of the premature and full-term infant (Simopoulos^a, 1996).

Table 3. Effects of PUFA on several genes encoding enzyme proteins (Simopoulos, 1999).

Function, gene, and reference	LA	LNA	AA	EPA	DHA
Cell growth and early gene expression					
c-fos	---	---	↑	↓	↓
Egr-1	---	---	↑	↓	↓
Adhesion molecules					
VCAM-1 mRNA ²	---	---	↑	3	↓
Inflammation					
IL-1 β	---	---	↑	↓	↓
β-oxidation					
Acyl-CoA oxidase ⁴	↑	↑	↑	↑↑	↑
Growth factors					
PDGF	---	---	↑	↓	↓

(1) VCAM: vascular cell adhesion molecule;

(2) MUFAs also suppress VCAM1-mRNA, but to lesser degree than DHA;

(3) EPA has no effect by itself but enhances the effect of DHA;

(4) MUFAs also induce acyl-CoA oxidase mRNA.

1.8.4. Second messenger action

Essential fatty acids and their long-chain metabolites, and eicosanoids have second messenger like actions. Several hormones and growth factors activate phospholipase A2 (PLA2), which, in turn, induces the release of DGLA, AA, EPA, and DHA from the cell membrane lipid pool. These fatty acids are utilized for the formation of various eicosanoids and bring about their actions. It was noted that inhibition of PLA2 interferes with the action of various growth factors and cytokines, and proteins. For instance, various actions of tumor necrosis factor α (TNF- α) are dependent on its ability to induce the activity of PLA2, e.g., its tumoricidal action, and inhibitors of PLA2 completely inhibited this action of TNF- α . Polyunsaturated fatty acids seem to be essential for some, if not all, actions of various growth factors and cytokines. Polyunsaturated fatty acids enhance as well the activity of protein kinase C (PKC), a well-known second messenger (Das; 1988; Das; 2006).

In addition, PUFA can activate macrophages and polymorphonuclear leukocytes and increase free radical generation by these cells. These important actions of PUFA suggest that fatty acids have important second messenger actions (Das; 1988; Das; 2006).

1.8.5. Antibiotic-like actions

Polyunsaturated fatty acids show antibiotic-like actions (Sun et al., 2003; Das, 2006; Giamarellos-Bourboulis et al., 2004). For instance, linolenic acid rapidly killed cultures of *Staphylococcus aureus*, and hydrolyzed linseed oil (which contains both LA and ALA) can inactivate methicillin-resistant *S. aureus*. ALA promotes adhesion of *Lactobacillus casei* to mucosal surfaces and, thus, augments their growth. *Lactobacilli*, in turn, suppress the growth of pathogenic bacteria like *Helicobacter pylori*, *Shigella flexneri*, *Salmonella typhimurium*, *Pseudomonas aeruginosa*, *Clostridium difficile*, and *Escherichia coli*. Polyunsaturated fatty acids inactivate enveloped viruses and show anti-fungal properties. The anti-inflammatory and anti-bacterial, anti-viral, and anti-fungal actions of PUFA may explain some of their beneficial actions. In this context, it will be interesting to study whether local application or intravenous infusions of PUFA would help patients with various bacterial, viral and fungal infections to recover faster. Since neutrophils, T cells and macrophages release PUFA on stimulation; it is possible that this could be one of the defense mechanisms of the body to fight infections (Das, 2006).

1.8.6. Vision

DHA is found in very high concentrations in the cell membranes of the retina, which conserves and recycles DHA even when ω -3 fatty acid intake is low (Jeffrey et al.; 2001). Animal studies indicate that DHA is required for the normal development and function of the retina. Moreover, these studies suggest that there is a critical period during retinal development when inadequate DHA will result in permanent abnormalities in retinal function. Recent research indicates that DHA plays an important role in the regeneration of the visual pigment rhodopsin, which plays a critical role in the visual transduction system that converts light hitting the retina to visual images in the brain (San Giovanni and Chew, 2005).

1.8.7. Nervous System

Omega-3 fatty acids are central components of glial and neuronal membrane phospholipids, and take part in brain membrane remodeling and synthesis, and in signal transduction (Rapoport et al., 2001). In particular DHA can modulate membrane fluidity (synaptic plasticity), participate in signal transduction, and the biodynamic activity of neuronal membranes (Bourre et al., 1989, Bourre et al., 1991). In fact, proteins in the bilayer have

crucial cellular functions as they operate as receptors and transporters. Omega-3 fatty acids modify membrane fluidity by shifting cholesterol from the membrane (Yehuda *et al.*, 1998), while determine an optimal membrane fluidity as it is required for neurotransmitter binding and signaling within the cell (Heron *et al.*, 1980). DHA stimulates the expression of peroxisomal enzymes. These are essential for plasmalogen synthesis, which in turn is essential for myelin formation. Thus, DHA stimulates remyelination.

1.9. Recommended Dietary Intakes of EFA

Essential fatty acids, both ω -6 and ALA, have been part of our diet since the beginning of human life. Humans consumed about equal amounts of both. Over the past 150 years this balance has been upset. Current estimates in Western cultures suggest a ratio of ω -6 to ω -3 fatty acids of 10–20:1 instead of 1–4:1. However, nowadays many vegetable oils are greatly enriched in ω -6 PUFA (mainly as LA in corn, sunflower, safflower and soybean oils). The blood ratio of LA: ALA in populations with a typical Western-diet with high intake of LA has been reported to be as high as 100:1. The optimal ratio should be around 4 to 1 (Simopoulos, 1991; Simopoulos *et al.*, 1999; Simopoulos *et al.*, 2006).

It was recommended that during pregnancy and lactation women must ensure a DHA intake of 300 mg/day. Considering the large number of premature infants around the world, and the low number of women who breast feed, they also recommended that the infant formula be similar in the composition to breast milk (Simopoulos *et al.*, 1999). The European Commission recommends an ω -6 fatty acid intake of 4-8% of energy and an ω -3 fatty acid intake of 2 g/day of ALA and 200 mg/day of long-chain ω -3 fatty acids (EPA and DHA) (European Commission Directorate General for Health and Consumer Protection, 2001).

The World Health Organization recommends an ω -6 fatty acid intake of 5-8% of energy and an ω -3 fatty acid intake of 1-2% of energy (WHO/FAO, 2002). However, the Japan Society for Lipid Nutrition has recommended that LA intake be reduced to 3-4% of energy in Japanese people whose ω -3 fatty acid intakes average 2.6 g/day, including about 1 g/day of EPA + DHA (Hamazaki and Okuyama, 2003). The ALA dose may be easily obtained from flaxseed oil, mustard oil, nuts, leeks and green leafy vegetables such as purslane. As ALA is highly sensitive to oxidation (due to its three double bonds), a high intake of ALA should be balanced with a high intake of antioxidants (for example, in vegetables and fruits), to protect it from oxidation (Werneke *et al.*, 2006, Kris-Etherton *et al.*, 2002, Albert *et al.*, 1998; Krauss *et al.*, 2000). On the other hand, EPA and DHA doses are supplied by fish or fish oil

supplements (table 4). Mackerel, herring, salmon and trout are among the richest sources of EPA and DHA. Fish consumed 2.5–3 times per week would provide thus a combined intake of about 500 mg EPA and DHA per day. However, the current average daily intake of EPA and DHA combined in a typical Western diet is only about one fish serving every 10 days (that is, about 150 mg per day), which is approximately 0.15% of total dietary fat intake. Fresh, frozen, canned and smoked versions of oil-rich fish can also provide EPA and DHA (Werneke et al., 2006, Kris-Etherton et al., 2002, Albert et al., 1998 and Krauss et al., 2000).

The American Heart Association recommends that people without documented CHD eat a variety of fish (preferably oily) at least twice weekly, in addition to consuming oils and foods rich in ALA (Kris-Etherton et al., 2002). People with documented CHD are advised to consume approximately 1 g/day of EPA + DHA preferably from oily fish, or to consider EPA + DHA supplements in consultation with a physician. Patients who need to lower serum triglycerides may take 2-4 g/day of EPA + DHA supplements under a physician's care.

Table 4. Safe and effective doses of ω -3 fatty acid supplements for adults (Werneke et al., 2006, Kris-Etherton et al., 2002, Albert et al., 1998 and Krauss et al., 2000)

EPA and DHA

- The adequate daily intake of EPA and DHA for adults should be at least 220 mg of each per day.
- Two to three servings of fatty fish per week (roughly 1250 mg EPA and DHA per day) are generally recommended to treat psychiatric and neurological disorders.

Fish oil supplements

- 3000 to 4000 mg standardized fish oils per day (this amount corresponds to roughly 2 to 3 servings of fatty fish per week).
- Typically, a 1000 mg fish oil capsule has 180 mg EPA and 120 mg DHA.

ALA

- The adequate daily intake of ALA for adults should be roughly 2220 mg per day.

Flaxseed oil

- One or two tbsp of flaxseed oil per day is recommended for general health.
- Doses up to 3000 mg per day are recommended to prevent neurodegenerative disorders and doses up to 6000 mg per day may be recommended to treat these conditions.
- Doses > 3000 mg per day may worsen glycemia in patients with impaired glucose tolerance and diabetes and may rise in LDL-C in patients with hypertriglyceridemia.

Flaxseed

- 1 tbsp two to three times per day or 2 to 4 tbsp once per day. Grind before eating and take with lots of water.
 - Decoction (liquid prepared by boiling down the flaxseed in water): a rounded tbsp of whole seed simmered in 1 cup water for 10 to 15 min, strain and drink.
 - 100 g of raw flaxseed provides 22,800 mg of ALA
-

Chapter II

Heart anatomy and physiology

The
Truth
About
Yourt
Heart



2.1. Heart anatomy

The human heart is a hollow muscular organ, nearly the size of a closed fist that weighs approximately 300 grams in the adult male and 250 grams in the adult female. Weight and size varies depending on age, sex, height, nutritional status, and epicardial fat. The heart is a powerful muscular organ that pumps more than 3,000 gallons of blood every day to supply the body's cells with the nutrients needed for survival. It beats non-stop every minute of every hour, resting only for a fraction of a second between each contraction.

Unlike skeletal muscle, which contracts in response to nerve stimulation, specialized pacemaker cells at the entrance of the right atrium termed the sinoatrial node display the phenomenon of automaticity and are myogenic, meaning that they are self-excitabile without a requisite electrical impulse coming from the central nervous system. The rest of the myocardium conducts these action potentials by way of electrical synapses called gap junctions. It is because of this automaticity that an individual's heart does not stop when a neuromuscular blocker (such as succinylcholine or rocuronium) is administered, such as during general anesthesia.

2.1.1. The wall and Coverings of the Heart

The heart wall has three layers, from deep to superficial: epicardium, myocardium, and endocardium. The outermost layer of the heart, the *epicardium*, also known as the visceral pericardium, consists of epithelial cells that form a serous membrane that covers the entire heart. The innermost layer of the heart is known as the *endocardium*. It is a serous membrane that lines the inner surface of the heart, its valves, and the chordae tendineae, which are the cords that connect the free edges of the atrioventricular valves with the papillary muscles. The papillary muscles are muscle eminences on the walls of the ventricles. The endocardium is continuous with the intima (eg, the inner lining of arteries). The middle layer of the heart is the muscular layer known as the *myocardium*. It is responsible for the major pumping action of the ventricles. The myocardial cells have an intrinsic ability to contract in the absence of stimuli (ie, automaticity) and in a rhythmic manner (ie, rhythmicity), and to transmit nerve impulses (ie, conductivity) (Berne and Levy, 2000; Mader, 2004).

2.1.2. Heart chambers

The heart has four hollow chambers: two superior *atria* and two inferior *ventricles* (Figure7). Each atrium has a wrinkled anterior pouch called an auricle. Internally, the atria are separated by the *interatrial septum*, and the ventricles are separated by the *interventricular septum*. Therefore, the heart has a left and a right side. The thickness of a chamber's myocardium is suited to its function. The atria have thin walls, and they send blood into the adjacent ventricles. The ventricles are thicker, and they pump blood into blood vessels that travel to parts of the body. The left ventricle has a thicker wall than the right ventricle; the right ventricle pumps blood to the lungs, which are nearby. The left ventricle pumps blood to all the other parts of the body.

The *right atrium* has a thin muscle wall. It receives deoxygenated (ie, venous) blood from the head and upper extremities via the superior vena cava, from the trunk and lower extremities via the inferior vena cava, and from the coronary sinus, which drains blood from the myocardium. The coronary sinus empties into the right atrium just above the tricuspid valve. Most blood flow into the right atrium occurs during inspiration when right atrium pressure drops below that in the inferior and superior vena cava, causing the blood to flow from an area of higher to lower pressure. Normal filling pressure for the right atrium ranges from 0 to 8 mm Hg.

In the *right ventricle*, the cusps of the tricuspid valve are connected to fibrous cords, called the *chordae tendineae*. The chordae tendineae in turn are connected to the *papillary muscles*, which are conical extensions of the myocardium. Blood from the right ventricle passes through a *semilunar valve* into the pulmonary trunk. This particular valve prevents blood from flowing back into the right ventricle.

The right ventricle receives blood from the right atrium through the tricuspid valve and ejects it through the *semilunar valve* into the pulmonary artery where it travels to the lungs. This particular *semilunar valve* prevents blood from flowing back into the right ventricle. Normal systolic pressure in the right ventricle ranges from 15 to 28 mm Hg and end-diastolic pressure is 0 to 8 mm Hg. The *left atrium* receives oxygenated (ie, arterial) blood from the lungs through the right and left inferior and superior pulmonary veins. The wall of the left atrium is slightly thicker than that of the right atrium and breathing does not affect its filling. Blood passes from the left atrium into the left ventricle through the *bicuspid (mitral) valve* valve. Normal filling pressure ranges from 4 to 12 mm Hg.

The *left ventricle* has a thick muscular wall. It receives blood from the left atrium through the mitral valve and ejects it through the aortic valve to the systemic circulation via the aorta. Pressure in the left ventricle is high. Normal systolic pressure is 90 to 140 mm Hg and normal end-diastolic pressure is 4 to 12 mm Hg. The ventricular septum, a thick muscular area that becomes membranous as it nears the atrioventricular (AV) valves, separates the right and left ventricles. It houses electrical conduction tissue and provides stability for the ventricles during contraction.

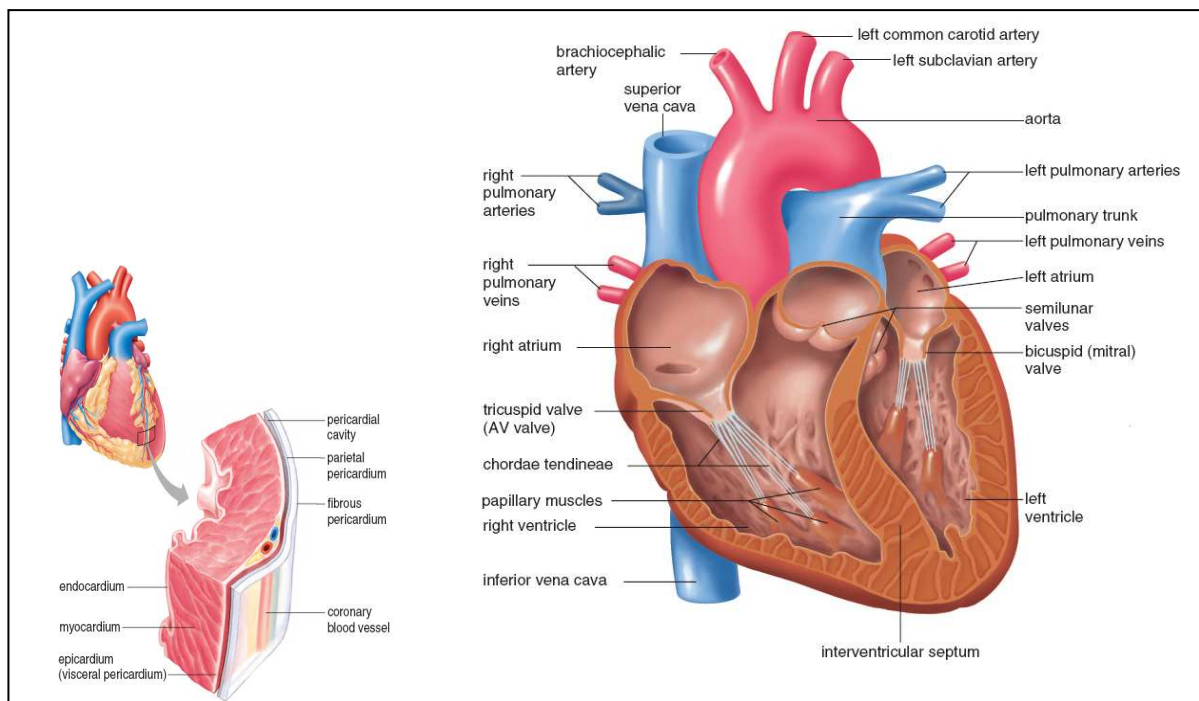

Figure 7: Internal heart anatomy (Mader, 2004).

2.2. Internal conduction (Stimulation) system

Unlike skeletal muscle, which contracts in response to nerve stimulation, specialized pacemaker cells at the entrance of the right atrium termed the sinoatrial node display the phenomenon of automaticity and are myogenic, meaning that they are self-excitable without a requisite electrical impulse coming from the central nervous system. The rest of the myocardium conducts these action potentials by way of electrical synapses called gap junctions. The conduction system coordinates the contraction of the atria and ventricles so that the heart is an effective pump (Berne and Levy, 2000).

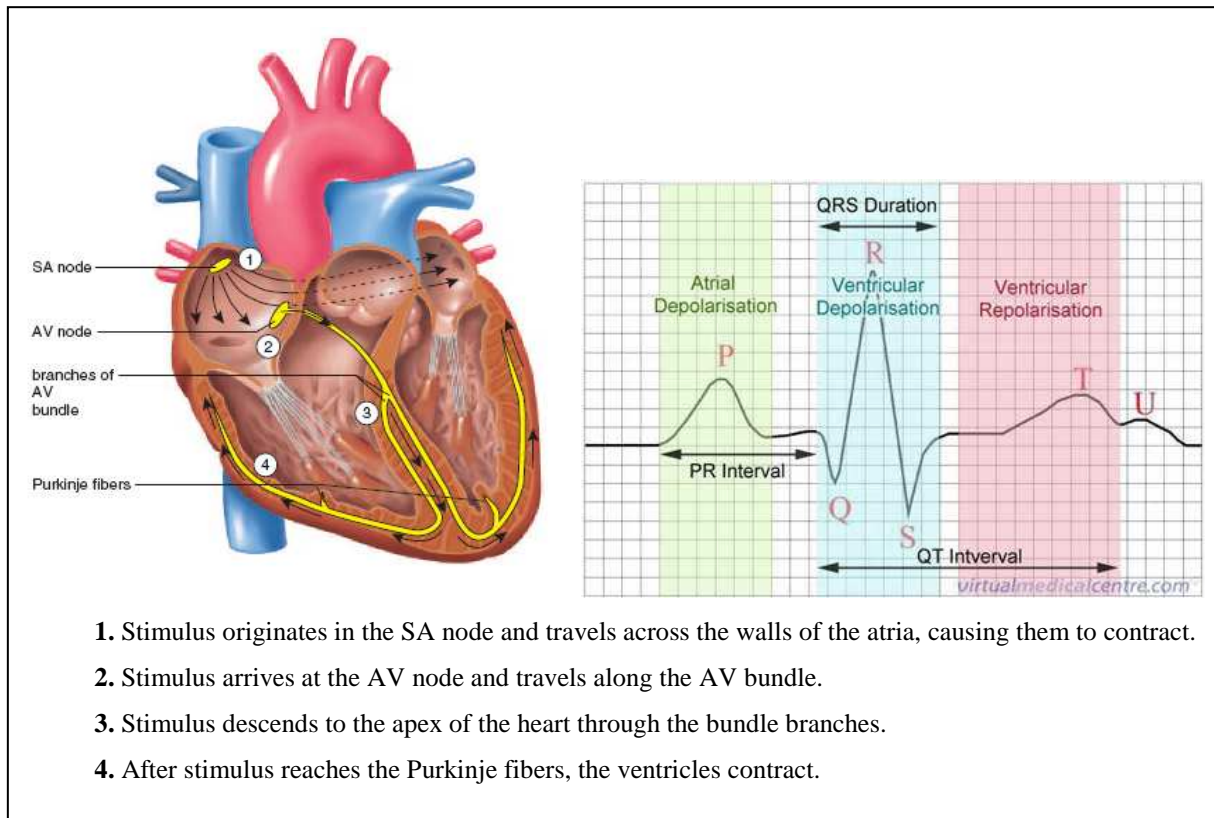

Figure 8: Conduction system of the heart and cardiogram (Mader, 2004).

The heartbeat is controlled by nodal tissue, which has both muscular and nervous characteristics. This unique type of cardiac muscle is located in two regions of the heart: The **SA (sinoatrial) node** is located in the upper posterior wall of the right atrium; the **AV (atrioventricular) node** is located in the base of the right atrium very near the interatrial septum (Figure 8).

The SA node which is called **pacemaker** initiates the heartbeat and automatically sends out an excitation impulse every 0.85 second. From the SA node, impulses spread out over the atria, causing them to contract. When the impulses reach the AV node, there is a slight delay that allows the atria to finish their contraction before the ventricles begin their contraction. The signal for the ventricles to contract travels from the AV node through the two branches of the **atrioventricular bundle (AV bundle)** before reaching the numerous and smaller **Purkinje fibers**. The AV bundle, its branches, and the Purkinje fibers consist of specialized cardiac muscle fibers that efficiently cause the ventricles to contract.

An area other than the SA node can become the pacemaker when it develops a rate of contraction that is faster than the SA node. This site, called an **ectopic pacemaker**, may cause an extra beat, if it operates only occasionally, or it can even pace the heart for a while. Caffeine and nicotine are two substances that can stimulate an ectopic pacemaker.

A graph that records the electrical activity of the myocardium during a cardiac cycle is called an “**Electrocardiogram**”, or **ECG**. An ECG is obtained by placing on the patient’s skin several electrodes that are wired to a voltmeter (an instrument for measuring voltage). As the heart’s chambers contract and then relax, the change in polarity is measured in millivolts. An ECG consists of a set of waves: the P wave, a QRS complex, and a T wave (Figure 8). The P wave represents depolarization of the atria as an impulse started by the SA node travels throughout the atria. The P wave signals that the atria are going to be in systole and that the atrial myocardium is about to contract. The QRS complex represents depolarization of the ventricles following excitation of the Purkinje fibers. It signals that the ventricles are going to be in systole and that the ventricular myocardium is about to contract. The QRS complex shows greater voltage changes than the P wave because the ventricles have more muscle mass than the atria. The T wave represents repolarization of the ventricles. It signals that the ventricles are going to be in diastole and that the ventricular myocardium is about to relax. Atrial diastole does not show up on an ECG as an independent event because the voltage changes are masked by the QRS complex. An ECG records the duration of electrical activity and therefore can be used to detect arrhythmia, an irregular or abnormal heartbeat. A rate of fewer than 60 heartbeats per minute is called **bradycardia**, and more than 100 heartbeats per minute is called **tachycardia**. Another type of arrhythmia is **fibrillation**, in which the heart beats rapidly but the contractions are uncoordinated. The heart can sometimes be defibrillated by briefly applying a strong electrical current to the chest (Mader, 2004; Berne and Levy, 2000).

2.3. Pumping Action of the Heart

The pumping action starts with the simultaneous contraction of the two atria. This contraction serves to give an added push to get the blood into the ventricles at the end of the slow-filling portion of the pumping cycle called "diastole." Shortly after that, the ventricles contract, marking the beginning of "systole." The aortic and pulmonary valves open and blood is forcibly ejected from the ventricles, while the mitral and tricuspid valves close to prevent backflow. At the same time, the atria start to fill with blood again. After a while, the ventricles relax, the aortic and pulmonary valves close, and the mitral and tricuspid valves open and the ventricles start to fill with blood again, marking the end of systole and the beginning of diastole. It should be noted that even though equal volumes are ejected from the right and the left heart, the left ventricle generates a much higher pressure than does the right ventricle (Berne and Levy, 2000).

2.4. Myocardium and mechanism of contraction and contractile function

An increase in myocardial fiber length, such as that occurring with an augmented ventricular filling during diastole, produces a more forceful ventricular contraction. This relationship between fiber length and strength of contraction is known as the Frank-Starling relationship or Starling's law (Berne and Levy, 2000).

Although the myocardium is made up of individual cells with discrete membrane boundaries, the cardiac myocytes that constitute the ventricles contract almost in unison, as do those of atria. The myocardium functions as a syncytium with an all-or-none response to excitation. Cell to cell conduction occurs through gap junctions that connect the cytosol of adjacent cells. During the upstroke of the action potential, voltage-gated Ca^{2+} channels open to admit extracellular Ca^{2+} into the cell. Calcium channels underlie the electrical activity of cells and form the means by which electrical signals are converted to responses within the cell (Figure 9). Calcium channels play an integral role in excitation in the heart and shaping the cardiac action potential. In addition, calcium influx through calcium channels is responsible for initiating contraction. Abnormalities in calcium homeostasis underlie cardiac arrhythmia, contractile dysfunction and cardiac remodeling (Hool, 2007).

The influx Ca^{2+} triggers the release of Ca^{2+} from the sarcoplasmic reticulum. The elevated intracellular Ca^{2+} produces contraction of the myofilaments. Relaxation of the myocardial fibers is accomplished by restoration of the resting cytosolic Ca^{2+} level by pumping Ca^{2+} back into the sarcoplasmic reticulum and exchanging it for extracellular Na^+ across the sarcolemma. Contractility is increased mainly by interventions that increase intracellular Ca^{2+} levels and decreased by interventions that decrease intracellular Ca^{2+} levels (Berne and Levy, 2000).

2.5. Energetic metabolism of myocardium

The heart has continuously high energy demands related to the maintenance of specialized cellular processes, including ion transport, sarcomeric function, and intracellular Ca^{2+} homeostasis. Myocardial workload (energy demand) and energy substrate availability (supply) are in continual flux, yet the heart has a limited capacity for substrate storage. Thus, ATP-generating pathways must respond proportionately to dynamic fluctuations in physiological demands and energy delivery (Berne and Levy, 2000; Huss and Kelly, 2005).

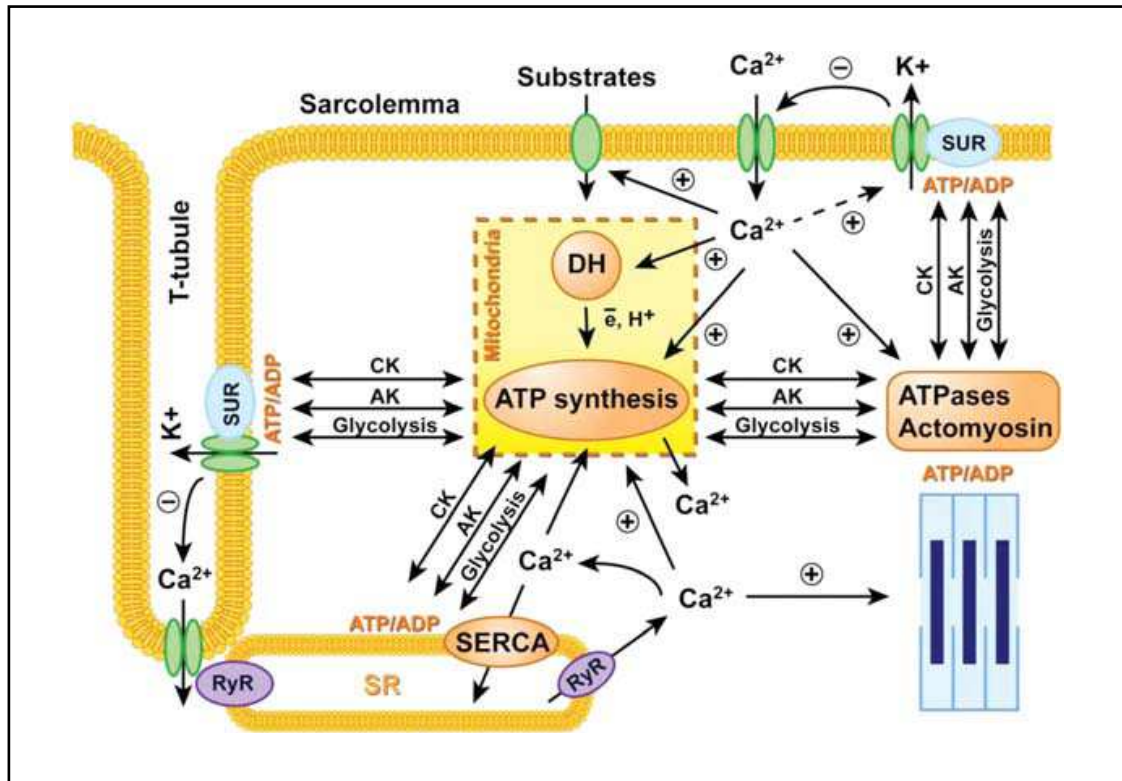

Figure 9. Cardiac excitation–contraction–energy coupling: synchronization electrical and metabolic pacing (Saks *et al.*, 2006). Sarcoplasmic reticulum (SR), Ryanodine receptor-channels (RyR), creatine kinase (CK), adenylate kinase (AK), SR Ca^{2+} -ATPase (SERCA).

Oxidation of fatty acids and glucose in mitochondria accounts for the vast majority of ATP generation in the healthy adult heart (Stanley and Chandler, 2002; Taegtmeyer, 1994). Fatty acids are the preferred substrate in the adult myocardium, supplying about 70% of total ATP (Bing *et al.*, 1954; Shipp *et al.*, 1961; Wisnecki *et al.*, 1987). Fatty acids derived from circulating triglyceride-rich lipoproteins and albuminbound nonesterified fatty acids are oxidized in the mitochondrial matrix by the process of fatty acid β -oxidation, whereas pyruvate derived from glucose and lactate is oxidized by the pyruvate-dehydrogenase (PDH) complex, localized within the inner mitochondrial membrane (Figure 10). Acetyl-CoA, derived from both pathways, enters the tricarboxylic acid (TCA) cycle. Reduced flavin adenine dinucleotide (FADH_2) and NADH are generated via substrate flux through the β -oxidation spiral and the TCA cycle, respectively. The reducing equivalents enter the electron transport chain, producing an electrochemical gradient across the mitochondrial membrane that drives ATP synthesis in the presence of molecular oxygen (oxidative phosphorylation).

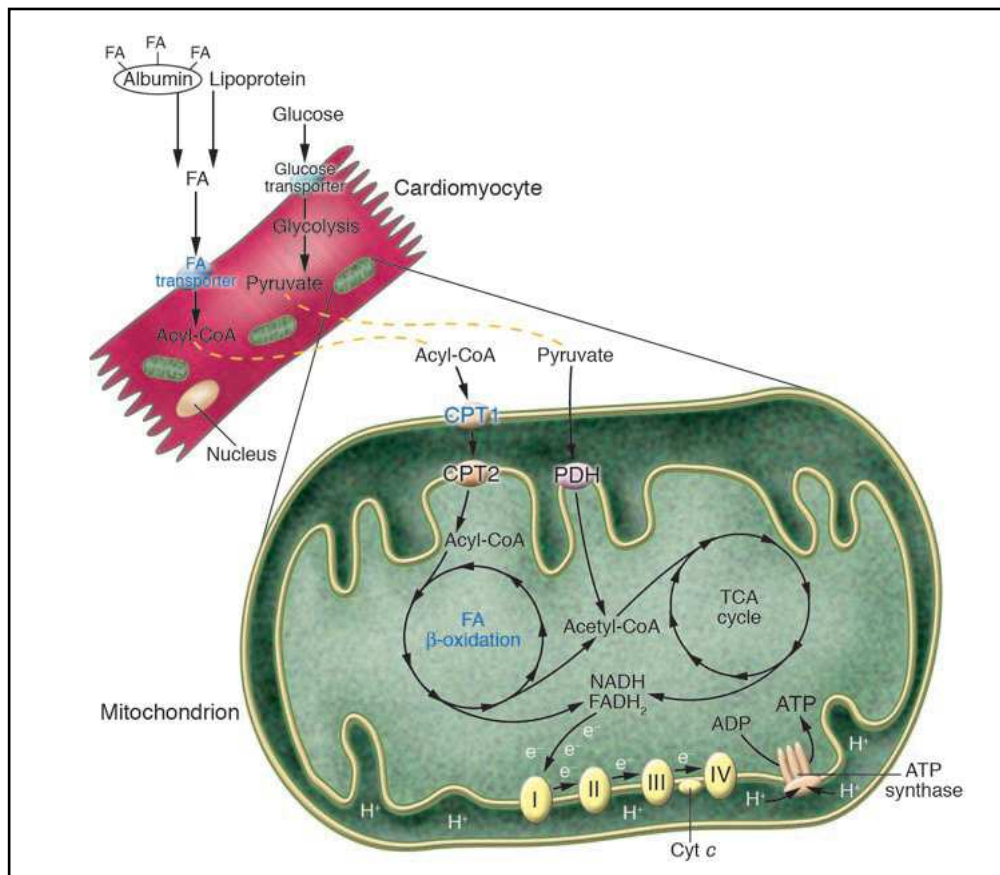

Figure 10. Pathways involved in cardiac energy metabolism (Huss and Kelly, 2005).

Recently, Saks and *al.* (2006) pointed out two interrelated systems regulating mitochondrial respiration and energy fluxes in cells:

- (1) The creatine kinase, adenylate kinase and glycolytic pathways that communicate flux changes generated by cellular ATPases within structurally organized enzymatic modules and networks; and
- (2) A secondary system based on mitochondrial participation in cellular calcium cycle, which adjusts substrate oxidation and energy-transducing processes to meet increasing cellular energy demands. By conveying energetic signals to metabolic sensors, coupled phosphotransfer reactions provide a high-fidelity regulation of the excitation–contraction cycle. Such integration of energetics with calcium signalling systems provides the basis for ‘metabolic pacing’, synchronizing the cellular electrical and mechanical activities with energy supply processes.

2.6. Myocardial ischemia and reperfusion

Myocardial ischemia exists when the reduction of coronary flow is so severe that the supply of oxygen to the myocardium is inadequate for the oxygen demands of the tissue leading to the cessation of oxidative phosphorylation (Reimer and Jennings, 1991; Reimer and Ideker, 1987; Buja, 1998, Opie, 1998). This causes tissue ATP and creatine phosphate concentrations to decrease with a concomitant rise in ADP, AMP and Pi concentrations. Although glycolysis is activated, it is unable to meet the demand of the beating heart for ATP.

The heart can usually survive a short period of ischaemia and then recover upon reperfusion. However, if the period of ischemia is too long, the tissue becomes irreversibly damaged (Hochachka, 1996; Opie, 1998, Hearse et de Leiris 1979; Mikelson *et al.*, 1990). Thus, it is important to restore the blood flow as soon as possible. Yet, paradoxically, such reperfusion can exacerbate the damage occurring during the ischaemic period (Figure 11). This is known as reperfusion injury and is accompanied by enzyme release and morphological changes characteristic of necrosis. The extent of damage can be visualized as an area of necrotic tissue known as the infarct whose area can be determined to provide a quantitative measure of injury, and some myocytes around the periphery of the infarct die by apoptosis (Buja *et al.*, 1988; Thandroyen *et al.*, 1992).

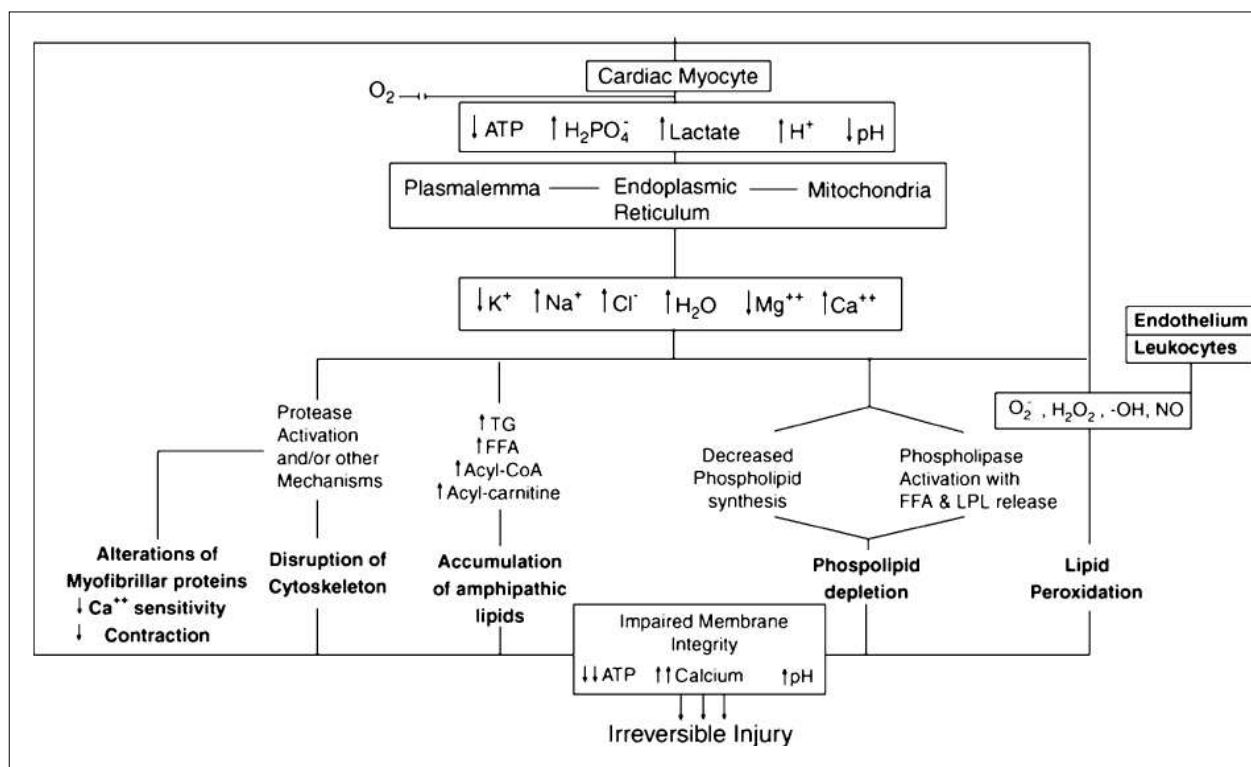

Figure 11: Pathogenesis of myocardial ischemic and reperfusion injury (Buja, 2005).

With loss of oxygen, mitochondrial oxidative phosphorylation rapidly stops, with a resultant loss of the major source of ATP production for energy metabolism. A compensatory increase in anaerobic glycolysis for ATP production leads to the accumulation of hydrogen ions and lactate, resulting in intracellular acidosis and inhibition of glycolysis, as well as mitochondrial fatty acid and residual energy metabolism. These metabolites may, indirectly, lead to ionic disturbances; in particular, they may alter both sodium and calcium homeostasis and contribute to electrical dysfunction. Increases in intracellular sodium (Na^+_i) may indeed have functional and proarrhythmogenic consequences, because increases in Na^+_i in turn generate Ca^{2+} loading via reverse $\text{Na}^+ - \text{Ca}^{2+}$ exchange (El Banani *et al.*, 2000; Pogwizd *et al.*, 2003, Feuvray, 2006, Buja *et al.*, 1988; Thandroyen *et al.*, 1992).

The altered metabolic milieu with a sustained increase in cytosolic Ca^{2+} leads to phospholipase activation and phospholipid degradation with release of lysophospholipids and free fatty acids. Impaired mitochondrial fatty acid metabolism results in the accumulation of free fatty acids, long-chain acyl CoA, and acyl carnitine, and these amphiphilic molecules, together with products of phospholipid degradation, incorporate into membranes and damage their function (Table 5) (Reimer and Jennings, 1991; Reimer and Ideker, 1987; Buja, 1998, Feuvray, 2006).

Ultrastructural features of the ischemic myocytes with metabolic derangements include swelling of mitochondria and sarcoplasmic reticulum, swelling of the cytoplasm, and margination and clumping of nuclear chromatin. Ultrastructural features of irreversible injury include flocculent (amorphous matrix) densities and linear densities in mitochondria and physical defects (holes) in the sarcolemma (Reimer and Jennings, 1991; Buja, 1998, Feuvray, 2006).

Table 5: The 3 stages of cell membrane injury and associated cellular ionic alterations during Ischemia (Buja *et al.*, 1993)

Discrete alterations in ionic transport systems
K ⁺ efflux
Mg ²⁺ increase followed by Mg ²⁺ loss
Ca ²⁺ increase
Na ⁺ , Cl ⁻ , and H ₂ O increases and further K ⁺ decrease
Increased permeability of the phospholipid bilayer
Increased permeability to Ca ²⁺ with potential for Ca ²⁺ loading and
Increase in total cell Ca ²⁺
Further changes in Na ⁺ , Cl ⁻ , K ⁺ , Mg ²⁺ , and H ₂ O
Leakage of smaller macromolecules
Physical disruption of the membrane
Holes in the membrane
Leakage of larger macromolecules
Equilibrium between the constituents of cell interior and exterior

Reperfusion clearly can limit the extent of myocardial necrosis with the magnitude of the sparing directly related to the timing of the intervention (Maxwell and Lip, 1997; Park and Lucchesi, 1998). However, the effects of reperfusion are complex and include some deleterious effects collectively referred to as reperfusion injury. This reperfusion injury involves the activation of an inflammatory cascade and is manifest as functional impairment, arrhythmia, and accelerated progression of cell death in certain critically injured myocytes. The major mediators of reperfusion injury are oxygen radicals, calcium loading, and neutrophils (Maxwell and Lip, 1997; Park and Lucchesi, 1998).

The reperfusion injury characteristics are: arrhythmia (Rochette *et al.*, 1980; Manning et Hearse, 1984), myocardial stunning which refers to the prolonged depression of contractile function of the salvaged myocardium that develops on reperfusion (Braunwald et Kloner, 1982) and speeding up the process of cell necrosis.

Several hypotheses have been proposed to explain the development of alterations associated with reperfusion of ischemic myocardium: the expansion of edema, the increase of the calcium overload, the release of endogenous catecholamines, cell injury accompanied by changes in the myocardial interstitium and microvasculature, and finally cell necrosis and inflammatory reaction with subsequent organization and healing.

Chapter III

Omega-3 PUFA and coronary heart disease



I've got something to tell you, Dad - I don't like fish...I mean I REALLY don't like fish...I HATE fish, Dad - there, I've said it now

Several effects of ω -3 PUFA have been demonstrated in experimental, epidemiological and clinical studies, e.g. antiarrhythmic, anti-inflammatory, antithrombotic and lipid lowering. Several studies have been conducted to determine the effects of dietary fats and coronary heart disease (CHD). The proposed factors that may account for the cardioprotective effects of ω -3 fatty acids are summarised in Table 6.

Table 6. Factors involved in CHD that may be affected by ω -3 long chain PUFA (Calder, 2004).

Factor	Effect
Serum TG	↓
Production of chemoattractants	↓
Production of growth factors	↓
Cell surface expression of adhesion molecules	↓
Production of inflammatory eicosanoids	↓
Blood pressure	↓
Endothelial relaxation	↓
Thrombosis	↓
Cardiac arrhythmias	↓
Heart rate variability	↓
Atherosclerotic plaque stability	↑

↑ = increase; ↓ = decrease.

3.1. Lipid lowering effects

The National Cholesterol Education Program Third Adult Treatment Panel (NCEP ATP III) recommends that patients with borderline (150–200 mg/dL) and high (>200 mg/dL) TG levels be treated with lifestyle modifications (NCEP, 2002). The NCEP ATP III also indicates that patients with high TG levels (200–499 mg/dL) may need pharmacologic therapy that targets non-high-density lipoprotein cholesterol (non-HDL): statins, fibrates, and nicotinic acid.

EPA and DHA increase intracellular degradation of apolipoprotein B-100-containing lipoproteins. This severely inhibits secretion of very-low-density lipoprotein (VLDL) and thereby lowers plasma triglyceride (TG) levels. In trials of subjects with TG levels >150 mg/dL (>1.69 mmol/L) taking the ω -3 fatty acids eicosapentaenoic acid (EPA) and/or docosahexaenoic acid (DHA) in dosages of 3.4–4 g/day, TG levels decreased by an average of 29% (Figure 12).

EPA and DHA are useful for treating severe hypertriglyceridemia, eg, TGs >11.3 mmol/L (1,000 mg/dL) (Connor *et al.*, 1993). EPA + DHA supplementation also appears to:

- Accelerate chylomicron TG clearance by increasing lipoprotein lipase activity (Park and Harris, 2003);
- Increase conversion of VLDL to low-density lipoprotein (LDL) (Chan *et al.*, 2002);
- Depress LDL synthesis, and reduce postprandial lipemia (Connor, 1994).

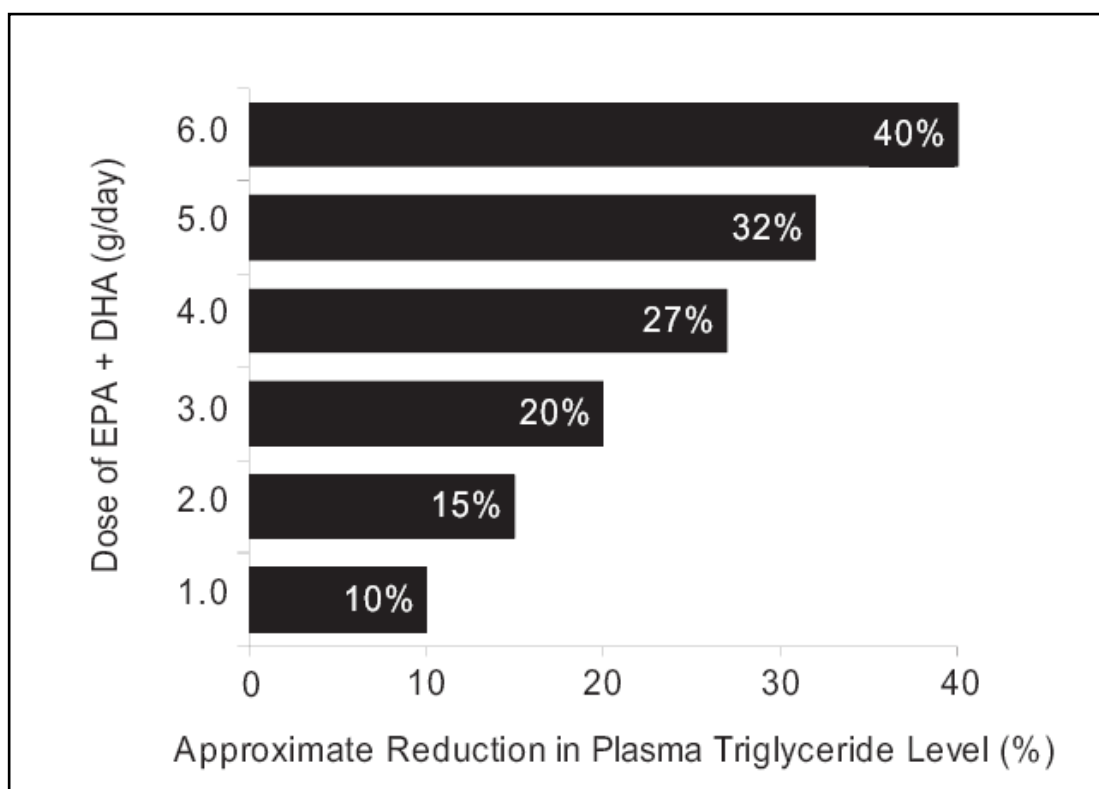

Figure 12: Approximate plasma triglyceride reduction per gram of combined EPA and DHA (Balk *et al.*, 2004).

3.2. Anti-inflammatory and antithrombotic effects

Epidemiologic studies of Greenland Eskimos and Japanese populations, both groups with high marine ω -3 fatty acid intakes, revealed low rates of chronic inflammatory disorders and autoimmune disorders in addition to low rates of cardiovascular disease.

Inflammation is recognized to play a key role in the progression of atherosclerosis (Ross, 1993; Ross, 1999). Dietary exposure to n -3 fatty acids decreased inflammatory activity therefore it could alter the progression of the disease (Michelle *et al.*, 2008). Direct intake of various PUFA alters the cell membrane fatty acid composition, which, in turn, modulates cell and tissue response to infection, injury and inflammatory events.

The ω -3 fatty acid EPA is a competitive substrate for the enzymes of the arachidonic acid cascade; involvement of EPA results in different end products, many of which oppose the products resulting from arachidonic acid metabolism (Figure 6) (Mori and Beilin, 2004).

Results of clinical trials in rheumatoid arthritis, psoriasis, asthma, inflammatory bowel disorders, and systemic lupus erythematosus suggest that ω -3 fatty acids have clinically important effects on chronic inflammation (Mori and Beilin, 2004; Simopoulos, 2002; Duffy *et al.*, 2004).

Omega-3 PUFA administration suppresses proinflammatory cytokine production and lymphocyte stimulation (Tavazzi *et al.*, 2004; Meydani *et al.*, 1991) in a subset of T lymphocytes in men and mice (Fowler *et al.*, 1993). Inhibition of inflammation and degradation in human osteoarthritic cartilage may be the basis for the effect of ω -3 PUFA in rheumatoid arthritis (Curtis *et al.*, 2002; Kremer, 2000). Omega-3 PUFA are also important in a number of experimental and clinical inflammatory reactions in the gastrointestinal tract (Nieto *et al.*, 1998; Marotta *et al.*, 1995; Yamashiro *et al.*, 1994; Miura *et al.*, 1993; Wu *et al.*, 2003)

Many of products of arachidonic acid metabolism have atherogenic and prothrombotic effects (Robinson and Stone, 2006).

- The ω -3 fatty acid EPA is a competitive substrate for the enzymes of the arachidonic acid cascade. Involvement ω -3 PUFA results in different end products, many of which oppose the products resulting from arachidonic acid metabolism.
- When ω -3 PUFA are available, thromboxane B3 with its few physiologic effects is produced rather than thromboxane B2, a potent vasoconstrictor and platelet activator derived from arachidonic acid.
- Available EPA further neutralizes the adverse effects of thromboxane B2 through the manufacture of prostaglandins that, along with those manufactured from arachidonic acid, inhibit platelet aggregation and promote vasodilation (Weber *et al.*, 1986, Calder, 2004).
- Omega-3 PUFA may also promoting the production of largely inactive leukotriene B5 and competitively inhibiting the production of highly inflammatory leukotriene B4 from AA.
- Altering the balance of downstream products from ω -6 and ω -3 fatty acids may also influence the arrhythmia threshold because almost all the prostaglandins produced

from arachidonic acid are proarrhythmic, whereas those produced from EPA are not (Li *et al.*, 1997).

- EPA also results in the production of less inflammatory and chemotactic eicosanoids than those derived from arachidonic acid (Simopoulos, 2002).
- Recently, an alternative pathway for the anti-inflammatory effects of ω -3 fatty acids has been proposed. Resolvin E1 is an oxidized derivative of EPA that reduces inflammation by suppressing the activation of nuclear factor- κ B and consequently the synthesis of inflammatory cytokines and chemokines (Prescott and Stenson, 2005).

3.3. Omega-3 PUFA and atherosclerosis

One of the leading causes of coronary heart disease is atherosclerosis, the main feature of which is the atheromatous plaque, a deposit of lipids and cell debris in the intima layer of the artery which partially blocks the lumen. It takes several years to form and may eventually fissure, triggering the development of a blood clot which adheres to the plaque and leads to myocardial infarction.

Several mechanisms have been proposed to explain how ω -3 PUFA might beneficially affect risk factors implicated in the pathogenesis of atherosclerosis and thrombotic disease (Table 7). These include improving vascular reactivity, decreasing platelet aggregation, lowering plasma triglycerides, decreasing blood pressure, preventing arrhythmias and reducing inflammation (Balk *et al.*, 2006, Calder 2004).

Epidemiological data have provided clear evidence that fish consumption is associated with a reduced risk of CVD and atherosclerosis (Eschen *et al.*, 2005; Schmidt *et al.*, 2005; Kris-Etherton *et al.*, 2002; Morris *et al.*, 1995). These beneficial effects of fish and other marine oils are thought to be largely attributable to the antiatherogenic and antithrombotic activity of long-chain ω -3 fatty acids EPA and DHA.

In a recent study, 188 patients scheduled for carotid endarterectomy were randomized to 1.4 g of marine ω -3 PUFA per day, ω -6 PUFA or control oil for a median period of 6 weeks (Thies *et al.*, 2003). The main findings from this study were that EPA and DHA were incorporated into carotid plaques in patients randomized to ω -3 PUFA, and those patients had less infiltration with macrophages and a thicker fibrous cap than the controls. These findings suggest that marine ω -3 PUFA may change the composition of atherosclerotic plaques making them less vulnerable to rupture.

In addition, the majority of animal studies has shown that fish oil feeding decreases atherosclerosis and thrombosis (Schmidt *et al.*, 2005; Kris-Etherton *et al.*, 2002; Zampolli *et al.*, 2005).

Omega-3 fatty acids reduce atherogenic risk factors. In humans ω -3 fatty acids decrease serum triglycerides and very low-density lipoprotein cholesterol especially in patients with mixed hyperlipidemia or marked hypertriglyceridaemia, while low-density lipoprotein cholesterol tends to be either elevated or unchanged (Leaf and Weber, 1988).

The process of atherosclerosis is closely linked to the health and integrity of endothelial cells (De Caterina and Zampolli; 2007). Several direct effects of ω -3 PUFA on endothelial activation have been demonstrated:

- Reduced production of cytokines such as interleukin (IL-1) and tumour necrosis factor (TNF) in lipopolysaccharide-stimulated monocytes (Endres *et al.*, 1989);
- Reduced production of mitogen and smooth muscle cell attractant platelet-derived growth factor (PDGF-A and B) protein and mRNA (Fox and DiCorleto, 1988; Kaminski *et al.*, 1993);
- Reduced expression of tissue factor by monocytes (Hansen *et al.*, 1989);
- Increase in endothelial nitric oxide bioavailability (Shimokawa and Vanhoutte, 1989);
- Specific down-regulation of gene expression for monocyte chemoattractant protein-1 (Baumann *et al.*, 1999);
- Reduced expression of endothelial adhesion molecules, which are essential for monocyte adhesion to sites of inflammation and dysfunctional endothelium (De Caterina and Massaro, 2005).

Table 7. Effects of ω -3 fatty acids on factors involved in the pathophysiology of atherosclerosis and inflammation (Simopoulos, 1999).

Factor	Function	Effect of ω -3 F.A on factor concentration
Arachidonic acid	Eicosanoid precursor, aggregates platelet, and stimulates white blood cells.	↓
Thromboxane A ₂	Platelet aggregation, vasoconstriction, increase intracellular Ca ²⁺	↓
Prostacyclin .	Prevents platelet aggregation, vasodilator, increase cyclic AMP.	↑
Leukotriene B ₄	Neutrophil chemoattractant increases intracellular Ca ²⁺	↓
Tissue plasminogen activator .	Increase endogenous fibrinolysis.	↑
Fibrinogen	Blood clotting factor	↓
Red blood cell deformability	Decreases tendency to thrombosis and improves oxygen delivery to tissues	↑
Platelet activating factor	Activates platelet and white blood cells	↓
Platelet-derived growth factor.	Chemoattractant and mitogen for smooth muscles and macrophages.	↓
Oxygen free radicals	Causes cellular damage, enhances LDL uptake via the scavenger pathway, stimulate arachidonic acid metabolism	↓
Lipid hydroperoxides	Stimulates eicosanoid formation .	↓
Interleukin 1 and tumor necrosis factor	Stimulate neutrophil oxygen free radical formation, lymphocyte proliferation, and platelet activation factor; express intercellular adhesion molecule1 on endothelial cells; and inhibits plasminogen activator and thus is procoagulant	↓
Endothelial-derived relaxation factor	Reduces arterial vasoconstrictor response	↑
VLDL	Related to LDL and HDL concentrations	↓
HDL	Decrease the risk of coronary heart disease .	↑
Lipoprotein (a)	Atherogenic and thrombogenic .	↓
Triacylglycerols and chylomicrons	Contribute to postprandial lipemia .	↓

3.4. Omega-3 PUFA and Blood pressure (BP)

Findings from observational studies suggest that modest fish consumption is associated with significantly lower systolic and diastolic blood pressure. Compared with intake < once per month, consumption of +3 times per week was associated with 5 mmHg lower systolic BP ($p < 0.001$) and 2 mmHg lower diastolic BP ($p < 0.001$) (Mozaffarian *et al.*, 2006).

Given the physiologic determinant of BP ($BP = \text{systemic vascular resistance (SVR)} \times \text{cardiac output}$, where cardiac output = stroke volume \times heart rate). Animal-experiments utilizing fish oil (Demaison *et al.*, 2000) suggest that the BP-lowering effect of ω -3 PUFA results from reduced SVR. Consistent with these experimental studies Mozaffarian *et al.* (2006) demonstrated as well that lower BP in individuals with fish intake resulted from lower SVR, and not from lower cardiac output.

In vitro, ω -3 PUFA induce nitric oxide production (Omura *et al.*, 2001) and profoundly alter cell membrane microenvironments, modifying location and function of caveolae proteins including eNOS (Li *et al.*, 2007^a; Li *et al.*, 2007^b). In human trials, fish oil attenuates peripheral vasoconstrictive responses to norepinephrine and angiotensin II (Kenny *et al.*, 1992; Chin *et al.*, 1993, Mori *et al.*, 2000), improves arterial wall compliance, and enhances vasodilatory responses (Mori *et al.*, 2000), each of which might account for reduction in SVR (Mozaffarian, 2007).

3.5. Omega-3 fatty acids and reduction of sudden death

Sudden cardiac death is the most common cause of mortality among patients surviving a myocardial infarction (MI), accounting for 50% to 60% of all deaths due to coronary artery disease (Lee *et al.*, 2004). Post-infarction treatment of patients with fish oil supplements is now considered as component of an effective approach to preventing mortality due to sudden cardiac death in this group at high risk. In 2003, the European Society of Cardiology published guidelines that recommended inclusion of fish oils as standard therapy for postinfarction management (De Backer *et al.*, 2003).

Among populations in which total fat intake is considerably <30% of total energy, yet mortality from cardiovascular disease (CVD) is low, fish and plant oils are the primary sources of fat consumed. Dietary patterns associated with low CVD mortality, have been identified in populations residing in Mediterranean regions. Subsequent studies included large numbers of men and women from diverse populations, ranging in age from 25 to 103 years,

residing in >30 countries, who were either free of CVD at baseline or had clinical evidence of coronary artery disease (CAD) (Zhang *et al.*, 1999; Gillum *et al.*, 2000; Erkkila *et al.*, 2003; He^a *et al.*, 2004; Dyerberg *et al.*, 2004).

The findings of longitudinal cohort and cross-sectional ecologic studies, together with data from case control and dietary intervention studies, have confirmed that significant reductions in mortality due to myocardial infarction (MI), ischemic heart disease, stroke, sudden cardiac death, and total CVD can be attributed to consumption of fish and other dietary sources of ω -3 fatty acids, as estimated from dietary histories, food records, food-frequency questionnaires, or agricultural food balance data, as well as from measurement of serum, membrane, and tissue ω -3 fatty acid concentrations. With few exceptions, cardioprotective benefits have been found with consumption of modest amounts of ω -3 fatty acids provided by an average intake of 25 to 57 g of fish high in ω -3 fatty acids consumed daily or an intake of an equivalent amount consumed in ≥ 1 fish meal weekly or even monthly (Gillum *et al.*, 2000; He^a *et al.*, 2004; Albert *et al.*, 1998; Hu *et al.*, 2002; He^b *et al.*, 2004; Daviglus *et al.*, 1997). In most of the populations examined, reductions in CVD mortality have been associated with fish consumption.

Because high intakes of ω -3 fatty acids are characteristic of fish-consuming populations, attention has focused largely on the benefits of EPA and DHA to explain the protective effects on CVD risk observed in these studies. Results from several observational and interventional studies also have demonstrated that regular consumption of a variety of ω -3 fatty acid sources; including fish oils, nuts, and soybean oil, in addition to dietary supplements that provide concentrated amounts of purified EPA and DHA; was inversely associated with CVD mortality or promoted significant reductions of 30% to 60% in CVD mortality (Erkkila *et al.*, 2003; He^a *et al.*, 2004; Hu *et al.*, 2002; He^b *et al.*, 2004; de Lorgeril *et al.*, 1999; Bucher *et al.*, 2002; Burr, 1992 ; Dolecek et Granditis; 1991).

Numerous epidemiologic and interventional studies have evaluated the associations and effects of ω -3 fatty acids and fish, as well as markers of ω -3 fatty acid intake, on CHD end points in a variety of populations. Healthy subjects and subjects at high risk for coronary disease, including those who had an MI, have been evaluated.

3.5.1. Epidemiologic Studies

Thirty two years ago Bang *et al.* (1976) suggested that the low occurrence of fatal coronary heart disease in Inuits (Eskimos) could be related to their high intake of marine ω -3 PUFA (10–14 g/day) which include EPA and DHA which are limited or absent in land animals and plants. This ecological study was the basis for the hypothesis that consumption of marine ω -3 PUFA could protect against coronary heart disease (Bang *et al.*, 1980). Additional observational studies have demonstrated lower rates of cardiovascular disease in several other populations with high fish consumption, such as the Japanese (Hirai *et al.*, 1980), and Alaskan natives (Middaugh, 1990).

Kromhout and colleagues (Kromhout *et al.*, 1985) examined CHD mortality rates among 12,763 healthy middle-aged men from 16 cohorts in the Seven Countries Study (SCS) using laboratory analyses of representative foods from each country to estimate average ω -3 fatty acid intakes. The vital status of all participants was verified at regular intervals over 25 years. This study has shown that the consumption of at least 30g of fish/day made it possible to reduce by 50% the coronary risk of mortality (Kromhout *et al.*, 1996; Sandker and *al.*, 1993). In Zutphen Study, one of the most cohort important studies, men who at least consumed 30g of fish/day had risks of coronary mortality divided by two compared to the individuals who never ate fish (Kromhout *et al.*, 1985). During the Zutphen Elderly Study, a prospective population based study; ALA intakes were estimated as a percentage of energy on the basis of data from dietary histories of 667 healthy survivors of the Dutch cohort of the SCS aged 64 to 84 years. This study suggested that consumption of at least one portion of fish per week may be associated with a reduced stroke incidence whereas ALA acid intake was not significantly associated with CAD risk (Oomen *et al.*, 2001; Keli *et al.*, 1994).

Similarly, Chicago Western Electric Study, a prospective study in 1,847 healthy men aged 40 to 55 years, assessed the impact of fish consumption, determined by diet history questionnaires, across tertiles (1 to 17 g/day, 18 to 34 g/day, and ≥ 35 g/day) on CVD end points over 30 years of follow-up. This study has shown that men who consumed 35 g or more of fish daily had lower risks of death from coronary heart disease (-38%) and from myocardial infarction (-67%) compared with those who consumed none (Daviglius *et al.*, 1997).

The US Physicians' Health Study, a prospective cohort study, was conducted in a population of 20,551 healthy male physicians ranging in age from 40 to 84 years at baseline to compare men who consumed no fish with less than once a month and once weekly. After 11 years of follow-up, this study has shown that a weekly fish consumption, compared with a monthly fish consumption, was connected to a reduction of the risk of sudden death (- 50%) and of total mortality (-50%). Neither dietary fish consumption nor ω -3 fatty acid intake was associated with a reduced risk of total myocardial infarction, non-sudden cardiac death, or total cardiovascular mortality. However, fish consumption was associated with a significantly reduced risk of total mortality (Albert *et al.* 1998; Morris *et al.*, 1995).

This study was continued during additional 6 years in the form of case-control study (94 men with a cardiac sudden death risk versus 184 control) and revealed an inverse relation between the blood ω -3 PUFA level and the risk of sudden death (Albert and *al.*, 2002). More exactly, the quartile of participants with the high blood ω -3 PUFA had 81% less risk to make a cardiac sudden death. The whole of the results of US Physicians Health Study thus suggests that it is through the AGPI ω -3 that consumption induced fish of the cardioprotectors effects. These prospective data suggest that consumption of fish at least once per week may have additional cardiovascular benefit.

Another case-control study was carried out in Seattle between 1988 and 1994 on 334 case patients with primary cardiac arrest, aged 25 to 74 years and 493 controls. Blood specimens from 82 cases (collected in the field) and 108 controls were analyzed to determine red blood cell membrane fatty acid composition, a biomarker of dietary ω -3 polyunsaturated fatty acid intake. Compared with no dietary intake of EPA and DHA, an intake of 5.5 g of ω -3 fatty acids per month (the equivalent of two fatty fish meal per week) was associated with a 50% reduction in the risk of primary cardiac arrest (Siscovick and *al.*, 1995). Compared with an ω -3 fatty acid level of 3.3% of total fatty acids in red blood cell membrane (the mean of the lowest quartile), an ω -3 fatty acid level of 5% of total fatty acids in red blood cell membrane (the mean of the third quartile) was associated with a 70% reduction in the risk of primary cardiac arrest (Siscovick and *al.*, 2000).

An additional cohort study, the Health Professionals Follow-Up Study, assessed ω -3 intake by a semiquantitative food-frequency questionnaire in 45,722 men aged 40 to 75 years over 14 years of follow-up (Mozaffarian^a *et al.*, 2005). After 6 years of follow-up, this study did not show any association between the consumption of ω -3 PUFA or the fish consumption and the risk of CHD (Ascherio and *al.*, 1995). While at 14-year follow-up, ALA intake was associated with a trend toward lower risk of nonfatal MI (Mozaffarian^a *et al.*, 2005). Other studies have also found no significant correlations between fish intake and the risk of CHD (Hu and Willet, 2001; Ascherio *et al.*, 1995, Simonsen *et al.*, 1987, Marckmann and Gronbaek, 1999). Nonetheless, some of these cohorts were characterized by population with high fish consumption at baseline, and they were probably already at low risk for CHD. The discordant results may also be ascribed to differences in design, study population, duration of observation, and the dose and nature of the ω -3 PUFA or fish oil. A recent systematic review by Marckmann and Gronbaek (1999) did suggest that higher-risk cohorts were more likely to benefit more from an increase fish intake than low-risk subjects, and it was estimated that consumption of 40–60 g of fish per day could reduce the risk of CHD death by 40–60% in these high risk groups.

In the Nurses' Health Study (Hu *et al.*, 2002), a longitudinal study, food-frequency questionnaires were used to assess dietary intake of ω -3 fatty acids and fish consumption prospectively in a large cohort of healthy 84 688 female nurses enrolled in the Nurses' Health Study, aged 34 to 59 years. During 16 years of follow-up, women who rarely ate fish (<1 per month), had 21%, 29%, 31% and 34% higher risk of CHD death than the women consuming fish from 1 to 3 times/month, 1 time/week, 2 to 4 times/week and beyond 5 times/week. This study has shown that variable fish consumption between 1-3 times/week and more than 5 times/week reduced the risk of CHD from 7 to 52%. The authors have concluded that higher consumption of fish and ω -3 fatty acids is associated with a lower risk of CHD, particularly CHD deaths (Hu *et al.*, 1999; Hu *et al.*, 2002). The same study has shown that after 10 years of follow-up in the NHS, risk of nonfatal MI was not significantly related to ALA intake; however, the trend toward lower mortality due to MI across quintiles of ALA intake was borderline significant (Hu *et al.*, 2002).

The National Health and Nutrition Examination Survey (NHANES) I Follow-Up Study was conducted over an average of 18.8 years in 8,825 healthy white and African American men and women aged 25 to 74 years. Fish intake was estimated at baseline from food-frequency data over 3 months. No consistent association of fish consumption and coronary heart disease incidence or mortality was seen (Gillum *et al.*, 2000).

The Cardiovascular Health Study (CVHS), a prospective study with 12 years of follow-up in 4,775 men and women aged ≥ 65 years and free of CVD, assessed fish consumption by food-frequency questionnaire and verified consumption by plasma EPA and DHA concentrations. Fish consumption was inversely associated with stroke mortality, with 27% lower risk of ischemic stroke with an intake of 1 to 4 times per week and 30% lower risk with intake of 5 or more times per week compared with an intake of less than once per month. These results suggest that fish consumption may influence stroke risk late in life (Mozaffarian^b *et al.*, 2005).

In the Japan Public Health Center-Based Study Cohort I, a population-based study in 41,578 healthy Japanese men and women aged 40 to 59 years, fish intakes were determined by food-frequency questionnaires over 477,325 person-years of follow-up. Fish consumption of 8 times per week (about 180 g/day) was associated with a 56% reduction in incidence of nonfatal MI and a 53% reduction in total MI when compared with fish intakes of 1 time per week (about 23 g/day) in men and women (Iso *et al.*, 2006).

Two prospective studies that assessed CVD risk based on ω -3 fatty acid status in populations at high risk are the European Multicenter Case-control Study on Antioxidants, Myocardial Infarction and Breast Cancer (EURAMIC) study and the Honolulu Heart Program (HHP) (Rodriguez *et al.*, 1996; Guallar *et al.*, 1999). In the EURAMIC study (Guallar *et al.*, 1999) comparisons were made between adipose tissue fatty acid concentrations of 639 men with previous MI and 700 control subjects in 8 European countries and Israel. In this large case-control no protective effect of DHA on the risk of myocardial infarction was detected. The protective effect of α -linolenic acid was attenuated after adjusting for classical risk factors (mainly smoking), may be further research are needed.

The HHP, a prospective study in 8,006 Japanese American men aged 45 to 65 years an average follow-up of 23 years, classified fish intake as <2 times per week or >2 times per week as determined by food-frequency questionnaire (Rodriguez *et al.*, 1996). A significant interaction was found among smokers between fish intake categories and CAD incidence and

mortality. Among smokers, age-adjusted mortality rates significantly increased with the number of cigarettes smoked daily only among those who consumed fish <2 times per week. In the subgroup of smokers who smoked the greatest number of cigarettes, the risk factor-adjusted relative risk for mortality due to CAD when fish was consumed >2 times per week was 50% that observed when fish was consumed <2 times per week. Among smokers who consumed fish >2 times per week, CAD mortality was not increased (Rodriguez *et al.*, 1996).

In an ecologic study by Zhang and colleagues (1999), fish consumption was estimated as a percentage of total energy (ranged from 0.23% to 10.43% with a mean of 1.53%) on the basis of food balance sheets of men and women of varying health status, aged 45 to 74 years, residing in 36 countries using Food and Agriculture Organization of the United Nations (FAO) and World Health Organization (WHO) data. There was a significant inverse correlation after adjusting for confounders and concluded that fish consumption is associated with a reduced risk from all-cause, ischemic heart disease, and stroke mortality at the population level.

Yamagishi *et al.* (2008) conducted a prospective study consisting of 57,972 Japanese men and women. Dietary intakes of fish and ω -3 PUFA were determined by food frequency questionnaire, and participants were followed up for 12.7 years. They found inverse associations between fish and ω -3 PUFA dietary intakes and cardiovascular mortality, especially for heart failure (18% to 19% lower risk) suggesting a protective effect of fish intake on cardiovascular diseases.

3.5.2. Interventional Studies

In the DART study, 2033 Welshmen with recent MI randomized to receive at least two servings of fatty fish per week (200–400 g/ week) (or about 3 fish oil capsules: 900 mg EPA and DHA per day if they could not tolerate the fish) had a significant 29% reduction in both cardiac and total mortality within 4 months of the study until the end of the 2 years of follow up compared with the non-fish supplementation groups (Burr *et al.*, 1989; Burr *et al.*, 1994). However, there was no significant reduction in the incidence of recurrent non-fatal MI. Indeed, this early reduction in mortality observed in the DART trial has led to the hypothesis that ω -3 PUFA might have an anti-arrhythmic effect as the underlying protective mechanism, rather than anti-thrombotic or anti-arteriosclerotic (Burr *et al.*, 1989; Burr *et al.*, 1994).

The subsequent results from the much larger trial the Gruppo Italiano per lo Studio della Sopravvivenza nell'Infarto miocardico Prevenzione (*GISSI-prevenzione*) trial (1999); that included 11324 recently discharged post-MI patients; found that after 3.5 years follow-up, patients randomized to daily supplement of 1 g capsule containing 600 mg of EPA and 300 mg of DHA as ethyl esters, on a background of a Mediterranean-type diet had a significant relative risk reduction for the main cardiovascular end points (cardiovascular death, non-fatal MI, and stroke) by 20%, cardiovascular death by 30%, and in a subanalysis the risk of sudden death alone was reduced by as much as 45% (Figure 13). Whereas, oral vitamin E 300 mg (given as one capsule of synthetic alpha-tocopherol) supplementation was without any significant cardiovascular benefit. Furthermore, this degree of risk reduction was achieved in Italian post-MI survivors, whose dietary habit was the 'typical' Mediterranean diet, suggesting that greater benefits might possibly be seen with ω -3 PUFA in a Western-style diet typified by high consumption of saturated fats and low intake of ω -3 PUFA.

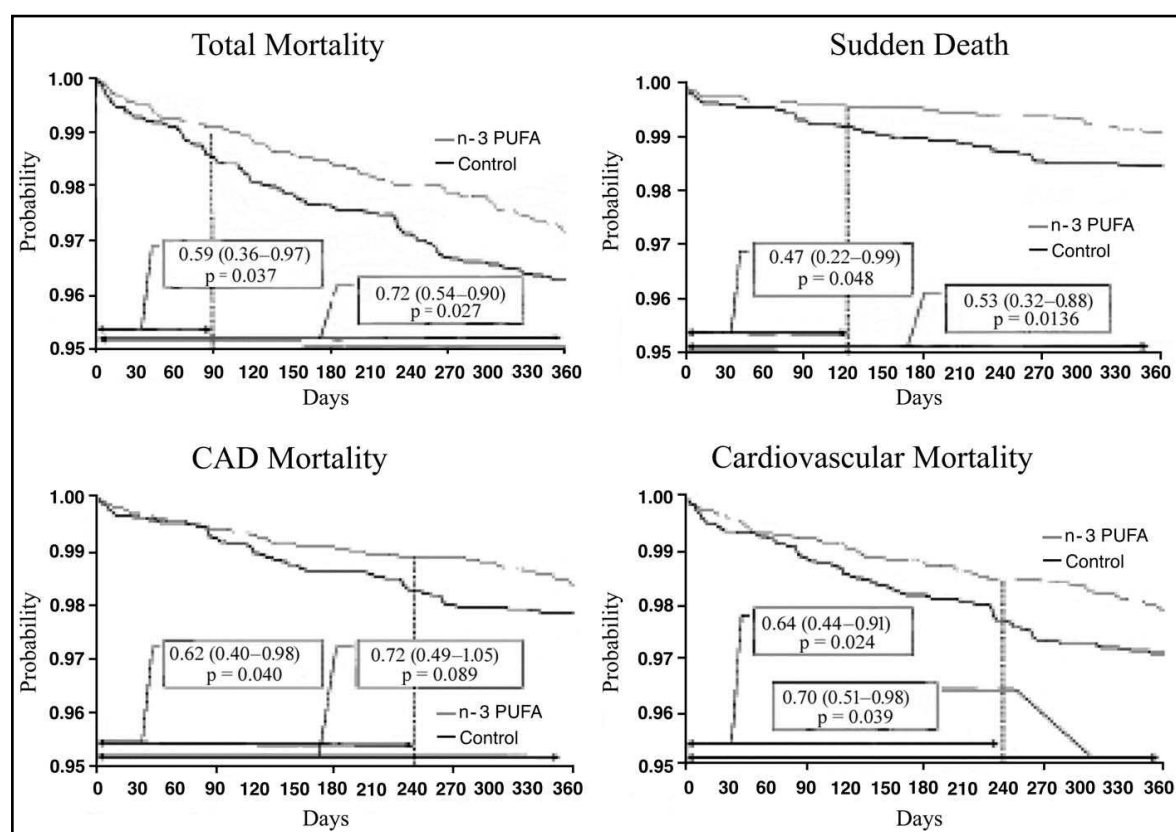

Figure 13. Early benefit of omega-3 fatty acid therapy on total mortality, sudden death, coronary artery disease mortality, and cardiovascular mortality in GISSI. Probability measurements represent relative risk (95% confidence interval). n-3 PUFA= omega-3 polyunsaturated fatty acids (Marchioli et al., 2002).

Although simple nutrients, the ω -3 PUFA are therefore much more effective than certain drugs (aspirin, beta-blockers, angiotensin converting enzymes (ACE) inhibitors and/or lipid lowering statins) prescribed for the secondary prevention. Importantly, the intervention was well-tolerated and had no serious side-effects during the trial. In the interventional Scandinavian Simvastatine Survival Study, Scandinavian Simvastatine Survival Study investigators (1994) have shown that statins can save 1 life out of 28,8 in 5,4 years. In contrast, 2 fish portions/week may save 1 life out of 28 in 2 years in the DART study (Burr *et al.*, 1989). Another example is the CARE study (Cholesterol And Recurrent Events) (Sacks *et al.*, 1996) which revealed that the pravastatine is efficient to save 1 life on 7,4 in 5 years, ten times less effective than the consumption ω -3 PUFA. In the GISSI Prevenzione Trial, it was 5,7 lives saved on 1000 patients/year (GISSI-Prevenzione investigators, 1999). The results from the GISSI-Prevenzione trial were further reaffirmed by the recently published time-course data re-analysis (Marchioli *et al.*, 2002), which showed that the survival curves for patients receiving treatment began to diverge early after randomization, and that their total mortality was significantly lowered after 3 months. Survival was predominantly due to a reduction in the risk of sudden cardiac death, which became statistically significant by 4 months. Hence, as in the DART trial, such an early effect of ω -3 PUFA on total mortality and sudden death supports the hypothesis of 'an anti-arrhythmic effect' of these fatty acids.

The Lyon Diet Heart Study from France was the first secondary prevention trial designed to test the hypothesis that a Mediterranean ALA-rich diet may improve prognosis in survivors of a first MI (with 303 control and 302 experimental subjects, mean age 53 years). This study reported a 50–70% lower risk of recurrent risk (Figure 14) after a mean follow-up of 46 months per patient, as measured by different combinations of outcome measures, including cardiac death and non-fatal MI in the active group who received a Mediterranean diet (with more fish, more fibre with cereals, bread, fresh vegetables and fruits, but less animal fat) supplemented with ALA (in particular, olive and canola oils for salad and food preparation, and canola-oil-based margarine to spread on bread) when compared to controls who received 'usual care'. Control patients consumed about 0.7g of ALA per day, compared with about 1.8g in the experimental group, with a ratio of LA: ALA of about 10:1 in controls, compared to 4:1 in the experimental group, resulting in significant differences in the fatty acid composition of both circulating plasma lipids and cell membrane phospholipids. The investigators found that ALA plasma concentrations 2 months after randomization were significantly and inversely associated with the risk of CHD recurrence, and in particular, with fatal recurrences, including the prevention of sudden death (de Lorgeril *et al.*, 1998; de Lorgeril *et al.*, 1999).

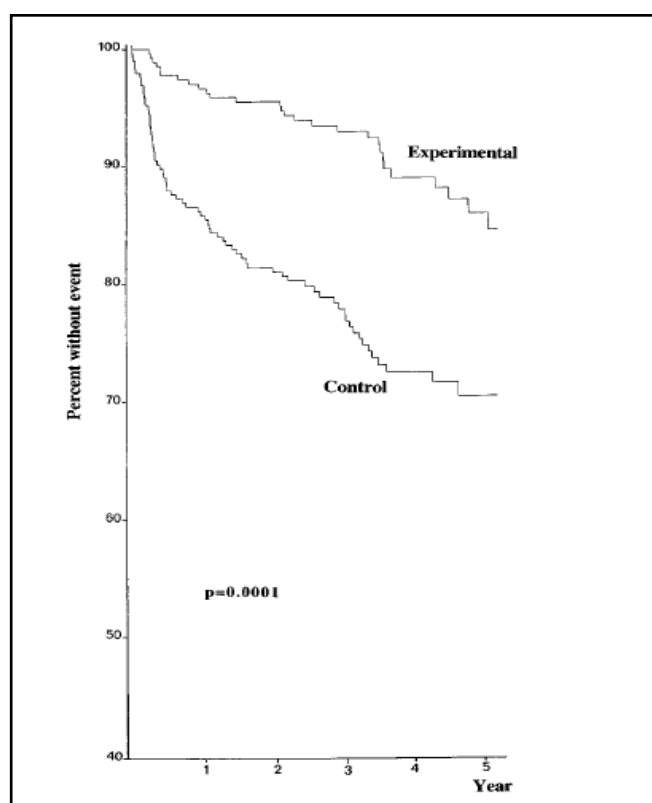

Figure 14. Cumulative survival without nonfatal infarction and without major secondary end points; Experimental group = Mediterranean type diet (de Lorgeril *et al.*, 1999).

Another randomized controlled trial, the Indian Diet Heart Study (Singh *et al.*, 1992), randomized 505 patients with a recent MI (within 48 h of event) to either a control diet (about 28% of the total calories) or a low-fat diet (about 24% of the total calories). This trial reported a significant reduction in the risk of cardiac events: a 42% reduction in cardiac mortality and a 45% reduction in all-cause mortality after one year of follow-up (Singh *et al.*, 1992). In fact, CHD events were reduced in the experimental group as early as 6 weeks after randomization. In this trial, patients in the experimental group with a low-fat diet were encouraged to eat a healthy diet rich in vegetables, fruits, nuts and grain products, which are the main sources of α -LNA. The observations from the Indian Diet Heart study are consistent with earlier studies on the Seventh Day Adventists (Fraser *et al.*, 1992) and American nurses (Hu *et al.*, 2002), which also suggested that eating nuts was associated with a lower risk of CHD.

In another secondary prevention, placebo-controlled trial, the Indian Experiment of Infarct Survival (Singh *et al.*, 1997), 4360 patients less than 1 day after MI were randomized to one of three arms: a group receiving fish oil capsules (EPA 1.08 g/day and DHA 0.72 g/day), a

group receiving mustard seed oil, 20 g/day (ALA 2.9 g/day), and a control group (aluminum hydroxide 100 mg/day). After 1 year, total cardiac events (total cardiac deaths and non-fatal MI) were significantly fewer in the fish oil and mustard oil groups compared with the placebo group (24.5% and 28.0%, respectively, vs. 34.7%). Interestingly, this study also revealed that, compared to placebo, patients who received fish oil capsules or mustard oil had significantly lower risk for total cardiac arrhythmias (28.7% vs. 13.1% and 13.3%, respectively).

The Japan EPA Lipid Intervention Study (JELIS) is large primary and secondary prevention trial in Japanese men and women which tested the hypothesis that addition of 1.8 g/day of highly purified EPA to statin therapy can reduce the incidence of major cardiovascular events in Japanese patients with hypercholesterolemia (Yokoyama, 2005; Yokoyama *et al.*, 2007). JELIS randomized 14,981 patients for primary prevention and 3,664 patients for secondary prevention in a prospective open-label, blinded end-point study with a 4.6-year follow-up. Most notably in this study, in addition to the large sample size, all patients were given low-dose statin therapy and continued to consume a diet rich in ω -3 fatty acids. At the end of 54 months, the incidence of major coronary events was reduced 19%, including the composite end point of nonfatal MI, CAD death, unstable angina, and revascularization procedures. The incidence of unstable angina and nonfatal coronary events was also significantly reduced, but the incidence of sudden death and coronary death was unchanged. Changes in the serum ratio of ω -3 fatty acids to ω -6 fatty acids, expressed as the ratio of EPA to arachidonic acid, were predictive of coronary death and MI. The findings from this study suggest that the benefits of ω -3 fatty acids may also be found in populations consuming large quantities of fish and that at higher doses of ω -3 fatty acids, cardioprotective effects other than arrhythmia reduction may be observed (Figure 15). Trends in reduction of the incidence of unstable angina and nonfatal coronary events suggest that other plaque-stabilizing properties may also be involved with ω -3 fatty acid therapy.

Absence of significant effect on cardiac death in JELIS is probably due to much lower baseline risk in controls, attributable at least partly to high background consumption of fish. Figure 15 shows relative risk (95% CI) in each trial, comparing patients taking fish oil with controls (Mozaffarian, 2007).

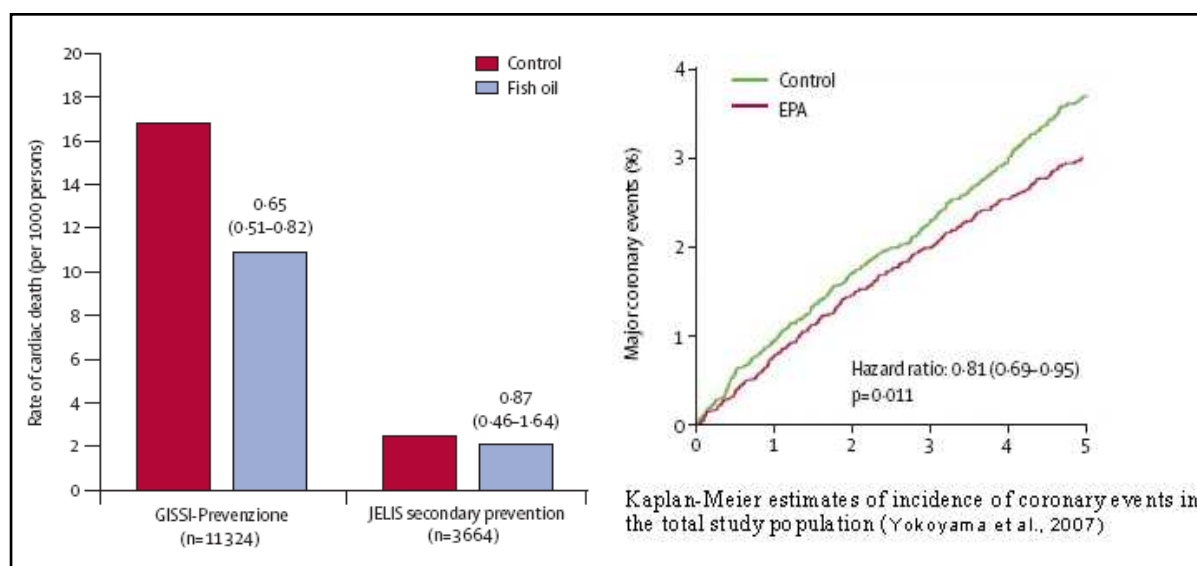

Figure 15: Cardiac death in patients with prevalent coronary heart disease in GISSI-Prevenzione and JELIS trials of fish-oil consumption (Mozaffarian, 2007).

The Cardiovascular Heart Study cohort examined the relation between risk of ischemic heart disease mortality due to arrhythmia and fish consumption, based on dietary recall and verified by plasma phospholipid ω -3 fatty acid content (Mozaffarian et al., 2003). 3910 adults aged >65 years without history of cardiovascular disease were followed up for approximately 9.3 years. Among 247 deaths from ischemic heart disease, 148 arrhythmic deaths were identified. Arrhythmic death was decreased significantly by 68% among those with a baseline fish consumption of >3 times weekly compared to those who consumed fish <1 time weekly. Although the investigators used plasma phospholipids ω -3 fatty acid content to verify fish consumption, the amount of fish consumption was obtained through dietary recall and was subject to recall bias, especially when patients were followed for an average of 9.3 years.

In a recent study of data from 97 randomized, placebo-controlled trials of different lipid-lowering interventions that included ω -3 fatty acids and diet in addition to pharmacologic therapy with 3-hydroxy-3-methylglutaryl coenzyme A reductase inhibitors (statins), fibrates, resins, and niacin, the most favorable effects of treatment compared with controls were observed with statins and ω -3 fatty acids. Omega-3 fatty acids were associated with reductions of 23% in all-cause mortality and 32% in cardiac mortality compared with reductions of 13% and 22% in all cause and cardiac mortality, respectively, for statins (Studer et al., 2005).

Norwegian Vegetable Oil Experiment is a double blind study where more than 13000 men (between 50 and 59 years) were randomized to consume either 5,5g ALA/day (=10 ml of linseed oil) or 5,5g LA/day (=10 ml of sunflower oil) during 1 year. There were 40 and 43 cases of total cardiac death in the control and experimental groups respectively. Additionally, there were 27 new cases of coronary disease or sudden death in each group (Ascherio *et al.*, 1995). In Another study, Mediterranean Alpha Linolenic Enriched Groningen Dietary Intervention (MARGARIN), 124 men and 158 women (with multiple cardiovascular risk factors) were randomly assigned in a double-blind trial to consume a margarine rich in either ALA [46% linoleic acid (LA; 18:2 ω -6) and 15% ALA] or LA (58% LA and 0.3% ALA). After 2 years of study, no benefit was observed; the LA and ALA groups presented a comparable risk of ischemic cardiopathy (Bemelmans *et al.*, 2002).

3.6. Omega3 fatty acids and reduction of arrhythmias

3.6.1. Ventricular tachycardia and fibrillation

Ventricular tachycardia and ventricular fibrillation are life-threatening arrhythmias and they are the main cause of sudden cardiac death (Zipes and Wellens, 1998).

An attractive way to test effects of fish oil on arrhythmia is to employ patients with an implantable cardioverter defibrillator (ICD). An ICD detects arrhythmia and delivers electric stimuli to restore normal heart rhythm (Figure 16). Arrhythmic events and electric treatments are stored in the ICD memory.

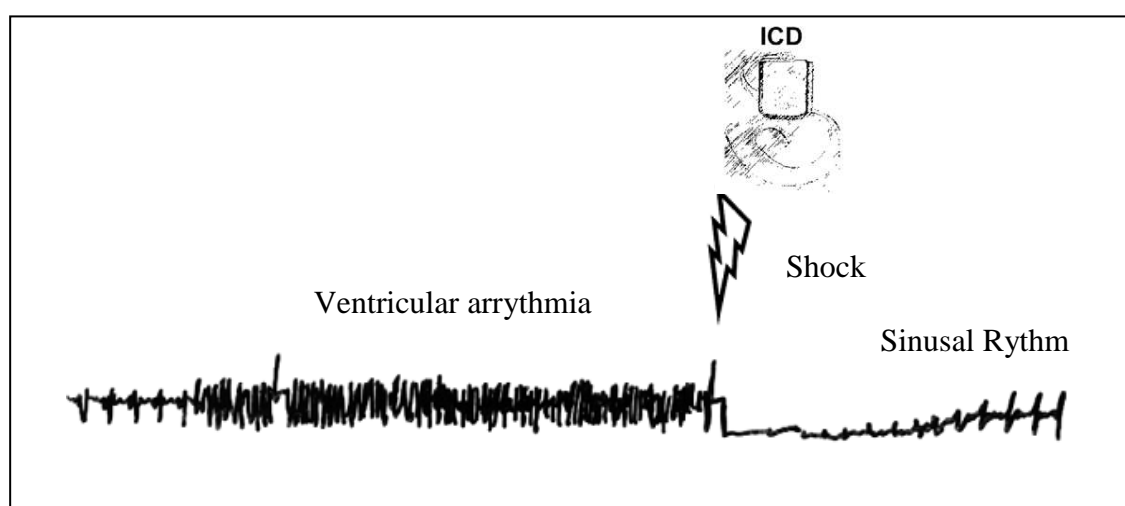

Figure 16. Implantable cardioverter defibrillator (ICD) detects arrhythmia and provides a shock to restore normal rhythm (Brouwer^a *et al.*, 2006).

Trials on ω -3 PUFA and lifethreatening ventricular arrhythmias have been performed in patients with an ICD. The first trial by Raitt et al. (2005) reported that fish oil supplementation did not reduce the risk of ventricular tachycardia or ventricular fibrillation and may be proarrhythmic in some patients. This trial included 200 patients who have received ICD because of a recent episode of sustained ventricular tachycardia (VT) or ventricular fibrillation (VF). Patients were assigned to receive fish oil 1.8 g per day (73% ω -3 fatty acid) or placebo (olive oil). The follow-up time was up to two years, during which all ICD events were noted. After two years there was no significant effect of fish oil on the time to first ventricular tachycardia or ventricular fibrillation; 66% of the patients in the fish oil group had experienced ventricular arrhythmia versus 60% in the placebo group ($p = 0.19$). In the subset of 133 patients whose qualifying arrhythmia was VT, showed that, in these patients, the recurrence of ventricular tachycardia or ventricular fibrillation was significantly higher on fish oil than on placebo treatment (Raitt et al., 2005). Therefore, the study results appeared to suggest that fish oil may actually be proarrhythmic in patients who have received an ICD for secondary prevention of sudden cardiac death, particularly in patients whose qualifying arrhythmia for ICD is sustained VT. Unlike previous studies, these patients developed sustained VT/VF not due to myocardial infarction. Perhaps fish oil only benefits certain types of ventricular arrhythmia. In addition, it is known that consumption of monounsaturated fat such as olive oil, which was used as the control agent in this study, may also decrease risk of cardiovascular disease (Perez-Jimenez et al., 2005). Therefore, the results may have shown that olive oil was better than fish oil in reducing recurrent VT/VF but not that fish oil was proarrhythmic. Further studies need to explore this question (Cheng and Santoni, 2008).

The second trial was the FAAT trial (Leaf et al.; 2005). Leaf and colleagues evaluated the potential antiarrhythmic effects of fish oil in 402 patients who had received an ICD for secondary prevention of sudden cardiac death because of cardiac arrest, sustained VT, or syncope with inducible VT or VF. Patients received either fish oil 4 g per day or placebo (olive oil) for 12 months. Unfortunately, a rather large group of patients in this trial discontinued intake of study capsules (35%), which decreased the power of the study. Although patients in the fish oil group experienced a 28% reduction in incidence of recurrent VT/VF or all-cause mortality at 12-month follow-up (Figure 17). Similarly, this study also utilized olive oil as control. Therefore, olive oil may as well have a beneficial effect on CVD.

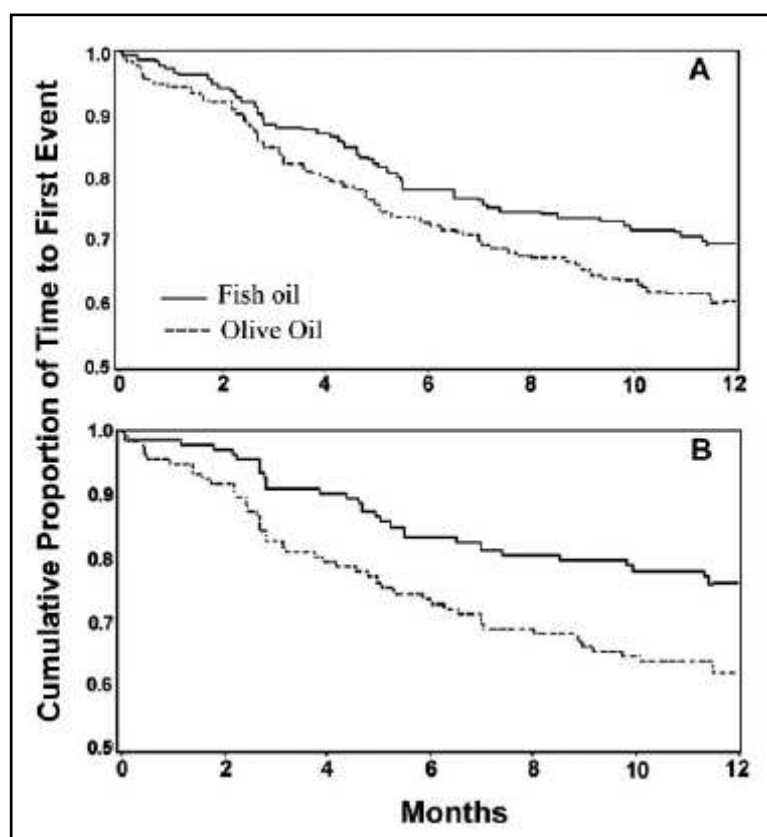

Figure 17. Kaplan-Meier analyses of the time to first implantable cardioverter defibrillator shock for ventricular tachycardia or fibrillation or death due to any cause in the Fatty Acid Antiarrhythmia Trial (FAAT) for (A) the total study population ($n = 402$) and (B) for the patients who were compliant with treatment for ≥ 11 months ($n = 233$) (Leaf *et al.*; 2005).

Brouwer^b *et al.* (2006) carried out the Study on ω -3 fatty acids and ventricular Arrhythmia (SOFA) which was a randomized, placebo-controlled, double-blind trial that enrolled 546 patients with ICD and prior documented malignant VT/VF. The effect of fish oil in preventing recurrent arrhythmic events was evaluated. Patients were assigned to either 2 g per day of fish oil or placebo (sunflower seed oil). Fish oil did not significantly reduce recurrent VT/VF events and all-cause mortality in a follow-up of a median of 356 days (Figure 18). Sunflower seed oil also contains a high level of polyunsaturated fatty acid and has been demonstrated to favorably alter cholesterol profile and factor VII coagulant activity (Allman-Farinnelli *et al.*, 2005). Therefore, the lack of cardioprotective effect of ω -3 fatty acid demonstrated in this study may have been due to the fact that both groups of patients were receiving cardioprotective effect from the different oils used.

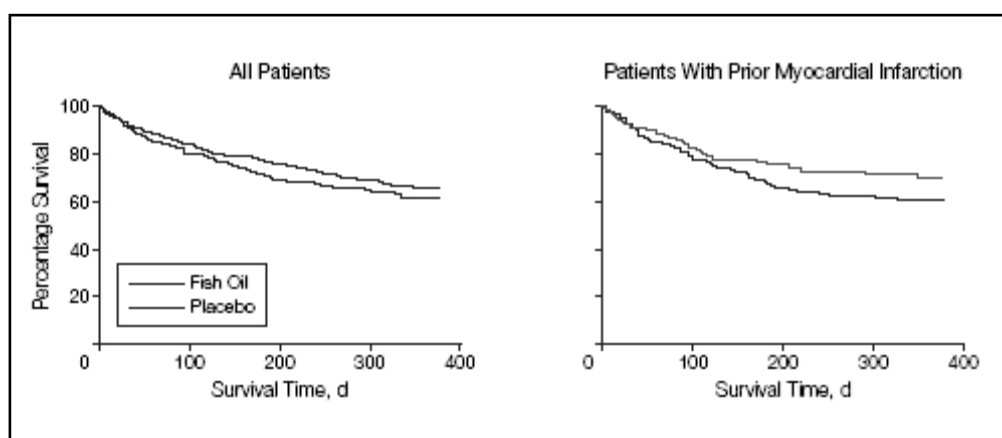

Figure 18. Kaplan-Meier Estimates of Survival Patients Included in the SOFA Trial (Brouwer *et al.*, 2006).

Metcalf and colleagues studied the change in inducibility of VT in 12 patients with ischemic heart disease who had documented inducible VT, after 6 weeks of supplementation of fish oil of 3 g per day (Metcalf *et al.*, 2008). Fourteen other patients (who received no treatment) were enrolled to control for fluctuations of inducibility. At the end of the 6-week treatment period, 42% of patients in the fish oil group had no inducible VT, 42% required more aggressive stimulation in order to induce VT, 8% required identical stimulation for VT induction, and 8% required less stimulation to induce VT compared to 7%, 36%, 36%, and 21%, respectively, in the control group (Metcalf *et al.*, 2008). The investigators concluded that fish oil may have an antiarrhythmic effect. It is important to note, however, that this study enrolled a very small number of patients, and additional dietary consumption of fish oil or other polyunsaturated fatty acid was not controlled. Larger studies are needed to confirm the results.

Alpha-linolenic acid, an ω -3 fatty acid, has not been sufficiently studied in humans to determine whether it possesses a similar antiarrhythmic effect as ω -3 fatty acid from fish. Ander *et al.* (2004) have demonstrated a supplementation of flaxseed in the diet of 16 rabbits protected them against VF induced by ischemic reperfusion. Studies need to be performed to confirm whether a similar effect exists in humans.

According to the conflicting results of these trials, recommendation of routinely using fish oil therapy in all patients at risk for life-threatening VT cannot be established. This may be due to the different population studied, different formulation of ω -3 fatty acid used, the differences in the consumption of fish versus fish oil supplements, and the different comparative oil used

for control. There may be other beneficial ingredients in addition to ω -3 fatty acid when consuming fish instead of just consuming supplements. More studies with enough power to evaluate the effects of this supplement in a variety of subgroups are necessary. In addition, the exact mechanisms of ω -3 fatty acid need to be explored further.

3.6.2. Evidence in Atrial Fibrillation (AF)

In addition to VT/VF, ω -3 fatty acids have also been investigated for preventing and treating AF. Atrial fibrillation is a particular problem among elderly (Kannel et al., 1998). It is the most common sustained arrhythmia.

The Cardiovascular Health Study mentioned above also found that consumption of tuna or other broiled or baked fish of 1–4 times per week was associated with a 28% lower risk of atrial fibrillation (HR = 0.72, 95% CI = 0.58–0.91, $p = 0.005$) compared with intake of less than once per month (Mozaffarian^a et al., 2004). Adjusting for a history of or the presence of MI or congestive heart failure did not change the results. This study also confirmed a significant relation between plasma phospholipid EPA and DHA concentrations and consumption of tuna or other broiled or baked fish. In contrast, the beneficial effect was not observed with the consumption of fried fish or fish sandwiches (fish burgers). The authors ascribe the difference between fish and fish burgers to differences in ω -3 fatty acid content.

Frost and colleagues examined the association between consumption of ω -3 fatty acid from fish and risk of AF or flutter (Frost and Vestergaard, 2005). Forty-seven thousand nine hundred and fortynine (47,949) patients from the Danish Diet, Cancer, and Health Study cohort were evaluated for consumption of ω -3 fatty acids from fish and risk of AF or flutter during a follow-up of approximately 5.7 years. There was no significant difference in incident of AF and atrial flutter among patients in different quintile of ω -3 fatty acids consumption. This is in line with the finding of Brouwer and colleagues in the Rotterdam Study in 5184 subjects. After a mean follow-up of 6.4 years 312 subjects from Rotterdam had developed atrial fibrillation. Intake of EPA and DHA was not associated with risk of atrial fibrillation (RR = 1.18; 95% CI 0.88–1.57 for the third compared to the first tertile of intake) (Brouwer^c et al., 2006).

Italian researchers used fish oil in a trial to prevent the occurrence of atrial fibrillation after coronary artery bypass graft surgery (CABG) (Calo *et al.*, 2005). A total of 160 patients were randomly divided into two groups receiving either 2 g of ω -3 PUFA daily from at least 5 days before the surgery until the day of discharge from the hospital, or no treatment. The incidence of postoperative AF was significantly reduced in the ω -3 fatty acid group compared with placebo (15.2% versus 33%, $p= 0.013$) (Calo *et al.*, 2005). This suggests that supplementation with ω -3 PUFA around surgery protects against postoperative atrial fibrillation.

3.7. Experimental studies of Omega-3 PUFA on arrhythmias and electrophysiology

Experimental models of cardiac arrhythmia including rats, marmoset monkeys and dogs have been used to demonstrate the relationship between dietary lipids, cardiac membrane lipid composition, myocardial function, and the biochemical mechanisms underlying antiarrhythmic effects in relation to nutritional components (Table 8).

The first study investigating the possible antiarrhythmic effects of fish oil fatty acids was performed in 1988 by McLennan *et al.* In their experiments, rats were fed diets in which the major fat component was controlled. At the end of the 3 months dietary period, they ligated the left anterior descending coronary artery of the rats and counted the number of animals that died of sustained ventricular fibrillation. They found that, while some rats died of arrhythmias in the group receiving sunflower seed oil, no rat died in the group receiving tuna fish oil (rich in ω -3 LC-PUFA). They also reported a similar antiarrhythmic action of the ω -3 LC-PUFA in marmosets (McLennan *et al.*, 1992). Similar results have been obtained in rats by other investigators.

To investigate a possible direct effect of ω -3 LC-PUFA on ischaemia-induced ventricular fibrillation, Billman *et al.* (1999) used another approach to supply the fatty acids. A surgically induced anterior myocardial infarction was produced in dogs, and a hydraulic inflatable cuff was set around the left circumflex artery so it could be compressed at will. The dogs were then trained to run on a treadmill during the month allowed for recovery from the surgery. Upon exercise, the coronary occlusion caused about 60% of the dogs to go into a fatal ventricular fibrillation within two minutes of the coronary flow stop. The intravenous administration of EPA or DHA (free FA) 90 minutes before the exercise reversibly prevented fatal ischaemia-induced arrhythmias, confirming the studies of (McLennan *et al.*, 1988; McLennan *et al.*, 1992).

However, a difference remains between Billman's and McLennan's results. In their work, Billman *et al.* (1999) did not find any difference between the antiarrhythmic effects of EPA and DHA in dogs. McLennan *et al.* (1996) compared the effect of low dose (0.4 – 1.1% of energy intake) of EPA and DHA on rat ischaemia-induced arrhythmias. They found that DHA was able to prevent these arrhythmias while EPA was not. The difference between the results could originate from the way of administration of the oils: in one experiment, FA were administered in the diet while in the other, they were perfused intravenously. Another hypothesis relies on the model used. Indeed, it is not obvious that lipid metabolism is the same in rats and dogs. This point is a very important one and has to be clarified before extrapolating results obtained in animals to observations made in human epidemiological studies.

Table 8: Effect of (ω -3) polyunsaturated fatty acid supplementation on arrhythmia in experimental animals

References	Animal model	Diet treatment	Duration of supplementation	Results
Culp et al., 1980	Mongrel Dogs	Menhaden oil 25% energy	36-45 d	↓ IS ↓ VEB
Hock et al., 1987	Rats	5% energy menhaden oil	4 wk	No effect on VEB
McLennan et al., 1988	Rats	Tuna fish oil 12 g/100 g diet	12 wk	↓ VEB ↑ VFT No effect on VF ↓ VT
Yanagisawa et al., 1988	Rats	Lamprey oil 5 g/100 g diet	4 wk	↓ Ischemic injury
Hock et al., 1990	Rats	5% energy menhaden oil	4 wk	↓ VT ↓ VF
McLennan et al., 1990	Rats	Tuna fish oil 12 g/100 g diet	9 mo	↓ VT
Sargent and Riemersma, 1990	Rats	Purified fish oil 7% energy	8 wk	↓ VF
Charnock et al., 1991	Rats	SO/ FO 2.1 g/100 g diet	44 wk	↓ VPB, ventricular premature beats ↓ VT No effect on VF
Charnock et al., 1992	Marmoset monkeys	Fish oil 6 g/100 g diet	24 mo	↑ VFT No effect on VF
McLennan et al., 1992	Marmoset monkeys	Tuna fish oil 18,8% energy	24 mo	↑ VFT ↓ VF
Paulson et al., 1992	Rats	Menhaden oil 5 g/100 g diet	15 weeks	↑ Performance recovery
McLennan et al., 1993	Rats	Fish oil 12 g/100 g diet	12 wk	↓ VPB ↓ VF
Oskarsson et al., 1993	Mongrel dogs	EPA 0,06 g/ kg body weight/ d	6 wk	↓ IS
McLennan, 1993	Marmoset monkeys	Purified fish oil 3 g/100 g diet	16 wk	↑ VFT

References	Animal model	Diet treatment	Duration of supplementation	Results
Yang et al., 1993	Rats	Fish oil 12g/100g diet (40% ω -3 PUFA)	4 wk	↓ Cardiac contraction ↓ Coronary perfusion pressure
Billman et al., 1994	Mongrel dogs	Fish oil fatty emulsion 70% ω -3 PUFA	i.v. infusion 60 min prior ischemia	↓ FV
Demaison et al., 1994	Rats	SO/ FO (1:1) 10g/100 g diet	8 wk	↑ post-ischémic aortic flow
Kinoshita et al., 1994	Mongrel dogs	EPA 100 mg/ kg body weight/ day	8 wk	↓ FV ↓ TV
Zhu et al., 1994	Rats	Fish oil 12g/100g diet	1 wk 8 wk	No effect ↓ IS
McLennan and Dalimore, 1995	Rats	Canola oil 12g/100g diet	12 wk	↓ VT ↓ VF
McLennan et al., 1996	Rats	EPA ethyl ester 1,1% energy) DHA ethyl ester 1,1% energy ou DHA 0,4% energy +EPA 0,3% energy	5 wk 5 wk 5 wk	↓ VF No effect ↓ VF
Pepe and McLennan 1996	Rats	Purified fish oil 12 g/100 g diet	16 weeks	↓ FV
Billman et al., 1999	Mongrel dogs	Perfusion of ALA or d'EPA or de DHA at 1% (v/v)	i.v. Perfusion 90 min prior l'ischémie	↓ VF
Ogita et al., 2003	Rabbits	EPA (600 mg/ kg/ d)	2 wk	↓ IS
Mc Guinness et al., 2006	Rabbits	EPA-DHA emulsion (5 mL/kg)	4 days over 4 hours via the marginal ear vein	↓ IS

FO: fish oil; SF: saturated fat; VF: ventricular fibrillation; VT: ventricular tachycardia; VFT, ventricular fibrillation threshold; VEB, ventricular ectopic beats; VPB, ventricular premature beats, IS: infarct size.

Additional data from studies in cultured neonatal cardiomyocytes also supported the antiarrhythmic properties of ω -3 fatty acids (Table 9). Whereas dietary studies support mechanisms mediated by changes in ω -3 fatty acids or their metabolites in plasma and vascular tissues, studies in isolated animal hearts and cultured neonatal cardiac myocytes support mechanisms related to direct effects on the electrophysiology of the heart. In cultured cardiomyocytes ω -3 PUFA modulated the conductance of ion channels in the membrane and, thereby, prevent occurrence of arrhythmia (Leaf *et al.*, 1999).

Table 9: Effect of (ω -3) polyunsaturated fatty acid supplementation on arrhythmia in vitro

REFERENCE	ANIMAL MODEL	DIET TREATMENT	DURATION	RÉSULTATS
Hallaq <i>et al.</i> , 1990	Cultured rat cardiomyocytes	Fish oil 5 μ mol/L EPA	3–5 d incubation in medium	↓ Myocyte contraction rate
Hallaq <i>et al.</i> 1992	Cultured rat cardiomyocytes	Fish oil 5–10 μ mol/L EPA/DHA		↓ Ouabain induced arrhythmia (contraction rate)
Kang and Leaf 1994	Cultured rat cardiomyocytes	Fish oil 5–10 μ mol/L EPA/DHA	3 min perfusion	↓ Myocyte contraction rate
Kang <i>et al.</i> 1995	Cultured rat cardiomyocytes	Fish oil 10 μ mol/L EPA	1–2 min	↑ Depolarizing current
Kang and Leaf 1995	Cultured rat cardiomyocytes	Fish oil 5–10 μ mol/L	2–3 min	↓ Isoproterenol induced VF
Xiao <i>et al.</i> 1995	Cardiomyocytes de rats	10–15 μ mol/L EPA		↓ Blocking effects on Na channel
Kang and Leaf 1996	Cardiomyocytes de rats	3 μ mol/L EPA		No effect on LPC induced arrhythmia
Nasa <i>et al.</i> , 1998	Cardiomyocytes de rats	Fish oil 0,15 g/100 g (40% EPA and 60% DHA) EPA or DHA 1g/kg/jour	4 wk	↑ reduce cell death ↑ reduce cell death

LPC: lysophosphatidylcholine; VF: ventricular fibrillation

These studies have generated several possible mechanisms of action:

- Incorporation of ω -3PUFA into cardiac membrane phospholipids (McLennan *et al.*, 2001) might increase membrane fluidity (Leifert *et al.*, 1999). However, there is no hard evidence that such changes in membrane fluidity have significant effects on electrophysiology *in vivo*.
- Omega-3 PUFA may also affect sodium (Kang and Leaf, 1996; Xiao *et al.* 1995; Xiao *et al.* 1998) and calcium (Xiao *et al.* 1997; Rodrigo *et al.*, 1999) currents through heart cell membranes, which control heart rhythm. The ω -3PUFA are thought to prolong the duration of the inactivated state of these channels and reduce their conductance (Kang and Leaf, 2000).
- Finally, incorporation of ω -3PUFA into cardiac membrane phospholipids might influence the production of a variety of eicosanoids that may lower vulnerability to arrhythmias and, in this way, prevent ventricular fibrillation during myocardial ischaemia and reperfusion (Charnock, 1999).

Animal and *in vitro* experiments thus suggest mechanisms through which ω -3 PUFA from fish might exert anti-arrhythmic properties although the exact mechanisms are still unclear.

3.8. Potential mechanisms of anti-arrhythmic effects

3.8.1. Effect of (ω -3) PUFA on membrane phospholipids

It is believed that changes in the lipid composition of biological membranes lead to changes in their function. This is the case for the cardiac membrane (sarcolemma) also (Charnock 1994). Cardiac sarcolemma plays a major role in regulating the movement of ions entering and leaving the cell. Receptors involved in cellular signalling, transporters and enzymes are embedded in the membrane lipid bilayer, and any changes to the fatty acid composition of this membrane could affect their functions. The influence on cardiac membrane function by dietary lipids has been demonstrated in both man and experimental animals (Spector and Yorek, 1985).

It has been suggested that diet-induced changes in the fatty acid composition of cardiac muscle cell membranes are associated with development of arrhythmia (Charnock, 1992; McLennan *et al.*, 1990; McLennan *et al.*, 1993) and have anti-necrotic effects (Culp *et al.*, 1980; Hock *et al.*, 1987, Yanagisawa *et al.* 1988; Yang *et al.*, 1993; Nasa *et al.*, 1998, Charnock *et al.*, 1985). Hallaq *et al.* (1992) observed that alterations in the fatty acid

composition of the culture medium in which cardiac myocytes were grown also altered myocyte function. Changes in cardiac phospholipids and the free fatty acids (FFA) composition brought about by manipulation of dietary fatty acids with ω -3 PUFA has been repeatedly demonstrated as antiarrhythmic (Charnock *et al.* 1992, McLennan *et al.* 1990, McLennan 1993).

Therefore, changes in the lipid composition of cardiac cell membranes induced by dietary modification can influence the availability of Ca^{2+} for excitation-contraction coupling, which in turn could lead to the development of the arrhythmic state. Membrane phospholipids control the transfer of ions across the membrane, and fatty acid composition of membrane phospholipids may influence the properties of specific ion channels like the calcium and sodium channels (Hallaq *et al.* 1990).

The activation of Phospholipase enzyme is another mechanism that has been proposed to explain degradation of cardiac membranes after long periods of ischemia. Grynberg *et al.*, (1992) in their study using cardiomyocytes cultured separately in EPA- and DHA-supplemented media, they found that phospholipase activity was lower in the EPA medium under hypoxic conditions, suggesting that this could explain the decreased membrane degradation during ischemia. They concluded that the activity of phospholipase in the cardiac cell could be influenced by phospholipid fatty acid composition.

The cardiac sarcoplasmic reticulum (CSR) is an important store of calcium for the activation of myocardial contraction. Relaxation occurs primarily by the energy dependent reuptake of calcium by the CSR. Fish oil supplementation caused a decrease in CSR function, and ω -3 PUFA were found to readily accumulate in CSR phospholipids (Taffet *et al.*, 1993). Dietary ω -3 PUFA also modulate physico-chemical properties of sarcolemma. EPA and DHA are taken up by the myocardium into membrane phospholipids like phosphatidyl choline and phosphatidyl ethanolamine. This uptake is largely at the expense of arachidonic acid (Swanson and Kinsella, 1986).

3.8.2. Direct effects of ω -3 PUFA on FFA composition of the myocardium

It was believed that after an acute myocardial infarction, arrhythmias were metabolically induced by acute lipid mobilization from adipose tissue which resulted in high free fatty acids (FFA) levels in the plasma and myocardial cells (Kurien and Olivier, 1970).

This excess of FFA was supposed to be arrhythmogenic and could increase the severity of ischemic damage. Under normal conditions tissue level of FFA is very low. The majority of fatty acids are oxidized in mitochondria to provide energy, and a small part is esterified and stored in the triglycerides and phospholipids (Van der Vusse, 1992). After meals, glucose is the preferred fuel for myocardial oxidative metabolism, but during fasting FFA becomes the preferred fuel. During ischemia when a part of the myocardium becomes anaerobic, fatty acid oxidation is disturbed, and unoxidized FFA accumulate. It is thought that this accumulation of FFA is toxic to the heart and may stimulate arrhythmias (Olivier and Opie, 1994). Riemersma *et al.* (1988) noted that there was elevation in plasma FFA in patients immediately after acute myocardial infarction and postulated that this be a predisposing factor to the development of arrhythmias. Elevated levels of myocardial FFA have also been observed in experimental animals subjected to ischemia (Feuvray, 1981).

de Leiris^a *et al.* (1975) compared the effects of many perfusion mediums (palmitate, glucose, Palmitate insulin-albumin bounded on the myocardium sensibility to infarction in rats. Compared to the other substrates, palmitate reduced much more cardiac rate and strongly increased lactate deshydrogenase release in reperfusion. de Leiris *et al.* emphasized the role of FFA in the development of myocardium infarct (de Leiris^b *et al.*, 1975; de Leiris *et al.*, 1978).

Several mechanisms have been suggested as to how the increased FFA levels may trigger arrhythmias. One hypothesis suggests that during ischemia, β -oxidation of lipids in mitochondria is inhibited and causes accumulation of intracellular acylcarnitine and acyl-CoA. This acylcarnitine in turn inhibits the Ca^{2+} pump of the sarcoplasmic reticulum and calcium channels, causing an increase in Ca^{2+} levels in the myocardial cells and thus causing arrhythmias (Corr *et al.* 1984, Huang *et al.* 1992). Another study lending support to this hypothesis reported the effects of increased FFA levels on ventricular arrhythmias using ventricular fibrillation threshold (VFT) as an index of arrhythmogenicity (Makiguchi *et al.* 1991). They observed that the arrhythmogenicity of FFA was due to a direct effect on the myocardial cells and due to the effect of FFA esters such as long-chain acylcarnitine and acyl-CoA. They speculated that the effect of NEFA was related to calcium overload in the myocardial cells.

Another proposed mechanism suggests that altered proportions of AA, EPA or DHA in myocardium as a result of altered dietary fatty acids could lead to alterations in the FFA pool used as immediate substrates for eicosanoid production. Consequently, the intake of ω -3 PUFA could lead then lead to an alteration in the production of myocardial TXA₂ and the vulnerability of the heart to develop arrhythmia during ischemia (Charnock *et al.*, 1992). That study demonstrated that after feeding rats a mixed diet relatively high in saturated fat and containing ω -3 PUFA, the FFA had a direct effect on the heart by reducing the amount of eicosanoids and was one of the major factors which determined the vulnerability of the heart to develop VF, despite the very low FFA concentration in the myocardial cells.

Additional hypothesis stated that ω -3 PUFA either free or integrated in the membrane phospholipids, have antiarrhythmic effects. Billman *et al.* (1994) demonstrated that an intravenous infusion of fish oil emulsion containing EPA and DHA prior to inducing ischemia successfully prevented ischemia-induced VF in dogs. Since infusion was carried out 60 min before inducing ischemia, the possibility that the effect of fish oil was mediated via incorporation of ω -3 PUFA in sarcolemmal membranes was ruled out. The authors attributed the antiarrhythmic effects of fish oil to FFA and postulated that free ω -3 PUFA, not saturated or monounsaturated fatty acids, prevented arrhythmia.

In a study of isolated myocytes, Kang and Leaf (1996) have demonstrated that PUFA including AA, EPA and DHA can bind to the sodium pump and prevent arrhythmias. They also found that AA is rapidly converted to TXA₂, which is proarrhythmic. Thus, only ω -3 PUFA qualified for possessing antiarrhythmic properties. Saturated and MUFA did not significantly bind to the Na⁺ channel and were not believed to be antiarrhythmic. They concluded that ω -3 PUFA did not have to be incorporated into membrane phospholipids because only free PUFA showed antiarrhythmic potential.

Weylandt *et al.* (1996) have shown that in cardiac myocytes cultured in a medium supplemented with EPA and DHA, no antiarrhythmic effects were observed despite the membrane enrichment with EPA and DHA. They concluded that ω -3 PUFA exert antiarrhythmic actions as free acids and not in phospholipids (Weylandt *et al.*, 1996). But this *in vitro* system does not induce the release of FFA as in *in vivo* system where catecholamines and calcium activate phospholipase enzymes, which in turn trigger the release of FFA following ischemia (Nair *et al.*, 1997).

McLennan *et al.* stated that the antiarrhythmic effect of fish oil depend on the enrichment of myocardial membrane with ω -3 PUFA especially with DHA. They demonstrated that DHA prevents arrhythmias more effectively than EPA (McLennan *et al.*, 1996; McLennan, 2001).

Finally, Nair *et al.* (1997) hypothesized that immediately following myocardial infarct FFA are released from the hydrolysis of membrane phospholipids, and the type of FFA released determines the arrhythmic response of the myocardium. The authors precised that the incorporation of ω -3PUFA into myocyte membrane is essential for antiarrhythmic action. Indeed, these ω -3 PUFA are the only fatty acids which are readily available for release as free acids to prevent arrhythmia.

3.8.3. Effects of ω -3 PUFA on ion channels, exchangers and intracellular calcium

Intracellular free calcium ions (Ca^{2+}) serve as a cofactor for several enzymatic processes required for cellular growth. Furthermore, an increase in cellular Ca^{2+} is associated with enhanced cell contraction, vasoconstriction and cell proliferation and, thus, may be involved in the development of cardiovascular diseases (Locher *et al.*, 1991). Among various biochemical derangements, the increase in intracellular Ca^{2+} plays a permissive role in the development of arrhythmia (Niggli, 2007). During myocardial ischaemia, ischaemic tissues are partially depolarized and are hyperexcitable, and the voltage-dependent sodium channel is more vulnerable to activation by any small depolarizing stimuli, which may initialize and propagate a serious tachyarrhythmia.

Regulation of intracellular calcium at cellular microdomain levels is described in Figure 19. Briefly, the influx of calcium in cardiomyocytes in response to hormonal and mechanical stimulation mainly occurs through L-type Ca^{2+} channels in sarcolemmal (SL) membranes (Berridge, 2006). This influx of calcium then triggers the release of Ca^{2+} from the sarcoplasmic reticulum (SR) through ryanodine-sensitive Ca^{2+} channels; this process is generally known as calcium-induced calcium release. Released Ca^{2+} is then utilized for the regulation of cellular processes, particularly its binding to troponin C, which causes conformational changes of the tropomyosin and allows the myosin head to interact with actin to generate contractile force. Ca^{2+} is then sequestered from the cytosol by the SR- Ca^{2+} ATPase pump and stored in the lumen of SR until the next event. Mitochondria are also known to store large quantities of Ca^{2+} , but their role in the contraction-relaxation cycle in the normal heart is poorly understood. In fact, these organelles are considered to serve as a Ca^{2+}

reservoir to prevent the occurrence of intracellular Ca^{2+} overload in diseased myocardium. Therefore, under normal physiological conditions, intracellular levels of Ca^{2+} are tightly controlled by a number of key enzymes, including voltage-dependent channels, the $\text{SL-Na}^+-\text{Ca}^{2+}$ exchanger, receptor-mediated calcium channels and the ryanodine receptor (RyR) and SR-Ca^{2+} ATPase pump. Any abnormalities in any of these key regulators contribute to abnormal Ca^{2+} handling and, thus, lead to cardiac dysfunction, including arrhythmia generation, hypertrophy and myocardial stunning.

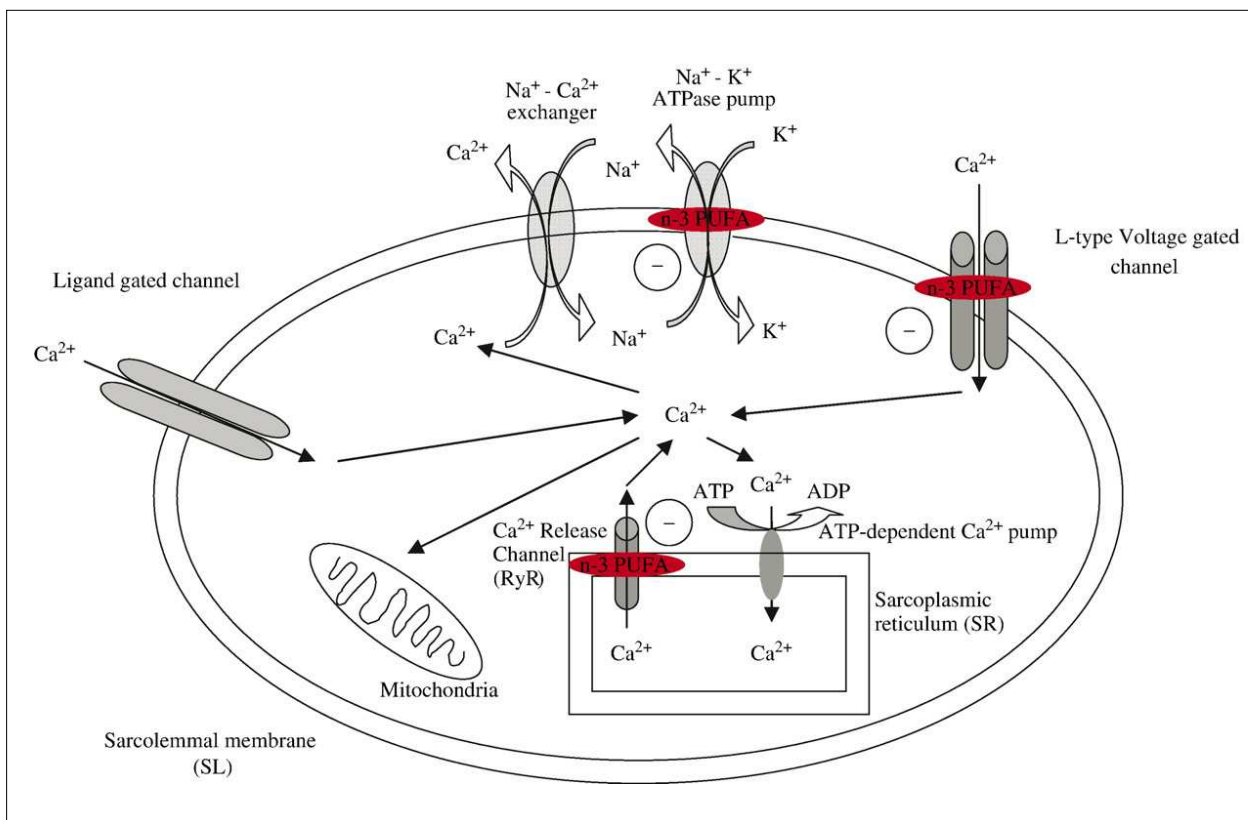

Figure 19. Effect of ω -3 PUFA on intracellular calcium regulation (Siddiqui et al., 2008).

Research in various laboratories has demonstrated that calcium transport in isolated cardiac myocytes from fish oil-fed rats and mice was altered (Karmazyn, 1987; Swanson et al., 1989; Kinsella et al. 1990; Hallaq et al., 1990). Kinsella et al. (1990) provides the initial evidence for the role of dietary ω -3 PUFA in regulation of Ca^{2+} release from endoplasmic reticulum. They demonstrated that there was an increase in Ca^{2+} uptake by endoplasmic reticulum which was associated with the prevention of arrhythmias in rats fed with fish oil enriched diet. Hallaq et al. (1990 and 1992) demonstrated that DHA prevents arrhythmias more effectively than EPA by modulating L-type calcium channels in the sarcolemma of cardiac myocytes,

which prevents cytosolic free calcium levels from increasing to toxic levels. ω -3 PUFA are not merely acting as calcium channel blockers but as modulators, or valves, that control the influx and efflux of calcium to maintain normal contractility of the myocytes (Leaf and Weber, 1988; Hallaq *et al.*, 1990).

Hallaq *et al.* (1990) have shown that EPA and DHA (5 μ M) can prevent arrhythmias, fibrillation and contracture in isolated rat cardiac myocytes induced by toxic concentrations of ouabain, a cardiac glycoside that binds to the α -subunit of membrane-bound Na^+ , K^+ -ATPase (Wallick *et al.*, 1974). Ouabain inhibits Na^+ , K^+ -ATPase pump and changes the electrophysiology of the myocardial cell causing sodium ions accumulation which in turn causes accumulation of calcium ions resulting in increased contraction and spontaneous beating rate in the myocytes. In myocytes incubated with AA there was no change after exposure to ouabain, while in myocytes incubated with EPA, ouabain toxicity was prevented. The authors suggested that EPA incorporated in membrane phospholipids, unlike AA, blocked ouabain binding which prevented the Ca^{2+} levels from increasing and thus preserved normal physiological levels of calcium. The same group (Hallaq *et al.*, 1992) studied isolated rat cardiac myocytes using nitrendipine, an inhibitor of the L-type calcium channel. They found that EPA protected the cardiac myocytes from ouabain toxicity by preventing the increase in free calcium to toxic channels, not due to the incorporation of the ω -3 PUFA in membrane phospholipids. Hallaq *et al.* (1992) demonstrated that fish oil fatty acids exert a dual effect; they prevented excessive calcium influx but in the same time increased calcium influx when it was insufficient.

Two other PUFA, linoleic acid (18:2, ω -6) and linolenic acid (18:3, ω -3), also exhibited similar but less potent effects compared with EPA. In contrast, neither oleic acid (18:1, ω -9) nor saturated fatty acids (18:0, 14:0, 12:0) affected contraction rate (Hallaq *et al.*, 1992). These studies have shown that the beneficial effects of fish oil in preventing fatal arrhythmias in myocardial ischemia are at least in part mediated by modulating the dihydropyridine-sensitive L-type calcium current (Hallaq *et al.*, 1992).

Similarly, Leaf (1995) demonstrated that ω -3 PUFA modulate calcium current through the L-type calcium channels within minutes of adding EPA or DHA to the perfusing medium of the cultured cardiac myocytes.

Rinaldi *et al.*, 2002 supported the previous results. After a DHA pretreatment (10 μM) of rat cardiomyocytes acutely (20 min) or chronically (72 h), it prevented intracellular rise in Ca^{2+} by binding to the L-type calcium channel. Furthermore, Hirafuji *et al.* (2001) demonstrated that DHA can also suppress Ca^{2+} influx through the L-type voltage-dependent channels in vascular smooth muscle cells. They suggested that the suppressive effect of DHA on Ca^{2+} influx in vascular smooth muscle cells may contribute to the beneficial properties of DHA in cardiovascular disorders (Hirafuji *et al.*, 1998).

Both EPA and DHA are known to be antiarrhythmic. They depress surface membrane electrical excitability (Kang *et al.*, 1995; Billman *et al.*, 1994). The effect of ω -3 PUFA on the L-type Ca^{2+} channel appears to be due to their direct binding to the channel proteins. Recent studies suggest that ω -3 PUFA exert antiarrhythmic effects by direct interactions with SL ion channels rather than indirectly by perturbing membrane phospholipid packing (Kang and Leaf, 1996; Pound *et al.*, 2001). ω -3 PUFA are neither fully incorporated into membrane phospholipids nor covalently bound to any constituents of the myocyte to produce the antiarrhythmic effect (Kang and Leaf, 1996).

However, in the studies performed by Xiao *et al.* (2001 and 2006), ALA ω -3 and ω -6 PUFA (LA and AA), but not oleic acid (ω -9) or saturated fatty acids, were also able to inhibit the Na^+ channel. These observations provide evidence that a specific binding site for the both the ω -6 and ω -3 PUFA exists on the Na^+ channel and that these fatty acid bindings result in the modulatory effects on the ion channel currents.

In addition to the effects on L-type Ca^{2+} channels, there is, strong evidence that part of the antiarrhythmic action of PUFA is mediated through inhibition of the Ca^{2+} -release mechanism of the SR. Consistent with this suggestion, it has been shown that EPA (10 μM) exerted part of its antiarrhythmic action by directly interacting with the RyR in rat cardiomyocytes (Negretti *et al.*, 2000; Swan *et al.*, 2003).

Accumulation of hydrogen during ischemia stimulates activity of the sodium/hydrogen exchanger to remove hydrogen in exchange for sodium. Increased activity of the exchanger causes an accumulation of intracellular sodium, which stimulates sodium/calcium exchange for removal of sodium at the expense of increasing calcium entry. Overloading the cells with calcium through this mechanism can also generate arrhythmia. Thus, one of the most potent ways in protecting the myocardium from ischemic reperfusion injury is inhibition of the Na^+/H^+ exchange mechanism (Theroux *et al.*, 2000).

During myocardial ischemia, the transmembrane Na^+/H^+ exchanger maintains myocardial cell pH integrity but may paradoxically precipitate cell necrosis. In a clinical trial, Theroux *et al.* (2000) showed the potential benefit of caporide a specific Na^+/H^+ exchange inhibitor in preventing the risk of cardiac death. It has been shown in an animal model that at higher molar concentrations of the ω -3 PUFA, EPA and DHA (25–100 μmol) may inhibit sarcolemmal Na^+/H^+ exchange, and thereby protect the myocardium from arrhythmias and cell death after ischaemia-reperfusion injury (Goel *et al.*, 2002). This appeared to be a specific effect of these PUFA, because 50 μmol linoleic acid or linolenic acid had no significant effect on Na^+/H^+ exchange.

The pumps Na^+/K^+ -ATPase and Ca^{2+} -ATPase play a significant role in the contraction and relaxation cycles of the cardiac muscle by maintaining ion levels within the myocytes (Vajreshwari and Narayanareddy, 1992). Kinoshita *et al.* (1994) found that EPA supplementation increased the activity of Ca^{2+} -ATPase within the myocardial cells, and this reduced the severity of the arrhythmias by inhibiting the Ca^{2+} accumulation following ischemia.

The $\text{Ca}^{2+}/\text{Mg}^{2+}$ -ATPase pump from sarcoplasmic reticulum is another important system in the contraction/relaxation cycle which is markedly influenced by the levels of ω -6 and ω -3 PUFA in membrane lipids. In diets enhanced with fish oils rich in EPA and DHA, the activity of $\text{Ca}^{2+}/\text{Mg}^{2+}$ -ATPase is decreased (Kinsella *et al.*, 1990).

3.8.4. Effects of ω -3 PUFA on enzymes and receptors

Dietary ω -3 PUFA may influence the fluidity and the activity of enzymes required for energy production and of many lipid-protein dependent receptors functions (Figure 20).

Fish oil ingestion also affects cyclooxygenase enzyme activity, thus altering the pathways of eicosanoid metabolism (Knapp, 1993). Fish oil has been found to affect phospholipase enzyme activity. Activation of phospholipase A2 causes elevation of intracellular calcium. Phospholipase D activity is associated with the sarcolemma and is believed to be involved in second messenger signalling systems (Dai *et al.*, 1995). The activities of adenylyl cyclase and 5'-nucleotidase are markedly influenced by the levels of ω -6 and ω -3 PUFA in membrane lipids. A diet rich in EPA and DHA increases the activity of adenylyl cyclase and 5'-nucleotidase (Kinsella *et al.*, 1990).

Receptors in the sarcolemma are largely involved in the regulation of contractility and/or heart rates. There is considerable evidence that changes in the fatty acid composition of the phospholipids may alter the agonist–receptor binding characteristics, thus influencing the receptor-mediated signaling pathway (Skuladottir et al., 1993).

β -Adrenergic receptors are involved in competitive inhibition by β -blockers or antagonists, the result of which can increase or decrease heart rate and contraction (Opie, 1991). Incorporation of ω -3 PUFA into cell membranes affects both β - and α -adrenergic systems. A few studies have demonstrated that increasing DHA content in the phospholipids of isolated rat cardiomyocytes resulted in a significantly higher positive chronotropic effect on stimulation of the β -adrenergic receptors with isoproterenol. This effect of DHA appeared to be due to a decreased affinity of the β -receptors for the ligand without alteration of the number of β -receptor binding sites, which also caused a significant decrease in cyclic AMP (cAMP) production (Grynberg et al., 1995; Grynberg et al., 1996).

Dubois et al. (1992) have shown that the enrichment of cardiomyocytes by EPA or DHA (100 μ mol) increases the intracellular concentration of cGMP and cAMP and decreased their cGMP-PDE specific activity. These effects might be a direct interaction between nonesterified fatty acids and the PDE enzyme. In an in vitro system, DHA was shown to inhibit the cytosolic PDE activity of an adult rat heart (Picq et al., 1996).

It is clear from these studies that ω -3 PUFA can affect cellular levels of cAMP and cGMP by affecting both cyclase and PDE activities, which may indirectly affect calcium mobilization from L-type calcium channels and, thus, play a role in preventing abnormal cardiac contractility and arrhythmia generation (Hartzell and Fischmeister, 1986; Kuriyama et al., 1995).

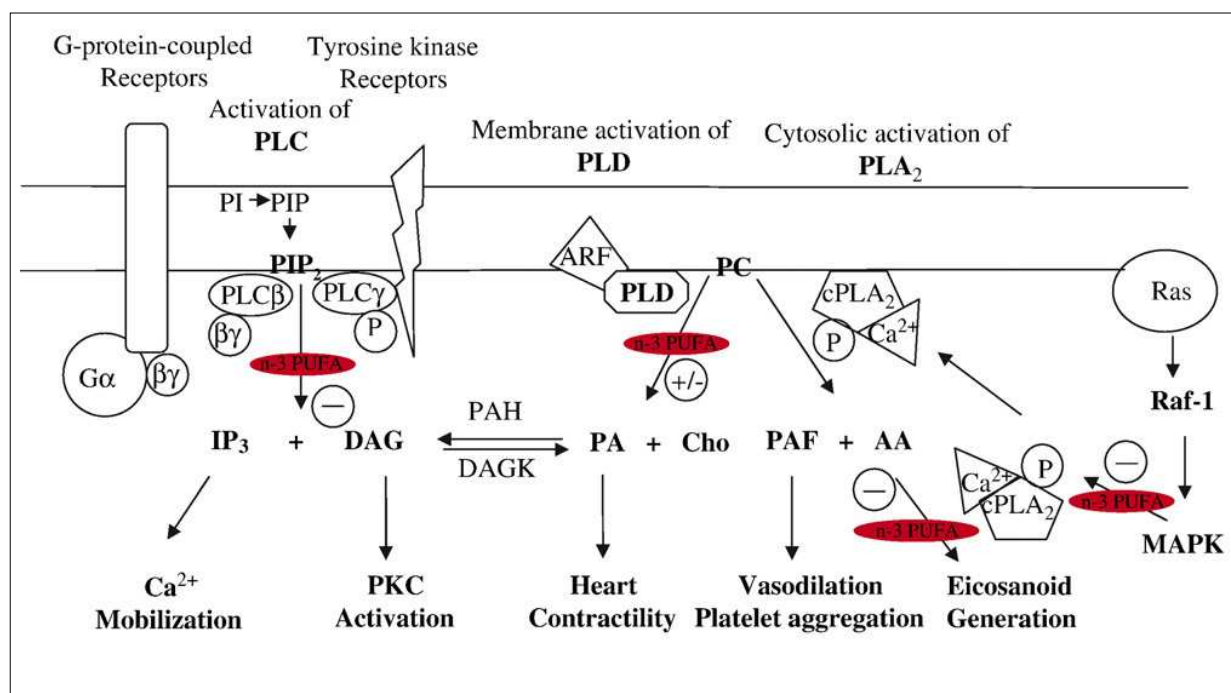

Figure 20. Regulation of phospholipase activities by ω -3 PUFA in cardiovascular functions (Siddiqui *et al.*, 2008).

In addition to their effects on adrenergic receptors and intracellular calcium, ω -3 PUFA also affect kinase-mediated serine/threonine and tyrosine phosphorylation of cellular proteins. Protein phosphorylation by protein kinases plays an essential role in signal transduction between the plasma membrane and nucleus and has a key role in regulating Ca²⁺ influx in cardiomyocytes (Levitan, 1994).

3.8.5. Effects of ω -3 PUFA on myocardial mitochondria

Mitochondria are also known to store large quantities of Ca²⁺. In fact, these organelles are considered to serve as a Ca²⁺ sink to prevent the occurrence of intracellular Ca²⁺ overload in diseased myocardium. Therefore, under normal physiological conditions, intracellular levels of Ca²⁺ are tightly controlled by a number of key enzymes, including voltage dependent channels, the SL-Na⁺-Ca²⁺ exchanger, receptor mediated calcium channels and the ryanodine receptor (RyR) and SR-Ca²⁺ ATPase pump. Any abnormalities in any of these key regulators contribute to abnormal Ca²⁺ handling and, thus, lead to cardiac dysfunction, including arrhythmia generation, hypertrophy and myocardial stunning (Gunter et Pfeiffer, 1990).

Stillwell et al. (1997) have shown that after the fusion of DHA into mouse mitochondrial membranes by DHA incubation increased mitochondrial membrane fluidity and have decreased membrane potentials.

Studies in isolated rat hearts have shown that the hearts of animals fed an ω -3 PUFA diet produce ATP at a lower oxygen cost. Their mitochondrial membranes also use energy more effectively (Grynberg et al., 1997). This moderate reduction in the oxygen requirement is of little consequence in normal circumstances. But in ischemia, due to the oxygen deprivation, it is a key element in myocardial protection.

Chapter IV

What is an Implantable Cardioverter Defibrillator?

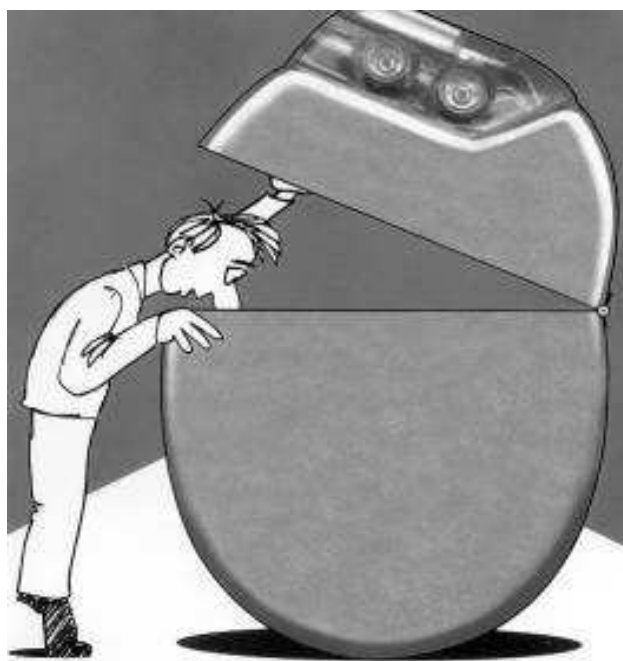

4.1. Historical Background of CID

Defibrillation was first demonstrated in 1899 by Prevost and Batelli, two physiologists from University of Geneva, Switzerland. They discovered that small electric shocks could induce ventricular fibrillation in dogs, and that larger charges would reverse the condition (Meyer, 1988). The first use on a human was in 1947 by Claude Beck, professor of surgery at Case Western Reserve University. Beck's theory was that ventricular fibrillation often occurred in hearts which were fundamentally healthy, in his terms "Heart too good to die", and that there must be a way of saving them. Beck first used the technique successfully on a 14 year old boy who was being operated on for a congenital chest defect. The boy's chest was surgically opened, and manual cardiac massage was undertaken for 45 minutes until the arrival of the defibrillator. Beck used internal paddles on either side of the heart, along with procainamide, a heart drug, and achieved return of normal sinus rhythm. The patient fully recovered without neurological or cardiac residual, and the findings were rapidly published (Beck *et al.*, 1947). This life-saving success with intraoperative, open-chest defibrillation led to its immediate acceptance throughout the world and to the subsequent development of external and implantable defibrillators.

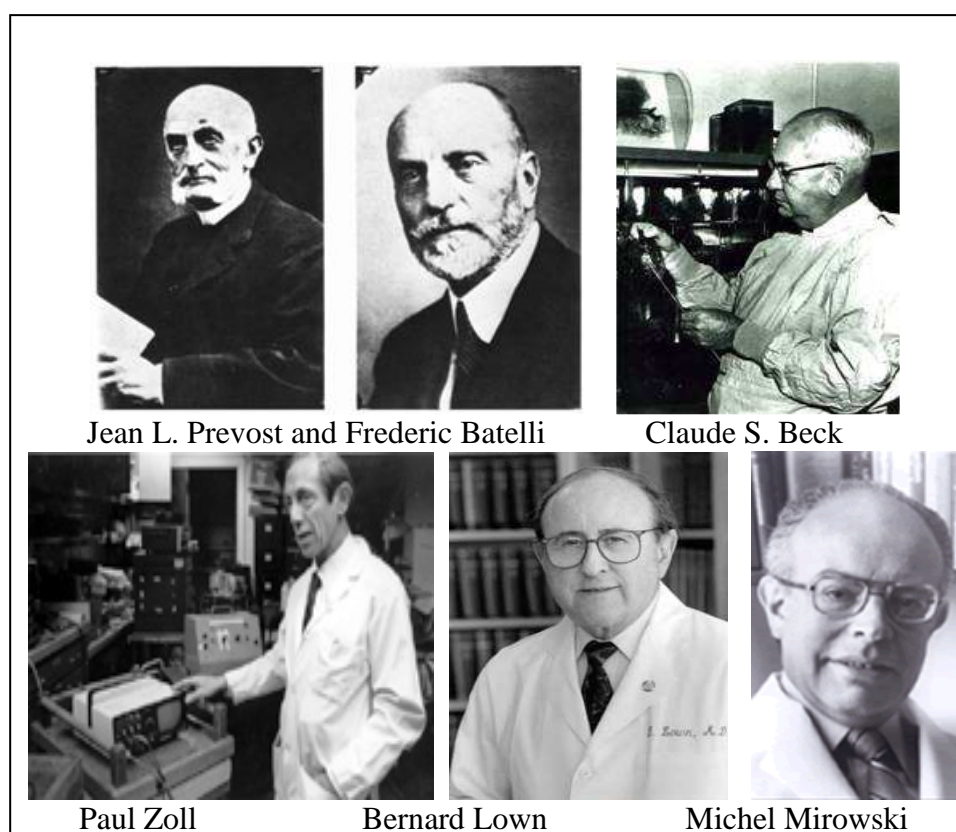

Figure 21. History of fibrillation and defibrillation.

Electrical device therapy with pacing and defibrillation rapidly developed during the 1950s and early 1960s by Dr Paul Zoll who subsequently focused on external defibrillation, and in 1956, he performed the first successful human external defibrillation using a device with a 15-A alternating current that produced 710 volts across the chest for 0.15 seconds (Zoll et al., 1956). In the early 1960s, Dr Bernard Lown demonstrated the superiority and safety of direct current vs alternating current for external, transthoracic defibrillation (Lown et al., 1962). Dr Michel Mirowski and associates (1980) miniaturized the components of the external defibrillator into a device small enough to be implanted in humans and coupled it with a unique sensing algorithm to discriminate between normal rhythm and VF. After documenting the safety and efficacy of automatic internal cardiac defibrillation in animals, they reported clinical success in 3 patients in 1980. This success ushered in the implantable defibrillator era that led to a series of randomized trials documenting the improved survival of high-risk cardiac patients with an implantable cardioverter defibrillator (ICD).

4.2. Definition of ICD

An implantable cardioverter defibrillator (ICD) is a device that is implanted in the chest to constantly monitor and correct abnormal heart rhythms (arrhythmias). ICDs have been proven to prolong survival in patients who either have suffered or are at risk of suffering serious abnormal heart rhythms that are most often the result of a damaged heart (Reiffel and Dizon, 2002). ICD therapy is often prescribed for patients who have experienced at least one episode of ventricular tachycardia or ventricular fibrillation, previous cardiac arrest, or drug therapy that was ineffective in controlling the tachyarrhythmia or that caused severe side effects, but now the majority of indications are for prophylactic reasons for patients who are at risk of sudden death (ejection fraction below 30-35).

The modern ICD is a relatively small (about 30 cm³, 69-78 g) device (Figure 22) that is implanted under the pectoral muscle, most commonly in the upper chest (Figure 23) but occasionally beneath the abdominal skin or muscles, with the use of a combination of local anaesthesia and light sedation. The implantation procedure, much like implanting a permanent pacemaker, has become very safe. The ICD consists of a battery (which can last 3 to 6 years), energy delivery components, and electronic circuitry, which all are sealed in one case.

The ICD is connected to the heart via one or more, thin and coated wires (electrodes) that travel in the veins between the implant site and the heart (Figure 24). Through these electrodes, the ICD monitors a patient's heart rhythm and delivers corrective electrical treatments appropriate for the specific types of heart rhythm disturbances that it may detect.



Figure 22: ICD, showing relative size.

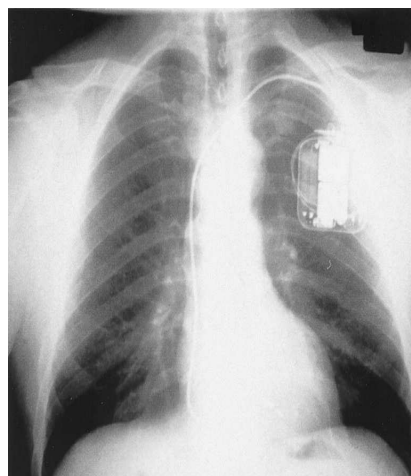

Figure 23: Implanted ICD as seen by chest x-ray.

There are different types of ICDs. The ICD leads can be attached to only one heart chamber, typically the ventricle, and this is called a single chamber ICD. The leads can be attached to both chambers on the same side of the heart (atrium and ventricle), and this is called a dual chamber ICD. The most complex type of ICD, the biventricular ICD, is designed specifically for patients with heart failure and has leads attached to three chambers (right atrium, right ventricle and left ventricle).

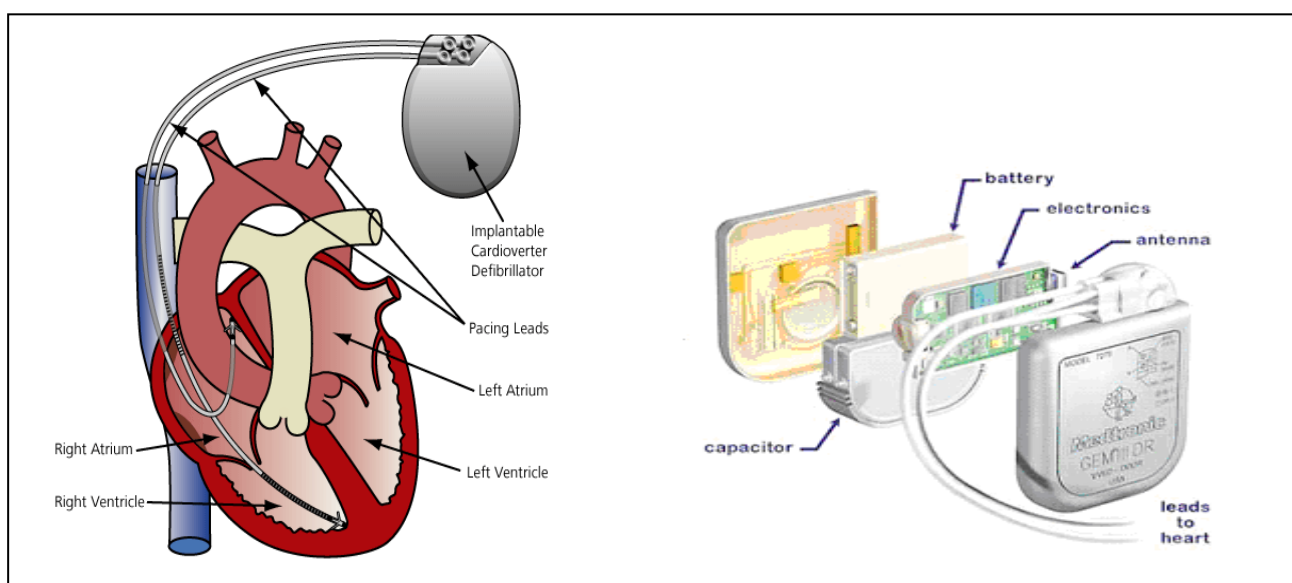

Figure 24: ICD Structure.

4.3. How do ICDs Work?

A defibrillator constantly monitors the heart rate and rhythm, it works 24 hours a day. If an abnormality is detected by the ICD, then an electrical impulse (shock) or a series of impulses are delivered to various locations on the heart to restore normal heart function. A defibrillator is individually programmed by the physician for the specific heart problem of the patient. The specific types of heart therapies available for programming by a physician include the following (Guidant, 2008).

Anti-Tachycardia Pacing (ATP): When the heart beats too fast, a condition called tachycardia occurs. To remedy tachycardia, the ICD delivers a series of small electrical impulses to the heart muscle to restore a normal heart rate and rhythm (short bursts overdrive pacing) (Figure 25).

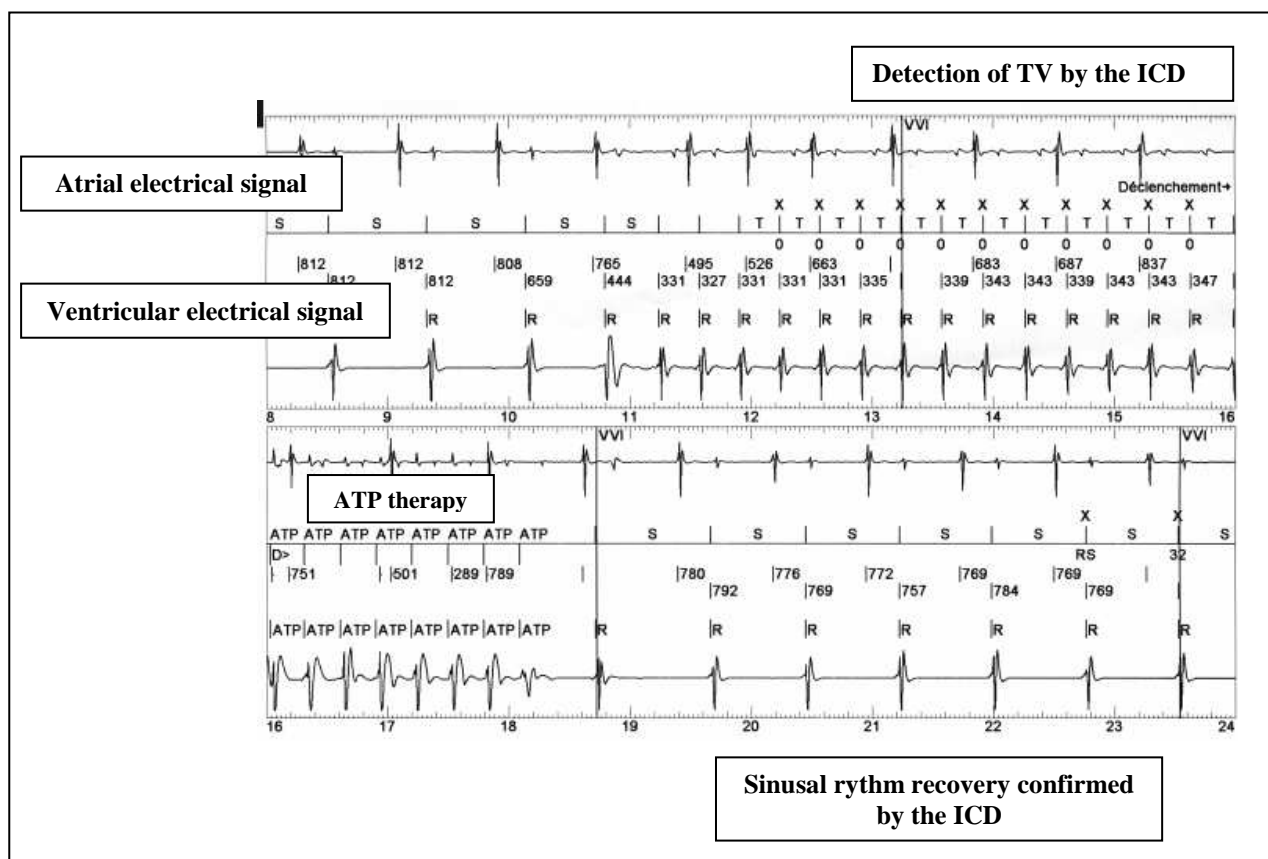

Figure 25: example of anti-tachycardia pacing (ATP).

Cardioversion: when pacing electrical impulses, such as ATP, do not provide a return to a normal heart rate, then cardioversion is used. Cardioversion provides one low-energy shock, delivered to the heart to return the heart rate to normal (1-5 J).

Defibrillation: defibrillation is used when to stop a ventricular fibrillation event. It is one high-energy shock, typically to the ventricle (25 to 42 J) (Figure 26).

Episode	Date	Heure	Type
56	10-DEC-2002	21:48	Spontané
Paramètres Détection initiale programmés			
	>205	FV:	
	>160	TV: Début 9 % Et Stabilité 30 ms	
		SRO 3:00 m:s	
Temps écoulé			
	Détection initiale	Zone FV	
	Fréquence moy. préessai	203 min-1	
	Stabilité mesurée	158 ms	
	Début mesure	N/R % N/R ms	
00:01	Essai 1 FV Choc 1	Déviés - Non reconfirmé	
	Traitement délivré	11,0 s	
	Durée de charge	2	
	Impédance mesurée	247 min-1	
	Fréq moyenne posttentative		
	Redétection	Zone FV	
	Fréquence moy. préessai	202 min-1	
	Stabilité mesurée	132 ms	
00:17	Essai 2 FV Choc 1	31J, Biphase	
	Traitement délivré	0,5 s	
	Durée de charge	38	
	Impédance mesurée	320 min-1	
	Fréq moyenne posttentative		
	Redétection	Zone FV	
	Fréquence moy. préessai	286 min-1	
	Stabilité mesurée	14 ms	
00:22	Essai 3 FV Choc 2	31J, Biphase	
	Traitement délivré	8,4 s	
	Durée de charge	37	
	Impédance mesurée	282 min-1	
	Fréq moyenne posttentative		
	Redétection	Zone FV	
	Fréquence moy. préessai	316 min-1	
	Stabilité mesurée	46 ms	
00:35	Essai 4 FV Choc maximum	31J, Biphase	
	Traitement délivré	8,7 s	
	Durée de charge	37	
	Impédance mesurée	85 min-1	
	Fréq moyenne posttentative		
01:15	Fin de l'épisode		

Figure 26: example of cardioverter recorded shock.

Bradycardia Pacing: When the heart beats too slowly, a condition called bradycardia occurs. Bradycardia pacing delivers constant electrical impulses to the heart to speed up the heart rate. An ICD is also a pacemaker.

The ICD also records heart activity and can transmit this information to the physician during a routine check, allowing the physician to better diagnose and monitor the underlying conditions causing the patient's arrhythmia.

4.4. Benefits of ICD therapy

Cardiovascular disease is the leading cause of death and disability in developed countries around the world over the last century, with a considerable part due to heart failure. Worldwide, sudden cardiac death comprises 50% of overall cardiac mortality in developed countries (Kadish *et al.*, 2000). Changes in myocardial metabolism play an important role in the aetiology of cardiovascular disease, and are therefore an interesting base for novel interventions.

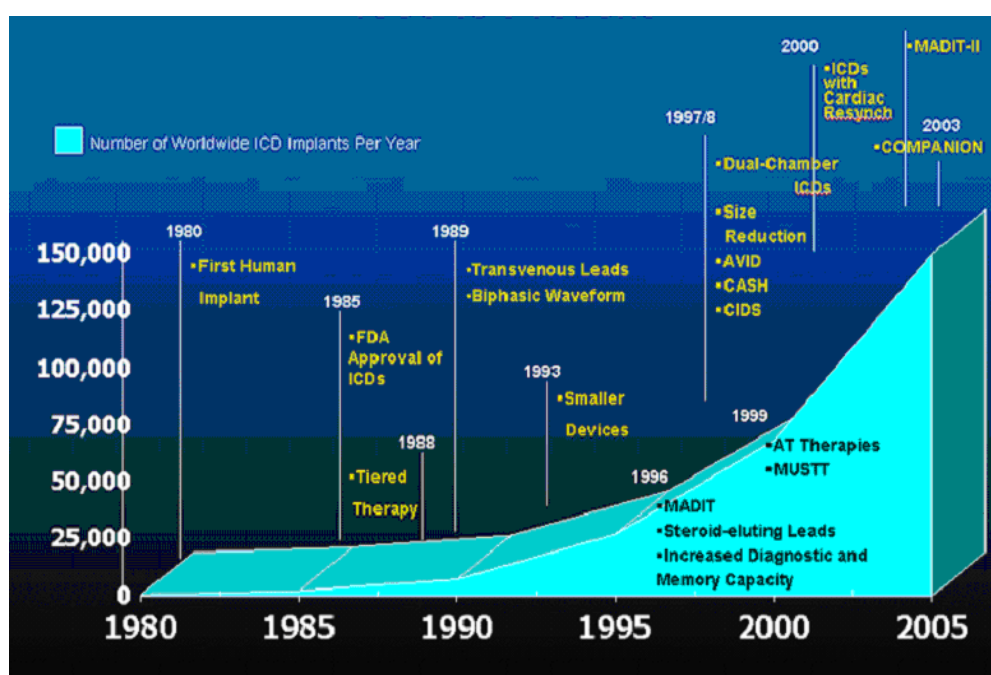

Figure 27: Evolution of ICD therapy: 1980-2005 (Goldenberg and Moss, 2008).

Data from epidemiological studies have demonstrated high rates of recurrence of life-threatening arrhythmias (30%-50% in 2 years) during follow-up among patients who experienced life-threatening ventricular tachyarrhythmias (Figure 27). ICD therapy was initially studied for the secondary prevention of arrhythmic mortality in this population (Mirowski *et al.*, 1980; Lehmann *et al.*, 1988; Saksena^a *et al.*, 1996; Tchou *et al.*, 1988; Connolly^a *et al.*, 2000; Kuck *et al.*, 2000). Afterwards, it has been shown that the risk of patients with left ventricular dysfunction who did not experience prior life-threatening arrhythmias in patients with prior myocardial infarction (MI) (Bigger, 1984; Buxton, 1984). Multiple clinical trials have established that ICD use results in improved survival compared with antiarrhythmic agents for secondary prevention of SCD (Zipes *et al.*, 1997; Wever *et al.*, 1995; Siebels *et al.*, 1994; Connolly^a *et al.*, 2000; Kuck *et al.*, 2000; Connolly^b *et al.*, 2000;

Ezekowitz et al., 2003; Lee et al., 2003). Large prospective, randomized, multicenter studies have also established that ICD therapy is effective for primary prevention of sudden death and improves total survival in selected patient populations who have not previously had a cardiac arrest or sustained VT (Zipes et al., 2006; Zwanziger et al., 2006; Mushlin et al., 1998; Mark et al., 2006; Moss et al., 1996; Bigger, 1997; Buxton et al., 1999; Kadish et al., 2000; Hohnloser et al., 2004; Moss et al., 2002; Bristow et al., 2004).

A summary of prospective randomized primary and secondary prevention ICD trials are presented in Table 10 and Table 11, respectively.

Table 10: Clinical features and results of the 3 Major Secondary Prevention ICD Trials (Goldenberg and Moss, 2008)

<i>Clinical Features</i>	<i>Study</i>		
	AVID (AVID, 1997)	CIDS (Connolly et al., 2000)	CASH (Kuck et al., 2000)
Sample size	1016	659	288
Design	ICD vs antiarrhythmic drugs	ICD vs amiodarone	ICD vs amiodarone vs metoprolol
Patients	Resuscitated from near-fatal VF or postcardioversion from sustained VT	Resuscitated VF or VT or with unmonitored syncope	Survivors of cardiac arrest secondary to documented ventricular arrhythmias
Age, y	65	63	58
Men, %	79	84	80
Ischemic cause %	81	82	73
Ejection fraction, %	32	33	46
Follow-up, mo	18	36	57
Primary end point	All-cause mortality	All-cause mortality	All-cause mortality
Results			
Events, %	Non-ICD: 24 ICD: 16	Non-ICD: 30 ICD: 25	Non-ICD: 44 ICD: 36
Risk reduction with ICD	28% ($P = .002$)	20% ($P = .14$)	23% ($P = .08$)

Table 11: Clinical Features and Results of the 7 Major Primary Prevention ICD Trials (Goldenberg and Moss, 2008).

Clinical Features	Study						
	MADIT (Moss et al., 1996)	CABG-Patch (Bigger, 1997)	MADIT-II (Moss et al., 2002)	COMPANION (Bristow et al., 2004)	DEFINITE (Hohnloser et al., 2004)	DINAMIT (Kadish et al., 2004)	SCD-HeFT (Bardy et al., 2005)
Sample size	196	900	1232	1520	458	674	2521
Design	ICD vs antiarrhythmic drugs as conventional therapy	ICD vs no antiarrhythmic drugs as conventional therapy	ICD vs OPT	CRT vs CRT-D vs OPT	ICD vs OPT	ICD vs OPT	ICD vs OPT vs OPT + amiodarone
Patients	Previous MI, EF \leq 35%, NSVT, EPS+	CAD, abnormal SAECG, EF \leq 35%,	Prior MI, EF \leq 30%	I + CM, EF \leq 35%, QRS $>$ 120 ms	NICM with EF $<$ 36%	NICM, EF \leq 35%, NSVT or 10 PVC/24 h	I & NICM, EF \leq 35%
Age, y	63	64	64	67	58	62	60
Men, %	92	83	84	68	71	76	77
Ischemic cause %	100	10	100	55	0	100	52
Ejection fraction, %	26	27	23	21	21	28	25
Follow-up, mo	27	32	20	14	29	30	46
Results							
Crude death rate, %	Non-ICD: 39 ICD: 12	Non-ICD: 5 ICD: 4	Non-ICD: 20 ICD: 14	Medical: 25 CRT: 21 CRT-D: 18	Non-ICD: 17 ICD: 12	Non-ICD:17 ICD: 19	Placebo: 29 Amiodarone: 28 ICD: 22
Risk reduction with ICD	54% ($P = .001$)	None	31% ($P = .02$)	40% ($P < .001$)	35% ($P = .08$)	None	23% ($P = .007$)

CAD: coronary artery disease; EPS+, positive findings (inducible ventricular tachycardia) on electrophysiologic study; I & NICM, ischemic and nonischemic cardiomyopathy; NSVT, nonsustained VT; OPT, optimal pharmacologic therapy; PVC, premature ventricular contraction; SAECG, signal-averaged electrocardiogram; CRT: Cardiac resynchronization therapy; MI: Myocardial infarction

4.5. When is ICD therapy the right choice?

Over the last 2 decades, ICD technology has dramatically improved. Transvenous lead placement, programmability, biphasic wave forms, back-up and antitachycardic pacing, superior arrhythmias recognition, and charge times have markedly enhanced the ease of implantation as well as the efficiency of these remarkable devices. An ICD may be recommended in any of the following cases:

- 1) Patients who have survived ≥ 1 episode of ventricular tachycardia or fibrillation,
- 2) Patients who have had or are at a high risk of having sudden cardiac arrest:
 - Patients with ejection fractions of less than 30 to 35%.
 - Patients whose clinical profile indicates a high likelihood of developing sustained ventricular tachycardia or fibrillation,
 - Patients at a high risk for SCD because of an inherited heart abnormality

Although appropriate ICD use prevents SCD and improves overall survival, this therapy was underused in many potentially eligible patients (Moss et al., 1996; Buxton, 1999; Moss et al., 2002; Kadish et al., 2004; Bardy^a et al., 2005; Voigt et al., 2004; Ruskin et al., 2002; Hernandez et al., 2007). Guidelines for the management of ventricular arrhythmias and the prevention of SCD were updated by the American College of Cardiology (ACC)/American Heart Association (AHA) Task Force and the European Society of Cardiology Committee for Practice Guidelines in 2006 (Zipes et al., 2006). It is also noteworthy that these guidelines stipulate that patients should be on optimal medical therapy, and they have a reasonable expectation of survival with a good functional status for more than a year (Zipes et al., 2006; Al-Khatib et al., 2008; Gillinov, 2008). ICD therapy is effective for secondary and primary prevention of sudden death and improves total survival.

4.5.1. Secondary prevention of sudden cardiac death

Secondary prevention refers to prevention of SCD in those patients who have survived a prior sudden cardiac arrest or sustained VT (Zipes et al., 2006).

4.5.1.1. Implantable cardioverter-defibrillator therapy for cardiac arrest and sustained ventricular tachycardia

Evidence from multiple randomized controlled trials supports the use of ICDs for secondary prevention of sudden cardiac arrest. In patients resuscitated from cardiac arrest, the ICD is associated with clinically and statistically significant reductions in sudden death and total mortality compared with antiarrhythmic drug therapy in prospective randomized controlled trials (Zipes *et al.*, 2006; AVID, 1997; Wever *et al.*, 1995; Siebels *et al.*, 1994; Connolly^b *et al.*, 2000; Kuck *et al.*, 2000; Connolly^a *et al.*, 2000; Ezekowitz *et al.*, 2003; Lee *et al.*, 2003).

4.5.1.2. Coronary Artery Disease

Patients with coronary artery disease represent the majority of patients receiving devices in prior reports of patients surviving cardiac arrest. Evidence strongly supports a survival benefit in such patients with an ICD compared with other therapy options (AVID *et al.*, 1997; Connolly^b *et al.*, 2000; Kuck *et al.*, 2000).

4.5.1.3. Nonischemic Dilated Cardiomyopathy

Patients with nonischemic DCM and prior episodes of VF or sustained VT are at high risk for recurrent cardiac arrest. Empirical antiarrhythmic therapy or drug therapy guided by electrophysiological testing has not been demonstrated to improve survival in these patients. The ICD has been shown to be superior to amiodarone for secondary prevention of VT and VF (Connolly^b *et al.*, 2000; Kuck *et al.*, 2000, Powell *et al.*, 1993). On the basis of these data, the ICD is the preferred treatment for patients with nonischemic DCM resuscitated from prior cardiac arrest from VF or VT.

4.5.1.4. Hypertrophic Cardiomyopathy

HCM is an inherited heart muscle disease that affects approximately 1 of every 500 persons in the general population and is the most common cause of cardiac arrest in individuals younger than 40 years of age (Maron *et al.*, 2000). HCM should be suspected as the cause of cardiac arrest in young individuals during exertion, because exercise increases the risk of life-threatening ventricular arrhythmias with this condition (Maron *et al.*, 2000).

Sudden death may also be the first manifestation of the disease in a previously asymptomatic individual. A history of prior cardiac arrest indicates a substantial risk of future VT or VF with this condition. The ICD is the preferred therapy for such patients with HCM resuscitated from prior cardiac arrest (Maron *et al.*, 2000; Begley *et al.*, 2003).

4.5.1.5. Arrhythmogenic Right Ventricular Dysplasia/ Cardiomyopathy

Arrhythmogenic RV dysplasia/cardiomyopathy (ARVD/C) is a genetic condition characterized by fibrofatty infiltration of the RV and less commonly the LV. It usually manifests clinically with sustained monomorphic VT with left bundle morphology in young individuals during exercise. There are no prospective randomized trials of pharmacological therapy versus ICD therapy in patients with ARVD/C for secondary prevention of SCD; however, observational reports from multiple centers consistently demonstrate a high frequency of appropriate ICD use for life-threatening ventricular arrhythmias and a very low rate of arrhythmic death in patients with ARVD/C treated with an ICD (Link *et al.*, 1995; Corrado *et al.*, 2003; Pezawas *et al.*, 2006; Gillis *et al.*, 2003; Hodgkinson *et al.*, 2005; Roguin *et al.*, 2004; Tavernier *et al.*, 2001; Wichter *et al.*, 2004).

4.5.1.6. Genetic Arrhythmia Syndromes

Genetic syndromes that predispose to sustained VT or VF include the long- and short-QT syndromes, Brugada syndrome, idiopathic VF, and catecholaminergic polymorphic VT (Moss *et al.*, 2000; Zareba *et al.*, 2003; Viskin *et al.*, 2003; Goel *et al.*, 2004; Monnig *et al.*, 2005; Goldenberg *et al.*, 2006; Hobbs *et al.*, 2006; Schimpf *et al.*, 2003; Brugada *et al.*, 2004). These primary electrical conditions typically exist in the absence of any underlying structural heart disease and predispose to cardiac arrest. On the basis of the absence of any clear or consistent survival benefit of pharmacological therapy for those individuals with these genetic arrhythmia syndromes, the ICD should be the preferred therapy.

4.5.1.7. Syncope With Inducible Sustained Ventricular Tachycardia

Patients with syncope of undetermined origin in whom clinically relevant VT/VF is induced at electrophysiological study should be considered candidates for ICD therapy. In these patients, the induced arrhythmia is presumed to be the cause of syncope (Link *et al.*, 1995;

Garcia-Moran et al., 2002; Brodsky et al., 2002; LeLorier et al., 2002; Grimm et al., 2003; Pezawas et al., 2003; Farmer et al., 2003; Brebilla-Perrot et al., 2005; Brilakis et al., 2005; Guttigoli et al., 2005; Sanchez et al., 2005). In patients with hemodynamically significant and symptomatic inducible sustained VT, ICD therapy can be a primary treatment option.

4.5.2. Primary Prevention of Sudden Cardiac Death

Primary prevention of SCD refers to the use of ICDs in individuals who are at risk for but have not yet had an episode of sustained VT, VF, or resuscitated cardiac arrest.

Primary prevention of SCD refers to the use of ICDs in individuals who are at risk for but have not yet had an episode of sustained VT, VF, or resuscitated cardiac arrest. Clinical trials have evaluated the risks and benefits of the ICD in prevention of sudden death and have improved survival in multiple patient populations, including those with prior MI and heart failure due to either coronary artery disease or nonischemic DCM. Prospective registry data are less robust but still useful for risk stratification and recommendations for ICD implantation in selected other patient populations, such as those with HCM, ARVD/C, and the long-QT syndrome. In less common conditions (e.g., Brugada syndrome, catecholaminergic polymorphic VT, cardiac sarcoidosis, and LV noncompaction), clinical reports and retrospectively analyzed series provide less rigorous evidence in support of current recommendations for ICD use, but this constitutes the best available evidence for these conditions.

4.5.3. Advanced Heart Failure and Cardiac Transplantation

Patients with moderate to severe heart failure face the twin risks of terminal heart failure decompensation and death due to unanticipated ventricular tachyarrhythmias. In patients with heart failure who have not previously had a life-threatening arrhythmia, the first event identifies them as being at higher risk than before for both sudden death and death due to heart failure, with the majority of patients surviving less than 2 years (Zwanziger et al., 2006; Mark et al., 2006). When ICD or CRT-D (biventricular ICD) implantation is discussed with these patients, the probability of both life-saving and inappropriate shocks should be placed in the context of the overall anticipated mortality with heart failure, the expected duration of life prolongation after effective therapies, and the likely evolution to limiting symptoms and ultimately death due to pump failure (Stevenson and Desai, 2006).

Candidates for transplantation constitute a special case of severe heart failure because of the likelihood of prolonged survival after transplantation, with 50% of patients currently surviving at 10 years after transplantation. The high rate of sudden death on the transplant waiting list merits ICD implantation in most candidates with heart failure who are awaiting transplantation out of the hospital. The ICD has been highly effective as a bridge to transplantation for these individuals both with and without a prior history of lifethreatening arrhythmias.

At the same time, the use of ICDs has expanded from sudden death survivors to prophylactic implantation in patients who are at an increased risk of sudden death, significantly expanding the population of individuals with ICDs.

4.6. Follow-Up Procedures

All patients with ICDs require periodic and meticulous follow-up to ensure safety and optimal device performance, as well as to monitor a patient's clinical status (Schoenfeld, 2007). The goals of ICD follow-up include monitoring of device system function; optimization of performance for maximal clinical effectiveness and system longevity; minimization of complications; anticipation of replacement of system components and tracking devices under advisory; ensuring timely intervention for clinical problems; patient tracking, education, and support; and maintenance of ICD system records.

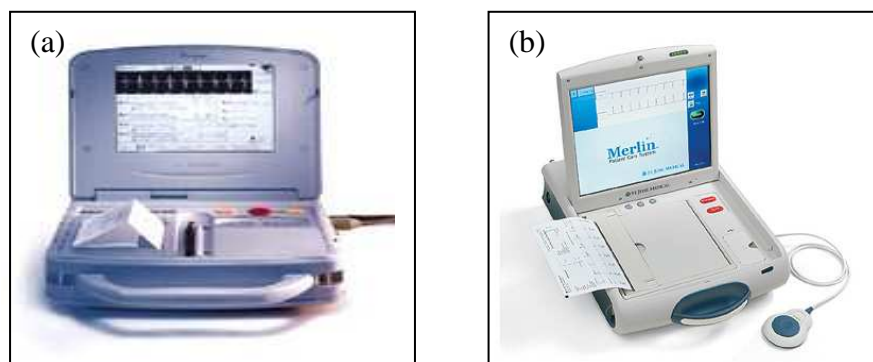

Figure 28: ICD programmer (a) Guidant and (b) St. Jude

The follow-up of an ICD patient must be individualized in accordance with the patient's clinical status and conducted by a physician fully trained in ICD follow-up (Curtis et al., 2004; Senges-Becker et al., 2005). Particular attention should be given to review of sensing parameters, programmed defibrillation and pacing therapies, device activation, and event logs.

ICD recipients should be encouraged to carry proper identification and information about their device at all times. Patients receiving these devices can experience transient or sustained device-related anxiety. Education and psychological support before, during, and after ICD insertion are highly desirable and can improve the patient's quality of life (Vlay et al., 1989; Luderitz et al., 1993).

Guidant		VENTAK AVIII D		
Imprimé le	13-FEV-2003 15:15			
Patient	JASPARI DOMINIQUE			
Centre	[REDACTED]			
Programme		Générateur d'imp. Guidant:		
Modèle	2920	Modèle	1831	
Série	035635	Série	105870	
Logiciel Guidant :		ROM Version	1.0.02	
Modèle	2843			
Version	4.0			
Compteurs				
Données récentes :		Episodes :	16 à 33	
		Dates :	31-JUL-2002 à 13-FEV-2003	
		Dernière R à z	Depuis Implantation	
Compteurs d'épisodes		31-JUL-2002		
Traitées				
Traitement FV		1	4	
Traitement TV		4	7	
Traitement TV-1		0	0	
Traitement commandé		0	1	
Non traitées				
Aucun traitemt. programmé		0	0	
Episodes non-soutenus		20	40	
Total épisodes		25	52	
Réponse Tachy Atriale		0	2	
Compteurs de traitements				
Chocs tentés				
Délivrés - Détection satisfait		4	15	
- Commandés par médecin		3	8	
Déviés - Non reconfirmé		0	1	
- Commandés par médecin		1	6	
		0	0	
Modes ATP tentés				
Délivrés - Détection satisfait		4	7	
- Commandés par médecin		4	7	
		0	0	
Taux de réussite première tentative :				
	Délivrés	Convertis	Accélérés	% réussi
Zone FV	1	1	---	100
Zone TV	4	2	1	50
Zone TV-1	0	0	0	0

Figure 29: Example of recorded shocks by the ICD.

- After implantation: the patient with an ICD is monitored at regular intervals over time (usually every 3 months) to evaluate:
- What rhythm disturbances have been detected,
 - What electrical treatments have been delivered and whether they worked, and whether the electrical treatments should be modified (ie, by altering the number and rate of pacing pulses or the energy level of a defibrillation shock).
 - Measure of how much energy is left in the battery, the function of the electrodes,
 - What symptoms the patient has experienced, and whether any other factors that could alter ICD treatments (eg, disease or medication changes) have appeared.

- Regular Controls: every 6 months
- Controls following a shock:
 - One isolated shock (Especially after the first shock): Checking within 48 hours at the monitoring center.
 - Two shocks or more: contact the monitoring center for urgent and immediate control
- Additional control in case of surgery.

Monitoring is performed non-invasively, ie, by applying a programming wand over the chest to allow communication between the ICD and an external computer via electromagnetic waves that are not detectable by or harmful to the patient (Figures 28).

When the amount of energy stored in the battery has declined by a predetermined percentage, elective replacement of the ICD is scheduled. This avoids the very rare possibility of having inadequate energy in the battery to power the ICD when an electrical treatment is needed. As long as the electrode wires are functioning well, only the generator needs to be replaced, and this is a simple procedure.

4.7. Cost-effectiveness of ICD therapy

Long-term follow-up studies have consistently demonstrated that cumulative medical costs are increased substantially among patients receiving an ICD (Zwanziger *et al.*, 2006; Mark *et al.*, 2006; Weiss *et al.*, 2002; O'Brien *et al.*, 2001; Larsen *et al.*, 2002). The early studies of ICD cost-effectiveness were based on mathematical models and relied on nonrandomized studies to estimate clinical efficacy and cost. These studies found cost-effectiveness ratios between 17 000 USD to 29 000 USD per year of life saved (Saksena^b *et al.*, 1996; Kupersmith *et al.*, 1995; Larsen *et al.*, 1992). In France, the rate of implementation has increased between 2003 and 2008, from 42 to 110 DAI per million capita. Nearly 7000 patients receive an ICD each year (Sciences et avenir, 2008). The cost of such intervention is about 17 000 to 20 000 Euro.

4.8. Omega-3 PUFA and arrhythmia risk in patients with an implantable defibrillator

Despite the advances made in pharmacologic and nonpharmacologic (devices and surgical procedures) management of cardiac arrhythmias, supraventricular and ventricular arrhythmias continue to be a major public health problem (Cheng and Santoni, 2008). Antiarrhythmic agents help terminate and prevent arrhythmias; however, many of them require close therapeutic monitoring due to their side-effect and drug interaction profiles. Therefore, research has focused on finding alternative, safer, preventive, and therapeutic strategies.

Clinicians frequently are asked whether dietary fat intake influences the risk of coronary heart disease. However, many clinicians remain unclear about the role of dietary fat and fatty acids in the occurrence of CHD (Taubes, 2001; Siscovick *et al.*, 2003).

The new diet– heart hypothesis can be characterized by the following syllogism (Siscovick *et al.*, 2003):

- (1) Dietary ω -3 PUFA intake increases cell membrane and free fatty acid ω -3 PUFA levels;
- (2) higher ω -3 PUFA levels favorably alter cardiac ion channel function;
- (3) altered ion channel function modifies the cardiac action potential; and
- (4) alteration in the action potential reduces myocardial vulnerability to ventricular fibrillation, the major life-threatening arrhythmia that results in sudden cardiac death in the setting of myocardial ischemia.

Taken individually, each element of this syllogism is now supported by evidence from one or more research paradigms, including animal-experimental, cell biology, genetic, nutritional, and epidemiological studies. Of particular importance, evidence from randomized clinical trials of either fatty fish intake or low-dose ω -3 PUFA supplementation in post-myocardial infarction patients provides additional support for the new diet-heart hypothesis (Burr *et al.*, 1989; GISSI, 1999). Evidence from observational studies and controlled trials indicates that, in addition to their effects as essential nutrients, intake of the marine very long-chain ω -3 PUFA reduces the risk of fatal coronary heart disease and, in particular, of sudden cardiac death (Kromhout *et al.*, 1985; Albert *et al.*, 1998; Albert *et al.*, 2002; GISSI, 1999; Burr *et al.*, 1989). Sudden cardiac death forms a major part of mortality from cardiovascular disease and is, in most cases, a direct consequence of cardiac arrhythmia (Huikuri *et al.*, 2001). Omega-3 PUFA may exert their protective effects through reducing the susceptibility to cardiac arrhythmia.

It is still unclear exactly how ω -3 fatty acids exert their antiarrhythmic effects, and whether such effects come from the EPA component or the DHA component or both is unknown. However, several mechanisms have been postulated. Structurally, ω -3 fatty acids have structures similar to other that of antiarrhythmic agents used currently in that they have a long acyl hydrocarbon tail, greater than 2 unsaturated carbon-carbon double bonds, and a free carboxyl group at one end (Reiffel and McDonald, 2006). It is also believed that ω -3 fatty acids may have an indirect effect through cardiac control of the autonomic nervous system, increasing heart rate variability and baroreflex sensitivity (Christensen *et al.*, 2001; Brouwer *et al.*, 2002). A high variability in heart rate is an indication of good cardiac adaptability, implying a well-functioning autonomic control mechanism, thus lowering the risk of arrhythmia (Smyth *et al.*, 1969). Electrophysiologically, ω -3 fatty acids may also exert an antiarrhythmic effect by inhibiting the fast, voltage-dependent sodium and L-type calcium channels (Kang and Leaf, 1996; Xiao *et al.*, 1997). Omega-3 fatty acids are thought to act on the final common pathway affecting excitability of the cardiac myocyte and prevent calcium overload during stress. In addition, by incorporating more ω -3 fatty acids into cardiac membrane phospholipids, they may reduce the ω -6 fatty acid/ ω -3 fatty acid ratio, which may shift the myocardium from a proarrhythmic to an antiarrhythmic state (Chrysohoou, 2007). Finally, ω -3 fatty acids may have direct effects on the inositol lipid cycle and cell signaling on the cell membrane, via their anti-inflammatory effects mediated by eicosanoids (Charnock, 1999).

MATERIAL & METHODS

PART I

**Modulation of myocardial resistance to ischemia-reperfusion injury
by dietary saturated and polyunsaturated fatty acids
Insights into the concept of *Mediterranean omega-3 preconditioning***

I. Animals

This study conforms to the Guide for the Care and Use of Laboratory Animals, National Academic Press, Washington, DC, 1996. Male Wistar rats (IFFA-Credo, L'Abresle, France) were used throughout this investigation. All animals received a basic laboratory solid low fat chow diet (regime A04, UAR, Villemoisson-sur-Orge, France) and water *ad libitum*. All rats (n=48 for blood and cardiac lipid measurements and n=48 for cardiac experiments) were fed dietary supplements by gavages during 8 weeks daily at the same hour of the day.

Animals were randomly divided into three groups according to their dietary supplements. Animals in the palm oil group (PO) were supplemented with 650 μ l palm fat (Palmella, Germany), rich in saturated fatty acids but low in ω 6 and ω 3. Animals in the sunflower group (SO) were supplemented with 650 μ l Sunflower oil (Lesieur Inc, France) poor in saturated and ω 3 but rich in ω 6 and those in the "Mediterranean group" (MED) were supplemented with 650 μ l of a mix of plant and marine ω 3 (Mixalpha 3*, Synergia, Beaune-sur-Arzon, France). Mixalpha is a mixture of linseed and fish oils.

The fatty acid composition of the palm, sunflower and Mixalpha oils is shown in Table 12. The dose of 600 mg Mixalpha was calculated to bring the final diet of the MED group to a ratio of 18:2 ω 6/18:3 ω 3 close to 1 which is the recognised optimal ratio for adequate protection and conversion of 18:3 ω 3 to the very long-chain ω 3. The food intake in each group was checked every day, animals were weighed once a week and housed under conditions of constant temperature, humidity and standard light-dark cycle 12h/12h.

Table 12: Fatty acid composition of Standard food, PO, SO and Mixalpha oils (% of total fatty acids)

Fatty acids	Standard Food	PO	SO	Mixalpha 3*
Saturated				
C14:0	0,5	1,1	-	0,1
C16:0	17,6	49,5	5.8	3,9
C18:0	2	4,9	4.7	1,9
Monounsaturated				
C18:1 ω 9	18,9	35	27.5	9,5
C16:1 ω 7	0,8	0,2	0.1	0,3
C18:1 ω 7	1,2	0,6	0.5	0,6
Polyunsaturated				
Total ω 6	51,7	8,1	60.6	12,3
C18:2 ω 6	51,2	8,1	59.6	11,4
C20:4 ω 6	0,3	-	0.8	0,4
Total ω 3	6,3	0,1	0.2	71,3
C18:3 ω 3	3,8	0,1	0.1	47,4
C20:5 ω 3	1,1	-	0.1	7.4
C22:5 ω 3	0,2	-	-	1,5
C22:6 ω 3	1,8	-	-	15

*Mixalpha 3® is protected against peroxydation by 0,3% vitamin E, 0,2% krill (shrimp antioxydant) and kept cold in the dark.

II. Cardiac experiments: *ex vivo* isolated perfused heart model

2.1. Anesthesia and heart isolation

Rats were anaesthetized with pentobarbital sodium (Sanofi, 40 mg/kg, i.p.) and heparinized (Sigma; 100UI/rat, i.v.) via the saphenous vein. After chest opening, hearts were excised, and then immediately washed in cold Krebs-Henseleit buffer (4°C) in order to stop the contractile activity and preserve the energetic resources (Krebs and Henseleit, 1932).

2.2. Isolated perfused heart model

The isolated perfused heart model, as originated by Oscar Langendorff (1895) more than a century ago, has become a predominant technique in pharmacological and physiological research. The technique allows the examination of cardiac contractile strength, heart rate and vascular effects without the complications of an intact animal model. This technique includes two modes of perfusion:

- **Perfusion at constant flow:** the flow is imposed by a peristaltic pump. The vascular resistance will then determine the perfusion pressure.
- **Perfusion at constant pressure:** in which the perfusate solution flows by gravity from a thermostatically column whose level is kept constant (1m above the heart) by a system of Mariotte vases. Under these conditions, vascular resistances determine the perfusion flow.

In our study, the experimental protocol on isolated perfused hearts was realized by a system of perfusion at constant pressure (Figure 30).

Immediately after removing, the heart was suspended by the aorta to a stainless steel cannula which drives the oxygenated perfusion fluid. A small incision is made in the pulmonary artery to facilitate the flow of coronary effluent outside the heart. The main nodal tissues are destroyed by removing the right atrium and making an incision at the atrioventricular node. The heart was then paced at 5 Hz (300 bpm) via a monopolar electrode placed on the left atrial wall, connected to a stimulator (6021 SRI, LDT, Edenbridge, Kent, UK) and perfused at a constant pressure of 9.81 kPa (1 m H₂O) using the Langendorff mode with Krebs-Henseleit crystalloid buffer (Hock *et al.*, 1987; Yanagisawa *et al.*, 1988, Demaison *et al.*, 1994).

Perfusate solution composition

The composition of the perfusate solution as described by Krebs and Henseleit (1932) is the following (mM):

- NaCl	118,00
- NaHCO ₃	25,00
- Glucose	11,10
- KCl	4,75
- CaCl ₂ , 2H ₂ O	1,36
- MgSO ₄ , 7H ₂ O	1,19
- KH ₂ PO ₄	1,18

This solution is prepared the day of experimentation, filtered just before its use (pore size = 0,8µm), and equilibrated with a mixture of O₂/CO₂ (95%/5%) at 37°C, pH 7.4.

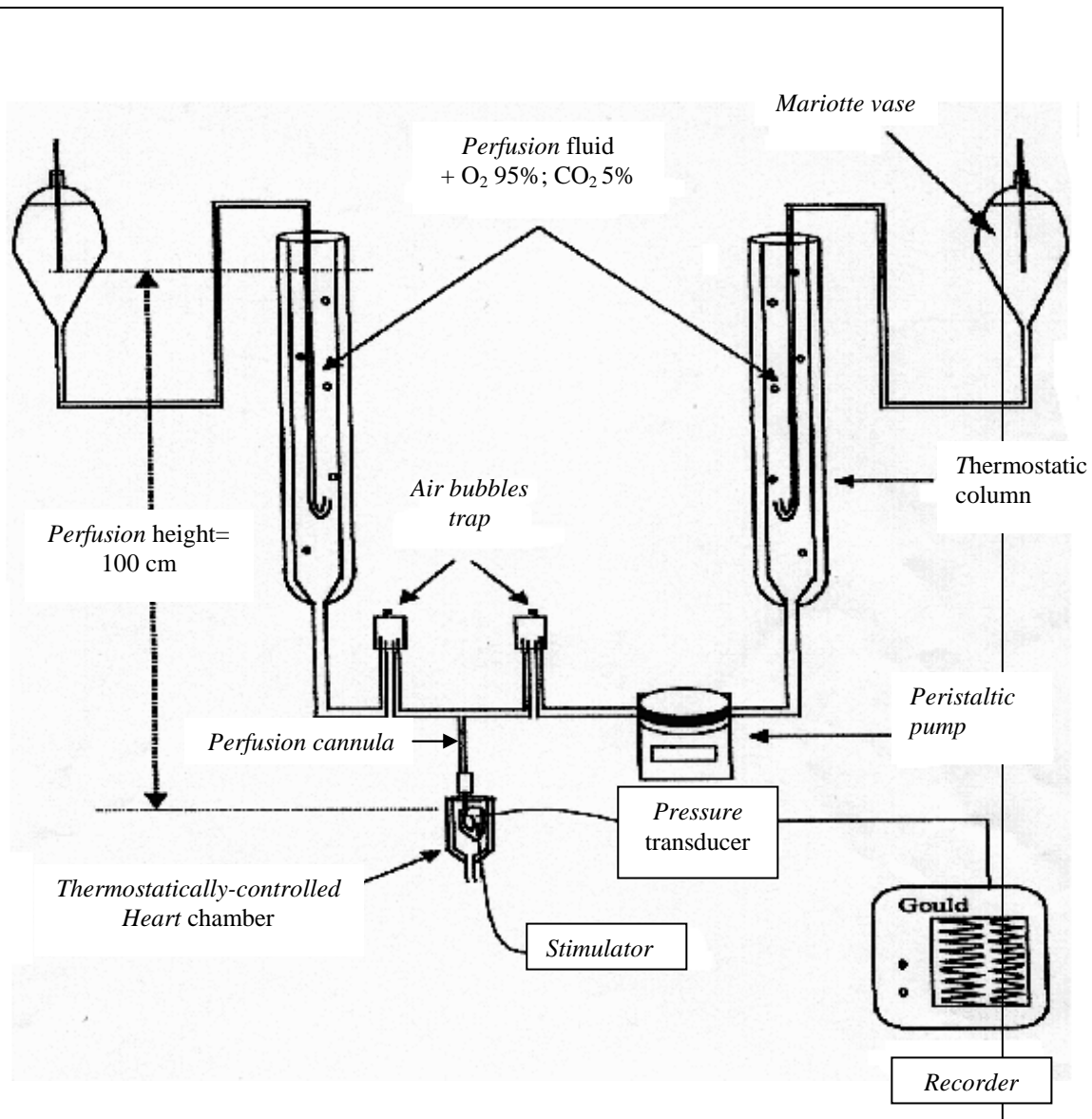

Figure 30: Perfusion at constant pressure model of isolated rat heart.

2.3. Intra-ventricular balloon

In this model of aortic perfusion, ventricles remain empty and the heart has no measurable external mechanical work. To get a quantifiable activity, we introduced a noncompliant water-filled ultra thin balloon into the left ventricular cavity with a volume adjusted to preset a baseline end-diastolic pressure of 4 ± 0.5 mmHg to maintain the volume of the ventricular cavity at a constant value (Guiraud et al., 2004; Guiraud et al., 2008; Toufekstian et al.; 2008). Under these conditions, the heart achieves an external work and gives valuable data on cardiac pump function. Left ventricular (LV) pressure was measured with a transducer (Statham P23ID, Gould Allco, Ballainvilliers, France) and recorded on Power Lab software (Macintosh connected to the balloon by a stiff polyethylene catheter).

2.4. Evaluation of hemodynamic variables

This experimental model determines the different variables representing the ventricular function:

- Coronary flow (DC), measured from coronary effluents, expressed in ml/min every 5 minutes.
- Heart rate, registered through the pressure transducer, expressed in beats per minute (bpm).
- Systolic (LVSP) and diastolic (LVDP) pressures of the left ventricle recorded through the pressure transducer and are expressed in millimeters of mercury (mm Hg). From these two variables, the developed left ventricular pressure (LVDevP) mmHg can be deduced.
- Positive (+dP/dt) and negative (-dP/dt) derivatives of left ventricle pressure which represent an index of contraction kinetic and ventricular relaxation. They are expressed in mmHg/s.

2.5. Regional Ischemia/Reperfusion Protocol

A 5-0 silk snare was passed under the left-coronary artery close to its origin. After 15-min equilibration period and normoxic perfusion, the left coronary artery was occluded by tightening the snare for 30 minutes and then reperfused for 120 minutes.

All hearts were kept at 37° C in a thermostatically controlled glass chamber throughout the experiment protocol. For each heart, coronary flow was measured and myocardial function was recorded after 15-min stabilization and then every 10 minutes (Guiraud et al., 2004; Guiraud et al., 2008; Toufekstian et al.; 2008).

After 120 minutes of reperfusion and retightening of the coronary snare, a solution of Evans Blue was injected through the aorta to delineate the non-stained risk zone (RZ). The hearts were then briefly frozen in liquid nitrogen and stored at -20°C.

2.6. Histoenzymology coloration

The frozen hearts were cut with a multi-blades scalpel into 6 to 8 transverse slices of 1mm thickness. Slices were rinsed in NaCl 0.9% and then incubated in 1% TTC in sodium phosphate buffer (Na_2HPO_4 0,2 M; NaH_2PO_4 0,2 M; equilibrated to pH 7,4 avec NaOH 6 N) at 37° C during 20 minutes to stain viable cells in the risk zone. Slices were then rinsed in NaCl 0.9%, and stored 4 days in formol 10% (pH 7.4).

In every slice, it is possible to distinguish (Figure 31): a normo-perfused zone (colored with blue Evans), the risk zone (red and white color) formed of the non infarcted ischemic zone (red) and the infarcted zone (white).

The slices are weighed, scanned (scanner Scan Wise, Kodak) and the area of each colored zone was calculated using image software (NIH AutoExtractor 1.51). Volumes of risk zone (RZ) and infarct zone (IZ) are calculated using the formula: Σ (area of the zone concerned x weight of the slice). The RZ is expressed as a percentage of the total ventricular mass (VT) and IZ is expressed as a percentage of the RZ (Guiraud et al., 2004; Guiraud et al., 2008; Toufekstian et al.; 2008).

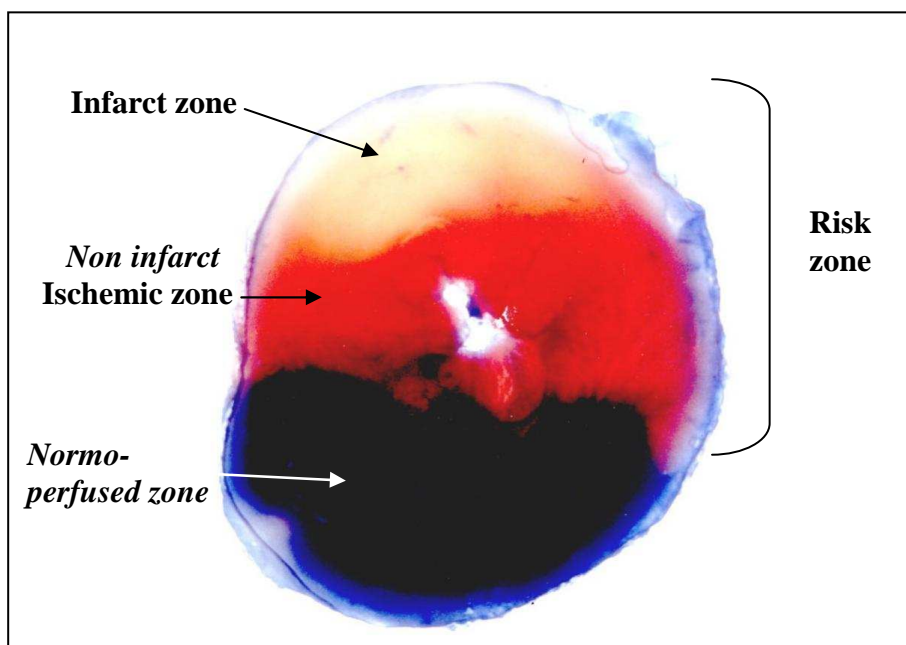

Figure 31: TTC Histoenzymology coloration.

III. Samples Preparation

3.1. Preparation of blood samples

Blood sampling was carried out in the morning on anesthetized non-heparinized rats. After excision of the heart for mitochondria preparation, a sample of blood was immediately taken in the ribcage. The blood sample, collected on EDTA tube, was centrifuged at 1500g for 10 minutes at 4 °C. The plasma was aliquoted and the red cells were washed 2 times with a saline solution, centrifuged after each wash at 1500g for 10 minutes at 4 °C. The erythrocyte clot was removed and aliquoted. Plasma and erythrocytes samples were kept at -80 °C until lipid analysis.

3.2. Mitochondria preparation

Cardiac mitochondria were isolated using an enzymatic digestion and differential centrifugations (Saks *et al.*, 1985). All steps of this protocol should be done at 4 °C. Two rats were used to collect an adequate amount of mitochondrial samples.

After anesthesia, hearts were removed and placed in solution A (Table 13). The hearts were cleaned then cut in half and washed several times in buffer A to avoid contamination of the sample by the endothelium (endothelial cells, smooth muscle cells, and fibroblasts), red cells and other blood cells. The ventricular tissue (about 2 g) was put into a cup, minced very finely with scissors and then placed in a solution of trypsin (buffer B). After 30 min of enzymatic digestion, the protease was inactivated by the addition of trypsin inhibitor (buffer C). The lysate was then grounded into a glass Potter–Elvehjem (Figure 32) with a Teflon piston (clearance 0,7-0,8 mm) followed by 4-5 centrifugations at 200 rpm. The homogenate was then diluted with buffer D.



Figure 32: Potter–Elvehjem.

Homogenate was centrifuged for 10 min at 600g and the supernatant was decanted and centrifuged at 8000g for 15min to obtain the mitochondrial pellet. The upper layer was discarded and the tightly packed dark pellet was resuspended and washed 3 times.

Mitochondria were purified on a discontinuous gradient consisting of 6% percoll, 17% and 35% metrizamide (Storrie and Madden, 1990). After 30 min centrifugation at 50000g, a narrow band was recuperated to sediment mitochondria for 10 min at 8000g. The mitochondrial fraction was recuperated between metrizamide 35% and metrizamide 17% then was washed in buffer E, 10 minutes at 8000g. Purified mitochondria were resuspended in 200 µl buffer G then aliquoted and stored at -80 °C.

Table 13: Buffers composition used for mitochondria isolation.

Buffers	Compounds	Concentrations	pH
A	Sucrose Hepes EDTA	0,3 M 10 mM 0,2 mM	pH 7,2 (KOH)
B	Buffer A trypsin	0,0125 % (w/v)	pH 7,2 (KOH)
C	Buffer A Free fat BSA Inhibitor trypsin	0,1 % (w/v) 0,065 % (w/v)	pH7,2 (KOH)
D	Buffer A BSA	0,1 % (w/v)	pH 7,2 (KOH)
E	Sucrose Hepes EDTA Free fat BSA	0,3 M 10 mM 0,2 mM 0,1 % (w/v)	pH 7,4 (KOH)
F	Sucrose Hepes EDTA Free fat BSA	0,25 M 10 mM 0,2 mM 0,1 % (w/v)	pH 7,4 (KOH)
G	Tris HCl	10mM	pH 7,4 (KOH)
Metrizamide 35%	Metrizamide Buffer F	35% (w/v)	pH 7,4 (KOH)
Metrizamide 17%	Metrizamide 35% Buffer F	17% (w/v)	pH 7,4 (KOH)
Percoll 6%	Percoll Buffer F	6% (v/v)	pH 7,4 (KOH)

IV. Determination of proteins

The determination of mitochondrial proteins was realised using the Coomassie Protein Assay Reagent kit (Pierce, Rockford, Illinois, USA). A method derived from the Bradford method (Bradford, 1976) was used to quantify the total proteins of a sample. The principle is based on a colour reaction conducted under acidic medium and produced by the binding of the blue reagent of Coomassie to proteins. A brown colour changes to blue with a modification of the maximum absorption of 465 nm to 595 nm.

A standard series of bovine serum albumin (BSA) from 0.03 to 1 g/l was prepared then 10 µl of each standard concentration: 0.03, 0.06, 0.12, 0.25, 0.5 and 1 g/l, were deposited in triplicate on a micro-plate. After addition of 200 µl of reagent, the plate was agitated before measuring the optical density at 595 nm.

The mitochondrial sample was first diluted to 1/50, 1/100 and 1/200, and then the same protocol as that described for standards was applied. Afterwards, the protein concentration was determined by transposing the optical density of the sample on the standard curve:

$f(\text{Abs}_{595}) = \text{concentration BSA}$.

V. Determination of fatty acid profile

Lipids and fatty acid composition of plasma and erythrocyte phospholipids as well as fatty acid composition of mitochondrial phospholipids were analyzed by Gas Chromatography (GC) (Figure 33).

Fatty acid methyl esters were separated and quantified on a Hewlett Packard gas chromatograph Model 5890. This apparatus consists of a flame ionization electronic detector connected to a recorder and a column (column ALLTECH, phase AT-WAX: length = 30 m, inner diameter = 0, 25 µm, film thickness = 0.25 µm). The column is a tube filled with porous grains of very polar resin (75% cyano-propylphenyldiethylsiloxane) representing the stationary phase responsible for retaining the sample molecules depending on their size and their electrical charge.

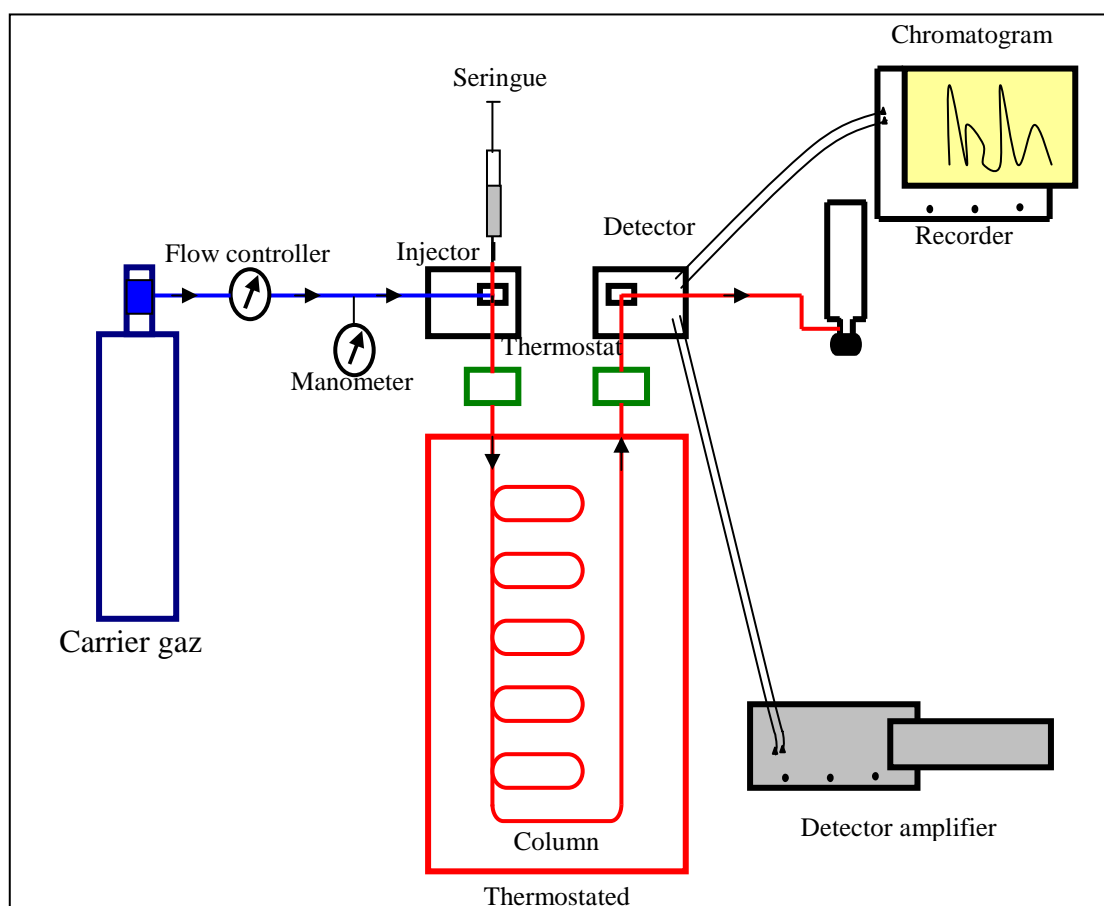

Figure 33: Gaz chromatography.

- **Total lipid extraction**

Total lipids were extracted with the presence of an internal standard (heptadecaenoic acid C17:0) by a solvent mixture: hexane / isopropanol (Hara and *al.*, 1978) in a single-phase system to avoid a loss of acid phospholipids, the more acidic of the aqueous phase (Koloravoric et *al.*, 1986).

- **Lipid saponification and fatty acid methylation**

Fat extract was totally evaporated with nitrogen, and then lipids were saponified with methanolic sodium hydroxide. The free fatty acids were then methylated with boron trifluoride methanol (Rockerbie et *al.*, 1979).

- **Fatty acids extraction and GC**

Methylated fatty acids were extracted with heptane, dissolved in a low volume of hexane and then injected into the gas chromatograph. The peaks were identified and quantified using a standard mixture and an internal standard carefully calibrated and processed under similar conditions.

VI. Fatty acid analyses of plasma and erythrocytes

Lipid profile of the blood provides important information about the diet. The fatty acid profile of plasma (free fatty acids, triglycerides, cholesterol esters and phospholipids) is a very effective index of the essential fatty acids status (Siguel *et al.*, 1987) and their metabolism (Lepage and *al.*, 1989) while, the fatty acid profile of erythrocytes is an indication of the lipid composition of cell membranes.

Reagents

- Fatty acid standards (Table 14)
- Internal standard: heptadecanoic acid (100 µg/ml d'heptane)
- Physiological serum
- Extraction solvent: hexane/isopropanol 3:2 (v/v)
- Methanolic sodium hydroxide 0,5 M
- Boron trifluoride methanol 14%
- NaCl 5,65 M
- Heptane
- Hexane

6.1. Total lipids extraction

200 µl of internal standard was dried in a test tube under nitrogen. Aliquots of 150 µl plasma or 400 µl erythrocytes were added. The volume was completed to 500 µl with saline solution and 8 ml hexane/ isopropanol were added. After vortexation and rotary agitation (30 min), the tube was centrifuged at 3000g during 10 min at 4 ° C. The upper phase (7 ml) was aspirated and evaporated under nitrogen while the remaining phase was rinsed with 4 ml hexane / isopropanol. The tube was vortexed, agitated 15 minutes and centrifuged (3000g, 10 min at 4 ° C). The upper phase (4 ml) is collected, added to the previous fraction, and then evaporated under nitrogen.

6.2. Total lipid saponification and fatty acid methylation

1 ml methanolic NaOH was added to the dry extract. The tube was vortexed and placed in an oven at 100 °C for 10 min. Methylation was achieved by addition of 700 µl boron trifluoride methanol at 14%, the test tube was vortexed then heated during 10 minutes at 100 °C.

Table 14: Fatty acid composition of the standard mixture.

<i>Fatty acids standards</i>	<i>Nomenclature</i>	<i>Final concentration (µg/ml heptane)</i>
C14:0	Myristic acid	10
C16:0	Palmitic acid	50
C16:1ω-7 cis	almitoleic acid	10
C18:0	Stearic acid	10
C18:1ω-9 cis	Oleic acid	50
C18:1ω-7	<i>cis</i> vaccenic acid	10
C18:2ω-6 cis	Linoleic acid	40
C18:3ω-6 cis	gamma linolenic acid	10
C18:3ω-3	Linolenic acid	20
C20:0	Arachidic acid	10
C20:2ω-6	Eicosadienoic acid	10
C20:3ω-9	Eicosatrienoic ω-9 acid	10
C20:3ω-6	Gamma homo linolenic acid	10
C20:4ω-6	Arachidonic acid	10
C20:5ω-3	Eicosapentaenoic acid	10
C22:4ω-6	Docosatetraenoic acid	10
C22:5ω-3	Docosapentaenoic acid	10
C22:6ω-3	Docosahexaenoic acid	10

6.3. Extraction of methylated fatty acids and GC

Methylated fatty acids were extracted with 2 ml saturated NaCl (retention of salts in the bottom of the tube) and 5 ml of heptane (recovery of lipids in the upper phase). The tube was vortexed, rotating agitated during 15 minutes and centrifuged at 3000g, for 10min at 4 °C. The upper phase (4 ml) was collected and dried under nitrogen. The dry extract of methylated fatty acids was dissolved in 250 to 300 µl hexane. One µL of this solution was then injected into the column.

To facilitate a better separation, the initial temperature of the oven of the chromatogram was 50 °C and then progressively increased at the following levels:

- 1) 50 °C / min up to 140 °C
- 2) 1.4 °C / min up to 165 °C
- 3) 4 °C / min up to a maximum temperature of 250 °C maintained for 15 minutes.

6.4. Standard mixture analyses

6.4.1. Fatty acid methylation

In a test tube, 200 μ l internal standard and 500 μ l standard mixture were dried under nitrogen. 200 μ l boron trifluoride methanol at 14% were added. The tube was placed in an oven at 100 °C for 10 min.

6.4.2. Extraction of methylated fatty acids and GC

Methylated fatty acids were extracted with 1 ml of distilled water and 2 ml of heptane. The tube was vortexed and agitated with a rotary shaker for 10 minutes. The sample was then centrifuged at 3000g, for 10 min at 4 °C. The upper phase (1.6 ml) was collected and evaporated under nitrogen. The methylated fatty acids were dissolved in a volume of 200 μ l hexane. 1 μ l of this mixture was injected into the column. The programmed temperature of the oven was the same as for the sample.

6.4.3. Peaks identification and expression of results

Methyl ester peaks were identified by comparing their retention times to those of a standard mixture and the internal standard. The chromatogram displays the area of each peak. From these data, each fatty acid was expressed as a percentage of total fatty acids according to the formula:

$$\text{Fatty acid } \lambda \text{ (\%)} = \left[\frac{\text{Peak area of fatty acid } \lambda}{\text{Sum of the area of all peaks of fatty acids}} \right] \times 100$$

6.5. Fatty acid composition of mitochondrial phospholipids

Mitochondrial phospholipids

phosphatidylcholine and phosphatidylethanolamine are the main phospholipids of cardiac mitochondria, they account for approximately 80% of total phospholipids (Table 15). Regarding to cardiolipin, the specific phospholipid of mitochondria, it accounts for 10 to 20% of total phospholipids. Cardiac mitochondria contain small amount of phosphatidylglycerol, the precursor of cardiolipin except in beef cardiac mitochondria (Wheeldon *et al.*, 1965). Mitochondria contain also 1 to 6 % of phosphatidylinositol and 1 to 3% of phosphatidylserine, phosphatidic acid, lysophosphatidylcholine and sphingomyelin.

Tableau 15: Phospholipidic composition of cardiac mitochondria in various mammals.

Source (reference)	Phospholipids (% total phospholipids)								
	PC	PE	CL	PI	PS	Pac	LPC	SM	PG
Rat (Palmer <i>et al.</i> , 1981)	41	44	8	3	1	-	1	1	-
Pig (Comte <i>et al.</i> , 1976)	42	31	18	5	-	-	1	2	1
Sheep (Getz <i>et al.</i> , 1968)	43	35	10	1	1	2	-	2	4
Beef (Wheeldon <i>et al.</i> , 1965)	38	30	16	6	1	-	-	3	11
Rabbit (Nagatamo <i>et al.</i> , 1980)	40	41	11	1	1	-	3	2	-
Human (Ansell and Spanner, 1968)	43	34	18	5	-	-	-	-	-

Pac: phosphatidic acid; CL: cardiolipine; LPC: lysophosphatidylcholine; PC: phosphatidylcholine; PE: phosphatidylethanolamine; PG: phosphatidylglycerol; PI: phosphatidylinositol; PS: phosphatidylserine; SM: sphingomyelin.

Although the inner and outer mitochondrial membranes are linked, these two membranes have different composition. Indeed, the phospholipids/proteins ratio is much higher in the outer membrane than in the inner membrane since the external membrane contains more lipids than the inner one. The phospholipidic composition is also different between these two membranes (Table 16).

Tableau 16: Phospholipidic composition of mitochondrial inner and external membranes of pig heart (Comte *et al.*, 1976).

	Phospholipides (% phospholipides totaux)						
	PL	PC	PE	CL	PI	LPC	SM
Inner membrane	310	27	38	25	3	2	1
External membrane	510	56	28	<1	9	1	5

CL: cardiolipin; LPC: lysophosphatidylcholine; PC: phosphatidylcholine; PE: phosphatidylethanolamine; PI: phosphatidylinositol; PS: phosphatidylserine; SM: sphingomyelin.

Fatty acid composition of mitochondrial phospholipids

The composition in fatty acids of mitochondrial phospholipids is different between each phospholipid (table 17). Cardiolipin for example is excessively rich in linolic acid, while phosphatidylethanolamine is very rich in stearate and very long chain polyunsaturated fatty acids; mainly in DHA and AA. Regarding the other fatty acids, the composition deffers between species. For instance, the phosphatidylethanolamine of rat heart is rich in palmitate (Palmer *et al.*, 1981) while that of beef is rich in linoleic acid (Wheeldon *et al.*, 1965). About phosphatidylcholine, 30% of total fatty acids are represented by palmitate and oleic acid. For the remained fatty acids, differences exist between the species. In the rat for example, the phosphatidylcholine contains approximately 50% of AA and stearate while LA represents almost 40% of the fatty acids of beef phosphatidylcholine.

Biosynthesis and degradation of mitochondrial phospholipids

The mitochondrial membranes undergo continuously a lipidic remodeling. The majority of phospholipids of the inner and outer membranes are synthesized in the sarcoplasmic reticulum. The inner membrane catalyses the conversion of the phosphatidylserine into phosphatidylethanolamine via the phosphatidylserine decarboxylase. Likewise, the synthesis of cardiolipin takes place in the inner membrane. The phospholipids synthesized in the sarcoplasmic reticulum are transferred in the mitochondria to the membrane junctions with the reticulum called MAMs (mitochondria-associated membranes) (Achleitner *et al.*, 1999; Vance and Shiao, 1996). The phosphatidyléthanolamine can turn over in the reticulum to be methylated and form the phosphatidylcholine (Vance and Shiao, 1996).

Phospholipases are present in all cellular membranes. In mitochondria, phospholipases are in charge to hydrolyze mitochondrial membrane phospholipids. For instance, phospholipase A1 is located on the external face of the outer mitochondrial membrane (*Palmer et al., 1981*) and phospholipase A2, a Ca²⁺-dependent phospholipase located on the matrix side of the inner mitochondrial membrane (*Nimmo et al., 1979*).

Tableau 17: Fatty acid composition of the three main mitochondrial phospholipids of rat heart (*Palmer et al., 1981*) and beef heart (*Wheeldon et al., 1965*) (% total fatty acids).

	Phosphatidylcholine	Phosphatidylethanolamine	Cardiolipin
C14:0			
Rat	0,1	0,2	0
Beef	-	-	-
C16:0			
Rat	19,7	8,5	0,4
Beef	22,6	1,8	1,3
C16:1 ω-7			
Rat	0,2	0,1	0,3
Beef	2,2	0,0	2,5
C18:0			
Rat	23,5	29,1	0,1
Beef	5,5	32,8	0,0
C18:1 ω-9 (OA)			
Rat	10,1	6,0	3,1
Beef	13,5	4,4	9,0
C18:2 ω-6 (LA)			
Rat	15,7	7,5	94,4
Beef	36,7	15,6	84,0
C18:3 ω-3 (ALA)			
Rat	-	-	-
Beef	2,5	0,8	2,7
C20:3 ω-6			
Rat	0,3	0,1	0,5
Beef	5,9	3,6	0,0
C20:4 ω-6 (AA)			
Rat	21,3	19,2	0,5
Beef	9,7	36,3	0,0
C20:5 ω-3 (EPA)			
Rat	0,4	0,4	0,0
Beef	1,1	4,7	0,0
C22:4 ω-6			
Rat	0,4	0,5	0,0
Beef	-	-	-
C22:5 ω-3 (DPA)			
Rat	1,9	2,6	0,2
Beef	-	-	-
C22:6 ω-3 (DHA)			
Rat	5,5	23,9	0,5
Beef	-	-	-

6.5.1. Separation of phospholipids

After lipid extraction, mitochondrial phospholipids were separated from the total lipid extract by thin layer chromatography on silica gel plates with chloroform/methanol/water solvent. Phosphatidylcholine (PC), phosphatidylethanolamine (PE) and cardiolipine (CL) spots were scraped directly into test tubes, dissolved in chloroform/methanol, evaporated under nitrogen and mixed with heptadecanoic acid (Comte et *al.*, 1971). Afterwards, the same method used for blood fatty acid analysis was applied.

Reagents

- Physiological serum
- Extraction solvent: hexane/isopropanol 3:2 (v/v)
- Chloroform/methanol 2:1 (v/v)
- Migration solvent: chloroform/methanol/water 65:25:4 (v/v)
- Rhodamine B 0,005% (w/v) in distilled water
- Iodine solution 1,25% (w/v) in methanol
- Internal standard: heptadecanoic acid 100 µg/ml heptane
- Phospholipid standards mixture 1mg/ml in chloroform/methanol

6.5.2. Total lipid extraction

In a glass tube, 400 µl physiological serum and 8 ml hexane/isopropanol were added to 100 µl of mitochondrial suspension. The extraction of total lipids was identical to that previously described. At the end of the extraction, dry extract was washed with 3 ml of chloroform/methanol. After centrifugation at 3000 g for 10 minutes at 4 °C, the upper phase (2.5 ml) was collected and evaporated under nitrogen.

Thin Layer Chromatography (TLC)

A volume of 150 ml of migration solvent was placed at the bottom of the chromatography tank (Figure 34) in which a filter paper was left to saturate at least 1 hour to obtain a homogeneous atmosphere and thus a uniform migration of all deposits.

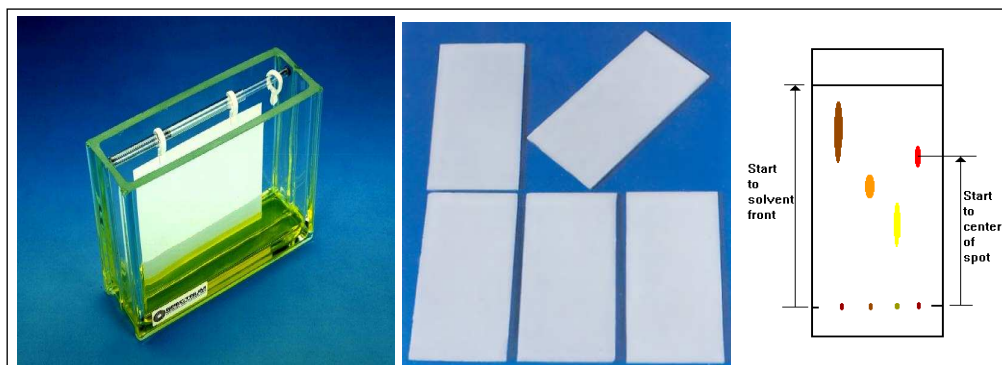

Figure 34: Thin layer chromatography.

The silica gel plate chromatography (Merckeurolab, Fontenay-sous-bois, France) was activated by heating in an oven at 100 °C for 20 min.

The mitochondrial dried extract was rinsed with 500 μ l chloroform/methanol. After evaporation, the sample and 4 standard mixtures were dissolved in 100 μ l chloroform/methanol and deposited on the plate (sample = 40 μ l, standards = 20 μ l).

The plate was then placed in the migration tank. When the solvent reached 0.5 cm from the upper edge of the plate, the migration of phospholipids was complete.

Spot revelation and identification

A solution of Rhodamine B 0.005% was spread on the plate and showed the following colorful spots:

Purple: cardiolipin (CL), phosphatidylethanolamine (PE), phosphatidylinositol (PI), phosphatidylserine (PS)

Orange-pink: L- α lysophosphatidylcholine (LPC), phosphatidylcholine (PC), sphingomyelin (SM)

Pink: phosphatidylserine (PS)

The spray of iodine solution 1.25% colored in brown unsaturated substances, fatty acids esters and nitrogen lipids. The quantitatively important phospholipids absorbed more iodine and appeared in more intense color.

The fitting spot was carefully delineated with a scalpel, scraped with a spatula and the silica powder was recovered in a glass tube. After adding 4 ml of chloroform/methanol, the tube was vortexed and centrifuged at 3000g for 10 minutes at 4 °C.

The solvent was transferred into a tube containing 200 μl internal standard C17:0 and evaporated for GC analysis.

Before injection, dry methylated fatty acids were dissolved in a volume between 50 and 150 μl hexane. The programming chromatograph is identical to that described for blood fatty acid analysis.

6.5.2. Quantitative analysis of mitochondrial phospholipids

The TLC-FID Iatroscan (Iatron laboratory, Tokyo, Japan) is a technique involving the thin layer chromatography to a Flame Ionization Detector which can make quantitative analyses on complex mixtures of lipids (Hiramatsu *et al.*, 1980; Kaimal et Shanta, 1984; Rao *et al.*, 1985). The Iatroscan method is divided into several steps: lipids extraction, dilution in chloroform/methanol, and deposit on rods (thin bars in quartz impregnated with silica gel Chromarod S-III, Iatron laboratory, Tokyo, Japan). After migration in appropriate solvents, the substances put on rods were burned in the DIF (Figure 35). Detected compounds were represented by peaks. Abundant compounds represented greater surface. The retention time was used to identify each peak of the mixture. A standard curve helps then to quantify each compound.

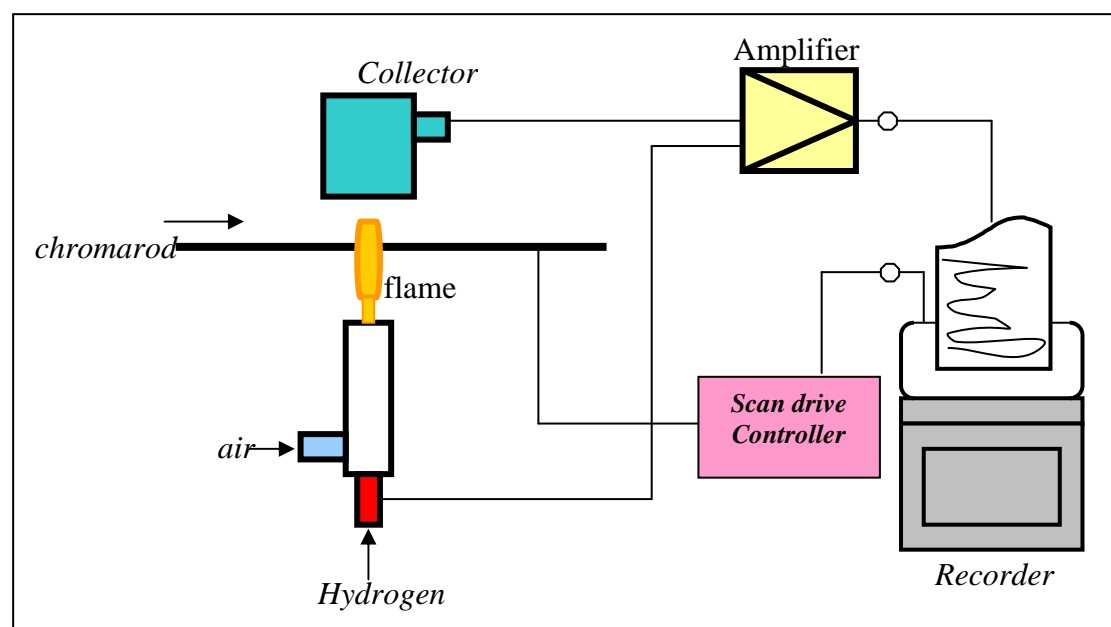

Figure 35: Principle of Flame Ionization Detector.

Reagents

- Physiological serum
- Extraction solvents: hexane/isopropanol 3:2 (v/v)
- Chloroform/methanol 2:1 (v/v)
- Saturated NaCl 33% (w/v) in distilled water
- Migration solvents for neutral lipids: hexane/ ethylic ether / formic acid 175:24:0,4 (v/v)
- Migration solvents for phospholipids: chloroform/methanol/water/formic acid 160:80:8:1 (v/v)
- Saturated NaCl 5,65M (33g NaOH/100 ml distilled water)
- Internal standard: cholesterol acetate (1mg/ml d'heptane)
- Phospholipids standards mixture: CL, LPC, PC, PE, PI, PS et SM (increasing concentrations from 0,25 to 2 mg/ml in chloroform/methanol)

6.5.2.1. Total lipid extraction

The method was similar to that described in 5.2.1., cholesterol acetate was used as internal standard.

Preparation of chromatography tanks

- Tank of conditioning rods: a volume of 150 ml of saturated NaCl (33%) and a paper of saturation were deposited in the chromatography tank to ensure a constant humidity on the rods.
- Dual tank system for neutral lipids and phospholipids: a small tank placed in a large one containing 90 and 100 ml respectively of appropriate migration solvent (see reagents above). Three sides of the bigger tank were wrapped by saturation paper. The fourth saturation paper was placed in large tank before being placed in the container 15 minutes before the migration. This process allows a good solvent saturation in the small tank and better migration reproducibility.

The rods were burned by Iatrosan 1 to 2 times to ensure their cleanliness. The lipid extract was dissolved in 200 µl chloroform/methanol and then deposited on rods.

Neutral lipid migration

The rods were placed in the conditioning tank for 10 min before being placed in the small tank of neutral fat for 30 min at 20 °C. After 5 min drying at 100 °C, the rods were placed in the Iatroscan to be burned. At the end of this migration, the retention time of internal standard was obtained.

Phospholipid Migration

After neutral fat burning, the rods were introduced in the small tank of phospholipids. After 45 minutes of migration, the rods were dried 5 minutes at 100 °C and burned in Iatroscan. After this second migration, the different phospholipids were separated according to their hydrophobicity. The more polar phospholipids migrate further: LPC> SM> PC> IP> PS> PE> CL.

Calibration Curve

Every standard mixture (0.25 to 2.00 mg / ml) was mixed with the internal standard (1 mg / ml) and processed in conditions similar to those of the sample. A standard curve was then compiled from the chromatograms of the internal standard and corresponding standard mixture. The y-axis represented the ratio of peak surfaces (area of standard mixture peak / surface internal standard peak) while x-axis represented the ratio of the concentrations (concentration of lipid mixture standard / concentration of the internal standard).

Phospholipid Quantification

For each peak identified as mitochondrial phospholipid, a ratio of surface (peak surface of mitochondrial phospholipid / peak surface of internal standard) was calculated. The value was plotted on a standard curve to determine the concentration of each mitochondrial phospholipid. Results were expressed in µg/mg proteins (dosage made before extracting lipid and according method described in Section V) and in % of total phospholipids.

VII. Blood fatty acids analysis

7.1. Total Cholesterol (TC)

The determination of total cholesterol (free cholesterol + esterified cholesterol) was done using a cholesterol assay Kit PAP 500 (Bio Mérieux, Marcy l'étoile, France) based on the following enzymatic method (Richmond, 1973; Allain et al., 1974):

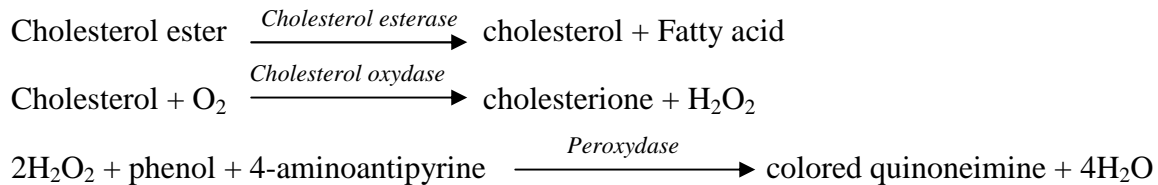

Reagent 1 (peroxidase 100 U/I, cholesterol oxidase 200 U/I, cholesterol esterase 125 U/I, 4-aminoantipyrine 0.5 mM) was mixed with reagent 2 (3-*N*-morpholino propanesulfonic acid buffer (MPOS) 50 mM, phenol 15 mM, sodium cholate 3,74 mM).

10 µl sample were added to 1 ml of the reaction mixture reagent 1-reagent 2. After an incubation period of 10 minutes at room temperature, the optical density was measured at 500 nm. The standard serum was processed under similar conditions. From these results, we calculated the concentration of TC according to the formula:

$$[\text{TC sample}] = (\text{OD sample} / \text{OD standard}) \times [\text{standard}]$$

7.2. HDL-cholesterol

The determination of HDL-cholesterol was realised using the direct HDL cholesterol kit (Bio Mérieux, Marcy l'étoile, France). The principle is based on the adsorption of all lipoproteins (except HDL-cholesterol) by the synthetic polyanions present in the first reagent, thus converting these lipoproteins in a stable form. Regarding free HDL particles, they are solubilized by the detergent of the first reagent, which will allow to determine cholesterol coming from the HDL fraction by enzymatic pathways in the presence of cholesterol oxidase and cholesterol esterase.

The protocol is similar to that described in 6.4.1. with the exception of reagents.

Reagent 1: polyanion, 4-amino-antipyrine 0,67 mM, MES buffer, conservator.

Reagent 2: cholesterol oxydase 1,6 UI/ml, cholesterol esterase 1,25 UI/ml, peroxydase, detergent, sulfutyl toluidine 1mM, MES buffer, conservator.

7.3. Triglycerides

The mix of triglycerides was done using the enzymatic triglyceride kit PAP 1000 (Bio Merieux, Marcy l'Etoile, France) based on the following enzymatic method (Fossati and Prencipe, 1982):

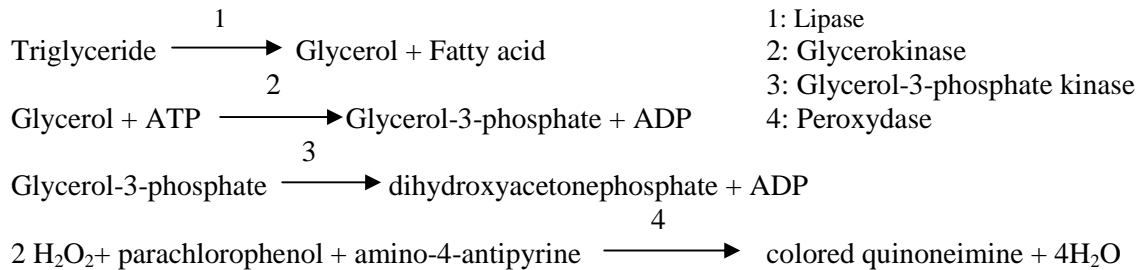

The protocol was similar to that described in 6.4.1. with the exception of reagents.

Reagent 1: Buffer TRIS pH 7,6 100 mM, parachlorophenol 2,7 mM, magnesium 4 mM

Reagent 2: lipase 1000 UI, glycerokinase 200 UI, glycerol-3-phosphate oxydase 2000 UI, peroxydase 200 UI, ATP 0,8 mM.

VIII. Statistics

Data were expressed as mean ± SEM. Statistical analyses were performed using Stat View software (Abacus Concepts, Inc., Berkeley CA, 1992). Measurements were analyzed by ANOVA with between group differences tested by post-hoc application of Tukey's test. For all tests, p<0.05 was considered significant.

PART II

Plant and Marine Omega-3 fatty acids and ventricular arrhythmias in French patients with Implantable Cardioverter Defibrillators “*the Grenoble city Omegadef Study*”

I. Clinical research in France

France has one of the best health care systems in the world according to the World Health Organization. This international acclaim is built upon a highly reputed clinical research sector as well as a strict, but clear and simple regulatory and legislative framework.

The implementation of clinical trials in France has been restricted since 1988 by law n° 88-1138 of December 20, 1988 known as the “Huriet-Sérusclat” law and its decree of application, the purpose of which is to protect persons who are acting as subjects for clinical research. This law gives a patient freedom to choose whether or not to be part of a clinical trial and this without committing himself for the whole duration of the trial.

This legislative and legal provision was modified by the transposition in French law of European directive 2001/20/EC of April 4, 2001 relating to the application of good clinical practice in the control of clinical trials of drugs for human use.

During this transposition, new provisions aimed at standardizing the level of public protection for whatever the health product biomedical research (RBM) is. The regulation of RBM over medical devices and medical devices in vitro diagnostic was thus modified.

The new provisions were introduced by law n° 2004-806 of August 9, 2004 relating to public health policy and its decree of application n° 2006-477 of April 26, 2006, and by the decrees and decisions relative to it. The whole texts came into force as from August 27, 2006 (Ministry for Health and Solidarity, 2006).

Before the trial starts, the practitioner is obliged to explain the purpose of the experiment (its objectives, methodology, duration, limitations and risks). The principal concerns and requirements of this law are that clinical trials be based upon the most up-to-date scientific knowledge, the necessity of obtaining the subject's consent, and the advice from the regional Committee for the Protection of Persons (CPP). Any error in the application of this law may lead to penalties, both for the investigator and the program director.

Ethics Committees (CPP - Comité de Protection des Personnes): These **Ethics Committees** are independent committees made up of representatives from the medical and paramedical professions as well as persons outside the health fields (legal expert, persons qualified in ethics and social matters), to whom all research projects must be submitted for an opinion. Their role is to examine the study protocol and deliver an opinion on the conditions of validity of the research in respect of the protection of subjects, payment rendered, the scientific relevance of the project, the adequacy of the means in relation to the objectives, and the qualifications of the investigator(s).

II. Study design

The ω -3 PUFA have been demonstrated to have antiarrhythmic properties in experimental models and to prevent fatal ventricular arrhythmias and sudden cardiac death in high-risk patients. Therefore, our objective was to determine whether omega-3 PUFA may be associated with beneficial antiarrhythmic effects in high-risk patients.

This observational study was performed at Grenoble University Hospital from June 2004 until July 2007. Three groups of investigators participated in this study:

- Departement of Cardiology at Grenoble University Hospital (Pr J. Machecourt and Pr G. Vanzetto);
- Department of Integrated Biology CHU (DBI) (Pr A. Favier);
- “Coeur & Nutrition” laboratory (Pr J. de Leiris and Pr F. Boucher);
- The principal investigators were P. Defaye and M. de Lorgeril, and G. Vanzetto was co-investigator.

Two hundred thirty eight patients with implantable cardioverter defibrillators (ICDs) who were at high risk for fatal ventricular arrhythmias were included. The research protocol was approved by the regional Consultative Committee for the Protection of Persons in Medical Research (CCPPRB) in accordance with “Huriet-Sérusclat” law and a written fully informed consent (see below) was obtained from all participants before inclusion.

Consecutive patients in whom an ICD has been implanted for primary or secondary prevention of sudden cardiac death were eligible. Inclusion criteria were heart disease due to ischemic and non-ischemic cardiac diseases. Exclusion criteria included the age of patients (<18), major modification in their diet and/or omega-3 fatty acids supplementation after blood sampling. At each visit for routine follow-up of the ICD, patients were asked about major changes in their diet and about intake of omega-3 capsules.

All subjects underwent blood sampling for lipid profile analysis, and answered a questionnaire concerning their medication and their usual omega-3 fatty acid intakes notably fish consumption (Report form). Included patients were followed for at least 12 months. Routine follow-up of the ICD was scheduled every 6 months or once a year. At each visit, an ICD interrogation was performed. Ventricular arrhythmias as requiring ATP or shock therapy as well as ventricular fibrillation were documented. A printout of each episode of ICD therapy was reviewed by the local investigators and a report was then written. All clinical data were recorded in a customized case report form (see below).

III. Laboratory methods

3.1. Blood analysis and fatty acid determination

Blood samples for measurement of fatty acid composition were collected into EDTA. They were separated into plasma and packed cells by centrifugation and kept frozen at -70°C until extraction of Fatty acids could be performed. At this temperature, the composition of RBC FAs has been demonstrated to remain stable for at least 4 years (Hodson *et al.*, 2002). After thawing, omega-3 fatty acids were analyzed by direct methylation of red blood cells. Fatty acids methyl esters thus generated were analyzed by capillary gas chromatography as previously described in section VI.

3.2. Omega-3 index determination

The “Omega-3 index” is the combined percentage of EPA and DHA of total fatty acids in red blood cell membranes (Harris and von Schacky, 2004). Harris and von Schacky (2004) proposed that the content of EPA + DHA in RBC membranes (expressed as a percent of total fatty acids) be considered a new risk factor for death from CHD and especially SCD because red blood cell (RBC) membranes reflect cardiac membrane omega-3 fatty acids content.

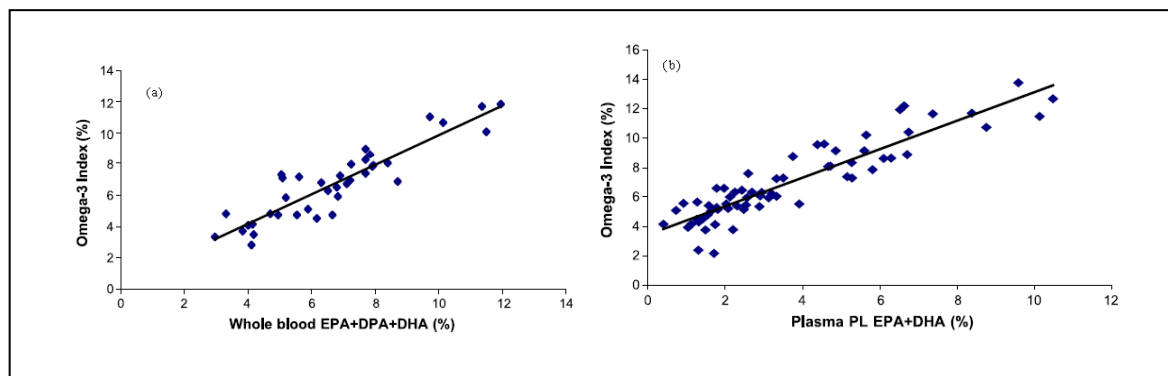

Figure 36. The Omega-3 Index: (a) vs. whole blood long chain omega-3 FA, (b) vs. plasma phospholipid (PL).

Omega-3 index correlates well with other biomarkers of omega-3 fatty acid intake. These biomarkers that are highly correlated with the omega-3 index include the concentration of total long-chain ω -3 PUFA (EPA+ DPA+ DHA) in whole blood (Albert *et al.*, 2002), of EPA+ DHA in plasma phospholipids (Figure 36) (Lemaitre *et al.*, 2002), and of EPA in serum cholesterol esters (Erkkila *et al.*, 2003).

The omega-3 index may also be an independent risk factor compared with estimated dietary intake of ω -3 PUFA (Siscovick et al., 1995) due to the difficulty in the assessment of real dietary EPA + DHA intake (due to fish containing varying amounts of EPA and DHA) or to individual differences related to incorporation, metabolism, or genetic variability (Harris and von Schacky, 2004).

Harris and von Schacky (2004) proposed that the “omega-3 index” be considered a new risk factor for death from CHD. They also suggested preliminary targets or cut-points to segregate those at low, intermediate and high risk based on a combination of a survey of the literature and correlations between intakes and omega-3 index levels determined experimentally. They estimated that a cardioprotective target level for the omega-3 index appeared to be about 8%, and the level associated with the increased risk for CHD death was <4% (Figure 37). Omega-3 index can quickly and easily be increased simply by consuming more long-chain omega-3 FA.

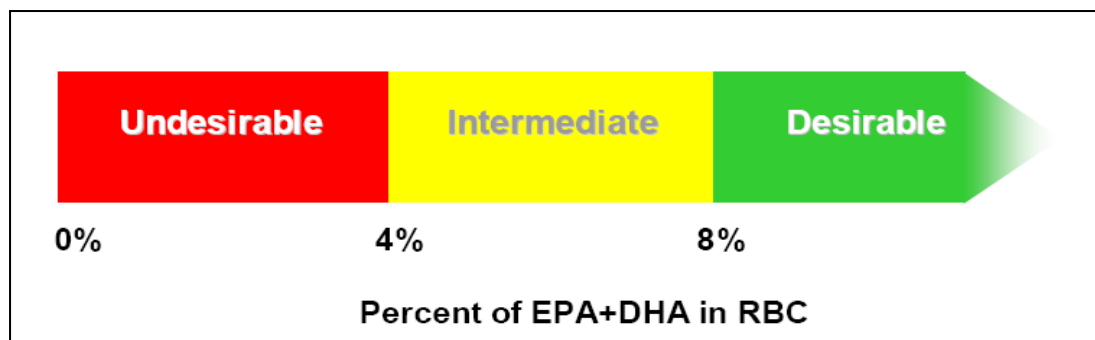

Figure 37: Proposed Risk Zones for the Omega-3 Index (Harris and von Schacky, 2004).

The widespread clinical implementation of the omega-3 index will allow clinicians to detect omega-3 “insufficiency”, to better stratify patients with respect to risk for CHD death and may be SCD, and could ultimately contribute to a reduced burden of CHD (Harris, 2007).

Harris and von Schacky (2004) defined the omega-3 index as the combined percentage of EPA and DHA of total fatty acids in red blood cell membranes (RBC). They recommended measuring the EPA+DHA content of RBC membranes for the following reasons (Harris and von Schacky 2004; Harris, 2007):

- Standardized methodology
- Low biological variability
- High analytical reproducibility
- Measurable in fasting or fed samples

- RBC FA composition stable for at least 4 years frozen at -70 to -80°C
- RBC FA composition is less influenced by day-to-day variations and by dyslipidemia than are plasma FAs
- The half-life of RBC EPA+DHA is 4-6 times longer than that of serum EPA+DHA
- RBC EPA+DHA is highly correlated with other omega-3 biomarkers such as whole serum, serum phospholipids, and whole blood (which can be measured in a dried blood spot).

IV. Statistical analysis

The relevant end point was defined as an appropriate ICD intervention, i.e. shock or anti-tachycardia pacing (ATP), for spontaneous ventricular tachyarrhythmias (VT or VF), or death from cardiac cause.

4.1. Descriptive analysis

When the normality was accepted, the quantitative parameters have been expressed as mean value \pm standard deviation and described with the median, 25th et 75th percentile when the normality was rejected. Qualitative parameters were expressed in actual percentage.

4.2. Inferential analysis

The *Shapiro-Wilks* test was executed to check the normality of the parameters. When the conditions of application of parametric tests were not met, nonparametric tests were then completed. The *Pearson* correlation test was used to demonstrate links between quantitative parameters, after checking their normality. To demonstrate the links between qualitative parameters, the *Chi-square* test was implemented. When $p \leq 0.05$, the difference was considered statistically significant.

The method of *Kaplan-Meier* was executed to estimate the survival curves of each cohort. The comparison between curves of the event occurrence (cardiac death, shock and ATP) was performed using the test of *Log-Rank*. A multivariate analysis, the *Cox proportional hazard model* type (ascending and descending), was carried out with and without adjustment for the following co-variables age, sex, ischemic heart disease, alcohol consumption, tobacco use, body mass index, diabetes and linoleic acid (C18:2 ω -6).

**FORMULAIRE D'INFORMATION ET DE CONSENTEMENT POUR LE
RECUEIL DE DONNEES**

Le Docteura proposé de participer a une étude d'évaluation médicale des acides gras omega-3 chez des patients porteurs d'un défibrillateur automatique implantable (Etude OMEGADEF).

Le but de ce travail est de réaliser une évaluation médicale, ainsi qu'une évaluation des concentrations cellulaires (globules rouges) en acides gras omega-3 des patients ayant bénéficié de l'implantation d'un défibrillateur automatique implantable (DAI).

Il m'a été précisé que j'étais libre d'accepter ou de refuser de participer à cette recherche et qu'en tout état de cause ma prise en charge serait absolument identique sauf le recueil par ponction veineuse au pli du coude d'un tube de 7.5 ml de sang lors d'une consultation ambulatoire ou lors de mon hospitalisation.

Les données enregistrées à l'occasion de cette étude feront l'objet de façon anonyme et confidentielle, conformément à la loi «informatique et libertés», d'un traitement informatique et statistiques.

Votre droit d'accès et de rectification s'exerce auprès des responsables de l'étude, les Docteurs P. Defaye et M. de Lorgeril.

Nom et Prénom du patient:.....

Nom et prénom du médecin:.....

N° de téléphone:

Fait à:**le**

Signature du médecin

Signature du patient

Ce document est à réaliser en 2 exemplaires originaux, dont l'un doit être gardé par le médecin et l'autre remis au patient donnant son consentement.

DATE DE RECRUTEMENT (Jour de la prise de sang): **J** |__|__| **M** |__|__| **A** |__|__|__|__|

DONNEES ADMINISTRATIVES

AGE |__|__|

Sexe : M F

Statut professionnel : Actif Retraité Sans emploi/Sans profession

STATUT CLINIQUE

- **Antécédents familiaux:** accident cardiaque chez un apparenté du premier degré (mort subite ou Arythmie maligne). OUI NON

- **Tabac :** OUI NON Cigarettes/jour: |__|__|

- **Surcharge pondérale:** Poids (kg) |__|__|__| Taille (m) |__|, |__|__|

- **HTA :** (PA > 140/90 ou traitement) OUI NON

- **Diabète :** (glycémie > 1,27 g/l ou traitement) Type I: OUI NON

Type II: OUI NON

- **Cholestérol :** (>2,50 g/l ou traitement) OUI NON

TRAITEMENT EN COURS

	OUI	NON	INCONNU
Amiodarone			
Bêtabloquant			
Autre Antiarythmique			
Statine			
Antiplaquettaire			
Anticoagulant			
IEC			

HISTOIRE DE LA MALADIE CARDIAQUE

- Cardiopathie ischémique OUI NON
- Cardiomyopathie dilatée OUI NON
- Antécédents d'infarctus OUI NON
- Infarctus antérieur OUI NON
- FEVG | _ | _ | %

INDICATION GLOBALE DU DAI

- Mort subite ressuscitée Syncope TV/FV Prophylactique

QUESTIONNAIRE NUTRITIONNEL

- Capsules d'AG oméga-3 ou autres compléments avec des AG oméga-3 : OUI NON

- Fréquence de consommation de poisson

	< 1 portion par semaine	1 à 2 portions par semaine	> 2 portions par semaine	Par mois	Rarement ou jamais
Tous les poissons					

Quels sont les poissons que vous consommez le plus souvent ?

- Poissons gras (Thon, sardine, saumon, hareng, maquereau, truite...)
 Poissons maigres (Sole, cabillaud, crustacées,...)
 Poissons gras et poissons maigres

- Consommez-vous régulièrement les huiles suivantes ?

	OUI	NON
Huile de colza		
Huile de soja		
Huile de noix		
Huiles de germe de blé, de chanvre, de cameline, de lin, perilla		
Huile "Primevère"		
Huile "Isio4"		
Ne sait pas		

- Consommez-vous régulièrement de la margarine ou une autre pâte à tartiner ? OUI NON

Si oui, précisez le nom de ou des margarines utilisées

Margarine riche en Omega-3? OUI NON

- Fréquence de consommation de noix

	< 1fois/sem	1 ou 2 fois/sem	> 2fois/sem	Tous les jours	Par mois	En saison	Rarement ou jamais
NOIX							

- Consommez-vous régulièrement des graines de lin ? OUI NON

- Consommez-vous régulièrement des produits enrichis en Omega-3 ? OUI NON

- Consommation d'alcool

Nombre de verres ou doses usuelles de boissons alcoolisées par semaine en moyenne :

Vin	Bière	Autres boissons alcoolisées

- Combien de repas par semaine prenez-vous à l'extérieur ?

DONNEES ECG

- Rythme : Sinusal FA Flutter/TA Autre
- Trouble de la conduction : Aucun BBG BBD BB atypique
 BAVI BAVII PM
- Durée du QRS : |__|__|__| ms
- Anomalie spécifique : aucune trouble de la repolarisation type Brugada QT long
 autres anomalies, préciser :

Antécédents de trouble du rythme auriculaire paroxystique: OUI NON INCONNU

Si Oui, préciser: FA Flutter TA

Antécédents d'arythmie ventriculaire spontanée documentée OUI NON INCONNU

- Type: FV Flutter ventriculaire TdP/TV polymorphe
 TV monomorphe TVNS TDP
- Tolérance de l'arythmie: Arrêt cardio-respiratoire Syncope Lipothymie Palpitation
 Dyspnée Douleurs thoracique Asymptomatique

Antécédents de Syncope + TV ou FV déclenchable OUI NON

DAI**Date de l'implantation du DAI** |__|__| |__|__| |__|__|__|__|

(Si la date d'implantation du DAI est ancienne (plus de 6 mois avant la prise de sang), renseigner les données rétrospectives en fin de cahier)

Visite N° 1 (jour de la prise de sang) : |__|__| |__|__| |__|__|__|__|

(Interrogation du DAI depuis l'implantation ou depuis la dernière interrogation)

1- Choc :

		Approprié	Inapproprié
Nombre total d'épisodes	__ __	__ __	__ __
Date du premier choc :	__ __	__ __	__ __ __ __

2- FV/TV enregistrées et traitées :

		FV	TV (<240)
Nombre total d'épisodes	__ __	__ __	__ __
Date du premier enregistrement :	__ __	__ __	__ __ __ __

3- ATP :

Nombre total d'épisodes	__ __
Date du premier ATP :	__ __ __ __ __ __ __ __

4- Arythmies enregistrées non traitées:

Nombre total d'épisodes	__ __
-------------------------	-------

Visite N° 2 (6 mois après la prise de sang) : |__|__| |__|__| |__|__|__|__|

- Modifications nutritionnelles majeures OUI NON

- Capsules Omega-3 OUI NON

- Hospitalisation au cours des 6 derniers mois OUI NON

Cause :

Mort subite

Arythmie Ventriculaire maligne

IC

Accident Coronarien

Embolie pulmonaire

AVC

Embolie périphérique

Autre :

Dates : |__|__| |__|__| |__|__|__|__|

- Hospitalisation au cours des 6 derniers mois OUI NON

Cause :

Mort subite

Arythmie Ventriculaire maligne

IC

Accident Coronarien

Embolie pulmonaire

AVC

Embolie périphérique

Autre :

Dates : |__|__| |__|__| |__|__|__|__|

- Décès OUI NON

Date du décès : |__|__| |__|__| |__|__|__|__|

DAI**Date de l'implantation du DAI** | | | | | | | | | |**Visite N° 2 (6 mois après la prise de sang) :** | | | | | | | | | |
(Interrogation du DAI depuis la dernière visite)**1- Choc :**

		Approprié	Inapproprié
Nombre total d'épisodes			
Date du premier choc :			

2- FV/TV enregistrées et traitées :

		FV	TV (<240)
Nombre total d'épisodes			
Date du premier enregistrement :			

3- ATP :

Nombre total d'épisodes	
Date du premier ATP :	

4- Arythmies enregistrées non traitées:

Nombre total d'épisodes	
-------------------------	--

Visite N°3 (12 mois après la prise de sang) : | _ | _ | | _ | _ | | _ | _ | _ | _ |

- Modifications nutritionnelles majeures OUI NON

- Capsules Omega-3 OUI NON

- Hospitalisation au cours des 6 derniers mois OUI NON

Cause :

Mort subite

Arythmie Ventriculaire maligne

IC

Accident Coronarien

Embolie pulmonaire

AVC

Embolie périphérique

Autre :

Dates : | _ | _ | | _ | _ | | _ | _ | _ | _ |

- Hospitalisation au cours des 6 derniers mois OUI NON

Cause :

Mort subite

Arythmie Ventriculaire maligne

IC

Accident Coronarien

Embolie pulmonaire

AVC

Embolie périphérique

Autre :

Dates : | _ | _ | | _ | _ | | _ | _ | _ | _ |

- Décès OUI NON

Date du décès : | _ | _ | | _ | _ | | _ | _ | _ | _ |

DAI**Date de l'implantation du DAI** |__|__| |__|__| |__|__|__|__|**Visite N° 3 (12 mois après la prise de sang) :** |__|__| |__|__| |__|__|__|__|

(Interrogation du DAI depuis la dernière visite)

1- Choc :

	Approprié	Inapproprié
Nombre total d'épisodes	__ __	__ __
Date du premier choc :	__ __ __ __ __ __ __ __	

2- FV/TV enregistrées et traitées :

	FV	TV (<240)
Nombre total d'épisodes	__ __	__ __
Date du premier enregistrement :	__ __ __ __ __ __ __ __	

3- ATP :

Nombre total d'épisodes	__ __
Date du premier ATP :	__ __ __ __ __ __ __ __

4- Arythmies enregistrées non traitées:

Nombre total d'épisodes	__ __
-------------------------	-------

Visite N° 4 (18 mois après la prise de sang) : |__|__| |__|__| |__|__|__|__|

- Modifications nutritionnelles majeures OUI NON

- Capsules Omega-3 OUI NON

- Hospitalisation au cours des 6 derniers mois OUI NON

Cause :

Mort subite

Arythmie Ventriculaire maligne

IC

Accident Coronarien

Embolie pulmonaire

AVC

Embolie périphérique

Autre :

Dates : |__|__| |__|__| |__|__|__|__|

- Hospitalisation au cours des 6 derniers mois OUI NON

Cause :

Mort subite

Arythmie Ventriculaire maligne

IC

Accident Coronarien

Embolie pulmonaire

AVC

Embolie périphérique

Autre :

Dates : |__|__| |__|__| |__|__|__|__|

- Décès OUI NON

Date du décès : |__|__| |__|__| |__|__|__|__|

DAI**Date de l'implantation du DAI** |__|__|__|__|__|__|**Visite N° 4 (18 mois après la prise de sang) :** |__|__|__|__|__|__|
(Interrogation du DAI depuis la dernière visite)**1- Choc :**

	Approprié	Inapproprié
Nombre total d'épisodes	__ __	__ __
Date du premier choc : (Depuis la précédente visite)	__ __ __ __ __ __	

2- FV/TV enregistrées et traitées :

	FV	TV (<240)
Nombre total d'épisodes	__ __	__ __
Date du premier enregistrement : (Depuis la précédente visite)	__ __ __ __ __ __	

3- ATP :

Nombre total d'épisodes	__ __
Date du premier ATP : (Depuis la précédente visite)	__ __ __ __ __ __

4- Arythmies enregistrées non traitées:

Nombre total d'épisodes	__ __
-------------------------	-------

Visite N°5 (24 mois après la prise de sang) : | _ | _ | | _ | _ | | _ | _ | _ | _ | _

- Modifications nutritionnelles majeures OUI NON

- Capsules Omega-3 OUI NON

- Hospitalisation au cours des 6 derniers mois OUI NON

Cause :

Mort subite

Arythmie Ventriculaire maligne

IC

Accident Coronarien

Embolie pulmonaire

AVC

Embolie périphérique

Autre :

Dates : | _ | _ | | _ | _ | | _ | _ | _ | _ | _

- Hospitalisation au cours des 6 derniers mois OUI NON

Cause :

Mort subite

Arythmie Ventriculaire maligne

IC

Accident Coronarien

Embolie pulmonaire

AVC

Embolie périphérique

Autre :

Dates : | _ | _ | | _ | _ | | _ | _ | _ | _ | _

- Décès OUI NON

Date du décès : | _ | _ | | _ | _ | | _ | _ | _ | _ | _

DAI**Date de l'implantation du DAI** |__|__|__|__|__|__|**Visite N° 5 (24 mois après la prise de sang) :** |__|__|__|__|__|__|
(Interrogation du DAI depuis la dernière visite)**1- Choc :**

	Approprié	Inapproprié
Nombre total d'épisodes	__ __	__ __
Date du premier choc : (Depuis la précédente visite)	__ __ __ __ __ __	

2- FV/TV enregistrées et traitées :

	FV	TV (<240)
Nombre total d'épisodes	__ __	__ __
Date du premier enregistrement : (Depuis la précédente visite)	__ __ __ __ __ __	

3- ATP :

Nombre total d'épisodes	__ __
Date du premier ATP : (Depuis la précédente visite)	__ __ __ __ __ __

4- Arythmies enregistrées non traitées:

Nombre total d'épisodes	__ __
-------------------------	-------

DONNEES RETROSPECTIVES DU DAI

(Si la date d'implantation est ancienne, c'est-à-dire plus de 6 mois avant la prise de sang)

Date de l'implantation du DAI |__|__| |__|__| |__|__|__|**Date de la visite (-1) d'interrogation du DAI :** |__|__| |__|__| |__|__|__|

(Plus de 6 mois environ avant la prise de sang)

1- Choc :

	Approprié	Inapproprié
Nombre total d'épisodes	__ __	__ __
Date du premier choc :	__ __ __ __ __ __ __	

2- FV/TV enregistrées et traitées :

	FV	TV (<240)
Nombre total d'épisodes	__ __	__ __
Date du premier enregistrement :	__ __ __ __ __ __ __	

3- ATP :

Nombre total d'épisodes	__ __
Date du premier ATP :	__ __ __ __ __ __ __

4- Arythmies enregistrées non traitées:

Nombre total d'épisodes	__ __
-------------------------	-------

Date de la visite (-2) d'interrogation du DAI : |__|__| |__|__| |__|__|__|

(Plus de 12 mois environ avant la prise de sang)

1- Choc :

	Approprié	Inapproprié
Nombre total d'épisodes	__ __	__ __
Date du premier choc :	__ __ __ __ __ __ __	

2- FV/TV enregistrées et traitées :

	FV	TV (<240)
Nombre total d'épisodes	__ __	__ __
Date du premier enregistrement :	__ __ __ __ __ __ __	

3- ATP :

Nombre total d'épisodes	__ __
Date du premier ATP :	__ __ __ __ __ __ __

4- Arythmies enregistrées non traitées:

Nombre total d'épisodes	__ __
-------------------------	-------

DONNEES RETROSPECTIVES DU DAI**Date de la visite (-3) d'interrogation du DAI :** |__|__|__|__|__|__|__|

(Plus de 18 mois environ avant la prise de sang)

1- Choc :

	Approprié	Inapproprié
Nombre total d'épisodes	__ __	__ __
Date du premier choc :	__ __ __ __ __ __	

2- FV/TV enregistrées et traitées :

	FV	TV (<240)
Nombre total d'épisodes	__ __	__ __
Date du premier enregistrement :	__ __ __ __ __ __	__ __

3- ATP :

Nombre total d'épisodes	__ __
Date du premier ATP :	__ __ __ __ __ __

4- Arythmies enregistrées non traitées:

Nombre total d'épisodes	__ __
-------------------------	-------

Date de la visite (-4) d'interrogation du DAI : |__|__|__|__|__|__|__|

(Plus de 24 mois environ avant la prise de sang)

1- Choc :

	Approprié	Inapproprié
Nombre total d'épisodes	__ __	__ __
Date du premier choc :	__ __ __ __ __ __	

2- FV/TV enregistrées et traitées :

	FV	TV (<240)
Nombre total d'épisodes	__ __	__ __
Date du premier enregistrement :	__ __ __ __ __ __	__ __

3- ATP :

Nombre total d'épisodes	__ __
Date du premier ATP :	__ __ __ __ __ __

4- Arythmies enregistrées non traitées:

Nombre total d'épisodes	__ __
-------------------------	-------

RESULTS & DISCUSSION

PART I

**Modulation of myocardial resistance to ischemia-reperfusion injury
by dietary saturated and polyunsaturated fatty acids
Insights into the concept of *Mediterranean omega-3 preconditioning***

I. RESULTS

1.1. Food consumption and energy supply

After 8-week supplementation, the SO group was slightly heavier compared with the PO and MED groups although the differences did not achieve statistical significance (Figure 38). In the lipid measurement experiments, two animals in the SO group were eliminated from the analysis of cardiac phospholipids due to technical problems. In the cardiac experiments, nine animals were lost during either the gavages period or at the moment of the cardiac experiments. Finally, we excluded five animals at the end of the cardiac experiments because of total absence of ischemia (lack of ischemic zone) leaving 13, 10 and 11 rats in the PO, SO and MED groups respectively for the analyses of infarct size and LV function.

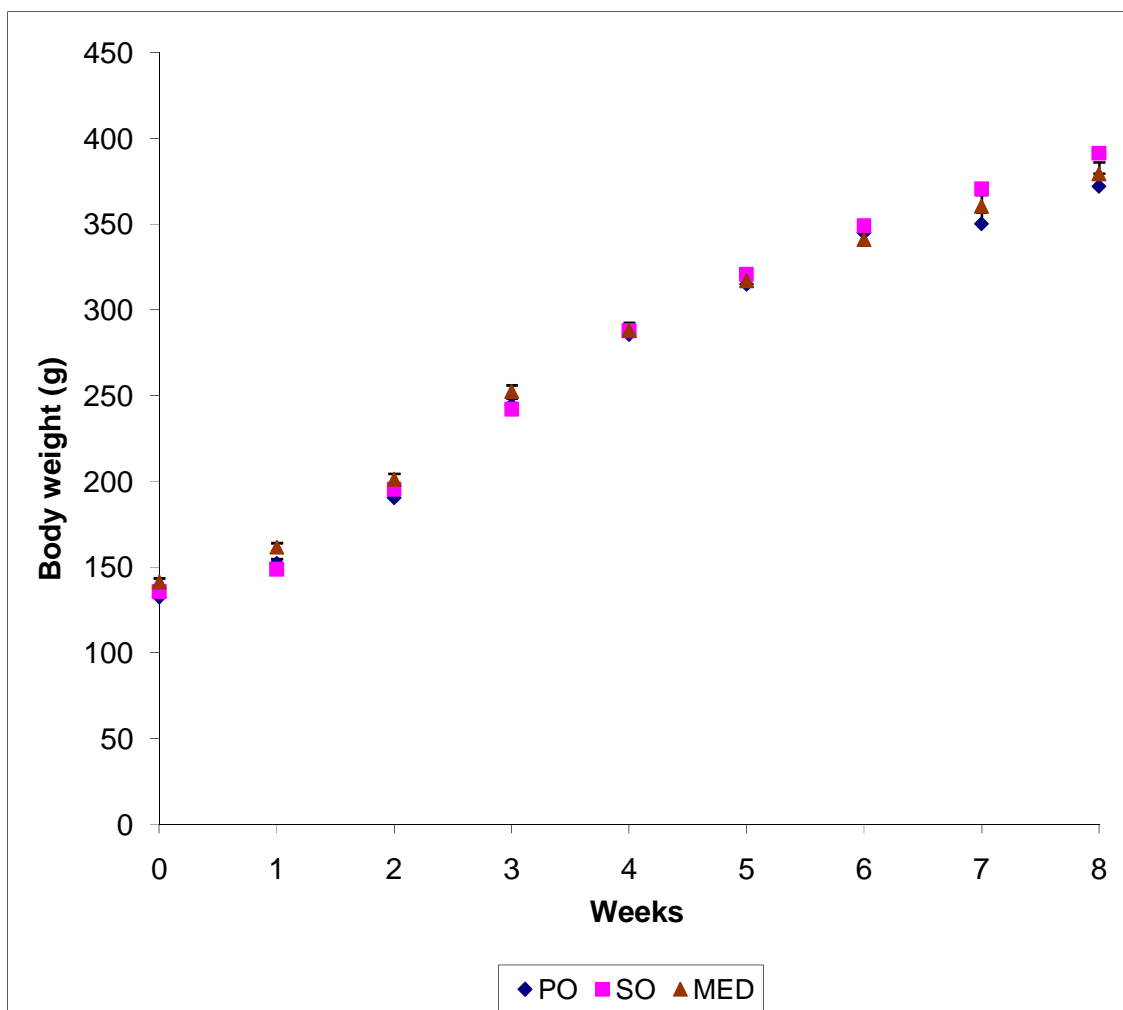

Figure 38: Effect of 8-week fat supplementation on body weight in the 3 groups

The increased weight in the SO group may be due to the consistently higher food intake. The MixA3 group is the lowest in terms of food consumption and energy supply followed by PO group (Table 18).

Table 18: Food consumption and energy supply in Palm (PO), Sunflower (SO) and Mix-A3 (MED) groups

	PO	SO	MED	P Anova
Standard food (g/day/rat)	21±0.4	23±0.2	21.1±0.4	<0.0001
Standard food (kcal/day/rat)	59.53±1.6	64.41±0.8	59.82±1.6	<0.0001
Total food (kcal/day/rat)	64.93±1.1	69.81±0.7	65.22±1.0	<0.0001

Means ± SEM, Total food = Standard food + Supplement

As shown in Table 19, there was no difference between the 3 groups for fats from standard food and total fat intakes. The main differences between groups regarded saturated, ω -3 and ω -6.

Table 19: Fat intakes in the 3 groups

	PO (n=16)	SO (n=16)	MED (n=16)	P
Standard food (mg/day/rat)	630 ± 11.7	696±6.9	603 ± 10.5	NS
Fat supplement (mg/day/rat)	600	600	600	-
Total fats (% total energy)	17.33 ± 0.1	17.02±0.1	17.25 ± 0.1	NS
Saturated (mg/day/rat)	464.6 ± 2.4 ¹	208.0±1.4	159.5 ± 2.1	<0.0001
Polyunsaturated (mg/day/rat)				
Total ω-6	374.3 ± 6.1	723.4±3.6 ²	386.8 ± 5.4	<0.0001
C18:2 ω -6	371.2 ± 6.0	713.5±3.5	378.4 ± 5.4	<0.0001
C20:4 ω -6	1.9 ± 0.0 ³	6.5±0.0	4.2 ± 0.0	<0.0001
Total ω-3	44.0 ± 0.8	49.2±0.5	469.6 ± 0.7 ⁴	<0.0001
C18:3 ω -3	24.5 ± 0.4	27.7±0.3	307.4 ± 0.4 ⁴	<0.0001
C20:5 ω -3	6.9 ± 0.1	8.2± 0.1	51.1 ± 0.1 ⁴	<0.0001
C22:5 ω -3	1.3 ± 0.1	1.6±0.1	10.2 ± 0.1 ⁴	<0.0001
C22:6 ω -3	11.3 ± 0.2	12.5±0.1	100.9 ± 0.2 ⁴	<0.0001

Means ± SEM. ¹ p<0.0001 vs. SO and MED, ² p<0.0001 vs. PO and MED, ³ p<0.0001 vs. SO and MED, ⁴ p<0.0001 vs. PO and SO.

1.2. Blood lipids and fatty acid profile

Blood lipids and plasma fatty acids are shown in Table 20. Total and HDL cholesterol were significantly lower in the MED group while triglycerides were not significantly different. Regarding plasma fatty acids, the main differences between groups were for total ω -6 ($p<0.0001$) and arachidonic acid (20:4 ω -6 $p<0.0001$) which were strikingly lower in the MED group. Total plasma ω -3 and each individual ω -3 were strikingly higher in the MED group ($p<0.0001$).

Table 20: Blood lipids (g/L) and plasma fatty acids (as % of total fatty acids)

	PO (n=16)	SO (n=16)	MED (n=16)	P
Blood lipids				
Total cholesterol	0.53±0.04	0.56±0.03	0.41±0.02	0.001
HDL cholesterol	0.30±0.01	0.33±0.01	0.25±0.01	0.001
Triglycerides	1.50±0.20	1.36±0.25	1.00±0.06	0.13
Plasma saturated fatty acids				
C14:0	0.81±0.05	0.70±0.05	0.68±0.04	0.11
C16:0	21.7±0.46 ¹	19.3±0.39	19.3±0.58	0.001
C18:0	5.73±0.26	6.19±0.19	5.62±0.19	0.11
Plasma polyunsaturated fatty acids				
Total ω-6	42.7±1.15	49.3±1.34	36.2±0.89 ²	<0.0001
C18:2 ω -6	26.2±0.78	28.2±0.66 ³	25.8±0.61	0.03
C20:4 ω -6	14.9±0.91	19.1±0.95	9.32±0.41 ²	<0.0001
Total ω-3	5.90±0.17	4.84±0.14	21.0±0.71 ²	<0.0001
C18:3 ω -3	1.08±0.09	0.97±0.03	4.40±0.15 ²	<0.0001
C20:5 ω -3	0.74±0.03	0.55±0.02	6.95±0.36 ²	<0.0001
C22:5 ω -3	0.55±0.03	0.52±0.02	2.37±0.10 ²	<0.0001
C22:6 ω -3	3.22±0.13	2.57±0.12	6.98±0.28 ²	<0.0001

Mean ± SEM; ¹ $p<0.01$ vs. SO and MED; ² $p<0.0001$ vs. PO and SO; ³ $p<0.05$ vs. PO and MED.

Erythrocyte fatty acid composition is shown in Table 21. There was no significant difference between groups for total saturated and total polyunsaturated fatty acids. The main difference between groups regarded total ω -6 and total ω -3 ($p<0.0001$). In addition, in the MED group, 20:4 ω -6 was remarkably lower ($p<0.0001$) and 20:5 ω -3 higher ($p<0.0001$) compared to the

PO and SO groups giving a ratio 20:4 ω -6/20:5 ω -3 of 66, 127 and 4.5 respectively for the PO, SO and MED groups respectively ($p < 0.0001$).

Table 21: Erythrocyte fatty acids (as % of total fatty acids) in the 3 groups

	PO (n=16)	SO (n=16)	MED (n=16)	P
Saturated				
C14:0	0.23±0.01	0.25±0.02	0.24±0.01	0.80
C16:0	25.1±0.33	24.0±0.23	24.7±0.35	0.10
C18:0	11.6±0.38	12.9±0.31	11.6±0.45	0.07
Polyunsaturated				
Total ω-6	45.7±0.51	47.7±0.44	36.8±0.44 ¹	<0.0001
C18:2 ω -6	11.8±0.25	12.3±0.25	12.7±0.34	0.08
C20:4 ω -6	31.0±0.47	31.9±0.35	22.4±0.39 ¹	<0.0001
Total ω-3	6.37±0.17	4.83±0.13	15.9±0.42 ¹	<0.0001
C18:3 ω -3	0.09±0.02	0.06±0.02	0.57±0.02 ¹	<0.0001
C20:5 ω -3	0.47±0.02	0.25±0.02	4.93±0.20 ¹	<0.0001
C22:5 ω -3	1.51±0.05	1.18±0.04	3.91±0.14 ¹	<0.0001
C22:6 ω -3	4.18±0.13	3.22±0.09	6.49±0.18 ¹	<0.0001

Mean \pm SEM; ¹ $p < 0.0001$ MED vs. PO and SO.

Table 22 shows the fatty acid composition of the 3 main phospholipids of cardiac mitochondria. Apart from cardiolipin, the main differences between groups were for total ω -3 and for each ω -3 (which were consistently higher in the MED group), and for 20:4 ω -6 which was again lowered in MED compared to PO and SO. In phosphatidylcholine and phosphatidylethanolamine, the main differences between groups were for total and each individual ω -3 and for 20:4 ω -6. In cardiolipin, saturated fatty acids were consistently higher in PO.

Table 22: Fatty acid composition of mitochondrial phospholipids in myocardial cells (expressed as % of total fatty acids).

	PO (n=16)	SO (n=14)	MED (n=16)	P
Phosphatidylcholine				
Total saturated	45.0±0.91	45.0±1.27	41.6±0.69	<0.05
Total ω-6	40.7±0.97	38.8±1.18	38.0±0.60	0.15
C18:2ω-6	17.6±0.61	20.11±0.64	21.2±0.75	<0.005
C20:4ω-6	21.9±0.71	17.5±0.69	15.7±0.89	<0.0001
Total ω-3	3.51±0.20	3.64±0.13	11.2±0.40	<0.0001
C18:3ω-3	0.02±0.01	0.07±0.01	0.41±0.03	<0.0001
C20:5ω-3	0.17±0.02	0.10±0.01	1.13±0.06	<0.0001
C22:5ω-3	0.77±0.06	0.82±0.04	2.13±0.09	<0.0001
C22:6ω-3	2.55±0.14	2.65±0.11	7.49±0.34	<0.0001
Phosphatidylethanolamine				
Total saturated	44.1±1.11	36.3±0.13	38.8±1.08	<0.0001
Total ω-6	31.3±0.84	36.1±1.01	21.6±0.73	<0.0001
C18:2ω-6	8.87±0.51	12.1±0.63	8.93±0.59	<0.005
C20:4ω-6	20.4±0.55	22.0±0.45	11.7±0.29	<0.0001
Total ω-3	16.6±0.62	19.6±0.96	34.0±1.70	<0.0001
C18:3ω-3	0.01±0.01	0.06±0.01	0.46±0.03	<0.0001
C20:5ω-3	0.20±0.01	0.18±0.015	1.24±0.05	<0.0001
C22:5ω-3	1.41±0.1	1.68±0.07	2.70±0.13	<0.0001
C22:6ω-3	15.0±0.54	17.6±0.90	29.6±1.59	<0.0001
Cardiolipin				
Total saturated	11.95±0.42	5.54±0.26	5.58±11.80	<0.0001
Total ω-6	81.13±0.62	89.24±0.40	86.63±0.28	<0.0001
C18:2ω-6	78.64±0.60	87.81±0.40	84.86±0.31	<0.0001
C20:4ω-6	0.72±0.02	0.59±0.02	0.54±0.02	<0.0001
Total n ω-3	0.97±0.03	0.69±0.05	2.86±0.17	<0.0001
C18:3ω-3	0.21±0.01	0.15±0.01	1.53±0.12	<0.0001
C20:5ω-3	0.08±0.01	0.06±0.01	0.34±0.01	<0.0001
C22:5ω-3	0.25±0.007	0.21±0.01	0.45±0.03	<0.0001
C22:6ω-3	0.43±0.02	0.28±0.02	0.54±0.04	<0.0001

1.3. Cardiac experiments

At baseline and throughout the ischemia-reperfusion period, there was no significant difference between groups for hemodynamics. In particular, left ventricular function and coronary flow at baseline (normoxic perfusion) were not different between groups (Table 23, A). Likewise, after 30-min and 120-min reperfusion (Tables 20, B and C), we found no significant difference between groups for coronary flow, diastolic pressure and LVDevP.

Table 23: Left ventricular function in the 3 experimental groups.

[A]: after 15-min stabilization (baseline)

	PO (n=13)	SO (n=10)	MED (n=11)	P
Coronary flow (ml/min)	15.3± 0.3	15.1± 0.5	14.1± 0.4	NS
Diastolic pressure (mmHg)	4.2±0.1	3.9±0.1	4.4±0.1	NS
LVDevP (mmHg)	140±9	132±10	124±7.1	NS
+dP/dt (mmHg/s)	3545±106	3462±150	3313±148	NS
-dP/dt (mmHg/s)	2122±101	2198±152	2100±97	NS

[B]: after 30-min ischemia and 30-min reperfusion

	PO	SO	MED	P
Coronary flow (% baseline)	79.9 ±1.4	81.5 ±2.5	80.8 ±3.0	NS
Diastolic pressure (mmHg)	27.7 ±1.4	26.6±2.5	25.6 ±2.2	NS
LVDevP (% baseline)	63.7±2.5	66.3±30	70.2±2.5	NS
+dP/dt (% baseline)	61.7±3.1	71.8±4.4	71.4±3.4	NS
-dP/dt (% baseline)	75.8±3.7	79.2±3.6	77.7±3.3	NS

[C]: after 120-min reperfusion

	PO	SO	MED	P
Coronary flow (% baseline)	58.4±2.1	63.6±2.7	58.1±3.4	NS
Diastolic pressure (mmHg)	36.9±1.5	33.8±3.4	36.2 ±2.4	NS
LVDevP (% baseline)	46.3±1.9	46.5±3.9	46.4±2.4	NS
+dP/dt (% baseline)	47.5±2.6	53.1±3.5	53.5±2.8	NS
-dP/dt (% baseline)	54.0±4.3	59.0±2.4	55.5±4.1	NS

The risk zone was not different in the three groups (Figure 39). In contrast, infarct size (Figure 39) was significantly different between groups, 37.7 ± 2.1 , 32.9 ± 1.5 and 28.6 ± 1.7 % of risk zone in the PO, SO and MED groups respectively (ANOVA $p < 0.01$). Compared with PO and SO, MED reduced infarct size by 24.1 % and 13.1 % respectively ($p < 0.05$). When PO and SO (the two groups with low ω -3) were pooled together and compared with MED (with high ω -3), infarct size was still significantly smaller ($p < 0.05$) with 35.3 ± 1.4 for PO+SO and 28.6 ± 1.7 for MED (Figure 40). When PO and MED (the two groups with low ω -6) were pooled together and compared with SO (with high ω -6), there was no significant difference.

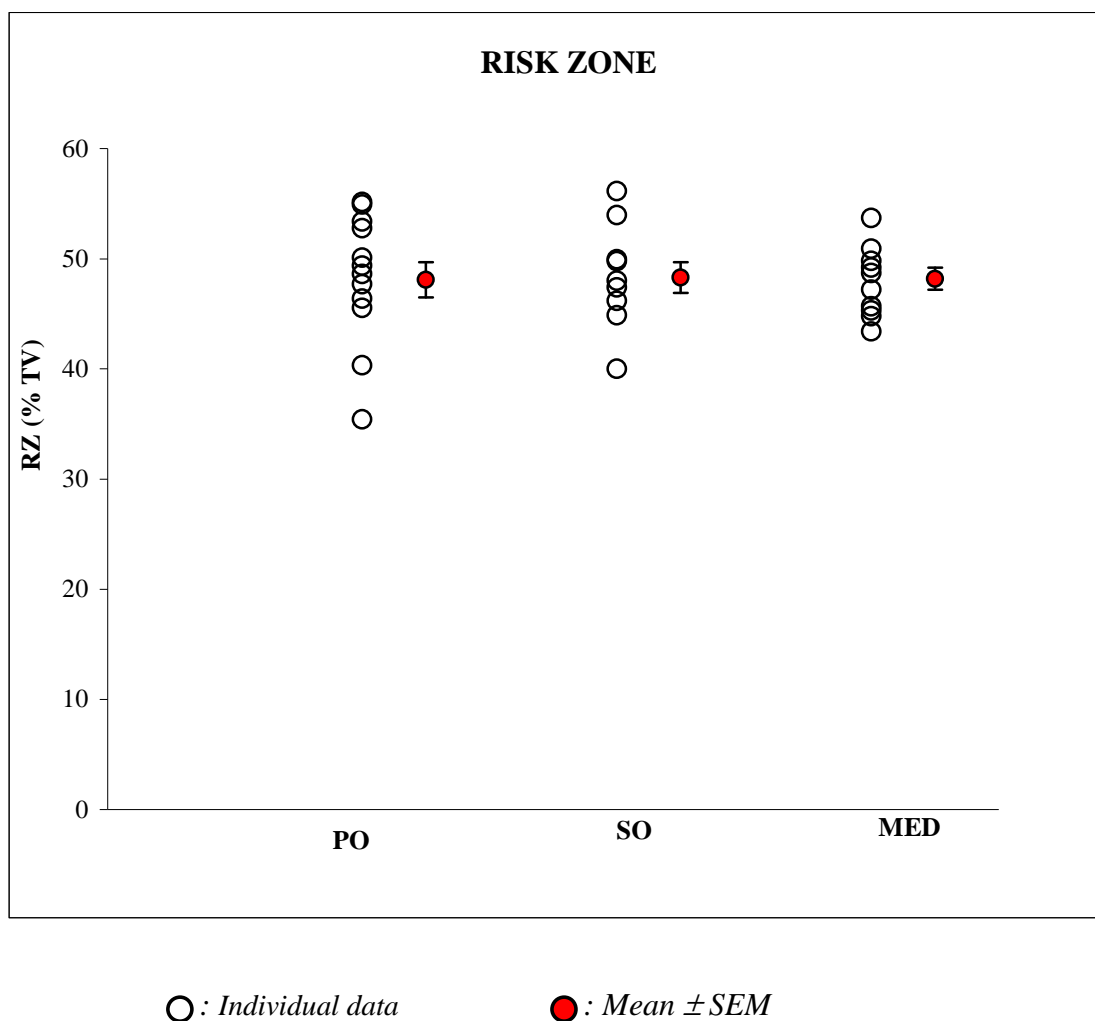
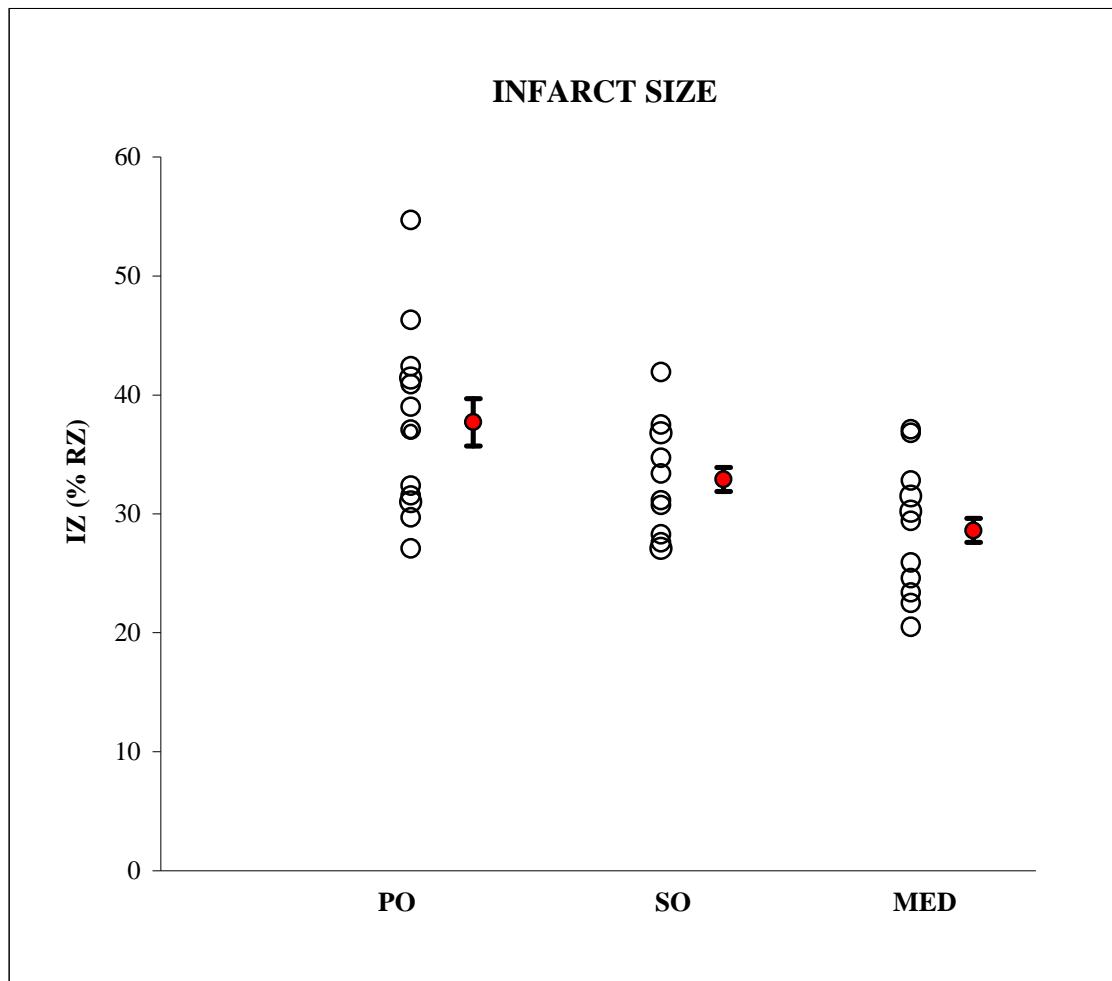
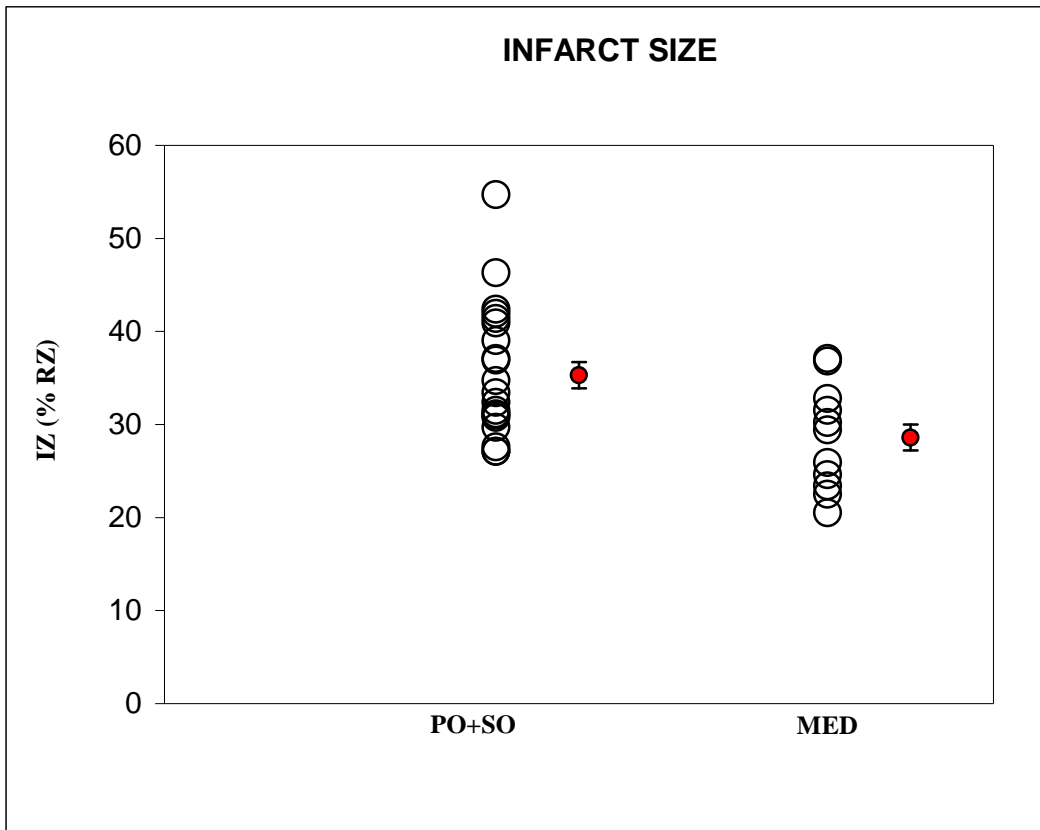

Figure 39: Risk zone (% total LV volume) in the 3 experimental groups (P: NS)



○ : Individual data and group means ● : Mean ± SEM.

Figure 40: Infarct size (% risk zone) in the 3 experimental groups ($P < 0.05$)



○ : Individual data and group means ● : Mean ± SEM.

Figure 41: Comparison of infarct size MED vs. PO+SO ($p < 0.05$)

II. DISCUSSION

This is the first study showing that one of the most common MED fatty acid profile results in improved myocardial resistance to ischemia-reperfusion injury. Thus, part of the protection resulting from the adoption of a traditional MED by humans might be due to smaller infarct size following ischemia-reperfusion. Whatever the precise molecular mechanism, this kind of relative myocardial resistance looks like the “ethanol preconditioning” (Guiraud et al., 2004; Guiraud et al., 2008) and the flavonoid-induced state of myocardial resistance to ischemia-reperfusion injury (Toufekstian et al., 2008) that we recently described. Although both moderate ethanol drinking and high flavonoid intake are major components of the traditional MED, it does not mean that MED is protective only through the induction of myocardial relative myocardial resistance to ischemia-reperfusion. Actually, there are other pathways (haemostasis, for instance) through which lipid or non lipid MED factors could protect against CHD (de Lorgeril et al., 1994; de Lorgeril et al., 1999; Kris-Etherton, 2002; Trichopoulou et al., 2003; Knoop et al., 2004).

2.1. Clinical implication

In the present study, we have examined the effects of a MED fatty acid profile with high ω -3 intake associated with low intakes in saturated fatty acids and ω -6. It means that the observed protection against ischemia-reperfusion likely resulted from interplay between several lipid factors and not from a unique nutrient. This is a common problem encountered in both experimental and clinical nutrition because any change in the diets of experimental animals or humans is multi-factorial. When studying diets with identical energy intake, reduction of one nutrient results in a proportional increase in one or several other nutrients (de Lorgeril and Salen, 2002). It is often difficult to decide whether one individual factor is more active than the others or whether one particular change is more important than the others.

The next issue is therefore to examine whether the beneficial effect of that MED fatty acid profile is predominantly due to one of this component. For instance, as shown on Figure 40, hearts of rats with high saturated fat intake were the less resistant compared with the two other groups. On the other hand, this study shows that for the same amounts of fat, hearts of rats receiving ω -3 are relatively more resistant to ischemia-reperfusion injury compared with

those receiving ω -6. This is probably of clinical relevance because high ω -6 intake has been encouraged for many years to replace saturated fats in the context of cholesterol-lowering diets to prevent CHD in humans (de Lorgeril and Salen, 2000; de Lorgeril and Salen, 2002). This study shows that the ω -6-rich dietary strategy is not optimal, at least in terms of myocardial resistance to ischemia-reperfusion, and actually confirms clinical trials which suggested no beneficial effect of ω -6-rich diets (de Lorgeril and Salen, 2000; de Lorgeril and Salen, 2002). Thus, the present study clearly indicates that to induce a significant resistance against ischemia-reperfusion injury, the best strategy would be to decrease both saturated fats and ω -6 and to increase ω -3, as also suggested by clinical trials (de Lorgeril *et al.*, 1994; de Lorgeril *et al.*, 1999; Kris-Etherton, 2001; Trichopoulou *et al.*, 2003; Knoops *et al.*, 2004, GISSI, 1999).

2.2. The potential importance of ω -3 fatty acids in myocardial resistance to ischemia-reperfusion

Previous experimental studies have been conducted to evaluate the effects of specific dietary fatty acids on the ischemic myocardium and their ability to prevent myocardial complications (Culp *et al.*, 1980 ; Hock *et al.*, 1987 ; Yanagisawa *et al.*, 1988 ; Hock *et al.*, 1990 ; McLennan *et al.*, 1993; Yang *et al.*, 1993 ; Demaison *et al.*, 1994 ; Kinoshita *et al.*, 1994 ; Oskarsson *et al.*, 1993 ; Zhu *et al.*, 1994 ; Engelbrecht *et al.*, 2005 ; McLennan and Dallimore, 1995 ; McLennan *et al.*, 1996 ; Nair *et al.*, 1997 ; Takeo *et al.*, 1998; Billman *et al.*, 1999 ; Ogita *et al.*, 2003). Most studies, however, did not specifically study the myocardial resistance to regional ischemia-reperfusion, rather the effects of dietary fats on global ischemia-reperfusion and ventricular arrhythmias. In addition, most of them suffer from some methodological weaknesses, for instance too short ischemia to induce cell necrosis. In other studies, there was no clear definition of the comparison groups in terms of dietary fatty acid profile and the biochemical changes induced by the tested diets in cell membranes and specifically in the myocardium were not properly evaluated. Finally, most studies focused on very-long chain (marine) ω -3 or fish oil (and not plant ω -3) with the main objective to show that they reduce the risk of ventricular arrhythmias. Only few groups actually tested the myocardial resistance to regional ischemia-reperfusion although it is the best experimental model of myocardial infarction. For instance, Oskarsson *et al.* (1993) have shown that marine ω -3 reduce infarct size in a canine model of ischemia-reperfusion. In that study, however, the

total amounts of fats were not similar in the experimental and control groups leaving the possibility that the smaller infarct size was not the result of a protection induced by marine ω -3. Actually, in a study of transient regional ischemia-reperfusion with appropriate control groups, marine ω -3 did not reduce infarct size (Force *et al.*, 1989). In that study, fats were given in the control groups under the form of corn oil (rich in ω -6 but poor in saturated fatty acids and ω -3) or beef tallow (rich in saturated fats but poor in ω -6 and ω -3). Thus, the dietary protocol was quite similar as the one used in our present study but the results were different since our MED rats were protected whereas there was no effect of marine ω -3 in the study of Force *et al.* (1989). The main difference between the two studies is that we gave both plant and marine ω -3 to our rats whereas Force *et al.* (1989) were given marine ω -3 only. This raises the possibility that alpha-linolenic acid (ALA), the main plant ω -3, was the protective factor in our study.

Few studies have suggested that ALA may have a direct protective effect on the heart (Fiaccavento *et al.*, 2006; Al-Khalifa *et al.*, 2007) or the brain (Heurteaux *et al.*, 2006), and to our knowledge no study examined the specific effect of ALA on regional ischemia-reperfusion and infarct size. In our study, ALA was considerably higher in the plasma, erythrocyte membranes and mitochondrial phospholipids of the MED rats compared with the PO and SO rats, but the relative contribution of ALA to total fatty acid remained quite small (Tables 20 and 21). In a previous pilot study, we did not observe protection with ALA-rich oils. Thus, the protective role of ALA by itself (given without marine ω -3) remains speculative. It is noteworthy that in an animal model of hereditary cardiomyopathy, ALA supplementation resulted in preservation of myocardial structure and function (Fiaccavento *et al.*, 2006). This study, however, did not investigate the effect of ALA in the context of ischemia-reperfusion. One possibility would be that ALA is cardioprotective against regional ischemia-reperfusion injury when it is associated with marine ω -3, or when given in the context of MED. A third possibility is that ALA supplementation was protective by two mechanisms: by itself and through induction of a massive reduction of the concentrations of arachidonic acid (AA), the main ω -6 in cell membrane and mitochondrial phospholipids. Despite higher dietary AA intake compared with the PO group and similar levels of linoleic acid (C18:2 ω -6, the precursor of AA), the MED rats had considerably lower AA levels (30 to 50% lower levels) compared with PO and SO. This suggests that ALA supplementation

induced a strong inhibition of the endogenous synthesis of AA from its precursor linoleic acid, a result that was not unexpected (Clandinin *et al.*, 1994; Sprecher *et al.*, 1995; Brenna, 2002; Nakamura and Nara, 2004). It could be argued that supplementation in marine ω -3 (as in the study by Force *et al.*, 1989), also results in decreased AA. However, the decrease in AA following a diet rich in both marine ω -3 and ALA is much more important than after supplementation in marine ω -3 only. In a parallel study (data not shown) where only marine ω -3 were given to rats, the decrease in plasma AA reached 23% (against 51% with the MED fatty acids) and the ratio AA/EPA decreased by 75% only against 96% with the MED fatty acids. The next question is whether such a decrease in AA levels may explain, at least partly, the protection observed in our study and the lack of protection in the study by Force *et al.* using similar isolated heart model and comparable control groups (Force *et al.*, 1989).

AA is often presented as a major player in CHD complications (Hjelte and Nilsson, 2005) and likely responsible for cell damage occurring after ischemia-reperfusion (Oe, 1994). A massive accumulation of AA and lipoxygenase and cytochrome P450 epoxygenase metabolites has been reported in the post-ischemic myocardium (Adamek *et al.*; 2007, Sexton *et al.*, 2007; Gross *et al.*, 2007). However, beside the production of well-characterized detrimental AA-metabolites, production of protective end-products of AA metabolism has also been reported (Gross *et al.*, 2005). Thus, from these previous and our own data, it is difficult to reach a conclusion. Further studies using complex experimental models to examine the biological effects of the many and various AA metabolites on the heart are therefore required to evaluate whether decreased AA levels in our model of ischemia-reperfusion actually result in better resistance to regional ischemia-reperfusion.

2.3. MED fatty acid profile and hemodynamics

We didn't find any difference in LVDevP and diastolic pressure as well as in coronary flow between the three groups before and after ischemia-reperfusion. It is indeed quite surprising that the limitation of infarct size was not associated with improvement in ventricular function. It is well known, however, that brief periods of ischemia can have both negative effect on ventricular function and a powerful protective effect against cell necrosis (Kloner and Jennings, 2001). Thus, in our study, the chronically preconditioned hearts might have developed a kind of myocardial stunning that could have masked the better recovery of post-

ischemic function compared to the experimental groups. On the other hand, if the isolated heart model is a good model to study acute regional myocardial response to ischemia-reperfusion (infract size) independently from the *biological milieu*, it is likely not the good one to examine long-term post-ischemic LV function recovery. Post infarction recovery would be more consistently determined 2 to 7 days following the acute ischemic episode. An *in vivo* model would have been more appropriate for that purpose. Further studies using such a model are needed to study the effect of MED dietary fatty acid profile on long-term LV function recovery.

2.4. Limitations of the study

The main limitation of that study is the lack of clear explanation regarding the mechanisms of relative myocardial resistance to ischemia-injury induced by the MED fatty acid profile. Since this study was not designed to specifically explore the mechanisms through which any specific fatty acid combination induces resistance to ischemia-reperfusion injury, we can only speculate on the beneficial effects of the association of plant and marine ω -3. Also, from these data, it is difficult to separate the effects of reducing saturated and ω -6 fatty acids and the effects of increasing plant and marine ω -3. Finally, as discussed above, further studies using complex protocols are needed to decide whether striking reduction of AA in the context of MED is protective.

This study actually suggests that MED induces a kind of chronic “preconditioning state”. The relative protection is indeed observed when using an isolated heart system model with exclusion of all extra-cardiac factors potentially influenced by dietary fats and potentially playing a role in the induction of a chronic resistant state. This relative protection therefore was likely largely dependent on changes to the cardiac tissue itself. However, we cannot rule out the possibility that modification in the vasculature of the heart for instance may be involved in the protection. It is also possible that these lipid factors were not directly responsible for the protection but did induce generation of another signaling molecule that itself is responsible for the beneficial action. Further studies are required in different animal models to confirm our data and identify the molecular signaling pathway involved in the observed protection.

We conclude that a MED fatty acid profile, with its plant and marine ω -3 components, in a relative cardiac resistance to ischemia-reperfusion. From a clinical point a view, this is a

confirmation that the Mediterranean diet appears to be the optimal diet to reduce CHD complications including those resulting from myocardial injury.

PART II

**Plant and Marine Omega-3 fatty acids and ventricular
arrhythmias in French patients with Implantable Cardioverter
Defibrillators “*the Grenoble city Omegadef Study*”**

I. Results

We enrolled in this observational study 238 ICD patients from the Grenoble university hospital. Mean follow-up duration was 30 months. The distribution of the different types of cardiac disease in these patients is presented in Figure 42. The main cardiac disease is ischemic (61%) followed by the dilated (congestive) cardiomyopathy (24%).

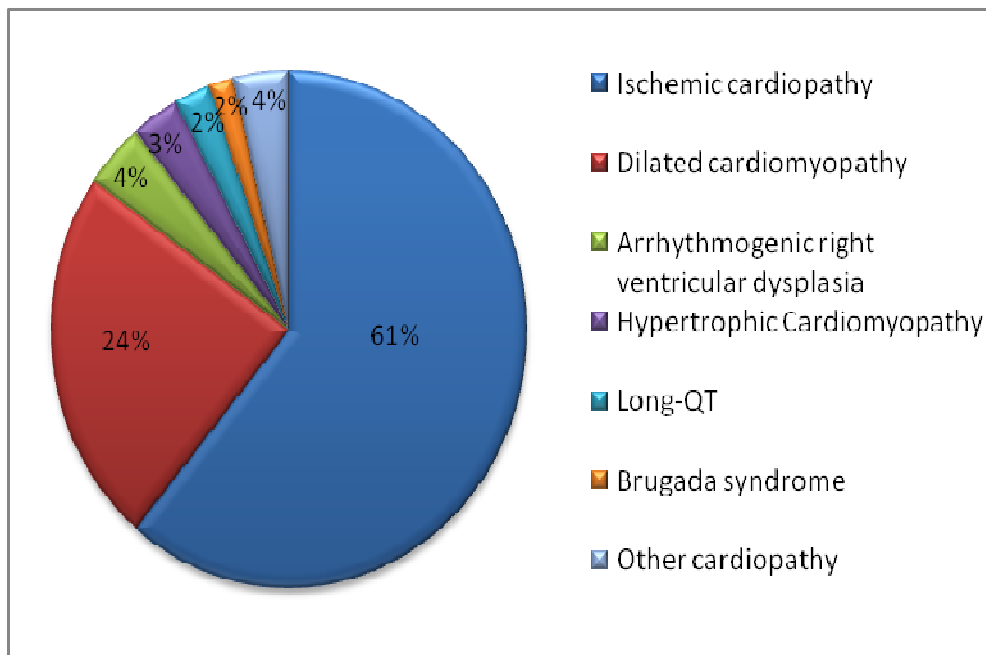

Figure 42. Distribution of the cardiac diseases in Omegadef patients.

1.1. Baseline clinical characteristics

Tables 21-26 show the baseline characteristics of the Omegadef patients with and without events. The two groups were statistically comparable concerning sex, age, ejection fraction, type of cardiac disease, medication, indication for ICD implantation, fish consumption, alcohol intake and the fatty acid profile. All patients had higher contents of plant (ALA) and marine omega-3 fatty acids (EPA and DHA), therefore a comparable omega-3 index (Tables 24-29).

Table 24: Age, sex, and other variables of the patients (0: without events, 1: with events)

Parameters	All patients (N=238)	0 (N=139)	1 (N=99)	p
Age, mean±SEM	238	61±14	66±13	>0.05
Sex, n (%)				>0.05
Male	204	122(60)	82(40)	
female	34	21(62)	13(38)	
Professional status, n (%)	238	143(60)	95(39)	>0.05
active	61	40(65)	21(34)	
Retired	160	90(56)	70(43)	
without job	17	13(76)	4(23)	
Weight (kg), mean±SEM	236	76.±14	76.±14	>0.05
Height (m), mean±SEM	234	1.7±0.1	1.7±0.1	>0.05
BMI (Kg/m²), mean±SEM	234	26±4	27±5	>0.05

Table 25: Risk factors of the patients (0: without events, 1: with events)

Parameters	All patients (N=238)	0 (N=139)	1 (N=99)	p
Family antecedents, n (%)	111	68(61)	43(38)	>0.05
Hypertension, n (%)	77	50(64)	27(35)	>0.05
High cholesterol, n (%)	79	49(62)	30(37)	>0.05
Smoking, n (%)	27	18(66)	9(33)	>0.05
Number of cigarettes/jour, mean±SEM	27	12±7	12±6	>0.05
Diabetes, n (%)	28	21(75)	7(25)	>0.05
diabetes type I	7	5(71)	2(29)	
diabetes type II	21	16(76)	5(24)	

Table 26: Medication of the patients (0: without events, 1: with events)

Parameters	All patients (N=238)	0 (N=139)	1 (N=99)	p
Amiodarone	78	44(56)	34(44)	>0.05
β-blockers	193	114(59)	79(41)	>0.05
Other antiarrhythmic agents	4	3(75)	1(25)	>0.05
Statin	116	72(62)	44(37)	>0.05
Antiplatelets	45	31(69)	14(31)	>0.05
Anticoagulant	80	43(54)	37(46)	>0.05
ACE inhibitor	161	99(61)	62(39)	>0.05

Table 27: Coronary heart disease and indication for ICD of the patients (0: without events, 1: with events)

Parameters	All patients (N=238)	0 (N=139)	1 (N=99)	p
Ischemic Cardiomyopathy, n (%)	149	87(58)	62(42)	>0.05
Infarct History, n (%)	99	60(61)	39(39)	>0.05
Anterior Infarct, n (%)	59	39(66)	20(34)	>0.05
Dilated Cardiomyopathy, n (%)	58	34(59)	24(41)	>0.05
Indication for ICD, n (%)				
Resuscitated sudden death	33	20(61)	13(39)	0.001
TV/FV	104	47(45)	57(55)	0.001
Syncope	4	3(75)	1(25)	0.001
Prophylactic	97	73(75)	24(25)	0.001
LVEF % mean±SEM	238	35±14	37±14	>0.05

Table 28: Dietary habits of patients of the patients (0: without events, 1: with events)

Parameters	All patients (N=238)	0 (N=139)	1 (N=99)	p
Alcohol n (%)	163	97(60)	66(41)	>0.05
Alcohol (doses/ week), mean±SEM	163	8.6±11	8.2±10	>0.05
Wine (doses/ week)	163	6.1±7.7	6.7±8.7	>0.05
Beer (doses/ week)	163	1.8±5	0.6±2	>0.05
Others (doses/ week)	163	0.9±3.5	0.9±1.9	>0.05
Fish intake, n (%)	238	143(70)	95(40)	>0.05
Rarely or never	7	4(57)	3(43)	
Once per month	18	13(72)	5(28)	
<1 portion/week	20	13(65)	7(35)	
1-2 portions/week	171	99(58)	72(42)	
>2 portions/week	22	14(64)	8(36)	
Kind of fish, n (%)				>0.05
Fatty fish	25	18(72)	7(28)	
Lean fish	22	10(46)	12(55)	
All kinds of fish	189	114(60)	75(40)	
Omega-3 supplementation capsules	8	7(88)	1(13)	>0.05
Fat and oil intake, n (%)				
Canola oil	44	26(59)	18(41)	>0.05
Soybean oil	7	5(71)	2(29)	>0.05
Walnut oil	60	34(57)	26(43)	>0.05
“Primevère” oil	3	2(67)	1(33)	>0.05
“Isio4” oil	71	43(61)	28(39)	>0.05
Margarines	96	54(56)	42(44)	>0.05
Margarine rich in ω-3 fatty acids	45	25(56)	20(44)	>0.05
Walnuts intake, n (%)	238	143(60)	95(40)	>0.05
Linseed	4	2(50)	2(50)	>0.05
Number of outside meals /week	238	0.7±2.2	0.97±2.5	>0.05

Table 29: Blood lipids (as mMol/L) and Red Blood Cells Fatty acid (as % of total fatty acids) of the patients (0: without events, 1: with events)

Parameters	0 (N=138)	1 (N=99)	p
C18:2 ω-6 (LA)	10.80±1.76	11.25±1.84	>0.05
C18:3 ω-3 (ALA)	0.16±0.05	0.16±0.06	>0.05
C20:5 ω-3 (EPA)	1.18±0.51	1.14±0.52	>0.05
C22:5 ω-3 (DPA)	3.05±0.38	3.05±0.48	>0.05
C22:6 ω-3 (DHA)	7.61±1.59	7.50±1.48	>0.05
Omega-3 Index*	8.79±1.76	8.64±1.59	>0.05
<i>Trans</i> fatty acids	0.08±0.05	0.08±0.48	>0.05
Total Cholesterol	4.29±1.00	4.41±0.90	>0.05
Triglycerides	1.98±1.08	2.12±1.17	>0.05
HDL	1.12±0.35	1.16±0.31	>0.05

*The omega-3 index was calculated from EPA + DHA as % of total fatty acid content.

1.2. Deaths and number of events

There were 17 deaths during the study; only 7 deaths were classified as due to cardiac causes. The cardiac deaths were largely due to progressive congestive heart failure. Ninety nine patients had an event (appropriate shock or ATP for TV/FV) during the study follow up. One patient was eliminated from the analysis because of the absence of the related red blood cells fatty acid results due to a technical problem.

1.3. Hazard Ratios for studied parameters

Tables 27 show hazard ratios associating age, sex, ischemic cardiac disease, alcohol, BMI, diabetes and smoking with arrhythmic complications. Except for the age which tend to be significant, the others parameters did not affect recurrence.

Table 30: Multivariate Proportional-Hazards analyses

Parameters	Hazard Ratio	95% CI	P
Age (years)	1.02	1.00-1.04	0.03
Sex (Female vs. Male)	0.99	0.52-1.94	>0.05
Ischemic cardiopathy (Yes or No)	0.86	0.52-1.40	>0.05
Alcohol (doses/week)	0.78	0.48-1.24	>0.05
BMI (Kg/m ²)	1.01	0.96-1.07	>0.05
Diabetes (Yes or No)	0.74	0.36-1.54	>0.05
Smoking (Yes or No)	0.95	0.44-2.02	>0.05

95% CI means 95% confidence interval

Thus after adjustment for age, sex, ischemic cardiac disease, alcohol, BMI, diabetes and smoking, there were no significant interactions between red blood cell phospholipids ALA and EPA+DPA+DHA and the risk of arrhythmic complication in these patients. Analyses of *trans* fatty acids showed the same trend.

Table 31: Proportional hazard model associating the different ω -3 fatty acids with arrhythmic complications after adjustment for C18:2, age, sex, ischemic cardiac disease, alcohol, BMI, diabetes and smoking.

Parameters	Risk Ratio	95% CI	P
ALA (C18:3 ω -3)	1.11	0.61-2.03	>0.05
EPA+DPA+DHA	1.47	0.82-2.63	>0.05
DPA (C22:5 ω -3)	0.51	0.29-0.86	0.01
Trans	0.84	0.47-1.49	>0.05

95% CI means 95% confidence interval

1.4. Omega-3 fatty acids and arrhythmic complications

There were no significant differences in red blood cell phospholipids omega-3 fatty acids in different quartiles of the studied parameters (Table 23). It is noteworthy that patients had in average high contents of both plant (ALA) and marine omega-3 fatty acids (EPA and DHA), therefore a comparable omega-3 index. The distribution of events in each quartile is shown in tables 24, 25 and 26.

There was a non-significant trend toward a reduction in the total number of events in the two studied parameters (ALA, EPA+DPA+DHA) ($P=0.99$). Figure 43 show a crossover between quartiles, no significant information may be described from the Kaplan-Meyer analyses.

1.5. Trans fatty acids and arrhythmic complications

The level of *trans* fatty acids was low in the different quartiles. Expectedly, *Trans* fatty acids did not affect recurrence and ($P= 0.55$).

Figure 43: Kaplan-Meier analyses of the time to ICD shock or antitachycardia pacing for VT/VF or death from cardiac cause.

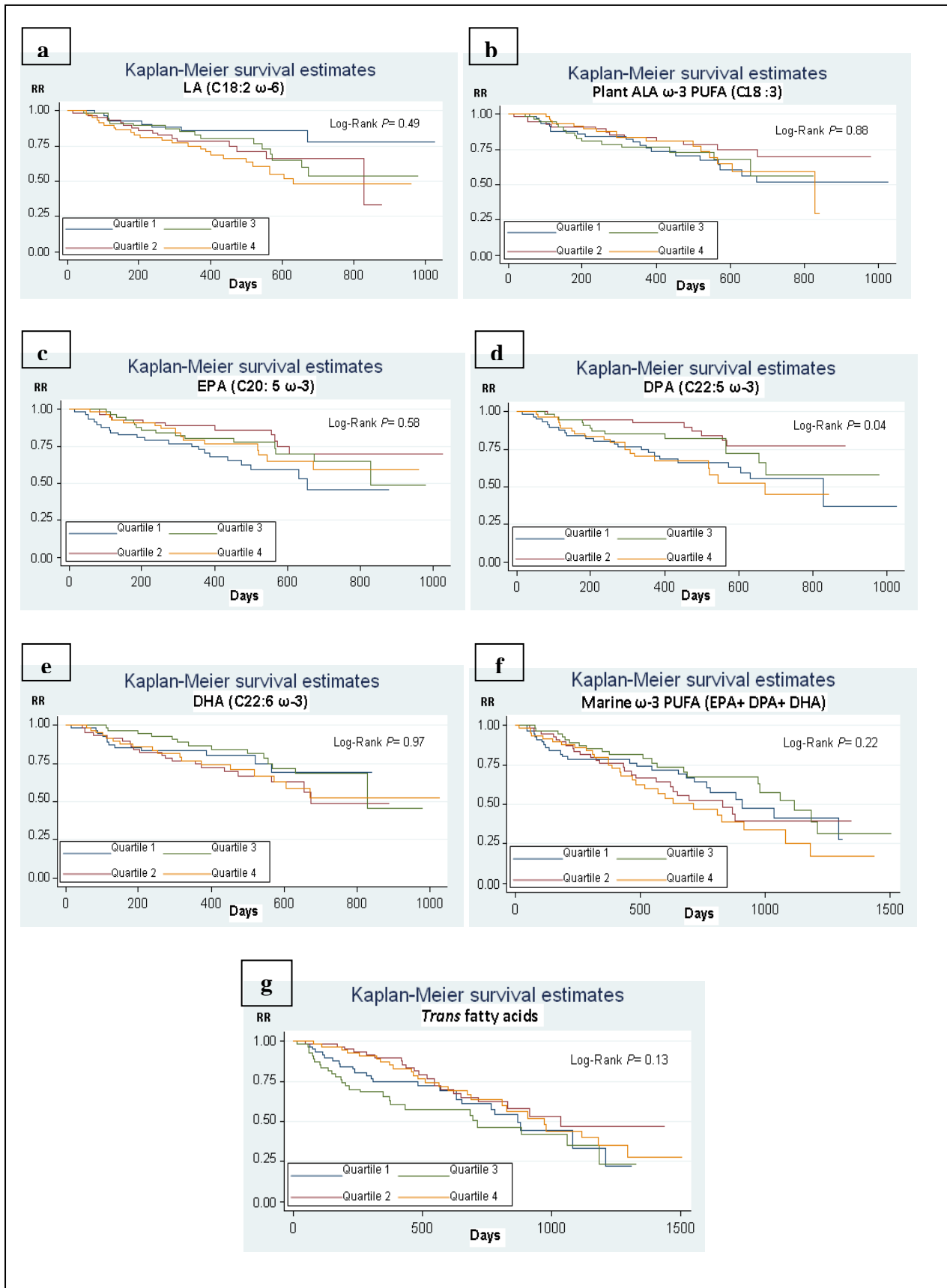

Table 32: Patients characteristics in the different quartiles according to plant ω -3 PUFA (ALA)

Parameters	Quartile 1	Quartile 2	Quartile 3	Quartile 4	p
	(N=60) (0.10±0.01)	(N=59) (0.13±0.01)	(N=59) (0.16±0.01)	(N=59) (0.23±0.04)	
Age (years)	63±12	65±11	61±14	62±16	>0.05
Sex, n (%)					>0.05
Male number	50(83)	51(86)	53(90)	49(83)	
Female number	10(17)	8(14)	6(10)	10(17)	
Weight (kg), mean±SEM	80±15	76.77±13	75±12	73±13	>0.05
Height (m), mean±SEM	1.70±0.1	1.69±0.1	1.7±0.1	1.7±0.1	>0.05
BMI (Kg/m ²), mean±SEM	28±5	27±4	26±3	25±4	>0.05
Smoking, n (%)	5(8)	7(12)	4(7)	11(19)	>0.05
Diabetes, n (%)	9(16)	9(15)	6(10)	4(7)	>0.05
Ischemic Cardiomyopathy, n (%)	33(55)	43(73)	35(59)	37(63)	>0.05
Alcohol	39(65)	43(73)	41(69)	39(66)	>0.05
Blood lipids (as mMol/L)and Red Blood Cells Fatty acid (as % of total fatty acids)					
LA	10.8±2.1	10.7±1.5	10.9±1.8	11.5±1.8	>0.05
Trans fatty acids	0.09±0.05	0.09±0.05	0.08±0.05	0.08±0.04	>0.05
EPA	0.96±0.4	1.21±0.5	1.22±0.6	1.26±0.6	>0.05
DHA	7.92±1.7	7.75±1.5	7.53±1.5	7.05±1.5	>0.05
EPA+ DPA+ DHA	11.81±2.1	11.98±1.9	11.82±2.1	11.50±1.8	>0.05
Omega-3 index	8.88±1.5	8.96±1.6	8.75±1.5	8.31±1.4	>0.05
Total cholesterol	4.33±1.1	4.29±0.8	4.43±0.9	4.29±0.9	>0.05
Triglycerides	2.13±1.1	2.17±1.2	1.97±1.1	1.89±1.1	>0.05
HDL	1.05±0.3	1.12±0.3	1.15±0.3	1.21±0.4	>0.05
Number of events	25	24	25	25	>0.05

*The omega-3 index was calculated from EPA + DHA as % of total fatty acid content.

Table 33: Patients characteristics in the different quartiles according to marine omega-3 PUFA (EPA+ DPA +DHA)

Parameters	Quartile 1 (N=60) 9.39±0.82	Quartile 2 (N=59) 11.06±0.34	Quartile 3 (N=59) 12.32±0.43	Quartile 4 (N=59) 14.41±1.09	p
Age (years)	63±15	61±15	64±12	63±12	>0.05
Sex, n (%)					>0.05
Male number	53(88)	46(78)	53(90)	51(86)	
Female number	7(11)	13(22)	6(10)	8(14)	
Weight (kg), mean±SEM	77±14	77±14	75±13	76±14	>0.05
Height (m), mean±SEM	1.7±0.1	1.7±0.1	1.7±0.1	1.7±0.1	>0.05
BMI (Kg/m²), mean±SEM	27±5	27±4	26±4	26±4	>0.05
Smoking, n (%)	9(15)	6(10)	2(3)	10(17)	>0.05
Diabetes, n (%)	7(12)	9(15)	7(12)	5(7)	>0.05
Ischemic Cardiomyopathy, n (%)	30(50)	32(54)	43(73)	43(73)	0.01
Alcohol	39(65)	36(61)	46(78)	41(69)	>0.05
Blood lipids (as mMol/L)and Red Blood Cells Fatty acid (as % of total fatty acids)					
LA	11.4±1.8	11.3±1.8	11.0±1.8	10.3±1.6	>0.05
<i>Trans</i> fatty acids	0.08±0.05	0.09±0.04	0.09±0.05	0.09±0.05	>0.05
ALA (C18:3)	0.16±0.1	0.17±0.1	0.15±0.1	0.16±0.1	>0.05
EPA	0.77±0.2	1.00±0.2	1.14±0.26	1.76±0.6	>0.05
DHA	5.80±0.9	6.96±0.6	8.21±0.6	9.33±1.0	>0.05
Total cholesterol	4.17±1.1	4.60±1.1	4.15±0.8	4.42±0.8	>0.05
Triglycerides	2.00±1.1	2.29±1.3	1.87±1.1	2.01±1.1	>0.05
HDL	1.11±0.3	1.13±0.4	1.12±0.3	1.18±0.4	>0.05
Number of events	25	25	25	24	>0.05

Table 34: Patients characteristics in the different quartiles according to *trans* fatty acids

Parameters	Quartile 1	Quartile 2	Quartile 3	Quartile 4	p
	(N=60) (0.03±0.01)	(N=59) (0.06±0.01)	(N=59) (0.10±0.01)	(N=59) (0.15±0.03)	
Age (years)	66±12	63±15	62±13	60±13	>0.05
Sex, n (%)					>0.05
Male number	53(88)	51(86)	52(88)	47(80)	
Female number	7(12)	8(14)	7(12)	12(20)	
Weight (kg), mean±SEM	78±14	76±13	77±13	74±14	>0.05
Height (m), mean±SEM	1.7±0.1	1.7±0.1	1.7±0.1	1.7±0.1	>0.05
BMI (Kg/m²), mean±SEM	27±5	26±4	26±4	26±4	>0.05
Smoking, n (%)	7(12)	9(15)	9(15)	2(3)	>0.05
Diabetes, n (%)	8(13)	6(10)	5(9)	9(16)	>0.05
Ischemic Cardiomyopathy, n (%)	37(61)	34(58)	41(69)	36(61)	>0.05
Alcohol	49(82)	42(71)	34(58)	37(63)	0.03
Blood lipids (as mMol/L)and Red Blood Cells Fatty acid (as % of total fatty acids)					
LA	10.91±1.9	11.22±2.0	10.85±1.7	10.96±1.5	>0.05
ALA	0.16±0.1	0.16±0.1	0.16±0.1	0.15±0.1	>0.05
EPA	1.21±0.6	1.17±0.5	1.16±0.5	1.13±0.5	>0.05
DHA	7.41±1.6	7.53±1.6	7.71±1.5	7.62±1.5	>0.05
EPA+ DPA+ DHA	11.66±2.0	11.80±2.1	11.90±1.9	11.76±1.9	>0.05
Omega-3 index	8.62±1.5	8.70±1.7	8.87±1.9	8.75±1.7	>0.05
Total cholesterol	4.41±0.9	4.36±0.9	4.36±1.1	4.20±0.9	>0.05
Triglycerides	2.00±0.9	2.09±1.3	1.98±1.2	2.09±1.2	>0.05
HDL	1.17±0.4	1.09±0.3	1.14±0.4	1.12±0.3	>0.05
Number of events	26	21	27	25	>0.05

*The omega-3 index was calculated from EPA + DHA per total fatty acid content.

I. Discussion

Omega-3 fatty acids have been widely reported to have impressive protective effects on CHD. Numerous epidemiological studies and clinical trials have supported this issue (GISSI, 1999; Marchioli et al., 2002; Albert et al., 1998 and 2002; Siscovick et al., 1995 and 2000; Burr et al., 1989, de Lorgeril et al., 1994 and 1999, Mozaffarian et al., 2003). Likewise, the beneficial antiarrhythmic effects of ω -3 fatty acids were reported in animal and laboratory studies (McLennan et al., 1988, 1992 and 1993; Billman et al., 1994, 1997 and 1999; Kang et al., 1994; 1995 and 1996; Xiao et al., 1995, 1997, and 2001; Leaf et al., 2003). As a result of this evidence, the American Heart Association has recommended 2 fatty fish meals per week for the general population and 1 g of EPA/ DHA per day for patients with coronary artery disease (Kris-Etherton et al., 2002). Similarly, the US Food and Drug Administration has authorized a qualified health claim of a reduction in the risk of coronary artery disease for food containing EPA and DHA (FDA, 2004).

Moreover, both Harris et al. (2004) and Owen et al. (2004) have shown that red blood cell (RBC) EPA + DHA (expressed as weight percentage of total fatty acids; hereafter termed the omega-3 index) can serve as a surrogate of cardiac omega-3 fatty acids content. The use of RBC reduce the influence from recent food intake since fatty acids in RBC incorporate gradually, reflecting the regular exposure to ω -3 in the diet over several weeks (Cao et al., 2006; Sullivan et al., 2006).

In view of the fact that sudden cardiac death is usually preceded by ventricular arrhythmia (Huikuri, 2001) the hypothesis that ω -3 PUFA would have powerful antiarrhythmic effects was interesting. The aim of our study was to test this hypothesis that RBC omega-3 fatty acids (ALA, EPA and DHA) in patients with ICD would prolong the time to first ICD event for VT/VF or death and to check out the correlation between the omega-3 index and arrhythmia recurrence in these patients. However, in the present study such correlation was not observed. There was no significant difference either in individual ω -3 fatty acids (ALA, EPA and DHA) or in omega-3 index between quartiles. However, it comes into view that the RBC omega-3 index in these patients (8.6 ± 1.59 to 8.8 ± 1.76) was at levels that have been previously reported to protect against fatal arrhythmias (Figure 38) (Albert et al., 2002; Siscovick et al., 1995; Mozaffarian et al., 2003, Harris, 2007).

In a case control study on primary arrest Siscovick *et al.* (1995) demonstrated a risk reduction of 90% (OR 0.1, 95% CI, 0.1-0.4) associated with RBC EPA+DHA in the upper quartile (mean 6.5%) as compared to the lowest quartile (mean 3.3%).

The same inverse relationship has been demonstrated for total long chain omega-3 fatty acids (EPA+ DPA+DHA) and risk of SCD in the Physicians Health Study (Albert *et al.*, 2002). By mathematical transformation of whole blood EPA+ DPA+DHA to estimate omega-3 index, Harris and von Schacky (2004) have suggested a 90% reduction of risk associated with omega-3 index in the range of 6.1- 10.1 % (upper quartile) compared to an index of 2.4-4.5 % (lowest quartile).

Similar relationship has been demonstrated for plasma phospholipid DHA + EPA and risk of fatal ischemic heart disease in the Cardiovascular Health Study (Lemaitre^a *et al.*, 2002). Arrhythmic death was decreased significantly by 68% among those with a baseline fish consumption of >3 times weekly compared to those who consumed fish <1 time weekly (OR 0.30, 95% CI, 0.12 to 0.76). Converting the reported phospholipid EPA + DHA values to the omega-3 index revealed that those subjects with an omega-3 index of about 8.9% were at 70% lower risk for fatal ischemic disease than those with an index of about 6.9% (Harris and von Schacky, 2004).

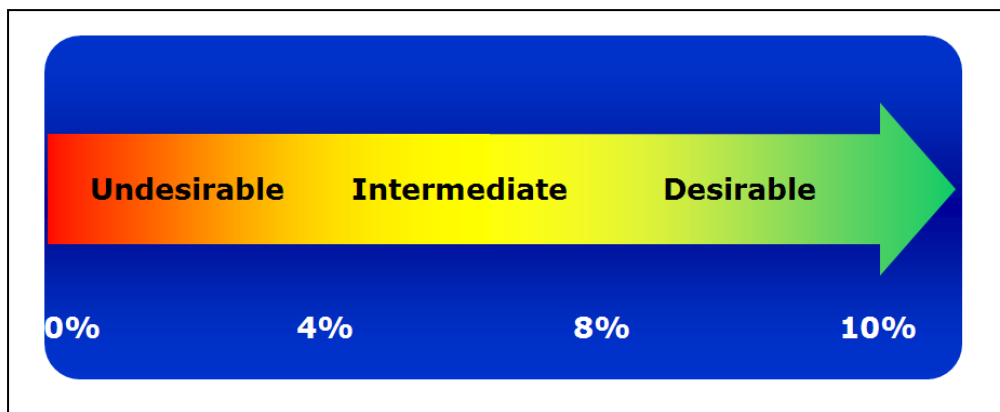

Figure 38: Proposed Omega-3 Index Risk Zones: Relative Risk for Death from CHD (Harris and von Schacky, 2004).

In a prospective, placebo-controlled trial by Leaf *et al.* (2005), randomized ICD patients to fish oil (2.6 g EPA+ DHA daily) during 12 months had higher content of EPA and DHA in RBC compared to the patients who received olive oil (7.6 ± 0.3 versus 3.5 ± 0.1 , $p < 0.0001$) whereas at baseline, there were no differences (3.4 ± 1.2 versus 3.5 ± 1.2 , respectively).

Although patients in the fish oil group experienced a 28% reduction in incidence of recurrent VT/VF or all-cause mortality, this difference was not statistically significant. The use of olive oil as control in this study may as well have a beneficial effect on cardiovascular disease (Perez-Jimenez *et al.*, 2005).

Further randomized clinical trials have shown that dietary changes or supplements to increase omega-3 PUFA intake result in a reduced risk of sudden death without a consistent change in risk of myocardial infarction. The GISSI study tested the effects of EPA + DHA supplementation on death from CHD. Patients receiving modern cardiac pharmacotherapy were randomized to 850 mg/day of EPA + DHA, 300 mg/day of vitamin E, both, or to the unsupplemented control group. After 3.5 years of follow up, the group given just the EPA + DHA experienced a 20% reduction in all-cause mortality, a 35% decrease in cardiac death, and a 45% reduction in sudden death ($P < 0.01$) compared to the control group. These effects became statistically significant within 3-4 months of randomization (GISSI, 1999; Marchioli *et al.*, 2002). Harris and von Schacky (2004) suggested that intakes of about 900 mg/day of EPA + DHA would produce an Omega-3 Index of about 9.5

Recently, a study by Aarsetoy *et al.* (2008) support a protective effect of ω -3 FAs against VF during the acute ischemic phase of a MI. The median value of omega-3 index in the VF group was 4.88 % as compared to 6.08 in the control group ($p = 0.013$). A 1% increase of the omega-3 index was associated with a 48% reduction in risk of VF (OR 0.52, CI 95%, 0.28-0.96; $p = 0.037$).

There have been 3 adverse reports (Burr *et al.*, 2003; Raitt *et al.*, 2005; Brouwer *et al.*, 2006). In the first negative study, higher mortality was reported in those advised to consume more oily fish or to take fish oil capsules than in those not so advised (HR, 1.54; 95% CI, 1.06-2.23). The reason for which this trial failed to reduce risk is not known. It is possible that in this unblinded study, overall compliance with cardiovascular health recommendations was poor because patients consuming a fish diet or fish oil thought they were protected (Raitt *et al.*, 2005).

In the second small trial, Raitt *et al.* (2005) have shown that among patients with ICD, fish oil supplementation does not reduce the risk of VT/VF and may even be proarrhythmic in some patients (HR of 1.4, 95% CI, 0.96-2.0). Patients randomized to receive fish oil (1.8 g/d) had an increase of omega-3 PUFAs in red blood cell membranes from 4.7% to 6.8% at one month and continued to increase to 8.3% at 3 months with no significant change thereafter. The RBC levels of ω -3 fish oil fatty acids seem to be at levels that have been previously reported to protect against fatal arrhythmias (Albert *et al.*, 2002; Siscovick *et al.*, 1995; Mozaffarian *et al.*, 2003, Harris, 2007). No change in RBC fatty acids was observed in patients receiving placebo (olive oil) over 24 months of follow-up. Unlike previous studies, these patients developed sustained VT/VF not due to myocardial infarction. Beside the possibility of a chance effect in a trial with a quite small sample size, a possible interpretation is that fish oil only benefits certain types of ventricular arrhythmia. In addition, it is known that consumption of monounsaturated fat such as olive oil, which was used as the control agent in this study, may also decrease risk of cardiovascular disease (Perez-Jimenez *et al.*, 2005). Therefore, the results may have shown that olive oil was better than fish oil in reducing recurrent VT/VF but not that fish oil was proarrhythmic. Further studies are needed to explore this question.

A third study showed no significant reduction in the primary outcome of ICD therapy for VT/VF or death in patients with ICD. Brouwer^b *et al.* (2006) in the Study on Omega-3 Fatty acids and ventricular Arrhythmia (SOFA) found that 2 g fish oil (consisting of 464 mg eicosapentaenoic acid, 335 mg docosahexaenoic acid, and 162 mg other omega-3 PUFAs) did not significantly reduce recurrent VT/VF events and all-cause mortality compared to placebo (high-oleic acid sunflower oil) (70% vs. 67% respectively). In contrast to the previous study, Brouwer^b *et al.* (2006) did not find that fish oil may have proarrhythmic properties. Harris and von Schacky (2004) suggested that the intake of 2 g of omega-3 fatty acids daily induces an increase of omega-3 index from $4.7 \pm 0.9\%$ to $11.6 \pm 2.4\%$.

Sunflower seed oil used as control also contains a high level of polyunsaturated fatty acids and has been demonstrated to be cardioprotective (Allman-Farinnelli *et al.*, 2005). Therefore, the lack of benefits of omega-3 fatty acid demonstrated in this study may have been due to the fact that both groups of patients were receiving cardioprotective effect from the different oils used.

Recently, another study by Wilhelm *et al.* (2008) concluded that in heart failure patients, the red blood cell fatty acid profile is altered. Omega-3 fatty acids are elevated and predict the risk of ventricular arrhythmias. Omega-3 fatty acids predict the risk of ventricular arrhythmias. Twelve percent of patients in the lowest quartile had ventricular arrhythmias, as compared to 54% of patients in the highest quartile ($P = 0.02$).

According to the conflicting results of these trials, recommendation of routinely using fish oil therapy in all patients at risk for life-threatening ventricular arrhythmias cannot be established. This may be due to the different population studied, different formulation of omega-3 fatty acid used, the differences in the consumption of fish versus fish oil supplements, and the different comparative oil used for control. There may be other beneficial ingredients in addition to omega-3 fatty acid when consuming fish instead of just consuming supplements. More studies with enough power to evaluate the effects of this supplement in a variety of subgroups are necessary. In addition, the exact mechanisms of omega-3 fatty acid need to be explored further.

The new diet– heart hypothesis can be characterized by the following syllogism (Siscovick *et al.*, 2003):

- (1) Dietary ω -3 PUFA intake increases cell membrane and free fatty acid ω -3 PUFA levels;
- (2) Higher ω -3 PUFA levels favorably alter cardiac ion channel function;
- (3) Altered ion channel function modifies the cardiac action potential;
- (4) Alteration in the action potential reduces myocardial vulnerability to ventricular fibrillation, the major life-threatening arrhythmia that results in sudden cardiac death in the setting of myocardial ischemia.

Taken individually, each element of this syllogism is now supported by evidence from one or more research paradigms, including animal-experimental, cell biology, genetic, nutritional, and epidemiological studies. Of particular importance, evidence from randomized clinical trials of either fatty fish intake or low-dose ω -3 PUFA supplementation in post–myocardial infarction patients provides additional support for the new diet– heart hypothesis (Burr *et al.*, 1989; GISSI, 1999). Evidence from observational studies and controlled trials indicates that, in addition to their effects as essential nutrients, intake of the marine very long-chain n -3 PUFA reduces the risk of fatal coronary heart disease and, in particular, of sudden cardiac death (Kromhout *et al.*, 1985; Albert *et al.*, 1998; Albert *et al.*, 2002; GISSI, 1999; Burr *et al.*, 1989). Sudden cardiac death forms a major part of mortality from cardiovascular disease and

is, in most cases, a direct consequence of cardiac arrhythmia (Huikuri et al., 2001). *n*3 PUFA may exert their protective effects through reducing the susceptibility to cardiac arrhythmia. It is still unclear exactly how omega-3 fatty acids exert their antiarrhythmic effects, and whether such effects come from the EPA component or the DHA component or both is unknown. However, several mechanisms have been postulated. Structurally, omega-3 fatty acids have structures similar to other antiarrhythmic agents used currently in that they have a long acyl hydrocarbon tail, greater than 2 unsaturated carbon-carbon double bonds, and a free carboxyl group at one end (Reiffel and McDonald, 2006). It is also believed that omega-3 fatty acids may have an indirect effect through cardiac control of the autonomic nervous system, increasing heart rate variability and baroreflex sensitivity (Christensen et al., 2001; Brouwer et al., 2002). A high variability in heart rate is an indication of good cardiac adaptability, implying a well-functioning autonomic control mechanism, thus lowering the risk of arrhythmia (Smyth et al., 1969). Electrophysiologically, omega-3 fatty acids may also exert an antiarrhythmic effect by inhibiting the fast, voltage-dependent sodium and L-type calcium channels (Kang and Leaf, 1996; Xiao et al., 1997). Omega-3 fatty acids are thought to act on the final common pathway affecting excitability of the cardiac myocyte and prevent calcium overload during stress. In addition, by incorporating more omega-3 fatty acids into cardiac membrane phospholipids, they may reduce the omega-6 fatty acid/omega-3 fatty acid ratio, which may shift the myocardium from a proarrhythmic to an antiarrhythmic state (Chrysohoou, 2007). Finally, omega-3 fatty acids may have direct effects on the inositol lipid cycle and cell signaling on the cell membrane, via their anti-inflammatory effects mediated by eicosanoids (Charnock, 1999).

Dietary intake of *Trans* fatty acids, which are produced largely by partial hydrogenation of vegetable oils (and to some extent by prolonged heating), and coronary heart disease (CHD) risk have been positively correlated in several cohort studies (Hu et al., 1997; Kromhout et al., 1995; Oh et al., 2005) and case-control studies (Mozaffarian et al., 2006; Lemaitre^a et al., 2002 and Lemaitre 2006; Baylin et al., 2003; Clifton et al., 2004). Mozaffarian et al. (2006) estimated a pooled relative risk of 1.23 (95% CI, 1.11 to 1.37) for every 2% energy from *trans* fat intake at baseline. The association was stronger in the Nurses' Health Study when repeated measures of diet were analyzed: multivariable relative risk of CHD was 1.33 (95% CI, 1.04 to 1.70) associated with 2% energy from *trans* fat intake (Oh et al., 2005).

The hydrogenation of oils rich in ω -6 fatty acids to form margarines has led to increased amounts of *trans* fatty acids in the food supply (Simopoulos, 1997). Hydrogenation also reduces the essential fatty acid content in oil, both ω -6 and ω -3. Untreated soybean, for example, contains 7% omega-3 fatty, when partially hydrogenated this content drops to 3% (Sanders, 1985; Simopoulos and Robinson, 1998).

In a recent case control study, low levels of *Trans* fatty acids are inversely associated with acute coronary syndromes (acute myocardial infarction or unstable angina) (Robert et al., 2008). In ACS cases, blood cell content of the major *trans* isomer of oleic acid (elaidic acid) was 13.3% higher than in controls ($P < 0.0001$). In a prospective study of *trans* fatty acids in erythrocytes and risk of coronary heart disease, Sun et al. (2007) provide further evidence that high *trans* fat consumption remains a significant risk factor for CHD. They found that total *trans* fatty acid content in erythrocytes (1.17-2.23%) was significantly correlated with dietary intake of *trans* fat ($P < 0.01$) and was associated with increased plasma low-density lipoprotein cholesterol ($P < 0.06$), decreased plasma high-density lipoprotein cholesterol concentrations ($P < 0.01$), and increased plasma low-density lipoprotein to high-density lipoprotein ratio ($P < 0.01$). After adjustment for age, smoking status, and other dietary and lifestyle cardiovascular risk factors, higher total *trans* fatty acid content in erythrocytes was associated with an elevated risk of CHD. Block et al. (2008) found that erythrocyte *trans* fatty acids (3.34-3.78%) were inversely associated with ACS.

Our study showed that patients had lower RBC *trans* fatty acids (0.03 ± 0.01 to 0.15 ± 0.03); Therefore there was no incidence on VT/FV recurrence (RR 0.84, 0.55 CI, 0.47-1.49).

Lemaitre^b et al. (2002) observed moderate associations between erythrocyte or plasma phospholipid *trans* fatty acid content and increased risks of sudden death and fatal CHD. Similarly, in a Costa Rican population Baylin et al detected a positive association between adipose tissue *trans* fatty acid contents and an elevated risk of non-fatal MI (Baylin et al., 2003). Clifton et al. (2004) showed that, after *trans* fat was eliminated from margarines sold in Australia, the positive associations observed between *trans*fatty acid contents in adipose tissue and the risk of nonfatal MI were diminished.

Trans fatty acids take the place of the essential fatty acids in the cell membranes. They also interfere with the desaturation and elongation of both linoleic and linolenic acid (Simopoulos and Robinson, 1998; Sanders, 1985; Rosenthal and Doloresco, 1984). In more detail, *trans* fatty acids are incorporated into cell membrane phospholipids, leading to decreased fluidity of membranes. Nutritionally, *trans* fatty acids behave similarly to saturated fatty acids. *Trans* fatty acids have different effects on different enzyme systems in lipid metabolism (Mahfouz et al., 1980).

Nestel et al. (1992) found that 7% of energy of *trans* fatty acids in the diet significantly raised LDL cholesterol and lowered HDL, and increased triglycerides, and Lp(a). (Lp(a) is an atherogenic and thrombogenic lipoprotein that contributes to atherosclerosis, *trans* fatty acids may also increase platelet aggregation, which contribute to thrombosis (Gautheron and Renaud, 1992). Margarine and shortening should not be promoted for the prevention of atherosclerosis and heart disease, and *trans* fatty acids should not be recommended as substitutes for saturated fats (Simopoulos^c, 1996). Saturated and *trans* fatty acids could be replaced largely by oils high in monounsaturated fats, such as rapeseed (canola) oil and olive oil (Katan et al., 1997).

CONCLUSION

The Mediterranean diet is considered the most favorable diet to prevent coronary heart disease (CHD), it is still unknown whether adoption of this diet may result in improved myocardial resistance to ischemia-reperfusion injury and may potentially prevent ventricular arrhythmias. Therefore, this work was focused to investigate whether a diet low in saturated fats and omega-6 fatty acids (ω -6) but rich in plant and marine omega-3 fatty acids (ω -3), may result in smaller infarct size and better left ventricular function recovery in a rat model of regional ischemia-reperfusion and to determine in a clinical study whether omega-3 PUFA could be associated with beneficial antiarrhythmic effects in high-risk patients. The obtained results demonstrate a great accumulation of ω -3 and a parallel decrease of arachidonic acid in plasma, cell membranes and cardiac mitochondria in rat model. Also, induced smaller infarct size compared with the control groups ($p < 0.01$).

Results from *The Grenoble city Omegadef Study*; after adjustment for age, sex, ischemic cardiac disease, alcohol, BMI, diabetes and smoking, did not show any significant interactions between red blood cell phospholipids ALA and EPA+DPA+DHA and the risk of arrhythmic complication in these patients. Analyses of *trans* fatty acids showed the same trend. It is noteworthy that patients had in average high contents of both plant (ALA) and marine omega-3 fatty acids (EPA and DHA), therefore a comparable omega-3 index. In the same time, the level of *trans* fatty acids was low in the different quartiles. Absence of significant effect on cardiac events in this population is probably due to much lower baseline risk, attributable at least partly to high background consumption of plant and marine omega-3 fatty acids reflected by the RBC omega-3 index and to the low consumption of *trans* fatty acids.

It can be concluded from research presented in this thesis that ω -3 PUFA possess potent beneficial effects on the CHD. Nevertheless, additional studies are needed to evaluate the effect and the cardioprotective mechanism of omega-3 fatty acid on arrhythmia before this therapy can be recommended to high-risk patients.

BIBLIOGRAPHY

BIBLIOGRAPHY

A

Aarsetoy H, Ponitz V, Nilsen OB, Grundta H, Harris WS, Nilsen DWT. Low levels of cellular omega-3 increase the risk of ventricular fibrillation during the acute ischaemic phase of a myocardial infarction. *Resuscitation* 2008; 78, 258-264.

Achleitner G, Gaigg B, Krasser A, Kainersdorfer E, Kohlwein S. Association between the endoplasmic reticulum and mitochondria of yeast facilitates interorganelle transport of phospholipids through membrane contact. *Eur J Biochem* 1999;264:545-553.

Adamek A, Jung S, Dienesch C, Laser M, Ertl G, Frantz S. Role of 5-lipoxygenase in myocardial ischemia-reperfusion injury in mice. *Eur J Pharmacol* 2007;571:51-4.

Albert CM, Campos H, Stampfer MJ, Ridker PM, Manson JE et al. Blood levels of long chain n-3 fatty acids and the risk of sudden death. *New Engl J Med* 2002; 346:1113-8.

Albert CM, Hennekens CH, O'Donnell CJ, Ajani UA, Carey VJ, Willett WC, Ruskin JN and Manson JE. Fish consumption and risk of sudden cardiac death. *JAMA* 1998; 279:23-28.

Al-Khatib SM, Sanders GD, Carlson M, Cicic A, Curtis A et al. Preventing tomorrow's sudden cardiac death today: Dissemination of effective therapies for sudden cardiac death prevention. *Am Heart J* 2008; 1-10.

Allain C, Pool L, Chan C, Richmond W, Fu P. Enzymatic determination of total serum cholesterol. *Clin Chem* 1974;20:470-475.

Allman-Farinnelli MA, Gomes K, Favaloro EJ, Petocz PA diet rich in high-oleic sunflower oil favorably alters low-density lipoprotein cholesterol, triglycerides and factor VII coagulant activity. *J Am Diet Assoc* 2005; 105:1071-1079.

Ambring A, Johansson M and Axelsen M et al. Mediterranean-inspired diet lowers the ratio of serum phospholipid n-6 to n-3 fatty acids, the number of leukocytes and platelets, and vascular endothelial growth factor in healthy subjects. *Am J Clin Nutr* 2006; 83: 575-581.

Ander BP, Weber AR, Rampersad PP et al. Dietary flaxseed protects against ventricular fibrillation induced by ischemia reperfusion in normal and hypercholesterolemic rabbits. *J Nutr* 2004; 134:3250-3256.

Ansell G, Spanner B. Plasmalogenase activity in normal and demyelinating tissue of the central nervous system. *Biochem J* 1968;108:207-209.

Ascherio A, Katan MB, Zock PL, Stampfer MJ, Willett WC. Trans fatty acids and coronary heart disease. *N Engl J Med* 1999;340:1994-1998.

Ascherio A, Rimm EB, Stampfer MJ, Giovannucci EL, Willett WC. Dietary intake of marine n-3 fatty acids, fish intake, and the risk of coronary disease among men. *N Engl J Med* 1995; 332:977-82.

B

Baer DJ, Judd JT, Clevidence BA, Tracy RP. Dietary fatty acids affect plasma markers of inflammation in healthy men fed controlled diets: a randomized crossover study. *Am J Clin Nutr* 2004;79:969-973.

Balk E, Chung M, Lichtenstein A, Chew P, Kupelnick B, Lawrence A, DeVine D, Lau J, for the Tufts-New England Medical Center Evidence-Based Practice Center, Boston, MA. Effects of Omega-3 Fatty Acids on Cardiovascular Risk Factors and Intermediate Markers of Cardiovascular Disease: Summary, Evidence Report/Technology Assessment No. 93. Rockville, MD: Agency for Healthcare Research and Quality; 2004. AHRQ Publication No. 04-E010-2.

Balk EM, Lichtenstein AH, Chung M, Kupelnick B, Chew P and Lau J. Effects of omega-3 fatty acids on serum markers of cardiovascular disease risk: a systematic review, *Atherosclerosis* 2006; 189:19-30.

Bang HO, Dyerberg J, Hjoorne N. The composition of food consumed by Greenland Eskimos. *Acta Med Scand* 1976; 200(1- 2):69-73.

Bang HO, Dyerberg J, Sinclair HM. The composition of the Eskimo food in north western Greenland. *Am J Clin Nutr* 1980; 33(12):2657-2661.

Bardy^a GH, Lee KL and Mark DB et al. Amiodarone or an implantable cardioverter-defibrillator for congestive heart failure. *N Engl J Med* 2005; 352:225-237.

Bardy^b GH, Lee K.L. and Mark DB et al. Sudden Cardiac Death in Heart Failure Trial (SCD-HeFT) Investigators. Amiodarone or an implantable cardioverter-defibrillator for congestive heart failure. *N Engl J Med* 2005; 352:225-237.

Baumann KH, Hessel F, Larass I, Muller T, Angerer P, Kiefl R, et al. Dietary omega-3, omega-6, and omega-9 unsaturated fatty acids and growth factor and cytokine gene expression in unstimulated and stimulated monocytes. A randomized volunteer study. *Arterioscler Thromb Vasc Biol* 1999, 19: 59-66.

Baylin A, Kabagambe EK, Ascherio A, et al. High 18:2 trans-fatty acids in adipose tissue are associated with increased risk of nonfatal acute myocardial infarction in Costa Rican adults. *J Nutr* 2003; 133: 1186-91.

Beck C, Pritchard W and Weil H. Ventricular fibrillation of long duration abolished by electric shock. *JAMA* 1947; 135:985-986.

Begley DA, Mohiddin SA, Tripodi D, Winkler JB, Fananapazir L. Efficacy of implantable cardioverter defibrillator therapy for primary and secondary prevention of sudden cardiac death in hypertrophic cardiomyopathy. *Pacing Clin Electrophysiol* 2003; 26:1887-96.

Bemelmans WJ, Broer J, Feskens EJ, Smit AJ, Muskiet FA, Lefrandt JD, Bom VJ, May JF, Meyboom-de Jong B. *Am J Clin Nutr* 2002; 75(2):221-7.

Berne RM and Levy MN. Principles of physiology. Third edition. Edition: Berne & Levy 2000; pp 185-375.

Berridge MJ. Calcium microdomains: organization and function. *Cell Calcium* 2006; 40:405-12.

Berry, G. S. and Gapaul, H. S. 1982. Biology of ourselves: A study of human biology. John Wiley & sons Canada limited. 14: 327-348.

Bigger JT, Fleiss JL and Kleiger R et al. The relationships among ventricular arrhythmias, left ventricular dysfunction, and mortality in the 2 years after myocardial infarction. *Circulation* 1984; 69:250-258.

Bigger JT. Prophylactic use of implanted cardiac defibrillators in patients at high risk for ventricular arrhythmias after coronary-artery bypass graft surgery. Coronary Artery Bypass Graft (CABG) Patch Trial Investigators. *N Engl J Med* 1997; 337:1569-1575.

Billman G, Hallaq H, Leaf A. Prevention of ischemia-induced ventricular fibrillation by ω -3 fatty acids. *Proc Natl Acad Sci* 1994; 91: 4427-4430.

Billman G, Kang J, Leaf A. Prevention of sudden cardiac death by dietary pure ω -3 polyunsaturated fatty acids in dogs. *Circulation* 1999; 99:2452-2457.

Billman G, Kang JX, Leaf A. Prevention of ischemia-induced cardiac sudden death by n-3 polyunsaturated fatty acids. *Lipids* 1997; 32: 1161-1168.

Bing RJ, Siegel, A, Ungar I and Gilbert M. Metabolism of the human heart. II. Studies on fat, ketone and amino acid metabolism. *Am J Med* 1954; 16:504-515.

Block RC, Harris S, Reid KJ, and Spertus JA. Omega-6 and trans fatty acids in blood cell membranes: A risk factor for acute coronary syndromes? (2008); *Am Heart J*;156:1117-23

Bourre JM, Dumont O, Piciotti M, Clement M, Chaudiere J, Bonneil M et al. Essentiality of omega 3 fatty acids for brain structure and function. *World Rev Nutr Diet* 1991; 66:103-17.

Bourre JM, Francois M, Youyou A, Dumont O, Piciotti M, Pascal G et al. The effects of dietary α -linolenic acid on the composition of nerve membranes, enzymatic activity, amplitude of electrophysiological parameters, resistance to poisons and performance of learning tasks in rats. *J Nutr* 1989; 119: 1880-92.

Bradford M. A rapid and sensitiv method for the quantitation of microgram quantities of protein utilizing the principle protein-dye bindong. *Anal Biochem* 1976;72:248-254.

Braunwald E, Kloner R. The stunned myocardium: prolonged postischemic ventricular dysfunction. *Circulation* 1982; 66:1146-1149.

Brembilla-Perrot B, Suty-Selton C, Claudon O, et al. Significance of inducible ventricular flutter-fibrillation after myocardial infarction. *Pacing Clin Electrophysiol* 2005; 28:938-43.

Brenna T. Efficiency of conversion of α -linolenic acid to long chain n-3 fatty acids in man. *Curr Opin Clin Nutr Metab* 2002; 5:127-32.

Brilakis ES, Friedman PA, Maounis TN, et al. Programmed ventricular stimulation in patients with idiopathic dilated cardiomyopathy and syncope receiving implantable cardioverter-defibrillators: a case series and a systematic review of the literature. *Int J Cardiol* 2005; 98:395-401.

Bristow MR, Saxon L.A. and Boehmer J. et al., Cardiac-resynchronization therapy with or without an implantable defibrillator in advanced chronic heart failure. *N Engl J Med* 2004; 350:2140-2150.

Brodsky MA, Mitchell LB, Halperin BD, Raitt MH, Hallstrom AP. Prognostic value of baseline electrophysiology studies in patients with sustained ventricular tachyarrhythmia: the Antiarrhythmics Versus Implantable Defibrillators (AVID) trial. *Am Heart J* 2002; 144:478-84.

Brouwer IA, Zock PL, van-Amelsvoort LG et al. Association between n-3 fatty acid status in blood and electrocardiographic predictors of arrhythmia risk in healthy volunteers. *Am J Cardiol* 2002; 89:629-631.

Brouwer^a IA, Geelen Anouk, Katan Martijn B. n-3 Fatty acids, cardiac arrhythmia and fatal coronary heart disease. *Progress in Lipid Research* 2006; 45: 357-367

Brouwer^b IA, Zock PL, Camm AJ et al. Effect of fish oil on ventricular tachyarrhythmia and death in patients with implantable cardioverter defibrillators: The Study on Omega- 3 Fatty Acids and Ventricular Arrhythmia (SOFA) randomized trial. *JAMA* 2006; 295:2613-2619.

Brouwer^c IA, Heeringa J, Geleijnse JM, Zock PL, Witteman JC. Intake of very long-chain n–3 fatty acids from fish and incidence of atrial fibrillation. The Rotterdam Study. *Am Heart J* 2006; 151:857-62.

Brugada R, Hong K, Dumaine R, et al. Sudden death associated with short-QT syndrome linked to mutations in HERG. *Circulation* 2004; 109:30-5.

Bucher HC, Hengstler P, Schindler C, Meier G. N-3 polyunsaturated fatty acids in coronary heart disease: a meta-analysis of randomized controlled trials. *Am J Med* 2002; 112:298-304.

Budowski P and Crawford MA. Alpha-Linolenic acid as regulator of the metabolism of arachidonic acid. Dietary implications of n-6: n-3 fatty acids. *Proc Nutr Soc* 1985; 44: 221-229.

Buja LM, Eigenbrodt ML, Eigenbrodt EH. Apoptosis and necrosis: basic types and mechanisms of cell death. *Arch Pathol Lab Med* 1993; 117:1208-14.

Buja LM, Hagler HK, Willerson JT. Altered calcium homeostasis in the pathogenesis of myocardial ischemic and hypoxic injury. *Cell Calcium* 1988; 9:205-17.

Buja LM. Modulation of the myocardial response to ischemia. *Lab Invest* 1998; 78:1345-73.

Buja LM. Myocardial ischemia and reperfusion injury. *Cardiovascular Pathology* 2005; 14:170– 175.

Burr M, Sweetham P, Fehily A. Diet and reinfarction. *Eur Heart J* 1994; 15:1152-1153.

Burr ML, Ashfield-Watt PA, Dunstan FD, Fehily AM, Breay P, Zotos PC, Haboubi NA, Elwood PC. Lack of benefit of dietary advice to men with angina: controlled trial. *Eur J Clin Nutr* 2003; 57:193-200.

Burr ML, Fehily AM, Gilbert JF, Rogers S, Holliday RM, Sweetnam PM, Elwood PC, Deadman NM. Effect of changes in fat, fish and fibre intakes on death and myocardial reinfarction: diet and reinfarction trial (DART). *Lancet* 1989; 2:757-761.

Burr ML. Fish food, fish oil and cardiovascular disease. *Clin Exp Hypertens A* 1992; 14:181-192.

Buxton AE, Lee KL, Fisher JD, Josephson ME, Prystowsky EN, Hafley G. A randomized study of the prevention of sudden death in patients with coronary artery disease. Multicenter Unsustained Tachycardia Trial Investigators. *N Engl J Med* 1999; 341:1882-90.

Buxton AE, Marchlinski FE and Waxman HL et al. Prognostic factors in nonsustained ventricular tachycardia. *Am J Cardiol* 1984; 53:1275-1279.

Buzina R, Suboticanec K and Saric M. Diet patterns and health problems: Diet in southern Europe. *Ann Nutr Metab* 1991; 35 (suppl 1): 32-40.

C

Calder PC. Dietary modification of inflammation with lipids. *Proc Nutr Soc* 2002; 61(3):345-358.

Calder PC. n-3 fatty acids and cardiovascular disease: evidence explained and mechanisms explored. *Clin Sci* 2004;107:1–11.

Calderon F, Kim H.Y., Docosahexaenoic acid promotes neurite growth in hippocampal neurons. *J Neurochem* 2004; 90:979-988.

Calo L, Bianconi L, Colivicchi F, Lamberti F, Loricchio ML, et al. n-3 Fatty acids for the prevention of atrial fibrillation after coronary artery bypass surgery: a randomized, controlled trial. *JACC* 2005; 45:1723-8.

Cao J, Schwichtenberg KA, Hanson NQ, Tsai MY. Incorporation and clearance of omega-3 fatty acids in erythrocyte membranes and plasma phospholipids. *Clin Chem* 2006; 52(12):2265-72.

Chan DC, Watts GF, Barrett PH, Beilin LJ, Redgrave TG, Mori TA. Regulatory effects of HMG CoA reductase inhibitor and fish oils on apolipoprotein B-100 kinetics in insulin-resistant obese male subjects with dyslipidemia. *Diabetes* 2002;51:2377–2386.

Charnock J, McLennan P, Abeywardena M. Dietary modulation of lipid metabolism and mechanical performance of the heart. *Mol Cell Biol* 1992; 116:19-25.

Charnock JS, Abeywardena MY, McLennan PL. Diet and cardiac arrhythmia: Effects of lipids on age related changes in myocardial function in the rat. *Ann Nutr Metab* 1985; 29:306.

Charnock JS, Crozier GL & Woodhouse J. Gamma linolenic acid, blackcurrant seed and evening primrose oil in the prevention of cardiac arrhythmia in aged rats. *Nutr. Res* 1994; 14: 1089-1099.

Charnock JS, McLennan PL, Sundram K, Abeywardena MY. Omega-3 PUFA's reduce the vulnerability of the rat heart to ischemic arrhythmia in the presence of a high intake of saturated animal fat. *Nutr Res* 1991; 11:1025-1034.

Charnock JS. Omega-3 polyunsaturated fatty acids and ventricular fibrillation: the possible involvement of eicosanoids. *Prostag Leukot Essent Fatty Acids* 1999; 61:243-7.

Cheng JWM and Santoni F. Omega-3 Fatty Acid: A Role in the Management of Cardiac Arrhythmias? *The Journal of Alternative and Complementary Medicine* 2008; 14 (8):000-000

Chin JP, Gust AP, Nestel PJ, Dart AM. Marine oils dose-dependently inhibit vasoconstriction of forearm resistance vessels in humans. *Hypertension* 1993; 21:22-28.

Christensen JH, Skou HA, Fog L, et al. Marine n-3 fatty acids, wine intake and heart rate variability in patients referred for coronary angiography. *Circulation* 2001; 103:651-657.

Christensen JP, Christensen MS, Dyerberg, Schmidt E. Heart rate variability and fatty acid content of blood cell membranes: a dose-response study with n-3 fatty acids. *Am J Clin Nutr* 1999;70:331-337.

Chrysohoou C, Panagiotakos DB, Pitsavos C, et al. Long-term fish consumption is associated with protection against arrhythmia in healthy persons in a Mediterranean region: The ATTICA study. *Am J Clin Nutr* 2007; 85:1385-1391.

Clandinin MT, Jumpsen J, Suh M. Relationship between fatty acid, accretion, membrane composition, and biologic functions. *J Pediatrics* 1994; 125: S25-S32.

Clarke SD and Amstrong MK. Suppression of rat liver fatty acid synthetase mRNA level by fish oil. *FASEB J* 1988; 2: A852.

Clarke SD and Jump DB. Dietary polyunsaturated fatty acid regulation of gene transcription. *Ann Rev Nutr* 1994 ; 14: 83-98.

Cleland LG, James MJ, Neumann MA, D'Angelo M and Gibson RA. Linoleate inhibits EPA incorporation from dietary fish-oil supplements in human subjects, *Am J Clin Nutr* 1992; 55:395-399.

Clifton PM, Keogh JB, Noakes M. Trans fatty acids in adipose tissue and the food supply are associated with myocardial infarction. *J Nutr* 2004; 134:874-9.

Colate TP. Food: the chemistry of its components. Second ed. *Royal Society of Chemistry Paperbacks* 1992; 4: 51-83.

Comte J, Gautheron D, Peypoux F, Michel G. Lipid composition and endogenous respiration of pig heart mitochondria. *Lipid* 1971;6:882-888.

Comte J, Maisterrena B, Gautheron D. Lipid composition and protein profiles of outer and inner membranes from pig heart mitochondria. Comparison with microsomes. *Biochim Biophys Acta* 1976;419:271-284.

Connolly^a SJ, Hallstrom AP, Cappato R, et al. Meta-analysis of the implantable cardioverter defibrillator secondary prevention trials. AVID, CASH and CIDS studies. Antiarrhythmics vs Implantable Defibrillator study. Cardiac Arrest Study Hamburg. Canadian Implantable Defibrillator Study. *Eur Heart J* 2000; 21:2071-8.

Connolly^b SJ, Gent M, Roberts RS, et al. Canadian implantable defibrillator study (CIDS): a randomized trial of the implantable cardioverter defibrillator against amiodarone. *Circulation* 2000; 101:1297-302.

Connor W. The impact of dietary omega-3 fatty acids on the synthesis and clearance of apo B lipoproteins and chylomicrons: Proceedings of the Scientific Conference on Omega-3 Fatty Acids in Nutrition, Vascular Biology, and Medicine, American Heart Association 1994; Houston, TX.

Connor WE and Connor SL. Should a low-fat, high-carbohydrate diet be recommended for every one? *The New England Journal of Medicine* 1997; 562-567.

Connor WE. Importance of n-3 fatty acids in health and disease. *Am J Clin Nutr* 2000; 71:171-175.

Corr P, Gross R, Sobel B. Amphipathic metabolites and membrane dysfunction in ischemic myocardium. *Circulation res* 1984; 55:135-154.

Corrado D, Leoni L, Link MS, et al. Implantable cardioverterdefibrillator therapy for prevention of sudden death in patients with arrhythmogenic right ventricular cardiomyopathy/dysplasia. *Circulation* 2003; 108:3084-91.

Crawford MA. The balance between α -linolenic and linoleic acid. In: The role of fats in human nutrition. Ed. Padley F. B., Podmore J., Brun J. P., Brut R. and Nicols B. W. Ellis Howord Ltd 1985; 5: 62-83.

Croft KD, Beilin LJ, Vandongen R and Mathews E. Dietary modification of fatty acid and prostaglandin synthesis in the rat. *Biochem Biophys Acta* 1984; 795: 196-207.

Culp B, Lands W, Lucches B, Pitt B, Romson J. The effect of dietary supplementation of fish oil on experimental myocardial infarction. *Prostaglandins* 1980; 20:1021-1031.

Curtis AB, Ellenbogen KA, Hammill SC, et al. Clinical competency statement: training pathways for implantation of cardioverter defibrillators and cardiac resynchronization devices. *Heart Rhythm* 2004; 1:371-5.

Curtis CL, Rees SG, Little CB, Flannery CR, Hughes CE, Wilson C et al. Pathologic indicators of degradation and inflammation in human osteoarthritic cartilage are abrogated by exposure to n-3 fatty acids. *Arthritis Rheum* 2002; 46:1544-1553.

D

Dai J, Williams SA and Ziegelhoffer A. Structure-activity relationship of the effect of cis-unsaturated fatty acids and heart sarcolemmal phospholipase D activity. *Prostaglandins Leukot Essent Fatty Acids* 1995; 52: 167-171.

Das M, Gherghiceanu M, Lekli I, Mukherjee S, Popescu LM, Das DK. Essential role of lipid raft in ischemic preconditioning. *Cell Physiol Biochem* 2008; 21:325-34.

Das N, Horrobin DF, Begin, M.E., Huang, Y.S. et al., Clinical significance of essential fatty acids. *Nutrition* 1988; 4:337-342.

Das N. Essential fatty acids: biochemistry, physiology and pathology. *Biotechnol. J.* 2006, 1, 420-439.

Das N. Essential fatty acids: Biology and their clinical implications. *Asian Pacific J Pharmacol* 1991; 6:317-330.

Daviglus ML, Stamler J, Orenca AJ, Dyer AR, Liu K, Greenland P, Walsh MK, Morris D, Shekelle RB. Fish consumption and the 30-year risk of fatal myocardial infarction. *N Engl J Med* 1997; 336:1046-1053.

De Backer G, Ambrosioni E, Borch-Johnsen K, Brotons C, Cifkova R, Dallongeville J, Ebrahim S, Faergeman O, Graham I, Mancia G, et al, European guidelines on cardiovascular

disease prevention in clinical practice: Third Joint Task Force of European and Other Societies on Cardiovascular Disease Prevention in Clinical Practice. *Eur Heart J* 2003; 24:1601-1610.

De Caterina R and Massaro M. Omega-3 fatty acids and the regulation of expression of endothelial pro-atherogenic and pro-inflammatory genes. *J Membr Biol* 2005; 206:103-116.

De Caterina R and Zampoli AM. Omega-3 fatty acids, atherogenesis, and endothelial activation. *J Cardiovasc Med* 2007; 8 (suppl 1): S11-S14.

De Caterina R, Madonna R, Hassan J, Procopio AD: Nutrients and gene expression; in Simopoulos AP, Pavlou KN (eds): Nutrition and Fitness: Diet, Genes, Physical Activity and Health. *World Rev Nutr Diet* 2001; 89:23-52

De Gomez DNT and Brenner RR. Oxidative desaturation of alpha-linolenic, linoleic, and stearic acids by human liver microsomes. *Lipids* 1975; 10: pp 315.

De Leiris J, Opie L. Effect of substrates and of coronary artery ligation on mechanical performance and on release of lactate dehydrogenase and creatine phosphokinase in isolated working rat hearts. *Cardiovasc Res* 1978; 12:585-596.

De Leiris^a J, Opie L, Lubbe W, Bricknell O. Effect of substrate on enzyme release after coronary artery ligation in isolated rat heart. *Recent Adv Stud Cardiac Struct Metab* 1975; 10:291-293.

De Leiris^b J, Lubbe WF, Opie LH. Effects of free fatty acid and glucose on enzyme release in experimental myocardial infarction. *Nature* 1975;153:746-747.

De Lorgeril M and Salen P. Modified Cretan Mediterranean diet in the prevention of Coronary Heart Disease and Cancer. Simopoulos AP, and Visioli F (eds): Mediterranean diets. *World Rev Nutr Diet Basel Karger* 2000; 87:1-23.

De Lorgeril M, Renaud S, Mamelle N, Salen P, Martin JL, Monjaud I, Guidollet J, Touboul P, Delaye J. Mediterranean alpha-linolenic acid-rich diet in secondary prevention of coronary heart disease. *Lancet* 1994; 343:1454-1459.

De Lorgeril M, Salen P, Martin JL, Monjaud I, Boucher P and Mamelle N. Mediterranean Dietary Pattern in a Randomized Trial Prolonged Survival and Possible Reduced Cancer Rate. Original investigation. *Arch Intern Med* 1998; 158:1181-1187.

De Lorgeril M, Salen P, Martin JL, Monjaud I, Delaye J, Mamelle N. Mediterranean diet, traditional risk factors, and the rate of cardiovascular complications after myocardial infarction: final report of the Lyon Diet Heart Study. *Circulation* 1999; 99:779-785.

de Lorgeril M, Salen P. Diet as preventive medicine in cardiology. *Curr Opin Cardiol* 2000; 15:364-70.

de Lorgeril M, Salen P. Fish and N-3 fatty acids for the prevention and treatment of coronary heart disease: nutrition is not pharmacology. *Am J Med* 112:316-9, 2002.

de Roos NM, Bots ML, Katan MB. Replacement of dietary saturated fatty acids by trans fatty acids lowers serum HDL cholesterol and impairs endothelial function in healthy men and women. *Arterioscler Thromb Vasc Biol* 2001;21:1233-1237.

Demaison L, Sergiel J, Moreau D, Grynberg A. Influence of the phospholipid n-6/n-3 polyunsaturated fatty acid ratio on the mitochondrial oxidative metabolism before and after myocardial infarction. *Biochim Biophys Acta* 1994; 1227:53-59.

Demaison L, Blet, Sergiel J, Gregoire S, Argaud D. Effect of dietary polyunsaturated fatty acids on contractile function of hearts isolated from sedentary and trained rats. *Reprod Nutr Dev* 2000; 40:1493-1499.

Dietary Guidelines Advisory Committee. Nutrition and your health: dietary guidelines for Americans: 2005 Dietary Guidelines Advisory Committee report. Washington, D.C.: Department of Agriculture, 2005 (<http://www.health.gov/dietaryguidelines/dga2005/report/>).

Dolecek TA, Granditis G. Dietary polyunsaturated fatty acids and mortality in the Multiple Risk Factor Intervention Trial (MRFIT). *World Rev Nutr Diet* 1991; 66:205–216.

Dolecek TA. Epidemiologic evidence of relationships between dietary polyunsaturated fatty acids and mortality in the Multiple Risk Factor Intervention Trial. *Proc. Soc. Exp. Biol. Med* 1992; 200:177-182.

Dubois M, Croset M, Nemoz G, Lagarde M, Prigent AF. Modulation of cyclic nucleotide phosphodiesterase by dietary fats in rat heart. *Lipids* 1992; 27:746-54.

Duffy E, Meenagh G, McMillan S, Strain J, Hannigan B, Bell A. The clinical effect of dietary supplementation with omega-3 fish oils and/or copper in systemic lupus erythematosus. *J Rheumatol* 2004; 31:1551–1556.

Dyerberg J, Eskesen DC, Andersen PW, Astrup A, Buemann B, Christensen JH, Clausen P, Rasmussen BF, Schmidt EB, Tholstrup T, et al. Effects of trans- and n-3 unsaturated fatty acids on cardiovascular risk markers in healthy males: an 8 weeks dietary intervention study. *Eur J Clin Nutr* 2004; 58:1062-1070.

E

El Banani H, Bernard M, Baetz D, Cabanes E, Cozzone P, Lucien A, Feuvray D. Changes in intracellular sodium and pH during ischaemia-reperfusion are attenuated by trimetazidine. Comparison between low- and zero-flow ischaemia. *Cardiovasc Res* 2000; 47(4):637-9.

Endres S, Ghorbani R, Kelly VE, Georgilis K, Lonnemann G, van der Meer JW, et al. The effect of dietary supplementation with n-3 polyunsaturated fatty acids on the synthesis of interleukin-1 and tumor necrosis factor by mononuclear cells. *N Engl Med* 1989; 265-271.

Engelbrecht AM, Engelbrecht P, Genade S, Niesler C, Page C, Smuts M, Lochner A. Long-chain polyunsaturated fatty acids protect the heart against ischemia/reperfusion-induced injury via a MAPK dependent pathway. *J Moll Cell Cardiol* 39:940–54, 2005.

Erkkila AT, Lehto S, Pyorala K, Uusitupa MI. n-3 Fatty acids and 5-y risks of death and cardiovascular disease events in patients with coronary artery disease. *Am J Clin Nutr* 2003; 78:65-71.

Eschen O, Christensen JH, Toft E and Schmidt EB. Soluble adhesion molecules and marine n-3 fatty acids in patients referred for coronary angiography, *Atherosclerosis* 2005; 180: 327-331.

European Commission Directorate General for Health and Consumer Protection. Eurodiet: Nutrition and Diet for Healthy Lifestyles in Europe. 2001. Available at: <http://eurodiet.med.uoc.gr/>.

Ezekowitz JA, Armstrong PW, McAlister FA. Implantable cardioverter defibrillators in primary and secondary prevention: a systematic review of randomized, controlled trials. *Ann Intern Med* 2003; 138:445-52.

F

Farmer DM, Swygman CA, Wang PJ, Mark EN, III, Link MS. Evidence that nonsustained polymorphic ventricular tachycardia causes syncope (data from implantable cardioverter defibrillators). *Am J Cardiol.* 2003; 91:606-9.

Feskens EJM, Bowles CH and Kromhout D. Association between fish intake and coronary heart disease mortality-differences in normoglycemic and glucose intolerant elderly subjects. *Diabetes Care* 1993; 16:1029-1034.

Feuvray D. Arrhythmia and metabolism. *Heart Metab* 2006; 33:3-4.

Feuvray D. Ultrastructural, functional, and metabolic correlates in the ischemic rat heart. Effects of substrates. *Am J Physiol* 1981; 240:391-398.

Fiaccavento R, Carotenuto F, Minieri M, Masuelli L, Vecchini A, Bei R, Modesti A, Binaglia L, Fusco A, Bertoli A, Forte G, Carosella L, Di Nardo P. Alpha-linolenic acid-enriched diet prevents myocardial damage and expands longevity in cardiomyopathic hamsters. *Am J Pathol* 2006; 169:1913-24.

Food and Drug Administration. FDA acts to provide better information to consumers on *trans* fats 2005; (<http://www.fda.gov/oc/initiatives/transfat/>).

Force T, Malis CD, Guerrero JL, Varadarajan GS, Bonventre JV, Weber PC, Leaf A. n-3 fatty acids increase postischemic blood flow but do not reduce myocardial necrosis. *Am J Physiol* 1989; 257:H1204-10.

Fossati P, Prencipe L. Serum triglycerides determined colorimetrically with an enzyme that produces hydrogen peroxide. *Clin Chem* 1982;29:2077-2080.

Fowler KH, Chapkin RS, McMurray DN. Effects of purified dietary n-3 ethyl esters on murine T lymphocyte function. *J Immunol* 1993; 151:5186-5197.

Fox PL, DiCorleto PE. Fish oils inhibit endothelial cell production of platelet-derived growth factor-like protein. *Science* 1988; 241:453-456.

Fraser GE, Sabate J, Beeson WL, Strahan TM. A possible protective effect of nut consumption on risk of coronary heart disease. The Adventist Health Study. **Arch Intern Med** 1992; 152:1416-24.

Frost L, Vestergaard P. n-3 fatty acids consumed from fish and risk of atrial fibrillation or flutter: The Danish Diet, Cancer, and Health Study. *Am J Clin Nutr* 2005; 81:50-54.

G

Galli C, Agradi E, Petroni A and Tremoli E. Differential effects of dietary fatty acids on the accumulation of arachidonic acid and its metabolic conversion through the cyclooxygenase and lipoxygenase in vascular tissues. *Lipids* 1981; 16: 165-172.

Garattini S. Long-chain n-3 fatty acids in lipid rafts: implications for anti-inflammatory effects. *J cardiovasc med* 2007; 8 (suppl): S30-S33.

Garcia-Moran E, Mont L, Cuesta A, Matas M, Brugada J. Low recurrence of syncope in patients with inducible sustained ventricular tachyarrhythmias treated with an implantable cardioverterdefibrillator. *Eur Heart J* 2002; 23:901-7.

Gautheron P and Renaud S. Hyperlipidemia induced hypercoagulable state in rat. Role of an increased activity of platelet phosphatidylserine in response to certain dietary fatty acids. *Thromb Res* 1992; 1: 353.

Getz G, Bartley W, Lurie D, Notton B. The phospholipids of various sheep organs, rat liver and of their subcellular fractions. *Biochim Biophys Acta* 1968;152:325-339.

Giamarellos-Bourboulis EJ, Mouktaroudi M, Adamis T, Koussoulas V et al. n-6 polyunsaturated fatty acids enhance the activities of ceftazidime and amikacin in experimental

sepsis caused by multidrug-resistant *Pseudomonas aeruginosa*. *Antimicrob Agents Chemother* 2004; 48:4713-4717.

Gillinov AM. Commentary on the American College of Cardiology/ American Heart Association/Heart Rhythm Society Guidelines for Device-Based Therapy of Cardiac Rhythm Disorders: Surgery for Acquired Cardiovascular Disease. *The Journal of Thoracic and Cardiovascular Surgery In press* 2008.

Gillis AM, Sheldon RS, Wyse DG, Duff HJ, Cassidy MR, Mitchell LB. Clinical and electrophysiologic predictors of ventricular tachyarrhythmia recurrence in patients with implantable cardioverter defibrillators. *J Cardiovasc Electrophysiol* 2003; 14:492-8.

Gillum RF, Mussolino M and Madans JH. The relation between fish consumption, death from all causes, and incidence of coronary heart disease the NHANES I Epidemiologic Follow-up Study, *J Clin Epidemiol* 2000; 53:237-244.

GISSI-Prevenzione Investigators. Dietary supplementation with n-3 polyunsaturated fatty acids and vitamin E after myocardial infarction: results of the GISSI-Prevenzione trial. *Lancet* 1999; 354: 447-455

Goel AK, Berger S, Pelech A, Dhala A. Implantable cardioverter defibrillator therapy in children with long QT syndrome. *Pediatr Cardiol* 2004; 25:370-8.

Goel DP, Maddaford TG, Pierce GN. Effects of omega-3 polyunsaturated fatty acids on cardiac sarcolemmal Na⁺/ H⁺ exchange. *Am J Physiol Heart Circ Physiol* 2002; 283:H1688-94.

Goldenberg I and Moss AJ. Implantable Device Therapy. *Progress in Cardiovascular Diseases* 2008; 50(6):449-474.

Goldenberg I, Mathew J, Moss AJ, et al. Corrected QT variability in serial electrocardiograms in long QT syndrome: the importance of the maximum corrected QT for risk stratification. *J Am Coll Cardiol* 2006; 48:1047-52.

Graber R, Sumida C and Nunez EA. Fatty acids and cell signal transduction. *Jour Lipid Mediat Cell Signal* 1994; 9: 91-116.

Grimm W, Herzum I, Muller HH, Christ M. Value of heart rate variability to predict ventricular arrhythmias in recipients of prophylactic defibrillators with idiopathic dilated cardiomyopathy. *Pacing Clin Electrophysiol* 2003; 26:411-5.

Gross GJ, Falck JR, Gross ER, Isbell M, Moore J, Nithipatikom K. Cytochrome P450 and arachidonic acid metabolites: role in myocardial ischemia/reperfusion injury revisited. *Cardiovasc Res* 2005 ; 68:18-25.

Gross GJ, Hsu A, Falck JR, Nithipatikom K. Mechanisms by which epoxyeicosatrienoic acids (EETs) elicit cardioprotection in rat hearts. *J Mol Cell Cardiol* 2007; 42:687-91.

Grynberg A, Fournier A, Sergiel JP, Athias P. Effect of docosahexaenoic acid and eicosapentaenoic acid in the phospholipids of rat heart muscle cells on adrenoceptor responsiveness and mechanism. *J Mol Cell Cardiol* 1995; 27:2507-20.

Grynberg A, Fournier A, Sergiel JP, Athias P. Membrane docosahexaenoic acid vs. eicosapentaenoic acid and the beating function of the cardiomyocyte and its regulation through the adrenergic receptors. *Lipids* 1996; 31(Suppl):S205-10.

Grynberg A, Nalbhone G, Leonardi J, Lafont H and Athias P. Eicosapentaenoic and docosahexaenoic acids in cultured rat ventricular myocytes and hypoxia induced alterations of phospholipase-A activity. *Mol Cell Biochem* 1992; 116: 75-78.

Grynberg A et al. Acides gras omega-3 et pr?vention cardiovasculaire. *Cah. Nutr. Di?t* 1997 ; 32:107-114.

Guallar E, Aro A, Jimenez FJ, Martin-Moreno JM, Salminen I, van't Veer P, Kardinaal AF, Gomez-Aracena J, Martin BC and Kohlmeier L et al. Omega-3 fatty acids in adipose tissue and risk of myocardial infarction the EURAMIC study, *Arterioscler Thromb Vasc Biol* 19 (1999), pp. 1111-1118.

Guidant (2008), <http://www.access-media.net/guidant-recall/defibrillators.htm>

Guiraud A, de Lorgeril M, Boucher F, Berthonneche C, Rakotosavo A, de Leiris. J. Cardioprotective effect of chronic low dose ethanol drinking. Insights into the concept of ethanol preconditioning. *J Mol Cell Cardiol* 2004;36:561-566.

Guiraud A, de Lorgeril M, Zeghichi S, Francois Laporte F, Salen P, Saks V, Berraud N, Boucher F, de Leiris J. Interactions of ethanol drinking with omega-3 fatty acids in rats. Potential consequences for the cardiovascular system. *Br J Nutr* 2008;29:1-8.

Gunter T, Pfeiffer D. Mechanisms by which mitochondria transport calcium. *Am J Physiol* 1990; 258:755-786.

Gustafsson AB, Gottlieb RA. Heart mitochondria: gates of life and death. *Cardiovasc Res* 2008; 77:334-343.

Guttigoli AB, Wilner BF, Stein KM, et al. Usefulness of prolonged QRS duration to identify high-risk ischemic cardiomyopathy patients with syncope and inducible ventricular tachycardia. *Am J Cardiol* 2005; 95:391-4.

H

Hallaq H, Sellmayer A, Smith T, Leaf A. Protective effects of eicosapentaenoic acid on ouabain toxicity in neonatal rat cardiac myocytes. *Proc Natl Acad Sci USA* 1990; 87:7834-7838.

Hallaq H, Smith T, Leaf A. Modulation of dihydropyridine-sensitive calcium channels in heart cells by fish oil fatty acids. *Proc Natl Acad Sci USA* 1992; 89:1760-1764.

Hamazaki T, Okuyama H. The Japan Society for Lipid Nutrition recommends to reduce the intake of linoleic acid. A review and critique of the scientific evidence. *World Rev Nutr Diet* 2003; 92:109-132.

Han SN, Leka LS, Lichtenstein AH, Ausman LM, Schaefer EJ, Meydani SN. Effect of hydrogenated and saturated, relative to polyunsaturated, fat on immune and inflammatory responses of adults with moderate hypercholesterolemia. *J Lipid Res* 2002;43:445-452.

Hansen JB, Olsen JO, Wilsgard L, Osterud B. Effects of dietary supplementation with cod liver oil on monocyte thromboplastin synthesis, coagulation and fibrinolysis. *J Intern Med Suppl* 1989; 731:133-139.

Hara A, Radin N. Lipid extraction of tissues with a low toxicity solvent. *Anal Bioch* 1978; 90:420-426.

Harris WS, Miller Michael, Tighe AP, Davidson MH, Schaefer EJ. Omega-3 fatty acids and coronary heart disease risk: Clinical and mechanistic perspectives. *Atherosclerosis* 2008; 197:12-24.

Harris WS, Sands SA, Windsor SL, et al. Omega-3 fatty acids in cardiac biopsies from heart transplantation patients. Correlation with erythrocytes and response to supplementation. *Circulation* 2004; 110:1645-9.

Harris WS. Omega-3 Fatty Acids and Cardiovascular Disease: A Case for Omega-3 Index as a New Risk Factor. *Pharmacological Research* 2007, *in press*.

Harris WS., and von Schacky C. The Omega-3 Index: a new risk factor for death from coronary heart disease? *Preventive Medicine* 2004; 39:212-220.

Hartzell HC, Fischmeister R. Opposite effects of cyclic GMP and cyclic AMP on Ca²⁺ current in single heart cells. *Nature* 1986; 323: 273-5.

He^a K, Song Y, Daviglius ML, Liu K, Van Horn L, Dyer AR, Goldbourt U, Greenland P. Fish consumption and incidence of stroke: a metaanalysis of cohort studies. *Stroke* 2004; 35:1538-1542.

Hearse D, de Leiris J. Enzymes in cardiology. Diagnosis and research. John Wiley and sons Chichester 1979; pp3-11.

He^b K, Song Y, Daviglius ML, Liu K, Van Horn L, Dyer AR, Greenland P. Accumulated evidence on fish consumption and coronary heart disease mortality: a meta-analysis of cohort studies. *Circulation* 2004; 109:2705-2711.

Hernandez AF, Fonarow GC, Liang L et al. and the GWTG Steering Committee and Hospitals, Sex and racial differences in the use of implantable cardioverter-defibrillators among patients hospitalized with heart failure, *JAMA* 2007; 298 :1525-1532.

Heron DS, Shinitzky M, Hershkowitz M, Samuel D. Lipid fluidity markedly modulates the binding of serotonin to mouse brain membranes. *Proc Natl Acad Sci* 1980; 77:7463-7.

Heurteaux C, Laigle C, Blondeau N, Jarretou G, Lazdunski M. Alpha-linolenic acid and riluzole treatment confer cerebral protection and improve survival after focal brain ischemia. *Neuroscience* 2006;137:241-51.

Hirafuji M, Ebihara T, Kawahara F, Hamaue N, Endo T, Minami M. Inhibition by docosahexaenoic acid of receptor-mediated Ca(2+) influx in rat vascular smooth muscle cells stimulated with 5-hydroxytryptamine. *Eur J Pharmacol* 2001; 427:195-201.

Hirafuji M, Ebihara T, Kawahara F, Nezu A, Taminura A, Saito H, et al. Effect of docosahexaenoic acid on intracellular calcium dynamics in vascular smooth muscle cells from normotensive and genetically hypertensive rats. *Res Commun Mol Pathol Pharmacol* 1998; 102:29-42.

Hirai A, Hamazaki T, Terano T, et al. Eicosapentaenoic acid and platelet function in Japanese. *Lancet* 1980; 2:1132-1133.

Hiramatsu K, Nosaki H, Arimori S. A new method to quantitate lipid contents in human platelets by thin layer chromatography with flame ionization detection. *Tokai J Exp Clin Med* 1980;5:177-186.

Hjelte LE, Nilsson A. Arachidonic acid and ischemic heart disease. *J Nutr* 2005; 135:2271-3.

Hobbs JB, Peterson DR, Moss AJ, et al. Risk of aborted cardiac arrest or sudden cardiac death during adolescence in the long-QT syndrome. *JAMA* 2006; 296:1249-54.

Hochachka PW, Buck LT, Doll CJ, Land SC. Unifying theory of hypoxia tolerance: molecular/metabolic defense and rescue mechanisms for surviving oxygen lack. *Proc Natl Acad Sci USA* 1996; 93:9493-9498.

Hock C, Beck D, Bodine R, Reibel D. Influence of dietary n-3 fatty acids on myocardial ischemia and reperfusion. *Am J Physiol Heart Circ Physiol* 1990; 259:H1518-H1526.

Hock C, Holahan M, Reibel D. Effect of dietary fish oil on myocardial phospholipids and myocardial ischaemic damage. *Am J Physiol* 1987; 252:H544-H560.

Hodgkinson KA, Parfrey PS, Bassett AS, et al. The impact of implantable cardioverter-defibrillator therapy on survival in autosomal-dominant arrhythmogenic right ventricular cardiomyopathy (ARVD5). *J Am Coll Cardiol* 2005; 45:400-8.

Hodson L, Skeaff CM, Wallace AJ, Arribas GL. Stability of plasma and erythrocyte fatty acid composition during cold storage. *Clin Chem Acta* 2002; 321:63-7.

Hohnloser SH, Kuck KH, Dorian P et al. Prophylactic use of an implantable cardioverter-defibrillator after acute myocardial infarction. *N Engl J Med* 2004; 351:2481-8.

Holman RT. Influence of hydrogenated fats on the metabolism of polyunsaturated fatty acids. The role of fats in human nutrition. Ed. Padley F. B., Podmore J., Brun J. P., Brut R. and Nicols B. W. Ellis Horwood Ltd. 1985; 4: 48-61.

Holub BJ. Fish oils and cardiovascular disease. *CMAJ* 1989; 141:1063.

Hool LC. What Cardiologists Should Know About Calcium Ion Channels and Their Regulation by Reactive Oxygen Species. *Heart, Lung and Circulation* 2007; 16:361-372.

Hu FB, Bronner LL, Willett WC, Stampfer MJ, Rexrode KM, Albert CM, Hunter D and Manson JE. Fish and omega-3 fatty acid intake and risk of coronary heart disease in women, *JAMA* 2002; 287:1815-1821.

Hu FB, Stampfer MJ, Manson JE et al. Dietary fat intake and the risk of coronary heart disease in women. *N Engl J Med* 1997; 337:1491-9.

Hu FB, Stampfer MJ, Manson JE, Rimm EB, Wolk A, Colditz GA, Hennekens CH and Willett WC. Dietary intake of alpha-linolenic acid and risk of fatal ischemic heart disease among women. *Am J Clin Nutr* 1999; 69:890-897.

Hu FB, Willett WC. Diet and coronary heart disease: findings from the Nurses' Health Study and Health Professionals' Follow-up Study. *J Nutr Health Aging* 2001; 5:132-8.

Huang J, Xian H, Bacaner M. Long chain fatty acids activate calcium channels in ventricular myocytes. *Proc Natl Acad Sci USA* 1992; 89:6452-6456.

Huikuri HV, Castellanos A, Myerburg RJ. Sudden death due to cardiac arrhythmias. *New Engl J Med* 2001; 345:1473-82.

Huss JM. and Kelly D P. Mitochondrial energy metabolism in heart failure: a question of balance. *J Clin Invest* 2005; 115:547-555.

I

Indu M, Ghafoorunissa I. n-3 fatty acids in indiets diet-comparison of the effects of precursor (alpha-linolenic acid) vs product (long-chain n-3 polyunsaturated fatty acids). *Nutr Res* 1992; 12:569-82.

Iso H, Kobayashi M, Ishihara J, Sasaki S, Okada K, Kita Y, Kokubo Y and Tsugane S., Intake of fish and n3 fatty acids and risk of coronary heart disease among Japanese the Japan Public Health Center-Based (JPHC) Study Cohort I, *Circulation* 2006; 113:195-202.

J

Jeffrey BG, Weisingerb HS, Neuringer M, Mitcheli DC. The role of docosahexaenoic acid in retinal function. *Lipids* 2001; 36(9):859-871.

K

Kadish A, Dyer A, Daubert JP et al. and for the Defibrillators in Non-ischemic Cardiomyopathy Treatment Evaluation (DEFINITE) Investigators, Prophylactic defibrillator implantation in patients with non-ischemic dilated cardiomyopathy. *N Engl J Med* 2004; 350:2151-2158.

Kadish A, Quigg R, Schaechter A, Anderson KP, Estes M, Levine J. Defibrillators in nonischemic cardiomyopathy treatment evaluation. *Pacing Clin Electrophysiol* 2000; 23:338-43.

Kagawa Y, Nishizawa M et al. Eicosapolyenoic acids of serum lipids of Japanese Islanders with low incidence of cardiovascular diseases. *J. Nutr. Sci. Vitaminol* 1982; (Tokyo). 28: 441-453.

Kaimal T, Shanta N. Quantitative analysis of lipid on copper (II) sulfate impregnated chromarods. *J of Chromatography* 1984;288:177-186.

Kallithraka S, El-Jazouli A, Zeghichi S. Mediterranean diet in the Magreb. Simopoulos A.P. &Visioli F. (eds): Mediranean diets. *World Rev Nut Diet. Basal. Karger* 2000; 87: 160-179.

Kaminski WE, Jendraschak E, Kiefl R, von Schacky C. Dietary omega-3 fatty acids lower levels of platelet-derived growth factor mRNA in human mononuclear cells. *Blood* 1993; 81:1871-1879.

Kang JX and Leaf A. Effects of long-chain polyunsaturated fatty acids on the contraction of neonatal rat cardiac myocytes. *Proc Natl Acad Sci USA* 1994; 91:9886-9890

Kang JX, Leaf A. Evidence that free polyunsaturated fatty acids modify Na-channels by directly binding to the channel proteins. *Proc Natl Acad Sci USA* 1996; 93: 3542-3546.

- Kang JX**, Leaf A. Prevention and termination of beta-adrenergic agonist- induced arrhythmias by free polyunsaturated fatty acids in neonatal rat cardiac myocytes. *Biochem Biophys Res Commun* 1995; 208: 629-636.
- Kang JX**, Leaf A. Prevention of fatal cardiac arrhythmias by polyunsaturated fatty acids. *Am J Clin Nutr* 2000; 71:202S-7S.
- Kang JX**, Xiao YF, Leaf A. Free, long-chain, polyunsaturated fatty acids reduce membrane electrical excitability in neonatal rat cardiac myocytes. *Proc Natl Acad Sci USA* 1995; 92:3997-4001.
- Kannel W**, Wolf PA, Benjamin EJ, Levy D. Prevalence, incidence, prognosis, and predisposing conditions for atrial fibrillation: population-based estimates. *Am J Cardiol* 1998; 82:2N-9N.
- Karmazyn M**, Horackova M, Murphy MG. Effects of dietary cod liver oil on fatty-acid composition and calcium transport in isolated adult rat ventricular myocytes and on the response of isolated hearts to ischemia and reperfusion. *Can J Physiol Pharmacol* 1987; 65:201-9.
- Katan MB**, Grundy MS and Willet WC. Should low-fat, high-carbohydrate diet be recommended for every one? Clinical debate. *N Eng J of Med* 1997; pp 562-567.
- Katan MB**, Zock PL and Mensin KP. Dietary oils, serum lipoprotein, and coronary heart disease. *Am J Nut* 1995; 61 (suppl 1): 1368-1373.
- Keli SO**, Feskens EJ and Kromhout D. Fish consumption and risk of stroke the Zutphen Study, *Stroke* 1994; 25: 328-332.
- Kinoshita B**, Itoh K, Nishida-Naka? M. Antiarrhythmic effects of eicosapentaenoic acid during myocardial infarction enhanced cardiac microsomal (Ca²⁺-Mg²⁺)-ATPase activity. *Jpn J Circ* 1994; 58:903-912.
- Kinsella J**, Lokesh B, Stone R. Dietary n-3 polyunsaturated fatty acids and amelioration of cardiovascular disease: possible mechanisms. *Am J clin Nutr* 1990; 52:1-28.
- Kloner R**, Jennings R. Consequences of brief ischemia: stunning, preconditioning, and their clinical implications. *Circulation* 2001; 104:3158-67.
- Knapp H**. Essential fatty acids and eicosanoids. In: "Physiological and biochemical effects of n-3 fatty acids in man". Edition: AOCS Publication, Champaign (IL). Edition: Sinclair A, Gibson R; 1993:p330-333.
- Knoops KT**, de Groot L, Kromhout D. Mediterranean diet, lifestyle factors, and 10-year mortality in elderly European men and women. The HALE Project. *JAMA* 2004 ; 292:1433-9.

Koloravoric L, Fournier NC. A comparison of extraction methods for the isolation of phospholipids from biological sources. *Anal Bioch* 1986;156:244-250.

Krauss RM, Eckel RH, Howard B, Appel LJ, Daniels SR and Deckelbaum RJ. AHA Scientific Statement: AHA dietary guidelines revision: a statement for healthcare professionals from the nutrition committee of the American Heart Association, *Circulation* 2000; 102 (18):2284-2299.

Krebs H, Henseleit K. Untersuchungen über die Harnstoffbildung im Tierkörper. *Hoppe Seyler's Z* 1932;210:33-66.

Kremer JM. n-3 fatty acids supplements in rheumatoid arthritis. *AM J Clin Nutr* 2000; 71(Suppl): 349S-351S.

Kris-Etherton PM, Harris WS, Appel LJ. Fish consumption, fish oil, omega-3 fatty acids, and cardiovascular disease. *Circulation* 2002; 106(21):2747-2757.

Kromhout D, Bloemberg BP, Feskens EJ, Hertog MG, Menotti A, Blackburn H. Alcohol, fish, fibre and antioxidant vitamins intake do not explain population differences in coronary heart disease mortality. *Int J Epidemiol* 1996; 25:753-759.

Kromhout D, Bosschieter EB, de-Lezenne-Coulander C. The inverse relation between fish consumption and 20-year mortality from coronary heart disease. *New Engl J Med* 1985; 312:1205-9.

Kromhout D, Menotti A, Bloemberg B, et al. Dietary saturated and trans fatty acids and cholesterol and 25-year mortality from coronary heart disease: the Seven Countries Study. *Prev Med* 1995;24: 308-15.

Kuck KH, Cappato R, Siebels J, Ruppel R. Randomized comparison of antiarrhythmic drug therapy with implantable defibrillators in patients resuscitated from cardiac arrest: the Cardiac Arrest Study Hamburg (CASH). *Circulation*. 2000; 102:748-54.

Kupersmith J, Hogan A, Guerrero P, et al. Evaluating and improving the cost-effectiveness of the implantable cardioverter-defibrillator. *Am Heart J* 1995; 130:507-15.

Kurien V, Oliver M. A metabolic cause of arrhythmias during acute myocardial hypoxia. *Lancet* 1970; 1:813-815.

Kuriyama H, Kitamura K, Nabata H. Pharmacological and physiological significance of ion channels and factors that modulate them in vascular tissues. *Pharmacol Rev* 1995; 47:387-573.

L

La Vecchia C, Harris RE, Wynder EL : Comparative epidemiology of cancer between the United States and Italy. *Cancer Res* 1988; 48:7285-7293.

Lands WM, Morris A and Libelt B. Quantitative effects of dietary polyunsaturated fats on the composition of fatty acids in rat tissues. *Lipids* 1990; 25: 505-516.

Langendorff O. Untersuchungen am ?berlebenden Sa?gertierherzen. *Pfl?g Arch* 1895;61: 291-332.

Larsen G, Hallstrom A, McAnulty J, et al. Cost-effectiveness of the implantable cardioverter-defibrillator versus antiarrhythmic drugs in survivors of serious ventricular tachyarrhythmias: results of the Antiarrhythmics Versus Implantable Defibrillators (AVID) economic analysis substudy. *Circulation* 2002; 105:2049-57.

Larsen GC, Manolis AS, Sonnenberg FA, Beshansky JR, Estes NA, Pauker SG. Cost-effectiveness of the implantable cardioverterdefibrillator: effect of improved battery life and comparison with amiodarone therapy. *J Am Coll Cardiol* 1992; 19:1323-34.

Leaf A and Weber PC. Cardiovascular effects of n-3 fatty acids. *N Engl Med* 1988; 54:438-463.

Leaf A, Albert CM, Josephson M, Steinhaus D, Kluger J et al. Prevention of fatal arrhythmias in high-risk subjects by fish oil n-3 fatty acid intake. *Circulation* 2005; 112:2762-8.

Leaf A, Kang JX, Xiao YF, Billman GE. n-3 fatty acids in the prevention of cardiac arrhythmias. *Lipids* 1999; 34(Suppl.):S187-9.

Leaf A. Omega-3 fatty acids and prevention of ventricular fibrillation. *Prostaglandins Leukot Essent Fatty Acids* 1995; 52:197-8.

Lee DS, Austin PC, Rouleau JL, Liu PP, Naimark D, Tu JV. Predicting mortality among patients hospitalized for heart failure: derivation and validation of a clinical model. *JAMA* 2003; 290: 2581-7.

Lee KW, Hamaad A, MacFadyen RJ, Lip GY. Effects of dietary fat intake in sudden death: reduction of death with omega-3 fatty acids. *Curr Cardiol Rep* 2004; 6:371-378.

Lehmann MH, Steinman RT and Schuger CD et al. The automatic implantable cardioverter defibrillator as antiarrhythmic treatment modality of choice for survivors of cardiac arrest unrelated to acute myocardial infarction. *Am J Cardiol* 1988; 62:803-805.

Leifert WR, McMurchie EJ, Saint DA. Inhibition of cardiac sodium currents in adult rat myocytes by n-3 polyunsaturated fatty acids. *J Physiol Lond* 1999; 520 Pt 3:671-9.

LeLorier P, Krahn AD, Klein GJ, Yee R, Skanes AC. Comparison of patients with syncope with left ventricular dysfunction and negative electrophysiologic testing to cardiac arrest

survivors and patients with syncope and preserved left ventricular function and impact of an implantable defibrillator. *Am J Cardiol* 2002; 90:77-9.

Lemaitre RN, King IB, Mozaffarian D et al. n-3 polyunsaturated fatty acids, fatal ischemic heart disease and non-fatal myocardial infarction in older adults. The Cardiovascular Health study. *Am J Clin Nutr* 2002; 76:319-25.

Lemaitre^b RN, King IB, Raghunathan TE, Pearce RM, Weinmann S, Knopp RH, Copass MK, Cobb LA, Siscovick DS. Cell membrane trans-fatty acids and the risk of primary cardiac arrest. *Circulation* 2002;105:697-701.

Lemaitre RN, King IB, Mozaffarian D et al. Plasma phospholipid trans fatty acids, fatal ischemic heart disease, and sudden cardiac death in older adults: the Cardiovascular Health Study. *Circulation* 2006; 114:209-15.

Lepage G, Levy E, Ronco N, Smith L, Galeano N, Roy C. Direct transfer of plasma fatty acid in cystic fibrosis. *J Lip res* 1989;30:1483-1490.

Levitan IB. Modulation of ion channels by protein phosphorylation and dephosphorylation. *Annu Rev Physiol* 1994; 56:193-212.

Li Q, Zhang Q, Wang M, Liu F, Zhao S, Ma J, et al. Docosahexaenoic acid affects endothelial nitric oxide synthase in caveolae. *Arch Biochem Biophys*. Jun 29 2007.

Li Q, Zhang Q, Wang M, Zhao S, Ma J, Luo N, et al. Eicosapentaenoic acid modifies lipid composition in caveolae and induces translocation of endothelial nitric oxide synthase. *Biochimie*. Jan 2007; 89:169-177.

Li Y, Kang J, Leaf A. Differential effects of various eicosanoids on the contraction of cultured neonatal rat cardiomyocytes. *Prostaglandins* 1997; 54:511-530.

Link MS, Haugh CJ, Costeas XF, et al. Implantable cardioverter defibrillator in arrhythmogenic right ventricular dysplasia; short and long term results. *Pacing Clin Electrophysiol* 1995; 19:717.

Locher R, Sachinidis A, Brunner C, Vetter W. Intracellular free calcium concentration and thromboxane A₂ formation of vascular smooth muscle cells are influenced by fish oil and n-3 eicosapentaenoic acid. *Scand J Clin Lab Invest* 1991; 51:541-7.

Lopez-Garcia E, Schulze MB, Meigs JB, et al. Consumption of trans fatty acids is related to plasma biomarkers of inflammation and endothelial dysfunction. *J Nutr* 2005;135:562-566.

Lown B, Amarasingham R and Neuman J. New method for terminating cardiac arrhythmias. Use of synchronized capacitor discharge. *JAMA* 1962; 182:548-555.

Luderitz B, Jung W, Deister A, Marneros A, Manz M. Patient acceptance of the implantable cardioverter defibrillator in ventricular tachyarrhythmias. *Pacing Clin Electrophysiol* 1993; 16:1815-21.

M

- Ma DW**, Seo J, Swintzer KC, Fan YY, McMurray DN, Lupton JR et al. n-3 PUFA and membrane microdomains: a new frontier in bioactive lipid research. *J Nutr Biochem* 2004; 15:700-706.
- Mader SS**. Understanding Human Anatomy & Physiology, Fifth Edition. The *McGraw-Hill Companies* 2004; pp 224-230.
- Mahfouz M**, Johnson S and Holman RT. The effect of isomeric trans 18:1 acids on the desaturation of palmitic acid, linoleic, and eicosa-8,11,14-trienoic acids by rat liver microsomes. *Lipids* 1980; 15: 100.
- Makiguchi M**, Kamaguchi H and Tamura M. Effects of palmitic acid and fatty acid binding protein on ventricular fibrillation threshold in the perfused rat heart. *Cardiovascular Drugs and Therapy* 1991; 5:753-762.
- Manning A**, Hearse D. Reperfusion-induced arrhythmias: mechanisms and prevention. *J Mol Cell Cardiol* 1984; 16:497-518.
- Mantzioris, E.**, James, M. J., Gibson, R. A. and Cleland, L. G. Dietary substitution with α -linolenic acid-rich vegetable oil increases eicosapentaenoic acid concentrations in tissues. *Am. J Clin Nutr* 1994. 59: 1304-1309.
- Marangoni F**, Masconi C, Gallela G and Galli C. Increments of dietary linoleate raise liver arachidonate, but markedly reduce heart n-6 and n-3 fatty acids in the rat. *Lipids* 1992; 27: 624-628.
- Marchioli R**, Barzi F, Bomba E et al. Early protection against sudden death by n-3 polyunsaturated fatty acids after myocardial infarction: time-course analysis of the results of the Gruppo Italiano per lo Studio della Sopravvivenza nell'Infarto Miocardico (GISSI) Prevenzione. *Circulation* 2002; 105:1897-1903.
- Marckmann P**, Gronbaek M. Fish consumption and coronary heart disease mortality. A systematic review of prospective cohort studies. *Eur J Clin Nutr* 1999; 53:585-90.
- Mark DB**, Nelson CL, Anstrom KJ et al. Cost-effectiveness of defibrillator therapy or amiodarone in chronic stable heart failure: results from the Sudden Cardiac Death in Heart Failure Trial (SCD-HeFT). *Circulation* 2006; 114:135-42.
- Maron BJ**, Shen WK, Link MS et al. Efficacy of implantable cardioverter-defibrillators for the prevention of sudden death in patients with hypertrophic cardiomyopathy. *N Engl J Med* 2000; 342:365-73.

Marotta F, Chui DH, Safran P, Rezakovic I, Zhong GG, Ideo G. Shark fin enriched diet prevents mucosal lipid abnormalities in experimental acute colitis. *Digestion* 1995; 56:46-51.

Mauger JF, Lichtenstein AH, Ausman LM, et al. Effect of different forms of dietary hydrogenated fats on LDL particle size. *Am J Clin Nutr* 2003;78:370-375.

Maxwell SRJ, Lip GYH. Reperfusion injury: a review of the pathophysiology, clinical manifestations and therapeutic options. *Int J Cardiol* 1997; 58:95-117.

Mc Lennan PL, Abeywardena M, Charnock J. Reversal of the arrhythmogenic effects of long-term saturated fatty acid intake by dietary n-3 and n-6 polyunsaturated fatty acids. *Am J Clin Nutr* 1990;51:53-58.

McGuinness J, Neilan TG, Sharkasi A, Bouchier-Hayes D and Redmond JM. Myocardial protection using an omega-3 fatty acid infusion: Quantification and mechanism of action. *J Thorac Cardiovasc Surg* 2006; 132:72-79

McLennan PL and Dallimore JA. Dietary canola oil modifies myocardial fatty acids and inhibits cardiac arrhythmias in rats. *J Nutr* 1995; 125:1003-1009.

McLennan PL, Abeywardena MY, Charnock JS. Dietary fish oil prevents ventricular fibrillation following coronary artery occlusion and reperfusion. *Am Heart J* 1988; 116:709-717.

McLennan PL, Bridle TM, Abeywardena MY, Charnock JS. Dietary lipid modulation of ventricular fibrillation threshold in the marmoset monkey. *Am Heart J* 1992; 123:1555-1561.

McLennan PL, Bridle, TM, Abeywardena MY and Charnock JS. Comparative efficiency of n-3 and n-6 polyunsaturated fatty acids in modulating ventricular fibrillation threshold in marmoset monkeys. *Am J Clin Nutr* 1993; 58: 666-669.

McLennan PL, Howe P, Abeywardena MY, Muggli R., Raederstoff D, Mano, Rayner, T and Head R. The cardiovascular protective role of eicosapentaenoic acid on ouabain toxicity in neonatal rat cardiac myocytes. docosahexaenoic acid. *Eur J Pharmacol* 1996; 300: 83-89.

McLennan PL. Myocardial membrane fatty acids and the antiarrhythmic actions of dietary fish oil in animal models. *Lipids* 2001; 36 Suppl: S111-14.

McLennan, PL. Relative effects of dietary saturated, monounsaturated and polyunsaturated fatty acids on cardiac arrhythmias in rats. *Am J Clin Nutr* 1993; 57: 207-212.

Mensink RP, Zock PL, Kester AD, Katan MB. Effects of dietary fatty acids and carbohydrates on the ratio of serum total to HDL cholesterol and on serum lipids and apolipoproteins: a meta-analysis of 60 controlled trials. *Am J Clin Nutr* 2003;77:1146-1155.

Metcalf PG, Sanders P, James MJ, et al. Effect of dietary n-3 polyunsaturated fatty acids on the inducibility of ventricular tachycardia in patients with ischemic cardiomyopathy. *Am J Cardiol* 2008; 101:758–761.

Meydani SN, Endres S, Woods MM, Goldin BR, Soo C, Morrill-Labrode A, et al. Oral (n-3) fatty acid supplementation suppresses cytokine production and lymphocyte proliferation: comparison between young and older women. *J Nutr* 1991; 121:547-555.

Meyer J.A., "Claude Beck and cardiac resuscitation", *Ann Thorac Surg* 1988; 45:103-5

Micallef MA and Garg ML. Anti-inflammatory and cardioprotective effects of n-3 polyunsaturated fatty acids and plant sterols in hyperlipidemic individuals. *In press. Atherosclerosis* (2008).

Middaugh J. Cardiovascular deaths among Alaskan natives, 1980–1986. *Am J Public Health* 1990; 80:282-285.

Mikelson J, Simpson P, Lucchesi B. Ischemic heart disease: pathology and pharmacology management. In: Antonaccio M, "Cardiovascular Pharmacology". Edition: Raven Press, New York (3rd edition) 1990, pp293-340.

Ministry for Health and Solidarity, 2006. <http://afssaps.sante.fr>

Mirowski M, Reid PR and Mower MM et al. Termination of malignant ventricular arrhythmias with an implanted automatic defibrillator in human beings, *N Engl J Med* 1980; 303:322:324.

Miura S, Imaeda H, Shiozaki H, Kurose I, Fukumura D, Tashiro H, et al. Attenuation of endotoxin-induced intestinal microcirculatory damage by eicosapentanoic acid. *Am J Physiol* 1993; 264(Pt.1):G828-G834.

Monnig G, Kobe J, Loher A, et al. Implantable cardioverterdefibrillator therapy in patients with congenital long-QT syndrome: a long-term follow-up. *Heart Rhythm* 2005; 2:497-504.

Mori T, Beilin L. Omega-3 fatty acids and inflammation. *Curr Atheroscler Rep* 2004; 6:461–467.

Mori TA, Watts GF, Burke V, Hilme E, Puddey IB, Beilin LJ. Differential effects of eicosapentaenoic acid and docosahexaenoic acid on vascular reactivity of the forearm microcirculation in hyperlipidemic, overweight men. *Circulation* 2000; 102:1264-1269.

Morris M, Manson J, Rosner B, Buring J, Willett W, Hennekens C. Fish consumption and cardiovascular disease in the physicians' health study: a prospective study. *Am J Epidemiol* 1995; 142:166-175.

Moss AJ, Hall WJ, Cannom DS et al. Improved survival with an implanted defibrillator in patients with coronary disease at high risk for ventricular arrhythmias. Multicenter Automatic Defibrillator Implantation Trial Investigators, *N Engl J Med* 1996; 335:1933-1940.

Moss AJ, Zareba W and Hall WJ et al. Prophylactic implantation of a defibrillator in patients with myocardial infarction and reduced ejection fraction, *N Engl J Med* 2002; 346:877-883.

Moss AJ. Implantable cardioverter defibrillator therapy: the sickest patients benefit the most. *Circulation*. 2000; 101:1638-40.

Mozaffarian D, Katan MB, Ascherio A, et al. Trans fatty acids and cardiovascular disease. *N Engl J Med* 2006; 354:1601-13.

Mozaffarian D, Psaty BM, Rimm EB, Lemaitre RN, Burke GL, et al. Fish intake and risk of incident atrial fibrillation. *Circulation*, 2003; 107:1372-1377.

Mozaffarian D. n-3 fatty acids, and cardiovascular haemodynamics. *J Cardiovasc Med* 2007; 8 (suppl 1): S23-S26.

Mozaffarian^a D, Ascherio A, Hu FB, Stampfer MJ, Willett WC, Siscovick DS and Rimm EB. Interplay between different polyunsaturated fatty acids and risk of coronary heart disease in men. *Circulation* 2005; 111:157-164.

Mozaffarian^a D, Psaty BM, Rimm EB, Lemaitre RN, Burke GL, Lyles MF, Lefkowitz D, Siscovick DS. Fish intake and risk of incident atrial fibrillation. *Circulation* 2004; 110:368-373.

Mozaffarian^b D, Longstreth Jr WT, Lemaitre RN, Manolio TA, Kuller LH, Burke GL and Siscovick DS. Fish consumption and stroke risk in elderly individuals the Cardiovascular Health Study. *Arch Intern Med* 2005; 165:200-206.

Mozaffarian^b D, Rimm EB, King IB, Lawler RL, McDonald GB, Levy WC. Trans fatty acids and systemic inflammation in heart failure. *Am J Clin Nutr* 2004;80:1521-1525.

Murphy E, Steenbergen C. Mechanisms underlying acute protection from cardiac ischemia-reperfusion injury. *Physiol Rev* 88: 581-609, 2008.

Mushlin AI, Hall WJ, Zwanziger J, et al. The cost-effectiveness of automatic implantable cardiac defibrillators: results from MADIT. Multicenter Automatic Defibrillator Implantation Trial. *Circulation* 1998; 97:2129-35.

N

Nagatamo T, Hattori K, Ikeda M, Shimada K. Lipid composition of sarcolemma, mitochondria and sarcoplasmic reticulum from newborn and adult rabbit cardiac muscle. *Biochem med* 1980; 23:108-118.

- Nair SS**, Leitch J, Falconer J, Garg ML. Cardiac (n-3). Nonesterified fatty acids are selectively increased in fish oilfed pigs following myocardial ischemia. *J Nutr* 1999; 129:1518-1523.
- Nair SS**, Leitch JW, Falconer J, Garg ML. Prevention of cardiac arrhythmia by dietary (n-3) polyunsaturated fatty acids and their mechanism of action. *J Nutr* 1997; 127:383-93.
- Nakamura MT**, Nara TY. Structure, function, and dietary regulation of delta6, delta5, and delta9 desaturases. *Annu Rev Nutr* 2004; 24:345-76.
- Nasa Y**, Hayashi M, Sasaki H, hayashi J, Takeo S. Long-term supplementation with eicosapentaenoic acid salvages cardiomyocytes from hypoxia/reoxygenation-induced injury in rats fed with fish-oil deprived diet. *Jpn J Pharmacol* 1998; 77: 137-146.
- NCEP (Third Report of the National Cholesterol Education Program)** Expert Panel on Detection, Evaluation, and Treatment of High Blood Cholesterol in Adults (Adult Treatment Panel III). *Circulation* 2002,106:3143–421.
- Negretti N**, Perez MR, Walker D, O'Neill SC. Inhibition of sarcoplasmic reticulum function by polyunsaturated fatty acids in intact, isolated myocytes from rat ventricular muscle. *J Physiol* 2000; 523(2):367-75.
- Nestel P**, Noakes M, Melling B, McArthur R, Clifton P, Janus E and Abbey M. Plasma lipoprotein lipid and Lp(a) changes with substitution of elaidic acid for oleic acid in the diet. *J Lipid Res* 1992; 33:1029.
- Nieman DC**. Exercise, Immunology, and Nutrition. In Simopoulos AP, Pavlou KN (eds): Nutrition and Fitness: Metabolic Studies in Health and Disease. *World Rev Nutr Diet* 2001; 90: 89-101
- Nieto N**, Fernandez MI, Torres MI, Rios A, Suarez MD, Gil A. Dietary monounsaturated n-3 and n-6 long-chain polyunsaturated fatty acids affect cellular antioxidant defense system in rats with experimental ulcerative colitis induced by trinitrobenzene sulfonic acid. *Dig Dis Sci* 1998; 43:2676-2687.
- Niggli E**. The cardiac sarcoplasmic reticulum: filled with Ca²⁺ and surprises [comment]. *Circ Res* 2007; 100:5-6.
- Nimmo H**. The location of glycerol phosphate acyltransferase and fatty acyl CoA synthase on the inner surface of the mitochondrial outer membrane. *FEBS* 1979;101:262-264.
- Norell S**, Ahlbom A, Feychling M and Pedersen NL. Fish consumption and mortality from coronary heart disease. *Br Med J* 1986; 293:426.

O

O'Brien BJ, Connolly SJ, Goeree R et al. Cost-effectiveness of the implantable cardioverter-defibrillator: results from the Canadian Implantable Defibrillator Study (CIDS). *Circulation* 2001; 103:1416-21.

Oe H, Kuzuya T, Oshida S, Nishida M, Tada M. calcium overload and cardiac myocyte cell damage induced by arachidonate lipoxygenation. *Am J Physiol* 1994; 267:H1396-402.

Ogita H, Node K, Asanuma H, Sanada S, Takashima S, Minamino, Soma M. Eicosapentenoic acid reduces myocardial injury induced by ischemia and reperfusion in rabbits hearts. *J Cardiovasc Pharmacol* 2003; 41:964-969.

Oh K, Hu FB, Manson JE, et al. Dietary fat intake and risk of coronary heart disease in women: 20 years of follow-up of the Nurses' Health Study. *Am J Epidemiol* 2005; 161:672-679.

Olivier M F and Opie L H. Effects of glucose and fatty acids on myocardial ischaemia and arrhythmias. *Lancet* 1994; 343: 155-158.

Ollis TE, Meyer, BJ, Howe PR. Australian food sources and intakes of omega-6 and omega-3 polyunsaturated fatty acids. *Ann Nutr Metab* 1999; 43:346-355.

Omura M, Kobayashi S, Mizukami, Mogami K, et al. Eicosapentanoic acid (EPA) induces Ca²⁺-independent activation and translocation of endothelial nitric oxide synthase and endothelium-dependent vasorelaxation. *FEBS Lett* 2001; 487:361-366.

Oomen CM, Ocke MC, Feskens EJ, Kok FJ and Kromhout D. α -Linolenic acid intake is not beneficially associated with 10-y risk of coronary artery disease incidence the Zutphen Elderly Study. *Am J Clin Nutr* 2001; 74:457-463.

Opie LH. The heart: Physiology, from cell to circulation. Third edition. Lippincott-Raven publishers 1998; pp 515-560.

Opie, LH. (1991) The Heart. Physiology and Metabolism. Raven Press, New York.

Oskarsson H, Godwin J, Gunnar R, Thomas J. Dietary fish oil supplementation reduces myocardial infarct size in a canine model of ischemia and reperfusion. *JACC* 1993; 21:1280-1285.

Owen AJ, Peter-Przyborowska BA, Hoy AJ, McLennan PL. Dietary fish oil dose-and time-response effects on cardiac phospholipid fatty acid composition. *Lipids* 2004;39:955-61.

P

Palmer J, Schmid P, Pfeiffer D, Schmid H. Lipids and lipolytic enzyme activities of rat heart mitochondria. *Arch Biochem Biophys* 1981,211:674-682.

- Park JL**, Lucchesi BR. Mechanisms of myocardial reperfusion injury. *Ann Thorac Surg* 1998; 68:1905-12.
- Park Y**, Harris W. Omega-3 fatty acid supplementation accelerates chylomicron triglyceride clearance. *J Lipid Res* 2003;44:455– 463.
- Paulson DJ**, Smith JM, Zhao J and Bowman J. Effects of dietary fish oil on myocardial ischemic/reperfusion injury of Wistar Kyoto and stroke-prone spontaneously hypertensive heart. *Metabolism* 1992; 41:533-539
- Pepe S** and McLennan PL. Dietary fish oil confers direct antiarrhythmic properties on the myocardium of rats. *J Nutr* 1996; 126, 34-42
- Pepe S**, McLennan PL. Cardiac membrane fatty acid composition modulates myocardial oxygen consumption and postischemic recovery of contractile function. *Circulation* 2002; 105:2303-2308.
- Perez-Jimenez F**, Alvarez de Cienfuegos G, Badimon L et al. International conference on the healthy effect of virgin olive oil. *Eur J Clin Invest* 2005; 35:421-424.
- Pezawas T**, Stix G, Kastner J et al. Unexplained syncope in patients with structural heart disease and no documented ventricular arrhythmias: value of electrophysiologically guided implantable cardioverter defibrillator therapy. *Europace* 2003; 5:305-12.
- Pezawas T**, Stix G, Kastner J, Schneider B, Wolzt M, Schmidinger H. Ventricular tachycardia in arrhythmogenic right ventricular dysplasia/ cardiomyopathy: clinical presentation, risk stratification and results of long-term follow-up. *Int J Cardiol* 2006; 107:360-8.
- Picq M**, Dubois M, Grynberg A, Lagarde M, Prigent AF. Specific effects of n-3 fatty acids and 8-bromo-cGMP on the cyclic nucleotide phosphodiesterase activity in neonatal rat cardiac myocytes. *J Mol Cell Cardiol* 1996; 28:2151-61.
- Pietinen P**, Ascherio A, Korhonen P, et al. Intake of fatty acids and risk of coronary heart disease in a cohort of Finnish men: the Alpha-Tocopherol, Beta-Carotene Cancer Prevention Study. *Am J Epidemiol* 1997;145:876-887.
- Pogwizd SM**, Sipido KR, Verdonck F, Bers DM. Intracellular Na in animal models of hypertrophy and heart failure: contractile function and arrhythmogenesis. *Cardiovasc Res* 2003;57(4):887-896.
- Pound EM**, Kang JX, Leaf A. Partitioning of polyunsaturated fatty acids, which prevent cardiac arrhythmias, into phospholipid cell membranes. *J Lipid Res* 2001; 42:346-51.

Powell AC, Fuchs T, Finkelstein DM, et al. Influence of implantable cardioverter-defibrillators on the long-term prognosis of survivors of out-of-hospital cardiac arrest. *Circulation* 1993; 88:1083-92.

Prescott S, Stenson W. Fish oil fix. *Nat Med* 2005; 11:596–598.

R

Raitt MH, Connor WE, Morris C, Kron J, Halperin B, et al. Fish oil supplementation and risk of ventricular tachycardia and ventricular fibrillation in patients with implantable defibrillators: a randomized controlled trial. *JAMA* 2005; 293:2884-91.

Rao G, Riley D, Larkin E. Comparison of thin layer chromatography/flame ionization detection system with other methods for the quantitative analysis of liver lipid contents in alcohol-fed rats and controls. *Lipids* 1985;20:531-535.

Rapoport SI, Chang MCJ and Spector AA. Delivery and turnover of plasma-derived essential PUFAs in mammalian brain. *J Lipid Res* 2001; 42:678-685.

Rauch B, Schiele R, Schneider S, et al. Highly purified omega-3 fatty acids for secondary prevention of sudden cardiac death after myocardial infarction: Aims and methods of the OMEGA-study. *Cardiovasc Drugs Ther* 2006; 20:365-375.

Reiffel JA and Dizon J. The Implantable Cardioverter-Defibrillator: Patient Perspective. *Circulation* 2002;105:1022-1024

Reiffel JA, McDonald A. Antiarrhythmic effect of omega-3 fatty acids. *Am J Cardiol* 2006; 98(suppl):50i–60i.

Reimer KA, Ideker RE. Myocardial ischemia and infarction: anatomic and biochemical substrates for ischemic cell death and ventricular arrhythmias. *Hum Pathol* 1987; 18:462-75.

Reimer KA, Jennings RB. Myocardial ischemia, hypoxia, and infarction. In: Fozzard HA, Haber E, Jennings RB, Katz AM, Morgan HE, editors. *The heart and cardiovascular system: scientific foundations*. 2nd ed. New York: Raven Press, 1991. pp. 1875-973.

Renaud S, de Lorgeil M. Dietary lipids and their relation to Ischemic heart disease: from epidemiology to prevention. *J Intern Med* 1989; 225(suppl 1): 39-46.

Renaud S, Gosey F, Dumont E, Thevenon C, Otrtchanian E and Martin JL. Influence of long-term diet modification in Moselle farmers. *Am J Clin Nutr* 1986; 43:136-150.

Richmond W. Preparation and properties of a cholesterol oxidase from *Nocardia* sp. and its application to the enzymatic assay of total cholesterol in serum. *Clin Chem* 1973;19:1950-1956.

Riemersma R, Sargent C, Saman S, Rebergen S, Abraham R. Dietary fatty acids and ischemic arrhythmias. *Lancet* 1988; 2:285-286.

Rinaldi B, Di Pierro P, Vitelli MR, D'Amico M, Berrino L, Rossi F, et al. Effects of docosahexaenoic acid on calcium pathway in adult rat cardiomyocytes. *Life Sci* 2002; 71:993-1004.

Robinson JG and Stone N J. Antiatherosclerotic and Antithrombotic Effects of Omega-3 Fatty Acids. *Am J Cardiol* 2006; 98 (4A):39i– 49i

Roche HM, Zampelas A and Knapper JME. Effect of long-term olive oil dietary intervention on postprandial triglycerol and factor VII metabolism. *Am J Clin Nutr* 1998; 68: 552-560.

Rochette L, Didier JL, Moreau D, Bralet J. Effect of substrate on release of myocardial norepinephrine and ventricular arrhythmias following reperfusion on the ischemic isolated working rat heart. *J Cardiovasc Pharmacol* 1980;2:267-279.

Rockerbie R, Dobson R, Frohlich J. Gas chromatographic analysis of patterns of fatty acids of cholesteryl esters and phosphatidylcholine. *Clin Chem* 1979;25:1411-1414.

Rodrigo GC, Dhanapala S, Macknight AD. Effects of eicosapentaenoic acid on the contraction of intact, and spontaneous contraction of chemically permeabilized mammalian ventricular myocytes. *J Mol Cell Cardiol* 1999;31:733-43.

Rodriguez BL, Sharp DS, Abbott RD, Burchfiel CM, Masaki K, Chyou PH, Huang B, Yano K and Curb JD. Fish intake may limit the increase in risk of coronary heart disease morbidity and mortality among heavy smokers the Honolulu Heart Program. *Circulation* 1996; 94:952–956.

Roguin A, Bomma CS, Nasir K et al. Implantable cardioverterdefibrillators in patients with arrhythmogenic right ventricular dysplasia/ cardiomyopathy. *J Am Coll Cardiol* 2004; 43:1843-52.

Rose DP and Connolly JM. Omega-3 fatty acids as cancer chemopreventive agents. *Elsevier Inc. Pharmacology and Therapeutics* 1999; 83:217-244.

Rosenthal MD, Doloresco MA. The effects of trans fatty acids on fatty acyl delta-5 desaturation by human skin fibroblast. *Lipids* 1984; 19: 869.

Ross R. Mechanisms of disease: atherosclerosis –An inflammatory disease. *N Eng J Med* 1999; 340: 115–126.

Ross R. The pathogenesis of atherosclerosis: a perspective for the 1990s. *Nature* (London) 1993; 362: 801–809.

Rucker R and Tinker D. The role of nutrition in gene expression: A fertile field for the application of molecular biology. *J Nutr* 1986; 116:177.

Ruskin JN, Camm AJ and Zipes DP et al. Implantable cardioverter defibrillator utilization based on discharge diagnoses from Medicare and managed care patients. *J Cardiovasc Electrophysiol* 2002; 13:38-43.

Ruthing DJ, Meckling-Gill KA. Both (n-3) and (n-6) fatty acids stimulate wound healing in the rat intestinal epithelial cell line, IEC-6. *J Nutr* 1999; 129: 1791-1798.

S

Sacks F, Pfeffer M, Moye L, Rouleau J, Rutherford J, Cole T, Brown L, Warnica J, Arnold J, Wun C, Davis B, Braunwald E. The effect of pravastatin on coronary events after myocardial infarction in patients with average cholesterol levels. Cholesterol and Recurrent Events Trial investigators. *N Engl J Med* 1996; 335:1001-1019.

Saks V, Dzeja P, Schlattner U, Vendelin M, Terzic A and Wallimann T. Cardiac system bioenergetics: metabolic basis of the Frank-Starling law. *J Physiol* 2006; 571.2: 253–273.

Saks VA, Kuznetsov AV, Kupriyanov VV, et al. Creatine kinase of rat heart mitochondria. The demonstration of functional coupling to oxidative phosphorylation in an inner membrane-matrix preparation. *J Biol Chem* 1985;260:7757-64.

Saksena^a S, Breithardt G and Dorian P et al. Nonpharmacological therapy for malignant ventricular arrhythmias: implantable defibrillator trials. *Prog Cardiovasc Dis* 1996; 38:429-444.

Saksena^b S, Madan N, Lewis C. Implanted cardioverter-defibrillators are preferable to drugs as primary therapy in sustained ventricular tachyarrhythmias. *Prog Cardiovasc Dis* 1996; 38:445-54.

Salem, N., Simopoulos, A. P., Galli, C., Lagarde, M. and Knapp, H. R. Eds. Fatty acids and lipids from cell biology to human disease. *Lipids* 1996; 31:S1-S326.

Sampath H, Ntambi JM. Polyunsaturated fatty acid regulation of gene expression. *Nutr Rev* 2004; 62(9):333-339.

San Giovanni JP, Chew EY. The role of omega-3 long-chain polyunsaturated fatty acids in health and disease of the retina. *Prog Retin Eye Res.* 2005;24(1):87-138.

Sanchez JM, Katsiyannis WT, Gage BF, et al. Implantable cardioverter-defibrillator therapy improves long-term survival in patients with unexplained syncope, cardiomyopathy, and a negative electrophysiologic study. *Heart Rhythm* 2005; 2:367-73.

Sanders TAB. The importance of eicosapentaenoic and docosahexanoic acids. In: The role of fats in human nutrition. Ed. Padley F. B., Podmore J., Brun J. P., Brut R. and Nicols B. W. Ellis Horwood Ltd. 1985; 7: 101-110.

Sandker GN, Kromhout D, Aravanis C, Bloemberg BP, Mensink RP, Karalias N and Katan MB. Serum cholesteryl ester fatty acids and their relation with serum lipids in elderly men in Crete and the Netherlands. *Eur J Clin Nutr* 1993; 47: 201-208.

Sands SA, Reid KJ, Windsor SL, Harris WS. The impact of age, body mass index, and fish intake on the EPA and DHA content of human erythrocytes. *Lipids* 2005; 40:343-7.

Sargent CA and Riemersma RA. Polyunsaturated fatty acids and cardiac arrhythmia. *Biochem Soc Trans* 1990; 18: 1077-1078.

Scandinavian Simvastatin Survival Study. Randomised trial of cholesterol lowering in 4444 patients with coronary heart disease: the Scandinavian Simvastatin Survival Study (4S). *Lancet* 1994; 344:1383-1389.

Schimpf R, Wolpert C, Bianchi F et al. Congenital short QT syndrome and implantable cardioverter defibrillator treatment: inherent risk for inappropriate shock delivery. *J Cardiovasc Electrophysiol* 2003; 14:1273-7.

Schmidt EB, Arnesen H, De Caterina R, Rasmussen H, Kristensen SD. Marine n-3 polyunsaturated fatty acids and coronary heart disease. Part I: background, epidemiology, animal data, effects on risk factors and safety. *Thromb Res* 2005; 115: 163-170.

Schoenfeld MH. Contemporary pacemaker and defibrillator device therapy: challenges confronting the general cardiologist. *Circulation*. 2007;115:638-53.

Sciences et avenir, 2008. Une machine au coeur du c?ur. (http://sciencesetavenirmensuel.nouvelobs.com/hebdo/parution/p738/articles/a380091_une_machine_au_coeur_du_coeur.html).

Senges-Becker JC, Klostermann M, Becker R et al. What is the “optimal” follow-up schedule for ICD patients? *Europace* 2005; 7: 319-26.

Sexton A, McDonald M, Cayla C, Thiemermann C, Ahluwalia A. 12-lipoxygenase-derived eicosanoids protect against myocardial ischemia-reperfusion injury via activation of neuronal TRPV1. *FASEB J* 2007; 21:2695-703.

Shekelle RB, Missell L, Paul O, Shryock AM and Stamler J. Fish consumption and mortality from coronary heart disease. *N Eng J Med* 1985; 313:820.

Shimokawa H, Vanhoutte PM. Dietary omega-3 fatty acids and endothelium-dependent relaxations in porcine coronary arteries. *Am J Physiol* 1989; 256 (Pt 2): H968-973.

Shipp JC, Opie LH and Challoner D. Fatty acid and glucose metabolism in the perfused heart. *Nature* 1961. 189:1018-1019.

Siddiqui RA., Harvey KA., Zaloga GP. Modulation of enzymatic activities by n-3 polyunsaturated fatty acids to support cardiovascular health. *Journal of Nutritional Biochemistry* 2008;19:417-437

Siebels J, Kuck KH. Implantable cardioverter defibrillator compared with antiarrhythmic drug treatment in cardiac arrest survivors (the Cardiac Arrest Study Hamburg). *Am Heart J* 1994; 127:1139-44.

Siguel E, Chee K, Gong J, Schaefer E. Criteria for essential fatty acid deficiency in plasma assessed by capillary column chromatography. *Clin Chem* 1987;33:1869-1873.

Simonsen T, Vartun A, Lyngmo V, Nordoy A. Coronary heart disease, serum lipids, platelets and dietary fish in two communities in northern Norway. *Acta Med Scand* 1987; 222:237-45.

Simopoulos AP and Cleland LG, Editors, Omega-6/omega-3 essential fatty acid ratio: the scientific evidence. *World rev nutr diet, Karger, Basel* 2003;92:1-22.

Simopoulos AP, Pavlou KN. Nutrition and Fitness: Diet, Genes, Physical Activity and Health. *World Rev Nutr Diet* 2001; 89: 12-22.

Simopoulos AP. Evolutionary aspects of diet, the omega-6/omega-3 ratio and genetic variation: nutritional implications for chronic diseases. *Biomedicine & Pharmacotherapy*, 2006, 60(9):502-507.

Simopoulos AP. Omega-3 fatty acids in health and disease and in growth and development. *Am J Clin Nutr* 1991; 54:438-463.

Simopoulos AP. Omega-3 fatty acids in inflammation and autoimmune diseases. *J Am Coll Nutr* 2002;21:495–505.

Simopoulos, A. P. 1999. Essential Fatty acids in health and chronic disease. *Am. J. Clin. Nutr.* 70 (suppl): 560S-569S.

Simopoulos, AP. and Robinson J. The Omega plan. New York, Harper Collins 1998;1-55.

Simopoulos, AP. and Sidossis, L.S. What is special about the traditional Diet of Greece. Simopoulos A.P. & Visioli F. (eds): Mediterranean diets. *World Rev Nut Diet*. Basal. Karger. 2000; 87: 24- 42.

Simopoulos, AP. Omega-6 fatty acids/ Omega-3 fatty acids Ratio and Trans fatty acids in Non-Insulin Dependent Diabetes Mellitus. *Annals New York Academy of Sciences Reprinted from Lipids and Syndromes of Insulin Resistance* 1997; 827: 328-335.

Simopoulos^a, AP. Omega-3 fatty acids. Part I: Metabolic effects of Omega-3 fatty acids and essentiality. *Handbook of Lipids in Human Nutrition* 1996. Chapter 2.2: 51-72.

Simopoulos^b, AP. Epidemiological aspects of omega-3 fatty acids in disease states. Omega-3 fatty acids part II. *Handbook of Lipids in Human Nutrition*. CRC Press Inc. 1996; 75-89.

- Simopoulos^b, AP.** Genetic Variation and Nutrition. Part 2. *Nutrition Today* 1995; 30 (5): 194-206.
- Simopoulos^c, AP.** Trans fatty acids. *Handbook of lipids in Human Nutrition*. CRC Press Inc. 1996; Ch. 2-4: 91-99.
- Singh R,** Rastogi S, Verma R, Laxmi B, Singh R, Ghosh S, Niaz M. Randomised controlled trial of cardioprotective diet in patients with recent acute myocardial infarction: results of one year follow up. *Br Med J* 1992; 304:1015-1019.
- Singh RB,** Niaz MA, Sharma JP, Kumar R, Rastogi V, Moshiri M Randomized, double-blind, placebo-controlled trial of fish oil and mustard oil in patients with suspected acute myocardial infarction. *The Indian experiment of infarct survival-4. Cardiovasc Drugs Ther* 1997; 11: 485-491.
- Siscovick D,** Raghunathan T, King I, Weinmann S, Bovbjerg V, Kushi L, Cobb LA, Copass M, Psaty B, Lemaitre R, Retzlaff B, Knopp R. Dietary intake of long-chain n-3 polyunsaturated fatty acids and the risk of primary cardiac arrest. *Am J Clin Nutr* 2000; 71:208-212.
- Siscovick DS,** Lemaitre RN, Mozaffarian D. The fish story : a diet-heart hypothesis with clinical implications: n-3 polyunsaturated fatty acids, myocardial vulnerability, and sudden death. *Circulation* 2003; 107:2632-2634
- Siscovick DS,** Raghunathan TE, King I, Weinman S, Wicklund KG, Albright J, Bovbjerg V, Arbogast P, Smith H, Kushi LH, Cobb LA, Copass MA, Psaty BM, Lemaitre R, Retzlaff B, Childs M, Knopp RH. Dietary intake and cell membrane levels of long chain n-3 polyunsaturated fatty acids and the risk of primary cardiac arrest. *JAMA* 1995; 274:1363-1367.
- Skuladottir GV,** Schioth HB, Gudbjarnason S. Polyunsaturated fatty acids in heart muscle and alpha 1-adrenoceptor binding properties. *Biochim Biophys Acta* 1993; 1178:49-54.
- Smyth HS,** Sleight P, Pickering GW. Reflex regulation of arterial pressure during sleep in man: A quantitative method of assessing baroreflex sensitivity. *Circ Res* 1969; 24:109-121.
- Spector, AA** and Yorek MA. Membrane lipid composition and cellular function. *J Lipid Res* 1985; 26:1015-1035.
- Sprecher H,** Luthria DL, Mohammed BS, Baykousheva SP. Re-evaluation of the pathways for the biosynthesis of polyunsaturated fatty acids. *J Lipid Res* 1995;36: 2471-7.
- Stampfer MJ,** Sacks FM, Salvini S, Willett WC, Hennekens CH. A prospective study of cholesterol, apolipoproteins, and the risk of myocardial infarction. *N Engl J Med* 1991;325:373-381.

Stanley WC and Chandler MP. Energy metabolism in the normal and failing heart: potential for therapeutic interventions. *Heart Fail Rev* 2002; 7:115-130.

Stevenson LW, Desai AS. Selecting patients for discussion of the ICD as primary prevention for sudden death in heart failure. *J Card Fail* 2006; 12:407-12.

Stillwell W, Jensi LJ, Crump FT and Ehringer W. Effect of docosahexaenoic acid on mouse mitochondrial membrane properties. *Lipids* 1997; 32, 497-506.

Stillwell W, Wassal SR. Docosahexaenoic acid: membrane properties of a unique fatty acid. *Chem Phys Lipids* 2003; 126: 1-27.

Storrie B and Madden E. Isolation of subcellular organelles. *Methods in enzymology* in Academic Press 1990;182:203-225.

Studer M, Briel M, Leimenstoll B, Glass TR, Bucher HC. Effect of different antilipidemic agents and diets on mortality: a systematic review. *Arch Intern Med* 2005; 165:725-730.

Sullivan BL, Williams PG, Meyer BJ. Biomarker validation of a long-chain omega-3 polyunsaturated fatty acid food frequency questionnaire. *Lipids* 2006;41(9):845-50.

Sun CQ, O'Connor CJ, Robertson A. Antibacterial actions of fatty acids and monoglycerides against *Helicobacter pylori*. *FEMS Immunol Med Microbiol.* 2003, 36:9-17.

Sun Q, Ma J, Campos H, Hankinson SE, Manson JE., Stampfer MJ, Rexrode KM, Willett WC and Hu FB. A Prospective Study of Trans Fatty Acids in Erythrocytes and Risk of Coronary Heart Disease. *Circulation* 2007;115:1858-1865.

Swan JS, Dibb K, Negretti N, O'Neill SC, Sitsapesan R. Effects of eicosapentaenoic acid on cardiac SR Ca⁽²⁺⁾-release and ryanodine receptor function. *Cardiovasc Res* 2003; 60:337-46.

Swanson JE, Lekesh BR, Kinsella JE. Ca⁺²/Mg⁺² ATPase of mouse cardiac sarcoplasmic reticulum is affected by membrane n-6 and n-3 polyunsaturated fatty acid content. *J Nutr* 1989; 119:364-372.

Swanson, JE and Kinsella JE. Dietary n-3 polyunsaturated fatty acids: modification of rat cardiac lipids and fatty acid composition. *J Nutr* 1986; 116:514-523.

T

Taegtmeyer H. Energy metabolism of the heart: from basic concepts to clinical applications. *Curr Probl Cardiol* 1994; 19:59-113.

Taffet G, Pharm T, Bick D et al. the calcium uptake of the heart sarcoplasmic reticulum is altered by the dietary lipid. *J Membr Biol* 1993; 131:35-42.

Takeo S, Nasa Y, Tanonaka K, Yabe K, Nojiri M, Hayashi M, Ida K, Yanai K. Effects of long term treatment with eicosapentaenoic acid on the heart subjected to ischemia/reperfusion and hypoxia/reoxygenation in rats. *Mol Cell Biochem* 1998;188:199-208.

Taubes G. Nutrition: the soft science of dietary fat. *Science* 2001; 291: 2536-2545.

Tavazzi L, Tognoni G, Franzosi MG, Latini R, Maggioni AP, Marchioli R, et al., on behalf of the GISSI-HF Investigators. Rationale and design of the GISSI Heart Failure trial: A large trial to assess the effects of n-3 polyunsaturated fatty acids and rosuvastatin in symptomatic congestive heart failure. *Eur J Heart Fail* 2004; 6:635-641.

Tavernier R, Gevaert S, De SJ et al. Long term results of cardioverter-defibrillator implantation in patients with right ventricular dysplasia and malignant ventricular tachyarrhythmias. *Heart* 2001; 85:53-6.

Tchou PJ, Kadri N and Anderson J et al., Automatic implantable cardioverter defibrillators and survival of patients with left ventricular dysfunction and malignant ventricular arrhythmias. *Ann Intern Med* 109 (1988);pp. 529-534.

Thandroyen FT, Bellotto D, Katayama A, Hagler HK, Willerson JT, Buja LM. Subcellular electrolyte alterations during hypoxia and following reoxygenation in isolated rat ventricular myocytes. *Circ Res* 1992; 71:106-19.

The Antiarrhythmics versus Implantable Defibrillators (AVID) Investigators. A comparison of antiarrhythmic-drug therapy with implantable defibrillators in patients resuscitated from near-fatal ventriculararrhythmias. *N Engl J Med* 1997; 337:1576-83.

Theroux P, Chaitman BR, Danchin N, Erhardt L, Meinertz T, Schroeder JS, Tognoni G, White HD, Willerson JT, Jessel A. Inhibition of the sodium-hydrogen exchanger with cariporide to prevent myocardial infarction in high-risk ischemic situations. Main results of the GUARDIAN trial. Guard during ischemia against necrosis (GUARDIAN) Investigators. *Circulation* 2000; 102:3032-8.

Thies F, Garry JG, Yaqoob P, et al. Association of n-3 polyunsaturated fatty acids with stability of atherosclerotic plaques: a randomised trial. *Lancet* 2003; 361: 477-485.

Toufekstian MC, de Lorgeril M, Nagy N, Salen P, Boucher F, de Leiris J, on behalf of the FLORA consortium. Chronic dietary intake of plant-derived anthocyanins protects the rat heart against ischemia-reperfusion injury. *J Nutr* 138:747-752, 2008.

Tremoli E, Petroni, A, Maderna, P, Colli, S, Paoletti, R, Galli, C, Ferro-Luzzi A, Stazzullo P, Mancini M, Puska P, Lacono J and Dougherty R. Dietary interventions in north Karelia, Finland and south Italy: modification of dietary thromboxane B₂ formation in platelets of male subjects only. *Atherosclerosis* 1986; 59: 101-111.

Trichopoulou A, Costacou T, Barnia C, Trichopoulos D. Adherence to a Mediterranean diet and survival in a Greek population. *N Engl J Med* 2003; 348:2599-608.

U

Uchiyama T, Engelman RM, Maulik N, Das DK. Role of Akt signaling in mitochondrial survival pathway triggered by hypoxic preconditioning. *Circulation* 2004 ; 109:3042-9.

US Food and Drug Administration (2004). FDA announces qualified health claims for omega-3 fatty acids [press release]. Washington, DC.

V

Vajreshwari A, Narayanareddy K. Effect of dietary fats on some membrane-bound enzyme activities, membrane lipid composition and fatty acid profiles of rat heart sarcolemma. *Lipids* 1992; 27:339-343.

Vance J, Schiao Y. Intracellular trafficking of phospholipids: import of phosphatidylserine into mitochondria. *Anticancer Res* 1996;16:1333-1339.

Van der Vusse G, Glatz J, Stam H. fatty acid homeostasis in the normoxic and ischemic heart. *Physiol Rev* 1992; 72:881-940.

Viskin S. Implantable cardioverter defibrillator in high-risk long QT syndrome patients. *J Cardiovasc Electrophysiol* 2003; 14:1130-1.

Vlay SC, Olson LC, Fricchione GL, Friedman R. Anxiety and anger in patients with ventricular tachyarrhythmias. Responses after automatic internal cardioverter defibrillator implantation. *Pacing Clin Electrophysiol* 1989; 12:366 -73.

Voigt A, Ezzeddine R and Barrington W et al. Utilization of implantable cardioverter-defibrillators in survivors of cardiac arrest in the United States from 1996 to 2001. *J Am Coll Cardiol* 2004; 44:855-858.

W

Wallick ET, Dowd F, Allen JC, Schwartz A. The nature of the transport adenosine triphosphatase–digitalis complex. VII. Characteristics of ouabagenin–Na⁺,K⁺-adenosine triphosphatase interaction. *J Pharmacol Exp Ther* 1974; 189:434-44.

Weber P, Fischer S, von Shacky C, Lorenz R, Strasser T. The conversion of dietary eicosapentaenoic acid to prostanoids and leukotrienes in man. *Prog Lipid Res* 1986;25:273–276.

- Weiss JP**, Saynina O, McDonald KM, McClellan MB, Hlatky MA. Effectiveness and cost-effectiveness of implantable cardioverter defibrillators in the treatment of ventricular arrhythmias among Medicare beneficiaries. *Am J Med.* 2002; 112:519-27.
- Weiss LA**, Barrett-Connor E and von Muhlen D. Ratio of n-6 to n-3 fatty acids and bone mineral density in older adults: the Rancho Bernardo Study. *Am J Clin Nutr* 2005; 81:934-938.
- Werneke U**, Turner T and Priebe S. Complementary medicines in psychiatry: review of effectiveness and safety, *Br J Psychiatry* 2006; 188:109-201.
- Wever EF**, Hauer RN, van Capelle FL, et al. Randomized study of implantable defibrillator as first-choice therapy versus conventional strategy in postinfarct sudden death survivors. *Circulation* 1995; 91: 2195-203.
- Weylandt K**, Kang J, Leaf A. Polyunsaturated fatty acids exert antiarrhythmic actions as free acids rather than in phospholipids. *Lipids* 1996; 31:977-982.
- Wheeldon L**, Schumert Z, Turner D. Lipid composition of heart muscle homogenate. *J Lip Res* 1965;6:481-489.
- WHO/FAO**, World Health Organization, Food and Agriculture Organization. Joint WHO/FAO Expert Consultation on Diet, Nutrition and the Prevention of Chronic Diseases. 2002.
- Wichter T**, Paul M, Wollmann C, et al. Implantable cardioverter/ defibrillator therapy in arrhythmogenic right ventricular cardiomyopathy: single-center experience of long-term follow-up and complications in 60 patients. *Circulation* 2004; 109:1503-8.
- Wilhelm M**, Tobiasa R, Asskali F, Kraehner R, Kuly S, Klinghammer L, Boehles H, and Daniel WG, Red blood cell omega-3 fatty acids and the risk of ventricular arrhythmias in patients with heart failure. *Am Heart J* 2008; 155:971-7.
- Williams MM**. Foods: Experimental perspectives. 3rd Ed. Pub. New Jersey (US): Merrill. 1997; 7: 141-154.
- Wisnecki, JA**, Gertz, EQ, Neese RA and Mayr M. Myocardial metabolism of free fatty acids: studies with 14C labelled substrates in humans. *J Clin Invest* 1987; 79:359-366.
- Wu XT**, Li JS, Zhao XF, Li N, Ma YK, Zhuang W, et al. Effects of n-3 fatty acid, fructose-1, 6-diphosphate and glutamine on mucosal cell proliferation and apoptosis of small bowel graft after transplantation in rats. *World J Gastroenterol* 2003; 9:1323-1326.

X

Xiao YF, Gomez AM, Morgan JP, Lederer WJ, Leaf A. Suppression of voltage-gated L-type Ca²⁺ currents by polyunsaturated fatty acids in adult and neonatal rat ventricular myocytes. *Proc Natl Acad Sci USA* 1997; 94:4182-7.

Xiao YF, Kang JX, Morgan JP, Leaf A. Blocking effects of polyunsaturated fatty acids on Na⁺ channels of neonatal rat ventricular myocytes. *Proc Natl Acad Sci USA* 1995; 92:11000-4.

Xiao YF, Ke Q, Wang SY, Auktor K, Yang Y, Wang GK, et al. Single point mutations affect fatty acid block of human myocardial sodium channel alpha subunit Na⁺ channels. *Proc Natl Acad Sci* 2001; 98:3606-11.

Xiao YF, Ma L, Wang SY, Josephson M, Wang GK, Morgan JP, et al. Potent block of inactivation-deficient Na⁺ channels by n-3 polyunsaturated fatty acids. *Am J Physiol Cell Physiol* 2006; 290: C362-70.

Xiao YF, Wright SN, Wang GK, Morgan JP, Leaf A. Fatty acids suppress voltage-gated Na⁺ currents in HEK293t cells transfected with the alpha-subunit of the human cardiac Na⁺ channel. *Proc Natl Acad Sci USA* 1998; 95:2680-5.

Y

Yamagishi K, Iso H, Date C, Fukui M, Wakai K, Kikuchi S, Inaba Y, Tanabe N, Tamakoshi A and JACC Study Group. Fish, ω-3 polyunsaturated fatty acids, and mortality from cardiovascular diseases in a nationwide community-based cohort of Japanese men and women: the JACC (Japan collaborative cohort study for evaluation of cancer risk) study. *Journal of the American College of Cardiology* 2008; 52(12): 988-996.

Yamashiro Y, Ohtsuka Y, Yabuta K, the regulation of intestinal hypersensitivity reactions to ovalbumin by omega-3 fatty acid enriched diet: studies of IEL and LPL in mucosal damage. *Acta Paediatr Jpn* 1994; 36:550-556.

Yanagisawa A, Matsukura T, Aoki N, Miyagawa M, Satoh K, Metori K, Mineo S, Ishikawa K. Protection of the rat myocardium from ischemic injury by dietary lamprey oil. *Ecosanoids* 1988; 1:93-100.

Yang, BC, Saldeen TGP, Bryant JL, Nichols WW and Mehta JL. Long term dietary fish oil supplementation protects against ischemia-reperfusion-induced myocardial dysfunction in isolated rat heart. *Am Heart J* 1993; 126: 1287-1292.

Yehuda S, Rabinovitz S, Mostofsky DI. Modulation of learning and neuronal membrane composition in the rat by essential fatty acid preparation: time course analysis. *Neurochem Res* 1998; 23:627-34.

Yokoyama M, Origasa H, Matsuzaki M, et al. Effects of eicosapentaenoic acid (EPA) on major coronary events in hypercholesterolemic patients (JELIS): a randomised open-label blinded endpoint analysis. *Lancet* 2007; 369: 1090-98.

Yokoyama M. Effects of eicosapentaenoic acid (EPA) on major cardiovascular events in hypercholesterolemic patients: The Japan EPA Lipid Intervention Study (JELIS), *Circulation* 2005; 112:3362-3363.

Z

Zampolli A, Bysted A, Leth T, Mortensen A, De Caterina R, Falk E. Contrasting effect of fish oil supplementation on the development of atherosclerosis in murine models, *Artherosclerosis* 2005; 184:78–85.

Zareba W, Moss AJ, Daubert JP, Hall WJ, Robinson JL, Andrews M. Implantable cardioverter defibrillator in high-risk long QT syndrome patients. *J Cardiovasc Electrophysiol* 2003; 14:337-41.

Zeghichi S, Kallithraka S, Mediterranean diet in the Maghreb : An update. "World Review of Nutrition and Dietetics". Simopoulos AP., Visioli F. (Eds.) : More on the Mediterranean diets. *World Rev Nutr Diet Basal Karger* 2007, vol 87, 160:179.

Zeghichi S, Kallithraka S, Simopoulos AP, Kyriotakis Z. Nutritional Composition of Selected Wild Plants in the Diet of Crete. Simopoulos AP, Gopalan C (eds): Plants in Human Health and Nutrition Policy. *World Rev Nutr Diet*. Basel, Karger, 2003;(91):22-40

Zhang J, Sasaki S, Amano K and Kesteloot H. Fish consumption and mortality from all causes, ischemic heart disease, and stroke an ecological study. *Prev Med* 1999; 28:520-529.

Zhu B, Sievers R, Sun Y. Is the reduction of myocardial infarct size by dietary fish oil the result of altered platelet function. *Am Heart J* 1994; 127:744-755.

Zipes D P., D. Wyse G, Friedman P L., Epstein A E., Hallstrom A P., Greene H L, Schron E B., Domanski M. A comparison of antiarrhythmic drug therapy with implantable defibrillators in patients resuscitated from near-fatal ventricular arrhythmias. The Antiarrhythmics versus Implantable Defibrillators (AVID) Investigators, *N Engl J Med* 1997, 337:1576-1583.

Zipes DP, Camm AJ, Borggreffe M, et al. ACC/AHA/ESC 2006 guidelines for management of patients with ventricular arrhythmias and the prevention of sudden cardiac death: a report of the American College of Cardiology/American Heart Association Task Force and the European Society of Cardiology Committee for Practice Guidelines (Writing Committee to Develop Guidelines for Management of Patients With Ventricular Arrhythmias and the Prevention of SuddenCardiac Death). *J Am Coll Cardiol* 2006; 48:e247-e346.

Zipes DP, Wellens HJ. Sudden cardiac death. *Circulation* 1998; 98:2334-51.

Zoll P, Linenthal A and Gibson W et al. Termination of ventricular fibrillation in man by externally applied electric countershock. *N Engl J Med* 1956; 254:727-732.

Zwanziger J, Hall WJ, Dick AW, et al. The cost effectiveness of implantable cardioverter-defibrillators: results from the Multicenter Automatic Defibrillator Implantation Trial (MADIT)-II. *J Am Coll Cardiol* 2006; 47:2310-8.

LIST OF FIGURES

Figure 1. Saturated fatty acids (SA), Monounsaturated fatty acids (MUFA), Polyunsaturated fatty acids (PUFA), and <i>trans</i> fatty acids.....	17
Figure 2. Polyunsaturated fatty acids (PUFA) derived from ALA and LA.....	20
Figure 3. Content of ω -3 PUFA in Fish (g/100 g of fresh uncooked fish).....	22
Figure 4. Metabolism of essential fatty acids.....	27
Figure 5. Oxidative metabolism of AA and EPA.....	28
Figure 6. Opposing effects of ω -6 and ω -3 fatty acids on the arachidonic acid cascade.....	31
Figure 7. Internal heart anatomy.....	40
Figure 8. Conduction system of the heart and cardiogram.....	41
Figure 9. Cardiac excitation–contraction–energy coupling: synchronization electrical and metabolic pacing.....	44
Figure 10. Pathways involved in cardiac energy metabolism.....	45
Figure 11. Pathogenesis of myocardial ischemic and reperfusion injury.....	46
Figure 12. Approximate plasma triglyceride reduction per gram of combined EPA and DHA.....	51
Figure 13. Early benefit of omega-3 fatty acid therapy on total mortality, sudden death, coronary artery disease mortality, and cardiovascular mortality in GISSI.....	63
Figure 14. Cumulative survival without nonfatal infarction and without major secondary end points. Experimental group = Mediterranean type diet.....	65
Figure 15: Cardiac death in patients with prevalent coronary heart disease in GISSI-Prevenzione and JELIS trials of fish-oil consumption.....	67
Figure 16. Implantable cardioverter defibrillator (ICD) detects arrhythmia and provides a shock to restore normal rhythm.....	68
Figure 17. Kaplan-Meier analyses of the time to first implantable cardioverter defibrillator shock for ventricular tachycardia or fibrillation or death due to any cause in the Fatty Acid Antiarrhythmia Trial.....	70
Figure 18. Kaplan-Meier Estimates of Survival Patients Included in the SOFA Trial.....	71
Figure 19. Effect of ω -3 PUFA on intracellular calcium regulation.....	73
Figure 20. Regulation of phospholipase activities by ω -3 PUFA in cardiovascular functions.....	88
Figure 21. History of fibrillation and defibrillation.....	91

Figure 22. ICD, showing relative size.....	93
Figure 23. Implanted ICD as seen by chest x-ray.....	93
Figure 24. ICD Structure.....	93
Figure 25. example of anti-tachycardia pacing (ATP).....	94
Figure 26. example of cardioverter recorded shock.....	95
Figure 27. Evolution of ICD therapy: 1980-2005.....	96
Figure 28. ICD programmer (a) Guidant and (b) St. Jude.....	104
Figure 29. Example of recorded shocks by the ICD.....	105
Figure 30: Perfusion at constant pressure model of isolated rat heart.....	113
Figure 31: TTC Histoenzymology coloration.....	115
Figure 32: Potter–Elvehjem.....	116
Figure 33: Gaz chromatography.....	120
Figure 34: Thin layer chromatography.....	128
Figure 35: Principle of Flame Ionization Detector.....	129
Figure 36. The Omega-3 Index.....	137
Figure 37: Proposed Risk Zones for the Omega-3 Index.....	138
Figure 38: Effect of 8-week fat supplementation on body weight in the 3 groups.....	158
Figure 39: Risk zone (% total LV volume) in the 3 experimental groups (P: NS).....	164
Figure 40: Infarct size (% risk zone) in the 3 experimental groups (P<0.05).....	165
Figure 41: Comparison of infarct size MED vs. PO+SO (p<0.05).....	166
Figure 42. Distribution of cardiopathy in Omegadef Patients.....	174
Figure 43: Kaplan-Meyer analyses of the time to ICD shock or antitachycardia pacing for VT/VF or death from cardiac cause.....	181

LIST OF TABLES

Table 1. Structure and taxonomy of fatty acids.....	15
Table 2. Content of ω -3 and ω -6 PUFA in nuts and in seeds and in Oils.....	21
Table 3. Effects of PUFA on several genes encoding enzyme.....	33
Table 4. Safe and effective doses of ω -3 fatty acid supplements for adults.....	36
Table 5. The 3 stages of cell membrane injury and associated cellular ionic alterations during Ischemia.....	48
Table 6. Factors involved in CHD that may be affected by ω -3 long chain PUFA.....	50
Table 7. Effects of ω -3 fatty acids on factors involved in the pathophysiology of atherosclerosis and inflammation.....	55
Table 8. Effect of (ω -3) polyunsaturated fatty acid supplementation on arrhythmia in experimental animals.....	75
Table 9. Effect of (ω -3) polyunsaturated fatty acid supplementation on arrhythmia in vitro.....	77
Table 10. Clinical features and results of the 3 Major Secondary Prevention ICD Trials.....	98
Table 11. Clinical Features and Results of the 7 Major Primary Prevention ICD Trials.....	99
Table 12. Fatty acid composition of Standard food, PO, SO and Mixalpha oils (% of total fatty acids).....	111
Table 13. Buffers composition used for mitochondria isolation.....	118
Table 14. Fatty acid composition of the standard mixture.....	122
Tableau 15. Phospholipidic composition of cardiac mitochondria in various mammals.....	124
Tableau 16. Phospholipidic composition of mitochondrial inner and external membranes of pig heart.....	125
Tableau 17. Fatty acid composition of the three main mitochondrial phospholipids of rat heart and beef heart.....	126
Table 18. Food consumption and energy supply in Palm (PO), Sunflower (SO) and Mix-A3 (MED) groups.....	159
Table 19. Fat intakes in the 3 groups.....	159
Table 20. Blood lipids (g/L) and plasma fatty acids (as % of total fatty acids).....	160
Table 21. Erythrocyte fatty acids (as % of total fatty acids) in the 3 groups.....	161

Table 22. Fatty acid composition of mitochondrial phospholipids in myocardial cells (expressed as % of total fatty acids).....	162
Table 23. Left ventricular function in the 3 experimental groups.....	163
Table 24. Age, sex, professional status and BMI of the patients.....	175
Table 25. Risk factors of the patients.....	175
Table 26. Medication of the patients.....	176
Table 27. Coronary heart disease and indication for ICD of the patients.....	176
Table 28. Dietary habits of patients of the patients.....	177
Table 29. Blood lipids (as mMol/L)and Red Blood Cells Fatty acid (as % of total fatty acids) of the patients.....	178
Table 30. Multivariate Proportional-Hazards analyses.....	179
Table 31. Proportional hazard model with adjustment for.....	179
Table 32. Patients characteristics in the different quartiles according to plant ω -3 PUFA (ALA).....	182
Table 33. Patients characteristics in the different quartiles according to marine omega-3 PUFA (EPA+ DPA +DHA).....	183
Table 34. Patients characteristics in the different quartiles according to <i>Trans</i> fatty acids.....	184

ABBREVIATIONS

AA	arachidonic acid
Abs	absorbance
ACC	American College of Cardiology
ADP	adenosine diphosphate
AF	atrial fibrillation
AHA	American Heart Association
AK	adenylate kinase
ALA	α -linolenic acid
AMP	adenosine monophosphate
ARVD/C	Arrhythmogenic RV dysplasia/cardiomyopathy
ATP	adenosine triphosphate
ATP	anti-tachycardia pacing
AV	atrioventricular
BMI	Body mass index
BSA	bovine serum albumin
CABG	coronary artery bypass graft
CCPPRB	Consultative Committee for the Protection of Persons in Medical Research
CI	Confidence interval
CK	creatine kinase
CL	cardiolipine
COX	cyclooxygenases
CPP	Committee for the Protection of Persons
CRP	C-reactive protein
CSR	Sarcoplasmic reticulum
CVD	Cardiovascular disease
CVHS	The Cardiovascular Health Study
DAI	Défibrilateur automatique implantable
DC	Coronary flow
DCM	dilated cardiomyopathy
DGLA	dihomo- γ -linolenic acid
DHA	docosahexaenoic acid
DPA	docosapentaenoic acid
DPA	docosapentaenoic acid
+dp/dt	positive derivatives of left ventricle pressure
-dp/dt	negative derivatives of left ventricle pressure
ECG	electrocardiogram
EDTA	ethylenediaminetetraacetic acid
EFA	essential fatty acids
EPA	eicosapentaenoic acid
EURAMIC	European Multicenter Case-control Study on Antioxidants, Myocardial Infarction and Breast Cancer
FA	fish oil
FAAT trial	Fatty Acid Antiarrhythmia Trial
FADH	flavin adenine dinucleotide

FAO	Food and Agriculture Organization of the United Nations
FFA	free fatty acids
GC	gas chromatography
GISSI	Gruppo Italiano per lo Studio della Sopravvivenza nell'Infarto miocardico Prevenzione trial
GLA	γ -linolenic acid
HCM	hypertrophic cardiomyopathy
HDL	high density lipoprotein
HHP	The Honolulu Heart Program
HR	Heart rate
ICD	implantable cardioverter defibrillator
ICD	implantable cardioverter defibrillator
ILs	interleukines
IS	Infarct size
IZ	infarct zone
JELIS	The Japan EPA Lipid Intervention Study
LA	linoleic acid
LA	Linoleic acid
LDL	low density lipoprotein
LPC	L-a lysophosphatidylcholine
LPC	lysophosphatidylcholin
LPX	lipoxygenases
LTs	leukotrienes
LV	Left ventricular
LVDevP	developed left ventricular pressure
LVDP	left ventricular diastolic pressure
LVEF	Left ventricular ejection fraction
LVSP	left ventricular systolic pressure
MED	mediterranean
MixA3	Mixalpha 3*
MUFA	monounsaturated fatty acids
NADH	nicotinamide adenine dinucleotide
NCEP	The National Cholesterol Education Program Third Adult Treatment Panel
NHANES	The National Health and Nutrition Examination Survey
OA	oleic acid
PC	phosphatidylcholine
PDGF	platelet-derived growth factor
PDH	pyruvate-dehydrogenase
PE	phosphatidylethanolamine
PG	prostaglandins
Pi	phosphate inorganique
PI	phosphatidylinositol
PI	phosphatidylinositol
PKC	protein kinase C
PLA2	phospholipase A2
PO	Palm oil

PS	phosphatidylserine
PUFA	polyunsaturated fatty acids
RBM	biomedical research
RYR	Ryanodine receptor-channels
SA	sinoatrial
SCD	Sudden cardiac death
SERCA	SR Ca ²⁺ -ATPase
SF	saturated fat
SFA	saturated fatty acids
SL	sarcolemmal
SM	sphingomyelin
SO	Sunflower oil
SOFA	Study on ω -3 fatty acids and ventricular Arrhythmia
TC	total cholesterol
TCA	tricarboxylic acid
TG	triglycerides
TNF-α	tumor necrosis factor α
TTC	2,3-triphényl-tétrazolium
TX	thromboxanes
VEB	ventricular ectopic beats
VEGF	vascular endothelial growth factor
VF	Ventricular fibrillation
VFT	ventricular fibrillation threshold
VLC-PUFA	very long chain polyunsaturated fatty acids
VLDL	very low density lipoprotein
VPB	ventricular premature beats
VT	Ventricular tachycardia
WHO	World Health Organization

Abstract

Although the Mediterranean diet (MED) is considered the optimal diet to prevent coronary heart disease (CHD), it is still unknown whether adoption of MED may result in improved myocardial resistance to ischemia-reperfusion injury and may potentially prevent ventricular arrhythmias. Accordingly, the first experimental study was carried out to investigate whether a diet low in saturated fats and omega-6 fatty acids ($\omega 6$) but rich in plant and marine omega-3 fatty acids ($\omega 3$), a typical MED fatty acid profile, may result in smaller infarct size and better left ventricular function (LVF) recovery in a rat model of regional ischemia-reperfusion. Results demonstrate a great accumulation of $\omega 3$ and a parallel decrease of arachidonic acid in plasma, cell membranes and cardiac mitochondria. Also, the MED rats developed smaller infarct size compared with the control groups ($p < 0.01$) while LVF recovery was not different in the three groups. The second epidemiologic study was carried out to determine whether $\omega 3$ have beneficial antiarrhythmic effects in patients at high risk for fatal ventricular arrhythmias. Two hundred thirty eight patients with implantable cardioverter defibrillators (ICDs) were included at Grenoble University Hospital. The primary end point was time to first ICD event for ventricular tachycardia or fibrillation (VT or VF) or death from cardiac cause. Red blood cells fatty acids was analyzed and the Omega-3 Index was calculated from eicosapentaenoic acid and docosahexaenoic acid. Results did not show significant differences neither in individual omega-3 fatty acids (ALA, EPA and DHA) nor in omega-3 index between quartiles. However, it comes into view that the RBC omega-3 index in these patients (8.6 ± 1.59 to 8.8 ± 1.76) was already at levels that have been previously reported to be cardioprotective.

Key words: *Omega-3 fatty acids, Mediterranean diet, myocardial infarct, arrhythmia, Omega-3 index.*

Résumé

Bien que le régime méditerranéen (MED) soit considéré comme le meilleur régime alimentaire pour prévenir les maladies cardiaques, on ignore toujours si l'adoption de MED résulte en une amélioration de la résistance du myocarde à l'ischémie et la reperfusion et en une prévention des arythmies ventriculaires. En conséquence, nous avons mené deux études : (1) vérifier si un profil lipidique de type MED; faible en gras saturés et en acides gras oméga-6 ($\omega 6$) et riche en acides gras oméga-3 ($\omega 3$) d'origines végétale et marine; peut réduire la taille d'infarctus et une meilleure récupération de la fonction ventriculaire gauche (FVG) dans un modèle de rat. Les rats MED ont été comparés avec des rats recevant des régimes riches en acides gras saturés ou en acides gras $\omega 6$. Les résultats montrent une grande accumulation des $\omega 3$ et une diminution de l'acide arachidonique dans le plasma, les membranes des cellules cardiaques et dans les mitochondries. Pareillement, les rats MED avaient une taille infarctus plus réduite par rapport aux deux autres groupes, tandis que FVG récupération n'était pas différente dans les trois groupes. La deuxième étude épidémiologique a été menée au Centre Hospitalier Universitaire de Grenoble pour déterminer une éventuelle corrélation entre les oméga-3 et la survenue de complications rythmiques. Deux cent trente huit patients porteurs de défibrillateurs automatiques implantables (DEF) ont été inclus. La composition en acides gras des globules rouges a été analysé et l'index oméga-3 a été calculée à partir de l'acide eicosapentaénoïque et acide docosahexaénoïque. Aucune différence significative entre les acides gras oméga-3 (ALA, EPA et DHA) ou l'index oméga-3 et la survenue d'événements n'a été observée entre quartiles. Néanmoins, l'index oméga-3 chez ces patients était déjà à des niveaux qui ont été démontrés avoir un pouvoir cardioprotecteur (8.6 ± 1.59 à 8.8 ± 1.76).

Mots clés: *Acides gras oméga 3; diète méditerranéenne; infarctus du myocarde; arythmies; Indice Omega-3.*

Thèse préparée au sein du laboratoire Cœur & Nutrition, Université Joseph Fourier, Grenoble 1.