

Quantum propagation of guided matter waves: Anderson localization and atom laser

Juliette Billy

Supervision: Philippe Bouyer & Vincent Josse

*Atom Optics group
Laboratoire Charles Fabry de l'Institut d'Optique*



Ultracold atoms and condensed matter

Ultracold atoms

Bose -Einstein condensate

Anderson *et al.*
Science 1995

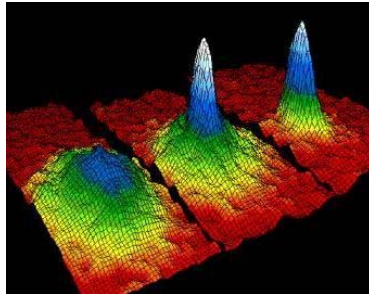

Matterwaves

$$\lambda_{dB} \sim d$$

Condensed matter

Superfluid



Supraconductors

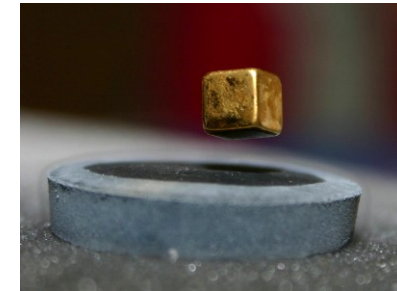

Geometries: 1D, 2D, 3D, lattices...

« clean » potentials without absorption

Observation tools:

wavefunction, momentum distribution...

Tunable interactions:

Feshbach resonances, BEC dilution

Conductivity measurement

Presence of phonons

Coulomb interactions between electrons

Ultracold atoms and condensed matter

Ultracold atoms

Bose -Einstein condensate

Anderson et al.
Science 1995

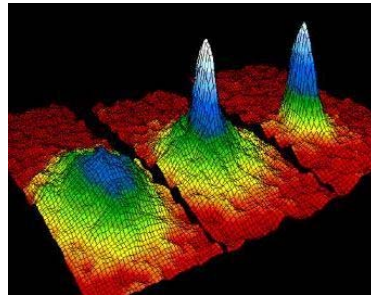

Matterwaves

$$\lambda_{dB} \sim d$$

Condensed matter

Superfluid

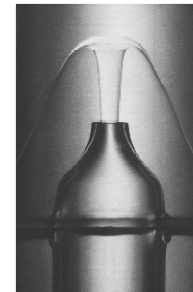

Supraconductors

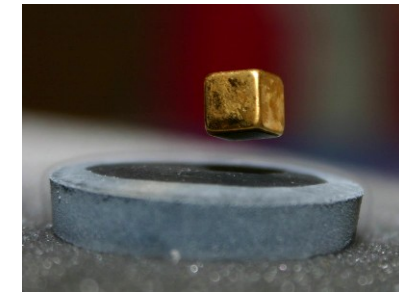

Ultracold atoms = « simple » and well controlled systems

⇒ condensed matter *simulators*

Mott transition (Superfluid – Insulator)

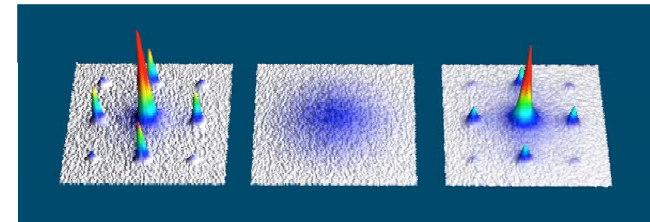
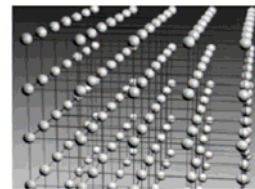

M. Greiner et al. Nature 2002

Quantum transport phenomena

*Mainly studied in Condensed Matter → Fundamental concept in physics
(conduction of electrons)*

Single particule effect (no interactions) : linear propagation

- *Tunneling effect / quantum reflection*
- *Fabry-Perot cavity effect*
- *Bloch oscillations in periodic potential*
- *Anderson localization through disorder*

Many body effect (interactions) : non linear propagation

- *Superfluidity*
- *Atomic blockade (analog to Coulomb blockade)*
- *Solitonic propagation (Bright/ Dark)*

Quantum transport with Bose-Einstein Condensates

Linear propagation:

Quantum reflection on surfaces:

T. Pasquini *et al.*
PRL 2006

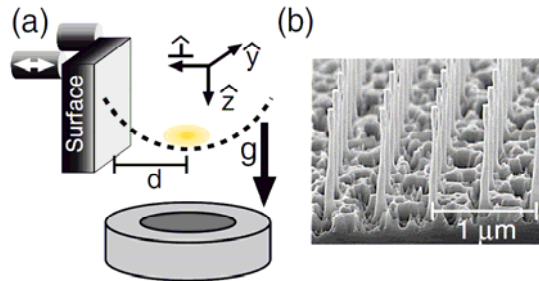

Bloch oscillations:

M. Ben Dahan *et al.*
PRL 1996

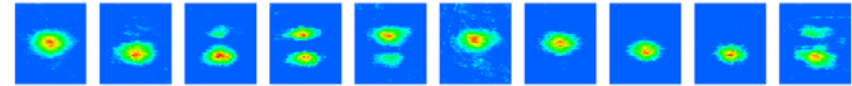

G. Roati *et al.* PRL 2004

Non linear : bright or dark solitons / shock waves

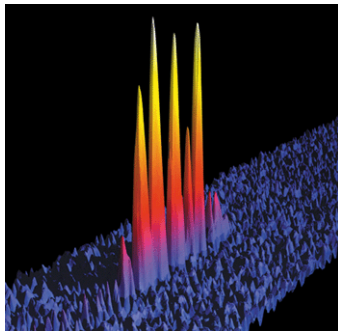

K Strecker *et al.* Nature 2002

L. Khaykovich *et al.* Science 2002

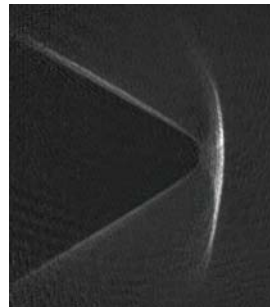

E. Cornell group

Jila, Boulder 2005

I. Carusotto *et al.* PRL 2006

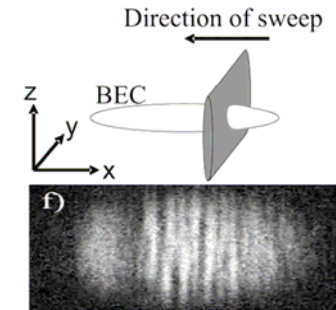

P. Engels and C. Atherton

PRL 2007

Propagation of guided matterwaves (1D)

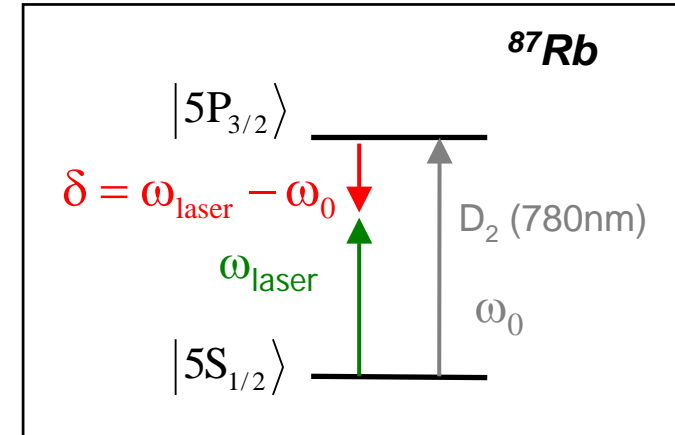
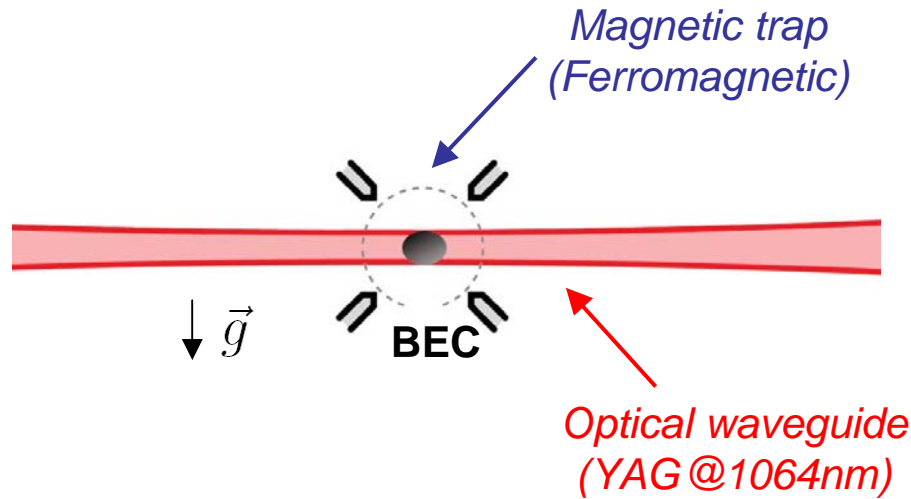

$$V_{\text{dip}} \propto \frac{I(r)}{\delta} \quad \begin{array}{ll} \delta < 0 & \text{attractive} \\ \delta > 0 & \text{repulsive} \end{array}$$

BEC + horizontal guide
= guided matterwaves

$$\lambda_{\text{dB}} = \frac{h}{mv} \approx \mu\text{m}$$



Quantum propagation through
optical potentials: size $\sim \mu\text{m}$

Propagation of guided matterwaves (1D)

BEC + horizontal guide
= guided matterwaves

$$\lambda_{dB} = \frac{h}{mv} \approx \mu m$$



Quantum propagation through
optical potentials: size ~ μm

1. Anderson localisation of an expanding BEC in presence of disorder

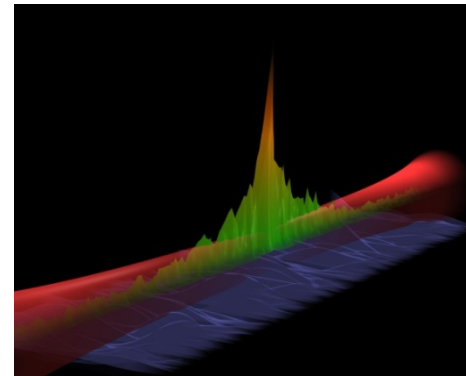

2. Developpement of a new atomic source: *guided atom laser*

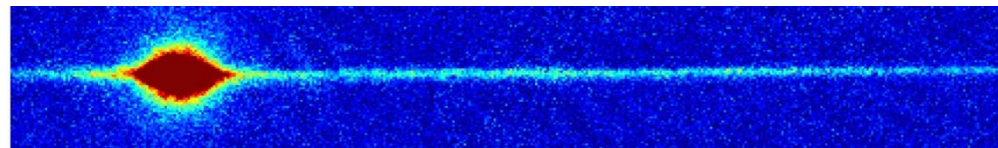

1. Anderson localization



Predicted for condensed matter (electrons):

P.W. Anderson Phys. Rev. 1958

⇒ Metal-Insulator transition induced by disorder (no interactions)

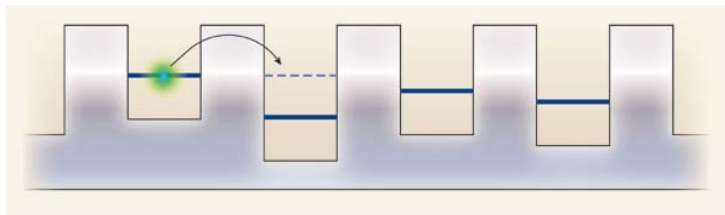
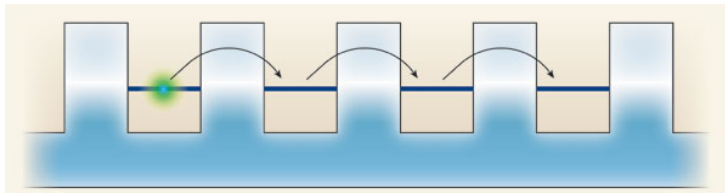

Anderson Localization with expanding BEC in disorder

First experiments in 2005

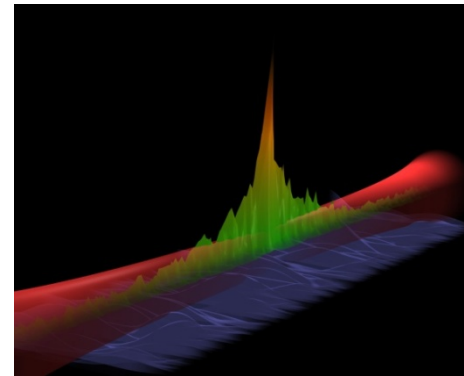

General context: disorder + interactions

New quantum phase (Bose Glass...)

B. Damski et al. PRL 2003

2. Guided Atom Laser

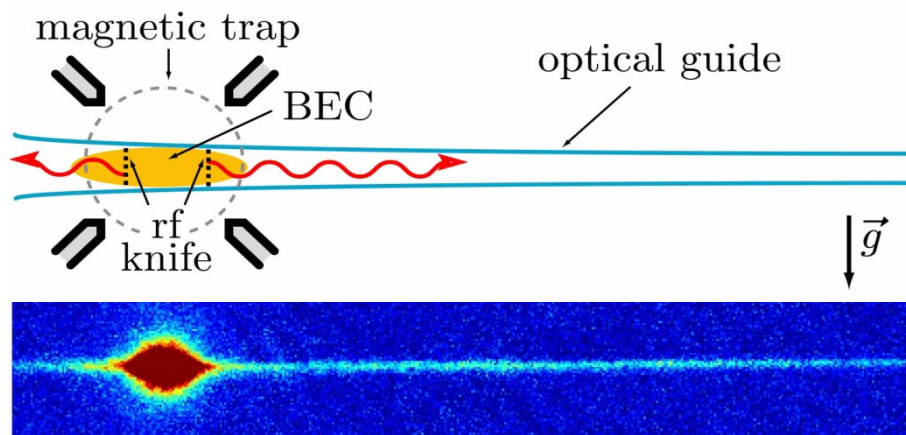

W. Guerin *et al.* PRL (2006)

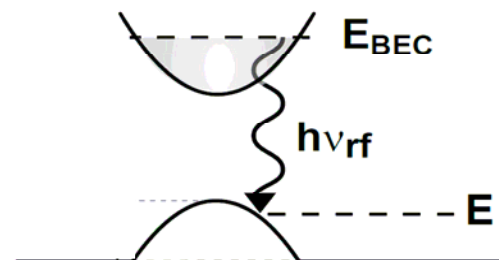

Well defined energy E
Controlled flux \Rightarrow interactions

$$\lambda_{\text{dB}} \simeq \mu\text{m}$$

2. Guided Atom Laser

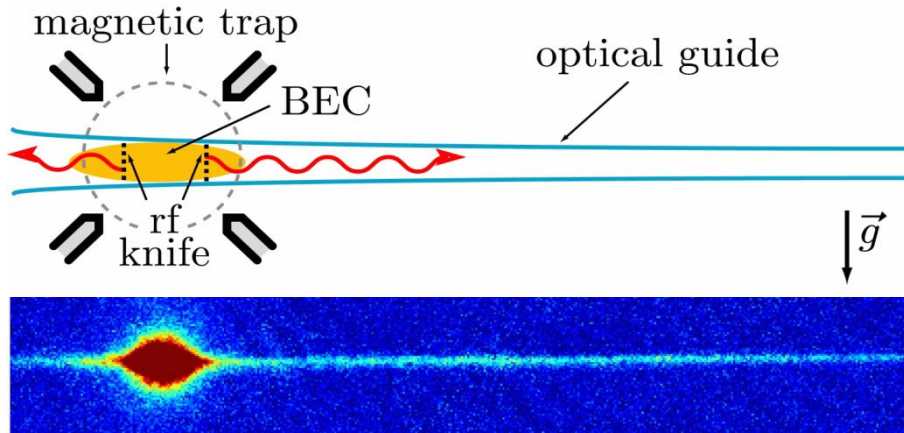

W. Guerin *et al.* PRL (2006)

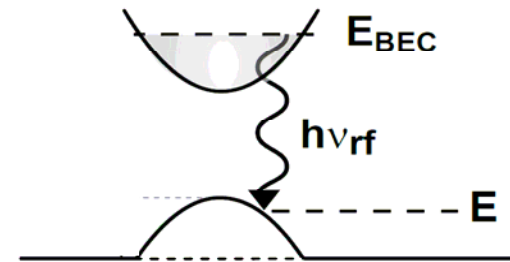

Well defined energy E
Controlled flux \Rightarrow interactions

$$\lambda_{dB} \simeq \mu\text{m}$$

Spectral linewidth measurement:

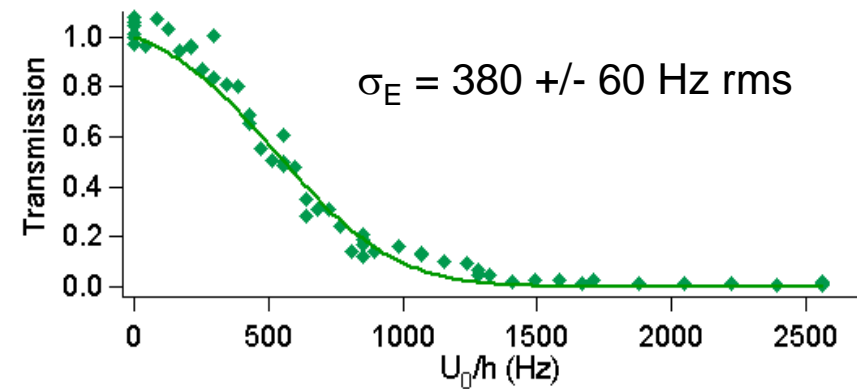
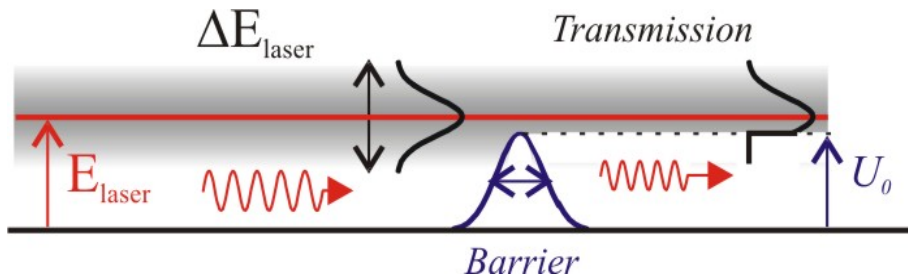

Outline

1. Anderson Localization (AL)



P.W. Anderson
Phys. Rev. 1958

- *Introduction and motivations*
- *Scheme of 1D Anderson localization in laser speckle*
- *Experimental realization and results*
- *Conclusion*

2. Perspectives

Outline

1. Anderson Localization (AL)



P.W. Anderson
Phys. Rev. 1958

- *Introduction and motivations*

Localization of waves

Weak disorder : weak localization

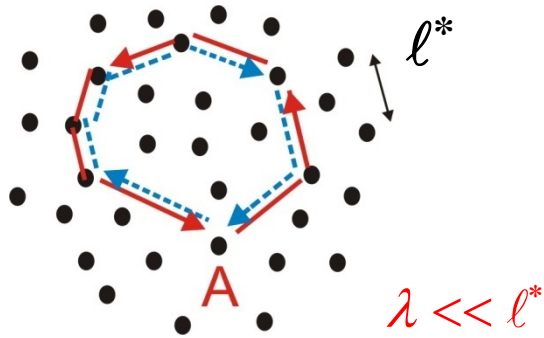

Interferences on closed loops

⇒ Enhanced (x2) return probability

⇒ Decrease of diffusion constant

Localization of waves

Weak disorder : weak localization

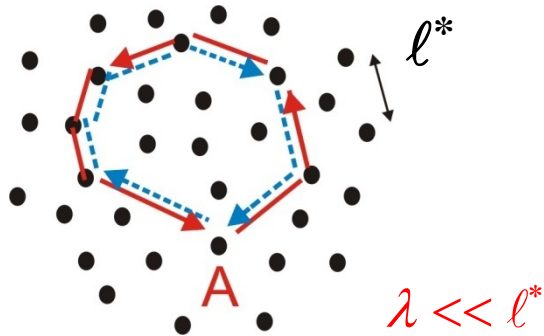

Interferences on closed loops

⇒ Enhanced (x2) return probability

⇒ Decrease of diffusion constant

Strong disorder : localized – extended states transition

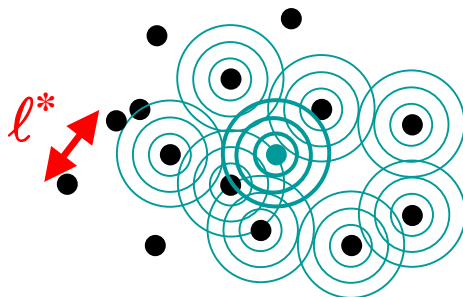

⇒ **wavefunction are exponentially localized**

⇒ **Dimensionality**

[1D, 2D : all states localized
3D : transition (mobility edge)

Mobility edge (Ioffe Regel)

$$\lambda \approx l^*$$

Strong localization with classical waves

Problematic :
Discrimination absorption / localization

Classical waves :
Ultrasound, μ -waves, light

Geometries :
- quasi-1D, 2D, 3D
- Photonic crystals

Signatures :
- Transmission (static / time resolved)
- Fluctuations
- Wavefunction imaging

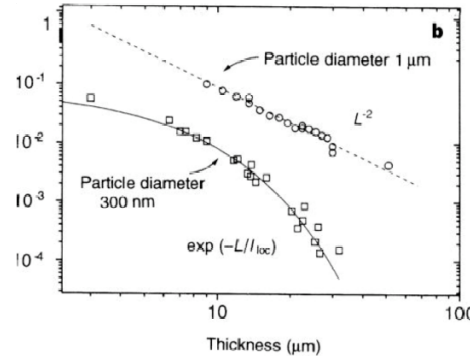

D. Wiersma et al. Nature 97

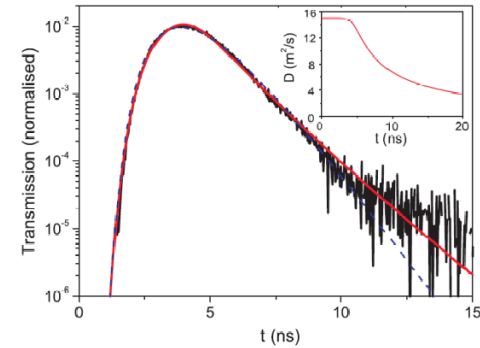

C.M. Aegerter et al. EPL 06

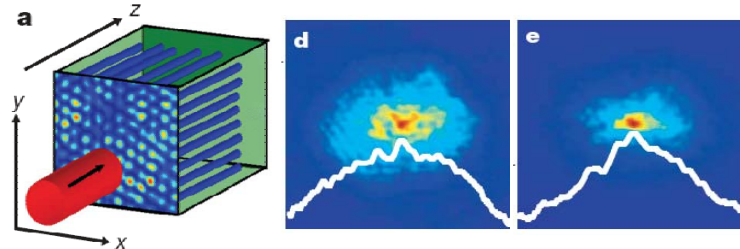

T. Schwartz et al. Nature 07

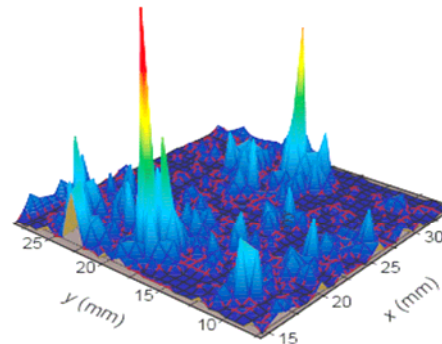

H. Hu et al. Nature Physics 08

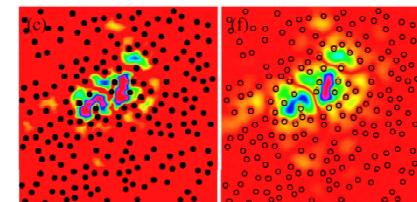

D. Laurent et al. PRL 08

Anderson localization: still an active field !

Remaining challenges

Behavior of the transition (3D) ? (critical exponents)

C.M. Aegerter et al. EPL 2006

Effects of non-linearities ? (interaction)

1D : Y. Lahini et al. PRL 2008

2D : T. Schwartz et al. Nature 2007

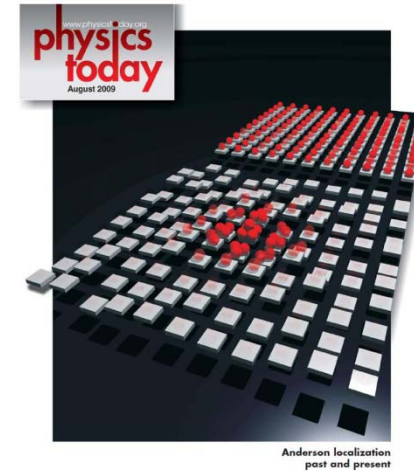

Anderson localization: still an active field !

Remaining challenges

Behavior of the transition (3D) ? (critical exponents)

C.M. Aegerter et al. EPL 2006

Effects of non-linearities ? (interaction)

1D : Y. Lahini et al. PRL 2008

2D : T. Schwartz et al. Nature 2007

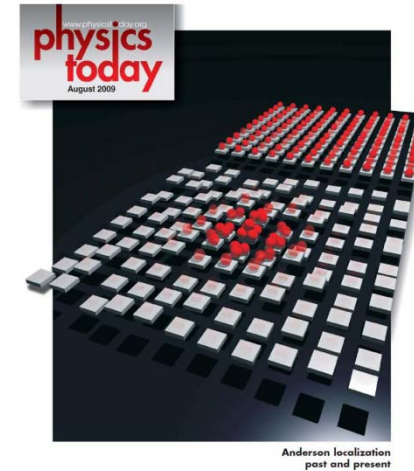

Experiments with matterwaves ?

Since 80's: indirect observations (conductivity) with electrons

Anderson localization: still an active field !

Remaining challenges

Behavior of the transition (3D) ? (critical exponents)

C.M. Aegerter et al. EPL 2006

Effects of non-linearities ? (interaction)

1D : Y. Lahini et al. PRL 2008

2D : T. Schwartz et al. Nature 2007



Experiments with matterwaves ?

Since 80's: indirect observations (conductivity) with electrons

**Dynamical localisation
with cold atoms**

J. Chabé et al. PRL 2009

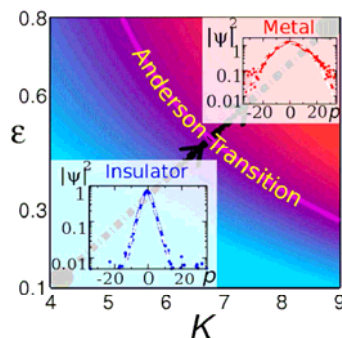

Anderson localization: still an active field !

Remaining challenges

Behavior of the transition (3D) ? (critical exponents)

C.M. Aegerter et al. EPL 2006

Effects of non-linearities ? (interaction)

1D : Y. Lahini et al. PRL 2008

2D : T. Schwartz et al. Nature 2007



Experiments with matterwaves ?

Since 80's: indirect observations (conductivity) with electrons

**Dynamical localisation
with cold atoms**

J. Chabé et al. PRL 2009

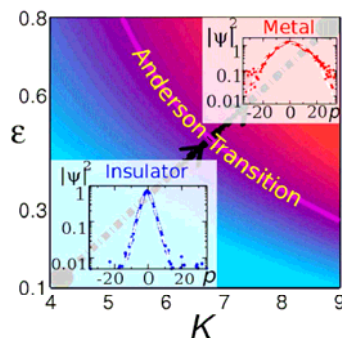

*Since 2005: experimental activity with
cold atoms*

D. Clément et al. PRL 2005

C. Fort et al. PRL 2005

T. Schulte et al. PRL 2005

Anderson localization with cold atoms ?

- Cold atoms = controlled systems
- Direct observation of localized wavefunctions
- Critical exponents in 3D ?

Controlled random optical potentials:

Speckle pattern

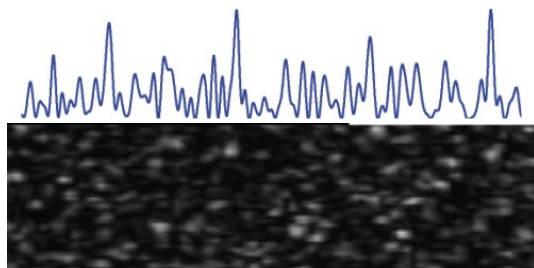

Horak et al. PRA 1998

Bi-chromatic lattice

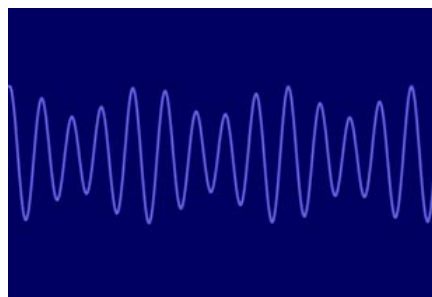

Damski et al. PRL 2003

Impurities in optical lattice

Gavish & Castin PRL 2005

Atomic chips

Esteve et al. PRA 2004

+

Our disordered potential: laser speckle

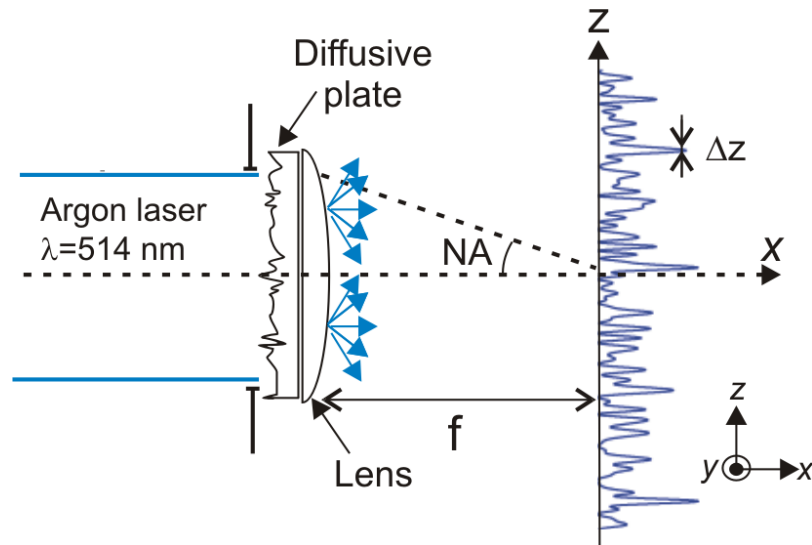

Laser speckle : diffraction from a rough plate



$$V_{random} \propto \frac{I(r)}{\delta}$$

Blue detuned (atomic transition @ 780 nm)
= repulsive potential

A controlled disorder:

⇒ Disorder strength = laser intensity

$$\sigma_V = \langle V \rangle \equiv V_R$$

⇒ Correlation length = numerical aperture

$$\Delta z = \frac{\lambda}{2(N.A.)}$$

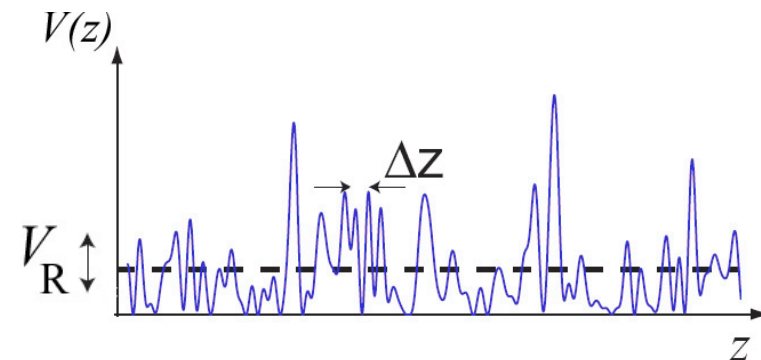

D. Clément et al. NJP 2006

Outline

1. Anderson Localization (AL)

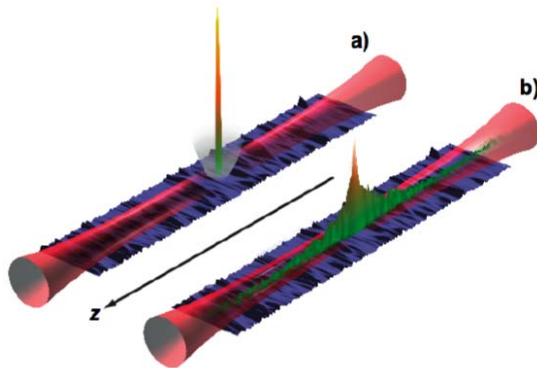

- *Scheme of 1D Anderson localization in laser speckle*

1D Anderson localization of matterwave

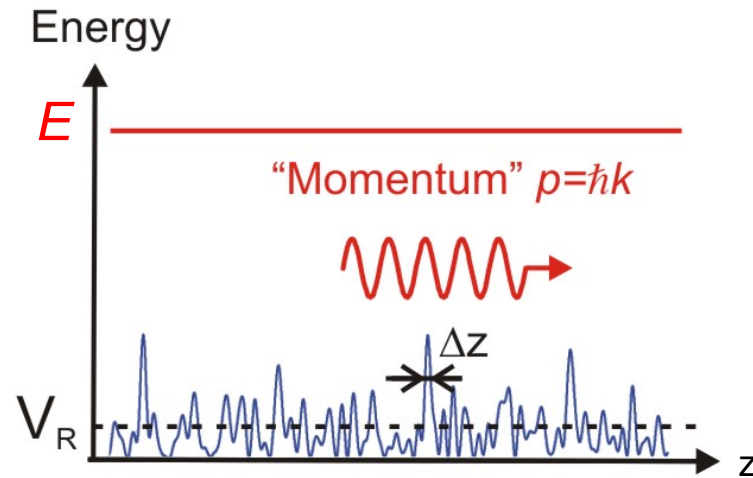

Propagation in weak disorder

$$E = \frac{p^2}{2m} = \frac{\hbar^2 k^2}{2m} \gg V_R$$

No classical trapping

Classical : atoms « fly » above disorder

1D Anderson localization of matterwave

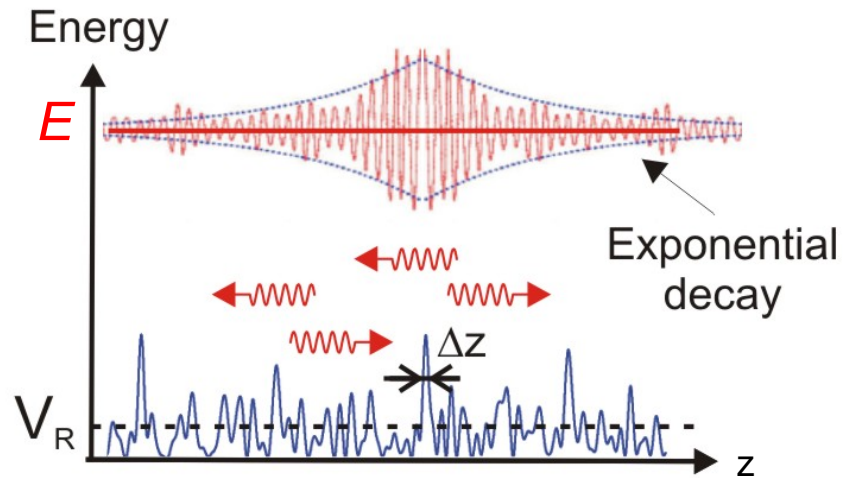

Propagation in weak disorder

$$E = \frac{p^2}{2m} = \frac{\hbar^2 k^2}{2m} \gg V_R$$

No classical trapping

Classical : atoms « fly » above disorder

Quantum : - destructive multiples interferences

- *single particule effect (no interaction)*

1D: All wavefunction are exponentially localized

Lyapunov exponent:

$$\frac{1}{L_{loc}(k)} = \gamma(k) = -\lim_{|z| \rightarrow +\infty} \left\langle \frac{\log\{r(z)\}}{|z|} \right\rangle \quad (p = \hbar k)$$

Weak disorder regime

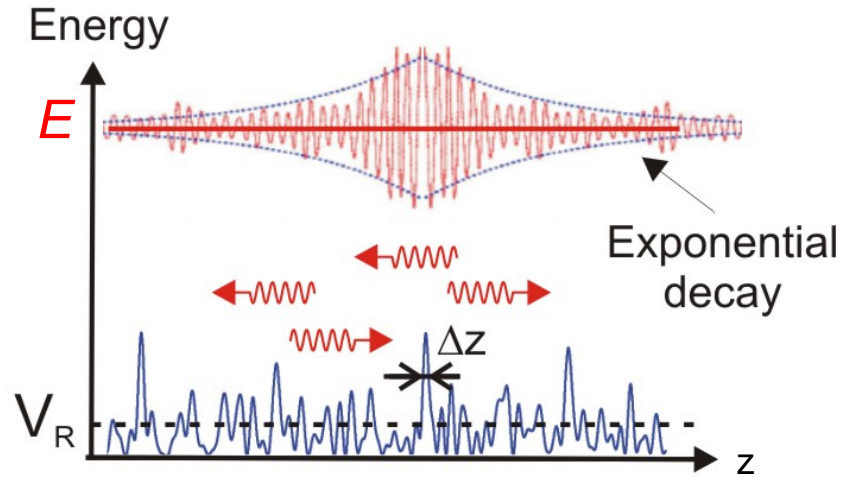

Localization at 1st order:

Disorder contains the spatial component $2k_{atom}$

1st order calculation (Born approximation) :

$$\gamma(k_{atom}) \propto C(2k_{atom}) \quad (p = \hbar k)$$

Frequency distribution of disorder

Bragg condition (momentum conservation)

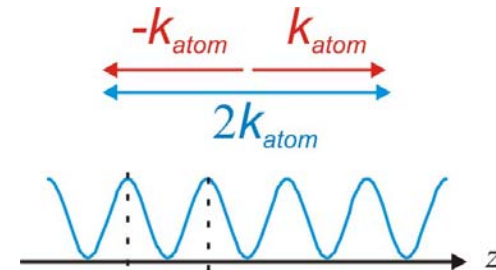

Weak disorder regime

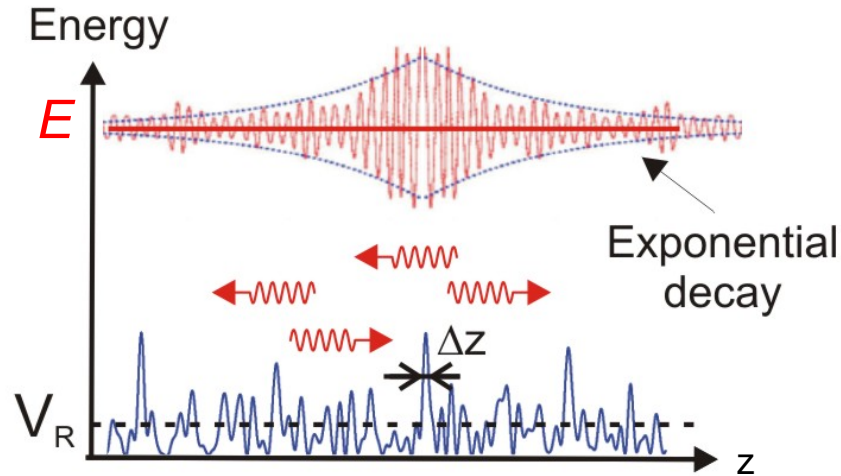

Localization at 1st order:

Disorder contains the spatial component $2k_{atom}$

1st order calculation (Born approximation) :

$$\gamma(k_{atom}) \propto C(2k_{atom}) \quad (p = \hbar k)$$

Frequency distribution of disorder

Bragg condition (momentum conservation)

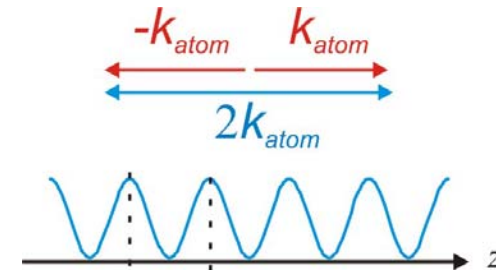

⇒ 2 important distributions

Atomic momentum distribution : $D(k_{atom})$
 (↔ expansion from a BEC)

Spatial frequency distribution : $C(2k_{atom})$
 (↔ speckle characteristics)

Scheme for localization of an expanding BEC

L. Sanchez-Palencia *et al.*, PRL **98**, 210401, 2007

1D expansion of BEC in
weak disorder ($V_R \ll \mu_{in}$)

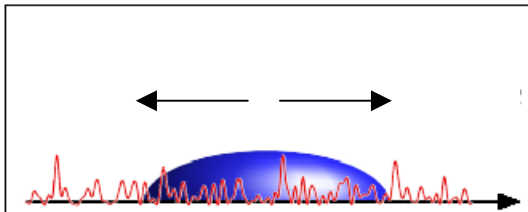
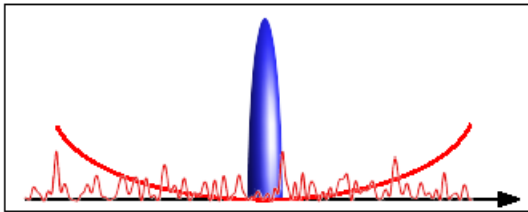

Exponential decay in the wings ?

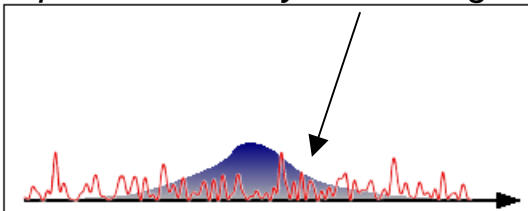

Scheme for localization of an expanding BEC

L. Sanchez-Palencia *et al.*, PRL **98**, 210401, 2007

1D expansion of BEC in weak disorder ($V_R \ll \mu_{in}$)

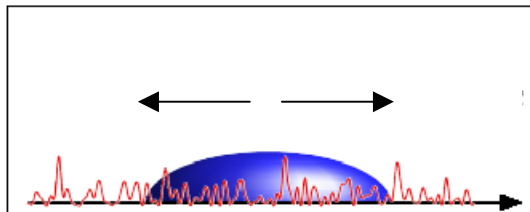
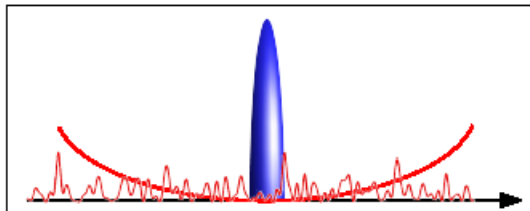

Exponential decay in the wings ?

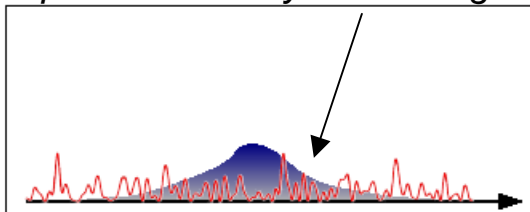

Matterwave k-distribution:

Interaction energy ($\sim \mu_{in}$) converted into kinetic energy

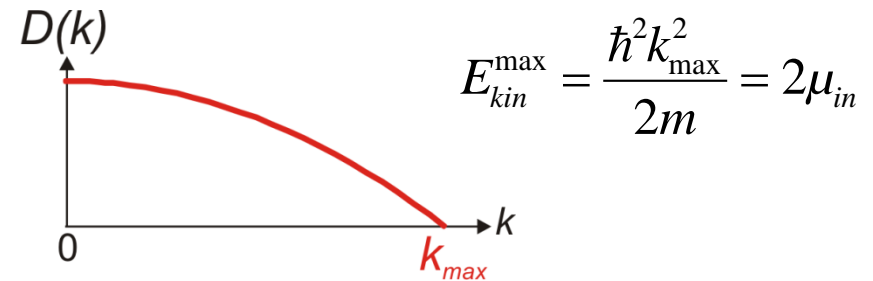

Castin & Dum PRL 1996

Disorder k-distribution:

High frequency cut-off k_c given by diffraction limit

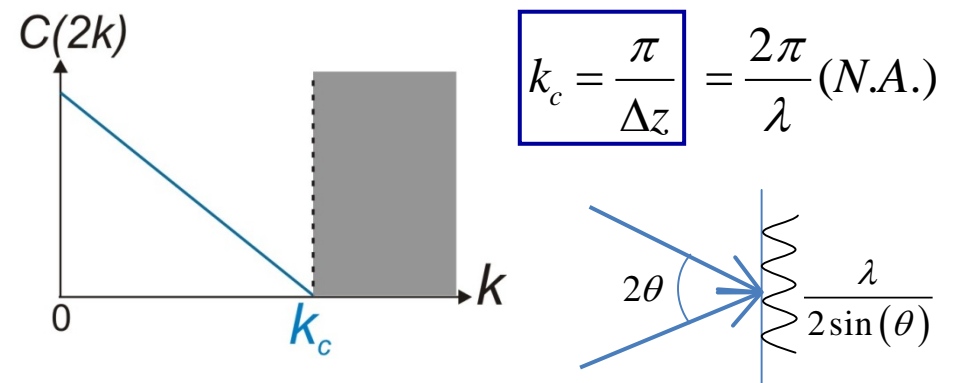

Scheme for localization of an expanding BEC

L. Sanchez-Palencia *et al.*, PRL **98**, 210401, 2007

1D expansion of BEC in weak disorder ($V_R \ll \mu_{in}$)

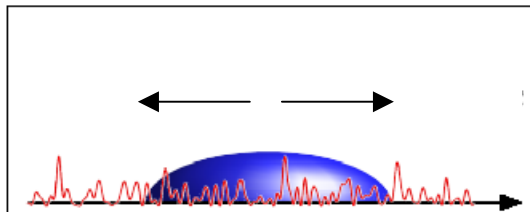
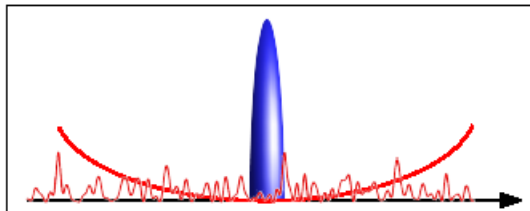

Exponential decay in the wings ?

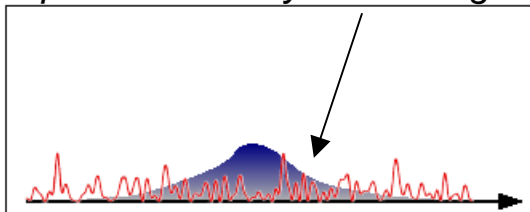

**Exponential localization of matterwave:
All k-components localize**

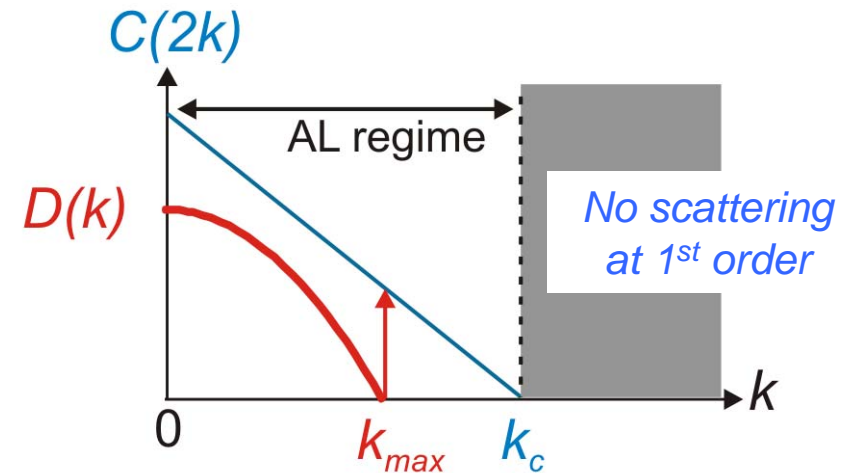

$$k_{max} < k_c$$

Preliminary experiments:

- $k_{max} \gg k_c$
- interactions

D. Clément et al. PRL 2005
C. Fort et al. PRL 2005
T. Schulte et al. PRL 2005

Outline

1. Anderson Localization (AL)

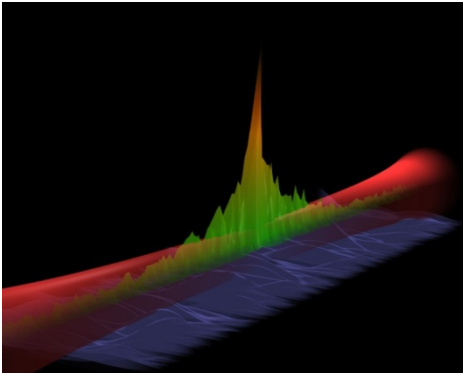

- *Experimental realization and results*

^{87}Rb BEC

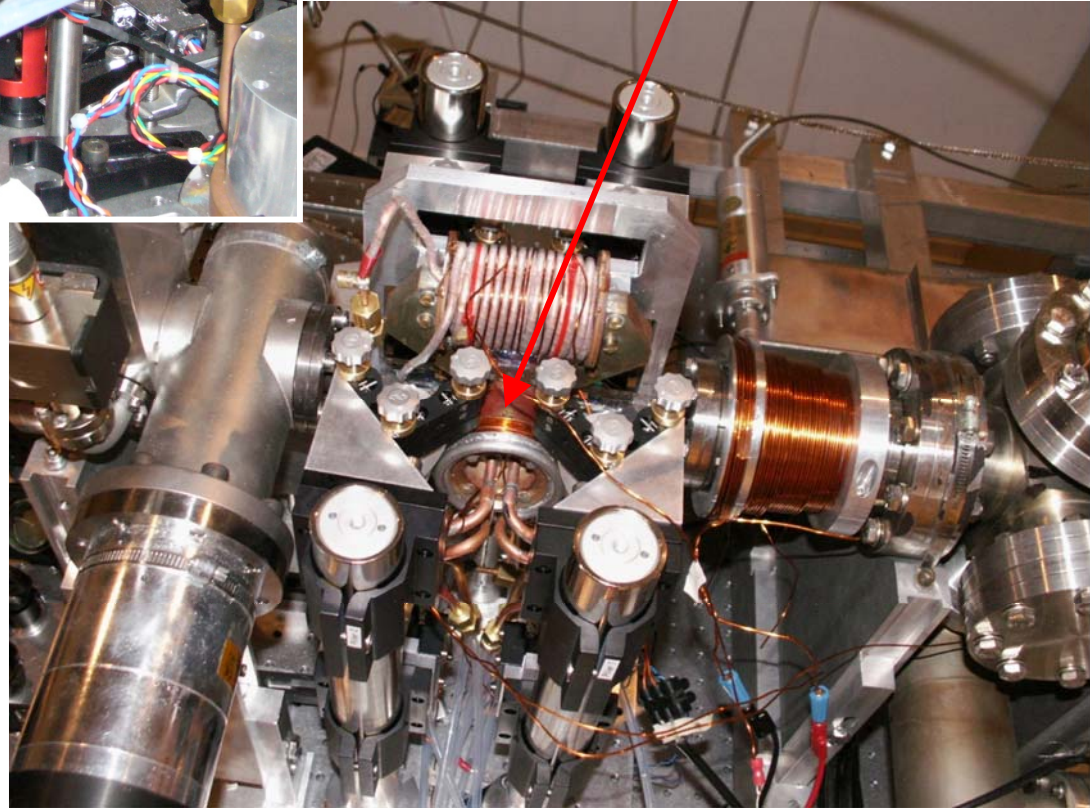
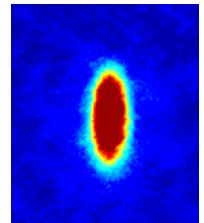
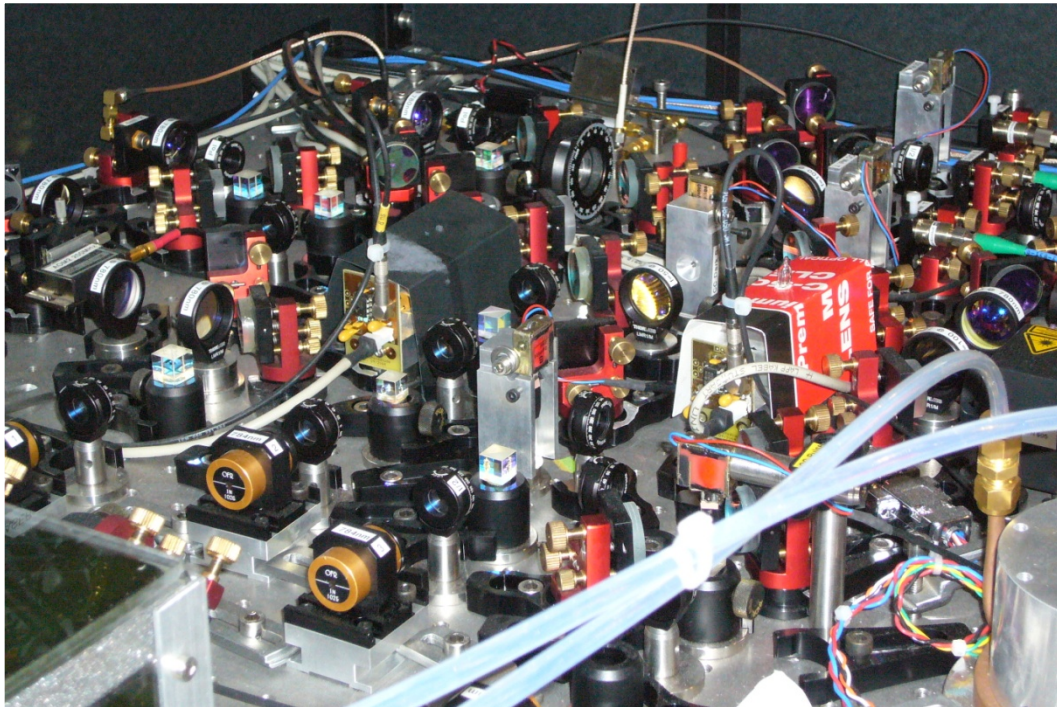

Experimental « road map »

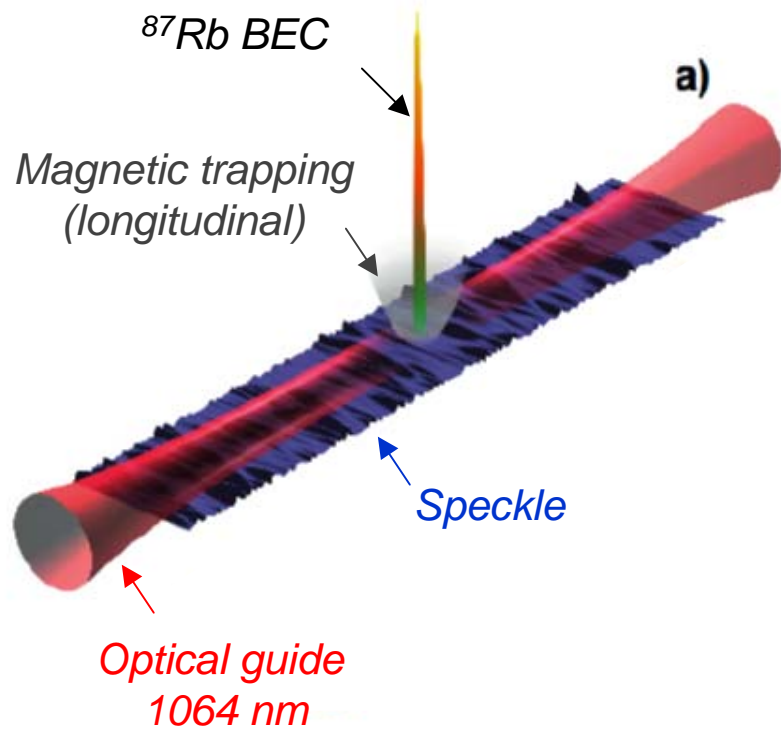

Condition :

$$k_{\text{max}} < k_c$$

Experimental « road map »

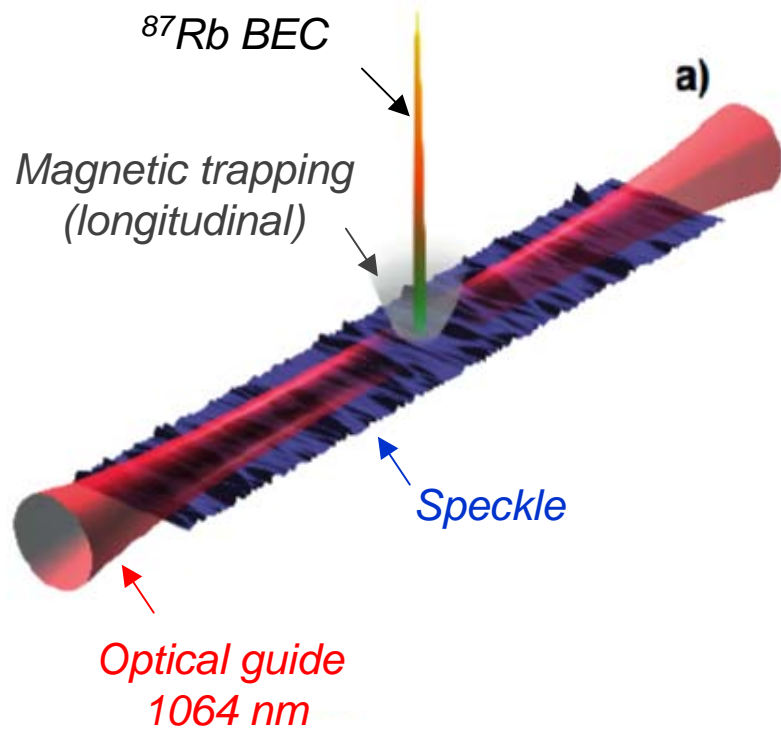

Condition :

$$k_{\max} < k_c$$

1. large $k_c \rightarrow$ Very thin speckle

Experimental « road map »

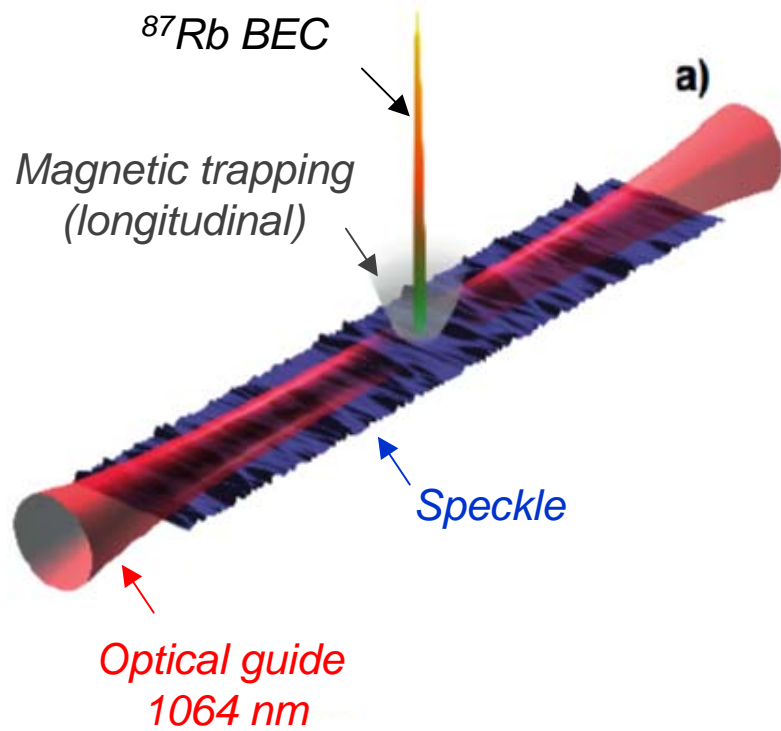

Condition :

$$k_{\text{max}} < k_c$$

1. large $k_c \rightarrow$ Very thin speckle $k_c = 3.85 \mu\text{m}^{-1}$

Blue light @ 514 nm
High N.A. = 0.3

$$\Delta z = 0.8 \mu\text{m}$$

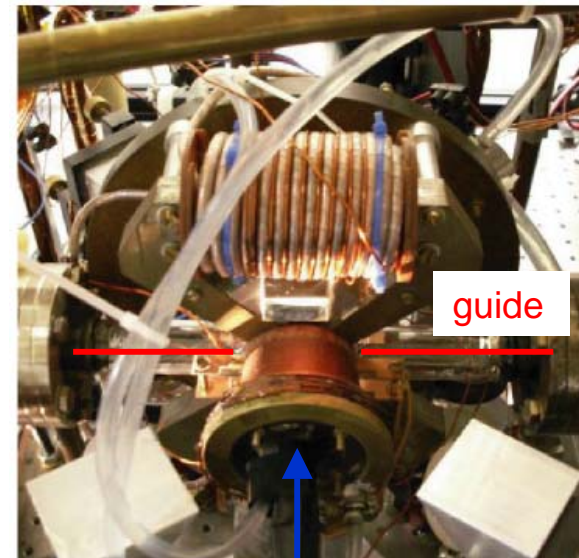
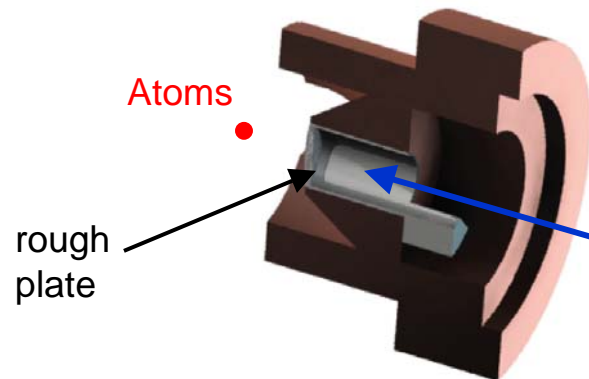

Beam @ 514nm

Experimental « road map »

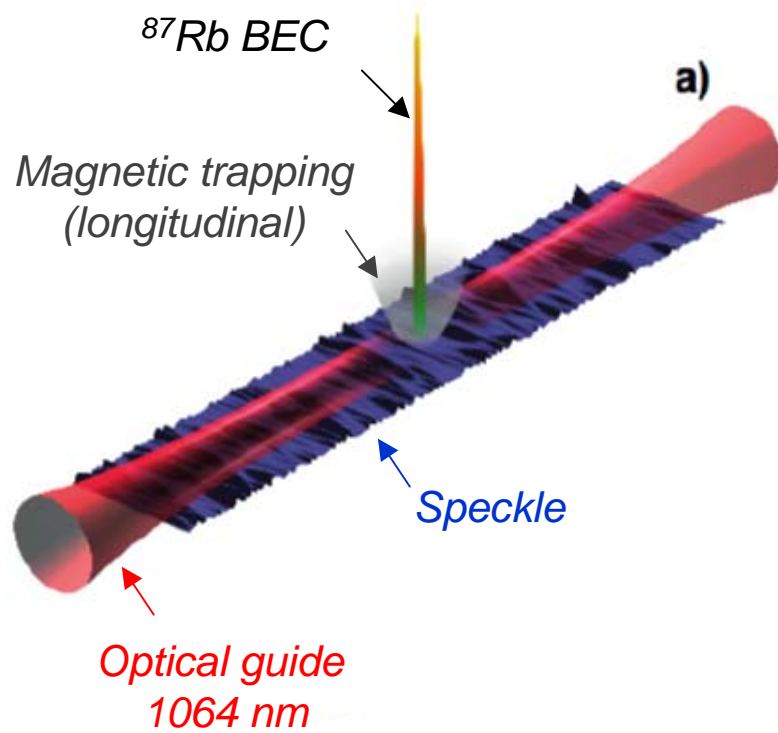

Condition :

$$k_{\max} < k_c$$

1. large $k_c \rightarrow$ Very thin speckle $k_c = 3.85\mu\text{m}^{-1}$
2. small $k_{\max} \rightarrow$ Dilute BEC

Experimental « road map »

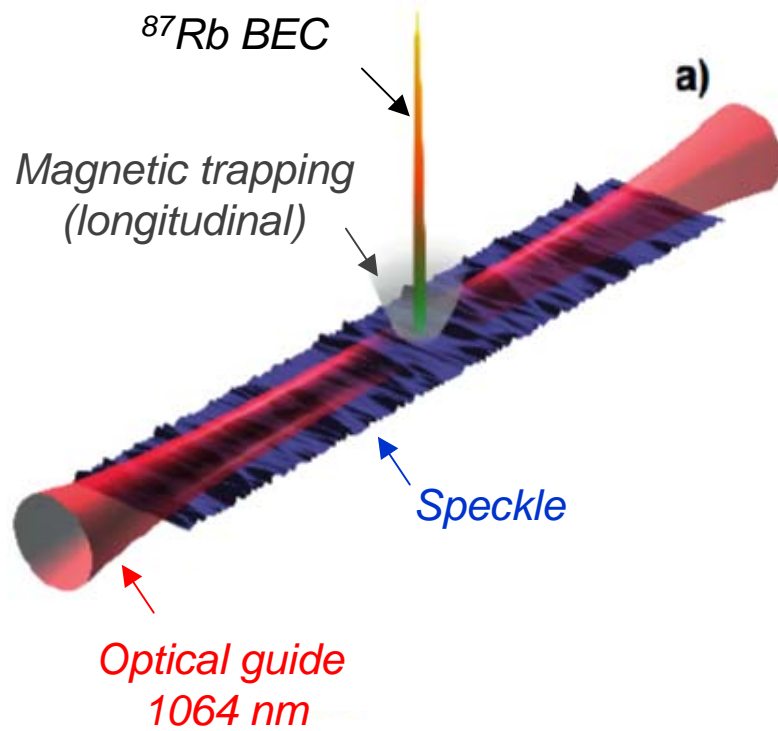

Condition :

$$k_{\max} < k_c$$

1. large $k_c \rightarrow$ Very thin speckle $k_c = 3.85 \mu\text{m}^{-1}$
2. small $k_{\max} \rightarrow$ Dilute BEC

Low number of atoms: $1.7 \cdot 10^4$
Weak trap frequencies

$$\mu_{in} = 220 \text{ Hz}$$

Experimental « road map »

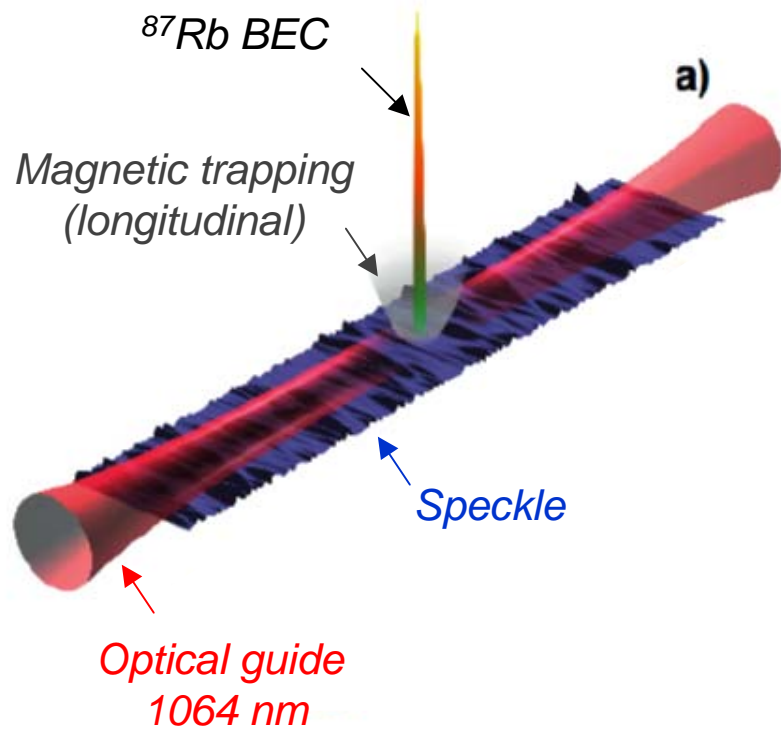

Condition :

$$k_{\max} < k_c$$

1. large $k_c \rightarrow$ Very thin speckle $k_c = 3.85 \mu\text{m}^{-1}$
2. small $k_{\max} \rightarrow$ Dilute BEC
3. large $L_{\text{loc}} \rightarrow$ Expansion over few millimeters

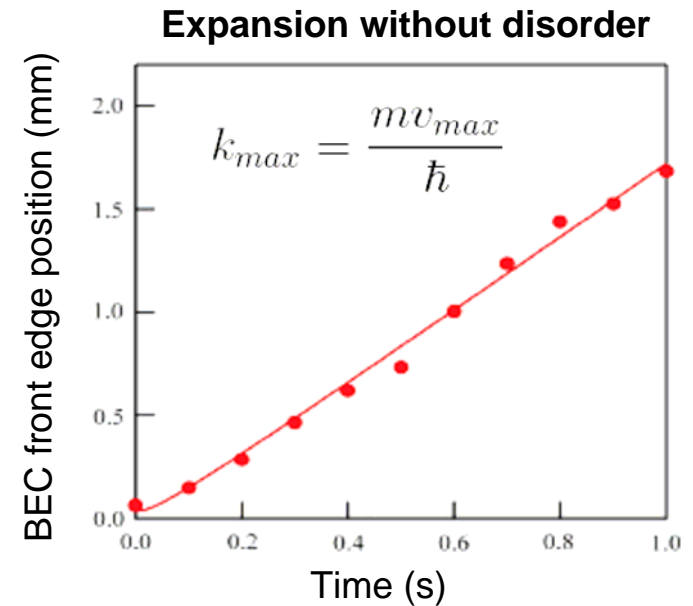
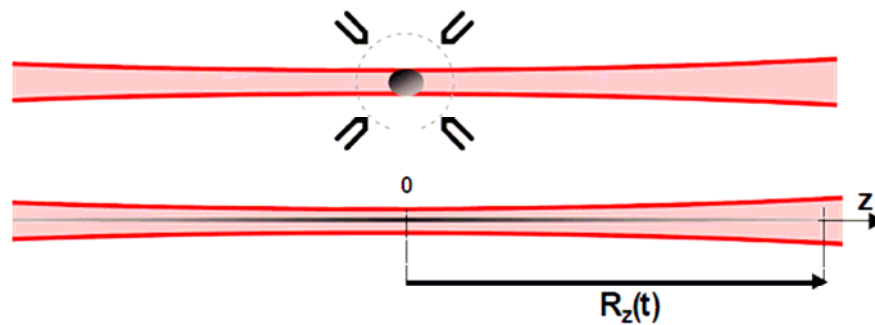

Experimental « road map »

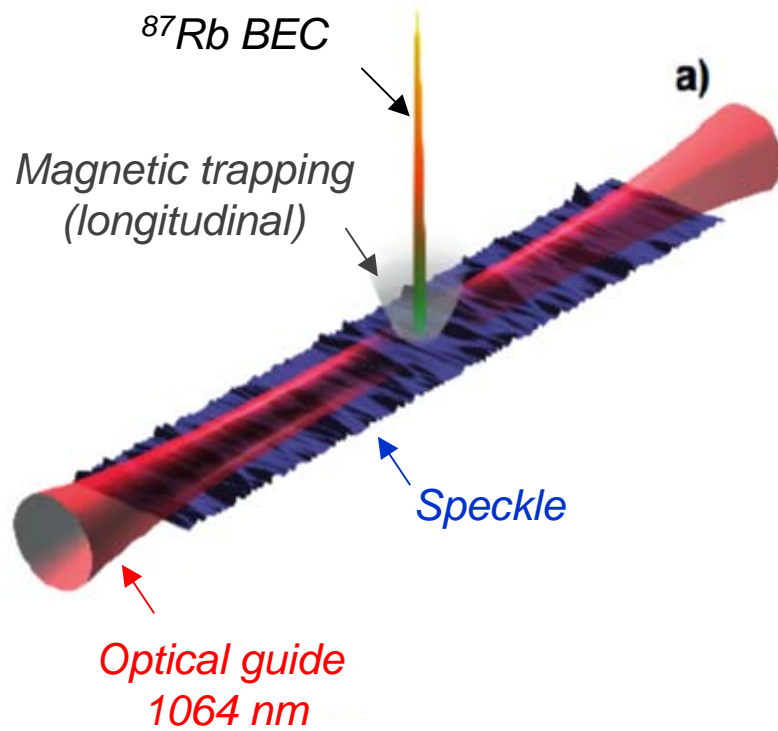

Condition :

$$k_{\max} < k_c$$

1. large $k_c \rightarrow$ Very thin speckle $k_c = 3.85\mu\text{m}^{-1}$
2. small $k_{\max} \rightarrow$ Dilute BEC
3. large $L_{\text{loc}} \rightarrow$ Expansion over few millimeters

$$k_{\max} = 2.47\mu\text{m}^{-1} < k_c = 3.85\mu\text{m}^{-1}$$

\Rightarrow **Condition for AL satisfied !**

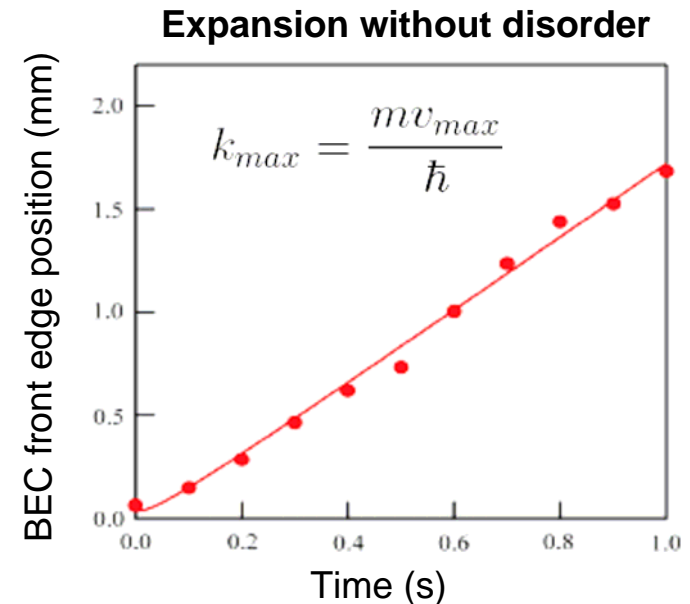

Expansion in disorder

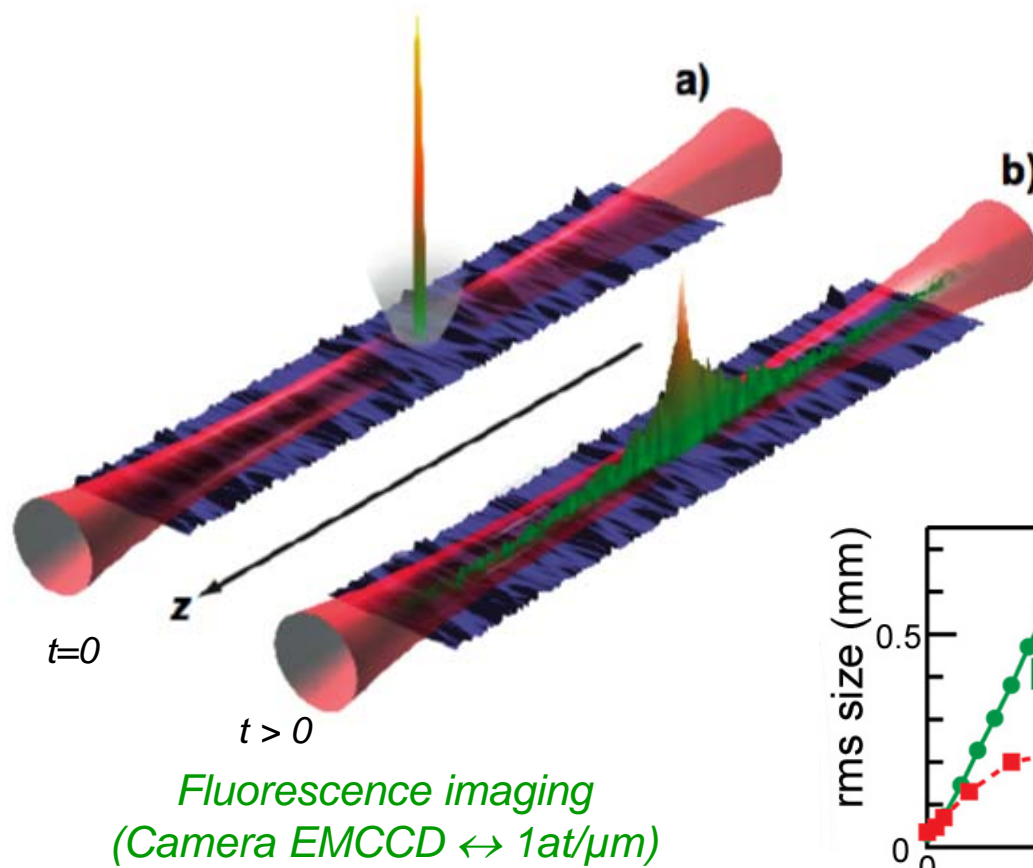

$$k_{max} < k_c$$

+ weak disorder $V_R/\mu_{in} = 0.12 \ll 1$

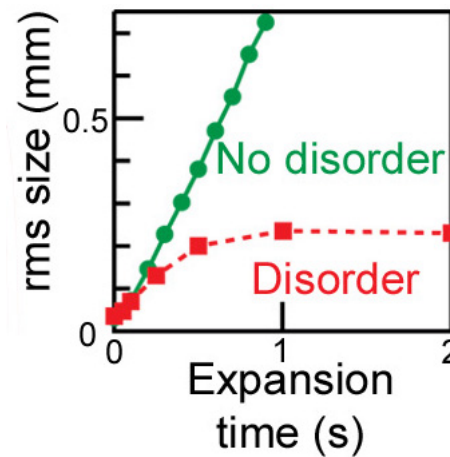
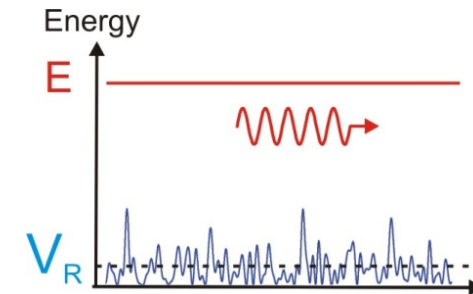

\Rightarrow Matterwave is stopped by weak disorder (after around 1s of propagation)

Signature of Anderson Localization

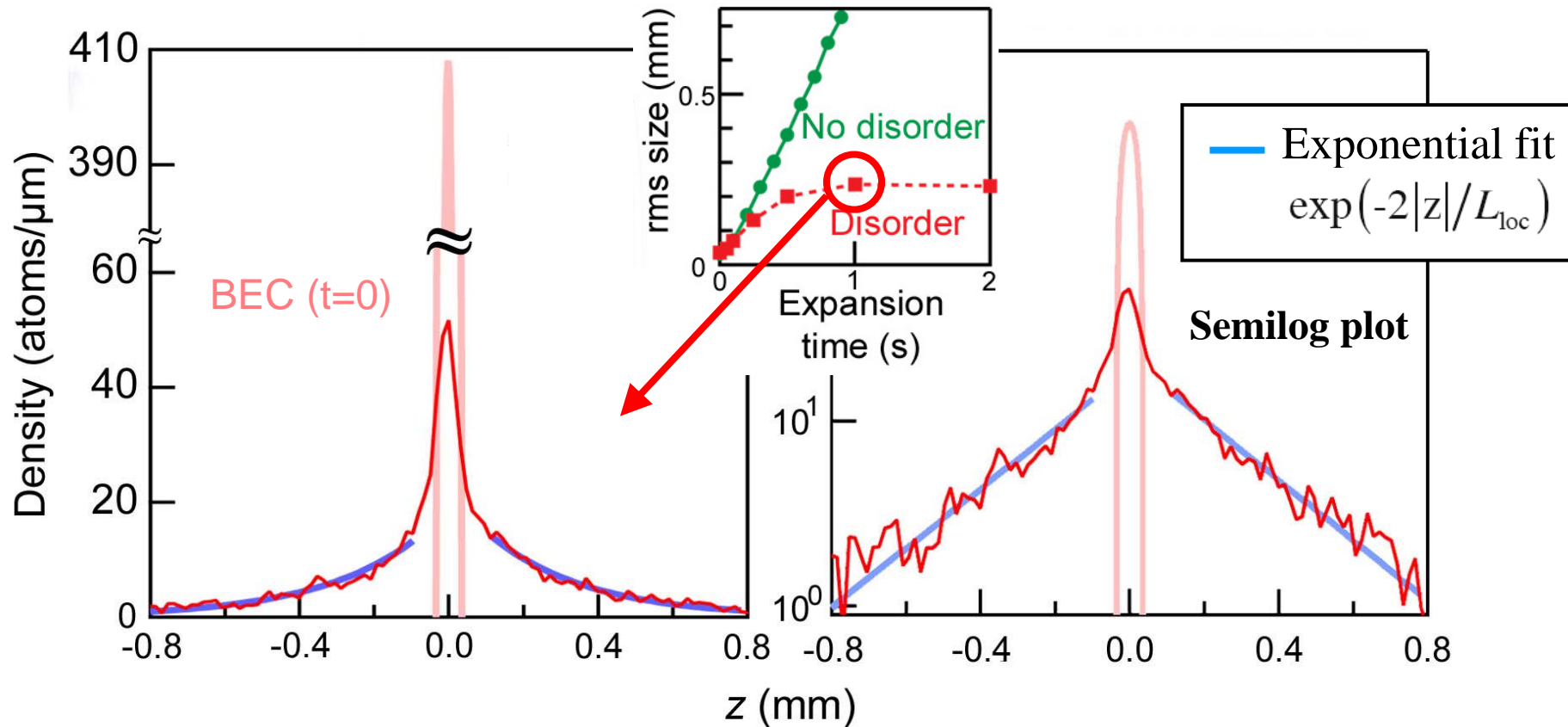

⇒ Exponential decay in the wings (no interactions)

⇒ Stationary profiles (not shown)

Localization length

$L_{\text{Loc}}=530 \pm 80 \mu\text{m}$

Localization length vs disorder amplitude

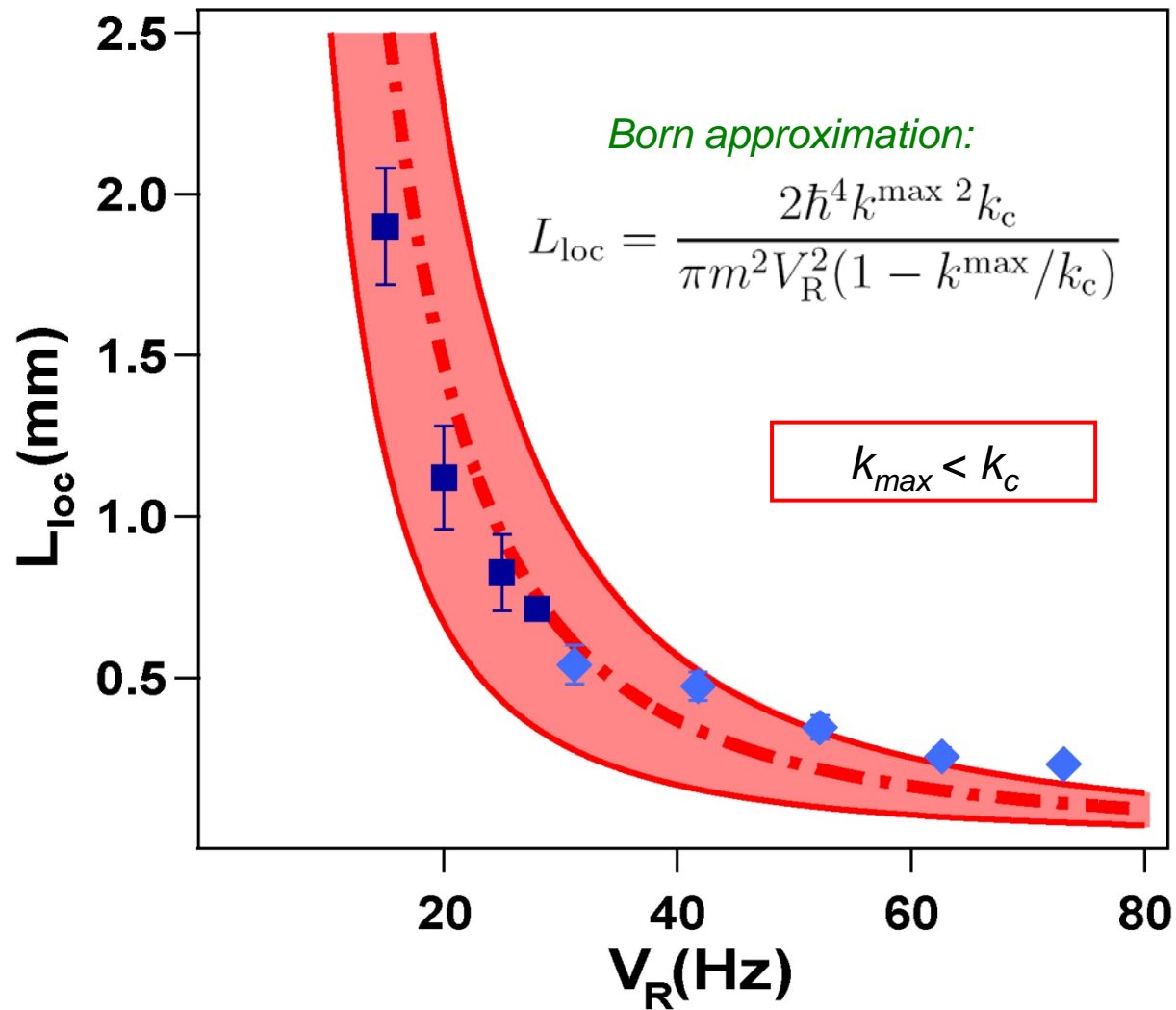

⇒ Good agreement *with no adjustable parameters*

Beyond the effective mobility edge ($k_{\max} > k_c$)

Same scheme with N_{at} (x10):

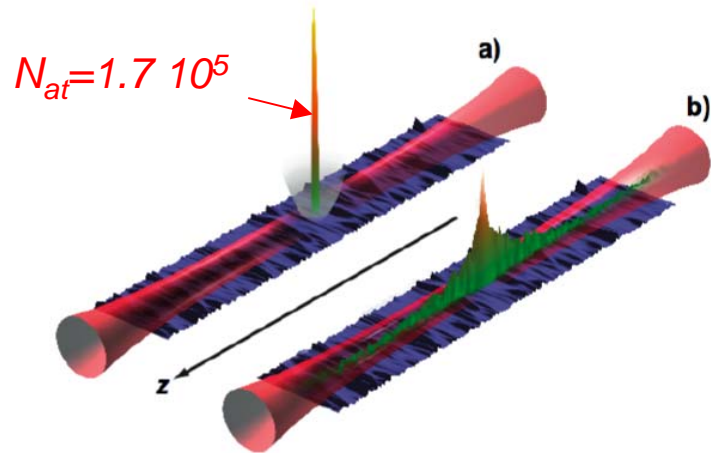

k_{\max} increases \Rightarrow

$$k_{\max} > k_c$$

Theory : algebraic decay
LSP et al. PRL 2007

$$n_{1D} \propto 1/z^2$$

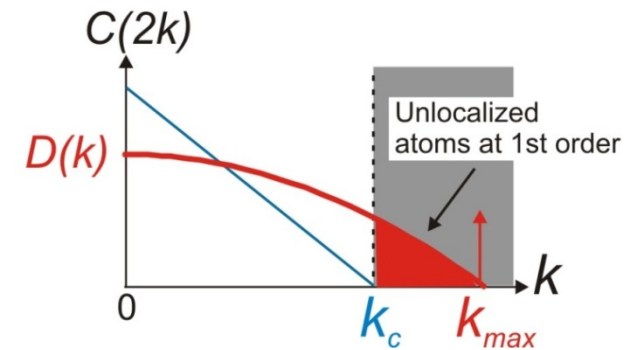

Beyond the effective mobility edge ($k_{max} > k_c$)

Same scheme with N_{at} (x10):

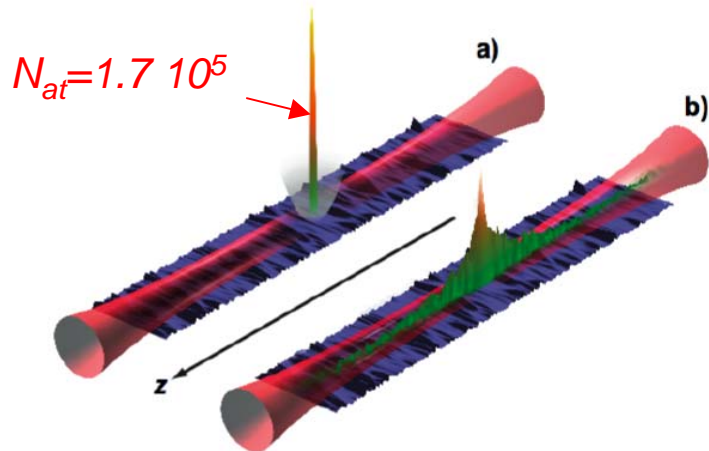

k_{max} increases \Rightarrow

$$k_{max} > k_c$$

Theory : algebraic decay
LSP et al. PRL 2007

$$n_{1D} \propto 1/z^2$$

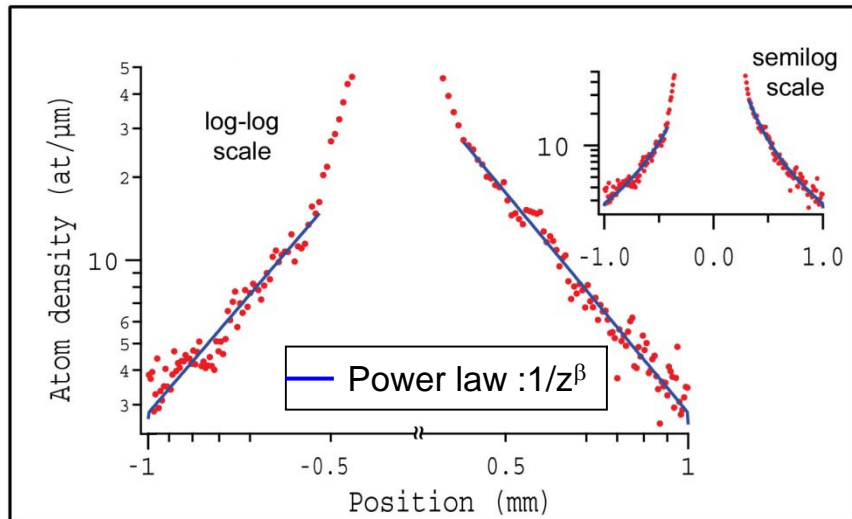
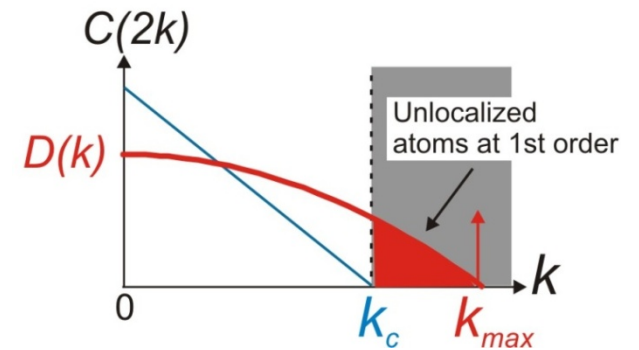

Observation of stationary localized profiles

$$n_{1D} \propto 1/z^\beta \quad \text{with} \quad \beta = 1.96 \pm 0.06$$

Conclusion

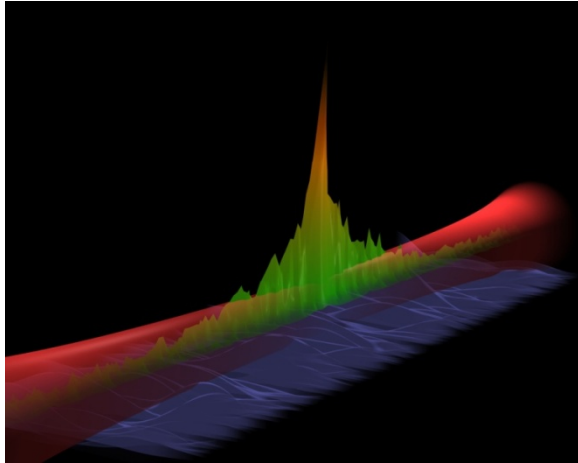

- 1D Anderson localization of matterwaves without interaction
- Speckle disorder: two localization regimes (exponential & algebraic)
- Good agreement theory / experiment

Conclusion

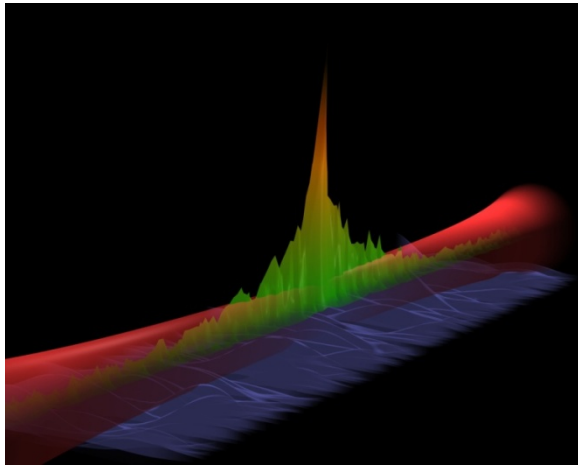

- 1D Anderson localization of matterwaves without interaction
- Speckle disorder: two localization regimes (exponential & algebraic)
- Good agreement theory / experiment

- Related results in Florence (M. Inguscio group)

G. Roati et al. Nature 2008

Disorder : bi-chromatic lattice

No interactions : Feshbach resonance ^{39}K

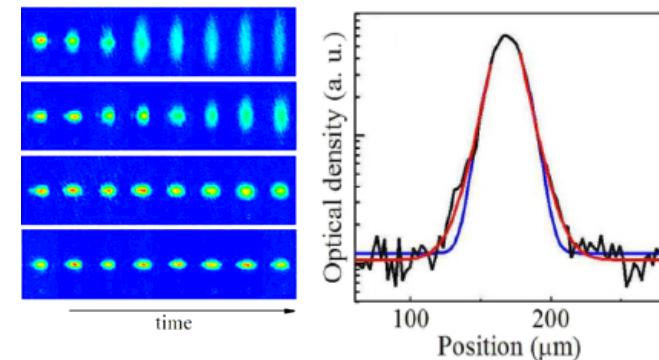

Cold atoms = « good candidate » to study disordered systems

Outline

2. Perspectives

Anderson localization in higher dimensions

2D: critical dimensionality

3D: real transition (critical exponent, mobility edge position)

R.C. Kuhn et al. NJP 2007

S. Skipetrov et al. PRL 2008

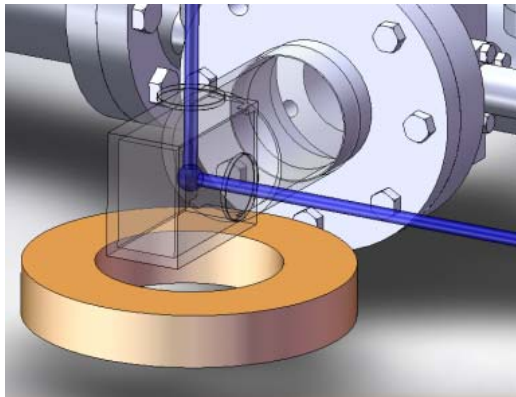

On the experiment: 3D Anderson localisation

→ 3D expansion of matterwaves in laser speckle

Anderson localization in higher dimensions

2D: critical dimensionality

3D: real transition (critical exponent, mobility edge position)

R.C. Kuhn et al. NJP 2007

S. Skipetrov et al. PRL 2008

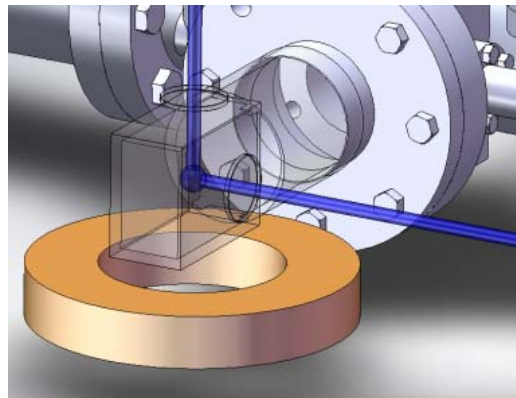

On the experiment: 3D Anderson localisation

→ 3D expansion of matterwaves in laser speckle

→ 3D expansion of BEC:

magnetic levitation to compensate gravity

→ 3D speckle realisation: crossed speckles

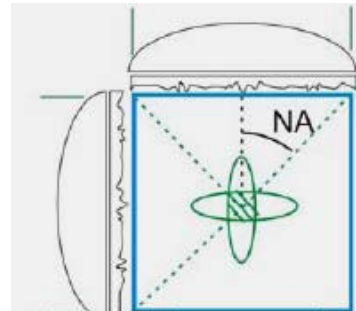
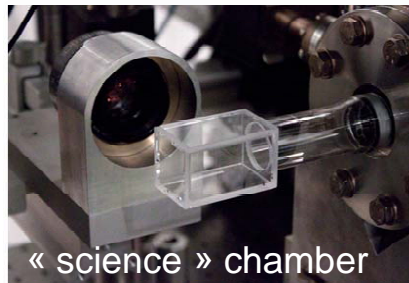

1D Anderson localization with guided atom laser

Localization of the guided atom laser in presence of disorder:

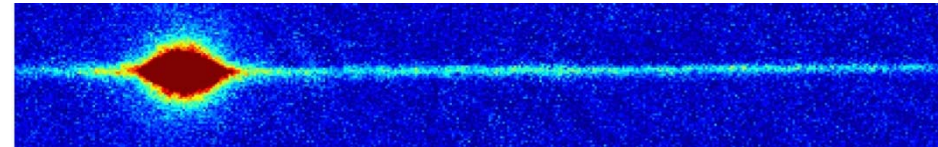

Transport experiment:
linear and non-linear propagation

T. Paul *et al.* PRA 2009

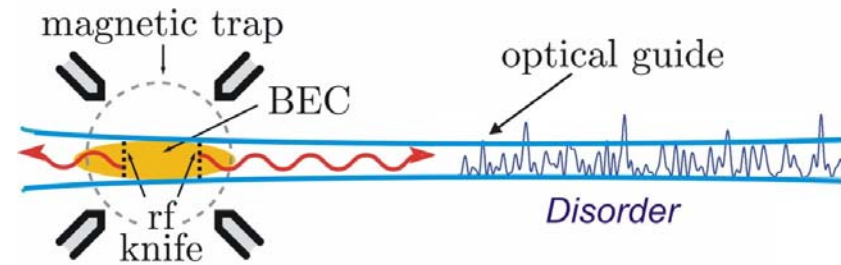

→ **Effects of interactions on AL: localization in « real systems »**

1D Anderson localization with guided atom laser

Localization of the guided atom laser in presence of disorder:

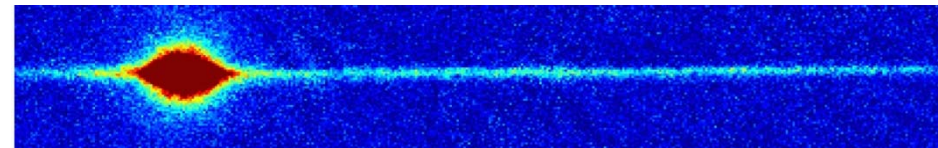

Transport experiment:
linear and non-linear propagation

T. Paul *et al.* PRA 2009

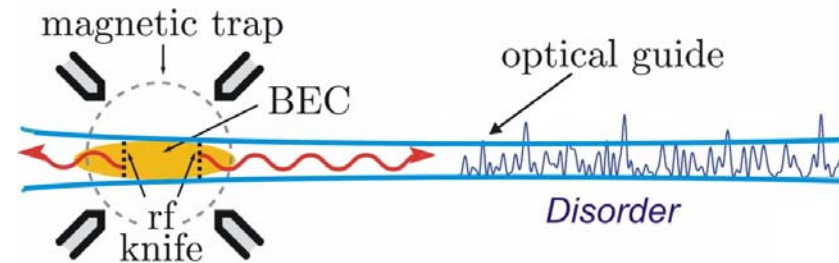

→ **Effects of interactions on AL: localization in « real systems »**

Florence (1D)
Feshbach resonance ^{39}K
B. Deissler *et al.* arxiv 2009

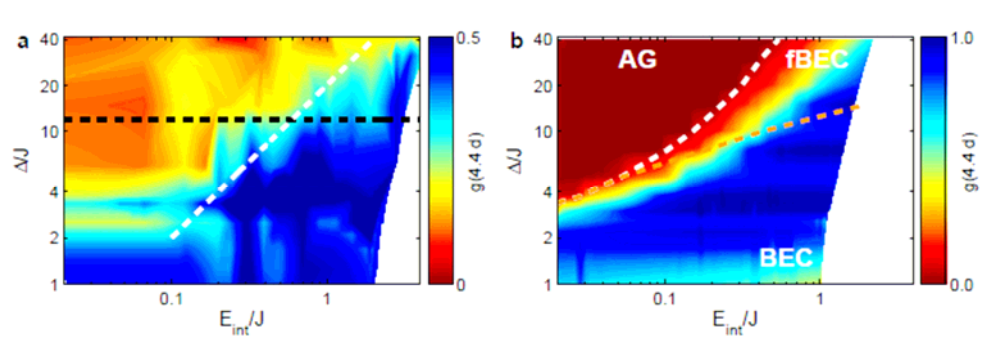

Quantum propagation with guided atom laser

Quantum tunneling through a single thin optical barrier

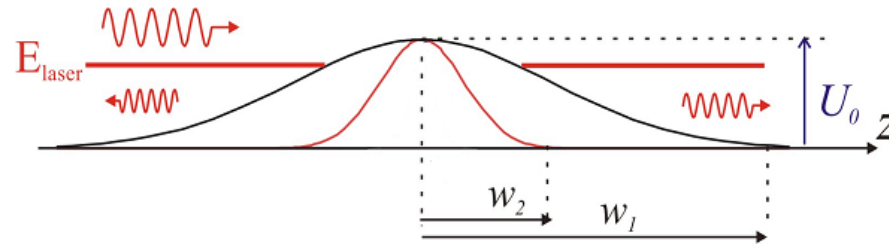

Atomic Fabry-Pérot cavity: transport through a double barrier

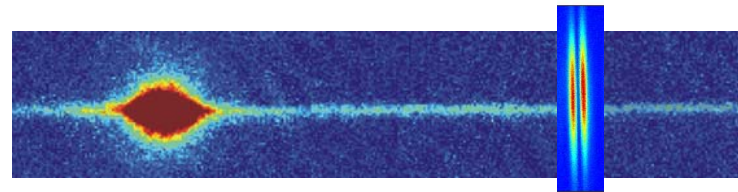

- Frequency filtering
 - Atom interactions \rightarrow non classical atomic state
- Towards blockade effect*

I. Carusotto PRA 2001

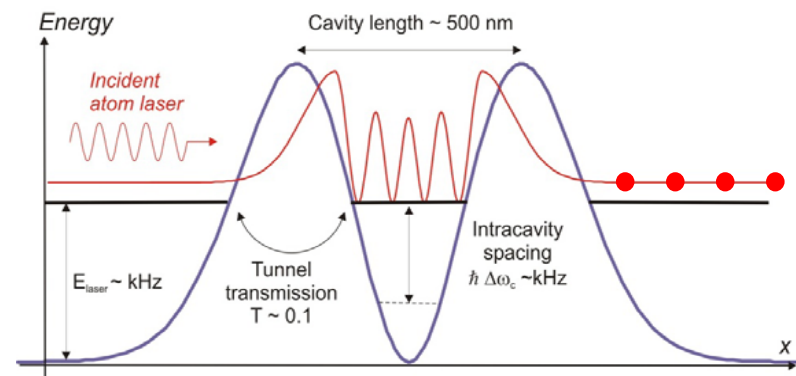

Thanks...



André Willing and Frédéric Moron



**Pierre Chavel
Alain Aspect
Philippe Bouyer
Vincent Josse**



**Eric Willemenot
Marie-Lise Duplaquet**

William Guerin, Zhanchun Zuo, Alain Bernard, Patrick Cheinet, Fred Jendrzejewski, Stephan Seidel

Theory team: **Laurent Sanchez- Palencia,**
Ben Hambrecht, Pierre Lugan and David Clément

Thanks...

To all members of the Atom Optics group....

« TP » Supoptique: Lionel, Thierry and Cédric

To all members of Institut d'Optique !

