



HAL
open science

Biodiversité, origine et évolution des Cunoniaceae : implications pour la conservation de la flore de Nouvelle-Calédonie

Yohan Pillon

► **To cite this version:**

Yohan Pillon. Biodiversité, origine et évolution des Cunoniaceae : implications pour la conservation de la flore de Nouvelle-Calédonie. Biologie végétale. Université de la Nouvelle-Calédonie, 2008. Français. NNT : 2008NCAL0022 . tel-00493106

HAL Id: tel-00493106

<https://theses.hal.science/tel-00493106>

Submitted on 18 Jun 2010

HAL is a multi-disciplinary open access archive for the deposit and dissemination of scientific research documents, whether they are published or not. The documents may come from teaching and research institutions in France or abroad, or from public or private research centers.

L'archive ouverte pluridisciplinaire **HAL**, est destinée au dépôt et à la diffusion de documents scientifiques de niveau recherche, publiés ou non, émanant des établissements d'enseignement et de recherche français ou étrangers, des laboratoires publics ou privés.



Université de la Nouvelle-Calédonie
Ecole Doctorale : Milieux Insulaires Ultra-Marins

THESE

Présentée par

Yohan PILLON

Pour obtenir le grade de
Docteur en Sciences de l'Université de la Nouvelle-Calédonie
Spécialité : Biologie et Agronomie

Biodiversité, origine et évolution des Cunoniaceae : implications pour la conservation de la flore de Nouvelle-Calédonie

Soutenue publiquement le 9 décembre 2008 devant le jury composé de :

LOWRY II P.P.	Curator, Missouri Botanical Garden	Rapporteur
GEMMILL C.E.	Senior lecturer, University of Waikato	Rapporteur
PONCET V.	Chargé de recherche, IRD Montpellier	Examineur
AMIR H.	Professeur, Université de la Nouvelle-Calédonie	Directeur de thèse
MUNZINGER J.	Chargé de recherche, IRD Nouméa	Co-directeur de thèse
CHASE M.W.	Professor, Royal Botanic Gardens, Kew	Co-directeur de thèse

Résumé

La Nouvelle-Calédonie est considérée comme une zone prioritaire pour la préservation de la biodiversité à l'échelle mondiale en raison de sa flore riche, originale et menacée. Pour mieux comprendre l'histoire de cette flore, une étude a été menée sur la famille des Cunoniaceae, qui compte dans l'archipel 88 espèces et 7 genres d'arbres et d'arbustes, dont le « faux-tamanou » et le « chêne rouge ». Quatre nouvelles espèces dans le genre *Codia* et deux dans le genre *Cunonia* ont été mises en évidence. Une phylogénie moléculaire des genres *Acsmithia* et *Spiraeanthemum* suggère qu'ils devraient être considérés comme un seul genre : *Spiraeanthemum*, car le genre *Acsmithia* est paraphylétique.

Sur un plan biogéographique, les affinités des Cunoniaceae et de la flore de Nouvelle-Calédonie sont plus fortes avec l'Australie. Néanmoins, une analyse comparative globale à l'échelle de l'ensemble des plantes à fleurs montre que certaines lignées sont surreprésentées en Nouvelle-Calédonie, et d'autres sont sous-représentées, et ceci ne peut pas être entièrement expliqué par la biogéographie. Il semblerait que certaines lignées possèderaient une exaptation (« pré-adaptation ») aux sols ultramafiques (terrains miniers) qui aurait pu faciliter leur installation et leur diversification sur l'archipel. C'est notamment le cas du clade COM (Celastrales, Oxalidales et Malpighiales) auquel appartiennent les Cunoniaceae.

L'histoire évolutive du genre *Codia* a été reconstruite à l'aide de marqueurs moléculaires et indique que l'adaptation aux terrains miniers est potentiellement ancestrale dans ce genre. L'hybridation a joué un rôle important dans la diversification du genre, et plusieurs espèces d'origine hybride présentent des caractères morphologiques absents chez les espèces parentales (phénotypes transgressifs). Certaines espèces qui se sont hybridées ont des distributions clairement distinctes aujourd'hui, suggérant des changements dans la répartition de ces espèces pouvant être liés aux périodes glaciaires du Quaternaire. Chez le genre *Spiraeanthemum*, des différences génétiques nettes ont été observées au sein de *S. ellipticum* et *S. pubescens* entre les populations du sud de la Grande Terre sur sol ultramafique et les populations du nord sur sol non-ultramafique, suggérant l'existence d'espèces cryptiques.

La flore de l'archipel possède également de nombreuses lignées reliques qui représentent une importante diversité phylogénétique. Chez les Cunoniaceae, une corrélation significative a été trouvée entre la position systématique et l'activité biologique des espèces. La diversité phylogénétique serait ainsi corrélée positivement à la valeur potentielle de la biodiversité, ce qui justifierait sa conservation. Face aux menaces qui pèsent sur la flore de la Nouvelle-Calédonie, notamment les feux, les espèces envahissantes, l'exploitation minière et le réchauffement climatique, il est important d'employer la meilleure stratégie pour la préservation de la biodiversité. Ainsi, il semble urgent de protéger les lignées reliques, mais aussi de préserver les processus qui permettent l'apparition de nouvelles espèces. Il s'agit notamment de protéger les sites qui présentent une mosaïque de sols où la cohabitation et l'hybridation d'espèces différant par leurs écologies deviennent possibles.

Mots-clés : Nouvelle-Calédonie, flore, Cunoniaceae, phylogénie, systématique, évolution, conservation, hybridation

Abstract

New Caledonia is considered as a biodiversity hotspot because of its rich, unique and threatened flora. In order to better understand the history of this flora, a study was carried out on the Cunoniaceae family, which comprises 88 species and 7 genera of shrubs and trees in New Caledonia, including "faux-tamanou" and "chêne rouge". Four new species in the genus Codia and two in the genus Cunonia have been described. A molecular phylogeny of the genera Acsmithia and Spiraeanthemum suggest that they should be considered as a single genus: Spiraeanthemum, because of the paraphyly of Acsmithia.

The Cunoniaceae of New Caledonia have greatest biogeographical affinities with Australian ones, as for the entire flora of the archipelago. Nevertheless, a global comparative analysis including all flowering plants shows that some lineages are over- or under-represented in New Caledonia, and this can not entirely be explained by biogeography. It seems possible that some lineages possess an exaptation ("pre-adaptation") to grow on ultramafic soils (serpentine in a broad sense), that could have facilitated their settlement and diversification on the archipelago. This is for example the case of the COM clade (Celastrales, Oxalidales and Malpighiales) to which Cunoniaceae belong.

The evolutionary history of the genus Codia was reconstructed using molecular markers and indicates that adaptation to ultramafic soils may be ancestral to the entire genus. Hybridisation has played an important role in the diversification of the genus, and several species of hybrid origin have morphological characters that are not found in parental species (transgressive phenotypes). Some parental species that used to hybridise no longer co-occur, suggesting that considerable range alteration has happened, and this may be linked to the Quaternary ice ages. In the genus Spiraeanthemum, considerable genetic differences have been observed within S. ellipticum and S. pubescens between southern populations on ultramafic soils and northern population on non-ultramafic soils, suggesting the existence of cryptic species.

The archipelago also hosts several relict lineages which represent an important phylogenetic diversity. In Cunoniaceae, a significant correlation was found between systematics and bioactivity. Phylogenetic diversity is therefore positively correlated with the potential value of biodiversity, justifying its conservation. Considering the threats to the New Caledonian flora, including fire, invasive species, mining and climate change, it is important to implement the best strategy for its preservation. Thus it will be necessary to protect the relict lineages and also to preserve the processes that generate new species. This includes protecting the sites with a mosaic of soils where species with different ecology come into contact and can hybridize.

Key words: New Caledonia, flora, Cunoniaceae, phylogeny, systematics, evolution, conservation, hybridisation

REMERCIEMENTS

Je tiens tout d'abord à remercier Jérôme Munzinger qui m'aura suivi et supporté pendant tout ce parcours. Il m'a rapidement fait confiance, laisser libre, et a su trouver les moyens nécessaires à mon travail et résoudre les problèmes auxquels j'ai pu être confrontés. Il aura été mon paratonnerre contre les ennuis administratifs et aura trouvé les financements pour m'envoyer en mission, que ce soit pour les congrès ou pour le terrain à Vanuatu à deux reprises, et pour ceci en particulier, je lui suis très reconnaissant.

Je tiens à remercier Hamid Amir qui m'a également beaucoup aidé au cours de cette thèse, qui m'a fait confiance et laisser libre tout en me suivant avec sagesse. Toujours disponible, il m'aura également assisté dans mes premiers enseignements à l'université.

Many thanks go to Mark Chase. We have been working together since 2002, and I can't see any reason why this could stop. Mark has always trusted me and supported me in my projects and quickly offered his help for this PhD. Albeit very busy, he has always been available and definitely knowledgeable.

Je remercie Pete Lowry et Chrissen Gemmill d'avoir accepté d'être rapporteurs pour ce travail, et Valérie Poncet pour avoir accepté d'être examinatrice.

For sure this work would not have been possible without Helen Fortune Hopkins. Before starting this work, I had never touched any herbarium specimen and knew nothing about taxonomic work. Helen taught me a lot about taxonomy, readily shared her unpublished data at the beginning, and then involved me in her work and publications. I am very happy and proud of our collaboration. I hope you will find a comfortable and interesting position soon.

Je tiens à remercier toute l'équipe de botanique du centre IRD de Nouméa pour leur aide. Frédéric Rigault et Gilles Dagostini m'ont beaucoup appris sur le terrain, Fred surtout m'a sorti de pas mal de situations informatiques embarrassantes. Tanguy Jaffré aura toujours été disponible pour partager un peu de sa connaissance très vaste. Jacqueline Fambart-Tinel restera la fée de l'herbier avec son éternel sourire, tant qu'on ne lui parle pas de choses qui fâchent. Williams Nigote lui aussi aura partagé facilement sa bonne humeur insulaire. Je remercie Laure Barrabé qui m'aura souvent subi, mais a toujours été à l'écoute ; je pense que nous avons beaucoup appris ensemble, et merci encore pour les nombreuses relectures. Je voulais remercier Vanessa Hequet pour sa bonne humeur bruyante et ses blagues douteuses.

Beaucoup d'autres personnes du laboratoire m'ont également accompagnées sur le terrain et / ou ont bien voulu partager un peu de leur bonne humeur, je pense à David Kurpysz, Isabelle Spir, Romain Barrière et bien d'autres qui sont passés en botanique.

Je tiens à remercier mes collègues du LIVE (autrefois LBPVA puis MABIOM) à l'Université de la Nouvelle-Calédonie pour leur accueil et leur aide. Je remercie particulièrement Bruno Fogliani pour sa collaboration précieuse, et, ainsi que Valérie Médevielle, pour leur aide dans les enseignements. J'adresse une mention particulière à mes collègues thésards, Alexandre Lagrange, Charly Zongo, Nicolas Mondiet, ainsi que Nicolas Lebouvier pour les bons moments passés à Nouville, plus souvent au nakamal que sur le campus.

I wish to thank my many friends and colleagues in the Jodrell laboratory at Kew for their help and friendships, especially Mike Fay, Vincent Savolainen, Olivier Maurin, Guillaume Gigot, Félix Forest, Dion Devey, Martyn Powell, Jim Clarkson, Rhian Smith, Laura Kelly, Maria Vorontsova, Robyn Cowan, Nina Rønsted, Laszlo Csiba and Edith Kapinos.

Many thanks also to Jason Bradford for providing many samples at the beginning of this study.

Je tiens à remercier le personnel de l'herbier du Museum National d'Histoire Naturelle à Paris ((P) et du jardin botanique de Kew (K) pour l'accès à leurs collections.

Je voulais aussi remercier mes collègues entomologistes, Hervé Jourdan, Alan Vergnes et Bruno Gatimel. Ils m'auront accompagné sur leur terrain, dans des conditions parfois extrêmes (au-delà de 1000 m), et m'auront entraîné dans pas mal de leurs mauvais coups, tenailles japonaises et autres plans shopping. Merci pour les cafés et les sorties sur les piémonts du Ouen-Toro.

Je tiens également à remercier les collègues de biologie moléculaire, Céline Gomez et Michel Lebrun, les collègues du CNRS, Vincent Dumontet, Cyril Poullain et Anaïs Cardineau pour leur aide et leur bonne humeur. Je remercie Julien Chiaramonti et les différents membres de l'administration, de la documentation et du garage pour leur efficacité bien souvent vérifiée.

Je voulais remercier les nombreuses personnes qui ont bien voulu m'accompagner sur leur terrain. Beaucoup d'endroits m'auraient été inaccessibles sans eux. Daniel et Irène Letocart m'ont maintes fois convié dans leurs expéditions botaniques et gastronomiques. Je remercie les chefs des tribus de Temala et de Paola, les guides Didier et Jean qui m'ont permis d'accéder à leurs montagnes. De nombreuses autres personnes m'ont également

accompagnées et j'en oublierai certainement ici : Gordon MacPherson, Elizabeth Brown, Myriam Gaudeul, Arnaud Mouly et Gildas Gateblé... Les missions sur le Mont Panié, accompagnées de Maurice et Julio n'auraient pas été possibles sans l'aide de notre regretté Henri Blaffart. Henri aura disparu trop tôt pour voir la description de plusieurs espèces nouvelles qui ont été découvertes grâce à lui et qu'il aurait probablement appréciée.

Je tiens à remercier les organisateurs de l'expédition Santo 2006 à Vanuatu, et les nombreux collègues scientifiques et guides qui m'auront accompagné au cours de cette mission, ainsi qu'à celles des îles Torres et de Wallis. Finalement cela pourrait bien être mes meilleurs souvenirs de mes années de thèse.

Je garderai un souvenir impérissable de certains lieux qui m'auront inspiré au cours de ce travail, les serres tropicales du jardin botanique de Kew qui me réchauffaient le cœur durant les hivers londoniens passés à la paillasse, Luganville où j'ai conçu le plan de ce travail, et le centre culturel Tjibaou où j'ai effectué maintes relectures.

A tous ceux dont j'ai croisé la route pendant ces quelques années et qui m'auront apporté leur aide, leur soutien moral, leur bonne humeur, notamment mes collègues thésards, Laure Carassou, Lydiane Mattio, Isabelle Jollit, Camille Mellin, Anne-Sophie Kerbrat, Benoît Flamand, les collègues d'Ouvéa au sourire éternel, et une mention spéciale pour François Wadra à qui je pardonnerai son manque de respect.

Je tiens à remercier mes proches, ma famille et mes amis d'être restés en contact et de me pardonner mon expatriation volontaire et mon dévouement borné pour la science.

AVERTISSEMENT

Le contenu de cette thèse est bilingue. Le chapitre principal est rédigé en français et fait référence aux articles scientifiques rédigés en anglais situés en annexe, chacun précédé d'un résumé en français.

Des nouveautés taxonomiques sont citées dans le texte mais le présent document ne doit pas être considéré comme leur publication effective. Les combinaisons et espèces nouvelles sont ou seront publiées dans les articles scientifiques au moment de leur parution dans des journaux plus largement accessibles.

Océan

Baie N'ji, 26 juin 1875

*La nuit tombe sur la baie silencieuse et dans l'ombre
aboient les brisants.*

*Ô mer ! Devant toi l'esprit s'apaise, souffrir même n'est plus
rien, savoir est tout.*

*Mais saurons-nous jamais ? La science est une torche entre
les mains des éclaireurs ; à mesure qu'on la porte en avant,
l'ombre se fait en arrière.*

Atu fond de quel gouffre aller chercher la vérité ?

*Est-il une utopie qui ne devienne à son heure réalité ? Est-il
une science qui ne doive se transformer ? Qu'importe, cherchons
toujours, l'horizon s'éclaircit.*

*En attendant, disons à la vieille Europe les récits de l'enfance
de l'humanité.*

Louise Michel.

Aux amis d'Europe, légendes et chansons de gestes canaques.

TABLE DES MATIERES

Introduction.....	1
La famille des Cunoniaceae en Nouvelle-Calédonie.....	5
Origine de la flore de Nouvelle-Calédonie : biogéographie et « exaptation »	14
Géologie de la Nouvelle Calédonie	14
« Out of Gondwana » ou « Tabula rasa »	15
Biogéographie des Cunoniaceae	17
Pourquoi y a-t-il autant de Cunoniaceae en Nouvelle-Calédonie ?	21
Diversification des Cunoniaceae en Nouvelle-Calédonie	27
Généralités	27
Importance des conditions édaphiques	28
Une évolution complexe des genres <i>Codia</i> et <i>Spiraeanthemum</i>	30
Adaptation aux terrains ultramafiques : fidélité et origine	32
Caractères nouveaux apparus chez les espèces d'origine hybride.....	33
Les traces de migrations passées.....	34
La conservation de la flore de Nouvelle-Calédonie.....	38
Importance de la biodiversité.....	38
Lien entre la diversité phylogénétique et la valeur de la biodiversité.....	40
Menaces sur la flore de la Nouvelle-Calédonie	41
Modalités de préservation de la flore de Nouvelle-Calédonie.....	45
Préservation des lignées anciennes	45
Préservation des processus de diversification.....	48
Le risque de l'homogénéisation	50
Conclusions.....	53
Bibliographie	56
Article I : Four new species in the endemic genus <i>Codia</i> (Cunoniaceae) from New Caledonia	65
Article II : Two new species of <i>Cunonia</i> (Cunoniaceae) from New Caledonia	81
Article III : A molecular and morphological survey of generic limits of <i>Acsmithia</i> and <i>Spiraeanthemum</i> (Cunoniaceae)	95
Article IV : <i>Geissois</i> (Cunoniaceae), another example of the Melanesian connection	105
Article V : Selective immigration in the insular flora of New Caledonia, an example of exaptation to ultramafic soils.....	109
Article VI : Reticulate evolution on a mosaic of soils: diversification of the New Caledonian endemic genus <i>Codia</i> (Cunoniaceae).....	149
Article VII : Gene recombination, cryptic species and hybridization in the genus <i>Spiraeanthemum</i> (Cunoniaceae) from New Caledonia.....	189
Article VIII : Evidence for a correlation between systematics and bioactivity in New Caledonian Cunoniaceae and its implications for screening and conservation	223

Introduction

Nos botanistes n'eurent pas à se plaindre du défaut d'occupation ; chaque jour ils découvraient de nouvelles plantes.

James Cook
Voyage dans l'hémisphère austral, et autour du monde, 1774
Traduit de l'anglais par M. Hodges (1778)

La Nouvelle-Calédonie est un archipel de 18 500 km² situé dans le sud-ouest de l'Océan Pacifique. Elle est constituée d'une île principale, la Grande Terre, prolongée au nord par les îles Belep et au sud par l'île des Pins, ainsi que des îles Loyauté à l'est. Elle fait partie des rares zones au monde à être à la fois une zone prioritaire pour la conservation de la biodiversité terrestre (Myers, 1988; Myers *et al.*, 2000; Mittermeier *et al.*, 2004) et marine (Roberts *et al.*, 2002). Sa flore est particulièrement renommée pour sa diversité, avec plus de 3200 espèces de plantes vasculaires indigènes, pour son originalité, étant donné que 74% de ces espèces sont endémiques au territoire (Jaffré *et al.*, 2001) et les menaces qui pèsent sur celle-ci (Bouchet *et al.*, 1995; Gargominy *et al.*, 1996; Jaffré *et al.*, 1998a; Morat *et al.*, 1999).

L'originalité de la flore néo-calédonienne ne se limite pas seulement à son fort taux d'endémisme, mais à sa composition particulière. La Nouvelle-Calédonie est l'archipel qui possède la plus grande diversité de conifères de toute la zone pacifique (de Laubenfels, 1996), avec des éléments charismatiques comme les *Araucaria* (*A. columnaris* : pin colonnaire) ou les *Agathis* (kaoris) de la famille des Araucariaceae. *Parasitaxus ustus* (Podocarpaceae), seule gymnosperme parasite au monde (de Laubenfels, 1959), est endémique à la Nouvelle-Calédonie.

La Nouvelle-Calédonie possède également une forte concentration d'angiospermes basales, des lignées qui n'appartiennent ni au grand groupe des Monocotylédones ni aux Eudicotylédones, et qui seraient apparues avant celles-ci (Figure 1). L'une des plantes de Nouvelle-Calédonie les plus célèbres auprès des botanistes est probablement *Amborella*

trichopoda, seule espèce connue du genre *Amborella*, de la famille des Amborellaceae et de l'ordre des Amborellales. Ce sont les études de phylogénies moléculaires (Soltis *et al.*, 1997; Qiu *et al.*, 1999; Soltis *et al.*, 1999; Jansen *et al.*, 2007) qui ont montré que cette plante est à elle seule le groupe frère de toutes les autres plantes à fleurs actuelles. De plus, d'autres lignées rares et anciennes sont présentes en Nouvelle-Calédonie, comme les genres *Trimenia* (Trimeniaceae, Austrobaileyales) et *Ascarina* (Chloranthaceae, Chloranthales). La lignée des Magnoliids est également abondamment représentée sur l'île avec notamment les Canellales (essentiellement *Zygogynum*, Winteraceae) et les Laurales. Un aperçu de la position de ces lignées sur l'arbre phylogénétique des plantes à fleurs est donné sur la figure 1.

La Nouvelle-Calédonie présente également un certain nombre d'espèces possédant des caractéristiques écologiques ou physiologiques originales. *Blechnum francii* (Blechnaceae) est une fougère aquatique pouvant vivre entièrement immergée à plusieurs mètres de profondeur dans certaines rivières du sud de la Grande Terre (Veillon, 1981). *Cerberiopsis candelabrum* (Apocynaceae) est une espèce monocarpique, qui ne fleurit et ne fructifie qu'une seule fois, mais de façon massive, avant de mourir (Veillon, 1971; Read *et al.*, 2006). Il s'agit d'un cas d'autant plus rare qu'il concerne un arbre de grande taille et très ramifié. Avec Cuba, La Nouvelle-Calédonie possède également la plus grande concentration au monde d'espèces hyperaccumulatrices de métaux lourds, et de nickel plus particulièrement (Brooks, 1998). Ces plantes peuvent contenir dans leurs tissus des doses élevées de métaux qui sont létales pour le commun des plantes. L'exemple le plus marquant est celui de *Sebertia acuminata* (Sapotaceae), dont le latex est bleu-vert en raison de sa forte concentration en nickel, qui représente jusqu'à 25% de son poids sec (Jaffré *et al.*, 1976).

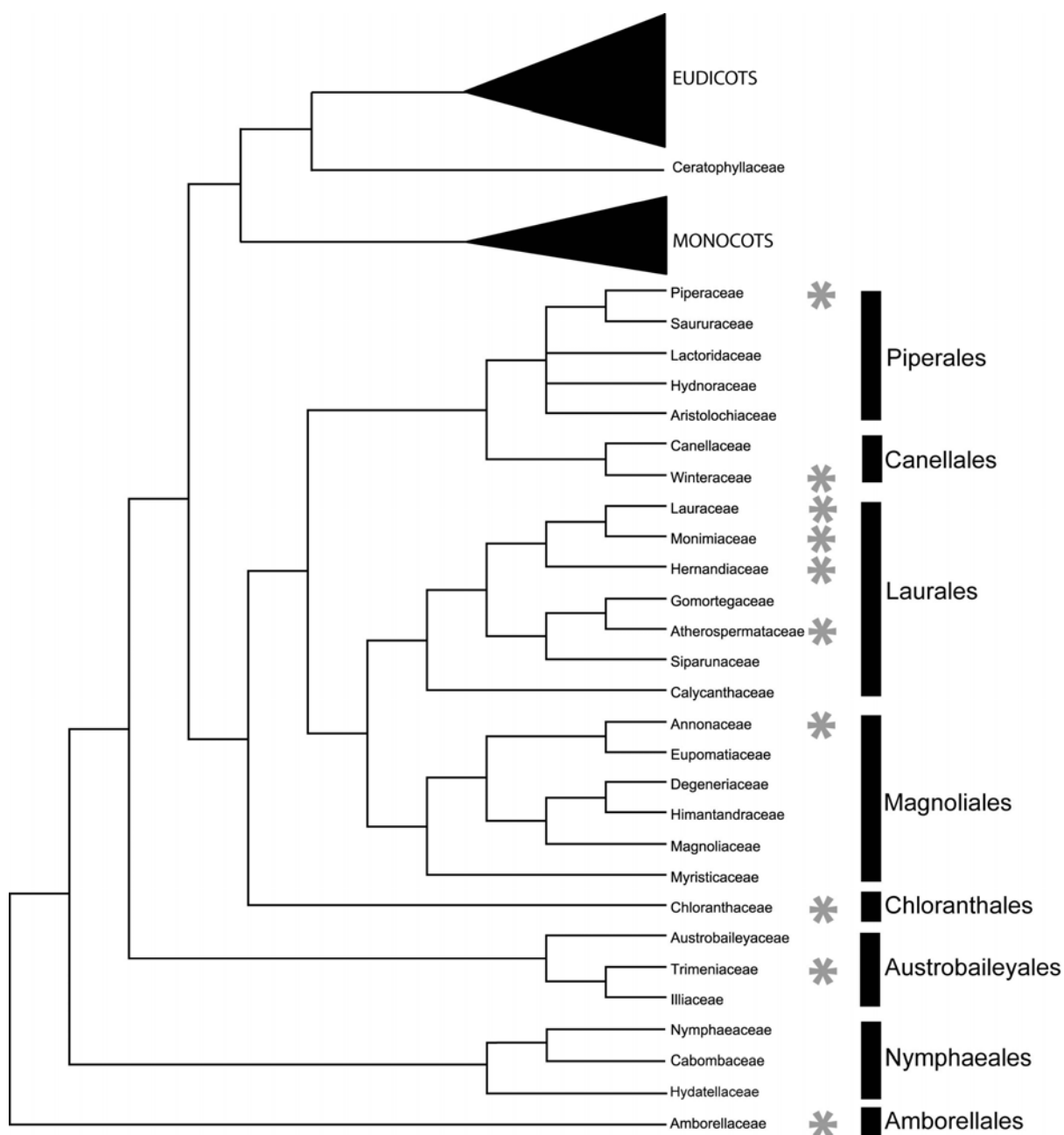

Figure 1. *Arbre phylogénétique des angiospermes, d’après Davies et al. (2004a), Jansen et al. (2007), Saarela et al. (2007) et Moore et al. (2007). Les familles présentes en Nouvelle-Calédonie sont indiquées par une étoile.*

L’origine de la diversité et de l’originalité de la flore de la Nouvelle-Calédonie a souvent été expliquée par la diversité de ses sols, et notamment par l’importance des sols ultramafiques (ou terrains miniers) qui couvrent environ le tiers de la surface de l’archipel.

Ces sols présentent un certain nombre de caractéristiques défavorables au développement des plantes : pauvreté en minéraux nutritifs (N, P, K), fort ratio Mg/Ca, toxicité du nickel (et autres métaux lourds), et une faible disponibilité de l'eau (Proctor, 2003). Les sols de Nouvelle-Calédonie peuvent généralement être classés en deux groupes : ultramafiques et non-ultramafiques. Bien que cela semble assez réducteur au regard de la diversité des conditions édaphiques présentes en Nouvelle-Calédonie tant pour l'un et l'autre groupe de sols, cette simple dichotomie se reflète très bien dans la répartition des espèces au sein de l'archipel. Ainsi, Jaffré et al. estimaient en 1993 que 1176 espèces de plantes à graines (39% de espèces indigènes) ne se trouvaient que sur les terrains ultramafiques.

Pour expliquer l'origine de la diversité et de l'originalité de la flore de Nouvelle-Calédonie, des études à différentes échelles taxonomiques et géographiques sont nécessaires. Une première approche consiste à considérer la flore dans son intégralité. Une autre approche s'appuie sur un groupe en particulier, jugé représentatif, qui fait l'objet d'une recherche plus poussée. Dans le présent travail, la famille des Cunoniaceae a été étudiée plus en détail, notamment à l'aide de l'outil moléculaire pour reconstituer son histoire évolutive à travers sa phylogénie.

La famille des Cunoniaceae en Nouvelle-Calédonie

Pancheria sp., Cunoniacées = jaamwité ; arbuste qui donne le pouvoir de voir les d'UU, esprits qui frappent mortellement leurs victimes, la nuit. Pour l'utiliser, il faut recevoir le pouvoir de quelqu'un qui l'a déjà.

Marie-Joseph Dubois
Notes d'ethno-botanique sur l'île des Pins, Nouvelle-Calédonie, 1978

Cette partie s'appuie sur les articles suivants :

Article I : Hopkins HCF, Fogliani B, Pillon Y (2007) Four new species in the endemic genus *Codia* (Cunoniaceae) from New Caledonia. *Kew Bulletin* **62**, 259-274.

Article II : Pillon Y, Hopkins HCF, Bradford JC (2008) Two new species of *Cunonia* (Cunoniaceae) from New Caledonia. *Kew Bulletin* **63**, 419-431.

Article III : Pillon Y, Hopkins HCF, Munzinger J, Chase MW (2009) A molecular and morphological survey of generic limits of *Acsmithia* and *Spiraeanthemum* (Cunoniaceae). *Systematic Botany* **34**, sous presse.

Les Cunoniaceae représentent une famille d'arbres et d'arbustes comprenant 27 genres et plus de 300 espèces (Bradford *et al.*, 2004). Elles appartiennent à l'ordre des Oxalidales, au sein des Eudicotylédones (Angiosperm Phylogeny Group II, 2003). Restreintes à l'hémisphère sud, elles sont présentes en Amérique Latine (particulièrement dans les Andes), l'Afrique Australe, Madagascar et les Mascareignes (îles Maurice et Réunion), l'Asie du Sud-Est et l'est de l'Australie. Largement réparties dans le Pacifique, et très diversifiées dans l'arc mélanésien, elles se rencontrent au sud jusqu'en Nouvelle-Zélande et à l'est à Rapa (Polynésie Française). Elles sont présentes dans la plupart des îles hautes du Pacifique et sont absentes des atolls coralliens, de Micronésie et d'Hawaii. La phylogénie de la famille est relativement bien connue grâce à des études morphologiques (Hufford & Dickison, 1992) et moléculaires (Bradford & Barnes, 2001; Bradford, 2002; Sweeney *et al.*, 2004, figure 2).

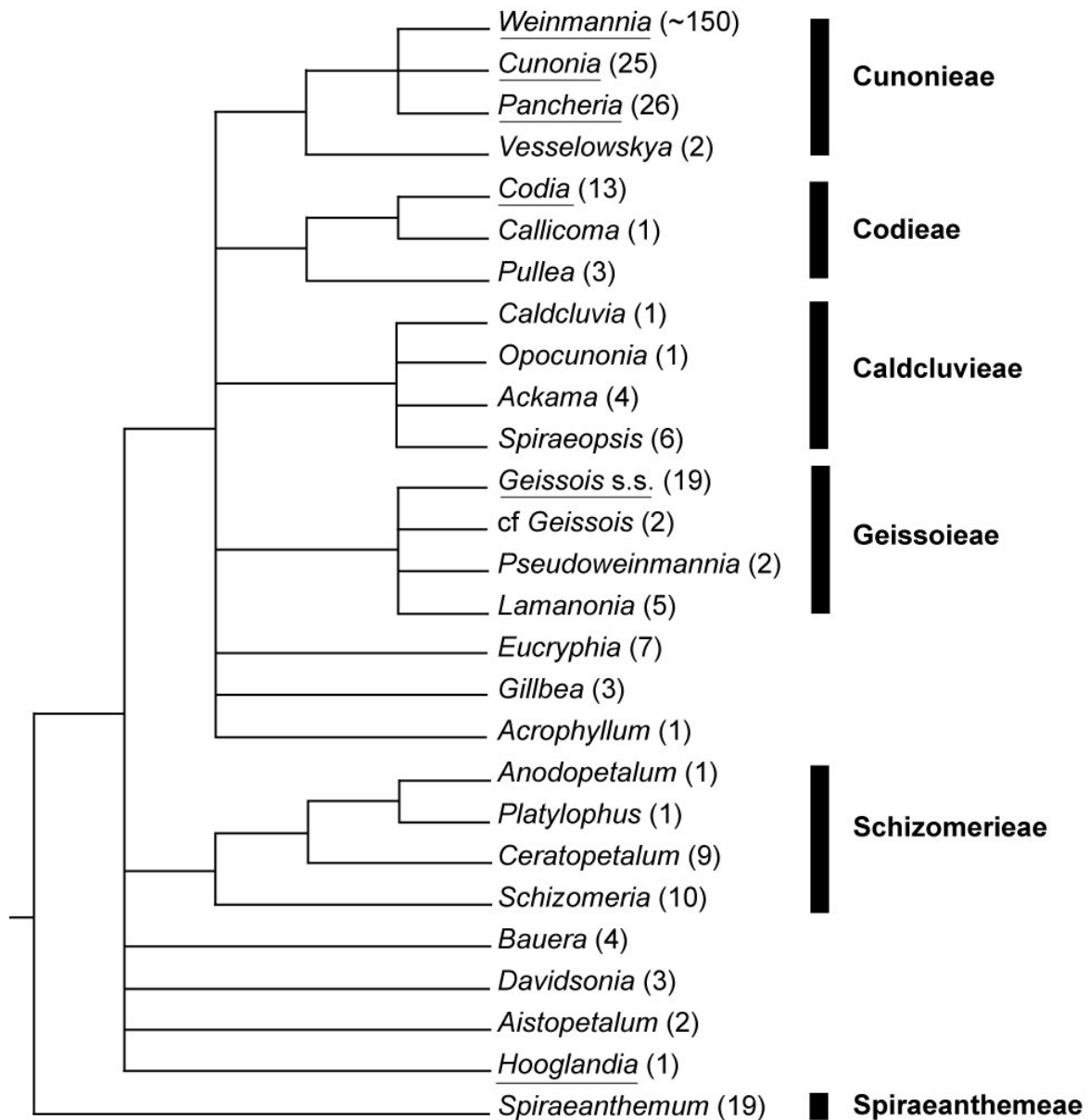

Figure 2. *Phylogénie simplifiée de la famille des Cunoniaceae, d'après les études morphologiques et moléculaires de Bradford et Barnes (2001), Bradford (2004) Sweeney et al. (2004) et Pillon et al. (non publié). Le nombre total d'espèces est indiqué entre parenthèses pour chaque genre, les genres présents en Nouvelle-Calédonie sont soulignés. Les noms en gras à droite correspondent aux différentes tribus reconnues par Bradford et Barnes (2001) et Bradford (2004).*

La Nouvelle-Calédonie représente le plus grand centre de diversité des Cunoniaceae avec 88 espèces, toutes endémiques, réparties entre 7 genres, dont 3 sont endémiques. Les membres de la famille y sont aisément reconnaissables par une combinaison de caractères facilement observables : feuilles simples ou composées (pennées ou palmées), à marge entière ou dentée, opposées ou verticillées, stipules inter- ou plus rarement intra-pétiolaires et généralement de grande taille, fruits généralement secs. Une clé pratique des genres de Nouvelle-Calédonie est présentée dans la figure 3.





				
	inflorescences en boule	inflorescences en épi ou en grappe, à l'extrémité des rameaux, généralement dressées, parfois horizontales (à fleurs vertes dans ce cas)	inflorescences ramifiées	inflorescences plus ou moins pendantes, sur les branches, parfois à l'aisselle des feuilles, fleurs rouges
	feuilles opposées	Feuilles simples, sans dent, fruits laineux indehiscent Codia	inflorescences blanches, stipules lancéolées peu visibles, fruit s'ouvrant d'abord par le sommet Weinmannia	Hooglandia
		Feuilles composées, dentées, fruits dehiscent Pancheria confusa	inflorescences blanches ou colorées, stipules souvent en forme de cuillère, fruit s'ouvrant d'abord par la base Cunonia	Geissois
	feuilles verticillées par 3 ou plus	Feuilles simples, sans dent, à pilosité rousse, fruits laineux indehiscent Codia albifrons ou Codia triverticillata		
		Feuilles simples ou composées, au moins avec quelques dents, fruits dehiscent Pancheria		Spiraeanthemum

Figure 3. Clé pratique des genres de Cunoniaceae présents en Nouvelle-Calédonie. Cette clé n'est valide que pour les Cunoniaceae de Nouvelle-Calédonie.

Au-delà de sa diversité qui fait des Cunoniaceae une des dix familles de plantes à fleurs les plus diversifiées en Nouvelle-Calédonie (huitième, Jaffré *et al.*, 2001), cette famille occupe également une place importante dans les écosystèmes de l'archipel. Les Cunoniaceae forment souvent des peuplements grégaires et dominent fréquemment certains types de végétations : maquis minier de basse et moyenne altitude (*Codia* spp., *Pancheria* spp., Virot, 1956; Jaffré, 1980), maquis minier d'altitude (*Cunonia* spp., *Pancheria* spp., Virot, 1956) ou maquis d'altitude sur roche acide (Bradford & Jaffré, 2004), forêt de basse et moyenne altitude (*Codia* spp., *Geissois* spp.) tant sur roches ultramafiques (Jaffré & Veillon, 1990) que non-ultramafiques (Jaffré & Veillon, 1995), forêt d'altitude (*Cunonia* spp., *Weinmannia* spp., Nasi *et al.*, 2002), végétation marécageuse ou rivulaire (*Cunonia* spp., *Pancheria* spp., *Spiraeanthemum pedunculatum*, Virot, 1956; Jaffré, 1980) et la végétation secondaire des terrains non miniers (*Codia incrassata*, *Geissois racemosa*, *Pancheria beauverdiana*). Bien que présentes sur toute la Grande-Terre, l'île des Pins et les îles Belep, elles sont absentes de la forêt sèche ou des îles Loyautés au substrat calcaire (Morat *et al.*, 2001). Certaines espèces sont hyperaccumulatrices de nickel, notamment dans les genres *Geissois* et *Pancheria* (Jaffré *et al.*, 1979; Jaffré, 1980, p. 164; Brooks, 1998).

La liste des espèces de Cunoniaceae actuellement reconnues en Nouvelle-Calédonie est la suivante :

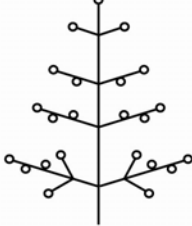
Codia albicans Vieill. ex Pamp.
Codia albifrons (Brongn. ex Schinz & Guillaumin) Baker f.
Codia belepensis H.C.Hopkins
Codia discolor (Brongn. & Gris) Guillaumin
Codia ferruginea Brongn. & Gris
Codia incrassata Pamp.
Codia jaffrei H.C.Hopkins & B.Fogliani
Codia mackeeana H.C.Hopkins & B.Fogliani
Codia microphylla Vieill. ex Guillaumin
Codia montana J.R.Forst. & G.Forst.
Codia nitida Schltr.
Codia spatulata Brongn. & Gris
Codia triverticillata H.C.Hopkins & Pillon

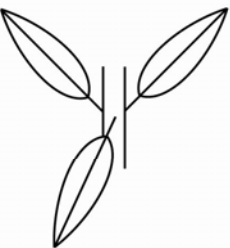
Cunonia alticola Guillaumin
Cunonia aoupiniensis Hoogland
Cunonia atrorubens Schltr.
Cunonia austrocaledonica Brongn. ex Guillaumin
Cunonia balansae Brongn. & Gris
Cunonia bullata Brongn. & Gris
Cunonia cerifera Hoogland
Cunonia deplanchei Brongn. & Gris
Cunonia dickisonii Pillon & H.C.Hopkins
Cunonia koghicola H.C.Hopkins, J.Bradford & Pillon
Cunonia lenormandii Vieill. ex Brongn. & Gris
Cunonia linearisepala (Guillaumin) Bernardi
Cunonia macrophylla Brongn. & Gris
Cunonia montana Schltr.
Cunonia pseudoverticillata Guillaumin
Cunonia pterophylla Schltr.
Cunonia pulchella Brongn. & Gris
Cunonia purpurea Brongn. & Gris
Cunonia rotundifolia Däniker
Cunonia rupicola Hoogland
Cunonia schinziana Däniker
Cunonia varijuga Hoogland
Cunonia vieillardii Brongn. & Gris
Cunonia sp. nov. [Munzinger 666]

Geissois balansae Brongn. & Gris ex Guillaumin
Geissois bradfordii H.C. Hopkins
Geissois hippocastanifolia Guillaumin
Geissois hirsuta Brongn. & Gris
Geissois intermedia Vieill. ex Pamp.
Geissois lanceolata (Guillaumin) H.C.Hopkins
Geissois magnifica Baker f.
Geissois montana Vieill. ex Brongn. & Gris
Geissois polyphylla Lécarré ex Guillaumin
Geissois pruinosa Brongn. & Gris
Geissois racemosa Labill.
Geissois trifoliolata Guillaumin
Geissois velutina Guillaumin ex H.C.Hopkins

Hooglandia ignambiensis McPherson & Lowry

Pancheria ajiearoana H.C.Hopkins, Pillon & J.Bradford ined.
Pancheria alaternoides Brongn. & Gris
Pancheria beauverdiana Pamp.
Pancheria billardierei (D.Don) Pamp.
Pancheria brunhesii Pamp.
Pancheria calophylla Guillaumin
Pancheria communis Baker f.
Pancheria confusa Guillaumin
Pancheria dognyensis H.C.Hopkins, Pillon & J.Bradford ined.

Pancheria elegans Brongn. & Gris
Pancheria engleriana Schltr.
Pancheria ferruginea Brongn. & Gris
Pancheria gatopensis Guillaumin
Pancheria heterophylla Vieill. ex Guillaumin
Pancheria hirsuta Vieill. ex Pamp.
Pancheria humboldtiana Guillaumin ex H.C.Hopkins & J.Bradford ined.
Pancheria mcphersonii H.C.Hopkins, Pillon & J.Bradford ined.
Pancheria minima J.Bradford
Pancheria multijuga Guillaumin ex H.C.Hopkins & J.Bradford ined.
Pancheria ouaiemensis J.Bradford
Pancheria phillyreoides Brongn. & Gris ex Guillaumin
Pancheria reticulata Guillaumin
Pancheria robusta Guillaumin
Pancheria rubrivenia Baker f.
Pancheria ternata Brongn. & Gris
Pancheria sp. nov. [Schlechter 15135]

Spiraeanthemum brongniartianum Schltr.
Spiraeanthemum collinum (Hoogland) Pillon
Spiraeanthemum densiflorum Brongn. & Gris
Spiraeanthemum ellipticum Pamp.
Spiraeanthemum meridionale (Hoogland) Pillon
Spiraeanthemum pedunculatum Schltr.
Spiraeanthemum pubescens Pamp.

Weinmannia dichotoma Brongn. & Gris var *dichotoma*
Weinmannia dichotoma Brongn. & Gris var *monticola* (Däniker) comb. ined.
Weinmannia ouaiemensis (Guillaumin & Viro) Hoogland
Weinmannia paitensis Schltr.
Weinmannia serrata Brongn. & Gris

Un bref état des lieux de la taxonomie est ici dressé pour chaque genre présent en Nouvelle-Calédonie, selon un ordre reflétant leurs affinités.

Le genre *Spiraeanthemum* (tribu Spiraeanthemeae, figure 4) inclut les espèces précédemment placées dans le genre *Acsmithia*, qui est paraphylétique d'après les analyses moléculaires (article III). Ce genre a fait l'objet de plusieurs travaux taxonomiques (Hoogland, 1979; Hoogland, 1987, article III). Trois groupes peuvent être distingués dans ce taxon. Il s'agit notamment de *Spiraeanthemum* s.s. (*Spiraeanthemum* au sens strict) qui



Figure 4. *Spiraeanthemum ellipticum*

correspond aux espèces à feuilles opposées, présentes de l'archipel des Bismarck aux Samoa, et absentes de Nouvelle-Calédonie. Les deux autres groupes correspondent aux espèces qui étaient placées dans le genre *Acsmithia* par Hoogland, dont les feuilles sont verticillées. Le premier groupe (groupe densiflorum) contient *S. densiflorum* de Nouvelle-Calédonie et les espèces d'Australie et de Nouvelle-Guinée et est caractérisé par des inflorescences ramifiées près de la base. Le second groupe (groupe *brongniartianum*) contient toutes les autres espèces de Nouvelle-Calédonie et *S. vitiense* de Fidji, dont les carpelles ne possèdent qu'un seul ovule. Ce serait a priori le seul genre de la famille qui aurait colonisé la Nouvelle-Calédonie par deux fois. Ce genre est souvent considéré comme assez primitif au sein de la famille et est le groupe frère du reste de la famille (Bradford & Barnes, 2001).



Figure 5. *Hooglandia ignambiensis*
(Photo P. Lowry)

Le genre *Hooglandia* (figure 5) n'a été décrit qu'en 2004 par McPherson et Lowry à partir des seules récoltes connues faites en 2002 sur le Mont Ignambi (McPherson & Lowry, 2004). Une récolte de Vieillard, collecteur en Nouvelle-Calédonie à la fin du XIX^e siècle, sans localité ni date précise, a été plus tard retrouvée à l'herbier du Muséum National d'Histoire Naturelle de Paris, parmi les échantillons de Connaraceae. Ce genre monospécifique est endémique de la Nouvelle-Calédonie et occupe une position phylogénétique isolée au sein de la famille (Sweeney *et al.*, 2004). Dans l'archipel, c'est la seule espèce de la famille à posséder un fruit charnu.

Le genre *Geissois* s.s. (tribu Geissoieae, figure 6), compte 13 espèces en Nouvelle-Calédonie, les autres se trouvant à Fidji, à Vanuatu, et dans la province de Temotu (Vanikoro)



Figure 6. *Geissois magnifica*

aux îles Salomon. L'espèce type du genre est *Geissois racemosa*, plus communément connue sous le nom de « faux-tamanou ». Celui-ci fut découvert et décrit par Labillardière, un botaniste français accompagnant d'Entrecasteaux dans sa quête vaine de l'expédition La Pérouse, et qui débarqua à Balade en 1793. Le genre a été révisé récemment (Hopkins, 2006; Hopkins, 2007). Le genre est ici considéré dans son sens strict

(*Geissois* s.s.), les deux espèces australiennes présentent des différences morphologiques (Hopkins, 2008) qui justifieraient leur placement dans un genre différent (Hopkins et al., non publié).



Figure 7. *Codia incrassata*

Le genre *Codia* (tribu Codieae, figure 7) est endémique de la Nouvelle-Calédonie et contient 13 espèces. Il fut découvert et décrit par les Forster père et fils, les premiers naturalistes européens à poser le pied en Nouvelle-Calédonie, au cours du second voyage de James Cook en 1774. Il a également fait

l'objet d'une révision taxonomique récente (Hopkins, 2005, article I). *Codia cinerascens*, connue uniquement du spécimen type, devrait être considérée comme une forme anormale de *C. albicans*. Des fossiles de feuilles ont été attribués à ce genre en Australie (Barnes *et al.*, 2001), où se trouve son plus proche parent, le genre *Callicoma* (Bradford & Barnes, 2001).

Les trois genres *Cunonia*, *Pancheria* et *Weinmannia* appartiennent à la tribu des Cunoniaceae, qui inclut également le genre *Vesselowskyia* d'Australie (Bradford & Barnes, 2001).

Le genre *Cunonia* (figure 8) compte 24 espèces en Nouvelle-Calédonie, et une seule en Afrique Australe. Ce genre a été monographié par Hoogland (manuscrit non publié) qui a



Figure 8. *Cunonia atrorubens*



Figure 9. *Pancheria communis*



Figure 10. *Weinmannia dichotoma*

décrit cinq nouvelles espèces (Hoogland *et al.*, 1997), auxquelles deux espèces doivent encore être ajoutées (article II). Deux espèces reconnues par Hoogland devraient être mises en synonymie, *C. nervosa* avec *C. montana*, et *C. bernieri* avec *C. lenormandii*. Une espèce, apparemment restreinte au mont Tchinguou reste encore à décrire (Hopkins & Pillon, manuscrit en préparation).

Le genre *Pancheria* (figure 9) est le plus grand genre endémique de Nouvelle-Calédonie de part son nombre d'espèces (Jaffré *et al.*, 2001). Il compterait 26 espèces d'après les révisions en cours (Bradford & Jaffré, 2004; Hopkins & Bradford, sous presse; Hopkins *et al.*, sous presse).

Le genre *Weinmannia* (figure 10) compte quatre espèces en Nouvelle-Calédonie (Hopkins *et al.*, 1998). La variabilité dans la taille des feuilles de *W. dichotoma* a encouragé certains auteurs à distinguer une autre espèce *W. monticola* pour les formes à grande feuille. Celle-ci serait mieux traitée comme une variété de *W. dichotoma*. Ce genre est le plus répandu et le plus diversifié de la famille. Il est présent dans les principaux archipels du Pacifique, notamment l'arc mélanésien et la Nouvelle-Zélande, et est le seul genre à avoir atteint la Polynésie. Six espèces sont endémiques à la Polynésie Française (Hopkins & Florence, 1998).

Origine de la flore de Nouvelle-Calédonie : biogéographie et « exaptation »

Je tombe d'accord que l'on conçoit difficilement un si grand nombre d'îles basses et de terres presque noyées, sans supposer un continent qui en soit voisin. Mais la géographie est une science de faits ; on n'y peut rien donner dans son cabinet à l'esprit de système, sans risquer les plus grandes erreurs qui souvent ensuite ne se corrigent qu'aux dépens des navigateurs.

*Louis-Antoine de Bougainville
Voyage autour du monde, 1771*

Cette partie s'appuie sur les articles suivants :

Article IV : Pillon Y (sous presse) *Geissois* (Cunoniaceae), another example of the Melanesian connection. In: *The Natural History of Santo* (ed. Bouchet P), Paris.

Article V : Pillon Y, Lebrun M, Amir H, Munzinger J (en préparation) Selective immigration in the insular flora of New Caledonia, an example of exaptation to ultramafic soils.

Géologie de la Nouvelle-Calédonie

La Nouvelle-Calédonie a connu une histoire géologique complexe, résumée notamment par Picard (1999) et Pelletier (2006). Plusieurs évènements majeurs sont à souligner : la séparation de la Nouvelle-Calédonie de l'Australie (et du super continent Gondwana) il y a 80 millions d'années (fin du Crétacé, Picard, 1999), l'immersion probablement complète de l'île dans la première moitié de l'ère tertiaire (-65 à -40 millions d'années) et finalement la subduction d'un fragment de croûte océanique accompagnée de l'émersion de l'île il y a 35-45 millions d'années (Eocène). L'altération de cette croûte océanique est à l'origine des sols ultramafiques et des gisements de nickel de Nouvelle-Calédonie.

« *Out of Gondwana* » ou « *Tabula rasa* »

Le grand nombre de lignées dites anciennes ou primitives a généralement été interprété comme la conséquence d'un isolement très ancien de la flore de Nouvelle-Calédonie (Raven & Axelrod, 1972; Morat, 1993; Morat *et al.*, 1994; Lowry, 1998) depuis sa séparation du reste du Gondwana il y a 80 millions d'années (Picard, 1999; McLoughlin, 2001; Pelletier, 2006). Cependant ce scénario est incompatible avec l'histoire géologique de la Nouvelle-Calédonie qui implique que la flore actuelle de l'île n'aurait pas plus de 35-45 millions d'années et serait entièrement le résultat de dispersion longue distance (Pelletier, 2006) comme cela avait été suggéré plus tôt pour la Nouvelle-Zélande (Pole, 1994; McGlone, 2005). La présence de lignées anciennes a été utilisée dans de nombreux cas comme la preuve et la conséquence d'un long isolement. Inversement la présence d'un groupe sur plusieurs fragments du Gondwana était souvent considérée comme la preuve de l'ancienneté d'un groupe. De tels raisonnements sont donc fréquemment circulaires. De plus il existe plusieurs cas avérés de lignées plus anciennes que les îles dont elles sont endémiques. Par exemple, le genre *Monimia* (Monimiaceae) est endémique des Mascareignes qui sont des îles volcaniques de moins de 8 millions d'années. Sa séparation avec son groupe frère actuel, le genre *Palmeria* (Nouvelle-Guinée, Australie), remonterait cependant à 52 millions d'années (Renner, 2004). Ainsi, Renner (2004) suggère que la présence antérieure des ancêtres de *Monimia* à Madagascar doit être envisagée pour expliquer la présence du genre sur l'île Maurice et l'île de la Réunion. De même, le genre *Hillebrandia* (Begoniaceae), seul représentant d'une lignée d'au moins 50 millions d'années, est endémique des îles Hawaii, qui sont plus jeunes d'au moins 20 millions d'années (Clement *et al.*, 2004). Il est donc possible qu'*Amborella* ait eu une histoire similaire, en colonisant la Nouvelle-Calédonie depuis l'Australie par exemple et en disparaissant plus tard de cette terre d'origine. Ceci expliquerait comment une lignée ancienne pourrait se trouver sur une île plus jeune. Aujourd'hui

l'hypothèse d'une reconstitution complète de la biodiversité de Nouvelle-Calédonie après son immersion au cours du Tertiaire est de plus en plus acceptée (Murienne *et al.*, 2005; Grandcolas *et al.*, 2008). Si la flore de Nouvelle-Calédonie n'aurait pas plus de 35-45 millions d'années, il semblerait que certaines colonisations et radiations soient bien plus jeunes (Murienne *et al.*, 2005; Grandcolas *et al.*, 2008) c'est notamment le cas des palmiers de la sous-famille des Arecoideae, qui représentent l'essentiel des palmiers de l'île (Tableau 1).

Tableau 1 : Age et diversité des différentes lignées de palmiers endémiques de la sous-famille des Arecoideae ayant colonisé la Nouvelle-Calédonie. Les nombres d'espèces sont pris dans Pintaud et Baker (2008) et les âges dans Savolainen *et al.* (2006, données annexes). L'âge du « tronc » correspond à la divergence entre la lignée calédonienne et le plus proche parent non-calédonien et donne un âge maximum pour l'évènement de colonisation. L'âge de la « couronne » correspond à la divergence la plus ancienne au sein de la lignée calédonienne et donne un âge minimum pour l'évènement de colonisation. L'âge du groupe contenant toutes ces lignées est de 11 millions d'années.

Groupe	Nombre d'espèces	Age du « tronc » (Ma)	Age de la « couronne » (Ma)
<i>Actinokentia/Chambeyronia/Kentiopsis</i>	8	5,1	1,7
<i>Clinosperma/Cyphokentia</i>	6	9,7	5,1
<i>Basselinia</i>	13	7,6	4,2
<i>Cyphosperma balansae</i>	1	7,6	-
<i>Burretiokentia/Cyphophoenix</i>	9	8,4	5,9

Biogéographie des Cunoniaceae

La distribution australe des Cunoniaceae et la répartition disjointe de certains genres sur plusieurs continents comme *Eucryphia* (Amérique du Sud et Australie) ou *Cunonia* (Afrique australe et Nouvelle-Calédonie) sont des éléments remarquables de la biogéographie de la famille. Raven et Axelrod (1974) suggéraient ainsi que la famille aurait colonisé les différents continents de l'hémisphère sud lorsque ceux-ci formaient encore le Gondwana.

Le domaine de la biogéographie a connu un second souffle au cours des dernières années avec l'utilisation d'horloges moléculaires, même si cette méthode fait débat et nécessite une application rigoureuse (Graur & Martin, 2004; Sanderson *et al.*, 2004). Cette méthode a notamment permis à Warren et Hawkins (2006) de dater les différents nœuds de la phylogénie de la famille. Ils ont utilisé pour cela les données moléculaires de la phylogénie publiée par Bradford et Barnes (2001), le riche registre fossile de la famille en Australie à l'époque du Tertiaire (Barnes *et al.*, 2001) et la présence d'un fossile du Crétacé en Europe attribué à cette famille (Schönenberger *et al.*, 2001). Les affinités biogéographiques des différents genres présents en Nouvelle-Calédonie sont discutées ici successivement.

Le genre *Spiraeanthemum s.l.* est le groupe frère de tout le reste de la famille des Cunoniaceae, et se structure en trois sous-groupes d'après les données moléculaires et morphologiques (article III). Deux de ces groupes sont représentés en Nouvelle-Calédonie, correspondant ainsi à deux colonisations indépendantes. La terre d'origine des *Spiraeanthemum* de Nouvelle-Calédonie ne peut pas être déterminée avec certitude, il est possible qu'elle se trouve en Nouvelle-Guinée qui présente quatre espèces, ou en Australie qui possède une espèce au Queensland ainsi que des fossiles du Tertiaire (Barnes *et al.*, 2001). Le genre est également présent sur d'autres îles du Pacifique d'origine volcanique et a priori d'origine postérieure à l'émersion de la Nouvelle-Calédonie : îles Salomon, Vanuatu, Fidji et Samoa (Neall & Trewick, 2008). Il est possible que la Nouvelle-Calédonie soit la terre

d'origine des *Spiraeanthemum* de ces îles, notamment de *Spiraeanthemum s.s.* dont le centre de diversité se trouve à Fidji et de *Spiraeanthemum vitiense* très proche morphologiquement de l'espèce néo-calédonienne *S. brongniartianum*. Aucune espèce du groupe densiflorum n'ayant été incluse dans l'étude de Warren & Hawkins (2006) alors qu'il est le groupe frère du reste du genre, il n'est pas possible d'évaluer l'âge du genre. La divergence entre *Spiraeanthemum s.s.* et le groupe brongniartianum daterait d'environ 21 millions d'années (divergence entre *S. ellipticum* et *S. samoense*, Warren & Hawkins, 2006).

Le genre *Hooglandia* est phylogénétiquement isolé (Sweeney *et al.*, 2004). Il n'a pas été inclus dans l'analyse de Warren et Hawkins (2006), mais une analyse indépendante (Pillon *et al.*, non publié) suggère que la divergence entre *Hooglandia* et son groupe frère (tout le reste de la famille sauf *Spiraeanthemum*) daterait d'environ 65 millions d'années. Il serait donc possible que sa lignée soit plus ancienne que l'émersion de la Nouvelle-Calédonie. Cependant, le genre *Aistopetalum*, endémique de la Nouvelle-Guinée et qui présente des affinités morphologiques (McPherson & Lowry, 2004) n'a pas encore été inclus dans une analyse de phylogénie moléculaire. Si les deux genres étaient groupes frères, un âge plus récent serait probablement obtenu pour la lignée de *Hooglandia*.

Le genre *Geissois s.s.* appartient à la tribu des Geissoieae, qui contient également *Lamanonia* (Amérique du Sud), *Pseudoweinmannia* (Australie) et un genre non décrit en Australie (cf *Geissois*, voir plus haut). La phylogénie de la tribu n'est pas encore résolue, notamment par l'absence du genre *Lamanonia* dans l'échantillonnage de Bradford et Barnes (2001). L'origine de *Geissois* en Nouvelle-Calédonie ne peut donc pas encore être déterminée, même si une origine australienne semble plus probable, car parmi les trois genres les plus proches de *Geissois* deux sont endémiques d'Australie, le troisième en Amérique du Sud est nettement plus distant géographiquement. *Geissois denhamii*, endémique de Vanuatu, se trouve au cœur du groupe d'espèces de Nouvelle-Calédonie (article IV). La Nouvelle-

Calédonie serait ainsi le point d'origine de *Geissois* à Vanuatu, et il est probable qu'il en soit de même pour les espèces de Fidji et de l'est des îles Salomon. Cette situation serait similaire à celle du genre *Turrilia* (Proteaceae), endémique de Fidji et de Vanuatu, dont les ancêtres, se trouvaient probablement en Nouvelle-Calédonie (Mast *et al.*, 2008).

Le genre *Codia*, bien qu'aujourd'hui endémique de Nouvelle-Calédonie, est connu à l'état fossile en Australie (Barnes *et al.*, 2001) où se trouve son groupe frère *Callicoma*, endémique d'Australie (Bradford & Barnes, 2001). La divergence entre *Codia* et son groupe frère n'excéderait pas 44 millions d'années (Warren & Hawkins, 2006) Cet âge est probablement une sur-estimation car l'arbre de Warren et Hawkins place *Codia* comme groupe frère de *Callicoma*+*Pullea* alors que les analyses précédentes basées sur les mêmes données moléculaires indique que *Codia* et *Callicoma* sont groupes frères (bootstrap de 81, Bradford & Barnes, 2001). Une origine australienne du genre *Codia* semble donc probable, et son arrivée en Nouvelle-Calédonie serait effectivement plus récente que la ré-émersion de l'île.

Les relations phylogénétiques au sein de la tribu des Cunonieae (*Cunonia*, *Pancheria*, *Vesselowskyia* et *Weinmannia*) sont peu résolues et peu soutenues notamment entre plusieurs groupes majeurs qui sont par contre bien définis d'un point de vue morphologique et confortés par les analyses moléculaires (Bradford, 2002) : *Pancheria* (endémique de la Nouvelle-Calédonie), *Cunonia capensis* (Afrique australe), le groupe des *Cunonia* de Nouvelle-Calédonie et les cinq sections du genre *Weinmannia* : *Fasciculatae* (Asie du Sud-Est et Mélanésie), *Inspersae* (Madagascar), *Leiospermum* (Mélanésie, incluant la Nouvelle-Calédonie, et Polynésie), *Spicatae* (Madagascar) et *Weinmannia* (Amérique Latine et Mascareignes). L'origine des groupes appartenant à cette tribu en Nouvelle-Calédonie est donc difficile à déterminer, la monophylie du genre *Cunonia* à la répartition singulière n'a pas été vérifiée. De plus, l'existence de fossiles du genre *Weinmannia* en Australie (Barnes *et al.*,

2001) où il est aujourd'hui absent indique que des événements d'extinctions se sont produits dans ce groupe et rendent son histoire biogéographique difficile à reconstruire. *Weinmannia* section *Weinmannia* est particulièrement énigmatique car il présenterait un cas très original de dispersion longue distance de l'Amérique vers les Mascareignes (île Maurice et Réunion, Bradford, 1998; Bradford, 2002). Le groupe *Cunonia-Pancheria-Weinmannia* n'aurait pas plus de 45 millions d'années d'après Warren et Hawkins (2006), donc la présence du genre *Cunonia* en Afrique du Sud semble plutôt s'expliquer par un événement de dispersion longue distance que par une migration sur terre ferme via le Gondwana. Les radiations des genres *Cunonia*, *Pancheria* et *Weinmannia* en Nouvelle-Calédonie seraient également confirmées comme plus récentes que l'immersion probable de l'île.

D'une manière générale il est nécessaire de souligner que des événements d'extinction importants se sont produits dans l'histoire de la famille des Cunoniaceae, ce qui a contribué à une biogéographie actuelle assez surprenante par certains aspects. On peut ainsi noter la disparition en Australie au cours du Tertiaire des genres *Codia* (aujourd'hui endémique de Nouvelle-Calédonie) et *Weinmannia* (répandu et présent sur toutes les îles entourant l'Australie). Le genre *Lamanonia* présent aujourd'hui uniquement en Amérique du Sud (Brésil, Argentine et Paraguay) est connu à l'état fossile en Amérique du Nord, dans des sédiments du Dakota datant du Tertiaire (Hickey, 1977). Le plus vieux fossile attribué à ce jour à la famille des Cunoniaceae date du Crétacé et a été trouvé en Europe (Schönenberger *et al.*, 2001), alors que la famille est aujourd'hui pratiquement absente au nord de l'Equateur. Des situations similaires sont rencontrées pour les familles des Balanopaceae et des Trimeniaceae, endémiques de l'Océanie, dont des fossiles de fleurs ou de pollen ont été identifiés dans l'hémisphère nord (Muller, 1981; Yamada *et al.*, 2008). Davantage d'études sur les fossiles de Cunoniaceae seraient donc souhaitables. Ils seraient notamment à rechercher en Afrique continentale ou en Nouvelle-Calédonie où aucun fossile n'est connu.

De plus, des erreurs d'identifications des fossiles ne sont pas à exclure et certains spécimens mériteraient d'être réexaminés à la lumière des dernières données phylogénétiques et morphologiques.

Les Cunoniaceae de Nouvelle-Calédonie semblent avoir des affinités plus fortes avec l'Australie comme cela a également pu être observé pour les Sapotaceae (Bartish *et al.*, 2005), même si des évènements d'extinctions ont obscurci ces connexions. Des liens avec la Nouvelle-Guinée sont également possibles, notamment pour le genre *Spiraeanthemum*. L'histoire du genre *Codia* pourrait être généralisée aux autres genres de la Nouvelle-Calédonie à savoir une colonisation de l'archipel après son émergence et disparition des espèces australiennes au cours du Tertiaire. L'Australie a effectivement connu une période d'aridification au cours du Tertiaire qui aurait été accompagnée de l'extinction ou la raréfaction de nombreux groupes inféodés aux forêts tropicales humides comme certaines angiospermes basales (Morley, 2001). Le climat de la Nouvelle-Calédonie serait lui resté relativement stable au cours du Tertiaire (Morley, 2001) et aurait pu servir de refuge à ces lignées. L'émergence de la Nouvelle-Calédonie étant nettement antérieure à la formation des îles volcaniques formant Vanuatu et Fidji, la colonisation de ces îles se serait faite à partir du premier archipel. Ce serait notamment le cas de *Geissois* (article IV), du genre *Turillia* (Proteaceae, Mast *et al.*, 2008) et potentiellement de *Spiraeanthemum* et de *Weinmannia*, bien que l'influence de la Nouvelle-Guinée dans la formation des flores de Vanuatu et Fidji a probablement été forte.

Pourquoi y a-t-il autant de Cunoniaceae en Nouvelle-Calédonie ?

La concentration d'espèces de Cunoniaceae en Nouvelle-Calédonie est remarquable, étant donné que l'archipel abrite près d'un tiers des espèces de la famille. La famille a probablement colonisé l'île à 8 reprises, une fois pour chaque genre sauf pour

Spiraeanthemum, où il y a probablement eu deux évènements de colonisation (article III). A l'exception de *Hooglandia* et du groupe densiflorum du genre *Spiraeanthemum*, une diversification plus ou moins importante a suivi la colonisation, particulièrement chez *Codia*, *Cunonia*, *Geissois* et *Pancheria* qui ont tous plus de 10 espèces. Par comparaison (Tableau 2), pour une surface nettement plus grande, l'Australie abrite un plus grand nombre de genres de Cunoniaceae (15), pour un nombre d'espèces nettement inférieur (36). Les genres australiens sont généralement peu diversifiés, avec un maximum de huit espèces, car la plupart compte une ou deux espèces.

Tableau 2. Liste des genres de Cunoniaceae présents en Australie et en Nouvelle-Calédonie et d'Asteraceae présents en Nouvelle-Calédonie.

Cunoniaceae Nouvelle-Calédonie 7 genres, 87 espèces	Cunoniaceae Australie 15 genres, 36 espèces	Asteraceae Nouvelle-Calédonie 21 genres, 34 espèces
<i>Codia</i> 13 spp. <i>Cunonia</i> 24 spp. <i>Geissois</i> 13 spp. <i>Hooglandia</i> 1 sp. <i>Pancheria</i> 25 spp. <i>Spiraeanthemum</i> 7 spp. <i>Weinmannia</i> 4 spp.	<i>Ackama</i> 2 spp. <i>Acrophyllum</i> 1 sp. <i>Anodopetalum</i> 1 sp. <i>Bauera</i> 3 spp. <i>Callicoma</i> 1 sp. <i>Ceratopetalum</i> 8 spp. <i>Davidsonia</i> 3 spp. <i>Eucryphia</i> 5 spp. cf. <i>Geissois</i> 2 spp. <i>Gillbea</i> 2 spp. <i>Pseudoweinmannia</i> 2 spp. <i>Pullea</i> 1 sp. <i>Schizomeria</i> 2 spp. <i>Spiraeanthemum</i> 1 sp. <i>Vesselowskyia</i> 2 spp.	<i>Blumea</i> 9 spp. <i>Brachycome</i> 2 spp. <i>Centipeda</i> 1 sp. <i>Cineraria</i> 1 sp. <i>Eclipta</i> 1 sp. <i>Epaltes</i> 1 sp. <i>Glossocardia</i> 1 sp. <i>Gnaphalium</i> 1 sp. <i>Helichrysum</i> 1 sp. <i>Lagenophora</i> 3 spp. <i>Lipochaeta</i> 1 sp. <i>Pseudelephantopus</i> 1 sp. <i>Pseudognaphalium</i> 1 sp. <i>Pterocaulon</i> 3 spp. <i>Sigesbeckia</i> 1 sp. <i>Synedrella</i> 1 sp. <i>Tridax</i> 1 sp. <i>Vernonia</i> 1 sp. <i>Vittadinia</i> 1 sp. <i>Wedelia</i> 1 sp. <i>Wollastonia</i> 1 sp.

D'une manière générale, la diversification nette des Cunoniaceae (spéciation moins extinction) semble avoir été plus intense en Nouvelle-Calédonie qu'en Australie. Pour comparaison, la famille des Asteraceae qui possède de bonne capacité de dispersion, compte en Nouvelle-Calédonie 21 genres qui correspondent probablement à autant d'évènements de colonisation. Cependant la plupart de ces genres sont très peu diversifiés, avec un maximum de neuf espèces, mais plus souvent avec une ou deux espèces. La famille des Asteraceae semble donc peu prédisposée à se diversifier en Nouvelle-Calédonie, malgré de nombreuses introductions, probablement liées à une bonne capacité de dispersion permise par leurs graines de petites tailles (Harper *et al.*, 1970).

La famille des Cunoniaceae appartient à l'ordre des Oxalidales, qui comprend également d'autres familles de taille modeste comme les Elaeocarpaceae, les Connaraceae et les Oxalidaceae, représentées en Nouvelle-Calédonie par des espèces endémiques. La première, en particulier, est bien diversifiée. De plus, plusieurs genres appartenant à des mêmes familles comme les Araliaceae et les Sapotaceae se sont également diversifiés de manières remarquables en Nouvelle-Calédonie. Ainsi il semblerait que les groupes apparentés aient des succès comparables en Nouvelle-Calédonie et ceci mérite d'être testé à plus large échelle en considérant toutes les plantes à fleurs.

En utilisant comme hypothèse nulle que la Nouvelle-Calédonie correspond à un échantillonnage aléatoire de la flore du globe, il est possible d'identifier les familles qui sont sur ou sous représentées en Nouvelle-Calédonie. Par exemple, selon cette hypothèse, si 10% des plantes du globe sont des orchidées, on peut s'attendre à ce que 10% des plantes autochtones et endémiques de Nouvelle-Calédonie soient des orchidées.

Une analyse phylogénétique comparée permet de déterminer si la sur- ou la sous-représentation de certaines familles est indépendante ou au contraire corrélée avec leur lien de parenté. Il est ainsi possible de mettre en évidence des groupes au sein des angiospermes qui

concentrent un grand nombre des familles sur- ou sous-représentées en Nouvelle-Calédonie (Figure 10). Par exemple les groupes suivants sont particulièrement représentés : le clade COM (contenant les ordres des Celastrales, Oxalidales et Malpighiales), les Myrtaceae, les Sapindales, les Gentianales, les Apiales et l'alliance des Myrsinaceae (Ericales). Par contre les groupes suivants sont assez peu représentés : les Lamiales, Asterales, Fabales (article V). D'une manière générale, la flore de Nouvelle-Calédonie possède davantage de Rosidées, et moins d'Asteridées et de Monocotylédones.

Une interprétation possible du plus grand succès de certaines lignées serait de postuler qu'elles étaient pré-adaptées à se développer en Nouvelle-Calédonie (Jaffré *et al.*, 1987). En effet, puisque lors de son émergence, l'île était entièrement recouverte de péridotites, comme le suggère Pelletier (2006), les espèces qui colonisèrent l'île ont du faire face à la double difficulté d'atteindre la Nouvelle-Calédonie et de s'y développer. Les espèces ayant d'emblée une plus grande capacité à se développer sur sols ultramafiques ont eu un avantage non négligeable. Les Malpighiales possèdent peut-être cet avantage, étant donné qu'elles concentrent à elles seules 40% des espèces hyperaccumulatrices de nickel connues (Brooks, 1998).

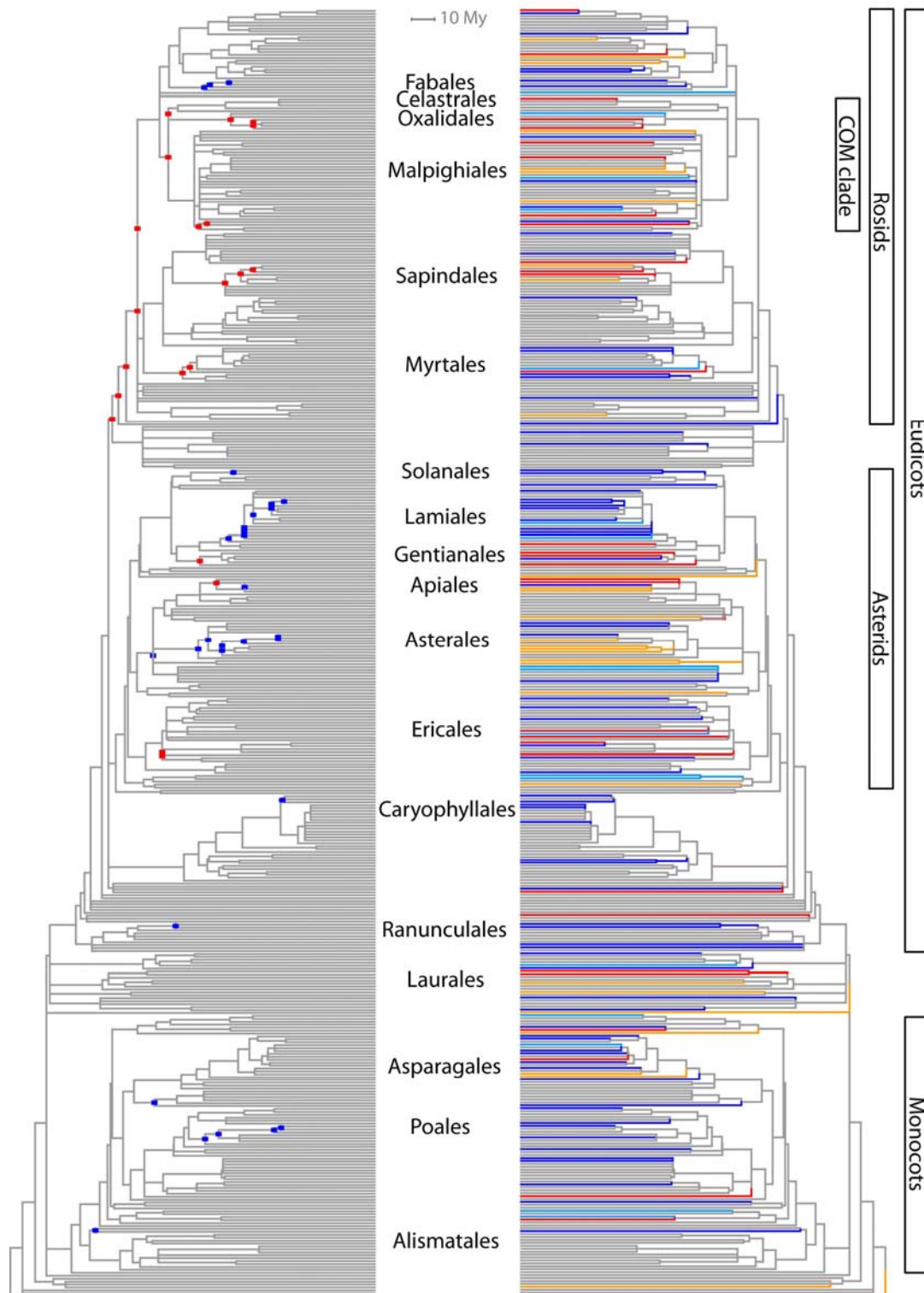

Figure 10. Représentation des familles de Nouvelle-Calédonie selon leur position phylogénétique au sein des angiospermes. L'arbre de gauche montre les nœuds avec des index de représentation significativement plus élevés (carré rouge) ou moins élevés (carré bleu) qu'attendu par chance. L'arbre de droite indique les familles qui sont significativement surreprésentées (rouge et orange) ou sous-représentées en Nouvelle-Calédonie (bleu foncé ou bleu clair ; voir article V pour le détail).

Des cas de pré-adaptation sont connus dans la littérature, il s'agit notamment du cas d'*Arabidopsis halleri*. Cette espèce est une hyperaccumulatrice de zinc originaire d'Europe. Le caractère hyperaccumulateur est constitutif chez cette espèce car les plantes présentes en conditions naturelles dans des milieux pauvres en zinc sont capables d'accumuler celui-ci si on leur en fournit. Les populations métallicoles présentes sur des sols pollués se seraient formées plusieurs fois indépendamment et leur capacité à accumuler le zinc est plus importante (Pauwells *et al.*, 2005). *Arabidopsis halleri* semblait donc prédisposée à pousser sur ces sols pollués en zinc, et le caractère hyperaccumulateur n'a été que renforcé à plusieurs reprises dans ces milieux anthropogéniques. L'hyperaccumulation reste néanmoins un cas particulier d'adaptation aux sols ultramafiques, mais elle possède l'avantage d'être facilement mesurable comparé à d'autres caractères (sclérophylle, croissance lente,...). De même il semblerait que certaines plantes présentes dans la végétation méditerranéenne de la Californie aient été pré-adaptées à ce milieu car leurs ancêtres présentaient déjà des caractéristiques foliaires adaptées au milieu sec (feuilles petites et coriaces) malgré leur origine tropicale ou tempérée-froide (Ackerly, 2004).

Il est possible que beaucoup de plantes de Nouvelle-Calédonie soient un exemple d'« exaptation » aux terrains ultramafiques. Exaptation est un terme créé par Gould & Vrba pour remplacer le terme de pré-adaptation (Gould & Lewontin, 1979; Gould & Vrba, 1982). Un exemple simple d'exaptation est la plume des oiseaux, qui serait apparue dans un premier temps comme isolant thermique, puis qui se serait avérée utile pour le vol. Il reste néanmoins à clarifier les bases d'une exaptation aux terrains ultramafiques. Elle repose peut-être sur des mécanismes physiologiques qui ont été détournés à de multiples reprises pour faire face aux contraintes associées à ces types de sol.

Diversification des Cunoniaceae en Nouvelle-Calédonie

Gaïac, plante pionnière, je n'entretiens pas seulement l'arbre que tu es, mais ce que tu représentes pour moi, pour nous, toi l'arbre-ancêtre, symbole d'une alliance forte qui unit le sang et la sève, le rouge et le blanc, dans un corps de chair noire, dans un corps de bois vert où l'Histoire s'est écrite. [Le jardinier]

*Pierre Gope
La Parenthèse, 2005*

Cette partie s'appuie sur les articles suivants :

Article VI : Pillon Y, Munzinger J, Amir H, Hopkins HCF, Chase MW (sous presse)
Reticulate evolution on a mosaic of soils: diversification of the New Caledonian endemic genus *Codia* (Cunoniaceae). *Molecular Ecology*.

Article VII : Pillon Y, Munzinger J, Hopkins HCF, Amir H, Chase MW (en préparation) Gene recombination, cryptic species and hybridization in the genus *Spiraeanthemum* (Cunoniaceae) from New Caledonia.

Généralités

Les îles du Pacifique possèdent une biodiversité importante et font presque toutes partie de l'un des « hotspot » de biodiversité (Myers *et al.*, 2000; Mittermeier *et al.*, 2004). Les îles océaniques sont fréquemment qualifiées de « laboratoire de l'évolution », notamment les îles Galápagos qui auraient inspiré à Charles Darwin sa théorie de l'évolution. Cette importante diversité et originalité des îles du Pacifique s'expliquent notamment par plusieurs facteurs. Tout d'abord, la plupart se trouve entre les Tropiques, or la biodiversité est généralement plus importante à proximité de l'équateur (Gaston & Spicer, 1998). L'éloignement de beaucoup d'îles des continents les plus proches limite les événements de dispersion (MacArthur & Wilson, 1963) et augmente ainsi le taux d'endémisme. Le très grand nombre d'îles dans l'Océan Pacifique constitue un ensemble très fragmenté pour la

biodiversité terrestre, propice à la spéciation allopatrique. L'isolement géographique entre les îles limite fortement les flux de gènes entre les populations insulaires qui évoluent ainsi indépendamment. Cette diversification par voie allopatrique peut être particulièrement importante chez certains genres comme *Cyrtandra* (Gesneriaceae), qui compte plus d'une centaine d'espèces à travers le Pacifique, dont plusieurs sont endémiques d'une seule île ou un archipel. Par exemple *Cyrtandra mareensis* est endémique de Maré (îles Loyauté), *Cyrtandra futunae* est endémique de Futuna et Alofi (Gillet, 1973). Néanmoins, si l'on peut s'attendre à ce que la biodiversité de la plupart des îles du Pacifique soit caractérisée par un nombre important d'espèces et un fort taux d'endémisme, la flore de Nouvelle-Calédonie dépasse largement dans ces domaines Fidji (1302 espèces indigènes de plantes à fleurs dont 36,5% sont endémiques), dont la superficie et le climat sont comparables (Jaffré *et al.*, 2001). Elle dépasse également la Nouvelle-Zélande (Jaffré *et al.*, 2001) qui, malgré un climat tempéré dans la majeure partie de l'archipel où l'on peut s'attendre à une biodiversité moindre (Davies *et al.*, 2004b), est néanmoins plus de 10 fois plus grande.

Importance des conditions édaphiques

La Nouvelle-Calédonie présente une grande diversité de substrats offrant des conditions de vie très contrastées pour les plantes (Jaffré, 1993) : roches métamorphiques (schistes, etc.), basaltes, roches siliceuses (phtanites), roches calcaires, roches ultramafiques (péridotites, serpentines), etc. Une distinction est particulièrement marquée entre les sols ultramafiques et non-ultramafiques, 50% des Cunoniaceae de Nouvelle-Calédonie ne se trouvent que sur le premier type de sol, 30% sur le second, et seulement 20% sur les deux. La diversité des conditions édaphiques est également une hypothèse avancée pour expliquer la richesse spécifique de la flore du Cap en Afrique du Sud (Goldblatt & Manning, 2002) ou du sud-ouest de l'Australie (Hopper, 1979; Hopper & Gioia, 2004), deux autres « hotspots » de

biodiversité. Les inselbergs de Guyane, massifs granitiques isolés au milieu de la forêt tropicale, sont un milieu très fragmenté propice à la diversification de certains groupes de plantes qui se sont adaptées à ces conditions de vie difficiles (Sarhou *et al.*, 2001; Barbará *et al.*, 2007). Cette situation trouve un écho en Nouvelle-Calédonie avec les massifs miniers de la côte ouest (Figure 11) qui s'étendent du Mé Maoya aux îles Belep, et incluent entre autres le Boulinda, le Koniambo et le dôme de la Tiébaghi. Ils sont isolés entre eux par des plaines basses et de natures géologiques très différentes (basaltes, sédiments). Ces massifs ressemblent donc à des milieux insulaires et chacun possède effectivement un certain nombre d'espèces qui leur sont propres notamment dans les genres *Bikkia* (Rubiaceae, Jérémie & Hallé, 1976), *Medicosma* (Rutaceae, Hartley, 1985) et surtout *Phyllanthus* (Phyllanthaceae, Schmid, 1991).

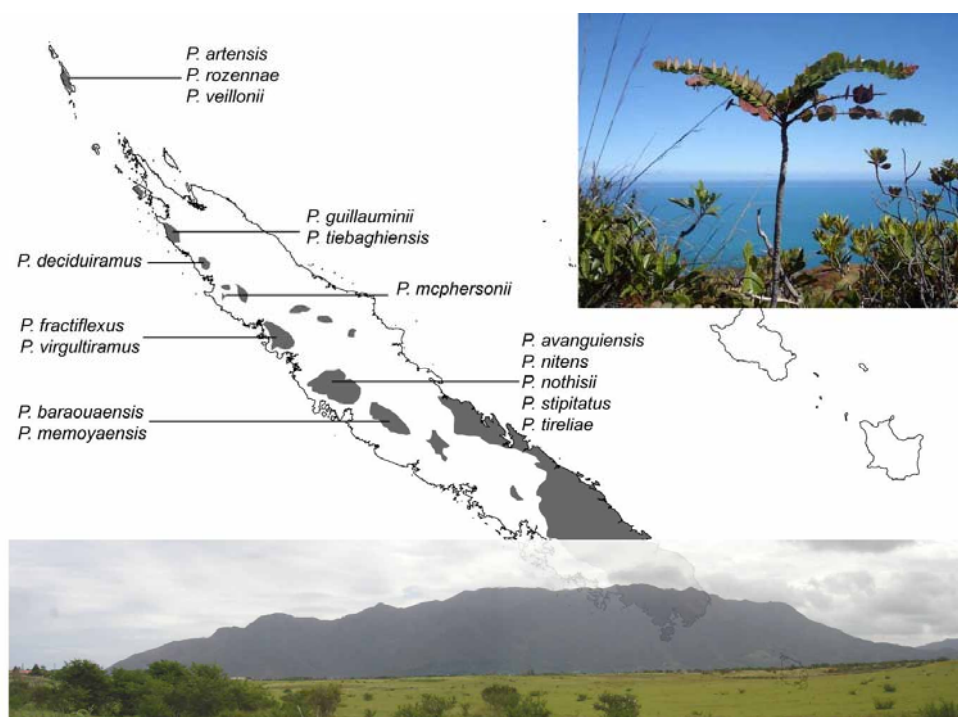

Figure 11. Micro-endémisme chez le genre *Phyllanthus* (Phyllanthaceae) sur les massifs miniers de la côte ouest de la Nouvelle-Calédonie. Les sols ultramafiques sont indiqués en gris. En bas, le massif de Koniambo, vu depuis la route transversale Koné-Tiwaka ; en médaillon, *Phyllanthus poumensis*.

L'adaptation à de nouvelles conditions édaphiques est considérée comme un facteur favorisant les évènements de spéciation (Kruckeberg, 1986). Le mode de spéciation attendu serait plutôt parapatric, car des populations voisines d'une même espèce se développant dans des conditions écologiques différentes vont diverger progressivement. De telles divergences écologiques peuvent se produire relativement rapidement et sur de faibles distances (Snaydon & Davies, 1976; Gauthier *et al.*, 1998; Savolainen *et al.*, 2006). Chez les plantes, les phénomènes de spéciation par hybridation sont également communs (Rieseberg & Willis, 2007). Une espèce hybride peut dans certains cas présenter un phénotype « extrême », qui ne correspond ni à l'un ou l'autre des espèces parentes ou aucun état intermédiaire, et qui est qualifié de « transgressif ». De telles espèces hybrides peuvent ainsi occuper des habitats nouveaux. Par exemple, trois espèces de tournesol d'Amérique du Nord *Helianthus anomalus*, *H. deserticola* and *H. paradoxus*, toutes issues du croisement entre *H. annuus* et *H. petiolaris* se sont adaptées respectivement aux dunes de sable, au désert et aux marais saumâtres (Rieseberg *et al.*, 2003; Rieseberg *et al.*, 2007). D'autre part, les phénomènes d'hybridation ont joué un rôle important dans la diversification de certaines lignées de plantes dans d'autres systèmes insulaires (Baldwin, 1997; Francisco-Ortega *et al.*, 1997).

Une évolution complexe des genres *Codia* et *Spiraeanthemum*

Les analyses moléculaires révèlent une histoire complexe des genres *Codia* (article VI) et *Spiraeanthemum* (article VII), marquée par des phénomènes récurrents d'hybridation et des cas d'espèces cryptiques.

L'évolution au sein du genre *Codia* (figure 12) implique des événements d'hybridation probables entre quatre espèces parentales, *C. ferruginea*, *C. incrassata*, *C. jaffrei* et *C. nitida* et peut-être une lignée éteinte. *Codia albifrons*, *C. belepensis*, *C. microphylla*, *C. spatulata* et

C. triverticillata seraient le résultat du croisement entre *C. jaffrei* et un membre du groupe *C. ferruginea-C. incrassata*. *Codia albicans* et *C. montana* seraient chacune le résultat du croisement entre une lignée éteinte et, respectivement, le groupe *C. ferruginea-C. incrassata* et *C. jaffrei*. Les origines, probablement hybrides, de *C. mackeeana* et *C. discolor* sont moins claires.

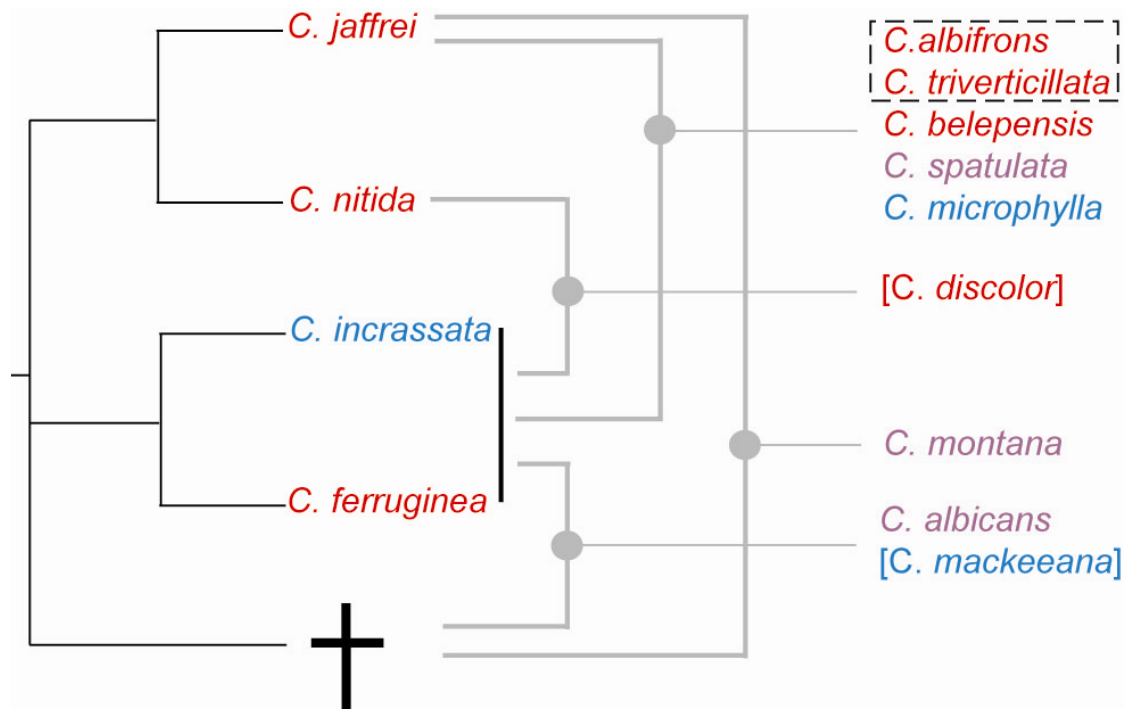

Figure 12. Scénario hypothétique de l’histoire évolutive du genre *Codia* en Nouvelle-Calédonie. La croix indique une lignée probablement éteinte aujourd’hui. Les espèces se développant sur sols ultramafiques sont indiquées en rouge, celles se développant sur sols non-ultramafiques en bleu et celles se développant sur les deux types de sols sont indiqués en violet. Les parentés des espèces indiquées entre crochet sont incertaines

Dans le genre *Spiraeanthemum* (article VII), de fréquents évènements de recombinaison génétique ont rendu la reconstitution de l’histoire évolutive du genre difficile. Néanmoins il a été possible d’observer une importante disparité génétique entre les populations de *S. ellipticum* de la chaîne du Mont Panié et les populations du sud, suggérant qu’il s’agit en fait de deux espèces distinctes. De même les populations du nord et sud de *S.*

pubescens sont également très différentes. Là où les études morphologiques ne considèrent qu'une seule espèce, les études génétiques montrent qu'il existe probablement deux espèces au sein de *S. ellipticum* et *S. pubescens*. Il s'agirait donc de deux exemples d'espèces cryptiques (Bickford *et al.*, 2007). Des événements d'hybridation ont aussi probablement marqué l'histoire des autres espèces, notamment *S. collinum*, *S. pedunculatum* et les populations du sud de *S. ellipticum*.

Adaptation aux terrains ultramafiques : fidélité et origine

D'une manière générale, les différentes espèces de Cunoniaceae montrent une certaine fidélité à un type de sol, c'est-à-dire qu'elles ne se rencontrent que sur sols ultramafiques (50% d'entre elles) ou que sur sol non-ultramafiques (30% d'entre elles). Plus globalement, 1176 espèces de plantes seraient restreintes aux sols ultramafiques de Nouvelle-Calédonie (Jaffré *et al.*, 1987; Morat, 1993). Dans le genre *Spiraeanthemum*, seules deux espèces sont rencontrées à la fois sur roches ultramafiques et non-ultramafiques : *S. ellipticum* et *S. pubescens*. La différence génétique entre les populations du sud sur sols ultramafiques de *S. ellipticum* et de *S. pubescens* et celles du nord sur sols non-ultramafiques montrent qu'elles devraient être considérées comme des espèces différentes. Dans le genre *Codia*, seules trois espèces se développent sur les deux types de sols : *C. albicans*, *C. montana* et *C. spatulata* et ont toutes une origine hybride. Les espèces d'origine hybride ont fréquemment des origines multiples (Soltis & Soltis, 1999), c'est-à-dire qu'elles ont été formées par des croisements répétés entre les mêmes espèces parentales. Il est donc possible que les populations des sols ultramafiques et non-ultramafiques de ces trois espèces soient issues de croisements indépendants. Ainsi, il semblerait que les quelques espèces des genres *Spiraeanthemum* et *Codia* qui ont une écologie large aient toutes des origines multiples. La fidélité des espèces de

ces genres serait donc plus importante encore que la classification basée sur la morphologie ne le suggère.

Chez le genre *Codia*, l'adaptation aux sols ultramafiques serait soit ancestrale au genre entier, ou serait apparue deux fois, chez *C. ferruginea* d'une part, et chez l'ancêtre commun de *C. jaffrei* et *C. nitida* d'autre part (Figure 12). Les espèces d'origine hybride se développant sur sol ultramafique ont au moins un parent qui se développe sur ce type de sol, dont elles auraient ainsi hérité de cette adaptation. Chez le genre *Spiraeanthemum*, l'adaptation aux sols ultramafiques serait également apparue une seule fois (article VII). L'adaptation aux sols ultramafiques est donc un caractère nettement moins plésiomorphe, du moins chez les Cunoniaceae, que ne le suggérait de Kok (2002). L'hybridation constitue probablement un « raccourci » permettant l'acquisition de ce caractère.

Caractères nouveaux apparus chez les espèces d'origine hybride



Figure 12. *Codia albifrons*, une espèce à feuilles verticillées

La comparaison entre les espèces d'origine hybride et leurs parents hypothétiques met en évidence un certain nombre de caractères nouveaux chez ces espèces. Toutes les espèces du genre *Codia* ont des feuilles opposées, sauf *C. albifrons* (figure 12) et *C. triverticillata*, qui ont des feuilles verticillées. Ces deux espèces d'origine hybride ont les mêmes parents et sont peut être les descendants d'un unique évènement d'hybridation après lequel elles se seraient différenciées. *Codia microphylla* (origine hybride) n'est connu que de quelques localités au nord de Koumac (Col d'Arama, etc.) et semble être spécialiste des substrats sédimentaires siliceux (phtanites), milieux secs et pauvres couverts d'une végétation basse de type maquis. La seule autre espèce de *Codia* qui peut éventuellement être rencontrée dans ce milieu est une autre espèce

d'origine hybride : *C. montana* dont le spectre écologique est plus large. Ainsi, les Cunoniaceae de Nouvelle-Calédonie possèdent plusieurs cas d'espèces hybrides présentant des caractères nouveaux et une spécialisation écologique, rappelant le cas des tournesols d'Amérique du Nord (Rieseberg *et al.*, 2007).

Les traces de migrations passées

Plusieurs éléments suggèrent que les aires de répartition de différentes espèces de *Codia* ont beaucoup évolués au cours du temps. Ainsi, les espèces qui se sont hybridées ne sont plus aujourd'hui en contact car leurs aires de distribution ne se chevauchent pas (Figure 14). De plus certaines espèces d'origine hybride se trouvent aujourd'hui complètement isolées de leurs deux parents. La formation d'espèces d'origine hybride nécessite généralement la présence des deux espèces parentales à proximité l'une de l'autre pour qu'il y ait un nombre suffisant de fécondation croisée pour générer des hybrides, et ainsi un nombre suffisant d'hybrides pour qu'une nouvelle espèce puisse se former parmi eux. De plus, les *Codia* seraient plutôt pollinisées par des insectes (abeilles et coléoptères, Hopkins *et al.* manuscript non publié), donc la dispersion par le pollen est probablement limitée à des distances faibles (quelques kilomètres, et probablement beaucoup moins).

Il est possible que les oscillations climatiques du Tertiaire aient joué un rôle dans ces mouvements d'espèces. A des périodes plus sèches, la forêt humide devait être moins répandue qu'elle ne l'est aujourd'hui et avec une répartition probablement différente. Les espèces ont dû se déplacer pour se maintenir dans des conditions favorables. De la même manière des périodes d'expansions de la forêt humide ont pu se produire lors de périodes très humides.

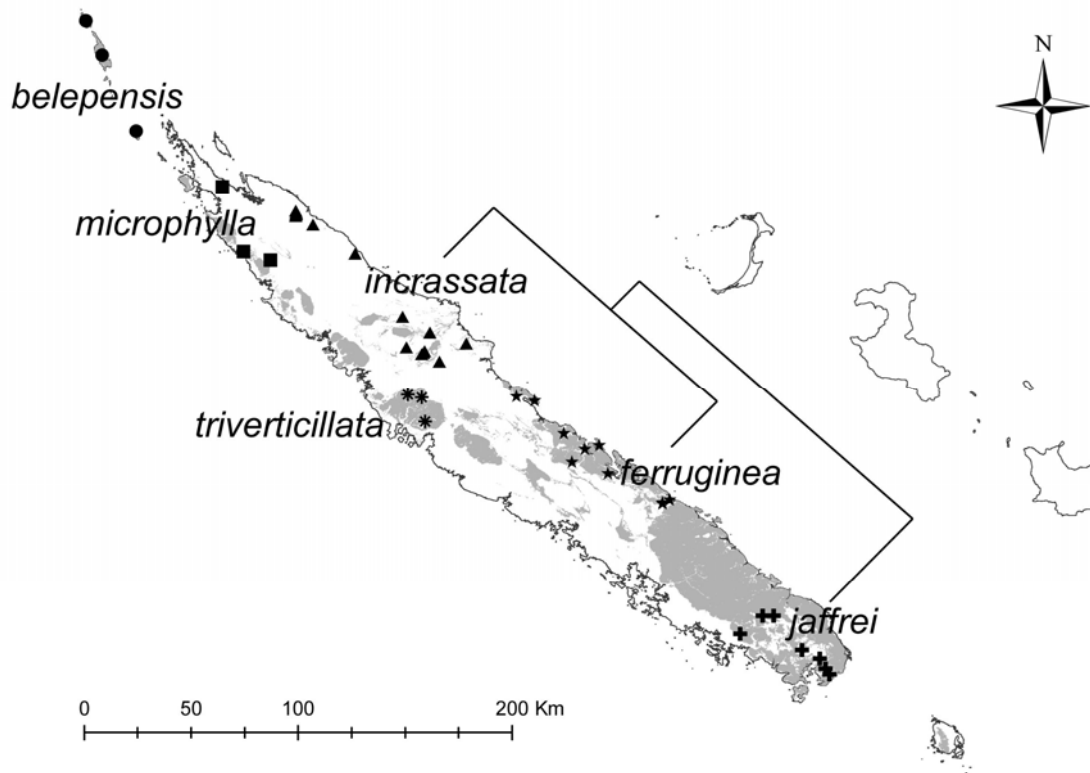

Figure 14. *Distribution des trois principales espèces parentales (C. ferruginea, C. incrassata et C. jaffrei) et trois espèces hybrides issus de leur croisement (C. belepensis, C. microphylla et C. triverticillata). Les sols ultramafiques sont indiqués en gris.*

L'importance des glaciations sur la génétique des plantes et des animaux a été largement étudiée en Europe (Hewitt, 2000), où la région méditerranéenne a servi de refuge pendant les périodes froides à de nombreux groupes animaux ou végétaux. Ce phénomène est encore peu étudié sous les Tropiques, même si les études phytogéographiques suggèrent que les oscillations climatiques du Pléistocène ont également marquées la végétation de l'Amérique tropicale (Prance, 1982). Virot (1956) avait déjà envisagé l'impact des variations climatiques sur la flore de Nouvelle-Calédonie, et les études palynologiques ont également confirmé différentes successions dans le type de végétation de certaines régions du sud de l'île (Stevenson *et al.*, 2001; Stevenson & Hope, 2005). Cependant, l'importance des variations climatiques sur la répartition actuelle des espèces de Nouvelle-Calédonie est restée

peu étudiée mis à part le cas des palmiers (Pintaud & Jaffré, 2001; Pintaud *et al.*, 2001). Les refuges glaciaires potentiels se trouveraient dans les zones les plus arrosées de la Nouvelle-Calédonie, notamment dans le sud et le nord-est de la Grande Terre, qui concentrent un grand nombre d'espèces rares de palmiers (figure 15). Les espèces parentales dans le genre *Codia* se trouvent toutes aujourd'hui dans les zones sud et est. Une répartition préférentielle des espèces parentales dans les zones refuges est un phénomène qui a également été observé en Europe (Abbott & Brochmann, 2003; Pillon *et al.*, 2006).

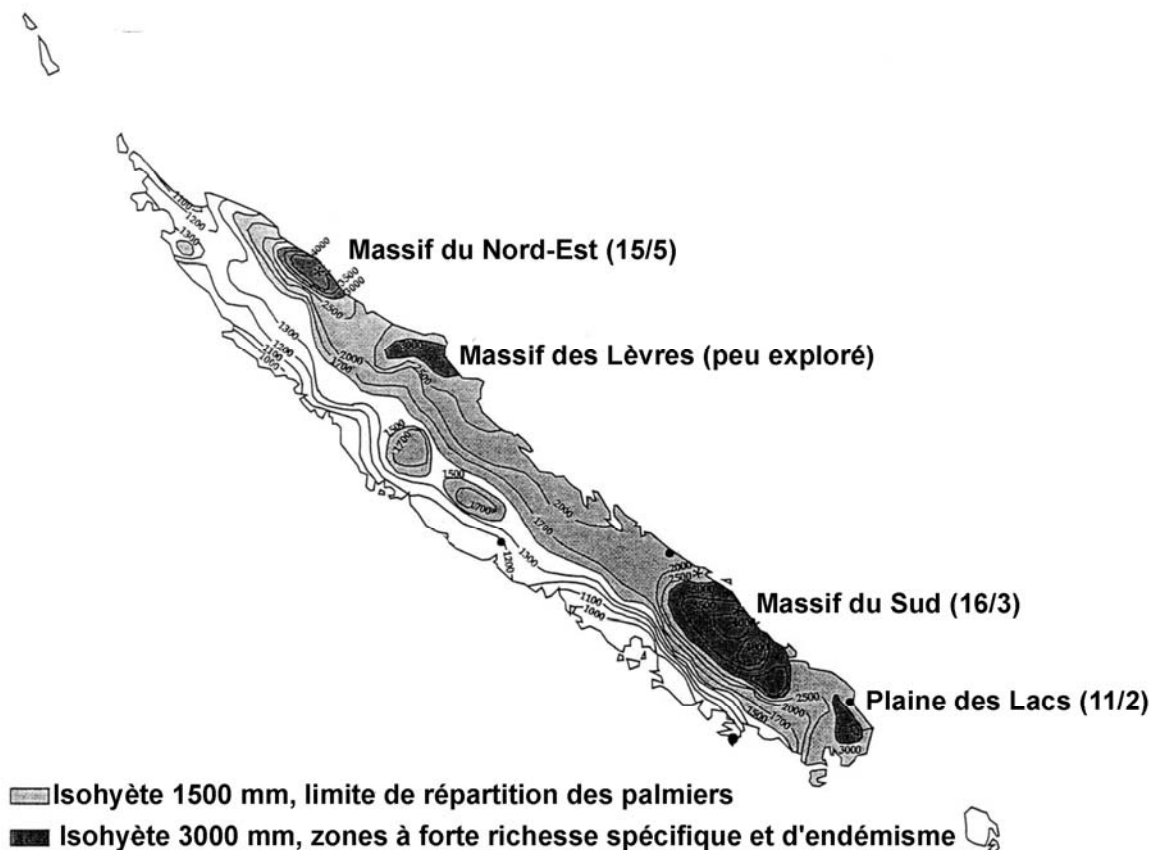

Figure 15. Précipitations et zones refuges hypothétiques des palmiers de Nouvelle-Calédonie, d'après Pintaud *et al.* (2001). Les nombres entre parenthèses indiquent le nombre d'espèces total et le nombre d'espèces micro-endémiques de chaque zone refuge hypothétique.

Les oscillations climatiques seraient ainsi à l'origine de périodes alternées d'expansion et de rétraction dans la répartition de certaines espèces, y compris des Cunoniaceae. Ce

phénomène favorise les évènements de spéciation allopatrique dans les phases de retrait, et de spéciation parapatrique dans les phases d'avancée. De plus les mouvements géographiques des espèces facilitent la rencontre d'espèces auparavant isolées qui peuvent s'hybrider et former de nouvelles combinaisons.

La conservation de la flore de Nouvelle-Calédonie

*Ils ont partagé le monde
Plus rien ne m'étonne [...]
Si tu me laisses l'uranium
Moi je te laisse l'aluminium [...]*

*Jiken Jah Fakoly
Coup de Zeule, 2004*

Cette partie s'appuie sur l'article suivant :

Article VIII : Pillon Y, Fogliani B (2009) Evidence for a correlation between systematics and bioactivity in New Caledonian Cunoniaceae and its implications for screening and conservation. *Pacific Science* **63**, 97-103.

Importance de la biodiversité

Les Cunoniaceae ont une valeur dans plusieurs domaines, qu'elle soit déjà exploitée ou encore à développer. Plusieurs espèces sont utilisées dans la médecine traditionnelle mélanésienne (Fogliani *et al.*, 2002a), notamment dans le traitement de la ciguatera, la fièvre, les maux de tête, la fatigue ou comme coupe-faim. Plus récemment des études de « screening » sur 50 espèces de Cunoniaceae de Nouvelle-Calédonie ont montré que la plupart de celles-ci possèdent des activités anti-microbiennes ou anti-fongiques (Fogliani *et al.*, 2002a) ainsi que des propriétés anti-oxydantes (Fogliani *et al.*, 2002b). Ces activités seraient associées à la présence en abondance de tannins chez les Cunoniaceae, et en particulier de certains ellagitannins (Fogliani *et al.*, 2005).

Bien que ne jouissant pas de la popularité d'autres bois comme le kaori (*Agathis* spp., Araucariaceae), le houp (*Montrouziera* spp., Clusiaceae) ou le chêne gomme (*Arillastrum gummiferum*, Myrtaceae), etc., les Cunoniaceae ont été exploitées pour leur bois depuis le

début des colonies pénitentiaires (Sebert & Pancher, 1874). De nombreuses espèces atteignent des tailles importantes et fournissent un bois de qualité, notamment pour l'ébénisterie (Sebert & Pancher, 1874; Sarlin, 1954; CIRAD-Forêt, 1992). C'est le cas pour plusieurs espèces des genres *Geissois* (*G. racemosa* = faux-tamanou) et *Codia*, ainsi que *Cunonia austrocaledonica* et *Pancheria ternata*. Ces espèces pourraient donc faire l'objet de développement pour la sylviculture, notamment les espèces du genre *Geissois* dont la germination est aisée et la croissance relativement rapide. De nombreuses espèces de Cunoniaceae ont également un potentiel horticole (Godard *et al.*, 1978), notamment les espèces des genres *Cunonia* et *Geissois*. De plus le caractère pionnier et l'abondance naturelle de plusieurs espèces dans les maquis miniers en font d'excellents candidats pour la restauration écologique des sites miniers après exploitation (Jaffré & Pelletier, 1992), en particulier *Codia* spp. Malheureusement la multiplication de ce genre s'est avérée jusqu'ici difficile.

Plusieurs espèces de Cunoniaceae sont connues pour être hyperaccumulatrices de nickel, *Pancheria engleriana* (Jaffré, 1980, p. 164; Brooks, 1998), ainsi que toutes les espèces de *Geissois* naturellement présentes sur sols ultramafiques (Jaffré *et al.*, 1979). Les espèces dites métallophytes ont un potentiel important dans des domaines comme la restauration écologique, la phytoremédiation (dépollution des sols), ou la phytoextraction (Whiting *et al.*, 2004). Cette dernière, consistant à utiliser les plantes pour extraire les métaux lourds du sol, constituerait une alternative aux mines à ciel ouvert, mais elle reste à être développée. Bien que les Cunoniaceae n'aient pas des concentrations tissulaires de nickel aussi élevées que certaines espèces de *Phyllanthus* ou de *Psychotria* (Brooks, 1998), ce désavantage pourrait être compensé par leur croissance plus rapide et leur biomasse potentiellement plus importante.

Lien entre la diversité phylogénétique et la valeur de la biodiversité

Il existe de nombreuses façons de mesurer la biodiversité (Purvis & Hector, 2000). Une des mesures les plus récemment apparues est la diversité phylogénétique (Faith, 1992). Selon cette approche, toutes les espèces n'ont pas la même valeur. Certaines sont plus originales que d'autres. Par exemple, on peut considérer que l'unique espèce de *Welwitschia* a davantage de valeur que l'une des nombreuses espèces de pissenlit (*Taraxacum*, Vane-Wright *et al.*, 1991). La diversité phylogénétique se mesure ainsi comme la somme des histoires évolutives des espèces d'une communauté. Bien que la diversité phylogénétique et la diversité spécifique soient étroitement corrélées (Rodrigues & Gaston, 2002), il existe néanmoins des exceptions selon les groupes, les zones et les échelles géographiques (Pillon *et al.*, 2006; Forest *et al.*, 2007).

Si plusieurs auteurs ont défendu l'importance de préserver la diversité phylogénétique (Faith, 1992; Mace *et al.*, 2003), les raisons sont souvent restées assez philosophiques. Cependant, le lien entre systématique et activité biologique a pu être testé grâce à une étude sur la mesure de l'activité biologique d'une cinquantaine d'espèces de Cunoniaceae contre dix souches microbiennes suivant un protocole standard (Fogliani *et al.*, 2002a). Il a ainsi été observé que les espèces proches d'un point de vue phylogénétique avaient plus de chance de présenter une activité biologique similaire (article VIII). De même plus des espèces sont éloignées, plus elles ont de chance de posséder une activité biologique différente. De la même manière des liens entre la phylogénie et l'utilité médicinale ou économique des plantes d'Afrique du Sud (Forest *et al.*, 2007) ou entre la phylogénie et la composition chimique des espèces du genre *Narcissus* (Rønsted *et al.*, 2008) ont été observés. Ainsi la préservation d'un maximum de diversité phylogénétique permet de préserver un maximum d'usage potentiel des plantes, notamment pharmaceutique.

Un autre exemple qui permet d'illustrer l'importance de la diversité phylogénétique est le cas d'*Amborella trichopoda*, de la famille monotypique et endémique des Amborellaceae, considérée à partir 1997 comme le groupe frère de toutes les autres angiospermes actuelles (Soltis *et al.*, 1997; Mathews & Donoghue, 1999; Soltis *et al.*, 1999). En comparaison avec les quatre autres familles endémiques de Nouvelle-Calédonie, le nombre de publications scientifiques concernant *Amborella* a augmenté brutalement à compter de cette date (Pillon & Munzinger, 2005). Cette plante possède une valeur importante pour la communauté scientifique. Les études de cette espèce située à la base de l'arbre des angiospermes sont déterminantes dans la compréhension de l'évolution des plantes à fleurs. En effet, un caractère présent chez *Amborella* et toute autre espèce d'angiospermes est probablement ancestral à l'ensemble des plantes à fleurs. De plus, on peut s'attendre à ce *qu'Amborella* ait conservé certains caractères primitifs disparus chez la plupart des angiospermes comme l'absence de vaisseaux (Bailey & Swamy, 1948). De plus l'abondance des transferts de gènes horizontaux dans le génome mitochondrial de cette espèce (Bergthorsson *et al.*, 2004) explique également l'intérêt que lui porte les scientifiques. Il est d'ailleurs possible que le génome entier d'*Amborella* soit bientôt séquencé (Soltis *et al.*, 2008).

Menaces sur la flore de la Nouvelle-Calédonie

Les menaces pesant actuellement sur la flore de la Nouvelle-Calédonie sont nombreuses et ont été synthétisées par Morat *et al.* (1999) : les feux, l'exploitation minière, les activités agro-pastorales, la surexploitation et le prélèvement abusif de certaines espèces, l'invasion par certaines espèces végétales introduites. A cette liste viennent s'ajouter aussi l'urbanisation, et les cerfs, en particulier pour la forêt sèche (Bouchet *et al.*, 1995). Parmi ces menaces citées, deux sont particulièrement importantes pour les Cunoniaceae de Nouvelle-Calédonie : les incendies et l'exploitation minière.

La présence de charbon dans les sédiments anciens montre qu'il y avait des feux en Nouvelle-Calédonie bien avant l'arrivée des premiers hommes (Stevenson *et al.*, 2001). Il est possible que ces feux aient une importance dans le maintien d'une végétation non-forestière comme le maquis minier. En effet, les feux ont un rôle déterminant dans la répartition des écosystèmes (Bond *et al.*, 2005), et notamment dans la persistance du fynbos dans la flore du Cap en Afrique du Sud (Goldblatt & Manning, 2002), qui est une végétation arbustive riche en Proteaceae, rappelant le maquis minier néo-calédonien. Des espèces de Cunoniaceae très distinctes d'un point de vue morphologique et d'origines probablement anciennes ne s'observent que dans le maquis, telles que *Cunonia macrophylla*, *C. schinziana* et *Pancheria hirsuta* (figure 16). Il est donc probable que ce type de végétation soit relativement ancien.

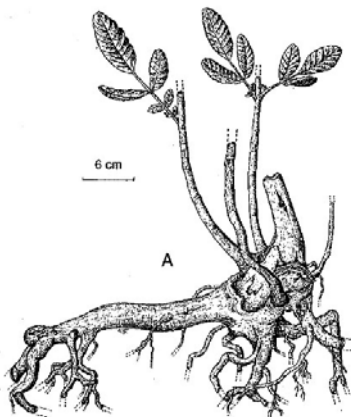

Figure 16. Rejet de *Pancheria hirsuta* après un incendie, d'après Jaffré *et al.* (1998b)

Si plusieurs espèces de Cunoniaceae de maquis comme *Pancheria hirsuta* sont capables de repartir après un feu à partir de rejets (Jaffré *et al.*, 1998b), ceci ne semble pas nécessairement généralisable à l'ensemble de la famille. *Pancheria robusta* est une espèce d'arbuste de maquis d'altitude connu seulement de trois localités : la Montagne des Sources, le Mont Kouakoué et le Mont Pénari. Une partie de la réserve intégrale de la Montagne

des Sources a été affectée par un feu en décembre 2005. Un an après ce feu, les individus de *P. robusta* affectés par ce feu n'avaient pas produit de rejet et sont probablement morts. Cette espèce ne semble donc pas résistante au feu, ou du moins aux feux intenses. Elle possède les feuilles les plus coriaces du genre et de la famille en Nouvelle-Calédonie, ce qui est probablement lié aux conditions de vie difficile caractérisant les maquis d'altitude sur roches ultramafiques. De plus, il est possible qu'il y ait un compromis entre la résistance au feu et à l'adaptation à des conditions environnementales extrêmes. A l'instar du chêne-gomme

(*Arillastrum gummiferum*, Myrtaceae), il est également probable qu'un certain nombre d'espèces forestières ne soit pas résistant au feu.

A ce jour, la plupart des sites miniers en activité en Nouvelle-Calédonie se trouve sur la côte est entre Thio et Houaïlou, et sur la côte ouest de Poya à Poum. Ces zones de roches ultramafiques ne possèdent aucun espace légalement protégé, bien que l'on y trouve des espèces à répartition restreinte. Par exemple *Codia ferruginea* et *Geissois magnifica* ne se trouvent que sur les roches ultramafiques de la côte est, *Codia triverticillata* et *Geissois lanceolata* ne se trouvent que sur les massifs ultramafiques de la côte ouest. Le sud de la Nouvelle-Calédonie possède la plus forte concentration d'espèces de Cunoniaceae dont un certain nombre est relativement rare. Par exemple, *Codia jaffrei*, *Cunonia cerifera* et *Spiraeanthemum pedunculatum* ne sont connus que de quelques forêts et ont une aire de répartition déjà très fragmentée suite aux exploitations forestières passées et aux passages successifs des feux. Le démarrage de l'exploitation des latérites du sud risque donc à nouveau de réduire les populations de telles espèces. Il faut également rappeler que la plupart des espaces naturels protégés ne bénéficient pas d'une interdiction complète de l'exploitation minière (Jaffré *et al.*, 1998a) ceci concerne notamment les Monts Humboldt et Kouakoué, importants sites d'endémisme pour les Cunoniaceae (Munzinger *et al.*, 2008, article II).

Une menace importante qui n'avait pas encore été évoquée par Morat *et al.* (1999) est le réchauffement climatique. Certains de ses effets sont aujourd'hui bien connus du grand public : montée du niveau de la mer, blanchiment du corail (Hoegh-Guldberg *et al.*, 2007), accroissement de l'intensité des cyclones (Emanuel, 2005), etc. Le réchauffement climatique induit également des changements dans la répartition des espèces vers les pôles et les plus hautes altitudes afin de se maintenir dans leur optimum de température (Parmesan *et al.*, 1999; Parmesan & Yohe, 2003). De nombreuses espèces risquent de ne pas être capable de migrer suffisamment vite et seraient ainsi menacées d'extinction (Thomas *et al.*, 2004),

notamment si elles ont des capacités de dispersion limitées et si leur habitat est fragmenté. Pour les espèces d'altitude, le réchauffement climatique provoque une réduction inéluctable de la surface d'habitat adéquate (Thomas *et al.*, 2006). Un écosystème qui serait particulièrement menacé par le réchauffement climatique sont les forêts humides d'altitudes, dites « forêts à mousse » (Nasi *et al.*, 2002), « forêts à nuage » ou forêts oro-néphéliques (Virot, 1956). Ces forêts où les troncs d'arbres sont couverts de nombreuses épiphytes, mousses, orchidées, mais surtout d'hépatiques et de fougères (Hymenophyllaceae) qui correspondent à des conditions climatiques et orographiques très particulières (Pounds *et al.*, 1999; Still *et al.*, 1999). De telles formations sont présentes en Nouvelle-Calédonie, notamment sur les Monts Mou et Humboldt. Si de nombreuses études sur les effets du réchauffement climatique ont été réalisées en Europe et en Amérique du Nord, son impact a aussi été observé de façon claire en Nouvelle-Zélande (Wardle & Coleman, 1992), mais n'a pas encore fait l'objet d'étude en Nouvelle-Calédonie.

En Nouvelle-Calédonie, de nombreuses espèces sont restreintes aux végétations montagnardes, comme les familles endémiques des Paracryphiaceae et Strasburgeriaceae, ainsi que de nombreuses espèces de *Metrosideros* (Myrtaceae) ou de Cunoniaceae. Le maquis montagnard des Monts Humboldt, Kouakoué et de la Montagne des Sources est ainsi l'habitat unique de 19 espèces rares et aujourd'hui menacées (Munzinger *et al.*, 2008). De la même manière, la chaîne du Mont Panié (incluant les Mont Colnett et Ignambi) possède plusieurs espèces micro-endémiques qui ne sont rencontrées que dans la végétation orophile (Venter & Munzinger, 2007; Hopkins *et al.*, sous presse; Pillon & Nootboom, sous presse). Chez les Cunoniaceae, *Pancheria rubrivenia* apparaît comme une espèce particulièrement menacée (Figure 17). Celle-ci n'est connue que de deux montagnes, le Mont Tonine (1076 m) et le Mont Grandié (948 m). La population du Mont Tonine est confinée à l'arrête sommitale, à environ 30 m sous le sommet (obs. pers. 25 mai 2006). L'état de la population du Mont



Figure 16. Mont Tonine (Touho) avec *Pancheria rubrivenia* en médaillon

Grandié n'est pas connu, mais ce massif étant plus bas et plus petit, on peut s'attendre à ce que la population ne soit pas plus importante. En Californie, l'altitude moyenne des espèces dominantes des montagnes de Santa Rosa a augmenté de 65m en trente ans (Kelly

& Goulden, 2008). Si *P. rubrivenia* réagit de la même façon, l'espèce pourrait s'éteindre prochainement.

Un des impacts du réchauffement climatique qui a été le plus fréquemment observé est la migration des espèces vers les pôles, comme la migration des espèces européennes de papillons vers le nord pour se maintenir à leur optimum de température (Parmesan *et al.*, 1999; Parmesan & Yohe, 2003). En Nouvelle-Calédonie, le réchauffement climatique pourrait ainsi pousser les espèces à migrer vers le Sud ; l'extrémité sud de Grande-Terre pourrait ainsi jouer le rôle de refuge dans les décennies et justifie sa préservation.

Modalités de préservation de la flore de Nouvelle-Calédonie

Préservation des lignées anciennes



Figure 18 *Strasburgeria robusta*

La Nouvelle-Calédonie est remarquable par la concentration des lignées anciennes qu'elle possède. Cinq familles de plantes à fleurs sont endémiques à l'archipel : Amborellaceae, Oncothecaceae, Paracryphiaceae, Phellinaceae et Strasburgeriaceae (Figure 18). De plus la Nouvelle-Calédonie est le principal centre de diversité de plusieurs familles comme

les Balanopaceae, les Myodocarpaceae et les Sphenostemonaceae. Elle partage avec la Tasmanie la famille des Campynemataceae et avec la Nouvelle-Zélande les Xeronemataceae.

D'autres espèces ont une position phylogénétique remarquable (tableau 3). Le genre endémique *Canacomyrica* est le groupe frère de tout le reste des Myricaceae (Herbert *et al.*, 2006) et le genre endémique *Platyspermatum* est le groupe frère du reste des Alseuosmiaceae (Lundberg & Bremer, 2003).

Tableau 3. Exemple de groupes reliques présents en Nouvelle-Calédonie

Genre endémique	Age de la lignée	Référence
<i>Amborella</i>	140-180 Ma	Bell et al. (2005)
<i>Paracryphia</i>	78 Ma	Bremer et al. (2004)
<i>Campynemanthe</i>	73 Ma	Janssen & Bremer (2004)
<i>Nemuaron</i>	70 Ma	Renner (2004)
<i>Hooglandia</i>	65 Ma	Pillon et al., obs. pers.
<i>Phelline</i>	62 Ma	Bremer et al. (2004)

Comme nous l'avons indiqué plus haut, la persistance de ces lignées anciennes pourrait s'expliquer par une relative stabilité climatique de la Nouvelle-Calédonie au cours du Tertiaire et par la présence plus ou moins continue de forêts humides, alors que l'Australie a connu une aridification marquée à la fin du Tertiaire (Morley, 2001).

La Nouvelle-Calédonie recèle donc une importante diversité phylogénétique. L'unique espèce d'*Amborella*, aurait une plus grande valeur qu'une espèce de *Phyllanthus*, dont il existe plus d'un millier d'espèces à travers le monde et plus d'une centaine en Nouvelle-Calédonie (Schmid, 1991). La disparition d'*Amborella trichopoda* impliquerait donc la disparition d'un genre, d'une famille et d'un ordre entier, ainsi que le seul témoin d'au moins 140 millions d'années d'histoire évolutive.

La famille des Cunoniaceae illustre à elle seule les contrastes présents dans la flore de Nouvelle-Calédonie entre des lignées rares et anciennes comme le genre monotypique *Hooglandia* et des radiations importantes comme les genres *Cunonia* et *Pancheria*. Les différents hotspots de biodiversité à travers le monde présentent clairement des différences en terme de diversité phylogénétique. Par exemple, l'essentiel des espèces végétales endémiques du Karoo, une zone semi désertique d'Afrique du Sud, appartient à une radiation massive et rapide d'une seule famille, les Aizoaceae (Klak *et al.*, 2004). Une telle zone possède donc une diversité phylogénétique faible malgré le grand nombre d'espèces présente et son fort taux d'endémisme. La Nouvelle-Calédonie serait davantage comparable à des zones comme la province du Cap (Goldblatt & Manning, 2002) ou le sud-ouest de l'Australie (Hopper & Gioia, 2004), qui contiennent à la fois des groupes reliques et des radiations récentes. La préservation de cette diversité phylogénétique nécessite donc des stratégies de conservation ciblées sur des espèces reliques, notamment une conservation ex-situ.

Comme la stabilité climatique de la Nouvelle-Calédonie explique peut être la persistance de plusieurs lignées anciennes (Morley, 2001), à une échelle locale celles-ci pourraient être encore plus abondantes dans certaines zones particulières de l'archipel. En effet les zones à plus fortes précipitations (figure 15) ont pu servir de refuge pendant les évènements glaciaires du Tertiaire et du Quaternaire et auraient ainsi une plus forte richesse spécifique et un plus fort taux de micro-endémisme, ce sont notamment le massif du nord-est, le massif des Lèvres, le massif du sud et la plaine des lacs (Pintaud & Jaffré, 2001; Pintaud *et al.*, 2001). Ces zones possèdent également une plus forte concentration d'espèces parentales chez *Codia*. Des études sur d'autres groupes que les palmiers et les Cunoniaceae, seraient désirables pour confirmer l'existence de tels refuges et leur délimitation, notamment des études de génétique des populations à l'échelle infra-spécifique. Comme cela est observé pour les refuges d'Europe, on peut également s'attendre à observer une plus grande originalité

génétique (Petit *et al.*, 2003), mais ceci reste à confirmer pour la Nouvelle-Calédonie. Ces zones sont donc d'excellentes candidates comme aires protégées, en particulier dans le contexte d'un réchauffement climatique global (voir ci-dessous).

Préservation des processus de diversification



Figure 18. Mont Koghis

La biodiversité est régie à une échelle locale et globale par des processus de colonisation et d'extinction locale, de spéciation et d'extinction globale d'espèces (Hubbell, 2001). Cependant il est désormais admis que le taux d'extinction s'est considérablement accru au cours des derniers siècles sous l'effet des activités humaines (Gaston & Spicer, 1998). Au-delà de la préservation de chacune des espèces vivantes, il est également important de préserver les conditions nécessaires aux processus qui génèrent de la biodiversité et notamment de nouvelles espèces (Erwin, 1991; Cowling & Pressey, 2001; Moritz, 2002).

Les processus d'hybridation semblent relativement importants dans la genèse de nouvelles espèces dans les genres *Codia* et peut-être aussi chez *Spiraeanthemum* (article VI & VII). Des études sur d'autres groupes seraient néanmoins nécessaires pour évaluer dans quelles mesures cela s'étend aux autres familles de plantes à fleurs de Nouvelle-Calédonie. Les fluctuations climatiques passées et les migrations qu'elles ont impliquées ont permis à certaines espèces de se trouver transitoirement en contact et de s'hybrider. D'autres zones favorables au phénomène d'hybridation sont les interfaces entre milieux distincts où des espèces qui ne cohabitent pas d'ordinaire se trouvent à proximité les unes des autres. Les Monts Koghis (figure 19) représentent une telle interface où le substrat est constitué d'une matrice complexe de péridotites, serpentines et de roches volcano-sédimentaires. Cet espace

permet ainsi de regrouper côte à côte des espèces comme *Cunonia balansae*, restreint aux sols ultramafiques, *C. austrocaledonica*, restreint aux roches volcano-sédimentaires, ainsi que des espèces à écologie plus large comme *C. linearisepala*. Il est probable qu'un évènement d'hybridation entre deux de ces espèces soit à l'origine de la formation de *C. koghicola* (article II). Deux espèces sont par ailleurs connues seulement des Mont Koghis, *Lasiochlamys tricostemona* (Flacourtiaceae), et *Burretiokentia koghiensis* (Arecaceae), mais une éventuelle origine hybride de celles-ci n'a pas encore été envisagée ou testée à notre connaissance. Ces sites présentant une interface aussi complexe entre milieux différents et possédant encore une végétation bien préservée ne sont pas si fréquents et devraient être préservés. Ainsi la forêt de la Thy présente aussi le même type d'interface que les Mont Koghis avec également la présence de granite. Le col de Pétchikara entre Thio et Canala présente une alternance de roches volcano-sédimentaires, de serpentines et de péridotites qui se traduit de manière visible par l'alternance de populations de *Geissois racemosa* (restreint aux sols non-ultramafiques) et de *Geissois magnifica* (restreint aux sols ultramafiques), qui ne se côtoient pas d'ordinaire.

La préservation des processus de diversification serait une stratégie probablement plus efficace, simple et économique à mettre en place pour les groupes à diversification intense et rapide. Les genres en cours de radiation peuvent posséder de nombreuses espèces rares et mal délimitées, comme des espèces d'origine hybride, à faible originalité phylogénétique. Plutôt que de consacrer un grand effort à préserver de telles espèces, il est préférable de s'assurer que les conditions nécessaires à leur formation soient maintenues (Pillon *et al.*, 2006). Typiquement, il est probablement plus avantageux économiquement de maintenir les conditions nécessaires à la formation d'une espèce comme *C. koghicola*, ce qui sera également probablement favorable à la diversification d'autres groupes de plantes, plutôt que de préserver cette espèce en particulier qui est peut être reproductible.

Le risque de l'homogénéisation

La flore de Nouvelle-Calédonie possède un taux d'endémisme exceptionnel la classant au troisième rang des flores insulaires (Jaffré *et al.*, 2001). Cette flore est également très structurée avec un micro-endémisme marqué (Bradford & Jaffré, 2004; Munzinger *et al.*, 2008). Celui-ci s'explique notamment par la diversité des conditions édaphiques car de nombreuses espèces ont des exigences écologiques étroites. Le relief accidenté présente à la fois des barrières favorisant l'isolement des populations et des montagnes isolées où certaines espèces sont adaptées aux conditions montagnardes. Les îles Belep, les îles Loyauté et l'île des Pins constituent également des zones isolées propices à la dérive génétique et la formation de nouvelles espèces, tout comme les massifs miniers de la côte ouest qui offrent une structure en inselberg. Les fluctuations climatiques du passé ont également largement influencé l'histoire évolutive des plantes et leur répartition actuelle. Comme le suggérait Stephen Jay Gould (1989), il est probable que si le film de la vie était rejoué, le résultat ne pourrait qu'être différent.

La structuration de la flore semble de plus sous-estimée étant donné la présence d'espèces cryptiques dans le genre *Spiraeanthemum* (article VII), liées aux conditions écologiques et à la géographie. Des études similaires sur d'autres groupes seraient nécessaires pour évaluer la fréquence de telles espèces cryptiques. Peu d'études de génétique des populations sont encore disponibles pour vérifier si la structuration géographique des espèces au sein d'un genre se reflète dans la structure génétique au sein d'une espèce. Les seules études disponibles sur le santal (Bottin *et al.*, 2005; Bottin *et al.*, 2007) et deux espèces de pins colonnaires (*Araucaria columnaris* et *A. nemorosa*, Kettle *et al.*, 2007) suggèrent une différenciation génétique importante des populations. Cependant, ces espèces ne sont pas réellement représentatives de la flore de Nouvelle-Calédonie, car elles sont rares et menacées pour deux d'entre elles, et sont restreintes à la forêt sèche ou aux milieux côtiers. La structure

génétique des espèces présentes sur les massifs miniers de la côte ouest en particulier mériterait d'être étudiée. La biodiversité peut également se mesurer également en terme de diversité génétique, qui détermine quant à elle le potentiel évolutif des espèces (Lande, 1988). La préservation d'une simple liste d'espèces n'est donc pas suffisante, il est également nécessaire de préserver la diversité génétique présente en chacune d'elle pour assurer leur pérennité.

Les introductions d'espèces étrangères constituent non seulement une menace pour la flore de Nouvelle-Calédonie (Gargominy *et al.*, 1996), mais contribue également à une banalisation de celle-ci car des espèces endémiques rares sont souvent remplacées par des espèces dont la répartition est souvent large, traduisant un phénomène d'homogénéisation biologique à l'échelle globale (Lockwood *et al.*, 2000). De plus une homogénéisation est également possible lorsque ce sont des espèces indigènes qui sont multipliées et replantées, notamment en Nouvelle-Calédonie dans le cadre de la restauration écologique des sites miniers. Ainsi, des essais de replantation au sommet du Mont Kaala (Province nord) ont été réalisés avec *Geissois pruinosa*, une espèce assez commune, mais restreinte à la Province Sud. Une espèce de *Geissois* est pourtant connue à la base du massif du Kaala : *G. intermedia*. Ceci illustre le risque que quelques espèces dont la multiplication est maîtrisée soient replantées indistinctement sur les différents massifs miniers. Lorsque des espèces du même genre sont déjà présentes sur le site, des cas d'hybridation qui auraient autrement été impossible pourraient être observés. Si l'hybridation peut être à l'origine de nouvelles espèces, elle peut également dans certains cas en menacer d'autres. Ainsi, une espèce rare peut être « absorbée » génétiquement par une espèce plus commune et disparaître (Bleeker *et al.*, 2007), comme dans le cas de *Cercocarpus traskiae* (Rosaceae, Rieseberg & Gerber, 1995). Il est donc préférable d'utiliser systématiquement les espèces présentes sur les sites miniers avant exploitation, ce qui nécessite des inventaires adéquats et la maîtrise de la culture de

nombreuses espèces. Ces recommandations devraient être également appliquées à tout projet de transplantations d'espèces, comme la reforestation. De plus, il n'est pas suffisant d'utiliser les espèces locales, mais il est aussi nécessaire d'utiliser les génotypes locaux. Ceux-ci peuvent dans certains cas présenter des adaptations locales qui leur assureront un meilleur développement (Broadhurst *et al.*, 2006). De plus un génotype étranger peut lui aussi se montrer envahissant au sein d'une population végétale locale, ce qui peut aboutir à l'homogénéisation génétique d'une espèce (Howard *et al.*, 2008). L'utilisation des individus présents localement sur le site comme source génétique est également un moyen idéal pour éviter d'utiliser une espèce cryptique à la place d'une autre, surtout en l'absence d'étude génétique. Le maintien de la diversité génétique dans les banques de graines ou les pépinières et le suivi de leurs origines sont donc des challenges importants pour la restauration écologique (Broadhurst *et al.*, 2006; Kettle *et al.*, 2008).

Conclusions

*Parana la terre devant toi attend tes plantations
Pense à demain,
Demain au soleil plein de questions.*

*Henri Hizo
Invocation [extrait]*

Une mise au point systématique de la famille des Cunoniaceae indique qu'elle est finalement composée de 88 espèces et 7 genres en Nouvelle-Calédonie. De nouvelles espèces ont été décrites dans les genres *Codia* et *Cunonia*, quatre espèces sont en cours de description dans le genre *Pancheria* et une dans le genre *Cunonia* (Hopkins *et al.*, sous presse). Le genre *Acsmithia* est paraphylétique et doit être considéré comme un synonyme du genre *Spiraeanthemum*.

La composition originale de la flore de Nouvelle-Calédonie et plus particulièrement l'abondance et la diversité des Cunoniaceae pourraient s'expliquer par une exaptation de certaines lignées aux sols ultramafiques de l'archipel. Au-delà des capacités de dispersion, la prédisposition de certaines lignées à se développer sur les terrains miniers aurait déterminé le succès de différents groupes de plantes lors de l'installation sur l'archipel. Ce facteur pourrait ainsi affecter sensiblement la biogéographie de la Nouvelle-Calédonie car celle-ci n'aurait pas été nécessairement colonisée par les sources les plus proches, mais parfois par des plantes d'origine lointaine mais possédant l'exaptation aux sols ultramafiques. Bien que l'exaptation reste une hypothèse qui mérite encore d'être confortée, elle pourrait cependant être utilisée pour cibler les études de l'adaptation des plantes aux sols ultramafiques, notamment de la tolérance et de l'hyperaccumulation des métaux lourds, sur différents groupes qui possèderaient cette exaptation, à savoir le clade COM (Celastrales, Oxalidales, Malpighiales), les Sapindales, les Myrtaceae, les Apiales, les Gentianales et le groupe des Myrsinaceae. Le même mécanisme adaptatif aurait pu apparaître à plusieurs reprises au sein de chaque groupe,

mais les mécanismes adaptatifs de ces ensembles pourraient être différents. Ceci permettrait d'orienter les recherches sur l'accumulation des métaux lourds par des plantes qui pourraient être par la suite utilisée pour la phytoremédiation ou la phytoextraction des métaux (Whiting *et al.*, 2004).

Les évènements d'hybridation ont joué un rôle important dans la radiation du genre *Codia*, et aurait permis une diversification morphologique et écologique, avec l'apparition de phénotypes transgressifs absents chez les parents comme les feuilles verticillées et l'adaptation aux phtanites. Des espèces cryptiques ont été détectées chez *Spiraeanthemum*, notamment chez *S. ellipticum* et *S. pubescens* qui se développent à la fois sur sols ultramafiques et non-ultramafiques. Elles seraient chacune constituées de deux espèces correspondant aux deux types de sols. Davantage de travaux moléculaires seraient nécessaires pour affiner notre vision de l'évolution des genres *Codia* et *Spiraeanthemum* avec un échantillonnage plus conséquent et en utilisant plutôt des méthodologies empruntées à la génétique des populations comme les AFLPs (Amplified Fragment Length Polymorphisms).

Les exemples d'espèces cryptiques sont rares chez les plantes (Bickford *et al.*, 2007) et méritent davantage d'études, notamment en Nouvelle-Calédonie sur d'autres familles que les Cunoniaceae. La présence d'espèces cryptiques chez des plantes à large écologie suggère que davantage d'attention doit être donnée à celles-ci dans les traitements taxonomiques. Il est également probable que la richesse spécifique de la Nouvelle-Calédonie soit sous-estimée.

Des études phylogénétiques complémentaires sur les genres *Cunonia* et *Pancheria* seraient aussi utiles pour comprendre l'évolution des espèces micro-endémiques d'altitude, nombreuses dans ces genres, et également de confirmer l'origine hybride de *C. koghicola*. Cependant l'étude d'autres familles sera également nécessaire car les Cunoniaceae ne sont pas entièrement représentative de la flore de la Nouvelle-Calédonie. Par exemple, la famille des Cunoniaceae présentent un micro-endémisme assez faible sur les massifs miniers de la côte

ouest, qui représentent un milieu très fragmenté et menacé, qui est au contraire très marqué chez les genres *Phyllanthus* (114 espèces, Phyllanthaceae) et *Medicosma* (15 espèces, Rutaceae). Ceci permettrait de comprendre la diversification des plantes sur ces massifs comparables à des inselbergs qui représentent un milieu très fragmenté et menacé. De plus la famille des Cunoniaceae est absente de la forêt sèche et des îles Loyauté, contrairement au genre *Diospyros* (34 espèces, Ebenaceae) qui y est bien représenté. Des études préliminaires sont disponibles pour ce genre, mais la résolution est assez faible au sein de la radiation néo-calédonienne (Duangjai *et al.*, soumis). Enfin, il n'existe pas chez les Cunoniaceae d'espèces qui ont des exigences édaphiques fortes comme des espèces inféodées aux serpentines (au sens strict) ou aux roches calcaires, contrairement à des groupes comme le genre *Acropogon* (23 espèces, Malvaceae) ou la famille des Sapotaceae.

La flore de la Nouvelle-Calédonie possède une importante diversité phylogénétique, or celle-ci est étroitement liée à la valeur de la biodiversité, notamment son potentiel pharmaceutique, ce qui justifie sa préservation. *Amborella*, en particulier, possède une grande valeur scientifique qui continuera probablement à grandir dans les années à venir. Une grande attention doit donc être donnée à la préservation des lignées reliques. Il est également nécessaire de s'assurer de la pérennité des processus de diversification qui permettent la production de nouvelles espèces. Les sites présentant une mosaïque complexe de substrat favorable aux phénomènes d'hybridation devraient être préservés. La flore de Nouvelle-Calédonie étant naturellement très structurée avec un micro-endémisme important, il est nécessaire de respecter cette structure en limitant la transplantation irraisonnée d'espèces introduites ou indigènes. La conservation de la biodiversité de Nouvelle-Calédonie devra faire face à d'importants défis pour les décennies à venir : les feux de brousse, les espèces envahissantes, un développement minier soutenu, et le réchauffement climatique dont les conséquences sont encore peu étudiées.

Bibliographie

- Abbott RJ, Brochmann C (2003) History and evolution of the Arctic flora: in the footsteps of Eric Hultén. *Molecular Ecology* **12**, 299-313.
- Ackerly DD (2004) Adaptation, niche conservatism and convergence: comparative studies of leaf evolution in the California chaparral. *The American Naturalist* **163**, 654-671.
- Angiosperm Phylogeny Group II (2003) An update of the Angiosperm Phylogeny Group classification for the orders and families of flowering plants: APG II. *Botanical Journal of the Linnean Society* **141**, 399-436.
- Bailey IW, Swamy BGL (1948) *Amborella trichopoda* Baill., a new morphological type of vesselless dicotyledon. *Journal of the Arnold Arboretum* **29**, 245-254.
- Baldwin BG (1997) Adaptive radiation of the Hawaiian silversword alliance: congruence and conflict of phylogenetic evidence from molecular and non-molecular investigations. In: *Molecular evolution and adaptive radiation* (eds. Givnish TJ, Sytsma KJ), pp. 103-128. Cambridge University Press, Cambridge, United Kingdom.
- Barbará T, Martinelli G, Fay MF, Mayo SJ, Lexer C (2007) Population differentiation and species cohesion in two closely related plants adapted to neotropical high-altitude 'inselberg', *Alcantarea imperalis* and *Alcantarea geniculata* (Bromeliaceae). *Molecular Ecology* **16**, 1981-1992.
- Barnes RW, Hill RS, Bradford JC (2001) The history of Cunoniaceae in Australia from macrofossil evidence. *Australian Journal of Botany* **49**, 301-320.
- Bartish IV, Swenson U, Munzinger J, Anderberg AA (2005) Phylogenetic relationships among New Caledonian Sapotaceae (Ericales): molecular evidence for generic polyphyly and repeated dispersal. *American Journal of Botany* **92**, 667-673.
- Bell CD, Soltis DE, Soltis PS (2005) The age of the angiosperms: a molecular timescale without a clock. *Evolution* **59**, 1245-1258.
- Bergthorsson U, Richardson AO, Young GJ, Goertzen LR, Palmer JD (2004) Massive horizontal transfer of mitochondrial genes from diverse land plant donors to the basal angiosperm *Amborella*. *Proceedings of the National Academy of Science of the USA* **101**, 17747-17752.
- Bickford D, Lohman DJ, Sodhi NS, *et al.* (2007) Cryptic species as a window on diversity and conservation. *Trends in Ecology and Evolution* **22**, 148-155.
- Bleeker W, Schmitz U, Ristow M (2007) Interspecific hybridisation between alien and native plant species in Germany and its consequences for native biodiversity. *Biological Conservation* **137**, 248-253.
- Bond WJ, Woodward FI, Midgley GF (2005) The global distribution of ecosystems in a world without fire. *New Phytologist* **165**, 525-538.
- Bottin L, Verhaegen D, Tassin J, *et al.* (2005) Genetic diversity and population structure of an insular tree, *Santalum austrocaledonicum* in New Caledonian archipelago. *Molecular Ecology* **14**, 1979-1989.
- Bottin L, Tassin J, Nasi R, Bouvet J-M (2007) Molecular, quantitative and abiotic variables for the delineation of evolutionary significant units: case of sandalwood (*Santalum austrocaledonicum* Vieillard) in New Caledonia. *Conservation Genetics* **8**, 99-1009.
- Bouchet P, Jaffré T, Veillon J-M (1995) Plant extinction in New Caledonia: protection of sclerophyll forest urgently needed. *Biodiversity and Conservation* **4**, 415-428.
- Bradford JC (1998) A cladistic analysis of species groups in *Weinmannia* (Cunoniaceae) based on morphology and inflorescence structure. *Annals of the Missouri Botanical Garden* **85**, 565-593.

- Bradford JC, Barnes RW (2001) Phylogenetics and classification of Cunoniaceae (Oxalidales) using chloroplast DNA sequences and morphology. *Systematic Botany* **26**, 354-385.
- Bradford JC (2002) Molecular phylogenetics and morphological evolution in Cunoniaceae (Cunoniaceae). *Annals of the Missouri Botanical Garden* **89**, 491-503.
- Bradford JC, Hopkins HCF, Barnes RW (2004) Cunoniaceae. In: *The families and genera of vascular plants* (ed. Kubitzki K), pp. 91-111. Springer, Berlin.
- Bradford JC, Jaffré T (2004) Plant species microendemism and conservation of montane maquis in New Caledonia: two new species of *Pancheria* (Cunoniaceae) from the Roche Ouaième. *Biodiversity and Conservation* **13**, 2253-2273.
- Bremer K, Friis EM, Bremer B (2004) Molecular phylogenetic dating of Asterid flowering plants shows early Cretaceous diversification. *Systematic Biology* **53**, 496-505.
- Broadhurst LM, Thrall AG, Murray BG (2006) Sourcing seed for *Acacia acinacea*, a key revegetation species in south eastern Australia. *Conservation Genetics* **7**, 49-63.
- Brooks RR (1998) Geobotany and hyperaccumulators. In: *Plants that hyperaccumulate heavy metals. Their role in phytoremediation, microbiology, archaeology, mineral exploitation and phytomining* (ed. Brooks RR), pp. 55-94. CAB International, Wallingford.
- CIRAD-Forêt (1992) *Bois des DOM-TOM. Tome III - Nouvelle-Calédonie*. Département forestier du CIRAD, Nogent-sur-Marne.
- Clement WL, Tebbitt MC, Forrest LL, *et al.* (2004) Phylogenetic position and biogeography of *Hillebrandia sandwicensis* (Begoniaceae): a rare Hawaiian relict. *American Journal of Botany* **91**, 905-917.
- Cowling RM, Pressey RL (2001) Rapid plant diversification: planning for an evolutionary future. *Proceedings of the National Academy of Science of the USA* **98**, 5452-5457.
- Davies TJ, Barraclough TG, Chase MW, *et al.* (2004a) Darwin's abominable mystery: insights from a supertree of the angiosperms. *Proceedings of the National Academy of Science of the USA* **101**, 1904-1909.
- Davies TJ, Barraclough TG, Savolainen V, Chase MW (2004b) Environmental causes for plant biodiversity gradients. *Philosophical Transactions of the Royal Society of London B* **359**, 1645-1656.
- de Kok R (2002) Are plant adaptations to growing on serpentine soil rare or common? A few case studies from New Caledonia. *Adansonia* **24**, 229-238.
- de Laubenfels DJ (1959) Parasitic conifer found in New Caledonia. *Science* **130**, 97.
- de Laubenfels DJ (1996) Gondwanan conifers on the Pacific Rim. In: *The origin and evolution of Pacific Islands biotas, New Guinea to Eastern Polynesia: patterns and processes* (eds. Keast A, Miller SE), pp. 261-265. SPB Academic Publishing, Amsterdam.
- Duangjai S, Munzinger J, Samuel R, *et al.* (soumis) Origin and evolution of endemic *Diospyros* (Ebenaceae) species from New Caledonia. *Molecular Phylogenetics and Evolution*.
- Emanuel K (2005) Increasing destructiveness of tropical cyclones over the past 30 years. *Nature* **436**, 686-688.
- Erwin TL (1991) An evolutionary basis for conservation strategies. *Science* **253**, 750-752.
- Faith DP (1992) Conservation evaluation and phylogenetic diversity. *Biological Conservation* **61**, 1-10.
- Fogliani B, Bouraïma-Madjebi S, Medevielle V, Pineau R (2002a) Screening of 50 Cunoniaceae species from New Caledonia for antimicrobial properties. *New Zealand Journal of Botany* **40**, 511-520.

- Fogliani B, Bouraïma-Madjebi S, Pineau R, Cabalion P (2002b) Screening of fifty Cunoniaceae species from New Caledonia for inhibitors of xanthine oxidase and scavengers of superoxide anions. *Pharmaceutical Biology* **40**, 526-533.
- Fogliani B, Raharivelomanana P, Bianchini J-P, Bouraïma-Madjebi S, Hnawia E (2005) Bioactive ellagitannins from *Cunonia macrophylla*, an endemic Cunoniaceae of New Caledonia. *Phytochemistry* **66**, 241-247.
- Forest F, Grenyer R, Rouget M, *et al.* (2007) Preserving the evolutionary potential of floras in biodiversity hotspots. *Nature* **445**, 757-760.
- Francisco-Ortega J, Crawford DJ, Santos-Guerra A, Jansen RK (1997) Origin and evolution of *Argyranthemum* (Asteraceae: Anthemideae) in Macaronesia. In: *Molecular evolution and adaptive radiation* (eds. Givnish TJ, Sytsma KJ), pp. 407-431. Cambridge University Press, Cambridge.
- Gargominy O, Bouchet P, Pascal M, Jaffré T, Tourneur J-C (1996) Conséquences des introductions d'espèces animales et végétales sur la biodiversité en Nouvelle-Calédonie. *Rev. Ecol. (Terre Vie)* **51**, 375-402.
- Gaston KJ, Spicer JI (1998) *Biodiversity: an Introduction*. Blackwell Science Ltd., Oxford.
- Gauthier P, Lumaret R, Bedecarrats A (1998) Ecotype differentiation and coexistence of two parapatric tetraploid subspecies of cockfoot (*Dactylis glomerata*) in the Alps. *New Phytologist* **139**, 741-750.
- Gillet GW (1973) The genus *Cyrtandra* (Gesneriaceae) in the South Pacific. *University of California Publications in Botany* **66**, 1-59.
- Godard P, Jaffré T, Themereau A (1978) *Fleurs en Nouvelle-Calédonie. Tome I - Fleurs des jardins*. Les éditions françaises d'Océanie, Nouméa.
- Goldblatt P, Manning JC (2002) Plant diversity of the Cape region of southern Africa. *Annals of the Missouri Botanical Garden* **89**, 281-302.
- Gould SJ, Lewontin RC (1979) The spandrels of San Marco and the panglossian paradigm: a critique of the adaptationist programme. *Proceedings of the Royal Society of London B* **205**, 581-598.
- Gould SJ, Vrba ES (1982) Exaptation--a missing term in the science of form. *Paleobiology* **8**, 4-15.
- Gould SJ (1989) *Wonderful life: the Burgess shale and the nature of history*. W. W. Norton & Co., New York.
- Grandcolas P, Muriene J, Robillard T, *et al.* (2008) New Caledonia: a very old Darwinian island? *Philosophical Transactions of the Royal Society of London B* **363**, 3309-3317.
- Graur D, Martin W (2004) Reading the entrails of chickens: molecular timescales of evolution and the illusion of precision. *Trends in Ecology and Evolution* **20**, 80-86.
- Harper JL, Lovell PH, Moore KG (1970) The shape and sizes of seeds. *Annual Reviews of Ecology and Systematics* **1**, 327-356.
- Hartley TG (1985) A revision of the genus *Medicosma* (Rutaceae). *Australian Journal of Botany* **33**, 27-64.
- Herbert J, Chase MW, Möller M, Abbott RJ (2006) Nuclear and plastid DNA sequences confirm the placement of the enigmatic *Canacomyrca monticola* in Myricaceae. *Taxon* **55**, 349-357.
- Hewitt GM (2000) The genetic legacy of the Quaternary ice ages. *Nature* **405**, 907-913.
- Hickey LJ (1977) *Stratigraphy and paleobotany of the Golden Valley formation (early Tertiary) of western North Dakota*. The Geological Society of America, Inc.
- Hoegh-Guldberg O, Mumby PJ, Hooten AJ, *et al.* (2007) Coral reef under rapid climate change and ocean acidification. *Science* **318**, 1737-1742.
- Hoogland RD (1979) Studies in the Cunoniaceae. II. The genera *Caldcluvia*, *Pullea*, *Acsmithia* and *Spiraeanthemum*. *Blumea* **25**, 481-505.

- Hoogland RD (1987) Studies in the Cunoniaceae. IV. Further notes on New Caledonian *Acsmithia*. *Adansonia* **4**, 393-397.
- Hoogland RD, Jérémie J, Hopkins HCF (1997) Le genre *Cunonia* (Cunoniaceae) en Nouvelle-Calédonie. Description de cinq espèces nouvelles. *Adansonia* **19**, 7-19.
- Hopkins HCF, Florence J (1998) A revision of *Weinmannia* (Cunoniaceae) in Malesia and the Pacific. 4. The Society, Marquesas and Austral Islands. *Adansonia* **20**, 107-130.
- Hopkins HCF, Hoogland RD, Bradford JC (1998) A revision of *Weinmannia* (Cunoniaceae) in Malesia and the Pacific. 3. New Guinea, Solomon Islands, Vanuatu and Fiji, with notes on the species of Samoa, Rarotonga, New Caledonia and New Zealand. *Adansonia* **20**, 67-106.
- Hopkins HCF (2005) Nomenclature and typification in the endemic genus *Codia* (Cunoniaceae) from New Caledonia. *Adansonia* **27**, 243-254.
- Hopkins HCF (2006) Nomenclature and typification in *Geissois* (Cunoniaceae) in the South-West Pacific. *Adansonia* **28**, 311-327.
- Hopkins HCF (2007) *Geissois bradfordii*, a new species of Cunoniaceae from New Caledonia. *Kew Bulletin* **62**, 275-280.
- Hopkins HCF (2008) The morphology of stipules and inflorescences in *Geissois sensus stricto* (Cunoniaceae). *Kew Bulletin* **63**, 625-638.
- Hopkins HCF, Bradford JC (sous presse) Nomenclature and typification in the endemic genus *Pancheria* (Cunoniaceae) from New Caledonia. *Adansonia*.
- Hopkins HCF, Pillon Y, Bradford JC (sous presse) The endemic genus *Pancheria* (Cunoniaceae) in New Caledonia: notes on morphology and the description of three new species. *Kew Bulletin*.
- Hopper SD (1979) Biogeographical aspects of speciation in the South-West Australian flora. *Annual Reviews of Ecology and Systematics* **10**, 399-422.
- Hopper SD, Gioia P (2004) The Southwest Australian floristic region: evolution and conservation of a global hot spot of biodiversity. *Annual Reviews of Ecology and Systematics* **35**, 623-650.
- Howard RJ, Travis SE, Sikes BA (2008) Rapid growth of a Eurasian haplotype of *Phragmites australis* in a restored brackish marsh in Louisiana, USA. *Biological Invasions* **10**, 369-379.
- Hubbell SP (2001) *The Unified Neutral Theory of Biodiversity and Biogeography*. Princeton University Press, Princeton and Oxford.
- Hufford L, Dickison WC (1992) A phylogenetic analysis of Cunoniaceae. *Systematic Botany* **17**, 181-200.
- Jaffré T, Brooks RR, Lee J, Reeves RD (1976) *Sebertia acuminata*: a hyperaccumulator of Nickel from New Caledonia. *Science* **193**, 579-580.
- Jaffré T, Brooks RR, Trow JM (1979) Hyperaccumulation of Nickel by *Geissois* species. *Plant and Soil* **51**, 157-162.
- Jaffré T (1980) *Etude écologique du peuplement végétal des sols dérivés de roches ultrabasiques en Nouvelle-Calédonie*. ORSTOM, Paris.
- Jaffré T, Morat P, Veillon J-M, MacKee HS (1987) Changements dans la végétation de la Nouvelle-Calédonie au cours du Tertiaire : la végétation et la flore des roches ultrabasiques. *Adansonia* **4**, 365-391.
- Jaffré T, Veillon J-M (1990) Etude floristique et structurale de deux forêts denses humides sur roches ultrabasiques en Nouvelle-Calédonie. *Adansonia* **3-4**, 243-273.
- Jaffré T, Pelletier B (1992) *Plantes de Nouvelle-Calédonie permettant de révégétaliser des sites miniers*. Société Métallurgique le Nickel - SLN, Nouméa.
- Jaffré T (1993) The relationship between ecological diversity and floristic diversity in New Caledonia. *Biodiversity Letters* **1**, 82-87.

- Jaffré T, Veillon J-M (1995) Structural and floristic characteristics of a rain forest on schist in New Caledonia : a comparison with an ultramafic rain forest. *Adansonia* **17**, 201-226.
- Jaffré T, Bouchet P, Veillon J-M (1998a) Threatened plants of New Caledonia: is the system of protected areas adequate? *Biodiversity and Conservation* **7**, 109-135.
- Jaffré T, Rigault F, Dagostini G (1998b) Impact des feux de brousse sur les maquis ligno-herbacés des roches ultrabasiques de Nouvelle-Calédonie. *Adansonia* **20**, 173-189.
- Jaffré T, Morat P, Veillon J-M, Rigault F, Dagostini G (2001) *Composition et caractérisation de la flore indigène de Nouvelle-Calédonie*. Institut de Recherche pour le Développement, Nouméa.
- Jansen RK, Cai Z, Raubeson LA, *et al.* (2007) Analysis of 81 genes from 64 plastid genomes resolves relationships in angiosperms and identifies genome-scale evolutionary patterns. *Proceedings of the National Academy of Science of the USA* **104**, 19369-19374.
- Janssen T, Bremer K (2004) The age of major monocot groups inferred from 800+ *rbcL* sequences. *Botanical Journal of the Linnean Society* **146**, 385-398.
- Jérémie J, Hallé N (1976) Le genre *Bikkia* (Rubiaceae-Condamineae) en Nouvelle-Calédonie. *Adansonia* **15**, 341-355.
- Kelly AE, Goulden ML (2008) Rapid shifts in plant distribution with recent climate change. *Proceedings of the National Academy of Science of the USA* **105**, 11823-11826.
- Kettle CJ, Hollingsworth PM, Jaffré T, Moran B, Ennos R (2007) Identifying the early genetic consequences of habitat degradation in a highly threatened tropical conifer, *Araucaria nemorosa* Laubenfels. *Molecular Ecology* **16**.
- Kettle CJ, Ennos RA, Jaffré T, Gardner M, Hollingsworth PM (2008) Cryptic genetic bottlenecks during restoration of an endangered tropical conifer. *Biological Conservation* **141**, 1953-1961.
- Klak C, Reeves G, Hedderson T (2004) Unmatched tempo of evolution in Southern African semi-desert ice plants. *Nature* **427**, 63-65.
- Kruckeberg AR (1986) An essay: the stimulus of unusual geologies for plant speciation. *Systematic Botany* **11**, 455-463.
- Lande R (1988) Genetics and demography in biological conservation. *Science* **241**, 1455-1460.
- Lockwood JL, Brooks TM, McKinney ML (2000) Taxonomic homogenization of the global avifauna. *Animal Conservation* **3**, 27-35.
- Lowry PP (1998) Diversity, endemism, and extinction in the flora of New Caledonia: a review. In: *Rare, Threatened, and Endangered Floras of Asia and the Pacific Rim* (eds. Peng C-I, Lowry PP), pp. 181-206. Institute of Botany, Academia Sinica Monograph, Taipei.
- Lundberg J, Bremer K (2003) A phylogenetic study of the order Asterales using one morphological and three molecular data sets. *International Journal of Plant Science* **164**, 553-578.
- MacArthur RH, Wilson EO (1963) An equilibrium theory of insular zoogeography. *Evolution* **17**, 373-387.
- Mace GM, Gittleman JL, Purvis A (2003) Preserving the tree of life. *Science* **300**, 1707-1709.
- Mast AR, Willis CL, Jones EH, Downs KM, Weston PH (2008) A smaller *Macadamia* from a more vagile tribe: inference of phylogenetic relationships, divergence times, and diaspore evolution in *Macadamia* and relatives (tribe Macadamieae; Proteaceae). *American Journal of Botany* **95**, 843-870.
- Mathews S, Donoghue MJ (1999) The root of angiosperm phylogeny inferred from duplicate phytochrome genes. *Science* **286**, 947-950.
- McGlone MS (2005) Goodbye Gondwana. *Journal of Biogeography* **32**, 739-740.

- McLoughlin S (2001) The breakup history of Gondwana and its impact on pre-Cenozoic floristic provincialism. *Australian Journal of Botany* **49**, 271-300.
- McPherson G, Lowry PP (2004) *Hooglandia*, a newly discovered genus of Cunoniaceae from New Caledonia. *Annals of the Missouri Botanical Garden* **91**, 260-265.
- Mittermeier RA, Gil PR, Hoffmann M, *et al.* (2004) *Hotspots revisited*. Cemex, Mexico.
- Moore MJ, Bell CD, Soltis PS, Soltis DE (2007) Using plastid genome-scale data to resolve enigmatic relationships among basal angiosperms. *Proceedings of the National Academy of Science of the USA* **104**, 19363-19368.
- Morat P (1993) Our knowledge of the flora of New Caledonia: endemism and diversity in relation to vegetation types and substrates. *Biodiversity Letters* **1**, 72-81.
- Morat P, Jaffré T, Veillon J-M (1994) Richesse et affinités floristiques de la Nouvelle-Calédonie: conséquences directes de son histoire géologique. *Mémoire de la Société de Biogéographie* **IV**, 111-123.
- Morat P, Jaffré T, Veillon J-M (1999) Menaces sur les taxons rares et endémiques de la Nouvelle-Calédonie. *Bulletin de la Société Botanique du centre-ouest* **19**, 129-144.
- Morat P, Jaffré T, Veillon J-M (2001) The flora of New Caledonia's calcareous substrates. *Adansonia* **23**, 109-127.
- Moritz C (2002) Strategies to protect biological diversity and the evolutionary processes that sustain it. *Systematic Biology* **51**, 238-254.
- Morley RJ (2001) Why are there so many primitive angiosperms in the rain forests of Asia-Australasia? In: *Faunal and floral migrations and evolution in SE Asia-Australasia* (eds. Metcalfe I, Smith JMB, Morwood M, Davidson I). A.A. Balkema publishers, Lisse.
- Muller J (1981) Fossil pollen records of extant angiosperms. *Botanical review* **47**, 1-142.
- Munzinger J, McPherson G, Lowry PP (2008) A second species in the endemic New Caledonian genus *Gastrolepis* (Stemonuraceae) and its implications for the conservation status of high-altitude maquis vegetation: coherent application of the IUCN Red List criteria is urgently needed in New Caledonia. *Botanical Journal of the Linnean Society* **157**, 775-783.
- Murienne J, Grandcolas P, Piulachs MD, *et al.* (2005) Evolution on a shaky piece of Gondwana: is local endemism recent in New Caledonia? *Cladistics* **21**, 2-7.
- Myers N (1988) Threatened biotas: "hot spots" in tropical forests. *The Environmentalist* **8**, 187-208.
- Myers N, Mittermeier RA, Mittermeier CG, da Fonseca GAB, Kent J (2000) Biodiversity hotspots for conservation priorities. *Nature* **403**, 853-858.
- Nasi R, Jaffré T, Sarrailh J-M (2002) Les forêts de montagne de la Nouvelle-Calédonie. *Bois et forêt des tropiques* **274**, 5-18.
- Neall VC, Trewick SA (2008) The age and origin of the Pacific islands: a geological overview. *Philosophical Transactions of the Royal Society of London B* **363**, 3293-3308.
- Parmesan C, Ryrholm N, Stefanescu C, *et al.* (1999) Poleward shifts in geographical ranges of butterfly species associated with regional warming. *Nature* **399**, 579-583.
- Parmesan C, Yohe G (2003) A globally coherent fingerprint of climate change impacts across natural systems. *Nature* **421**, 37-42.
- Pauwells M, Saumitou-Laprade P, Holl A-C, Petit D, Bonnin I (2005) Multiple origin of metallicolous populations of the pseudometallophyte *Arabidopsis halleri* (Brassicaceae) in Central Europe: the cpDNA testimony. *Molecular Ecology* **14**, 4403-4414.
- Pelletier B (2006) Geology of the New Caledonia region and its implications for the study of the New Caledonian biodiversity. In: *Compendium of marine species from New*

- Caledonia* (eds. Payri CE, Richer de Forges B), pp. 17-30. Centre IRD de Nouméa, Nouméa.
- Petit RJ, Aguinalde I, de Beaulieu J-L, *et al.* (2003) Glacial refugia: hotspots but not melting pots of genetic diversity. *Science* **300**, 1563-1565.
- Picard M (1999) *L'archipel néo-calédonien, 300 millions d'années pour assembler les pièces d'un puzzle géologique*. Centre de Documentation Pédagogique de Nouvelle-Calédonie, Nouméa.
- Pillon Y, Munzinger J (2005) *Amborella* fever and its (little) implication in conservation. *Trends in Plant Science* **10**, 519-520.
- Pillon Y, Fay MF, Shipunov AB, Chase MW (2006) Species diversity versus phylogenetic diversity: a practical study in the taxonomically difficult genus *Dactylorhiza* (Orchidaceae). *Biological Conservation* **129**, 4-13.
- Pillon Y, Nooteboom HP (sous presse) A new species of *Symplocos* (Symplocaceae) from Mont Panié (New Caledonia). *Adansonia*.
- Pintaud J-C, Jaffré T (2001) Patterns of diversity and endemism in palms on ultramafic rocks in New Caledonia. *South African Journal of Science* **97**, 548-550.
- Pintaud J-C, Jaffré T, Puig H (2001) Chorology of New Caledonian palms and possible evidence of Pleistocene rain forest refugia. *Compte Rendus de l'Académie des Sciences de Paris, Sciences de la vie* **324**, 453-463.
- Pintaud J-C, Baker WJ (2008) A revision of the palm genera (Arecaceae) of New Caledonia. *Kew Bulletin* **63**, 61-73.
- Pole M (1994) The New Zealand flora--entirely long-distance dispersal? *Journal of Biogeography* **21**, 625-635.
- Pounds JA, Fogden MPL, Campbell JH (1999) Biological response to climate change on a tropical mountain. *Nature* **398**, 611-615.
- Prance GT (1982) A review of the phytogeographic evidences for Pleistocene climate change in the Neotropics. *Annals of the Missouri Botanical Garden* **69**, 594-624.
- Proctor J (2003) Vegetation and soil and plant chemistry on ultramafic rocks in the tropical Far East. *Perspectives in plant ecology, evolution and systematics* **6**, 105-124.
- Purvis A, Hector A (2000) Getting the measure of biodiversity. *Nature* **405**, 212-219.
- Qiu Y-L, Lee J, Bernasconi-Quadroni F, *et al.* (1999) The earliest angiosperms: evidence from mitochondrial, plastid and nuclear genomes. *Nature* **402**, 404-407.
- Raven PH, Axelrod DI (1972) Plate tectonics and australasian paleobiogeography. *Science* **176**, 1379-1386.
- Raven PH, Axelrod DI (1974) Angiosperm biogeography and past continental movements. *Annals of the Missouri Botanical Garden* **61**, 539-673.
- Read J, Sanson GD, Jaffré T, Burd M (2006) Does tree size influence timing of flowering in *Cerberiopsis candelabra* (Apocynaceae), a long-lived monocarpic rain-forest tree. *Journal of Tropical Ecology* **22**, 621-629.
- Renner SS (2004) Variation in diversity among Laurales, early Cretaceous to present. *Biologische Skrifter* **55**, 441-458.
- Rieseberg LH, Gerber D (1995) Hybridization in the Catalina Island mountain Mahogany (*Cercocarpus traskiae*): RAPD evidence. *Conservation Biology* **9**, 199-203.
- Rieseberg LH, Raymond O, Rosenthal DM, *et al.* (2003) Major ecological transitions in wild sunflowers facilitated by hybridization. *Science* **301**, 1211-1216.
- Rieseberg LH, Kim S-C, Randell RA, *et al.* (2007) Hybridization and the colonization of novel habitats by annual sunflowers. *Genetica* **129**, 149-165.
- Rieseberg LH, Willis JH (2007) Plant speciation. *Science* **317**, 910-914.
- Roberts CM, McClean CJ, Veron JEN, *et al.* (2002) Marine biodiversity hotspots and conservation priorities for tropical reefs. *Science* **295**, 1280-1284.

- Rodrigues ASL, Gaston KJ (2002) Maximising phylogenetic diversity in the selection of networks of conservation areas. *Biological Conservation* **105**, 103-111.
- Rønsted N, Savolainen V, Mølgaard P, Jäger AK (2008) Phylogenetic selection of *Narcissus* species for drug discovery. *Biochemical Systematics and Ecology* **36**, 417-422.
- Saarela JM, Rai HS, Doyle JA, *et al.* (2007) Hydatellaceae identified as a new branch near the base of the angiosperm phylogenetic tree. *Nature* **446**, 312-315.
- Sanderson MJ, Thorne JL, Wikström N, Bremer K (2004) Molecular evidence on plant divergence times. *American Journal of Botany* **91**, 1656-1665.
- Sarlin P (1954) *Bois et forêt de la Nouvelle-Calédonie*. Centre technique forestier tropical, Nogent-sur-Marne.
- Sarthou C, Samadi S, Boisselier-Dubayle M-C (2001) Genetic structure of the saxicole *Pitcairnia geyskesii* (Bromeliaceae) on inselbergs in French Guyana. *American Journal of Botany* **88**, 861-868.
- Savolainen V, Anstett MC, Lexer C, *et al.* (2006) Sympatric speciation in palms on an oceanic island. *Nature* **441**, 210-213.
- Schmid M (1991) Euphorbiaceae - Phyllanthoideae. *Phyllanthus*. In: *Flore de la Nouvelle-Calédonie et Dépendances* (eds. Morat P, MacKee HS), pp. 31-323. Muséum National d'Histoire Naturelle, Paris.
- Schönenberger J, Friis EM, Matthews ML, Endress PK (2001) Cunoniaceae in the Cretaceous of Europe: evidence from fossils flowers. *Annals of Botany* **88**, 423-437.
- Sebert H, Pancher I (1874) *Notice sur les bois de la Nouvelle-Calédonie*. Arthus Bertrand, Editeur, Paris.
- Snaydon RW, Davies MS (1976) Rapid population differentiation in a mosaic environment. *Heredity* **37**, 9-25.
- Soltis DE, Soltis PS, Nickrent DL, *et al.* (1997) Angiosperm phylogeny inferred from 18S ribosomal DNA sequences. *Annals of the Missouri Botanical Garden* **84**, 1-49.
- Soltis DE, Soltis PS (1999) Polyploidy: recurrent formation and genome evolution. *Trends in Ecology and Evolution* **14**, 348-352.
- Soltis DE, Albert V, Leebens-Mack J, *et al.* (2008) The *Amborella* genome: an evolutionary reference for plant biology. *Genome Biology* **9**, 402.
- Soltis PS, Soltis DE, Chase MW (1999) Angiosperm phylogeny inferred from multiple genes as a tool for comparative biology. *Nature* **402**, 402-404.
- Stevenson J, Dodson JR, Prosser IP (2001) A late Quaternary record of environmental change and human impact from New Caledonia. *Palaeogeography, Palaeoclimatology, Palaeoecology* **168**, 97-123.
- Stevenson J, Hope G (2005) A comparison of late Quaternary forest changes in New Caledonia and northeastern Australia. *Quaternary Research* **64**, 372-383.
- Still CJ, Foster PN, Schneider SH (1999) Simulating the effects of climate change on tropical montane cloud forests. *Nature* **398**, 608-610.
- Sweeney PW, Bradford JC, Lowry PP (2004) Phylogenetic position of the New Caledonian endemic genus *Hooglandia* (Cunoniaceae) as determined by maximum parsimony analysis of chloroplast DNA. *Annals of the Missouri Botanical Garden* **91**, 266-274.
- Thomas CD, Cameron A, Green RE, *et al.* (2004) Extinction risk from climate change. *Nature* **427**, 145-148.
- Thomas CD, Franco AMA, Hill JK (2006) Range retractions and extinction in the face of climate warming. *Trends in Ecology and Evolution* **21**, 415-416.
- Vane-Wright RI, Humphries CJ, Williams PH (1991) What to protect?--Systematics and the agony of choice. *Biological Conservation* **55**, 235-254.
- Veillon J-M (1971) Une Apocynaceae de Nouvelle-Calédonie *Cerberiopsis candelabrum* Vieill. *Adansonia* **11**, 625-639.

- Veillon J-M (1981) Réhabilitation de l'espèce *Blechnum francii* Rosenstock, fougère aquatique de la Nouvelle-Calédonie. *Adansonia* **2**, 241-247.
- Venter S, Munzinger J (2007) *Paphia paniensis* (Ericaceae), a new species from New Caledonia critically compared with *P. neocaledonica*. *New Zealand Journal of Botany* **45**, 503-508.
- Viot R (1956) *La végétation canaque*. Faculté des Sciences de l'université de Paris, Paris.
- Wardle P, Coleman MC (1992) Evidence for rising upper limits of four native New Zealand forest trees. *New Zealand Journal of Botany* **30**, 303-314.
- Warren BH, Hawkins JA (2006) The distribution of species diversity across a flora's component lineages: dating the Cape's 'relicts'. *Proceedings of the Royal Society of London B* **273**, 2149-2158.
- Whiting SN, Reeves RD, Richards D, *et al.* (2004) Research priorities for conservation of metallophyte biodiversity and their potential for restoration and site remediation. *Restoration Ecology* **12**, 106-116.
- Yamada T, Nishida H, Umebayashi M, Uemara K, Kato M (2008) Oldest record of Trimeniaceae from the Early Cretaceous of northern Japan. *BMC Evolutionary Biology* **8**, 135.

Article I

Hopkins HCF, Fogliani B, Pillon Y (2007) Four new species in the endemic genus *Codia* (Cunoniaceae) from New Caledonia. *Kew Bulletin* **62**, 259-274.



Les descriptions, illustrations, cartes de répartition et statuts de conservation sont données pour quatre nouvelles espèces de *Codia* de Nouvelle-Calédonie, dans le Pacifique sud-ouest. *Codia jaffrei* H. C. Hopkins & B. Fogliani et *C. mackeeana* H. C. Hopkins & B. Fogliani sont des arbres de grande taille croissant en forêt sur sols ultramafiques et non-ultramafiques respectivement, alors que *C. belepensis* H. C. Hopkins et *C. triverticillata* H. C. Hopkins & Pillon sont des arbustes de maquis minier. *Codia triverticillata* est la deuxième espèce du genre à posséder des feuilles verticillées plutôt qu'opposées.

Contribution de l'auteur : l'auteur a participé à la description de *C. triverticillata* et a réalisé l'évaluation du statut IUCN préliminaire des quatre espèces décrites dans l'article.

Four new species in the endemic genus *Codia* (*Cunoniaceae*) from New Caledonia

Helen C. F. Hopkins¹, Bruno Fogliani² & Yohan Pillon^{2,3}

Summary. Descriptions, illustrations, distribution maps and conservation assessments are provided for four new species of *Codia* from New Caledonia in the south-west Pacific. *Codia jaffrei* H. C. Hopkins & B. Fogliani and *C. mackeeana* H. C. Hopkins & B. Fogliani are quite large trees, occurring in forest on ultramafic and non-ultramafic substrates respectively, while *C. belepensis* H. C. Hopkins and *C. triverticillata* H. C. Hopkins & Pillon are shrubs in ultramafic scrub ('maquis'). *Codia triverticillata* is the second species in the genus with whorled, rather than opposite, leaves.

Key words. *Codia*, *Cunoniaceae*, New Caledonia, new species, ultramafic.

Introduction

Codia J. R. Forst. & G. Forst. is one of three genera of *Cunoniaceae* endemic to New Caledonia, the others being *Pancheria* Brongn. & Gris and the monotypic *Hooglandia* McPherson & Lowry (Bradford *et al.* 2004). *Codia* was last treated taxonomically by Guillaumin (1941, 1948), but an account in progress for the *Flore de la Nouvelle-Calédonie* has shown that some new taxa need to be described. With the names published here and the changes proposed in Hopkins (2005), the number of species currently recognised is 14.

Codia is a genus of small trees and shrubs or sometimes larger trees that have simple, opposite or occasionally whorled leaves with entire margins (except in *C. ferruginea* Brongn. & Gris, where the margin is sinuate or rarely toothed), interpetiolar stipules, sweetly scented bisexual flowers in usually white to pale yellow (or occasionally reddish or pinkish) capitula, and indehiscent wind-dispersed fruits with very abundant brown woolly hairs. The flowers and fruits are fairly uniform and provide few useful taxonomic characters at species level and so species delimitation relies largely on features of the leaves and stipules, these generally correlating with distribution and ecology. The characters used to distinguish between species are principally: (a) leaves — arrangement, size, shape, thickness, venation, and especially indumentum; (b) stipules — shape, size, persistence, indumentum; (c) peduncles — length,

thickness, indumentum; (d) capitula — diameter, colour at anthesis, and to a limited extent indumentum on the calyx lobes. However, species delimitation in this genus is often rather problematic, probably because of hybridization and introgression (in prep.), and often some intermediates are found between generally well distinguished taxa.

The descriptions give characters for mature (i.e. fully expanded) adult leaves and stipules on fertile shoots unless otherwise indicated. Young adult leaves in some species have more indumentum than when fully expanded or the hairs may be of a different colour, and sometimes the young adult leaves have quite dense indumentum in species whose mature adult leaves are glabrous or almost so, and rarely vice versa. Fully expanded leaves in juvenile plants (seedling and saplings), on coppice shoots and shoots sprouting from near the base of trees are often different from those on fertile shoots and can usually only be identified by association with adult foliage. For instance, the margins of seedling leaves generally have large, coarse teeth, although leaves in adult plants are usually entire. In saplings and on regrowth shoots, the leaves and stipules are often larger than in the adult foliage and may have a slightly different shape. The presence or absence of dense pale indumentum on the abaxial surface of such leaves appears to be unrelated to whether or not it is present in mature adult leaves.

Accepted for publication November 2006.

¹ Masons Arms, Hutton Roof, Carnforth, Lancashire, LA6 2PE, and Herbarium, Royal Botanic Gardens, Kew, Richmond, TW9 3AB, U.K. E-mail: h.fortune@kew.org

² M.A.B.I.O.M., Université de la Nouvelle-Calédonie, B.P. R4, 98851 Nouméa Cedex, New Caledonia. E-mail: bfogliani@univ-nc.nc

³ Laboratoire de Botanique, Institut de recherche pour le développement, B.P. A5, 98848 Nouméa Cedex, New Caledonia. E-mail: yohan.pillon@noumea.ird.nc

Table 1. The main differences between *Codia* and *Pancheria*.

	<i>Codia</i>	<i>Pancheria</i>
# species and their distribution	14, New Caledonia	c. 25, New Caledonia
leaf arrangement	usually opposite (in whorls of 3 in <i>C. albifrons</i> and <i>C. triverticillata</i>)	usually in whorls of 3, 4 or 5 (opposite in <i>P. confusa</i>)
leaves	simple	simple or compound (trifoliolate or imparipinnate)
leaf margin	entire (except sinuous to coarsely toothed in <i>C. ferruginea</i>)	notched, at least minutely so (except ± entire in <i>P. vieillardii</i>)
indumentum of dense, white, felty hairs on abaxial leaf surface	present in some species	not present (some indumentum in <i>P. ferruginea</i> but leaf margin distinctly toothed, and in <i>P. hirsuta</i> but not felty and white, and leaf pinnate)
flowers	bisexual; stamens and styles exerted	unisexual and plants dioecious; male flowers with exerted stamens; female flowers with minute stamens, not exerted
ovary	inferior or semi-inferior, upper surface densely hairy	superior, puberulous in some species
styles	slender and exerted, only slightly shorter than filaments	short, beak-like, often curved
fruit	individual fruits indehiscent, outwardly little changed from flowers except for development of very abundant lanate hairs, capitulum in fruit readily disintegrating	individual fruitlets dehiscent, lacking abundant lanate hairs, remaining attached to receptacle at dehiscence though capitulum tardily disintegrating after seeds gone

The flowers and fruits are not described in detail for the new taxa since they appear to be similar in all species of *Codia*, except for small differences in size, and the capitula in fruit are similar in size to those at anthesis though rapidly disintegrating. In the flowers, the number of locules corresponds to the number of styles, i.e. 2(–3), and each locule contains two ovules, attached to the placenta laterally, towards the base (Fig. 1D). The narrow thread-like continuation of the placenta can be traced up into each style (Fig. 1D, right side). A single round seed develops per fruit (Fig. 1G).

Comments on conservation status use the categories proposed by the IUCN, version 3.1 (IUCN 2001). Protected areas within New Caledonia are listed in Gargominy (2003), with a discussion of conservation legislation and threats.

As is common for many plant taxa in New Caledonia, species of *Codia* generally show a strong relationship with their substrate and are frequently confined to soils derived either from ultramafic rocks or from non-ultramafic ones.

Codia is sometimes confused in the field with *Pancheria*, which also usually has small capitula of whitish or yellowish flowers, rather coriaceous leaves and interpetiolar stipules. As in *Codia*, *Pancheria* species are shrubs, small trees or occasionally large

trees that occur in forest and scrub, often on ultramafic substrates. In general, the two genera can be readily distinguished by the leaves, which are usually opposite in *Codia* and usually whorled in *Pancheria*, but the description here of a second species of *Codia* with whorled leaves means that this simple distinction is insufficient. Table 1 gives a summary of the main differences between the two genera, which otherwise show a remarkable degree of convergence since they are not closely related to one another, *Codia* belonging to the tribe *Codieae* and *Pancheria* to the *Cunonieae* (Bradford & Barnes 2001).

Taxonomy

1. *Codia belepensis* H. C. Hopkins, *sp. nov.*

Codiae spatulatae Brongn. & Gris atque *C. montanae* J. R. Forst. & G. Forst. foliis adultis evolutis supra parum tantum nitentibus et infra indumento pallido coacto carenti similis, sed ab ambabus caulibus fertilibus stipulas persistentes cordatas (nec caducas anguste triangulares) ferentibus differt. Typus: New Caledonia, [Province Nord], Ile Yandé, Puagone, 50–100 m, 6 Oct. 1970, fr., MacKee 22638 (holotypus P! – P00428237; isotypus NOU!).

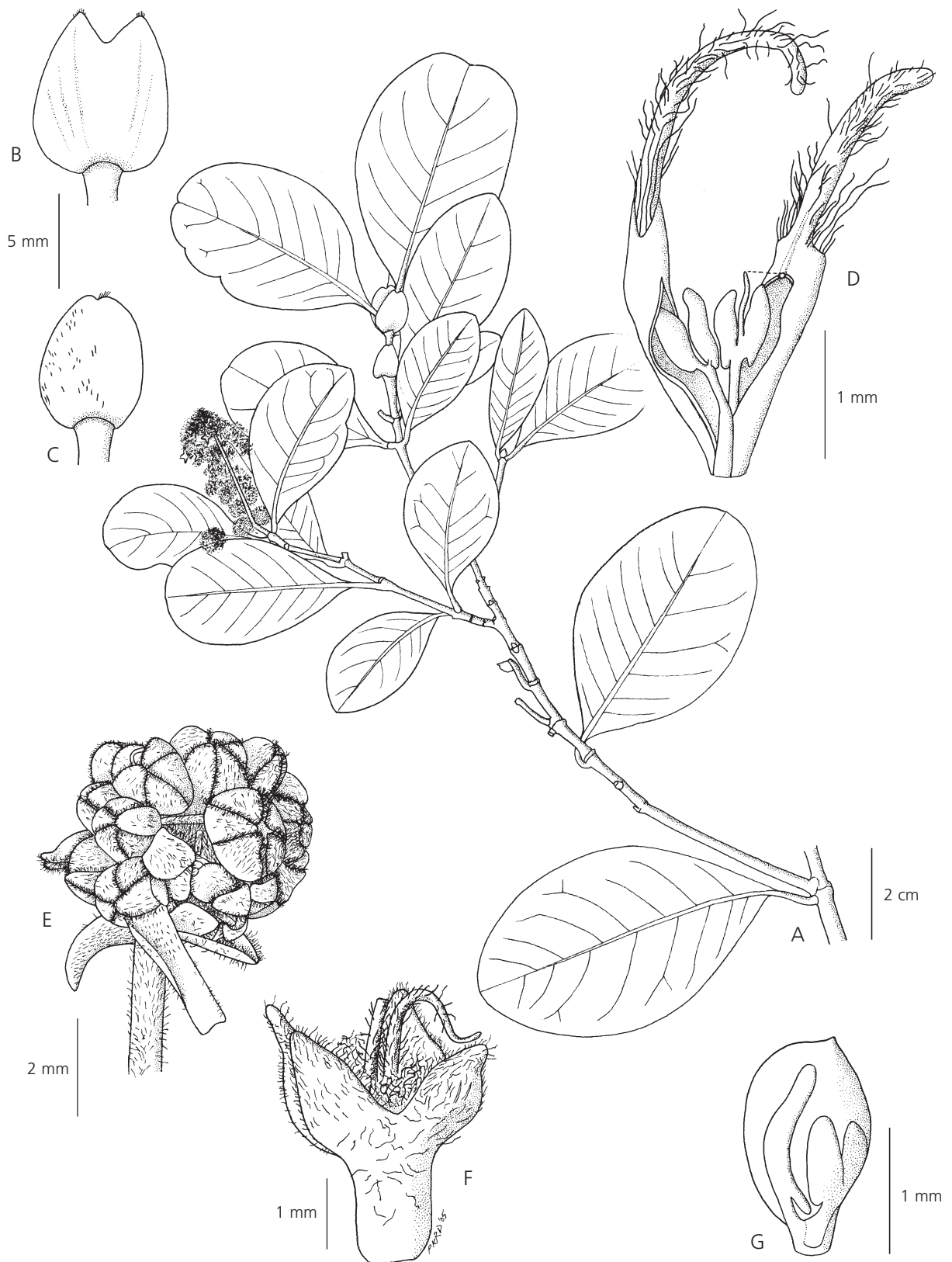

Fig. 1. *Codia belepensis* **A** habit, in fruit; **B**, **C** stipules; **D** gynoecium, the ovary cut open to reveal 2 ovules in each locule, the placenta on the right broken, each locule surmounted by a style; **E** capitulum in bud; **F** fruit, with 4 calyx lobes and remnants of 2 styles; **G** almost mature seed with 2 undeveloped ovules and part of placenta remaining attached. **A – D**, **F – G** MacKee 22638; **E** Montrouzier 64. DRAWN BY PATRICIA K. R. DAVIES.

Callicoma integrifolia Montrouz. ex Guillaumin (1911: 135), nom. inval., pro syn. sub *C. spatulata*.

Shrubs or small *trees* 1–3 m tall. Young stems 2–3 mm diameter, initially with minute hairs 0.1 mm long, later glabrescent and sometimes slightly pruinose. *Stipules* cordate, 0.6–1 × 0.5–1 cm, usually persistent at several nodes, abaxial surface with sparse adpressed hairs; apex acute or sometimes bifid. *Leaves* opposite and decussate. Petioles 0.4–1.2 cm long, minutely pubescent, glabrescent. Leaf blades obovate-elliptic, 3.8–7.2 × 2.3–4 cm, cuneate at the base and rounded, retuse or obtuse at the apex, thin-coriaceous, flat; adaxial surface somewhat shiny, glabrous or glabrescent, a few sparse minute hairs persisting on the midrib; abaxial surface dull, glabrous or glabrescent, or sometimes some white indumentum of minute hairs persisting towards the margins; margin entire, flat or minutely recurved; midrib not extending to tip if apex retuse; 2° veins 7

–9 on either side of midrib, flat above and minutely prominent below, median ones at 40–60° to midrib, brochidodromous. Peduncles to 3.5 cm long × 1 mm diameter, minutely hairy. *Capitula* c. 0.5 cm diameter in bud, colour not reported, composed of c. 25 flowers. Base of flower to tips of calyx lobes 2.5–4 mm; calyx lobes ovate, c. 2 mm long, with some minute indumentum on abaxial surface to tips; petals absent; filaments 3–3.5 mm long; anther connective not apiculate; styles 2–3 mm long, hairy for most of their length. Fig. 1.

DISTRIBUTION AND HABITAT. *Codia belepensis* is known from three small islands to the north of Grande Terre, Ile Pott and Ile Art, which are the largest of the Iles Belep, and Ile Yandé to their south. It is described on specimens labels as occurring in scrub (“maquis dégradé” and “maquis dense”) on ultramafic substrates, including “serpentine alterée”, to 300 m elevation. Map 1.



Map 1. Distributions of *Codia belepensis* (●), *C. mackeeana* (■) and *C. jaffrei* (◆) in New Caledonia. The main areas of ultramafic substrates, especially peridotite, are shown in grey, simplified from Paris (1981).

MATERIAL EXAMINED. NEW CALEDONIA, PROVINCE NORD.

Ile Yandé, Puagone, 50 – 100 m, 6 Oct. 1970, fr., *MacKee* 22638 (NOU; P holotype); Ile Yandé, Mt Yandé, summit, 250 – 300 m, 7 Oct. 1970, st., *MacKee* 22698 (NOU, P); *ibid.*, regrowth from 22698, 7 Oct. 1970, st., *MacKee* 22699 (NOU, P); Ile Art, Feb., fl., *Montrouzier* 64 (P); Ile Yandé, 5 Oct. 2005, st., *Munzinger* & *Swenson* 3031, (NOU); Ile Pott, above the Paguotte property, 50 m, May 1939, fr., *Viro* 245 (P × 3).

LOCAL NAME. ‘Taan’ (fide *Montrouzier* 64).

CONSERVATION STATUS. The three islands from which *Codia belepensis* is known have a combined surface area of about 75 km² and none of them has protected area status. Although this species was described on the label of *MacKee* 22698 as dominant in scrub on Ile Yandé, the population there seems to be localised (J. Munzinger pers. comm., 2005). Since it occurs in scrub, it is likely to be well adapted to burning; however, severe burning or disturbance (e.g. by pigs on Ile Yandé, J. Munzinger pers. comm. 2005) may lead to irreversible degradation of habitat through erosion, and so we give a provisional threat status of EN B1ab(i,ii,iii)+2ab(i,ii,iii).

DISCUSSION. *Codia belepensis* belongs to the group of species that generally lacks dense white felty indumentum on the underside of the mature adult foliage, though it can be present in leaves on regrowth shoots (e.g. *MacKee* 22699) and there is some white indumentum on some adult leaves in *Viro* 245. This species is most similar to *C. montana* and *C. spatulata*, which are abundant in the northern part of Grande Terre especially in scrub and sometimes found on ultramafic substrates, but it differs from both in having broadly cordate, not narrowly triangular, stipules. *Montrouzier* 64 and *Viro* 245 were referred to by Guillaumin (1911, 1946) as *Codia spatulata* (“*spatulata*”).

Another species in this group that also has fairly persistent stipules and is often a shrub in scrub on ultramafic substrates is *C. nitida* Schltr. It is common in the south of Grande Terre and also occurs on some ultramafic massifs up the western side. It differs from *C. belepensis* by having leaves that are usually very shiny, often on both surfaces, with the secondary veins scarcely visible on the abaxial surface, stipules that are ovate and rounded at the apex, rather than cordate and acute or bifid at the apex, and peduncles that are longer and thinner.

While both the type of *C. belepensis* and *Montrouzier* 64 have notched stipules (Fig. 1B, C), the stipules are not always notched in this species and this character is occasionally seen in other taxa (e.g. *C. mackeeana*, Fig. 2C). Notched tips in stipules are related to the timing of fusion of the stipule primordia (see Schimanski & Rozefelds 2002, with reference to *Geissois*) and also occur in the related genus *Callicoma* (Melville 1972).

2. *Codia mackeeana* H. C. Hopkins & B. Fogliani, sp. nov. *Codiae spatulatae* Brongn. & Gris foliis adultis evolutis infra sine indumentuo pallido coacto carenti similis, sed caulibus fertilibus stipulas ovatas cordatasve atque plerumque persistentes (neque triangulares cauducas) ferentibus, lamina elliptica vel late elliptica vel obovata (nec elliptica vel obcordata spatulatave) atque venis secundariis inferioribus ad angulam latam [55 – 75°] (nec angustam [40 – 60°]) orientibus, foliis etiam subcoriaceis (nec coriaceis) atque ad marginem leviter undulatis (nec omino planis) differt. Typus: New Caledonia, Province Sud, Col d’Amieu, 21°36.5’S 165°48.5’E, 350 – 400 m, 20 April 2004, fr., *Fogliani* 120 (holotypus P; isotypi AK, B, BM, CANB, E, G, K × 2, MO × 2, NOU × 2, P, US).

Trees 6 – 15 m tall, the trunk to 40 cm diameter with rough bark. Young stems 2 – 4 mm diameter, glabrous and sometimes rather pruinose or with sparse minute hairs 0.1 mm long, almost glabrescent. *Stipules* ovate to cordate, to 1.3 × 1 cm, generally persistent at several nodes, glabrous on both surfaces or with some tiny adpressed hairs 0.1 mm long; apex broadly acute to obtuse or rarely slightly bifid. *Leaves* opposite (or very rarely in 3s) and decussate. Petioles 0.5 – 2 cm long, glabrous. Leaf blades elliptic, broadly elliptic, ovate or obovate, 5.7 – 10 × 4 – 7 cm, cuneate at the base and rounded or obtuse at the apex, subcoriaceous, undulating towards the margin; both surfaces glabrous, adaxial surface slightly shiny when dry; margin entire; 2° veins 7 – 9 on either side of midrib, flat above and slightly prominent below, median ones at a relatively wide angle to midrib (55 – 75°), brochidodromous. Peduncles 1.1 × 3.5 cm long × 1 mm diameter, minutely hairy, the hairs 0.1 – 0.2 mm long. *Capitula* at anthesis 0.5 × 0.7 cm diameter, white or yellowish white, composed of c. 25 flowers. Base of flower to tips of calyx lobes 1.8 – 2 mm; calyx lobes ovate to triangular, 1 – 1.2 mm long with sparse indumentum of minute pale hairs on the abaxial surface; petals absent; filaments to 4 mm long; anther connective minutely apiculate or not; styles 1.5 – 2 mm long, hairy for most of their length. Fig. 2.

DISTRIBUTION AND HABITAT. *Codia mackeeana* is confined to wet forest in central Grande Terre, at medium elevation (300 – 550 m) on non-ultramafic substrates. Most of the collections are from the region of Farino, Col d’Amieu and Boghen valley (alternative spelling: Boguen), although *MacKee* 38963 is from Plateau de Tango, as is *Bradford et al.* 1026 (20°59’S 165°05’E, 400 m, 4 Dec. 2000, K!, MO!, NOU!), which is very probably juvenile foliage of this species but not included in the list below. According to Paris (1981), the rocks at both Col d’Amieu and Plateau de Tango include middle Triassic to Jurassic undifferentiated volcano-sedimentary formations and terrigenous

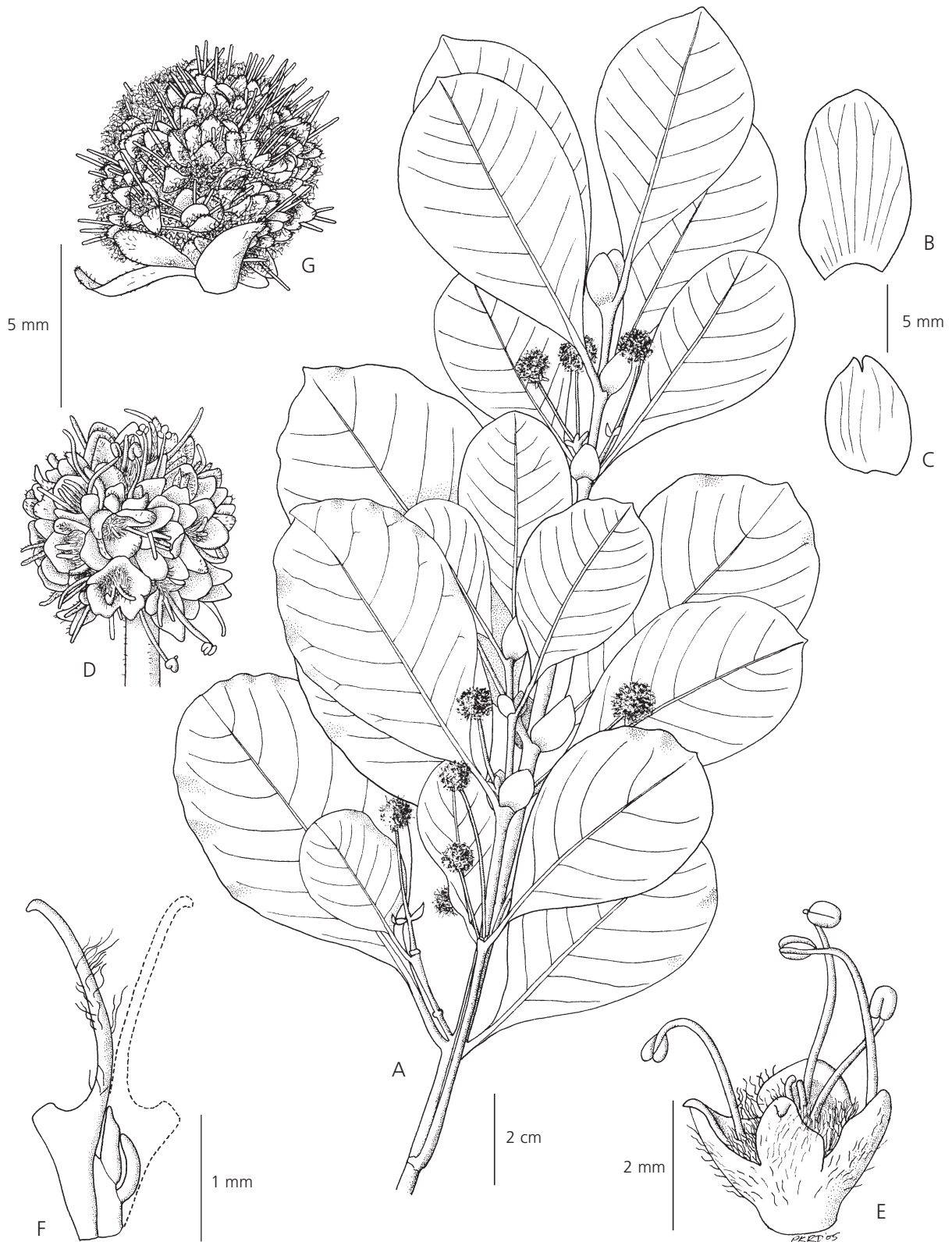

Fig. 2. *Codia mackeeana* **A** habit, in early fruiting stage; **B**, **C** stipules; **D** capitulum at late flowering stage, with most of the stamens fallen and lanate hairs on top of ovary; **E** single flower from **D**, with 4 calyx lobes, 4 of 8 stamens remaining, and 2 styles; **F** gynoecium, left side intact showing ovary wall and style, right side cut open to reveal ovules; **G** capitulum at fruiting stage, the lanate hairs more developed. **A – C**, **F – G** *Fogliani* 120; **D – E** *MacKee* 13470. DRAWN BY PATRICIA K. R. DAVIES.

deposits, and the Massif de Boghen largely comprises sedimentary “green schists”. The forest at Col d’Amieu was described in Jaffré & Veillon (1995). Map 1.

MATERIAL EXAMINED. NEW CALEDONIA, PROVINCE SUD: NE of Col d’Amieu, SW of Koh Forest, below Mé Chevyaxwai, 21°34’S 165°50’E, 284 m, 2 Dec. 2000, buds, *Bradford et al.* 1016 (K, MO, NOU); Col d’Amieu, 21°36.5’S 165°48.5’E, 350 – 400 m, 20 April 2004, fr., *Fogliani* 120 (AK, B, BM, CANB, E, G, K × 2, MO × 2, NOU × 2, P holotype, US); Mé Ori, 28 km NW of La Foa, 500 m, 21 Nov. 1979, fl., *Hartley* 15015 (NOU); Col d’Amieu, 21°35.5’S 165°48’E, 355 m, 28 Nov. 2000, st. & juv., *Hopkins et al.* 6512 (K, MO, NOU); Col d’Amieu, road to Col Toma, 400 m, 20 Jan. 1965, fr., *MacKee* 12020 (NOU, P); Ridge N of Col d’Amieu, 550 m, 24 Sept. 1968, fl., *MacKee* 13470 (NOU, P); Col d’Amieu, 450 m, 1 March 1968, yfr., *MacKee* 18436 (NOU, P); Boguen River valley above Katrikoin, 18 Oct. 1979, fl., *McPherson* 1947 (NOU, P); *ibid.*, towards Mé Ori, 500 m, 21 Nov. 1979, fl., *McPherson* 2115 (NOU); Col d’Amieu, 450 – 500 m, 12 Oct. 1967, fr., *Schmid* 2417 (NOU, P); Col d’Amieu, st., *Schodde* 5224 (P); Farino, 400 m, 16 Jan. 1987, buds & fl., *Veillon* 6260 (NOU, P). **PROVINCE NORD:** Plateau de Tango, Tiwaka side, 400 m, 17 Apr. 1981, yfr., *MacKee* 38963 (NOU, P). **PRECISE LOCALITY UNKNOWN:** s.dat., st., “Lécart” (sic = *Lécard*) 38 (P).

CONSERVATION STATUS. *Codia mackeeana* is known from two distinct areas in central New Caledonia but it is not clear whether this disjunction is an artefact of collecting or a reflection of the actual distribution, since much of the intervening area appears geologically and ecologically suitable. In the Farino – Col d’Amieu – Boghen valley area (c. 400 km²), where it is common, part of the population lies within the Reserve Spéciale de Faune du Col d’Amieu et Table Unio, but this reserve does not offer protection to plants, and forests in the Col d’Amieu area have been logged in the past. On the Plateau de Tango (less than 20 km²), plantations of the introduced and invasive Caribbean Pine, *Pinus caribaea* Morlet have been established, and native rain forest only persists as small patches. Therefore, in both areas, forestry activity, whether through logging or plantations, represents a threat to the habitat of this species. Large specimens of *Codia* have been exploited in southern New Caledonia, and it is likely though not definite that this includes *C. mackeeana*. As this species is currently known from fewer than five localities and its area of occupancy does not exceed 500 km², it might qualify as Endangered. However, because we believe that it is reasonably likely that it will be found in other localities (most likely between Col d’Amieu and Plateau de Tango) and that habitat decline is only moderate, we give *C. mackeeana* a provisional status of VU B2ab(i,ii,iii), noting that further exploration is desirable to refine this status.

ETYMOLOGY. This species is named to commemorate Hugh S. MacKee, who, together with his wife Margaret, collected almost 900 numbers of *Cunoniaceae* in New Caledonia, including four of this species.

DISCUSSION. This taxon is rather unusual in *Codia* in being quite a large forest tree confined to non-ultramafic substrates. It belongs to the group whose mature adult foliage generally lacks dense white indumentum on the lower surface, the others being *C. belepensis*, *C. microphylla* Guillaumin, *C. montana*, *C. nitida* and *C. spatulata*. Within this group its distinctive characters include secondary veins at a wide angle to the midrib and subcoriaceous leaf blades which are usually undulating towards the margin; it shares with *C. belepensis* the character of rather persistent cordate stipules.

3. *Codia jaffrei* H. C. Hopkins & B. Fogliani, sp. nov.
Codiae discolori (Brongn. & Gris) Guillaumin foliis adultis evolutis infra indumentum densum pallidum e pilis minutis curvatis constantem ferentibus similis, sed indumento e venis maioribus carenti vel foliis interdum omnino glabrescentibus (nec indumento in venis tertiaribus persistenti) et stipulis late cordatis saepe persistentibus (nec anguste triangularibus semper caducis) differt. Typus: New Caledonia, [Province Sud], Rivière Bleue, 150 m, 15 March 1981, fl., *MacKee* 38826 (holotypus P! – P00428230; isotypi NOU!, P! – P00428231).

Trees 8 – 25 m with trunk to 60 cm diameter, or rarely a shrub to 3 m. Bark pale brown, rough. Young stems fairly thick, c. 0.5 cm diameter, quite densely covered with straw-coloured indumentum, the hairs c. 0.5 mm long, glabrescent. *Stipules* broadly cordate, to 1.1 × 1.1 cm, or sometimes elliptic-ovate, to 1.5 cm long, persistent at several nodes or caducous, with ± dense, minute, adpressed hairs on both surfaces; apex obtuse or occasionally bifid. *Leaves* opposite and decussate. Petioles 0.5 – 0.8 cm long, initially with dense indumentum of minute hairs, gradually lost. Leaf blades elliptic or somewhat obovate, 7.5 – 14.5 × 5 – 9.5 cm, cuneate to broadly cuneate at the base and rounded or retuse at the apex, coriaceous, flat; adaxial surface glabrous or sparsely hairy-glabrescent, especially on the midrib; abaxial surface with dense to sparse indumentum of minute, white or fawn hairs on the intervenium, absent from the main veins (i.e. midrib, 2° and 3° veins) and thinner over the 4° veins, with some sparse, longer, straight hairs to 0.4 mm long, or sometimes intervenium glabrous/glabrescent; margin entire; 2° veins 7 – 9 (– 11) on either side of midrib, flat above and minutely prominent below, median ones at 55 – 75° to midrib, brochidodromous. Peduncles (0.5 –) 1 – 5.5 cm long

× 1.5 mm diameter, densely hairy, the hairs to 0.4 mm long. *Capitula* at anthesis 0.6–0.9 cm diameter, white, composed of c. 27 flowers. Base of flower to tips of calyx lobes 2.7–3 mm; calyx lobes triangular-ovate, c. 2 mm long, with fairly dense indumentum of minute hairs on the abaxial surface; petals usually absent or occasionally present and then to 2 × 0.2 mm; filaments 3–4 mm long; anther connective apiculate; styles 1.5–2 mm long, hairy for most of their length. Fig. 3.

DISTRIBUTION AND HABITAT. *Codia jaffrei* occurs in quite tall wet forest at low elevation (to 300 m) in southern Grande Terre, especially on ultramafic substrates. The type of forest where it occurs near Rivière Bleue, on ultramafic soil, was described by Jaffré & Veillon (1991). It is also known from forest in the Vallée de Thy, which has mosaic of both ultramafic and non-ultramafic rock types including peridotite (mostly at higher elevation), granodiorite, and Cretaceous sandstone (Picard 1999), and based on the altitude of *MacKee* 28360, *C. jaffrei* might occur here on sandstone. Map 1.*

MATERIAL EXAMINED. NEW CALEDONIA, PROVINCE SUD: Upper R. Blanche, Mois de Mai, 300 m, 22 June 1951, st., *Baumann* 13928 (P); *ibid.*, 300 m, st., *Baumann* 14014 (G, P); Mois de Mai, 200 m, 24 Aug. 1951, fr., *Baumann* 14962 or 14964 (both numbers given on different labels on same sheet) (P); Mois de Mai, 250 m, 16 Aug. 1951, fr., *Baumann* 15270 (G, K, P); R. Bleue, 200 m, 27–28 March 1968, fr., *Bernardi* 12421 (G, P); Parc Rivière Bleue, near R. Bleue, 22°06'S 166°41'E, 160 m, 23 Nov. 2002, st., *Bradford et al.* 1152 (K, MO, NOU); Port Boisé, above mouth of the Kwé, 10 m, 1 May 2003, fr., *Dagostini & Rigault* 675 (NOU); Foot of Mts Oungoune, 25 May 1925, st., *Franc* 1930 (P); Between R. Blanche and R. Bleue, 160 m, 12 June 1951, fr., *Hurliman* 1524 (P); Thy Valley, 100–300 m, 29 Jan. 1956, fl., *MacKee* 3883 (E, K, P); Path from Port Boisé, 200 m, 28 June 1968, fl./fr., *MacKee* 19050 (NOU, P); Vallée de Thy, 30 m, 24 March 1974, fl., *MacKee* 28360 (P); Rivière Bleue, 150 m, 15 March 1981, fl., *MacKee* 38826 (NOU, P holotype); Pic du Grand Kaori, 22 March 2005, st., *Pillon* 38 (NOU); Forêt Nord, 24 Nov. 2005, st., *Pillon* 185 (NOU); Forêt Nord, 7 March 2006, st., *Pillon et al.* 320 (K, NOU); Bon Secours, 7 Apr. 1966, fl., *Veillon* 697 (NOU, P). **PRECISE LOCALITY UNKNOWN:** s.dat., fl., *Deplanche* 44 (K, P).

CONSERVATION STATUS. Although *Codia jaffrei* is known from several localities and is sometimes abundant, the fact that it is quite a large forest tree and rarely found in scrub means that it is vulnerable to forest

clearance. This species has probably been exploited in the past for timber, but logging is no longer a major threat in southern New Caledonia. About half the collections come from the Parc Provincial Rivière Bleue; part of the Vallée de Thy is also a Provincial Park, and this species occurs in some smaller botanical reserves in southern Grande Terre, including Forêt Nord and Grand Lac, as well as in a few unprotected patches of rain forest nearby. Although the Rivière Bleue Provincial Park is currently well protected, even there, the forest is vulnerable to fire. Other nature reserves are not staffed and several populations are threatened by the forthcoming expansion of nickel mining, with the building of the plant for nickel processing near Goro. Based on its area of occupancy (not exceeding 2000 km²) and the fragmentation and expected decline of its habitat, we assign a provisional conservation status of VU B1ab(i,ii,iii,iv,v)+2ab(i,ii,iii,iv,v).

ETYMOLOGY. This species is named for Tanguy Jaffré of the Institut de recherche pour le développement (IRD), Nouméa, with thanks for his help in facilitating fieldwork on the *Cunoniaceae*.

DISCUSSION. Morphologically, *C. jaffrei* is distinguished by its stipules and the indumentum on the abaxial surface of the leaves, though it shows some variation in both these characters. The type of *C. jaffrei* has round-cordate and rather persistent stipules (Fig. 3A), though the stipules can also be somewhat caducous, leaving a broad, curved or inverted U-shaped scar, and occasionally they are ovate-elliptic and larger (e.g. to 1.6 cm in *MacKee* 28360). In the type and about half the collections cited, the abaxial leaf surface is covered with a dense, pale, rather persistent indumentum of minute curved, almost scurfy hairs (Fig. 3C) that is absent or thinner on the midrib, secondary and tertiary veins, thin over the quaternary ones, and generally much less persistent over the intervenium. In the remainder of the collections, the indumentum is more sparse or even lacking in a few specimens with cordate stipules or broad stipular scars (such as *Bernardi* 12421, *Deplanche* 44, *MacKee* 28360 and *Veillon* 697). In all cases there may be sparse longer straight hairs on the abaxial leaf surface. The occurrence of petals in *Codia* is rather erratic in some species (Hopkins 2005), and while petals usually appear to be absent, some are present in *MacKee* 3883. Unfortunately few of the collections have capitula at anthesis when the presence of petals can be determined with certainty.

Some of the specimens included here in *Codia jaffrei* have been considered for some time to represent a distinct taxon close to *C. discolor* (e.g.

* An additional locality, Pic du Pin (*Pillon & Munzinger* 614, 250–300 m, 9 Jan. 2007, st., K, NOV, P) lies within the same area but is not included on the distribution map.

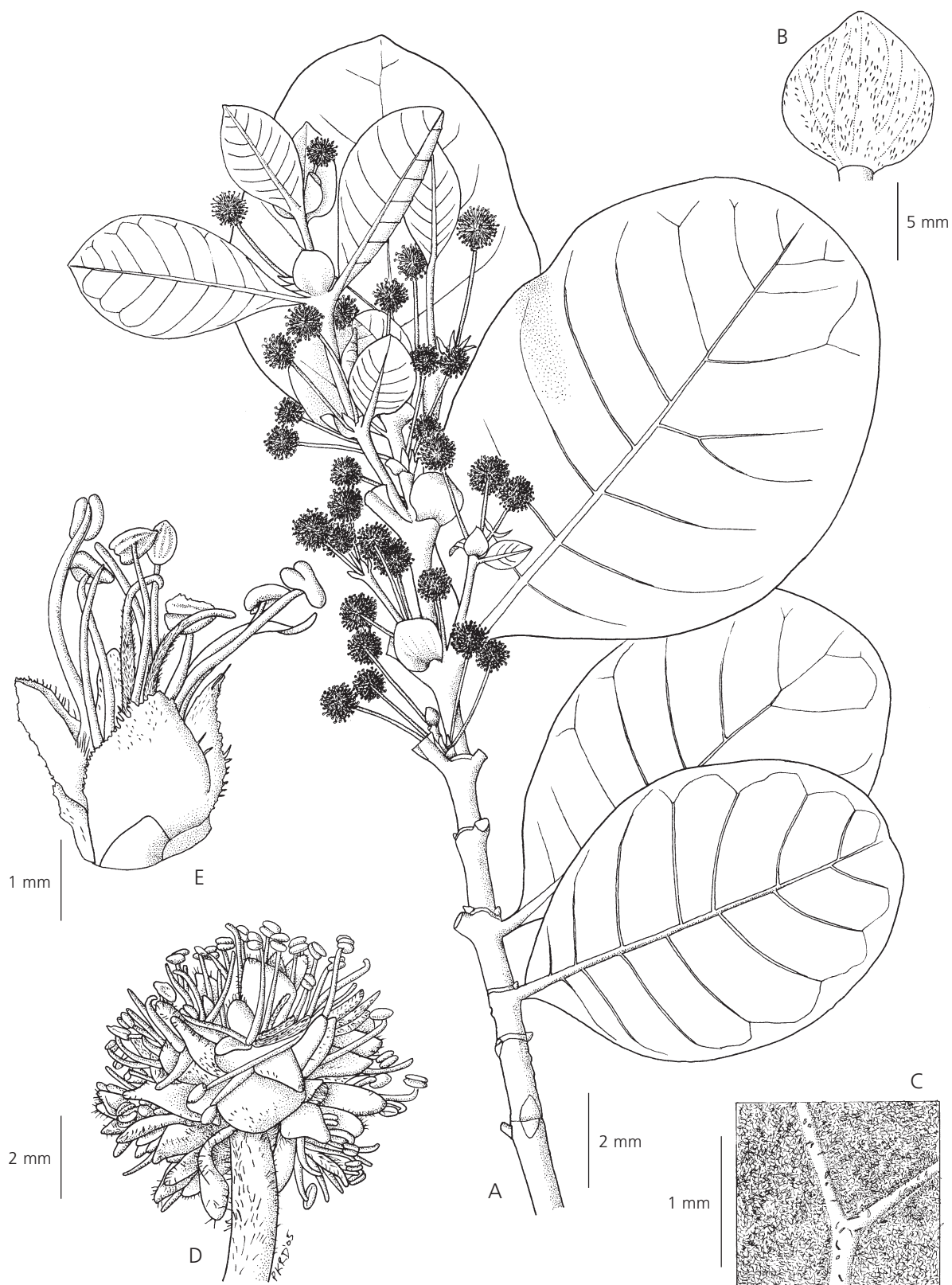

Fig. 3. *Codia jaffrei* **A** habit, in flower; **B** stipule; **C** detail of abaxial leaf surface showing indumentum of minute curved hairs; **D** capitulum at flowering stage; **E** single flower from **D**. **A – E** MacKee 38826. DRAWN BY PATRICIA K. R. DAVIES.

Guillaumin 1964), with which *C. jaffrei* is sympatric. The two species are distinguished by their stipules, which are narrowly triangular and strongly caducous, leaving a short straight scar in *C. discolor*. Other differences include the dense pale indumentum on the abaxial leaf surface, which is strongly persistent in *C. discolor*, so that only the midrib and secondary veins are visible.

The two species overlap in leaf size, *C. jaffrei* always having quite large leaves (7.5–14.5 × 5–9.5 cm) while *C. discolor* has small to large leaves (3–12 [–15] × 1.7–7.7 cm). When they overlap in size, the leaf shape is often slightly different, being elliptic-obovate in *C. jaffrei* and often broadly obovate or obcordate in *C. discolor*, though this distinction is a tendency only. Large-leaved forms of *C. discolor* are mostly shrubs from scrub (“maquis dégradé”) on the Plaine des Lacs, where this species is often very abundant. *Codia discolor* is confined to ultramafic substrates and occurs as far north as Monéo on the east side of Grande Terre and Mé Maoya on the west.

As distinguished by the stipules and indumentum, *C. discolor* is generally a shrub in ultramafic scrub while *C. jaffrei* is usually a forest tree, though there are exceptions. For instance, specimens of *C. jaffrei* from shrubs in scrub include *Dagostini & Rigault* 675 and *MacKee* 28360. Specimens of *C. discolor* whose label data indicate that they are from trees and/or forest include: *Dickison* 234 from Mt Dzumac (NOU!), *MacKee* 34820 from Les Dalmates (NOU!, P!), *MacKee* 37911 from Ouenarou (NOU!, P!), *MacKee* 43429 from Rivière des Lacs (NOU!, P!), *Schmid* 2738 from Rivière Bleue (NOU!, P!) and *Veillon* 3043 from Haute Ouinée (NOU!, P!). The two species occur in sympatry in several forests in the south of New Caledonia, such as Forêt Nord and Pic du Grand Kaori (Pillon *et al.* pers. obs.).

Variation in *Codia jaffrei* and its occasional morphological and ecological overlap with *C. discolor* are an example of the intergradation between taxa mentioned in the introduction, and suggest introgression following hybridization. Despite some overlap between these species, preliminary DNA sequence work suggests that there are molecular differences (Pillon unpublished).

Codia jaffrei also has some features in common with some collections of *C. incrassata* Pamp., such as *Bradford & Hopkins* 1083 (Mt Ignambi, 620 m, 10 Dec. 2000, st., K!, NOU!, MO!), *MacKee* 14734 (Col de Kouiri, towards La Ouaième, 400–500 m, 18 Apr. 1966, fl., P!), *MacKee* 28410 (Tiwaka, Inédète, 350 m, 30 March 1974, fl., P!) and *Vieillard* 2661 (Pic de Pouébo, 1861–67, fr., P!), the type of *C. incrassata* var. *rufinervis* (Guillaumin) H. C. Hopkins. However, *C. incrassata* occurs in the northern part of the island, generally in forest on non-ultramafic substrates.

While *C. incrassata* var. *incrassata* is very distinctive because it has short internodes with congested, almost round, sessile leaves that are cordate at the base, accompanied by large, broadly cordate, persistent stipules, the type of var. *rufinervis* and collections close to it have slightly smaller stipules and more widely spaced leaves that are elliptic to obovate and slightly pandurate, and are thus reminiscent of *C. jaffrei*. However, in *C. jaffrei* the secondary veins are usually slightly fewer (7–9 on either side of the midrib) and at a wider angle to the midrib (55–75° in median ones) than in *C. incrassata* var. *rufinervis* (2° veins 8–10, at 40–55°).

Guillaumin (1964) identified several collections of *C. jaffrei* as *C. discolor* var. *cinerascens* (Pamp.) Guillaumin, which has been recently elevated to *C. cinerascens* (Pamp.) H. C. Hopkins. The type of the latter is *Vieillard* 2660, 1861–67 (holotype G!; isotypes BM!, K!, P!), from “Ouatendé, Gatope”, near the town of Voh, about 300 km north of the distribution of *C. jaffrei*. *Caldwell s.n.* (Ouétendé [sic], K!, received in 1871) is also probably part of the type gathering (see discussion of Caldwell material in Hopkins 2006). These specimens are superficially similar to *C. jaffrei* in having quite broad (not narrowly triangular) stipules and indumentum on the abaxial leaf surface that is not very persistent. However, they have relatively small leaves (blades to 6.5–9 × 4–5 cm) compared with *C. jaffrei*, with somewhat longer petioles (1.2–2 cm) and smaller stipules (to 0.8 × 0.5 cm). For the present *C. cinerascens* is treated as a distinct, albeit poorly known, taxon.

4. *Codia triverticillata* H. C. Hopkins & Pillon, sp. nov.

Codiae albicanti Pamp. foliis infra indumento coacto obtectis, indumento in costis atque venis secundariis plerumque sparsiore vel carenti, similis, sed foliis in verticillum trifoliatum (nec paribus oppositis) dispositis et pedunculis crassioribus indumentum longiore rufo-brunneum ferentibus (nec pedunculis tenuibus indumentum breve hinnuleum ferentibus) differt. *Codiae albifronti* (Schinz & Guillaumin) Baker f. foliis in verticillum trifoliatum dispositis similis, sed venis secundariis foliorum infra prominulis (nec planis) atque indumento foliorum infra in costis atque venis secundariis sparsiore vel carenti (nec venis omnibus indumento denso obtectis) differt. Typus: New Caledonia, [Province Nord], E of Kopéto, Aiguilles de Muéo, [21°10'54"S 165°05'45"E], 900 m, 28 Nov. 1980, fl., *Morat* 6640 (holotypus P! – P00428176; isotypus NOU!).

Shrub or small tree to 0.7–3 m high. Young stems 3–4 mm diameter; indumentum on young stems, stipules and young adult leaves dense, reddish brown, in two layers, a short and felty layer of curled hairs

underneath, overtopped by a less dense layer of erect, straight or slightly crispate hairs, to 1.5 mm long. *Stipules* ovate-triangular to broadly ovate-triangular, to $1 \times 0.5 - 0.7$ cm, somewhat carinate, persistent only at the most distal node(s); adaxial and abaxial surfaces with dense indumentum. *Leaves* in whorls of 3 per node. Petioles 3 – 6 mm long, with dense, short, felty indumentum. Leaf blades ovate-elliptic, $2.7 - 6 \times 2 - 4 (-5.8)$ cm, rounded or slightly cordate at the base, and rounded, obtuse or occasionally acute at the apex, coriaceous; adaxial surface somewhat shiny and glabrous except sometimes for remnants of indumentum on proximal part of midrib, midrib glabrescent; abaxial surface with dense white felty indumentum on intervenium and over smaller veins, absent from the midrib, 2° and a few 3° veins, with some sparse, longer, straight hairs; margin entire and slightly irregular to sinuate, minutely recurved; 2° veins 6 – 11 on either side of midrib, slightly indented on adaxial surface and

markedly prominent on abaxial surface, median ones at $40 - 45^\circ$ to midrib, appearing eucamptodromous to brochidodromous. Peduncles c. 1 cm long \times 3 mm diameter, with dense indumentum of reddish brown crispate hairs, to 1.5 mm long. *Capitula* at anthesis c. 1.3 cm diameter, cream, composed of c. 52 flowers. Base of flower to tips of calyx lobes 4 – 4.5 mm; calyx lobes elliptic-ovate, c. 3 mm long, with dense indumentum of short yellow hairs on adaxial surface; petals absent; filaments 4 – 5 mm long; anther connective slightly apiculate; styles c. 3 mm long, hairy for most of their length. Fig. 4.

DISTRIBUTION AND HABITAT. *Codia triverticillata* occurs in scrub (“maquis”, “maquis très dégradé”), at medium to high elevation (600 – 1150 m) on ultramafic substrates, including “péridotite altérée” on Mt Kopéto, Mt Paéoua to its east and Mt Boulinda to its south, on the western side of central Grande Terre. Map 2.

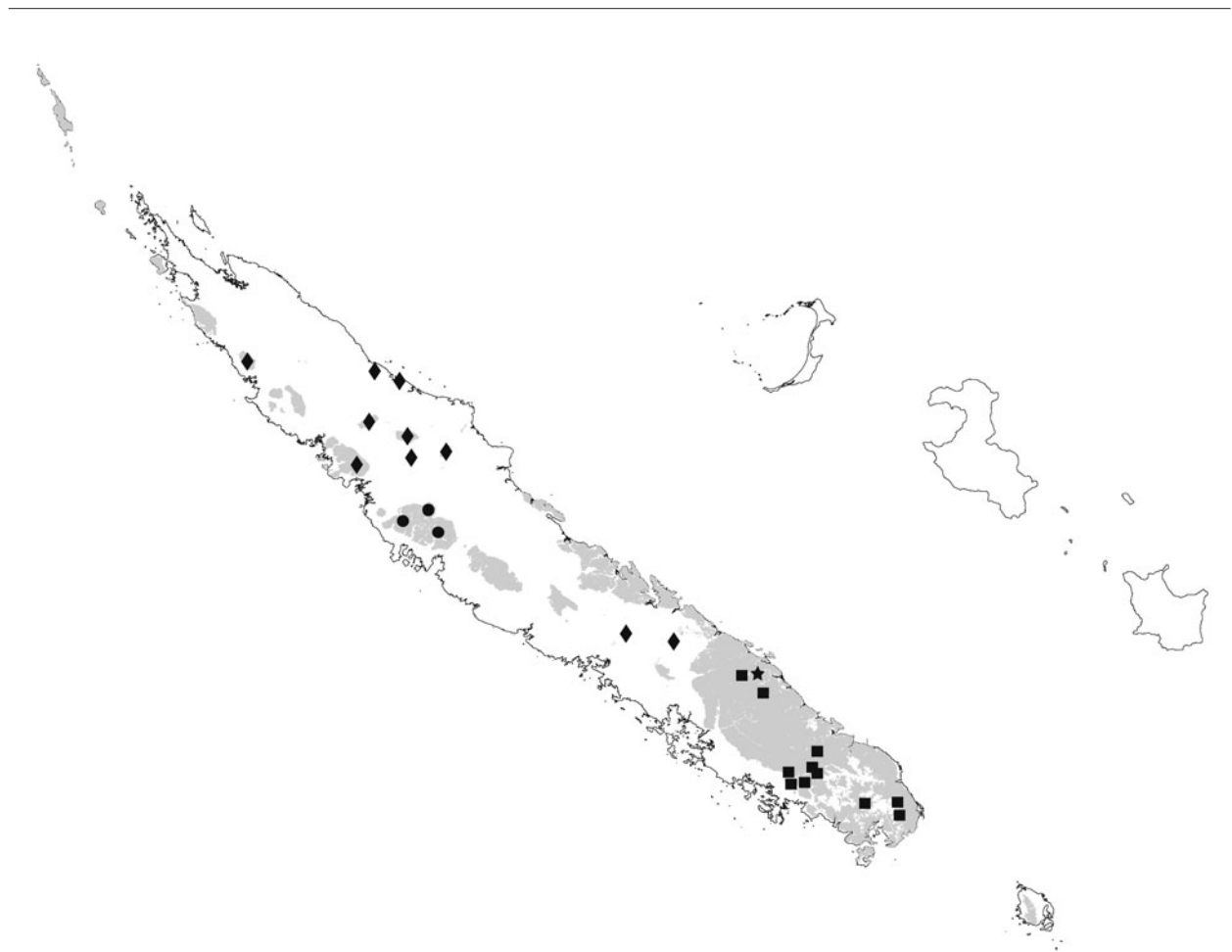

Map 2. Distributions of *Codia triverticillata* (●), *C. albicans* (◆), *C. albifrons* (■) and the locality of the type of '*C. fusca*' (★) in New Caledonia. The main areas of ultramafic substrates, especially peridotite, are shown in grey, simplified from Paris (1981).

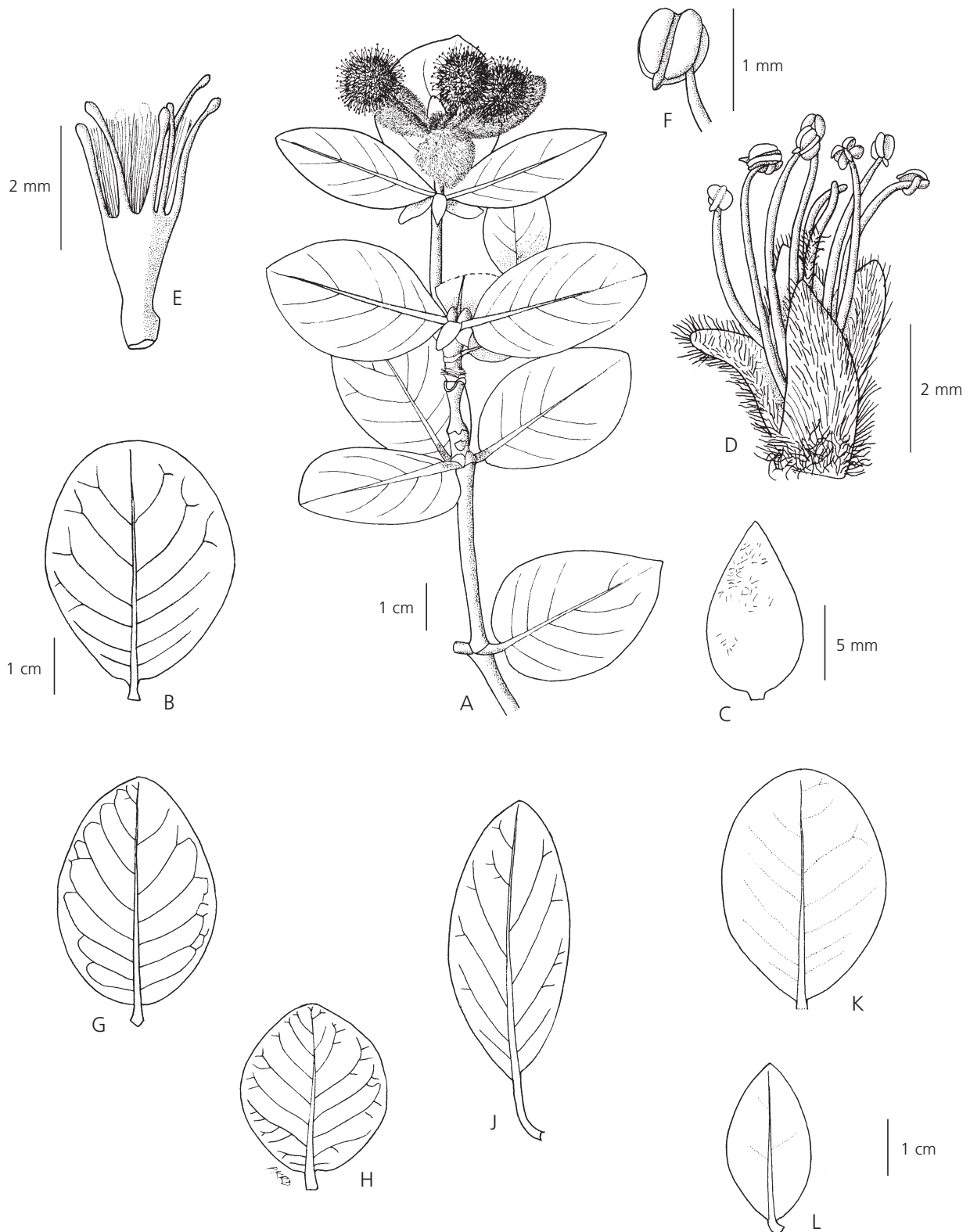

Fig. 4. *Codia triverticillata* **A** habit, in flower; **B** leaf, abaxial surface, indicating venation visible; **C** stipule; **D** flower at anthesis; **E** old flower, the calyx lobes removed to reveal the filaments (the anthers having fallen) and hairs on the upper surface of the ovary; **F** anther. *Codia albicans* **G** – **J** leaves, abaxial surface, indicating visible venation. *Codia albifrons* **K** – **L** leaves, abaxial surface, indicating visible venation. **A**, **C** – **F** Pillon *et al.* 137; **B** Morat 6640; **G** McPherson & Munzinger 18084; **H** Bradford *et al.* 1067; **J** MacKee 18395; **K** Bradford *et al.* 1162; **L** Veillon 5875. DRAWN BY PATRICIA K. R. DAVIES.

MATERIAL EXAMINED. NEW CALEDONIA, PROVINCE NORD: Paéoua, 21°8' – 21°10'S 165°3' – 165°7'E, 950 m, 13 Aug. 1965, buds, *Bernardi* 10135 (K, P); Mt Kopéto, summit plateau, 900 – 1000 m, 6 July 1967, buds & fr., *MacKee* 17122 (NOU, P × 2); Mt Boulinda, plateau to N, 1000 – 1150 m, 28 Aug. 1967, buds, *MacKee* 17370 (P × 2); E of Kopéto, Aiguilles de Muéo, 900 m, 28 Nov. 1980, fl., *Morat* 6640 (NOU, P holotype); Kopéto, 165°1'17"E 21°10'15"S, 1050 m, 19 July 2005, fl., *Pillon*, *Barrabé* & *Rigault* 137 (K, NOU, P); Boulinda, Mt Poya, 800 m, 28 Apr. 1965, buds, *Schmid* 170 (NOU, P); Kopéto, N side, 600 m, 11 Dec. 1970, fr., *Veillon* 2214 (NOU); Paéoua, summit of Pic 1142, 16 Oct. 1986, buds, *Veillon* 6085 (NOU, P).

CONSERVATION STATUS. Although *Codia triverticillata* is often very abundant, it has a very limited distribution which lies outside current conservation areas. As a component of scrub rather than forest, it is likely to survive some disturbance of its habitat, but this habitat is severely threatened. The upper part of Mt Kopéto is being intensively mined for nickel, and most of the large population of *C. triverticillata* there will shortly disappear. Both Mt Paéoua and Mt Boulinda have been mined in the past and will probably be exploited again in the future. Since the entire massif of Kopéto – Paéoua – Boulinda covers less than 450 km² and because of the forthcoming destruction of much of its habitat, we give *C. triverticillata* a provisional threat status of EN B1ab(i,ii,iii,v)+2ab(i,ii,iii,v). This species may be a suitable candidate for the revegetation of mining sites within its current natural distribution.

DISCUSSION. *Codia triverticillata* has a unique combination of characters, with leaves in whorls of three per node and the mature adult leaves with the midrib, secondary, and sometimes some tertiary veins very prominent and visible on the abaxial surface through the white felty indumentum. The inflorescence is fairly condensed with relatively short, thick peduncles, densely covered with longish, red-brown, crispate hairs, and the capitula are quite large. Young leaves on adult twigs are also very densely red-brown hairy on both surfaces, the indumentum being rapidly lost on the adaxial surface as the leaf expands. As is usual in *Codia*, the venation is basically brochidodromous (e.g. *Veillon* 2214) but sometimes it can appear eucamptodromous in *C. triverticillata* when the thin parts of the arching secondary veins are not visible through the indumentum on the abaxial surface and are indistinct on the adaxial surface.

Although most plants of *C. triverticillata* are similar to one another and show the characters described above, significant morphological variation can be observed within populations (Y. Pillon pers. obs.). For instance, *Pillon et al.* 148 (*C. cf. triverticillata*, Mt Boulinda, 720 m, 20 July 2005, K!, NOU!, P!) from a sterile individual with indumentum typical for *C.*

triverticillata has particularly dense foliage of opposite leaves, each with a distinct petiole and markedly lanceolate blade. Such variation could perhaps be explained by hybridisation with *C. montana*, which often co-occurs with it, and emphasizes the need to consider the characters seen in populations as a whole, especially when individuals plants of *Codia* may be difficult to identify.

Codia triverticillata is most likely to be confused with *C. albicans* because of the similarity of the indumentum on the leaves and the venation. However, *C. albicans* has consistently opposite leaves and its peduncles are markedly thinner and sometimes longer, with short, fawn indumentum. It occurs in forest and scrub on both ultramafic and non-ultramafic substrates, mostly in the northern part of Grande Terre but extending as far south as Mt Nakada (Map 2).

Whorled leaves occur sporadically in most species of *Codia* but *C. albifrons* is the only other species with leaves habitually in threes [but see discussion below of *C. fusca* (Schltr.) H. C. Hopkins], the remaining species all having opposite leaves. *Codia albifrons* is confined to scrub and low forest on ultramafic substrates in areas of very high rainfall in southern Grande Terre, irrespective of altitude, such as Plaine des Lacs and Montagne des Sources (Map 2). *Codia triverticillata* is compared with *C. albicans* and *C. albifrons* in Table 2.

Codia triverticillata also bears a superficial resemblance to *Schlechter* 15363 (B – image!), the holotype of *C. fusca* from 400 m at Ngoye in south-east Grande Terre. Both taxa have leaves in whorls of three per node with dense pale indumentum on the abaxial surface, but they are not an exact match. Most of the leaves of *Schlechter* 15363 have an evenly curved margin and thus resemble *C. albifrons*, although a few have a more irregular, slightly sinuous margin reminiscent of *C. albicans*, *C. ferruginea* and *C. triverticillata*. As regards the indumentum on the abaxial leaf surface and the extent to which the secondary veins are visible through it, *Schlechter* 15363 is again intermediate between *C. albifrons* on the one hand and *C. albicans*, *C. ferruginea* and *C. triverticillata* on the other. Although in many parts of the world the distance of 150 km that separates Ngoye from Kopéto – Paéoua – Boulinda would be insignificant in terms of distribution, microendemism in New Caledonia means that some taxa have very restricted distributions (e.g. Bradford & Jaffré 2004, Jaffré & Fambart 2002, Pintaud *et al.* 2001), and *Schlechter* 15363 cannot be considered sympatric with *C. triverticillata*. These localities are also separated by the central chain of mountains, which is composed of non-ultramafic rocks and may well present a barrier to the dispersion of these species. Another collection from Ngoye (*Compton* 970, River Ngoye, 500 ft, fr., BM!) and one from Haute Cambouï to the west

Table 2. Comparison of *Codia albicans*, *C. albifrons* and *C. triverticillata*.

<i>Codia</i> species	<i>C. albicans</i>	<i>C. albifrons</i>	<i>C. triverticillata</i>
substrate — ultramafic (UM) or non-ultramafic (NUM)	NUM & UM	UM	UM
distribution within Grande Terre	mostly in N, but S to Mt Rembai and Mt Nakada	S	massifs on W side
habitat and elevation	maquis and forest, (50 –) 400 – 1080 m	maquis and low forest in areas of very high rainfall, 170 – 1050 m	maquis at high elevation, 600 – 1150 m
# leaves per node	2	3	3
indumentum on young stems	fairly dense, yellowish fawn, hairs short, some ± erect	densely felty, white to orangey, hairs long, matted-woolly and flattened	dense, reddish brown, under-layer felty, overtopped by quite long, erect, straight or crispate hairs
leaf margin	often slightly sinuate	entire and very regularly curved	often slightly sinuate
petiole	(0.3 –) 0.6 – 1 cm	0.3 – 0.5 cm	0.3 – 0.6 cm
abaxial leaf surface	2° and sometimes some 3° veins prominent and readily visible, with indumentum thinner than over intervenium	2° venation flat and scarcely visible, with indumentum as thick as over intervenium (may be lost eventually over 2° veins in old leaves)	2° and sometimes some 3° veins prominent and readily visible, with indumentum thinner than over intervenium
peduncle	0.5 – 2.5 cm long × 1 – 1.5 mm diameter, with fairly dense indumentum of short, yellowish fawn hairs (0.5 – 1 mm long), some ± erect and crispate	0.5 – 2 (– 3) cm long × 1.5 mm diameter, with dense indumentum of erect, orangey, crispate hairs (to 1 mm long)	to 1 cm long × 3 mm diameter, with dense indumentum of erect, reddish brown crispate hairs (to 1.5 mm long)
capitulum	0.5 – 0.9 cm diameter	0.9 – 1 cm diameter	c. 1.3 cm diameter
petals	absent	present	absent

(MacKee 23114, 900 – 1000 m, 23 Dec. 1970, fl., NOU!, P!) are similarly close to *C. albifrons* but not entirely typical. These three specimens are considered to be a local variant of *C. albifrons*, possibly involving some hybridization with *C. ferruginea* or *C. albicans*.

Acknowledgements

Work on *Codia* by HCFH for the *Flore de la Nouvelle-Calédonie* was supported in part by a visiting research fellowship at the Museum National d'Histoire Naturelle, Paris, kindly arranged by Prof. Philippe Morat. Facilities for completing the work were provided by the Royal Botanic Gardens, Kew. Curators of the following herbaria allowed access to specimens or provided images: B, BM, E, G, K, MO, NOU, P. Fieldwork in New Caledonia by HCFH was supported by the National Geographic Society, via a grant to Jason Bradford, and the Royal Botanic Gardens, Kew (TOBU fund). The Institut de recherche pour le développement (IRD) provided facilities in Nouméa and HCFH especially thanks Tanguy Jaffré, Jacqueline Fambart-Tinel and Gilles Dagostini for their help. The illustrations were

drawn by Patricia K.R. Davies whose careful work is much appreciated, and we thank Melanie Wilmot-Dear and Maria Vorontsova for translating the diagnoses into Latin, and Jason Bradford for his collaboration in the field.

References

- Bradford, J. C. & Barnes, R. W. (2001). Phylogenetics and classification of *Cunoniaceae* (*Oxalidales*) using chloroplast DNA sequences and morphology. *Syst. Bot.* 26: 354 – 385.
- , Hopkins, H. C. F. & Barnes, R.W. (2004). *Cunoniaceae*. In: K. Kubitzki (ed.), *The Families and Genera of Vascular Plants* 6: 91 – 111.
- & Jaffré, T. (2004). Plant species microendemism and conservation of montane maquis in New Caledonia: two species of *Pancheria* (*Cunoniaceae*) from the Roche Ouaième. *Biodivers. & Conservation* 13: 2253 – 2273.
- Gargominy, O. (ed.) (2003). *Biodiversité et conservation dans les collectivités françaises d'Outre-Mer*. Comité français pour l'U.I.C.N., Paris.

- Guillaumin, A. (1911). Catalogue des plantes phanérogames de la Nouvelle-Calédonie et dépendances. Ann. Mus. Colon. Marseille, sér. 2, 9: 77 – 290.
- (1941). Matériaux pour la Flore de la Nouvelle-Calédonie. LVI. Révision des *Cunoniacées*. Bull. Soc. Bot. France 87: 242 – 256. (dated 1940, published 1941).
- (1946). Contributions à la flore de la Nouvelle-Calédonie LXXXVI. Plantes récoltées par L. Virot (suite). Bull. Mus. Natl. Hist. Nat., sér. 2, 18: 355 – 361.
- (1948). Flore analytique et synoptique de la Nouvelle-Calédonie. Phanérogames. Office de la Recherche Scientifique Coloniale, Paris.
- (1964). Résultats scientifiques de la mission franco-suisse de botanique en Nouvelle-Calédonie (1950 – 1952). III. Mém. Mus. Natl. Hist. Nat., B, Bot. 15: 1 – 93.
- Hopkins, H. C. F. (2005). Nomenclature and typification in the endemic genus *Codia* (*Cunoniaceae*) from New Caledonia. *Adansonia*, sér. 3, 27: 243 – 254.
- (2006). Nomenclature and typification in *Geissois* (*Cunoniaceae*) in the SW Pacific. *Adansonia*, sér. 3, 28: 311 – 327.
- IUCN. (2001). IUCN Red List Categories and Criteria. Version 3.1. IUCN, Gland, Switzerland.
- Jaffré, T. & Fambart, J. (2002). Quatre nouvelles espèces de *Soulamea* (*Simaroubaceae*) de Nouvelle-Calédonie. *Adansonia*, sér. 3, 24: 159 – 168.
- & Veillon, J.-M. (1991). Etude floristique et structurale de deux forêts denses humides sur roches ultrabasiqes en Nouvelle-Calédonie. Bull. Mus. Natl. Hist. Nat., B, *Adansonia* 12: 243 – 273 (dated 1990, published 1991).
- & —— (1995). Structural and floristic characteristics of a rain forest on schist in New Caledonia: a comparison with an ultramafic rain forest. Bull. Mus. Natl. Hist. Nat., B, *Adansonia* 17: 201 – 226.
- Melville R. (1972). On the nature of the bud scales in the *Cunoniaceae*. *Kew Bull.* 26: 477 – 485.
- Paris, J.-P. (1981). Géologie. In: Atlas de La Nouvelle-Calédonie et Dépendances, planche 9. ORSTOM, Paris.
- Picard, M. (1999). L'archipel néo-calédonien. Centre de Documentation Pédagogique de Nouvelle-Calédonie, Nouméa.
- Pintaud, J.-C., Jaffré, T., & Puig, H. (2001). Chorology of New Caledonian palms and possible evidence of Pleistocene rain forest refugia. *Compt. Rend. Acad. Sci. Paris, sér. 3, Sci. Vie* 324: 453 – 463.
- Schimanski, L. J. & Rozefelds, A. C. (2002). Comparative morphology of the Australian species of *Geissois* (*Cunoniaceae*). *Austral. Syst. Bot.* 15: 221 – 236.

Article II

Pillon Y, Hopkins HCF, Bradford JC (2008) Two new species of *Cunonia* (Cunoniaceae) from New Caledonia. *Kew Bulletin* **63**, 419-431.



Les descriptions, illustrations, cartes de répartition et statuts de conservation sont donnés pour deux nouvelles espèces de *Cunonia* de Nouvelle-Calédonie. *Cunonia dickisonii* Pillon & H. C. Hopkins est restreint au maquis minier d'altitude des Monts Humboldt et Kouakoué. *Cunonia koghicola* H. C. Hopkins, J. Bradford & Pillon est une espèce de forêt humide de basse et moyenne altitude dans la région du Mont Koghi. Les irrégularités dans la forme de ses feuilles et de ses nervures suggèrent qu'elle aurait peut-être une origine hybride. Le micro-endémisme sur les Monts Humboldt et Kouakoué est brièvement discuté.

Two new species of *Cunonia* (*Cunoniaceae*) from New Caledonia

Yohan Pillon^{1,2}, Helen C. F. Hopkins³ & Jason C. Bradford⁴

Summary. Descriptions, illustrations, distribution maps and conservation assessments are provided for two new species of *Cunonia* from New Caledonia. *Cunonia dickisonii* Pillon & H. C. Hopkins is endemic to montane ultramafic scrub at high elevation on Mts Humboldt and Kouakoué. *Cunonia koghicola* H. C. Hopkins, J. Bradford & Pillon is from wet forest at low to medium elevation in the region of Mt Koghi, and irregularities in leaf shape and venation suggest it may be of hybrid origin. Microendemism on Mt Humboldt and Mt Kouakoué is briefly discussed.

Key Words. *Cunonia*, *Cunoniaceae*, hybrid speciation, microendemism, New Caledonia, ultramafic.

Introduction

The genus *Cunonia* has a curious distribution. It was originally described from South Africa, where a single species, *C. capensis* L., is a tree in wet forest and scrub (Coates Palgrave & Coates Palgrave 2003) but the remaining 25 or so species are all endemic to New Caledonia in the south-west Pacific.

Cunonia is a genus of shrubs, small trees or occasionally larger trees, which in New Caledonia are often associated with the ultramafic substrates that cover about a third of the main island (Paris 1981). Like other *Cunoniaceae*, *Cunonia* is absent from the calcareous Loyalty Islands. *Cunonia* species have simple or compound (trifoliolate or imparipinnate) opposite leaves with interpetiolar stipules, flowers in racemes or modified racemes and capsular fruit. The genus can be distinguished from its more widespread relative *Weinmannia* by the stipules, which are often spoon-shaped in bud in *Cunonia* (versus ovate to triangular in bud in *Weinmannia*), the floral disc, which is adnate to the ovary in *Cunonia* (versus free and annular or lobed in *Weinmannia*), the fruits, which are circumbasally and then acropetally dehiscent in *Cunonia* (versus basipetally dehiscent in *Weinmannia*), and the seeds, which are winged and lack hairs in *Cunonia* (versus without wings but with hairs in *Weinmannia*) (Bradford *et al.* 2004). In a phylogenetic analysis of the tribe *Cunoniae* based on the sequences

of two genes, Bradford (2002) found that *Weinmannia* sect. *Weinmannia* was sister to a group comprising all other *Weinmannia*, *Cunonia* and *Pancheria*. In other words, *Weinmannia* may be paraphyletic with *Cunonia* and *Pancheria* nested within it. However, the clade of *Weinmannia* sect. *Weinmannia* is on a long branch and a tree with a monophyletic *Weinmannia* is only one step longer, and the latter topology could not be rejected statistically. Thus as stated by Bradford (2002), “it would therefore be premature to consider *Weinmannia* paraphyletic based on this data”. Because of the characters stated above that distinguish *Cunonia* and *Weinmannia* morphologically and the ease of the distinction in the field, we adopted a conservative approach and keep the two genera as distinct as they have always been since Linnaeus described them. Resolving the exact relationships within the tribe *Cunoniae* using molecular markers is likely to be a difficult task. Preliminary studies using other plastid or nuclear markers found no structure within this tribe with very short deep branches suggesting that the different sections of *Weinmannia*, *Cunonia capensis*, the New Caledonian *Cunonia* and *Pancheria* diverged almost simultaneously.

A draft revision of *Cunonia* for the “Flore de la Nouvelle-Calédonie” in the 1980s by R. D. Hoogland (unpublished ms at P) included five new species that were published shortly after his death, along with a key

Accepted for publication October 2007.

¹ Laboratoire de Botanique, Institut de Recherche pour le Développement, BP A5, 98848, Nouméa, New Caledonia. e-mail: pillon@noumea.ird.nc

² Laboratoire des Mécanismes Adaptatifs et Biomolécules des plantes endémiques à la Mélanésie (MABioM), Université de la Nouvelle-Calédonie, BP 4477, 98847, Nouméa, New Caledonia.

³ Herbarium, Royal Botanic Gardens, Kew, Richmond, Surrey, TW9 3AB, UK. e-mail: h.fortune@kew.org

⁴ Renewable Energy Development Institute, 121 W. Commercial St., Willits, CA 95490, USA. e-mail: jason@redinet.org

and discussion of inflorescence morphology (Hoogland *et al.* 1997). Hoogland's taxonomic treatment is largely uncontroversial, and species delimitation within *Cunonia* is generally straightforward, contrary to what is observed in other genera of New Caledonian *Cunoniaceae* such as *Codia* and to some extent *Geissois*, which contain species complexes. Here we describe two new species, *Cunonia dickisonii* and *C. koghicola*, which both have restricted distributions and are examples of microendemism in the flora of New Caledonia. Hoogland probably overlooked the taxon named here as *C. dickisonii* because at the time of his treatment, only two specimens were available at P, one sterile and the other with a single short inflorescence. He assigned both specimens to *C. alticola* Guillaumin, which according to his manuscript could have white or pink flowers and simple or pinnate leaves. The collection of a fully blooming plant on Mt Kouakoué made by McPherson, Munzinger & Labat in 2004 allows the distinction of two entities within Hoogland's concept of *C. alticola*: plants with white flowers and a mixture of simple and pinnate leaves (*C. alticola sensu stricto*) and plants with reddish flowers and only simple leaves (*C. dickisonii*). As regards the second of our new species, Hoogland noticed the atypical morphology of the specimens from Mt Koghi that are assigned here to *C. koghicola*, but he identified them as *C. cf. pulchella*.

Taxonomy

1. *Cunonia dickisonii* Pillon & H. C. Hopkins sp. nov. inter species simplicifolias *Cunoniae*, simillissima est *C. bullatae* Brongn. & Gris atque *C. rotundifoliae* Däniker, qui etiam frutices sunt et summum montium Novae Caledoniae australis habitant. Ab ambabus autem combinatione singulari characterum, floribus rubidis ut in *C. rotundifolia* atque foliis bullatis, *C. bullatae* similibus sed minus manifeste, differt. Typus: *McPherson, Munzinger & Labat* 19340, New Caledonia, Province Sud, Mt Kouakoué, 21°58'6"S 166°30'16"E, 1200 m, 7 Nov. 2004, fl. (holotypus P!; isotypus MO!).

Dense bushy-topped *shrub* c. 1 m high. Bark rugose with marked lenticels. Young twigs c. 3 mm diameter, with semi-erect, wavy trichomes (hereafter hairs) 1 mm long, older stems glabrescent. *Leaves* opposite, simple, 1 – 2 (– 4) pairs at the tip of each twig. Petioles 2 – 8 mm long. Leaf blades ovate to obovate, 2.8 – 4.5 × 1.6 – 2.8 cm, base cuneate or rounded, apex rounded to truncate or retuse, lamina bullate, coriaceous, margin toothed and minutely reflexed; adaxial surface hirsute in fresh leaves, the hairs semi-erect and wavy, to 1.5 mm long, strongly persistent on midrib (and petiole), otherwise glabrescent after drying; abaxial surface fairly densely tomentose on midrib and veins (and petiole), intervenium sparsely

hirsute, the hairs ± straight and adpressed, to 2 mm long; secondary veins 5 – 6 on either side of midrib, forming an angle of c. 30° – 45° with the latter; primary and secondary veins prominent below, sunken above, tertiary veins clearly distinct on both surfaces; secondary venation semicraspedodromous, the veins branching toward the margin, each branch ending at the sinus of a tooth. *Stipules* cordate-ovate, to 10 × 8 mm, rounded at base and apex, with abaxial surface densely hairy, the hairs ± adpressed, 1.5 mm long, and adaxial surface glabrous. *Inflorescences* of 2 opposite simple racemes (type 2 of Hoogland *et al.* 1997), with an apical bud between their bases. Inflorescence axis 1 – 5.5 cm long including a peduncle of 1 – 10 mm, covered with curly and erect hairs, to 2 mm long. Floral bracts lanceolate, 3 × 1 mm, hairy on abaxial surface. Pedicel short, < 1 mm, hairy. *Flowers*: sepals 5, ovate, 1.2 × 1 mm, minutely hairy on abaxial surface; petals 5, reddish, ovate, 2 – 2.5 × 1.2 – 1.5 mm, glabrous; stamens 10, filaments to 4 mm long, anthers c. 0.5 mm long; disc 0.2 mm high; ovary ovoid, 1.5 mm long, hairy; styles 2, each 3 mm long, glabrous. *Fruits* not seen. Figs. 1, 2.

DISTRIBUTION AND HABITAT. This species is restricted to montane maquis on ultramafic rocks on Mt Humboldt and Mt Kouakoué, above 1000 m. Map. 1.

MATERIAL EXAMINED. NEW CALEDONIA. Province Sud: Mt Humboldt, sommet nuageux, 1500 – 1600 m, 23 Sept. 1951, st., *Baumann-Bodenheim* 15454 (P); Mt Kouakoué, 1500 m, 9 Dec. 1976, fl., *MacKee* 32428 (P); *ibid.*, 21°58'6"S 166°30'16"E, 1200 m, 7 Nov. 2004, fl., *McPherson, Munzinger & Labat* 19340 (MO, P, type); *ibid.*, 1350 – 1450 m, 28 April 2006, st., *Pillon, Gaudeul, Brown & McPherson* 374 (K, MO, NOU, P); *ibid.*, 21°58'01"S 166°32'34"E, 1044 m, 1 Dec. 2002, st., *Tronchet, Munzinger, Le Borgne & Oddi* 605 (P).

CONSERVATION ASSESSMENT. The area of Mt Humboldt and Mt Kouakoué above 1000 m is considerably less than 150 km². The first author spent several days on both mountains and found that *Cunonia dickisonii* was uncommon in both localities, except on the summital crest of Mt Kouakoué. Although the upper parts of both mountains are botanical reserves, these areas still do not benefit from a mining ban, and therefore future mining for nickel cannot be ruled out (Jaffré *et al.* 1998). Furthermore, fire is a major threat to primary vegetation and nature reserves are as much at risk as areas without legal protection. Finally, because this species is restricted to the upper part of two of the highest mountains of New Caledonia, global warming may reduce the area of suitable habitat in the future. *C. dickisonii* is here given the provisional status of Endangered: EN B1ab(i,ii,iii)+2ab(i,ii,iii).

ETYMOLOGY. This species is named to commemorate William C. Dickison, who conducted extensive anatomical studies on *Cunoniaceae* and other New Caledonian plant families.

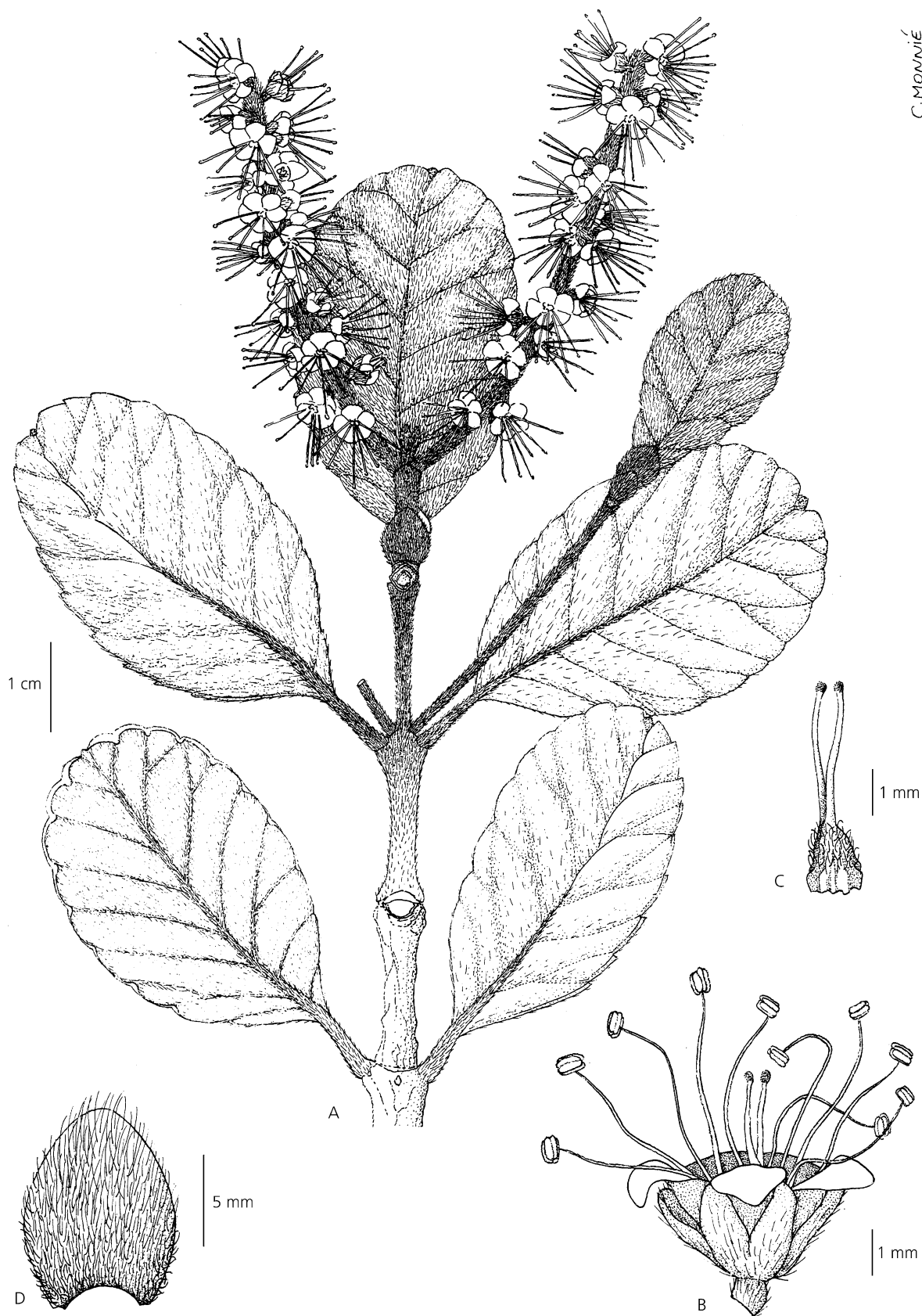

Fig. 1. *Cunonia dickisonii*. A twig with leaves and inflorescence; B flower; C gynoecium; D stipule. A – D McPherson et al. 19340.
DRAWN BY CÉCILE MONNIÉ.



Fig. 2. *Cunonia dickisonii* in flower. McPherson *et al.* 19340, photo by J. Munzinger.

DISCUSSION. Although the fruits and seeds of *Cunonia dickisonii* are not known, we did not hesitate to assign it to the genus *Cunonia* rather than to *Weinmannia*. Besides the affinities to some New Caledonian species of *Cunonia* (see below), the floral disc is not clearly distinct from the ovary, whereas in all New Caledonian *Weinmannia* species the disc consists of free segments that alternate with the stamens. Some species of *Weinmannia* in Malesia have pinkish flowers though none are as red as in *C. dickisonii*, and all species of *Weinmannia* in New Caledonia have white flowers.

Among the species of *Cunonia* with simple leaves which include *C. balansae* Brongn. & Gris, *C. bullata* and *C. rotundifolia*, *C. dickisonii* appears closely allied to the last two and like them, it is a dense bushy-topped shrub with coriaceous leaves. They are all found in the same habitat: maquis at high elevation on ultramafic soil, and all three occur on Mt Humboldt and Mt Kouakoué at similar altitudes. This new species differs from *C. bullata* by its reddish (not white) flowers, and in its leaves, which are only slightly bullate with minutely reflexed margins (not strongly bullate, like Savoy cabbage, with markedly revolute margins in *C. bullata*), and with the upper surface more or less shiny (not glaucous). It differs from *C. rotundifolia* by having quite long, coarse, \pm erect caducous hairs on the underside of the leaves through which the

venation is readily visible, rather than having a dense indumentum of short, straight, pale, adpressed, persistent hairs through which the secondary veins are scarcely apparent. In *C. rotundifolia*, the leaves are sessile or nearly so and generally smaller (< 3 cm), and the apex is more pointed and never retuse, although in both, the leaves are restricted to the tips of the shoots.

As mentioned above, material of *Cunonia dickisonii* was treated by Hoogland (key in Hoogland *et al.* 1997 and unpublished ms at P) as a uniformly simple-leaved form of *C. alticola*. The two taxa resemble one another in their slightly bullate leaves and their longish, coarse indumentum, but *C. alticola* usually has imparipinnate leaves, with the terminal leaflet much larger than the laterals, which are in 1 – 2 pairs, with only occasional simple leaves present. The two species differ in flower colour: red in *C. dickisonii* and white in *C. alticola*. *Cunonia alticola* is known from several mountains in southern New Caledonia, including Mts Humboldt and Kouakoué, at 800 – 1300 m.

Endemism on Mts Humboldt and Kouakoué

The high altitude maquis of Mts Humboldt and Kouakoué is particularly rich in *Cunoniaceae*, including several rare species. Besides *Cunonia dickisonii* and

C. rotundifolia, two species of *Pancheria*, both invalidly published by Guillaumin (1964) under the names *P. humboldtiana* and *P. multijuga* are restricted to these two mountains, the latter occurring also on Montagne des Sources. *Pancheria robusta* Guillaumin and *Cunonia pseudoverticillata* Guillaumin occur only on Mt Kouakoué and Montagne des Sources, whereas *Acsmithia elliptica* (Pamp.) Hoogland, *C. alticola* and *C. bullata* are more widespread on the mountain tops of the southern ultramafic massif of New Caledonia, including Mts Humboldt and Kouakoué.

Endemic species in various other families, such as *Cupressaceae*, *Myrtaceae* and *Proteaceae*, are also known only from the montane maquis of Mts Humboldt and Kouakoué. Some of these taxa were initially known only from Mt Humboldt, as Mt Kouakoué is less accessible and has been less well collected in the past, but several have now been found on the latter mountain during recent expeditions (2000 onwards). Few if any are only known from Mt Kouakoué.

As in *Cunonia* and *Pancheria* (Bradford & Jaffré 2004), micro-endemism at high altitude is common in several genera in other families, with species endemic to Mts Humboldt, Kouakoué and other mountains, such as Roche Ouaième or Mt Panié: e.g. *Beauprea* (*Proteaceae*, Virot 1967), *Dracophyllum* (*Ericaceae*, Virot 1975) and *Metrosideros* (*Myrtaceae*, Dawson 1992).

2. *Cunonia koghicola* H. C. Hopkins, J. Bradford & Pillon **sp. nov.** *Cunoniae alticolae* Guillaumin foliis plerumque imparipinnatis foliolo terminali quam foliolis lateralibus multo maiore, foliolis lateralibus plerumque 1 – 2 paribus, foliis simplicibus etiam interdum praesentibus similis. A *C. alticola* laminis ± planis, venatione secundaria utrinque plana vel minute prominenti (nec pagina adaxiali laminae inter venas secundarias leniter convexa, nec venis secundariis in pagina adaxiali valde prominentibus) et stipulis pilos tenues rectos sericeos adpressos cinereos albosve ferentibus (nec indumento stipularum biformi, pilis grossis brunneolis erectis multo longioribus quam pilis densis brevibus crispis) differt. Typus: New Caledonia, [Province Sud], Mt Koghi, near Hermitage, 500 m, 19 Jan. 1968, fr., MacKee 18310 (holotypus P! P00479443; isotypi K!, NOU!; also BR, L, Z *fide* Hoogland, unpublished notes at P).

Tree to 20 (30?) m; bark brown, fairly rough. Young stems 2 – 3 mm diameter, with minute, pale, adpressed hairs; young woody stems with prominent pale lenticels, glabrescent. *Leaves* opposite, simple or mostly imparipinnate, with 1 – 2 (– 3) pairs of lateral leaflets; occasional leaves irregular, with one or two lateral leaflets partially to completely fused to terminal leaflet. Compound leaves: petiole 1.5 – 2.5 (– 3) cm long, not

winged; rachis segments 1 – 1.5 cm long, with minute wings extending c. 1 mm on either side; petiole and rachis with minute pale hairs, glabrescent; lateral leaflets sessile, elliptic, largest per leaf to 3.8 (– 5.2) × 1.5 (– 2.3) cm, slightly unequal at the base, apex broadly acute; terminal leaflet elliptic, ovate or trullate, substantially larger than largest lateral leaflets [(1.5 –) 1.7 – 2.3 × as long], mostly 4.5 – 6 (– 9) × 2 – 3.2 (– 5.5) cm, base cuneate and sometimes attenuate into rachis, apex obtuse or broadly acute; leaflet blades flat, subcoriaceous; intervenium of both surfaces glabrous or sometimes a few minute hairs visible with a binocular (c. × 25), minute hairs often persisting on midrib and sometimes on secondary veins; leaflet margin with numerous small, forward-pointing teeth; secondary veins in terminal leaflets 11 – 14 (– 20) on either side of midrib; venation drying flat or minutely prominent on both surfaces; secondary veins semicraspedodromous, branching towards the margin, each branch ending at the sinus of a tooth. Simple leaves (with no articulation between petiole and blade) few or absent, usually just below inflorescence; petiole to 1.5 cm long, not winged; blade to 7.8 × 4 cm but usually smaller. *Stipules* spatulate, basal part terete, to 5 mm long, distal part widely or very widely ovate, to 7 × 7 mm, apex rounded, with abaxial surface silky-hairy, densely so in proximal part, generally glabrescent towards the margins, the hairs grey or white, adpressed, to 0.5 mm long. *Inflorescence* consisting either of one raceme on either side of apical bud or of bidents (a pair of racemes on a common peduncle, with a bud in the angle between their bases) and then commonly with one bident on either side of main shoot axis, the bud between the racemes dormant during flowering but starting to develop during fruiting (inflorescence Type 3 of Hoogland *et al.* 1997) or sometimes 1 – 3 bidents at most distal node of a shoot. Inflorescence axis to 9 cm long, including peduncle of 0.5 – 1.3 cm, covered with minute, pale, adpressed hairs, to 0.3 mm long; flowers to c. 70 per raceme. Floral bracts linear, to 1 mm long, minutely hairy, fugaceous. Pedicels 1 – 2 mm long, minutely hairy. *Flowers*: sepals 5, triangular, c. 1.5 × 1 mm, apex obtuse, abaxial surface sparsely and minutely hairy; petals 5, white, ovate-elliptic, c. 2.5 × 1.5 mm, apex rounded, lamina thin, glabrous; stamens 10, filaments to 4 mm long, anthers 0.5 mm long; disc with indentations corresponding to bases of filaments; ovary ovoid-conical, c. 1 mm long, minutely hairy; styles 2, each 2.5 – 3 mm long, glabrous. *Capsules* c. 5 × 2.5 mm, valves very sparsely hairy or glabrescent, bases of styles persisting at least in immature capsules. Seeds ± flattened, spindle-shaped in outline, to 3 mm long, minutely winged around edges. Figs. 3, 4, 5.

FLORAL BIOLOGY AND PHENOLOGY. According to the label associated with Bradford *et al.* 1104 and 1150, the



Fig. 3. *Cunonia koghicola*. A in flower; B vegetative shoot with prominent lenticels. A Pillon *et al.* 178, photo by Y. Pillon; B Bradford *et al.* 1104, photo by J. C. Bradford.

flower buds are green and the flowers have green sepals, white petals and filaments, and red to maroon anthers. The disc when fresh is green and produces abundant sweet nectar, the ovary is green and the styles are white. The scent is faint and not very sweet. Young fruits are green. On the label of *Hoogland & Jérémie* 12903 it is reported that the flowers (old?) attracted millipedes (“myriapodes” or “iules” in French). Flowers have been collected from September to December and mature fruits in April.

DISTRIBUTION AND HABITAT. This species is restricted to south-west Grande Terre, occurring in quite tall wet forest and at the forest edge, at 130 – 500 m, on non-ultramafic substrates. Map. 1.

MATERIAL EXAMINED. NEW CALEDONIA. Province Sud: Mts Koghis, near Auberge, 480 – 590 m, 7 April 1996, fr., *Bradford & Hopkins* 606 (MO, NOU, P); *ibid.*, 22°10'39" S 166°30'27" E, 465 m, 12 Dec. 2000, fl., *Bradford, Fogliani, Hopkins & Donovan* 1104 (K, MO, NOU); *ibid.*, same tree as *Bradford et al.* 1104, 21 Nov. 2002, fl. & yfr., *Bradford & Hopkins* 1150 (K × 2, MO, NOU); Thy, 130 m, 8 Sept. 1980, buds & fl., *Brinon* 797 (NOU); Mt Koghi, 300 m, Oct. 1906, buds & fl., *Franc* 561 (L, P); *ibid.*, Oct. 1907, buds & fl., *Franc* 561 série A (K, P); Mt Dzumac, 300 m, late Oct. 1906, fl., *Franc* 561bis (L); Mts Koghis, Station d'altitude, 450 m, 19 Nov. 1988, yfr., *Hoogland & Jérémie* 12903 (P); *ibid.*, nr. Hermitage, 500 m, 19 Jan. 1968, yfr., *MacKee* 18310 (K, NOU, P, type); Mt Koghis, 470 m, 22 Nov. 2005, fl., *Pillon, Dagostini & Rigault* 178 (K, MO, NOU, P); *ibid.*, 400 m, 19 Jan. 1968, fr., *Pillon & Zongo* 612 (NOU); *ibid.*, 400 m, 22°11'44" S 166°30'14" E, st., *Schodde* 5300 (P). Without precise locality: s.dat., buds, fl. & fr., *Franc* 561 (BM × 2, K × 2 [1 sheet “Nouméa”, 1 sheet s. loc., p.p.]).

NUMBERS OF INDIVIDUALS AND LOCALITIES. Three localities are mentioned on specimen labels — Mt Koghi

(alternative spellings Mt or Mts Koghis), Vallée de Thy (alternative spellings Thi or Ti) and Mt Dzumac.

Most collections are from Mt Koghi, where “Auberge”, “Station d'altitude” and “near Hermitage, 500 m” probably all refer to the same place, i.e. the end of the side road up the small valley eastwards from Route 1. Despite differences among label data (e.g. altitudes ranging from 300 to 500 m), collections were probably made from the same population at the forest edge at the start of the hiking tracks, next to the hotel. This population currently consists of about ten mature individuals plus saplings. Although a wider area was searched, only two other plants were observed by the first author elsewhere in the vicinity, a few hundred metres from the others, at the edge between rainforest and niaouli savanna.

The Vallée de Thy is quite close to the Auberge at Mt Koghi, separated from it by the Mt Bouo – Mt Malawi watershed. The population size in Vallée de Thy is unknown, and the area has not been visited by botanists over the last few years because the area has become unsafe.

The collection by Franc from L labelled “561bis, bords d'un ravin descend' du Dzumac” is more problematical. Franc seems to have used the number 561 to refer to a species rather than a single gathering, and other sheets, labelled “Franc 561” or “Franc 561 series A”, either give the locality as Mt Koghi or were distributed without locality data. The material on all the sheets labelled 561 is similar and there is a possibility that the locality of Mt Dzumac is incorrect.

However, even if this locality is correct, it is possible that the plant no longer occurs on Mt Dzumac, since it is a reasonably well collected locality but this plant has not been found there again. Other examples of plants recorded from Mt Dzumac a century or so ago and not

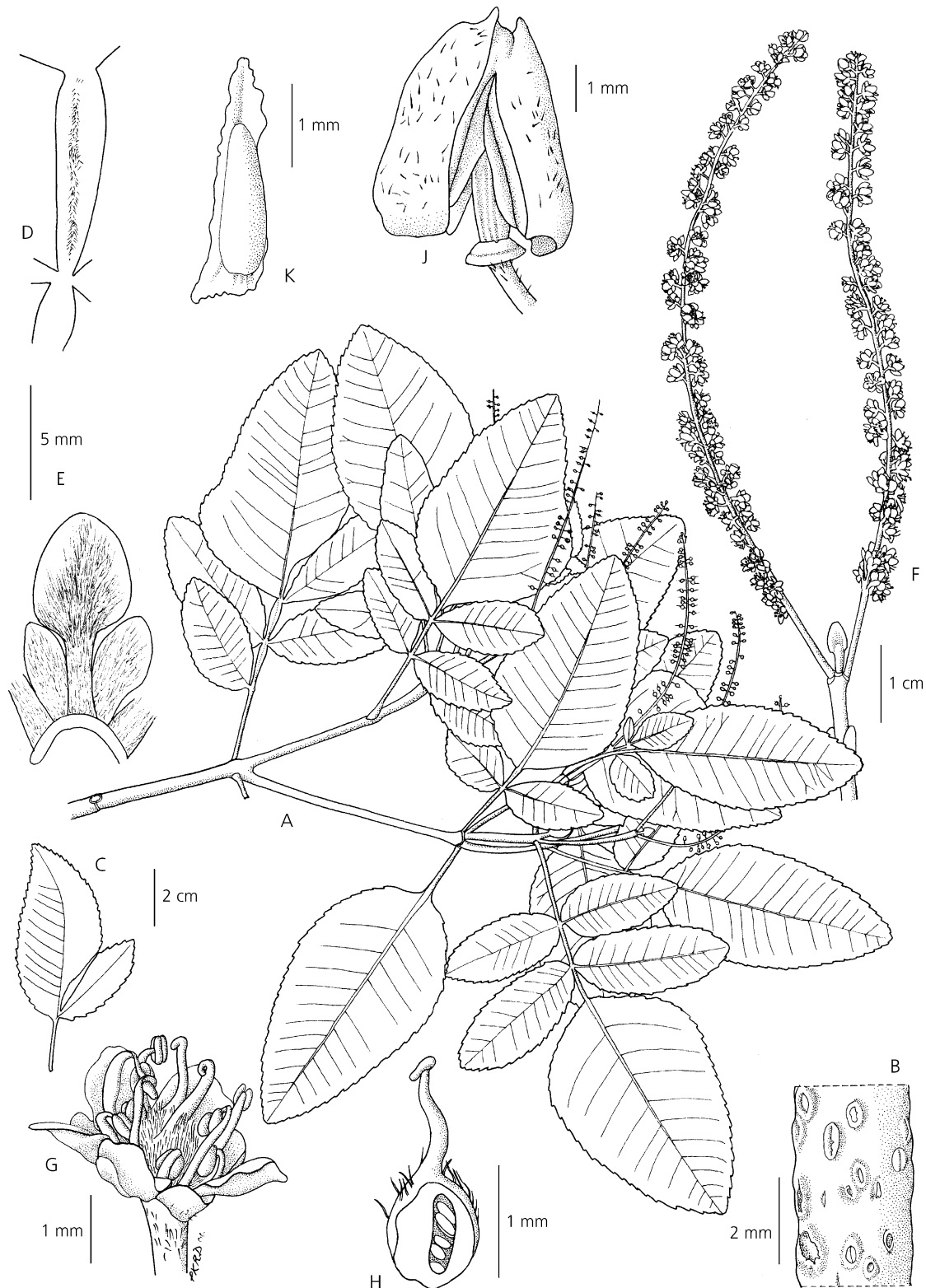

Fig. 4. *Cunonia koghicola*. A twig with leaves and inflorescence; B section of twig showing lenticels; C an irregular leaf; D winged section of leaf rachis between lateral and terminal leaflets; E shoot apex consisting of spatulate stipules forming the apical bud, with buds on either side in the axils of opposite petiole-bases, and a η -shaped stipular scar; F inflorescence consisting of two racemes with spatulate bud (stipules) between their bases; G flower; H half of a gynoecium, showing ovules and a single style; J dehiscent capsule; K seed with membranous marginal wing. A Hoogland & Jérémie 12903; B, C, D, E MacKee 18310; F, G, H Franc 561; J, K Bradford & Hopkins 606. DRAWN BY PATRICIA K.R. DAVIES.

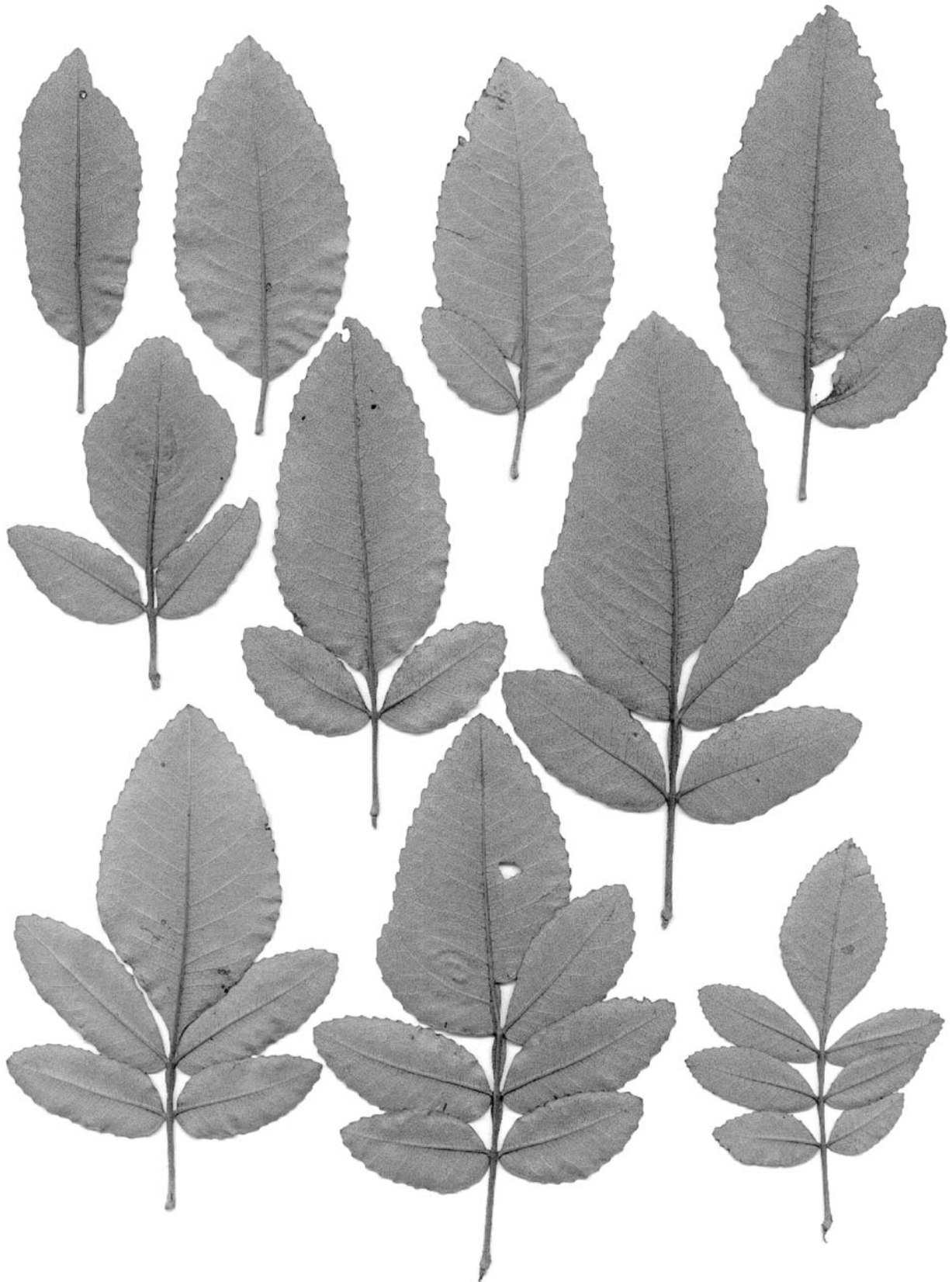
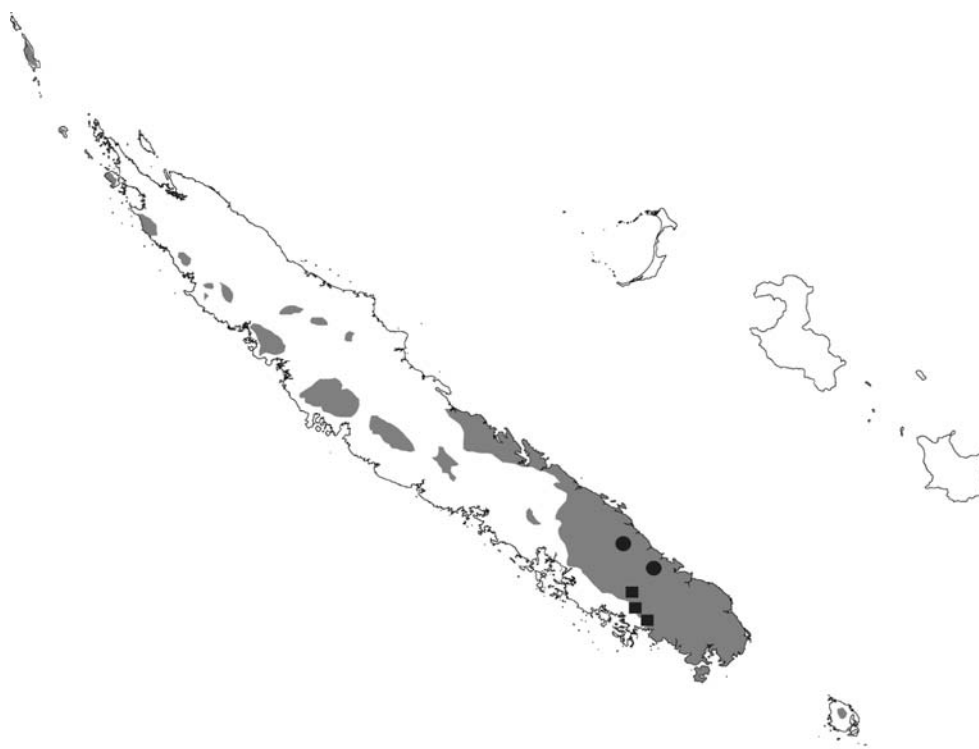

Fig. 5. *Cunonia koghicola*. Abaxial surfaces of a selection of leaves illustrating irregularities in form and venation. Pillon *et al.* 178, photo by Y. Pillon.



Map 1. Distribution of *Cunonia dickisonii* (●) and *C. koghicola* (■) in New Caledonia. Main areas of ultramafic shown in grey, simplified from Paris (1981).

documented there since include *Bikkia parviflora* Schltr. (*Rubiaceae*), which was described from two collections made by Le Rat in 1903. The path used by Le Rat to reach Mt Dzumac in the early part of the 20th century was different from the trail used today, and a visit to the original locality in 2006 revealed that the vegetation had been recently burnt and is now very degraded (L. Barrabé & J. Munzinger, pers. comm.). It is likely that Franc also used this earlier route.

CONSERVATION ASSESSMENT. *Cunonia koghicola* is known from three localities, Mt Koghi, Vallée de Thy and Mt Dzumac, the last one being doubtful, and even if accepted, the plant is possibly extinct there. Forest near the Auberge at Mt Koghi is currently treated as a nature reserve by the owner but has no legal protection. There is a recreational park at the entrance to the forest and some individuals of *C. koghicola* actually mark its limit. Forested land below the Auberge, down the road towards Route 1, is in demand for housing, especially since it is close to the rapidly expanding city of Nouméa. The number of collections of *C. koghicola* from this locality may reflect the fact that individuals occur at the forest edge close to the Auberge, but the population of *C. koghicola* may only consist of about ten mature individuals plus saplings. The northern part of the Vallée de Thy is a Provincial Park, but we do not know if the population of

C. koghicola is inside the boundary or not. Mt Dzumac has no legal protection. Besides potential threats from development, fire is also a threat, particularly where the forest is bordered by scrub and habitation, as on Mt Koghi, in Vallée de Thy and along the lower part of the road to Mt Dzumac. With an extent of occurrence much less than 5000 km², an area of occupancy much less than 500 km² and the current threat to its habitat, *C. koghicola* is provisionally assigned a status of endangered (EN). Further field work would be needed, especially in Vallée de Thy, to determine whether this species might be more appropriately treated as critically endangered (CR) due to small population sizes. EN B1ab(i,ii,iii,v)+2ab(i,ii,iii,v).

ETYMOLOGY. This species is so named because it grows on Mt Koghi, just north of Nouméa, the slopes and peaks of which are exceptionally rich in species of *Cunoniaceae*.

DISCUSSION. *Cunonia koghicola* is a striking plant, mature individuals being quite large trees with dark green, shiny leaves and erect racemes of white flowers projecting beyond the foliage (Fig. 4). Most of the leaves are trifoliolate or imparipinnate with the terminal leaflet much larger than the laterals, although a few simple leaves (and small trifoliolate leaves) are often present just below the inflorescence. Another feature of *C. koghicola* is the occasional presence of irregular leaves, where one or two lateral

leaflets are partly to completely fused with the terminal leaflet, often making the latter asymmetrical (Fig. 4 A,C, Fig. 5). Where a lateral leaflet is completely fused with the terminal one, the outline of the resulting blade sometimes bulges at this point and/or the secondary veins are unequally spaced and their angle to the midrib is irregular, the basal ones being at a more acute angle than more distal ones (Fig. 5).

The single specimen from Vallée de Thy (*Brinon* 797) differs from the collections from Mt Koghi in having slightly smaller leaves with narrower terminal leaflets. In addition, the leaves are always either simple or strictly imparipinnate.

The only other species of *Cunonia* which has a mixture of simple, trifoliolate and imparipinnate leaves, and in which the terminal leaflet in compound leaves is much larger than the largest laterals, is *C. alticola*. These two taxa can generally be distinguished by the form of the leaflets (*C. koghicola*: blades flat with the secondary venation flat or minutely prominent; *C. alticola*: blades slightly convex between the secondary veins on the adaxial surface, and the secondary veins markedly prominent on the abaxial surface). In *C. koghicola*, fully expanded adult leaves are \pm glabrous to the naked eye, whereas the leaves of *C. alticola* are usually glabrescent on the adaxial surface and quite densely and persistently coarsely hairy on the abaxial surface, with the longest hairs on the veins being 1 – 2 mm long. The stipules in *C. koghicola* have grey, silky, adpressed hairs, but are often glabrescent towards the margins, whereas the indumentum on the stipules of *C. alticola* consists of long, brownish, coarse hairs over a dense under-layer of short, curly ones. One collection of *C. alticola* from scrub on ultramafic at 940 m on the Mt Dzumac road (*Pillon et al.* 55, K!, NOU!) is unusual in having a rather silky indumentum on the stipules and shorter hairs on the leaves. The inflorescence axes of *C. koghicola* have a covering of minute hairs, in *C. alticola* they are densely covered in long, coarse, brown hairs. Both *C. koghicola* and *C. alticola* are restricted to southern Grande Terre and both occur at Mt Koghi, *C. koghicola* in wet forest at about 550 m and *C. alticola* in stunted ridge forest, south of Mt Bouo at 920 – 1040 m (*Bradford & Hopkins* 1142 & 1143, both MO!, NOU!). As its name suggests, *C. alticola* generally occurs at high elevation (see discussion of *C. dickisonii*), and it often shows leaf irregularities similar to those of *C. koghicola*.

Cunonia koghicola can also be compared with *C. balansae*, *C. pulchella* Brongn. & Gris and *C. austrocaledonica* Brongn. & Gris, which all occur on Mt Koghi but are widespread in New Caledonia, and also have white flowers and a rather silky indumentum, especially on the stipules. The comparison of these species in Table 1 shows that *C. koghicola* is intermediate in

several respects between *C. balansae* and either *C. pulchella* or *C. austrocaledonica*, suggesting that it may be of a hybrid origin. If it is has a hybrid origin, *C. balansae* could well be one parent, but *C. koghicola* differs from both it and *C. pulchella* in being a large tree, and in this it resembles *C. austrocaledonica*. Whereas *Bradford et al.* 1104 (Mt Koghi) and *Brinon* 797 (Vallée de Thy) are here assigned to *C. koghicola*, *Bradford et al.* 1105 (collected next to 1104) and *Brinon* 798 (collected in Valley de Thy at 140 m versus 130 m for 797) are both clearly referable to *C. austrocaledonica*. One sheet of *Franc* 561 (s.loc., K) has two fragments of *C. austrocaledonica* mounted on the same sheet as material of *C. koghicola*. Therefore *C. austrocaledonica* always seems to be present in the vicinity of *C. koghicola*, which strengthens the idea that it may be one of the parental taxa. A further possible parent is *C. linearisepala* (Guillaumin) Bernardi, which has trifoliolate leaves and also occurs in the area.

The irregularities in leaf shape and venation observed in *Cunonia koghicola* (Figs. 4, 5) as in *C. alticola* may also be indicative of hybridisation. Rather similar irregularities occur, for example, in the leaves of some polyploid *Sorbus* that have hybrid origins, sometimes involving backcrossing due to leaky apomixis (*Robertson & Sydes* 2006), e.g. *Sorbus aucuparia* L. [leaves pinnate] \times *S. aria* Crantz [leaves entire], see *Stace* (1997 Figs. pp. 372 – 373). Variation in the number of lateral leaflets in *C. koghicola* (0 – 3 pairs) is probably not in itself enough to suggest a hybrid origin.

Although there appears to be good evidence that *Cunonia koghicola* may be of hybrid origin, we have chosen to describe it for several reasons. (1) A population comprising at least 10 individuals exists, with morphologically similar plants known from two or possibly three localities. In some other cases of suspected hybridisation in *Cunonia*, only a single individual is known, or plants occur at only a single locality. (2) We do not yet have definite evidence that *C. koghicola* is a hybrid, and even if it proves to be one, it is naturally occurring, not cultivated. (3) A name would be useful since it is a striking plant represented by several herbarium collections. (4) Trees produce flowers and fruits with seeds, though we do not know if the seeds are fertile. (5) If species hybridise readily, and we suspect that many *Cunoniaceae* in New Caledonia do, hybridisation may have contributed to the ancestry of some taxa. Morphology on its own is probably not sufficient to discriminate a cluster of F1 hybrids and a population of young species of hybrid origin.

On the basis of intermediate morphology, there are other examples of possible hybrids in *Cunoniaceae* represented by one or a few herbarium collections. For instance, other possible hybrids involving *Cunonia balansae* include: *MacKee* 16652 (P!) from Mt Kaala (leaves simple, mostly small; flowers pink), *MacKee*

Table 1. Comparison of *Cunonia austrocaledonica*, *C. balansae*, *C. koghicola* and *C. pulchella*.

<i>Cunonia</i> sp.	<i>austrocaledonica</i>	<i>balansae</i>	<i>koghicola</i>	<i>pulchella</i>
simple leaves	none	all	few	none
imparipinnate leaves	all	none	most	all
no. pairs lateral leaflets	5–9	0	(0–) 1–2 (–3)	(1–) 2–4
segments of leaf rachis	scarcely winged	n/a	narrowly winged, wings extending to 1 mm on either side	winged, wings extending to 3 mm on either side
ratio of length of terminal leaflet to largest laterals	1–1.3	n/a	(1.5–) 1.7–2.3	1.1–1.2
indumentum on stipules	silky, often glabrescent towards margins	silky, uniformly and markedly grey	silky, often glabrescent towards margins	densely hairy, hairs can exceed 1 mm
lenticels on twigs	conspicuous (clearer than surrounding bark)	inconspicuous	conspicuous (clearer than surrounding bark)	conspicuous (clearer than surrounding bark)
inflorescence type*	Type 3	Type 2	mostly Type 3	Type 3
flower colour	white	white	white	white
ovary	strigose	sparsely hairy or glabrous	sparsely hairy	strigose
distribution and elevation	widespread, including Mt Koghi and Vallée de Thy; 140–1300 m	widespread, including Mt Koghi, Vallée de Thy and Mt Dzumac; to 1000 m	Mt Koghi, Vallée de Thy and perhaps Mt Dzumac; 130–550 m	widespread, including Mt Koghi, Vallée de Thy and Mt Dzumac; above 450 m
habitat	forest	forest and scrub	forest	forest
habit	shrub or tree to 35 m	shrub or tree to c. 16 m	tree to c. 20 m	shrub or tree to c. 15 m
soil type (UM = ultramafic, NUM = non-ultramafic)	NUM	UM	NUM	NUM + UM

*Inflorescence types as defined in Hoogland *et al.* (1997) are an indication only and some variation occurs in most species.

22228 (P!) from Haute Népoui, Oua Peoué, W slope of Mt Paéoua (leaves small, simple or with two or three leaflets; flowers white), both of which are probable hybrids with *C. lenormandii* Brongn. & Gris, and Hopkins 6520 (K!, NOU!, P!) from the summit of Mt Do (leaves simple, small; flowers deep pink; possibly *C. balansae* × *C. atrorubens* Schltr.).

Among other genera of *Cunoniaceae* in New Caledonia, possible hybrids with intermediate morphology occur occasionally in *Geissois* and *Pancheria*, and are quite common in *Codia*, during the evolution of which hybridisation appears to have played a significant role as inferred by molecular markers (Y. Pillon *et al.*, unpublished).

As mentioned above, similar leaf irregularities are occasionally also found in *Cunonia alticola*, which could perhaps be a hybrid involving *C. balansae* and a species from high elevation with coarse, brown indumentum, such as *C. pterophylla* Schltr. Leaf irregularities also occur occasionally in *Pancheria*, for instance in *P. heterophylla* Guillaumin, which is possibly *P. hirsuta* Pamp. × *P. engleriana* Schltr. and known from Mt Mou (type: Vieillard 2252, 1861 – 1867, P!; also Hopkins & Bradford 6632, K!, MO!, NOU!, P!; Pillon & Barrabé 162, NOU!) and Rivière Blanche (Hürlimann 3404, G!, P!). However, irregularities also occur in the leaves of *Anodopetalum biglandulosum* (Hook.) Hook. f. (*Cunoniaceae*) from Tasmania (Barnes & Rozefelds 2000), but on present evidence they are not apparently related to hybridisation. In this monotypic genus, the adult leaves are unifoliolate whereas those on coppice shoots or shoots in shade are occasionally bi- or tri-lobed, “often to the extent where the lobes apparently form distinct leaflets” (Barnes & Rozefelds 2000: 269 & Figs. 4 – 6).

Endemism on Mt Koghi

Mt Koghi has been relatively well investigated locality due to its accessibility and proximity to Nouméa. At least two species are restricted to this mountain: *Lasiochlamys trichostemonia* (Guillaumin) Sleumer (*Salicaceae* or *Flacourtiaceae*, Lescot 1980) and *Burretio kentia koghiensis* Pintaud & Hodel (*Areaceae*, Pintaud & Hodel 1998). An unusual feature of the forests on Mt Koghi and in the Vallée de Thy is the complex mosaic formed by the geological substrate, which includes peridotite, serpentinite, sedimentary rocks and, in the Vallée de Thy, granite (Paris 1981). These forests therefore provide interfaces where species that grow on different substrates, such as *Cunonia balansae* and *C. austrocaledonica*, can be found in close proximity and may hybridise. Such areas may be important in the evolution of some groups and may therefore have a high conservation value.

Acknowledgments

The authors wish to thank the curators at K, MO, NOU, P for providing facilities and access to their collections, and BM and L for the loan of further material. We are grateful to Patricia K. R. Davies and Cécile Monnié for the fine drawings. YP thanks the staff of the Laboratoire de Botanique (IRD Nouméa) for advice and assistance during field work and Jérôme Munzinger in particular for the picture of *Cunonia dickisonii*. Field work on Mt Kouakoué was made possible by the support of the Province Sud (New Caledonia) and a grant of the National Geographic Society (Grant 7579-04) to Jérôme Munzinger. Fieldwork by HCFH and JCB was supported by the EU Human Capital and Mobility Fund (HCFH) and Missouri Botanical Garden (JCB) in 1996 and the National Geographic Society (both) in 2000 and 2002. Two anonymous reviewers provided useful comments on the manuscript.

References

- Barnes, R. W. & Rozefelds, A. C. (2000). Comparative morphology of *Anodopetalum* (*Cunoniaceae*). *Austral. Syst. Bot.* 13: 267 – 282.
- Bradford, J. C. (2002). Molecular phylogenetics and morphological evolution in *Cunoniaceae* (*Cunoniaceae*). *Ann. Missouri Bot. Gard.* 89: 491 – 503.
- & Jaffré, T. (2004). Plant species microendemism and conservation of montane maquis in New Caledonia: two new species of *Pancheria* (*Cunoniaceae*) from the Roche Ouaième. *Biodivers. Conserv.* 13: 2253 – 2273.
- , Hopkins, H. C. F. & Barnes, R. W. (2004). *Cunoniaceae*. In: K. Kubitzki (ed.), *The families and genera of vascular plants*, pp. 91 – 111. Springer-Verlag, Berlin.
- Coates Palgrave, K. & Coates Palgrave, M. (2003). *Trees of Southern Africa*. Struik publishers, Cape Town.
- Dawson, J. W. (1992). *Myrtaceae — Leptospermoideae*. Flore de la Nouvelle-Calédonie et Dépendances vol. 18. Muséum National d’Histoire Naturelle, Paris.
- Guillaumin, A. (1964). Résultats Scientifiques de la Mission Franco-Suisse de Botanique en Nouvelle-Calédonie (1950 – 1952). sér. 3, Mém. Mus. Natl. Hist. Nat. B, Bot. 15: 1 – 93.
- Hoogland, R. D., Jérémie, J. & Hopkins, H. C. F. (1997). Le genre *Cunonia* (*Cunoniaceae*) en Nouvelle-Calédonie. Description de cinq espèces nouvelles. *Adansonia* 19: 7 – 19.
- Jaffré, T., Bouchet, P., Veillon, J.-M. (1998). Threatened plants of New Caledonia: is the system of protected areas adequate? *Biodivers. Conserv.* 7: 109 – 135.
- Lescot, M. (1980). Flacourtiacées. Flore de la Nouvelle-Calédonie et Dépendances 9: 3 – 134. Muséum National d’Histoire Naturelle, Paris.

- Paris, J. -P. (1981). Géologie de la Nouvelle-Calédonie: un essai de synthèse. Editions du B.R.G.M., Orléans.
- Pintaud, J. -C. & Hodel, D. R. (1998). Three new species of *Burvetiokentia*. *Principes* 42: 152 – 155, 160 – 166.
- Robertson, A. & Sydes, C. (2006). *Sorbus pseudomeinichii*, a new endemic *Sorbus* (*Rosaceae*) microspecies from Arran, Scotland. *Watsonia* 26: 9 – 14.
- Stace, C. A. (1997). *New Flora of the British Isles*. Cambridge University Press, Cambridge.
- Virost, R. (1967). Protéacées. Flore de la Nouvelle-Calédonie et Dépendances, vol. 2. Muséum National d'Histoire Naturelle, Paris.
- (1975). Epacridacées. Flore de la Nouvelle-Calédonie et Dépendances, vol. 6. Muséum National d'Histoire Naturelle, Paris.

Article III

Pillon Y, Hopkins HCF, Munzinger J, Chase MW (2009) A molecular and morphological survey of generic limits of *Acsmithia* and *Spiraeanthemum* (Cunoniaceae). *Systematic Botany* **34**, 141-148.



Une analyse phylogénétique de la tribu des Spiraeanthemeae (Cunoniaceae) a été conduite afin de clarifier les relations entre les genres *Acsmithia* et *Spiraeanthemum*. Trois marqueurs moléculaires, à savoir une région chloroplastique (intron *trnL* et l'espace intergénique *trnL-trnF*) et deux gènes nucléaires simple copie (*ncpGS* et *PHYC*) ont été séquencés dans ce but. L'analyse indépendante des trois marqueurs et une analyse combinée montrent chacune que le genre *Acsmithia* est paraphylétique, par l'inclusion du genre *Spiraeanthemum* dans celui-ci. Une étude morphologique de toutes les espèces de la tribu confirme la présence de deux groupes au sein d'*Acsmithia*. L'un comprend les espèces d'Australie, de Nouvelle-Guinée et *A. densiflora* de Nouvelle-Calédonie, et est caractérisé par des carpelles multiovulés. L'autre groupe contient toutes les autres espèces de Nouvelle-Calédonie et *A. vitiensis* de Fidji et est caractérisé par un ovule unique par carpelle. Cette étude montre que les caractères utilisés jusqu'ici pour distinguer *Acsmithia* et *Spiraeanthemum*, la phyllotaxie et le système sexuel, sont homoplasiques, comme dans plusieurs autres groupes de Cunoniaceae. Une circonscription large du genre *Spiraeanthemum* est ici retenue, et inclut les espèces placées auparavant dans *Acsmithia*. Deux nouvelles combinaisons sont proposées : *Spiraeanthemum collinum* (Hoogland) Pillon et *Spiraeanthemum meridionale* (Hoogland) Pillon. *Spiraeanthemum austrocaledonicum* est considérée comme un synonyme de *Spiraeanthemum densiflorum*.

A Molecular and Morphological Survey of Generic Limits of *Acsmithia* and *Spiraeanthemum* (Cunoniaceae)

Yohan Pillon,^{1,2} Helen C.F. Hopkins,³ Jérôme Munzinger,^{1,5} and Mark W. Chase⁴

¹Laboratoire de Botanique, Institut de Recherche pour le Développement, BP A5, 98848 Nouméa Cedex, New Caledonia

²Laboratoire Insulaire du Vivant et de l'Environnement, Université de la Nouvelle-Calédonie, BP 4477, 98847 Nouméa Cedex, New Caledonia

³c/o The Herbarium, Royal Botanic Gardens, Kew, Richmond, Surrey, TW9 3AB, U.K.

⁴Jodrell Laboratory, Royal Botanic Gardens, Kew, Richmond, Surrey, TW9 3DS, U.K.

⁵Author for correspondence (munzinge@noumea.ird.nc)

Communicating Editor: Javier Francisco-Ortega

Abstract—A phylogenetic analysis was conducted on the tribe Spiraeanthemeae (Cunoniaceae) to clarify relationships of *Acsmithia* and *Spiraeanthemum*. Three molecular markers, one plastid region (*trnL* intron and *trnL-trnF* intergenic spacer) and two nuclear single copy genes (*nepGS* and *PHYC*), were sequenced for this purpose. The independent analysis of the three markers and a combined analysis all showed that *Acsmithia* is paraphyletic since *Spiraeanthemum* is nested within it. A morphological survey of all species in the tribe confirmed the existence of two groups within *Acsmithia*. One comprises the species from Australia, New Guinea, and *A. densiflora* from New Caledonia and is characterised by multiple ovules per carpel. The other group contains all the remaining New Caledonian species plus *A. vitiensis* from Fiji and is characterized by a single ovule per carpel. The study shows that characters previously used to distinguish *Acsmithia* and *Spiraeanthemum*, phyllotaxy and sexual system, are homoplasious as in several other groups of Cunoniaceae. A broad circumscription of the genus *Spiraeanthemum* is adopted here that includes the species formerly placed in *Acsmithia*. Two new combinations are proposed: *Spiraeanthemum collinum* and *Spiraeanthemum meridionale*. *Spiraeanthemum austrocaledonicum* is considered a synonym of *Spiraeanthemum densiflorum*.

Keywords—glutamine synthetase, Melanesia, New Caledonia, nuclear single copy gene, phyllotaxy, sexual system.

Cunoniaceae (Oxalidales) are a predominantly Southern Hemisphere family of trees and shrubs consisting of 27 genera and ca. 300 species (Bradford et al. 2004). Molecular phylogenetic studies of the family (Bradford and Barnes 2001) allowed circumscription of a number of monophyletic tribes within the family for several groups of genera that had been allied previously on morphological grounds (Hufford and Dickson 1992). Tribe Spiraeanthemeae was shown to be sister to the remainder of the family (Bradford and Barnes 2001; Sweeney et al. 2004) and consists of two genera: *Acsmithia* Hoogland and *Spiraeanthemum* A. Gray. The members of this tribe are unique in the family in being apocarpous (but see the recently described *Hooglandia* McPherson & Lowry which is monomerous, McPherson and Lowry 2004) and a close relationship has been suggested with *Brunellia* Ruiz & Pavón (Hufford and Dickson 1992), the only genus of Brunelliaceae, a closely related family within Oxalidales. Synapomorphies of Spiraeanthemeae include epidermal glands, pocket domatia along the midvein, and synchronously maturing flowers (Bradford and Barnes 2001). Within Cunoniaceae, none of these characters is unique to this tribe; the combination is, however, unique.

As currently circumscribed *Acsmithia*, consists of 14 species from eastern Malesia, Australia, New Caledonia, and Fiji; and *Spiraeanthemum* comprises six species from the Bismarck Archipelago, Bougainville, Solomon Islands, Vanuatu, Fiji, and Samoa. *Acsmithia*, named after Albert C. Smith, an authority of the flora of Fiji, was described in 1979 by R. D. Hoogland to accommodate species formerly included in *Spiraeanthemum* which have whorled leaves and hermaphroditic flowers, whereas *Spiraeanthemum* s.s. is characterized by opposite leaves and unisexual flowers (dioecious). Although recognition of two genera was questioned by Hufford and Dickson (1992), they have been considered as distinct in all regional treatments of the family published since 1979 (Smith 1985; Hopkins and Hoogland 2002), in Hoogland (unpublished manuscript for the Flore de la Nouvelle-Calédonie et Dépendances) and in the generic survey of the family by Bradford et al. (Bradford and Barnes 2001;

Bradford et al. 2004). As part of a study on the evolution of the family in New Caledonia and Vanuatu, a molecular phylogeny of the tribe Spiraeanthemeae in this region is presented here, along with a survey of morphological characters. We were interested in assessing the monophyly of *Acsmithia* in New Caledonia and the biogeographical patterns of both *Acsmithia* and *Spiraeanthemum*.

MATERIALS AND METHODS

Molecular Analysis—Leaf material of *Acsmithia* and *Spiraeanthemum* was dried in the field in silica gel (Chase and Hills 1991) and DNA was extracted following a modified CTAB protocol (Csiba and Powell 2006). *Brunellia* (Brunelliaceae), *Hooglandia* (Cunoniaceae, unplaced to tribe), and *Platylophus* D. Don (Cunoniaceae, tribe Schizomerieae) were also included as outgroups. The plastid *trnL-F* region (*trnL* intron and *trnL-trnF* spacer) was amplified with the primers *c* and *f* from Taberlet et al. (1991) using a standard protocol (e.g. Pillon et al. 2007). A portion of the chloroplast-expressed glutamine synthetase (*nepGS*), a nuclear single-copy gene, was amplified using the primers 687F and 994R of Emswiler and Doyle (1999). PCR reaction mix included 45 µL of 2.5 mM MgCl₂ Reddy PCR Master Mix 1.1× (ABgene Ltd, Surrey, U.K.), 1 µL of 0.4% bovine serum albumin (BSA), 0.5 µL of each primer (100 ng/µL) and 3 µL of template DNA. The following PCR program was used: 2 min at 94°C, 38 cycles of 1 min at 94°C, 1 min at 50°C, 1 min 30 sec at 72°C and a final extension of 5 min at 72°C. A portion of the first exon of phytochrome C (*PHYC*), another nuclear single-copy gene, was amplified using the primers *PhyC-F* and *PhyC-R* from Samuel et al. (2005). The PCR reaction mix included 45 µL of 1.5 mM MgCl₂ Reddy PCR Master Mix 1.1× (ABgene Ltd), 1.5 µL of 0.4% bovine serum albumin (BSA), 0.5 µL of each primer (100 ng/µL), 1 µL of DMSO and 2 µL of template DNA. The following PCR program was used: 3 min at 94°C, 38 cycles of 1 min at 94°C, 1 min at 50°C, 1 min at 72°C and a final extension of 10 min at 72°C. For nuclear genes, cloning for some accessions was necessary to separate alleles. Alignment and phylogenetic analyses were carried out with PAUP*4.01b10 (Swofford 2002). To recover the most parsimonious trees, we used branch and bound searches. Robustness of tree topology was assessed using bootstrapping with 100 replicates, also with branch and bound searches. For the combined analysis, a single allele was retained for each accession; we chose the allele that appeared as the most ancestral (the one on the shortest branch). For *Brunellia* the sequences from two different species were combined. The list of species, vouchers and GenBank accession numbers are provided in the appendix. Sequence datasets and phylogenetic trees were deposited in TreeBASE (study number S2119).

Morphology—Morphological characters either observed by us or mentioned in the literature as differing between *Spiraeanthemum* and *Acsmithia* or varying among *Acsmithia* species were scored with the aid of a binocular microscope ($\times 10$ – 40 magnification) for all species in both genera in the herbaria at Kew (K) and Nouméa (NOU). The only character not scored by us was the number of ovules per carpel, for which data were taken from Hoogland (1979, unpublished manuscript, and Hopkins and Hoogland 2002). Literature sources used to suggest possible characters included these works by Hoogland as well as Bradford and Barnes (2001), Bradford et al. (2004), Dickison (1984), Rutishauser and Dickison (1989), Hufford and Dickison (1992), Hyland and Whiffin (1993), and Smith (1952, 1985).

RESULTS

Molecular Analysis—Detailed statistics for each DNA region studied are provided in Table 1. The two nuclear single copy genes both had a greater proportion of variable and parsimony informative characters than the plastid *trnL* region. The *ncpGS* region was particularly informative, with nearly 20% of sites variable, over ca. 1,200 base pairs. It is thus a promising tool for phylogenetic studies in Cunoniaceae and Oxalidales in general.

Analysis of *trnL-F* sequences (Fig. 1) indicates that the two accessions of *Acsmithia densiflora* from New Caledonia form a monophyletic group that is sister to a well-supported group (94 bootstrap percentage, BP) consisting of all other species of the tribe. In this group we can distinguish *Spiraeanthemum* s.s. as well supported (91 BP); it is represented by *S. macgillivrayi* (Vanuatu) and *S. samoense* (Samoa). The sister group of *Spiraeanthemum* s.s. is a moderately supported clade (67 BP) consisting of four species of New Caledonian *Acsmithia*: *A. brongniartiana*, *A. elliptica*, *A. meridionalis*, and *A. pubescens* (hereafter referred to as the brongniartiana group).

Analysis of *ncpGS* (Fig. 1) also recovered *A. densiflora* as sister to the remaining members of Spiraeanthemeae, and *Spiraeanthemum* s.s. as sister to the brongniartiana group represented by *A. brongniartiana* and *A. pubescens*. Monophyly of the brongniartiana group and of the clade *Spiraeanthemum* s.s.-brongniartiana group are both well supported (99 and 100 BP). In the PHYC analysis (Fig. 1), *A. densiflora* is again sister to the remaining members of the tribe. *Spiraeanthemum macgillivrayi* is sister to the brongniartiana group represented by *A. brongniartiana*, *A. collina*, *A. elliptica*, *A. pedunculata*, and *A. pubescens*.

In the combined analysis (Fig. 1), we recovered the same topology as for the three separate analyses, with a strongly supported (100 BP) Spiraeanthemeae structured as followed (*A. densiflora* (*Spiraeanthemum* s.s.; brongniartiana group)) with 100 BP for the brongniartiana group and *Spiraeanthemum* s.s. plus the brongniartiana group. A combined analysis including all taxa for which at least one of the loci was available was

also conducted. The topology recovered was identical to the one recovered in the reduced dataset with no missing loci, but bootstrap support was lower, it is therefore not shown here.

Morphology—Since the phylogenetic analysis suggested that three groups of species could be recognised within *Spiraeanthemum-Acsmithia* (see discussion), morphology is described largely in terms of these groups. Species of *Acsmithia* not included in the phylogenetic analysis were assigned initially to either the brongniartiana group or the densiflora group on the basis of their ovule number.

STIPULES AND APICAL BUDS—Two types of interpetiolar stipules were found, and among the species with small, linear stipules, two types of apical buds occur.

In *Spiraeanthemum* s.s., interpetiolar stipules are large, ovate to oblong-elliptic, and attached broadly at the base. In dormant apical buds, opposite stipules are adpressed around their margins to enclose the developing leaves; after separating, they are caducous or sometimes briefly persistent, and leave a long, curved scar.

In both the brongniartiana and densiflora groups, interpetiolar stipules are narrowly triangular to linear, with a small attachment at the base (see Rutishauser and Dickison 1989, Figs. 80–82, *A. densiflora*, given as *A. undulata*). Although stipules overtop leaves in small buds (Rutishauser and Dickison 1989), in dormant apical buds they are not contiguous with one another and do not enclose the developing leaves, which are visible between them and larger; as the apical bud starts to develop, stipules are usually fugaceous, leaving a small round or elliptic scar. It appears that stipules are not smaller in these two groups only because whorled phyllotaxis means that more stipules and petioles are present at each node; their shape and persistence differs from those in *Spiraeanthemum* s.s.

Apical buds in both *Spiraeanthemum* s.s. and the densiflora group are hairy, whereas in the brongniartiana group they are glabrous and varnished except in *A. pubescens*, with some rare exceptions (e.g. *A. pubescens*: Pancher Mus. Neocal. 191, some apical buds glabrous and varnished; *A. meridionalis*: Bernardi 12434, apical bud hairy with some varnish).

LEAVES—These have either toothed margins and craspedodromous or semicraspedodromous venation, or entire margins with brochidodromous venation. Although distinctive patterns of venation can be picked out, some species or individuals within each group have a more generalized type of venation, so these categories are of only limited use.

Three species in *Spiraeanthemum* s.s. (*S. serratum*, *S. samoensis*, and *S. macgillivrayi*) have markedly serrate margins with numerous teeth and semicraspedodromous venation in which branches of the secondary veins reach the margin at the sinus of a tooth. The secondary veins are numerous, regularly spaced along the midrib, parallel to one another across the blade, and prominent on the abaxial surface; leaf blades are flat. In *S. bougainvillense*, teeth are much smaller and the pattern of secondary veins is less marked, whereas in *S. graefei* and *S. katakata* margins can be entire or toothed, in which case teeth are small.

In the brongniartiana group, all species have entire margins and brochidodromous venation. Secondary veins are not especially numerous, but they are usually regularly spaced and parallel and either flat or prominent on the abaxial surface; leaf blades are flat or slightly bullate.

In the densiflora group, especially in New Guinea, the leaf margin is commonly entire or sometimes weakly toothed,

TABLE 1. Statistics for each DNA sequences used in the phylogenetic analysis of the tribe Spiraeanthemeae.

	<i>trnL</i>	PHYC	<i>ncpGS</i>	combined
# Taxa	11	10	10	7
# Characters	952	650	1254	2856
# Constant characters	880	586	1022	2503
# Variable characters	72 (7.5%)	64 (9.8%)	232 (18.5%)	353 (12.6%)
# Parsimony informative characters	20 (2.1%)	21 (3.1%)	107 (8.5%)	114 (4%)
# Trees	13	2	1	1
Consistency Index	0.988	0.985	0.953	0.969
Retention Index	0.97	0.979	0.93	0.928

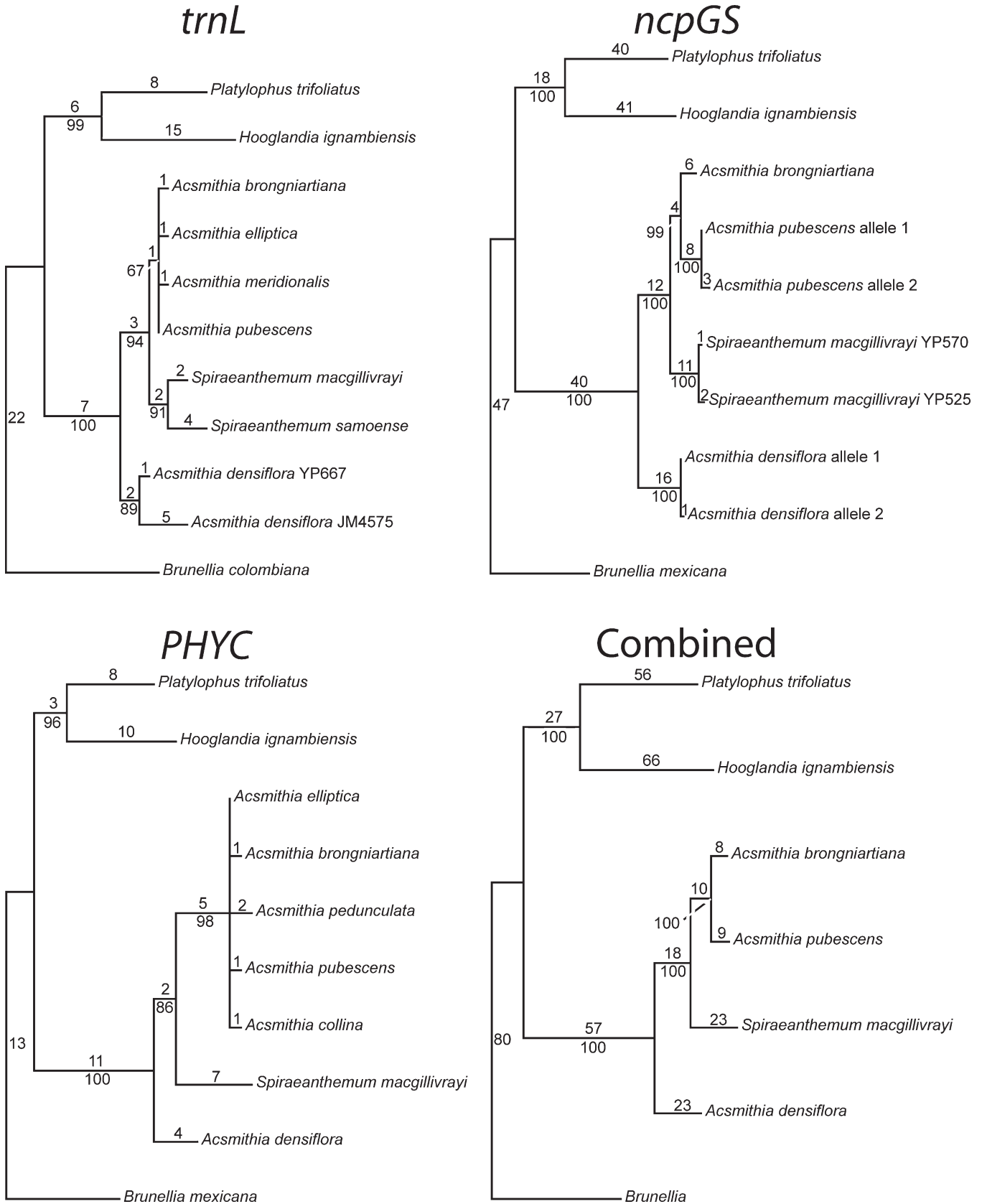

especially in *A. reticulata*, and venation is brochidodromous to craspedodromous, in which case secondary veins reach the margin at the tip of a tooth. The secondary veins are typically few and irregularly spaced along the midrib, sometimes with weaker veins between them, and they are often not parallel to one another across the blade. Veins are prominent on the abaxial surface, and leaf blades are flat to bullate. Only in *A. davidsonii* are leaves sometimes strongly toothed.

INFLORESCENCES—In all species except *A. davidsonii*, panicles are typically axillary, and in most species they are exclusively axillary, although, especially in the densiflora group in New Guinea, median panicles are also found occasionally. *Acsmithia davidsonii* has predominantly median panicles.

The branching pattern within panicles changes acropetally. In general, branching initially follows the phyllotaxis of the leaves (opposite and decussate in *Spiraeanthemum* s.s. and whorled in *Acsmithia*, but see comments for densiflora group) and switches distally to become more or less alternate or irregular.

Considering only axillary panicles, first branches on the main axis are produced well above the base in *Spiraeanthemum* s.s. and the brongniartiana group. However, in *S. macgillivrayi* subsp. *macgillivrayi*, axillary buds or panicles are occasionally accompanied by additional axillary buds (e.g. *Pillon* 570, *Wheatley* 341), and in the brongniartiana group, leaf axils occasionally contain two panicles in series (e.g. *A. brongniartiana*: *Balansa* 2303, *MacKee* 4432, 15327, 30991; *A. meridionalis*: *Bernardi* 12434, *Pancher* s.n.; *A. pubescens*: *MacKee* 37894; *A. vitiensis*: *Horne* 1104, 1113). Usually one of these panicles is much larger than the other, giving the appearance of a single panicle that is branched at the base of its main axis.

In the densiflora group (except *A. davidsonii*), first branches of axillary panicles are usually at or just above the base of the main axis, one on either side of it, i.e. these branches appear more or less opposite (possibly by abortion of other branches), rather than whorled. More distal branching is usually whorled and then eventually alternate to irregular. In median panicles in this group, including those of *A. davidsonii*, first branches are well above the base.

The difference between basally branched panicles in the densiflora group and additional axillary panicles in the brongniartiana group is that in the former, first branches are approximately lateral, in a plane perpendicular to that of the leaf axil, whereas in the latter additional axes arising near the base are in the same plane as the axil. However, this difference can only be seen with a binocular microscope.

This could be shown diagrammatically (leaves shown as opposite for simplicity) as:

densiflora group: sequence: petiole, axillary bud with lateral branches, main stem, axillary bud with lateral branches, petiole.

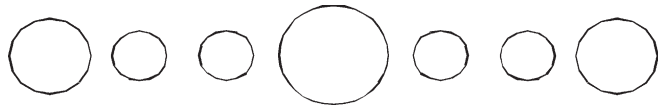
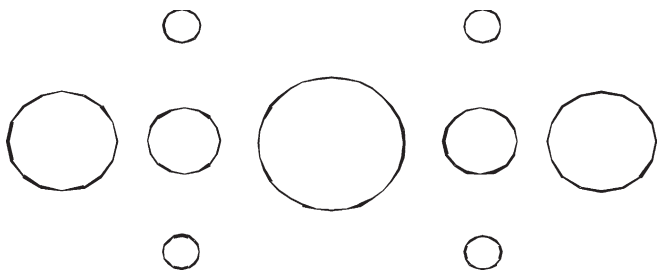

brongniartiana group: sequence: petiole, two axillary buds in series, main stem, two axillary buds in series, petiole.

FLOWERS—Although flowers in *Acsmithia* are normally bisexual, some rare exceptions have been found in *A. meridionalis*, in *MacKee* 42518 and 42993, in which 5 and 15%, respectively, of flowers lacked carpels (Hoogland unpubl. results), as in the male flowers of *Spiraeanthemum* s.s. (fide Smith 1985).

OVULES AND SEEDS—The number of ovules per carpel correlates strongly with seed morphology (one ovule per carpel and seeds with a flattened wing, or, more than one ovule per carpel and seeds ellipsoid to spindle-shaped).

Species in the brongniartiana group have one ovule per carpel, and mature seeds are ellipsoid or flattened-ellipsoid with a flat, membranous wing at one end or obliquely at one end (see Dickison 1984, Fig. 54 – *A. elliptica*, Fig. 55–56 – *A. pubescens*).

In the densiflora group, the number of ovules is usually two or four (rarely three, five or six), and mature seeds are ellipsoid with a small, thin tail at each end that is easily detached (see Dickison 1984, Fig. 57 – *A. reticulata*). A similar picture is seen in *Spiraeanthemum* s.s. in which number of ovules per carpel is two and mature seeds are spindle-shaped, ellipsoid in middle and tapering gradually towards either end (see Dickison 1984, Fig. 52 – *S. katakata*). However, no real difference exists between seeds in *Spiraeanthemum* s.s. and the densiflora group, although tails are perhaps more ephemeral in the latter.

REJECTED CHARACTERS—Gland dots on the intervenium appear to be present in all species, although they are not always easily seen in old leaves and on old specimens. Domatia occur in the angle between secondary veins and the midrib in all species, although not necessarily on all leaves or all specimens, and in a few species they are small. Some species have additional domatia in the angle between major branches of the secondary veins towards the margin. Domatia vary from simple hair-tufts to pits and pouches (Hopkins and Hoogland 2002, Fig. 3), and, although certain types are more common in certain species, they are too variable to be taxonomically useful. The number of calyx lobes and carpels, form of disc, and extent to which carpels are connate towards their bases all appear to show more variation within species than between them.

DISCUSSION

Separate and combined analyses of the three DNA regions all showed that two groups can clearly be distinguished within New Caledonian *Acsmithia*. The first consists of *A. densiflora* only and the second (the brongniartiana group) of the remaining species. The brongniartiana group is a well supported, and a more complete analysis (*Pillon* et al. unpubl. results) shows that it includes all New Caledonian taxa except *A. densiflora* and *A. austrocaledonica*, which is in fact conspecific with *A. densiflora* (see below). The brongniartiana group and *Spiraeanthemum* s.s. form a well-supported clade to which *A. densiflora* is sister.

Acsmithia densiflora can be distinguished from species of the brongniartiana group by a number of morphological features (Table 2) including number of ovules per carpel.

TABLE 2. Comparative morphology between the different species and species group of *Acsmithia* and *Spiraeanthemum*. Rare occurrences are given in brackets. A = axillary, M = median. ? = see text.

species	stipules	apical bud	Number of leaves per node	leaf margin	position of panicles	branching in axillary panicles	additional axillary buds	sexual expression	Number ovules per carpel	seed shape
densiflora group										
<i>densiflora</i>	narrowly triangular	hairy	3	entire	A	near base	no	bisexual	4 (to 6)	ellipsoid with tails
<i>integrifolia</i>	narrowly triangular	hairy	3 or 4	entire	A + M	near base	no	bisexual	4	not seen
<i>parvifolia</i>	narrowly triangular	hairy	3 (4)	entire	A + M	near base	no	bisexual	2	ellipsoid with tails
<i>pulleana</i>	narrowly triangular	hairy	3 or 4	mostly entire	A (M)	near base	no	bisexual	2 (3)	ellipsoid with tails
<i>reticulata</i>	narrowly triangular	hairy	3 or 4	toothed to ± entire	A	near base	no	bisexual	2 (3)	ellipsoid with tails
<i>dauidsonii</i>	narrowly triangular	hairy	3 (4)	toothed	M (A)	above base	no	bisexual	2–4	ellipsoid with tails
brongniartiana group										
<i>brongniartiana</i>	narrowly triangular	glabrous/varnished	3 (4)	entire	A	above base	yes?	bisexual	1	with membranous wing
<i>collina</i>	narrowly triangular	glabrous/varnished	3–5	entire	A	above base	no	bisexual	1	with membranous wing
<i>elliptica</i>	narrowly triangular	glabrous/varnished	4	entire	A	above base	no	bisexual	1	with membranous wing
<i>meridionalis</i>	narrowly triangular	glabrous/varnished	4 (5)	entire	A	above base	yes?	bisexual	1	with membranous wing
<i>pedunculata</i>	narrowly triangular	glabrous/varnished	4	entire	A	above base	no	bisexual	1	with membranous wing
<i>pubescens</i>	narrowly triangular	hairy	4	entire	A	above base	no	bisexual	1	with membranous wing
<i>vitiensis</i>	narrowly triangular	glabrous/varnished	3 or 4 (5)	entire	A	above base	yes?	bisexual	1	with membranous wing
Spiraeanthemum s.s.										
<i>bougainvillense</i>	ovate-elliptic	hairy	2	toothed	A	above base	no	dioecious	2	spindle-shaped/ellipsoid
<i>macgillivrayi</i>	ovate-elliptic	hairy	2	toothed	A	above base	yes	dioecious	2	spindle-shaped/ellipsoid
<i>graeffei</i>	ovate-elliptic	hairy	2	toothed to entire	A	above base	no	dioecious	2	spindle-shaped/ellipsoid
<i>katakata</i>	ovate-elliptic	hairy	2	entire to ± toothed	A (M)	above base	no	dioecious	2	spindle-shaped/ellipsoid
<i>serratum</i>	ovate-elliptic	hairy	2	toothed	A	above base	no	dioecious	2	spindle-shaped/ellipsoid
<i>samoensis</i>	ovate-elliptic	hairy	2	toothed	A	above base	no	dioecious	2	spindle-shaped/ellipsoid

This character was the first used in Hoogland's key to the species of *Acsmithia* (Hoogland 1979) and allows placement of non-New Caledonian species of *Acsmithia* in one or the other group, even though material was not available for molecular analysis.

Acsmithia vitiensis, the only species of *Acsmithia* in Fiji, is morphologically similar to *A. brongniartiana* and like all species of the brongniartiana group has a single ovule per carpel. *Acsmithia pulleana* (type of *Acsmithia*), *A. parvifolia*, *A. integrifolia*, *A. reticulata* (all from New Guinea), and *A. dauidsonii* (Australia) have several (two to four or rarely six) ovules per carpel, as in *A. densiflora*.

The two groups within *Acsmithia* also differ in other characters. Members of the densiflora group all have hairy apical buds, whereas in the brongniartiana group apical buds are glabrous and often resinous, with the notable exception of *A. pubescens*. Axillary panicles in the densiflora group are ramified at, or close to, the base (within the first few millimeters), whereas those in the brongniartiana group have a marked peduncle, often extending a third or more of the total length of the panicles. Seeds in the densiflora group are ellipsoid with a small tail at either end, whereas those in the brongniartiana group are flattened to ellipsoid with a membranous wing at one end.

Within the densiflora group, *Acsmithia dauidsonii* has several characters that are unusual: leaves are sometimes strongly toothed; panicles are mostly median, and even in axillary ones, the lowest branches are above the base. However, the number of ovules, shape of the seeds, and secondary venation are all consistent with other members of the densiflora group.

The morphological survey also confirmed a character shared by the two groups within *Acsmithia* but not by *Spiraeanthemum* that was first noted briefly by Smith (1952). In *Acsmithia* stipules are small and narrowly triangular, whereas in *Spiraeanthemum* s.s. they are larger and broadly ovate to oblong-elliptic. This second type of stipule is common, although not universal, throughout Cunoniaceae (Rutishauser and Dickson 1989).

Evolution of the different characters observed can be tracked by comparing them with the topology observed in the molecular trees. The following characters are homoplasious in *Spiraeanthemeae* and have either evolved twice or are ancestral in the tribe but show a reversal: narrowly triangular stipules, hairy apical buds, whorled leaves, bisexual flowers, multiple ovules per carpel and spindle-shape/ellipsoid seeds. The densiflora group has a single autapomorphy, panicles branched near the base, and the clade *Spiraeanthemum* s.s. – brongniartiana group is also only characterised by a single character, a clearly pedunculate inflorescence. Autapomorphies for *Spiraeanthemum* s.s. include opposite leaves, ovate-elliptic stipules and dioecy. Autapomorphies for the brongniartiana group include glabrous apical buds, a single ovule per carpel, seeds with membranous wings and adaptation to ultramafic soils in New Caledonia. Future biochemical studies may provide further characters to support these groups, as bioactivity and taxonomy are well correlated within Cunoniaceae (Pillon and Fogliani 2009).

In terms of biogeography, the densiflora group is restricted to the relatively ancient landmasses of New Guinea, Australia and New Caledonia (Fig. 2) and has a distribution comparable to *Dubouzetia* Brong. & Gris (Elaeocarpaceae, Coode 2004) or *Sphenostemon* Baill. (Sphenostemonaceae, Jérémie 1997).

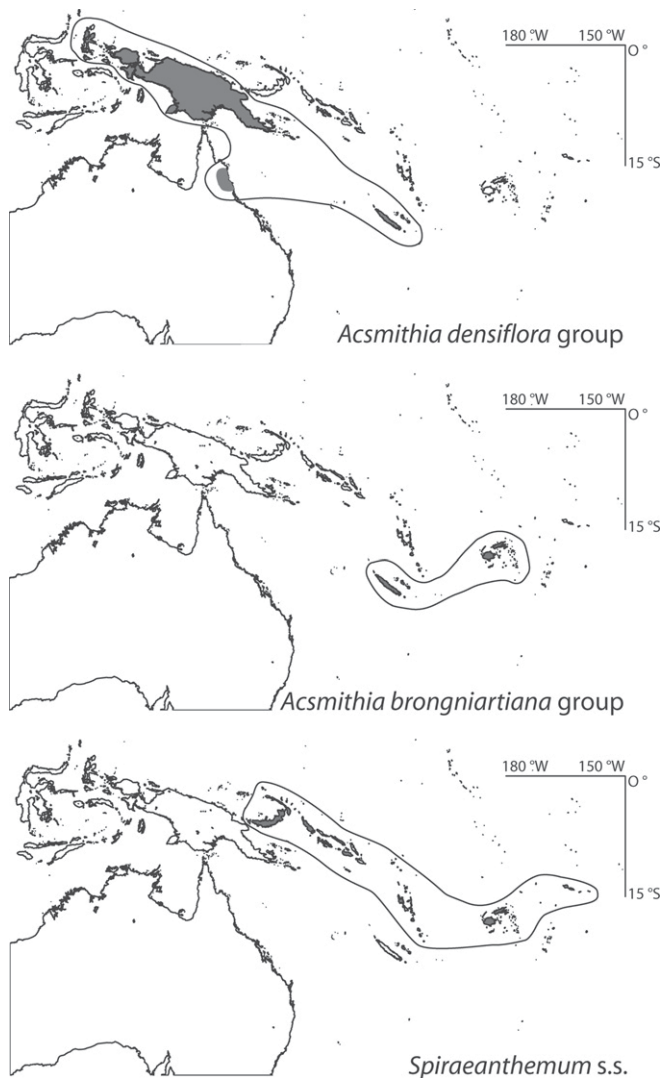

FIG. 2. Distribution of the *Acsmithia densiflora* group, the *Acsmithia brongniartiana* group and *Spiraeanthemum* s.s.

The brongniartiana group, restricted to New Caledonia and Fiji (Fig. 2), can be compared to *Acropyle* Pilg. (Podocarpaceae, de Laubenfels 1996) and can be considered as a typical eastern Melanesian endemic, like *Cyphosperma* H. Wendl. (Arecaceae, Dowe and Cabalion 1996) or *Geissois* Labill. s.s. (Cunoniaceae, Hopkins 2006). *Spiraeanthemum* s.s. has a relatively large distribution covering most islands of the Melanesian arc from New Britain to Fiji and extending to western Polynesia (Samoa) but excluding New Caledonia (Fig. 2): most of these islands have a volcanic origin. Several palm genera show similar distributions, e.g. *Metroxylon* Rottb., *Clinostigma* H. Wendl., and *Physokentia* Becc. (Dowe and Cabalion 1996). *Spiraeanthemum* s.s. reaches its western limit in the Bismarck Archipelago and the Solomon Islands. Another group of Cunoniaceae that reaches its distributional limit here is the Pacific section of *Weinmannia*, sect. *Leiospermum* (D. Don) Engl., but its distribution is wider than that of *Spiraeanthemum* s.s. as it extends eastwards to French Polynesia and southwards to New Caledonia and New Zealand (Hopkins and Bradford 1998).

Acsmithia was created to accommodate species of *Spiraeanthemum* with whorled leaves and hermaphroditic flowers, as opposed to those with opposite leaves and a

dioecious sexual system in *Spiraeanthemum* s.s. However, it seems that whorled leaves and hermaphroditism are ancestral characters within the tribe Spiraeanthemeae, and transitions between opposite and whorled leaves have occurred several times in the course of the evolution of Cunoniaceae. For instance, in the New Caledonian endemic genus *Pancheria* Brong. & Gris, all species have whorled leaves with the exception of *P. confusa* Guillaumin, which has opposite ones. Conversely, all species of *Codia* J.R. Forst. & G. Forst., which is also endemic to New Caledonia, usually have opposite leaves except for *C. albifrons* (Brongn. ex Schinz & Guillaumin) Baker f. and *C. triverticillata* H.C. Hopkins & Pillon in which they are whorled (Hopkins et al. 2007). Whorled leaves are clearly derived when mapped onto a phylogenetic tree of *Codia* (Pillon et al. unpubl. results), and they have been recorded as a rare occurrence in most taxa in this genus. In *Pullea glabra* Schltr. in New Guinea, both opposite and verticillate leaves occur regularly within a single species, in var. *glabra* and var. *verticillata* Hoogland respectively. Teratological cases are not uncommon in Cunoniaceae, and for example in *Cunonia* L., in which all species normally have opposite leaves, twigs with whorled leaves have been observed on a potted plant of *C. pterophylla* Schltr. (Pillon pers. obs.). Sexual systems are also labile characters that can show great variability, as seen for instance in *Weinmannia* L. (Hopkins and Bradford 1998), and, furthermore, sexual systems are capable of evolving quickly (e.g. Sakai et al. 1997). Thus phyllotaxis and sexual system, even in combination, can be misleading characters in classification of Cunoniaceae.

The paraphyly of *Acsmithia* implies that taxonomic changes need to be made. Two alternatives are possible: either we could treat tribe Spiraeanthemeae as a single genus, *Spiraeanthemum* s.l., or as three distinct genera: *Spiraeanthemum* s.s., a narrowly defined *Acsmithia* comprising the densiflora group, and an undescribed genus which would contain all New Caledonian and Fijian species except for *A. densiflora*. The first alternative is preferred for several reasons. Firstly, the densiflora and brongniartiana groups are morphologically similar, and differences between them are in characters that are difficult to observe; splitting *Acsmithia* into two would not aid generic identification by a nonspecialist nor by anyone without a microscope. Secondly, although *Spiraeanthemum* s.s. and the brongniartiana group each have several synapomorphies, the densiflora group has only one (axillary panicle branching near base), which is absent in one of its members and can be confused with a similar, though rare, character state in the brongniartiana group. A broad circumscription of *Spiraeanthemum* requires two new combinations, which are proposed below.

TAXONOMIC TREATMENT

SPIRAEANTHEMUM A. Gray, Proc. Amer. Acad. Arts Sci. 3: 128. 1854.—LECTOTYPE (of Smith 1952): *Spiraeanthemum samoense* A. Gray.

ACSMITHIA Hoogland, Blumea 25: 493. 1979.—TYPE: *Acsmithia pulleana* (Schltr.) Hoogland, syn. nov.

Spiraeanthemum collinum (Hoogland) Pillon comb. nov. Basionym: *Acsmithia collina* Hoogland, Bull. Mus. Natl. Hist. Nat. B, Adansonia, 9: 396. dated 1987, published 1988.—TYPE: NEW CALEDONIA. Mé Maoya: contrefort sud du Djiaouma, 800 m, 7 March 1976, MacKee 30809 (holotype: P!; isotypes: CANB, L, MO, NOU!, P, Z).

TABLE 3. List of taxa currently accepted in *Spiraeanthemum*. Species belonging to *Spiraeanthemum* s.s., the densiflorum and brongniartianum group are marked with a S, D and B respectively.

Australia
<i>Spiraeanthemum davidsonii</i> F. Muell. [D]
New Guinea and Moluccas
<i>Spiraeanthemum integrifolium</i> Pulle [D]
<i>Spiraeanthemum parvifolium</i> Schltr. [D]
<i>Spiraeanthemum pulleana</i> Schltr. [D]
<i>Spiraeanthemum reticulatum</i> Schltr. [D]
Solomon Islands, New Britain, New Ireland and Bougainville
<i>Spiraeanthemum bougainvillense</i> Hoogland [S]
<i>Spiraeanthemum macgillivrayi</i> Seem. subsp. <i>kajewskii</i> (Perry) Hoogland [S]
Vanuatu
<i>Spiraeanthemum macgillivrayi</i> Seem. subsp. <i>macgillivrayi</i> [S]
New Caledonia
<i>Spiraeanthemum brongniartianum</i> Schltr. [B]
<i>Spiraeanthemum collinum</i> (Hoogland) Pillon [B]
<i>Spiraeanthemum densiflorum</i> Brongn. & Gris [D]
<i>Spiraeanthemum ellipticum</i> Vieill. ex Pamp. [B]
<i>Spiraeanthemum meridionale</i> (Hoogland) Pillon [B]
<i>Spiraeanthemum pedunculatum</i> Schltr. [B]
<i>Spiraeanthemum pubescens</i> Pamp. [B]
Fiji
<i>Spiraeanthemum graeffei</i> Seem. [S]
<i>Spiraeanthemum katakata</i> Seem. [S]
<i>Spiraeanthemum serratum</i> Gillespie [S]
<i>Spiraeanthemum vitiense</i> A. Gray [B]
Samoa
<i>Spiraeanthemum samoense</i> A. Gray [S]

Spiraeanthemum meridionale (Hoogland) Pillon comb. nov. Basionym: *Acsmithia meridionalis* Hoogland, Bull. Mus. Natl. Hist. Nat. B, Adansonia, 9: 396. dated 1987, published 1988.—TYPE: NEW CALEDONIA. haute Yaté: Rivière Bleue, 150 m, 15 March 1981, MacKee 388821 (holotype: P!; isotypes: L, MO, NOU!, P, Z).

Examination of herbarium material determined by Hoogland as *Acsmithia densiflora* and *A. austrocaledonica* failed to reveal any consistent characters to distinguish between them. In his unpublished manuscript for the “Flore de la Nouvelle-Calédonie et Dépendances” Hoogland mentioned two characters: number of ovules per carpel, given as four or sometimes three or six in *A. densiflora* and two or sometimes three in *A. austrocaledonica*, and, the stamens, which are generally twice as many as the sepals in *A. densiflora* and generally fewer than twice as many in *A. austrocaledonica*. Both characters are overlapping and difficult to observe. Furthermore both species have the same ecology, distribution, and type locality. We propose here to consider the two species as synonyms.

SPIRAEANTHEMUM DENSIFLORUM Brongn. & Gris, Bull. Soc. Bot. France 9: 74. 1862.—TYPE: NEW CALEDONIA. Balade: 1855–60, Vieillard 566 (holotype: P!; isotype: P!).

Spiraeanthemum austrocaledonicum Brongn. & Gris, Bull. Soc. Bot. France 9: 74. 1862.—TYPE: NEW CALEDONIA. Balade: 1855–60, Vieillard 568 (holotype: P!; isotypes: BM, G, K, P), syn. nov.

As newly circumscribed, *Spiraeanthemum*, sole genus of Spiraeanthemeae, consists of 19 species, distributed in Australia, Melanesia, and western Polynesia (Table 3).

ACKNOWLEDGMENTS. We wish to thank all staff and students of the Botanical Laboratory at IRD for assistance in the field. We also thank the organizers of the Santo 2006 expedition in Vanuatu during which material

of *Spiraeanthemum macgillivrayi* was collected, Gerardo Salazar for collecting *Brunellia*, and Pete Lowry and the Missouri DNA bank for providing material of *Hooglandia*. We are grateful to Edith Kapinos, Laszlo Csiba, Olivier Maurin, Dion Devey, and Martyn Powell for their help in the Jodrell Laboratory and to Laura Kelly, Maria Vorontsova, and Jim Clarkson for discussion on nuclear single copy genes. Completion of the study in Nouméa was made possible by Michel Lebrun, who allowed access to the molecular platform, and the help of Céline Gomez and Emeline Lhuillier. Anaïs Cardineau and Cyril Poullain (CNRS) provided a Macintosh computer to complete data analysis. We thank two anonymous reviewers and the editors for their helpful comments on this manuscript.

LITERATURE CITED

- Bradford, J.C. and R.W. Barnes. 2001. Phylogenetics and classification of Cunoniaceae (Oxalidales) using chloroplast DNA sequences and morphology. *Systematic Botany* 26: 354–385.
- Bradford, J.C., H.C.F. Hopkins, and R.W. Barnes. 2004. Cunoniaceae. Pp. 91–111 in *The families and genera of vascular plants* vol. 6, ed. K. Kubitzki. Berlin: Springer.
- Chase, M.W. and H.G. Hills. 1991. Silica gel: an ideal material for field preservation of leaf samples for DNA studies. *Taxon* 40: 215–220.
- Coode, M.J.E. 2004. Elaeocarpaceae. Pp. 135–144 in *The families and genera of vascular plants* vol. 6, ed. K. Kubitzki. Berlin: Springer.
- Csiba, L. and M.P. Powell. 2006. DNA extraction protocols. Pp. 48–51 in *DNA and tissue banking for biodiversity and conservation: theory, practice and uses*, eds. V. Savolainen, M.P. Powell, K. Davis, G. Reeves, and A. Corthals. Kew, Richmond: Royal Botanic Gardens.
- de Laubenfels, D.J. 1996. Gondwanan conifers on the Pacific Rim. Pp. 261–265 in *The origin and evolution of Pacific Islands biotas, New Guinea to Eastern Polynesia: patterns and processes*, eds. A. Keast, and S.E. Miller. Amsterdam: SPB Academic Publishing.
- Dickison, W.C. 1984. Fruits and seeds of the Cunoniaceae. *Journal of the Arnold Arboretum* 65: 149–190.
- Dowe, J.L. and P. Cabalion. 1996. A taxonomic account of Arecaceae in Vanuatu, with descriptions of three new species. *Australian Systematic Botany* 9: 1–60.
- Emshwiller, E. and J.J. Doyle. 1999. Chloroplast-expressed glutamine synthetase (*ncpGS*): potential utility for phylogenetic studies with an example from *Oxalis* (Oxalidaceae). *Molecular Phylogenetics and Evolution* 12: 310–319.
- Hoogland, R.D. 1979. Studies in the Cunoniaceae. II. The genera *Caldcluvia*, *Pullea*, *Acsmithia*, and *Spiraeanthemum*. *Blumea* 25: 481–505.
- Hopkins, H.C.F. 2006. Nomenclature and typification in *Geissois* (Cunoniaceae) in the South-West Pacific. *Adansonia* 28: 311–327.
- Hopkins, H.C.F. and J.C. Bradford. 1998. A revision of *Weinmannia* (Cunoniaceae) in Malesia and the Pacific. 1. Introduction and an account of the species of Western Malesia, the Lesser Sunda Islands and the Moluccas. *Adansonia* 20: 5–41.
- Hopkins, H.C.F. and R.D. Hoogland. 2002. Cunoniaceae. Pp. 53–165 in *Flora Malesiana*, ed. H.P. Notoebom. Leiden: Nationaal Herbarium Nederland.
- Hopkins, H.C.F., B. Fogliani, and Y. Pillon. 2007. Four new species in the endemic genus *Codia* (Cunoniaceae) from New Caledonia. *Kew Bulletin* 62: 259–274.
- Hufford, L. and W.C. Dickison. 1992. A phylogenetic analysis of Cunoniaceae. *Systematic Botany* 17: 181–200.
- Hyland, B.P. and T. Whiffin. 1993. Australian Tropical Rain Forest Trees, an interactive identification system, vol. 2: Cunoniaceae. Canberra: CSIRO.
- Jérémie, J. 1997. Sphenostemonaceae. Pp. 3–21 in *Flore de la Nouvelle-Calédonie et Dépendances*, ed. P. Morat. Paris: Muséum National d'Histoire Naturelle.
- McPherson, G. and P.P. Lowry II. 2004. *Hooglandia*, a newly discovered genus of Cunoniaceae from New Caledonia. *Annals of the Missouri Botanical Garden* 91: 260–265.
- Pillon, Y. and B. Fogliani. 2009. Evidence for a correlation between systematics and bioactivity in New Caledonian Cunoniaceae and its implications for screening and conservation. *Pacific Science* 63: 97–103.
- Pillon, Y., M.F. Fay, M. Hedrén, R.M. Bateman, D.S. Devey, A.B. Shipunov, M. Van Der Bank, and M.W. Chase. 2007. Evolution and temporal diversification of western European polyploid species complexes in *Dactylorhiza* (Orchidaceae). *Taxon* 56: 1185–1208.
- Rutishauser, R. and W.C. Dickison. 1989. Developmental morphology of stipules and systematics of the Cunoniaceae and presumed allies. I. Taxa with interpetiolar stipules. *Botanica Helvetica* 99: 147–169.

- Sakai, A.K., S.G. Weller, W.L. Wagner, P.S. Soltis, and D.E. Soltis. 1997. Phylogenetic perspectives on the evolution of dioecy: adaptive radiation in the endemic Hawaiian genera *Schiedea* and *Alsinodendron* (Caryophyllaceae: Alsinoideae). Pp. 455–474 in *Molecular Evolution and Adaptive Radiation*, eds. T. J. Givnish, and K. J. Sytsma. Cambridge: Cambridge University Press.
- Samuel, R., H. Kathriarachchi, P. Hoffmann, M.H.J. Barfuss, K.J. Wurdack, C.C. Davis, and M.W. Chase. 2005. Molecular phylogenetics of Phyllanthaceae: evidence from plastid *matK* and nuclear *PHYC* sequences. *American Journal of Botany* 92: 132–141.
- Smith, A.C. 1952. Studies of Pacific Island plants, XII, the Cunoniaceae of Fiji and Samoa. *Journal of the Arnold Arboretum* 33: 119–149.
- Smith, A.C. 1985. Cunoniaceae. Pp. 5–26 in *Flora Vitiensis Nova. A new flora of Fiji*, ed. A.C. Smith. Lawai, Hawai'i; Pacific Tropical Botanical Garden.
- Sweeney, P.W., J.C. Bradford, and P.P. Lowry II. 2004. Phylogenetic position of the New Caledonian endemic genus *Hooglandia* (Cunoniaceae) as determined by maximum parsimony analysis of chloroplast DNA. *Annals of the Missouri Botanical Garden* 91: 266–274.
- Swofford, D.L. 2002. PAUP*: Phylogenetic Analysis Using Parsimony (and Other Methods) 4.0 Beta. Sunderland, Sinauer Associates, Inc.
- Taberlet, P., L. Gielly, G. Pautou, and J. Bouvet. 1991. Universal primers for amplification of three non-coding regions of chloroplast DNA. *Plant Molecular Biology* 17: 1105–1109.
- APPENDIX. List of taxa, country of collection, voucher reference (voucher location), and GenBank accession number for *trnL*, *PHYC*, and *ncpGS*.
- Brunellia colombiana* Cuatrec., Colombia, Bradford 753 (MO), AF299187 & AF299240, —, —; *Brunellia mexicana* Standl., Mexico, Salazar s.n. (MEXU), —, EU867237, EU867247; *Hooglandia ignambiensis* McPherson & Lowry, New Caledonia, Lowry 5767 [Type] (CANB,G,MO,NOU,P), AY549639 & AY549640, EU867229, EU867239; *Platylophus trifoliatus* (L. f.) D. Don, South Africa, Goldblatt 10888 (MO), AF299177 & AF299230, —, —; *Platylophus trifoliatus* (L. f.) D. Don, South Africa, Chase 5726 (K), —, EU867228, EU867238; *Spiraeanthemum brongniartianum* Schltr., New Caledonia, Pillon et al. 87 (K,MO,NOU,P), EU867221, EU867231, EU867240; *Spiraeanthemum collinum* (Hoogland) Pillon, New Caledonia, Pillon et al. 464 (K,NOU,P), —, EU867233, —; *Spiraeanthemum densiflorum* Brongn. & Gris, New Caledonia, Pillon 667 (NOU), EU867225, EU867235, EU867243 & EU867244; *Spiraeanthemum densiflorum* Brongn. & Gris, New Caledonia, Munzinger et al. 4575 (K,MO,NOU,P), EU867226, —, —; *Spiraeanthemum ellipticum* Vieill. ex Pamp., New Caledonia, Pillon et al. 20 (K,NOU,P), EU867222, EU867230, —; *Spiraeanthemum macgillivrayi* Seem. subsp. *macgillivrayi*, Vanuatu, Pillon et al. 570 (K,MO,NOU,P,PVNH), EU867227, EU867236, EU867245; *Spiraeanthemum macgillivrayi* Seem. subsp. *macgillivrayi*, Vanuatu, Pillon et al. 525 (NOU,P), —, —, EU867246; *Spiraeanthemum meridionale* (Hoogland) Pillon, New Caledonia, Pillon et al. 1 (NOU), EU867223, —, —; *Spiraeanthemum pedunculatum* Schltr., New Caledonia, Pillon et al. 437 (NOU), —, EU867234, —; *Spiraeanthemum pubescens* Pamp., New Caledonia, Pillon & Munzinger 82 (K,NOU,P), EU867224, EU867232, EU867241 & EU 867242; *Spiraeanthemum samoense* A. Gray, Samoa, Bradford 809 (MO,NOU), AF299160 & AF299213, —, —

Article IV

Pillon Y (sous presse) *Geissois* (Cunoniaceae), another example of the Melanesian connection. In: *The Natural History of Santo* (ed. Bouchet P), Paris.



Le genre *Geissois* (Cunoniaceae) contient 18 espèces réparties en Nouvelle-Calédonie, à Vanuatu, à Fidji et aux îles Salomons. Une analyse moléculaire montre que *Geissois denhamii*, l'espèce endémique du Vanuatu se trouve au milieu du groupe d'espèces de Nouvelle-Calédonie. Ceci montre que le genre *Geissois* aurait colonisé le Vanuatu à partir de la Nouvelle-Calédonie, qui est probablement le berceau du genre. C'est en effet dans cet archipel que l'on observe la plus grande concentration d'espèces et la plus grande diversité morphologique.

Geissois (Cunoniaceae), another example of the Melanesian connection

Yohan Pillon

The genus *Geissois*, taken in the strict sense (i.e., excluding the Australian species), a member of the family Cunoniaceae, is a group of trees and shrubs endemic to the islands of the Pacific. It is easily distinguished by its opposite palmately compound leaves and its bright red flowers arranged in bottle-brush like inflorescences (Figure 1) that attract nectarivorous birds. Besides their ornamental potential, species of *Geissois* provide valuable timber and several species possess antibiotic and anti oxidant properties, a feature shared by many Cunoniaceae.



Figure 1. *Geissois denhamii* above Penaorou camp, Santo

The genus encompasses 18 species, 13 of which are endemic to New Caledonia, three to Fiji, one to Temotu Province (Vanikoro) in the Solomon Islands, and one to Vanuatu. *Geissois*

denhamii (Figure 2), the of Vanuatu species, ranges from Vanua-Lava in the North to Anatom in the South and is present on most of the larger islands, including Santo. It is a small to large tree found in primary rainforest or sometimes in secondary vegetation (“white grass”) at medium to high elevation, including the summit of Mt. Tabwemasana.

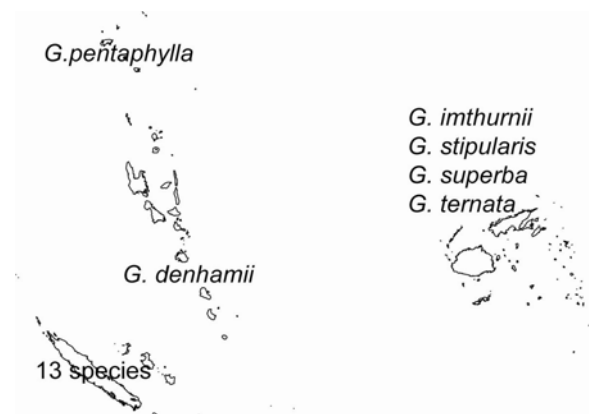

Figure 2. Distribution of the 18 species of *Geissois*

The Santo 2006 expedition provided an opportunity to collect material for a phylogenetic study of Cunoniaceae largely focused on the taxa occurring on New Caledonia. Two nuclear genes were sequenced for all members of *Geissois* from New Caledonia and Vanuatu, and the results were used to reconstruct the relationships among the species. The phylogenetic tree (Figure 2) indicates a

close relationship between *G. denhamii* and the New Caledonia species, with *G. denhamii* nested within the New Caledonia group (Figure 3), suggesting that the ancestor of *G. denhamii* originated in New Caledonia. Although the Fijian and Solomon Island species have not yet been included in the phylogenetic studies, a similar position can be expected for them.

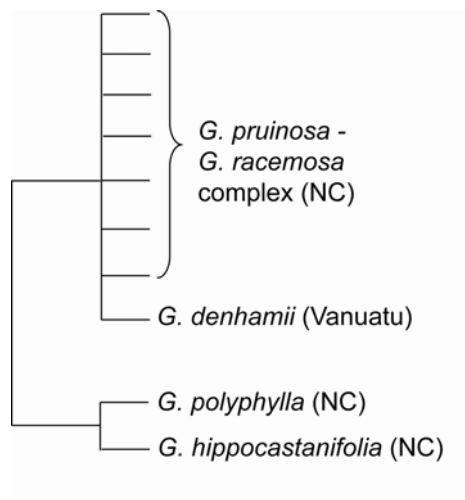

Figure 3. Phylogenetic tree of *Geissois* based on DNA sequences (*ncpGS* gene)

New Caledonia is home to the largest number of species and the greatest morphological diversity within *Geissois* genus, and it seems plausible that this old archipelago was the cradle of the genus. As the islands of Vanuatu emerged from sea through the process of volcanism, the genus no doubt reached them through long-distance dispersal, which was facilitated by small winged seeds that can easily be carried by the wind. Thus *Geissois* is similar to other genus such as *Megastylis* (Orchidaceae), *Oxera* (Lamiaceae), and the genera of Araliaceae mentioned above, all of which likewise had members that dispersed from New Caledonia (or in one case Fiji) to Vanuatu, demonstrating the biogeographic affinities between these neighboring Melanesian archipelagos.

Article V

Pillon Y, Lebrun M, Amir H, Munzinger J (en préparation) Selective immigration in the insular flora of New Caledonia, a case of exaptation to ultramafic soils?



La Nouvelle-Calédonie, archipel du Pacifique sud-ouest, est réputée pour sa flore riche et originale. Certains groupes comme les Cunoniaceae semblent y avoir connu un succès particulier car les multiples évènements de colonisation de cette famille ont donné lieu dans la plupart des cas à une diversification intense. En comparaison, les Asteraceae, qui ont des capacités de dispersion plus élevées y sont peu diversifiées. Pour tester si des familles proches ont plus de chance d’avoir un succès similaire en Nouvelle-Calédonie, nous avons utilisé une phylogénie complète des familles d’angiospermes. Les familles ont été considérées comme sur- ou sous-représentées par comparaison à une hypothèse nulle où cette flore serait un échantillon aléatoire de la flore mondiale. Nous avons trouvé que les familles sur- ou sous-représentées n’étaient pas réparties aléatoirement mais étaient souvent regroupées entre elles. Les Rosids sont particulièrement bien représentées, contrairement aux Asterids ou aux Monocotylédones. Un groupe particulièrement diversifié, le clade COM (Celastrales, Oxalidales et Malpighiales) contient une grande partie des espèces hyper-accumulatrices de nickel. Une hypothèse possible pour expliquer les biais dans la sur-représentation de certaines familles serait que celles-ci aient été pré-adaptées aux sols ultramafiques (« serpentines ») qui couvraient auparavant la grande majorité de l’île. Les sols ultramafiques sont des milieux peu favorables à la croissance des plantes et des plantes qui auraient été pré-adaptées à de tels types de sols auraient eu un avantage certain après leur dispersion. La composition particulière de la flore de la Nouvelle-Calédonie pourrait ainsi s’expliquer par un phénomène d’exaptation aux sols ultramafiques.

**Selective immigration in the flora of New Caledonia,
an example of exaptation to ultramafic soils**

Yohan Pillon^{1,2}, Michel Lebrun³, Hamid Amir² & Jérôme Munzinger¹

¹ Laboratoire de Botanique, Institut de Recherche pour le Développement, BP A5, 98848
Nouméa Cedex, New Caledonia

² Laboratoire Insulaire du Vivant et de l'Environnement, Université de la Nouvelle-Calédonie,
BP 4477, 98847 Nouméa Cedex, New Caledonia

³ Laboratoire des Symbioses Tropicales et Méditerranéennes, Institut de Recherche pour le
Développement, BP A5, 98848 Nouméa Cedex, New Caledonia

Corresponding author : Yohan Pillon pillon@noumea.ird.nc

ABSTRACT

The establishment of an oceanic island flora is generally thought to be mostly constrained by long distance dispersal. New Caledonia, an archipelago in the south-west Pacific, represents a particular model for island biogeography because of its rich, unique and threatened flora associated with its large surface of ultramafic soils (“serpentine”). Therefore, New Caledonia is regarded as one of the world’s biodiversity hotspots. Using a comparative analysis, we found that families that were under- or over-represented in this flora were more phylogenetically clustered than expected by chance. Despite their high dispersability, daisies and grasses are poorly diversified in New Caledonia and belong to locally under-represented orders. Several orders concentrate over-represented families, which also contain a high proportion of species known to hyperaccumulate heavy-metals, for example Malpighiales order and its nickel hyperaccumulator species. These groups may have been pre-adapted to grow on ultramafic soils, and would have been more successful after dispersal onto New Caledonia. Thus the possession of particular traits useful to face the challenging conditions for plant growth of ultramafic soils, i.e. an exaptation to ultramafic soils, may be more important than dispersal capacity to colonise successfully New Caledonia.

Keywords: New Caledonia, Biogeography, *Amborella*, ultramafic, Exaptation, hyperaccumulation

INTRODUCTION

In their theory of island biogeography, MacArthur and Wilson (1963) suggested that the number of species on islands could be explained by a dynamic equilibrium between the rate of immigration and the rate of local extinction. Thus two factors would be determinant for island biodiversity: the size of the island and its distance from the source area. In his unified neutral theory of biodiversity and biogeography (or shortly neutral theory), Hubbell (2001) extended the theory by adding another factor: speciation rate.

Species richness and relative abundance in a metacommunity could be explained by a single figure, θ , known as the fundamental biodiversity number, which only depends on two parameters: metacommunity size and speciation rate. Species diversity and abundance within a local community (island) could simply be explained by two extra factors: community size and immigration rate.

New Caledonia represents a particular model for illustrating the biogeography of islands. Located in the south-west Pacific, with an area of ca. 19,000 km², it is composed of one main island (ca. 16,000 km²) surrounded by several smaller ones and is situated ca. 1500 km east of Australia. New Caledonia was once part of Gondwana and split from Australia ca. 80 My ago (McLoughlin 2001). However, the deep sea deposits of early tertiary indicate that the island has long been under sea level, from the end of the secondary to mid-tertiary. The island emerged in middle-late Eocene (ca. 35-45 My ago), when the ophiolitic nappe covered the entire island (Pelletier 2006). This implies that plant species colonized the newly emerged island through long-distance dispersal from surrounding sources (Grandcolas et al. 2008; Pelletier 2006). The presence of old lineages has suggested that some small islands may have been present near New Caledonia and could have served as refugia while the main island was under water (Pelletier 2006). Nevertheless, the presence of ancient lineages on island should not be considered as a proof of ancient biota since several of them appeared to be older than

the islands to which they are now endemic, e.g. *Hillebrandia* in Hawaii (Clement et al. 2004) or *Monimia* in the Mascarenes (Renner 2004). A young origin of the New Caledonian flora is supported by recent works using molecular clocks where the investigated plant radiations have occurred within the last 20 My, e.g. palms (Savolainen et al. 2006, supplemental data), *Metrosideros* (Warren & Hawkins 2006, supplemental data), or the tribe Macadamieae in Proteaceae (Mast et al. 2008). The likely origin for most New Caledonian plants is Australia, because of its proximity and large size offering a large number of propagules. Strong affinities have indeed been found between the two floras (Morat 1993). Beyond their similarities, some striking differences are also observed such as the absence or poor representation in New Caledonia of some genera that are extremely diverse and abundant in Australia like *Acacia* or *Eucalyptus* for example.

The Cunoniaceae family is an example of the contrasting histories of these two floras (see Supplementary data). Eighty eight species are endemic to New Caledonia, distributed in 7 genera, whereas Australia has only 36 species distributed in 15 genera. Cunoniaceae have reached eight times New Caledonia and diversified subsequently in most cases, in up to 25 species for *Cunonia* or *Pancheria*. In contrast, the most species rich Australian genus has eight species but most have only one or two. Australian genera of Cunoniaceae have significantly less species than the New Caledonian ones and the number of species per monophyletic group (per radiation) is also lower. By comparison, Asteraceae in New Caledonia are represented by 21 genera (none endemic) and 34 native species, with nine species for the largest genus, but mostly with a single non-endemic species per genus. Asteraceae have small seeds (Harper et al. 1970) and great dispersal capacity, they reach New Caledonia many times but never diversified intensively there. Asteraceae thus seem to be less successful success in colonizing New Caledonia. Cunoniaceae belong to the Oxalidales order composed of six small or medium size families, and among them, the Elaeocarpaceae,

Connaraceae and Oxalidaceae ones are also represented by endemic families. Elaeocarpaceae for example is represented by three phylogenetically independent radiations in New Caledonia (Crayn et al. 2006). Thus plant genera and families that have intensively diversified in New Caledonia seem phylogenetically clustered.

To investigate some putative phylogenetic pattern in the success of different groups in the New Caledonian flora, we identified the families that are over- or under-represented by comparing their actual numbers of indigenous and endemic species with their expected numbers of species if this flora was a random subset of the world flora. Using a supertree of the angiosperm and an index of representation, we looked at possible clustering between over- and under-represented families

MATERIAL & METHODS

To test for phylogenetic pattern of over-representation in the flora of New Caledonia, we considered all angiosperm families and took their total number of species worldwide from Stevens (2001 onwards), and the total number of indigenous and endemic species from Jaffré et al. (2001). We used the complete family tree of Davies et al. (2004), available from the Phylomatic website (Webb & Donoghue 2005).

To assess if one family was more or less represented than expected in New Caledonia, we compared the observed number of indigenous/endemic species with the expected number if the flora of New Caledonia was a random set of the world flora (null model). For instance, if 10% of the world angiosperms are orchids, 10% of indigenous and endemic New Caledonian angiosperms should be orchids. In the absence of a species checklist of the region surrounding New Caledonia that probably served as the source of dispersal, no finer analysis could be done.

To test for phylogenetic correlation with over-representation we calculated for each family the following representation index:

$$R = \ln\left(\frac{N_{obs} + 1}{N_{exp} + 1}\right)$$

Where N_{obs} is the number of indigenous or endemic species observed in New Caledonia, and N_{exp} is the number of indigenous or endemic species expected in New Caledonia under a null model. We tested for phylogenetic signal in the representation index variation by using Phylocom (Webb et al. 2007). Nodes which a significantly higher or smaller mean of representation index (threshold 5%) were mapped onto a phylogenetic tree.

RESULTS

Families that have a number of endemic species which is significantly higher or lesser than expected under the null model are mapped onto a phylogenetic tree in figure 1, which also shows nodes with significant deviation from random in the value of the representation index. Results obtained with indigenous or endemic species are mostly congruent (supplemental information II & III) but we will focus our discussion on the latter ones since the contrast between under- and over-represented families is stronger in this case.

Most nodes with significant values are found within Eudicots and often match clusters of families that are either over-represented or clusters under-represented. Rosids present a large number of nodes with significantly higher value of the representation index mean value, especially in the following clades: Sapindales, Myrtales and the COM clade sensu Zhu et al. (2007), which includes Celastrales, Oxalidales, Malpighiales. All of these clades have a concentration of families that are over-represented in New Caledonia. Significantly lower values are only observed in the Fabales. Asterids have a large number of nodes with significantly lower value of the representation index, especially in Lamiales and Asterales.

Some clades display higher values than expected: Gentianales, Apiales and the Myrsinaceae clade within Ericales (Myrsinaceae, Primulaceae, Theophrastaceae, Maesaceae and Sapotaceae); all of these clades have families that are over-represented in New Caledonia.

Altogether, the COM clade, Sapindales, Myrtaceae, Gentianales, Apiales and the Myrsinaceae clade contain ca. 21% of the world angiosperm species, but encompass 55% and 65% of the indigenous and endemic species of New Caledonia respectively. Fabales, Lamiales and Asterales represent 27% of the world angiosperm species, but only 9% and 7% of the indigenous and endemic species of the flora.

DISCUSSION

The comparative analysis shows that the most represented and the least represented groups in the New Caledonia flora are not randomly distributed within the angiosperm phylogenetic tree. Some groups are particularly well-represented and form the major component of the New Caledonian flora: the COM clade (including Malpighiales), Sapindales, Myrtaceae, Gentianales, Apiales and the Myrsinaceae clade. Other groups are poorly represented: Fabales, Asterales and Lamiales.

A possible explanation for this phylogenetic constrains is the importance of biogeography. New Caledonia could be the cradle of over-represented groups thus explaining their abundance there. However as the island was sunk into deep water in the Tertiary (Pelletier 2006), its biota might not be older than the emersion ca. 35-45 My ago. Thus the overall biota of New Caledonia is too young to be the birth place of most angiosperm families and even less of entire orders, which are generally older than 80 My, corresponding to the split period between New Caledonia and Australia (McLoughlin 2001). Furthermore, the fact that Cunoniaceae diversified more intensively in New Caledonia than in Australia suggests that evolution of this two floras was different, in spite of their likely common origin.

The most represented groups in New Caledonia might be characterised by a high-dispersability that allowed them to colonize the island first. However well-dispersed groups with small seeds such as Asteraceae or Poaceae (Harper et al. 1970) are under-represented in New Caledonia, whereas several families with large seeds such as Arecaceae, Ebenaceae and Sapotaceae (Harper et al. 1970) are over-represented. Asteraceae and Poaceae are represented by many non-endemic genera indicating a great number of dispersal events, but this never led to any major radiation, contrary to families such as Cunoniaceae. Among the well-represented families, Myrtaceae and Rubiaceae are both represented by species with small wind-dispersed seeds and large zoochorous fruits dispersed by birds or flying foxes. It is striking that some genera that do not seem to be particularly adapted to long distance dispersal because of their large seeds colonized New Caledonia on multiple occasions: *Syzygium* (Myrtaceae, Biffin et al. 2006), Arecoid Palms (Norup et al. 2006), Macadamieae (Proteaceae, Mast et al. 2008) or *Planchonella* (Sapotaceae, Swenson et al. 2007). This tends to suggest that beyond the ability to disperse, the ability to settle and diversify in New Caledonia might be the key factor to explain the composition of this insular flora.

As New Caledonia emerged in the Tertiary, the island was largely covered by the ophiolitic nappe (Pelletier 2006). The weathering of this geological assemblage mostly composed of peridotites has resulted in the formation of ultramafic soils (“serpentine”), which are not favourable to plant growth: low fertility, high Mg/Ca ratio, high concentration of heavy metals (Mn, Ni, Co, Cr, etc.) and low-water holding capacity (Proctor 2003). Thus colonizing plants had to face the double challenge to disperse over long-distance and then to be able to grow on the ultramafic soils of the island. One can expect that this represented two major obstacles for successful immigrants. It is unlikely that the successful immigrants were already growing on ultramafic soils before arriving in New Caledonia as these soils are rare and represent small surfaces on surrounding landmasses. To our knowledge, no phylogenetic

study was published describing that any New Caledonian group is directly related to a non New Caledonian group growing on ultramafic soils. However it is possible that some species may readily have a higher potential to adapt to such soils, as previously suggested by Kruckeberg (1986): “There is substantial evidence that populations have both the potential—by being preadapted—to tolerate unusual edaphic situations and often do become tolerant to them”. This was also suggested by Jaffré et al. (Jaffré et al. 1987) for New Caledonian plants.

Nickel hyperaccumulation may be seen as a symptom of such groups that are preadapted to ultramafic soils. Two angiosperm genera *Phyllanthus* s.l. including *Glochidion* (Phyllanthaceae Hoffmann et al. 2006; Kathriarachchi et al. 2006) and *Psychotria* (Rubiaceae) contain a large number of nickel hyperaccumulating species (24 and 32 respectively) distributed across several continents (Brooks 1998; Reeves 2003). These two genera are actually the two most diverse genera of the New Caledonian flora and belong to groups that are over-represented: Malpighiales and Gentianales. Although both genera are large with more than 1,000 species, most of the families with comparable size do not have as many nickel hyperaccumulating species. Nickel hyperaccumulating *Phyllanthus* s.l. species are known from Cuba, New Caledonia, Dominican Republic, Puerto Rico, Indonesia and Philippines (Reeves 2003). Cuban and New Caledonia *Phyllanthus* are not closely related (Kathriarachchi et al. 2006), so the hyperaccumulation trait appeared at least twice. The broad distribution range of the genus suggests a much larger number of appearances of this characteristic. Similarly nickel-hyperaccumulating species of *Psychotria* are known from Cuba, Puerto Rico, Australia and New Caledonia, and multiple evolution of the trait is likely. Thus, these genera seem more efficient to adapt to ultramafic soils.

Nickel hyperaccumulation evolved also twice in Cunoniaceae within *Geissois* and *Pancheria* (Brooks 1998; Jaffré 1980), two genera that are not closely related (Bradford &

Barnes 2001). Even though nickel hyperaccumulation is not known in this family outside New Caledonia, the case of *Weinmannia clemensiae*, endemic to the ultramafic soils of Mt Kinabalu and Mt Tambuyukon in Borneo (Hopkins & Hoogland 2002) suggests that the adaptation to this type of soils in this family is rather plesiomorphic as observed in other groups (de Kok 2002). Of the 250 species cited by Brooks (1998) as nickel-hyperaccumulator in, almost 40% of them belong to Malpighiales. So it seems that nickel-hyperaccumulation may be more likely to evolve in this order than in any other.

Among the over-represented clades in New Caledonia, nickel hyperaccumulating plants are known from the three orders Celastrales, Oxalidales and Malpighiales of the COM clade, Sapindales, Gentianales, the Myrsinaceae clade, but not so far in Apiales and Myrtaceae. However nickel-hyperaccumulation should not be considered as a necessary condition to ultramafic soils adaptation.

Other heavy metals are accumulated by plants from the same groups or from families with no known nickel hyperaccumulators, e.g. manganese is accumulated by some Apocynaceae, Myrtaceae and Proteaceae (Jaffré 1980). These three families are also over-represented in New Caledonia. A positive correlation is generally observed between the phylogenetic relationships and the amount of different heavy-metals in shoots (Broadley et al. 2001), suggesting that the overall pattern is not related to a single metal but rather to most of them.

In contrast, only four grass species grow naturally on New Caledonia ultramafic soils: *Setaria jaffrei* and the three species of the endemic genus of dwarf bamboo *Greslania*, so Poaceae do not seem to deal with ultramafic soils, thus explaining their under-representation, in spite of their dispersal capacity. Some families that are under-represented in New Caledonia do gather hyperaccumulating species such as Brassicaceae. However, the latter ones are mostly located in temperate areas and especially in northern hemisphere, thus

biogeographic and climatic constraints could explain their under-representation. Regarding Asteraceae and Fabaceae, their number of hyperaccumulating species is rather modest considering their large species numbers.

Heavy-metals accumulation should nevertheless only be seen as a symptom of adaptation to ultramafic soils. Most adapted species are tolerant by excluding and not hyperaccumulating heavy metals. Indeed, heavy metals are only one of the several constraints occurring in those soils since plants have also to deal with a high Mg/Ca ratio, poor fertility and drought. Consequently, plants associated to such soils often have small and/or tough leaves (Read et al. 2006).

The high occurrence of independent evolution of characters such as adaptation to ultramafic soils and heavy-metal hyperaccumulation in one given clade reminds the multiple evolution of symbiosis allowing atmospheric nitrogen fixation in the “nitrogen fixing clade” within Rosids (Soltis et al. 1995), mycoheterotrophy in Dioscoreales (Merckx et al. 2006), C-4 metabolisms in grasses (Christin et al. 2007), aerial parasitism in Santalales (Vidal-Russel & Nickrent 2008), etc. It might be hypothesized that the most represented clades in New Caledonia are those that present a potential pre-adaptation or rather an exaptation to ultramafic soils. According to Gould & Vrba (1982), exaptations are “features that now enhance fitness but were not built by natural selection for their current role”. Thus, groups with an exaptation to ultramafic soils would have been much more successful in colonizing New Caledonia, would have settled first and possibly diversified more. As erosion removed the layer of ultramafic soils, these groups would have been advantaged to invade the non-ultramafic soils, in comparison to newly colonizing long-distance dispersers.

Only few studies suggested that there could be some filter which could select the colonizer of a given biota, apart from high dispersability. However, while studying plants of the California chaparral, Ackerly (2004) found that small leaves, a generally accepted

adaptation to Mediterranean-type climate were already present in the ancestor of the chaparral lineage growing in cool temperate or subtropical conditions. He thus suggested that “ancestors of chaparral taxa had already acquired appropriate traits that contributed to their success under Mediterranean-type climates”. The importance of exaptation in the origin of a given flora would deserve deeper investigation. For example, the long-distance dispersal of *Ourisia* from the Andes to New Zealand and Tasmania (Meudt & Simpson 2006) suggests that getting adapted to alpine climate may be more difficult than to cross the oceans and could also illustrate Donoghue’s paradigm “It’s easier to move than to evolve” (Donoghue 2008). In addition, these examples seem contradictory with one of the hypotheses of the neutral theory of Hubbell (2001) that has not been the most challenged so far: the assumption that there is equal probability of immigration or speciation among species in a community.

The possible existence of an exaptation of some groups to ultramafic soils has multiple implications. It can first explain the peculiar composition of the flora of New Caledonia, the great representation of some families such as Araliaceae, Cunoniaceae, Myrtaceae, or Rubiaceae, and the poor representation or absence of other: Zingiberaceae, Lamiaceae... It could also explain the great diversity of conifers, especially Araucariaceae. New Caledonia is well-known for its concentration of basal angiosperms, although the opinion on which plant families are the most primitive has greatly changed over the past decade with the advances of molecular phylogenetics. It has generally been assumed that ultramafic soils may have offered protection to primitive groups against more successful advanced groups (Morat 1993). If one considers the most basal angiosperms of the flora of New Caledonia, *Amborella* and *Trimenia*, both are restricted to non-ultramafic soils, so this hypothesis is not supported. Laurales are well represented in New Caledonia, especially Lauraceae and a number of families that are small at a worldwide scale (Atherospermataceae, Hernandiaceae, Monimiaceae). Several families of Laurales were once thought to be primitive, but the order

may also present the exaptation to ultramafic soils which could explain its good representation in the New Caledonia flora, although we did not find significant value for the order in our analysis. The currently accepted position of Magnoliids, to which Laurales belongs, does not indicate that it is much more basal than either Monocots or Eudicots. Thus the influence of ultramafic soils on the persistence of basal angiosperms is not really supported and it is possible that *Amborella* is a relatively recent migrant in New Caledonia.

The identification of several unrelated clades with exaptation to ultramafic soils may be useful in the study of the mechanisms involved in the adaptation to ultramafic soils. Within one given clade, the same mechanism may have evolved multiple times and these mechanisms may be different between these clades. Although most work on heavy-metal hyperaccumulation has been done on Brassicaceae, other groups should also be investigated, for example the Myrsinaceae clade, which contains perhaps the most dramatic example of nickel hyperaccumulation, *Sebertia acuminata* (Sapotaceae, Jaffré et al. 1976). The COM clade is probably another model group as it contains a large number of nickel-hyperaccumulators, as well as black cottonwood, for which the sequence of the entire genome is available (Tuskan et al. 2006). The latter belongs to Salicaceae, along with genera with known nickel hyperaccumulating species such as *Casearia*, *Homalium* and *Xylosma*, that used to be placed in Flacourtiaceae (Chase et al. 2002).

The possible exaptation to ultramafic soils may be useful to predict the most successful invasive species in New Caledonia, as ultramafic soils are generally little affected by invasion. Not surprisingly, the most serious invasive species on the ultramafic soils of New Caledonia is *Pinus caribaea* (Pinaceae), which has been introduced from Tropical America, where it is naturally found on ultramafic soils. Thus, species that already grow on ultramafic soils in their home range or species belonging to a clade with the exaptation should be looked after.

ACKNOWLEDGMENTS

The authors wish to thank Nadia Robert for reviewing an earlier version of the manuscript.

REFERENCES

- Ackerly, D. D. 2004 Adaptation, niche conservatism and convergence: comparative studies of leaf evolution in the California chaparral. *The American Naturalist* **163**, 654-671.
- Biffin, E., Craven, L. A., Crisp, M. D. & Gadek, P. A. 2006 Molecular systematics of *Syzygium* and allied genera (Myrtaceae): evidence from the chloroplast genome. *Taxon* **55**, 79-94.
- Bradford, J. C. & Barnes, R. W. 2001 Phylogenetics and classification of Cunoniaceae (Oxalidales) using chloroplast DNA sequences and morphology. *Systematic Botany* **26**, 354-385.
- Broadley, M. R., Willey, N. J., Wilkins, J. C., Baker, A. J. M., Mead, A. & White, P. J. 2001 Phylogenetic variation in heavy metal accumulation in angiosperms. *New Phytologist* **152**, 9-27.
- Brooks, R. R. 1998 Geobotany and hyperaccumulators. In *Plants that hyperaccumulate heavy metals. Their role in phytoremediation, microbiology, archaeology, mineral exploitation and phytomining* (ed. R. R. Brooks), pp. 55-94. Wallingford: CAB International.
- Chase, M. W., Zmarty, S., Lledó, M. D., Wurdack, K. J., Swensen, S. M. & Fay, M. F. 2002 When in doubt, put it in Flacourtiaceae: a molecular phylogenetic analysis based on plastid *rbcL* DNA sequences. *Kew Bulletin* **57**, 141-181.

- Christin, P.-A., Salamin, N., Savolainen, V., Duvall, M. R. & Besnard, G. 2007 C-4 photosynthesis evolved in grasses via parallel adaptive genetic changes. *Current Biology* **17**, 1241-1247.
- Clement, W. L., Tebbitt, M. C., Forrest, L. L., Blair, J. E., Brouillet, L., Eriksson, T. & Swensen, S. M. 2004 Phylogenetic position and biogeography of *Hillebrandia sandwicensis* (Begoniaceae): a rare Hawaiian relict. *American Journal of Botany* **91**, 905-917.
- Crayn, D. M., Rosetto, M. & Maynard, D. J. 2006 Molecular phylogeny and dating reveals an oligo-miocene radiation of dry-adapted shrubs (former Tremandraceae) from rainforest tree progenitors (Elaeocarpaceae) in Australia. *American Journal of Botany* **93**, 1328-1342.
- Davies, T. J., Barraclough, T. G., Chase, M. W., Soltis, P. S., Soltis, D. E. & Savolainen, V. 2004 Darwin's abominable mystery: insights from a supertree of the angiosperms. *Proceedings of the National Academy of Science of the USA* **101**, 1904-1909.
- de Kok, R. 2002 Are plant adaptations to growing on serpentine soil rare or common? A few case studies from New Caledonia. *Adansonia* **24**, 229-238.
- Donoghue, M. J. 2008 A phylogenetic perspective on the distribution of plant diversity. *Proceedings of the National Academy of Science of the USA* **105**, 11549-11555.
- Gould, S. J. & Vrba, E. S. 1982 Exaptation--a missing term in the science of form. *Paleobiology* **8**, 4-15.
- Grandcolas, P., Murienne, J., Robillard, T., Desutter-Grandcolas, L., Jourdan, H., Guilbert, E. & Deharveng, L. 2008 New Caledonia: a very old Darwinian island? *Philosophical Transactions of the Royal Society of London B* **363**, 3309-3317.
- Harper, J. L., Lovell, P. H. & Moore, K. G. 1970 The shape and sizes of seeds. *Annual Reviews of Ecology and Systematics* **1**, 327-356.

- Hoffmann, P., Kathriarachchi, H. & Wurdack, K. J. 2006 A phylogenetic classification of Phyllanthaceae (Malpighiales; Euphorbiaceae sensu lato). *Kew Bulletin* **61**, 37-53.
- Hopkins, H. C. F. & Hoogland, R. D. 2002 Cunoniaceae. In *Flora Malesiana*, vol. 16 (ed. H. P. Notojoso), pp. 53-165. Leiden: Nationaal Herbarium Nederland.
- Hubbell, S. P. 2001 *The Unified Neutral Theory of Biodiversity and Biogeography*. Princeton and Oxford: Princeton University Press.
- Jaffré, T. 1980 *Etude écologique du peuplement végétal des sols dérivés de roches ultrabasiques en Nouvelle-Calédonie*. Travaux et documents de l'ORSTOM. Paris: ORSTOM.
- Jaffré, T., Brooks, R. R., Lee, J. & Reeves, R. D. 1976 *Sebertia acuminata*: a hyperaccumulator of Nickel from New Caledonia. *Science* **193**, 579-580.
- Jaffré, T., Morat, P., Veillon, J.-M. & MacKee, H. S. 1987 Changements dans la végétation de la Nouvelle-Calédonie au cours du Tertiaire : la végétation et la flore des roches ultrabasiques. *Adansonia* **4**, 365-391.
- Jaffré, T., Morat, P., Veillon, J.-M., Rigault, F. & Dagostini, G. 2001 *Composition and characterisation of the native flora of New Caledonia*. Documents Scientifiques et Techniques. Nouméa: Institut de Recherche pour le Développement.
- Kathriarachchi, H., Samuel, R., Hoffmann, P., Milnarec, J., Wurdack, K. J., Ralimanana, H., Stuessy, T. F. & Chase, M. W. 2006 Phylogenetics of tribe Phyllantheae (Phyllanthaceae; Euphorbiaceae sensu lato) based on *nrITS* and plastid *matK* DNA sequence data. *American Journal of Botany* **93**, 637-655.
- Kruckeberg, A. R. 1986 An essay: the stimulus of unusual geologies for plant speciation. *Systematic Botany* **11**, 455-463.
- MacArthur, R. H. & Wilson, E. O. 1963 An equilibrium theory of insular zoogeography. *Evolution* **17**, 373-387.

- Mast, A. R., Willis, C. L., Jones, E. H., Downs, K. M. & Weston, P. H. 2008 A smaller *Macadamia* from a more vagile tribe: inference of phylogenetic relationships, divergence times, and diaspora evolution in *Macadamia* and relatives (tribe Macadamieae; Proteaceae). *American Journal of Botany* **95**, 843-870.
- McLoughlin, S. 2001 The breakup history of Gondwana and its impact on pre-Cenozoic floristic provincialism. *Australian Journal of Botany* **49**, 271-300.
- Merckx, V., Schols, P., Maas-van de Kamer, H., Maas, P., Huysmans, S. & Smets, E. 2006 Phylogeny and evolution of Burmanniaceae (Dioscoreales) based on nuclear and mitochondrial data. *American Journal of Botany* **93**, 1684-1698.
- Meudt, H. M. & Simpson, B. B. 2006 The biogeography of the austral, subalpine genus *Ourisia* (Plantaginaceae) based on molecular phylogenetic evidence: South American origin and dispersal to New Zealand and Tasmania. *Biological Journal of the Linnnean Society* **87**, 479-513.
- Morat, P. 1993 Our knowledge of the flora of New Caledonia: endemism and diversity in relation to vegetation types and substrates. *Biodiversity Letters* **1**, 72-81.
- Norup, M. V., Dransfield, J., Chase, M. W., Barfod, A. S., Fernando, E. S. & Baker, W. J. 2006 Homoplasious character combinations and generic delimitation: a case study from the Indo-Pacific arecoid palms (Arecaceae: Areceae). *American Journal of Botany* **93**, 1065-1080.
- Pelletier, B. 2006 Geology of the New Caledonia region and its implications for the study of the New Caledonian biodiversity. In *Compendium of marine species from New Caledonia* (ed. C. E. Payri & B. Richer de Forges), pp. 17-30. Nouméa: Centre IRD de Nouméa.
- Proctor, J. 2003 Vegetation and soil and plant chemistry on ultramafic rocks in the tropical Far East. *Perspectives in Plant Ecology, Evolution and Systematics* **6**, 105-124.

- Read, J., Sanson, G. D., De Garine-Wichatitsky, M. & Jaffré, T. 2006 Sclerophylly in two contrasting tropical environments: low nutrients vs. low rainfall. *American Journal of Botany* **93**, 1601-1614.
- Reeves, R. D. 2003 Tropical hyperaccumulators of metals and their potential for phytoextraction. *Plant and Soil* **249**, 57-65.
- Renner, S. S. 2004 Variation in diversity among Laurales, early Cretaceous to present. *Biologiske Skrifter* **55**, 441-458.
- Savolainen, V., Anstett, M. C., Lexer, C., Hutton, I., Clarkson, J. J., Norup, M. V., Powell, M. P., Springate, D., Salamin, N. & Baker, W. J. 2006 Sympatric speciation in palms on an oceanic island. *Nature* **441**, 210-213.
- Soltis, D. E., Soltis, P. S., Morgan, D. R., Swensen, S. M., Mulli, B. C., Dowd, J. M. & Martin, P. G. 1995 Chloroplast gene sequence data suggest a single origin of the predisposition for symbiotic nitrogen-fixation in angiosperms. *Proceedings of the National Academy of Science of the USA* **92**, 2647-2651.
- Stevens, P. F. 2001 onwards Angiosperm Phylogeny Website.
- Swenson, U., Munzinger, J. & Bartish, I. V. 2007 Molecular phylogeny of *Planchonella* (Sapotaceae) and eight new species from New Caledonia. *Taxon* **56**, 329-354.
- Tuskan, G. A., DiFazio, S., Jansson, S., Bohlmann, J., Grigoriev, I., Hellsten, U., Putnam, N., Ralph, S., Rombauts, S., Salamov, A., Schein, J., Sterck, L., Aerts, A., Bhalerao, R. R., Bhalerao, R. P., Blaudez, D., Boerjan, W., Brun, A., Brunner, A., Busov, V., M. Campbell, Carlson, J., Chalot, M., Chapman, J., Chen, G.-L., Cooper, D., Coutinho, P. M., Couturier, J., Covert, S. & Cronk, Q. C. B. 2006 The Genome of Black Cottonwood, *Populus trichocarpa* (Torr. & Gray) *Science* **313**, 1596-1604.
- Vidal-Russel, R. & Nickrent, D. L. 2008 The first mistletoe: origins of aerial parasitism in Santalales. *Molecular Biology and Evolution* **47**, 523-527.

- Warren, B. H. & Hawkins, J. A. 2006 The distribution of species diversity across a flora's component lineages: dating the Cape's 'relicts'. *Proceedings of the Royal Society of London B* **273**, 2149-2158.
- Webb, C. O., Ackerly, D. D. & Kembel, S. W. 2007 Phylocom: software for the analysis of community phylogenetic structure and character evolution.
- Webb, C. O. & Donoghue, M. J. 2005 Phylomatic: tree assembly for applied phylogenetics. *Molecular Ecology Notes* **5**, 181-183.
- Zhu, X.-Y., Chase, M. W., Qiu, Y.-L., Kong, H.-Z., Dilcher, D. L., Li, J.-H. & Chen, Z.-D. 2007 Mitochondrial *matR* sequences help to resolve deep phylogenetic relationships in rosids. *BMC Evolutionary Biology* **7**, 217.

Figure 1. Representation of New Caledonian families mapped on the phylogenetic tree of the angiosperms. The left hand side tree shows nodes which have a significantly higher (red square) or lower (blue square) mean representation index than expected. The right hand side tree shows families which are significantly over- or under-represented in the flora of New Caledonia. Red: over-represented families with more than 100 species and $p < 0.05$. Orange: over-represented families with more than 100 species and $0.05 < p < 0.1$ or families with fewer than 100 species and $p < 0.05$. Dark blue: under-represented families with more than 100 species and $p < 0.05$. Light blue: under-represented families with more than 100 species and $0.05 < p < 0.1$ or families with less than 100 species and $p < 0.05$.

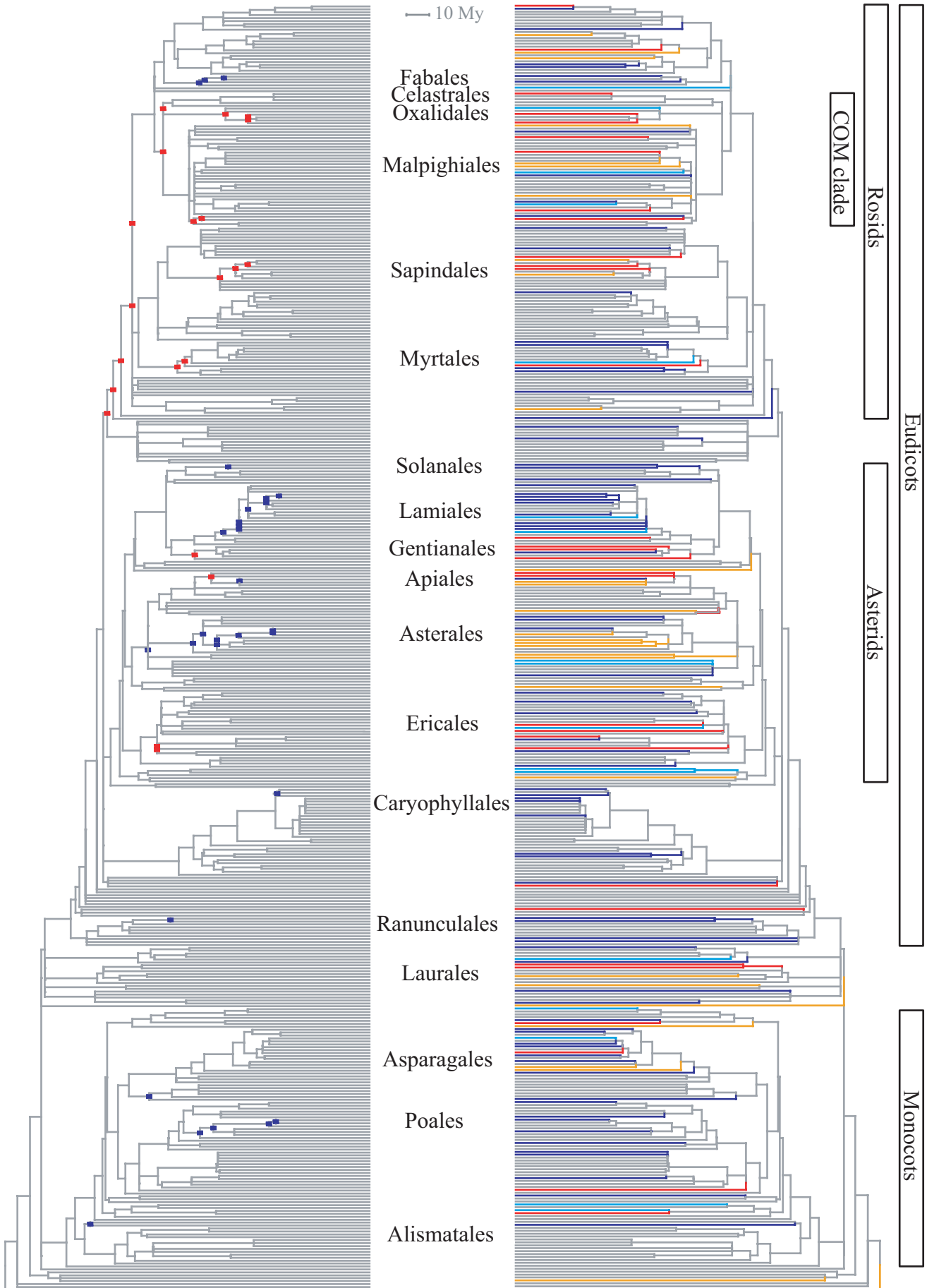

Supporting Information I

The numbers of species per genera in New Caledonian Cunoniaceae were compared with those of Australian Cunoniaceae and with those of New Caledonian Asteraceae.

Table 1. List of genera of Cunoniaceae occurring in New Caledonia and Australia and of Asteraceae occurring in New Caledonia. Species number are taken from Jaffré et al. (1) et Bradford et al. (2) and Pillon et al. (unpublished).

Cunoniaceae	Cunoniaceae	Asteraceae
New Caledonia	Australia	New Caledonia
7 genera, 88 species	15 genera, 36 species	21 genera, 34 species
<i>Codia</i> 13 spp. <i>Cunonia</i> 24 spp. <i>Geissois</i> 13 spp. <i>Hooglandia</i> 1 sp. <i>Pancheria</i> 25 spp. <i>Spiraeanthemum</i> 7 spp. (1+6) <i>Weinmannia</i> 4 spp.	<i>Ackama</i> 2 spp. <i>Acrophyllum</i> 1 sp. <i>Anodopetalum</i> 1 sp. <i>Bauera</i> 3 spp. <i>Callicoma</i> 1 sp. <i>Ceratopetalum</i> 8 spp. <i>Davidsonia</i> 3 spp. <i>Eucryphia</i> 5 spp. <i>Geissois</i> 2 spp. <i>Gillbea</i> 2 spp. <i>Pseudoweinmannia</i> 2 spp. <i>Pullea</i> 1 sp. <i>Schizomeria</i> 2 spp. <i>Spiraeanthemum</i> 1 sp. <i>Vesselowskyia</i> 2 spp.	<i>Blumea</i> 9 spp. <i>Brachycome</i> 2 spp. <i>Centipeda</i> 1 sp. <i>Cineraria</i> 1 sp. <i>Eclipta</i> 1 sp. <i>Epaltes</i> 1 sp. <i>Glossocardia</i> 1 sp. <i>Gnaphalium</i> 1 sp. <i>Helichrysum</i> 1 sp. <i>Lagenophora</i> 3 spp. <i>Lipochaeta</i> 1 sp. <i>Pseudelephantopus</i> 1 sp. <i>Pseudognaphalium</i> 1 sp. <i>Pterocaulon</i> 3 spp. <i>Sigesbeckia</i> 1 sp. <i>Synedrella</i> 1 sp. <i>Tridax</i> 1 sp. <i>Vernonia</i> 1 sp. <i>Vittadinia</i> 1 sp. <i>Wedelia</i> 1 sp. <i>Wollastonia</i> 1 sp.

On average, New Caledonian genera have significantly more species than Australian genera of Cunoniaceae (Mann-Whitney U-test, $p < 0.01$) and significantly more species than New Caledonian genera of Asteraceae (Mann-Whitney U-test, $p < 0.01$).

To compare the number of species per radiation (per monophyletic group), we used the current phylogenetic hypothesis of Cunoniaceae based Bradford & Barnes (3), Bradford (4), Pillon et al. (5, unpublished).

All New Caledonian species within a given genus probably form a monophyletic group (3) (4), implying a single event of colonisation per genus, with the exception of *Spiraeanthemum*, which is represented by two distinct groups of species (5). Similarly the 15 Australian genera probably represent as many monophyletic groups (3), with the possible exception of *Pseudoweinmannia* and *Geissois* p.p. which may represent a monophyletic group (Pillon et al. unpublished). In a conservative approach we considered these two genera as a single monophyletic group.

None of the genera of Asteraceae are endemic to New Caledonia and are relatively widespread; they probably represent as many independent events of colonisation of New Caledonia. This approach is rather conservative as several genera such as *Blumea* are represented by several non-endemic species that probably represent as many colonisation events.

The number of species per monophyletic group was significantly higher in New Caledonian Cunoniaceae than Australian Cunoniaceae (Mann-Whitney U-test, $p < 0.01$) or than New Caledonia Asteraceae (Mann-Whitney U-test, $p < 0.01$).

REFERENCES

1. Jaffré T, Morat P, Veillon J-M, Rigault F, Dagostini G (2001) *Compostion and characterisation of the native flora of New Caledonia* (Institut de Recherche pour le Développement, Nouméa).
2. Bradford JC, Hopkins HCF, Barnes RW (2004) Cunoniaceae. in *The families and genera of vascular plants*, ed. Kubitzki, K. (Springer, Berlin), pp. 91-111.
3. Bradford JC, Barnes RW (2001) Phylogenetics and classification of Cunoniaceae (Oxalidales) using chloroplast DNA sequences and morphology. *Syst. Bot.* 26:354-385.
4. Bradford JC (2002) Molecular phylogenetics and morphological evolution in Cunonieae (Cunoniaceae). *Ann. Missouri Bot. Gard.* 89:491-503.
5. Pillon Y, Hopkins HCF, Munzinger J, Chase MW (in press) A molecular and morphological survey of generic limits of *Acsmithia* and *Spiraeanthemum* (Cunoniaceae). *Syst. Bot.*

Supporting information II

Representation of New Caledonian families in the indigenous flora of New Caledonia mapped on the phylogenetic tree of the angiosperms. Nodes with a significantly higher mean representation index than expected by chance are indicated by a red square, those with a significantly lower value with a blue square. Families which are significantly over- or under-represented in the indigenous flora of New Caledonia are indicated in colour. Red: over-represented families with more than 100 species and $p < 0.05$. Orange: over-represented families with more than 100 species and $0.05 < p < 0.1$ or families with fewer than 100 species and $p < 0.05$. Dark blue: under-represented families with more than 100 species and $p < 0.05$. Light blue: under-represented families with more than 100 species and $0.05 < p < 0.1$ or families with less than 100 species and $p < 0.05$.

10.0

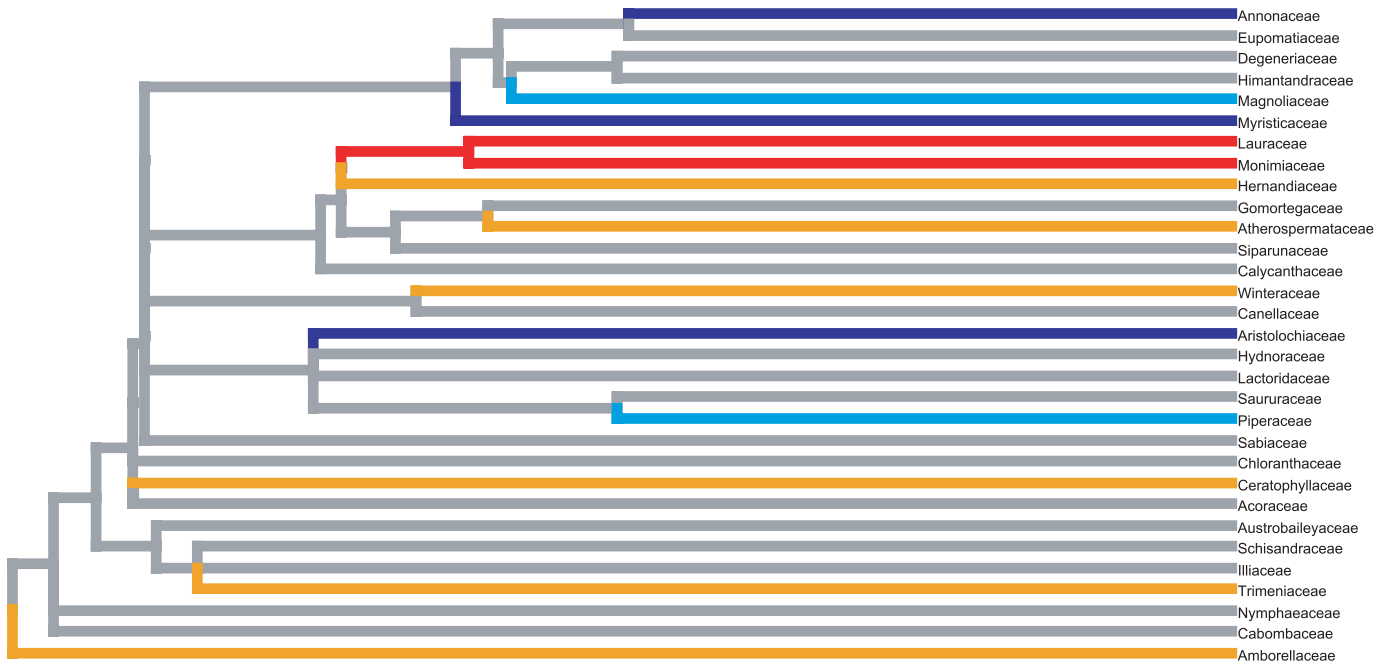

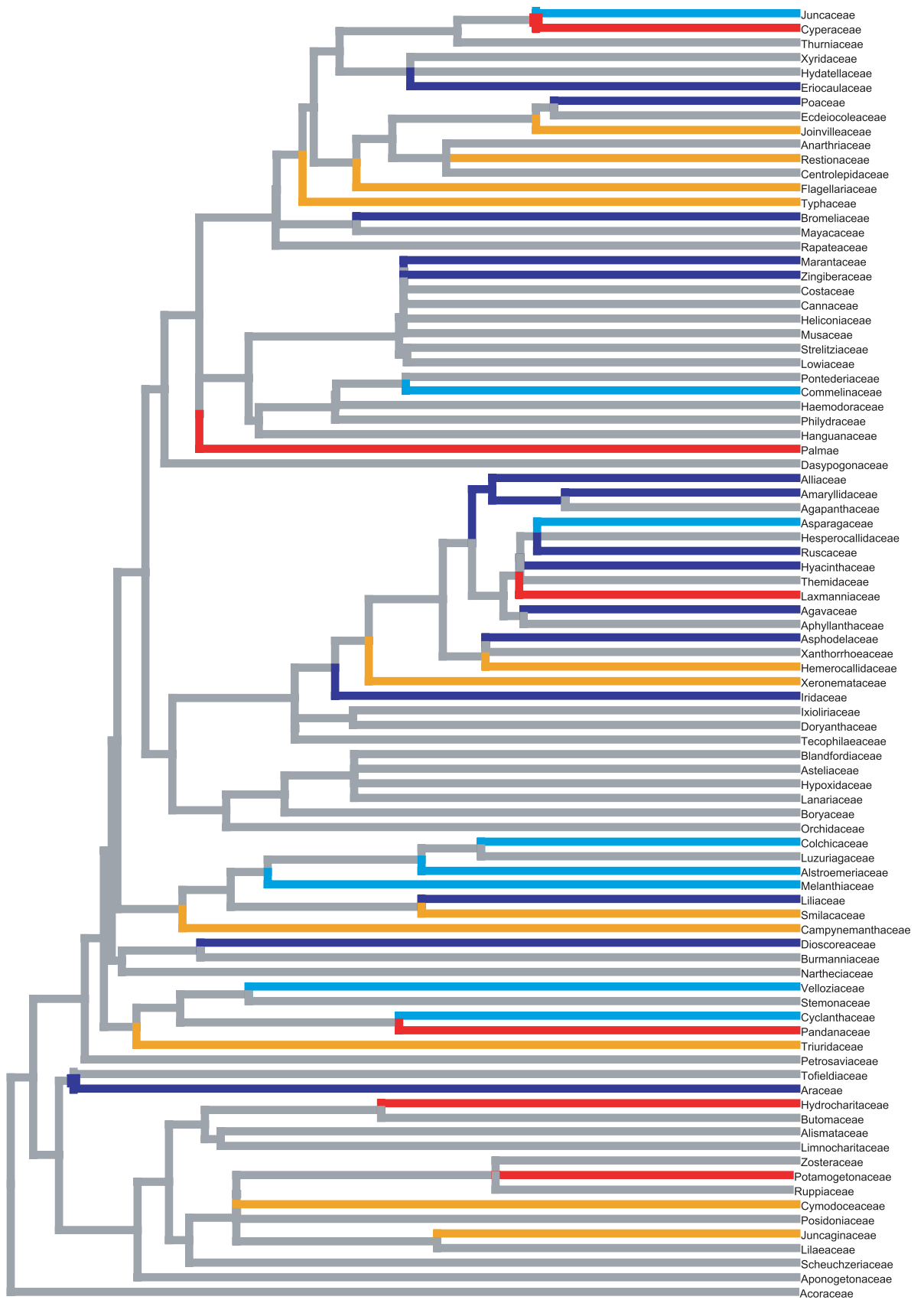

Monocots

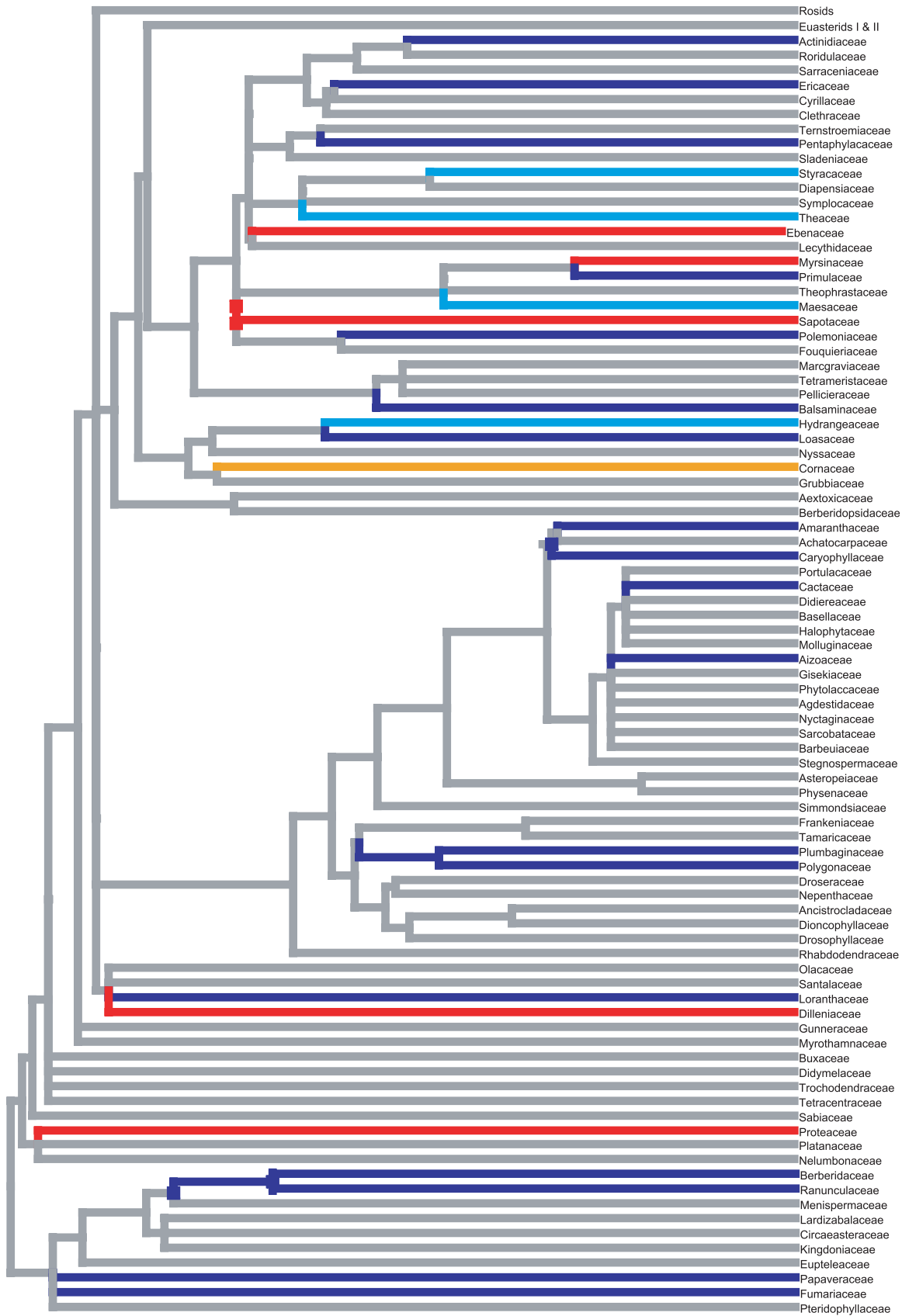

Eudicots

10.0

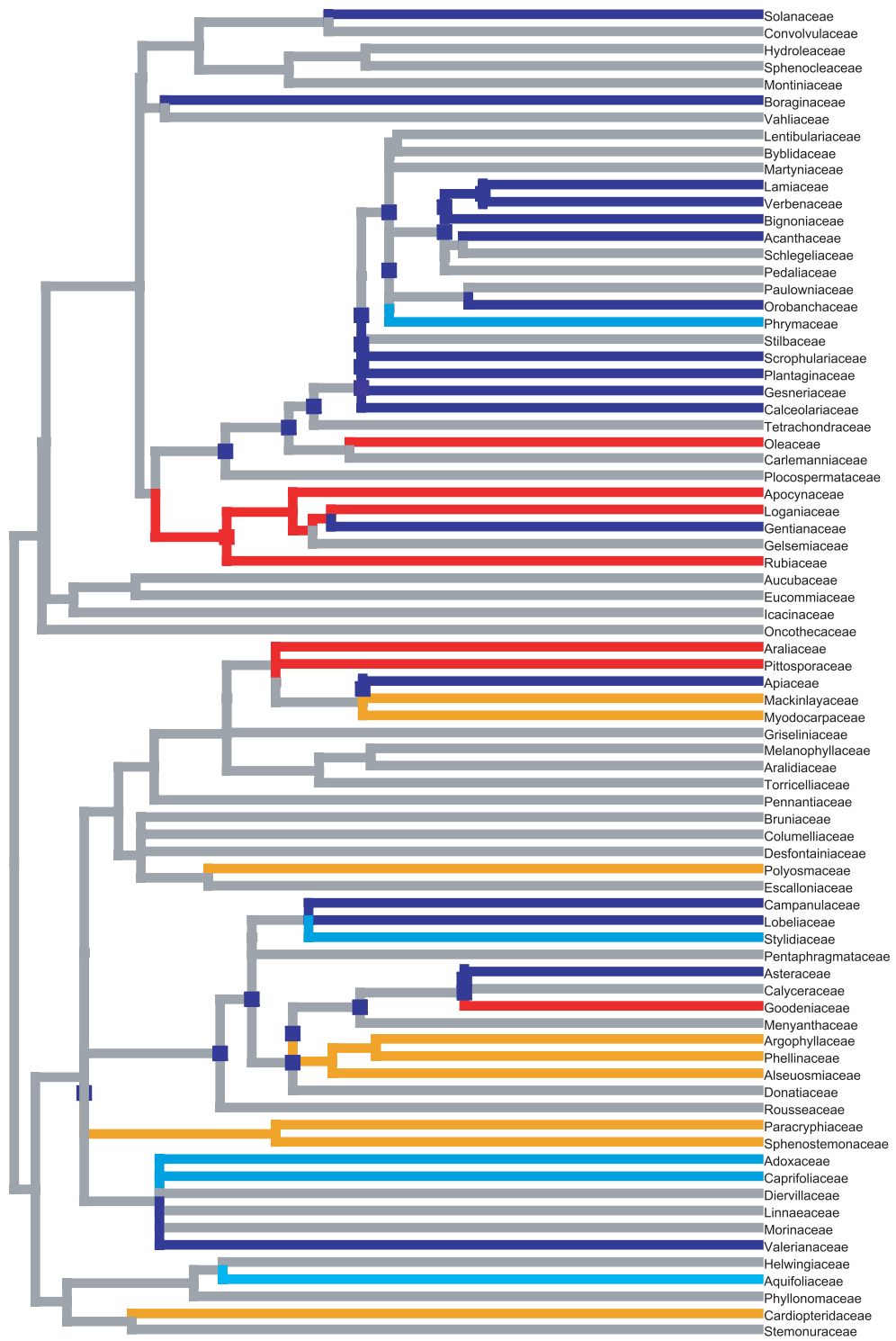

Euasterids I & II

10.0

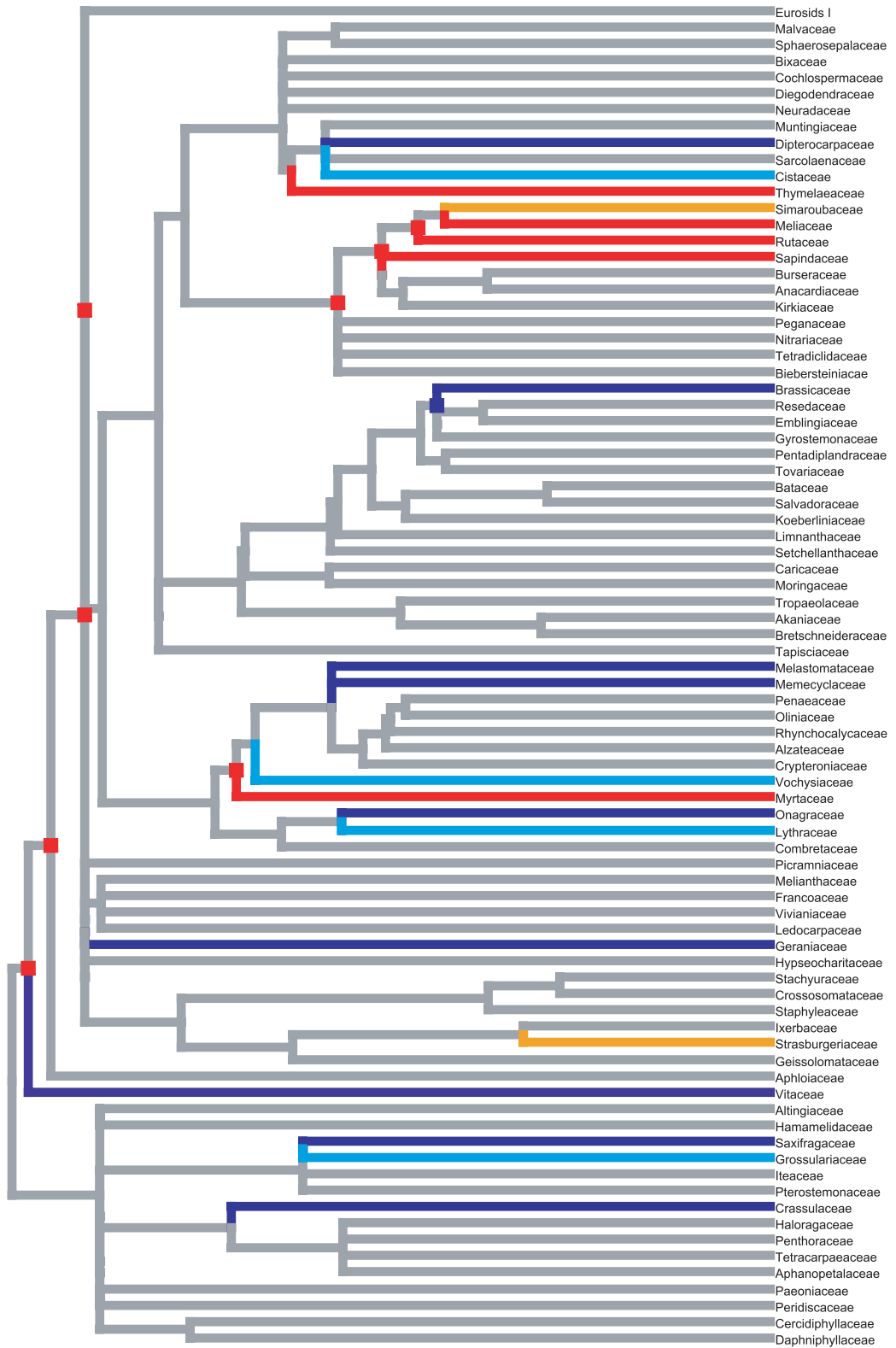

Rosids

10.0

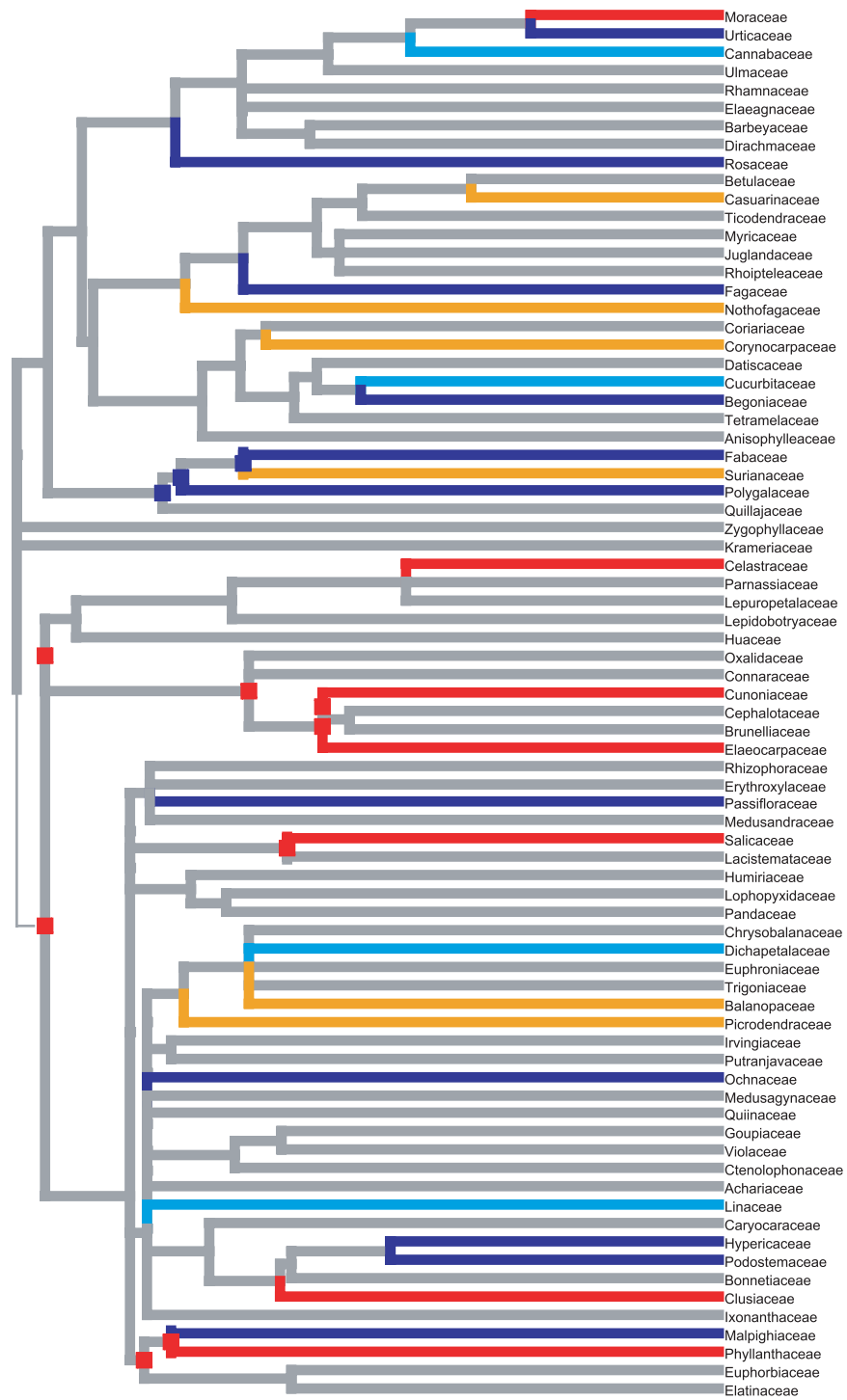

Eurosid I

Supporting information III

Representation of New Caledonian families in the endemic flora of New Caledonia mapped on the phylogenetic tree of the angiosperms. Nodes with a significantly higher mean representation index than expected by chance are indicated by a red square, those with a significantly lower value with a blue square. Families which are significantly over- or under-represented in the endemic flora of New Caledonia are indicated in colour. Red: over-represented families with more than 100 species and $p < 0.05$. Orange: over-represented families with more than 100 species and $0.05 < p < 0.1$ or families with fewer than 100 species and $p < 0.05$. Dark blue: under-represented families with more than 100 species and $p < 0.05$. Light blue: under-represented families with more than 100 species and $0.05 < p < 0.1$ or families with less than 100 species and $p < 0.05$.

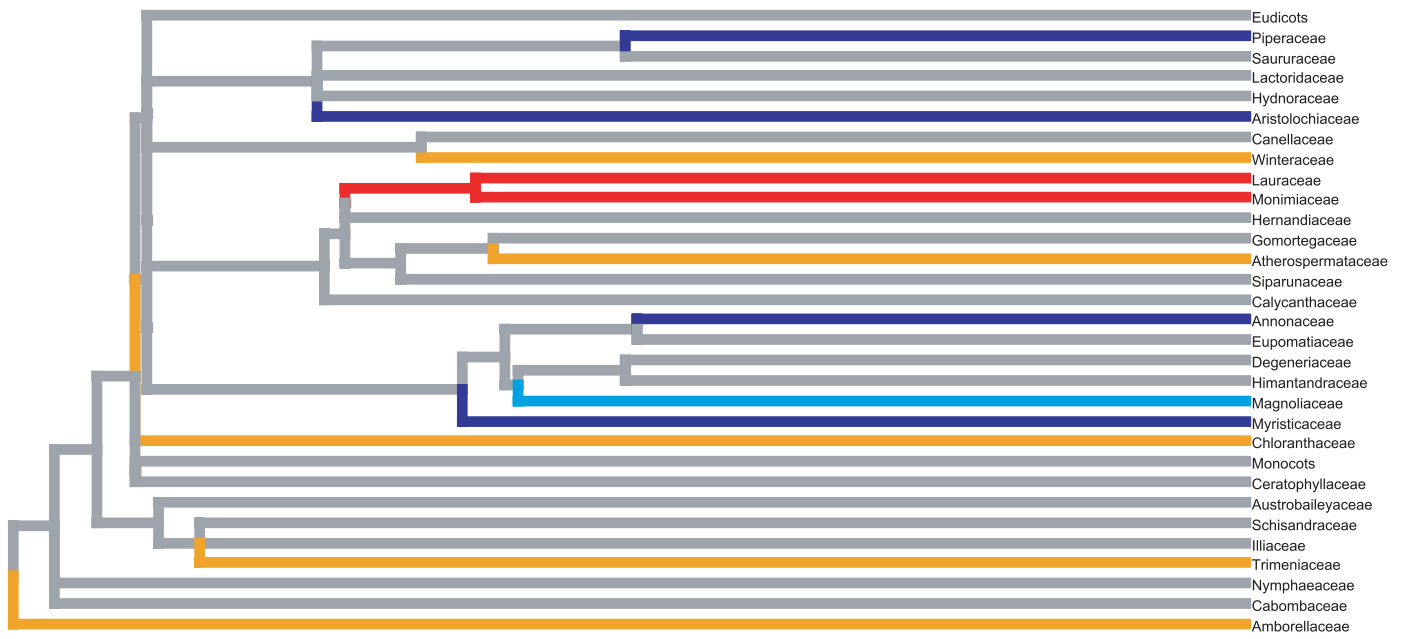

10.0

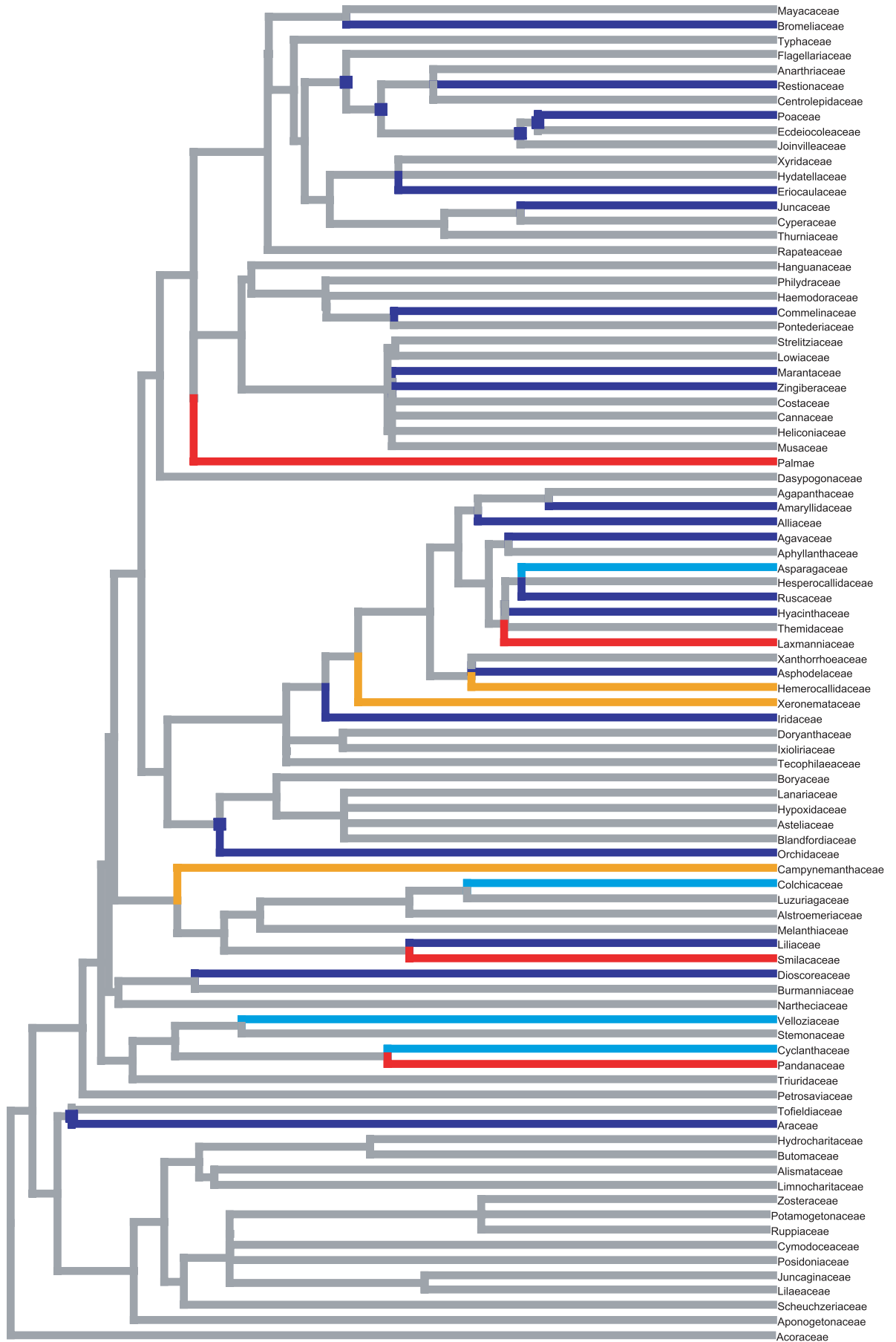

Monocots

10.0

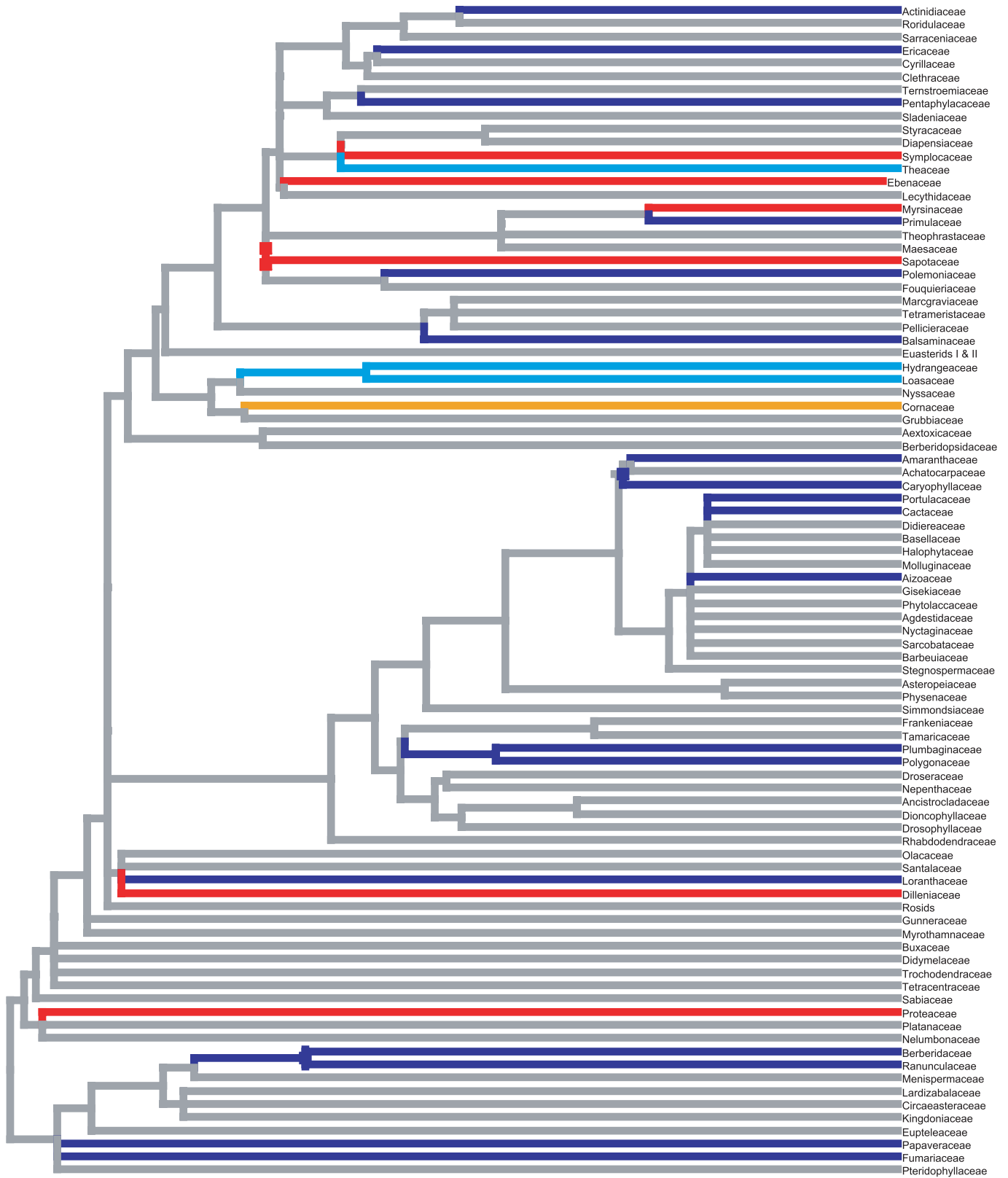

Eudicots

10.0

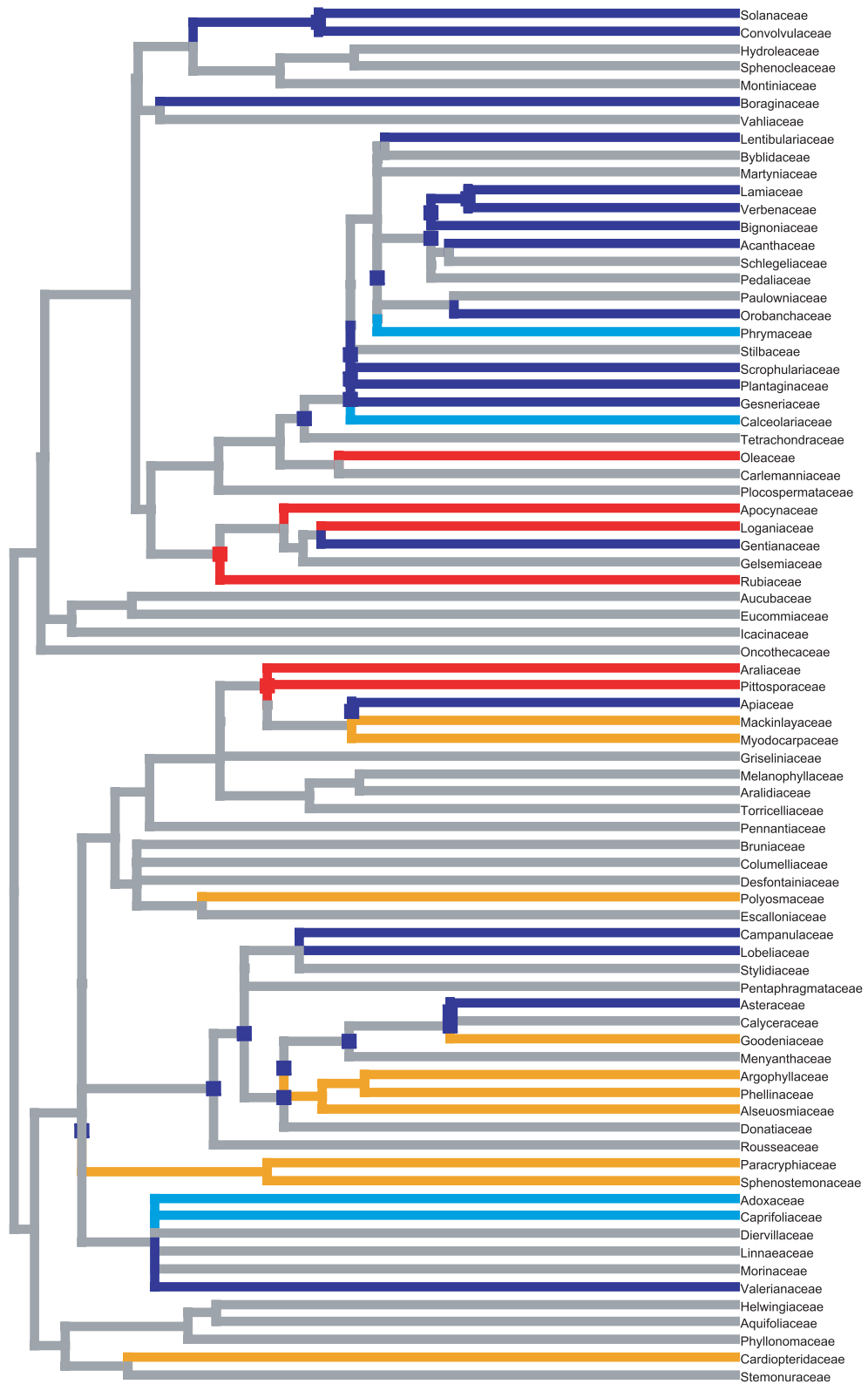

Euasterids I & II

10.0

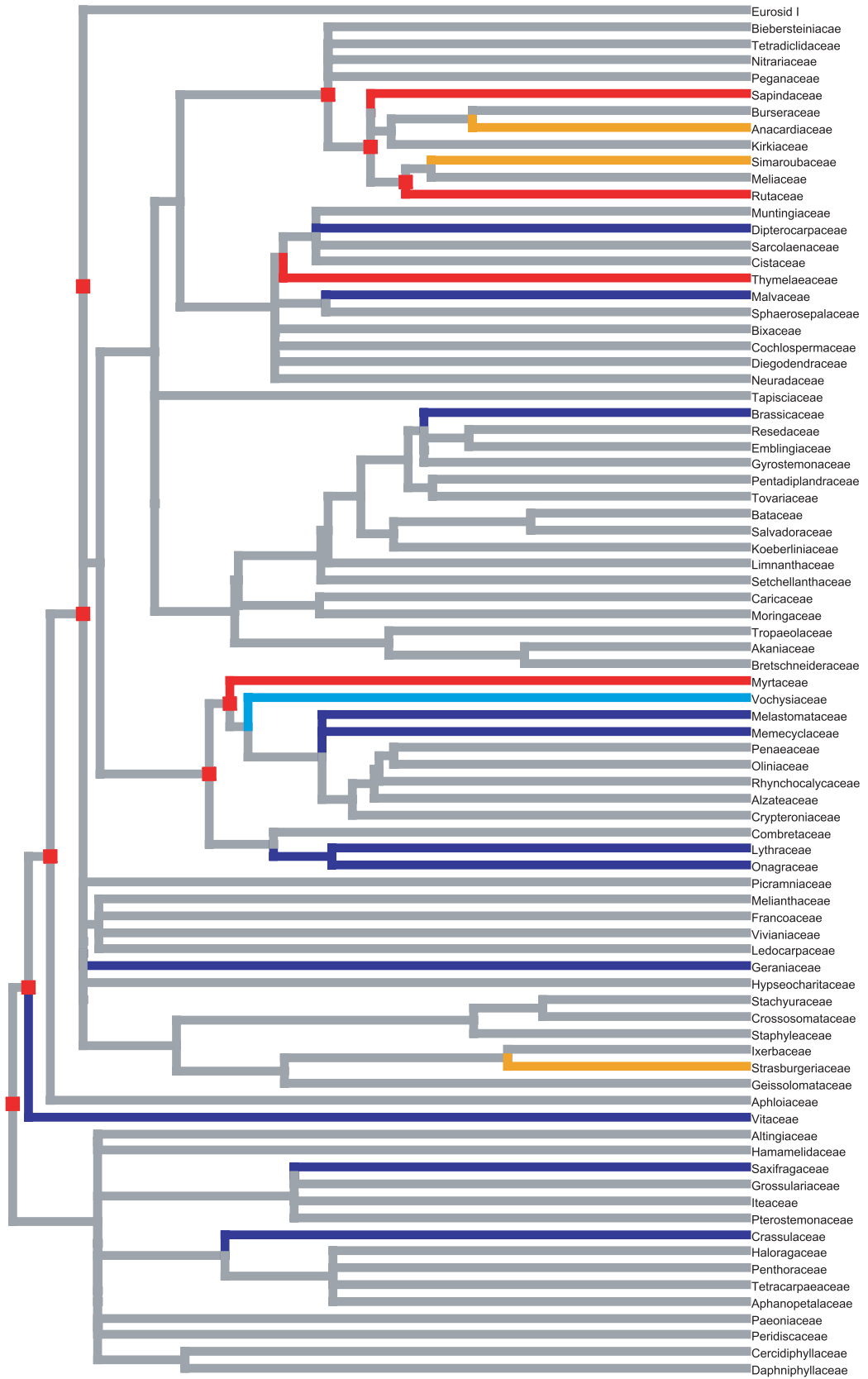

Rosids

10.0

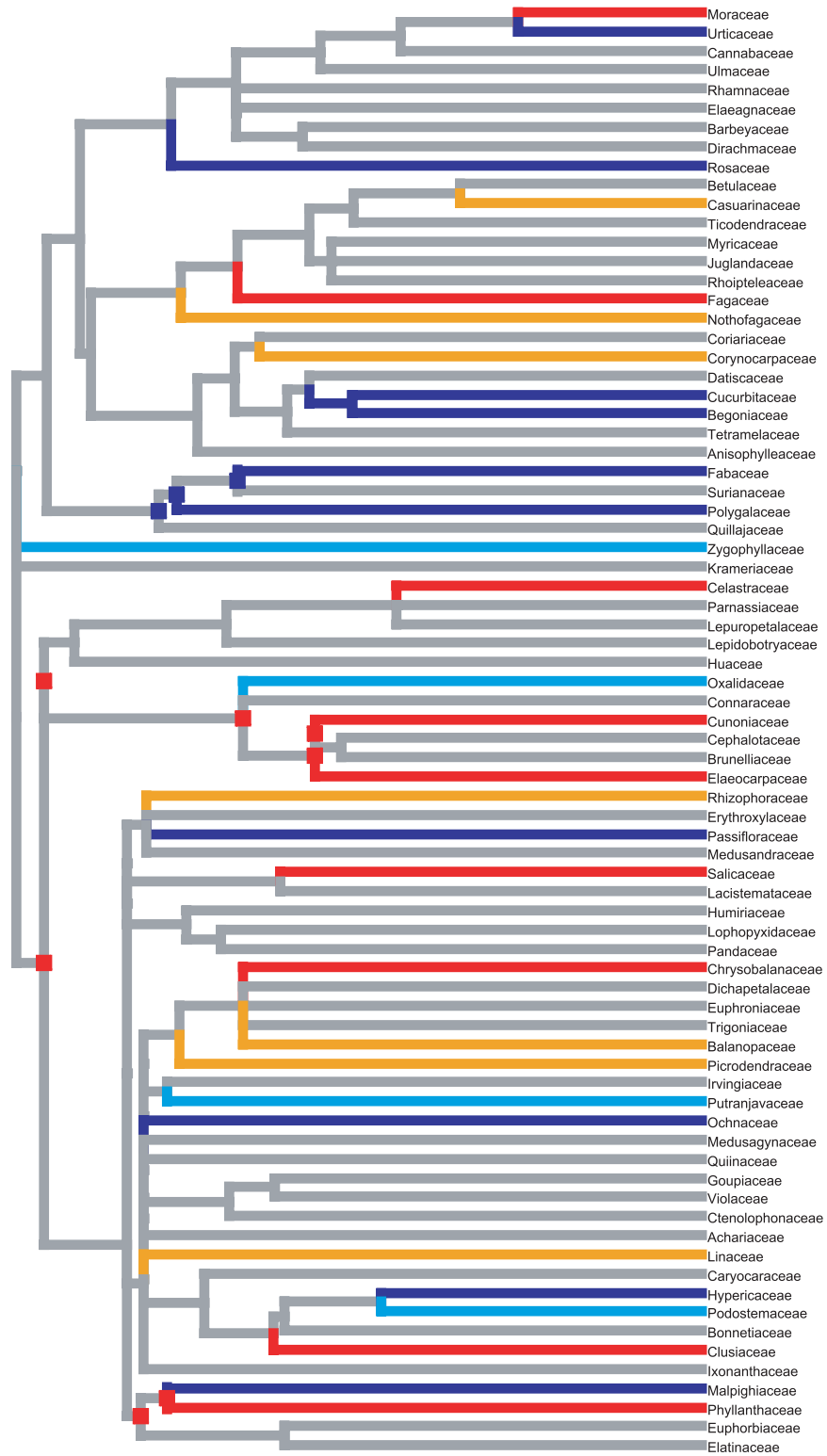

Eurosid I

Article VI

Pillon Y, Munzinger J, Amir H, Hopkins HCF, Chase MW (sous presse) Reticulate evolution on a mosaic of soils: diversification of the New Caledonian endemic genus *Codia* (Cunoniaceae). *Molecular Ecology*



L'histoire évolutive du genre *Codia*, endémique de la Nouvelle-Calédonie, a été reconstituée à l'aide de trois gènes nucléaires simples copies. Il semble probable que plus de la moitié des espèces de *Codia* aient une origine hybride. En l'absence de données cytologiques, nous ne savons pas s'il s'agit de polyploïdes. L'adaptation aux sols ultramafiques est probablement un caractère plésiomorphe pour le genre. Certaines espèces d'origine hybride

présentes des caractéristiques morphologiques absentes chez les espèces parentales, c'est-à-dire des phénotypes transgressifs. Des modifications importantes dans l'aire de répartition de certaines espèces ont eu lieu car certaines espèces parentales ne sont plus présentes en sympatrie et sont aujourd'hui confinées à d'hypothétiques refuges de forêt humide. Dans certains cas, les espèces d'origines hybrides ne se trouvent plus en présence d'aucune des espèces parentales. Ces résultats ont des conséquences pour la mise en place de stratégies de conservation, par exemple la préservation en priorité des espèces parentales ex situ. De plus les zones de contact présentant différents types de sols où les phénomènes d'hybridation sont plus probables devraient être préservées, permettant ainsi de maintenir les processus de spéciation.

**Reticulate evolution on a mosaic of soils: diversification of the New
Caledonian endemic genus *Codia* (Cunoniaceae)**

Yohan Pillon^{1,2}, Jérôme Munzinger¹, Hamid Amir², Helen C.F. Hopkins³ & Mark W. Chase⁴

¹ Laboratoire de Botanique, Institut de Recherche pour le Développement, BP A5, 98848
Nouméa Cedex, New Caledonia

² Laboratoire Insulaire du Vivant et de l'Environnement, Université de la Nouvelle-Calédonie,
BP R4, 98851 Nouméa Cedex, New Caledonia

³ c/o The Herbarium, Royal Botanic Gardens, Kew, Richmond, Surrey, TW9 3AB, UK

⁴ Jodrell Laboratory, Royal Botanic Gardens, Kew, Richmond, Surrey, TW9 3AB, UK

Keywords: New Caledonia, biogeography, hybrid speciation, island, rainforest refugia,
serpentine

Corresponding author : Jérôme Munzinger

Laboratoire de Botanique, Institut de Recherche pour le Développement, BP A5, 98848

Nouméa Cedex, New Caledonia

Fax (+687) 26 43 26

jerome.munzinger@noumea.ird.nc

Running Title: Reticulate evolution in New Caledonian *Codia*

ABSTRACT

We reconstructed the evolutionary history of *Codia*, a plant genus endemic to the New Caledonia biodiversity hotspot in the south-west Pacific, using three single-copy nuclear genes. It seems likely that more than half of *Codia* species have a hybrid origin, but in the absence of cytological information, it is not known whether polyploids occur. Adaptation to ultramafic soils is possibly a plesiomorphic character for the entire genus. We found that species of hybrid origin can have some morphological characters absent in putative parental species, i.e. they exhibit transgressive phenotypes. There is evidence of considerable range alteration post-origin in several species because some likely parental species of hybrid taxa no longer co-occur and are confined to putative rainforest refugia; in some cases, hybrid species do not now co-occur with either of their parental species. These results have implications for the design of conservation strategies, for example prioritization of parental species for ex-situ conservation and preservation of the contact zones between soil types where hybridization is more likely to occur (i.e. conserving the possibility for the process to continue rather than trying to conserve taxa).

INTRODUCTION

Identification of the best strategies for conservation requires not only better knowledge of biodiversity but also better understanding of the evolutionary processes involved in its production (Erwin, 1991; Smith *et al.*, 1993; Cowling & Pressey, 2001; Moritz, 2002). Among factors involved in plant speciation, two may be considered particularly important: hybridization (Rieseberg, 1997) and polyploidization (Ramsey & Schemske, 1998). A large number of model groups have been the subject of studies of hybridization and/or polyploidization, but substantial biases exist in their choice. Many are crops, ornamentals or weeds, and most have one or more of the following characteristics: brief life history, easy cultivation, and temperate climatic preferences (with biases towards native plants of Europe and North America). Although most biodiversity lies in the tropics, comparatively few data are available for tropical plants, particularly woody taxa.

New Caledonia is an archipelago in the south-western Pacific well-known for its rich and unique flora (Jaffré *et al.*, 2001), and considered by Meyers *et al.* (2000) as a global biodiversity hotspot. Its endemic flora is composed of a large number of relict lineages, such as conifers, early diverging angiosperms (including *Amborella*), and magnoliids (Jaffré *et al.*, 2001), as well as major radiations in genera such as *Phyllanthus* (114 species), *Psychotria* (87 species) and *Syzygium* (68 species). A factor often used to explain the peculiarity of the New Caledonian flora is the importance of the ultramafic soils that cover roughly one-third of the main island's surface (Jaffré, 1993). Ultramafic soils, including serpentine in the strict sense, have several characteristics that are limiting for plant growth: low fertility (low N, P, K), high Mg/Ca ratio, high concentrations of heavy metals (Co, Cr, Ni etc.), low water-holding capacity and increased susceptibility to fire (Proctor, 2003). In New Caledonia, large areas of ultramafic substrates are covered by scrubby vegetation termed "maquis" in which levels of species endemism can exceed 90% (Jaffré *et al.*, 2001), especially at high elevation.

Relatively few studies have investigated diversification of particular groups within New Caledonia (but see Eibl *et al.*, 2001; de Kok, 2002; Swenson *et al.*, 2007) compared with areas such as Hawaii (Price & Wagner, 2004) or the Cape region of South Africa (Linder, 2005). Molecular phylogenetics is an ideal tool to evaluate evolutionary processes within endemic groups, but the choice of adequate markers is an important issue. Plastid genes and nuclear ribosomal regions are not the most appropriate genomic regions for tracking hybridization (Small *et al.*, 2004) because the first are generally inherited uniparentally (generally maternally in angiosperms, Corriveau & Coleman, 1988), and the second are subject to concerted evolution (Baldwin *et al.*, 1995), which tends to erase one of the parental copies in species of hybrid origin (Chase *et al.*, 2003). In many cases, concerted evolution in hybrids is strongly biased towards the maternal parent (Pillon *et al.*, 2007), and thus both these categories of markers may indicate congruent evolutionary histories leaving no evidence of hybridization. Single-copy nuclear genes provide better markers for this task, although use of such loci is often difficult due to the lack of universal primers and their often unpredictable modes of evolution.

To investigate processes that have been important in diversification of the New Caledonian flora, and particularly to examine the importance of soil diversity and the possible occurrence of hybridization, we aimed to reconstruct the evolutionary history of the endemic genus *Codia*. This genus belongs to Cunoniaceae, a principally Southern Hemisphere family of 27 genera and ca. 300 species (Bradford *et al.*, 2004) that is well represented in New Caledonia. *Codia* consists of some 14 species (Hopkins, 2005; Hopkins *et al.*, 2007) of often gregarious trees and shrubs that sometimes dominate maquis and rainforests. With species on both ultramafic and non-ultramafic (e.g. sedimentary, basaltic and metamorphic) substrates, *Codia* comprises both widespread and micro-endemic species on the main island (Grande Terre), Yandé and the Belep islands. Species delimitation has been problematic; little

variation is seen in reproductive morphology, but species are often variable in vegetative characters and in some cases hybridization has been suspected (e.g. Hopkins *et al.*, 2007). Through reconstruction of the evolutionary history of this genus using molecular markers, we hoped to gain insights into its morphological and ecological diversification, its biogeography, and the processes that may have triggered this radiation, which would help to demonstrate how this process may be conserved.

MATERIAL & METHODS

All but one species currently recognized in *Codia* according to recent taxonomic works (Hopkins, 2005; Hopkins *et al.*, 2007) were sampled in this study. Material was unavailable for just *C. cinerascens*, known only from the type collection made in the 19th century that indicates a vague locality (“Montagnes d’Ouatendé, Gatope”). In spite of extensive field work, no plant matching this type was found. Although the type of *C. cinerascens* is morphologically distinctive, the broad stipules and minute indumentum on the leaves recall *C. albicans*, and it may be an anomalous form of this species or a cross between it and perhaps *C. spatulata* (Hopkins & Pillon, unpublished). A single accession was used for each species. Because of technical limitations, we chose to multiply the markers rather than the accessions to increase the resolution, since preliminary studies showed that the level of molecular variation within *Codia* was low. Species of *Spiraeanthemum* and *Geissois* were used as outgroups (Pillon *et al.*, 2009; Pillon, unpublished).

Preliminary studies showed that classic markers would be of limited use for the present study. For instance, multiple copies of ITS were recovered in most species of Cunoniaceae (Bradford, 2002; Pillon, unpublished). For plastid genes, little variation was found within the genera of this family (Bradford, 2002; Pillon *et al.*, 2009; Pillon, unpublished), and the level of variation in two candidate genes for plant DNA barcoding

(Kress *et al.*, 2005; Chase *et al.*, 2007), *matK* and *psbA-trnH*, is also low (Pillon, unpublished). This led us to search for suitable single-copy genes. Ideally, the choice of such genes should be based on a number of criteria, including a high-level of variation and the absence of similar orthologous genes, duplication, and recombination (Small *et al.*, 2004). However, when working on non-model organisms, one constraint is the availability of primers that allow amplification of such genes. We thus selected genes that had previously been used in groups that are closely related to Cunoniaceae: *ncpGS* (chloroplast-expressed glutamine synthetase) was used in *Oxalis* (Oxalidaceae, Emshwiller & Doyle, 1999), which belongs to Oxalidales, the same order as Cunoniaceae; *GapC* (glyceraldehyde 3-phosphate dehydrogenase, also known as *G3pdh*) was used in *Manihot* (Euphorbiaceae, Olsen & Schaal, 1999); and the first exon of *PHYC* (phytochrome C) was used in Phyllanthaceae (Samuel *et al.*, 2005); the latter two families both belong to Malpighiales, an order close to Oxalidales (Zhu *et al.*, 2007). In *Populus trichocarpus*, the most closely related model group for which the entire genome has been sequenced (Tuskan *et al.*, 2006), one homolog of *GapC* is found in linkage group I and homologs of *ncpGS* are found in linkage groups VIII and X. These two genes are thus not linked in *Populus*, and *PHYC* is missing in this model species (Howe *et al.*, 1998).

Leaf material was dried in the field in silica gel (Chase & Hills, 1991), and DNA was extracted with a modified CTAB protocol (Csiba & Powell, 2006). A portion of *ncpGS* was amplified using the primers 687F and 994R of Emshwiller & Doyle (1999). The amplification mix included 45µL of 2.5mM MgCl₂ Reddy PCR Master Mix 1.1× (ABgene Ltd), 1µL of 0.4% bovine serum albumin (BSA), 0.5µL of each primer (100ng/µL) and 3µL of template DNAs of unknown concentrations. The following amplification protocol was used: 2 min at 94°C, 38 cycles of 1 min at 94°C, 1 min at 50°C, 1 min 30 s at 72°C and a final extension of 5 min at 72°C. A portion of *PHYC* was amplified using the primer *PHYC-F* and *PHYC-R* from

Samuel *et al.* (2005). The amplification mix included 45µL of 1.5mM MgCl₂ Reddy PCR Master Mix 1.1× (ABgene Ltd), 1.5µL of 0.4% bovine serum albumin (BSA), 0.5 µL of each primer (100ng/µL), 1 µL of DMSO and 2µL of template DNAs of unknown concentrations. The following protocol was used: 3 min at 94°C, 38 cycles of 1 min at 94°C, 1 min at 50°C, 1 min at 72°C and a final extension of 10 min at 72°C. A portion of *GapC* was amplified using the primer GPD_X7F and GPD_X9R from Strand *et al.* (1997). The amplification mix included 45µL of 2.5mM MgCl₂ Reddy PCR Master Mix 1.1× (ABgene Ltd), 1.µL of 0.4% bovine serum albumin (BSA), 0.5 µL of each primer (100ng/µL) and 3µL of template DNAs of unknown concentrations. The following protocol was used: 2 min at 94°C, 38 cycles of 1 min at 94°C, 1 min at 53°C, 1 min at 72°C and a final extension of 5 min at 72°C.

In the case of *ncpGS*, the amplification product could generally be sequenced directly. If electrophoregrams showed the presence of more than one allele/copy in an accession, and if these alleles differed in length or by more than one base pair, then the PCR product was cloned. An average of six clones were routinely sequenced. Further clones were sequenced if all polymorphisms observed in the electrophoregrams from the direct sequencing were not recovered. *PHYC* was also able to be sequenced directly. When more than one allele was observed at this locus, sequences of these alleles/copies were deduced by comparison with alleles found in the other accessions that were homozygous. This was necessary for only two accessions. When directly sequenced, *GapC* did not give clean results, and therefore amplification products of all accessions were cloned (up to six clones sequenced per accession in order to account for the heterogeneity observed). For this marker, a consensus sequence was created for each uniquely clustering set of clones, which removed the effects of substitutions induced by the PCR and cloning procedures. For *ncpGS*, the comparison between cloned and direct sequences allowed removal of most such artefacts. DNA sequences

have been submitted to Genbank (accession numbers FJ595023-FJ595081, see supplementary data for full details).

Alignment and phylogenetic analyses were carried out with PAUP*4.01b10 (Swofford, 2002). We searched for putative recombination events using the GARD software (Kosakovsky Pond *et al.*, 2006). A distance matrix between alleles was built with MEGA (Kumar *et al.*, 2004) and used to create a network with TCS (Clement *et al.*, 2000). To represent relationships between the species of *Codia* using all three DNA regions (“total evidence” approach), distances between species were calculated using POEAD (Joly & Bruneau, 2006) and used to build a split network (Huson & Bryant, 2006).

RESULTS

The total length of the aligned *nepGS* matrix was 1062 base pairs (bp); 54 sites were variable, 12 of which were potentially parsimony informative. The aligned matrices of *PHYC* and *GapC* were 579 and 873 bp long, respectively; they displayed 9 and 46 variable sites and provided 8 and 10 potentially parsimony informative sites, respectively. No evidence of recombination in any of the sequences was found with the GARD software.

Networks for alleles of *nepGS*, *PHYC* and *GapC* found in *Codia* are shown in figure 1, and table 1 shows the distribution of these alleles among species. For *nepGS* and *GapC*, up to four allele groups could be distinguished in the network, and these alleles were designated A, I, J and N, corresponding to the following species: *C. albicans*, *C. incrassata*, *C. jaffrei* and *C. nitida*. For *PHYC*, no obvious clear-cut groups were found, in contrast to the situation for the two other genes, and two groups (I and J) were tentatively delimited by comparison with these other genes. For none of the loci did we ever recover more than two alleles in a given accession.

Four species had genomes with alleles belonging to single allele-groups. In *Codia jaffrei*, we recovered a single allele (group J) for all three genes; in *C. incrassata*, we also recovered a single allele (group I) for all three genes. For *C. ferruginea*, a single allele was recovered for *nepGS* and *PHYC*, but two similar alleles (with a difference of two substitutions between them) were found for *GapC*; all these alleles belonged to group I. *Codia nitida* produced two similar but unique alleles (group N) for *nepGS*; for *PHYC*, it had the J1 allele, and for *GapC*, the N1 allele, which is nested in group I. A phylogenetic tree based on the combined analysis of the three genes for these four species using maximum parsimony showed that *C. nitida* and *C. jaffrei* form a clade (73 bootstrap percentage, BP) that is sister to another clade composed of *C. ferruginea* and *C. incrassata* (99 BP, data not shown).

For each of the other nine species of *Codia*, we recovered in at least one of the three genes two distinct alleles that belonged to different groups. Five species, *C. albifrons*, *C. belepensis*, *C. microphylla*, *C. spatulata* and *C. triverticillata*, displayed a combination of alleles from groups I and J. *Codia albicans* and *C. mackeeana* had a combination of alleles from groups A and I, and *C. montana* a combination of A and J. *Codia discolor* produced alleles of the J group for *PHYC* and *GapC* and alleles from groups I and N for *nepGS*.

A split-graph showing relationships of the *Codia* species is shown in figure 2. Little structure is observed, but species that combine I and J alleles cluster between *C. incrassata* and *C. jaffrei*.

DISCUSSION

LIMITS OF NUCLEAR SINGLE-COPY GENES

Amplification of all three nuclear single-copy genes was reasonably easy and consistent. Direct sequencing from the PCR products was possible for *nepGS* and *PHYC*;

when directly sequenced, *GapC* produced electrophoregrams with abundant polymorphisms, so cloning was always necessary.

In the absence of cytological data, we have no way to assess the existence of polyploidy in *Codia*. Although cases of suspected hybridization have been observed in the field, we have no evidence of their fertility and evolutionary potential. Thus, for a given accession, we could not estimate the number of alleles to expect. When direct sequencing is possible, homozygotes can clearly be distinguished from accessions with two or more alleles, but if multiple alleles exist, then cloning is necessary to tease them apart. One issue is the number of alleles to be recovered. If the direct sequence is readable, i.e. the different alleles have the same length (no net indel differences in their sequences), cloned sequences can be compared with the direct sequence, and if all alleles have been recovered, their variability should explain all polymorphisms observed in the directly sequenced electropherograms. If the direct sequence is not readable, then recovery of both alleles with more than a 95% chance of success requires the sequencing of at least six clones.

When direct sequencing is not successful, it is *a priori* not possible to know the number of alleles to expect. However, if one sequences six clones and recovers only a single allele, the chance that the accession is a homozygote is greater than 95% (96.875% exactly); conversely if the accession is a heterozygote, the chance that both alleles will be recovered is also more than a 95%. However, as one increases the number of accessions, the chance of missing an allele increases. When investigating two heterozygous accessions, chances of recovering both alleles from both accessions are $96.875\% \times 96.875\% \approx 93.8\%$. Thus a higher chance exists for a heterozygote to be undetected. For a sample like ours (13 accessions), we would need to sequence nine clones (calculation not shown) to assure a 95% chance of detecting all heterozygotes. Thus, as one increases the number of accessions and genes, sequencing becomes time consuming and costly.

In our study, a high probability exists that some alleles for *GapC* were missed and some heterozygotes not detected. In contrast, we are confident that all homozygotes for *nepGS* and *PHYC* were detected and that by comparison with the direct sequences, most alleles in heterozygotes were probably recovered. Thus, we have given greater weight to the results obtained with *nepGS* than to those obtained both with *PHYC*, which exhibits low variability, and with *GapC*, for which some alleles were probably missed.

An ideal nuclear single-copy gene would be one that can be sequenced directly so that both homozygotes and individuals with multiple alleles are readily identified. When no variation in length is found between alleles in accessions with multiple alleles, it is easier to compare the direct sequence and the cloned sequences and thus check that all alleles have been recovered. Recovering all alleles in polyploids with three or more alleles is difficult; to avoid artefacts occurring during PCR or cloning, production of multiple clones for each allele is also advantageous.

EVIDENCE FOR RETICULATE EVOLUTION IN *CODIA*

In networks based on *nepGS* and *GapC* (Fig. 1), two large groups of alleles could clearly be distinguished, I and J, between which the root was connected. Two smaller allele groups, A and N, could also be distinguished. In the network based on *PHYC* sequences, these groups are not clearly separated due to the low level of variation in this gene, and for most of the following discussion this gene will therefore not be considered.

In our results, we observed two categories of species. *Codia ferruginea*, *C. incrassata*, *C. jaffrei* and *C. nitida* represent the first and were homozygous for all three genes or had alleles that were similar and belong to the same allele group. All other species examined, which represent the second category, exhibit for at least one of these genes two alleles that belong to different groups. A possible explanation of this pattern of variation is reticulate

evolution within *Codia*, in which species of the second category are the result of hybridization events between species belonging to the first category. An alternative hypothesis would be incomplete lineage sorting, where, in an extreme case, most alleles would be present in most species, and homozygotes and heterozygotes would have been randomly sampled. Because a single accession was used for each species, it is not possible to infer whether the same pattern would have been observed if more individuals per species had been sampled. Nevertheless several observations suggest that hybridization, not incomplete lineage sorting, best explains our results.

First, consistent relationships between *Codia ferruginea*, *C. incrassata* and *C. jaffrei* observed for all three genes may be sufficient to rule out alternative hypotheses such as incomplete lineage sorting or an ancestral duplication event predating the radiation of *Codia* that gave rise to the modern species, which was then followed by random loss of gene copies. Sequences of *ncpGS* from one additional accession of *C. spatulata* and of *C. ferruginea*, each from a location different from the one previously sampled, revealed alleles of group I and J for the first one and a single allele of the I group for the second, which is consistent with what we had already observed (Pillon, unpublished).

Heterozygotes make up a large proportion of the sampling and were also recovered in rare species such as *Codia belepensis*. This species is only found on a few islands off the northern coast of New Caledonia, where it is the only species of the genus present. Thus, although one might predict that this species would be fixed for a single allele through genetic drift, two distinct alleles were recovered in the *ncpGS* analysis.

Most heterozygotes sampled had alleles that were far apart in the networks; in the case of incomplete lineage sorting, heterozygotes would be more likely to have alleles that are similar due to more recent divergence. Furthermore, the two alleles found in such

heterozygotes were generally both derived, as suggested by their being placed at the tips of networks, contrary to what would be expected in a case of incomplete lineage sorting.

Several heterozygote accessions such as those of *Codia albicans*, *C. montana* and *C. triverticillata* showed a consistent pattern for both *nepGS* and *GapC*: they combined two alleles from the I and J groups in each analysis. The species that exhibit different patterns for the two genes are those displaying alleles from two distinct groups in *nepGS* and a single group in *GapC*. However, as mentioned above, some alleles have probably been missed for this gene, especially when fewer than six clones were sequenced. In spite of this possibility, all species displaying alleles from two groups of *GapC* also showed alleles from two distinct groups in *nepGS*, with the exception of *C. mackeeana*. Furthermore, in homoploid hybrid species, one parental allele is commonly lost soon after formation (Howarth & Baum, 2005; Friar *et al.*, 2008). Thus we believe that most heterozygotes observed in this study are species of hybrid origin; this seems clear for species such as *C. albicans*, *C. montana* and *C. triverticillata*, which show consistent patterns for two genes, and for *C. spatulata*, which shows the same pattern in two accessions. It is possible that both hybridization and incomplete lineage sorting (and possibly also introgression) explain the pattern observed. The use of multiple accessions in each species would have been useful to clearly demonstrate that some species have a hybrid origin since they would be expected to be fixed heterozygotes. Future studies will require an enlarged sampling, and due to the technical limits associated with nuclear single-copy genes discussed above, alternative markers such as AFLPs would probably be preferable. Such markers are cheaper, more easily applicable to a large sampling and provide a large number of markers spread across the genome. However their analysis is more complex and they do not necessarily allow to clearly identifying the parents of the species of hybrid origin (see e.g. Hedrén *et al.*, 2001).

No chromosome counts are available for *Codia*, and thus it is not known if the species of presumed hybrid origin are homoploid or polyploid. We never found more than two alleles in any accession, although low variability of the markers used and difficulties of recovering multiple alleles in cloning make detection of more than two alleles in putative polyploids difficult. For *GapC*, we detected in some species of putative hybrid origin two distinct alleles corresponding to a single parental group, and thus if one assumes that the other parental allele(s) have been missed in the cloning procedure, such accessions may be polyploids. Currently few cytological data are available for New Caledonian plants, and this study demonstrates the importance of such data. Our results are, nonetheless, more consistent with all species being diploids, but this obviously needs further investigation.

EVOLUTIONARY HISTORY OF *CODIA*

Four species of *Codia* did not show signs of hybridization in any of the analyses: *C. ferruginea*, *C. incrassata*, *C. jaffrei* and *C. nitida*. All three genes indicate a close relationship between *C. ferruginea* and *C. incrassata* and show that *C. jaffrei* is more distantly related (Fig. 1). The placement of *C. nitida* was somewhat different in the analyses of *nepGS* and *GapC*. In the *GapC* tree, it is nested in the group containing *C. ferruginea* and *C. incrassata*, whereas in the *nepGS* network it is clearly distinct from the other two species; its alleles are also different from those of both the *jaffrei* group and the *ferruginea-incrassata* group by three and four substitutions, respectively. The combined analysis of the three genes suggests the following relationships: ((*C. jaffrei*, *C. nitida*)(*C. incrassata*, *C. ferruginea*)). These species are subsequently referred to as “parental species”.

All other species of *Codia* examined exhibited alleles from two groups for at least one gene, and we therefore consider them to be species of hybrid origin (hereafter “hybrid species”). Five of them, *C. albifrons*, *C. belepensis*, *C. microphylla*, *C. spatulata* and *C.*

triverticillata, have combinations from the I and J allele groups and can be considered the result of a cross or crosses between *C. jaffrei* and a member of the *ferruginea-incrassata* group. *Codia albicans* and *C. montana* each produced alleles belonging to two distinct groups, A and I for the former and A and J for the latter. Alleles of group A were not found in any parental lineage and may be the legacy of an extinct element that gave rise to *C. albicans* via a cross with a member of the *ferruginea-incrassata* group; it also is likely to have produced *C. montana* by crossing with *C. jaffrei*. *Codia mackeeana* also has alleles from both the A and I groups according to the *GapC* tree, but for *ncpGS*, no A allele was recovered. It is possible that the history of this species is more complex. *Codia discolor* shows peculiar patterns; for *ncpGS* it has a combination of alleles from the I and N groups, for *PHYC* it has two alleles that are similar to each another and distinct from all others, and for *GapC* it has one allele from the J group. The parentage suggested by *ncpGS* alone would be a combination of the I and N genomes, but the two other genes do not support this hypothesis. Further genes and sampling will be necessary to clarify the origin of this species. A summary of the putative evolutionary history of the genus *Codia* is presented in figure 3.

In the split graph produced by the combined analysis of all three loci presented in figure 2, species of presumed hybrid origin appear in between their putative parents. With the possible exceptions of *Codia montana* and *C. albicans*, it is not possible to distinguish which species are the results of hybridization events. Species with the same parentage do not form clear clusters, and their parentage is not directly interpretable from the graph. A possible weakness of POFAD is that it does not take into account missing alleles, which could be either experimental artefacts or truly the result of natural loss. Older homoploid hybrids would not be expected to exhibit both parental alleles, as demonstrated in *Helianthus* (Rieseberg *et al.*, 2003), *Scaevola* (Howarth & Baum, 2005) and *Dubautia* (Friar *et al.*, 2008), and some of the “missing” alleles in our study may no longer be present in the putative hybrid

species. Thus if one considers two species with the same parentage, one of which has lost one of the parental alleles for a given gene, these two species would not appear in exactly the same place on the tree; one will appear closer to one of the parents. The existence of an extinct parental lineage cannot be detected with this method.

MORPHOLOGY OF *CODIA*

Differences in reproductive characters are few in *Codia*, and most differences between species involve features of the leaves (especially the shape of the blade and the amount and type of indumentum) and stipules (especially size and shape; table 2). Several different patterns of character distribution are observed in hybrid taxa compared with their putative parents.

Our results show that novel characters can occur in hybrid species relative to their parents. For example, most species of *Codia* have opposite leaves, but two consistently have leaves in whorls of three: *C. albifrons* and *C. triverticillata*, both of which have a combination of the I and J genomes and are thus products of hybridization between opposite-leaved parents. Both also share the unique J2 allele for *PHYC*, suggesting they diverged from a common ancestor after the hybridization event or that their parents shared this allele. Thus, it is not clear if the appearance of this novel feature represents a single event or two parallel ones. Whorled leaves can be considered as a transgressive phenotype, comparable to what has been observed in hybrid species of *Helianthus* (Rieseberg *et al.*, 2003; Rieseberg *et al.*, 2007).

Another novel character found only in species of putative hybrid origin is narrowly triangular stipules, which are found in *C. discolor*, *C. montana* and *C. spatulata*; each of these has a different genomic combination (Table 1), suggesting that this character has resulted from several different crosses. Examples of the converse, where characters seen in ancestral species have been lost in hybrids, also occur. For instance, *C. belepensis*, *C. microphylla* and

C. spatulata all lack the pale felty indumentum present in the adult foliage of their putative parents (*C. ferruginea*, *C. incrassata* and *C. jaffrei*).

The occurrence of petals shows a slightly different pattern. Petals occur consistently in *Codia albifrons* (I and J alleles) and *C. montana* (A and J alleles), and they have been observed occasionally or rarely in six other species, including the parental species *C. incrassata* and *C. nitida*. Importantly, both of the other genera in the tribe Codieae, *Callicoma* and *Pullea* (Bradford & Barnes, 2001), have flowers that lack petals, suggesting that this could therefore be the ancestral condition for the group.

ECOLOGY OF *CODIA*

The preferred soil types (ultramafic or non-ultramafic) of *Codia* species are summarised in table 2, together with an indication of habitat, which can include open scrub and maquis, other disturbed situations such as roadsides and along tracks, and forest edges and interiors. Although some species have restricted ecological preferences, several show a degree of plasticity.

The four parental species with no evidence of hybridization are each restricted to a single soil type: *Codia ferruginea*, *C. jaffrei* and *C. nitida* only grow on ultramafic soils, and *C. incrassata* occurs only on non-ultramafic substrates. Thus, adaptation to ultramafic soils appears either to be ancestral for the genus and to have been lost in *C. incrassata*, or it may have evolved twice, in the *C. jaffrei*-*C. nitida* clade and in *C. ferruginea*.

Most hybrid species are restricted to one type of soil, but three occur on both (*Codia albicans*, *C. montana* and *C. spatulata*). The lack of sub-grouping within the I group of alleles does not allow us to distinguish whether *C. ferruginea* or *C. incrassata* is the parent of the putative hybrid species with an allele of the I group. It is also possible that these two species diverged subsequent to the hybridization events. Furthermore the ecology of the putative

extinct parental lineage is not known. However, with the exception of *C. albicans* and *C. mackeeana*, at least one of the parents of each hybrid species grows on ultramafic soils. This implies that adaptation to these distinctive soils can be transmitted from parent to daughter species and can be lost, even if both parents grow on ultramafic soils.

Adaptation to ultramafic soils in *Codia* is possibly plesiomorphic, as de Kok (2002) suggested for five other genera in New Caledonia. However, he used cladistic analyses based on morphological characters, which cannot detect reticulate evolution. A plesiomorphic adaptation to ultramafic soils would not be surprising if, as suggested by Pelletier (2006), New Caledonia was entirely covered by ophiolite as it re-emerged from a period of deep-sea submersion in the late-middle Eocene (around -35My). Patterson & Givnish (2003) found that adaptation to serpentine substrates in Californian *Calochortus* (Liliaceae) evolved at least seven times and was thus highly homoplasious, but again, because they used only plastid markers, cases of hybridization may have been missed.

It is clear that soil type is a significant factor in the current distribution of *Codia* since 10 of 13 species are restricted to either ultramafic or non-ultramafic soils. The importance of soil type in constraining distribution is strengthened by evidence of past range movements (see below), which suggests that dispersal is not a limiting factor. Fruits of *Codia* are small, indehiscent and woolly, and appear to be wind dispersed.

The three *Codia* species with broad ecological preferences, *C. albicans*, *C. montana* and *C. spatulata* (the last two being the most widespread members of the genus) are all putatively of hybrid origin. *Codia albicans* is polymorphic, and the limits between *C. montana* and *C. spatulata* are not clear in parts of their range, especially in north-western New Caledonia. It is possible that these taxa have had multiple origins, as is commonly observed for hybrid species (Soltis *et al.*, 1999), and this could help to explain their polymorphic morphology. Alternatively, these species could each have had a single origin and

intermediates between them might be the result of recent hybridization in zones where they come into contact with one another, or their variation could be due to a combination of these processes.

Codia microphylla is rare and known only from a few localities in northern New Caledonia. Although herbarium specimens provide few data on its ecology, field observations suggest that this species may be restricted to phtanite, a type of siliceous sedimentary rock, that gives rise to dry, nutrient poor soils that support a short shrubby vegetation. The only other species of *Codia* that is sometimes found in this environment is *C. montana*, another hybrid species. Thus, adaptation to this novel habitat, unoccupied by any of the parental species, may have been facilitated by hybridization, as was observed in similar situations in *Helianthus* (Rieseberg *et al.*, 2003; Rieseberg *et al.*, 2007).

BIOGEOGRAPHY OF *CODIA*

Each of the four parental species has a relatively small geographical range. *Codia incrassata* is restricted to the area of mica-schist and sediments of north-eastern New Caledonia, and *C. ferruginea* is restricted to the ultramafic strip along the central-eastern part of the island (Fig. 4). *Codia jaffrei* is only found in the far south, and *C. nitida* also occurs in this region, as well as in a few isolated localities in the north-west. The southern part of Grande Terre and much of the eastern seaboard have higher rainfall than other parts of New Caledonia (Service d'Hydrologie de l'ORSTOM, 1981; Caudmont & Maitrepierre, 2007), and three of the parental species are largely restricted to the wettest areas; the part of the east coast where *C. ferruginea* occurs is somewhat drier. Studies on palms (Pintaud & Jaffré, 2001; Pintaud *et al.*, 2001) have suggested that the wet areas in the south and east of New Caledonia may have been refugia for rainforest taxa during the drier episodes of the Pleistocene, and the biased occurrence of diploid parental species in glacial refugia is a common feature in several

polyploid complexes in Europe (Trewick *et al.*, 2002; Abbott & Brochmann, 2003; Pillon *et al.*, 2007). All the species of *Codia* occurring on the markedly drier western coast of New Caledonia have a hybrid origin, except *C. nitida* (see above), which is nevertheless rare there. Further work is needed to confirm the importance of rainforest refugia in New Caledonia and to locate them precisely, and population genetics of relatively widespread species (Taberlet *et al.*, 1998) could potentially shed some lights on this issue.

Another striking distributional feature of *Codia* is that the main species involved in the production of hybrids, *C. jaffrei* on one side and the *ferruginea-incrassata* group on the other, do not have overlapping ranges (Fig. 4). However, hybridization between these taxa probably took place when the parental species (the ancestors of the modern taxa) occurred in sympatry; since the origin of the hybrids, the ranges of the parental taxa must have shifted, leaving their modern descendents in allopatry. Similar shifts in ranges of the parents of hybrids are thought to have occurred in *Nicotiana* (Chase *et al.*, 2003). Transgressive hybrids are well known for their altered ranges relative to their parental taxa. Hybridization events that have given rise to most species of *Codia* were thus probably relatively ancient, and their current distributions may not be representative of earlier points in their history. We have little information about alterations in climate and vegetation types between the emergence of New Caledonia in the late Eocene (Pelletier, 2006) and today, but changes in Quaternary vegetation have been charted by palynological studies (Stevenson *et al.*, 2001; Stevenson & Hope, 2005; Cabioch *et al.*, 2008).

Further evidence of alterations in distribution comes from hybrid species that have restricted distributions and do not co-occur with their parents; these include *Codia belepensis*, *C. microphylla* and *C. triverticillata*. *Codia belepensis* is an extreme case as it is restricted to three islands off the north of Grande Terre, Yandé, Art and Pott, where it is the only member of the genus present. The two species with whorled leaves, *C. albifrons* and *C. triverticillata*,

which are possibly descended from the same hybrid ancestor, do not co-occur at present; the former is restricted to the south of New Caledonia, and the other is found on only three mountains near the north-western coast: Kopeto, Boulinda and Paéoua.

Considerable range alterations, such as those we have hypothesised to have occurred in *Codia*, have been detected in other genera such as *Gossypium*, in which Cronn *et al.* (2003) found evidence of introgression in the Mexican cotton *G. gossypioides* from an African species. Similarly, all species of *Nicotiana* sect. *Suaveolentes* (Chase *et al.*, 2003), restricted to Africa (Namibia) and Oceania and comprising ca. 25 species, are the result of a single hybridisation involving parents from two lineages that are now confined to South America. Barraclough and Vogler (2000) suggested using the level of range overlap between sister species to determine the dominant mode of speciation: sympatric or allopatric, but when applied to South African *Protea*, Barraclough and Reeves (2005) found evidence for extensive range movements of species, preventing them from determining the mode of speciation in this genus. Hybrid speciation has been important in *Codia*, despite what contemporary species distributions suggest. Range changes could be a common and important phenomenon that obscures both biogeographic patterns and the historical diversification of a clade.

IMPLICATIONS FOR CONSERVATION

New Caledonian biodiversity is currently facing multiple threats, including fires, nickel mining, invasive species and climate change. The small size of the Archipelago (18,500 km²) and importance of micro-endemism almost certainly mean that a large proportion of New Caledonian species are susceptible to extinction and should be included in the IUCN Red List, the updating of which is urgently needed for New Caledonia (Munzinger

et al., 2008). Prioritisation of species and areas to preserve is needed, especially as few ex-situ conservation programs currently exist for threatened species in New Caledonia.

Vane-Wright *et al.* (1991) suggested that some species have higher conservation value than others, i.e. they have no close relatives. For example, the two recently described species, *Codia jaffrei* and *C. triverticillata* (Hopkins *et al.*, 2007), are both directly threatened by mining activities and have been assigned the provisional IUCN status of vulnerable (VU) and endangered (EN), respectively. Based on the level of threat, conservation priority might be given to the more threatened species, *C. triverticillata*. However, *C. jaffrei* represents a distinct parental lineage, whereas *C. triverticillata* is a hybrid species with a genomic content similar to that of several other species, e.g. *C. albifrons* and *C. belepensis*. The evolutionary potential of *C. jaffrei* may therefore be considered higher as it might hybridize again with other parental species to give rise to new hybrid taxa, and thus, it could be argued that *C. jaffrei* is of greater conservation importance than *C. triverticillata*.

The results of this study support the idea of Pintaud *et al.* (2001) and Pintaud & Jaffré (2001) that the southern and eastern parts of New Caledonia may have served as rainforest refugia during the climatic oscillations of the Pleistocene. Southern New Caledonia is the most species-rich region for Cunoniaceae; in addition, of the five families endemic to the Archipelago (Amborellaceae, Oncothecaceae, Paracryphiaceae, Phellinaceae and Strasburgeriaceae), all but Amborellaceae occur there, and two (Oncothecaceae and Strasburgeriaceae) are restricted to this area. Refugia are also expected to host greater genetic diversity (Taberlet *et al.*, 1998) and more rare genotypes (Petit *et al.*, 2003) within species and to represent important areas for the long-term persistence of biodiversity (Taberlet & Cheddadi, 2002). Thus, these possible refugia should be given greater conservation attention, the network of southern reserves should be re-enforced and new reserves should be designated on the eastern coast where there are currently almost none (Jaffré *et al.*, 1998).

It has been argued that it is important to preserve the conditions required for the persistence of evolutionary processes that generate biodiversity (Smith *et al.*, 1993; Cowling & Pressey, 2001; Moritz, 2002). This could be a particularly appropriate strategy in the case of species complexes that are evolving rapidly and/or where species delimitations are controversial (Ennos *et al.*, 2005; Pillon *et al.*, 2006). In New Caledonia, most plant species are restricted to one type of substrate, either ultramafic or non-ultramafic, and zones between these two soil types that still have intact vegetation are not numerous, but they provide evolutionarily important opportunities for some species to co-occur. One such site is Mont Koghis, close to the capital city of Nouméa, where rainforest covers a complex matrix of soils derived from peridotite, serpentine, and sedimentary rocks, and species that are not normally sympatric due to divergent ecological preferences are found in close proximity. It appears likely that hybridization between species with different substrate preferences has given rise to *Cunonia koghicola* on this mountain (Pillon *et al.*, 2008). Such sites should be preserved to maintain one of the evolutionary processes that have contributed to the remarkable biodiversity of New Caledonia.

REFERENCES

- Abbott RJ, Brochmann C (2003) History and evolution of the Arctic flora: in the footsteps of Eric Hultén. *Molecular Ecology* **12**, 299-313.
- Baldwin BG, Sanderson MJ, Porter JM, *et al.* (1995) The ITS region of nuclear ribosomal DNA: a valuable source of evidence on angiosperm phylogeny. *Annals of the Missouri Botanical Garden* **82**, 247-277.
- Barracough TG, Vogler AP (2000) Detecting the geographical pattern of speciation from species-level phylogenies. *The American Naturalist* **155**, 419-434.
- Barracough TG, Reeves G (2005) The causes of speciation in flowering plant lineages: species-level DNA trees in the African genus *Protea*. In: *Plant species-level systematics: new perspectives on pattern and process* (eds. Bakker FT, Chatrou LW, Gravendeel B, Pelsers PB), pp. 31-46. A. R. G. Gantner Verlag, Ruggell.
- Bradford JC, Barnes RW (2001) Phylogenetics and classification of Cunoniaceae (Oxalidales) using chloroplast DNA sequences and morphology. *Systematic Botany* **26**, 354-385.
- Bradford JC (2002) Molecular phylogenetics and morphological evolution in Cunoniaceae (Cunoniaceae). *Annals of the Missouri Botanical Garden* **89**, 491-503.
- Bradford JC, Hopkins HCF, Barnes RW (2004) Cunoniaceae. In: *The families and genera of vascular plants* (ed. Kubitzki K), pp. 91-111. Springer, Berlin.
- Cabioch G, Wirmann D, Sémah A-M, Corrège T, Le Cornier F (2008) Evolution des paléoenvironnements dans le Pacifique lors de la dernière déglaciation : exemples en Nouvelle-Calédonie et au Vanuatu. *Journal de la Société des Océanistes* **126-127**, 1-13.
- Caudmont S, Maitrepierre L (2007) *Atlas climatique de la Nouvelle-Calédonie*. Météo France, Nouméa.

- Chase MW, Hills HG (1991) Silica gel: an ideal material for field preservation of leaf samples for DNA studies. *Taxon* **40**, 215-220.
- Chase MW, Knapp S, Cox AV, *et al.* (2003) Molecular systematics, GISH and the origin of hybrid taxa in *Nicotiana* (Solanaceae). *Annals of Botany* **92**, 107-127.
- Chase MW, Cowan RS, Hollingsworth PM, *et al.* (2007) A proposal for a standardised protocol to barcode all land plants. *Taxon* **56**, 295-299.
- Clement M, Posada D, Crandall KA (2000) TCS: a computer program to estimate gene genealogies. *Molecular Ecology* **9**, 1657-1659.
- Corriveau JL, Coleman AW (1988) Rapid screening method to detect potential biparental inheritance of plastid DNA and results for over 200 angiosperm species. *American Journal of Botany* **75**, 1443-1458.
- Cowling RM, Pressey RL (2001) Rapid plant diversification: planning for an evolutionary future. *Proceedings of the National Academy of Science of the USA* **98**, 5452-5457.
- Cronn R, Small RL, Haselkorn T, Wendel JF (2003) Cryptic repeated genomic recombination during speciation in *Gossypium gossypioides*. *Evolution* **57**, 2475-2489.
- Csiba L, Powell MP (2006) DNA extraction protocols. In: *DNA and tissue banking for biodiversity and conservation: theory, practice and uses* (eds. Savolainen V, Powell MP, Davis K, Reeves G, Corthals A), pp. 48-51. Royal Botanic Gardens, Kew, Richmond.
- de Kok R (2002) Are plant adaptations to growing on serpentine soil rare or common? A few case studies from New Caledonia. *Adansonia* **24**, 229-238.
- Eibl JM, Plunkett GM, Lowry PP (2001) Evolution of *Polyscias* sect. *Tieghemopanax* (Araliaceae) based on nuclear and chloroplast DNA sequence data. *Adansonia* **23**, 23-48.

- Emshwiller E, Doyle JJ (1999) Chloroplast-expressed glutamine synthetase (ncpGS): potential utility for phylogenetic studies with an example from *Oxalis* (Oxalidaceae). *Molecular Phylogenetics and Evolution* **12**, 310-319.
- Ennos RA, French GC, Hollingsworth ML (2005) Conserving taxonomic complexity. *Trends in Ecology and Evolution* **20**, 165-168.
- Erwin TL (1991) An evolutionary basis for conservation strategies. *Science* **253**, 750-752.
- Friar EA, Prince LM, Cruse-Sanders JM, *et al.* (2008) Hybrid origin and genomic mosaicism of *Dubautia scabra* (Hawaiian silversword alliance, Asteraceae, Madiinae). *Systematic Botany* **33**, 589-597.
- Hedrén M, Fay MF, Chase MW (2001) Amplified fragment length polymorphisms (AFLP) reveal details of polyploid evolution in *Dactylorhiza* (Orchidaceae). *American Journal of Botany* **88**, 1868-1880.
- Hopkins HCF (2005) Nomenclature and typification in the endemic genus *Codia* (Cunoniaceae) from New Caledonia. *Adansonia* **27**, 243-254.
- Hopkins HCF, Fogliani B, Pillon Y (2007) Four new species in the endemic genus *Codia* (Cunoniaceae) from New Caledonia. *Kew Bulletin* **62**, 259-274.
- Howarth DG, Baum DA (2005) Genealogical evidence of homoploid hybrid speciation in an adaptive radiation of *Scaevola* (Goodeniaceae) in the Hawaiian islands. *Evolution* **59**, 948-961.
- Howe GT, Bucciaglia PA, Hackett WP, *et al.* (1998) Evidence that the phytochrome gene family in black cottonwood has one *PHYA* locus and two *PHYB* loci but lacks members of the *PHYC/F* and *PHYE* subfamilies. *Molecular Biology and Evolution* **15**, 160-175.
- Huson DH, Bryant D (2006) Application of phylogenetic networks in evolutionary studies. *Molecular Biology and Evolution* **23**, 254-267.

- Jaffré T (1993) The relationship between ecological diversity and floristic diversity in New Caledonia. *Biodiversity Letters* **1**, 82-87.
- Jaffré T, Bouchet P, Veillon J-M (1998) Threatened plants of New Caledonia: is the system of protected areas adequate? *Biodiversity and Conservation* **7**, 109-135.
- Jaffré T, Morat P, Veillon J-M, Rigault F, Dagostini G (2001) *Composition and characterisation of the native flora of New Caledonia* Institut de Recherche pour le Développement, Nouméa. www.ird.nc/images/Jaffr%E9%20et%20al,%202001-flore%20nc.pdf.
- Joly S, Bruneau A (2006) Incorporating allelic variation for reconstructing the evolutionary history of organisms from multiple genes: an example from *Rosa* in North America. *Systematic Biology* **55**, 623-636.
- Kosakovsky Pond SL, Posada D, Gravenor MB, Woelk CH, Frost SDW (2006) GARD: a genetic algorithm for recombination detection. *Bioinformatics* **22**, 3096-3098.
- Kress WJ, Wurdack KJ, Zimmer EA, Weigt LA, Janzen DH (2005) Use of DNA barcodes to identify flowering plants. *Proceedings of the National Academy of Science of the USA* **102**, 8369-8374.
- Kumar S, Tamura K, Nei M (2004) MEGA 3: Integrated software for molecular evolutionary genetic analysis and sequence alignment. *Briefings in Bioinformatics* **5**, 150-163.
- Linder HP (2005) Evolution of diversity: the Cape flora. *Trends in Plant Science* **10**, 536-541.
- Moritz C (2002) Strategies to protect biological diversity and the evolutionary processes that sustain it. *Systematic Biology* **51**, 238-254.
- Munzinger J, McPherson G, Lowry II PP (2008) A second species in the endemic New Caledonian genus *Gastrolepis* (Stemonuraceae) and its implications for the conservation status of high-altitude maquis vegetation: coherent application of the

- IUCN Red List criteria is urgently needed in New Caledonia. *Botanical Journal of the Linnean Society* **157**, 775-783.
- Myers N, Mittermeier RA, Mittermeier CG, da Fonseca GAB, Kent J (2000) Biodiversity hotspots for conservation priorities. *Nature* **403**, 853-858.
- Olsen KM, Schaal BA (1999) Evidence on the origin of cassava: phylogeography of *Manihot esculenta*. *Proceedings of the National Academy of Science of the USA* **96**, 5586-5591.
- Patterson TB, Givnish TJ (2003) Geographic cohesion, chromosomal evolution, parallel adaptive radiations, and consequent floral adaptations in *Calochortus* (Calochortaceae): evidence from a cpDNA phylogeny. *New Phytologist* **161**, 253-264.
- Pelletier B (2006) Geology of the New Caledonia region and its implications for the study of the New Caledonian biodiversity. In: *Compendium of marine species from New Caledonia* (eds. Payri CE, Richer de Forges B), pp. 17-30. Centre IRD de Nouméa, Nouméa. www.ird.nc/biodec/downloads/Compendium/Version%20v%E9rrouill%E9e/Pelletier-v.pdf.
- Petit RJ, Aguinalde I, de Beaulieu J-L, *et al.* (2003) Glacial refugia: hotspots but not melting pots of genetic diversity. *Science* **300**, 1563-1565.
- Pillon Y, Fay MF, Shipunov AB, Chase MW (2006) Species diversity versus phylogenetic diversity: a practical study in the taxonomically difficult genus *Dactylorhiza* (Orchidaceae). *Biological Conservation* **129**, 4-13.
- Pillon Y, Fay MF, Hedrén M, *et al.* (2007) Evolution and temporal diversification of western European polyploid species complexes in *Dactylorhiza* (Orchidaceae). *Taxon* **56**, 1185-1208.
- Pillon Y, Hopkins HCF, Bradford JC (2008) Two new species of *Cunonia* (Cunoniaceae) from New Caledonia. *Kew Bulletin* **63**, 419-431.

- Pillon Y, Hopkins HCF, Munzinger J, Chase MW (2009) A molecular and morphological survey of generic limits of *Acsmithia* and *Spiraeanthemum* (Cunoniaceae). *Systematic Botany* **34**, in press.
- Pintaud J-C, Jaffré T (2001) Patterns of diversity and endemism in palms on ultramafic rocks in New Caledonia. *South African Journal of Science* **97**, 548-550.
- Pintaud J-C, Jaffré T, Puig H (2001) Chorology of New Caledonian palms and possible evidence of Pleistocene rain forest refugia. *Compte Rendus de l'Académie des Sciences de Paris, Sciences de la vie* **324**, 453-463.
- Price JP, Wagner WL (2004) Speciation in Hawaiian angiosperms lineages: cause, consequence and mode. *Evolution* **58**, 2185-2200.
- Proctor J (2003) Vegetation and soil and plant chemistry on ultramafic rocks in the tropical Far East. *Perspectives in plant ecology, evolution and systematics* **6**, 105-124.
- Ramsey J, Schemske DW (1998) Pathways, mechanisms, and rates of polyploid formation in flowering plants. *Annual Reviews of Ecology and Systematics* **29**, 467-501.
- Rieseberg LH (1997) Hybrid origins of plant species. *Annual Reviews of Ecology and Systematics* **28**, 359-389.
- Rieseberg LH, Raymond O, Rosenthal DM, *et al.* (2003) Major ecological transitions in wild sunflowers facilitated by hybridization. *Science* **301**, 1211-1216.
- Rieseberg LH, Kim S-C, Randell RA, *et al.* (2007) Hybridization and the colonization of novel habitats by annual sunflowers. *Genetica* **129**, 149-165.
- Samuel R, Kathriarachchi H, Hoffmann P, *et al.* (2005) Molecular phylogenetics of Phyllanthaceae: evidence from plastid *matK* and nuclear *PHYC* sequences. *American Journal of Botany* **92**, 132-141.
- Service d'Hydrologie de l'ORSTOM (1981) Eléments généraux du climat. In: *Atlas de la Nouvelle-Calédonie et dépendance* (ed. Sautter G). Editions de l'ORSTOM, Paris.

- Small RL, Cronn RC, Wendel JF (2004) Use of nuclear genes for phylogeny reconstruction in plants. *Australian Systematic Botany* **17**, 145-170.
- Smith TB, Bruford MW, Wayne RK (1993) The preservation of process: the missing element of conservation program. *Biodiversity Letters* **1**, 164-167.
- Soltis PS, Soltis DE, Chase MW (1999) Angiosperm phylogeny inferred from multiple genes as a tool for comparative biology. *Nature* **402**, 402-404.
- Stevenson J, Dodson JR, Prosser IP (2001) A late Quaternary record of environmental change and human impact from New Caledonia. *Palaeogeography, Palaeoclimatology, Palaeoecology* **168**, 97-123.
- Stevenson J, Hope G (2005) A comparison of late Quaternary forest changes in New Caledonia and northeastern Australia. *Quaternary Research* **64**, 372-383.
- Strand AE, Leebens-Mack J, Milligan BG (1997) Nuclear DNA-based markers for plant evolutionary biology. *Molecular Ecology* **6**, 113-118.
- Swenson U, Munzinger J, Bartish IV (2007) Molecular phylogeny of *Planchonella* (Sapotaceae) and eight new species from New Caledonia. *Taxon* **56**, 329-354.
- Swofford DL (2002) PAUP*: *Phylogenetic analysis using parsimony (and other methods)* 4.0 Beta. Florida State University.
- Taberlet P, Fumagalli L, Wust-Saucy A-G, Cosson J-F (1998) Comparative phylogeography and postglacial colonization routes in Europe. *Molecular Ecology* **7**, 453-464.
- Taberlet P, Cheddadi R (2002) Quaternary refugia and persistence of biodiversity. *Science* **297**, 2009-2010.
- Trewick SA, Morgan-Richards M, Russell SJ, *et al.* (2002) Polyploidy, phylogeography and Pleistocene refugia of the rockfern *Asplenium ceterach*: evidence from chloroplast DNA. *Molecular Ecology* **11**, 2003-2012.

- Tuskan GA, DiFazio S, Jansson S, *et al.* (2006) The genome of black cottonwood, *Populus trichocarpa* (Torr. & Gray) *Science* **313**, 1596-1604.
- Vane-Wright RI, Humphries CJ, Williams PH (1991) What to protect?—Systematics and the agony of choice. *Biological Conservation* **55**, 235-254.
- Zhu X-Y, Chase MW, Qiu Y-L, *et al.* (2007) Mitochondrial *matR* sequences help to resolve deep phylogenetic relationships in rosids. *BMC Evolutionary Biology* **7**, 217.

ACKNOWLEDGMENTS

The authors wish to thank the Direction de l'Environnement (Province Sud) and DDEE (Province Nord) for permitting scientific collections in New Caledonia. We also thank all staff and students of the Botanical Laboratory at IRD, Alan Vergnes and Hervé Jourdan for assistance in the field. Jason Bradford also kindly provided some leave material. We are grateful to Edith Kapinos, Laszlo Csiba, Olivier Maurin, Dion Devey, and Martyn Powell for their help in the Jodrell Laboratory and to Laura Kelly, Maria Vorontsova, Nina Rønsted, and Jim Clarkson for discussions on nuclear single-copy genes. Anaïs Cardineau and Cyril Poullain (CNRS) provided a Macintosh computer to complete data analysis. We thank Pete Lowry and one anonymous reviewer for comments on an earlier version of the manuscript.

Table 1. List of alleles found in each *Codia* accession and their supposed genomic composition. Uncertain genomic compositions are in parenthesis. For *GapC*, the number of clones successfully sequenced is indicated in parenthesis.

Species	<i>ncpGS</i>	<i>PhyC</i>	<i>GapC</i>	Genome
<i>C. albicans</i>	A2,I10	A1,J1	A1,I10 (4)	A,I
<i>C. albifrons</i>	I3,J3	J2	I1,I8 (5)	I,J
<i>C. belepensis</i>	I8,J6	J3	I2,I4 (4)	I,J
<i>C. discolor</i>	I5,N3	J4,J5	J2 (5)	(I,N)
<i>C. ferruginea</i>	I4	I2	I9,I11 (3)	I
<i>C. incrassata</i>	I2	I3	I7 (3)	I
<i>C. jaffrei</i>	J1	J1	J1 (6)	J
<i>C. mackeeana</i>	I1,I9	I1,J1	A3,I3 (6)	A,I
<i>C. microphylla</i>	I6,J4	-	J4,J5 (6)	I,J
<i>C. montana</i>	A1,J7	A1	A2,J6 (4)	A,J
<i>C. nitida</i>	N1,N2	J1	N1 (4)	N
<i>C. spatulata</i>	I7,J5	I1	I5 (1)	I,J
<i>C. triverticillata</i>	I1,J2	J2	I6,J3 (5)	I,J

Table 2. Ecology and morphology of *Codia* species.

Species	substrate ¹		habitat ²		# leaves per node	pale, indumentum on lower leaf surface	felty on leaves	arachnoid on leaves	hairs	stipules ³	petals
<i>C. albicans</i>	UM	NUM	(F)	M	2	+		--		A	--
<i>C. albifrons</i>	UM		(F)	M	3	+		++		A	++
<i>C. belepensis</i>	UM			M	2	--		--		A	--
<i>C. discolor</i>	UM		(F)	M	2	+		--		B	(+)
<i>C. ferruginea</i>	UM			M	2	+		+		A	(+)
<i>C. incrassata</i>		NUM	F	(M)	2	+		--		A	--
<i>C. jaffrei</i>	UM		F		2	+		--		A	(+)
<i>C. mackeeana</i>		NUM	F		2	--		--		A	--
<i>C. microphylla</i>		NUM		M	2	--		(+)		A-B	(+)
<i>C. montana</i>	UM	NUM	(F)	M	2	--		--		B	++
<i>C. nitida</i>	UM		(F)	M	2	--		--		C	(+)
<i>C. spatulata</i>	UM	NUM	F	M	2	--		--		B	(+)
<i>C. triverticillata</i>	UM			M	3	+		--		A	--

Rare occurrences are in parentheses.

¹ UM = ultramafic, NUM = non-ultramafic.

² F = forest, M = maquis and/or other types of scrub.

³ A = triangular, broadly ovate or cordate ; B = narrowly triangular ; C = elliptic.

Figure 1. Network of alleles obtained with *npcGS*, *PHYC* and *GapC*.

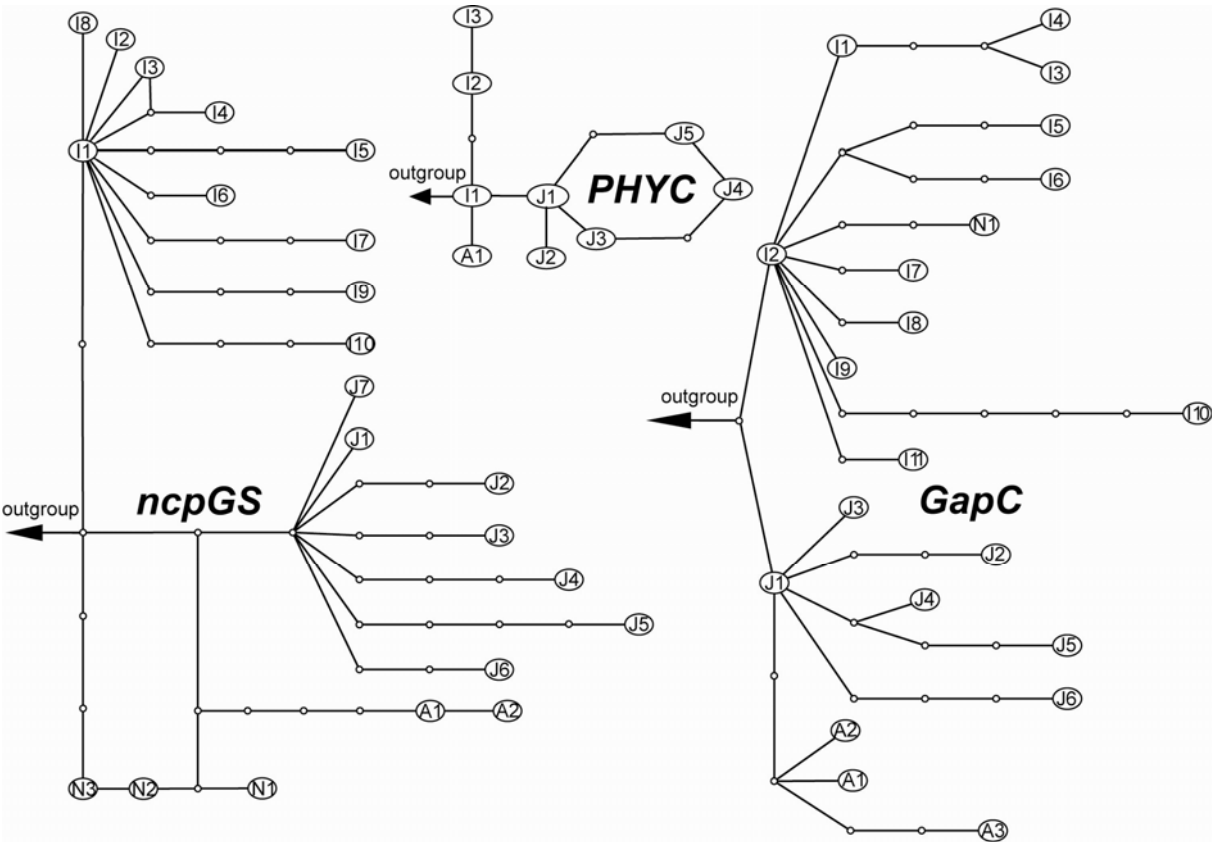

Figure 2. Split network of the species of *Codia* based on all three genes (*nepGS*, *PHYC* and *GapC*). The predicted placement of the putative extinct parental lineage is shown by dashed lines.

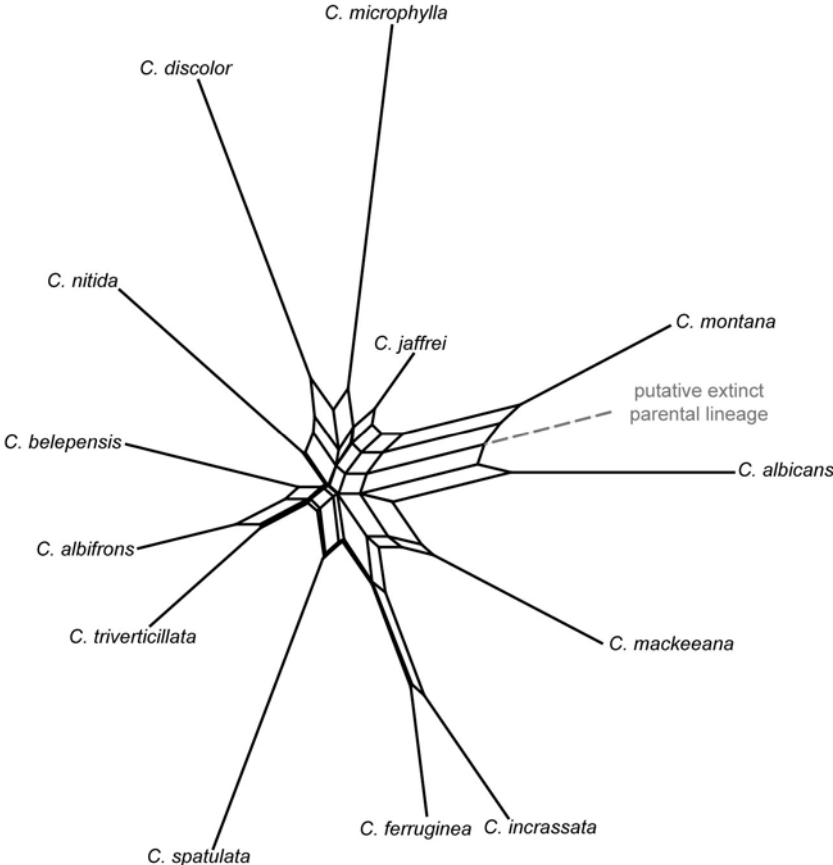

Figure 3. Summary diagram depicting the hypothetical relationships between the species of *Codia*. The cross indicates a putatively extinct lineage. Species with uncertain parentage are shown in brackets. Species growing on ultramafic soils are shown in red, species growing on non-ultramafic soils in blue, and species growing on both types of soils in purple. The dashed rectangle indicates the two species with whorled leaves.

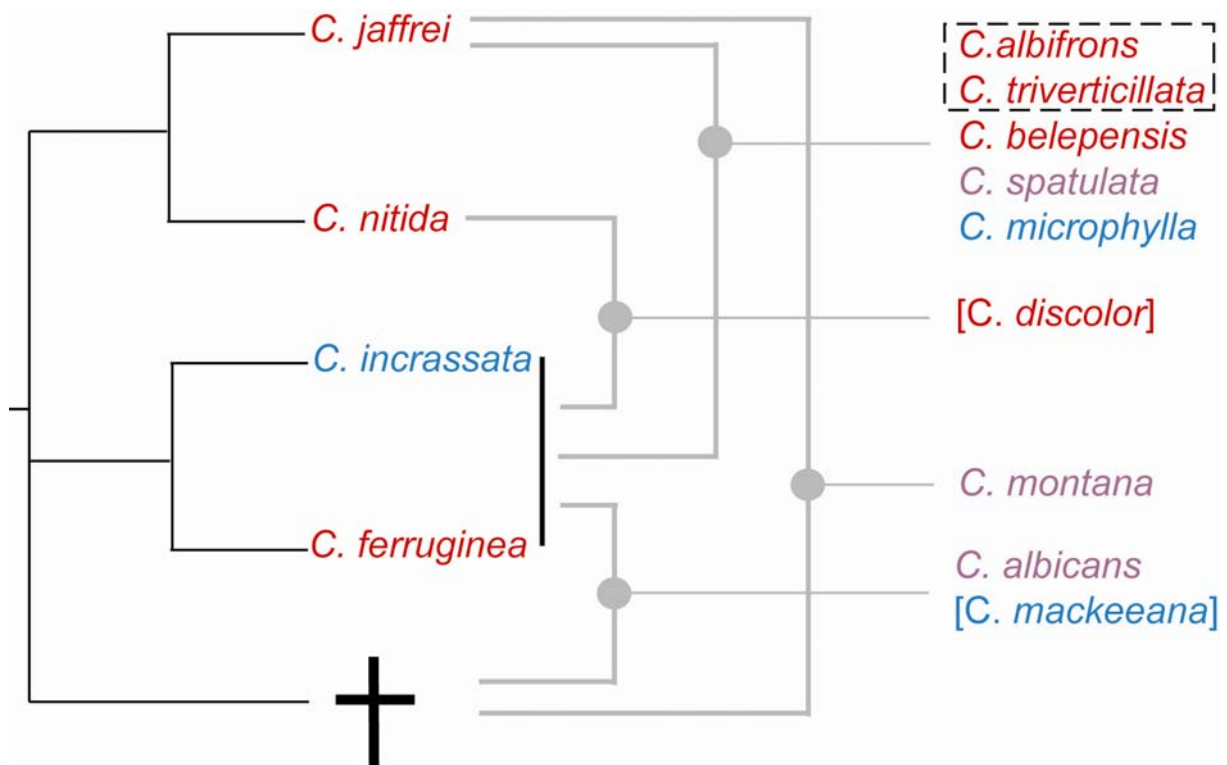
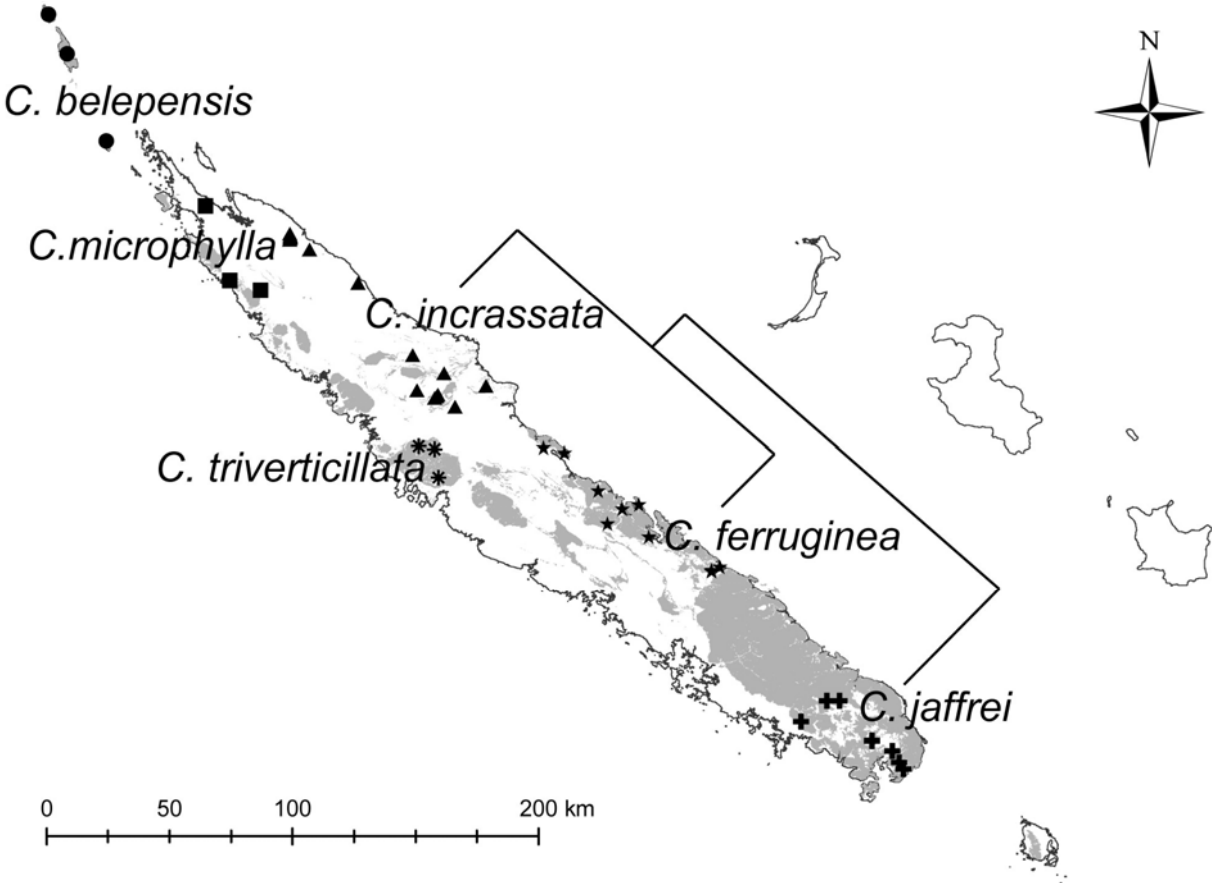

Figure 4. Distributions of the three parental species *C. ferruginea*, *C. incrassata* and *C. jaffrei* and three species that are suspected to be the result of hybridisation between them: *C. belepensis*, *C. microphylla* and *C. triverticillata*. Areas covered with ultramafic soils are shown in grey.



Supplementary data. List of *Codia* accessions included in the study with voucher information and GenBank accessions number for DNA sequences.

Species	Voucher	Herbarium	Locality	<i>ncpGS</i>	<i>PhyC</i>	<i>GapC</i>
<i>Codia albicans</i> Vieill. ex Pamp.	Pillon et al. 478	NOU	Hienghène	FJ595023	FJ595046	FJ595061
				FJ595024	FJ595047	FJ595062
<i>Codia albifrons</i> (Brongn. ex Schinz & Guillaumin) Baker f.	Bradford & Hopkins 1144	MO,NOU	Koghis	FJ595025	FJ595048	FJ595063
				FJ595026		FJ595064
<i>Codia belepensis</i> H.C.Hopkins	Munzinger & Swenson 3031	NOU	Yandé	FJ595027	FJ595049	FJ595065
				FJ595028		FJ595066
<i>Codia discolor</i> (Brongn. & Gris) Guillaumin	Bradford et al. 1193	MO,NOU	Thio	FJ595029	FJ595050	FJ595067
				FJ595030	FJ595051	
<i>Codia ferruginea</i> Brongn. & Gris	Pillon & Barrabé 330	NOU	Cap Bocage	FJ595031	FJ595052	FJ595068
						FJ595069
<i>Codia incrassata</i> Pamp.	Pillon & Munzinger 80	K,P,NOU	Mandjélia	FJ595032	FJ595053	FJ595070
<i>Codia jaffrei</i> H.C.Hopkins & Fogliani	Pillon 38	NOU	Grand Kaori	FJ595033	FJ595054	FJ595071
<i>Codia mackeeana</i> H.C.Hopkins & Fogliani	Fogliani & Hopkins 120 [Type]	K,P,NOU	Col d'Amieu	FJ595034	FJ595055	FJ595072
				FJ595035	FJ595056	FJ595073
<i>Codia microphylla</i> Vieill. ex Guillaumin	Munzinger 2956	NOU	Col d'Arama	FJ595036	-	FJ595074
				FJ595037		FJ595075
<i>Codia montana</i> J.R.Forst. & G.Forst.	Pillon & Vergnes 225	NOU	Tao	FJ595038	FJ595057	FJ595076
				FJ595039		FJ595077
<i>Codia nitida</i> Schltr.	Bradford & Hopkins 1149	MO,NOU	Koghis	FJ595040	FJ595058	FJ595078
<i>Codia spatulata</i> Brongn. & Gris	Pillon 158	NOU	Lac de Yaté	FJ595042	FJ595059	FJ595079
				FJ595043		
<i>Codia triverticillata</i> H.C.Hopkins & Pillon	Pillon et al. 137	K,P,NOU	Kopeto	FJ595044	FJ595060	FJ595080
				FJ595045		FJ595081

Article VII

Pillon Y, Hopkins HCF, Munzinger J, Amir H, Chase MW (en préparation) Gene recombination, cryptic species and hybridization in the genus *Spiraeanthemum* (Cunoniaceae) from New Caledonia.



Spiraeanthemum (Cunoniaceae) est un genre océanien avec un centre de diversité en Nouvelle-Calédonie, où il est représenté par sept espèces. La diversification de ce genre a été étudiée à l'aide de deux gènes nucléaires simple-copie : *nepGS* et *GapC*, et des analyses phylogénétiques basées sur le maximum de parcimonie, le maximum de vraisemblance et des réseaux de recombinaisons. Nous avons détecté plusieurs cas de recombinaisons dans les deux gènes, ce qui a rendu la reconstruction de l'histoire évolutive du genre difficile. En ce qui concerne les espèces *S. ellipticum* et *S. pubescens*, les populations du sud de la Grande Terre sur sols ultramafiques sont génétiquement différentes des populations du nord sur sol non-ultramafiques. En l'absence de différences morphologiques visibles entre ces populations, elles devraient être considérées comme des espèces différentes dites cryptiques. L'origine de celles-ci pourrait être expliquée par l'évolution parallèle de morphologie similaire, de tri allélique aboutissant à la fixation d'allèles différents, ou des événements d'introgession différentiels entre le nord et le sud aboutissant à des substitutions d'allèles. Les espèces à spectre écologique large pourraient ainsi être des concepts artificiels. Ceci suggère qu'elles devraient être traitées avec attention dans les monographies, et que la diversité spécifique de la flore de Nouvelle-Calédonie est peut-être sous-estimée.

**Gene recombination, cryptic species and hybridization in the genus
Spiraeanthemum (Cunoniaceae) from New Caledonia**

Yohan Pillon^{1,2}, Helen C.F. Hopkins³, Jérôme Munzinger¹, Hamid Amir² & Mark W. Chase⁴

¹ Laboratoire de Botanique, Institut de Recherche pour le Développement, BP A5, 98848
Nouméa Cedex, New Caledonia

² Laboratoire Insulaire du Vivant et de l'Environnement, Université de la Nouvelle-Calédonie,
BP R4, 98851 Nouméa Cedex, New Caledonia.

³ c/o The Herbarium, Royal Botanic Gardens, Kew, Richmond, Surrey, TW9 3AB, UK

⁴ Jodrell laboratory, Royal Botanic Gardens, Kew, Richmond, Surrey, TW9 3AB, UK

Short title: Cryptic species in New Caledonian *Spiraeanthemum*

Corresponding author: YP yohan.pillon@noumea.ird.nc

Phone (+687) 26 09 28

Fax (+687) 26 43 26

ABSTRACT

The Oceanian genus *Spiraeanthemum* (Cunoniaceae) has a centre of diversity in New Caledonia, where it is represented by seven species. Its diversification was investigated using two nuclear single-copy genes: *ncpGS* and *GapC*, and phylogenetic analyses were based on maximum parsimony, maximum likelihood, and recombination networks. We detected several cases of gene recombination in both datasets, and these have obscured the history of the genus. Within *S. ellipticum* and *S. pubescens*, accessions from southern populations on ultramafic soils were genetically different from accessions from northern populations on non-ultramafic soils. Given that no obvious morphological characters distinguish these populations, they may be considered cryptic species. The origin of these cryptic species may be explained by the parallel evolution of similar morphology, differential lineage sorting leading to differential fixation of alleles, or different introgression patterns in north and south leading to allele displacement. Species with broad ecologies may thus be artificial concepts. This suggests that they should be treated more critically in monographs and that the species richness of the flora of New Caledonia may be underestimated.

Keywords: Biodiversity hotspot, phylogeny, serpentine, taxonomic inflation, ultrabasic

INTRODUCTION

Cryptic species are “two or more distinct species that are erroneously classified (and hidden) under one species name” (Bickford et al., 2007). The importance of cryptic species probably varies among ecosystems and taxonomic groups, and few studies are available in the tropics. Few cases are known in higher plants (Bickford et al., 2007), among which is the *Caesalpinia hintonii* complex (Fabaceae) in Mexican dry forest which contains two sibling species (sensu Bickford et al., 2007) in *C. oyamae* that are geographically distinct. Other recently reported examples belong to the genus *Allium* where sibling species and cryptic species that are only distantly related have been recovered in molecular phylogenetic analysis (Gruschidze et al., 2008). Cryptic species have also been reported in *Potamogeton* (Whittall et al., 2004), *Veronica* (Martínez-Ortega et al., 2004) and possibly *Liparis* (Pillon et al., 2007), although in these cases the “cryptic species” revealed by molecular data were already described taxa, and so were not really cryptic, but rather poorly distinct. New examples of cryptic species are revealed every year with the use of molecular tools in a wide range of organisms (Rieseberg et al., 2009), especially animals, but reports in flowering plants are still few. This lack of examples of cryptic species in plants is probably linked to the low variability observed in most markers used for molecular phylogenetics, which has also made DNA barcoding more difficult in plants than in animals so far (Chase et al., 2007). Nevertheless, methodologies used in population genetics would be expected to have revealed more cases of cryptic species in plants if they were common.

New Caledonia is an archipelago in the southwestern Pacific, well known for its rich, unique and endangered flora, and hence its recognition as a biodiversity hotspot for conservation priorities (Myers et al., 2000). It is often considered that the richness of this flora is linked to the diversity of edaphic conditions found on the main island (Jaffré, 1993). About one-third of the island is covered with ultramafic soils, which have several characteristics that

are limiting for plant growth: low fertility (low N, P, K), high Mg/Ca ratio, high concentrations of heavy metals (Co, Cr, Ni etc.), low water-holding capacity and increased susceptibility to fire (Proctor, 2003). These soils, including those that are derived from “true” serpentine, present a challenging environment for plant growth, but the level of endemism in the flora of New Caledonia is very high, exceeding 90% (Jaffré et al., 2001). Other soil types in New Caledonia are often referred to as non-ultramafic, and they develop from rocks that include limestone, basalt, shale, etc. This basic dichotomy between ultramafic and non-ultramafic soils is a quick way to define the ecology of plant species because the majority are found on one or the other type, even though this may imply a disjunct or fragmented distribution. Jaffé et al. (1987) considered that 1176 species of seed plant were restricted to ultramafic substrate (see also Morat, 1993).

To assess the validity of the circumscription of some species with broad soil preferences, we investigated the molecular systematics of the genus *Spiraeanthemum* (Cunoniaceae), a genus of 18 species of trees and shrubs distributed from the Moluccas to Samoa, including New Guinea, Queensland the Solomon Islands, Vanuatu, Fiji, and New Caledonia, which has the largest number of species (Hoogland, 1979, 1987; Pillon et al., 2009a). The genus can be divided into three groups (Pillon et al., 2009a), two of which occur in New Caledonia. The first (densiflorum group) has a single New Caledonian species, *S. densiflorum*, which is characterised by hairy apical buds, inflorescences ramified near the base and several ovules per carpel, its closest relatives are the Australian and New Guinean species. The brongniartianum group is characterised by a single ovule per carpel and pedunculate inflorescences and comprises six species in New Caledonia plus one, *S. vitiense* in Fiji. The third group is *Spiraeanthemum sensu stricto*, which occurs on several Pacific islands but not New Caledonia; its species have hairy apical buds, opposite leaves, pedunculate inflorescences and two ovules per carpel.

Of the six species in the brongniartianum group in New Caledonia (Fig. 1), *Spiraeanthemum meridionale* and *S. pedunculatum* are restricted to ultramafic soils in the south ; *S. collinum* has a scattered distribution on a few ultramafic massifs in the centre ; *S. brongniartianum* is widespread on non-ultramafic soils, and *S. pubescens* is also widespread but occurs on both ultramafic and non-ultramafic soils. Finally *S. ellipticum* is scattered on a few mountains in the north on non-ultramafic soils, in the south on ultramafic ones , and is absent in between. The disjunction in the range and ecology of *S. ellipticum* raises doubts about its circumscription.

In this study, we wanted to assess the circumscription of species in *Spiraeanthemum* using molecular markers. We selected for this purpose two nuclear single-copy genes, *ncpGS* and *gapC*, which have already been used successfully in Cunoniaceae (Pillon et al., 2009a; Pillon et al., 2009b). Nuclear single-copy genes are generally more informative than the most commonly used markers such as plastid or nuclear ribosomal loci because of their higher variability, biparental inheritance and general absence of concerted evolution (Mort and Crawford, 2004; Small et al., 2004). Previous work has shown that plastid genes display low levels of variation within genera of Cunoniaceae (Bradford, 2002, Pillon, unpublished), including within the brongniartianum group (Pillon et al., 2009a), and that multiple paralogs of ITS are recovered in several genera (Bradford, 2002, Pillon, unpublished).

MATERIAL & METHODS

All currently accepted species in the genus *Spiraeanthemum* (see Pillon et al., 2009a) in New Caledonia were sampled. The main focus of this study was the brongniartianum group and multiple accessions per species were used whenever possible. Accessions of *S. densiflorum* (densiflorum group, New Caledonia) and *S. macgillivrayi* (*Spiraeanthemum* s.s., Vanuatu) were used as outgroups. A previous study showed that the brongniartianum group

was a well-supported monophyletic group to which *S. macgillivrayi* and *S. densiflorum* were successive sister groups, and these relationships were also strongly supported by bootstrap percentages (Pillon et al., 2009a). No material of *S. vitiense* (Fiji), the only species of the brongniartianum group occurring outside New Caledonia, was available. Leaf material was dried in the field in silica gel (Chase and Hills, 1991), and DNA was extracted with a CTAB protocol (Csiba and Powell, 2006).

A portion of chloroplast-expressed glutamine synthetase (*ncpGS*), a nuclear single-copy gene, was amplified using the primers 687F and 994R of Emshwiller & Doyle (1999). The amplification mix included 45 μ L of 2.5mM MgCl₂ Reddy PCR Master Mix 1.1 \times (ABgene Ltd), 1 μ L of 0.4% bovine serum albumin (BSA), 0.5 μ L of each primer (100ng/ μ L) and 3 μ L of template DNAs of unknown concentrations. The following amplification program was used: 2 min at 94°C, 38 cycles of 1 min at 94°C, 1 min at 50°C, 1 min 30 s at 72°C and a final extension of 5 min at 72°C. A portion of the glyceraldehyde 3-phosphate dehydrogenase (*GapC*, also known as *G3pdh*), another nuclear single-copy gene was amplified using the primers GPDX7F and GPDX9R from Strand et al. (1997). The amplification mix included 45 μ L of 2.5mM MgCl₂ Reddy PCR Master Mix 1.1 \times (ABgene Ltd), 1 μ L of 0.4% bovine serum albumin (BSA), 0.5 μ L of each primer (100ng/ μ L) and 3 μ L of template DNA. The following program was used: 2 min at 94°C, 38 cycles of 1 min at 94°C, 1 min at 53°C, 1 min at 72°C and a final extension of 5 min at 72°C.

In *Populus trichocarpus* (Salicaceae), the most closely related model group for which the entire genome has been sequenced (Tuskan et al., 2006), one homolog of *GapC* is found in linkage group I and homologs of *ncpGS* are found in linkage groups VIII and X. These two genes are thus not linked in *Populus* and it can be expected that the same is true in *Spiraeanthemum*.

NcpGS was sequenced directly. If electrophoregrams showed the presence of more than one allele in the accession and if these alleles differed in length or in more than one base, the PCR product was cloned. An average of six clones was routinely sequenced. Further clones were sequenced if all the diversity observed in the electrophoregram from the direct sequencing was not recovered. *GapC* did not give satisfactory results through direct sequencing, and thus all accessions were cloned and sequenced (up to six clones per accession). A consensus sequence was built for each cluster of clones on the phylogenetic tree in order to remove substitutions produced during PCR. The list of species, vouchers and Genbank accession numbers appears in table 1.

Alignment and phylogenetic analysis were carried out with PAUP*4.01b10 (Swofford, 2002). The most parsimonious trees were recovered using branch-and-bound searches for *GapC* and heuristic searches with tree bisection reconnection (TBR) branch swapping for *ncpGS*. Maximum likelihood analyses were carried out using PHYML (Guindon and Gascuel, 2003; Guindon et al., 2005) with a HKY model. Split networks were reconstructed using Splitstree4 (Huson and Bryant, 2006). Outgroups were not included in splitnetwork because their inclusion leads to graphical distortion since they are on a long branch and we wanted to emphasize the ingroup (the brongniartianum group).

We looked for putative recombination events using the software GARD (Kosakovsky Pond et al., 2006) with the single breakpoint detection method and the GARD method, assuming no rate variation among sites. Recombinant sequences were then searched by examination of the alignments. Sequences were excluded from the dataset until no crossovers were observed in the networks. We then ran the phylogenetic analysis again excluding all recombinant alleles.

RESULTS

Detailed information on the *ncpGS* and *GapC* datasets is given in table 2. No sequence of *GapC* was obtained for *Spiraeanthemum meridionale*, but otherwise both genes were successfully amplified and sequenced for at least one accession of each New Caledonian species of *Spiraeanthemum*. The accession Pillon *et al.* 20 of *S. ellipticum* had at least two alleles according to the direct sequencing, but only one was successfully recovered by cloning. Fewer accessions were sequenced for *GapC* as direct sequencing was not possible and cloning was necessary in each case.

Using the single-breakpoint detection method, we found no cases of recombination in the *ncpGS* dataset and one in the *GapC* dataset. With the GARD algorithm, several cases of recombination were detected in both datasets. Identification of recombinant sequences required a detailed examination of the alignment, and by eye, we detected six recombinant sequences in the *ncpGS* dataset and a single one in the *GapC* dataset. The recombination networks (see below) indicate two further recombinant sequences in the *ncpGS* dataset and one in *GapC*. Table 3 provides the base composition of the different accessions at the parsimony-informative sites for *ncpGS*.

Phylogenetic analyses of *GapC* sequences give the same topology with maximum parsimony and maximum likelihood, so only the first is shown (Fig. 2). In this phylogenetic tree, two groups can be distinguished, A and B. Group A consists of the northern accessions of both *Spiraeanthemum pubescens* and *S. ellipticum*, plus one of two alleles of *S. collinum* (allele 1). Group B contains *S. brongniartianum*, the southern accession of *S. ellipticum*, and allele 2 of *S. collinum*, which may be a recombinant sequence. No southern accession of *S. pubescens* was included. For *S. pedunculatum*, allele 2 also belonged to group B but allele 1 showed evidence of recombination around position 430; the first part of the alignment

(positions 1-429) clustered with group A, and the second part (positions 430-910) with group B.

In the *ncpGS* analysis, a well-supported monophyletic group A was recovered in both maximum parsimony and maximum likelihood analyses (figure 3), and contained the two northern accessions of *Spiraeanthemum ellipticum* and the two northern accessions of *S. pubescens*. Group B formed a polytomy with little internal resolution and group A was nested in it; it contained the two accessions of *S. brongniartianum*, the single accession of *S. collinum*, both accessions of *S. meridionale*, both of *S. pedunculatum*, the single accession of southern *S. pubescens* and the two southern accessions of *S. ellipticum*. Several nodes were not present in the strict consensus in the maximum parsimony analysis, and neither were these nodes supported in the maximum likelihood analysis. We tentatively recognised subgroups, B1 to B5, excluding the putative recombinant sequences. B1 is recovered in both analyses as part of the sister group to group A. Group B2 and group B3 were each supported as monophyletic in the maximum likelihood analysis with 85 and 76 bootstrap values. Putative recombinant sequences either formed clusters with subgroups B1 to B5, or independent clades.

When all putative recombinant sequences were excluded from the *ncpGS* analysis, a better resolved phylogenetic tree was obtained using maximum likelihood (figure 4), with higher bootstrap percentages to support the monophyly of group A and of subgroups B2 and B3. Group B was recovered as monophyletic (85 bootstrap percentage), but on a short branch. The topology obtained with the maximum parsimony analysis was the same except that group B was not monophyletic; subgroup B5 was recovered as sister to group A, but without bootstrap support.

Recombination networks based on *ncpGS* and *GapC* sequence data are shown in figure 5. Groups A and B can be recognised in both cases. In the *GapC* analysis, two

crossovers were detected involving groups A and B, whereas in the *nepGS* analysis, all the crossovers detected were within group B, and almost no structure could be observed within the latter, apart from subgroups B2 and B3. When the outgroups were included, the rooting was rather imprecise because of the recombination events within the ingroup, but the outgroup tended to branch in between groups A and B.

DISCUSSION

RECOMBINATION

Recombination events seem to have been common in *Spiraeanthemum*, especially in *nepGS*, but also in *GapC*, which was less well sampled. Because of the commonness of the phenomenon, it is difficult to clearly tease apart recombinant from non-recombinant sequences. Recombination networks also detect cases of recombination that were not found by visual inspection of the alignments. Up to eight cases of recombination for *nepGS* are suggested here; two possibly involved a double recombination in the gene. Some recombination may be associated with PCR and revealed only because of cloning (these recombinations would be unlikely to be observed in direct sequencing because they would be a minority signal), but their high frequency suggests this is not the most likely explanation. Examination of the direct sequences of *S. meridionale* shows that the differences between the two alleles all occur in the last 163 base pairs, so this case at least, recombination is not an artefact; and if differences are evident in direct sequencing, they are probably present in roughly 50% of the PCR copies, which is too frequent for them to be the result of PCR alone. Furthermore, no evidence of recombination was found in a phylogenetic study of *Codia* using the same set of markers and carried out at the same time (Pillon et al., 2009b).

We do not know why recombination in *nepGS* is so common in *Spiraeanthemum*. Many more cases were observed for this gene than for GapC (only two instances), but the latter was less well sampled, and furthermore, *nepGS* is longer, so recombination events are more likely to occur. With a comparable level of variability, *nepGS* offers more variable sites, which makes recombination easier to detect. We are not aware of cases of recombination for either gene in the literature. A possible explanation for the commonness of recombination events is frequent hybridisation during the history of the genus (see below).

A first consequence of recombination is that it affects the reconstruction of phylogenetic trees by increasing homoplasy. The large number of nodes that collapse in the strict consensus in the *nepGS* analysis is probably the consequence of this phenomenon. The exclusion of these sequences gives a much better resolved phylogenetic tree with good to strong support for most nodes, although some questions remain (e.g. concerning the monophyly of group B).

Within group B, most of the alleles recovered in the *npGS* analysis could either be assigned to one of the subgroups B2, B3, B4 and B5, or were clearly recombinant between two alleles of these subgroups, i.e. they had no unique substitutions. However, allele 1 of *S. collinum* was assigned to subgroup B1, it did not show any signs of recombination when examined by eye, but the recombination network indicates that it may be a recombinant. Several alleles shared unique substitutions with this allele and have been assumed to be recombinant between this allele and one from another subgroup. Thus we may not have found the genuine B1 allele (i.e. with no recombination), and possibly the original sequence has been lost because of recombination. The frequent occurrence of recombination may be homogenising the allele pool and it is possible that some alleles are being lost.

So far few phylogenetic studies of plants have reported recombination in nuclear single-copy genes, though exceptions include Cinnamoyl CoA reductase in *Eucalyptus* (Poke

et al., 2006), *PHOT* (phototropin) in *Verbena* (Yuan and Olmstead, 2008), and *Alcohol dehydrogenase* and *LEAFY/FLORICAULA* in *Nicotiana* (Kelly et al. unpublished). Gene recombination will have to be considered as pitfall of nuclear single-copy genes in future phylogenetic studies.

EVIDENCE FOR THE EXISTENCE OF CRYPTIC SPECIES

In spite of recombination, both analyses suggest the existence of two sets of alleles within *Spiraeanthemum*, group A and group B. The distinctiveness of the two groups is supported by a clear phylogenetic distance in both *ncpGS* and *GapC* analysis. Group A is recovered as monophyletic in both analyses, but the monophyly of group B is only well-supported in the *GapC* analysis. In the *ncpGS* analysis, the two accessions each of northern *S. ellipticum* and northern *S. pubescens* belong to group A, and the two accessions of southern *S. ellipticum* and southern *S. pubescens* cluster in group B. For *GapC*, where the number of samples was fewer, the single northern accessions of *S. ellipticum* and *S. pubescens* both fall into clade A, whereas the single accession of southern *S. ellipticum* is found in clade B. Thus, southern and northern populations of *S. ellipticum* and of *S. pubescens* seem to be genetically distinct. This is particularly clear for *S. ellipticum* for which congruent patterns are observed for both genes; two accessions of each species in each geographical area were included.

In terms of morphology, *Spiraeanthemum ellipticum* and *S. pubescens* are clearly distinct from one another and from other members of the genus e.g. *S. ellipticum* has resinous apical buds and sessile obovate leaves, whereas *S. pubescens* has hairy apical buds and lanceolate leaves with a distinct petiole. Both species can be shrubs or trees in forest or scrub, but *S. ellipticum* is restricted to high elevation (mostly 900-1600m), whereas *S. pubescens* generally occurs at low to medium elevation (mostly 0-700m). No morphological differences are observed between the northern and southern populations of these species and the main

difference is in their ecology, since the southern populations of both are found on ultramafic soils, and the northern populations occur on non-ultramafic ones . The lack of morphological differences that correlate with the patterns observed in molecular markers suggests that these may be examples of cryptic species.

Southern and northern populations of *Spiraeanthemum ellipticum* cannot be considered as sibling species (sensu Bickford et al., 2007) as they are not each other's closest relatives according to the phylogenetic analyses presented here (Figs. 2 & 3). It would be puzzling if the same morphologies had evolved in parallel in groups A and B, but this is not the only possible scenario, and not the most likely .

An alternative hypothesis is that alleles of groups A and B were both present in a pool of species that included *Spiraeanthemum ellipticum* and *S. pubescens*, and that parallel lineage sorting in northern and southern populations fixed alleles of groups A and B respectively (Fig. 6, middle diagram). This could have occurred either through random genetic drift or possibly natural selection due to the ecological conditions prevailing on non-ultramafic and ultramafic soils.

A third alternative is that either the southern or the northern populations, or both, underwent hybridization and introgression (Fig. 6, bottom diagram). In this scenario, one or both populations would have acquired alleles from another species growing in the vicinity, and these new alleles would have replaced the ancestral ones of this species. Thus transgression within group A and/or group B would have obscured the histories of both *Spiraeanthemum ellipticum* and *S. pubescens*.

Whatever the process involved, the congruent allelic differences at two a priori unlinked loci between northern and southern populations of *S. ellipticum* leads us to conclude that they are now two distinct but cryptic species.

IMPLICATIONS FOR THE EVOLUTION OF THE NEW CALEDONIAN FLORA

Overall, ecology seems to correlate better with our molecular results than does morphology. In the tree based on maximum likelihood (Fig. 4), Group A includes only accessions from populations occurring in the north on non-ultramafic soils (*S. ellipticum* p.p., *S. pubescens* p.p.), and all accessions growing on ultramafic soils had alleles belonging to group B. According to the phylogenetic tree based on *ncpGS* sequences with the exclusion of recombinant sequences, adaptation to ultramafic soils may have evolved only once in *Spiraeanthemum*, in the clade containing groups B2, B3 and B5. This corroborates our results in *Codia* (Pillon et al., 2009b) which showed that adaptation to ultramafic soils may not be as plesiomorphic as suggested by de Kok (2002).

The complex geology of New Caledonia strongly constrains the distribution of plants. Most species are either restricted to ultramafic or non-ultramafic soils, and thus their distributions are generally expected to match one portion of the geological map. Species recorded from both type of soils represent a small portion of the flora. In Cunoniaceae, ca. 50% of the species are restricted to ultramafic soils, 30% are restricted to non-ultramafic soils, and only 20% occur on both (Pillon et al., unpublished). The reported occurrence in taxonomic revisions of species on both ultramafic and non-ultramafic substrates, perhaps even the majority of cases, may be due to misidentification, inadequate label data, or problems of species delimitation, although complex local ecological and geological conditions or genuine ecological plasticity might be involved in some instances.

The two species of *Spiraeanthemum* (*S. ellipticum* and *S. pubescens*) that are both ecologically and genetically heterogeneous suggest that ecology may sometimes be a more reliable way to define species than morphology. Modern species concepts have never been applied to the New Caledonian flora, which has largely been monographed using a strictly

morphological definition for species. The presence of cryptic species correlating with soil preferences within a morphologically coherent “species” suggests that the fidelity to soils may be higher than thought in the flora of New Caledonia. In *Codia* (Cunoniaceae), species occur on both types of soil all have a hybrid origin (Pillon et al., 2009b), and it is possible that such hybrid species were formed on multiple occasions. Two of these species are clearly heterogeneous but their morphological variation can not be readily resolved, and the same is true for some ecologically variable species in *Weinmannia* and *Pancheria* (Hopkins et al. in prep.).

If morphological species with broad ecologies are actually multiple species, it implies that the total number of taxa in the New Caledonian flora may be currently underestimated. It would be valuable to investigate species with broad ecological preferences more thoroughly, because in some cases, less obvious morphological variation may correlate with ecology. Such an approach has been applied to *Planchonella* (Sapotaceae) in combination with molecular work (Swenson et al., 2007), and the number of species recognised has significantly increased since the previous revision by Aubréville (1967). The application of genetics to the New Caledonian flora is thus likely to lead to some “taxonomic inflation” (Isaac et al., 2004).

WHAT IS THE TRUE *SPIRAEANTHEMUM ELLIPTICUM*?

No morphological characters could be found to distinguish southern and northern populations in either *Spiraeanthemum ellipticum* or *S. pubescens*. We can not rule out the possibility that some will be found in the future, but in general, *Spiraeanthemum* offers relatively few useful morphological characters. Morphometrics might provide insights, but the material available so far for the northern population of *S. ellipticum* is inadequate for this type

of analysis. Only three collections are available, none of which is in full flower, and access to the two known localities (Mont Panié and Mont Colnett) is difficult.

The lectotype of *Spiraeanthemum ellipticum* is *Vieillard 2643* (P!), collected in 1865, and composed of several fragments. The label indicates the locality as “Fond de la rivière de Hienguen” (End/ bed of Hienghène river), and the closest extant locality is Mont Panié, so this specimen probably belongs to the northern population. However, the locality suggests that the plant was collected at low elevation but all other collections are from high elevation. It seems likely that the locality is wrong or inexact, and it is also possible that the fragments were taken from different plants; problems with locality data and mixed gatherings are relatively common in Vieillard’s collections. So it is not possible to determine whether the type was prepared from southern or northern material. DNA extraction from this old specimen would be challenging, and the PCR amplification of a nuclear single-copy gene necessary to distinguish southern and northern population is unlikely.

Because no morphological characters currently distinguish southern and northern populations of *S. ellipticum* and because of problems with the type, we choose not to alter the delimitation of *Spiraeanthemum ellipticum*. Nevertheless, for conservation purpose it should be kept in mind that the two populations represent distinct units. This species is restricted to high elevation that may be considered threatened because of climate change, and the northern population is known so far from only two localities.

Our sampling of *Spiraeanthemum pubescens* was not adequate to draw firm conclusions about whether more than one taxon can be recognised. Because no clear geographical gap exists between northern and southern populations, further sampling is needed, especially in the central part of its distribution .

EVIDENCE FOR HYBRIDISATION

The frequency of recombination in *Spiraeanthemum* suggests that hybridisation has probably been important in the history of this genus. For both genes we investigated, we found clearly distinct alleles with the absence of true intermediates (excluding recombinants), suggesting that a period of genetic isolation (typically a speciation event) allowed distinct alleles to become fixed in some populations and intermediate alleles to be lost. Thus we think that recombination events occurred during secondary contact between species/populations.

In the *GapC* analysis, *Spiraeanthemum collinum* (YP464) and *S. pedunculatum* (YP437) both displayed alleles or portion of alleles that belong to both groups A and B, suggesting a hybridisation event between these two population groups. However this is not reflected in the *ncpGS* analysis where there is no recombination event between alleles of group A and B, nor accessions exhibiting alleles of both groups. However, both accessions of *S. collinum* and *S. pedunculatum* display a mixture of alleles of subgroup B1, B2 and B3 in the *ncpGS* analysis. The true (ancestral) B1 allele was not recovered during this study, but the phylogenetic analysis suggests that it may be closer to the group A than to the rest of group B. Thus these two accessions would also have a combination of alleles from group B and something close to group A, which would be a congruent scenario for the two datasets. Furthermore, this would imply that some species might have had a hybrid origin. Similarly, one accession of *S. ellipticum* (YP672) and one of *S. pedunculatum* (YP637) each present one allele of subgroup B2 and one of subgroup B3, and it is also possible that these two species had a hybrid origin, and *S. pedunculatum* would then have had two separate origins.

Hybrid speciation has been suspected in several other genera of Cunoniaceae from New Caledonia (Pillon et al., 2008; Hopkins et al., 2009; Pillon et al., 2009b), but considering that recombination has seriously obscured the history of *Spiraeanthemum* and the uncertainty

surrounding the subgroup B1, hybrid speciation should only be considered as a hypothesis for this genus. Currently no chromosome counts are available which could provide information on the occurrence of polyploids in *Spiraeanthemum*.

ACKNOWLEDGMENTS

The authors wish to thank the Direction de l'environnement (DENV, Province Sud) and Direction du développement économique et de l'environnement (DDEE, Province Nord) for permitting scientific collections in New Caledonia. We thank all staff and students of the Botanical Laboratory at IRD for assistance in the field. Daniel and Irène Letocart, the late Henri Blaffart and the guides of the Dayu-Biik association, Steve Farino and Maurice Wanguene, also provided importance assistance in the field. We also thank the organisers of the Santo 2006 expedition in Vanuatu during which material of *Spiraeanthemum macgillivrayi* was collected. Jason Bradford also kindly provided some leaf material. We are grateful to Edith Kapinos, Laszlo Csiba, Olivier Maurin, Dion Devey, and Martyn Powell for their help in the Jodrell Laboratory and to Laura Kelly, Nina Rønsted, and Jim Clarkson for discussion on nuclear single-copy genes. Anaïs Cardineau and Cyril Poullain (CNRS) provided a Macintosh computer to carry out data analyses.

REFERENCES

- Aubréville, A., 1967. Sapotacées. In: Aubréville, A. (Ed.), Flore de la Nouvelle-Calédonie et Dépendances. Muséum National d'Histoire Naturelle, Paris, pp. 1-168.
- Bickford, D., Lohman, D.J., Sodhi, N.S., Ng, P.K.L., Meier, R., Winkler, K., Ingram, K.K., Das, I., 2007. Cryptic species as a window on diversity and conservation. *Trends Ecol. Evol.* 22, 148-155.
- Bradford, J.C., 2002. Molecular phylogenetics and morphological evolution in Cunoniaceae (Cunoniaceae). *Ann. Missouri Bot. Gard.* 89, 491-503.
- Chase, M.W., Hills, H.G., 1991. Silica gel: an ideal material for field preservation of leaf samples for DNA studies. *Taxon* 40, 215-220.
- Chase, M.W., Cowan, R.S., Hollingsworth, P.M., van den Berg, C., Madriñan, S., Petersen, G., Seberg, O., Jørgensen, T., Cameron, K.M., Carine, M., Pedersen, N., Hedderson, T.A.J., Conrad, F., Salazar, G.A., Richardson, J.E., Hollingsworth, M.L., Barraclough, T.G., Kelly, L., Wilkinson, M., 2007. A proposal for a standardised protocol to barcode all land plants. *Taxon* 56, 295-299.
- Csiba, L., Powell, M.P., 2006. DNA extraction protocols. In: Savolainen, V., Powell, M.P., Davis, K., Reeves, G., Corthals, A. (Eds.), DNA and tissue banking for biodiversity and conservation: theory, practice and uses. Royal Botanic Gardens, Kew, Richmond, pp. 48-51.
- de Kok, R., 2002. Are plant adaptations to growing on serpentine soil rare or common? A few case studies from New Caledonia. *Adansonia* 24, 229-238.
- Emshwiller, E., Doyle, J.J., 1999. Chloroplast-expressed glutamine synthetase (ncpGS): potential utility for phylogenetic studies with an example from *Oxalis* (Oxalidaceae). *Mol. Phyl. Evol.* 12, 310-319.

- Gruschidze, M., Fritsch, R.M., Blattner, F.R., 2008. Phylogenetic analysis of *Allium* subg. *Melanocrommyum* infers cryptic species and demands a new sectional classification. *Mol. Phyl. Evol.* 49, 997-1007.
- Guindon, S., Gascuel, O., 2003. A simple, fast, and accurate algorithm to estimate large phylogenies by maximum likelihood. *Syst. Biol.* 52, 696-704.
- Guindon, S., Lethiec, F., Duroux, P., Gascuel, O., 2005. PHYML online--a web server for fast maximum likelihood-base phylogenetic inference. *Nucleic Acids Res.* 33, W557-W559.
- Hoogland, R.D., 1979. Studies in the Cunoniaceae. II. The genera *Caldcluvia*, *Pullea*, *Acsmithia* and *Spiraeanthemum*. *Blumea* 25, 481-505.
- Hoogland, R.D., 1987. Studies in the Cunoniaceae. IV. Further notes on New Caledonian *Acsmithia*. *Adansonia* 4, 393-397.
- Hopkins, H.C.F., Pillon, Y., Bradford, J.C., 2009. The endemic genus *Pancheria* (Cunoniaceae) in New Caledonia: notes on morphology and the description of three new species. *Kew Bull.*, in press.
- Huson, D.H., Bryant, D., 2006. Application of phylogenetic networks in evolutionary studies. *Mol. Biol. Evol.* 23, 254-267.
- Isaac, N.J.B., Mallet, J., Mace, G.M., 2004. Taxonomic inflation: its influence on macroecology and conservation. *Trends Ecol. Evol.* 19, 464-469.
- Jaffré, T., Morat, P., Veillon, J.-M., MacKee, H.S., 1987. Changements dans la végétation de la Nouvelle-Calédonie au cours du Tertiaire : la végétation et la flore des roches ultrabasiques. *Adansonia* 4, 365-391.
- Jaffré, T., 1993. The relationship between ecological diversity and floristic diversity in New Caledonia. *Biodiv. Lett.* 1, 82-87.

- Jaffré, T., Morat, P., Veillon, J.-M., Rigault, F., Dagostini, G., 2001. Composition and characterisation of the native flora of New Caledonia. Institut de Recherche pour le Développement, Nouméa.
- Kosakovsky Pond, S.L., Posada, D., Gravenor, M.B., Woelk, C.H., Frost, S.D.W., 2006. GARD: a genetic algorithm for recombination detection. *Bioinformatics* 22, 3096-3098.
- Martínez-Ortega, M., Delgado, L., Albach, D.C., Elena-Rosselló, J.A., Rico, E., 2004. Species boundaries and phylogeographic patterns in cryptic taxa inferred from AFLP markers: *Veronica* subgen. *Pentasepalae* (Scrophulariaceae) in the Western Mediterranean. *Syst. Bot.* 29, 965-986.
- Morat, P., 1993. Our knowledge of the flora of New Caledonia: endemism and diversity in relation to vegetation types and substrates. *Biodiv. Lett.* 1, 72-81.
- Mort, M.E., Crawford, D.J., 2004. The continuing search: low-copy nuclear sequences for lower-level plant molecular phylogenetic studies. *Taxon* 53, 257-261.
- Myers, N., Mittermeier, R.A., Mittermeier, C.G., da Fonseca, G.A.B., Kent, J., 2000. Biodiversity hotspots for conservation priorities. *Nature* 403, 853-858.
- Pillon, Y., Qamaruz-Zaman, F., Fay, M.F., Hendoux, F., Piquot, Y., 2007. Genetic diversity and ecological differentiation in the endangered fen orchid (*Liparis loeselii*). *Conserv. Genet.* 8, 177-184.
- Pillon, Y., Hopkins, H.C.F., Bradford, J.C., 2008. Two new species of *Cunonia* (Cunoniaceae) from New Caledonia. *Kew Bull.* 63, 419-431.
- Pillon, Y., Hopkins, H.C.F., Munzinger, J., Chase, M.W., 2009a. A molecular and morphological survey of generic limits of *Acsmithia* and *Spiraeanthemum* (Cunoniaceae). *Syst. Bot.* 34, in press.

- Pillon, Y., Munzinger, J., Amir, H., Hopkins, H.C.F., Chase, M.W., 2009b. Reticulate evolution on a mosaic of soils: diversification of the New Caledonian endemic genus *Codia* (Cunoniaceae). *Mol. Ecol.*, in press.
- Poke, F.S., Martin, D.P., Steane, D.A., Vaillancourt, R.E., Reid, J.B., 2006. The impact of intragenic recombination on phylogenetic reconstruction at the sectional level in *Eucalyptus* when using a single copy nuclear gene (cinnamoyl CoA reductase). *Mol. Phyl. Evol.* 39, 160-170.
- Proctor, J., 2003. Vegetation and soil and plant chemistry on ultramafic rocks in the tropical Far East. *Perspectives in plant ecology, evolution and systematics* 6, 105-124.
- Rieseberg, L.H., Vines, T., Kane, N., 2009. Editorial and retrospective 2008. *Mol. Ecol.* 18, 1-20.
- Small, R.L., Cronn, R.C., Wendel, J.F., 2004. Use of nuclear genes for phylogeny reconstruction in plants. *Aust. Syst. Bot.* 17, 145-170.
- Strand, A.E., Leebens-Mack, J., Milligan, B.G., 1997. Nuclear DNA-based markers for plant evolutionary biology. *Mol. Ecol.* 6, 113-118.
- Swenson, U., Munzinger, J., Bartish, I.V., 2007. Molecular phylogeny of *Planchonella* (Sapotaceae) and eight new species from New Caledonia. *Taxon* 56, 329-354.
- Swofford, D.L., 2002. PAUP*: *Phylogenetic analysis using parsimony (and other methods)* 4.0 Beta. Florida State University.
- Tuskan, G.A., DiFazio, S., Jansson, S., Bohlmann, J., Grigoriev, I., Hellsten, U., Putnam, N., Ralph, S., Rombauts, S., Salamov, A., Schein, J., Sterck, L., Aerts, A., Bhalerao, R.R., Bhalerao, R.P., Blaudez, D., Boerjan, W., Brun, A., Brunner, A., Busov, V., M. Campbell, Carlson, J., Chalot, M., Chapman, J., Chen, G.-L., Cooper, D., Coutinho, P.M., Couturier, J., Covert, S., Cronk, Q.C.B., 2006. The genome of black cottonwood, *Populus trichocarpa* (Torr. & Gray) *Science* 313, 1596-1604.

- Whittall, J.B., Hellquist, C.B., Schneider, E.L., Hodges, S.A., 2004. Cryptic species in an endangered pondweed community (*Potamogeton*, Potamogetonaceae) revealed by AFLP markers. *Am. J. Bot.* 91, 2022-2029.
- Yuan, Y.-W., Olmstead, R.G., 2008. Evolution and phylogenetic utility of the *PHOT* gene duplicates in the *Verbena* complex (Verbenaceae): dramatic intron size variation and footprint of ancestral recombination. *Am. J. Bot.* 95, 1166-1176.

Table 1. List of accessions used in the molecular analyses, with information on voucher, locality of origin and Genbank accession numbers.

Species	Voucher	Voucher location	Locality	<i>ncpGS</i>	<i>GapC</i>
<i>Spiraeanthemum brongniartianum</i> Schltr. [S]	Bradford et al. 1179	MO,NOU	Plateau de Dogny	x	
<i>Spiraeanthemum brongniartianum</i> Schltr. [N]	Pillon et al. 87	K,MO,NOU,P	Mont Panié, Tao	EU867240	x
<i>Spiraeanthemum collinum</i> (Hoogland) Pillon .	Pillon et al. 464	K,NOU,P	Mé Maoya, Djiaouma	x	x
<i>Spiraeanthemum densiflorum</i> Brong. & Gris	Pillon 667	NOU	Col d'Amieu	EU867243 & EU867244	x
<i>Spiraeanthemum ellipticum</i> Vieill. ex Pamp. [S1]	Pillon et al. 20	K,NOU,P	Mont Humboldt	x	x
<i>Spiraeanthemum ellipticum</i> Vieill. ex Pamp. N1]	Pillon et al. 347	K,MO,NOU,NSW,P	Mont Panié	x	x
<i>Spiraeanthemum ellipticum</i> Vieill. ex Pamp. [S2]	Pillon & Barrabé 672	NOU	Montagne Sources des	x	
<i>Spiraeanthemum ellipticum</i> Vieill. ex Pamp. [N2]	Pillon et al. 616	NOU	Mont Colnett	x	
<i>Spiraeanthemum macgillivrayi</i> Seem. [1]	Pillon et al. 570	K,MO,NOU,P,PVNH	Vanuatu, Santo	EU867245	x
<i>Spiraeanthemum macgillivrayi</i> Seem. [2]	Pillon et al. 525	NOU,P	Vanuatu, Santo	EU867246	
<i>Spiraeanthemum meridionale</i> (Hoogland) Pillon [1]	Pillon et al. 1	NOU	Bois du Sud	x	
<i>Spiraeanthemum meridionale</i> (Hoogland) Pillon [2]	Pillon & Munzinger 636	NOU	Pic du Pin	x	
<i>Spiraeanthemum pedunculatum</i> Schltr. [1]	Pillon et al. 437	NOU	Bois du Sud	x	x
<i>Spiraeanthemum pedunculatum</i> Schltr. [2]	Pillon & Munzinger 637	K,NOU,P	Pic du Pin	x	
<i>Spiraeanthemum pubescens</i> Pamp. [N1]	Pillon & Munzinger 82	K,NOU,P	Mandjélie	EU867241 & EU867242	x
<i>Spiraeanthemum pubescens</i> Pamp. [N2]	Munzinger et al. 4014	NOU,P	Mandjélie	x	
<i>Spiraeanthemum pubescens</i> Pamp. [S]	Pillon et al. 316	K,NOU,P	Col de Mouirange	x	

Table 2. Information on the datasets for the two genes (*ncpGS* and *GapC*) included in the study.

	<i>ncpGS</i>	<i>GapC</i>
Number of accessions included	17	8
Length of alignment	1210	910
Variable sites	108 (8.9 %)	84 (9.2 %)
Parsimony informative sites	64 (5.2 %)	52 (5.7%)

Table 3. Base composition at the parsimony-informative sites in the *ncpGS* sequences recovered in the species of *Spiraeanthemum* belonging to the brongniartianum group. The dashes indicate a gap between position 351 and 381. Putative recombination sites are indicated by a vertical line, and the phylogenetic group to which each allele/segment belong is given in the last column. Asterisks indicate putative recombinant alleles, only detected in the recombination network.

	61	100	111	112	116	165	250	298	307	330	361	400	676	725	761	796	839	858	962	984	1072	1081	1097	1191	group
<i>S. ellipticum</i> [N1]	C	T	A	C	T	G	T	G	G	C	C	T	T	A	C	G	T	T	G	T	A	T	A	C	A
<i>S. ellipticum</i> [N2] allele 2	C	T	A	C	T	G	T	G	G	C	C	T	T	A	C	G	T	T	G	T	A	T	A	C	A
<i>S. pubescens</i> [N1] allele 2	C	T	A	C	T	G	T	G	G	C	C	T	T	A	C	G	T	T	G	T	A	T	A	C	A
<i>S. pubescens</i> [N2] allele 1	C	T	A	C	T	G	T	G	G	C	C	T	T	A	C	G	T	T	G	T	A	T	A	C	A
<i>S. ellipticum</i> [N2] allele 1	T	T	A	C	T	G	T	G	G	C	C	T	T	A	G	G	T	T	G	T	A	T	A	C	A
<i>S. pubescens</i> [N1] allele 1	T	T	A	C	T	G	T	G	G	C	C	T	T	A	G	G	T	T	G	T	A	T	A	C	A
<i>S. pubescens</i> [N2] allele 2	T	T	A	C	T	G	T	G	G	C	C	T	T	A	G	G	T	T	G	T	A	T	A	C	A
<i>S. collinum</i> allele 1	T	T	A	T	T	T	T	G	A	C	C	T	C	A	G	A	A	T	A	C	A	T	A	G	B1*
<i>S. ellipticum</i> [S2] allele 1	T	A	A	C	T	T	T	A	A	T	-	T	C	G	G	G	A	G	A	C	G	T	T	G	B2
<i>S. pedunculatum</i> [1] allele 2	T	A	A	C	T	T	T	A	A	T	-	T	C	G	G	G	A	G	A	C	G	T	T	G	B2
<i>S. pedunculatum</i> [2] allele 2	T	A	A	C	T	T	T	A	A	T	-	T	C	G	G	G	A	G	A	C	G	T	T	G	B2
<i>S. pubescens</i> [S]	T	A	A	C	T	T	T	A	A	T	-	T	C	G	G	G	A	G	A	C	G	T	T	G	B2
<i>S. ellipticum</i> [S2] allele 2	T	T	A	C	T	T	G	G	A	T	T	T	C	G	G	G	A	T	A	C	G	T	T	G	B3
<i>S. pedunculatum</i> [2] allele 1	T	T	A	C	T	T	G	G	A	T	T	T	C	G	G	G	A	T	A	C	G	T	T	G	B3
<i>S. brongniartianum</i> [S] allele 1	T	T	A	C	T	T	T	G	A	T	C	C	C	G	G	G	A	T	A	C	A	C	A	G	B4
<i>S. brongniartianum</i> [N]	T	A	A	C	T	T	T	G	A	C	C	T	C	G	G	G	A	T	A	C	A	C	A	G	B4*
<i>S. meridionale</i> [1]	T	A	G	C	C	T	T	G	A	T	C	T	C	G	G	G	A	T	A	C	G	T	T	G	B5
<i>S. brongniartianum</i> [S] allele 2	T	A	A	C	T	T	C	G	A	T	C	C	C	A	G	A	A	T	A	C	A	C	A	G	B4+B1+B4
<i>S. collinum</i> allele 2	T	T	A	C	T	T	G	A	A	T	-	T	C	G	G	G	A	T	A	C	G	T	T	G	B3+B2+B3
<i>S. ellipticum</i> [S1] allele 1	T	A	A	C	T	T	T	A	A	T	-	T	C	A	G	A	A	T	A	C	A	T	A	G	B2+B1
<i>S. meridionale</i> [1]	T	A	G	C	C	T	T	G	A	T	C	T	C	G	G	G	A	T	A	C	A	T	A	G	B5+B1
<i>S. meridionale</i> [2]	T	T	A	T	T	T	T	G	A	C	C	T	C	G	G	G	A	T	A	C	G	T	T	G	B1+B5
<i>S. pedunculatum</i> [1] allele 1	T	A	A	C	T	T	T	G	A	C	C	T	C	A	G	A	A	T	A	C	A	T	A	G	B2+B1

Figure 1. Distribution of the six species of *Spiraeanthemum* belonging to the brongniartianum group (Pillon et al., 2009a) in New Caledonia. Names of localities sampled and type localities are indicated. The type locality of *S. pedunculatum* (“région du Sud”) is imprecise and could match any of the extant populations of this species, and it is therefore not shown. Areas of ultramafic soils are indicated in grey.

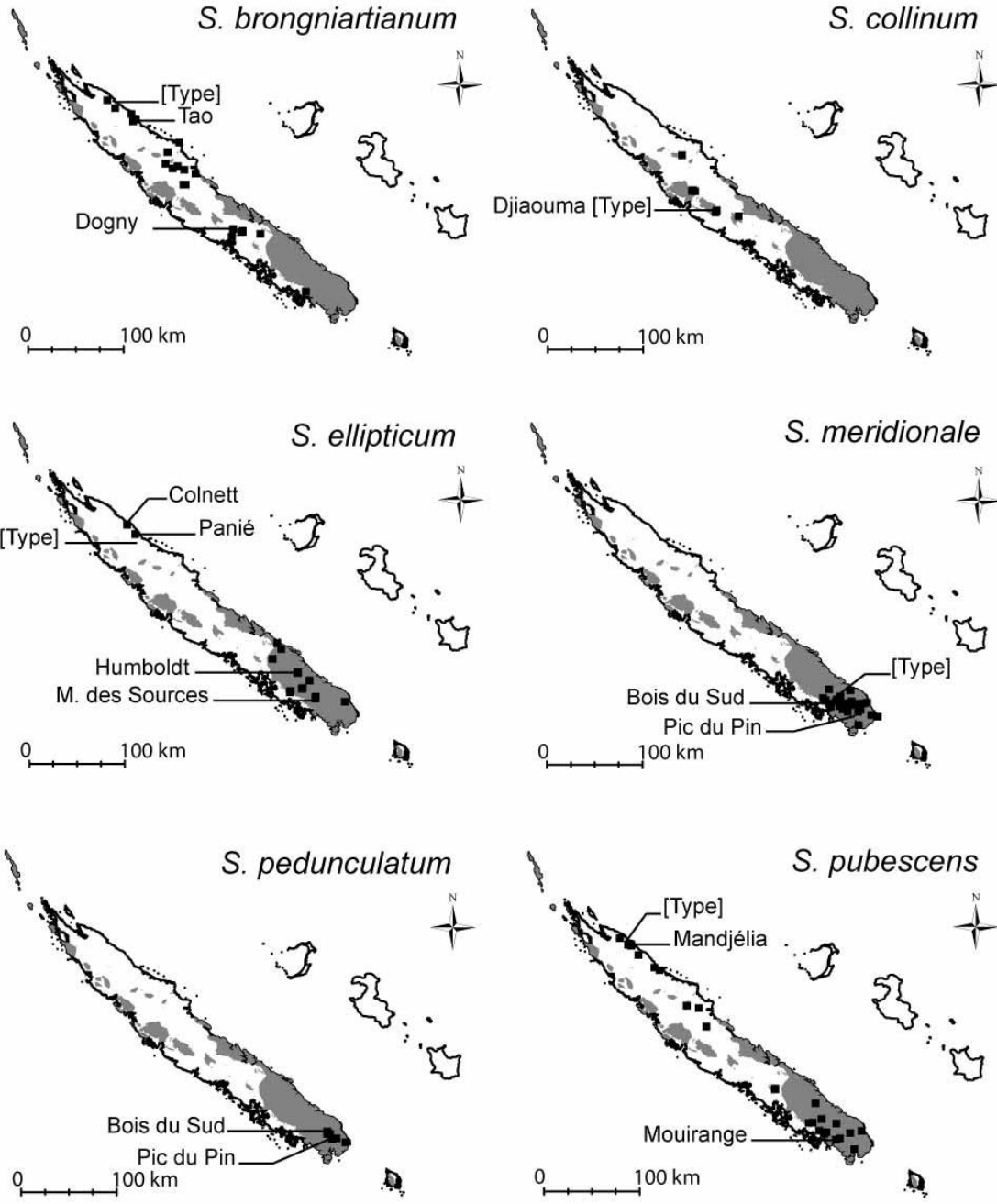

Figure 2. One of the three most parsimonious trees based on the phylogenetic analysis of *GapC* sequences. Numbers above branches are branch lengths, and numbers below branches are bootstrap percentages. Positions for the recombinant allele 1 of *S. pedunculatum* are shown in grey according to which part of the sequence was included in the analysis: part 1 (base 1 to 429), part 2 (base 430 to 910). The asterisk indicates a recombinant sequences detected in the recombination network.

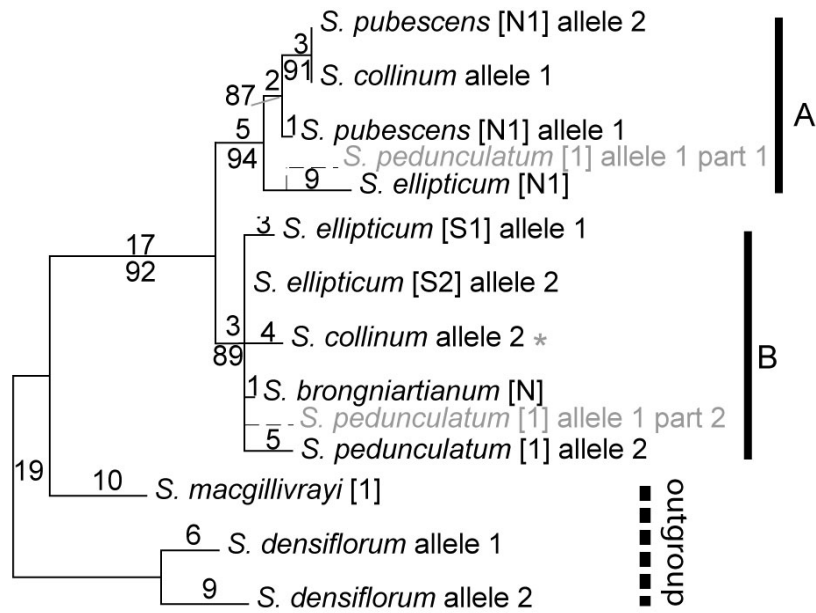

Figure 3. Phylogenetic tree of *Spiraeanthemum* based on *ncpGS* sequence data. Left: one of 195 shortest trees from a maximum parsimony analysis. Numbers above branches are branch lengths, and numbers below branches are bootstrap percentages. Nodes that collapse in the strict consensus are indicated by arrowheads. Right: tree obtained with maximum likelihood analysis. Numbers below branches are bootstrap percentages. Grey asterisks indicate alleles that are putatively recombinant, large asterisk: recombination detected by eye, small asterisk: recombination only detected with the recombination network.

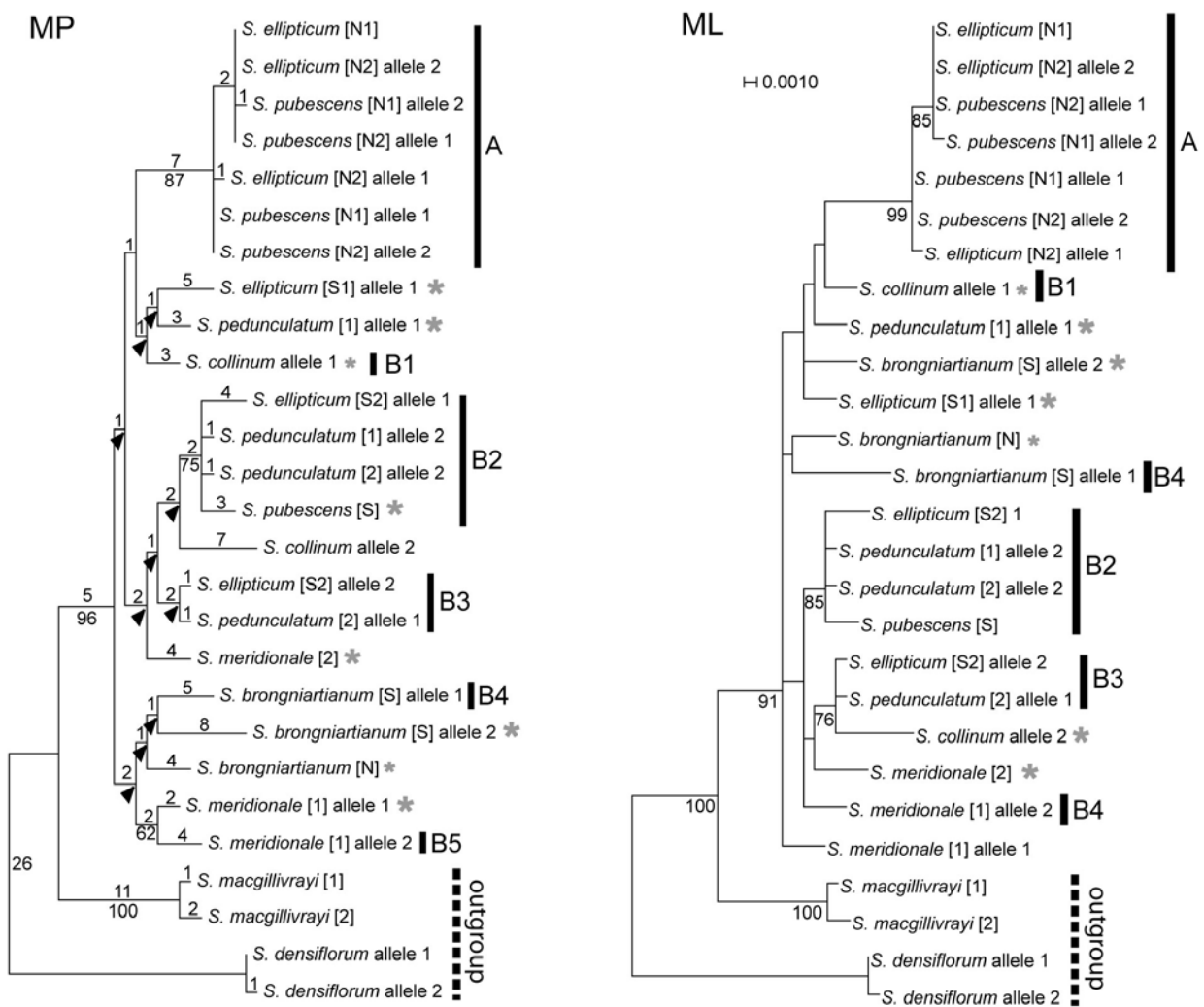

Figure 4. Phylogenetic tree of *Spiraeanthemum* using maximum likelihood based on *nepGS* sequence data, with recombinant sequences excluded. Numbers below branches are bootstrap percentages.

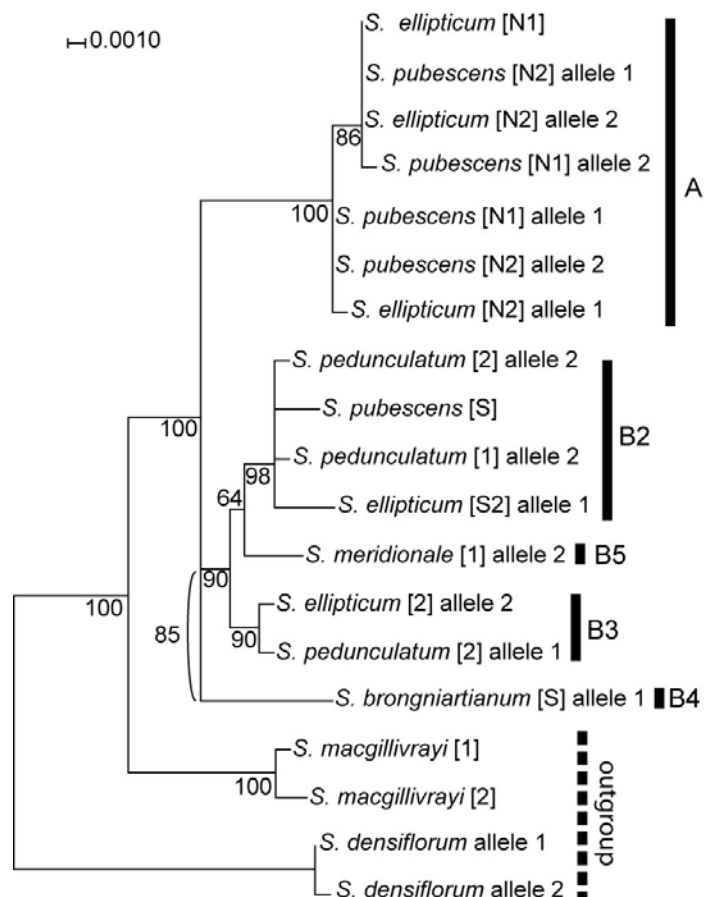

Figure 5. Recombination networks for *Spiraeanthemum* (brongniartianum group) based on *ncpGS* and *GapC* sequences. Dashed lines represent crossovers. Grey asterisks indicate alleles that are putatively recombinant, large asterisk: recombination detected by eye, small asterisk: recombination only detected with the recombination network.

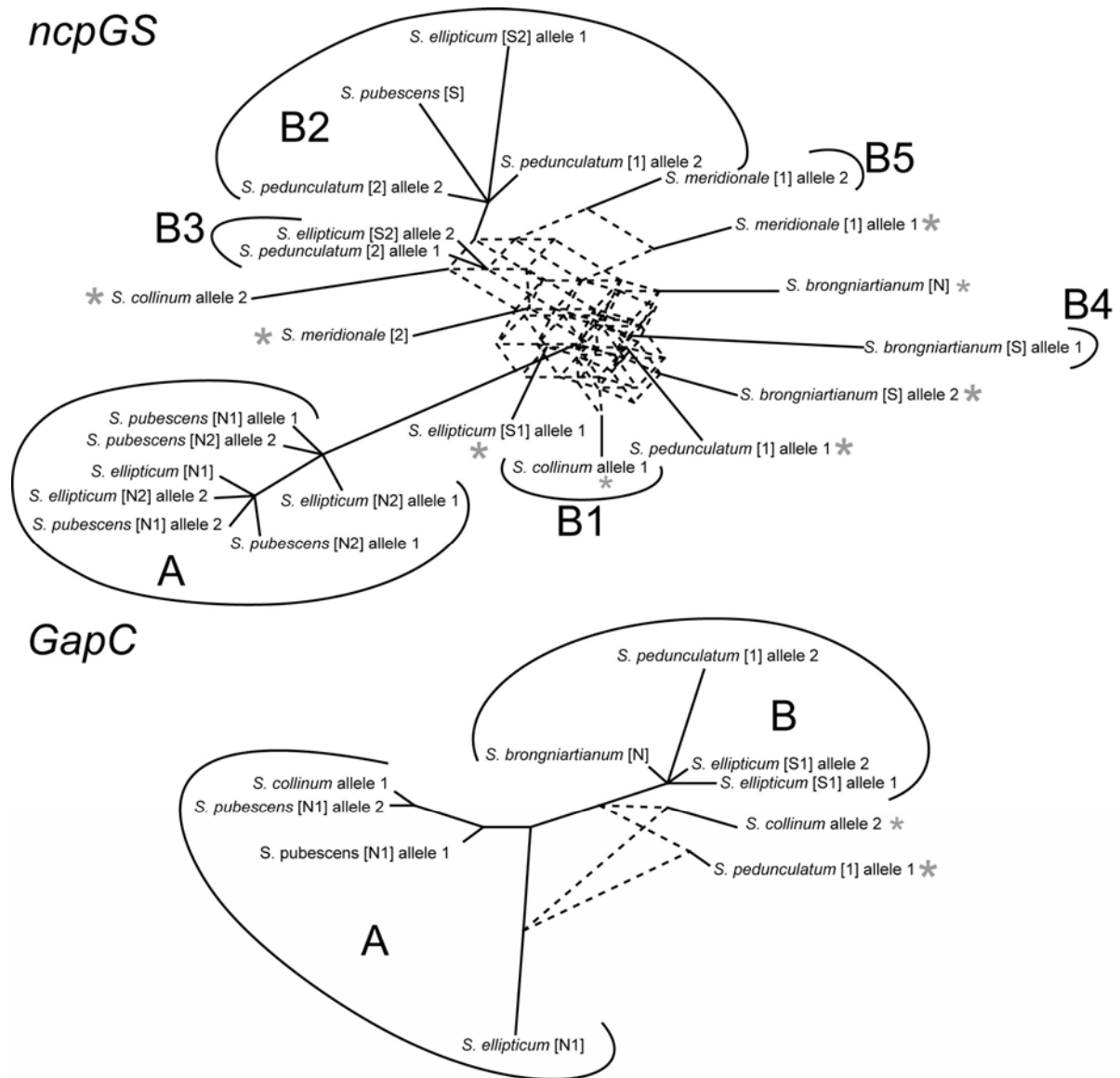
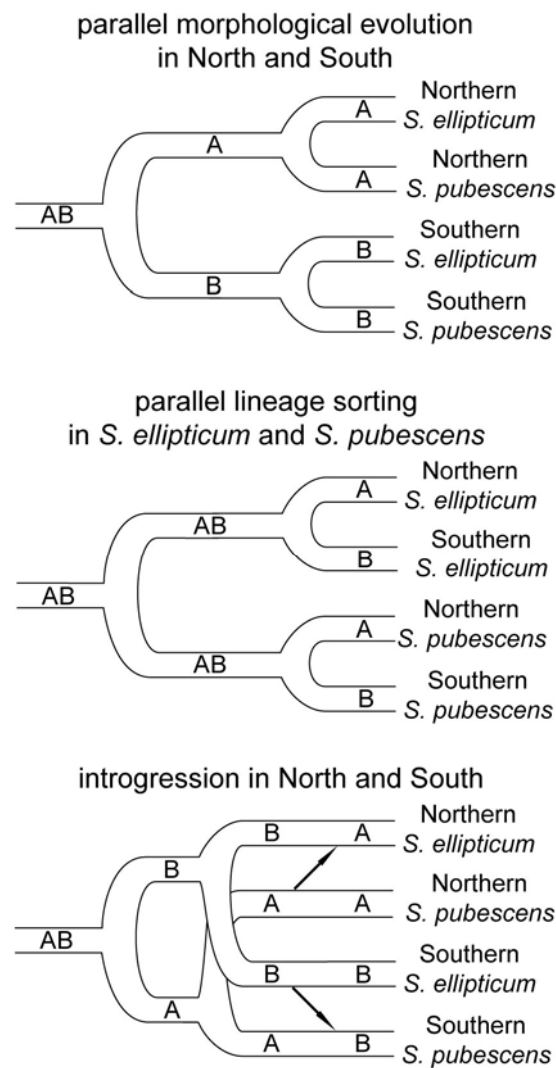
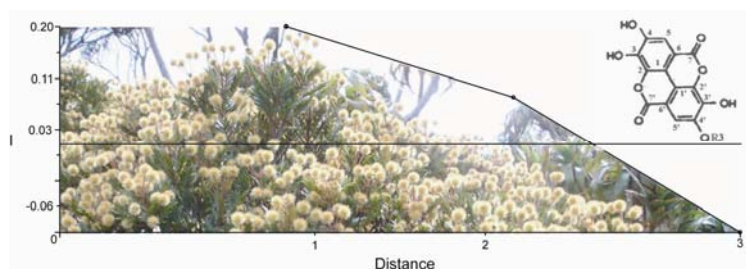

Figure 6. Possible scenarios for the origin of cryptic species in *Spiraeanthemum*. For simplification only *S. ellipticum* and *S. pubescens* are shown here, but other species of the brongniartianum group are expected to behave similarly to the southern population of *S. pubescens*. In the third scenario, arrows indicate introgression events, and an alternative, equally likely hypothesis can be obtained by interchanging A and B and interchanging *S. ellipticum* and *S. pubescens*.



Article VIII

Pillon Y, Fogliani B (2009) Evidence for a correlation between systematics and bioactivity in New Caledonian Cunoniaceae and its implications for screening and conservation. *Pacific Science* **63**, 97-103.



Il est généralement admis qu'il existe une corrélation claire entre la systématique et les métabolites secondaires présents chez les plantes. Cependant, en

raison de l'homoplasie fréquente des caractères chimiques, ceci est resté difficile à démontrer avec des méthodes statistiques. Nous avons ici utilisé deux tests non paramétriques sur un jeu de données publiées, où 50 espèces de Cunoniaceae de Nouvelle-Calédonie ont été testées pour leur activité contre plusieurs souches de pathogènes. En utilisant l'index I de Moran, nous avons montré que dans deux des neuf tests contre des souches pathogènes, il y avait une similarité significativement plus importante qu'attendu dans les activités des espèces appartenant au même genre et des différences significativement plus fortes qu'attendues entre les espèces appartenant à des tribus différentes. En considérant ensemble l'activité biologique contre toutes les souches pathogènes dans un test de Mantel, nous avons également trouvé une corrélation significative entre l'activité biologique et la distance phylogénétique dans deux des quatre tests. Ceci a des implications multiples pour la conservation de la biodiversité. La recherche de nouvelles molécules et de nouvelles activités biologiques devrait se faire préférentiellement sur des espèces réparties largement sur l'arbre de la vie. Il est également nécessaire de préserver autant de diversité phylogénétique que possible afin de s'assurer que le plus grand réservoir de composés naturels reste disponible pour les générations futures.

Evidence for a Correlation between Systematics and Bioactivity in New Caledonian Cunoniaceae and Its Implications for Screening and Conservation¹

Yohan Pillon^{2,3} and Bruno Fogliani³

Abstract: It is generally assumed that there is a good correlation between systematics and the secondary compounds found in plants. However because of the frequent homoplasy of chemical characters this has been difficult to test using statistical methods. Here we applied two nonparametric tests on a published data set, where 50 species of New Caledonian Cunoniaceae were screened for bioactivity against several pathogenic strains. Using Moran's *I* index we showed that in two of nine tests against pathogenic strains there was a significantly higher similarity than expected in bioactivities between species belonging to the same genus and a significantly higher than expected dissimilarity in bioactivity between species belonging to different tribes. When considering the bioactivities against all pathogenic strains with Mantel tests, we also found significant correlation between bioactivity and phylogenetic distance in two of four tests. This has implications in screening and conservation. Searches for new molecules and bioactivity should preferentially be made on species spread across the tree of life. There is also a need to preserve as much phylogenetic diversity as possible to make sure that the widest reservoir of natural compounds remains available for future generations.

BIOCHEMISTRY HAS PLAYED an important role in plant systematics (see, e.g., Grayer et al. 1999) by providing insights into the relationships between species (Albach et al. 2005, Petrakis et al. 2005), within families such as the Cunoniaceae (Bate-Smith 1977), and between families (Grayer et al. 1999). However, chemical compounds are characters that are often affected by homoplasy because similar compounds can appear independently several times in the course of evolution or might be lost secondarily (Wink and Mo-

hamed 2003, Albach et al. 2005). Some of these problems may also be explained by sampling issues because a single taxon may not always be representative of a higher group (Grayer et al. 1999) or by variation associated with geography (van Heerden et al. 2005) or ontogeny (Çirak et al. 2006).

Secondary compounds are economically important because they can be used as, or be the base for, active molecules in pharmaceutical chemistry (Young 1999, Butler 2004); they can also be important for the production of pesticides, perfumes, and other compounds. It is quite possible that the tropical floras being screened for new molecules today could provide the basis for tomorrow's new medicines (Butler 2004). Because it is now accepted that biodiversity is facing an important crisis, the economic value of that diversity may be a strong argument in favor of increasing conservation efforts on wild species (Balmford et al. 2002). If there is a significant correlation between chemical composition of species and their relatedness, then conservation strategies should be implemented to preserve the widest spectrum of the tree of life

¹ Manuscript accepted 27 March 2008.

² Corresponding author: Laboratoire de Botanique, Institut de Recherche pour le Développement, BP A5, 98848 Nouméa Cedex, New Caledonia (phone: (+687) 26 09 28; fax: (+687) 26 43 26; e-mail: pillon@noumea.ird.nc).

³ Laboratoire Insulaire du Vivant et de l'Environnement, Université de la Nouvelle-Calédonie, BP R4, 98851 Nouméa Cedex, New Caledonia.

(Mace et al. 2003) to ensure that the greatest diversity of molecules remains available.

The correlation between biochemistry and systematics has generally been accepted, but there has been little supporting evidence that it is statistically significant, probably because of the homoplasmy of chemical characters. Few studies are available that have investigated a large number of taxa with multiple tests using a standard protocol. In this study we conducted statistical analysis on the results obtained by Fogliani et al. (2002*a*), who tested the activity of 50 species of Cunoniaceae against 10 pathogenic strains, and show that there is a significant and positive correlation between species bioactivity and their relatedness. Specifically, we used nonparametric tests such as Moran's *I* index that have proven their efficiency at revealing taxonomic patterns (Lockwood et al. 2002). New Caledonian Cunoniaceae have been the subject of extensive taxonomic work over the past decades (Hoogland et al. 1997, Hopkins 2005, 2006, 2007, Hopkins et al. 2007, Pillon et al. in press), and a tribal classification (Bradford et al. 2004) based on morphological (Hufford and Dickson 1992) and molecular (Bradford and Barnes 2001) phylogenies is available. This taxonomic scheme was used to provide rough estimates of phylogenetic distances between species.

MATERIALS AND METHODS

Data

Fogliani et al. (2002*a*) tested the bioactivity of 50 of the ca. 90 species of Cunoniaceae endemic to New Caledonia, representing six genera and four tribes following the most recent classification of Cunoniaceae (Bradford and Barnes 2001, Bradford et al. 2004). Activities against eight bacteria strains and two fungi were assessed. In most cases the activity of ethyl acetate and methanol extract of leaf and bark were tested. A disk containing the extract was placed in a petri dish containing a culture of each strain. In the presence of antimicrobial activities, an inhibition zone can be observed around the disk. The diameter of this zone is used as a measure of the strength of the activity.

Independence of Variables

The independence of variables needed to be assessed before further testing. Correlation of activities between bark and leaf extracts and ethyl acetate and methanol were tested by the mean of a chi-squared test. We tested if species showing activity in their bark were more likely to show activity in their leaves for a given solvent, and similarly we tested if species showing antimicrobial properties with the methanol extract of their leaves or bark were more likely to show properties with the ethyl acetate of the same part of the plant. Correlation between activities against the different pathogenic strains was also assessed (for an extract with a given solvent from a given part of the plant). Chi-squared tests were only conducted on a contingency table where all expected occurrences exceeded five.

Test of the Correlation between Systematics and Bioactivity

Moran's *I* index was used to test if there was a significant similarity in the bioactivity of species belonging to the same taxonomic group (genus or tribe). Moran's *I* index was calculated for each test against pathogenic strains for leaf or bark extracts with ethyl acetate or methanol. Only tests where at least 10 species showed activities were included. We established three distance classes (1, 2, and 3) between species depending on their phylogenetic distance: 1, if they belong to the same genus; 2, if they belong to the same tribe; 3, if they belong to different tribes. The Moran's *I* index tests whether species that are closely related phylogenetically have similar activity.

One single test against one pathogen provides little statistical power to detect significant correlation for several reasons. In most cases, few species showed activity against a given pathogen, and this activity does not follow a normal distribution. To increase the sensitivity of the tests we used another approach. We took into consideration the 10 pathogenic strains in a single statistical test known as the Mantel test. Activities were centered and reduced (i.e., for each species we

calculated the activity of the species minus the average over all species divided by the standard deviation over all). The aim of this procedure was to give a similar weight to each pathogenic strain. “Bioactive” distance was calculated for each pair of species as the geometric distance between their activities against all 10 pathogenic strains:

$$BD_{ij} = \sqrt{\sum_k (a_{ik} - a_{jk})^2}$$

BD is the “bioactive” distance between species i and j . a_{ik} and a_{jk} are the activity of species i and j , respectively, against the pathogenic strain k .

We used the same phylogenetic distance as for the Moran’s I index. The Mantel test assesses the correlation between “bioactive” distance and phylogenetic distance. One thousand replicates were used to evaluate the significance of the test.

Both Moran’s I index and the Mantel test were computed with the software PASSAGE (Rosenberg 2002).

RESULTS

Independence of Variables

The conditions necessary to apply the chi-squared test (expected occurrence of at least five) to test the correlation between activities of leaf and bark extracts or of the two solvent extracts were satisfied in only a few cases. The chi-squared test always indicated a significant positive correlation between the activities of bark and leaf extract (test of methanol extract against *Fusarium oxysporum*, $P < .0001$; and *Corynebacterium accolans*, $P = .003$) but no significant correlation between ethyl acetate and methanol extract in the single case tested (test of bark extract against *Corynebacterium accolans*). Therefore activities of bark and leaves were considered as nonindependent variables.

Correlation between activities against the different pathogenic strains was also assessed (for an extract with a given solvent from a given part of the plant). In four cases this could be tested; in three cases there was no significant correlation: activity of ethyl ace-

tate extract from bark against *Staphylococcus aureus* and *Erwinia carotovora*, activity of methanol extract from bark against *Corynebacterium accolans* and *Fusarium oxysporum*, and activity of methanol extract from leaves against *Corynebacterium accolans* and *Fusarium oxysporum*. In only one case we found a significant correlation of activity against two microbial strains: activity of ethyl acetate extract from bark against *Corynebacterium accolans* and *Staphylococcus aureus* ($P = .006$). Therefore we assumed that the different microbial strains could be reasonably considered as independent measures of bioactivity.

Test of the Correlation between Systematics and Bioactivity

Nine tests against pathogenic strains could be tested with the Moran’s I index; results for each test and the average over the nine tests are displayed in Figure 1. In the case of the activity of the methanol extract from leaves against *Corynebacterium accolans*, the value of the Moran’s I index ($I = 0.059$) was significantly higher ($P = .008$) than expected by chance for species belonging to the same genus. Thus activities between congeneric species were closer than expected by chance. Concerning the activity of the ethyl acetate extract from bark against *Corynebacterium accolans*, we observed Moran’s I index values that were significantly higher than expected for species belonging to the same genus ($I = 0.201$; $P < .001$) or to the same tribe ($I = 0.081$; $P = .028$). If a Bonferroni correction (Rice 1989) is applied to account for multiple tests (nine in total), the second I value would still be significant. In turn, species belonging to different tribes showed significantly different activities in two cases (Figure 1), with or without a Bonferroni correction. The seven other tests did not show values that were significantly different from expectation. Average Moran’s I index for the nine tests showed that overall, I values are positive for species belonging to the same genus (similar activities), negative but close to zero for species belonging to the same tribe, and lower for species belonging to different tribes (dissimilar activities).

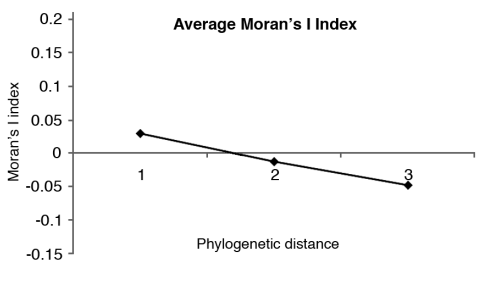
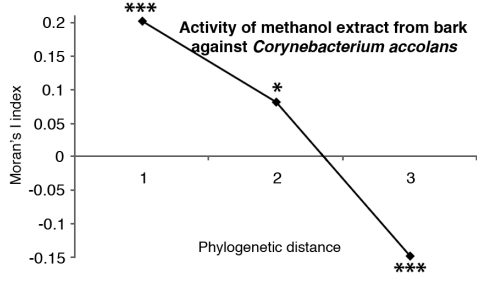
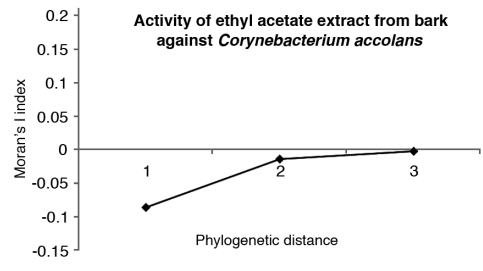
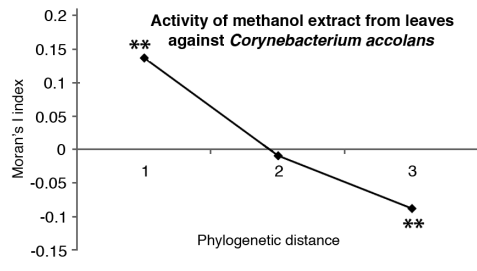
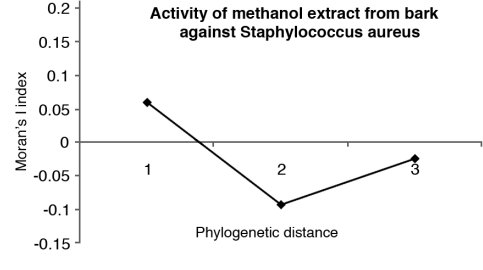
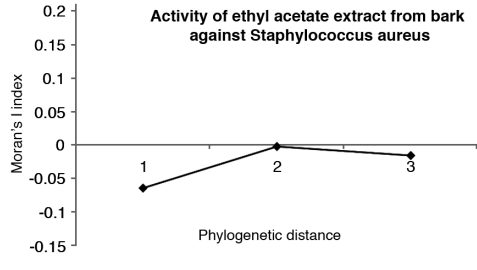
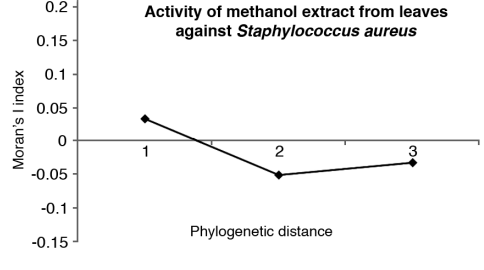
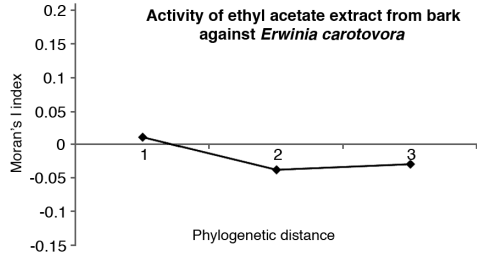
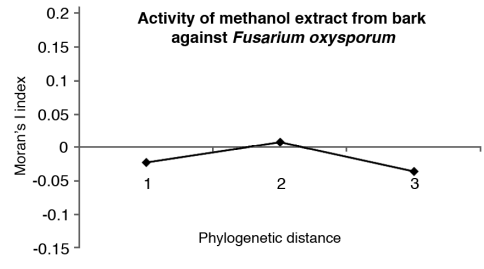
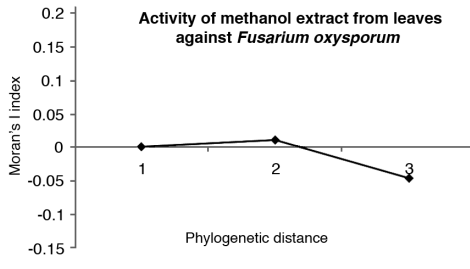

Because the correlation between activities against different strains is limited, we considered that pooling them was reasonable and that potential addition effects would be limited. This justifies the use of the “bioactive” distance, which takes into account the activities against the different pathogenic strains altogether. On the other hand we tested separately the activities of bark and leaf extracts using ethyl acetate and methanol, considering that activities of bark and leaf extracts were at least partially correlated.

Mantel tests revealed a significant correlation between phylogenetic distance and “bioactive” distance for methanol extract of bark and leaves ($P = .001$ in both cases) and no significant correlation in the two other cases (ethyl acetate extract of bark and leaves). The first two tests were still statistically significant after applying a Bonferroni correction.

DISCUSSION

It is generally accepted that biochemistry is well correlated with systematics. However this has been difficult to test in a statistical manner because of the inadequacy of the data available. Chemical characters are often binary (presence/absence) and bear little information. It is relatively rare that a large number of characters are available for a large number of taxa. Data generated by different studies may not be comparable, because different protocols were used. Therefore few cladistics analyses have been carried out on chemical characters. Nevertheless when Bininda-Emonds et al. (2001) built cladistics using the lipids of the anal sac secretion of felids, they found good congruence with the existing taxonomic scheme. This was made

possible by the large number of compounds included in their matrix (400).

Although several of our tests were non-significant, the few significant ones indicated a positive correlation between bioactivity and systematics. We believe that the lack of significant values is due to insufficient data, particularly the small number of species displaying activity against a given pathogenic strain, which limits the statistical power of the tests. The use of the Bonferroni correction shows that the few significant values observed are not due to chance as we multiplied statistical tests but to a genuine pattern. Also, because activities against pathogenic strains are not fully independent, there may be some addition effects that could enhance significance of the Mantel test for which we pooled the data. However, each activity was considered separately when we used the Moran's I index; therefore this cannot solely explain the significant correlation we observed.

Species that are closely related are more likely to have similar bioactivity. This can probably be explained by the fact that closely related species have the same active molecules. Nevertheless we cannot exclude other possibilities (e.g., species with similar activities may have similar amounts of the active molecules or have different molecules with the same bioactivity or other explanations). In turn, species that are not closely related are more likely to have different activities; this bears strong implications in screening and conservation.

Most of the world's biodiversity is found in the tropics, and the tropical floras are indeed being intensively screened for new active molecules (Butler 2004). Because many plant species are still to be discovered (Prance

FIGURE 1. Correlograms obtained for activity of different extracts (methanol or ethyl acetate extract from bark or leaves) against different pathogenic strains. Moran's I index is a measure of autocorrelation (i.e., it indicates whether species tend to have activities that are more similar [positive autocorrelation] or more different [negative autocorrelation] than expected by chance). It is calculated for species belonging to the same genus (phylogenetic distance = 1), for species belonging to the same tribe but different genera (phylogenetic distance = 2), and for species belonging to different tribes (phylogenetic distance = 3). Moran's I index expected value is -0.023 ; positive values for I indicate positive autocorrelation and negative values for I indicate negative autocorrelation. Asterisks indicate I values that are significantly different from those expected by chance (*, $P < .05$; **, $P < .01$; ***, $P < .001$).

et al. 2000), most species have never been studied for their bioactivity, and some are likely to disappear before they can be sufficiently surveyed. This is true for New Caledonian Cunoniaceae in particular, where many species remain undescribed and new genera are still being discovered (e.g., McPherson and Lowry 2004). The flora of the island is also being screened for new bioactivities (Bosisio et al. 2000, Fogliani et al. 2002*a,b*) and is threatened by fires, introduced species, and the continued development of nickel mining.

Thus, species included in screening should be spread out across the tree of life to increase the likelihood of finding new and useful bioactive molecules. Also, because the sampling for testing bioactivity is sometimes relatively destructive or because the discovery of interesting molecules may lead to unsustainable exploitation, red-listed and rare species could be avoided for screening purposes and instead be replaced by closely related and more abundant species.

Vane-Wright et al. (1991) argued that each species should not be given equal weight in conservation (e.g., the single species of *Welwitschia* versus one of the many species of *Taraxacum*). The fact that phylogenetically isolated taxa are more likely to have original bioactivity may be a good argument to prioritize them in conservation planning. The potentially high economic value of some natural products should be kept in mind, because it is a strong argument in favor of the preservation of biodiversity (Young 1999).

ACKNOWLEDGMENTS

We thank Jean-François Arnaud for assistance with the software. We are grateful to an anonymous reviewer and especially Zachary Rogers for carefully reviewing an early version of the manuscript.

Literature Cited

- Albach, D. C., R. J. Grayer, G. C. Kite, and S. R. Jensen. 2005. *Veronica*: Acylated flavone glycosides as chemosystematic markers. *Biochem. Syst. Ecol.* 33:1167–1177.
- Balmford, A., A. Bruner, P. Cooper, R. Costanza, S. Farber, R. E. Green, M. Jenkins, P. Jefferis, V. Jessamy, J. Madden, K. Munro, N. Myers, S. Naeem, J. Paavola, M. Rayment, S. Rosendo, J. Roughgarden, K. Trumer, and R. K. Turner. 2002. Economic reasons for conserving wild nature. *Science* (Washington, D.C.) 297:950–953.
- Bate-Smith, E. C. 1977. Chemistry and taxonomy of the Cunoniaceae. *Biochem. Syst. Ecol.* 5:95–105.
- Bininda-Emonds, O. R. P., D. M. Decker-Flum, and J. L. Gittleman. 2001. The utility of chemical signals as phylogenetic characters: An example from the Felidae. *Biol. J. Linn. Soc.* 72:1–15.
- Bosisio, E., D. Mascetti, and P. Cabalion. 2000. Screening of plants from New Caledonia and Vanuatu for inhibitory activity of xanthine oxydase and elastase. *Pharm. Biol.* 38:18–24.
- Bradford, J. C., and R. W. Barnes. 2001. Phylogenetics and classification of Cunoniaceae (Oxalidales) using chloroplast DNA sequences and morphology. *Syst. Bot.* 26:354–385.
- Bradford, J. C., H. C. F. Hopkins, and R. W. Barnes. 2004. Cunoniaceae. Pages 91–111 in K. Kubitzki, ed. *The families and genera of vascular plants*. Springer, Berlin.
- Butler, M. S. 2004. The role of natural product chemistry in drug discovery. *J. Nat. Prod. (Lloydia)* 67:2141–2153.
- Çirak, C., B. Sağlam, A. Kemal Ayan, and K. Kevseroglu. 2006. Morphogenetic and diurnal variation of hypericin in some *Hypericum* species from Turkey during the course of ontogenesis. *Biochem. Syst. Ecol.* 34:1–13.
- Fogliani, B., S. Bouraïma-Madjebi, V. Medevielle, and R. Pineau. 2002*a*. Screening of 50 Cunoniaceae species from New Caledonia for antimicrobial properties. *N. Z. J. Bot.* 40:511–520.
- Fogliani, B., S. Bouraïma-Madjebi, R. Pineau, and P. Cabalion. 2002*b*. Screening of fifty Cunoniaceae species from New Caledonia for inhibitors of xanthine oxidase and scav-

- engers of superoxide anions. *Pharm. Biol.* 40:526–533.
- Grayer, R. J., M. W. Chase, and M. S. J. Simmonds. 1999. A comparison between chemical and molecular characters for the determination of phylogenetic relationships among plant families: An appreciation of Hegnauer's "Chemotaxonomie der Pflanzen." *Biochem. Syst. Ecol.* 27:369–393.
- Hoogland, R. D., J. Jérémie, and H. C. F. Hopkins. 1997. Le genre *Cunonia* (Cunoniaceae) en Nouvelle-Calédonie: Description de cinq espèces nouvelles. *Adansonia* 19:7–19.
- Hopkins, H. C. F. 2005. Nomenclature and typification in the endemic genus *Codia* (Cunoniaceae) from New Caledonia. *Adansonia* 27:243–254.
- . 2006. Nomenclature and typification in *Geissois* (Cunoniaceae) in the South-West Pacific. *Adansonia* 28:311–327.
- . 2007. *Geissois bradfordii*, a new species of Cunoniaceae from New Caledonia. *Kew Bull.* 62:275–280.
- Hopkins, H. C. F., B. Fogliani, and Y. Pillon. 2007. Four new species in the endemic genus *Codia* (Cunoniaceae) from New Caledonia. *Kew Bull.* 62:259–274.
- Hufford, L., and W. C. Dickison. 1992. A phylogenetic analysis of Cunoniaceae. *Syst. Bot.* 17:181–200.
- Lockwood, J. L., G. J. Russell, J. L. Gittleman, C. C. Daehler, M. L. McKinney, and A. Purvis. 2002. A metric for analyzing taxonomic patterns of extinction risk. *Conserv. Biol.* 16:1137–1142.
- Mace, G. M., J. L. Gittleman, and A. Purvis. 2003. Preserving the tree of life. *Science* (Washington, D.C.) 300:1707–1709.
- McPherson, G., and P. P. Lowry II. 2004. *Hooglandia*, a newly discovered genus of Cunoniaceae from New Caledonia. *Ann. Mo. Bot. Gard.* 91:260–265.
- Petrakis, P. V., M. Couladis, and V. Roussis. 2005. A method for detecting the biosystematic significance of the essential oil composition: The case of five Hellenic *Hypericum* L. species. *Biochem. Syst. Ecol.* 33:873–898.
- Pillon, Y., H. C. F. Hopkins, and J. C. Bradford. in press. Two new species of *Cunonia* (Cunoniaceae) from New Caledonia. *Kew Bull.*
- Prance, G. T., H. Beentje, J. Dransfield, and R. Johns. 2000. The tropical flora remains undercollected. *Ann. Mo. Bot. Gard.* 87:67–71.
- Rice, W. R. 1989. Analyzing tables of statistical tests. *Evolution* 43:223–225.
- Rosenberg, M. S. 2002. PASSAGE: Pattern analysis, spatial statistics, and geographical exegesis, version 1.0. Department of Biology, Arizona State University, Tempe.
- Vane-Wright, R. I., C. J. Humphries, and P. H. Williams. 1991. What to protect?—Systematics and the agony of choice. *Biol. Conserv.* 55:235–254.
- van Heerden, F. R., B.-E. van Wyk, A. M. Viljoen, and P. A. Stoekamp. 2005. Phenolic variation in wild populations of *Aspalathus linearis* (rooibos tea). *Biochem. Syst. Ecol.* 31:885–895.
- Wink, M., and G. I. A. Mohamed. 2003. Evolution of chemical defense traits in the Leguminosae: Mapping of distribution patterns of secondary metabolites on a molecular phylogeny inferred from nucleotide sequences of the *rbcL* gene. *Biochem. Syst. Ecol.* 31:897–917.
- Young, R. N. 1999. Importance of biodiversity to the modern pharmaceutical industry. *Pure Appl. Chem.* 71:1655–1661.

Résumé

La Nouvelle-Calédonie est considérée comme une zone prioritaire pour la préservation de la biodiversité à l'échelle mondiale en raison de sa flore riche, originale et menacée. Pour mieux comprendre l'histoire de cette flore, une étude a été menée sur la famille des Cunoniaceae, qui compte dans l'archipel 88 espèces et 7 genres d'arbres et d'arbustes, dont le « faux-tamanou » et le « chêne rouge ». Quatre nouvelles espèces dans le genre *Codia* et deux dans le genre *Cunonia* ont été mises en évidence. Une phylogénie moléculaire des genres *Acsmithia* et *Spiraeanthemum* suggère qu'ils devraient être considérés comme un seul genre : *Spiraeanthemum*, car le genre *Acsmithia* est paraphylétique.

Sur un plan biogéographique, les affinités des Cunoniaceae et de la flore de Nouvelle-Calédonie sont plus fortes avec l'Australie. Néanmoins, une analyse comparative globale à l'échelle de l'ensemble des plantes à fleurs montre que certaines lignées sont surreprésentées en Nouvelle-Calédonie, et d'autres sont sous-représentées, et ceci ne peut pas être entièrement expliqué par la biogéographie. Il semblerait que certaines lignées possèderaient une exaptation (« pré-adaptation ») aux sols ultramafiques (terrains miniers) qui aurait pu faciliter leur installation et leur diversification sur l'archipel. C'est notamment le cas du clade COM (Celastrales, Oxalidales et Malpighiales) auquel appartiennent les Cunoniaceae.

L'histoire évolutive du genre *Codia* a été reconstruite à l'aide de marqueurs moléculaires et indique que l'adaptation aux terrains miniers est potentiellement ancestrale dans ce genre. L'hybridation a joué un rôle important dans la diversification du genre, et plusieurs espèces d'origine hybride présentent des caractères morphologiques absents chez les espèces parentales (phénotypes transgressifs). Certaines espèces qui se sont hybridées ont des distributions clairement distinctes aujourd'hui, suggérant des changements dans la répartition de ces espèces pouvant être liés aux périodes glaciaires du Quaternaire. Chez le genre *Spiraeanthemum*, des différences génétiques nettes ont été observées au sein de *S. ellipticum* et *S. pubescens* entre les populations du sud de la Grande Terre sur sol ultramafique et les populations du nord sur sol non-ultramafique, suggérant l'existence d'espèces cryptiques.

La flore de l'archipel possède également de nombreuses lignées reliques qui représentent une importante diversité phylogénétique. Chez les Cunoniaceae, une corrélation significative a été trouvée entre la position systématique et l'activité biologique des espèces. La diversité phylogénétique serait ainsi corrélée positivement à la valeur potentielle de la biodiversité, ce qui justifierait sa conservation. Face aux menaces qui pèsent sur la flore de la Nouvelle-Calédonie, notamment les feux, les espèces envahissantes, l'exploitation minière et le réchauffement climatique, il est important d'employer la meilleure stratégie pour la préservation de la biodiversité. Ainsi, il semble urgent de protéger les lignées reliques, mais aussi de préserver les processus qui permettent l'apparition de nouvelles espèces. Il s'agit notamment de protéger les sites qui présentent une mosaïque de sols où la cohabitation et l'hybridation d'espèces différant par leurs écologies deviennent possibles.

Mots-clés : Nouvelle-Calédonie, flore, Cunoniaceae, phylogénie, systématique, évolution, conservation, hybridation

Abstract

New Caledonia is considered as a biodiversity hotspot because of its rich, unique and threatened flora. In order to better understand the history of this flora, a study was carried out on the Cunoniaceae family, which comprises 88 species and 7 genera of shrubs and trees in New Caledonia, including "faux-tamanou" and "chêne rouge". Four new species in the genus Codia and two in the genus Cunonia have been described. A molecular phylogeny of the genera Acsmithia and Spiraeanthemum suggest that they should be considered as a single genus: Spiraeanthemum, because of the paraphyly of Acsmithia.

The Cunoniaceae of New Caledonia have greatest biogeographical affinities with Australian ones, as for the entire flora of the archipelago. Nevertheless, a global comparative analysis including all flowering plants shows that some lineages are over- or under-represented in New Caledonia, and this can not entirely be explained by biogeography. It seems possible that some lineages possess an exaptation ("pre-adaptation") to grow on ultramafic soils (serpentine in a broad sense), that could have facilitated their settlement and diversification on the archipelago. This is for example the case of the COM clade (Celastrales, Oxalidales and Malpighiales) to which Cunoniaceae belong.

The evolutionary history of the genus Codia was reconstructed using molecular markers and indicates that adaptation to ultramafic soils may be ancestral to the entire genus. Hybridisation has played an important role in the diversification of the genus, and several species of hybrid origin have morphological characters that are not found in parental species (transgressive phenotypes). Some parental species that used to hybridise no longer co-occur, suggesting that considerable range alteration has happened, and this may be linked to the Quaternary ice ages. In the genus Spiraeanthemum, considerable genetic differences have been observed within S. ellipticum and S. pubescens between southern populations on ultramafic soils and northern population on non-ultramafic soils, suggesting the existence of cryptic species.

The archipelago also hosts several relict lineages which represent an important phylogenetic diversity. In Cunoniaceae, a significant correlation was found between systematics and bioactivity. Phylogenetic diversity is therefore positively correlated with the potential value of biodiversity, justifying its conservation. Considering the threats to the New Caledonian flora, including fire, invasive species, mining and climate change, it is important to implement the best strategy for its preservation. Thus it will be necessary to protect the relict lineages and also to preserve the processes that generate new species. This includes protecting the sites with a mosaic of soils where species with different ecology come into contact and can hybridize.

Key words: New Caledonia, flora, Cunoniaceae, phylogeny, systematics, evolution, conservation, hybridisation