



HAL
open science

Analyse et applications

Bessem Samet

► **To cite this version:**

Bessem Samet. Analyse et applications. Mathématiques [math]. Ecole Supérieure des Sciences et Techniques de Tunis, 2010. tel-00493107

HAL Id: tel-00493107

<https://theses.hal.science/tel-00493107>

Submitted on 18 Jun 2010

HAL is a multi-disciplinary open access archive for the deposit and dissemination of scientific research documents, whether they are published or not. The documents may come from teaching and research institutions in France or abroad, or from public or private research centers.

L'archive ouverte pluridisciplinaire **HAL**, est destinée au dépôt et à la diffusion de documents scientifiques de niveau recherche, publiés ou non, émanant des établissements d'enseignement et de recherche français ou étrangers, des laboratoires publics ou privés.



HABILITATION UNIVERSITAIRE
Spécialité: Mathématiques

Présentée par

Bessem SAMET

Sujet

ANALYSE ET APPLICATIONS

Soutenance le 16 Juin 2010 devant le jury:

Mr. Habib Maagli

Mr. Jean-Michel Ghidaglia

Mr. Hassine Maatoug

Mr. Mohamed Sifi

Mr. Sami Omar

Président

Rapporteur

Rapporteur

Membre

Membre

HABILITATION UNIVERSITAIRE
Spécialité: Mathématiques

Présentée par

Bessem SAMET

Sujet

ANALYSE ET APPLICATIONS

Soutenance le 16 Juin 2010 devant le jury:

Mr. Habib Maagli

Mr. Jean-Michel Ghidaglia

Mr. Hassine Maatoug

Mr. Mohamed Sifi

Mr. Sami Omar

Président

Rapporteur

Rapporteur

Membre

Membre

الإهداء

Dédicace

الى من سكن الثرى ورحل عني...الى روح ابي الطاهرة

A la mémoire de mon père

Remerciements

Je tiens à exprimer toute ma gratitude et ma profonde reconnaissance envers le Professeur Mohamed Masmoudi, pour l'attention particulièrement bienveillante dont il m'avait entourée et l'influence déterminante qu'il avait exercée sur mon activité de chercheur, durant la préparation de ma thèse de doctorat à l'université Paul Sabatier de Toulouse.

Je remercie chaleureusement Monsieur Habib Maagli, Professeur à la Faculté des Sciences de Tunis, de m'avoir fait l'honneur d'accepter de présider le jury de soutenance.

Je suis très reconnaissant à Monsieur Jean-Michel Ghidaglia, Professeur des Universités à l'ENS Cachan, qui m'a fait plaisir d'accepter de rapporter ce travail.

Je remercie Monsieur Hassine Maatoug, Maître de Conférence à l'Ecole Supérieure des Sciences et Technologies de Hammam Sousse, de m'avoir fait l'honneur d'accepter d'être rapporteur et membre du jury.

Je souhaite remercier vivement le Professeur Mohamed Sifi, Directeur de l'Institut Préparatoire Aux Etudes d'Ingénieurs de Tunis de m'avoir fait l'honneur d'accepter d'être membre du jury.

Mes plus sincères remerciements à Monsieur Sami Omar, Maître de Conférence à l'Ecole Supérieure des Sciences et Techniques de Tunis, pour son acceptation d'être membre du jury.

Je voudrais remercier Monsieur Sami Baraket, Professeur à la Faculté des Sciences de Tunis, de m'avoir accueilli dans son équipe de recherche Analyse non linéaire et géométrie.

Je remercie tous mes collègues de l'Ecole Supérieure des Sciences et Techniques de Tunis avec une attention particulière à Monsieur Abdeljelil Baccari.

Je remercie tous mes collègues du département de mathématiques de la Faculté des Sciences de Tunis avec une attention particulière à Monsieur Nejmeddine Chorfi, Mme Amel Baraket et Mme Ines Ben Omrane.

Mes remerciements vont aussi à tous mes amis avec une attention particulière à Mohamed Jleli, Habib Yazidi, Taysir Goucha et Abdelhamid Zaghdani.

Un grand merci à ma tante Fathia Samet et à son mari Jilani Lamlouli. Je remercie aussi mon beau-père Mohamed Jrad et ma belle-mère Fattouma Jrad.

Je tiens à remercier mes parents et ma sœur pour leur aide et leurs encouragements. Enfin, je remercie ma femme Ikram de m'avoir toujours soutenu et pour sa patience.

Bessem

Curriculum Vitae

Curriculum Vitae

Nom et Prénom : SAMET Bessem

Date et lieu de naissance : Né le 05 Mai 1976 à Tunis.

Situation de famille : Marié.

Nationalité : Tunisienne.

Adresse Personnelle : Cité de Marché, Bloc G appart n°50, Megrine 2033, Tunis.

Adresse Professionnelle : Ecole Supérieure des Sciences et Techniques de Tunis, Département de Mathématiques, 5, Avenue Taha Hussein-Tunis, B.P. :56, Bab Menara-1008, Tunisie.

Tél : 97978938

E-mail : bessem.samet@gmail.com

Site web : www.sametbessem.com

Situation actuelle : Maître Assistant en Mathématiques Appliquées à l'Ecole Supérieure des Sciences et Techniques de Tunis (ESSTT).

Cursus universitaire

● 29 Mars 2004 : **Thèse de Doctorat en Mathématiques Appliquées de l'Université Paul Sabatier de Toulouse (France).**

-Titre : Analyse asymptotique topologique pour les équations de Maxwell et applications.

-Directeur de thèse : Mohamed Masmoudi (Université Paul Sabatier de Toulouse).

-Rapporteurs : Jacques Blum (Université de Nice-Sophia-Antipolis), Habib Ammari (CNRS), Xavier Antoine (Université Paul Sabatier), Jean-Claude Nedelec (Ecole Polytechnique, Palaiseau).

-**Mention : Très honorable.**

● 1999-2000 : **DEA en Mathématiques Appliquées à l'Université Paul Sabatier de Toulouse.**

-**Mention : Assez Bien.**

● 1998-1999 : **Maitrise de Mathématiques à la faculté des Sciences de Tunis.**

-**Mention : Bien.**

● Juin 1994 : **Baccalauréat, section Mathématiques.**

Activité en matière d'enseignements

Enseignements

● 2001-2003 : **Vacataire à l'Institut National des Sciences Appliquées de Toulouse.**

Matières enseignées :

– TD d'Optimisation en 4^{ème} année de Génie Mathématique.

– TP d'Optimisation sur Matlab en 4^{ème} année de Génie Mathématique.

- 2003-2004 : **Attaché Temporaire d’Enseignements et de Recherche à l’Institut National des Sciences Appliquées de Toulouse.**

Matières enseignées : TD de Mathématiques générales niveau Bac+3 dans les filières Génie Civil et Génie Mécanique : Transformée de Laplace, Fourier, Introduction aux E.D.P, Optimisation.

- 2004 - 2007 : **Assistant à l’Ecole Supérieure des Sciences et Techniques de Tunis.**

Matières enseignées :

- 2004-2005 :
 - TD d’Algèbre et Géométrie en seconde année tronc commun.
 - TD d’Analyse Numérique en troisième année Physiques Appliquées.
- 2005-2006 :
 - TD d’Analyse en première année tronc commun.
 - TD d’Analyse Numérique en deuxième année Mathématiques et Informatiques.
- 2006-2007 :
 - Cours et TD d’Analyse Numérique en troisième année Physiques Appliquées.
 - TD d’Analyse en première année tronc commun.

- Depuis 2007 : **Maître Assistant à l’Ecole Supérieure des Sciences et Techniques de Tunis.**

Matières enseignées :

- 2007-2008 :
 - Cours et TD d’Analyse en première année License appliquée et fondamentale.
 - Cours et TD d’Analyse Numérique en troisième année Physiques Appliquées.
- 2008-2010 : Cours et TD d’Analyse en première année cycle préparatoire.

Activités pédagogiques

Analyse première année cours et exercices corrigés (en collaboration avec Mohamed Jleli), Livre publié par le Centre de Publication Universitaire.

Activité en matière de recherche

Thèmes de recherche

- Optimisation de formes.
- Equations aux dérivées partielles.
- Analyse de convexité.
- Théorie du point fixe.

Equipe de recherche

Depuis 2007, je suis membre de l’unité de recherche : **Analyse non linéaire et géométrie** dirigée par Professeur Sami Baraket.

Encadrement

Co-encadrement avec Professeur Sami Baraket de Ines Ben Omrane dans sa Thèse intitulée : *Etude de quelques équations aux dérivées partielles non-linéaires issues de la géométrie et de la physique.*

Publications scientifiques

1. I. B. Omrane, M. Jleli, B. Samet, The Wentz problem associated to the modified Helmholtz operator on weighted Sobolev spaces, **accepted (2009) in Advanced Nonlinear Studies**
2. B. Samet, Topological sensitivity analysis with respect to a small hole located at the boundary of the domain, **Asymptotic Analysis. 66 (1) (2010) 35-49.**
3. B. Samet, H. Yazidi, An extension of Banach fixed point theorem for mappings satisfying a contractive condition of integral type, **accepted (2009) in Italian Journal of Pure and Applied Mathematics.**
4. B. Samet, A fixed point theorem in a generalized metric space for mappings satisfying a contractive condition of integral type, **Int. Journal of Math. Analysis. 3 (26) (2009) 1256-1271.**
5. M. Jleli, B. Samet, The Kannan's fixed point theorem in a cone rectangular metric space, **J.Nonlinear Sci. Appl. 2 (3) (2009) 161-167.**
6. A. Baccari, B. Samet, An extension of Polyak's theorem in a Hilbert space, **J. Optim Theory Appl. 140 (2009) 409-418.**
7. M. Jleli, B. Samet, The Wentz problem associated to the modified Helmholtz operator, **J. Math. Anal. Appl. 339 (2008) 332-343.**
8. M. Jleli, B. Samet, Generalization of the Wentz problem for a large class of operators, **International Journal of Modern Mathematics. 2(2) (2007) 205-216.**
9. M. Masmoudi, J. Pommier, B. Samet, The topological asymptotic expansion for the Maxwell equations and some applications, **Inverse problems. 21 (2005) 547-564.**
10. J. Pommier, B. Samet, The topological asymptotic for the Helmholtz equation with Dirichlet condition on the boundary of an arbitrarily shaped hole, **SIAM Journal On Control and Optimization. 43(3) (2004) 899-921.**
11. M. Masmoudi, P. Mader, B. Samet, The topological asymptotic expansion and its applications to optimal design, **European Congress on Computational Methods in Applied Sciences and Engineering, 2004.**
12. S. Amstutz, N. Dominguez, B. Samet, Sensitivity analysis with respect to the insertion of small inhomogeneities, **European Congress on Computational Methods in Applied Sciences and Engineering, 2004.**
13. M. Masmoudi, B. Samet, Application of the topological asymptotic expansion to inverse scattering problems, **Numerical Methods For Scientific Computing Variational Problems And Applications, 2003.**
14. B. Samet, The topological asymptotic with respect to a singular boundary perturbation, **CR Acad. Sci. Paris, Ser. I 336 (2003) 1033-1038.**
15. B. Samet, S. Amstutz, M. Masmoudi, The topological asymptotic for the Helmholtz equation, **SIAM Journal On Control and Optimization. 42(5) (2003) 1523-1544.**

Communications

1. L'asymptotique topologique pour l'équation de Helmholtz, **Dans 35 ème Congrès National d'Analyse Numérique, La Grande Motte, France, 2003.**
2. The topological asymptotic for the Maxwell equations, **Colloque du GDR, Applications Nouvelles de l'Optimisation de Forme, Luminy, Juillet 2003.**

Synthèse des travaux de recherche

Synthèse des travaux

Ce mémoire regroupe les résultats obtenus durant la préparation de mon doctorat en Mathématiques Appliquées à l'université Paul Sabatier de Toulouse et après le doctorat. Quatre thèmes distincts ont été développés :

- La méthode de la dérivée topologique en optimisation de formes et applications,
- Constante optimale dans l'inégalité de Wente pour l'opérateur de Helmholtz modifié,
- Convexité par transformation quadratique en dimension infinie,
- Quelques généralisations du principe de contraction de Banach.

Thème I. La dérivée topologique en optimisation de formes (Articles 1-8)

◆ Introduction

L'optimisation de formes est un thème très porteur en Mathématiques Appliquées. L'un de ses attraits est que cette discipline marie les techniques les plus fines de l'analyse moderne aux applications industrielles les plus concrètes et aux secteurs de haute technologie (électromagnétisme, aéronautique, automobile, matériaux...). Elle consiste à rechercher la géométrie d'un objet qui soit optimale vis à vis de certains critères.

De manière assez générale, les problèmes d'optimisation de formes rencontrés dans les sciences de l'ingénieur peuvent être modélisés de la façon suivante :

$$\min_{\Omega \in \mathcal{O}} J(\Omega, u_\Omega), \quad (1)$$

où \mathcal{O} est un ensemble de domaines admissibles et u_Ω est la solution d'une certaine équation aux dérivées partielles posée dans Ω .

En dehors des méthodes stochastiques comme les algorithmes génétiques [13] qui restent d'un coût de calcul élevé, les techniques usuelles d'optimisation requièrent le calcul de la dérivée de la fonction coût. Il apparaît donc important de pouvoir disposer de la dérivée du critère qu'on souhaite minimiser. Et c'est là que les difficultés commencent ! En effet, pour des raisons évidentes, on a l'habitude de ne définir une notion de différentiabilité que dans des espaces vectoriels normés. Or l'ensemble des domaines de \mathbb{R}^N n'est pas muni d'une telle structure d'espace vectoriel.

Plusieurs possibilités ont été étudiées :

- En optimisation de formes classique [5,11], chaque domaine $\Omega \in \mathcal{O}$ est écrit sous la forme $\Omega = F(\Omega_0)$, où Ω_0 est un domaine de référence et F est une fonction de transport. C'est l'application F qui est utilisée comme paramétrisation. Dans ces conditions, une variation infinitésimale de forme se traduit uniquement par un petit déplacement de la frontière du domaine. Dans ce cadre, la topologie ne peut pas changer. Par exemple, si Ω_0 est simplement connexe, alors tous les domaines Ω obtenus par itérations successives seront simplement

connexes. C'est le principal défaut de la méthode, car dans beaucoup d'applications, les bonnes géométries contiennent un certain nombre de trous, nombre qui n'est pas connu a priori.

- L'optimisation de formes topologique consiste à rechercher la géométrie d'un objet qui soit optimale vis à vis d'un critère donné, sans connaissance a priori sur sa topologie, c'est-à-dire sur le nombre de trous qu'il peut contenir. Plusieurs stratégies ont été élaborées pour y parvenir : la méthode des lignes de niveaux (level-sets) [2], la méthode d'homogénéisation [1, 12] et la méthode de la dérivée topologique.

La méthode qui nous intéresse ici est la méthode de la dérivée topologique. Elle consiste à étudier le comportement du critère lors de la création d'un petit trou à l'intérieur du domaine. En effet, le calcul de son développement asymptotique par rapport à la taille du trou fournit une direction de descente qui est à la base de nouveaux algorithmes d'optimisation de formes.

Plus précisément, soit Ω un ouvert borné de \mathbb{R}^N ($N = 2$ ou 3) et $\mathcal{J}(\Omega) = J(\Omega, u_\Omega)$ est le critère à minimiser. Nous notons $B(x, \varepsilon)$ la boule ouverte de centre $x \in \Omega$ et de rayon $\varepsilon > 0$ et $\overline{B(x, \varepsilon)}$ désigne la fermeture de $B(x, \varepsilon)$. Dans la plus part des cas, la variation $\mathcal{J}(\Omega \setminus \overline{B(x, \varepsilon)}) - \mathcal{J}(\Omega)$ admet un développement asymptotique par rapport à $\varepsilon \rightarrow 0$ sous la forme :

$$\mathcal{J}(\Omega \setminus \overline{B(x, \varepsilon)}) - \mathcal{J}(\Omega) = f(\varepsilon)g(x) + o(f(\varepsilon)), \quad (2)$$

où $f(\varepsilon) > 0$, $f(\varepsilon) \rightarrow 0$ quand $\varepsilon \rightarrow 0$, et g est une fonction qui dépend seulement de x . L'expression (2) est appelée asymptotique topologique et la fonction g est appelée dérivée (ou gradient) topologique. A chaque itération, un certain pourcentage de matière est enlevé ou inséré (selon la nature du problème) aux endroits où g est la plus négative. Ainsi, la forme optimale Ω^* est caractérisée par :

$$g(x) \geq 0, \quad \forall x \in \Omega^*.$$

Cette méthode nécessite donc de connaître $f(\varepsilon)$ et $g(x)$. Ces quantités dépendent de l'équation aux dérivées partielles vérifiée par u_Ω et la condition aux limites imposée sur le bord du trou. La dérivée topologique g s'exprime en général en fonction de u_Ω et p_Ω , où p_Ω est l'état adjoint défini sur le domaine Ω . Ainsi, pour calculer g , deux EDP sont à résoudre : une EDP pour calculer u_Ω et une autre pour calculer p_Ω .

Les premiers travaux sur ce sujet sont dus à A. M. IL'IN [8], V. Maz'ya, S. Nazarov et B. Plamenevskij [10]. Ils ont obtenu des développements asymptotiques à un ordre quelconque de la variation de la solution et de certaines fonctions coût (énergie, première valeur propre) pour divers problèmes de la physique et un grand nombre de perturbations de domaine. A. Schumacher [14] eut le premier l'idée d'utiliser ce genre de développements en optimisation de forme : en élasticité linéaire, il a déterminé la variation à l'ordre 1 de la compliance par rapport à la taille d'un trou inséré à l'intérieur du domaine, ce qui le renseignait sur le meilleur endroit où alléger la structure. Puis, toujours en élasticité, J. Sokolowski et A. Zochowski [15] ont étendu ce résultat à une certaine catégorie de fonctions coût. Ensuite, en utilisant une technique de troncature de domaine et une généralisation de la méthode adjointe, M. Masmoudi [9] a obtenu l'asymptotique topologique pour l'équation de Laplace avec condition de Dirichlet au bord d'un trou circulaire. Cette méthodologie a ensuite été adaptée à l'étude de trous de forme quelconque avec condition de Dirichlet ou de Neumann [6,7].

Sur ce sujet, nous avons établi des formules d'asymptotique topologique pour des problèmes plus difficiles que ceux considérés jusqu'alors :

- Equation de Helmholtz en dimension 2 et 3 avec une condition de Dirichlet sur le bord du trou [Articles 1-3, 5],
- Equation de Helmholtz en dimension 2 et 3 par rapport à une inhomogénéité [Articles 4-5],
- Equations de Maxwell en dimension 3 par rapport à une inhomogénéité [Article 6],

– Equation de Laplace avec un trou sur le bord du domaine [Articles 7-8].

Sur le plan numérique, nous avons confirmé que la méthode de la dérivée topologique était d'une grande efficacité dans de nombreux domaines : optimisation de guides d'onde en dimension 2 et 3 (Articles 1,5), détection de mines enfouis dans un sol (Articles 2-3), identification d'objets diélectriques (Article 4), détection d'objets métalliques en dimension 3 (Article 6).

◆ Equation de Helmholtz : condition de Dirichlet sur le bord du trou

Soit Ω un domaine borné de \mathbb{R}^N ($N = 2$ ou 3) de frontière Γ assez régulière. Le critère à minimiser est défini par :

$$j(0) = \mathcal{J}(\Omega) = J(u_\Omega) = F(u_{\Omega|\mathcal{D}}), \quad (3)$$

où \mathcal{D} est domaine voisin du bord Γ , $u_\Omega \in H^1(\Omega)$ est la solution du problème :

$$\begin{cases} \Delta u_\Omega + \alpha u_\Omega &= 0 & \text{dans } \Omega, \\ \partial_n u_\Omega &= h & \text{sur } \Gamma, \end{cases} \quad (4)$$

avec $\alpha = k^2$, $k \in \mathbb{C}^*$, ∂_n la dérivée normale sur Γ , $h \in H^{-1/2}(\Gamma)$ et $F : H^1(\mathcal{D}) \rightarrow \mathbb{R}$ une fonction assez régulière.

Soit ω un ouvert borné de \mathbb{R}^N contenant l'origine et $x_0 \in \Omega$. Pour tout paramètre positif ε suffisamment petit, nous définissons la cavité $\omega_\varepsilon = x_0 + \varepsilon\omega$ et le domaine perforé $\Omega_\varepsilon = \Omega \setminus \overline{\omega_\varepsilon}$. Un changement de coordonnées nous permet d'imposer pour l'étude théorique $x_0 = 0$. Nous nous intéressons à $u_{\Omega_\varepsilon} \in H^1(\Omega_\varepsilon)$ la solution du problème perturbé :

$$\begin{cases} \Delta u_{\Omega_\varepsilon} + \alpha u_{\Omega_\varepsilon} &= 0 & \text{dans } \Omega_\varepsilon, \\ u_{\Omega_\varepsilon} &= 0 & \text{sur } \partial\omega_\varepsilon, \\ \partial_n u_{\Omega_\varepsilon} &= h & \text{sur } \Gamma. \end{cases} \quad (5)$$

On pose :

$$j(\varepsilon) = \mathcal{J}(\Omega_\varepsilon) = J(u_{\Omega_\varepsilon}) = F(u_{\Omega_\varepsilon|\mathcal{D}}), \quad \forall \varepsilon > 0. \quad (6)$$

Nous rechercherons le comportement asymptotique de la différence $j(\varepsilon) - j(0)$ lorsque ε tend vers zéro.

Remarque. La condition aux limites sur Γ est sans influence sur la sensibilité topologique. Elle pourrait être remplacée par n'importe quelle condition telle que les problèmes (4) et (5) soient bien posés.

La méthode adjointe généralisée

Nous rappelons que cette méthode a été introduite par M. Masmoudi dans [9]. Nous la généralisons au cas un peu plus compliqué d'un champs complexe et d'un problème non coercif.

Soit \mathcal{V} un espace de Hilbert sur \mathbb{C} . Pour tout $\varepsilon \geq 0$, on considère une forme sesquilinéaire et continue a_ε sur \mathcal{V} . On suppose qu'il existe une constante $A > 0$ telle que :

$$\inf_{u \neq 0} \sup_{v \neq 0} \frac{|a_0(u, v)|}{\|u\|_{\mathcal{V}} \|v\|_{\mathcal{V}}} \geq A. \quad (7)$$

On dit que a_0 satisfait la condition inf-sup ou encore la condition de coercivité généralisée. On suppose aussi qu'il existe une forme sesquilinéaire et continue δ_a sur \mathcal{V} telle que :

$$\|a_\varepsilon - a_0 - f(\varepsilon)\delta_a\|_{\mathcal{L}_2(\mathcal{V})} = o(f(\varepsilon)), \quad (8)$$

où $f(\varepsilon) > 0$ et $f(\varepsilon) \rightarrow 0$ quand $\varepsilon \rightarrow 0$. Ici, $\|\cdot\|_{\mathcal{L}_2(\mathcal{V})}$ désigne la norme sur l'espace des formes sesquilinéaires sur \mathcal{V} . Pour tout $\varepsilon \geq 0$, on pose $u_\varepsilon \in \mathcal{V}$ le solution de :

$$a_\varepsilon(u_\varepsilon, v) = \ell(v), \quad \forall v \in \mathcal{V}, \quad (9)$$

où ℓ est une forme semilinéaire sur \mathcal{V} .

Proposition 1. *Sous les hypothèses (7) et (8), on a :*

$$\|u_\varepsilon - u_0\|_{\mathcal{V}} = O(f(\varepsilon)).$$

En effet, la condition inf-sup vérifiée par a_0 implique l'existence de $v_\varepsilon \in \mathcal{V}$, $v_\varepsilon \neq 0$ tel que :

$$A\|u_\varepsilon - u_0\|_{\mathcal{V}}\|v_\varepsilon\|_{\mathcal{V}} \leq |a_\varepsilon(u_\varepsilon - u_0, v_\varepsilon)|,$$

ce qui implique

$$\begin{aligned} A\|u_\varepsilon - u_0\|_{\mathcal{V}}\|v_\varepsilon\|_{\mathcal{V}} &\leq |a_\varepsilon(u_0, v_\varepsilon) - \ell(v_\varepsilon)| \\ &= |a_\varepsilon(u_0, v_\varepsilon) - a_0(u_0, v_\varepsilon)| \\ &= |(a_\varepsilon - a_0 - f(\varepsilon)\delta_a)(u_0, v_\varepsilon) + f(\varepsilon)\delta_a(u_0, v_\varepsilon)| \\ &\leq o(f(\varepsilon))\|u_0\|_{\mathcal{V}}\|v_\varepsilon\|_{\mathcal{V}} + f(\varepsilon)\|\delta_a\|_{\mathcal{L}_2(\mathcal{V})}\|u_0\|_{\mathcal{V}}\|v_\varepsilon\|_{\mathcal{V}}. \end{aligned}$$

On simplifie par $\|v_\varepsilon\|_{\mathcal{V}}$, on obtient :

$$\|u_\varepsilon - u_0\|_{\mathcal{V}} \leq \frac{\|u_0\|_{\mathcal{V}}}{A} (o(f(\varepsilon)) + f(\varepsilon)\|\delta_a\|_{\mathcal{L}_2(\mathcal{V})}) = O(f(\varepsilon)),$$

d'où le résultat. ■

On considère maintenant la fonction coût :

$$j(\varepsilon) = J(u_\varepsilon), \quad \forall \varepsilon \geq 0,$$

où $J : \mathcal{V} \rightarrow \mathbb{R}$ vérifie :

$$J(u + h) = J(u) + \mathcal{R}(L_u(h)) + o(\|h\|_{\mathcal{V}}), \quad \forall u, h \in \mathcal{V}. \quad (10)$$

Ici, \mathcal{R} désigne la partie réelle d'un nombre complexe et L_u est une forme linéaire et continue sur \mathcal{V} . On pose $p_0 \in \mathcal{V}$ la solution de :

$$a_0(v, p_0) = -L_{u_0}(v), \quad \forall v \in \mathcal{V}. \quad (11)$$

On appelle p_0 l'état adjoint associé à la fonction coût J . Le résultat suivant nous donne l'expression asymptotique de la variation $j(\varepsilon) - j(0)$ par rapport à $\varepsilon \rightarrow 0$.

Théorème 1. *Sous les hypothèses (7), (8) et (10), on a :*

$$j(\varepsilon) = j(0) + f(\varepsilon)\mathcal{R}(\delta_a(u_0, p_0)) + o(f(\varepsilon)).$$

On écrit :

$$\begin{aligned}
j(\varepsilon) - j(0) &= J(u_\varepsilon) - J(u_0) \\
&= J(u_\varepsilon) - J(u_0) + \mathcal{R}(a_\varepsilon(u_\varepsilon, p_0) - a_0(u_0, p_0)) \\
&= J(u_\varepsilon) - J(u_0) + \mathcal{R}(a_\varepsilon(u_\varepsilon, p_0) - a_0(u_\varepsilon, p_0) + a_0(u_\varepsilon - u_0, p_0)) \\
&= \mathcal{R}(L_{u_0}(u_\varepsilon - u_0) + a_0(u_\varepsilon - u_0, p_0)) + o(\|u_\varepsilon - u_0\|_{\mathcal{V}}) + \mathcal{R}((a_\varepsilon - a_0)(u_0, p_0)) \\
&\quad + \mathcal{R}((a_\varepsilon - a_0)(u_\varepsilon - u_0, p_0)) \\
&= \mathcal{R}((a_\varepsilon - a_0 - f(\varepsilon)\delta_a)(u_0, p_0)) + f(\varepsilon)\mathcal{R}(\delta_a(u_0, p_0)) + \mathcal{R}((a_\varepsilon - a_0 - f(\varepsilon)\delta_a)(u_\varepsilon - u_0, p_0)) \\
&\quad + f(\varepsilon)\mathcal{R}(\delta_a(u_\varepsilon - u_0, p_0)) \\
&= f(\varepsilon)\mathcal{R}(\delta_a(u_0, p_0)) + o(f(\varepsilon)).
\end{aligned}$$

D'où le résultat. ■

La troncature de domaine

Le problème perturbé (5) est posé sur un espace fonctionnel qui dépend de ε :

$$\mathcal{V}_\varepsilon = \{u \in H^1(\Omega_\varepsilon) \mid u|_{\partial\omega_\varepsilon} = 0\}.$$

La méthode adjointe généralisée nécessite un espace fonctionnel \mathcal{V} indépendant de ε . La technique de troncature fournit une formulation équivalente posée dans le domaine fixe :

$$\Omega_R = \Omega \setminus \overline{B(0, R)}, \quad 0 < \varepsilon < R.$$

On pose :

$$\Gamma_R = \partial B(0, R).$$

Pour $\varepsilon > 0$, soit $T_\varepsilon : H^{1/2}(\Gamma_R) \rightarrow H^{-1/2}(\Gamma_R)$ l'opérateur Dirichlet-to-Neumann défini par :

$$T_\varepsilon \varphi = \partial_n u_\varepsilon^\varphi,$$

où u_ε^φ est la solution de :

$$\begin{cases} \Delta u_\varepsilon^\varphi + \alpha u_\varepsilon^\varphi = 0 & \text{dans } B(0, R) \setminus \overline{\omega_\varepsilon}, \\ u_\varepsilon^\varphi = \varphi & \text{sur } \Gamma_R, \\ u_\varepsilon^\varphi = 0 & \text{sur } \partial\omega_\varepsilon. \end{cases}$$

Pour $\varepsilon = 0$, soit $T_0 : H^{1/2}(\Gamma_R) \rightarrow H^{-1/2}(\Gamma_R)$ l'opérateur Dirichlet-to-Neumann défini par :

$$T_0 \varphi = \partial_n u_0^\varphi,$$

où u_0^φ est la solution de :

$$\begin{cases} \Delta u_0^\varphi + \alpha u_0^\varphi = 0 & \text{dans } B(0, R), \\ u_0^\varphi = \varphi & \text{sur } \Gamma_R. \end{cases}$$

On définit l'espace fonctionnel fixe exigé par la méthode adjointe généralisée par :

$$\mathcal{V} = H^1(\Omega_R).$$

Soit $u_0 \in \mathcal{V}$ la solution du problème (4) tronqué :

$$\begin{cases} \Delta u_0 + \alpha u_0 & = 0 & \text{dans } \Omega_R, \\ \partial_n u_0 + T_0 u_0 & = 0 & \text{sur } \Gamma_R, \\ \partial_n u_0 & = h & \text{sur } \Gamma. \end{cases} \quad (12)$$

Pour $\varepsilon > 0$, soit $u_\varepsilon \in \mathcal{V}$ la solution du problème (5) tronqué :

$$\begin{cases} \Delta u_\varepsilon + \alpha u_\varepsilon & = 0 & \text{dans } \Omega_R, \\ \partial_n u_\varepsilon + T_\varepsilon u_\varepsilon & = 0 & \text{sur } \Gamma_R, \\ \partial_n u_\varepsilon & = h & \text{sur } \Gamma. \end{cases} \quad (13)$$

Par construction, on la

Proposition 2. *On a u_0 est la restriction à Ω_R de la solution u_Ω de (4). Pour tout $\varepsilon > 0$, u_ε est la restriction à Ω_R de la solution u_{Ω_ε} de (5).*

La fonction coût (6) peut s'écrire alors sous la forme :

$$j(\varepsilon) = J(u_\varepsilon), \quad \forall \varepsilon \geq 0,$$

avec

$$a_\varepsilon(u_\varepsilon, v) = \ell(v), \quad \forall v \in \mathcal{V},$$

où

$$a_\varepsilon(u, v) = \int_{\Omega_R} \nabla u(x) \cdot \overline{\nabla v}(x) \, dx - \alpha \int_{\Omega_R} u(x) \cdot \overline{v}(x) \, dx + \int_{\Gamma_R} T_\varepsilon u \cdot \overline{v} \, ds, \quad \forall u, v \in \mathcal{V}$$

et

$$\ell(v) = \int_{\Gamma} h \cdot \overline{v} \, ds, \quad \forall v \in \mathcal{V}.$$

Pour pouvoir appliquer Théorème 1, il faut alors regarder le comportement asymptotique de la variation $a_\varepsilon - a_0$. On voit facilement que :

$$(a_\varepsilon - a_0)(u, v) = \int_{\Gamma_R} (T_\varepsilon - T_0)u \cdot \overline{v} \, ds, \quad \forall u, v \in \mathcal{V}. \quad (14)$$

L'étude est ainsi ramenée au calcul asymptotique de la variation $T_\varepsilon - T_0$.

Le cas N=2 pour un trou circulaire [Article 1]

Dans le cas de dimension $N = 2$, où $\omega_\varepsilon = B(0, \varepsilon)$, on montre que :

$$\|T_\varepsilon - T_0 - R(\varepsilon)\delta_T\|_{\mathcal{L}(H^{1/2}(\Gamma_R), H^{-1/2}(\Gamma_R))} = o(f(\varepsilon)), \quad (15)$$

où

$$R(\varepsilon) = \frac{-1}{\log \varepsilon}$$

et $\delta_T : H^{1/2}(\Gamma_R) \rightarrow H^{-1/2}(\Gamma_R)$ est défini par :

$$\delta_T \varphi = \frac{1}{R J_0^2(kR)} \varphi_0, \quad (16)$$

où J_0 est la fonction de Bessel de première espèce d'ordre zéro et φ_0 est le coefficient de Fourier de φ d'ordre zéro. Par (14) et (16), on obtient :

$$\|a_\varepsilon - a_0 - f(\varepsilon)\delta_a\|_{\mathcal{L}_2(\mathcal{V})} = o(f(\varepsilon)),$$

où

$$f(\varepsilon) = \frac{-2\pi}{\log \varepsilon}$$

et

$$\delta_a(u, v) = \frac{u^{mean}}{J_0(kR)} \cdot \frac{\overline{v^{mean}}}{J_0(kR)}, \quad \forall u, v \in \mathcal{V}.$$

Ici, u^{mean} et v^{mean} sont respectivement les valeurs moyennes de u et de v sur Γ_R . En particulier, pour $u = u_0$ et $v = p_0$ (l'état adjoint tronqué), on obtient :

$$\delta_a(u_0, p_0) = u_0(0) \cdot \overline{p_0}(0) = u_\Omega(0) \cdot \overline{p_\Omega}(0),$$

où p_Ω est l'état adjoint initial défini sur Ω . Finalement, par Théorème 1, on obtient :

$$\mathcal{J}(\Omega \setminus \overline{B(0, \varepsilon)}) = \mathcal{J}(\Omega) + \frac{-2\pi}{\log \varepsilon} \mathcal{R}(u_\Omega(0) \cdot \overline{p_\Omega}(0)) + o\left(\frac{1}{\log \varepsilon}\right). \quad (17)$$

Remarque. On montre (voir Article 2) qu'en dimension $N = 2$, la formule (17) est indépendante de la forme du trou.

Le cas N=3 pour un trou de forme quelconque [Articles 2,3,5]

Dans le cas où ω est un trou de forme quelconque, nous proposons la technique suivante pour obtenir un développement asymptotique de $T_\varepsilon - T_0$. L'idée principale consiste à approcher $u_\varepsilon^\varphi - u_0^\varphi$ par la solution d'un problème extérieur à ω_ε , où seulement la partie principale de l'opérateur non-homogène est considérée. Plus précisément, pour étudier la variation $(T_\varepsilon - T_0)\varphi$, $\varphi \in H^{1/2}(\Gamma_R)$, nous regardons d'abord le comportement asymptotique de $u_\varepsilon^\varphi - u_0^\varphi$, ce qui est naturel vu que :

$$(T_\varepsilon - T_0)\varphi = \partial_n(u_\varepsilon^\varphi - u_0^\varphi).$$

La variation $u_\varepsilon^\varphi - u_0^\varphi$ est solution de :

$$\begin{cases} \Delta(u_\varepsilon^\varphi - u_0^\varphi) + \alpha(u_\varepsilon^\varphi - u_0^\varphi) = 0 & \text{dans } B(0, R) \setminus \overline{\omega_\varepsilon}, \\ u_\varepsilon^\varphi - u_0^\varphi = 0 & \text{sur } \Gamma_R, \\ u_\varepsilon^\varphi - u_0^\varphi = -u_0^\varphi & \text{sur } \partial\omega_\varepsilon. \end{cases}$$

Nous approchons $u_\varepsilon^\varphi - u_0^\varphi$ par $u_{\varepsilon, \varphi}$ solution de :

$$\begin{cases} \Delta u_{\varepsilon, \varphi} + \alpha u_{\varepsilon, \varphi} = 0 & \text{dans } B(0, R) \setminus \overline{\omega_\varepsilon}, \\ u_{\varepsilon, \varphi} = 0 & \text{sur } \Gamma_R, \\ u_{\varepsilon, \varphi} = -u_0^\varphi(0) & \text{sur } \partial\omega_\varepsilon. \end{cases}$$

Cette première approche se justifie facilement par l'utilisation d'un développement de Taylor de u_0^φ . Nous approchons ensuite $u_{\varepsilon, \varphi}$ par v_ε^φ , où

$$v_\varepsilon^\varphi(x) = v_\omega^\varphi(x/\varepsilon)$$

et v_ω^φ est la solution du problème extérieur :

$$\begin{cases} \Delta v_\omega^\varphi = 0 & \text{dans } \mathbb{R}^3 \setminus \bar{\omega}, \\ v_\omega^\varphi = 0 & \text{à } \infty, \\ v_\omega^\varphi = -u_0^\varphi(0) & \text{sur } \partial\omega. \end{cases}$$

Nous exprimons v_ε^φ sous la forme :

$$v_\varepsilon^\varphi(x) = \varepsilon \left(\int_{\partial\omega} p_\omega(x) ds \right) E(x) + O(\varepsilon^2),$$

où E est la solution fondamentale du laplacien et $p_\omega \in H^{-1/2}(\partial\omega)$ est la solution de l'équation intégrale :

$$\int_{\partial\omega} E(y-x)p_\omega(x) ds = -u_0^\varphi(0), \quad \forall y \in \partial\omega.$$

En posant :

$$P_\omega^\varphi(x) = \left(\int_{\partial\omega} p_\omega(x) ds \right) E(x),$$

nous obtenons :

$$(u_\varepsilon^\varphi - u_0^\varphi)(x) = \varepsilon P_\omega^\varphi(x) + \mathcal{E}(x), \quad (18)$$

où $\mathcal{E}(x)$ est un reste.

Si nous introduisons l'opérateur δ_T défini par :

$$\delta_T \varphi = \partial_n P_\omega^\varphi, \quad \forall \varphi \in H^{1/2}(\Gamma_R),$$

où ∂_n est la dérivée normale sur Γ_R , nous obtenons :

$$\|T_\varepsilon - T_0 - \varepsilon \delta_T\|_{\mathcal{L}(H^{1/2}(\Gamma_R), H^{-1/2}(\Gamma_R))} = O(\varepsilon).$$

Ce résultat est non exploitable, la méthode adjointe généralisée exige $o(\varepsilon)$ et non $O(\varepsilon)$. C'est ici qu'intervient le fait que l'opérateur considéré (opérateur de Helmholtz) est non-homogène. Pour cela, nous corrigeons l'approximation (18) par la prise en compte du terme diagonal, en utilisant un terme correctif Q_ω^φ , solution de :

$$\begin{cases} \Delta Q_\omega^\varphi + \alpha Q_\omega^\varphi = \alpha P_\omega^\varphi & \text{dans } B(0, R), \\ Q_\omega^\varphi = P_\omega^\varphi|_{\Gamma_R} & \text{sur } \Gamma_R. \end{cases}$$

En posant δ_T l'opérateur défini par :

$$\delta_T \varphi = \partial_n (P_\omega^\varphi - Q_\omega^\varphi), \quad \forall \varphi \in H^{1/2}(\Gamma_R),$$

nous obtenons le résultat désiré :

$$\|T_\varepsilon - T_0 - \varepsilon \delta_T\|_{\mathcal{L}(H^{1/2}(\Gamma_R), H^{-1/2}(\Gamma_R))} = o(\varepsilon).$$

Enfin, par application du Théorème 1, on obtient le développement asymptotique suivant :

$$\mathcal{J}(\Omega \setminus \bar{\omega}_\varepsilon) = \mathcal{J}(\Omega) + \varepsilon \mathcal{R} [A_\omega(u_\Omega(0)) \cdot \bar{p}_\Omega(0)] + o(\varepsilon),$$

où $A_\omega(u_\Omega(0))$ est une quantité qui dépend de la forme du trou. Dans le cas particulier où ω est la sphère unité, nous obtenons :

$$\mathcal{J}(\Omega \setminus \bar{\omega}_\varepsilon) = \mathcal{J}(\Omega) + 4\pi\varepsilon \mathcal{R}(u_\Omega(0) \cdot \bar{p}_\Omega(0)) + o(\varepsilon).$$

◆ Insertion d'une inhomogénéité

Dans [Articles 4-5], nous nous intéressons à l'insertion de petites inhomogénéités dans les coefficients de l'équation de Helmholtz en dimension $N = 2$ et 3 . Plus précisément, on considère l'EDP :

$$\operatorname{div}(\alpha_\varepsilon \nabla u_\varepsilon) + \beta_\varepsilon u_\varepsilon = 0,$$

où

$$\alpha_\varepsilon(x) = \begin{cases} \alpha_0 & \text{si } x \in \Omega \setminus \overline{\omega_\varepsilon} \\ \alpha_1 & \text{si } x \in \omega_\varepsilon \end{cases} \quad \text{et} \quad \beta_\varepsilon(x) = \begin{cases} \beta_0 & \text{si } x \in \Omega \setminus \overline{\omega_\varepsilon} \\ \beta_1 & \text{si } x \in \omega_\varepsilon. \end{cases}$$

Les coefficients α_0 , α_1 , β_0 et β_1 étant des constantes réelles. Pour l'estimation de la solution, nous nous inspirons de la méthode utilisée dans [16]. La fonction coût considérée est définie par :

$$j(\varepsilon) = J_\varepsilon(u_\varepsilon), \quad \forall \varepsilon \geq 0,$$

où $J_\varepsilon : H^1(\Omega) \rightarrow \mathbb{R}$ est une fonction assez régulière. Les hypothèses demandées sur la fonction J_ε sont données dans [Article 4]. Nous avons établi le résultat suivant :

$$j(\varepsilon) - j(0) = \varepsilon^N \mathcal{R} \left\{ (\alpha_1 - \alpha_0) \nabla u_0(0)^T \cdot \mathcal{M}_\omega \overline{\nabla p_0(0)} - (\beta_1 - \beta_0) |\omega| u_0(0) \cdot \overline{p_0(0)} + \delta J \right\} + o(\varepsilon^N),$$

où p_0 est un état adjoint et \mathcal{M}_ω est une matrice qui dépend de la forme de ω . Dans le cas particulier où ω est la boule unité, nous obtenons :

$$j(\varepsilon) - j(0) = \varepsilon^N \mathcal{R} \left\{ \frac{N\alpha_0(\alpha_1 - \alpha_0)}{(N-1)\alpha_0 + \alpha_1} |\omega| \nabla u_0(0) \cdot \overline{\nabla p_0(0)} - (\beta_1 - \beta_0) |\omega| u_0(0) \cdot \overline{p_0(0)} + \delta J \right\} + o(\varepsilon^N).$$

Notons que le terme δJ qui apparaît dans ces formules dépend du choix de la fonction coût considérée.

Remarque. En prenant $\alpha_0 = 1$, $\beta_0 = k^2$ et en faisant tendre α_1 et β_1 vers 0, on trouve les formules du trou avec condition de Neumann sur le bord pour l'opérateur de Helmholtz $\Delta + k^2 I$.

Dans [Article 6], nous nous intéressons à l'insertion de petites inhomogénéités dans les coefficients des équations de Maxwell en dimension 3. Plus précisément, on considère l'EDP :

$$\nabla \times (\alpha_\varepsilon \nabla \times H_\varepsilon) + \beta_\varepsilon H_\varepsilon = 0.$$

Pour l'estimation de la solution, nous nous inspirons de la méthode utilisée dans [3]. Dans le cas d'une inhomogénéité de forme quelconque, nous obtenons :

$$j(\varepsilon) - j(0) = \varepsilon^3 \mathcal{R} \left\{ (\alpha_1 - \alpha_0) \nabla \times H_0(0) \cdot \overline{\mathcal{M}_\omega(\alpha_1/\alpha_0) \nabla \times p_0(0)} + \beta_0 (1 - \beta_0/\beta_1) H_0(0) \cdot \overline{\mathcal{M}_\omega(\beta_0/\beta_1) p_0(0)} \right\} + o(\varepsilon^3),$$

où \mathcal{M}_ω est une matrice qui dépend de la forme de ω . Dans le cas particulier où ω est la boule unité, nous obtenons :

$$j(\varepsilon) - j(0) = 4\pi \varepsilon^3 \mathcal{R} \left\{ \frac{\alpha_0(\alpha_1 - \alpha_0)}{\alpha_0 + 2\alpha_1} \nabla \times H_0(0) \cdot \overline{\nabla \times p_0(0)} + \frac{\beta_0(\beta_1 - \beta_0)}{\beta_1 + 2\beta_0} H_0(0) \cdot \overline{p_0(0)} \right\} + o(\varepsilon^3).$$

◆ Insertion d'un trou sur le bord du domaine

Dans [Article 7], nous étudions le cas d'un trou situé sur le bord du domaine. Plus précisément, nous considérons le problème suivant. Soit Ω un domaine borné du plan. Une partie Γ_0 du bord est définie par deux segments formant un angle de sommet O (l'origine) et de mesure $\lambda\pi$, $0 < \lambda \leq 2$. Nous notons u_Ω la solution du problème de Laplace posé dans le domaine Ω , vérifiant $u_\Omega = 0$ sur Γ_0 et une condition aux limites sur $\Gamma_1 = \partial\Omega \setminus \overline{\Gamma_0}$. Pour $\varepsilon > 0$ assez petit, nous considérons le domaine perturbé $\Omega_\varepsilon = \Omega \setminus \overline{S_\varepsilon}$, où S_ε est le secteur défini par :

$$S_\varepsilon = \{(r, \theta) \mid 0 \leq r < \varepsilon, 0 \leq \theta \leq \lambda\pi\}.$$

Notre but consiste à donner une expression asymptotique de la variation $J(u_{\Omega_\varepsilon}) - J(u_\Omega)$, où u_{Ω_ε} est la solution du problème de Laplace posé dans le domaine perturbé Ω_ε avec une condition de Dirichlet imposée sur l'arc de cercle joignant les deux segments du secteur S_ε . Dans le cas $\lambda^{-1} \in \mathbb{N}^*$, nous obtenons :

$$J(u_{\Omega_\varepsilon}) - J(u_\Omega) = \pi \left[\left(\frac{1}{\lambda} \right)! \right]^{-2} \varepsilon^{2/\lambda} \frac{\partial^{1/\lambda} u_\Omega}{\partial x^{1/\lambda}}(O) \frac{\partial^{1/\lambda} p_\Omega}{\partial x^{1/\lambda}}(O) + o(\varepsilon^{2/\lambda}),$$

où p_Ω est l'état adjoint. Nous remarquons que l'expression de la dérivée topologique dépend de l'angle de singularité. Plus l'angle est petit et plus des dérivées d'ordre élevé de l'état direct et l'état adjoint apparaissent.

Dans [Article 8], nous considérons un cas similaire mais avec différentes conditions aux limites sur le bord du trou : Dirichlet, Neumann et Robin.

Bibliographie

1. G. Allaire, *Shape optimization by the homogenization method*, Springer, Applied Mathematics Sciences Vol. 146, 2002.
2. G. Allaire, F. Jouve, A. M. Toader, *A level-set method for shape optimization*, C. R. Acad. Sci. Paris, Ser. I 334, pp. 1125-1130, 2002.
3. H. Ammari, M. S. Vogelius, D. Volkov, *Asymptotic formulas for perturbations in the electromagnetic fields due to the presence of inhomogeneities of small diameter II. The full Maxwell equations*, J. Math. Pures Appl. 80, pp. 769-814, 2001.
4. S. Garreau, PH. Guillaume, M. Masmoudi, *The topological asymptotic for PDE systems : the elasticity case*, SIAM J. Control Optim. 39(6), pp. 1756-1778, 2001.
5. PH. Guillaume, *Dérivées d'ordre supérieur en conception optimale de forme*, Thèse de l'Université Paul Sabatier, 1994.
6. PH. Guillaume, K. Sid Idris, *The topological asymptotic expansion for the Dirichlet problem*, SIAM J. Control Optim. 41(4), pp. 1052-1072, 2002.
7. PH. Guillaume, K. Sid Idris, *Topological sensitivity and shape optimization for the Stokes equations*, SIAM J. Control Optim. 43(1), pp. 1-31, 2004.
8. A. M. IL'IN, *Matching of asymptotic expansions of solutions of boundary value problems*, Translations of Mathematical monographs, Vol. 102, 1992.
9. M. Masmoudi, *The topological asymptotic*, Computational methods for control applications, Ed. H. Kawarada and J. Périaux, International Series GAKUTO, 2002.

10. V. Maz'ya, S. Nazarov, B. Plamenevskij, *Asymptotic theory of elliptic boundary value problems in singularly perturbed domains*, Operator theory, advances and applications, Vol. 101, Birkhäuser Verlag, 2000.
11. F. Murat, J. Simon, *Sur le contrôle par un domaine géométrique*, Thèse d'état, Paris, 1976.
12. F. Murat, L. Tartar, *Calcul des variations et homogénéisation*, Les méthodes de l'homogénéisation : théorie et applications en physique, Eyrolles, Paris, pp. 319-369, 1985.
13. M. Shoenauer, L. Kallel, F. Jouve, *Mechanics inclusions identification by evolutionary computation*, Revue européenne des éléments finis, 5(5-6), pp. 619-648, 1996.
14. A. Schumacher, *Topologieoptimisierung von Bauteilstrukturen unter Verwendung von Lopchpositionierungskriterien*, Thèse, Universität-Gesamthochschule-Siegen, 1995.
15. J. Sokolowski, A. Zochowski, *On the topological derivative in shape optimization*, Technical report, INRIA, 1997.
16. M. S. Vogelius, D. Volkov, *Asymptotic formulas for perturbations in the electromagnetic fields due to the presence of inhomogeneities of small diameter*, Math. Model. Numer. Anal. 34, pp. 723-748, 2000.

Thème II. Inégalité de Wente pour l'équation de Helmholtz modifiée (Articles 9-11)

◆ Introduction

Inégalité de Wente

Soit Ω un ouvert de \mathbb{R}^2 et $X : \Omega \rightarrow \mathbb{R}^3$ une immersion conforme, c'est-à-dire :

- X est de classe C^1 , $\text{rg}(dX(x_1, x_2)) = 2 \forall x = (x_1, x_2) \in \Omega$,
- $|X_{x_1}| \equiv |X_{x_2}|$, $(X_{x_1}, X_{x_2}) = 0$ dans Ω ,

où X_{x_i} désigne la dérivée partielle de X par rapport à la variable x_i ($i = 1, 2$) et (\cdot, \cdot) désigne le produit scalaire usuel sur \mathbb{R}^3 . On montre alors que X vérifie l'équation des surfaces à courbure moyenne prescrite :

$$-\Delta X = 2H(x_1, x_2) \cdot (X_{x_1} \times X_{x_2}), \quad (19)$$

où $H(x_1, x_2)$ représente la courbure moyenne au point $X(x_1, x_2)$ de la surface $S = X(\Omega)$ et \times désigne le produit vectoriel entre deux vecteurs de \mathbb{R}^3 . On pose :

$$X(x) = (X^1(x), X^2(x), X^3(x)), \quad \forall x \in \Omega,$$

où $X^i : \Omega \rightarrow \mathbb{R}$, $i = 1, 2, 3$. Le système (19) s'écrit alors :

$$\begin{pmatrix} -\Delta X^1 \\ -\Delta X^2 \\ -\Delta X^3 \end{pmatrix} = 2H(x) \cdot \begin{pmatrix} X_{x_1}^2 X_{x_2}^3 - X_{x_1}^3 X_{x_2}^2 \\ X_{x_1}^3 X_{x_2}^1 - X_{x_1}^1 X_{x_2}^3 \\ X_{x_1}^1 X_{x_2}^2 - X_{x_1}^2 X_{x_2}^1 \end{pmatrix}$$

ou encore :

$$\begin{cases} -\Delta X^1 &= 2H(x) \det \nabla(X^2, X^3), \\ -\Delta X^2 &= 2H(x) \det \nabla(X^3, X^1), \\ -\Delta X^3 &= 2H(x) \det \nabla(X^1, X^2). \end{cases}$$

En prenant $H(x) = H_0$ une constante, chaque composante X^i ($i = 1, 2, 3$) vérifie alors un problème du type :

$$-\Delta \Phi_0 = \det \nabla u = a_{x_1} b_{x_2} - a_{x_2} b_{x_1} \text{ dans } \Omega, \quad (20)$$

où $u = (a, b)$. Avec la condition aux limites (condition de Dirichlet) :

$$(D) : \quad \begin{cases} \Phi_0 &= 0 \text{ sur } \partial\Omega \text{ si } \Omega \text{ est borné,} \\ \Phi(x) &\rightarrow 0 \text{ quand } |x| \rightarrow +\infty \text{ si } \Omega = \mathbb{R}^2, \end{cases}$$

le problème (20)-(D) est connu en littérature sous le nom du problème de Wente classique.

Si on remplace le terme source dans (20) par une fonction quelconque $f \in L^1(\Omega)$, la solution du problème (20)-(D) sera seulement dans $W_{\text{loc}}^{1,p}(\Omega)$ avec $1 \leq p < 2$. Cependant, pour $f = a_{x_1} b_{x_2} - a_{x_2} b_{x_1}$, où $a, b \in H^1(\Omega)$, H. Wente [13] et H. Brezis, J. M. Coron [4] ont obtenu une régularité plus forte de la solution du problème (20)-(D). Ils ont obtenu le résultat suivant.

Théorème 2. (Brezis-Coron)

Soit Ω un ouvert borné et régulier de \mathbb{R}^2 . Supposons que $a, b \in H^1(\Omega)$ et soit $\Phi_0 \in W_0^{1,1}(\Omega)$ l'unique solution de (20)-(D). Alors, $\Phi_0 \in C(\bar{\Omega}) \cap H_0^1(\Omega)$ et

$$\|\Phi_0\|_{L^\infty(\Omega)} + \|\nabla \Phi_0\|_{L^2(\Omega)} \leq C(\Omega) \|\nabla a\|_{L^2(\Omega)} \|\nabla b\|_{L^2(\Omega)}, \quad (21)$$

où $C(\Omega)$ est une constante positive qui dépend de Ω .

Démonstration. On suppose pour le moment que $a, b \in \mathcal{D}(\mathbb{R}^2)$ et on pose :

$$\psi = E * (a_{x_1} b_{x_2} - a_{x_2} b_{x_1}),$$

où E est la solution fondamentale de $-\Delta$:

$$E(x_1, x_2) = \frac{1}{2\pi} \ln \left(\frac{1}{r} \right), \quad r = (x_1^2 + x_2^2)^{1/2}.$$

Alors,

$$-\Delta \psi = a_{x_1} b_{x_2} - a_{x_2} b_{x_1} \text{ dans } \mathbb{R}^2. \quad (22)$$

En coordonnées polaires, on a :

$$a_{x_1} b_{x_2} - a_{x_2} b_{x_1} = \frac{1}{r} (a_r b_\theta - a_\theta b_r) = \frac{1}{r} [(ab_\theta)_r - (ab_r)_\theta].$$

Après quelques manipulations, on obtient :

$$\psi(0) = \frac{1}{2\pi} \int_{\theta=0}^{2\pi} \int_{r=0}^{+\infty} \frac{1}{r} (ab_\theta) \, dr \, d\theta.$$

D'autre part, on a :

$$\int_0^{2\pi} ab_\theta \, d\theta = \int_0^{2\pi} (a - \bar{a}) b_\theta \, d\theta,$$

où

$$\bar{a}(r) = \frac{1}{2\pi} \int_0^{2\pi} a(r, \sigma) \, d\sigma.$$

Par l'inégalité de Cauchy-Schwartz, on obtient :

$$\left| \int_0^{2\pi} ab_\theta \, d\theta \right| \leq \|a - \bar{a}\|_{L^2(0,2\pi)} \|b_\theta\|_{L^2(0,2\pi)} \leq \|a_\theta\|_{L^2(0,2\pi)} \|b_\theta\|_{L^2(0,2\pi)}.$$

Encore par l'inégalité de Cauchy-Schwartz, on obtient :

$$\begin{aligned} |\psi(0)| &\leq \frac{1}{2\pi} \left(\int_0^{+\infty} \|a_\theta\|_{L^2(0,2\pi)}^2 \frac{1}{r} \, dr \right)^{1/2} \left(\int_0^{+\infty} \|b_\theta\|_{L^2(0,2\pi)}^2 \frac{1}{r} \, dr \right)^{1/2} \\ &\leq \frac{1}{2\pi} \|\nabla a\|_{L^2(\mathbb{R}^2)} \|\nabla b\|_{L^2(\mathbb{R}^2)}. \end{aligned}$$

Par suite, on obtient :

$$\|\psi\|_{L^\infty(\mathbb{R}^2)} \leq \frac{1}{2\pi} \|\nabla a\|_{L^2(\mathbb{R}^2)} \|\nabla b\|_{L^2(\mathbb{R}^2)}. \quad (23)$$

Par (20) et (22), on a :

$$\Delta(\Phi_0 - \psi) = 0 \text{ dans } \Omega.$$

Par le principe de maximum, on obtient :

$$\|\Phi_0 - \psi\|_{L^\infty(\Omega)} \leq \|\Phi_0 - \psi\|_{L^\infty(\partial\Omega)} = \|\psi\|_{L^\infty(\partial\Omega)}. \quad (24)$$

Ainsi, (23)-(24) nous donne :

$$\|\Phi_0\|_{L^\infty(\Omega)} \leq 2\|\psi\|_{L^\infty(\Omega)} \leq \frac{1}{\pi} \|\nabla a\|_{L^2(\mathbb{R}^2)} \|\nabla b\|_{L^2(\mathbb{R}^2)}. \quad (25)$$

En multipliant (20) par Φ_0 , on obtient :

$$\int_{\Omega} |\nabla \Phi_0|^2 \leq \|\Phi_0\|_{L^\infty(\Omega)} \|\nabla a\|_{L^2(\Omega)} \|\nabla b\|_{L^2(\Omega)} \leq \frac{1}{\pi} \|\nabla a\|_{L^2(\mathbb{R}^2)}^2 \|\nabla b\|_{L^2(\mathbb{R}^2)}^2. \quad (26)$$

Par (26)-(27), on obtient :

$$\|\Phi_0\|_{L^\infty(\Omega)} + \|\nabla \Phi_0\|_{L^2(\Omega)} \leq \left(\frac{1}{\pi} + \frac{1}{\sqrt{\pi}} \right) \|\nabla a\|_{L^2(\mathbb{R}^2)} \|\nabla b\|_{L^2(\mathbb{R}^2)}. \quad (27)$$

On regarde maintenant le cas général où $a, b \in H^1(\Omega)$. On sait qu'il existe un opérateur de prolongement

$$P : H^1(\Omega) \rightarrow H^1(\mathbb{R}^2)$$

linéaire, tel que pour tout $w \in H^1(\Omega)$

$$\begin{aligned} Pw|_{\Omega} &= w, \\ \|Pw\|_{H^1(\mathbb{R}^2)} &\leq C(\Omega) \|w\|_{H^1(\Omega)}, \end{aligned}$$

où $C(\Omega)$ dépend seulement de Ω . Dans la suite, $C(\Omega)$ désigne n'importe quelle constante dépendant de Ω . Notons $\tilde{a} = Pa \in H^1(\mathbb{R}^2)$ et $\tilde{b} = Pb \in H^1(\mathbb{R}^2)$. En utilisant la densité de $\mathcal{D}(\mathbb{R}^2)$ dans $H^1(\mathbb{R}^2)$, (27) et la bilinéarité de \det , on obtient $\Phi_0 \in C(\bar{\Omega}) \cap H_0^1(\Omega)$ et

$$\begin{aligned} \|\Phi_0\|_{L^\infty(\Omega)} + \|\nabla \Phi_0\|_{L^2(\Omega)} &\leq C(\Omega) \|\nabla \tilde{a}\|_{L^2(\mathbb{R}^2)} \|\nabla \tilde{b}\|_{L^2(\mathbb{R}^2)} \\ &\leq C(\Omega) \|a\|_{H^1(\Omega)} \|b\|_{H^1(\Omega)}. \end{aligned}$$

Posons maintenant :

$$\bar{a} = \frac{1}{|\Omega|} \int_{\Omega} a \quad \text{et} \quad \bar{b} = \frac{1}{|\Omega|} \int_{\Omega} b.$$

Il est facile de voir que Φ_0 ne change pas si on remplace a par $a - \bar{a}$ et b par $b - \bar{b}$. Par suite, on a :

$$\|\Phi_0\|_{L^\infty(\Omega)} + \|\nabla \Phi_0\|_{L^2(\Omega)} \leq C(\Omega) \|a - \bar{a}\|_{H^1(\Omega)} \|b - \bar{b}\|_{H^1(\Omega)}.$$

Remarquons que $a - \bar{a}$ (resp. $b - \bar{b}$) appartient à

$$V = \left\{ w \in H^1(\Omega) \mid \int_{\Omega} w = 0 \right\}.$$

On peut alors appliquer l'inégalité de Poincaré-Wirtinger et on obtient :

$$\|\Phi_0\|_{L^\infty(\Omega)} + \|\nabla \Phi_0\|_{L^2(\Omega)} \leq C(\Omega) \|\nabla a\|_{L^2(\Omega)} \|\nabla b\|_{L^2(\Omega)}.$$

■

Remarque. Pour pouvoir utiliser l'opérateur de prolongement P et l'inégalité de Poincaré, il faut une certaine régularité sur Ω et $\partial\Omega$. Dans [4], la démonstration ci-dessus est faite dans le cas où Ω est la boule unité. Les régularités exigées sont toutes satisfaites dans ce cas.

L'inégalité (21) est appelée inégalité de Wentz. On montre de même le

Théorème 3. *Supposons que $a, b \in H^1(\mathbb{R}^2)$ et Soit $\Phi_0 \in W_{loc}^{1,1}(\mathbb{R}^2)$ la solution de (20)-(D). Alors, il existe $C(\mathbb{R}^2) > 0$ tel que :*

$$\|\Phi_0\|_{L^\infty(\mathbb{R}^2)} + \|\nabla \Phi_0\|_{L^2(\mathbb{R}^2)} \leq C(\mathbb{R}^2) \|\nabla a\|_{L^2(\mathbb{R}^2)} \|\nabla b\|_{L^2(\mathbb{R}^2)}.$$

Autre démonstration du Théorème 3

Dans cette partie, on donne une autre démonstration du Théorème 3. Cette démonstration est due à Béthuel et Ghidaglia [3].

Dans [6], Coifman-Lions-Meyer-Semmes ont montré que si $u = (a, b) \in H^1(\mathbb{R}^2) \times H^1(\mathbb{R}^2)$, alors $\det \nabla u \in \mathcal{H}^1(\mathbb{R}^2)$, où $\mathcal{H}^1(\mathbb{R}^2)$ est l'espace de Hardy. On rappelle que :

$$\mathcal{H}^1(\mathbb{R}^2) = \{f \in L^1(\mathbb{R}^2) \mid f^* \in L^1(\mathbb{R}^2)\},$$

où

$$f^*(x) = \sup_{\varepsilon > 0} \left| \frac{1}{\varepsilon^2} \int_{\mathbb{R}^2} \rho \left(\frac{x-y}{\varepsilon} \right) f(y) dy \right|$$

et $\rho \in \mathcal{D}(\mathbb{R}^2)$, $\rho \geq 0$, $\rho \not\equiv 0$ (Fefferman et Stein [9]) ont montré que cet espace ne dépend pas du choix de ρ . On peut caractériser $\mathcal{H}^1(\mathbb{R}^2)$ par le fait que $f \in L^1(\mathbb{R}^2)$ et que $R_j f \in L^1(\mathbb{R}^2)$, $j = 1, 2$, où les R_j sont les transformées de Riesz. Cet espace est muni de la norme :

$$\|f\|_{\mathcal{H}^1(\mathbb{R}^2)} = \|f\|_{L^1(\mathbb{R}^2)} + \|f^*\|_{L^1(\mathbb{R}^2)}.$$

Théorème 4. (*Coifman-Lions-Meyer-Semmes*)

Soient a, b dans $H^1(\mathbb{R}^2)$ et $u = (a, b)$. La fonction $\det \nabla u$ appartient à l'espace de Hardy $\mathcal{H}^1(\mathbb{R}^2)$ et il existe une constante $C > 0$ telle que :

$$\|\det \nabla u\|_{\mathcal{H}^1(\mathbb{R}^2)} \leq C \|\nabla a\|_{L^2(\mathbb{R}^2)} \|\nabla b\|_{L^2(\mathbb{R}^2)}.$$

Démonstration. Puisque $f = \det \nabla u \in L^1(\mathbb{R}^2)$, il reste à montrer que $f^* \in L^1(\mathbb{R}^2)$. On choisit ρ tel que $\int_{\mathbb{R}^2} \rho = 1$ et $\text{supp } \rho \subset B(0, 1)$. Notons :

$$w(y) = a(y) - \bar{a}, \quad \bar{a} = \frac{1}{\pi \varepsilon^2} \int_{B(x, \varepsilon)} a(z) dz.$$

On a $f(y) = \det \nabla \bar{u}(y)$, où $\bar{u} = (w, b)$. Par une intégration par parties, on obtient :

$$\frac{1}{\varepsilon^2} \int_{\mathbb{R}^2} f(y) \rho \left(\frac{x-y}{\varepsilon} \right) dy = \frac{1}{\varepsilon^3} \int_{B(x, \varepsilon)} (R_1 b_{x_2} - R_2 b_{x_1}) w dy,$$

où $R_i(y) = \frac{\partial \rho}{\partial x_i} \left(\frac{x-y}{\varepsilon} \right)$. Par suite, on obtient :

$$\left| \frac{1}{\varepsilon^2} \int_{\mathbb{R}^2} f(y) \rho \left(\frac{x-y}{\varepsilon} \right) dy \right| \leq \frac{C_0}{\varepsilon^3} \int_{B(x, \varepsilon)} |a(y) - \bar{a}| |\nabla b| dy. \quad (28)$$

Par l'inégalité de Hölder, on obtient :

$$\begin{aligned} \frac{1}{\varepsilon^3} \int_{B(x, \varepsilon)} |a(y) - \bar{a}| |\nabla b| dy &= \frac{1}{\varepsilon^2} \int_{B(x, \varepsilon)} \left| \frac{a(y) - \bar{a}}{\varepsilon} \right| |\nabla b| dy \\ &\leq \left(\frac{1}{\varepsilon^2} \int_{B(x, \varepsilon)} \left| \frac{a(y) - \bar{a}}{\varepsilon} \right|^3 dy \right)^{1/3} \left(\frac{1}{\varepsilon^2} \int_{B(x, \varepsilon)} |\nabla b|^{3/2} dy \right)^{2/3} \\ (\text{par l'inégalité de Sobolev-Poincaré}) &\leq C_1 \left(\frac{1}{\varepsilon^2} \int_{B(x, \varepsilon)} |\nabla a|^{6/5} dy \right)^{5/6} \left(\frac{1}{\varepsilon^2} \int_{B(x, \varepsilon)} |\nabla b|^{3/2} dy \right)^{2/3} \\ &\leq C_1 (M(|\nabla a|^{6/5})(x))^{5/6} (M(|\nabla b|^{3/2})(x))^{2/3}, \end{aligned}$$

où

$$M(g)(x) = \sup_{\varepsilon > 0} \frac{1}{\varepsilon^2} \int_{B(x, \varepsilon)} |g|(y) dy$$

désigne la fonction maximale de Hardy-Littlewood. Notons que cette fonction opère continuellement sur L^p , $p > 1$. Ainsi, revenons à (28), on obtient :

$$\begin{aligned} \int_{\mathbb{R}^2} f^*(x) dx &\leq C_2 \int_{\mathbb{R}^2} M(|\nabla a|^{6/5})^{5/6} M(|\nabla b|^{3/2})^{2/3} dx \\ (\text{inégalité de Cauchy-Schwartz}) &\leq C_2 \left(\int_{\mathbb{R}^2} M(|\nabla a|^{6/5})^{5/3} dx \right)^{1/2} \left(\int_{\mathbb{R}^2} M(|\nabla b|^{3/2})^{4/3} dx \right)^{1/2} \\ &= C_2 \|M(|\nabla a|^{6/5})\|_{L^{5/3}(\mathbb{R}^2)}^{5/6} \|M(|\nabla b|^{3/2})\|_{L^{4/3}(\mathbb{R}^2)}^{2/3} \\ &\leq C_3 \left(\int_{\mathbb{R}^2} |\nabla a|^{6/5 \cdot 5/3} dx \right)^{3/5 \cdot 5/6} \left(\int_{\mathbb{R}^2} |\nabla b|^{3/2 \cdot 4/3} dx \right)^{3/4 \cdot 2/3} \\ &= C_3 \left(\int_{\mathbb{R}^2} |\nabla a|^2 dx \right)^{1/2} \left(\int_{\mathbb{R}^2} |\nabla b|^2 dx \right)^{1/2}. \end{aligned}$$

Ceci achève la preuve du Théorème 4. ■

Le dual de $\mathcal{H}^1(\mathbb{R}^2)$ a été identifié par Fefferman [8] comme étant l'espace $BMO(\mathbb{R}^2)$ de John et Nirenberg. Rappelons que $f \in L^1_{\text{loc}}(\mathbb{R}^2)$ appartient à $BMO(\mathbb{R}^2)$ s'il existe une constante C telle que pour toute boule $B \subset \mathbb{R}^2$, il existe une constante $\gamma(B, f)$ telle que :

$$\int_B |f(x) - \gamma|^2 dx \leq C|B|.$$

La constante optimale dans l'inégalité ci-dessus est notée $\|f\|_{BMO}^2$ ce qui définit une norme sur $BMO(\mathbb{R}^2)$ quotienté par les fonctions constantes.

On a les résultats suivants.

Proposition 3. (voir [11])

Pour tout $x \in \mathbb{R}^2$, la solution fondamentale du Laplacien dans \mathbb{R}^2 : $E_x(y) = -1/2\pi \ln(\|x - y\|)$ appartient à $BMO(\mathbb{R}^2)$.

Remarque. Chanillo et Yan [5] ont montré que le résultat ci-dessus est aussi valable si on considère la solution fondamentale d'un opérateur uniformément elliptique de la forme :

$$L = \text{div}(A(x)\nabla \cdot),$$

où $A(x) = (a_{i,j}(x))_{1 \leq i, j \leq 2}$ et $a_{i,j} \in L^\infty(\mathbb{R}^2)$, $\forall i, j$.

Maintenant, on peut obtenir facilement le résultat du Théorème 3. Soient alors $a, b \in H^1(\mathbb{R}^2)$ et Φ_0 la solution de (20)-(D). On peut écrire alors que :

$$\Phi_0(0) = -\frac{1}{2\pi} \int_{\mathbb{R}^2} \det \nabla u(x) \ln \|x\| dx,$$

où $u = (a, b)$. Par Proposition 3, la dualité $\mathcal{H}^1(\mathbb{R}^2) - BMO(\mathbb{R}^2)$ et Théorème 4, on obtient immédiatement :

$$\begin{aligned} \|\Phi_0\|_{L^\infty(\mathbb{R}^2)} &\leq \|\det \nabla u\|_{\mathcal{H}^1(\mathbb{R}^2)} \left\| \frac{1}{2\pi} \ln(\|\cdot\|) \right\|_{BMO(\mathbb{R}^2)} \\ &\leq C \|\nabla a\|_{L^2(\mathbb{R}^2)} \|\nabla b\|_{L^2(\mathbb{R}^2)}. \end{aligned}$$

Etant donné que $\Delta\Phi_0 \in \mathcal{H}^1(\mathbb{R}^2)$, $\frac{\partial^2\Phi_0}{\partial x_i\partial x_j}$ est aussi dans $\mathcal{H}^1(\mathbb{R}^2)$. Ainsi, $\Phi_0 \in W_{\text{loc}}^{2,1}(\mathbb{R}^2)$ et donc Φ_0 est continue sur \mathbb{R}^2 .

Remarque. Sous les hypothèses du Théorème 2, on obtient facilement la continuité de Φ_0 sur Ω . Il suffit de prolonger $a, b \in H^1(\Omega)$ par $\tilde{a}, \tilde{b} \in H^1(\mathbb{R}^2)$ et de considérer $\widetilde{\Phi}_0$ la solution de (20)-(D) avec \tilde{a} et \tilde{b} au lieu de a et b . La fonction $\Phi_0 - \widetilde{\Phi}_0$ est harmonique dans Ω et donc régulière dans Ω . Puisque $\widetilde{\Phi}_0$ est continue, Φ_0 est alors continue sur Ω .

Théorème 2 avec une constante universelle

► Cas de la boule unité.

D'après Théorème 2, on sait qu'il existe une constante $C > 0$ telle que :

$$\|\Phi_0\|_{L^\infty(B(0,1))} + \|\nabla\Phi_0\|_{L^2(B(0,1))} \leq C\|\nabla a\|_{L^2(B(0,1))} \|\nabla b\|_{L^2(B(0,1))}.$$

► Cas d'un ouvert borné simplement connexe de frontière C^1 .

Si Ω est un ouvert borné simplement connexe de frontière C^1 , alors il existe une transformation conforme :

$$\begin{aligned} T : \Omega &\rightarrow B(0,1) \\ x = (x_1, x_2) &\mapsto Tx = (T_1(x_1, x_2), T_2(x_1, x_2)). \end{aligned}$$

Par définition d'une transformation conforme, on a :

$$\frac{\partial T_1}{\partial x_1} = \frac{\partial T_2}{\partial x_2} \quad \text{et} \quad \frac{\partial T_1}{\partial x_2} = -\frac{\partial T_2}{\partial x_1}. \quad (29)$$

Par (29), on obtient facilement que T_1 et T_2 sont harmoniques :

$$\frac{\partial^2 T_1}{\partial x_1^2} + \frac{\partial^2 T_1}{\partial x_2^2} = \frac{\partial^2 T_2}{\partial x_1^2} + \frac{\partial^2 T_2}{\partial x_2^2} = 0. \quad (30)$$

Soient $a, b \in H^1(\Omega)$ et Φ_0 la solution de (20)-(D) dans Ω . On pose :

$$\tilde{a}(y) = a \circ T^{-1}(y), \quad \tilde{b}(y) = b \circ T^{-1}(y), \quad \widetilde{\Phi}_0(y) = \Phi_0 \circ T^{-1}(y), \quad \forall y \in B(0,1)$$

ou encore :

$$\tilde{a}(T(x)) = a(x), \quad \tilde{b}(T(x)) = b(x), \quad \widetilde{\Phi}_0(T(x)) = \Phi_0(x), \quad \forall x \in \Omega.$$

On obtient alors :

$$\left\{ \begin{array}{l} a_{x_1}(x) = \tilde{a}_{y_1}(T(x)) \frac{\partial T_1}{\partial x_1} + \tilde{a}_{y_2}(T(x)) \frac{\partial T_2}{\partial x_1} \\ a_{x_2}(x) = \tilde{a}_{y_1}(T(x)) \frac{\partial T_1}{\partial x_2} + \tilde{a}_{y_2}(T(x)) \frac{\partial T_2}{\partial x_2} \end{array} \right. \quad \text{et} \quad \left\{ \begin{array}{l} b_{x_1}(x) = \tilde{b}_{y_1}(T(x)) \frac{\partial T_1}{\partial x_1} + \tilde{b}_{y_2}(T(x)) \frac{\partial T_2}{\partial x_1} \\ a_{x_2}(x) = \tilde{b}_{y_1}(T(x)) \frac{\partial T_1}{\partial x_2} + \tilde{b}_{y_2}(T(x)) \frac{\partial T_2}{\partial x_2} \end{array} \right.$$

Soit :

$$(a_{x_1}b_{x_2} - a_{x_2}b_{x_1})(x) = \begin{vmatrix} \frac{\partial T_1}{\partial x_1} & \frac{\partial T_1}{\partial x_2} \\ \frac{\partial T_2}{\partial x_1} & \frac{\partial T_2}{\partial x_2} \end{vmatrix} (\tilde{a}_{y_1}\tilde{b}_{y_2} - \tilde{a}_{y_2}\tilde{b}_{y_1})(T(x)). \quad (31)$$

D'autre part, on a :

$$\begin{aligned}\Delta\Phi_0(x) &= \frac{\partial^2\widetilde{\Phi}_0}{\partial y_1^2}(T(x)) \left[\left(\frac{\partial T_1}{\partial x_2} \right)^2 + \left(\frac{\partial T_1}{\partial x_1} \right)^2 \right] + 2 \frac{\partial^2\widetilde{\Phi}_0}{\partial y_1\partial y_2}(T(x)) \left[\left(\frac{\partial T_1}{\partial x_2} \right) \left(\frac{\partial T_2}{\partial x_2} \right) + \left(\frac{\partial T_2}{\partial x_1} \right) \left(\frac{\partial T_1}{\partial x_1} \right) \right] \\ &+ \frac{\partial\widetilde{\Phi}_0}{\partial y_1}(T(x)) \left[\frac{\partial^2 T_1}{\partial x_2^2} + \frac{\partial^2 T_1}{\partial x_1^2} \right] + \frac{\partial^2\widetilde{\Phi}_0}{\partial y_2^2}(T(x)) \left[\left(\frac{\partial T_2}{\partial x_2} \right)^2 + \left(\frac{\partial T_2}{\partial x_1} \right)^2 \right] + \frac{\partial\widetilde{\Phi}_0}{\partial y_2}(T(x)) \left[\frac{\partial^2 T_2}{\partial x_2^2} + \frac{\partial^2 T_2}{\partial x_1^2} \right].\end{aligned}$$

Par (29)-(30), on obtient :

$$\Delta\Phi_0(x) = \left[\left(\frac{\partial T_1}{\partial x_1} \right)^2 + \left(\frac{\partial T_2}{\partial x_1} \right)^2 \right] \Delta\widetilde{\Phi}_0(T(x))$$

ou encore :

$$\Delta\Phi_0(x) = \begin{vmatrix} \frac{\partial T_1}{\partial x_1} & \frac{\partial T_1}{\partial x_2} \\ \frac{\partial T_2}{\partial x_1} & \frac{\partial T_2}{\partial x_2} \end{vmatrix} \Delta\widetilde{\Phi}_0(T(x)). \quad (32)$$

Puisque $\det(DT) = \begin{vmatrix} \frac{\partial T_1}{\partial x_1} & \frac{\partial T_1}{\partial x_2} \\ \frac{\partial T_2}{\partial x_1} & \frac{\partial T_2}{\partial x_2} \end{vmatrix} \neq 0$ (même > 0), par (20)-(D), (31) et (32), on obtient :

$$\begin{cases} -\Delta\widetilde{\Phi}_0 = \widetilde{a}_{y_1}\widetilde{b}_{y_2} - \widetilde{a}_{y_2}\widetilde{b}_{y_1} & \text{dans } B(0,1) \\ \widetilde{\Phi}_0 = 0 & \text{sur } \partial B(0,1). \end{cases}$$

D'après le cas précédent, on a :

$$\|\widetilde{\Phi}_0\|_{L^\infty(B(0,1))} + \|\nabla\widetilde{\Phi}_0\|_{L^2(B(0,1))} \leq C \|\nabla\widetilde{a}\|_{L^2(B(0,1))} \|\nabla\widetilde{b}\|_{L^2(B(0,1))}. \quad (33)$$

Déjà il est clair que :

$$\|\widetilde{\Phi}_0\|_{L^\infty(B(0,1))} = \|\Phi_0\|_{L^\infty(\Omega)}. \quad (34)$$

Maintenant, par le théorème d'intégration par changement de variable, on a :

$$\begin{aligned}\|\nabla\widetilde{\Phi}_0\|_{L^2(B(0,1))}^2 &= \int_{B(0,1)=T(\Omega)} |\nabla\widetilde{\Phi}_0(y)|^2 dy \\ &= \int_{\Omega} |\nabla\widetilde{\Phi}_0(T(x))|^2 \det(DT) dx \\ &= \int_{\Omega} \frac{1}{\det(DT)^2} (DT^{-1})^t DT^{-1} \nabla(\widetilde{\Phi}_0 \circ T)(x) \cdot \nabla(\widetilde{\Phi}_0 \circ T)(x) \det(DT) dx.\end{aligned}$$

On vérifie facilement que :

$$(DT^{-1})^t DT^{-1} = \det(DT) I_2,$$

où I_2 est la matrice identité d'ordre 2. Par suite, on obtient :

$$\|\nabla\widetilde{\Phi}_0\|_{L^2(B(0,1))}^2 = \int_{\Omega} |\nabla(\widetilde{\Phi}_0 \circ T)(x)|^2 dx = \int_{\Omega} |\nabla\Phi_0|^2(x) dx = \|\nabla\Phi_0\|_{L^2(\Omega)}^2.$$

Ainsi,

$$\|\nabla\widetilde{\Phi}_0\|_{L^2(B(0,1))} = \|\nabla\Phi_0\|_{L^2(\Omega)}, \quad \|\nabla\widetilde{a}\|_{L^2(B(0,1))} = \|\nabla a\|_{L^2(\Omega)}, \quad \|\nabla\widetilde{b}\|_{L^2(B(0,1))} = \|\nabla b\|_{L^2(\Omega)}. \quad (35)$$

En fin, par (33)-(35), on obtient :

$$\|\Phi_0\|_{L^\infty(\Omega)} + \|\nabla\Phi_0\|_{L^2(\Omega)} \leq C\|\nabla a\|_{L^2(\Omega)}\|\nabla b\|_{L^2(\Omega)},$$

où C est une constante universelle (constante indépendante de Ω).

► Cas d'un ouvert borné quelconque.

Dans le cas d'un ouvert borné quelconque (non nécessairement simplement connexe), la recherche d'une constante universelle est plus compliquée. La démonstration est basée sur l'utilisation de la formule de la coaire [7] et les propriétés de la solution fondamentale du Laplacien. Pour plus de détails, voir ([3, 5]).

Constante optimale dans l'inégalité de Wente

Il est naturel de s'intéresser aux constantes optimales associées à l'inégalité (21). Notons :

$$C_\infty^0(\Omega) := \sup_{\nabla a, \nabla b \neq 0} \frac{\|\Phi_0\|_{L^\infty(\Omega)}}{\|\nabla a\|_{L^2(\Omega)}\|\nabla b\|_{L^2(\Omega)}}$$

et

$$C_2^0(\Omega) := \sup_{\nabla a, \nabla b \neq 0} \frac{\|\nabla\Phi_0\|_{L^2(\Omega)}}{\|\nabla a\|_{L^2(\Omega)}\|\nabla b\|_{L^2(\Omega)}}.$$

► Constante optimale pour la norme $\|\cdot\|_{L^\infty(\Omega)}$.

Dans [1], S.Baraket a démontré les résultats suivants.

Théorème 5. (*Baraket*)

Supposons que $\Omega = \mathbb{R}^2$, alors on a : $C_\infty^0(\mathbb{R}^2) = \frac{1}{2\pi}$.

Théorème 6. (*Baraket*)

Soit Ω un ouvert borné et régulier de \mathbb{R}^2 . Alors, on a : $C_\infty^0(\Omega) \geq \frac{1}{2\pi}$.

Si de plus Ω est simplement connexe, on a : $C_\infty^0(\Omega) = \frac{1}{2\pi}$.

Dans [12], P. Topping a généralisé le résultat de S. Baraket pour un domaine borné quelconque, non nécessairement simplement connexe : on a toujours $C_\infty^0(\Omega) = \frac{1}{2\pi}$. Sa démonstration est basée sur l'utilisation de la formule de la coaire, les propriétés de la fonction de Green du Laplacien avec une condition de Dirichlet sur le bord du domaine et l'inégalité isopérimétrique.

► Constante optimale pour la norme $\|\cdot\|_{L^2(\Omega)}$.

L'étude de la constante optimale pour la norme $\|\cdot\|_{L^2(\Omega)}$ est due à Ge. Yuxin [10]. Il a obtenu le résultat suivant.

Théorème 7. (*Yuxin*)

Soit Ω un ouvert borné et régulier de \mathbb{R}^2 . Alors, on a : $C_2^0(\Omega) = \sqrt{\frac{3}{16\pi}}$.

◆ Equation de Helmholtz modifiée avec Jacobien comme terme source

Nous nous sommes intéressés au problème suivant. Soient Ω un ouvert de \mathbb{R}^2 , α une constante strictement positive, $u = (a, b) \in H^1(\Omega, \mathbb{R}^2)$ et Φ_α solution de :

$$-\Delta\Phi_\alpha + \alpha\Phi_\alpha = \det \nabla u \text{ dans } \Omega \quad (36)$$

avec la condition aux limites (D). L'opérateur $-\Delta + \alpha I$ est appelé opérateur de Helmholtz modifié. Le terme modifié provient du fait que $\alpha > 0$ (dans le cas $\alpha < 0$, c'est l'opérateur de Helmholtz).

Régularité de la solution

Proposition 4. *Soient Ω un ouvert borné et régulier de \mathbb{R}^2 et $a, b \in H^1(\Omega)$. Alors (36)-(D) admet une et une seule solution $\Phi_\alpha \in H_0^1(\Omega) \cap C(\overline{\Omega})$. De plus, on a :*

$$\|\Phi_\alpha\|_{L^\infty(\Omega)} + \frac{\|\nabla\Phi_\alpha\|_{L^2(\Omega)}^2 + \alpha\|\Phi_\alpha\|_{L^2(\Omega)}^2}{\|\nabla\Phi_\alpha\|_{L^2(\Omega)}} \leq C\|\nabla a\|_{L^2(\Omega)}\|\nabla b\|_{L^2(\Omega)}, \quad (37)$$

où $C > 0$ est une constante universelle.

Démonstration. On pose Ψ_α la solution du problème :

$$\begin{cases} -\Delta\Psi_\alpha + \alpha\Psi_\alpha = -\alpha\Phi_0 & \text{dans } \Omega \\ \Psi_\alpha = 0 & \text{sur } \partial\Omega, \end{cases} \quad (38)$$

où Φ_0 est la solution de (20)-(D) (problème de Wente classique). D'après la régularité de Φ_0 , on a (au minimum) $\Psi_\alpha \in H_0^1(\Omega) \cap C(\overline{\Omega})$. On vérifie facilement que :

$$\Phi_\alpha = \Psi_\alpha + \Phi_0.$$

D'après la régularité de Φ_0 , il est clair que $\Phi_\alpha \in H_0^1(\Omega) \cap C(\overline{\Omega})$. De plus, par le principe de maximum, on obtient :

$$\|\Phi_\alpha\|_{L^\infty(\Omega)} \leq \|\Psi_\alpha\|_{L^\infty(\Omega)} + \|\Phi_0\|_{L^\infty(\Omega)} \leq 2\|\Phi_0\|_{L^\infty(\Omega)} \leq C_1\|\nabla a\|_{L^2(\Omega)}\|\nabla b\|_{L^2(\Omega)},$$

où C_1 est une constante > 0 indépendante de Ω . D'autre part, on a :

$$-\Delta\Phi_\alpha + \alpha\Phi_\alpha = -\Delta\Phi_0 \quad \text{dans } \Omega.$$

En multipliant par Φ_α , on obtient :

$$\|\nabla\Phi_\alpha\|_{L^2(\Omega)}^2 + \alpha\|\Phi_\alpha\|_{L^2(\Omega)}^2 = \int_{\Omega} \nabla\Phi_0 \cdot \nabla\Phi_\alpha \, dx \leq \|\nabla\Phi_0\|_{L^2(\Omega)}\|\nabla\Phi_\alpha\|_{L^2(\Omega)}.$$

Par suite,

$$\frac{\|\nabla\Phi_\alpha\|_{L^2(\Omega)}^2 + \alpha\|\Phi_\alpha\|_{L^2(\Omega)}^2}{\|\nabla\Phi_\alpha\|_{L^2(\Omega)}} \leq C_2\|\nabla a\|_{L^2(\Omega)}\|\nabla b\|_{L^2(\Omega)},$$

où C_2 est une constante > 0 indépendante de Ω . ■

Notons alors :

$$C_\infty^\alpha(\Omega) := \sup_{\nabla a, \nabla b \neq 0} \frac{\|\Phi_\alpha\|_\infty}{\|\nabla a\|_2 \|\nabla b\|_2}, \quad C_2^\alpha(\Omega) := \sup_{\nabla a, \nabla b \neq 0} \frac{\|\nabla\Phi_\alpha\|_2^2 + \alpha\|\Phi_\alpha\|_2^2}{\|\nabla a\|_2 \|\nabla b\|_2 \|\nabla\Phi_\alpha\|_2}.$$

Nous nous sommes intéressés aux constantes optimales $C_\infty^\alpha(\Omega)$ et $C_2^\alpha(\Omega)$.

Constantes optimales pour l'opérateur de Helmholtz modifié [Article 9]

La difficulté principale de ce travail est due au non-homogénéité de l'opérateur considéré. Plus précisément, contrairement à l'opérateur de Laplace, L'EDP considérée est non invariante par transformation conforme.

Dans [Article 9], nous avons obtenu les résultats suivants.

Théorème 8. *Supposons que $\Omega = \mathbb{R}^2$, alors on a :*

$$C_\infty^\alpha(\mathbb{R}^2) = C_\infty^0(\mathbb{R}^2) = \frac{1}{2\pi}, \quad \forall \alpha > 0.$$

Théorème 9. *Soit Ω un ouvert borné et régulier de \mathbb{R}^2 . On a :*

$$\frac{1}{2\pi} \leq C_\infty^\alpha(\Omega) \leq \frac{1}{\pi}, \quad \forall \alpha > 0.$$

Remarque. Le théorème ci-dessus nous donne seulement un encadrement de la constante optimale. La détermination exacte de $C_\infty^\alpha(\Omega)$ reste un problème ouvert.

Théorème 10. *Soit Ω un ouvert borné et régulier de \mathbb{R}^2 . On a :*

$$C_2^\alpha(\mathbb{R}^2) \leq \sqrt{3/32\pi} \leq C_2^\alpha(\Omega) \leq \sqrt{3/16\pi}, \quad \forall \alpha > 0.$$

Remarque. Il sera intéressant de voir s'il y a un moyen de déterminer la valeur exacte de la constante optimale $C_2^\alpha(\Omega)$.

◆ Problème de Wentz pour une large classe d'opérateurs [Article 10]

Dans [Article 10], nous généralisons le travail précédent pour une large classe d'opérateurs. Plus précisément, nous considérons le problème :

$$\begin{cases} A\vec{U}_A = \vec{F} \text{ dans } \mathbb{R}^2 \\ \lim_{|x| \rightarrow +\infty} \vec{U}_A(x) = \vec{0}, \end{cases} \quad (39)$$

où A est un opérateur elliptique, \vec{U}_A et \vec{F} sont deux vecteurs de \mathbb{R}^N donnés par :

$$\begin{aligned} \vec{U}_A(x) &= (U_A^1(x), U_A^2(x), \dots, U_A^N(x)), \quad x \in \mathbb{R}^2 \\ \vec{F}(x) &= (F^1(x), F^2(x), \dots, F^N(x)). \end{aligned}$$

Pour tout $i \in \{1, 2, \dots, N\}$, la composante F^i est donnée par :

$$F^i := a_{x_1}^i b_{x_2}^i - a_{x_2}^i b_{x_1}^i = \det \nabla u^i,$$

où $u^i = (a^i, b^i) \in H^1(\mathbb{R}^2, \mathbb{R}^2)$.

Nous introduisons maintenant quelques notations qui seront utilisées dans la suite. Soit \vec{X} une fonction vectorielle définie par :

$$\vec{X}(x) = (X^1(x), X^2(x), \dots, X^N(x)), \quad \forall x \in \mathbb{R}^2.$$

Nous notons par $\|\cdot\|_\infty$ la norme définie par :

$$\|\vec{X}\|_\infty := \sup_{1 \leq i \leq N} \|X^i\|_\infty.$$

La distribution matricielle $E_A \in \mathcal{D}'(\mathbb{R}^2, \mathbb{R}^{N \times N})$ désigne la solution fondamentale de l'opérateur A telle que chaque colonne E_A^j est la solution de :

$$AE_A^j = \delta_{e_j} \text{ dans } \mathbb{R}^2,$$

où δ est la distribution de Dirac et $(e_j)_{j=1,2,\dots,N}$ est la base canonique de \mathbb{R}^N .

Nous supposons que les hypothèses suivantes sont satisfaites.

(H1) : Le problème (39) admet une et une seule solution dans $H^1(\mathbb{R}^2)^N$.

(H2) : La solution fondamentale E_A s'écrit sous la forme :

$$E_A(x) = \kappa f(r)I_N + G_A(x),$$

où κ est une constante positive, $r = |x|$, I_N est la matrice identité et $G_A = (G_A(i, j))_{1 \leq i, j \leq N}$ satisfait :

$$\begin{cases} G_A(i, j) \in L^\infty(\mathbb{R}^2), \forall i, j \in \{1, 2, \dots, N\}, \\ \exists j \in \{1, 2, \dots, N\} \mid \frac{\partial}{\partial r}(G_A(i, j)) = 0, \forall i \in \{1, 2, \dots, N\}. \end{cases}$$

(H3) : La fonction f est de classe C^1 sur $(0, +\infty)$ et vérifie :

$$\begin{cases} \lim_{r \rightarrow 0^+} r f(r) = 0, \\ r \mapsto r f'(r) \in L^\infty(0, +\infty), \\ \sup_{r \geq 0} r |f'(r)| = 1. \end{cases}$$

(H4) : Nous supposons que :

$$A\vec{U}_A(x + x_0) = \vec{F}(x + x_0), \forall (x, x_0) \in \mathbb{R}^2 \times \mathbb{R}^2.$$

Notons que les hypothèses (H1)-(H4) sont vérifiées par une large classe d'opérateurs. Des exemples de tels opérateurs seront précisés plus loin.

Les principaux résultats obtenus sont les suivants.

Théorème 11. *Nous avons l'estimation suivante :*

$$\|\vec{U}_A\|_\infty \leq (\kappa + \nu) \sum_{i=1}^N \|\nabla a^i\|_2 \|\nabla b^i\|_2,$$

où $\nu := \sup_{1 \leq i, j \leq N} \|G_A(i, j)\|_\infty$.

Nous définissons alors la quantité optimale :

$$C_\infty^A(\mathbb{R}^2) := \sup_{(a, b) \in V} \frac{\|\vec{U}_A\|_\infty}{\sum_{i=1}^N \|\nabla a^i\|_2 \|\nabla b^i\|_2},$$

où

$$V = \{(a, b) \in H^1(\mathbb{R}^2, \mathbb{R}^{2N}) \mid \exists i_0 \in \{1, 2, \dots, N\}, \|\nabla a^{i_0}\|_2 \|\nabla b^{i_0}\|_2 \neq 0\}.$$

Nous avons alors le :

Théorème 12. Soit $g :]0, +\infty[\rightarrow \mathbb{R}$ une fonction vérifiant :

- (1) $g \in C^\infty(0, +\infty) \setminus \{0\}$
- (2) $r \mapsto rg^2(r) \in L^1(0, +\infty)$
- (3) $r \mapsto r^3g'^2(r) \in L^1(0, +\infty)$
- (4) $\lim_{r \rightarrow 0^+} rg(r) = 0$
- (5) $\lim_{r \rightarrow 0^+} r^2f(r)g^2(r) = 0.$

Alors, on a l'estimation suivante :

$$\kappa \mathcal{L}_A(g) \leq C_\infty^A(\mathbb{R}^2) \leq (\kappa + \nu),$$

où $\mathcal{L}_A(g)$ est donné par :

$$\mathcal{L}_A(g) := \frac{\left| \int_0^{+\infty} r^2 f'(r) g^2(r) dr \right|}{\int_0^{+\infty} r^3 g'^2(r) dr}.$$

Opérateur de Laplace

Comme premier exemple, nous considérons le cas où $A = -\Delta$ et $N = 1$. Dans ce cas, la solution fondamentale de cet opérateur est donnée par :

$$E_A(x) = -\frac{1}{2\pi} \ln r, \quad \forall x \in \mathbb{R}^2 \setminus \{0\}.$$

Il est facile de voir que les hypothèses (H1)-(H4) sont satisfaites avec :

$$\kappa = \frac{1}{2\pi}, \quad f(r) = -\ln r \quad \text{et} \quad G_A \equiv 0.$$

Par Théorème 11 et Théorème 12, nous obtenons alors :

$$\frac{1}{2\pi} \mathcal{L}_{-\Delta}(g) \leq C_\infty^{-\Delta}(\mathbb{R}^2) \leq \frac{1}{2\pi},$$

pour toute fonction $g :]0, +\infty[\rightarrow \mathbb{R}$ vérifiant les propriétés (1)-(5) du théorème 12.

Pour tout $\varepsilon > 0$, nous considérons la fonction g_ε définie par :

$$g_\varepsilon(r) := r^{\varepsilon-1} e^{-r/2}, \quad \forall r > 0.$$

Pour tout $\varepsilon > 0$, la fonction g_ε satisfait les propriétés (1)-(5) du théorème 12. D'où :

$$\frac{1}{2\pi} \mathcal{L}_{-\Delta}(g_\varepsilon) \leq C_\infty^{-\Delta}(\mathbb{R}^2) \leq \frac{1}{2\pi}, \quad \forall \varepsilon > 0.$$

Nous montrons que :

$$\mathcal{L}_{-\Delta}(g_\varepsilon) \rightarrow 1 \quad \text{quand} \quad \varepsilon \rightarrow 0^+.$$

Ainsi, nous retrouvons la valeur de la constante optimale :

$$C_\infty^{-\Delta}(\mathbb{R}^2) = \frac{1}{2\pi}.$$

Opérateur de Helmholtz modifié

Dans cet exemple, l'opérateur A est donné par :

$$A = -\Delta + \alpha I,$$

où α est une constante positive et $N = 1$. Dans ce cas, la solution fondamentale de A est donnée par :

$$E_A(x) = \frac{1}{2\pi} K_0(\sqrt{\alpha} r), \quad \forall x \in \mathbb{R}^2 \setminus \{0\},$$

où K_0 est la fonction de Bessel modifiée de deuxième espèce et d'ordre 0. Dans ce cas, nous avons :

$$\kappa = \frac{1}{2\pi}, \quad f(r) = K_0(\sqrt{\alpha} r) \quad \text{et} \quad G_A \equiv 0.$$

Par Théorème 11 et Théorème 12, nous obtenons alors :

$$\frac{1}{2\pi} \mathcal{L}_{-\Delta+\alpha I}(g_\varepsilon) \leq C_\infty^{-\Delta+\alpha I}(\mathbb{R}^2) \leq \frac{1}{2\pi}, \quad \forall \varepsilon > 0.$$

Nous montrons que :

$$\mathcal{L}_{-\Delta+\alpha I}(g_\varepsilon) \rightarrow 1 \quad \text{quand} \quad \varepsilon \rightarrow 0^+.$$

Ainsi, nous retrouvons la valeur de la constante optimale :

$$C_\infty^{-\Delta+\alpha I}(\mathbb{R}^2) = \frac{1}{2\pi}.$$

Opérateur de Lamé

Ici, nous étudions le cas de l'opérateur de Lamé. Plus précisément, nous prenons :

$$A\vec{U} = -\mu\Delta\vec{U} - (\lambda + \mu)\nabla(\operatorname{div}\vec{U}),$$

où les constantes λ et μ sont les coefficients de Lamé ($\lambda \geq 0$, $\mu > 0$) et $N = 2$. La solution fondamentale $E_A \in \mathcal{D}'(\mathbb{R}^2, \mathbb{R}^{2 \times 2})$ de l'opérateur A est donnée par :

$$E_A(x) = \beta \ln r I_2 + \gamma e_r e_r^T, \quad \forall x \in \mathbb{R}^2 \setminus \{0\},$$

où

$$\beta = -\frac{\lambda + 3\mu}{4\pi\mu(\lambda + 2\mu)}, \quad \gamma = \frac{\lambda + \mu}{4\pi\mu(\lambda + 2\mu)},$$

$e_r = x/r$ et e_r^T est le vecteur transposé de e_r . Dans ce cas, nous avons :

$$\kappa = -\beta, \quad f(r) = -\ln r, \quad G_A(x) = \gamma e_r e_r^T \quad \text{et} \quad \nu = \gamma.$$

Par Théorème 11 et Théorème 12, nous obtenons alors :

$$-\beta \mathcal{L}_A(g_\varepsilon) \leq C_\infty^A(\mathbb{R}^2) \leq -\beta + \gamma, \quad \forall \varepsilon > 0.$$

Nous montrons que :

$$\mathcal{L}_A(g_\varepsilon) \rightarrow 1 \quad \text{quand} \quad \varepsilon \rightarrow 0^+.$$

Ainsi, nous obtenons l'estimation :

$$-\beta \leq C_\infty^A(\mathbb{R}^2) \leq -\beta + \gamma.$$

◆ Problème de Wente pour l'opérateur de Helmholtz modifié dans des espaces de Sobolev avec poids [Article 11]

Dans [Article 11], nous considérons le problème de Wente associé à l'opérateur de Helmholtz modifié dans des espaces de Sobolev avec poids. Notre travail peut être considéré comme une extension de celui de S. Baraket et L. B. Chaabane dans [2]. Avant de présenter les principaux résultats obtenus, nous introduisons quelques notations et définitions qui seront utilisées plus tard.

Dans la suite, nous prenons $\Omega \in \{\mathbb{R}^2, B_1\}$, où B_1 est la boule unité de \mathbb{R}^2 . Soit $\omega \not\equiv 0$ une fonction positive de $L^1_{\text{loc}}(\Omega)$. Nous définissons $\|\cdot\|_{2,\omega}$ par :

$$\|f\|_{2,\omega} = \left(\int_{\Omega} f^2(x)\omega(x) dx \right)^{1/2}.$$

Nous notons par $H_{\omega}(\Omega)$ la fermeture de $\mathcal{D}(\Omega)$ muni de la norme :

$$\|\cdot\|_{2,\omega} + \|\nabla \cdot\|_{2,\omega}. \quad (40)$$

Si ω^{-1} est aussi dans $L^1_{\text{loc}}(\Omega)$, nous introduisons l'espace :

$$V_{\omega}(\Omega) = \{(a, b) \in H_{\omega}(\Omega) \times H_{\omega^{-1}}(\Omega) \mid \nabla a \not\equiv 0, \nabla b \not\equiv 0\}.$$

Nous disons que la fonction ω vérifie (A1) si :

$$(A1) : \omega \text{ est une fonction radiale } (\omega(x) = w(r) \text{ où } r = \|x\|).$$

Pour tout $(a, b) \in V_{\omega}(\Omega)$, soit Φ_{α} la solution de (36)-(D). Notre premier résultat est le suivant.

Théorème 13. *Si ω vérifie (A1) et $\omega, \omega^{-1} \in C(\Omega) \cap L^{\infty}(\Omega)$, alors*

$$\sup_{(a,b) \in V_{\omega}(\Omega)} \frac{|\Phi_{\alpha}(0)|}{\|\nabla a\|_{2,\omega} \|\nabla b\|_{2,\omega^{-1}}} = \frac{1}{2\pi}.$$

Remarque. La condition $\omega, \omega^{-1} \in L^{\infty}(\Omega)$ implique que $V_{\omega}(\Omega) \subset \{(a, b) \mid \nabla a, \nabla b \in L^2(\Omega)\}$. Par le résultat de Brezis-Coron [4], ceci implique que Φ_0 solution de (20)-(D) (problème de Wente classique) appartient à $C_0(\Omega)$, l'ensemble des fonction continues sur Ω et prenant la valeur zéro sur le bord de Ω . Dans le cas $\alpha > 0$, par le principe de maximum, nous avons $\|\Phi_{\alpha}\|_{L^{\infty}(\Omega)} \leq 2\|\Phi_0\|_{L^{\infty}(\Omega)}$. Ainsi, par densité, nous avons $\Phi_{\alpha} \in C_0(\Omega)$ pour tous $a, b \in V_{\omega}(\Omega)$. Cette remarque est aussi valable pour tout autre espace $\mathcal{V} \subset \{(a, b) \mid \nabla a, \nabla b \in L^2(\Omega)\}$, en particulier, pour les deux théorèmes qui suivent.

En général, lorsque ω ou ω^{-1} n'appartient pas à $C(\Omega)$, nous ne pouvons pas avoir un résultat optimal. Pour étudier un cas plus général, nous avons besoin d'introduire d'autres espaces fonctionnels et d'autres conditions.

Nous introduisons l'espace $\tilde{H}_{\omega}(\Omega)$ la fermeture de $\mathcal{D}(\Omega \setminus \{0\})$ muni de la norme (40) et l'espace :

$$\tilde{V}_{\omega}(\Omega) = \{(a, b) \in \tilde{H}_{\omega}(\Omega) \times \tilde{H}_{\omega^{-1}}(\Omega) \mid \nabla a \not\equiv 0, \nabla b \not\equiv 0\}.$$

Nous disons que ω satisfait (A2) si :

$$(A2) : \omega \in \mathcal{C}^2(\Omega \setminus \{0\}), \omega > 0 \text{ et}$$

$$\Delta \left(\sqrt{\omega(x)} \right) \geq 0, \quad \Delta \left(\frac{1}{\sqrt{\omega(x)}} \right) \geq 0 \text{ dans } \Omega \setminus \{0\}. \quad (41)$$

Si ω satisfait aussi (A1), nous écrivons : $\omega(x) = w(r) = e^{v(r)}$. Dans ce cas, (41) est équivalente à :

$$\left| v''(r) + \frac{1}{r}v'(r) \right| \leq \frac{1}{2}v'^2(r) \text{ in } (0, +\infty) \text{ or } (0, 1).$$

Remarque. Sous les hypothèses (A1)-(A2), nous avons :

$$\begin{aligned} h_\omega^1(x) &\equiv \|x\|^2 \left(\frac{1}{2}\Delta\omega - \frac{1}{4}|\nabla\omega|^2\omega^{-1} \right) \omega^{-1} \\ &= \frac{r^2}{2} \left(v''(r) + \frac{1}{r}v'(r) + \frac{1}{2}v'^2(r) \right) \geq 0 \end{aligned}$$

et

$$\begin{aligned} h_\omega^2(x) &\equiv \|x\|^2 \left(-\frac{1}{2}\Delta\omega + \frac{3}{4}|\nabla\omega|^2\omega^{-1} \right) \omega^{-1} \\ &= \frac{r^2}{2} \left(-v''(r) - \frac{1}{r}v'(r) + \frac{1}{2}v'^2(r) \right) \geq 0. \end{aligned}$$

Nous avons obtenu le résultat suivant.

Théorème 14. *Sous les hypothèses (A1)-(A2), nous avons :*

$$\sup_{(a,b) \in \tilde{V}_\omega^*(\Omega)} \frac{|\Phi_\alpha(0)|}{\|\nabla a\|_{2,\omega} \|\nabla b\|_{2,\omega^{-1}}} \leq \frac{1}{2\pi} \frac{1}{\sup_{i=1,2} \left(1 + \inf_{x \in \Omega} h_\omega^i(x) \right)^{1/2}},$$

où

$$\tilde{V}_\omega^*(\Omega) = \tilde{V}_\omega(\Omega) \cap \{(a, b) \mid \nabla a, \nabla b \in L^2(\Omega)\}.$$

Notons par :

$$W_p(\Omega) = \{(a, b) \in V_\omega(\Omega), (a, b)(x) = g(\|x\|)(\omega(x)^{-1/2}x_1, \omega(x)^{1/2}x_2)\}$$

et

$$W_r(\Omega) = \{(a, b) \in V_\omega(\Omega), (a, b)(x) = g(\|x\|)x\},$$

où $g \in \mathcal{C}^\infty(0, +\infty)$ si $\Omega = \mathbb{R}^2$ et $g \in \mathcal{C}^\infty(0, 1)$ si $\Omega = B_1$. Soit $V_p(\Omega)$ (resp. $V_r(\Omega)$) la fermeture de $W_p(\Omega)$ (resp. $W_r(\Omega)$) dans $V_\omega(\Omega)$ muni de la norme (40). Nous notons :

$$V_p^*(\Omega) = \{(a, b) \in V_p(\Omega) \mid \nabla a \neq 0, \nabla b \neq 0\}$$

et

$$V_r^*(\Omega) = \{(a, b) \in V_r(\Omega) \mid \nabla a, \nabla b \in L^2(\Omega)\}.$$

Soit ω une fonction radiale ($\omega(x) = w(r)$).

Nous disons que ω vérifie (A3) si :

$$(A3) : \lim_{r \rightarrow 0} r^2 w(r) = \lim_{r \rightarrow 0} r^2 w^{-1}(r) = 0.$$

Nous disons que ω vérifie (A4) si :

$$(A4) : \lim_{r \rightarrow 0} r^3 w'(r) = \lim_{r \rightarrow 0} r^3 (w^{-1}(r))' = 0.$$

Nous avons le

Théorème 15. *Supposons que les hypothèses (A1)-(A2) sont vérifiées. Alors,*

1. *Si (A4) est satisfaite, nous avons :*

$$\frac{C(\Omega)}{\prod_{i=1}^2 \left(1 + \sup_{x \in \Omega} h_{\omega}^i(x)\right)^{1/2}} \leq \sup_{(a,b) \in V_p^*(\Omega)} \frac{2\pi|\Phi_{\alpha}(0)|}{\|\nabla a\|_{2,\omega} \|\nabla b\|_{2,\omega^{-1}}} \leq \frac{1}{\prod_{i=1}^2 \left(1 + \inf_{x \in \Omega} h_{\omega}^i(x)\right)^{1/2}},$$

où $C(\mathbb{R}^2) = 1$ et $C(B_1) = \sqrt{\alpha}K_1(\sqrt{\alpha})$. Ici, K_1 est la fonction de Bessel modifiée de premier ordre de second espèce.

2. *Si (A3)-(A4) sont satisfaites et $(a, b) \in V_r^*(\Omega)$, nous avons :*

$$\|\Phi_{\alpha}\|_{\infty} \leq \frac{1}{\pi} \frac{\|\nabla a\|_{2,\omega} \|\nabla b\|_{2,\omega^{-1}}}{\prod_{i=1}^2 \left(1 + \inf_{x \in \Omega} h_{\omega}^i(x)\right)^{1/2}}.$$

Remarque. Nous avons :

$$V_p^*(\Omega) \subset \{(a, b) \mid \nabla a, \nabla b \in L^2(\Omega)\}.$$

Pour le vérifier, il suffit de voir que pour tous $a, b \in W_p(\Omega)$, nous avons :

$$\|\nabla a\|_{2,\omega} \geq \|\nabla a\|_{L^2(\Omega)}$$

et

$$\|\nabla b\|_{2,\omega^{-1}} \geq \|\nabla b\|_{L^2(\Omega)}.$$

Par densité, ces inégalités sont satisfaites pour tous $a, b \in V_p^*(\Omega)$.

Bibliographie

1. S. Baraket, *Estimations of the best constant involving the L^{∞} norm in Wente's inequality*, Ann. Fac. Sci. Toulouse. 3, pp. 373-386, 1996.
2. S. Baraket, L. B. Chaabane, *The Wente inequality on weighted Sobolev spaces*, Houston Journal of Mathematics, University of Houston. 29 No. 4, pp. 1065-1075, 2003.
3. F. Bethuel, J. M. Ghidaglia, *Regularity of solutions of certain elliptic equations in dimension two and the co-area formula*, Journées Equations aux dérivées partielles, pp. 1-36, 1993.
4. H. Brezis, J-M. Coron, *Multiple solutions of H-system and Rellich's conjecture*, Comm. Pure Appl. Math. 37, pp. 149-187, 1984.
5. S. Chanillo, Y.Y. Li, *Continuity of solutions of uniformly elliptic equations in \mathbb{R}^2* , Manuscripta Math. 77, pp. 415-434, 1992.
6. R. Coifman, P.L. Lions, Y. Meyer, S. Semmes, *Compensated compactness and Hardy spaces*, J. Math. Pures Appl. 72, pp. 247-286, 1993.
7. H. Federer, *Geometric measure theory*, Springer-Verlag, Berlin, 1969.
8. C. Fefferman, *Characterizations of bounded mean oscillations*, Bull. Amer. Math. Soc. 77, pp. 587-588, 1971.
9. C. Fefferman, E. Stein, *H^p spaces of several variables*, Acta Maths. 19, pp. 137-193, 1971.

10. Y. Ge, *Estimations of the best constant involving the L^2 norm in Wente's inequality*, COCV. 3, pp. 263-300, 1998.
11. E. Stein, *Harmonic analysis : real-variable methods, orthogonality, and oscillatory integrals*, Princeton University Press, 1993
12. P. Topping, *The optimal constant in the Wente's L^∞ estimate*, Comment. Math. Helev. 72, pp. 316-328, 1997.
13. H. C. Wente, *An existence theorem for surfaces of constant mean curvature*, J. Math. Anal. Appl. 26, pp. 318-344, 1969.

Thème III. Convexité par transformation quadratique en dimension infinie (Article 12)

◆ Introduction

Soit A une matrice complexe d'ordre n . Considérons l'ensemble (numerical range) :

$$W(A) := \{z^*Az \mid z \in \mathbb{C}^n, \|z\|_{\mathbb{C}^n} = 1\}.$$

En 1918, O. Toeplitz [7] a prouvé que le bord de $W(A)$ est convexe. Il a également conjecturé que l'ensemble $W(A)$ lui-même est convexe. Un an après, F. Hausdorff [3] a prouvé cette conjecture. Le théorème de Toeplitz-Hausdorff est un résultat très important qui est appliqué dans beaucoup de domaines des mathématiques. Ce théorème peut être considéré comme premier résultat sur la convexité des formes quadratiques.

Dans le cas réel, le premier résultat est dû à L. L. Dines [2] en 1941. Considérons les deux formes quadratiques réelles :

$$f_i(x) := (A_i x, x)_{\mathbb{R}^n}, \quad i = 1, 2, \quad f(x) := (f_1(x), f_2(x)), \quad \forall x \in \mathbb{R}^n,$$

où A_i est une matrice réelle symétrique d'ordre n et $(\cdot, \cdot)_{\mathbb{R}^n}$ désigne le produit scalaire usuel sur \mathbb{R}^n . L. L. Dines a prouvé que l'ensemble $D \subset \mathbb{R}^2$ défini par :

$$D := \{f(x) \mid x \in \mathbb{R}^n\}$$

est convexe et il est fermé sous quelques hypothèses supplémentaires.

Le prochain résultat important a été obtenu par L. Brickman [1]. Il a prouvé que si $n \geq 3$, alors l'ensemble $B \subset \mathbb{R}^2$ défini par :

$$B := \{f(x) \mid \|x\|_{\mathbb{R}^n} = 1\}$$

est convexe compact.

Ces papiers sont les contributions principales sur la convexité des formes quadratiques et les mathématiciens essayent de les généraliser de plusieurs manières.

Théorème de Toeplitz-Hausdorff

Théorème 16. (*Toeplitz-Hausdorff*)

Soit A une matrice complexe d'ordre n ($n \geq 2$). Alors, l'ensemble :

$$W(A) = \{z^*Az \mid z \in \mathbb{C}^n, \|z\|_{\mathbb{C}^n} = 1\}$$

est convexe compact.

Démonstration. La compacité de $W(A)$ est facile à vérifier. En effet, la fonction $f : \mathbb{C}^n \rightarrow \mathbb{C}$ définit par :

$$f(u) = u^*Au, \quad \forall u \in \mathbb{C}^n$$

est continue sur \mathbb{C}^n . Par suite, pour tout compact K de \mathbb{C}^n , on a $f(K)$ est un compact de \mathbb{C} . La sphère unité :

$$\mathcal{S}(\mathbb{C}^n) = \{u \in \mathbb{C}^n \mid \|u\|_{\mathbb{C}^n} = 1\}$$

étant compacte de \mathbb{C}^n . Par suite, $W(A) = f(\mathcal{S}(\mathbb{C}^n))$ est un ensemble compact de \mathbb{C} .

La preuve de la convexité est la partie la plus difficile de la démonstration. Fixons $\alpha, \beta \in W(A)$ tels que $\alpha \neq \beta$ et $\lambda \in (0, 1)$. La question est de montrer que :

$$\lambda\alpha + (1 - \lambda)\beta \in W(A). \quad (42)$$

Par définition de $W(A)$, ils existent deux vecteurs unitaires $u, v \in \mathbb{C}^n$ tels que :

$$\alpha = u^*Au \quad \text{et} \quad \beta = v^*Av.$$

Les deux vecteurs u et v sont linéairement indépendants. En effet, si ce n'est pas le cas, il existe $\theta \in \mathbb{C}$ tel que $u = \theta v$. Comme u et v sont unitaires, il suit que $\|u\|_{\mathbb{C}^n} = \|\theta v\|_{\mathbb{C}^n} = |\theta| = 1$. Par suite, $\alpha = (\theta v)^*A(\theta v) = |\theta|^2 v^*Av = \beta$. On obtient ainsi une contradiction avec le fait que $\alpha \neq \beta$.

Maintenant, soit :

$$B = \frac{-\beta}{\alpha - \beta}I_n + \frac{1}{\alpha - \beta}A,$$

où I_n est la matrice identité d'ordre n . On vérifie facilement que :

$$u^*Bu = 1 \quad \text{et} \quad v^*Bv = 0. \quad (43)$$

On pose :

$$X = \frac{1}{2}(B + B^*) \quad \text{et} \quad Y = \frac{1}{2i}(B - B^*).$$

Alors $B = X + iY$, et les deux matrices X et Y sont hermitiennes. Par (43), on obtient facilement :

$$u^*Xu = 1, \quad u^*Yu = 0, \quad v^*Xv = 0, \quad v^*Yv = 0. \quad (44)$$

Sans restriction de la généralité, on peut supposer que u^*Yv est imaginaire pur. Si non, on peut remplacer v par $e^{i\theta_0}v$ avec un choix particulier de θ_0 .

Comme u et v sont linéairement indépendants, pour tout $t \in [0, 1]$, on peut définir :

$$z(t) = \frac{tu + (1 - t)v}{\|tu + (1 - t)v\|_{\mathbb{C}^n}},$$

qui est évidemment un vecteur unitaire. Comme Y est une matrice hermitienne et u^*Yv est imaginaire pur, par (44), on vérifie facilement que :

$$z(t)^*Yz(t) = 0, \quad \forall t \in [0, 1].$$

Par suite,

$$z(t)^*Bz(t) = z(t)^*Xz(t) = \frac{t^2 + 2t(1 - t) \operatorname{Re}(v^*Xu)}{\|tu + (1 - t)v\|_{\mathbb{C}^n}^2}, \quad \forall t \in [0, 1],$$

où Re désigne la partie réelle d'un nombre complexe. Ainsi, la fonction $g : [0, 1] \rightarrow \mathbb{R}$ définie par :

$$g(t) = z(t)^*Bz(t), \quad \forall t \in [0, 1]$$

est continue sur $[0, 1]$. D'autre part, on a $g(0) = 0$ et $g(1) = 1$. Comme $\lambda \in (0, 1)$, par le théorème des valeurs intermédiaires, il existe $t_0 \in [0, 1]$ tel que :

$$g(t_0) = z(t_0)^*Bz(t_0) = \lambda.$$

Posons maintenant $w = z(t_0)$. D'une part, on a $\|w\|_{\mathbb{C}^n} = 1$. D'autre part, on a :

$$w^*Aw = (\alpha - \beta) \left(\frac{\beta}{\alpha - \beta} + w^*Bw \right) = \beta + \lambda(\alpha - \beta) = \lambda\alpha + (1 - \lambda)\beta.$$

Ainsi, (42) est satisfaite, ce qui termine la démonstration. ■

Théorème de Dines

Théorème 17. (Dines)

Soient A_1 et A_2 deux matrices symétriques d'ordre n ($n \geq 2$). Alors, l'ensemble $D \subset \mathbb{R}^2$ défini par :

$$D := \{(x^t A_1 x, x^t A_2 x) \mid x \in \mathbb{R}^n\}$$

est convexe.

Démonstration. Ecrivons D sous la forme :

$$D = \{(P(x), Q(x)) \mid x \in \mathbb{R}^n\},$$

où P et Q sont les formes quadratiques homogènes définies par :

$$P(x) = x^t A_1 x, \quad Q(x) = x^t A_2 x, \quad \forall x \in \mathbb{R}^n.$$

Si $M \in D$ est un point distinct de l'origine O , tout point du segment $[O, M]$ appartient à D puisque $P(rx) = r^2 P(x)$ et $Q(rx) = r^2 Q(x)$ pour tout nombre réel r . Par suite, si M et N sont deux points distincts de D tels que les vecteurs \overrightarrow{OM} et \overrightarrow{ON} sont colinéaires, tout point du segment $[M, N]$ appartient à D .

Dans la suite, nous considérons alors deux points distincts $M(x_1, y_1)$ et $N(x_2, y_2)$ dans D tels que :

$$x_2 y_1 - x_1 y_2 \neq 0.$$

Sans restriction de la généralité, nous pouvons supposer que :

$$x_2 y_1 - x_1 y_2 = d^2 > 0. \quad (45)$$

Les points M et N sont dans D , ils vérifient :

$$\begin{cases} x_1 = P(z_1), & x_2 = P(z_2), \\ y_1 = Q(z_1), & y_2 = Q(z_2), \end{cases} \quad (46)$$

où $z_i \in \mathbb{R}^n$, $i = 1, 2$.

Fixons maintenant $\lambda \in (0, 1)$. La question est de montrer que le système d'équations :

$$P(z) = x_1 + \lambda(x_2 - x_1), \quad Q(z) = y_1 + \lambda(y_2 - y_1) \quad (47)$$

admet au moins une solution $z \in \mathbb{R}^n$.

Ecrivons la variable z (à déterminer) sous la forme :

$$z = \rho(z_1 \cos \theta + z_2 \sin \theta), \quad (48)$$

où ρ et θ sont des réels à déterminer de telle sorte que (47) soit satisfaite. Injectons l'expression de z dans (47), nous obtenons :

$$x_1 + \lambda(x_2 - x_1) = \rho^2 P(z_1 \cos \theta + z_2 \sin \theta), \quad y_1 + \lambda(y_2 - y_1) = \rho^2 Q(z_1 \cos \theta + z_2 \sin \theta). \quad (49)$$

Éliminons ρ^2 dans (49), nous obtenons :

$$y_1 P(z_1 \cos \theta + z_2 \sin \theta) - x_1 Q(z_1 \cos \theta + z_2 \sin \theta) = \lambda T(\theta), \quad (50)$$

où

$$T(\theta) = (y_1 - y_2)P(z_1 \cos \theta + z_2 \sin \theta) - (x_1 - x_2)Q(z_1 \cos \theta + z_2 \sin \theta). \quad (51)$$

Ici, la quantité $T(\theta)$ est une fonction quadratique en $\cos \theta$ et $\sin \theta$. Ecrivons la sous la forme :

$$T(\theta) = \alpha \cos^2 \theta + \beta \sin^2 \theta + 2\gamma \cos \theta \sin \theta.$$

Calculons $T(0)$, $T(\pm\pi/2)$ et utilisons (45), nous obtenons :

$$\alpha = \beta = d^2 > 0.$$

Par suite,

$$T(\theta) = d^2 + 2\gamma \cos \theta \sin \theta.$$

Si $\gamma \geq 0$, alors $T(\theta) > 0$ pour $\theta \in [0, \pi/2]$. Si $\gamma < 0$, alors $T(\theta) > 0$ pour $\theta \in [-\pi/2, 0]$.

Sans restriction de la généralité, prenons le cas $\gamma \geq 0$. Nous pouvons alors définir la fonction $f : [0, \pi/2] \rightarrow \mathbb{R}$ par :

$$f(\theta) = \frac{y_1 P(z_1 \cos \theta + z_2 \sin \theta) - x_1 Q(z_1 \cos \theta + z_2 \sin \theta)}{T(\theta)}, \quad \forall \theta \in [0, \pi/2].$$

La fonction f étant continue sur $[0, \pi/2]$ et $f(0) = 0$, $f(\pi/2) = 1$. Par le théorème des valeurs intermédiaires, il existe alors $\theta_0 \in [0, \pi/2]$ tel que $f(\theta_0) = \lambda$. Ainsi, (50) est satisfaite pour $\theta = \theta_0$. Ensuite, nous vérifions facilement que les deux équations dans (49) sont satisfaites pour $\theta = \theta_0$ et $\rho^2 = \rho_0^2 = d^2/T(\theta_0)$. Par suite, $z_0 = \rho_0(z_1 \cos \theta_0 + z_2 \sin \theta_0)$ est une solution de (47), ce qui termine la démonstration. ■

Théorème de Brickman

Le théorème suivant a été prouvé par Brickman en 1961 [1].

Théorème 18. (*Brickman*)

Soient A_1 et A_2 deux matrices symétriques d'ordre $n \geq 3$. Alors, l'ensemble $B(A_1, A_2) \subset \mathbb{R}^2$ défini par :

$$B(A_1, A_2) := \{(x^t A_1 x, x^t A_2 x) \mid \|x\|_{\mathbb{R}^n} = 1\}$$

est convexe.

Démonstration. La démonstration originale de ce théorème est basée sur des arguments de géométrie différentielle, elle est due à Pépin [5].

La preuve est basée sur les deux lemmes suivants.

Lemme 1. Soit $P : \mathbb{R}^2 \rightarrow \mathbb{R}^2$ une application affine. Alors, il existe deux matrices \widetilde{A}_1 et \widetilde{A}_2 symétriques d'ordre n telles que :

$$P(B(A_1, A_2)) = B(\widetilde{A}_1, \widetilde{A}_2).$$

Lemme 2. Soit un entier $n \geq 3$. Si x et y sont deux points de \mathbb{R}^n tels que $x^t A_1 x = y^t A_1 y = 0$ et $(x^t A_2 x)(y^t A_2 y) < 0$, alors il existe un autre point $z \in \mathbb{R}^n$ tel que $\|z\|_{\mathbb{R}^n} = 1$ et $z^t A_1 z = z^t A_2 z = 0$.

En utilisant les deux lemmes précédents, on peut démontrer le théorème facilement. On suppose que $B(A_1, A_2)$ est non réduit à $\{0\}$. Soient a et b deux points distincts de $B(A_1, A_2)$. Par définition de $B(A_1, A_2)$, on a :

$$a = x^t A_1 x, x \in \mathbb{R}^n, \|x\|_{\mathbb{R}^n} = 1 \text{ et } b = y^t A_1 y, y \in \mathbb{R}^n, \|y\|_{\mathbb{R}^n} = 1.$$

Soit c un point quelconque sur le segment ouvert entre a et b . La question est de montrer que $c \in B(A_1, A_2)$. Soit $P : \mathbb{R}^2 \rightarrow \mathbb{R}^2$ une bijection affine telle que $P(c) = (0, 0)$ et $P(a) = (0, 1)$. Par suite, il existe $\beta < 0$ tel que $P(b) = (0, \beta)$. Par Lemme 1, il existe deux matrices \widetilde{A}_1 et \widetilde{A}_2 symétriques d'ordre n telles que $P(B(A_1, A_2)) = B(\widetilde{A}_1, \widetilde{A}_2)$. On a :

$$x^t \widetilde{A}_1 x = 0, x^t \widetilde{A}_2 x = 1, y^t \widetilde{A}_1 y = 0, y^t \widetilde{A}_2 y = \beta < 0.$$

Appliquons maintenant Lemme 2, il existe alors $z \in \mathbb{R}^n$ tel que $\|z\|_{\mathbb{R}^n} = 1$ et $z^t \widetilde{A}_1 z = z^t \widetilde{A}_2 z = 0$. Ceci implique que $(0, 0) \in B(\widetilde{A}_1, \widetilde{A}_2) = P(B(A_1, A_2))$, ou encore $c = P^{-1}(0, 0) \in B(A_1, A_2)$, ce qui termine la démonstration. ■

Remarque. Si $n = 2$, l'ensemble $B(A_1, A_2)$ n'est pas en général convexe. Voici un contre-exemple :

$$A_1 = \begin{pmatrix} 1 & 0 \\ 0 & -1 \end{pmatrix} \quad \text{et} \quad A_2 = \begin{pmatrix} 0 & 1 \\ 1 & 0 \end{pmatrix}.$$

Alors, $B(A_1, A_2)$ est le cercle unité de \mathbb{R}^2 .

Théorème de Polyak

► Le cas de trois formes quadratiques.

On rappelle les définitions suivantes.

Un ensemble $\mathcal{K} \subset \mathbb{R}^n$ est un cône si $x \in \mathcal{K}$ implique que $\lambda x \in \mathcal{K}$ pour tout $\lambda > 0$.

On dit que l'ensemble K vérifie la propriété (H) si :

$$(H) \quad x \in \mathcal{K}, x \neq 0 \Rightarrow -x \notin \mathcal{K}.$$

Soient A_1, A_2 et A_3 trois matrices symétriques d'ordre $n \geq 3$. On définit l'ensemble $W(A_1, A_2, A_3) \subset \mathbb{R}^3$ par :

$$W(A_1, A_2, A_3) := \{(x^t A_1 x, x^t A_2 x, x^t A_3 x) \mid x \in \mathbb{R}^n\}.$$

B. T. Polyak a montré le résultat suivant [6].

Théorème 19. *Les conditions suivantes sont équivalentes :*

(a) $\exists \mu = (\mu_1, \mu_2, \mu_3) \in \mathbb{R}^3$ tel que :

$$\mu_1 A_1 + \mu_2 A_2 + \mu_3 A_3 > 0.$$

(b) L'ensemble $W(A_1, A_2, A_3)$ est un cône convexe fermé vérifiant (H), et

$$x^t A_1 x = x^t A_2 x = x^t A_3 x = 0 \Rightarrow x = 0.$$

La démonstration de ce résultat est basée sur le théorème de Brickman.

► Le cas de deux fonctions quadratiques.

Considérons les fonctions quadratiques :

$$\begin{aligned}\varphi_i(x) &:= x^t A_i x + 2x^t a_i + \alpha_i, \quad i = 1, 2, \\ \varphi(x) &:= (\varphi_1(x), \varphi_2(x)),\end{aligned}$$

où $x \in \mathbb{R}^n$, $a_i \in \mathbb{R}^n$, $\alpha_i \in \mathbb{R}$ et A_i sont des matrices symétriques d'ordre $n \geq 2$. On pose :

$$\Phi := \{\varphi(x) \mid x \in \mathbb{R}^n\} \subset \mathbb{R}^2.$$

B. T. Polyak a montré le résultat suivant [6].

Théorème 20. *Supposons qu'il existe $\mu = (\mu_1, \mu_2) \in \mathbb{R}^2$ tel que :*

$$\mu_1 A_1 + \mu_2 A_2 > 0.$$

Alors, Φ est un convexe fermé.

◆ Transformation quadratique en dimension infinie

Dans [Article 12], nous considérons des fonctions quadratiques définies sur un espace de Hilbert de dimension infinie. La motivation principale de ce travail provient de la théorie de contrôle optimal, où beaucoup de problèmes font intervenir la minimisation d'une fonction quadratique sur un sous-ensemble convexe fermé d'un espace de Hilbert de dimension infinie. Plus précisément, dans ce travail, nous généralisons Théorème 19 et Théorème 20 en prenant à la place de \mathbb{R}^n un espace de Hilbert H de dimension infinie.

Nos principaux résultats sont les suivants.

Dans toute cette partie, H désigne un \mathbb{R} -espace de Hilbert de dimension infinie et séparable. L'espace H est muni d'un produit scalaire $(\cdot, \cdot)_H$. Considérons les fonctions quadratiques :

$$\varphi_i(x) := (A_i x, x)_H + 2(a_i, x)_H + \alpha_i, \forall x \in H, i = 1, 2,$$

où $A_i : H \rightarrow H$ sont deux opérateurs linéaires bornés sur H , $a_i \in H$ et $\alpha_i \in \mathbb{R}$. Considérons l'ensemble $\Phi_H \subset \mathbb{R}^2$ défini par :

$$\Phi_H := \{(\varphi_1(x), \varphi_2(x)) \mid x \in H\}.$$

Dans un premier temps, nous étudions la fermeture de l'ensemble Φ_H . Notre résultat est le suivant.

Théorème 21. *On suppose que :*

1. $A_i : H \rightarrow H$ est un opérateur compact pour tout $i = 1, 2$.
2. $\exists \mu = (\mu_1, \mu_2) \in \mathbb{R}^2 \mid \mu_1 A_1 + \mu_2 A_2 > 0$.

Alors, l'ensemble Φ_H est fermé.

Le résultat suivant nous montre que sous certaines hypothèses, la fermeture de Φ_H est une condition suffisante pour assurer sa convexité. Un tel résultat est similaire à celui trouvé par V. A. Yakubovich [8], mais sous autres hypothèses.

Théorème 22. *On suppose que :*

1. $A_i : H \rightarrow H$ est auto-adjoint pour tout $i = 1, 2$.
2. $\exists \mu = (\mu_1, \mu_2) \in \mathbb{R}^2 \mid \mu_1 A_1 + \mu_2 A_2 > 0$.

3. L'ensemble Φ_H est fermé.

Alors, Φ_H est un ensemble convexe.

Une conséquence immédiate du Théorème 21 et Théorème 22 est la suivante.

Corollaire 1. *On suppose que :*

1. $A_i : H \rightarrow H$ est compact et auto-adjoint pour tout $i = 1, 2$.
2. $\exists \mu = (\mu_1, \mu_2) \in \mathbb{R}^2 \mid \mu_1 A_1 + \mu_2 A_2 > 0$.

Alors, l'ensemble Φ_H est un fermé convexe.

Remarque. Corollaire 1 est une extension du résultat obtenu par M. R. Hestenes dans [4], où seulement des formes quadratiques ont été considérées.

Considérons maintenant les formes quadratiques :

$$f_i(x) = (A_i x, x)_H, \quad \forall x \in H, \quad i = 1, 2, 3,$$

où $A_i : H \rightarrow H$ sont des opérateurs linéaires bornés. Soit $F_H \subset \mathbb{R}^3$ l'ensemble défini par :

$$F_H = \{(f_1(x), f_2(x), f_3(x)) \mid x \in H\}.$$

Nous avons le

Théorème 23. *On suppose que $A_i : H \rightarrow H$ est compact et auto-adjoint pour tout $i = 1, 2, 3$. Les assertions suivantes sont équivalentes :*

1. $\exists \mu = (\mu_1, \mu_2, \mu_3) \in \mathbb{R}^3$ tel que :

$$\mu_1 A_1 + \mu_2 A_2 + \mu_3 A_3 > 0. \tag{52}$$

2. L'ensemble F_H est un cône convexe fermé vérifiant (H), et les formes quadratiques $f_1(x)$, $f_2(x)$ et $f_3(x)$ n'ont aucun zéro commun excepté zéro.

Bibliographie

1. L. Brickman, *On the Field of Values of a Matrix*, Proceedings of the American Mathematical Society, Vol. 12, pp. 61-66, 1961.
2. L. L. Dines, *On the Mapping of Quadratic Forms*, Bulletin of the American Mathematical Society, Vol. 47, pp. 494-498, 1941.
3. F. Hausdorff, *Der Wertvorrat einer Bilinearform*, Mathematische Zeitschrift, Vol. 3, pp. 314-316, 1919.
4. M. R. Hestenes, *Optimization Theory*, Robert E. Krieger Publishing Company, Huntington, New York, 1981.
5. H. Pépin, *Answer to a problem posed by J.-B. Hiriart-Urruty*, Revue de la filière Mathématiques (RMS), 3, pp. 171-172, 2004.
6. B. T. Polyak, *Convexity of Quadratic Transformations and Its Use in Control and Optimization*, Journal of Optimization Theory and Applications, Vol. 99, No. 3, pp. 553-583, 1998.
7. O. Toeplitz, *Das algebraische Analogon zu einem Satz von Fejer*, Mathematische Zeitschrift, Vol. 2, pp. 187-197, 1918.
8. V. A. Yakubovich, *Nonconvex Optimization Problem : the Infinite-Horizon Linear-Quadratic Control Problem with Quadratic Constraints*, Systems & Control Letters, Vol. 19, pp. 13-22, 1992.

Thème IV. Quelques généralisations du principe de contraction de Banach (Articles 13-15)

◆ Introduction

Soient X un ensemble non vide et $T : X \rightarrow X$ une application donnée. Si un point $\xi \in X$ vérifie $T\xi = \xi$, on dit que ξ est un point fixe de T . Dans beaucoup de cas, pour résoudre un problème d'existence, on se ramène à la recherche d'un point fixe d'une certaine fonction. Le premier résultat dans ce sujet est dû à S. Banach [2]. Ce résultat est connu sous le nom du principe de contraction de Banach.

Théorème 24. (*Banach, 1922*)

Soient (X, d) un espace métrique complet et $T : X \rightarrow X$ une application telle qu'il existe $k \in (0, 1)$ tel que :

$$d(Tx, Ty) \leq kd(x, y), \quad \forall x, y \in X. \quad (53)$$

Alors, T admet un unique point fixe $\xi \in X$. De plus, pour tout $x \in X$, la suite $(T^n x)_{n \in \mathbb{N}}$ converge vers ξ .

Démonstration. Soit x_0 un point arbitraire de X . Soit $(x_n)_{n \in \mathbb{N}}$ la suite définie par $x_n = T^n x_0$ pour tout $n \in \mathbb{N}$. Par (53), nous avons :

$$d(x_2, x_1) = d(Tx_1, Tx_0) \leq kd(x_1, x_0).$$

De même, nous avons :

$$d(x_3, x_2) = d(Tx_2, Tx_1) \leq kd(x_2, x_1) \leq k^2 d(x_1, x_0).$$

Par suite, nous avons :

$$d(x_{n+1}, x_n) \leq k^n d(x_1, x_0), \quad \forall n \in \mathbb{N}.$$

Soient maintenant $m, n \in \mathbb{N}$ tels que $m > n$. Nous avons :

$$\begin{aligned} d(x_n, x_m) &\leq d(x_n, x_{n+1}) + d(x_{n+1}, x_{n+2}) + \cdots + d(x_{m-1}, x_m) \\ &\leq \frac{k^n}{1-k} d(x_1, x_0). \end{aligned}$$

Comme $k \in (0, 1)$, la suite $(x_n)_{n \in \mathbb{N}}$ est de Cauchy, elle converge donc vers $\xi \in X$. La fonction T étant continue, nous avons :

$$\xi = \lim_{n \rightarrow +\infty} x_{n+1} = \lim_{n \rightarrow +\infty} Tx_n = T\left(\lim_{n \rightarrow +\infty} x_n\right) = T\xi.$$

Par suite, ξ est un point fixe de T . Supposons maintenant que ξ et η sont deux points fixes de T tels que $\xi \neq \eta$. Par (53), nous avons :

$$d(\xi, \eta) = d(T\xi, T\eta) \leq kd(\xi, \eta) < d(\xi, \eta).$$

Nous obtenons alors une contradiction, ce qui prouve l'unicité du point fixe. ■

Remarque. La démonstration ci-dessus est classique. Autres démonstrations du principe de contraction de Banach existent en littérature. La plus récente est due à O. Valero (2008) [22].

Le principe de contraction de Banach joue un rôle très important en analyse non linéaire. Beaucoup de généralisations de ce principe existent en littérature, voir [5, 6, 7, 8, 9, 10, 12, 14, 15, 17, 18, 20] et autres. Voici quelques généralisations.

Contraction de Meir-Keeler

Dans [17], A. Meir et E. Keeler ont obtenu la généralisation suivante. Leur résultat est connu sous le nom de Meir-Keeler contraction.

Théorème 25. (*Meir-Keeler, 1969*)

Soient (X, d) un espace métrique complet et $T : X \rightarrow X$ une application vérifiant : pour tout $\varepsilon > 0$, il existe $\delta(\varepsilon) > 0$ tel que

$$\varepsilon \leq d(x, y) < \varepsilon + \delta(\varepsilon) \Rightarrow d(Tx, Ty) < \varepsilon. \quad (54)$$

Alors, T admet un unique point fixe $\xi \in X$. De plus, pour tout $x \in X$, la suite $(T^n x)_{n \in \mathbb{N}}$ converge vers ξ .

Remarque. La contraction de Meir-Keeler généralise bien celle de Banach. En effet, si (53) est satisfaite, (54) l'est aussi. Pour le vérifier, il suffit de poser pour tout $\varepsilon > 0$, $\delta = \frac{\varepsilon(1-k)}{k}$.

Démonstration. Remarquons que la condition (54) implique que T est strictement contractante :

$$d(Tx, Ty) < d(x, y), \quad \forall x, y \in X, x \neq y. \quad (55)$$

Par suite, l'application T est continue et a au plus un point fixe. Soit maintenant $x_0 \in X$, posons :

$$x_n = T^n x_0, \quad \forall n \in \mathbb{N}.$$

Si jamais il existe $n \in \mathbb{N}$ tel que $x_n = x_{n+1}$, le problème sera résolu. Nous éliminons alors ce cas trivial. D'après (55), la suite $(d(x_{n+1}, x_n))_{n \in \mathbb{N}}$ est strictement décroissante, étant minorée (0 un minorant), elle converge. Supposons que :

$$d(x_{n+1}, x_n) \downarrow c > 0 \text{ quand } n \rightarrow +\infty.$$

Pour n assez grand, nous avons :

$$c \leq d(x_{n+1}, x_n) < c + \delta(c).$$

Par (54), nous obtenons alors $d(x_{n+2}, x_{n+1}) < c$, ce qui est impossible. Alors, nécessairement :

$$d(x_{n+1}, x_n) \downarrow 0 \text{ quand } n \rightarrow +\infty. \quad (56)$$

Sans restriction de la généralité, nous pouvons supposer que :

$$\delta(\varepsilon) < \varepsilon, \quad \forall \varepsilon > 0. \quad (57)$$

Soit maintenant $\varepsilon > 0$ fixé. Par (56), il existe un certain $k \in \mathbb{N}$ tel que :

$$d(x_{k+1}, x_k) < \delta(\varepsilon). \quad (58)$$

Considérons maintenant l'ensemble :

$$\Lambda := \{x \in X \mid d(x, x_k) < \varepsilon + \delta(\varepsilon)\}.$$

Montrons que :

$$T(\Lambda) \subset \Lambda. \quad (59)$$

Soit $x \in \Lambda$ ($x \neq x_k$). Deux cas se présentent.

◇ Premier cas : $d(x, x_k) \leq \varepsilon$. Dans ce cas, nous avons :

$$d(Tx, x_k) \leq d(Tx, Tx_k) + d(x_k, x_k) < d(x, x_k) + \delta(\varepsilon) \text{ (par (55) et (58))} \leq \varepsilon + \delta(\varepsilon).$$

Dans ce cas, nous avons alors $Tx \in \Lambda$.

◇ Deuxième cas : $\varepsilon < d(x, x_k) < \varepsilon + \delta(\varepsilon)$. Dans ce cas, nous avons :

$$d(Tx, x_k) \leq d(Tx, Tx_k) + d(x_k, x_k) < \varepsilon + \delta(\varepsilon) \text{ (par (54) et (58))} .$$

Dans ce cas aussi, nous avons $T(x) \in \Lambda$.

Ainsi, (59) est satisfaite. Par suite, nous avons :

$$x_n \in \Lambda, \forall n \geq k. \tag{60}$$

Par (60), pour tous $n, m \geq k$, nous obtenons :

$$d(x_n, x_m) \leq d(x_n, x_k) + d(x_k, x_m) < 2(\varepsilon + \delta(\varepsilon)) < 4\varepsilon \text{ (par (57)).}$$

La suite $(x_n)_{n \in \mathbb{N}}$ est alors de Cauchy dans (X, d) qui est complet. Il existe alors $\xi \in X$ tel que :

$$d(x_n, \xi) \rightarrow 0 \text{ quand } n \rightarrow +\infty.$$

En fin, par (55), il est facile de voir que ξ est l'unique point fixe de T . ■

Contraction de Matkowski

Le résultat suivant est dû à J. Matkowski [16].

Théorème 26. (*Matkowski, 1980*)

Soient (X, d) un espace métrique complet et $T : X \rightarrow X$ une application vérifiant :

$$d(Tx, Ty) < d(x, y), \forall x, y \in X, x \neq y$$

et $\forall \varepsilon > 0, \exists \delta(\varepsilon) > 0$ tel que :

$$\varepsilon < d(x, y) < \varepsilon + \delta(\varepsilon) \Rightarrow d(Tx, Ty) \leq \varepsilon.$$

Alors, T admet un unique point fixe $\xi \in X$. De plus, pour tout $x \in X$, la suite $(T^n x)_{n \in \mathbb{N}}$ converge vers ξ .

Ce théorème se démontre d'une manière analogue au précédent.

Contraction de Dass-Gupta

Dans [8], B. K. Dass et S. Gupta ont obtenu le résultat suivant.

Théorème 27. (*Dass-Gupta, 1975*)

Soient (X, d) un espace métrique complet et $T : X \rightarrow X$ une application vérifiant :

$$d(Tx, Ty) \leq \alpha d(y, Ty) \frac{1 + d(x, Tx)}{1 + d(x, y)} + \beta d(x, y), \forall x, y \in X, \tag{61}$$

où $\alpha > 0, \beta > 0, \alpha + \beta < 1$. Alors, T admet un unique point fixe $\xi \in X$. De plus, pour tout $x \in X$, la suite $(T^n x)_{n \in \mathbb{N}}$ converge vers ξ .

Démonstration. Soit $x_0 \in X$ fixé. Posons :

$$x_n = T^n x_0, \quad \forall n \in \mathbb{N}.$$

Par (61), nous obtenons :

$$d(x_n, x_{n+1}) = d(Tx_{n-1}, Tx_n) \leq \alpha d(x_n, x_{n+1}) + \beta d(x_{n-1}, x_n), \quad \forall n \in \mathbb{N}^*.$$

Par suite,

$$d(x_n, x_{n+1}) \leq \frac{\beta}{1-\alpha} d(x_{n-1}, x_n), \quad \forall n \in \mathbb{N}^*.$$

Soit :

$$d(x_n, x_{n+1}) \leq \left(\frac{\beta}{1-\alpha} \right)^n d(x_0, x_1), \quad \forall n \in \mathbb{N}.$$

Comme

$$0 < \frac{\beta}{1-\alpha} < 1,$$

la suite $(x_n)_{n \in \mathbb{N}}$ est de Cauchy, elle converge alors vers $\xi \in X$. Montrons que ξ est un point fixe de T . Par (61), nous avons :

$$d(\xi, T\xi) \leq d(\xi, Tx_n) + d(Tx_n, T\xi) \leq d(\xi, Tx_n) + \alpha d(\xi, T\xi) \frac{1 + d(x_n, x_{n+1})}{1 + d(x_n, \xi)} + \beta d(x_n, \xi),$$

c'est-à-dire :

$$d(\xi, T\xi) \leq \frac{1 + d(x_n, \xi)}{(1-\alpha) + d(x_n, \xi) - \alpha d(x_n, x_{n+1})} [d(\xi, x_{n+1}) + \beta d(x_n, \xi)] \rightarrow 0 \text{ quand } n \rightarrow +\infty.$$

Par suite, $T\xi = \xi$.

Maintenant, si $\eta \in X$ est aussi un point fixe de T , par (61), nous obtenons :

$$d(\xi, \eta) = d(T\xi, T\eta) \leq \beta d(\xi, \eta),$$

c'est-à-dire :

$$(1-\beta)d(\xi, \eta) \leq 0.$$

Comme $\beta < 1$, nous devons avoir $d(\xi, \eta) = 0$, ou encore $\xi = \eta$. ■

◆ Contraction de type intégrale [Articles 13-14]

A. Branciari a démontré récemment le théorème suivant [4].

Théorème 28. (*Branciari, 2002*)

Soient (X, d) un espace métrique complet, $c \in (0, 1)$, $\varphi : [0, +\infty) \rightarrow [0, +\infty)$ localement intégrable et $T : X \rightarrow X$ tels que :

$$\int_0^s \varphi(t) dt > 0, \quad \int_0^{d(Tx, Ty)} \varphi(t) dt \leq c \int_0^{d(x, y)} \varphi(t) dt \quad (62)$$

pour tout $s > 0$ et pour tous $x, y \in X$. Alors, T admet un unique point fixe.

Remarque. En prenant $\varphi \equiv 1$, nous retrouvons bien le théorème de Banach.

La contraction de Branciari est une contraction de Meir-Keeler

Dans [21], T. Suzuki a prouvé que Théorème 28 est un cas particulier du Théorème 25. Autrement dit, la contraction de Branciari est une contraction de Meir-Keeler. Sa démonstration est basée sur le théorème suivant.

Théorème 29. (*Suzuki, 2007*)

Soient (X, d) un espace métrique et $T : X \rightarrow X$ une application donnée. Supposons qu'il existe une fonction $\theta : [0, +\infty) \rightarrow [0, +\infty)$ vérifiant :

- (a) $\theta(0) = 0$ et $\theta(t) > 0$ pour tout $t > 0$.
- (b) θ est croissante et continue à droite.
- (c) Pour tout $\varepsilon > 0$, il existe $\delta(\varepsilon) > 0$ tel que :

$$\theta(d(x, y)) < \varepsilon + \delta(\varepsilon) \Rightarrow \theta(d(Tx, Ty)) < \varepsilon \quad (63)$$

pour tous $x, y \in X$.

Alors, T satisfait la contraction de Meir-Keeler (54).

Démonstration. Fixons $\varepsilon > 0$. Puisque $\theta(\varepsilon) > 0$, par (c), il existe $\alpha > 0$ tel que :

$$\theta(d(u, v)) < \theta(\varepsilon) + \alpha \Rightarrow \theta(d(Tu, Tv)) < \theta(\varepsilon). \quad (64)$$

Par la continuité à droite de θ , il existe $\delta > 0$ tel que :

$$\theta(\varepsilon + \delta) < \theta(\varepsilon) + \alpha. \quad (65)$$

Soient $x, y \in X$ tels que $\varepsilon \leq d(x, y) < \varepsilon + \delta$. Comme θ est croissante, par (65), nous avons :

$$\theta(d(x, y)) \leq \theta(\varepsilon + \delta) < \theta(\varepsilon) + \alpha.$$

Par (64), nous obtenons $\theta(d(Tx, Ty)) < \theta(\varepsilon)$. Comme θ est croissante, nous avons $d(Tx, Ty) < \varepsilon$, et la contraction de Meir-Keeler est satisfaite. ■

Le résultat suivant est une conséquence immédiate du Théorème 29. Il suffit de poser $\theta(s) = \int_0^s \varphi(t) dt$ pour tout $s \geq 0$.

Corollaire 2. Soient (X, d) un espace métrique et $T : X \rightarrow X$ une application donnée. Soit $\varphi : [0, +\infty) \rightarrow [0, +\infty)$ une fonction localement intégrable et vérifiant :

$$\int_0^s \varphi(t) dt > 0, \quad \forall s > 0. \quad (66)$$

Supposons que pour tout $\varepsilon > 0$, il existe $\delta(\varepsilon) > 0$ tel que :

$$\int_0^{d(x, y)} \varphi(t) dt < \varepsilon + \delta(\varepsilon) \Rightarrow \int_0^{d(Tx, Ty)} \varphi(t) dt < \varepsilon \quad (67)$$

pour tous $x, y \in X$. Alors, T satisfait la contraction de Meir-Keeler (54).

Corollaire 3. Supposons que toutes les hypothèses du Théorème 28 sont vérifiées. Alors, T satisfait la contraction de Meir-Keeler (54).

Démonstration. Il suffit de poser $\delta(\varepsilon) = \varepsilon \left(\frac{1-c}{c} \right)$ pour tout $\varepsilon > 0$. ■

Remarque. D'après Corollaire 3, Théorème 28 est un corollaire du Théorème 25.

Contraction de type intégrale généralisant la contraction de Dass-Gupta [Article 13]

Dans [Article 13], nous avons établi un théorème de point fixe avec une contraction de type intégrale qui généralise le résultat de Dass-Gupta (voir Théorème 27). Notre résultat est le suivant.

Théorème 30. *Soient (X, d) un espace métrique complet, $\varphi : [0, +\infty) \rightarrow [0, +\infty)$ localement intégrable et $T : X \rightarrow X$ une application donnée. Posons :*

$$m(x, y) = d(y, Ty) \frac{1 + d(x, Tx)}{1 + d(x, y)}, \quad \forall x, y \in X.$$

Supposons que pour tous $x, y \in X$, nous avons :

$$\int_0^{d(Tx, Ty)} \varphi(t) dt \leq \alpha \int_0^{m(x, y)} \varphi(t) dt + \beta \int_0^{d(x, y)} \varphi(t) dt, \quad (68)$$

où $\alpha, \beta > 0$, $\alpha + \beta < 1$ et

$$\int_0^\varepsilon \varphi(t) dt > 0, \quad \forall \varepsilon > 0.$$

Alors, T admet un unique point fixe $\xi \in X$. De plus, pour tout $x \in X$, la suite $(T^n x)_{n \in \mathbb{N}}$ converge vers ξ .

Remarque. En prenant $\varphi \equiv 1$, nous retrouvons bien le résultat du Théorème 27.

Nous illustrons le théorème ci-dessus par l'exemple suivant. Soit

$$X = \left\{ \frac{1}{n} + a \mid n \in \mathbb{N}^* \right\} \cup \{a\},$$

où a est un nombre réel fixé. L'ensemble X est muni de la distance standard $d(x, y) = |x - y|$. Nous considérons l'application $T : X \rightarrow X$ définie par :

$$Tx = \begin{cases} \frac{1}{n+1} + a & \text{si } x = \frac{1}{n} + a, \\ a & \text{si } x = a. \end{cases}$$

Dans ce cas, la contraction de Dass-Gupta (61) n'est pas vérifiée. En effet, si nous prenons $x = \frac{1}{n} + a$, $n \in \mathbb{N}^*$ et $y = a$, nous obtenons :

$$d(Tx, Ta) \leq \alpha d(a, Ta) \frac{1 + d(x, Tx)}{1 + d(x, a)} + \beta d(x, a), \quad \forall n \in \mathbb{N}^*.$$

Par suite, nous avons :

$$\frac{n}{n+1} \leq \beta, \quad \forall n \in \mathbb{N}^*.$$

Pour $n \rightarrow +\infty$, nous obtenons la contradiction suivante : $1 \leq \beta$. Cependant, l'application T satisfait (68) pour $\varphi(t) = t^{1/t-2}(1 - \ln t)$ pour $t > 0$, $\varphi(0) = 0$, $\beta = 1/2$ et $\alpha \in (0, 1/2)$.

Contraction de type intégrale dans l'espace métrique de Branciari [Article 14]

Dans [3], A. Branciari a introduit la notion d'espace métrique généralisé. Il a généralisé le théorème du point fixe de Banach dans un tel espace.

Définition 1. (Branciari, 2000)

Soient X un ensemble non vide et $d : X \times X \rightarrow [0, +\infty)$ une application vérifiant :

(i) $d(x, y) = 0 \Leftrightarrow x = y$.

(ii) $d(x, y) = d(y, x)$ pour tous $x, y \in X$.

(iii) $d(x, y) \leq d(x, w) + d(w, z) + d(z, y)$ pour tous $x, y \in X$, pour tous $w, z \in X \setminus \{x, y\}$, $w \neq z$.

Dans ce cas, l'application d est appelée métrique généralisée sur X et le couple (X, d) est appelé espace métrique généralisé (e.m.g).

Il est clair qu'un espace métrique est un espace métrique généralisé. Le contraire n'est pas vrai en général, comme le montre l'exemple suivant.

Exemple. Soient $X = \mathbb{R}$ et $\alpha > 0$. Posons $d : X \times X \rightarrow [0, +\infty)$ l'application définie par :

$$d(x, y) = \begin{cases} 0 & \text{si } x = y, \\ 3\alpha & \text{si } x, y \in \{1, 2\}, x \neq y, \\ \alpha & \text{si } x \text{ ou } y \notin \{1, 2\}, x \neq y. \end{cases}$$

Il est facile de vérifier que (X, d) est un e.m.g. Par contre, (X, d) n'est pas un espace métrique. Pour le vérifier, il suffit de remarquer que :

$$3\alpha = d(1, 2) > d(1, 3) + d(3, 2) = \alpha + \alpha.$$

Définition 2. (Branciari, 2000)

Soient (X, d) un e.m.g, $(x_n)_{n \in \mathbb{N}}$ une suite dans X et $x \in X$.

- Nous disons que $(x_n)_{n \in \mathbb{N}}$ converge vers x par rapport à d si :

$$d(x_n, x) \rightarrow 0 \text{ quand } n \rightarrow +\infty.$$

- Nous disons que $(x_n)_{n \in \mathbb{N}}$ est une suite de Cauchy dans (X, d) si :

$$d(x_n, x_m) \rightarrow 0 \text{ quand } n, m \rightarrow +\infty.$$

- Nous disons que (X, d) est complet, si toute suite de Cauchy dans (X, d) est convergente dans X .

Dans [Article 14], nous avons établi le résultat suivant.

Théorème 31. Soient (X, d) un e.m.g complet, $c \in (0, 1)$, $\varphi : [0, +\infty) \rightarrow [0, +\infty)$ localement intégrable et $T : X \rightarrow X$ tels que :

$$\int_0^s \varphi(t) dt > 0, \quad \int_0^{d(Tx, Ty)} \varphi(t) dt \leq c \int_0^{d(x, y)} \varphi(t) dt \tag{69}$$

pour tout $s > 0$ et pour tous $x, y \in X$. Alors, T admet un unique point fixe $\xi \in X$. De plus, pour tout $x \in X$, $d(T^n x, \xi) \rightarrow 0$ quand $n \rightarrow +\infty$.

Nous illustrons le résultat ci-dessus par l'exemple suivant.

Exemple. Soit $X = \{1, 2, 3, 4\}$. Nous posons $d : X \times X \rightarrow [0, +\infty)$ l'application définie par :

$$\begin{aligned} d(1, 2) &= d(2, 1) = 3 \\ d(2, 3) &= d(3, 2) = d(1, 3) = d(3, 1) = 1 \\ d(1, 4) &= d(4, 1) = d(2, 4) = d(4, 2) = d(3, 4) = d(4, 3) = 4. \\ d(1, 1) &= d(2, 2) = d(3, 3) = d(4, 4) = 0. \end{aligned}$$

Nous avons (X, d) est un e.m.g complet. Notons que (X, d) n'est pas un espace métrique standard puisque :

$$3 = d(1, 2) > d(1, 3) + d(3, 2) = 1 + 1 = 2.$$

Définissons maintenant l'application $T : X \rightarrow X$ par :

$$Tx = \begin{cases} 3 & \text{si } x \neq 4, \\ 1 & \text{si } x = 4. \end{cases}$$

L'application T vérifie (69) avec $\varphi(t) = e^t$ et $c = e^{-3}$. Ainsi, T admet un unique point fixe, qui est $\xi = 3$.

◆ Théorème du point fixe de Kannan dans un espace métrique cône généralisé [Article 15]

Espace métrique de Huang-Zhang (Cone metric space)

Récemment, L. G. Huang et X. Zhang [11] ont introduit la notion d'espace métrique cône (cone metric space), où l'ensemble des nombres réels est remplacé par un espace de Banach partiellement ordonné. Ils ont établi des théorèmes de point fixe dans un tel espace.

Soit E un espace de Banach et $P \subseteq E$. Le sous-ensemble P est dit un cône si :

- (i) P est fermé, $P \neq \emptyset$ et $P \neq \{0\}$.
- (ii) $ax + by \in P$ pour tous $x, y \in P$, pour tous $a, b \geq 0$.
- (iii) $P \cap (-P) = \{0\}$.

Pour un cône donné $P \subseteq E$, nous pouvons définir une relation d'ordre partiel \leq dans E par rapport à P comme suit :

$$x \leq y \Leftrightarrow y - x \in P, \forall x, y \in E.$$

Nous notons $x < y$ pour dire que $x \leq y$ et $x \neq y$. Nous notons $x \ll y$ pour dire que $y - x \in \text{int}P$, où $\text{int}P$ désigne l'intérieur de P . Le cône P est dit normal, s'il existe une constante $k > 0$ telle que :

$$0 \leq x \leq y \Rightarrow \|x\|_E \leq k\|y\|_E, \forall x, y \in E.$$

Dans ce cas, le réel k est appelé constante normale de P .

Dans la suite, nous supposons que E est un espace de Banach, P est un cône de E avec $\text{int}P \neq \emptyset$ et \leq est une relation d'ordre partiel par rapport à P .

Définition 3. (Huang-Zhang, 2007)

Soit X un ensemble non vide. Supposons qu'une application $d : X \times X \rightarrow E$ satisfait :

- (i) $0 \leq d(x, y)$ pour tous $x, y \in X$ et $d(x, y) = 0 \Leftrightarrow x = y$.
- (ii) $d(x, y) = d(y, x)$ pour tous $x, y \in X$.
- (iii) $d(x, y) \leq d(x, z) + d(z, y)$ pour tous $x, y, z \in X$.

L'application d est appelée une métrique cône sur X et le couple (X, d) est appelé espace métrique cône (cone metric space).

Exemple. Soient $E = \mathbb{R}^2$, $P = \{(x, y) \in E \mid x \geq 0, y \geq 0\}$, $X = \mathbb{R}$ et l'application $d : X \times X \rightarrow E$ définie par :

$$d(x, y) = (|x - y|, \alpha|x - y|),$$

où α est une constante positive. Alors, (X, d) est un espace métrique cône [11].

Définition 4. (Huang-Zhang, 2007)

Soient (X, d) un espace métrique cône, $x \in X$ et $(x_n)_{n \in \mathbb{N}}$ une suite dans X . Alors,

- La suite $(x_n)_{n \in \mathbb{N}}$ converge vers x si :

$$\forall c \gg 0, \exists N \in \mathbb{N} \mid d(x_n, x) \ll c, \forall n \geq N.$$

- La suite $(x_n)_{n \in \mathbb{N}}$ est de Cauchy si :

$$\forall c \gg 0, \exists N \in \mathbb{N} \mid d(x_n, x_m) \ll c, \forall n, m \geq N.$$

- (X, d) est complet si toute suite de Cauchy dans X est convergente.

Divers théorèmes de point fixe ont été obtenu dans [11] dans un espace métrique cône. Dans tous ces résultats, le cône P est supposé normal. Juste après, Sh. Rezapour et R. Hamlbarani [19] ont obtenu des résultats plus forts. D'une part, ils ont remarqué qu'il n'existe aucun cône normal avec une constante normale $k < 1$. Ce résultat est intéressant et il n'est pas difficile à vérifier. En effet, supposons que P est un cône normal avec une constante normale $k < 1$. Soit $x \in P$, $x \neq 0$. Prenons $0 < \varepsilon < 1$ tel que $k < 1 - \varepsilon$. Alors, $(1 - \varepsilon)x \leq x$, ce qui nous donne $1 - \varepsilon \leq k$, ce qui est impossible. D'autre part, Sh. Rezapour et R. Hamlbarani ont obtenu les mêmes résultats de L. G. Huang et X. Zhang, mais en éliminant l'hypothèse de normalité.

Les principaux résultats obtenus dans [19] sont donnés par le théorème suivant.

Théorème 32. (Rezapour-Hamlbarani, 2008)

Soient (X, d) un espace métrique cône complet et $T : X \rightarrow X$ une application vérifiant l'une des conditions suivantes :

- (i) $d(Tx, Ty) \leq kd(x, y)$, $\forall x, y \in X$, $k \in (0, 1)$.
- (ii) $d(Tx, Ty) \leq k(d(Tx, x) + d(Ty, y))$, $\forall x, y \in X$, $k \in (0, 1/2)$.
- (iii) $d(Tx, Ty) \leq k(d(Tx, y) + d(x, Ty))$, $\forall x, y \in X$, $k \in (0, 1/2)$.

Alors, T admet un unique point fixe $\xi \in X$. De plus, pour tout $x \in X$, la suite $(T^n x)_{n \in \mathbb{N}}$ converge vers ξ .

Espace métrique cône généralisé (Cone rectangular metric space)

En s'inspirant de l'idée de A. Branciari [3], A. Azam, M. Arshad et I. Beg [1] ont introduit la notion d'espace métrique cône généralisé (cone rectangular metric space), où l'inégalité triangulaire est remplacée par une inégalité rectangulaire.

Soient E un espace de Banach, P un cône de E avec $\text{int}P \neq \emptyset$ et \leq une relation d'ordre partiel par rapport à P .

Définition 5. (Azam-Arshad-Beg, 2009)

Soit X un ensemble non vide. Supposons qu'une application $d : X \times X \rightarrow E$ satisfait :

- (i) $0 \leq d(x, y)$ pour tous $x, y \in X$ et $d(x, y) = 0 \Leftrightarrow x = y$.
- (ii) $d(x, y) = d(y, x)$ pour tous $x, y \in X$.
- (iii) $d(x, y) \leq d(x, w) + d(w, z) + d(z, y)$ pour tous $x, y \in X$, pour tous $w, z \in X \setminus \{x, y\}$, $w \neq z$.

L'application d est appelée une métrique cône généralisée sur X et le couple (X, d) est appelé espace métrique cône généralisé (cone rectangular metric space).

Dans [1], le résultat suivant a été établi.

Théorème 33. (Azam-Arshad-Beg, 2009)

Soient (X, d) un espace métrique cône généralisé complet, P un cône normal et $T : X \rightarrow X$ une application vérifiant :

$$d(Tx, Ty) \leq \lambda d(x, y), \quad \forall x, y \in X,$$

où $\lambda \in (0, 1)$. Alors, T admet un unique point fixe $\xi \in X$. De plus, pour tout $x \in X$, la suite $(T^n x)_{n \in \mathbb{N}}$ converge vers ξ .

Extension du théorème de Kannan [Article 15]

Dans ce travail, contrairement au cas d'un espace métrique cône, nous avons montré qu'une suite convergente dans un espace métrique cône généralisé n'admet pas nécessairement une unique limite. Voici un exemple qui illustre notre remarque.

Nous prenons $E = \mathbb{R}$ et $P = [0, +\infty)$. Soient $(x_n)_{n \in \mathbb{N}^*}$ une suite dans \mathbb{Q} , $a, b \in \mathbb{R} \setminus \mathbb{Q}$, $a \neq b$. Nous posons $X = \{x_1, x_2, \dots, x_n, \dots\} \cup \{a, b\}$ et $d : X \times X \rightarrow E$ l'application définie par :

$$\begin{cases} d(x, x) & = 0, \quad \forall x \in X, \\ d(x, y) & = d(y, x), \quad \forall x, y \in X, \\ d(x_n, x_m) & = 1, \quad \forall n, m \in \mathbb{N}^*, n \neq m, \\ d(x_n, b) & = 1/n, \quad \forall n \in \mathbb{N}^*, \\ d(x_n, a) & = 1/n, \quad \forall n \in \mathbb{N}^*, \\ d(a, b) & = 1. \end{cases}$$

Remarquons que (X, d) n'est pas un espace métrique cône puisque l'inégalité triangulaire n'est pas satisfaite :

$$1 = d(x_2, x_3) > d(x_2, a) + d(a, x_3) = \frac{5}{6}.$$

Cependant, (X, d) est un espace métrique cône généralisé. Comme $d(x_n, a) = 1/n \rightarrow 0$ quand $n \rightarrow +\infty$, alors $(x_n)_{n \in \mathbb{N}^*}$ converge vers a dans (X, d) . De même, comme $d(x_n, b) = 1/n \rightarrow 0$ quand $n \rightarrow +\infty$, alors $(x_n)_{n \in \mathbb{N}^*}$ converge vers $b \neq a$ dans (X, d) . Remarquons aussi que la suite convergente $(x_n)_{n \in \mathbb{N}^*}$ n'est pas de Cauchy dans (X, d) puisque $d(x_n, x_m) = 1$ pour tous $n, m \in \mathbb{N}^*$, $n \neq m$.

Nous avons aussi montré que le fameux théorème de Kannan [13] reste vrai si nous travaillons dans un espace métrique cône généralisé.

Théorème 34. Soient (X, d) un espace métrique cône généralisé complet, P un cône normal et $T : X \rightarrow X$ une application vérifiant :

$$d(Tx, Ty) \leq \alpha(d(Tx, x) + d(Ty, y)), \quad \forall x, y \in X, \quad (70)$$

où $\alpha \in (0, 1/2)$ est une constante donnée. Alors, T admet un unique point fixe $\xi \in X$. De plus, pour tout $x \in X$, la suite $(T^n x)_{n \in \mathbb{N}}$ converge vers ξ .

Nous illustrons ce résultat par l'exemple suivant.

Exemple. Soient $E = \mathbb{C}$ et $P = \{x + iy \mid x, y \in \mathbb{R}, x, y \geq 0\}$. Posons $X = \{1, 2, 3, 4\}$ et $d : X \times X \rightarrow E$ l'application définie par :

$$\begin{aligned} d(x, x) &= 0 \\ d(1, 2) &= d(2, 1) = 3 + 9i \\ d(2, 3) &= d(3, 2) = d(1, 3) = d(3, 1) = 1 + 3i \\ d(1, 4) &= d(4, 1) = d(2, 4) = d(4, 2) = d(3, 4) = d(4, 3) = 4 + 12i. \end{aligned}$$

Nous avons (X, d) un espace métrique cône généralisé complet mais non un espace métrique cône :

$$3 + 9i = d(1, 2) > d(1, 3) + d(3, 2) = 2 + 6i.$$

Maintenant, considérons l'application $T : X \rightarrow X$ définie par :

$$Tx = \begin{cases} 3 & \text{si } x \neq 4, \\ 1 & \text{si } x = 4. \end{cases}$$

Nous remarquons que l'application T n'est pas contractante au sens standard :

$$|T4 - T2| = 2 = |4 - 2|.$$

Cependant, l'hypothèse (70) est satisfaite pour $\alpha = 1/3$. Par Théorème (34), T admet un unique point fixe, qui est $\xi = 3$.

Bibliographie

1. A. Azam, M. Arshad, I. Beg, *Banach contraction principle on cone rectangular metric spaces*, Appl. Anal. Discrete Math. 3, pp. 236-241, 2009.
2. S. Banach, *Sur les opérations dans les ensembles abstraits et leur application aux équations intégrales*, Fund. Math. 3, 133-181, 1922.
3. A. Branciari, *A fixed point theorem of Banach-Caccioppoli type on a class of generalized metric spaces*, Publ. Math. Debrecen, 57 1-2, pp. 31-37, 2000.
4. A. Branciari, *A fixed point theorem for mappings satisfying a general contractive condition of integral type*, IJMMS 29 :9, pp. 531-536, 2002.
5. J. Caristi, *Fixed point theorems for mappings satisfying inwardness conditions*, Trans. Amer. Math. Soc. 215, 241-251, 1976.
6. J. Caristi, W.A. Kirk, *Geometric fixed point theory and inwardness conditions*, Lecture Notes in Math, Vol. 490, Springer, Berlin, pp. 74-83, 1975.
7. Lj. B. Ćirić, *A generalization of Banach's contraction principle*, Proc. Amer. Math. Soc. 45, pp. 267-273, 1974.
8. B. K. Dass, S. Gupta, *An extension of Banach contraction principle through rational expression*, Indian J. pure appl. Math. 6, pp. 1455-1458, 1975.
9. I. Ekeland, *On the variational principle*, J. Math. Anal. Appl. 47, pp. 324-353, 1974.
10. I. Ekeland, *Nonconvex minimization problems*, Bull. Amer. Math. Soc. 1, pp. 443-474, 1979.
11. L. G. Huang, X. Zhang, *Cone metric spaces and fixed point theorems of contractive mappings*, J. Math. Anal. Appl. 332, pp. 1468-1476, 2007.
12. G. Jungck, *Commuting mappings and fixed points*, Amer. Math. Monthly 83, pp. 261-263, 1976.
13. R. Kannan, *Some results on fixed points*, Bull. Calcutta. Math.Soc. 60, pp. 71-76, 1968.
14. W.A. Kirk, *Contraction mappings and extensions*, in : W.A. Kirk, B. Sims (Eds.), Handbook of Metric Fixed Point Theory, Kluwer Academic Publishers, Dordrecht, pp. 1-34, 2001.
15. W.A. Kirk, *Fixed points of asymptotic contractions*, J. Math. Anal. Appl. 277, pp. 645-650, 2003.

16. J. Matkowski, *Fixed point theorems for contractive mappings in metric spaces*, Casopis Pro Pestovant Matematiky, Vol. 105, No. 4, pp. 341-344, 1980.
17. A. Meir, E. Keeler, *A theorem on contraction mappings*, J. Math. Anal. Appl. 28, pp. 326-329, 1969.
18. S. B. Nadler Jr., *Multi-valued contraction mappings*, Pacific J. Math. 30, pp. 475-488, 1969.
19. Sh. Rezapour, R. Hamlbarani, *Some notes on the paper : Cone metric spaces and fixed point theorems of contractive mappings*, J. Math. Anal. Appl. 345, pp. 719-724, 2008.
20. T. Suzuki, *Generalized distance and existence theorems in complete metric spaces*, J. Math. Anal. Appl. 253, pp. 440-458, 2001.
21. T. Suzuki, *Meir-Keeler contractions of integral type are still Meir-Keeler contractions*, International Journal of Mathematics and Mathematical Sciences, Vol 2007, Article ID 39281, 6 pages.
22. O. Valero, *On Banach's fixed point theorem and formal balls*, Applied Sciences, Vol.10, pp. 256-258, 2008.

Mes Publications

Article 1 :

The topological asymptotic for the Helmholtz equation

SIAM J. Control Optim. 42(5) (2003)1523-1544

THE TOPOLOGICAL ASYMPTOTIC FOR THE HELMHOLTZ EQUATION*

BESSEM SAMET[†], SAMUEL AMSTUTZ[†], AND MOHAMED MASMOUDI[†]

Abstract. The aim of the topological sensitivity analysis is to obtain an asymptotic expansion of a functional with respect to the creation of a small hole in the domain. In this paper such an expansion is obtained for the Helmholtz equation with a Dirichlet condition on the boundary of a circular hole. Some applications of this work to waveguide optimization are presented.

Key words. topological optimization, shape optimization, topological gradient, topological asymptotic, Helmholtz equation, waveguides, adjoint equation

AMS subject classifications. 49Q10, 49Q12, 78A25, 78A40, 78A45, 78A50, 35J05

DOI. S0363012902406801

1. Introduction. Classical shape optimization methods are based on the perturbation of the boundary of the initial shape. The initial and the final shapes have the same topology. The aim of topological optimization is to find an optimal shape without any a priori assumption about the topology of the structure. Many important contributions in this field are concerned with structural mechanics and, in particular, the minimization of the compliance (external work) subject to a volume constraint. In view of the fact that the optimal structure generally has a large number of small holes, most authors [3, 5, 15] have considered composite material optimization. Using the homogenization theory, Allaire and Kohn [3] exhibit a class of laminated materials with an explicit expression for the optimal material at any point of the structure. The range of application of this approach is quite restricted. For this reason, global optimization techniques like genetic algorithms and simulated annealing are used in order to solve more general problems [26]. Unfortunately, these methods are very slow.

The topological gradient has been introduced by Schumacher [27] to minimize a cost function $j(\Omega) = J(\Omega, u_\Omega)$, where u_Ω is the solution to a PDE defined in the domain Ω . The idea is to create a spherical hole $B(x, \varepsilon)$ of radius ε around a point x in Ω . Generally, an asymptotic expansion of the function j can be obtained in the following form:

$$(1.1) \quad j(\Omega \setminus \overline{B(x, \varepsilon)}) - j(\Omega) = f(\varepsilon)g(x) + o(f(\varepsilon)).$$

The function $f(\varepsilon)$ is positive and tends to zero with ε . We call this expansion the topological asymptotic. To minimize the criterion, we have to create holes where g is negative. The optimality condition $g \geq 0$ in Ω is exactly what Buttazzo and Dal Maso [6] have obtained for the Laplace equation, using a relaxed formulation. The topological gradient $g(x)$ has been computed by Schumacher [27] in the case of compliance minimization with Neumann condition on the boundary of the hole. In the same context, Sokolowski [25] gave some mathematical justifications in the

*Received by the editors April 30, 2002; accepted for publication (in revised form) April 2, 2003; published electronically November 6, 2003.

<http://www.siam.org/journals/sicon/42-5/40680.html>

[†]UFR MIG, Université Paul Sabatier and CNRS UMR 5640 MIP, 118 route de Narbonne 31062 Toulouse Cedex 4, France (samet@mip.ups-tlse.fr, amstutz@mip.ups-tlse.fr, masmoudi@mip.ups-tlse.fr).

plane stress case and generalized it to various cost functions. A topological sensitivity framework using an adaptation of the adjoint method and a truncation technique has been introduced in [16] in the case of an homogeneous Dirichlet condition imposed on the boundary of a circular hole. The fundamental property of the adjoint technique is to provide the variation of a function with respect to a parameter by using a solution u_Ω and an adjoint state p_Ω which do not depend on the chosen parameter. From the numerical viewpoint, only two systems have to be solved for obtaining $g(x)$ for all $x \in \Omega$. This observation leads to very efficient numerical algorithms. In [10, 11, 12], the topological sensitivity has been obtained in the contexts of linear elasticity, the Poisson equation, and the Stokes problem with general shape functions and arbitrary shaped holes. These publications are concerned with PDE operators whose symbols are homogeneous polynomials.

In this paper, we are interested in the differential operator

$$P = \sum_{i=1}^2 \frac{\partial^2}{\partial x_i^2} + k^2,$$

whose symbol is not homogenous. First, an adaptation of the adjoint method to the topological context is proposed in section 2 for the operator P . Next, a waveguide problem, the truncation method, and the explicit expression of the topological asymptotic are presented in section 3. Finally, an optimization algorithm and some applications of the topological gradient to waveguide optimization are given in section 4. This work was done in collaboration with Alcatel Space Industries.

2. A generalized adjoint method. In this section, the adjoint method is adapted to topological optimization. Let \mathcal{V} be a fixed complex Hilbert space. For $\varepsilon \geq 0$, let $a_\varepsilon(\cdot, \cdot)$ be a sesquilinear and continuous form on \mathcal{V} and l_ε be a semilinear and continuous form on \mathcal{V} . We consider the following assumptions.

Hypothesis 1. There exists a sesquilinear and continuous form δ_a , a semilinear and continuous form δ_l , and a real function $f(\varepsilon) > 0$ defined on \mathbb{R}_+^* such that

$$(2.1) \quad \lim_{\varepsilon \rightarrow 0} f(\varepsilon) = 0,$$

$$(2.2) \quad \|a_\varepsilon - a_0 - f(\varepsilon)\delta_a\|_{\mathcal{L}_2(\mathcal{V})} = o(f(\varepsilon)),$$

$$(2.3) \quad \|l_\varepsilon - l_0 - f(\varepsilon)\delta_l\|_{\mathcal{L}(\mathcal{V})} = o(f(\varepsilon)),$$

where $\mathcal{L}(\mathcal{V})$ (respectively, $\mathcal{L}_2(\mathcal{V})$) denotes the space of continuous and semilinear (respectively, sesquilinear) forms on \mathcal{V} .

Hypothesis 2. There exists a constant $\alpha > 0$ such that

$$\inf_{u \neq 0} \sup_{v \neq 0} \frac{|a_0(u, v)|}{\|u\|_{\mathcal{V}} \|v\|_{\mathcal{V}}} \geq \alpha.$$

We say that a_0 satisfies the inf-sup condition.

According to (2.2), there exists a constant $\beta > 0$ (independent of ε) such that

$$\inf_{u \neq 0} \sup_{v \neq 0} \frac{|a_\varepsilon(u, v)|}{\|u\|_{\mathcal{V}} \|v\|_{\mathcal{V}}} \geq \beta \quad \forall \varepsilon \geq 0.$$

For $\varepsilon \geq 0$, we suppose that the following problem has one solution: find $u_\varepsilon \in \mathcal{V}$ such that

$$(2.4) \quad a_\varepsilon(u_\varepsilon, v) = l_\varepsilon(v) \quad \forall v \in \mathcal{V}.$$

According to Hypothesis 2, this solution is unique. We have the following lemma.

LEMMA 2.1. *If Hypotheses 1 and 2 are satisfied, then*

$$\|u_\varepsilon - u_0\|_{\mathcal{V}} = O(f(\varepsilon)).$$

Proof. It follows from Hypothesis 2 that there exists $v_\varepsilon \in \mathcal{V}, v_\varepsilon \neq 0$, such that

$$\beta \|u_\varepsilon - u_0\|_{\mathcal{V}} \|v_\varepsilon\|_{\mathcal{V}} \leq |a_\varepsilon(u_\varepsilon - u_0, v_\varepsilon)|,$$

which implies

$$\begin{aligned} & \beta \|u_\varepsilon - u_0\|_{\mathcal{V}} \|v_\varepsilon\|_{\mathcal{V}} \\ & \leq |a_\varepsilon(u_0, v_\varepsilon) - l_\varepsilon(v_\varepsilon)| \\ & = |a_\varepsilon(u_0, v_\varepsilon) - (l_\varepsilon - l_0 - f(\varepsilon)\delta_l)(v_\varepsilon) - l_0(v_\varepsilon) - f(\varepsilon)\delta_l(v_\varepsilon)| \\ & = |(a_\varepsilon(u_0, v_\varepsilon) - a_0(u_0, v_\varepsilon)) - (l_\varepsilon - l_0 - f(\varepsilon)\delta_l)(v_\varepsilon) - f(\varepsilon)\delta_l(v_\varepsilon)| \\ & \leq |a_\varepsilon(u_0, v_\varepsilon) - a_0(u_0, v_\varepsilon) - f(\varepsilon)\delta_a(u_0, v_\varepsilon)| + |l_\varepsilon(v_\varepsilon) - l_0(v_\varepsilon) - f(\varepsilon)\delta_l(v_\varepsilon)| \\ & \quad + f(\varepsilon)(|\delta_a(u_0, v_\varepsilon)| + |\delta_l(v_\varepsilon)|). \end{aligned}$$

Using Hypothesis 1, we obtain

$$\beta \|u_\varepsilon - u_0\|_{\mathcal{V}} \|v_\varepsilon\|_{\mathcal{V}} \leq (o(f(\varepsilon)) + f(\varepsilon)(\|\delta_a\|_{\mathcal{L}_2(\mathcal{V})}\|u_0\|_{\mathcal{V}} + \|\delta_l\|_{\mathcal{L}(\mathcal{V})})) \|v_\varepsilon\|_{\mathcal{V}}. \quad \square$$

Consider now a cost function $j(\varepsilon) = J(u_\varepsilon)$, where the functional J satisfies

$$(2.5) \quad J(u + h) = J(u) + \Re(L_u(h)) + o(\|h\|_{\mathcal{V}}) \quad \forall u, h \in \mathcal{V}.$$

Here, L_u is a linear and continuous form on \mathcal{V} . We suppose that the following problem has a unique solution p_0 , called the adjoint state: find $p_0 \in \mathcal{V}$ such that

$$(2.6) \quad a_0(v, p_0) = -L_{u_0}(v) \quad \forall v \in \mathcal{V}.$$

For $\varepsilon \geq 0$, we define the Lagrangian operator \mathcal{L}_ε by

$$\mathcal{L}_\varepsilon(u, v) = J(u) + a_\varepsilon(u, v) - l_\varepsilon(v) \quad \forall u, v \in \mathcal{V}.$$

The next theorem gives the asymptotic expansion of $j(\varepsilon)$.

THEOREM 2.2. *If Hypotheses 1 and 2 are satisfied, then*

$$(2.7) \quad j(\varepsilon) - j(0) = f(\varepsilon)\Re(\delta_{\mathcal{L}}(u_0, p_0)) + o(f(\varepsilon)),$$

where u_0 is the solution to (2.4) with $\varepsilon = 0$, p_0 is the adjoint state solution to problem (2.6), and

$$\delta_{\mathcal{L}}(u, v) = \delta_a(u, v) - \delta_l(v) \quad \forall u, v \in \mathcal{V}.$$

Proof. We have that

$$j(\varepsilon) = \mathcal{L}_\varepsilon(u_\varepsilon, v) \quad \forall \varepsilon \geq 0, \quad \forall v \in \mathcal{V}.$$

Next, choosing $v = p_0$, we obtain

$$\begin{aligned} j(\varepsilon) - j(0) &= \mathcal{L}_\varepsilon(u_\varepsilon, p_0) - \mathcal{L}_0(u_0, p_0) \\ &= J(u_\varepsilon) - J(u_0) + a_\varepsilon(u_\varepsilon, p_0) - a_0(u_0, p_0) + l_0(p_0) - l_\varepsilon(p_0) \\ &= J(u_\varepsilon) - J(u_0) + \Re(a_\varepsilon(u_\varepsilon, p_0) - a_0(u_0, p_0)) - \Re(l_\varepsilon(p_0) - l_0(p_0)) \\ &= J(u_\varepsilon) - J(u_0) + \Re(a_\varepsilon(u_\varepsilon, p_0) - a_0(u_\varepsilon, p_0) + a_0(u_\varepsilon - u_0, p_0)) \\ & \quad - \Re(l_\varepsilon(p_0) - l_0(p_0) - f(\varepsilon)\delta_l(p_0)) - f(\varepsilon)\Re(\delta_l(p_0)). \end{aligned}$$

Using (2.5), we have that

$$J(u_\varepsilon) - J(u_0) = \Re(L_{u_0}(u_\varepsilon - u_0)) + o(\|u_\varepsilon - u_0\|_{\mathcal{V}}).$$

Hence,

$$\begin{aligned} j(\varepsilon) - j(0) &= \Re(a_\varepsilon(u_\varepsilon, p_0) - a_0(u_\varepsilon, p_0)) + \Re(a_0(u_\varepsilon - u_0, p_0) + L_{u_0}(u_\varepsilon - u_0)) + o(\|u_\varepsilon - u_0\|_{\mathcal{V}}) \\ &\quad - \Re(l_\varepsilon(p_0) - l_0(p_0) - f(\varepsilon)\delta_l(p_0)) - f(\varepsilon)\Re(\delta_l(p_0)). \end{aligned}$$

Using that p_0 is the adjoint solution, we obtain

$$\begin{aligned} j(\varepsilon) - j(0) &= \Re(a_\varepsilon(u_\varepsilon, p_0) - a_0(u_\varepsilon, p_0)) + o(\|u_\varepsilon - u_0\|_{\mathcal{V}}) \\ &\quad - \Re(l_\varepsilon(p_0) - l_0(p_0) - f(\varepsilon)\delta_l(p_0)) - f(\varepsilon)\Re(\delta_l(p_0)) \\ &= \Re((a_\varepsilon - a_0)(u_\varepsilon, p_0)) + \Re((a_\varepsilon - a_0)(u_\varepsilon - u_0, p_0)) + o(\|u_\varepsilon - u_0\|_{\mathcal{V}}) \\ &\quad - \Re(l_\varepsilon(p_0) - l_0(p_0) - f(\varepsilon)\delta_l(p_0)) - f(\varepsilon)\Re(\delta_l(p_0)). \end{aligned}$$

It follows from Hypothesis 1 that

$$\begin{aligned} j(\varepsilon) - j(0) &= f(\varepsilon)\Re(\delta_a(u_0, p_0)) + o(f(\varepsilon)) + f(\varepsilon)\Re(\delta_a(u_\varepsilon - u_0, p_0)) + o(f(\varepsilon))\|u_\varepsilon - u_0\|_{\mathcal{V}} \\ &\quad + o(\|u_\varepsilon - u_0\|_{\mathcal{V}}) - f(\varepsilon)\Re(\delta_l(p_0)). \end{aligned}$$

Finally, from Lemma 2.1 and the hypothesis $\lim_{\varepsilon \rightarrow 0} f(\varepsilon) = 0$, we have

$$j(\varepsilon) = j(0) + f(\varepsilon)\Re(\delta_a(u_0, p_0) - \delta_l(p_0)) + o(f(\varepsilon)),$$

since δ_a is continuous by assumption. \square

3. A waveguide problem. In this section, we study a problem of a waveguide as a component of a spatial antenna feeding system. Because the waveguide \mathcal{O} has a uniform thickness, $\mathcal{O} = \Omega \times]a, b[$, $\Omega \subset \mathbb{R}^2$, and the electric field has a vertical polarization (normal to Ω), the three-dimensional problem can be reduced to a two-dimensional problem in Ω , called the H-plane model. We assume that Ω is a domain of \mathbb{R}^2 with a regular boundary $\Gamma = \Gamma_0 \cup \Gamma_1 \cup \dots \cup \Gamma_N$, $N \in \mathbb{N}^*$. We denote by u_Ω the normal component to Ω of the electric field. It is a solution to the Helmholtz problem:

$$(3.1) \quad \begin{cases} \Delta u_\Omega + k^2 u_\Omega &= 0 & \text{in } \Omega, \\ u_\Omega &= 0 & \text{on } \Gamma_0, \\ \partial_n u_\Omega - ik u_\Omega &= h_j & \text{on } \Gamma_j, j = 1, 2, \dots, N, \end{cases}$$

where $\partial_n u_\Omega$ is the normal derivative of u_Ω , $k \in \{k \in \mathbb{C}^* / \Im(k) \geq 0\}$, and $h_j \in H_{00}^{\frac{1}{2}}(\Gamma_j)'$ for all $j \in \{1, 2, \dots, N\}$. The first boundary condition means that Γ_0 is a perfect metallic surface. When $h_j = 0$, the last equation is an approximate absorbing boundary condition (the normal incident plane waves are completely absorbed). When $h_j \neq 0$, it is a transmission condition. We prove in section 5.1 that problem (3.1) has one and only one solution in the Hilbert space

$$(3.2) \quad \mathcal{V}_\Omega = \{u \in H^1(\Omega), u = 0 \text{ on } \Gamma_0\}.$$

Here and in the following, all the Sobolev spaces involve complex-valued functions.

For a given $x \in \Omega$, let us consider the perforated open set $\Omega_\varepsilon = \Omega \setminus \overline{B(x, \varepsilon)}$, where x is a point of Ω and $B(x, \varepsilon)$ is the ball of center x and of radius ε (see Figure 1). We

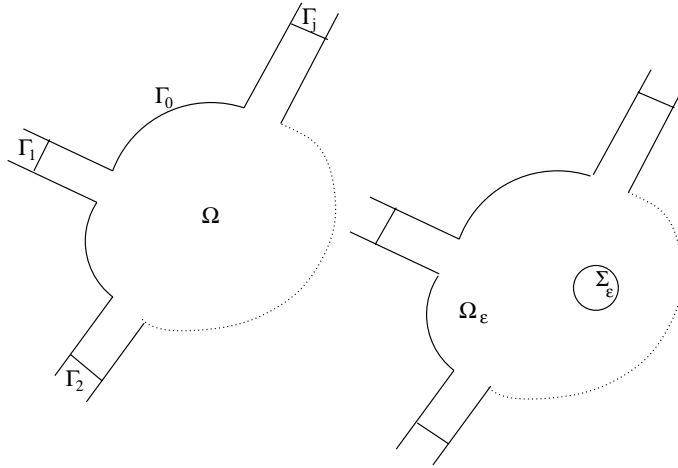

FIG. 1. The initial domain and the same domain after the perforation.

assume that $\varepsilon > 0$ is small enough, and we denote $\Sigma_\varepsilon = \partial B(x, \varepsilon)$. Our aim is to get the sensitivity analysis of u_{Ω_ε} , being the unique solution (see section 5.1) to

$$(3.3) \quad \begin{cases} \Delta u_{\Omega_\varepsilon} + k^2 u_{\Omega_\varepsilon} = 0 & \text{in } \Omega_\varepsilon, \\ u_{\Omega_\varepsilon} = 0 & \text{on } \Gamma_0, \\ u_{\Omega_\varepsilon} = 0 & \text{on } \Sigma_\varepsilon, \\ \partial_n u_{\Omega_\varepsilon} - ik u_{\Omega_\varepsilon} = h_j & \text{on } \Gamma_j, j = 1, 2, \dots, N, \end{cases}$$

with respect to ε at $\varepsilon = 0$. The solution of problem (3.3) is defined on the variable open set Ω_ε ; thus it belongs to a functional space which depends on ε . Hence, if we want to derive the asymptotic expansion of a function of the form

$$(3.4) \quad j(\varepsilon) = J(u_{\Omega_\varepsilon}),$$

we cannot apply directly the tools of section 2, which require a fixed functional space. In classical shape optimization, this requirement can be satisfied with the help of a domain parameterization technique [13, 20, 17]. This technique involves a fixed domain and a bi-Lipshitz map between this domain and the modified one. In the topology optimization context, such a map does not exist between Ω and Ω_ε . However, a functional space independent of ε can be constructed by using a domain truncation technique.

3.1. The domain truncation. Let $R > \varepsilon$ be such that the ball $B(x, R)$ is included in Ω . The boundary of $B(x, R)$ is denoted by Σ_R . The truncated domain $\Omega \setminus \overline{B(x, R)}$ is denoted by Ω_R , and D_ε denotes the corona $B(x, R) \setminus \overline{B(x, \varepsilon)}$ (see Figure 2).

For a $\Psi \in H^{1/2}(\Sigma_R)$, we consider u_Ψ^ε the solution to the problem

$$(3.5) \quad \begin{cases} \Delta u_\Psi^\varepsilon + k^2 u_\Psi^\varepsilon = 0 & \text{in } D_\varepsilon, \\ u_\Psi^\varepsilon = \Psi & \text{on } \Sigma_R, \\ u_\Psi^\varepsilon = 0 & \text{on } \Sigma_\varepsilon \end{cases}$$

and the *Dirichlet-to-Neumann* operator

$$T^\varepsilon : \begin{matrix} H^{1/2}(\Sigma_R) \\ \Psi \end{matrix} \longrightarrow \begin{matrix} H^{-1/2}(\Sigma_R), \\ T^\varepsilon \Psi = \nabla u_\Psi^\varepsilon \cdot n|_{\Sigma_R}, \end{matrix}$$

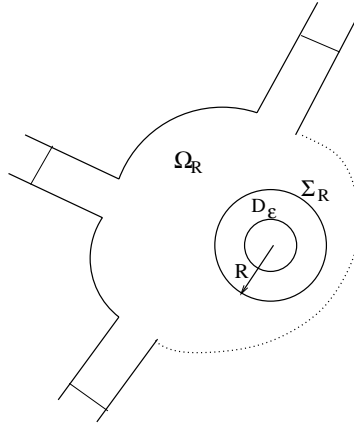

FIG. 2. *The truncated domain.*

where $n_{|\Sigma_R}$ denotes the outward normal to the boundary Σ_R . Using the Poincaré inequality, we obtain that, for $\varepsilon < R < (\sqrt{2}|k|)^{-1}$, problem (3.5) is coercive. Hence it has one and only one solution.

We consider the truncated problem: find u_ε such that

$$(3.6) \quad \begin{cases} \Delta u_\varepsilon + k^2 u_\varepsilon &= 0 & \text{in } \Omega_R, \\ u_\varepsilon &= 0 & \text{on } \Gamma_0, \\ \partial_n u_\varepsilon + T^\varepsilon u_\varepsilon &= 0 & \text{on } \Sigma_R, \\ \partial_n u_\varepsilon - ik u_\varepsilon &= h_j & \text{on } \Gamma_j, j = 1, 2, \dots, N. \end{cases}$$

The variational formulation associated to problem (3.6) is the following: find $u_\varepsilon \in \mathcal{V}_R$ such that

$$(3.7) \quad a_\varepsilon(u_\varepsilon, v) = l(v) \quad \forall v \in \mathcal{V}_R,$$

where the functional space \mathcal{V}_R , the sesquilinear form a_ε , and the semilinear form l are defined by

$$(3.8) \quad \mathcal{V}_R = \{u \in H^1(\Omega_R), u = 0 \text{ on } \Gamma_0\},$$

$$(3.9) \quad a_\varepsilon(u, v) = \int_{\Omega_R} \nabla u \cdot \overline{\nabla v} \, dx - k^2 \int_{\Omega_R} u \overline{v} \, dx + \int_{\Sigma_R} (T^\varepsilon u) \overline{v} \, d\gamma(x)$$

$$(3.10) \quad -ik \sum_{j=1}^N \int_{\Gamma_j} u \overline{v} \, d\gamma(x),$$

$$(3.11) \quad l(v) = \sum_{j=1}^N \int_{\Gamma_j} h_j \overline{v} \, d\gamma(x).$$

Here, $\nabla u \cdot \overline{\nabla v} = \sum_{i=1}^2 \frac{\partial u}{\partial x_i} \frac{\partial \overline{v}}{\partial x_i}$ and $d\gamma(x)$ is the Lebesgue measure on the boundary. The following result is standard in PDE theory.

PROPOSITION 3.1. *Problem (3.6) has one and only one solution in \mathcal{V}_R which is the restriction to Ω_R of the solution to (3.3).*

Proof. Existence: Applying the definition of T^ε , we prove that the restriction to Ω_R of the solution to (3.3) is a solution to (3.6).

Uniqueness: Any solution u to problem (3.6) can be extended in Ω_ε to the solution to problem (3.3): we use the solution u_Ψ^ε to (3.5) with $\Psi = u|_{\Sigma_R}$. \square

We have now at our disposal the fixed Hilbert space \mathcal{V}_R required by section 2. We assume that the function J is defined in a neighbor part of Γ . Then we have

$$(3.12) \quad j(\varepsilon) = J(u_{\Omega_\varepsilon}) = J(u_\varepsilon) \quad \forall \varepsilon \geq 0.$$

3.2. Variation of the sesquilinear form. The variation of the sesquilinear form $a_\varepsilon - a_0$ reads

$$(3.13) \quad a_\varepsilon(u, v) - a_0(u, v) = \int_{\Sigma_R} ((T^\varepsilon - T^0)u) \bar{v} d\gamma(x).$$

Hence, the problem reduces to the computation of $(T^\varepsilon - T^0)\Psi$ for $\Psi = u|_{\Sigma_R}$. We have the following proposition.

PROPOSITION 3.2. *The solution u_Ψ^ε to problem (3.5) and the operator T^ε are given by the explicit expressions:*

$$u_\Psi^\varepsilon(r, \theta) = \sum_{n \in \mathbb{Z}} \frac{J_n(kr)Y_n(k\varepsilon) - J_n(k\varepsilon)Y_n(kr)}{J_n(kR)Y_n(k\varepsilon) - Y_n(kR)J_n(k\varepsilon)} \psi_n e^{in\theta}$$

and

$$(3.14) \quad T^\varepsilon \psi = k \sum_{n \in \mathbb{Z}} \frac{J'_n(kR)Y_n(k\varepsilon) - J_n(k\varepsilon)Y'_n(kR)}{J_n(kR)Y_n(k\varepsilon) - Y_n(kR)J_n(k\varepsilon)} \psi_n e^{in\theta},$$

where (r, θ) are the polar coordinates in \mathbb{R}^2 , (Ψ_n) are the Fourier coefficients of Ψ , and (J_n) and (Y_n) are, respectively, the Bessel functions of the first and the second kind.

Proof. We have in polar coordinates

$$u_\Psi^\varepsilon(r, \theta) = \sum_{n \in \mathbb{Z}} c_n(r) e^{in\theta},$$

where $c_n(r)$ satisfies the differential equation:

$$\frac{d^2 c_n}{dr^2} + \frac{1}{r} \frac{dc_n}{dr} + \left(k^2 - \frac{n^2}{r^2}\right) c_n(r) = 0 \quad \forall n \in \mathbb{Z},$$

and thus c_n is a linear combination of J_n and Y_n Bessel functions:

$$c_n(r) = a_n J_n(kr) + b_n Y_n(kr) \quad \forall n \in \mathbb{Z}.$$

Using the boundary conditions, we obtain

$$a_n = \frac{Y_n(k\varepsilon)}{J_n(kR)Y_n(k\varepsilon) - Y_n(kR)J_n(k\varepsilon)} \psi_n, \quad b_n = \frac{-J_n(k\varepsilon)}{J_n(kR)Y_n(k\varepsilon) - Y_n(kR)J_n(k\varepsilon)} \psi_n. \quad \square$$

In particular, for $\varepsilon = 0$ we have the following proposition.

PROPOSITION 3.3. *The solution u_Ψ^0 and the operator T^0 are given by the explicit expressions*

$$u_\Psi^0(r, \theta) = \sum_{n \in \mathbb{Z}} \frac{J_n(kr)}{J_n(kR)} \psi_n e^{in\theta}$$

and

$$(3.15) \quad T^0 \psi = k \sum_{n \in \mathbb{Z}} \frac{J'_n(kR)}{J_n(kR)} \psi_n e^{in\theta},$$

where u_ψ^0 is the solution to (3.5) for $\varepsilon = 0$.

For $\Psi \in H^s(\Sigma_R)$, let

$$(3.16) \quad \|\psi\|_{s, \Sigma_R}^2 = \sum_{n \in \mathbb{Z}} |\psi_n|^2 (1 + |n|)^{2s}$$

be the norm of Ψ in this space. The so defined norm is equivalent to the usual norm of $H^s(\Sigma_R)$. We introduce the operator:

$$\begin{aligned} \delta_T : H^{1/2}(\Sigma_R) &\longrightarrow H^{-1/2}(\Sigma_R), \\ \Psi &\longmapsto \delta_T \Psi = \frac{1}{RJ_0^2(kR)} \Psi_0. \end{aligned}$$

We have the following lemma.

LEMMA 3.4. *We have that*

$$\left\| T^\varepsilon - T^0 - \frac{-1}{\log(\varepsilon)} \delta_T \right\|_{\mathcal{L}(H^{1/2}(\Sigma_R); H^{-1/2}(\Sigma_R))} = o\left(\frac{-1}{\log(\varepsilon)}\right).$$

Proof. Let $\Psi \in H^{\frac{1}{2}}(\Sigma_R)$. Using the series (3.14) and (3.15), we obtain

$$\begin{aligned} (T^\varepsilon - T^0)\psi &= k \sum_{n \in \mathbb{Z}} \frac{J'_n(kR)Y_n(k\varepsilon) - J_n(k\varepsilon)Y'_n(kR)}{J_n(kR)Y_n(k\varepsilon) - Y_n(kR)J_n(k\varepsilon)} \psi_n e^{in\theta} - k \sum_{n \in \mathbb{Z}} \frac{J'_n(kR)}{J_n(kR)} \psi_n e^{in\theta} \\ &= k \sum_{n \in \mathbb{Z}^*} \frac{J'_n(kR)Y_n(k\varepsilon) - J_n(k\varepsilon)Y'_n(kR)}{J_n(kR)Y_n(k\varepsilon) - Y_n(kR)J_n(k\varepsilon)} \psi_n e^{in\theta} - k \sum_{n \in \mathbb{Z}^*} \frac{J'_n(kR)}{J_n(kR)} \psi_n e^{in\theta} \\ &\quad - k \frac{Y'_0(kR)J_0(kR) - Y_0(kR)J'_0(kR)}{J_0^2(kR)} \frac{J_0(k\varepsilon)J_0(kR)}{J_0(kR)Y_0(k\varepsilon) - Y_0(kR)J_0(k\varepsilon)} \psi_0. \end{aligned}$$

We have that [1]

$$\begin{aligned} \frac{Y'_0(kR)J_0(kR) - Y_0(kR)J'_0(kR)}{J_0^2(kR)} &= \frac{W\{J_0(kR), Y_0(kR)\}}{J_0^2(kR)} \\ &= \frac{2}{\pi kR} \frac{1}{J_0^2(kR)}, \end{aligned}$$

where W is the Wronskian. Then

$$(3.17) \quad \begin{aligned} (T^\varepsilon - T^0)\psi &= k \sum_{n \in \mathbb{Z}^*} \frac{J_n(k\varepsilon)Y_n(kR)}{Y_n(k\varepsilon)J_n(kR) - Y_n(kR)J_n(k\varepsilon)} \left(\frac{J'_n(kR)}{J_n(kR)} - \frac{Y'_n(kR)}{Y_n(kR)} \right) \psi_n e^{in\theta} \\ &\quad - \frac{2}{\pi} \frac{J_0(k\varepsilon)J_0(kR)}{J_0(kR)Y_0(k\varepsilon) - Y_0(kR)J_0(k\varepsilon)} \frac{1}{RJ_0^2(kR)} \psi_0. \end{aligned}$$

We have the following formula [1]:

$$(3.18) \quad Y_0(k\varepsilon) = \frac{2}{\pi} \left(\log\left(\frac{k\varepsilon}{2}\right) + \gamma \right) J_0(k\varepsilon) + \varepsilon\alpha(\varepsilon),$$

where γ denotes Euler’s constant and $\alpha(\varepsilon) \rightarrow 0$ when $\varepsilon \rightarrow 0$. We insert (3.18) into (3.17):

$$(T^\varepsilon - T^0)\psi = \varepsilon R_\varepsilon \Psi + \frac{-1}{\log(\varepsilon)} \left(1 + \frac{M}{\log(\varepsilon)} + \varepsilon \theta(\varepsilon) \right)^{-1} \delta_T \Psi,$$

where M is a constant independent of ε , $\theta(\varepsilon) \rightarrow 0$ when $\varepsilon \rightarrow 0$ and

$$R_\varepsilon \psi = \sum_{n \in \mathbb{Z}^*} \frac{k}{\varepsilon} \frac{J_n(k\varepsilon)Y_n(kR)}{Y_n(k\varepsilon)J_n(kR) - Y_n(kR)J_n(k\varepsilon)} \left(\frac{J'_n(kR)}{J_n(kR)} - \frac{Y'_n(kR)}{Y_n(kR)} \right) \psi_n e^{in\theta}.$$

Then

$$\left(T^\varepsilon - T^0 - \frac{-1}{\log(\varepsilon)} \delta_T \right) \psi = \varepsilon R_\varepsilon \psi + O(1) \left(\frac{-1}{\log(\varepsilon)} \right)^2 \frac{1}{R J_0^2(kR)} \psi_0.$$

Using (3.16), we have

$$\begin{aligned} \| R_\varepsilon \psi \|_{-\frac{1}{2}; \Sigma_R}^2 &= \sum_{n \in \mathbb{Z}^*} \frac{|k|^2}{\varepsilon^2} \left| \frac{J_n(k\varepsilon)Y_n(kR)}{Y_n(k\varepsilon)J_n(kR) - Y_n(kR)J_n(k\varepsilon)} \right|^2 \\ &\quad \cdot \left| \frac{J'_n(kR)}{J_n(kR)(1+|n|)} - \frac{Y'_n(kR)}{Y_n(kR)(1+|n|)} \right|^2 (1+|n|)|\psi_n|^2. \end{aligned}$$

Let us prove that there exists a constant $c > 0$ (independent of Ψ and ε) such that for all $0 < \varepsilon < \varepsilon_0 < R$,

$$\| R_\varepsilon \psi \|_{-\frac{1}{2}; \Sigma_R} \leq c \| \psi \|_{\frac{1}{2}; \Sigma_R}.$$

We have [1]

$$\frac{1}{1+|n|} \frac{J'_n(kR)}{J_n(kR)} = -\frac{1}{1+|n|} \frac{J_{n+1}(kR)}{J_n(kR)} + \frac{n}{1+|n|} \frac{1}{kR}$$

and for $n \rightarrow \infty$

$$J_n(z) \sim (2\pi n)^{-\frac{1}{2}} \left(\frac{ez}{2n} \right)^n.$$

Then

$$\lim_{n \rightarrow \infty} \frac{1}{1+|n|} \frac{J_{n+1}(kR)}{J_n(kR)} = 0$$

and

$$\left| \frac{1}{1+|n|} \frac{J'_n(kR)}{J_n(kR)} \right| \leq c \quad \forall n \in \mathbb{Z}^*.$$

Here and in what follows, c is a positive constant independent of the data (e.g., of ε and n). Similarly, we have

$$\left| \frac{1}{1+|n|} \frac{Y'_n(kR)}{Y_n(kR)} \right| \leq c \quad \forall n \in \mathbb{Z}^*.$$

Hence,

$$\left| \frac{J'_n(kR)}{J_n(kR)(1+|n|)} - \frac{Y'_n(kR)}{Y_n(kR)(1+|n|)} \right| \leq c \quad \forall n \in \mathbb{Z}^*.$$

We denote

$$f_n(\varepsilon) = \frac{1}{\varepsilon} \left| \frac{J_n(k\varepsilon)Y_n(kR)}{Y_n(k\varepsilon)J_n(kR) - Y_n(kR)J_n(k\varepsilon)} \right|.$$

We have also

$$f_n(\varepsilon) = \left| \frac{\varepsilon J_n(kR)Y_n(k\varepsilon)}{J_n(k\varepsilon)Y_n(kR)} - \varepsilon \right|^{-1}.$$

We show in section 5.3 that there exist n_0 and ε_0 such that

$$(3.19) \quad \left| \varepsilon \frac{J_n(kR)}{J_n(k\varepsilon)} \right| \geq c \left(\frac{R}{\varepsilon} \right)^{n-1} \quad \forall n \geq n_0, \quad \forall \varepsilon < \varepsilon_0$$

and

$$(3.20) \quad \left| \frac{Y_n(k\varepsilon)}{Y_n(kR)} \right| \geq c \left(\frac{R}{\varepsilon} \right)^n \quad \forall n \geq n_0, \quad \forall \varepsilon < \varepsilon_0.$$

Using (3.19) and (3.20), we obtain

$$\left| \frac{\varepsilon Y_n(k\varepsilon)J_n(kR)}{J_n(k\varepsilon)Y_n(kR)} \right| \geq c \quad \forall n \geq n_0, \quad \forall \varepsilon < \varepsilon_0$$

and

$$f_n(\varepsilon) \leq c \quad \forall n \geq n_0, \quad \forall \varepsilon < \varepsilon_0.$$

For $p \in \{1, 2, \dots, n_0 - 1\}$, we have $f_p(\varepsilon) \rightarrow 0$ when $\varepsilon \rightarrow 0$. Then

$$f_n(\varepsilon) \leq c \quad \forall n \in \mathbb{Z}^*, \quad \forall \varepsilon < \varepsilon_0.$$

Hence

$$\|R_\varepsilon \psi\|_{-\frac{1}{2}, \Sigma_R} \leq c \|\psi\|_{\frac{1}{2}, \Sigma_R} \quad \forall \psi \in H^{\frac{1}{2}}(\Sigma_R).$$

This completes the proof. \square

From this lemma we obtain the following proposition.

PROPOSITION 3.5. *Let δ_a be the sesquilinear and continuous form defined on \mathcal{V}_R by*

$$\delta_a(u, v) = \frac{u^{mean} \overline{v^{mean}}}{J_0(kR) J_0(kR)},$$

where u^{mean} and v^{mean} denote, respectively, the mean values of u and v on Σ_R . We have

$$\left| a_\varepsilon(u, p) - a_0(u, p) - \frac{-2\pi}{\log(\varepsilon)} \delta_a(u, p) \right| = o\left(\frac{-1}{\log(\varepsilon)}\right) \|u\|_{\mathcal{V}_R} \|p\|_{\mathcal{V}_R} \quad \forall u, p \in \mathcal{V}_R.$$

3.3. The asymptotic expansion. We prove in section 5.2 that the sesquilinear form a_0 satisfies Hypothesis 2 (inf-sup condition).

The adjoint problem is the following: find $p_\Omega \in \mathcal{V}_\Omega$ such that

$$(3.21) \quad \int_\Omega (\nabla v \cdot \overline{\nabla p_\Omega} - k^2 v \overline{p_\Omega}) dx - ik \sum_{j=1}^N \int_{\Gamma_j} v \overline{p_\Omega} d\gamma(x) = -L_{u_\Omega}(v) \quad \forall v \in \mathcal{V}_\Omega.$$

This problem has one and only one solution (see section 5.1). If $L_{u_\Omega} \in H_{00}^{\frac{1}{2}}(\Gamma_m)'$, $m \in \{1, 2, \dots, N\}$, the strong formulation of problem (3.21) is

$$(3.22) \quad \begin{cases} \Delta p_\Omega + \bar{k}^2 p_\Omega &= 0 & \text{in } \Omega, \\ p_\Omega &= 0 & \text{on } \Gamma_0, \\ \partial_n p_\Omega + i\bar{k} p_\Omega &= -L_{u_\Omega} & \text{on } \Gamma_m, \\ \partial_n p_\Omega + i\bar{k} p_\Omega &= 0 & \text{on } \Gamma_j, j \in \{1, 2, \dots, N\} \setminus \{m\}. \end{cases}$$

Hence, all the assumptions of section 2 are satisfied and we can apply the adjoint method. Then we have the following theorem.

THEOREM 3.6. *The function j has the following asymptotic expansion:*

$$j(\varepsilon) - j(0) = \frac{-2\pi}{\log(\varepsilon)} \Re(u_\Omega(x) \overline{p_\Omega}(x)) + o\left(\frac{-1}{\log(\varepsilon)}\right).$$

Proof. Using Theorem 2.2, we obtain

$$j(\varepsilon) - j(0) = \frac{-2\pi}{\log(\varepsilon)} \Re(\delta_a(u_0, p_0)) + o\left(\frac{-1}{\log(\varepsilon)}\right),$$

where u_0 is the solution to (3.7) for $\varepsilon = 0$ and p_0 is the solution to the adjoint problem

$$(3.23) \quad a_0(v, p_0) = -L_{u_0}(v) \quad \forall v \in \mathcal{V}_R.$$

As observed in Proposition 3.1, u_0 is the restriction to Ω_R of u_Ω . Let us prove that the same property holds for p_0 and p_Ω . For $v \in \mathcal{V}_\Omega$, we denote by p_R and v_R the restriction of p_Ω and v to Ω_R . On the one hand, we have

$$(3.24) \quad \begin{aligned} & \int_\Omega (\nabla v \cdot \overline{\nabla p_\Omega} - k^2 v \overline{p_\Omega}) dx - ik \sum_{j=1}^N \int_{\Gamma_j} v \overline{p_\Omega} d\gamma(x) \\ &= \int_{\Omega_R} (\nabla v_R \cdot \overline{\nabla p_R} - k^2 v_R \overline{p_R}) dx - ik \sum_{j=1}^N \int_{\Gamma_j} v_R \overline{p_R} d\gamma(x) + \int_{D_0} (\nabla v \cdot \overline{\nabla p_\Omega} - k^2 v \overline{p_\Omega}) dx \\ &= \int_{\Omega_R} (\nabla v_R \cdot \overline{\nabla p_R} - k^2 v_R \overline{p_R}) dx - ik \sum_{j=1}^N \int_{\Gamma_j} v_R \overline{p_R} d\gamma(x) + \int_{\Sigma_R} (T^0 v_R) \overline{p_R} d\gamma(x) \\ &= a_0(v_R, p_R). \end{aligned}$$

On the other hand, due to the fact that J is defined in a neighbor part of Γ , we have that $J(u) = J(u_R)$ for all $u \in \mathcal{V}_\Omega$. Hence

$$(3.25) \quad L_{u_\Omega}(v) = L_{u_0}(v_R).$$

Then, gathering (3.24), (3.21), and (3.25), we obtain

$$a_0(v_R, p_R) = -L_{u_0}(v_R) \quad \forall v_R \in \mathcal{V}_R,$$

which proves that p_R is the solution to (3.23). Then p_0 is the restriction to Ω_R of p_Ω . It remains to prove that $\delta_a(u_\Omega|_{\Omega_R}, p_\Omega|_{\Omega_R}) = u_\Omega(x) \cdot p_\Omega(x)$. Using that u_Ω is the solution to the Helmholtz equation in the ball $B(x, R)$, we obtain

$$u_\Omega(x) = \frac{u_\Omega|_{\Sigma_R}^{mean}}{J_0(kR)}.$$

Similarly, we have

$$\bar{p}_\Omega(x) = \frac{\overline{p_\Omega|_{\Sigma_R}^{mean}}}{J_0(kR)}.$$

Hence

$$\begin{aligned} \delta_a(u_0, p_0) &= \delta_a(u_\Omega|_{\Omega_R}, p_\Omega|_{\Omega_R}) \\ &= u_\Omega(x) \overline{p_\Omega(x)}. \end{aligned}$$

This completes the proof. \square

Then the topological gradient is

$$g = \Re(u_\Omega \bar{p}_\Omega).$$

4. Numerical results.

4.1. T-shaped waveguide. We use the topological gradient to design an H-plane T-shaped waveguide. The geometric constraints are shown in Figure 3(a). The input Γ_1 is excited by the TE10 mode (see the second boundary condition of (4.1)): the excitation is given by

$$u_e(y) = \cos\left(\frac{\pi y}{d}\right) \quad \forall y \in \Gamma_1.$$

We follow the two ideas [22]:

- the initial guess is the free space;
- instead of minimizing the reflected energy, we maximize the transmitted energy on Γ_2 and Γ_3 .

At the beginning, only the input and output channels have metallic boundaries. In order to use the finite element method, the design domain is delimited by a fictitious boundary Γ_4 on which an absorbing condition is imposed (see Figure 3(b)). The problem is modeled as follows:

$$(4.1) \quad \begin{cases} \Delta u + k^2 u &= 0 & \text{in } \Omega, \\ u &= 0 & \text{on } \Gamma_0, \\ \partial_n u - ik'u &= \partial_n u_e - ik'u_e & \text{on } \Gamma_1, \\ \partial_n u - ik'u &= 0 & \text{on } \Gamma_2, \Gamma_3, \\ \partial_n u - ik'u &= 0 & \text{on } \Gamma_4, \end{cases}$$

where $k^2 = k'^2 + \frac{\pi^2}{d^2}$, d being the length of Γ_1 . The perfect conduction on the metallic boundary leads to the first boundary condition $u = 0$ on Γ_0 . The third

boundary condition prevents reflections on Γ_2, Γ_3 . The last equation is an approximate absorbing boundary condition. Here and in the following, we take $k = 10$.

The cost function to maximize is

$$J(u) = |S_{12}(u)|^2 + |S_{13}(u)|^2,$$

where $S_{1j}(u)$ is given by

$$S_{1j}(u) = \int_{\Gamma_j} u|_{\Gamma_j} \cos\left(\frac{\pi x}{d}\right) dx, \quad j \in \{2, 3\}.$$

The adjoint state is the solution to

$$(4.2) \quad \begin{cases} \Delta \bar{p} + k^2 \bar{p} = 0 & \text{in } \Omega, \\ \bar{p} = 0 & \text{on } \Gamma_0, \\ \partial_n \bar{p} - ik' \bar{p} = 0 & \text{on } \Gamma_1, \\ \partial_n \bar{p} - ik' \bar{p} = -2\overline{S_{12}(u)} \cos\left(\frac{\pi x}{d}\right) & \text{on } \Gamma_2, \\ \partial_n \bar{p} - ik' \bar{p} = -2\overline{S_{13}(u)} \cos\left(\frac{\pi x}{d}\right) & \text{on } \Gamma_3, \\ \partial_n \bar{p} - ik' \bar{p} = 0 & \text{on } \Gamma_4. \end{cases}$$

Then the topological gradient is $g = \Re(u\bar{p})$ (see Figure 4(b)). We are interested in the relative loss of energy

$$P(u) = \frac{E_e - (E_2 + E_3)(u)}{E_e},$$

where E_e is the entering energy and $E_j(u)$ is the outgoing energy through Γ_j , $j \in \{2, 3\}$.

We present here the topological optimization procedure. The underlying idea is the following: in the ℓ th step of the process, if \bar{x} is such that the topological gradient is higher than a certain value t_ℓ , we insert at this point a Dirichlet node (metal). The constant t_ℓ is chosen by the user, which allows him to take into account other constraints, for example the feasibility. The process is stopped when the topological gradient is everywhere negative in the design domain or when the shape suits the designer. The algorithm is as follows.

- Initialization: choose the initial domain Ω_0 , and set $\ell = 0$. The domain Ω_0 is meshed and it is identified with the set of the nodes: $\Omega_0 = \{x_k, k \in \{1, 2, \dots, n\}\}$. The grid is fixed during the process.
- Repeat:
 1. compute u_ℓ, p_ℓ the direct and adjoint solutions in the domain Ω_ℓ ,
 2. compute the topological gradient $g_\ell = \Re(u_\ell \bar{p}_\ell)$,
 3. set $\Omega_{\ell+1} = \Omega_\ell \setminus \{x_k, g_\ell(x_k) \geq t_{\ell+1}\}$,
 4. $\ell \leftarrow \ell + 1$.

Figure 4 shows the isovalues of $|u|$ and the topological gradient for the initial geometry. In this case, 94.4% of the energy is lost. After two iterations, the loss is reduced to 2.02% (see Figure 5) and the topological gradient is everywhere negative. The last step consists of smoothing the boundary of the domain by inserting some metal where $|u|$ is close to zero. The loss of energy of this waveguide is equal to 1.5% (see Figure 6). The convergence history is given by Figure 7.

4.2. L-shaped waveguide. Here, we use the topological gradient like a decision help system to build a junction between two rectangular waveguides. The initial

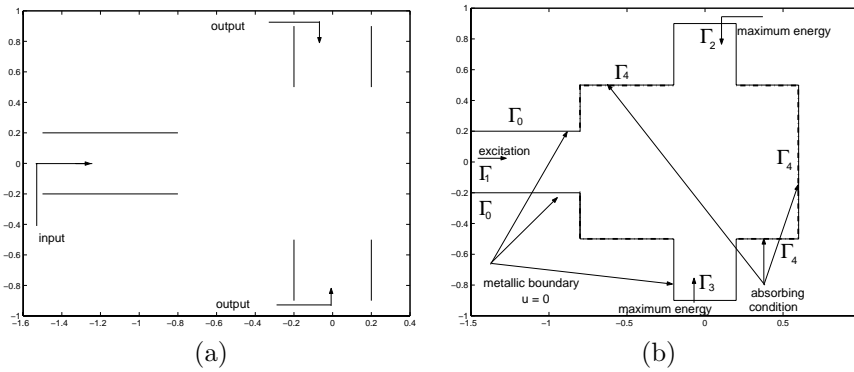

FIG. 3. The initial geometry (a) and the design domain (b).

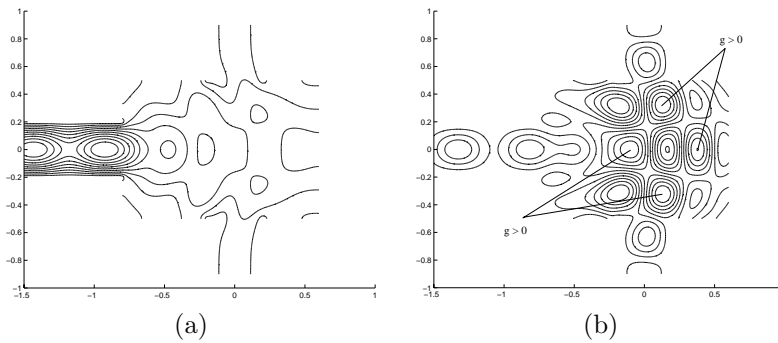

FIG. 4. Modulus of the electric field (a) and topological gradient (b).

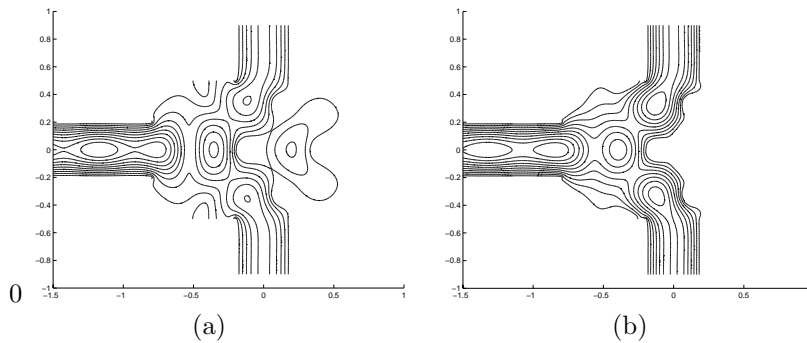

FIG. 5. Modulus of the electric fields obtained after a first iteration (a) and after two iterations (b).

geometry and the design domain are given by Figure 8. The cost function to maximize is

$$J(u) = |S_{12}(u)|^2.$$

Figure 9(a) shows the isovalues of $|u|$ for the initial geometry. In this case, 95.43% of the energy is lost. We observe that the topological gradient is high on a quarter

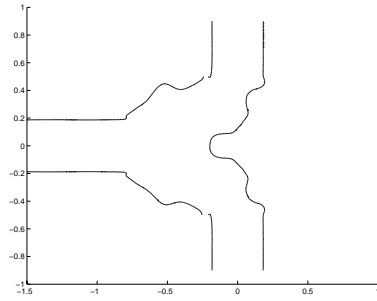

FIG. 6. *Final geometry.*

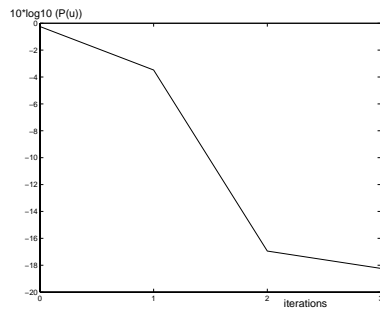

FIG. 7. *Convergence history.*

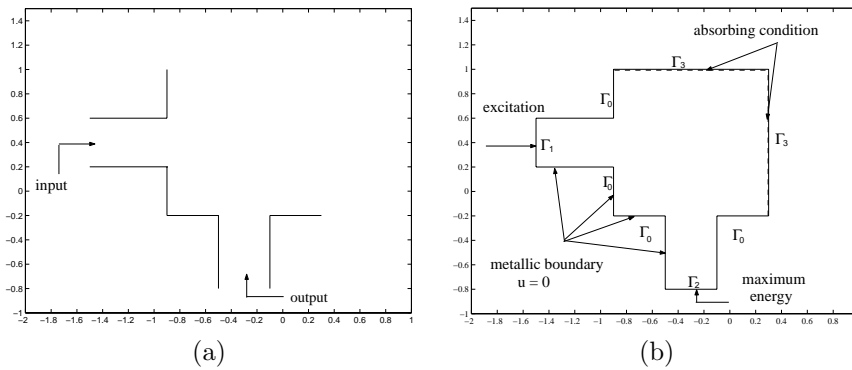

FIG. 8. *The initial geometry (a) and the design domain (b).*

of circle where we decide to put metal (see Figure 9(b)). The loss of energy of the obtained waveguide is now equal to 0.34% (see Figure 10).

4.3. U-shaped waveguide. Here, the initial guess is a metallic cavity. The geometry of the waveguide is shown in Figure 11. The cost function to maximize is

$$J(u) = |S_{12}(u)|^2.$$

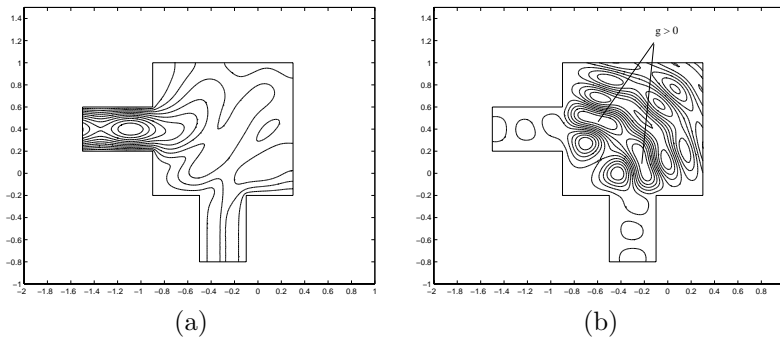

FIG. 9. Modulus of the electric field (a) and topological gradient (b).

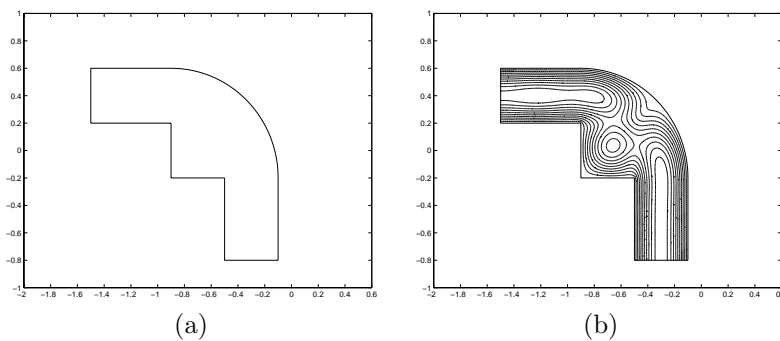

FIG. 10. Final geometry (a) and modulus of the electric field (b).

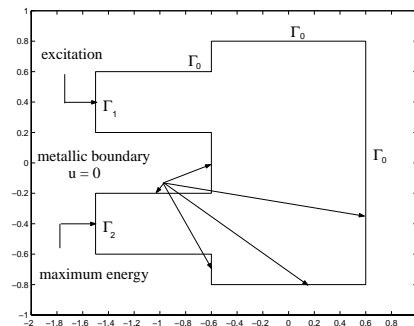

FIG. 11. Geometry of the initial guide.

Figure 12(a) shows the isovalues of $|u|$ for the initial geometry. In this case, 88.45% of the energy is reflected. There are three local maximas of the topological gradient (see Figure 12(b)). At each local maxima, we introduce a pointwise Dirichlet condition (a metallic plot). The new energy distribution is shown in Figure 13(a). The loss of energy is now equal to 39.19%. A new analysis is performed: after the introduction of another metallic plot, we obtain the design of Figure 13(b). The objective is fulfilled; the loss of energy is equal to 0.7%. For feasibility reasons, we decide not to insert additional plots.

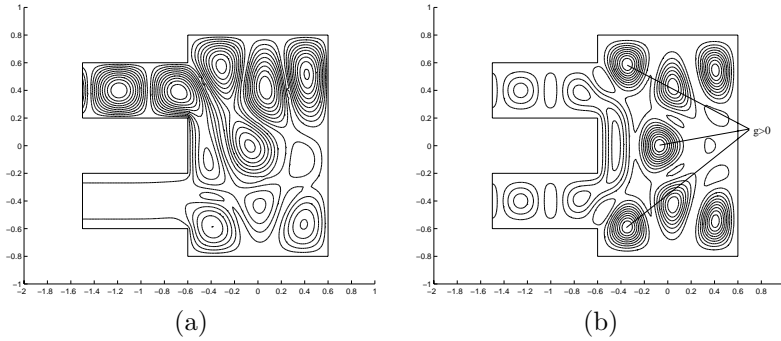

FIG. 12. Modulus of the electric field (a) and topological gradient (b).

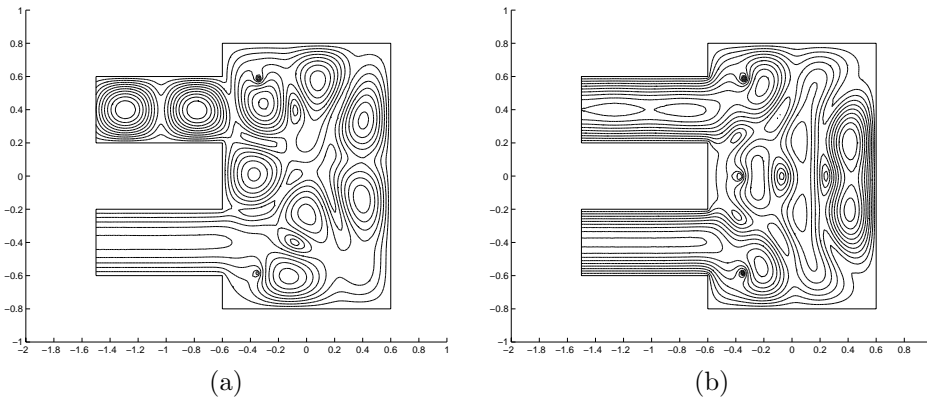

FIG. 13. Modulus of the electric fields obtained after a first iteration (a) and after two iterations (b).

5. Appendix.

5.1. Existence and uniqueness of the solution. Here we establish the existence and uniqueness of the solution to problem (3.1). Replacing Ω with Ω_ε , the argumentation would be the same for problem (3.3). Without any loss of generality, we suppose here that $N = 1$. The variational form of problem (3.1) is the following: find $u \in \mathcal{V}_\Omega$ satisfying

$$(5.1) \quad a(u, v) = l(v) \quad \forall v \in \mathcal{V}_\Omega,$$

where the functional space \mathcal{V}_Ω , the sesquilinear form a , and the semilinear form l are defined by

$$\begin{aligned} \mathcal{V}_\Omega &= \{v \in H^1(\Omega), v = 0 \text{ on } \Gamma_0\}, \\ a(u, v) &= \int_\Omega (\nabla u \cdot \nabla \bar{v} - k^2 u \bar{v}) \, dx - ik \int_{\Gamma_1} u \bar{v} \, d\gamma(x), \\ l(v) &= \int_{\Gamma_1} g \bar{v} \, d\gamma(x). \end{aligned}$$

We split a in the following form:

$$(5.2) \quad a(u, v) = b(u, v) + c(u, v),$$

where b and c are defined by

$$(5.3) \quad b(u, v) = \int_{\Omega} (\nabla u \cdot \overline{\nabla v} + u\overline{v}) \, dx,$$

$$(5.4) \quad c(u, v) = -(1 + k^2) \int_{\Omega} u\overline{v} \, dx - ik \int_{\Gamma_1} u\overline{v} \, d\gamma(x).$$

We recall the following result which is a consequence of the Lax–Milgram theorem.

LEMMA 5.1. *For all $f \in \mathcal{V}'_{\Omega}$, there exists a unique $u_f \in \mathcal{V}_{\Omega}$ such that*

$$b(u_f, v) = \langle f, v \rangle_{\mathcal{V}'_{\Omega}, \mathcal{V}_{\Omega}}.$$

The operator $f \mapsto u_f$ is continuous from \mathcal{V}'_{Ω} to \mathcal{V}_{Ω} .

We define

$$\begin{aligned} \mathcal{C} : \mathcal{V}_{\Omega} &\longrightarrow \mathcal{V}_{\Omega}, \\ u &\longmapsto \mathcal{C}u \end{aligned}$$

such that

$$(5.5) \quad b(\mathcal{C}u, v) + c(u, v) = 0 \quad \forall v \in \mathcal{V}_{\Omega}.$$

We have the following lemma.

LEMMA 5.2. *The operator \mathcal{C} is compact.*

Proof. By Lemma 5.1, it suffices to prove that the operator

$$u \longmapsto c(u, \cdot)$$

from \mathcal{V}_{Ω} to \mathcal{V}'_{Ω} is compact. Let (u_i) be a sequence bounded in \mathcal{V}_{Ω} . The imbeddings $\mathcal{V}_{\Omega} \rightarrow L^2(\Omega)$ and $H^{\frac{1}{2}}_{00}(\Gamma_1) \rightarrow L^2(\Gamma_1)$ are compact; then there exists a subsequence always denoted by (u_i) such that

$$u_i \rightarrow w_1 \text{ in } L^2(\Omega)$$

and

$$\gamma_0 u_i \rightarrow w_2 \text{ in } L^2(\Gamma_1).$$

Then

$$c(u_i, \cdot) \rightarrow l_{w_1}^{w_2} \text{ in } \mathcal{V}'_{\Omega},$$

where $l_{w_1}^{w_2}$ is defined by

$$\langle l_{w_1}^{w_2}, v \rangle_{\mathcal{V}'_{\Omega}, \mathcal{V}_{\Omega}} = -(1 + k^2) \int_{\Omega} w_1 \overline{v} \, dx - ik \int_{\Gamma_1} w_2 \overline{v} \, d\gamma(x) \quad \forall v \in \mathcal{V}_{\Omega}.$$

Hence the operator \mathcal{C} is compact. \square

Using (5.5), problem (5.1) can be written as follows: find $u \in \mathcal{V}_{\Omega}$ such that

$$(5.6) \quad b((I - \mathcal{C})u, v) = l(v) \quad \forall v \in \mathcal{V}_{\Omega}.$$

We have the following lemma.

LEMMA 5.3. For $k \in \{k \in \mathbb{C}^* / \Im(k) \geq 0\}$, the following problem has no nontrivial solution: find $u \in \mathcal{V}_\Omega$ such that

$$(5.7) \quad a(u, v) = 0 \quad \forall v \in \mathcal{V}_\Omega.$$

Proof. Let u be a solution to problem (5.7). For $v = u$, we have

$$a(u, u) = 0.$$

Then

$$(5.8) \quad \int_\Omega |\nabla u|^2 dx - k^2 \int_\Omega |u|^2 dx - ik \int_{\Gamma_1} |u|^2 d\gamma(x) = 0.$$

By writing $k = k_1 + ik_2$, where $(k_1, k_2) \in \mathbb{R}^2$ and using (5.8), we obtain

$$(5.9) \quad \int_\Omega |\nabla u|^2 dx - (k_1^2 - k_2^2) \int_\Omega |u|^2 dx + k_2 \int_{\Gamma_1} |u|^2 d\gamma(x) = 0$$

and

$$(5.10) \quad k_1 \int_{\Gamma_1} |u|^2 d\gamma(x) + 2k_1k_2 \int_\Omega |u|^2 dx = 0.$$

Two cases can arise:

- First case: $k_2 > 0$. If $k_1 = 0$, using (5.9) we obtain

$$\int_\Omega |\nabla u|^2 dx + k_2^2 \int_\Omega |u|^2 dx + k_2 \int_{\Gamma_1} |u|^2 d\gamma(x) = 0.$$

Then $u = 0$ in Ω . If $k_1 \neq 0$, using (5.10) we obtain

$$\int_{\Gamma_1} |u|^2 d\gamma(x) + 2k_2 \int_\Omega |u|^2 dx = 0.$$

Then $u = 0$ in Ω .

- Second case: $k_2 = 0$ and $k_1 \neq 0$. Using (5.10), we obtain

$$u = 0 \quad \text{on } \Gamma_1.$$

Let $\tilde{\Omega}$ be a regular domain containing Ω and so that $\Gamma_0 \subset \partial\tilde{\Omega}$. Extending u by zero in $\tilde{\Omega} \setminus \Omega$, we obtain a function \tilde{u} that satisfies

$$\Delta\tilde{u} + k^2\tilde{u} = 0 \quad \text{in } \mathcal{D}'(\tilde{\Omega}).$$

This extension is analytic; it is equal to zero in an open subset of a connected domain; thus $\tilde{u} = 0$ in $\tilde{\Omega}$.

This completes the proof. \square

By Lemmas 5.2 and 5.3, and by using the Fredholm alternative, we obtain the following result.

THEOREM 5.4. *For $k \in \{k \in \mathbb{C}^* / \Im(k) \geq 0\}$, problem (5.1) has one and only one solution.*

5.2. The inf-sup condition. Our aim is to prove that the sesquilinear form a_0 defined by (3.9) for $\varepsilon = 0$ satisfies the inf-sup condition (see Hypothesis 2). We have the following lemma.

LEMMA 5.5. *The sesquilinear form a defined in (5.1) satisfies the inf-sup condition.*

Proof. Let $u \in \mathcal{V}_\Omega$. We set $v = (I - \mathcal{C})u$, where \mathcal{C} is the operator defined by (5.5). According to (5.5), we have

$$\begin{aligned} a(u, v) &= b(v, v) \\ &= \|(I - \mathcal{C})u\|_{\mathcal{V}_\Omega} \|v\|_{\mathcal{V}_\Omega} \\ &\geq \alpha \|u\|_{\mathcal{V}_\Omega} \|v\|_{\mathcal{V}_\Omega}, \end{aligned}$$

where $\alpha = \|(I - \mathcal{C})^{-1}\|_{\mathcal{L}(\mathcal{V}_\Omega, \mathcal{V}_\Omega)}^{-1}$. Thus the sesquilinear form a satisfies the inf-sup condition. \square

We have the following result.

PROPOSITION 5.6. *The sesquilinear form a_0 satisfies the inf-sup condition.*

Proof. We have

$$a_0(u, v) = \int_{\Omega_R} (\nabla u \cdot \overline{\nabla v} - k^2 u \overline{v}) \, dx + \int_{\Sigma_R} (T^0 u) \overline{v} \, d\gamma(x) - ik \int_{\Gamma_1} u \overline{v} \, d\gamma(x) \quad \forall u, v \in \mathcal{V}_R.$$

For all $u \in \mathcal{V}_R$ we set

$$\tilde{u} = \begin{cases} u & \text{in } \Omega_R, \\ u_\psi^0 & \text{in } B(x, R), \end{cases}$$

where $\psi = u|_{\Sigma_R}$ and u_ψ^0 is the solution to

$$\begin{cases} \Delta u_\psi^0 + k^2 u_\psi^0 = 0 & \text{in } B(x, R), \\ u_\psi^0 = \psi & \text{on } \Sigma_R. \end{cases}$$

It can easily be proved that

$$a_0(u, v|_{\Omega_R}) = a(\tilde{u}, v) \quad \forall u \in \mathcal{V}_R, \quad \forall v \in \mathcal{V}_\Omega.$$

According to Lemma 5.5, there exists $v \in \mathcal{V}_\Omega, v \neq 0$, such that

$$\begin{aligned} a_0(u, v|_{\Omega_R}) &= a(\tilde{u}, v) \geq \alpha \|\tilde{u}\|_{\mathcal{V}_\Omega} \|v\|_{\mathcal{V}_\Omega} \\ &\geq \alpha \|u\|_{\mathcal{V}_R} \|v|_{\Omega_R}\|_{\mathcal{V}_R}. \end{aligned}$$

This completes the proof. \square

5.3. Some useful inequalities. We have the following proposition.

PROPOSITION 5.7. *There exists $c > 0$ such that*

$$\left| \varepsilon \frac{J_n(kR)}{J_n(k\varepsilon)} \right| \geq c \left(\frac{R}{\varepsilon} \right)^{n-1} \quad \forall n \geq n_0, \quad \forall \varepsilon < \varepsilon_0.$$

Proof. The Bessel function $J_n(z)$ is defined by

$$J_n(z) = \left(\frac{1}{2}z\right)^n \sum_{p=0}^{+\infty} \frac{(-\frac{1}{4}z^2)^p}{p!\Gamma(n+p+1)}.$$

Then we have

$$\begin{aligned} \varepsilon \frac{J_n(kR)}{J_n(k\varepsilon)} &= \varepsilon \left(\frac{R}{\varepsilon}\right)^n \frac{\sum_{p=0}^{+\infty} \frac{(-\frac{1}{4}k^2R^2)^p}{p!\Gamma(n+p+1)}}{\sum_{p=0}^{+\infty} \frac{(-\frac{1}{4}k^2\varepsilon^2)^p}{p!\Gamma(n+p+1)}} \\ &= \varepsilon \left(\frac{R}{\varepsilon}\right)^n \frac{(\Gamma(n+1))^{-1} + \sum_{p=1}^{+\infty} \frac{(-\frac{1}{4}k^2R^2)^p}{p!\Gamma(n+p+1)}}{(\Gamma(n+1))^{-1} + \sum_{p=1}^{+\infty} \frac{(-\frac{1}{4}k^2\varepsilon^2)^p}{p!\Gamma(n+p+1)}} \\ &= \varepsilon \left(\frac{R}{\varepsilon}\right)^n \frac{1 + \sum_{p=1}^{+\infty} \frac{n!}{p!(n+p)!} \left(-\frac{1}{4}k^2R^2\right)^p}{1 + \sum_{p=1}^{+\infty} \frac{n!}{p!(n+p)!} \left(-\frac{1}{4}k^2\varepsilon^2\right)^p} \\ &= \left(\frac{R}{\varepsilon}\right)^{n-1} u_n(\varepsilon), \end{aligned}$$

where $u_n(\varepsilon)$ is defined by

$$u_n(\varepsilon) = \frac{R + \sum_{p=1}^{+\infty} \frac{Rn!}{p!(n+p)!} \left(-\frac{1}{4}k^2R^2\right)^p}{1 + \sum_{p=1}^{+\infty} \frac{n!}{p!(n+p)!} \left(-\frac{1}{4}k^2\varepsilon^2\right)^p}.$$

It is easy to see that the series which intervene in the expression of $u_n(\varepsilon)$ converge normally with respect to (n, ε) . Hence, we have

$$\lim_{(n,\varepsilon) \rightarrow (\infty,0)} u_n(\varepsilon) = R.$$

Using the limit definition, there exists $c > 0$ such that

$$|u_n(\varepsilon)| \geq c \quad \forall n \geq n_0, \quad \forall \varepsilon < \varepsilon_0.$$

This completes the proof. \square

By the same techniques we obtain the following result.

PROPOSITION 5.8. *There exists $c > 0$ such that*

$$\left| \frac{Y_n(k\varepsilon)}{Y_n(kR)} \right| \geq c \left(\frac{R}{\varepsilon}\right)^n \quad \forall n \geq n_0, \quad \forall \varepsilon < \varepsilon_0.$$

REFERENCES

- [1] M. ABRAMOWITZ AND I. A. STEGUN, *Handbook of Mathematical Functions*, Dover, New York, 1964.
- [2] G. ALLAIRE AND R. KOHN, *Optimal bounds on the effective behavior of a mixture of two well-ordered elastic materials*, Quart. Appl. Math., 51 (1993), pp. 643–674.
- [3] G. ALLAIRE AND R. KOHN, *Optimal design for minimum weight and compliance in plane stress using extremal microstructures*, Eur. J. Mech. A Solids, 12 (1993), pp. 839–878.
- [4] M. BECKER, *Optimisation topologique de structure en variables discrètes*, Technical report, Université de Liège, Liège, Belgium, 1996.
- [5] M. BENDSOE, *Optimal Topology Design of Continuum Structure: An Introduction*, Technical report, Department of Mathematics, Technical University of Denmark, Lyngby, Denmark, 1996.
- [6] G. BUTTAZZO AND G. DAL MASO, *Shape optimization for Dirichlet problems: Relaxed formulation and optimality conditions*, Appl. Math. Optim., 23 (1991), pp. 17–49.
- [7] J. CÉA, *Conception optimale ou identification de forme, calcul rapide de la dérivée directionnelle de la fonction coût*, RAIRO Modél. Math. Anal. Numér., 20 (1986), pp. 371–402.
- [8] J. CÉA, A. GIOAN, AND J. MICHEL, *Quelques résultats sur l'identification de domaines*, Calcolo, 10 (1973), pp. 207–232.
- [9] R. DAUTRAY AND J.-L. LIONS, *Analyse mathématique et calcul numérique pour les sciences et les techniques*, Collection CEA, Masson, Paris, 1987.
- [10] S. GARREAU, PH. GUILLAUME, AND M. MASMOUDI, *The topological asymptotic for PDE systems: The elasticity case*, SIAM J. Control Optim., 39 (2001), pp. 1756–1778.
- [11] PH. GUILLAUME AND K. SID IDRIS, *The topological asymptotic expansion for the Dirichlet problem*, SIAM J. Control Optim., 41 (2002), pp. 1042–1072.
- [12] PH. GUILLAUME AND K. SID IDRIS, *Topological sensitivity and shape optimization for the Stokes equations*, Numer. Math., submitted.
- [13] P. GUILLAUME AND M. MASMOUDI, *Computation of high order derivatives in optimal shape design*, Numer. Math., 67 (1994), pp. 231–250.
- [14] P. GUILLAUME, *Dérivées d'ordre supérieur en conception optimale de forme*, Thèse, Université Paul Sabatier, Toulouse, France, 1994.
- [15] J. JACOBSEN, N. OLHOFF, AND E. RONHOLT, *Generalized Shape Optimization of Three-Dimensional Structures Using Materials with Optimum Microstructures*, Technical report, Institute of Mechanical Engineering, Aalborg University, Aalborg, Denmark, 1996.
- [16] M. MASMOUDI, *The topological asymptotic*, in Computational Methods for Control Applications, R. Glowinski, H. Kawarada, and J. Periaux, eds., GAKUTO Internat. Ser. Math. Sci. Appl. 16, Tokyo, Japan, 2001, pp. 53–72.
- [17] M. MASMOUDI, *Outils pour la conception optimale de formes*, Thèse d'état, Université de Nice, Sophia-Antipolis, France, 1987.
- [18] M. MASMOUDI, *Numerical solution for exterior problems*, Numer. Math., 51 (1987), pp. 87–101.
- [19] M. MASMOUDI, *Résolution numérique de problèmes extérieurs*, Thèse présentée à l'université de Nice, Sophia-Antipolis, France, 1979.
- [20] F. MURAT AND J. SIMON, *Sur le contrôle par un domaine géométrique*, Thèse d'état, Université Pierre et Marie Curie, Paris, 1976.
- [21] F. MURAT AND L. TARTAR, *Calcul des variations et homogénéisation*, in Les méthodes de l'homogénéisation: Théorie et Applications en Physique, Eyrolles, Paris, 1985, pp. 319–369.
- [22] P. MADER, *Optimisation topologique pour la conception de composants guidés*, Thèse, Université Paul Sabatier, Toulouse, France, 2002.
- [23] J.-C. NÉDÉLEC, *Acoustic and Electromagnetic Equations*, Springer, New York, 2000.
- [24] P. A. RAVIART AND J. M. THOMAS, *Introduction à l'analyse numérique des équations aux dérivées partielles*, Masson, Paris, 1988.
- [25] J. SOKOLOWSKI AND A. ŻOCHOWSKI, *On the topological derivative in shape optimization*, SIAM J. Control Optim., 37 (1999), pp. 1251–1272.
- [26] M. SHOENAUER, L. KALLEL, AND F. JOUVE, *Mechanics inclusions identification by evolutionary computation*, Revue européenne des éléments finis, 5 (1996), pp. 619–648.
- [27] A. SCHUMACHER, *Topologieoptimierung von Bauteilstrukturen unter Verwendung von Lophpositionierungskriterien*, Ph.D. thesis, Universität-Gesamthochschule Siegen, Siegen, Germany, 1995.
- [28] CH. VASSALLO, *Théorie des guides d'ondes électromagnétiques*, Collection Technique et scientifique des Télécommunications, Eyrolles, Paris, 1985.

Article 2 :

The topological asymptotic for the Helmholtz equation with Dirichlet condition on the boundary of an arbitrarily shaped hole
SIAM J. Control Optim. 43(3) (2004) 899-921

THE TOPOLOGICAL ASYMPTOTIC FOR THE HELMHOLTZ EQUATION WITH DIRICHLET CONDITION ON THE BOUNDARY OF AN ARBITRARILY SHAPED HOLE*

JULIEN POMMIER[†] AND BESSEM SAMET[‡]

Abstract. The aim of the topological sensitivity analysis is to obtain an asymptotic expansion of a design functional with respect to the creation of a small hole in the domain. In this paper, such an expansion is obtained for the Helmholtz equation, in two and three space dimensions, with a Dirichlet condition on the boundary of an arbitrarily shaped hole. In this case, the main difficulty is related to the nonhomogeneous symbol of the Helmholtz operator. In the numerical part of this work, we will show that the topological sensitivity method is very promising for solving shape inverse problems in electromagnetic applications.

Key words. topological optimization, topological asymptotic, topological gradient, nonhomogeneous problem, Helmholtz equation, shape inversion, electromagnetic applications, inverse scattering

AMS subject classifications. 49Q10, 49Q12, 78A25, 78A40, 78A45, 78A50, 35J05

DOI. 10.1137/S036301290241616X

1. Introduction. The same numerical methods are generally used in shape inversion and optimal shape design. There are mainly two categories of shape inversion or shape optimization methods. In the first category we deform continuously the boundary of the object to be optimized in order to decrease a given cost function [5, 20, 25, 28, 31]. The final shape has the same topology as the initial shape given by the designer. Therefore, to reach the optimal geometry, we need a priori knowledge of its topology. However, the topology of the optimal shape is often the main unknown in object detection problems. For example, the knowledge of the number and the locations of buried mines is more important than their accurate shapes. The second category of algorithms allows topology modifications. Many important contributions in this field are concerned with structural mechanics and, in particular, the optimization of the compliance (external work) subject to a volume constraint [4, 16]. In view of the fact that the optimal structure has generally a large number of small holes, most authors [1, 3, 14] have considered composite material optimization. Using the homogenization theory, Allaire and Kohn [1] exhibit a class of laminated materials with an explicit expression for the optimal material at any point of the structure. In this case, the optimal solution is not a classical design—it is a distribution of composite materials. Then penalization methods must be applied in order to retrieve a realistic shape. For all these reasons, global optimization methods are used to solve more general problems [15, 26]. Unfortunately these methods are quite slow.

More recently, Eschenauer and Olhoff [7], Schumacher [27], C ea et al. [6], Garreau, Guillaume, and Masmoudi [8], Sokolowski and Zochowski [29, 30], and Nazarov and Sokolowski [21] presented a method to obtain the optimal topology by calculating the so-called topological gradient (or topological derivative). This gradient is a function

*Received by the editors October 16, 2002; accepted for publication (in revised form) December 11, 2003; published electronically September 18, 2004.

<http://www.siam.org/journals/sicon/43-3/41616.html>

[†]D epartement de G enie Math ematique, INSA Toulouse and CNRS UMR 5640 MIP, Complex Scientifique de Rangueil, F-31077 Toulouse cedex 4, France (pommier@gmm.insa-tlse.fr).

[‡]UMR MIG, Universit  Paul Sabatier and CNRS UMR 5640 MIP, 118 route de Narbonne, F-31062 Toulouse cedex, France (samet@mip.ups-tlse.fr).

defined in the domain of interest where, at each point, it gives the sensitivity of the cost function when a small hole is created at that point. This approach seems to be general and efficient. To present the basic idea, we consider Ω a domain of \mathbb{R}^n , where n equals 2 or 3, and $j(\Omega) = J(u_\Omega)$ a cost function to be minimized, where u_Ω is the solution to a given PDE problem defined in Ω . For $\varepsilon > 0$, let $\Omega_\varepsilon = \Omega \setminus \overline{x_0 + \varepsilon\omega}$ be the subset obtained by removing a small part $\overline{x_0 + \varepsilon\omega}$ from Ω , where $x_0 \in \Omega$ and $\omega \subset \mathbb{R}^n$ is a fixed open and bounded subset containing the origin. We can generally prove that the variation of the criterion is given by the asymptotic expansion

$$(1.1) \quad j(\Omega_\varepsilon) = j(\Omega) + f(\varepsilon)g(x_0) + o(f(\varepsilon)),$$

$$(1.2) \quad \lim_{\varepsilon \rightarrow 0} f(\varepsilon) = 0, \quad f(\varepsilon) > 0.$$

This expansion is called the topological asymptotic. To minimize the criterion, we have to create holes where g (called the topological gradient) is negative.

In this paper, using the adjoint method and the domain truncation technique introduced in [17], we compute the topological asymptotic expansion for the Helmholtz equation in two and three space dimensions with a Dirichlet condition on the boundary of an arbitrarily shaped hole. The originality of this work is that the symbol of the Helmholtz operator is nonhomogeneous. The basic idea is to say that the leading term of the topological asymptotic expansion is given by the principal part of the operator in the case of a Dirichlet condition on the boundary of the hole. Our work generalizes the contribution of Guillaume and Sid Idris [9] for the Poisson equation and is easily applicable to other problems for which the symbol of the operator is nonhomogeneous, as, for example, the quasi-Stokes problem and the elastic waves problem. In the numerical part, we present some applications that illustrate the ability of the topological sensitivity approach to solve inverse scattering problems.

As a background to our work, we cite the contributions of Il'in [11, 12, 13] for the construction of asymptotic expansions of solutions to boundary value problems in domains with small holes, as in the case of second order scalar equations, by the use of the method of matched asymptotic expansions. Various spectral problems in domains with small holes are investigated by Maz'ya et al. [23, 24, 18, 22]. In [32], Vogelius and Volkov provided a rigorous derivation for solutions to the time-harmonic Maxwell's equations of a transverse electric (TE) nature, in the presence of a finite number of diametrically small inhomogeneities. Based on layer potential techniques, Ammari and Kang [2] provided a rigorous derivation of complete asymptotic expansions for solutions to the Helmholtz equation in two and three dimensions, in the presence of small inhomogeneities in the domain. In our work, we derive asymptotic expansions not for solutions, but for a given cost function.

The generalized adjoint method is recalled in section 2. Next, the formulation of the Helmholtz problem is presented in section 3 and its truncated version is described in section 4. Section 5 presents the main results whose proofs are given in section 6. Finally, numerical examples illustrate in section 7 the abilities of the topological sensitivity to solve inverse scattering problems.

2. A generalized adjoint method. In this section, the generalized adjoint method introduced in [17, 8] is slightly modified. The first modification is due to the fact that the cost function is defined in a \mathbb{C} -Hilbert space and takes values in \mathbb{R} ; then it is not differentiable. For this reason, the differentiability property is replaced by the formulation (2.5). The second modification is due to the fact that the sesquilinear form associated with our problem is not coercive. For this reason, the coercivity property is replaced by the inf-sup condition (see Hypothesis 2).

Let \mathcal{V} be a fixed complex Hilbert space. For $\varepsilon \geq 0$, let $a_\varepsilon(\cdot, \cdot)$ be a sesquilinear and continuous form on \mathcal{V} and let l_ε be a semilinear and continuous form on \mathcal{V} . We consider the following assumptions.

Hypothesis 1. There exists a sesquilinear and continuous form δa , a semilinear and continuous form δ_l , and a real function $f(\varepsilon) > 0$ defined on \mathbb{R}^*_+ such that

$$(2.1) \quad \lim_{\varepsilon \rightarrow 0} f(\varepsilon) = 0,$$

$$(2.2) \quad \|a_\varepsilon - a_0 - f(\varepsilon)\delta a\|_{\mathcal{L}_2(\mathcal{V})} = o(f(\varepsilon)),$$

$$(2.3) \quad \|l_\varepsilon - l_0 - f(\varepsilon)\delta_l\|_{\mathcal{L}(\mathcal{V})} = o(f(\varepsilon)),$$

where $\mathcal{L}(\mathcal{V})$ (respectively, $\mathcal{L}_2(\mathcal{V})$) denotes the space of continuous and semilinear (respectively, sesquilinear) forms on \mathcal{V} .

Hypothesis 2. There exists a constant $\alpha > 0$ such that

$$\inf_{u \neq 0} \sup_{v \neq 0} \frac{|a_0(u, v)|}{\|u\|_{\mathcal{V}} \|v\|_{\mathcal{V}}} \geq \alpha.$$

We say that a_0 satisfies the inf-sup condition.

According to (2.2), there exists a constant $\beta > 0$ independent of ε such that

$$\inf_{u \neq 0} \sup_{v \neq 0} \frac{|a_\varepsilon(u, v)|}{\|u\|_{\mathcal{V}} \|v\|_{\mathcal{V}}} \geq \beta.$$

For $\varepsilon \geq 0$, let u_ε be the solution to the following problem: Find $u_\varepsilon \in \mathcal{V}$ such that

$$(2.4) \quad a_\varepsilon(u_\varepsilon, v) = l_\varepsilon(v) \quad \forall v \in \mathcal{V}.$$

We have the following lemma.

LEMMA 2.1. *If Hypotheses 1 and 2 are satisfied, then*

$$\|u_\varepsilon - u_0\|_{\mathcal{V}} = O(f(\varepsilon)).$$

Proof. It follows from Hypothesis 2 that there exists $v_\varepsilon \in \mathcal{V}, v_\varepsilon \neq 0$, such that

$$\beta \|u_\varepsilon - u_0\|_{\mathcal{V}} \|v_\varepsilon\|_{\mathcal{V}} \leq |a_\varepsilon(u_\varepsilon - u_0, v_\varepsilon)|,$$

which implies

$$\begin{aligned} \beta \|u_\varepsilon - u_0\|_{\mathcal{V}} \|v_\varepsilon\|_{\mathcal{V}} &\leq |a_\varepsilon(u_0, v_\varepsilon) - l_\varepsilon(v_\varepsilon)| \\ &= |a_\varepsilon(u_0, v_\varepsilon) - (l_\varepsilon - l_0 - f(\varepsilon)\delta_l)(v_\varepsilon) - l_0(v_\varepsilon) - f(\varepsilon)\delta_l(v_\varepsilon)| \\ &= |(a_\varepsilon(u_0, v_\varepsilon) - a_0(u_0, v_\varepsilon)) - (l_\varepsilon - l_0 - f(\varepsilon)\delta_l)(v_\varepsilon) - f(\varepsilon)\delta_l(v_\varepsilon)| \\ &\leq |a_\varepsilon(u_0, v_\varepsilon) - a_0(u_0, v_\varepsilon) - f(\varepsilon)\delta a(u_0, v_\varepsilon)| \\ &\quad + |l_\varepsilon(v_\varepsilon) - l_0(v_\varepsilon) - f(\varepsilon)\delta_l(v_\varepsilon)| + f(\varepsilon)(|\delta a(u_0, v_\varepsilon)| + |\delta_l(v_\varepsilon)|). \end{aligned}$$

Using Hypothesis 1 we obtain

$$\beta \|u_\varepsilon - u_0\|_{\mathcal{V}} \|v_\varepsilon\|_{\mathcal{V}} \leq (o(f(\varepsilon)) + f(\varepsilon)(\|\delta a\|_{\mathcal{L}_2(\mathcal{V})}\|u_0\|_{\mathcal{V}} + \|\delta_l\|_{\mathcal{L}(\mathcal{V})})) \|v_\varepsilon\|_{\mathcal{V}}. \quad \square$$

Consider now a cost function $j(\varepsilon) = J(u_\varepsilon)$, where the functional J satisfies

$$(2.5) \quad J(u + h) = J(u) + \Re(L_u(h)) + o(\|h\|) \quad \forall u, h \in \mathcal{V},$$

where L_u is a linear and continuous form on \mathcal{V} .

For $\varepsilon \geq 0$, we define the Lagrangian operator \mathcal{L}_ε by

$$\mathcal{L}_\varepsilon(u, v) = J(u) + a_\varepsilon(u, v) - l_\varepsilon(v) \quad \forall u, v \in \mathcal{V}.$$

The next theorem gives the asymptotic expansion of $j(\varepsilon)$.

THEOREM 2.2. *If Hypotheses 1 and 2 are satisfied, then*

$$(2.6) \quad j(\varepsilon) - j(0) = f(\varepsilon)\Re(\delta_{\mathcal{L}}(u_0, p_0)) + o(f(\varepsilon)),$$

where u_0 is the solution to (2.4) with $\varepsilon = 0$, and p_0 is the solution to the following adjoint problem: Find $p_0 \in \mathcal{V}$ such that

$$(2.7) \quad a_0(v, p_0) = -L_{u_0}(v) \quad \forall v \in \mathcal{V}$$

and

$$\delta_{\mathcal{L}}(u, v) = \delta a(u, v) - \delta_l(v) \quad \forall u, v \in \mathcal{V}.$$

Proof. We have that

$$j(\varepsilon) = \mathcal{L}_\varepsilon(u_\varepsilon, v) \quad \forall \varepsilon \geq 0 \quad \forall v \in \mathcal{V}.$$

Next, choosing $v = p_0$, we obtain

$$\begin{aligned} j(\varepsilon) - j(0) &= \mathcal{L}_\varepsilon(u_\varepsilon, p_0) - \mathcal{L}_0(u_0, p_0) \\ &= J(u_\varepsilon) - J(u_0) + a_\varepsilon(u_\varepsilon, p_0) - a_0(u_0, p_0) + l_0(p_0) - l_\varepsilon(p_0) \\ &= J(u_\varepsilon) - J(u_0) + \Re(a_\varepsilon(u_\varepsilon, p_0) - a_0(u_0, p_0)) - \Re(l_\varepsilon(p_0) - l_0(p_0)) \\ &= J(u_\varepsilon) - J(u_0) + \Re(a_\varepsilon(u_\varepsilon, p_0) - a_0(u_\varepsilon, p_0) + a_0(u_\varepsilon - u_0, p_0)) \\ &\quad - \Re(l_\varepsilon(p_0) - l_0(p_0) - f(\varepsilon)\delta_l(p_0)) - f(\varepsilon)\Re(\delta_l(p_0)). \end{aligned}$$

Using (2.5), we have that

$$J(u_\varepsilon) - J(u_0) = \Re(L_{u_0}(u_\varepsilon - u_0)) + o(\|u_\varepsilon - u_0\|).$$

Hence,

$$\begin{aligned} j(\varepsilon) - j(0) &= \Re(a_\varepsilon(u_\varepsilon, p_0) - a_0(u_\varepsilon, p_0)) + \Re(a_0(u_\varepsilon - u_0, p_0) + L_{u_0}(u_\varepsilon - u_0)) \\ &\quad + o(\|u_\varepsilon - u_0\|) - \Re(l_\varepsilon(p_0) - l_0(p_0) - f(\varepsilon)\delta_l(p_0)) - f(\varepsilon)\Re(\delta_l(p_0)). \end{aligned}$$

Using that p_0 is the adjoint solution, we obtain

$$\begin{aligned} j(\varepsilon) - j(0) &= \Re(a_\varepsilon(u_\varepsilon, p_0) - a_0(u_\varepsilon, p_0)) + o(\|u_\varepsilon - u_0\|) \\ &\quad - \Re(l_\varepsilon(p_0) - l_0(p_0) - f(\varepsilon)\delta_l(p_0)) - f(\varepsilon)\Re(\delta_l(p_0)) \\ &= \Re((a_\varepsilon - a_0)(u_0, p_0)) + \Re((a_\varepsilon - a_0)(u_\varepsilon - u_0, p_0)) + o(\|u_\varepsilon - u_0\|) \\ &\quad - \Re(l_\varepsilon(p_0) - l_0(p_0) - f(\varepsilon)\delta_l(p_0)) - f(\varepsilon)\Re(\delta_l(p_0)). \end{aligned}$$

It follows from Hypothesis 1 that

$$\begin{aligned} j(\varepsilon) - j(0) &= f(\varepsilon)\Re(\delta a(u_0, p_0)) + o(f(\varepsilon)) + f(\varepsilon)\Re(\delta a(u_\varepsilon - u_0, p_0)) + o(f(\varepsilon))\|u_\varepsilon - u_0\| \\ &\quad + o(\|u_\varepsilon - u_0\|) - f(\varepsilon)\Re(\delta_l(p_0)). \end{aligned}$$

Finally, from Lemma 2.1 and the hypothesis $\lim_{\varepsilon \rightarrow 0} f(\varepsilon) = 0$, we have

$$j(\varepsilon) = j(0) + f(\varepsilon)\Re(\delta a(u_0, p_0) - \delta_l(p_0)) + o(f(\varepsilon)),$$

since δ_a is continuous by assumption. \square

3. The Helmholtz problem in a domain with a small hole. Let Ω be an open and bounded subset of \mathbb{R}^n with boundary $\Gamma = \Gamma_0 \cup \Gamma_1$, $n = 2$ or 3 . The Helmholtz problem is

$$(3.1) \quad \begin{cases} \Delta u_\Omega + k^2 u_\Omega &= 0 & \text{in } \Omega, \\ u_\Omega &= 0 & \text{on } \Gamma_0, \\ \frac{\partial u_\Omega}{\partial n} &= \Lambda u_\Omega + \Theta & \text{on } \Gamma_1, \end{cases}$$

where $k \in \mathbb{R}^*$, $\Theta \in H_{00}^{\frac{1}{2}}(\Gamma_1)'$, and $\Lambda \in \mathcal{L}(H_{00}^{\frac{1}{2}}(\Gamma_1), H_{00}^{\frac{1}{2}}(\Gamma_1)')$.

We define

$$(3.2) \quad \begin{cases} \mathcal{V}(\Omega) &= \{v \in H^1(\Omega), v = 0 \text{ on } \Gamma_0\}, \\ a(\Omega, u, v) &= \int_\Omega \nabla u \cdot \nabla \bar{v} \, dx - k^2 \int_\Omega u \bar{v} \, dx - \langle \Lambda u, \bar{v} \rangle, \\ \ell(v) &= \langle \Theta, \bar{v} \rangle, \end{cases}$$

where $\langle \cdot, \cdot \rangle$ is the duality product between $H_{00}^{\frac{1}{2}}(\Gamma_1)'$ and $H_{00}^{\frac{1}{2}}(\Gamma_1)$. The variational formulation associated with (3.1) is the following: Find $u_\Omega \in \mathcal{V}(\Omega)$ such that

$$(3.3) \quad a(\Omega, u_\Omega, v) = \ell(v) \quad \forall v \in \mathcal{V}(\Omega).$$

We consider the following assumption.

Hypothesis 3. The operator Λ is split into $\Lambda_0 + \Lambda_1$, with $\Lambda_1 \in \mathcal{L}(H_{00}^{\frac{1}{2}}(\Gamma_1), H_{00}^{\frac{1}{2}}(\Gamma_1)')$, and satisfies

$$(3.4) \quad \Re \langle \Lambda_1 \psi, \bar{\psi} \rangle \leq 0 \quad \forall \psi \in H_{00}^{\frac{1}{2}}(\Gamma_1),$$

and $\Lambda_2 \in \mathcal{L}(H_{00}^{\frac{1}{2}}(\Gamma_1), H_{00}^{\frac{1}{2}}(\Gamma_1))$. We assume the following property of uniqueness.

Hypothesis 4. We have

$$(3.5) \quad a(\Omega, u, v) = 0 \quad \forall v \in \mathcal{V}(\Omega) \Rightarrow u = 0,$$

$$(3.6) \quad a(\Omega, u, v) = 0 \quad \forall u \in \mathcal{V}(\Omega) \Rightarrow v = 0.$$

From the Lax–Milgram theorem and the fact that the imbeddings $\mathcal{V}_\Omega \rightarrow L^2(\Omega)$ and $H_{00}^{\frac{1}{2}}(\Gamma_1) \rightarrow L^2(\Gamma_1)$ are compact, and due to the Fredholm alternative, we obtain the following result (see, e.g., [10] for a detailed argument).

PROPOSITION 3.1. *If Hypotheses 3 and 4 are satisfied, we have the following:*

1. *Problem (3.3) has one and only one solution.*
2. *The sesquilinear form $a(\Omega, \cdot, \cdot)$ satisfies the inf-sup condition: There exists a constant $a > 0$ such that*

$$(3.7) \quad \inf_{u \neq 0} \sup_{v \neq 0} \frac{|a_\Omega(u, v)|}{\|u\|_{\mathcal{V}(\Omega)} \|v\|_{\mathcal{V}(\Omega)}} \geq a.$$

For a given $x_0 \in \Omega$, consider the modified open subset $\Omega_\varepsilon = \Omega \setminus \bar{\omega}_\varepsilon$, $\omega_\varepsilon = x_0 + \varepsilon\omega$, where ω is a fixed open and bounded subset of \mathbb{R}^n containing the origin ($\omega_\varepsilon = \emptyset$ if $\varepsilon = 0$), whose boundary $\partial\omega$ is connected and piecewise of class \mathcal{C}^1 . The modified solution u_{Ω_ε} satisfies

$$(3.8) \quad \begin{cases} \Delta u_{\Omega_\varepsilon} + k^2 u_{\Omega_\varepsilon} &= 0 & \text{in } \Omega_\varepsilon, \\ u_{\Omega_\varepsilon} &= 0 & \text{on } \Gamma_0, \\ u_{\Omega_\varepsilon} &= 0 & \text{on } \partial\omega_\varepsilon, \\ \frac{\partial u_{\Omega_\varepsilon}}{\partial n} &= \Lambda u_{\Omega_\varepsilon} + \Theta & \text{on } \Gamma_1. \end{cases}$$

The function u_{Ω_ε} is defined on the variable open set Ω_ε , and thus belongs to a functional space which depends on ε . Hence, if we want to derive the asymptotic expansion of a function of the form

$$(3.9) \quad j(\varepsilon) = J(u_{\Omega_\varepsilon}),$$

we cannot apply directly the tools of section 2, which require a fixed functional space. For this reason, we use the domain truncation method introduced in [17] to avoid this complication.

4. The truncation method. Let $R > 0$ be such that the closed ball $\overline{B(x_0, R)}$ is included in Ω . It is supposed throughout this paper that ε remains small enough so that $\overline{\omega_\varepsilon} \subset B(x_0, R)$. The truncated open subset is defined by

$$(4.1) \quad \Omega_R = \Omega \setminus \overline{B(x_0, R)}.$$

The open subset $B(x_0, R) \setminus \overline{\omega_\varepsilon}$ is denoted by D_ε (see Figure 4.1). For $\varphi \in H^{\frac{1}{2}}(\Gamma_R)$ and $\varepsilon > 0$, let u_ε^φ be the solution to the following problem: Find u_ε^φ such that

$$(4.2) \quad \begin{cases} \Delta u_\varepsilon^\varphi + k^2 u_\varepsilon^\varphi = 0 & \text{in } D_\varepsilon, \\ u_\varepsilon^\varphi = 0 & \text{on } \partial\omega_\varepsilon, \\ u_\varepsilon^\varphi = \varphi & \text{on } \Gamma_R, \end{cases}$$

where Γ_R is the boundary of the ball $B(x_0, R)$. For $\varepsilon = 0$, u_0^φ is the solution to

$$(4.3) \quad \begin{cases} \Delta u_0^\varphi + k^2 u_0^\varphi = 0 & \text{in } B(x_0, R), \\ u_0^\varphi = \varphi & \text{on } \Gamma_R. \end{cases}$$

Using the Poincaré inequality, it can easily be seen that for $R < \frac{1}{\sqrt{2|k|}}$, (4.2) has one and only one solution.

For $\varepsilon \geq 0$, the Dirichlet-to-Neumann operator T_ε is defined by

$$T_\varepsilon : \begin{array}{l} H^{1/2}(\Gamma_R) \longrightarrow H^{-1/2}(\Gamma_R), \\ \varphi \longmapsto T_\varepsilon \varphi = \nabla u_\varepsilon^\varphi \cdot n|_{\Gamma_R}, \end{array}$$

where the normal $n|_{\Gamma_R}$ is chosen outward to D_ε on Γ_R and $\partial\omega_\varepsilon$.

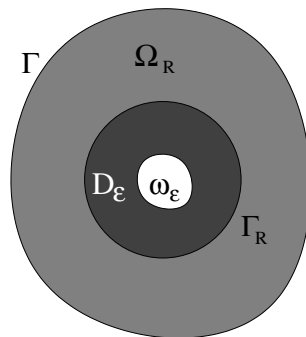

FIG. 4.1. The truncated domain.

Finally, we define for $\varepsilon \geq 0$ the solution u_ε to the truncated problem

$$(4.4) \quad \begin{cases} \Delta u_\varepsilon + k^2 u_\varepsilon &= 0 & \text{in } \Omega_R, \\ u_\varepsilon &= 0 & \text{on } \Gamma_0, \\ \frac{\partial u_\varepsilon}{\partial n} &= \Lambda u_\varepsilon + \Theta & \text{on } \Gamma_1, \\ \frac{\partial u_\varepsilon}{\partial n} - T_\varepsilon u_\varepsilon|_{\Gamma_R} &= 0 & \text{on } \Gamma_R. \end{cases}$$

The variational formulation associated with (4.4) is as follows: Find $u_\varepsilon \in \mathcal{V}_R$ such that

$$(4.5) \quad a_\varepsilon(u_\varepsilon, v) = \ell(v) \quad \forall v \in \mathcal{V}_R,$$

where the functional space \mathcal{V}_R and the sesquilinear form a_ε are defined by

$$(4.6) \quad \mathcal{V}_R = \{v \in H^1(\Omega_R); v|_{\Gamma_0} = 0\},$$

$$(4.7) \quad a_\varepsilon(u, v) = \int_{\Omega_R} \nabla u \cdot \nabla \bar{v} \, dx - k^2 \int_{\Omega_R} u \cdot \bar{v} \, dx - \langle \Lambda u, \bar{v} \rangle + \int_{\Gamma_R} T_\varepsilon u|_{\Gamma_R} \bar{v} \, d\gamma(x).$$

Here, \int_{Γ_R} denotes the duality product between $H^{1/2}(\Gamma_R)$ and $H^{-1/2}(\Gamma_R)$. The following result is standard in PDE theory.

PROPOSITION 4.1. *Problems (3.8) and (4.4) have a unique solution. Moreover, the restriction to Ω_R of the solution u_{Ω_ε} to (3.8) is the solution u_ε to (4.4).*

We now have at our disposal the fixed Hilbert space \mathcal{V}_R required by section 2. We assume that the following hypothesis holds.

Hypothesis 5. The function J introduced in (3.9) is defined in a neighboring part of Γ and satisfies

$$J(u + h) = J(u) + \Re(L_u(h)) + o(\|h\|) \quad \forall u, h \in \mathcal{V}_R,$$

where L_u is a linear and continuous form on \mathcal{V}_R .

Then we obtain that

$$(4.8) \quad j(\varepsilon) = J(u_{\Omega_\varepsilon}) = J(u_\varepsilon) \quad \forall \varepsilon \geq 0.$$

Remark 1. We can also consider a more general cost function (see, e.g., [9]); the truncation method does not restrict the choice of the function. In the numerical part of this work, only measurements on the boundary of the domain are used. For this reason and to simplify the presentation, we considered the previous assumption about the cost function.

Let v_Ω be the solution to the adjoint problem

$$(4.9) \quad a(\Omega, w, v_\Omega) = -L_{u_0}(w) \quad \forall w \in \mathcal{V}(\Omega),$$

where the functional space $\mathcal{V}(\Omega)$ and the sesquilinear form $a(\Omega, \cdot, \cdot)$ are defined in (3.2). It has been shown in Proposition 4.1 that u_0 is the restriction to Ω_R of u_Ω . Similarly, v_0 , the solution to

$$(4.10) \quad a_0(w, v_0) = -L_{u_0}(w) \quad \forall w \in \mathcal{V}_R,$$

is the restriction to Ω_R of v_Ω .

5. The main results. This section contains the main results of this paper. All the proofs are reported in section 6. Henceforth, we have to distinguish between the cases $n = 2$ and $n = 3$. This is due to the fact that the fundamental solutions to the Laplace equation in \mathbb{R}^2 and \mathbb{R}^3 have an essentially different asymptotic expansion at infinity, and (5.1) has generally no solution if $n = 2$.

5.1. The three-dimensional case. Possibly changing the coordinate system, we can suppose for convenience that $x_0 = 0$. In order to derive the topological sensitivity of the function j , we introduce two auxiliary problems.

The first problem, called the *exterior problem*, is formulated in $\mathbb{R}^3 \setminus \bar{\omega}$ and consists of finding v_ω , solution to

$$(5.1) \quad \begin{cases} -\Delta v_\omega &= 0 & \text{in } \mathbb{R}^3 \setminus \bar{\omega}, \\ v_\omega &= 0 & \text{at } \infty, \\ v_\omega &= u_\Omega(x_0) & \text{on } \partial\omega, \end{cases}$$

where u_Ω is the solution to the direct problem (3.1). Here, one can remark that just the principal part of the Helmholtz operator is used, which was described by the Laplace equation. The function v_ω can be expressed by a single layer potential on $\partial\omega$. Let

$$(5.2) \quad E(y) = \frac{1}{4\pi r}$$

with $r = \|y\|$. It is a fundamental solution for the Laplace equation in \mathbb{R}^3 . Then the function v_ω reads

$$(5.3) \quad v_\omega(y) = \int_{\partial\omega} E(y-x)p_\omega(x) d\gamma(x), \quad y \in \mathbb{R}^3 \setminus \bar{\omega},$$

where $p_\omega \in H^{-\frac{1}{2}}(\partial\omega)$ is the solution to boundary integral equation

$$(5.4) \quad \int_{\partial\omega} E(y-x)p_\omega(x) d\gamma(x) = u_\Omega(x_0) \quad \forall y \in \partial\omega.$$

For x bounded and large $r = \|y\|$, we have

$$(5.5) \quad E(y-x) = E(y) + O\left(\frac{1}{r^2}\right),$$

and the asymptotic expansion at infinity of the function v_ω is given by

$$(5.6) \quad v_\omega(y) = P_\omega(y) + W_\omega(y),$$

$$(5.7) \quad P_\omega(y) = A_\omega(u_\Omega(x_0)) E(y),$$

$$(5.8) \quad A_\omega(u_\Omega(x_0)) = \int_{\partial\omega} p_\omega(x) d\gamma(x),$$

$$(5.9) \quad W_\omega(y) = O\left(\frac{1}{r^2}\right).$$

Notice that $P_\omega \in L^m_{loc}$ for all $m < 3$. Clearly, the function $\alpha \mapsto A_\omega(\alpha)$ is linear on \mathbb{R} , and the number $A_\omega(\alpha)$ depends on the shape of ω .

The second problem, which we call *interior problem*, is formulated in $D_0 = B(x_0, R)$ and consists to find Q_ω^1 solution to

$$(5.10) \quad \begin{cases} \Delta Q_\omega^1 + k^2 Q_\omega^1 &= 0 & \text{in } D_0, \\ Q_\omega^1 &= P_\omega|_{\Gamma_R} & \text{on } \Gamma_R. \end{cases}$$

Here, the idea is to consider an interior and exterior problem that gives a good “first order approximation” of $(u_\varepsilon^\varphi - u_0^\varphi)|_{D_\varepsilon}$, $\varphi = u_{\Omega|\Gamma_R}$, in the form $f(\varepsilon)(Q_\omega^1 - P_\omega)$, in a way which will be stated precisely in section 6. But the given formulation (5.10) of the interior problem, which is the “natural” choice, is not sufficient to get the behavior needed by the adjoint technique described in section 2. More precisely, in this case one can construct the sesquilinear form δa but there is no positive function $f(\varepsilon)$ such that $\|a_\varepsilon - a_0 - f(\varepsilon)\delta a\|_{\mathcal{L}_2(\mathcal{V}_R)} = o(f(\varepsilon))$. Indeed, one can observe through the proof of Proposition 6.7 that the behavior of $\|a_\varepsilon - a_0 - f(\varepsilon)\delta a\|_{\mathcal{L}_2(\mathcal{V}_R)}$ is not of order $o(\varepsilon)$, but only of order $O(\varepsilon)$. This is due to the approximation used on the exterior problem (5.1), where just the principal part of the operator is considered. For this reason, a new term Q_ω^2 is used in order to correct the error caused by this approximation. We construct Q_ω^2 as the solution to

$$(5.11) \quad \begin{cases} \Delta Q_\omega^2 + k^2 Q_\omega^2 &= k^2 P_\omega & \text{in } D_0, \\ Q_\omega^2 &= 0 & \text{on } \Gamma_R. \end{cases}$$

Setting $Q_\omega = Q_\omega^1 + Q_\omega^2$, then Q_ω is the solution to

$$(5.12) \quad \begin{cases} \Delta Q_\omega + k^2 Q_\omega &= k^2 P_\omega & \text{in } D_0, \\ Q_\omega &= P_\omega|_{\Gamma_R} & \text{on } \Gamma_R. \end{cases}$$

Using the corrected interior problem (5.12), one can derive the good approximation of $(u_\varepsilon^\varphi - u_0^\varphi)|_{D_\varepsilon}$. The main result is the following, which will be proved in section 6.

THEOREM 5.1. *Let $j(\varepsilon) = J(u_{\Omega_\varepsilon})$ be a cost function satisfying Hypothesis 5. Then the topological asymptotic expansion is given by*

$$(5.13) \quad j(\varepsilon) - j(0) = \varepsilon \Re \left(A_\omega(u_\Omega(x_0)) \overline{v_\Omega(x_0)} \right) + o(\varepsilon),$$

where u_Ω is the direct state solution to (3.1) and v_Ω is the adjoint state solution to (4.9).

Then the topological gradient is given by

$$g(x) = \Re \left(A_\omega(u_\Omega(x)) \overline{v_\Omega(x)} \right) \quad \forall x \in \Omega,$$

and only two systems must be solved in order to compute $g(x)$ for all $x \in \Omega$.

When ω is the unit ball $B(0, 1)$, then $v_\omega(y)$, $P_\omega(y)$, and $W_\omega(y)$ can be computed explicitly:

$$(5.14) \quad v_\omega(y) = \frac{u_\Omega(x_0)}{r} = P_\omega(y), \quad W_\omega(y) = 0, \quad 0 \neq y \in \mathbb{R}^3.$$

Then it follows from (5.2) and (5.7) that

$$(5.15) \quad A_\omega(u_\Omega(x_0)) = 4\pi u_\Omega(x_0).$$

We have the following result.

COROLLARY 5.2. *Under the assumptions of Theorem 5.1 and when ω is the unit ball $B(0, 1)$, the topological asymptotic expansion is given by*

$$(5.16) \quad j(\varepsilon) - j(0) = 4\pi\varepsilon \Re \left(u_\Omega(x_0) \overline{v_\Omega(x_0)} \right) + o(\varepsilon).$$

5.2. The two-dimensional case. In this section, we intend to derive the asymptotic expansion of the function j in the two-dimensional case. The technique used is similar to that of the three-dimensional case. We use the principal part of the Helmholtz operator to derive the topological sensitivity expression. Next, we briefly describe the transposition of the previous results to the two-dimensional case. As before, u_Ω and the adjoint state v_Ω are, respectively, the solutions to (3.1) and (4.9).

The exterior problem must now be defined differently than in (5.1). It consists of finding v_ω , the solution to

$$(5.17) \quad \begin{cases} -\Delta v_\omega & = 0 & \text{in } \mathbb{R}^2 \setminus \bar{\omega}, \\ v_\omega(y)/\log r & = u_\Omega(x_0) & \text{at } \infty, \\ v_\omega & = 0 & \text{on } \partial\omega. \end{cases}$$

A fundamental solution for the Laplace equation in \mathbb{R}^2 is given by

$$(5.18) \quad E(y) = -\frac{1}{2\pi} \log r.$$

The function v_ω has the form

$$(5.19) \quad v_\omega(y) = u_\Omega(x_0) \log \|y\| + P_\omega + W_\omega(y),$$

where P_ω is constant and $W_\omega(y) = o(1)$ at infinity [9]. In the next proposition (where ω is not supposed to be a ball), one can observe that in the two-dimensional case the topological sensitivity does not depend on the shape of the hole ω , in contrast to the three-dimensional case.

THEOREM 5.3. *The assumptions are the same as in Theorem 5.1. The function j has the asymptotic expansion*

$$(5.20) \quad j(\varepsilon) = j(0) - \frac{2\pi}{\log \varepsilon} \Re \left(u_\Omega(x_0) \overline{v_\Omega(x_0)} \right) + o \left(\frac{1}{\log \varepsilon} \right).$$

The proof for the two-dimensional case uses the same tools as the three-dimensional case (see section 6) and will not be repeated.

6. Proofs. This section consists of the proof of Theorem 5.1. The variation of the sesquilinear form a_ε reads

$$(6.1) \quad a_\varepsilon(u, v) - a_0(u, v) = \int_{\Gamma_R} (T_\varepsilon - T_0)u\bar{v} \, d\gamma(x).$$

Hence, the problem reduces to the analysis of $(T_\varepsilon - T_0)\varphi$ for $\varphi \in H^{\frac{1}{2}}(\Gamma_R)$. More precisely, it will be shown that there exists an operator $\delta T \in \mathcal{L}(H^{\frac{1}{2}}(\Gamma_R), H^{-\frac{1}{2}}(\Gamma_R))$ such that

$$(6.2) \quad \|T_\varepsilon - T_0 - \varepsilon\delta T\|_{\mathcal{L}(H^{\frac{1}{2}}(\Gamma_R), H^{-\frac{1}{2}}(\Gamma_R))} = O(\varepsilon^{3/2}).$$

Consequently, defining δa by

$$(6.3) \quad \delta a(u, v) = \int_{\Gamma_R} \delta T u \bar{v} \, d\gamma(x) \quad \forall u, v \in \mathcal{V}_R$$

will yield straightforwardly

$$(6.4) \quad \|a_\varepsilon - a_0 - \varepsilon\delta a\|_{\mathcal{L}(H^{\frac{1}{2}}(\Gamma_R), H^{-\frac{1}{2}}(\Gamma_R))} = O(\varepsilon^{3/2}).$$

First we need some definitions and preliminary lemmas.

6.1. Definitions. For convenience, the following norms and seminorms are chosen for the functional spaces which will be used.

- For a bounded and open subset $\mathcal{O} \subset \mathbb{R}^3$ and $m \geq 0$, the Sobolev space $H^m(\mathcal{O})$ is equipped with the norm defined by

$$\|u\|_{m,\mathcal{O}}^2 = \sum_{j=0}^m |u|_{j,\mathcal{O}}^2,$$

where the seminorms $|u|_{j,\mathcal{O}}$ are given by

$$(6.5) \quad |u|_{j,\mathcal{O}}^2 = \sum_{|\alpha|=j} \int_{\mathcal{O}} |\partial_{\alpha} u|^2 dx.$$

- For a given $\varepsilon > 0$, the space $H^{\frac{1}{2}}(\Gamma_{R/\varepsilon})$ is equipped with the norm

$$\|u\|_{\frac{1}{2},\Gamma_{R/\varepsilon}} = \inf\{\|v\|_{1,C(R/2\varepsilon,R/\varepsilon)}; v|_{\Gamma_{R/\varepsilon}} = u\},$$

where $C(r,r') = \{x \in \mathbb{R}^3; r < \|x\| < r'\}$.

- The dual space $H^{-\frac{1}{2}}(\Gamma_{R/\varepsilon})$ is equipped with the natural norm

$$\|w\|_{-\frac{1}{2},\Gamma_{R/\varepsilon}} = \sup\{\langle w, v \rangle_{-\frac{1}{2},\frac{1}{2}}; v \in H^{\frac{1}{2}}(\Gamma_{R/\varepsilon}); \|v\|_{\frac{1}{2},\Gamma_{R/\varepsilon}} = 1\},$$

where $\langle \cdot, \cdot \rangle_{-\frac{1}{2},\frac{1}{2}}$ is the duality product between $H^{\frac{1}{2}}(\Gamma_{R/\varepsilon})$ and $H^{-\frac{1}{2}}(\Gamma_{R/\varepsilon})$.

6.2. Preliminary lemmas. Recall that $x_0 = 0$. We will use extensively the following change of variable: For a given function u defined on a subset \mathcal{O} , the function \tilde{u} is defined on $\tilde{\mathcal{O}} = \mathcal{O}/\varepsilon$ by

$$\tilde{u}(y) = u(x), \quad y = \frac{x}{\varepsilon}.$$

LEMMA 6.1. *We have that*

$$(6.6) \quad |u|_{1,\mathcal{O}} = \varepsilon^{1/2} |\tilde{u}|_{1,\tilde{\mathcal{O}}},$$

$$(6.7) \quad \|u\|_{0,\mathcal{O}} = \varepsilon^{3/2} \|\tilde{u}\|_{0,\tilde{\mathcal{O}}}.$$

Proof. Due to $\nabla u(x) = \nabla \tilde{u}(y)/\varepsilon$ and to definition (6.5), we have

$$|u|_{1,\mathcal{O}}^2 = \int_{\mathcal{O}} |\nabla u|^2 dx = \frac{1}{\varepsilon^2} \int_{\tilde{\mathcal{O}}} |\nabla \tilde{u}|^2 \varepsilon^3 dy.$$

Similarly, we have

$$\|u\|_{0,\mathcal{O}} = \varepsilon^{3/2} \|\tilde{u}\|_{0,\tilde{\mathcal{O}}}. \quad \square$$

LEMMA 6.2 (see [9]). *For $\varphi \in H^{\frac{1}{2}}(\partial\omega)$, let v be the solution to the problem*

$$(6.8) \quad \begin{cases} -\Delta v & = 0 & \text{in } \mathbb{R}^3 \setminus \bar{\omega}, \\ v & = 0 & \text{at } \infty, \\ v & = \varphi & \text{on } \partial\omega. \end{cases}$$

The function v is split into

$$\begin{aligned} v(y) &= V(y) + W(y), \\ V(y) &= E(y) \int_{\partial\omega} p(x) \, d\gamma(x), \end{aligned}$$

where $E(y) = \frac{1}{4\pi\|y\|}$ and $p \in H^{-\frac{1}{2}}(\partial\omega)$ is the unique solution to

$$(6.9) \quad \int_{\partial\omega} E(y-x)p(x) \, d\gamma(x) = \varphi(y) \quad \forall y \in \partial\omega.$$

There exists a constant $c > 0$ (independent of φ and ε) such that

$$\begin{aligned} \|V\|_{0,C(R/2\varepsilon,R/\varepsilon)} &\leq c\varepsilon^{-1/2}\|\varphi\|_{\frac{1}{2},\partial\omega}, \\ |V|_{1,C(R/2\varepsilon,R/\varepsilon)} &\leq c\varepsilon^{1/2}\|\varphi\|_{\frac{1}{2},\partial\omega}, \\ \|V\|_{0,D_\varepsilon/\varepsilon} &\leq c\varepsilon^{-1/2}\|\varphi\|_{\frac{1}{2},\partial\omega}, \\ |V|_{1,D_\varepsilon/\varepsilon} &\leq c\|\varphi\|_{\frac{1}{2},\partial\omega}, \\ \|W\|_{0,C(R/2\varepsilon,R/\varepsilon)} &\leq c\varepsilon^{1/2}\|\varphi\|_{\frac{1}{2},\partial\omega}, \\ |W|_{1,C(R/2\varepsilon,R/\varepsilon)} &\leq c\varepsilon^{3/2}\|\varphi\|_{\frac{1}{2},\partial\omega}, \\ \|W\|_{0,D_\varepsilon/\varepsilon} &\leq c\|\varphi\|_{\frac{1}{2},\partial\omega}. \end{aligned}$$

LEMMA 6.3. We assume that $R < \frac{1}{\sqrt{2}|k|}$. For a given $\varepsilon > 0$, $f_\varepsilon \in L^2(D_\varepsilon)$, and $\varphi \in H^{\frac{1}{2}}(\Gamma_R)$, let v_ε be the solution to

$$(6.10) \quad \begin{cases} \Delta v_\varepsilon + k^2 v_\varepsilon &= f_\varepsilon & \text{in } D_\varepsilon, \\ v_\varepsilon &= 0 & \text{on } \partial\omega_\varepsilon, \\ v_\varepsilon &= \varphi & \text{on } \Gamma_R. \end{cases}$$

There exists a constant $C(R, k) > 0$ (independent of φ and ε) such that

$$(6.11) \quad \|v_\varepsilon\|_{1,D_\varepsilon} \leq C(R, k) \left(\|\varphi\|_{\frac{1}{2},\Gamma_R} + \|f_\varepsilon\|_{0,D_\varepsilon} \right).$$

Proof. Let $\mathcal{R}\varphi$ be the lifting of φ in the space $H^1(C(R/2, R))$ such that $\mathcal{R}\varphi|_{\Gamma_{R/2}} = 0$. We extend $\mathcal{R}\varphi$ by zero to the domain D_ε . We denote this extension by $\widetilde{\mathcal{R}\varphi}$. It belongs to $H^1(D_\varepsilon)$. We introduce

$$(6.12) \quad u_\varepsilon = \widetilde{\mathcal{R}\varphi} - v_\varepsilon,$$

$$(6.13) \quad g_\varepsilon = -f_\varepsilon + \Delta \widetilde{\mathcal{R}\varphi} + k^2 \widetilde{\mathcal{R}\varphi}.$$

The function g_ε belongs to the space $H^{-1}(D_\varepsilon)$ and the new unknown u_ε is the solution to

$$(6.14) \quad \begin{cases} \Delta u_\varepsilon + k^2 u_\varepsilon &= g_\varepsilon & \text{in } D_\varepsilon, \\ u_\varepsilon &= 0 & \text{on } \partial\omega_\varepsilon, \\ u_\varepsilon &= 0 & \text{on } \Gamma_R. \end{cases}$$

Using the Poincaré inequality and the elliptic regularity, we obtain

$$(6.15) \quad \|u_\varepsilon\|_{1,D_\varepsilon} \leq \left(\frac{1 + 2R^2}{1 - 2k^2 R^2} \right) \|g_\varepsilon\|_{-1,D_\varepsilon}.$$

Finally, the result follows from (6.12), (6.13), (6.15), and the continuity of the lifting \mathcal{R} . \square

Here and in what follows, we assume that $R < \frac{1}{\sqrt{2|k|}}$.

LEMMA 6.4. For $\varepsilon > 0$ and $\psi \in H^1(D_0)$, let X_ε be the solution to the problem

$$(6.16) \quad \begin{cases} \Delta X_\varepsilon + k^2 X_\varepsilon &= 0 & \text{in } D_\varepsilon, \\ X_\varepsilon &= \psi & \text{on } \partial\omega_\varepsilon, \\ X_\varepsilon &= 0 & \text{on } \Gamma_R. \end{cases}$$

There exists a constant $c > 0$ (independent of φ and ε) such that for all $\varepsilon > 0$,

$$(6.17) \quad |X_\varepsilon|_{1,C(R/2,R)} \leq c\varepsilon \|\psi(\varepsilon y)\|_{\frac{1}{2},\partial\omega},$$

$$(6.18) \quad \|X_\varepsilon\|_{0,D_\varepsilon} \leq c\varepsilon \|\psi(\varepsilon y)\|_{\frac{1}{2},\partial\omega},$$

$$(6.19) \quad |X_\varepsilon|_{1,D_\varepsilon} \leq c\varepsilon^{1/2} \|\psi(\varepsilon y)\|_{\frac{1}{2},\partial\omega}.$$

Proof. Let \tilde{v}_ε be the solution to the exterior problem

$$(6.20) \quad \begin{cases} -\Delta \tilde{v}_\varepsilon &= 0 & \text{in } \mathbb{R}^3 \setminus \bar{\omega}, \\ \tilde{v}_\varepsilon &= 0 & \text{at } \infty, \\ \tilde{v}_\varepsilon &= \psi(\varepsilon y) & \text{on } \partial\omega. \end{cases}$$

The function X_ε can be written

$$X_\varepsilon = v_\varepsilon - w_\varepsilon,$$

where $v_\varepsilon(x) = \tilde{v}_\varepsilon\left(\frac{x}{\varepsilon}\right)$. The function w_ε itself is the solution to

$$(6.21) \quad \begin{cases} \Delta w_\varepsilon + k^2 w_\varepsilon &= k^2 v_\varepsilon & \text{in } D_\varepsilon, \\ w_\varepsilon &= 0 & \text{on } \partial\omega_\varepsilon, \\ w_\varepsilon &= v_\varepsilon & \text{on } \Gamma_R. \end{cases}$$

It follows from Lemma 6.3 that there exists a constant $c > 0$ such that

$$(6.22) \quad \|w_\varepsilon\|_{1,D_\varepsilon} \leq c \left(\|v_\varepsilon|_{\Gamma_R}\|_{\frac{1}{2},\Gamma_R} + k^2 \|v_\varepsilon\|_{0,D_\varepsilon} \right).$$

It follows from Lemmas 6.1 and 6.2 that

$$(6.23) \quad \|v_\varepsilon|_{\Gamma_R}\|_{\frac{1}{2},\Gamma_R} \leq c \|v_\varepsilon\|_{1,C(R/2,R)}$$

$$(6.24) \quad \leq c \left(\|v_\varepsilon\|_{0,C(R/2,R)} + |v_\varepsilon|_{1,C(R/2,R)} \right)$$

$$(6.25) \quad = c \left(\varepsilon^{3/2} \|\tilde{v}_\varepsilon\|_{0,C(R/2\varepsilon,R/\varepsilon)} + \varepsilon^{1/2} |\tilde{v}_\varepsilon|_{1,C(R/2\varepsilon,R/\varepsilon)} \right)$$

$$(6.26) \quad \leq c\varepsilon \|\psi(\varepsilon y)\|_{\frac{1}{2},\partial\omega}.$$

We have that

$$(6.27) \quad \|v_\varepsilon\|_{0,D_\varepsilon} = \varepsilon^{3/2} \|\tilde{v}_\varepsilon\|_{0,D_\varepsilon/\varepsilon}$$

$$(6.28) \quad \leq c\varepsilon \|\psi(\varepsilon y)\|_{\frac{1}{2},\partial\omega}.$$

From (6.22), (6.26), and (6.28), we obtain that

$$(6.29) \quad \|w_\varepsilon\|_{1,D_\varepsilon} \leq c\varepsilon \|\psi(\varepsilon y)\|_{\frac{1}{2},\partial\omega}.$$

Then we have

$$(6.30) \quad |X_\varepsilon|_{1,C(R/2,R)} = |v_\varepsilon - w_\varepsilon|_{1,C(R/2,R)}$$

$$(6.31) \quad \leq |v_\varepsilon|_{1,C(R/2,R)} + |w_\varepsilon|_{1,C(R/2,R)}$$

$$(6.32) \quad \leq c\varepsilon \|\psi(\varepsilon y)\|_{\frac{1}{2},\partial\omega} + \|w_\varepsilon\|_{1,D_\varepsilon}$$

$$(6.33) \quad \leq c\varepsilon \|\psi(\varepsilon y)\|_{\frac{1}{2},\partial\omega},$$

$$(6.34) \quad \|X_\varepsilon\|_{0,D_\varepsilon} \leq \|v_\varepsilon\|_{0,D_\varepsilon} + \|w_\varepsilon\|_{1,D_\varepsilon}$$

$$(6.35) \quad \leq c\varepsilon \|\psi(\varepsilon y)\|_{\frac{1}{2},\partial\omega},$$

$$(6.36) \quad |X_\varepsilon|_{1,D_\varepsilon} \leq |v_\varepsilon|_{1,D_\varepsilon} + |w_\varepsilon|_{1,D_\varepsilon}$$

$$(6.37) \quad \leq \varepsilon^{1/2} |\tilde{v}_\varepsilon|_{1,D_\varepsilon/\varepsilon} + \|w_\varepsilon\|_{1,D_\varepsilon}$$

$$(6.38) \quad \leq c\varepsilon^{1/2} \|\psi(\varepsilon y)\|_{\frac{1}{2},\partial\omega} + c\varepsilon \|\psi(\varepsilon y)\|_{\frac{1}{2},\partial\omega}$$

$$(6.39) \quad \leq c\varepsilon^{1/2} \|\psi(\varepsilon y)\|_{\frac{1}{2},\partial\omega}.$$

This completes the proof. \square

Lemmas 6.3 and 6.4 are summarized in the following lemma.

LEMMA 6.5. For $\varepsilon > 0$, $\varphi \in H^{\frac{1}{2}}(\Gamma_R)$, $\psi \in H^1(D_0)$, and $f_\varepsilon \in L^2(D_\varepsilon)$, let v_ε be the solution to the problem

$$(6.40) \quad \begin{cases} \Delta v_\varepsilon + k^2 v_\varepsilon &= f_\varepsilon & \text{in } D_\varepsilon, \\ v_\varepsilon &= \psi & \text{on } \partial\omega_\varepsilon, \\ v_\varepsilon &= \varphi & \text{on } \Gamma_R. \end{cases}$$

There exists a constant $c > 0$ (independent of φ , ψ , f_ε , and ε) such that for all $\varepsilon > 0$,

$$(6.41) \quad |v_\varepsilon|_{1,C(R/2,R)} \leq c \left(\varepsilon \|\psi(\varepsilon y)\|_{\frac{1}{2},\partial\omega} + \|\varphi\|_{\frac{1}{2},\Gamma_R} + \|f_\varepsilon\|_{0,D_\varepsilon} \right),$$

$$(6.42) \quad \|v_\varepsilon\|_{0,D_\varepsilon} \leq c \left(\varepsilon \|\psi(\varepsilon y)\|_{\frac{1}{2},\partial\omega} + \|\varphi\|_{\frac{1}{2},\Gamma_R} + \|f_\varepsilon\|_{0,D_\varepsilon} \right),$$

$$(6.43) \quad |v_\varepsilon|_{1,D_\varepsilon} \leq c \left(\varepsilon^{1/2} \|\psi(\varepsilon y)\|_{\frac{1}{2},\partial\omega} + \|\varphi\|_{\frac{1}{2},\Gamma_R} + \|f_\varepsilon\|_{0,D_\varepsilon} \right).$$

LEMMA 6.6. Let u belong to the space $H^1(C(R/2,R))$ and satisfy $\Delta u + k^2 u = 0$ in $C(R/2,R)$, $u|_{\Gamma_R} = 0$. Then there exists a constant $c > 0$ (independent of u) such that

$$(6.44) \quad \|\nabla u.n|_{\Gamma_R}\|_{-\frac{1}{2},\Gamma_R} \leq c|u|_{1,C(R/2,R)}.$$

Proof. Let $\varphi \in H^{\frac{1}{2}}(\Gamma_R)$. We define v as the solution to the problem

$$\begin{cases} \Delta v &= 0 & \text{in } C(R/2,R), \\ v &= 0 & \text{on } \Gamma_{R/2}, \\ v &= \varphi & \text{on } \Gamma_R. \end{cases}$$

Using the Green formula, we obtain

$$\int_{\Gamma_R} \nabla u.n|_{\Gamma_R} \bar{\varphi} \, d\gamma(x) = \int_{C(R/2,R)} \nabla u.\nabla \bar{v} \, dx - k^2 \int_{C(R/2,R)} u \bar{v} \, dx.$$

Then we have

$$\begin{aligned} \left| \int_{\Gamma_R} \nabla u.n|_{\Gamma_R} \bar{\varphi} \, d\gamma(x) \right| &\leq |u|_{1,C(R/2,R)} \|v\|_{1,C(R/2,R)} + k^2 \|u\|_{0,C(R/2,R)} \|v\|_{1,C(R/2,R)} \\ &\leq |u|_{1,C(R/2,R)} \|\varphi\|_{\frac{1}{2},\Gamma_R} + ck^2 |u|_{1,C(R/2,R)} \|\varphi\|_{\frac{1}{2},\Gamma_R} \\ &\leq c|u|_{1,C(R/2,R)} \|\varphi\|_{\frac{1}{2},\Gamma_R}. \end{aligned}$$

This completes the proof. \square

6.3. Variation of the sesquilinear form. The variation of the sesquilinear form a_ε reads

$$a_\varepsilon(u, v) - a_0(u, v) = \int_{\Gamma_R} (T_\varepsilon - T_0)u\bar{v} \, d\gamma(x).$$

For $\varphi \in H^{\frac{1}{2}}(\Gamma_R)$, recall that u_ε^φ is the solution to (4.2), or to (4.3) if $\varepsilon = 0$. Let v_ω^φ be the solution to the problem

$$(6.45) \quad \begin{cases} \Delta v_\omega^\varphi = 0 & \text{in } \mathbb{R}^3 \setminus \bar{\omega}, \\ v_\omega^\varphi = 0 & \text{at } \infty, \\ v_\omega^\varphi = u_0^\varphi(x_0) & \text{on } \partial\omega. \end{cases}$$

As in (5.6) and (5.7), let $P_\omega^\varphi(y) = A_\omega(u_0^\varphi(x_0))E(y)$ be the dominant part of v_ω^φ , and let Q_ω^φ be the solution to the associated interior problem

$$(6.46) \quad \begin{cases} \Delta Q_\omega^\varphi + k^2 Q_\omega^\varphi = k^2 P_\omega^\varphi & \text{in } D_0, \\ Q_\omega^\varphi = P_\omega^\varphi|_{\Gamma_R} & \text{on } \Gamma_R. \end{cases}$$

The linear operator δT (independent of ε) is defined as follows:

$$(6.47) \quad \begin{aligned} \delta T : H^{1/2}(\Gamma_R) &\longrightarrow H^{-1/2}(\Gamma_R), \\ \varphi &\longmapsto \delta T\varphi = \nabla(Q_\omega^\varphi - P_\omega^\varphi) \cdot n|_{\Gamma_R}. \end{aligned}$$

PROPOSITION 6.7. *The operator T_ε admits the following asymptotic expansion:*

$$\|T_\varepsilon - T_0 - \varepsilon\delta T\|_{\mathcal{L}(H^{\frac{1}{2}}(\Gamma_R), H^{-\frac{1}{2}}(\Gamma_R))} = O(\varepsilon^{3/2}).$$

Proof. Let $\varphi \in H^{\frac{1}{2}}(\Gamma_R)$. For simplicity we drop the superscript $(\cdot)^\varphi$. For $y = x/\varepsilon$, we have

$$v_\omega(y) = P_\omega(y) + W_\omega(y),$$

with $P_\omega(\frac{x}{\varepsilon}) = \varepsilon P_\omega(x)$ and $W_\omega(y) = O(\frac{1}{\|y\|^2})$. Let

$$\psi_\varepsilon(x) = (T_\varepsilon - T_0 - \varepsilon\delta T)\varphi(x).$$

We have

$$\begin{aligned} \psi_\varepsilon(x) &= (\nabla u_\varepsilon - \nabla u_0 - \varepsilon(\nabla Q_\omega - \nabla P_\omega)) \cdot n|_{\Gamma_R} \\ &= \nabla \left(w_\varepsilon(x) - W_\omega\left(\frac{x}{\varepsilon}\right) \right) \cdot n|_{\Gamma_R}, \end{aligned}$$

where w_ε is defined by

$$w_\varepsilon(x) = u_\varepsilon(x) - u_0(x) - \varepsilon Q_\omega(x) + v_\omega\left(\frac{x}{\varepsilon}\right).$$

The function w_ε is the solution to

$$(6.48) \quad \begin{cases} \Delta w_\varepsilon + k^2 w_\varepsilon = k^2 W_\omega(x/\varepsilon) & \text{in } D_\varepsilon, \\ w_\varepsilon = W_\omega(x/\varepsilon) & \text{on } \Gamma_R, \\ w_\varepsilon = -u_0(x) + u_0(0) - \varepsilon Q_\omega(x) & \text{on } \partial\omega_\varepsilon. \end{cases}$$

In order to apply Lemma 6.5, we have to estimate the right-hand side terms, as follows.

- In D_ε , we have

$$\|W_\omega(x/\varepsilon)\|_{0,D_\varepsilon} = \varepsilon^{3/2} \|W_\omega(y)\|_{0,D_\varepsilon/\varepsilon}.$$

Using Lemma 6.2, we obtain

$$\begin{aligned} \|W_\omega(y)\|_{0,D_\varepsilon/\varepsilon} &\leq c \|u_0(x_0)\|_{\frac{1}{2},\partial\omega} \\ &\leq c |u_0(x_0)| \\ &\leq c \|\varphi\|_{\frac{1}{2},\Gamma_R}. \end{aligned}$$

Then we have

$$\|W_\omega(x/\varepsilon)\|_{0,D_\varepsilon} \leq c\varepsilon^{3/2} \|\varphi\|_{\frac{1}{2},\Gamma_R}.$$

- On Γ_R , using Lemmas 6.1 and 6.2 and the elliptic regularity, we obtain

$$\begin{aligned} \|W_\omega(x/\varepsilon)\|_{\frac{1}{2},\Gamma_R} &\leq c \|W_\omega(x/\varepsilon)\|_{1,C(R/2,R)} \\ &\leq c (\|W_\omega(x/\varepsilon)\|_{0,C(R/2,R)} + |W_\omega(x/\varepsilon)|_{1,C(R/2,R)}) \\ &= c \left(\varepsilon^{3/2} \|W_\omega(y)\|_{0,C(R/2\varepsilon,R/\varepsilon)} + \varepsilon^{1/2} |W_\omega(y)|_{1,C(R/2\varepsilon,R/\varepsilon)} \right) \\ &\leq c\varepsilon^2 \|u_0(x_0)\|_{\frac{1}{2},\partial\omega} \\ &\leq c\varepsilon^2 |u_0(x_0)| \\ &\leq c\varepsilon^2 \|\varphi\|_{\frac{1}{2},\Gamma_R}. \end{aligned}$$

- On $\partial\omega_\varepsilon$, putting

$$\theta_\varepsilon(x) = \frac{-u_0(x) + u_0(x_0) - \varepsilon Q_\omega(x)}{\varepsilon},$$

we have for small ε

$$\begin{aligned} \|\theta_\varepsilon(\varepsilon y)\|_{\frac{1}{2},\partial\omega} &\leq c \|\theta_\varepsilon(\varepsilon y)\|_{1,\omega} \\ &= c \left\| \frac{u_0(\varepsilon y) - u_0(x_0)}{\varepsilon} + Q_\omega(\varepsilon y) \right\|_{1,\omega} \\ &\leq c (\|u_0\|_{C^2(B(0,R/2))} + \|Q_\omega\|_{C^1(B(0,R/2))}) \\ &\leq c \|\varphi\|_{\frac{1}{2},\Gamma_R}. \end{aligned}$$

We can now apply Lemma 6.5, which gives

$$\begin{aligned} |w_\varepsilon|_{1,C(R/2,R)} &\leq c \left(\varepsilon^{3/2} \|\varphi\|_{\frac{1}{2},\Gamma_R} + \varepsilon^2 \|\varphi\|_{\frac{1}{2},\Gamma_R} + \varepsilon \|\varepsilon \theta_\varepsilon(\varepsilon y)\|_{\frac{1}{2},\partial\omega} \right) \\ &\leq c\varepsilon^{3/2} \|\varphi\|_{\frac{1}{2},\Gamma_R}. \end{aligned}$$

Finally, it follows from Lemmas 6.1 and 6.6 that

$$\begin{aligned} \|\psi\|_{-\frac{1}{2},\Gamma_R} &= \|\nabla(w_\varepsilon - W_\omega(x/\varepsilon)) \cdot n|_{\Gamma_R}\|_{-\frac{1}{2},\Gamma_R} \\ &\leq c (|w_\varepsilon|_{1,C(R/2,R)} + |W_\omega(x/\varepsilon)|_{1,C(R/2,R)}) \\ &= c \left(|w_\varepsilon|_{1,C(R/2,R)} + \varepsilon^{1/2} |W_\omega(y)|_{1,C(R/2\varepsilon,R/\varepsilon)} \right) \\ &\leq c \left(\varepsilon^{3/2} \|\varphi\|_{\frac{1}{2},\Gamma_R} + \varepsilon^2 \|\varphi\|_{\frac{1}{2},\Gamma_R} \right) \\ &\leq c\varepsilon^{3/2} \|\varphi\|_{\frac{1}{2},\Gamma_R}. \end{aligned}$$

Hence,

$$\|T_\varepsilon - T_0 - \varepsilon\delta T\|_{\mathcal{L}(H^{\frac{1}{2}}(\Gamma_R), H^{-\frac{1}{2}}(\Gamma_R))} = O(\varepsilon^{3/2}). \quad \square$$

The asymptotic expansion of the sesquilinear form a_ε follows now straightforwardly.

PROPOSITION 6.8. *Let*

$$\delta a(u, v) = \int_{\Gamma_R} \delta T u \bar{v} \, d\gamma(x), \quad u, v \in \mathcal{V}_R.$$

Then the asymptotic expansion of the sesquilinear form a_ε is given by

$$\|a_\varepsilon - a_0 - \varepsilon\delta a\|_{\mathcal{L}(H^{\frac{1}{2}}(\Gamma_R), H^{-\frac{1}{2}}(\Gamma_R))} = O(\varepsilon^{3/2}).$$

6.4. Proof of Theorem 5.1. The proof of this theorem is done in two steps. First, we prove that Hypothesis 2 is satisfied. More precisely, we prove that the sesquilinear form a_0 satisfies the inf-sup condition. Second, we apply Theorem 2.2 to compute the topological asymptotic expansion.

6.4.1. The first step: The inf-sup condition. For all $u \in \mathcal{V}_R$, we set

$$\tilde{u} = \begin{cases} u & \text{in } \Omega_R, \\ u_0^\varphi & \text{in } B(x_0, R), \end{cases}$$

where $\varphi = u|_{\Gamma_R}$ and u_0^φ is the solution to

$$\begin{cases} \Delta u_0^\varphi + k^2 u_0^\varphi = 0 & \text{in } B(x_0, R), \\ u_0^\varphi = \varphi & \text{on } \Gamma_R. \end{cases}$$

It can easily be proved that

$$a_0(u, v|_{\Omega_R}) = a(\Omega, \tilde{u}, v) \quad \forall u \in \mathcal{V}_R \quad \forall v \in \mathcal{V}(\Omega),$$

where the functional space $\mathcal{V}(\Omega)$ and the sesquilinear form $a(\Omega, \cdot, \cdot)$ are defined by (3.2). From Proposition 3.1, the sesquilinear form $a(\Omega, \cdot, \cdot)$ satisfies the inf-sup condition. As a consequence, there exists $v \in \mathcal{V}(\Omega), v \neq 0$, such that

$$\begin{aligned} a_0(u, v|_{\Omega_R}) = a(\Omega, \tilde{u}, v) &\geq a\|\tilde{u}\|_{\mathcal{V}(\Omega)}\|v\|_{\mathcal{V}(\Omega)} \\ &\geq a\|u\|_{\mathcal{V}_R}\|v|_{\Omega_R}\|_{\mathcal{V}_R}. \end{aligned}$$

Then a_0 satisfies the inf-sup condition and Hypothesis 2 is satisfied.

6.4.2. Applying Theorem 2.2. All the hypotheses of section 2 are satisfied and we can apply Theorem 2.2. We obtain the following asymptotic formula:

$$\begin{aligned} j(\varepsilon) - j(0) &= \varepsilon\Re(\delta a(u_\Omega, v_\Omega)) + o(\varepsilon) \\ &= \varepsilon\Re\left(\int_{\Gamma_R} \nabla(Q_\omega^\varphi - P_\omega^\varphi) \cdot n|_{\Gamma_R} \bar{v}_\Omega \, d\gamma(x)\right) + o(\varepsilon), \end{aligned}$$

where $\varphi = u_\Omega|_{\Gamma_R} = u_0|_{\Gamma_R}$. Thanks to Green's formula and (6.46), we obtain that

$$\begin{aligned} \int_{\Gamma_R} \nabla(Q_\omega^\varphi - P_\omega^\varphi) \cdot n|_{\Gamma_R} \bar{v}_\Omega \, d\gamma(x) &= k^2 \int_{D_0} P_\omega \bar{v}_\Omega \, dx + \int_{\Gamma_R} \nabla \bar{v}_\Omega \cdot n|_{\Gamma_R} P_\omega \, d\gamma(x) \\ (6.49) \qquad \qquad \qquad &- \int_{\Gamma_R} \nabla P_\omega \cdot n|_{\Gamma_R} \bar{v}_\Omega \, d\gamma(x). \end{aligned}$$

It can be shown that

$$\begin{aligned}
 \int_{\Gamma_R} \nabla \overline{v_\Omega} \cdot n_{|\Gamma_R} P_\omega \, d\gamma(x) - \int_{\Gamma_R} \nabla P_\omega \cdot n_{|\Gamma_R} \overline{v_\Omega} \, d\gamma(x) &= A_\omega(u_\Omega(x_0)) \langle -\Delta E, \overline{v_\Omega} \psi \rangle_{\mathcal{D}'(D_0), \mathcal{D}(D_0)} \\
 &\quad - k^2 \int_{D_0} P_\omega \overline{v_\Omega} \, dx \\
 &= A_\omega(u_\Omega(x_0)) \langle \delta, \overline{v_\Omega} \psi \rangle_{\mathcal{D}'(D_0), \mathcal{D}(D_0)} \\
 &\quad - k^2 \int_{D_0} P_\omega \overline{v_\Omega} \, dx \\
 &= A_\omega(u_\Omega(x_0)) \overline{v_\Omega(x_0)} - k^2 \int_{D_0} P_\omega \overline{v_\Omega} \, dx,
 \end{aligned}$$

where $\psi \in \mathcal{D}(D_0)$ satisfies $\psi(x_0) = 1$. We insert this expression into (6.49) and obtain the desired result.

7. Numerical results: Buried objects detection. We consider a simple problem of detection of metallic objects buried in soil. The aim is to find the number and the positions of metallic objects (supposedly infinite in the \vec{e}_z direction) using scattered field measurements from a monostatic antenna horizontally translated above the soil. This is a rough model of the facilities described in [19]. The two-dimensional Helmholtz equation is solved with time-domain finite differences (FDTD), the frequency-domain solution obtained with a Fourier transform. The antenna is roughly approximated by a single source point, which will be translated at various locations above the soil. At each point of the mesh, the topological sensitivity will be computed.

Let $\mathcal{X} = \{x_i\}_{i=1, \dots, n_x}$ be the set of the successive locations of the source (and sensors, since the antenna is supposed to be monostatic), and let $\mathcal{F} = \{f_i\}_{i=1, \dots, n_f}$ be the set of measurement frequencies. Let ε_s be the soil permittivity. The set of metallic objects buried in the soil is denoted by Ω .

We associate with Ω a set of “measurements” $\mathcal{M}(\Omega)$. At each couple $(x_i, f_j) \in \mathcal{X} \times \mathcal{F}$, we first define the field u_{x_i, f_j}^Ω , the solution of

$$(7.1) \quad \begin{cases} \Delta u + k_j^2 u &= s_{x_i} & \text{in } \mathbb{R}^2 \setminus \overline{\Omega}, \\ u &= 0 & \text{on } \partial\Omega, \\ \lim_{r \rightarrow \infty} \sqrt{r}(\partial_r u - ik_j u) &= 0, \end{cases}$$

where s_{x_i} represents a source point centered at x_i , and where

$$\begin{aligned}
 k_j^2(x) &= \varepsilon(x) \mu \omega_j^2, \\
 w_j &= 2\pi f_j, \\
 \varepsilon(x) &= \begin{cases} \varepsilon_0 & \text{if } x \geq 0, \\ \varepsilon_s & \text{if } x < 0. \end{cases}
 \end{aligned}$$

Then the “measurements” are $\mathcal{M}(\Omega) = \{m_{x_i, f_j}(\Omega)\}$. In our numerical tests, $m_{x_i, f_j}(\Omega)$ is the value of the scattered field at point x_i .

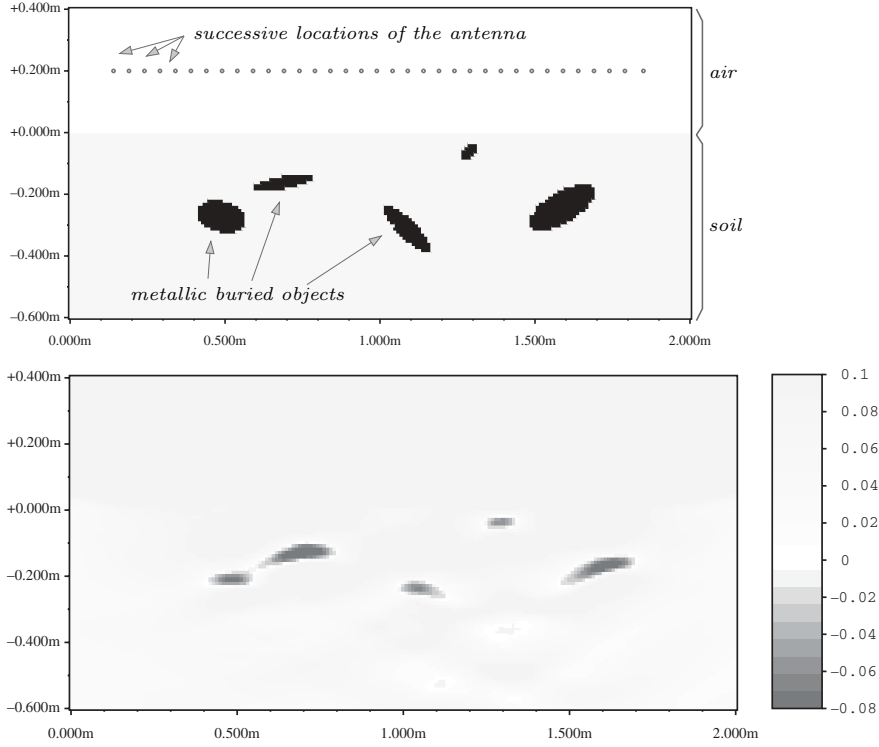

FIG. 7.1. Repartition of metallic objects in the soil and the corresponding topological sensitivity computed on empty flat soil (dry soil, flat surface $\varepsilon_r = 2.3$, 20 frequencies ranging from 400MHz to 2GHz).

Reference measurements $\widetilde{\mathcal{M}} = \{\widetilde{m}_{x_i, f_j}\}$ are those values obtained from the real objects in the soil. Ideally, these would have been real measurements, but in the following numerical results, we consider only synthetic data obtained via FDTD.

The cost function, which expresses the adequacy between the measurements obtained for a distribution of metallic objects Ω and the reference data, is

$$(7.2) \quad j(\Omega) = \|\mathcal{M} - \widetilde{\mathcal{M}}\|^2 = \sum_{i,j} j_{x_i, f_j}(\Omega),$$

where

$$(7.3) \quad j_{x_i, f_j}(\Omega) = |m_{x_i, f_j}(\Omega) - \widetilde{m}_{x_i, f_j}|^2.$$

Applying the expression of the topological asymptotic (see Proposition 5.3), one has

$$(7.4) \quad j(\Omega \setminus \overline{B(x, \varepsilon)}) - j(\Omega) = \sum_{i,j} -\frac{2\pi}{\log \varepsilon} \Re \left(u_{x_i, f_j}^\Omega(x) \overline{v_{x_i, f_j}^\Omega(x)} \right) + o \left(\frac{1}{\log \varepsilon} \right),$$

where v_{x_i, f_j}^Ω is the adjoint state associated with the couple (x_i, f_j) .

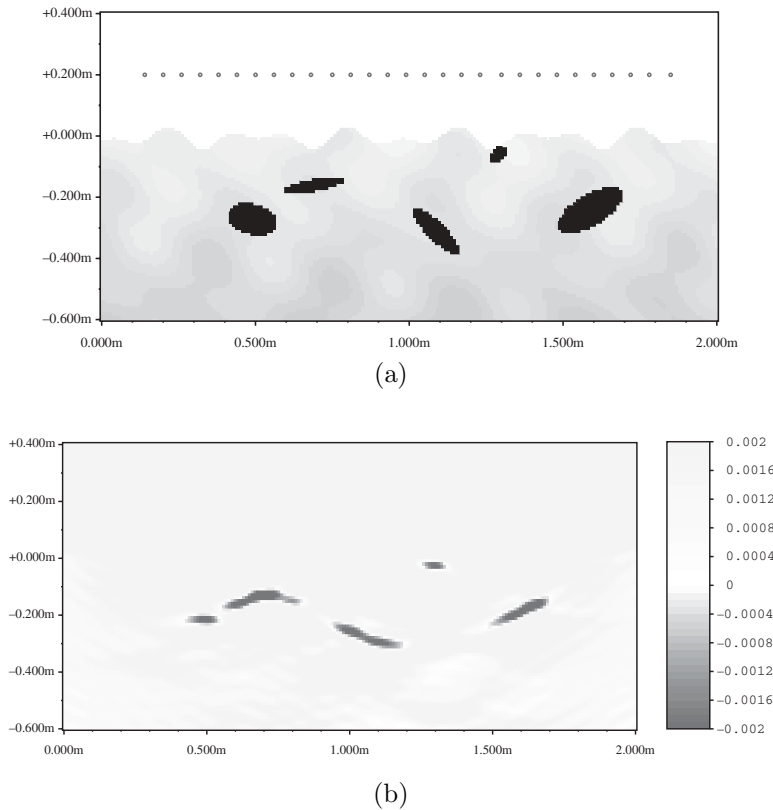

FIG. 7.2. (a) *Reference distribution of objects. The measures are computed on a dry inhomogeneous soil (ε_s ranging from 1.6 to 4.15) with a rough surface, using 29 measurement points and 20 frequencies ranging from 260MHz to 1.86GHz.* (b) *Topological sensitivity computed on a flat empty homogeneous soil ($\varepsilon_s = 2.3$).*

The first example (see Figure 7.1) shows the topological sensitivity computed on an “ideal” case: There is no noise on the data, and the reference soil is a flat and homogeneous dry sand soil. One can see that the top of the five objects is clearly identified by the negative values of the topological sensitivity. This topological sensitivity can be obtained very quickly since it is evaluated on an empty flat soil, which is invariant by translation: All direct states and adjoint states are just horizontal translations of a “canonical” solution. The computational cost is only 10 seconds on a 300MHz personal computer.

The second example (see Figure 7.2) is a little more realistic: The data is artificially noised since the reference data $\tilde{\mathcal{M}}$ was obtained on a nonflat inhomogeneous soil, while the topological sensitivity was still computed on a flat homogeneous soil. One can observe that, although the objects are still located correctly, the image (see Figure 7.2(b)) is a bit distorted.

The third example shows that using an iterative process might give good results at the expense of some computational cost. In this example, the basic iterative algorithm just inserts a metal point at the point where the topological sensitivity is the most negative. Then the topological sensitivity is reevaluated, taking into account the metal points inserted at previous iterations, etc. Figure 7.3 shows the objects and the metal points that were inserted at iterations 10 and 55.

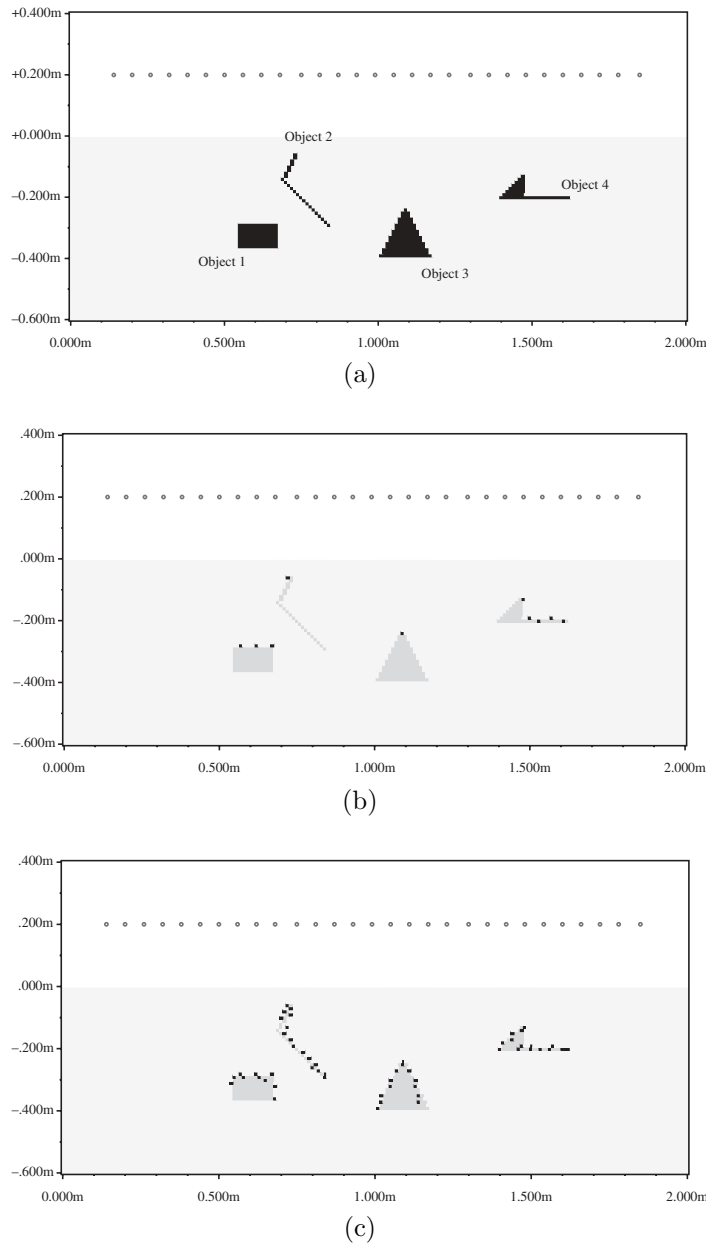

FIG. 7.3. (a) *Redistribution of objects.* The measures are computed on a dry flat inhomogeneous soil ($\epsilon_s = 2.3$), 29 measurement points, and 20 frequencies ranging from 490MHz to 3.29GHz. (b) Iteration 10. (c) Iteration 55.

REFERENCES

[1] G. ALLAIRE AND R. KOHN, *Optimal design for minimum weight and compliance in plane stress using extremal microstructures*, European J. Mech. A Solids, 12 (1993), pp. 839–878.
 [2] H. AMMARI AND H. KANG, *Boundary layer techniques for solving the Helmholtz equation in the presence of small inhomogeneities*, J. Math. Anal. Appl., 296 (2004), pp. 190–208.
 [3] M. BENDSOE, *Optimal Topology Design of Continuum Structure: An Introduction*, Technical

- report, Technical University of Denmark, Lyngby, Denmark, 1996.
- [4] E. BONNETIER AND C. CONCA, *Approximation of Young measures by functions and application to a problem of optimal design for plates with variable thickness*, Proc. Roy. Soc. Edinburgh Sect. A, 124 (1994), pp. 399–422.
 - [5] J. CÉA, *Conception optimale ou identification de forme, calcul rapide de la dérivée directionnelle de la fonction coût*, RAIRO Modél. Math. Anal. Numér., 20 (1986), pp. 371–402.
 - [6] J. CÉA, S. GARREAU, PH. GUILLAUME, AND M. MASMOUDI, *Shape and topological optimizations connection*, Comput. Methods Appl. Mech. Engrg., 188 (2000), pp. 713–726.
 - [7] H. A. ESCHENAUER AND N. OLSHOFF, *Topology optimization of continuum structures: A review*, Appl. Mech. Rev., 54 (2001), pp. 331–390.
 - [8] S. GARREAU, PH. GUILLAUME, AND M. MASMOUDI, *The topological asymptotic for PDE systems: The elasticity case*, SIAM J. Control Optim., 39 (2001), pp. 1756–1778.
 - [9] PH. GUILLAUME AND K. SID IDRIS, *The topological asymptotic expansion for the Dirichlet problem*, SIAM J. Control Optim., 41 (2002), pp. 1042–1072.
 - [10] F. IHLENBURG AND I. BABUSKA, *Finite element solution of the Helmholtz equation with high wave number II: The h-p version of the FEM*, SIAM J. Numer. Anal., 34 (1997), pp. 315–358.
 - [11] A. M. IL'IN, *A boundary value problem for the elliptic equation of second order in a domain with a narrow slit. I. The two-dimensional case*, Math. USSR-Sb., 28 (1976), pp. 459–480 (in English).
 - [12] A. M. IL'IN, *Study of the asymptotic behavior of the solution of an elliptic boundary value problem in a domain with a small hole*, Trudy Sem. Petrovsk., 6 (1981), pp. 57–82 (in Russian).
 - [13] A. M. IL'IN, *Matching of Asymptotic Expansions of Solutions of Boundary Value Problems*, Transl. Math. Monogr. 102, American Mathematical Society, Providence, RI, 1992.
 - [14] J. JACOBSEN, N. OLSHOFF, AND E. RONHOLT, *Generalized Shape Optimization of Three-Dimensional Structures Using Materials with Optimum Microstructures*, Technical report, Institute of Mechanical Engineering, Aalborg University, Aalborg, Denmark, 1996.
 - [15] C. KANE AND M. SCHOENAUER, *Optimization topologique de formes par algorithmes génétiques*, Rev. Française de Mécanique, 4 (1997), pp. 237–246.
 - [16] R. V. KOHN AND M. S. VOGELIUS, *Thin plates with rapidly varying thickness, and their relation to structural optimization*, in Homogenization and Effective Moduli of Materials and Media, J. L. Ericksen et al., eds., IMA Vol. Math. Appl. 1, Springer-Verlag, New York, 1986, pp. 126–149.
 - [17] M. MASMOUDI, *The topological asymptotic expansion*, in Computational Methods for Control Applications, H. Kawarada and J. Periaux, eds., GAKUTO Internat. Ser. Math. Sci. Appl. 16, Tokyo, 2002, pp. 53–72.
 - [18] V. G. MAZ'YA, S. A. NAZAROV, AND B. A. PLAMENEVSKIJ, *Asymptotic expansions of the eigenvalues of boundary value problems for the Laplace operator in domains with small holes*, Math USSR-Izv., 48 (1984), pp. 347–371 (in Russian); Math. USSR-Izv., 24 (1985), pp. 321–345 (in English).
 - [19] P. MILLOT, J. C. BUREAU, P. BORDERIES, E. BACHELIER, C. PICHOT, E. LEBRUSQ, E. LEBRUSQ, E. GUILIANTON, AND J. Y. DAUVIGNAC, *Experimental study of near surface radar imaging of buried objects with adaptive focussed synthetic aperture processing*, in Subsurface Sensing Technologies and Applications II, Proceedings of SPIE 4129, 2000, pp. 515–523.
 - [20] F. MURAT AND S. SIMON, *Etudes de problèmes d'optimal design*, in Optimization Techniques: Modeling and Optimization in the Service of Man. Part 2, Lecture Notes in Comput. Sci. 41, Springer-Verlag, Berlin, 1976, pp. 54–62.
 - [21] S. A. NAZAROV AND J. SOKOLOWSKI, *Asymptotic Analysis of Shape Functionals*, Rapport de recherche de l'INRIA, RR-4633, 2002.
 - [22] S. A. NAZAROV, *Asymptotic expansions of eigenvalues*, Leningrad University, 1987 (in Russian).
 - [23] S. OZAWA, *Singular Hadamard's variation of domains and eigenvalues of Laplacian*, Part 1, Proc. Japan Acad. Ser. A Math. Sci., 56 (1980), pp. 306–310.
 - [24] S. OZAWA, *Singular Hadamard's variation of domains and eigenvalues of Laplacian*, Part 2, Proc. Japan Acad. Ser. A Math. Sci., 57 (1981), pp. 242–246.
 - [25] O. PIRONNEAU, *Optimal Shape Design for Elliptic Systems*, Springer-Verlag, New York, 1984.
 - [26] M. SCHOENAUER, L. KALLEL, AND F. JOUVE, *Mechanics inclusions identification by evolutionary computation*, Rev. Européenne Élé. Finis, 5 (1996), pp. 619–648.
 - [27] A. SCHUMACHER, *Topologieoptimierung von Bauteilstrukturen unter Verwendung von Lochpositionierungskriterien*, Doctoral Thesis, Siegen University, Siegen, Germany, 1996.
 - [28] J. SIMON, *Differentiation with respect to the domain in boundary value problems*, Numer. Funct. Anal. Optim., 2 (1980), pp. 649–687.

- [29] J. SOKOŁOWSKI AND A. ZOCHOWSKI, *On the topological derivative in shape optimization*, SIAM J. Control Optim., 37 (1999), pp. 1251–1272.
- [30] J. SOKOŁOWSKI AND A. ZOCHOWSKI, *Topological derivatives for elliptic problems*, Inverse Problems, 15 (1999), pp. 123–134.
- [31] J. SOKOŁOWSKI AND J. P. ZOLESIO, *Introduction to Shape Optimization: Shape Sensitivity Analysis*, Springer Ser. Comput. Math. 16, Springer-Verlag, Berlin, 1992.
- [32] M. S. VOGELIUS AND D. VOLKOV, *Asymptotic formulas for perturbations in the electromagnetic fields due to the presence of inhomogeneities of small diameter*, Math. Model. Numer. Anal., 34 (2000), pp. 723–748.

Article 3 :

Apploication of the topological asymptotic expansion to inverse scattering problems

Numerical Methods For Scientific Computing Variational Problems And Applications (2003)

APPLICATION OF THE TOPOLOGICAL ASYMPTOTIC EXPANSION TO INVERSE SCATTERING PROBLEMS

M. Masmoudi*

J. Pommier

B. Samet

Mathématiques pour l'Industrie et la Physique
UMR 5640, CNRS-Université Paul Sabatier-INSA.
118 route de Narbonne, 31062 Toulouse, cedex 4, France
Email: masmoudi@mip.ups-tlse.fr, pommier@gmm.insa-tlse.fr, samet@mip.ups-tlse.fr

Abstract. *The aim of the topological sensitivity analysis is to obtain an asymptotic expansion of a design functional with respect to the creation of a small hole in the domain. In this paper, such an expansion is obtained for the Helmholtz equation with a Dirichlet condition on the boundary of an arbitrary shaped hole. The proposed method is general and can be easily adapted to other type of boundary conditions. Numerical results are presented in the context of buried objects detection.

Key words: shape optimization, topological gradient, topological asymptotic, Helmholtz equation, adjoint equation, inverse scattering.

*Jacques, continue to connect people, to link theoretical with applied research, and to develop research programs, aimed at meeting industrial challenges. Thank you for giving us the opportunity to be in touch with real problems.

1 INTRODUCTION

Classical shape optimization methods are based on the perturbation of the boundary of the initial shape. The initial and the final shape have the same topology.

The aim of topological optimization is to find an optimal shape without any *a priori* assumption about the topology of the structure. Unlike the case of classical shape optimization, the topology of the structure may change during the optimization process, as, for example, through the inclusion of holes.

Many important contributions in this field are concerned with structural mechanics and in particular the optimization of the compliance (external work) subject to a volume constraint. In view of the fact that the optimal structure has generally a large number of small holes, most authors¹⁻³ have considered composite material optimization. Using the homogenization theory G. Allaire *and al.*¹ exhibit a class of laminated materials with an explicit expression for the optimal material at any point of the structure. In this case, the optimal solution is not a classical design: it is a distribution of composite materials. Then penalization methods must be applied in order to retrieve a realistic shape.

For all these reasons, global optimization techniques like genetic algorithms and simulated annealing are used in order to solve more general problems.

Recently, the notion of topological sensitivity brings a new approach for shape optimization. It provides an asymptotic expansion of a shape function with respect to the creation of a small hole in the domain. To present the basic idea, we consider Ω a domain of \mathbb{R}^n , $n = 2, 3$ and $j(\Omega) = J(u_\Omega)$ a cost function to be minimized, where u_Ω is solution to a given PDE problem defined in Ω . For $\varepsilon > 0$, let $\Omega_\varepsilon = \Omega \setminus \overline{x_0 + \varepsilon\omega}$ be the subset obtained by removing a small part $\overline{x_0 + \varepsilon\omega}$ from Ω , where $x_0 \in \Omega$ and $\omega \subset \mathbb{R}^n$ is a fixed open and bounded subset containing the origin. Then, an asymptotic expansion of the function j is obtained in the following form:

$$j(\Omega_\varepsilon) = j(\Omega) + f(\varepsilon)g(x_0) + o(f(\varepsilon)) \quad (1)$$

$$\lim_{\varepsilon \rightarrow 0} f(\varepsilon) = 0, \quad f(\varepsilon) > 0. \quad (2)$$

We call this expansion the topological asymptotic. To minimize the criterion, we have to create holes where g is negative.

The first definition of the topological sensitivity has been introduced by A. Schumacher⁴ under the name of *bubble method* in the context of compliance optimization for linear elasticity problems. In the same context, J. Sokolowski⁵ gave some mathematical justifications in the plane stress case, and generalized it to various cost functions. A topological sensitivity framework using an adaptation of the adjoint method and a truncation technique has been introduced in⁶ in the case of an homogeneous Dirichlet condition imposed on the boundary of a circular hole. The fundamental property of an adjoint technique is to provide the variation of a function with respect to a parameter by using a solution u_Ω and an adjoint state p_Ω which do not depend on the chosen parameter. From the numerical view point, only two systems have to be solved for obtaining $g(x)$ for all $x \in \Omega$. This observation leads to very efficient numerical algorithms. In,⁷ the topological asymptotic expansion has been obtained for the Poisson equation with general shape functions and arbitrary shaped holes. In,⁸ it has been established in the context of linear elasticity. All these contributions concern operators which symbol is an homogeneous polynomial. In this paper, we analyse the case of the Helmholtz equation with Dirichlet condition imposed on the boundary of an arbitrary shaped hole. For this purpose,

the technique used in⁷ for the Poisson equation with non circular holes is adapted to the nonhomogeneous Helmholtz equation case. The basic idea is to approach the Helmholtz problem by the exterior Laplace problem. The theoretical part of this work is discussed in two dimensional and three dimensional cases. In the three dimensional case, it will be shown that the topological sensitivity $g(x_0)$ depends on the shape of the hole. In contrast, it will be shown that in the two dimensional case the topological sensitivity is independent of the shape of the hole.

First, an adaptation of the adjoint method to the topological context is proposed in section 2. Next, the formulation of the Helmholtz problem is presented in section 3 and its truncated version is described in section 4. Section 5 presents the main results whose proofs are given in section 6. Finally, numerical examples illustrate in section 7 the abilities of the topological sensitivity to solve inverse scattering problems.

2 A GENERALIZED ADJOINT METHOD

In this section, the adjoint method is adapted to topological optimization. Let \mathcal{V} be a fixed complex Hilbert space. For $\varepsilon \geq 0$, let $a_\varepsilon(\cdot, \cdot)$ be a sesquilinear and continuous form on \mathcal{V} and l_ε be a semilinear and continuous form on \mathcal{V} . We consider the following assumptions.

Hypothesis 1 *There exists a sesquilinear and continuous form δa , a semilinear and continuous form δl , and a real function $f(\varepsilon) > 0$ defined on \mathbb{R}_+^* such that*

$$\lim_{\varepsilon \rightarrow 0} f(\varepsilon) = 0, \quad (3)$$

$$\|a_\varepsilon - a_0 - f(\varepsilon)\delta a\|_{\mathcal{L}_2(\mathcal{V})} = o(f(\varepsilon)), \quad (4)$$

$$\|l_\varepsilon - l_0 - f(\varepsilon)\delta l\|_{\mathcal{L}(\mathcal{V})} = o(f(\varepsilon)), \quad (5)$$

where $\mathcal{L}(\mathcal{V})$ (respectively $\mathcal{L}_2(\mathcal{V})$) denotes the space of continuous and semilinear (respectively sesquilinear) forms on \mathcal{V} .

Hypothesis 2 *There exists a constant $\alpha > 0$ such that*

$$\inf_{u \neq 0} \sup_{v \neq 0} \frac{|a_0(u, v)|}{\|u\|_{\mathcal{V}} \|v\|_{\mathcal{V}}} \geq \alpha.$$

We say that a_0 satisfies the inf-sup condition.

According to (4), there exists a constant $\beta > 0$ independent of ε such that

$$\inf_{u \neq 0} \sup_{v \neq 0} \frac{|a_\varepsilon(u, v)|}{\|u\|_{\mathcal{V}} \|v\|_{\mathcal{V}}} \geq \beta.$$

For $\varepsilon \geq 0$, let u_ε be the solution to the problem : find $u_\varepsilon \in \mathcal{V}$ such that

$$a_\varepsilon(u_\varepsilon, v) = l_\varepsilon(v) \quad \forall v \in \mathcal{V}. \quad (6)$$

We have the following lemma.

Lemma 1 *If hypotheses 1 and 2 are satisfied, then*

$$\|u_\varepsilon - u_0\|_{\mathcal{V}} = O(f(\varepsilon)).$$

Consider now a cost function $j(\varepsilon) = J(u_\varepsilon)$, where J is a real functional, defined on the complex Hilbert space \mathcal{V} . We have to give a meaning to its derivative:

$$J(u+h) = J(u) + \Re(L_u(h)) + o(\|h\|_{\mathcal{V}}) \quad \forall u, h \in \mathcal{V}, \quad (7)$$

where L_u is a linear and continuous form on \mathcal{V} , and \Re is the real part of a complex number.

For $\varepsilon \geq 0$, we define the Lagrangian operator \mathcal{L}_ε by

$$\mathcal{L}_\varepsilon(u, v) = J(u) + a_\varepsilon(u, v) - l_\varepsilon(v) \quad \forall u, v \in \mathcal{V}.$$

The next theorem gives the asymptotic expansion of $j(\varepsilon)$.

Theorem 1 *If hypotheses 1 and 2 are satisfied, then*

$$j(\varepsilon) - j(0) = f(\varepsilon)\Re(\delta_{\mathcal{L}}(u_0, p_0)) + o(f(\varepsilon)), \quad (8)$$

where u_0 is the solution to Equation (6) with $\varepsilon = 0$, p_0 is the solution to the adjoint problem: find $p_0 \in \mathcal{V}$ such that

$$a_0(v, p_0) = -L_{u_0}(v) \quad \forall v \in \mathcal{V} \quad (9)$$

and

$$\delta_{\mathcal{L}}(u, v) = \delta a(u, v) - \delta_l(v), \quad \forall u, v \in \mathcal{V}.$$

3 FORMULATION OF THE PROBLEM

Let Ω be an open and bounded domain of \mathbb{R}^n with boundary $\Gamma = \Gamma_0 \cup \Gamma_1$, $n = 2$ or 3 . Here, Γ_0 is the boundary of an obstacle, and Γ_1 is an artificial surface of the absorbing boundary condition. The Helmholtz problem is

$$\begin{cases} \Delta u_\Omega + k^2 u_\Omega = 0 & \text{in } \Omega, \\ u_\Omega = 0 & \text{on } \Gamma_0, \\ \frac{\partial u_\Omega}{\partial n} = \Lambda u_\Omega + \Theta & \text{on } \Gamma_1, \end{cases} \quad (10)$$

where $k \in \mathbb{R}^*$, $\Theta \in H_{00}^{\frac{1}{2}}(\Gamma_1)'$ and $\Lambda \in \mathcal{L}(H_{00}^{\frac{1}{2}}(\Gamma_1), H_{00}^{\frac{1}{2}}(\Gamma_1)')$.

We define

$$\begin{cases} \mathcal{V}(\Omega) & = \{v \in H^1(\Omega); v|_{\Gamma_0} = 0\}, \\ a(\Omega, u, v) & = \int_{\Omega} \nabla u \cdot \nabla \bar{v} \, dx - k^2 \int_{\Omega} u \bar{v} \, dx - \langle \Lambda u, \bar{v} \rangle, \\ \ell(v) & = \langle \Theta, \bar{v} \rangle, \end{cases} \quad (11)$$

where $\langle \cdot, \cdot \rangle$ is the duality product between $H_{00}^{\frac{1}{2}}(\Gamma_1)'$ and $H_{00}^{\frac{1}{2}}(\Gamma_1)$. The variational formulation associated to problem (10) is the following: find $u_\Omega \in \mathcal{V}(\Omega)$ such that

$$a(\Omega, u_\Omega, v) = \ell(v) \quad \forall v \in \mathcal{V}(\Omega). \quad (12)$$

We consider the following assumption.

Hypothesis 3 *The operator Λ is split into $\Lambda_0 + \Lambda_1$ with*

- $\Lambda_1 \in \mathcal{L}(H_{00}^{\frac{1}{2}}(\Gamma_1), H_{00}^{\frac{1}{2}}(\Gamma_1)'),$ and satisfies

$$\Re \langle \Lambda_1 \psi, \bar{\psi} \rangle \leq 0 \quad \forall \psi \in H_{00}^{\frac{1}{2}}(\Gamma_1), \quad (13)$$

- $\Lambda_2 \in \mathcal{L}(H_{00}^{\frac{1}{2}}(\Gamma_1), H_{00}^{\frac{1}{2}}(\Gamma_1)).$

We assume the following property of uniqueness

Hypothesis 4 *We have*

$$a(\Omega, u, v) = 0 \quad \forall v \in \mathcal{V}(\Omega) \Rightarrow u = 0, \quad (14)$$

$$a(\Omega, u, v) = 0 \quad \forall u \in \mathcal{V}(\Omega) \Rightarrow v = 0. \quad (15)$$

From the Lax-Milgram theorem and the fact that the imbeddings $\mathcal{V}_\Omega \rightarrow L^2(\Omega)$ and $H_{00}^{\frac{1}{2}}(\Gamma_1) \rightarrow L^2(\Gamma_1)$ are compact, and due to the Fredholm alternative, we obtain (see *e.g.*⁹ for a detailed argumentation) the following result.

Proposition 1 *If hypotheses 3 and 4 are satisfied, we have that*

1. *Problem (12) has one and only one solution*
2. *The sesquilinear form $a(\Omega, \cdot, \cdot)$ satisfies the inf-sup condition:*

$$\inf_{u \neq 0} \sup_{v \neq 0} \frac{|a_\Omega(u, v)|}{\|u\|_{\mathcal{V}(\Omega)} \|v\|_{\mathcal{V}(\Omega)}} > 0. \quad (16)$$

For a given $x_0 \in \Omega$, consider the modified open subset $\Omega_\varepsilon = \Omega \setminus \bar{\omega}_\varepsilon$, $\omega_\varepsilon = x_0 + \varepsilon\omega$, where ω is a fixed open and bounded subset of \mathbb{R}^n containing the origin ($\omega_\varepsilon = \emptyset$ if $\varepsilon = 0$), whose boundary $\partial\omega$ is connected and piecewise of class \mathcal{C}^1 . The modified solution u_{Ω_ε} satisfies

$$\begin{cases} \Delta u_{\Omega_\varepsilon} + k^2 u_{\Omega_\varepsilon} = 0 & \text{in } \Omega_\varepsilon, \\ u_{\Omega_\varepsilon} = 0 & \text{on } \Gamma_0, \\ u_{\Omega_\varepsilon} = 0 & \text{on } \partial\omega_\varepsilon, \\ \frac{\partial u_{\Omega_\varepsilon}}{\partial n} = \Lambda u_{\Omega_\varepsilon} + \Theta & \text{on } \Gamma_1. \end{cases} \quad (17)$$

The function u_{Ω_ε} is defined on the variable open set Ω_ε , thus it belongs to a functional space which depends on ε . Hence, if we want to derive the asymptotic expansion of a function of the form

$$j(\varepsilon) = J(u_{\Omega_\varepsilon}), \quad (18)$$

we cannot apply directly the tools of section 2, which require a fixed functional space.

In classical shape optimization, this requirement can be satisfied with the help of a domain parameterization technique.¹¹⁻¹³ This technique involves a fixed domain and a bi-Lipshitz map between this domain and the modified one. In the topology optimization context, such a map does not exist between Ω and Ω_ε . However, a

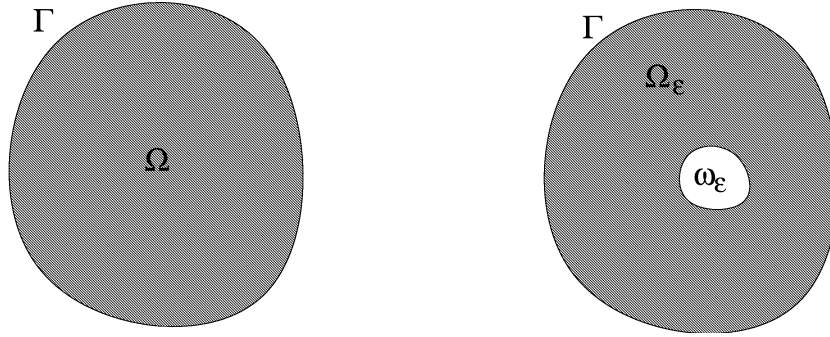

Figure 1: The initial domain and the same domain after inclusion of the hole.

functional space independent of ε can be constructed by using a domain truncation technique. This technique is needed only for analysis, and will never be used for practical computation. During the optimization process, the two systems which have to be solved at each step are (10) and the adjoint problem associated to the cost function (18).

4 THE TRUNCATED PROBLEM

Let $R > 0$ be such that the closed ball $\overline{B(x_0, R)}$ is included in Ω . It is supposed throughout this paper that ε remains small enough so that $\overline{\omega_\varepsilon} \subset B(x_0, R)$. The truncated open subset is defined by $\Omega_R = \Omega \setminus \overline{B(x_0, R)}$. The open subset $B(x_0, R) \setminus \overline{\omega_\varepsilon}$

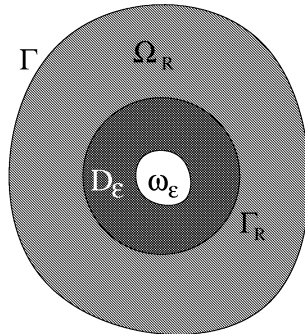

Figure 2: The truncated domain.

is denoted by D_ε (see Figure 2). For $\varphi \in H^{\frac{1}{2}}(\Gamma_R)$ and $\varepsilon > 0$, let u_ε^φ be the solution to the problem: find u_ε^φ such that

$$\begin{cases} \Delta u_\varepsilon^\varphi + k^2 u_\varepsilon^\varphi = 0 & \text{in } D_\varepsilon, \\ u_\varepsilon^\varphi = 0 & \text{on } \partial\omega_\varepsilon, \\ u_\varepsilon^\varphi = \varphi & \text{on } \Gamma_R, \end{cases} \quad (19)$$

where Γ_R is the boundary of the ball $B(x_0, R)$. For $\varepsilon = 0$, u_0^φ is the solution to

$$\begin{cases} \Delta u_0^\varphi + k^2 u_0^\varphi = 0 & \text{in } B(x_0, R), \\ u_0^\varphi = \varphi & \text{on } \Gamma_R. \end{cases} \quad (20)$$

Using the Poincaré inequality, it can easily be seen that for $R < (\sqrt{2}|k|)^{-1}$, problems (19) and (20) have one and only one solution.

For $\varepsilon \geq 0$, the Dirichlet-to-Neumann operator T_ε is defined by

$$\begin{aligned} T_\varepsilon : H^{1/2}(\Gamma_R) &\longrightarrow H^{-1/2}(\Gamma_R) \\ \varphi &\longmapsto T_\varepsilon \varphi = \nabla u_\varepsilon^\varphi \cdot n|_{\Gamma_R}, \end{aligned}$$

where the normal $n|_{\Gamma_R}$ is chosen outward to D_ε on Γ_R and $\partial\omega_\varepsilon$.

Finally, we define for $\varepsilon \geq 0$ the solution u_ε to the truncated problem

$$\begin{cases} \Delta u_\varepsilon + k^2 u_\varepsilon &= 0 & \text{in } \Omega_R, \\ u_\varepsilon &= 0 & \text{on } \Gamma_0, \\ \frac{\partial u_\varepsilon}{\partial n} &= \Lambda u_\varepsilon + \Theta & \text{on } \Gamma_1, \\ \frac{\partial u_\varepsilon}{\partial n} - T_\varepsilon u_\varepsilon|_{\Gamma_R} &= 0 & \text{on } \Gamma_R. \end{cases} \quad (21)$$

The variational formulation associated to (21) is: find $u_\varepsilon \in \mathcal{V}_R$ such that

$$a_\varepsilon(u_\varepsilon, v) = \ell(v) \quad \forall v \in \mathcal{V}_R, \quad (22)$$

where the functional space \mathcal{V}_R and the sesquilinear form a_ε are defined by

$$\mathcal{V}_R = \{v \in H^1(\Omega_R); v|_{\Gamma_0} = 0\}, \quad (23)$$

$$a_\varepsilon(u, v) = \int_{\Omega_R} \nabla u \cdot \nabla \bar{v} \, dx - k^2 \int_{\Omega_R} u \cdot \bar{v} \, dx - \langle \Lambda u, \bar{v} \rangle + \int_{\Gamma_R} T_\varepsilon u|_{\Gamma_R} \bar{v} \, d\gamma(x). \quad (24)$$

Here, \int_{Γ_R} denotes the duality product between $H^{1/2}(\Gamma_R)$ and $H^{-1/2}(\Gamma_R)$.

The following result is standard in PDE theory.

Proposition 2 *Problems (17) and (21) have a unique solution. Moreover, the restriction to Ω_R of the solution u_{Ω_ε} to problem (17) is the solution u_ε to problem (21).*

We have now at our disposal the fixed Hilbert space \mathcal{V}_R required by section 2. We assume (for simplicity) that the function (18) is defined in a neighbor part of Γ . Then we have

$$j(\varepsilon) = J(u_{\Omega_\varepsilon}) = J(u_\varepsilon) \quad \forall \varepsilon \geq 0. \quad (25)$$

5 ASYMPTOTIC EXPANSION OF THE COST FUNCTION

This section contains the main results of this paper. All the proofs are reported in section 6. Henceforth we have to distinguish the cases $n = 2$ and $n = 3$. This is due to the fact that the fundamental solutions to the Laplace equation in \mathbb{R}^2 and \mathbb{R}^3 have an essentially different asymptotic expansion at infinity, and problem (26) has generally no solution if $n = 2$.

5.1 The three dimensional case

Possibly changing the co-ordinate system, we can suppose for convenience that $x_0 = 0$. In order to derive the topological sensitivity of the function j , we introduce two auxiliary problems.

The first problem, which we call the “exterior problem”, is formulated in $\mathbb{R}^3 \setminus \bar{\omega}$ and consists to find v_ω , solution to

$$\begin{cases} -\Delta v_\omega &= 0 & \text{in } \mathbb{R}^3 \setminus \bar{\omega}, \\ v_\omega &= 0 & \text{at } \infty, \\ v_\omega &= u_\Omega(x_0) & \text{on } \partial\omega, \end{cases} \quad (26)$$

where u_Ω is the solution to the direct problem (10).

Here, one can remark that just the principal part of the Helmholtz operator is used, which described by the Laplace equation. The function v_ω can be expressed by a single layer potential on $\partial\omega$. Let

$$E(y) = \frac{1}{4\pi r} \quad (27)$$

with $r = \|y\|$. It is a fundamental solution for the Laplace equation in \mathbb{R}^3 . Then, the function v_ω reads¹⁵

$$v_\omega(y) = \int_{\partial\omega} E(y-x) p_\omega(x) d\gamma(x), \quad y \in \mathbb{R}^3 \setminus \bar{\omega}, \quad (28)$$

where $p_\omega \in H^{-\frac{1}{2}}(\partial\omega)$ is the solution to boundary integral equation

$$\int_{\partial\omega} E(y-x) p_\omega(x) d\gamma(x) = u_\Omega(x_0), \quad \forall y \in \partial\omega. \quad (29)$$

For x bounded and large $r = \|y\|$, we have

$$E(y-x) = E(y) + O\left(\frac{1}{r^2}\right) \quad (30)$$

and the asymptotic expansion at infinity of the function v_ω is given by

$$v_\omega(y) = P_\omega(y) + W_\omega(y), \quad (31)$$

$$P_\omega(y) = A_\omega(u_\Omega(x_0)) E(y), \quad (32)$$

$$A_\omega(u_\Omega(x_0)) = \int_{\partial\omega} p_\omega(x) d\gamma(x), \quad (33)$$

$$W_\omega(y) = O\left(\frac{1}{r^2}\right). \quad (34)$$

Notice that $P_\omega \in L_{loc}^m$ for all $m < 3$. Clearly, the function $\alpha \mapsto A_\omega(\alpha)$ is linear on \mathbb{R} , and the number $A_\omega(\alpha)$ depends on the shape of ω .

The second problem, which we call “interior problem”, is formulated in $D_0 = B(x_0, R)$ and consists to find Q_ω^1 solution to

$$\begin{cases} \Delta Q_\omega^1 + k^2 Q_\omega^1 &= 0 & \text{in } D_0, \\ Q_\omega^1 &= P_\omega|_{\Gamma_R} & \text{on } \Gamma_R. \end{cases} \quad (35)$$

Here, the idea is to consider an interior and exterior problems that give a good “first order approximation” of $(u_\varepsilon^\varphi - u_0^\varphi)|_{D_\varepsilon}$, $\varphi = u_\Omega|_{\Gamma_R}$, in the form $f(\varepsilon)(Q_\omega^1 - P_\omega)$, in a way which will be stated precisely in section 6.

But, the given formulation (35) of the interior problem, which is the “natural” choice, is not sufficient to get the behavior needed by the adjoint technique described in section 2. More precisely, in this case one can construct the sesquilinear form δa but there is no positive function $f(\varepsilon)$ such that $\|a_\varepsilon - a_0 - f(\varepsilon)\delta a\|_{\mathcal{L}_2(\mathcal{V}_R)} = o(f(\varepsilon))$. Indeed, one can observe through the proof of Proposition 4 that the behavior of $\|a_\varepsilon - a_0 - f(\varepsilon)\delta a\|_{\mathcal{L}_2(\mathcal{V}_R)}$ is not of order $o(\varepsilon)$, but only of order $O(\varepsilon)$. This due to the approximation used on the exterior problem (26), where just the principal part of the operator is considered. For this reason, a new term Q_ω^2 is used in order to correct the error caused by this approximation. We construct Q_ω^2 as solution to

$$\begin{cases} \Delta Q_\omega^2 + k^2 Q_\omega^2 &= k^2 P_\omega & \text{in } D_0, \\ Q_\omega^2 &= 0 & \text{on } \Gamma_R. \end{cases} \quad (36)$$

Setting $Q_\omega = Q_\omega^1 + Q_\omega^2$, then Q_ω is solution to

$$\begin{cases} \Delta Q_\omega + k^2 Q_\omega &= k^2 P_\omega & \text{in } D_0, \\ Q_\omega &= P_\omega|_{\Gamma_R} & \text{on } \Gamma_R. \end{cases} \quad (37)$$

Using the corrected interior problem (37), one can derive the good approximation of $(u_\varepsilon^\varphi - u_0^\varphi)|_{D_\varepsilon}$. The main result is the following, which will be proved in section 6.

Theorem 2 *Let $j(\varepsilon) = J(u_\varepsilon)$ be a cost function satisfying the following hypothesis*

$$J(u + h) = J(u) + \Re(L_u(h)) + o(\|h\|) \quad \forall u, v \in \mathcal{V}_R, \quad (38)$$

where L_u is a linear and continuous form on \mathcal{V}_R and u_ε , $\varepsilon \geq 0$ is the solution to (21).

Let $v_0 \in \mathcal{V}_R$ be the solution to the adjoint equation

$$a_0(w, v_0) = -L_{u_0}(w), \quad \forall w \in \mathcal{V}_R. \quad (39)$$

Then, the function j has the following asymptotic expansion

$$j(\varepsilon) = j(0) + \varepsilon \Re(\delta j(x_0)) + o(\varepsilon) \quad (40)$$

with

$$\delta j(x_0) = \int_{\Gamma_R} \nabla(Q_\omega - P_\omega) \cdot n|_{\Gamma_R} \overline{v_0} \, d\gamma(x). \quad (41)$$

The function $\Re(\delta j(x_0))$ is called the topological sensitivity or the topological gradient. Moreover, as j is usually independent of R and $\delta j(x_0)$ is independent of ε , it follows from the uniqueness of an asymptotic expansion that $\Re(\delta j(x_0))$ is also independent of R .

Practically, we need just to compute the solution u_Ω to (10) and v_Ω the solution to the associated adjoint problem, which is solution to

$$a(\Omega, w, v_\Omega) = -L_{u_\Omega}(w), \quad \forall w \in \mathcal{V}(\Omega), \quad (42)$$

where the functional space $\mathcal{V}(\Omega)$ and the sesquilinear form $a(\Omega, \cdot, \cdot)$ are defined in (11).

It has been shown in Proposition 2 that u_0 is the restriction to Ω_R of u_Ω . Similarly,

v_0 is the restriction to Ω_R of v_Ω , this can be proved in the same way than.¹⁴ Consequently, the function u_Ω (or u_0) and the adjoint state v_Ω (or v_0) do not depend on x_0 . Hence, the basic property of an adjoint technique is here satisfied. Therefore, only two systems must be solved in order to compute the topological sensitivity $\delta j(x)$ for all $x \in \Omega$.

Corollary 1 *Under the assumptions of theorem 2, we have*

$$\delta j(x_0) = A_\omega(u_\Omega(x_0)) \overline{v_\Omega(x_0)}. \quad (43)$$

When ω is the unit ball $B(0, 1)$, then $v_\omega(y)$, $P_\omega(y)$ and $W_\omega(y)$ can be computed explicitly:

$$v_\omega(y) = \frac{u_\Omega(x_0)}{r} = P_\omega(y), \quad W_\omega(y) = 0, \quad 0 \neq y \in \mathbb{R}^3. \quad (44)$$

Then it follows from (27) (32) that

$$A_\omega(u_\Omega(x_0)) = 4\pi u_\Omega(x_0). \quad (45)$$

Then, we have the following result.

Corollary 2 *Under the assumptions of theorem 2 and when ω is the unit ball $B(0, 1)$, we have that*

$$\delta j(x_0) = 4\pi u_\Omega(x_0) \overline{v_\Omega(x_0)}. \quad (46)$$

5.2 The two dimensional case

In this paragraph, we intend to derive the asymptotic expansion of the function j in two dimensional case. The technical used is similar to that of the three dimensional case. We use the principal part of the Helmholtz operator to derive the topological sensitivity expression. Next, we briefly describe the transposition of the previous results to the two dimensional case. As before, u_Ω and the adjoint state v_Ω are respectively the solutions to (10) and (42).

The exterior problem must now be defined differently than in (26). It consists to find v_ω , solution to

$$\begin{cases} -\Delta v_\omega & = 0 & \text{in } \mathbb{R}^2 \setminus \overline{\omega}, \\ v_\omega(y)/\log r & = u_\Omega(x_0) & \text{at } \infty, \\ v_\omega & = 0 & \text{on } \partial\omega. \end{cases} \quad (47)$$

A fundamental solution for the Laplace equation in \mathbb{R}^2 is given by

$$E(y) = -\frac{1}{2\pi} \log r. \quad (48)$$

The function v_ω has the form

$$v_\omega(y) = u_\Omega(x_0) \log \|y\| + P_\omega + W_\omega(y), \quad (49)$$

where P_ω is constant and $W_\omega(y) = o(1)$ at infinity.¹⁵ In the next proposition (where ω is not supposed to be a ball), one can observe that in the two dimensional case the topological sensitivity does not depend on the shape of the hole ω , in contrast to the three dimensional case.

Proposition 3 *The assumptions are the same as in theorem 2. The function j has the following asymptotic expansion*

$$j(\varepsilon) = j(0) - \frac{2\pi}{\log \varepsilon} \Re \left(u_\Omega(x_0) \overline{v_\Omega(x_0)} \right) + o \left(\frac{1}{\log \varepsilon} \right). \quad (50)$$

The proof uses the same tools as for the three dimensional case (see section 6) and will not be repeated for the two dimensional case.

6 PROOFS

This section consists in the proof of theorem 2. The variation of the sesquilinear form a_ε reads

$$a_\varepsilon(u, v) - a_0(u, v) = \int_{\Gamma_R} (T_\varepsilon - T_0)u\bar{v} \, d\gamma(x). \quad (51)$$

Hence, the problem reduces to the analysis of $(T_\varepsilon - T_0)\varphi$ for $\varphi \in H^{\frac{1}{2}}(\Gamma_R)$. More precisely, it will be shown that there exists an operator $\delta T \in \mathcal{L} \left(H^{\frac{1}{2}}(\Gamma_R), H^{-\frac{1}{2}}(\Gamma_R) \right)$ such that

$$\|T_\varepsilon - T_0 - \varepsilon\delta T\|_{\mathcal{L}(H^{\frac{1}{2}}(\Gamma_R), H^{-\frac{1}{2}}(\Gamma_R))} = O(\varepsilon^{3/2}). \quad (52)$$

Consequently, defining δa by

$$\delta a(u, v) = \int_{\Gamma_R} \delta T u \bar{v} \, d\gamma(x) \quad \forall u, v \in \mathcal{V}_R \quad (53)$$

will yield straightforwardly

$$\|a_\varepsilon - a_0 - \varepsilon\delta a\|_{\mathcal{L}(H^{\frac{1}{2}}(\Gamma_R), H^{-\frac{1}{2}}(\Gamma_R))} = O(\varepsilon^{3/2}). \quad (54)$$

First we need some definitions and preliminary lemmas.

6.1 Definitions

For convenience, the following norms and semi-norms are chosen for the functional spaces which will be used.

- For a bounded and open subset $\mathcal{O} \subset \mathbb{R}^3$ and $m \geq 0$, the sobolev space $H^m(\mathcal{O})$ is equipped with the norm defined by

$$\|u\|_{m, \mathcal{O}}^2 = \sum_{j=0}^m |u|_{j, \mathcal{O}}^2,$$

where the semi-norms $|u|_{j, \mathcal{O}}$ are given by

$$|u|_{j, \mathcal{O}}^2 = \sum_{|\alpha|=j} \int_{\mathcal{O}} |\partial_\alpha u|^2 \, dx. \quad (55)$$

- For a given $\varepsilon > 0$, the space $H^{\frac{1}{2}}(\Gamma_{R/\varepsilon})$ is equipped with the following norm:

$$\|u\|_{\frac{1}{2}, \Gamma_{R/\varepsilon}} = \inf \{ \|v\|_{1, C(R/2\varepsilon, R/\varepsilon)}; v|_{\Gamma_{R/\varepsilon}} = u \},$$

where $C(r, r') = \{x \in \mathbb{R}^3; r < \|x\| < r'\}$.

- The dual space $H^{-\frac{1}{2}}(\Gamma_{R/\varepsilon})$ is equipped with the natural norm

$$\|w\|_{-\frac{1}{2}, \Gamma_{R/\varepsilon}} = \sup\{|\langle w, v \rangle_{-\frac{1}{2}, \frac{1}{2}}; v \in H^{\frac{1}{2}}(\Gamma_{R/\varepsilon}); \|v\|_{\frac{1}{2}, \Gamma_{R/\varepsilon}} = 1\},$$

where $\langle, \rangle_{-\frac{1}{2}, \frac{1}{2}}$ is the duality product between $H^{\frac{1}{2}}(\Gamma_{R/\varepsilon})$ and $H^{-\frac{1}{2}}(\Gamma_{R/\varepsilon})$.

6.2 Preliminary lemmas

Recall that $x_0 = 0$. We will use extensively the following change of variable: for a given function u defined on a subset \mathcal{O} , the function \tilde{u} is defined on $\tilde{\mathcal{O}} = \mathcal{O}/\varepsilon$ by

$$\tilde{u}(y) = u(x), \quad y = \frac{x}{\varepsilon}.$$

Lemma 2 *We have that*

$$|u|_{1, \mathcal{O}} = \varepsilon^{1/2} |\tilde{u}|_{1, \tilde{\mathcal{O}}} \quad (56)$$

$$\|u\|_{0, \mathcal{O}} = \varepsilon^{3/2} \|\tilde{u}\|_{0, \tilde{\mathcal{O}}}. \quad (57)$$

Lemma 3 *For $\varphi \in H^{\frac{1}{2}}(\partial\omega)$ let v be the solution to the problem*

$$\begin{cases} -\Delta v = 0 & \text{in } \mathbb{R}^3 \setminus \bar{\omega}, \\ v = 0 & \text{at } \infty, \\ v = \varphi & \text{on } \partial\omega. \end{cases} \quad (58)$$

The function v is split into

$$\begin{aligned} v(y) &= V(y) + W(y) \\ V(y) &= E(y) \int_{\partial\omega} p(x) d\gamma(x), \end{aligned}$$

where $E(y) = \frac{1}{4\pi\|y\|}$ and $p \in H^{-\frac{1}{2}}(\partial\omega)$ is the unique solution to

$$\int_{\partial\omega} E(y-x)p(x) d\gamma(x) = \varphi(y) \quad \forall y \in \partial\omega. \quad (59)$$

There exists a constant $c > 0$ (independent of φ and ε) such that

$$\begin{aligned} \|V\|_{0, C(R/2\varepsilon, R/\varepsilon)} &\leq c\varepsilon^{-1/2} \|\varphi\|_{\frac{1}{2}, \partial\omega} \\ |V|_{1, C(R/2\varepsilon, R/\varepsilon)} &\leq c\varepsilon^{1/2} \|\varphi\|_{\frac{1}{2}, \partial\omega} \\ \|V\|_{0, D_\varepsilon/\varepsilon} &\leq c\varepsilon^{-1/2} \|\varphi\|_{\frac{1}{2}, \partial\omega} \\ |V|_{1, D_\varepsilon/\varepsilon} &\leq c \|\varphi\|_{\frac{1}{2}, \partial\omega} \\ \|W\|_{0, C(R/2\varepsilon, R/\varepsilon)} &\leq c\varepsilon^{1/2} \|\varphi\|_{\frac{1}{2}, \partial\omega} \\ |W|_{1, C(R/2\varepsilon, R/\varepsilon)} &\leq c\varepsilon^{3/2} \|\varphi\|_{\frac{1}{2}, \partial\omega} \\ \|W\|_{0, D_\varepsilon/\varepsilon} &\leq c \|\varphi\|_{\frac{1}{2}, \partial\omega}. \end{aligned}$$

Lemma 4 For $\varepsilon > 0$, $\varphi \in H^{\frac{1}{2}}(\Gamma_R)$, $\psi \in H^1(D_0)$ and $f_\varepsilon \in L^2(D_\varepsilon)$, let v_ε be the solution to the problem

$$\begin{cases} \Delta v_\varepsilon + k^2 v_\varepsilon = f_\varepsilon & \text{in } D_\varepsilon, \\ v_\varepsilon = \psi & \text{on } \partial\omega_\varepsilon, \\ v_\varepsilon = \varphi & \text{on } \Gamma_R. \end{cases} \quad (60)$$

There exists a constant $c > 0$ (independent of φ , ψ , f_ε and ε) such that for all $\varepsilon > 0$,

$$|v_\varepsilon|_{1,C(R/2,R)} \leq c \left(\varepsilon \|\psi(\varepsilon y)\|_{\frac{1}{2},\partial\omega} + \|\varphi\|_{\frac{1}{2},\Gamma_R} + \|f_\varepsilon\|_{0,D_\varepsilon} \right) \quad (61)$$

$$\|v_\varepsilon\|_{0,D_\varepsilon} \leq c \left(\varepsilon \|\psi(\varepsilon y)\|_{\frac{1}{2},\partial\omega} + \|\varphi\|_{\frac{1}{2},\Gamma_R} + \|f_\varepsilon\|_{0,D_\varepsilon} \right) \quad (62)$$

$$|v_\varepsilon|_{1,D_\varepsilon} \leq c \left(\varepsilon^{1/2} \|\psi(\varepsilon y)\|_{\frac{1}{2},\partial\omega} + \|\varphi\|_{\frac{1}{2},\Gamma_R} + \|f_\varepsilon\|_{0,D_\varepsilon} \right). \quad (63)$$

Lemma 5 Let u belongs to the space $H^1(C(R/2, R))$ and satisfies $\Delta u + k^2 u = 0$ in $C(R/2, R)$, $u|_{\Gamma_R} = 0$. Then, there exists a constant $c > 0$ (independent of u) such that

$$\|\nabla u \cdot n|_{\Gamma_R}\|_{-\frac{1}{2},\Gamma_R} \leq c |u|_{1,C(R/2,R)}. \quad (64)$$

6.3 Variation of the sesquilinear form

The variation of the sesquilinear form a_ε reads

$$a_\varepsilon(u, v) - a_0(u, v) = \int_{\Gamma_R} (T_\varepsilon - T_0) u \bar{v} \, d\gamma(x).$$

For $\varphi \in H^{\frac{1}{2}}(\Gamma_R)$, recall that u_ε^φ is the solution to (19) or (20) if $\varepsilon = 0$. Let v_ω^φ be the solution to the problem

$$\begin{cases} \Delta v_\omega^\varphi = 0 & \text{in } \mathbb{R}^3 \setminus \bar{\omega}, \\ v_\omega^\varphi = 0 & \text{at } \infty, \\ v_\omega^\varphi = u_0^\varphi(x_0) & \text{on } \partial\omega. \end{cases} \quad (65)$$

Like in (31)-(32), Let $P_\omega^\varphi(y) = A_\omega(u_0^\varphi(x_0)) E(y)$ be the dominant part of v_ω^φ , and let Q_ω^φ be the solution to the associated interior problem

$$\begin{cases} \Delta Q_\omega^\varphi + k^2 Q_\omega^\varphi = k^2 P_\omega^\varphi & \text{in } D_0, \\ Q_\omega^\varphi = P_\omega^\varphi|_{\Gamma_R} & \text{on } \Gamma_R. \end{cases} \quad (66)$$

The linear operator δT (independent of ε) is defined as follows:

$$\begin{aligned} \delta T : H^{1/2}(\Gamma_R) &\longrightarrow H^{-1/2}(\Gamma_R), \\ \varphi &\longmapsto \delta T \varphi = \nabla(Q_\omega^\varphi - P_\omega^\varphi) \cdot n|_{\Gamma_R}. \end{aligned} \quad (67)$$

Proposition 4 The operator T_ε admits the following asymptotic expansion

$$\|T_\varepsilon - T_0 - \varepsilon \delta T\|_{\mathcal{L}(H^{\frac{1}{2}}(\Gamma_R), H^{-\frac{1}{2}}(\Gamma_R))} = O(\varepsilon^{3/2}).$$

Proof:

Let $\varphi \in H^{\frac{1}{2}}(\Gamma_R)$. For simplicity we drop the subscripts $(\cdot)^\varphi$. For $y = x/\varepsilon$, we have

$$v_\omega(y) = P_\omega(y) + W_\omega(y),$$

with $P_\omega\left(\frac{x}{\varepsilon}\right) = \varepsilon P_\omega(x)$ and $W_\omega(y) = O\left(\frac{1}{\|y\|^2}\right)$. Let

$$\psi_\varepsilon(x) = (T_\varepsilon - T_0 - \varepsilon\delta T) \varphi(x).$$

We have

$$\begin{aligned} \psi_\varepsilon(x) &= (\nabla u_\varepsilon - \nabla u_0 - \varepsilon(\nabla Q_\omega - \nabla P_\omega)) \cdot n|_{\Gamma_R} \\ &= \nabla \left(w_\varepsilon(x) - W_\omega\left(\frac{x}{\varepsilon}\right) \right) \cdot n|_{\Gamma_R}, \end{aligned}$$

where w_ε is defined by

$$w_\varepsilon(x) = u_\varepsilon(x) - u_0(x) - \varepsilon Q_\omega(x) + v_\omega\left(\frac{x}{\varepsilon}\right).$$

The function w_ε is solution to

$$\begin{cases} \Delta w_\varepsilon + k^2 w_\varepsilon &= k^2 W_\omega(x/\varepsilon) && \text{in } D_\varepsilon, \\ w_\varepsilon &= W_\omega(x/\varepsilon) && \text{on } \Gamma_R, \\ w_\varepsilon &= -u_0(x) + u_0(0) - \varepsilon Q_\omega(x) && \text{on } \partial\omega_\varepsilon. \end{cases} \quad (68)$$

In order to apply Lemma 4, we have to estimate the right-hand side terms.

- in D_ε , we have

$$\|W_\omega(x/\varepsilon)\|_{0,D_\varepsilon} = \varepsilon^{3/2} \|W_\omega(y)\|_{0,D_\varepsilon/\varepsilon}.$$

Using lemma 3, we obtain

$$\begin{aligned} \|W_\omega(y)\|_{0,D_\varepsilon/\varepsilon} &\leq c \|u_0(x_0)\|_{\frac{1}{2},\partial\omega} \\ &\leq c |u_0(x_0)| \\ &\leq c \|\varphi\|_{\frac{1}{2},\Gamma_R}. \end{aligned}$$

Then, we have

$$\|W_\omega(x/\varepsilon)\|_{0,D_\varepsilon} \leq c\varepsilon^{3/2} \|\varphi\|_{\frac{1}{2},\Gamma_R}.$$

- On Γ_R , using Lemma (2), Lemma (3) and the elliptic regularity, we obtain

$$\begin{aligned} \|W_\omega(x/\varepsilon)\|_{\frac{1}{2},\Gamma_R} &\leq c \|W_\omega(x/\varepsilon)\|_{1,C(R/2,R)} \\ &\leq c (\|W_\omega(x/\varepsilon)\|_{0,C(R/2,R)} + |W_\omega(x/\varepsilon)|_{1,C(R/2,R)}) \\ &= c (\varepsilon^{3/2} \|W_\omega(y)\|_{0,C(R/2\varepsilon,R/\varepsilon)} + \varepsilon^{1/2} |W_\omega(y)|_{1,C(R/2\varepsilon,R/\varepsilon)}) \\ &\leq c\varepsilon^2 \|u_0(x_0)\|_{\frac{1}{2},\partial\omega} \\ &\leq c\varepsilon^2 |u_0(x_0)| \\ &\leq c\varepsilon^2 \|\varphi\|_{\frac{1}{2},\Gamma_R}. \end{aligned}$$

- On $\partial\omega_\varepsilon$, putting

$$\theta_\varepsilon(x) = \frac{-u_0(x) + u_0(x_0) - \varepsilon Q_\omega(x)}{\varepsilon},$$

we have for small ε

$$\begin{aligned} \|\theta_\varepsilon(\varepsilon y)\|_{\frac{1}{2}, \partial\omega} &\leq c \|\theta_\varepsilon(\varepsilon y)\|_{1, \omega} \\ &= c \left\| \frac{u_0(\varepsilon y) - u_0(x_0)}{\varepsilon} + Q_\omega(\varepsilon y) \right\|_{1, \omega} \\ &\leq c \left(\|u_0\|_{C^2(B(0, R/2))} + \|Q_\omega\|_{C^1(B(0, R/2))} \right) \\ &\leq c \|\varphi\|_{\frac{1}{2}, \Gamma_R}. \end{aligned}$$

We can now apply Lemma 4, which gives

$$\begin{aligned} |w_\varepsilon|_{1, C(R/2, R)} &\leq c \left(\varepsilon^{3/2} \|\varphi\|_{\frac{1}{2}, \Gamma_R} + \varepsilon^2 \|\varphi\|_{\frac{1}{2}, \Gamma_R} + \varepsilon \|\varepsilon \theta_\varepsilon(\varepsilon y)\|_{\frac{1}{2}, \partial\omega} \right) \\ &\leq c \varepsilon^{3/2} \|\varphi\|_{\frac{1}{2}, \Gamma_R}. \end{aligned}$$

Finally, it follows from Lemma (2) and Lemma (5) that

$$\begin{aligned} \|\psi\|_{-\frac{1}{2}, \Gamma_R} &= \|\nabla(w_\varepsilon - W_\omega(x/\varepsilon)) \cdot n|_{\Gamma_R}\|_{-\frac{1}{2}, \Gamma_R} \\ &\leq c \left(|w_\varepsilon|_{1, C(R/2, R)} + |W_\omega(x/\varepsilon)|_{1, C(R/2, R)} \right) \\ &= c \left(|w_\varepsilon|_{1, C(R/2, R)} + \varepsilon^{1/2} |W_\omega(y)|_{1, C(R/2\varepsilon, R/\varepsilon)} \right) \\ &\leq c \left(\varepsilon^{3/2} \|\varphi\|_{\frac{1}{2}, \Gamma_R} + \varepsilon^2 \|\varphi\|_{\frac{1}{2}, \Gamma_R} \right) \\ &\leq c \varepsilon^{3/2} \|\varphi\|_{\frac{1}{2}, \Gamma_R}. \end{aligned}$$

Hence,

$$\|T_\varepsilon - T_0 - \varepsilon \delta T\|_{\mathcal{L}(H^{\frac{1}{2}}(\Gamma_R), H^{-\frac{1}{2}}(\Gamma_R))} = O(\varepsilon^{3/2}).$$

□

The asymptotic expansion of the sesquilinear form a_ε follows now straightforwardly.

Proposition 5 *Let*

$$\delta a(u, v) = \int_{\Gamma_R} \delta T u \bar{v} \, d\gamma(x) \quad u, v \in \mathcal{V}_R.$$

Then the asymptotic expansion of the sesquilinear form a_ε is given by

$$\|a_\varepsilon - a_0 - \varepsilon \delta a\|_{\mathcal{L}(H^{\frac{1}{2}}(\Gamma_R), H^{-\frac{1}{2}}(\Gamma_R))} = O(\varepsilon^{3/2}).$$

6.4 Proof of Theorem 2

We have the following result.¹⁶

Proposition 6 *The sesquilinear form a_0 defined in (24) for $\varepsilon = 0$, satisfies the inf-sup condition.*

All the hypotheses of section 2 are satisfied and we can apply Theorem 1:

$$\begin{aligned} j(\varepsilon) - j(0) &= \varepsilon \Re(\delta a(u_\Omega, v_\Omega)) + o(\varepsilon) \\ &= \varepsilon \Re \left(\int_{\Gamma_R} \nabla(Q_\omega^\varphi - P_\omega^\varphi) \cdot n_{|\Gamma_R} \overline{v_\Omega} \, d\gamma(x) \right) + o(\varepsilon), \end{aligned}$$

where $\varphi = u_{\Omega|\Gamma_R} = u_{0|\Gamma_R}$. Then, the proof of Theorem 2 is achieved.

7 NUMERICAL RESULTS: BURIED OBJECTS DETECTION

We will consider here a simple problem of detection of metallic objects buried in the soil. The problem here is based on a 2D/TM model, hence we are looking for infinite metallic wires placed in the z direction. The aim is to find the number and the locations of metallic objects, using scattered field measurements from a mono-static antenna horizontally translated above the soil. This is a rough model of the problem described in.¹⁷ The 2D Helmholtz equation is solved by the Finite Differences Time-Domain (FDTD) method. The frequency-domain solution being obtained with a Fourier transform. The antenna is roughly approximated by a punctual source, which will be translated at various locations above the soil.

Let $\mathcal{X} = \{x_i\}_{i=1..n_x}$ be the set of the successive locations of the source (and sensors, since the antenna is supposed to be mono-static), and $\mathcal{F} = \{f_j\}_{j=1..n_f}$ the set of measurement frequencies. Let ε_s be the soil permittivity. The area occupied by the buried objects is denoted by Ω .

We associate to Ω a set of “measurements” $\mathcal{M}(\Omega)$: at each couple $(x_i, f_j) \in \mathcal{X} \times \mathcal{F}$, we consider the field u_{x_i, f_j}^Ω , solution to

$$\begin{cases} \Delta u + k_j^2 u &= s_{x_i} & \text{in } \mathbb{R}^2 \setminus \overline{\Omega}, \\ u &= 0 & \text{on } \partial\Omega, \\ \lim_{r \rightarrow \infty} \sqrt{r}(\partial_r u - iku) &= 0, \end{cases} \quad (69)$$

where s_{x_i} represents a source point located at x_i , and where

$$\begin{aligned} k_j^2(x) &= \varepsilon(x) \mu \omega_j^2, \\ w_j &= 2\pi f_j, \end{aligned}$$

$$\varepsilon(x) = \begin{cases} \varepsilon_0 & \text{if } x \geq 0, \\ \varepsilon_s & \text{if } x < 0. \end{cases}$$

Then the “measurements” are $\mathcal{M}(\Omega) = \{m_{x_i, f_j}(\Omega)\}$, where $m_{x_i, f_j}(\Omega)$ is the value of the scattered field at the point x_i .

We call *reference measurements* $\widetilde{\mathcal{M}} = \{\widetilde{m}_{x_i, f_j}\}$ the measured data. For the moment, we only consider synthetic data obtained via FDTD.

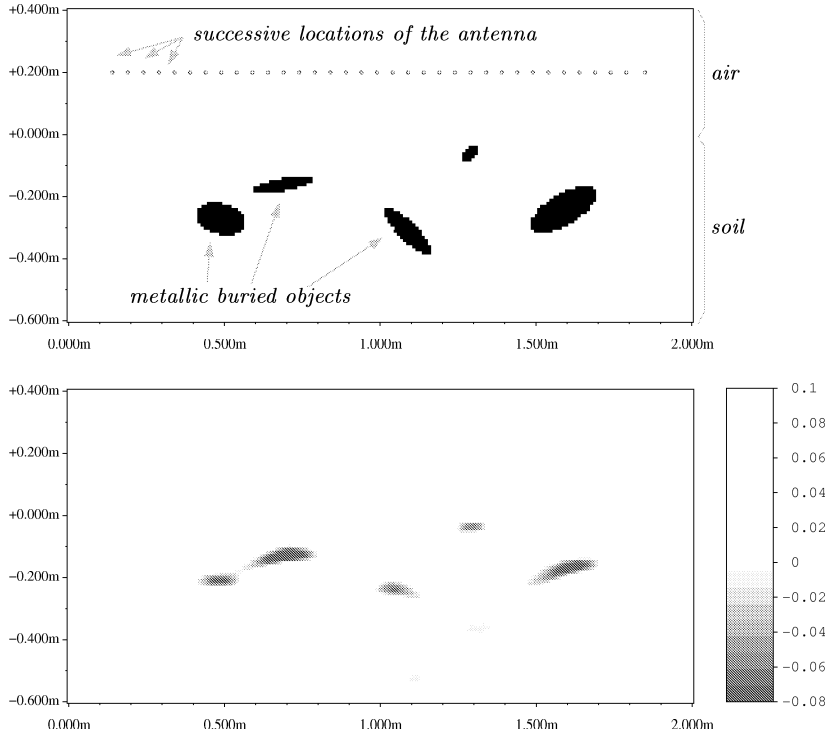

Figure 3: Repartition of metallic objects in the soil, and the corresponding topological sensitivity computed on an empty flat soil (dry soil, flat surface $\varepsilon_r = 2.3$, 20 Frequencies ranging from 400MHz to 2GHz).

We have to minimize the cost function that evaluates the discrepancy between measured data and the response obtained for a given distribution of metallic objects:

$$j(\Omega) = \|\mathcal{M} - \widetilde{\mathcal{M}}\|^2 = \sum_{i,j} j_{x_i, f_j}(\Omega), \quad (70)$$

where

$$j_{x_i, f_j}(\Omega) = |m_{x_i, f_j}(\Omega) - \widetilde{m}_{x_i, f_j}|^2. \quad (71)$$

Applying the expression of the topological asymptotic (see Proposition 3), one obtains

$$j(\Omega \setminus \overline{B(x, \varepsilon)}) - j(\Omega) = \sum_{i,j} -\frac{2\pi}{\log \varepsilon} \Re \left(u_{x_i, f_j}^\Omega(x) \overline{v_{x_i, f_j}^\Omega(x)} \right) + o\left(\frac{1}{\log \varepsilon}\right), \quad (72)$$

where v_{x_i, f_j}^Ω is the adjoint state associated to the couple (x_i, f_j) .

The first example (see Figure 3) shows the topological sensitivity computed in a simple case: the data is not noisy and the reference soil is a flat and homogeneous dry sand soil. One can see that the top of the five objects is clearly identified by the negative region of the topological sensitivity. This topological sensitivity can be obtained very quickly since it is evaluated on a flat soil without mines, which is invariant by translation: all direct states and adjoint states are just horizontal translations of a “canonical” solution. The computational cost is only 10 seconds on a 300MHz personal computer.

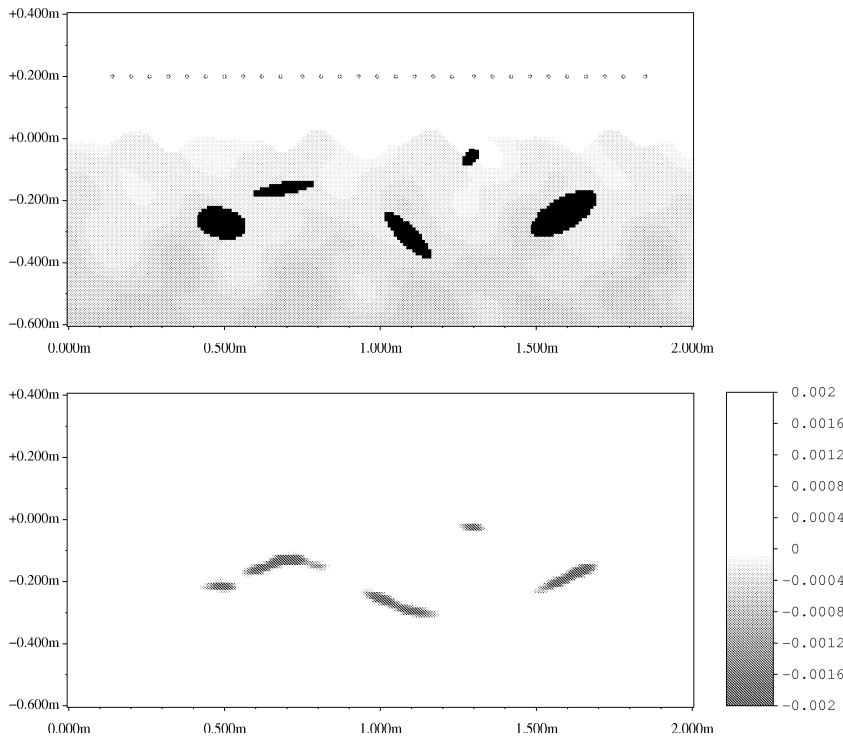

Figure 4: Topological sensitivity with noisy data (dry soil, rough surface, ε_r ranging from 1.6 to 4.15, 20 frequencies in $[0.26MHz - 1.86GHz]$).

The second example (see Figure 4) is a little bit more realistic: the data is noisy since the reference data $\tilde{\mathcal{M}}$ was obtained on a non-flat inhomogeneous soil, while the topological sensitivity was still computed on a flat homogeneous soil. One can observe that, although the objects are still located correctly, the image is a little bit distorted.

The third example shows that it is possible to improve the accuracy of the buried objects using an iterative process. In this example, the basic iterative algorithm just inserts a metal point at the point where the topological sensitivity is the most negative. Then the topological sensitivity is reevaluated, taking into account the metal points inserted at previous iterations, etc.. Figure 5 shows the objects and the metal points that were inserted at iteration 10 and iteration 55.

8 Conclusion

With only one evaluation of the direct and adjoint electrical field, we have a good idea on the buried objects. The proposed method is very efficient if we can compute the adjoint. Unfortunately, in many industrial environment, the adjoint is not so easy to compute. For this reason, genetic algorithms¹⁸⁻²⁰ remain the most general approach.

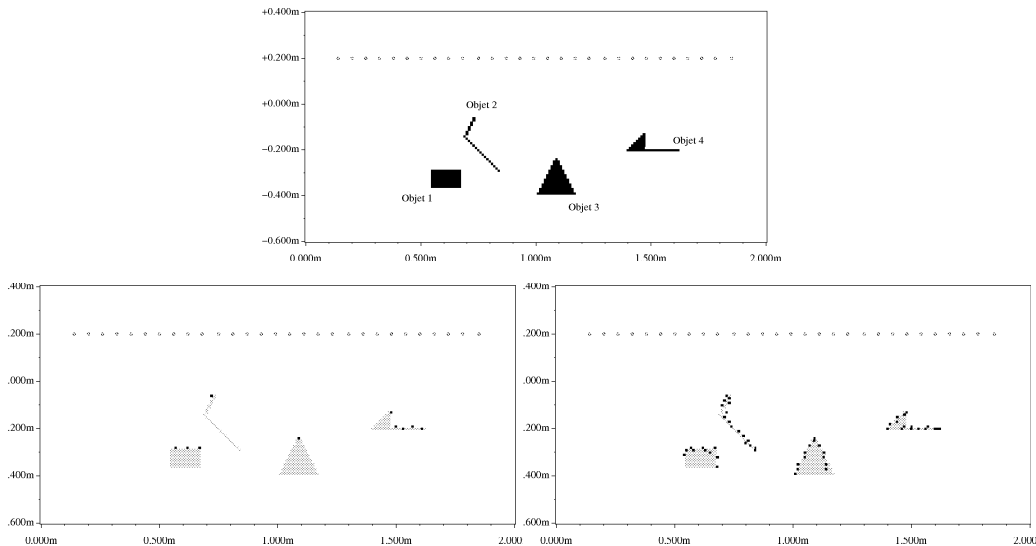

Figure 5: Iterative process: original objects on top, and results at iterations 10 and 55.

REFERENCES

- [1] G. Allaire and R. Kohn, *Optimal design for minimum weight and compliance in plane stress using extremal microstructures*, European Journal of Mechanics, A/Solids , 12(6):839-878, (1993).
- [2] M. Bendsoe, *Optimal topology design of continuum structure: an introduction*, Technical report, Departement of mathematics, Technical University of Denmark, DK2800 Lyngby, Denmark, (1996).
- [3] J. Jacobsen, N. Olhoff, and E. Ronholt, *Generalized shape optimization of three-dimensionnal structures using materials with optimum microstructures*, Technical report, Institute of Mechanical Engineering, Aalborg University, DK-9920 Aalborg, Denmark, (1996).
- [4] A. Schumacher, *Topologieoptimierung von Bauteilstrukturen unter Verwendung von Lopchposition-ierungskriterien*, thèse, Universitat-Gesamthochschule-Siegen, (1995).
- [5] J. Sokolowski and A. Zochowski, *On the topological derivative in shape optimization*, Technical report, INRIA, (1997).
- [6] M. Masmoudi, *The Topological Asymptotic*, in Computational Methods for Control Applications, ed.H. Kawarada and J. Periaux, International Series GAKUTO, (2002).
- [7] P. Guillaume and K. Sididris, *The topological asymptotic expansion for the Dirichlet problem*, accepted in SIAM journal on Control and Optimization.
- [8] S. Garreau, P. Guillaume and M. Masmoudi, *The topological sensitivity for linear isotropic elasticity*, European conference on computational Mechanics (ECCM99), rapport MIP 99.45.

-
- [9] F. Ihlenburg and I. Babuska, *Finite element solution of the Helmholtz equation with high wave number partII: the h-p version of the FEM*, Siam J. Numer. Anal. Vol. 34, No. 1, pp. 315-358, February 1997.
- [10] M. Becker, *Optimisation topologique de structure en variables discrètes*, Université de Liège, (1996).
- [11] P. Guillaume and M. Masmoudi, *Computation of high order derivatives in optimal shape design*, Numerische Mathematik 67, 231-250, (1994).
- [12] F. Murat and J. Simon, *Sur le contrôle par un domaine géométrique*, thèse d'état, Paris, (1976).
- [13] M. Masmoudi, *Outils pour la conception optimale de formes*, thèse d'état, Université de Nice, (1987).
- [14] J. Céa, *Conception optimale ou identification de forme, calcul rapide de la dérivée directionnelle de la fonction coût*, M.A.A.N., 20(3):371-402, (1986).
- [15] R. Dautray and J.-L. Lions, *Analyse mathématique et calcul numérique pour les sciences et les techniques*, Masson, collection CEA, (1987).
- [16] B. Samet, S. Amstutz, and M. Masmoudi, *The topological asymptotic for the Helmholtz equation*, submitted.
- [17] P. Millot, J.C. Bureau, P. Borderies, E. Bachelier, C. Pichot, E. Lebrusq, E. Lebrusq, E. Guilianon, and J.Y. Dauvignac, *Experimental study of near surface radar imaging of buried objects with adaptive focussed synthetic aperture processing*, in subsurface Sensing Technologies and Applications II, Proceedings of SPIE Vol. 4129, pages 515-523. CamNyugen, (2000).
- [18] M. Shoenauer, L. Kallel and F. Jouve, *Mechanics inclusions identification by evolutionary computation*, Revue européenne des éléments finis, 5(5-6):619-648, (1996).
- [19] J. Periaux, R. Mkinen, P. Neittaanmki, and J. Toivanen, *A genetic algorithm for multiobjective design optimization in aerodynamics and electromagnetics*, In Computational Fluid Dynamics '98, Proceedings of the ECCOMAS 98 Conference, volume 2, pages 418-422, Athens, Greece, 1998. K. D. Papailiou et al. (eds), Wiley;
- [20] R. Glowinski Ramos, A. M. and J. Periaux, *Nash equilibria for the multiobjective control of linear partial differential equations*, Journal of Optimization theory and Applications, 112(3):457-498, (2002).

Article 4 :

Sensitivity analysis with respect to the insertion of small inhomogeneities

European Congress on Computational Methods in Applied Sciences and Engineering (2004)

SENSITIVITY ANALYSIS WITH RESPECT TO THE INSERTION OF SMALL INHOMOGENEITIES

S. Amstutz*, N. Dominguez^{‡,†}, and B. Samet*

*Mathématiques pour l'Industrie et la Physique, UMR 5640
Université Paul Sabatier, 118 route de Narbonne, 31062 Toulouse Cedex 4, France
e-mail: amstutz@mip.ups-tlse.fr, samet@mip.ups-tlse.fr

† Airbus France, 316 route de Bayonne, 31060 Toulouse Cedex 03, France
e-mail: nicolas.dominguez@airbus.com

‡ Laboratoire d'Acoustique Métrologie et Instrumentation, Université Paul Sabatier, 118 route
de Narbonne, 31062 Toulouse Cedex 4, France

Key words: shape optimization, shape inversion, topological sensitivity.

Abstract. *In the present work, the topological asymptotic analysis is extended to the case of the insertion of small inhomogeneities in the domain. As a model example, we consider solutions to the Helmholtz equation in two and three dimensions:*

$$\operatorname{div}(\alpha_\varepsilon \nabla u_\varepsilon) + \beta_\varepsilon u_\varepsilon = 0,$$

where $(\alpha_\varepsilon, \beta_\varepsilon)$ are the piecewise constant functions equal to (α_1, β_1) inside the inhomogeneity $x_0 + \varepsilon B$, B denoting a fixed subdomain of \mathbb{R}^d , and (α_0, β_0) outside. An adjoint method is used to determine an asymptotic expansion of a given criterion in the form

$$J_\varepsilon(u_\varepsilon) - J_0(u_0) = f(\varepsilon)G(x_0) + o(f(\varepsilon)).$$

Arbitrary shaped inhomogeneities and a large class of cost functions are considered. Those results are illustrated by some numerical experiments in the contexts of the localization of dielectric inhomogeneities with the help of electromagnetic waves and of defects detection in aircraft structures.

1 Introduction

The aim of the topological sensitivity analysis is to obtain an asymptotic expansion of a shape functional with respect to the creation of a small hole inside the domain. The principle is the following. One considers a cost function $\mathcal{J}(\Omega) = J(\Omega, u_\Omega)$ where u_Ω is the solution to a partial differential equation defined in the domain $\Omega \subset \mathbb{R}^d$ ($d=2$ or 3), a point $x_0 \in \Omega$ and a fixed domain $B \subset \mathbb{R}^d$, containing the origin. One searches for an asymptotic expansion of $\mathcal{J}(\Omega \setminus \overline{(x_0 + \varepsilon B)})$ when ε tends to 0. In most cases, it reads in the form

$$\mathcal{J}(\Omega \setminus \overline{(x_0 + \varepsilon B)}) - \mathcal{J}(\Omega) = f(\varepsilon)G(x_0) + o(f(\varepsilon)). \quad (1)$$

Here, $f(\varepsilon)$ is an explicit positive function going to zero with ε and the function G , the “topological gradient” (or “topological derivative”), is in general easy to compute. Expansion (1) is called the “topological asymptotic”. Hence, to minimize the criterion \mathcal{J} , one has to create holes at some points \tilde{x} where the topological gradient is negative. For more details about this approach we refer the reader to S. Garreau et al. [11], Ph. Guillaume and K. Sididris [13], M. Masmoudi [14], A. Schumacher [17], A.A. Novotny et al. [15], J. Sokolowski and A. Żochowski [18]. In all these works, the authors consider only one way of perturbing the domain: the insertion of a hole.

Another situation, firstly studied by D.J. Cedio-Fengya, S. Moskow and M.S. Vogelius [9], consists in perturbing the domain by the insertion of small inhomogeneities with constitutive parameters different from those of the background medium. In this paper, the authors are interested in the identification of conductivity imperfections by the use of boundary measurements. Other references can be found in [4, 3, 5, 2, 21, 6, 1]. In all these publications, only asymptotic formulas of solutions and of very particular cost functions are given.

In the present work, we combine both previous approaches, that is, we compute the topological asymptotic with respect to the insertion of small inhomogeneities in the domain. As a model example, we consider solutions to the Helmholtz equation in two and three dimensions, but the methodology presented here applies also to many other linear PDEs, as for example in elasticity. An adjoint method is used to derive the expressions of $f(\varepsilon)$ and $G(x_0)$ for any $x_0 \in \Omega$ (see Formula (1)).

The paper is organized as follows. The adjoint method is described in Section 2. The Helmholtz problem with inhomogeneities and the adjoint equation are presented in Section 3. In Section 4, we determine the expression of the topological asymptotic. Some particular cases of cost functions and of shape of inserted objects are exhibited in Section 5. The case of a metallic object (hole with Neumann condition) is formally retrieved [7]. Section 6 is devoted to some numerical experiments. In all the paper, the most technical proofs are omitted.

2 The adjoint method

Let \mathcal{V} be a complex Hilbert space. For all $\varepsilon \geq 0$, let a_ε be a sesquilinear and continuous form on \mathcal{V} and ℓ_ε be a semilinear and continuous form on \mathcal{V} . We assume that for all $\varepsilon \geq 0$, the problem

$$\begin{cases} u_\varepsilon \in \mathcal{V} \\ a_\varepsilon(u_\varepsilon, v) = \ell_\varepsilon(v) \quad \forall v \in \mathcal{V} \end{cases} \quad (2)$$

has one and only one solution. Consider now a cost function $j(\varepsilon) = J_\varepsilon(u_\varepsilon) \in \mathbb{R}$, $\varepsilon \geq 0$. We assume that, for all $\varepsilon \geq 0$, the function $J_\varepsilon : \mathcal{V} \rightarrow \mathbb{R}$ is differentiable on the real field at the point u_0 : there exists $L_\varepsilon \in \mathcal{L}(\mathcal{V}, \mathbb{C})$ such that

$$J_\varepsilon(u_0 + h) - J_\varepsilon(u_0) = \Re L_\varepsilon(h) + o(\|h\|_{\mathcal{V}}). \quad (3)$$

Suppose that the following hypotheses hold.

Hypothesis 1 *There exists two complex numbers δa and $\delta \ell$ and a function $f(\varepsilon) \geq 0$ such that*

$$(a_\varepsilon - a_0)(u_0, v_\varepsilon) = f(\varepsilon)\delta a + o(f(\varepsilon)), \quad (4)$$

$$(\ell_\varepsilon - \ell_0)(v_\varepsilon) = f(\varepsilon)\delta \ell + o(f(\varepsilon)), \quad (5)$$

$$\lim_{\varepsilon \rightarrow 0} f(\varepsilon) = 0, \quad (6)$$

where v_ε is the solution, that is supposed to exist and to be unique, to

$$a_\varepsilon(u, v_\varepsilon) = -L_\varepsilon(u) \quad \forall u \in \mathcal{V}. \quad (7)$$

We call v_0 the adjoint state.

Hypothesis 2 *There exists two real numbers δJ_1 and δJ_2 such that*

$$J_\varepsilon(u_\varepsilon) = J_\varepsilon(u_0) + \Re L_\varepsilon(u_\varepsilon - u_0) + f(\varepsilon)\delta J_1 + o(f(\varepsilon)), \quad (8)$$

$$J_\varepsilon(u_0) = J_0(u_0) + f(\varepsilon)\delta J_2 + o(f(\varepsilon)). \quad (9)$$

Then, we have the following result (see [7]).

Theorem 1 *The variation of the cost function with respect to ε is given by*

$$j(\varepsilon) - j(0) = f(\varepsilon)\Re(\delta j) + o(f(\varepsilon)),$$

where $\delta j = \delta a - \delta \ell + \delta J$ and $\delta J = \delta J_1 + \delta J_2$.

3 Problem formulation

3.1 The Helmholtz problem

Let Ω be a bounded, smooth subdomain of \mathbb{R}^d , $d = 2$ or 3 . For simplicity we take $\partial\Omega$ to be \mathcal{C}^∞ , but this condition could be considerably weakened. We suppose that in Ω is inserted a small inhomogeneity $\omega_\varepsilon = \varepsilon B$, where $B \subset \mathbb{R}^d$ is a bounded, smooth (\mathcal{C}^∞) domain containing 0 (the origin) and ε is the order of magnitude of the diameter of the inhomogeneity. For $\varepsilon \geq 0$, let u_ε be the solution to the Helmholtz problem

$$\begin{cases} \nabla \cdot (\alpha_\varepsilon \nabla u_\varepsilon) + \beta_\varepsilon u_\varepsilon = 0 & \text{in } \Omega, \\ \partial_n u_\varepsilon = \Lambda u_\varepsilon + \sigma & \text{on } \partial\Omega. \end{cases} \quad (10)$$

Here, $\Lambda \in \mathcal{L}(H^{\frac{1}{2}}(\partial\Omega), H^{-\frac{1}{2}}(\partial\Omega))$, $\sigma \in H^{-\frac{1}{2}}(\partial\Omega)$, \mathbf{n} denotes the outward unit normal to $\partial\Omega$ and $\alpha_\varepsilon, \beta_\varepsilon$ are the piecewise constant functions defined by

$$\alpha_\varepsilon(x) = \begin{cases} \alpha_0 & \text{if } x \in \Omega \setminus \overline{\omega_\varepsilon}, \\ \alpha_1 & \text{if } x \in \omega_\varepsilon, \end{cases} \quad \beta_\varepsilon(x) = \begin{cases} \beta_0 & \text{if } x \in \Omega \setminus \overline{\omega_\varepsilon}, \\ \beta_1 & \text{if } x \in \omega_\varepsilon, \end{cases} \quad (11)$$

where $\alpha_0, \alpha_1, \beta_0$ and β_1 are some constants. The variational formulation associated to (10) reads

$$\begin{cases} u_\varepsilon \in H^1(\Omega) \\ a_\varepsilon(u_\varepsilon, v) = \ell(v) \quad \forall v \in H^1(\Omega), \end{cases} \quad (12)$$

where, for all $u, v \in H^1(\Omega)$,

$$a_\varepsilon(u, v) = \int_\Omega \alpha_\varepsilon \nabla u \cdot \overline{\nabla v} \, dx - \int_\Omega \beta_\varepsilon u \overline{v} \, dx - \alpha_0 \int_{\partial\Omega} (\Lambda u) \overline{v} \, ds, \quad (13)$$

$$\ell(v) = \alpha_0 \int_{\partial\Omega} \sigma \overline{v} \, ds. \quad (14)$$

In all the paper, the duality products between $H^{-1/2}$ and $H^{1/2}$ are denoted by an integral. We assume that the following hypotheses hold.

Hypothesis 3 *The operator Λ is split into $\Lambda = \Lambda_0 + \Lambda_1$ where*

- $\Lambda_0 \in \mathcal{L}(H^{\frac{1}{2}}(\partial\Omega), H^{-\frac{1}{2}}(\partial\Omega))$ and satisfies

$$\Re \int_{\partial\Omega} (\Lambda_0 \varphi) \overline{\varphi} \, ds(x) \leq 0 \quad \forall \varphi \in H^{\frac{1}{2}}(\partial\Omega).$$

- $\Lambda_1 \in \mathcal{L}(H^{\frac{1}{2}}(\partial\Omega), H^{\frac{1}{2}}(\partial\Omega))$.

Hypothesis 4 For all $\varepsilon \geq 0$, we have

$$\{a_\varepsilon(u, v) = 0 \quad \forall v \in H^1(\Omega)\} \implies u = 0, \quad (15)$$

$$\{a_\varepsilon(u, v) = 0 \quad \forall u \in H^1(\Omega)\} \implies v = 0. \quad (16)$$

We have the following result.

Proposition 2 *If Hypotheses 3 and 4 are satisfied, then for all $\varepsilon \geq 0$ Problem (12) has one and only one solution.*

Such a boundary condition on $\partial\Omega$ often appears in wave propagation problems, but it could be replaced without any change in the analysis by any other boundary condition provided that PDE (10) is well-posed.

3.2 The cost function and the adjoint problem

We consider a cost function $j(\varepsilon) = J_\varepsilon(u_\varepsilon) \in \mathbb{R}$, $\varepsilon \geq 0$. We set $\mathcal{V} = H^1(\Omega)$ and we assume that J_ε is “ \mathbb{R} -differentiable” in the sense of Equation (3). Moreover, we suppose that Hypothesis 2 holds with $f(\varepsilon) = \varepsilon^d$ and that L_0 satisfies the following hypothesis.

Hypothesis 5 *The linear form L_0 , considered as a distribution, coincides in a neighborhood of the origin with a function of regularity H^2 . Furthermore,*

$$\|L_\varepsilon - L_0\|_{H^1(\Omega)'} = O(\varepsilon^{d/2}).$$

For all $\varepsilon \geq 0$, we define v_ε as the solution to the problem

$$\begin{cases} v_\varepsilon \in H^1(\Omega), \\ a_\varepsilon(u, v_\varepsilon) = -L_\varepsilon(u) \quad \forall u \in H^1(\Omega). \end{cases} \quad (17)$$

We have the following result.

Proposition 3 *If Hypotheses 3 and 4 are satisfied, then Problem (17) has one and only one solution.*

4 Establishment and statement of the main result

Let us first study the variation of the solution.

4.1 Preliminary estimates

Lemma 4 *We have*

$$\|u_\varepsilon - u_0\|_{H^1(\Omega)} = O(\varepsilon^{d/2}), \quad (18)$$

$$\|v_\varepsilon - v_0\|_{H^1(\Omega)} = O(\varepsilon^{d/2}), \quad (19)$$

$$\|u_\varepsilon - u_0\|_{H^1(\Omega \setminus \overline{B(0, R)})} = O(\varepsilon^d), \quad (20)$$

$$\|u_\varepsilon - u_0\|_{L^2(\Omega \setminus \overline{\omega_\varepsilon})} = O(\varepsilon^d), \quad (21)$$

$$\|u_\varepsilon - u_0\|_{L^2(\Omega)} = O(\varepsilon^{\frac{d}{2} + 1 - \delta}), \quad (22)$$

where R denotes any fixed radius such that $\overline{B(0, R)} \subset \Omega$, $\delta = 0$ in $3D$, $\delta > 0$ in $2D$.

We denote $w_\varepsilon = v_\varepsilon - v_0$.

Lemma 5 *We have*

$$\begin{aligned} \int_{\omega_\varepsilon} u_0 \cdot \overline{w_\varepsilon} \, dx &= o(\varepsilon^d). \\ \int_{\omega_\varepsilon} u_0 \cdot \overline{v_0} \, dx &= \varepsilon^d |B| u_0(0) \cdot \overline{v_0(0)} + o(\varepsilon^d). \\ \int_{\omega_\varepsilon} \nabla u_0 \cdot \overline{\nabla v_0} \, dx &= \varepsilon^d |B| \nabla u_0(0) \cdot \overline{\nabla v_0(0)} + o(\varepsilon^d). \end{aligned}$$

We introduce now the function Φ solution to

$$\begin{cases} \Delta \Phi = 0 \text{ in } B \text{ and } \mathbb{R}^d \setminus \overline{B}, \\ \Phi \text{ is continuous across } \partial B, \\ \frac{\alpha_0}{\alpha_1} (\partial_n \Phi)^+ - (\partial_n \Phi)^- = -\mathbf{n}, \\ \lim_{|y| \rightarrow \infty} |\Phi(y)| = 0. \end{cases} \quad (23)$$

Here, \mathbf{n} denotes the outward unit normal to ∂B ; superscript $+$ and $-$ indicate the limiting values as we approach ∂B from outside B , and from inside B , respectively.

Lemma 6 *We have the asymptotic expansion*

$$\int_{\partial \omega_\varepsilon} \partial_n u_0 \overline{w_\varepsilon} \, ds = \varepsilon^d \left(\frac{\alpha_0}{\alpha_1} - 1 \right) \nabla u_0(0)^T \left[\int_{\partial B} \mathbf{n} \otimes \Phi(y) \, ds(y) \right] \overline{\nabla v_0(0)} + o(\varepsilon^d),$$

where \otimes denotes the tensorial product between two vectors, that is,

$$U \otimes V = (U_i V_j)_{1 \leq i, j \leq d} \quad \forall U, V \in \mathbb{R}^d.$$

Proof. We can write

$$\int_{\partial \omega_\varepsilon} \partial_n u_0 \overline{w_\varepsilon} \, ds = \int_{\partial \omega_\varepsilon} \nabla u_0(0) \cdot \mathbf{n} \overline{w_\varepsilon} \, ds + \int_{\partial \omega_\varepsilon} [\nabla u_0(x) \cdot \mathbf{n} - \nabla u_0(0) \cdot \mathbf{n}] \overline{w_\varepsilon} \, ds. \quad (24)$$

By a change of variable we obtain

$$\int_{\partial \omega_\varepsilon} [\nabla u_0(x) \cdot \mathbf{n} - \nabla u_0(0) \cdot \mathbf{n}] \overline{w_\varepsilon} \, ds(x) = \varepsilon^{d-1} \int_{\partial B} [\nabla u_0(\varepsilon y) \cdot \mathbf{n} - \nabla u_0(0) \cdot \mathbf{n}] \overline{w_\varepsilon(\varepsilon y)} \, ds(y).$$

Yet, we have

$$\left| \int_{\partial B} [\nabla u_0(\varepsilon y) \cdot \mathbf{n} - \nabla u_0(0) \cdot \mathbf{n}] \overline{w_\varepsilon(\varepsilon y)} \, ds(y) \right| \leq c \|(\nabla u_0(\varepsilon y) \cdot \mathbf{n} - \nabla u_0(0) \cdot \mathbf{n})\|_{-\frac{1}{2}, \partial B} \|w_\varepsilon(\varepsilon y)\|_{\frac{1}{2}, \partial B}.$$

A Taylor expansion, the trace theorem and a change of variable yield

$$\left| \int_{\partial B} [\nabla u_0(\varepsilon y) \cdot \mathbf{n} - \nabla u_0(0) \cdot \mathbf{n}] \overline{w_\varepsilon(\varepsilon y)} \, ds(y) \right| \leq c\varepsilon \left(\frac{1}{\varepsilon^{d/2}} \|w_\varepsilon\|_{L^2(\omega_\varepsilon)} + \varepsilon^{1-d/2} |w_\varepsilon|_{1,\omega_\varepsilon} \right).$$

Using the Hölder inequality, we obtain that for all $p, q \in [1, +\infty]$ with $1/p + 1/q = 1$,

$$\|w_\varepsilon\|_{L^2(\omega_\varepsilon)} \leq \varepsilon^{d/2q} \|w_\varepsilon\|_{L^{2p}(\omega_\varepsilon)}.$$

We choose $p = 3$ and $q = 3/2$. Using the fact that, by Lemma 4, $\|w_\varepsilon\|_{H^1(\Omega)} = O(\varepsilon^{d/2})$ and the Sobolev imbedding theorem, we obtain

$$\left| \int_{\partial B} [\nabla u_0(\varepsilon y) \cdot \mathbf{n} - \nabla u_0(0) \cdot \mathbf{n}] \overline{w_\varepsilon(\varepsilon y)} \, ds(y) \right| \leq c\varepsilon(\varepsilon^{d/3} + \varepsilon).$$

Then,

$$\int_{\partial\omega_\varepsilon} [\nabla u_0(x) \cdot \mathbf{n} - \nabla u_0(0) \cdot \mathbf{n}] \overline{w_\varepsilon} \, ds(x) = o(\varepsilon^d). \quad (25)$$

In [21], it is proved that for all $y \in \partial B$,

$$\overline{w_\varepsilon(\varepsilon y)} = \varepsilon \left(\frac{\alpha_0}{\alpha_1} - 1 \right) \Phi(y) \cdot \overline{\nabla v_0(0)} + R_\varepsilon(y), \quad (26)$$

where

$$\|R_\varepsilon(y)\|_{C(\partial\omega)} = \begin{cases} O(\varepsilon^2 \ln \varepsilon) & \text{if } d = 2, \\ O(\varepsilon^{\frac{5}{2}}) & \text{if } d = 3. \end{cases} \quad (27)$$

In this paper, the proof is presented in 2D only but the 3D case is obtained by following exactly the same principle. The only thing to be changed is the fundamental solution of the Laplace operator. Using a change of variable, (26) and (27), we obtain that

$$\int_{\partial\omega_\varepsilon} \nabla u_0(0) \cdot \mathbf{n} \overline{w_\varepsilon} \, ds = \varepsilon^d \left(\frac{\alpha_0}{\alpha_1} - 1 \right) \nabla u_0(0)^T \left[\int_{\partial B} \mathbf{n} \otimes \Phi(y) \, ds(y) \right] \overline{\nabla v_0(0)} + o(\varepsilon^d). \quad (28)$$

From (24), (25) and (28) we deduce the desired result. \square

4.2 Variation of the sesquilinear form

Here, our aim is to determine δa , $\delta \ell$ and $f(\varepsilon)$ such that Hypothesis 1 holds. The sesquilinear form ℓ defined in (14) is independent of ε . Then, we have

$$\delta \ell = 0. \quad (29)$$

The determination of δa starts from the fact that

$$(a_\varepsilon - a_0)(u_0, v_\varepsilon) = (\alpha_1 - \alpha_0) \int_{\omega_\varepsilon} \nabla u_0 \cdot \overline{\nabla v_\varepsilon} \, dx - (\beta_1 - \beta_0) \int_{\omega_\varepsilon} u_0 \cdot \overline{v_\varepsilon} \, dx. \quad (30)$$

Hence,

$$\begin{aligned} (a_\varepsilon - a_0)(u_0, v_\varepsilon) &= (\alpha_1 - \alpha_0) \int_{\omega_\varepsilon} \nabla u_0 \cdot \overline{\nabla w_\varepsilon} \, dx + (\alpha_1 - \alpha_0) \int_{\omega_\varepsilon} \nabla u_0 \cdot \overline{\nabla v_0} \, dx \\ &\quad - (\beta_1 - \beta_0) \int_{\omega_\varepsilon} u_0 \cdot \overline{w_\varepsilon} \, dx - (\beta_1 - \beta_0) \int_{\omega_\varepsilon} u_0 \cdot \overline{v_0} \, dx. \end{aligned}$$

The Green formula yields

$$\begin{aligned} (a_\varepsilon - a_0)(u_0, v_\varepsilon) &= (\alpha_1 - \alpha_0) \left[\int_{\partial\omega_\varepsilon} \frac{\partial u_0}{\partial n} \overline{w_\varepsilon} \, ds + \int_{\omega_\varepsilon} \nabla u_0 \cdot \overline{\nabla v_0} \, dx \right] \\ &\quad - (\beta_1 - \beta_0) \int_{\omega_\varepsilon} u_0 \cdot \overline{v_0} \, dx + \left(\frac{\alpha_1}{\alpha_0} \beta_0 - \beta_1 \right) \int_{\omega_\varepsilon} u_0 \cdot \overline{w_\varepsilon} \, dx. \end{aligned} \quad (31)$$

Then it follows from (31) and Lemmas 5 and 6 that the following proposition holds.

Proposition 7 *We have*

$$\begin{aligned} (a_\varepsilon - a_0)(u_0, v_\varepsilon) &= \varepsilon^d (\alpha_1 - \alpha_0) \nabla u_0(0)^T \left[\left(\frac{\alpha_0}{\alpha_1} - 1 \right) \int_{\partial B} \mathbf{n} \otimes \Phi(y) \, ds(y) + |B|I \right] \overline{\nabla v_0(0)} \\ &\quad + \varepsilon^d (\beta_0 - \beta_1) |B| u_0(0) \overline{v_0(0)} + o(\varepsilon^d). \end{aligned}$$

Then, Hypothesis 1 is satisfied with $f(\varepsilon) = \varepsilon^d$ and

$$\begin{aligned} \delta a &= (\alpha_1 - \alpha_0) \nabla u_0(0)^T \left[\left(\frac{\alpha_0}{\alpha_1} - 1 \right) \int_{\partial B} \mathbf{n} \otimes \Phi(y) \, ds(y) + |B|I \right] \overline{\nabla v_0(0)} \\ &\quad + (\beta_0 - \beta_1) |B| u_0(0) \overline{v_0(0)}. \end{aligned}$$

4.3 The topological asymptotic expansion

Provided that the cost function satisfies Hypothesis 2 (see Section 5.1 for some examples), all the assumptions of the adjoint method are checked and the topological asymptotic expansion is given by Theorem 1. We obtain the following result.

Theorem 8 *The cost function j has the following asymptotic expansion:*

$$\begin{aligned} &j(\varepsilon) - j(0) \\ &= \varepsilon^d \Re \left\{ (\alpha_1 - \alpha_0) \nabla u_0(0)^T (P + |B|I) \overline{\nabla v_0(0)} - (\beta_1 - \beta_0) |B| u_0(0) \overline{v_0(0)} + \delta J \right\} + o(\varepsilon^d). \end{aligned}$$

with

$$P = \left(\frac{\alpha_0}{\alpha_1} - 1 \right) \int_{\partial B} \mathbf{n} \otimes \Phi(y) \, ds(y), \quad \delta J = \delta J_1 = \delta J_2. \quad (32)$$

This matrix P only depends on the shape of B and on the ratio α_0/α_1 .

5 Particular cases

5.1 Particular cost functions

Our goal here is to give some examples of cost function satisfying Hypotheses 2 and 5. The proof of the following theorem is omitted.

Theorem 9 *We consider three cases.*

1. **First example.** *We denote $D_R = \Omega \setminus \overline{B(0, R)}$, R being a fixed radius such that $\overline{B(0, R)} \subset \Omega$. We consider a cost function of the form: $j(\varepsilon) = J_\varepsilon(u_\varepsilon) = J(u_\varepsilon|_{D_R})$. We assume that there exists L , a linear and continuous form on $H^1(D_R)$ such that*

$$J(u_{0|D_R} + h) = J(u_{0|D_R}) + \Re(L(h)) + o(\|h\|_{1,D_R}) \quad \forall h \in H^1(D_R).$$

Then, Hypotheses 2 and 5 are satisfied with

$$L_\varepsilon(u) = L(u|_{D_R}) \quad \forall u \in H^1(\Omega), \forall \varepsilon \geq 0$$

and

$$\delta J_1 = \delta J_2 = 0.$$

2. **Second example.** *It consists in the cost function*

$$j(\varepsilon) = J_\varepsilon(u_\varepsilon) = \int_{\Omega} \alpha_\varepsilon |u_\varepsilon - u_d|^2 dx,$$

where $u_d \in H^2(\Omega)$. Hypotheses 2 and 5 are satisfied with

$$L_\varepsilon(u) = 2 \int_{\Omega} \alpha_\varepsilon u \cdot \overline{(u_0 - u_d)} dx \quad \forall u \in H^1(\Omega),$$

$$\delta J_1 = 0,$$

$$\delta J_2 = (\alpha_1 - \alpha_0) |B| |u_0(0) - u_d(0)|^2.$$

3. **Third example.** *It consists in the cost function*

$$j(\varepsilon) = J_\varepsilon(u_\varepsilon) = \int_{\Omega} \alpha_\varepsilon |\nabla(u_\varepsilon - u_d)|^2 dx,$$

where $u_d \in H^3(\Omega)$. Hypotheses 2 and 5 are satisfied with

$$L_\varepsilon(u) = 2 \int_{\Omega} \alpha_\varepsilon \nabla u \cdot \overline{\nabla(u_0 - u_d)} dx \quad \forall u \in H^1(\Omega),$$

$$\delta J_1 = (\alpha_1 - \alpha_0) \nabla u_0(0)^T P \overline{\nabla u_0(0)},$$

$$\delta J_2 = (\alpha_1 - \alpha_0) |B| |\nabla u_0(0) - \nabla u_d(0)|^2,$$

where P is the matrix defined by (32).

5.2 Particular shaped dielectric objects

When B is the unit ball, we can explicitly determine Φ , the solution to Problem (23). In this special case we have

$$\Phi(y) = \frac{1}{(d-1)\frac{\alpha_0}{\alpha_1} + 1} \times \begin{cases} y & \text{in } B, \\ \frac{y}{|y|^d} & \text{in } \mathbb{R}^d \setminus \overline{B}. \end{cases} \quad (33)$$

Using Theorem 8 and (33) we obtain the following result.

Corollary 10 (ball) *If B is the unit ball, the matrix P of Theorem 8 reads*

$$P = \frac{\alpha_0 - \alpha_1}{(d-1)\alpha_0 + \alpha_1} |B| I$$

and the function j has the following asymptotic expansion:

$$j(\varepsilon) - j(0) = \varepsilon^d \Re \left\{ \frac{d\alpha_0(\alpha_1 - \alpha_0)}{(d-1)\alpha_0 + \alpha_1} |B| \nabla u_0(0) \cdot \overline{\nabla v_0(0)} - (\beta_1 - \beta_0) |B| u_0(0) \overline{v_0(0)} + \delta J \right\} + o(\varepsilon^d).$$

We now consider the case where B is an ellipse. We have the following result.

Corollary 11 (ellipse) *If B is an ellipse whose semi-major axis is of length a , and whose semi-minor axis is of length b (2D problem), the matrix P reads*

$$P = \pi ab (\alpha_0 - \alpha_1) \begin{pmatrix} \frac{1}{\alpha_0 a + \alpha_1 b} & 0 \\ 0 & \frac{1}{\alpha_0 b + \alpha_1 a} \end{pmatrix}$$

and the function j has the following asymptotic expansion:

$$j(\varepsilon) - j(0) = \varepsilon^2 \Re \left\{ (\alpha_1 - \alpha_0) \nabla u_0(0)^T P' \overline{\nabla v_0(0)} - (\beta_1 - \beta_0) \pi ab u_0(0) \overline{v_0(0)} + \delta J \right\} + o(\varepsilon^2),$$

with

$$P' = \pi ab \begin{pmatrix} \frac{\alpha_0(1+a) + \alpha_1(b-1)}{\alpha_0 a + \alpha_1 b} & 0 \\ 0 & \frac{\alpha_0(1+b) + \alpha_1(a-1)}{\alpha_0 b + \alpha_1 a} \end{pmatrix}.$$

For the expression of the function Φ we refer the reader to [8].

5.3 Metallic objects

Choosing $\alpha_1 \rightarrow 0$, $\beta_1 \rightarrow 0$, $\alpha_0 = 1$ and $\beta_0 = k^2$ (Helmholtz equation with Neumann condition on the boundary of a hole), we obtain formally from Corollary 10 and Corollary 11 the following results. In Corollaries 12 and 14, in the case $d = 2$, we retrieve former formulas [7].

Corollary 12 (ball) *If B is the unit ball and ω_ε is a hole with $\partial_n u_\varepsilon = 0$ on $\partial\omega_\varepsilon$, we obtain*

$$P = \frac{1}{d-1}|B|I$$

and

$$j(\varepsilon) - j(0) = \varepsilon^d \Re \left\{ \frac{-d}{d-1} |B| \nabla u_0(0) \cdot \overline{\nabla v_0(0)} + |B| k^2 u_0(0) \overline{v_0(0)} + \delta J \right\} + o(\varepsilon^d).$$

Corollary 13 (ellipse) *If B is an ellipse whose semi-major axis is of length a , and whose semi-minor axis is of length b , ω_ε is a hole and $\partial_n u_\varepsilon = 0$ on $\partial\omega_\varepsilon$, we obtain*

$$P = \pi \begin{pmatrix} b & 0 \\ 0 & a \end{pmatrix}$$

and

$$j(\varepsilon) - j(0) = \varepsilon^2 \Re \left\{ -\nabla u_0(0)^T P' \overline{\nabla v_0(0)} + \pi a b k^2 u_0(0) \overline{v_0(0)} + \delta J \right\} + o(\varepsilon^2),$$

with

$$P' = \pi \begin{pmatrix} (a+1)b & 0 \\ 0 & (b+1)a \end{pmatrix}.$$

Setting $b \rightarrow 0$, we obtain formally from Corollary 13 the following result.

Corollary 14 (straight crack) *If B is the segment $[-a, a] \times \{0\}$ and $\partial_n u_\varepsilon = 0$ on $\partial\omega_\varepsilon$, we obtain that*

$$j(\varepsilon) - j(0) = \varepsilon^2 \Re \left(-\pi a (\nabla u_0(0) \cdot \mathbf{n}) (\overline{\nabla v_0(0) \cdot \mathbf{n}}) + \delta J \right) + o(\varepsilon^2).$$

6 Numerical experiments

6.1 Identification of dielectric inhomogeneities

The sensitivity formulas are used here to identify dielectric objects with the help of electromagnetic waves and boundary measurements in 2D. Consider an open and bounded subset Ω of \mathbb{R}^2 whose boundary Γ is a regular polygon of n sides $\Gamma_i, i = 1, \dots, n$. A dielectric object whose properties are known is supposed to lie inside Ω . On each side of the external

boundary Γ is successively emitted an electromagnetic wave. The problem is modeled as follows:

$$\begin{cases} \operatorname{div}(\alpha \nabla u_i^m) + \beta u_i^m = 0 & \text{in } \Omega, \\ \partial_n u_i^m - i k u_i^m = 0 & \text{on } \Gamma_l, l \neq i, \\ \partial_n u_i^m - i k u_i^m = -2ik & \text{on } \Gamma_i. \end{cases}$$

In this PDE, u_i^m represents the vertical component of the electric field for an H -plane polarization, it represents the vertical component of the magnetic field for an E -plane polarization. The coefficients α and β are piecewise constant functions of the point x , respectively equal to α_1 and β_1 inside \mathcal{O} (see Table 1), $\alpha_0 = 1$, $\beta_0 = k^2 \in \mathbb{C}$ outside.

	α_1	β_1
H -plane	$\frac{1}{\nu^2}$	$\frac{\nu^2 k^2}{\mu_r}$
E -plane	$\frac{\mu_r}{\nu^2}$	$\mu_r k^2$

Table 1: PDE coefficients in electromagnetism (ν and μ_r denote respectively the index of refraction and the relative permeability of the object)

We assume that we have at our disposal the measurements

$$S_{ij}^m = S_j(u_i^m) = \int_{\Gamma_j} u_i^m ds, \quad i, j = 1, \dots, n.$$

To detect the actual object thanks to the knowledge of the matrix $(S_{ij}^m)_{i,j=1,\dots,n}$, we look for the best locations to insert small circular inhomogeneities to minimize the cost function

$$J(u_1, \dots, u_n) = \sum_{i=1}^n \sum_{j=1}^n |S_j(u_i) - S_{ij}^m|^2.$$

That information is provided by the topological gradient corresponding to that perturbation:

$$G(x) = \sum_{i=1}^n \Re \left(\frac{2\alpha_0(\alpha_0 - \alpha_1)}{\alpha_0 + \alpha_1} \nabla u_i(x) \cdot \overline{\nabla v_i(x)} - (\beta_1 - \beta_0) u_i(x) \overline{v_i(x)} \right),$$

where the n direct states u_i and the n adjoint states v_i are defined by:

$$\begin{cases} \Delta u_i + k^2 u_i = 0 & \text{in } \Omega, \\ \partial_n u_i - i k u_i = 0 & \text{on } \Gamma_l, l \neq i, \\ \partial_n u_i - i k u_i = -2ik & \text{on } \Gamma_i, \end{cases}$$

$$\begin{cases} \Delta \overline{v_i} + k^2 \overline{v_i} = 0 & \text{in } \Omega, \\ \partial_n \overline{v_i} - i k \overline{v_i} = 0 & \text{on } \Gamma_l, l \neq i, \\ \partial_n \overline{v_i} - i k \overline{v_i} = -2 \sum_{j=1}^n \overline{(S_j(u_i) - S_{ij}^m)} & \text{on } \Gamma_i. \end{cases}$$

Figure 1 shows three computations, performed in only one iteration with the parameters $k = 10$ and $n = 32$. The measurements are simulated numerically.

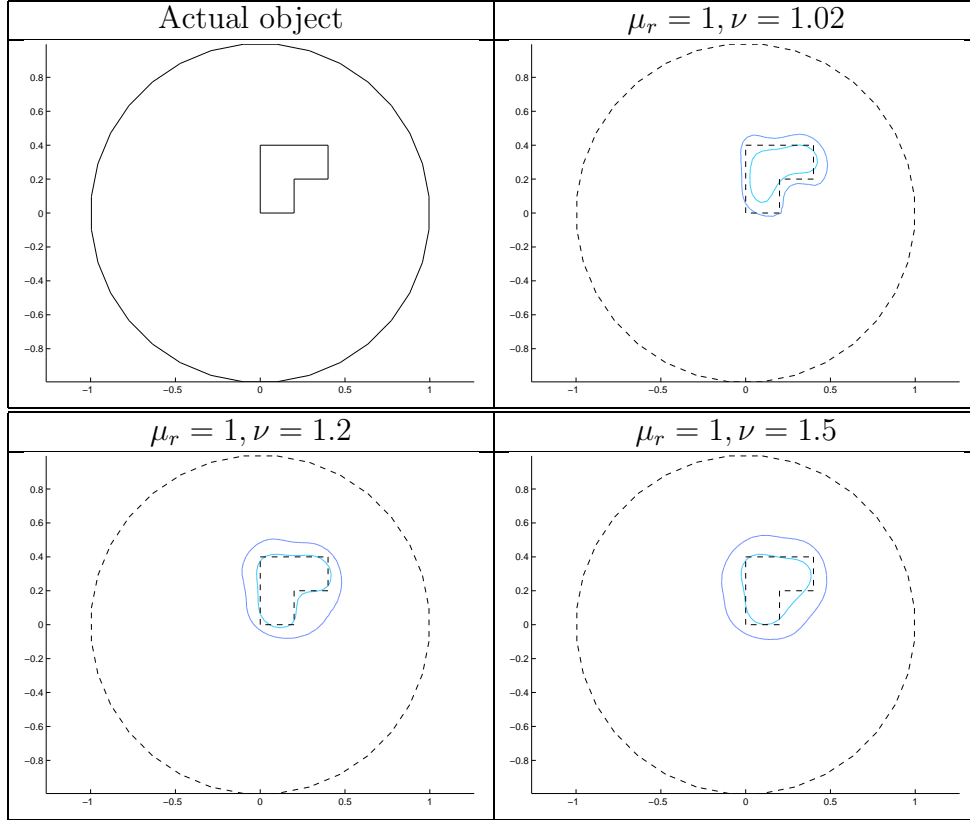

Figure 1: The actual object and two negative isovalues of the topological gradient

6.2 Defects detection in aircraft structures

It is of particular interest to apply the topological asymptotic approach to the equations of elastodynamics. Indeed many target detection methods involved in fields such as non destructive testing, submarine detection or medical imaging, use the so called pulse-echo method with acoustic or elastic waves at ultrasonic frequencies. The basic principle is the one of echography, i.e. a short pulse source is sent through the medium with an emitter/receiver apparatus and the variation of elastic properties of the medium (characterizing the kind of target) generates scattered waves that are recorded by the receiving apparatus. The major step is then to be able to read the results so that to detect, localize and characterize the target. The topological gradient is a great prospect for the automatical interpretation of these kind of results. It is clear that the pulse-echo method is intrinsically a transient phenomenon, then in order to mimic it we need to

derive asymptotic formulas for the elastodynamics equations in the time domain.

To do so we extend the formulas obtained in the theoretical part of the present paper in the time-harmonic case to the dynamic problem by using the duality of the frequency and time domain through the Fourier transform. The time domain problem associated to the linear elasticity problem reads

$$\rho \frac{\partial^2 u}{\partial t^2} - \operatorname{div} \sigma(u) = 0. \quad (34)$$

Then the corresponding time-harmonic problem is

$$\rho \omega^2 \hat{u} - \operatorname{div} \sigma(\hat{u}) = 0,$$

where $\hat{u}(x, \omega) = \int_{\mathbb{R}} u(t, x) e^{-i\omega t} dt$ is the Fourier transform of $u(x, t)$. Then starting with the cost function of the time domain problem and using successively Fubini's theorem and Parseval's equality, it comes

$$J(u) = \frac{1}{2} \int_{\mathbb{R}} \left(\int_{\Gamma_m} |u - u_m|^2 dx \right) dt = \int_{\mathbb{R}} \left(\frac{1}{2} \int_{\Gamma_m} |\hat{u} - \hat{u}_m|^2 dx \right) d\omega = \int_{\mathbb{R}} J^\omega(\hat{u}(\cdot, \omega)) d\omega. \quad (35)$$

At a given frequency, the asymptotic expansion for $J^\omega(\hat{u}(\cdot, \omega))$ is known. Starting from

$$J(u_\epsilon) - J(u_0) = \int_{\mathbb{R}} (J^\omega(\hat{u}_\epsilon(\cdot, \omega)) - J^\omega(\hat{u}_0(\cdot, \omega))) d\omega, \quad (36)$$

then using (35) and Parseval's equality, and assuming that $\int_{\mathbb{R}} o(\epsilon^2) d\omega \sim o(\epsilon^2)$, one obtains the expressions for the time domain problem. Denoting $\hat{u}_0 = \hat{u}_0(x_0, \omega)$ to simplify the writing, one has for instance for 2D Neumann plane stress (see Corollary 12 with the polarization tensor replaced by the one obtained by Garreau et al [12]):

$$\begin{aligned} & J(u_\epsilon) - J(u_0) \\ &= \pi \epsilon^2 \int_{\mathbb{R}} \left(-\frac{(\mu + \eta)}{2\mu\eta} (4\mu\sigma(\hat{u}_0) : \varepsilon(\hat{v}_0) + (\eta - 2\mu)\operatorname{tr}\sigma(\hat{u}_0)\operatorname{tr}\varepsilon(\hat{v}_0)) + \rho\omega^2 \hat{u}_0 \cdot \hat{v}_0 \right) d\omega + o(\epsilon^2) \\ &= \pi \epsilon^2 \int_{\mathbb{R}} \left(-\frac{(\mu + \eta)}{2\mu\eta} (4\mu\sigma(u_0) : \varepsilon(v_0) + (\eta - 2\mu)\operatorname{tr}\sigma(u_0)\operatorname{tr}\varepsilon(v_0)) - \rho \partial_t u_0 \cdot \partial_t v_0 \right) dt + o(\epsilon^2). \end{aligned} \quad (37)$$

The topological gradient at any point $x_0 \in \Omega$ is then

$$G(x_0) = \int_{\mathbb{R}} \left(-\frac{(\mu + \eta)}{2\mu\eta} (4\mu\sigma(u_0) : \varepsilon(v_0) + (\eta - 2\mu)\operatorname{tr}\sigma(u_0)\operatorname{tr}\varepsilon(v_0)) - \rho \partial_t u_0 \cdot \partial_t v_0 \right) dt.$$

Practically we will not have access to the solutions for $t \in \mathbb{R}$, but only over an interval $[0, T]$. Then T must be taken large enough so that the amplitude of the fields in the computation domain after the time T is weak enough to be neglected when computing the topological gradient.

6.2.1 The forward solver

It can be shown that the adjoint problem can be solved with the forward solver provided attention is paid to the fact that the adjoint problem solves backward in time from $t = T$ to $t = 0$.

We use a finite difference C++ code following Virieux numerical scheme [19] which is accurate at the order 2 in space and time and intrinsically centered. It allows one to take into account abrupt ruptures of elastic properties or density such as fluid/solid interfaces. This code is integrated to the software ACEL developed by M. Tanter [20] and which is dedicated to the simulation of acoustic and elastic wave propagation. The boundary conditions at the edges of the computation domain are either of the classical Dirichlet and Neumann type, or of absorbing type to simulate unbounded propagation. The implemented absorbing conditions are Perfectly Matched Layers following Collino and Tsogka [10].

6.2.2 Numerical results

In this section we present numerical results relative to non destructive testing. The measurement step is up to now replaced by a numerical solving of the forward problem in the presence of obstacles. The presented results are 2D since the 3D code is still being developed.

Unique Defect in an isotropic solid

The considered medium is an isotropic aluminium slab of density $\rho = 2572 \text{ kg.m}^{-3}$, the compressional (index p) and shear (index s) speeds of propagation are $v_p = 6408 \text{ m.s}^{-1}$ and $v_s = 3228 \text{ m.s}^{-1}$. The ultrasonic linear array is placed at the bottom of the slab. We use a 55 sensors array, all of them being used in emission and receive. Absorbing conditions are positioned at the boundaries of the computation domain, except at the bottom where a Dirichlet condition models the presence of the sensors.

The emitted signal is a pulse of $1 \mu\text{s}$ at the central frequency of 2 MHz (fig. 2). The defect is as shown on figure 3(a), it corresponds to a cylindrical hole whose size is of the order of the compressional wavelength λ_p . Then the boundary condition at the edges of the defect is 2D Neumann.

The position of the defect is clearly pointed out by the high level values of the topological gradient. The negative values (in red) indicate the bottom of the defect. Indeed, since we insonify from the bottom of the slab, it is clear that we have information about the shape of the bottom of the defect, and poor information in the acoustical shadow zones.

Let us now test the ability of the method to detect multiple defects of different sizes and shapes.

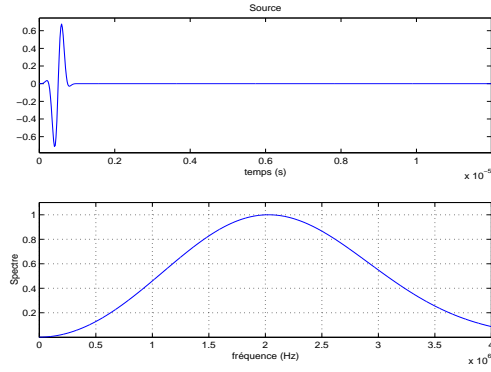

Figure 2: Source : temporal signal (top), frequency spectrum (bottom)

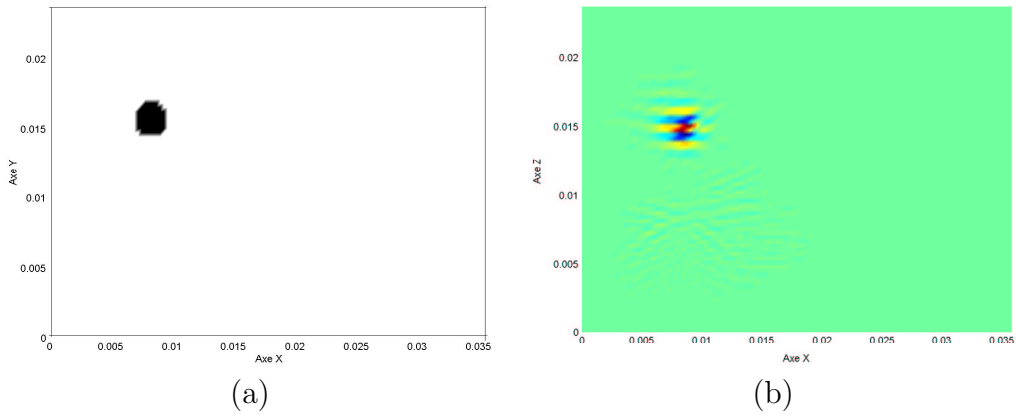

Figure 3: Detection of a unique defect. (a) Position of the defect, (b) Levels of the topological gradient

Multiple shaped defects

We put five defects of various shapes in the aluminium slab (fig. 4(a)). Their horizontal sizes vary from $\frac{\lambda_p}{5}$ to $\frac{3\lambda_p}{2}$. These defects are well resolved since they are separated from more than a wavelength. We use the same linear array and source as in the previous example. In order to draw nearer to experimental non destructive testing conditions, we have added white noise to the simulated measurements. Figures 4(b)(c)(d) show the levels of the topological gradient when the noise level is respectively of 0%, 5% and 10% of the maximum recorded value. In each presented result, the five defects are detected

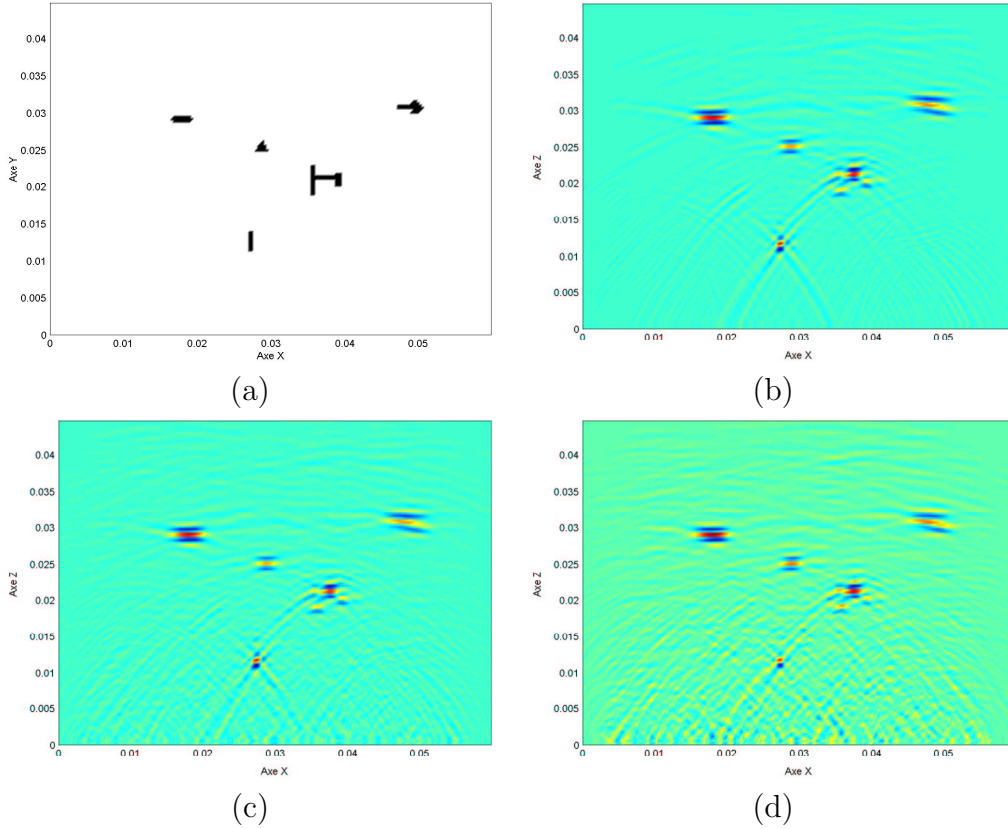

Figure 4: Detection of multiple shaped defects. (a) Positions of the defects, (b)-(d) Levels of the topological gradient (b) with no added noise, (c) with 5% of noise, (d) with 10% of noise

and localized. The approximate sizes and shapes of the obstacles are obtained, excepted in the shadow zones. It is very interesting to see that the method has a robust behavior upon addition of noise to the simulated measurements. It allows one to be optimistic as for the application of the method to experimental measurements that are intrinsically noisy.

REFERENCES

- [1] C. Alves, H. Ammari. *Boundary integral formulas for the reconstruction of imperfections of small diameter in an elastic medium*, SIAM J. Appl. Math. 62 (2001), 94-106.
- [2] H. Ammari. *An inverse initial boundary value problem for the wave equation in the presence of imperfections of small volume*, SIAM J. Control Optim. 41 (2003), 1194-1211.
- [3] H. Ammari, D. Volkov. *Asymptotic formulas for perturbations in the eigenfrequencies of the full Maxwell equations due to the presence of imperfections of small diameter*, Asympt. Anal. 30 (2002), 331-350.
- [4] H. Ammari, S. Moskow. *Asymptotic expansions for eigenvalues in the presence of small inhomogeneities*, Math. Meth. Appl. Sci. 26 (2003), 67-75.
- [5] H. Ammari, H. Kang. *A new method for reconstructing electromagnetic inhomogeneities of small volume*, Inverse problems 19 (2003), 63-71.
- [6] H. Ammari, H. Kang. *Boundary layer techniques for solving the Helmholtz equation in the presence of small inhomogeneities*, submitted to J. Math. Anal. Appl.
- [7] S. Amstutz. *The topological asymptotic for the Helmholtz equation: insertion of a hole, a crack and a dielectric object*, Rapport MIP no. 03-05.
- [8] M. Brühl, M. Hanke and M.S. Vogelius. *A direct impedance tomography algorithm for locating small inhomogeneities*, to appear in Numer. Math.
- [9] D.J. Cedio-Fengya, S. Moskow and M.S. Vogelius. *Identification of conductivity imperfections of small diameter by boundary measurements. Continuous dependence and computational reconstruction*, Inverse problems 14 (1998), 553-595.
- [10] F. Collino, C. Tsogka, *Application of the Perfectly Matched Layer Model to the Linear Elastodynamic Problem in Anisotropic Heterogeneous Media*, Geophysics 66 (1), 294-307, 2001.
- [11] S. Garreau, P. Guillaume and M. Masmoudi. *The topological sensitivity for linear isotropic elasticity*, European conference on computational Mechanics (ECCM99), 1999, rapport MIP no. 99.45.
- [12] S. Garreau, Ph. Guillaume, M. Masmoudi, *The topological Asymptotic for PDE systems: the elasticity case*, SIAM J. Control Optim. 39 (6), 1756-1778, 2001.
- [13] P. Guillaume, K. Sididris. *The topological asymptotic expansion for the Dirichlet problem*, accepted in SIAM journal on Control and Optimization.

- [14] M. Masmoudi. *The Topological Asymptotic*, in Computational Methods for Control Applications, International Series GAKUTO, 2002.
- [15] A.A. Novotny, R.A. Feijóo, E. Taroco and C. Padra. *Topological sensitivity analysis*, Comput. Methods Appl. Mech. Engrg. 192 (2003) 803-829.
- [16] J. Pommier, B. Samet. *The topological asymptotic for the Helmholtz equation with Dirichlet condition on the boundary of an arbitrary shaped hole*, submitted to SIAM Journal on Control and Optimization.
- [17] A. Schumacher. *Topologieoptimierung von Bauteilstrukturen unter Verwendung von Lopchpositionierungskriterien*, Thesis, Universität-Gesamthochschule Siegen, 1995.
- [18] J. Sokolowski, A. Żochowski. *On the topological derivative in shape optimization*, Technical report, INRIA, 1997.
- [19] J. Virieux, *P-SV wave propagation in heterogeneous media: Velocity-stress finite-difference method*, Geophysics 51 (4), 889-901, 1986.
- [20] M. Tanter, Software URL : <http://www.loa.espci.fr/~michael/fr/accel/acceltest.htm>
- [21] M.S. Vogelius, D. Volkov. *Asymptotic formulas for perturbations in the electromagnetic fields due to the presence of inhomogeneities of small diameter*, Math. Model. Numer. Anal. 34, pp. 723-748, 2000.

Article 5 :

The topological asymptotic expansion and its applications to optimal design

European Congress on Computational Methods in Applied Sciences and Engineering (2004)

THE TOPOLOGICAL ASYMPTOTIC EXPANSION AND ITS APPLICATIONS TO OPTIMAL DESIGN

M. Masmoudi*, P. Mader†, and B. Samet*

* Mathématiques pour l'Industrie et la Physique
UMR 5640, CNRS-Université Paul Sabatier-INSA, 118 route de Narbonne, 31062 Toulouse
Cedex 4
e-mails: masmoudi@mip.ups-tlse.fr, samet@mip.ups-tlse.fr

† Alcatel Space Industries
Space Antenna Department, 26, Avenue J.F. Champollion, 31037, Toulouse, France
e-mail: philippe.mader@space.alcatel.fr

Key words: Topological optimization, Shape optimization, topological gradient, topological asymptotic, waveguides.

Abstract. *In this paper, we present some strategies to obtain the topological asymptotic expansion with respect to different kinds of a domain perturbations. Some applications of this work to waveguides optimization in two and three dimensions are presented.*

1 INTRODUCTION

Topological optimization methods become very attractive for industrial applications. It becomes possible to satisfy more challenging specifications of industrial products by allowing modifications of the topology of the initial design. The most relevant topological optimization methods are based on the computation of a level set function:

- The material density in the case of the topological optimization via the homogenization theory [1, 2, 3, 4]. An optimal shape is derived from the optimization of material properties. The range of application of this approach is quite restrictive.
- The built-in level set function in the level set method [5, 6]. This approach gives very promising results. Even if it belongs to the classical shape optimization methods, it allows the modification of the number of connected components of the domain. Unfortunately, in this method, the resulting optimal shape is strongly dependent on the initial guess.
- The topological gradient provided by the topological asymptotic expansion, which is the concern of this paper.

In the latter case, at convergence, the positivity of the topological gradient inside the final domain provides a necessary and sufficient optimality condition. To present the basic idea, we consider Ω a domain of \mathbb{R}^n ($n=2$ or 3) and $j(\Omega) = J(u_\Omega)$ a cost function to be minimized, where u_Ω is the solution to a given PDE problem defined in Ω . For $\varepsilon > 0$, let $\Omega_\varepsilon = \Omega \setminus \overline{x_0 + \varepsilon\omega}$ be the subset obtained by removing a small part $\overline{x_0 + \varepsilon\omega}$ from Ω , where $x_0 \in \Omega$ and $\omega \subset \mathbb{R}^n$ is a fixed domain containing the origin. We can generally prove that the variation of the criterion is given by the asymptotic expansion:

$$j(\Omega_\varepsilon) = j(\Omega) + f(\varepsilon)g(x_0) + o(f(\varepsilon)), \quad (1)$$

$$\lim_{\varepsilon \rightarrow 0} f(\varepsilon) = 0, f(\varepsilon) > 0. \quad (2)$$

This expansion is called the topological asymptotic. To minimize the criterion j we just have to create infinitely small holes at some points \tilde{x} where the topological gradient (or sensitivity) $g(\tilde{x})$ is negative. For more details about this approach, we refer the reader to S. Garreau et al. [7], P. Guillaume and K. Sididris [8], H. Eschenauer and A. Schumacher [9], A.A. Novotny et al. [10] and J. Sokolowski and S. Nazarov [11]. In all these works, only the insertion of a hole is considered to modify the domain.

In this paper, the topological asymptotic analysis for the Helmholtz equation in two and three dimensions is presented. Here, we consider two cases of domain perturbation: insertion of holes and insertion of inhomogeneities. As a background to our work, we cite the contribution of H. Ammari et al. [12] for the study of solutions to the time-harmonic Maxwell equations in the presence of small inhomogeneities in the domain. Other contributions in this context can be found in [13, 14, 15, 16]. In all these publications, only

asymptotic formulas of solutions are given. Here, we derive asymptotic expansions not for solutions but for a given cost function.

The paper is organized as follows. In Section 2, we present different methods to obtain the topological asymptotic expansion with respect to the insertion of a hole in the domain. In Section 3, we consider the case of a perturbation resulting from the insertion of interior inhomogeneities. A large class of cost functions is considered. Finally, an optimization algorithm and some applications of the topological gradient to wave guides optimization are given in Section 4.

2 THE FIRST KIND OF PERTURBATION: INSERTION OF HOLES

2.1 Formulation of the problem

Let Ω be a bounded domain of \mathbb{R}^n with boundary Γ , $n = 2$ or 3 . The initial PDE problem is the following: find $u_\Omega \in H^1(\Omega)$ such that

$$\begin{cases} \Delta u_\Omega + \beta u_\Omega = 0 & \text{in } \Omega, \\ \partial_n u_\Omega = h & \text{on } \Gamma, \end{cases} \quad (3)$$

where β is a positive constant, $\partial_n u_\Omega$ is the normal derivative of u_Ω and $h \in H^{-\frac{1}{2}}(\Gamma)$. The boundary condition imposed on Γ could be replaced without any influence on the topological sensitivity analysis by any boundary condition.

Let ω be a bounded domain of \mathbb{R}^n containing the origin. For any sufficiently small parameter $\varepsilon > 0$, we consider the perforated domain $\Omega_\varepsilon = \Omega \setminus \overline{\omega_\varepsilon}$, where $\omega_\varepsilon = x_0 + \varepsilon\omega$ and $x_0 \in \Omega$. Let $u_{\Omega_\varepsilon} \in H^1(\Omega_\varepsilon)$ the solution to the perturbed problem:

$$\begin{cases} \Delta u_{\Omega_\varepsilon} + \beta u_{\Omega_\varepsilon} = 0 & \text{dans } \Omega_\varepsilon, \\ u_{\Omega_\varepsilon} = 0 & \text{sur } \partial\omega_\varepsilon, \\ \partial_n u_{\Omega_\varepsilon} = h & \text{sur } \Gamma. \end{cases} \quad (4)$$

We consider a cost function

$$j(\varepsilon) = J(u_{\Omega_\varepsilon|_{\mathcal{O}}}), \quad (5)$$

where \mathcal{O} is a neighbor part of Γ and J is a differentiable map from $H^1(\mathcal{O})$ into \mathbb{R} . We wish to obtain an asymptotic expansion of the variation $j(\varepsilon) - j(0)$ when ε tends to zero.

2.2 Mathematical tools

2.2.1 The generalized adjoint method

In this section, we recall the framework introduced in [17] which extends the adjoint method [18] to the topology shape optimization. Let \mathcal{V} be a Hilbert space. For $\varepsilon \geq 0$, let a_ε be a bilinear and continuous form on \mathcal{V} . We assume that there exists a constant $\alpha > 0$ such that

$$\inf_{u \neq 0} \sup_{v \neq 0} \frac{|a_0(u, v)|}{\|u\|_{\mathcal{V}} \|v\|_{\mathcal{V}}} \geq \alpha. \quad (6)$$

We say that a_0 satisfies the inf-sup condition. Assume that there exists a bilinear and continuous form δ_a and a real function $f(\varepsilon) > 0$ defined on \mathbb{R}^*_+ such that

$$\|a_\varepsilon - a_0 - f(\varepsilon)\delta_a\|_{\mathcal{L}_2(\mathcal{V})} = o(f(\varepsilon)), \quad (7)$$

$$\lim_{\varepsilon \rightarrow 0} f(\varepsilon) = 0, \quad (8)$$

where $\mathcal{L}_2(\mathcal{V})$ denotes the space of continuous and bilinear forms on \mathcal{V} .

For $\varepsilon \geq 0$, let u_ε be the solution to the problem: find $u_\varepsilon \in \mathcal{V}$ such that

$$a_\varepsilon(u_\varepsilon, v) = l(v) \quad \forall v \in \mathcal{V}, \quad (9)$$

where l is a linear and continuous form on \mathcal{V} . Consider now a function $j(\varepsilon) = J(u_\varepsilon)$, where J is a differentiable map from \mathcal{V} into \mathbb{R} . Next, the Lagrangian \mathcal{L} is defined by

$$\mathcal{L}(\varepsilon, u, v) = a_\varepsilon(u, v) - l(v) + J(u), \quad \forall \varepsilon \geq 0, u \in \mathcal{V}, v \in \mathcal{V}. \quad (10)$$

We have that

$$j(\varepsilon) - j(0) = \mathcal{L}(\varepsilon, u_\varepsilon, v) - \mathcal{L}(0, u_0, v), \quad \forall v \in \mathcal{V}. \quad (11)$$

Theorem 1 *The function j has the following asymptotic expansion:*

$$j(\varepsilon) - j(0) = f(\varepsilon)\delta_a(u_0, v_0) + o(f(\varepsilon)),$$

where v_0 is the solution to the adjoint problem: find $v_0 \in \mathcal{V}$ such that

$$a_0(w, v_0) = -DJ(u_0)w, \quad \forall w \in \mathcal{V}.$$

The function u_{Ω_ε} , solution to (4), belongs to a functional space which depends on ε . Hence, if we want to derive the asymptotic expansion of the cost function

$$j(\varepsilon) = J(u_{\Omega_\varepsilon|_{\mathcal{O}}}),$$

we cannot apply directly Theorem 1, which requires a fixed functional space. However, a functional space independent of ε can be constructed by using the following domain truncation technique.

2.2.2 The domain truncation technique

Let $R > \varepsilon$ be such that the ball $B(x_0, R)$ is included in Ω . The boundary of $B(x_0, R)$ is denoted by Γ_R , the truncated domain $\Omega \setminus \overline{B(x_0, R)}$ is denoted by Ω_R and D_ε denotes the corona $B(x_0, R) \setminus \overline{\omega_\varepsilon}$ (see Figure 1).

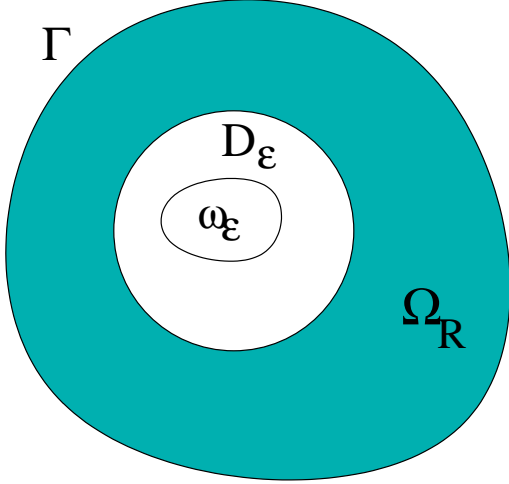

Figure 1: The truncated domain.

For all $\varepsilon \geq 0$, we introduce the *Dirichlet-to-Neumann* operator

$$\begin{aligned} T_\varepsilon : H^{1/2}(\Gamma_R) &\longrightarrow H^{-1/2}(\Gamma_R) \\ \varphi &\longmapsto T_\varepsilon \varphi = \nabla u_\varepsilon^\varphi \cdot n|_{\Gamma_R}, \end{aligned} \quad (12)$$

where $n|_{\Gamma_R}$ denotes the outward normal to the boundary Γ_R and u_ε^φ is the solution to

$$\begin{cases} \Delta u_\varepsilon^\varphi + \beta u_\varepsilon^\varphi = 0 & \text{in } D_\varepsilon, \\ u_\varepsilon^\varphi = \varphi & \text{on } \Gamma_R, \\ u_\varepsilon^\varphi = 0 & \text{on } \partial\omega_\varepsilon. \end{cases} \quad (13)$$

For all $\varepsilon \geq 0$, let u_ε be the solution to the truncated problem:

$$\begin{cases} \Delta u_\varepsilon + \beta u_\varepsilon = 0 & \text{in } \Omega_R, \\ \partial_n u_\varepsilon + T_\varepsilon u_\varepsilon = 0 & \text{on } \Gamma_R, \\ \partial_n u_\varepsilon = h & \text{on } \Gamma. \end{cases} \quad (14)$$

The variational formulation associated to Problem (14) is the following: find $u_\varepsilon \in \mathcal{V}_R$ such that

$$a_\varepsilon(u_\varepsilon, v) = l(v), \quad \forall v \in \mathcal{V}_R, \quad (15)$$

where the functional space \mathcal{V}_R the bilinear form a_ε and the linear form l are defined by

$$\begin{aligned} \mathcal{V}_R &= H^1(\Omega_R), \\ a_\varepsilon(u, v) &= \int_{\Omega_R} \nabla u \cdot \nabla v \, dx - \beta \int_{\Omega_R} uv \, dx + \int_{\Gamma_R} (T_\varepsilon u)v \, d\sigma(x), \\ l(v) &= \int_{\Gamma} hv \, d\sigma(x). \end{aligned} \quad (16)$$

The following result is standard in PDE theory.

Proposition 1 *The restriction to Ω_R of the solution to (4) is the solution to (14).*

We have now at our disposal the fixed Hilbert space \mathcal{V}_R required by the generalized adjoint method. Using Proposition 1, function (5) can be redefined in the following way:

$$j(\varepsilon) = J(u_{\Omega_\varepsilon|\mathcal{O}}) = J(u_\varepsilon), \quad \forall \varepsilon \geq 0. \quad (17)$$

Now, to obtain the asymptotic expansion of the cost function j , we must compute $f(\varepsilon)$ and δ_a such that the hypothesis (7) is satisfied.

2.3 Variation of the bilinear form

The variation of the bilinear form a_ε (see (16)) reads

$$a_\varepsilon(u, v) - a_0(u, v) = \int_{\Gamma_R} (T_\varepsilon - T_0)uv \, d\sigma(x). \quad (18)$$

Hence, the problem reduces to the analysis of $(T_\varepsilon - T_0)\varphi$ for $\varphi \in H^{1/2}(\Gamma_R)$. More precisely, it will be shown that there exists an operator $\delta_T \in \mathcal{L}(H^{1/2}(\Gamma_R), H^{-1/2}(\Gamma_R))$ such that

$$\|T_\varepsilon - T_0 - f(\varepsilon)\delta_T\|_{\mathcal{L}(H^{1/2}(\Gamma_R), H^{-1/2}(\Gamma_R))} = o(f(\varepsilon)). \quad (19)$$

Then, defining δ_a by

$$\delta_a(u, v) = \int_{\Gamma_R} (\delta_T u)v \, d\sigma(x), \quad u, v \in \mathcal{V}_R,$$

will yield straightforwardly

$$\|a_\varepsilon - a_0 - f(\varepsilon)\delta_a\|_{\mathcal{L}_2(\mathcal{V})} = o(f(\varepsilon)).$$

2.4 Asymptotic expansion of $(T_\varepsilon - T_0)$

2.4.1 The first method: the use of Fourier series

In the particular case when ω is the unit ball, using the Fourier series, we can obtain an explicit expression of the operator T_ε . For example, in the two dimensional case, we have

$$T_\varepsilon\varphi = \sqrt{\beta} \sum_{n \in \mathbb{Z}} \frac{J'_n(\sqrt{\beta}R)Y_n(\sqrt{\beta}\varepsilon) - J_n(\sqrt{\beta}\varepsilon)Y'_n(\sqrt{\beta}R)}{J_n(\sqrt{\beta}R)Y_n(\sqrt{\beta}\varepsilon) - Y_n(\sqrt{\beta}R)J_n(\sqrt{\beta}\varepsilon)} \varphi_n e^{in\theta}, \quad (20)$$

where (φ_n) are the Fourier coefficients of φ , (J_n) and (Y_n) are respectively the Bessel functions of the first and the second kind. Using that [19]

$$Y_0(\sqrt{\beta}\varepsilon) = \frac{2}{\pi} \left(\log(\sqrt{\beta}\varepsilon/2) + \gamma \right) J_0(\sqrt{\beta}\varepsilon) + \varepsilon\alpha(\varepsilon),$$

where γ denotes the Euler's constant and $\alpha(\varepsilon) \rightarrow 0$ when $\varepsilon \rightarrow 0$, we obtain [20] that

$$\|T_\varepsilon - T_0 - \frac{-1}{\log(\varepsilon)}\delta_T\|_{\mathcal{L}(H^{1/2}(\Gamma_R), H^{-1/2}(\Gamma_R))} = o\left(\frac{1}{\log(\varepsilon)}\right),$$

where the operator δ_T is given by

$$\delta_T\varphi = \frac{1}{RJ_0^2(\sqrt{\beta}R)}\varphi_0, \quad \forall \varphi \in H^{1/2}(\Gamma_R).$$

2.4.2 The second method: approximation by the solution to the integral equation

When ω is an arbitrary shaped hole, we propose the following method [21] to compute the asymptotic expansion of $(T_\varepsilon - T_0)$. The basic idea consists in approaching $u_\varepsilon^\varphi - u_0^\varphi$ by the solution to an exterior problem, where only the principal part of the non-homogeneous operator is used, which is described by the Laplace equation. More precisely, to compute the asymptotic expansion of $(T_\varepsilon - T_0)$, we start by looking at the asymptotic behavior of $u_\varepsilon^\varphi - u_0^\varphi$ since

$$(T_\varepsilon - T_0)\varphi = \nabla(u_\varepsilon^\varphi - u_0^\varphi) \cdot n|_{\Gamma_R}.$$

We recall that for $\varepsilon \geq 0$ and $\varphi \in H^{\frac{1}{2}}(\Gamma_R)$, the function u_ε^φ is the solution to problem (13) and we take $n = 3$. The variation $u_\varepsilon^\varphi - u_0^\varphi$ is the solution to

$$\begin{cases} \Delta(u_\varepsilon^\varphi - u_0^\varphi) + \beta(u_\varepsilon^\varphi - u_0^\varphi) = 0 & \text{in } D_\varepsilon, \\ u_\varepsilon^\varphi - u_0^\varphi = -u_0^\varphi & \text{on } \partial\omega_\varepsilon, \\ u_\varepsilon^\varphi - u_0^\varphi = 0 & \text{on } \Gamma_R. \end{cases} \quad (21)$$

We approximate $u_\varepsilon^\varphi - u_0^\varphi$ by $u_{\varepsilon,\varphi}$ solution to

$$\begin{cases} \Delta u_{\varepsilon,\varphi} + \beta u_{\varepsilon,\varphi} = 0 & \text{in } D_\varepsilon, \\ u_{\varepsilon,\varphi} = -u_0^\varphi(0) & \text{on } \partial\omega_\varepsilon, \\ u_{\varepsilon,\varphi} = 0 & \text{on } \Gamma_R. \end{cases} \quad (22)$$

This first approximation can be easily proved by the use of a Taylor development of the function u_0^φ . Then, we approximate $u_{\varepsilon,\varphi}$ by v_ε^φ , where $v_\varepsilon^\varphi(x) = v_\omega^\varphi\left(\frac{x}{\varepsilon}\right)$ and v_ω^φ is the solution to the exterior problem

$$\begin{cases} -\Delta v_\omega^\varphi = 0 & \text{in } \mathbb{R}^3 \setminus \bar{\omega}, \\ v_\omega^\varphi = 0 & \text{at } \infty, \\ v_\omega^\varphi = -u_0^\varphi(0) & \text{on } \partial\omega. \end{cases} \quad (23)$$

The function v_ε^φ can be expressed by a single layer potential on $\partial\omega$. We have that

$$v_\varepsilon^\varphi(x) = \varepsilon \left(\int_{\partial\omega} p_\omega(x) d\sigma(x) \right) E(x) + O(\varepsilon^2), \quad (24)$$

where E is the fundamental solution for the Laplace equation in \mathbb{R}^3 and $p_\omega \in H^{-\frac{1}{2}}(\partial\omega)$ is the solution to the integral equation

$$\int_{\partial\omega} E(y-x)p_\omega(x) d\gamma(x) = -u_0^\varphi(0), \quad \forall y \in \partial\omega.$$

Let $P_\omega^\varphi(x) = \left(\int_{\partial\omega} p_\omega(x) d\sigma(x)\right) E(x)$, we can write that

$$(u_\varepsilon^\varphi - u_0^\varphi)(x) = \varepsilon P_\omega^\varphi(x) + R(\varepsilon). \quad (25)$$

If we introduce the operator δT defined by

$$\delta T\varphi = \nabla P_\omega^\varphi \cdot n|_{\Gamma_R} \quad \forall \varphi \in H^{\frac{1}{2}}(\Gamma_R), \quad (26)$$

we obtain that

$$\|T_\varepsilon - T_0 - \varepsilon\delta T\|_{\mathcal{L}(H^{\frac{1}{2}}(\Gamma_R), H^{-\frac{1}{2}}(\Gamma_R))} = O(\varepsilon).$$

But, this result is not sufficient to get the behavior needed by the generalised adjoint method who requires $o(\varepsilon)$ not $O(\varepsilon)$. This due to the approximation used on the exterior problem (23), where just the principal part of the operator is considered. For this reason, a new term Q_ω^φ is used in order to correct the error caused by the approximation (25). We construct Q_ω^φ as solution to

$$\begin{cases} \Delta Q_\omega^\varphi + \beta Q_\omega^\varphi &= \beta P_\omega^\varphi & \text{in } D_0, \\ Q_\omega^\varphi &= P_\omega^\varphi|_{\Gamma_R} & \text{on } \Gamma_R. \end{cases} \quad (27)$$

Now, the operator δT is defined by

$$\delta T\varphi = \nabla(P_\omega^\varphi - Q_\omega^\varphi) \cdot n|_{\Gamma_R} \quad \forall \varphi \in H^{\frac{1}{2}}(\Gamma_R), \quad (28)$$

and we have that

$$\|T_\varepsilon - T_0 - \varepsilon\delta T\|_{\mathcal{L}(H^{\frac{1}{2}}(\Gamma_R), H^{-\frac{1}{2}}(\Gamma_R))} = o(\varepsilon). \quad (29)$$

2.4.3 A comparison between the first and the second method

The first method can be used only when the hole has a particular shape. The advantage of this method is that it allows to obtain an explicite expression of the variation $T_\varepsilon - T_0$, what gives us a precise idea about the term dominating. However, in the case of a non-homogeneous operator, the use of this method involves many difficulties: the general term of the series is expressed by the help of special functions (Bessel functions in our case), the study of the behavior of the general term when $n \rightarrow \infty$ and $\varepsilon \rightarrow 0$, the uniform convergence of the series,...Nevertheless, when we dont have good knowledge about the operator properties, this method can be used for a first approach. By the use of the second method, we can study the case of an arbitrary shaped hole. Then, this later is more general and it does not necessitate many calculations.

2.5 The topological asymptotic expansion

2.5.1 The two dimensional case

In the next theorem, where ω is not supposed to be a ball, one can observe that in two dimensional case the topological sensitivity does not depend on the shape of the hole ω [20], in contrast to the three dimensional case.

Theorem 2 *In the two dimensional case, the topological asymptotic expansion is given by*

$$j(\varepsilon) - j(0) = -\frac{2\pi}{\log(\varepsilon)} u_\Omega(x_0) v_\Omega(x_0) + o\left(\frac{1}{\log(\varepsilon)}\right),$$

where u_Ω and v_Ω denote respectively the direct and the adjoint state.

2.5.2 The three dimensional case

In [21], the following result is proved.

Theorem 3 *In the three dimensional case, the topological asymptotic expansion is given by*

$$j(\varepsilon) - j(0) = \varepsilon \left(\int_{\partial\omega} p_\omega(x) d\sigma(x) \right) v_\Omega(x_0) + o(\varepsilon),$$

where $p_\omega \in H^{-\frac{1}{2}}(\partial\omega)$ is the solution to the integral equation

$$\int_{\partial\omega} E(y-x) p_\omega(x) d\gamma(x) = u_\Omega(x_0), \quad \forall y \in \partial\omega.$$

and v_Ω is the adjointe state.

Corollary 1 *When ω is the unit ball, the topological asymptotic expansion is given by*

$$j(\varepsilon) - j(0) = 4\pi\varepsilon u_\Omega(x_0) v_\Omega(x_0) + o(\varepsilon),$$

where u_Ω and v_Ω denote respectively the direct and the adjoint state.

3 THE SECOND KIND OF PERTURBATION: INSERTION OF INHOMOGENEITIES

3.1 Formulation of the problem

Let Ω be a bounded domain of \mathbb{R}^n , $n = 2$ or 3 . We suppose that Ω contains a small inhomogeneity ω_ε of the form $\omega_\varepsilon = \varepsilon\omega$, where $\omega \subset \mathbb{R}^n$ is a bounded domain containing 0 (the origin) and ε is the order of magnitude of the diameter of the inhomogeneity. Let u_ε be the solution to the Helmholtz problem:

$$\begin{cases} \nabla \cdot (\alpha_\varepsilon \nabla u_\varepsilon) + \beta_\varepsilon u_\varepsilon = 0 & \text{in } \Omega, \\ \partial_n u_\varepsilon = h & \text{on } \Gamma. \end{cases} \quad (30)$$

Here, $\Gamma = \partial\Omega$, $h \in H^{-\frac{1}{2}}(\Gamma)$ and α_ε is a piecewise constant function defined by

$$\alpha_\varepsilon(x) = \begin{cases} \alpha_0 & \text{if } x \in \Omega \setminus \overline{\omega_\varepsilon}, \\ \alpha_1 & \text{if } x \in \omega_\varepsilon, \end{cases} \quad (31)$$

where α_0 and α_1 are positive constants. The piecewise constant function β_ε is defined analogously.

We consider a cost function $j(\varepsilon) = J_\varepsilon(u_\varepsilon) \in \mathbb{R}$, where J_ε is a differentiable function, defined in $H^1(\Omega)$. Our aim is to compute an asymptotic expansion of the variation $j(\varepsilon) - j(0)$ with respect to ε .

3.2 Variational formulation

The variational formulation associated to (30) is: find $u_\varepsilon \in H^1(\Omega)$ such that

$$a_\varepsilon(u_\varepsilon, v) = l(v) \quad \forall v \in H^1(\Omega), \quad (32)$$

where for all u, v in $H^1(\Omega)$,

$$a_\varepsilon(u, v) = \int_{\Omega} \alpha_\varepsilon \nabla u \cdot \nabla v \, dx - \int_{\Omega} \beta_\varepsilon uv \, dx, \quad (33)$$

$$l(v) = \alpha_0 \int_{\Gamma} hv \, d\sigma(x). \quad (34)$$

In the next section, we present two different methods to compute the topological asymptotic expansion in the case of the insertion of small inhomogeneities in the domain.

3.3 Different possibilities

3.3.1 The first possibility: the use of the generalized adjoint method

As a first possibility, we can use the generalized adjoint method presented in Section 2.2.1. In this situation, the functional space where the perturbed problem is defined ($\mathcal{V} = H^1(\Omega)$) is independent of the parameter ε . But, like in the case of the insertion of a hole, we can not apply directly the generalized adjoint method. More precisely, the variation $(a_\varepsilon - a_0)(u_0, v_0)$ is given by

$$(a_\varepsilon - a_0)(u_0, v_0) = (\alpha_1 - \alpha_0) \int_{\omega_\varepsilon} \nabla u_0 \cdot \nabla v_0 \, dx - (\beta_1 - \beta_0) \int_{\omega_\varepsilon} u_0 v_0 \, dx.$$

Using a Taylor development of u_0 and v_0 , we can prove that

$$(a_\varepsilon - a_0)(u_0, v_0) = \varepsilon^n |\omega| ((\alpha_1 - \alpha_0) \nabla u_0(0) \cdot \nabla v_0(0) - (\beta_1 - \beta_0) u_0(0) v_0(0)) + o(\varepsilon^n).$$

If we write that the topological gradient is given by

$$\delta_a(u_0, v_0) = |\omega| ((\alpha_1 - \alpha_0) \nabla u_0(0) \cdot \nabla v_0(0) - (\beta_1 - \beta_0) u_0(0) v_0(0)),$$

we obtain a wrong result, since the bilinear form δ_a is not continuous in $H^1(\Omega)$. For this reason, we must use the domain truncation technic, that assures the continuity of the obtained bilinear form δ_a .

3.4 The second possibility: an adjoint method for the inhomogeneities

Let \mathcal{V} be a Hilbert space. For all $\varepsilon \geq 0$, let a_ε be a bilinear and continuous form on \mathcal{V} and l be a linear and continuous form on \mathcal{V} . We assume that for all $\varepsilon \geq 0$, The following problem: find $u_\varepsilon \in \mathcal{V}$ such that

$$a_\varepsilon(u_\varepsilon, v) = l(v) \quad \forall v \in \mathcal{V} \quad (35)$$

has one and only one solution. Consider now a cost function $j(\varepsilon) = J_\varepsilon(u_\varepsilon) \in \mathbb{R}$, $\varepsilon \geq 0$. Suppose that the following hypotheses hold.

Hypothesis 1 *There exist a function $f(\varepsilon) > 0$ and two real numbers δJ_1 and δJ_2 such that*

$$J_\varepsilon(u_\varepsilon) = J_\varepsilon(u_0) + DJ_\varepsilon(u_0).(u_\varepsilon - u_0) + f(\varepsilon)\delta J_1 + o(f(\varepsilon)), \quad (36)$$

$$J_\varepsilon(u_0) = J_0(u_0) + f(\varepsilon)\delta J_2 + o(f(\varepsilon)), \quad (37)$$

$$\lim_{\varepsilon \rightarrow 0} f(\varepsilon) = 0. \quad (38)$$

Hypothesis 2 *There exist a real number δ_a such that*

$$(a_\varepsilon - a_0)(u_0, v_\varepsilon) = f(\varepsilon)\delta_a + o(f(\varepsilon)), \quad (39)$$

where v_ε is the solution to

$$a_\varepsilon(w, v_\varepsilon) = -DJ_\varepsilon(u_0).w \quad \forall w \in \mathcal{V}. \quad (40)$$

It is supposed that for all $\varepsilon \geq 0$, Problem (40) has one and only one solution. We call v_0 the adjoint state. We have the following result.

Theorem 4 *The variation of the cost function j with respect to ε is given by*

$$j(\varepsilon) - j(0) = f(\varepsilon)\delta j + o(f(\varepsilon)),$$

where $\delta j = \delta_a + \delta J$ and $\delta J = \delta J_1 + \delta J_2$.

Then, to obtain the topological gradient expression, we must compute the two real numbers δ_a and δJ .

3.5 A comparison between the first and the second possibility

The domain truncation technic is a general method which is independent of the type of the domain perturbation. However, when the cost function is defined in all the doamin, the use of this technic presents some difficulties (see [8]). The second method does not require a domain truncation and it allows us to study easily general cost functions.

3.6 The topological asymptotic expansion

All the results presented in this section were proved in [22].

3.6.1 The general case

Theorem 5 *The variation $j(\varepsilon) - j(0)$ has the following asymptotic expansion:*

$$j(\varepsilon) - j(0) = \varepsilon^n \left\{ (\alpha_1 - \alpha_0) \nabla u_0(0)^T \left[\left(\frac{\alpha_0}{\alpha_1} - 1 \right) \int_{\partial\omega} \mathbf{n} \otimes \Phi(y) \, ds(y) + |\omega| I \right] \nabla v_0(0) - (\beta_1 - \beta_0) |\omega| u_0(0) v_0(0) + \delta J \right\} + o(\varepsilon^n),$$

where δJ is a real number who depends of the choice of the function j (see Table 1), \otimes denotes the tensorial product between two vectors; $U \otimes V = (U_i V_j)_{1 \leq i, j \leq n} \quad \forall U, V \in \mathbb{R}^n$ and Φ is the solution to

$$\begin{cases} \Delta \Phi = 0 \text{ in } \omega \text{ and } \mathbb{R}^n \setminus \bar{\omega}, \\ \Phi \text{ is continuous across } \partial\omega, \\ \frac{\alpha_0}{\alpha_1} \left(\frac{\partial \Phi}{\partial n} \right)^+ - \left(\frac{\partial \Phi}{\partial n} \right)^- = -\mathbf{n}, \\ \lim_{|y| \rightarrow \infty} |\Phi(y)| = 0. \end{cases}$$

Here, \mathbf{n} denotes the outward unit normal to $\partial\omega$; superscript $+$ and $-$ indicate the limiting values as we approach $\partial\omega$ from outside ω , and from inside ω , respectively.

3.6.2 The case of a spherical inhomogeneity

In the particular case when ω is the unit ball, we have the following result.

Corollary 2 *When ω is the unit ball, the variation $j(\varepsilon) - j(0)$ has the following asymptotic expansion:*

$$j(\varepsilon) - j(0) = \varepsilon^n \left\{ \frac{n\alpha_0(\alpha_1 - \alpha_0)}{(n-1)\alpha_0 + \alpha_1} |\omega| \nabla u_0(0) \cdot \nabla v_0(0) - (\beta_1 - \beta_0) |\omega| u_0(0) v_0(0) + \delta J \right\} + o(\varepsilon^n).$$

3.6.3 Particular cost functions

The following table presents some examples of cost functions. For each case, the expression of the real number δJ is given for a spherical inhomogeneity.

The cost function	δJ
$j(\varepsilon) = J(u_\varepsilon _\Gamma)$	0
$j(\varepsilon) = \int_\Omega \alpha_\varepsilon u_\varepsilon - u_d ^2 dx$	$(\alpha_1 - \alpha_0) \omega u_0(0) - u_d(0) ^2$
$j(\varepsilon) = \int_\Omega \alpha_\varepsilon \nabla(u_\varepsilon - u_d) ^2 dx$	$(\alpha_1 - \alpha_0) \omega \nabla u_0(0) - \nabla u_d(0) ^2$ $-\frac{(\alpha_1 - \alpha_0)^2}{(n-1)\alpha_0 + \alpha_1} \omega \nabla u_0(0) ^2$

Table 1: Some examples of cost functions.

3.6.4 The case of a Neumann condition on the boundary of the hole

To obtain the topological asymptotic expansion in the case of a Neumann condition on the boundary of the hole, it suffices to tend α_1 and β_1 to zero, in the expression given by Theorem 5. We obtain the following result.

Corollary 3 *In the case of a Neumann condition on the boundary of a spherical hole, the variation $j(\varepsilon) - j(0)$ is given by*

$$j(\varepsilon) - j(0) = \varepsilon^n \left\{ \frac{-n}{n-1} |\omega| \nabla u_0(0) \cdot \nabla v_0(0) + |\omega| (\beta_0/\alpha_0) u_0(0) v_0(0) + \delta J \right\} + o(\varepsilon^n).$$

4 SOME APPLICATIONS

4.1 L-shaped waveguide

In this example, we use the topological gradient to optimize a H-plane L-shaped waveguide. The initial domain is presented on Figure 2. It is composed from two rectangular waveguides and a square zone divided into 40×40 cells (c_{ij} with $1 \leq i, j \leq 40$). According to the iterations of the algorithm, the meshes can be empty or metallic. With the exception of the two access ports, the boundary of the waveguide is metallic. The input Γ_1 is excited by the TE₁₀ mode: the excitation is given by

$$u_e(y) = \cos\left(\frac{\pi y}{d}\right), \quad \forall y \in \Gamma_1,$$

where d is the length of Γ_1 . Our aim is to minimize the reflexion coefficient S_{11} in the 11.7-12.5 GHz range. In this example, we take 9 values of frequencies: $f_d = 11.7 + (d-1) \times 0.1$, where $d = 1, \dots, 9$.

The cost function to minimize is given by

$$J = \sum_{d=1}^9 (|S_{12}(f_d)| - 1)^2 + (|S_{21}(f_d)|^2 - 1)^2. \quad (41)$$

We remark that the choice of the cost function implies a symmetry in the optimization.

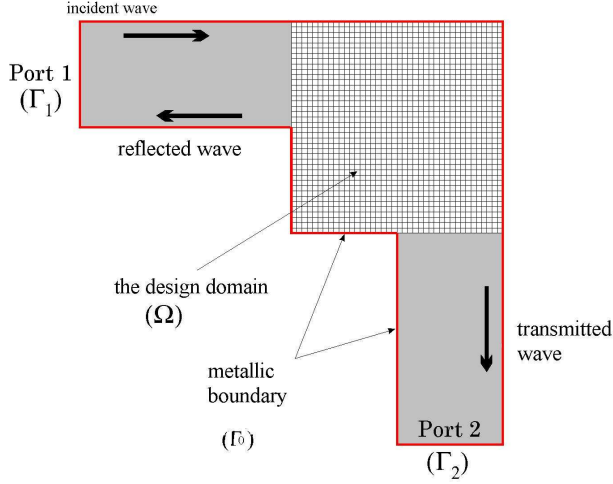

Figure 2: The initial domain.

To compute the cost function, we must solve for a given frequency the two following problems:

$$\begin{cases} \Delta E_1(f_d) + k_0^2 E_1(f_d) = 0 & \text{in } \Omega, \\ E_1(f_d) = 0 & \text{on } \Gamma_0, \\ \partial_n E_1(f_d) - ik E_1(f_d) = 2ik \sin\left(\frac{\pi y}{d}\right) & \text{on } \Gamma_1, \\ \partial_n E_1(f_d) - ik E_1(f_d) = 0 & \text{on } \Gamma_2, \end{cases} \quad (42)$$

$$\begin{cases} \Delta E_2(f_d) + k_0^2 E_2(f_d) = 0 & \text{in } \Omega, \\ E_2(f_d) = 0 & \text{on } \Gamma_0, \\ \partial_n E_2(f_d) - ik E_2(f_d) = 0 & \text{on } \Gamma_1, \\ \partial_n E_2(f_d) - ik E_2(f_d) = 2ik \sin\left(\frac{\pi y}{d}\right) & \text{on } \Gamma_2, \end{cases} \quad (43)$$

where $k^2 = k_0^2 - (\pi/d)^2$.

The initial solution of the problem is very bad. The value of the cost function is $J^0 = 16.95$. The function that we use for the optimization algorithm is the sum for the frequency band of the topological gradient values:

$$g(x, y) = \sum_{d=1}^9 g_{f_d}(x, y), \quad (44)$$

where g_{f_d} is the topological gradient associated to the frequency f_d . We recall that

$$g_{f_d}(x, y) = \Re \left(E_1(f_d) \overline{v_1(f_d)} + E_2(f_d) \overline{v_2(f_d)} \right), \quad (45)$$

where $v_1(f_d)$ and $v_2(f_d)$ are the adjoint states.

We present here the topological optimization algorithm. The underlying idea consists in inserting a Dirichlet node (metal) where the topological gradient is very negatif. The algorithm is the following:

- Step 0: Choose the initial domain Ω^0 . We pose as an optimization domain the cells $c_{i,j}$, where $1 \leq i, j \leq 40$.
- Step 1: Compute the cost function J^l . Compute the topological gradient $G^l(x, y)$. We take (\tilde{x}, \tilde{y}) such that:

$$G^l(\tilde{x}, \tilde{y}) = \min_{x,y} G^l(x, y) \text{ and } G^l(\tilde{x}, \tilde{y}) < 0.$$

The cell c_{ij} such that $(\tilde{x}, \tilde{y}) \in c_{ij}$ is converted into a metallic plot. The new domain is given by $\Omega^{l+1} = \Omega^l \setminus c_{ij}$.

- The stop criterion: $G^l(x, y) \geq 0, \quad \forall (x, y) \in \Omega^l$.

Figure 3.(a) shows the isovalues of the topological gradient for the initial geometry. One notes the presence of two symmetrical local minimas. At each local minima, we introduce a metallic plot. A new analysis is performed: after the introduction of another metallic plot, we obtain the design of Figure 3.(b).

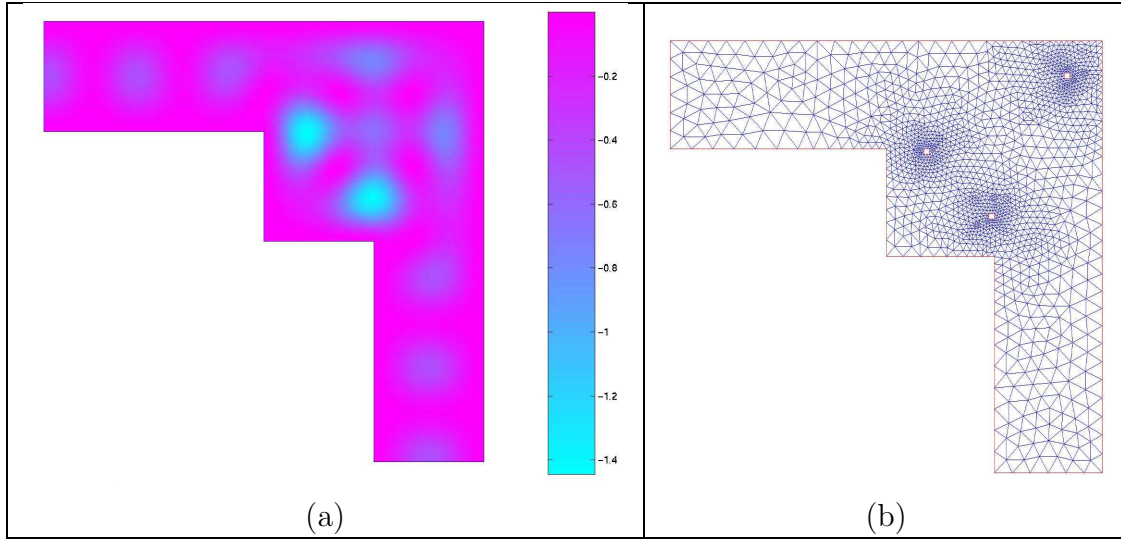

Figure 3: The topological gradient(a) and the optimal solution (b).

The optimal solution was found after two iterations. The corresponding cost function is given by $J^2 = 0.38$. Although the solution is better than the initial geometry, it is not satisfactory industrially. indeed, the final coefficient of reflexion is lesser than -40db only on a very low bandwidth. This is due to the fact that the optimization domain is a metallic cavity which produces many reflexions. Then, the initial problem that we posed adds an additional difficulty for the optimization. For this reason, we pose the initial problem differently. More precisely, at the first iteration, the two waveguides are not connected (see Figure 4.(a)), and the topological gradient is computed in the free-space rectangular region (see Figure 4.(b)). Using this topological gradient, a new and original junction shape is obtained (see Figure 5) which has a very small reflexion coefficient (lesser than -40db).

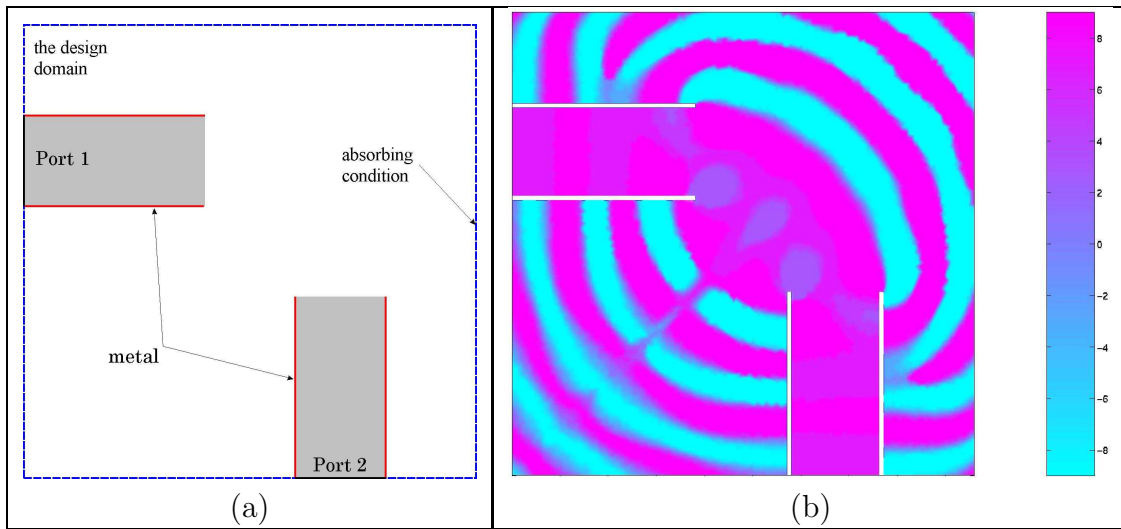

Figure 4: The initial geometry(a) and the topological gradient(b).

4.2 T-shaped waveguide

In this example, we use the topological gradient to design an E-plane T-shaped waveguide. In the beginning, only the input and output channels have metallic boundaries (see Figure 7.(b)). Our aim is to obtain a reflexion coefficient S_{11} lesser than -25 db in the 19-21 GHz range. Here, we take 5 values of frequencies: $f_d = 19 + (d - 1) \times 0.5$, where $d = 1, \dots, 5$. The cost function to minimize is given by

$$J = \sum_{d=1}^5 \left(|S_{31}(f_d)| - \frac{1}{\sqrt{2}} \right)^2 + \left(|S_{21}(f_d)| - \frac{1}{\sqrt{2}} \right)^2. \quad (46)$$

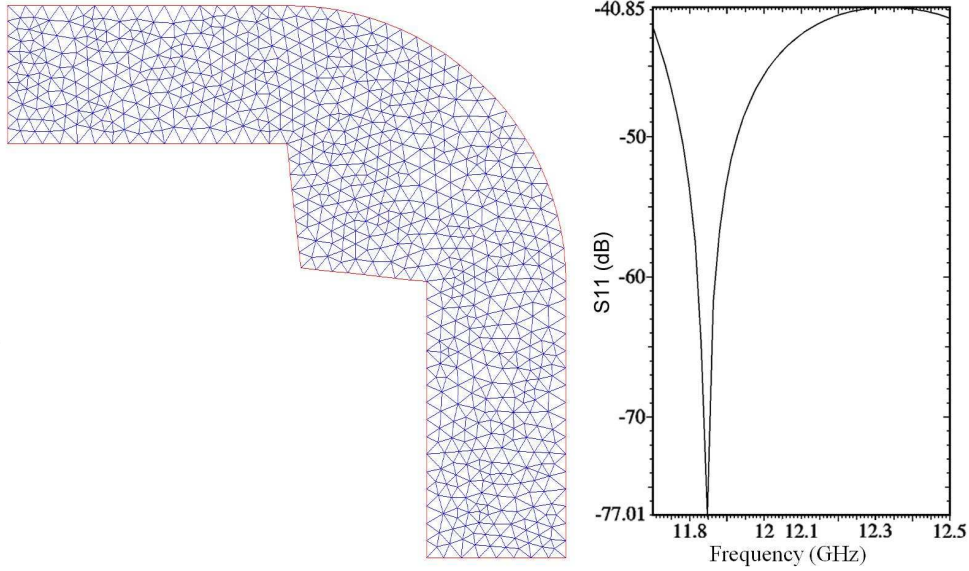

Figure 5: The optimal solution.

Figure 6 shows the classical structure of the component.

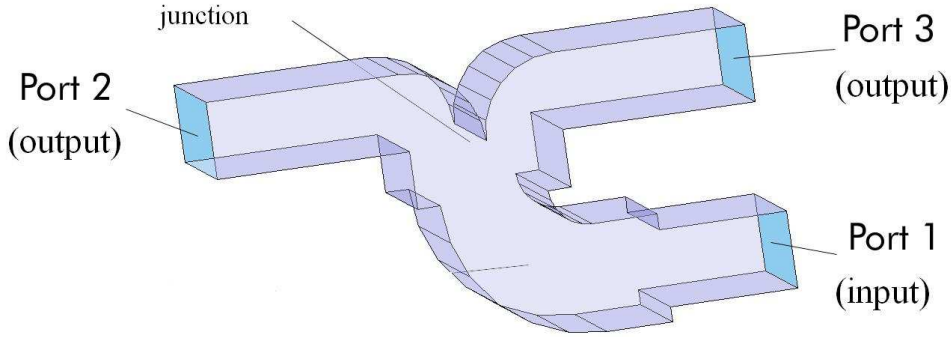

Figure 6: The classical structure of the component.

The topological gradient associated to a given frequency f_d is [22]:

$$g_{f_d}(x, y) = -\pi \Re \left(2 \nabla E(f_d) \cdot \overline{\nabla v(f_d)} - k^2 E(f_d) \overline{v(f_d)} \right), \quad (47)$$

where $E(f_d)$ and $v(f_d)$ are respectively the direct and the adjoint state. We use the same strategy as the preceding example. Figure 7.(a) shows the isovalues of the topological gradient computed in the free space. The optimal shape is given by Figure 8.(a) and the obtained reflexion coefficient in the 19-21 GHz range is given by Figure 8.(b).

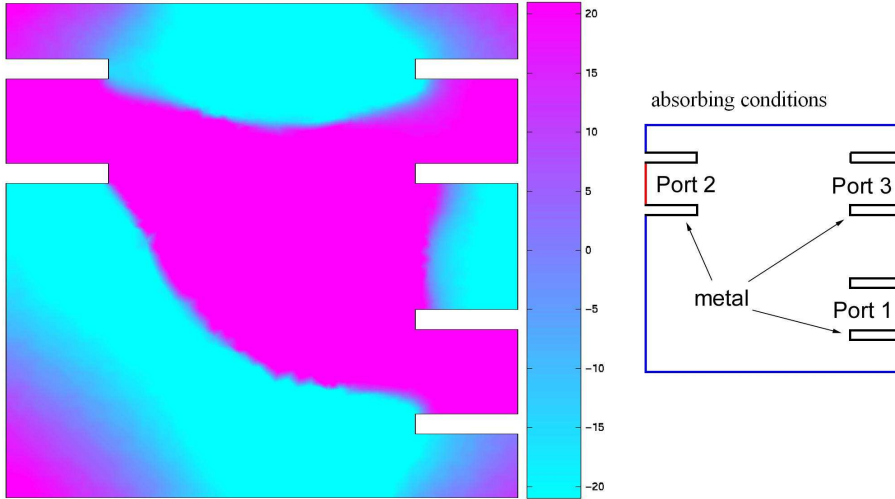

Figure 7: The topological gradient (a) and the design domain (b).

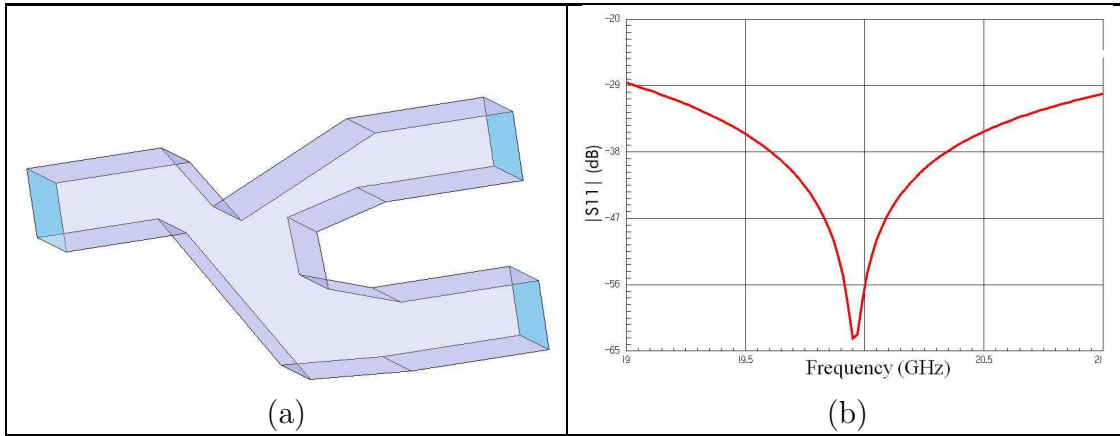

Figure 8: The optimal solution(a) and the reflexion coefficients(b).

4.3 Optimization of a septum polarizer

In this example, our aim is to find an optimal shape of a septum for a polarizer (see Figure 9) constituted by three access: a common access for the right and the left circular polarization and two standard access. The goal of the septum is to separate the signal with the right and the left circular polarization. Each output access receive one of these two signals. Here, we work in the 6.9-7.2 GHz range. We search a reflexion coefficient lesser than -25 db and a rate of ellipticity lesser than 0.2 db. The rate of ellipticity is

given by:

$$r = 20 \log_{10} \frac{|E_x|}{|E_y|}.$$

The initial domain is given by Figure 10. The cost function to minimize is defined by

$$J = \sum_{d=1}^7 (|S_{31}(f_d) + iS_{41}(f_d)| - 1)^2 + (|S_{32}(f_d) + iS_{42}(f_d)|)^2 \\ + (|S_{31}(f_d) - iS_{41}(f_d)|)^2 + (|S_{32}(f_d) - iS_{42}(f_d)| - 1)^2,$$

where $f_d = 6.9 + (d - 1) \times 0.05$ GHz. For a given frequency f_d , the topological gradient is [22]:

$$g_{f_d}(x, y, z) = -2\pi\Re \left(\nabla \times E(f_d) \cdot \overline{\nabla \times v(f_d)} - 2k^2 E(f_d) \cdot \overline{v(f_d)} \right), \quad (48)$$

where $E(f_d)$ and $v(f_d)$ are respectively the direct and the adjoint state.

The topological gradient and the modified geometry at the first iteration are given by Figure 11. The obtained results at the second iteration are given by Figure 12. The optimal solution is obtained after 14 iterations (see Figure 13). The convergence history is given by Figure 14. The reflexion coefficient and the rate of ellipticity are given by Figure 15 and Figure 16.

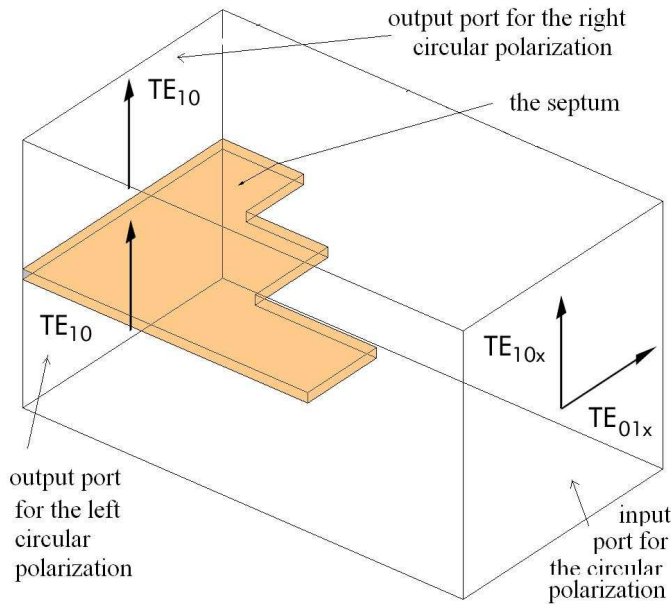

Figure 9: The septum polarizer.

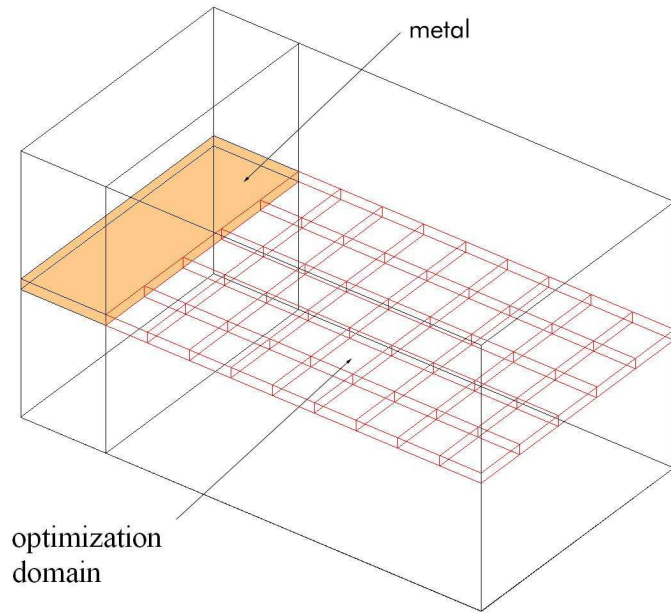

Figure 10: The initial domain.

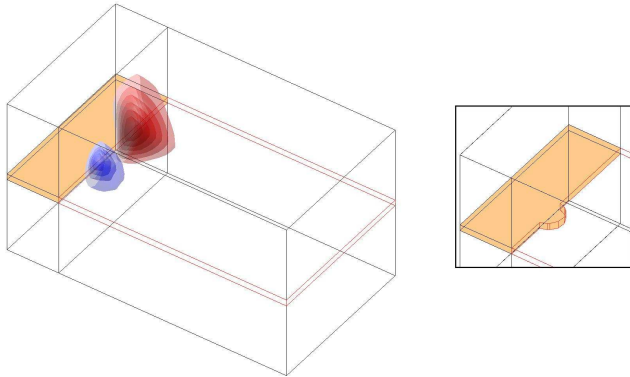

Figure 11: The topological gradient and the modified geometry (the first iteration).

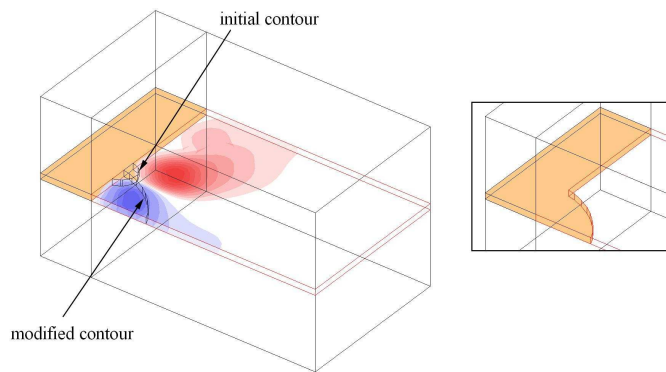

Figure 12: The topological gradient and the modified geometry (the second iteration).

REFERENCES

- [1] G. Allaire and R. Kohn, *Optimal bounds on the effective behavior of a mixture of two well-ordered elastic materials*, *Quart. Appl. Math.*, 51, 643-674, 1994.
- [2] M. Bendsoe, *Optimal Topology Design of continuum Structure: An Introduction*, Technical report, Department of Mathematics, Technical University of Denmark, DK2800 Lyngby, Denmark, 1996.
- [3] J. Jacobsen, N. Oolhoff, and E. Ronholt, *Generalized Shape Optimization of Three-Dimensional Structures Using Materials with Optimum Microstructures*, Technical report, Institute of Mechanical Engineering, Aalborg University, DK-9920 Aalborg, Denmark, 1996.
- [4] F. Murat and L. Tartar, *Calcul des variations et homogénéisation*, *Les Méthodes de l'Homogénéisation: Théorie et Applications en Physiques*, Eyrolles, Paris, 319-369, 1985.

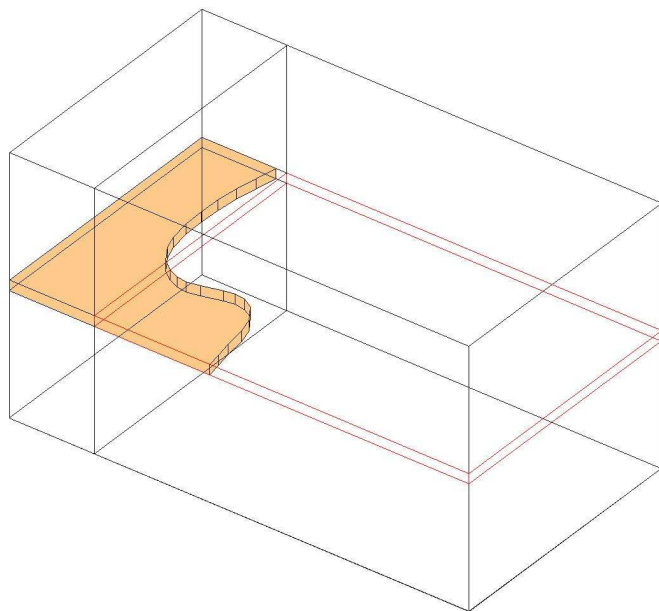

Figure 13: The optimal shape.

- [5] G. Allaire, F. Jouve, and A.M. Toader, *A level-set method for shape optimization*, C. R. Acad. Sci, Série I, (334), 1125-1130, 2002.
- [6] S. Osher and F. Santosa, *Level Set methods for optimization problems involving geometry and constraints*, J. Comp. Phys., 171, 272-288, 2001.
- [7] S. Garreau, P. Guillaume, and M. Masmoudi, *The topological sensitivity for linear isotropic elasticity*, rapport MIP no 99.45, 1999.
- [8] P. Guillaume and K. Sididris, *The topological asymptotic expansion for the Dirichlet problem*, SIAM J. Control Optim, Vol. 41 (4), 1042-1072, 2002.
- [9] H. Eschenauer and A. Schumacher, *Bubble method for topology and shape optimization of structures*, Structural Optim. 8, 42-51, 1994.
- [10] A.A. Novotny, R.A. Feijóo, E. Taroco, and C. Padra, *Topological sensitivity analysis*, Comput. Methods Appl. Mech. Engrg. 192, 803-829, 2003.
- [11] S. Nazarov and J. Sokolowski, *Asymptotic analysis of shape functionals*, J. Math. Pures Appl. (9), 82, no. 2, 125-196, 2003.
- [12] H. Ammari, MS. Vogelius, and D. Volkov, *Asymptotic formulas for perturbations in the electromagnetic fields due to the presence of inhomogeneities of small diameter II. The full Maxwell equations*, J. Math. Pures Appl. 80, 8, 769-814, 2001.

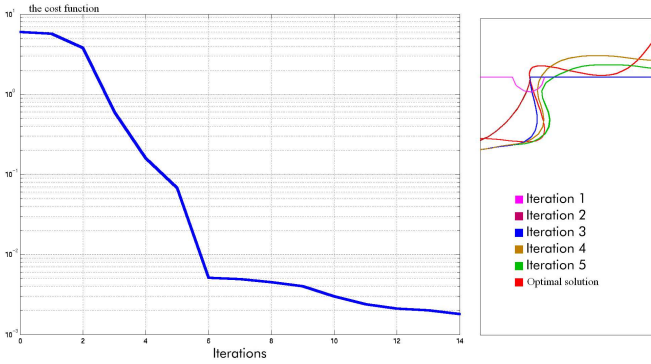

Figure 14: Convergence history and modifications of the septum.

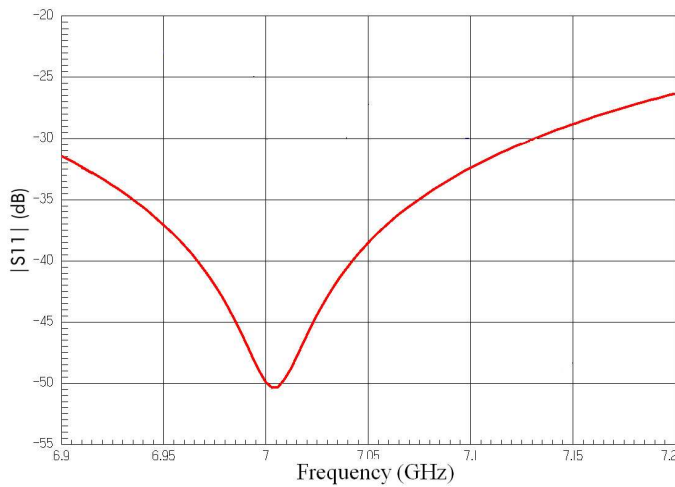

Figure 15: The reflexion coefficient.

- [13] H. Ammari, S. Moskow and M.S. Vogelius, *Boundary integral formulas for the reconstruction of electric and electromagnetic inhomogeneities of small volume*, ESAIM: COCV 9, 49-66, 2003.
- [14] M.S. Vogelius and D. Volkov, *Asymptotic formulas for perturbations in the electromagnetic fields due to the presence of inhomogeneities of small diameter*, *M²AN* 34, 723-748, 2000.
- [15] C. Alves and H. Ammari, *Boundary integral formulas for the reconstruction of imperfections of small diameter in an elastic medium*, *SIAM J. Appl. Math.* 62, 94-106, 2001.
- [16] A. Khelifi, *Electromagnetic scattering from small dielectric inhomogeneities*, PHD Thesis, Ecole Polytechnique, 2002.

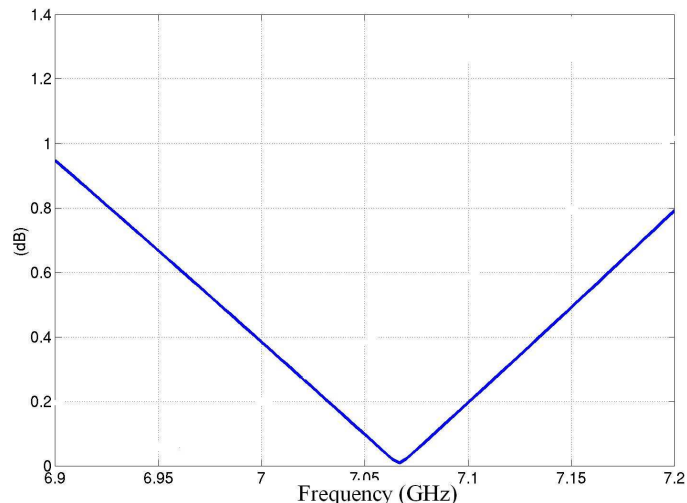

Figure 16: The rate of ellipticity.

- [17] M. Masmoudi, *The topological asymptotic*, in Computational Methods for Control Applications, R.Glowinski, H. Kawarada and J. Periaux eds., GAKUTO Internat. Ser. Math. Sci. Appl. Vol. 16, 53-72, 2001.
- [18] J. Cea, *Conception optimale ou identification de forme, calcul rapide de la drive directionnelle de la fonction coût*, M.A.A.N., 20(3):371-402, 1986.
- [19] Abramowitz and Stegun, *Handbook of Mathematical Functions*, Dover 1964.
- [20] B. Samet, S. Amstutz, and M. Masmoudi, *The topological asymptotic for the Helmholtz equation*, SIAM J. Control Optim, Vol. 42 (5), 1523-1544, 2003.
- [21] J. Pommier and B. Samet, *The topological asymptotic for the Helmholtz equation with Dirichlet condition on the boundary of an arbitrary shaped hole*, to appear in SIAM J. Control Optim, 2004.
- [22] B. Samet, *L'analyse asymptotique topologique pour les équations de Maxwell et applications*, Thèse présentée à l'Université Paul Sabatier de Toulouse, 2004.

Article 6 :

The topological asymptotic expansion for the Maxwell equations
and applications

Inverse problems. 21 (2005) 547-564

The topological asymptotic expansion for the Maxwell equations and some applications

Mohamed Masmoudi¹, Julien Pommier² and Bessem Samet¹

¹ CNRS-Laboratoire MIP, Université Paul Sabatier, 118 Route de Narbonne, 31062 Toulouse Cedex 4, France

² INSA Toulouse, 135 Avenue de Rangueil, 31077 Toulouse Cedex 4, France

E-mail: masmoudi@mip.ups-tlse.fr, pommier@gmm.insa-tlse.fr and samet@mip.ups-tlse.fr

Received 24 May 2004, in final form 12 January 2005

Published 23 February 2005

Online at stacks.iop.org/IP/21/547

Abstract

The aim of the topological sensitivity analysis is to derive an asymptotic expansion of a design functional with respect to a topological perturbation of the domain. In this paper, such an expansion is obtained for the 3D Maxwell equations when we introduce a small dielectric object in the domain and when we insert a small metallic obstacle. Some numerical results are presented in the context of buried object detection and shape inversion of 3D objects in free space from time-domain scattered field data.

(Some figures in this article are in colour only in the electronic version)

1. Introduction

Topological optimization methods have become very attractive for industrial applications. It has become possible to satisfy more challenging specifications of industrial products by allowing modifications of the topology of the initial design.

The most relevant topological optimization methods are based on the computation of a level set function:

- The material density in the case of the topological optimization via the homogenization theory. An optimal domain is defined by a threshold of the material density function [2, 3, 6].
- The built-in level set function in the level set method [1, 22].
- The topological gradient provided by the topological asymptotic expansion, which is the concern of this paper.

In the latter case, at convergence, the positivity of the topological gradient inside the final domain provides a necessary and sufficient optimality condition. We will present in this paper the topological asymptotic expansion for the Maxwell equations. Then we will

show that our topological optimization method is very promising for solving shape inverse problems in electromagnetic applications.

In [2, 3, 6], the optimal shape is derived from the optimization of material properties. The range of application of this approach is quite restricted. The difficulties arise when we have to identify highly contrasted media: electromagnetic identification of metallic objects in free space or identification of an obstacle immersed in a fluid. In both cases, the boundary condition that appears on the surface of the obstacle is of Dirichlet type. For these reasons, global optimization methods are used to solve more general problems [14, 23]. Unfortunately, these methods are quite slow. The more recent level set method [1, 22] gives very promising results. Even if it belongs to the classical shape optimization methods, it allows the modification of the topology of the domain. However, in practice it does not allow for the nucleation of new holes and the optimal design depends largely on the initial guess.

The topological asymptotic expansion seems to be general and efficient. To present the basic idea, we consider Ω a domain of \mathbb{R}^n ($n = 2$ or 3) and $j(\Omega) = J(u_\Omega)$ a cost function to be minimized, where u_Ω is the solution to a given PDE problem defined in Ω . For $\varepsilon > 0$, let $\Omega_\varepsilon = \Omega \setminus \overline{x_0 + \varepsilon\omega}$ be the subset obtained by removing a small part $\overline{x_0 + \varepsilon\omega}$ from Ω , where $x_0 \in \Omega$ and $\omega \subset \mathbb{R}^n$ is a fixed domain containing the origin. We can generally prove that the variation of the criterion is given by the asymptotic expansion:

$$j(\Omega_\varepsilon) = j(\Omega) + f(\varepsilon)g(x_0) + o(f(\varepsilon)), \quad (1)$$

$$\lim_{\varepsilon \rightarrow 0} f(\varepsilon) = 0, f(\varepsilon) > 0. \quad (2)$$

This expansion is called the topological asymptotic. To minimize the criterion j , we just have to create infinitely small holes at some points \tilde{x} where the topological gradient (or sensitivity) $g(\tilde{x})$ is negative.

The first definition of the topological gradient has been introduced by Schumacher *et al* [24] under the name *bubble method* in the context of compliance optimization for linear elasticity problems. In [12, 17], using an adaptation of the adjoint method [7] and a domain truncation technique, Garreau *et al* presented a method to obtain the topological asymptotic expansion. For more details about this approach, we refer the reader to [5, 13, 19–21, 25, 26]. In all these works, only the insertion of a hole is considered to modify the domain.

In this paper, using an adjoint method, we derive the topological asymptotic expansion for the 3D Maxwell equations. Here, we consider two cases of domain perturbation: the insertion of a dielectric object and the insertion of a metallic obstacle (a hole). The latter result is obtained formally by considering the limit of the topological asymptotic expansion when the permittivity goes to infinity and the permeability goes to zero. As a background to our work, we cite the contribution of Vogelius *et al* [4] for the study of solutions to the time-harmonic Maxwell equations in the presence of small inhomogeneities in the domain. Other contributions in this context can be found in [8, 11, 15, 27, 28]. In these publications, asymptotic formulae of solutions are given. These results are not oriented to shape optimization. Their straightforward application leads to the resolution of a PDE problem for each point of the domain.

In section 2, we present the adjoint method. The main contribution of this paper is to make the topological gradient g easy to compute by using the adjoint state. The formulation of the Maxwell problem with a small inhomogeneity, the adjoint problem and the cost function are presented in section 3. In section 4, we compute topological asymptotic expansions when we insert a dielectric object in the domain and when we create a spherical hole. Some numerical results are presented in section 5, in the context of buried object detection and the shape inversion of 3D objects in free space from time-domain scattered field data.

2. The adjoint method

Let us consider two complex Hilbert spaces \mathcal{V} and \mathcal{W} . For all $\varepsilon \geq 0$, let a_ε be a sesquilinear and continuous form on \mathcal{V} and ℓ_ε be a semilinear and continuous form on \mathcal{V} . We assume that for all $\varepsilon \geq 0$, the following problem:

$$\begin{cases} u_\varepsilon \in \mathcal{V}, \\ a_\varepsilon(u_\varepsilon, v) = \ell_\varepsilon(v) \quad \forall v \in \mathcal{V}, \end{cases} \quad (3)$$

has one and only one solution. Let $j(\varepsilon)$ denote the function given by

$$j(\varepsilon) = J \circ \gamma(u_\varepsilon) \quad \forall \varepsilon \geq 0, \quad (4)$$

where $J : \mathcal{W} \rightarrow \mathbb{R}$ and $\gamma : \mathcal{V} \rightarrow \mathcal{W}$ is a linear operator. In this section, we provide an asymptotic expansion of the variation $j(\varepsilon) - j(0)$ with respect to the parameter ε . The function J is defined in a complex Hilbert space and takes values in \mathbb{R} . As a consequence, this function is not differentiable. For this reason, we replace the differentiability property by the following hypothesis.

Hypothesis 1. For all $u \in \mathcal{W}$, there exists a linear and continuous form on \mathcal{W} denoted by L_u such that

$$J(u + h) = J(u) + \operatorname{Re} L_u(h) + o(\|h\|_{\mathcal{W}}) \quad \forall h \in \mathcal{W}, \quad (5)$$

where Re denotes the real part of a complex number and $\|\cdot\|_{\mathcal{W}}$ is the norm of \mathcal{W} .

For all $\varepsilon \geq 0$, let v_ε denote the solution to the problem

$$\begin{cases} v_\varepsilon \in \mathcal{V}, \\ a_\varepsilon(w, v_\varepsilon) = -L_{\gamma(u_0)}(\gamma(w)) \quad \forall w \in \mathcal{V}, \end{cases} \quad (6)$$

where u_0 is the solution to problem (3) for $\varepsilon = 0$. It is supposed that problem (6) has one and only one solution. We call v_0 the adjoint state. We assume that the following hypothesis holds.

Hypothesis 2. There exist a function $f(\varepsilon) > 0$, $\lim_{\varepsilon \rightarrow 0^+} f(\varepsilon) = 0$, and two complex numbers δa and $\delta \ell$ such that

$$\|\gamma(u_\varepsilon - u_0)\|_{\mathcal{W}} = O(f(\varepsilon)), \quad (7)$$

$$(a_\varepsilon - a_0)(u_0, v_\varepsilon) = f(\varepsilon)\delta a + o(f(\varepsilon)), \quad (8)$$

$$(\ell_\varepsilon - \ell_0)(v_\varepsilon) = f(\varepsilon)\delta \ell + o(f(\varepsilon)). \quad (9)$$

The next theorem gives the asymptotic expansion of the variation $j(\varepsilon) - j(0)$ with respect to ε .

Theorem 1. Suppose that hypotheses 1 and 2 are satisfied. The variation of the cost function j with respect to ε is given by

$$j(\varepsilon) - j(0) = f(\varepsilon) \operatorname{Re}(\delta j) + o(f(\varepsilon)),$$

where $\delta j = \delta a - \delta \ell$.

Proof. We have that

$$\begin{aligned} j(\varepsilon) - j(0) &= (J\circ\gamma(u_\varepsilon) - J\circ\gamma(u_0)) + \operatorname{Re}(a_\varepsilon(u_\varepsilon, v_\varepsilon) - a_0(u_0, v_\varepsilon)) - \operatorname{Re}(\ell_\varepsilon(v_\varepsilon) - \ell_0(v_\varepsilon)) \\ &= (J\circ\gamma(u_\varepsilon) - J\circ\gamma(u_0)) + \operatorname{Re}(a_\varepsilon(u_0, v_\varepsilon) - a_0(u_0, v_\varepsilon)) \\ &\quad + \operatorname{Re} a_\varepsilon(u_\varepsilon - u_0, v_\varepsilon) - \operatorname{Re}(\ell_\varepsilon(v_\varepsilon) - \ell_0(v_\varepsilon)). \end{aligned}$$

Using the linearity of γ , (5) and (7), we obtain that

$$\begin{aligned} J\circ\gamma(u_\varepsilon) - J\circ\gamma(u_0) &= \operatorname{Re} L_{\gamma(u_0)}(\gamma(u_\varepsilon - u_0)) + o(\|\gamma(u_\varepsilon - u_0)\|_{\mathcal{V}}) \\ &= \operatorname{Re} L_{\gamma(u_0)}(\gamma(u_\varepsilon - u_0)) + o(f(\varepsilon)). \end{aligned}$$

Hence, we obtain that

$$\begin{aligned} j(\varepsilon) - j(0) &= \operatorname{Re}(a_\varepsilon(u_0, v_\varepsilon) - a_0(u_0, v_\varepsilon)) - \operatorname{Re}(\ell_\varepsilon(v_\varepsilon) - \ell_0(v_\varepsilon)) \\ &\quad + \operatorname{Re}(a_\varepsilon(u_\varepsilon - u_0, v_\varepsilon) + L_{\gamma(u_0)}(\gamma(u_\varepsilon - u_0))) + o(f(\varepsilon)). \end{aligned}$$

It follows from (8) and (9) that

$$j(\varepsilon) - j(0) = f(\varepsilon) \operatorname{Re}(\delta a - \delta \ell) + \operatorname{Re}(a_\varepsilon(u_\varepsilon - u_0, v_\varepsilon) + L_{\gamma(u_0)}(\gamma(u_\varepsilon - u_0))) + o(f(\varepsilon)).$$

It follows from (6) that

$$\operatorname{Re}(a_\varepsilon(u_\varepsilon - u_0, v_\varepsilon) + L_{\gamma(u_0)}(\gamma(u_\varepsilon - u_0))) = 0 \quad \forall \varepsilon \geq 0.$$

As a consequence, we obtain that

$$j(\varepsilon) - j(0) = f(\varepsilon) \operatorname{Re}(\delta a - \delta \ell) + o(f(\varepsilon)). \quad \square$$

3. Problem formulation

3.1. The perturbed problem

Let Ω be a bounded open domain of \mathbb{R}^3 , with a smooth boundary. For simplicity, we take $\partial\Omega$ to be C^∞ , but this regularity condition could be considerably weakened. We suppose that Ω contains a small inhomogeneity D_ε of the form $D_\varepsilon = \varepsilon B$, where B is a bounded, smooth (C^∞) domain containing 0 (the origin) and ε is the order of magnitude of the diameter of the inhomogeneity. The magnetic field in the presence of the inhomogeneity is denoted as H_ε . It is the solution to

$$\begin{cases} \nabla \times (\alpha_\varepsilon \nabla \times H_\varepsilon) - \beta_\varepsilon H_\varepsilon = 0 & \text{in } \Omega, \\ \alpha_\varepsilon (\nabla \times H_\varepsilon) \times \mathbf{n} = g & \text{on } \partial\Omega. \end{cases} \quad (10)$$

Here, \mathbf{n} denotes the outward unit normal to $\partial\Omega$ and α_ε is a piecewise constant function defined by

$$\alpha_\varepsilon(x) = \begin{cases} \alpha_0 & \text{if } x \in \Omega \setminus \overline{D_\varepsilon}, \\ \alpha_1 & \text{if } x \in D_\varepsilon, \end{cases} \quad (11)$$

where α_0 and α_1 are positive constants: $\alpha_0 > 0, \alpha_1 > 0$. If we allow the degenerate case $\varepsilon = 0$, then the function $\alpha_0(x)$ equals the constant α_0 . The piecewise constant function β_ε is defined analogously. Problem (10) can be formulated as follows:

$$\begin{cases} \nabla \times (\alpha_0 \nabla \times H_\varepsilon) - \beta_0 H_\varepsilon = 0 & \text{in } \Omega \setminus \overline{D_\varepsilon}, \\ \nabla \times (\alpha_1 \nabla \times H_\varepsilon) - \beta_1 H_\varepsilon = 0 & \text{in } D_\varepsilon, \\ H_\varepsilon \times \mathbf{n} \text{ is continuous across } \partial D_\varepsilon, \\ \alpha_0 (\nabla \times H_\varepsilon)^+ \times \mathbf{n} - \alpha_1 (\nabla \times H_\varepsilon)^- \times \mathbf{n} = 0 & \text{on } \partial D_\varepsilon, \\ \beta_0 H_\varepsilon^+ \cdot \mathbf{n} - \beta_1 H_\varepsilon^- \cdot \mathbf{n} = 0 & \text{on } \partial D_\varepsilon, \\ \alpha_0 (\nabla \times H_\varepsilon) \times \mathbf{n} = g & \text{on } \partial\Omega. \end{cases} \quad (12)$$

Here, \mathbf{n} denotes the outward unit normal to ∂D_ε (and to $\partial\Omega$); superscript $+$ and $-$ indicate the limiting values as we approach ∂D_ε from outside D_ε , and from inside D_ε , respectively. The magnetic field, H_0 , in the absence of the inhomogeneity, satisfies

$$\begin{cases} \nabla \times (\alpha_0 \nabla \times H_0) - \beta_0 H_0 = 0 & \text{in } \Omega, \\ \alpha_0 (\nabla \times H_0) \times \mathbf{n} = g & \text{on } \partial\Omega. \end{cases} \quad (13)$$

The variational formulation associated with problem (13) is: find $H_0 \in \mathcal{V}$ such that

$$a_0(H_0, v) = \ell(v) \quad \forall v \in \mathcal{V}, \quad (14)$$

where the functional space \mathcal{V} , the sesquilinear form a_0 and the semilinear form ℓ are defined by

$$\mathcal{V} = H(\text{curl}, \Omega), \quad (15)$$

$$a_0(u, v) = \int_{\Omega} \alpha_0 \nabla \times u \cdot \overline{\nabla \times v} \, dx - \int_{\Omega} \beta_0 u \cdot \bar{v} \, dx, \quad (16)$$

$$\ell(v) = \int_{\partial\Omega} g \cdot \bar{v} \, d\sigma_x. \quad (17)$$

We recall that the functional space $H(\text{curl}, \Omega)$ is given by $H(\text{curl}, \Omega) = \{u \in L^2(\Omega)^3 : \nabla \times u \in L^2(\Omega)^3\}$. Here, we assume that $g \in TH_{\text{div}}^{-\frac{1}{2}}(\partial\Omega)$, where $TH_{\text{div}}^{-\frac{1}{2}}(\partial\Omega)$ denotes the space of tangential vector fields on $\partial\Omega$ that lie in $H^{-\frac{1}{2}}(\partial\Omega)$ and whose surface divergences also lie in $H^{-\frac{1}{2}}(\partial\Omega)$. In (17), the integral on $\partial\Omega$ is to be interpreted as the duality pairing between the appropriate spaces of distributions and test functions. We assume that the following hypothesis holds.

Hypothesis 3. *The variational problem (14) has a unique solution (for all g).*

Similarly, the variational formulation of problem (10) is: find $H_\varepsilon \in \mathcal{V}$ such that

$$a_\varepsilon(H_\varepsilon, v) = \ell(v) \quad \forall v \in \mathcal{V}, \quad (18)$$

where the sesquilinear form a_ε is given by

$$a_\varepsilon(u, v) = \int_{\Omega} \alpha_\varepsilon \nabla \times u \cdot \overline{\nabla \times v} \, dx - \int_{\Omega} \beta_\varepsilon u \cdot \bar{v} \, dx, \quad \forall u, v \in \mathcal{V}. \quad (19)$$

In [4], it is proved that hypothesis 3 leads to the unique solvability of (18). We have the following result [4].

Proposition 1. *Suppose that hypothesis 3 is satisfied. There exists $\varepsilon_0 > 0$ such that given an arbitrary $g \in TH_{\text{div}}^{-\frac{1}{2}}(\partial\Omega)$, and any $0 < \varepsilon < \varepsilon_0$, problem (18) has a unique solution H_ε .*

3.2. The adjoint problem and the cost function

Let us consider the function $J : \mathcal{W} \rightarrow \mathbb{R}$, where the functional space \mathcal{W} is given by $\mathcal{W} = H(\text{curl}, \mathcal{O})$ and \mathcal{O} is a neighbour part of $\partial\Omega$. We define the cost function by $j(\varepsilon) = J(H_{\varepsilon|\mathcal{O}})$, $\forall \varepsilon \geq 0$. Here, the function γ defined in (4) is given by $\gamma(u) = u|_{\mathcal{O}}$, $\forall u \in \mathcal{V}$. In the numerical part of this work, only measurements on the boundary of the domain are used. For this reason, and to simplify the presentation, we considered the previous assumption about the cost function. We recall that the function J is not differentiable. For this reason, we assume that hypothesis 1 is satisfied.

For all $\varepsilon \geq 0$, we define v_ε the solution to the following problem: find $v_\varepsilon \in \mathcal{V}$ such that

$$a_\varepsilon(w, v_\varepsilon) = -L_{H_0|\mathcal{O}}(w|_{\mathcal{O}}) \quad \forall w \in \mathcal{V}, \quad (20)$$

where H_0 is the solution to problem (14).

Hypothesis 4. *We assume that for $\varepsilon = 0$, problem (20) has a unique solution.*

As in proposition 1, this assumption leads to the unique solvability of problem (20) when ε is small enough [4].

4. Asymptotic expansions

4.1. The main result

By $\Phi_j, 1 \leq j \leq 3$, we denote the solution to

$$\begin{cases} \Delta \Phi_j = 0 & \text{in } \mathbb{R}^3 \setminus \bar{B} \text{ and in } B, \\ \Phi_j \text{ is continuous across } \partial B, \\ c(\nabla \Phi_j \cdot \mathbf{n})^+ - (\nabla \Phi_j \cdot \mathbf{n})^- = 0 & \text{on } \partial B, \\ \Phi_j(y) - y_j \rightarrow 0 & \text{as } |y| \rightarrow \infty, \end{cases} \tag{21}$$

where $c > 0$. The existence and uniqueness of Φ_j can be established (in the real, as well as in the complex case) using single layer potentials with suitably chosen densities, see [9, 10]. We now define the polarization tensor $M(c)$ by

$$M_{ij}(c) = c^{-1} \int_B \frac{\partial}{\partial y_i} \Phi_j \, dy, \quad 1 \leq i, \quad j \leq 3. \tag{22}$$

The principal result of this paper is given by the following theorem.

Theorem 2. *We assume that hypotheses 1, 3 and 4 are satisfied. The asymptotic expansion of $j(\varepsilon) - j(0)$ with respect to ε is given by*

$$\varepsilon^3 \operatorname{Re} \left\{ (\alpha_1 - \alpha_0) \nabla \times H_0(0) \cdot \overline{M \left(\frac{\alpha_1}{\alpha_0} \right) \nabla \times v_0(0)} \right. \\ \left. - \beta_0 \left(1 - \frac{\beta_0}{\beta_1} \right) H_0(0) \cdot \overline{M \left(\frac{\beta_0}{\beta_1} \right) v_0(0)} \right\} + o(\varepsilon^3),$$

where H_0 is the solution to (14), v_0 is the adjoint state, solution to (20) for $\varepsilon = 0$, and M is the polarization tensor introduced in (22).

When B is the unit ball $B(0, 1)$, the polarization tensor M is given by [8]

$$M_{ij}(c) = \frac{3|B|}{1+2c} \delta_{ij} \quad \forall c > 0, \quad 1 \leq i, \quad j \leq 3. \tag{23}$$

Insertion of (23) with $c = \frac{\alpha_1}{\alpha_0}$ (and $c = \frac{\beta_0}{\beta_1}$) into the topological asymptotic expansion given by theorem 2 yields to the following result.

Corollary 1. *Under the assumptions of theorem 2 and when B is the unit ball, the topological asymptotic expansion is given by*

$$j(\varepsilon) - j(0) = 4\pi \varepsilon^3 \operatorname{Re} \left\{ \frac{\alpha_0(\alpha_1 - \alpha_0)}{\alpha_0 + 2\alpha_1} \nabla \times H_0(0) \cdot \overline{\nabla \times v_0(0)} \right. \\ \left. + \frac{\beta_0(\beta_0 - \beta_1)}{\beta_1 + 2\beta_0} H_0(0) \cdot \overline{v_0(0)} \right\} + o(\varepsilon^3).$$

Setting $\alpha_1 \rightarrow 0$ and $\beta_1 \rightarrow 0$ in the formula presented in corollary 1, we retrieve formally the topological asymptotic expansion with respect to the insertion of a spherical hole $D_\varepsilon = \varepsilon B$ with the boundary condition $(\nabla \times H_\varepsilon) \times \mathbf{n} = 0$ on ∂D_ε [16].

Corollary 2. *The topological asymptotic expansion with respect to the insertion of a spherical hole $D_\varepsilon = \varepsilon B$ with the boundary condition $(\nabla \times H_\varepsilon) \times \mathbf{n} = 0$ on ∂D_ε is given by*

$$j(\varepsilon) - j(0) = 2\pi \varepsilon^3 \operatorname{Re} \{ -2\alpha_0 \nabla \times H_0(0) \cdot \overline{\nabla \times v_0(0)} + \beta_0 H_0(0) \cdot \overline{v_0(0)} \} + o(\varepsilon^3).$$

4.2. Preliminary lemmas

Let us introduce the vector field h^* solution to

$$\begin{cases} \Delta h^* = 0 & \text{in } \mathbb{R}^3 \setminus \overline{B} \text{ and in } B, \\ \nabla \cdot h^* = 0 & \text{in } \mathbb{R}^3 \setminus \overline{B} \text{ and in } B, \\ \alpha_0(\nabla \times h^*)^+ \times \mathbf{n} - \alpha_1(\nabla \times h^*)^- \times \mathbf{n} = (\alpha_1 - \alpha_0)(\nabla \times v_0)(0) \times \mathbf{n}, \\ \beta_0(h^* \cdot \mathbf{n})^+ = \beta_1(h^* \cdot \mathbf{n})^- & \text{on } \partial B \text{ and } h^* \times \mathbf{n} \text{ is continuous across } \partial B, \\ h^*(y) = O(|y|^{-1}) & \text{uniformly as } |y| \rightarrow \infty, \end{cases} \quad (24)$$

and the scalar function solution to

$$\begin{cases} \Delta q^* = 0 & \text{in } \mathbb{R}^3 \setminus \overline{B} \text{ and in } B, \\ q^* \text{ is continuous across } \partial B, \\ \beta_0(\nabla q^* \cdot \mathbf{n})^+ - \beta_1(\nabla q^* \cdot \mathbf{n})^- = (\beta_1 - \beta_0)v_0(0) \cdot \mathbf{n} & \text{on } \partial B, \\ \lim_{|y| \rightarrow \infty} q^*(y) = 0, \end{cases} \quad (25)$$

where \mathbf{n} denotes the outward unit normal to ∂B .

Lemma 1. *We have the following estimates:*

$$\|(H_\varepsilon - H_0)|_{\mathcal{O}}\| = O(\varepsilon^3), \quad (26)$$

$$\left\| \nabla_x \times \left(v_\varepsilon(x) - v_0(x) - \varepsilon h^* \left(\frac{x}{\varepsilon} \right) \right) \right\|_{L^2(\Omega)} = O(\varepsilon^{5/2}), \quad (27)$$

$$\left\| v_\varepsilon(x) - v_0(x) - \nabla_y q^* \left(\frac{x}{\varepsilon} \right) \right\|_{L^2(\Omega)} = O(\varepsilon^{5/2}). \quad (28)$$

Proof. We refer the reader to [4]. □

Lemma 2. *We have that*

$$|B|v_0(0) + \int_B \nabla_y q^*(y) \, dy = \frac{\beta_0}{\beta_1} M \left(\frac{\beta_0}{\beta_1} \right) v_0(0), \quad (29)$$

and

$$|B|\nabla \times v_0(0) + \int_B \nabla_y \times h^*(y) \, dy = M \left(\frac{\alpha_1}{\alpha_0} \right) \nabla \times v_0(0), \quad (30)$$

where M is the polarization tensor given by (22).

Proof. We refer the reader to [4]. □

Lemma 3. *We have that*

$$\int_{D_\varepsilon} \nabla \times H_0 \cdot \overline{\nabla \times w_\varepsilon} \, dx = \varepsilon^3 \nabla \times H_0(0) \cdot \overline{\int_B \nabla \times h^*(y) \, dy} + O(\varepsilon^4),$$

where $w_\varepsilon = v_\varepsilon - v_0$.

Proof. We have that

$$\begin{aligned} \int_{D_\varepsilon} \nabla \times H_0 \cdot \overline{\nabla \times w_\varepsilon} \, dx &= \int_{D_\varepsilon} \nabla \times H_0 \cdot \overline{\left(\nabla_x \times \left(w_\varepsilon - \varepsilon h^* \left(\frac{x}{\varepsilon} \right) \right) \right)} \, dx \\ &+ \varepsilon \int_{D_\varepsilon} (\nabla \times H_0(x) - \nabla \times H_0(0)) \cdot \overline{\nabla_x \times h^* \left(\frac{x}{\varepsilon} \right)} \, dx \\ &+ \varepsilon \int_{D_\varepsilon} \nabla \times H_0(0) \cdot \overline{\nabla_x \times h^* \left(\frac{x}{\varepsilon} \right)} \, dx. \end{aligned}$$

- Using the Cauchy–Schwartz inequality, we obtain that

$$\left| \int_{D_\varepsilon} \nabla \times H_0 \cdot \overline{\left(\nabla_x \times \left(w_\varepsilon - \varepsilon h^* \left(\frac{x}{\varepsilon} \right) \right) \right)} dx \right| \leq \varepsilon^{3/2} |B|^{1/2} \|\nabla \times H_0\|_{L^\infty(\Omega)} \left\| \nabla_x \times \left(w_\varepsilon - \varepsilon h^* \left(\frac{x}{\varepsilon} \right) \right) \right\|_{L^2(\Omega)}.$$

From (27) it follows that

$$\left| \int_{D_\varepsilon} \nabla \times H_0 \cdot \overline{\left(\nabla_x \times \left(w_\varepsilon - \varepsilon h^* \left(\frac{x}{\varepsilon} \right) \right) \right)} dx \right| = O(\varepsilon^4). \tag{31}$$

- By a change of variable, we obtain that

$$\begin{aligned} \int_{D_\varepsilon} (\nabla \times H_0(x) - \nabla \times H_0(0)) \cdot \overline{\nabla_x \times h^* \left(\frac{x}{\varepsilon} \right)} dx \\ = \varepsilon^2 \int_B (\nabla \times H_0(\varepsilon y) - \nabla \times H_0(0)) \cdot \overline{\nabla \times h^*(y)} dy. \end{aligned}$$

Using the Taylor expansion, we obtain that

$$\left| \int_B (\nabla \times H_0(\varepsilon y) - \nabla \times H_0(0)) \cdot \overline{\nabla \times h^*(y)} dy \right| = O(\varepsilon).$$

Then, it follows that

$$\left| \int_{D_\varepsilon} (\nabla \times H_0(x) - \nabla \times H_0(0)) \cdot \overline{\nabla_x \times h^* \left(\frac{x}{\varepsilon} \right)} dx \right| = O(\varepsilon^3). \tag{32}$$

- Using a change of variable, we obtain that

$$\int_{D_\varepsilon} \nabla \times H_0(0) \cdot \overline{\nabla_x \times h^* \left(\frac{x}{\varepsilon} \right)} dx = \varepsilon^2 \nabla \times H_0(0) \cdot \overline{\int_B \nabla \times h^*(y) dy}. \tag{33}$$

By a combination of (31)–(33), we obtain the desired result. \square

Lemma 4. *We have that*

$$\int_{D_\varepsilon} H_0 \cdot \overline{w_\varepsilon} dx = \varepsilon^3 H_0(0) \cdot \overline{\int_B \nabla q^*(y) dy} + O(\varepsilon^4),$$

where $w_\varepsilon = v_\varepsilon - v_0$.

Proof. We have

$$\begin{aligned} \int_{D_\varepsilon} H_0 \cdot \overline{w_\varepsilon} dx &= \int_{D_\varepsilon} H_0 \cdot \overline{\left(w_\varepsilon - \nabla_y q^* \left(\frac{x}{\varepsilon} \right) \right)} dx + \int_{D_\varepsilon} H_0(0) \cdot \overline{\nabla_y q^* \left(\frac{x}{\varepsilon} \right)} dx \\ &+ \int_{D_\varepsilon} (H_0(x) - H_0(0)) \cdot \overline{\nabla_y q^* \left(\frac{x}{\varepsilon} \right)} dx. \end{aligned}$$

- Using the Cauchy–Schwartz inequality, we obtain

$$\left| \int_{D_\varepsilon} H_0 \cdot \overline{\left(w_\varepsilon - \nabla_y q^* \left(\frac{x}{\varepsilon} \right) \right)} dx \right| \leq |B|^{1/2} \varepsilon^{3/2} \|H_0\|_{L^\infty(\Omega)} \left\| w_\varepsilon - \nabla_y q^* \left(\frac{x}{\varepsilon} \right) \right\|_{L^2(\Omega)}.$$

From (28) it follows that

$$\left| \int_{D_\varepsilon} H_0 \cdot \overline{\left(w_\varepsilon - \nabla_y q^* \left(\frac{x}{\varepsilon} \right) \right)} dx \right| = O(\varepsilon^4). \tag{34}$$

- Using a change of variable and the Taylor expansion, it is easy to see that

$$\left| \int_{D_\varepsilon} (H_0(x) - H_0(0)) \cdot \overline{\nabla_y q^* \left(\frac{x}{\varepsilon} \right)} dx \right| = O(\varepsilon^4). \tag{35}$$

- By a change of variable, we obtain

$$\int_{D_\varepsilon} H_0(0) \cdot \overline{\nabla_y q^* \left(\frac{x}{\varepsilon} \right)} dx = \varepsilon^3 H_0(0) \cdot \overline{\int_B \nabla q^*(y) dy}. \tag{36}$$

By a combination of (34)–(36), we obtain the desired result. □

Lemma 5. *We have*

$$\int_{D_\varepsilon} \nabla \times H_0 \cdot \overline{\nabla \times v_0} dx = \varepsilon^3 |B| \nabla \times H_0(0) \cdot \overline{\nabla \times v_0(0)} + O(\varepsilon^4), \tag{37}$$

$$\int_{D_\varepsilon} H_0 \cdot \overline{v_0} dx = \varepsilon^3 |B| H_0(0) \cdot \overline{v_0(0)} + O(\varepsilon^4). \tag{38}$$

Proof. We have

$$\begin{aligned} \int_{D_\varepsilon} \nabla \times H_0 \cdot \overline{\nabla \times v_0} dx &= \int_{D_\varepsilon} ((\nabla \times H_0 \cdot \overline{\nabla \times v_0})(x) - (\nabla \times H_0 \cdot \overline{\nabla \times v_0})(0)) dx \\ &\quad + \varepsilon^3 |B| \nabla \times H_0(0) \cdot \overline{\nabla \times v_0(0)}. \end{aligned}$$

Using a change of variable, we obtain that

$$\begin{aligned} \int_{D_\varepsilon} \nabla \times H_0 \cdot \overline{\nabla \times v_0} dx &= \varepsilon^3 \int_B ((\nabla \times H_0 \cdot \overline{\nabla \times v_0})(\varepsilon y) - (\nabla \times H_0 \cdot \overline{\nabla \times v_0})(0)) dy \\ &\quad + \varepsilon^3 |B| \nabla \times H_0(0) \cdot \overline{\nabla \times v_0(0)}. \end{aligned}$$

Using the Taylor expansion, it is easy to see that

$$\left| \int_B ((\nabla \times H_0 \cdot \overline{\nabla \times v_0})(\varepsilon y) - (\nabla \times H_0 \cdot \overline{\nabla \times v_0})(0)) dy \right| = O(\varepsilon).$$

Then, the asymptotic expansion given by (37) is proved. In a similar manner, we can prove the asymptotic expansion given by (38). □

4.3. Proof of main result

The main result of this paper is given by theorem 2. To obtain the asymptotic expansion of the variation $j(\varepsilon) - j(0)$ with respect to ε by the use of theorem 1, we must check that hypothesis 2 is satisfied and calculate $f(\varepsilon)$, δa and $\delta \ell$. The following proposition gives an asymptotic expansion of the variation $(a_\varepsilon - a_0)(H_0, v_\varepsilon)$ with respect to ε .

Proposition 2. *The variation $(a_\varepsilon - a_0)(H_0, v_\varepsilon)$ has the following asymptotic expansion:*

$$\begin{aligned} \varepsilon^3 \left\{ (\alpha_1 - \alpha_0) \nabla \times H_0(0) \cdot \overline{M \left(\frac{\alpha_1}{\alpha_0} \right) \nabla \times v_0(0)} \right. \\ \left. - \beta_0 \left(1 - \frac{\beta_0}{\beta_1} \right) H_0(0) \cdot \overline{M \left(\frac{\beta_0}{\beta_1} \right) v_0(0)} \right\} + O(\varepsilon^4). \end{aligned}$$

Proof. Using (16) and (19), we obtain that

$$(a_\varepsilon - a_0)(H_0, v_\varepsilon) = \int_\Omega (\alpha_\varepsilon - \alpha_0) \nabla \times H_0 \cdot \overline{\nabla \times v_\varepsilon} dx + \int_\Omega (\beta_0 - \beta_\varepsilon) H_0 \cdot \overline{v_\varepsilon} dx. \tag{39}$$

From the definition of the function α_ε (and the function β_ε), it follows that

$$(a_\varepsilon - a_0)(H_0, v_\varepsilon) = (\alpha_1 - \alpha_0) \int_{D_\varepsilon} \nabla \times H_0 \cdot \overline{\nabla \times v_\varepsilon} dx + (\beta_0 - \beta_1) \int_{D_\varepsilon} H_0 \cdot \overline{v_\varepsilon} dx. \quad (40)$$

Denoting $w_\varepsilon = v_\varepsilon - v_0$, we obtain that

$$\begin{aligned} (a_\varepsilon - a_0)(H_0, v_\varepsilon) &= (\alpha_1 - \alpha_0) \left(\int_{D_\varepsilon} \nabla \times H_0 \cdot \overline{\nabla \times w_\varepsilon} dx + \int_{D_\varepsilon} \nabla \times H_0 \cdot \overline{\nabla \times v_0} dx \right) \\ &\quad + (\beta_0 - \beta_1) \int_{D_\varepsilon} H_0 \cdot \overline{v_0} dx + (\beta_0 - \beta_1) \int_{D_\varepsilon} H_0 \cdot \overline{w_\varepsilon} dx. \end{aligned} \quad (41)$$

A combination of the identity (41) with the estimates presented in lemmas 3–5 gives

$$\begin{aligned} (a_\varepsilon - a_0)(H_0, v_\varepsilon) &= \varepsilon^3 (\alpha_1 - \alpha_0) \nabla \times H_0(0) \cdot \overline{\left(\int_B \nabla \times h^*(y) dy + |B| \nabla \times v_0(0) \right)} \\ &\quad + \varepsilon^3 (\beta_0 - \beta_1) H_0(0) \cdot \overline{\left(|B| v_0(0) + \int_B \nabla q^*(y) dy \right)} + O(\varepsilon^4). \end{aligned}$$

A combination of the last identity with (29) and (30) yields the desired result. \square

We recall that the semilinear form ℓ defined in (17) is independent of the parameter ε . As a consequence, the scalar $\delta\ell$ is given by

$$\delta\ell = 0. \quad (42)$$

A combination of (26), proposition 2 and (42) shows that hypothesis 2 is satisfied with $f(\varepsilon) = \varepsilon^3$ and

$$\delta a = \left\{ (\alpha_1 - \alpha_0) \nabla \times H_0(0) \cdot \overline{M \left(\frac{\alpha_1}{\alpha_0} \right) \nabla \times v_0(0)} - \beta_0 \left(1 - \frac{\beta_0}{\beta_1} \right) H_0(0) \cdot \overline{M \left(\frac{\beta_0}{\beta_1} \right) v_0(0)} \right\}.$$

Applying theorem 1, we obtain exactly the statement of theorem 2.

5. Numerical results: application to inverse scattering problems

In this section, we present some numerical results obtained by the use of the topological asymptotic approach in electromagnetic contexts. The treated examples belong to the class of shape inversion problems. We distinguish two categories of examples:

- A first category of examples allowing us to validate our approach to detecting metallic objects buried in soil.
- A second category of problems allowing us to test our approach to detecting objects in free space using given scattered field data.

Each example is very general and it is not a precise application to a posed real problem. Here, our principal goal is to show the possibilities offered by the topological asymptotic approach to treating electromagnetic problems in various contexts.

All the results presented in this section were obtained by only one iteration. We will show that the topological gradient computed in the first iteration gives us a good idea about the unknown objects.

5.1. Buried objects detection

We will particularly focus on the following problem: we look to determine the number and the positions of metallic objects buried in a soil using scattered field measurements. To obtain these measurements, a mono-static antenna was placed about 30 cm above the soil. This antenna enables us to get a measurement of the scattered field for a set of frequencies fixed between 500 MHz and 2.5 GHz. Then, the antenna is horizontally translated by some centimetres and a new measurement is made and so on. This is a rough model of the problems described in [18]. The only difference here is that the antenna used is not directional, it will be assimilated into a point source, sending out a spherical wave. Starting from these measurements, and hypotheses on the soil nature, the objective is to reconstruct very rapidly the shapes of metallic objects existing in the soil. To simplify the computations as well as the post-treatment of the results, the adopted model is a 2D model with a transverse magnetic polarization. We use the topological asymptotic expansion for the Helmholtz equation with Dirichlet condition on the boundary of the hole [21]. The 2D Helmholtz equation is solved by the finite difference time-domain method (FDTD), the frequency-domain solution being obtained with a Fourier transform.

5.1.1. The inverse scattering problem. Let $\mathcal{X} = \{x_i\}_{i=1,\dots,n_x}$ be the set of successive locations of the source (and sensors, since the antenna is supposed to be mono-static) and $\mathcal{F} = \{f_i\}_{i=1,\dots,n_f}$ the set of measurement frequencies. Let ε_s be the soil permittivity and σ_s its conductivity. The area occupied by the buried objects is denoted by Ω . For each couple $(x_i, f_j) \in \mathcal{X} \times \mathcal{F}$, we consider the field E_{x_i, f_j}^Ω , the solution to

$$\begin{cases} \Delta E_{x_i, f_j}^\Omega + k_j^2 E_{x_i, f_j}^\Omega = s_{x_i} & \text{in } \mathbb{R}^2 \setminus \overline{\Omega}, \\ E_{x_i, f_j}^\Omega = 0 & \text{on } \partial\Omega, \\ \lim_{r \rightarrow \infty} \sqrt{r} (\partial_r E_{x_i, f_j}^\Omega - ik E_{x_i, f_j}^\Omega) = 0, \end{cases} \quad (43)$$

where s_{x_i} represents a source point located at x_i , and where

$$\begin{aligned} k_j^2(x) &= \varepsilon(x)\mu\omega_j^2 + i\omega_j\mu\sigma(x), \\ w_j &= 2\pi f_j, \\ (\varepsilon(x), \sigma(x)) &= \begin{cases} (\varepsilon_0, 0) & \text{if } x \geq 0, \\ (\varepsilon_s, \sigma_s) & \text{if } x < 0. \end{cases} \end{aligned}$$

We associate with Ω a set of measurements $\mathcal{M}(\Omega)$ defined by $\mathcal{M}(\Omega) = \{m_{x_i, f_j}(\Omega) := \langle d_{x_i}, E_{x_i, f_j}^\Omega \rangle\}$, where d_{x_i} is the measurement function (in our numerical tests, $m_{x_i, f_j}(\Omega)$ is the value of the scattered field at the source point x_i).

We call reference measurements $\tilde{\mathcal{M}} = \{\tilde{m}_{x_i, f_j}\}$ the values which are obtained with the real objects in the soil. Ideally, these would have been real measurements, but in the following numerical results, we only consider synthetic data obtained via FDTD.

The cost function that evaluates the adequacy between the measurements obtained for a distribution of metallic objects Ω and the reference data is

$$j(\Omega) = \sum_{i,j} |m_{x_i, f_j}(\Omega) - \tilde{m}_{x_i, f_j}|^2.$$

In this case, the topological asymptotic expansion is given by [21]

$$j(\Omega \setminus \overline{D_\varepsilon}) - j(\Omega) = \sum_{i,j} -\frac{2\pi}{\log \varepsilon} \operatorname{Re} \left(E_{x_i, f_j}^\Omega(x) \cdot \overline{v_{x_i, f_j}^\Omega(x)} \right) + o\left(\frac{1}{\log \varepsilon}\right), \quad (44)$$

where $D_\varepsilon = B(x, \varepsilon)$ and v_{x_i, f_j}^Ω is the adjoint state.

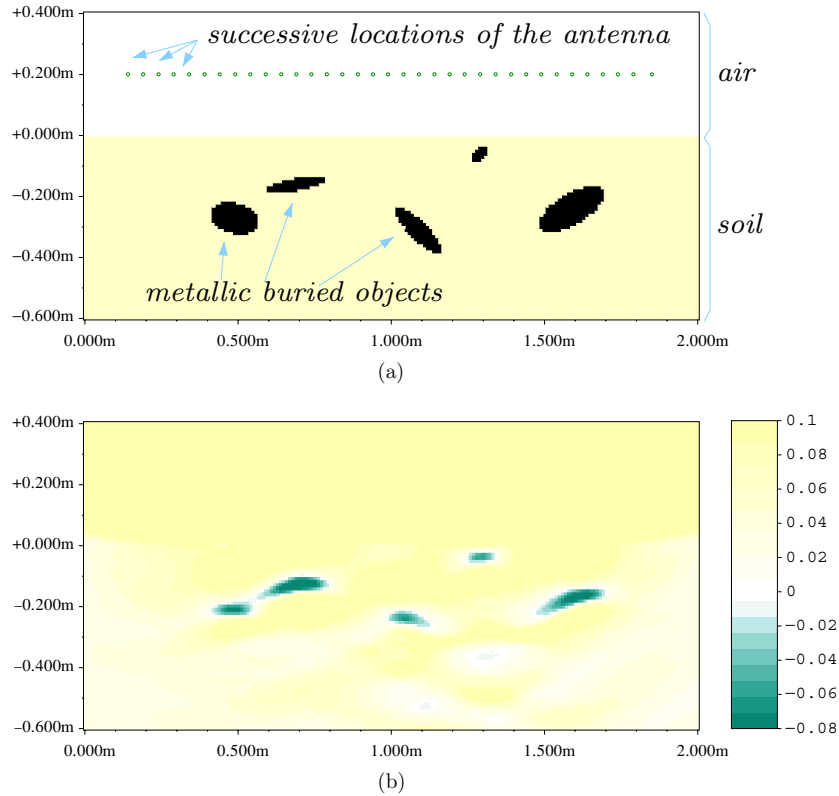

Figure 1. Repartition of metallic objects in the soil and the corresponding topological sensitivity computed on empty flat soil. (a) Metallic objects (dry soil (depth 0.6 m), flat surface ($\epsilon_s = 2.3, \sigma_s = 0$); 35 measurement points located at 20 cm above the soil; 20 frequencies in the range 400 MHz to 2 GHz) and (b) topological sensitivity.

Once we have a solver able to evaluate the direct and the adjoint states, the numerical applications become very simple. Since the problem was formulated in the frequency domain, but we have many frequencies, we choose to use an FDTD code. The frequency-domain solution is obtained using a Fourier transform. This allows, for instance, to obtain the solutions of problem (43) for 20 frequencies using 200×200 grid size, in a few seconds.

5.1.2. Flat and homogeneous dry sandy soil. Figure 1(a) shows a test case example. The reference measurements are obtained by FDTD and the data are not noisy. The soil corresponds to a very dry sand. Five metallic objects are present in this soil. The different positions of the antenna are illustrated in figure 1(a) by small circles. We have employed here 20 different frequencies in the range 400 MHz to 2 GHz. In the soil where $\epsilon_s = 2.3$, these frequencies correspond to wavelengths fixed between 6.5 and 32 cm. The computing domain of 2 m over 1 m is discretized using a 201×101 grid with step size $h = 1$ cm and the PML are applied in its borders.

Once the reference measurements are obtained, the topological gradient given by (44) is computed using a grid identical to that of figure 1(a), but in the absence of metallic objects. Figure 1(b) illustrates this result. One can see that the top of the five objects is clearly identified by the negative region of the topological gradient obtained by only one iteration. This topological sensitivity can be computed very quickly since it is evaluated on a flat soil

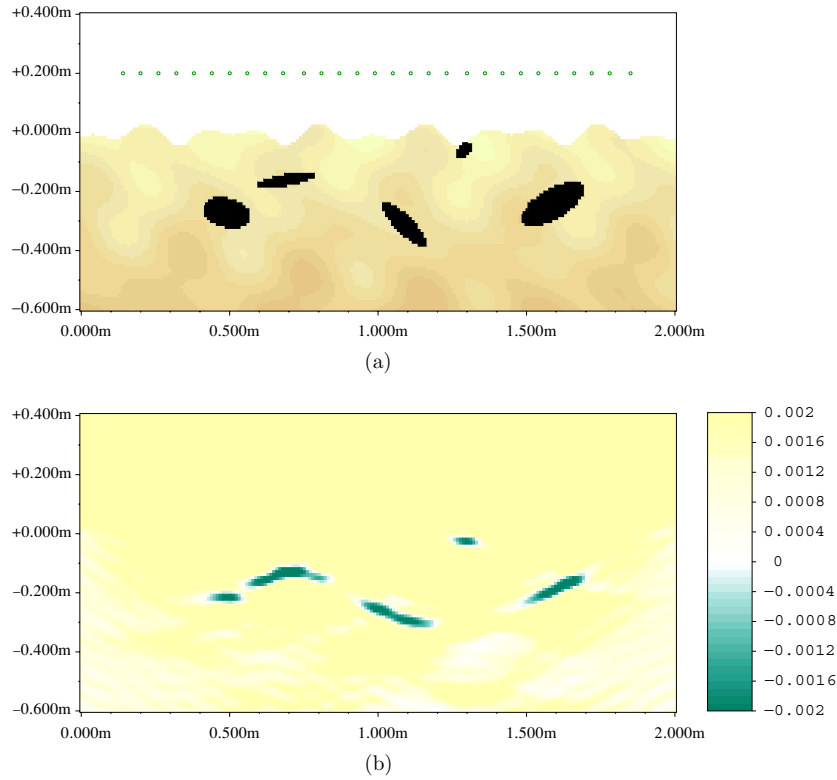

Figure 2. Topological sensitivity with noisy data. (a) Reference distribution of objects (dry soil with rough surface (ε_s ranging from 1.6 to 4.15, $\sigma_s = 0$); 29 measurement points, 20 frequencies in the range 0.26 MHz–1.86 GHz) and (b) topological sensitivity on a flat empty homogeneous soil ($\varepsilon_s = 2.3$).

without mines, which is invariant by translation: all direct states and adjoint states are just horizontal translations of a ‘canonical’ solution. The computational cost is only 10 s on a 300 MHz personal computer. We could consider the following process, that is to say placing the metal in the zones where the topological gradient is negative enough and calculate a new topological gradient in the presence of these metal points. However, we should not expect to get the complete shape of the buried objects. Only their outside face illuminated by the incident wave is expected to be found.

5.1.3. Non-flat inhomogeneous soil. It is important to make sure that the results remain satisfactory when the data are disturbed. The soil properties in particular (permittivity, conductivity, presence of pebbles, irregular surface) are very variable quantities. We check the stability of the topological sensitivity when the real soil does not correspond to the fictitious (and flat) soil upon which we calculate the topological sensitivity. This situation is illustrated in figure 2(a). The reference measurements have been achieved on a hilly soil with a relative permittivity ε_s ranging from 1.6 to 4.15. The topological gradient is calculated on a flat soil with a constant permittivity $\varepsilon_s = 2.3$. However, as shown in figure 2(b), we find the five objects with images slightly modified compared to the previous result.

5.1.4. Soil with high permittivity. In this example, we study the case of a soil having a high permittivity. Hence, the waves quickly vanish in the soil and its surface is highly reflective:

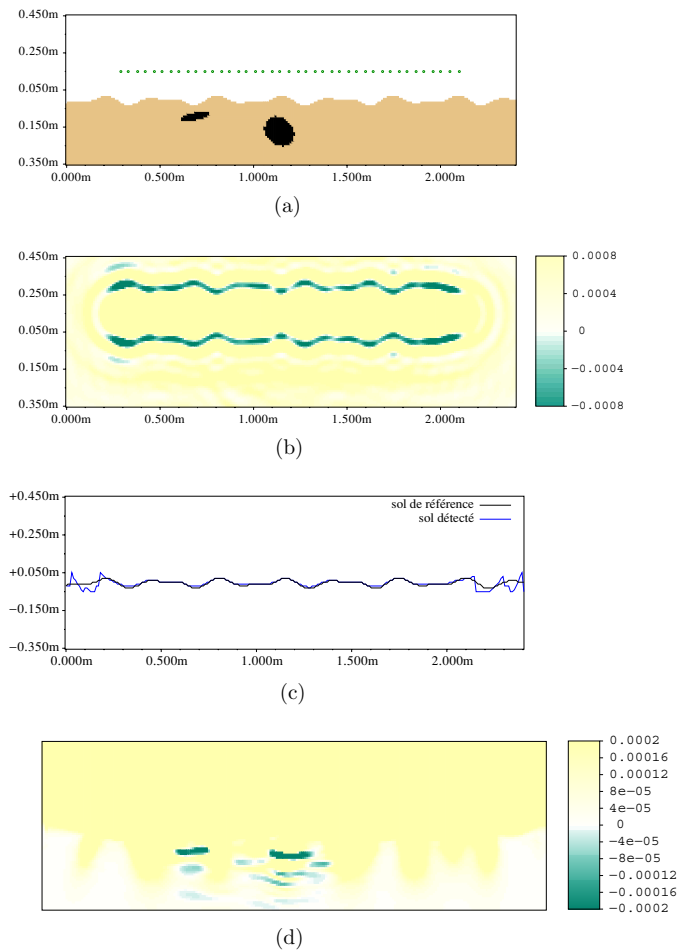

Figure 3. Topological sensitivity in two steps. (a) Reference distribution (41 measurement points; 30 frequencies in the range 0.33 GHz–1 GHz; wet soil ($\epsilon_s = 13$, $\sigma_s = 0.05$)), (b) topological asymptotic computed on an empty initial guess (no soil at all), with respect to small balls of undergrass, (c) detected soil surface and (d) topological sensitivity taking into account the detected soil surface.

its roughness has a great influence on the measurements and computing a topological sensitivity without taking into account its roughness would give an irrelevant result. So we proceed in two steps:

- Reconstruction of the soil profile.
- Calculation of the topological sensitivity taking into account the irregular profile of the soil.

The reconstruction of the soil profile follows exactly the previously exposed principle used for the detection of metallic objects. The only difference here is that the topological sensitivity is computed in free space (without soil and without mines) with respect to small balls of undergrass instead of small balls of metal. Figure 3(a) shows a test case example of the soil detection with a high permittivity $\epsilon_s = 13$, as well as a relatively important conductivity $\sigma_s = 0.05$. On the reference model, measurements have been done for 30 frequencies fixed between 0.33 GHz and 1 GHz.

If the soil is detected with enough precision, as is the case in figure 3(c), we can move to the second step, which is the most costly in time. In fact, the expression for the topological sensitivity remains the same as in the previous examples, but we can no longer obtain the direct states and the adjoint states through the translation of a canonical solution, since the soil is irregular. It is necessary then to make the direct and the adjoint state resolution for each measurement point. The FDTD code spends most of the time on the calculation of the Fourier transform of the temporal signal to get the frequency solution at each point of the domain. In this example, using a Pentium-II with 350 MHz, this calculation lasted 10 min. Figure 3(d) shows the computed topological sensitivity taking into account the detected soil surface. The result is satisfactory, nevertheless, we distinguish a certain number of parasitic marks.

5.2. Shape inversion of 3D objects in free space

The next numerical tests follow a different approach. We now consider time-domain measurements in the context of 3D Maxwell equations. The topological sensitivities for 3D Maxwell equations and 2D transverse magnetic are very different. The main difference is the behaviour of the function $f(\varepsilon)$, since ε^3 goes much faster to zero with ε than $1/\log \varepsilon$, we will not have to face the difficulties arising from a large variation of the solution when a relatively small (i.e. $\simeq 1/20$ th of wavelength) metallic sphere is inserted. Using a time-domain solver, it is possible to keep the computational cost very low with respect to the size of the problems. The same FDTD code is used to compute the direct solution and the adjoint solution (which is computed backward, from the last time step to the first time step), and the topological sensitivity is just the integration with respect to time t of their product. Indeed, the expression for the topological sensitivity that was used in these experiments is simply

$$G(x) = \operatorname{Re} \int_0^T E(x, t) \cdot \overline{v(x, t)} dt,$$

where $E(x, t)$ (resp. $v(x, t)$) is the electric field solution of the direct (resp. adjoint) problem.

The following examples have been done in free space. The employed source is also different, we are concerned now with plane waves. Those have the advantage of uniformly illuminating the objects, hence a topological sensitivity with more resemblance to the objects looked for.

5.2.1. Detection of metallic edges of a cube. The first example is a cube of metallic edges with side length 10 cm, placed in free space. The object is illuminated by six plane waves whose time-domain signal is a Gaussian distribution (the central frequency is equal to zero and the width of the Gaussian distribution is less than 10 time steps). The measurements are the values, for each time step, of the tangential electric field along a ‘virtual surface’ enclosing the cube. This ‘virtual surface’ is a cube with side length 40 cm. The mesh size here is $140 \times 140 \times 140$ and the step size of the mesh is equal to 5 mm. Figure 4 represents the initial object and an iso-value surface of the corresponding topological sensitivity computed in the virtual surface without the object (free space).

5.2.2. Detection of a more complex object. We can wonder now if the previous result is not biased by the particular incidences of the plane waves which lighten the six faces of the cube successively. The following example (figure 5) where the unknown object has a more complex shape (Mickey head) shows that there is nothing to that supposition since the object this time has no particular structure with regard to the directions of the incident waves.

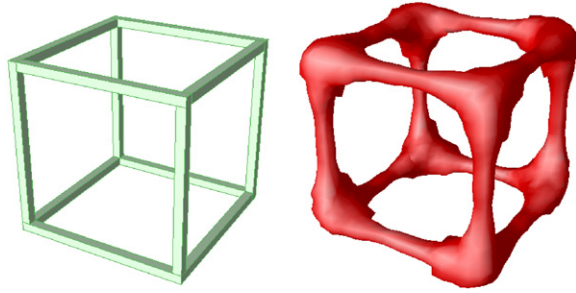

Figure 4. Metallic edges of a cube and an iso-value surface of the corresponding topological sensitivity (computed in free space as an initial guess).

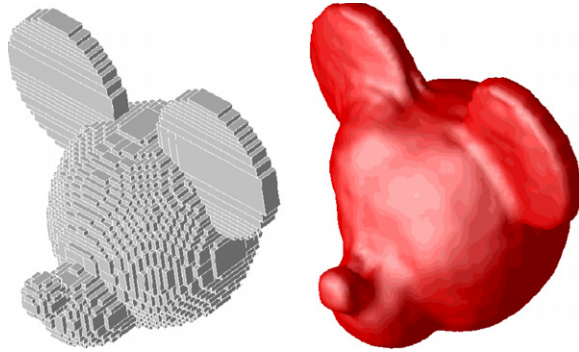

Figure 5. Topological sensitivity for a slightly more complex object.

5.2.3. Topological sensitivity with respect to the insertion of an infinitely small wire. Another major difference with the 2D transverse magnetic polarization case is that the topological sensitivity expression for the 3D Maxwell equations depends on the shape of the holes. So one can try to see if the result is improved if the metallic obstacles are no longer spherical but ‘oriented’: the expression for an infinitely small wire of direction d is

$$\operatorname{Re} \int_0^T (E(t) \cdot d) \overline{(v(t) \cdot d)} dt,$$

where E (resp. v) is the electric field solution of the direct (resp. adjoint) problem. We can write that

$$\operatorname{Re} \int_0^T (E(t) \cdot d) \overline{(v(t) \cdot d)} dt = \left(\operatorname{Re} \int_0^T A(t) dt \right) d \cdot d,$$

where

$$A(t) = \frac{E(t) \otimes \overline{v(t)} + v(t) \otimes \overline{E(t)}}{2}.$$

Then at each point of the domain, the optimal orientation of the wire is given by

$$\min_{d \in \mathbb{R}^3, \|d\|=1} \left(\operatorname{Re} \int_0^T A(t) dt \right) d \cdot d.$$

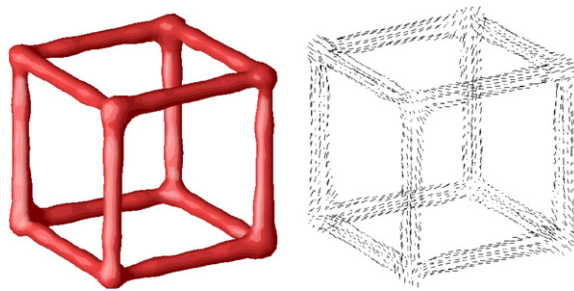

Figure 6. An isosurface of the topological sensitivity for optimally oriented infinitely small wires.

Hence, we have two interesting pieces of information:

- The variation of the cost function, for an optimally oriented wire, is given by the smallest eigenvalue of

$$\operatorname{Re} \int_0^T A(t) dt.$$

- The corresponding eigenvector gives the optimal orientation of the wire.

Applying this new topological sensitivity to the wired cube of figure 4, we show a significant improvement of the result. Figure 6 shows an isosurface of the obtained topological sensitivity.

6. Conclusion

In the theoretical part of this work, we have presented a new adjoint method leading to the topological asymptotic expansion for a linear PDE problem with respect to the insertion of a small inhomogeneity in the domain. In particular, we have considered the case of the 3D Maxwell equations. We have also obtained the topological asymptotic expansion with respect to a perturbation created by a spherical metallic obstacle (hole). This latter result was gotten formally by considering the limit when $\alpha_1 \rightarrow 0$ and $\beta_1 \rightarrow 0$.

We have applied the topological asymptotic approach to solve some inverse scattering problems. We have presented two categories of examples:

- The detection of metallic objects buried in soil. Different cases were considered: flat and homogeneous dry sandy soil, non-flat inhomogeneous soil and soil with high permittivity and conductivity.
- Detection of 3D metallic objects placed in free space from time-domain scattered field data.

The obtained results are satisfactory and show the abilities of the topological asymptotic approach to solve inverse scattering problems. One of its main advantages is its speed: it is not necessary to do many iterations, a satisfactory result is generally obtained in the first iteration.

It would be interesting to apply this approach to less academic problems than those presented in this paper. In particular, the detection of objects buried in soil has to be applied in the three-dimensional case and the modellization of the source antenna is to be improved.

References

- [1] Allaire G, Jouve F and Toader A M 2002 A level-set method for shape optimization *C. R. Acad. Sci.* **334** 1125–30

- [2] Allaire G and Kohn R 1993 Optimal design for minimum weight and compliance in plane stress using extremal microstructures *Eur. J. Mech. A* **12** 839–78
- [3] Allaire G and Kohn R 1993 Optimal bounds on the effective behavior of a mixture of two well-ordered elastic materials *Q. Appl. Math.* **51** 643–74
- [4] Ammari H, Vogelius M S and Volkov D 2001 Asymptotic formulas for perturbations in the electromagnetic fields due to the presence of inhomogeneities of small diameter II. The full Maxwell equations *J. Math. Pures Appl.* **80** 769–814
- [5] Amstutz S and Dominguez N 2004 Topological sensitivity analysis for the insertion of holes and cracks with Neumann condition: the case of non-homogeneous operators *Modelisation Math. Anal. Number* submitted
- [6] Bendsoe M and Kikuchi N 1988 Generating optimal topologies in structural design using a homogenisation method *Comput. Meth. Appl. Mech. Eng.* **71** 197–224
- [7] Céa J 1986 Conception optimale ou identification de forme, calcul rapide de la dérivée directionnelle de la fonction coût *Modelisation Math. Anal. Number.* **20** 371–402
- [8] Cedio-Fengya D J, Moskov S and Vogelius M S 1998 Identification of conductivity imperfections of small diameter by boundary measurements. Continuous dependence and computational reconstruction *Inverse Problems* **14** 553–95
- [9] Colton D and Kress R 1992 *Integral Equation Methods in Scattering Theory* (Malabar, FL: Krieger)
- [10] Folland G B 1976 *Introduction to Partial Differential Equations* (Princeton, NJ: Princeton University Press)
- [11] Friedman A and Vogelius M S 1989 Identification of small inhomogeneities of extreme conductivity by boundary measurements: a theorem of continuous dependence *Arch. Ration. Mech. Anal.* **105** 299–326
- [12] Garreau S, Guillaume P and Masmoudi M 1999 The topological sensitivity for linear isotropic elasticity *European Conf. on Computational Mechanics (ECCM99), Rapport MIP 99.45*
- [13] Guillaume P and Sidiris K 2002 The topological asymptotic expansion for the Dirichlet problem *SIAM J. Control Optim.* **41** 1042–72
- [14] Kane C and Schoenauer M 1997 Optimisation topologique de formes par algorithmes génétiques *Rev. Française Mécanique* **4** 237–46
- [15] Khelifi A 2002 Electromagnetic scattering from small dielectric inhomogeneities *PhD Thesis Ecole Polytechnique*
- [16] Mader P 2002 Optimisation topologique pour la conception de composants guidés *Thèse Université Paul Sabatier, Toulouse*
- [17] Masmoudi M 2002 The topological asymptotic *Computational Methods for Control Applications (International Series GAKUTO)* ed H Kawarada and J Periaux
- [18] Millot P, Bureau J, Borderies P, Bachelier E, Pichot C, LE Brusq E, Guillanton E and Dauvignac J 2000 Experimental study of near surface radar imaging of buried objects with adaptive focussed synthetic aperture processing *Subsurface Sensing Technologies and Applications II (Proc. SPIE 4129) (Cam Nyugen)* pp 515–23
- [19] Nazarov S A and Sokolowski J 2002 Asymptotic analysis of shape functionals *Rapport de recherche de l'INRIA RR-4633*
- [20] Novotny A A, Fej6o R A, Padra C and Taroco E 2003 Topological sensitivity analysis *Comput. Methods Appl. Mech. Eng.* **192** 803–29
- [21] Samet B, Amstutz S and Masmoudi M 2003 The topological asymptotic for the Helmholtz equation *SIAM J. Control Optim.* **42** 1523–44
- [22] Santosa F 1996 A level set approach for inverse problems involving obstacles *ESAIM: Control, Optim. Calc. Var.* **1** 17–33
- [23] Schoenauer M, Kallel L and Jouve F 1996 Mechanics inclusions identification by evolutionary computation *Rev. Euro. Éléments Finis* **5** 619–48
- [24] Schumacher A, Kobolev V V and Eschenauer H A 1994 Bubble method for topology and shape optimization of structures *J. Struct. Optim.* **8** 42–51
- [25] Sokolowski J and Zochowski A 1999 Topological derivatives for elliptic problems *Inverse Problems* **15** 123–34
- [26] Sokolowski J and Zochowski A 1999 On the topological derivative in shape optimization *SIAM J. Control Optim.* **37** 1251–72
- [27] Vogelius M S and Volkov D 2000 Asymptotic formulas for perturbations in the electromagnetic fields due to the presence of inhomogeneities of small diameter *Modelisation Math. Anal. Number.* **34** 723–48
- [28] Volkov D 2001 An inverse problem for the time harmonic Maxwell equations *PhD Thesis Rutgers University, New Brunswick, NJ*

Article 7 :

The topological asymptotic with respect to a singular boundary perturbation

CR Acad. Sci. Paris. Ser I. 336 (2003) 1033-1038



ELSEVIER

Available online at www.sciencedirect.com

SCIENCE @ DIRECT®

C. R. Acad. Sci. Paris, Ser. I 336 (2003) 1033–1038

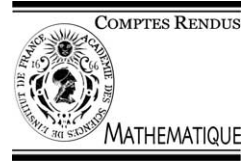

Numerical Analysis

The topological asymptotic with respect to a singular boundary perturbation

Bessem Samet

MIP, UMR 5640, CNRS-Université Paul Sabatier-INSA, 118, route de Narbonne, 31062 Toulouse cedex, France

Received 5 March 2003; accepted after revision 16 May 2003

Presented by Olivier Pironneau

Abstract

The aim of the topological sensitivity analysis is to obtain an asymptotic expansion of a design functional with respect to the insertion of a small hole in the domain. The question that we address here is what happens if the hole is located at the boundary of the domain and what happens if the boundary is not regular. The adjoint method and the domain truncation technique are proposed to solve this problem. As a model example, we consider the Laplace equation in a domain with a corner. **To cite this article:** *B. Samet, C. R. Acad. Sci. Paris, Ser. I 336 (2003)*.

© 2003 Académie des sciences. Published by Éditions scientifiques et médicales Elsevier SAS. All rights reserved.

Résumé

L'asymptotique topologique par rapport à une perturbation singulière du bord. Le but de la sensibilité topologique est d'obtenir une expression asymptotique d'une fonctionnelle de forme par rapport à l'insertion d'un petit trou dans le domaine. Dans cette Note, nous considérons le cas d'un petit trou situé sur un coin du domaine. La méthode de l'état adjoint et la technique de troncature de domaine sont proposées pour résoudre ce problème. Nous considérons comme exemple modèle, l'équation de Laplace posée dans un domaine avec un coin. **Pour citer cet article :** *B. Samet, C. R. Acad. Sci. Paris, Ser. I 336 (2003)*.

© 2003 Académie des sciences. Published by Éditions scientifiques et médicales Elsevier SAS. All rights reserved.

Version française abrégée

La méthode de la sensibilité topologique est basée sur l'idée suivante. Soit une fonction coût $\mathcal{J}(\Omega) = J(\Omega, u_\Omega)$, où Ω est un ouvert de \mathbb{R}^d , $d \geq 2$, et u_Ω est la solution d'un problème aux dérivées partielles posé dans le domaine Ω . Si nous créons un trou $B(x, \varepsilon)$ dans le domaine Ω , nous pouvons montrer (dans la plupart des cas) que la variation de la fonction coût admet l'expression asymptotique suivante :

$$\mathcal{J}(\Omega \setminus \overline{B(x, \varepsilon)}) - \mathcal{J}(\Omega) = f(\varepsilon)G(x) + o(f(\varepsilon)). \quad (1)$$

La fonction $f(\varepsilon)$ est strictement positive et tend vers zéro avec ε . L'expression (1) est appelée « asymptotique topologique ». La fonction G définie dans (1) est appelée « gradient topologique ». Pour minimiser notre critère,

E-mail address: samet@mip.ups-tlse.fr (B. Samet).

nous devons créer des trous où le gradient est négatif. L’asymptotique topologique a été obtenue pour des problèmes divers [1–10]. Tous ces problèmes ont en commun le fait que le trou est assez loin du bord du domaine. Dans cette Note, nous considérons le problème suivant. Soit Ω un ouvert borné du plan. Une partie Γ_0 du bord est définie par deux segments formant un angle $\lambda\pi$, $0 < \lambda < 2$ (voir Fig. 1). Nous notons u_Ω la solution du problème de Laplace posé dans le domaine Ω , vérifiant $u = 0$ sur Γ_0 et une condition aux limites sur $\Gamma_1 = \partial\Omega \setminus \overline{\Gamma_0}$. Pour $\varepsilon > 0$ (assez petit), nous considérons le domaine perturbé $\Omega_\varepsilon = \Omega \setminus \overline{S_\varepsilon}$, où S_ε est le secteur (voir Fig. 1) défini par $S_\varepsilon = \{(r, \theta) ; 0 \leq r < \varepsilon, 0 \leq \theta \leq \lambda\pi\}$. Notre but est de donner une expression asymptotique de la variation $J(u_{\Omega_\varepsilon}) - J(u_\Omega)$, où u_{Ω_ε} est la solution du problème de Laplace dans le domaine perturbé avec une condition de Dirichlet imposée sur l’arc de cercle joignant les deux segments du secteur S_ε (problème (8)).

Dans cette Note, nous utilisons la méthode de l’état adjoint et une technique de troncature de domaine [4] pour déterminer une formule générale de l’asymptotique topologique (Theorem 2.5). Ensuite, nous étudions le cas particulier où $\lambda^{-1} \in \mathbb{N}^*$ (Corollary 2.6).

1. Introduction

Classical shape optimization methods are based on the perturbation of the boundary of the initial shape. The initial and the final shape have the same topology. The aim of topological optimization is to find an optimal shape without any *a priori* assumption about the topology of the structure. Unlike the case of classical shape optimization, the topology of the structure may change during the optimization process, as, for example, through the inclusion of holes. Recently, the notion of topological sensitivity brings a new approach for topological optimization. It provides an asymptotic expansion of a shape function with respect to the creation of a small hole in the domain. To present the basic idea, we consider Ω a domain of \mathbb{R}^d , $d \geq 2$, and $\mathcal{J}(\Omega) = J(u_\Omega)$ a cost function to be minimized, where u_Ω is solution to a given PDE problem defined in Ω . For $\varepsilon > 0$, let $\Omega \setminus \overline{B(x, \varepsilon)}$ be the perturbed domain. Then, an asymptotic expansion of the function \mathcal{J} can be obtained in the following form:

$$\mathcal{J}(\Omega \setminus \overline{B(x, \varepsilon)}) - \mathcal{J}(\Omega) = f(\varepsilon)G(x) + o(f(\varepsilon)). \tag{2}$$

Here, $f(\varepsilon)$ is an explicit positive function going to zero with ε . Hence, to minimize the criterion \mathcal{J} we just have to create infinitely small holes at some points \tilde{x} where the function G (called the topological gradient) is negative. The expression (2) is called “topological asymptotic”. The topological asymptotic has been obtained for various problems [1–10]. In all these publications, the hole is located far enough from the boundary of the domain. In this work, we consider an initial domain $\Omega \subset \mathbb{R}^2$ with a corner. The perturbed domain is defined by $\Omega_\varepsilon = \Omega \setminus \overline{S_\varepsilon}$, where S_ε is given by $S_\varepsilon = \{(r, \theta) ; 0 \leq r < \varepsilon, 0 \leq \theta \leq \lambda\pi\}$, $0 < \lambda < 2$ (see Fig. 1). Our aim is to obtain the topological

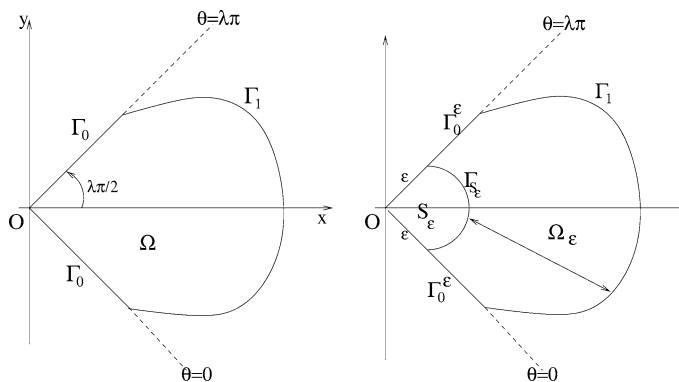

Fig. 1. The initial domain and the same domain after perturbation.

Fig. 1. Le domaine initial et le domaine perturbé.

asymptotic for the Laplace equation in the corner domain Ω . We use the adjoint method and a domain truncation technique [4] to obtain a general formula of the topological asymptotic ($0 < \lambda < 2$). In the case of $\lambda^{-1} \in \mathbb{N}^*$, we obtain a simplified formula.

2. The Laplace problem in a domain with a corner

2.1. The adjoint method

In this subsection, we recall the adjoint method introduced in [1]. Let \mathcal{V} be a Hilbert space. For all $\varepsilon \geq 0$, let a_ε be a bilinear and continuous form on \mathcal{V} and ℓ be a linear and continuous form on \mathcal{V} . We assume that for all $\varepsilon \geq 0$, the bilinear form a_ε is coercive. Using the Lax–Milgram theorem, the following problem: find $u_\varepsilon \in \mathcal{V}$ such that

$$a_\varepsilon(u_\varepsilon, v) = \ell(v) \quad \forall v \in \mathcal{V} \tag{3}$$

has one and only one solution. We consider a cost function: $j(\varepsilon) = J(u_\varepsilon)$, where $J \in \mathcal{C}^1(\mathcal{V}, \mathbb{R})$. Let $v_0 \in \mathcal{V}$ the solution to the adjoint problem:

$$a_0(v, v_0) = -DJ(u_0) \cdot v \quad \forall v \in \mathcal{V}. \tag{4}$$

We call v_0 the adjoint state. We assume that

$$\|a_\varepsilon - a_0 - f(\varepsilon)\delta_a\|_{\mathcal{L}_2(\mathcal{V})} = o(f(\varepsilon)), \tag{5}$$

where $f(\varepsilon) > 0$, $\lim_{\varepsilon \rightarrow 0^+} f(\varepsilon) = 0$ and δ_a is a bilinear and continuous form on \mathcal{V} . We have the following theorem.

Theorem 2.1. *We have that*

$$j(\varepsilon) - j(0) = f(\varepsilon)\delta_a(u_0, v_0) + o(f(\varepsilon)).$$

2.2. Problem formulation

Let Ω be a bounded domain of \mathbb{R}^2 . The boundary of Ω , denoted by $\partial\Omega$, is assumed to be smooth except at a point O , in the vicinity of which $\partial\Omega$ is defined by two straight line segments Σ_1, Σ_2 forming an angle $\lambda\pi$, $0 < \lambda < 2$ (see Fig. 1). The boundary $\partial\Omega$ is split into parts Γ_0, Γ_1 such that $\Gamma_0 = \Sigma_1 \cup \Sigma_2$ and $\Gamma_1 = \partial\Omega \setminus \overline{\Gamma_0}$. We consider the Laplace problem: find $u_\Omega \in \mathcal{V}(\Omega)$ such that

$$\begin{cases} -\Delta u_\Omega = 0 & \text{in } \Omega, \\ u_\Omega = 0 & \text{on } \Gamma_0, \\ \frac{\partial u_\Omega}{\partial n} = h & \text{on } \Gamma_1, \end{cases} \tag{6}$$

where $h \in H_{00}^{1/2}(\Gamma_1)'$ and the functional space $\mathcal{V}(\Omega)$ is defined by: $\mathcal{V}(\Omega) = \{v \in H^1(\Omega); v|_{\Gamma_0} = 0\}$. It is clear that problem (6) has one and only one solution. We consider now a cost function $\mathcal{J}(\Omega) = J(u_\Omega)$. We assume (for simplicity) that the function J is defined in a neighbor part of Γ_1 . The adjoint problem is: find $v_\Omega \in \mathcal{V}(\Omega)$ such that:

$$a(v, v_\Omega) = -DJ(u_\Omega) \cdot v \quad \forall v \in \mathcal{V}(\Omega), \tag{7}$$

where $a(u, v) = \int_\Omega \nabla u \cdot \nabla v \, dx \quad \forall u, v \in \mathcal{V}(\Omega)$. Let u_{Ω_ε} be the solution to the perturbed problem

$$\begin{cases} -\Delta u_{\Omega_\varepsilon} = 0 & \text{in } \Omega_\varepsilon, \\ u_{\Omega_\varepsilon} = 0 & \text{on } \Gamma_{S_\varepsilon} \cup \Gamma_0^\varepsilon, \\ \frac{\partial u_{\Omega_\varepsilon}}{\partial n} = h & \text{on } \Gamma_1, \end{cases} \tag{8}$$

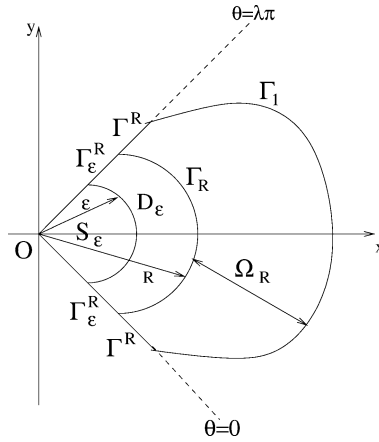

Fig. 2. The truncated domain.
 Fig. 2. Le domaine tronqué.

where $\Gamma_0^\varepsilon = \{(r, \theta); r > \varepsilon, \theta \in \{0, \lambda\pi\}\} \cap \Gamma_0$ and $\Gamma_{S_\varepsilon} = \{(r, \theta); r = \varepsilon, 0 \leq \theta \leq \lambda\pi\}$.

The function u_{Ω_ε} is defined on the variable set Ω_ε , thus it belongs to a functional space which depends on ε . Hence, if we want to derive the asymptotic expansion of a function of the form $j(\varepsilon) = J(u_{\Omega_\varepsilon})$, we cannot apply directly the tools of Subsection 2.1, which require a fixed functional space. However, a functional space independent of ε can be constructed by using a domain truncation technique.

2.3. The domain truncation

Let $R > \varepsilon$ be such that the sector $\overline{S_R}$ is included in Ω . Here, S_R is defined by: $S_R = \{(r, \theta); 0 \leq r < R, 0 \leq \theta \leq \lambda\pi\}$. We introduce the following notations: the truncated domain $\Omega \setminus \overline{S_R}$ is denoted by Ω_R , $D_\varepsilon = S_R \setminus \overline{S_\varepsilon}$, $\Gamma_\varepsilon^R = \{(r, \theta); \varepsilon \leq r \leq R, \theta \in \{0, \lambda\pi\}\}$, $\Gamma^R = \{(r, \theta); r \geq R, \theta \in \{0, \lambda\pi\}\} \cap \Gamma_0$ and $\Gamma_R = \{(r, \theta); r = R, 0 \leq \theta \leq \lambda\pi\}$ (see Fig. 2). For $\varphi \in H_{00}^{1/2}(\Gamma_R)$ and $\varepsilon > 0$, we consider u_ε^φ the solution to the problem

$$\begin{cases} -\Delta u_\varepsilon^\varphi = 0 & \text{in } D_\varepsilon, \\ u_\varepsilon^\varphi = 0 & \text{on } \Gamma_{S_\varepsilon} \cup \Gamma_\varepsilon^R, \\ u_\varepsilon^\varphi = \varphi & \text{on } \Gamma_R. \end{cases} \tag{9}$$

For $\varepsilon = 0$, u_0^φ is the solution to the problem

$$\begin{cases} -\Delta u_0^\varphi = 0 & \text{in } D_0, \\ u_0^\varphi = 0 & \text{on } \partial D_0 \setminus \overline{\Gamma_R}, \\ u_0^\varphi = \varphi & \text{on } \Gamma_R, \end{cases} \tag{10}$$

where $D_0 = S_R$. For $\varepsilon \geq 0$, let T_ε be the Dirichlet-to-Neumann operator defined by: $T_\varepsilon \varphi = \nabla u_\varepsilon^\varphi \cdot n|_{\Gamma_R}$, where $n|_{\Gamma_R}$ is the outward normal to the boundary Γ_R . The truncated problem is: find $u_\varepsilon \in \mathcal{V}(\Omega_R)$ such that

$$\begin{cases} -\Delta u_\varepsilon = 0 & \text{in } \Omega_R, \\ u_\varepsilon = 0 & \text{on } \Gamma^R, \\ \frac{\partial u_\varepsilon}{\partial n} = h & \text{on } \Gamma_1, \\ \frac{\partial u_\varepsilon}{\partial n} + T_\varepsilon u_\varepsilon|_{\Gamma_R} = 0 & \text{on } \Gamma_R, \end{cases} \tag{11}$$

where the functional space $\mathcal{V}(\Omega_R)$ is defined by

$$\mathcal{V}(\Omega_R) = \{v \in H^1(\Omega_R); v|_{\Gamma^R} = 0\}. \tag{12}$$

The variational formulation associated to problem (11) is the following: find $u_\varepsilon \in \mathcal{V}(\Omega_R)$ such that

$$a_\varepsilon(u_\varepsilon, v) = \ell(v) \quad \forall v \in \mathcal{V}(\Omega_R), \tag{13}$$

where the bilinear form a_ε and the linear form ℓ are defined by: $a_\varepsilon(u, v) = \int_{\Omega_R} \nabla u \cdot \nabla v \, dx + \int_{\Gamma^R} T_\varepsilon u \cdot v \, d\gamma$ and $\ell(v) = \int_{\Gamma^1} h \cdot v \, d\gamma(x)$. The following result is standard in PDE theory.

Proposition 2.2. *Problem (11) has one and only one solution which is the restriction to Ω_R of the solution to (8).*

We have now at our disposal the fixed Hilbert space $\mathcal{V}(\Omega_R)$ required by the adjoint method. The variation of the bilinear form $a_\varepsilon - a_0$ can be written:

$$(a_\varepsilon - a_0)(u, v) = \int_{\Gamma^R} (T_\varepsilon - T_0)u \cdot v \, d\gamma(x). \tag{14}$$

Hence, our problem reduces to the computation of $(T_\varepsilon - T_0)\varphi$ for $\varphi = u|_{\Gamma^R}$.

2.4. The asymptotic expansion

We have the following result.

Proposition 2.3. *The operator T_ε is given by the explicit expression:*

$$T_\varepsilon \varphi = \sum_{n \in \mathbb{N}^*} \left(\frac{n}{\lambda} \right) \frac{\varepsilon^{n/\lambda} R^{(-n/\lambda)-1} + \varepsilon^{-n/\lambda} R^{(n/\lambda)-1}}{\varepsilon^{-n/\lambda} R^{n/\lambda} - \varepsilon^{n/\lambda} R^{-n/\lambda}} \varphi_n \sin\left(n \frac{\theta}{\lambda}\right), \quad \forall \varphi \in H_{00}^{1/2}(\Gamma_R),$$

where $\varphi_n = \int_0^{\lambda\pi} \varphi(R, \theta) \sin(n\theta/\lambda) \, d\theta$.

We introduce the operator δ_T defined by: $\delta_T \varphi = 2/(\lambda R^{(2/\lambda)+1})\varphi_1 \sin(\theta/\lambda)$. Using Proposition 2.3, we obtain the following result.

Proposition 2.4. *We have that*

$$\|T_\varepsilon - T_0 - \varepsilon^{2/\lambda} \delta_T\|_{\mathcal{L}(H_{00}^{1/2}(\Gamma_R), H_{00}^{1/2}(\Gamma_R)')} = o(\varepsilon^{2/\lambda}).$$

It follows from Proposition 2.4, (14) and Theorem 2.1 that the following theorem holds.

Theorem 2.5. *The function j has the following asymptotic expansion:*

$$j(\varepsilon) - j(0) = \varepsilon^{2/\lambda} \delta_a(u_\Omega, v_\Omega) + o(\varepsilon^{2/\lambda}),$$

where u_Ω is the solution to (6), v_Ω is the solution to (7) and δ_a is defined by:

$$\delta_a(u, v) = \pi \frac{u_1}{R^{1/\lambda}} \frac{v_1}{R^{1/\lambda}}, \quad \forall u, v \in \mathcal{V}(\Omega_R). \tag{15}$$

Here, $X_1 = 2(\lambda\pi)^{-1} \int_0^{\lambda\pi} X(R, \theta) \sin(\frac{\theta}{\lambda}) \, d\theta$, $X = u$ or v .

As j is usually independent of R and $\delta_a(u_\Omega, v_\Omega)$ is independent of ε , it follows from the uniqueness of an asymptotic expansion that $\delta_a(u_\Omega, v_\Omega)$ is also independent of R . Using (15) leads to the following result.

Corollary 2.6. *If $\lambda^{-1} \in \mathbb{N}^*$, then*

$$j(\varepsilon) - j(0) = \pi \left[\left(\frac{1}{\lambda} \right)! \right]^{-2} \varepsilon^{2/\lambda} \frac{\partial^{1/\lambda} u_{\Omega}}{\partial x^{1/\lambda}}(O) \frac{\partial^{1/\lambda} v_{\Omega}}{\partial x^{1/\lambda}}(O) + o(\varepsilon^{2/\lambda}). \quad (16)$$

Remark. In our situation, we computed the expansion of the topological asymptotic by the use of the adjoint method and the domain truncation technique. However, other interesting cases seem worthy of study. For example, what happen if the initial angle is rounded? or if one cut it by a straight line? These questions are open.

Acknowledgements

I thank the referee for useful comments.

References

- [1] H. Eschenauer, A. Schumacher, Bubble method for topology and shape optimization of structures, *Structural Optim.* 8 (1994) 42–51.
- [2] S. Garreau, P. Guillaume, M. Masmoudi, The topological sensitivity for linear isotropic elasticity, in: *European Conference on Computational Mechanics (ECCM99)*, 1999, rapport MIP 99.45.
- [3] T. Lewinski, J. Sokolowski, Topological derivative for nucleation of non-circular voids, *Rapport de recherche No. 3798*, INRIA-Lorraine, 1999.
- [4] M. Masmoudi, The topological asymptotic, in: H. Kawarada, J. Periaux (Eds.), *Computational Methods for Control Applications*, Internat. Ser. GAKUTO, 2002.
- [5] B. Samet, S. Amstutz, M. Masmoudi, The topological asymptotic for the Helmholtz equation, *SIAM J. Control Optim.*, accepted.
- [6] B. Samet, J. Pommier, The topological asymptotic for the Helmholtz equation with Dirichlet condition on the boundary of an arbitrary shaped hole, *SIAM J. Control Optim.*, submitted.
- [7] A. Schumacher, *Topologieoptimierung von Bauteilstrukturen unter Verwendung von Lochpositionierungskriterien*, Ph.D. Thesis, Universität-Gesamthochschule-Siegen, Siegen, 1995.
- [8] J. Sokolowski, J.-P. Zolesio, *Introduction to shape Optimization. Shape Sensitivity Analysis*, Springer-Verlag, 1992.
- [9] J. Sokolowski, A. Zochowski, On topological derivative in shape optimization, *SIAM J. Control Optim.* 37 (1999) 1251–1272.
- [10] J. Sokolowski, A. Zochowski, Topological derivatives for elliptic problems, *Inverse Problems* 15 (1999) 123–134.

Article 8:

Topological sensitivity analysis with respect to a small hole
located at the boundary of the domain

Asymptotic Analysis. 66(1) (2010)35-49

Asymptotic Analysis 00 (2009) 1–15
 DOI 10.3233/ASY-2009-0957
 IOS Press

1

Topological sensitivity analysis with respect to a small hole located at the boundary of the domain

Bessem Samet

Ecole Supérieure des Sciences et Techniques de Tunis, Département de Mathématiques, 5, Avenue Taha Hussein-Tunis, B.P. 56, Bab Menara-1008, Tunisie
E-mail: bessem.samet@gmail.com

Abstract. The topological sensitivity analysis consists to study the variation of a shape functional with respect to emerging of small holes in the interior of the domain occupied by the body. In this paper, we consider the case of a hole located at the boundary of the domain. The topological asymptotic expansion is derived for the Laplace equation in three cases: Dirichlet condition, Neumann condition and Robin condition on the boundary of the hole.

Keywords: topological derivative, Laplace equation, singularity

1. Introduction

The topological sensitivity analysis method has been recognized as a promising tool to solve topology optimization problems. It consists to provide an asymptotic expansion of a shape functional with respect to the size of a small inclusion inserted inside the domain. This method was introduced by Schumacher [8] in the context of compliance minimization. Then, Sokolowski and Zochowski [9] generalized it to more general shape functionals by involving an adjoint state. To present the basic idea, let us consider a variable domain Ω of \mathbb{R}^2 and a cost functional $j(\Omega) = J(u_\Omega)$ to be minimized, where u_Ω is the solution to a given PDE defined over Ω . For a small parameter $\varepsilon \geq 0$, let $\Omega \setminus \overline{B(x_0, \varepsilon)}$ be the perturbed domain obtained by the creation of a circular hole of radius ε around the point $x_0 \in \Omega$. The topological sensitivity analysis provides an asymptotic expansion of $j(\Omega \setminus \overline{B(x_0, \varepsilon)})$ when ε tends to zero in the form:

$$j(\Omega \setminus \overline{B(x_0, \varepsilon)}) - j(\Omega) = f(\varepsilon)g(x_0) + o(f(\varepsilon)).$$

In this expression, $f(\varepsilon)$ denotes an explicit positive function going to zero with ε , $g(x_0)$ is called the topological derivative and it can be computed easily. Consequently, to minimize the criterion j , one has to create holes at some points \hat{x} where $g(\hat{x})$ is negative.

The topological derivative has been obtained for various problems, arbitrary shaped holes and a large class of cost functionals. Notably, one can cite the papers [1–3,7] where such formulas are proved by using a functional framework based on a domain truncation technique and a generalization of the adjoint method introduced by Masmoudi [5]. An other interesting approach based on classical shape sensitivity

analysis was proposed by Novotny, Feijóo, Padra and Taroco [6]. In all these publications, the hole is located far enough from the boundary of the domain.

The question that we address here is what happens if the hole is located at the boundary of the domain and what happens if the boundary is not regular. We consider the Laplace equation as a model example and we discuss three cases: Dirichlet condition, Neumann condition and Robin condition on the boundary of the hole. Our approach is based on the generalized adjoint method and the truncation technique introduced by Masmoudi [5].

2. Problem formulation

2.1. The initial problem

We consider a bounded domain $\Omega \subset \mathbb{R}^2$ with a corner singularity at the origin with $\partial\Omega = \Gamma_0 \cup \Gamma_1$. The geometry of the domain is given by Fig. 1. Here, $0 < \lambda < 2$. The initial problem is: find $u_\Omega \in \mathcal{V}(\Omega)$ such that

$$\begin{cases} -\Delta u_\Omega = 0 & \text{in } \Omega, \\ u_\Omega = 0 & \text{on } \Gamma_0, \\ \partial_n u_\Omega = \alpha & \text{on } \Gamma_1, \end{cases} \quad (2.1)$$

where ∂_n denotes the normal derivative, the functional space $\mathcal{V}(\Omega)$ is given by

$$\mathcal{V}(\Omega) = \{u \in H^1(\Omega) \mid u = 0 \text{ on } \Gamma_0\}$$

and $\alpha \in H_{00}^{1/2}(\Gamma_1)'$. We recall that, for an open manifold Σ such that $\bar{\Sigma} \subset \tilde{\Sigma}$ where $\tilde{\Sigma}$ is a smooth, open and bounded manifold of the same dimension as Σ , we have

$$H_{00}^{1/2}(\Sigma) = \{u|_\Sigma \mid u \in H^{1/2}(\tilde{\Sigma}) \text{ and } u|_{\tilde{\Sigma} \setminus \bar{\Sigma}} = 0\}.$$

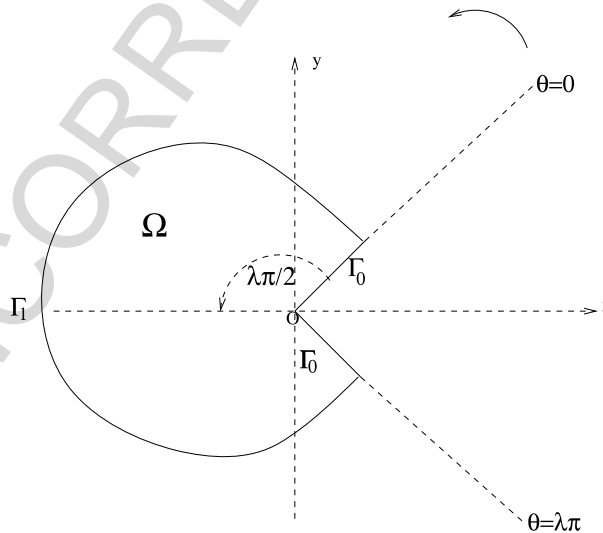

Fig. 1. The initial domain.

1 It is endowed with the norm defined for all $u \in H^{1/2}(\tilde{\Sigma})$ by

$$2 \quad \|u|_{\Sigma}\|_{H_0^{1/2}(\Sigma)} = \|u\|_{H^{1/2}(\tilde{\Sigma})}.$$

3 For more details concerning these Sobolev spaces, we refer the reader to [4].

4 2.2. The cost function and the adjoint state

5 We consider a cost function

$$6 \quad J: H_0^{1/2}(\Gamma_1) \rightarrow \mathbb{R}$$

7 and we assume that J is differentiable. We define the adjoint state $p_{\Omega} \in \mathcal{V}(\Omega)$ solution to:

$$8 \quad \begin{cases} -\Delta p_{\Omega} = 0 & \text{in } \Omega, \\ p_{\Omega} = 0 & \text{on } \Gamma_0, \\ \partial_n p_{\Omega} = -DJ(u_{\Omega}|_{\Gamma_1}) & \text{on } \Gamma_1. \end{cases} \quad (2.2)$$

9 2.3. Perturbation of the domain

10 For $\varepsilon > 0$, we define the perturbed domain by: $\Omega_{\varepsilon} = \Omega \setminus \omega_{\varepsilon}$, where ω_{ε} is the sector defined by

$$11 \quad \omega_{\varepsilon} = \{(r, \theta) \mid 0 \leq r < \varepsilon, 0 \leq \theta \leq \lambda\pi\}.$$

12 The boundary of Ω_{ε} is given by

$$13 \quad \partial\Omega_{\varepsilon} = \Gamma_{0,\varepsilon} \cup \partial\omega_{\varepsilon} \cup \Gamma_1,$$

14 where

$$15 \quad \Gamma_{0,\varepsilon} = \{(r, \theta) \in \partial\Omega \mid r > \varepsilon, \theta \in \{0, \lambda\pi\}\}.$$

16 The geometry of the perturbed domain is given by Fig. 2.

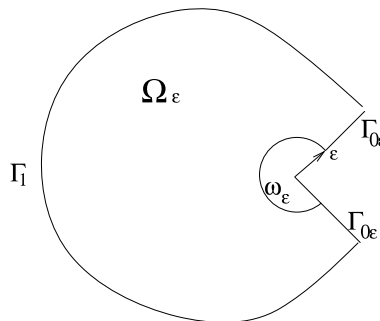

17 Fig. 2. The perturbed domain.

Now, let u_{Ω_ε} be the solution to the perturbed problem:

$$\begin{cases} -\Delta u_{\Omega_\varepsilon} = 0 & \text{in } \Omega_\varepsilon, \\ u_{\Omega_\varepsilon} = 0 & \text{on } \Gamma_{0,\varepsilon}, \\ \gamma_1 u_{\Omega_\varepsilon} + \gamma_2 \partial_n u_{\Omega_\varepsilon} = 0 & \text{on } \partial\omega_\varepsilon, \\ \partial_n u_{\Omega_\varepsilon} = \alpha & \text{on } \Gamma_1, \end{cases} \quad (2.3)$$

where γ_1 and γ_2 are two real constants.

2.4. The aim of the paper

For $\varepsilon \geq 0$, we denote:

$$j(\varepsilon) = \begin{cases} J(u_{\Omega_\varepsilon|_{\Gamma_1}}) & \text{if } \varepsilon > 0, \\ J(u_{\Omega|_{\Gamma_1}}) & \text{if } \varepsilon = 0. \end{cases} \quad (2.4)$$

In this paper, our aim is to obtain an asymptotic expansion of $j(\varepsilon) - j(0)$ with respect to $\varepsilon \rightarrow 0^+$. We discuss three cases:

- $\gamma_1 = 1$ and $\gamma_2 = 0$ (Dirichlet condition).
- $\gamma_1 = 0$ and $\gamma_2 = 1$ (Neumann condition).
- $\gamma_1 = \gamma_2 = 1$ (Robin condition).

3. Preliminaries

In this section, we recall briefly the generalized adjoint method introduced by Masmoudi in [5].

Let \mathcal{V} be a real fixed Hilbert space equipped with the norm $\|\cdot\|_{\mathcal{V}}$, $\mathcal{L}(\mathcal{V})$ denotes the space of linear continuous forms on \mathcal{V} and $\mathcal{L}_2(\mathcal{V})$ denotes the space of bilinear continuous forms on \mathcal{V} . Let $\ell \in \mathcal{L}(\mathcal{V})$ and for all $\varepsilon \geq 0$, let $a_\varepsilon \in \mathcal{L}_2(\mathcal{V})$.

We assume that the following hypotheses hold.

Hypothesis 3.1. *The bilinear form a_0 is coercive:*

$$\exists c > 0 \mid a_0(u, u) \geq c \|u\|_{\mathcal{V}}^2, \quad \forall u \in \mathcal{V}.$$

Hypothesis 3.2. *There exist a real function f and $\delta_a \in \mathcal{L}_2(\mathcal{V})$ such that:*

$$\begin{aligned} f(\varepsilon) &\rightarrow 0 \quad \text{as } \varepsilon \rightarrow 0^+, \\ \|a_\varepsilon - a_0 - f(\varepsilon)\delta_a\|_{\mathcal{L}_2(\mathcal{V})} &= o(f(\varepsilon)). \end{aligned}$$

According to Hypotheses 3.1 and 3.2, the bilinear form a_ε depends continuously on ε . Hence, there exists $\varepsilon_0 > 0$ and $d > 0$ such that for every $\varepsilon \in [0, \varepsilon_0]$, the following uniform coercivity condition holds:

$$a_\varepsilon(u, u) \geq d \|u\|_{\mathcal{V}}^2, \quad \forall u \in \mathcal{V}.$$

By the Lax–Milgram’s theorem, for $\varepsilon \in [0, \varepsilon_0]$, the following problem:

$$\begin{cases} \text{Find } u_\varepsilon \in \mathcal{V} \text{ such that} \\ a_\varepsilon(u_\varepsilon, v) = \ell(v), \forall v \in \mathcal{V} \end{cases} \quad (3.1)$$

has one and only one solution.

Proposition 3.1. *Under Hypotheses 3.1 and 3.2, we obtain the following estimate:*

$$\|u_\varepsilon - u_0\|_{\mathcal{V}} = O(f(\varepsilon)).$$

We consider now a cost function

$$j(\varepsilon) = J(u_\varepsilon), \quad \forall \varepsilon \in [0, \varepsilon_0],$$

where $J: \mathcal{V} \rightarrow \mathbb{R}$ is a differentiable function: for every $u \in \mathcal{V}$, there exists a linear continuous form $DJ(u) \in \mathcal{L}(\mathcal{V})$ such that

$$J(u + h) = J(u) + DJ(u) \cdot h + o(\|h\|_{\mathcal{V}}).$$

Under Hypothesis 3.1, the adjoint problem:

$$\begin{cases} \text{Find } p_0 \in \mathcal{V} \text{ such that} \\ a_0(v, p_0) = -DJ(u_0) \cdot v, \forall v \in \mathcal{V} \end{cases} \quad (3.2)$$

has one and only one solution called adjoint state.

For $\varepsilon \geq 0$, we define the Lagrangian operator \mathcal{L}_ε by

$$\mathcal{L}_\varepsilon(u, v) = J(u) + a_\varepsilon(u, v) - \ell(v), \quad \forall u, v \in \mathcal{V}.$$

We observe that

$$j(\varepsilon) - j(0) = \mathcal{L}_\varepsilon(u_\varepsilon, v) - \mathcal{L}_0(u_0, v), \quad \forall v \in \mathcal{V}.$$

Now, the asymptotic expansion of $j(\varepsilon) - j(0)$ as $\varepsilon \rightarrow 0$ is given by the following theorem.

Theorem 3.1. *If Hypotheses 3.1 and 3.2 hold, then*

$$j(\varepsilon) - j(0) = f(\varepsilon)\delta_a(u_0, p_0) + o(f(\varepsilon)),$$

where u_0 is the direct state solution to (3.1) for $\varepsilon = 0$ and p_0 is the adjoint state solution to (3.2).

4. Reformulation of the problem in a fixed functional space

The perturbed solution u_{Ω_ε} to (2.3) is defined on the variable set Ω_ε , thus it belongs to a functional space which depends on ε . Hence, if we want to derive the asymptotic expansion of $j(\varepsilon) - j(0)$, where j is defined by (2.4), we cannot apply directly the tools of the previous section, which require a fixed functional space. However, a functional space independent of ε can be constructed by using the domain truncation technique introduced in [5].

4.1. Truncation of the domain

For $R > \varepsilon$, we define the truncated domain:

$$\Omega_R = \Omega \setminus \overline{\omega_R},$$

where ω_R is the sector given by

$$\omega_R = \{(r, \theta) \mid 0 \leq r < R, 0 \leq \theta \leq \lambda\pi\}.$$

The parameter R is chosen such that $\overline{\omega_R} \subset \Omega$. The boundary of ω_R is denoted by Γ_R . The boundary of the truncated domain Ω_R is given by

$$\partial\Omega_R = \Gamma_1 \cup \Sigma_0 \cup \Gamma_R,$$

where

$$\Sigma_0 = \{(r, \theta) \in \partial\Omega \mid r > R, \theta \in \{0, \lambda\pi\}\}.$$

We denote

$$D_\varepsilon = \{(r, \theta) \mid \varepsilon < r < R, 0 \leq \theta \leq \lambda\pi\}.$$

The boundary of D_ε is given by

$$\partial D_\varepsilon = \partial\omega_\varepsilon \cup \Gamma_R \cup \Gamma_{\varepsilon,R},$$

where $\Gamma_{\varepsilon,R}$ is defined by

$$\Gamma_{\varepsilon,R} = \{(r, \theta) \mid \varepsilon < r < R, \theta \in \{0, \lambda\pi\}\}.$$

We denote

$$\Gamma_{0,R} = \{(r, \theta) \mid 0 \leq r < R, \theta \in \{0, \lambda\pi\}\}.$$

The geometry of the truncated domain is given by Fig. 3.

4.2. Reformulation of the problem

We introduce the Dirichlet-to-Neumann operator

$$T_0 : H_{00}^{1/2}(\Gamma_R) \rightarrow H_{00}^{1/2}(\Gamma_R)'$$

defined by

$$T_0\varphi = \nabla u_0^\varphi \cdot n|_{\Gamma_R}, \quad \forall \varphi \in H_{00}^{1/2}(\Gamma_R),$$

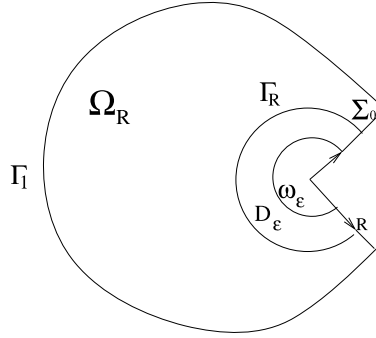

Fig. 3. The truncated domain.

where $n_{|\Gamma_R}$ is the outward normal to the boundary Γ_R and u_0^φ is the solution to:

$$\begin{cases} -\Delta u_0^\varphi = 0 & \text{in } \omega_R, \\ u_0^\varphi = 0 & \text{on } \Gamma_{0,R}, \\ u_0^\varphi = \varphi & \text{on } \Gamma_R. \end{cases} \quad (4.1)$$

For $\varepsilon > 0$, we introduce the Dirichlet-to-Neumann operator

$$T_\varepsilon : H_{00}^{1/2}(\Gamma_R) \rightarrow H_{00}^{1/2}(\Gamma_R)'$$

defined by

$$T_\varepsilon \varphi = \nabla u_\varepsilon^\varphi \cdot n_{|\Gamma_R}, \quad \forall \varphi \in H_{00}^{1/2}(\Gamma_R),$$

where u_ε^φ is the solution to:

$$\begin{cases} -\Delta u_\varepsilon^\varphi = 0 & \text{in } D_\varepsilon, \\ u_\varepsilon^\varphi = 0 & \text{on } \Gamma_{\varepsilon,R}, \\ \gamma_1 u_\varepsilon^\varphi + \gamma_2 \partial_n u_\varepsilon^\varphi = 0 & \text{on } \partial \omega_\varepsilon, \\ u_\varepsilon^\varphi = \varphi & \text{on } \Gamma_R. \end{cases} \quad (4.2)$$

Now, we introduce the fixed functional space $\mathcal{V}(\Omega_R)$ defined by

$$\mathcal{V}(\Omega_R) = \{u \in H^1(\Omega_R) \mid u = 0 \text{ on } \Sigma_0\}.$$

Let $u_0 \in \mathcal{V}(\Omega_R)$ the solution to the truncated problem:

$$\begin{cases} -\Delta u_0 = 0 & \text{in } \Omega_R, \\ u_0 = 0 & \text{on } \Sigma_0, \\ \partial_n u_0 + T_0 u_0 = 0 & \text{on } \Gamma_R, \\ \partial_n u_0 = \alpha & \text{on } \Gamma_1. \end{cases} \quad (4.3)$$

The variational formulation associated to (4.3) is the following:

$$\begin{cases} \text{Find } u_0 \in \mathcal{V}(\Omega_R) \text{ such that} \\ a_0(u_0, v) = \ell(v), \forall v \in \mathcal{V}(\Omega_R), \end{cases} \quad (4.4)$$

1 where

$$2 \quad a_0(u, v) = \int_{\Omega_R} \nabla u \cdot \nabla v \, dx + \int_{\Gamma_R} (T_0 u) v \, d\Gamma_R, \quad \forall u, v \in \mathcal{V}(\Omega_R) \quad 3$$

4 and

$$5 \quad \ell(v) = \int_{\Gamma_1} \alpha v \, d\Gamma_1, \quad \forall v \in \mathcal{V}(\Omega_R). \quad 6$$

7 We admit temporarily that the continuous bilinear form a_0 is coercive. It is standard to prove the follow-
8 ing result. 9

10 **Proposition 4.1.** *Problem (4.4) has one and only one solution in $\mathcal{V}(\Omega_R)$ that is the restriction to Ω_R of*
11 *the solution to (2.1):* 12

$$13 \quad u_0 = u_{\Omega|\Omega_R}. \quad 14$$

15 We define now the truncated adjoint state solution to:

$$16 \quad \begin{cases} \text{Find } p_0 \in \mathcal{V}(\Omega_R) \text{ such that} \\ a_0(v, p_0) = -DJ(u_0|_{\Gamma_1}) \cdot v, \forall v \in \mathcal{V}(\Omega_R). \end{cases} \quad (4.5) \quad 17$$

18 We have the following standard result. 19

20 **Proposition 4.2.** *Problem (4.5) has one and only one solution in $\mathcal{V}(\Omega_R)$ that is the restriction to Ω_R of*
21 *the solution to (2.2):* 22

$$23 \quad p_0 = p_{\Omega|\Omega_R}. \quad 24$$

25 For $\varepsilon > 0$, let $u_\varepsilon \in \mathcal{V}(\Omega_R)$ be the solution to the truncated problem:

$$26 \quad \begin{cases} -\Delta u_\varepsilon = 0 & \text{in } \Omega_R, \\ u_\varepsilon = 0 & \text{on } \Sigma_0, \\ \partial_n u_\varepsilon + T_\varepsilon u_\varepsilon = 0 & \text{on } \Gamma_R, \\ \partial_n u_\varepsilon = \alpha & \text{on } \Gamma_1. \end{cases} \quad (4.6) \quad 27$$

28 The variational formulation associated to (4.6) is the following: 29

$$30 \quad \begin{cases} \text{Find } u_\varepsilon \in \mathcal{V}(\Omega_R) \text{ such that} \\ a_\varepsilon(u_\varepsilon, v) = \ell(v), \forall v \in \mathcal{V}(\Omega_R), \end{cases} \quad (4.7) \quad 31$$

32 where

$$33 \quad a_\varepsilon(u, v) = \int_{\Omega_R} \nabla u \cdot \nabla v \, dx + \int_{\Gamma_R} (T_\varepsilon u) v \, d\Gamma_R, \quad \forall u, v \in \mathcal{V}(\Omega_R). \quad 34$$

35 We admit temporarily that the continuous bilinear form a_ε is uniformly coercive for $0 < \varepsilon \leq \varepsilon_0 < R$. 36

37 We have the following result. 38

39 39

40 40

41 41

42 42

43 43

44 44

45 45

46 46

Proposition 4.3. For $0 < \varepsilon \leq \varepsilon_0 < R$, Problem (4.7) has one and only one solution in $\mathcal{V}(\Omega_R)$ that is the restriction to Ω_R of the solution to (2.3):

$$u_\varepsilon = u_{\Omega_\varepsilon|_{\Omega_R}}, \quad \forall 0 < \varepsilon \leq \varepsilon_0 < R.$$

We have now at our disposal the fixed Hilbert space $\mathcal{V}(\Omega_R)$ required by Section 3. Now, we introduce the function $\tilde{J}: \mathcal{V}(\Omega_R) \rightarrow \mathbb{R}$ defined by

$$\tilde{J}(u) = J(u|_{\Gamma_1}), \quad \forall u \in \mathcal{V}(\Omega_R).$$

It is clear that \tilde{J} is a differentiable function since J is differentiable on $H_0^{1/2}(\Gamma_1)$ and the trace function $u \mapsto u|_{\Gamma_1}$ is linear. By Propositions 4.1 and 4.3, we can redefine the cost function (2.4) as follows:

$$j(\varepsilon) = \begin{cases} \tilde{J}(u_\varepsilon) & \text{if } 0 < \varepsilon \leq \varepsilon_0 < R, \\ \tilde{J}(u_0) & \text{if } \varepsilon = 0. \end{cases} \quad (4.8)$$

Now, to apply Theorem 3.1, we have to check Hypotheses 3.1 and 3.2.

5. Computation of the topological derivative

We start by checking that Hypothesis 3.1 holds. We have the following result:

Proposition 5.1. For $\varphi \in H_0^{1/2}(\Gamma_R)$, the solution to problem (4.1) and the Dirichlet-to-Neumann operator T_0 are given by the explicit expressions:

$$u_0^\varphi(r, \theta) = \sum_{n \in \mathbb{N}^*} \frac{r^{n/\lambda}}{R^{n/\lambda}} \varphi_n \sin\left(\frac{n\theta}{\lambda}\right),$$

$$T_0\varphi(R, \theta) = \sum_{n \in \mathbb{N}^*} \frac{n}{\lambda R} \varphi_n \sin\left(\frac{n\theta}{\lambda}\right),$$

where (r, θ) are the polar coordinates in \mathbb{R}^2 and (φ_n) are the Fourier coefficients of φ

$$\varphi_n = \frac{2}{\lambda\pi} \int_0^{\lambda\pi} \varphi(R, \theta) \sin\left(\frac{n\theta}{\lambda}\right) d\theta.$$

Proof. The solution to (4.1) can be written as follows:

$$u_0^\varphi(r, \theta) = \sum_{n \in \mathbb{N}^*} u_n(r) \sin\left(\frac{n\theta}{\lambda}\right).$$

The condition $-\Delta u_0^\varphi = 0$ implies that

$$u_n(r) = A_n r^{n/\lambda}, \quad \forall n \in \mathbb{N}^*.$$

Using the boundary condition $u_0^\varphi = \varphi$ on Γ_R , we obtain the desired result. \square

By the previous proposition, we show that:

$$\int_{\Gamma_R} (T_0\varphi)\varphi \geq 0, \quad \forall \varphi \in H_{00}^{1/2}(\Gamma_R).$$

Then, the coercivity of a_0 is checked.

Now, let us check Hypothesis 3.2. We should obtain an asymptotic expansion of the variation $a_\varepsilon - a_0$ as $\varepsilon \rightarrow 0^+$. We have

$$(a_\varepsilon - a_0)(u, v) = \int_{\Gamma_R} [(T_\varepsilon - T_0)u]v \, d\Gamma_R, \quad \forall u, v \in \mathcal{V}(\Omega_R).$$

Then, the computation of an asymptotic expansion of $a_\varepsilon - a_0$ is equivalent to the computation of an asymptotic expansion of $T_\varepsilon - T_0$.

We have the following result.

Proposition 5.2. For $\varphi \in H_{00}^{1/2}(\Gamma_R)$, the solution to problem (4.2) and the Dirichlet-to-Neumann operator T_ε are given by the explicit expressions:

$$u_\varepsilon^\varphi(r, \theta) = \sum_{n \in \mathbb{N}^*} \frac{(n\gamma_2/\lambda - \gamma_1\varepsilon)r^{n/\lambda} + \varepsilon^{2n/\lambda}(n\gamma_2/\lambda + \gamma_1\varepsilon)r^{-n/\lambda}}{\varepsilon^{2n/\lambda}R^{-n/\lambda}(n\gamma_2/\lambda + \gamma_1\varepsilon) - R^{n/\lambda}(\gamma_1\varepsilon - n\gamma_2/\lambda)} \varphi_n \sin\left(\frac{n\theta}{\lambda}\right)$$

and

$$T_\varepsilon\varphi(R, \theta) = \sum_{n \in \mathbb{N}^*} \frac{n}{\lambda R} \frac{(n\gamma_2/\lambda - \gamma_1\varepsilon)R^{n/\lambda} - \varepsilon^{2n/\lambda}(n\gamma_2/\lambda + \gamma_1\varepsilon)R^{-n/\lambda}}{\varepsilon^{2n/\lambda}R^{-n/\lambda}(n\gamma_2/\lambda + \gamma_1\varepsilon) - R^{n/\lambda}(\gamma_1\varepsilon - n\gamma_2/\lambda)} \varphi_n \sin\left(\frac{n\theta}{\lambda}\right).$$

Proof. The solution to (4.2) can be written as follows:

$$u_\varepsilon^\varphi(r, \theta) = \sum_{n \in \mathbb{N}^*} (A_n r^{n/\lambda} + B_n r^{-n/\lambda}) \sin\left(\frac{n\theta}{\lambda}\right).$$

Using the boundary conditions, we obtain the following system:

$$\begin{cases} A_n R^{n/\lambda} + B_n R^{-n/\lambda} = \varphi_n, \\ A_n \left(\frac{n\gamma_2}{\lambda} \varepsilon^{2n/\lambda} + \gamma_1 \varepsilon^{2n/\lambda+1} \right) + B_n \left(\gamma_1 \varepsilon - \frac{n\gamma_2}{\lambda} \right) = 0. \end{cases}$$

By solving this system, we obtain the desired result. \square

5.1. First case: Dirichlet condition on the boundary of the hole

In this case, we have $\gamma_1 = 1$ and $\gamma_2 = 0$.

For $\varphi \in H^s(\Gamma_R)$, let

$$\|\varphi\|_{s, \Gamma_R}^2 = \sum_{n \in \mathbb{N}} |\varphi_n|^2 (1 + |n|)^{2s}$$

be the norm of φ in $H^s(\Gamma_R)$. The so defined norm is equivalent to the usual norm of $H^s(\Gamma_R)$.

We introduce the operator $\delta_T : H_{00}^{1/2}(\Gamma_R) \rightarrow H_{00}^{1/2}(\Gamma_R)'$ defined by

$$\delta_T \varphi(R, \theta) = \frac{2}{\lambda R^{2/\lambda+1}} \varphi_1 \sin\left(\frac{\theta}{\lambda}\right), \quad \forall \varphi \in H_{00}^{1/2}(\Gamma_R).$$

We have the following result.

Proposition 5.3. *We have*

$$\|T_\varepsilon - T_0 - \varepsilon^{2/\lambda} \delta_T\|_{\mathcal{L}(H_{00}^{1/2}(\Gamma_R), H_{00}^{1/2}(\Gamma_R)')} = o(\varepsilon^{2/\lambda}).$$

Proof. Using Propositions 5.1 and 5.2, by putting $\gamma_1 = 1$ and $\gamma_2 = 0$, we obtain

$$\begin{aligned} (T_\varepsilon - T_0)\varphi(R, \theta) &= \sum_{n \in \mathbb{N}^*} \frac{2n}{\lambda} \frac{\varepsilon^{n/\lambda} R^{-n/\lambda-1}}{\varepsilon^{-n/\lambda} R^{n/\lambda} - \varepsilon^{n/\lambda} R^{-n/\lambda}} \varphi_n \sin\left(\frac{n\theta}{\lambda}\right) \\ &= \varepsilon^{2/\lambda} \delta_\varphi(R, \theta) (1 - \varepsilon^{2/\lambda} R^{-2/\lambda})^{-1} \\ &\quad + \sum_{n \geq 2} \frac{2n}{\lambda} \frac{\varepsilon^{n/\lambda} R^{-n/\lambda-1}}{\varepsilon^{-n/\lambda} R^{n/\lambda} - \varepsilon^{n/\lambda} R^{-n/\lambda}} \varphi_n \sin\left(\frac{n\theta}{\lambda}\right). \end{aligned}$$

Then, we can write

$$\begin{aligned} (T_\varepsilon - T_0 - \varepsilon^{2/\lambda} \delta_T)\varphi(R, \theta) &= \frac{2\varepsilon^{2/\lambda}}{\lambda R^{2/\lambda+1}} \varphi_1 \sin\left(\frac{\theta}{\lambda}\right) [(1 - \varepsilon^{2/\lambda} R^{-2/\lambda})^{-1} - 1] \\ &\quad + \sum_{n \geq 2} \frac{2n}{\lambda} \frac{\varepsilon^{n/\lambda} R^{-n/\lambda-1}}{\varepsilon^{-n/\lambda} R^{n/\lambda} - \varepsilon^{n/\lambda} R^{-n/\lambda}} \varphi_n \sin\left(\frac{n\theta}{\lambda}\right). \end{aligned}$$

Then

$$\|(T_\varepsilon - T_0 - \varepsilon^{2/\lambda} \delta_T)\varphi\|_{H_{00}^{1/2}(\Gamma_R)'} \leq o(\varepsilon^{2/\lambda}) \|\varphi\|_{H_{00}^{1/2}(\Gamma_R)} + \mathcal{E}_\varepsilon(\varphi),$$

where

$$\mathcal{E}_\varepsilon^2(\varphi) = \sum_{n \geq 2} \frac{4n^2}{\lambda^2(1+n)^2} \frac{\varepsilon^{2n/\lambda} R^{-2n/\lambda-1}}{(\varepsilon^{-n/\lambda} R^{n/\lambda} - \varepsilon^{n/\lambda} R^{-n/\lambda})^2} (1+n) |\varphi_n|^2.$$

Since $\frac{4n^2}{\lambda^2(1+n)^2}$ is a convergent sequence, there exists a constant $c_1 > 0$ such that

$$\frac{4n^2}{\lambda^2(1+n)^2} \leq c_1, \quad \forall n \geq 2.$$

On the other hand, we have

$$\frac{\varepsilon^{2n/\lambda} R^{-2n/\lambda-1}}{(\varepsilon^{-n/\lambda} R^{n/\lambda} - \varepsilon^{n/\lambda} R^{-n/\lambda})^2} = \varepsilon^{6/\lambda} \frac{\varepsilon^{(4n-6)/\lambda}}{R^{4n/\lambda+1}} \frac{1}{(1 - (\varepsilon/R)^{2n/\lambda})^2}.$$

Since ε is small enough, we take $\varepsilon \leq \varepsilon_0 < R$. Then

$$\frac{\varepsilon^{2n/\lambda} R^{-2n/\lambda-1}}{(\varepsilon^{-n/\lambda} R^{n/\lambda} - \varepsilon^{n/\lambda} R^{-n/\lambda})^2} \leq \varepsilon^{6/\lambda} \frac{1}{R^{6/\lambda+1} (1 - (\varepsilon_0/R)^{2n/\lambda})^2} \leq c_2 \varepsilon^{6/\lambda}, \quad \forall n \geq 2.$$

Then, we obtain

$$\mathcal{E}_\varepsilon^2(\varphi) \leq c_1 c_2 \varepsilon^{6/\lambda} \|\varphi\|_{H_{00}^{1/2}(\Gamma_R)}^2$$

that implies

$$\mathcal{E}_\varepsilon(\varphi) = o(\varepsilon^{2/\lambda}) \|\varphi\|_{H_{00}^{1/2}(\Gamma_R)}.$$

This completes the proof. \square

Now, let us introduce the continuous bilinear form $\delta_a \in \mathcal{L}_2(\mathcal{V}(\Omega_R))$ defined by

$$\delta_a(u, v) = \pi \frac{u_1}{R^{1/\lambda}} \frac{v_1}{R^{1/\lambda}}, \quad \forall u, v \in \mathcal{V}(\Omega_R).$$

Since

$$(a_\varepsilon - a_0)(u, v) = \int_{\Gamma_R} [(T_\varepsilon - T_0)u] v \, d\Gamma_R,$$

using the previous proposition, we obtain immediately the following proposition.

Proposition 5.4. *We have*

$$\|a_\varepsilon - a_0 - \varepsilon^{2/\lambda} \delta_a\|_{\mathcal{L}_2(\mathcal{V}(\Omega_R))} = o(\varepsilon^{2/\lambda}).$$

Now, all the hypotheses required by Section 3 are satisfied and we can apply Theorem 3.1 to compute the topological derivative.

Theorem 5.1. *We have*

$$j(\varepsilon) - j(0) = \varepsilon^{2/\lambda} \delta_a(u_\Omega|_{\Omega_R}, p_\Omega|_{\Omega_R}) + o(\varepsilon^{2/\lambda}),$$

where u_Ω is the solution to the direct problem (2.1) and p_Ω is the solution to the adjoint problem (2.2).

Remark 5.2. As j is usually independent of R and $\delta_a(u_\Omega|_{\Omega_R}, p_\Omega|_{\Omega_R})$ is independent of ε , it follows from the uniqueness of an asymptotic expansion that $\delta_a(u_\Omega|_{\Omega_R}, p_\Omega|_{\Omega_R})$ is also independent of R .

In the particular case when $\lambda^{-1} \in \mathbb{N}^*$, it is not difficult to show the following proposition.

Proposition 5.5. *If $\lambda^{-1} \in \mathbb{N}^*$, we have*

$$j(\varepsilon) - j(0) = \pi \left[\left(\frac{1}{\lambda} \right)! \right]^{-2} \varepsilon^{2/\lambda} \frac{\partial^{1/\lambda} u_\Omega}{\partial x^{1/\lambda}}(O) \frac{\partial^{1/\lambda} p_\Omega}{\partial x^{1/\lambda}}(O) + o(\varepsilon^{2/\lambda}).$$

5.2. *Second case: Neumann condition on the boundary of the hole*

In this case, we have $\gamma_1 = 0$ and $\gamma_2 = 1$.

We introduce the operator $\delta_T : H_{00}^{1/2}(\Gamma_R) \rightarrow H_{00}^{1/2}(\Gamma_R)'$ defined by

$$\delta_T \varphi(R, \theta) = \frac{-2}{\lambda R^{2/\lambda+1}} \varphi_1 \sin\left(\frac{\theta}{\lambda}\right), \quad \forall \varphi \in H_{00}^{1/2}(\Gamma_R).$$

We have the following result.

Proposition 5.6. *We have*

$$\|T_\varepsilon - T_0 - \varepsilon^{2/\lambda} \delta_T\|_{\mathcal{L}(H_{00}^{1/2}(\Gamma_R), H_{00}^{1/2}(\Gamma_R)')} = o(\varepsilon^{2/\lambda}).$$

The proof is similar to that of Proposition 5.3.

As in the previous case, by introducing the continuous bilinear form δ_a defined by

$$\delta_a(u, v) = -\pi \frac{u_1}{R^{1/\lambda}} \frac{v_1}{R^{1/\lambda}}, \quad \forall u, v \in \mathcal{V}(\Omega_R),$$

we obtain the following theorem.

Theorem 5.3. *We have*

$$j(\varepsilon) - j(0) = \varepsilon^{2/\lambda} \delta_a(u_\Omega|_{\Omega_R}, p_\Omega|_{\Omega_R}) + o(\varepsilon^{2/\lambda}),$$

where u_Ω is the solution to the direct problem (2.1) and p_Ω is the solution to the adjoint problem (2.2).

In the particular case when $\lambda^{-1} \in \mathbb{N}^*$, we obtain the following proposition.

Proposition 5.7. *If $\lambda^{-1} \in \mathbb{N}^*$, we have*

$$j(\varepsilon) - j(0) = -\pi \left[\left(\frac{1}{\lambda} \right)! \right]^{-2} \varepsilon^{2/\lambda} \frac{\partial^{1/\lambda} u_\Omega}{\partial x^{1/\lambda}}(O) \frac{\partial^{1/\lambda} p_\Omega}{\partial x^{1/\lambda}}(O) + o(\varepsilon^{2/\lambda}).$$

5.3. Third case: Robin condition on the boundary of the hole

In this case, we have $\gamma_1 = \gamma_2 = 1$.

We introduce the operator $\delta_T : H_{00}^{1/2}(\Gamma_R) \rightarrow H_{00}^{1/2}(\Gamma_R)'$ defined by:

$$\delta_T \varphi(R, \theta) = \frac{2}{\lambda R^{2/\lambda+1}} \varphi_1 \sin\left(\frac{\theta}{\lambda}\right), \quad \forall \varphi \in H_{00}^{1/2}(\Gamma_R).$$

We have the following result.

Proposition 5.8. *We have*

$$\|T_\varepsilon - T_0 - \varepsilon^{2/\lambda} \delta_T\|_{\mathcal{L}(H_{00}^{1/2}(\Gamma_R), H_{00}^{1/2}(\Gamma_R)')} = o(\varepsilon^{2/\lambda}).$$

By introducing the continuous bilinear form δ_a defined by

$$\delta_a(u, v) = \pi \frac{u_1}{R^{1/\lambda}} \frac{v_1}{R^{1/\lambda}}, \quad \forall u, v \in \mathcal{V}(\Omega_R),$$

we obtain the following theorem.

Theorem 5.4. *We have*

$$j(\varepsilon) - j(0) = \varepsilon^{2/\lambda} \delta_a(u_\Omega|_{\Omega_R}, p_\Omega|_{\Omega_R}) + o(\varepsilon^{2/\lambda}),$$

where u_Ω is the solution to the direct problem (2.1) and p_Ω is the solution to the adjoint problem (2.2).

In the particular case when $\lambda^{-1} \in \mathbb{N}^*$, we obtain the following proposition.

Proposition 5.9. *If $\lambda^{-1} \in \mathbb{N}^*$, we have*

$$j(\varepsilon) - j(0) = \pi \left[\left(\frac{1}{\lambda} \right)! \right]^{-2} \varepsilon^{2/\lambda} \frac{\partial^{1/\lambda} u_\Omega}{\partial x^{1/\lambda}}(O) \frac{\partial^{1/\lambda} p_\Omega}{\partial x^{1/\lambda}}(O) + o(\varepsilon^{2/\lambda}).$$

References

- [1] S. Garreau, Ph. Guillaume and M. Masmoudi, The topological asymptotic for PDE systems: the elasticity case, *SIAM J. Control. Optim.* **39**(6) (2001), 1756–1778.
- [2] Ph. Guillaume and K. Sidiqis, The topological asymptotic expansion for the Dirichlet problem, *SIAM J. Control. Optim.* **41**(4) (2002), 1052–1072.
- [3] M. Hassine and M. Masmoudi, The topological asymptotic expansion for the quasi-Stokes problem, *ESAIM: Control, Optimisation and Calculus of Variations* **10**(4) (2004), 478–504.
- [4] J.L. Lions and E. Magenes, *Problèmes aux limites non homogènes et applications, Vol. 1*, Dunod, Paris, 1968.
- [5] M. Masmoudi, *The Topological Asymptotic in Computational Methods for Control Applications*, International Series GAKUTO, 2002.
- [6] A.A. Novotny, R.A. Feijóo, C. Padra and E. Taroco, Topological sensitivity analysis, *Comput. Methods Appl. Mech. Engrg.* **192** (2003), 803–829.
- [7] B. Samet, S. Amstutz and M. Masmoudi, The topological asymptotic for the Helmholtz equation, *SIAM J. Control. Optim.* **2**(5) (2003), 1523–1544.

- 1 [8] A. Schumacher, Topologieoptimisierung von Bauteilstrukturen unter Verwendung von Lophpositionierungskriterien, 1
2 Thesis, Universität-Gesamthochschule-Siegen, 1995. 2
3 [9] J. Sokolowski and A. Zochowski, On the topological derivative in shape optimization, *SIAM J. Control. Optim.* **37** (1999), 3
4 1241–1272. 4
5 5
6 6
7 7
8 8
9 9
10 10
11 11
12 12
13 13
14 14
15 15
16 16
17 17
18 18
19 19
20 20
21 21
22 22
23 23
24 24
25 25
26 26
27 27
28 28
29 29
30 30
31 31
32 32
33 33
34 34
35 35
36 36
37 37
38 38
39 39
40 40
41 41
42 42
43 43
44 44
45 45
46 46

Article 9:

The Wentz problem associated to the modified Helmholtz operator

J. Math. Anal. Appl. 339 (2008) 332-343



The Wenté problem associated to the modified Helmholtz operator

Mohamed Jleli, Bessem Samet *

*Ecole Supérieure des Sciences et Techniques de Tunis, Département de Mathématiques, 5, Avenue Taha Hussein, Tunis,
 B.P. 56, Bab Menara 1008, Tunisia*

Received 18 April 2007

Available online 14 July 2007

Submitted by Steven G. Krantz

Abstract

In this paper, we consider the solution to Wenté's problem with the modified Helmholtz operator $-\Delta + \alpha I$, where α is a positive constant. We study the best constant in the so-called Wenté's inequality. At first, we consider the best constant associated to the L^∞ norm. Next, We study the case of the L^2 norm.

© 2007 Elsevier Inc. All rights reserved.

Keywords: Wenté's inequality; Best constant; Modified Helmholtz operator

1. Introduction and statement of the results

Given a vector field $u \in H^1(\mathbb{R}^2, \mathbb{R}^2)$, it is clear that $\det(\nabla u)$ belongs to $L^1(\mathbb{R}^2, \mathbb{R})$. However, due to its algebraic structure, this quantity has some higher regularity properties. In [10], Coifman et al. proved that $\det(\nabla u)$ lies in the generalized Hardy space $\mathcal{H}^1(\mathbb{R}^2)$, a strict subspace of $L^1(\mathbb{R}^2)$. For more details about the generalized Hardy space, we refer to [15].

The quantity $\det(\nabla u)$ appears in a large number of partial differential equations from geometry and physics. In particular, it appears in the classical Wenté problem which arises in the study of constant mean curvature immersions [17]. Let Ω be a smooth and bounded domain in \mathbb{R}^2 . Given $u = (a, b) \in H^1(\Omega, \mathbb{R}^2)$, we consider $\Phi_0 \in L^1(\Omega, \mathbb{R})$, a weak solution of the classical Wenté problem

$$\begin{cases} -\Delta \Phi_0 = \det(\nabla u) = a_{x_1} b_{x_2} - a_{x_2} b_{x_1} & \text{in } \Omega, \\ \Phi_0 = 0 & \text{on } \partial\Omega, \end{cases} \quad (1)$$

where $x = (x_1, x_2) \in \Omega$ and a_{x_i} denotes the partial derivative of a with respect to the variable x_i , for $i = 1, 2$. If $\Omega = \mathbb{R}^2$, we replace the boundary condition in (1) by the limit condition $\lim_{r \rightarrow +\infty} \Phi_0(x) = 0$, where $r = \|x\| = \sqrt{x_1^2 + x_2^2}$. It is proved in [8,18] that Φ_0 is in $H^1(\Omega) \cap C^0(\overline{\Omega})$ and there exists a positive constant $C(\Omega)$ such that

$$\|\Phi_0\|_\infty + \|\nabla \Phi_0\|_2 \leq C(\Omega) \|\nabla a\|_2 \|\nabla b\|_2, \quad \forall (a, b) \in H^1(\Omega, \mathbb{R}^2), \quad (2)$$

* Corresponding author.

E-mail addresses: jlelimohamed@gmail.com (M. Jleli), bessem.samet@gmail.com (B. Samet).

where $\|\cdot\|_p$ denotes the standard L^p norm. Note that this estimate is completely nontrivial since the right-hand side of (1) lies a priori in $L^1(\Omega, \mathbb{R}^2)$, so standard elliptic theory implies only $\Phi_0 \in L^p(\Omega)$ with $p < 1$. But $\det(\nabla u)$ is indeed in the Hardy space, which enable us to get better estimate.

Denoted by

$$C_\infty^0(\Omega) := \sup_{\nabla a, \nabla b \neq 0} \frac{\|\Phi_0\|_\infty}{\|\nabla a\|_2 \|\nabla b\|_2} \tag{3}$$

and

$$C_2^0(\Omega) := \sup_{\nabla a, \nabla b \neq 0} \frac{\|\nabla \Phi_0\|_2}{\|\nabla a\|_2 \|\nabla b\|_2}. \tag{4}$$

It is proved in [3,16] that $C_\infty^0(\Omega) = 1/2\pi$ and in [12] that $C_2^0(\Omega) = \sqrt{(3/16\pi)}$.

In [4], a generalization of problem (1) in higher dimensions is given. The author supposed that $u \in W^{1,n}(\mathbb{R}^n, \mathbb{R}^n)$ and he replaced the operator $-\Delta$ in (1) by $(-\Delta)^{n/2}$. He proved that Φ_0 belongs to $L^\infty(\mathbb{R}^n)$, for $1 \leq k \leq n$, $\nabla^k \Phi_0$ is in $L^{n/k}(\mathbb{R}^n)$ and he also showed that

$$\|\Phi_0\|_\infty + \|\nabla^k \Phi_0\|_{n/k} \leq C \|\nabla u\|_n^n.$$

Moreover, he gave the best constant involving the L^∞ norm. In [1,6], the authors studied the best constant involving the L^∞ norm of evolutionary Wentze's problem associated to the wave and the heat operators.

In this paper, we consider the Wentze's problem associated to the modified Helmholtz operator. More precisely, we deal with the following problem:

$$\begin{cases} -\Delta \Phi_\alpha + \alpha \Phi_\alpha = a_{x_1} b_{x_2} - a_{x_2} b_{x_1} & \text{in } \Omega, \\ \Phi_\alpha = 0 & \text{on } \partial\Omega, \end{cases} \tag{5}$$

where Ω is a smooth and bounded domain in \mathbb{R}^2 and α is a positive constant. Note that this problem has one and only one solution in $H_0^1(\Omega) \cap C^0(\bar{\Omega})$. To show this, it is sufficient to remark that

$$\Phi_\alpha = \Phi_0 + \Psi_\alpha,$$

where $\Phi_0 \in H_0^1(\Omega) \cap C^0(\bar{\Omega})$ is the solution to (1) and $\Psi_\alpha \in H_0^1(\Omega)$ is the solution to

$$-\Delta \Psi_\alpha + \alpha \Psi_\alpha = -\alpha \Phi_0 \quad \text{in } \Omega.$$

Now, let us denote

$$C_\infty^\alpha(\Omega) := \sup_{\nabla a, \nabla b \neq 0} \frac{\|\Phi_\alpha\|_\infty}{\|\nabla a\|_2 \|\nabla b\|_2}, \quad C_2^\alpha(\Omega) := \sup_{\det(\nabla a, \nabla b) \neq 0} \frac{\|\nabla \Phi_\alpha\|_2^2 + \alpha \|\Phi_\alpha\|_2^2}{\|\nabla a\|_2 \|\nabla b\|_2 \|\nabla \Phi_\alpha\|_2}. \tag{6}$$

Our results are the following theorems.

Theorem 1. For all $\alpha > 0$, the solution Φ_α to

$$\begin{cases} -\Delta \Phi_\alpha + \alpha \Phi_\alpha = a_{x_1} b_{x_2} - a_{x_2} b_{x_1} & \text{in } \mathbb{R}^2, \\ \lim_{r \rightarrow +\infty} \Phi_\alpha(x) = 0, \end{cases} \tag{7}$$

exists and satisfies the following inequality:

$$\|\Phi_\alpha\|_\infty \leq \frac{1}{2\pi} \|\nabla a\|_2 \|\nabla b\|_2, \quad \forall (a, b) \in H^1(\mathbb{R}^2, \mathbb{R}^2).$$

Moreover, we have

$$C_\infty^\alpha(\mathbb{R}^2) = C_\infty^0(\mathbb{R}^2) = \frac{1}{2\pi}, \quad \forall \alpha > 0.$$

Theorem 2. Let Ω be a smooth and bounded domain in \mathbb{R}^2 . Then, we have

$$\frac{1}{2\pi} \leq C_\infty^\alpha(\Omega) \leq \frac{1}{\pi}, \quad \forall \alpha > 0.$$

Theorem 3. Let Ω be a smooth and bounded domain in \mathbb{R}^2 . Then, we have

$$C_2^\alpha(\mathbb{R}^2) \leq \sqrt{3/32\pi} \leq C_2^\alpha(\Omega) \leq \sqrt{3/16\pi}, \quad \forall \alpha > 0.$$

2. Proof of Theorem 1

2.1. Preliminary lemmas

In order to prove Theorem 1, we need some preliminary lemmas.

Lemma 1. (See [8].) For all $a, b \in H^1(\mathbb{R}^2)$, we have the following estimate:

$$\left| \int_0^{2\pi} a b_\theta d\theta \right| \leq \|a_\theta\|_{L^2(0,2\pi)} \|b_\theta\|_{L^2(0,2\pi)},$$

where the subscript denote the partial differentiation with respect to the polar coordinate θ .

Proof. We can write that

$$\int_0^{2\pi} a b_\theta d\theta = \int_0^{2\pi} (a - \bar{a}) b_\theta d\theta,$$

where \bar{a} is the zero order Fourier coefficient of a :

$$\bar{a} = \frac{1}{2\pi} \int_0^{2\pi} a(r, \theta) d\theta.$$

Using the Cauchy–Schwartz and Poincaré inequalities, we obtain that

$$\left| \int_0^{2\pi} a b_\theta d\theta \right| \leq \|a - \bar{a}\|_{L^2(0,2\pi)} \|b_\theta\|_{L^2(0,2\pi)} \leq \|a_\theta\|_{L^2(0,2\pi)} \|b_\theta\|_{L^2(0,2\pi)}. \quad \square$$

Lemma 2. We have that

- (1) $\lim_{x \rightarrow 0^+} x K_0(x) = 0$,
- (2) $|x K_1(x)| \leq 1, \forall x \geq 0$,

where K_0 and K_1 are respectively the modified Bessel function of the second kind with zero order and the modified Bessel function of the second kind with first order.

For more details about the Bessel functions, we refer the reader to [2,7,9,13,14].

Proof of Lemma 2. We have the following asymptotic expansion (see [2]):

$$K_0(x) = (\ln 2 - \ln x - \gamma) + O(x^2), \quad x \rightarrow 0^+,$$

where γ is the Euler constant. Then, $\lim_{x \rightarrow 0^+} x K_0(x) = 0$ and (1) is proved. We have

$$K_1(x) = \frac{1}{x} \int_0^{+\infty} \frac{\cos(xt)}{(t^2 + 1)^{3/2}} dt, \quad \forall x > 0,$$

which gives

$$|xK_1(x)| \leq \int_0^{+\infty} \frac{1}{(t^2 + 1)^{3/2}} dt, \quad \forall x \geq 0$$

and (2) follows since

$$\int_0^{+\infty} \frac{1}{(t^2 + 1)^{3/2}} dt = 1. \quad \square$$

Using the residue theorem [11], we obtain the following result.

Lemma 3. *We have that*

$$\int_0^{+\infty} \sigma^{2\varepsilon-1} e^{-(1-i\sqrt{\alpha t})\sigma} d\sigma = \frac{\Gamma(2\varepsilon)}{(1-i\sqrt{\alpha t})^{2\varepsilon}}, \quad \forall t \geq 0, \forall \varepsilon > 0, \forall \alpha \geq 0,$$

where Γ denotes the Gamma function.

By adapting the strategy used in [3], we obtain the following result.

Lemma 4. *Let $g :]0, +\infty[\rightarrow \mathbb{R}$ be a function that satisfies the following properties:*

- (a) $g \in C^\infty(\mathbb{R}_+^* \setminus \{0\})$.
- (b) $\sigma \mapsto \sigma g^2(\sigma)$ belongs to $L^1(\mathbb{R}_+^*)$.
- (c) $\sigma \mapsto \sigma^3 g'^2(\sigma)$ belongs to $L^1(\mathbb{R}_+^*)$.

Let us denote

$$L^\alpha(g) := \frac{\int_0^{+\infty} \sqrt{\alpha} K_1(\sqrt{\alpha}\sigma) \sigma^2 g^2(\sigma) d\sigma}{\int_0^{+\infty} \sigma^3 g'^2(\sigma) d\sigma}.$$

Then, we have that

$$2\pi C_\infty^\alpha(\mathbb{R}^2) \geq L^\alpha(g).$$

Proof. Let g be a function which satisfies properties (a)–(c). Define $\zeta \in \mathcal{D}(\mathbb{R}^2)$ by

$$\zeta(\sigma) := \begin{cases} 1 & \text{if } |\sigma| \leq 1, \\ 0 & \text{if } |\sigma| \geq 2 \end{cases} \quad \text{and } 0 \leq \zeta \leq 1.$$

We let

$$a^n(x_1, x_2) := x_1 g_n(r) \quad \text{and} \quad b^n(x_1, x_2) := x_2 g_n(r),$$

where the function g_n is given by

$$g_n(\sigma) := \zeta(\sigma/n)g(\sigma), \quad \forall n \in \mathbb{N}^*.$$

It is clear that $a^n, b^n \in \mathcal{D}(\mathbb{R}^2)$ for all $n \in \mathbb{N}^*$. We consider now Φ_α^n the solution to

$$-\Delta \Phi_\alpha^n + \alpha \Phi_\alpha^n = a_{x_1}^n b_{x_2}^n - a_{x_2}^n b_{x_1}^n \quad \text{in } \mathbb{R}^2,$$

with the limit condition:

$$\lim_{|x| \rightarrow +\infty} \Phi_\alpha^n(x) = 0.$$

We have that

$$\Phi_\alpha^n = E * (a_{x_1}^n b_{x_2}^n - a_{x_2}^n b_{x_1}^n), \tag{8}$$

where E is the fundamental solution of the modified Helmholtz operator $-\Delta + \alpha I$, for all $\alpha > 0$. In [11], it is shown that

$$E(x_1, x_2) = \frac{1}{2\pi} K_0(\sqrt{\alpha}r).$$

In polar coordinates, we have

$$a_{x_1}^n b_{x_2}^n - a_{x_2}^n b_{x_1}^n = \frac{1}{2r} (r^2 g_n^2(r))'. \tag{9}$$

Using (8) and (9), we obtain

$$\varphi_\alpha^n(0) = \frac{1}{2} \int_0^{+\infty} K_0(\sqrt{\alpha}r) (r^2 g_n^2(r))' dr.$$

Using that $K_0'(r) = -K_1(r)$ and an integration by parts, we obtain

$$\varphi_\alpha^n(0) = \frac{1}{2} \int_0^{+\infty} \sqrt{\alpha}r K_1(\sqrt{\alpha}r) r g_n^2(r) dr. \tag{10}$$

By simple calculus, we obtain

$$\|\nabla a_n\|_{L^2}^2 = \|\nabla b_n\|_{L^2}^2 = \pi \int_0^{+\infty} r^3 g_n'^2(r) dr. \tag{11}$$

It follows from (10) and (11) that

$$C_\infty^\alpha(\mathbb{R}^2) \geq \frac{1}{2\pi} L^\alpha(g_n). \tag{12}$$

To obtain the desired result, it will be sufficient to prove that

$$L^\alpha(g_n) \rightarrow L^\alpha(g), \quad \text{when } n \rightarrow +\infty.$$

Let us denote

$$\mathcal{I}(g) := \int_0^{+\infty} \sqrt{\alpha}r K_1(\sqrt{\alpha}r) r g^2(r) dr \quad \text{and} \quad \mathcal{J}(g) := \int_0^{+\infty} r^3 g'^2(r) dr.$$

• We have that

$$\mathcal{I}(g) - \mathcal{I}(g_n) = \int_0^{+\infty} F_n(r) dr,$$

where

$$F_n(r) := \sqrt{\alpha}r K_1(\sqrt{\alpha}r) [1 - \zeta^2(r/n)] r g^2(r).$$

It is easy to show that

$$F_n(r) \rightarrow 0 \quad \text{when } n \rightarrow +\infty, \quad \forall r > 0.$$

Using Lemma 2, we obtain

$$|F_n(r)| \leq r g^2(r), \quad \forall n \in \mathbb{N}^*.$$

Using the property (b) in Lemma 4 and the dominated convergence theorem, we obtain

$$\int_0^{+\infty} F_n(r) dr \rightarrow 0, \quad \text{when } n \rightarrow +\infty,$$

which gives

$$\mathcal{I}(g) - \mathcal{I}(g_n) \rightarrow 0, \quad \text{when } n \rightarrow +\infty.$$

• We have that

$$\mathcal{J}(g) - \mathcal{J}(g_n) = A_n + B_n + C_n.$$

Where A_n , B_n and C_n are defined as follows:

$$A_n := \int_0^{+\infty} \frac{r^3}{n^2} \zeta'^2(r/n) g^2(r) dr,$$

$$B_n := 2 \int_0^{+\infty} \frac{r^3}{n} \zeta'(r/n) \zeta(r/n) g(r) g'(r) dr,$$

$$C_n := - \int_0^{+\infty} r^3 [1 - \zeta^2(r/n)] g'^2(r) dr.$$

Using the property (b) in Lemma 4, we obtain

$$|A_n| \leq C \int_n^{2n} r g^2(r) dr \rightarrow 0, \quad \text{when } n \rightarrow +\infty.$$

We have

$$|B_n| \leq C \int_n^{2n} r^2 |g'(r)| |g(r)| dr \rightarrow 0, \quad \text{when } n \rightarrow +\infty.$$

Using the property (c) in Lemma 4, we obtain

$$|C_n| \leq \int_n^{+\infty} r^3 g'^2(r) dr \rightarrow 0, \quad \text{when } n \rightarrow +\infty.$$

Hence,

$$\mathcal{J}(g) - \mathcal{J}(g_n) \rightarrow 0, \quad \text{when } n \rightarrow +\infty.$$

This achieves the proof. \square

It is easy to show that for all $\varepsilon > 0$, the function

$$g_\varepsilon(\sigma) := \sigma^{\varepsilon-1} e^{-\sigma/2}, \quad \sigma > 0 \tag{13}$$

satisfies properties (a)–(c) of Lemma 4.

Now, we are able to prove the given results in Theorem 1.

2.2. The proof

We will adapt the strategy used in [8]. We can assume that $a, b \in \mathcal{D}(\mathbb{R}^2)$. Then, We have that:

$$\Phi_\alpha = E * (a_{x_1} b_{x_2} - a_{x_2} b_{x_1}).$$

In polar coordinates we have:

$$a_{x_1} b_{x_2} - a_{x_2} b_{x_1} = \frac{1}{r}(a_r b_\theta - a_\theta b_r).$$

Thus

$$\begin{aligned} \Phi_\alpha(0) &= \frac{1}{2\pi} \int_0^{2\pi} \int_0^{+\infty} K_0(\sqrt{\alpha}r)(a_r b_\theta - a_\theta b_r) dr d\theta \\ &= \frac{1}{2\pi} \int_0^{2\pi} \int_0^{+\infty} K_0(\sqrt{\alpha}r)[(ab_\theta)_r - (ab_r)_\theta] dr d\theta \\ &= \frac{1}{2\pi} \int_0^{2\pi} \int_0^{+\infty} K_0(\sqrt{\alpha}r)(ab_\theta)_r dr d\theta. \end{aligned}$$

Using an integration by parts and the limit expansion given by Lemma 2, we obtain

$$\int_0^{+\infty} K_0(\sqrt{\alpha}r)(ab_\theta)_r dr = -\sqrt{\alpha} \int_0^{+\infty} K'_0(\sqrt{\alpha}r)ab_\theta dr.$$

Recall that $K'_0(r) = -K_1(r)$. Then, we obtain

$$\Phi_\alpha(0) = \frac{1}{2\pi} \int_0^{2\pi} \int_0^{+\infty} \sqrt{\alpha}r K_1(\sqrt{\alpha}r) \frac{1}{r} ab_\theta dr d\theta = \frac{1}{2\pi} \int_0^{+\infty} \sqrt{\alpha}r K_1(\sqrt{\alpha}r) \frac{1}{r} \int_0^{2\pi} ab_\theta d\theta dr.$$

Using Lemma 1, we obtain

$$2\pi |\Phi_\alpha(0)| \leq \int_0^{+\infty} |\sqrt{\alpha}r K_1(\sqrt{\alpha}r)| \frac{\|a_\theta\|_{L^2(0,2\pi)} \|b_\theta\|_{L^2(0,2\pi)}}{r} dr.$$

Using the estimate given by Lemma 2 and the Cauchy–Schwartz inequality, we obtain

$$\begin{aligned} 2\pi |\Phi_\alpha(0)| &\leq \int_0^{+\infty} \frac{1}{r} \|a_\theta\|_{L^2(0,2\pi)} \|b_\theta\|_{L^2(0,2\pi)} dr \\ &\leq \left(\int_0^{+\infty} \frac{1}{r} \|a_\theta\|_{L^2(0,2\pi)}^2 dr \right)^{1/2} \left(\int_0^{+\infty} \frac{1}{r} \|b_\theta\|_{L^2(0,2\pi)}^2 dr \right)^{1/2} \\ &\leq \|\nabla a\|_2 \|\nabla b\|_2. \end{aligned} \tag{14}$$

Remark that the problem is invariant by translation, considering $\Phi_\alpha(x + x_0)$ for any $x_0 \in \mathbb{R}^2$, we get easily that (14) holds if we replace 0 by any $x_0 \in \mathbb{R}^2$, so the first result of Theorem 1 is achieved, and we have that

$$C_\infty^\alpha(\mathbb{R}^2) \leq \frac{1}{2\pi}.$$

This step consists to show that

$$C_\infty^\alpha(\mathbb{R}^2) \geq \frac{1}{2\pi}.$$

We will adapt the strategy used in [3]. Using Lemma 4, we obtain that

$$2\pi C_\infty^\alpha(\mathbb{R}^2) \geq L^\alpha(g_\varepsilon),$$

where g_ε is given by (13) and

$$L^\alpha(g_\varepsilon) = \frac{\int_0^{+\infty} \sqrt{\alpha r} K_1(\sqrt{\alpha r}) r^{2\varepsilon-1} e^{-r} dr}{(\varepsilon - 1)^2 \Gamma(2\varepsilon) - (\varepsilon - 1) \Gamma(2\varepsilon + 1) + \frac{\Gamma(2\varepsilon+2)}{4}}.$$

We have that

$$x K_1(x) = \int_0^{+\infty} \frac{\cos(xt)}{(t^2 + 1)^{3/2}} dt, \quad \forall x \geq 0.$$

Then,

$$\int_0^{+\infty} \sqrt{\alpha r} K_1(\sqrt{\alpha r}) r^{2\varepsilon-1} e^{-r} dr = \int_0^{+\infty} \int_0^{+\infty} \frac{\cos(\sqrt{\alpha r} t)}{(t^2 + 1)^{3/2}} dt r^{2\varepsilon-1} e^{-r} dr = \int_0^{+\infty} \frac{1}{(t^2 + 1)^{3/2}} F(\varepsilon, t) dt,$$

where

$$F(\varepsilon, t) := \int_0^{+\infty} \cos(\sqrt{\alpha r} t) r^{2\varepsilon-1} e^{-r} dr.$$

We use that $\cos x = \mathcal{R}(e^{ix})$, where \mathcal{R} denotes the real part of a complex number. Then,

$$F(\varepsilon, t) = \mathcal{R}\left(\int_0^{+\infty} r^{2\varepsilon-1} e^{-(1-i\sqrt{\alpha t})r} dr\right).$$

It follows from Lemma 3 that

$$F(\varepsilon, t) = \mathcal{R}\left(\frac{1}{(1-i\sqrt{\alpha t})^{2\varepsilon}}\right) \Gamma(2\varepsilon)$$

and

$$\int_0^{+\infty} \sqrt{\alpha r} K_1(\sqrt{\alpha r}) r^{2\varepsilon-1} e^{-r} dr = \Gamma(2\varepsilon) \int_0^{+\infty} \frac{1}{(t^2 + 1)^{3/2}} \mathcal{R}\left(\frac{1}{(1-i\sqrt{\alpha t})^{2\varepsilon}}\right) dt.$$

We conclude that

$$2\pi C_\infty^\alpha(\mathbb{R}^2) \geq \frac{\Gamma(2\varepsilon) \int_0^{+\infty} \frac{1}{(t^2+1)^{3/2}} \mathcal{R}\left(\frac{1}{(1-i\sqrt{\alpha t})^{2\varepsilon}}\right) dt}{(\varepsilon - 1)^2 \Gamma(2\varepsilon) - (\varepsilon - 1) \Gamma(2\varepsilon + 1) + \frac{\Gamma(2\varepsilon+2)}{4}} \geq \frac{\int_0^{+\infty} \frac{1}{(t^2+1)^{3/2}} \mathcal{R}\left(\frac{1}{(1-i\sqrt{\alpha t})^{2\varepsilon}}\right) dt}{(\varepsilon - 1)^2 - 2\varepsilon(\varepsilon - 1) + (\varepsilon/2)(2\varepsilon + 1)}.$$

Using that

$$\left| \frac{1}{(1-i\sqrt{\alpha t})^{2\varepsilon}} \right| \leq 1, \quad \int_0^{+\infty} \frac{1}{(t^2 + 1)^{3/2}} dt = 1,$$

and the dominated convergence theorem, we obtain that

$$\frac{\int_0^{+\infty} \frac{1}{(t^2+1)^{3/2}} \mathcal{R}\left(\frac{1}{(1-i\sqrt{\alpha t})^{2\varepsilon}}\right) dt}{(\varepsilon - 1)^2 - 2\varepsilon(\varepsilon - 1) + (\varepsilon/2)(2\varepsilon + 1)} \rightarrow 1$$

when ε tends to zero. Then,

$$C_\infty^\alpha(\mathbb{R}^2) \geq \frac{1}{2\pi}.$$

This achieves the proof of Theorem 1.

3. Proof of Theorem 2

We can write that

$$\Phi_\alpha = \Phi_0 + \Psi_\alpha, \tag{15}$$

where Φ_0 is the solution to (1) associated to $u = (a, b) \in H^1(\Omega, \mathbb{R}^2)$, and Ψ_α is the solution to

$$\begin{cases} -\Delta \Psi_\alpha + \alpha \Psi_\alpha = -\alpha \Phi_0 & \text{in } \Omega, \\ \Psi_\alpha = 0 & \text{on } \partial\Omega. \end{cases} \tag{16}$$

By the maximum principle, we have that

$$\|\Psi_\alpha\|_\infty \leq \|\Phi_0\|_\infty. \tag{17}$$

By P. Topping's result [16], we have that

$$\|\Phi_0\|_\infty \leq \frac{1}{2\pi} \|\nabla a\|_2 \|\nabla b\|_2, \quad \forall (a, b) \in H^1(\Omega, \mathbb{R}^2). \tag{18}$$

Using (15), the triangular inequality, (17) and (18), we obtain that

$$\|\Phi_\alpha\|_\infty \leq \|\Phi_0\|_\infty + \|\Psi_\alpha\|_\infty \leq 2\|\Phi_0\|_\infty \leq \frac{1}{\pi} \|\nabla a\|_2 \|\nabla b\|_2, \quad \forall (a, b) \in H^1(\Omega, \mathbb{R}^2).$$

We conclude that

$$C_\infty^\alpha(\Omega) \leq \frac{1}{\pi}.$$

In this step, we will prove that $C_\infty^\alpha(\Omega) \geq \frac{1}{2\pi}$. In [3], it is proved that for all $\varepsilon > 0$, there exists $u = (a, b) = (x_1 g(r), x_2 g(r)) \in \mathcal{D}(\mathbb{R}^2, \mathbb{R}^2)$, such that

$$\frac{|\Phi_0(0)|}{\|\nabla a\|_{L^2(\mathbb{R}^2)} \|\nabla b\|_{L^2(\mathbb{R}^2)}} > \frac{1}{2\pi} - \varepsilon, \tag{19}$$

where Φ_0 is the solution to (1) in \mathbb{R}^2 , associated to u . For $\lambda > 0$, we define for all $x \in \mathbb{R}^2$:

$$\begin{aligned} u_\lambda(x) &:= u(\lambda x), \\ a_\lambda(x) &:= a(\lambda x), \\ b_\lambda(x) &:= b(\lambda x), \\ \Phi_{0,\lambda}(x) &:= \Phi_0(\lambda x). \end{aligned}$$

We can assume that Ω contains 0 and $\text{supp } u_\lambda \subset \Omega$ (for λ large enough). It is easy to show that $\Phi_{0,\lambda}$ satisfies:

$$-\Delta \Phi_{0,\lambda} = \det(\nabla u_\lambda) \quad \text{in } \mathbb{R}^2. \tag{20}$$

Let $\Phi_{\alpha,\lambda}$ be the solution to

$$\begin{cases} -\Delta \Phi_{\alpha,\lambda} + \alpha \Phi_{\alpha,\lambda} = \det(\nabla u_\lambda) & \text{in } \Omega, \\ \Phi_{\alpha,\lambda} = 0 & \text{on } \partial\Omega. \end{cases} \tag{21}$$

Then,

$$\xi_\lambda := \Phi_{\alpha,\lambda} - \Phi_{0,\lambda} \tag{22}$$

satisfies:

$$\begin{cases} -\Delta \xi_\lambda + \alpha \xi_\lambda = -\alpha \Phi_{0,\lambda} & \text{in } \Omega, \\ \xi_\lambda = -\Phi_{0,\lambda} & \text{on } \partial\Omega. \end{cases} \quad (23)$$

We know that

$$\det(\nabla u(x)) = \frac{1}{2r} (r^2 g^2(r))', \quad \forall x \in \mathbb{R}^2.$$

Then, Φ_0 is given by:

$$\Phi_0(r) = \frac{1}{2} \int_r^{+\infty} \sigma g^2(\sigma) d\sigma.$$

Since g is a function with a compact support, it is the same for Φ_0 . Then, if λ is large enough, we obtain that

$$\xi_\lambda(x) = 0 \quad \text{on } \partial\Omega. \quad (24)$$

By a change of variable, we obtain for λ large enough that

$$\|\Phi_{0,\lambda}\|_{L^2(\Omega)} = \frac{\|\Phi_0\|_{L^2(\mathbb{R}^2)}}{\lambda}. \quad (25)$$

It follows from (23)–(25) that

$$\|\xi_\lambda\|_{H^2(\Omega)} = O\left(\frac{1}{\lambda}\right), \quad \lambda \rightarrow +\infty. \quad (26)$$

We know that in the two dimensional case, the imbedding $H^2(\Omega) \rightarrow C^0(\overline{\Omega})$ is continuous. Then, by (26), we obtain

$$\|\xi_\lambda\|_\infty \rightarrow 0 \quad \text{when } \lambda \rightarrow +\infty. \quad (27)$$

Using that $\text{supp } u_\lambda \subset \Omega$ and by a change of variable, we obtain that

$$\|\nabla a\|_{L^2(\mathbb{R}^2)} = \|\nabla a_\lambda\|_{L^2(\Omega)} \quad \text{and} \quad \|\nabla b\|_{L^2(\mathbb{R}^2)} = \|\nabla b_\lambda\|_{L^2(\Omega)}. \quad (28)$$

Using that $\Phi_0(0) = \Phi_{0,\lambda}(0)$, and combining (19), (22) and (28), we obtain

$$\begin{aligned} \frac{1}{2\pi} - \varepsilon &\leq \frac{|\xi_\lambda(0) - \Phi_{\alpha,\lambda}(0)|}{\|\nabla a\|_{L^2(\mathbb{R}^2)} \|\nabla b\|_{L^2(\mathbb{R}^2)}} \\ &\leq \frac{\|\xi_\lambda\|_\infty}{\|\nabla a\|_{L^2(\mathbb{R}^2)} \|\nabla b\|_{L^2(\mathbb{R}^2)}} + \frac{|\Phi_{\alpha,\lambda}(0)|}{\|\nabla a_\lambda\|_{L^2(\Omega)} \|\nabla b_\lambda\|_{L^2(\Omega)}} \\ &\leq \frac{\|\xi_\lambda\|_\infty}{\|\nabla a\|_{L^2(\mathbb{R}^2)} \|\nabla b\|_{L^2(\mathbb{R}^2)}} + C_\infty^\alpha(\Omega). \end{aligned}$$

By tending λ to $+\infty$, we obtain from (27) that

$$\frac{1}{2\pi} - \varepsilon \leq C_\infty^\alpha(\Omega).$$

This inequality is true for all $\varepsilon > 0$. By tending ε to 0, we obtain

$$\frac{1}{2\pi} \leq C_\infty^\alpha(\Omega).$$

Then, the proof of Theorem 2 is achieved.

4. Proof of Theorem 3

Let us denote E_α the energy functional, defined by

$$E_\alpha := \|\nabla \Phi_\alpha\|_2^2 + \alpha \|\Phi_\alpha\|_2^2,$$

where Φ_α is the solution to (5), associated to $u = (a, b) \in H^1(\Omega, \mathbb{R}^2)$. We have that

$$-\Delta \Phi_\alpha + \alpha \Phi_\alpha = -\Delta \Phi_0, \quad (29)$$

where Φ_0 is the solution to (1), associated to u . Multiplying (29) by Φ_α and integrating over Ω , we obtain

$$E_\alpha = \int_{\Omega} \nabla \Phi_0 \nabla \Phi_\alpha.$$

Then,

$$E_\alpha \leq \|\nabla \Phi_0\|_2 \|\nabla \Phi_\alpha\|_2.$$

On the other hand, we know that $C_2^0(\Omega) = \sqrt{3/16\pi}$ (see [12]). Then, we obtain

$$\frac{E_\alpha}{\|\nabla \Phi_\alpha\|_2} \leq \|\nabla \Phi_0\|_2 \leq \sqrt{3/16\pi} \|\nabla a\|_2 \|\nabla b\|_2, \quad \forall (a, b) \in H^1(\Omega, \mathbb{R}^2).$$

We conclude that

$$C_2^\alpha(\Omega) \leq \sqrt{3/16\pi}.$$

By the same arguments, replacing Ω by \mathbb{R}^2 , and using that $C_2^0(\mathbb{R}^2) = \sqrt{3/32\pi}$ (see [5,12]), we obtain that

$$C_2^\alpha(\mathbb{R}^2) \leq \sqrt{3/32\pi}.$$

In [12], it is proved that $C_2^0(\mathbb{R}^2)$ is achieved by

$$a(x_1, x_2) = \frac{x_1}{1+r^2} \quad \text{and} \quad b(x_1, x_2) = \frac{x_2}{1+r^2}.$$

The corresponding solution Φ_0 is given by

$$\Phi_0 = \frac{c}{1+r^2},$$

where c is a positive constant. It is easy to show that Φ_0 belongs to $L^2(\mathbb{R}^2)$. Let us recall some notations used in the proof of Theorem 2. For $\lambda > 0$, we let $a_\lambda(x) = a(\lambda x)$, $b_\lambda(x) = b(\lambda x)$, $u_\lambda(x) = u(\lambda x)$ and $\Phi_{0,\lambda}(x) = \Phi_0(\lambda x)$. Let $\Phi_{\alpha,\lambda}$ be the solution to (21). We can write that

$$\Phi_{\alpha,\lambda} = \Phi_{0,\lambda} + \xi_\lambda,$$

where ξ_λ is the solution to (23). We have that

$$\xi_\lambda = \xi_{\lambda,1} + \xi_{\lambda,2}, \tag{30}$$

where $\xi_{\lambda,1}$ is the solution to

$$\begin{cases} -\Delta \xi_{\lambda,1} + \alpha \xi_{\lambda,1} = -\alpha \Phi_{0,\lambda} & \text{in } \Omega, \\ \xi_{\lambda,1} = 0 & \text{on } \partial\Omega \end{cases} \tag{31}$$

and $\xi_{\lambda,2}$ is the solution to

$$\begin{cases} -\Delta \xi_{\lambda,2} + \alpha \xi_{\lambda,2} = 0 & \text{in } \Omega, \\ \xi_{\lambda,2} = -\Phi_{0,\lambda} & \text{on } \partial\Omega. \end{cases} \tag{32}$$

We have that

$$\|\xi_{\lambda,1}\|_{H^2(\Omega)} = O\left(\frac{1}{\lambda}\right), \quad \lambda \rightarrow +\infty. \tag{33}$$

Using that $\|\Phi_{0,\lambda}\|_{C^1(\partial\Omega)} \rightarrow 0$ when $\lambda \rightarrow +\infty$, and by the trace theorem, we obtain that

$$\|\xi_{\lambda,2}\|_{H^1(\Omega)} \rightarrow 0 \quad \text{when } \lambda \rightarrow +\infty. \tag{34}$$

By (30), (33) and (34), we conclude that

$$\|\xi_\lambda\|_{H^1(\Omega)} \rightarrow 0 \quad \text{when } \lambda \rightarrow +\infty$$

which implies that

$$\|\nabla \xi_\lambda\|_{L^2(\Omega)} \rightarrow 0 \quad \text{when } \lambda \rightarrow +\infty. \tag{35}$$

It is easy to check that

$$\|\nabla\Phi_{0,\lambda}\|_{L^2(\Omega)} \rightarrow \|\nabla\Phi_0\|_{L^2(\mathbb{R}^2)}, \tag{36}$$

$$\|\nabla a_\lambda\|_{L^2(\Omega)} \rightarrow \|\nabla a\|_{L^2(\mathbb{R}^2)}, \tag{37}$$

$$\|\nabla b_\lambda\|_{L^2(\Omega)} \rightarrow \|\nabla b\|_{L^2(\mathbb{R}^2)}, \tag{38}$$

when $\lambda \rightarrow +\infty$. On the other hand, we have

$$C_2^\alpha(\Omega) \geq \frac{\|\nabla\Phi_{\alpha,\lambda}\|_{L^2(\Omega)}}{\|\nabla a_\lambda\|_{L^2(\Omega)}\|\nabla b_\lambda\|_{L^2(\Omega)}} \geq \frac{\|\nabla\Phi_{0,\lambda}\|_{L^2(\Omega)}}{\|\nabla a_\lambda\|_{L^2(\Omega)}\|\nabla b_\lambda\|_{L^2(\Omega)}} - \frac{\|\nabla\xi_\lambda\|_{L^2(\Omega)}}{\|\nabla a_\lambda\|_{L^2(\Omega)}\|\nabla b_\lambda\|_{L^2(\Omega)}}. \tag{39}$$

Finally, from (35)–(39), and by passing to the limit as $\lambda \rightarrow +\infty$, we obtain that

$$C_2^\alpha(\Omega) \geq \frac{\|\nabla\Phi_0\|_{L^2(\mathbb{R}^2)}}{\|\nabla a\|_{L^2(\mathbb{R}^2)}\|\nabla b\|_{L^2(\mathbb{R}^2)}} = \sqrt{3/32\pi}.$$

Then, the proof of Theorem 3 is achieved.

Acknowledgments

We thank Dong Ye and the anonymous referees for helpful comments on the paper.

References

- [1] I. Abid, S. Baraket, I. Bazarbacha, T. Ouni, Best constant involving the L^∞ of evolutionary Wentze’s problem associated to wave operator, *J. Math. Anal. Appl.* 325 (2) (2007) 866–878.
- [2] M. Abramowitz, I.A. Stegun, *Handbook of Mathematical Functions*, Dover, New York, 1964.
- [3] S. Baraket, Estimations of the best constant involving the L^∞ norm in Wentze’s inequality, *Ann. Fac. Sci. Toulouse Math.* (6) 5 (3) (1996) 373–385.
- [4] S. Baraket, The Wentze problem in higher dimensions, *Comm. Partial Differential Equation* 26 (9–10) (2001) 1497–1508.
- [5] S. Baraket, M. Dammak, Estimation of the best constant involving the L^2 norm of the higher-order Wentze problem, *Abstr. Appl. Anal.* 2005 (2005) 599–606.
- [6] S. Baraket, M. Dammak, M. Jleli, D. Ye, Integrability of $\det \nabla u$ and evolutionary Wentze’s problem associated to heat operator, *Chinese Ann. Math.*, in press.
- [7] F. Bowman, *Introduction to Bessel Functions*, Dover Publications, New York, 1958.
- [8] H. Brezis, J.M. Coron, Multiple solutions of H-system and Rellich’s conjecture, *Comm. Pure Appl. Math.* 37 (1984) 149–187.
- [9] M. Chipot, W. Gangbo, B. Kawohl, On some nonlocal variational problems, *Anal. Appl. (Singap.)* 4 (4) (2006) 345–356.
- [10] R. Coifman, P.L. Lions, Y. Meyer, S. Semmes, Compensated compactness and Hardy spaces, *J. Math. Pures Appl.* 72 (1993) 247–286.
- [11] R. Dautray, J.L. Lions, *Analyse mathématique et calcul numérique pour les sciences et les techniques*, Masson, 1988.
- [12] Y. Ge, Estimations of the best constant involving the L^2 norm in Wentze’s inequality, *ESAIM Control Optim. Calc. Var.* 3 (1998) 263–300.
- [13] V. Radulescu, A study of some special functions with Lie theory, *Stud. Cercet. Mat.* 43 (1991) 67–71.
- [14] V. Radulescu, *Partial Differential Equations*, Craiova University Press, 1999.
- [15] E. Stein, *Harmonic Analysis*, Princeton University Press, Princeton, 1993.
- [16] P. Topping, The optimal constant in the Wentze’s L^∞ estimate, *Comment. Math. Helv.* 72 (1997) 316–328.
- [17] H.C. Wentze, An existence theorem for surfaces of constant mean curvature, *J. Math. Anal. Appl.* 26 (1969) 318–344.
- [18] H.C. Wentze, Large solutions to the volume constrained Plateau problem, *Arch. Ration. Mech. Anal.* 75 (1980) 59–77.

Article 10:

Generalization of the Wentz problem for a large class of operators

International Journal of Modern Mathematics. 2(2) (2007) 205-216

Generalization of the Wente Problem for a Large Class of Operators

Mohamed Jleli and Bessem Samet

Received May 25, 2007; Revised June 20, 2007

Abstract

In this paper, we generalize the Wente problem for a large class of operators. In particular, we study the best constant associated to the L^∞ norm in the so-called Wente inequality.

Keywords: Generalized Wente problem, Wente's inequality, best constant, L^∞ norm.

2000 Mathematics Subject Classification: 35C15, 35J05, 35J45, 31A10.

1 Introduction and Statement of the Results

Given a vector field $u \in H^1(\mathbb{R}^2, \mathbb{R}^2)$, it is clear that $\det(\nabla u)$ belongs to $L^1(\mathbb{R}^2, \mathbb{R})$. However, due to its algebraic structure, this quantity has some suitable regularity properties. In [7], R. Coifman *et al.* proved that $\det(\nabla u)$ lies in the generalized Hardy space $\mathcal{H}^1(\mathbb{R}^2)$, a strict subspace of $L^1(\mathbb{R}^2)$. For more details about the generalized Hardy space, we refer to [11].

The quantity $\det(\nabla u)$ appears in a large number of partial differential equations from geometry and physics. In particular, it appears in the classical Wente problem that arises in the study of constant mean curvature immersions [13]. Let Ω be a smooth and bounded domain in \mathbb{R}^2 . Given $u = (a, b) \in H^1(\Omega, \mathbb{R}^2)$, we consider $U_{-\Delta} \in L^1(\Omega, \mathbb{R})$, a weak solution to the classical Wente problem

$$\begin{cases} -\Delta U_{-\Delta} &= \det(\nabla u) = a_{x_1} b_{x_2} - a_{x_2} b_{x_1} \text{ in } \Omega, \\ U_{-\Delta} &= 0 \text{ on } \partial\Omega, \end{cases} \quad (1.1)$$

where $x = (x_1, x_2) \in \Omega$ and a_{x_i} denotes the partial derivative of a with respect to the variable x_i , for $i = 1, 2$. If $\Omega = \mathbb{R}^2$, we replace the boundary condition in (1.1) by the limit condition $\lim_{r \rightarrow +\infty} U_{-\Delta}(x) = 0$, where $r = \|x\| = \sqrt{x_1^2 + x_2^2}$. It is proved in [4, 14] that $U_{-\Delta}$ is in $H^1(\Omega) \cap C^0(\Omega)$ and there exists a positive constant $C^{-\Delta}(\Omega)$ such that

$$\|U_{-\Delta}\|_\infty + \|\nabla U_{-\Delta}\|_2 \leq C^{-\Delta}(\Omega) \|\nabla a\|_2 \|\nabla b\|_2, \quad \forall (a, b) \in H^1(\Omega, \mathbb{R}^2), \quad (1.2)$$

where $\|\cdot\|_p$ denotes the L^p norm. Note that this estimate is not true in general if we replace the right hand side of (1.1) by an arbitrary function in $L^1(\Omega, \mathbb{R})$. We set

$$C_\infty^{-\Delta}(\Omega) := \sup_{\nabla a, \nabla b \neq 0} \frac{\|U_{-\Delta}\|_\infty}{\|\nabla a\|_2 \|\nabla b\|_2} \quad (1.3)$$

and

$$C_2^{-\Delta}(\Omega) := \sup_{\nabla a, \nabla b \neq 0} \frac{\|\nabla U_{-\Delta}\|_2}{\|\nabla a\|_2 \|\nabla b\|_2}. \quad (1.4)$$

It was proved in [3, 12] that $C_\infty^{-\Delta}(\Omega) = 1/(2\pi)$ and in [9] that $C_2^{-\Delta}(\Omega) = \sqrt{3/(16\pi)}$ (see also [1, 5, 6]). In this paper, we consider \vec{U}_A the solution to the following problem

$$\begin{cases} A\vec{U}_A = \vec{F} & \text{in } \mathbb{R}^2, \\ \lim_{|x| \rightarrow +\infty} \vec{U}_A(x) = \vec{0}, \end{cases} \quad (1.5)$$

where A belongs to a family of elliptic operators that will be defined later, \vec{U}_A and \vec{F} are two vectors of \mathbb{R}^N ($N \geq 1$) given by

$$\vec{U}_A(x) = (U_A^1(x), U_A^2(x), \dots, U_A^N(x))^T \quad (x \in \mathbb{R}^2)$$

and

$$\vec{F}(x) = (F^1(x), F^2(x), \dots, F^N(x))^T \quad (x \in \mathbb{R}^2).$$

Here, for all $i \in \{1, 2, \dots, N\}$, F^i is defined by

$$F^i := a_{x_1}^i b_{x_2}^i - a_{x_2}^i b_{x_1}^i,$$

where $a^i, b^i \in H^1(\mathbb{R}^2)$.

Now, we introduce some notations that will be used later. Let \vec{X} be a vector function defined by

$$\vec{X}(x) = (X^1(x), X^2(x), \dots, X^N(x))^T, \quad \forall x \in \mathbb{R}^2.$$

We denote by $\|\cdot\|_\infty$ the following norm

$$\|\vec{X}\|_\infty := \sup_{1 \leq i \leq N} \|X^i\|_\infty.$$

The matrix distribution $E_A \in \mathcal{D}'(\mathbb{R}^2, \mathbb{R}^{N \times N})$ is the fundamental solution of the operator A , that is, each column E_A^j is a solution to

$$AE_A^j = \delta_{e_j} \text{ in } \mathbb{R}^2,$$

where δ is the Dirac distribution and $(e_j)_{j=1,2,\dots,N}$ is the canonical basis of \mathbb{R}^N .

We assume that the following hypotheses hold.

Hypothesis 1.1. Problem (1.5) has a unique solution in $H^1(\mathbb{R}^2)^N$.

Hypothesis 1.2. The fundamental solution of the operator A takes the following form

$$E_A(x) = \kappa f(r)I_N + G_A(x), \quad (1.6)$$

where κ is a positive constant, I_N is the identity matrix and $G_A = (G_A(i, j))_{1 \leq i \leq j \leq N}$ satisfies

$$G_A(i, j) \in L^\infty(\mathbb{R}^2), \quad \forall i, j \in \{1, 2, \dots, N\} \quad (1.7)$$

$$\frac{\partial}{\partial r}(G_A(i, 1)) = 0, \quad \forall i \in \{1, 2, \dots, N\}. \quad (1.8)$$

Remark 1.1. Note that we can replace (1.8) by a more general condition

$$\exists j \in \{1, 2, \dots, N\} \mid \frac{\partial}{\partial r}(G_A(i, j)) = 0, \quad \forall i \in \{1, 2, \dots, N\}.$$

Here, we consider only the condition (1.8) to simplify the notations.

Hypothesis 1.3. We assume that $f \in C^1(0, +\infty)$ and that

$$\lim_{r \rightarrow 0^+} r f(r) = 0 \quad (1.9)$$

$$r \mapsto r f'(r) \in L^\infty(0, +\infty) \quad (1.10)$$

$$\sup_{r \geq 0} r |f'(r)| = 1. \quad (1.11)$$

Hypothesis 1.4. We assume that

$$A \vec{U}_A(x + x_0) = \vec{F}(x + x_0), \quad \forall (x, x_0) \in \mathbb{R}^2 \times \mathbb{R}^2. \quad (1.12)$$

Note that these hypotheses are satisfied for a large class of operators. We will show later some examples of such operators. Now, we present the main results of this paper.

Theorem 1.1. *We have the following estimate*

$$\|\vec{U}_A\|_\infty \leq (\kappa + \nu) \sum_{i=1}^N \|\nabla a^i\|_2 \|\nabla b^i\|_2, \quad (1.13)$$

where $\nu := \sup_{1 \leq i \leq j \leq N} \|G_A(i, j)\|_\infty$.

We Assume that there exists $i_0 \in \{1, 2, \dots, N\}$ such that $a^{i_0}, b^{i_0} \in V$, where V is given by

$$V := \{w \in H^1(\mathbb{R}^2), w \neq \text{constant}\}.$$

Set

$$C_\infty^A(\mathbb{R}^2) := \sup \frac{\|\vec{U}_A\|_\infty}{\sum_{i=1}^N \|\nabla a^i\|_2 \|\nabla b^i\|_2}.$$

We then have the following result.

Theorem 1.2. Let $g :]0, +\infty[\rightarrow \mathbb{R}$ be a function satisfying the following properties

- a) $g \in C^\infty(0, +\infty) \setminus \{0\}$
- b) $r \mapsto rg^2(r) \in L^1(0, +\infty)$
- c) $r \mapsto r^3g'^2(r) \in L^1(0, +\infty)$
- d) $\lim_{r \rightarrow 0^+} rg(r) = 0$
- e) $\lim_{r \rightarrow 0^+} r^2f(r)g^2(r) = 0$.

Then, the best constant $C_\infty^A(\mathbb{R}^2)$ satisfies the following estimate

$$\kappa \mathcal{L}_A(g) \leq C_\infty^A(\mathbb{R}^2) \leq (\kappa + \nu), \quad (1.14)$$

where $\mathcal{L}_A(g)$ is given by

$$\mathcal{L}_A(g) := \frac{\left| \int_0^{+\infty} r^2 f'(r) g^2(r) dr \right|}{\int_0^{+\infty} r^3 g'^2(r) dr}.$$

2 Applications to Some Operators

In this section, we give some examples of differential operators A satisfying the required hypotheses. In the first example, we consider the Laplace operator. Applying Theorems 1.1 and 1.2, we retrieve the obtained result in [3, 12]. In the second example, we consider the modified Helmholtz operator, and the best constant obtained in [10] is retrieved. Finally, we study the case of the Lamé operator.

2.1 The Laplace operator

As the first example, we take $A = -\Delta$ and $N = 1$. In this case, the fundamental solution of the considered operator is given by

$$E_A(x) = -\frac{1}{2\pi} \ln r, \quad \forall x \in \mathbb{R}^2 \setminus \{0\}.$$

It is easy to verify that Hypotheses 1.1-1.4 are satisfied with

$$\kappa = \frac{1}{2\pi}, \quad f(r) = -\ln r \quad \text{and} \quad G_A \equiv 0.$$

Applying Theorems 1.1 and 1.2, we obtain that

$$\frac{1}{2\pi} \mathcal{L}_{-\Delta}(g) \leq C_\infty^{-\Delta}(\mathbb{R}^2) \leq \frac{1}{2\pi}, \quad (2.1)$$

for all function g satisfying properties a)-e) of Theorem 1.2. For all $\varepsilon > 0$, we consider the function g_ε defined by

$$g_\varepsilon(r) := r^{\varepsilon-1} e^{-r/2}, \quad \forall r > 0. \quad (2.2)$$

It is easy to show that the considered function satisfies properties a)-e) of Theorem 1.2. Using (2.1), we obtain

$$\frac{1}{2\pi} \mathcal{L}_{-\Delta}(g_\varepsilon) \leq C_\infty^{-\Delta}(\mathbb{R}^2) \leq \frac{1}{2\pi}, \forall \varepsilon > 0. \tag{2.3}$$

It was proved in [3] that $\mathcal{L}_{-\Delta}(g_\varepsilon) \rightarrow 1$ when $\varepsilon \rightarrow 0^+$. Finally, by tending ε to zero in (2.3), we obtain that

$$C_\infty^{-\Delta}(\mathbb{R}^2) = \frac{1}{2\pi}.$$

2.2 The modified Helmholtz operator

In this example, the operator A is given by

$$A = -\Delta + \alpha I,$$

where α is a positive constant and $N = 1$. The fundamental solution of the considered operator is given by [8]

$$E_A(x) = \frac{1}{2\pi} K_0(\sqrt{\alpha}r), \quad \forall x \in \mathbb{R}^2 \setminus \{0\}.$$

Here, K_0 is the modified Bessel function of the second kind with zero order. For more details about Bessel functions, we refer the reader to [2]. In this case, we have

$$\kappa = \frac{1}{2\pi}, f(r) = K_0(\sqrt{\alpha}r) \text{ and } G_A \equiv 0.$$

To check that Hypothesis 1.3 is satisfied, we need some properties about the Bessel function K_0 . These properties are given in the following lemma.

Lemma 2.1. *we have*

- a) $\lim_{r \rightarrow 0^+} rK_0(\sqrt{\alpha}r) = 0$
- b) $\sup_{r > 0} r|K_0'(\sqrt{\alpha}r)| = 1.$

Proof. We have the following asymptotic expansion [2]

$$K_0(t) = (\ln 2 - \ln t - \gamma) + O(t^2) \text{ when } t \rightarrow 0^+,$$

where γ is the Euler constant. Then, the property a) is satisfied. On the other hand, we have that

$$K_0'(\sqrt{\alpha}r) = -\sqrt{\alpha}K_1(\sqrt{\alpha}r), \tag{2.4}$$

where K_1 is the modified Bessel function of the second kind with first order. It is given explicitly by

$$K_1(t) = \frac{1}{t} \int_0^{+\infty} \frac{\cos(yt)}{(y^2 + 1)^{3/2}} dy, \quad \forall t > 0. \tag{2.5}$$

Then, we obtain that

$$|tK_1(t)| \leq \int_0^{+\infty} \frac{1}{(y^2 + 1)^{3/2}} dy = 1, \quad \forall t \geq 0. \quad (2.6)$$

Finally, the property b) is an immediate consequence of (2.4), (2.5) and (2.6). \square

Now, it is clear that Hypotheses 1.1-1.4 are satisfied, and we can apply Theorems 1.1 and 1.2. We obtain that

$$\frac{1}{2\pi} \mathcal{L}_{-\Delta+\alpha I}(g) \leq C_{\infty}^{-\Delta+\alpha I}(\mathbb{R}^2) \leq \frac{1}{2\pi},$$

for all function g satisfying properties a)-e) of Theorem 1.2. As in the first example, we take $g = g_{\varepsilon}$, where g_{ε} is given by (2.2). Then,

$$\frac{1}{2\pi} \mathcal{L}_{-\Delta+\alpha I}(g_{\varepsilon}) \leq C_{\infty}^{-\Delta+\alpha I}(\mathbb{R}^2) \leq \frac{1}{2\pi}, \quad \forall \varepsilon > 0. \quad (2.7)$$

The following result was proved in [10].

Lemma 2.2. *We have*

$$\lim_{\varepsilon \rightarrow 0^+} \mathcal{L}_{-\Delta+\alpha I}(g_{\varepsilon}) = 1.$$

Finally, using Lemma 2.2, and tending ε to zero in (2.7), we obtain that

$$C_{\infty}^{-\Delta+\alpha I}(\mathbb{R}^2) = \frac{1}{2\pi}.$$

2.3 The Lamé operator

Here, we study the case of the Lamé operator. More precisely, we take

$$A\vec{U} = -\mu\Delta\vec{U} - (\lambda + \mu)\nabla(\operatorname{div}\vec{U}),$$

where the constants (λ, μ) denote the Lamé coefficients ($\lambda \geq 0, \mu > 0$). The fundamental solution $E_A \in \mathcal{D}'(\mathbb{R}^2, \mathbb{R}^{2 \times 2})$ of the operator A is given by [8]

$$E_A(x) = \beta \ln r I_2 + \gamma e_r e_r^T, \quad \forall x \in \mathbb{R}^2 \setminus \{0\},$$

where

$$\beta = -\frac{\lambda + 3\mu}{4\pi\mu(\lambda + 2\mu)}, \quad \gamma = \frac{\lambda + \mu}{4\pi\mu(\lambda + 2\mu)},$$

$e_r = x/r$ and e_r^T is the transposed vector of e_r . In this case, we have that

$$\kappa = -\beta, f(r) = -\ln r, G_A(x) = \gamma e_r e_r^T \text{ and } \nu = \gamma.$$

All the hypotheses 1.1-1.4 are satisfied. Applying Theorems 1.1 and 1.2, we obtain

$$-\beta \mathcal{L}_A(g) \leq C_{\infty}^A(\mathbb{R}^2) \leq -\beta + \gamma, \quad (2.8)$$

for all function g satisfying Hypotheses a)-e) of Theorem 1.2. By considering the function g_ε defined by (2.2), we obtain that

$$-\beta \mathcal{L}_A(g_\varepsilon) \leq C_\infty^A(\mathbb{R}^2) \leq -\beta + \gamma, \forall \varepsilon > 0. \tag{2.9}$$

Note that in this case, we have

$$\mathcal{L}_A(g_\varepsilon) = \mathcal{L}_{-\Delta}(g_\varepsilon) \rightarrow 1 \text{ when } \varepsilon \rightarrow 0^+. \tag{2.10}$$

By (2.9) and (2.10), we conclude that

$$-\beta \leq C_\infty^A(\mathbb{R}^2) \leq -\beta + \gamma.$$

Remark 2.1. In this case, we don't know exactly the value of the best constant $C_\infty^A(\mathbb{R}^2)$. It will be interesting to study this problem. Here, the difficulty is that the fundamental solution of the considered operator is not radial as like as the previous cases.

3 Proofs of the Main Results

3.1 Proof of Theorem 1.1

We will adapt the strategy used in [4]. We can assume that $a^i, b^i \in \mathcal{D}(\mathbb{R}^2), i = 1, 2, \dots, N$. Then, we have

$$\vec{U}_A(0) = \int_{\mathbb{R}^2} E_A(x) \vec{F}(x) dx.$$

For $i = 1, 2, \dots, N$, we obtain that

$$U_A^i(0) = \sum_{j=1}^N \int_{\mathbb{R}^2} E_A(i, j)(x) F^j(x) dx, \tag{3.1}$$

where

$$E_A(i, j)(x) = \kappa f(r) \delta_{ij} + G_A(i, j)(x), \quad 1 \leq i \leq j \leq N. \tag{3.2}$$

Here, δ_{ij} is the Kronecker symbol. By (3.1) and (3.2), we obtain that

$$U_A^i(0) = \kappa \int_{\mathbb{R}^2} f(r) F^i(x) dx + \sum_{j=1}^N \int_{\mathbb{R}^2} G_A(i, j)(x) F^j(x) dx. \tag{3.3}$$

In polar coordinates, we have

$$F^i(x) = \frac{1}{r} (a_r^i b_\theta^i - a_\theta^i b_r^i) = \frac{1}{r} [(a^i b_\theta^i)_r - (a^i b_r^i)_\theta]. \tag{3.4}$$

Using a change of variable and (3.4), we obtain

$$\int_{\mathbb{R}^2} f(r) F^i(x) dx = \int_{\theta=0}^{2\pi} \int_{r=0}^{\infty} f(r) (a^i b_\theta^i)_r dr d\theta.$$

Integrating by parts and using the property (1.9) of Hypothesis 1.3, we obtain that

$$\int_{\mathbb{R}^2} f(r)F^i(x) dx = - \int_{\theta=0}^{2\pi} \int_{r=0}^{\infty} f'(r)a^i b_{\theta}^i dr d\theta. \quad (3.5)$$

On the other hand, we have [4]

$$\left| \int_0^{2\pi} a^i b_{\theta}^i d\theta \right| \leq \|a_{\theta}^i\|_{L^2(0,2\pi)} \|b_{\theta}^i\|_{L^2(0,2\pi)}. \quad (3.6)$$

Then, by (3.5), (3.6), the property (1.11) of Hypothesis 1.3, and the Cauchy-Schwarz inequality, we obtain that

$$\begin{aligned} \left| \int_{\mathbb{R}^2} f(r)F^i(x) dx \right| &\leq \int_{r=0}^{+\infty} r|f'(r)| \frac{1}{r} \|a_{\theta}^i\|_{L^2(0,2\pi)} \|b_{\theta}^i\|_{L^2(0,2\pi)} dr \\ &\leq \int_{r=0}^{+\infty} \frac{1}{r} \|a_{\theta}^i\|_{L^2(0,2\pi)} \|b_{\theta}^i\|_{L^2(0,2\pi)} dr \\ &\leq \left(\int_{r=0}^{+\infty} \frac{1}{r} \|a_{\theta}^i\|_{L^2(0,2\pi)}^2 dr \right)^{1/2} \left(\int_{r=0}^{+\infty} \frac{1}{r} \|b_{\theta}^i\|_{L^2(0,2\pi)}^2 dr \right)^{1/2} \\ &\leq \|\nabla a^i\|_2 \|\nabla b^i\|_2. \end{aligned}$$

We conclude that

$$\left| \int_{\mathbb{R}^2} f(r)F^i(x) dx \right| \leq \sum_{j=1}^N \|\nabla a^j\|_2 \|\nabla b^j\|_2, \quad \forall i \in \{1, 2, \dots, N\}. \quad (3.7)$$

Now, we will estimate the second term in (3.3). We will use the following lemma.

Lemma 3.1. *For all $j \in \{1, 2, \dots, N\}$, we have*

$$\int_{\mathbb{R}^2} |F^j(x)| dx \leq \|\nabla a^j\|_2 \|\nabla b^j\|_2.$$

Proof. Let

$$V^j = (a_{x_1}^j, a_{x_2}^j, 0)^T \quad \text{and} \quad W^j = (b_{x_1}^j, b_{x_2}^j, 0)^T, \quad 1 \leq j \leq N.$$

We have that

$$V^j \wedge W^j = F^j e_3.$$

Then,

$$|F^j| = \|V^j \wedge W^j\| \leq \|V^j\| \|W^j\|,$$

and by the Cauchy-Schwarz inequality, we obtain that

$$\int_{\mathbb{R}^2} |F^j(x)| dx \leq \int_{\mathbb{R}^2} \|V^j\| \|W^j\| dx \leq \left(\int_{\mathbb{R}^2} \|V^j\|^2 dx \right)^{1/2} \left(\int_{\mathbb{R}^2} \|W^j\|^2 dx \right)^{1/2}.$$

On the other hand,

$$\int_{\mathbb{R}^2} \|V^j\|^2 dx = \|\nabla a^j\|_2^2 \quad \text{and} \quad \int_{\mathbb{R}^2} \|W^j\|^2 dx = \|\nabla b^j\|_2^2.$$

The proof is completed. \square

It follows from Lemma 3.1 and Hypothesis 1.2 that

$$\begin{aligned} \left| \sum_{j=1}^N \int_{\mathbb{R}^2} G_A(i, j)(x) F^j(x) dx \right| &\leq \sum_{j=1}^N \int_{\mathbb{R}^2} |G_A(i, j)(x)| |F^j(x)| dx \\ &\leq \nu \sum_{j=1}^N \int_{\mathbb{R}^2} |F^j(x)| dx \\ &\leq \nu \sum_{j=1}^N \|\nabla a^j\|_2 \|\nabla b^j\|_2. \end{aligned} \quad (3.8)$$

By (3.3), (3.7) and (3.8), we obtain that

$$|U_A^i(0)| \leq (\kappa + \nu) \sum_{j=1}^N \|\nabla a^j\|_2 \|\nabla b^j\|_2. \quad (3.9)$$

Since the considered problem is invariant by translation (see Hypothesis 1.4), considering $U_A^i(x + x_0)$ for any $x_0 \in \mathbb{R}^2$, we get easily that (3.9) holds if we replace 0 by any $x_0 \in \mathbb{R}^2$. Finally, we deduce that

$$\|\vec{U}_A\|_\infty \leq (\kappa + \nu) \sum_{j=1}^N \|\nabla a^j\|_2 \|\nabla b^j\|_2.$$

The proof of Theorem 1.1 is completed. \square

3.2 Proof of Theorem 1.2

By the previous result, we obtain immediately that

$$C_\infty^A(\mathbb{R}^2) \leq \kappa + \nu. \quad (3.10)$$

Let g be a function satisfying the properties required by Theorem 1.2. Let us define $\psi \in \mathcal{D}(\mathbb{R}^2)$ by

$$\psi(\sigma) := \begin{cases} 1 & \text{if } |\sigma| \leq 1 \\ 0 & \text{if } |\sigma| \geq 2 \end{cases} \quad \text{and} \quad 0 \leq \psi(\sigma) \leq 1 \quad \text{if } 1 < |\sigma| < 2.$$

We let

$$a_n^1(x_1, x_2) = x_1 g_n(r) \quad \text{and} \quad b_n^1(x_1, x_2) = x_2 g_n(r),$$

where

$$g_n(\sigma) := \psi(\sigma/n)g(\sigma), \forall \sigma > 0, \forall n \in \mathbb{N}^*.$$

We take

$$a_n^i(x_1, x_2) = b_n^i(x_1, x_2) = 0, \quad \forall i \in \{2, 3, \dots, N\}.$$

We consider now $\overrightarrow{U_{A,n}}$ the solution to

$$A\overrightarrow{U_{A,n}} = \overrightarrow{F_n} \text{ in } \mathbb{R}^2,$$

with the limit condition

$$\lim_{|x| \rightarrow +\infty} \overrightarrow{U_{A,n}}(x) = \overrightarrow{0}.$$

Here, the vector $\overrightarrow{F_n}$ is given by $\overrightarrow{F_n} = (F_n^1, F_n^2, \dots, F_n^N)^T$, where

$$F_n^1 = (a_n^1)_{x_1}(b_n^1)_{x_2} - (a_n^1)_{x_2}(b_n^1)_{x_1} \quad \text{and} \quad F_n^i = 0 \quad \forall i \in \{2, 3, \dots, N\}. \quad (3.11)$$

In polar coordinates, we have

$$F_n^1 = \frac{1}{2r} \frac{\partial(r^2 g_n^2)}{\partial r}. \quad (3.12)$$

We have

$$\overrightarrow{U_{A,n}}(0) = \int_{\mathbb{R}^2} E_A(x) \overrightarrow{F_n}(x) dx.$$

For $i = 1, 2, \dots, N$, we obtain that

$$U_{A,n}^i(0) = \sum_{j=1}^N \int_{\mathbb{R}^2} E_A(i, j)(x) F_n^j(x) dx.$$

Using (3.11), we obtain

$$U_{A,n}^i(0) = \int_{\mathbb{R}^2} E_A(i, 1)(x) F_n^1(x) dx. \quad (3.13)$$

It follows from (3.12), (3.13) and Hypothesis 1.2, that

$$\begin{aligned} U_{A,n}^i(0) &= \kappa\pi \int_{r=0}^{+\infty} \delta_{i1} f(r) \frac{\partial(r^2 g_n^2)}{\partial r} dr + \frac{1}{2} \int_{\theta=0}^{2\pi} G_A(i, 1) \left(\underbrace{\int_{r=0}^{+\infty} \frac{\partial(r^2 g_n^2)}{\partial r} dr}_0 \right) d\theta \\ &= \kappa\pi \int_{r=0}^{+\infty} \delta_{i1} f(r) \frac{\partial(r^2 g_n^2)}{\partial r} dr. \end{aligned}$$

Integrating by parts and using the hypothesis e) required by Theorem 1.2, we obtain that

$$U_{A,n}^i(0) = -\kappa\pi \delta_{i1} \int_{r=0}^{+\infty} f'(r) r^2 g_n^2(r) dr. \quad (3.14)$$

By simple calculus, we obtain that

$$\|\nabla a_n^1\|_2^2 = \|\nabla b_n^1\|_2^2 = \pi \int_0^{+\infty} r^3 g_n'^2 dr. \tag{3.15}$$

By taking $i = 1$ in (3.14), and using (3.15), we obtain immediately that

$$\kappa \frac{\left| \int_0^{+\infty} f'(r)r^2 g_n^2(r) dr \right|}{\int_0^{+\infty} r^3 g_n'^2(r) dr} \leq C_\infty^A(\mathbb{R}^2). \tag{3.16}$$

In [3], it was proved that

$$\int_0^{+\infty} r^3 g_n'^2(r) dr \rightarrow \int_0^{+\infty} r^3 g'^2(r) dr, \text{ when } n \rightarrow +\infty. \tag{3.17}$$

On the other hand, we have

$$\int_0^{+\infty} f'(r)r^2 g_n^2(r) dr - \int_0^{+\infty} f'(r)r^2 g^2(r) dr = \int_0^{+\infty} r f'(r)(\psi^2(r/n) - 1) r g^2(r) dr.$$

Using that $\lim_{n \rightarrow +\infty} (\psi^2(r/n) - 1) = 0$, property (1.10) of Hypothesis 1.3, property b) required by Theorem 1.2, and the dominated convergence theorem, we obtain that

$$\int_0^{+\infty} r f'(r)(\psi^2(r/n) - 1) r g^2(r) dr \rightarrow 0, \text{ when } n \rightarrow +\infty.$$

Then,

$$\int_0^{+\infty} f'(r)r^2 g_n^2(r) dr \rightarrow \int_0^{+\infty} f'(r)r^2 g^2(r) dr, \text{ when } n \rightarrow +\infty. \tag{3.18}$$

Finally, by combining (3.16), (3.17) and (3.18), we conclude that

$$\kappa \frac{\left| \int_0^{+\infty} f'(r)r^2 g^2(r) dr \right|}{\int_0^{+\infty} r^3 g'^2(r) dr} \leq C_\infty^A(\mathbb{R}^2).$$

Then, the proof of Theorem 1.2 is achieved. □

Acknowledgments

It is pleasure to thank S. Baraket for insightful comments and assistance through this work. We also thank the anonymous referees for their helpful comments on the paper.

References

- [1] I. Abid, S. Baraket, I. Bazarbacha and T. Ouni, *Best constant involving the L^∞ of evolutionary Wentze's problem associated to wave operator*, J. Math. Anal. Appl. **325** (2007), 866–878.
- [2] M. Abramowitz and I. A. Stegun, *Handbook of Mathematical Functions*, Dover, New York, 1964.
- [3] S. Baraket, *Estimations of the best constant involving the L^∞ norm in Wentze's inequality*, Ann. Fac. Sci. Toulouse Math. **6** (1996), 373–385.
- [4] H. Brezis and J. M. Coron, *Multiple solutions of H-system and Rellich's conjecture*, Comm. Pure Appl. Math. **37** (1984), 149–187.
- [5] S. Baraket and M. Dammak, *Estimation of the best constant involving the L^2 norm of the higher-order Wentze problem*, Abstr. Appl. Anal. **2005** (2005), 599–606.
- [6] M. Chipot, W. Gangbo, and B. Kawohl, *On some nonlocal variational problems*, Anal. Appl. (Singap.) **4** (2006), 345–356.
- [7] R. Coifman, P. L. Lions, Y. Meyer, and S. Semmes, *Compensated compactness and Hardy spaces*, J. Math. Pures Appl. **72** (1993), 247–286.
- [8] R. Dautray and J. L. Lions, *Analyse mathématique et calcul numérique pour les sciences et les techniques*, Collection Masson **7**, 1988.
- [9] Y. Ge, *Estimations of the best constant involving the L^2 norm in Wentze's inequality*, Contr. Optim. Calc. Var. **3** (1998), 263–300.
- [10] M. Jleli and B. Samet, *The Wentze problem associated to the modified Helmholtz operator*, submitted to Journal of Mathematical Analysis and Applications.
- [11] E. Stein, *Harmonic Analysis*, Princeton University Press, Princeton, 1993.
- [12] P. Topping, *The optimal constant in the Wentze's L^∞ estimate*, Comment. Math. Helv. **72** (1997), 316–328.
- [13] H. C. Wentze, *An existence theorem for surfaces of constant mean curvature*, J. Math. Anal. Appl. **26** (1969), 318–344.
- [14] H. C. Wentze, *Large solutions to the volume constrained Plateau problem*, Arch. Ration. Mech. Anal. **75** (1980), 59–77.

Mohamed Jleli: Ecole Supérieure des Sciences et Techniques de Tunis, Département de Mathématiques, 5, Avenue Taha Hussein - Tunis, B.P.:56, Bab Menara-1008, Tunisie.

E-mail address: jlelimohamed@gmail.com

Bessem Samet: Ecole Supérieure des Sciences et Techniques de Tunis, Département de Mathématiques, 5, Avenue Taha Hussein - Tunis, B.P.:56, Bab Menara-1008, Tunisie.

E-mail address: bessem.samet@gmail.com

Article 11:

The Wentz problem associated to the modified Helmholtz operator on weighted Sobolev spaces

To appear in Advanced Nonlinear Studies

The Wentz problem associated to the modified Helmholtz operator on weighted Sobolev spaces

Ines Ben Omrane

*Département de Mathématiques,
Faculté des Sciences de Tunis, Campus Universitaire, 2092 Tunis, Tunisia
e-mail: benomraneines@gmail.com.*

Mohamed Jleli

*Department of Mathematics,
King Saud University, Saudi Arabia
e-mail: jlelimohamed@gmail.com.*

Bessem Samet

*Département de Mathématiques,
Ecole Supérieure des Sciences et Techniques de Tunis, 5 Avenue Taha Hussein, 1008, Tunisia
e-mail: bessem.samet@gmail.com.*

October 8, 2009

Abstract

In this paper, we give a weighted version of regularity of solutions of the Wentz problem associated to the modified Helmholtz operator $-\Delta + \alpha I$, where α is a positive constant.

2000 Mathematics Subject Classification. 35C15, 35J05, 35J45.

Key words. Wentz inequality, weighted Sobolev spaces, modified Helmholtz operator.

1 Introduction

Let Ω be a bounded domain of \mathbb{R}^2 , given $u = (a, b) \in H^1(\Omega, \mathbb{R}^2)$, we consider Φ_α the solution to

$$\begin{cases} -\Delta\Phi_\alpha + \alpha\Phi_\alpha = a_{x_1}b_{x_2} - a_{x_2}b_{x_1} & \text{in } \Omega, \\ \Phi_\alpha = 0 & \text{on } \partial\Omega, \end{cases} \quad (1.1)$$

where α is a positive constant, $x = (x_1, x_2) \in \Omega$ and a_{x_i} denotes the partial derivative of a with respect to the variable x_i , $i = 1, 2$. If $\Omega = \mathbb{R}^2$, we replace the boundary condition in (1.1) by the limit condition $\lim_{\|x\| \rightarrow +\infty} \Phi_\alpha(x) = 0$, where

$\|x\| = r = \sqrt{x_1^2 + x_2^2}$. The considered operator $-\Delta + \alpha I$ is often referred to the modified Helmholtz operator or the Yukawa operator. It appears in many applications, for examples, in implicit marching schemes for the heat equation, in Debye-Huckel theory, and in the linearization of the Poisson-Boltzmann equation [10, 11, 12]. In Debye-Huckel theory, the constant $\sqrt{\alpha}$ represents the inverse of the electron Debye length which measures the distance over which an individual charged particle can exert an effect, while in quantum physics, $\sqrt{\alpha}$ is known as the screening constant parameter.

In [7], R. Coifman, P.L. Lions, Y. Meyer and S. Semmes proved that the function $\det \nabla u = a_{x_1} b_{x_2} - a_{x_2} b_{x_1}$ possesses some regularity properties and belongs to the Hardy space. S. Chanillo in [6] gives a direct proof of the same result without using Hardy space theory and generalized this one to weighted version.

In the case $\alpha = 0$, Problem (1.1) is the classical Wentz problem:

$$\begin{cases} -\Delta \Phi_0 = a_{x_1} b_{x_2} - a_{x_2} b_{x_1} & \text{in } \Omega, \\ \Phi_0 = 0 & \text{on } \partial\Omega. \end{cases} \quad (1.2)$$

It was proved in [5] that there exists $C_0(\Omega)$ that depends only on Ω such that:

$$\|\Phi_0\|_\infty + \|\nabla \Phi_0\|_2 \leq C_0(\Omega) \|\nabla a\|_2 \|\nabla b\|_2, \quad \forall u = (a, b) \in H^1(\Omega, \mathbb{R}^2). \quad (1.3)$$

Denote by:

$$C_\infty^0(\Omega) = \sup_{(a,b) \in V} \frac{\|\Phi_0\|_\infty}{\|\nabla a\|_2 \|\nabla b\|_2} \quad \text{and} \quad C_2^0(\Omega) = \sup_{(a,b) \in V} \frac{\|\nabla \Phi_0\|_2}{\|\nabla a\|_2 \|\nabla b\|_2},$$

where $V = \{(a, b) \in H^1(\Omega, \mathbb{R}^2) \mid \nabla a \neq 0, \nabla b \neq 0\}$. It was proved in [2, 13, 14] that $C_\infty^0(\Omega) = \frac{1}{2\pi}$ and in [15] that $C_2^0(\Omega) = \sqrt{\frac{3}{16\pi}}$. An extension of these results to the case of the modified Helmholtz operator was given in [9].

In [4], the authors gave a weighted version of regularity of solutions of the classical Wentz problem (1.2). In this work, the same purpose is considered for the case of the modified Helmholtz operator.

2 Statement of the results

We take $\Omega = \mathbb{R}^2$ or $\Omega = B_1$, where B_1 is the unit ball. Let $\omega \neq 0$ be a non-negative function in $L_{loc}^1(\Omega)$. We define:

$$\|f\|_{2,\omega} = \left(\int_\Omega f^2(x) \omega(x) dx \right)^{1/2}. \quad (2.1)$$

We denote by $H_\omega(\Omega)$ the closure of $\mathcal{C}_0^\infty(\Omega)$ equipped with the norm:

$$\|\cdot\|_{2,\omega} + \|\nabla \cdot\|_{2,\omega}. \quad (2.2)$$

Here, $\mathcal{C}_0^\infty(\Omega)$ is the space of \mathcal{C}^∞ compact supported functions. If ω^{-1} is also in $L^1_{loc}(\Omega)$, we introduce the space:

$$V_\omega(\Omega) = \{(a, b) \in H_\omega(\Omega) \times H_{\omega^{-1}}(\Omega) \mid \nabla a \neq 0, \nabla b \neq 0\}. \quad (2.3)$$

We say that the function ω satisfies (A1) if:

$$(A1): \omega \text{ is a radial function (i.e. } \omega(x) = w(r) \text{ where } r = \|x\|).$$

For all $(a, b) \in V_\omega(\Omega)$, let Φ_α be the solution to (1.1). Our first result is the following.

Theorem 2.1 *If ω satisfies (A1) and $\omega, \omega^{-1} \in \mathcal{C}^0(\Omega) \cap L^\infty(\Omega)$, then*

$$\sup_{(a,b) \in V_\omega(\Omega)} \frac{|\Phi_\alpha(0)|}{\|\nabla a\|_{2,\omega} \|\nabla b\|_{2,\omega^{-1}}} = \frac{1}{2\pi}. \quad (2.4)$$

Remark 2.1 Condition $\omega, \omega^{-1} \in L^\infty(\Omega)$ implies that $V_\omega(\Omega) \subset \{(a, b) \mid \nabla a, \nabla b \in L^2(\Omega)\}$. By the result of Brezis and Coron [5], this implies that Φ_0 solution to (1.2) belongs to $\mathcal{C}_0(\Omega)$, the set of continuous functions on Ω vanishing at the boundary. In the case $\alpha > 0$, by the maximum principle, we have (see the proof of Theorem 2.3) $\|\Phi_\alpha\|_\infty \leq 2\|\Phi_0\|_\infty$. Then, by density, we have $\Phi_\alpha \in \mathcal{C}_0(\Omega)$ for all $a, b \in V_\omega(\Omega)$. This remark is also available for any other space $\mathcal{V} \subset \{(a, b) \mid \nabla a, \nabla b \in L^2(\Omega)\}$, in particular, for Theorem 2.2 and Theorem 2.3.

In general, when ω or $\omega^{-1} \notin \mathcal{C}^0(\Omega)$, we are not able to get the optimal result. For studying more general case, we need to introduce others spaces and conditions.

We introduce the space $\tilde{H}_\omega(\Omega)$ which is the closure of $\mathcal{C}_0^\infty(\Omega \setminus \{0\})$ equipped with the norm (2.2) and the space:

$$\tilde{V}_\omega(\Omega) = \{(a, b) \in \tilde{H}_\omega(\Omega) \times \tilde{H}_{\omega^{-1}}(\Omega) \mid \nabla a \neq 0, \nabla b \neq 0\}. \quad (2.5)$$

We say that ω satisfies (A2) if:

$$(A2): \omega \in \mathcal{C}^2(\Omega \setminus \{0\}), \omega > 0 \text{ and we have:}$$

$$\Delta(\sqrt{\omega(x)}) \geq 0, \Delta\left(\frac{1}{\sqrt{\omega(x)}}\right) \geq 0 \text{ in } \Omega \setminus \{0\}. \quad (2.6)$$

If ω satisfies also (A1), so we write $\omega(x) = w(r) = e^{v(r)}$. In this case, (2.6) is equivalent to:

$$\left|v''(r) + \frac{1}{r}v'(r)\right| \leq \frac{1}{2}v'^2(r) \text{ in } (0, +\infty) \text{ or } (0, 1).$$

Remark 2.2 Under the assumptions (A1)-(A2), we have:

$$\begin{aligned} h_\omega^1(x) &\equiv \|x\|^2 \left(\frac{1}{2} \Delta \omega - \frac{1}{4} |\nabla \omega|^2 \omega^{-1} \right) \omega^{-1} \\ &= \frac{r^2}{2} \left(v''(r) + \frac{1}{r} v'(r) + \frac{1}{2} v'^2(r) \right) \geq 0 \end{aligned}$$

and

$$\begin{aligned} h_\omega^2(x) &\equiv \|x\|^2 \left(-\frac{1}{2} \Delta \omega + \frac{3}{4} |\nabla \omega|^2 \omega^{-1} \right) \omega^{-1} \\ &= \frac{r^2}{2} \left(-v''(r) - \frac{1}{r} v'(r) + \frac{1}{2} v'^2(r) \right) \geq 0. \end{aligned}$$

Our second result is the following.

Theorem 2.2 *Assuming that (A1)-(A2) hold, then we have:*

$$\sup_{(a,b) \in \tilde{V}_\omega^*(\Omega)} \frac{|\Phi_\alpha(0)|}{\|\nabla a\|_{2,\omega} \|\nabla b\|_{2,\omega^{-1}}} \leq \frac{1}{2\pi} \frac{1}{\sup_{i=1,2} \left(1 + \inf_{x \in \Omega} h_\omega^i(x) \right)^{1/2}}, \quad (2.7)$$

where

$$\tilde{V}_\omega^*(\Omega) = \tilde{V}_\omega(\Omega) \cap \{(a, b) \mid \nabla a, \nabla b \in L^2(\Omega)\}.$$

Denote by

$$W_p(\Omega) = \{(a, b) \in V_\omega(\Omega), (a, b)(x) = g(\|x\|)(\omega(x)^{-1/2} x_1, \omega(x)^{1/2} x_2)\} \quad (2.8)$$

and

$$W_r(\Omega) = \{(a, b) \in V_\omega(\Omega), (a, b)(x) = g(\|x\|)x\}, \quad (2.9)$$

where $g \in \mathcal{C}^\infty(0, +\infty)$ if $\Omega = \mathbb{R}^2$ and $g \in \mathcal{C}^\infty(0, 1)$ if $\Omega = B_1$. Let $V_p(\Omega)$ and $V_r(\Omega)$ the closure respectively of $W_p(\Omega)$ and $W_r(\Omega)$ in $V_\omega(\Omega)$ equipped with the norm (2.2). We denote:

$$V_p^*(\Omega) = \{(a, b) \in V_p(\Omega) \mid \nabla a \neq 0, \nabla b \neq 0\} \quad (2.10)$$

and

$$V_r^*(\Omega) = \{(a, b) \in V_r(\Omega) \mid \nabla a, \nabla b \in L^2(\Omega)\}. \quad (2.11)$$

Let ω be a radial function ($\omega(x) = w(r)$).

We say that ω satisfies (A3) if:

$$(A3): \lim_{r \rightarrow 0} r^2 w(r) = \lim_{r \rightarrow 0} r^2 w^{-1}(r) = 0.$$

We say that ω satisfies (A4) if:

$$(A4): \lim_{r \rightarrow 0} r^3 w'(r) = \lim_{r \rightarrow 0} r^3 (w^{-1}(r))' = 0.$$

We prove

Theorem 2.3 *Assuming that (A1) and (A2) hold. Then,*

1. *If (A4) is satisfied, we have:*

$$\frac{C(\Omega)}{\prod_{i=1}^2 \left(1 + \sup_{x \in \Omega} h_{\omega}^i(x)\right)^{1/2}} \leq \sup_{(a,b) \in V_p^*(\Omega)} \frac{2\pi |\Phi_{\alpha}(0)|}{\|\nabla a\|_{2,\omega} \|\nabla b\|_{2,\omega^{-1}}} \leq \frac{1}{\prod_{i=1}^2 \left(1 + \inf_{x \in \Omega} h_{\omega}^i(x)\right)^{1/2}}, \quad (2.12)$$

where $C(\mathbb{R}^2) = 1$ and $C(B_1) = \sqrt{\alpha} K_1(\sqrt{\alpha})$. Here, K_1 is the first-order modified Bessel function of the second kind.

2. *If (A3) and (A4) are satisfied and $(a, b) \in V_r^*(\Omega)$, we have:*

$$\|\Phi_{\alpha}\|_{\infty} \leq \frac{1}{\pi} \frac{\|\nabla a\|_{2,\omega} \|\nabla b\|_{2,\omega^{-1}}}{\prod_{i=1}^2 \left(1 + \inf_{x \in \Omega} h_{\omega}^i(x)\right)^{1/2}}. \quad (2.13)$$

Remark 2.3 We have:

$$V_p^*(\Omega) \subset \{(a, b) \mid \nabla a, \nabla b \in L^2(\Omega)\}.$$

To show this, by (3.27)-(3.28), for all $a, b \in W_p(\Omega)$, we have:

$$\|\nabla a\|_{2,\omega} \geq \|\nabla a\|_2$$

and

$$\|\nabla b\|_{2,\omega^{-1}} \geq \|\nabla b\|_2.$$

By density, these inequalities hold also for all $a, b \in V_p^*(\Omega)$.

3 Proofs

We start by giving some preliminaries results which are used later.

3.1 Preliminaries

In [5] the following result was proved.

Lemma 3.1 *For all $a, b \in H^1(\Omega)$, we have the following estimate:*

$$\left| \int_0^{2\pi} ab_{\theta} d\theta \right| \leq \|a_{\theta}\|_{L^2(0,2\pi)} \|b_{\theta}\|_{L^2(0,2\pi)},$$

where the subscript denote the partial differentiation with respect to the polar coordinate θ .

Through this paper we will use the following modified Bessel functions:

$$\begin{aligned} I_n(x) &= \frac{1}{\pi} \int_0^\pi e^{x \cos t} \cos(nt) dt, \quad x \in \mathbb{R}, n \in \mathbb{N}, \\ K_n(x) &= \frac{\Gamma(n+1/2)}{\sqrt{\pi}} \left(\frac{2}{x}\right)^n \int_0^{+\infty} \frac{\cos(xt)}{(t^2+1)^{n+1/2}} dt, \quad x > 0, n \in \mathbb{N}, \end{aligned}$$

where Γ is the gamma function.

The following properties are standard in Bessel functions theory (see [1]).

Lemma 3.2 *We have:*

$$\begin{aligned} (1) \quad K'_0 &= -K_1 \text{ and } I'_0 = I_1 & (2) \quad K_0(x) &\sim -\ln x \text{ (} x \rightarrow 0^+ \text{)} \\ (3) \quad f(x) &= xK_1(x) \leq f(0) = 1, \forall x \geq 0 & (4) \quad I_0(x) &\geq I_0(0) = 1, \forall x \geq 0 \\ (5) \quad I_1(x) &\geq I_1(0) = 0, \forall x \geq 0 & (6) \quad 0 &< K_0(x) < K_1(x), \forall x > 0 \\ (7) \quad I_0(x)K_1(x) &+ I_1(x)K_0(x) = 1/x, \forall x > 0. \end{aligned}$$

Denote by G the Green function associated to the operator $-\Delta + \alpha I$ on B_1 , i.e.

$$\begin{cases} -\Delta G + \alpha G = \delta_0 & \text{in } B_1, \\ G = 0 & \text{on } \partial B_1. \end{cases} \quad (3.1)$$

The following result is standard in PDE theory [8].

Lemma 3.3 *The Green function associated to the operator $-\Delta + \alpha I$ on B_1 is given by:*

$$G(x) = \mathcal{G}(r) = \frac{1}{2\pi} \left(K_0(\sqrt{\alpha}r) - \frac{K_0(\sqrt{\alpha})}{I_0(\sqrt{\alpha})} I_0(\sqrt{\alpha}r) \right), \quad r = \|x\|.$$

We have the following result.

Lemma 3.4 *The following estimate holds:*

$$2\pi r |\mathcal{G}'(r)| \leq 1, \quad \forall r \in (0, 1).$$

Proof. By Lemma 3.2, we obtain:

$$2\pi r |\mathcal{G}'(r)| = \sqrt{\alpha}r (K_1(\sqrt{\alpha}r) + s(\sqrt{\alpha}) I_1(\sqrt{\alpha}r)),$$

where $s(t) = \frac{K_0(t)}{I_0(t)}$, $\forall t > 0$. Using Lemma 3.2, it is easy to check that s is a decreasing function in $(0, +\infty)$. Then, we obtain:

$$s(\sqrt{\alpha}) \leq s(\sqrt{\alpha}r), \quad \forall r \in (0, 1).$$

Using this inequality, properties (7) and (4) of Lemma 3.2, we obtain:

$$\begin{aligned} 2\pi r |\mathcal{G}'(r)| &\leq \sqrt{\alpha}r (K_1(\sqrt{\alpha}r) + s(\sqrt{\alpha}r) I_1(\sqrt{\alpha}r)) \\ &= \sqrt{\alpha}r \left(K_1(\sqrt{\alpha}r) + \frac{K_0(\sqrt{\alpha}r)}{I_0(\sqrt{\alpha}r)} I_1(\sqrt{\alpha}r) \right) \\ &= \frac{\sqrt{\alpha}r}{I_0(\sqrt{\alpha}r)} (K_1(\sqrt{\alpha}r) I_0(\sqrt{\alpha}r) + K_0(\sqrt{\alpha}r) I_1(\sqrt{\alpha}r)) \\ &= \frac{1}{I_0(\sqrt{\alpha}r)} \leq 1 \end{aligned}$$

and the proof is achieved. □

By Lemma 3.2, the following result is easy to check.

Lemma 3.5 *We have:*

$$\lim_{r \rightarrow 0^+} r\mathcal{G}'(r) = -\frac{1}{2\pi}.$$

3.2 Proof of Theorem 2.1

First case: $\Omega = \mathbb{R}^2$.

We suppose that $a, b \in \mathcal{C}_0^\infty(\mathbb{R}^2)$. The general case can be obtained by approximation argument. We will apply similar arguments used in [5, 2, 9]. In fact, we have:

$$\Phi_\alpha = E * (a_{x_1} b_{x_2} - a_{x_2} b_{x_1}),$$

where E is the fundamental solution to the modified Helmholtz operator, given by:

$$E = \frac{1}{2\pi} K_0(\sqrt{\alpha}\|x\|). \text{ We obtain:}$$

$$\begin{aligned} 2\pi\Phi_\alpha(0) &= \int_{\mathbb{R}^2} K_0(\sqrt{\alpha}\|x\|)(a_{x_1} b_{x_2} - a_{x_2} b_{x_1}) dx \\ &= \int_{r=0}^{+\infty} \int_{\theta=0}^{2\pi} K_0(\sqrt{\alpha}r)(a_r b_\theta - a_\theta b_r) d\theta dr \\ &= \int_0^{+\infty} \int_0^{2\pi} K_0(\sqrt{\alpha}r)[(ab_\theta)_r - (ab_r)_\theta] d\theta dr \\ &= \int_0^{+\infty} \int_0^{2\pi} K_0(\sqrt{\alpha}r)(ab_\theta)_r d\theta dr. \end{aligned}$$

Using an integration by parts and $K_0' = -K_1$, we obtain:

$$\int_0^{+\infty} K_0(\sqrt{\alpha}r)(ab_\theta)_r dr = \int_0^{+\infty} \sqrt{\alpha}K_1(\sqrt{\alpha}r)ab_\theta dr.$$

Then,

$$2\pi\Phi_\alpha(0) = \int_0^{+\infty} \sqrt{\alpha}rK_1(\sqrt{\alpha}r) \frac{1}{r} \left(\int_0^{2\pi} ab_\theta d\theta \right) dr.$$

Using Lemma 3.1 and (3) of Lemma 3.2, we obtain:

$$\begin{aligned} 2\pi|\Phi_\alpha(0)| &\leq \int_0^{+\infty} |\sqrt{\alpha}rK_1(\sqrt{\alpha}r)| \frac{1}{r} \left(\int_0^{2\pi} a_\theta^2 d\theta \right)^{1/2} \left(\int_0^{2\pi} b_\theta^2 d\theta \right)^{1/2} dr \\ &\leq \int_0^{+\infty} \frac{1}{r} \left(\int_0^{2\pi} a_\theta^2 d\theta \right)^{1/2} \left(\int_0^{2\pi} b_\theta^2 d\theta \right)^{1/2} dr. \end{aligned}$$

Since ω is a radial function, we get:

$$2\pi|\Phi_\alpha(0)| \leq \left(\int_0^{+\infty} \int_0^{2\pi} \frac{1}{r} a_\theta^2 w d\theta dr \right)^{1/2} \left(\int_0^{+\infty} \int_0^{2\pi} \frac{1}{r} b_\theta^2 w^{-1} d\theta dr \right)^{1/2}$$

$$\begin{aligned}
&\leq \left(\int_{\mathbb{R}^2} |\nabla a|^2 w \, dx \right)^{1/2} \left(\int_{\mathbb{R}^2} |\nabla b|^2 w^{-1} \, dx \right)^{1/2} \\
&\leq \|\nabla a\|_{2,\omega} \|\nabla b\|_{2,\omega^{-1}}.
\end{aligned}$$

So we deduce that:

$$\sup_{(a,b) \in V_\omega(\Omega)} \frac{|\Phi_\alpha(0)|}{\|\nabla a\|_{2,\omega} \|\nabla b\|_{2,\omega^{-1}}} \leq \frac{1}{2\pi}. \quad (3.2)$$

Now, we turn to prove the inverse inequality of (3.2). Here, we don't need to suppose (A1). Let $g \in C_0^\infty(0, +\infty)$. For all $\rho > 0$, we denote:

$$(a_\rho, b_\rho)(x) = g\left(\frac{r}{\rho}\right) \frac{x}{\rho}, \quad \forall x \in \mathbb{R}^2,$$

where $r = \|x\|$. Let Φ_α^ρ be the solution to (1.1) corresponding to a_ρ and b_ρ . As in [9], after a change of variables, and using Lemma 3.2, we obtain:

$$\Phi_\alpha^\rho(0) = \frac{1}{2} \int_0^{+\infty} \sqrt{\alpha} \rho r K_1(\sqrt{\alpha} \rho r) r g^2(r) \, dr \rightarrow \frac{1}{2} \int_0^{+\infty} r g^2(r) \, dr, \quad \text{as } \rho \rightarrow 0. \quad (3.3)$$

Furthermore,

$$\|\nabla a_\rho\|_{2,\omega}^2 = \int_0^{2\pi} \int_0^{+\infty} (r g^2(r) + r^3 g'^2(r) \cos^2 \theta + r^2 (g^2)'(r) \cos^2 \theta) \omega(\rho x) \, dr \, d\theta.$$

Using an integration by parts and the continuity of ω , we obtain:

$$\|\nabla a_\rho\|_{2,\omega}^2 \rightarrow \pi \omega(0) \int_0^{+\infty} r^3 g'^2(r) \, dr, \quad \text{as } \rho \rightarrow 0. \quad (3.4)$$

In the same way, we prove:

$$\|\nabla b_\rho\|_{2,\omega^{-1}}^2 \rightarrow \pi \omega^{-1}(0) \int_0^{+\infty} r^3 g'^2(r) \, dr, \quad \text{as } \rho \rightarrow 0. \quad (3.5)$$

By (3.3), (3.4) and (3.5), we get:

$$\sup_{(a,b) \in V_\omega(\Omega)} \frac{|\Phi_\alpha(0)|}{\|\nabla a\|_{2,\omega} \|\nabla b\|_{2,\omega^{-1}}} \geq \frac{1}{2\pi} L^0(g), \quad (3.6)$$

where

$$L^0(g) = \frac{\int_0^{+\infty} r g^2(r) \, dr}{\int_0^{+\infty} r^3 g'^2(r) \, dr}. \quad (3.7)$$

Choosing $g_\varepsilon(r) = r^{\varepsilon-1} e^{-r/2}$ with $\varepsilon > 0$. By density, (3.6) holds also for g_ε and we obtain:

$$\sup_{(a,b) \in V_\omega(\Omega)} \frac{|\Phi_\alpha(0)|}{\|\nabla a\|_{2,\omega} \|\nabla b\|_{2,\omega^{-1}}} \geq \frac{1}{2\pi} L^0(g_\varepsilon), \quad \forall \varepsilon > 0.$$

On the other hand, we have:

$$L^0(g_\varepsilon) = \frac{\Gamma(2\varepsilon)}{(\varepsilon - 1)^2\Gamma(2\varepsilon) - (\varepsilon - 1)\Gamma(2\varepsilon + 1) + \frac{\Gamma(2\varepsilon+2)}{4}} \rightarrow 1, \text{ as } \varepsilon \rightarrow 0.$$

Then, we get:

$$\sup_{(a,b) \in V_\omega(\Omega)} \frac{|\Phi_\alpha(0)|}{\|\nabla a\|_{2,\omega} \|\nabla b\|_{2,\omega^{-1}}} \geq \frac{1}{2\pi}. \quad (3.8)$$

By (3.2) and (3.8), we obtain the desired result. Then, the proof is achieved for the case $\Omega = \mathbb{R}^2$.

Second case: $\Omega = B_1$.

We can assume that $a, b \in \mathcal{C}_0^\infty(B_1)$. We have:

$$\begin{aligned} \Phi_\alpha(0) &= \int_{B_1} G(x)(a_{x_1}b_{x_2} - a_{x_2}b_{x_1}) dx \\ &= \int_{r=0}^1 \int_{\theta=0}^{2\pi} \mathcal{G}(r)(a_r b_\theta - a_\theta b_r) d\theta dr \\ &= \int_0^1 \int_0^{2\pi} \mathcal{G}(r)[(ab_\theta)_r - (ab_r)_\theta] d\theta dr \\ &= \int_0^1 \int_0^{2\pi} \mathcal{G}(r)(ab_\theta)_r d\theta dr. \end{aligned}$$

Using an integration by parts and the property (2) of Lemma 3.2, we obtain:

$$\int_0^1 \mathcal{G}(r)(ab_\theta)_r dr = - \int_0^1 \mathcal{G}'(r)ab_\theta dr.$$

Then,

$$\Phi_\alpha(0) = - \int_0^1 r\mathcal{G}'(r) \frac{1}{r} \int_0^{2\pi} ab_\theta d\theta dr.$$

Using Lemmas 3.1 and 3.4, we obtain:

$$\begin{aligned} |\Phi_\alpha(0)| &\leq \frac{1}{2\pi} \int_0^1 \frac{1}{r} \left(\int_0^{2\pi} a_\theta^2 d\theta \right)^{1/2} \left(\int_0^{2\pi} b_\theta^2 d\theta \right)^{1/2} dr \\ &\leq \frac{1}{2\pi} \|\nabla a\|_{2,\omega} \|\nabla b\|_{2,\omega^{-1}}. \end{aligned}$$

So we deduce that:

$$\sup_{(a,b) \in V_\omega(\Omega)} \frac{|\Phi_\alpha(0)|}{\|\nabla a\|_{2,\omega} \|\nabla b\|_{2,\omega^{-1}}} \leq \frac{1}{2\pi}. \quad (3.9)$$

Let us prove now the inverse inequality of (3.9). As in the previous case, we don't need to suppose (A1). Let g be a function in $\mathcal{C}_0^\infty(0, +\infty)$ with a compact support $K \subset (0, 1)$. As in the previous case, for all $\rho > 0$, we denote:

$$(a_\rho, b_\rho)(x) = g\left(\frac{r}{\rho}\right) \frac{x}{\rho}, \quad \forall x \in B_1,$$

where $r = \|x\|$. Let Φ_α^ρ be the solution to (1.1) corresponding to a_ρ and b_ρ . Using an integration by parts, a change of variable and Lemma 3.5, we obtain:

$$\Phi_\alpha^\rho(0) = -\pi \int_0^1 \rho r \mathcal{G}'(\rho r) r g^2(r) dr \rightarrow \frac{1}{2} \int_0^1 r g^2(r) dr, \text{ as } \rho \rightarrow 0. \quad (3.10)$$

As in the previous case, using the continuity of ω and ω^{-1} , we obtain:

$$\|\nabla a_\rho\|_{2,\omega}^2 \rightarrow \pi \omega(0) \int_0^1 r^3 g'^2(r) dr, \text{ as } \rho \rightarrow 0 \quad (3.11)$$

$$\|\nabla b_\rho\|_{2,\omega^{-1}}^2 \rightarrow \pi \omega^{-1}(0) \int_0^1 r^3 g'^2(r) dr, \text{ as } \rho \rightarrow 0. \quad (3.12)$$

By (3.10), (3.11) and (3.12), we obtain:

$$\sup_{(a,b) \in V_\omega(\Omega)} \frac{|\Phi_\alpha(0)|}{\|\nabla a\|_{2,\omega} \|\nabla b\|_{2,\omega^{-1}}} \geq \frac{1}{2\pi} \ell^0(g), \quad (3.13)$$

where

$$\ell^0(g) = \frac{\int_0^1 r g^2(r) dr}{\int_0^1 r^3 g'^2(r) dr}. \quad (3.14)$$

Choosing $g_\varepsilon(r) = r^{\frac{\varepsilon}{2}-1} - 1$ with $\varepsilon > 0$. By density, (3.13) holds for $g = g_\varepsilon$. Then,

$$\sup_{(a,b) \in V_\omega(\Omega)} \frac{|\Phi_\alpha(0)|}{\|\nabla a\|_{2,\omega} \|\nabla b\|_{2,\omega^{-1}}} \geq \frac{1}{2\pi} \ell^0(g_\varepsilon), \quad \forall \varepsilon > 0.$$

On the other hand, we have:

$$\ell^0(g_\varepsilon) \rightarrow 1, \text{ as } \varepsilon \rightarrow 0.$$

We deduce that:

$$\sup_{(a,b) \in V_\omega(\Omega)} \frac{|\Phi_\alpha(0)|}{\|\nabla a\|_{2,\omega} \|\nabla b\|_{2,\omega^{-1}}} \geq \frac{1}{2\pi}. \quad (3.15)$$

Combining (3.9) and (3.15), we obtain the desired result. Then, the proof of Theorem 2.1 is achieved. \square

3.3 Proof of Theorem 2.2

We will adapt the strategy used in [4]. By density, we can suppose that $a, b \in \mathcal{C}_0^\infty(\Omega \setminus \{0\})$. Denote:

$$\tilde{a}(x) = \omega(x)^{1/2} a(x) \text{ and } \tilde{b}(x) = \omega(x)^{-1/2} b(x).$$

By simple calculus, we obtain:

$$a_{x_1} b_{x_2} - a_{x_2} b_{x_1} = \frac{1}{r} (\tilde{a}_r \tilde{b}_\theta - \tilde{a}_\theta \tilde{b}_r) + \frac{1}{2r} \omega^{-1} [(\tilde{a}\tilde{b})_r \omega_\theta - (\tilde{a}\tilde{b})_\theta \omega_r].$$

Since ω satisfies (A1), then

$$a_{x_1} b_{x_2} - a_{x_2} b_{x_1} = \frac{1}{r} (\tilde{a}_r \tilde{b}_\theta - \tilde{a}_\theta \tilde{b}_r) - \frac{1}{2r} \omega^{-1} (\tilde{a}\tilde{b})_\theta \omega_r. \quad (3.16)$$

First case: $\Omega = \mathbb{R}^2$.

In this case, we have:

$$\Phi_\alpha(0) = \frac{1}{2\pi} \int_{\mathbb{R}^2} K_0(\sqrt{\alpha}\|x\|) (a_{x_1} b_{x_2} - a_{x_2} b_{x_1}) dx.$$

Using (3.16), we obtain:

$$\begin{aligned} \Phi_\alpha(0) &= \frac{1}{2\pi} \int_{r=0}^{+\infty} \int_{\theta=0}^{2\pi} K_0(\sqrt{\alpha}r) (\tilde{a}_r \tilde{b}_\theta - \tilde{a}_\theta \tilde{b}_r) d\theta dr \\ &= \frac{1}{2\pi} \int_0^{+\infty} \int_0^{2\pi} K_0(\sqrt{\alpha}r) (\tilde{a}\tilde{b})_r d\theta dr \\ &= \frac{1}{2\pi} \int_0^{+\infty} \int_0^{2\pi} \sqrt{\alpha}r K_1(\sqrt{\alpha}r) \frac{1}{r} (\tilde{a} - \tilde{a}) \tilde{b}_\theta d\theta dr, \end{aligned}$$

where $\tilde{a}(r) = \frac{1}{2\pi} \int_0^{2\pi} \tilde{a}(re^{i\sigma}) d\sigma$. By Lemma 3.2, we obtain:

$$\begin{aligned} |\Phi_\alpha(0)| &\leq \frac{1}{2\pi} \int_0^{+\infty} \int_0^{2\pi} \frac{1}{r} |\tilde{a} - \tilde{a}| |\tilde{b}_\theta| d\theta dr \\ &\leq \frac{1}{2\pi} \left(\int_0^{+\infty} \int_0^{2\pi} \frac{1}{r} |\tilde{a} - \tilde{a}|^2 d\theta dr \right)^{1/2} \left(\int_0^{+\infty} \int_0^{2\pi} \frac{1}{r} \tilde{b}_\theta^2 d\theta dr \right)^{1/2} \quad (3.17) \end{aligned}$$

Now, we will estimate $\|\nabla a\|_{2,\omega}$ and $\|\nabla b\|_{2,\omega^{-1}}$. We have:

$$\begin{aligned} \|\nabla a\|_{2,\omega}^2 &= \int_{\mathbb{R}^2} |\nabla(\omega^{-1/2}\tilde{a})|^2 \omega dx \\ &= \int_{\mathbb{R}^2} \left(\frac{\tilde{a}^2}{4} \omega^{-2} |\nabla\omega|^2 - \tilde{a}\omega^{-1} \nabla\tilde{a} \cdot \nabla\omega + |\nabla\tilde{a}|^2 \right) dx. \end{aligned}$$

On the other hand, we have:

$$\begin{aligned} 2 \int_{\mathbb{R}^2} \tilde{a}\omega^{-1} \nabla\tilde{a} \cdot \nabla\omega dx &= \int_{\mathbb{R}^2} \tilde{a}^2 (|\nabla\omega|^2 \omega^{-1} - \Delta\omega) \omega^{-1} dx + \int_0^{2\pi} [rw'(r)a^2]_0^{+\infty} d\theta \\ &= \int_{\mathbb{R}^2} \tilde{a}^2 (|\nabla\omega|^2 \omega^{-1} - \Delta\omega) \omega^{-1} dx. \end{aligned}$$

Then,

$$\|\nabla a\|_{2,\omega}^2 = \int_0^{+\infty} \int_0^{2\pi} \frac{1}{r} h_\omega^1 \tilde{a}^2 d\theta dr + \int_0^{+\infty} \int_0^{2\pi} \left(r \tilde{a}_r^2 + \frac{\tilde{a}_\theta^2}{r} \right) d\theta dr. \quad (3.18)$$

We have:

$$\int_0^{2\pi} \tilde{a}^2 d\theta \geq \int_0^{2\pi} |\tilde{a} - \bar{\tilde{a}}|^2 d\theta \text{ and } \int_0^{2\pi} \tilde{a}_\theta^2 d\theta \geq \int_0^{2\pi} |\tilde{a} - \bar{\tilde{a}}|^2 d\theta. \quad (3.19)$$

By (3.18), (3.19) and the hypothesis (A2), we get:

$$\|\nabla a\|_{2,\omega}^2 \geq \left(1 + \inf_{x \in \mathbb{R}^2} h_\omega^1(x) \right) \int_0^{+\infty} \int_0^{2\pi} \frac{1}{r} |\tilde{a} - \bar{\tilde{a}}|^2 d\theta dr. \quad (3.20)$$

In the same way, we prove that:

$$\|\nabla b\|_{2,\omega^{-1}}^2 = \int_0^{+\infty} \int_0^{2\pi} \frac{1}{r} h_\omega^2 \tilde{b}^2 d\theta dr + \int_0^{+\infty} \int_0^{2\pi} \left(r \tilde{b}_r^2 + \frac{\tilde{b}_\theta^2}{r} \right) d\theta dr \quad (3.21)$$

and by the hypothesis (A2), we get:

$$\|\nabla b\|_{2,\omega^{-1}}^2 \geq \int_0^{+\infty} \int_0^{2\pi} \frac{1}{r} \tilde{b}_\theta^2 d\theta dr. \quad (3.22)$$

By combining (3.17), (3.20) and (3.22), we obtain:

$$\frac{|\Phi_\alpha(0)|}{\|\nabla a\|_{2,\omega} \|\nabla b\|_{2,\omega^{-1}}} \leq \frac{1}{2\pi} \frac{1}{\left(1 + \inf_{x \in \mathbb{R}^2} h_\omega^1(x) \right)^{1/2}}.$$

Finally, since a and b play symmetric roles, we deduce that:

$$\frac{|\Phi_\alpha(0)|}{\|\nabla a\|_{2,\omega} \|\nabla b\|_{2,\omega^{-1}}} \leq \frac{1}{2\pi} \frac{1}{\sup_{i=1,2} \left(1 + \inf_{x \in \mathbb{R}^2} h_\omega^i(x) \right)^{1/2}}.$$

Second case: $\Omega = B_1$.

By (3.16), we have:

$$\begin{aligned} \Phi_\alpha(0) &= \int_{B_1} G(x)(a_{x_1} b_{x_2} - a_{x_2} b_{x_1}) dx \\ &= \int_{r=0}^1 \int_{\theta=0}^{2\pi} \mathcal{G}(r)(\tilde{a}_r \tilde{b}_\theta - \tilde{a}_\theta \tilde{b}_r) d\theta dr \\ &= \int_0^1 \int_0^{2\pi} \mathcal{G}(r)(\tilde{a} \tilde{b}_\theta)_r d\theta dr \\ &= \int_0^1 \int_0^{2\pi} -r \mathcal{G}'(r) \frac{1}{r} (\tilde{a} - \bar{\tilde{a}}) \tilde{b}_\theta d\theta dr. \end{aligned}$$

Using Lemma 3.4, we obtain:

$$\begin{aligned} |\Phi_\alpha(0)| &\leq \frac{1}{2\pi} \int_0^1 \int_0^{2\pi} \frac{1}{r} |\tilde{a} - \bar{a}| |\tilde{b}_\theta| \, d\theta \, dr \\ &\leq \frac{1}{2\pi} \left(\int_0^1 \int_0^{2\pi} \frac{1}{r} |\tilde{a} - \bar{a}|^2 \, d\theta \, dr \right)^{1/2} \left(\int_0^1 \int_0^{2\pi} \frac{1}{r} \tilde{b}_\theta^2 \, d\theta \, dr \right)^{1/2} \end{aligned} \quad (3.23)$$

Using the same calculus as in the previous case, we get:

$$\|\nabla a\|_{2,\omega}^2 \geq \left(1 + \inf_{x \in B_1} h_\omega^1(x) \right) \int_0^1 \int_0^{2\pi} \frac{1}{r} |\tilde{a} - \bar{a}|^2 \, d\theta \, dr \quad (3.24)$$

and

$$\|\nabla b\|_{2,\omega^{-1}}^2 \geq \int_0^1 \int_0^{2\pi} \frac{1}{r} \tilde{b}_\theta^2 \, d\theta \, dr. \quad (3.25)$$

Combining (3.23), (3.24) and (3.25), the desired result holds for the case $\Omega = B_1$. Then, the proof of theorem 2.2 is achieved. \square

3.4 Proof of Theorem 2.3

We start by studying the

First case: $\Omega = \mathbb{R}^2$.

1. First, we give the proof of (2.12). Let $(a, b) \in W_p(\Omega)$. We assume that $g \in C_0^\infty(0, +\infty)$. In this case, we have:

$$\Phi_\alpha(0) = \frac{1}{2} \int_0^{+\infty} \sqrt{\alpha r} K_1(\sqrt{\alpha r}) r g^2(r) \, dr.$$

By Lemma 3.2, we have:

$$|\Phi_\alpha(0)| \leq \frac{1}{2} \int_0^{+\infty} r g^2(r) \, dr. \quad (3.26)$$

By simple calculus, we get:

$$\|\nabla a\|_{2,\omega}^2 = \pi \left(\int_0^{+\infty} r h_\omega^1 g^2 \, dr + \int_0^{+\infty} r^3 g'^2 \, dr \right) \quad (3.27)$$

$$\|\nabla b\|_{2,\omega^{-1}}^2 = \pi \left(\int_0^{+\infty} r h_\omega^2 g^2 \, dr + \int_0^{+\infty} r^3 g'^2 \, dr \right) \quad (3.28)$$

and

$$\int_0^{+\infty} r^3 g'^2 \, dr = \int_0^{+\infty} r g^2 \, dr + \int_0^{+\infty} r (r g)^2 \, dr. \quad (3.29)$$

Combining (3.27), (3.28) and (3.29), we get:

$$\|\nabla a\|_{2,\omega} \|\nabla b\|_{2,\omega^{-1}} \geq \pi \prod_{i=1}^2 \left(1 + \inf_{x \in \mathbb{R}^2} h_\omega^i(x) \right)^{1/2} \int_0^{+\infty} r g^2 \, dr. \quad (3.30)$$

By (3.26) and (3.30), we deduce that:

$$\sup_{(a,b) \in V_p^*(\Omega)} \frac{2\pi|\Phi_\alpha(0)|}{\|\nabla a\|_{2,\omega}\|\nabla b\|_{2,\omega^{-1}}} \leq \frac{1}{\prod_{i=1}^2 \left(1 + \inf_{x \in \mathbb{R}^2} h_\omega^i(x)\right)^{1/2}}.$$

By (3.27) and (3.28), we obtain:

$$\sup_{(a,b) \in V_p^*(\Omega)} \frac{2\pi|\Phi_\alpha(0)|}{\|\nabla a\|_{2,\omega}\|\nabla b\|_{2,\omega^{-1}}} \geq \frac{\int_0^{+\infty} \sqrt{\alpha r} K_1(\sqrt{\alpha r}) r g^2(r) dr}{\prod_{i=1}^2 \left(\sup_{x \in \mathbb{R}^2} h_\omega^i(x) \int_0^{+\infty} r g^2 dr + \int_0^{+\infty} r^3 g'^2 dr \right)^{1/2}}. \quad (3.31)$$

Taking $g_\varepsilon(r) = r^{\varepsilon-1} e^{-r/2}$ with $\varepsilon > 0$. By density, (3.31) holds for g_ε . So, we obtain:

$$\sup_{(a,b) \in V_p^*(\Omega)} \frac{2\pi|\Phi_\alpha(0)|}{\|\nabla a\|_{2,\omega}\|\nabla b\|_{2,\omega^{-1}}} \geq \frac{\int_0^{+\infty} \sqrt{\alpha r} K_1(\sqrt{\alpha r}) r g_\varepsilon^2(r) dr}{\prod_{i=1}^2 \left(\sup_{x \in \mathbb{R}^2} h_\omega^i(x) \Gamma(2\varepsilon) + \Gamma(2\varepsilon)(1 + O_\varepsilon(1)) \right)^{1/2}}. \quad (3.32)$$

In [9], it was proved that:

$$\int_0^{+\infty} \sqrt{\alpha r} K_1(\sqrt{\alpha r}) r g_\varepsilon^2(r) dr = \Gamma(2\varepsilon) \int_0^{+\infty} \frac{1}{(t^2 + 1)^{3/2}} \operatorname{Re} \left(\frac{1}{(1 - i\sqrt{\alpha t})^{2\varepsilon}} \right) dt, \quad (3.33)$$

where Re denotes the real part of a complex number. Using (3.33), the dominated convergence theorem, when ε tends to 0 in (3.32), we obtain:

$$\sup_{(a,b) \in V_p^*(\Omega)} \frac{2\pi|\Phi_\alpha(0)|}{\|\nabla a\|_{2,\omega}\|\nabla b\|_{2,\omega^{-1}}} \geq \frac{1}{\prod_{i=1}^2 \left(1 + \sup_{x \in \mathbb{R}^2} h_\omega^i(x)\right)^{1/2}}$$

and the proof of (2.12) is achieved.

2. Now, we give the proof of (2.13). Let $(a, b) \in V_r^*(\Omega)$, we can write that:

$$\Phi_\alpha = \Phi_0 + \Psi_\alpha, \quad (3.34)$$

where Φ_0 is the solution to (1.2) and Ψ_α is the solution to:

$$-\Delta \Psi_\alpha + \alpha \Psi_\alpha = -\alpha \Phi_0 \text{ in } \Omega \quad \text{and} \quad \lim_{\|x\| \rightarrow +\infty} \Psi_\alpha(x) = 0.$$

By the maximum principle, we have:

$$\|\Psi_\alpha\|_\infty \leq \|\Phi_0\|_\infty. \quad (3.35)$$

On the other hand, in [3] it was proved that

$$\|\Phi_0\|_\infty \leq \frac{1}{2\pi} \frac{\|\nabla a\|_{2,\omega} \|\nabla b\|_{2,\omega^{-1}}}{\prod_{i=1}^2 \left(1 + \inf_{x \in \mathbb{R}^2} h_\omega^i(x)\right)^{1/2}}. \quad (3.36)$$

Then, by (3.34), (3.35) and (3.36), we obtain:

$$\|\Phi_\alpha\|_\infty \leq 2\|\Phi_0\|_\infty \leq \frac{1}{\pi} \frac{\|\nabla a\|_{2,\omega} \|\nabla b\|_{2,\omega^{-1}}}{\prod_{i=1}^2 \left(1 + \inf_{x \in \mathbb{R}^2} h_\omega^i(x)\right)^{1/2}}.$$

Second case: $\Omega = B_1$.

1. Let us prove (2.12). Let $(a, b) \in W_p(\Omega)$. In this case, we have:

$$\Phi_\alpha(0) = -\pi \int_0^1 r \mathcal{G}'(r) r g^2(r) dr.$$

By Lemma 3.4, we obtain:

$$|\Phi_\alpha(0)| \leq \frac{1}{2} \int_0^1 r g^2(r) dr. \quad (3.37)$$

As in the previous case, we check that

$$\|\nabla a\|_{2,\omega}^2 = \pi \left(\int_0^1 r h_\omega^1 g^2 dr + \int_0^1 r^3 g'^2 dr \right) \quad (3.38)$$

$$\|\nabla b\|_{2,\omega^{-1}}^2 = \pi \left(\int_0^1 r h_\omega^2 g^2 dr + \int_0^1 r^3 g'^2 dr \right) \quad (3.39)$$

and

$$\int_0^1 r^3 g'^2 dr = \int_0^1 r g^2 dr + \int_0^1 r (r g)'^2 dr. \quad (3.40)$$

Combining (3.38), (3.39) and (3.40), we get:

$$\|\nabla a\|_{2,\omega} \|\nabla b\|_{2,\omega^{-1}} \geq \pi \prod_{i=1}^2 \left(1 + \inf_{x \in B_1} h_\omega^i(x)\right)^{1/2} \int_0^1 r g^2 dr. \quad (3.41)$$

By (3.37) and (3.41), we deduce that:

$$\sup_{(a,b) \in V_p^*(\Omega)} \frac{2\pi |\Phi_\alpha(0)|}{\|\nabla a\|_{2,\omega} \|\nabla b\|_{2,\omega^{-1}}} \leq \frac{1}{\prod_{i=1}^2 \left(1 + \inf_{x \in B_1} h_\omega^i(x)\right)^{1/2}}.$$

By (3.38) and (3.39), we obtain:

$$\sup_{(a,b) \in V_p^*(\Omega)} \frac{|\Phi_\alpha(0)|}{\|\nabla a\|_{2,\omega} \|\nabla b\|_{2,\omega^{-1}}} \geq \frac{\int_0^1 -r\mathcal{G}'(r)rg^2(r) dr}{\prod_{i=1}^2 \left(\sup_{x \in B_1} h_\omega^i(x) \int_0^1 rg^2 dr + \int_0^1 r^3 g'^2 dr \right)^{1/2}}. \quad (3.42)$$

Taking $g_\varepsilon(r) = r^{\varepsilon-1}$ with $\varepsilon > 0$. By density, (3.42) holds for g_ε . So, we obtain:

$$\sup_{(a,b) \in V_p^*(\Omega)} \frac{|\Phi_\alpha(0)|}{\|\nabla a\|_{2,\omega} \|\nabla b\|_{2,\omega^{-1}}} \geq \frac{2\varepsilon \int_0^1 -r\mathcal{G}'(r)rg_\varepsilon^2(r) dr}{\prod_{i=1}^2 \left(\sup_{x \in B_1} h_\omega^i(x) + (\varepsilon - 1)^2 \right)^{1/2}}. \quad (3.43)$$

On the other hand, we have:

$$-r\mathcal{G}'(r) = \frac{1}{2\pi} \left(\sqrt{\alpha}rK_1(\sqrt{\alpha}r) + \frac{K_0(\sqrt{\alpha})}{I_0(\sqrt{\alpha})} \sqrt{\alpha}rI_1(\sqrt{\alpha}r) \right) \geq \frac{1}{2\pi} \sqrt{\alpha}rK_1(\sqrt{\alpha}r).$$

Note that $x \mapsto xK_1(x)$ is a decreasing function in $(0, +\infty)$, so we get:

$$-r\mathcal{G}'(r) \geq \frac{1}{2\pi} \sqrt{\alpha}K_1(\sqrt{\alpha}), \quad \forall r \in (0, 1).$$

Then,

$$\int_0^1 -r\mathcal{G}'(r)rg_\varepsilon^2(r) dr \geq \frac{1}{2\pi} \sqrt{\alpha}K_1(\sqrt{\alpha})(2\varepsilon)^{-1}. \quad (3.44)$$

By (3.43) and (3.44), we obtain:

$$\sup_{(a,b) \in V_p^*(\Omega)} \frac{2\pi|\Phi_\alpha(0)|}{\|\nabla a\|_{2,\omega} \|\nabla b\|_{2,\omega^{-1}}} \geq \frac{\sqrt{\alpha}K_1(\sqrt{\alpha})}{\prod_{i=1}^2 \left(\sup_{x \in B_1} h_\omega^i(x) + (\varepsilon - 1)^2 \right)^{1/2}}. \quad (3.45)$$

Now, when ε tends to 0 in (3.45), we get:

$$\sup_{(a,b) \in V_p^*(\Omega)} \frac{2\pi|\Phi_\alpha(0)|}{\|\nabla a\|_{2,\omega} \|\nabla b\|_{2,\omega^{-1}}} \geq \frac{\sqrt{\alpha}K_1(\sqrt{\alpha})}{\prod_{i=1}^2 \left(\sup_{x \in B_1} h_\omega^i(x) + 1 \right)^{1/2}}.$$

Then, (2.12) is proved.

2. For (2.13), the proof is similar to that given in the previous case. \square

Acknowledgements: It is pleasure to thank S. Baraket for assistance through this work. We thank also the referee for his careful reading of the paper, his valuable ideas and for fixing some details.

References

- [1] M. Abramowitz and I. A. Stegun, *Handbook of Mathematical Functions*, Dover, New York, 1964.
- [2] S. Baraket, *Estimations of the best constant involving the L^∞ norm in Wente's inequality*, Ann. Fac. Sci. Toulouse. **3** (1996), 373-386.
- [3] S. Baraket and I. Bazarbacha, *The Wente problem for a singular elliptic equation*, J. Math. Anal. Appl. **284** (2003), 711-723.
- [4] S. Baraket and L. B. Chaabane, *The Wente inequality on weighted Sobolev spaces*, Houston Journal of Mathematics, University of Houston, **29** No. 4 (2003), 1065-1075.
- [5] H. Brezis and J-M. Coron, *Multiple solutions of H-system and Rellich's conjecture*, Comm. Pure Appl. Math. **37** (1984), 149-187.
- [6] S. Chanillo, *Sobolev inequalities involving divergence free maps*, Comm. in P.D.E. **16** (1991), 1969-1994.
- [7] R. Coifman, P.L. Lions, Y. Meyer and S. Semmes, *Compensated compactness and Hardy spaces*, J. Math. Pures Appl. **72** (1993), 247-286.
- [8] R. Dautray and J. L. Lions, *Analyse mathématique et calcul numérique pour les sciences et les techniques*, Masson, 1988.
- [9] M. Jleli and B. Samet, *The Wente problem associated to the modified Helmholtz operator*, J. Math. Anal. Appl. **339** (2008), 332-343.
- [10] A. H. Juffer, E. F. F. Botta, B. A. M. V. Keulen, A. V. D. Ploeg and H. J. C. Berendsen, *The electric potential of a macromolecule in a solvent: a fundamental approach*, J. Comput. Phys. **97** (1991), 144.
- [11] J. Liang and S. Subramaniam, *Computation of molecular electrostatics with boundary element methods*, Biophys. J. **73** (1997), 1830.
- [12] W. B. Russell, D. A. Seville and W. R. Schowalter, *Colloidal Dispersions*, Cambridge Univ. Press, Cambridge (1989).
- [13] P. Topping, *The optimal constant in the Wente's L^∞ estimate*, Comment. Math. Helv. **72** (1997), 316-328.
- [14] H. C. Wente, *Large solutions to the volume constrained Plateau problem*, Arch. Rat. Mech. Anal. **75** (1980), 59-77.
- [15] Y. Ge, *Estimations of the best constant involving the L^2 norm in Wente's inequality*, Contr. Optim. and Calc. of Var. **3** (1998), 263-300.

Article 12:

An extension of Polyak's theorem in a Hilbert space

J. Optim Theory Appl. 140 (2009) 409-418

An Extension of Polyak's Theorem in a Hilbert Space

A. Baccari · B. Samet

Published online: 20 September 2008
© Springer Science+Business Media, LLC 2008

Abstract Let H be an infinite-dimensional real Hilbert space equipped with the scalar product $(\cdot, \cdot)_H$. Let us consider three linear bounded operators,

$$A_i : H \rightarrow H, \quad i = 1, 2, 3.$$

We define the functions

$$\begin{aligned} \varphi_i(x) &= (A_i x, x)_H + 2(a_i, x)_H + \alpha_i, \quad \forall x \in H, \quad i = 1, 2, \\ f_i(x) &= (A_i x, x)_H, \quad \forall x \in H, \quad i = 1, 2, 3, \end{aligned}$$

where $a_i \in H$ and $\alpha_i \in \mathbb{R}$. In this paper, we discuss the closure and the convexity of the sets $\Phi_H \subset \mathbb{R}^2$ and $F_H \subset \mathbb{R}^3$ defined by

$$\begin{aligned} \Phi_H &= \{(\varphi_1(x), \varphi_2(x)) \mid x \in H\}, \\ F_H &= \{(f_1(x), f_2(x), f_3(x)) \mid x \in H\}. \end{aligned}$$

Our work can be considered as an extension of Polyak's results concerning the finite-dimensional case.

Keywords Convexity · Closure · Quadratic functions · Hilbert space

A. Baccari (✉) · B. Samet
Département de Mathématiques, Ecole Supérieure des Sciences et Techniques de Tunis,
5, Avenue Taha Hussein-Tunis, B.P.:56, Bab Menara 1008, Tunisie
e-mail: abdjl.baccari@fst.rnu.tn

B. Samet
e-mail: bessem.samet@gmail.com

1 Introduction

In 1918, O. Toeplitz (Ref. [1]) considered a quadratic form z^*Az , where A is an $n \times n$ complex matrix. He proved that the set of values of this form for z belonging to the unit sphere in \mathbb{C}^n has a convex boundary. He also conjectured that the set itself is convex. One year later, F. Hausdorff (Ref. [2]) proved this conjuncture. The Toeplitz-Hausdorff theorem is a very important result that is applied in many fields of mathematics. This theorem can be formulated as follows: the set

$$W(A) = \{z^*Az \mid \|z\|_{\mathbb{C}^n} = 1\}$$

is convex in the set \mathbb{C} of complex numbers. This result can be considered as the first assertion on convexity of quadratic maps.

For the real field, the first result is due to Dines (Ref. [3]) in 1941. Let us consider two real quadratic forms

$$f_i(x) = (A_i x, x)_{\mathbb{R}^n}, \quad i = 1, 2, \quad f(x) = (f_1(x), f_2(x)),$$

where A_i are $n \times n$ real symmetric matrices, $x \in \mathbb{R}^n$ and $(\cdot, \cdot)_{\mathbb{R}^n}$ is the standard scalar product in \mathbb{R}^n . Dines proved that the set $D \subset \mathbb{R}^2$ defined by

$$D = \{f(x) \mid x \in \mathbb{R}^n\}$$

is convex and it is closed as well under some additional hypotheses.

The next important result was obtained by Brickman (Ref. [4]). He proved that

$$B = \{f(x) \mid \|x\|_{\mathbb{R}^n} = 1\}$$

is a convex compact subset of \mathbb{R}^2 when $n \geq 3$. The same statement was obtained independently in Ref. [5]. Some deep links of this result can be found in Ref. [6].

These papers are the main contributions on convexity of quadratic maps, and mathematicians tried in several ways to generalize them.

Let us consider the functions

$$\begin{aligned} \varphi_i(x) &= (A_i x, x)_{\mathbb{R}^n} + 2(a_i, x)_{\mathbb{R}^n} + \alpha_i, \quad i = 1, 2, \\ f_i(x) &= (A_i x, x)_{\mathbb{R}^n}, \quad i = 1, 2, 3, \end{aligned}$$

where $x \in \mathbb{R}^n$, $a_i \in \mathbb{R}^n$, $\alpha_i \in \mathbb{R}$, and A_i are $n \times n$ real symmetric matrices. Denote

$$\begin{aligned} \Phi &= \{(\varphi_1(x), \varphi_2(x)) \mid x \in \mathbb{R}^n\} \subset \mathbb{R}^2, \\ F &= \{(f_1(x), f_2(x), f_3(x)) \mid x \in \mathbb{R}^n\} \subset \mathbb{R}^3. \end{aligned}$$

In Ref. [7], Polyak proved the following results.

Theorem 1.1 *Suppose that $n \geq 2$ and there exists $\mu = (\mu_1, \mu_2) \in \mathbb{R}^2$ such that*

$$\mu_1 A_1 + \mu_2 A_2 > 0.$$

Then, Φ is closed and convex.

Here, the notation $\mu_1 A_1 + \mu_2 A_2 > 0$ means that the matrix $\mu_1 A_1 + \mu_2 A_2$ is positive definite.

Theorem 1.2 *For $n \geq 3$, the following assertions are equivalent:*

(i) $\exists \mu = (\mu_1, \mu_2, \mu_3) \in \mathbb{R}^3$ such that

$$\mu_1 A_1 + \mu_2 A_2 + \mu_3 A_3 > 0;$$

(ii) *the set F is an acute closed convex cone and the quadratic forms $f_1(x), f_2(x), f_3(x)$ have no common zero except zero.*

In this paper, we consider quadratic functions defined in an infinite dimensional Hilbert space. The main motivation for that stems from control theory where there are many problems involving the minimization of a quadratic function on a closed convex subset of an infinite dimensional Hilbert space.

Various results concerning convexity of quadratic maps in a general Hilbert space exist. Let us recall some important works:

- In Ref. [8], P. 354, Lemma 7.1, Hestenes proved the following result: let P and Q be quadratic forms on a real Hilbert space H ; then the set

$$D_H = \{(P(x), Q(x)) \mid x \in H\}$$

is a convex cone. This result can be considered as a generalization of the Dines theorem to the infinite dimensional case.

- In Refs. [9, 10], Matveev proved the following result.

Let A_1, A_2, \dots, A_m be self-adjoint continuous linear mappings on a real Hilbert space H equipped with the scalar product $(\cdot, \cdot)_H$, let q_1, q_2, \dots, q_m denote the associated continuous quadratic forms on H (i.e., $q_i(x) = (A_i x, x)_H$ for all $x \in H$). If, for any $(\lambda_1, \dots, \lambda_m) \in \mathbb{R}^m$, the maximal and the minimal points of the spectrum of $\lambda_1 A_1 + \dots + \lambda_m A_m$ are not isolated eigenvalues of finite geometric multiplicity, then the range of the unit sphere of H under the quadratic mapping $q = (q_1, \dots, q_m)$ is almost convex.

- In Ref. [11], Yakubovich obtained the following result.

Let H be a real Hilbert space with scalar product $(\cdot, \cdot)_H$, $z^0 \in H$ and let

$$q_i(z) = q_i^0(z) + (g_i, z)_H + \gamma_i, \quad i = 0, 1, \dots, m,$$

be continuous quadratic functionals. Here, $g_i \in H$, $\gamma_i \in \mathbb{R}$ and

$$q_i^0(z) = (A_i z, z)_H, \quad \forall z \in H,$$

where A_i are self-adjoint bounded operators on H . Let \mathcal{F} be a subspace in H and let $\mathcal{L} = \mathcal{F} + z^0$. Denote

$$\mathcal{P} = \{(q_0(z), \dots, q_m(z)) \mid z \in \mathcal{L}\}.$$

Under some hypotheses (q_0, \dots, q_m form an S-system), the closure $\overline{\mathcal{P}}$ of \mathcal{P} is a convex set.

For other results concerning convexity of quadratic maps in an infinite dimensional case, one can refer to Refs. [12, 13].

The purpose of this paper is to extend Theorem 1.1 and Theorem 1.2 in an infinite dimensional real Hilbert space H . More precisely, we are concerned by studying the closure and the convexity of the sets Φ and F when x belongs to a Hilbert space H .

2 Statement of Results

2.1 Preliminaries

We start by recalling some definitions and fixing some notations which are used throughout.

We work in an infinite dimensional real Hilbert space H equipped with the scalar product denoted by $(\cdot, \cdot)_H$ and the associated norm denoted by $\|\cdot\|_H$. We assume that H is separable which implies that it admits a hilbertian basis $B = (e_k)_{k=1}^\infty$. We recall that B is a Hilbertian basis if and only if

$$(e_k, e_t)_H = \begin{cases} 1, & \text{if } k = t, \\ 0, & \text{if } k \neq t \end{cases}$$

and

$$\overline{B} = H,$$

where \overline{B} is the closure of B .

We say that a sequence $(x_n)_{n \in \mathbb{N}}$ in H is weakly convergent to $x \in H$ and we denote $x_n \rightharpoonup x$ if and only if

$$(x_n, v)_H \rightarrow (x, v)_H, \quad \text{as } n \rightarrow +\infty, \quad \forall v \in H.$$

Let $A : H \rightarrow H$ be a linear bounded operator.

- We say that A is self-adjoint if and only if

$$(Ax, y)_H = (x, Ay)_H, \quad \forall x, y \in H.$$

- We say that A is compact if and only if, for all sequence $(x_n)_{n \in \mathbb{N}}$ in H , we have

$$x_n \rightharpoonup x \Rightarrow \|Ax_n - Ax\|_H \rightarrow 0, \quad \text{as } n \rightarrow +\infty.$$

- The notation $A > 0$ means that

$$\exists \alpha > 0 \mid (Ax, x)_H \geq \alpha \|x\|_H^2, \quad \forall x \in H.$$

For more details concerning these definitions, one can refer to Ref. [14].

A set $K \subset \mathbb{R}^n$ is a cone if $x \in K$ implies $\lambda x \in K$ for all $\lambda > 0$. It is acute if K contains no straight lines, i.e., $x \in K, x \neq 0$ imply $-x \notin K$.

2.2 Main Results and Proofs

Let us consider the nonhomogeneous quadratic functions

$$\varphi_i(x) = (A_i x, x)_H + 2(a_i, x)_H + \alpha_i, \quad \forall x \in H, i = 1, 2,$$

where $A_i : H \rightarrow H$ are two linear bounded operators, $a_i \in H$ and $\alpha_i \in \mathbb{R}$. Let us consider the set $\Phi_H \subset \mathbb{R}^2$ defined by

$$\Phi_H = \{(\varphi_1(x), \varphi_2(x)) \mid x \in H\}.$$

First, we focus on the closure of the set Φ_H . Our result can be formulated as follows.

Theorem 2.1 *We assume that:*

- (i) $A_i : H \rightarrow H$ is compact for all $i = 1, 2$.
- (ii) $\exists \mu = (\mu_1, \mu_2) \in \mathbb{R}^2 \mid \mu_1 A_1 + \mu_2 A_2 > 0$.

Then, the set Φ_H is closed.

Proof Let $(x_n)_{n \in \mathbb{N}}$ be a sequence in H such that

$$(\varphi_1(x_n), \varphi_2(x_n)) \rightarrow (y_1, y_2), \quad \text{as } n \rightarrow +\infty. \tag{1}$$

We have to prove that there exists $x \in H$ such that $(y_1, y_2) = (\varphi_1(x), \varphi_2(x))$.

First, let us prove that $(x_n)_{n \in \mathbb{N}}$ is necessarily a bounded sequence in H . We have

$$\begin{aligned} &|\mu_1 \varphi_1(x_n) + \mu_2 \varphi_2(x_n)| \\ &= |\mu_1 (A_1 x_n, x_n)_H + \mu_2 (A_2 x_n, x_n)_H + 2(\mu_1 a_1 + \mu_2 a_2, x_n)_H + \mu_1 \alpha_1 + \mu_2 \alpha_2| \\ &\geq \mu_1 (A_1 x_n, x_n)_H + \mu_2 (A_2 x_n, x_n)_H - 2|(\mu_1 a_1 + \mu_2 a_2, x_n)_H| - |\mu_1 \alpha_1 + \mu_2 \alpha_2|. \end{aligned}$$

By condition (ii), we have

$$\exists \alpha > 0 \mid \mu_1 (A_1 x, x)_H + \mu_2 (A_2 x, x)_H \geq \alpha \|x\|_H^2, \quad \forall x \in H. \tag{2}$$

Using (2) and the Cauchy-Schwarz inequality, we get

$$|\mu_1 \varphi_1(x_n) + \mu_2 \varphi_2(x_n)| \geq \alpha \|x_n\|_H^2 - 2\|\mu_1 a_1 + \mu_2 a_2\|_H \|x_n\|_H - |\mu_1 \alpha_1 + \mu_2 \alpha_2|. \tag{3}$$

Assuming that $(x_n)_{n \in \mathbb{N}}$ is not bounded in H . Then, there exists a subsequence of $(x_n)_{n \in \mathbb{N}}$ denoted by $(x_{k(n)})_{n \in \mathbb{N}}$ such that $\|x_{k(n)}\|_H \rightarrow +\infty$ as $n \rightarrow +\infty$. Using (3), we obtain

$$|\mu_1 \varphi_1(x_{k(n)}) + \mu_2 \varphi_2(x_{k(n)})| \rightarrow +\infty, \quad \text{as } n \rightarrow +\infty.$$

This situation is of course impossible since $\mu_1 \varphi_1(x_n) + \mu_2 \varphi_2(x_n) \rightarrow \mu_1 y_1 + \mu_2 y_2$ as $n \rightarrow +\infty$. We deduce that $(x_n)_{n \in \mathbb{N}}$ is bounded.

Since $(x_n)_{n \in \mathbb{N}}$ is a bounded sequence in H , there exists a subsequence of $(x_n)_{n \in \mathbb{N}}$ denoted by $(x_{\alpha(n)})_{n \in \mathbb{N}}$ such that

$$x_{\alpha(n)} \rightharpoonup x, \tag{4}$$

where $x \in H$. The compactness of A_i ($i = 1, 2$) implies that

$$\|A_i x_{\alpha(n)} - A_i x\|_H \rightarrow 0, \quad \text{as } n \rightarrow +\infty, \quad \forall i = 1, 2. \quad (5)$$

On the other hand, we have

$$(A_i x_{\alpha(n)}, x_{\alpha(n)})_H = (A_i x_{\alpha(n)} - A_i x, x_{\alpha(n)})_H + (A_i x, x_{\alpha(n)})_H. \quad (6)$$

Using the Cauchy-Schwarz inequality, we obtain

$$|(A_i x_{\alpha(n)} - A_i x, x_{\alpha(n)})_H| \leq \|A_i x_{\alpha(n)} - A_i x\|_H \|x_{\alpha(n)}\|_H.$$

Since $(x_{\alpha(n)})_{n \in \mathbb{N}}$ is bounded, by (5), we obtain

$$(A_i x_{\alpha(n)} - A_i x, x_{\alpha(n)})_H \rightarrow 0, \quad \text{as } n \rightarrow +\infty. \quad (7)$$

Using (4), we obtain

$$(A_i x, x_{\alpha(n)})_H \rightarrow (A_i x, x)_H, \quad \text{as } n \rightarrow +\infty. \quad (8)$$

From (6)–(8),

$$(A_i x_{\alpha(n)}, x_{\alpha(n)})_H \rightarrow (A_i x, x)_H, \quad \text{as } n \rightarrow +\infty, \quad \forall i = 1, 2. \quad (9)$$

By (4), we obtain

$$(a_i, x_{\alpha(n)})_H \rightarrow (a_i, x)_H, \quad \text{as } n \rightarrow +\infty, \quad \forall i = 1, 2. \quad (10)$$

Then, by (9) and (10), we obtain

$$\varphi_i(x_{\alpha(n)}) \rightarrow \varphi_i(x), \quad \text{as } n \rightarrow +\infty, \quad \forall i = 1, 2. \quad (11)$$

Finally, by (1) and (11), we get:

$$y_i = \varphi_i(x), \quad \forall i = 1, 2,$$

and the proof is achieved. \square

Now, we are going to show that under some hypotheses, the closure of the set Φ_H is a sufficient condition to assure its convexity. Such result is similar to that obtained by Yakubovich (Ref. [11]) under other hypotheses.

Theorem 2.2 *We assume that:*

- (i) $A_i : H \rightarrow H$ is self-adjoint for all $i = 1, 2$.
- (ii) $\exists \mu = (\mu_1, \mu_2) \in \mathbb{R}^2 \mid \mu_1 A_1 + \mu_2 A_2 > 0$.
- (iii) The set Φ_H is closed.

Then, Φ_H is a convex set.

Proof Let $B = (e_k)_{k=1}^\infty$ be a Hilbertian basis of H . For m large enough, let us denote H_m the subspace of H generated by the vectors $\{e_1, e_2, \dots, e_m\}$. We denote by $r_m : H \rightarrow H_m$ the orthogonal projection in H_m . We recall that

$$r_m x = \sum_{k=1}^m (x, e_k)_H e_k \rightarrow x, \quad \text{as } m \rightarrow +\infty, \quad \forall x \in H. \tag{12}$$

We define the symmetric matrices $(A_{1,m}, A_{2,m}) \in \mathcal{M}_m(\mathbb{R}) \times \mathcal{M}_m(\mathbb{R})$ by

$$\begin{aligned} A_{1,m}(i, j) &= (A_1 e_i, e_j)_H, \quad \forall i, j \in \{1, 2, \dots, m\}, \\ A_{2,m}(i, j) &= (A_2 e_i, e_j)_H, \quad \forall i, j \in \{1, 2, \dots, m\}. \end{aligned}$$

We consider the two nonhomogeneous quadratic functions

$$\begin{aligned} \varphi_{1,m}(X) &= (A_{1,m} X, X)_{\mathbb{R}^m} + 2(a_{1,m}, X)_{\mathbb{R}^m} + \alpha_1, \quad \forall X \in \mathbb{R}^m, \\ \varphi_{2,m}(X) &= (A_{2,m} X, X)_{\mathbb{R}^m} + 2(a_{2,m}, X)_{\mathbb{R}^m} + \alpha_2, \quad \forall X \in \mathbb{R}^m, \end{aligned}$$

where $(\cdot, \cdot)_{\mathbb{R}^m}$ denotes the standard scalar product in \mathbb{R}^m , $a_{1,m}$ and $a_{2,m}$ are given by

$$\begin{aligned} a_{1,m} &= ((r_m a_1, e_1)_H, (r_m a_1, e_2)_H, \dots, (r_m a_1, e_m)_H)^T, \\ a_{2,m} &= ((r_m a_2, e_1)_H, (r_m a_2, e_2)_H, \dots, (r_m a_2, e_m)_H)^T. \end{aligned}$$

We define the set Φ_m by

$$\Phi_m = \{(\varphi_1(x), \varphi_2(x)) \mid x \in H_m\}.$$

It is easy to show that

$$\Phi_m = \{(\varphi_{1,m}(X), \varphi_{2,m}(X)) \mid X \in \mathbb{R}^m\}.$$

By Polyak’s theorem (Theorem 1.1), we know that the set Φ_m is convex.

Let us consider now $(x, y) \in H^2$ and $\lambda \in]0, 1[$. We have to prove that

$$\lambda(\varphi_1(x), \varphi_2(x)) + (1 - \lambda)(\varphi_1(y), \varphi_2(y)) \in \Phi_H. \tag{13}$$

Since Φ_m is a convex set, there exists $z_m \in H_m \subset H$ such that

$$\begin{aligned} \lambda\varphi_1(r_m x) + (1 - \lambda)\varphi_1(r_m y) &= \varphi_1(z_m), \\ \lambda\varphi_2(r_m x) + (1 - \lambda)\varphi_2(r_m y) &= \varphi_2(z_m). \end{aligned}$$

Using (12) and the continuity of φ_i ($i = 1, 2$), we obtain

$$(\varphi_1(z_m), \varphi_2(z_m)) \rightarrow \lambda(\varphi_1(x), \varphi_2(x)) + (1 - \lambda)(\varphi_1(y), \varphi_2(y)), \quad \text{as } m \rightarrow +\infty.$$

Finally, the closure of the set Φ_H implies (13). This completes the proof. □

An immediate consequence of Theorems 2.1 and 2.2 is the following.

Corollary 2.1 *We assume that*

- (i) $A_i : H \rightarrow H$ is compact and self-adjoint for all $i = 1, 2$,
- (ii) $\exists \mu = (\mu_1, \mu_2) \in \mathbb{R}^2 \mid \mu_1 A_1 + \mu_2 A_2 > 0$.

Then, Φ_H is closed and convex.

Remark 2.1 Corollary 2.1 is an extension of the result obtained by Hestenes in Ref. [8], where only quadratic forms were considered.

Now, let us consider three quadratic forms,

$$f_i(x) = (A_i x, x)_H, \quad \forall x \in H, \quad i = 1, 2, 3,$$

where $A_i : H \rightarrow H$ are linear bounded operators. Let $F_H \subset \mathbb{R}^3$ be the set defined by

$$F_H = \{(f_1(x), f_2(x), f_3(x)) \mid x \in H\}.$$

We have the following result.

Theorem 2.3 *We assume that $A_i : H \rightarrow H$ is compact and self-adjoint for all $i = 1, 2, 3$. Then, the following assertions are equivalent.*

- (i) *There exists $\mu = (\mu_1, \mu_2, \mu_3) \in \mathbb{R}^3$ such that*

$$\mu_1 A_1 + \mu_2 A_2 + \mu_3 A_3 > 0. \tag{14}$$

- (ii) *The set F_H is an acute closed convex cone and the quadratic forms $f_1(x), f_2(x), f_3(x)$ have no common zero except zero.*

Proof (1) \Rightarrow (2). Let $\lambda > 0$ and $(y_1, y_2, y_3) \in F_H$. To check that F_H is a cone, we should prove that $\lambda y = (\lambda y_1, \lambda y_2, \lambda y_3) \in F_H$. By the definition of the set F_H , there exists $x \in H$ such that $y_i = f_i(x), i = 1, 2, 3$. Then,

$$\lambda y_i = (A_i \sqrt{\lambda} x, \sqrt{\lambda} x)_H = f_i(\sqrt{\lambda} x), \quad i = 1, 2, 3,$$

and F_H is a cone set.

Let us prove now that F_H is an acute set. Let $y = (y_1, y_2, y_3) \in F_H$ such that $y \neq 0$ and assuming that $-y \in F_H$. Then, there exists $x^0 \in H, x^0 \neq 0$ and there exists $x^1 \in H, x^1 \neq 0$ such that

$$y_i = f_i(x^0), \quad -y_i = f_i(x^1), \quad i = 1, 2, 3.$$

Thus, by (14),

$$\begin{aligned} y_1 \mu_1 + y_2 \mu_2 + y_3 \mu_3 &> 0, \\ y_1 \mu_1 + y_2 \mu_2 + y_3 \mu_3 &< 0, \end{aligned}$$

and we obtain a contradiction. Then, $-y \notin F_H$ and F_H is an acute set.

It is easy to check that the quadratic forms $f_1(x), f_2(x), f_3(x)$ have no common zero except zero. In fact, if there exists $x_0 \in H, x_0 \neq 0$ such that

$$f_i(x_0) = 0, \quad i = 1, 2, 3,$$

(14) implies that

$$\mu_1 f_1(x_0) + \mu_2 f_2(x_0) + \mu_3 f_3(x_0) > 0,$$

and we obtain a contradiction.

Now, let us prove the closure of the set F_H . Let $(x_n)_{n \in \mathbb{N}}$ be a sequence in H such that

$$f_i(x_n) \rightarrow y_i, \quad \text{as } n \rightarrow +\infty, \quad i = 1, 2, 3. \tag{15}$$

As in the proof of Theorem 2.1, condition (14) implies that $(x_n)_{n \in \mathbb{N}}$ is bounded and there exists a subsequence of $(x_n)_{n \in \mathbb{N}}$ denoted by $(x_{\alpha(n)})_{n \in \mathbb{N}}$ such that

$$x_{\alpha(n)} \rightharpoonup x, \tag{16}$$

where $x \in H$. Using the compactness of the bounded operators A_i , we get

$$\|A_i x_{\alpha(n)} - A_i x\|_H \rightarrow 0, \quad \text{as } n \rightarrow +\infty, \quad i = 1, 2, 3. \tag{17}$$

By (16) and (17), we obtain

$$f_i(x_{\alpha(n)}) \rightarrow f_i(x) \quad \text{as } n \rightarrow +\infty, \quad i = 1, 2, 3. \tag{18}$$

Finally, from (15) and (18), we obtain

$$y_i = f_i(x), \quad i = 1, 2, 3,$$

and the closure of the set F_H is proved.

As in the proof of Theorem 2.2, the convexity is obtained by approximating the set F_H by the set

$$F_m = \{(f_1(x), f_2(x), f_3(x)) \mid x \in H_m\},$$

that is convex by Polyak’s theorem (Theorem 1.2).

(ii) \Rightarrow (i). Since F_H is an acute closed convex cone in $\mathbb{R}^3, \exists c = (c_1, c_2, c_3) \in \mathbb{R}^3$ such that $(c, f)_{\mathbb{R}^3} > 0, \forall f \in F_H, f \neq 0$. Let $x \in H, x \neq 0$. Since f_1, f_2, f_3 have no common zero except zero, we have $(f_1(x), f_2(x), f_3(x)) \neq (0, 0, 0)$. Then, condition (i) holds by tacking $\mu = c$. □

Remark 2.2 In this work, the Hilbert space H is assumed to be separable. This hypothesis assures the existence of a Hilbertian basis that enables us to project each element of H in a finite dimensional space. If H is not separable, we don’t know if our obtained results remain true. This question can be considered as an open problem.

References

1. Toeplitz, O.: Das algebraische Analogon zu einem Satz von Fejer. *Math. Z.* **2**, 187–197 (1918)
2. Hausdorff, F.: Der Wertvorrat einer Bilinearform. *Math. Z.* **3**, 314–316 (1919)
3. Dines, L.L.: On the mapping of quadratic forms. *Bull. Am. Math. Soc.* **47**, 494–498 (1941)
4. Brickman, L.: On the field of values of a matrix. *Proc. Am. Math. Soc.* **12**, 61–66 (1961)
5. Yakubovich, V.A.: The S-procedure in nonlinear control theory. *Vestn. Leningr. Univ.* **1**, 62–77 (1971) (in Russian)
6. Vershik, A.M.: Quadratic forms positive on a cone and quadratic duality. *Zap. Nauchn. Semin. LOMI* **134**, 59–83 (1984) (in Russian)
7. Polyak, T.B.: Convexity of quadratic transformations and its use in control and optimization. *J. Optim. Theory Appl.* **99**(3), 553–583 (1998)
8. Hestenes, R.M.: *Optimization Theory*. Robert E. Krieger, Huntington (1981)
9. Matveev, A.S.: Lagrange duality in nonconvex optimization theory and modifications of the Toeplitz-Hausdorff theorem. *St. Petersburg. Math. J.* **7**, 787–815 (1996)
10. Matveev, A.S.: On the convexity of the ranges of quadratic mappings. *St. Petersburg. Math. J.* **10**, 343–372 (1999)
11. Yakubovich, V.A.: Nonconvex optimization problem: The infinite-horizon linear-quadratic control problem with quadratic constraints. *Syst. Control Lett.* **19**, 13–22 (1992)
12. Arutyunov, V.A., Rozova, N.V.: Regular zeros of a quadratic mapping and local controllability of nonlinear systems. *Differ. Equ.* **35**, 723–728 (1999)
13. Mergretsky, A., Treil, S.: Power distribution inequalities in optimization and robustness of uncertain systems. *Math. Syst. Estim. Control* **3**, 301–319 (1993)
14. Brezis, H.: *Analyse Fonctionnelle, Théorie et Applications*. Masson, Paris (1983)

Article 13:

An extension of Banach fixed point theorem for mappings
satisfying a contractive condition of integral type

To appear in Italian Journal of Pure and Applied Mathematics

AN EXTENSION OF BANACH FIXED POINT THEOREM FOR MAPPINGS SATISFYING A CONTRACTIVE CONDITION OF INTEGRAL TYPE

BESSEM SAMET AND HABIB YAZIDI

ABSTRACT. We establish a fixed point theorem for mappings satisfying a general contractive inequality of integral type. The obtained result can be considered as an extension of the theorem of Branciari (2002) and the theorem of Dass and Gupta (1975).

1. INTRODUCTION

In [2], Branciari established the following theorem.

Theorem 1. *Let (X, d) be a complete metric space, $c \in]0, 1[$, and let $f : X \rightarrow X$ be a mapping such that for each $x, y \in X$,*

$$\int_0^{d(fx, fy)} \varphi(t) dt \leq c \int_0^{d(x, y)} \varphi(t) dt,$$

where $\varphi : [0, +\infty[\rightarrow [0, +\infty[$ is a Lebesgue-integrable mapping which is summable on each compact subset of $[0, +\infty[$, nonnegative, and such that

$$\forall \varepsilon > 0, \int_0^\varepsilon \varphi(t) dt > 0.$$

Then, f admits a unique fixed point $a \in X$ such that for each $x \in X$, $f^n x \rightarrow a$ as $n \rightarrow +\infty$.

It was mentioned in [2] that Theorem 1 could be extended to more general contractive conditions. For example, in [9], Rhoades established that Theorem 1 holds if we replace $d(x, y)$ by

$$\max \left\{ d(x, y), d(x, fx), d(y, fy), \frac{d(x, fy) + d(y, fx)}{2} \right\}.$$

Other works in this direction include [1, 4, 11, 12]. In [10], Suzuki proved that Theorem 1 of Branciari is a particular case of the famous Meir-Keeler fixed point theorem [8]. More precisely, he proved that under hypotheses of Theorem 1, f is an MKC, i.e., for every $\varepsilon > 0$, there exists $\delta > 0$ such that

$$d(x, y) < \varepsilon + \delta \Rightarrow d(fx, fy) < \varepsilon$$

and then, f admits a unique fixed point.

In this paper, we obtain an extension of Theorem 1 through rational expression. Our obtained result extends and improves the result of Dass and Gupta [7]. Other results on fixed point theorems through rational expression can be found in [3, 5, 6].

2000 *Mathematics Subject Classification.* 54H25, 47H10.

Key words and phrases. Fixed point; Rational expression; Contractive condition.

2. MAIN RESULT

Our main result is the following.

Theorem 2. *Let (X, d) be a complete metric space and let $f : X \rightarrow X$ be a given mapping. We denote*

$$(1) \quad m(x, y) = d(y, fy) \frac{[1 + d(x, fx)]}{1 + d(x, y)}, \quad \forall x, y \in X.$$

We assume that for each $x, y \in X$,

$$(2) \quad \int_0^{d(fx, fy)} \varphi(t) dt \leq \alpha \int_0^{m(x, y)} \varphi(t) dt + \beta \int_0^{d(x, y)} \varphi(t) dt,$$

where $\alpha > 0$, $\beta > 0$, $\alpha + \beta < 1$ and $\varphi : [0, +\infty[\rightarrow [0, +\infty[$ is a Lebesgue-integrable mapping which is summable on each compact subset of $[0, +\infty[$, nonnegative and such that

$$(3) \quad \int_0^\varepsilon \varphi(t) dt > 0, \quad \forall \varepsilon > 0.$$

Then, f admits a unique fixed point $a \in X$ such that for each $x \in X$, $f^n x \rightarrow a$ as $n \rightarrow +\infty$.

Proof. Let $x \in X$ and define the sequence $(x_n) \subset X$ by $x_0 = x$ and $x_n = f^n x$ for each integer $n \geq 1$. From (2),

$$(4) \quad \int_0^{d(x_n, x_{n+1})} \varphi(t) dt \leq \alpha \int_0^{m(x_{n-1}, x_n)} \varphi(t) dt + \beta \int_0^{d(x_{n-1}, x_n)} \varphi(t) dt.$$

Using (1),

$$\begin{aligned} m(x_{n-1}, x_n) &= d(x_n, x_{n+1}) \frac{[1 + d(x_{n-1}, x_n)]}{1 + d(x_{n-1}, x_n)} \\ &= d(x_n, x_{n+1}). \end{aligned}$$

Substituting into (4), one obtains

$$\begin{aligned} \int_0^{d(x_n, x_{n+1})} \varphi(t) dt &\leq \frac{\beta}{1 - \alpha} \int_0^{d(x_{n-1}, x_n)} \varphi(t) dt \\ &\leq \left(\frac{\beta}{1 - \alpha} \right)^2 \int_0^{d(x_{n-2}, x_{n-1})} \varphi(t) dt \\ &\leq \left(\frac{\beta}{1 - \alpha} \right)^3 \int_0^{d(x_{n-3}, x_{n-2})} \varphi(t) dt \\ &\leq \dots \\ (5) \quad &\leq \left(\frac{\beta}{1 - \alpha} \right)^n \int_0^{d(x_0, x_1)} \varphi(t) dt. \end{aligned}$$

Since $\frac{\beta}{1 - \alpha} \in]0, 1[$, taking the limit of (5), as $n \rightarrow +\infty$, gives

$$(6) \quad \lim_{n \rightarrow +\infty} \int_0^{d(x_n, x_{n+1})} \varphi(t) dt = 0,$$

which from (3) implies that

$$(7) \quad \lim_{n \rightarrow +\infty} d(x_n, x_{n+1}) = 0.$$

We now show that (x_n) is Cauchy. Suppose that it is not. Then, there exists an $\varepsilon > 0$ such that for each $p \in \mathbb{N}$ there are $m(p), n(p) \in \mathbb{N}$, with $m(p) > n(p) > p$, such that

$$(8) \quad d(f^{m(p)}x, f^{n(p)}x) \geq \varepsilon, \quad d(f^{m(p)-1}x, f^{n(p)}x) < \varepsilon.$$

Hence

$$\begin{aligned} \varepsilon \leq d(f^{m(p)}x, f^{n(p)}x) &\leq d(f^{m(p)}x, f^{m(p)-1}x) + d(f^{m(p)-1}x, f^{n(p)}x) \\ &< d(f^{m(p)}x, f^{m(p)-1}x) + \varepsilon. \end{aligned}$$

Using (7) and tacking $p \rightarrow +\infty$, we get

$$(9) \quad d(f^{m(p)}x, f^{n(p)}x) \rightarrow \varepsilon^+ \text{ as } p \rightarrow +\infty.$$

This implies that

$$(10) \quad \exists k \in \mathbb{N} \mid p > k \Rightarrow d(f^{m(p)+1}x, f^{n(p)+1}x) < \varepsilon.$$

In fact, if there exists a subsequence $(p_k) \subset \mathbb{N}$, $p_k > k$, $d(f^{m(p_k)+1}x, f^{n(p_k)+1}x) \geq \varepsilon$, we obtain from (2),

$$(11) \quad \int_0^\varepsilon \varphi(t) dt \leq \alpha \int_0^{m(f^{m(p_k)}x, f^{n(p_k)}x)} \varphi(t) dt + \beta \int_0^{d(f^{m(p_k)}x, f^{n(p_k)}x)} \varphi(t) dt.$$

On the other hand, we have

$$(12) \quad \begin{aligned} m(f^{m(p_k)}x, f^{n(p_k)}x) &= d(f^{n(p_k)}x, f^{n(p_k)+1}x) \frac{[1 + d(f^{m(p_k)}x, f^{m(p_k)+1}x)]}{1 + d(f^{m(p_k)}x, f^{n(p_k)}x)} \\ &\rightarrow 0 \text{ as } k \rightarrow +\infty. \end{aligned}$$

Tacking $k \rightarrow +\infty$ in (11), using (9) and (12), we get

$$\int_0^\varepsilon \varphi(t) dt \leq \beta \int_0^\varepsilon \varphi(t) dt,$$

which is a contradiction being $\beta \in]0, 1[$ and the integral being positive. Then, (10) holds. Let us prove now that

$$(13) \quad \exists \sigma_\varepsilon \in]0, \varepsilon[, p_\varepsilon \in \mathbb{N} \mid p > p_\varepsilon \Rightarrow d(f^{m(p)+1}x, f^{n(p)+1}x) < \varepsilon - \sigma_\varepsilon.$$

If (13) is not true, by (10), there exists a subsequence $(p_k) \subset \mathbb{N}$ such that

$$(14) \quad d(f^{m(p_k)+1}x, f^{n(p_k)+1}x) \rightarrow \varepsilon^- \text{ as } k \rightarrow +\infty.$$

By (2), we obtain

$$(15) \quad \int_0^{d(f^{m(p_k)+1}x, f^{n(p_k)+1}x)} \varphi(t) dt \leq \alpha \int_0^{m(f^{m(p_k)}x, f^{n(p_k)}x)} \varphi(t) dt + \beta \int_0^{d(f^{m(p_k)}x, f^{n(p_k)}x)} \varphi(t) dt$$

with

$$m(f^{m(p_k)}x, f^{n(p_k)}x) = d(f^{n(p_k)}x, f^{n(p_k)+1}x) \frac{[1 + d(f^{m(p_k)}x, f^{m(p_k)+1}x)]}{1 + d(f^{m(p_k)}x, f^{n(p_k)}x)}.$$

Tacking $k \rightarrow +\infty$ in (15), we get

$$\int_0^\varepsilon \varphi(t) dt \leq \beta \int_0^\varepsilon \varphi(t) dt,$$

which is a contradiction, since $\beta \in]0, 1[$. Now, we can deduce the Cauchy character of $(f^n x)$. In fact, for each natural number $p > p_\varepsilon$, we have

$$\begin{aligned} \varepsilon \leq d(f^{m(p)}x, f^{n(p)}x) &\leq d(f^{m(p)}x, f^{m(p)+1}x) + d(f^{m(p)+1}x, f^{n(p)+1}x) \\ &\quad + d(f^{n(p)+1}x, f^{n(p)}x) \\ &< d(f^{m(p)}x, f^{m(p)+1}x) + (\varepsilon - \sigma_\varepsilon) + d(f^{n(p)+1}x, f^{n(p)}x) \\ &\rightarrow \varepsilon - \sigma_\varepsilon \text{ as } p \rightarrow +\infty. \end{aligned}$$

Thus $\varepsilon \leq \varepsilon - \sigma_\varepsilon$ which is a contradiction. We conclude that $(f^n x)$ is Cauchy.

By the completeness of X , there is $a \in X$ such that $f^n x \rightarrow a$ as $n \rightarrow +\infty$. We shall now show that $fa = a$. Suppose by contradiction that $d(a, fa) > 0$. We have

$$(16) \quad 0 < d(a, fa) \leq d(a, f^{n+1}x) + d(f^{n+1}x, fa).$$

First, let us prove that $d(f^{n+1}x, fa) \rightarrow 0$ as $n \rightarrow +\infty$. In fact, we have

$$0 \leq d(f^{n+1}x, fa) \leq d(f^{n+1}x, a) + d(a, fa).$$

Since $(d(f^{n+1}x, a))$ is a convergent sequence (it converges to zero), then $(d(f^{n+1}x, fa))$ is a bounded sequence. Assume that there exists a subsequence $(d(f^{n(k)+1}x, fa))$ such that $d(f^{n(k)+1}x, fa) \rightarrow \ell \in]0, +\infty[$ as $k \rightarrow +\infty$. By (2), we obtain

$$\int_0^{d(f^{n(k)+1}x, fa)} \varphi(t) dt \leq \alpha \int_0^{d(a, fa) \frac{1+d(f^{n(k)}x, f^{n(k)+1}x)}{1+d(f^{n(k)}x, a)}} \varphi(t) dt + \beta \int_0^{d(f^{n(k)}x, a)} \varphi(t) dt.$$

Letting k tends to $+\infty$, we obtain

$$(17) \quad \int_0^\ell \varphi(t) dt \leq \alpha \int_0^{d(a, fa)} \varphi(t) dt.$$

On the other hand, using (16) and (3), we get

$$0 < \int_0^{d(a, fa)} \varphi(t) dt \leq \int_0^{d(a, f^{n(k)+1}x) + d(f^{n(k)+1}x, fa)} \varphi(t) dt.$$

Letting $k \rightarrow +\infty$, we obtain

$$(18) \quad 0 < \int_0^{d(a, fa)} \varphi(t) dt \leq \int_0^\ell \varphi(t) dt.$$

Combining (17) and (18), we obtain

$$0 < \int_0^{d(a, fa)} \varphi(t) dt \leq \alpha \int_0^{d(a, fa)} \varphi(t) dt,$$

which is a contradiction, since $0 < \alpha < 1$. Then, $d(f^{n+1}x, fa) \rightarrow 0$ as $n \rightarrow +\infty$. Now, letting $n \rightarrow +\infty$ in (16), we get

$$0 < d(a, fa) \leq d(a, f^{n+1}x) + d(f^{n+1}x, fa) \rightarrow 0.$$

We deduce that a is a fixed point of f .

Suppose now that there are two distinct points $a, b \in X$ such that $fa = a$ and $fb = b$, then by (2) we have the contradiction

$$\begin{aligned} 0 < \int_0^{d(a, b)} \varphi(t) dt &= \int_0^{d(fa, fb)} \varphi(t) dt \leq \alpha \int_0^{m(a, b)} \varphi(t) dt + \beta \int_0^{d(a, b)} \varphi(t) dt \\ &= \beta \int_0^{d(a, b)} \varphi(t) dt < \int_0^{d(a, b)} \varphi(t) dt. \end{aligned}$$

The proof is thus completed. \square

By tacking $\varphi \equiv 1$ in Theorem 2, we retrieve the following result of Dass and Gupta [7].

Corollary 1. *Let (X, d) be a complete metric space and let $f : X \rightarrow X$ be a mapping such that for all $x, y \in X$,*

$$(19) \quad d(fx, fy) \leq \alpha d(y, fy) \frac{1 + d(x, fx)}{1 + d(x, y)} + \beta d(x, y),$$

where $\alpha > 0$, $\beta > 0$ and $\alpha + \beta < 1$. Then, f admits a unique fixed point.

The following example shows that (2) is indeed a proper extension of (19).

Example 1. Let $X = \{\frac{1}{n} + a \mid n \in \mathbb{N}^*\} \cup \{a\}$, where a is a fixed real number. We endow X with the Euclidean metric d : $d(x, y) := |x - y|$ for all $x, y \in X$. It is clear that (X, d) is a complete metric space. We consider the self-mapping $f : X \rightarrow X$ defined by

$$fx = \begin{cases} \frac{1}{n+1} + a & \text{if } x = \frac{1}{n} + a, \\ a & \text{if } x = a. \end{cases}$$

First, we see that the contractive condition of Dass and Gupta (19) is not satisfied in this case. In fact, suppose that (19) is satisfied. By tacking $x = \frac{1}{n} + a$, $n \in \mathbb{N}^*$ and $y = a$, we get

$$d(fx, fy) \leq \alpha d(y, fy) \frac{1 + d(x, fx)}{1 + d(x, y)} + \beta d(x, y), \quad \forall n \in \mathbb{N}^*.$$

This implies that

$$\frac{1}{n+1} \leq \frac{\beta}{n}, \quad \forall n \in \mathbb{N}^*,$$

i.e.,

$$\frac{n}{n+1} \leq \beta, \quad \forall n \in \mathbb{N}^*.$$

Letting $n \rightarrow +\infty$, we get $1 \leq \beta$ and we obtain a contradiction. However, f satisfies (2) with $\varphi(t) = t^{1/t-2}(1 - \ln t)$ for $t > 0$, $\varphi(0) = 0$, $\beta = 1/2$ and $\alpha \in]0, 1/2[$ (see [2] for details).

Remark 1. In [10], Suzuki proved that Theorem1 of Branciari is a particular case of the famous Meir-Keeler fixed point theorem [8]. It will be interesting to see if a link exists between the proposed contractive condition (2) and the MKC condition. We pose this as an open problem.

REFERENCES

1. A. Aliouche. *A common fixed point theorem for weakly compatible mappings in symmetric spaces satisfying a contractive condition of integral type*. Journal of Mathematical Analysis and Applications, vol. 322, no. 2 (2006), 796-802.
2. A. Branciari. *A fixed point theorem for mappings satisfying a general contractive condition of integral type*. Int. J. Math. Math. Sci. 29 (2002), no. 9, 531-536.
3. H. Chatterjee. *On generalization of Banach Contraction Principle*. Indian J. Pure appl. Math., 10 (1979), 400-403.
4. A. Djoudi and A. Aliouche. *Common fixed point theorems of Gregus type for weakly compatible mappings satisfying contractive conditions of integral type*. Journal of Mathematical Analysis and Applications, vol. 329, no. 1 (2007), 31-45.

5. P. Das. *Some results on fixed points in complete metric spaces*. Indian J. Pure appl . Math.,13(3) (1982), 303-308.
6. G. S. Jeong and B. E. Rhoades. *Some remarks for improving fixed point theorems for more than two maps*. Indian Journal of Pure and Applied Mathematics, 28(9)(1997), 1177-1196.
7. B. K. Dass and S. Gupta. *An extension of Banach contraction principle through rational expression*. Indian J.pure appl . Math., 6 (1975), 1455-1458.
8. A. Meir and E. Keeler. *A theorem on contraction mappings*. Journal of Mathematical Analysis and Applications, vol. 28, no. 2 (1969), 326-329.
9. B. E. Rhoades. *Two fixed point theorems for mappings satisfying a general contractive condition of integral type*. IJMMS. 63 (2003), 4007-4013.
10. T. Suzuki. *Meir-Keeler Contractions of Integral Type Are Still Meir-Keeler Contractions*. International Journal of Mathematics and Mathematical Sciences, Volume 2007, Article ID 39281, 6 pages.
11. D. Turkoglu and I. Altun. *A common fixed point theorem for weakly compatible mappings in symmetric spaces satisfying an implicit relation*. Boletn de la Sociedad Matematica Mexicana, 13 (1) (2007), 195-205.
12. P. Vijayaraju, B. E. Rhoades and R. Mohanraj. *A fixed point theorem for a pair of maps satisfying a general contractive condition of integral type*. International Journal of Mathematics and Mathematical Sciences, vol. 2005, no. 15, 2359-2364.

Bessem Samet

Ecole Supérieure des Sciences et Techniques de Tunis, Département de Mathématiques,
5, Avenue Taha Hussein-Tunis, B.P.:56, Bab Menara-1008, Tunisie.

E-mail address: bessem.samet@gmail.com

Habib Yazidi

Ecole Supérieure des Sciences et Techniques de Tunis, Département de Mathématiques,
5, Avenue Taha Hussein-Tunis, B.P.:56, Bab Menara-1008, Tunisie.

E-mail address: Habib.Yazidi@esstt.rnu.tn

Article 14:

A fixed point theorem in a generalized metric space for mappings satisfying a contractive condition of integral type

Int. Journal of Math. Analysis. 3 (26) (2009) 1265-1271

A Fixed Point Theorem in a Generalized Metric Space for Mappings Satisfying a Contractive Condition of Integral Type

Bessem Samet

Ecole Supérieure des Sciences et Techniques de Tunis
Département de Mathématiques
5, Avenue Taha Hussein-Tunis, B.P.:56
Bab Menara-1008, Tunisie
bessem.samet@gmail.com

Abstract. We establish a fixed point theorem in the generalized metric space introduced by Branciari for mappings satisfying a general contractive inequality of integral type. The obtained result can be considered as an extension of the theorem of Branciari (2002).

Mathematics Subject Classification: 54H25, 47H10

Keywords: Generalized metric space; Fixed point

1. INTRODUCTION

In [2], Branciari established the following theorem.

Theorem 1. *Let (X, d) be a complete metric space, $c \in]0, 1[$, and let $f : X \rightarrow X$ be a mapping such that for each $x, y \in X$,*

$$(1) \quad \int_0^{d(fx, fy)} \varphi(t) dt \leq c \int_0^{d(x, y)} \varphi(t) dt,$$

where $\varphi : [0, +\infty[\rightarrow [0, +\infty[$ is a Lebesgue-integrable mapping which is summable on each compact subset of $[0, +\infty[$, nonnegative, and such that

$$\forall \varepsilon > 0, \int_0^\varepsilon \varphi(t) dt > 0.$$

Then, f admits a unique fixed point $a \in X$ such that for each $x \in X$, $\lim_{n \rightarrow \infty} f^n x = a$.

Theorem 1 is a generalization of the Banach-Caccioppoli principle. In fact, putting $\varphi(t) = 1$ for each $t \geq 0$, we obtain

$$\int_0^{d(fx, fy)} 1 \, dt = d(fx, fy) \leq cd(x, y) = c \int_0^{d(x, y)} 1 \, dt.$$

Then, a Banach-accioppoli contraction also satisfies (1). The converse is not true in general (see [2]).

In [3], Rhoades proved that Theorem 1 holds if we replace $d(x, y)$ in (1) by

$$m(x, y) = \max \left\{ d(x, y), d(x, fx), d(y, fy), \frac{d(x, fy) + d(y, fx)}{2} \right\}.$$

The purpose of this paper is to establish that Theorem 1 is also valid if we replace the metric space (X, d) by the generalized metric space (or shortly g.m.s) introduced by Branciari in [1].

Definition 1. Let X be a nonempty set. Suppose that the mapping $d : X \times X \rightarrow [0, +\infty)$, satisfies:

1. $d(x, y) = 0 \Leftrightarrow x = y$
2. $d(x, y) = d(y, x)$ for all $x, y \in X$
3. $d(x, y) \leq d(x, w) + d(w, z) + d(z, y)$ for all $x, y \in X$ and for all distinct points $w, z \in X \setminus \{x, y\}$ (rectangular property).

Then d is called a generalized metric and (X, d) is a generalized metric space (or shortly g.m.s).

Definition 2. Let (X, d) be a g.m.s, (x_n) be a sequence in X and $x \in X$.

- We say that (x_n) converges to x with respect to d if and only if

$$d(x_n, x) \rightarrow 0 \text{ as } n \rightarrow +\infty.$$

- We say that (x_n) is Cauchy if and only if

$$d(x_n, x_m) \rightarrow 0 \text{ as } n, m \rightarrow +\infty.$$

- We say that (X, d) is complete if and only if every Cauchy sequence in X is convergent in X .

2. MAIN RESULT

We have obtained the following result.

Theorem 2. Let (X, d) be a complete g.m.s, $c \in]0, 1[$, and let $f : X \rightarrow X$ be a mapping such that for each $x, y \in X$,

$$(2) \quad \int_0^{d(fx, fy)} \varphi(t) \, dt \leq c \int_0^{d(x, y)} \varphi(t) \, dt,$$

where $\varphi : [0, +\infty[\rightarrow [0, +\infty[$ is a Lebesgue-integrable mapping which is summable on each compact subset of $[0, +\infty[$, nonnegative, and such that

$$(3) \quad \forall \varepsilon > 0, \int_0^\varepsilon \varphi(t) \, dt > 0.$$

Then, f admits a unique fixed point $a \in X$ such that for each $x \in X$, $\lim_{n \rightarrow \infty} f^n x = a$.

Proof. Let $x \in X$ and consider the sequence (x_n) defined by $x_n = f^n x$ for all $n \in \mathbb{N}$. By (2), we have

$$\int_0^{d(fx, f^2x)} \varphi(t) dt \leq c \int_0^{d(x, fx)} \varphi(t) dt.$$

Again

$$\begin{aligned} \int_0^{d(f^2x, f^3x)} \varphi(t) dt &\leq c \int_0^{d(fx, f^2x)} \varphi(t) dt \\ &\leq c^2 \int_0^{d(x, fx)} \varphi(t) dt. \end{aligned}$$

Similarly

$$\int_0^{d(f^3x, f^4x)} \varphi(t) dt \leq c^3 \int_0^{d(x, fx)} \varphi(t) dt.$$

Thus in general, if n is a positive integer, then

$$(4) \quad \int_0^{d(f^n x, f^{n+1} x)} \varphi(t) dt \leq c^n \int_0^{d(x, fx)} \varphi(t) dt.$$

We divide the proof into two cases.

Case I. First, assume that $f^m x = f^n x$ for some $m, n \in \mathbb{N}$, $m \neq n$. Let $m > n$, then $f^{m-n}(f^n x) = f^n x$, i.e., $f^k y = y$ where $k = m - n$, $y = f^n x$. Now if $k > 1$

$$\begin{aligned} \int_0^{d(y, fy)} \varphi(t) dt &= \int_0^{d(f^k y, f^{k+1} y)} \varphi(t) dt \\ &\leq c \int_0^{d(f^{k-1} y, f^k y)} \varphi(t) dt \\ (\text{by (4)}) &\leq c^k \int_0^{d(y, fy)} \varphi(t) dt. \end{aligned}$$

Then,

$$(5) \quad (1 - c^k) \int_0^{d(y, fy)} \varphi(t) dt \leq 0.$$

Assume that $y \neq fy$, then $d(y, fy) > 0$, and by (3), we obtain

$$\int_0^{d(y, fy)} \varphi(t) dt > 0.$$

Since $0 < c < 1$, we obtain a contradiction with (5). Hence $fy = y$, i.e., y is a fixed point of f .

Case II. Assume that $f^m x \neq f^n x$ for all $m, n \in \mathbb{N}$, $m \neq n$. Let $n \in \mathbb{N}$, we have

$$\begin{aligned}
 \int_0^{d(f^n x, f^{n+2} x)} \varphi(t) dt &\leq c \int_0^{d(f^{n-1} x, f^{n+1} x)} \varphi(t) dt \\
 &\leq c^2 \int_0^{d(f^{n-2} x, f^n x)} \varphi(t) dt \\
 &\leq \dots \\
 (6) \qquad \qquad \qquad &\leq c^n \int_0^{d(x, f^2 x)} \varphi(t) dt.
 \end{aligned}$$

Taking the limit of (4), as $n \rightarrow +\infty$, gives

$$\lim_{n \rightarrow +\infty} \int_0^{d(f^n x, f^{n+1} x)} \varphi(t) dt = 0$$

which, from (3), implies that

$$(7) \qquad \qquad \qquad \lim_{n \rightarrow +\infty} d(x_n, x_{n+1}) = 0.$$

We now show that $(f^n x)$ is Cauchy. Suppose that it is not. Then, there exists an $\varepsilon > 0$ such that for each $p \in \mathbb{N}$ there are $m(p), n(p) \in \mathbb{N}$, with $m(p) > n(p) > p$, such that

$$(8) \qquad \qquad \qquad d(f^{m(p)} x, f^{n(p)} x) \geq \varepsilon, \quad d(f^{m(p)-1} x, f^{n(p)} x) < \varepsilon.$$

Hence

$$\begin{aligned}
 \varepsilon \leq d(f^{m(p)} x, f^{n(p)} x) &\leq d(f^{m(p)} x, f^{m(p)-2} x) + d(f^{m(p)-2} x, f^{m(p)-1} x) \\
 &\quad + d(f^{m(p)-1} x, f^{n(p)} x) \\
 &< d(f^{m(p)} x, f^{m(p)-2} x) + d(f^{m(p)-2} x, f^{m(p)-1} x) + \varepsilon.
 \end{aligned}$$

Then, using (4), (6) and tacking $p \rightarrow +\infty$, we get

$$(9) \qquad \qquad \qquad d(f^{m(p)} x, f^{n(p)} x) \rightarrow \varepsilon^+ \text{ as } p \rightarrow +\infty.$$

This implies that

$$(10) \qquad \qquad \qquad \exists k \in \mathbb{N} \mid p > k \Rightarrow d(f^{m(p)+1} x, f^{n(p)+1} x) < \varepsilon.$$

In fact, if there exists a subsequence $(p_k) \subset \mathbb{N}$, $p_k > k$, $d(f^{m(p_k)+1} x, f^{n(p_k)+1} x) \geq \varepsilon$, we obtain

$$\begin{aligned}
 \varepsilon &\leq d(f^{m(p_k)+1} x, f^{n(p_k)+1} x) \\
 &\leq d(f^{m(p_k)+1} x, f^{m(p_k)} x) + d(f^{m(p_k)} x, f^{n(p_k)} x) + d(f^{n(p_k)} x, f^{n(p_k)+1} x) \\
 &\rightarrow \varepsilon \text{ as } k \rightarrow +\infty,
 \end{aligned}$$

and from (2)

$$\int_0^{d(f^{m(p_k)+1} x, f^{n(p_k)+1} x)} \varphi(t) dt \leq c \int_0^{d(f^{m(p_k)} x, f^{n(p_k)} x)} \varphi(t) dt,$$

letting now $k \rightarrow +\infty$, we get

$$\int_0^\varepsilon \varphi(t) dt \leq c \int_0^\varepsilon \varphi(t) dt,$$

which is a contradiction since $c \in]0, 1[$ and $\int_0^\varepsilon \varphi(t) dt > 0$. Then, (10) holds. Let us prove now that

$$(11) \quad \exists \sigma_\varepsilon \in]0, \varepsilon[, p_\varepsilon \in \mathbb{N} \mid p > p_\varepsilon \Rightarrow d(f^{m(p)+1}x, f^{n(p)+1}x) < \varepsilon - \sigma_\varepsilon.$$

If (11) is not true, by (10), there exists a subsequence $(p_k) \subset \mathbb{N}$ such that

$$d((f^{m(p_k)+1}x, f^{n(p_k)+1}x) \rightarrow \varepsilon^- \text{ as } k \rightarrow +\infty.$$

Then, from

$$\int_0^{d(f^{m(p_k)+1}x, f^{n(p_k)+1}x)} \varphi(t) dt \leq c \int_0^{d((f^{m(p_k)}x, f^{n(p_k)}x)} \varphi(t) dt,$$

tending $k \rightarrow +\infty$, we obtain also a contradiction that $\int_0^\varepsilon \varphi(t) dt \leq c \int_0^\varepsilon \varphi(t) dt$. Hence, (11) holds. Now, the Cauchy character is easy to obtain. In fact, for each naturel number $p > p_\varepsilon$, we have

$$\begin{aligned} \varepsilon \leq d(f^{m(p)}x, f^{n(p)}x) &\leq d(f^{m(p)}x, f^{m(p)+1}x) + d(f^{m(p)+1}x, f^{n(p)+1}x) \\ &\quad + d(f^{n(p)+1}x, f^{n(p)}x) \\ &< d(f^{m(p)}x, f^{m(p)+1}x) + (\varepsilon - \sigma_\varepsilon) + d(f^{n(p)+1}x, f^{n(p)}x) \\ &\rightarrow \varepsilon - \sigma_\varepsilon \text{ as } p \rightarrow +\infty. \end{aligned}$$

Thus $\varepsilon \leq \varepsilon - \sigma_\varepsilon$ which is a contradiction. We conclude that $(f^n x)$ is Cauchy.

By the completeness of X , there is $a \in X$ such that $f^n x \rightarrow a$ as $n \rightarrow +\infty$. We shall now show that $fa = a$. We divide this proof into two parts.

◇ First, assume that $f^r x \neq a, fa$ for any $r \in \mathbb{N}$. Then, we have

$$d(a, fa) \leq d(a, f^n x) + d(f^n x, f^{n+1}x) + d(f^{n+1}x, fa) \rightarrow 0 \text{ as } n \rightarrow +\infty.$$

In fact, by the definition of the limit, we have $d(a, f^n x) \rightarrow 0$ as $n \rightarrow +\infty$. By (7), $d(f^n x, f^{n+1}x) \rightarrow 0$ as $n \rightarrow +\infty$. On the other hand, we have

$$\int_0^{d(f^{n+1}x, fa)} \varphi(t) dt \leq c \int_0^{d(f^n x, a)} \varphi(t) dt \rightarrow 0 \text{ as } n \rightarrow +\infty$$

which gives by (3) that $d(f^{n+1}x, fa) \rightarrow 0$ as $n \rightarrow +\infty$. Hence, we conclude that $d(a, fa) = 0$, i.e., $a = fa$.

◇ Next, assume that $f^s x = a$ or $f^s x = fa$ for some $s \in \mathbb{N}$. Obviously $x \neq a$. Now, one may easily verify that $(f^n a)$ is a sequence with the following properties

- (a) $f^n a \rightarrow a$ as $n \rightarrow +\infty$.
- (b) $f^p a \neq f^r a$ for any $p, r \in \mathbb{N}, p \neq r$.

So,

$$(12) \quad \int_0^{d(f^{n+1}a, fa)} \varphi(t) dt \leq c \int_0^{d(f^n a, a)} \varphi(t) dt \rightarrow 0 \text{ as } n \rightarrow +\infty.$$

On the other hand, we have

$$|d(f^{n+1}a, fa) - d(a, fa)| \leq d(f^{n+1}a, f^{n+2}a) + d(f^{n+2}a, a) \rightarrow 0 \text{ as } n \rightarrow +\infty.$$

Hence,

$$(13) \quad \int_0^{d(f^{n+1}a, fa)} \varphi(t) dt \rightarrow \int_0^{d(a, fa)} \varphi(t) dt.$$

Now, from (12) and (13) it follows that

$$\int_0^{d(a, fa)} \varphi(t) dt = 0$$

which implies that $d(a, fa) = 0$, i.e., $a = fa$.

Suppose now that there are two distinct points $a, b \in X$ such that $fa = a$ and $fb = b$. By (2), we obtain the following contradiction

$$0 < \int_0^{d(a, b)} \varphi(t) dt = \int_0^{d(fa, fb)} \varphi(t) dt \leq c \int_0^{d(a, b)} \varphi(t) dt < \int_0^{d(a, b)} \varphi(t) dt.$$

Then, the fixed point of f is unique, that is the limit of $f^n x$ as $n \rightarrow +\infty$. \square

Now, we give a simple example that illustrate Theorem 2. Let $X = \{1, 2, 3, 4\}$. Define $d : X \times X \rightarrow \mathbb{R}$ as follows:

$$\begin{aligned} d(1, 2) &= d(2, 1) = 3 \\ d(2, 3) &= d(3, 2) = d(1, 3) = d(3, 1) = 1 \\ d(1, 4) &= d(4, 1) = d(2, 4) = d(4, 2) = d(3, 4) = d(4, 3) = 4. \end{aligned}$$

Then (X, d) is a complete generalized metric space but (X, d) is not a metric space because it lacks the triangular property:

$$3 = d(1, 2) > d(1, 3) + d(3, 2) = 1 + 1 = 2.$$

Now define a mapping $f : X \rightarrow X$ as follows:

$$\begin{cases} fx = 3 & \text{if } x \neq 4 \\ fx = 1 & \text{if } x = 4. \end{cases}$$

Then, f satisfies (2) with $\varphi(t) = e^t$ and $c = e^{-3}$. Hence, f admits a unique fixed point that is $a = 3$.

REFERENCES

1. A. Branciari. *A fixed point theorem of Banach-Caccippoli type on a class of generalized metric spaces*. Publ. Math. Debrecen, 57 1-2(2000), 31-37.
2. A. Branciari. *A fixed point theorem for mappings satisfying a general contractive condition of integral type*. Int. J. Math. Math. Sci. 29 (2002), no. 9, 531-536.
3. B. E. Rhoades. *Two fixed point theorems for mappings satisfying a general contractive condition of integral type*. IJMMS. 63 (2003), 4007-4013.

Received: April, 2009

Article 15:

The Kannan's fixed point theorem in a cone rectangular metric space

J. Nonlinear Sci. Appl. 2 (3) 161-167

THE KANNAN'S FIXED POINT THEOREM IN A CONE RECTANGULAR METRIC SPACE

MOHAMED JLELI¹ AND BESSEM SAMET^{2*}

Communicated by I. Beg

ABSTRACT. Recently, Azam, Arshad and Beg introduced the notion of cone rectangular metric spaces by replacing the triangular inequality of a cone metric space by a rectangular inequality. In this paper, we extend the Kannan's fixed point theorem in such spaces.

1. INTRODUCTION

If (X, d) is a complete metric space and $T : X \rightarrow X$ is a contraction, i.e.,

$$d(Tx, Ty) \leq \alpha d(x, y)$$

for all $x, y \in X$ with $\alpha \in [0, 1)$, then the widely known Banach's contraction mapping principle tells that T has a unique fixed point in X . A lot of generalizations of this theorem have been done, mostly by relaxing the contraction condition and sometimes by withdrawing the requirement of completeness or even both [4, 5, 6, 7, 10, 11, 12, 13].

Huang and Zhang [8] have introduced the concept of cone metric space, where the set of real numbers is replaced by an ordered Banach space, and they have established some fixed point theorems for contractive type mappings in a normal cone metric space. The study of fixed point theorems in such spaces is followed by some other mathematicians, see [1, 9].

Following the idea of Branciari [3], Azam, Arshad and Beg [2] extended the notion of cone metric spaces by replacing the triangular inequality by a rectangular inequality. The aim of this paper is to extend the Kannan's fixed point theorem

Date: Received: 10 April 2009 ; Revised 07 June 2009.

* Corresponding author.

2000 *Mathematics Subject Classification.* Primary 47H10; Secondary 54E35, 54E50.

Key words and phrases. Cone rectangular metric space; Kannan's fixed point theorem.

[11] in such spaces. We start by recalling some definitions introduced in [2, 8] and preliminary results.

Let E always be a real Banach space and P a subset of E . P is called a cone if and only if:

- (i) P is closed, nonempty, and $P \neq \{0\}$.
- (ii) $a, b \in \mathbb{R}$, $a, b \geq 0$, $x, y \in P \Rightarrow ax + by \in P$.
- (iii) $x \in P$ and $-x \in P \Rightarrow x = 0$.

Given a cone $P \subset E$, we define a partial ordering \leq with respect to P by:

$$x \leq y \Leftrightarrow y - x \in P.$$

We shall write $x < y$ to indicate that $x \leq y$ but $x \neq y$, while $x \ll y$ will stand for $y - x \in \text{int } P$, $\text{int } P$ denotes the interior of P .

The cone P is called normal if there is a number $k > 0$ such that for all $x, y \in E$,

$$0 \leq x \leq y \Rightarrow \|x\| \leq k\|y\|,$$

where $\|\cdot\|$ is the norm in E . In this case, the number k is called the normal constant of P .

In the following we always suppose E is a Banach space, P is a cone in E with $\text{int } P \neq \emptyset$ and \leq is partial ordering with respect to P .

Definition 1.1. Let X be a nonempty set. Suppose the mapping $d : X \times X \rightarrow E$ satisfies:

- (a) $0 < d(x, y)$ for all $x, y \in X$, $x \neq y$ and $d(x, y) = 0$ if and only if $x = y$.
- (b) $d(x, y) = d(y, x)$ for all $x, y \in X$.
- (c) $d(x, y) \leq d(x, u) + d(u, v) + d(v, y)$ for all $x, y \in X$ and for all distinct points $u, v \in X \setminus \{x, y\}$ (rectangular property).

Then d is called a cone rectangular metric on X , and (X, d) is called a cone rectangular metric space.

Not that any cone metric space is a cone rectangular metric space but the converse is not true in general.

Example 1.2. Let $E = \mathbb{R}^2$, $P = \{(x, y) \in E \mid x, y \geq 0\}$, $X = \mathbb{R}$, $d : X \times X \rightarrow E$ such that

$$d(x, y) = \begin{cases} (0, 0) & \text{if } x = y, \\ (3\alpha, 3) & \text{if } x \text{ and } y \text{ are in } \{1, 2\}, x \neq y, \\ (\alpha, 1) & \text{if } x \text{ and } y \text{ can not both at a time in } \{1, 2\}, x \neq y, \end{cases}$$

where $\alpha > 0$ is a constant. Then (X, d) is a cone rectangular metric space but it is not a cone metric space since we have $d(1, 2) = (3\alpha, 3) > d(1, 3) + d(3, 2) = (2\alpha, 2)$.

Example 1.3. Let $E = \mathbb{R}^2$, $P = \{(x, y) \in E \mid x, y \geq 0\}$, $X = \{a, b, c, e\}$ and $d : X \times X \rightarrow E$ such that

$$\begin{cases} d(x, x) = (0, 0), \forall x \in X, \\ d(x, y) = d(y, x), \forall x, y \in X, \\ d(a, b) = (3, \alpha), \\ d(a, c) = d(b, c) = (1, \alpha), \\ d(a, e) = d(b, e) = d(c, e) = (2, \alpha), \end{cases}$$

where $\alpha > 0$ is a constant. Then (X, d) is a cone rectangular metric space but it is not a cone metric space since we have $d(a, b) = (3, \alpha)$ and $d(a, c) + d(c, b) = (2, 2\alpha)$ but $(3, \alpha)$ and $(2, 2\alpha)$ cannot be compared with respect to \leq .

Definition 1.4. Let (X, d) be a cone rectangular metric space. Let (x_n) be a sequence in X and $x \in X$. If for every $c \in E$, $c \gg 0$ there is N such that for all $n > N$, $d(x_n, x) \ll c$, then (x_n) is said to be convergent to x and x is the limit of (x_n) . We denote this by $x_n \rightarrow x$ as $n \rightarrow +\infty$.

The proof of this result is identical to the proof of ([8]-Lemma 1).

Lemma 1.5. Let (X, d) be a cone rectangular metric space, P be a normal cone. Let (x_n) be a sequence in X . Then,

$$x_n \rightarrow x \text{ as } n \rightarrow +\infty \Leftrightarrow \|d(x_n, x)\| \rightarrow 0 \text{ as } n \rightarrow +\infty.$$

Note that if (X, d) is a cone metric space and (x_n) is a convergent sequence in X , then the limit of (x_n) is unique ([8]-Lemma 2). In our case, the uniqueness of the limit is not satisfied in general. We give an example to illustrate this remark.

Example 1.6. We take $E = \mathbb{R}$ and $P = \{x \in \mathbb{R} \mid x \geq 0\}$. Let $(x_n)_{n \in \mathbb{N}^*}$ be a sequence in \mathbb{Q} and $a, b \in \mathbb{R} \setminus \mathbb{Q}$, $a \neq b$. We put $X = \{x_1, x_2, \dots, x_n, \dots\} \cup \{a, b\}$ and we consider $d : X \times X \rightarrow \mathbb{R}$ defined by

$$\begin{cases} d(x, x) &= 0, \forall x \in X, \\ d(x, y) &= d(y, x), \forall x, y \in X, \\ d(x_n, x_m) &= 1, \forall n, m \in \mathbb{N}^*, n \neq m, \\ d(x_n, b) &= \frac{1}{n}, \forall n \in \mathbb{N}^*, \\ d(x_n, a) &= \frac{1}{n}, \forall n \in \mathbb{N}^*, \\ d(a, b) &= 1. \end{cases}$$

We remark that (X, d) is not a cone metric space because we have

$$d(x_2, x_3) = 1 > d(x_2, a) + d(a, x_3) = \frac{1}{2} + \frac{1}{3} = \frac{5}{6}.$$

However, (X, d) is a cone rectangular metric space. Now, since $d(x_n, a) = \frac{1}{n} \rightarrow 0$ as $n \rightarrow +\infty$, we obtain that $x_n \rightarrow a$ as $n \rightarrow +\infty$. Also, we have $d(x_n, b) = \frac{1}{n} \rightarrow 0$ as $n \rightarrow +\infty$ and then $x_n \rightarrow b$ as $n \rightarrow +\infty$.

Definition 1.7. Let (X, d) be a cone rectangular metric space, (x_n) be a sequence in X . If for any $c \in E$ with $0 \ll c$, there is N such that for all $n, m > N$, $d(x_n, x_m) \ll c$, then (x_n) is called a Cauchy sequence in X .

The proof of the following result is similar to the proof of ([8]-Lemma 4).

Lemma 1.8. Let (X, d) be a cone rectangular metric space and P be a normal cone. Let (x_n) be a sequence in X . Then (x_n) is a Cauchy sequence if and only if $d(x_n, x_m) \rightarrow 0$ as $n, m \rightarrow +\infty$.

Note that if (X, d) is a cone metric space and (x_n) is a convergent sequence in X , then (x_n) is a Cauchy sequence ([8]-Lemma 3). In our case, this result is not true in general. In fact, in Example 1.6, the sequence (x_n) is convergent but we have $d(x_n, x_m) \rightarrow 1$ as $n, m \rightarrow +\infty$.

Definition 1.9. Let (X, d) be a cone rectangular metric space. If every Cauchy sequence is convergent in X , then X is called a complete cone rectangular metric space.

In this particular case, the uniqueness of the limit is satisfied.

Lemma 1.10. Let (X, d) be a complete cone rectangular metric space, P be a normal cone with normal constant k . Let (x_n) be a Cauchy sequence in X and suppose that there is N such that

- (i) $x_n \neq x_m$ for all $n, m > N$.
- (ii) x_n, x are distinct points in X for all $n > N$.
- (iii) x_n, y are distinct points in X for all $n > N$.
- (iii) $x_n \rightarrow x$ and $x_n \rightarrow y$ as $n \rightarrow +\infty$.

Then $x = y$.

Proof. For any $c \in E$ with $0 \ll c$, there is ν such that

$$d(x_n, x) \ll c, \quad d(x_n, y) \ll c \quad \text{and} \quad d(x_n, x_m) \ll c$$

for all $n, m > \nu$. For all $n, m > \max(N, \nu)$, We have

$$d(x, y) \leq d(x, x_n) + d(x_n, x_m) + d(x_m, y) \leq 3c.$$

Hence, $\|d(x, y)\| \leq 3k\|c\|$. Since c is arbitrary $d(x, y) = 0$; therefore $x = y$. \square

2. MAIN RESULT

In this section, we derive a fixed point theorem in a cone rectangular metric space. Our obtained result generalizes the well known Kannan's theorem.

Theorem 2.1. Let (X, d) be a complete cone rectangular metric space, P be a normal cone with normal constant k . Suppose a mapping $T : X \rightarrow X$ satisfies the contractive condition

$$d(Tx, Ty) \leq \alpha(d(Tx, x) + d(Ty, y)), \quad \forall x, y \in X, \quad (2.1)$$

where $\alpha \in [0, 1/2)$. Then,

- (i) T has a unique fixed point in X .
- (ii) For any $x \in X$, the iterative sequence $(T^n x)$ converges to the fixed point.

Proof. Let $x \in X$. We have

$$d(Tx, T^2x) \leq \alpha(d(Tx, x) + d(Tx, T^2x)),$$

i.e.,

$$d(Tx, T^2x) \leq \frac{\alpha}{1-\alpha} d(x, Tx).$$

Again

$$d(T^2x, T^3x) \leq \alpha(d(Tx, T^2x) + d(T^2x, T^3x))$$

i.e.,

$$d(T^2x, T^3x) \leq \frac{\alpha}{1-\alpha} d(Tx, T^2x) \leq \left(\frac{\alpha}{1-\alpha}\right)^2 d(x, Tx).$$

Thus in general, if n is a positive integer, then

$$d(T^n x, T^{n+1} x) \leq \left(\frac{\alpha}{1-\alpha}\right)^n d(x, Tx) = r^n d(x, Tx),$$

where $r = \frac{\alpha}{1-\alpha} \in [0, 1)$.

We divide the proof into two cases.

First case: Let $T^m x = T^n x$ for some $m, n \in \mathbb{N}$, $m \neq n$. Let $m > n$. Then $T^{m-n}(T^n x) = T^n x$, i.e. $T^p y = y$ where $p = m - n$, $y = T^n x$. Now since $p > 1$, we have

$$\begin{aligned} d(y, Ty) &= d(T^p y, T^{p+1} y) \\ &\leq r^p d(y, Ty). \end{aligned}$$

Since $r \in [0, 1)$, we obtain $-d(y, Ty) \in P$ and $d(y, Ty) \in P$ which implies that $\|d(y, Ty)\| = 0$, i.e., $Ty = y$.

Second case: Assume that $T^m x \neq T^n x$ for all $m, n \in \mathbb{N}$, $m \neq n$. Clearly, we have

$$d(T^n x, T^{n+1} x) \leq r^n d(x, Tx) \leq \frac{r^n}{1-r} d(x, Tx)$$

and

$$\begin{aligned} d(T^n x, T^{n+2} x) &\leq \alpha(d(T^{n-1} x, T^n x) + d(T^{n+1} x, T^{n+2} x)) \\ &\leq \alpha(r^{n-1} d(x, Tx) + r^{n+1} d(x, Tx)) \\ &\leq r^n d(x, Tx) + r^{n+1} d(x, Tx) \\ &\leq \frac{r^n}{1-r} d(x, Tx). \end{aligned}$$

Now if $m > 2$ is odd then writing $m = 2\ell + 1$, $\ell \geq 1$ and using the fact that $T^p x \neq T^r x$ for $p, r \in \mathbb{N}$, $p \neq r$, we can easily show that

$$\begin{aligned} d(T^n x, T^{n+m} x) &\leq d(T^n x, T^{n+1} x) + d(T^{n+1} x, T^{n+2} x) + \dots + d(T^{n+2\ell} x, T^{n+2\ell+1} x) \\ &\leq r^n d(x, Tx) + r^{n+1} d(x, Tx) + \dots + r^{n+2\ell} d(x, Tx) \\ &\leq \frac{r^n}{1-r} d(x, Tx). \end{aligned}$$

Again if $m > 2$ is even then writing $m = 2\ell$, $\ell \geq 2$ and using the same arguments as before, we can get

$$\begin{aligned} &d(T^n x, T^{n+m} x) \\ &\leq d(T^n x, T^{n+2} x) + d(T^{n+2} x, T^{n+3} x) + d(T^{n+3} x, T^{n+4} x) + \dots + d(T^{n+2\ell-1} x, T^{n+2\ell} x) \\ &\leq r^n d(x, Tx) + r^{n+2} d(x, Tx) + r^{n+3} d(x, Tx) + \dots + r^{n+2\ell-1} d(x, Tx) \\ &\leq \frac{r^n}{1-r} d(x, Tx). \end{aligned}$$

Thus combining all the cases we have

$$d(T^n x, T^{n+m} x) \leq \frac{r^n}{1-r} d(x, Tx), \quad \forall m, n \in \mathbb{N}.$$

Hence, we get

$$\|d(T^n x, T^{n+m} x)\| \leq k \frac{r^n}{1-r} \|d(x, Tx)\|, \quad \forall m, n \in \mathbb{N}.$$

Since $k \frac{r^n}{1-r} \|d(x, Tx)\| \rightarrow 0$ as $n \rightarrow +\infty$, $(T^n x)$ is a Cauchy sequence. By the completeness of X , there is $x^* \in X$ such that $T^n x \rightarrow x^*$ as $n \rightarrow +\infty$.

We shall now show that $Tx^* = x^*$. Without any loss of generality, we can assume that $T^r x \neq x^*, Tx^*$ for any $r \in \mathbb{N}$. We have

$$\begin{aligned} d(x^*, Tx^*) &\leq d(x^*, T^n x) + d(T^n x, T^{n+1} x) + d(T^{n+1} x, Tx^*) \\ &\leq d(x^*, T^n x) + d(T^n x, T^{n+1} x) + \alpha(d(T^n x, T^{n+1} x) + d(x^*, Tx^*)) \end{aligned}$$

which implies that

$$d(x^*, Tx^*) \leq \frac{1}{1-\alpha} (d(x^*, T^n x) + (1+\alpha)d(T^n x, T^{n+1} x)).$$

Hence,

$$\|d(x^*, Tx^*)\| \leq \frac{k}{1-\alpha} (\|d(x^*, T^n x)\| + (1+\alpha)\|d(T^n x, T^{n+1} x)\|) \rightarrow 0 \text{ as } n \rightarrow +\infty.$$

So we obtain $d(Tx^*, x^*) = 0$, i.e., $x^* = Tx^*$.

Now, if y^* is another fixed point of T , then

$$d(x^*, y^*) = d(Tx^*, Ty^*) \leq \alpha(d(x^*, Tx^*) + d(y^*, Ty^*)) = 0$$

which implies that $\|d(x^*, y^*)\| = 0$, i.e., $x^* = y^*$. □

To illustrate Theorem 2.1, we give the following example.

Example 2.2. Let $E = \mathbb{C}$ and $P = \{x + iy \mid x, y \in \mathbb{R}, x, y \geq 0\}$ a normal cone in E . Let $X = \{1, 2, 3, 4\}$. Define $d : X \times X \rightarrow E$ by

$$\begin{aligned} d(x, x) &= 0 \\ d(1, 2) &= d(2, 1) = 3 + 9i \\ d(2, 3) &= d(3, 2) = d(1, 3) = d(3, 1) = 1 + 3i \\ d(1, 4) &= d(4, 1) = d(2, 4) = d(4, 2) = d(3, 4) = d(4, 3) = 4 + 12i. \end{aligned}$$

Then (X, d) is a complete cone rectangular metric space but (X, d) is not a cone metric space because it lacks the triangular property

$$3 + 9i = d(1, 2) > d(1, 3) + d(3, 2) = 2 + 6i.$$

Now, define a mapping $T : X \rightarrow X$ as follows

$$Tx = \begin{cases} 3 & \text{if } x \neq 4 \\ 1 & \text{if } x = 4. \end{cases}$$

We remark that T is not a contractive mapping with respect to the standard metric in X because we have

$$|T4 - T2| = 2 = |4 - 2|.$$

However, T satisfies

$$d(Tx, Ty) \leq \alpha(d(x, Tx) + d(y, Ty)), \quad \forall x, y \in X$$

with $\alpha = \frac{1}{3}$. Applying Theorem 2.1, we obtain that T admits a unique fixed point, that is $x^* = 3$.

Note that in this example, results of Huang and Zhang [8] are not applicable to obtain the fixed point of the mapping T on X , since (X, d) is not a cone metric space.

Acknowledgements: The authors would like to thank Professor Ismat Beg for providing them with the reference [2].

REFERENCES

1. M. Abbas and G. Jungck, Common fixed point results for noncommuting mappings without continuity in cone metric spaces, *J. Math. Anal. Appl.*, 341 (2008), 416-420. 1
2. A. Azam, M. Arshad and I. Beg, Banach contraction principle on cone rectangular metric spaces, *Appl. Anal. Discrete Math.*, (to appear). 1, 2
3. A. Branciari, A fixed point theorem of Banach-Caccioppoli type on a class of generalized metric spaces, *Publ. Math. Debrecen*, 57 1-2 (2000), 31-37. 1
4. H. Chatterjee, On generalization of Banach Contraction Principle, *Indian J. Pure appl. Math.*, 10 (1979), 400-403. 1
5. Lj. B. Ćirić, On contraction type mappings, *Math. Balkanica*, 1 (1971), 52-57. 1
6. Lj. B. Ćirić, A generalization of Banach's contraction principle, *Proc. Am. Math. Soc.*, 45 (1974), 267-273. 1
7. B. K. Dass and S. Gupta, An extension of Banach contraction principle through rational expression, *Indian J. Pure appl. Math.*, 6 (1975), 1455-1458. 1
8. L.G. Huang and X. Zhang, Cone metric spaces and fixed point theorems of contractive mappings. *J. Math. Anal. Appl.*, 332 (2007), 1468-1476. 1, 1, 1, 1, 1, 2.2
9. D. Ilic and V. Rakocevic, Common fixed points for maps on cone metric space, *J. Math. Anal. Appl.*, 341 (2008), 876-882. 1
10. R. Kannan, Some results on fixed points, *Bull. Cal. Math. Soc.*, (60) 1-2 (1968), 71-76. 1
11. R. Kannan, Some results on fixed points-II. *Amer. Math. Monthly*, (76)(1969), 405-408. 1
12. D. Mihet, A counterexample to "Common fixed point theorem in probabilistic quasi-metric spaces", *J. Nonlinear Sci. Appl.* 1 (2008), no. 2, 121-122. 1
13. A. R. Shabani and S. Ghasempour, Common fixed point theorem in probabilistic quasi-metric spaces, *J. Nonlinear Sci. Appl.* 1 (2008), no. 1, 31-35. 1

¹ DEPARTMENT OF MATHEMATICS, TUNIS COLLEGE OF SCIENCES AND TECHNIQUES, 5 AVENUE TAHA HUSSEIN, BP, 56, BAB MANARA, TUNIS.

E-mail address: jlelimohamed@gmail.com

² DEPARTMENT OF MATHEMATICS, TUNIS COLLEGE OF SCIENCES AND TECHNIQUES, 5 AVENUE TAHA HUSSEIN, BP, 56, BAB MANARA, TUNIS.

E-mail address: bessem.samet@gmail.com