



**Chemical, spectroscopic, and *ab initio*
modelling approach to interfacial reactivity
applied to selenite ion retention by siderite**

Vivien BADAUT

Advisor : G. Moutiers

Tutoring : M. L. Schlegel, P. Zeller, M. Descostes

The long-term high-level nuclear waste (HLW) storage



Introduction

- Outline
- Chemistry
- XAS
- Ab initio*
- Conclusions
- Outlook



Nuclear spent fuel

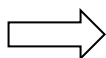

High activity nuclear glass



High Level Waste

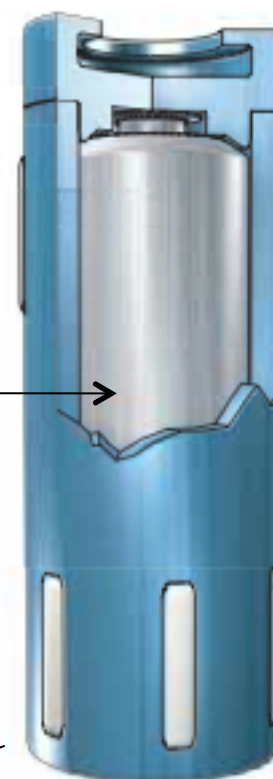

Iron canister

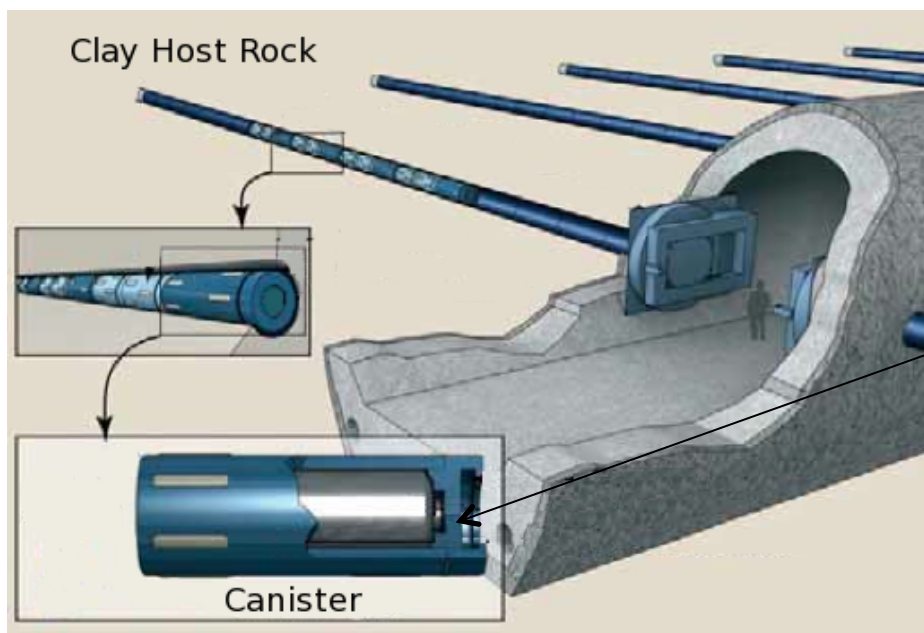

Storage in deep geological formation (Callovo-Oxfordian clay rock)

Evolution of an HLW storage (1)



Introduction

Outline

Chemistry

XAS

Ab initio

Conclusions

Outlook

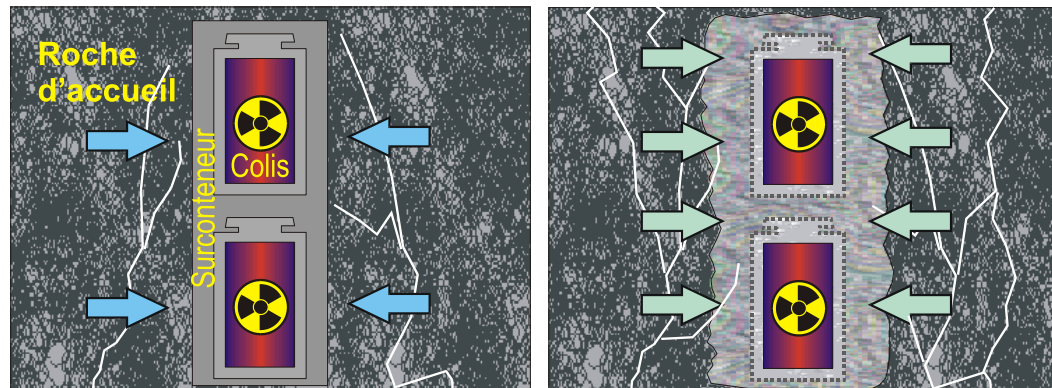

≈ 10 years

Aqueous
resaturation

≈ 100 years

Canister
corrosion



Siderite-containing
corrosion layer⁽¹⁾

¹M.L. Schlegel *et al.* (2008), *Appl. Geochem.* **23** (9), 2619-2633

Siderite: a corrosion product of the iron canister

Siderite ($\text{Fe}^{\text{II}}\text{CO}_3$) forms in the corrosion layer

Siderite often controls redox in anoxic natural environment



Introduction

- Outline
- Chemistry
- XAS
- Ab initio
- Conclusions
- Outlook

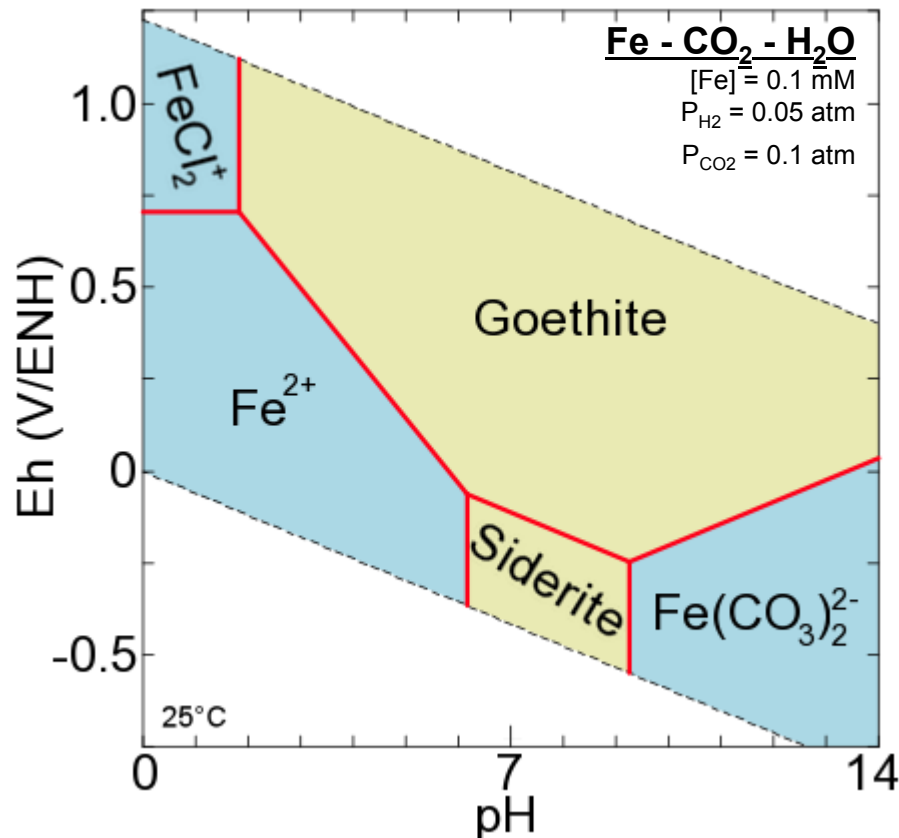

Thermodynamic predominance of aqueous (blue) and solid (yellow) iron species in the Fe-H₂O-CO₂ system.

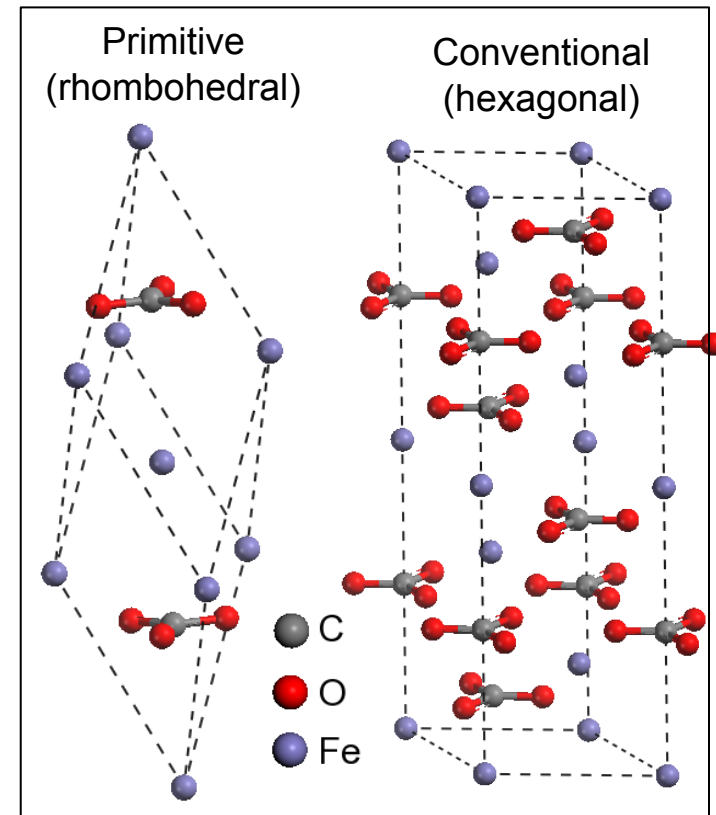

Siderite crystallographic cells

Evolution of an HLW storage (2)



Introduction

Outline

Chemistry

XAS

Ab initio

Conclusions

Outlook

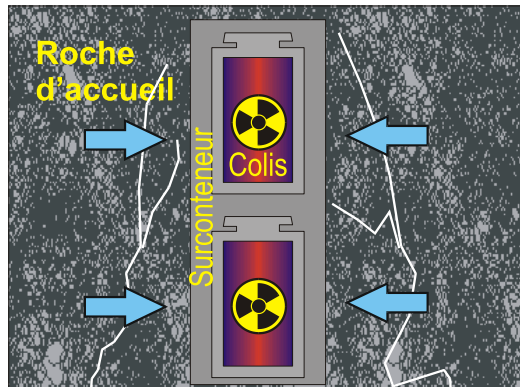

≈ 10 years

Aqueous
resaturation

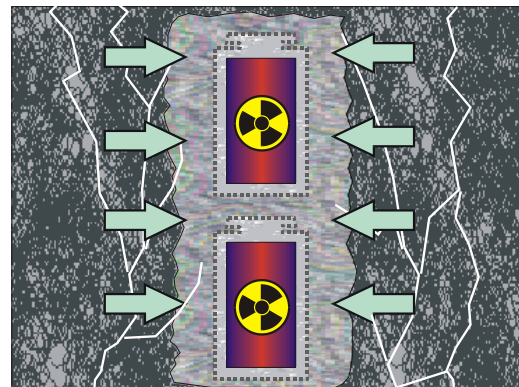

≈ 100 years

Canister
corrosion



Siderite-containing
corrosion layer

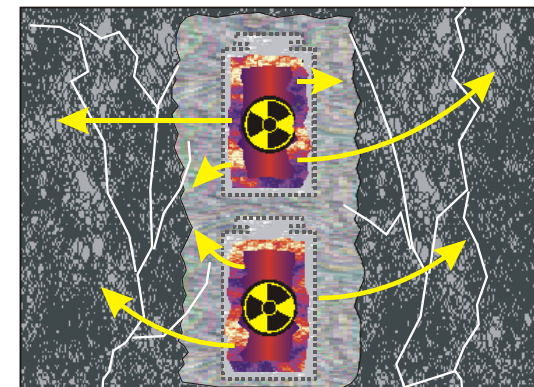

≈ 1000 years

Radionuclide
lixiviation and
migration



⁷⁹Se among
other radionuclides

Selenium: an important contributor to the potential radiotoxicity

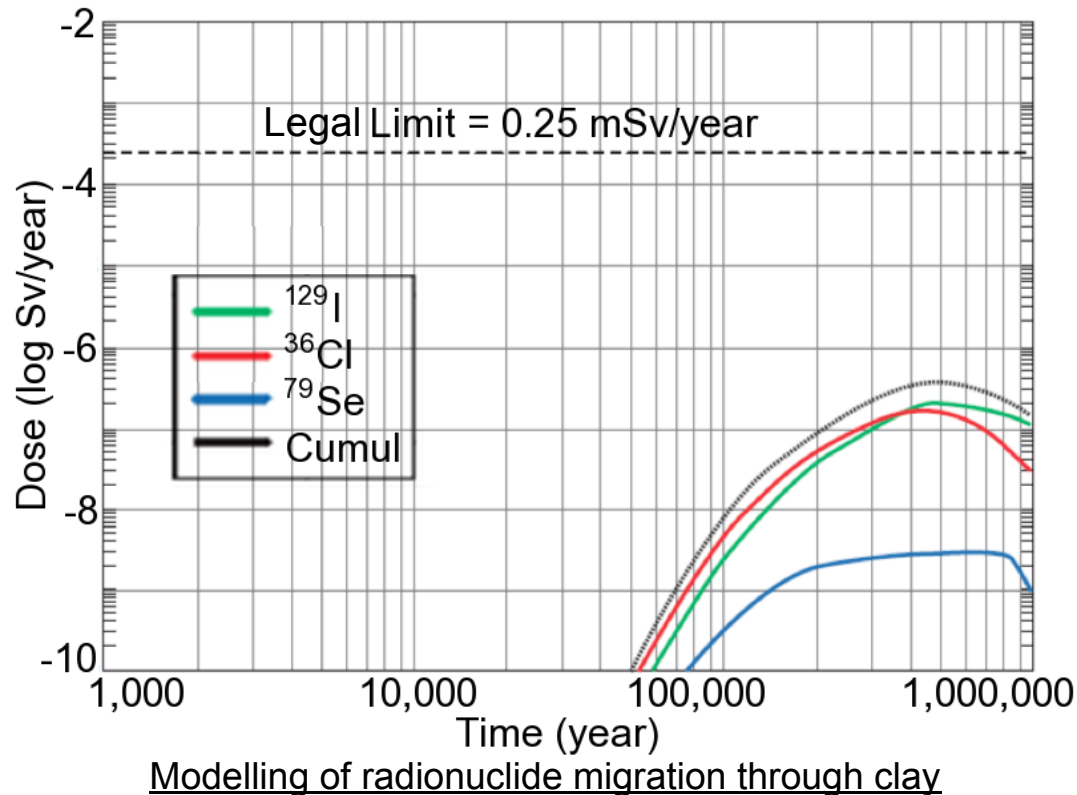

- Soluble (mobile) as **selenite (SeO_3^{2-})** and **selenate (SeO_4^{2-})**
- **Se(0,-II)** forms sparingly soluble solid phases

^{79}Se is a **long life** radionuclide ($T_{1/2} \approx 10^5$ years) and should be lixiviated as **selenite (SeO_3^{2-})**.

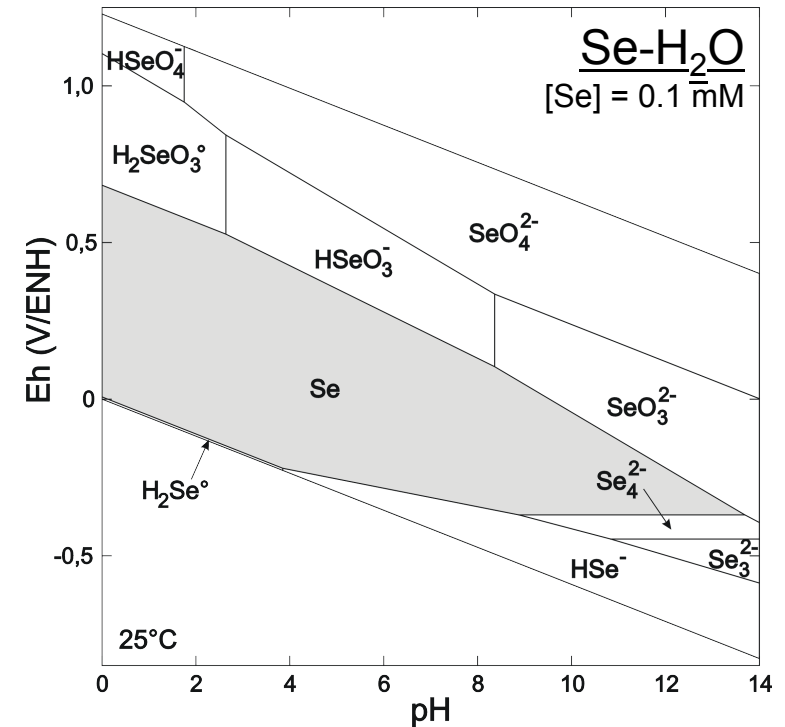

Modelling did not take into account the canister corrosion layer

Selenite ion stability in the presence of siderite

Possible selenium species in equilibrium with siderite:



Introduction

- Outline
- Chemistry
- XAS
- Ab initio
- Conclusions
- Outlook

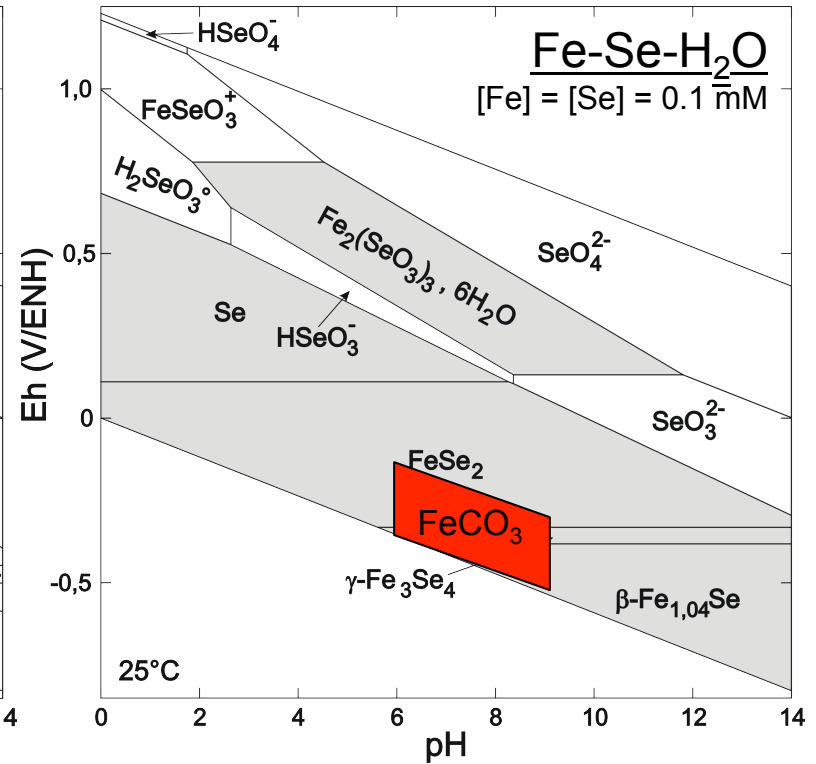
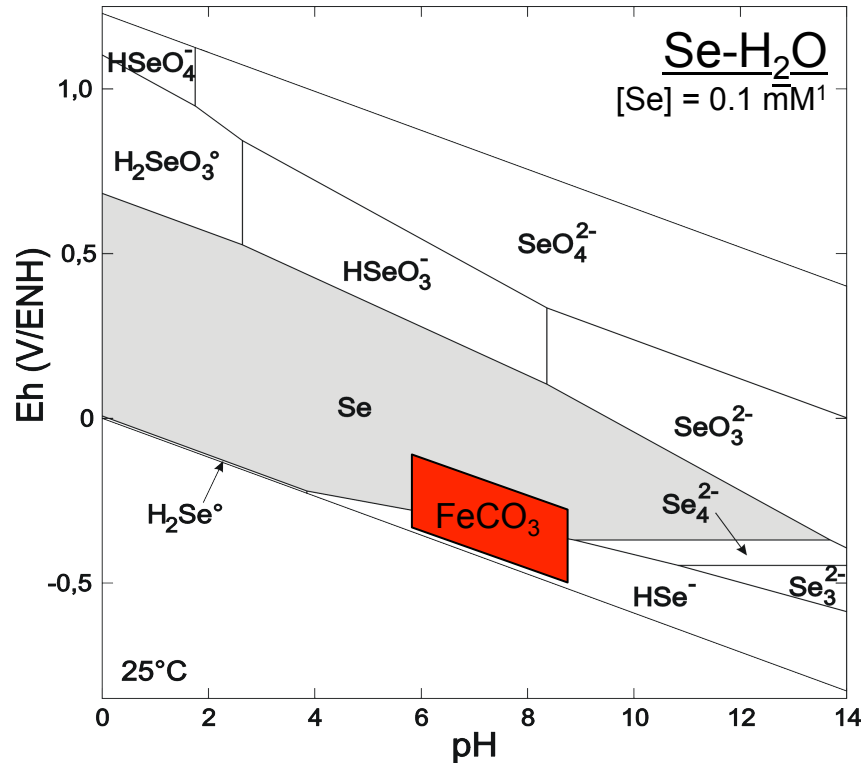

From a thermodynamic point of view, selenite is instable and should reduce as Se^0 or Fe_xSe_y .



Introduction

Outline

Chemistry

XAS

Ab initio

Conclusions

Outlook

Objectives:

- investigate siderite retention mechanism of selenite ion
- foresee long term behaviour

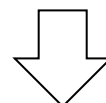

Methods:

1. Controlled environment chemistry of selenite retention by siderite
 2. Spectroscopy (X-ray absorption spectroscopy)
 3. Atomistic modelling (Density Functional Theory)
- } Molecular scale

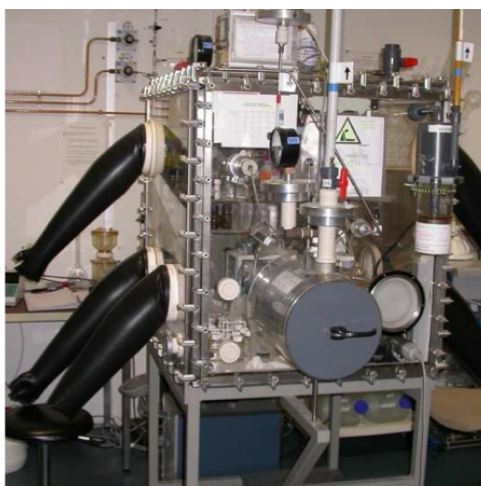

Preparation of synthetic siderite suspensions



Introduction

Outline

Chemistry

XAS

Ab initio

Conclusions

Outlook

Why synthetic siderite ?

- Siderite oxidation products (goethite, ferrihydrite) could compete with siderite for selenite retention
- Natural siderite sample rarely pure (Mg, Mn...)



Siderite synthesis in reducing glovebox
(H₂/CO₂/N₂ 5:10:8)

Precipitation from oversaturated solution
(0.3 M FeCl₂, 0.8 M NaHCO₃, 48 h)

**Crystalline siderite (XRD)
intergrown 100 nm crystals**

Suspension in equilibrium with siderite:

Wet crystals redissolved in C_{HCO₃⁻} = 0.05 M,
I = 0.1M NaCl, C_s = 70 g/L.
> 48 h equilibration prior to use

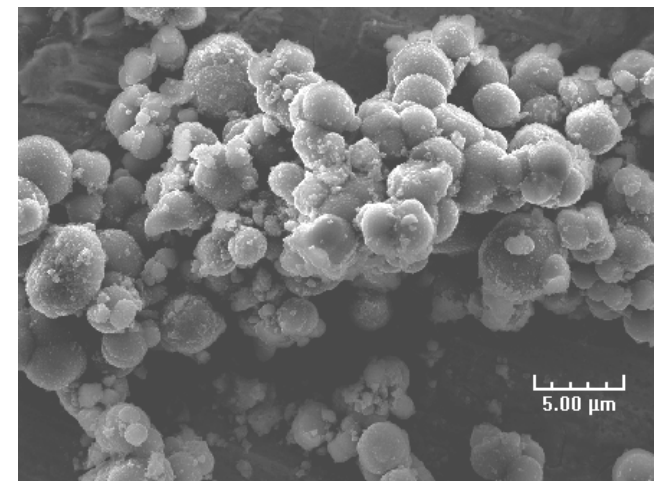
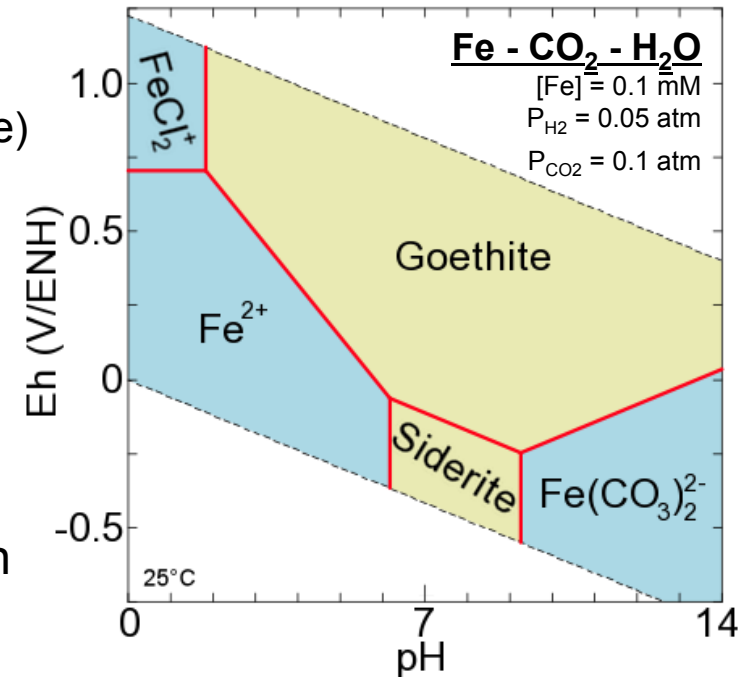

Evolution of total aqueous selenium concentration with time:

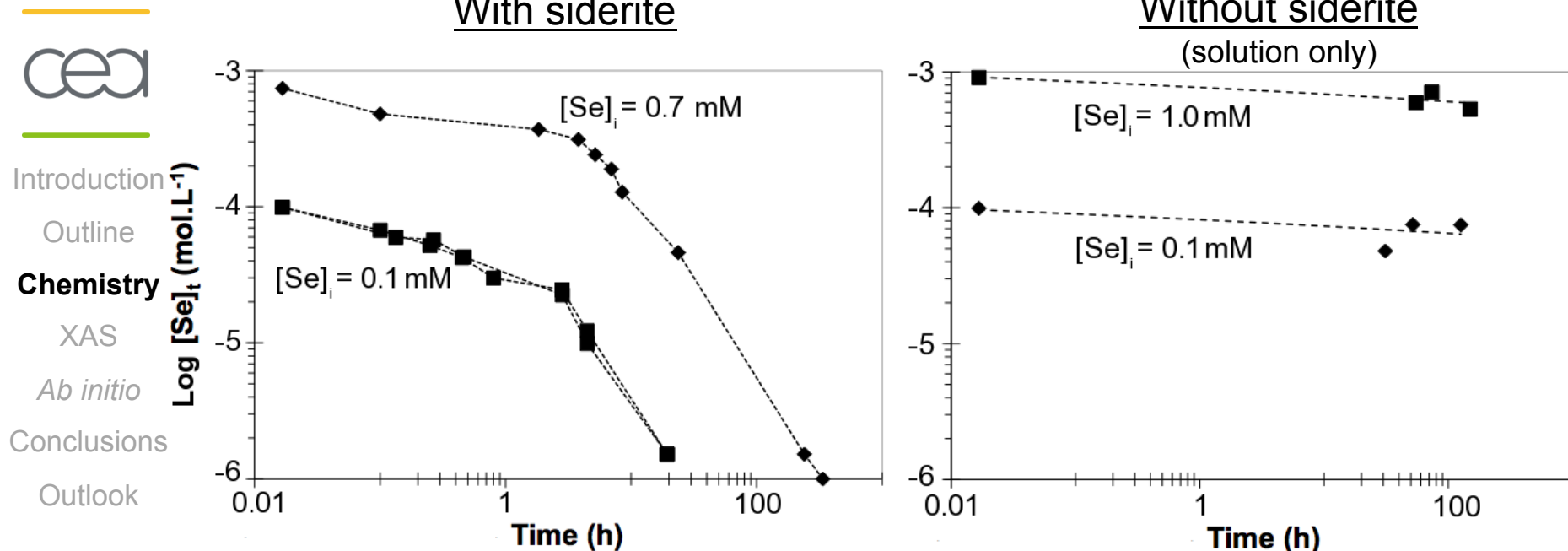

n(Se) immobilized after 100h:

>99 %

≈30 %

>99 %

≈20 %



Siderite is **mainly** responsible of selenite removal

- Introduction
- Outline
- Chemistry**
- XAS
- Ab initio
- Conclusions
- Outlook

Selenite reduction: formation of a new solid phase



Introduction

Outline

Chemistry

XAS

Ab initio

Conclusions

Outlook

Short time (6 h.)

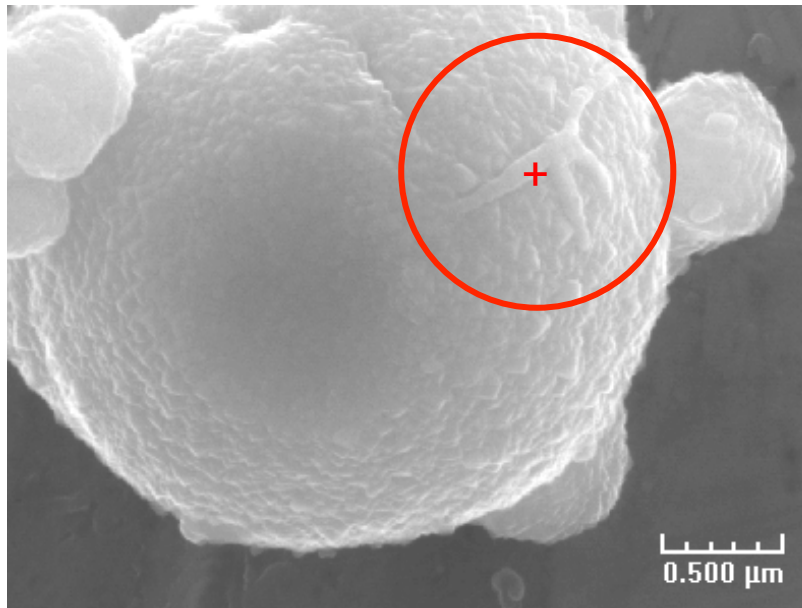

Long time (10 d.)

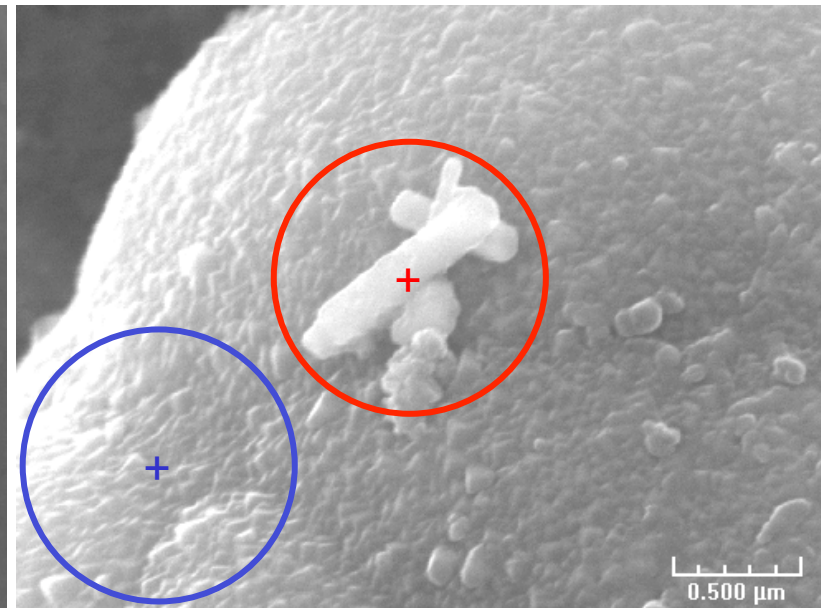

SEM, Secondary electron x40000

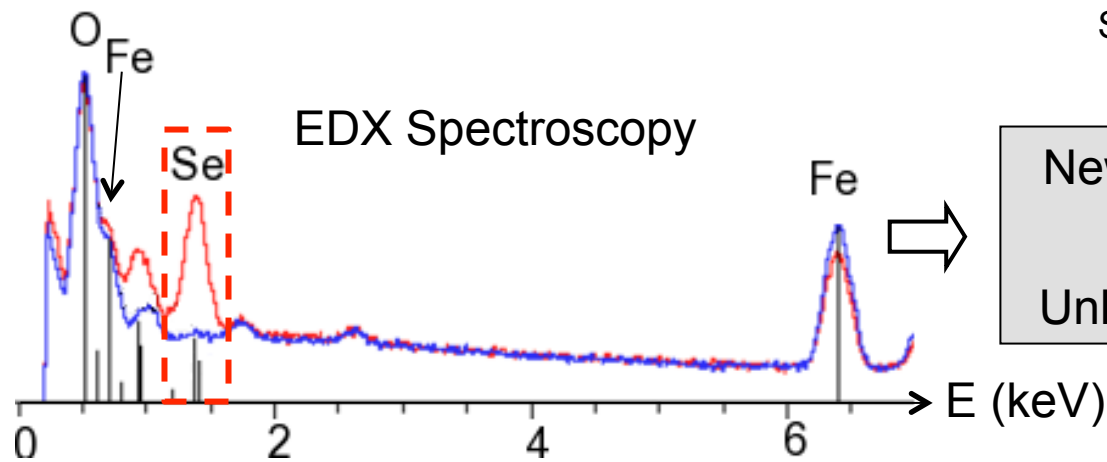

New selenium-bearing solid
-
Unknown exact composition

Se K α edge (12658 eV)



Introduction

Outline

Chemistry

XAS

Ab initio

Conclusions

Outlook

Ex situ

- Wet paste conditioning
- Frozen in N₂
- Measurements in cryostat (N₂/He)
⇒ Solid, low T.

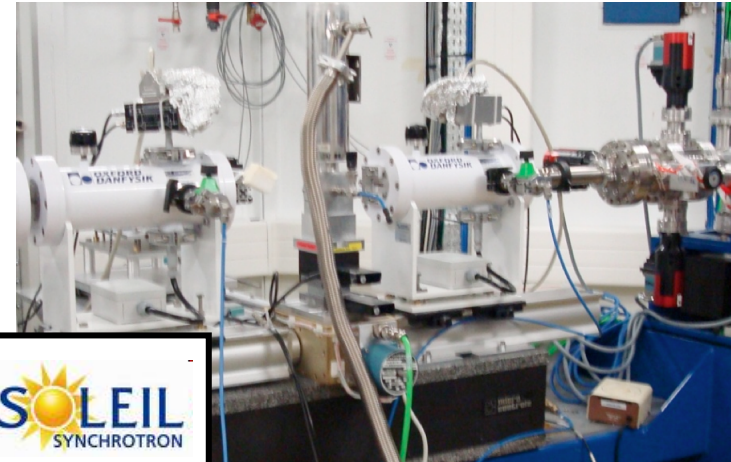

SAMBA @



&

BM29 @



In situ

- In electrochemistry cell
- Imposed redox potential \approx siderite
- On-site selenite injection
⇒ Suspension, ambient T.

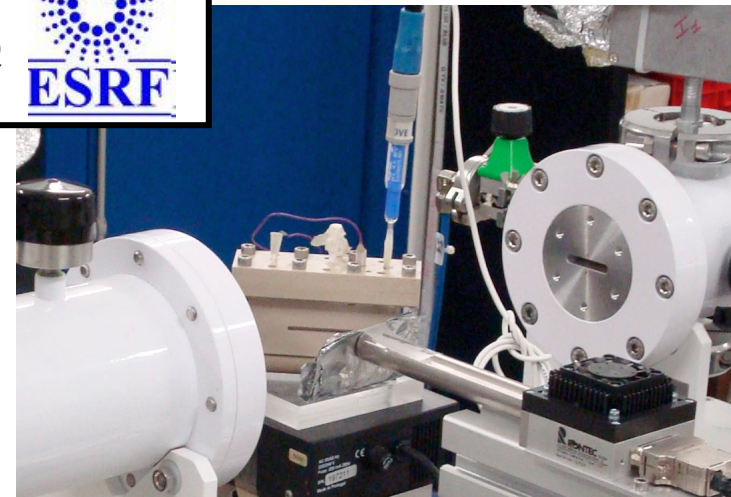

In situ XANES characterization of selenite retention

In electrochemical cell:



Introduction

Outline

Chemistry

XAS

Ab initio

Conclusions

Outlook

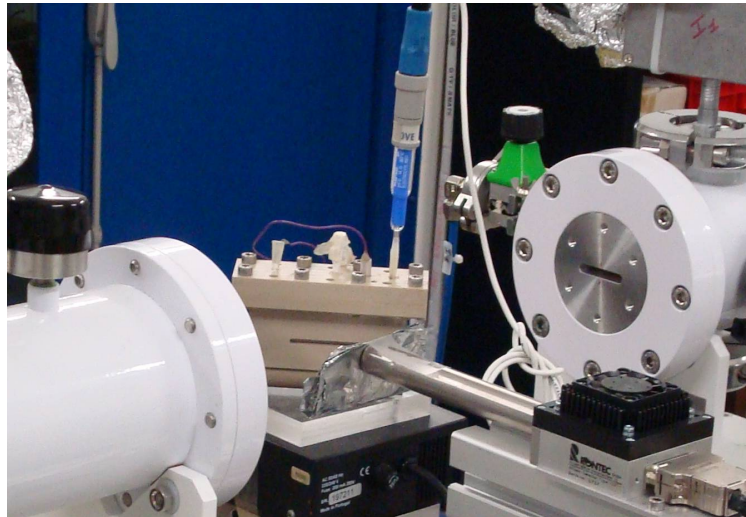

$E = -0.25$ mV/ENH, potentiostatic.
Siderite suspension (70 g.L^{-1})
 $[\text{Se}]_i = 1 \text{ mM}$

Small currents – no electrochemical
selenite reduction

XANES: Se(IV) conversion to Se(≤ 0)

EXAFS: poor signal/noise ratio caused
by low selenium concentration

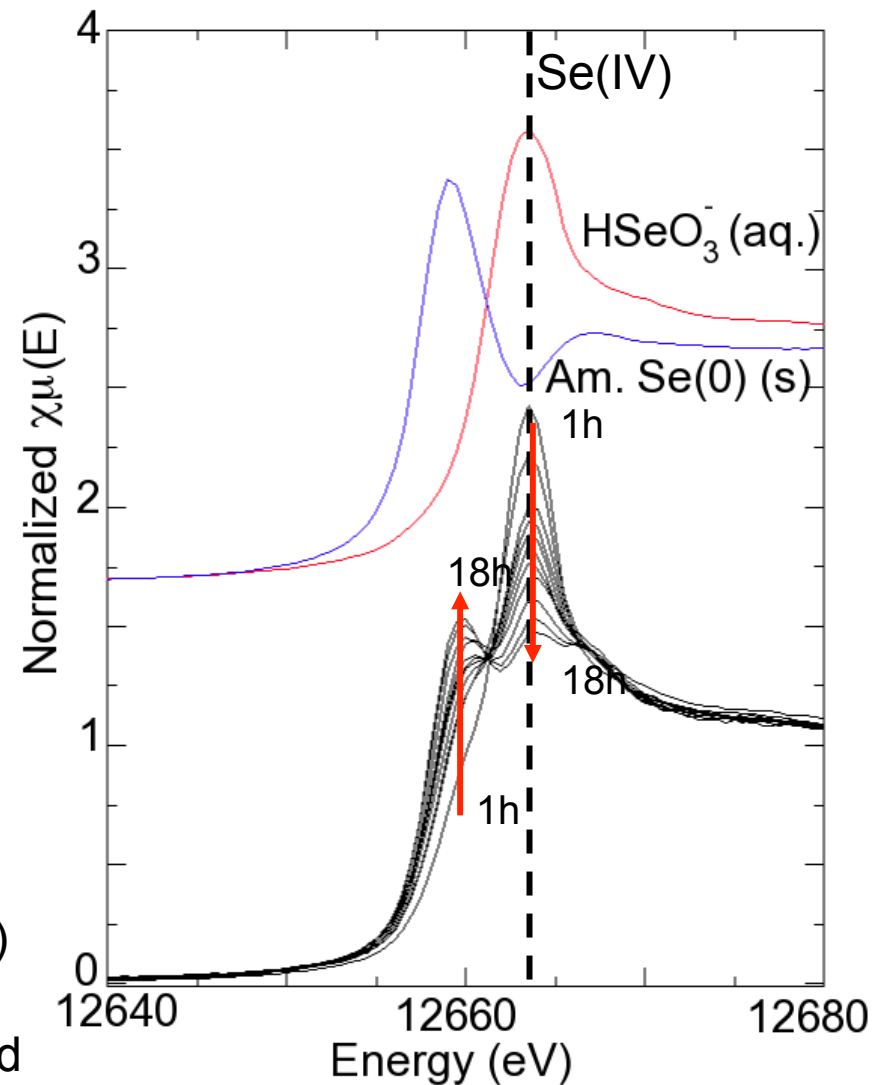

Without siderite
(solution only)

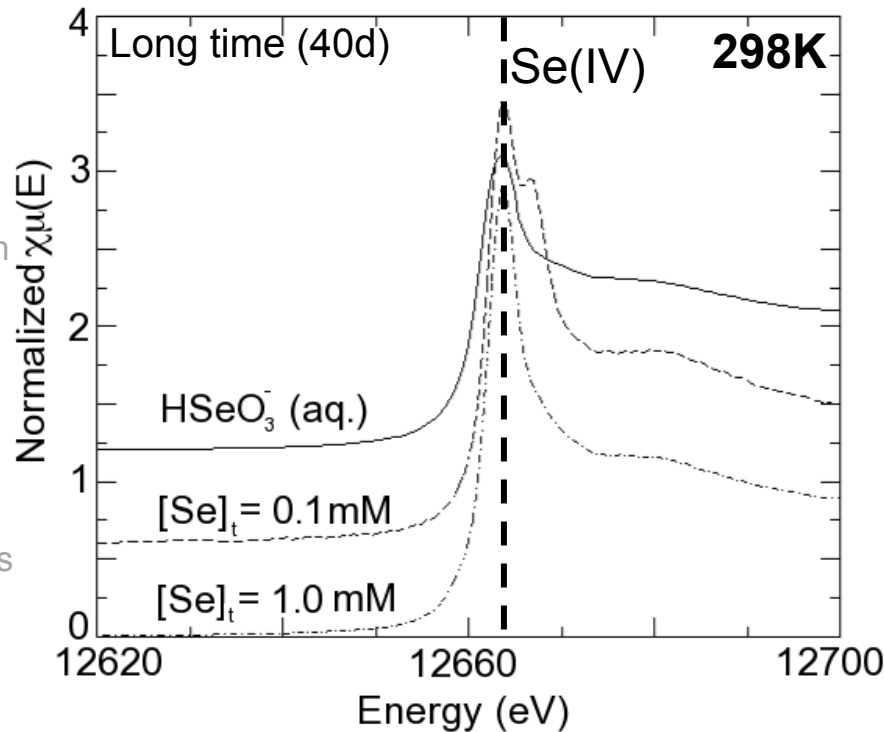

⇒ **No reduction** of selenite after 40 days

Small photo-oxidation (Se^{IV} to Se^{VI})

With siderite

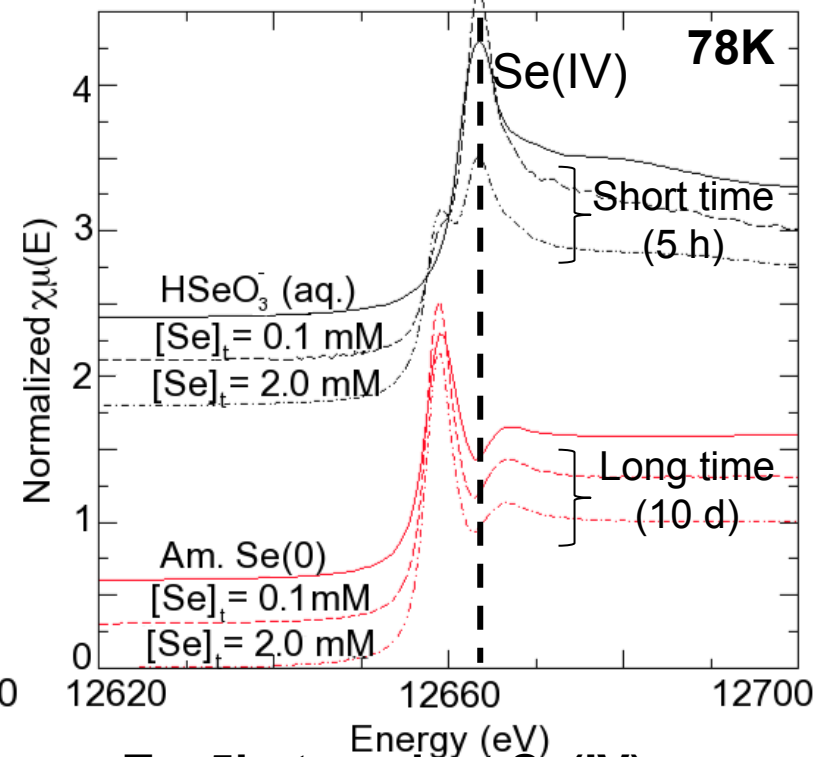

⇒ **T = 5h: transient Se(IV) species** in the solid phase

⇒ **Total reduction** of Se(IV) to Se(0) after 10 days

⇒ **Two different kinetics:** Immobilization/reduction

- Introduction
- Outline
- Chemistry
- XAS**
- Ab initio
- Conclusions
- Outlook

Characterization of end product by *ex situ* EXAFS

- Introduction
- Outline
- Chemistry
- XAS**
- Ab initio
- Conclusions
- Outlook

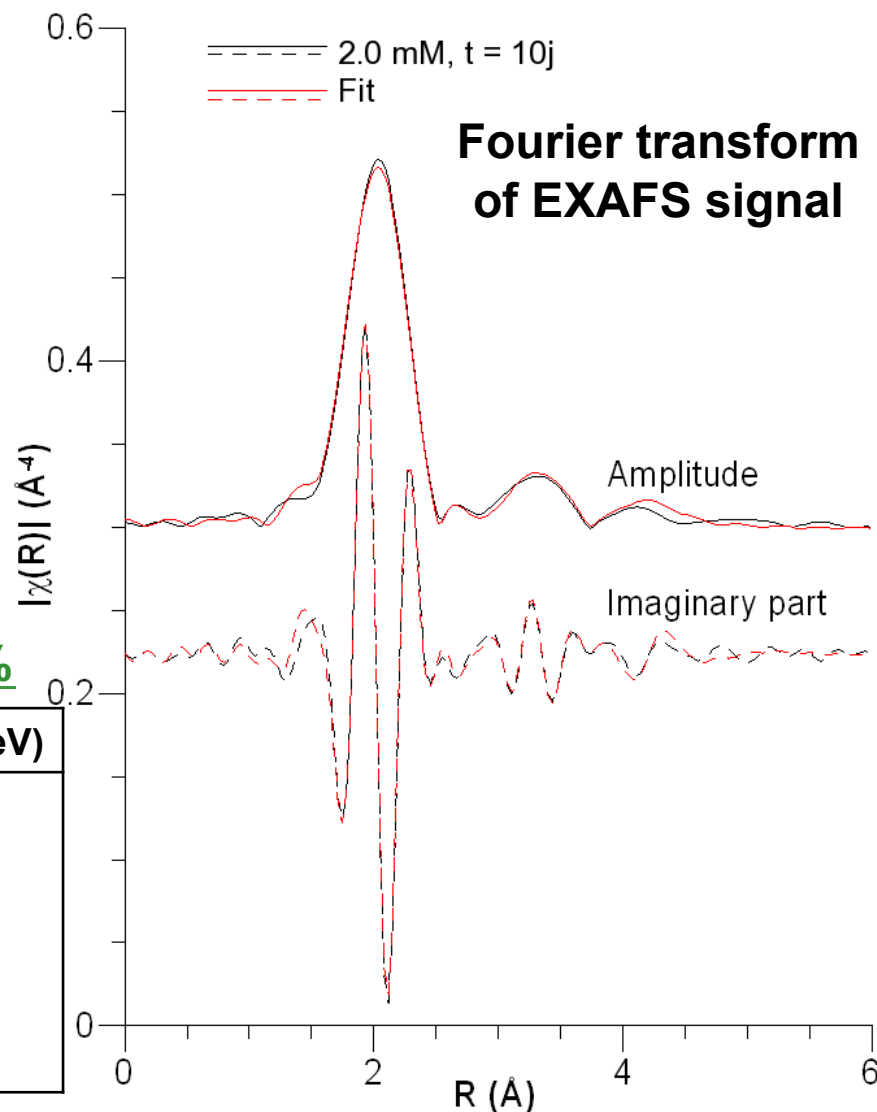
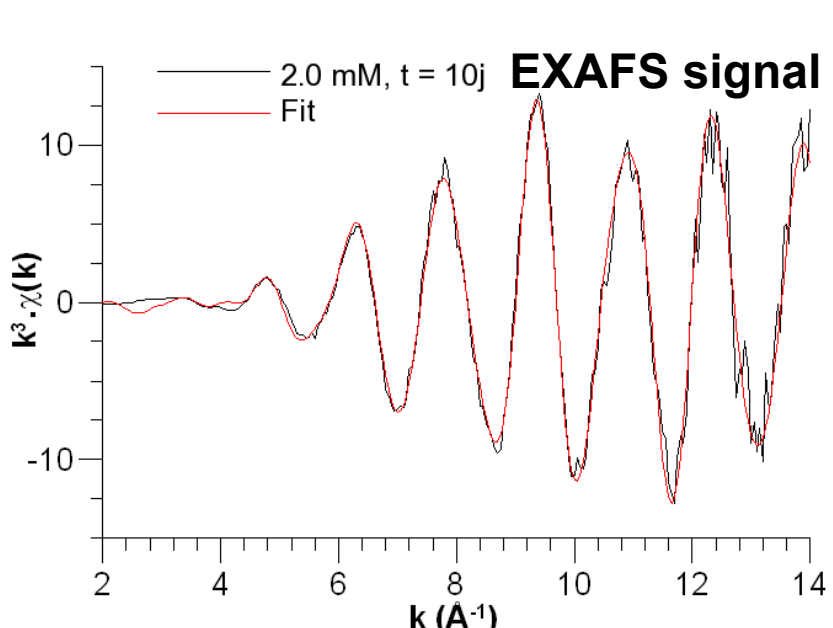

Trigonal (grey) Se⁰ ; R fact. = 0.4 %

S ₀ ²	N x type	R (Å)	σ ² (Å ⁻¹)	ΔE ₀ (eV)
0.98	2 x Se	2.35	0.001	7.5
	4 x Se	3.42	0.016	
	2 x Se	3.67	0.005	
	6 x Se	4.28	0.018	
	4 x Se	4.44	0.015	

Characterization of end product by *ex situ* EXAFS



- Introduction
- Outline
- Chemistry
- XAS**
- Ab initio*
- Conclusions
- Outlook

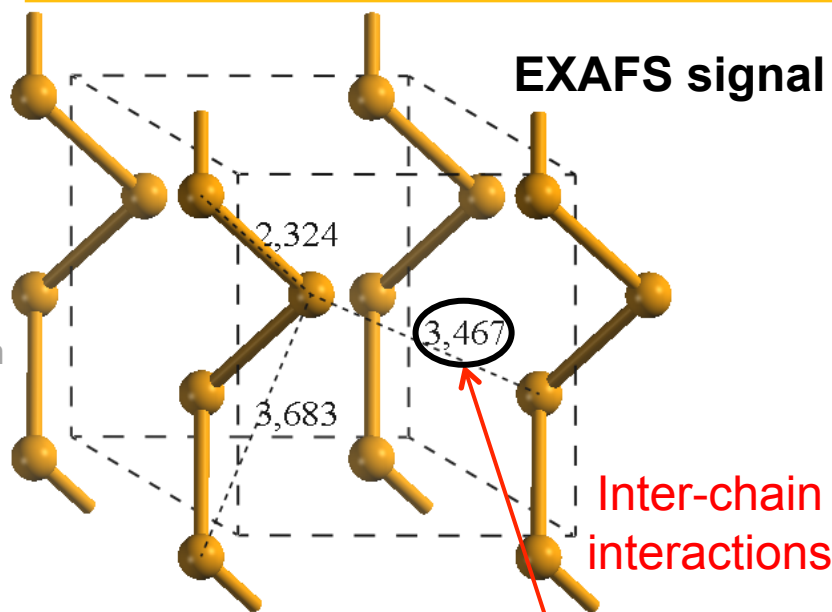

Trigonal (grey) Se⁰ ; R fact. = 0.4 %

S ₀ ²	N x type	R (Å)	σ ² (Å ⁻¹)	ΔE ₀ (eV)
0.98	2 x Se	2.35	0.001	7.5
	4 x Se	3.42	0.016	
	2 x Se	3.67	0.005	
	6 x Se	4.28	0.018	
	4 x Se	4.44	0.015	

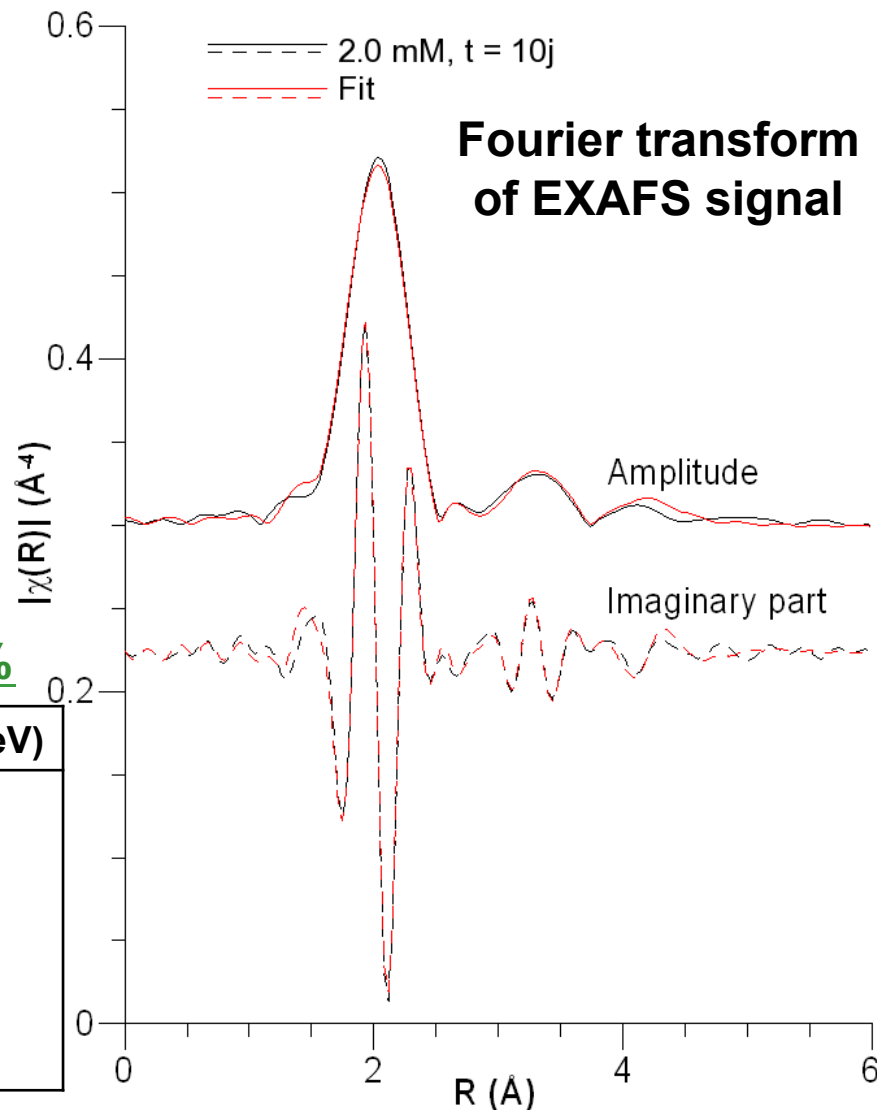

Poorly crystallized trigonal "grey" selenium

Characterization of intermediate Se(IV) species by *ex situ* EXAFS

Se(IV) immobilized in the solid phase at short reaction time



Introduction

Outline

Chemistry

XAS

Ab initio

Conclusions

Outlook

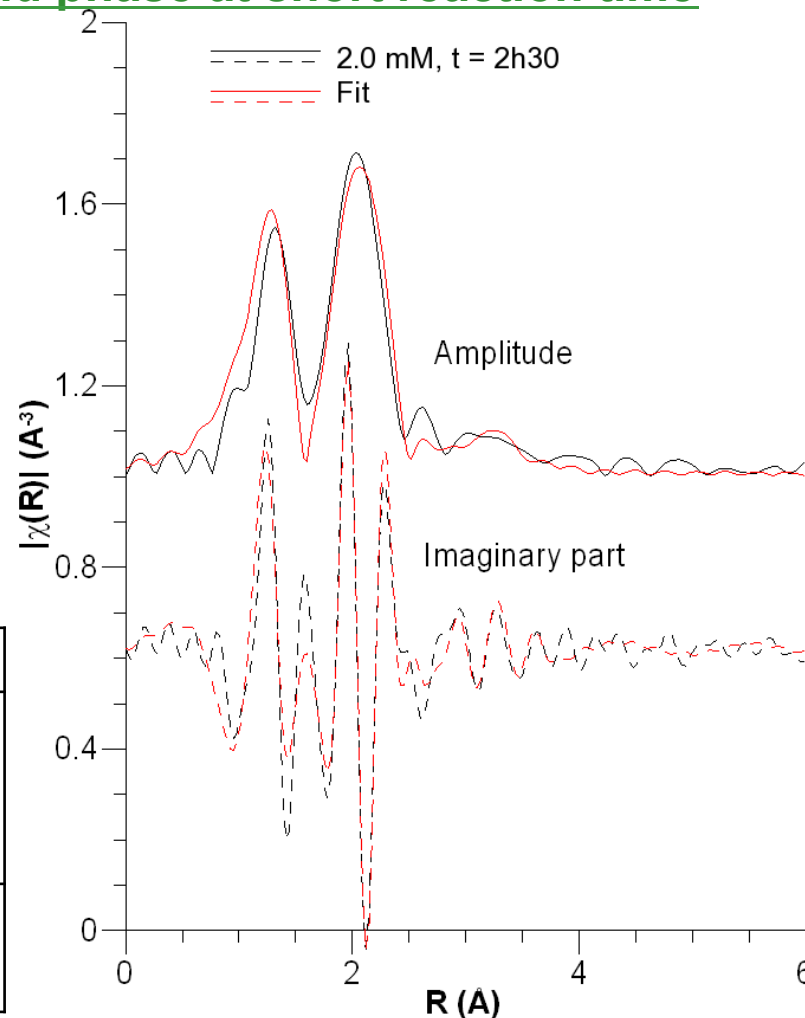
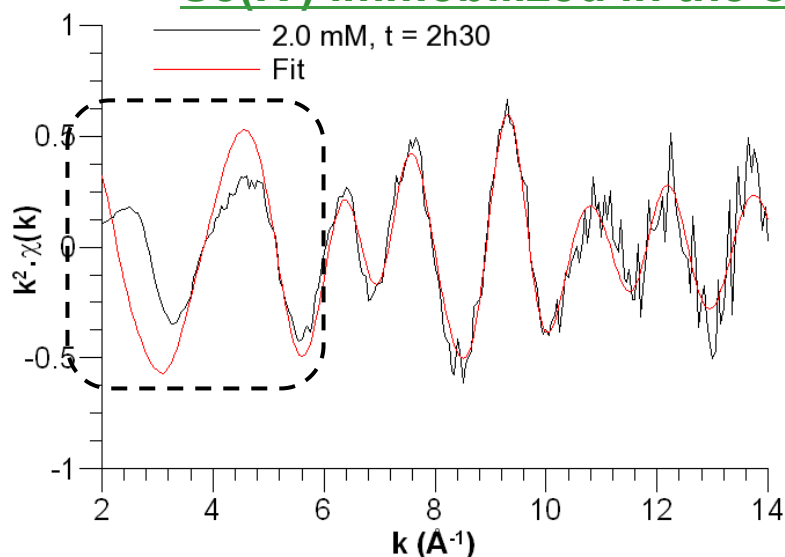

Grey-Se⁰ + SeO₃: R fact. = 6.5 %

Type	N x type	R (Å)	σ ² (Å ⁻¹)	E ₀ (eV)
50 % Se ⁰ (grey)	2 x Se	2.37	0.003	9.2
	4 x Se	3.39	0.017	
	2 x Se	3.69	0.010	
50 % SeO ₃	3 x O	1.70	0.003	4.2
	6 x O-O	3.14	0.008	

Not conclusive enough to point to a specific structural model



Intermediate Se(IV) solid species not identified

DFT modelling of siderite surface complexes: subsystems

-
- cea
-
- Introduction
- Outline
- Chemistry
- XAS
- Ab initio**
- Conclusions
- Outlook

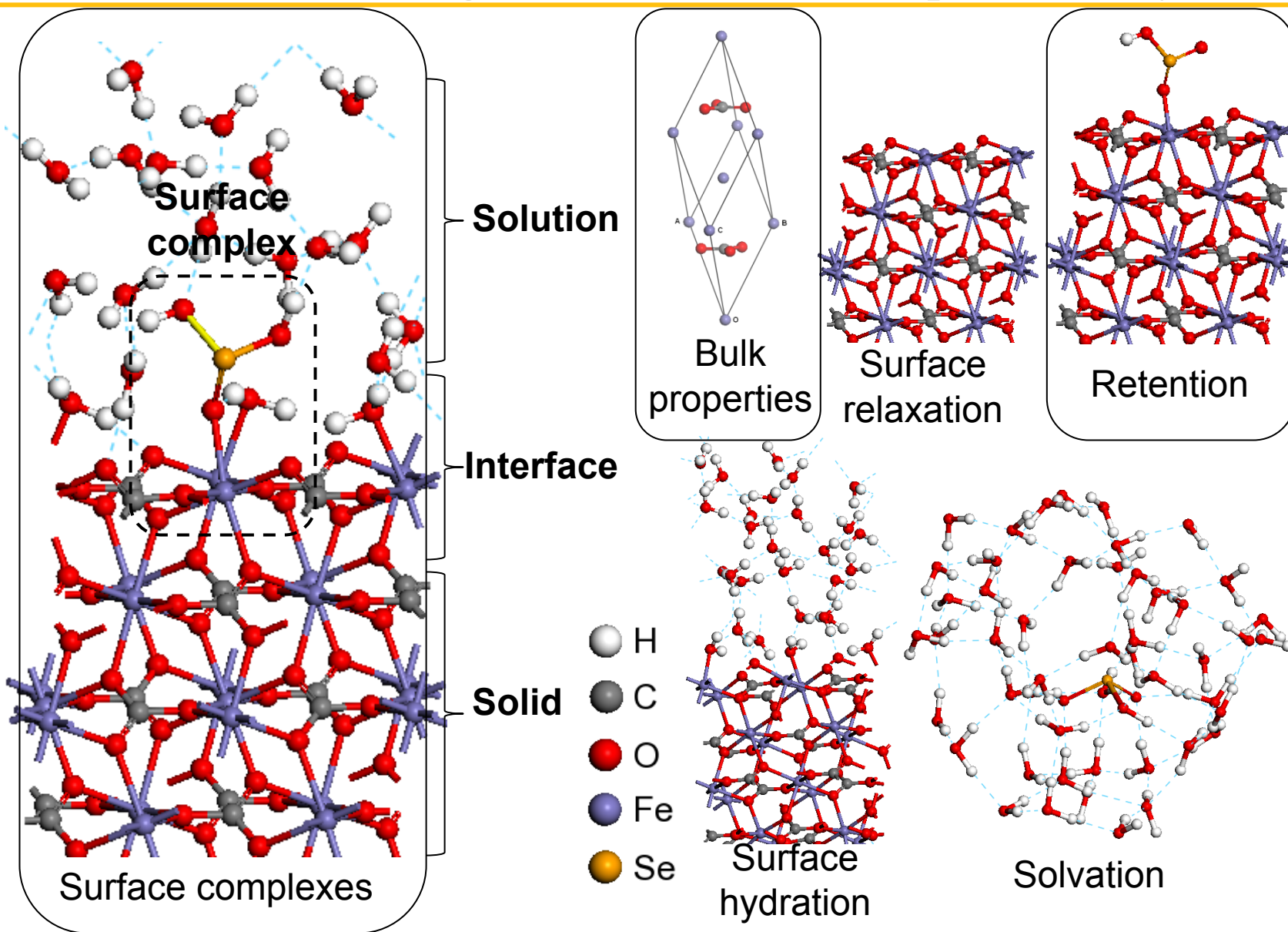

Bulk FeCO₃: electronic structure

Using the crystallographic symmetry operations and the primitive cell:

Structures & Energies: OK. But...



- Introduction
- Outline
- Chemistry
- XAS
- Ab initio**
- Conclusions
- Outlook

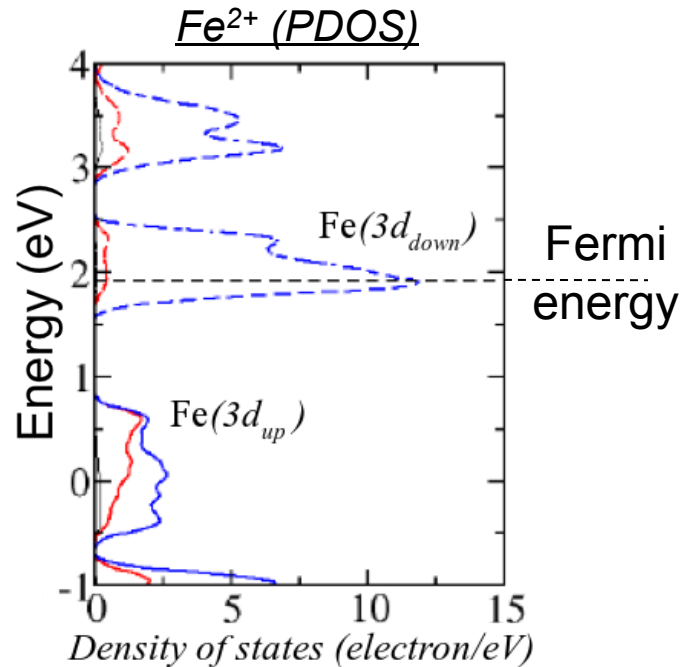

Fermi level DOS $\neq 0$
 \Rightarrow **Metallic ?**

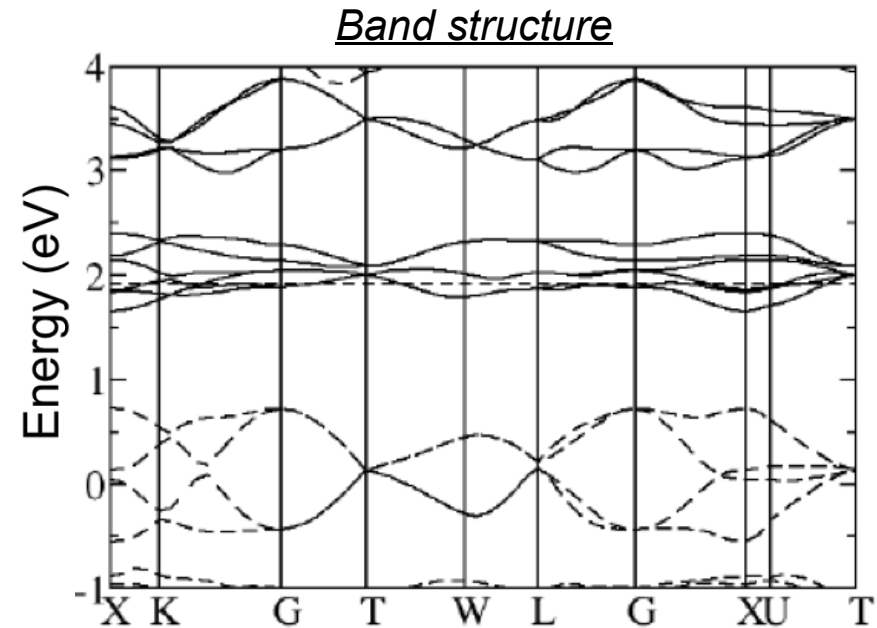

Band sticking near Fermi level
 - caused by **ground state degeneracy**
 - causing « metallic » DOS
 - however, **band dispersion \neq metal**

- Experimentally, siderite is insulating
- Incorrect description of the last (3d⁶) electron ?

This electron is responsible of siderite redox !

Bulk FeCO₃: numerical symmetry effects

Symmetry constraints are reduced when building surfaces



Introduction

Outline

Chemistry

XAS

Ab initio

Conclusions

Outlook

With R $\bar{3}c$ symmetry operations applied on electronic density:

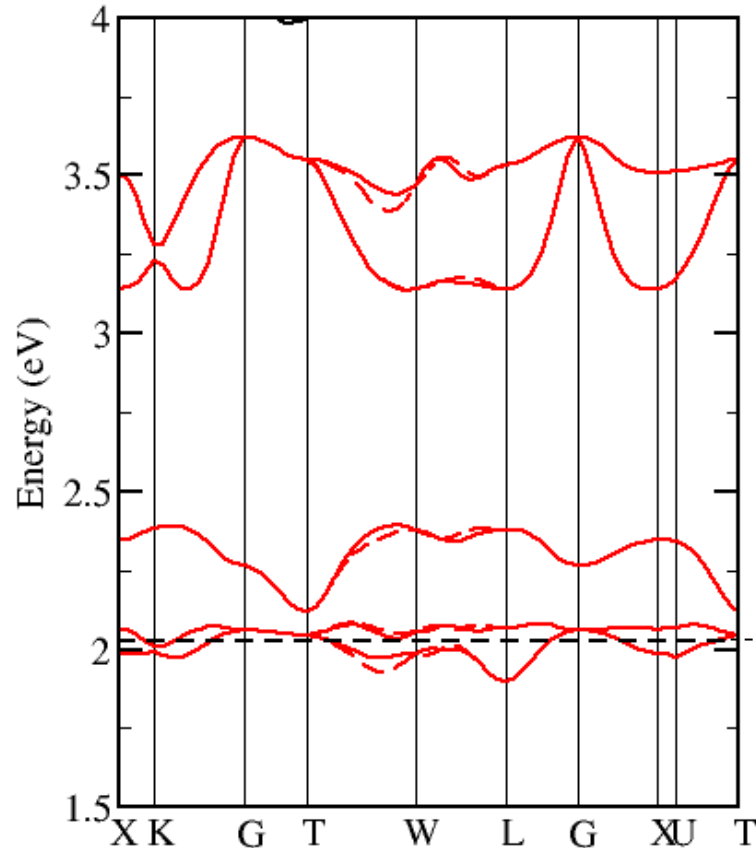

Without any applied symmetry operations (P1):

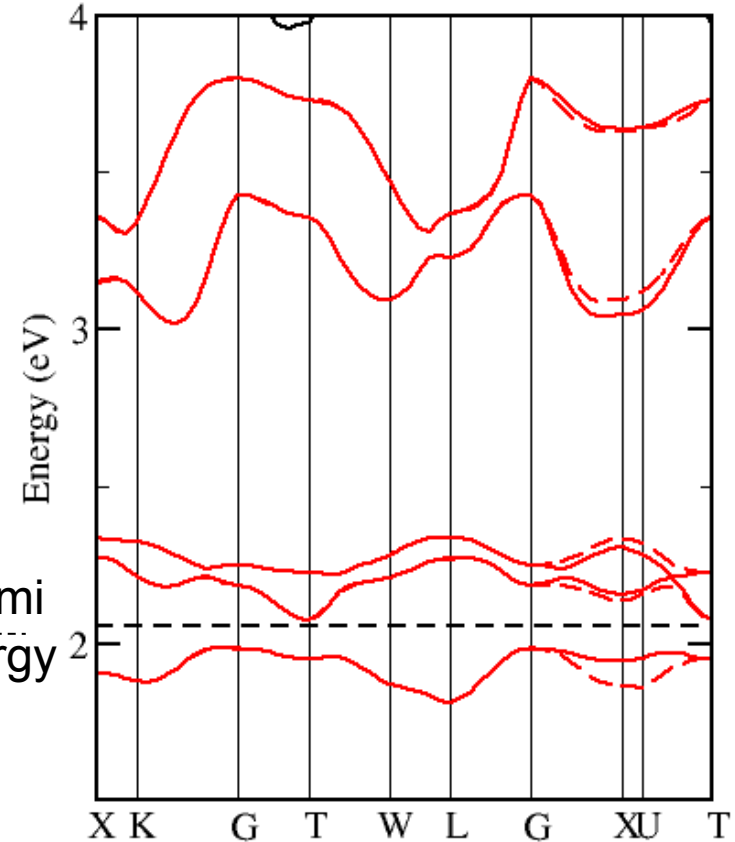

Symmetry constraints are reduced when building surfaces



Introduction

Outline

Chemistry

XAS

Ab initio

Conclusions

Outlook

Iron 3d orbitals
(electronic isodensity surfaces)

C_{3i} sym.

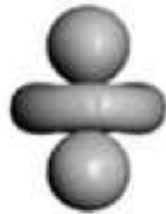

C₁ sym.

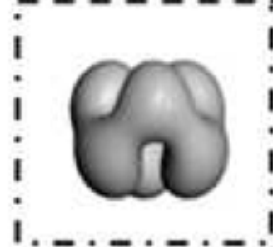
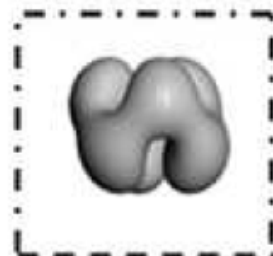

Fermi level

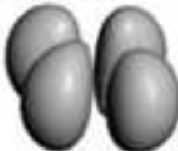

Without any applied symmetry operations (P1):

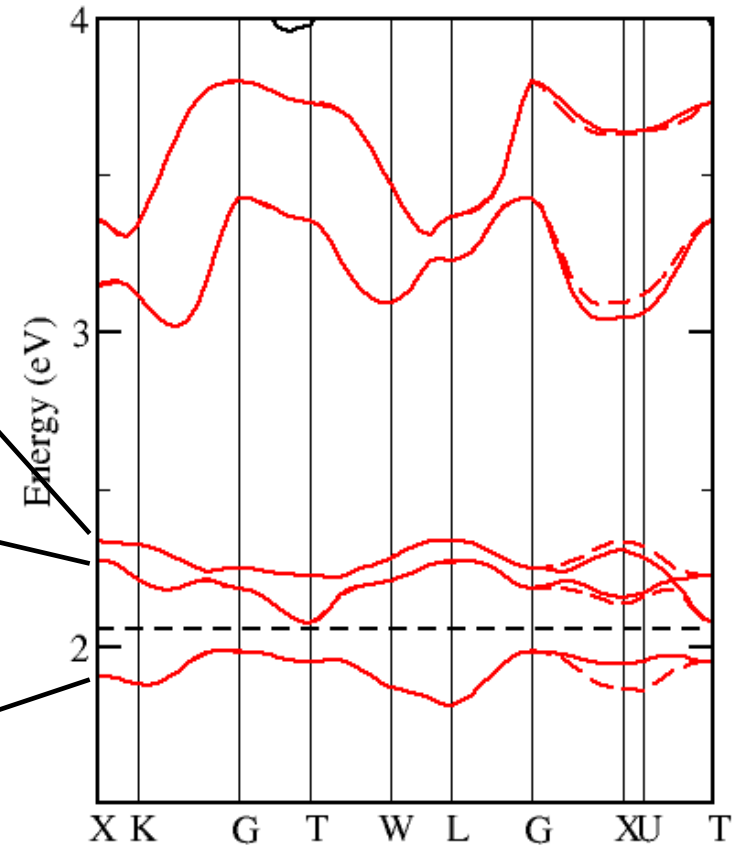

Symmetry constraints are reduced when building surfaces



Introduction

Outline

Chemistry

XAS

Ab initio

Conclusions

Outlook

Iron 3d orbitals
(electronic isodensity surfaces)

C_{3i} sym.

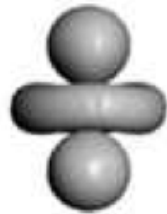

C₁ sym.

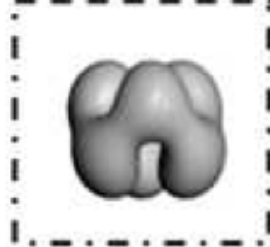
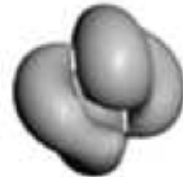
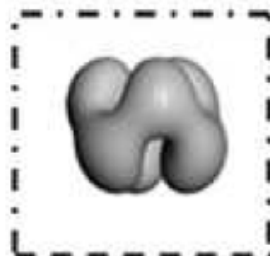

Fermi level

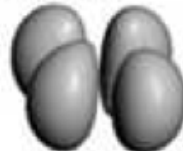

Without any applied symmetry operations (P1):

- Electronic symmetry breaking: density symmetry \neq crystal symmetry
- SCF & geometry optimization convergence issues
- Heavy calculations
- Results are not reproducible
- But there is a (null) gap...

Several almost degenerate pseudo-ground states, causing the convergence issues

Bulk FeCO₃: numerical symmetry independent DFT ground state

The translation operations of the primitive cell are not compatible with the symmetry of the ground state electronic density



DFT ground state: P2₁/a cell

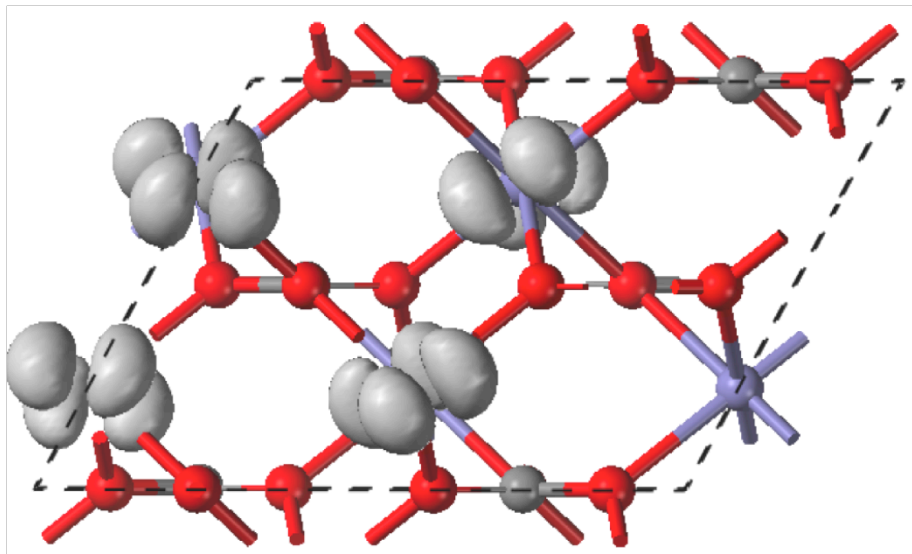

New primitive cell

Orbital ordering

incompatible with the primitive cell (2 Fe/cell)



Energy stabilization
(3 kJ.mol⁻¹)



- Fewer convergence issues
- Insulating
- Minor atomic position differences (<0.01 Å)

Introduction

Outline

Chemistry

XAS

Ab initio

Conclusions

Outlook



Introduction

Outline

Chemistry

XAS

Ab initio

Conclusions

Outlook

On the $(10\bar{1}4)$ perfect surface:

- Non-polar
- Perfect cleavage plane (as in other carbonates)

Using magnesite (MgCO_3) as a calculation intermediate

- Isomorphous with siderite
- In our DFT modelling, $\Delta V(\text{siderite-magnesite}) < 1\%$
- Fewer electrons = quick & easy calculations

1. Speed up the calculation

1. Magnesite geometry optimization
2. $\text{Mg}^{2+}/\text{Fe}^{2+}$ substitution
3. Geometry optimization continuation



$\frac{\text{computational time}}{2}$

2. Direct identification of d electron effects on chemistry

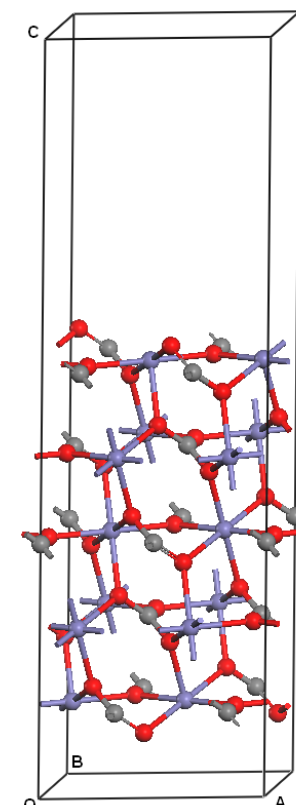

Siderite supercell containing the $(10\bar{1}4)$ perfect surface

H₂O retention on siderite/magnesite (10 $\bar{1}$ 4) perfect surface

Energies expressed as :

$$E_{\text{surface-bond}} = E_{\text{bonded}} - (E_{\text{surface}} + E_{\text{molecule}})$$

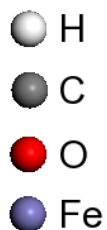
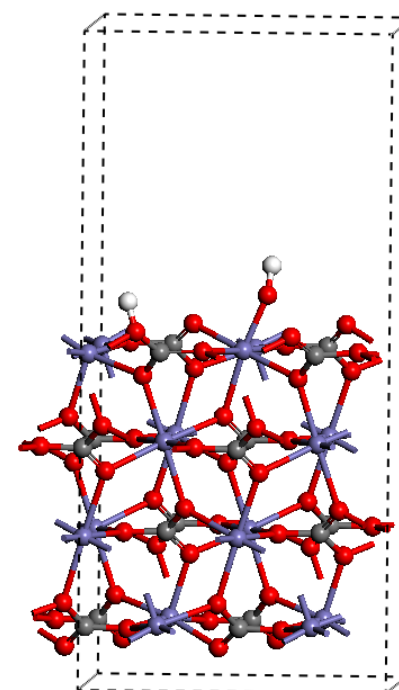
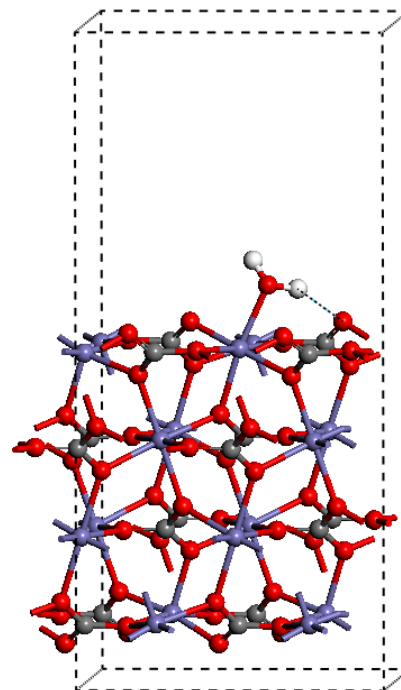
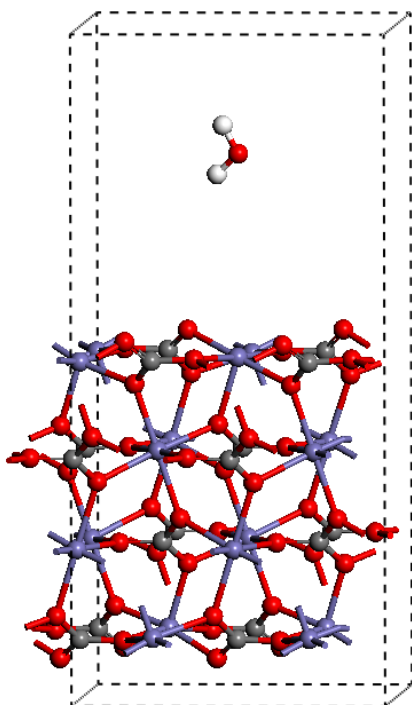
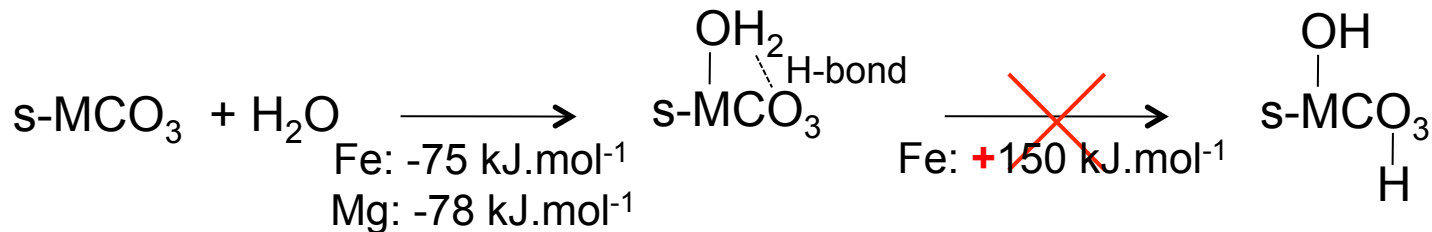

Introduction

Outline

Chemistry

XAS

Ab initio

Conclusions

Outlook

H₂O retention on siderite/magnesite (10 $\bar{1}$ 4) perfect surface

Energies expressed as :

$$E_{\text{surface-bond}} = E_{\text{bonded}} - (E_{\text{surface}} + E_{\text{molecule}})$$

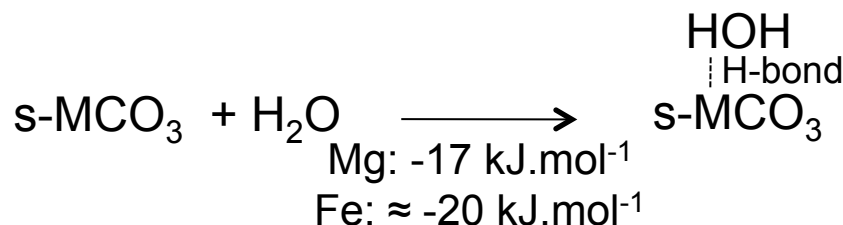
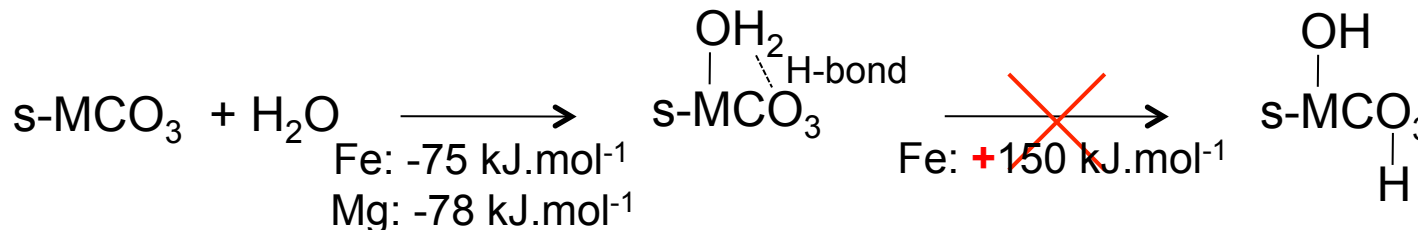

$$E_{\text{surface-bond}} (\equiv \text{Mg-OH}_2) = -61 \text{ kJ.mol}^{-1} \approx E_{\text{hydration}}$$

In both cases:

- Bonding between H₂O and surface through M-O
- Same as with other carbonates (e.g. calcite⁽¹⁾)
- Structural agreement with modelling studies^{(2), (3), (4)}

WRIGHT *et al.* ⁽⁴⁾ : $E_{\text{hydration}}(\text{MgCO}_3) = -60.7 \text{ kJ.mol}^{-1}$

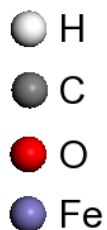
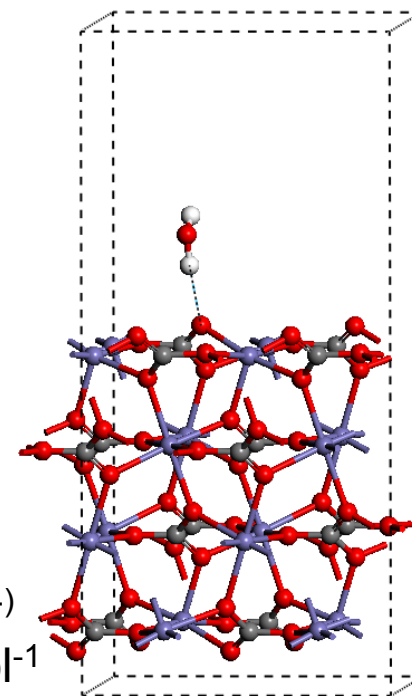

Introduction

Outline

Chemistry

XAS

Ab initio

Conclusions

Outlook

(1) P. FENTER & N. C. STURCHIO (2004). *Progress in Surface Science* **77**, pp. 171 – 258.

(2) S. KERISIT, S. C. PARKER & J. H. HARDING (2003). *Journal of Physical Chemistry B* **107**, pp. 7676 – 7682.

(3) N. H. DE LEEUW & S. C. PARKER (1997). *Journal of the Chemical Society, Faraday Transaction* **93**, pp. 467 – 475.

(4) K. WRIGHT, R. T. CYGAN & B. SLATER (2001). *Physical Chemistry, Chemical Physics* **3**, pp. 839 – 844.

O₂ retention on siderite/magnesite (10 $\bar{1}$ 4) perfect surface



Introduction

Outline

Chemistry

XAS

Ab initio

Conclusions

Outlook

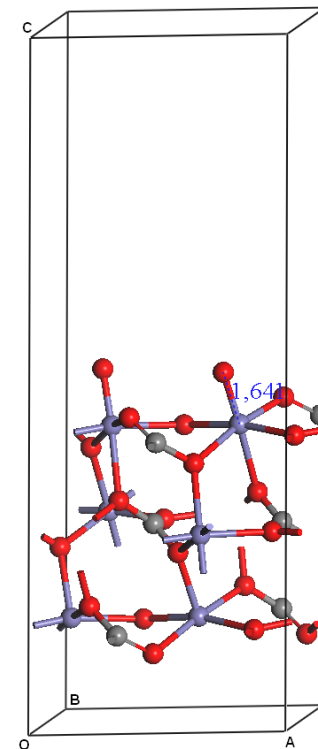
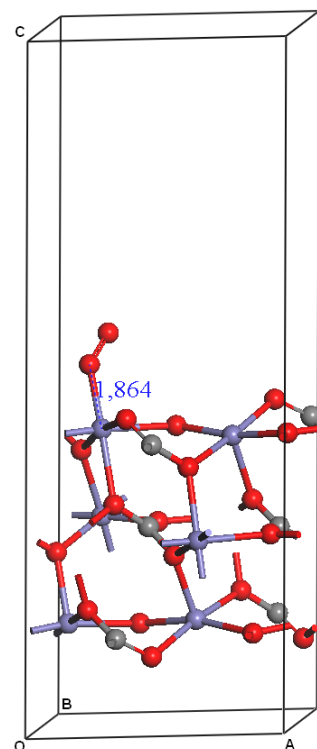
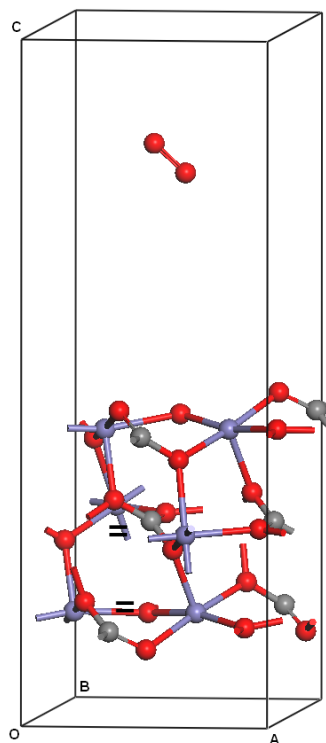
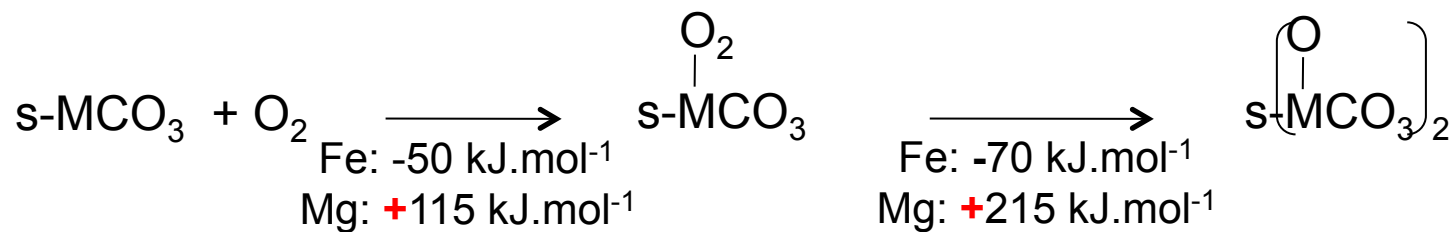
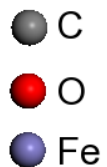

O₂ retention on siderite/magnesite (10 $\bar{1}$ 4) perfect surface

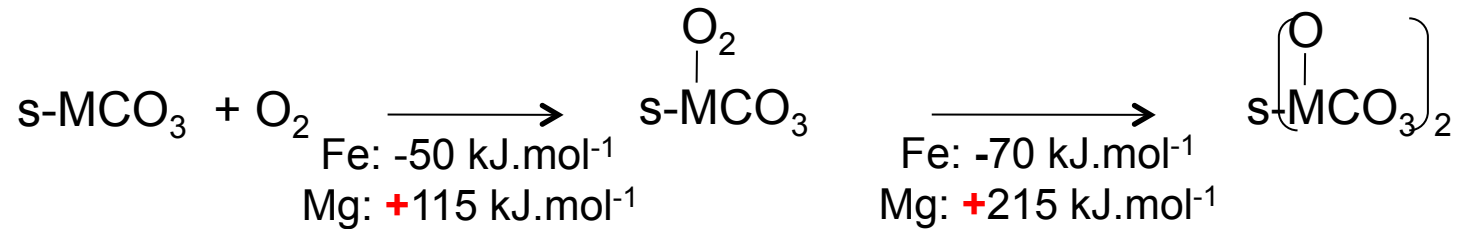

Introduction

Outline

Chemistry

XAS

Ab initio

Conclusions

Outlook

Different behaviours:

- In magnesite, no bonding
- In siderite, dissociative sorption is favoured

	Fe BVM charge
Pure surface	2,0
$\equiv\text{Fe-O}_2$ bond	2,4
$\equiv\text{Fe-O}$ bond	3,2

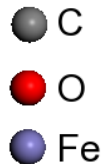

Covalent
Fe – O
bond

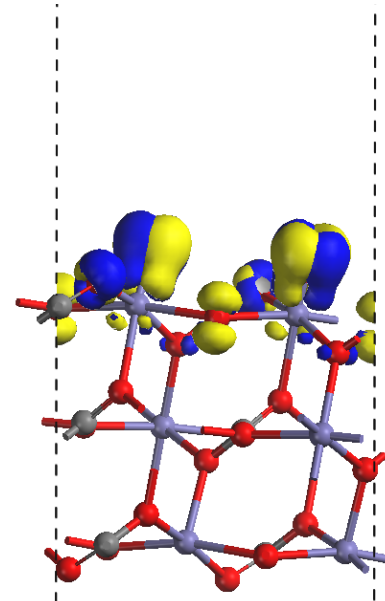

In presence of oxygen, siderite oxidizes/magnesite does not.
DFT results in agreement with elementary chemistry

Selenite surface complexes on magnesite perfect surface. (1) without H₂O

Selenite surface complexes on magnesite:



Case 1: Surface anion substitution

$$E_{\text{bonding}}(\text{AS}) = -17 \text{ kJ.mol}^{-1}$$

Case 2: Bidentate surface complex

$$E_{\text{bond}}(\text{BSC}) = -48 \text{ kJ.mol}^{-1}$$

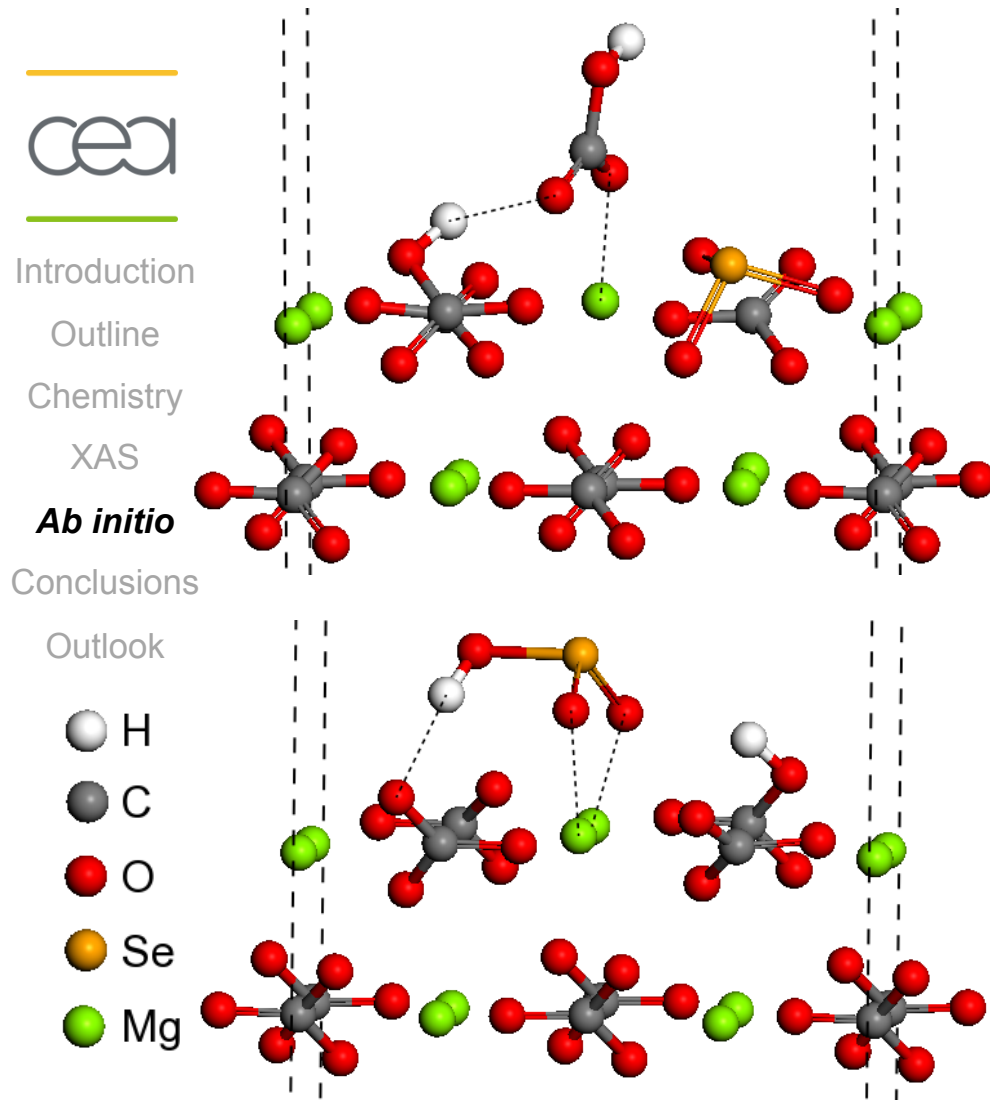

Is BSC the most stable?

Selenite surface complexes on magnesite perfect surface. (1) without H₂O



Introduction

Outline

Chemistry

XAS

Ab initio

Conclusions

Outlook

● H

● C

● O

● Se

● Mg

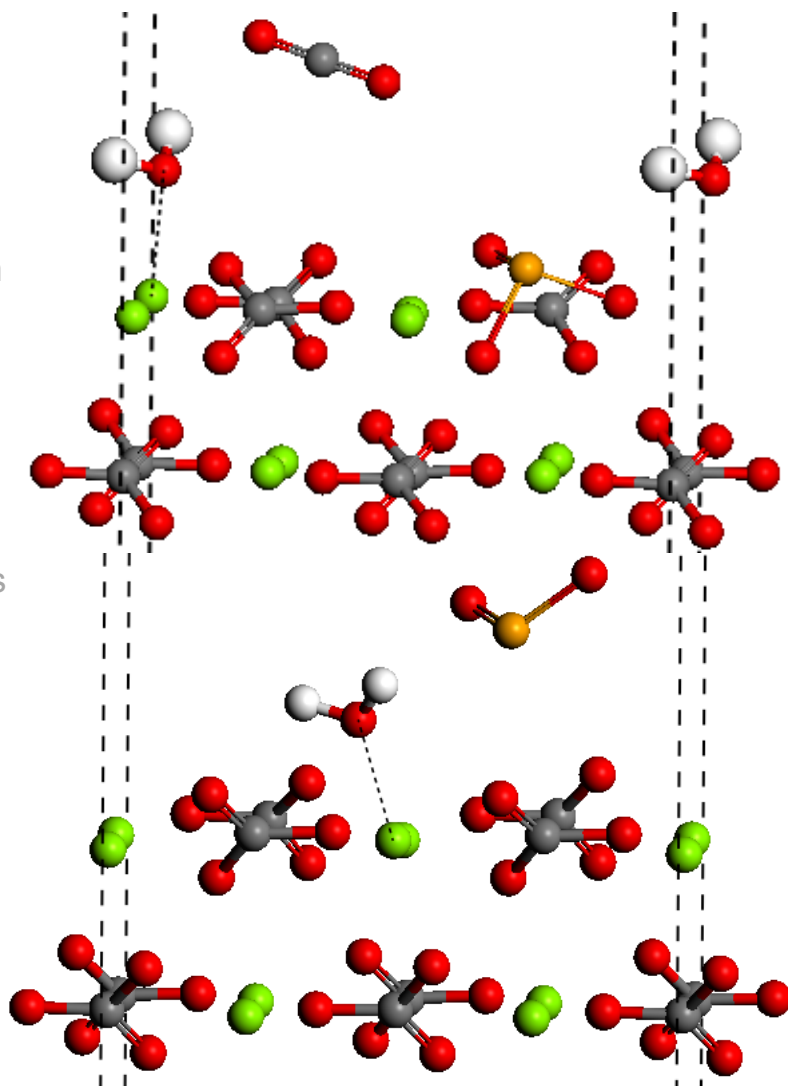

Selenite surface complexes on magnesite:



Case 1: Surface anion substitution

$$E_{\text{bonding}}(\text{AS}) = -17 \text{ kJ.mol}^{-1}$$

Overcoming an activation barrier

$$E_{\text{bonding}}(\text{BSC}') = -63 \text{ kJ.mol}^{-1}$$

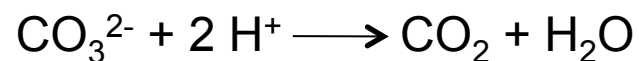

Case 2: Bidentate surface complex

$$E_{\text{bond}}(\text{BSC}) = -48 \text{ kJ.mol}^{-1}$$

Overcoming an activation barrier

$$E_{\text{bonding}}(\text{AS}') = -51 \text{ kJ.mol}^{-1}$$

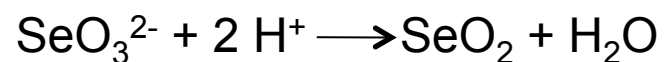

Hydration should stabilize selenite/carbonate anions

Selenite surface complex on magnesite perfect surface. (1) with H₂O

Hydrated selenite surface complexes: which one is the most stable ?

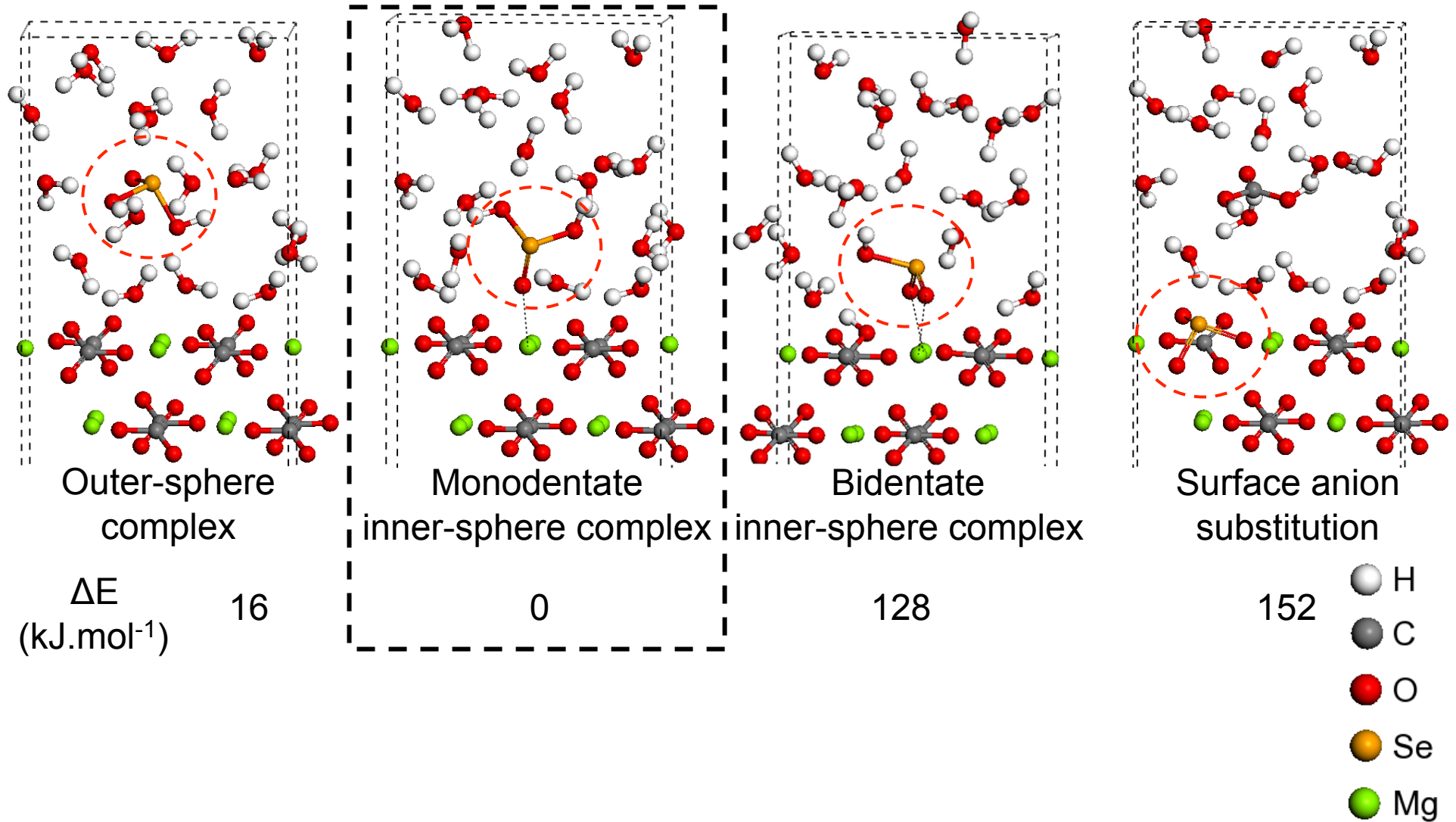

Selenite surface complex on magnesite perfect surface. (1) with H₂O

Hydrated selenite surface complexes: which one is the most stable ?

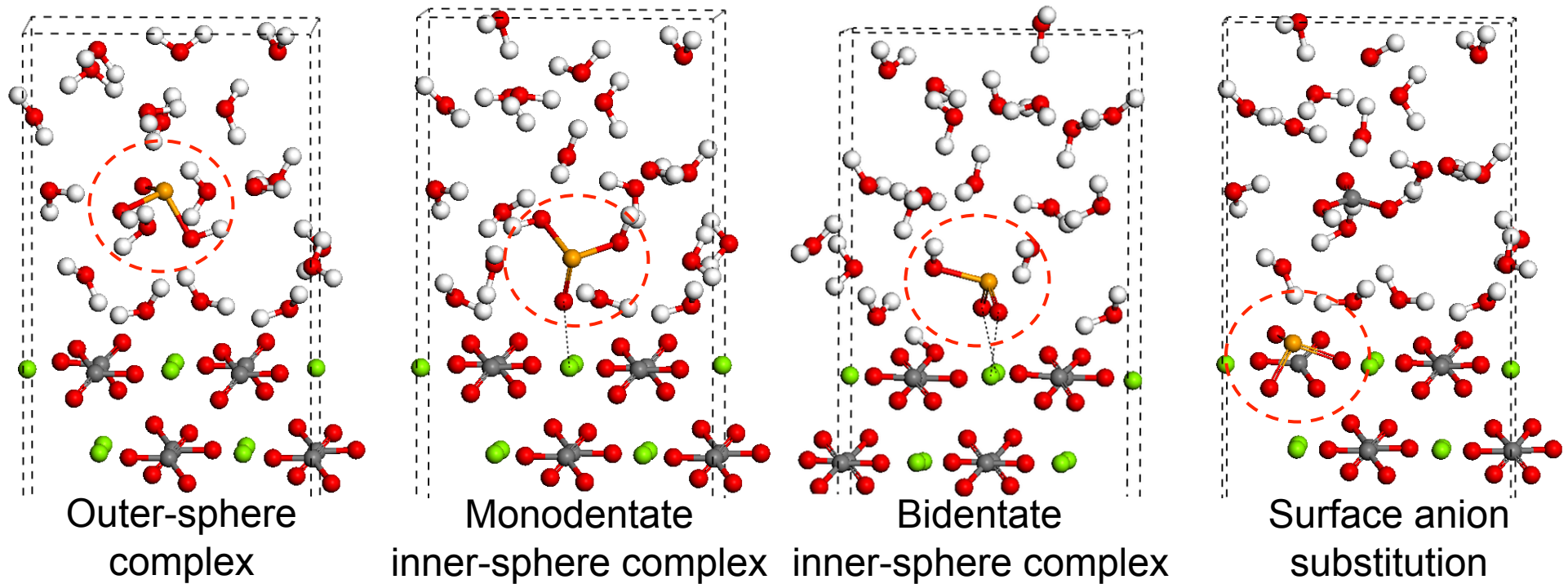

ΔE (kJ.mol⁻¹) 16 *Which one is the most stable ?* 0

128

152
↓
127

- H
- C
- O
- Se
- Mg

After moving one H₂O and geometry optimization: $\Delta E = 25$ kJ.mol⁻¹

⇒ Extremely constrained water network.
Representativity of a single calculation ?



Introduction

Outline

Chemistry

XAS

Ab initio

Conclusions

Outlook

Conclusions

Quantitative retention and reduction of selenite by siderite:

- retention is quantitative for $t > 24$ h
- reduction is quantitative for $t < 10$ j
- Reduction product is identified as **poorly crystallized trigonal Se⁰ (grey)**
- Intermediate Se(IV) solid species were **observed but not characterized**

} Distinct kinetics

Oral communications at *Goldschmidt '09* & *EXAFS 14* conferences ; V. Badaut, M.L. Schlegel, M. Descostes, P. Zeller & G. Moutiers (2009). Selenite and Selenate Reduction by Siderite: in situ and ex situ XAS Experiments. *Geochimica & Cosmochimica Acta*, **73** (13) A67.

DFT ground state of siderite:

- DFT ground state electronic density is not compatible with crystalline symmetry
- New primitive cell with orbital ordering

Oral communication at *Réunion générale du GDR-DFT++* (2009).

V. Badaut, P. Zeller, B. Dorado & M.L. Schlegel. Symmetry and properties of siderite according to density functional theory. *Submitted to Physical Review B*.

DFT modelling of properties on siderite surfaces:

- Simple surface phenomenon correctly described (water retention, oxydation)
- First selenite retention study *on magnesite* showed hydration is needed for ion stability

Long way to go for surface complexes modelling on *siderite*



Introduction

Outline

Chemistry

XAS

Ab initio

Conclusions

Outlook

Selenite contribution to repository radiotoxicity should be low
immobilized as sparingly soluble Se^0 in the canister's corrosion layer

To confirm it :

Could these results be extrapolated to **lower** selenium concentration ?

Role of **surface defects** on reactivity ?

Effect of **competing ions** ?

(DFT)

Passage from **static 0 K** results to **macroscopic repository** conditions ?



Thanks to:

M. Ruffoni, M. Vacari (BM29, ESRF)

S. Belin, E. Fonda (SAMBA, SOLEIL)

H. Badji, C. Blanc, L. Salmon (LRSI, CEA)

J-L. Flèche and all the team (LM2T, CEA)

B. Grenut (L3MR, CEA)

Support from GDR PARIS & GDR DFT ++

L'association MAIOT

&

Les amis et la famille pour leur soutien



Crystal Field Theory applied to siderite

- Hexagonal crystal ($R\bar{3}c$, 167), rhomboedrical primitive cell
- Octahedral FeO_6 compressed along (111) $\rightarrow C_{3i}$

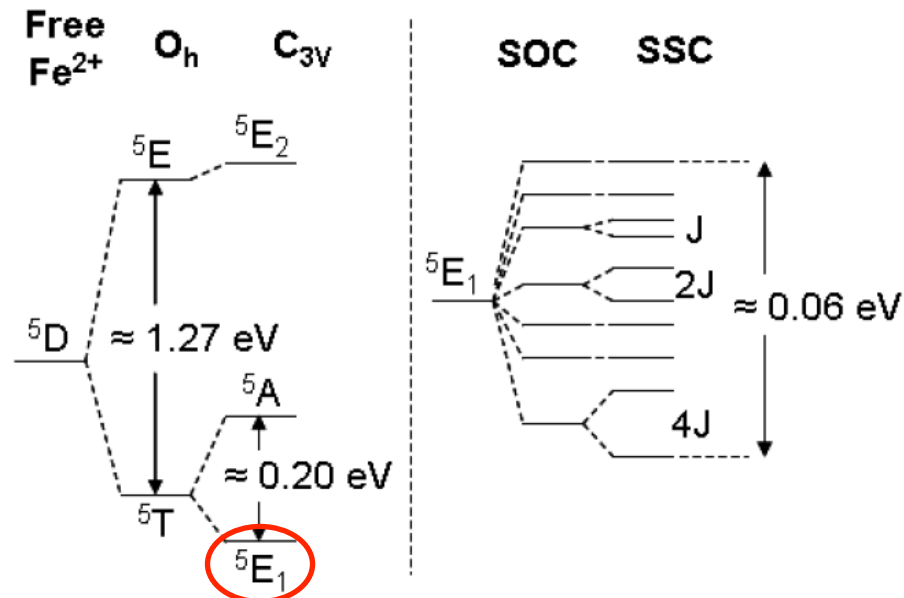

State degeneracy of free Fe^{2+} in siderite crystal field ^{1,2}

Without CSO, ground state degeneracy

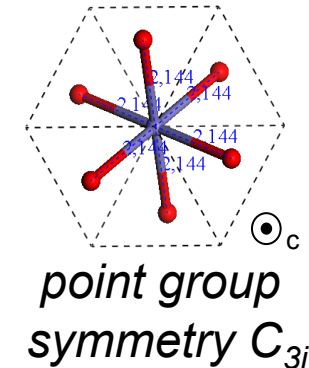
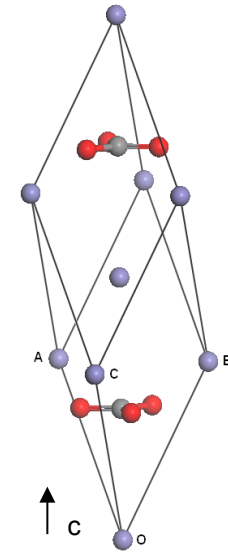

¹ Kanamori, J. *Progress of Theoretical Physics*. 1958, **20** (6), 890 – 908

² Yi-Yang, Z. & Chung-Hao, Y. *Phys. Rev. B*. 1993, **47** (9), 5451 - 5454

Population of the *d* states of Fe²⁺ :

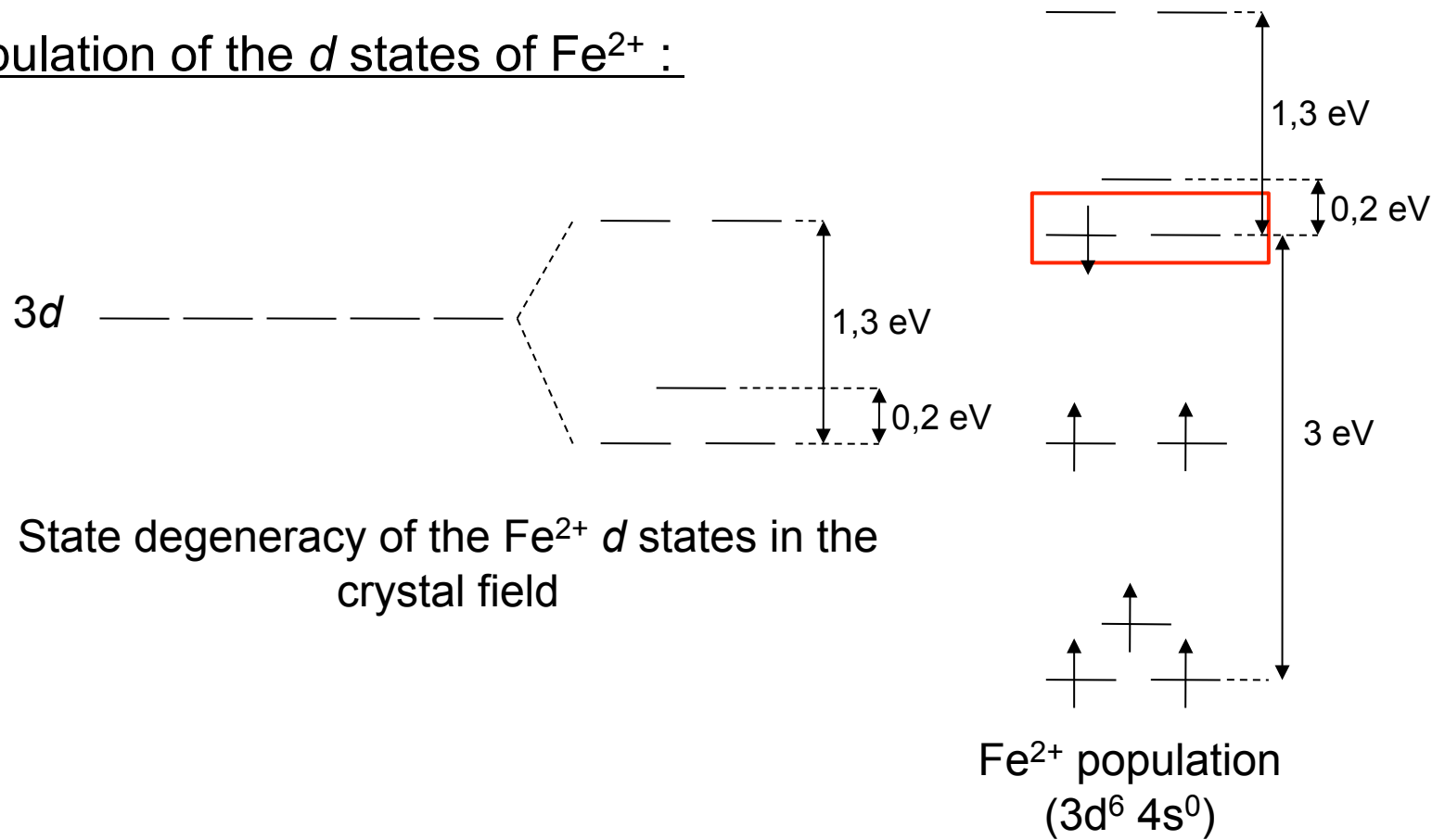

State degeneracy of the Fe²⁺ *d* states in the crystal field

Last occupied level: **ion degeneracy**

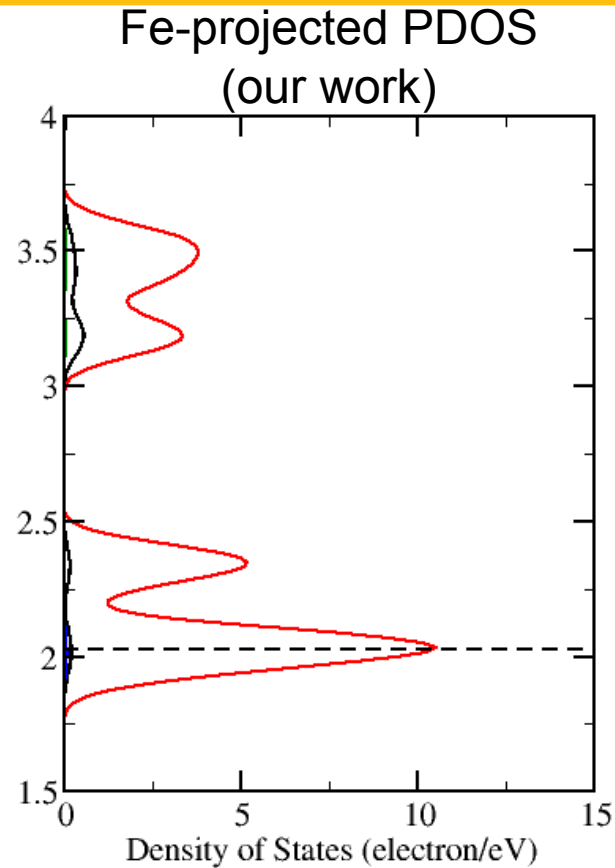
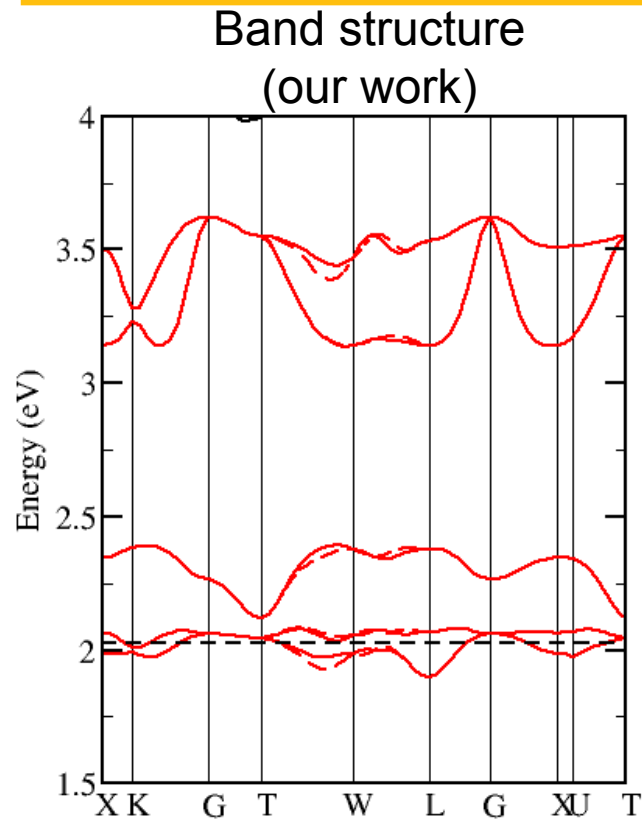

Monoelectronic iron 3d states in CFT¹

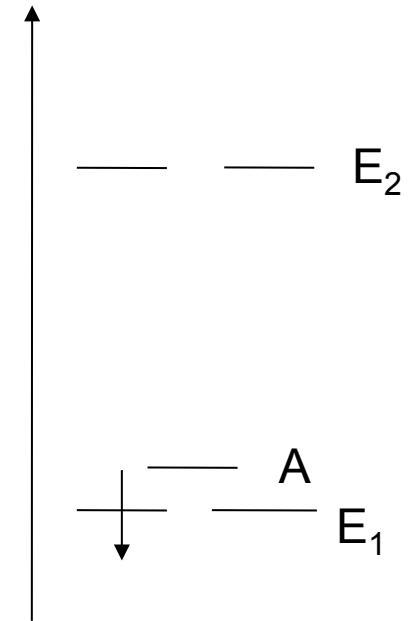

- Good energetic agreement between DFT-GGA and crystal field theory
- Siderite Fundamental state degeneracy in DFT is caused by the monoelectronic states degeneracy in Fe²⁺ (⇨ metallic ?)

¹Yi-Yang, Z. & Chung-Hao, Y. *Phys. Rev. B.* 1993, **47** (9), 5451 - 5454

Full band structure & Iron PDOS in siderite with 167 symmetry

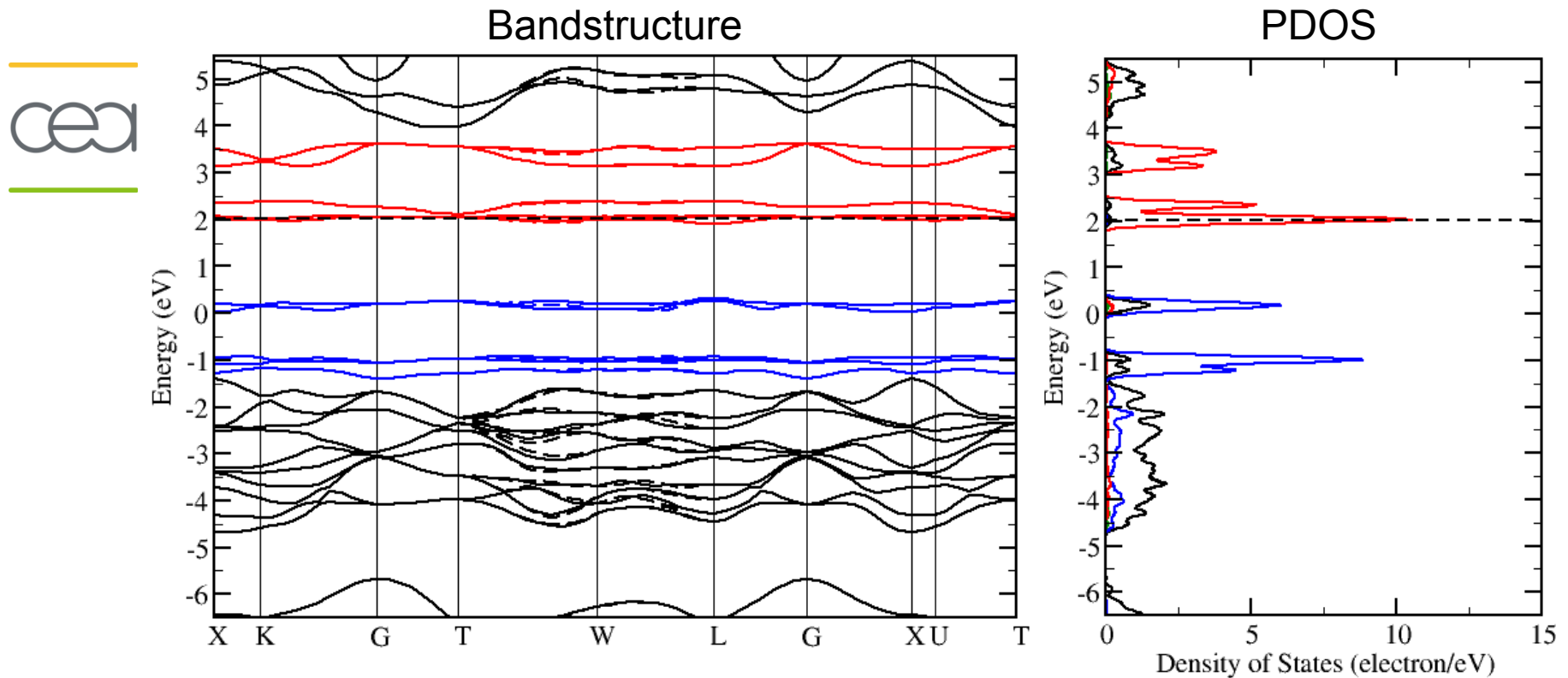

- Fermi level: iron 3d states
- Flat bands: localized states – ionic type
- In blue and red : projection of the d states of majority spins and minority spins of the iron on a localized basis set