

Summary of the report to obtain HDR

Contribution to the design and the modelling
of mechatronic systems (and their mechanical
subsystems)

Wilfrid Marquis-Favre

January 3, 2007

Preamble

This report is organized as follows. Chapter 1 is of Curriculum Vitae that summarizes my research, teaching and administrative activities. Chapter 2 entitled "Activity report since my nomination" is a report of my research projects, of my teaching activity and of my administrative charge in a more detailed presentation. Chapter 3 entitled "Developments of research activities" is fully devoted to the technical presentation of my main research studies during eight years. It shows how these works have progressively moved from a 'postdoctoral' context with studies in the continuity of my Ph. D. thesis to a real will to animate a research axis by proposing new subjects in our laboratory. During the in-between period I appropriated the tools and the methodologies of this research axis. Chapter 4 "Conclusion and perspectives" conclude this report and give a number of research propositions for pursuing the engaged works. Finally, appendices summarize my scientific productions, my participation to the scientific community and contract activity, and the most significative productions.

Contents

1	Curriculum Vitae	5
1.1	Research activities	5
1.2	Teaching activities	7
1.3	Administrative activities	7
2	Activity report since my nomination	9
2.1	Research activities	9
2.1.1	Positioning	9
2.1.2	Developments on the <i>Virtual prototyping</i> axis	13
2.1.3	Developments on the <i>Mechatronics modelling</i> axis	13
2.1.4	Supervision	13
2.1.5	Responsibility	14
2.2	Teaching activities	14
2.2.1	Teaching report	14
2.2.2	Module description	14
2.2.3	Pedagogical publications	14
2.2.4	Supervision of End of Studies Projects, work experience and foreign students (graduate studies)	14
2.3	Administrative activities	14
2.4	Conclusion	14
3	Presentation of research activities	15
3.1	Mechatronic modelling in multibody mechanics and vehicle dynamics	15
3.1.1	Planar mechanical component library for AMESim	16
3.1.1.1	Introduction	16
3.1.1.2	Developments presentation	16
3.1.1.3	Conclusion	16
3.1.2	Automotive vehicle models	17
3.1.2.1	Introduction	17
3.1.2.2	Full vehicle model	17
3.1.2.3	Vehicle in parking model	17
3.1.2.4	Conclusion	19
3.1.3	Multibody bond graph representation of a suspension	19
3.1.3.1	Introduction	19
3.1.3.2	Pseudo Mc Pherson suspension model	20
3.1.3.3	Conclusion	20
3.1.4	Modelling of the tire sliding phenomenon	21
3.1.4.1	Introduction	21
3.1.4.2	Tire description	25
3.1.4.3	Global models	25
3.1.4.4	Proposed model	25
3.1.4.5	Conclusion	35
3.2	Contribution to the sizing methodology	36
3.2.1	Recall on the sizing methodology	36

3.2.1.1	Introduction	36
3.2.1.2	Methodology presentation	37
3.2.1.3	MS1 and application example	37
3.2.2	Sizing methodology extension	42
3.2.2.1	Introduction	42
3.2.2.2	Motivations for extending the methodology	42
3.2.2.3	Power steering constraint concept	42
3.2.2.4	Behavior constraint concept	42
3.2.2.5	Concept of synergy or global sizing	43
3.2.2.6	Conclusion	45
3.2.3	Actuation line structures	46
3.2.3.1	Introduction	46
3.2.3.2	Actuation structure classification	46
3.2.3.3	Conclusion	49
3.3	Introduction of optimization in the sizing methodology	50
3.3.1	Bond graph representation of an optimization problem	51
3.3.1.1	Introduction	51
3.3.1.2	Procedure for building an optimization problem bond graph	51
3.3.1.3	Methods and algorithms for optimization	51
3.3.1.4	Toward numerical simulation	52
3.3.1.5	Conclusion	52
3.3.2	Minimization problem of the output to specified trajectory distances	52
3.3.2.1	Introduction	52
3.3.2.2	Conclusion	52
4	Conclusion and perspectives	55
4.1	General report	55
4.2	Actions under progress	56
4.2.1	Software transfer: MS1 specifications	56
4.2.1.1	For the sizing methodology	56
4.2.1.2	Modelica code translator	56
4.2.2	Methodology developments	56
4.2.2.1	METISSE project	56
4.2.2.2	SIMPA2 project	56
4.2.2.3	Collaboration with Volvo Powertrain	56
4.2.2.4	Flexible robot design for laparoscopy	56
4.3	Perspectives	57
4.3.1	Of research	57
4.3.1.1	... on the axis <i>Mechatronics modelling</i>	57
4.3.1.2	... on the axis <i>Virtual prototyping</i>	57
4.3.1.3	... on the axis <i>Control</i>	60
4.3.1.4	Submitted projects	60
4.3.2	of teaching	61
4.3.3	of responsibilities	61
A	Scientific publications	65
B	Participation to community and contract activity	69
C	Significant productions	73

Chapter 1

Curriculum Vitae

Assistant Professor (nominated the 1st of September 1998) in the Laboratoire d'Automatique Industrielle -LAI- (Industrial Automation Laboratory) of the Institut National des Sciences Appliquées of Lyon -INSA de Lyon- (National Institute of Applied Sciences of Lyon).

Ph. D. thesis in Industrial Automation: 1994-1997

Thesis at LAI of INSA de Lyon (Dir. Pr. Serge Scavarda).

Engineering degree: 1992

Mechanical Engineering Department, INSA de Lyon.

1.1 Research activities

Responsibility and project participations

Local: In charge of the research axis *Virtual Prototyping* of the Fluidtronics team and later the Fluid power, Transport and Robotics team -FTR- of LAI (since 2003).

Regional:

- Setting up and animation of a group in the area of Lyon for a reflection on modelling and simulation of pluridisciplinary physical systems using bond graph language (1999-2003).
- Participation to a regional project (2001-2003), topic Modelling and Control of Complex Dynamic Systems.

National:

- Member of the reviewer board of the national journey LMCS (Logiciels pour la Modélisation et le Calcul Scientifique -Software tools for Modelling and Scientific Calculus-) of the 30th of November at the University Center Léonard de Vinci and co-organized by IFP (Institut Français du Pétrole -French Institute of Petroleum-) and the University Léonard de Vinci.
- In charge for the LAI of the project SimPA2 (Simulation pour le Procédé et l'Automatique 2 - Simulation for Process and Control 2-) in the ANR-RNTL framework (Agence National de la Recherche-Réseau National des Technologies Logicielles -Research National Agency-National Network of Software Technologies-). Subventions: 103k€ inclusive of tax. Duration: 3 years. Ph. D. student recruiting.
- In charge for the LAI of the METISSE project (Méthodes numériques et Techniques Informatiques pour la Simulation et la Synthèse en Environnement -Numerical Methods and Computer Techniques for Simulation and Synthesis in Environment-) in the framework of RNTL and in this project, responsible for a sub-project. Subventions: 132k€ exclusive of tax. 2 post-doctorat researcher recruiting.

- Development of a planar mechanics component library (commercialization in 2004) for software AMESim (Imagine Society).
- Participation to the program PREDIT 2, topic Design-Manufacturing in collaboration with PSA Peugeot Citroën society.

International :

- Member of the scientific board of the automation international school of Lille (France, 2000): Bond graph methodology.
- Specifications of software MS1 developed by Francis Lorenz (Belgium).

Project submissions:

- Project submission for the Research Cluster *Transport, Territoires et Société* (Transport, Territories and Society) of Rhône-Alpes Region.
- Participation to a project submission for the Competitiveness center *Lyon Urban Trucks&Bus 2015* and managed by the LAMCOS (Laboratoire de Mécanique des Contact et des Systèmes -Laboratory of Contact and Systems Mechanics-).
- Participation to the submission of a Program Multi-Education managed by the CETHIL (Centre de Thermique de Lyon -Center of Thermal Sciences of Lyon).

Supervision

- 2 post-doctorats under way [26, 27, 38]¹.
- 4 Ph.D. theses in co-supervision (50%) (one of which defended the 13th of February 2003 and 3 under way) [6, 17, 20, 21, 24, 26, 27].
- Student trainings of postgraduate certificate students (3 of which in co-supervision at 50%).

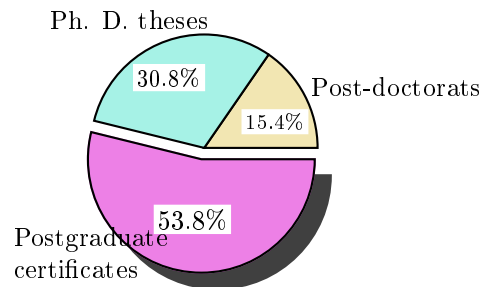

Scientific publications (see list of publications in appendix A)

- 9 publications in international journals with review.
- 19 publications in international congresses with proceedings and review.
- 2 chapters in collective books.
- 2 national seminars.
- 4 contract reports (1 for the PREDIT 2, 2 for the RNTL-METISSE, 1 for the ANR-RNTL SIMPA2).

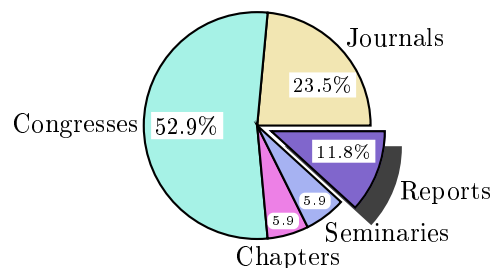

Reviews

- 6 publications in international journals.
- 21 publications in international congresses.
- 3 publications in national congresses.

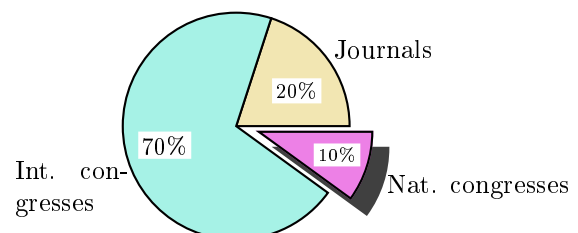

¹Numbers in brackets refer to the list of publications in appendix A.

1.2 Teaching activities

A typical year (2005-2006):

196 hours practical equivalent.

Automation: 72 hours practical equ.

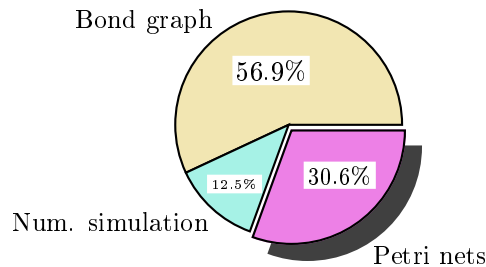

Mechanics: 124 hours practical equ.

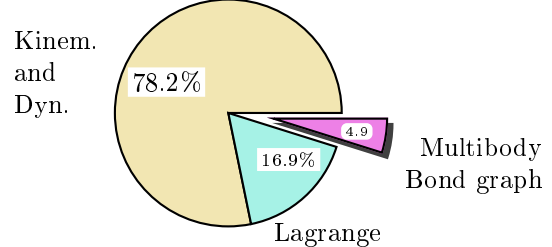

Total teaching since 1994

Automation: since 1994

- Modelling and bond graph language (class, practical and practical work, 246h pract. equ., first and final 2 years of degree course and graduate studies).
- Systems of equations, Numerical methods, Simulation (class, 187h practical equ., graduate studies).
- Servoing, Regulation, Sequential logic (practical work, 64h practical equ., final 2 years of degree course).
- Petri nets (practical, 22h, final 2 years of degree course).

Mechanics: since 1995

- Kinematics and Dynamics (Newton-Euler and Lagrange) (class and practical, 1393h practical equ., first and final 2 years of degree course).
- Numerical resolution of equations (class, 36h practical equ., graduate studies).
- Multibody bond graph (class, 57h practical equ., graduate studies).

Supervision: since 1996

- 18 End of studies projects, 11 of which in co-supervision at 50% (Engineer students INSA-Mechanical Engineering Dpt).
- 4 student trainings in laboratory.
- 1 following-up work of student training (supervision by Imagine society).
- 1 synthesis project.

1.3 Administrative activities

2004-:

Organisation and animation of the monthly scientific meetings of FTR team of LAI.

2004-2005:

- Member of the laboratory senate.
- Recruiting committee for a professor of sport at INSA of Lyon.

2001-2005:

- In charge of the Centre d'Intérêt Ingénierie des Systèmes Automatisés: Analyse et Conception (Center of Automated System Engineering: Analysis and Design) which receives the final year engineering students of the Mechanical Engineering Department at INSA of Lyon for a specialization and their End of Studies Projects.
- In charge of the database of the laboratory and of its web site.

2000:

Participation to a working group for the set up of the laboratory web pages at INSA of Lyon.

depuis 1999:

In charge of the kinematics and rigid body dynamics modules of the groups ASINSA (Asian and French students) of the first 2 years of degree course at INSA of Lyon.

1994-2001:

Setting up of the *fluidetronics* team web pages and maintaining of the LAI web pages.

Chapter 2

Activity report since my nomination

Context

I do my research in the Laboratoire d'Automatique Industrielle (LAI) at the Institut National des Sciences Appliquées de Lyon (INSA de Lyon -National Institute of Applied Sciences of Lyon-) as an assistant Professor since September 1998. I teach at INSA in the first 2 years of degree course that receive 1520 students, and in the department of mechanical engineering that awards a degree to 130 engineers per year, receives 50 Ph. D. students and relies on 40 teachers/researchers and 8 laboratories.

The LAI is constituted of about 12 teachers/researchers developing research at the frontier between Automation and Mechanics that leads it to be a recognized laboratory in the domains of mechatronics and event systems. Its objectives are to understand the physical phenomena and to model them in order to design complex systems (principally mechatronic) having fault tolerant behavior. For this the LAI is composed of two teams: the 3SP team (Sûreté et Supervision des Systèmes de Production -Safety and Supervision of Manufacturing Systems-) relying principally on discrete event theory, and the FTR team (Fluid power, Transport et Robotique -Fluid Power, Transportation and Robotics-) using continuous system theory, and issued from the fusion in January 2005 of the teams *Fluidetronics* and *Robotics* (Fig. 2.1).

Concerning the team FTR, it has a matrix organization (see Tab. 2.1). The methodology activities, vertical axes of research, are: multiphysics and multiscale *Modeling*, *Virtual prototyping* and more particularly sizing on dynamic and energy criteria, and *Control*. The three horizontal privileged domains of application are Mechatronics and fluid power (historic application domain of the team), surgery robotics and transportation. The clearly displayed objectives of the team is to cross these axes, the ones about methodologies, and the others concerning the applications, in order to reenforce its local, national and international position. Table 2.1 displays the researchers in this organization.

The forthcoming creation of a Mixte Unity of Research CNRS entitled laboratoire AMPERE and issued from the fusion between the CEGELY (Centre de Génie Electrique de Lyon -Center of Electrical Engineering of Lyon-) and the LAI will split the team FTR vertical axes among two new teams, The EASy (Equipe Actionneurs et Systèmes -Actuators and Systems team-) and the Control team. The scientific priority and the projects shared between these two teams will enable research to be pursued and the developments put in perspectives in my works (section 4.3.1) to be engaged. This new laboratory will start in January 2007 and will be constituted of about 45 teachers/researchers.

2.1 Research activities

2.1.1 Positioning

Key words

- *Modelling, simulation, analysis and design of mechatronic systems.*

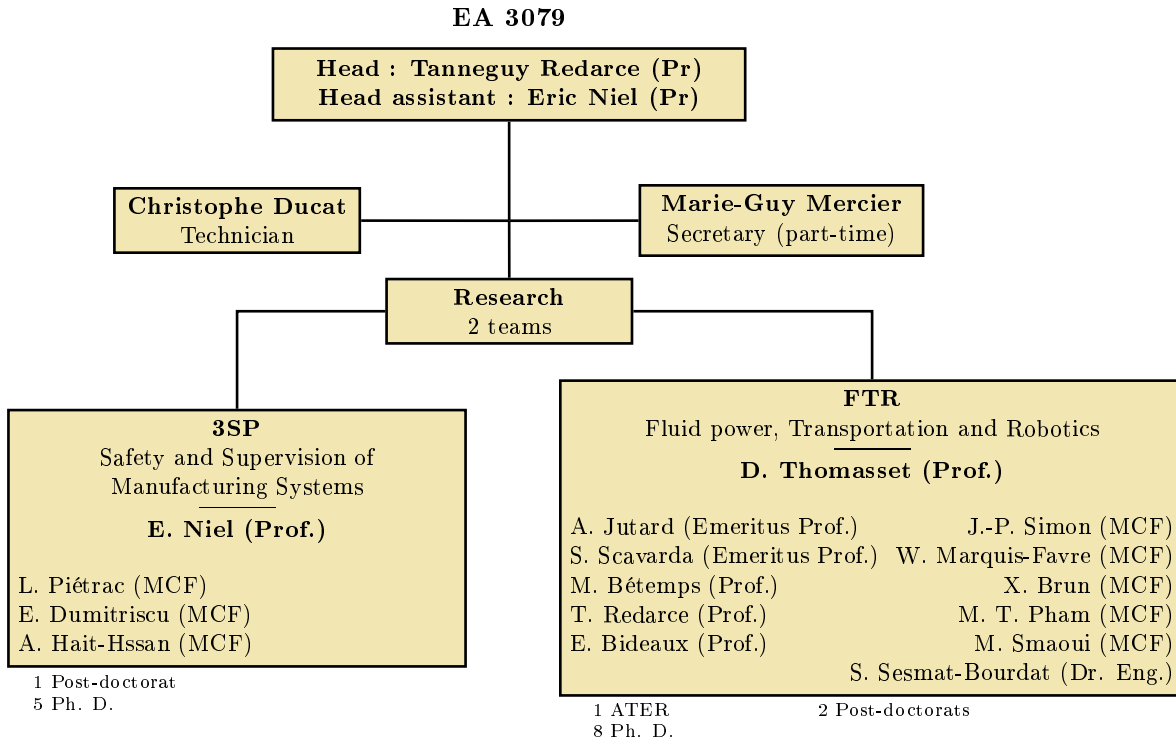

Figure 2.1: LAI organization chart

	Modelling	Virtual prototyping	Control
Surgery robotics	MB-AJ-MTP-TR	MB-AJ-MTP-WMF	MB-MTP-TR-XB
	Villegas-Medina		Olaby
Mechatronics and Fluid power	SS-SSB-EB	SS-EB-WMF	DT-XB-JPS
	De Giorgi	Mouhib	Chereji
Transportation	SS-EB-SSB-JPS-WMF	SS-EB-JPS-WMF	XB-MS-DT
	Jardin	Mohsine	Girin
			Renard

MB : Maurice Bêteemps, EB : Eric Bideaux, XB : Xavier Brun, AJ : Alain Jutard, WMF : Wilfrid Marquis-Favre, MTP : Minh Tu Pham, TR : Tanneguy Redarce, SS : Serge Scavarda, SSB : Sylvie Sesmat, JPS : Jean-Pierre Simon, MS : Mohamed Smaoui, DT : Daniel Thomasset

Ph. D., ATER, Post-doctorats

Table 2.1: Scientific organization of team FTR

<i>Team FTR</i>		<i>Team 3SP</i>
3 research axes		
<i>Virtual prototyping</i> Formalization of the problems posed by the sizing of a mechatronic system for specifications given in terms of dynamic and energy criteria.	<i>Modelling</i> Bond graph modelling and simulation of the dynamic behavior of fluid power systems and more particularly, electropneumatic systems.	<i>Control</i> Study of the potentialities given by the modern automation methods and more particularly those of the nonlinear control in the fluid power system context.
		
Investigation field of my research in the application domains of transportation, surgery robotics and mechatronic systems		

Table 2.2: Research context in the LAI

- *Sizing methodology, bond graph language, inversion, optimization.*
- *Kinematics and dynamics of multibody mechanical systems, analytical mechanics.*
- *Vehicle dynamics, surgery robotics.*

2 research axes

- *Virtual prototyping*: set up of methodologies and tools for aiding sizing and design of mechatronic systems on dynamic and energy criteria.
- *Mechatronic modelling*: contribution to the modelling of mechanical subsystems in a mechatronic context.

My work (see Tab. 2.2) is principally carried out in the *Virtual prototyping* and *Modelling* research axes in the team *Fluid power, Transportation and Robotics* (FTR) of the Laboratoire d'Automatique Industrielle (LAI) at the Institut National des Sciences Appliquées de Lyon (INSA de Lyon). A summary of the projects with respect to my research axes is given in Table 2.3.

The *Virtual prototyping* axis aims at developing a methodology and specifying computer-aided tools for sizing mechatronic systems on dynamic and energy criteria. The methodology is based on an inverse state-model approach coupled to the use of bond graph language. On this research axis and in the framework of the PREDIT 2 programme, I co-supervised (Ph. D. thesis of Olivier Méchin) the works done on the application of the methodology in an industrial context (collaboration with PSA Peugeot Citroën). Today I animate the developments that aim at coupling the methodology with optimization methods (post-doctoral positions of Omar Mouhib and Amine Moshine, and Ph. D. thesis of Bogdan Chereji in the framework of the RNTL METISSE project) and at extending its application (Ph. D. thesis of Audrey Jardin in the framework of the ANR-RNTL SIMPA2).

		Projects and promotion		value exc. of tax
	Planar mechanics library for AMESim (1998-) Total: 26k€ + royalties (9800€)	PREDIT 2 (2000-2004), topic Design-Manufacturing Total: 315,5k€	Region (2000-2002), topic Modelling and Control of Complex Dynamic Systems Total: 16,4k€	RNTL (2003-2006) METISSE project, in charge of a sub-project Total: 132k€
Axes				
Virtual prototyping		2 trainings		2 post-doctorats 1 Ph. D.1 master
Mechatronic modelling	6 ESP 1 training (follow-up)	1 Ph. D. CIFRE		
	·IMAGINE ·REXROTH ·BOSCH GROUP ·RENAULT ·ISTIL	·PSA PEUGEOT ·CITROËN ·LORENZ ·SIMULATION ·Oradea University (Roumania)	·LMST (INSA de Lyon) ·LTDS (ECL)	·IMAGINE ·PSA PEUGEOT ·CITROËN ·LMS France ·CADOE ·CS-SI ·IFP ·Sneema Moteurs ·EADS-CCR ·IMFT, LEEI (ENSEEIH) ·D2S (ECL) ·INRIA ·Oradea University (Roumania)
Industrial and university collaborations linked with the projects				

to be continued

continuing

Projects and promotion			
	Laparoscopy (2004-2007)	ANR-RNTL (2006-2009) SIMPA2 project Total: 103k€ inc. of tax	Contracts and other trainings (1998-) Total: 47,5k€ exc. of tax
Axes			
Virtual prototyping	1 Ph. D. 1 master	1 Ph. D.	3 DEA 2 ESP
Mechatronic modelling			2 DEA 10 EPS 2 trainings
	HCL	· CRIL TECHNOLOGY · EDF · IFP · IMAGINE · INRIA · PELAB (Sweden) · PSA PEUGEOT CITROËN	· REXROTH BOSCH GROUP · PSA PEUGEOT CITROËN · KOYO STEERING EUROPE · ANTONOV AUTOMOTIVE TECHNOLOGIES FRANCE · MICROTURBO · SCHNEIDER · RENAULT · R.V.I. · ALSTOM · DLR (Germany) · OTIS FRANCE
Indus. and univ. linked to the projects			

Table 2.3: Organisation of projects and collaborations with respect to the research axes

Concerning the *Modelling* axis, I bring my expertise in the bond graph modelling of multibody mechanical systems acquired during my Ph. D. thesis. This enables the study context of treated systems by the team to be enlarged to their mechanical environment generally multibody. I also contribute to the bond graph language development in a general manner a better formalization and use in mechatronics. Recently I bring my experience in the multibody mechanical modelling to the surgery robotics and more particularly to a project of a flexible robot design for laparoscopy (Gérardo Villegas-Medina's Ph. D. thesis)

2.1.2 Developments on the *Virtual prototyping* axis

Not translated.

2.1.3 Developments on the *Mechatronics modelling* axis

Not translated.

2.1.4 Supervision

Not translated.

2.1.5 Responsibility

Not translated.

2.2 Teaching activities

Not translated.

2.2.1 Teaching report

2.2.2 Module description

2.2.3 Pedagogical publications

2.2.4 Supervision of End of Studies Projects, work experience and foreign students (graduate studies)

2.3 Administrative activities

Not translated.

2.4 Conclusion

Not translated.

Chapter 3

Presentation of research activities

This chapter is devoted to a more technical presentation of my principal research works. It is organized in three parts showing the progressive transition from the developments in the continuity of my Ph. D. thesis to more recent ones. First section 3.1 is devoted to the coupling between bond graph modelling and the domains of the multibody mechanical systems and vehicle dynamics. Then section 3.2 shows my taking over of axis *Virtual prototyping* research works of team FTR. Finally section 3.3 presents the starting up of new works in particular linked to the introduction of optimisation in the sizing methodology developed in the LAI.

3.1 Mechatronic modelling in multibody mechanics and vehicle dynamics

Context

Works presented in this part concern the *Mechatronic modelling* research axis principally linked to the application domains of the multibody mechanical systems and vehicle dynamics. They are the logical continuation of my Ph. D. thesis works since they use some of its results (for instance the one of the multibody privileged representation of a suspension -section 3.1.3-) and take advantage of my acquired expertise during this period (for instance use of Baumgarte stabilization in the planar mechanics library for AMESim -section 3.1.1-).

These works were done in different frameworks such as End of Studies Projects of engineering students (planar mechanics library for AMESim development -section 3.1.1- or multibody bond graph representation of a suspension -section 3.1.3-), student training for postgraduate certificate (tire modelling -section 3.1.4-), or CIFRE Ph. D. (half government-funded and industrially-funded) in the PREDIT 2 program (automotive vehicle models -section 3.1.2-).

In this section the four following developments are presented:

- planar mechanical component library for AMESim (section 3.1.1),
- automotive vehicle models (section 3.1.2),
- multibody bond graph representation of a suspension (section 3.1.3),
- modelling of tire sliding phenomenon (section 3.1.4).

3.1.1 Planar mechanical component library for AMESim

3.1.1.1 Introduction

The motivation for building this library appeared in 1998 from the need to enlarge the use of AMESim, developed by the society Imagine, to systems including planar mechanics. Number of applications justify this will in the automotive engineering (crankshaft, opening, ...), in aeronautics (undercarriage, aileron actuation, ...), or in hydraulics (digger, ...) The choice of AMESim was justified by the previous collaborations between Imagine and the LAI (pneumatic component library) and its use in education and research.

After having set up the theoretical bases of this library in 1998, I supervise an End of Studies Project in 1999 for the development of a first prototype in AMESim. In the following year this prototype was used for the application of a manual gear box mechanical control (with rods) in the framework of a second End of Studies Project in collaboration with Renault. These works showed not only the feasibility of such a library in AMESim but also the operational level of the prototype in a test version for manufacturers using AMESim. Nevertheless this version remained not simple to manipulate due to a particular attention to pay for a consistent initialisation of the modeled mechanism and the lack of a graphical interface for its visualization in 2D.

The period that followed was devoted to the set up, by the LAI and Imagine, of examples both academical (quadratorhomb, pendulum, small chain, quick return mechanism, ...) and industrial (aileron actuation, digger, automotive opening, ...) A new End of Studies Project in 2003 in collaboration with Rexroth Bosch Group on the comparison in simulation of a digger model between AMESim and Simpack, a multibody code. The results gave full satisfaction and at the same time Imagine started the industrialization of the library. A work experience that I followed up enabled an automatic initialization module of planar mechanical models and a graphical interface the visualization and the animation of the mechanisms modeled, to be built.

Today the library is commercialized under the name PLM (Planar Mechanism) in AMESim and is the object of a royalties contract between Imagine and the LAI.

The principal contribution from a theory point of view is the set up of generic expressions for the constraint equations of geometrical type in joints. These expressions can be used for every new constraint of this kind. These developments took advantage of my teaching position in mechanics, of the mechatronic approach in the *Modelling* research axis of team FTR and finally of my Ph. D. thesis works concerning multibody mechanical system modelling through bond graph language and the necessary reformulation of the models for simulation. These developments were the object of two publications in a journal [Mar06c, Mar06d] and one in a congress proceeding [Arm04].

3.1.1.2 Developments presentation

See [Mar06c, Mar06d] in the appendix C document.

3.1.1.3 Conclusion

The principal contribution of this work was to express the constraint equation of geometrical type explicitly in terms of geometric space vectors and to use them in this form instead of express them in terms of scalar variables. This showed the existence of a generic expression of constraints whatever the joint is. The generic formulation proposed can be reused for developing other models of joint constraints.

The modelling proposed is based on Lagrange equations and the Lagrange multipliers methods for the body components, and on the Baumgarte stabilization applied to constraint equations in the joint components. This choice results from the necessity of the use of dependent coordinates in pre-oriented and organized component models in terms of equations. They are the intrinsic AMESim requirements that impose this strategy.

Finally two extensions of this library have been studied in the framework of two End of Studies

Projects (2004) in collaboration with Imagine. The first aimed at developing contact joint components. The second extension aimed at studying the feasibility of extending the library to spatial mechanics. These projects remained for the moment in a development phase.

3.1.2 Automotive vehicle models

3.1.2.1 Introduction

This work was done in the framework of the PREDIT 2 program (1998-2004), topic Design-Manufacturing. It was carried out during the Ph. D. Thesis of Olivier Méchin (2000-2003) for who one of the goals was to validate in simulation the sizing methodology developed at the LAI in particular on industrial applications. These works were undertaken in collaboration with PSA Peugeot Citroën and required the set up of automotive vehicle models answering different criteria. These models had to be:

- represented by bond graph,
- relevant from their components and phenomena point of view in agreement with the sizing aimed,
- relevant from the life situations point of view with respect to which they are simulated,
- with the same inputs and outputs as the manufacturer's ones,
- validated with respect to the models of PSA Peugeot Citroën that are experimentally validated.

The first requirement is linked to the methodology that uses bond graph language. The second item is linked to the sized systems envisaged during the Ph. D. thesis namely the EPS (Electric Power Steering system) and the suspensions. This second item is also linked to the model level required by the proposed methodology. The third point is linked to the manufacturer approach in his design goal. The fourth item is linked to the specifications furnished by the principal and finally the last item is linked to the validity of the sizing undertaken and thus to the effectiveness of the methodology proposed.

The analysis of the manufacturer's approach in the vehicle design enabled principally two models to be pointed out for the sizing of the EPS and the suspensions. The first model is a full vehicle model that will be put in different life situations and different tests during driving conditions for the energy and dynamic sizing of both EPS and suspensions. A full vehicle model is essential for a realistic behavior on one hand, and to obtain the right force levels in the steering column, the suspensions and the braking system on the other hand. The second model is vehicle in parking. This model was pointed out from the analysis of the manufacturer's design approach as important for the EPS sizing.

The difficulty to set up bond graph representations of these models is principally due to the manufacturer oriented form of the models as well as the use of black boxes and tables. Bond graph modelling thus required to well understand these models and also to master modelling in the vehicle dynamics domain.

The co-supervision of this thesis enabled for me a progressive transition from my research during the doctoral period concerning the bond graph representation of multibody mechanics, to the research axis *Virtual prototyping* of the FTR team. The principal contributions are on one hand bringing my expertise in this domain, and on the other hand, the set up of design-oriented models enabling the sizing methodology to be fully exploited on transportation applications, one of the activity axes of the team. These works gave one publication [Mar06a].

3.1.2.2 Full vehicle model

See [Mar06a] in the appendix C document.

3.1.2.3 Vehicle in parking model

The model of vehicle in parking is a particular model since in this case the vehicle does not go. It enables the steering system in this life situation to be characterized and also constitutes an aid to its sizing. The

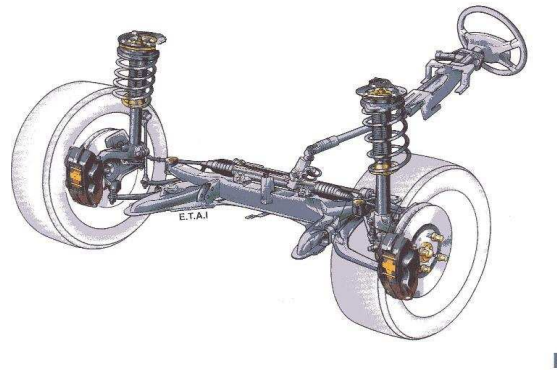

Figure 3.1: Schema of a vehicle front axle.

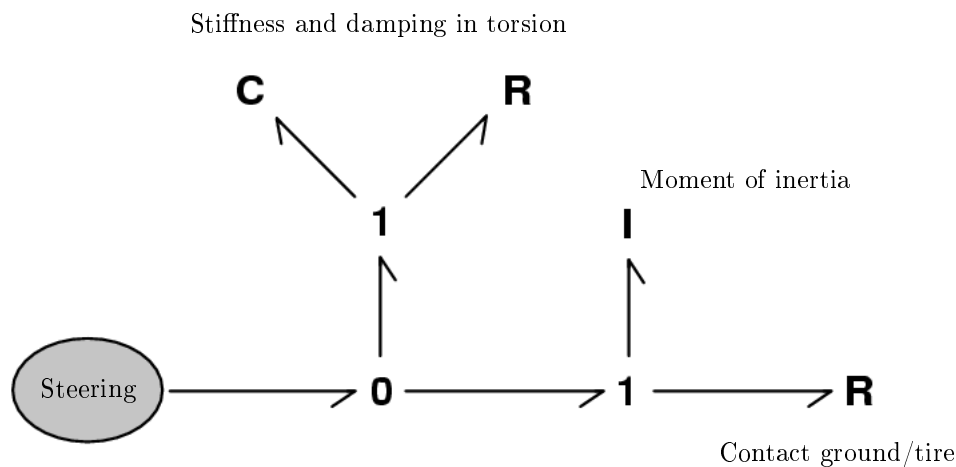

Figure 3.2: Bond graph representation of the tire model in the parking life situation.

vehicle being still the inertial effects are not considered. The only motions are those induced by the front axle kinematics. Thus this model simply retains in the full vehicle model the elements of the steering system, the front axle, the wheels and the tires as well as the EPS.

The forces from the vehicle body are the gravity action that comes from the height variation of the body when steering. The ground/tire interaction takes into account of the weight. A front axle of a vehicle is given Fig. 3.1.

The bond graph representation of the steering system model is the same as the one given for the full vehicle. On the other hand, in the life situation in parking, the tire cannot be defined by Pacejka's formalism nor by a vertical model. In fact the vehicle dynamics disappears in this model. Only the torsion behavior can be taken into account. The tire is thus characterized by a stiffness and a damping determined by experimental data. The corresponding phenomena are then represented by a pair of C and R elements. The I element models the kinetics phenomena of the wheel in rotation and is characterized by the wheel moment of inertia (Fig. 3.2).

The contact ground/tire is principally associated to dry friction but also enables indirectly the vehicle weight action to be modeled on the steering system. In fact for different vehicle loads the friction (Coulomb's friction) changes and corresponds to a R element parametrized by the load and also depending on the type of ground surface (Fig. 3.2).

The model established for the parking life situation is correlated with existing measurements. There was no reference model because the tire modelling in parking maneuver do not agree with measurements. Consequently the verifications undertaken aimed at finding on one hand the Jeantaud's diagram in

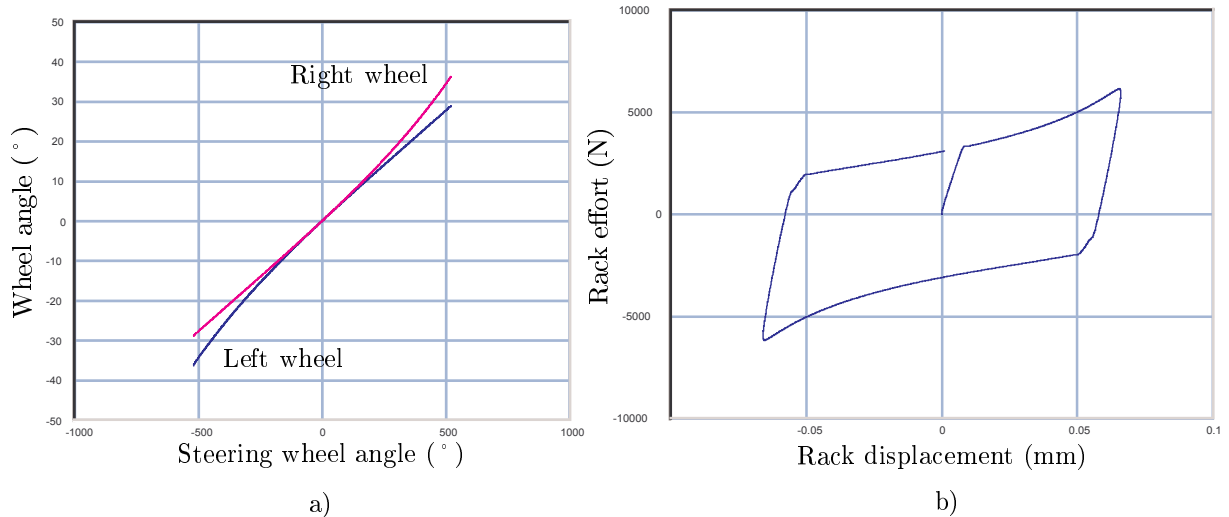

Figure 3.3: a) Jeantaud's diagram, and b) Rack effort evolution.

agreement with the one measured on the vehicle, and on the other hand, the efforts acting on the rack axis. It was thus difficult to give a correlation level with a reference model. The obtained results seemed in agreement with reality and then were considered as valid, in agreement with PSA Peugeot Citroën. Figures 3.3a and 3.3b present respectively the Jeantaud's diagram obtained by the front axle model simulation and the evolution of the rack effort versus its displacement.

3.1.2.4 Conclusion

The principal contribution of this work was on one hand bringing my expertise in multibody mechanics modelling in particular in the vehicle dynamics domain to obtain a bond graph representation of the studied model, and on the other hand, adapting the model level so it can answer to a sizing objective in two life situations of the vehicle.

However it appears two dissatisfactions with the adopted models. The first one concerns the axle kinematics which is for the manufacturer encapsulated in an input/output model obtained by static measurements. The first drawback is the operating mode of the characterization not corresponding to a vehicle that goes. The second drawback is the fact that any new axle requires experiments for setting the model. The second dissatisfaction is linked to the ground/tire interaction model when vehicle goes. On one hand it also issues from an input/output model or black box with the Pacejka's magic formula experimentally established in a stationary configuration, and on the other hand, it requires the use of *ad hoc* element in the bond graph representation showing the inability to correctly interpret the energy phenomena played in the ground/tire interaction. The two following sections present works in view of answering to these two dissatisfactions.

3.1.3 Multibody bond graph representation of a suspension

3.1.3.1 Introduction

This work was carried out in the framework of an End of Studies Project (2004) of a Spanish student from the Cataluña University in school exchange with INSA of Lyon in the Mechanical Engineering Department. It is in the continuity of the works of modelling undertaken in the PREDIT 2 program and more particularly in Olivier Méchin's Ph. D. thesis partly presented in section 3.1.2. The motivation of this work comes from the approach in great part not satisfying for the suspension modelling during the PREDIT 2 works. In fact this approach corresponds to the automotive manufacturer approach and the vehicle dynamics domain. This requires on one hand an experimental static characterization to

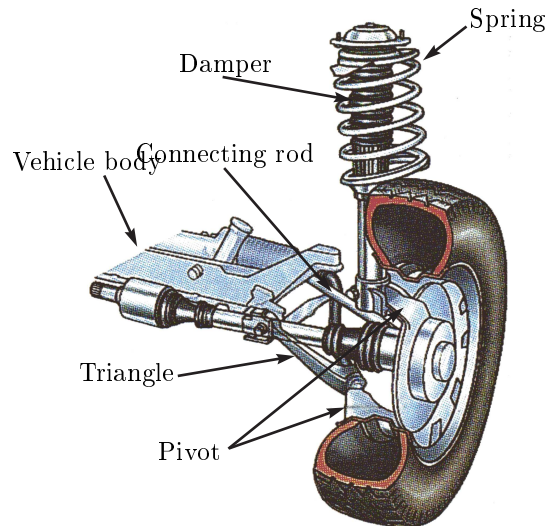

Figure 3.4: Schema of a pseudo Mc Pherson suspension.

determine the axle elasto-kinematics, and on the other hand, the physical existence of the system to realize characterization. This second point is in contradiction with a design work in particular in an early stage of the design. On the other hand when the suspension structure is given, a multibody modelling, parametrized, is well adapted to a design and sizing activity.

Thus the multibody bond graph representation of a pseudo Mc Pherson suspension has been set up during this project. It has fully exploited my Ph. D. works in particular concerning the application of the privileged representation in case of multibody systems having kinematic loops. The result shall replace the *ad hoc* element characterized by the elasto-kinematic tables by a representation that takes into account of the kinetic phenomena.

3.1.3.2 Pseudo Mc Pherson suspension model

This section presents the suspension model with the hypotheses retained. A schema of pseudo Mc Pherson suspension is given figure 3.4. Figure 3.5 shows the joint schema between the different bodies considered in the suspension. Then the following figures present the word bond graph (Fig. 3.6) and the multibond graphs for the different bodies and joints (Fig. 3.7 for the triangle, Fig. 3.8 for the pivot, Fig. 3.9 for the connecting rod, Fig. 3.10 for the damper piston, Fig. 3.11 for revolute joints, Fig. 3.12 for spherical joints and Fig. 3.13 for the translational-revolute joint) which are connected as displayed in the word bond graph.

3.1.3.3 Conclusion

My contribution in this work consisted of guiding in a correct and relevant manner the modelling of a multibody mechanical system. Here again I took advantage of my expertise acquired on the bond graph representation in this domain.

A multibond graph structure is now available for a model of a pseudo Mc Pherson suspension but no simulation and thus no validation has been carried out with respect to reference models due to a lack of time in this project. A first step will be to validate this representation alone and then to connect it to the vehicle model in order to do global validation. This connection will require however to revise projections and coordinate transformations since the inertial frame of reference will not be any more attached to the vehicle. This global representation shall then be used for the sizing works on automotive systems and for structural analyses.

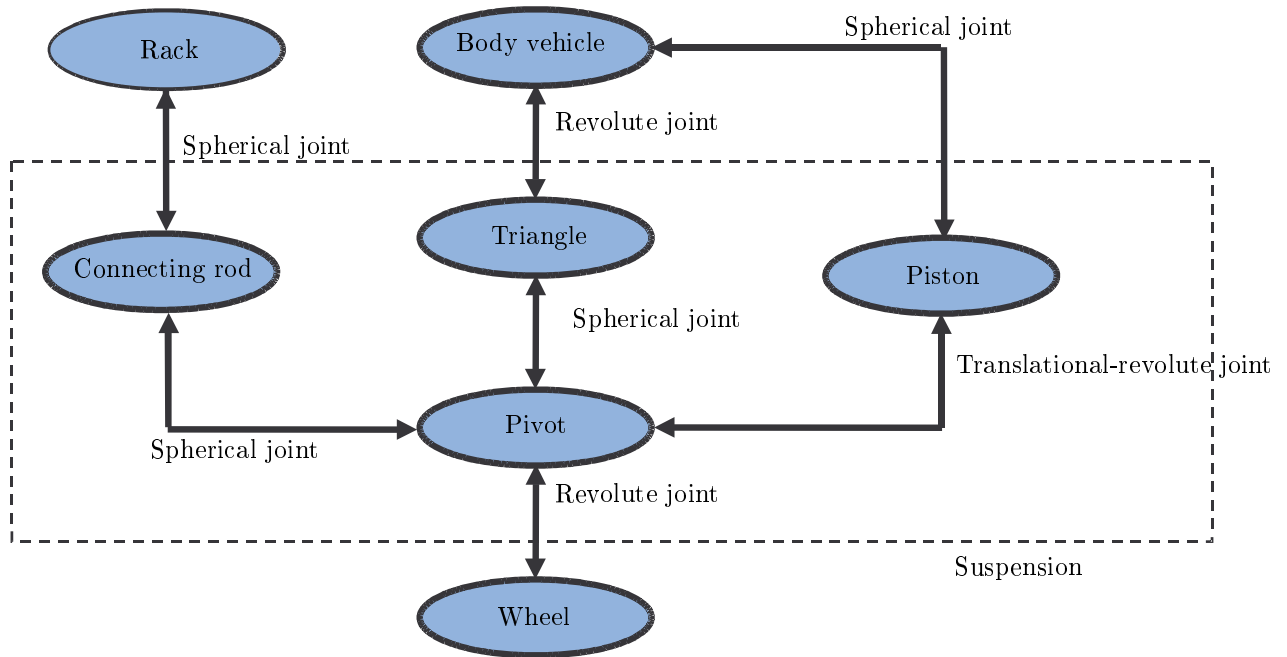

Figure 3.5: Joint schema of the pseudo Mc Pherson suspension.

3.1.4 Modelling of the tire sliding phenomenon

3.1.4.1 Introduction

These works are also, like those on the suspension, in the continuity of Olivier Méchin's Ph. D. thesis in the PREDIT 2 program and in particular of the part concerning the automotive vehicle modelling. The dissatisfaction of the tire bond graph representation motivated this project that took part in the framework of Alessandro Zin's postgraduate certificate (2001-2002).

In the vehicle dynamics domain, the tire behavior and the dynamic phenomena at the ground/wheel interface lie on, among others, the tire sliding characterization. This is measured by an angle between two kinematic variables and energy phenomenon modelling (dissipation and viscoelasticity) in the tire and the axle principally uses this angular variable.

Concerning the vehicle bond graph representation taking into account of these cornering phenomena, it shows a discrepancy between the vehicle dynamics approach and the classical notion in bond graph of power and energy variables. This gap is first due to the use of a variable defined in bond graph language as a generalized displacement in place of a flow variable for dissipation phenomena. In fact a wide spread model in vehicle dynamics is the input/output model of Pacejka. Concerning the cornering phenomena, showing among others dissipation phenomena, the Pacejka's magic formula relates the transversal effort or cornering effort (effort variable) at the ground/wheel interface to the sliding angle (generalized displacement variable). Moreover the variable pair (cornering force and sliding angle) belongs to two different physical domains, namely those of translation mechanics for the effort and of rotational mechanics for the angle.

Thus these works propose to investigate the tire cornering phenomena in the vehicle dynamics domain in order to obtain a consistent representation with the energy bond graph approach.

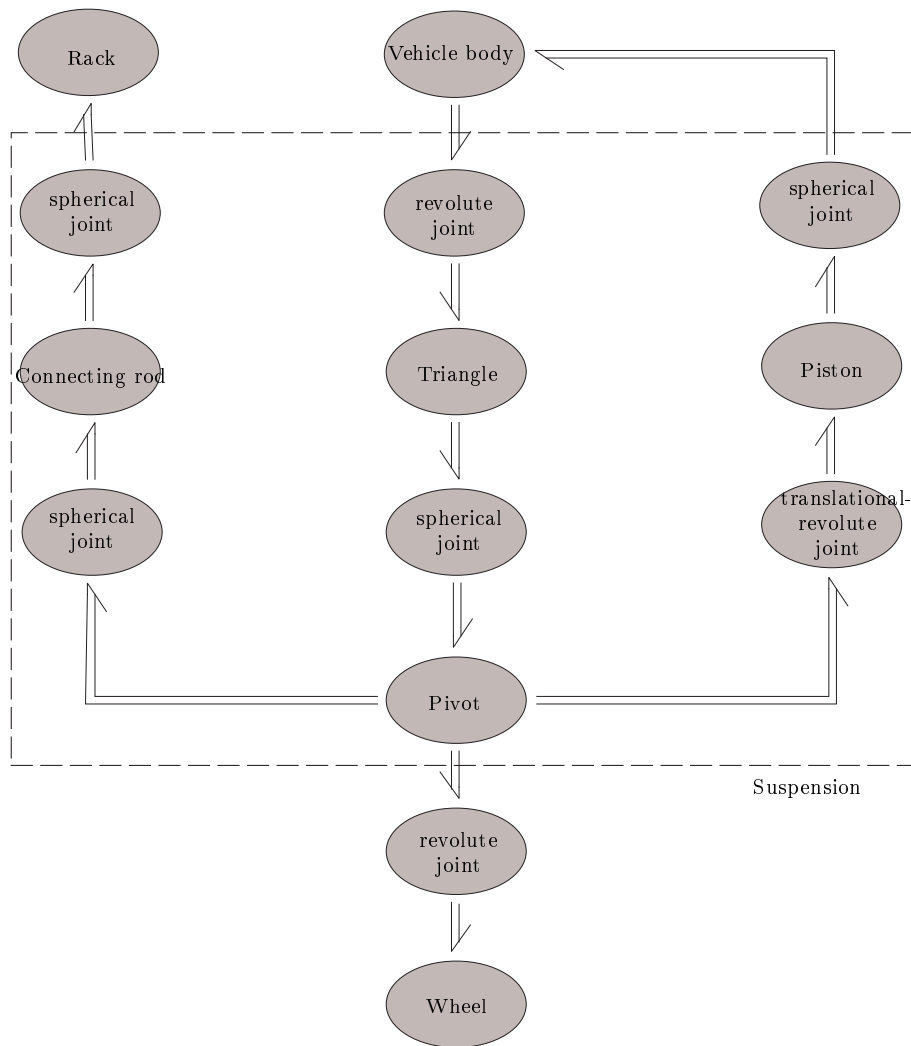

Figure 3.6: Pseudo Mac Pherson suspension word bond graph.

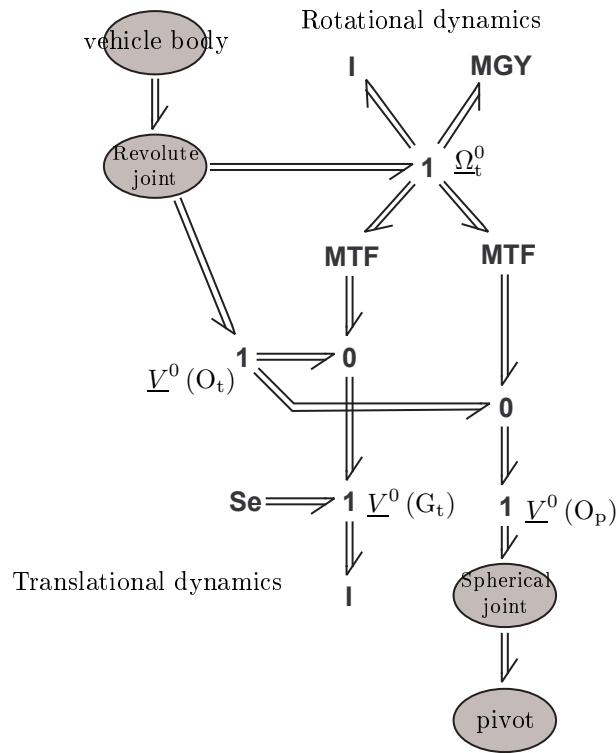

Figure 3.7: Triangle multibond graph representation.

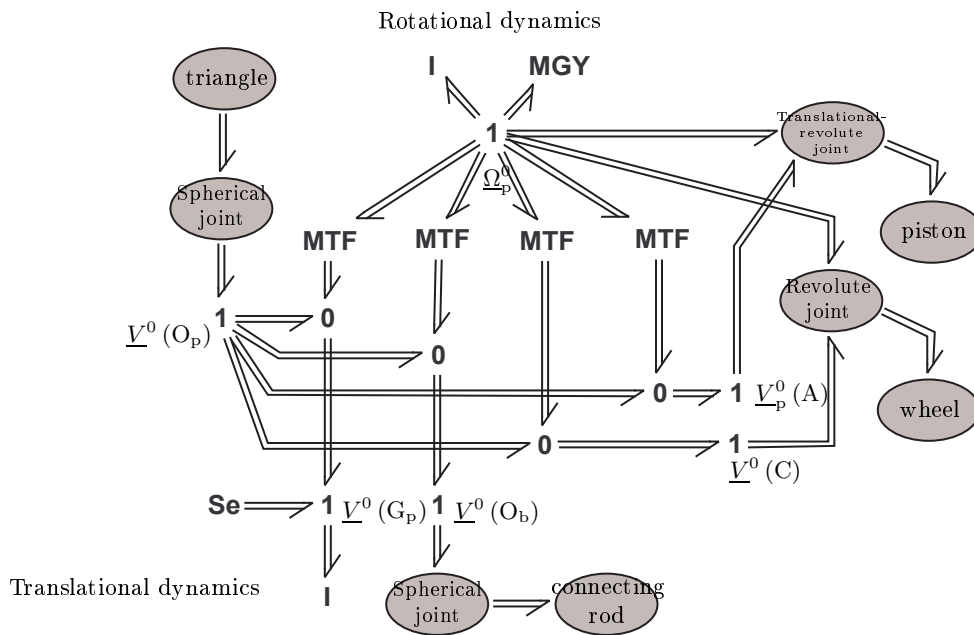

Figure 3.8: Pivot multibond graph representation.

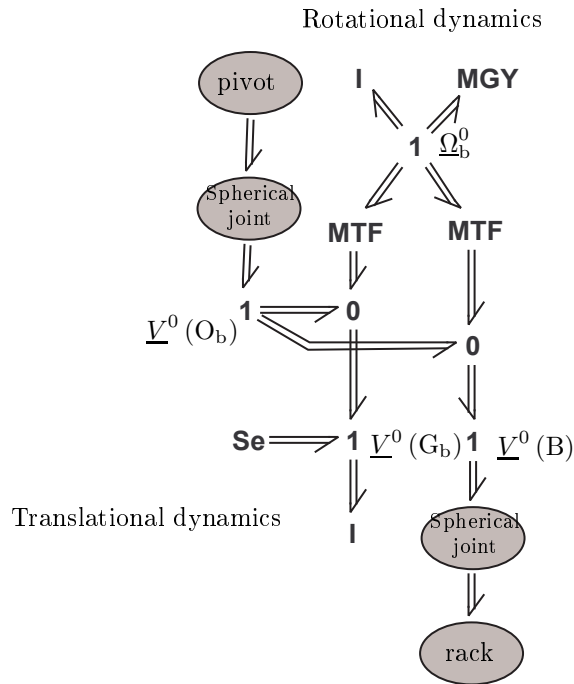

Figure 3.9: Connecting rod multibond graph representation.

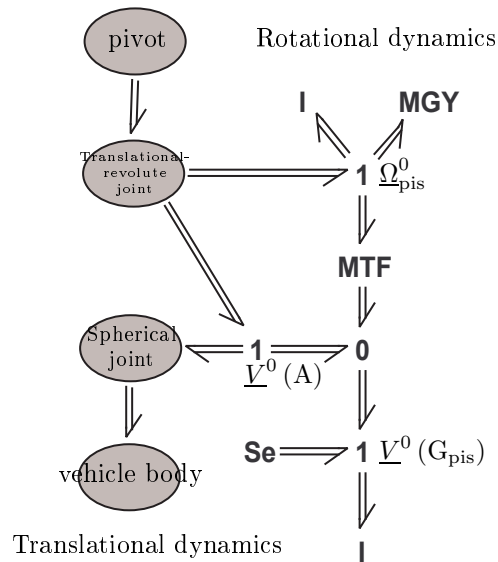

Figure 3.10: Piston multibond graph representation.

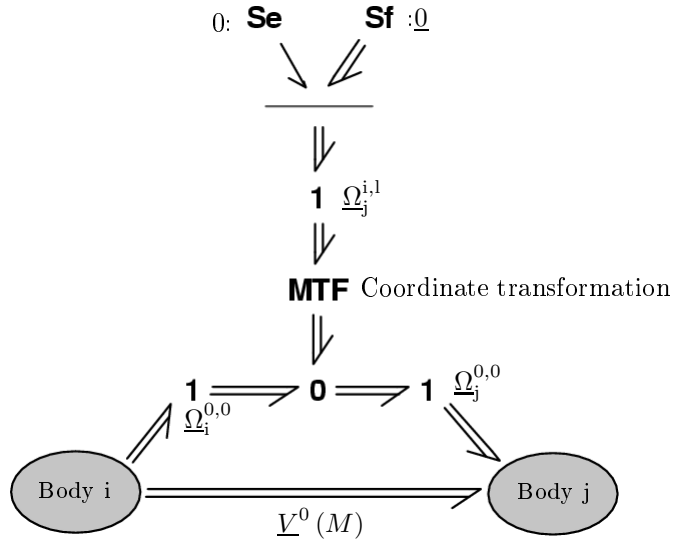

Figure 3.11: Revolute joint multibond graph representation.

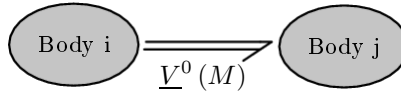

Figure 3.12: Spherical joint multibond graph representation.

3.1.4.2 Tire description

Reference frame and wrench

This section defines the different angles (steering angle β and camber angle γ) for the wheel orientation (Fig. 3.14) and the efforts between the ground and the wheel in particular the cornering force and the self alignment torque. It gives a brief overview of the tire structure (Fig. 3.15) where components like the patch over the ground contact NST, the tread KM and the contact patch ADC will play an important role in the model proposed. Concerning the cornering force denoted $Y_{0/1}$ and the self alignment torque denoted $N_{0/1}$, experimental results are given figure 3.16.

3.1.4.3 Global models

This section briefly presents the Pacejka's magic formulas, the principles of the contact patch ADC deformation (Fig. 3.17, 3.18, 3.19 and 3.20), Fromm's model (Fig. 3.21 and 3.22) and Fromm's model with deformable patch over the ground contact NST (Fig. 3.23). The latter will be important for the proposed model.

3.1.4.4 Proposed model

Hypotheses

The proposed model lies on deformable patch over ground contact NST where only transversal phenomena are considered. The longitudinal phenomena are not taken into account and the wheel height is assumed constant. This latter is supposed longitudinally rigid and not subjected to any torque (driving or braking). In this model the tire crushing and conicity effects inducing a zero cornering force for a non zero sliding angle are neglected as well as a residual torque for this non zero sliding angle, a pushing force and a conicity torque. This model aims at expressing the cornering force and the self alignment torque as

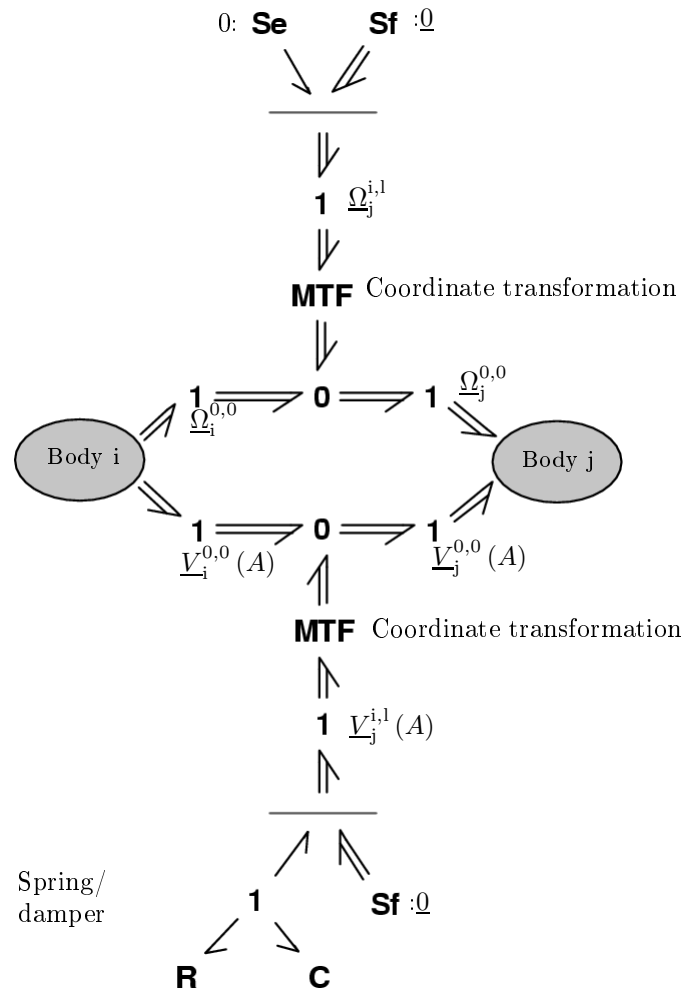

Figure 3.13: Translational-revolute joint multibond graph representation.

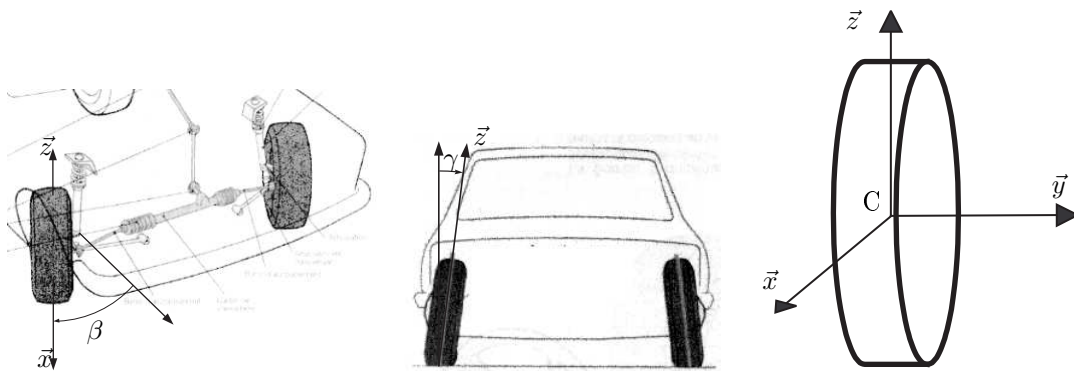

Figure 3.14: Wheel frame of reference and angle variables.



Figure 3.15: Sectional view of a tire.

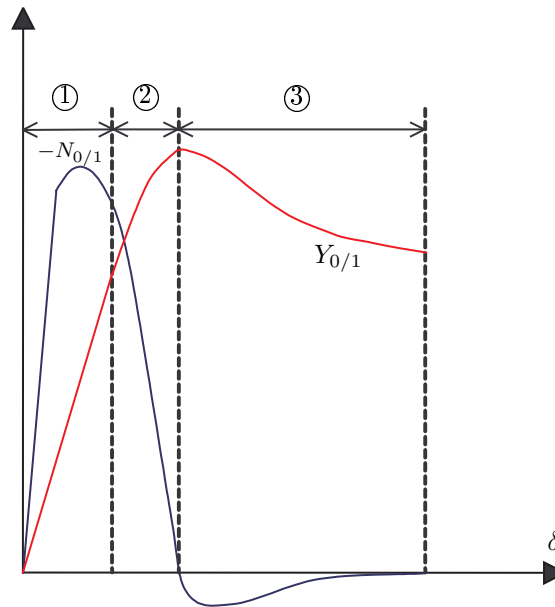

Figure 3.16: Graphs of $Y_{0/1}$ and $-N_{0/1}$ versus sliding angle.

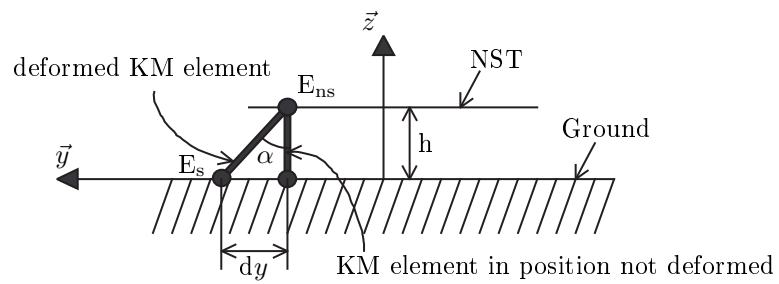

Figure 3.17: Schema of a tire sectional view at the contact patch.

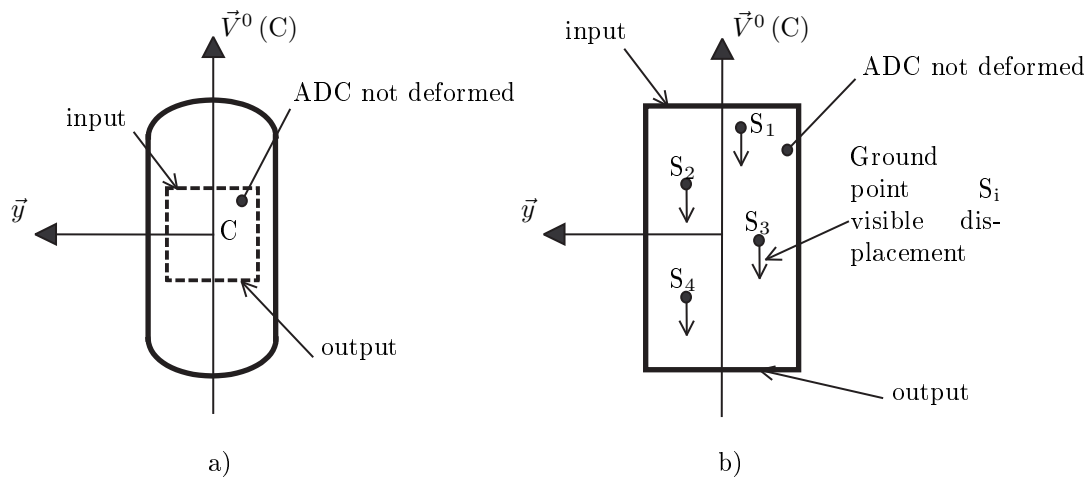

Figure 3.18: Schema of the contact patch ADC top view for straight run.

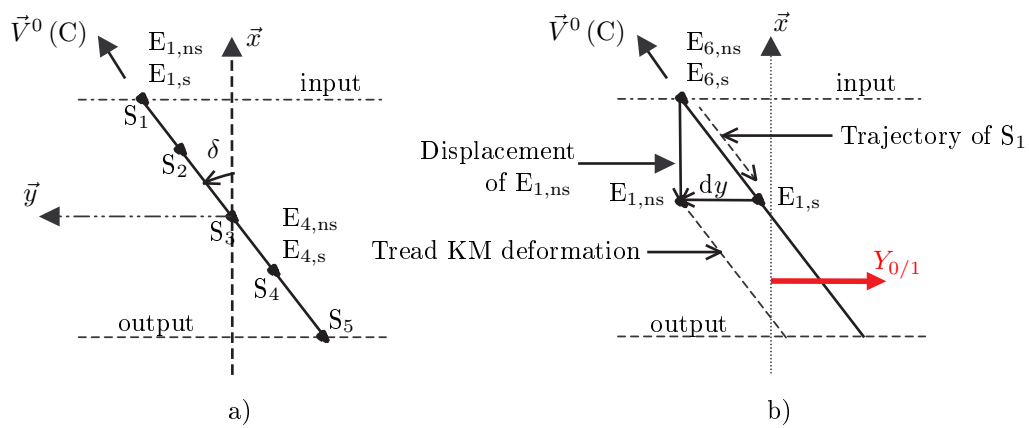

Figure 3.19: Element behavior a) when crushing, b) after a moment of run.

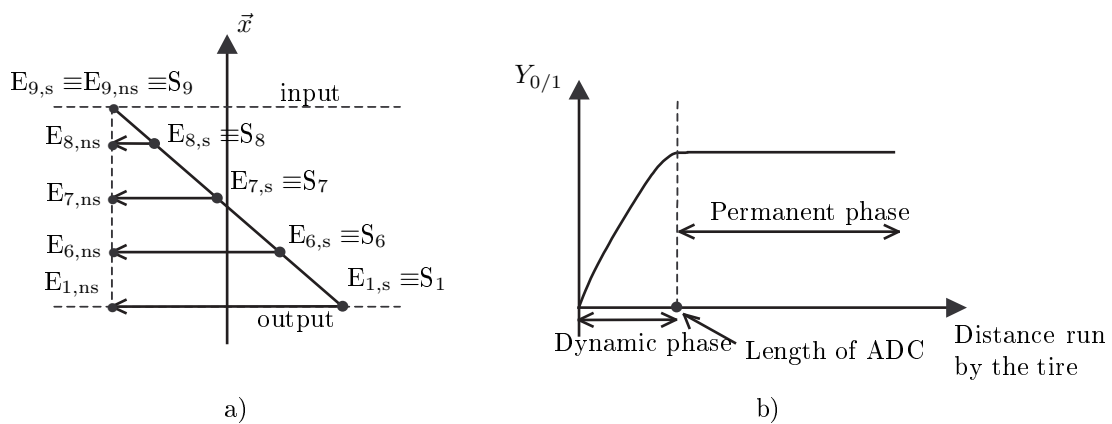

Figure 3.20: Tread KM element deformation in permanent phase.

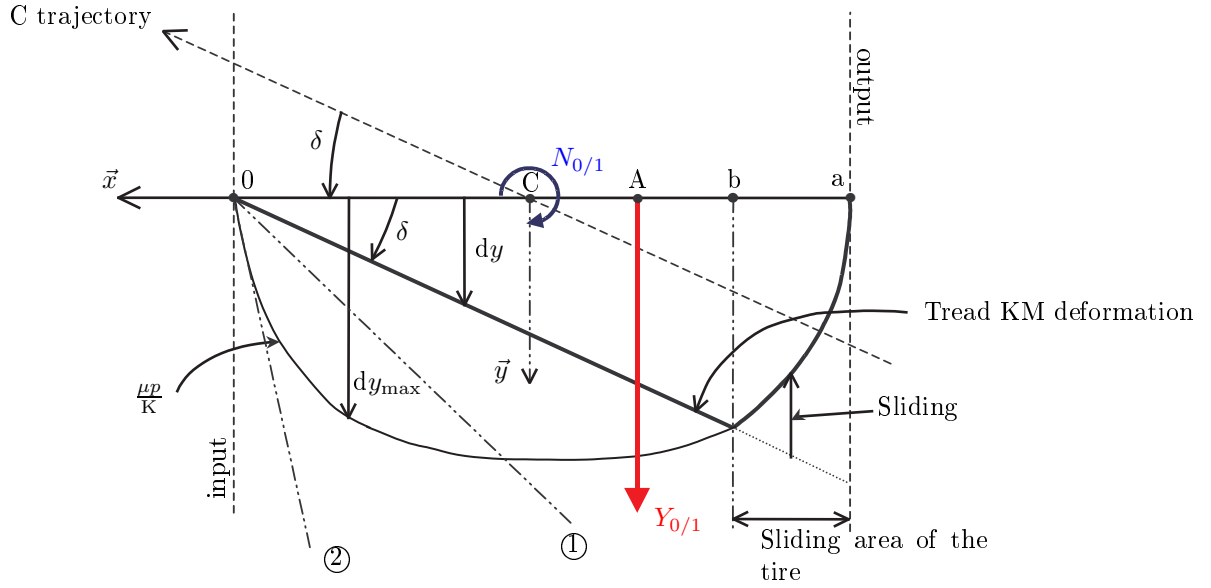

Figure 3.21: Patch over ground contact NST deformation in Fromm's model.

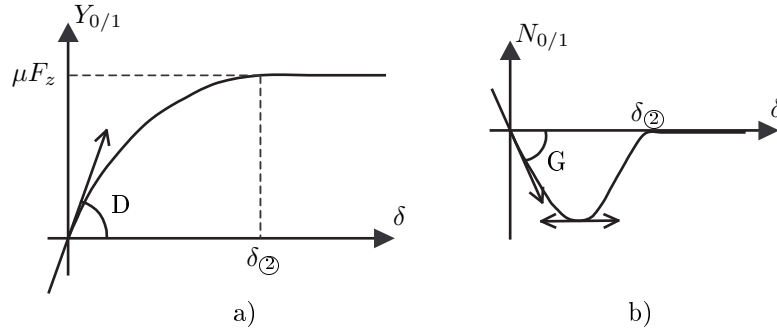

Figure 3.22: Graphs of $Y_{0/1}$ and $N_{0/1}$ versus sliding angle in Fromm's model.

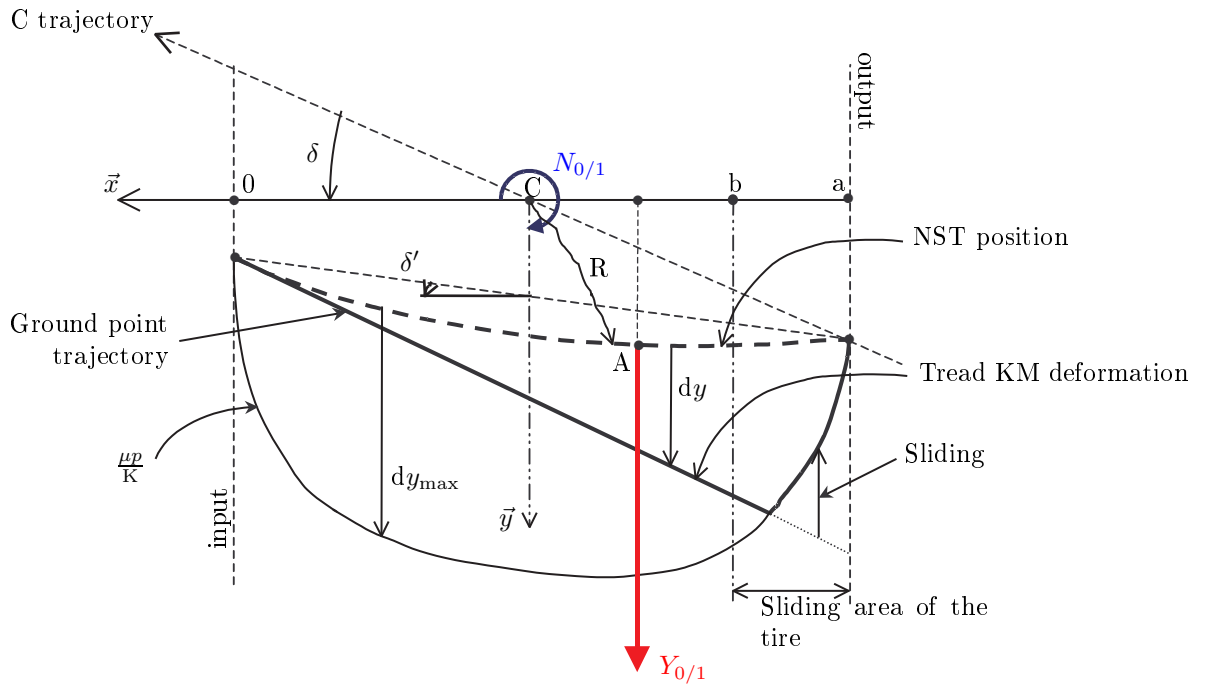

Figure 3.23: Tire deformations in deformable NST model.

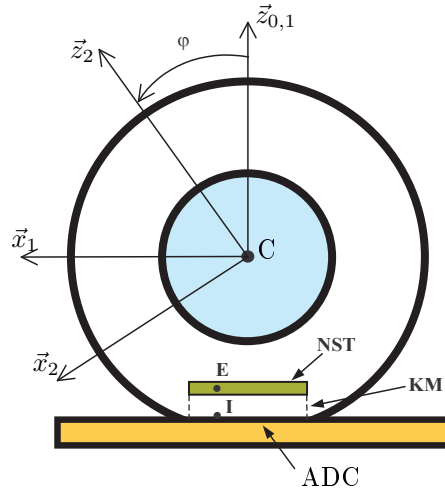

Figure 3.24: Frames and notations for the wheel.

functions of time (and thus implicitly as functions of the sliding angle as well), in transient and permanent responses. Moreover the possibility to choose as input data the steering angle β will enable to calculate $Y_{0/1}$ and $N_{0/1}$ as functions of this angle.

Furthermore the following notations and frames are adopted (Fig. 3.24):

- ground: body S_0 to which is attached the inertial frame of reference R_0 ,
- wheel plane to which is attached the frame of reference R_1 in translation in plane (\vec{x}_0, \vec{y}_0) and in rotation (steering β) with respect to R_0 around axis $\vec{z}_{0,1}$,
- the rim fixed to the wheel: body S_2 to which is attached the frame of reference R_2 in rotation with respect to R_1 around axis $(C, \vec{y}_{1,2})$ (rotation φ),
- the contact patch ADC to which the point I is linked,
- the portion of the tread KM (without mass) in contact with ground through contact patch ADC,
- the portion of patch over ground contact NST over the tread KM and the patch contact ADC, to which is attached the point E located above point I when tire is not deformed.

The notations for the position and velocity vectors are the following:

- $\overrightarrow{MN} = (x_{MN}, y_{MN}, z_{MN})$ for the position vector and its components in the frame R_1 ,
- $\vec{V}^i(M) = (V_x^i(M), V_y^i(M), V_z^i(M))$ for the point M velocity vector with respect to the frame of reference i and its components in the frame R_1 ,
- $\vec{V}_j^i(M) = (V_{x_j}^i(M), V_{y_j}^i(M), V_{z_j}^i(M))$ for the driving velocity of point M in the motion of j with respect of the reference frame i and its components in the frame R_1 .

Junction structure for the sliding phenomenon

The kinematic relations involving the point E attached to the NST, the wheel center and the different angular wheel velocities enable the figure 3.25 junction structure to be set up. The driving velocity formula at point E in the motion of the rim with respect to the inertial frame of reference $\vec{V}_1^0(E) = \vec{V}^0(C) + \vec{\Omega}_1^0 \wedge \overrightarrow{CE}$ in projection onto the axes \vec{x}_1 and \vec{y}_1 provides the figure 3.25a and 3.25b junction structures. The velocity compositions of point E $\vec{V}^0(E) = \vec{V}_1^0(E) + \vec{V}^1(E)$ and $\vec{V}^0(E) = \vec{V}_{adc}^0(E) + \vec{V}^{adc}(E)$ in projection onto axis \vec{y}_1 provide respectively the figure 3.25c and 3.25d junction structures.

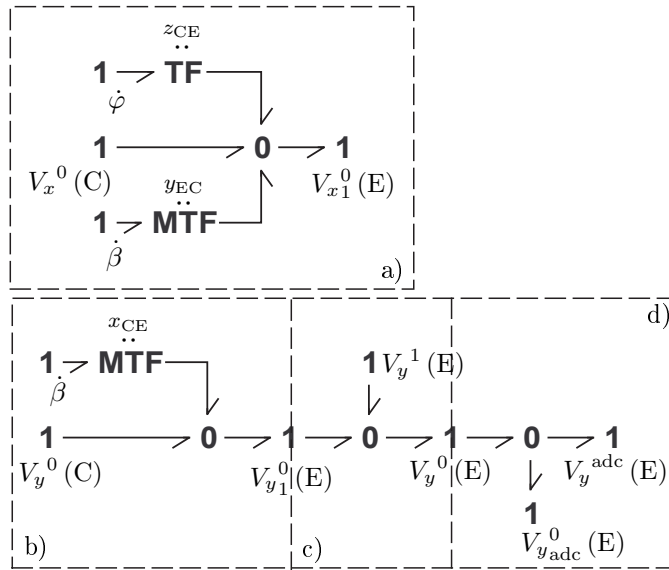

Figure 3.25: Junction structure for the sliding phenomenon.

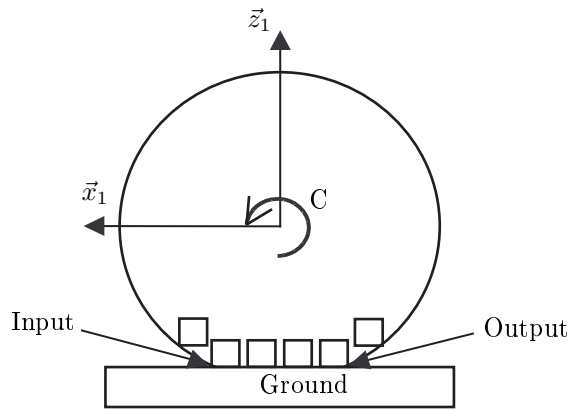

Figure 3.26: Discretization of the area above the tire contact patch ADC.

Modelling principle

Undeniably the sliding phenomena are governed on one hand by the sticking/sliding modes of tread KM points in contact with ground, and on the other hand, by the deformations of the tread and the patch over ground contact NST between the rim and the ground. To be able to model this it is chosen to discretize along the axis \vec{x}_1 the contact patch, the tread KM and the deformable NST all directly above the contact in a certain number of slices (Fig. 3.26). The tire part located in this area will be constituted of the tread and the NST deformable. The part of the tire “far” from this discretized area will be considered as rigidly linked to the rim. Each slice is composed of a mass element of NST, of a massless element of ADC, of massless components equivalent to pairs of springs/dampers and associated to deformation and shear phenomena, here supposed viscoelastic, along axis \vec{y}_1 . These pairs of springs/dampers are located between the NST and the ADC for the tread KM, between two adjacent NST elements and between the NST elements and the rim (Fig. 3.27). In this manner the retained idea is to model, in the ADC area, a circulation along axis \vec{x}_1 of tire elements while they go, these elements having dynamics along axis \vec{y}_1 .

Moreover to model a continuity between the elements directly above ADC and those out of this area, one mass element of NST and components springs/dampers coupling this element of NST to the one above ADC on one hand, and to the rim on the other hand, are added. For the external slices to the ADC area it is assumed that the points I on the external layer of KM are not swerved with respect to the points

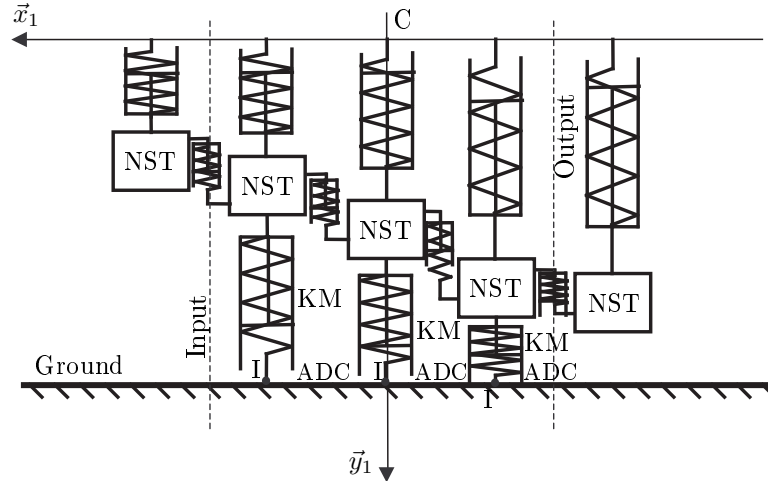

Figure 3.27: Slices composition in the ADC area.

E linked to the NST in the same slice (this assumption is materialized by the absence of components springs/dampers between the mass NST and the contact patch ADC). Finally, in the ADC area, if there is no sticking between the contact patch ADC element and the ground, then the corresponding point I slips with a ground velocity $\vec{V}_{\text{adc}}^0(I) = V_{\text{glis}}\vec{y}_1$.

This modelling principle lies on a Lagrangian approach where a lumped parameter system is considered (contrary to an Eulerian approach where the discretization model is the one of a distributed parameter system governed by partial differential equations) [Kar78a].

Bond graph representation of a tire slice

This section presents the bond graph representation of a tire “motif” corresponding to a slice previously defined and composed of a NST element, an ADC element and spring/damper elements for the interactions NST/rim, NST/ADC through the tread KM and NST/NST in deformation. On the figure 3.25 junction structure basis, the different energy elements are introduced to give the bond graph representation of a tire slice (Fig. 3.28).

The phenomena associated to the spring/damper elements and taken into account in a tire slice are introduced in the representation through C and R elements respectively. These pairs of elements are connected onto 1-junctions associated to the velocities to which these elements develop their power i.e. $V_y^1(E)$ for the coupling between NST and the rim, the difference between the point E velocities of two adjacent NST elements for the coupling NST/NST, and $V_y^{\text{adc}}(E)$ for the coupling between NST and ADC. The kinetic phenomena of NST masses in motion are taken into account through an I-element connected to the 1-junction associated to the absolute velocity of point E $V_y^0(E)$.

The presence of the C-R pair for the coupling between NST and ADC is valid in the case where the point I of ADC sticks to the ground. In the case where it slips phenomena change. It is then supposed that this point I stands upright above the point E and moves in the same manner as if it was attached to it. A sliding friction is then modeled and taken into account through a R-element connected to the 1-junction associated to the slip velocity $V_{y_{\text{adc}}}^0(E) = V_{y_{\text{adc}}}^0(I)$, junction that disappeared in figure 3.28. The X0-junction on which are connected the R-element and the pair of the previous C-R elements is a conditional 0-junction that enables the exclusive switch between the sticking and the slipping modes.

Finally two zero effort sources are connected on these conditional 0-junctions for representing the slices external to the ADC on the same bond graph. For the slice in front of the ADC input the X0-junction “switches” to the zero effort source and “disconnects” the R-element and the pair of C-R elements which are no more active on this slice. For the slice behind the ADC area the second X0-junction “switches” at the same time as the first does to the zero effort source for decoupling this slice from the pair of C-R elements and the bond behind.

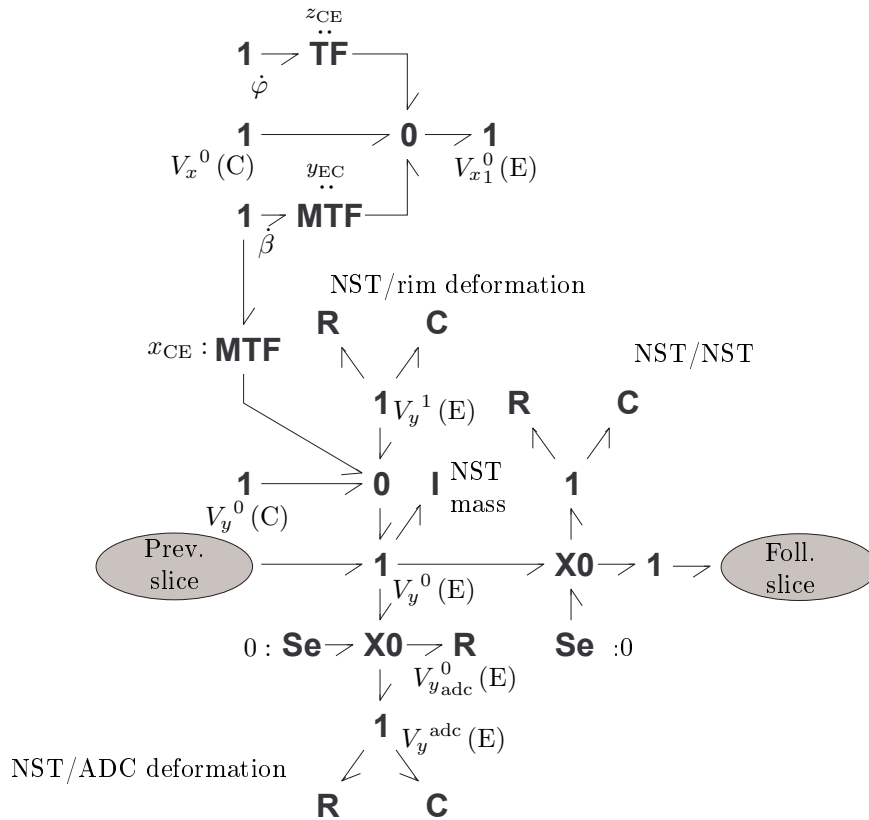

Figure 3.28: Bond graph representation of a tire slice.

Thus the model principle is that the slices previously described flow in the ADC area from the input to the output while the wheel turns, linking back to the wheel when they get out behind the ADC area. As soon as a slice gets out, another one gets in in front of the ADC area. While the tire goes the slices turns with the wheel. At certain times one slice will get out of the ADC area and another one will get in. The idea is to conserve always the same bond graph representation globally for the predefined set of slices and to change the parameter values and state variables of each slice when a certain distance is run. A word bond graph representation of the tire model proposed is given in figure 3.29 where the bond graph for each slice word is the one of figure 3.28. In this representation six slices are considered four of which are in the area above ADC. In view of the model simulation inputs in flow have been chosen by connecting flow sources for the wheel center velocity $\vec{V}^0(C)$, the steering velocity $\dot{\beta}$, and the wheel angular velocity $\dot{\phi}$.

Results and criticism

The sliding tire model proposed became operational in simulation only at the end of the postgraduate certificate training. The results only provide the first tendencies and a more thorough work is needed to improve and to fully take advantage of this model. The first simulations aim at getting closer the conditions of Pacejka's experiments (section 3.1.4.3) for a first comparison in stationary conditions. Constant inputs on flow sources corresponding to the wheel center velocity, and the wheel angular velocity were imposed. An animation shows from a qualitative point of view the NST and ADC configurations with respect to the wheel and the ADC area at a certain time (Fig. 3.30). It is possible to note the NST swerve (figurative sphere upper layer) and the tread KM deformation (difference between figurative sphere lower and upper layers).

From the quantitative point of view, in stabilized response, the curves giving the cornering force and the self alignment torque as function of the sliding angle were plotted (Fig. 3.31 and 3.32). For angles less than 6.4° these curves show interesting tendencies and orders with respect to experimental results

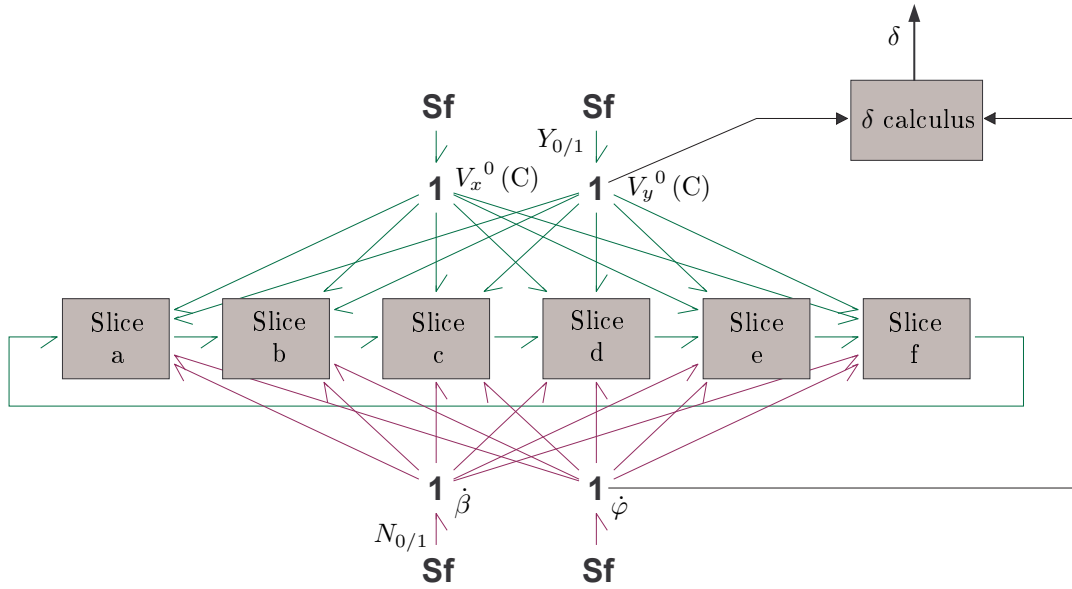

Figure 3.29: Word bond graph representation of a sliding tire.

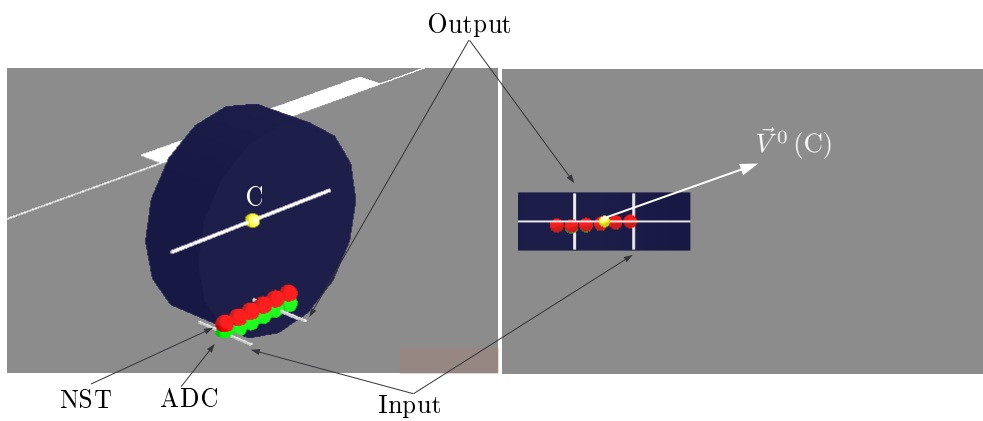

Figure 3.30: Sliding tire model animation.

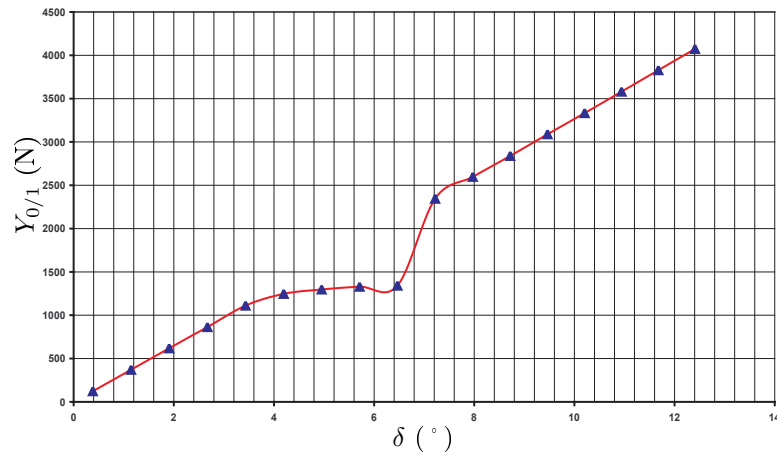

Figure 3.31: Cornering force versus sliding angle in stabilized response.

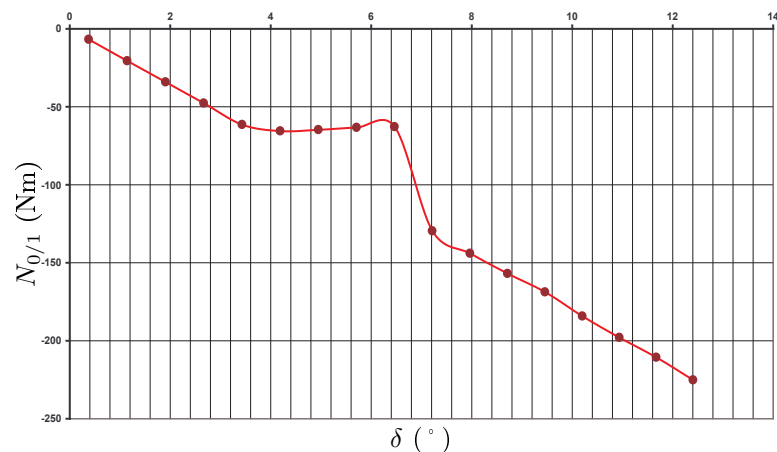

Figure 3.32: Self alignment torque versus sliding angle in stabilized response.

(Fig. 3.16). However for angles greater than 6.4° the curves show an increasing linear evolution again of the cornering force and the self alignment torque. Furthermore the undertaken simulations showed a strong presence of discontinuities associated to the switching mechanism between the slices. Finally the observation of sticking and slipping modes shows that the latter is solicited only in transient phase generally.

3.1.4.5 Conclusion

My contribution in this work is original with respect to the domain to which the automobile tire belongs to. In fact my will was to adopt at the same time a Lagrangian point of view for the elements circulating in the slices which are issued from the discretization in the contact patch area, and another point of view, very close to the Eulerian one, where the circulation of these elements are considered in the slices. Such an approach is already present in [Kar78b] but in the tire application, the Lagrangian dynamics is along a perpendicular axis to the flowing direction of the tire elements. Following the works on the automotive vehicle modelling (section 3.1.2), my will was also to have an energy approach of the tire modelling allowing the use of bond graph language.

Though the criticism of the previous results, the model proposed presents a certain number of possibilities. The sliding angle is no more a phenomenon input enabling the mechanical actions to be determined but an output resulting from the tire dynamics. This is a dynamic model that allows to simulate transient response of tire swerve. The sticking and slipping phenomena of the different ADC parts can be

reproduced. The classical parameters of vehicle dynamics can still be observed like sliding and torque rigidities. All the model parameters have a strong physical interpretation contrary to certain of the Pacejka’s magic formulas. The dependency on the contact patch ADC width can be taken into account by a similar discretization along the width. A matrix would then be obtained for which the number of slices could change in order to take into account of the non uniformity of the contact patch ADC longitudinally. Moreover the coupling between both longitudinal and transversal dynamics would be possible. Also it can be envisaged to introduce and couple vertical dynamics. Due to the discretization this model does not require any integration of a space variable for the cornering force and the self alignment torque calculus as it is the case in Fromm’s model. However the model enables the pressure repartition on the different slices to be taken into account. Also the coupling with propulsion or braking actions can be easily introduced in the bond graph representation of the model proposed.

A first encouraging step is marked in the consistent tire modelling with the bond graph representation and thus with an energy approach. Contrary to the Pacejka’s formulas this approach enables a dynamic behavior to be taken into account. Number of ideas are possible to improve this model. A work on the parameters would first allow to define a more realistic behavior qualitatively and quantitatively speaking. The switching between sticking and slipping modes seems also to have a great importance to reproduce the tire behavior. Then it is envisageable to work with non linear models on certain phenomena associated to the patch over the ground contact and the tread structures or also associated to friction of the contact patch to the ground. Finally the discretization drawback is to introduce discontinuities associated to switching between slices. Another point is thus to work toward the energy conservation in the circulation mechanism of the elements in the contact patch area.

3.2 Contribution to the sizing methodology

Context

The works presented in this section constitute a pivotal part of my research as an associate professor. They are at a pivotal moment between my first years after my nomination and my activities more exploratory led today (see section 3.3). They also correspond to a thematic transition between my “post-doctoral” research on the bond graph representation of multibody mechanical systems and a research axis of the team FTR on the *Virtual prototyping*. Finally they are pivotal works between automation and mechanics domains enabling tools and concepts of each to be exploited.

The works presented are in great part in the framework of the PREDIT 2 program in which I co-supervised Olivier Méchin’s Ph. D. thesis in collaboration with PSA Peugeot Citroën.

In this section the following three developments are presented:

- recall on the sizing methodology (section 3.2.1),
- sizing methodology extension (section 3.2.2),
- actuation line structures (section 3.2.3).

3.2.1 Recall on the sizing methodology

3.2.1.1 Introduction

The sizing methodology development takes place on the research axis *Virtual prototyping* of the LAI. This axis starts with Serge Scavarda’s original idea to combine inversion of model and bond graph language [Sca91]. It is now in place since more than fifteen years with a first Ph. D. thesis in 1991 [Ama91] in collaboration with the *Unité Génie Robotique* of CEA about the evaluation, on dynamic and energy criteria, of actuation line performances in mobile robotics. This work, in the continuity of Coeuillet’s [Coe69] and Vukobratovic’s ones [Vuk87], starts the set up of an original methodology developed at the

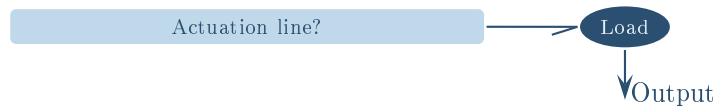

Figure 3.33: Simplified problem of the sizing methodology proposed.

LAI and first based on the use of scattering variables. It is then applied to design problems like for instance pneumatic servovalve sizing or technological comparison of actuation lines on energy criteria.

The introduction in 1995 of the bicausality concept by Peter Gawthrop marks an important date in the *Virtual prototyping* research axis developments. Serge Scavarda immediately sees the bicausality utility in the sizing context and introduces it in the methodology developed. Bicausality, combined among others to causality and power line concepts, enables the inversion problem to be posed in a clever way and results to be obtained more rapidly in particular by avoiding the use of scattering variables. A new version of the methodology is then proposed in 1997 during the Fotsu-Ngwompo's Ph. D. works [Fot97]. It sets up an aid to the design and more particularly to the sizing of actuation lines on dynamic and energy criteria [Fot96, Fot99, Fot01a, Fot01b]. The basis concept is model inversion. This approach enables all the data of the sizing problem to be used at the very beginning to specify an actuation line, to select components and validate them in terms of power variables (effort/flow) and power. This approach enables the number of iterations to be decreased in the design process, also a better knowledge of the component limitation origins in the case they do not satisfy the criteria, and these limitations more precisely to be measured. This methodology shall contribute to a more rapid and adapted design to the posed problem of the mechatronic system sizing on dynamic and energy criteria.

The methodology also lies on the bond graph representation on one hand to verify necessary conditions for the resolution of the sizing posed problem, and on the other hand, to determine the inverse state model providing the solution to the problem. Sizing is dynamic because specification, selection and validation are made on each point of the specified trajectories (functions of time) on the outputs. In this way the critical points are necessary envisaged, the safety margins can be measured and the time of transient evolution in critical zones precisely evaluated.

In the framework of the METISSE project of the RNTL I developed an example introduced by Roger Fotsu-Ngwompo during his Ph. D. thesis [Fot97]. It serves for illustrating the recall on the methodology and also the recent developments realized to implement its features in the tool MS1 developed by Francis Lorenz.

3.2.1.2 Methodology presentation

The methodology is summarized in both figures 3.33 and 3.34 where starting from the problem of designing an actuation line it guides, by an inverse approach, for verifying the adequacy between the load structure and the specifications, selecting, validating the component in front of the load and repeating chronologically these steps until the device of energy furniture and the open loop control. See also [Fot99, Fot01a, Fot01b] in the documents attached.

3.2.1.3 MS1 and application example

The example is a two revolute axes robot (Fig. 3.35). Its bicausal bond graph representation is given figure 3.36 where are displayed the specifications on the terminal point trajectory (Fig. 3.37) and the actuation lines to size. The simulation results is given only for the axis 1 actuation line. MS1 makes use of a database of prerecorded manufacturer components (Fig. 3.38) and systematizes selection and validation of appropriate components in terms of power variables an power (Fig. 3.39). Finally simulation results are given in figures 3.40 and 3.41 respectively for a not validated and a validated drive.

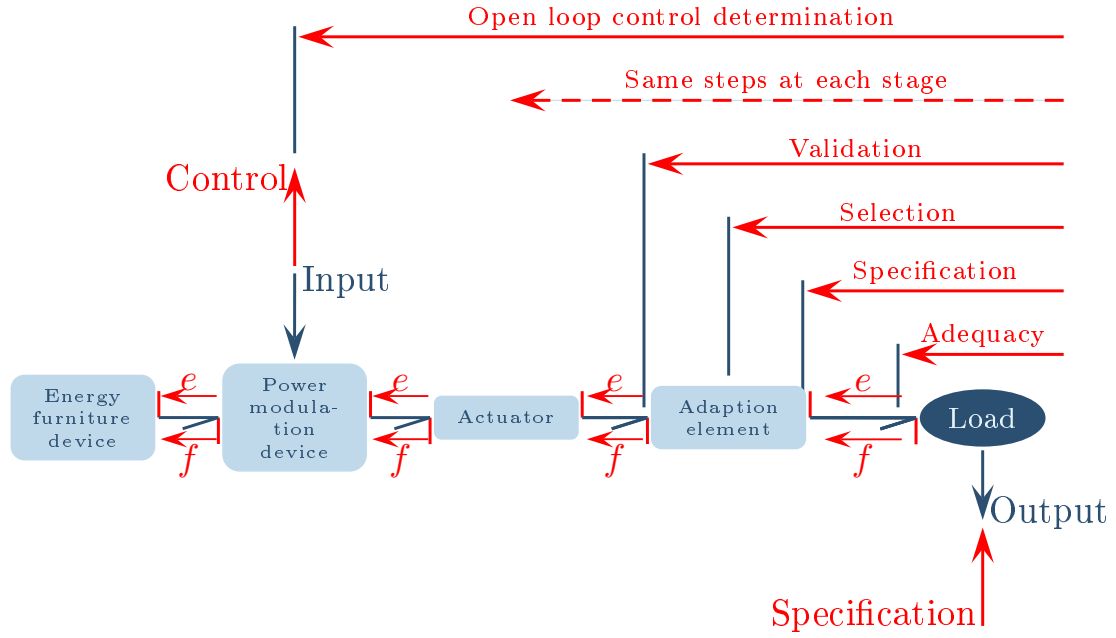

Figure 3.34: Schema of the simplified principle of an actuation line sizing.

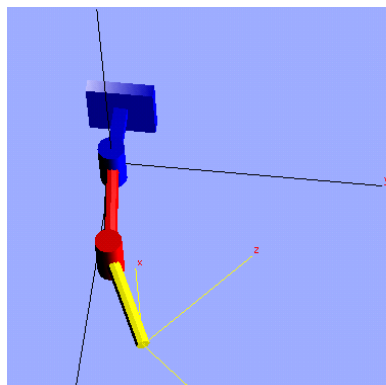

Figure 3.35: 2 revolute axes robot.

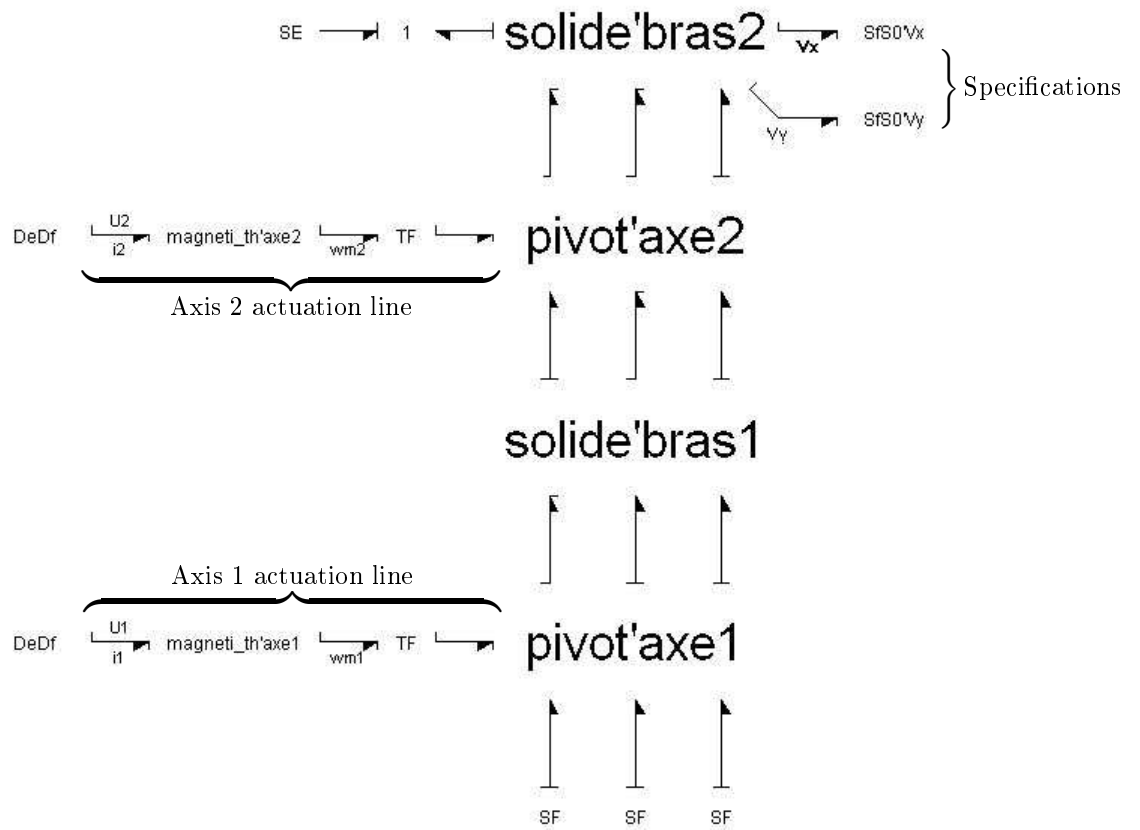

Figure 3.36: bicausal bond graph of the 2 axes robot.

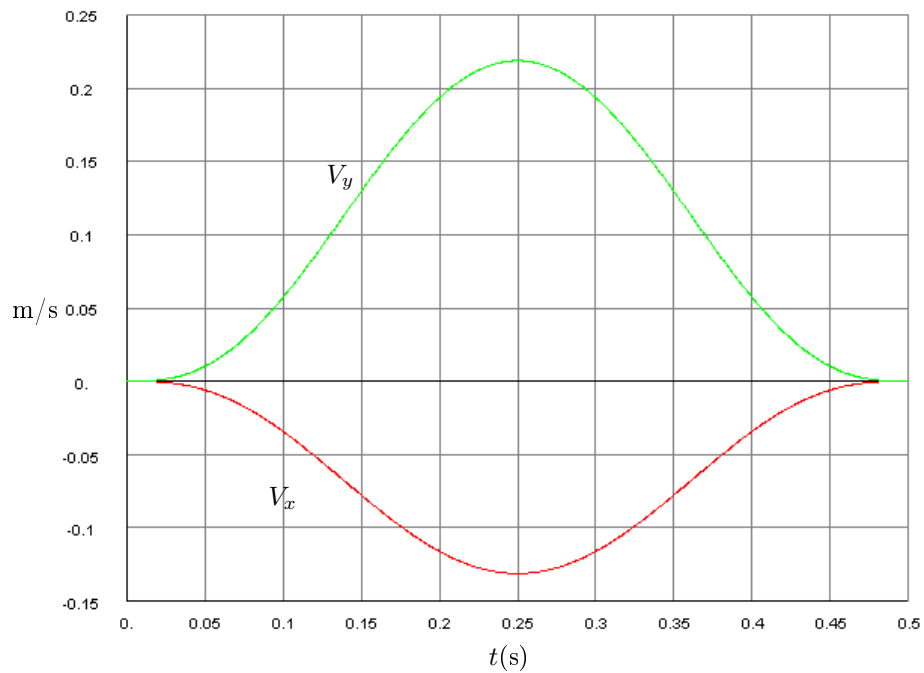

Figure 3.37: Output trajectory specifications.

Identification	Caractérisation		Modélisation
	Entrée	Sortie	
Mcc_mpth_1	P 12,66 e 15,27 f 0,829	12,62 0,0127 994,3	Sys magneti_th Mod Mdl_1 Par Par_1
Mcc_mpth_2	P 12,931 e 19,34 f 0,669	12,926 0,013 994,3	Sys magneti_th Mod Mdl_1 Par Par_2
Mcc_mpth_3	P 12,994 e 21,73 f 0,598	12,925 0,013 994,3	Sys magneti_th Mod Mdl_1 Par Par_3
Mcc_mpth_4	P 12,942 e 24,42 f 0,53	12,925 0,013 994,3	Sys magneti_th Mod Mdl_1 Par Par_4
Mcc_mpth_5	P 13,07 e 30,54 f 0,428	13,02 0,0131 994,3	Sys magneti_th Mod Mdl_1 Par Par_5

Enr : 16 sur 33

Nouveau Editer Effacer Quitter

Figure 3.38: Electrical drive sample.

```
Essai du composant de librairie <Mcc_mpth_1>.
(magneti_th.Mdl_1/Par_1)
```

	Réalisé	Pourcents	Autorisé
P in max	3.96328	31.31	12.66 OK
E in max	4.6918	30.73	15.27 OK
F in max	0.844723	101.90	0.829 KO
P out max	0.0517616	0.41	12.62 OK
E out max	0.0130317	102.61	0.0127 KO
F out max	5.78983	0.58	994.3 OK

```
Essai du composant de librairie <Mcc_mpth_5>.
(magneti_th.Mdl_1/Par_5)
```

	Réalisé	Pourcents	Autorisé
P in max	3.78427	28.95	13.07 OK
E in max	8.99397	29.45	30.54 OK
F in max	0.420759	98.31	0.428 OK
P out max	0.0517616	0.40	13.02 OK
E out max	0.0130317	99.48	0.0131 OK
F out max	5.78983	0.58	994.3 OK

Figure 3.39: Results of a validation phase on a drive series.

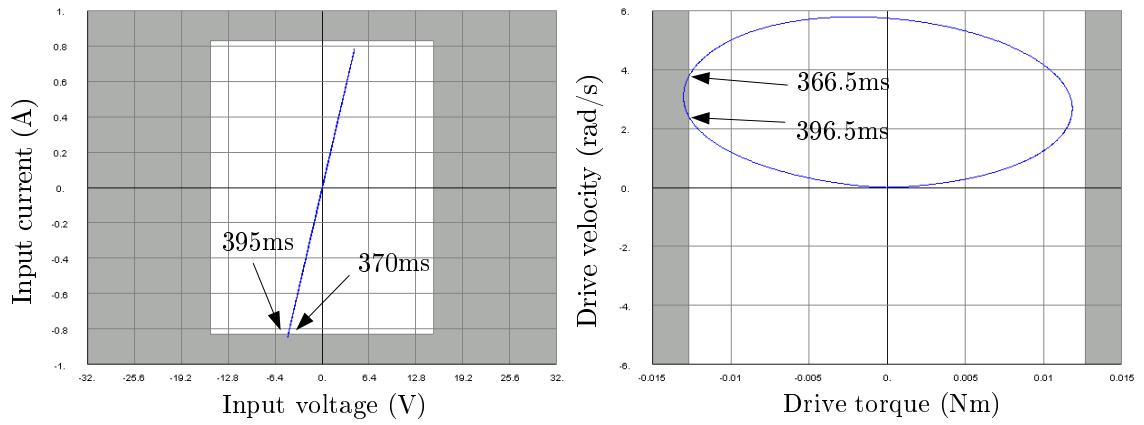

Figure 3.40: Simulation results for the drive not validated.

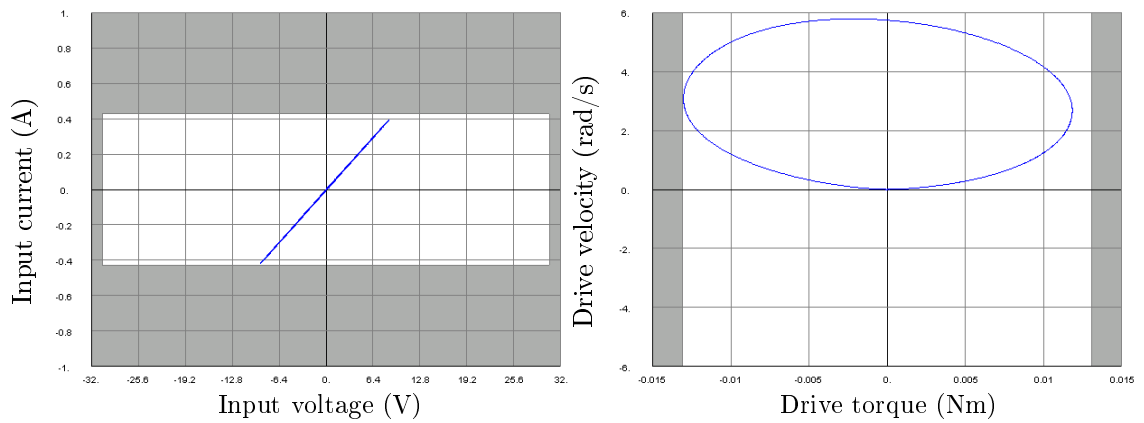

Figure 3.41: Simulation results for the drive validated.

3.2.2 Sizing methodology extension

3.2.2.1 Introduction

These works were carried out in the framework of the PREDIT 2 program during Olivier Méchin's Ph. D. thesis in collaboration with PSA Peugeot Citroën. One of the main objectives was to validate the methodology on industrial applications and in particular on automotive applications. These applications were the EPS and the suspension systems. Some difficulties to directly apply the methodology has motivated its extension. Further more the notion of global or synergy sizing has been introduced. Finally an actuation line structure classification has been set up with respect to the mechanical load degrees of liberty in view of furnishing an aid to determine the specifications.

3.2.2.2 Motivations for extending the methodology

The motivations for extending the methodology have two origins each of which being associated to an automotive example. Concerning the EPS the difficulty was in the form of the manufacturer specifications that are not generally functions of time as the methodology requires. For the suspensions the problem was a singularity in the inverse model that cannot be overcome without extra model manipulation.

However as illustration on suspensions, the methodology was applied successfully on a simplified vehicle model freeing itself from any singularity. This model is the one of a longitudinal bicycle vehicle in deceleration. The results enabled for instance, depending on the pitching and pumping specifications, to see if it was necessary to introduce an active part on the suspension passive basis. These works was the object of an international congress publication [Méc02].

3.2.2.3 Power steering constraint concept

See [Méc03] in the appendix C document.

3.2.2.4 Behavior constraint concept

Problem

The works followed by PSA Peugeot Citroën also motivated to apply the methodology to automotive suspension systems. This enables a multivariable case to be tested since here four actuation lines are the sizing objective and four outputs are thus to be specified. The principal sizing objectives of the suspensions are comfort and road holding. In these works where the methodology is tested on industrial cases only life situations of a car in curve on one hand, and a car in curve combined to a braking on the other hand, are considered. Other life situations also important for sizing and corresponding to comfort prestations for the car passing over an obstacle exist but are not envisaged here. In this context the specified outputs correspond to yaw, pitching, rolling and pumping vehicle behaviors.

Contrary to the EPS case the methodology application problem is here essentially in the structure analysis phase in order to invert the model. In fact this model corresponds to a full vehicle one and the power lines involved in the inversion between the suspension components and the outputs to be specified necessarily go through the bond graph junction structure of the vehicle model. That was not the case for the EPS. Now the structure is relatively complex. The analysis showed the necessity to use MS1 for identifying in a systematic way the inversion possibilities. Furthermore the analysis also showed the existence of a static singularity associated to the form of the model and corresponding to a vehicle position where the suspensions axes are all parallel with the vehicle vertical axis. This singularity leads to an inverse model not defined for this position and thus to the impossibility to determine the suspension forces from the specified outputs. This situation corresponds to the fact that it is impossible in this configuration to induce an instantaneous yaw motion for the vehicle. In inverse if the yaw output is specified in this configuration the model exploitation then leads to a division by zero.

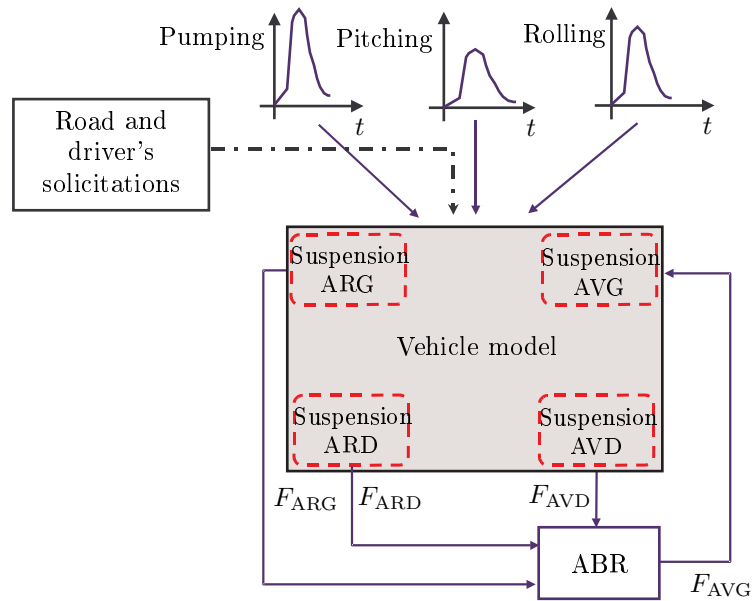

Figure 3.42: Behavior constraint concept: Anti-Banking Repartition for suspensions.

Extension

One first solution can be to deal with the singularity locally in time by switching to a degenerate inverse model that frees itself from the yaw specification. A second solution is to use only three output specifications (pitching, rolling, pumping) and to introduce a constraint between the fourth suspension and other variables in the model precisely to specify this suspension. This solution led to the methodology extension. This extension converges to a large extent toward the reflections during the methodology application to the EPS and the corresponding solution adopted.

The methodology extension coming from its application to suspensions has a different origin than the one stemming from the EPS but it is totally similar in its implementation. In fact this extension stems not so much from the difficulties to express the output specifications as functions of time but from the mathematical structure of the model to invert which possesses a singularity. It was then decided to free oneself from one specification on one of the outputs, namely the yaw, and to directly specify a suspension effort as a function of other variables in the system. The specifications on the three other outputs, pitching, rolling and pumping of the vehicle are conserved. The relation introduced corresponds to the well-known concept in the manufacturer, the one of Anti-Banking Repartition which corresponds to the coordinated and researched action of the suspensions with respect to the vehicle behavior (Fig. 3.42). This type of specification introduces the concept of behavior constraint. The implementation of this relation is totally analogous to the one carried out for the EPS with one difference: it concerns not a load output specification but directly an output of one of the suspensions to size.

This extension enabled the suspension sizing to be undertaken successfully in simulation. It also opened other possibilities and a strong possibility toward both passive and active suspension sizing.

3.2.2.5 Concept of synergy or global sizing

One possibility not expected at the beginning of Olivier Méchin's Ph. D. thesis appeared with both automotive system studies, the EPS and suspensions. The methodology application to these systems was undertaken firstly separately. It was then not difficult to envisage to combine both sizings in a unique one aiming at specifying, selecting and validating simultaneously the both systems (Fig. 3.43).

In fact the vehicle behavior results from all the couplings between these different systems but the previous sizings was undertaken separately. The choice for one system constrains in return the performances

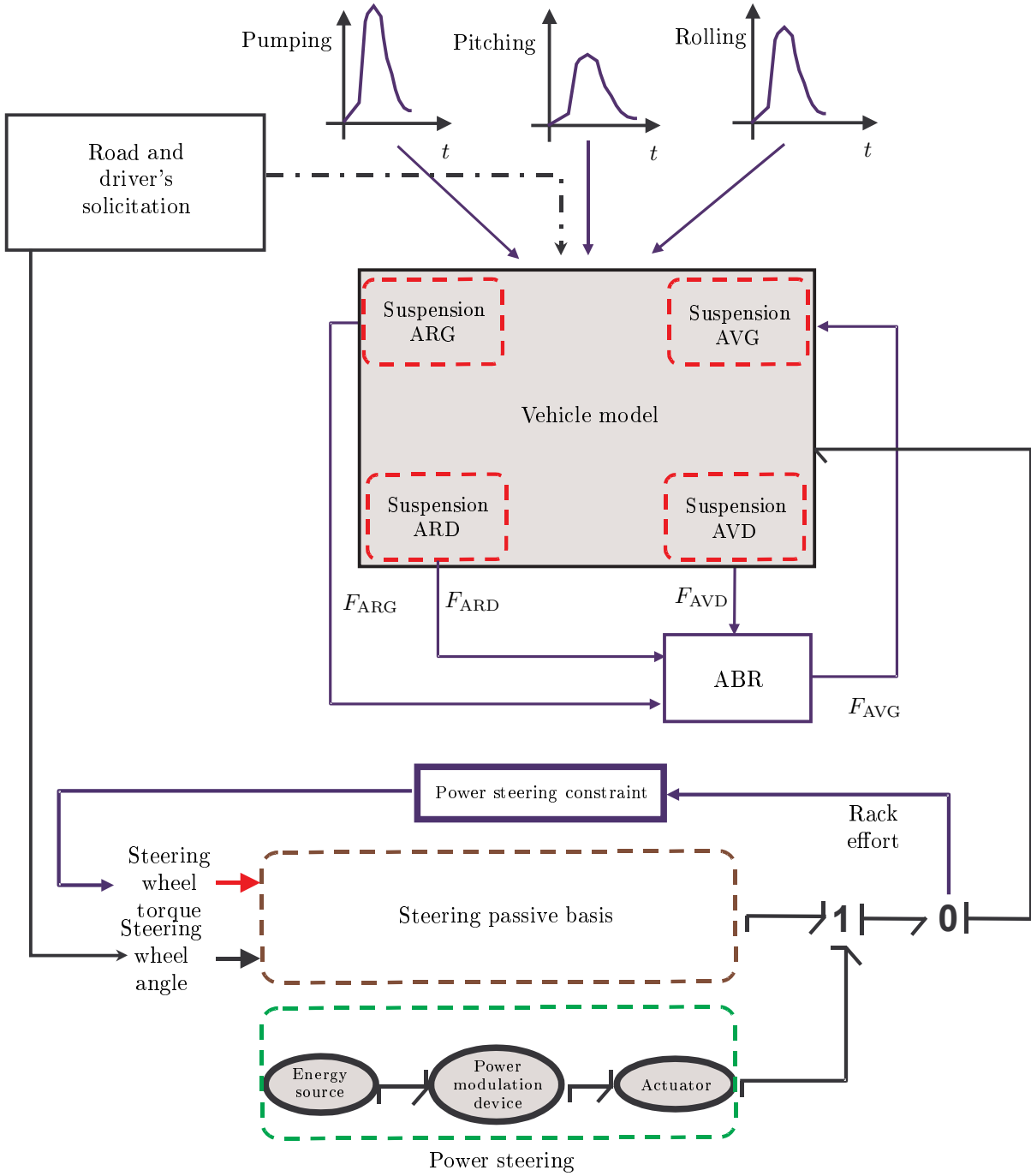
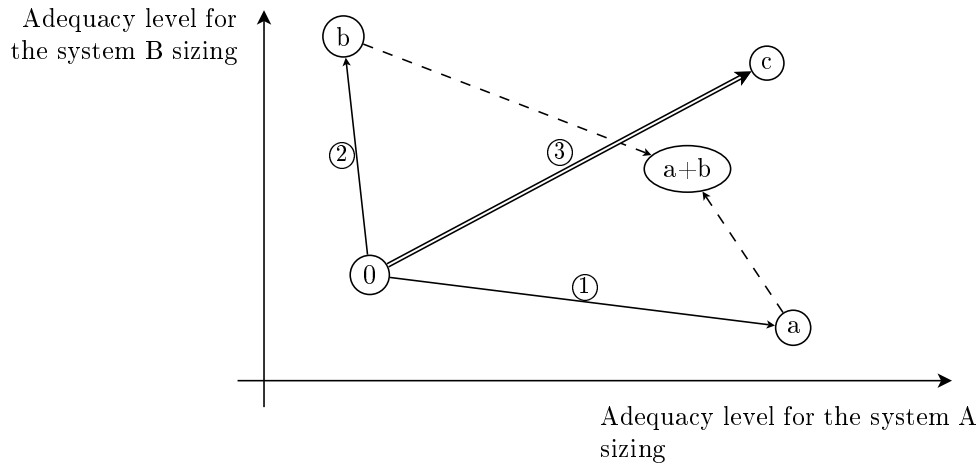

Figure 3.43: EPS and suspensions simultaneous sizing.



Sizing phases for:

- ①: system A alone,
- ②: system B alone,
- ③: systems A and B simultaneously.

Sizing states:

- 0: initial,
- a: final for system A alone,
- b: final for system B alone,
- a+b: final after system A and B gathering,
- c: final for systems A and B together.

Figure 3.44: Synergy sizing concept.

expected for the other. With separate sizings (phases ① and ② in figure 3.44) one system design enables the expected adequacy for it alone to be achieved but generally at the expense of the other systems to design (states a for system A -EPS for instance- and b for system B -suspensions for instance-). Once the systems gathered, a trade-off has to be found (state a+b). Then the system adequacy for their own criteria must be locally verified.

On the contrary synergy sizing consists of a simultaneous design of the different systems (phase ③ in figure 3.44) taking into account at the very beginning the coupling between them. According to this, on the figure 3.43 example, the steering wheel torque objectives defined by the methodology lead to the power steering design but, at the same time, have an indirect influence on suspension sizing. Likewise the pumping, pitching and rolling specifications affect the EPS sizing which shall be easily studied.

3.2.2.6 Conclusion

The extension of the methodology is now available which takes into account of specifications in form of constraints between the model variables. These constraints refer to the concept of power steering level (for instance for the EPS) or to the concept of behavior requirement (for instance Anti-Banking Repartition for suspensions). These results enabled not only the methodology to be validated but also its application field to be increased.

Furthermore the idea of a synergy or global sizing approach takes benefits of the methodology features and enables to be envisaged to specify, select and validate several vehicle systems in one go and simultaneously. This approach takes into account at the very beginning of all the couplings between the systems for their sizing and all the output specifications. No doubt that this idea of synergy or global sizing shall permit to raise higher levels of performances in the mechatronic system design.

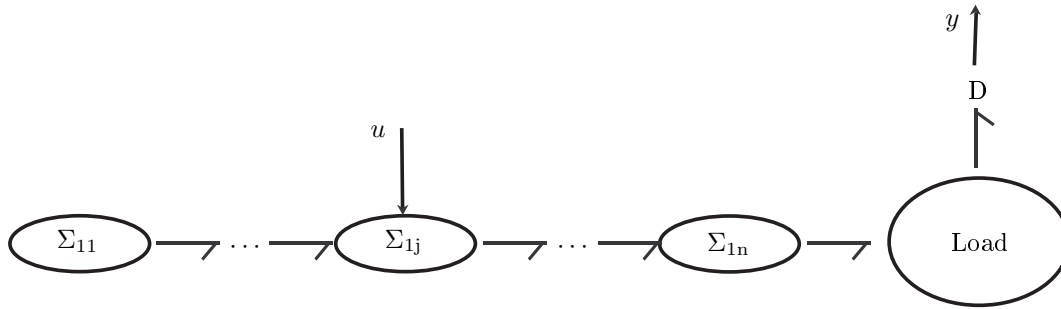

Figure 3.45: Mono-actuated load word bond graph.

3.2.3 Actuation line structures

3.2.3.1 Introduction

Also in the framework of Olivier Méchin’s Ph. D. thesis the analysis of the manufacturer approach for vehicle design and the difficulties met at the beginning to apply the methodology imposed on one hand, to try to formalize the relationship between the actuation structure and the function assigned to load, and on the other hand, to start a reflection on the specification possibilities of an actuation line in terms of form (in a general way from the mathematical point of view), and of output localization. This first reflection was led essentially in a mechanical load context and with respect to de degrees of freedom (understood as kinematic degrees of freedom) of this load.

3.2.3.2 Actuation structure classification

The works carried out on vehicle system sizing permitted to make clearly appear the necessity of placing the reflection from the relationship point of view between the actuator number and the load degree of freedom. A first formalization led to present in a generic way the structures met in the application examples and to set up a classification of actuation structures together with their bond graph representations. This classification, well inspired from the robotics domain, enables iso-actuated, degenerate iso-actuated and over-actuated loads to be distinguished. This classification shall permit to explain the difficulties appeared when using principal specifications. In fact the suspension car, for instance, corresponds to a degenerate case of iso-actuation due to a mathematical model locally not invertible with respect to the inputs/outputs considered. Consequently it was not possible to use the specifications in a classical manner in the proposed methodology. The EPS example illustrates a case of over-actuation where a secondary actuation line assists a principal one. In this case it is preferable then to use one specification on the power steering degree rather than directly on the output.

This section presents a first step toward a classification. In this context it does not pretend to be exhaustive with respect to all the cases of actuation/load systems that may be envisaged. Moreover it is strongly linked to the application cases treated in the automotive axle systems (EPS and suspensions). However it presents the interest to set up a formalization basis that shall be extended in perspective of a generalization.

Mono-actuated load: iso-actuation

The generic structure presented in this section is the case considered in Fotsu’s works [Fot97, Fot99, Fot01a, Fot01b]. It consists of an actuation line acting on a load with one degree of freedom (Fig. 3.45). The detector associated to the specified output is represented by the letter D. The imposed and measured variables can be efforts and/or flows. Moreover the open loop control variable u is an input of a power modulation device.

The inverse model of this structure, from the output y and if it exists, is a series of inverse models

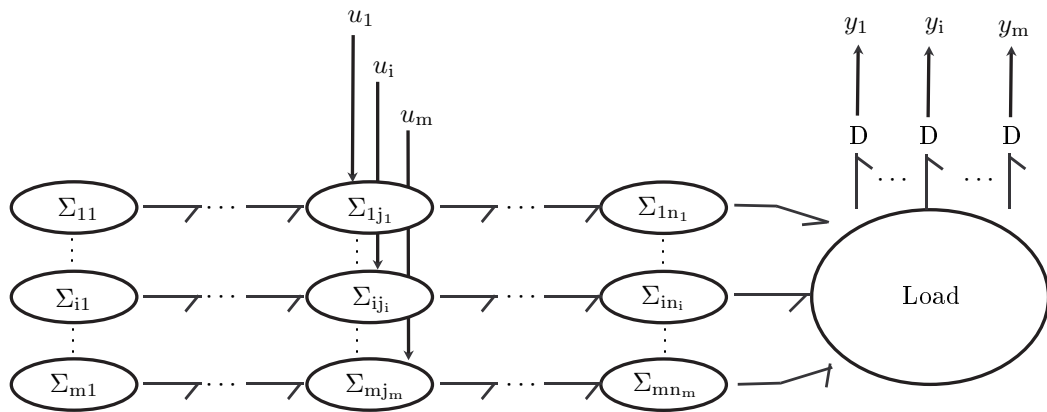

Figure 3.46: Word bond graph of a Multi-actuated load with iso-actuation.

from the load and the different actuation line components until the power modulation device (Σ_{1j}) if the input u is researched, or until the energy furniture device (Σ_{11}) if it must be specified. The relative input-output degree is thus the sum of the relative degrees of the load and the different components constituting the actuation line. This degree indicates the differentiability condition that the specification must satisfied.

Concerning the specifications if the structural and mathematical invertibility conditions are verified, this class of problems do not impose nothing particular in general. Restrictions may come from the incapacity to specify the output trajectory as a function of time but these restrictions are of the principal responsibility who has the possibility to use the constraint concept and to free himself from the output specification. However the methodology imposes that the trajectories are functions of time sufficiently differentiable. Finally this class of problems corresponds to a SISO from the state space representation point of view.

Multi-actuated load: iso-actuation

This class of problems corresponds to the case of a load with several actuation lines the number of which is equal to its degree of freedom (Fig. 3.46).

The input/output relative degrees are the sums of the input/output relative degrees of the load and the different components constituting the actuation lines.

From the state space representation point of view the class of problems presented in this section is a generalization of the previous one to systems MIMO [Fot01a, Fot01b]. Concerning the specifications if the invertibility conditions are verified structurally and mathematically the application context of the methodology using functions of time for the specified trajectories are still valid. However if the structural conditions are clearly expounded in the methodology no study have been carried out concerning the mathematical conditions yet. These latter apply to the invertibility and differentiability properties of the element constitutive laws of the bond graph representation. It is important to recall here that the structural conditions are necessary but not sufficient.

Multi-actuated load: degenerate iso-actuation

The model structures presented in the previous sections correspond to those already studied with the methodology. The class now presented stems from the vehicle model set up in section 3.1.2. In fact the methodology was applied to the design problem of the suspensions. From the structure point of view this is an application case of the previous class with four actuation lines and four outputs associated to four degrees of freedom of the load initially specified (rolling, pitching, yaw and pumping).

The peculiarity of this class resides in the load kinematical structure. By analogy to the robotic

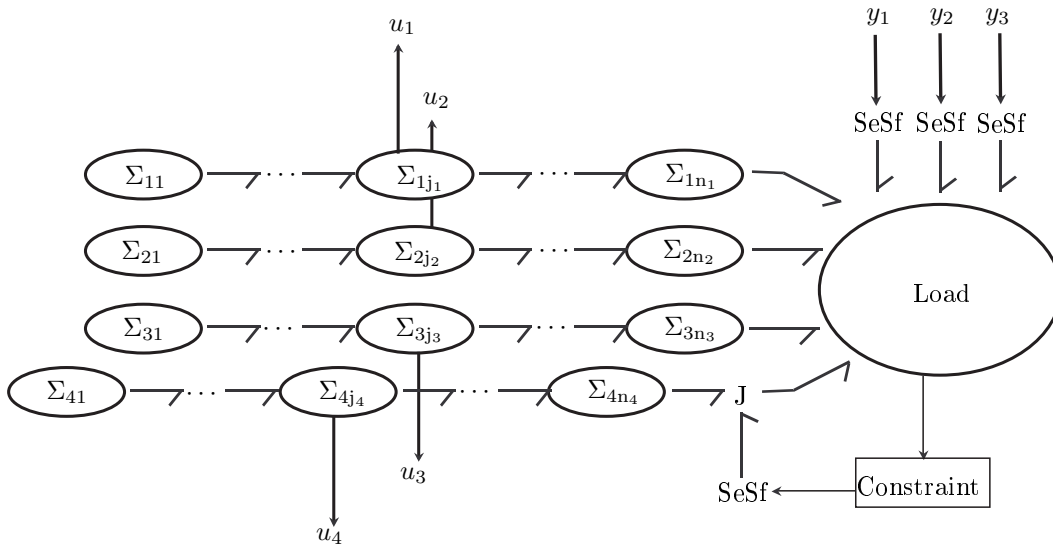

Figure 3.47: Word bond graph representing a specification solution for a load with degenerate iso-actuation.

domain this structure presents a static singularity. This singularity indicates that, in the corresponding configuration, locally, the actuation lines have no more action on all the degrees of freedom resulting in a “degenerate” iso-actuation. In fact the load model is not invertible in this point of configuration space and the specifications cannot apply simultaneously. One first solution is not to use all the specifications and to replace one by using a constraint between certain variables. This solution is illustrated by the figure 3.47 word bond graph for a four actuation line example where the letter J denotes a bond graph junction.

The use of a constraint requires a partial inversion of the load since an output does not change its role for an input. The input/output relative degrees are the sums of the input/output relative degrees of the load and the different components constituting the actuation lines (except for the fourth one). The input-output relative degree for the last actuation line is simply the sum of the relative degrees of the different components between the input u_4 and the junction J.

Multi-actuated load: over-actuation

The bond graph structure presented in this section is issued from the bond graph models worked out in section 3.1.2 on the steering system. It is constituted of a principal line (strictly mechanical bond between the steering wheel and the rack) permitting the wheel steering. The power steering system associated to the principal line has the function of assisting i.e. furnishing an effort and reducing consequently the one experienced by the driver. The good management of this energy contribution shall improve, by the steering wheel torque, the feeling (and the information) that the driver has on the vehicle behavior. These different acknowledgments led to consider that a power steering system, independently of its technology, is composed of a principal actuation line (the one starting from the driver) and a secondary actuation line consisting of the power steering system. Both actuation lines converge on the same load input port. Consequently they can act together on an unique degree of freedom of the load and thus correspond to an over-actuation. The elimination of one of these lines does not eliminate any action possibility on the involved degree of freedom. In the EPS context a generic representation of the corresponding structure is given in figure 3.48.

Concerning the specifications they apply to one of the principal actuation line components and no more to the load. Consequently the objective is the sizing of the secondary line that verifies the specification requirements on the principal line. The inversion procedure application enables the inverse model to be obtained (if it is invertible) which is constituted of a unique path between the control u and the output y . However when applying the methodology to the steering system a trajectory function of time

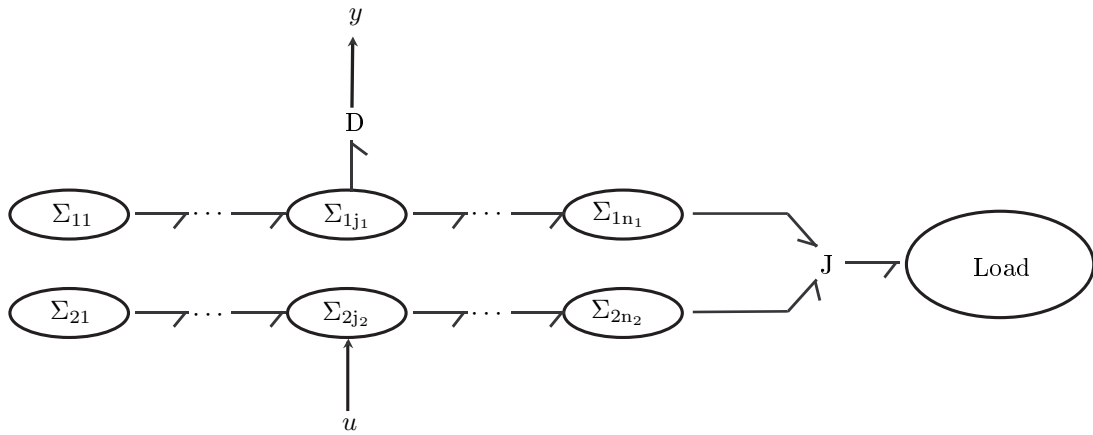

Figure 3.48: Word bond graph of an over-actuated load in the context of assistance and of a specification on the principal line.

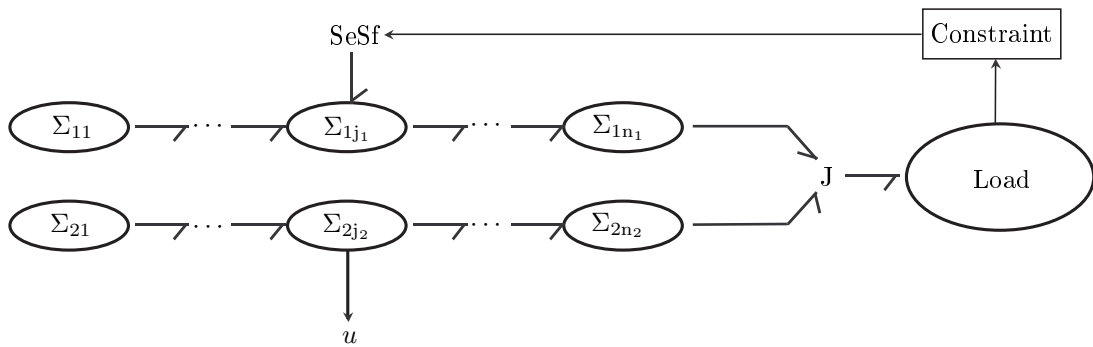

Figure 3.49: Word bond graph of a over-actuated load with constraint.

on the output could not be defined. This problem overlapped to the one of over-actuation and had to be otherwise treated. Due to the structure of power steering type the concept of assistance, which corresponds to a function of a load variable was considered. Then a relation between a load variable and the steering wheel torque was created (Fig. 3.49).

For this class of structure over-actuation of the load is deliberate and the assistance concept associated to this over-actuation is not a problem answer linked to the load function. In this context it seems logical that the assistance line cannot be sized with the load specifications. Moreover it is to be supposed that these specifications on the load may already be used for the principal actuation line sizing. Consequently the problem to which the assistance answers is linked the principal actuation line and its sizing lies on specifications on one variable of the principal line in relation with the load. This relation exactly points out the assistance degree.

3.2.3.3 Conclusion

My contribution in this work tried to work out, with respect to the given design objectives, an appropriate classification of actuation structures. This classification, based here on the concept of mechanical degree of freedom and so associated to the actuation kinematical function associated, shall bring an aid for the specification set up or for their analysis in term of specification structural validity.

Identification of loads belonging to the both classes of degenerate iso-actuation and over-actuation should have indicated right at the beginning that it was not possible to exploit the specifications in the same way as the methodology originally required. Thus the constraint introduced in the methodology extension (section 3.2.2) are a solution for these classes. However beyond the solution proposed this

classification gives indications on the specification possibility and their localisation i.e. the outputs on which they can apply. Consequently and before the methodology application a validation phase of load specifications can be set up.

These different results lead to define a procedure in three steps:

1. the first step consists of defining for the bond graph model structure whether the system is:
 - mono-actuated,
 - multi-actuated in iso-actuation,
 - multi-actuated in degenerate iso-actuation,
 - over-actuated,
 - mixte.
2. The second step consists of studying the requirements resulting from the specifications as being:
 - on the load,
 - on a component of the actuation line,
 - on a component and on the load.
3. The third step consists of verifying if, depending on the requirements and the model, the methodology application is carried out:
 - directly using functions of time,
 - indirectly by adding relations,
 - in a mixte way (functions of time and relations).

It is question here of a first step toward systematizing the methodology application. This work has to be continued and developed in particular with the study of new structures that will increase the application domain of inversion methodology.

In this context it is essential to work with the concept of power line. In fact it enables the classification introduced to be generalized and the reflection on the specification possibilities to be placed at an energy level. This work has been carried out in a second Ph. D. thesis in the framework of the PREDIT 2 program and co-supervised by Serge Scavarda and Eric Bideaux. However number of works are still to be done. For instance the relations introduced with the methodology extension free certain initial constraints but impose a study to be undertaken on the structural involvements that they have, for example, on the solution conditions of the models augmented with these relations.

3.3 Introduction of optimization in the sizing methodology

Context

The works presented in this last part constitute the more recent developments and an important contribution from myself in the research axis *Virtual prototyping* of team FTR in the LAI. They mark the third phase of my research activities since my nomination where I begin to measure my role in a research team. These works aim at the sizing methodology extension developed by the LAI as well but they constitute by themselves a new important step. The optimization introduction is not a contribution for optimization neither to reproduce in a classical manner the methodologies based on optimization for design. There is a real will in this research to methodologically innovate by coupling different tools.

The idea of introducing optimization in the sizing methodology stems from the works carried out in Olivier Méchin's Ph. D. thesis in the framework of the PREDIT2 program partly exposed in section 3.2. The works presented here is essentially in line with two RNTL projects (METISSE 2003-2005 and

SIMPA2 2006-2009) of which I am in charge for the LAI. In this context I co-supervise Bogdan Chereji's Ph. D. thesis (2003-2006) funded by a MIRA subvention and LAI fundings, Audrey Jardin's Ph. D. thesis (2006-2009) funded by the SIMPA2 project, and I supervise two post-doctorats funded by the METISSE project.

In this part the following two developments are presented:

- bond graph representation of an optimization problem (section 3.3.1),
- minimization problem of the output to the specified trajectory distances (section 3.3.2).

3.3.1 Bond graph representation of an optimization problem

3.3.1.1 Introduction

The optimization introduction into bond graph language has beginnings in 2001 while I looked for formulating variational principles of analytical mechanics in this language. In fact a bond graph representation is implicitly the result of a variational principle application for obtaining a dynamic system equations. My idea was then to express an optimization problem in bond graph. The tools used was the Euler-Lagrange conditions, necessary conditions of a functional extremalization, here under constraints of differential equation type because applied to dynamic systems. At this point the first results enabled to converge with those already obtained at the LAI about the bond graph representation of an adjoint system from the automation point of view [Xia00].

When these developments feasibility was proved I proposed and supervised the post graduate certificate training of Bogdan Chereji to formulate these developments on an example and to initialize a procedure. Then I proposed and co-supervised Bogdan Chereji's Ph. D. thesis (2003-2006) which the objective was to formalize in a general manner the procedure previously started on an example and to establish its effectiveness proof. The extension to problems under constraints of inequality type, the numerical resolution and an application to an electromechanical example are also proposed in this thesis. These works are part of the RNTL-METISSE project (2003-2005). The mathematical aspects of these works led me also to solicit researchers of the Institut Camille Jordan for dealing with the theoretical developments rigorously.

This work of translation in bond graph language of an optimisation problem, though it furnishes a new tool for formulating it, is not the end of the developments. In fact it has to be put in perspective of the sizing methodology extension developed in the research axis *Virtual prototyping*. This methodology is based among others on bond graph language so it was essential to translate into bond graph an optimization problem.

The developments presented here gave a publication in an international journal [Mou07b], three publications in international congresses [Mar05, Che06, Mou06] and a publication submission in an international journal [Mar06b].

3.3.1.2 Procedure for building an optimization problem bond graph

See [Mar05, Mou07b] in documents attached and appendix C document.

3.3.1.3 Methods and algorithms for optimization

This section presents a classification of optimization problems. It enables the optimization problem presented in the previous section to be situated and the more adapted numerical methods for its resolution to be found.

3.3.1.4 Toward numerical simulation

See [Che06] in documents attached.

3.3.1.5 Conclusion

My contribution in this work is original and full in the life cycle of a research idea from its emergence, its development until putting it in perspective for using it in more general objectives of research. My will was to combine a domain (dynamic optimization) and a tool (bond graph language) not combined yet as far as I know, and to extend a methodology. This shall permit in perspective to answer new design problems.

For a certain category of models and in the context of the optimal control, a procedure building in a systematic way the bond graph representation of the optimization problem is now available. Its effectiveness is also proved. In the linear case it was shown that the numerical exploitation of the obtained equation system was possible. These works constitute an original contribution and with no doubt also it does for the research at LAI. The tools developed now can be used in the research axis *Virtual prototyping* in perspective of coupling with the sizing methodology. However the class of treated systems remains limited and work has to be done for extending to non linear systems and for exploiting them in simulation.

In parallel of this procedure set up, a more complex example has been chosen to illustrate it. It is an asynchronous drive which the model is constituted of a permeance circuit and internal dissipations that will be the object of optimization. The model validation is in progress at this moment.

Finally the bond graph formulation of an optimization problem brings a new point of view and a graphical visualization on this type of problem. In fact this approach can facilitate the analysis of the coupling between state and co-state or the output role assigned to the inputs to determine. In particular the bond graph representation clearly shows that the co-state variables can be interpreted as co-energy variables and that, by an appropriate variable mapping, energy variables corresponding to them can be pointed out on energy storage elements. Finally the procedure and the proof of its effectiveness showed generic stages for the representation which shall be exploited for other type of optimisation problems.

3.3.2 Minimization problem of the output to specified trajectory distances

3.3.2.1 Introduction

They are the more recent developments that aim at using optimization in the sizing methodology. They are part of the RNTL-METISSE project and in particular Omar Mouhib's works during its post-doctorat position in the LAI (2005-2006). Compared to the first developments on the optimization topic (section 3.3.1), these works consider a criteria minimizing between the model outputs and their specified trajectory specifications. This direction of work stems from the results of Olivier Méchin's thesis (section 3.2). In fact for overcoming the difficulties of expressing specifications as functions of time, the idea is to express some criteria as performance indices to minimize. This formulation enables to express the will for the designer to get closer of his requirements.

These developments furnished a publication in an international congress [Mou07a].

See [Mou07a] in documents attached.

3.3.2.2 Conclusion

My contribution in this work is about the extension of the previous developments (section 3.3.1) considering a new criterion in the dynamic optimization problem and the integration of the results obtained in the design methodology. My idea is now, with this integration, to be able to carry out sizing problems

satisfying different specification simultaneously. I see an unquestionable possibility for the manufacturer preoccupations in design as show discussions with PSA Peugeot Citroën show it for instance.

The bond graph representation of an optimal control problem is extended to a minimization criterion of the output to reference trajectory distances. The proof exploited the generic phases already set up for the criterion of the dissipated energy minimization. This shows the possibilities for extending the bond graph representation again to other criteria.

The minimization of the output to reference trajectory distances offers interesting perspectives for sizing when the specifications can be expressed in this form. This is the objective of the works on the formulation of this type of optimization problem in bond graph language in view of the coupling with the sizing methodology. These developments are in progress in the framework of Omar Mouhib's post-doctorat position in the RNTL-METISSE project.

Chapter 4

Conclusion and perspectives

4.1 General report

During these eight years as an associate professor at the LAI, my activities showed a strong and logical interaction between teaching and research. In fact the pedagogical rightness and rigor required by my teaching contributed to a relevant and thorough reflection for the research developments and, in return, my research works served my teaching by means of certain education module set up. Also number of End of Studies Projects contributed to the progress of research developments (see sections 3.1.1 and 3.1.3). Likewise the works concerning for instance the multibody modelling in the planar mechanics (section 3.1.1) or the automotive (sections 3.1.2 and 3.1.3) domains take benefits of my expertise acquired in my teaching. Also the more recent works on the optimization introduction into bond graph language and then in the sizing methodology lie on the same theoretical bases as those issued from Lagrange's mechanics which I teach as well. In return the education modules about bond graph mechatronic modelling and more particularly multibody mechanical system modelling, as well as the modules associated to simulation and to the numerical aspects of simulation in the mechatronic domain (see section 2.2.2), take directly benefits from expertise of my research activities.

My position in research is definitively at the intersection of automation and mechanics.

That was the case during my Ph. D. thesis works and this position is reenforced since the progressive evolution toward the research topics of the laboratory in *Modelling of mechatronic systems* firstly, and then in *Virtual prototyping*. On these both topics the activities are coupled and in synergy the ones serving the others. For instance the modelling works about automotive vehicle (section 3.1.2) are in perspective of the sizing methodology application to this domain (section 3.2). Furthermore the co-supervision of Olivier Méchin's Ph. D. thesis in the framework of the PREDIT 2 program in collaboration with PSA Peugeot Citroën enabled me to progressively appropriate the activities of the research axis *Virtual prototyping* and more particularly of the sizing methodology developed (section 3.2). The contributions then appeared on this topic with the start of reflections on structural aspects essentially associated to mechanics (section 3.2.3), and by introducing dynamic optimization in the methodology (section 3.3). Here again this last topic is not uncoupled from mechanics since optimization development bases stem from the variational principles having initially their field application in analytical mechanics. Moreover these latter works exploiting the tools of the optimal control domain mark the beginnings, in the context of my research, of a new synergy concerning the third research axis of the team FTR on *Control* with the axis *Virtual prototyping*. In this perspective it is to note new works about the application of Baumgarte stabilization, usually used in the multibody mechanics domain (section 3.1.1), to sliding mode control (section 4.3.1.3). These developments complete the previous ones by fitting into a synergy between the axes *Control* and *Modelling* of the team FTR.

Finally, more recently, a research topic begins about developments in the research axis *Virtual prototyping* in particular in the mechanical domain. This topic is attached to the co-supervision of Gerardo Villegas-Medina's Ph. D. thesis on a flexible robot design. A reflection starts about mechanism synthesis and can pretend to the sizing methodology extension in this early phase of design (section 4.3.1.2).

4.2 Actions under progress

4.2.1 Software transfer: MS1 specifications

The transfer of our research activities to industry in particular from the axis *Virtual prototyping* requires a software transfer of the tools and methodologies developed. This transfer is being carried out in the tool MS1 with a bond graph input and with Modelica language as well.

4.2.1.1 For the sizing methodology

This section presents the methodology features introduced in MS1 developed by Francis Lorenz since the PREDIT 2 program.

4.2.1.2 Modelica code translator

In the ANR-RNTL SIMPA2 project framework a funding is devoted to the development of a translator for generating the Modelica code of a model from its bond graph.

4.2.2 Methodology developments

4.2.2.1 METISSE project

A prolongation until July 2007 has been obtained for METISSE project to pursue the developments started with two post-doctorat researchers on coupling optimization and the sizing methodology, and on studying the benefit of optimization in the specification writing.

4.2.2.2 SIMPA2 project

Beside the objective to develop a compiler on Modelica language basis, this project will enable us to continue the studies on the specifications writing, the structural aspects of design and the invertibility mathematical criteria within bond graph language.

4.2.2.3 Collaboration with Volvo Powertrain

In the research axes *Virtual prototyping* and *Control* of the team FTR of the LAI, a collaboration with Volvo Powertrain started in December 2005 in the framework of the Ph. D. thesis of Sylvain Renard. I take part of the work meetings of this thesis which deal with modelling of hybrid power train for trucks and optimization of associated controls.

4.2.2.4 Flexible robot design for laparoscopy

I co-supervise Gerardo Villegas-Medina's Ph. D. thesis (2004-2007) which deals with the design of flexible robot for laparoscopy. First steps about mechanism synthesis with respect to geometrical specifications are under study. Actuation and control will also have to be carried out.

4.3 Perspectives

4.3.1 Of research

4.3.1.1 ... on the axis *Mechatronics modelling*

A first perspective is to pursue suspension modelling in a multibody bond graph context. Next steps is to implement the model already obtained (section 3.1.3) in a simulation tool with bond graph input like 20Sim [20S04] for instance and to compare to models introduced in devoted multibody codes like Simpack for instance [sim04]. An End of Studies Project can be adapted for this work.

A second perspective is the validation of the tire sliding model (section 3.1.4). Works can be done on the tire structure which has to be more realistically taken into account through better parameters and more appropriate constitutive phenomenon laws, better managing of the switching mechanism between slices for attenuating the discontinuities consequences, and improvement of the global structure of the model in terms of numbers of slices and the coupling with longitudinal and vertical dynamics. One validation objective for instance is that this model gives at least equivalent results as Pacejka's models do in stationary behavior. This work is envisaged in post-graduate certificate trainings for example.

4.3.1.2 ... on the axis *Virtual prototyping*

This is today the most open axis in investigation possibilities. I try here to define the principal ones.

MS1 development

MS1 development has to be pursued in particular by implementing the recent features and the work on optimisation for instance. First perspectives concern the selection and validation criteria which must extend the existing ones on the power variables and the power. Table 4.1 shows some bases for this extension. The criterion definitions refer to information coming from:

- the specifications (in red in the table - **specified values**),
- the manufacturer's data (in blue in the table - **given values**) for the component to be validated or selected,
- the simulation results of the inverse model (in green in the table - **calculated values**).

Most of these criteria can be used in a validation and/or selection phase.

Figure 4.1 shows a synopsis of possible strategies for the use of MS1 and figure 4.2 displays the different features already implemented in MS1 and those that remain to be introduced. These works have to be done directly with Francis Lorenz with fundings coming from national or European projects.

Sizing methodology development

Optimisation problem extension.

The extension consists of taking into account of different limit conditions (free or constrained on time and/or state), of time varying models, of nonlinear models for instance. A Ph. D. thesis framework seems to be adapted for this work.

Numerical aspects of optimization.

Simulation is essential in this topic and it was easily resolved for linear model by determining a priori initial co-states. For nonlinear models the issue will be real and a priori determination of initial co-state

	Criteria	Selection (S) and/or validation (V)	Notes
Criteria on power, power variables and dynamic variables			
A.1	$P_{cons} \geq P_{spec}$	S/V	These criteria on power and power variable are available in the actual version of MS1.
A.2	$e_{cons} \geq e_{spec}$	S/V	
A.3	$f_{cons} \geq f_{spec}$	S/V	
A.4	$var_{cons} \leq ou \geq var_{spec}$	V (or even S)	Criterion applying to any variable of the component.
A.5	$P_{cons} \geq P_{spec}/\eta$	S	Enables to take a priori into account of an adaptation element efficiency between the actuator and the load (example of a gear).
A.6	$e_{cons}/e_{spec} \geq r \geq f_{spec}/f_{cons}$	S	Enables to take into account of the adaptation element parameter.
Dynamic and energy criteria			
B.1	$t_{cons} \geq t_{spec}$	S/V	t corresponds to a working time out of admissible zone. This criterion can be derived following the working zones of a component (intermittent, acceleration, ...)
B.2	$[\omega_b, \omega_h] \subset [\omega_{b,spec}, \omega_{h,spec}]$	S/V	Problem of frequency range.
B.3	$\tau \leq \tau_{spec}$	V (or even S)	τ and $\tau_{r5\%}$: time constant and time response at 5%. ω_0 : eigen pulsation. z : damping (can be obtained from τ and ω_0). $A_{\%}$: overshooting.
B.4	$\omega_0 \leq \omega_{0,spec}$	V (or even S)	
B.5	$z \leq (ou \geq) z_{spec}$	V (or even S)	
B.6	$\tau_{r5\%} \leq \tau_{r5\%,spec}$	V (or even S)	
B.7	$A_{\%} \leq A_{\%,spec}$	V (or even S)	
B.8	Criteria of the poles and zeros of a component linear model transfer function. This kind of criterion can be useful in a filtering or stability study objective for instance.		
System and economical criteria			
C.1	$\eta \geq \eta_{spec}$	S/V	Efficiency problem.
C.2	$m \leq m_{spec}$	S/V	Mass problem.
C.3	$dim \leq ou \geq dim_{spec}$	S/V	Bulk problem.
C.4	$d_{vie} \geq d_{vie,spec}$	S/V	Life time problem.
C.5	$cot \leq cot_{spec}$	S/V	Cost problem.
C.6	$f(p_1, \dots, p_m, x_1, \dots, x_n) \leq \alpha_{spec}$	S/V	Multi objective criterion where the function f is a weighting of different parameters p_i and different variables x_j which are found in the other criteria.

Table 4.1: Selection and validation criteria

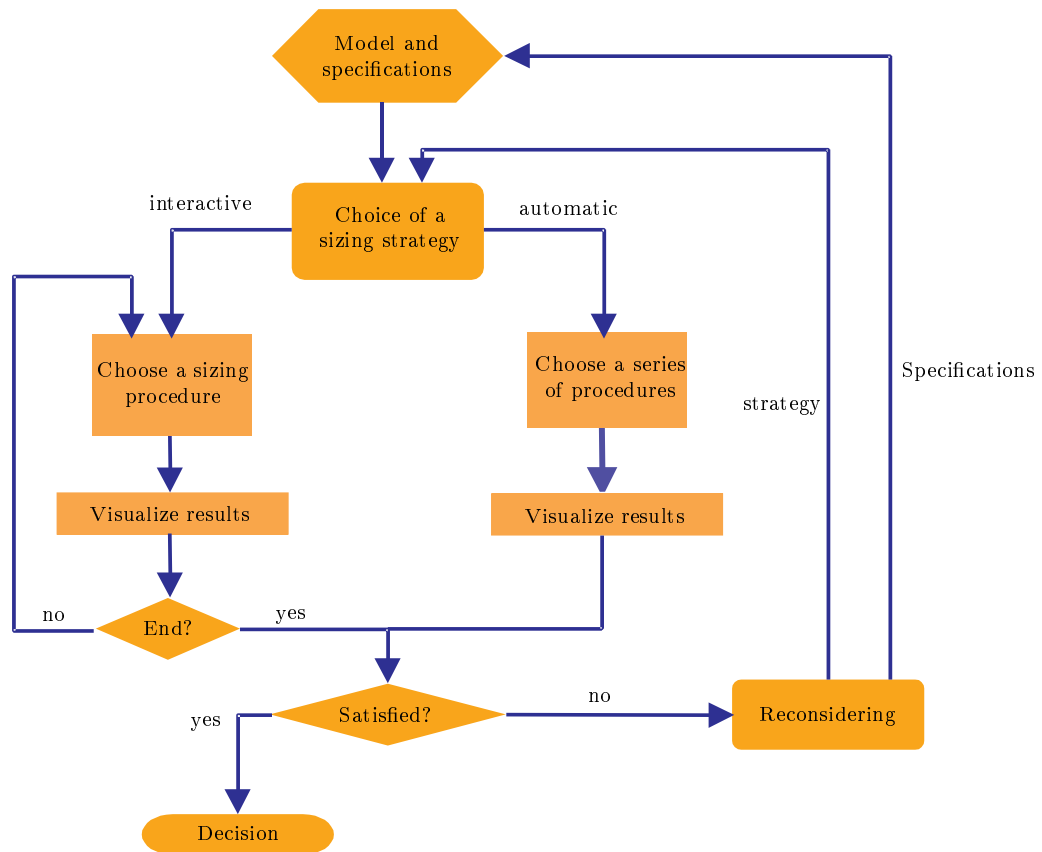

Figure 4.1: Synopsis of sizing strategies in MS1

will no more work. Ideas like global time discretization or shooting methods will have to be worked out. A post-graduate certificate training seems to appropriate for this work.

Methodology/optimization coupling.

The work envisaged on this topic is to combine different types of specifications for the methodology like functions of time and output to specified trajectory distances enabling non squared model in terms of inputs and outputs to be treated. Post-doctorat researchers are envisaged for this work.

Specification writing.

This perspective aims at taking benefits of the recent developments like with optimization for instance to propose rules to write relevant specifications with respect to the design problem. A post-doctorat researcher is actually working on this topic.

Structural aspects of the methodology.

The perspective here is to undertake a study on the interaction between the structural position of specifications and their number, and the model structure to which apply the specifications. The idea is to find out, in a given design problem, which sizing are feasible and if not how to reformulate correctly the design problem by considering for example:

- only a part of the specified outputs on the model if the problem is over constrained.

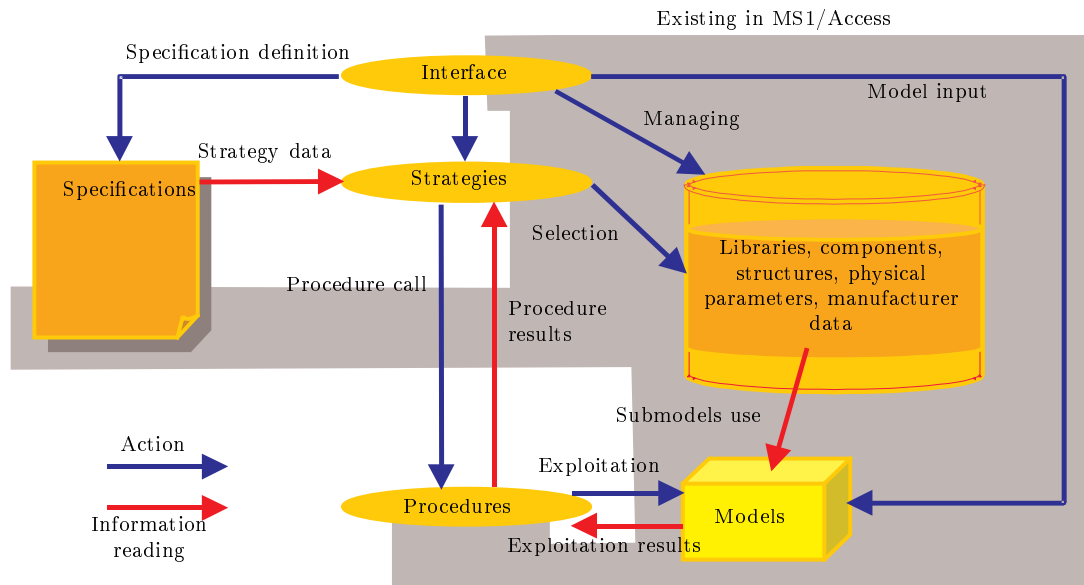

Figure 4.2: Flowchart of concepts and their interactions in MS1

- extra outputs to be specified if the problem is under constrained. A priori the total number of specified outputs must be equal to the input number of the direct model.
- in-between squared cases with loss of iso-actuation (linked to concepts of assistant constraints or singularities for instance).

This work can be undertaken in a Ph. D. thesis framework.

Methodology of kinematic structure design

The idea is here to extend the methodology to mechanism synthesis with the same approach of inverse model and bond graph language and to base the choice of a mechanism on dynamic and energy criteria.

4.3.1.3 ... on the axis *Control*

The idea here is to pursue the work on the use of Baumgarte stabilization for robust control. A study on the method parameter has to be undertaken for answering to the time problem to make the system stick on the sliding surface for instance.

4.3.1.4 Submitted projects

Research cluster *Transportation, Territories and Society*

Project on the truck design based on active security, comfort and energy consumption combined criteria.

Competitiveness center *Lyon Urban Trucks&Bus 2015*

Associated to the previous project it concerns the aspects more technological of truck design.

Pluri-Education Program *VerT*

This project for funding research equipments concerns the automotive engine and its control.

4.3.2 of teaching

Not summarized.

4.3.3 of responsibilities

Not summarized.

Bibliography

- [20S04] 20Sim. <http://www.20sim.com/>, 2004.
- [Ama91] Amara, M. *Contribution à l'étude des aspects énergétiques en robotique mobile*. Scientifique, Institut National des Sciences Appliquées de Lyon, 1991.
- [Arm04] Armbruster, C., Botellé, E., Marquis-Favre, W. Introduction of innovative analysis methods in frequency- and energy- domain for the development of hydraulic component. In *IFK '04 Internationales Fluidtechnisches Kolloquium*, volume 1, pages 197–214, 2004.
- [Che06] Chereji, B., Mouhib, O., Marquis-Favre, W., Thomasset, D., Pousin, J., Picq, M. An optimal control problem: bond graph representation and solver implementation. In F. Breiteneker I. Troch, editor, *5th MATHMOD Vienna*, page 8, Vienna, Austria, February 8-10 2006.
- [Coe69] Coeuillet, J. Choix des moteurs de servomécanismes. *Automatisme*, 2:56–57, février 1969.
- [Fot96] Fotsu-Ngwompo, R., Scavarda, S., Thomasset, D. Inversion of linear time-invariant siso systems modelled by bond graph. *Journal of the Franklin Institute*, 333(B):157–174, 1996.
- [Fot97] Fotsu-Ngwompo, R. *Contribution au Dimensionnement des Systèmes sur des Critères Dynamiques et Énergétiques - Approche par Bond Graph*. Ph. d. thesis, Institut National des Sciences Appliquées de Lyon, 1997.
- [Fot99] Fotsu-Ngwompo, R., Scavarda, S. Dimensioning problems in system design using bicausal bond graphs. *Simulation Practice and Theory*, 7:577–587, 1999.
- [Fot01a] Fotsu-Ngwompo, R., S. Scavarda, Thomasset, D. Physical model-based inversion in control systems design using bond graph representation. part 1: Theory. *Proceedings of the IMECHE Part I Journal of Systems and Control Engineering*, 215:95–103, 2001.
- [Fot01b] Fotsu-Ngwompo, R., S. Scavarda, Thomasset, D. Physical model-based inversion in control systems design using bond graph representation. part 2: Applications. *Proceedings of the IMECHE Part I Journal of Systems and Control Engineering*, 215:105–112, 2001.
- [Kar78a] Karnopp, D. A bond graph modeling philosophy for thermofluid systems. *Transactions of the ASME, Journal of System Dynamics, Measurement and Control*, 100, March 1978.
- [Kar78b] Karnopp, D. The energetic structure of multibody dynamic systems. *Journal of The Franklin Institute*, 306:165–181, 1978.
- [Mar05] Marquis-Favre, W., Chereji, B., Thomasset, D., Scavarda, S. Bond graph representation of an optimal control problem: the dc motor example. In *ICBGM '05 International Conference of Bond Graph Modelling and simulation*, pages 239–244, New Orleans, USA, January 23-27 2005.
- [Mar06a] Marquis-Favre, W., Bideaux, E., Méchin, O., Scavarda, S., Guillemard, F., Ébalard, M. A mechatronic bond graph modelling of an automotive vehicle. *Mathematical and Computer Modelling of Dynamical Systems*, 12(2-3):189–202, April-June 2006. Special issue on Bond Graph Modelling.

-
- [Mar06b] Marquis-Favre, W., Mouhib, O., Chereji, B., Thomasset, D., Pousin, J., Picq, M. Bond graph formulation of an optimal control problem for linear time-invariant systems. *Soumis au Journal of the Franklin Institute*, page 23, 2006.
- [Mar06c] Marquis-Favre, W., Scavarda, S., Bideaux, E. A planar mechanical library in the amesim simulation software. part I: Formulation of dynamics equations. *Simulation Modelling Practice and Theory*, 14(1):25–46, 2006.
- [Mar06d] Marquis-Favre, W., Scavarda, S., Bideaux, E. A planar mechanical library in the amesim simulation software. part II: Library composition and illustrative example. *Simulation Modelling Practice and Theory*, 14(2):95–111, 2006.
- [Méc02] Méchin, O., Marquis-Favre, W., Scavarda, S., Ferbach, P. A dynamic sizing methodology in the context of an automotive application. In *ASME International Mechanical Engineering Congress and Exhibition, Dynamic Systems and Control Division, Symposium on Automated Modeling*, page 9, New Orleans, USA, November 17-22 2002.
- [Méc03] Méchin, O., Marquis-Favre, W., Scavarda, S., Ferbach, P. Sizing of an electric power steering system on dynamic and energy criteria. In *ICBGM'03 International Conference on Bond Graph Modelling and Simulation*, pages 137–147, Orlando, USA, january, 19-23 2003.
- [Mou06] Mouhib, O., Chereji, B., Marquis-Favre, W., Thomasset, D., Pousin, J., Picq, M. Procedure for the bond graph construction of an optimal control problem. In *13th IFAC Workshop on Control Applications of Optimisation, CAO'06*, pages 69–74, Paris-Cachan, France, 26-28 April 2006.
- [Mou07a] Mouhib, O., Chereji, B., Marquis-Favre, W., Bideaux, E., Thomasset, D. Bond graph representation of an optimal control problem for output error minimization. In *Accepté à l'ICBGM'07 International Conference of Bond Graph Modelling and simulation*, San Diego, USA, January 15-17 2007.
- [Mou07b] Mouhib, O., Chereji, B., Marquis-Favre, W., Thomasset, D., Pousin, J., Picq, M. Procedure for the bond graph construction of an optimal control problem. *International Journal of Tomography & Statistics, Special Issue on: Control Applications of Optimisation - control and aeronautics, optimal control, control of partial differential equations*, W07(5):56–61, 2007.
- [Sca91] Scavarda, S., Amara, M., Richard, E. Determination of the input power in terms of output variables using bond graph. In *IMACS-IFAC Symposium MCTS 91 Modelling and Control of Technological Systems*, pages 1–5, Lille, France, 7 mai-10mai 1991.
- [sim04] *SIMPACK Reference Guide - SIMPACK Release 8.6*, 5th November 2004.
- [Vuk87] Vukobratovic, M., Katic, D., Potkonjak, V. Computer-assisted choice of electrohydraulic servosystems for manipulation robots using complete mathematical models. *Mechanical Machine Theory*, 22(5):431–439, 1987.
- [Xia00] Xia, X. *Contribution à l'Analyse du Comportement Dynamique et Energétique d'un Système Linéaire et Stationnaire Modélisé par un Bond Graph Bicausal*. Ph. d. thesis, Institut National des Sciences Appliquées de Lyon, 2000.

Appendix A

Scientific publications

9 publications in international journal with review

- [1] Favre, W., Scavarda, S. Bond graph representation of multibody systems with kinematic loops. *Journal of the Franklin Institute*, 335B:643–660, 1998.
- [2] Favre, W., Scavarda, S. A representation for planar contact joints in the multibody mechanical bond graph library. *Proceedings of the IMECHE Part I Journal of Systems and Control Engineering*, 212:305–313, 1998.
- [3] Marquis-Favre, W., Scavarda, S. Alternative causality assignment procedures in the mechanical domain. *Journal of Dynamic Systems, Measurement, and Control*, 124(3):457–463, 2002.
- [4] Marquis-Favre, W., Scavarda, S., Bideaux, E. A planar mechanical library in the amesim simulation software. part i: Formulation of dynamics equations. *Simulation Modelling Practice and Theory*, 14(1):25–46, 2006.
- [5] Marquis-Favre, W., Scavarda, S., Bideaux, E. A planar mechanical library in the amesim simulation software. part ii: Library composition and illustrative example. *Simulation Modelling Practice and Theory*, 14(2):95–111, 2006.
- [6] Marquis-Favre, W., Bideaux, E., Méchin, O., Scavarda, S., Guillemard, F., Ébalard, M. A mechatronic bond graph modelling of an automotive vehicle. *Mathematical and Computer Modelling of Dynamical Systems*, 12(2-3):189–202, April-June 2006. Special issue on Bond Graph Modelling.
- [7] Bideaux, E., Marquis-Favre, W., Scavarda, S. Equilibrium set investigation using bicausality. *Mathematical and Computer Modelling of Dynamical Systems*, 12(2-3):127–140, April-June 2006. Special issue on Bond Graph Modelling.
- [8] Bideaux, E., Laffite, J., Derkaoui, A., Marquis-Favre, W., Scavarda, S., Guillemard, F. System design using an inverse approach: Application to the hybrid vehicle powertrain. *Journal Européen des Systèmes Automatisés*, pages 279–290, June 2006.
- [9] Mouhib, O., Chereji, B., Marquis-Favre, W., Thomasset, D., Pousin, J., Picq, M. Procedure for the bond graph construction of an optimal control problem. *International Journal of Tomography & Statistics, Special Issue on: Control Applications of Optimisation - control and aeronautics, optimal control, control of partial differential equations*, W07(5):56–61, 2007.

19 publications in international congresses with review and proceedings

- [10] Favre, W., Scavarda, S. Application of the bond graph privileged frame representation to the example of the delta robot. In *CESA '96 IMACS Multiconference, Symposium on Modelling Analysis and Simulation*, volume 1, pages 518–522, Lille, France, July 9-12 1996.
- [11] Favre, W., Scavarda, S. Bond graph representation of point contact between two bodies with parametered outline curves in planar multibody mechanical systems. In *ICBGM '97 International Conference on Bond Graph Modeling and Simulation*, volume 29, pages 289–294, Phoenix, USA, January 12-15 1997.
- [12] Favre, W., Scavarda, S. Introduction of baumgarte stabilisation schemas in the multibond graph representation. In *CESA '98 IMACS Multiconference, Computational engineering in systems applications*, pages 278–282, Hammamet, Tunisia, April 1-4 1998.
- [13] Marquis-Favre, W., Scavarda, S. A procedure for generating the lagrange equations from the bond graph representation using the λ -multiplier method. In *ICBGM '99 International Conference on Bond Graph Modeling and Simulation*, pages 263–268, San Francisco, USA, January 17-20 1999.
- [14] Marquis-Favre, W., Scavarda, S. Alternative causality assignment procedures in bond graph language. In *ASME International Mechanical Engineering Congress and Exposition, Dynamic Systems and Control Division, Symposium on Automated Modeling*, volume 2, pages 817–824, Orlando, USA, November 5-10 2000.
- [15] Marquis-Favre, W., Bideaux, E., Scavarda, S. Cohérence sur le signe du déplacement généralisé dans la représentation bond graph des ressorts. In *CIFA '00 Conférence Internationale Francophone d'Automatique*, pages 742–747, Lille, France, 5-8 juillet 2000.
- [16] Bideaux, E., Marquis-Favre, W., Scavarda, S. Formulation of the constitutive relations in the bicausal bond graph: symbolic and numerical issues. In *IFAC '00 International Federation of Automatic Control, Conference on Mechatronic Systems*, volume II, pages 711–716, Darmstadt, Germany, September 18-20 2000.
- [17] Méchin, O., Marquis-Favre, W., Scavarda, S., Ébalard, M., Guillemard, F. Aide à la validation des composants d'un système mécatronique dans l'automobile. In *SIA Congress Vehicle Dynamics*, pages 119–126, Lyon, France, 6-7 juin 2001.
- [18] Marquis-Favre, W., Scavarda, S., Bideaux, E. Accounting for sizing parameters and boundary geometry in the bond graph representation of energetic elements. In *ICBGM '01 International Conference on Bond Graph Modeling and Simulation*, pages CD-ROM, Phoenix, USA, January 7-11 2001.
- [19] Bideaux, E., Martin de Argenta, D., Marquis-Favre, W., Scavarda, S. Applying causality and bicausality to multi-port elements in bond graphs. In *ICBGM '01 International Conference on Bond Graph Modeling and Simulation*, pages CD-ROM, Phoenix, USA, January 7-11 2001.
- [20] Méchin, O., Marquis-Favre, W., Scavarda, S., Ferbach, P. A dynamic sizing methodology in the context of an automotive application. In *ASME International Mechanical Engineering Congress and Exhibition, Dynamic Systems and Control Division, Symposium on Automated Modeling*, page 9, New Orleans, USA, November 17-22 2002.
- [21] Méchin, O., Marquis-Favre, W., Scavarda, S., Ferbach, P. Sizing of an electric power steering system on dynamic and energy criteria. In *ICBGM '03 International Conference on Bond Graph Modelling and Simulation*, pages 137–147, Orlando, USA, January, 19-23 2003.
- [22] Marquis-Favre, W., Xia, X., Scavarda, S. Bicausality-based procedures for transfer and transmission matrix determination of single source single load linear systems. In *ICBGM '03 International Conference on Bond Graph Modeling and Simulation*, pages 128–133, Orlando, USA, January 19-23 2003.

- [23] Armbruster, C., Botellé, E., Marquis-Favre, W. Introduction of innovative analysis methods in frequency- and energy- domain for the development of hydraulic component. In *IFK '04 Internationales Fluidtechnisches Kolloquium*, volume 1, pages 197–214, 2004.
- [24] Marquis-Favre, W., Chereji, B., Thomasset, D., Scavarda, S. Bond graph representation of an optimal control problem: the dc motor example. In *ICBGM '05 International Conference of Bond Graph Modelling and simulation*, pages 239–244, New Orleans, USA, January 23-27 2005.
- [25] Bideaux, E., Laffite, J., Derkaoui, A., Marquis-Favre, W., Scavarda, S., Guillemard, F. Design of a hybrid vehicle powertrain using an inverse methodology. In *Power Transmission and Motion Control, PTMC'2005*, pages 317–332, Bath, U.K., September 10-12 2005.
- [26] Mouhib, O., Chereji, B., Marquis-Favre, W., Thomasset, D., Pousin, J., Picq, M. Procedure for the bond graph construction of an optimal control problem. In *13th IFAC Workshop on Control Applications of Optimisation, CAO '06*, pages 69–74, Paris-Cachan, France, 26-28 April 2006.
- [27] Chereji, B., Mouhib, O., Marquis-Favre, W., Thomasset, D., Pousin, J., Picq, M. An optimal control problem: bond graph representation and solver implementation. In F. Breitenacker I. Troch, editor, *5th MATHMOD Vienna*, page 8, Vienna, Austria, February 8-10 2006.
- [28] Mouhib, O., Chereji, B., Marquis-Favre, W., Bideaux, E., Thomasset, D. Bond graph representation of an optimal control problem for output error minimization. In *Accepté à l'ICBGM '07 International Conference of Bond Graph Modelling and simulation*, San Diego, USA, January 15-17 2007.

2 chapters in collective books

- [29] Marquis-Favre, W., Bideaux, E. *Les bond graphs*, chapter Systèmes mécaniques multicorps, pages 161–202. Hermès, Paris, 2000.
- [30] Marquis-Favre, W. chapter Simulation des mécanismes. *Techniques de l'ingénieur*. remise du manuscrit : février 2006.

4 contract reports

- [31] Marquis-Favre, W. Rapport intermédiaire du projet METISSE du RNTL. 1^{er} semestre, Institut National des Sciences Appliquées de Lyon, 2004.
- [32] Bideaux, E., Guillemard, F., Marquis-Favre, W., Scavarda, S., Simon, J.-P. Rapport final. Programme predict 2, groupe thématique conception-production : Aide à la conception et au dimensionnement énergétique des systèmes mécatroniques, Institut National des Sciences Appliquées de Lyon, 2006.
- [33] Marquis-Favre, W. Rapport final du projet METISSE du RNTL. Technical report, Institut National des Sciences Appliquées de Lyon, 2006.
- [34] Bouskela, D., Demay, E., Souyri, A., Guillemard, F., Marquis-Favre, W., Thomasset, D., Benjelloun-Dabaghi, Z. Expression de besoins pour un environnement de modélisation et simulation basé sur un compilateur modelica open source. Technical report, Programme ANR-RNTL SIMPA2, 2006.

2 national seminars

- [35] Marquis-Favre, W. Bond graph multicorps. Ecole Internationale d'Automatique de Lille sur la méthodologie bond graph, 28 août - 1^{er} septembre 2000.
- [36] Marquis-Favre, W. Plm amesim. Journées Utilisateur AMESim, Universités/Ecoles d'ingénieurs, 27 novembre 2003.

Ph. D. thesis

- [37] Favre, W. *Contribution à la représentation bond graph des systèmes mécaniques multicorps*. PhD thesis, Institut National des Sciences Appliquées de Lyon, 1997.
Directeur : Serge Scavarda.
Soutenue le 18 décembre 1997 à l'INSA de Lyon.
Mention très honorable avec félicitations du jury.
Jury : MM. D. Le Houédec (rapporteur), M. Lebrun (rapporteur), P. Breedveld (rapporteur), Mme G. Dauphin-Tanguy, L. Jézéquel, M. Fayet, S. Scavarda.

1 submission to an international journal with review

- [38] Marquis-Favre, W., Mouhib, O., Chereji, B., Thomasset, D., Pousin, J., Picq, M. Bond graph formulation of an optimal control problem for linear time-invariant systems. *Soumis au Journal of the Franklin Institute*, page 23, 2006.

Appendix B

Participation to community and contract activity

6 reviews for international journals

- Of 2 submissions for the Journal of the Franklin Institute in 1998.
- Of 1 submission for the Journal Européen des Systèmes Automatisés in 2003.
- Of 1 submission for the Special issue on Bond Graph Modelling of the journal Mathematical and Computer Modelling of Dynamical Systems in 2003
- Of 1 submission for the Special issue Mécatronique & Systèmes Multi-Physiques Pilotés of the Journal Européen des Systèmes Automatisés in 2006.
- Of 1 submission for the Journal of Mechanical Design in 2006.

21 reviews for international congresses

- Of 1 submission for the ICBGM'97 International Conference on Bond Graph Modeling, January 12-15, 1997, Phoenix, Arizona, *usa*.
- Of 2 submissions for the ICBGM'99 International Conference on Bond Graph Modeling, January 17-20 1999, San Francisco, California, USA.
- Of 2 submissions for the CIFA'00 Conférence Internationale Francophone d'Automatique, 5-8 juillet 2000, Lille, France.
- Of 1 submission for the ASME International Mechanical Engineering Congress and Exposition, Dynamic Systems and Control Division, November 5-10 2000, Orlando, Florida, USA.
- Of 1 submission for the ICBGM'01 International Conference on Bond Graph Modeling, January 7-11 2001, Phoenix, Arizona, USA.
- Of 2 submissions for the ASME International Mechanical Engineering Congress and Exposition, Automated Modeling Symposium, November 11-16, 2001, New York, USA.
- Of 1 submission for the CIFA'02 Conférence Internationale Francophone d'Automatique, 8-10 juillet 2002, Nantes, France.
- Of 1 submission for the IEEE Systems, Man and Cybernetics, October 6-9, 2002, Hammamet, Tunisia.

- Of 2 submissions for the 2002 ASME International Mechanical Engineering Congress and Exposition, Symposium on Automated Modeling, November 17-22, 2002, New Orleans, Louisiana, USA.
- Of 1 submission for the 2003 ASME International Mechanical Engineering Congress and Exposition, Symposium on Automated Modeling, November 15-21, 2003, Washington, D.C., USA.
- Of 1 submission for the CIFA'04 Conférence Internationale Francophone d'Automatique, 8-10 juillet 2002, Nantes, France.
- Of 1 submission for IMAACA'04 International Conference on « Integrated Modeling and Analysis in Applied Control and Automation », October 28-30, 2004, Genoa, Italy.
- Of 1 submission for the 2004 ASME International Mechanical Engineering Congress and Exposition, Symposium on Automated Modeling, November 15-21, 2004, Anaheim, California, USA.
- Of 1 submission for IMAACA'05 Integrated Modeling and Analysis in Applied Control and Automation, October 20-22, 2005, Marseilles, France.
- Of 1 submission for INCOM'06 12th IFAC Symposium on Information Control Problems in Manufacturing, 17-19 mai 2006, Saint-Etienne, France.
- Of 2 submissions for ECMS'06 20th European Conference on Modelling and Simulation, May 28-31, 2006, Sankt Augustin, Germany.

3 reviews for a national congress

- Of 3 submissions for the JDMACS'05 Journées Doctorales Modélisation, Analyse et Conduite des Systèmes dynamiques, 7-9 septembre 2005, Lyon, France.

1 participation in a Ph. D. thesis board

Raisin, J.-P. *Contribution à l'optimisation de la régulation load sensing d'une pompe hydraulique à cylindrée variable.*

PhD thesis, Université des Sciences et techniques de Lille, 2002.

Co-supervisors: B. Landjerit, C. Herbelot.

Defense December the 10th 2002 at Lille 1 University.

Board: R. Boudet (reviewer), A. Gerard (reviewer), M. Di Fabrizio, J. Oudin, W. Marquis-Favre, B. Landjerit, C. Herbelot.

Chairman of a session in an international congress

ICBGM'01 International Conference on Bond Graph Modeling and Simulation.

Session *Mechanics*.

Phoenix, USA, January 7-11.

2001.

4 research programs

Regional:

Research program priority topics (2000-2002): topic "Modelling and control of complex dynamic systems".

Partners: LMST (Laboratoire de Mécanique des Structures) of INSA of Lyon (managing), LTDS

(Laboratoire de Tribologie et de Dynamique des Systèmes) of the Ecole Centrale de Lyon, LAI.
Fundings: 16,4k€.

National :

- PREDIT 2 (2000 - 2004): topic Design-Manufacturing.
Partners: PSA Peugeot-Citroën (managing), LAI (scientific responsible).
Fundings: 315,5k€ exclusive of tax.
- RNTL METISSE (2003 - 2006, extension accepted until July 2007)
Scientific responsible for the LAI.
Partners: Imagine (managing), LMS France, Cadoc, IMFT-LEEI ENSEEIHT, INRIA, D2S ECL, CS SI, IFP, Snecma Moteurs, EADS-CCR, PSA Peugeot Citroën.
Fundings: 132k€ exclusive of tax.
- ANR-RNTL SimPA2 (2006 - 2009).
Scientific responsible for the LAI.
Partners: CRIL Technology, EDF (managing), IFP, Imagine, INRIA Rocquencourt, PELAB (Sweden), PSA Peugeot Citroën.
Fundings: 103k€ inclusive of tax.

Appendix C

Significant productions

[31, 32, 33, 34]