



**HAL**  
open science

# OPTIMIZATION OF INVESTMENTS IN GAS NETWORKS

Jean Andre

► **To cite this version:**

Jean Andre. OPTIMIZATION OF INVESTMENTS IN GAS NETWORKS. Mathematics [math]. Université du Littoral Côte d'Opale, 2010. English. NNT: . tel-00539689

**HAL Id: tel-00539689**

**<https://theses.hal.science/tel-00539689>**

Submitted on 24 Nov 2010

**HAL** is a multi-disciplinary open access archive for the deposit and dissemination of scientific research documents, whether they are published or not. The documents may come from teaching and research institutions in France or abroad, or from public or private research centers.

L'archive ouverte pluridisciplinaire **HAL**, est destinée au dépôt et à la diffusion de documents scientifiques de niveau recherche, publiés ou non, émanant des établissements d'enseignement et de recherche français ou étrangers, des laboratoires publics ou privés.

THESIS FOR THE DEGREE OF DOCTOR IN ECONOMICS

---

# Optimization of investments in gas networks

---

*Author:*

Jean ANDRÉ

*Supervisor:*

Pr. Daniel DE WOLF

*Committee members :*

Pr. Frédéric BONNANS, INRIA & Ecole Polytechnique

Dr. Fabrice CHAUVET, HDR, EDF R&D, Reviewer

Pr. Daniel DE WOLF, Université du Littoral Côte d'Opale, Advisor

Pr. Marc PREVOST, Université du Littoral Côte d'Opale, Chair

Dr. Delphine SINOQUET, Institut Francais du Pétrole

Pr. Yves SMEERS, Université Catholique de Louvain, Reviewer

September 2010

UNIVERSITÉ LILLE NORD DE FRANCE

ECOLE DOCTORALE SESAM/DOCTORAL SCHOOL IN BUSINESS,  
ECONOMICS, URBAN PLANNING AND MANAGEMENT

# Contents

<b>1</b>	<b>Introduction</b>	<b>6</b>
1.1	The Natural gas Supply Chain . . . . .	6
1.2	Main drivers for investment in natural gas supply chain . . . . .	8
1.2.1	Demand drives investments . . . . .	8
1.2.2	Additional incentives to invest . . . . .	9
1.2.3	Other project examples . . . . .	11
1.3	Main Features of existing pipeline systems . . . . .	12
1.3.1	Gas Trunklines . . . . .	12
1.3.2	Gas Networks . . . . .	13
1.4	Problem Definition . . . . .	15
1.5	Designing pipeline networks for the future: Hydrogen networks . . .	15
<b>2</b>	<b>Operations Research and Gas Networks: State of the art</b>	<b>17</b>
2.1	Origin of gas simulation . . . . .	17
2.2	Optimization of the operations . . . . .	18
2.3	Designing straight gunbarrel pipelines . . . . .	19
2.3.1	Usual rules of thumbs . . . . .	19
2.3.2	First attempts to apply OR techniques . . . . .	19
2.4	OR methods overview applied to pipeline network design . . . . .	20
2.4.1	Topology optimization of pipe networks . . . . .	20
2.4.2	Methods for optimal sizing of pipe networks . . . . .	20
2.5	Position of the thesis . . . . .	21
<b>3</b>	<b>Physical Background</b>	<b>22</b>
3.1	Pipes . . . . .	22
3.2	Compression Power . . . . .	24
<b>4</b>	<b>Increasing the network capacity : always the best choice?</b>	<b>27</b>
4.1	Network simulation . . . . .	27
4.1.1	Potential Formulation . . . . .	27
4.1.2	Network equilibrium problem . . . . .	30
4.1.3	Network performance criteria . . . . .	32
4.2	Paradox formulation . . . . .	32
4.3	Analysis . . . . .	36
4.4	When will the paradox not occur? . . . . .	39
4.5	How to detect the paradox? . . . . .	40
<b>5</b>	<b>Investment Optimization Models</b>	<b>42</b>
5.1	Model 1 : Gas trunkline from one source to one consumption node .	42
5.1.1	Objective function . . . . .	42
5.1.2	Constraints . . . . .	43

5.1.3	Program . . . . .	44
5.2	Model 2 : Topology/sizing of single source pipeline distribution systems . . . . .	44
5.3	Model 3 : Pipe reinforcement of multi source transportation networks	45
<b>6</b>	<b>Design : Optimal features</b>	<b>49</b>
6.1	Optimal features of gas trunklines . . . . .	49
6.1.1	General optimality conditions . . . . .	49
6.1.2	Optimal properties . . . . .	50
6.1.3	Optimal Values . . . . .	53
6.2	Characteristics of the optimal topology of single source pipeline distribution networks . . . . .	54
6.3	Numerical verifications . . . . .	55
<b>7</b>	<b>Sizing Methods</b>	<b>63</b>
7.1	Local search for joint topology/sizing optimization . . . . .	63
7.1.1	Topology initialisation . . . . .	63
7.1.2	Sizing of the continuous diameters on a tree . . . . .	64
7.1.3	Tree Improvement Heuristic . . . . .	65
7.1.4	Results . . . . .	65
7.2	Selection of pipe selections to reinforce on existing networks . . . . .	66
7.2.1	Pipe selection continuous program . . . . .	67
7.2.2	Solving the continuous program . . . . .	68
7.3	Branch & Bound algorithms for reinforcement problems . . . . .	69
7.3.1	General principles . . . . .	69
7.3.2	Reduced Branch & Bound . . . . .	70
7.3.3	Numerical Results . . . . .	71
<b>8</b>	<b>An extension : investment scheduling</b>	<b>77</b>
8.1	Modeling of the multi-period problem . . . . .	77
8.2	Dynamic programming . . . . .	79
8.2.1	Feasible State generation . . . . .	79
8.2.2	Principle of Optimality . . . . .	80
8.2.3	DP Algorithm . . . . .	81
8.3	Heuristics . . . . .	82
8.3.1	Principles . . . . .	82
8.3.2	Forward Algorithm . . . . .	83
8.3.3	Fast Forward Algorithm . . . . .	83
8.3.4	Backward algorithm . . . . .	84
8.4	Case Study . . . . .	85
8.4.1	Features of the tested network . . . . .	85
8.4.2	Pipe Selection . . . . .	85
8.4.3	Diameter Optimization . . . . .	85
8.4.4	Scheduling Optimization . . . . .	86
8.5	Tests on larger networks . . . . .	86
<b>9</b>	<b>Conclusions &amp; Future Works</b>	<b>91</b>
9.1	Conclusions . . . . .	91
9.1.1	Paradox . . . . .	91
9.1.2	Optimal features . . . . .	91
9.1.3	Combinatorial Pipe sizing . . . . .	92

9.1.4	Investment Scheduling . . . . .	92
9.2	Overall capacity reinforcement problem . . . . .	92
9.2.1	With new compression stations . . . . .	93
9.2.2	With additional compression power on existing stations . . . . .	93
9.3	Strategic/Operational integration . . . . .	94
9.4	Robust design and sizing of gas networks . . . . .	94
9.4.1	Motivations . . . . .	94
9.4.2	A robust optimization model . . . . .	99
<b>A</b>	<b>Compression power: Numerical approximations</b>	<b>107</b>
<b>B</b>	<b>Extended Models: Mathematical formulation</b>	<b>109</b>
B.1	Installation of new compressor stations . . . . .	109
B.2	Installation of additional compression power . . . . .	109
B.3	Strategic/Operational bilevel model . . . . .	110
B.4	Robust Optimization model . . . . .	110

# Acknowledgements

These research works have been carried out mainly during my time spent with the Simulation Optimisation section of the R&D Division of Gaz de France with the support and funding of the Strategic Division of GRTgaz, the operator of the French gas pipeline networks and also from the French National Research Agency (ANR) for the 2006 ECOTRANSHY Project on assessment of future transportation systems for hydrogen.

At first, I would like to thank Professor Daniel De Wolf, my supervisor, for having accepted me as a student coming from the industrial world. A special thank to Fabrice Chauvet, my manager when I was at Gaz de France, who encouraged me to initiate this work and see the value of such a PhD thesis.

During all my years working at the R&D Center in Gaz de France, I met a lot of people with whom discussions were especially rich and fruitful. These discussions provided me guidance for my own researches in the right directions. At early stages, Tony Pillay provided me his knowledge and deep understanding of the gas networks optimization. His constant curiosity brought to my attention special paradoxical behaviors.

With the help of Professor Frederic Bonnans, I looked thoroughly into the mathematical side of these problems and helped me to see the generalities we can draw from these works.

Interactions with experts in their fields like Tom Van Der Hoeven from Gasunie or Jean Brac from IFP were very enlightening for me.

Last but not the least, I am very grateful to my wife Sophie for her constant support that helped me a lot to achieve this thesis.

## Abstract

The natural gas networks require very important investments to cope with a still growing demand and to satisfy the new regulatory constraints. The gas market deregulation imposed to the gas network operators, first, transparency rules of a natural monopoly to justify their costs and ultimately their tariffs, and, second, market fluidity objectives in order to facilitate access for competition to the end-users.

These major investments are the main reasons for the use of optimization techniques aiming at reducing the costs. Due to the discrete choices (investment location, limited choice of additional capacities, timing) crossed with physical non linear constraints (flow/pressures relations in the pipe or operating ranges of compressors), the programs to solve are Large Mixed Non Linear Programs (MINLP). As these types of programs are known to be hard to solve exactly in polynomial times (NP-hard), advanced optimization methods have to be implemented to obtain realistic results.

The objectives of this thesis are threefold. First, one states several investment problems modeling of natural gas networks from industrial world motivations. Second, one identifies the most suitable methods and algorithms to the formulated problems. Third, one exposes the main advantages and drawbacks of these methods with the help of numerical applications on real cases.

Les réseaux de transport de gaz naturel nécessitent des investissements très importants pour faire face à une demande toujours croissante en énergie et pour satisfaire des contraintes réglementaires de plus en plus importantes. En effet, la libéralisation des marchés gaziers a imposé aux opérateurs de transport de gaz, d'une part, des règles de transparence d'un monopole naturel pour justifier leurs dépenses et, in fine, leurs tarifs, et, d'autre part, des objectifs de fluidification du marché afin de faciliter l'accès à la concurrence des clients finaux.

Ces investissements majeurs justifient l'utilisation de techniques d'optimisation permettant de réduire leurs coûts. Au vue de la présence de choix discrets (choix de la localisation des investissements, choix limité de capacités supplémentaires, planification temporelle) en combinaison avec des contraintes physiques non linéaires (représentant la relation entre l'écoulement et les pressions dans les canalisations ou la plage de fonctionnement des compresseurs), les programmes à résoudre sont des programmes d'optimisation non linéaires en nombres entiers (PNLNE) de grandes tailles. Ce type de programmes étant connu pour être particulièrement difficile à résoudre en temps polynomial (NP-difficile), des méthodes avancées d'optimisation doivent être mises en oeuvre pour obtenir des réponses réalistes.

Les objectifs de cette thèse sont au nombre de trois. Il s'agit d'abord de proposer une modélisation des problèmes d'investissement dans les réseaux de transport de gaz à partir des motivations du monde industriel. Il s'agit ensuite d'identifier les méthodes et algorithmes les plus adéquats pour résoudre les problèmes ainsi formulés. Il s'agit enfin d'évaluer les avantages et les inconvénients de ces méthodes à l'aide d'applications numériques sur des cas réels.

# Chapter 1

## Introduction

### 1.1 The Natural gas Supply Chain

**Natural gas** is one the main energy vector in the world. The worldwide yearly natural gas consumption represents in 2005 **is worth of 25% of the total primary energy consumption** according to the International Energy Agency and the US Energy Information Agency [51, 100]<sup>1</sup>. The natural gas supply chain at a worldwide level can be decomposed into :

- *production* where gas is extracted from earth with drilling techniques. It can be off-shore or on-shore fields associated or not to crude oil fields (on these dual fields, for a long time -in the 60s and the 70s-, natural gas was considered as a by-product of oil and was burnt). The main current production areas in 2006 are located in Russia (22%), US (18%), Canada (6%), Algeria, UK, Norway (3% each), ... (see IEA [52]). While two third of the production is domestically used by these producing countries, one third of the production is exported to consuming countries that have not enough internal resources. According to BP stats ([26]), the total proven reserves at the end of 2007 are estimated to 177 Trillion cubic meter located at 41% in the Middle East and at 25% in Russia. If the extraction rate were stable in the future years, current known reserves are estimated to sustain 60 years. But, as the gas consumption is continuously growing, this horizon could be significantly reduced.
- *transport* from production areas to remote consumption areas. The transportation of gas can be made with several means :
  - through **transmission high pressure pipelines** which are mainly built to ensure gas delivery on ground within a radius of roughly less than 4000 km. For example, the longest pipelines in the world are located in Russia with at least a length of 5000 km to transport gas from Siberia to the European Union. Pipelines can also be built under the sea when it is technically possible. For example, pipes are easy to lay in the deepness of the North Sea to transport gas from Norway to Continental Europe unlike the Mediterranean sea or the surroundings of Japan where the deep ground is not suitable to accommodate pipelines.

---

<sup>1</sup>roughly 33000 TWh (tera or trillion or  $10^{12}$  Wh) or 3000 billion cubic meter per annum i.e. bcma (with an average gross caloric value of 11 KWh per cubic meter of natural gas) out of a global energy consumption of 140000 TWh



To push gas on large distances, gas is pressurized to an high level (between 68 and 80 bars) thanks to compressor stations. To resist to high pressure, these pipelines are made of steel and the costs are strongly depending on the global steel market. In this thesis, we will mainly focus on these transmission pipeline systems.

- with **Liquefied Natural Gas (LNG)** for transporting gas on largest distances than pipelines and mainly on seas. To transport LNG, some specific installations are required:
  1. liquefaction plants that are located on the coasts of production countries. Most of the time, on-ground pipelines are necessary to connect remote production areas to liquefaction plants (like in Algeria with production fields located in the South far from the liquefaction plants). The liquefaction process uses a large amount of energy to cool gas at cryogenic temperature (-183 Celsius degrees). This process requires investments in liquefaction assets on the long term.
  2. LNG tankers are boats that are especially designed to keep natural gas in very large tanks at a cryogenic temperature. The total energy amount inside a LNG tanker is worth the annual consumption of a middle size city of 200.000 inhabitants. Regarding the amounts of energy and money at stake, LNG tankers fleet is mainly made of recent boats with high maintenance programs to guarantee deliveries in good conditions. Engines of LNG tankers are feeded with the vaporized natural gas coming from the tank.
  3. Regasification plants that are located on the coasts of consumption countries. These regasification plants are useful to regasify natural gas at atmospheric temperature and to recompress gas to be transported in downstream pipelines <sup>2</sup>.

These two transportation modes (pipelines and LNG) are often combined to carry gas from production fields far from coasts to be liquefied and then to be regasified into pipeline networks based in consumption countries.

- *storage*. **Underground storages** keep large amounts of gas under pressure. Most of the time, these facilities are salt caverns or aquifers (where water has been removed) and are mainly based in consumption countries without internal production. These facilities have several roles for gas importing countries:
  - to **balance the differences between low-demand season (summer) and high-demand season (winter)**. Since the gas from production areas is continuously delivered within a range (yearly, monthly and daily contractual minimal and maximal take-or-pay quantities), the excess of gas is injected into storages in summer and the lack of gas in winter is withdrawn from storages to prevent from shortage. In Europe, only UK and Norway are not importing countries and then do not have underground storages.

---

<sup>2</sup>in France, 3 LNG terminals are existing owned by GDFSUEZ and TOTAL (Montoir de Bretagne, Fos I and II). A project leaded by EDF is on going in Dunkerque

- to **ensure the security of supply in case of a disruption in the deliveries**. Let us note that the European Union recommends to its members to have a 2 month reserve in case of total delivery shutdown [101]. As a reminder, we can see in the recent past some examples: the Ukrainian crisis which regularly occurs in the winter since 2006 where Russia shutdowns the pipes as soon as Ukraine does not pay its bills or accidents on the liquefaction plants of Skidda in Algeria in 2004 <sup>3</sup>.
- to **reduce the gas cost** by purchasing gas when it is cheap and by reselling it when prices are raising. This is a the most recent use of storages due to the arrival of storage operators.

**Cryogenic storages** exist also for 2 purposes:

- as a **temporary storage on regasification plants** to handle the timeframe between arrivals of boats and the diffusion on the gas network.
- as a **permanent reserve for remote or hard access to cities**. We can observe this use in Japan where long pipelines can not be built due to the geographical (crossing mountains) and sismological constraints.
- *distribution systems* that make possible to deliver gas to end-users. These distribution networks are mainly made of :
  - **low pressure pipelines** without compressor stations. These systems mainly supply urban areas and represent very huge total lengths. At the outlet of these systems, the **targeted end-users are mainly the heating and cooking households markets**.
  - sometimes transmission networks can be partially used for delivery purposes since large customers can be directly plugged onto the transmission networks. These **large customers are often industrial plants** that needs natural gas for chemical processes, for large furnaces (like steel works), producing sugar...
  - *cryogenic truck fleets*. In that cases, cryogenic trucks feed on a regular basis cryogenic tanks.

The natural gas supply chain requires therefore a large number of assets that makes this industry very capital intensive.

## 1.2 Main drivers for investment in natural gas supply chain

### 1.2.1 Demand drives investments

Investments decisions are mainly based on the notion of Return on Investment (ROI) which compares the total cost of an initial investment with the total future income that can be drawn of the operation of this asset. For a physical asset, this ROI will be calculated based on the regular (monthly, yearly) future revenues

---

<sup>3</sup><http://www.ferc.gov/industries/lng/safety/safety-record.asp>

	2000	2005	2015	2005-2015*
OECD	1 409	1 465	1 726	1.70%
North America	799	765	887	1.50%
Europe	477	550	639	1.50%
Pacific	133	149	201	3.00%
Transition economies	601	663	789	1.80%
Russia	395	431	516	1.80%
Developing countries	528	727	1 174	4.90%
China	28	51	131	9.90%
India	25	35	58	5.20%
Other Asia	131	177	262	4.00%
Middle East	182	261	394	4.20%
Africa	62	85	136	4.80%
Latin America	100	118	193	5.00%
<b>World</b>	<b>2 539</b>	<b>2 854</b>	<b>3 689</b>	<b>2.60%</b>
European Union	482	541	621	1.40%

\*Average annual rate of growth.  
Source: IEA WEO 2007, Reference Scenario.

Figure 1.1: World primary natural gas demand

over the asset lifetime. The future revenues will be estimated with forecasts of the asset's use.

In the past, increase of Gross Domestic Product in western countries has been followed with a significant increase of energy consumptions (natural gas consumption jumped from 100 to 500 TWh in France between 1970 and 2000 [76]). In this growing environment, the natural gas has been marketed as an primary energy source for heating and cooking purposes for households. Despite an high level of competition (since natural gas can be easily replaced), the natural gas obtained an significant market share (in France, 33% in the households sector and 34% in the industry in 2009 [76]) thanks to its flexibility and availability and to energy policies to reduce the dependancy to oil.

For the future, the forecasted increase in consumption is still based on a global annual rate of growth estimated at 3% in the next twenty years (see charts from IEA on Figure 1.1 [51]). Unlike in the past, natural gas is less sold as a primary energy source but to be converted into electricity. Hence, let us note that one of the *key future drivers of this demand comes from the use of natural gas to feed power plants* like Natural Gas Combined Cycle or Combined Heat and Power Units due to low capital costs, short leadtimes, and relatively light environmental footprints. Gas network operators like GRTgaz<sup>4</sup> in France or National Grid in the UK<sup>5</sup> have pointed out in their public forecasts the importance of *"gas demand in the power generation sector (...) to increase in subsequent years as new CCGT plant connects to the National Transmission System"* [77].

### 1.2.2 Additionnal incentives to invest

This good perspective in natural gas demand partially explains the very large number of investment projects at each piece of the supply chain. In addition to the increase in demand, 3 current drivers of investments in the natural gas industry can be identified: high energy prices, spatial reallocation, market deregulation and security of supply.

<sup>4</sup>[www.grtgaz.fr](http://www.grtgaz.fr)

<sup>5</sup>[www.nationalgrid.com/uk/](http://www.nationalgrid.com/uk/)

**High natural gas prices** In the last ten years (1999-2008), the natural gas prices have constantly increased. Natural gas prices evolution can be observed mainly from two points of view:

- historically, long term (basically for 20 years) agreements have been signed between production countries (or one their production companies) and distribution companies. These long-term contracts were designed to make large investment projects in production areas possible and to secure the supply in energy of the customers at rather cheap prices. In that agreements, *the natural gas molecule price is most of the time escalated on crude oil prices* negotiated on energy markets. In the last ten years (1999-2008), the yearly average crude oil price has rocketed from 16\$/barrel to 91\$/barrel <sup>6</sup> with a direct impact on natural gas prices.
- more recently, market places dedicated to natural gas have opened. These market places are associated with a physical delivery node on the gas network called *hubs* corresponding to an interconnection node or zone with no transportation fees inside. Several hubs are existing in the US and Europe. The hubs with the most important quantities exchanges are the Henry Hub in Louisiana and the NBP in the UK. On these 2 hubs, these prices have been multiplied by 3 to 4 between 1999 and 2007 according to BP stats [26].

These very high levels of energy prices make profitable most of the investment projects in the NG supply chain.

**Production/Consumption Spatial reallocation** From the production side, the main current production areas are quickly changing due the exhaustion of existing very large fields (for example, in the UK, the production rate dropped from 100 bcm/year in 2000 to 60 bcm/year in 2008 and is expected to fall at 30 bcma in 2018 [77]) and the arising of new fields (e.g. Alaska with considerable proven gas reserves of 1000 bcma and estimated resources of another 5700 bcma [53]).

To ensure deliveries to existing (Europe and North America which account for 40% of the total consumption) and future demand zones (like China with 10 % of yearly increase in the next ten years), it has yielded the generation of new investment projects (and not only to reinforce existing capacities) like several regasification terminals in the US or very large pipelines from Alaska to the USA through Canada.

**Market deregulation** For more than 10 years, the European natural gas network operators have to comply with EU Regulations to open the market to new players. As the natural gas networks are "natural monopolies" <sup>7</sup> in one precise area, the *network operators have to guarantee to regulation agencies that their networks are enough available and opened for any third parties* like shippers that desire to use the transmission network to buy or sell gas. To achieve these requirements, the main undertaken actions have been to *simplify the access with very simple tariff structures and organization*. Therefore, everyone should be able to ship gas from one entry point to another disregarding the route taken by the gas ("black box"

---

<sup>6</sup><http://www.wtrg.com/prices.htm>

<sup>7</sup>proved in V. Gordon, K. Gunsch and C. V. Pawluk A natural monopoly in natural gas transmission, Energy Economics, Volume 25, Issue 5, September 2003, Pages 473-485

effect). However, the transmission systems were not historically designed for the flexible use of entry points, but for flows that were known in advance, based on long-term supply contracts. For example, in France, because of its physical limitations, the transmission system was divided into 4 entry/exit zones on January 1, 2007, with a part of flow constraints still being passed on to users. In order to adapt the system to the market needs, GRTgaz has committed the investment needed to merge the three zones in northern France in 2009. This merger should bring real benefits to shippers, who will have unlimited possibilities to move their gas across the whole new North zone, from any entry point on that zone. It will also simplify the existing tariff structure.

Therefore, important investments have been carried out to *debottleneck crossing points between these zones and to facilitate the flow circulation* inside the boxes (liquid markets). Thanks to these large investments, the natural gas market have now the possibility to exchange natural gas on hubs where price and volumes can be shared.

**Security of supply** Some pipeline projects are set up to diversify the natural gas supplies and thus to guarantee the gas delivery. Two good examples are:

- the Nabucco project<sup>8</sup>. This pipeline of 3300 km will provide to the European Union an access to production zones in the Caspian sea and the Middle East through Turkey, Bulgaria, Romania, Hungary and Austria with a maximal capacity of 31 bcma without going through Russia. The total investment amount has been estimated at 7.9 billions €. This policy will reduce the dependency of Europe to the Russia market power.
- the NordStream<sup>9</sup>. This subsea pipeline of 1200 km will directly connect Russia to European Union (Germany) without crossing the Ukraine. Then, Russia is less dependent on Ukraine to carry its gas to western Europe. Total investment in the offshore pipeline is projected at 7.4 billion €.

As a conclusion, we can say that the emergence of a very large number of projects provides the motivation to have tools and methods to optimally size these new pipelines.

### 1.2.3 Other project examples

All these signals provide good visibility to investors and the number of investment projects is currently quite important (in "Natural Gas Market review 2008", the IEA dedicated its analysis on investments [53]):

- **on the LNG chain** with "*an unprecedented major expansion which is underway globally in regasification capacities*" at first in countries with long coasts like UK, Spain and US. This phenomenon has a direct impact on the LNG tankers fleet which has a very fast developing pace.
- **on pipelines** to connect on ground new production areas:
  - the pipeline projected additional capacity in the USA between 2005 and 2010 roughly reaches 137 bcf/day (1500 bcma)<sup>10</sup> what represents 38

---

<sup>8</sup><http://www.nabucco-pipeline.com/>

<sup>9</sup><http://www.nord-stream.com/>

<sup>10</sup>Additions to Capacity on the U.S. Natural Gas Pipeline Network: 2007,EIA

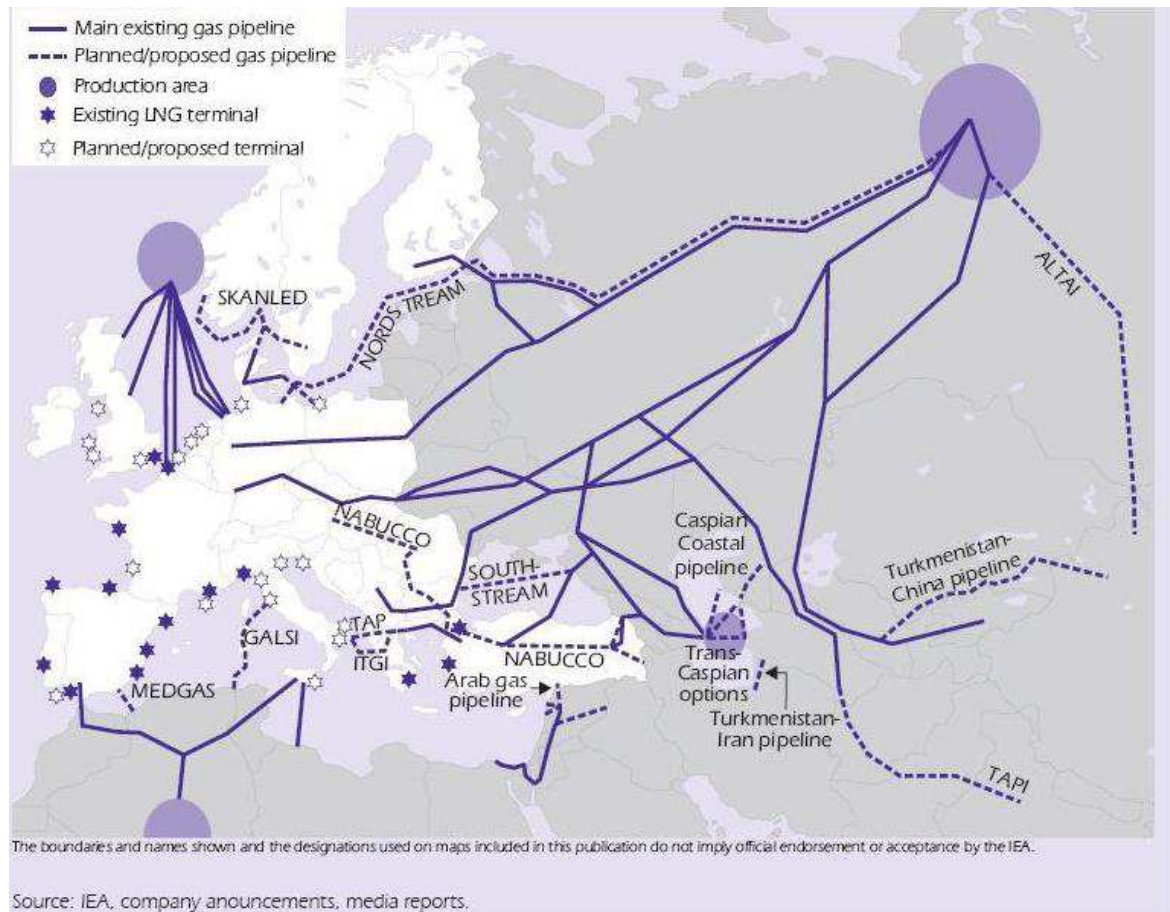

Figure 1.2: Major Pipeline projects in Europe

US Billion Dollars. We can note the Rockies Express Pipeline (REX) that connects the production area in excess of the Rocky Mountains to the East Coast with a pipeline of 2700 km will be completed in the next years.

- the total projected supply pipeline additional capacity in Europe is close to 161 bcma for a total cost of 37-38 billions of Euros in case of completion of all projects. The excess in production is clearly located in Russia with very large projects like the Nordstream (55 bcma) and Southstream (30 bcma) project to supply Western Europe.

There is a *strong interaction between pipeline and LNG asset investments*. For example, GRTgaz, the main French gas network operator, states that its first objective for development is "to create new entry capacity as required by the creation of planned LNG terminals or the expansion of existing LNG terminals" [46]. Figure 1.2 presents the main projects in Europe.

## 1.3 Main Features of existing pipeline systems

### 1.3.1 Gas Trunklines

The main international pipelines are long pipes from production to consumption areas usually called **gas trunklines**. According to the definition of US En-

ergy Information Agency [100], a gas trunkline system is a **long-distance, wide-diameter pipeline system** that generally links a major supply source (production area, natural gas processing plants...) with a market area. Between the producing area, or supply source, and the market area, a **number of compressor stations are located along the transmission system**. These stations contain one or more compressor units whose purpose is to receive the transmission flow (which has decreased in pressure since the previous compressor station) at an intake point, increase the pressure and rate of flow, and thus, maintain the circulation of natural gas along the pipeline. Compressor units that are used on a natural gas mainline transmission system are usually of the centrifugal (turbine) or reciprocating (piston) type. Most compressor units operate on natural gas (extracted from the pipeline flow); but in recent years, and mainly for environmental reasons, the use of electricity driven compressor units has been growing.

Historically, in the US, the gas trunklines were at first created to connect offshore plants in the Gulf of Texas to big cities all around the country. In Continental Europe, the main international pipelines come from Norway (in the North sea), Russia (that cross Poland, Austria or Czeck Republik) and from the Middle East (Iran Irak through Turkey and Eastern Europe). Huge trunklines are also existing between Russia and China or in South America (from Bolivia to Brazil). The design of these trunklines is very simple with one entry point and most of time, one exit point (some withdrawals can exist on trunklines that cross demand zones). Such long distance pipelines are quite easy to operate with oriented stable flows to pipe.

### 1.3.2 Gas Networks

In importing countries, the majority of the pipeline systems are more built on a *network structure* to link multiple sources located around the country to multiple diffuse consumptions points spread over the land (see Figure 1.3 illustrating the French network). In most of the countries, the network can be decomposed into 3 levels :

- the **main national transmission network** which takes the gas at entry points at 80 bar (1200 psi) and delivers gas to downstream networks at 45 bar. Between these points, gas is regularly compressed by on-line booster compressors (every 200 km approximately) and by interconnection compressor stations located at interconnection points connecting more than 2 pipe sections (up to 5 pipes). This main national network is then made of several loops what implies that several sections are not oriented (see Figure 1.3). The operations of looped networks with compressors are quite complex to manage since flow directions in compressor stations are part of the optimization process and moreover, the interconnection of several pipes have to be defined.
- the **regional transportation networks** which take gas from the national grid at 45 bar to deliver gas to downstream networks at 20 bar (mid-pressure operating conditions). The lengths of these networks are not exceeding 200 km from the sources and the delivery points. Therefore, no compression is needed to guarantee the delivery pressures. Sizes of the diameters are then rather high being included between 100 mm and 600 mm (4 to 24 inches).





Figure 1.3: French network structure (source:www.grtgaz.com)

They are often supplied by at most 3 connection nodes from the transmission network. The number of loops is rather low.

- **distribution networks** which take gas from the transportation networks at 20 bar to feed a complete set of delivery points at very low pressure (around 10 mmbar). These networks are highly meshed and match with the streets map of a town. The operations of such networks is mainly based on the control of valves which enable to open or close some parts of the network for better balance the network and for safety reasons.

**France is a good example of an interconnected network.** On the supply side, 5 entry points are located all around the borders (see Figure 1.3 two in the North from Norway and Holland, one in the East from Russia and two regasification terminals: one on the West Coast on Atlantic Ocean and on the South coast on Mediterranean Sea). On the demand side, large cities (more than 1 million inhabitants) are located everywhere with an attraction center at Paris. Let us note that these interconnected networks with undefined flow directions can be found in other countries than France:

- in some countries where gas demand is quite new (less than 15 years) like Spain where several LNG terminals on their coasts are interconnected.
- in other formerly production countries like UK or US where the homeland production rate is decreasing and gas begins to be imported from foreign countries to meet the increasing gas demand. We could note as a good example, the interconnector linking UK and France that was initially built to feed continental Europe with British gas that now is working in the reverse direction to provide gas to UK. Let us note also the development of several projects of LNG terminals in UK, in the US and also in France at Dunkerque.



## 1.4 Problem Definition

In the classical sense, the *pipeline design problem* can be addressed as follows. Suppose a gas pipeline is to be designed to transport a specified quantity of gas per time from the entry point to the gas demand point. Physical and contractual requirements at supply and delivery nodes (mainly minimal and maximal bounds on pressures) are known as well as the costs to buy and lay a pipeline or build a compressor station. In order to minimize the overall cost of creation of this mainline, the following design variables need to be determined:

- the number of compressor stations,
- the lengths of pipeline segments between compressor stations,
- the diameters of the pipeline segments,
- the suction and discharge pressures at each compressor station.

By multiplying the number of entry and exit points, we need to consider all the possible routes that link these points and to design each of this route with the same variables as the "basic problem" addressed before. Besides, this open problem has to account for geographical constraints (e.g. crossing mountains, rivers,...).

Therefore, the design of natural gas transmission involves a high number of alternatives.

Several problems will arise by focusing on one part or another of this decision variables set:

- *Pipeline Transmission Network design problem* is the more open problem with all the variables including both compressor and pipeline variables [42, 56, 92].
- *Pipeline Transportation Network design problem* does not consider the compressor stations. With only pipeline segments, the designer has to deal at first with the opening or not of the links between demand nodes or transit nodes. The second objective is to size correctly these links. In some cases, he has also to deal with the location of regulators that reduce pressures to control them lower than the maximum admissible operational pressure of downstream networks [67, 80, 39].
- *Pipeline Transportation Network reinforcement problem* considers that the transportation network already exists. On these networks, expanding capacities means to identify pipe sections to reinforce and to lay new pipelines along these existing sections (what is called "looping"). Each doubling diameter on arc is associated with a cost given by a stepwise function depending on the laying cost, the steel price, and the length of the pipe section. At the best of our knowledge, no paper are existing on this topic.

The complete state of the art will be detailed in the next chapter.

## 1.5 Designing pipeline networks for the future: Hydrogen networks

Over the next decades, hydrogen demand can develop to such an extent that the evolution of the production, transportation, storage and delivery for hydrogen

will change several times. Because of economies of scale benefits, the general idea in the recent papers [33, 14, 91] is that in the end a more centralized hydrogen supply system will evolve with a large-scale hydrogen pipeline infrastructure.

The design of future hydrogen pipelines becomes an important issue from a prospective point of view. The hydraulics of pipelines and compressors with hydrogen are really closed to the behavior laws for natural gas. Specificities of hydrogen (hydrogen has a lower molecular weight and viscosity than natural gas and however natural gas has a lower compressibility and a higher energy density than hydrogen) only affect some parameters in the equations.

However, in most of the recent existing prospective studies on hydrogen transportation, cost analyses are based on a rough estimate of the pipeline networks length. For example, the pipeline path is only based on the population density in Castello et al. [33] and Smit et al. [91]. Other studies compute the pipeline lengths from supply sources to consumptions by assuming topologies as star-like networks [14] or concentric rings [106]. Lin et al. [65] and Patay et al. [84] are more specific by building network topologies with the help of minimal spanning tree algorithms. Besides, in all these above mentioned studies, sizing is simplified by applying a unique diameter on all the sections of a network from a same geographical level (local, regional, national). Hence, costs are built by multiplying a unit cost per length with the estimated length.

Therefore, design methods for pipelines can find a new place in this field.

# Chapter 2

## Operations Research and Gas Networks: State of the art

### 2.1 Origin of gas simulation

Gas network computations started with the need to obtain the pressures at each nodes of a gas distribution network once the inlet pressure is known. Several techniques have been applied to solve the non linearities of the pressure drop equations in the pipelines. Gas simulation can be performed under transient or steady state.

**Transient simulation** of gas flows is based on partial derivative equations that represents the time dependent continuity and momentum state equations (see the Fluid Dynamics reference book of Joulie [55] and works around dynamic softwares like Simone [62]). These types of model are very detailed (gas composition, pipe geometry, friction factors, gas velocity...) and suitable to track the evolution of pressures at microscopic level in real time but also very useful for tracking the gas quality, the heat dynamics and the compressor thermodynamic behavior.

**Steady state simulation** is used to represent a snapshot of the network or the normal stabilized functioning of a gas network (typically one hour). In steady state simulations, the flow properties do not change with time at each point of the pipe. Steady state equations have been clearly established in major handbooks like those from Katz et al. [57] in 1959, or Mohitpour et al. [73] (last edition in 2003).

The **main challenges** came from the **resolution of large network system with the pressure drop equations on each element of the network**. The main techniques applied rely on the resolution of matrix inversion of linear approximation at each step of the algorithm (Osiadacz [81]). Other techniques has been based on OR techniques by Maugis [68]. He proposed to solve a convex minimization program and use the resulting dual variables of the program as pressures of the problem.

To tackle large-scale looped distribution passive networks, network reduction techniques have been applied like the use of spanning tree to reduce the number of variables to the connectors linking the branches of the tree [38]. More recently, Mohring and Hoffman [74] applied automated reduction techniques from the electronic sector to the gas networks.

## 2.2 Optimization of the operations

In the OR framework, the aforementioned **physical equations are considered as constraints to be fulfilled inside an minimization program with an objective function**. As the pressure drop equations are non convex, different techniques of linearization have been applied to fit into the usual LP framework. Midthun [71] applied Taylor expansion series to these equations on the specific case where the gas direction is known in the pipelines that provide convex equations. In the case of an integrated company (supplier and network operator), a linear objective function (sum of purchase costs on supply nodes) has been considered in the case of the gas transmission problem studied by De Wolf & Smeers [41]. To solve the non linearities of the pressure drop equations, the authors used an *a priori piecewise linearization of the non convex quadratic equations* before applying a revised version of the simplex algorithm. In the same vein, Tom Van der Hoeven proposed a dynamic linearization around current points with the *use of Sequential Linear Programming*. He exposed several possibilities of linearization in his book *Math in gas and the art of linearization* [102].

The **integration of compressors** have been challenging in the transmission network models due to complexity of these constraints (compression ratio and power inside bounds in particular <sup>1</sup>). In the case of an integrated company, the nonlinear relationships appeared only in the constraints. Due to the separation of commercial and transportation operators, the transportation company has the objective function to minimize the fuel consumed to compress the natural gas. The optimal set point of several compressor stations in series have been solved with Dynamic Programming techniques (Carter [32]). Wu et al [105] approximated the compression power curves through polynomials relaxation functions to be used after in a lower bounding algorithm. Midthun [71] took the assumption of a fixed inlet pressure of the compression station to linearize the compressor costs with a set of lower bound linear inequalities with flowrate and the outlet pressure. Bakhouya [12] directly inputed the compression functions in regular non linear solvers (GAMS with CONOPT) to find local optima useful on real networks. Tabkhi [95, 96] decomposed the problem of the non linearity of the pressure drop equations in considering a binary variable for each direction which provided convex constraints.

More recently, **a new complexity level has been reached with the automatic configuration of compressor stations**. The idea is not only to find the optimal set point that minimizes the cost but also to determine the optimal state of the compressor: open/close, normal/opposite direction, bypass... The complexity grows exponentially with the number of compressor stations available on a network. This multi-state optimization can only be handled with Mixed Integer Non Linear Programs (MINLP). In that framework, Martin et al. [70] approximated the nonlinearities by piece-wise linear functions. They discussed Special Ordered Set (SOS) Type k constraints, a generalization of SOS Type 2 constraints to higher dimensions, and they extended related branching algorithms. Peureux et al (US Patent 2009 [86]) proposed to apply a combination of methods: interior point method for continuous non linear optimization problems and interval propagation techniques associated to Branch and Bound techniques to solve this problem on large instances.

---

<sup>1</sup>the compression ratio is the ratio between outlet and inlet pressures. The compression power is the energy required to compress the gas. It depends on the flowrate and on the compression ratio. These two values have to be kept within operating bounds.

## 2.3 Designing straight gunbarrel pipelines

### 2.3.1 Usual rules of thumbs

To facilitate the calculation of the design of a pipeline, gas engineers proposed to reduce the high number of alternatives by applying criteria based on previous experiences and/or usual engineering practices. A first class of procedures is a trial and error process among several candidate designs proposed beforehand (Mohitpour, Golshan and Murray [73]). For that purpose, Lang [63] highlights the usefulness of simulation softwares to assess what is the best trade-off between compressor costs and pipeline costs. A second approach is to establish some optimal properties to reduce the number of variables. Hence, Cheeseman [35] states that the compression ratios giving the minimum energy consumption should be equal for each station. Kabirian and Hemmati [56] assume that the new compressor stations are located in the middle of pipes.

In the French handbook of Chapon on design and construction of gas transportation networks”[34], the following assumptions are made:

- the layout is horizontal,
- the flowrate  $Q$  is constant along the pipeline,
- the number of compressor stations is known.

Besides, the power is approximated by a specific logarithmic formulation. In this case, Chapon asserts, *without any proof*, that the resolution of the pipeline design problem with differential calculation leads to the following **optimal characteristics of the network**:

- diameters are equal on each pipeline segments (including the terminal segments)
- discharge pressures for all compressor stations are equal to the maximum admissible operational pressure of the pipelines
- compressor stations are equidistant, and hence, compressor ratios are equal.

Thanks to these properties, the **computation is strongly simplified with only two remaining variables** to determine: **one optimal diameter** and **one optimal compression ratio** for the whole pipeline. Then, it is only necessary to select the right number of compressor stations which minimizes the associated costs. Bouckly [19] presents a partial proof of the above properties but the arguments were not very clear and always limited to the Chapon’s framework. In his PhD thesis, Hafner [47] does not discuss the validity of these assertions and only details the calculation’s steps of the two last remaining variables. More recently, Ainouche [2] based his cost analysis on the same properties.

### 2.3.2 First attempts to apply OR techniques

Edgar et al. [42] were the first to apply mathematical programming techniques to such an open-ended problem. They considered the **minimization of the total cost of operation per year including the capital cost in their objective function** against which the above parameters are to be optimized. The capital

cost of the compressor stations was either a linear function of the horsepower or a linear function of the horsepower with a fixed capital outlay for zero horsepower to account for installation, foundation, and other costs. The first cost relationship allowed **direct application of non linear programming techniques**, but it did require the initial postulation of compressor location. The technique, when converged, indicated which compressor stations should be deleted. They solved the second scenario using the **branch and bound technique to handle the integer variables which are the number of compressors**. They applied their techniques not only to gunbarrel pipelines but also to branched systems (with fixed branch lengths).

Soliman and Murtagh [92] showed that a commercial nonlinear solver (MINOS, [75]) could be used to solve large instance of the continuous pipeline design problem (without fixed installation outlay) within moderate computing times.

More recently, Babu, et al. [17] applied Differential Evolution, an evolutionary computation technique, to the same problem and example as Edgar et al. [42]. Both scenarios above mentioned have been solved by these population based-search algorithms. They found optimal costs closed to the cost of Edgar et al. but the optimal variables were less close to their bounds than with Edgar et al.

## 2.4 OR methods overview applied to pipeline network design

### 2.4.1 Topology optimization of pipe networks

On the pipe networks (water, gas, hydrogen), the capacities are given by the non linear relations linking the flow and the pressures at the two ends of the pipe. The first works of design of networks of pipelines were done during the design of collecting networks of gas wells production. So, Rothfarb and al. [90] studied the optimal design of an offshore natural gas network. In [16], Baskaharan et al. are confronted to a similar problem of optimal design of a network of collection of several wells in a desert environment (Australia). They show that, under certain conditions, the **optimal collecting network is a treelike network**. Let us note that both works [90] and [16] consider only networks of collection of gas from several wells (multi-sources) but with a unique point of collection. That's defined the value of the flow on each arc. In [104], Walters uses the techniques of the dynamic programming to investigate all the possible trees on a water distribution network with several sources (springs) and the multiple wells (with potential fixed to sources and minimal potential in the points of exits). We shall note finally the recent works (2006) of Nie [79] on the topology of pipes networks with cycles and multi-sources by means of the use of neuronal networks.

### 2.4.2 Methods for optimal sizing of pipe networks

Because of the laying constraints of pipelines in industrial nations, the optimal topology of networks of pipelines problems gradually left the place with problems of the sizing of the diameters of the distribution networks with fixed topology.

The **main difficulty to handle in such sizing problem is the combinatorial choice of commercial available sizes**. These problems of sizing a piping system have been widely studied in the literature.

To tackle this problem in reasonable computation times, a first class of papers dealing with pipe network sizing (of either water or gas) uses meta-heuristics such as genetic algorithms, see [1, 28, 93, 103].

A second class of papers uses **methods based on continuous relaxation**. Hansen et al. [49] use a trust region successive linear programming method. Their algorithm directly handles the discrete choice of diameter but each step (in which the variation of diameter is continuous) needs a linearization of the objective function and constraints, as well as a procedure for adjusting the diameter in order to satisfy the lower bound on pressures. De Wolf and Smeers [39] (1996) deal only with the continuous variables of diameter. Their objective function combines the cost of purchasing gas at supply nodes and the investment cost on the network. They solve the resulting nonsmooth optimization problem using a bundle algorithm. Zhang and Zhu [108] propose to model the combinatorial aspect with one binary variable per diameter on each arc associated with a choice constraint on these variables (with a sum of binary variables equal to one). As they consider the continuous relaxation of their binary variables, they assume that they can split an arc into several parts, each one associated with only one discrete value of diameter. They proved that it is **not optimal to split an arc into more than two parts**. In order to compute a solution, they reformulate the problem as a bilevel program and use trust-region methods.

Let us remind the paper by Osiadacz and Gorecki [80] (1995) where a sequential quadratic algorithm is applied to a continuous relaxation. Flowrate variables are eliminated by assuming the gas speed on each pipeline to be constant. The continuous solution is then rounded to the nearest discrete diameter.

More recently, we shall note the works of Babonneau and Vial [11] on the design of the networks of water flowing due to the gravity.

Bakhouya [13] investigated an extension of the pipeline sizing problem *by including the sizing of the compressor station*. In that case, the optimization is to find the optimal trade-off between compression capacity and pipeline capacity. As a result of this study, the optimal solution prefers to increase the pipe sizes instead of compressor stations.

## 2.5 Position of the thesis

The objectives of the thesis are the following:

1. clearly establish the optimal properties of the design of a gas trunkline. As the best of our knowledge, no paper has been published to give a theoretical proof of the optimal properties to design a gas trunkline.
2. identify some pathological behaviors that can be counterintuitive to the "the more is the better" state of mind
3. improve the methods that associates both optimizations topology / dimensioning which are strongly connected.
4. address the reinforcement problem (by doubling some pipes) that have not be addressed before
5. include the timing aspect in the planning

# Chapter 3

## Physical Background

The main parts of a gas network are the pipelines and the compressor stations. In this part, we recall physical laws concerning these installations.

### 3.1 Pipes

Let us consider the physical parameters related to a single pipe:

- $Q$ , the flowrate in a pipe (in standard cubic meter/feet per hour),
- $P^i$ , the inlet pressure of the pipe (bar or psi),
- $P^j$ , the outlet pressure of the pipe (bar or psi),
- $\pi^i$ , the inlet square pressure (or inlet head) of the pipe (square bar or psi),
- $\pi^j$ , the outlet square pressure (or outlet head) of the pipe (square bar or psi),
- $L$ , the pipe length (km or miles),
- $D$  the internal pipe diameter (mm or inches).

Let us write the Weymouth equation [57],[73] modeling the pressure loss between the two ends of the pipe:

$$\pi^i - \pi^j = K_1 \cdot d \cdot T \cdot Z_{av}(\pi^i, \pi^j) \cdot \lambda(Q, D) \cdot Q^2 \cdot \frac{L}{D^5} \quad (3.1)$$

with

- $K_1$  (constant) function of  $P_0$ , the standard pressure,  $T_0$ , the standard temperature and  $\rho_A$ , the mass density of air,
- $d$ , the gas specific gravity compared to air,  $T$ , the gas temperature,
- $Z_{av}(\pi^i, \pi^j)$ , the average gas compressibility factor, function of the inlet and outlet pressures. Its expression is as follows, [73]:

$$Z_{av} = 1 + K_2 \cdot P_{av}(\pi^i, \pi^j) \quad (3.2)$$

where  $K_2 < 0$  is a constant and the average pressure  $P_{av}$ , defined as  $P_{av} = \frac{2}{3} \frac{P^i P^j}{P^i + P^j}$



- $\lambda(Q, D)$ , the friction factor depending on the diameter and the flow regime (laminar flow, transition flow, or turbulent flow according to the Nikuradze experimentations [78]). The friction factor is written with the Von Karman-Prandtl formulation for turbulent flow in rough pipes [43]. In that case, friction is no longer dependent on the flowrate  $Q$ .

$$\lambda = \frac{1}{(2 \log_{10}(\frac{k}{3700 * D}))^2}$$

In the rest of the thesis, several simplified versions of this pressure drop equation will be used by considering that the parameters  $\lambda(Q, D)$  and  $Z_{av}$  as constant with respect to the pressures and the flowrate:

- with the constant  $\beta = K_1.d.T.Z_{av}(\pi^i, \pi^j).\lambda(Q, D)$

$$\pi^i - \pi^j = \beta.Q^2.\frac{L}{D^5} \quad (3.3)$$

- with flow dependent constant  $\beta' = \beta.Q^2$  when the flowrate is constant:

$$\pi^i - \pi^j = \beta'.\frac{L}{D^5} \quad (3.4)$$

- with the length dependent constant  $C = L.\beta$

$$\pi^i - \pi^j = C.\frac{Q^2}{D^5} \quad (3.5)$$

- with the length/diameter dependent constant  $r = \frac{C}{D^5}$  that can be called *pipe resistance* when the diameter is constant:

$$\pi^i - \pi^j = r.Q^2 \quad (3.6)$$

- In some cases where the gas is flowing always in the same direction, the Weymouth equation will be written:

$$Q = k.\sqrt{\pi^i - \pi^j} \quad (3.7)$$

where the sign of  $\pi^i - \pi^j$  is known and positive and  $k$  can be called *pipe conductivity*

In this thesis, we will also sometimes consider that the **gas can flow in both directions in the pipeline**. Then, several ways have been investigated to model this feature:

- by using a sign function of  $sign(Q)$  [40]

$$\pi^i - \pi^j = C.sign(Q)Q^2.D^{-5} \quad (3.8)$$

- with a binary variable  $b$  and big M constraints controlling the sign of  $Q$  [95]

$$(2b - 1).(\pi^i - \pi^j) = C.Q^2.D^{-5} \quad (3.9)$$

$$(b - 1)M \leq Q \leq bM \quad (3.10)$$

- the selected way to model this feature in this thesis is to transform the square flowrate into an absolute value:

$$\pi^i - \pi^j = C.|Q|Q.D^{-5} \quad (3.11)$$

In that case, the sign of the flowrate is related to the direction of the flow.

Figure 3.1 presents the pressure drop equation. One can note the non convex nature of this function linking the main control variables of a pipeline.

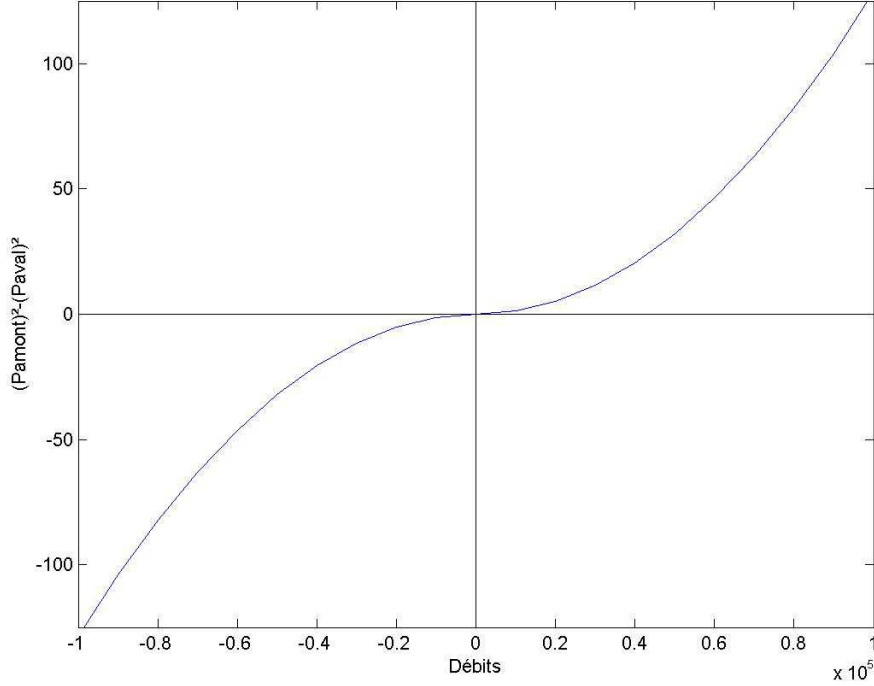

Figure 3.1: Pressure drop equation

## 3.2 Compression Power

Let us rename  $\pi^i$ , the suction square pressure and  $\pi^j$ , the discharge square pressure. The power of an adiabatic compressor is given by the following formula [57],[73]:

$$W = \frac{1}{\eta_{ad}} \cdot K_3 \cdot T^i \cdot Z_{av}(\pi^i, \pi^j) \cdot \frac{\gamma}{\gamma - 1} \cdot Q \cdot \left( \left( \frac{\pi^j}{\pi^i} \right)^{\frac{\gamma-1}{2\gamma}} - 1 \right), \quad (3.12)$$

with  $Z_{av}$  defined above (see (3.2)), and:

- $K_3$  (constant) function of  $P_0$ , standard pressure and  $T_0$ , standard temperature,
- $\gamma$ , the specific heat ratio,  $\eta_{ad}$ , the efficiency constant and  $T^i$ , the inlet temperature,

Some **simplified expression of the compressor power** have been investigated.

**Simplified approach 1** In [97], a logarithmic version is proposed by using the logarithm function of the compression rate:

$$W = K \cdot Q \cdot \log_{10} \frac{P^j}{P^i} \quad (3.13)$$

with  $\hat{K}$ , a coefficient depending on the compressor type (turbine driven, fuel engine driven, electric motor) compression rate and ambient on site condition.

**Simplified approach 2** In his thesis [102], T. van der Hoeven from Gasunie proposes a very simplified formula :

$$W = \mu \cdot Q \cdot \frac{P^j - P^i}{2/3 \cdot P^i + 1/3 \cdot P^j} \quad (3.14)$$

with  $\mu = 0.032$ . One can notice that the compressibility factor has been also considered as a constant like in the first approach.

The explanation (not given in [102]) of this approximation is detailed below.

Firstly, the approximation deals only with the following expression:

$$\frac{\gamma}{\gamma - 1} \left( \left( \frac{P^j}{P^i} \right)^{\frac{\gamma-1}{\gamma}} - 1 \right) \quad (3.15)$$

The first difference appears in  $\gamma$  which is set to  $\frac{4}{3} = 1.3333$  instead of  $\gamma = 1.309$  in the first expression.

Introducing  $\frac{P^j}{P^i} = 1 + x$ , the expression (3.15) can be equivalently written:  $4((1+x)^{1/4} - 1)$ . Let  $f(x) = (1+x)^{1/4}$ . We can approximate this expression with a Taylor development limited to second order in 0:

$$f(x) \simeq f(0) + \frac{f'(0)}{1!} \cdot x + \frac{f''(0)}{2!} \cdot x^2 = 1 + \frac{1}{4} \cdot x - \frac{3}{8} \cdot \frac{x^2}{2!}$$

Then,

$$4((1+x)^{1/4} - 1) \simeq x - \frac{3}{8} \cdot x^2$$

On the other hand, the part of the expression proposed by (3.14) regarding the pressures can be rewritten with  $x = \frac{P^j}{P^i} - 1$ :

$$\frac{P^j - P^i}{2/3 \cdot P^i + 1/3 \cdot P^j} = \frac{x}{1 + \frac{x}{3}}$$

Let  $g(x) = (1 + \frac{x}{3})^{-1}$ . Once again, an approximation of  $g$  with Taylor development limited to first order in 0 give :

$$g(x) \simeq 1 - \frac{x}{3}$$

Then,

$$\frac{x}{1 + \frac{x}{3}} \simeq x \left( 1 - \frac{x}{3} \right) = x - \frac{x^2}{3} \simeq x - \frac{3}{8} \cdot x^2$$

because  $1/3 \simeq 3/8$ . To conclude, if we take  $\gamma = \frac{4}{3}$ ,

$$\frac{\gamma}{\gamma - 1} \left( \left( \frac{P^j}{P^i} \right)^{\frac{\gamma-1}{\gamma}} - 1 \right) \simeq \frac{P^j - P^i}{2/3 \cdot P^i + 1/3 \cdot P^j}$$

**Simplified approach 3** The approach selected in this thesis is given below:

$$W = \gamma_1 \cdot Q \cdot \left( \left( \frac{P^j}{P^i} \right)^{\gamma_3} - \gamma_2 \right) \quad (3.16)$$

with the constants  $(\gamma_1, \gamma_2, \gamma_3)$ . The estimation of parameters  $\gamma_1$ ,  $\gamma_2$  et  $\gamma_3$  is based on average numerical value and the detailed numerical test are available in the appendix.

In the design model we are considering in this thesis, we will choose the first approximation. The compression horsepower will be written as follows<sup>1</sup>:

$$W = \gamma_1 \cdot Q \cdot \left( \left( \frac{\pi^j}{\pi^i} \right)^{\frac{\gamma_2}{2}} - 1 \right), \quad (3.17)$$

If several compressors are available in a same compressor station, the total horsepower is the sum of the powers of all compressors.

The constraints to be satisfied for a compressor station are the following:

- the compression rate  $\tau = \frac{\pi^j}{\pi^i}^{1/2}$  must be kept within a range delimited by a minimal compression rate  $\tau^{min}$  and a maximal compression rate  $\tau^{max}$ :

$$\tau^{min} \leq \tau(\pi^i, \pi^j) \leq \tau^{max}$$

Typically, the compression ratio ranges from 1 to 2. The minimal compression ratio can be higher than 1 due to minimal requirements to run the compressor even if the flowrate is equal to 0. In the rest of the thesis, it will be taken to 1.

- the power of the compressor station must be kept within the minimal and maximal horsepower

$$W^{min} \leq W(Q, \pi^i, \pi^j) \leq W^{max}$$

The minimal compression level is due to minimal requirements to run the compressor even if the flowrate is equal to 0. In the rest of the thesis, it will be taken equal to 1.

---

<sup>1</sup>Mandatory pressure drops at the entry and the exit of a compressor station are assumed to be negligible

# Chapter 4

## Increasing the network capacity : always the best choice?<sup>1</sup>

### 4.1 Network simulation

#### 4.1.1 Potential Formulation

**Basic potential formulation** Once the pipe diameters are fixed, one has to determine flows and pressures associated with these diameters. For a network only made of pipes, one can use the potential formulation already used by Maugis (1977, [68]), De Wolf & Smeers (1991, [40]) and Zhang & Zhu (1996,[108]). We recall hereafter the main feature of this potential formulation.

The potential formulation allows to exactly meet the pressure drop equation on the pipes by solving the following convex program minimizing the potential energy of the network:

$$\begin{cases} \min_Q \sum_{a \in A_{pipe}} \frac{1}{3} r_a |Q_a|^3 \\ MQ = b \end{cases} \quad (4.1)$$

where  $M$  is the node arcs incidence matrix of the graph representing the studied network,  $Q$  is the vector of flows and the equation  $MQ = b$  represents the node conservation constraints with  $b$ , the vector of the supply/demand in every node of the network.

Denoting by  $\pi^i$  the dual variables associated with the flow balance equations at each node  $i$ , the following optimality conditions are obtained:

$$r_a Q_a |Q_a| - \pi_a^i + \pi_a^j = 0, \quad \text{for all } a \in A_{pipe}$$

The latter coincide with the pressure fall equations 3.1. Since the potential energy is a strictly convex function of the flow in pipes, for a given right hand side  $b$  (of zero sum) of node conservation equations, the pressure drop equations together with the flow equations have a convex set of solution, whose pipe flows are unique, and associated multipliers are unique up to a constant.

**Generalized Potential Formulation** Let us first introduce a general variation (loss or gain) load law; some specific examples will be presented later. So, consider

---

<sup>1</sup>a first version of this chapter has been published in the paper *André J., Pillay T., Increasing the network capacity: Is it always the best choice?, Proceedings of 7th International Pipeline Conference, Volume 1, Paper no. IPC2008-64258 pp. 93-101, October, 2008.*

the following generalized potential formulation:

$$\min_Q \sum_{a \in A} G_a(Q_a); \quad \text{subject to} \quad MQ = b \quad (P_b)$$

where the potential function  $G_a(Q_a)$  is an extended real-valued (i.e., it has values in  $\mathbb{R} \cup \{\pm\infty\}$ ), lower semi continuous and convex. Problem  $P_b$  is said to be stable at point  $b$  if, when  $b'$  is close to  $b$ , problem  $P_{b'}$  is feasible.

**Lemma 1** *If problem  $P_b$  is stable, then any optimal solution  $Q$  is characterized by the existence of Lagrange multipliers  $\pi$  (called potentials) such that the following optimality system holds:*

$$MQ = b; \quad \partial G_a(Q_a) - \pi_a^i + \pi_a^j \ni 0, \quad \text{for all } a \in A. \quad (4.2)$$

**Proof** Since a perturbed right hand side  $b'$  has to be of zero sum, it is convenient to remove node flow conservation law at an arbitrary node, in order to recover the standard case with a square metric to inverse. The cost function being lower semi continuous convex, and the constraints being linear, the existence of Lagrange multipliers under the stability assumption is a standard result from convex analysis, see e.g. Theorem 2.168 in Bonnans and Shapiro [27].  $\blacksquare$

The expression of the dual problem in the sense of convex analysis (see Rockafellar [88]) is

$$\max_{\pi} d_b(\pi) \quad (D_b)$$

and the expression of the dual cost function  $d_b$  is

$$d_b(\pi) := \inf_Q \left\{ \sum_{a \in A} G_a(Q_a) - \pi \cdot (MQ - b) \right\} = \pi \cdot b - \sum_{a \in A} G_a^*(\pi_a^i - \pi_a^j) \quad (4.3)$$

where by  $G_a^*: \mathbb{R} \rightarrow \mathbb{R}$ , we denote the conjugate of  $G_a$ :

$$G_a^*(Q_a^*) := \sup_{Q_a} \{Q_a^* Q_a - G_a(Q_a)\}. \quad (4.4)$$

**Remark 4.1.1** *Under the hypotheses of lemma 1, by removing node flow conservation equation at an arbitrary node, we recover the standard framework. It follows that if problem  $(P_b)$  has a finite value, then its dual problem  $(D_b)$  has the same value, and has also a nonempty and bounded set of solutions, that coincides with the set of Lagrange multipliers at any primal solution.*

Let us now introduce specific examples of network elements:

- A *check valve* is a binary oriented element on a network : it is either open or closed. If the direction of the flow is imposed on arc  $a$  i.e.  $Q_a \geq 0$ , a *check valve* can be modeled as follows :  $G_a(Q_a) = 0$ , if  $Q_a \geq 0$ ,  $+\infty$  if not. We have that  $G_a(Q_a) = 0$  if  $Q_a > 0$ , and  $\partial G_a(0) = ]-\infty, 0]$ . Relation (4.2) is therefore equivalent to the complementarity system

$$Q_a \geq 0, \quad \pi_a^j \leq \pi_a^i, \quad \pi_a^j = \pi_a^i \quad \text{if } Q_a > 0 \quad (4.5)$$

which characterizes the behavior of an ideal valve.

- A *regulator* or a *compressor station* allow to adjust pressures. We can introduce a "virtual" fit of pressure  $\gamma_a$  with the function:  $G_a(Q_a) = \gamma_a Q_a$ , what imposes the differential of pressure:  $\gamma_a + \pi_a^j - \pi_a^i = 0$ . If  $Q_a \geq 0$ , we deal with a compressor station if  $\gamma_a < 0$  and with a regulator if  $\gamma_a > 0$ .
- More generally, *expansion* holds if  $G_a(Q_a)$  is nonincreasing on  $\mathbb{R}^-$  and nondecreasing on  $\mathbb{R}^+$ . Similarly, *compression* holds when  $G_a(Q_a)$  is nondecreasing on  $\mathbb{R}^-$  and nonincreasing on  $\mathbb{R}^+$  (the subdifferential appearing in (4.2) is then negative). However, a convex function cannot be both nondecreasing on  $\mathbb{R}^-$  and nonincreasing on  $\mathbb{R}^+$  (unless it is constant). So the potential formulation with compressors implies a choice of the flow sign. If, for instance, we decide that  $Q_a \geq 0$  for some arc  $a \in A$ , then we may choose any lower semi continuous, convex function  $G_a$ , nonincreasing on  $\mathbb{R}^+$ , and with values  $+\infty$  on  $\mathbb{R}^-$  (what enforces the sign condition for the flow) in order to model a compressor.

**Remark 4.1.2** *Note that deleting Kirchhoff's law at an arbitrary node implies to set the dual variable to zero at that node, and that the set of dual solutions is obviously invariant by addition of a constant.*

*If the primal problem has a solution, then flows over pipes are uniquely determined (since the cost function is strictly convex with respect to the latter), so that differences of potential along pipes and also of course regulators are uniquely determined. In particular, if the network is connected and consists only of pipes and regulators, then potentials are uniquely determined, up to a positive constant.*

**Generalized potential formulation applied to regulators** One uses the generalized potential formulation as follows:

$$\begin{cases} \min_Q \sum_{a \in A_{pipe}} \frac{1}{3} \cdot r_a \cdot |Q_a|^3 \\ 0 \leq Q_a \leq \overline{Q}_a, \text{ for all } a \in A_{reg} \\ MQ = b \end{cases} \quad (4.6)$$

With a null term  $\gamma_a = 0$ , for all  $a \in A_{reg}$  in the objective function, the dual point given by the potential formulation (4.6) will ensure equalities between inlet and outlet square pressure on the regulators  $\pi_a^i = \pi_a^j$  for all  $a \in A_{reg}$  what is sufficient to respect the pressure drop constraint on the regulators.

**Remark 4.1.3** *The generalized potential formulation can also take into account a mandatory pressure loss  $\Delta P_a^{min}$  through the regulators:*

$$P_a^i \geq P_a^j + \Delta P_a^{min}, \text{ for all } a \in A_{reg} \quad (4.7)$$

*where  $\Delta P_a^{min}$  is the minimal pressure drop (in bar) which has to be applied on this element.*

Let us see how to fix the parameter  $\gamma_a > 0$  that allows to meet the requirement (4.7). By definition,  $\gamma_a$  can be rewritten :

$$\gamma_a = \pi_a^i - \pi_a^j = (P_a^i - P_a^j) \cdot (P_a^i + P_a^j) \Leftrightarrow P_a^i - P_a^j = \gamma_a / (P_a^i + P_a^j)$$

To fulfill the constraint (4.7), we must have:

$$\gamma_a / (P_a^i + P_a^j) \geq \Delta P_a^{min} \Leftrightarrow \gamma_a \geq \Delta P_a^{min} \cdot (P_a^i + P_a^j)$$

In particular, if we choose  $\gamma_a = \Delta P_a^{min}(\overline{P_a^i} + \overline{P_a^j})$  with  $\overline{P_a^i}, \overline{P_a^j}$ , the maximal bounds on inlet and outlet pressures then the constraint (4.7) is satisfied.

The program to be solved is the following:

$$\left\{ \begin{array}{l} \min_Q \sum_{a \in A_{pipe}} \frac{1}{3} r_a |Q_a|^3 + \sum_{a \in A_{reg}} (\Delta P_a^{min}(\overline{P_a^i} + \overline{P_a^j})) Q_a \\ 0 \leq \underline{Q_a} \leq Q_a \leq \overline{Q_a}, \text{ for all } a \in A_{reg} \\ MQ = b \end{array} \right. \quad (4.8)$$

Note that the choice for  $\gamma_a$  can be too strongly constrained by setting a difference between the inlet and outlet pressures higher than  $\Delta P_a^{min}$ .

**Recovering bound constraints on pressures** The main drawback of the potential formulation is to provide a set of pressures satisfying the pressure loss equations, but not the bound constraints on the pressures:

$$\underline{\pi}^i \leq \pi^i \leq \overline{\pi}^i$$

The reason is that we can not control the range of variation of the dual variables of the potential formulation.

To overcome this difficulty, an optimization program is introduced by *minimizing the slack variable  $T$  corresponding to the maximum of the gaps between the actual pressures and the pressure bounds in order to recover feasibility*:

$$\left\{ \begin{array}{l} \min_{(Q, \pi, T)} T \\ r_a \cdot Q_a |Q_a| - \pi_a^i + \pi_a^j = 0, \forall a \in A_{pipe} \\ \pi^i - \overline{\pi}^i \leq T \\ \underline{\pi}^i - \pi^i \leq T, \forall i \in N \\ T \geq 0 \\ M_{reg}^T \pi \geq 0 \\ 0 \leq \underline{Q_a} \leq Q_a \leq \overline{Q_a}, \text{ for all } a \in A_{reg} \\ MQ = b \end{array} \right. \quad (4.9)$$

This program is non convex and should be difficult to solve. However, it can be easily solved thanks to:

- A feasible point of program (4.9) is provided by the generalized convex potential formulation (4.6). Thus, if a feasible point exists for all pressure bounds, the variable  $T$  of a solution of (4.9) will be equal to 0 (thanks to the positivity constraint on  $T$ ).
- in the general case, regulators are essential in order to have some degrees of freedom for obtaining a feasible solution. If the network includes no regulator, then flows over each arc are determined by the potential formulation, and hence, the only degree of freedom consists in a translation of energy heads  $\pi$ .

## 4.1.2 Network equilibrium problem

In the rest of this chapter, we will consider the following simplified form of the pressure drop equation:

$$\pi_a^i - \pi_a^j = C_a \cdot \frac{L_a}{D_a^5} \cdot Q_a \cdot |Q_a| \quad (4.10)$$



with  $C_a = K_1.d.T.Z_m(\pi_a^i, \pi_a^j).\lambda(Q_a, D_a)$  as a constant (see 3.5).

We define  $r_a = C_a \cdot \frac{L_a}{D_a^5}$  as the *resistance* (or *latency*) of an arc  $a$  and

$$k_a = \left(\frac{1}{r_a}\right)^{1/2} \quad (4.11)$$

as the *conductivity* of an arc  $a$ . Then one can rewrite the drop pressure equation in both equivalent manners:

$$\pi_a^i - \pi_a^j = r_a \cdot Q_a \cdot |Q_a| \quad (4.12)$$

$$Q_a = k_a \cdot |\pi_a^i - \pi_a^j|^{1/2} \cdot \text{sign}(\pi_a^i - \pi_a^j) \quad (4.13)$$

The flowrate  $Q_a$  can be positive or negative according to the direction of the flow in the arc. A positive flow implies that  $\pi_a^i > \pi_a^j$ . A negative flow implies that  $\pi_a^i < \pi_a^j$ .

To describe the topology of a network, we use the classical node-arc incidence matrix  $M$  with the following notations:

$$\begin{cases} m_{ia} = +1 & \text{if } i \text{ is the upstream node of arc } a \\ m_{ia} = -1 & \text{if } i \text{ is the downstream node of arc } a \\ m_{ia} = 0 & \text{otherwise} \end{cases} \quad (4.14)$$

Let us define  $b$ , the input/output demand vector on every nodes of the network with  $b_i > 0$  on supply nodes,  $b_i < 0$  on demand nodes and  $b_i = 0$  on transit nodes. Therefore, the flow balancing equations on each node can be summarized under this matrix form:

$$MQ = b \quad (4.15)$$

Rockafellar [87] defined the Network Equilibrium Problem (NEP) as follows. Given a input/output vector  $b$  with  $\sum_{i \in N} b_i = 0$  on a network  $G = (N, A)$ , find a head vector  $\Pi \in \mathbb{R}^{|N|}$  and a flowrate vector  $Q \in \mathbb{R}^{|A|}$  such that Eqn.(4.12) and (4.15) are satisfied.

Finding a solution to (NEP) can be made from several manners [87]. The most common way to obtain a solution seeks to solve a convex optimization program minimizing a potential energy whose optimality conditions are equivalent to the Eqn.(4.12) and (4.15). It guarantees the uniqueness of the solution in flows. Several versions of potential formulation have been discussed in previous paragraph with the programs (4.2)(4.6)(4.8).

Nevertheless, for gas engineers, (NEP) is not an enough complete model to comprehend the whole set of operational constraints. Especially, on multi-delivery networks, minimal delivery pressures must be fulfilled. In the same way, on a single-source network, the inlet pressure can not be infinitely increased and is also bounded with an upper bound. Let us define a new equilibrium program (NEP+) that includes bound constraints:

$$(NEP+) \begin{cases} \pi_a^i - \pi_a^j = r_a \cdot Q_a \cdot |Q_a|, \forall a \in A \\ MQ = b \\ \underline{\Pi} \leq \Pi \leq \bar{\Pi} \end{cases} \quad (4.16)$$

To find a solution  $(\Pi, Q)$  of (NEP+), the minimization of slack variables is given in the program (4.9).

### 4.1.3 Network performance criteria

#### Without pressure bounds

As the energy heads are decreasing along the pipelines, the power loss  $PL$  is a first criterion to assess network's efficiency. The total power loss  $PL$  in a network is defined by:

$$PL = \sum_{a \in A} Q_a \cdot (\pi_a^i - \pi_a^j) \quad (4.17)$$

We can write this equation as follows:  $PL = (M^T \Pi)^T Q = (\Pi^T M) Q = \Pi^T (MQ) = \Pi^T b$ . Thus,  $PL$  can be rewritten as follows:

$$PL = b^T \Pi \quad (4.18)$$

Note that if  $b = 0$  then we just found the well-known Tellegen's Theorem [38] which states that  $\sum_{a \in A} Q_a \cdot (\pi_a^i - \pi_a^j) = 0$  on every kind of energy potential networks.

On a two-terminal network where  $s$  is the supply node and  $d$  the delivery node (and  $b_s = -b_d$ ),  $PL$  can be reduced to  $PL = b_s(\pi^s - \pi^d)$ . On single-source multi-delivery networks, we can partition the set  $N$  into 3 subsets: the source  $s$ , the set of demand nodes  $N_d$  and  $N_t$ , the set of transit nodes. Then, in this case,

$$PL = \sum_{i \in N_d} b_i (\pi^i - \pi^s) \quad (4.19)$$

Since  $b_i < 0, \forall i \in N_d$  and  $\pi^s \geq \pi^i, \forall i \neq s$ ,  $PL$  is always positive.

Let us note the pressure differential between the supply and any delivery nodes  $i \in N_d$ :

$$\Delta \pi^i = \pi^s - \pi^i > 0 \quad (4.20)$$

#### With pressure bounds

By taking into account the pressure bounds, another way to assess the behavior of a network is to track the evolution of the vector  $\Delta \Pi = (\pi^s - \pi^i)_{i \in N_d}$ . By defining  $\overline{\Delta \pi^s}$  as the upper bound on the pressure of supply node and  $\underline{\Delta \pi^i}$  as the lower bound of the demand node  $i$ , we can introduce the maximal authorized pressure differential  $\overline{\Delta \pi^i} = \overline{\pi^s} - \underline{\pi^i}$ . Therefore, as long as this vector is kept under the maximal authorized pressure differential  $\overline{\Delta \pi^i} = \overline{\pi^s} - \underline{\pi^i}$ , the network is not saturated. If one of the components of the vector  $\Delta \Pi$  violates the maximal authorized pressure differential, we conclude to the *saturation of the network*.

## 4.2 Paradox formulation

In its simplest way, the *more-for-less paradox* can be formulated as follows: *given a gas network  $G = (N, A)$ , if we increase the conductivity  $k_a$  (see 4.11 for definition) of one of the arc  $a$  of the network, then the network performances could be lessened.*

As two definitions of network performance have been introduced in the previous section, two paradoxes can be exhibited:

1. given a vector  $b$ , if one conductivity  $k_a$  is increased, then the total power-loss  $PL$  (eq 4.19) is increased,

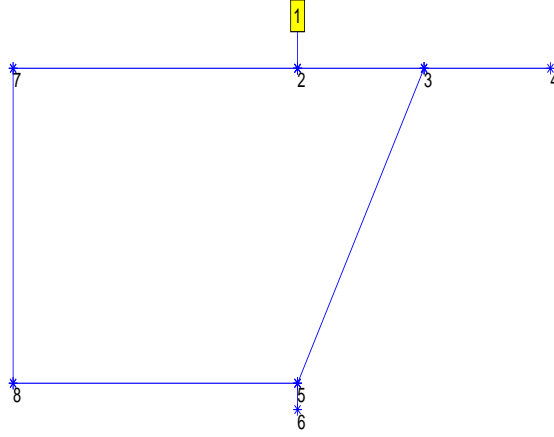

Figure 4.1: NETWORK TOPOLOGY

2. given a vector  $b$ , if one conductivity  $k_a$  is increased, then one of the component of  $\Delta\Pi$  (eq 4.20) is increased.

Note that the existence of the paradox does not automatically yield to the saturation of the network. The saturation depends on the values of maximal authorized pressure differentials for each consumption. If the latter are enough high, the paradox can not be highlighted.

*Calvert and Keady [31] have proved that, on a two terminal network, the total power-loss  $PL$  is a nonincreasing function of  $k_a$  whatever the vector  $b$  is. It means that the first formulation of the paradox can never occur on a two-terminal network.* Note that on a two terminal network with a given  $b$ , the two paradox formulations are equivalent. On the one hand, the power loss  $PL$  as afore mentioned can be expressed as  $PL = b(s)(\pi^s - \pi^d)$ . On the other hand, the vector  $\Delta\Pi$  is reduced to one component  $(\pi^s - \pi^d)$  since there is only one consumption node. Therefore, the two criteria will evolve in the same way.

In this chapter, we will exhibit *some counter-examples* that show that this result is no longer valid on single source multi delivery networks for both paradox formulations. Then, we will try to explain this paradoxical behavior and find some general features of these networks. As a consequence, we could have some insights to avoid the paradox while designing a network.

We illustrate the paradoxes with a very simple example described hereafter. The topology of the network is presented in Figure 4.1. The physical features of the initial network are shown in Table 4.2. The available inlet pressure at the supply node 1 is set to 68 bar and the minimal required pressure on consumption nodes 4 and 6 is set to 20 bar. Consumption nodes are with a demand of  $b(4) = -1.61$  mcm/d (million cubic meters per day) and  $b(6) = -1.78$  mcm/d. On the supply node 1,  $b(1) = 3.39$  mcm/d.

At this stage, diameters are the same on every arcs : 300 mm. Solving the (NEP+) on this first network provide the following results. The network is close to saturation with a high pressure differential between the supply node and the demand node 6 of nearly 48 (68 minus 20) bar, the maximal authorized gap. On the other demand node, pressure is high enough with about 22 bar in comparison with the required 20 bar. Consequently, by forecasting a consumption increase, a pipeline planner is likely to wish expanding its network capacity. For example, let us test the looping of the arc 8 (nodes 3,5) with a parallel pipeline of 400 mm. In this case, it can be observed that, as expected, the pressure at node 6 is higher

Arc	Upstream node	Downstream node	Length (km)
1	1	2	20
2	2	3	40
3	3	4	41
4	2	7	100
5	7	8	120
6	8	5	100
7	5	6	10
8	3	5	140

Table 4.1: NETWORK CHARACTERISTICS

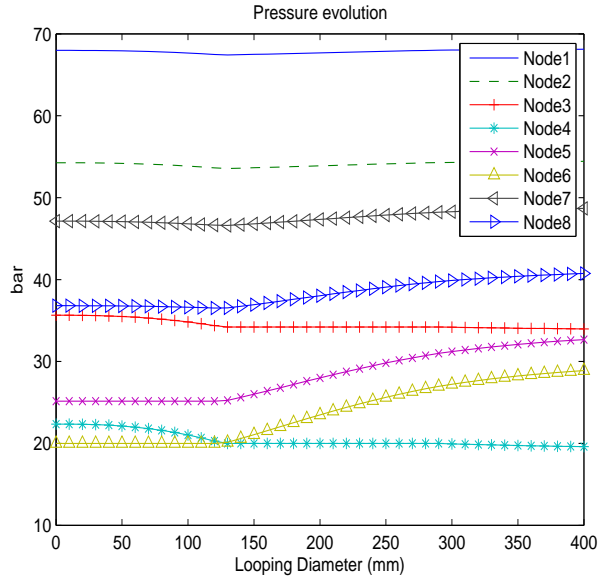

Figure 4.2: PRESSURE EVOLUTION

than before with 28 bar but, in the same time, *the pressure at node 4 has fallen under the minimal limit of 20 bar*. Thus, the paradox occurs: the new network's state is worse than the previous state without changing anything on the demand side.

To explain what happen between these two extremal states, we are now trying to progressively increase the conductivity of this arc and see the impact on the network variables (pressures, flowrates) and on performance criteria. Increasing the diameter of one arc implies increasing the conductivity of the same arc due to the relationship  $k_a = (\frac{D_a^5}{L_a \cdot C_a})^{1/2}$ .

First, we can make some general remarks from the Figures 4.2, 4.3, 4.4, 4.5 giving pressure, flowrate and pressure losses as a function of the doubling diameter:

- on Figure 4.3, we normally observe an increase in flow on arc 8 which attracts more gas with more capacity. In the same time, the flow on the alternative path 1-2-7-8-5 to feed the node 6 is decreasing. Flows on path 1-2-3-5 and on path 1-2-7-8-5 are converging toward the same value (see value on pipe 4 and 8).
- on Figures 4.4 and 4.5, the pressure differentials (and thus the power loss as well) on the two consumption nodes evolve just the opposite: the DP is

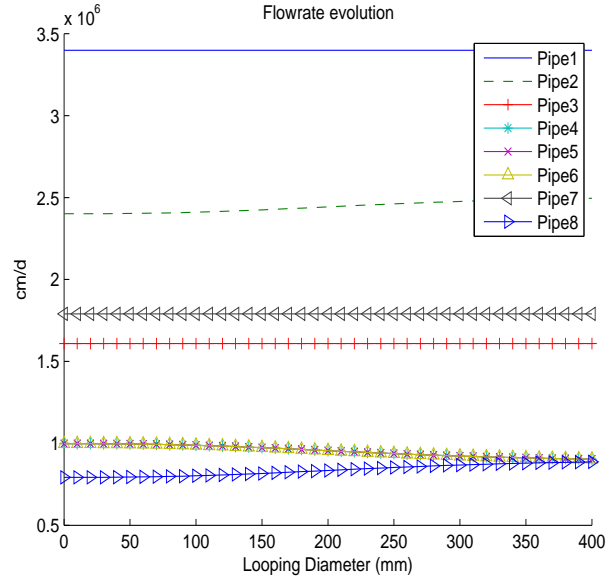

Figure 4.3: FLOWRATE EVOLUTION

always increasing on node 4 and decreasing on node 6 with the increase in diameter.

From these first observations, a simple explanation can be provided. Doubling arc 8 allows more flow going through the route made with arcs 2, 8 and 7 to the delivery node 6 than through arcs 4, 5 and 6. Hence, more pressure drop occurs along arc 2 and, therefore, the resulting problem (called paradox) of meeting the delivery pressure at node 4 of 20 bar appears.

Nevertheless, by looking carefully, we can observe several successive evolution stages :

1. from 0 to 130 *mm*,
  - (a) pressure on node 4 (Figure 4.2) gradually decreases (with a concave shape) whereas, in the same time, *pressure on node 6 is kept on its lower bound* (the pressure differential decreases on this node thanks to a slight decrease in the supply pressure at node 1). The shape of the pressure differentials are clearly convex for the node 4 and concave for the node 6 (see figure 4.5).
  - (b) a *clear counter-example to the extension of the theorem of Calvert and Keady*<sup>2</sup> from network without pressure bounds to networks with pressure bounds: *the total power loss summing the power loss on each consumption node is increasing with the increase in conductivity of the arc 8.*
2. from 130 to about 300 *mm*, *pressure at node 4 reaches its lower bound* (using the optimization vocabulary we say that this lower bound constraint becomes active on node 4). Therefore, *the worst pressure differential is not anymore located on node 6 and is now bears by the node 4*. This change implies nondifferentialibilities on each evolution curves (pressure, power loss, and pressure

---

<sup>2</sup>stating that the power loss can not decrease with the increase in conductivity of one arc of the network

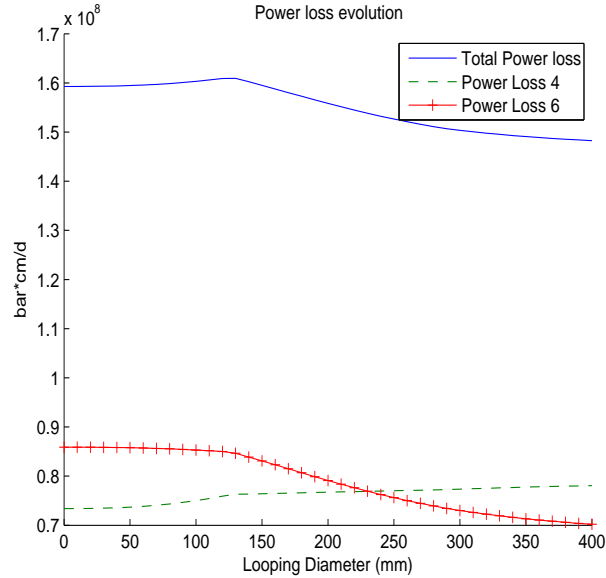

Figure 4.4: POWER LOSS EVOLUTION

differential). After these breaks, curve shapes are changing. Pressure differentials (pursuing their evolutions into the same directions) become concave on node 6 and linear (or almost linear) on node 4. The *total power loss function* (see Figure 4.4) goes now in the opposite direction: it *is now reduced with the increase in diameter*.

3. from about 300 to 400 mm, the pressure differential at node 4 goes through the maximal authorized gap and bound constraints on pressures are not anymore fulfilled. In other words, it means that *it is not anymore possible to find a point solving the (NEP+)*. The (NEP) is always solvable and the curve behavior are not changing at the sole exception of the pressure differential at node 4 which is now following a concave evolution.

### 4.3 Analysis

From the above observations, two paradoxical behaviors have been noted as long as the conductivity of one arc has been increased:

- the total power loss is increasing in a first stage then is decreasing in a second stage.
- the pressure differential of one consumption is continuously increasing to finally yield a unsatisfaction of one of the upper bound pressure.

Although the first behavior is worth of interest from a theoretical point of view, let us focus on the second paradoxical behavior which implies a clear infeasibility of the gas transport.

In this part, we will try to understand this phenomenon by first analytically solving the example thanks to the small size of the network.

Let us reduce the example network to its simplest topology (see Table 4.3).

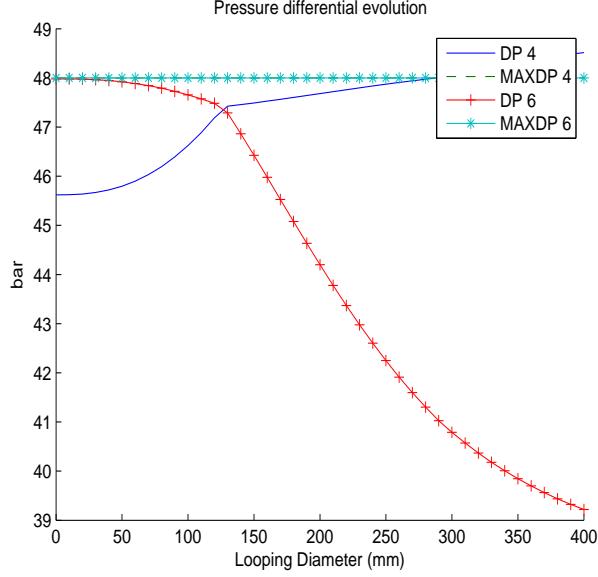

Figure 4.5: PRESSURE DIFFERENTIAL EVOLUTION

Arc	Upstream node	Downstream node
a	j	k
b	i	j
c	i	k

Table 4.2: REDUCED NETWORK CHARACTERISTICS

$$M = \begin{pmatrix} 0 & 1 & 1 \\ 1 & -1 & 0 \\ -1 & 0 & -1 \end{pmatrix}$$

In this network, there are one supply node (i) and two demand nodes (j and k). No intermediate transit nodes are existing. This feature allows to easily analyze the vector  $\Delta\pi_j, \Delta\pi_k$  since it corresponds to the pressure drop vector  $\Delta\pi_b = \pi_i - \pi_j, \Delta\pi_c = \pi_i - \pi_k$ .

Besides, the flow directions are known and all flows are positive. In other words, the absolute value is not necessary in the pressure drop equation.

The general idea of the analysis is to first analytically link the vector  $\Delta\Pi$  to the conductivities of any arcs of the network  $K = (k_a), \forall a \in A$  and, second, to derive this analytical function to better understand the involved parameters to the evolution of pressure differential.

Let us rewrite (NEP) with a more detailed manner:

$$(NEP) \begin{cases} Q_a = k_a \cdot (\pi_a^i - \pi_a^j)^{1/2}, \forall a \in A \\ \sum_{a \in A} m_{ia} \cdot Q_a = b_i, \forall i \in N \end{cases} \quad (4.21)$$

By substituting the first set of equation in the second set, we can write:

$$\sum_{a \in A} m_{ia} \cdot k_a \cdot (\Delta\pi_a)^{1/2} = b_i, \forall i \in N \quad (4.22)$$

what can be developed as follows:

$$\begin{cases} k_b \cdot (\Delta\pi_b)^{1/2} + k_c \cdot (\Delta\pi_c)^{1/2} = b_i \\ -k_b \cdot (\Delta\pi_b)^{1/2} + k_a \cdot (\Delta\pi_a)^{1/2} = b_j \\ -k_c \cdot (\Delta\pi_c)^{1/2} - k_a \cdot (\Delta\pi_a)^{1/2} = b_k \end{cases} \quad (4.23)$$

By substituting the pressure drops on arcs  $(b, c)$  with the pressure differentials of consumption nodes  $(j, k)$ :

$$\begin{cases} k_b \cdot (\Delta\pi_j)^{1/2} + k_c \cdot (\Delta\pi_k)^{1/2} = b_i \\ -k_b \cdot (\Delta\pi_j)^{1/2} + k_a \cdot (\Delta\pi_a)^{1/2} = b_j \\ -k_c \cdot (\Delta\pi_k)^{1/2} - k_a \cdot (\Delta\pi_a)^{1/2} = b_k \end{cases} \quad (4.24)$$

To express the demand pressure differentials  $\Delta\Pi = (\Delta\pi_j, \Delta\pi_k)$ , we just have to subtract the first equation with one the two others and we obtain:

$$\begin{cases} \Delta\pi_j = \left(\frac{1}{2k_b} \cdot (b_i - b_j - k_c \cdot (\Delta\pi_k)^{1/2} + k_a \cdot (\Delta\pi_a)^{1/2})\right)^2 \\ \Delta\pi_k = \left(\frac{1}{2k_c} \cdot (b_i - b_k - k_b \cdot (\Delta\pi_j)^{1/2} - k_a \cdot (\Delta\pi_a)^{1/2})\right)^2 \end{cases} \quad (4.25)$$

We have then the following analytical functions:

$$\begin{cases} \Delta\pi_j = g(k_a, k_b, k_c) = g(K) \\ \Delta\pi_k = h(k_a, k_b, k_c) = h(K) \end{cases} \quad (4.26)$$

We can now derive these functions. Let us begin with  $\Delta\pi_j$ . Let us consider the function  $f(\widehat{K}) = (b_i - b_j - k_c \cdot (\Delta\pi_k)^{1/2} + k_a \cdot (\Delta\pi_a)^{1/2})$  with  $\widehat{K} = (k_a, k_c)$ . Therefore,  $g(K) = \left(\frac{1}{2k_b} \cdot f(\widehat{K})\right)^2$ .

$$\frac{\partial g(K)}{\partial k_b} = -\frac{f^2(\widehat{K})}{2 \cdot k_b^3} < 0 \quad (4.27)$$

what confirms that the pressure drop on an arc is reduced with an increase in its own conductivity. With respect to the other conductivities:

$$\begin{cases} \frac{\partial g(K)}{\partial k_a} = \frac{1}{k_b^2} \cdot f(\widehat{K}) \cdot \frac{\partial f(\widehat{K})}{\partial k_a} \\ \frac{\partial g(K)}{\partial k_c} = \frac{1}{k_b^2} \cdot f(\widehat{K}) \cdot \frac{\partial f(\widehat{K})}{\partial k_c} \end{cases} \quad (4.28)$$

The function  $f$  can be expressed as follows:

$$\begin{aligned} f(\widehat{K}) &= b_i - b_j - Q_c + Q_a \\ &= b_i - b_j + b_k + Q_a + Q_a = 2Q_a - 2b_j = 2Q_b > 0 \end{aligned}$$

The partial derivatives of the function  $f$  gives:

$$\begin{cases} \frac{\partial f(\widehat{K})}{\partial k_a} = (\Delta\pi_a)^{1/2} > 0 \\ \frac{\partial f(\widehat{K})}{\partial k_c} = -(\Delta\pi_c)^{1/2} < 0 \end{cases} \quad (4.29)$$

We can conclude that

$$\frac{\partial \Delta\pi_j(K)}{\partial k_a} > 0 \quad (4.30)$$

what means that when the conductivity on the arc  $a$  increases, the more the pressure differential increases at node  $j$ .



## 4.4 When will the paradox not occur?

The increase in pressure differential with respect to one conductivity is then a *necessary condition* for the occurrence of the paradox. Conversely, if this necessary condition is not satisfied, then we can state that the network is immune against this paradox. In this part, we will establish a way to detect this necessary condition from the network structure. Let us call the tree network as the network of type ( $T$ ).

**Lemma 2** *On tree network with one supply  $s$ , the paradox can not occur.*

**Proof** On tree networks, flowrates are all known by summing for each arc all the demand flows located downstream this arc. Flowrates are not anymore variables of the problem and become exogenous parameters. The problem (NEP) can be reduced to find the head vector  $\Pi$  such as  $\pi_a^i - \pi_a^j = r_a \cdot Q_a^2, \forall a \in A$ . Let us note the unique path  $p(s, i)$  (given as a list of arcs) to connect the supply  $s$  to any of the node  $i$ . For each node, it can be reformulated as a constraint propagation from upstream to downstream  $\pi_i = \pi_s - \sum_{a \in p(s, i)} r_a Q_a^2, \forall i \in N$ . Therefore, the partial derivatives can be written as follows  $\forall i \in N$ :

$$\begin{cases} \frac{\partial \pi_i}{\partial r_a} = -Q_a^2 < 0, \forall a \in p(s, i) \\ \frac{\partial \pi_i}{\partial r_a} = 0, \forall i \in N, \forall a \notin p(s, i) \end{cases} \quad (4.31)$$

The pressure on any nodes *can not increase* with respect to the increase in any resistance of the network. ■

Let us call the networks with one supply  $s$  and directed flows as networks of type ( $G$ ) with several loops. Pressure differentials for every nodes  $i$  are equal to  $\pi_s - \pi_i$  for this type of network. On a cycled network, several paths  $p \in P_{(s, i)}$  can be enumerated to connect the supply node and one of the node.

From Euler's formula, the number of loops inside a network can be evaluated ( $nl = |A| - |N| + 1$ ). Let us define  $\tilde{M}$ , the reduced incidence matrix by deleting one of the row of the incidence matrix. Afterward, it is easy to deduce from the missing node the subsequent flows. A consumption node spanning tree  $T$  can be found on a meshed network (with a greedy algorithm for example). It means that it does exist one unique path  $p(s, i) \subset T$  between the source  $s$  and the demand node  $i \in N_d$ . Hence, the reduced incidence matrix  $\tilde{M}$  can be partitioned into 2 submatrices  $M_T$ , the reduced incidence matrix corresponding to the tree part of the network and  $M_C$  the reduced incidence matrix corresponding to the other arcs not included in the tree called the "chords":

$$\tilde{M} = [M_T | M_C] \quad (4.32)$$

On this type of network, we exhibit the following property:

**Lemma 3** *On network of type ( $G$ ), if the vector  $V = M_T^{-1} \cdot M_C$  is positive then the paradox can not occur.*

**Proof** The flow conservation can be reformulated as follows:

$$[M_T | M_C] \cdot Q = b \Leftrightarrow M_T \cdot Q_T + M_C \cdot Q_C = b \quad (4.33)$$

$M_T$  is a square matrix of size  $(|N| - 1)$  and is of full rank. Consequently,  $M_T$  is invertible. Therefore, we can express the flows on the tree according to the flows on the chords:

$$Q_T = M_T^{-1} \cdot b - M_T^{-1} \cdot M_C \cdot Q_C \quad (4.34)$$

Let us write the pressure differential for a consumption node  $i \in N_d$ :

$$\Delta\pi_i = \sum_{a \in p(s,i) \subset T} r_a \cdot Q_a^2 \quad (4.35)$$

Let us denote  $a'$  the arc on which the resistance is modified. Three cases can be distinguished:

- case 1: If  $a' \in p(s, i) \subset T$  then  $\frac{\partial \Delta\pi_i}{\partial r_{a'}} = Q_a^2 > 0$  whatever the flow variable  $Q_a$  is : the paradox does not appear.
- case 2: Let us define the set  $\bar{T}$  as the set  $T$  without the arcs of the path  $p(s, i)$ . If  $a' \in \bar{T}$  then  $\frac{\partial \Delta\pi_i}{\partial r_{a'}} = 0$  : there is no impact on the pressure differential.
- case 3 :If  $a' \in C$ , for an easier use of the equations, we prefer to evaluate  $\frac{\partial \Delta\pi_i}{\partial k_{a'}}$  instead of  $\frac{\partial \Delta\pi_i}{\partial r_{a'}}$ .

As each arc  $a \in T$ ,

$$\frac{\partial \Delta\pi_i}{\partial k_{a'}} = \sum_{a \in p(s,i)} r_a \cdot 2Q_a(k_{a'}) \cdot \frac{\partial Q_a}{\partial k_{a'}}, \forall a' \in C \quad (4.36)$$

$Q_a > 0$  since the flows are initially oriented. It remains to know the sign of  $\frac{\partial Q_a}{\partial k_{a'}}$ . From Eqn.(4.34),

$$\frac{\partial Q_a}{\partial k_{a'}} = (-M_T^{-1} \cdot M_C)_{a'} \cdot \frac{\partial Q_{a'}}{\partial k_{a'}} \quad (4.37)$$

The pressure drop laws can be extracted on the chord part:

$$Q_{a'} = k_{a'} \cdot (\Delta\pi_{a'})^{1/2}, \forall a' \in C \subset A \quad (4.38)$$

Then,

$$\frac{\partial Q_{a'}}{\partial k_{a'}} = (\Delta\pi_{a'})^{1/2} > 0, \forall a' \in C \subset A \quad (4.39)$$

As a consequence, if every elements of the vector  $(M_T^{-1} \cdot M_C)_{a'}$  with  $a' \in C$  are positive, then it guarantees that  $\frac{\partial \Delta\pi_i}{\partial k_{a'}}$  is negative (normal behavior). ■

If we detect one of the negative component of  $V = M_T^{-1} \cdot M_C$ , then it does not mean that the paradox will occur but it can give a clue to focus the analysis on this set of critical nodes. On very general meshed networks of type  $(G)$ , it has been established that, if the paradox occurs, it comes from the building or the reinforcement of chords.

## 4.5 How to detect the paradox?

In the previous section, we have shown a necessary condition to observe a paradox on common networks but this condition is not sufficient to yield infeasibility.

In this section, considering a large network, we are establishing a practical method to detect the occurrence of infeasibility by going to the limits of the paradox. This procedure is based on the assumption that *the pressure differential on*

each consumption node  $\pi^s - \pi^i, \forall i \in N_d$  is a monotonic (increasing or decreasing) function with respect to the evolution of conductivities. In other words, it means that the pressure differential derivatives are not changing of signs when the conductivities evolves. This assumption seems reasonable regarding the computation of the partial derivatives (see lemma 3) that are depending on the sum of elements of the node/arc matrix.

1. for each consumption node  $i \in N_d$ , assess by finite differences the partial derivatives of the pressure differential according the conductivity of each arcs of the network (or only those which are incumbent to be build or looped) at any given point (use of the assumption).
2. exclude from the initial set of demand nodes those whose all the partial derivatives are negative:  $\frac{\partial \Delta \pi_i}{\partial k_a} < 0, \forall a \in A$ . It is not possible to see the paradox on these nodes. Let denote  $\hat{N}_d$  the set of remaining nodes whose it does exist at least one conductivity yielding an increase in pressure differential :

$$i \in \hat{N}_d \text{ if and only if } \exists \hat{a} : \frac{\partial \Delta \pi_i}{\partial k_{\hat{a}}} > 0$$

3. for each  $i \in \hat{N}_d$  and for each  $\hat{a}$ , maximize the value of the pressure differential  $\Delta \pi_i$  by keeping the pressure differential within the maximal authorized bound. For this purpose, we can solve a continuous optimization program with only one variable of conductivity (or diameter).

Applying this procedure on the first example presented in the section 3, the only element of set  $\hat{N}_d$  is the node 4 with the associated arc  $\hat{a} = 8$  since the pressure differential on demand node 4 is the only one to decrease. The third step (maximization of the pressure differential) allows to reach an exact solution (293 mm) for the intersection between the pressure differential curve of node 4 and the maximal bound (see Fig. 4.5).

# Chapter 5

## Investment Optimization Models

In this chapter, we present the different models associated to investments on a gas networks from the simplest framework to the more sophisticated. Each model is represented within the form of a mathematical program to solve with:

- a clear objective function to minimize,
- variables (degrees of freedom)
- constraints on the variables : Bounds, linear and non linear relationships...

### 5.1 Model 1 : Gas trunkline from one source to one consumption node

In that first case, our goal is to determine the least-cost configuration of a trunkline (with compressors) linking one single supply node to one single delivery point without any withdrawals and assumptions on the compressor station location.

Let us define a "section"  $k$ , as the association of a pipe *followed* by a compressor station to offset the pressure drop. The compression occurs at the outlet of the section. There is no loss of generality in assuming such a structure, since either the compression ratio can be taken equal to 1, or the length of a section can be zero.

#### 5.1.1 Objective function

Edgar et al. [42], Boucly [19] or Soliman et al. [92] have established the cost model introduced hereafter.

The objective function comprises the sum of terms for each section consisting of:

- the annualized capital expenditure of the pipe and compressor,
- the operating cost of the compressor.

The annualized capital costs for each pipeline section depend linearly on the pipe diameter and length with a factor  $\alpha_p$ , the amortization factor reducing the capital cost to an annual cost.

Operating and maintenance charges  $O^c$  (OPEX) for a compressor station are directly related to the horsepower  $W$  ([42]).

The capital expenditure (CAPEX) of a compressor station is divided into two parts:

- an initial fixed installation outlay  $B$ ,
- a cost increasing with the power:  $C^c W$ , where  $C^c$  is the compressor capital cost per unit horsepower.

The function  $\varphi$  of compression costs yielded by the installation of a compressor station is then given by:

$$C_{comp} = \varphi\left(\frac{\pi^j}{\pi^i}\right) = \alpha^c W\left(\frac{\pi^j}{\pi^i}\right) + B, \quad (5.1)$$

where  $\alpha^c = O^c + C^c$  represents both annualized capital cost and operating cost per unit horsepower. Let us note that the CAPEX depends on the installed power although the OPEX depends on the used power (which is less than the installed power over the year). In this model, one considers that the factor for OPEX  $O^c$  per unit of power will take into account a annual use rate of capacity.

The problem is to find the number  $n$  of compressor stations, diameters  $D_k$ , section length  $L_k$ , and suction and discharge pressures  $(\pi_k^i, \pi_k^j)$  that to minimize the charges to lay pipes and/or build compressor stations:

$$\phi(D, L, \pi^i, \pi^j) := \sum_{k=1}^n \left( \alpha_p L_k D_k + \varphi\left(\frac{\pi_k^i}{\pi_k^j}\right) \right). \quad (5.2)$$

Note that, for fixed  $n$ , the constant  $B$  plays no role in the minimization problem.

### 5.1.2 Constraints

We adopt the following notations:

- $\pi_{k-1}^j$ : inlet head of section  $k$ , equal to the discharge head of the previous upstream section  $k - 1$ ,
- $\pi_k^i$ : outlet head of section  $k$ , is the suction head of the compressor station of that section.
- $\beta' := \beta Q^2$ , a fixed coefficient, since  $Q$  is given.

With these notations, the pressure drop equation on section  $k$  is as follows (see 3.1):

$$\pi_{k-1}^j - \pi_k^i = \beta' \frac{L_k}{D_k^\sigma}, \quad k = 1, \dots, n, \quad (5.3)$$

where the *input head*  $\pi_0^j$  and *output head*  $\pi_n^j$  are given, and  $\sigma \approx 5$  for gas networks (see 3.1). Since other values may be used for different fluids, and our results hold with an arbitrary value, we adopt this more general law. On every compressor station, the discharge pressure cannot be less than the suction pressure:

$$\pi_k^i \leq \pi_k^j, \quad k = 1, \dots, n. \quad (5.4)$$

In this model the square compression ratio  $\rho_k := \pi_k^j / \pi_k^i$  on section  $k$  has no other upper bound than the one deriving from pressure bounds<sup>1</sup>. The sum of length of section must equal the distance  $\ell$  between the supply node and the delivery point:

$$\sum_{k=1}^n L_k = \ell. \quad (5.5)$$

---

<sup>1</sup>no maximal compression rate of the compressor

In addition, upper and lower bounds are set on diameters and squares of pressures:

$$0 < D_{min} \leq D_k \leq D_{max}, \pi_{min} \leq \pi_k^s \leq \pi_{max}, \pi_{min} \leq \pi_k^d \leq \pi_{max}, \quad k = 1, \dots, n \quad (5.6)$$

with  $D_{min}, D_{max}$ , the minimal and maximal commercial diameter proposed on the market. Noting  $P_0$ , standard pressure, and  $MOP$ , the maximum operational pressure of the pipes equal for every section, we have that  $\pi_{min} := P_0^2$ ,  $\pi_{max} := MOP^2$ . Note that the lower bound  $D_{min}$  must be upper than 0 to avoid division by zero in the pressure drop relationship.

We remind that we consider here that the first inlet pressure and the last outlet pressure are equal to the maximal operating pressure.

### 5.1.3 Program

The program to solve is then the following (writing first equality constraints, then bound constraints and ending by general inequality constraints):

$$\left\{ \begin{array}{ll} \min_{D, L, \pi^i, \pi^o} \phi := \sum_{k=1}^n \left( \alpha_p L_k D_k + \varphi_k \left( \frac{\pi_k^j}{\pi_k^i} \right) \right) & \\ \beta' \frac{L_k}{D_k^\sigma} - \pi_{k-1}^j + \pi_k^i = 0, \quad k = 1, \dots, n & (a) \\ \ell - \sum_{k=1}^n L_k = 0, & (b) \\ \pi_0^j = \pi_{max}, \quad \pi_n^j = \pi_{max}, & (c) \\ \pi_k^i - \pi_k^j \leq 0, \quad k = 1, \dots, n & (d) \\ D_{min} \leq D_k \leq D_{max}, \quad k = 1, \dots, n & (e) \\ \pi_{min} \leq \pi_k^s \leq \pi_{max}, \quad k = 1, \dots, n & (f) \\ \pi_{min} \leq \pi_k^d \leq \pi_{max}, \quad k = 1, \dots, n-1 & (g) \end{array} \right. \quad (5.7)$$

By taking a compression cost function  $\varphi_k$  with minimal properties, this model is generic enough to be applied to any pipeline design problem.

## 5.2 Model 2 : Topology/sizing of single source pipeline distribution systems

We assume in the model 2 **several consumption points still fed by a unique gas source** (like in Model 1). These networks are known as **gas delivery or distribution network**. The pressure at the inlet node is considered high enough to supply every delivery nodes **without any intermediate gas compression**.

The costs of a gas pipeline decompose into capital expenditures (Capex) and operating costs (Opex). Capital expenditures, widely dominating, divide into two main items: the material costs and the installation cost. The operating costs are considered as a percentage of the capital cost. That explains that we use as criterion of costs only pipe investment costs including the installation cost.

The costs per kilometer is function of the pipe diameters  $D$  (mm) available in the literature that can be linear [42] like in the Model 1 for the pipes or quadratic [39], [47], [83] that can be in the following form:

$$c(D) = \alpha_0 + \alpha_1 D + \alpha_2 D^2 \quad (5.8)$$

As we have to deal with a network, we define:

- the set  $N$  corresponds to all the gas supply and gas consumption nodes of the network.
- The set  $A$  corresponds to all the arcs connecting two nodes of the network. The indexes  $i$  and  $j$  correspond to the entry and the exit of a pipe. This agreement obliges to introduce into the equation of head losses the sign of the flow. This allows to make valid this equation in both directions of the gas:

$$\pi_a^i - \pi_a^j = \beta Q_a^2 \frac{L_a}{D_a^5}, \forall a \in A \text{ such that } Q_a > 0$$

from equation 3.4.

- $M$  is the node arcs incidence matrix of the graph representing the studied network,  $Q$  is the vector of flows and the equation  $MQ = b$  represents the node conservation constraints with  $b$ , the vector of the supply/demand in every node of the network.

For the problem of optimal design and sizing of a gas transportation network, the complete mathematical model that we propose is the following one:

Find  $M$  such as

$$\begin{aligned} \min C(\pi, D, Q) &= \sum_{a \in A} c(D_a) \cdot L_a \\ \text{s.t.} &\left\{ \begin{array}{l} \pi_a^i - \pi_a^j = \beta Q_a^2 \frac{L_a}{D_a^5}, \forall a \in A \text{ such that } Q_a > 0 \\ MQ = b \\ D_{min} \leq D_a \leq D_{max}, \forall a \in A \\ \pi_{min} \leq \pi_i \leq \pi_{max}, \forall i \in N \end{array} \right. \end{aligned} \quad (5.9)$$

By satisfying the constraints of head losses, minimal and maximal pressures and minimal and maximal diameters available on the market, this model **looks for the optimal topology of a network and for optimal diameters of each used arc** (i.e. with strictly positive flows).

This program is first of all an integer program because of the **binary choice of opening the arcs**. Secondly, this program is nonlinear because of the non convex constraints. It is thus a **Mixed Integer Non linear Program** difficult to exactly solve.

### 5.3 Model 3 : Pipe reinforcement of multi source transportation networks

In the life of transportation/distribution networks (designed initially with the previous model 2), several evolutions and modifications could have been applied to the initial conception that make the network more reliable and flexible :

- additional sources could have been plugged to the network
- additional sections could have been built that create internal loops
- additional compression stations could have been set up at some critical points of the network to relieve a subpart of the network with extra pressure

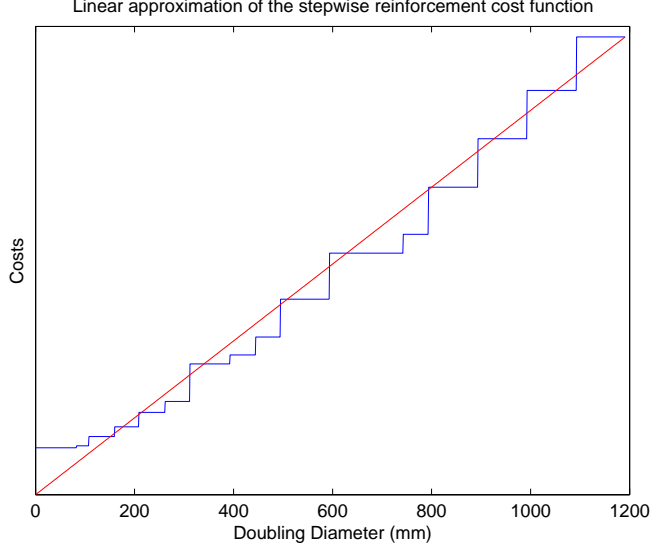

Figure 5.1: Stepwise diameter cost function

This is the reason why we consider in this third model an **multi source multi delivery** already existing network with a known topology.

Let's note that the model 3 includes the model 2. The network creation is a subcase of the network reinforcement problem by including the null diameter as a potential capacity.

The set of nodes of this network is denoted by  $N$ . With each node  $i$  are associated a pressure  $P^i$  and the energy head  $\pi^i := (P^i)^2$ . The set  $A$  of arcs is partitioned in a union of the set  $A_{pipe}$  of pipes, the set  $A_{reg}$  of regulators and the set  $A_{comp}$  of compressor stations. With each arc is associated a flow  $Q_a$ . Let  $M$  denote the node-arc incidence matrix, the (column) partition for pipes,  $M_{reg}$  the partition for regulators and  $M_{comp}$  the partition of compressor stations.

Let  $DI_a$  be the initial diameter on the existing pipeline. When a reinforcement need appears due to a too high flowrate, the solution that relieved the system consists of adding an additional pipe in parallel of the existing one to reduce the load on the first one. This operation is called "doubling" or "looping". Therefore, one needs to introduce the doubling diameter variables  $DD_a$ .

Each doubling diameter is associated with a cost given by the stepwise function  $c_a(DD_a)$  depending on the laying cost, the steel price, and the length of the pipe section. On figure 5.1, one can observe the different steps corresponding to the different available commercial diameters on the market.

Instead of manipulating two different diameters for the same section, one introduces the concept of equivalent diameter. Let us take  $Q_a^I$ , the flowrate in the initial pipe and  $Q_a^D$ , the flowrate in the doubling pipe. If we consider these two pipes in parallel and assuming that the gas flows in the same direction for both pipes, we can write  $Q_a^I = ((\pi_a^i - \pi_a^j).C_a^{-1}.DI_a^5)^{1/2}$  and  $Q_a^D = ((\pi_a^i - \pi_a^j).C_a^{-1}.DD_a^5)^{1/2}$ . Substituting these expressions of flows in the following expression  $Deq_a = (C_a.(\pi_a^i - \pi_a^j)^{-1}.(Q_a^I + Q_a^D)^2)^{1/5}$ , one obtains the equivalent diameter formula:

$$Deq_a = (DI_a^s + DD_a^s)^{1/s}. \quad (5.10)$$

The cost function according to this doubling diameter is also changed with a concave transformation as shown on Figure 5.2. This concave shape represents the



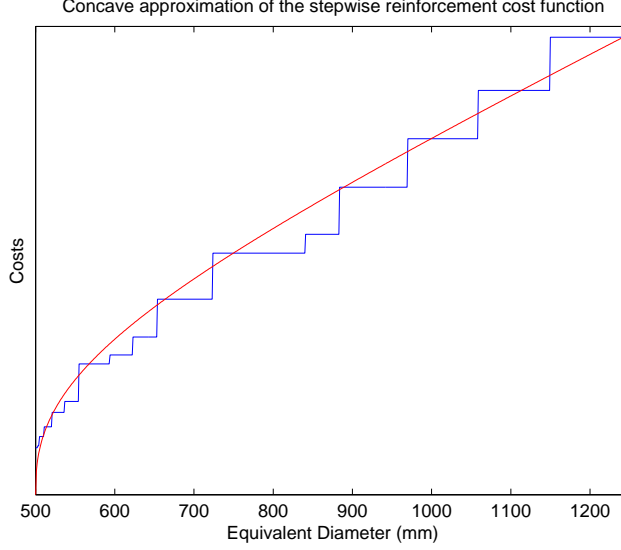

Figure 5.2: Stepwise equivalent diameter cost function

economy of scale by laying a high doubling diameter than smaller one.

Hence, from equation 3.5, one can replace  $D_a$  with the expression of the equivalent diameter of two pipes in parallel. Therefore, the equality constraint on a pipe is the following:

$$\pi_a^i - \pi_a^j = C_a \cdot Q_a \cdot |Q_a| \cdot (DI_a^s + DD_a^s)^{-5/s}, \forall a \in A_{pipe}$$

with  $s = 5/2$ .

As we wish to minimize the sum of the reinforcement costs, the resulting model is stated as follows:

$$\left\{ \begin{array}{l} \min_{(DD, Q, \pi)} \sum_{a \in A_{pipe}} c_a(DD_a) \\ \text{(i)} \quad DD_a \in \{0, \Delta_a^1, \dots, \Delta_a^k, \dots, \Delta_a^{max}\}, \forall a \in A_{pipe} \\ \text{(ii)} \quad \pi_a^i - \pi_a^j = C_a \cdot Q_a \cdot |Q_a| \cdot (DI_a^s + DD_a^s)^{-5/s}, \\ \quad \quad \quad \forall a \in A_{pipe} \\ \text{(iii)} \quad M_{reg}^T \pi \geq 0 \\ \text{(iv)} \quad W_a^{min} \leq W_a(Q_a, \pi_a^i, \pi_a^j) \leq W_a^{max}, \forall a \in A_{comp} \\ \text{(v)} \quad \tau_a^{min} \leq \tau_a(\pi_a^i, \pi_a^j) \leq \tau_a^{max}, \forall a \in A_{comp} \\ \text{(vi)} \quad \pi^{min} \leq \pi \leq \pi^{max} \\ \text{(vii)} \quad 0 \leq Q_a^{min} \leq Q_a \leq Q_a^{max}, \forall a \in A_{reg} \cup A_{comp} \\ \text{(viii)} \quad MQ = b \end{array} \right. \quad (5.11)$$

The constraints (iii) represent the fall of pressure on regulators. The bound constraints on pressure variables (vi) correspond to the contractual requirements on supply and delivery nodes. The bound constraints on flowrates (vii) correspond to the range within a compressor station or a valve must be operated. The constraints (viii) represent Kirchhoff's law of flow conservation.

One can write the equivalent form of this program with the equivalent diameters. A part of the non linearity is then transferred from the constraint to the objective function. Program (5.11) can be rewritten as follows:

$$\left\{ \begin{array}{l} \min_{(Deq, Q, \pi)} \sum_{a \in A_{pipe}} \tau_a(Deq_a) \\ \text{(i)} \quad Deq_a \in \{DI_a, Deq_a^1, \dots, Deq_a^k, \dots, \overline{Deq_a}\}, \text{ for all } a \in A_{pipe} \\ \text{(ii)} \quad \pi_a^i - \pi_a^j = C_a Deq_a^{-5} Q_a |Q_a|, \text{ for all } a \in A_{pipe} \\ \text{(5.11-iii) to (5.11-vi)} \end{array} \right. \quad (5.12)$$

with  $\tau_a(Deq_a) := c_a((Deq_a^s - DI_a^s)^{1/s})$ . The resulting program is (again) a mixed nonlinear, nonconvex program, having discrete variables  $Deq$  and continuous variables  $\pi$  and  $Q$ .

# Chapter 6

## Design : Optimal features<sup>1</sup>

### 6.1 Optimal features of gas trunklines

#### 6.1.1 General optimality conditions

Let us take the following program to solve:

$$\begin{cases} \min_x f(x) \\ g_i(x) = 0, \forall i = 1, \dots, m \\ h_j(x) \leq 0, \forall j = 1, \dots, l \end{cases} \quad (6.1)$$

where  $x \in R^n$ ,  $g$ , the equality constraints and  $h$ , the inequality constraints.

The Karush-Kuhn-Tucker necessary optimality conditions of a solution  $x^*$  of program (6.1) will be expressed as follows ([18],[54]).

Let  $x^*$  be a feasible solution and let  $\hat{J} = \{j : h_j(x^*) = 0\}$ , the indexes of active inequality constraints. Suppose that  $f$ , each  $h_j$  for  $j \in \hat{J}$  and each  $g_i$  for  $i = 1, \dots, m$  are continuously differentiable at  $x^*$ . The LICQ (Linear Independence Constraint Qualification) condition is that the family of gradients  $\{\nabla h_j(x^*)_{j \in \hat{J}}, \nabla g_i(x^*)_{i=1, \dots, m}\}$  is linearly independent.

If a local solution  $x^*$  of problem (6.1) satisfies LICQ, then there exists a family of scalars  $\{u_i\}_{i=1, \dots, m}$  and  $\{v_j\}_{j=1, \dots, l}$  satisfying the following Karush-Kuhn-Tucker (KKT) conditions:

$$\begin{cases} \nabla_x f(x^*) + \sum_{i=1}^m u_i \nabla_x g_i(x^*) + \sum_{j=1}^l v_j \nabla_x h_j(x^*) = 0 \\ g(x^*) = 0; h_j(x^*) \leq 0, v_j \geq 0, v_j h_j(x^*) = 0, \forall j = 1, \dots, l \end{cases} \quad (6.2)$$

The scalars  $u_i$  and  $v_j$  are called *Lagrangian multipliers* or *dual variables*.

The *Lagrangian function* for the problem (6.1) is defined as :

$$L(x, u, v) = f(x) + \sum_{i=1}^m u_i g_i(x) + \sum_{j=1}^l v_j h_j(x) \quad (6.3)$$

An equivalent expression of the KKT conditions is

$$\begin{cases} \nabla_x L(x^*) = 0 \\ g(x^*) = 0; h_j(x^*) \leq 0, v_j \geq 0, v_j h_j(x^*) = 0, \forall j = 1, \dots, l. \end{cases} \quad (6.4)$$

---

<sup>1</sup>An extended version of this chapter has been published in the paper *André J., Bonnans F., Optimal structure of gas transmission trunklines, Optimization and Engineering, Springer Netherlands Ed., Online first, November 2009*

Within this framework, additional bound constraints are considered as inequality constraints. If  $\underline{x} \leq x \leq \bar{x}$  then we can write the associated constraints:

$$g_k^{min}(x_k) = \underline{x}_k - x_k \leq 0, g_k^{max}(x_k) = x_k - \bar{x}_k \leq 0, \forall k = 1, \dots, n \quad (6.5)$$

If we consider  $\eta_k$  and  $\gamma_k$ , the multipliers associated to these two constraints (respectively) on each variable, then the Lagrangian function will be written such as:

$$f(x) + \sum_{i=1}^m u_i g_i(x) + \sum_{j=1}^l v_j h_j(x) + \sum_{k=1}^n \eta_k (\underline{x}_k - x_k) + \sum_{k=1}^n \gamma_k (x_k - \bar{x}_k) \quad (6.6)$$

The necessary conditions will be written :

$$\begin{cases} \nabla_x f(x^*) + \sum_{i=1}^m u_i \nabla_x g_i(x^*) + \sum_{j=1}^l v_j \nabla_x h_j(x^*) - \eta + \gamma = 0 \\ v_j h_j(x^*) = 0, v_j \geq 0, \forall j = 1, \dots, m \\ \eta_k (\underline{x}_k - x_k^*) = 0, \eta_k \geq 0, \forall k = 1, \dots, n \\ \gamma_k (x_k^* - \bar{x}_k) = 0, \gamma_k \geq 0, \forall k = 1, \dots, n \end{cases} \quad (6.7)$$

If  $x^*$  is out of bound (i.e.  $\underline{x} < x^* < \bar{x}$ ) then, due to the complementarity conditions, the necessary conditions are reduced to the formulation (6.2). If  $x^*$  is out of one of the bound (for example  $x^* < \bar{x}$ ), then we can conclude on the sign of the gradient of the Lagrangian:

$$\begin{cases} \nabla_x f(x^*) + \sum_{i=1}^m u_i \nabla_x g_i(x^*) + \sum_{j=1}^m v_j \nabla_x h_j(x^*) = \eta \geq 0 \\ v_j h_j(x^*) = 0, v_j \geq 0, \forall j = 1, \dots, m \\ \eta_k (\underline{x}_k - x_k^*) = 0, \eta_k \geq 0, \forall k = 1, \dots, n \end{cases} \quad (6.8)$$

### 6.1.2 Optimal properties

The considered program is the program (5.7) introduced in the Model 1 of Chapter 5.

Let us introduce the Lagrangian multipliers  $\lambda$ ,  $\mu$  and  $\eta$  respectively associated to pressure drop 5.7(a), total length 5.7(b) and compression constraints 5.7(d).

Let us write the restricted Lagrangian function (without the bound constraints on the variables) of program (5.7):

$$\begin{aligned} \mathcal{L}(D, L, \pi^i, \pi^j, \lambda, \mu, \eta) = & \sum_{k=1}^n \left( \alpha_p L_k D_k + \varphi_k \left( \frac{\pi_k^j}{\pi_k^i} \right) \right) \\ & + \sum_{k=1}^n \lambda_k \left( \frac{\beta' L_k}{D_k^\sigma} - \pi_{k-1}^j + \pi_k^i \right) \\ & + \mu \left( \ell - \sum_{k=1}^n L_k \right) + \sum_{k=1}^n \eta_k (\pi_k^s - \pi_k^d). \end{aligned} \quad (6.9)$$

with  $\varphi$  the compression cost function.

For later use, we note the expressions of the partial derivatives of the Lagrangian with respect to the primal variables (reminding that  $\rho_k := \pi_k^j / \pi_k^i$ ):

$$\frac{\partial \mathcal{L}}{\partial L_k} = \alpha_p D_k + \lambda_k \frac{\beta'}{D_k^\sigma} - \mu, \quad k = 1 \dots, n, \quad (6.10)$$

$$\frac{\partial \mathcal{L}}{\partial D_k} = \alpha_p L_k - \sigma \beta' L_k \frac{\lambda_k}{D_k^{\sigma+1}} = L_k \left( \alpha_p - \sigma \beta' \frac{\lambda_k}{D_k^{\sigma+1}} \right), \quad k = 1 \dots, n, \quad (6.11)$$

$$\frac{\partial \mathcal{L}}{\partial \pi_k^i} = -\frac{\pi_k^j}{(\pi_k^i)^2} \varphi'_k(\rho_k) + \lambda_k + \eta_k, \quad k = 1 \dots, n, \quad (6.12)$$

$$\frac{\partial \mathcal{L}}{\partial \pi_k^j} = \frac{1}{\pi_k^i} \varphi'_k(\rho_k) - \lambda_{k+1} - \eta_k, \quad k = 1 \dots, n-1. \quad (6.13)$$

Based on first order optimality conditions, we are going to prove the following properties of an optimal network.

**Property 4** *Any solution of the KKT system of (5.7) is such that all diameters are equal.*

$$D_k = D_{k+1}, \forall k = 1, \dots, n \quad (6.14)$$

**Proof**

Without loss of generality, we can consider that  $L_k$  is not on bound. Hence, the optimality condition related to the length variable can be written:

$$\frac{\partial \mathcal{L}}{\partial L_k} = \alpha^p D_k + \lambda_k \frac{\beta'}{D_k^\sigma} - \mu = 0 \Leftrightarrow -\lambda_k \frac{\beta'}{D_k^{\sigma+1}} = \alpha^p - \frac{\mu}{D_k} \quad (6.15)$$

From (6.11), we obtain using (6.15):

$$\begin{aligned} \frac{\partial \mathcal{L}}{\partial D_k} &= L_k \left( \alpha_p - \sigma \beta' \frac{\lambda_k}{D_k^{\sigma+1}} \right) \\ &= L_k \left( \alpha_p + \sigma \left( \alpha^p - \frac{\mu}{D_k} \right) \right) \\ &= L_k \left( \alpha^p (1 + \sigma) - \sigma \frac{\mu}{D_k} \right) = L_k \delta(D_k) \end{aligned} \quad (6.16)$$

with  $\delta(D) = \alpha^p (1 + \sigma) - \sigma \frac{\mu}{D}$ .

Let us assume on the contrary that the diameters are not equal.

Let us discuss the sign of  $\frac{\partial \mathcal{L}}{\partial D_k}$ :

- If  $D \mapsto \delta(D) := \alpha^p (1 + \sigma) - \sigma \frac{\mu}{D}$  is positive (negative) over  $[D^{min}, D^{max}]$ , then all diameters must be equal to their lower (upper bounds) to minimize the Lagrangian function with regard to the diameters and the contradiction follows from the fact that the lower bounds are equal.
- Otherwise  $\delta$  cannot have a constant sign when  $D_k$  varies over  $[D^{min}, D^{max}]$ . In that case, as  $\alpha^p (1 + \sigma) > 0$ , to allow  $\delta_k$  to be also negative,  $\mu$  has to be positive. Hence,  $\delta(D)$  is increasing with regard to  $D$ . Consequently, if we take, say 2 sections  $k$  and  $j$  with  $D_k < D_j$ , then  $D_k < D^{max}$  and  $D_j > D^{min}$  and, by the KKT system,  $\delta(D_k) \geq 0 \geq \delta(D_j)$ , and since  $\delta(D)$  is strictly increasing, this is a contradiction again. ■

As a corollary, all multipliers associated to drop pressure equation are all equal

:

$$\lambda_k = \frac{\alpha^p}{\sigma \beta'} \left[ \frac{\sigma \mu}{(\sigma + 1) \alpha^p} \right]^{(\sigma+1)} = \lambda, \forall k = 1, \dots, n \quad (6.17)$$

Note that if the length constraint is fulfilled then  $\mu > 0$  and  $\lambda_k \neq 0$ .

**Property 5** *At the optimum of (5.7), if all compressors are active then discharge pressures are all equal to the maximal operating pressure:*

$$\pi_k^j = MOP^2, \forall k = 1, \dots, n \quad (6.18)$$

**Proof** As we know that  $\lambda_k = \lambda_{k+1}$  for all  $k$  from (6.17), adding (6.12) and (6.13) gives for all  $k$ :

$$\begin{aligned} & \frac{\partial \mathcal{L}}{\partial \pi_k^i} + \frac{\partial \mathcal{L}}{\partial \pi_k^j} \\ &= \frac{\pi_k^j}{(\pi_k^i)^2} \varphi'_k(\rho_k) + \lambda_k + \eta_k + \frac{1}{\pi_k^i} \varphi'_k(\rho_k) - \lambda_{k+1} - \eta_k \\ &= \frac{1}{\pi_k^i} \varphi'_k(\rho_k) \left(1 - \frac{\pi_k^j}{\pi_k^i}\right) \end{aligned} \quad (6.19)$$

This is a negative amount since  $\varphi'(\rho_k) > 0$  (from the differential calcul of compression power equation 3.12,  $\pi_k^i \geq P_0^2 > 0$  and that compressors are active. Hence, at least one of the two partial derivatives is negative, which implies that one variable is at its upper bound. Since  $\pi_k^i < \pi_k^j$  then  $\pi_k^i$  is less than its upper bound  $MOP^2$  and from (6.8), it implies  $\frac{\partial \mathcal{L}}{\partial \pi_k^i} \geq 0$ . Therefore, the partial derivative with respect to the discharge pressure is strictly negative  $\frac{\partial \mathcal{L}}{\partial \pi_k^j} < 0$ . ■

**Property 6** *At the optimum of (5.7), if all compressors are active then suction pressures are all equal on each station of the pipeline:*

$$\pi_k^i = \pi_{k+1}^i, \forall k = 1, \dots, n - 1 \quad (6.20)$$

**Proof** If all compressor stations are running then  $\pi_k^j > \pi_k^i$  and  $\eta_k = 0$  for all  $k$  by application of KKT conditions. All components  $\lambda_k$  are equal say to some constant  $\lambda$  and using property 5, the partial derivative with respect to the suction pressure (6.12) can written as follows:

$$\frac{\partial \mathcal{L}}{\partial \pi_k^i} = -\frac{MOP^2}{(\pi_k^i)^2} \varphi' \left( \frac{MOP^2}{\pi_k^i} \right) + \lambda \quad (6.21)$$

From the definitions of  $W(\rho)$  (3.17) and  $\varphi(\rho)$  (B.1), we can express

$$\varphi'(\rho) = \alpha^c \gamma_1 \cdot Q \cdot \frac{\gamma_2}{2} \cdot \rho^{\frac{\gamma_2}{2}-1} = M_1 \cdot \rho^{\frac{\gamma_2}{2}-1}$$

with  $M_1 > 0$ . Then,

$$\frac{\partial \mathcal{L}}{\partial \pi_k^i} = -\frac{MOP^2}{(\pi_k^i)^2} \cdot M_1 \cdot \left( \frac{MOP^2}{\pi_k^i} \right)^{\frac{\gamma_2}{2}-1} + \lambda = -\frac{M_2}{(\pi_k^i)^{1+\frac{\gamma_2}{2}}} + \lambda \quad (6.22)$$

with  $M_2 > 0$  independent of the section  $k$ . Two cases have to be studied:

- if  $\pi_k^i > P_0^2$  then the optimal condition can be written:

$$\frac{\partial \mathcal{L}}{\partial \pi_k^i} = 0 \Leftrightarrow \pi_k^i = \left( \frac{M_2}{\lambda} \right)^{\frac{2}{2+\gamma_2}} \quad (6.23)$$

- if  $\pi_k^i = P_0^2$  then we only know that, from KKT system,  $\mathcal{L}$  is an increasing function with respect to  $\pi_k^i$ . It means that all suction pressures are equal to their minimal bounds.

In both cases, there is only one possible value, that therefore is the same for all  $k = 1$  to  $n$ . ■

**Property 7** *At the optimum of (5.7), if all compressors are active then compressor stations are equidistant:*

$$L_k = \frac{l}{n}, \forall k = 1, \dots, n$$

**Proof** The drop pressure equation (5.7-a) gives  $L_k = \frac{(\pi_{k-1}^j - \pi_k^i) D_k^\sigma}{\beta'}$ . With the optimal properties (4),(5),(6), all the variables  $D_k, \pi_k^i, \pi_k^j$  can be replaced and  $L_k = \frac{(MOP^2 - \pi^i) D^\sigma}{\beta'}$ . Hence,  $L_k$  has the same value whatever the section  $k$ . With the length constraint (5.7-a), we deduce  $L_k = \frac{l}{n}$  ■

In this part, we have proved that a gas transmission mainline have some optimal characteristics:

- (P1) diameters are all equal
- (P2) discharge pressures are equal to their maximal values.
- (P3) suction pressures are equal.
- (P4) compressor stations are equidistant.

### 6.1.3 Optimal Values

We can use the previous results in order to compute the optimal solution in a fast way, in the following manner.

Once the properties (P1),(P2),(P3) and (P4) are proved, the program (5.7) can be reformulated under a reduced form with the two remaining scalar variables  $\rho$  and  $D$ :

$$\begin{cases} \min_{(D,\rho)} \phi = \alpha^p l D + n \varphi(\rho) \\ 0 = \frac{\beta' l}{D^\sigma} - n MOP^2 (1 - 1/\rho) & \text{(a)} \\ \rho > 1 & \text{(b)} \\ D^{min} \leq D \leq D^{max} & \text{(c)} \end{cases} \quad (6.24)$$

With the scalar dual variable  $\lambda$  associated to the unique drop pressure equation (6.24 a) , let us consider the Lagrangian function of this program:

$$\mathcal{L}(D, \rho, \lambda) = \phi(D, \rho) + \lambda \left( \frac{\beta' l}{D^\sigma} - n MOP^2 (1 - 1/\rho) \right) \quad (6.25)$$

If  $D$  is out of bounds then the first-order optimality conditions are:

$$\begin{cases} \frac{\partial \mathcal{L}}{\partial D} = \alpha^p l - \sigma \lambda \frac{\beta' l}{D^{(\sigma+1)}} = 0 & \text{(i)} \\ \frac{\partial \mathcal{L}}{\partial \rho} = n \varphi'(\rho) - n \lambda \frac{MOP^2}{\rho^2} = 0 & \text{(ii)} \\ \frac{\partial \mathcal{L}}{\partial \lambda} = \frac{\beta' l}{D^\sigma} Q^2 - n MOP^2 (1 - 1/\rho) = 0 & \text{(iii)} \end{cases} \quad (6.26)$$

The primal variables can be expressed as functions of the dual variable. Nevertheless, we have to detail the formulation of the compressor power to establish

these relationships. In the case of  $\varphi = \alpha^c \gamma_1 Q(\rho^{\gamma_2/2} - 1)$  formulated from compression equation 3.17 and cost function B.1, then the conditions (i) et (ii) can be written as follows:

$$\begin{cases} D(\lambda) = \left(\frac{\sigma\beta'}{\alpha}\lambda\right)^{1/(\sigma+1)} & (i) \\ \rho(\lambda) = \left(\frac{MOP^2}{\alpha^c \gamma_1 \frac{\sigma}{2}}\lambda\right)^{\frac{2}{2+\gamma_2}} & (ii) \end{cases} \quad (6.27)$$

By substituting these expressions into the constraint (iii), a nonlinear equation is to solve in  $\lambda$ :

$$\frac{\beta'l}{D(\lambda)^\sigma} - nMOP^2(1 - 1/\rho(\lambda)) = 0 \quad (6.28)$$

This equation cannot be analytically solved but, the one-dimension solution can be approached with local resolution methods (as Newton). As soon as the  $\lambda$  is determined, the optimal values of  $D$  and  $\rho$  are immediately deduced.

## 6.2 Characteristics of the optimal topology of single source pipeline distribution networks

In the optimization program 5.9 of Model 2, the objective is to find the **best node-arc incidence matrix**  $M$  that can minimize the investment costs in pipes for a *pure distribution network* (without any compression stations).

From the equation 3.4, the pressure drop equation for investment can be rewritten in the following way:

$$D_a = \beta^{b_2} Q_a^{b_1} \left(\frac{L_a}{\pi_a^i - \pi_a^j}\right)^{b_2} \quad (6.29)$$

with  $b_1 = 2/5$  and  $b_2 = 1/5$ .

We demonstrate here that with the choice made within the framework of this thesis for the investment objective function and for the head losses equation, the optimal networks are trees by using the following result of Bhaskaran and al. [16]: **Lemma.** *Considering the head losses equation 6.29 and the following investment objective function:*

$$\min COST = \sum_{a \in A} L_a C(D_a). \quad (6.30)$$

*If the following condition is satisfied*

$$D_a \frac{C''(D_a)}{C'(D_a)} < \frac{1 - b_1}{b_1} \quad (6.31)$$

*then the optimal network is a tree.*

**Proof:** See Bhaskaran et Salzborn [16].

In this thesis, we consider both linear and quadratic function. As the quadratic version can always be reduced the linear version (with  $\alpha_2 = 0$ ), one considers the quadratic function:

$$C(D_{ij}) = \alpha_0 + \alpha_1 D_{ij} + \alpha_2 D_{ij}^2 \quad (6.32)$$

Let us check if this function satisfies the conditions of the previous Lemma. Compute now the first and second derivatives of our investment objective function:

$$\begin{aligned} C'(D_a) &= 2\alpha_2 D_{ij} + \alpha_1 \\ C''(D_a) &= 2\alpha_2 \end{aligned}$$



Compute now:

$$D_a \frac{C''(D_a)}{C'(D_a)} = D_a \frac{2\alpha_2}{2\alpha_2 D_{ij} + \alpha_1} = \frac{2\alpha_2 D_a}{2\alpha_2 D_a + \alpha_1}$$

Let us consider now the two following cases:

**Case 1.**  $\alpha_1 = 0$ . In this case, condition (6.31) becomes:

$$D_a \frac{C''(D_a)}{C'(D_a)} = \frac{2\alpha_2 D_a}{2\alpha_2 D_a} = 1 < \frac{1 - b_1}{b_1}$$

What is equivalent to say that:

$$b_1 < 1 - b_1 \Leftrightarrow b_1 < \frac{1}{2}$$

In our case, we have seen here above that  $b_1 = \frac{2}{5}$ . The condition is thus satisfied.

**Case 2.**  $\alpha_1 > 0$ . In this case, the condition (6.31) becomes :

$$D_a \frac{C''(D_a)}{C'(D_a)} = \frac{2\alpha_2 D_a}{2\alpha_2 D_a + \alpha_1} = \epsilon < \frac{1 - b_1}{b_1}$$

with  $\epsilon \in ]0, 1[$ . What is equivalent to:

$$\epsilon b_1 < 1 - b_1$$

or:

$$b_1(\epsilon + 1) < 1 \Leftrightarrow b_1 < \frac{1}{\epsilon + 1}$$

Examine the two limit cases:

$$\epsilon = 0 \quad \text{the condition becomes} \quad b_1 < 1$$

$$\epsilon = 1 \quad \text{the condition becomes} \quad b_1 < \frac{1}{2}$$

Thus, for all  $\epsilon \in ]0, 1[$ , if  $b_1 < \frac{1}{2}$ , the condition is satisfied. In our case,  $b_1 = \frac{2}{5}$ . The condition is thus satisfied.

This completes the proof. So, we have demonstrated that with the choice of investment objective function, the result of Baskharan et al. [16] remains valid in our case. The structure of the optimal network which we wish to conceive is thus a tree.

## 6.3 Numerical verifications

In order to check that the properties aforementioned are true, we propose in this section to run some tests on very simple networks by solving the program (5.7). Solving this program will be made with the continuous non linear solver SNOPT ([44]).

## A gunbarrel network

Available cost data in the literature are scarce. We choose to take those from Edgar ([42]) in Imperial Units. To stick to the notations from the modeling part of this paper, the values are the following:

- the amortization factor  $\alpha_p=870$  \$ per miles per inches (in  $C_{pipe} = \alpha_p LD$ )
- operating and maintenance charges for a compressor station  $O^c = 10$  \$ per horsepower.
- the initial fixed installation outlay from a compressor station  $B = 0$ ,
- the capital cost of a new installation  $C^c = 70$  \$ per horsepower.

which gives  $\alpha^c = 80$  \$ per horsepower in  $C_{comp} = \alpha^c W(\frac{\pi^j}{\pi^i}) + B$ .

To be consistent with these cost data, we choose to use hereafter only imperial units. In that case,  $\beta = \frac{10^{12}}{871^2}$  and  $\sigma = 16/3$  for the pressure drop equation and  $\gamma_1 = 214.98, \gamma_2 = 0.1939$  for the compression power equation (that will be expressed in horsepower). Upper bounds on compression rates are set to 2.

Let us take the design of a trunkline of 150 miles (around 241 km) with a maximal operating pressure of 1000 psia (close to 68.7 bars) what is a very common MOP on the French Transmission Network. The expected flowrate is 600 Million Cubic Feet a Day (roughly 17 Million Cubic Meter a Day).

In the following tests we denote the inlet and outlet pressures by  $P_{in} := \sqrt{\pi_0^j}$  and  $P_{out} := \sqrt{\pi_n^j}$ .

**Case 1**  $P_{in} = P_{out} = MOP$  **Figure 6.1** shows the associated pressure evolution along the pipeline from 1 to 4 compressor stations after solving the solver SNOPT. For one single compressor, all the compression work is located at the very end of the pipeline. For more than one compressor, one observes a **perfect verification of the optimal properties (P1-4)**: compressor stations are regularly placed and discharge pressures of in-between compression are equal to the MOP.

Not to start from the optimal solution, initialization of the solver SNOPT has been made with points rather far from the optimal value. For example, by taking the initial values of lengths at 20 % for the first section and the remaining sections equally located to fill the gap up to 100 % of the total length whatever the number of compressor stations is. Initial diameters are set to the maximal available commercial sizes of 50 inches. The solver always converged.

**Evolution of costs with respect to the number of compressors** can be seen in **Figure 6.2**. First, we can observe that, compression costs make up only 10% of the total investment cost. Second, while the number of compressor is increasing, the unit compression rate is decreasing and the compression cost is increasing. Third, although the cost of compression is increasing, the overall investment cost is slightly decreasing due to the savings yielded on the pipelines. The lesson learnt is the following: **the more the number of compressors, the cheaper the investment cost**. This phenomenon mainly comes from the lack of initial outlay in this example what gives incentives to investments in compression.

Number of Compressors	Diameter (inches)	Compression rate	Costs (M\$)
1	34.55	1.34	5.11
2	33.05	1.18	4.98
3	32.48	1.12	4.93
4	32.18	1.09	4.91
5	32	1.07	4.89

Table 6.1: Gunbarrel Network-Case 1: Optimal Characteristics with several compressors

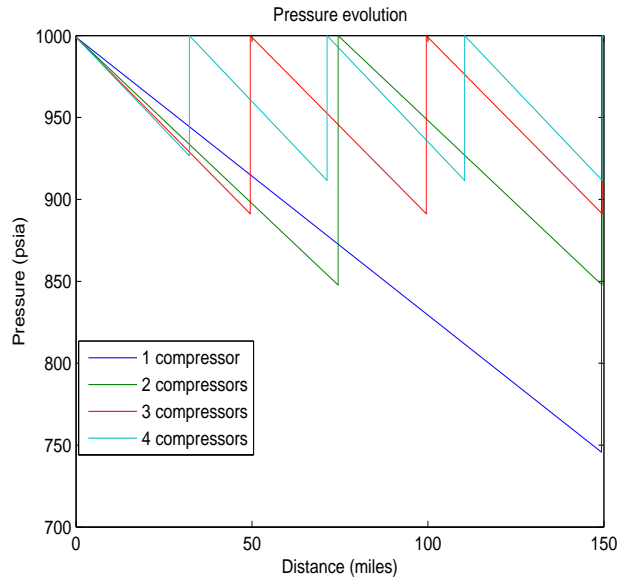

Figure 6.1: Gunbarrel Network-Case 1: Pressure evolution with  $P_{in} = P_{out} = MOP = 1000$  psia

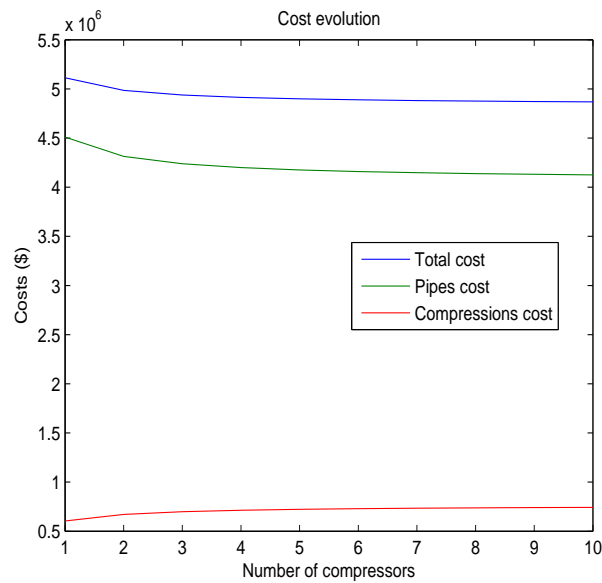

Figure 6.2: Gunbarrel Network-Case 1: Cost evolution with the increase of compressor stations

**Case 2**  $P_{in} = P_{out} < MOP$  In this case, we consider that the input pressure is equal to the output pressure but, on the contrary of the previous case, these pressures are lower than the MOP of the pipe. For example, let us take  $P_{in} = P_{out} = 750$  psia.

First of all, we solved this problem with SNOPT. Results are displayed on the **Figure 6.3**. We can see that the **properties (P1) – (P3) are satisfied**. Especially, for the first section, the first decision is to compensate for the lack in pressure with a near-zero length section in order to reach the maximal operating pressure. All following discharge pressures behave in the same way except at the delivery point where compression does not occur. On table 6.3, the property of equal diameters is well observed with a same diameter proposed on every section. One concludes that, **when the constraint (5.7-a) is not fulfilled ( $\pi_0^j < \pi^{max}, \pi_n^j < \pi^{max}$ ), the equal repartition of compressor stations does not appear with a concentration of the compressor stations in the first half of pipeline (where they are equidistant)**.

From a practical point of view, without the use of a solver, we propose hereafter a **fast computation method based on optimal properties**:

1. for the first section, we just have to compensate for the lack in pressure with a zero length section.
2. for the remaining sections, we have to determine the optimal location of the last active compressor. To approximate this location, we can take this length as the total length of a partial pipeline (bounded with the true total length) and find, for each length, on the upstream side, the optimal unique diameter and compressor ratio with the equations of part 6.1.3 and, on the downstream side, the corresponding diameter is directly determined from the knowledge of the remaining length, the inlet pressure and the outlet pressure.
3. place the compressor stations at equal distance from each other before the last compressor station location.

We can use this methodology for  $P_{out} < P_{in} = MOP$ , which is often the case in network design problems.

Number of Compressors	Diameter (inches)	Compression rates*	Costs (M\$)
1	34.55	1.79	5.112
2	32.37	1.23	5.030
3	31.91	1.13	5.014
4	31.71	1.09	5.008
5	31.6	1.07	5.004

\*(except the inlet compression for more than one compressor)

Table 6.2: Gunbarrel Network-Case 2: Optimal Characteristics with several compressors given by SNOPT

## A tree network

As the tree structure is optimal for single source distribution example, we test in this part the sizing and location of additional compression capacity on a treelike network.

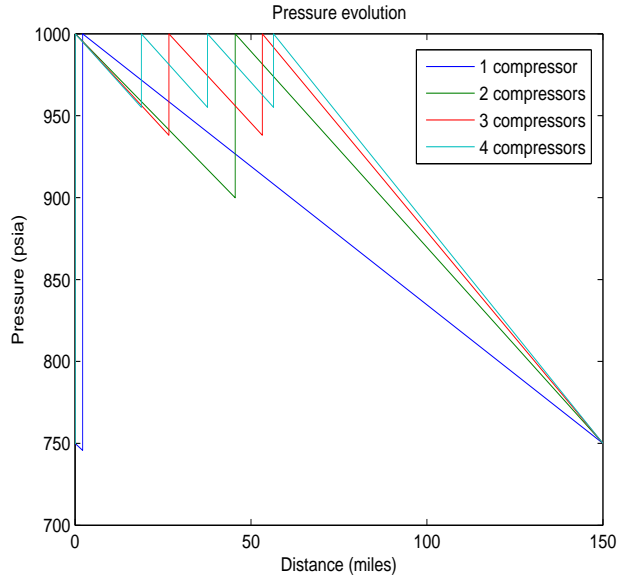

Figure 6.3: Gunbarrel Network-Case 2: Pressure evolution with  $P_{in} = P_{out} = 750$  psia  $< MOP = 1000$  psia

A tree network has been particularly studied in the literature [17, 42, 92]. The topology of this network is shown on **Figure 6.4**. This network is made of 3 branches (the first feeding the 2 downstream branches) and the lengths of each branch are respectively 163, 8, 33 miles. Demand on delivery nodes at the end of branches 2 and 3 are 300 MCFD. Cost data are the same as for the gunbarrel network.

We propose to apply the principles and methods described for gunbarrel networks to this tree network. The unknown variable of this problem is the pressure at the connection node located between the upstream branch and the 2 downstream branches (node 4 in this network). So, once this variable is set, we can **split the design problem into 3 independent gunbarrel networks design problems for each branch and apply the methods previously shown**. To double check the validity of the approach, we compute the local optimal solution with SNOPT as it has been made for the previous example.

On **Figures 6.5, 6.6 and 6.7**, one can see the results of the application of the methods with the pressure profile with respect to the variation of the connection pressure 4 from 500 psia (under the minimal pressure required at the end of branch 2) and 1000 psia (maximal operating pressure) with a step of 20 psia. On branch 1, we can see that compression is necessary to offset the pressure losses due to the length of this line. As for the case 2 of the previous example, properties 1, 2, 3 are fulfilled and property 4 is only visible when the pressure at node 4 reaches the maximal authorized pressure. On branches 2 and 3, compression facilities are not activated except for compression on node 4 for inlet pressures from upstream below 640 psia where compression is required to get pressures upper than 600 psia at the delivery node. Note that one of the main assumption to see properties 2, 3 and 4 was the activation of the compressor stations. Therefore, these properties are not seen but property 1 appears with a same diameter for each branch.

On **Figure 6.8**, we can track the cost evolution regarding the pressure at the connection node 4. First, we can note the continuous U-shape of this cost function. The first decreasing part of the function comes from the strong cost reduction on

downstream branches 2 and 3 yielded by the increase of the inlet pressure number 4. But, above 640 psia, this reduction is not enough to counterbalance the cost increase on branch 1 where the required terminal pressure is always increasing. **The total minimal cost is reached at 7.017 M\$ (for a pressure of 640 psia) what is slightly better than the best solution from [92] of 7.038 M\$.** It could be explained with the use of 2 intermediate compressor stations on Branch 1 instead of only one considered in the previous papers. This choice has been made to show the equal repartition of the compressors (Property 4) along the pipeline. The detailed optimal solution is given in Table 6.3.

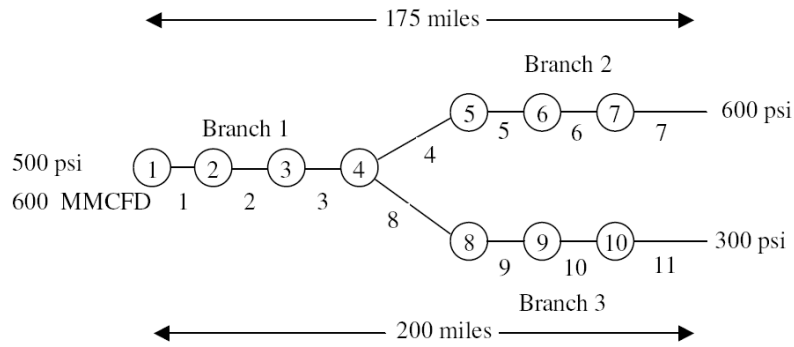

Figure 6.4: TREE NETWORK TOPOLOGY (example from [17, 42, 92])

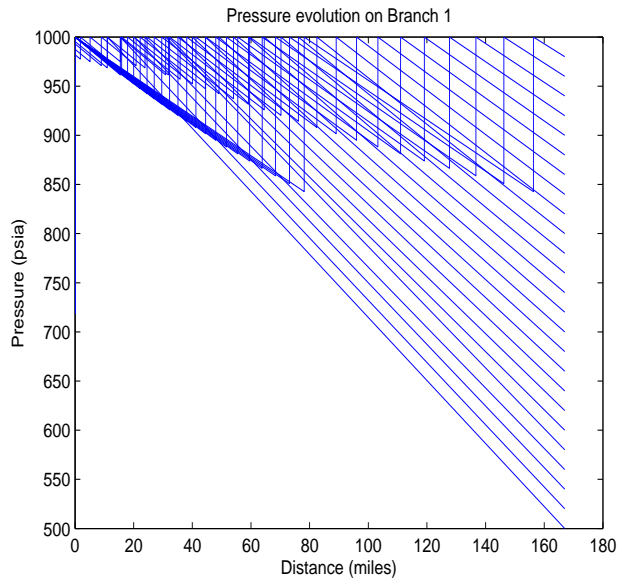

Figure 6.5: Tree Network: Pressure evolution on Branch 1 with variation of inter-connection pressure 4

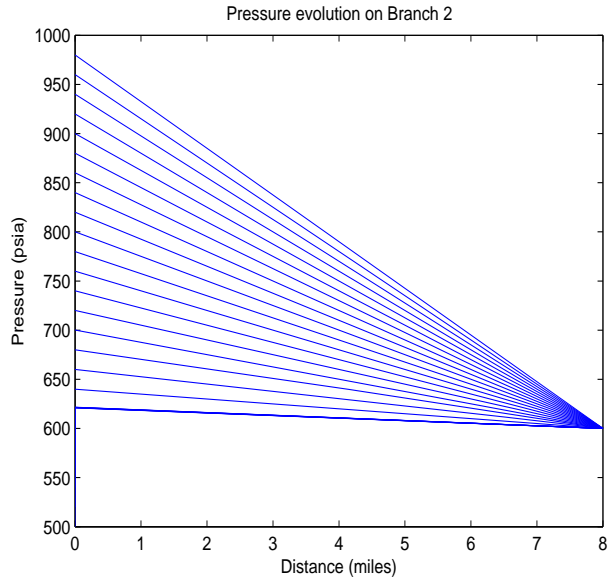

Figure 6.6: Tree Network: Pressure evolution on Branch 2 with variation of inter-connection pressure  $\phi$

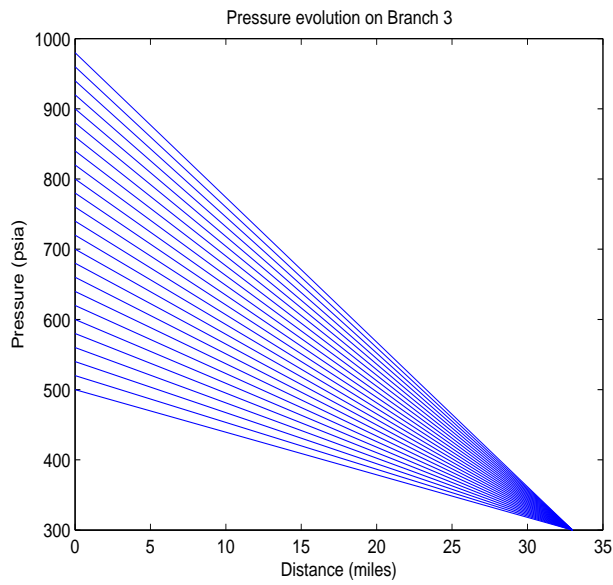

Figure 6.7: Tree Network: Pressure evolution on Branch 3 with variation of inter-connection pressure  $\phi$

Branch Number	Diameter (inches)	Compression rates	Branch lengths (miles)
1	31.74	1.05	(20,20,127)
2	23.2	1	(0,0,0,8)
3	21.33	1	(0,0,0,33)

Table 6.3: Tree Network: Detailed features of the optimal solution

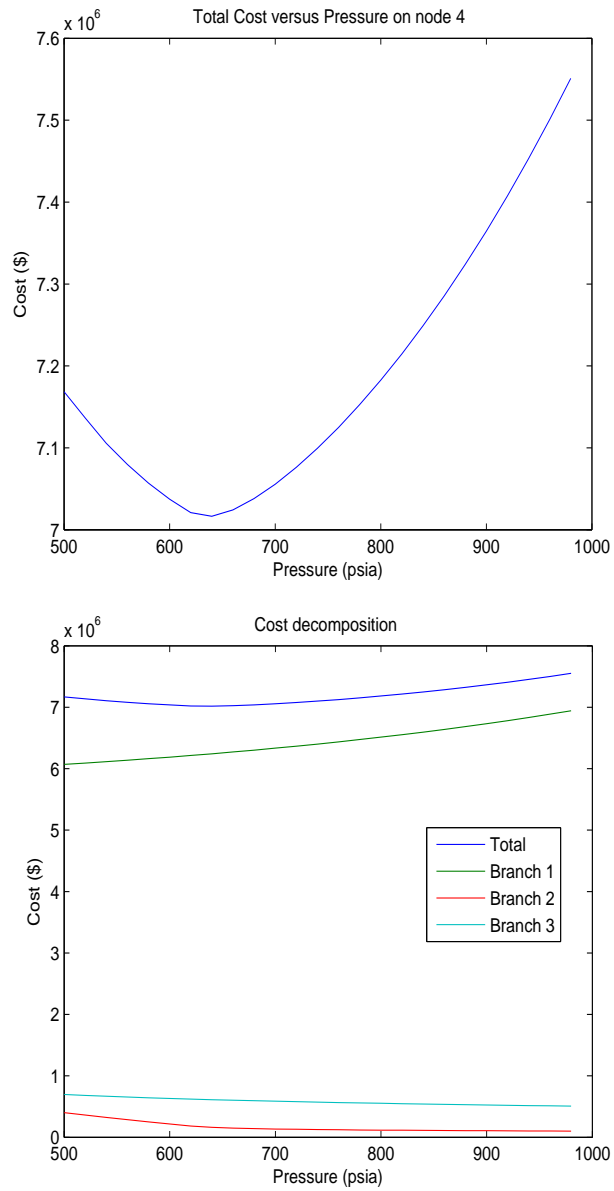

Figure 6.8: Tree Network: Total Cost evolution with respect to the interconnection pressure 4



# Chapter 7

## Sizing Methods<sup>12</sup>

We study in this chapter the main sizing methods to optimally **find the best capacity (diameters) for each section of a transmission or distribution network.**

The combinatorial aspect comes from 2 choices: the possibility to open arcs (topology change) and the commercial diameters that are available on the market. To give an idea of the exponential growth, on a network with 100 arcs and 10 diameter choices by arc, the number of combinations can reach  $10^{100}$ ! At first, we will investigate the methods for sizing new networks built from scratch. These problems will be naturally extended to reinforcement problems (that have not been studied previously at the best of our knowledge) that include the subcases of new network sizing.

### 7.1 Local search for joint topology/sizing optimization

In this section, we present the approach which we develop for the design and the sizing of a transportation or distribution gas network related to Model 2 of chapter 5. Indeed, we adapted the algorithms available in the literature and improved some of them. The proposed methodology of optimal design and sizing contains three main subroutines that we present here below.

#### 7.1.1 Topology initialisation

Taking advantage of the result indicating that the optimal network is treelike for single source basin from chapter 6, we use a classical algorithm for the determination of the minimal spanning tree (See Dolan and Aldous [38]). This algorithm aims at minimizing the total length of the tree that connects the source with the whole set of delivery node. We give as input the geographical coordinates of the

---

<sup>1</sup>A first version of the part 1 of this chapter has been published in the paper *André J., Brac J., De Wolf D., Ould Sidi M., Simonet A., Maisonnier G., Optimal Design and Dimensioning of Hydrogen Transmission Distribution Pipeline Networks, HEC Discussion Paper 2009 03/01, March 2009*

<sup>2</sup>A first version of the parts 2 and 3 of this chapter has been published in the paper *André J., Bonnans F., Cornibert L., Optimization of capacity expansion planning for gas transportation networks, European Journal of Operational Research, Volume 197, Issue 3, Pages 1019-1027, September 2009*

nodes of the network to determine the minimal length topology of the studied network.

### 7.1.2 Sizing of the continuous diameters on a tree

Considering a fixed topology of the tree, this module is dedicated to the optimal sizing of the diameters of a treelike network. Hence, the problem of optimization written in (5.9) is reduced to the program (7.1) below. The *flows are no more variables* with  $Q_a = \tilde{Q}_a$  because they are perfectly determined by the treelike structure.

$$\begin{aligned} \min C(\pi, D) &= \sum_{(a) \in T} (\alpha_0 + \alpha_1 D_a + \alpha_2 D_a^2) \cdot L_a \\ \text{s.t.} &\begin{cases} \pi_a^i - \pi_a^j = \beta \tilde{Q}_a^2 \frac{L_a}{D_a^5}, \forall a \in T \text{ such that } Q_a > 0 \\ MQ = b \\ 0 \leq D_a \leq D_{max}, \forall a \in T \\ \pi_{min} \leq \pi_i \leq \pi_{max}, \forall i \in N \end{cases} \end{aligned} \quad (7.1)$$

In that case, the set  $T$  only includes the arcs of the spanning tree and no longer from the complete graph. As output, we have a list of optimal diameters minimizing the setup costs and satisfying the head losses constraints.

This program, although containing no more combinatorial aspects, stays non-linear because of the presence of the pressure drop equations.

However, **in case of a linear objective cost function** (i.e.  $\alpha_0 = 0, \alpha_2 = 0$  and  $\zeta_a = \alpha_1 \cdot L_a$ ), we prove hereafter that one can have **a convex version of this program with a simple change of variables**.

Denoting by  $\eta_a := \beta L_a \tilde{Q}_a^2$  the (known) contribution of flows to the pressure drop equations, we can write the pressure drop equation as:

$$\pi_a^i - \pi_a^j = \frac{\eta_a}{D_a^5}, \text{ for all } a \in T \quad (7.2)$$

Using the change of variables  $\delta_a := 1/D_a^5$ , program (7.1) can be rewritten as the following convex program:

$$\begin{aligned} \min C(\pi, D) &= \sum_{a \in T} \zeta_a \delta_a^{-1/5} \\ \text{s.t.} &\begin{cases} \pi_a^i - \pi_a^j = \eta_a \cdot \delta_a, \forall a \in T \\ MQ = b \\ \delta_a \in [\frac{1}{D_{max}^5}, +\infty[, \forall a \in T \\ \pi_{min} \leq \pi_i \leq \pi_{max}, \forall i \in N \end{cases} \end{aligned} \quad (7.3)$$

The convexity of (7.3) follows from the linearity of constraints and the convexity of the cost function (whose domain is  $\mathbb{R}_+$ ).

To solve these programs 7.1 and 7.3, we used a nonlinear solver (SNOPT developed by Stanford university [44]) that guarantees the global optimum if the problem is convex and a local optimum if not.

### 7.1.3 Tree Improvement Heuristic

The algorithm described in Figure 7.1 is inspired by the works of Rothfarb and al. [90]. This heuristic aims at decreasing the investment cost of the initial minimal spanning tree by making local changes on arcs, and thus on the topology. This algorithm is initialized by the solution supplied by program 7.1 (optimization of diameters on a minimal spanning tree).

Unlike the approach of Rothfarb and al. [90], the cost assessment of every trees is done by solving the continuous sizing program 7.1 and not by dynamic programming.

---

#### Tree Improvement algorithm: Delta change

---

- Initialization of the tree and computation of the corresponding cost
  - Choose arbitrarily a node  $n_1$
  - Find  $n_{1,1}$ , the closest node in euclidian distance not connected to  $n_1$ .
  - Add the arcs  $(n_1, n_{1,1})$  and determine the created cycle.
  - Eliminate one by one the other arcs of the formed cycle by computing the cost of each new generated tree.
  - As soon as the cost is improved, adopt the new network and start again.
- 

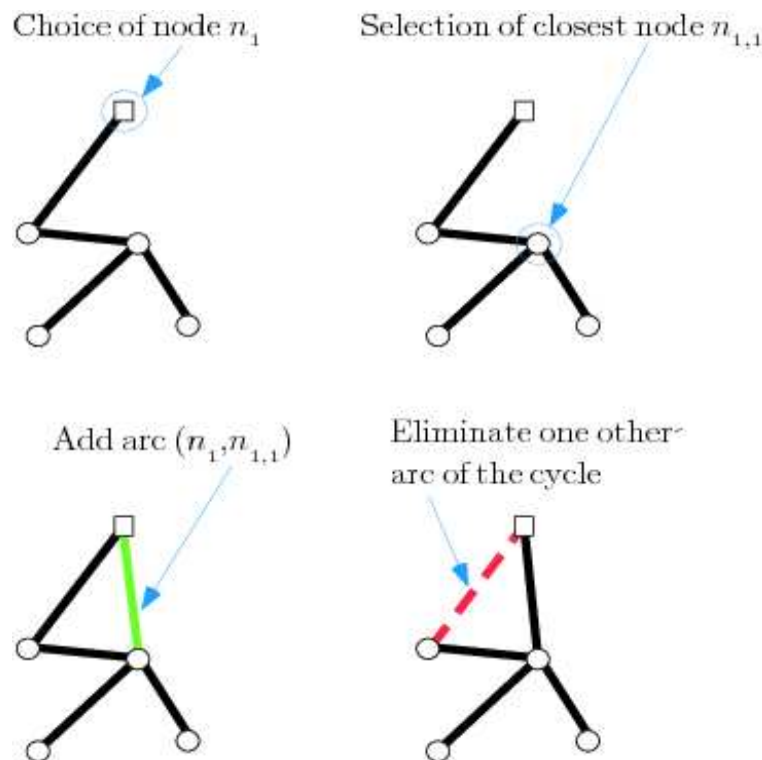

Figure 7.1: Delta Change Algorithm

### 7.1.4 Results

Two small networks were built to test the performances of the tree improvement heuristic and of its gain with regard to a minimal spanning tree algorithm. The two examples are composed of a set of consumption nodes (nodes 1 to 6) fed by a single gas source of hydrogen in this case (node 7). The pressure at the exit of the plant is 40 bar and the required pressure in the demand nodes is 36 bar.

The gas demands are identical on all consumption points ( $47\,214\text{ m}^3$  per day). Two geographical configurations were tested:

- *test 1* where the consumptions are concentrated in a square;
- *test 2* where the consumptions are scattered on a larger area.

Results of the application of the Delta Change algorithm are shown on **Figures 7.2 and 7.3**.

We notice that on both tests, the delta change allows to appreciably reduce the total investment costs of the network (approximately 7 % on the test 1 and 18 % on the test 2) what justifies the use of this tool to design the network.

Furthermore, contrary to the intuition collectively accepted, the cost decrease is made *by increasing the total length of the network of 5 km on the test 1 and more than 30 km on the test 2*. Therefore, the decrease of the costs results only from the *decline of the proposed diameters*.

Remark also that the topology of the optimal networks is not known in advance. The topology obtained with the delta change by starting from the same minimal spanning tree is strongly different in the case 1 compared to the case 2 (only 3 from the 6 arcs are the same).

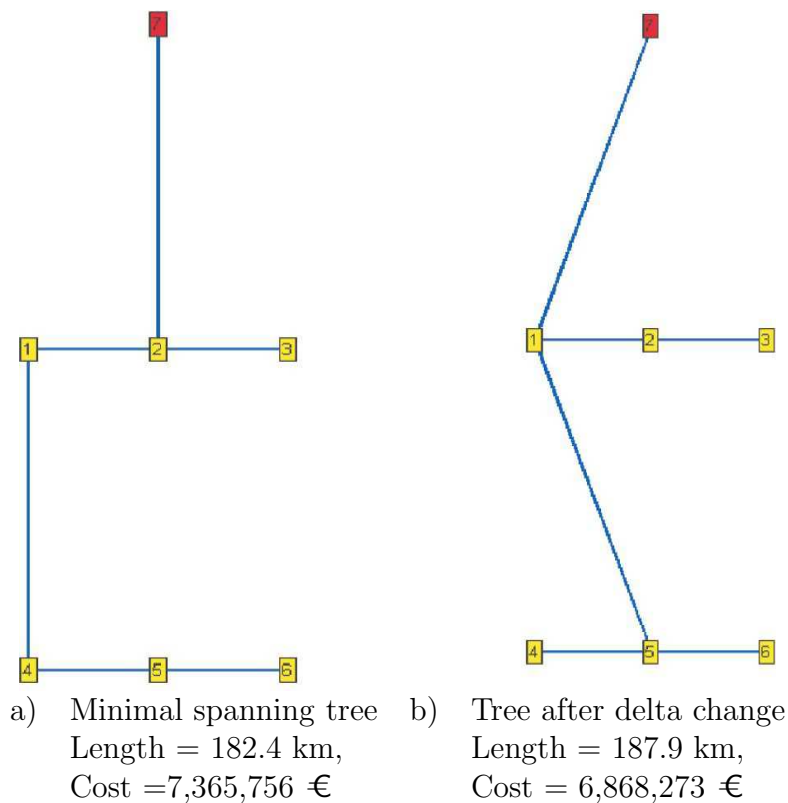

Figure 7.2: Test Network 1

## 7.2 Selection of pipe selections to reinforce on existing networks

From this section, we consider the existence of a known topology and we will focus on the resolution of the program 5.11 of Chapter 5.

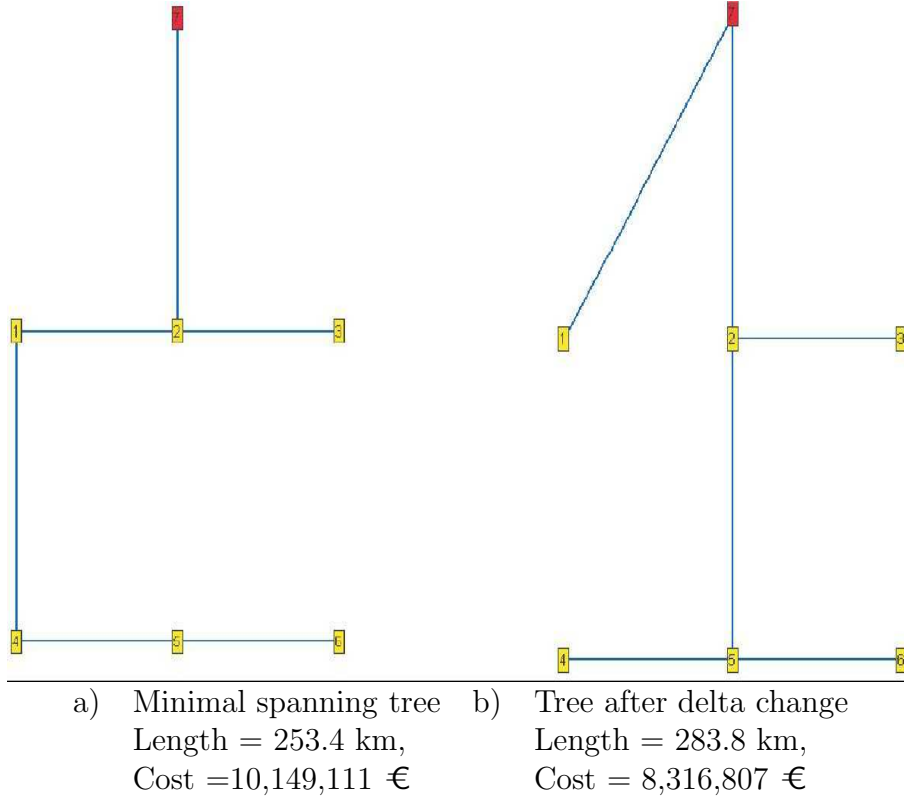

Figure 7.3: Test Network 2

To limit the difficulty of the combinatorial aspect from the diameter choice, a first stage is focused on the selection of the pipe sections to reinforce.

### 7.2.1 Pipe selection continuous program

The selected approach is to consider that the **variation range for the equivalent diameter is continuous from the minimal to the maximal diameter** as in the previous models 1 and 2 of Chapter 5.

In the framework of the equivalent program 5.12, it means that the following constraint on equivalent diameters:

$$Deq_a \in \{DI_a, Deq_a^1, \dots, Deq_a^k, \dots, \overline{Deq_a}\}$$

will be transformed into the continuous relaxation that allows the values  $Deq_a$  of diameters of additional pipes to be selected within a certain interval:

$$Deq_a \in [DI_a, \overline{Deq_a}], \text{ for all } a \in A_{pipe}$$

We extend the stepwise concave function  $\tau_a$  to  $[DI_a, \overline{Deq_a}]$ , by making it equal to  $\tau_a(Deq_a^{k+1})$  over  $]Deq_a^k, Deq_a^{k+1}]$ . This stepwise function can be approximated by a continuous concave function:

$$\phi_a(Deq_a) = \alpha_a(Deq_a^s - DI_a^s)^{1/s}$$

where  $\alpha_a = c_a(\overline{DD_a})/\overline{DD_a}$  is the slope of a linear approximation of the stepwise function when the initial diameter is equal to 0. The resulting continuous relaxation, whose solution will be denoted  $Deq^*$ , can therefore be stated as follows:

$$\begin{cases} \min_{(Deq, Q, \pi)} \sum_{a \in A_{pipe}} \alpha_a (Deq_a^s - DI_a^s)^{1/s} \\ Deq_a \in [DI_a, \overline{Deq_a}], \text{ for all } a \in A_{pipe} \\ (5.12\text{-ii}), (5.11\text{-iii}) \text{ to } (5.11\text{-vi}) \end{cases} \quad (7.4)$$

Figure 7.4 illustrates the continuous approximation on the discrete costs of two pipes (one with an initial diameter equal to 0 and another with an initial diameter equal to 500 mm).

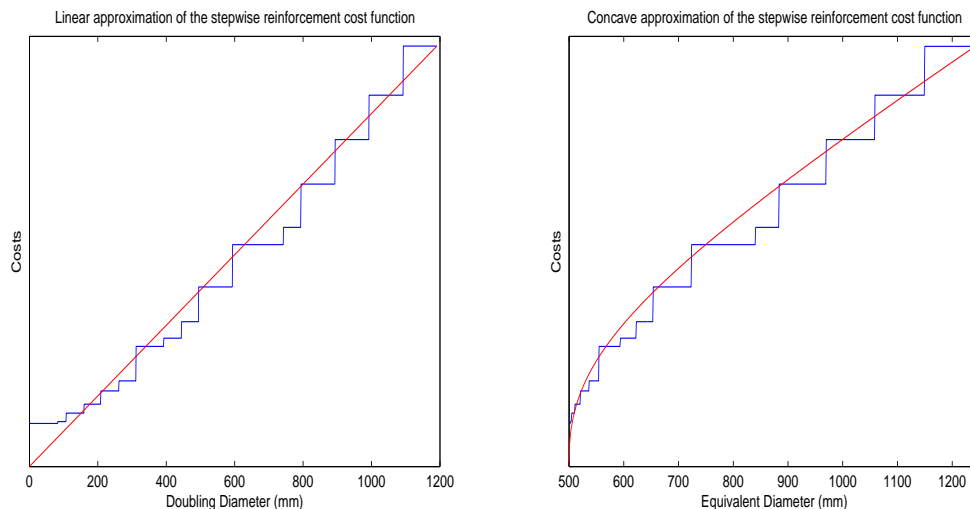

Figure 7.4: Relaxed objective functions

One can observe the concave shape of the cost function as soon as an initial diameter exists. This shape represents the decrease in the marginal cost with respect to the equivalent diameter.

## 7.2.2 Solving the continuous program

The use of a nonlinear solver is necessary to find a local optimum of the continuous relaxation problem (7.4). As this program is nonconvex in most cases, the "good" initialization of this solver will be particularly relevant to find a local optimum not so far from the global optimum. The first step is to find a feasible point. The second step is to improve this feasible point toward a better one.

This section describes the way to obtain a feasible point of the continuous relaxation of the problem by solving a convex problem.

Additional parallel pipes allow (for a given flow) to decrease pressure losses. The following principle of monotonic behavior is therefore often assumed: "the more we reinforce a network, the easier the constraints (of maximal pressure for suppliers and minimal pressure for consumers) are satisfied". Although this is not always the case as mentioned in Chapter 4, we consider it to be true for most practical applications. As a consequence, it is assumed that a first feasible point of the problem (7.4) can be obtained by setting all diameters to their maximal values and solving the resulting flow problem hereafter. Denote  $K_a := C_a / (\overline{Deq}_a)^5$ .

Once a point  $x^1 = (\overline{Deq}, Q^1, \pi^1)$  fulfilling all constraints of the feasibility program (4.9) (that ensures that all the pressure bounds will be satisfied at fixed capacity) is obtained, we can search for a (local) optimum using a nonlinear programming solver.

Note that, this first feasible point  $x^1$  is the worst possible, since it gives the highest reinforcement cost. We can assume that **this first point will be quite far from the global optimum**. Thus, we try to improve this initialization by generating another feasible point  $x^2$  from  $x^1$ .

In order to achieve this goal, we relax program (7.4) by using a linear lower bound of the concave cost. See the related approach used by Horst & Tuy (1993) in the case of minimization of concave function under linear constraints, based on piecewise linear lower bounds of concave functions.

Hence, denoting  $X_{rel}$ , the feasible set of (7.4),  $x^2 = (Deq^2, Q^2, \pi^2)$  is the local solution of the program below with  $x^1$  as an initial point:

$$\begin{cases} \min_{(Deq, Q, \pi)} \sum_{a \in A_{pipe}} \alpha_a \cdot (Deq_a - DI_a) \\ (Deq, Q, \pi) \in X_{rel} \end{cases} \quad (7.5)$$

This program is a nonconvex program (since  $X_{rel}$  remains nonconvex) and is solved with a nonlinear solver as SNOPT (Gill et al., [44]).

## 7.3 Branch & Bound algorithms for reinforcement problems

In this part, we tackle the Model 3 of Chapter 5 with the discrete choice of diameters among those diameters available on the market.

A Branch & Bound algorithm will be used here to improve the first solution provided by the relaxed problem (7.4). Maugis [68] already suggested the use of a Branch & Bound method for solving the design problem, although he gave little information about implementation or numerical efficiency.

The exploration space of the initial problem (5.11) is reduced to the pipes which have been proposed to be reinforced by the relaxed program (7.4) i.e.  $A_{pipe}^r = \{a \in A_{pipe} : Deq_a^* > 0\}$  with  $|A_{pipe}^r| = nar$ , the number of pipes to reinforce. The second part of the work is now to determine which are the optimal discrete diameters to lay out on these  $nar$  pipes among a list of commercially available sizes (considering  $\Delta_a^0 = 0$  as a commercial diameter). The reduced program to solve with a B&B algorithm is the following:

$$\begin{cases} \min_{(DD, Q, \pi)} \sum_{a \in A_{pipe}} c_a(DD_a) \\ DD_a \in [\Delta_a^0, \Delta_a^1, \dots, \Delta_a^k, \dots, \overline{\Delta}_a], \text{ for all } a \in A_{pipe}^r \\ DD_a = 0, \text{ for all } a \in A_{pipe} \setminus A_{pipe}^r \\ (5.11\text{-ii}) \text{ to } (5.11\text{-vi}) \end{cases} \quad (7.6)$$

### 7.3.1 General principles

Let  $DD^{ini}$  be the solution obtained after rounding the solution  $Deq^*$  up to the nearest commercial diameters:

$$DD_a^{ini} = \Delta_a^{ini}, \forall a \in A_{pipe}^r$$

In general, the corresponding solution of (4.9) will be feasible. In this way, we obtain an initial upper bound of the reinforcement cost  $c^{max}$ .

Then, the construction of the exploration tree is based on two steps (see Minoux [69]):

1. **Branching** is based on an ordering of pipes that were reinforced in the continuous relaxation by decreasing order:

$$\overline{c_{a_1}} \geq \overline{c_{a_2}} \geq \dots \geq \overline{c_{a_{nar}}}$$

with  $\bar{c}_a = c_a(\bar{\Delta}_a)$ , the maximal reinforcement cost of the pipe  $a$ . This ranking has the advantage to make "important" choices high in the tree and, hence, to cut bigger part of the space of combinations. By partition variables, we mean the choice of these arcs to be reinforced. For given partition variables, we explore values of the tree nodes *in ascending order of the discrete values of diameter*:

$$DD_a = \Delta_a^0 < \Delta_a^1 < \dots < \bar{\Delta}_a$$

with  $\Delta_a^0 = 0$ . The idea is to try first the smallest reinforcements, in order to get small upper bounds, at the risk of finding no feasible point during the first iterations.

2. At a node of the tree, assess the consequences *a minima* on the cost of the choices done higher in the tree (**Bounding**).

Let us denote  $(A_{pipe}^r)'$  (resp.  $(A_{pipe}^r)''$ ), the set of pipes on which the diameter is set (resp. free). We make a feasibility test for the branch by testing feasibility when all free diameters are set to their maximal value. In other words,

$$\begin{cases} K_a = C_a \cdot DI_a^{-5}, & \text{for all } a \in A_{pipe} \setminus A_{pipe}^r \\ K_a = C_a \cdot (Deq_a^{k'})^{-5}, & \text{for all } a \in (A_{pipe}^r)' \\ K_a = C_a \cdot (\overline{Deq}_a)^{-5}, & \text{for all } a \in (A_{pipe}^r)'' \end{cases}$$

This choice is based on the "bigger is better" principle. So, in practice, a program of type (4.9) is solved with diameters set to the above values, and the branch is declared to be unfeasible if a positive value is obtained.

Since this is just a feasibility test, we have, if feasibility holds, no more than the rough estimate  $c'_{min} = \sum_{a \in (A_{pipe}^r)'} \tau_a(Deq_a^{k'})$ .

Otherwise, we may take  $c'_{min} = +\infty$ . The cutting strategy is as follows:

- (a) if  $c'_{min} > c^{max}$ , then we may cut the corresponding branch of the tree (it does not contain the optimal solution).
- (b) if  $c'_{min} < c^{max}$ , then we continue the exploration of the branch by splitting the subset into smaller subsets. When all nodes of the branch are explored, we come back to step 1.

The exploration of the tree is done using the "in-depth first" strategy in order to reach quickly some leaves of the tree. The latter have an easily evaluated cost since all the diameters are set on each arc. If feasibility holds with a cost  $c$  less than the current upper bound  $c^{max}$ , then we update  $c^{max}$  with value  $c$ .

The algorithm stops once all combinations of diameters on every arcs have been explored. It means that all the leaves of the tree have been evaluated either implicitly (with a minimal bound) or explicitly (at the bottom of the tree).

### 7.3.2 Reduced Branch & Bound

To limit the search space of diameters, the initial solution  $DD^{ini}$  is not only used to determine the set  $A_{pipe}^r$  but also to obtain an information on the optimal diameters to lay out on the arcs  $a \in A_{pipe}^r$ . This approach is based on the assumption that the continuous diameters could be closed to the optimal discrete diameter. It is well-known that a optimal continuous relaxation can be far from the discrete solution especially with Mixed Integer Linear Program (MILP) (see



Minoux, [69]). In our case, the restriction of the search around the continuous solution is only a first step before extending the search to the whole commercial list in future works.

Therefore, a neighborhood study of the initial solution is done using a Branch & Bound algorithm with a reduced number of discrete diameters around  $DD^{ini}$  in order to strongly reduced the size of the problem (and, thus, the computation times).

These reduced Branch & Bound approaches are presented below according to the increasing size of the space of combinations to explore :

1. **B&B 1:** for each pipe, we test if we lay out or not a reinforcement (binary choice) with the proposed diameter by  $DD^{ini}$  ( $2^{nar}$  combinations):

$$DD_a \in \{0, \Delta_a^{k_{ini}}\}, \text{ for all } a \in A_{pipe}^r$$

2. **B&B 2:** for each pipe, we test if we lay out or not the proposed diameter by  $DD^{ini}$  as well as the immediate smaller diameter in the commercial list ( $3^{nar}$  combinations):

$$DD_a \in \{0, \Delta_a^{k_{ini}-1}, \Delta_a^{k_{ini}}\}, \text{ for all } a \in A_{pipe}^r$$

3. **B&B 3:** for each pipe, we test the same choices as B& B 2 widening the choice to the nearest bigger diameter to the solution  $DD^{ini}$  ( $4^{nar}$  combinations):

$$DD_a \in \{0, \Delta_a^{k_{ini}-1}, \Delta_a^{k_{ini}}, \Delta_a^{k_{ini}+1}\}, \text{ for all } a \in A_{pipe}^r$$

### 7.3.3 Numerical Results

#### Use of SNOPT

The nonlinear solver used to solve the programs (4.6),(4.9),(7.5) and (7.4) is SNOPT 7 (developed by the Systems Optimization Laboratory of Stanford University see Gill et al. [44]) called through MATLAB within the TOMLAB 4.8 framework. SNOPT is a well-established sequential quadratic programming (SQP) code, which is designed to work with sparse data structures, and therefore it can handle large-scale problems. SNOPT is highly effective for problems with a nonlinear objective function and large numbers of sparse linear constraints as Kirchhoff's laws of flow conservation on networks. However, the main weakness of these techniques used in an nonconvex framework is the need to provide an initial feasible point. Fortunately, for solving the feasibility program (4.9), we bypass this weakness thanks to the initialization given by the potential formulation (4.6) (which doesn't need any initial point since all the constraints are linear). For solving the ultimate dimensioning continuous program (7.4), this weakness is transformed as a strength in order to reach a better local optimum. Hence, as the solution of the linearized-objective program (7.5) is supposed to be a good guess as an initial solution for (7.4), all this information is used in the resolution of (7.4) with SNOPT. Further details on the algorithm can be found in Gill et al. [44, 45].

#### Study on a 2 pipe-network

In order to outline the nonlinearity and the nonconvexity of the cost function, a simple example has been set up. Let us consider the following network:

- two successive pipes of equal lengths and initial diameters (400 mm and 50 km),
- a supply node with a maximal pressure of 45 bar,
- two delivery nodes located one in the middle, the other at the end of the line (with an equal demand of  $174102 m^3/h$ ). The pressure on these nodes must be kept above 20 bar,

As 17 diameters are available between 0 and 1200 mm (with a step of 50 or 100 mm between tow successive diameters), the number of combinations to evaluate is  $17 \times 17 = 289$  combinations. In this case, the enumeration is possible and gives an optimal cost of 32150 kEuros with a doubling diameter of 500 mm on arc 1 and of 300 mm on arc 2.

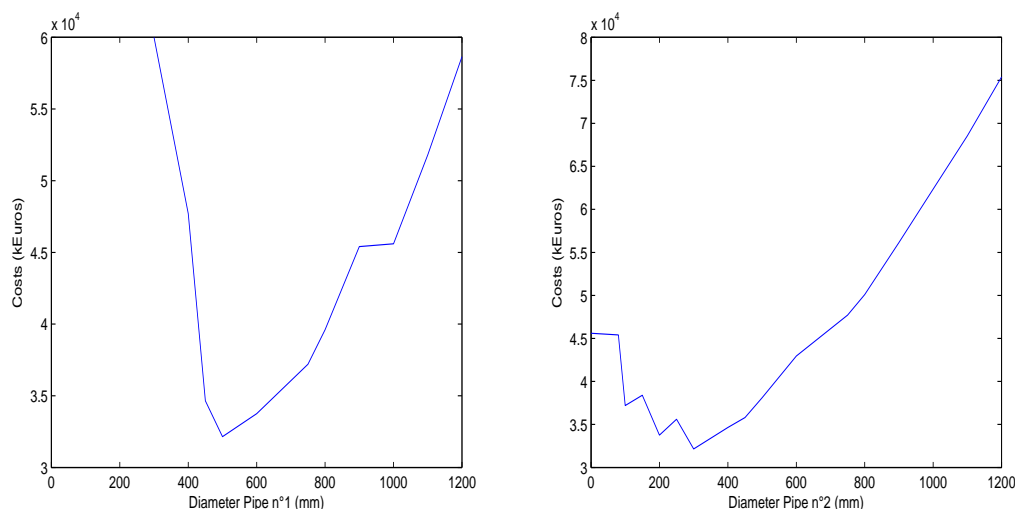

Figure 7.5: Discrete reinforcement cost on the 2 pipe-network

Figure 7.5 shows the 2-Dimension **best cost-responses of one pipe with regard to the other one**. Between 0 and 350 mm on the upstream pipe (pipe 1), the expanding cost is infinite since, whatever the value of diameter on the downstream pipe (pipe 2) is, it is not enough to satisfy the lower bound on delivery pressure. Between 350 mm and the optimal value of 500 mm, the overall cost is quickly decreasing because all little increase in diameter on the first pipe implies strong decrease in the diameter on the second pipe. Above the optimal value, the overall cost is increasing because the increase in capacity on pipe 1 has little impact on the capacity reduction on pipe 2. Although the overall shape of both functions seems to be convex, we observe the existence of local minima which removes the convex feature. These local minima appear because the transition between two successive values of discrete diameter on one pipe does not automatically yield a transition on the other pipe. For example, it happens on pipe 2 between 200 and 250 mm. The additional 50 mm on the second pipe is not enough to push the upstream pipe to "jump" to a lower value of diameter.

The continuous relaxation proposed in the part 7.2 allows us to determine a continuous local minimum.

Figure 7.6 shows the 2-dimension best cost-responses of each pipe with the continuous approximation of cost (see Figure 7.4) and with a step of discretization of 10 mm. The continuous relaxation smooths the shape of the objective function

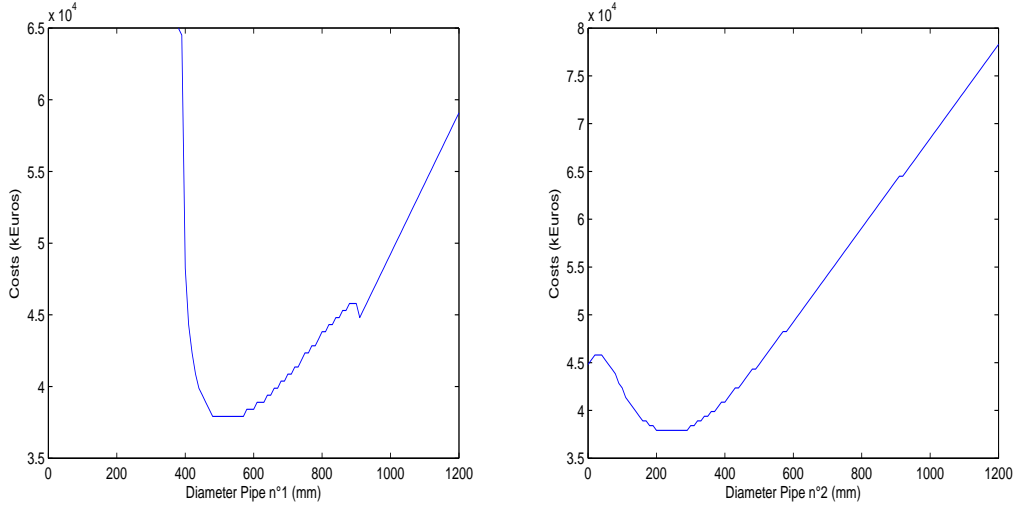

Figure 7.6: Continuous reinforcement cost on the 2 pipe-network

(with less "jump" effects). Nevertheless, the function is not anymore convex with the existence of local minimum. At the optimal value, the range of optimal points is large (from 500 to 590 mm on pipe 1 and from 210 to 290 on pipe 2). On this example, the solver SNOPT finds (533,255) as optimal continuous diameters (what is in the middle of the optimal range). Let us note that this range is closed to the optimal discrete point (500,300).

At the end of this step, the first discrete solution rounding the optimal continuous values up to the nearest commercial diameters gives a discrete solution (600,250) for a cost of 35600 k-€.

The B&B 1 doesn't modify the solution since we cannot reduce to zero neither arc 1 nor arc 2 while keeping these diameters. The B&B 2 proposes to put a diameter of 200 mm on the arc 2 (instead of 250) what brings down the cost to 33750 k-€. The B&B 3 reaches the best solution because it is necessary to increase the diameter of arc 2 from 250 to 300 mm and to decrease the diameter of arc 1 from 600 to 500 mm at the same time.

## Results on real networks

We have tested the methods described in this paper on a wide number of regional networks based on high scenarios of gas demand (since they take into account a forecast of the consumption growth over the next 20 or 30 years). Figure 7.7 shows the topology of two of them.

We present below the results on 9 networks in terms of cost and computation times with the following indicators for each network:

- features of the networks ( $L$ , the total length,  $na$ , the number of arcs and  $nn$  the number of nodes). The number of cycles  $nc$  can be deduced from Euler's formula:  $nc = na - nn + 1$  when  $nc$  is positive,
- $nar$ , the number of selected arcs by the relaxed program (7.4),
- $C_r^{ini}$ , the cost of the discretized solution of program (7.4) and the associated calculation times,
- costs of solutions given by B&B 1,2,3 and the associated calculation times.

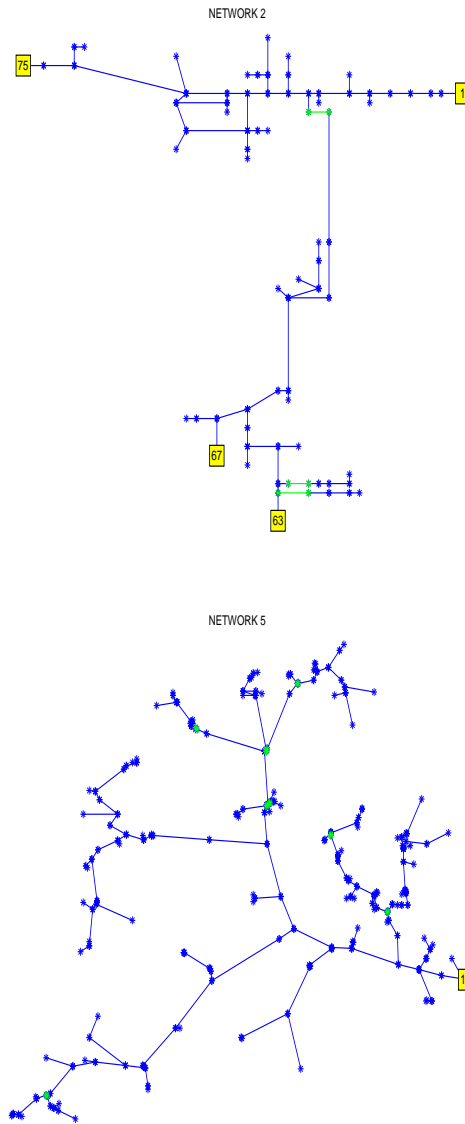

Figure 7.7: Examples of real French regional networks

Networks	Features		
	L (km)	nn	nc
<i>Net</i> <sub>01</sub>	91	17	0
<i>Net</i> <sub>02</sub>	73	75	2
<i>Net</i> <sub>03</sub>	90	71	0
<i>Net</i> <sub>04</sub>	366	88	3
<i>Net</i> <sub>05</sub>	718	243	8
<i>Net</i> <sub>06</sub>	248	38	0
<i>Net</i> <sub>07</sub>	137	30	0
<i>Net</i> <sub>08</sub>	129	55	0
<i>Net</i> <sub>09</sub>	1898	362	10

Networks	(7.4)+Rounding			B&B 1		B&B 2		B&B 3	
	nar	$C_r^{mi}$ (k€)	Times (s)	Costs (k€)	Times (s)	Costs (k€)	Times (s)	Costs (k€)	Times (s)
<i>Net</i> <sub>01</sub>	2	2131	8	2131	0.5	2131	1	2131	1
<i>Net</i> <sub>02</sub>	5	2484	4	2484	1	1835	6	1835	30
<i>Net</i> <sub>03</sub>	7	2799	17	2776	2	2397	14	2389	213
<i>Net</i> <sub>04</sub>	11	15497	5	9050	99	7795	1890	*	*
<i>Net</i> <sub>05</sub>	11	27162	44	23265	23	20750	839	*	*
<i>Net</i> <sub>06</sub>	12	18941	4	16547	5	16216	339	*	*
<i>Net</i> <sub>07</sub>	16	16519	8	13618	25	13563	791	*	*
<i>Net</i> <sub>08</sub>	17	29848	4	28772	3	27297	506	*	*
<i>Net</i> <sub>09</sub>	17	23697	1607	18789	1011	*	*	*	*

Table 7.1: Computation times of reduced B&B (\* means that the computation times have exceeded the maximal bound of 3600 s)

The results on real networks are sorted according to the number of selected pipes *nar* which are critical for the B & B calculation times. The computation times (with an Intel processor Pentium 4 2.66 GHz) are given as a rough guide in order to assess the exponential growth of the times in seconds with regard to the size of the problem.

We can see on these results that:

- the selection of arcs to reinforce is rather small compared with the total number of pipelines. It means that the (local) optimal solution provided by the relaxation is focused on a small set of pipelines with high enough diameters. In other terms, it represents the economy of scale given by the concave cost function seen on figure 7.4,
- for the selection of arcs given by the resolution of the relaxed program (7.4)+Rounding, we notice that the time to find a first solution is rather small (within one minute) on most of the networks. However, the effectiveness of SNOPT is seriously affected above 300 arcs (which represent about one thousand variables including diameters, flowrates and pressures) and in particular on *Net*<sub>09</sub>. This fact is consistent with the documentation of

SNOPT (Gill et al., [44]) which notes that the speed is strongly reduced if the number of variables exceeds one or two thousands as long as we have a wide number of nonlinear constraints,

- the number of cycles (between 0 and 10 depending on the network) has no impact on the computation times,
- the B & B algorithms can yield a lot of savings in comparison with the cost of the relaxation (up to 50% saved). These important gains can be partly explained by the overestimation given by the rounding of the continuous relaxation which creates unusefull capacities on the networks. In most cases, the costs of proposed solutions are improved as soon as we widen the search including new diameters in the list. Nevertheless, we cannot state that we have reached the global optimum of our problem (even though the costs remains equal for each B & B strategy).
- for a same B&B strategy, CPU times vary a lot from a network to another. These differences are directly tied to the role of the more expensive pipes on the networks (and the latter is not easy to predict). The choice of diameters on these pipes can cut the search tree at very different levels, and hence, can have a weak or strong impact on the algorithm's efficiency. We can also see that the exponential growth of CPU times (exceeding one hour) are a real barrier to carry on our extension of the list of diameters and to get better solutions.

# Chapter 8

## An extension : investment scheduling<sup>1</sup>

### 8.1 Modeling of the multi-period problem

Before dealing with a multistage problem, we need to find a set of pipes and diameters which satisfy all network constraints each year over the length of the planning horizon. In this aim, an approach (see Triadou, [98]) is to select, among all forecasted scenarios of demand, the maximal one on which the one-period optimization is applied. In most cases, the maximal demand is reached the last year of the planning horizon due to the constant growth of demands. This specific year will be called the "target year".

Once the *nar* pipes (see Chapter 7) to reinforce are determined (with diameter), the scheduling problem consists in setting up a capacity expansion planning of these new pipes over the next  $np$  number of periods considering that:

- the longer the expense is deferred, the lower the cost appears thanks to the discount rate applied each year. Hence, to compare the schedules with each other, we use the Net Present Value,
- the network constraints and demand satisfaction have to be fulfilled every year,
- a built pipe can not be removed (only increase of diameter is allowed),
- a pipe can be looped only once over the length of planning.

From now on, the variables  $DD$  doubling diameter,  $Q$ , flowrate and  $\pi$ , the pressure will be distinct for each period. An additional index  $p$  specifies the period.

As we know values of diameters for the end time of horizon ( $\Delta_a > 0, \forall a \in A_{pipe}^r, \Delta_a = 0, \forall a \notin A_{pipe}^r$ ), the program ( $P_{multip}$ ) to solve is the following:

---

<sup>1</sup>A first version of this chapter has been published in the paper *André J., Cornibert L., A tool to optimize the reinforcement costs of a gas transmission network, Proceedings of 38th Annual Meeting, Pipeline Simulation Interest Group, Williamsburg (VA), October 2006.*

$$\left\{ \begin{array}{l}
\min_{(DD, Q, \pi)} \sum_{p=1}^{np} \sum_{a=1}^{nar} \gamma_p UC(DD_{ap}) \\
\text{(i)} \quad DD_{ap} \in \{0, \Delta_a\}, \forall a \in A_{pipe}^r, \forall p \\
\text{(ii)} \quad \sum_{p=1}^{np} \frac{DD_{ap}}{\Delta_a} = 1, \forall a \in A_{pipe}^r \\
\text{(iii)} \quad \pi_{ap}^i - \pi_{ap}^j = \\
\quad C_a \cdot (DI_a^s + (\sum_{k=1}^p DD_{ak})^s)^{-5/s} \cdot Q_{ap} \cdot |Q_{ap}|, \\
\quad \forall a \in A_{pipe}^r, \forall p \\
\text{(iv)} \quad \pi_{ap}^i - \pi_{ap}^j = C_a \cdot (DI_a)^{-5} \cdot Q_{ap} \cdot |Q_{ap}|, \\
\quad \forall a \notin A_{pipe}^r, \forall p \\
\text{(v)} \quad W_a^{min} \leq W_a(Q_{ap}, \pi_{ap}^i, \pi_{ap}^j) \leq W_a^{max}, \\
\quad \forall a \in A_{comp}, \forall p \\
\text{(vi)} \quad \tau_a^{min} \leq \tau_a(\pi_{ap}^i, \pi_{ap}^j) \leq \tau_a^{max}, \forall a \in A_{comp}, \forall p \\
\text{(vii)} \quad \pi_{ap}^i \geq \pi_{ap}^j, \forall a \in A_{reg}, \forall p \\
\text{(viii)} \quad \pi_p^{min} \leq \pi_p \leq \pi_p^{max}, \forall p \\
\text{(ix)} \quad Q_{ap}^{min} \leq Q_{ap} \leq Q_{ap}^{max}, \forall a \in A_{reg} \cup A_{comp}, \forall p \\
\text{(x)} \quad MQ_p = b_p, \forall p
\end{array} \right. \quad (8.1)$$

with

- $UC(\cdot)$ , the "Undiscounted Costs" which reflect the total amount to be spent, in current currency unit over the planning horizon. In other words, if you could collapse all work and phases of the project into the current year, it would represent the cost of completing this work at the initial period with applied discount factors. This function associates for each pipe the cost to lay out the doubling diameter  $DD_{ap} = \Delta_a$ ,
- $\gamma_p = \frac{1}{(1+r)^{p-1}}$ , the reduction cost factor for period  $p$  according to the discount rate  $r$ .

The constraints (i) represent the choice to expand the capacity of the pipes. The constraints (ii) mean that we cannot loop a pipe twice within the  $np$  periods of time.

This problem belongs to the large class of multistage network design problem which are widely used in the telecommunication sector (Triadou [98], Kubat [58]). Unlike pipe sizing, time phasing on pipe networks has been little studied. Nevertheless, we can note the works of Yi [107] who solves the expansion time problem with the help of linear integer programming on single source tree networks. On gunbarell structures<sup>2</sup> with pipes and compressor stations, Olorunniwo and Jensen [82] showed that for an infinite horizon of time, the time of the optimum expansion of the pipeline segments and compressor stations can be determined independently of the pipe sizes and compressor capacity expansions. They also showed that the times of expansion for each facility can be determined independently of the other facilities. Hence they apply a decomposition approach where they change the complex multifacility capacity expansion problem into a series of much simpler single facility problems.

All of these papers do not deal with the discrete choice of diameter considering that it is possible to expand continuously the capacity of a gas network to match the increase of demand.

Let  $S_p$  be the set of sequential decisions  $(DD_1, DD_2, \dots, DD_p)$  satisfying the network constraints (iii) to (x) from period 1 to  $p$ , i.e. the set of feasible schedules.

<sup>2</sup>main pipeline with gas flowing in one direction compressed with multiple serial compressor stations



The previous program 8.1 can be rewritten only according to the doubling diameter:

$$\left\{ \begin{array}{l} \min_{(DD)} \sum_{p=1}^{np} \sum_{a=1}^{narenf} \gamma_p UC(DD_{ap}) \\ \text{(i)} \quad DD_{ap} = 0 \text{ or } \Delta_a, \forall a, \forall p \\ \text{(ii)} \quad \sum_{p=1}^{np} \frac{DD_{ap}}{\Delta_a} = 1, \forall a \in A_{pipe}^r \\ (DD_1, DD_2, \dots, DD_p) \in S_p, \forall p \end{array} \right. \quad (8.2)$$

To simplify, we can replace the control vector  $DD_{ap}$  by the binary variable  $u_{ap} = 0$  or  $1$  which notifies if we reinforce with the diameter  $\Delta_a$  at period  $p$  or not. The program 8.1 will then be rewritten as follows:

$$\left\{ \begin{array}{l} \min_u \sum_{p=1}^{np} \sum_{a=1}^{nar} \gamma_p UC(u_{ap}) \\ \text{(i)} \quad u_{ap} = 0 \text{ or } 1, \forall a \in A_{pipe}^r, \forall p \\ \text{(ii)} \quad \sum_{p=1}^{np} u_{ap} = 1, \forall a \in A_{pipe}^r \\ \text{(iii)} \quad (u_1, u_2, \dots, u_p) \in S_p, \forall p \end{array} \right. \quad (8.3)$$

Explicit enumeration of all combinations (every schedule) can not be carried out within reasonable calculation time since it means testing feasibility and evaluating costs for  $np \times np \times \dots \times np = np^{na}$ . For example, for 15 pipes over 10 periods,  $10^{15}$  combinations are generated.

We have to decompose the problem into smaller problems to solve it. A first approach is the dynamic programming approach.

## 8.2 Dynamic programming

Dynamic programming (named DP see Bertsekas [22]) is very suitable to solve problems where we have (1) an underlying discrete-time dynamic system and (2) a cost function that is additive over time. Both of these assumptions hold for our model ( $P_{multip}$ ). To take the same vocabulary as in [22], we consider the network as a "system" and we have to define the states  $x$  of our system.

### 8.2.1 Feasible State generation

Let  $X$  be the set of all possible reinforcement states (or levels) of a given network identical for each period  $p$ . This reinforcement set is made of different reinforcement combinations:

- State  $\{0\}$ : no pipe has been looped,
- State  $\{1\}$ : pipe 1 has been looped,
- State  $\{2\}$ : pipe 2 has been looped,
- State  $\{3\}$ : pipe 3 has been looped,
- State  $\{1, 2\}$ : pipes 1 and 2 have been looped,
- State  $\{2, 3\}$ : pipes 2 and 3 have been looped,
- ...,
- Maximal State: all pipes have been looped.

Therefore, the set  $X$  accomodates  $2^{nar}$  states per period.  $x$  will be denoted as an element of this set  $X$ . This state  $x$  can be represented with the help of a vector of size  $nar$  of which element  $a$  takes 1 if the arc  $a$  is reinforced and 0 if not. We have to test the feasibility of each state. We can see immediatly that this generation of states can lead to a very large number of combinations even for a modest number of variables. We are trying to handle this "curse of dimensionnality" by using the constraints of the problem.

We then have to build the subsets  $X_p \subset X$ , which include all the feasible states for each period  $p$ .

Let us introduce a link between successive periods with the function  $f_p$  which ties the states of a period  $x_p$  with the states of period  $x_{p+1}$ . With the definition of states given above, the discrete time equations associating the control variables  $u_p$  and the state of the system are:

$$x_{p+1} = x_p + u_{p+1}$$

Constraints (i) (increase of diameter) imply the constraint  $u_p \geq 0$  which can be translated as follows:

$$x_{p+1} - x_p = u_{p+1} \geq 0 \Leftrightarrow x_{p+1} \geq x_p$$

Consequently, using this property, we can write the algorithm of feasible state generation:

- **Initialization:** find the first period  $p_1$  where we can identify a saturated pattern,
- **at the first period**  $p_1$ , test the feasibility of all states included in  $X$  to establish the first set  $X_1$ ,
- **from period**  $p = p_1 + 1$  **to**  $np$ , **for each state**  $x_{p-1}^i \in X_{p-1}$ , generate all upper states  $x_p^j \geq x_{p-1}^i$  and assess the feasibility of these states if it has not been done before. If this state is feasible:  $x_p^j \rightarrow X_p$ .

If the demand follows an increasing trend, the size of the feasible set  $X_p$  should decrease with time.

We can deduce that each state  $x_p \in X_p$  sums up the historical decisions made before period  $p$ :

$$x_p = \sum_{k=1}^p u_k$$

## 8.2.2 Principle of Optimality

The advantage of DP is to avoid the evaluation of all schedules by using Bellman principle (see Bertsekas [22]): if a schedule to reach a reinforcement state is not optimal from period 1 to period  $p$ , then it cannot be included in the optimal schedules set from period 1 to  $p + 1$ .

Conversely, assume that we know  $u^* = \{u_1^*, u_2^*, \dots, u_{np}^*\}$ , the optimal reinforcement policy over the whole studied period of time. Let us consider the subproblem where we have to minimize the "cost-to-go" to a given state  $x_p$  at period  $p$ :  $\sum_{k=1}^p \gamma_k \cdot UC(u_k)$ . Then the truncated reinforcement policy  $\{u_1^*, u_2^*, \dots, u_k^*\}$  is optimal for this sub-problem.

### 8.2.3 DP Algorithm

The algorithm's aim is, for each period and each state, to dispose of the schedules which are not optimal and to keep only those which are optimal. Hence, at period  $np$ , among all schedules proposed to reach the final state, we choose the one with minimal cost.

The set of feasible states  $X_0$  at initial period 0 has only one single state  $x_0$  which corresponds to the no-reinforcement state. In a similar manner, the set of feasible states  $X_{np}$  has one single state  $x_{np}$  which corresponds to the full-reinforcement state. We consider that all pipes have to be looped at period  $np$ .

As the first and the last states  $x_0$  et  $x_{np}$  are given and since we can formulate the discrete-time equation forwards and backwards, the choice of processing forward or backward in time has no impact on the algorithm efficiency [?]. We expose hereafter the forward algorithm.

Let  $J_p(x_p)$ , the present optimal value to reach state  $x_p$ . The final optimal value  $J_{np}$  will be given at the last step of the following algorithm which proceeds from period 0 to  $np$ :

- **Initialization:** at period 0,  $J_0(x_0) = 0$ .
- **at period  $p_1$**  (first period of saturation), we have to assign, at each state  $x_{p_1}^i \in X_{p_1}$ , the cost to reach the states of period  $p_1$  from state  $x_0$  i.e. the undiscounted costs for each state multiplied with  $\gamma_{p_1}$ :

$$\forall x_{p_1}^i, J_1(x_{p_1}^i) = \gamma_{p_1} \cdot UC(x_{p_1}^i - x_0) = \gamma_{p_1} \cdot UC(x_{p_1}^i)$$

- **At each period  $p$  from  $p_1 + 1$  to  $np$ ,** we are going to evaluate each state. For a given state  $x_p^i$ , we first determine  $X_{p-1}(i)$ , the set of feasible states of period  $p - 1$  which can reach this state. One element of this set is denoted by  $x_{p-1}^j$  and is defined by the control constraint  $x_{p-1}^j - x_p^i \leq 0$ . The cost to go from state  $j$  to state  $i$  will be:  $\gamma_p \cdot UC(x_{p-1}^j - x_p^i) = \gamma_p \cdot UC(u_p^{ji})$ . The assignment of costs at each state of period  $p$  is written:

$$\forall x_p^i \in X_p, J_p(x_p^i) = \min_j (J_{p-1}(x_{p-1}^j) + \gamma_p \cdot UC(u_p^{ji}))$$

We also have to input for each state  $i$ , the decision  $(u_p^i)^*$ , argument of this minimization, in order to keep in memory the choice of the optimization:

$$(u_p^i)^* = \operatorname{argmin}_j (J_{p-1}(x_{p-1}^j) + \gamma_p \cdot UC(u_p^{ij}))$$

We store this decision in an optimal decision stack to reach this state  $x_p^i$  :  $(u_1^i, u_2^i, \dots, u_p^i)$  in order to remember, at the end of the process, the complete set of optimal decisions.

The proof that this algorithm outputs the optimal schedule is provided by Bertsekas [22].

Note that we can model this problem with a transition graph (see Bertsekas,[22]) where:

- nodes are states of each period,
- oriented arcs are the links from a period to another,

- the source node  $s$  corresponds to state  $x_0 \in X_0$
- the well node  $t$  corresponds to state  $x_{np} \in X_{np}$ .

A deterministic finite-state problem is equivalent to finding a shortest path from initial node  $s$  of the graph to the terminal node  $t$ . DP algorithm can be one algorithm to find out this shortest path.

## 8.3 Heuristics

### 8.3.1 Principles

The need of heuristics arises from the important computation time required by DP. Although the state generation has been limited, it still remains a big issue to process large networks.

The basic ideas of these heuristics is to solve the one-period problem stage by stage without taking into account the impact on the other period. However, to produce a consistent schedule (with growing diameter, without neither tripling nor removing pipes), it is necessary to use the results of the previous or next period to optimize one period.

As a matter of fact, with these heuristics, it is possible to process in both direction in time:

- forward in time, where we consider that investments done before year  $p$  will not to be planned anymore during the next years  $p' > p$ . If, at year  $p$ , a part of the set of diameters has been laid out, then we have to try to reinforce the network with other diameters,
- backward in time, beginning from the "target year" to the initial year. We also consider that expenditures done at year  $p$  will not be done earlier than period  $p$ :  $p' < p$ .

The first **advantage** of these methods is to guarantee that we have **reached a locally stable state for any period**: no additional reinforcement is necessary and **any removal of reinforcement implies violation of network constraints**. These heuristics allow to avoid overinvestments. The other advantage of these heuristics is that the combinatory is reduced through the progression in time (forward or backward) since the degrees of freedom are reduced each time a pipe is laid out.

The **drawback** in both cases, is the **lack of relationship between the expansion times**. For example, a big diameter laid out too early (which yields a more expensive net present value) could be delayed in laying out several less expensive short pipe sections. These heuristics have a common **"short sighted" behaviour**.

Note that the backward process requires that demand grows and supply pressures is at least stable or decreasing over the studied period. If this heuristic proposes a reinforcement at period  $p$  and if the demand at period  $p - 1$  is higher than at  $p$ , we can have a lack of pipes to satisfy the constraints at period  $p - 1$ .

### 8.3.2 Forward Algorithm

As we know the state  $x_{np}$  at the target year, the idea is to progress in time by **minimizing undiscounted cost each period  $p$** .

- **Initialization** we consider the set  $A_{pipe}^r$ ,
- **at first saturated period  $p_1$** , we solve the following one-period program (with undiscounted costs):

$$\left\{ \begin{array}{l} \min_{(x_{p_1} \in X_{p_1})} \sum_{a=1}^{nar} UC_a(x_{a,p_1}) \\ x_{a,p_1} = 0 \text{ or } 1, \forall a \in A_{pipe}^r \\ x_{a,p_1} = 0, \forall a \notin A_{pipe}^r \\ \text{(5.11-ii) to (5.11-viii)} \end{array} \right. \quad (8.4)$$

This program is the same as program 7.6 with a choice limited to 0 or 1 for  $x_a$ . It is solved with a reduced Branch & Bound (B&B 1). This program outputs a minimal state :  $x_{p_1}^{min}$ . Let  $(A_{pipe}^r)^{p_1}$  be the set of reinforced pipes at year  $p_1$ .

- **at each period  $p$  from  $p_1 + 1$  to  $np$** , we have the state  $x_{p-1}^{min}$  chosen for period  $p - 1$ . We determine the complementary set of pipes which have not been reinforced at year  $p - 1$ :

$$\overline{(A_{pipe}^r)^{p-1}} = A_{pipe}^r \setminus (A_{pipe}^r)^{p-1}$$

It is in this set that we are picking up the pipes to reinforce at year  $p$  to minimize the undiscounted costs under the constraint that the previous investments are made. It means solving the program:

$$\left\{ \begin{array}{l} \min_{(x_p \in X_p)} \sum_{a=1}^{nar} UC_a(x_{a,p}) \\ x_{a,p} = 0 \text{ or } 1, \forall a \in A_{pipe}^r \setminus (A_{pipe}^r)^{p-1} \\ x_{a,p} = 1, \forall a \in (A_{pipe}^r)^{p-1} \\ x_{a,p} = 0, \forall a \notin A_{pipe}^r \\ \text{(5.11-ii) to (5.11-viii)} \end{array} \right. \quad (8.5)$$

Hence, the solution of this program  $x_p^{min}(p-1)$  respects the diameter growth constraint:  $x_p^{min}(p-1) \geq x_{p-1}^{min}(p-2)$ .

Finally, we get as an output the list of (undiscounted) optimal states

$$(x_1^{min}, x_2^{min}(1), \dots, x_p^{min}(p-1), \dots, x_{np-1}^{min}(np-2), x_{np})$$

as well as the list of suboptimal solutions  $u_1, u_2, \dots, u_p, \dots, u_{np}$  deduced by differences :  $u_p = x_p^{min}(p-1) - x_{p-1}^{min}(p-2)$ .

### 8.3.3 Fast Forward Algorithm

At each period, computation times can be rather high to solve the problem 8.5. It especially occurs when the number of pipes to reinforce  $nar$  is high and/or the need to reinforce appears too late (which delays the reduction of the pipe set to reinforce).

Hence, we propose a variant of the above algorithm by replacing the problem 8.5 with a relaxed version of this program:

$$\left\{ \begin{array}{l} \min_{(x_p \in X_p)} \sum_{a=1}^{nar} UC_a(x_{a,p}) \\ x_{a,p} \in [0, 1], \forall a \in A_{pipe}^r \setminus (A_{pipe}^r)^{p-1} \\ x_{a,p} = 1, \forall a \in (A_{pipe}^r)^{p-1} \\ x_{a,p} = 0, \forall a \notin A_{pipe}^r \\ (5.11\text{-ii}) \text{ to } (5.11\text{-viii}) \end{array} \right. \quad (8.6)$$

This continuous program is the same as program 7.4 with a choice limited between 0 and 1 for  $x_a$ . It is solved with a nonlinear solver (such as SNOPT [44]) which processes faster than a reduced Branch & Bound even with a limited choice (as B&B 1). This program outputs a minimal state:  $x_p^{min}(p-1)$ . Therefore, at period  $p$ , as soon as the variable  $x_a^{min}$  is positive, we consider that the pipe  $a$  has to be reinforced from period  $p$  and not later.

### 8.3.4 Backward algorithm

As we know the state  $x_{np}$  at target year, the idea is to go back in time minimizing at each period the undiscounted costs.

- **Initialization** we consider the set  $A_{pipe}^r$ ,
- **at period  $np-1$** , we solve the following one-period program (with undiscounted costs) thanks to B&B algorithm:

$$\left\{ \begin{array}{l} \min_{(x_{np-1} \in X_{np-1})} \sum_{a=1}^{nar} UC_a(x_{a,np-1}) \\ x_{a,np-1} = 0 \text{ or } 1, \forall a \in A_{pipe}^r \\ x_{a,np-1} = 0, \forall a \notin A_{pipe}^r \\ (5.11\text{-ii}) \text{ to } (5.11\text{-viii}) \end{array} \right. \quad (8.7)$$

We determine a minimal state respecting the growth constraint:  $x_{np-1}^{min}(np) \leq x_{np}$  and we keep in memory the control variable  $u_{np} = x_{np} - x_{np-1}^{min}(np)$ . Let  $(A_{pipe}^r)^{np-1}$  be the set of pipes which are reinforced at year  $np-1$ .

- **at each period  $p$  from  $np-2$  to the first saturated period  $p_1$** , we have the state  $x_{p+1}^{min}$  chosen for period  $p+1$ . The complementary set of pipes which have not been reinforced at year  $p+1$  is defined as:

$$\overline{(A_{pipe}^r)^{p+1}} = A_{pipe}^r \setminus (A_{pipe}^r)^{p+1}$$

We solve the one-period program considering that investments made at period  $p+1$  are not possible to make at period  $p$ :

$$\left\{ \begin{array}{l} \min_{(x_p \in X_p)} \sum_{a=1}^{nar} UC_a(x_{a,p}) \\ x_{a,p} = 0 \text{ or } 1, \forall a \in A_{pipe}^r \setminus (A_{pipe}^r)^{p+1} \\ x_{a,p} = 0, \forall a \in (A_{pipe}^r)^{p+1} \\ x_{a,p} = 0, \forall a \notin A_{pipe}^r \\ (5.11\text{-ii}) \text{ to } (5.11\text{-viii}) \end{array} \right. \quad (8.8)$$

We get a minimal state  $x_p^{min}(p+1)$  and the consequent decision  $u_{p+1} = x_{p+1}^{min}(p+2) - x_p^{min}(p+1)$ . The growth constraints are properly fulfilled since  $x_{a,p}^{min} = 0 \leq x_{a,p+1}^{min} = 1, \forall a \in (A_{pipe}^r)^{p+1}$ .

Finally, we obtain the list of (undiscounted) optimal states

$$(x_1^{min}(2), x_2^{min}(3), \dots, x_p^{min}(p+1), \dots, x_{np-1}^{min}(np), x_{np})$$

as well as the list of suboptimal sequential decisions  $u_1, u_2, \dots, u_p, \dots, u_{np}$ .

## 8.4 Case Study

In this part, we present the behaviour of the previously described algorithms on a regional network without compressor stations.

### 8.4.1 Features of the tested network

**Figure 8.1** shows the topology of this network where we can see the pipe arcs, the valves arcs and, the supply nodes. At every nodes is associated a number. This network is made of 67 pipes (the diameters of wich are included between 4 and 27 inches) and 3 regulators with a total length of about 561 miles. The medium size of this network has been chosen to process all steps and options of the methods within reasonable times (less than 5 minutes). It contains no loops but it is supplied with four nodes. Hence, the existence of several gas sources implies that *we don't know the direction of the flow on the pipes of this network* (as in a looped network). Pressures on the nodes must be kept within lower bounds (290 psi on delivery nodes) and upper bounds (653 psi on supply nodes). The 31 delivery nodes are spread out on the entire network and represent in year 2005 88.3 millions cubic feet per day as a whole. Considering an linear increase rate of 2% each year, we have at our disposal the forecast of increasing demands over the 23 next years. All the other constraints remain stable over the planning horizon.

### 8.4.2 Pipe Selection

Let 2028 be the target year of reinforcement. If we apply the "do nothing" policy, the network will be congested in 2028 and consumers won't be supplied with high enough pressures. Hence, thanks to the resolution of the program 7.4, we are able to select only 5 pipes among 67 to minimize reinforcement costs. Note that the selection of arcs to reinforce is rather small compared with the total number of pipelines. It means that the (local) optimal solution provided by the relaxation is focused on a small set of pipelines with high enough diameters. In other terms, it represents the economy of scale given by the concave cost function seen. **Table 8.2** presents these pipes and the associated relaxed diameters. Comparing these relaxed diameters with the commercial list given in **Table 8.1**, we build a feasible solution rounding the initial solution up to the nearest available diameters. This first feasible solution is given in the third column of **Table 8.2**.

### 8.4.3 Diameter Optimization

Results of the Branch and Bound algorithms (see Chapter 7) are given in **Table 8.2**. The simplest algorithm B & B 1 does not bring any improvement which means that the removal of one of these diameters implies an unfeasibility. On the contrary, the possibility to choose the immediate smaller diameter than the initial proposal (B&B 2) on 3 pipes (30-31, 43-44, 44-47) brings down the cost

by 7% at 27040 k\$. The possibility to choose the nearest bigger diameter (B&B 3) has no impact on this cost. This levelling-off does not mean that we have reached the global optimum of our problem. This guarantee can be obtained if and only if we have explored all the combinations given by the commercial list.

#### 8.4.4 Scheduling Optimization

The financial value of postponement is given with the discounted rate  $r=8\%$ . After checking the "do nothing" policy on each year from year 2005 to 2028, we have detected as 2008 the first year when the network is saturated by the demand.

**Table 8.3** shows the results of the different scheduling methods: Dynamic Programming Algorithm (DPA), Forward Algorithm (FA), Fast Forward Algorithm (FFA) and Backward Algorithm (BA). In comparison with the value given by the DPA, we can assess the performances of the heuristics. Hence, on this example, we can see that the BA produces the same result as DPA. On the contrary, the FA and the FFA are far enough from the best result (with +7% and +14% respectively).

The best solution (15810 k\$) proposes to activate the expansion with pipe 31-32, which is the most expensive project (for undiscounted costs). The alternate solutions proposed in **Table 8.4** are a sensitivity analysis carried out with DP with regard to the first project. When an expansion plan is studied or revised (each year), the choice of the first project is of course the most important. Hence, if we replace in year 2008 the pipe 31-32 with pipe 43-44, it allows to postpone the most expensive project during 2 years (up to 2010) which gives quite the same undiscounted cost as the best cost (+1%). In like manner, if we begin with pipe 44-47 then pipes 31-32 and 43-44 are delayed and we lose no more than 2.5%. Eventually, the laying of the (undiscounted) cheapest diameters (30-31 and 47-49) at first gives the worst (optimal) choice with a loss of 4%.

### 8.5 Tests on larger networks

In the previous case study, computation times were not an issue since the number of reinforced pipes were not too high. Nevertheless, on the majority of the real networks, the number of reinforced pipes are higher and the computation times exponentially grows with regard to the number of pipes.

As the network is divided into a lot of small sections (due to the high number of delivery points), it is not always relevant to work with these too little sections of network especially with successive sections of networks. From an economic point of view, it could be not worth of interest to plan an expansion date for a section and another date for a upstream or downstream section because the fixed costs are reduced as we consider a large project instead of a lot of smaller projects. It is the reason why we will use, in this part, the *project to reinforce instead of the pipes to reinforce*. A **project is defined as a set of pipes which have the same date of laying**. Let  $nproj$  be the number of projects taken into account in our tests. Of course, this gathering of pipes in projects is very helpful in terms of computation times. Hence, the DPA can be tested on even large networks.

**Table 8.5** shows the costs and the associated CPU times of scheduling algorithms on several real regional networks. The features of these problems are specified with  $L$ , the total length,  $na$ , the number of arcs,  $nproj$ , the number of projects,  $nyear$ , the year number of the expansion plan. We can observe on these



results that, as expected, the DPA gives the best solution in all cases. On 2 networks out of 6, the heuristics also find the best solution. On this set of networks, the maximal gap between the best solution and those given by the heuristics do not exceed 5% for the FA and 20% for the BA whatever the network. The FFA can give very good solutions as for  $Net_{02}$  and  $Net_{04}$  (less than 2% of discrepancy) as well as very bad solutions as for  $Net_{01}$  and  $Net_{05}$ .

The CPU times for DPA, FA and BA mainly depend on the number of projects and the number of years. The search of the best solution with the DPA yields, in most cases, the worst CPU times. Heuristics help significantly to get a solution within shorter times than DPA. However, the combinatory search included in DPA can imply rather high times. FFA CPU times depend more on the number of arcs than the number of projects. Hence, FFA often gives the shortest CPU times except for networks of rather high size (more than 200 pipe sections). The nonlinear solver (SNOPT) to solve the relaxed program at each year, is very dependent on the number of variables (including flowrate on each arc and pressure on each node).

Internal Diameter (inches)	Internal Diameter (mm)
6.3	159.9
8.2	208.6
10.3	261.9
12.2	311.1
15.5	392.6
17.5	444.8
19.5	494.5
23.4	593.6

Table 8.1: Available Diameters

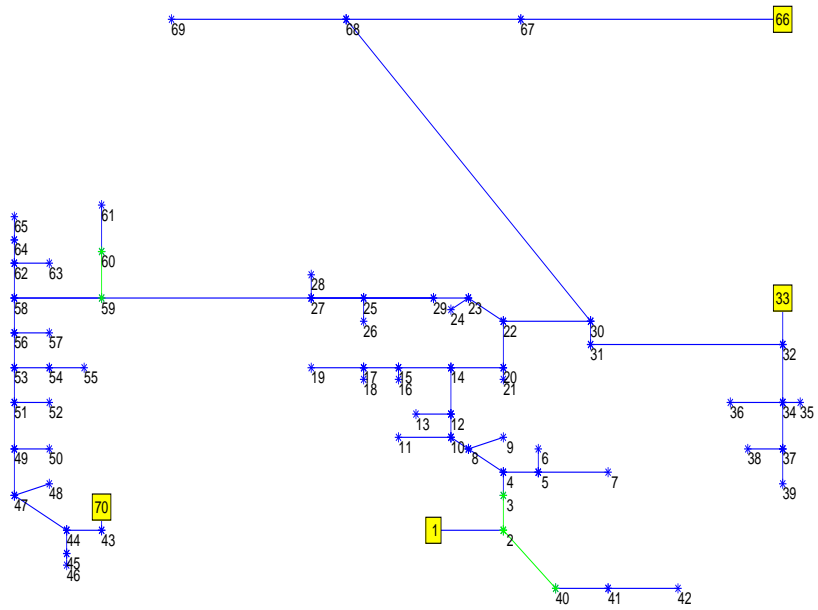

Figure 8.1: Case Study Network

Selected Pipes	(7.4)+Rounding		Diameter (inches)		
	Relaxed Diameter (inches)	Rounded Diameter (inches)	B&B1	B&B2	B&B3
30-31	10.0	10.3	10.3	8.2	8.2
31-32	10.0	10.3	10.3	10.3	10.3
43-44	11.4	12.2	12.2	10.3	10.3
44-47	11.1	12.2	12.2	10.3	10.3
47-49	10.5	12.2	12.2	12.2	12.2
Costs (kUSD)		29073	29073	27040	27040

Table 8.2: Case Study - Diameter Optimization

Selected Pipes	Diameter (inches)	DPA (Year)	FA (Year)	FFA (Year)	BA (Year)
30-31	8.2	2009	2013	2008	2009
31-32	10.3	2008	2011	2009	2008
43-44	10.3	2014	2008	2008	2014
44-47	10.3	2019	2010	2018	2019
47-49	12.2	2025	2009	2025	2025
Costs (kUSD)	27040	15810	18061	16877	15810

Table 8.3: Case Study - Scheduling Optimization - Results of DP and Heuristics

Pipes	Schedule 1 (Year)	Schedule 2 (Year)	Schedule 3 (Year)	Schedule 4 (Year)
30-31	2009	2009	2009	2008
31-32	2008	2010	2010	2009
43-44	2014	2008	2019	2016
44-47	2019	2019	2008	2022
47-49	2025	2025	2025	2008
Costs (kUSD)	15810	15947	16171	16465

Table 8.4: Case Study - Scheduling Optimization - Results of DP Algorithm (Sensitivity analysis)

	Features			
Networks	L (miles)	na	nproj	nyear
<i>Net</i> <sub>01</sub>	168	78	6	31
<i>Net</i> <sub>02</sub>	748	332	8	20
<i>Net</i> <sub>03</sub>	446	241	7	17
<i>Net</i> <sub>04</sub>	154	37	10	11
<i>Net</i> <sub>05</sub>	103	176	7	17
<i>Net</i> <sub>06</sub>	591	135	10	17

	DPA		FA		FFA		BA	
Networks	DC (k\$)	Times (s)	DC (k\$)	Times (s)	DC (k\$)	Times (s)	DC (k\$)	Times (s)
<i>Net</i> <sub>01</sub>	2438	63	2551	34	5765	7	2487	20
<i>Net</i> <sub>02</sub>	24387	1394	24387	885	24875	987	29028	158
<i>Net</i> <sub>03</sub>	14370	92	15006	80	14991	114	14945	51
<i>Net</i> <sub>04</sub>	8366	315	8433	153	8587	3	8548	64
<i>Net</i> <sub>05</sub>	310	210	310	122	453	70	310	37
<i>Net</i> <sub>06</sub>	23832	851	24156	531	24710	23	26064	38

Table 8.5: Discounted Costs and computation times on regional networks for the scheduling optimization

# Chapter 9

## Conclusions & Future Works

### 9.1 Conclusions

The main conclusions of this thesis can be summarized in four major points.

#### 9.1.1 Paradox

In Chapter 4, we have shown first that *more-for-less* paradox can be observed on a very general class of multi delivery gas networks taken into account bounds on pressures, even though previous works have proved that it could not happen on simple networks. A main result is that the power loss of a network can be higher with the increase in diameter of one arc. Then, it has been enlightened that the capacity increase can also yield infeasibility for the gas transport problem by violating the bound pressures. Two necessary conditions to the paradox have been established. They are based on the topology of the network. In particular, tree networks are immune against the paradox. As a conclusion, a procedure has been proposed to detect such paradoxes on every networks.

#### 9.1.2 Optimal features

In Chapter 6, thanks to the mathematical programming framework, we have proved the validity of the usual practices of pipeline engineers to design a gas trunkline: same diameter for each section, discharge pressures to their maximal bounds, suction pressures all equal and equidistant compressor stations. Nevertheless, some boundary conditions (on supply and delivery given pressures) have to be carefully considered before applying these principles. Hence, an high enough pressure at the inlet of a pipeline can make compression unuseful and properties on compression will not appear (with apparition of zero length sections). In case of required delivery pressure lower than the maximal operating pressure, the equidistant location property can not be applied to the last section. These properties have been checked with numerical tests on small gas networks. Future works could be focused on extending these properties to more realistic networks (with fixed pipeline segments lengths or withdrawals along the pipelines) and to use the theoretical results on larger numerical examples.

### 9.1.3 Combinatorial Pipe sizing

For combinatorial optimization of the diameters, the variations around the Branch and Bound technique presented in Chapter 7 have been successfully applied on the highly combinatorial reinforcement problem. After comparison to the optimal solutions, these heuristics obtain good quality solutions on small to medium scale real regional networks within reasonable computation times.

For larger networks with many sections and especially when reinforcement of many pipes is needed, the high CPU times limit the search to small sets of diameters. On the other hand, one can observe that there is room for improvement in the lower and upper estimates. Thus, to enlarge the exploration space, future researches could be conducted using improved lower bounds based on convex or Lagrangian relaxations.

### 9.1.4 Investment Scheduling

Dynamic programming techniques have been presented in Chapter 8 to carry out expansion planning studies on meshed regional transportation gas networks by proposing a "optimal" solution at each step of the decision process. The decomposition approach in two steps (diameter optimization and scheduling optimization) allows to process heuristics within reasonable time in order to get the least cost.

The numerical results have shown that CPU Times can be a limit of use of such methods on networks with a lot of pipes to reinforce. Coupled with diameter optimization, the 2 step optimization (capacity and scheduling) can reach too high computation times that will prevent an extensive search for optimality. Therefore, future researches will tackle the problem of reducing CPU times to handle larger number of networks and to improve solutions quality.

## 9.2 Overall capacity reinforcement problem

The models presented in this thesis have been voluntarily limited due to the highly combinatorial nature of the problems, the realistic physical and economical constraints to include and the requirements imposed in the industry to produce solutions within reasonable time.

We provide in this section to the reader some extensions of the models investigated in this thesis that could be relevant to be addressed in the natural gas industry in the future.

In model 1 of Chapter 5, the program focused on the minimization of CAPEX including both continuous compression power and diameters costs with a fixed flowrate on a single source single delivery pipeline. In the model 3, the compression capacities are considered as fixed in the case of multi source multi delivery networks. Then, a natural extension of these models is the **minimization of the total compression and pipes reinforcement costs of existing networks** by adding a decision variable: the additional compression power.

In that case, the **nature and the difficulty of the problem will be different whether we include new compression facility or not.**

### 9.2.1 With new compression stations

If new compression stations can be decided, the problem is highly open-ended since **every nodes of the network can be the place of a new compressor station**. Unlike the model 1 where the compressor location was a continuous variable, the problem becomes highly combinatorial with the introduction of binary variables controlling the opening of a compressor stations. Besides, on a two pipe connection, the direction of the compression can be in both ways since the gas can flow in both directions due to multi sources and loops.

The objective function includes the compression costs introduced in the Model 1, namely a linear function of the power installed in the compressor with a fixed installation cost.

One has to introduce two binary variables namely one indicating if the compression station is opened in the "direct" direction and one other indicating if the compression station is opened in the "backward" direction and 0 in the other case.

In that case, Model 3 can be extended by adding big-M constraints (assuming that we know extreme maximal values) to the existing constraints of program 5.11. These big-M constraints are introduced to handle the combinatorial aspect with linear constraints. The objective function will include a part for the compression installation and power cost. The complete mathematical formulation is exposed in Appendix B.1.

Some models around this model can be derived:

- This model can be simplified if we limit the number of possible locations for new compressor stations. In practical, some potential locations are selected due to environmental or budget constraints.
- This model can be strongly complicated with the possible creation of compression stations at the interconnection of more than 2 pipes on looped networks.

This program is a very large Mixed Integer Non Linear Program that has not been addressed at the best of our knowledge. Let us note that a first solution without any guarantee of optimality can be found by letting all the nodes without imposing any pressures constraints (only a flow link). This idea is taken from De Wolf and Smeers [40] that have applied this solution to a small set of compression stations for the Belgium networks where the flow directions are known.

### 9.2.2 With additional compression power on existing stations

In that case where we already know the location of existing compression station, the problem is limited to the size of the additional compressor we need to add. The fixed installation cost in the CAPEX function is not anymore significant since most of the fixed outlay costs have been paid at the initial stage. Then, no degrees of complexity are added compared to the model with only the introduction of the continuous variable of additional compression power. The complete mathematical formulation is exposed in Appendix B.2.

## 9.3 Strategic/Operational integration

The ultimate goal of a planner is to be sure that its strategic decision will be optimal over all the possible operating conditions of the asset. This approach aims at integrating the decision process by systematically checking the validity of a strategic decision on operational daily management.

In the previously defined framework, it can be seen as the need of integration of CAPital EXpenditure and OPERational EXpenditure. Actually, these costs are closely related. The choice of higher capacity at the beginning of a asset lifetime (higher diameter) can reduce drastically the cost to daily operate the gas network (less compression to offset the pressure drop) and conversely.

A bi level approach is proposed with:

- at the upper level the minimization of extra capacities in compression and pipelines
- at the lower level the minimization of compression costs bounded with the above selected capacities

The complete mathematical formulation is exposed in Appendix B.3.

From an economical organization viewpoint, the proposed bilevel optimization can be seen as a game with a leader and a follower. The leader will be the owner of the assets although the follower will be the operator of the asset. As the lower level decision are bounded by the upper level decisions, the feedback from the lower level will drive the decision at the upper level. The solution of this program can be found by replacing the low-level program with its KKT solutions. In that case, one has to use techniques to solve Complementarity Program (CP) since a complementarity constraint links primal and dual variables of the low-level program.

From a practical viewpoint, the deregulation process has given such model in Netherland where a clear separation does exist between the owner and the operator. One of the main pitfall of this approach comes from the huge combinatorial aspect that arises by mixing the combinatory of the sizes of the assets with the multiple configurations of interconnection nodes that have to be selected to find the best opex.

## 9.4 Robust design and sizing of gas networks

### 9.4.1 Motivations

#### Multi scenarios for multi user networks

The demand vector is considered as unique and the best representative of a peak situation on the network (worst case) in the models of this thesis. Nevertheless, as delivery networks are supplying multiple demands, peak for one customer does not mean peak for another customer. Demand peak scenarios can be statistically built with respect to 2 main types of consumers:

- the *household consumption* that is closely correlated to the temperature. For these customers, the identification of the coldest days of the year will be critical to not cut the delivery to a customer who is in high need of natural gas for heating purpose. For example, the design of the network for GRTgaz



is usually based on a scenario that can happen with a chance of 2% in one century called the 2% risk <sup>1</sup>,

- the *industrial consumption* will highly depend on the nature of the process that uses the natural gas. Peaks for industrials are often at a different time than the peaks for households. This is the reason why demand response incentives are implemented based on the possibility for an industrial to interrupt its load at a required time when the general load is too high (in exchange the industrial can obtain a discount on the unit price).

When these 2 types of demands are aggregated at the network level, several peak scenarios can be generated to cover all the possible cases. Combinations can be infinite with the possibility to set different risk levels according to the customers with the possibility to load interruptency or not. Besides, as the industrial basins are often located at remote locations far from the cities (especially on transmission/distribution networks), the structure of the flows can be highly different from one scenario to another.

### Multi scenarios for multi supplier networks

More recently, the need to address several scenarios of supply has been imposed by the market regulators . Due to the separation between the gas network operator and the natural gas sourcing/purchasing operators, the gas network operator does not control anymore the entry flows on its networks. In term of model, we can say that endogenous variables of the transportation company have been transformed into exogenous parameters. Therefore, the market regulator requires the best fluidity to make possible all combinations of available capacities at entry points of the networks. In that manner, gas suppliers can have freely access to the customers.

Therefore, the planner objective will be to propose investments in diameters that can cover all these different situations.

### Uncertain parameters in the future

All the investment problems mentioned in this thesis are **based on the perfect knowledge of all the input parameters** although several input parameters are unknown and in particular when we tackle the multi period problem for the future. We propose hereafter a selection of uncertain parameters :

- **Future demand** is often **based on an annual increase rate**. Due to the typical lifetime of a pipeline around 30 years, all decisions have to be made with an estimated target of the volume at that horizon. We discuss hereafter about the **impact of estimation errors of the increase rate on the diameter decision** made on a very simple pipeline :  $P_{in} = 68$  bars,  $P_{out} = 20$  bars,  $L = 200$ km and a current flowrate of  $Q = 500000m^3/h$ . The diameter is computed with the help of the simplified formula coming from the Weymouth equation  $D = (\frac{\pi^i - \pi^o}{\beta \cdot L \cdot Q^2})^{-1/5}$ . The laying cost of new pipeline selected is considered as known and quadratic  $c(D) = a_0 + a_1D + a_2D^2$  with the coefficient  $a_0 = 7.7476, a_1 = 0.0074782, a_2 = 0.00002518$  given in De Wolf & Smeers [40].

---

<sup>1</sup>www.grtgaz.com

On Figures 9.1, we observe the evolution of the demand, diameter and cost over the next 30 years in 6 cases of increase rate from  $-3\%$  to  $+3\%$  ( $+3\%$  is the one selected by the International Energy Agency Figure for the next 20 years globally [51]). One can see on these figures that the impact of an error on the increase rate can have a **dramatic impact on the final volume** (with a gap factor of 7 between the lowest and highest estimated volumes). Thanks to the physics of the fluids, **this impact is limited on the values of optimal diameters** with a gap factor reduced to 2. Eventually, the errors on the increase rate can increase the cost range between 600 000 and 1 300 000 €.

To complete the overall assessment, **what-if analysis has to be performed to assess the potential negative consequences of less expensive decisions now in case of other scenario realizations**: increase upstream compression at high energy costs, potential need to build an on-line compression station or to loop the current pipeline and ultimately penalty costs for disruption of gas delivery. With such a variation range, decisions could be very difficult to make especially when this range has to be compared to other investment projects to make within a limited budget.

- **Demand increase location** can also be considered. As a specificity of transportation/delivery networks, **demand increase can not be uniformly applied to all the consumption nodes** but a differentiation can be made according to the nature of the consumers connected to the node. A specific industrial customer can grow more quickly than another. This is in particular true for the location of new demands (typically new power plant, new underground storage or new LNG terminals as mentioned in the introduction) that can be highly uncertain.
- the **cost uncertainty** can also be considered. The unit costs for laying a pipe is directly related to the steel price. Over the 2005-2010 period the fluctuation of the steel has been very high with low price around 500 and peak at 1200\$/Tonnes (see Figure 9.2). As the investment decisions for the current year are based on an optimal schedule over the next 30 years, the today's decision can be affected by wrong future unit costs.

For compression stations, the difficulty comes from the estimation of the parameters of the linear installation cost function. Figure 9.3 presents a study of the Oil & Gas Journal summarizing the layout cost of 23 compression stations in 2005/2006 <sup>2</sup>. The variation of the costs shows that the parameters are strongly dependent on the project, its location,... Thus, it could be interesting to take into account this uncertainty into the decision of compression stations.

Let us note that the cost uncertainty grows with the future time steps. Nevertheless, to balance this effect, the later the reinforcement is planned, the less the cost has an impact on the initial stage decision since a discount factor is applied. The discount factor strongly reduces the future cost in the Net Present Value criterion.

---

<sup>2</sup>C. Smith, Special Report on Pipeline Economics, Oil & Gas Journal, 11 September 2006, pp 46-58

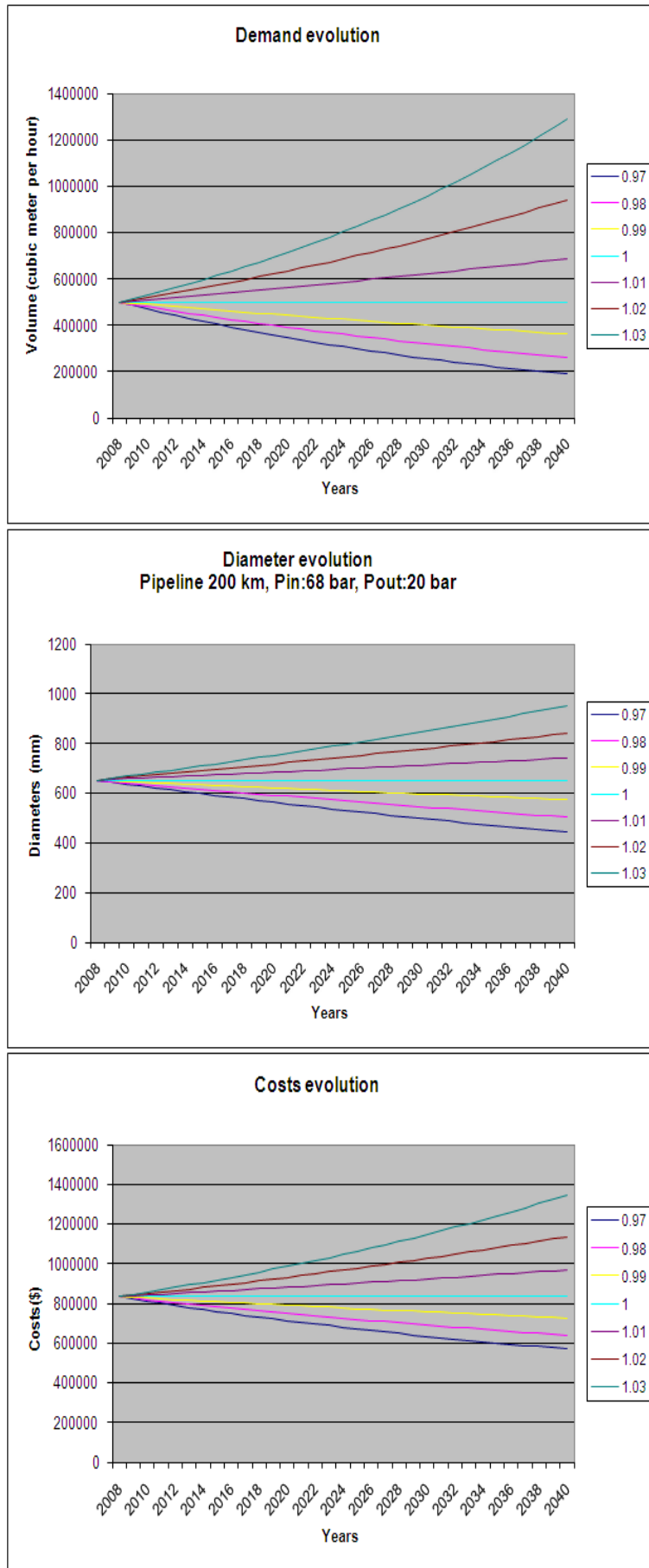

Figure 9.1: Demand/Diameter/Costs evolution with an error of annual increase rate

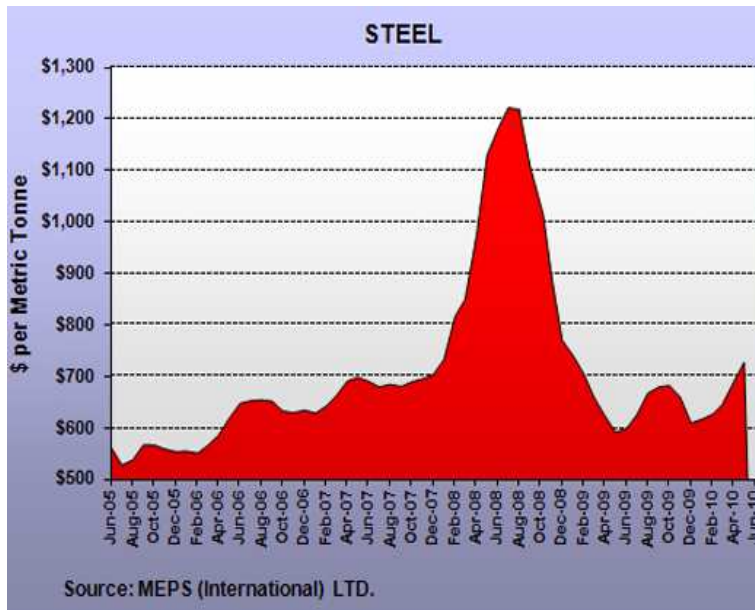

Figure 9.2: Steel Cost evolution

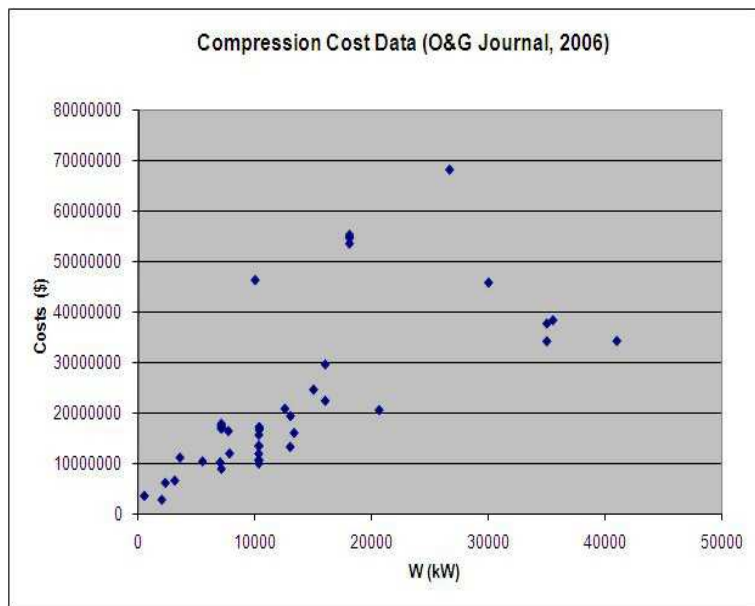

Figure 9.3: Compression Cost dispersion

## 9.4.2 A robust optimization model

To handle a set of possible scenarios for the input parameters, two main approaches can be used: Stochastic Programming [24] or Robust Optimization [66, 23]. Unlike the Stochastic Programs, Robust Optimization does not require any probability associated to the scenarios. Due to the difficulty to provide meaningful probabilities for the future scenario over a such long period and to the fact that the multi user and multi supplier scenarios have to be covered by the optimal decision variables **in any cases**, robust optimization is more suitable for this type of problems.

Two type of classical models existing in robust optimization [60] are the min/max cost and the min/max regret. The first one minimizes the maximal costs we can observe on each scenario (worst case approach) while the second one minimizes the maximal gap between the costs per scenario and the average value over all the scenarios.

If the objective investment function does not depend on the scenarios, the 2 frameworks are merged into one that minimize the objective function with respect to satisfy the constraints for each scenario.

This is the case in our problem if we limit the uncertainty to the demand with several demand vectors. The introduction of demand scenarios have multiplied the number of flowrate and pressure variables as well as the number of linear and non linear constraints. The challenge to solve such a program will be in the fact that the optimality is not guaranteed for each scenario. Estimation of the optimality gap could be useful to investigate. The complete mathematical formulation is exposed in Appendix B.4

# Bibliography

- [1] Abebe A.J., Solomatine D.P. Application of global optimization to the design of pipe networks. Proc. 3rd International Conference on Hydroinformatics, Copenhagen, August 1998.
- [2] Ainouche A., Economic Comparison of a number of Gas Supply Routes, 19th World Energy Congress, Sydney, 5-9 September 2004
- [3] Alperovich G., An economic interpretation of Braess' paradox. Int. J. Transport Economics 145 - 155 (1997)
- [4] An S., Li Q., Gedra T.W., Natural Gas and Electricity Optimal Power Flow, Proceedings of the IEEE/PES Transmission and Distribution Conference, and presented at the conference in Dallas TX, September 8, 2003.
- [5] André J., Bonnans F., Cornibert L., Optimization of capacity expansion planning for gas transportation networks, European Journal of Operational Research, Volume 197, Issue 3, Pages 1019-1027, September 2009
- [6] André J., Bonnans F., Optimal structure of gas transmission trunklines, Optimization and Engineering, Springer Netherlands Ed., Online first, November 2009
- [7] André J., Bonnans F., Cornibert L., Planning reinforcement of gas transportation networks using optimization methods. Proceedings of 19th Mini EURO Conference, Operational Research Methods and Models in the Energy Sector, 6-9 September 2006.
- [8] André J., Cornibert L., A tool to optimize the reinforcement costs of a gas transmission network, Proceedings of 38th Annual Meeting, Pipeline Simulation Interest Group, Williamsburg (VA), October 2006.
- [9] André J., Pillay T., Increasing the network capacity: Is it always the best choice?, Proceedings of 7th International Pipeline Conference, Volume 1, Paper no. IPC2008-64258 pp. 93-101, October, 2008.
- [10] André J., Brac J., De Wolf D., Ould Sidi M., Simonet A., Maisonnier G., Optimal Design and Dimensioning of Hydrogen Transmission Distribution Pipeline Networks, HEC Discussion Paper 2009 03/01, March 2009
- [11] Babonneau F., Vial J.Ph., NeatWork: A user guide. A decision support program for the design of gravity water distribution networks
- [12] Bakhouya B., De Wolf D., Solving the gas transmission problem with consideration of the compressors, ROADEF 9th conference, 2008

- [13] Bakhouya B., De Wolf D., Optimal dimensioning of pipe networks: the new situation when the distribution and the transportation functions are disconnected, 22th Conference on Quantitative Methods for Decision Making, 2008
- [14] Ball M., Wietschel M., Rentz O., Integration of a hydrogen economy into the German energy system: an optimising modelling approach, International Journal of Hydrogen Energy, Volume 32, Issues 10-11, Pages 1355-1368, July-August 2007
- [15] Bang Ye Wu, Kun-Mao Chao, Spanning Trees and Optimization Problems, Chapman & Hall/CRC Press, USA, 2004
- [16] Bhaskaran S., Salzborn F., Optimal design of gas pipeline networks. Journal of the operations research society, 30, pp.1047-1060, 1979
- [17] Babu B.V., Angira R., Chakole P.G., and Syed Mubeen J.H. Optimal Design of Gas Transmission Network Using Differential Evolution, Department of Chemical Engineering, Birla Institute of Technology & Science, Pilani-333031 (Rajasthan) India, 2003.
- [18] Bazaraa M.S., Sherali H.D., Shetty C.M., Nonlinear Programming, Theory and algorithms, Second Edition, John Wiley & Sons Inc., 1993
- [19] Boucly P., Conception optimale d'un réseau de transport, Support de formation "Information sur le transport et le stockage du gaz naturel", Centre de Formation aux Techniques gazières, AFGAZ, 1992
- [20] Bergendahl G., Efficient strategies for natural gas expansion under uncertainty : The case of Sweden, Energy Economics, Volume 10, Issue 2, Pages 100-106, April 1988.
- [21] Bean N.G., Kelly F.P., and Taylor P.G., Braess's paradox in loss networks. J. Applied Probability 34, 155 - 159, 1997
- [22] Bertsekas D.P., Dynamic programming and Optimal Control, Second Edition, Vol. 1. Massachusetts Institute of Technology. Athena Scientific, 2000.
- [23] Ben Tal A., Nemiroski A., Robust optimization methodology and applications, Mathematical Programming, Volume 92, Number 3, May, 2002.
- [24] Birge J.R., Louveaux F., Introduction to stochastic optimization, Springer series in Operations Research, 1997
- [25] Brimberg J., Hansen P., Lih K.W., Mladenovic N., Breton M., An Oil Pipeline Design Problem. Operations Research, Vol. 51, N.2, 228-239, March-April 2003.
- [26] BP Statistical Review of World Energy, BP p.l.c., June 2008
- [27] Bonnans J.F. and Shapiro A., Perturbation analysis of optimization problems, Springer-Verlag, New York, 2000
- [28] Boyd I.D., Surry P.D., Radcliffe N.J., Constrained Gas Network Pipe Sizing with Genetic Algorithms. Edinburgh Parallel Computing Centre, Technical Report 11, 1994

- [29] Braess D., Nagurney A., and Wakolbinger T., On a paradox of traffic planning. Translation from the original German *Transportation Science* 39, 446 - 450, 2005
- [30] Bonami, P., et al. An algorithmic framework for convex mixed integer non-linear programs, *Discrete Optimization* 5, 186-204, 2008
- [31] Calvert B. and Keady G., Braess'Paradox and Power-Law Nonlinearities in Networks, *J. Austral. Math. Soc. Ser. B*, volume 35, pages 1-22, 1993
- [32] Carter R., Pipeline Simulation Dynamic Programming after 30 years, PSIG Annual Meeting, 1998
- [33] Castello P., Tzimas E., Moretto P. and Paeteves S.D., 2005. Techno-economic assessment of hydrogen transmission and distribution systems in Europe in the medium and long term, European Commission, Joint Research Center.
- [34] Chapon M., Conception et Construction des réseaux de transport de gaz, Manuel pour le transport et la distribution du gaz, Livre IX, Edité par l'Association Technique de l'industrie du gaz en France, 1990, ISBN 2-86655-048-X
- [35] Cheeseman A. P., How to optimize Gas Pipeline Design by computer, *Oil & Gas Journal*, Vol. 69, pp. 64-68, December 1971,
- [36] Cleveland T., Milinusic M., Pipeline Optimization by Computer Simulation. International Pipeline Conference, 2000.
- [37] Didi Biha M., Kerivin H., Mahjoub A.R., Steiner Trees and polyhedra, *Discrete Applied Mathematics* 112, pp. 101-120, 2001
- [38] Dolan, A., Aldous J., *Networks and Algorithms, an Introductory Approach*, Ed. John Wiley & Sons, 1995
- [39] De Wolf D., Smeers Y., Optimal dimensioning of Pipe Networks with application to Gas Transmission Network. *Operations Research*, 44(4):596-608, 1996
- [40] De Wolf D., Janssens de Bisthoven O., Smeers Y.. The Simplex Algorithm Extended to Piecewise Linearly Constrained Problems II: An application to the Gas Transmission Problem. CORE Discussion Paper 9103, Université de Louvain, January 1991
- [41] De Wolf D., Smeers Y., The Gas Transmission Problem Solved by an Extension of the Simplex Algorithm, *Management Sciences*, Vol. 46, No 11, pp. 1454-1465, November 2000
- [42] Edgar T.F, Himmelblau D.M, Bickel T.C., Optimal Design of Gas Transmission Network, *Society of Petroleum Engineers Journal*, p. 96-104, 1978.
- [43] Friction Factors for large conduits flowing full. A Water Resources Technical Publication. Engineering Monograph n. 7, United States Department of the interior, Bureau of Reclamation, 1965, Reprinted: 1992.
- [44] Gill P., Murray W., Saunders M.A., SNOPT: An SQP Algorithm for Large-Scale Constrained Optimization, *SIAM Review*, 47(1):99-131, February 2005.



- [45] Gill P., Murray W., Saunders M.A., User's Guide of SNOPT Version 7: Software for Large-Scale Nonlinear Programming, Systems Optimization Laboratory, Stanford University, 2006.
- [46] GRTgaz, 10 year developement statement, 2008-2017, <http://www.grtgaz.com/>
- [47] Hafner M., Gaz naturel et production d'électricité : analyse technologique et économique de la génération d'électricité et du transport de gaz pour les pays du bassin méditerranéen, Thèse de doctorat, Ed. Technip, 1994
- [48] Hagstrom J.N., Abrams R.A., Characterizing Braess's paradox for traffic networks. Proc. of IEEE 2001 Conference on Intelligent Transportation Systems, pp. 837 - 842, 2001.
- [49] Hansen C.T., Madsen K., Nielsen H.B., Optimization of pipe networks. Mathematical Programming, 52:45-58, 1991.
- [50] Horst R., Tuy H., Global Optimization, Deterministic Approaches. Second, Revised Edition. Springer-Verlag, 1993.
- [51] International Energy Agency, <http://www.iea.org/Textbase/stats/surveys/NATGAS.PDF>,
- [52] International Energy Agency, Key Worlds Energy Statistics, 2006
- [53] International Energy Agency, Optimising investments and ensuring security in a high-priced environment, <http://www.iea.org/textbase/nppdf/free/2008/gasmarket2008.pdf>
- [54] John F., Extremum problems with inequalities as subsidiary conditions, in "Studies and Essays, R. Courant anniversary volume, Interscience, New York, p. 187-204, 1948.
- [55] Joulié R., Mécanique des fluides appliquée. Editions Ellipses, 1998.
- [56] Kabirian A., Hemmati M.R., A strategic planning model for natural gas transmission networks, Energy policy, Vol. 35, pp. 5656-5670, 2007
- [57] Katz D.L., Cornel D., Kobayashi R., Poettmann F.H., Vary J.A., Elenbaas J.R., Weinaug C.F., Handbook of Natural Gas Engineering, McGraw-Hill Book Company, Inc., New York, USA, 1959
- [58] Kubat P., MaxGregor Smith J., A multi-period network design problem for cellular telecommunication systems. European Journal of Operational Research 134, 439-456, 2001.
- [59] Keady G., The Colebrook-White formula for pipe networks. (Preprint Jan. 1995) J. Hydraulic Engineering (Amer.Soc.Civil Engineers), 1998.
- [60] Klopfenstein O., Robust Optimisation of telecommunications networks, PhD thesis, July 2008
- [61] Kolota G., What if They Closed 42d Street and Nobody Noticed?, The New York Times, 1990

- [62] Kralik, J., Stiegler P., Vostry Z.,Zavorka, J., SIMONE - A universal dynamic simulation model of gas pipeline networks, World Gas Conference, June 1988
- [63] Lang P., Transmission-System Design, The Journal of the Operational Research Society, Vol. 39, No. 5, pp. 459-466, May, 1988
- [64] Lauriere J.L., Eléments de programmation dynamique, Gauthier-Villars New York, Recherche opérationnelle appliquée 3, 1979.
- [65] Lin, Fan, Ogden, Sperling, The Hydrogen Infrastructure Transition Model (HIT) & Its Application in Optimizing a 50-year Hydrogen Infrastructure for Urban Beijing, UCD-ITS-RR- 06-05, 2005.
- [66] Malcolm S.A., Zanios S.A., Robust Optimization for Power Systems Capacity Expansion, Journal for Operational Research Society, Vol. 45, Number 9, pp. 1040-1049, 1994
- [67] Manojlovic V., Arsenovic M., Pajovic V., Optimized Design of a Gas-Distribution Pipeline Network. Applied Energy, 48:217-224, 1994.
- [68] Maugis J.J., Etude de réseaux de transport et de distribution de Fluide. RAIRO Recherche Oprationnnelle/Operations Research, 11(2):243-248, May 1977.
- [69] Minoux M., Mathematical programming: Theory and algorithms, New York, Wiley, 1986.
- [70] Martin A., Muller M., Moritz S., Mixed Integer Models for the Stationary Case of Gas Network Optimization, Math Program., Ser.B 105, 563-582, 2006
- [71] Midthun Kjetil Trovik, Optimization models for liberalized natural gas markets, NTNU, PhD Thesis, October 2007
- [72] Mangasarian O., Fromovitz S., The Fritz-John necessary optimality conditions in the presence of equality and inequality constraints. Journal of Mathematical Analysis and Applications 7, p. 37-47, 1967
- [73] Mohitpour, Golshan and Murray, Pipeline Design and Construction - A Practical Approach. Second Edition, ASME Press, USA, 2003
- [74] Mohring et al, Automated model reduction of complex Gas Pipeline Networks, PSIG Annual Conference, 2003
- [75] Murtagh B.A. and Saunders M.A., MINOS 5.5 USERS GUIDE. Technical Report SOL 83- 20R, Revised July 1998, Systems Optimization Laboratory, Department of Operations Research, Stanford University, Stanford, California 94305-4022, 1998.
- [76] Chiffres clés de l'énergie 2009, Ministère du developpement durable et de l'énergie, Edition Décembre 2009
- [77] Transporting Britains Energy 2009: Development of Energy Scenarios, National Grid, <http://www.nationalgrid.com/>

- [78] Nikuradze I., Features of the turbulent motion of fluids in smooth tubes, Problems of Turbulence, Ob'yed. Nauchno-Tekhn, Izd., Moscow, 1936, pp. 75150. Reprinted in english in J. Nikuradze, NACA Tech. Memo. 1292, 1950.
- [79] Nie Ting Ze, Optimal Lay-Out of Natural Gas Pipeline Network, 23rd World Gas Conference, Amsterdam, 2006.
- [80] Osiadacz A.J., Gorecki M., Optimization of Pipe Sizes for Distribution Gas Network Design. PSIG Conference, 27th Annual Meeting, October 1995.
- [81] Osiadacz A.J., Simulation and Analysis of Gas Networks, E. & F.N. Spon, London, 1987
- [82] Olorunniwo F.O., Jensen P.A., Optimal Capacity Expansion policy for natural Gas transmission networks-A decomposition approach. Engineering Optimization, Vol. 6, pp. 13-30, 1982
- [83] Parker N., Using Natural gas Transmission Pipeline Costs to Estimate Hydrogen Pipeline Costs, Technical report No. UCD-ITS-RR-04-3, Institute of Transportation Studies, University of California, Davis, 2005.
- [84] Patay E., Ghaffari A., Minoux M., Perrin J., Surrogate approximation for the cost evaluation of infrastructure development for hydrogen as an automotive fuel, Proceedings 19th Mini EURO Conference on the Energy Sector, ORMMES 06, 6-9 September 2006
- [85] Penchina C.M. and Penchina L.J., The Braess paradox in mechanical, traffic, and other networks. Amer. J. Phys. 71, 479 - 482, 2003
- [86] Peureux E., Casoetto B., Pillay T., Benoit M., Method for the automatic optimization of a natural gas transport network, US Patent 7561928, July, 14, 2009
- [87] Rockafellar R.T., Network flows and monotropic optimisation, Wiley, New York , 1984
- [88] Rockafellar R.T., Convex analysis, Princeton University Press, 1996.
- [89] Roughgarden T., On the severity of Braess's paradox: Designing networks for selfish users is hard. J. of Computer and System Sciences 72, 922 - 953, 2006
- [90] Rothfarb B., Frank H., Rosenbaum D.M., Steiglitz K and Kleitman D.J., Optimal design of offshore natural-gas pipeline systems. Operations research, 18(6), p. 992-1020, 1970
- [91] Smit R., Weeda M., De Groot A. Hydrogen infrastructure development in The Netherlands, International Journal of Hydrogen Energy 32, p. 1387-1395, 2007
- [92] Soliman F.I., Murtagh B.A., The solution of large-scale Gas Pipeline Design Problems, Engineering Optimization, Volume 6, Issue 2, pages 77 - 83, 1982
- [93] Surry P.D., Radcliffe N.J., Boyd I.D., A Multiobjective Approach to Constrained Optimisation of Gas-Supply Networks: The COMOGA Method. Evolutionary Computing: AISB Workshop. T.C. Fogarty, Springer-Verlag LNCS, 993:166-180, 1995.

- [94] Tabkhi F., Azzaro-Pantel C., Pibouleau L., Domenech S., Optimisation de Réseaux de Transport de Gaz Naturel, 6ieme Colloque des Systemes d'Information, Modélisation, Optimisation et commande en génie des procédés (SIMO'06), Toulouse, 11-12 octobre 2006
- [95] Tabkhi F., Optimisation de Reseaux de Transport de gaz, PhD Thesis, Institut National Polytechnique de Toulouse, December 2007
- [96] Tabkhi F., Azzaro-Pantel C., Pibouleau L., Domenech S., Total Cost Minimization of a High-Pressure Natural Gas Network, J. Energy Resour. Technol., Volume 131, Issue 4, December 2009
- [97] Tancre M., Conception optimale d'un réseau de transport, Support de formation "Information sur le transport et le stockage du gaz naturel", Centre de Formation aux Techniques gazières, AFGAZ, 25 au 28 Novembre 2002.
- [98] Triadou C., Dimensionnement de réseau multipériode et relaxation Lagrangienne. Actes du Congrès ROADEF, 2003.
- [99] Tomasgard A., Romo F., Fodstad M. and Midthun K., Optimization Models for the Natural Gas Value Chain in Geometric Modelling, Numerical Simulation, and Optimization, Applied Mathematics at SINTEF,
- [100] US Energy Information Administration-Natural Gas Pipelines-Transportation Process and Flow, <http://www.eia.doe.gov/>
- [101] European Directive on security of natural gas supply, [http://europa.eu/legislation\\_summaries/energy/](http://europa.eu/legislation_summaries/energy/)
- [102] Van der Hoeven T., Math in gas and the art of linearization, Gasunie, Energy Delta Institute, Hollande, March 2004.
- [103] Van Vuuren SJ, Application of genetic algorithms: Determination of the optimal pipe diameters. Water SA, 28(2), p. 217-226, April 2002.
- [104] Walters G.A., 1987. Dynamic programming approach to the optimal design of tree-like networks. Proceedings of the international conference on Optimization Techniques and Applications, Singapour, Singapore, p. 487-496.
- [105] Wu S., Rios-Mercado R.Z., Boyd E.A., and Scott R.L., Model relaxations for the fuel cost minimization of steady-state gas pipeline networks. Technical report, TR-99-01, Dept. of Computer Science, University of Chicago, January 1999.
- [106] Yang C. & Ogden J., Determining the lowest-cost hydrogen delivery mode. International Journal of Hydrogen Energy, 32(2), p. 268-286, 2007.
- [107] Yi F., Capacity planning for a natural gas pipeline in Sweden. Energy Economics, p. 211-215, July 1990.
- [108] Zhang J., Zhu D., A Bilevel Programming Method for Pipe Network Optimization. SIAM Journal on Optimization, 6(3), p. 838-857, 1996.

# Appendix A

## Compression power: Numerical approximations

The extended compression power formula can be written as follows:

$$W = \frac{1}{\eta_{ad}} \cdot \frac{100 \cdot P_0}{3600 \cdot T_0} \cdot T^i \cdot \frac{Z^m(P^j, P^i)}{Z_0} \cdot \frac{\gamma}{\gamma - 1} \cdot Q \cdot \left( \left( \frac{P^j}{P^i} \right)^{\frac{\gamma-1}{\gamma}} - 1 \right)$$

with the following constants:

- $P_0=1.01325$  bar,
- $T_0=273.15$ K,
- $\gamma = 1.309$ ,
- $Z_0 = 1$ ,
- $\eta_{ad}$ , efficiency constant, set to 0.75 for centrifugal turbine compressor associated to gas turbine,
- $T^i$ , the inlet temperature (Kelvin),

$Z^m(P^i, P^j)$ , the average compressibility factor depends itself on the inlet and the outlet pressure. It is calculated as follows:

$$Z^m = \frac{Z^i + Z^j}{2},$$

$$Z^k = \max(\min(1 + C_4^k \cdot P^k, 1), 0.6), k = i \text{ or } j$$

with

$$C_4^k = \frac{1}{1050} \cdot (0.1 \cdot HV + d - 1) \cdot (0.04 \cdot (T^k - T_0) - 3.6)$$

and the outlet temperature given by:

$$T^j = T^i + \frac{T^i}{\eta_{ad}} \cdot \left( \left( \frac{P^j}{P^i} \right)^{\frac{\gamma-1}{\gamma}} - 1 \right)$$

$HV$ , the Heating Value ( $\text{kWh}/\text{m}^3$ ) and  $d$ , the density depends on the gas quality (usually  $HV = 11.2 \text{ kWh}/\text{m}^3(\text{n})$  and  $d = 0.62$ ).

This power is adjusted to recover ISO conditions at 15C:

$$W_{ISO} = \frac{W}{pf_1 \cdot pf_2 \cdot pf_3}$$

with  $pf_1 = 0.95, pf_2 = 0.97, pf_3 = 0.98$ .

In the simplified formulation:

$$W = \gamma_1 \cdot Q \cdot \left( \left( \frac{P^j}{P^i} \right)^{\gamma_3} - \gamma_2 \right) \quad (\text{A.1})$$

the calculation of  $\gamma_2, \gamma_3$  is the following:  $\gamma_2 = 1$  et  $\gamma_3 = \frac{1.309-1}{1.309} \simeq 0.236$ .

Selecting average values on the factors  $Z_m = 0.9$  (assuming that this factor is no longer depending on inlet and outlet pressures),  $T^i = 288.15K$ ,  $\eta_{ad} = 0.75$  for turbine driven (0.8 for a engine driven), the calculation gives  $\gamma_1 \simeq 0.167$  with turbine (0.157 with an engine).

# Appendix B

## Extended Models: Mathematical formulation

### B.1 Installation of new compressor stations

The objective function includes the compression costs introduced in the Model 1:

$$C_{comp} = \alpha^c W \left( \frac{\pi^j}{\pi^i} \right) + B, \quad (\text{B.1})$$

The two binary variables are  $d_i = 1$  if the compression station is opened in the "direct" direction and  $e_i = 1$  if the compression station is opened in the "backward" direction and 0 in the other case.

Model 3 is extended by adding the following big-M constraints (assuming that we know extreme maximal values for  $\hat{Q}, \hat{\tau}, \hat{W}$ ) to the existing constraints (i) to (viii):

$$\left\{ \begin{array}{l} \text{(ix)} \quad e_i + d_i \leq 1 \\ \text{(x)} \quad e_i, d_i \in [0; 1] \\ \text{(xi)} \quad -\hat{Q}_i + d_i(Q_i^{min} + \hat{Q}) \leq Q_i \leq \hat{Q}_i + d_i(Q_i^{max} - \hat{Q}) \\ \text{(xii)} \quad -\hat{Q}_i + e_i(-Q_i^{min} + \hat{Q}) \leq Q_i \leq \hat{Q}_i + e_i(Q_i^{max} - \hat{Q}) \\ \text{(xiii)} \quad d_i * W_i^{min} - (1 - d_i)\hat{W}_i \leq W_i \leq d_i * W_i^{max} + (1 - d_i)\hat{W}_i \\ \text{(xiv)} \quad e_i * W_i^{min} - (1 - e_i)\hat{W}_i \leq -W_i \leq e_i * W_i^{max} + (1 - e_i)\hat{W}_i \\ \text{(xv)} \quad d_i * \tau_i^{min} - (1 - d_i)\hat{\tau}_i \leq \tau_i \leq d_i * \tau_i^{max} + (1 - d_i)\hat{\tau}_i \\ \text{(xvi)} \quad e_i * \tau_i^{min} - (1 - e_i)\hat{\tau}_i \leq -\tau_i \leq e_i * \tau_i^{max} + (1 - e_i)\hat{\tau}_i \end{array} \right. \quad (\text{B.2})$$

and the following objective function:

$$\min_{(DD, Q, \pi, e_i, d_i)} \sum_{a \in A_{pipe}} c_a(DD_a) + \sum_{i \in N} (e_i + d_i) \cdot C_{comp}(W_i) \quad (\text{B.3})$$

### B.2 Installation of additional compression power

Let us consider that the maximal bounds on compression station are becoming variables that can not take values below the existing capacities:  $\overline{W}_a \geq W_a^{max}$ .

Thus, the Model 3 can be extended in such way:

$$\min_{(DD, Q, \pi, \bar{W})} \sum_{a \in A_{pipe}} c_a(DD_a) + \sum_{a \in A_{comp}} C_{comp}(\bar{W}_a) \quad (B.4)$$

$$\left\{ \begin{array}{l} \text{(i)} \quad DD_a \in \{0, \Delta_a^1, \dots, \Delta_a^k, \dots, \Delta_a^{max}\}, \forall a \in A_{pipe} \\ \text{(ii)} \quad \pi_a^i - \pi_a^j = C_a \cdot Q_a \cdot |Q_a| \cdot (DI_a^s + DD_a^s)^{-5/s}, \\ \quad \quad \forall a \in A_{pipe} \\ \text{(iii)} \quad M_{reg}^T \pi \geq 0 \\ \text{(iv)} \quad W_a^{min} \leq W_a(Q_a, \pi_a^i, \pi_a^j) \leq \bar{W}_a, \forall a \in A_{comp} \\ \text{(v)} \quad \tau_a^{min} \leq \tau_a(\pi_a^i, \pi_a^j) \leq \tau_a^{max}, \forall a \in A_{comp} \\ \text{(vi)} \quad \pi^{min} \leq \pi \leq \pi^{max} \\ \text{(vii)} \quad 0 \leq Q_a^{min} \leq Q_a \leq Q_a^{max}, \forall a \in A_{reg} \cup A_{comp} \\ \text{(viii)} \quad MQ = b \\ \text{(ix)} \quad \bar{W}_a \geq W_a^{max} \end{array} \right.$$

### B.3 Strategic/Operational bilevel model

With a given maximal compression power (denoted  $\bar{W}$ ), the operating costs of a station corresponds to the energy consumption (kWh) required for running the station. This cost linearly depends on the natural gas as a fuel converted into energy:

$$c_{oper}^{comp} = \alpha_{oper}^{comp} \cdot \frac{HCV}{LCV \cdot \eta_{therm}} \cdot W \quad (B.5)$$

with :

- $\alpha_{oper}^{comp}$ , the unit cost of energy (in k€/kWh),
- HCV et LCV, the highest and lowest caloric value of the gas (en  $KWh/m^3$ ),
- $\eta_{therm}$ , thermal efficiency

The bi-level program can be formulated as follows:

$$\left\{ \begin{array}{l} \min_{(Deq, \bar{W})} CAPEX_{pipe}(Deq) + CAPEX_{comp}(\bar{W}) + OPEX(Deq, \bar{W}) \\ Deq_a \in \{0, Deq^1, Deq^2, \dots, Deq^l\}, \forall a \in A_{pipe} \\ \bar{W}_a \geq W_a^{max}, \forall a \in A_{comp} \\ OPEX(D, \bar{W}) = \left\{ \begin{array}{l} \min_{(Q, \pi)} \sum_{a \in A_{comp}} W_a(Q_a, \pi_a^i, \pi_a^j) \\ MQ = b \\ M_{reg}^T \pi \geq 0 \\ Q_a |Q_a| = K_a^2 Deq_a^5 (\pi_a^i - \pi_a^j), \forall a \in A_{pipe} \\ 0 \leq W_a(Q_a, \pi_a^i, \pi_a^j) \leq \bar{W}_a, \forall a \in A_{comp} \\ \underline{\pi}_i \leq \pi_i \leq \bar{\pi}_i, \forall i \in N \end{array} \right. \end{array} \right. \quad (B.6)$$

$$\text{with } c_{dim}^{comp}(\bar{W}) = \sum_{a \in A_{comp}} \alpha_{comp} \cdot \bar{W}_a + B$$

### B.4 Robust Optimization model

Let us denote the scenario index  $sc \in Scen$ . Two type of classical models existing in robust optimization [60] are the min/max cost and the min/max regret:

- min/max cost :

$$\min\{max_{sc} f_{sc}(x) | \forall sc, g_{sc}(x) \geq 0\}$$



- min/max regret

$$\min\{\max_{sc}(f_{sc}(x) - z_{sc})|\forall sc, g_{sc}(x) \geq 0\}$$

with  $z_{sc}$  the optimal value for each scenario.

If the objective investment function does not depend on the scenarios, the 2 frameworks are merged into one:

$$\min\{f(x)|\forall sc, g_{sc}(x) \geq 0\}$$

Let us state several demand vectors  $b_{sc}$ . The robust extended program of 5.11 in Model 3 will be the following:

$$\left\{ \begin{array}{l} \min_{(DD, Q_{sc}, \pi_{sc})} \sum_{a \in A_{pipe}} c_a(DD_a) \\ \text{(i)} \quad DD_a \in \{0, \Delta_a^1, \dots, \Delta_a^k, \dots, \Delta_a^{max}\}, \forall a \in A_{pipe} \\ \text{(ii)(sc)-} \quad \dots \\ \text{(vii)(sc)} \\ \text{(viii)} \quad MQ_{sc} = b_{sc}, \forall sc \text{ in } Scen \end{array} \right. \quad (\text{B.7})$$