



HAL
open science

Wireless Network Architecture for Long range Teleoperation of an Autonomous System

Zeashan Hameed Khan

► **To cite this version:**

Zeashan Hameed Khan. Wireless Network Architecture for Long range Teleoperation of an Autonomous System. Automatic. Institut National Polytechnique de Grenoble - INPG, 2010. English. NNT: . tel-00545474

HAL Id: tel-00545474

<https://theses.hal.science/tel-00545474>

Submitted on 10 Dec 2010

HAL is a multi-disciplinary open access archive for the deposit and dissemination of scientific research documents, whether they are published or not. The documents may come from teaching and research institutions in France or abroad, or from public or private research centers.

L'archive ouverte pluridisciplinaire **HAL**, est destinée au dépôt et à la diffusion de documents scientifiques de niveau recherche, publiés ou non, émanant des établissements d'enseignement et de recherche français ou étrangers, des laboratoires publics ou privés.

Université de Grenoble

No. attribué par la bibliothèque

--	--	--	--	--	--	--	--	--	--	--	--	--	--	--	--	--	--	--	--

THESE

pour obtenir le grade de

DOCTEUR DE L'UNIVERSITÉ DE GRENOBLE

Spécialité : AUTOMATIQUE-PRODUCTIQUE

préparée au Laboratoire GIPSA (Grenoble Image Parole Signal et Automatique)

dans le cadre de l'École Doctorale :

Électronique, Électrotechnique, Automatique, Traitement du Signal

présentée et soutenue publiquement

par

Zeashan Hameed KHAN

le 30 Novembre 2010

Titre :

**Wireless Network Architecture for Long range Teleoperation of an
Autonomous System**

JURY :

M. Michel ROBERT	Président
M. Abdelhamid MELLOUK	Rapporteur
Mme. Mireille BAYART	Rapporteur
M. Eric BENOIT	Examineur
M. Jean Marc THIRIET	Directeur de thèse
M. Denis GENON-CATALOT	Co-encadrant

To my parents,

my wife &

my children

Acknowledgement

My sincere thanks go to my advisor Jean Marc Thiriet, who was always the driving force and motivation for me. His trust and confidence from the very beginning gave me the opportunity of participating in this challenging research problem. His involvement with his originality has triggered and nourished my intellectual maturity that I will benefit from, for a long time to come. I would like to thank my co-advisor Denis Genon Catalot for his guidance, enthusiasm and his cooperation throughout the thesis duration. This work has greatly benefited from his comments and advice. I would also like to thank the jury members for their precious time and effort that they put to validate my research work. It was very encouraging for me that you accepted to be a part of my thesis jury.

My research group members namely Nadine, Sylvian, Alain, Suzanne, Daniel, Sylvie, Florent, Pierre, Christine and Michèle were the inspiring people and members of SA-IGA team at GIPSA-lab. A large and interdisciplinary research thesis such as my work can only be realized through a team work. My friends in the control systems department Amine, Mohamad and Hieu have actually participated in my work by encouraging with their constant support.

I gratefully acknowledge Jonathan Dumon (IE) of NeCS-team at GIPSA-lab, headed by Mr. Carlos Canudas de Wit (DR-CNRS), for his sincere advice and crucial contribution in the experimental work, which made him a backbone of this research and so to this thesis. My thanks goes to all GIPSA-lab, specially people in Automatic Control department, for their help, sincerity and permitting me to work in an ideal research environment. Thank you very much for all the inspirational discussions and experiences we shared over the years. I am also very much grateful to Marie-Thérèse, Patricia, Virginie, Daniel, Didier, Thierry and Olivier. I am specially thankful to Christian Commault, director of the ED-EEATS who encouraged me to continue my thesis in GIPSA-lab.

As my thesis was financed through Pak-France collaborative program, I am thankful to Higher Education Commission of Pakistan and Société Française d'Exportation des Ressources Educatives (SFERE) for their continuous funding and guidance throughout these four years. Finally, I would like to thank everybody who was important to the successful realization of my thesis, as well as expressing my apology that I could not mention personally one by one.

Zeashan H. Khan

Table of Contents

0.1	Overview of the thesis	26
0.1.1	Contribution	26
0.1.2	Thesis Outline	26
0.2	Journal and Best Paper Award	28
0.3	Conference Papers	29
0.4	Short Papers/Posters	30
1	State of the Art in Teleoperation	31
1.1	Introduction	31
1.2	Problem description	31
1.3	History of Teleoperation	33
1.4	Basic Concepts and Definitions	34
1.5	Types of Teleoperation	34
1.5.1	Unilateral Teleoperation	35
1.5.2	Bilateral Teleoperation	36
1.5.3	Supervisory Teleoperation	37
1.5.4	Coordinated Teleoperation	38
1.6	Teleoperation Requirements	38
1.7	Controller Design for Teleoperation	40
1.8	Network Selection for Teleoperation	41
1.9	Problems and Challenges	42
1.9.1	Controller Constraints	42
1.9.2	Computational Constraints	43
1.9.3	Communication Constraints	43
1.9.4	Delay in Teleoperation	44
1.9.5	Communication Imperfections	45
1.9.6	Master and Slave Synchronization	45
1.9.7	Cognitive Fatigue	46
1.9.8	Reliability Features	46
1.9.9	Manual and Autonomous Teleoperation	46
1.10	Application Areas	47
1.10.1	Remote manipulation	47
1.10.2	Telesurgery/Telemedicine	47
1.10.3	Vehicular control	49
1.10.4	Industrial Mining	52
1.10.5	Realtime Gaming	53
1.10.6	Cooperative Control	53
1.10.7	Distributed Computing	53

1.11	Conclusion	54
2	Quality of Service for Teleoperation	55
2.1	Introduction	55
2.2	Classification of QoS in Networked Teleoperation	56
2.2.1	Objective QoS	56
2.2.2	Subjective QoS	57
2.3	Network QoS	59
2.4	Media Access Methods (MDMs)	60
2.4.1	Centralized Access Method (CAM)	60
2.4.2	Decentralized/Distributed Access Methods (DAM)	60
2.5	Communication Channels	61
2.6	Quality of Service	62
2.6.1	Delay Types	62
2.6.2	Bandwidth and Packet Loss Ratio	63
2.6.3	QoS Perspectives	64
2.6.4	QoS Metrics	64
2.6.5	Factors Contributing to QoS	64
2.6.6	QoS in Wireless Networks	67
2.6.7	QoS Measurement	69
2.7	Types of Communication Networks	69
2.8	Types of Network Architecture	70
2.8.1	Network structure	70
2.8.2	Mobility	72
2.8.3	Connection of nodes	72
2.8.4	Interface/Interconnection	73
2.8.5	Number of Tier	73
2.8.6	Transmission Mode	74
2.9	Wired Networks	74
2.9.1	Local Area Networks (LANs)	74
2.9.2	Field buses	75
2.10	Wireless Networks	77
2.10.1	Wireless Sensor and actuator Network (WSAN)	77
2.10.2	Wireless LAN	79
2.10.3	Narrowband, Broadband and 3G	80
2.10.4	Application areas and Architectures	81
2.11	Network Traffic Characteristics	82
2.11.1	QoS Mechanisms and Methods	83
2.11.2	QoS Implementation	85
2.11.3	QoS in end-to-end IP Network	86
2.12	OSI Network architecture with QoS Contribution	88
2.12.1	QoS in OSI layers	88
2.12.2	QoS in Hybrid/Heterogeneous Wireless Networks	90
2.13	Conclusion	93
3	Control and Performance in Networked Teleoperation	95
3.1	Introduction	95
3.2	Control Architectures in Teleoperation	95
3.2.1	Adaptive Control	96
3.2.2	Robust Control	96

3.2.3	Damping Control	96
3.3	Passive Teleoperation architectures	97
3.3.1	Lawrence Architecture	98
3.3.2	Stability by Passivity	99
3.3.3	Anderson and Spong Architecture	100
3.3.4	Chopra and Spong Position Tracking Architecture	101
3.3.5	Recent Approaches in Passive Teleoperation	103
3.4	Effect of Digital Implementation	103
3.5	Effect of Network on Passive Teleoperation	104
3.5.1	Packet Loss Effect	105
3.5.2	Energy Supervised Data Reconstruction	105
3.6	Transparence in Teleoperation	105
3.6.1	H-matrix based transparence	106
3.6.2	Transparence Performance measurement	106
3.7	Compromise between Stability and Transparence	108
3.8	Conclusion	108
4	Networked Teleoperation- A Co-design Approach	109
4.1	Introduction	109
4.2	The Co-design Problem in NCS	110
4.2.1	Control of Network (CofNet)	110
4.2.2	Control over Network (CoverNet)	112
4.2.3	Co-design in Networks (CofNet for CoverNet)	113
4.3	Methods in Co-design	113
4.3.1	Static Controller Static Network (SCSN)	113
4.3.2	Dynamic Controller Static Network (DCSN)	114
4.3.3	Static Controller Dynamic Network (SCDN)	114
4.3.4	Dynamic Controller Dynamic Network (DCDN)	115
4.4	Real Time Multimedia for Teleoperation	116
4.4.1	Effect of packet loss on video quality	117
4.4.2	Effect of video quality on driver's performance	118
4.4.3	NeCS-Car Example	119
4.5	Co-Adaptation for Co-design	120
4.6	QoS Classification and Prediction	121
4.7	Comparison of different estimation techniques	123
4.7.1	Criteria	123
4.7.2	Test Conditions	124
4.7.3	Comparison tests	124
4.8	Co-design in Networked Teleoperation without QoS provisions	125
4.8.1	Pre-filtering	125
4.8.2	Quality of Service Estimation	126
4.8.3	Gain Scheduling	130
4.8.4	Quality of Control Estimation	130
4.8.5	Network QoS Control through Adaptation	132
4.8.6	Network Block	132
4.9	Co-design with QoS oriented Network Architecture	133
4.10	Prediction of Network Parameters	134
4.10.1	Training sets	134
4.10.2	SVM based Prediction Formulation	134
4.10.3	Prediction of Network Traffic	135

4.10.4	Prediction of Network delay and Packet losses	137
4.11	Conclusion	137
5	Teleoperation of a Steer-by-Wireless Benchmark	139
5.1	Introduction	139
5.2	NeCS-Car Steer-by-Wireless Benchmark	139
5.2.1	Hardware and Communication	140
5.2.2	Hybrid Network Architecture	142
5.3	Implementation of the Position Control Architecture	142
5.3.1	Non-reversible mechanism	144
5.3.2	Stability of the Time Varying Gain Scheduled Controller	145
5.4	NeCS-Car Modeling and Simulation	146
5.4.1	Criteria for Transparency	147
5.4.2	Analysis of Transparency with H-matrix	148
5.4.3	Simplified Co-design Architecture	153
5.4.4	Application to Networked Teleoperation	154
5.5	Implementation Results	155
5.5.1	Case-1: Static lab Tests	155
5.5.2	Case-2: Dynamic Tests	158
5.5.3	QoS Oriented Network Architecture	160
5.6	Conclusion	162
	Bibliography	165
A	NeCS-Car Parameters	183
B	Estimation of worst case M_s and B_{s_2}	185
C	Identification of TF	187
D	Reversibility Improvement in NeCS-Car	189
E	Introduction to Fuzzy Inference	195
F	Background on Support Vector Machines (SVM)	197

Abbreviations

AC	Access Categories
ACK	Acknowledgement
AODV	Ad-hoc On Demand Distance Vector routing Protocol
AIMD	Additive Increase, Multiplicative Decrease
AMP	Arbitrary Message Priority
ANFIS	Adaptive Neuro-Fuzzy Inference
AR	Augmented Reality
ASV	Autonomous Surface Vehicle
AWGN	Adaptive White Gaussian Noise
BEC	Binary Erasure Channel
BER	Bit Error Rate
BNC	Binary Noiseless Channel
BPSK	Binary Phase Shift Keying
CAM	Centralized Access Method
CAN	Controller Area Network
CBR	Constant Bit Rate
CDMA	Code Division Multiple Access
DAM	Decentralized Access Method
DiffServ	Differentiated Services
DVB	Digital Video Broadcasting
E2E	End to End
EDF	Earliest Deadline First
EDGE	Enhanced Data Rates for GSM Evolution
ETSI	European Telecommunication Standard Institute
FBN	Field Bus Network
FDI	Fault detection and Isolation
FDMA	Frequency division multiple access
FEC	Forward Error Correction
FER	Frame Error Rate

FIP	Factory Instrumentation Protocol
FIS	Fuzzy Inference System
FTC	Fault Tolerant Control
GNC	Guidance, Navigation and Control
GPRS	Global Packet Radio System
HSDPA	High Speed Downlink Packet Access
HSUPA	High Speed Uplink Packet Access
HTML	Hypertext Markup Language
IEEE	Institute of Electrical and Electronics Engineers
IETF	Internet Engineering Task Force
IntServ	Integrated Services
IP	Internet Protocol
ITU	International Telecommunication Union
JMF	Java Media Framework
JND	Just Noticeable Difference
HTML	Hypertext Markup Language
IRM	Intelligent Reconfiguration Monitor
ISDN	Integrated Services Digital Network
ISI	Inter Symbol Interference
ISM	Industrial, Scientific and Medical Band
LMI	Linear Matrix Inequalities
LOS	Line of Sight
LQI	Link Quality Indicator
LQR	Linear Quadratic Regulator
LQG	Linear Quadratic Gaussian
LTI	Linear Time Invariant
MANET	Mobile Ad hoc Network
MATI	Maximum Allowable Transmission Interval
MAM	Media Access Method
NCS	Networked Control System
MIMD	Multiple Increase Multiple Decrease
MOS	Mean Opinion Score
MPBW	Minimum Perception Bandwidth
MPLS	Multi Protocol Label Switching
NT	Networked Teleoperation
OLSR	Optimized Link State Routing
OSI	Open Systems Interconnection
OSPF	Open Shortest Path First

PBR	Peak Bit rate
PCF	Point Coordination Function
PHY	Physical Layer
PRNet	Packet Radio Network
PRBS	Pseudo Random Binary Signal
PSK	Phase Shift Keying
PSNR	Peak SNR
PSTN	Public Switched Telephone Network
QAM	Quadrature Amplitude Modulation
QoS	Quality of Service
QoC	Quality of Control
RoB	Requirement of Bandwidth
RPG	Rack and Pinion Gearset
RTP	Real time Protocol
RTCP	Real time Transmission Control Protocol
RTS	Request To Send
RTT	Round Trip Time
RSVP	Resource Reservation Setup Protocol
SBW	Steer By Wire
SCTP	Stream Control Transmission Protocol
SINR	Signal to Interference plus Noise Ratio
SLA	Service Level Agreement
SNR	Signal to Noise Ratio
SGT	Small Gain Theorem
SURAN	Survivable Radio Networks
TdS	Time delay Systems
TDMA	Time division multiple access
TMR	Triple Modular Redundancy
ToS	Type of Service
UAV	Unmanned Aerial Vehicle
UDP	User Datagram Protocol
UMTS	Universal Mobile Telecommunication System
UWV	Underwater Vehicle
VAD	Voice Activity Detection
VBR	Variable Bit rate
VLAN	Virtual LAN
VoIP	Voice over IP
WiMAX	World wide Interpretability for Microwave Access

Wifi..... Wireless Fidelity
WLAN Wireless Local Area Network
WMAN Wireless Metropolitan Area Network
WNCS Wireless NCS
WSN..... Wireless Sensor Network

List of Figures

1	Teleoperation over Network - Problem description	26
2	Thesis structure and interconnection of chapters	28
1.1	Unilateral Teleoperation	35
1.2	Bilateral Teleoperation with Camera Feedback	36
1.3	Bilateral Teleoperation with Camera and Force Feedback	36
1.4	Haptic and force feedback in Networked Teleoperation	39
1.5	Haptic Interfaces for Teleoperation (source: www.sensable.com , www.forcedimension.com)	40
1.6	Network delay Composition	44
1.7	Telesurgery Applications (source: www.intuitivesurgical.com)	48
1.8	Da Vinci network architecture E – Ethernet, S – Serial network	48
1.9	AIVA onboard platform with Bluetooth network (piconet)	49
1.10	Acoustic Modem Specification Comparison (source: www.link-quest.com)	51
1.11	Communication Architecture for teleoperation of ROMEO ROV	52
2.1	QoS Classification in Bilateral Teleoperation	56
2.2	Subjective, Objective and Network QoS in Bilateral Teleoperation	57
2.3	Basic Networked Communication	59
2.4	Network Categories	61
2.5	Adaptive Modulation and Coding (AMC) in 802.11b	67
2.6	Hierarchical Network for Industrial Automation	75

List of Figures

2.7	A WSAN architecture with long distance communication between BS p&q	77
2.8	Delay Vs Packet Size for 802.11g	78
2.9	Throughput Vs Packet Size for 802.11g	78
2.10	Bandwidth Efficiency Vs Packet Size for 802.11g with different data rates	79
2.11	WLAN 802.11 Network Architecture	80
2.12	WiMAX user classes and bandwidth allocation	81
2.13	Typical Communication delay over Ethernet	83
3.1	Wave transformation (Master) and its inverse transformation (Slave)	97
3.2	Two port network with passivity control	97
3.3	Lawrence teleoperation Architecture	98
3.4	Passivity based system representation	99
3.5	Bilateral Teleoperation with time delay	101
3.6	Bilateral Teleoperation with Position Control	102
3.7	Two port representation of Bilateral Teleoperation	106
4.1	Dimensions in NCS Communication-Control design	111
4.2	QoS adaptation through QoC Evaluation (SCDN)	114
4.3	QoS and QoC adaptation through Reconfiguration Monitor (DCDN)	115
4.4	Video Processing and transmission over Network	116
4.5	Effect of change in data rate and packet loss on video quality	118
4.6	PSNR variation with video data rate and packet loss	119
4.7	Basic ANFIS structure with 3 inputs	121
4.8	Architecture of 3 layers feed forward back propagation ANN	122
4.9	SVM Architecture	123
4.10	Generalized Adaptation Scheme for Bilateral Teleoperation	125
4.11	SNR variation with different path loss exponent	128

List of Figures

4.12	Membership Functions for FIS	128
4.13	QoS FIS with two inputs	129
4.14	Fuzzy QoS Surface	129
4.15	Fuzzy QoS FIS with SNR input	130
4.16	Delay, SNR and QoS Surface	131
4.17	Bounds of K-parameter Variation with delay τ	131
4.18	Packet rate effect on delay τ	131
4.19	Packet rate FIS with three inputs	132
4.20	Fuzzy Video Packet rate Surface	133
4.21	Bilateral Teleoperation with QoS options	133
4.22	Thresholding in SVM learning and prediction	136
4.23	The SVM based prediction of network data rate	136
5.1	NeCS-Car Embedded System and Communication Architecture	140
5.2	NeCS-Car Electromechanical Architecture	141
5.3	NeCS-Car electrical drive mechanism and linkages	142
5.4	Choosing between HLS and Zeroing with Energy Monitoring	143
5.5	Scattering variables over wireless network with Energy Monitoring	143
5.6	Reversibility Controller with Backlash	144
5.7	NeCS-Car Bilateral Teleoperation Architecture with Position Control	145
5.8	Master and Slave Position and Force Tracking	146
5.9	Position and Velocity Transparence ($b = bs_2 = 3, \Gamma_2 = Z_{t2}/Z_{e2}$)	148
5.10	Tracking Performance	148
5.11	H-matrix Bode plot (RTT = 6ms, K = 70)	149
5.12	Effect of delay on transparence	150
5.13	Round trip time (RTT) and synchronization in NT	151

List of Figures

5.14	NeCS-Car Ground Test Map and Pathloss Estimation	152
5.15	QoS Estimation with 3 input Fuzzy Inference (Off-line Test)	152
5.16	Comparison of Fuzzy QoS adaptation and No adaptation cases	153
5.17	Simplified Co-design Architecture	153
5.18	Video rate ascend and descend dynamics	154
5.19	STA01a: Static, Fixed video rate, No control excitations, No Adaptation	156
5.20	STA01b: Static, Adaptation of video flow with perturbations, No control excitations	156
5.21	STA02a: Static, Fixed video rate, With control excitations	157
5.22	STA02b: Static, Adaptation of video flow with perturbations, With control excitations	157
5.23	NeCS-Car trajectory for external tests	158
5.24	DYN03c: Dynamic, Video rate Adaptation, With Control Excitations	159
5.25	DYN03c: Tracking Performance	160
5.26	DYN03f: Dynamic, Without Adaptation, With Control Excitations	161
5.27	DYN03f: Tracking Performance	161
B.1	Worst case approximation of M_s and Bs_2 (without wheels)	185
D.1	Identification of transfer function Fe/T_s	190
D.2	PI controller for reversibility improvement ($K_p = 9.8, T_i = 0.43$)	190
D.3	Comparison of simulated and practical frequency response	191
D.4	Robust loop Shaping Design Bounds	192
D.5	Step Response with the Robust Controller	192
D.6	Singular Values of K and $K - K_r$	193
D.7	Response with full order and reduced order controller	193
E.1	Fuzzy logic Control Sequence	195

List of Tables

2.1	ITU–R Video quality standard	58
2.2	PSNR to MOS Conversion	58
2.3	Characteristic details of Wireless Protocols	68
2.4	Satellite Communication Frequency Bands	71
2.5	Field Bus Protocols and their Comparison	76
2.6	JMF Media Encodings	86
2.7	802.11e QoS levels	92
2.8	802.16e QoS Classes	92
3.1	Comparison of Time Delay in Teleoperation Approaches	98
3.2	Performance Criteria in Bilateral Teleoperation	108
4.1	Co-design methodologies	113
4.2	Comparison of different QoS estimation approaches	124
4.3	Comparison between NF, F and T_e	127
4.4	Fuzzy rule base inside the QoS Estimator with 2 inputs	129
4.5	Fuzzy rule base inside the QoS Estimator with 3 inputs	130
4.6	Fuzzy rule base inside the PR Controller	132
4.7	MSE threshold versus quality and performance of SVM prediction (packet size 1460 bytes, trace length 10K samples)	135

List of Tables

4.8	MSE threshold versus quality and performance of SVM prediction (Packet Size 366 Bytes, Trace length 10K Samples)	135
4.9	MSE threshold versus quality and performance of SVM prediction (packet size 10 bytes, trace length 10K samples)	136
5.1	NeCS-Car Test Configuration	155

Abstract

Networked teleoperation (NT) is an emerging area of technology, where human assisted Master and remote Slave devices communicate over a communication network for the exchange of command and sensor feedback information. For long range mobile teleoperation, this information travels over different types of heterogeneous/hybrid networks interconnected together with a compulsory network segment over wireless to permit increased mobility.

The independent design of control and network promotes the isolated objectives and the performance is degraded after an integration. It is also challenging if internet is used for teleoperation, instead of point to point communication. The mechanisms of QoS in one network protocol of the heterogeneous network needs mapping on any other network which is usually carried out with a multimedia point of view and not for the critical teleoperation data. The approach for networked teleoperation can be given a new dimension by adding quality of service (QoS) to different flows on need based priority and as a function of control and transparency criteria. This means to alter the network resources for teleoperation objective in order to transport the information to satisfy the end-to-end application needs. The network QoS perspective is important to consider in the co-design approach for teleoperation. However, the true meaning of end to end QoS must be defined for teleoperation. If we consider the QoS from the network point of view, it refers to the management of various flows or users as per their need and precedence. Whereas, from the teleoperation perspective, QoS is related to the quality of control (QoC) which includes stability, transparency and telepresence. Moreover, the human interface may have different requirements as per telepresence feeling which will result in varying network load.

To control network QoS, we need to measure or estimate it. Therefore, classification of QoS is performed with a fuzzy inference system which is able to distinguish between varying levels of QoS. In addition, it is also a challenging task for online decision for reconfiguration of network and control performance. We have used supervised methods for classification and prediction of QoS to be used in the proposed approach. Thus, data communication networks treat control information as best effort most of the time. conclusion the communication used in teleoperation uses a dedicated network/communication

In short, a co-design approach is formulated to treat the network QoS as a function of teleoperation objectives which are related to the quality of transparency and control. Alternatively, the video flow is

managed in order to effectively reduce the necessary throughput for instants when the network quality is not sufficient. We have considered two cases. First, without taking into account any network QoS mechanism (best effort flows only) and adapting application needs as per the teleoperation objectives. The second one considers a QoS oriented network in between the master and slave, where different priorities can be assigned to the teleoperation flows as per need. In the end, the proposed methodology is implemented on the NeCS-Car benchmark.

Résumé

La téléopération en réseau est une thématique émergente, où un humain (le maître) communique avec un esclave commandé à distance à travers un réseau de communication, pour l'échange des données de commande et de mesure. Pour la téléopération longue distance, ces informations traversent divers réseaux hétérogènes ou hybrides interconnectés ensemble. Nous traitons également le cas où un segment sera sans fil, ce qui permet d'envisager que l'esclave soit mobile (véhicule télé-opéré par exemple).

Une étude indépendante des aspects commande et des aspects réseau entraîne l'atteinte d'objectifs locaux, qui peuvent le cas échéant être ensuite fortement dégradés après l'intégration des deux aspects. L'utilisation de réseaux partagés, comme internet, en lieu et place d'une liaison dédiée (point à point, liaison virtuelle) est également un défi, en particulier dans le cas de la longue distance. Les mécanismes de qualité de service (QoS) d'un réseau, en particulier du réseau hétérogène, doivent pouvoir être traités par les autres réseaux ; ces points sont assez souvent traités avec un point de vue d'applications multimedia, plus rarement avec le point de vue de la téléopération *critique*. L'approche de téléopération en réseau peut profiter de ces mécanismes de qualité de service en utilisant des priorités ou des réservations de bandes passantes en fonction des critères de commande et de transparence. Cela peut entraîner une adaptation des ressources réseau en fonction des besoins des objectifs de téléopération afin de transporter l'information en satisfaisant les besoins *bout en bout* de l'application, cette notion devant être précisée.

Lorsqu'on considère la QoS avec un point de vue réseau, elle consiste principalement à la gestion de flux de communication, en prenant en compte des paramètres de besoin et d'ordonnement. Si l'on prend en compte le point de vue de la téléopération, la QoS entraîne des conséquences sur la qualité de commande (QdC) ce qui inclut la stabilité, la transparence et la téléprésence. De plus, l'interface humaine peut également avoir des besoins spécifiques en termes de téléprésence, ce qui peut entraîner des conséquences sur la répartition de la charge du réseau. Afin d'intégrer les deux approches de QoS et de QdC pour apporter une meilleure réponse au problème posé, nous proposons une approche de co-conception avec d'une part une adaptation de la QoS aux besoins de la QdC (qualité de la transparence) et d'autre part une adaptation de la QdC (par exemple dégradation de la qualité du flux vidéo) à la disponibilité du réseau.

Nous avons considéré deux cas de figures. Dans un premier temps, sans tenir compte des mécanismes

de QdS du réseau (approche dite du *meilleur effort* ou *best effort*) et par l'adaptation au mieux de l'application, pour répondre aux besoins de la téléopération.

La seconde approche considère un réseau orienté QdS entre le maître et l'esclave, où différentes priorités peuvent être attribuées aux flux nécessaires à la téléopération, en fonction des contextes. L'approche proposée est finalement mise en oeuvre sur NeCS-Car, la voiture téléopérée disponible au Laboratoire.

Introduction

Networked control systems (NCS) are essentially closed loop systems in which control related information from sensors, controllers and actuators is transmitted or received over a network. Networks are getting popular among control engineers as they are preferred in scenarios with a number of plants communicating with a number of distributed sensors and actuators. Using networks simplify the design and cut down installation and maintenance cost in industrial systems. Networked control systems are being utilized in manufacturing industry, robotics, distributed systems, energy generation systems and even in aeronautics and space applications [Hespanha et al., 2007]. NCS are considered as hybrid systems incorporating multidisciplinary areas of technology including computer networking and communication, mechatronics, signal processing, robotics, information technology, software engineering and control theory, and putting them together to achieve a single system which can efficiently work over a network. In wireless networks, the network is essentially composed of a wireless protocol. The motivation for considering wireless networks for autonomous systems is brought by two factors namely, *mobility* and support for *multi-system communication* through multiple access [Ahmad, 2005]. For a single vehicle case, point to point communication can easily be used (with the base station tracking the mobile user), however, for multiple systems, a wireless network is mandatory in applications e.g. formation control, trajectory tracking and path following of multiple autonomous systems [Fax & Murray, 2004].

For this thesis, we are considering a general problem of network architecture for long range teleoperation of an autonomous embedded system. By long range, we have two aspects. First, it can be taken as the teleoperation by using *long range communication protocols* e.g. cellular communication, satellite networks and relay stations etc. Secondly, long range may also be used to emphasize on *heterogeneous networks*. This is of utmost importance as the information passes through various networks using different networking layers, MAC protocols and service mechanisms to transport control information in NCS. Communication related phenomena e.g. delay, jitter and packet loss need to be considered in NCS.

Our focus is on the network architecture for co-design problem in control as the communication channel is constrained and limited in terms of bandwidth, data rate and latency. The objective is to maximize the control performance with a constrained channel having limited resources [Halevi & Ray, 1988]. Thus, in the co-design approach this goal can be met either by reducing the data rate, by increasing the

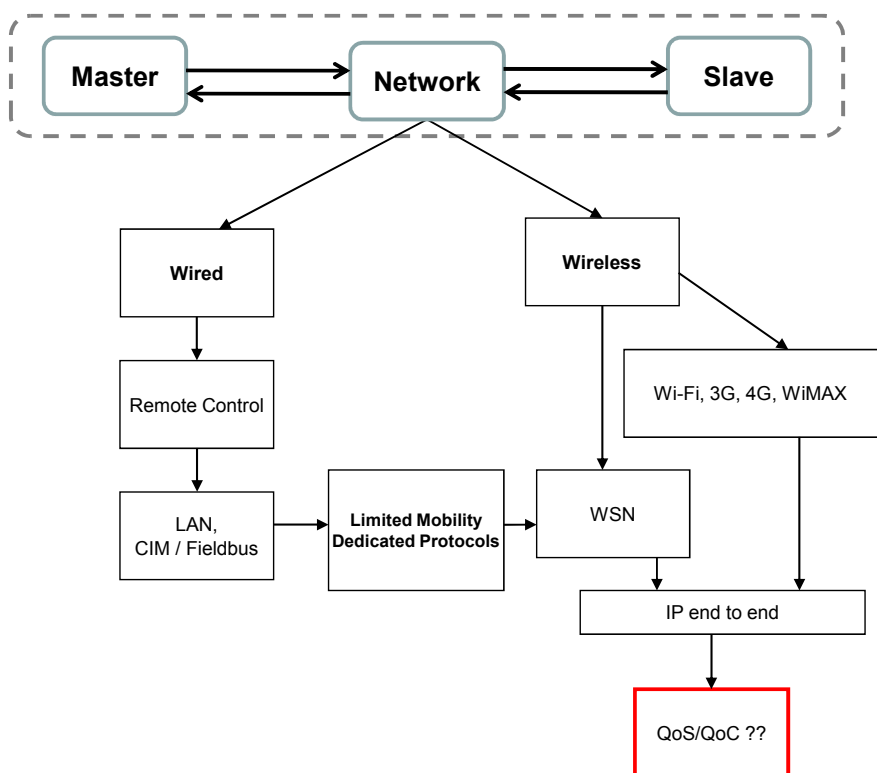

Figure 1: Teleoperation over Network - Problem description

sampling period, decreasing the number of bits per message etc. In addition, giving priority in network flows as per application demand can also contribute to the adaptation of QoS with respect to QoC.

0.1 Overview of the thesis

0.1.1 Contribution

The present work is divided in two parts. The first part discusses the individual problems and opportunities in the area of communication and control design. The second part mainly concentrates on the co-design problem and its application to the teleoperation of networked autonomous systems. This thesis presents a co-adaptation methodology with emphasis on the implementation for a benchmark problem.

0.1.2 Thesis Outline

This work has been divided into five chapters excluding the introduction part. The outline of these chapters is as follows:

State of the Art in Teleoperation: This chapter gives an over view of the state of the art in teleoperation with emphasis on the communication mechanisms used in each application. Some key definitions and design problems and challenges are discussed with examples to explain the control/communication tradeoff in networked teleoperation. Some technological areas have been presented in order to highlight the environmental restrictions and design limitations that vary from application to application.

Quality of Service for Teleoperation: This chapter presents the overview of networked communication with emphasis on wireless communication and the QoS aspects involved therein. Classification of QoS in networked teleoperation is discussed in detail for each segment involved in end-to-end communication. Thus, subjective, objective and network QoS are differentiated by taking into account their contribution in improving overall QoC in teleoperation. In addition, various types of network protocols known in the context of fieldbuses, wired and wireless networks are discussed with emphasis on network architectures for long range teleoperation. Several aspects are discussed depending at which OSI layer, QoS functionality is available e.g. for end-to-end IP architecture, OSI level 3 and 4 QoS mechanisms are preferred. In many cases, the application layer directly communicates with the network/data link layer to send time critical information in order to take advantage of inter layer communication.

Control and Performance in Networked Teleoperation: This chapter describes the influence of control architectures on teleoperation performance which is represented by the stability and transparency metrics. While various approaches in control design are discussed, especial emphasis is given to passive teleoperation known for its simplicity in design. However, from implementation point of view, some key precautions must be taken to minimize the effect of digital implementation and energy supervised data reconstruction to ensure *all time* passivity. The transparency in passive teleoperation is compromised due to excessive weight for stability in passive teleoperation, therefore, a tradeoff between stability and transparency is also presented at the end.

Networked Teleoperation- A Co-design Approach: The co-design problem in NCS is studied in this chapter with a strong bibliographical background on recent approaches. Two cases are considered, one in which no QoS support is available in the network. The second one considers a differentiation between the QoS nodes or flows, which requires assigning preferences to minimize delays and jitter which can augment the teleoperation performance. Various supervised learning techniques were analyzed for an intelligent decision to adapt video quality as per network QoS. A Fuzzy logic based adaptation mechanism is proposed to improve the performance in passivity based bilateral teleoperation with force feedback communicating over a network without QoS guarantees. Prediction of network parameters is also analyzed by machine learning to improve the online decision.

Teleoperation of a Steer-By-Wireless Benchmark: In this chapter, implementation of the co-design approach is realized on the test bench. The co-design strategy developed in the previous chapter is analyzed by taking into account the real time constraints. The co-design approach is implemented on the *NeCS-Car* which is a networked teleoperation benchmark at the Control Systems department of

GIPSA-lab, Grenoble. Detailed studies and simulation results of modeling, control and identification are presented for better understanding. Information loss strategies and parameter variation in the model with changing environments are also discussed. In the end, some guidelines and proposition for future work is presented which includes varying degree of autonomy of NeCS-Car for autonomous operation and handover in case of lowered QoS of the network.

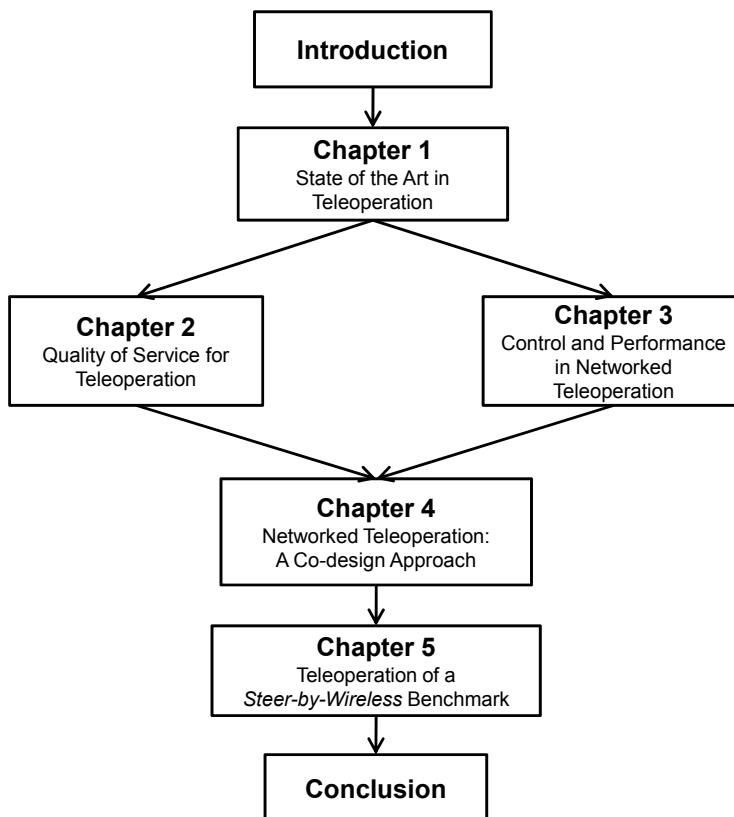

Figure 2: Thesis structure and interconnection of chapters

In Fig. 2, thesis flow with interconnection of chapters is shown. The introduction gives a general startup for the document while Chapter 1 describes the state of the art in teleoperation with approaches and application examples. Chapter 2 and 3 discuss QoS and QoC part in teleoperation respectively. Chapter 4 provides the Co-design approach while in Chapter 5, practical implementation of the scheme is presented with test bench results.

Publications:

0.2 Journal and Best Paper Award

- Furqan H. Khan and Zeashan H. Khan. *A Systematic Approach for Developing Mobile Information System based on Location Based Services*, Journal of Network Protocols and Algorithms (NPA),

Vol. 2, No. 2 (2010), ISSN 1943-3581

- Zeashan H. Khan, Denis Genon-Catalot and Jean Marc Thiriet, *Wireless Network Architecture for Diagnosis and Monitoring Applications*, MASAUM Journal of Computing, Vol. 1, No. 2 (2009), Page(s) 318-325
- Zeashan H. Khan, Denis Genon-Catalot and Jean Marc Thiriet, *Hierarchical Wireless Network Architecture for Distributed Applications*, ICWMC, Aug 23 – 29, 2009, Cannes/La Bocca, France (**Best paper award**)

0.3 Conference Papers

- Zeashan H. Khan, Denis Genon-Catalot and Jean Marc Thiriet, *A Co-design Approach for Bilateral Teleoperation over Hybrid Networks*, 18th Mediterranean Conference on Control and Automation (MED), June 23 – 25, 2010, Marakesh, Morocco
- Zeashan H. Khan, Denis Genon-Catalot and Jean Marc Thiriet, *Wireless Network architecture for Diagnosis and Monitoring Applications*, IEEE-CCNC, Jan 10 – 13, 2009, Las Vegas, USA
- Amine Mechraoui, Zeashan H. Khan, Jean-Marc Thiriet and Sylviane Gentil, *Co-design for wireless networked control of an intelligent mobile robot*, 6th international conference on informatics in control, automation & Robotics, ICINCO, July 4 – 5, 2009, Milan, Italy
- Amine Mechraoui, Zeashan H. Khan and Jean Marc Thiriet, *Effect of Packet Loss on the Quality of Control of a networked Mobile Robot*, IMCIST, Oct 12 – 14, 2009, Mragowo, Poland
- Zeashan H. Khan, Denis Genon-Catalot and Jean Marc Thiriet, *Co-design in Heterogeneous Wireless Networked Control Systems*, IMCIST 2009, Oct 12 – 14, 2009, Mragowo, Poland
- Zeashan H. Khan, Denis Genon-Catalot and Jean Marc Thiriet, *Wireless Network Architecture for Long Range teleoperation of Autonomous Systems*, Sensors Net, Dec 17 – 21, 2009, Monastir, Tunisia
- Mohamad Haffar, Zeashan H. Khan, Jean Marc Thiriet and Eric Savary, *An extension of IEC-61850 for solving selectivity problem in electrical substations*, 23rd IAR Workshop on Advanced Control and Diagnosis, Coventry, Nov 27 – 28, 2008, Coventry, UK
- C. Berbra, Zeashan H. Khan, S. Gentil, S. Lesecq and Jean-Marc Thiriet, *A Diagnosis Strategy for FDI in Wireless Networked Control System*, 7th IFAC international Conference on Field Buses and Networks (FET) in Industrial and Embedded Systems, Nov 7 – 9, 2007, Toulouse, France

0.4 Short Papers/Posters

- Zeashan H. Khan, Denis Genon-Catalot and Jean Marc Thiriet, Wireless Network Architecture for Long Range teleoperation of Autonomous Systems, *SensorNets - The First International School on Cyber-Physical and Sensor Networks*, Dec 17 – 21, 2009, Monastir, Tunisia
- Zeashan H. Khan, Denis Genon-Catalot and Jean Marc Thiriet, Architecture reseau longue distance pour de la téléopération de un système embarqué, *Journée du GIPSA-lab*, Oct 16 – 17, 2008, Annecy, France
- Zeashan H. Khan, Wireless Network Architecture for Distant Diagnosis and Surveillance. *Summer School on Monitoring and Coordination across Networked Autonomous entities*, Aug 17 – 22, 2008, Castle Ebernburg, Germany.

Chapter 1

State of the Art in Teleoperation

Contents

1.1	Introduction	31
1.2	Problem description	31
1.3	History of Teleoperation	33
1.4	Basic Concepts and Definitions	34
1.5	Types of Teleoperation	34
1.6	Teleoperation Requirements	38
1.7	Controller Design for Teleoperation	40
1.8	Network Selection for Teleoperation	41
1.9	Problems and Challenges	42
1.10	Application Areas	47
1.11	Conclusion	54

1.1 Introduction

This chapter presents the problems and motivation in teleoperation with emphasis on networked communication and protocols used in teleoperation. While the semiautonomous operation requires a communication link between the operator and the teleoperator, the fully autonomous operation is assumed to be performed as a stand alone system without human intervention [Daniel & McAree, 1998]. The *degree of autonomy* is not discussed here as it can vary from embedded redundancy and dependable functionality to fully-autonomous operation [Hokayem & Spong, 2006].

1.2 Problem description

Teleoperation refers to operate a vehicle or a system remotely via a communication link. Distances can vary from millimeters (nano-manipulation) to millions of kilometers (for space applications). The

essence of teleoperation involves core technologies from communication and control engineering. The various levels in teleoperation involve the mechanical manipulation at the lower end while supervisory control at the higher level. The continued development towards networked communication in all major areas of engineering and technology has witnessed revolutionary interest to introduce new protocols and methodologies in order to satisfy user application specific demands. Networked teleoperation is not an exception to this growing trend.

Due to constrained communication, feedback control systems are limited in the performance [Hartman, 2004]. In serial networks, messages are multiplexed in time. Through time sequencing of messages, all system components can share the same network cable. On the other hand, all messages have to be quantized, or be represented by a finite number of bits. Clearly, there is a trade-off between these two techniques: Given a fixed rate, one can use fewer bits per message and increase the number of messages per time, or vice versa. [Brockett, 1995] presents an interesting study concerning time sequencing and proposed a simple model of control networks and a design method of a central controller connected to sensors/actuators by a network. Because of the limitation on data rate, only one of the sensor/actuator pairs is allowed to communicate with the controller at each discrete instant. Quantization has been studied in the context of digital control and signal processing. Typically, quantizers round off the input signals uniformly with a fixed step size. In many previous works, the error caused by such quantization is modeled as noise, often uniform and white [Roberts & Mullis, 1987]. On the other hand, it is known that, even in a simple feedback setup, interesting and complicated behaviors such as limit cycle and chaotic trajectories can be observed [Ushio & Hirai, 1984]. Many of the recent deterministic treatments of quantizers in feedback systems follow the influential paper by [Delchamps, 1990]. [Elia & Mitter, 2001] proposed a stabilization technique for linear systems; a non-uniform quantizer is designed as a result of an optimization problem. [Brockett & Liberzon, 2000] studied the use of uniform but time-varying quantizers. In [Wong & Brockett, 1999], coding and time delay inherent in channels of networked control systems are explicitly taken into account, and a new notion of stability is introduced.

There are several types of time delay characteristic of serial networks e.g. the transmission time is the time it takes for a transmitter to send out data. Thus, to send N bits of data over a D bps channel, it takes N / D seconds. The consequence of time sequencing is also important and is the waiting time when a node has to send out a message, but cannot send due to a busy channel. This results in time-varying delay and is therefore difficult to determine. It is known that the delay in a feedback loop can destabilize the system, and there is an extensive research concerning the time delay systems (TdS). Some recent works relevant to control over networks can be found in [Yook et al., 2001]. One application example is the bilateral control of tele-robotic systems [Anderson & Spong, 1989], which often operate over the Internet. To reduce the amount of traffic over the network, control functions often have to be distributed over a system. The controllers in such systems are local in the sense that they can measure only a limited number of outputs and can control only certain actuators. Control of distributed systems has been studied in the area of decentralized control [Siljak, 1991]. This structure

may impose a severe limitation on the performance of these systems. The idea of information exchange among local controllers has been long studied e.g. in [Wang & Davison., 1978]. However, there is not much research that deals with the realistic, practical models of networks incorporating bandwidth issues. Other studies dealing with data rate issues include state estimation problems [Nair & Evans., 1997] and control of linear quadratic gaussian (LQG) systems [Mitter & Sahai, 1999].

1.3 History of Teleoperation

With the widespread technological evolution in the second half of the 20th century as well as the development of the informatics tools permitted the evolution of the teleoperated robotic systems in various application domains. As most of the other science and technological domains which have a history of evolution as a by-product of space and nuclear research, the history of teleoperation dates back in 1950's when the first force reflecting robotic manipulators were used in the nuclear industry [Kress et al., 1997]. In 1960's, General Electric (GE) developed the master device to remotely operate the nuclear plants [Burdea, 1996]. During 70's more efforts were put in space robotics. Stanford tactile teleoperation device used in haptics was a remarkable development. The *SM-229 servomanipulator* system, manufactured by Teleoperator systems in 1983 was the first manipulator system at Oak Ridge National Lab (ORNL) used for the development of human machine interface control system development [Clarke et al., 1983]. The *M2 servomanipulator* was developed in cooperation with central research labs (CRS) and ORNL was the first digitally controlled teleoperator [Herndon et al., 1984] which was awarded an IR100 award in 1984. In 1987, ORNL presented the *Advanced servomanipulator (ASM)*, which was the first 6-DOF, force reflecting and electrically actuated remotely maintainable teleoperator [Kuban et al., 1987]. The Laboratory Telerobotic Manipulator (LTM), was a 7-DOF, force reflecting, electrically actuated manipulator system for ground based research into space telerobotic activities [Herndon et al., 1989]. The Center for Engineering Systems Advanced Research Manipulator (CESARm) was a research manipulator and was the world's first dissimilar and redundant teleoperated manipulator employing stiffness/impedance control [Hogan, 1985]. The Dual Arm Work Module (DAWM) was developed in 1995, which had a two 6-DOF, hydraulically actuated telemanipulator for operator training, tool and fixture testing and development [Jansen & Kress, 1996].

Teleoperation was introduced in medical robotics by assigning them an active role in the operation theaters in early 80's. This gave rise to the concept of integrated use of medical imaging and other resources needed by the surgeons to view and control the surgical instruments over a network [D. Hopper & Reilly, 1996]. The first neurosurgery by an industrial robot was carried out in 1989 with another orthopedic surgery in 1992 and finally in 1994 an endoscopic mini-invasive surgery was carried out by the robot Aesop in the history of medical robotics [Salcudean & Yan, 1994].

1.4 Basic Concepts and Definitions

Some basic definitions are important to understand the teleoperation system and its performance. These are as under [Hokayem & Spong, 2006]:

Teleoperation is defined as the direct and continuous human control of a teleoperator [Sheridan, 1992*b*]. In remote teleoperation, we deal with the exchange of force and position.

Haptics technology refers to the communication of sense of touch back to the operator by applying mechanical stimulation (force or velocity feedback).

Teleoperator is the remote part or slave in teleoperation.

Operator in teleoperation system is usually a human controlling the slave from the master station through a human-machine interface (HMI).

Autonomy and degree of interaction for autonomous tele-robots is their capability of doing all or a major part of the assigned task. The distant operator only supervises the task.

Telepresence is the feeling of tele-existence by communicating rich sensor information to the operator end. Usually, the goal is to achieve higher *Telepresence* which means that the operator receives sufficient information about the teleoperator and the task environment displayed in a sufficiently natural way, that the operator feels physically present at the remote site [Dede & Tosunoglu, 2007]. A more restrictive definition of telepresence requires further that the teleoperator's dexterity match that of the bare-handed operator. Telepresence is sometimes used to mean virtual presence [Sheridan, 1992*b*]. It is achieved by projecting the operator's manipulatory dexterity to a remote environment while reflecting sensory feedback so realistically that the operator feels present in the remote site [Daniel & McAree, 1998].

Virtual Presence is used to augment the telepresence, multiple sensors are used so that the person wouldn't be able to distinguish between actual, telepresence, and virtual presence.

Anthropomorphism is related to the human friendly behavior of the teleoperated vehicle. This means that the remote robotic system is so much capable that it can be compared and approximated with the humans [D. Hopper & Reilly, 1996]. Thus, behavior of the application operated from far off is also very important for the system.

1.5 Types of Teleoperation

Teleoperation has many subclasses and types. For example, tele-automation goes beyond fully autonomous control in that it blends the human intelligence and action whenever needed [Shiratsuchi et al., 2007]. Tele-monitoring relates to a supervision mode (of a telemanipulator or a slave device) as

compared to telepresence which requires continuous operation.

Typical applications include remote manipulation of controlled tools and robots in design and manufacturing. Numerically controlled machines (CNCs) and car's manufacturing plants use teleoperated robots for multiple task assignment and collaborative functioning. In other cases, e.g. haptic teleoperation, system communicates force and position information both from the operator to the remote tool and back.

Teleoperation has several types depending upon the exchange of information between the master and slave [Hokayem & Spong, 2006]. The most practical NCS adopt a bilateral control structure, i.e. one controller located in the plant site, another in the operator site, and linked through the communication network [Yang & Cao, 2008]. For example, based on this control structure, robotic teleoperation uses the controller in the plant site to control the slave device, and uses the one in the operator site to control the master device. Another example is the advance control for manufacturing processes where, the controller in the plant site is responsible for the regulation of the normal situation. Once the performance of the controller is degraded due to the disturbance from the environment or the change of the production situation, the controller in the operator site is put in use for tuning the parameters and/or changing the desired input for the controller in the plant site.

In general, the types well mentioned in the literature are:

- Unilateral Teleoperation
- Bilateral Teleoperation
- Supervisory Teleoperation
- Coordinated Teleoperation

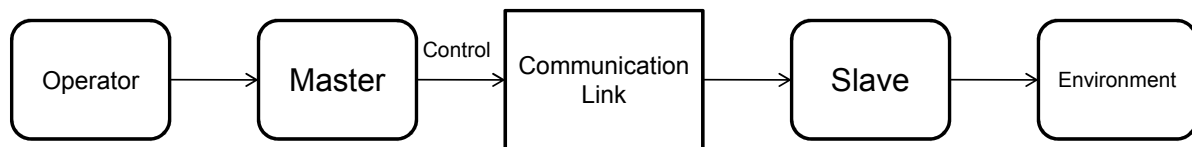

Figure 1.1: Unilateral Teleoperation

1.5.1 Unilateral Teleoperation

In unilateral teleoperation, the operator drives the robot with a non-force reflecting input device, either in *rate mode* or in *position mode*. In rate mode, the operator directly commands the robot velocity,

using either a teach pendant or a force/torque ball [Anderson, 1996]. In unilateral teleoperation the operator is dynamically decoupled from the system, and the operator impedance will not affect the system's response.

In unilateral teleoperation, the flow of information is limited and only unidirectional from master to slave. The feedback sensing is least or not available. This is shown in Fig. 1.1. Master system that is driven by the human operator sends the necessary inputs (e.g., position, and/or velocity) through the communications line to drive the slave system. There is no feedback information for the human operator during this type of manipulation. Instead, in most of the cases, the slave system has a local closed-loop control system, which uses the feedback signals within this control system.

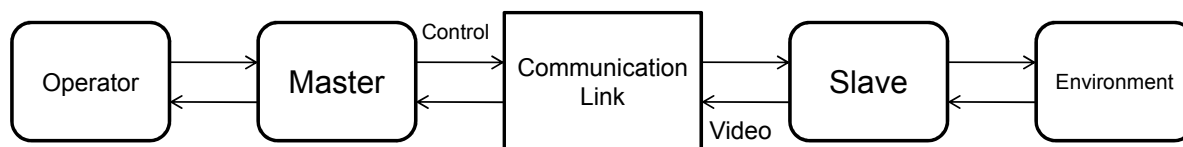

Figure 1.2: Bilateral Teleoperation with Camera Feedback

1.5.2 Bilateral Teleoperation

In bilateral teleoperation, there is a feedback from the slave side. In addition to camera, a force feedback is usually provided for better telepresence [Kragic & Christensen, 2002]. Real time feedback is available for operator's feedback. However, this is possible when delays in the control loop are bounded and compensated in the control design. The two cases are shown in Fig. 1.2 and Fig. 1.3.

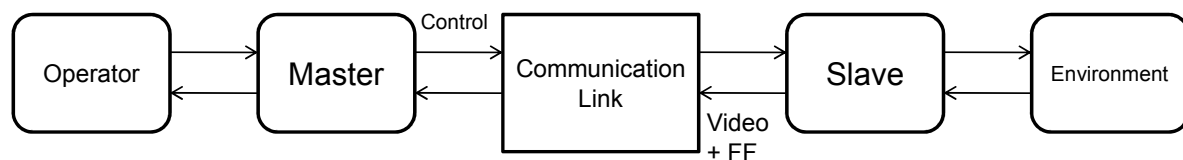

Figure 1.3: Bilateral Teleoperation with Camera and Force Feedback

In [Gupta et al., 2006], a wireless master slave embedded controller is used for controlling a teleoperated anthropomorphic robotic arm with gripping force sensing.

Types of Bilateral Teleoperation:

As stated in [Yamano et al., 2002], the bilateral teleoperation can be implemented in four different configurations as symmetric position servo type, force reflection type, force reflection servo type and parallel control type.

In bilateral teleoperation, usually the types are defined with respect to the Input-Output Pair which refers to the force, velocity or position pair that is used as input/output variable of interest. In force-force teleoperation, a force is input and as a result, a force is output at the slave side. The same is true for the velocity-velocity, force-velocity, velocity-force, position-position type teleoperation architecture.

Impedance controlled teleoperation refers to the case where, position is the input while force is the output. It is achieved by force-based actuators which are back drivable system. This allow *improved transparency* for example, most of the haptic devices such as the Phantom, MIS devices such as the da-Vinci have impedance control [Leven et al., 2005]. On the other hand, in admittance-controlled teleoperation, force is input and position is the output. It is achieved by velocity-based actuators which are not non-back drivable system, thus offering increased precision. Most of the industrial robots utilize admittance controlled teleoperation.

1.5.3 Supervisory Teleoperation

In supervisory teleoperation, the remote side is assumed to have sufficient tele-autonomy that the distant operator need only to act as a supervisor. The operator is in contact with the control task via a camera and send commands electrically by radio or wire. This is the standard form of teleoperation. As opposed to coordinated teleoperation, the operator monitors the remote teleoperator mostly and issues high level commands [Sheridan, 1992b].

In supervisory teleoperation, the operator only needs to send tracking coordinates or mode switching commands which need far less bandwidth, thus minimizing bandwidth requirements. Supervisory teleoperation is used where long delays are inevitable or low data rate is the priority due to communication limitations; therefore, *move and wait* policy is adopted [Sheridan, 1993]. Supervisory teleoperation can make use of unilateral or bilateral teleoperation. If the supervisor only provides rough motion trajectory or navigation coordinates with unilateral input device, it is supervisory unilateral teleoperation (SUT). However, if occasionally, supervisor can take full control of the vehicle with force feedback sensation, it will be supervisory bilateral teleoperation (SBT). It is also possible that the operator can choose between the SUT/SBT modes for flexible operation [D. Hopper & Reilly, 1996].

The supervisory teleoperation can be sub-categorized in two types namely *Autonomous Teleoperation* in which the robot is fully controlled via distant operator and the *Semiautonomous Teleoperation* where no closed loop operation is needed and operator does not need to do everything. Examples include Mars

rover in which different operating modes are configured with different mission programs in case of loss of communication.

1.5.4 Coordinated Teleoperation

The operator controls the actuation as an external loop. The local internal loop is sufficient to stabilize the system, which offers no delays as practiced in long range communication. However, there is not sufficient autonomy at the remote end. In coordinated teleoperation, one or more operators jointly carry out a task by using one or more remote teleoperator [Fong, 2001]. However, there is no autonomy included in the remote end. The remote loops are used only to close those control loops that the operator is unable to control because of the communication delay. A typical example of this is a teleoperator for whom the speed control has a remote loop and, instead of controlling the throttle position, the operator gives a speed set point. Digital closed loop control systems almost always fall into this category.

1.6 Teleoperation Requirements

The teleoperation requirements are a combination of requirements posed due to the stability and telepresence due to end-to-end communication constraints. Following are some of the details of these requirements.

Telepresence/Transparency Requirements

This refers to the experience or impression of being present at a location far off from the operation environment. Telepresence can be explained as the quality of a teleoperation experience [Dede & Tosunoglu, 2007].

The major requirement comes from the video link that is usually demanded as an integral part of telepresence. Different video coding and compression techniques are available that can guarantee certain frame rate and error rate [Sheridan, 1992*a*]. The multimedia requirements are soft and flexible that can vary with the type of applications. Implementation of telepresence is performed through voice (audition), video (visual), touch and remote actuation and manipulation (teleoperation). Application examples of telepresence include video conferencing, inspection, art, artificial intelligence, virtual reality, telerobotics etc. Teleoperation demands a strict telepresence, which is also application dependent [Hirche et al., 2005]. The communication network used for the teleoperation utilizes the geographic area networks (LAN, WAN etc) in most of the cases where the operator is in the city premises. The end network where the slave is considered, is away from the infrastructure at a far off place, is complemented through wireless network. Multi-modal telepresence is another performance parameter which refers to multi sensors data that could be used to provide the telepresence feeling [Shiratsuchi et al., 2007]. These

senses and actuation include visual, auditory, haptic, olfactory, gustatory feeling etc.

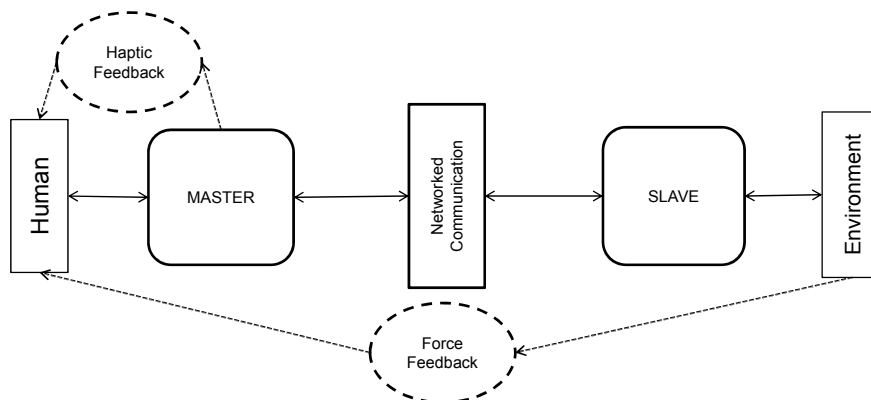

Figure 1.4: Haptic and force feedback in Networked Teleoperation

It is also interesting from a co-design perspective to adapt the video compression ratio or coding as per link quality [de Wit et al., 2009]. This area is also emerging and some techniques are available till today. In the case of communication unreliability, constant and varying time delay and packet loss, stability analysis is needed and must be ensured. For transparency, human-oriented analysis and design is required for qualification. In addition, haptic data compression is suggested in many cases, in order to send only the necessary information in compressed format [Steinbach et al., 2010].

Vision

In humans, about 90% of the perception information comes via vision. The human eyes are equipped with opto-mechanical systems which allow stereovision, focusing, fast pointing and varying field of view functions [Sheridan, 1992b]. The simplest vision feedback with static camera is enough in most of the cases. Head mounted display is an example of visual-sound feedback.

Hearing

The human ear can hear between 16-20KHz frequencies. The smallest audible intensity depends on the frequency; the minimum is between 1KHz and 6KHz and increases for lower and higher frequencies. Some industrial applications e.g. drilling requires hearing information.

Touch

The human touch sensors are mechanoreceptors which are activated by touch as pressure is applied on the tissues. These tactile sensors can be divided into two basic classes as follows:

Tactile Information (Haptic Feedback): It refers to the contact with the object by the mechanore-



Figure 1.5: Haptic Interfaces for Teleoperation (source: www.sensable.com, www.forcedimension.com)

ceptors within and around the contact region. Generally, both the force and tactile feedback come under the term *haptic feedback*. In the haptic feedback, the tactile skin sensors give the response to the operator as per motion experienced at the other end [Daniel & McAree, 1998]. Examples include CyberGlove, Haptic arm etc.

In order to operate the slave system, an interface is needed at the master end. Haptic devices serve the purpose of providing a tactile feedback through sense of touch (by using force or vibration feedback to the operator) [Kosuge et al., 1995]. Some of the famous haptic devices are shown in Fig. 1.5.

Kinesthetic information (Force Feedback): It means that the force generated by the teleoperator is fed back to the operator in order to generate a real response in gripping and manipulation task. Force feedback is essential for good telepresence in manipulation tasks.

1.7 Controller Design for Teleoperation

Due to the various non-linearities in the master and slave systems, delays in the communication system and environment nonlinearities, control design for teleoperation is a challenging problem.

Assumptions in Isolated design

The control design task in NT, can be considered with some assumptions and taking into account the communication systems as a delay. However, this reduces the system robustness and performance is usually degraded [Ghostine et al., 2006].

1. **Symmetric Delays:** A very common assumption (especially in teleoperation over wired networks), is that the delays are assumed symmetric in all communication paths. This is similar to the traditional NCS where delay in sensor-controller and controller-actuator ($\tau_{sc} = \tau_{ca}$) pair is

supposed to be constant. Thus, each can be considered equal to $\frac{RTT}{2}$. This may however not be true in actual scenarios [Branicky et al., 2000].

2. **Error free Communication:** In networked communication, due to channel conditions, errors are introduced into the data and bits are corrupted [Nguyen et al., 2009]. Thus, error detection and correction (FEC) is applied at the receiving end which needs added processing and the rejected frames count towards packet loss. However, for simple model, error free communication can be assumed.
3. **Constant delay:** In most cases, network delays are taken as constant and less than the sampling period T_s . However, in all practical measurements, they are found to vary between certain bounds [Hartman, 2004]. This variation is known as *Jitter*. In usual wired/wireless networks, this jitter is a fraction of the delay magnitude. However, in internet based communication, the jitter may have magnitudes which are multiples of a constant delay, making prediction difficult.
4. **Infinite buffer size:** Infinite buffer size is assumed throughout the analysis, so packet loss are only due to congestion over the network and not due to the buffer overflow.
5. **Under-loaded Network:** This is one of the assumption used to simplify design. In fact, if congestion is taken into account, finite buffer length and congestion control mechanism must also be simulated which complicate the design phase [Leven et al., 2005].

1.8 Network Selection for Teleoperation

In NT, selecting an appropriate communication network is an important part of the design cycle. In most of the cases, for example [Salcudean & Yan, 1994], [Sheridan, 1993], and [Maimone et al., 2007], a dedicated point to point communication network is used to ensure realtime performance with a very low constant delay. In [Hawkeye et al., 2009], a preliminary protocol named Interoperable Telesurgical Protocol (ITP) is proposed to accomodate many teleoperators and telesurgical systems. A high speed link of 10 Gbps with a minimum datarate of 100 Mbps ethernet is used between the teleoperators. This work is extended by taking into account session initiation protocol (SIP) and advanced haptics codecs in [Hawkeye et al., 2010]. Haptic codecs can provide standardized data interfaces for easily interconnecting novel robots. In the second case, when the information related to teleoperation passes through a hybrid, heterogeneous or internet, severe degradation due to the delay and jitter, connection loss and the presence of dead band can be experienced [Oboe & Fiorini, 1997]. Thus, for mobility, multiple systems communicating over the same network can share bandwidth e.g. as described in [Boughanmi et al., 2009], [Chitre et al., 2006] and [Vasilescu et al., 2007]. In [Murakami et al., 2008], the communication between master and slave is performed using both of WLAN and a wide coverage mobile IP communication device. The networked communication introduces new dynamics in the control loops when added as a medium of communication between controller and sensor/actuators or between

controllers for cooperative tasks. So, it is important to understand the flexibility as well as the constraints and limitations of each protocol while considering a teleoperation application.

1.9 Problems and Challenges

Due to the hybrid nature of NT and for a well performing design, various constraints are imposed by the control, computation and communication resources (C^3) [Zampieri, 2008]. Parametric uncertainties in the NCS model should also be considered while analyzing the effect of delays and communication loss between the networked components [Barger et al., 2003]. Here, we will discuss each such type of constraint that can effect the performance in NCS [Yang & Cao, 2008]. Due to the involvement of multiple technologies and heterogenous networks, teleoperation over a long distance pose several problems w.r.t quality of experience and teleoperator dynamics. A brief review of these issues are is given in the following subsections.

1.9.1 Controller Constraints

The general control design problem is a compromise between control action and performance. The guaranteed control schemes usually require large actuation to control an unstable plant and ensure good performance. On the other hand, small control force usually comes with some compromises on performance [Khan et al., 2009b]. Optimal control utilizes mathematical optimization for controller design by taking into account a performance criterion which is a function of state and control variables. For example, an LQR controller, minimizes the quadratic cost function by restricting Q and R as semi positive definite and positive definite matrices respectively, remain constant for the infinite horizon case and that (A,B) pair is controllable for making sure that the cost remains positive and bounded. which requires numerical solutions contrary to analytical solutions [Marti et al., 2002]. Thus the computational complexity increases if an embedded discrete time optimal control algorithm has to be run a numerical solution on every time step T.

A robust controller is designed to minimize the modeling imperfections, uncertainties and expected disturbances [Udwadia et al., 1996]. However, the knowledge of uncertainty and disturbance is necessary for an acceptable solution. For example, the McFarlane-Glover loop shaping design procedure (LSDP) minimizes the sensitivity of a system over its frequency spectrum, and this guarantees that the system will not greatly deviate from expected trajectories when disturbances enter the system. For a robust NCS, delay and jitter compact sets should be known a priori to design engineers. This imposes another constraint for an effective design [Friedman et al., 2004]. Once the bounds are not followed, the design remains no longer valid. For networked communication, the delays are stochastic and as network traffic is not known before hand, a worst case delay is assumed for the controller design [Cruz, 1991a]. In robust control design, the controller remains static as compared to adaptive control where the controller

is capable to adapt with the variation in the operating point.

Adaptive control design usually requires a reference model or identifies it during operation. Thus implementation of control and identification at the same time poses controller complexity problem as well as excessive computational resources for MIMO systems and if there is fast variation in operating conditions [Lepage et al., 2006].

1.9.2 Computational Constraints

The embedded controllers in NCS usually have low computational power to manage network scheduling and control algorithms. So, for control implementation, algorithms with low computational complexity are preferred, with special consideration to autonomous mobile platforms [Cervin et al., 2003]. This directly ensures low on-board power budget, which is always appreciated in good designs.

1.9.3 Communication Constraints

In practical scenarios, the networked communication doesn't offer zero delays and infinite bandwidth that can be neglected safely. The finite channel bandwidth requires to define signal classes for priority assignment, making delays lesser by efficient scheduling scheme. Obviously, the most priority signals on any network are the control signals dedicated to manage flows and acknowledgement signaling [Wilson et al., 2005].

The resource allocation problem in networks is also important because it is time dependent for control applications. If the system under consideration receives commands from a distant controller through a network, then in transition state, the communication requirements will be different than in the steady state [Munaretto et al., September 2002]. Similarly in distributed control and coordination scenario, sometimes messages will be more important than usual communication e.g. in hazard detection and alarming, formation control and other mission critical applications.

In addition, the network communication is asynchronous and usually a number of messages are exchanged during each sampling period, making analysis more difficult. In contrast to the Additive White Gaussian Noise (AWGN) channel characterized by a constant Signal-to-Noise Ratio (γ), in a wireless channel γ is time-variant due to multi-path effects and interference from other users operating in the same frequency band.

The network resources are usually limited. This means that there will always be constraints imposed by network bandwidth and latency which can be achieved once data is transmitted [Yook et al., 2001]. In addition, these constraints are variable w.r.t network traffic (i.e. utilization or network load) at certain time. In usual case, control of network traffic is not possible for users, including control systems engineers [Marti et al., 2002]. The specifications given to control engineers often include worst case

latencies (WCL) which directly affects the achievable sampling rates and jitter in the NCS. Thus, for NCS designers, one of the task is to minimize control traffic that is to be sent over the wired or wireless channel. Event based Control assures minimum possible traffic by sending command only when sensor data is received successfully. This surely reduces the network load.

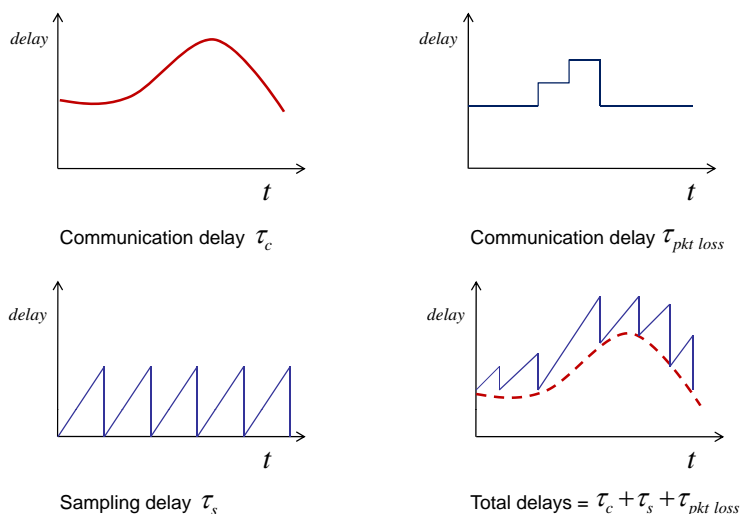

Figure 1.6: Network delay Composition

1.9.4 Delay in Teleoperation

In long range teleoperation, closed loop control is a challenge, due to excessive delays. This emphasis upon increased autonomy at the remote side. However, depending upon the type of mission, it is not always possible to increase the autonomy. A simple strategy in such scenarios is to perform move and wait teleoperation [Ferrell, 1965]. In addition, accurate models of robot, environment, network and human operator are needed. Direct teleoperation is preferred where small delays are expected in the communication network.

Historically, there are two main arenas of research in remote teleoperation which include underwater robotics and space-based robotics [Hokayem & Spong, 2006]. Both incur round-trip delays on the order of seconds when operated remotely. An excellent review of space teleoperation is available in [Sheridan, 1993]. More recently, some researchers are beginning to investigate the exciting prospect of utilizing the Internet as a medium for remote teleoperation. The internet is an interconnection of many heterogeneous and hybrid networks with the similar properties as that of any communication network. For our perspective there are delays that compromise the ability to have a closed-loop control or teleoperation. The unique aspect of internet based communication is its time varying nature of delays. Underwater and space-based robotics tend to have relatively constant delays whereas the jitter present is very small as compared to nominal delay. While, internet based communication is quite uncertain

and the delays have such variations that may exceed the nominal delay magnitude. So modeling the internet based delay is a research area in itself [Oboe & Fiorini, 1997].

In NT different delay models are used as per requirement and the type of network [Khan et al., 2010]. These delays can be classified as constant, varying (bounded, interval and piece wise) delays and with bounded jitter delay. Some of the common delay types in networks are shown in Fig. 1.6. The network delays are essentially composed of communication, sampling and packet loss delay [Wenjuan, 2009].

1.9.5 Communication Imperfections

Networked Communication has its advantages and problems. The medium is shared among different nodes depending on the MAC algorithm that may include CSMA/CD, AMP, Round Robin for wired networks while CSMA/CA for WLAN and TDMA, FDMA, CDMA, SDMA, DSMA etc for wireless cellular networks [Jurdak et al., 2004]. For wireless sensor networks, they include energy efficient and optimized routing based algorithms e.g. S-MAC, SIFT, DMAC, T-MAC, DS-MAC etc [Li et al., 2007].

A part from delay and its variation (jitter) as discussed above, there are other problems too that impact networked communication. These include packet loss/dropouts, limited communication bandwidth that usually worsens with the relative distance between master and slave system [Hartman, 2004]. Multi-operator teleoperation for complex Systems requires too many people to run one robot which involves hidden cost.

Different strategies have been implemented to cater for the communication imperfections as per application needs. For example, continuous teleoperation requires all time communication link. However, in dexterous manipulation, especially hand-eye coordination, continuous operation may not be needed.

1.9.6 Master and Slave Synchronization

Synchronization is being investigated in multiple linear/nonlinear engineering problems e.g. for chaotic systems, path following and coordinated control tasks [Arcak, 2007]. In bilateral teleoperation, synchronization (in time) between master and slave is very important for an optimal control and performance, otherwise the two master/slave positions will have a drift as shown in [Anderson & Spong, 1989]. Due to the multiple, heterogeneous, constant/variable time delays as described in Section 1.9.4, the tracking performance is hard to maintain for bilateral teleoperation. For passive systems, the master/slave velocities are synchronized in free motion, independent of the constant delay as described in [Chopra & Spong, 2007].

1.9.7 Cognitive Fatigue

Some of the most important challenges in NT include cognitive fatigue. With continuous mental work demanding *move and wait* actions result in decrements in cognitive function [Sheridan, 1993]. In remote surgery, a number of surgeons and staff are involved on both sides to operate the patient and follow the prescribed procedures. Some operations may extend to long durations with an evident fatigue associated with the remote teleoperation.

1.9.8 Reliability Features

It is essential that the system should never be harmed due to long time delays. This requires increased autonomy with enough redundance at the remote side. For example, in Mars rover, triple modular redundancy (TMR) for communication systems is used. As the rover collects data (photos, spectrometric information, system health and diagnostic information etc), it is sent back to the earth station. In addition, scientists and engineers on earth need to send commands and software updates to the rover. The Mars rover has three different radios to handle its communication with the ground station. This include direct line of sight as well as satellite communication.

When the earth is visible to the rover, the rover's antenna tracks the earth and can communicate directly to scientists and engineers. However, there is a 20-minute delay (RTT) because of the 322-million-km distance between the earth and Mars. The rover uses a 40-watt radio, and it transmits at only 12Kbps over this link. Because it is a direct link, NASA uses it to send commands to the rover and to get critical data back. This link is only available for about 3 hours per day during the alignment of the planets and the power requirements of the radio [Maimone et al., 2007].

1.9.9 Manual and Autonomous Teleoperation

The comparison of manual and autonomous mode of teleoperation is important to specify the choice of operation at some particular point of mission. For example, in space missions like Mars exploration, the manual operation is only possible when earth control station (ECS) and Mars rover are in line of sight. In all other situations, the Mars rover is supposed to perform autonomously. As mentioned above, the degree of autonomy (DoA) is directly related to the mission requirements, embedded sensor suite, onboard memory and computational power as well as the available bandwidth of the communication link for telemetry. In addition, an autonomous drive will require more power than a manual drive of the same distance [Biesiadecki et al., 2005]. The most significant is the area mapping and mission planning time because it takes a rover operator more time to identify obstacles and choose appropriate way points when sequencing a blind drive than when sequencing a drive using automatic navigation (AutoNav).

There is an additional long-term resource trade-off because humans can rapidly adapt their sequences

to deal with new environment (terrain types) or drive requirements, but changing the onboard software involves a lengthy software development, testing, and uplink process. Instead of a day-to-week turnaround in sequence development, software updates to cope with new terrain and drive techniques occur on a months-to-year cycle.

1.10 Application Areas

There are many areas in NT that are being used in medical, industrial and other scientific domains. Some notable field of application are as follows:

1.10.1 Remote manipulation

This includes monitoring and control in hazardous or difficult to reach areas [D. Hopper & Reilly, 1996]. Examples include mine detection, high temperature processing in industrial systems, deep underwater operations e.g. telecommunication cabling and immersed airplane search etc. In such applications, at proximity, usually wired networks are used for deterministic communication. However, in remote long range teleoperation, wireless networks are the only choice. Moreover, in underwater networks, the channel is constrained and information exchange is a challenge at long distances.

1.10.2 Telesurgery/Telemedicine

Telesurgery includes minimally invasive surgery, micro surgery etc being performed by a distant surgeon. Due to advancements in health care systems, minimally invasive surgery (MIS) is made possible which offers small or no incisions resulting in no scars and lesser heal up time. In surgery, the first commercial teleoperation system was *ZEUS*, developed by Computer Motion and Da-Vinci from *Intuitive Surgical*. Surgeons view the body organs with the help of small telescopes and tiny cameras. Surgical repairs in laparoscopy and heteroscopy are made with tiny instruments [Leven et al., 2005]. Thus, in telesurgery, surgeons can operate over long distances with tiny instruments attached to the robotic arms. QoS oriented communication requirements for transmission of clinical tests, X-rays, electrocardiograms and magnetic resonance scan for rapid diagnosis.

Real-time multimedia applications with audio/video conferencing are developed for health care systems to be used on the current TCP/IP internet [Hou et al., 2003]. In web-based tele-medicine system, multicast is often used to reduce network bandwidth demand when there are many receivers that are connected to the same source. RTP/UDP pair is preferred for media streams for minimum delay and jitter despite the packet loss due to unreliable end-to-end delivery.

The famous *Lindbergh Operation* on September 7, 2001 was the first transatlantic tele-surgical operation

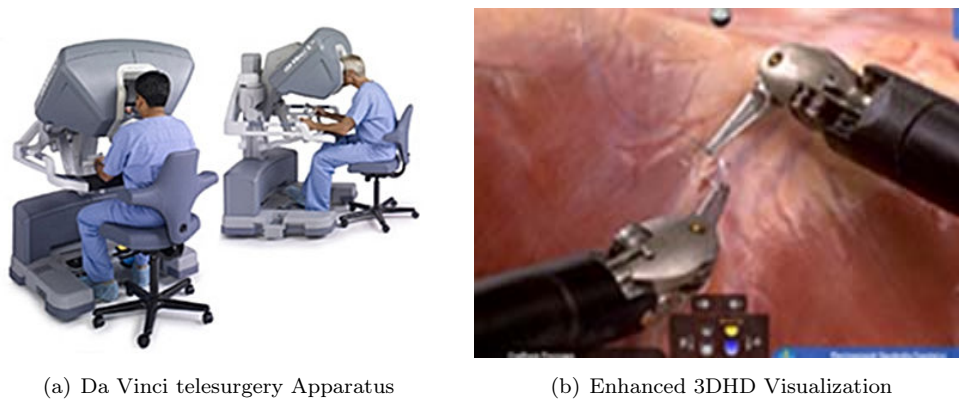

Figure 1.7: Telesurgery Applications (source: www.intuitivesurgical.com)

carried out by a team of French surgeons headed by Professor J. Marescaux. The surgeons were stationed at New York and the patient, a 68 yrs old woman was in an operation theater in IRCAD, Strasbourg, France to remove her gall bladder [Marescaux et al., 2002]. A round distance of more than 14,000 kms (8,700 miles) separated the two medical teams linked by a 500 Hz video camera and a high-speed fibre-optic line managed by France Telecom. The time delay between the surgeon’s movements and the return video image displayed on screen was less than 200 ms. The estimated safe lag time was 330 ms.

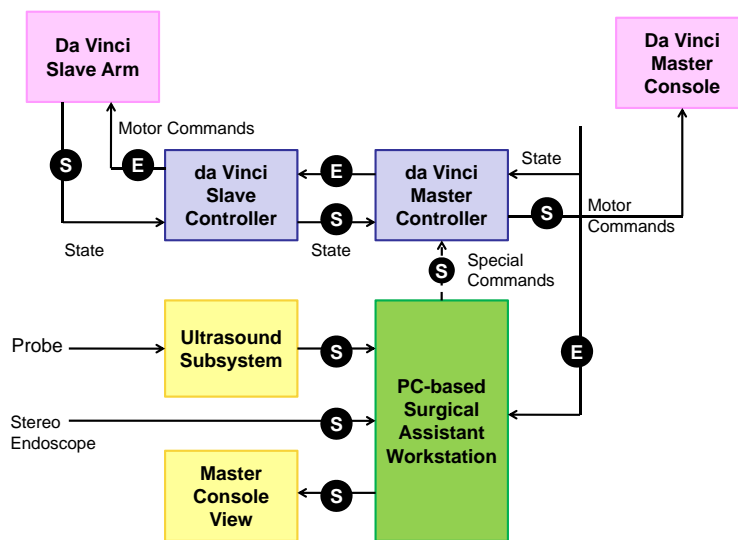

Figure 1.8: Da Vinci network architecture E – Ethernet, S – Serial network

One of the da Vinci endoscopic telesurgery system operated under ultrasound imaging is shown in Fig. 1.8, where an ethernet network connects the master and slave controller [Leven et al., 2005]. However, feedback and motor commands are sent through serial interface where devices are in proximity. The achieved accuracy is about 2.16 ± 1.43 mm using registered da Vinci kinematics.

1.10.3 Vehicular control

Aerial Vehicles (UAV)

Teleoperation of UAV refers to *fly by wireless* applications [Carvalho et al., 2008]. In aerial applications, remotely operated vehicles are used for aerial survey, mapping and volume sampling. This information can be utilized for multiple applications including monitoring and reconnaissance purposes. Telecontrol is inverse to the telemetry in the sense that the information flow is from ground to air instead of air to ground. In the command and control system for use on small UAVs, the required bandwidth is about 5% to the telemetry requirement [Quaritsch et al., 2010]. A 9600 bps, duplex, satellite link is preferred in such applications, which can be implemented using a small, light, relatively inexpensive satellite phone modem. This link is used for the entire duration of the flight when base station and autonomous vehicle are not in LOS. In [Coelho et al., 2006], a network architecture for a UAV system is present which comprises of an onboard Piconet (bluetooth) between various devices and for air to ground communication, two physical links (one for video and other for data) are used. Moreover, in order to achieve flexible operation, ground station functionality is spread among several networked computers (e.g. control, imagery, weather station etc.), which communicate over TCP/IP. The AVIA onboard platform is depicted in Fig. 1.9.

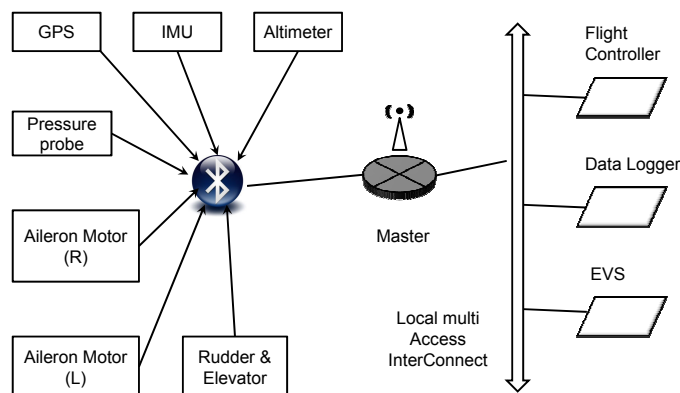

Figure 1.9: AVIA onboard platform with Bluetooth network (piconet)

Space Applications

In space exploration, the mission vehicle is teleoperated by the earth station. This is also true for the long distance surface exploration e.g. Lunar and Mars rovers. The distances involved introduce excessive delays, which results in *move and wait* control strategy [Sheridan, 1993]. As a part of NASA's Mars Pathfinder mission, the Sojourner rover became the first spacecraft to autonomously drive on another planet in July 1997. Sojourner was capable of autonomous operations involving terrain navigation, contingency response and resource management. It can autonomously navigate through rocky terrain

to position locations specified by the Earth-based operators [Bajracharya et al., 2008]. It used stereo cameras and five infrared laser stripers to detect hazards, in which case, it has several alternate strategies e.g. it would turn in place until the hazard was no longer visible, drive forward past it, and then resume driving to its way point etc. In case of completely unpredicted scenario, the vehicle is teleoperated by the earth station.

Ground Vehicles (UGV)

Autonomous ground vehicles are used in inaccessible or dangerous areas for humans. This includes mine detection, explosive search and operation in radioactive environment [McGovern, 1990]. Wireless networks are most often the chosen way of communication between the mobile UGV and the control center.

An example of teleoperation system for ground vehicles is STS [Robotics, 2001], which uses line of sight communication (1 Km) for video and telemetry in the 138 – 144 MHz license free band by using FHSS RF modems with 2 watts power. In [Surmann et al., 2008], a combination of UAV and UGV is used to form a UGAV as a teleoperated robotic platform. A mobile device (PDA) either commands the UAV or UGV. In addition, a UAV can be commanded by the UGV which also serves as the landing platform. RoboGuard is another example of mobile security robot used for surveillance [Birk & Kenn, 2002]. The system uses a special software architecture for hard and soft realtime scheduling. It uses a wireless end network connected to internet for remote operation.

Underwater Vehicles (UWV)

Underwater vehicles (UWV) or remotely operated vehicles (ROV) are one of the application of remote teleoperation operated by an operator aboard a vessel. They are linked to the ship/ASV by a tether (also known as an umbilical cable), a group of cables that carry electrical power, video and data signals back and forth between the operator and the vehicle. ROVs are highly maneuverable platforms for sea bed exploration e.g. for under-water oil search, pollution monitoring, distributed tactile surveillance, debris search in case of aircraft accident over sea, geological mapping, under-water cable repair, oil search, observation and other deep water missions.

Submersible ROVs are normally classified into categories based on their size, weight, ability and power. They are linked with the surface vehicles for guidance, control and telemetry communication via an optical-fiber point to point link for high speed realtime video and control. UWVs are however, fully autonomous and they communicate with ASV for data communication or with other UWVs for formation control. Underwater communication is a challenging area where the communication bandwidth is very limited as well as the multipath effects and the reduced data rates with increasing distance and depth [Quazi & Konard, 1982]. In addition, timing synchronization is also a problem [Hu et al., 2008]. A

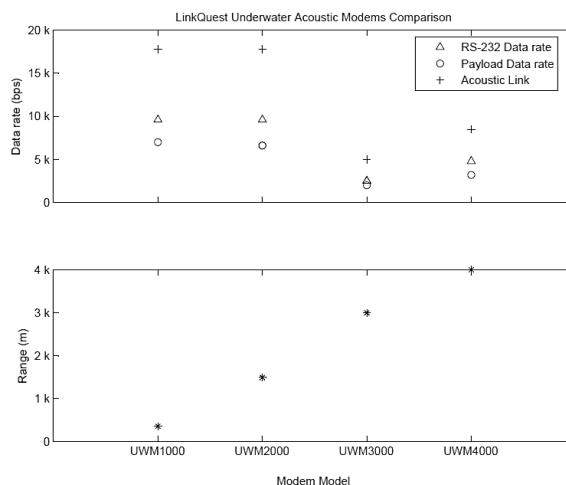

Figure 1.10: Acoustic Modem Specification Comparison (source: www.link-quest.com)

comparison of world's popular underwater acoustic modems is shown in Fig. 1.10 which clearly represents that the acoustic channel offers constrained communication over long distances.

The propagation speed of acoustic channel is five times lower as compared to the radio channel. Whereas, the propagation delay (0.67 s/km) with high variance can reduce the throughput considerably low with added problems of path loss, noise and multipath effects [Akyildiz et al., 2004]. The transmission loss depends on the range and frequency, characterized by the addition of the spherical spreading loss ($SSL = 20 * \log(R)$, where R is the slant range in meters) and the absorption loss ($R = a_0 * R$, where a_0 is the absorption coefficient in dB/km). Long range systems up to several Kms may have a bandwidth of only some kHz, while a short range system up to tens of meters can have a throughput of hundreds of kHz. The severe degradation due to multipath effects is noticeably low in vertical communication than in the horizontal communication. Comparatively high data rates are obtained in underwater communication for a vertical communication with a buoy floating at the top of UWV. In some cases, an airborne mobile network backbone is also considered for a large underwater network to communicate sensor/control data for teleoperation.

In a typical multivehicle underwater teleoperation network, two dimensional (horizontal and vertical) communications are present. The horizontal transceivers are used by the UWV for positioning, synchronization and cooperative control. While, the vertical transceivers function to relay sensor data to the surface station and the control commands to the UWV. In [Bruzzone et al., 2002], an internet based satellite teleoperation of the ROMEO ROV in Antartica is presented as shown in Fig. 1.11. The remote internet user access to Romeo located in Antartica via a satellite link. The surface network is ethernet based which interconnects pilot, scientific interface and control system.

It is obvious that underwater multivehicle coordination, control and path following requires a wireless communication network. This network is usually based on TDMA (short range)/ CDMA (long range)

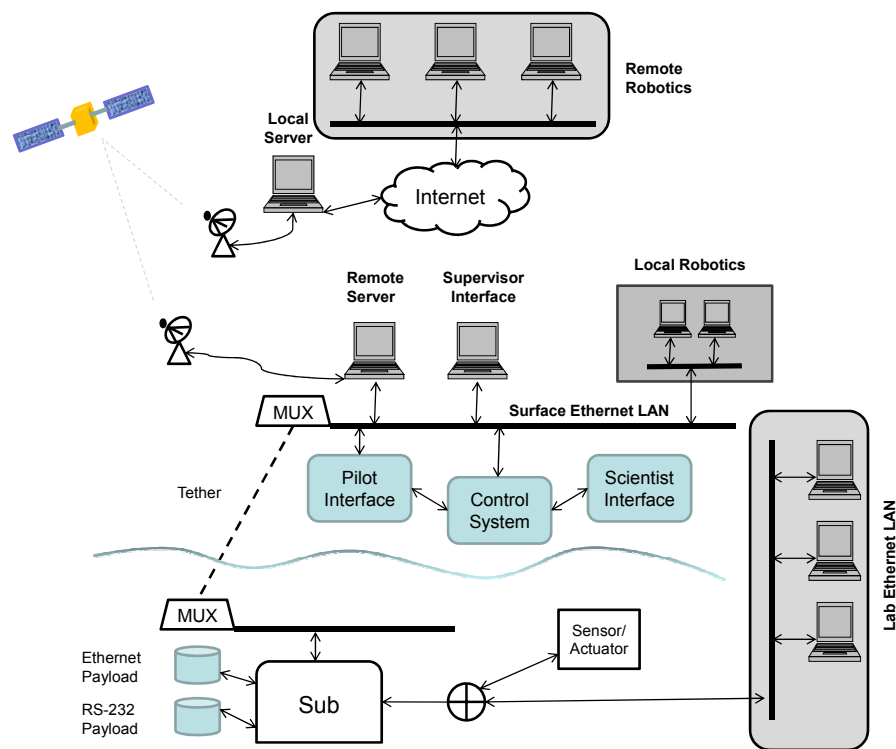

Figure 1.11: Communication Architecture for teleoperation of ROMEO ROV

protocol and self-synchronization e.g. in case of AquaNodes [Vasilescu et al., 2007]. A complete survey of practical issues in underwater networks are described in [Partan et al., 2006]. In [Chitre et al., 2006], an architecture for underwater networks is presented where a gateway buoy is used to connect the underwater network with the outside world. The efficient communication in underwater acoustic sensor networks is a challenging problem in research. Radio waves propagate at long distances through conductive sea water only at extra low frequencies (30-300 Hz), which require large antennae and high attenuation but are affected by scattering. Some current European Union (EU) research projects in this domain include GREX (EU-FP6), CO-3AUVs (EU-FP7), FeedNetback (EU-FP7) etc.

1.10.4 Industrial Mining

In mining, digging and rescue operations, teleoperation is used as the job is unsafe and inaccessible most of the time. For underground mining, the teleoperation usually refers to the actuation of functions of a mining machine from a portable control box linked to the machine through a radio transmitter. A modern computer based control of mining machinery by a long distance operator is described in [Kwitowski et al., 1992]. The wireless networks were found to add no advantages in the harsh underground environment. Therefore, in most of the cases, small diameter cables are used. Extensive sensors are however needed including thermocouple, current transducers, inclinometers, level sensors, pressure sensors and displacement transducers, angle transducers, video cameras etc for semi-automated miner

[Schiffbauer, 1986].

1.10.5 Realtime Gaming

The famous RoboCup is one of the many examples of real time gaming. It is possible for the operator by using a control device of their choice (mouse, joystick, key-board) to give robot immediate instructions on low-level actions to be taken, e.g. move, rotate, rotate camera etc [Wong et al., 2005]. The high level tasks include formation control, navigation, localization, catching the ball and forwarding it to the nearby companion. A famous example of Robot Soccer is RoboCup which is played by several online teams by an ad hoc wireless communication network at the robot end for inter-robot communication [Wisspeintner et al., 2006]. The game interface can also be connected to internet for long range teleoperation.

1.10.6 Cooperative Control

Multilateral control architectures for teleoperation in multimaster/multislave environments are getting popular in various industrial applications e.g. in car manufacturing units where multi robots participate in manufacturing by coordinating with each other. In some applications, dual masters are used for teleoperation control of kinematically redundant robotic slave manipulators [Malysz & Sirouspour, 2009]. Wireless networks allow multiple access with mobility, so a number of autonomous systems can collaborate over them. Such applications include cooperative multitasking, flocking, formation control and other interesting applications like collision avoidance system (CAS) in busy airspace where commercial airplanes as well as unmanned systems fly in closed proximity. In [Fong et al., 2003], multi robot remote driving with collaborative control is achieved through human robot interaction. In [Fong, 2001], teleoperation is considered to significantly improved by modeling the humans as collaborators rather than controller.

1.10.7 Distributed Computing

In distributed systems, many computers are integrated together over a network to get the benefits of memory and computational power [Khanna et al., 2007]. One of the interesting example is flight simulator where high power computing ensures real time simulation effects in the 6 DOF simulator's motion platform mounted over hydraulic/electrical actuators. With the use of Ethernet instead of analog/serial communication, the data rates of 10 Mbps (e.g. 10 BASE-T), 100 Mbps (100 BASE-T) and 1 Gbps (1000 BASE-T) are commonplace and secondly, simulator functions can be programmed across an array of interconnected processors rather than allocated to a single high-speed processor.

1.11 Conclusion

This chapter presents the literature survey on the long range teleoperation of remote systems with special focus to techniques and applications. In most cases, it has been observed that a point-to-point dedicated wired/fibre optic link is used for transporting information between master and slave systems. However, networked teleoperation permits cost effective solution for multiuser scenarios through multi-hop communication.

It has been highlighted that the limited data rate with constant/varying delay pose challenges in teleoperation which must be dealt by various methods including efficient network protocols, coding techniques, control algorithms as well as adaptation w.r.t communication limits. The fact that no single technique can be devised for limited data rate teleoperation clearly suggests a control/communication co-design approach.

Chapter 2

Quality of Service for Teleoperation

Contents

2.1	Introduction	55
2.2	Classification of QoS in Networked Teleoperation	56
2.3	Network QoS	59
2.4	Media Access Methods (MDMs)	60
2.5	Communication Channels	61
2.6	Quality of Service	62
2.7	Types of Communication Networks	69
2.8	Types of Network Architecture	70
2.9	Wired Networks	74
2.10	Wireless Networks	77
2.11	Network Traffic Characteristics	82
2.12	OSI Network architecture with QoS Contribution	88
2.13	Conclusion	93

2.1 Introduction

In real time teleoperation over a network, the networked communication functions to transfer information (voice, video, data etc) from one node to another or several other nodes. The area of networked communication is inspired by the rapid growth and technological advancements in microelectronics, software engineering and telecommunication. Thus, every subsystem poses its own limits due to complexity, power consumption, limited information handing capacity and environmental effects. All these limits are summed up for end-to-end performance in NT which finally determines the quality of teleoperation as compared to embedded control where no remote control is involved. This chapter provides significant information over the classification of QoS in networked teleoperation with network QoS only as one of the contributing block in overall end-to-end QoS. A detail of media access methods are described with

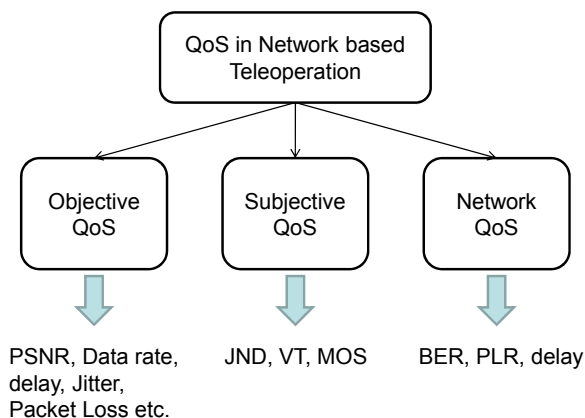

Figure 2.1: QoS Classification in Bilateral Teleoperation

special emphasis on wireless protocols. Later on, wireless network traffic characteristics are discussed with their contribution towards QoS as per OSI model.

2.2 Classification of QoS in Networked Teleoperation

In networked teleoperation, some information between master and slave devices may be of more importance than the other one. This means that a notion of preference can be given to the flows or ports in terms of the impact on transparency and teleoperation quality [Khan et al., 2009b]. For example, in case of scattering based passive teleoperation, the control data (wave variables) should be given higher priority as compared to the video flow from the slave. However, the question arises, *what if there is a critical situation where video quality is more important?* This requires an in depth analysis of all the subsystems and their QoS involved. Fig. 2.1 shows the classification of QoS in bilateral teleoperation applications.

Three QoS types are evident in long range teleoperation i.e. subjective, objective and network QoS as shown in the Fig. 2.1. They are discussed in the following section.

2.2.1 Objective QoS

The intrinsic or objective QoS refers to the quantitative aspects of the QoS based on direct measures of delay, packet loss, jitter, data rate, BER etc [Hardy, 2001]. It is shown in Fig. 2.2 that the objective QoS comes in between the master and slave including the network dynamics. Thus, the delay due to the master and slave mechanics add up with the network delay. The main contribution of the network delay comes from the propagation and queuing delay as long as no heavy processing like encryption or packetization by applications is needed [Cruz, 1991b]. For the video flow over network, we can distinguish data metrics which measure the fidelity of the signal without considering its contents and picture metrics

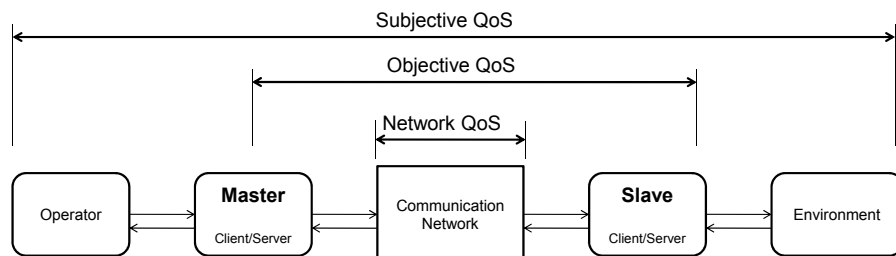

Figure 2.2: Subjective, Objective and Network QoS in Bilateral Teleoperation

which treat the video data as the visual information that it contains. For compressed video delivery over packet networks, there are packet/bit stream based metrics, which look at the packet header information and the encoded bitstream directly without fully decoding the video [Winkler & Mohandas, 2008].

Fig. 2.1 shows the dependency of objective QoS on delay, jitter, packet loss, PSNR etc. In data metrics, mean square error (MSE) and peak signal to noise ratio (PSNR) are the two important metrics. These metrics have some limitations as MSE is accurate only for the additive noise while PSNR is based on byte-by-byte comparison without taking into account the content of the data [Avcibas et al., 2002]. For picture metrics, various vision modeling and engineering approaches have been reported [Winkler, 2005*b*]. In vision modeling, various components of human vision system (HVS) are modeled while the engineering approach is based on the extraction and analysis of the video features which takes into account the psychophysical effects with the analysis of distortion and the image content [Wang et al., 2004].

2.2.2 Subjective QoS

It corresponds to the perceived service quality from the user perspective [Prokkola & Hanski, 2005]. As multimedia information is exchanged between the master and slave stations, video quality is degraded due to varying conditions, SNR and repetitive processing through different CODEC. Also, the reflected force from the environment which is communicated to the operator is also a part of the subjective QoS. In most of the cases, subjective QoS is much more difficult to measure than objective QoS, since the user experienced quality may vary with sex, age, vision and other psychophysical parameters. To measure subjective QoS includes test cases with real users, which leads to complex test setups with a lot of people involved in it. Mean opinion score (MOS) tests are often used in actual measurements [Seitz, 1994].

Subjective QoS Testing

In this type of testing, a number of users are asked to comment on the set of video clips from the slave station as per the quality they perceive. The average of these ratings are known as Mean Opinion Score (MOS). It is a five-point rating scale as shown in the Table 2.1.

MOS	Rating	Effect
5	Excellent	Imperceptible
4	Good	Perceptible but not annoying
3	Fair	Slightly Annoying
2	Poor	Annoying
1	Bad	Very Annoying

Table 2.1: ITU–R Video quality standard

MOS is then calculated as the mean of the numerical scores assigned by the subjects as $MOS = \frac{\sum N_k x_n}{N}$ where $k = e, g, f, p, u, n$ is the respective score and $N = 5$. Further details on MOS and its derivatives can be seen in [Park, 2005]. For objective measurement of video with source frame S and destination frame D , PSNR is quite useful as shown in Eq. 2.2.1.

$$PSNR(s, d) = 20 * \log \frac{V_{peak}}{MSE(s, d)} [dB] \quad (2.2.1)$$

Where, $V_{peak} = 2^{k-1}$, k bit color depth and $MSE(s,d)$ is the mean square error of source and destination frames. The PSNR and MOS can be combined by an adequate mapping as shown in Table 2.2 [Gross et al., 2004].

PSNR [dB]	MOS
>37	5 Excellent
31-37	4 Good
25-31	3 Fair
20-25	2 Poor
<20	1 Bad

Table 2.2: PSNR to MOS Conversion

A wide variety of subjective testing methods include psychophysical experiments based on the user perception [Engeldrum, 2000]. This includes visibility threshold (VT) and just noticeable difference (JND) as a measure of change in perception. ITU has recommended some criteria for larger quality ranges which suggest standard viewing conditions, criteria for conducting experiments and data analysis methods [ITU, 1998].

The main problem of subjective experiments are the limited number of tools for assessing multimedia quality as they require a large number of subjects and video sequences for reasonable video parametrization. However, subjective methods are always used as a benchmark in the validation of any objective QoS metric [Wolf & Pinson, 2002]. A number of QoS standards for video are in development by video quality expert group (VQEG) which was established in 1997. Different metrics have been defined to mimic the video quality. Many objective image quality measures have been proposed from simple mean squared error (MSE) metrics combined with some measures incorporating human visual perception. It is well-known that MSE is suitable to describe the subjective degradation perceived by a viewer. One such

approach is discussed in [A.B.Watson & Malo, 2002], where video quality metrics based on the Standard Spatial Observer (SSO) is shown to overcome the limitations of MSE. The DCT based video quality evaluation supersedes in performance as compared to MSE and PSNR methods, which do not take into account the spatial and temporal property of human perception [Watson, 1993]. In [Wang et al., 2004], structural similarity (SSIM) approach is presented as a measurement of structural distortion in video by making use of perceived image distortion. This is because the main function of the human visual system is to extract structural information from the viewing field, and the human visual system is highly adapted for this purpose. The SSIM index is defined as a product of luminance, contrast and structural comparison functions. An objective no-reference measure using local statistics in terms of noise and blur is discussed in [Kim & Davis, n.d.] to assess fine structure image/video quality for video surveillance applications. One of such composite scheme which combines subjective and objective QoS parameters proposed by [Hauske et al., 2003] and [Fitzek et al., 2005] by combining PSNR and frame rate (FR) for video quality assessment as shown in Eq 2.2.2:

$$Q_m = -0.45 * (PSNR_{mean}) + 17.9 - (FR - 5)/10 \tag{2.2.2}$$

which takes into account human perception as well.

2.3 Network QoS

The network QoS defines the capability to differentiate between different traffic classes (or users) as compared to other traffic (or users) [Park, 2005]. It also takes into account the parameters of data link e.g. SNR, BER and PLR which only gives a measure of successful delivery of data packets and not the essential video content. Some of the parameters of network QoS are shared with the objective QoS. It seems that the overall QoS in NT applications is rather a complex phenomenon which takes into account the hybrid parameters including systems dynamics, communication imperfections, human perception, haptics, environmental effects and nonlinearities of physical world in order to deliver certain quality of telepresence to the teleoperation supervisor.

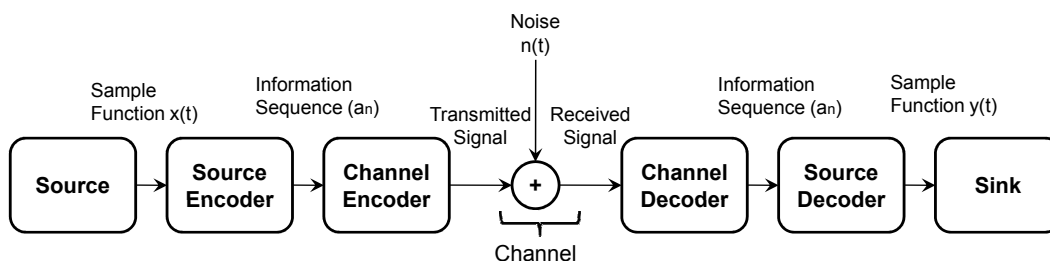

Figure 2.3: Basic Networked Communication

In Fig. 2.3, a general block level diagram of networked communication is shown which essentially consists

of the source and channel coding at the transmission end while respective decoding at the destination after passing through a noisy and shared communication medium.

2.4 Media Access Methods (MDMs)

The objective of media access methods is to ensure collision free transmission scheme. MDM decides which network entity will gain the access to the network. The choice of MDM describes the communication protocol, cost (installation/operation/maintenance) and complexity of the overall system. In general, two broad categories are available for MDM, namely centralized and decentralized.

2.4.1 Centralized Access Method (CAM)

In centralized access method, a single master controls the network and polls all the nodes connected to it (i.e., asks every node if they have any data to transmit) according to the periodic schedule. Slave nodes can transmit a message only when they are given permission by the master. This method is deterministic and is efficient for periodic signals as it has an approximately predetermined delay [Siljak, 1991]. However, when the number of nodes is large, the polling of messages can easily lead to an unacceptably large time delay in the system. An example of CAM is Factory Instrumentation Protocol (FIP) centralized architecture where a bus arbitrator, polls the slave stations periodically based on a predefined polling list. There also exist a mechanism to handle event-driven messages in FIP [WorldFIP, 1998]. Another example of CAM can be found in wireless networks, e.g. in WLAN 802.11, point coordination function (PCF) can be used where centralized access point (AP) polls all the connected nodes for data transmission [Simek et al., 2007].

2.4.2 Decentralized/Distributed Access Methods (DAM)

In a decentralized access method, there is no Master/Slave architecture. There are two types of DAMs [Jurdak et al., 2004].

- i) *Contention-free* e.g. TDMA, CDMA and FDMA at the channel level while token bus and token ring at the data link layer, where a token (which allows message transmission) is passed around among nodes in an order determined prior to the operation which ensures deterministic communication.
- ii) *Non-Contention free*, which are either based on random access (ALOHA, slotted-ALOHA etc), on carrier sense access (CSMA) or on collision avoidance with handshaking access (MACA, MACAW etc). In DAM, the media access rules are predefined and known to all communicating entities [Wang & Davison., 1978].

Other decentralized protocols include the Carrier Sense Multiple Access with Collision Detection (CSMA/CD) protocols, in which, each transmitting node first checks whether the channel is free. If

not, the node waits for some time and retries [Liu & Goldsmith, 2004]. However, if the channel is free, the node begins the transmission. Since two nodes may simultaneously start their transmissions, the nodes listen to the channel while transmitting to detect any collisions (sensed by different voltage levels than usual communication). There are several measures to handle the possible collisions, including the delayed retry (DR) method (e.g. in Ethernet), the collision resolution (CR) method (e.g. in CAN), and the collision avoidance (CA) method (e.g. in WLAN) [Lawrenz., 1997]. Because of the event-driven nature of the media access, CSMA methods are strong on aperiodic signals for control networks. The shortcoming is the cost due to the complexity in protocols and interfaces [Rackley, 2007].

In today's advanced technology, several combinations of CAMs and DAMs are used in most of the protocols to address the problem of time critical messages, access control and collision avoidance with simple design.

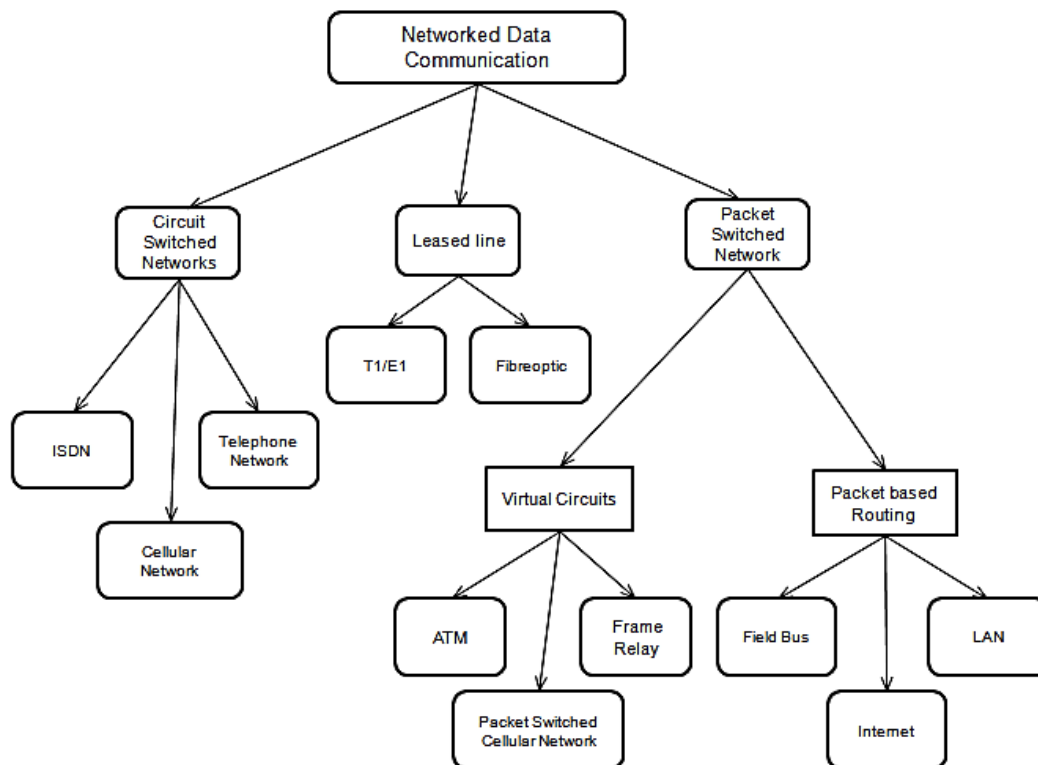

Figure 2.4: Network Categories

2.5 Communication Channels

The communication channel essentially connects a sender X and a receiver Y (or vice versa) over a channel with limited bandwidth, noise and signalling imperfections [Anttalainen, 2003]. Thus, a communication channel is a probabilistic system with input dependent output. If the probability distribution of output symbol given input $p(y|x)$ is dependent on the present input only, the channel is memoryless.

Otherwise, it would be a channel with feedback. The link between two terminals can be a discrete or continuous channel. Usually discrete case is preferred that is the channel where inputs and outputs are in finite alphabets. The advantage is that the results derived for the general discrete case lead to the results for the most used channel models such as binary symmetric, erasure, and Gaussian channels in most cases [Sklar, 2001]. The capacity of a channel allows the transfer of information at the maximum rate defined as $\mathcal{C} = \max_{p(x)} I(X; Y)$. Whereas, $p(x)$ is the error probability that may occur during information transfer between X and Y.

In a simple binary noiseless channel (BNC), the binary input is reproduced without change at the output resulting in the capacity \mathcal{C} of 1 bit. Whereas, a binary symmetric channel (BSC) considers noise, where bits are corrupted. The capacity of BSC is $\mathcal{C} = 1 + p \log p + (1 - p) \log(1 - p)$ bits per transmission. The binary erasure channel (BEC) is the one where bits are lost instead of corrupting. The receiver knows which bits have been erased [Goldsmith & Chua, 1998]. The maximum rate obtained for a communication depends on the channel coding. The rate of a sequence n with an index set M or (n, M) code is given as: $R = \frac{\log M}{n}$ bits per transmission. This rate will be achievable if there exists a sequence of $(n, 2^{nR})$ codes such that the maximal probability of error tends to zero as $n \rightarrow \infty$. The capacity of a discrete memoryless channel is the supremum of all achievable rates [Nair & Evans., 1997].

2.6 Quality of Service

The quality of service (QoS) for a communication system as defined by ITU-T (Recommendation E.8000 [ITU-TE.800]) is *"the collective effect of service performance which determine the degree of satisfaction of the user of the service"* With concern to network, the QoS is the ability of a network element to have some level of assurance that its traffic and service requirements can be satisfied [Marchese, 2007]. Thus, QoS manages bandwidth according to the network flexibility and application needs.

In actual, QoS depends on the statistical nature of network traffic. For QoS control, suitable service model should be defined and some network engineering is needed to meet a range of QoS performance requirements e.g., throughput, blocking probability, delay, jitter and packet loss, which are usually represented as a set of QoS parameters associated with the service model [Iancu et al., 2008]. Important QoS parameters to be considered are bandwidth, delay, delay variation and error rates.

2.6.1 Delay Types

The one-way delay normally describes the average delay that packets experience over a specific connection. Packet delays can be split into four components [Fiche & Hebuterne, 2004]:

1. Processing delay ($\tau_p(t)$): It is the time needed by network elements such as routers or end systems

to setup and process a packet and therefore, it depends on the processing speed of the network element hardware and the complexity of the functions to perform.

2. Transmission delay ($\tau_{mac}(t)$): It is the time needed to transmit a packet at a specific bit rate and it depends on the MAC protocol, transmission speed as well as the packet size of the transmitted information.
3. Queuing delay ($\tau_q(t)$): The time a packet stays in the queues of network elements is called the queuing delay. In case of congestion, the queues become larger resulting in longer queuing delays. It has an effective contribution in the variation of over all end-to-end delay as it is dependent on the network load which have time dependent variations.
4. Propagation delay ($\tau_{pr}(t)$): It describes the time needed by the signals to propagate through the physical medium. It is equal to the physical distance propagation velocity. In most of the cases, the propagation and queuing delay are the key contributors to delay as long as no heavy processing like encryption or packetization by applications is needed.

The overall delay may comprise on the sum of these time varying delays. In real-world networks, packets experience a delay on their path from the sender to the receiver, which is not constant but time varying, as the network conditions on a route and the devices change. This happens as a result of the fluctuation of Internet traffic and resulting queue sizes [Mogul, n.d.]. The delay is bounded by a minimum and maximum delay. The difference between these bounds is called *delay variation*. Since processing, transmission and propagation delay normally do not change for a given route, the variation in delay results from the varying queuing delay which can be compensated by buffering packets, either within routers or the receiving end systems [Iancu et al., 2008]. Since end-system memory is much cheaper than router memory, play-out buffers in the end system are preferred [Vidales et al., 2004].

2.6.2 Bandwidth and Packet Loss Ratio

The bandwidth describes the capacity of a link or end-to-end path, measured in bits per second (bps). The packet loss rate indicates the number of packets that do not reach the destination in relation to all sent packets. It has mainly two causes; either due to packet errors which arise in case of bad link quality (especially for wireless networks) or packet drops, e.g. due to congestion. It can be calculated as:

$$\text{Packet loss ratio} = \frac{(\text{SentPackets} - \text{RecievedPackets})}{\text{SentPackets}}$$

2.6.3 QoS Perspectives

The term quality of service is quite vague in the sense that it depends on different point of view. If QoS has an availability perspective, then it is more concerned to the availability of the network than other aspects [Marchese, 2007]. In the similar case, if the QoS has an orientation from the point of view of the application level of critical importance, then a *heartbeat* type correspondence can be ensured between the device and QoS manager, so that diagnosis and prognosis can be ensured based on past reports. This mode of functioning comes under the reliability and safety analysis [Ghostine et al., 2006].

In mobile telephony, the audio quality is the most important. Some of the measurements for the audio quality includes echo, distortion, noise, attenuation, interruption etc. These measurements can be used to generate a model which can give a MOS as mentioned by the ETSI (ETR 250) and the ITU (ITU-T Recommendation G.107) [ITU, 1998].

2.6.4 QoS Metrics

The performance metrics of QoS are usually regarded as: Availability, Delay, Jitter, Throughput and Packet loss rate. These parameters vary as per Service Level Agreement (SLA). In Fig. 4.1, a number of options are listed under Control of network (*CofNet*), which are available in the existing network protocols today. An easy approach to ensure network QoS is to choose among various protocols, the one which has real time support [Muller & Werner, 2009]. In [Ouferhat & Mellouk, 2010], energy and delay metrics are used for routing in WSN.

2.6.5 Factors Contributing to QoS

Before going to discuss the networked communication, it is important to revise the fundamental concepts in data communication to understand the dependency of QoS on these factors in every network protocol [Anttalainen, 2003].

Frequency band

The efficiency of any particular transmission method depends on the frequency of the signal being transmitted [Tafazolli, 2006]. With the help of CW modulation, the spectrum of the message is transferred to the suitable frequency band of the medium.

Channel bandwidth/Data rate

The Channel bandwidth in Hz defines the information-carrying capacity of a telecommunications channel. The term bandwidth is often used in place of data rate because they are closely related with each

other. Generally, the communication channels require voice, video and data traffic to pass over with their own bandwidth requirements [Siripongwutikorn et al., 2003]. For example, a telephone connection requires 4 kHz channel bandwidth, but television signals require 5 MHz bandwidth with better SNR. In digital systems the equivalent of Channel bandwidth is the data rate (R). For example, an analog telephone signal requires 64 Kbps and video with a bandwidth of 2 to 140 Mbps (depending on the coding scheme). In baseband transmission, a digital signal with r symbols per second, bauds, requires the transmission bandwidth B to be in hertz: $B \geq r/2$. This is the fundamental limit of the symbol rate that it should be at least equal to twice the bandwidth of the channel [Nair & Evans., 1997]. Thus the available bandwidth in hertz determines the maximum symbol rate in bauds.

Number of channels used

The number of channel used by a communication protocol has a great impact on the communication performance. The more the channels available, more bandwidth with lesser interference can be ensured. Some protocols e.g. IEEE 802.15.4 based Wireless HART, which uses frequency hopping in the 2.4 GHz ISM band, has the capability to detect interference and use channel blacklisting for robust performance.

Bit-rate

The bit rate (R) is specified in bits per second (bps) to specify the number of information units sent over a transmission medium in basic time units. The bit rate is sometimes referred to as the transfer rate, bandwidth/channel capacity, maximum throughput or connection speed. Generally, the bit rate depends on modulation rate according to $r_b = k \cdot r$ bps. Where k is the number of bits encoded into each symbol. r is the symbols per seconds (bauds). Then the number of symbol values is $M = 2^k$ and the bit rate is given as $r_b = r \log_2 M$ (bps). For example with BPSK, $k = 2$ and $r_b = 2r$. If 8-PSK is used, $k = 3$ and $r_b = 3r$. For 16-QAM, $k = 4$ and r_b is 4 times the baud rate.

Maximum Channel Capacity

The maximum channel capacity is limited theoretically by Shannon. He worked out by taking into account; bandwidth (B) and noise power (N), that the error-free bit rate through any transmission channel cannot exceed the maximum capacity (C) of the channel given by:

$$C = B \cdot \log_2(1 + \gamma) \quad (2.6.1)$$

where γ is the signal to noise ratio defined as:

$$\gamma_{dB} = 10 \cdot \log_{10}(\gamma) \text{ dB} \quad (2.6.2)$$

Bandwidth efficiency

Bandwidth efficiency η_b is a representation of the quality of modulation that is used to modulate the signal over a specific bandwidth while respecting the required bit rate. It is the ratio of the maximum bit rate (R_{max}) to the channel bandwidth (BW) in units of the bps/Hz. The bandwidth efficiency is expressed in Eq: (2.6.3) as:

$$\eta_b = \frac{R_{max}}{BW} \quad (2.6.3)$$

For WLAN, if we need to calculate η_b for 10 Mbps and bandwidth of 20 MHz. The η_b comes out to be 0.5 bps/Hz.

Signal Range

The signal range describes the distance up to which transmitted signal can be successfully received. In wired network, repeaters are used to regenerate the signals after some distance. The signal range is dependent on several factors for a wireless network. The noise in the environment, signal power, received signal strength, receiver sensitivity are some of the factors that may effect the signal range.

Modulation

The modulation represent the robustness of the signal in case of noise and interference. The modulation technique must ensure minimum possible ISI [Anttalainen, 2003]. The optimum modulation method for a particular system depends on the quality of the transmission channel. In voice-band modems, which uses low noise speech channels, very large constellations with hundreds of different combinations of phases and amplitudes are feasible [Schwartz, 1988]. In bad quality channels, such as in cellular networks, binary modulation may be the best choice. Phase modulation together with amplitude modulation is used in many modern digital transmission systems, such as in digital radio relay systems, voice-band modems, and digital video broadcasting (DVB) systems, which use 64-QAM [Sklar, 2001].

Adaptive Modulation and Coding

The usual design of the communication systems considers worst case channel conditions to always deliver an error rate below a specific limit. However, in adaptive transmission schemes, the channel quality is tracked by adapting the channel throughput to the actual channel state at a particular instant [Anttalainen, 2003]. This intelligent adaptation tracks the variation over the wireless channel to adapt the transmitted power level, symbol rate, coding scheme, constellation size, or any combination of these parameters with an objective of improving the link average spectral efficiency, i.e. the number of information bits transmitted per second per Hz bandwidth used.

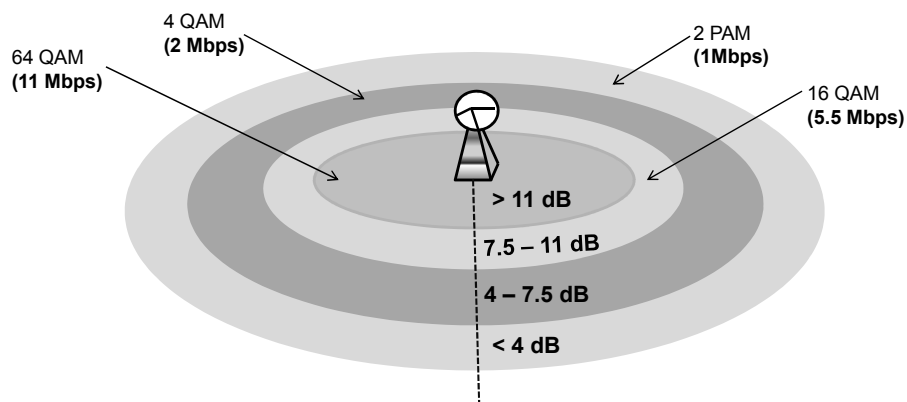

Figure 2.5: Adaptive Modulation and Coding (AMC) in 802.11b

Adaptive modulation and coding has the advantage of increasing the spectral efficiency of time varying wireless channel while maintaining a predictable bit error rate [Goldsmith & Chua, 1998]. Not only the modulation order varies but also the forward error correction scheme adjusts its code rate to the variations in the communication channel. This means that when the channel is in a poor state due to high fading (low SNR), the signal constellation size is reduced in order to improve fidelity and lowering the effective SNR to make transmission more robust. Similarly, in case of low fading or high gain (high SNR), the signal constellation size is increased in order to allow higher data rate modulation schemes to be employed with low probability of error, thus improving the instantaneous SNR ($\tilde{\gamma}$). This scenario is illustrated in Fig. 2.5, which shows that as the range increases, the 802.11b steps down to a lower modulation, whereas when closer to the base station, higher order modulations can be used for increased throughput. This feature is common in most of the 802.11 a/b/g WLAN cards available in the market today.

2.6.6 QoS in Wireless Networks

The legacy IP networks were aimed to provide best effort communication services whereas the network core remains simple while the end hosts have higher complexity level. However, in case of heavy traffics, congestion may degrade the IP performance, specially for the time critical applications. A comparison of wireless technologies is shown in Table 2.3. Various wireless protocols from wireless data networks as well as mobile telephony are compared w.r.t type, protocol, frequency spectrum used, bandwidth, data rate, bandwidth efficiency, modulation/spreading, range and QoS options. It can be noticed that these protocols are application oriented and their QoS policies are also dependent on the type of multimedia applications that run over these networks. Mobile telephony protocols e.g. GPRS and UMTS have low data rate but support mobility as an integrated feature. On the other hand, wireless data networks e.g. WLAN and WiMAX have high data rates but mobility is added as an add-on feature. Both types support some QoS features to differentiate some application types, users or flows [Fang & Ghosal, 2003].

Type	Protocol	Year	Frequency (GHz)	band	Bandwidth (MHz)	Data Rate (Mbps)	Bandwidth Efficiency (bps/Hz)	Modulation/Spreading	QoS	Range(Kms)
WPAN	Bluetooth v2.0	2004	2.4-2.4835		1	2.1	2.1	$\pi/4$ DQPSK/FHSS	No	0.01
	UWB	2007	4.8-10		500	480	0.96	OFDM	No	0.01
	ZigBee	2004	2.4-2.484		2	250 kbps	0.125	O-QPSK (DSSS)	Yes	0.01
WLAN	6loWPAN	2009	2.4-2.484		2	250 kbps	0.125	O-QPSK (DSSS)	Yes	0.01
	802.11a	1999	5		20	6~48	2.7	BPSK/QPSK/16,64QAM	Yes	0.07~0.1
WMAN	802.11b	1999	2.4-2.484		20	11	0.55	BPSK/QPSK/CK	Yes	0.035~0.11
	802.11g	2003	2.4-2.484		20	6~54	2.7	BPSK/QPSK/16,64QAM	Yes	0.1
	802.11n	2006	2.4/5		40	150	3.7	MIMO	Yes	0.07~0.16
	WiMAX 802.16	2001	10/66		28	32-134	4.5	QPSK/16,64QAM	Yes	5
	802.16a	2003	2/11		20	75	3.7	BPSK/QPSK/16,64QAM	Yes	10
	802.16d	2004	2/11		25	75	3	BPSK/QPSK/16,64QAM	Yes	8
WWAN	802.16e	2005	2/6		20	30	1.1	BPSK/QPSK/16,64QAM	Yes	5
	GSM	1992	0.9/1.8		2	9.6 kbps	0.05	GMSK	Yes	35
	GPRS	1997	0.9/1.8		2	80 kbps	0.4	GMSK	Yes	35
	UMTS	2000	1.8/2.2		5	2.048	0.4	QPSK/WCDMA	Yes	2
	EDGE	2003	0.9/1.8		2	100/200 kbps	1.2	8-PSK	Yes	30
	HSDPA	2004	0.873/1.9		5	14.4	2.8	QPSK/16-QAM	Yes	6
	HSUPA	2005	0.873/1.9		5	1.45	0.4	QPSK/16-QAM	Yes	5
	MBWA 802.20	2002	<3.5		1.25	1.24/0.3	1.0	OFDM	Yes	12
	Microwave Relay Station	2002	<3.5		1.25	1.24/0.3	1.0	OFDM	No	12

Table 2.3: Characteristic details of Wireless Protocols

2.6.7 QoS Measurement

The measurement of QoS is based on the estimation of network load, queuing performance, source traffic processes, large scale traffic flow models etc. However, for analysis purposes delay, jitter and throughput are usually used. In multimedia domain, quality of experience (QoE) is a popular term to describe the application and user oriented quality of video and multimedia services over network [Winkler, 2005 *a*]. Some of the factors which contribute to the user QoE include the quality expectations, video experience, individual interest of users, display type, viewing setup and haptic feedback from the remote site. For a teleoperation application, QoS combines the effect of network and application QoS on teleoperation performance.

2.7 Types of Communication Networks

The networks can be classified on various aspects [Schwartz, 1988]. In Fig. 2.4, network types are presented with their sub-categories. The leased lines are proprietary solutions that are costly and being inaccessible to general users, are out of the scope of this discussion. The broad classification of networked data communication comprises of circuit and packet switched networks [Anttalainen, 2003].

Circuit-switched networks are those networks, which have a dedicated connection established for the time of the data transfer between the source and the destination node [Iniewski et al., 2008]. It is the primary technology for voice telephone (PSTN), video telephone and video conferencing applications which uses a circuit that is established between the devices before the communication begins. While a route is reserved between the source and destination, the other clients must wait for the idle links. Circuit switching provides fixed bandwidth and very short and fixed communication delay [Fiche & Hebuterne, 2004]. However, the disadvantage lies into its inflexibility for data communications where the demand for transmission data rate changes dynamically with sharp variations.

Packet-switched networks are widely used and specially designed for digital data communication. Here, the transmitted data is divided into small chunks or packets to send through the network via different routes [Ahmad, 2005]. The packets contain transmitting node, route and destination node identifications, error detection and correction bits, sequence information as well as priority bits, if applicable. The packets are routed towards the destination by packet-switching nodes on the entire path through the network. The main disadvantage of switched technology is its incapability to provide a service for applications that require constant and low delay [Sklar, 2001].

There are two basic types of packet-switched networks: Connection oriented (virtual circuits) and Connection less (datagram transmission). The two are described as follows:

a) Connection less Packet Switching: In connection less packet switching, every packet has a destination address label with the packet sequence number so that it can be rearranged on reception [Anttalainen, 2003]. No prior agreement is needed for the communicating nodes therefore named *Connectionless*. A virtual connection is provided to the end user by a transport layer protocol, whereas the network layer offers connectionless service. Examples include WLAN and Ethernet with IP and UDP. The field bus protocols may be connection oriented or connection less [Thomesse, 2005].

b) Connection Oriented Packet Switching: In such networks, each packet has its connection ID as compared to the address in the connection less case to travel from one point to another. During the

connection setup phase, address information is passed to each node. Examples include X.25, Frame relay, ATM, WiMAX, MPLS (IPV6), TCP, Cellular Network etc. Some connection oriented protocols are designed to support both connection oriented and connectionless data [Fiche & Hebuterne, 2004]. Not all connection oriented packet switching is reliable e.g. Frame relay and ATM are unreliable protocols whereas TCP is reliable one.

2.8 Types of Network Architecture

In this section, different metrics for network architectures are discussed in details to have a clear idea of interconnection of network devices, drawbacks and advantages of different topologies and the protocols used therein. In principle, there are different aspects to differentiate network architectures. Our prime focus and interest is on the wireless networks as we are interested in mobile teleoperation applications. Following are some of the important aspects for the network architecture:

2.8.1 Network structure

The classification with respect to network structure usually includes three common architectures namely: Infrastructure based, Ad hoc and Mixed mode incorporating the two previous types.

- **Infrastructure based:** These are well managed and organized networks, whereas, the network hierarchy is already defined. All the devices participating in networking have their particular functions e.g. nodes, bridges, routers, hubs, switches, clients, servers etc [Ahmad, 2005]. Typical LANs and cellular network infrastructure fall in this category which are classified as per access distance as follows:

1. **Wireless area networks:** The wireless networks are categorized as wireless PAN, LAN, MAN and WAN based on the distance of communication and the volume of communicating devices [Rackley, 2007]. While WPANs have the smallest operational area, they are used as body area networks and to connect PDAs, mobile phones and accessories to form a small network based on bluetooth, ZigBee, Infrared etc.

WLANs are larger networks used for data communication between PCs.

Metropolitan wireless networks (WMANs) have higher capacity and permit handoff for mobile users e.g. WiMAX is a WMAN protocol. In wide area networks, wireless connectivity is even farther but data rate is not high enough [Simek et al., 2007]. Examples include GSM/GPRS, CDMA, Satellite networks etc.

2. **Cellular Networks:** Wireless communication is best observed in the mobile telephony and cellular networks. Each area is divided into hexagonal cells to offer mobile services. When the user travels from one cell to another, a handoff mechanism permits to continue the communication of the mobile user [Fiche & Hebuterne, 2004]. The mobile technology has been extended to 3G, 3.5G and now advancing 4G and beyond to offer more expansibility and performance.
3. **Microwave Relay Systems:** The microwave relay systems (MRS) are such radio systems that are usually deployed for point-to-point, line of sight wireless communication. They function as relays, converting digital data into the radio waves and vice versa [Tafazolli, 2006]. They also

Frequency Band	Frequency Range	Application
C-band	6/4 GHz	IntelSat 806, SDRS 5
L-band	1.5–1.6 GHz	IntelSat, INMARSAT, MAREC
Ku-band	14/12 GHz	TelStar 12, PAS 6B, Echostar 3
Ka-band	30/20 GHz	EchoStar 9
S-band	2.5–4 GHz	Mobile Services
V-band	37.5–50.2 GHz	Fixed Services
X-band	7.25–12 GHz	Military

Table 2.4: Satellite Communication Frequency Bands

perform supervisory functions for remote performance and fault monitoring from the network management center. Microwave radio relay systems usually operate at radio frequencies in the range from 1 to 40 GHz whereas, these frequencies are focused with parabolic dish antennas to last up to distances ranging from a few kilometers up to approximately 50 km depending on the transmission frequency and the system characteristics. The propagation loss is higher for the higher frequencies [Ahmad, 2005]. At very high frequencies, weather conditions may cause perturbation in transmission quality, which restricts the available frequency band.

4. **Satellite Communication:** The satellite communications employs a microwave repeater, which is located in a satellite. An Earth station transmits to the satellite at one frequency band (up-link) and the satellite essentially regenerates and transmits the signal back at another frequency band (down-link) to another ground station in most cases. The frequencies allocated by ITU for satellite communications are in the frequency range of 1 to 30 GHz. A brief comparison of satellite communication bands and their applications, adapted from [Ahmad, 2005], is shown in the Table 2.4.

The satellites used in the telecommunications network are usually located in a geostationary orbit (36,000 km from the Earth's equator) which appears to be in the same location all the time from the point of view of the Earth station [Rackley, 2007]. The large distances introduce a long transmission delay that is 250 ms (approximately) from the transmitting Earth station - Satellite - receiving Earth station path. The speaker has to wait for a response for approximately 0.5 seconds and this disturbs an interactive communication [Anttalainen, 2003].

The advantages of satellite communication includes their continued services to areas where no terrestrial infrastructure for telecommunications exists [Ahmad, 2005]. To provide wide coverage and quality in mobile telephone service with smaller delay, many lower orbit satellite telephone systems have been developed but they have not been successful because the cellular systems, such as GSM and CDMA, have the major share of land based mobile telephone business. However, for broadcast satellite TV services are popular, so that the TV channels may be received in any part of a continent simultaneously and cost low [Sklar, 2001]. The multimode mobile phones could use satellite or, if available, lower cost mobile network, such as GSM/GPRS or CDMA. Examples of these systems are Iridium and GlobalStar. A part from fixed and mobile telecom services in long range applications e.g. ships and aircraft, some other applications include navigational services (e.g. GLONASS, GPS, Galileo), Military communication etc.

- **Ad hoc:** There are two main types of wireless broadband ad-hoc network, these are autonomous peer to peer networks with no fixed infrastructure, and the hybrid mesh networks that combine

ad-hoc features with fixed infrastructure [Nusairat et al., 2008]. The two types are compatible and are positioned in the future technology to create wider areas of coverage and at the same time offering QoS based preferences.

Autonomous Peer to Peer Networks: Such networks are constructed from heterogeneous devices including cell phones, PDAs, laptops and other mobile and personal devices. When these are designed with built-in ad-hoc technology, all of these devices can serve as intermediate routers to create communication paths from one device to another [Pollard et al., 2006]. This multi hopping capability is based on the ability of devices to recognize one another, automatically join to form a network, and evaluate signal strength and other RF conditions to create the optimal data path at any given moment [Webb, 2007]. These are also known as the ubiquitous networks.

Hybrid Mesh Networks: Hybrid mesh networks include both static mesh routers, access points (APs) and mobile mesh clients. Static mesh routers are typically much less resource-constrained than mobile mesh clients, and are also often equipped with multiple radio interfaces [Le et al., 2009]. The hybrid network cooperate to create the optimal route, using the same dynamic route discovery as the autonomous peer-to-peer networks. In addition to routing, the fixed infrastructure may also provide (wired or wireless) back haul for connectivity to different ad-hoc networks, the LAN or Internet. In practice, infrastructure as well as ad hoc networks are interconnected to get the advantages of long range and mobility. Such scenarios are preferred in applications of autonomous mobile robots which exchange data in the ad hoc mesh network with one or more leader nodes functioning as a relay to communicate with the distant operator via infrastructure [Fiche & Hebuterne, 2004].

2.8.2 Mobility

The mobility aspect of a network architecture emphasizes on the interconnection of wireless networks with the infrastructure or an adhoc communication architecture [Jia et al., 2006]. In mobile networks, the nodes are mobile and they can leave or join a subnet. Thus, their network addresses can change. The mobile networks need mobility management as their connecting nodes need to perform handoff from one network to another [Ahmad, 2005]. *Mobile Ad hoc Networks* do not have a permanent network structure. Fixed WSN nodes use energy harvesting for long time operation e.g. Survivable Radio Networks (SURAN) are optimized for long life operation without battery replacements for a survivability period of many years [Le et al., 2009]. In [Gu et al., 2002], a hierarchical multi layer network architecture is presented for UAVs.

2.8.3 Connection of nodes

- **Flat:** A flat network doesn't need a bridge or router to connect all stations which can reach others without going through an interconnecting network device [Anttalainen, 2003]. A flat network is one network segment without any intermediary hardware devices. Examples include broadcast traffic networks which are used to improve traffic and reduce secondary delays within a workgroup.
- **Segmented:** A segmented network as opposed to a flat network is broken up into subnets to improve the performance [Ahmad, 2005]. Every network segment of a computer network uses interconnecting devices e.g. routers and bridges etc to communicate using the same physical layer.

- **Hierarchical:** In hierarchical network topology, a central root node in the top level of the hierarchy is connected to one or more other nodes that are, for example, one level lower or above in the hierarchy with a point-to-point connection [Iniewski et al., 2008]. This actually forms a hierarchy in the network topology. The horizontal communication is within the level, while vertical communication is carried out by a router or a gateway connected to the above or lower level. Hierarchical networks are also known as to use *tree* topology.
- **Hierarchical Mesh:** In such networks, one of the level (usually the lowest one) is a wireless mesh network which may be configured as a multiple-level hierarchical network, with each level of the hierarchy having multiple number of nodes [Silmane et al., 2009]. Several clusters of such nodes each having one or more sink nodes (gateways) may be connected to form a backbone in the hierarchical network topology [Khan et al., 2009a]. Tree based wireless mesh architecture have been analyzed for worst case end-to-end delay in [Waharte & Boutaba, 2005].

2.8.4 Interface/Interconnection

With respect to their interconnection, the network architecture can be divided into different categories as follows:

- **Hybrid Networks:** The hybrid networks are mostly considered as those interconnected networks which use different PHY layer and MAC protocols e.g. an ethernet network connected to WLAN router [Miller et al., 2003]. By utilizing hybrid networks, an increase in network capacity and long range coverage can be achieved [Liu et al., 2003].
- **Heterogeneous Networks:** Heterogeneous networks are the ones which have the same PHY layer but different MAC layer. protocols [Wilson et al., 2005]. Examples include WLAN mesh networks connected to WiMAX subscriber stations (SS).
- **Internet:** The internet is an interconnection of many different types of hybrid and heterogeneous networks including fiber optic links to satellite networked communication which supports the standard TCP/IP suite [Vidales et al., 2004]. The various applications of internet comprises of data communication, VOIP, video streaming, world wide web, blogging, web feeds etc.

2.8.5 Number of Tier

With respect to the number of tiers, the network architecture can be classified as:

- **One tier:** Such networks are comprised of a single network tier. Simple examples include an internal LAN in an office environment not connected to internet.
- **Two tier:** In two tier, an external network interconnection is necessary. Examples include an office LAN connected to another office LAN or internet service provider (ISP).
- **Three tier or more:** In multi tier network, many different hierarchical tiers may exist with different PHY layer requirements. For example a ground network connected to aerial network which is directly connected to communication satellite network.

2.8.6 Transmission Mode

With respect to the transmission mode, the network architecture can be divided into following categories:

- **Unicast:** It is a type of transmission in which information is sent from only one sender to only one receiver. In other words, Unicast transmission is between one-to-one nodes (involving two nodes only). Examples of Unicast transmission are http, SMTP, Telnet, SSH, pop3 etc. where the request for information is directed from one sender to only one receiver at the other end. All Ethernet and IP networks support this type of transmission.
- **Broadcast:** It is a type of transmission in which information is sent from just one computer but is received by all the computers connected to the network [Mogul, n.d.]. This would mean that every time a computer or a node would transmit a packet of type *broadcast*, all the other computers will receive that information packet. Another example is of the ARP (Address Resolution Protocol) which will broadcast the address resolution request to all other computers on the network.
- **Multicast:** It is very much different from unicast and broadcast both in definition and application. It is a type of communication in which there may be more than one sender and the information sent is meant for a set of receivers [te Sun et al., 2002]. It is possible that sometimes the information might not be directed towards any receiver at all. Multicast offers savings on bandwidth and is the preferred way of data communication when data is to be transmitted to a set of computers [Finlayson, 1999].
- **Anycast:** It functions similar to the multicast with the slight difference that one of the destination is chosen to receive the information based on the criteria of proximity or suitability [Partridge et al., 1993]. For example, the root DNS servers are actually clusters of servers which use anycast for decentralized information.

2.9 Wired Networks

Today, *networks are everywhere* from industrial systems and manufacturing plants to aircrafts, automobiles and railway systems [Kottenstette & Antsaklis, 2008]. Wired networks form a large part of existing network installations. In practice, the major differentiation can be made between the LANs and the dedicated field buses.

2.9.1 Local Area Networks (LANs)

Wired networks offer superior performances as compared to wireless counter part. Hubs, switches and routers are commonly used to form a network topology [Mackay et al., 2003]. Ethernet (and its variants) had been very famous because of its high capacity, data rate and low latencies. For wired LANs connected to internet, firewall is necessary as a security consideration. Ethernet hubs and switches does not support firewall but different softwares are installed on computer nodes in order to protect from malicious attacks [IDC, 2004]. A wide variety of commercial LANs uses ethernet with different media e.g. twisted pair versions for inter LAN communication while intra LAN (WAN, MAN etc.) backbone is based on fiber optic ethernet (FDDI).

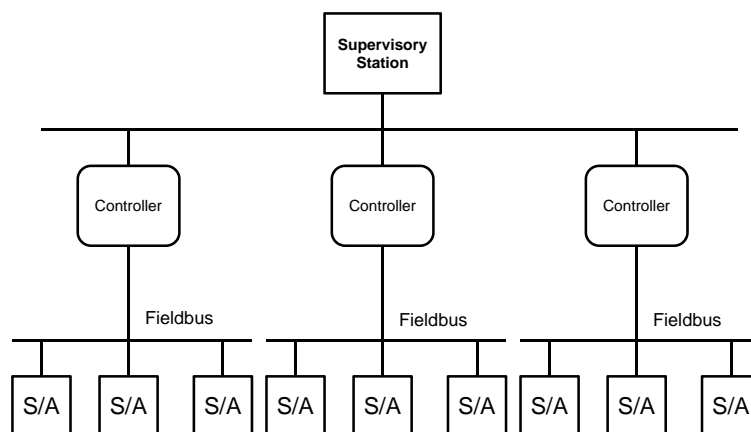

Figure 2.6: Hierarchical Network for Industrial Automation

2.9.2 Field buses

The industrial field buses are highly useful for control applications which require real time communication and QoS oriented message transfer. They use proprietary protocols and usually limited to a single location, however, in some applications they are found to communicate with the external world through gateways [Jordan, 1995]. Field bus networks (FBN) are commonly used in industrial systems for improved on-line monitoring, teleoperation and diagnosis, easy change-out and expansion of devices, improved local intelligence in the devices and better inter-operability between manufacturers [Bayart et al., 1999]. Some important field buses protocols include HART, Profibus, Profinet, Modbus, CANopen, WorldFIP etc. IEC 61158 was meant to standardize the fieldbuses by defining key characteristics for industrial control systems.

In FBN protocols, the application layer defines the content messages and the services required in supporting them. Network and transport layers have been omitted by almost every producer of FBN protocols. Due to this fact the protocol cannot *internet work* as can be done with the TCP/IP protocol over Ethernet. Therefore, most industrial FBN protocols are not directly able to communicate over multiple interconnected networks as with Ethernet and TCP/IP [IDC, 2004].

In industrial systems, several networks may compose a hierarchical structure for the interconnection of systems at various levels; e.g. as shown in the Fig. 2.6. This structure provides efficiency and reliability in the communication [Jordan, 1995]. Of the hierarchy of networks, at the lowest level is the control network which connects sensors and actuators to control devices. Compared to the higher level communication, the data size of messages is smaller here and the real time requirement is more critical. The controllers may also receive commands from supervisory systems located in a higher level. Profibus networks are popular in oil industry where thousands of temperature sensors, solenoid valves, and level switches are connected. In [Benoit et al., 2006], a safe design of CANopen distributed instruments is presented from reliability perspective. A detailed comparison and summary of popular FBPs is listed in Table 2.5.

FBP	A/D	Communication	MAC	Topology	Distance	Data rate (max)	Media	Nb of Devices	PDU
WorldFIP	D	Producer/Consumer	Bus arbiter access	Bus, Star	4Km	2.5Mbps	2	256	256 bytes
CAN	D	P/C, P2P	GSMa/AMP	Bus	500m/125kbps	1Mbps/40m	2	64	8 bytes
TT-CAN	D	P/C, P2P	GSMa/AMP, TT	Bus	500m/125kbps	1Mbps/40m	2	64	10 bytes
Interbus	D	M/S	None	Ring	12.8km	500kbps	4	256	8 bytes
HART	A,D	M/S	None	Bus	3km	1.2kbps	2	1w/ analog:64	32 bytes
W-HART	D	M/S	GSMa/CA	Tree, Star	200m	250kbps	Wireless	80-100	127 bytes
DeviceNet	D	M/S, MM, P2P	GSMa/NDBA	Bus	500m/125kbps	500kbps/100m	4	100	8 bytes
ControlNet	D	P/C	CTDMA	Bus, Star, Tree	5km	5Mbps	Coax	99	510 bytes
FIP	A,D	M/S	-	Bus	1000m	25Mbps	2	256	256 bytes
PROFIBUS (PA)	D	M/S, P2P	-	Bus	1.9km	31.25kbps	2	256	246 bytes
PROFIBUS (FMS)	D	M/S, P2P	-	Bus	1.9km	500kbps	2	127	246 bytes
PROFIBUS (DP)	D	M/S, P2P	-	Bus	1.9km	93.75kbps	2	127	246 bytes
Modbus	A,D	M/S	Token Passing	Bus	1.8km	1Mbps	2	247	32 bytes
FlexRay	TT, ET	M/S	-	Tree, Bus, Star	1.8km	10Mbps	2	32	254 bytes
ASI	A,D	M/S	Polling	Bus, Tree	100m	167kbps	2	31	4 bits
LON	D	M/S, P2P	Predictive Media	Bus, Tree	6.1km/5kbps	1.25Mbps	2	2	228 bytes
SERCOS	D	P2P	-	Ring	250m	16Mbps	2	245	16 bytes
Bitbus	D	M/S	-	Bus	13.2km/62.5kbps	1.5Mbps	2	250	5 bytes
ARCNET	D	P2P	Token Passing	Bus, Star, Ring	6km	10Mbps	3 Pairs	255	0-507 bytes

Table 2.5: Field Bus Protocols and their Comparison

2.10 Wireless Networks

Wireless networks are best suited for remote management and teleoperation of complex industrial plants as they offer more flexibility, reduced costs, better power management, ease in maintenance, and quick deployment in distant hard-to-reach areas where installation of conventional wired infrastructure is not possible [Ahmad, 2005].

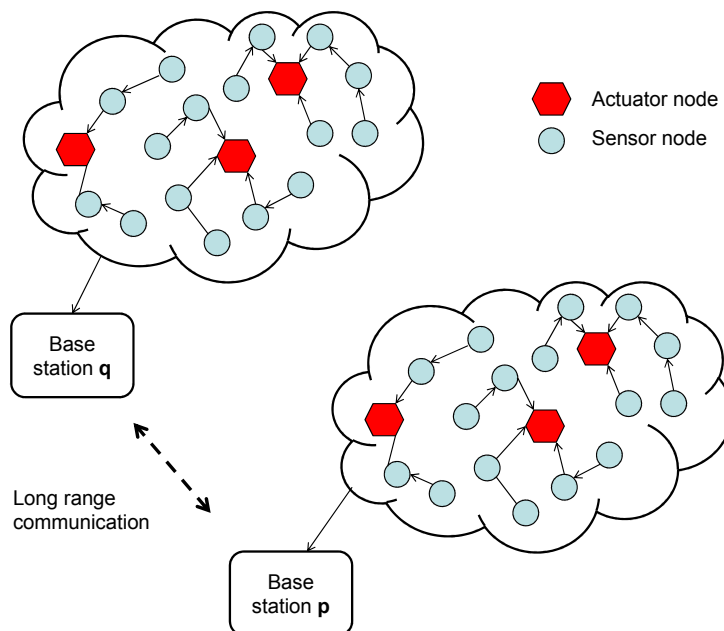

Figure 2.7: A WSAN architecture with long distance communication between BS p&q

The characteristics of the wireless channel that influence the scheduling at the air interface, typically includes the following assumptions of dynamically varying channel capacity, channel errors, contention based medium access, incomplete information about all nodes and power constraints at the nodes [Nangopal et al., 1999].

2.10.1 Wireless Sensor and actuator Network (WSAN)

Today, WSANs are popular research area as they can enable the *Internet of things* at little expense through remote sensing and actuation. From long range teleoperation perspective, wireless sensor & actuator networks (WSAN) are more appropriate as compared to pure sensing in WSN [Vannucci et al., 2005]. Fig. 2.7 shows an architecture for long range communication between two WSAN connected to base stations p & q. Each base station is connected to a WSAN on each side which can map a large area. The QoS issues are however very critical in large networks depending upon the routing protocol and the energy of the individual node which determines the operating life of the WSAN [Li et al., 2007]. Some of the QoS and optimization problem are addressed by TDMA scheduling for real time application of large clusters where measurements are reported periodically to perform control and actuation under a certain time constraint as in [Singh & Pesch, 2010]. This scheme is analyzed in terms of energy savings, number of time slots, slots reuse, throughput and packet dropout due to buffer congestion for the resource limited WSAN networks designed for industrial applications.

In [Thiem et al., 2010], a global wireless sensor/actuator research network (GWSAN) is formed through

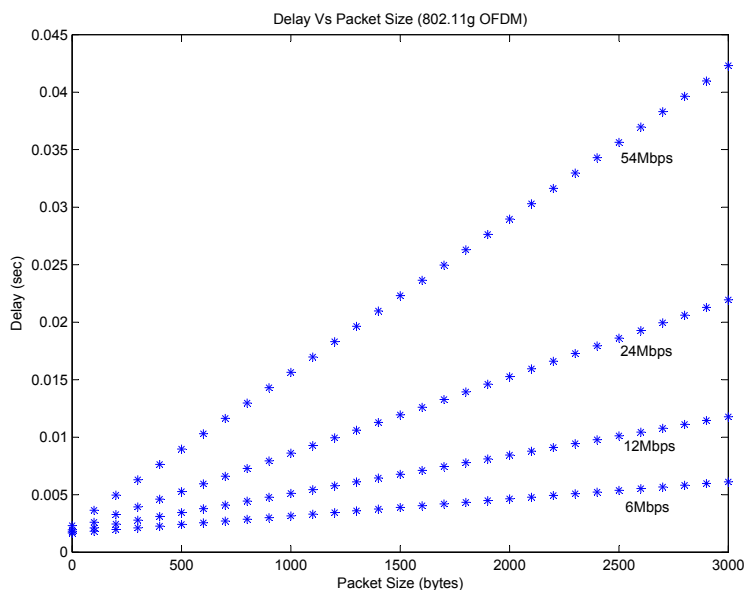

Figure 2.8: Delay Vs Packet Size for 802.11g

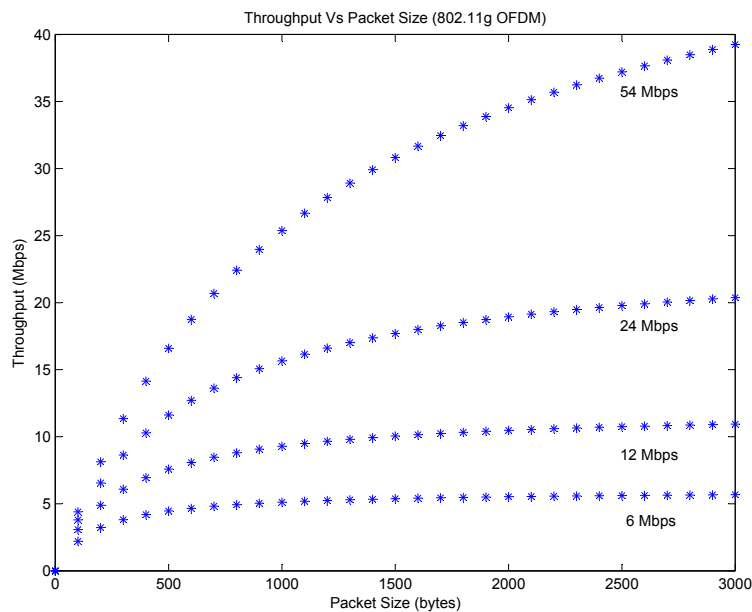

Figure 2.9: Throughput Vs Packet Size for 802.11g

the interconnection of about 10 WSN testbeds located in Asia and Europe for experimenting the Internet of Things and thus the Web of Things. For scalability, WSNs with low-power and low-latency on large-scale QoS-aware networks are preferred [De Mil et al., 2008]. Constrained resources, platform heterogeneity and dynamic network topology are some other challenging issues in WSN [Xia, 2008].

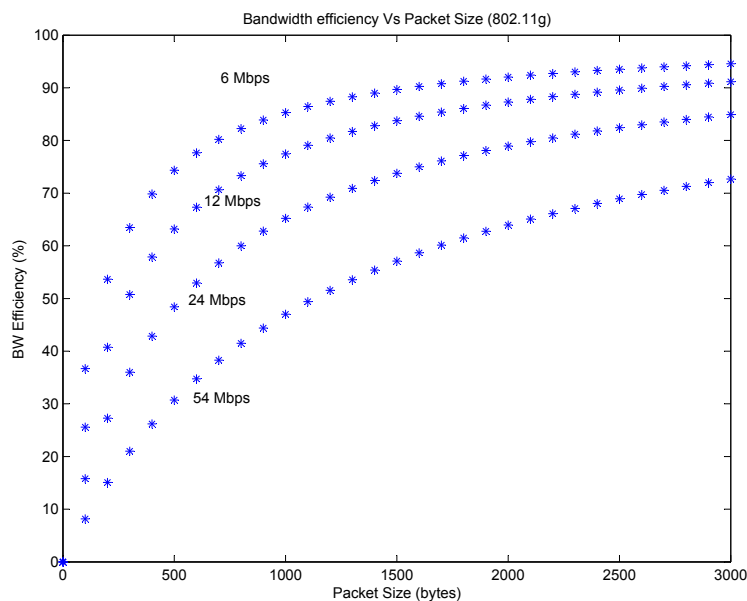

Figure 2.10: Bandwidth Efficiency Vs Packet Size for 802.11g with different data rates

2.10.2 Wireless LAN

The wireless local area network (WLAN) are short-haul high datarate wireless data transmission. WLAN standard IEEE 802.11 b/g is a popular WLAN protocol which uses the 2.4-GHz license free frequency band and its maximum data rate over the air interface is 11 Mbps (54 Mbps for g). IEEE 802.11b uses four different modulation schemes for the four data rates of 1, 2, 5.5, and 11 Mbps. If the quality of the radio channel becomes worse, an adaptive noise-tolerant modulation scheme is used and the data rate is reduced [Anttalainen, 2003]. The corresponding delay, throughput and bandwidth efficiency of WLAN 802.11g network with different packet sizes is shown in Fig. 2.8, Fig. 2.9 and Fig. 2.10 respectively.

A WLAN infrastructure based network architecture is shown in Fig. 2.11(a). The modes described in WLAN standard are infrastructure mode (or Master/access point (AP) mode), managed mode, ad hoc and monitor mode [Flickenger, 2007]. In master, access point (AP) or infrastructure mode, a service is created that looks like a traditional access point. The wireless nodes create a network with an SSID and channel, and offers network services on it e.g. authenticating wireless clients, handling channel contention, repeating packets, etc. Wireless nodes in master mode can only communicate with nodes associated with it in the managed or client mode. Managed mode nodes do not communicate with each other directly, and will only communicate with an associated master. Ad-hoc mode creates a *multipoint-to-multipoint* network where there is no single master node. In ad-hoc mode, each wireless node communicates directly with its neighbors which are within communication range as shown in Fig. 2.11(b).

IEEE defined 802.11n for high bandwidth communication allowing up to 300 Mbps. This is achieved by adding multiple-input multiple-output (MIMO) and 40 MHz channels to the PHY (physical layer), and frame aggregation to the MAC layer [Perahia, 2008]. IEEE 802.11n utilises 40 MHz channel bandwidth instead of 20 MHz in previous 802.11 PHY layers (802.11a (5 GHz) and 802.11g (2.4 GHz)) to transmit data. This allows for a doubling of the PHY data rate over a single 20 MHz channel.

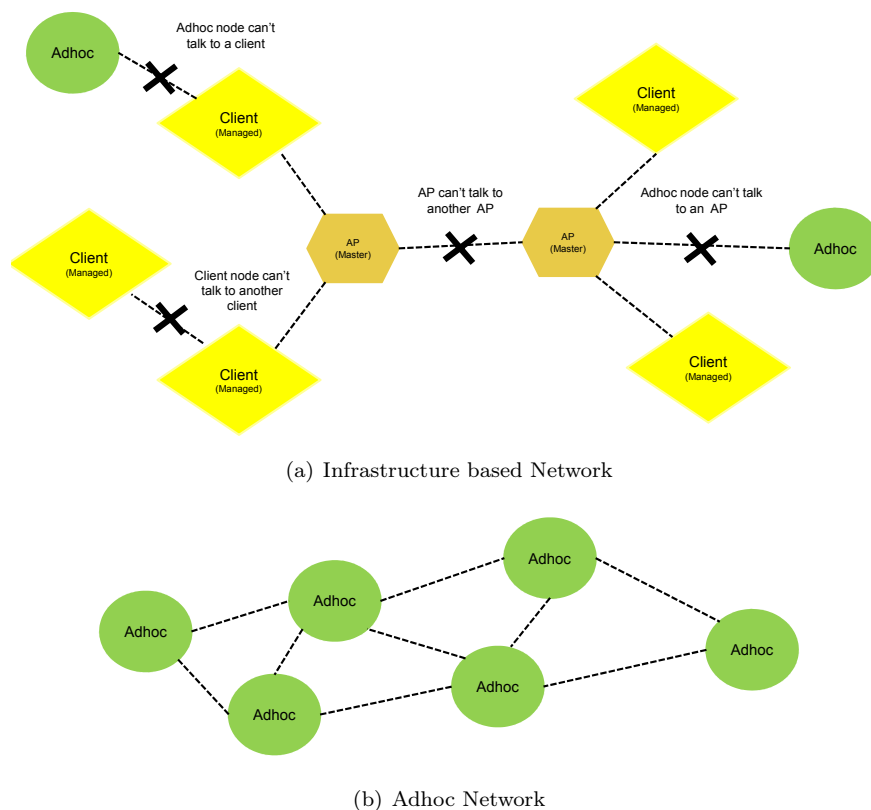

Figure 2.11: WLAN 802.11 Network Architecture

2.10.3 Narrowband, Broadband and 3G

Wireless networks are not limited to just WLANs. In fact, wireless local loop (WLL) systems based on the digital-enhanced cordless telephony (DECT) and code division multiple access (CDMA) standards are popular in developing countries as wireless narrowband communication systems. In wireless broadband, CDMA2000 and WiBro are popular while, WiMAX is a potential candidate for the wireless metropolitan area network (WMAN) which can be utilized for long range communication. IEEE 802.16e defines the mobile version of WiMAX. The flexible channel bandwidths and multiple levels of quality-of-service (QoS) support allow WiMAX to be used by service providers for differentiated high-bandwidth and low-latency entertainment applications [Andrews et al., 2007]. Mobile operators using GSM have deployed UMTS and HSDPA technologies as part of their 3G evolution. Traditional CDMA operators prefer solutions like deploying 1xEV-DO (1x evolution data optimized) as their 3G solution for broadband data. All these types of networks can be a part of heterogenous network that can be used for teleoperation. However, the interface of various types with and without QoS possibilities is a hard task to accomplish [Barry et al., 2001].

In WiMAX, the throughput capabilities are dependent on the channel bandwidth used, whereas 3G have a fixed channel bandwidth. WiMAX defines a selectable channel bandwidth from 1.25MHz to 20MHz, which allows for a very flexible deployment. In addition, Wi-Fi and WiMAX use OFDM modulation, as opposed to 3G (which utilizes CDMA), due to OFDM they support very high peak rates rates, greater flexibility, and higher average throughput and system capacity. Moreover, with OFDM, MIMO implementation, frequency diversity and multiuser diversity are easily achieved than 3G. However, 3G

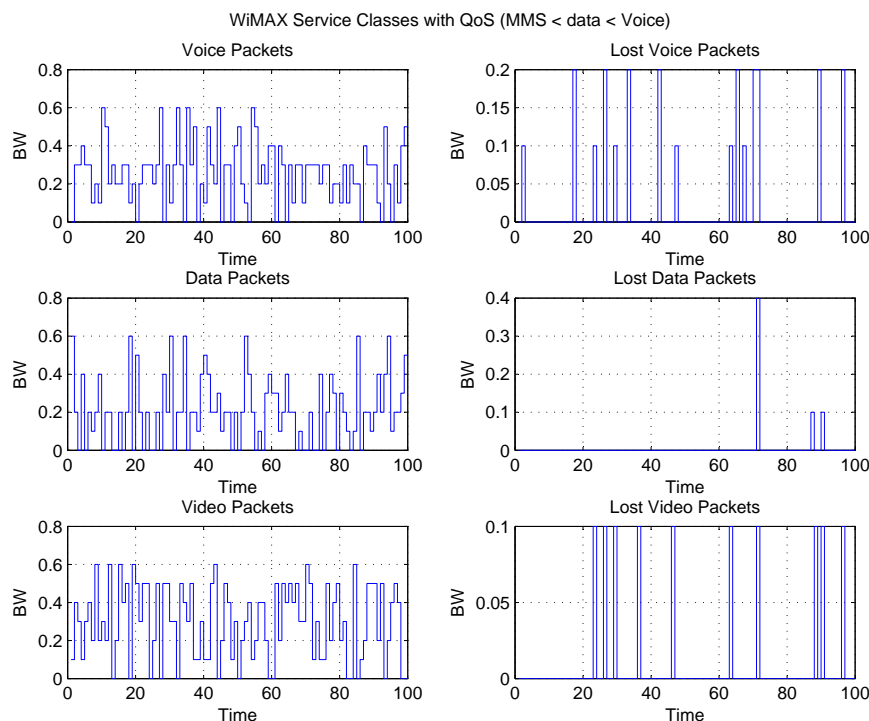

Figure 2.12: WiMAX user classes and bandwidth allocation

systems have mobility as an integrated feature whereas, WiMAX was designed as a fixed system and mobility was added as an add-on feature. Fig. 2.12 describes the QoS classes available over WiMAX. It can be seen that different voice, video and data users have different priorities and network resource allocation over WiMAX as configured and announced by base station (BS) to all subscriber stations (SS) for static and mobile network users. 3G systems like HSDPA also have a variety of QoS levels.

2.10.4 Application areas and Architectures

Wireless networked communication has many application areas. In a general context, the dependence of the control and diagnosis of industrial systems on physically connected communication infrastructure has been relaxed by the promising wireless technologies, ranging from wireless sensor networks to broadband and satellite networks [Sarkimaki et al., 2005].

In autonomous systems, it can be used in two ways. First within the cluster e.g. in case of multiple vehicles a local consensus is maintained for cooperative decisions. Vehicle-to-Vehicle communication (V2V) and formation control of multiple vehicles are some of the known examples as described in [Miller, 2008], [Yang et al., 2004] and [Gu et al., 2002]. On the other hand, if autonomous systems (for example, robotic vehicles) are controlled from outside via infrastructure, then this remote teleoperation becomes more complex. In such applications, long distance communication protocols are implemented with guaranteed service quality to ensure mission objectives. Examples include vehicle to infrastructure communication (V2I), teleoperated robotic arms with force and camera feedback for remote surgery, lunar rover controlled by earth station etc. Ad hoc or self organizing networks have each node acting as a source and destination for data. In addition, it also performs the function of a router. If mobility is considered, then infrastructure aids can be added in the network architecture to avoid communication

loss due to link breaks in the ad hoc network [Ahmad, 2005]. It is important to note that the basic IP networks being a best effort protocol was originally not designed for time critical control applications. However, recent advancements in bandwidth and reliability allow successful attempts of IP-based control [Kommineni & Malinowski, 2005]. Therefore, the relationship between the media type, network architecture, protocol type and the packet round trip time are important parameters for teleoperation applications. Thus, hybrid network architecture involving infrastructure as well as ad hoc network can also be considered in long range applications. Fault diagnosis is one of the objective in addition to control as there may be instants for unplanned scenarios or when backup redundancies are not sufficient for the required objectives, so an operator intervention may be necessary once the fault is diagnosed and identified [Bayart, 2008].

In this thesis, a network architecture is considered and analyzed for control and teleoperation of a remote system [Deflaugergues et al., 2009]. Thus, it is a co-design problem in which the objective is to maximize the control and diagnosis quality that will be affected due to the network quality of service (QoS) offered by the communication network [Khan et al., 2010]. In addition, as mentioned previously, the complexity of the problem will be raised when heterogeneous networks are required to satisfy the requirements of end-to-end network QoS which is further dependent on the QoS parameters (bandwidth, payload, delay, jitter, range, noise immunity), interference rejection and cost of communication [Marchese, 2007].

2.11 Network Traffic Characteristics

In order to understand the network dynamics, the terminology associated with the networked communication must be understood. Some important definitions are as follows:

Bandwidth: The bandwidth is defined as the number of bits per unit of time which is used either to express the transmission capacity of a network or the requirement of a transmitting host or application. Alternatively, the speed of an information flow is called bit rate.

Throughput: It is the number of bits which the network is capable of accepting and delivering per unit of time between two hosts. It is generally smaller than the bandwidth at which the network operates.

Burstiness: The burstiness is the characteristic of data streams having a more or less variable bit rate. The distinction can be made between the peak bit rate (PBR), i.e. the maximum number of bits over a short period of time, and the mean bit rate (MBR), i.e. the number of bits averaged over a long period of time, eventually during the complete session.

$$\varsigma = \frac{p_{avg}}{p_{peak}}$$

where ς is the burstiness ratio, p_{avg} and p_{peak} are the average and peak bit rates respectively. Usually, the multimedia applications produce a variable bit rate (VBR) traffic. If the traffic can be bounded, the model of linear bounded arrival processes (LBAP) can be applied. In this case, the maximum number of messages in a stream at time t yields a data rate of $R.t+B$. The stream is thus characterized by its rate R and its burst parameter B .

Latency: The latency or delay is the time elapsed during the emission of a data block at the sender, and its arrival at the receiver [Cruz, 1991a]. The round-trip time (RTT) measures the ability of smooth bidirectional communication which is defined as the time elapsing between the transmission of data and the reception of a response at the same host [Biaz & Vaidya, 2003]. If an electromagnetic signal travels at the speed of light between Zurich and the US West Coast (12000 Kms), the minimal latency

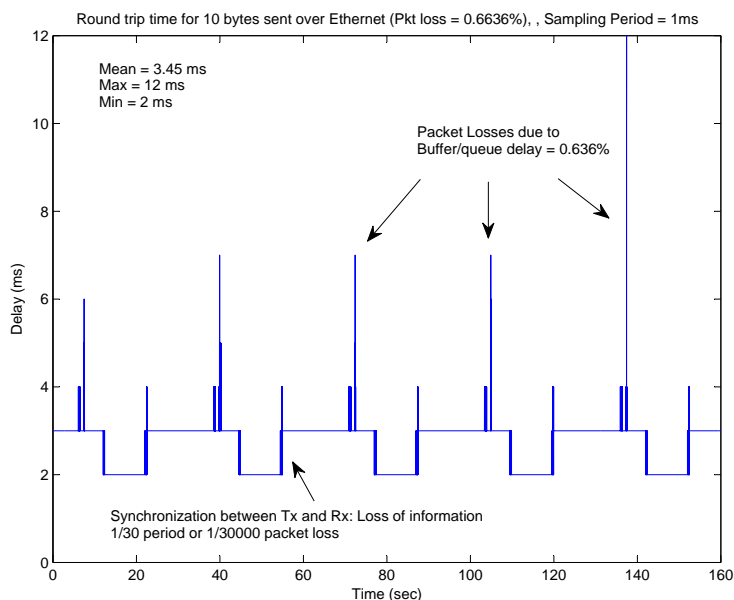

Figure 2.13: Typical Communication delay over Ethernet

to expect is 40 ms, and the minimum round-trip time is 80 ms [LAMBORAY, 2004]. In practice, the signal however does not employ the shortest path and additional latency is introduced because of the processing at routers and in the end systems.

Jitter: The jitter describes the variation of the latency. The jitter can be compensated by using buffers which introduces extra delay.

Error rates: For error rates, BER and FER are two important measures. Frame error rate (FER) indicates whether a frame has been received correctly at the other end or no while, BER measures the susceptibility of data networks to errors and quantifies the frequency of residual erroneous bits after transmission and internal corrections. The packet loss rate describes the frequency of lost packets and the packet error rate counts lost, duplicated and out-of-order packets [Kottenstette & Antsaklis, 2008]. Since the BER does not significantly influence the performance of the wired packet networks, the packet loss rate is usually considered by ignoring duplicated packets and considering delayed and out-of-order packets as lost packets. We have used this approach in our implementation that will be discussed in Chapter 6.

Depending on the transported information, different strategies exist to overcome the problem of erroneous packets. If error free transmission is needed, error correcting schemes (e.g. FEC) can be used for correcting bit inversions and retransmission schemes for retransmitting lost packets [Anttalainen, 2003]. In case of streamed real-time data, the missing packet is often replaced by, or extrapolated from, the previous packet, or the data is encoded redundantly to withstand the erroneous data.

2.11.1 QoS Mechanisms and Methods

Some of the popular methods in QoS management are as follows:

Resource Reservation

It refers to the methodology where by different flows or port addresses are assigned with certain portion of network resources [Park et al., 2003]. This means that they have guaranteed bandwidth and latencies despite the network load variation and traffic congestion.

Application Adaptation

The application adaptation strategy assumes that a strict resource reservation is not possible on a large scale, e.g. in the Internet, and, thus confers the responsibility of QoS to the application. While monitoring the network, the application reacts to changing networking conditions by adapting its operating point [Michaut & Lepage, 2002]. According to the principles of application level framing, the basic data unit of the distributed system should be governed by the application. However, the application adaptation does not provide QoS guarantees.

Error Control through Redundant data encoding

The redundant data encoding is used in order to make sure that the data corrupted due to the bit error is still useful due to the redundant information. Thus, the degraded QoS effects lesser to such systems.

Flow Control

For the control of flow, two different algorithms are commonly used namely leaky bucket and token bucket. The leaky bucket algorithm is a traffic shaping algorithm which follows the linear bounded arrival processes model. The token bucket algorithm guarantees a long-term average transmission rate while allowing for bursts. In addition, buffer size can also be varied with the increase in packet generation rate to minimize packet loss as per prioritized user flows [Munir et al., 2007].

Admission Control and Policing

The network level requires admission control when a communication path is set up. During set up, the communication channel demands for a specified type of resources, which are deduced from the traffic characteristic of the stream. Policing at the network level monitors if the communication channels respect the contracted traffic characteristic [Zhang & Phillis, 2001].

Guaranteed Services

The guaranteed Service approach just guarantees an upper bound for end-to-end delays as opposed to the Controlled Load Service (CLS) which simply implements a best-effort service in an unsaturated network, i.e. the network resources are supposed to be largely sufficient to handle the average traffic in the network [Lai et al., 2002].

2.11.2 QoS Implementation

The field of the QoS control includes applications related to the admission control, scheduling policy, routing protocol, flow control strategies and other resource allocation problems. Every QoS scheme has three distinctive processes, which are as follows [Park et al., 2003]:

- Traffic Classification
- Marking and Queuing
- Forwarding

Traffic classification is performed by tagging the frames and then identifying them later on based on their type to give them corresponding priorities. Tagging is the process of adding information to the frame in the form of a tag header to enable switches to forward frames only to specific ports that belong to a particular network or port instead of to all ports as done otherwise [Mackay et al., 2003]. Frames containing tag headers are called tagged frames. The tag header allows user priority information to be specified, source routing information to be specified and it includes MAC address format.

Virtual LANs (VLAN) are used to provide segmentation services (level 2 OSI). VLAN tags are most often used whereas, the formats of tag frames varies for different networks e.g. for Ethernet and for Token ring/FDDI networks, the tag header has two parts namely TPID and TCI. TPID is 2 bytes long for ethernet and 8 bytes for token ring/FDDI, and contains a predefined number that identifies the frame as a tagged frame. TCI is 2 bytes long and contains a three-bit priority number as well as a twelve-bit VLAN ID number. Per Class or per Flow resource reservation (bandwidth and buffer) uses priorities through scheduling, queue control and routing etc. In flow based control, QoS packet identification is used e.g. flow label and traffic class in IPv6, ToS and vector IP source address, IP destination address, Protocol, TCP/UDP source port, TCP/UDP destination port in IPv4 and MPLS label based identification in IPv6 are some of the notable examples. DiffServ and IntServ mechanisms in IPv4, while MPLS with IPv6 constitute the necessary QoS guarantees. For E2E QoS architecture, each network tier needs to show agreement in the overall QoS scheme.

MAC level QoS Support Lower level QoS support considers MAC level mechanisms for time critical data communication. In 802.15.4, guaranteed time slots (GTS) are used for beacon enabled communication. Polling in 802.11 PCF mode is another example. In 802.11e, different access categories (AC) are used for packet scheduling with different back off constants. In 802.16 WiMAX, type of service (ToS) flows are defined to characterize the UGS, rtPS, nrtPS and BE flows [Forum, 2006].

Preemptive Services The traffic control can be performed with preemption. Non preemptive service e.g. FIFO treats every traffic on first in first out basis. EDF is used in scheduling in WiMAX for rtPS as it selects the subscriber station (SS) based on their delay requirement [Nagaraju & Sarkar, 2009]. The information module needs to find the rtPS deadline information. To respect this deadline information, the UPS gets the time line to respect for delay requirement specification.

Admission Control This feature is supported in many networks which evaluates and verifies if a new requested connection is promoted, could it be supported for its QoS requirement and would it deteriorate other flows or no. Thus, the objective is to ascertain a level of QoS in the network by permitting user number and their requirements. In [El-Sayed et al., 2008], a detailed overview and challenges in quality of service models for heterogeneous networks are described.

Media name	Type	Bit rate	RTP payload type	Clock rate (Hz)
G.711 (μ -law)	Audio	64 kbps	0	8000
GSM	Audio	13.2 kbps	3	8000
G.723	Audio	≤ 6.3 kbps	4	8000
G.729	Audio	≤ 8 kbps	18	8000
DVI	Audio	32 kbps	5	8000
JPEG	Video	1.5 Mbps	26	90000
H.261	Video	64 kbps	31	90000
H.263	Video	≤ 64 kbps	34	90000

Table 2.6: JMF Media Encodings

2.11.3 QoS in end-to-end IP Network

In IPv4 networks, the QoS is performed through IntServ and DiffServ whereas DiffServ offers quality flows. In E2E IP networks the specific QoS support offered in respective protocols is mapped over DiffServ code points or MPLS (IPv6) flow labels that enable *QoS handshake* for E2E guarantees. Additionally, sub-channelization and MAP based signaling schemes, in some advanced protocols e.g. WiMAX, provide a flexible mechanism for optimal scheduling of space, frequency and time resources over the air on a frame by frame basis [Forum, 2006].

The legacy IP networks were aimed to provide *best effort* communication services whereas the network core remains simple while the end hosts have higher complexity level. However, in case of heavy traffics, congestion may degrade the IP performance, specially for the time critical applications. The motivation for IPv6 was enforced by two aspects namely a large address space (for UMTS and 3GPP use) and ease for E2E QoS. MPLS (IPv6) offers labels on each packet for QoS routing and preference. IPv6 has two QoS related fields in the header. First a 20 bit flow label corresponding to IntServ and secondly, the 8 bit traffic class indicator which can be configured as per DiffServ routing.

The guaranteed QoS requires that all packets transmitted in a session must follow the same path to the destination. As IP is not a connection oriented protocol, end to end QoS is a difficult task to carry out. There are two mechanisms for QoS over IP networks namely DiffServ and RSVP [Hardy, 2001]. In DiffServ, different service levels are defined by marking their headers for traffic type and priority. Networks routers read the headers to put the packets in priority wise queues. However, DiffServ provides no QoS guarantees as per latency and jitter. The resource reservation protocol (RSVP) is a signaling protocol used in IP networks to reserve resources for certain specified data flows. RSVP can only reserve the resources, however, it cannot guarantee that traffic will flow along the path on which the resource was reserved. The path along which data flows can change, as it is updated as nodes are added into the network. IP over ATM provides adequate QoS options where ATM protocol is supported by the network. Otherwise, MPLS based path definitions can provide efficient QoS by avoiding congested routes. MPLS can be considered as a bridge between connection less IP and connection oriented ATM protocol.

The IP traffic can be divided into three main levels i.e. Session level, Flow level and Packet level [Fiche & Hebuterne, 2004]. In the session level, the sessions arrive in accordance with a Poisson process of parameter p . Thus, for a link with a capacity C , if A is the arrival rate and v is the mean volume per session (in bits, for example, the product of mean bit rate and duration), the load of the link is then noted $p = A \cdot \frac{v}{C}$. In flow level, each session is made up of a succession of flows and periods of silence. The flows consist of the transfer of files, e-mails, images, etc. The traffic at flow level is *bursty*, and the volume of flows is also extremely variable. At the packet level, the traffic is extremely bursty and has so-called self

similarity characteristics, particularly because of the interaction of the origin traffic with flow control mechanisms (TCP) and error correction mechanisms. The idea is to combine IP QoS with the QoS available in other protocols at MAC layer. Different QoS frameworks are available at different layers in OSI. They can be managed to get an overall QoS level. For example, DiffServ (IPv4) in Network layer and 802.1 p/q and 802.11e can be associated together for heterogeneous network composed of internet, 802.3 Ethernet and WLAN 802.11e. It is possible to combine IP QoS in one tier and map the MAC layer QoS available in another tier over for example, IP DiffServ. IEEE 802.11e MAC layer QoS is mapped over IP DiffServ as provided in [Park et al., 2003].

Real time Communication over IP

The IP traffic may be structured into two main categories of flow, namely, the real-time flows which consist of the real-time transmission of voice or video type data, usually under the control of the UDP protocol (no flow control - no retransmission). Performance is mainly characterized by the minimization of the transfer delay (impact on the perception of interactivity by the user, possible need of echo cancelers), by the minimization of jitter and compliance with an intrinsic rate (necessity of image and voice samples synchronization). The elastic flows on the other hand, consist of the transfer of files, e-mails, Web pages, etc., usually under the control of the TCP protocol (flow control, retransmission).

The real time constraint is less restrictive whereas the transfer delays are in the order of one second remain acceptable. Performance is primarily characterized by the total transfer duration, or the effective average bit rate corresponding to the ratio of volume to duration. The IP traffic multiplexing model will be based on these characteristics by differentiating between real time traffic and the elastic traffic.

In addition, non-preemptive priority is assigned to real time traffic which means that initially the required bandwidth can be evaluated independently for each traffic category and after that the gains are considered by integration.

Real time traffic requirements

The real time requirements may be soft or hard but most of the telecommunication applications involving multimedia communication have soft realtime requirements which can tolerate latencies. In networked applications, the performance is expressed in terms of delay and packet loss rate. Hence, it is the key problem to evaluate the necessary bandwidth which corresponds to the lowest possible delays and packet loss. The bit rate generated by the traffic type (CBR/VBR) depends upon the coding characteristics as shown in Table 2.6. Here, all audio encodings use a fixed 8 kHz sampling rate while all video encodings fix sampling rate is 90 kHz. The video frame rate is 15 fps and image size is 352 x 288. It is important to note that a flow consisting of 1 packet of 200 bytes every 20 ms for a voice source handled in G.711 (80 kbit/s CBR) where voice is coded at 64 kbit/s generates one byte every 125 μ s and that 160 are put in every 20 ms in a G.711 packet intrinsically containing a header of 40 bytes resulting in a session created by a flow [Hou et al., 2003].

Whereas, if the voice is coded according to G.729A + VAD /silence suppression, a variable bit rate of 60 bytes is achieved, with the average bit rate less than 24 kbit/s. A session will be composed of flows corresponding to the active periods without silence gaps. Similarly, if we consider an H.263 video coding session, and assuming image by image transmission, the VBR flow will result in transmission of 20 kbits to 40 kbits average data rate (2 to 4 bursts) every 40 ms considering an ethernet frame of 1500 bytes. The traffic volume depends on the type of coding used e.g. (MPEG 1, MPEG 2, MPEG 4). These concepts will be recalled in the application scenario realized with NeCS-Car.

2.12 OSI Network architecture with QoS Contribution

Open Systems Interconnection (OSI) model is a reference model developed by ISO (International Organization for Standardization) in 1984, which gives a conceptual framework of standards for communication in the network across different equipments and applications by different vendors. The idea was to formulate a single framework for communication protocols proposed by different vendors. OSI is now considered as the primary architectural model for inter-computing and internet working communication [CISCO, 1992]. Most of the network communication protocols used today have a structure based on the OSI model where the communication process is piled up into 7 layers. These layers divide the tasks involved in moving information between networked entities into seven smaller and manageable task groups. A task or group of tasks is then assigned to each of the seven OSI layers. Each layer is reasonably self-contained so that the tasks assigned to each layer can be implemented independently to enable the solutions offered by one layer to be updated without adversely affecting the other layers. The OSI architecture standardizes four basic types of primitives at each layer, i.e. request, confirm, indication and response [Schwartz, 1988]. The layers are defined such that the changes in one layer do not effect the other layers. Thus, by partitioning the communication functions into layers, the problem at hand is more manageable and easy to handle.

2.12.1 QoS in OSI layers

The network QoS is configured at various levels depending on the type of protocol, its MAC mechanism, PHY layer etc. It is a well known practice today, to devise cross layer methods for QoS management, for which each layer mechanism should be well understood. In this section, a layer wise QoS contribution is presented as follows:

Physical Layer

The physical layer QoS is controlled by upper layers e.g. data link, network and/or application layer. Now-a-days, there are intelligent technologies which permit to provide QoS in the physical layer. It is controlled by cooperative tasking with higher layers which receive feedback of network quality from PHY layer. This is controlled by modulation, coding, topology control, intelligent beam forming, MIMO, channel blacklisting etc. These actions are based on PHY measurements of LQI, RSSI, ACK, interference detection, multi path effects, BER, FER etc.

Data link Layer

In data link layer, there may be different MAC protocols and the QoS depends directly on them. The QoS oriented MAC protocols include 802.1 p/q VLAN tagging, 802.11e ToS, WiMAX ACs etc.

Network/Transport Layer

This is the most discussed and most oftenly used network QoS level. The transport layer also participates in QoS functioning of the protocol through reliable communication. Examples include UDP, TCP, DCCP, SCTP etc. The Internet Protocol (IP) is the standard network protocol of the Internet and one of the most widely used network protocol. It enables two transport protocol entities, resident in different

end systems, to exchange message units in a transparent way. IP is a connection-less protocol where message units are transferred by using best effort (BE) approach. However, IPv6 protocol addresses the future needs of a growing Internet by offering a large more address space that is extended from 4 bytes to 16 bytes. The fixed part of the IP header is shortened and the processing at each intermediate node is reduced. Additional information is contained in multiple extension headers. Real-time streams can be marked using the priority field and QoS enforcement based on resource reservation which is made easier through the use of flow labels via MPLS. IPv6 also provides more security features at the network level than IPv4. At the transport level, two widely used protocols are TCP and UDP which are explained as follows:

User datagram protocol. The User Datagram Protocol (UDP) is a connection-less protocol for unreliable transmission of data. Hence, the sender cannot determine if the receiver has correctly received its data packet as there is no ACK of reception. In addition, no flow control is provided. A UDP destination address is specified by a network and host identifiers (IP-address) and a process identifier (port) at the receiver node. The combination of IP-address and port number is called a socket. UDP can be used for point-to-point and point-to-multi point communication. If an IP multicast is provided as destination address, UDP will use IP multicast for data transmission.

Transmission control protocol. The Transmission Control Protocol (TCP) offers a connection-oriented communication between two hosts, specified by their IP addresses and ports. TCP implements a byte stream abstraction, in which, the application decides how many bytes it writes to a stream or reads from it. Hence, the TCP implementation independently organizes the data and decides of the effective IP packet sizes. A selective automatic repeat request strategy is used for error recovery [Anttalainen, 2003]. Flow control is implemented by controlling the transmission window size at the sender. The transmission window size is decreased if the sender detects a saturation or congestion at the receiver. Several congestion avoidance schemes based on either packet loss detection or delay estimation have been proposed. Flow control is implemented by controlling the transmission window size at the sender [Park, 2005]. The transmission window size is decreased if the sender detects a saturation or congestion at the receiver.

TCP realizes closed loop control by implementing an additive increase, multiplicative decrease (AIMD) congestion avoidance algorithm. The rate increases linearly in the absence of packet loss but is halved whenever loss occurs. This behavior causes each flow to adjust its average sending rate to a value depending on the capacity and the current set of competing flows on the links of its path. Available bandwidth is shared in roughly fair proportions between all flows in progress. A simple model of TCP results in the following relationship between flow throughput B and the packet loss rate p :

$$B(p) = \frac{\text{constant}}{RTT(\sqrt{p})} \quad (2.12.1)$$

where RTT is the flow round trip time. This can also be interpreted as relating p to the realized throughput B . Since B actually depends on the set of flows in progress (each receiving a certain share of available bandwidth), we deduce that packet scale performance is mainly determined by flow level traffic dynamics. It can, in particular, deteriorate rapidly as the number of flows sharing a link increases. Scalable TCP replaces AIMD by MIMD (for multiplicative increase multiplicative decrease). This yields a stable and efficient congestion control at all link speeds. These advantages come, however, at the cost of a loss in fairness when several flows share the link.

One of the first rate-based congestion controls proposed a model of TCP congestion avoidance phase [Mathis et al., July 1997]. This model predicts the steady state of TCP in the scenario of a light to moderate loss ratio. This model is based on several assumptions. The first assumption is that TCP

avoids retransmission timeout. Secondly, this model also assumes that both the receiver and sender have sufficient receiver windows space. Furthermore, in this proposal the authors supposed that loss events are periodic. Based on this last assumption they apply a derivation to the stationary distribution of congestion window of an ideal TCP connection. This model results in modeling the TCP windows as described by the equation:

$$BW = \frac{MSS}{RTT} \frac{C}{\sqrt{p}} \quad (2.12.2)$$

Where C is a constant function of the acknowledgement policy and is usually equal to $\frac{\sqrt{3}}{2}$. RTT is the round trip time of the connection, MSS is the maximum segment size of TCP and p is the random packet loss at constant probability. More discussions on TCP variants can be found in [Marchese, 2007].

Session Layer

The session Layer establishes, manages and terminates connections (sessions) between cooperating applications and functions for enhanced reliability and adaptation, such as detection of failures and automatic recovery.

Presentation Layer

The presentation layer contributes to the QoS in the sense that it provides security services such as encryption, text compression and reformatting. Examples include secure sockets, CORBA data representation etc.

Application Layer

The application layer participates in QoS functioning of the protocol by giving preference to certain applications and cross layer communication for realtime data. Examples include HTTP, FTP, SMTP, CORBA etc. Application layer QoS is a widely used method which allows users to choose bandwidth arbitration, filtering, packet classification and traffic shaping as per application needs. For example RTSP, Modbus, IMAP etc. RTSP is an application which manages multiple reserved bandwidth streaming sessions if combined with RSVP [Schulzrinne & Casner, July 2003]. It is designed on top of RTP used for realtime multimedia applications streaming which breaks data into many packets whose size is determined according to the bandwidth available between client and server [Schulzrinne et al., 2003]. Upon reception of enough packets at the client end, the user starts experiencing the multimedia without waiting for complete download. Real time transport control protocol (RTCP) is used to gather statistics on quality aspects of the media distribution during a RTSP session, where it transmits this data to the session media source and other session participants. This information is later on used by the source for adaptive media encoding (codec) and detection of transmission faults.

2.12.2 QoS in Hybrid/Heterogeneous Wireless Networks

The long range teleoperation and remote manipulation requires a number of interconnected networks of same PHY medium but different protocols (Heterogeneous Networks) or different PHY medium with

different communication protocols (Hybrid Networks). From the application point of view, it is the end-to-end QoS that is required [Prokkola & Hanski, 2005].

With the advent of recent developments in new wireless network technologies (e.g., WiFi and WiMAX), it becomes more important to consider the interconnection of wireless networks for long range communication, seamless connectivity, richer services, and better quality for wireless data while supporting heterogeneity in communication technologies, network architectures, and applications. The integrated wireless network, which is a network of networks achieved after convergence of different heterogeneous wireless networks and communication technologies, is a viable tool to achieve this and attracts lots of research attention recently. The integrated wireless network is expected to be capable to provide high speed data rates in indoor and outdoor environments, with end-to-end QoS, offering any kind of services at anytime, anywhere, always on with seamless inter-operability and affordable cost.

The WLAN can be used to complement the WWAN services by providing high speed data rates to users in areas where WWAN fails to offer the required data rates. Various levels of interaction between WLAN and 3G networks have generated six different interworking architecture scenarios as specified by 3GPP *TR – 22.934* [3GPP, 2003]. The proposed scenarios gradually bring the two systems from non-coupled to very tightly coupled systems where the end user will be seamlessly roaming between the two systems and will be able to use both circuit-switched and packet-switched services. Several approaches for combining cellular and adhoc networks have been proposed by researchers [Lin & Hsu, 2000], [Wu, Chan & Mukherjee, 2000], [Wu et al., 2001], [Luo et al., 2003].

Some of these focus on higher total throughput through cell load balancing, some focus on enhancing call blocking/dropping probability [Wu, Mukerjee & Chan, 2000],[Wu et al., 2001], some focus on increasing the individual *user's* downlink rate [Luo et al., 2003], while others attempt to increase the range of high bandwidth channels [Lin & Hsu, 2000]. Some authors assume that the user equipment supports one radio interface and reserves some of the available channel bandwidth for ad hoc connectivity [Wu, Chan & Mukherjee, 2000],[Wu, Mukerjee & Chan, 2000], while others assume the user equipment can support multiple radio interfaces i.e. one for cellular and another for ad hoc and concurrently can be connected to both systems [Luo et al., 2003]. One common approach used by all previous researchers is the use of the non-coupled integrated system model. An architecture for the integrated wireless system which increase overall WWAN cellular system capacity and enhance the end users experience by providing the expected QoS [Nusairat et al., 2008]. In this architecture, the WLAN is connected to the 3G UMTS radio access network (UTRAN) through fast and secure direct communication media. The WWAN cellular traffic is transparently routed through the WLAN between the UTRAN system and mobiles. When a user is in the coverage of both UTRAN and WLAN and its cellular data rate degrades to a value not acceptable for the current QoS traffic class, the integrated wireless system will use the availability of the WLAN to bring back the data rate of the user to a rate acceptable by the current QoS traffic class parameters.

In another approach, cellular system with the ad hoc WLAN system is integrated whereas, the WLAN access point (AP) is connected to two systems namely the Internet service provider (ISP) for Internet/Intranet connectivity (current connection), and the UTRAN for cellular connectivity (new connection). This is different than the tightly coupled approach where the AP is connected to the packet-switched domain rather than to the RAN. In addition, in this approach, the UTRAN will need to handle two types of cellular connections with the user equipment; one direct and the other through a WLAN AP. The user connections are dynamically adjusted in the integrated system to admit new connections or to enhance the rate of a specific user which improves the overall performance.

User Priority	Designation (802.11d)	Access Category	Traffic Type
0	BE	0	Best Effort
1	BK	0	Best Effort
2	-	0	Best Effort
3	EE	1	Video Probe
4	CL	2	Video
5	VI	2	Video
6	VO	3	Voice
7	NC	3	Voice

Table 2.7: 802.11e QoS levels

Example 1: Hybrid Network

In hybrid networks, where two different physical layers are involved, QoS at MAC level is very popular and a mapping is used from one protocol to another for QoS support. We consider QoS enabled Ethernet network connected to WLAN 802.11e as a hybrid network. Ethernet supports 802.1 p/q QoS on MAC level. The 802.11e standard provides two MAC protocols, first one is the the mandatory EDCA (Enhanced Distributed Channel Access) and the second one is HCCA (HCF controlled channel access). HCCA provides polling access to the medium, QoS AP controls all the traffic of QoS stations (QSTA) which access by first sending a request to the QAP which contains traffic information e.g. maximum MSDU size and data rate etc. QAP will then reply by accepting or refusing the demand of QSTA. EDCA uses the usual CSMA/CA with priorities to access the shared medium. The various streams in stations are classified into eight priorities, referred as User Priorities mapped from 802.11d as shown in Table 2.7.

These user priorities are further mapped into four Access Categories (AC), which represent the voice and video streams that require a delay less than 10 ms and 100 ms respectively with minimal jitter. As observed from the Table 2.7, AC0 characterizes the best effort traffic, AC1 and AC2 are used for video probing and video, while AC3 represents the voice traffic. It is important to note that in 802.11e, each AC has its own queue (FIFO) which is specified by four variables i.e. Access Category Inter-Frame Spaces (AIFS), Transmission Opportunity (TXOP) Limits and Contention Windows (CW min/max) [Park et al., 2003]. Similar mapping is used between DiffServ and 802.11e for IP network.

Service	Real Time	QoS description	Traffic Type
BE	No	Max sustained rate, Traffic priority	E-mail
UGS	Yes	Max sustained rate, latency and jitter tolerance	Voice
rtPS	Yes	Min reserved rate, Max sustained rate, latency tolerance	Video
nrtPS	No	Min reserved rate, Max sustained rate, Traffic priority	FTP
ertPS	Yes	Min reserved rate, Max sustained rate, Max latency and jitter tolerance, Traffic priority	VOIP

Table 2.8: 802.16e QoS Classes

Example 2: Heterogenous Network

Here we take WLAN connected to WiMAX for long range communication. The WiMAX services and traffic types are shown in Table 2.8. In order to integrate WLAN and WiMAX, the link layer QoS in both protocols is mapped to the DiffServ classes for next generation network (NGN) compliance [Haffajee

& Chan, 2006]. This allows the interface of the two networks and hide the signaling differences from the user. Various architectures and QoS mechanisms are proposed in the context of NGN [K.Knightson et al., 2005].

2.13 Conclusion

This chapter provides an overview of networked communication. Various architectures are discussed with their pros and cons. Medium access techniques which are generally used in the networks are also highlighted. Wired networks and field buses are briefly discussed, whereas, wireless networks are described in more detail with their application areas and architectures. Network characteristics are discussed and layer wise contribution of OSI model in network QoS are described in detail. QoS in heterogenous/hybrid network is presented as a challenging task with problems and opportunities in subsequent cases of circuit switched and packet switched networks.

Chapter 3

Control and Performance in Networked Teleoperation

Contents

3.1	Introduction	95
3.2	Control Architectures in Teleoperation	95
3.3	Passive Teleoperation architectures	97
3.4	Effect of Digital Implementation	103
3.5	Effect of Network on Passive Teleoperation	104
3.6	Transparence in Teleoperation	105
3.7	Compromise between Stability and Transparence	108
3.8	Conclusion	108

3.1 Introduction

This chapter gives detail on the modeling, simulation and control of NT systems. An example case of NeCS-Car test bench is described to illustrate the methodology. After presenting a bird's eye view over different controller design techniques for teleoperation, passivity based scattering transformation is used to implement on the benchmark problem. Simulation results are presented and compared for the master and slave devices.

3.2 Control Architectures in Teleoperation

The main objective in teleoperation is to achieve artificial telepresence despite the fact that the operator is at a distance. In the early start of long distance teleoperation, the *move and wait* strategy was utilized whereby a command is sent and the operator waits for the execution [Ferrell, 1965]. With the development in the communication and control technologies, real time approach is used with delay tolerant approaches for teleoperation [Mulder, 2006].

Some of the recent approaches used in the control of teleoperation are:

- Nonlinear Methods e.g. Passivity based Control (PBC), Input to State Stability (ISS), Sliding Mode Control (SMC) etc.
- Robust Control e.g. H_∞ design, μ -Synthesis, Parameter Space etc.
- Adaptive Control
- Predictive Control (MPC)

Each of the proposed design has some advantages with some shortcomings from performance and implementation view point. The non-linear adaptive control (satisfying ISS) in teleoperation has the advantage of better control performance (with increased complexity) as compared to passivity based control which has high robustness margin but reduced tracking performance [Nuno et al., 2010]. Some popular methods are described in the following subsection.

3.2.1 Adaptive Control

In adaptive teleoperation control, the master and slave are subject to independent adaptive motion/force controllers that are able to withstand bounded parameter uncertainties. Thus adaptive scheme guarantees the stability in free space and in contact and is robust against time delays [Salcudean et al., 2000]. The master and slave are exchanged for reference and achieved position/force tracking respectively. The adaptive scheme is specially applicable to systems where dynamic parameter variations in environment are experienced e.g. soft/hard contacts including transition between them [Leeraphan et al., 2002].

3.2.2 Robust Control

In robust control techniques applicable to teleoperation, H_∞ control via loop shaping is a popular method [Fite, Goldfarb & Rubio, 2004]. Force reflecting teleoperation over the internet has been discussed in [Niemeyer & Slotine., 1998]. Bilateral teleoperation under time varying communication delay is applied in [Yokokohji et al., 1999]. In [Leeraphan et al., 2002], the authors discussed a stable adaptive bilateral control of transparent teleoperation through time-varying delay. Robust control for delay uncertainties in control input sent over a network by bounded uncertainties is discussed in [Udwadia et al., 1996].

3.2.3 Damping Control

It is the most commonly used method as a control strategy for teleoperation. By intelligently varying the damping, the energy of the system can be controlled resulting in a stable operation [Mulder, 2006]. Two popular methods in damping control are wave variables and passivity based control.

Wave Variables: The wave variables are closely related to the scattering theory [Haykin, 1970]. They are applicable to nonlinear systems however this approach is conservative. The wave variables are defined as follows:

$$u = \frac{bV + F}{\sqrt{2b}}, v = \frac{bV - F}{\sqrt{2b}} \quad (3.2.1)$$

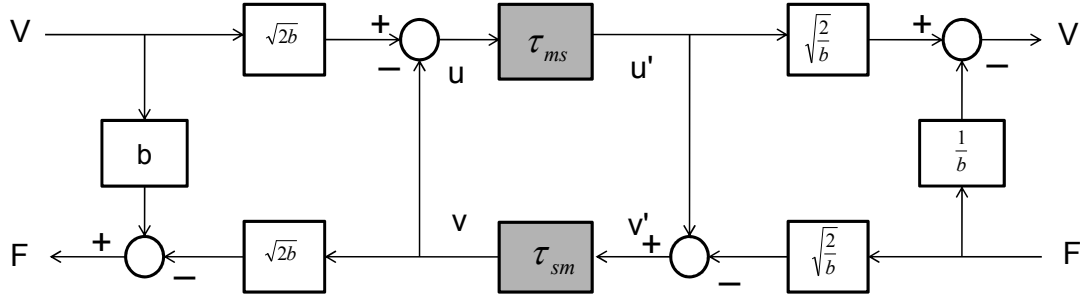

Figure 3.1: Wave transformation (Master) and its inverse transformation (Slave)

where b is a positive constant (or symmetric positive definite matrix) representing the characteristic wave impedance which can be tuned to control the damping. The wave transform is shown in and its inverse transform is shown in Fig. 3.1. A higher value of b introduces more damping into the system.

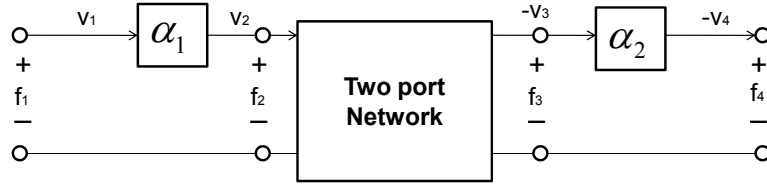

Figure 3.2: Two port network with passivity control

Passivity Control: In the passivity control, the master and slave mechanics are considered as dissipative (passive) systems. While, the two port network is made passive by adding damping as in [Ryu et al., 2005]. A passivity observer (PO) calculates the system energy whereas, the passivity controller (PC) adds damping whenever necessary to keep the over all system passive. The system is presented in Fig. 3.2 and the passivity condition is given as:

$$\int_0^t \frac{1}{2} u_{out}^T u_{out} d\tau \leq \int_0^t \frac{1}{2} u_{in}^T u_{in} d\tau \quad (3.2.2)$$

The advantage of the passivity control (PC) is that it is easily applicable to nonlinear systems without exact knowledge of the model. The down side is that the master and slave are considered passive systems and only passification of the communication block is considered.

3.3 Passive Teleoperation architectures

Many architectures have been proposed for teleoperation in the literature. In Table 3.1, some passivity based approaches are compared for their maximum round trip delay times [Yokokohji et al., 2001]. Each architecture has different complexity level and permit to tolerate different round trip time (RTT) delays.

Reference	Delay Time (RTT)	Approach
[Anderson & Spong, 1989]	400ms	Scattering Theory
[Niemeyer & Slotine., 1998]	1s	Wave Variables
[Kim, 1990]	1s	Shared Compliant Control
[Kosuge et al., 1995]	up to 1s	Virtual Time Delay

Table 3.1: Comparison of Time Delay in Teleoperation Approaches

3.3.1 Lawrence Architecture

In the architecture proposed by Lawrence four communication links are visible as shown in Fig. 3.3 [Lawrence, 1993]. Thus, the position command (X_h, X_s) at the master station is transformed into control forces (F_h, F_e).

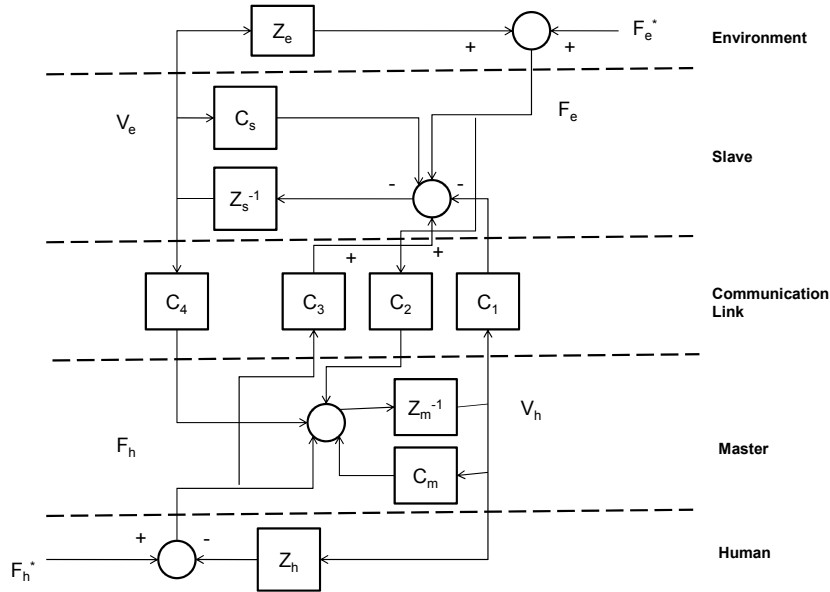

Figure 3.3: Lawrence teleoperation Architecture

Where Z_h , Z_s , Z_m and Z_e are the impedances of human operator, slave/master robotic arm and environment respectively. C_m and C_s are the controllers on the master/slave side such that $C_m := B_m + K_m \cdot s$ and $C_s := B_s + K_s \cdot s$ are the PI controllers. C_i is the channel of communication, where $i = 1, 2, 3$ and 4 respectively. V_h and V_e are the speed of the master and slave arm respectively. F_h^* is the force applied by the operator's arm. F_e^* is the perturbation force of the environment. F_h is the total force exerted by the operator on the master arm. We have $F_h = F_h^* - Z_h \cdot V_h$, where $Z_h \cdot V_h$ is the force that the environment exerts on the slave robot and which is given as $F_e = F_e^* - Z_e \cdot V_e$, where F_e^* is generally taken as zero.

This architecture is shown in Fig. 3.3 where 4 channels of communication guarantee a perfect telepresence and satisfactory stability margins. However, this architecture has some limitations. The four channels can practically introduce such long delays in distant teleoperation that the performance could be degraded. In addition, it requires four sensors that can increase cost. Other proposed architectures can give even better performance with a single force sensor. To prevent degradation in performance due to delay, passivity theory is used to design compensator.

3.3.2 Stability by Passivity

Passivity has its origin from an electrical circuit analogy. Stability by passivity is an approach used to generalize the notion of energy in dynamic systems and to describe the combination of subsystems in a Lyapunov like formalism [Leeraphan et al., 2002]. Various propositions have been made in the applications involving control in teleoperation like *scattering transformation* of Spong [Anderson & Spong, 1989], *scaling transformation* by Colgate [Colgate, 1991] and the *wave variable* approach of Niemeyer [Niemeyer & Slotine, 1991]. The communication system in the teleoperation can be modeled by a two-port network represented by a hybrid matrix $H(s)$ as discussed in [Anderson & Spong, 1989]. In general, a bilateral teleoperator can be modeled as an interconnection of n-port networks. By designing control laws which impose the passivity property on each of the network blocks, passivity of the interconnection may be guaranteed.

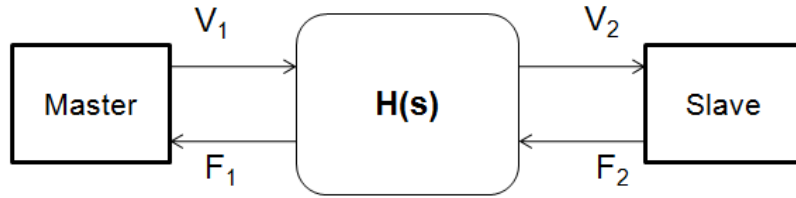

Figure 3.4: Passivity based system representation

The choice of reference is made such that the speed entering in the four ended 2 port network will remain positive as shown in Fig. 3.4. The hybrid matrix of this generalized system is defined as:

$$\begin{bmatrix} F_1(s) \\ V_2(s) \end{bmatrix} = H(s) \cdot \begin{bmatrix} V_1(s) \\ F_2(s) \end{bmatrix} \quad (3.3.1)$$

where s is the laplace variable in the complex frequency domain. A necessary and sufficient condition for the stability of the multivariable system is very difficult to obtain. However, a sufficient condition for the stability of the system based on passivity is adapted for these type of applications. In addition, this method permits to set free the constraints imposed by the operator impedance and the distant environment as well as to keep the system stable.

We define vectors as:

$$F(t) = [F_1 \quad F_2]^T \quad \& \quad V(t) = [V_1 \quad V_2]^T \quad (3.3.2)$$

which are the square summable function of time. The system is called passive if

$$\int F^T(t)V(t) dt \geq 0 \quad (3.3.3)$$

If this inequality is replaced with equality, the system is known as non-dissipative or without loss. We see that $F^T V$ represents a power such that its integration is its energy. The system is called passive if the energy entering the system is more important than the energy leaving it. It is also understood that since the energy is decreasing we conclude that a passive system is always stable. From the hybrid matrix above, we can determine if the system is passive or not. We define the scattering matrix $S(s)$ of

the system in Laplace domain, which relates the force and velocity as:

$$F(s) - V(s) = S(s) \cdot [F(s) + V(s)] S(s) = \begin{pmatrix} 1 & 0 \\ 0 & -1 \end{pmatrix} (H(s) - I)(H(s) + I)^{-1} \quad (3.3.4)$$

Next, we define x belongs to $L_2^\infty(R^+)$:

$$\|S\|_\infty = \sup \frac{\|Sx\|_2}{\|x\|_2} \quad (3.3.5)$$

with $\|S\| \neq 0$, so an n port system is passive, if only if $\|S\|_\infty \leq 1$ of the corresponding scattering matrix. Using scattering transformation, the problem of constant communication delays can be resolved. The scattering operator links the passivity with the Small Gain Theorem. A system is passive if its scattering operator has a norm equal to or less than unity [Niemeyer, 1996].

In the presence of a constant delay τ , the reference signals on master side as well as slave side are simply delayed by τ . For Eq. (3.3.4), the system is non passive and may therefore become unstable as the pure delay introduced by the communication channel generates energy. We find that:

$$\|S\|_\infty = \sup_w (|\tan(w\tau)| + |\sec(w\tau)|) = \infty \quad (3.3.6)$$

However, if we have a scattering matrix, where the transparenance is characterized by the time domain relations as:

$$F_1(t) = F_2(t - \tau) V_2(t) = V_1(t - \tau) \quad (3.3.7)$$

In this case the hybrid matrix is written as:

$$S(s) = \begin{pmatrix} 0 & e^{-s\tau} \\ e^{-s\tau} & 0 \end{pmatrix} \quad (3.3.8)$$

and we find that:

$$\|S\|_\infty = 1 \quad (3.3.9)$$

The system is thus passive and therefore stable.

3.3.3 Anderson and Spong Architecture

The first architecture proposed by Anderson and Spong in 1989 was based on the passivity for bilateral teleoperation, which assures robustness against the network delays in the loop and speed sensing as shown in the Fig. 3.5. This architecture neither guarantee the position tracking in stationary conditions nor force detection during the functioning of the system.

For that, we introduce a new scheme which utilize the traditional configuration based on passivity and by adding control of position on the master/slave side to track the position and force detection [Chopra

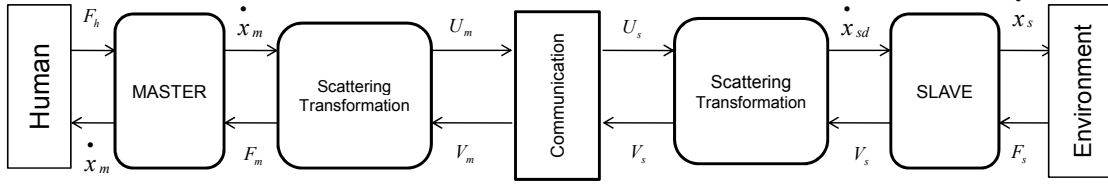

Figure 3.5: Bilateral Teleoperation with time delay

et al., 2006] as shown in Fig. 3.6. The master/slave dynamics can be modeled by the system's mass and damper characteristics as:

$$M_m \ddot{x}_m + B_m \dot{x}_m = F_h + T_m \quad (3.3.10a)$$

$$M_s \ddot{x}_s + B_{s1} \dot{x}_s = T_s - F_e \quad (3.3.10b)$$

Where T_m, T_s constitute the control couple applied to motors at the master/slave, M_s, M_m are the inertias, B_m and B_{S1} are the viscous frictions, F_h, F_e form the control couple from the operator and the environment and x_m, x_s are the positions. The scattering transformation is a combination of signal and power and is utilize to assure the passivity of the system in the presence of time delays so that the characteristics that describe the channel are similar to those of a transmission line without loss. The scattering variables (U_m, U_s, V_m, V_s) are transmitted across the delay line instead of the original velocities and forces. Thus, transformation is bijective i.e. one to one and therefore it is unique and invertible transformation [Niemeyer, 1996]. The equations governing a constant time-delay communication channel are given as:

$$U_s(t) = U_m(t - T) \quad (3.3.11a)$$

$$V_m(t) = V_s(t - T) \quad (3.3.11b)$$

The wave transformation is as under:

$$U_m = \frac{1}{\sqrt{2b}}(F_m + b\dot{x}_m); \quad V_m = \frac{1}{\sqrt{2b}}(F_m - b\dot{x}_m) \quad (3.3.12a)$$

$$U_s = \frac{1}{\sqrt{2b}}(F_s + b\dot{x}_{sd}); \quad V_s = \frac{1}{\sqrt{2b}}(F_s - b\dot{x}_{sd}) \quad (3.3.12b)$$

With \dot{x}_m is the speed of the master arm, \dot{x}_{sd} is the speed after the scattering transformation from the slave side, which is the desired speed of the system. The positive constant b plays a critical role in the system response in units of \sqrt{watt} . It can be chosen arbitrarily and it defines a characteristic impedance associated with the wave variables and directly affects the system behavior [Niemeyer & Slotine, 1991].

3.3.4 Chopra and Spong Position Tracking Architecture

In scenarios where the slave intermittently contacts the remote environment, the master and slave might not have the same initial position after an environment contact and thus keeping a track of

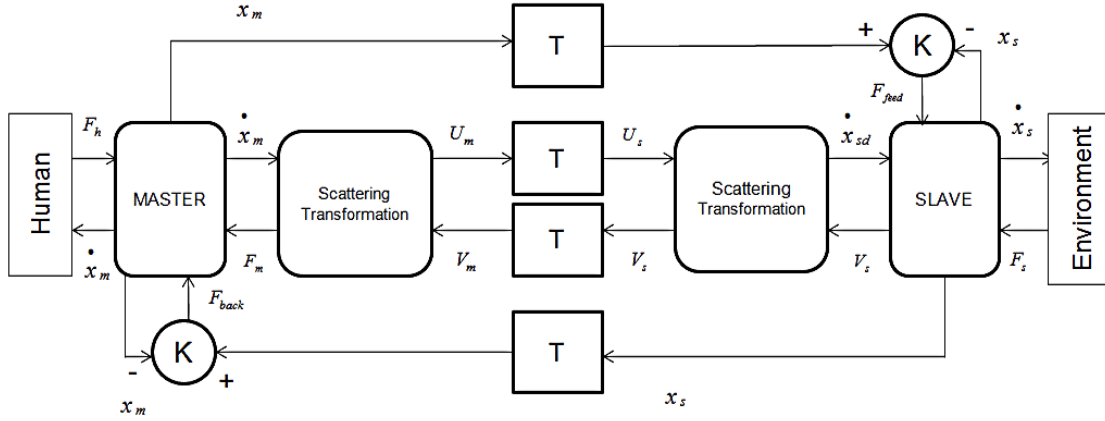

Figure 3.6: Bilateral Teleoperation with Position Control

master position may not be possible for the slave. This introduces a drift between the master and the slave position as only the master velocity is sent to the slave.

It was shown in [Chopra et al., 2006] that the transient error is dependent on delay while in the steady state position tracking $e(t) = x_m(t) - x_s(t)$ is dependent on their initial position difference even when there is no packet loss. If packet loss occur, it will deteriorate the response even more. Thus, the position control loop is added which modifies the system dynamics as:

$$\begin{aligned} M_m \ddot{x}_m + B_m \dot{x}_m &= F_h + F_{back} - F_m \\ M_s \ddot{x}_s + B_{s1} \dot{x}_s &= F_s + F_{feed} - F_e \end{aligned} \quad (3.3.13)$$

From Fig. 3.6, we can deduce that

$$T_s = F_{feed} - F_s \quad (3.3.14a)$$

$$F_s = B_{s2}(\dot{x}_{sd} - \dot{x}_s) \quad (3.3.14b)$$

$$F_{back} = K(x_s(t-T) - x_m) \quad (3.3.14c)$$

$$F_{feed} = K(x_m(t-T) - x_s) \quad (3.3.14d)$$

$$F_m(t) = F_s(t-T) + b\dot{x}_m(t) - b\dot{x}_{sd}(t-T) \quad (3.3.14e)$$

$$\dot{x}_{sd}(t) = \dot{x}_m(t-T) + \frac{1}{b} \cdot F_m(t-T) - \frac{1}{b} \cdot F_s(t) \quad (3.3.14f)$$

The stability is proposed with a Lyapunov function which puts the condition that:

$$K^2 \cdot T^2 < B_m \cdot B_{s1} \quad (3.3.15)$$

Using Barbalat's lemma it was shown that the tracking error defined in above can be re-written as:

$$e = x_m(t) - x_s(t) - \int_{t-T}^t \dot{x}_m(\tau) d\tau \quad (3.3.16)$$

From Eq. 3.3.15, we can define K_{pass} as the gain which should not be exceeded in order to respect passivity.

$$K_{pass} < \sqrt{\frac{B_m \cdot B_{s1}}{T^2}} \quad (3.3.17)$$

It is important to note that the stability of this architecture is proven by taking into account a fixed delay assumption. However, the simulation results proves that the system is stable under limited packet loss, however tracking performance is degraded. In addition, if the deviation in the delay is bounded whereas the control information is updated with a high sampling rate, the uncertainty occurs for a very short time as compared to slave dynamics (subjective) and doesn't effect its stability. The original architecture is valid for fixed delays (and a range of gain $0 < K < K^*$), however, it has been shown in [Anderson & Spong, 1989] that due to packet loss over the network, time varying delay starts degrading the tracking performance which is totally lost with 80% packet loss.

3.3.5 Recent Approaches in Passive Teleoperation

In passivity-based, scattering transformation and time-domain approaches are mostly used. Anderson and Song in 1989, proposed an architecture which permits to ensure stability with the reduced telepresence quality by degrading the performance to satisfy stability requirements imposed through passivity for the system at all times. They considered delay as constant for a linear time invariant case. Thus, their control algorithm can not deal with delay variance, which is quite probable in practical scenarios. Thus, some later work provided solution to the varying delay problem as in [Sano et al., 1998], which was based on gain scheduling. In [Niemeyer & Slotine, 2004], telemanipulation with a fixed delay is considered where the wave variables are transmitted over the communication channel along with their integrals. For better position control, [Ortega et al., 2003] uses wave variables that codify position and integral of position. Whereas, in [Nuno et al., 2007] the encoding of position and integral of force is implemented which was found suitable for restricted robotic teleoperation tasks. Including an integral of the measurement requires compensation (anti-windup filter) to get rid of the undesirable effects.

3.4 Effect of Digital Implementation

In most of the teleoperation benchmarks, a discrete time controller is implemented in the hardware. It has been shown by [Colgate et al., 1995] that a discrete controller interacting with the continuous time operator or environment can pose problems if sampling rate is not chosen high enough to conserve passivity. If a low sampling rate is chosen, a lot of physical damping is needed to keep the system passive all the time. The same problem was reported in [Colgate & Schenkel, 1997] as a nonlinear effect generated due to the sensor resolution or quantization which can be regarded as a high frequency noise. When this noise is differentiated (due to the control algorithm) it is amplified leading to sustained oscillations. Therefore the sensor resolution should be high enough to ensure passivity, otherwise, a lot of coulomb friction must be added to the system. For a virtual environment with stiffness k_e , the following conditions should be satisfied for passivity:

$$b_m \geq \frac{k_e \cdot T_s}{2} \quad (3.4.1)$$

$$c_m \geq \frac{k_e \cdot \Delta}{2} \quad (3.4.2)$$

where b_m and c_m are the viscous and coulomb friction coefficient, k_e is the environment stiffness, T_s is the sampling time and Δ is the encoder resolution. Thus the viscous friction should balance the stiffness and effective delay due to the sampling and ZOH and the phase lag of the ZOH is compensated by the phase lead of the viscosity. More important, the coulomb friction must dominate the step force changes due to the quantization to avoid limit cycles [Diolaiti et al., 2005].

3.5 Effect of Network on Passive Teleoperation

In the general NCS context, the minimum bit rate R of the feedback information needed for stability for a single input linear system to the fastest unstable mode of the system is given by the relation below [Kottenstette & Antsaklis, 2008]:

$$R > \log_2 \exp(\Sigma R(a_i)) \quad (3.5.1)$$

For networked teleoperation, the control information is coded in terms of force and velocity variables as seen in the previous section. The network plays an important role in the passivity based teleoperation scheme as the network dynamics can augment or decrease the performance quality. The passivity of scattering transformation is guaranteed, however, the communication of wave variables subject to time-varying delays incurred in the wireless communication must be accounted for in order to ensure passivity and stability of the overall closed loop system. In [Kottenstette et al., 2008], a passive sampler (PS) and passive hold (PH) are used to ensure that no energy is generated by the sample and hold devices and thus passivity is preserved.

The stability of the interconnected system is evident if the passivity of each subsystem can be ensured. However, it is interesting to analyze the stability of master and slave sub-systems interconnected to send and receive wave variables over a wired/wireless network and looking the network block as a sub-system [Kottenstette & Antsaklis, 2007]. Such an approach seems to address the inverse problem i.e. '*How to develop a reliable (wireless or wired) network for teleoperation?*', which is a dual problem of developing a reliable (control perspective) teleoperation system over a network. The co-design approach is the only answer to this problem from our point of view [Khan et al., 2010].

In [Anderson & Spong, 1989], the authors argue the stability of teleoperation by conversion of scattering transformation variables into wave variables, making communication block as a passive subsystem in case of fixed time delays. However, some recent research suggests that due to the time varying delays and packet loss, the instabilities occur as the delayed force and velocity information makes the communication channel non-passive [Berestesky et al., 2004]. It was shown in [Kottenstette & Antsaklis, 2007] that if the energy supervision is ensured, l_2 stability holds for fixed discrete time varying delays with/without packet drops. It has been further argued that in case of all or partial packet drops, the same stability criteria is applicable and it is valid for a delay duration as long as it respects the criteria. However, duplicate transmissions are not allowed and it is assumed that all duplicate packets must be dropped at the receivers and the current energy storage is being monitored.

3.5.1 Packet Loss Effect

It is interesting to note that the architecture presented above can be considered successfully only when a careful digital implementation (with an aspect of energy measure) is performed in order to keep the control loop stable. We adapted the methodology used in [Hirche, 2005] to consider as a relevant case for the implementation on NeCS-Car as described in Chapter 6. It is known that for passivity under time varying delay (e.g. due to packet loss), a choice must be made in between the hold last sample (HLS) and zeroing in order not to inject energy into the system which is respecting passivity otherwise [Steinbach et al., 2010].

The energy supervision can be applied to each sent/received pair of scattering variables. The input wave energy $\sum_k u_l^2(k)$ ($\sum_k v_r^2(k)$ for backward path) has to be transmitted over the communication network. In order to keep the additional network traffic as low as possible, the value of input energy is transmitted together with the wave variable in the same data packet. As the data packets and such the input energy information may possibly get lost the latest update of the input energy content available at the receiver at the time N is assumed to have the packet index $k^* = N - K$, where $K \geq D_1$ ($K \geq D_2$ for the backward path). The amount of virtual energy $E_{v,f}(N)$ ($E_{v,b}(N)$ for the backward path) is the difference between the wave energy input to the forward path until the time k^* and the wave energy output until the current time N .

$$\begin{aligned} E_{v,f}(N) &= \sum_{k=0}^{k^*} u_l^2(k) - \sum_{k=0}^N u_r^2(k) \\ E_{v,b}(N) &= \sum_{k=0}^{k^*} v_r^2(k) - \sum_{k=0}^N v_l^2(k) \end{aligned} \quad (3.5.2)$$

It can be argued that the energy supervised communication subsystem is passive, if the virtual energy storages for the forward and backward path are non-negative $E_{v,f}(N) \geq 0$ and $E_{v,b}(N) \geq 0 \quad \forall N$ as the energy balance for the forward and backward path with the virtual energy storage is larger than zero. Therefore, the passivity condition is satisfied.

3.5.2 Energy Supervised Data Reconstruction

The energy supervised data reconstruction is based on the supervision of the energy balance of the communication subsystem which is connected to the concept of time domain passivity. If the input energy to the communication subsystem is known at the receiver then a data reconstruction algorithm can be designed, such that never more energy is extracted from the communication subsystem than going into it, hence the passivity condition is satisfied as shown in Eq. 3.5.3.

$$E_{c,in}(N) = \sum_N^{k=0} u_l^2(k) - u_r^2(k) + v_l^2(k) - v_r^2(k) \geq 0 \quad \forall N \in \mathbb{Z} \quad (3.5.3)$$

3.6 Transparency in Teleoperation

Transparency refers to the *good feeling* of the task felt by the operator. Ideally, the operator feeling to sense the ground and environment should be the same as if he/she is directly interacting at the

teleoperator site. This concept is difficult to model and define as a mathematical formulation for quantitative performance measure. However, there are several approaches in the literature today e.g. [Zhu & Salcudean, 1995], [Lawrence, 1993] and [Fite, Shao & Goldfarb, 2004]. The classical approach takes into account the impedance matching between the master and the slave [Fite, Shao & Goldfarb, 2004]. As shown in the Fig. 3.7, the input/output and transmitted impedance can be compared for the evaluation of transparency. In [Kim & Chang, 2007], an extended transparency condition is defined based on trackability and immersivity.

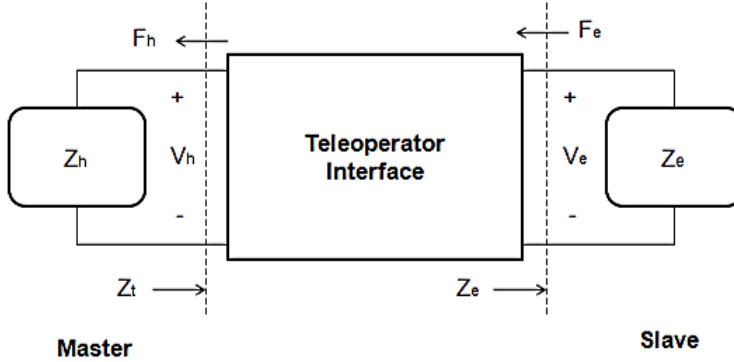

Figure 3.7: Two port representation of Bilateral Teleoperation

3.6.1 H-matrix based transparency

In most cases, the H-matrix is used to describe the transparency which relates the output variables slave velocity (V_s) and reflected force (F_h) with the input variables reflected force (F_e) and master velocity (V_m), as:

$$H = \begin{bmatrix} h_{11} & h_{12} \\ h_{21} & h_{22} \end{bmatrix} \quad (3.6.1)$$

where $h_{11} = \frac{F_h}{V_m}|_{F_e=0}$ is the master's impedance (Z_m), $h_{12} = \frac{F_h}{F_e}|_{V_m=0}$ is the force gain from slave to master (G_f), $h_{21} = \frac{V_s}{V_m}|_{F_e=0}$ is the velocity gain from master to slave (G_v) and $h_{22} = \frac{V_s}{F_e}|_{V_m=0}$ is the slave admittance (Y_s).

For *optimal transparency*, the master velocity should not affect the reflected force ($Z_m = 0$), the force and the velocity gain should match the master and slave dynamics ($G_f = G_v = 1$ resulting into $F_h = F_e$, $V_m = V_s$) and finally the slave should be unaffected by the external forces ($Y_s = 0$). However, these ideal requirements are rarely satisfied due to the sensor and actuator non-linearities and hardware limitations. Thus, other indicators e.g. achievable bandwidth (Z -width) of the teleoperator give information of transparency for varying environment stiffness and damping while still satisfying the stability requirements given by passivity [Flemmer & Wikander, 2003]. In fact, the two representations i.e. impedance and H-matrix based transparency are interconnected to some extent.

3.6.2 Transparency Performance measurement

Performance measurement of transparency is a quantitative evaluation based on the achieved degree of the control objective (e.g. stability and tracking), so the control objective and quantitiveness be-

come essential features in the quality of bilateral teleoperation. However, the performance in bilateral teleoperation is hard to quantify because of the QoC requirements, time delay and human haptic perception making it a multi-objective control problem. The selection of appropriate performance measure in bilateral teleoperation, is difficult to obtain due to the following reasons.

- There exist a compromise between stability and performance in passivity based teleoperation problems. This means that a stable passive teleoperation usually lacks in desired transparency or vice versa. Thus, the measure of only transparency is not sufficient for all needs of bilateral teleoperation.
- In the evaluation of transparency, frequency domain comparison based on the bode plot are used which is not a quantitative measurement.
- Human perception is usually neglected while evaluating transparency.

There has been much research to improve the transparency in networked BT. Transparency transfer function [Fite et al., 2001], similar to the measure of transparency, is a quantitative performance measure which use bandwidth concept. Impedance error measure [Kron & Schmidt, 2006] based on the measure of transparency is proposed as a quantitative performance measure. In addition, a transparency study considering human haptic perception is reported [Hirche et al., 2005]. Scaling teleoperation have been proposed to overcome dexterity limitations imposed by the small scale of the task as discussed in [Majima & Matsushima, 1991] and [Salcudean & Yan, 1994].

Beside control objectives, there has been much research based on control objective which is different from transparency. Ideal response [Yokokohji & Yoshikawa, 1994] is a well known control objective in bilateral teleoperation. From ideal response, performance index of maneuverability is proposed as a quantitative measure [Yokokohji & Yoshikawa, 1994]. Fidelity [Cavusoglu et al., 2002] is proposed as a control objective for tele-surgery, and a quantitative performance measure. Z-width [Colgate & Brown, 1994] is introduced as a control objective to maximize achievable dynamic range. Force-reflection ratio [Daniel & McAree, 1998], [Kuchenbecker & Niemeyer, 2006] presents the force ratio of the master force to the slave force, which is limited by stability. A μ -synthesis based formulation is used in [Kim et al., 2007] for the comparison of dynamic characteristics and sensory configurations in different bilateral teleoperation systems.

In practical implementation of bilateral teleoperation system, two objectives are of great interest from quality of control point of view i.e. trackability and immersivity. The former refers to how well the the input command is followed by the remote teleoperator (ideal case e.g. $X_e = X_h$ for position-position architecture), while the later exhibits the match between the transmitted impedance and the environment impedance (ideal case $Z_t = Z_e$). An extended transparency condition is defined based on these two control objectives i.e. trackability and immersivity functions and it uses the error vector magnitude to consider the time delay [Kim & Chang, 2007]. In the same work, meaningful perception bandwidth and compliance just-noticeable-difference for human haptic perception are introduced. Other psychophysical parameters used to represent human perception includes Minimum Perception Bandwidth (MPBW), Augmented Reality, Immersivity, Telepresence etc [Hirche et al., 2005].

The attaining degree of trackability is obtained as $\frac{X_e}{X_h}$. The effect of delay is perceived by two effects in the performance of bilateral teleoperation namely pure transmission delay (constant for a simple case) and distortion. The delay effect can be observed only from the phase margin while gain margin remains unaffected. On the other hand, the distortion effects both the gain and phase margin. The human operator force and velocity commands are known to be in the range of about 5 to 10 Hz [Burdea, 1996].

Quality of Control	Transparence	Human Perception
Maneuverability	Impedance error measurement	JND
Fidelity	Impedance ratio	MPBW
Z-Width	H-matrix parameters	Augmented reality (AR)
Force reflection ratio	Force and Position tracking	Immersivity
Trackability	Scaling	Telepresence

Table 3.2: Performance Criteria in Bilateral Teleoperation

3.7 Compromise between Stability and Transparence

It is important to note that there is a compromise between transparence and highly stable teleoperation [Hannaforde & Ryu, 2002]. In [Lawrence, 1993], a 4 channel architecture is used with dynamic controllers to ensure perfect transparence. In addition, it also proves that passivity of the architecture is not ensured perfectly while taking care of transparence. In [Yokokohji & Yoshikawa, 1994] the author proves that due to the perfect knowledge of the two manipulators at the master and slave side, a perfect transparence can be ensured but robustness is compromised in this case. In [Lawrence, 1993], the author proposes a compromise between stability and transparence by considering a *desired transparence* instead of perfect one. It is however emphasized that an ideal transparence gives the best perception of the variations in the environment. Thus, it is an effective approach to study the sensitivity of the impedance transmitted as compared to the variations in the real impedance by analyzing:

$$\|W_s \frac{dZ_t}{dZ_e} |_{Z_e=\hat{Z}_e}\|_2 = \|W_s \frac{-h_{12}h_{21}}{(1+h_{22}\hat{Z}_e)^2}\|_2 \quad (3.7.1)$$

where W_s is a low pass filter whose cut-off frequency represents the frequency where transparence is not ensured and \hat{Z}_e is an estimation of the environment impedance [Cavusoglu et al., 2002].

3.8 Conclusion

This chapter describes the teleoperation types, applications, requirements and their problems. Some history and previous work has been discussed for the control approaches already used in this area. Passivity based control (PBC) is more emphasized due to its easy implementation and understanding which emerge from fundamental energy functions. Several passivity based control architectures are compared with each other for their respective pros and cons. The study is focused mainly on the passivity based architectures e.g. [Anderson & Spong, 1989] and [Chopra et al., 2006]'s position based bilateral control architecture with force feedback. Its implementation on test bench will be discussed in chapter 5.

Chapter 4

Networked Teleoperation- A Co-design Approach

Contents

4.1	Introduction	109
4.2	The Co-design Problem in NCS	110
4.3	Methods in Co-design	113
4.4	Real Time Multimedia for Teleoperation	116
4.5	Co-Adaptation for Co-design	120
4.6	QoS Classification and Prediction	121
4.7	Comparison of different estimation techniques	123
4.8	Co-design in Networked Teleoperation without QoS provisions	125
4.9	Co-design with QoS oriented Network Architecture	133
4.10	Prediction of Network Parameters	134
4.11	Conclusion	137

4.1 Introduction

This chapter refers to the co-design approach for the networked teleoperation which can be regarded as a special case of NCS. It has been emphasized that an isolated design of controller and network architecture can be improved in performance through a co-design approach which combines the benefits of simultaneous tuning of controller and network. This approach effectively reduces the uncertainties and risks involved due to the communication imperfections.

As described in Chapter 3, the heterogenous and hybrid network architectures (embedded/off-board) are needed for long range communication. However, there are different mechanisms for traffic control and QoS guarantees in each protocol which must communicate with the QoS services of other protocols. Thus, the end-to-end QoS support must be ensured and priority must be defined for the control and multimedia flows in order to carry out teleoperation tasks in a QoS oriented network architecture. On the other hand, we propose an adaptation scheme for networked teleoperation which controls the video flow over network as a function of delay and transparency.

4.2 The Co-design Problem in NCS

The co-design or integrated/joint control and communication architecture is a widely known problem in networked control systems. The classical practice in NCS is to design control algorithms in an isolation i.e. without taking into account the complete network dynamics [Hartman, 2004]. A popular approach used to model a network in the closed loop is to represent it with a constant/variable delay and then robustness and stability analysis with performance parameters is performed to analyze the steady-state error and transient response characteristics [Zhang, 2001]. However, in reality, the delay is time varying as well as random and a statistical distribution may not be a suitable choice [Cruz, 1991*a*]. Also, some other network characteristics e.g. network protocol, traffic load, number of nodes, network imperfections like collision and retransmission of messages should also be taken into account as they influence the QoS offered by the networks [Halevi & Ray, 1988].

Therefore, in co-design approach, network issues like quantization, bandwidth, survivability, reliability, scalability, performance and delay characteristics should be jointly studied with the control system issues such as stability, performance, fault tolerance and adaptability [Branicky et al., 2003]. Recently, the co-design of control and CPU scheduling has received considerable attention [Cervin & Eker, 2005], whereas, network scheduling is a relatively new research problem [Nguyen et al., 2009].

Fig 4.1 presents a summary of the multi-dimensional control and communication interaction in NCS domain. They are described in the following sections.

4.2.1 Control of Network (CofNet)

The control of network refers to the network resource management where four approaches are used namely scheduling, medium access control (MAC), routing and topology control.

Scheduling

The network operating system (NOS) carries out the scheduling which includes both at the embedded device level (e.g. used in routers and switches) as well as the system application level i.e. the operating system installed on the network servers and workstations e.g. Windows Server 2008, Linux etc. Common examples of embedded operating systems include Cisco IOS (Internetwork Operating System), DD-WRT and Juniper Junos. The scheduling in networks has further types depending upon whether it is at the basic device level, router level or QoS scheduling. The device level scheduling may be preemptive scheduling or multilevel feedback. In preemptive scheduling, a task is privileged over others as per need while in the multilevel feedback, a process is given only one chance to complete at a given queue level before it is forced down to a lower level queue [Ho, 2008]. Thus, the basic level queue in multilevel feedback is round robin. Other types include cooperative scheduling, completely fair scheduling etc.

At the router level, mostly best effort scheduling is implemented which utilizes round robin, FIFO, fair queuing etc. In QoS scheduling, different priorities are assigned to different tasks (or packets) e.g. priority queuing, weighted fair queuing (WFQ) and sub-class based WFQ are some of the examples [Zhang et al., 2006].

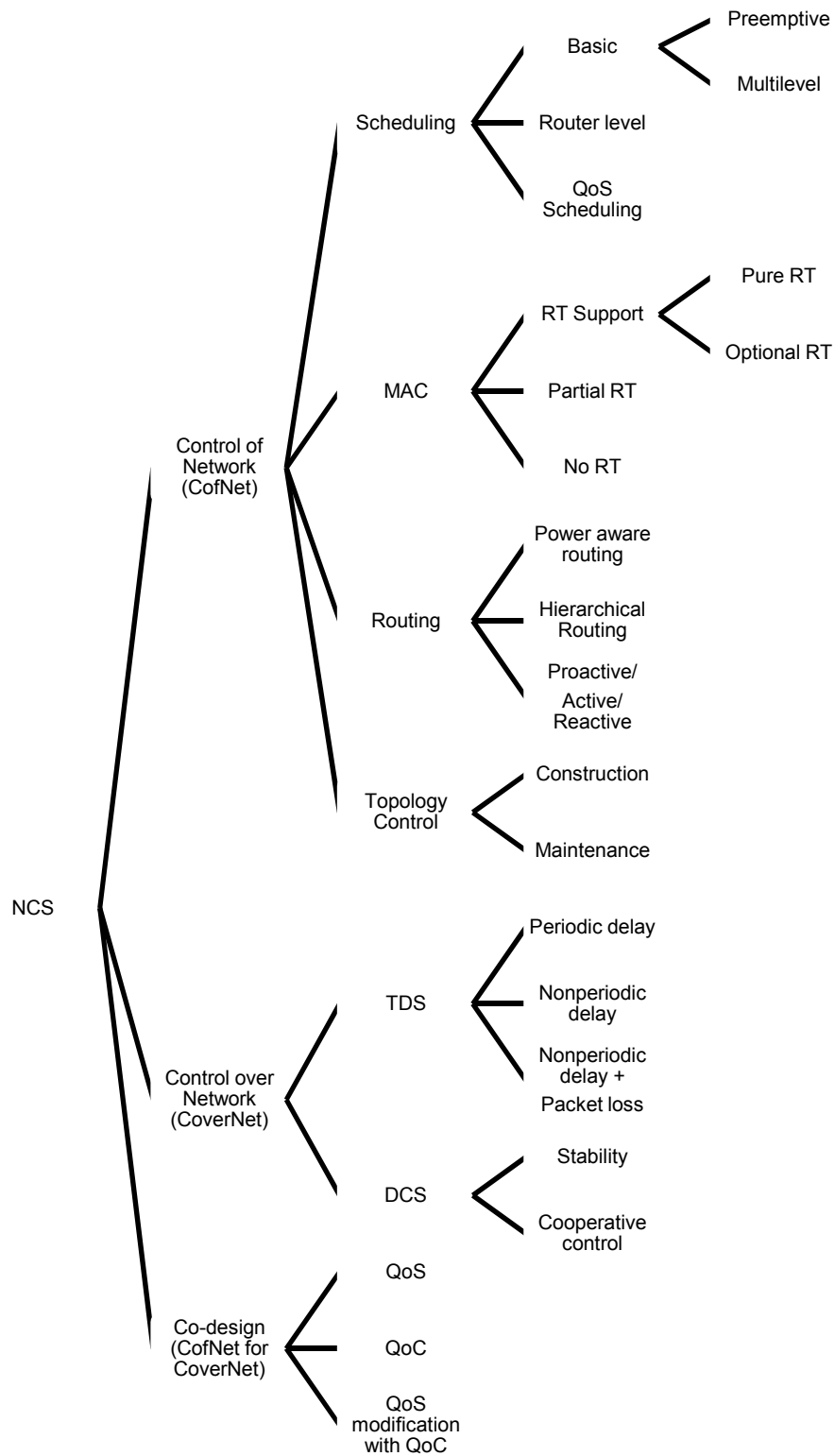

Figure 4.1: Dimensions in NCS Communication-Control design

MAC

At MAC level, the control of network is dependent on the protocol. The protocols may support pure realtime (RT) services or optional e.g. local interconnect network (LIN), time triggered protocols e.g. TTP/A, TTP/C, token based e.g. Token Bus, Token ring are pure RT. While, network control is assured through certain mechanisms in MAC protocols with optional RT support e.g. in W-HART, TT-CAN, FlexRay, TT Ethernet, Byte Flight, 802.11e etc. Some other QoS and priority mechanisms available in virtual bridged LANs include 802.1 p/q and 802.1d for link management [*IEEE Standards for Local and Metropolitan Area Networks: Media Access Control (MAC) Bridges*, 1991].

Partial RT support is provided in some MAC mechanisms e.g Polling, R-ALOHA, RT-MAC, CSMA-CR(CAN), FDDI etc [Singh & Tepe, 2009], [Verdone, 1996]. Whereas, some of the protocols did not have any RT support like ALOHA, Slotted ALOHA, CSMA-CA/CD etc.

Routing

Routing is a network layer mechanism for network control. It considers packets (network level) instead of tasks (at the CPU level). Routing may be objective based e.g. power aware routing in wireless networks aims to minimize the transmission power at the transmitter node. In hierarchical routing, the objective is to address network devices in a hierarchical fashion [Khan et al., 2009a]. For example, by adding subnets into subnets, a hierarchical network architecture can be realized [Naimi, 2005].

In proactive routing the routes are already calculated and stored in the form of a table. It is different from the Reactive routing where route calculation is online as per need. It is also known as on demand routing. Hybrid routing utilizes a combination of proactive and reactive approaches [Tee & Lee, 2009].

Topology Control

Topology control is another method used to change the initial network topology with an objective to optimize power and links as addressed in wireless ad-hoc networks [Chen et al., 2007]. It is further differentiated into topology construction which alters the initial topology and topology maintenance which preserves the connectivity between the nodes. More details can be found in [Santi, 2008].

4.2.2 Control over Network (CoverNet)

In CoverNet, various approaches are available to treat network behavior as per design objectives. In most of the cases, network delay is considered as in Time delay Systems (TdS), which is the most relevant measure from the control perspectives. Inside TdS, different delay types are considered e.g. fixed delay, known periodic delay, non-periodic bounded delay and Jitter (Robust Control) [Niculescu, 2001] and non-periodic bounded delay and Jitter with packet loss (MPC) [Chen et al., 2008]. For the delay with unknown bound Adaptive Control techniques are utilized [Chopra & Spong, 2007].

The second type of CoverNet is the Distributed Control Systems (DCS), in which multiple entities interact for self or collective objectives. Various specialities known in DCS include Local and Global stability/optimisation e.g. multivehicle formation stabilization and Cooperative control which includes flocking, consensus, rendezvous, cooperative tasking and spatiotemporal planning [Fax & Murray, 2004].

Approach	Control	Network	References
SCSN	Static	Static	[Franklin et al., 1994],[Friedman et al., 2004],[Marshall, 1992]
DCSN	Dynamic	Static	[Chow & Tipsuwan, 2001],[Eriksson & Johansson, 2007],[Lepage et al., 2006]
SCDN	Static	Dynamic	[Zampieri, 2008],[Chiang et al., 2001],[Marti et al., 2002]
DCDN	Dynamic	Dynamic	[Liberatore, 2006],[Marti et al., 2004],[Naghshabrizi & Hespanha, 2005]

Table 4.1: Co-design methodologies

4.2.3 Co-design in Networks (CofNet for CoverNet)

The Co-design methods refers to the modification of network QoS for QoC and vice versa. The important QoS parameters as mentioned above include delay, jitter, packet loss, bandwidth, network congestion, RSSI. Whereas, the QoC parameters takes into account the position, velocity and force errors etc. Resource allocation by admission control and service classes are also considered for improved network QoS. The control quality indicators comprises of stability, performance, optimality and robustness based quality factors. The commonly used metrics in QoC are Mean square error (MSE), Integral of absolute error (IAE) and Integral time absolute error (ITAE).

4.3 Methods in Co-design

We are inspired by the research done in the NCS domain to extend same concepts for bilateral teleoperation. However, the usual terminology for the communicating pair in NCS i.e. Controller and Sensor/Actuator (S/A) will be replaced by the Master/Slave for teleoperation at the end. In general, three methodologies can be seen in the context of distributed networked control as seen in [Barry et al., 2001], [Bayart, 2008], [Yook et al., 2001] and [Partan et al., 2006].

- 1) Fully decentralized control to eliminate the communication block between the Master/Slave for control purposes.
- 2) Improved communication algorithms and protocols (with or without QoS guarantees) to satisfy the application requirements.
- 3) '*Communicate only when needed*'- i.e. reduce the required communication between the Master/Slave.

For the present work, we want to keep the network block in the loop and therefore we will concentrate on the methodology 2 & 3 which can be further analyzed in detail. We will consider the interaction between control and network blocks as an *active* or *passive* contribution. As shown in Table 4.1, the co-design approaches in NCS are divided into four categories depending if the participating controller and the network are passive or active. The same concept can be extended to networked teleoperation.

4.3.1 Static Controller Static Network (SCSN)

It refers to the earlier designs where networked control is thought to be similar to discrete time control and is based on the worst case delay experienced with the network in the loop. Here, the controller and the network are designed independently. The end-to-end delay offered by the communication network is evaluated once or in many iterations and the controller is designed for worst case end to end delay [Friedman et al., 2004]. The parameters of the controller are fixed and not adaptable to changing network load or capacity. Furthermore, some latest robust design that ensure stability under worst conditions

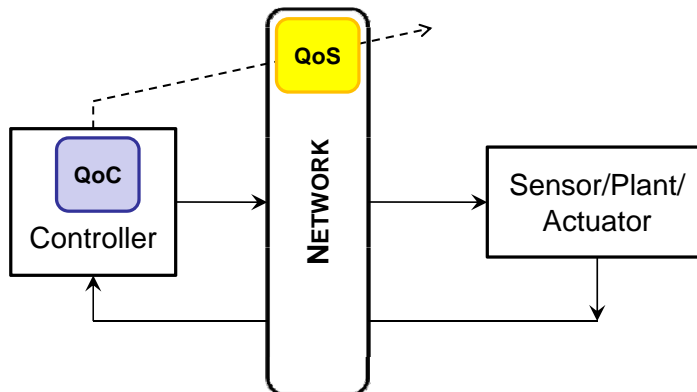

Figure 4.2: QoS adaptation through QoC Evaluation (SCDN)

also fall in this category. The teleoperator Master station must wait for the Slave response to decide further. Such *move and wait* type strategies were also used in space exploration [Sheridan, 1993].

4.3.2 Dynamic Controller Static Network (DCSN)

Theories and methods have been developed to adapt the controller to the shortcomings introduced by the network e.g. delays, jitter, packet losses and non-uniform/asynchronous sampling etc. These methods were used to estimate the network QoS assuming that it is not controllable. Thus, control is adapted with the changing network conditions in the DCSN approach as shown in Table 4.1. The controller is able to adapt itself with respect to the delay and network performance e.g. *Controller tuning for varying time delay systems (TdS)*. Some important contributions include tuning rules for PID controllers e.g. Ziegler and Nichols tuning (ZNT) [Ziegler & Nichols, 1942], KLT approximation [Eriksson & Johansson, 2007] and Optimization based PI controller tuning [G.P.Liu et al., 2003]. Delay prediction is also used to estimate and nullify delay effects by using observers/predictors. Smith predictor (SP) and the Modified Smith Predictor (MSP) are commonly used, which requires a plant model before hand. In [Naghshabrizi & Hespanha, 2005], observers for TdS have been discussed which serve the purpose of measurement reconstruction and smoothing in the case of packet losses. For jitter minimization, play-out buffer is usually implemented for elastic realtime NCS [Fukushima et al., 2004].

4.3.3 Static Controller Dynamic Network (SCDN)

In some cases, it may be interesting to improve the performance offered by the network instead of modifying the control parameters which may result in global performance degradation. It is only possible when guaranteed services are available from the network in terms of delay and jitter. This refers to SCDN approach as presented in the Table 4.1. In this case, a number of techniques able to adjust the QoS offered by a network are used in order to enhance QoC. This is achieved by assuring a certain performance level to a network data flow, while achieving an efficient and balanced utilization of the network resources [Zampieri, 2008]. Similarly, in [de Wit et al., 2009], a modified delta modulation ($\Delta - M$) algorithm is discussed for data compression aiming at reducing the amount of information that may be transmitted throughout the communication channel, and therefore permitting a better resource allocation and improvement of the permissible closed loop system bandwidth. This approach

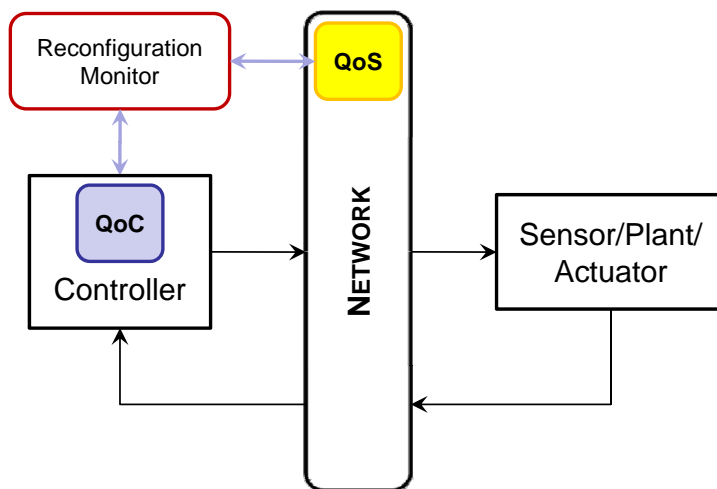

Figure 4.3: QoS and QoC adaptation through Reconfiguration Monitor (DCDN)

is illustrated in Fig. 4.2. In control of network, the interest is not just changing the behavior of the network but in adapting the network in accordance with the QoC demand. Therefore, an equation interconnecting QoC with QoS must be maintained throughout analysis and implementation. Thus, the control design doesn't care about the networked communication imperfections, however, firm QoS guarantees are available from network in terms of time delays, jitter and bandwidth. Such scenarios involve leased lines in late years. However, today, many wireless protocols offer QoS classes which not only support non-QoS (best effort) flows but also priority scheduling in terms of intelligent resource allocation to priority users and flows. Examples include round robin, TT-CAN, Flex-ray and Wireless HART (IEC 62591Ed.1.0) networks where time critical services are available and network can be assumed as deterministic subsystem with a fixed delay. A comparison of various wireless protocols with QoS support is listed in Table 2.3.

4.3.4 Dynamic Controller Dynamic Network (DCDN)

Here, the idea is to dynamically adapt the control and network parameters to gain maximum performance. The decision is taken by an intelligent reconfiguration monitor (IRC) which decides about the adaptation block depending upon the performance objectives and available dynamic range. In this approach, the two of the Control and Network parts are active in terms of application support and QoS guarantees [Marti et al., 2004]. Here, the objective is to form a general problem in terms of joint variables participating to optimize the global objective function. It can be safely assumed that QoC and QoS can influence each other for example, if network QoS degrades, the QoC will surely decline. Otherwise, if we need to improve the QoC we must demand more information from the other end (for example more sensor data) which can degrade QoS of the network. Thus, if network or the control quality deteriorates due to either cause, the active mechanism must maintain the objective, such that the overall effect of the perturbations could be minimized. It should be noted that the complete loss of communication (blackouts) is however not considered in this case which is more concerned to the system reliability and safety.

It is important to note that the reconfiguration in the QoC evaluation block enables the system to act on the network resources to adjust the QoS according to the application needs as shown in SCDN. The

QoS block executes the QoS adaptation e.g. resource allocation, change of user class, admission control etc. The choice of adaptation policy and mechanism depends on the protocols and the communication standards defined by the respective network. Thus, no single, generalized mechanism is available that can work with every network protocol as discussed in Chapter 3.

In general, the control data usually requires small packet size with strict delay guarantees. This means that looking at the average data rate is not sufficient for effective control over communication network. For example, transmitting 1 bit per second or 100 bits every 100 sec have the same average but its impact on the control performance is quite different. If more frequent transmission in small packets is not feasible (due to overhead and packet size constraints), the delays are inevitable and compensation is necessary as per application requirements. In addition, a video link is bandwidth greedy and being an integral part of the teleoperation, it is important so that the operator can visualize the effects of his command on the teleoperator [Hokayem & Spong, 2006]. However, it can tolerate delays depending on the type of video coding. To augment the effects of telepresence, force feedback is proposed which demands communicating the force exerted (by the environment) on the remote side to the operator for better sensing. The data rate guarantees and link capacity are applicable to video flow, while end-to-end delay bound is necessary for control and feedback information.

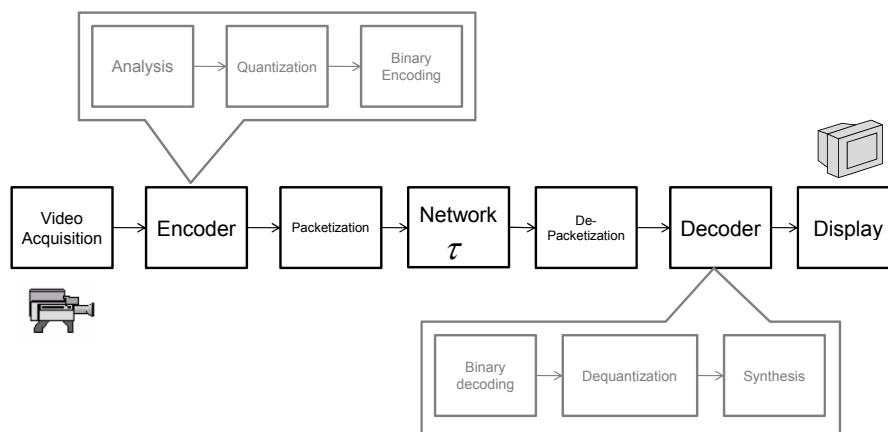

Figure 4.4: Video Processing and transmission over Network

4.4 Real Time Multimedia for Teleoperation

A generalized flow diagram for video processing and transmission over network is shown in Fig. 4.4, where video acquisition is carried out through a camera and fed to the encoder block which analyzes the video stream, quantizes it and use coding for the encoded stream. These bits are then packetized and sent over the network. On the other side of the network, the packets are received and decoded, de-quantized and synthesized for an appropriate format to display on the screen. The error detection and correction is also available at the receiving end which is not shown here.

For transparency and telepresence in bilateral teleoperation, transmission of real time multimedia is not possible with the classical best effort internet where packets may delay or lost arbitrarily. IETF has standardized RTP and RTCP which are compatible with the current TCP/IP internet. Based on RTP, several propositions have been implemented e.g. JMF 2.1.1 from Sun Microsystems for real time internet audio/video applications [Hou et al., 2003]. This implementation uses digital video streams captured

and transmitted over H.263/JPEG over RTP with a live environment feedback [Microsystems, 1999]. JMF media encoding is shown in Table 2.6. It can be noted from the table that H.261 and H.263 have a good compression ratio and lower bit rate as compared to JPEG, which make it ideal candidate for video conferencing where there is not a lot of action. So, for video H.263 and JPEG over RTP are implemented for video presentation and audio encodings select GSM and G.723 over RTP.

4.4.1 Effect of packet loss on video quality

To understand the effect of packet loss on the video communication between Master and Slave, test cases are considered with UDP packets with a data rate ranging from 0 to 1000 pk/sec. For 1000 pk/sec and frame rate of 25 fps, we have a data rate of 400 pk/frame. We utilized the embedded vision system coded in .bmp as 1 byte per pixel (gray scale images) and defined the percentage of packet loss (PPL) as the lost packets were replaced by the black pixels. If we code line by line, the black bands will appear when packets are lost. To draw the curve PSNR as a function of PPL, we delete the % PPL of the lost packets sent which corresponds to an average statistics.

In Fig. 4.5, three cases are considered with varying data rate, each evaluated with and without packet loss. By the variation of data rate, we mean to change the number of packets per frame. Lesser the number of packets per frame, bigger the pixel size we use to represent the frame (image in our case) resulting in poor resolution. The packet loss is distributed randomly over frame lines. In Fig. 4.5(a), 1000 pk/s frame is shown with excellent quality while in Fig. 4.5(b), same image with 20% packet loss is shown. The image resolution is varied in Fig. 4.5(c), where 500 pk/s and similarly Fig. 4.5(d) shows the packet loss version. In the third part, Fig. 4.5(e) represents the same image with just 200 pk/s and the effect of packet loss over this low resolution image is shown in Fig. 4.5(f). It can be clearly observed that when a low resolution frame (with line-by-line coding) is subject to packet loss, it will leave large bands of black lines for information loss representation as can be seen for Fig. 4.5(f). This scenario proves that it is not as simple as altering the resolution and effectively the data rate needed to send over network because errors and noise can have a great effect on the low resolution images as compared to the higher resolution images/frames making them useless for teleoperation.

In practice, a simple method to detect packet losses is to use packet identifiers of the video packets. For video, it is interesting to notice how much and which type of packets are lost e.g. in MPEG-4 coding, four different frame types with different information content are used. These are intra (I), Predictive (P) and bidirectional (B) frames [Klaue et al., 2003]. Thus, packet loss for video is defined as:

$$PL_{video} = \frac{nT_{rcv}}{nT_{tx}} \quad (4.4.1)$$

where, T is the type of data in the packet and nT_{tx} and nT_{rcv} are the number of type T packets transmitted and received. A video frame can be considered as a single coded image. The frame size for video may get bigger than the maximum transfer unit (MTU) of the network (Ethernet: 1500 bytes and WLAN: 2312 bytes) which are segmented to fit in a number of MTUs.

$$FL_{video} = \frac{nT_{rcv}}{nT_{tx}} \quad (4.4.2)$$

In addition to the frame and packet losses, delay and jitter have an important effect on the perceived video quality. The buffer scheme to minimize jitter introduces extra delay in the loop.

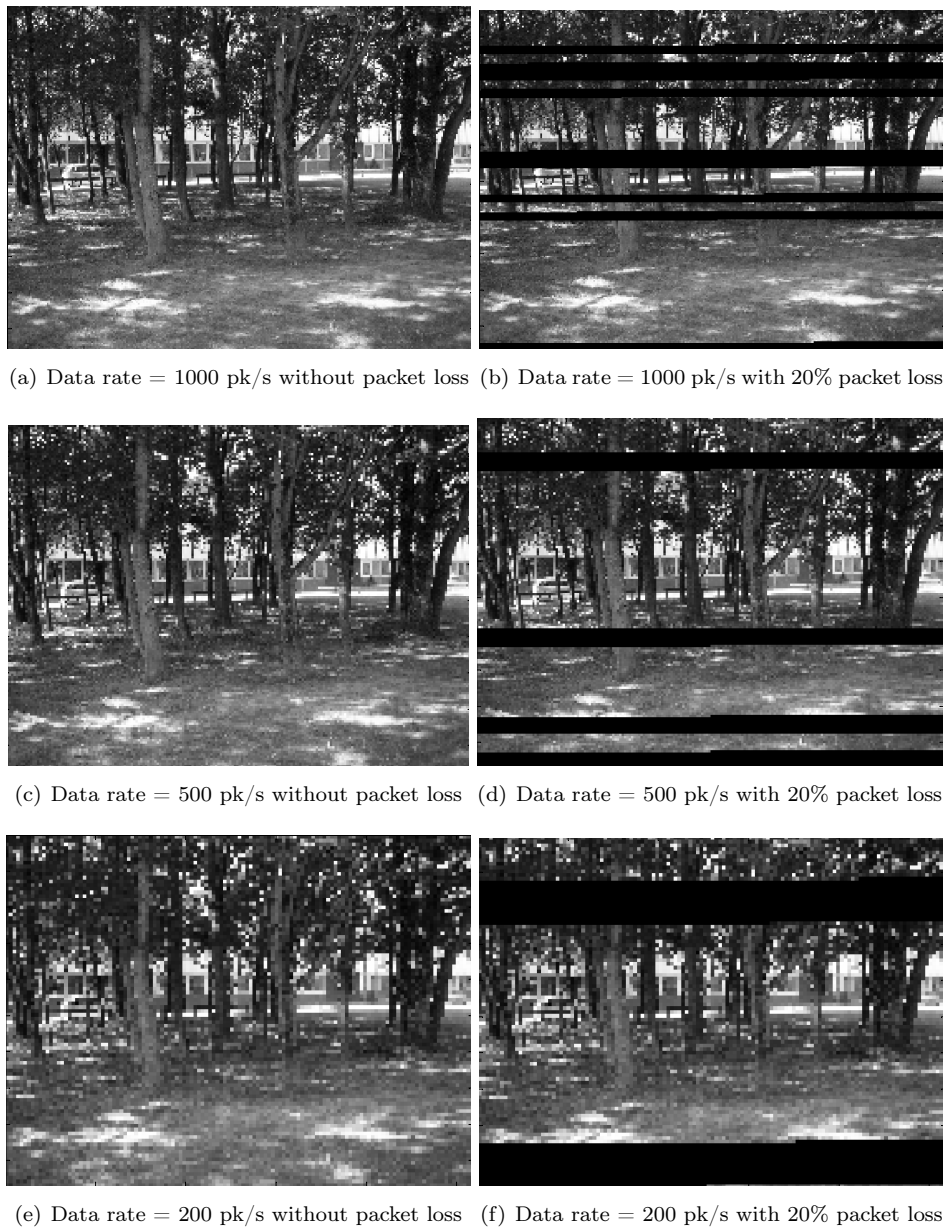

Figure 4.5: Effect of change in data rate and packet loss on video quality

In Fig. 4.6, the variation of peak signal to noise ratio (PSNR) due to the video data rate and packet loss is shown in sub-figure a & b respectively. It can be pointed out that the PSNR improves with increase in data rate for a fixed packet size. Whereas, it descend exponentially with an increase in packet loss from 0 to 100%.

4.4.2 Effect of video quality on driver's performance

The video quality in teleoperation is a challenging problem due to the complexity of the video systems and subsystems (multiplexers, codecs, routers, switches etc) as well as the complexity of visual perception

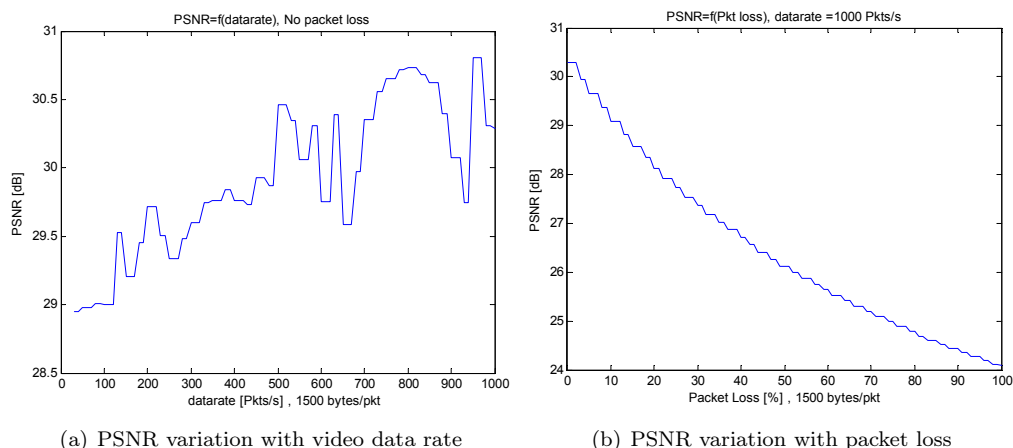

Figure 4.6: PSNR variation with video data rate and packet loss

to quantify the effect of video quality.

As mentioned above, compromise on video quality is made for a degraded network. However, it can result in slow response, distractibility and impaired performance as compared to human driver on the real vehicle. This is because the cognitive abilities (combined with physiology and psychophysics) to adapt and react based on information acquisition through eyes and skin and processing through brain and nervous system is so remarkable that it can not be obtained as a remote driver. Human driver models are eagerly searched to include in the teleoperation simulation in order to get realistic behavior in trajectory following in the scenario of low quality video available to the remote driver.

In [Salvucci et al., 2001] and [Goodrich & Boer, 2003], a cognitive architecture is used to describe a human driver on two levels namely operational and task level. Whereas, in [Barton et al., 2006], a human driver model with different viewing conditions and other visual cues is discussed. The reaction time of the driver comprises of:

- Mental Processing Time (MPT) is a composition of sensation, perception and recognition, situation awareness and decision sub tasks.
- Movement Time (MT) includes the reflex movement or normal muscle movement.
- Communication delays (τ_{com}) are included depending upon the distance, medium and protocol of communication.
- Teleoperator response time (TRT) has a time constant depending upon the dynamics of the teleoperator. A slave device consisting of mechanical assembly with gear-sets and mechanisms can take longer time to respond a human command sent by the master device.

4.4.3 NeCS-Car Example

From the safety point of view the teleoperator time is important to calculate e.g. for the case of NeCS-Car.

1) The *reaction distance* is dependent on the time taken by the master (human driver) and the two way communication delay. For example, if the NeCS-Car is moving at 35 Km/h (9.72 m/s), the driver

response takes 25 ms, Computational time is 25 ms and RTT on the communication link is 50 ms, then total distance covered before the car stops after 1 m.

2) The *brake engagement distance* is dependent on the time the brakes takes to engage. It can be approximated to 0.1 second as the electrical motor has a smaller rise time resulting in 1.38 m.

3) The physical force distance is the distance traveled once the brakes are engaged which can be assumed as 15 m.

Total Stopping Distance = $1 + 1.38 + 15 \approx 17$ m

This is an approximation made by neglecting several intermediate factors. In principle, various factors contributing to vary the stopping distance include cognitive load, psychological refractory period, age, gender, visibility, day/night time etc [Green, 2000].

4.5 Co-Adaptation for Co-design

In the co-design context, intelligent adaptation is necessary in order to reconfigure the subsystems for better performance guarantees. Artificial intelligence (AI) methods are very popular in problems where intelligent decision making is required. Often, a control strategy that is based on *soft knowledge* i.e. human experience in operating the plant, heuristics, common sense, or expert opinion can provide the remedy to these problems [Dote, 1998].

An intelligent controller may be interpreted as a computer-based controller that can *emulate* up to some extent, the reasoning procedures of a human expert in the specific subject area (control in the present context), to generate the necessary control actions. Soft intelligent control in general is more appropriate in some applications of process control, for example, when the process is complex and incompletely known, and when the control procedure cannot be expressed as a crisp algorithm [Deodhar et al., 2005]. The low-level fuzzy logic controller generates the low-level direct control signals. This approach has some drawbacks with respect to speed, accuracy, and sensitivity and may not be appropriate. A more desirable architecture is the high-level hierarchical structure. This is a supervisor control architecture where low-level direct control is done using conventional crisp techniques, while supervisory tasks such as process monitoring, performance assessment, tuning, adaptation, and restructuring are done by upper levels [Takai & Ushio, 2000].

Wireless network QoS is evaluated in several applications e.g. for topology control, intelligent routing and handover from one cell to another. The Intelligent multi attribute decision making (MADM) is required in wireless communication when mobile user needs to change current cell to perform handover can be performed by using artificial intelligence techniques. This also applies for the case of heterogenous networks (for vertical handoff rather than horizontal handoff for homogenous network) to choose from based on QoS performance parameters as in [Wilson et al., 2005]. In [Siripongwutikorn et al., 2002], fuzzy bandwidth control for QoS provisioning is presented while [Xia et al., 2005] describes a neural network based feedback scheduler for networked control system with flexible workload.

Fuzzy approach is found to be used in network domain for admission control, scheduling and policing as shown in [Kasiolas & Makrakis, 1999],[Zhang & Phillis, 2001],[Cheng & Chang, 1996],[Salamah & Lababidi, 2001] and [Barolli et al., 2001]. Fuzzy logic based handover in MC-CDMA system is discussed in [Yang et al., 2005] while fuzzy handoff optimization in 802.11 Networks is described in [Pubill & Perez-Neira, 2006]. Networked control systems also utilize AI techniques for scheduling, integrated design and reconfiguration in case of fault scenarios. In [Li et al., 2009], the authors presented Fuzzy Bandwidth Scheduling to manage the quality of control (QoC) and Requirement of Bandwidth (RoB)

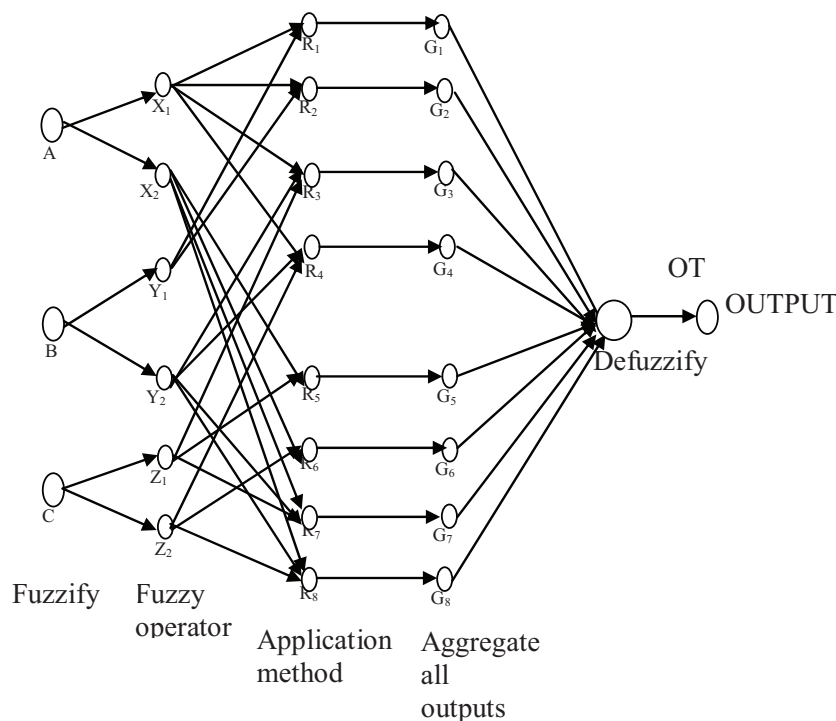

Figure 4.7: Basic ANFIS structure with 3 inputs

in NCS.

In literature, several methods are available for QoS estimation e.g. Link Quality Indicator (LQI) and Received Signal Strength Indicator (RSSI) are some important metrics which can describe the QoS [Dai et al., 2008],[Hardy, 2001]. Also, SNR is evaluated based on RSSI because in case of interference, signal power is enough but communication is no more possible, so noise estimation is performed to evaluate the signal power as compared to noise that results in bit error rate.

4.6 QoS Classification and Prediction

In networked communication, obtaining a model is a difficult task so mostly supervised or unsupervised learning (or training) is used for these measurement vectors to build a classifier or an estimator. Unsupervised learning is suitable for the large data sets and more complex models than with the supervised learning. Thus, in the unsupervised learning, no classes are defined a priori and the methodology can work for models with deep hierarchies e.g. Independent component analysis (ICA), Principle component analysis (PCA) and clustering algorithms are unsupervised methods [Xu, 1994]. In supervised learning, true class or parameter of the sample is used as opposed to the unsupervised learning. In addition, the supervised methods usually utilize off-line learning to develop a model. Some of the examples include fuzzy logic, neural networks, adaptive neural networks, SVM etc [Dote, 1998],[Zhu, 2005]. Since the network QoS can be classified based on the classes defined by supervised training of off-line data. Only supervised learning methods are discussed here for the classification of network quality of service.

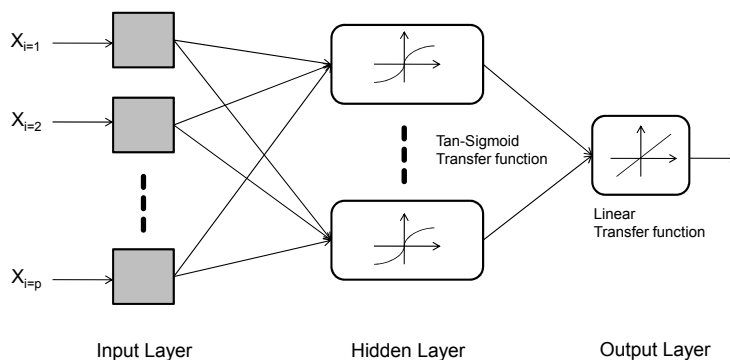

Figure 4.8: Architecture of 3 layers feed forward back propagation ANN

Fuzzy Vs other AI techniques

A simple two input QoS classification scenario is considered with delay and packet loss input. Both parameters are easily accessible and supposed to represent sufficient information about the QoS. Of course other parameters, like moving averages of those two, RSSI and GPS position data could augment the QoS classification precision. For fuzzy classifier, triangular and trapezoidal functions membership functions were used as these are the most suitable ones for the real time operation (See Appendix E). Also, the later implementation would be much easier with these functions. Since, the network conditions may change rapidly, we need to sample the input variables quite often, so the whole fuzzy block has to be computationally efficient. Therefore, the Sugeno-Type Fuzzy Inference with constant membership functions for the output are used here [Pirmez et al., 2007]. Since some rules may be redundant it should be possible to reduce the rule base matrix with the singular value decomposition (SVD).

During the development of the QoS classifier module, some alternative designs were considered e.g. *Adaptive Neuro-Fuzzy Inference System* (ANFIS) wherein a simple neural network replaces the strict membership functions and rules as shown in Fig. 4.7. This approach works similar to that of the classic neural networks. Since, the ANFIS module has to be taught with a quite large input/output data sets and the QoS output data can not be measured before hand, this method is highly dependent on the original fuzzy classifier and can be used simplify the initial FIS. Thus, output data from the original QoS module (with classic FIS) is used during the learning and testing processes.

Artificial Neural Network (ANN) is a computer system that simulates the learning process of human brain. It has the advantage to model complex nonlinearities in the data series. ANN is mostly utilized to compare with the ANFIS and in order to find the smallest network that could solve the QoS estimation problem [Xia et al., 2005]. The training data for the ANN are composed with the known input parameters and output/target values calculated with FIS, just like for the ANFIS as represented in Fig. 4.8. A feed forward network with a backward propagation is used in our case. The smallest usable network size turned out to be 7 neurons divided into 3 layers as follows:

- an input layer with 2 neurons corresponding to 2 system inputs
- a hidden layer with 4 neurons being the main part
- an output layer with 1 neuron corresponding to 1 output of the system

All neurons utilize bipolar sigmoidal function.

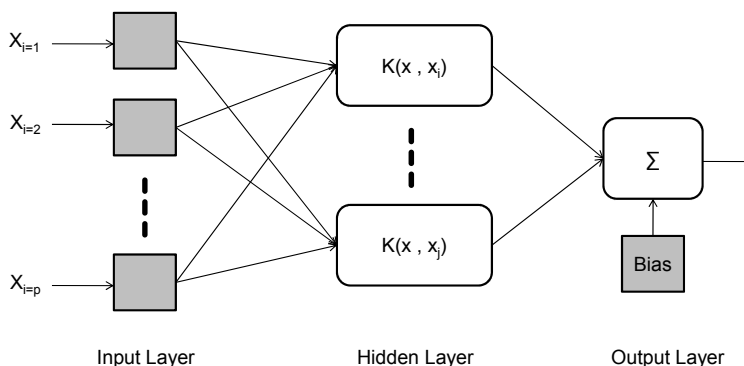

Figure 4.9: SVM Architecture

A simple *linear function* is also used since from the real world observations it seems that the QoS more heavily depends on the packet loss rate than the delay. Thus, the linear function takes the form as in Eq. 4.6.1:

$$QoS(delay, pktloss) = \frac{100 - pktloss}{100} - \frac{delay}{500} \quad (4.6.1)$$

Where, QoS is defined as a function of delay and packet loss. Each of them are normalized with the maximum value i.e. 100% for packet loss and 500 ms for RTT delay. For the output values less than zero are rounded up to zero.

The support vector machines (SVM) classification is known as an optimal method as it transforms the input vector sequence into theoretically infinite feature space [Xie, 2009]. The essential idea of SVM approximation is to map data into a high dimensional space by a nonlinear mapping and then performing linear regression in the feature space. Kernel functions are used for this transformation as shown in Fig 4.9. More details on the mathematical formulation and choice of kernels is presented in Appendix F. In general, SVM gives better results than ANFIS as it minimizes the structural risk as compared to the empirical risk minimized by ANFIS [Fang et al., 2002].

4.7 Comparison of different estimation techniques

4.7.1 Criteria

It is very difficult to objectively compare different approaches if there is no arbitral output values of the system. Therefore, five criteria are proposed:

- **Execution time per sample:** It is calculated with MATLAB tic/toc functions as an average of execution times for about 1 million samples. This parameter is subjective since it depends on the implementation of the particular algorithm and system load.
- **Flatness:** Since the main goal of the QoS estimation is a fuzzy output the function which transfers input parameters to QoS values should not be flat. Therefore, first partial derivatives are calculated for each parameter and checked against zero values in order to calculate flatness of the function.

- **Monotonicity:** It states that the function output values should decrease along with both input parameters used in the studies (delay and packet loss), which means that the function should be monotonic in the direction of each input parameter. To calculate function monotonicity second partial derivatives are checked against zero values.
- **Mean Square Error (MSE):** It is defined for the control points set. As mentioned before, there is no arbitral QoS output values that could be used to check quality of QoS estimation. Therefore, the only sensible way of checking this quality seems to be a comparison with a human-designed control set. This parameter is very subjective as it depends on the selection of the control points (or in other words human expectations from the classifier).
- **Ease of Hardware Implementation:** Since, the MATLAB toolbox are only meant for an evaluation process, an ease of implementation of each approach in hardware is also considered as an important criteria for comparing different QoS estimation techniques.

4.7.2 Test Conditions

In Table 4.2, a comparison of all of the proposed approaches has been shown. The best values in each criteria are in bold. These tests have been performed on Intel 2.26 GHz Core-2 Duo processor with MATLAB version R2008b. The following implementations of different systems were used:

- **FIS, ANFIS:** MATLAB Fuzzy Toolbox
- **ANN:** MATLAB Neural Networks Toolbox
- **Linear:** regular MATLAB functions
- **SVM:** LibSVM (3rd party MATLAB Toolbox)

Criteria	FIS	ANFIS	ANN	SVM	Linear
MSE	0.007345	0.009043	0.0092553	0.053355	0.0064029
Time (μs)	1.19	3.91	5.49	50.316	0.05
Monotonicity (%)	96	78	83	83.13	100
Flatness (%)	48	0	0	41.85	75
Implementation	moderate	moderate	moderate	difficult	easy

Table 4.2: Comparison of different QoS estimation approaches

4.7.3 Comparison tests

It can be observed from Table 4.2 that the linear discriminator has the least value of MSE, takes minimum time but it is monotonic and have high flatness percentage. On the other hand, FIS, ANFIS and ANN have close values for MSE with FIS as more monotonic than others, while the ANFIS and ANN have zero flatness which is a positive aspect. The implementation complexity for the three is moderate. SVM has a greater value of MSE, however more training may converge the MSE value. The computation time is greater and implementation is more difficult than others. FIS is considered as the QoS classifier in our work due to easy implementation and smaller execution time.

4.8 Co-design in Networked Teleoperation without QoS provisions

The network conditions are important to take into account for successful teleoperation. The co-adaptation of control with QoS requires a co-design approach. The wireless network QoS is evaluated in several applications e.g. for topology control, intelligent routing and handover from one cell to another in mobile telephony. The intelligent decision is required when mobile user needs to change current cell to perform handover. [Xia et al., 2005] describes a neural network based feedback scheduler for networked control systems with flexible workload. In network traffic control and QoS, prediction is an important task for effective policing and efficient bandwidth utilization. As mentioned in the previous section that the AI techniques are used for various network based decision e.g to switch between networks and for congestion estimation in sensor networks as noted in [Munir et al., 2007] and [Pirmez et al., 2007]. In [Din & Faisal, 2008], a fuzzy bandwidth prediction and policing is used in a DiffServ Aware Network.

In our proposition of co-design approach with best effort network services, following are the sub-blocks of the complete architecture as visible in Fig. 4.10. It is important to note that we are considering DCDN approach with lesser control over network as QoS provisions are not available and we use only network load to vary according to the network conditions and application demands.

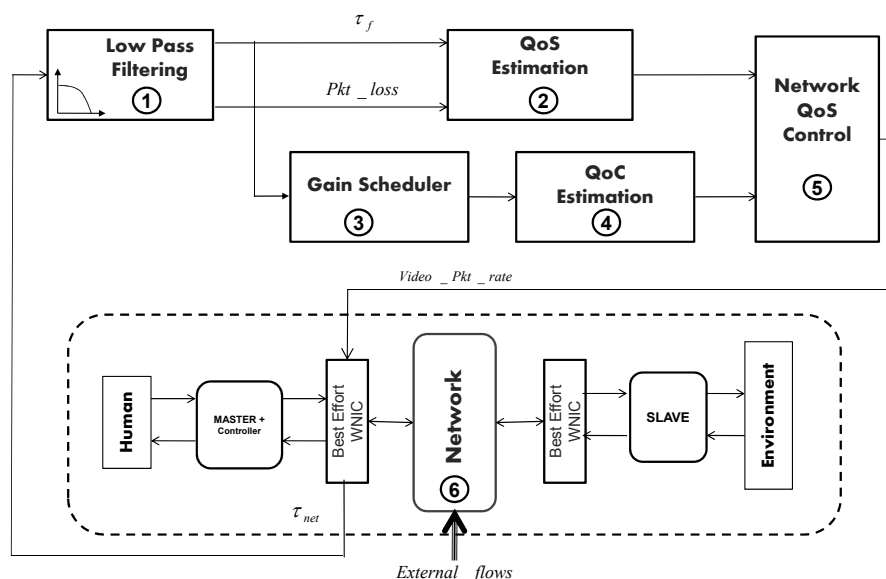

Figure 4.10: Generalized Adaptation Scheme for Bilateral Teleoperation

4.8.1 Pre-filtering

The first block of the co-design architecture comprises of filtering the delay and extracting the packet loss information from it. The raw delay measurement calculated every millisecond must be filtered by a low pass filter to minimize the noise effects. But at the same time the filter must not hide the delay dynamics. Thus, the choice of filter depends on the application requirements and decision resolution based on delay.

4.8.2 Quality of Service Estimation

The second block is the QoS module to estimate QoS from delay and packet loss. In literature, several methods are available for QoS estimation e.g. by evaluating received signal strength (RSS), signal to noise ratio (SNR), bit error rate (BER), Frame error rate (FER), available bandwidth, packet loss rate as presented in [Knoche & de Meer, 1997],[Zhang et al., 2006] and [Munir et al., 2007]. Our approach is to use fuzzy inference for estimation of QoS, with an update rate corresponding to the application dynamics. This will result in reconfiguring the network flows as well as the controller parameters in order to achieve appropriate gain values for position control, thus ensuring improved quality of control (QoC) in bilateral teleoperation.

802.11 b/g wireless Network

The 802.11g is an extended data rate version of 802.11 WLAN protocol. The choice of packet size is important for delay characteristics, throughput and bandwidth efficiency as shown in Fig. 2.9, Fig. 2.8 and Fig. 2.10. The maximum size of IP packet that can be transmitted without fragmentation over 802.11 WLAN ranges between 2245–2272 bytes as compared to 1500 bytes originally available over Ethernet [Yang et al., 2007].

SNR, Distance relationship

One of the important parameter in QoS estimation is signal to noise ratio (SNR), which varies with distance (d) and the environmental conditions. A general remark states that the SNR varies exponentially with the distance [Mechraoui et al., 2009]. The realized throughput is also based on SNR which means that when SNR has low values or there are more environmental noises, maximum data rate over the network decreases significantly and as a result QoS can not be ensured any more. For analysis purpose 802.11g WLAN model is considered with reference to 802.11 specifications and MOXA WLAN AP data sheet which (see Appendix) is later on used in the implementation.

The maximum channel capacity, C_{max} offered by a WLAN AP of bandwidth BW and SNR as defined by IEEE 802.11 is given as:

$$C_{max} = BW * \log_2(1 + SNR) \quad (4.8.1)$$

In the practical scenario, the bandwidth is affected due to the variations in SNR as there are environmental interferences and obstacles which result in time varying losses. The available data rate, frame rate, end to end packet delay and jitter for a WLAN user may be different as compared to the achieved one because it is a function of SNR and the traffic on the channel.

In order to calculate a relationship between SNR and distance (d) between transmitter and receptor, an accurate radio propagation model is important to predict the received signal strength (RSS) as a function of distance.

$$SNR = P_t + G_t + G_r - P_{loss} - N_{power} - A_{misc} \quad (4.8.2)$$

where, P_t is the transmitted power, G_t and G_r are T_x and R_x antenna gains respectively while P_{loss} is the path loss coefficient. A_{misc} comprises of miscellaneous attenuations. It is generally taken as equal

to 10 dB for an outdoor environment [Colandairaj et al., 2005]. For our analysis, we assume that the antennas are isotropic (i.e. $G_t = G_r = 0$ dB) and $P_t = 100$ mW \simeq -10 dB (max power from 802.11g standard) [IEEE, 2003]. Thus, noise power is given as:

$$NoisePower = 10 * \log(K * T_e * BW) + N.F \quad (4.8.3)$$

where NF is the noise figure, K is Boltzman constant, T_e is temperature in Kelvin and BW is the bandwidth. The generalized values of room temperature as 25°C ($273+25 = 298\text{K}$), Noise factor (NF) = 10 dB, BW = 20 MHz, T = 298 K and $K = 1.3807 \times 10^{-23}$ are considered, which gives noise power = -291 dB [Prado & Choi, 2003]. A comparison of noise figure, noise factor and noise temperature is shown in Table 4.3.

Noise Figure (NF)	Noise Factor (F)	Noise Temperature (T_e)
0 dB	1	0K
1 dB	1.26	75.1K
3 dB	2	290K
10 dB	10	2610K
20 dB	100	28,710K

Table 4.3: Comparison between NF, F and T_e

For free space propagation, the model is known as:

$$P_{loss}[dBm] = PL(d_0)[dBm] + 10 * n * \log\left(\frac{d}{d_0}\right) \quad (4.8.4)$$

where, $PL(d_0)$ is the path loss at some distance d_0 , $P(d_0)$ is the transmitted power measured at the reference distance d_0 and n is the path loss exponent which gives the path loss at distance d . To calculate $PL(d_0)$ in dB, Friis equation is used as follows [Webb, 2007]:

$$PL(d) = 10 \log\left[\left(\frac{4 * \pi * d * f}{c}\right)^2\right] \quad (4.8.5)$$

With $d_0 = 1$ m, $F_{802.11g} = 2.4$ GHz implies $\lambda = \frac{c}{f_{802.11g}} = 0.125$ m. The path loss and SNR are calculated for path loss exponent $n = 1, 2$ and 3 and without considering fading effects as shown in Fig. 4.11. In WLAN 802.11b, the adaptive modulation adapts the data rate with respect to the SNR is shown in Fig. 2.5. It has been assumed that ideal link conditions exist and SNR is considered as a function of distance only.

Fuzzy QoS module

Fuzzy inference system operates with fuzzy sets (F) which are characterized by a membership function $\mu_F(x)$ which gives the degree of similarity of x to F . Thus, FIS is capable of approximating any continuous function with an arbitrary bound B as classically reported in [Zadeh, 1983]. In engineering applications, the most widely used rule-based FIS are Mamdani or Takagi-Sugeno type. Sugeno FIS are more compact and computationally efficient, works well with optimization and adaptive techniques, have guaranteed continuity of the output surface and are ideal for online implementation, so their choice is evident for this work. Choice of appropriate membership functions (MFs) is very important

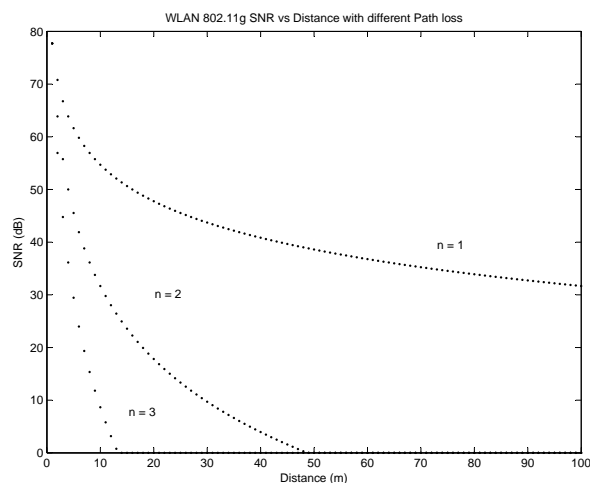

Figure 4.11: SNR variation with different path loss exponent

as it improves decision performance and computation time e.g. triangular and trapezoidal membership functions are preferred for online implementation. The membership functions used in our work are shown in Fig. 4.12.

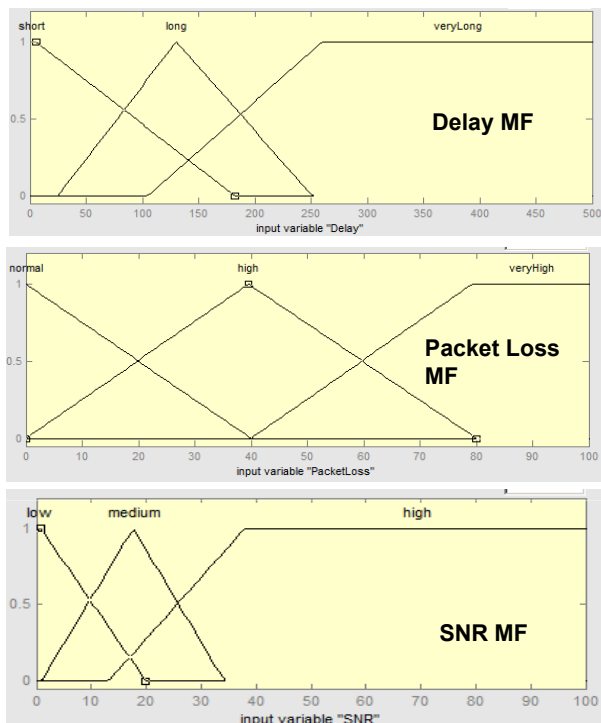

Figure 4.12: Membership Functions for FIS

Delay (DL) and packet loss (PL) are the two inputs for QoS fuzzy inference block as shown in Fig. 4.13. The range of delay varies from 0 to 500 ms, for packet loss it is 0 to 100 % and for QoS it is scaled between 0 and 1. The fuzzy rule base for QoS estimation is shown in Table 4.4, where QoS has more weight (α) for packet loss than delay. This is because information loss has a severe impact on transparency and stability.

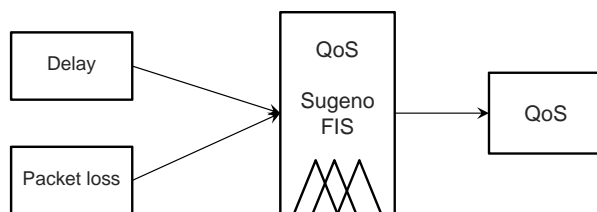

Figure 4.13: QoS FIS with two inputs

Rule	DL	PL	QoS	α
1	NE	LW	EX	1
2	NE	HH	GD	1
3	NE	VH	BD	1
4	SL	NE	EX	0.5
5	LG	NE	GD	0.5
6	VL	NE	BD	0.5

Table 4.4: Fuzzy rule base inside the QoS Estimator with 2 inputs

As noted from above that the simple rules are chosen to ensure rapid decision and low computation for online use. The various input variables are given states as none (NE), Low (LW), High (HH), Very High (VH), Small (SL), Large (LG), Very Large (VL). The QoS output is marked with Excellent (EX), Good (GD) and Bad (BD) levels.

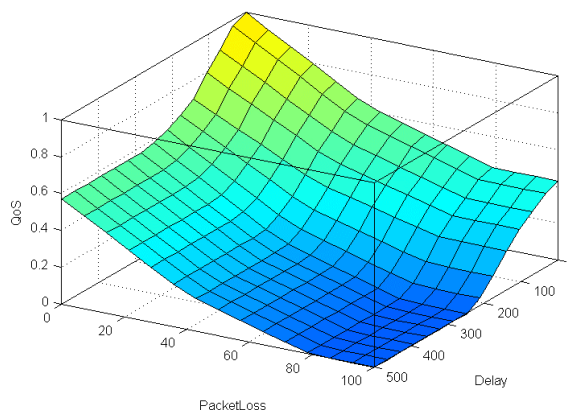

Figure 4.14: Fuzzy QoS Surface

Fig. 4.14 shows the surface representing the effect of delay and packet loss on QoS. In the second step, SNR is also added to the QoS decision with an aim to improve the QoS decision, specially when the mobile vehicle is moving away from the base station. The fuzzy rule base with 3 inputs is expressed in tabular form as shown in Table 4.5.

The three levels assigned to SNR are high (HH), medium (MD) and low (LW) as per distance from the Master station. The curve with path loss effect $n = 2$ is followed as a suitable environment. The fuzzy surface showing the relation of Delay, SNR and QoS are shown in Fig. 4.16 which clearly shows that QoS is only superior when delay is less than 100 ms and SNR is greater than 40dB.

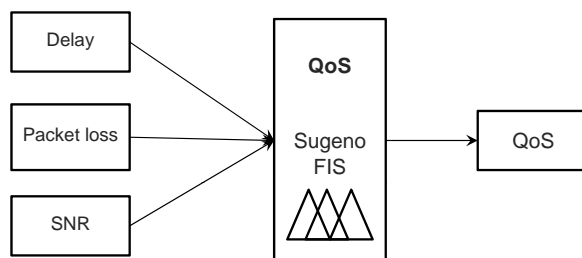

Figure 4.15: Fuzzy QoS FIS with SNR input

Rule	DL	PL	SNR	QoS	α
1	NE	LW	HH	EX	1
2	NE	HH	MD	GD	1
3	NE	VH	LW	BD	1
4	SL	NE	HH	EX	0.5
5	LG	NE	MD	GD	0.5
6	VL	NE	LW	BD	0.5

Table 4.5: Fuzzy rule base inside the QoS Estimator with 3 inputs

4.8.3 Gain Scheduling

The third block in the co-design architecture is the gain scheduling. With increasing delay, the gain for the position control loop needs to be decreased in order to respect passivity and therefore stability. The gain is adapted from the relation between delay τ and gain K as shown in Fig. 4.17.

The outer most curve shows the values of gain where stability is lost as experienced in real time. Next, the inner curve gives the limit imposed by the passivity condition as per Eq.3.3.17. The inner most curve shows the practical values of K_{pass} applied on the system which takes into account the worst case value of B_{s1} . Worst case damping values are used in the passivity criteria to make sure that the passivity is respected at all operating conditions. The variation in passivity condition is dependent on the time delay and varying values of master and slave damping B_m and B_{s1} respectively [Anderson & Spong, 1989]. B_{s1} varies due to the non-linearities e.g. backlash (0.2328 rad approximately), dry friction etc in the Rack and Pinion Gearset (RPG) as well as due to wheels in contact with the environment. Whereas, B_m is different for different drivers. The worst case values for B_{s1} and B_m are estimated as 1.3123 $N.m.s/rd$ (without wheels) and 0.0817 $N.m.s/rd$ (free steering) respectively.

4.8.4 Quality of Control Estimation

The fourth block is used to estimate QoC and the tracking performance. For QoC, the gain K of the position control loop is an important parameter. For a type zero system, the steady-state error in response to a step input of height A is defined as $e_{ss} = \frac{A}{1+K_p}$. Note that a large position error constant corresponds to a small steady-state error.

Thus, the value of K gives a direct measure of QoC that is evaluated in the further decision. Moreover, using control errors directly as a measure of control performance gives superior performance in tracking control. The error vectors of position, velocity and force can be weighted as per their significance to form a composite QoC function.

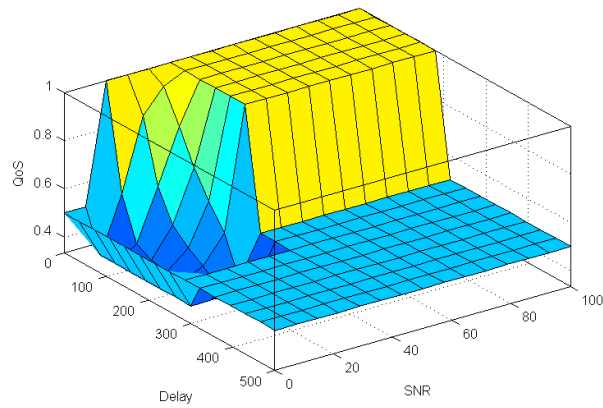

Figure 4.16: Delay, SNR and QoS Surface

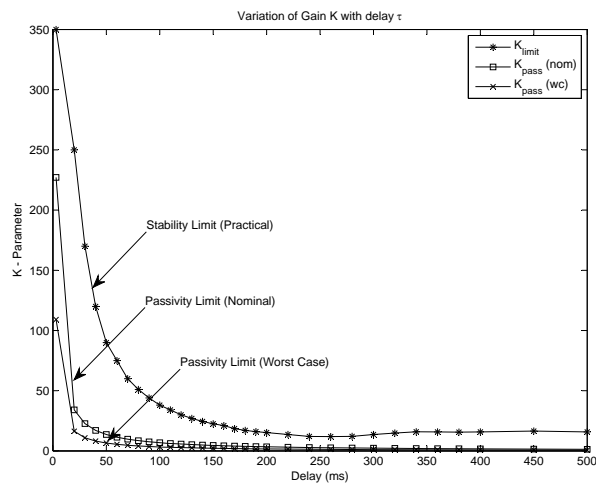

Figure 4.17: Bounds of K-parameter Variation with delay τ

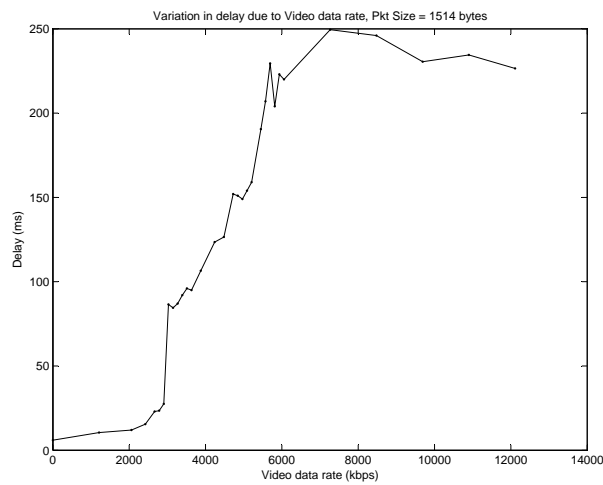

Figure 4.18: Packet rate effect on delay τ

4.8.5 Network QoS Control through Adaptation

The fifth block in the co-design architecture is the fuzzy QoS management block. The input variables includes QoS (estimated above), Control quality (QoC) and the distance between the Master and Slave station, while the output is the video packet rate as shown in Fig. 4.19. All these input and output variables are ranged between 0 and 1 except the distance which is taken from 0 to 100 m.

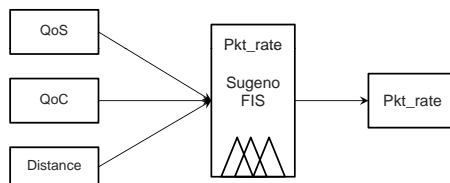

Figure 4.19: Packet rate FIS with three inputs

To control the delay experienced in the control loop, the video traffic can be varied. This variation can be performed in the steps of 10 packets/sec to vary from 10 packets (121 kbps) to 1000 packets (12.1 Mbps). The nonlinear relation between delay and video traffic is shown in Fig. 4.18 which is used in the simulation. The round trip time (RTT) delay from 0 ms to 500 ms is taken into account for NeCS-Car ($\tau \approx \tau_{RTT}/2$). Delay exceeding 500 ms is considered as communication breakdown and therefore the NeCS-Car emergency system takes over to stop the car immediately. The packet rate FIS surface is shown in Fig. 4.20.

Rule	QoS	QoC	Distance	PR	α
1	NE	GD	NE	HH	1
2	NE	BD	NE	LW	1
3	NE	AV	NE	MD	1
4	GD	NE	NE	HH	0.5
5	BD	NE	NE	LW	0.5
6	AV	NE	NE	MD	0.5
7	NE	NE	VL	LW	1

Table 4.6: Fuzzy rule base inside the PR Controller

As shown in the Table 4.6, the input variables are marked with none (NE), Good (GD), Bad (BD), Average (AV) and Very Large (VL). While the output has levels as High (HH), Low (LW), Medium (MD) for packet rate. It can be noted that the role of distance is limited in decision as given by a single rule which states that when the slave is farther than d_{max} , packet rate just can not be made better as the link capacity is limited. This is because the distance measure (GPS or estimated) has large estimation errors as compared to WLAN range and vehicle speed, therefore not suitable for online QoS management. Knowing that the QoC is the actual objective of our design, all QoC rules have double weight in the decision.

4.8.6 Network Block

The sixth block in the architecture is the network architecture and chosen protocol. In recent technologies, QoS classes are available to be mapped on flows and ports for guaranteed bandwidth and delay characteristics e.g. 802.11e, 802.1p/q, 802.16 etc. In addition, whether the network is wired or wireless, effects the performance as well. In wireless networks, interference and multi path phenomenons are

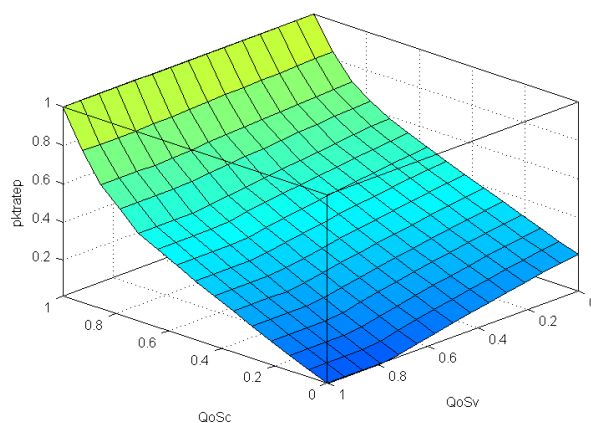

Figure 4.20: Fuzzy Video Packet rate Surface

troublesome. Dual band routers offer redundant frequency channels and two different SSIDs to switch network flows in case of degraded QoS over one channel. External flows are simulated to vary network load and observe performance changes. The QoS enabled architecture is a simplified version of the best effort adaptation architecture.

4.9 Co-design with QoS oriented Network Architecture

The Co-adaptation of control and network data rate is done based with the fuzzy QoS module decision in the case of best effort network. Here, we have better provisions for network QoS control and it is a better realization of DCDN approach. If the QoS is decreased due to increased delay and packet loss rate, the position control gain is reconfigured as well as the data rate of the video which is sent to the teleoperator. Now we consider the case when QoS is available with 802.11e traffic classes. The co-design architecture is shown in Fig. 4.21. The QoS classes over 802.11e are shown in Table 2.7.

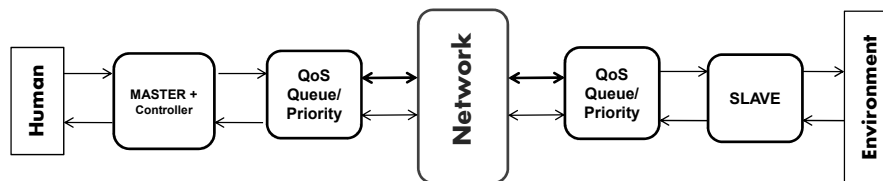

Figure 4.21: Bilateral Teleoperation with QoS options

In the QoS architecture, the control data is given the priority 6 and 7 ($AC = 3$) as voice packets. It has been assumed that control data with small data rate can be emulated as voice packets. The video data is sent with priority 4 and 5 ($AC = 2$) as usual. In addition to 802.11e, WLAN 802.11n hardware offers double canal (2.4 GHz/5 GHz) as well as with 802.11e QoS options. Thus, at the same time two SSIDs can be realized. From the reliability perspective, the control and video flows can be switched alternatively in case of low SNR on one canal.

A recent work is presented in [Habib et al., 2009], where 802.1d service classes are mapped to 802.11e access category. Thus, user priority 7 is used for mapping over $AC = 3$ (actually used for voice traffic) to be utilized for NCS data. It was shown that the packet loss rate will increment when maximum

number of retransmission is increased, it plays a reversible effect on the packet loss rate. On similar lines, for teleoperation purpose $AC = 2$ can be used for video and $AC = 3$ for control data. It can be argued that an optimum number of retransmissions must be calculated against certain noise rate which can guarantee a bounded delay (that should respect the period of the cyclic traffic). However, the implementation and dynamic adaptation of quality of service classes is not straight forward [Grilo et al., 2003].

4.10 Prediction of Network Parameters

Prediction of network parameters e.g. delay, packet loss and network traffic, can improve the adaptation mechanism. In this section, delay and traffic prediction are emphasized for better co-design performance. The same AI techniques used for classification can be used for *one-step-ahead* prediction. However, from the literature review, ANN and SVM model prediction is found superior in terms of transient response [Behzad et al., 2010]. While SVM out performs ANN for longer prediction horizons when fewer data events are available for model development. In addition, training error is relatively lower in SVM than found in ANN [Samsudin et al., 2010]. Hence, we discuss only support vector machines (SVM) based prediction as it has been found superior in performance for stochastic time series prediction that can be used for delay and traffic prediction over wireless network [Mukherjee et al., 1997].

4.10.1 Training sets

The learning data sets are also known as training sets. In most of the cases it is assumed that the samples are independent and identically distributed (i.i.d), meaning that all samples are selected from the same population of objects (in the simplest case, with equal probability). Also, the probability of one member of the population being selected is not allowed to depend on the selection of other members of the population.

4.10.2 SVM based Prediction Formulation

Support Vector Machine (SVM) is a widely used classification technique [Cristianini & Taylor, 2000]. [Suykens et al., 2002] explains the SVM and compares with other kernel-based learning methods. Support vector machine has many application in wireless networks e.g. for multiuser detection in CDMA communications as in [Gong & A.Kuh, 1999]. Nonlinear prediction of chaotic time series using support vector machine is formulated in [Mukherjee et al., 1997]. SVM based models for predicting WLAN traffic is used in [Feng et al., 2006]. In [Cao et al., 2003], SVM is used with adaptive parameters in time series forecasting.

During tests, the most important parameters turned out to be MSE check threshold, after tuning all other hyper-parameters that one gives us an ability to trade off quality of prediction (measured as MSE and NMSE) against performance (frequency of training). Table 4.7, 4.8 and 4.9 show how quality and performance (the lower the better) change versus MSE check threshold for a sample delay traces from NeCS-Car.

The set of hyperparameters (c , ϵ , α , κ , λ) is important to choose and is dependent on the application type. Out of these parameters, resolution represented by ϵ is set to 0.1 for finding appropriate hyperparameters. As can be noted from the Table 4.7, an increase in α , increases the training frequency

c	ϵ	α	κ	λ	MSE	NMSE	Training frequency (%)
1	0.1	0.5	16	100	1.6837	0.8147	86.32
1	0.1	1	16	100	1.6602	0.8033	56.69
1	0.1	4	16	100	1.5512	0.7506	5.08
1	0.1	10	16	100	2.2586	1.0929	0.32
1	0.1	100	16	100	2.7448	1.3281	0.01

Table 4.7: MSE threshold versus quality and performance of SVM prediction (packet size 1460 bytes, trace length 10K samples)

c	ϵ	α	κ	λ	MSE	NMSE	Training frequency (%)
0.5	0.1	1	16	100	0.3263	0.7956	452
0.5	0.1	2	16	100	0.3092	0.7538	106
0.5	0.1	3	16	100	0.3283	0.8004	17
0.5	0.1	4	16	100	0.3297	0.8038	15
0.5	0.1	10	16	100	0.4648	1.1332	6
0.5	0.1	100	16	100	0.4653	1.1344	1

Table 4.8: MSE threshold versus quality and performance of SVM prediction (Packet Size 366 Bytes, Trace length 10K Samples)

of the prediction. From Table 4.8, if c is reduced to half, number of trainings is significantly reduced with an increasing value of α . The Table 4.9 shows the effect of increasing α which reduces the training frequency effectively.

After looking at the above tables it is very clear that the alpha parameter has its optimal value and this value varies from trace to trace. Before trying to indicate the source of those variations, let's try to look more closely at how the alpha parameter influence quality and performance. Lower values of alpha in general mean more frequent training (lower performance) of the SVM model and better quality of predicted values. However it turns out that the lower values of alpha also result in additional training caused by noise, this means that for a short period of time (during the noise) quality of SVM prediction will increase, but shortly after it will go down and additional training will be required. Summing up, alpha parameter should be always chosen adequately to noise level in a signal.

4.10.3 Prediction of Network Traffic

Support Vector Machine is normally used in classification to find a hyperplane that divides a high dimensional space into two (or more) classes. However, in [Feng et al., 2006], a new use of SVM as an adaptive prediction tool is proposed. Fig. 4.22 illustrates the basic idea of the algorithm where the training is based on a threshold value set for the prediction error. Thus lower the threshold, more frequent the training will be performed.

The first step is to construct a number of training sets $\mathcal{K} = X_t, d_t$ measured at $t = 1, 2, \dots, (n-p)$. Where $X_t = (x_t, x_{t+1}, x_{t+2}, \dots, x_{t+p-1})$, $d_t = x_{t+p}$, n is the length of time series x_i and p is the dimensions of the training set \mathcal{K} . These training sets will be used for training and then prediction of future values.

In one step ahead prediction, the current measurement in hand is x_t at time t . We need to predict for time $t+1$, a future value of \hat{x}_{t+1} over a horizon of past values x_t, x_{t-1}, \dots, x_1 etc observed at time

c	ϵ	α	κ	λ	MSE	NMSE	Training frequency (%)
0.5	0.1	1	16	100	0.2227	0.4828	3.31
0.5	0.1	2	16	100	0.1806	0.3917	1.13
0.5	0.1	3	16	100	0.1953	0.4235	0.64
0.5	0.1	4	16	100	0.2164	0.4692	0.51
0.5	0.1	10	16	100	0.7791	1.6894	0.04
0.5	0.1	100	16	100	0.7804	1.6922	0.01

Table 4.9: MSE threshold versus quality and performance of SVM prediction (packet size 10 bytes, trace length 10K samples)

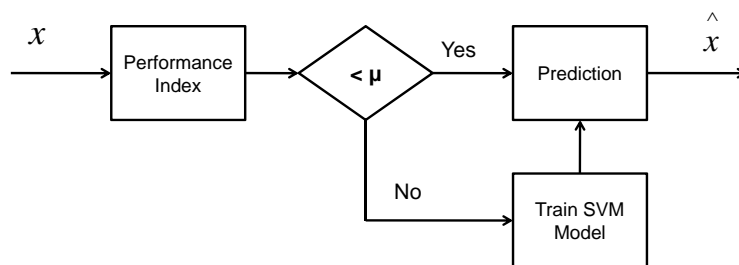

Figure 4.22: Thresholding in SVM learning and prediction

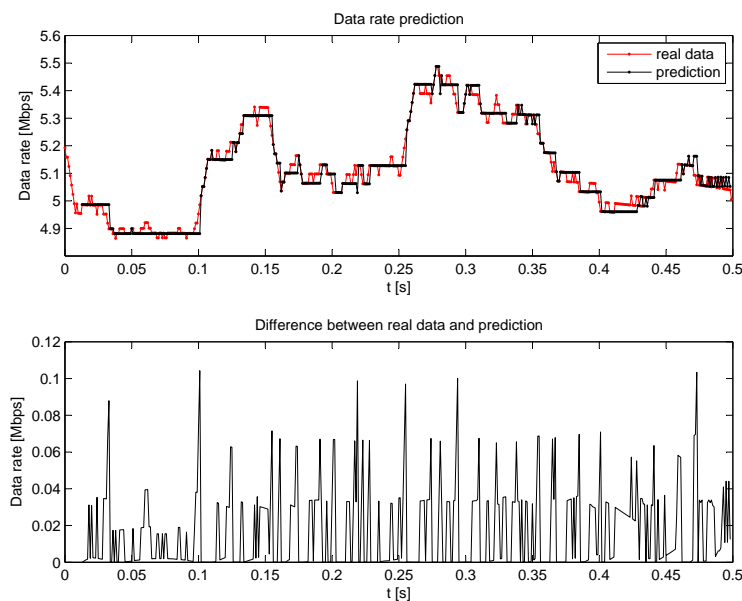

Figure 4.23: The SVM based prediction of network data rate

$t, t-1, \dots, 1$, respectively. The prediction function can be represented as:

$$\hat{x}_{t+1} = \{x_t, x_{t-1}, \dots, x_1\} \quad (4.10.1)$$

4.10.4 Prediction of Network delay and Packet losses

Delay prediction is another important network parameter. It is still an open research area ranging from nanosecond time scale to large time scale within the range of few seconds when communicating through satellite link [Sheridan, 1993]. Network delay forecast is interesting in network based real time control applications. In addition, it is also helpful in flow control, routing protocol design, network monitoring etc [Gamez et al., 2006]. In networked teleoperation based on passivity, the delay constraint ensures the passivity of the overall system. Therefore, delay forecasting can improve in advance, the quality of service and therefore the quality of experience in bilateral teleoperation. In our work, the training set comprises of different network traffic patterns obtained with varying packet sizes, delay and network types.

4.11 Conclusion

This chapter describes the Co-design methodology in networked control systems with emphasis on bilateral teleoperation. Various methods have been considered where QoC and QoS can be active or passive to respond the desired objectives. A fuzzy based adaptation scheme is described to quantify quality of service over network. The reconfiguration is performed when external flows degrade the QoS by introducing more delays and packet losses. This results in degraded QoC for control performance. The management of QoS may also include admission control and bandwidth allocation type mechanisms which restricts the external flows and manage them with respect to their priority. Two architectures have been presented, one with Best effort network and other with QoS support. However, the implementation of QoS support is a challenging issue in the wireless hardware available today.

Chapter 5

Teleoperation of a Steer-by-Wireless Benchmark

Contents

5.1	Introduction	139
5.2	NeCS-Car Steer-by-Wireless Benchmark	139
5.3	Implementation of the Position Control Architecture	142
5.4	NeCS-Car Modeling and Simulation	146
5.5	Implementation Results	155
5.6	Conclusion	162

5.1 Introduction

This chapter describes the implementation of the co-design approach on the NeCS-Car benchmark. The modeling, simulation and control part has already been covered in the previous chapter. The details cover the effect of lossy channel on the information flow for teleoperation. As QoS oriented wireless data networks e.g. WiMAX and mobile communication protocols e.g. GPRS are proprietary/licensed networks, so our implementation work considers best effort WLAN communication to adapt teleoperation flows with the network QoS. The artificial intelligence methods and supervised learning techniques based co-design methodology results in effective adaptation of network capacity as well as the teleoperation performance.

5.2 NeCS-Car Steer-by-Wireless Benchmark

One of the popular application of NT is the remote control of a steer-by-wireless (SBWL) system as there is a wireless link between the steering at the Master station and the driving motor in the slave vehicle. This is challenging due to the critical nature of the control/communication co-existence.

The NeCS-Car is a dedicated platform for teleoperation funded by the Networked Control System (NeCS) team at the Control Systems department of GIPSA-lab. A remote operator can drive the car

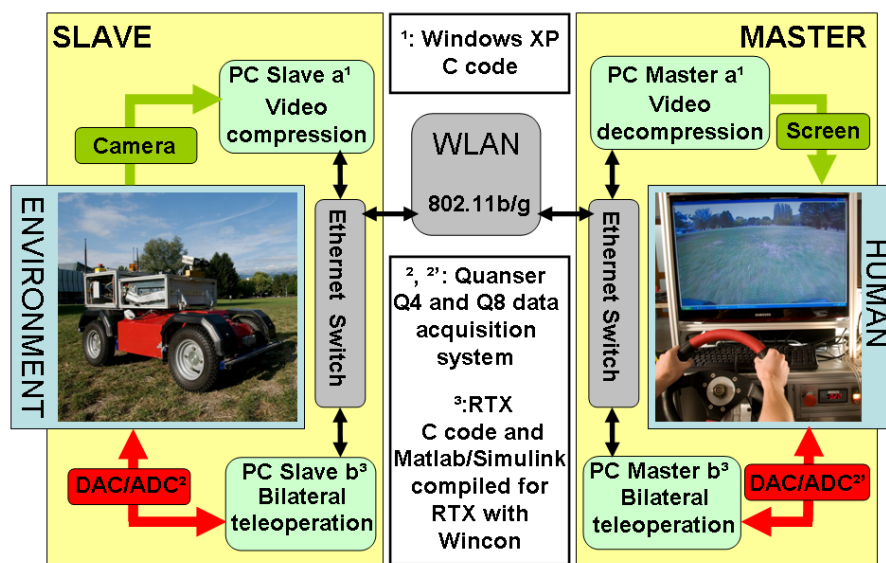

Figure 5.1: NeCS-Car Embedded System and Communication Architecture

via a hybrid (Ethernet + WLAN) networked communication by observing the video and force feedback. The system has an embedded PC installed on the mobile part while the control station has 2 PCs for video and control operations.

5.2.1 Hardware and Communication

The data exchanged between master and slave are time critical information because this 200 Kg vehicle can be driven up to speed of 10m/s on an uneven ground. The embedded PC hosts 2 operating systems, each having their own network card and can be considered as 2 separate PCs for video and the control system. For communication between the controller, the image processor and the IP video cameras, ethernet is used as the embedded network which is connected with a 100 Mbps switch linking the Slave with the Master via a WLAN router. The overall system architecture is shown in Fig. 5.1.

The control data (speed, position, brake, etc) is sent over UDP. The packet size for control information is 83 bytes (125 bytes with header) of data sent with a sampling rate of 1000 Hz (1 Mbps). About 20% of the traffic sent over UDP is lost. For video data, both TCP/IP or UDP/IP protocols and different compression algorithms were tested.

Two IP cameras with MPEG-4 compression for real time video can also be connected to the slave ethernet switch to generate traffic perturbations (data rate of 3.1 Mbps over TCP/IP measured while driving) over the network. For image data, TCP is used to ensure successful transmission. This is due to the fact that the image data has large packet size and a little loss of an MPEG compressed stream sequence can result into a number of missing frames, which affects the video quality. The image data is about 40KB sent every 40ms i.e. approx 10 Mbps after compression at the mobile platform. For the on-board camera mounted on NeCS Car, we used UDP packets coded in bmp format for non-real time video, where we can vary the video data rate (hence the quality of the frame where packet loss generates black bands in the received frames). The variation of frame rate (fps) to degrade or improve the video quality is not addressed here for simplicity. For control data reconstruction due to packet loss, our approach is similar to [Hirche, 2005] where scattering transform energy is exchanged to continuously

monitor the passivity condition in order to choose between the HLS and Zeroing.

About 20% of the traffic sent over UDP is lost but it doesn't affect the controller's performance. In case of packet losses the last value of the scattering variable is retained for continuous update of position. For image data, TCP is used to ensure successful transmission. The reason is that image data has large packet size and a little loss of unsequenced MPEG compressed stream can emerge into a number of missing frames reducing video quality. It is important to note that the packet payload is less than the maximum transmission unit (MTU), thus packet fragmentation is avoided.

Windows XP is used as currently the operating system on all PCs. However, for real time communication of the controller, Ardence *RTX*[®] interface is used. Controller is designed in Matlab/Simulink and it is converted to RTX which is a rapid prototyping product by Quanser. *RTX*[®] provides rapid start-up, direct control and ownership of scheduling, the highest availability, and use of the Windows development tools and common Windows APIs. Real-Time TCP/IP, included with *RTX*[®], provides tools to embed high performance real-time networking protocols into systems and applications. This is possible with the A/D and D/A converters on the Data Acquisition and Control Buffer (DACB) communicating with WinCon using the Real Time Execution (*RTX*[®]) Workshop installed in Simulink.

The platform is shown in Fig. 5.1. The force feedback is measured by a sensor mounted on the vehicle to capture the torque couple created by opposing forces at the vehicle motor. This force is fed back and realized through a D.C motor. The NeCS-Car has a motorized propulsion and direction control mechanism. The propulsion motor is connected in between the rear wheels while the steering motor transfers torque to the aft wheels via Rack and pinion gear set (RPG) with tie rod that is actually linked to the aft wheel assembly through steering arm. The RPG assembly converts the rotational motion of the steering motor into the linear motion which is needed to turn the wheels. In addition, it provides a gear reduction to turn the wheels smoothly.

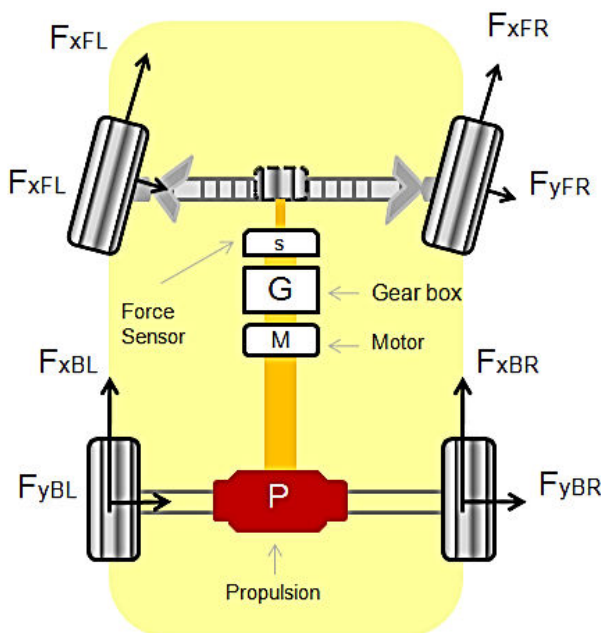

Figure 5.2: NeCS-Car Electromechanical Architecture

5.2.2 Hybrid Network Architecture

The network architecture uses a hybrid approach in the sense that WLAN 802.11 b/g is used to connect two Ethernet 802.3 networks at the two sides (Master & Slave). The two flows comprises of real time control data and IP video camera. However, QoS performance is not evaluated/used in this architecture. The MOXA WLAN cards permit to change the RTS threshold which acts as a switch to start the RTS/CTS four way handshake instead of two way basic access mechanism [Ye et al., 2006].

The video link is set over TCP to ensure good QoS at the transport layer. This ensures that all packets have successfully reached to the destination and retransmission is performed for the lost ones. However, excessive retransmissions (due to packet losses as a result of interference or excessive distance between the NeCS-Car and Operator) can deteriorate the video quality. The operator, however, has the choice to switch the video data rate at a lower rate (lower quality of images) so that network load can be decreased significantly. The down side of the wireless link is that there is more probability of data corruption and packet loss rate as the fading, noise and interference may corrupt the packets. In addition, MAC layer collisions may not be resolved timely which may cause delays or packet drops.

The mechanical assembly of the NeCS-Car is shown in Fig. 5.2 which shows the gearbox, motor, force sensor, RPG, propulsion motor and wheel assembly etc.

5.3 Implementation of the Position Control Architecture

This architecture is based on passivity theory which ensures stability. In practice, the human operator exerts some force (F_h) on the steering which couple τ_m exerted by the system. This measures the displacement coordinates of the steering, position X_m and speed X'_m .

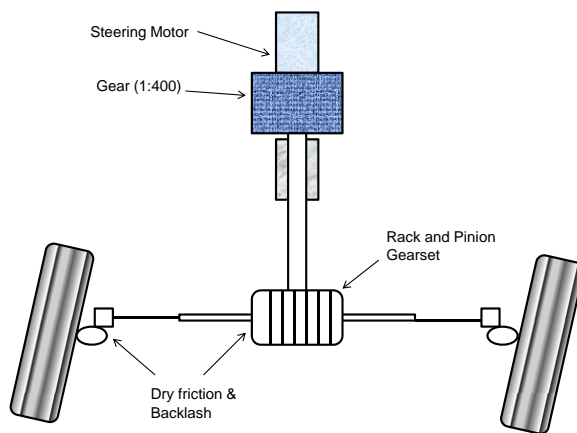

Figure 5.3: NeCS-Car electrical drive mechanism and linkages

This data is combined by the scattering transformation on both sides and is then sent towards the wheels in the form of command τ_s . A part of this command $\tau_s(F_s)$ is again sent to the steering. Packet loss strategy is implemented to ensure choice between HLS and zeroing as per energy calculations. Fig. 5.4 shows the energy of the master's scattering variables (E_m) whereas the choice is made in between the zeroing and HLS as per the result of monitoring. In Fig. 5.5, scattering variables (v_r, v_l) are compared during energy monitoring and in the sub-figure, a sudden jump in the energy can be noted during zeroing at 59 sec.

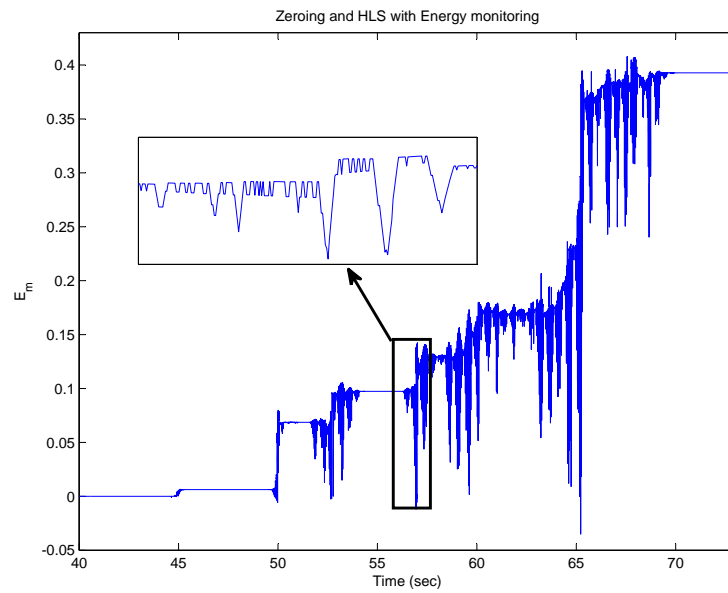

Figure 5.4: Choosing between HLS and Zeroing with Energy Monitoring

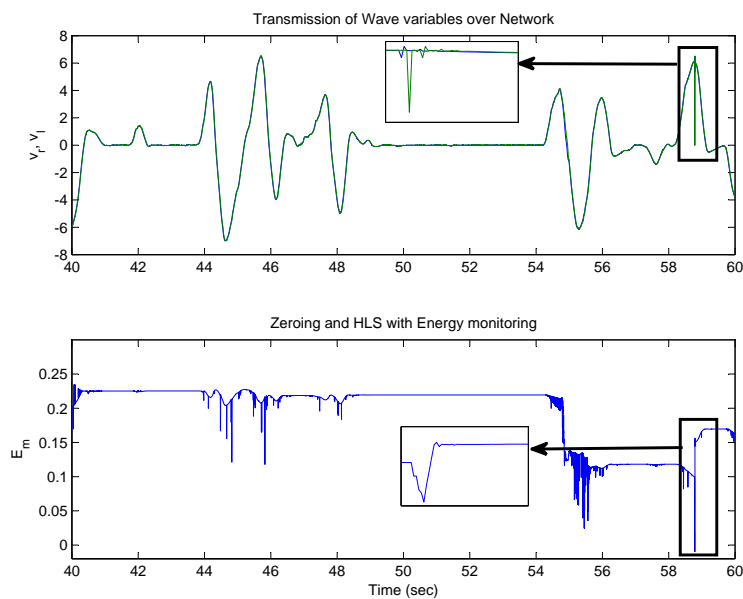

Figure 5.5: Scattering variables over wireless network with Energy Monitoring

5.3.1 Non-reversible mechanism

The present architecture doesn't utilize a force sensor to measure the force exerted on the tyres, which means that the actuator is reversible and utilize directly the force sent to the actuator. The force feedback to the steering is not actually at the wheels but at the actuator. The non-reversibility of the actuator results in degraded transparency of the overall system. This introduces a non-reversibility of the system. In fact, the wheel's parameters namely inertia and viscous friction are available at the measurement axis. This prohibits the steering wheel operated by the operator to sense the actual force exerted on the wheels. This is illustrated in Fig. 5.3.

The motor direction is downward which is connected to a gear reduction with 1 : 400. Dry friction and inertia affect the reversibility. The friction and backlash are the most common non-smooth nonlinearities that may deteriorate the control performances in the mechanical control systems. The friction is present in every mechanical system in which the moving parts are in contact. The backlash appears mainly in gear transmissions where the moving parts temporarily loose the direct contact. In NeCS-Car, the backlash causes play in the rack and pinion in the mechanical assembly that results in discontinuous motion transfer. Often backlash is present in gears due to play between the teeth of the gears but it severely effects the transparency. The other non-linearity commonly faced is the friction which refers to the force that resists the relative motion of the tyres and the ground in contact. Since friction plays an important role in the control of mechanical systems, a substantial amount of work exists on the modeling of friction but relatively little work has been done on the way it affects transparency and bilateral teleoperation performance.

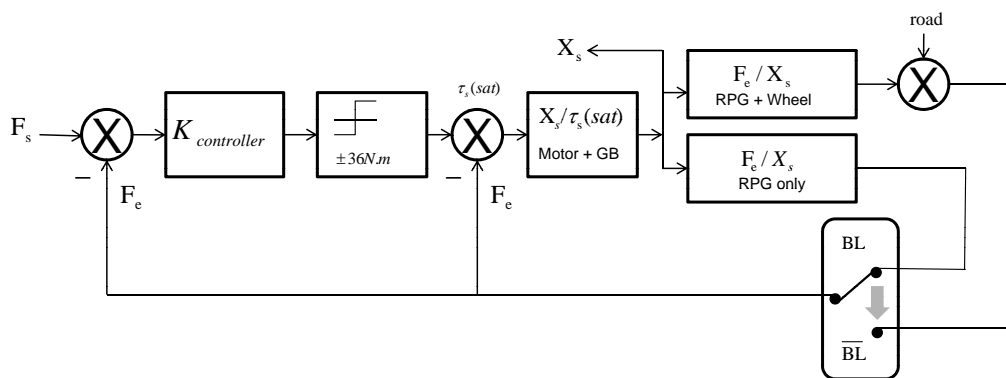

Figure 5.6: Reversibility Controller with Backlash

The steering mechanism of the NeCS-Car is similar to the ordinary four wheels car. This mechanism is known to provide a lesser mechanical advantage but at the same time lesser backlash and greater feedback for driver's feel. The rack and pinion is a gear assembly with the function to convert rotational motion into linear. The circular pinion rotates with its teeth over the grooves of the flat rack bar. A bigger motor may answer the problem but due to the space limitations, the modification is with held.

The fact that the actuator must be non-reversible cause a problem for the transparency of the system. The force applied on the steering, is not directly applied to the wheels but on the actuator as shown in the Fig. 5.6. We carried out the identification of the model with and without wheels to see the effects of backlash. In Fig. 5.7, the complete implementation architecture is depicted with the scattering transformation and position control loop. The work already done on this architecture utilizes experimental values for the system parameters which are not based on the theoretical studies. We have tried to couple

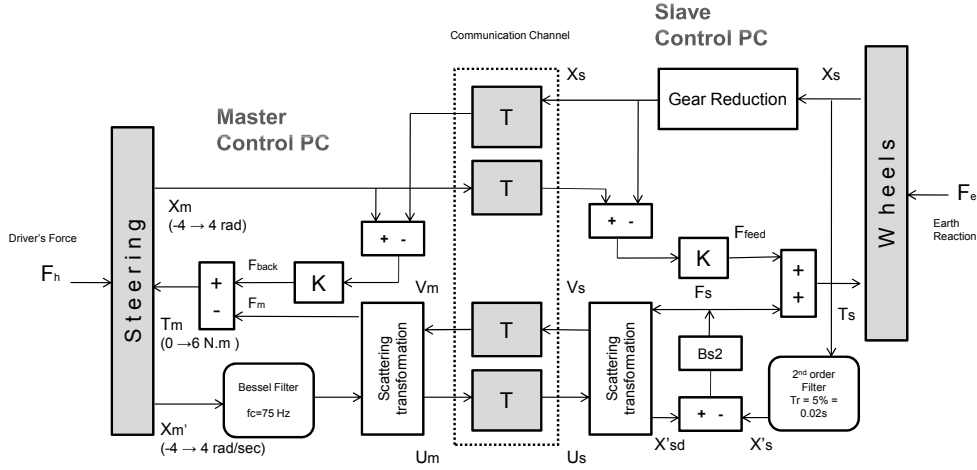

Figure 5.7: NeCS-Car Bilateral Teleoperation Architecture with Position Control

the experimental values with the theoretical ones to find a compromise that will permit us to obtain the best possible performance of the system with guaranteed stability. Appendix E describes in detail, the PI and robust controller design for reversibility improvement in NeCS-Car.

5.3.2 Stability of the Time Varying Gain Scheduled Controller

As described previously, teleoperation over wireless networks introduces time varying delay with packet loss and sometimes complete disconnection. The practical implementation is therefore challenging in the sense that safety mechanisms and strategy in case of communication loss and disconnection/reconnection procedures should be well defined. A complete analysis can be found in [Yokokohji et al., 2002].

It has been mentioned earlier that in our implementation, the scattering based transformation is supplemented with a packet loss strategy having an energy balance monitor (EBM) which decides to choose between the HLS and zeroing based on the energy of the scattering variables both at the master and slave side. The gain of the position control loop is time varying due to the variation in delay.

It is interesting to prove the stability of this time dependent switching controller. As the delay dynamics are fast, in order to avoid from the abrupt gain switching, the gain is passed through a low pass filter. For the stability analysis, it is important to analyze that at the moment of abrupt delay dynamics, at some point, the delay change is unobservable due to LPF. This may cause an uncertainty for a small period. Whether this short term uncertainty is of our interest or no, can be further analyzed as in [Weinmann, 2002]. For delay dynamics $\dot{\tau} < 1$, we assume a pure delay, otherwise it is considered as a packet loss. Suppose at an instant T_i , delay is τ and filtered delay is τ_f , and the difference $(\tau - \tau_f)$ is significant. $\tau < \tau_f \Rightarrow K < \frac{A}{\tau^2}$. Where $A = \sqrt{b_m \cdot b_s}$.

The sufficient condition to prove the stability of the switched controller requires that the dwell time and the switching set should be satisfied at the same time. On the other hand, the the rule of thumb in gain scheduling i.e., the requirement on the variation rate of the parameter was not explicitly linked with the suggested dwell time. For linear systems, the stability in the switched systems have been investigated in [Miller & Davison, 1989] and [Branicky, 1998]. In [Lee & Lim, 2000], a switching control scheme is described for $H - \infty$ gain scheduled controllers for nonlinear systems.

For a gain scheduled controller, stability analysis theory of a switched system is applied as discussed in [Hespanha & Morse, 1998] and [Zhao & Hill, 2008]. Due to the high sampling rates implemented in the digital controller, stability of the switched system for arbitrarily fast switching signals should be analyzed. In [Liberzon & Morse, 1999], it has been described that the asymptotic stability of a switched system for arbitrary switching signals can be established either by choosing a class of admissible switching signals or by showing that the family of individual subsystems possesses a common Lyapunov function (CLF).

The stability conditions for the linear 1-DOF teleoperator using Llewellyn's linear stability criterion are discussed in [Yokokohji et al., 2001]. In [Lozano et al., 2002], a time varying control strategy is used to recover the passivity with an assumption of bounded delay variation. We adopted the same strategy for our case and used a time varying controller for the position tracking which is found to be acting sufficiently good over the test bench. It has been assumed that the time derivative of the variable time delay does not grow or decrease faster than time itself i.e. $|\dot{\tau}(t)| < 1$. For the present case, we are assuming an asymptotically stable switched system robust to time delays with an energy supervised strategy in case of packet loss. Further details and mathematical proofs can be seen in [Nuno et al., 2009].

5.4 NeCS-Car Modeling and Simulation

The modeling and simulation of the NeCS-Car comprises of model identification and verification on the actual test-bench.

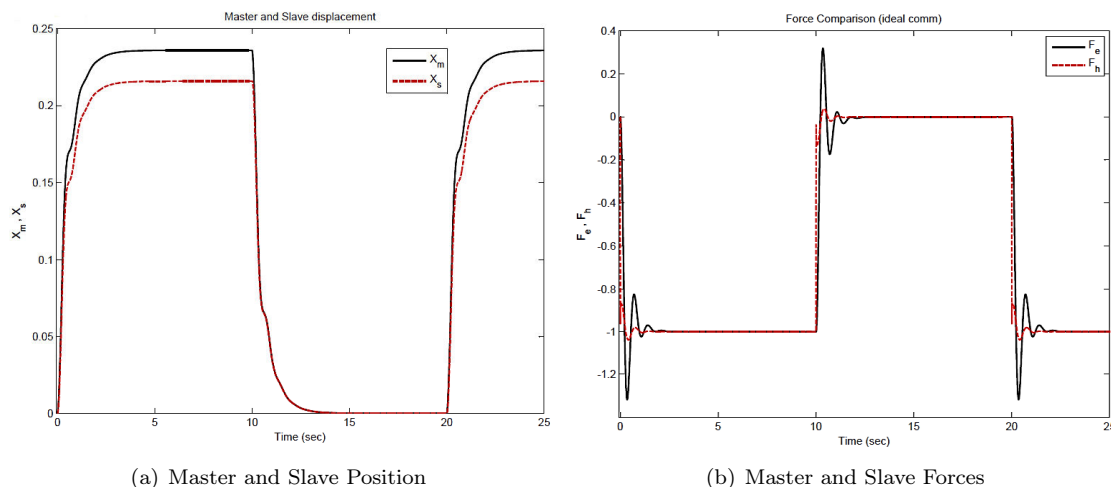

Figure 5.8: Master and Slave Position and Force Tracking

Fig. 5.8(a) and Fig. 5.8(b) represents the simulation results of the NeCS-Car model implemented in Matlab/Simulink. The position and force tracking loops in position control architecture results in the stable passive system. However, the steady state error can be seen in the position response which directly depends on the gain K in the position loop with passivity constraint.

The dynamic model of the steering is identified as $\frac{s \cdot X_m}{T_m} = \frac{1}{J_m \cdot s + B_m}$. The unknowns J_m and B_m in this

transfer function are identified to get the complete transfer function equal to:

$$\frac{s.X_m}{T_m} = \frac{35.21}{s + 2.875} \quad (5.4.1)$$

where as, $J_m = 0.0284 N.m.s^2 rad^{-1}$ and $B_m = 0.0817 N.m.s.rad^{-1}$ are the required coefficients.

5.4.1 Criteria for Transparency

To evaluate the transparency of the platform, we will utilize the transparency criterion described in [Fite, Goldfarb & Rubio, 2004]. The usual approach is as follows:

External Impedance: $Z_e(j\omega) = \frac{F_{em}}{s.X_s(j\omega)}$

Impedance transmitted to the operator: $Z_t(j\omega) = \frac{F_m}{s.X_m(j\omega)} = \Gamma.Z_e(j\omega)$

where Γ is the transfer function of the transparency. For position control architecture in bilateral teleoperation, the velocity and position transparency must be evaluated. It is more likely to deduce that for our case, the measured force F_e depends on the position as described in the model above. We have therefore, the external impedance and the impedance transmitted to the operator as mentioned above. The Bode plots below proves the comparison of the variations in the two impedances.

The variation of gain K with delay is shown in Fig. 4.17. The outer most curve shows the values of gain where stability is lost as experienced practically. This region must be avoided. Next, the inner curve is evaluated with the passivity condition given by Eq. 3.3.17, which is a rather strict condition to ensure stability. However, while respecting passivity, the performance is compromised. The inner most curve shows the practical values of K_{pass} applied on the system. To make sure that sufficient passivity is available, $K_{app} = a * K_{pass}$, where a can vary from 0 to 1. This variation is dependent on the time delay and varying value of B_{s1} . The value of B_{s1} varies due to the backlash (0.2328 rad approximately) and dry friction in RPG and wheels in contact with the environment. To simulate the variation of the delay, some functions are implemented in the hardware. In order to control the delay, video traffic can be varied. This variation can be performed in steps of 10 packets/sec to vary from 1.5 kbps to 750 kbps.

The transparency analysis of the teleoperation benchmark comprises of identification of input and output impedance. The first approach is to consider the velocity transparency given by:

$$\Gamma_1 = \frac{Z_{t1}}{Z_{e1}} \quad (5.4.2)$$

The nominal value of b_m and b_{s1} are 5.6833 $N.m.s/rd$ and 0.0817 $N.m.s/rd$ respectively.

As shown in the above figures that there is an apparent instability at higher frequencies. Now we adjusted $b = 3$ and $bs_2 = 3$ to perform better. There are very little oscillations in this case. The velocity and position transparency are shown in Fig. 5.9(a) and Fig. 5.9(b).

It can be concluded from this analysis that transparency is a complex phenomena in bilateral teleoperation. The time domain plots of the position and force comparison has revealed that while position tracking is very good as seen in Fig. 5.10(a), the force tracking is not well performed. This is shown in Fig. 5.10(b), that the reflected environment force is not tracking the input torque couple applied to the motor. There are two reasons for it. First due to the friction and backlash non-linearities, a

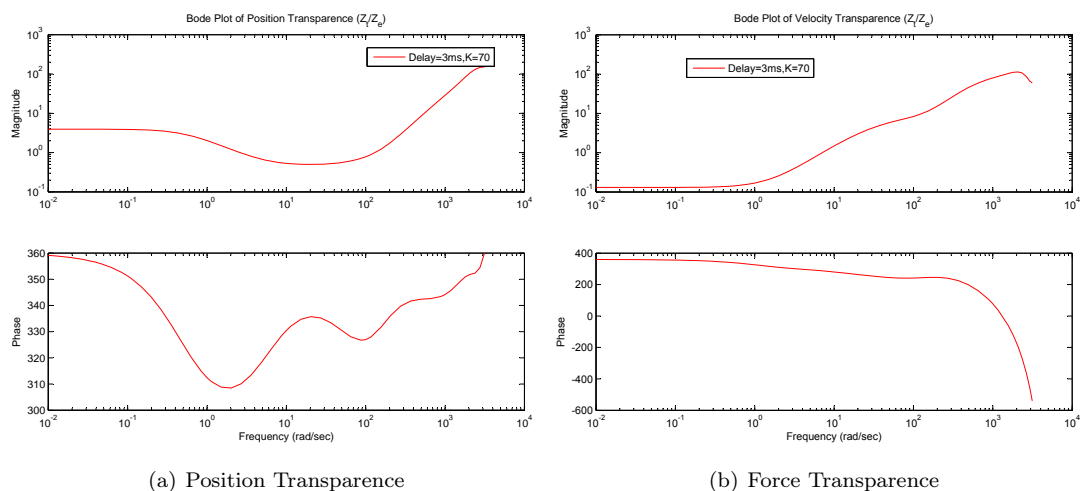
 Figure 5.9: Position and Velocity Transparency ($b = bs_2 = 3$, $\Gamma_2 = Z_{t2}/Z_{e2}$)

part of applied torque is dissipated in the nonlinear dynamics. Secondly, the force sensor is not much sensitive, when NeCS-car is in motion, there is a small feedback. However, when it stops, it has more jerky feedback.

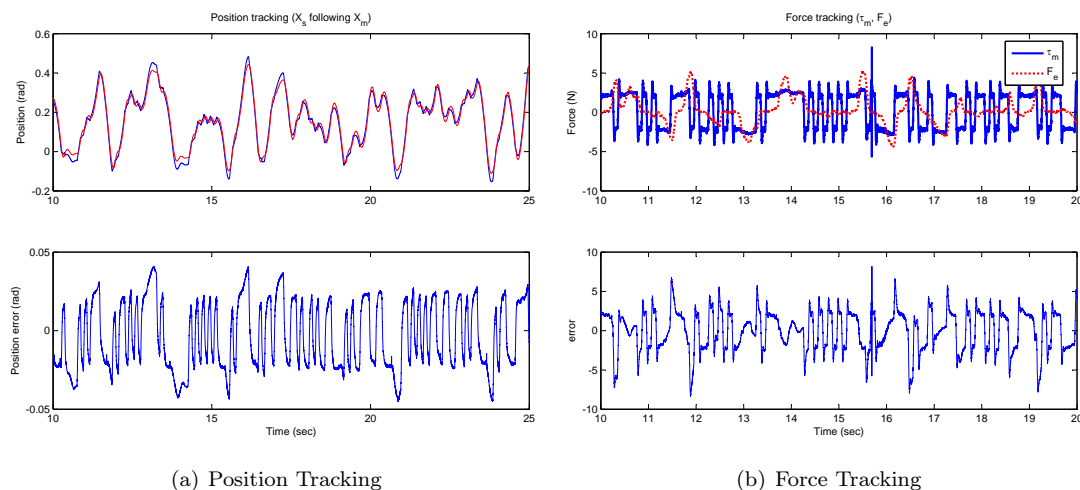

Figure 5.10: Tracking Performance

5.4.2 Analysis of Transparency with H-matrix

In this section we analyze the transparency in bilateral teleoperation applied to NeCS-Car based on the analysis of H-matrix as discussed in the previous chapter, H-matrix based transparency is presented. This has the advantage to analyze each of the four components of H-matrix and observe the case for the test system.

Since F_h is not directly measured, we assumed $F_h = -T_m$ to calculate h_{11} . The response is plotted in

Fig. 5.11(a). It shows that for an optimal transparency, h_{11} should be zero which is the case and the gain exceeds zero at a cutoff frequency of 2.5 rad/sec (0.4 Hz). This prevents the master velocity to affect the reflected force. For h_{22} , in order that the slave is unaffected by the external force, it should also be zero. Fig. 5.11(d) shows that for our case, it is justified and thus good transparency is available throughout. But as the delay and packet loss increases, the resonant peak tends to overshoot with some gain value that can deteriorate the transparency.

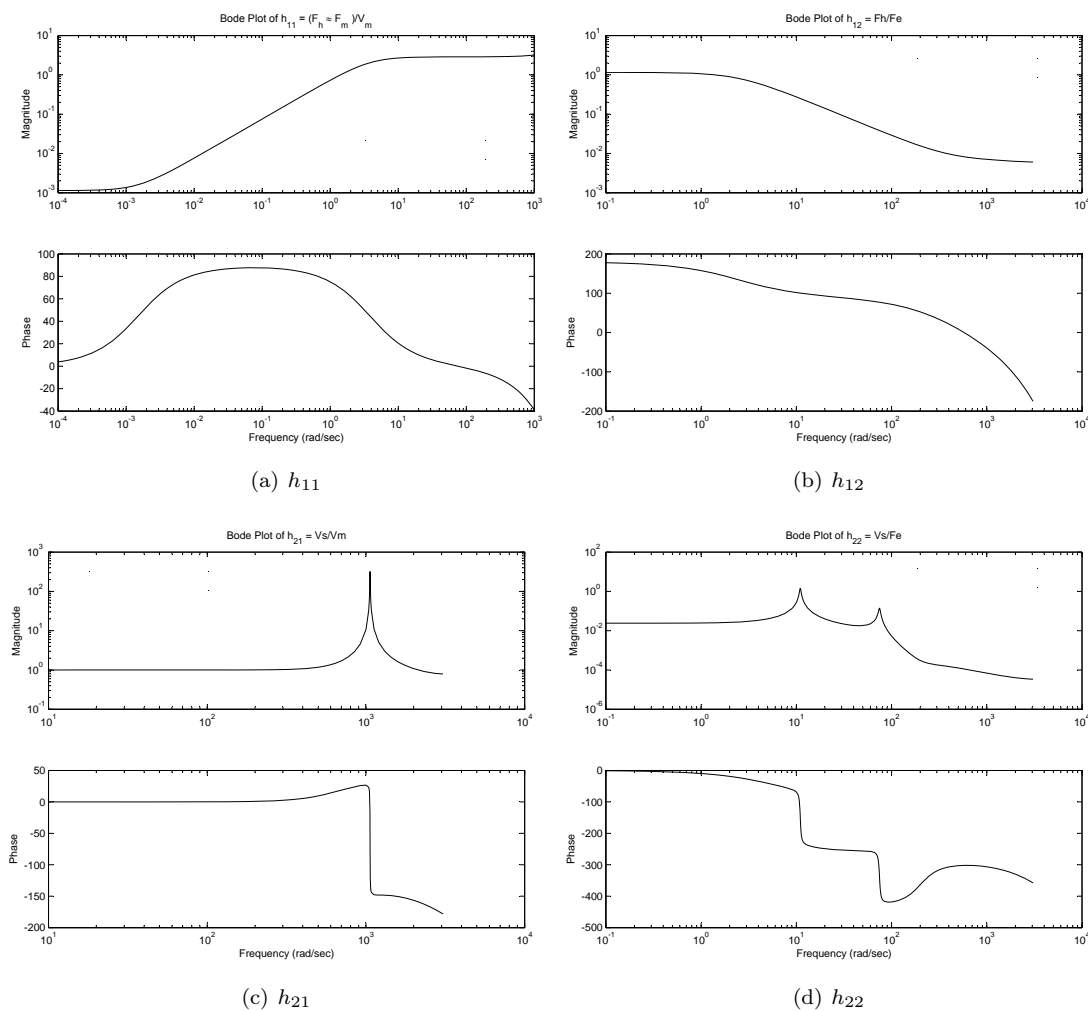

Figure 5.11: H-matrix Bode plot (RTT = 6ms, K = 70)

In Fig. 5.11(b), plot of h_{12} is shown. It proves that the operator requested force gain is unity in the bandwidth of interest. The same case applies to h_{21} which represents the velocity gain from master to slave. Fig. 5.11(c) shows that the velocity gain is also unity however, a sharp resonance peak appears in the zone of high frequency (1000 rad/sec = 159 Hz) which must be avoided. These H-matrix curves can be taken as a benchmark for further analysis. The controller ensures passivity and delay is 3 ms for one way. This reflects the response under ideal conditions that exhibits both the stability and transparency in bilateral teleoperation.

Next, we will analyze the effect of variation in delay and packet losses on these transfer functions. From the Fig. 5.6 and Fig. 5.7, τ_{pi} is the controller output and τ_m is the (steady state) torque applied on the

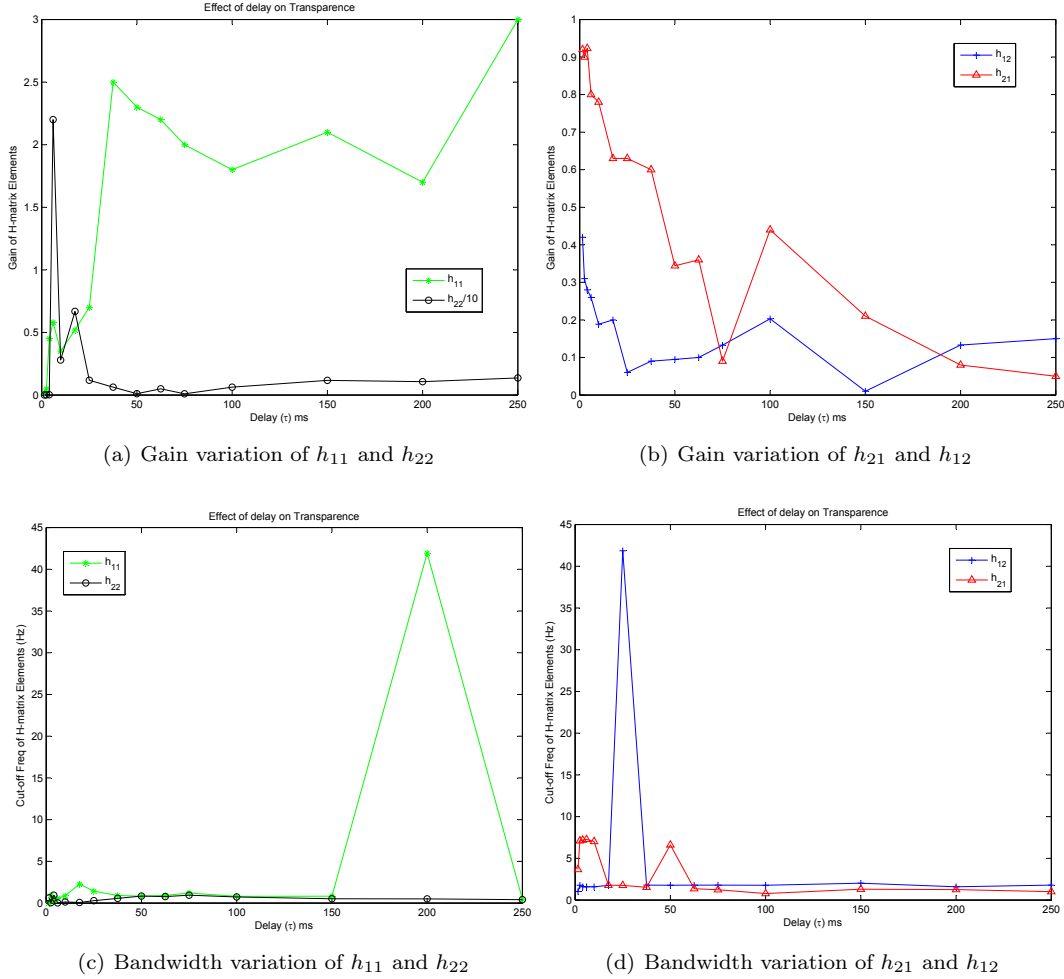

Figure 5.12: Effect of delay on transparency

steering at the master end. Thus $F_h = -\tau_m$ and $\hat{F}_e = \tau_s$ if we consider everything outside motor as environment. Otherwise if we take environment after the RPG, it will take into account the worst case B_s and M_s .

$$\hat{F}_e = -(B_s \dot{x}_s + M_s \ddot{x}_s - \tau_s)$$

The estimated force $\hat{F}_e = f_e$ follows well the commanded torque τ_s if we neglect the effects of friction and non-linearities. It can be noted that the measured reaction force f_e does not follow the applied torque efficiently.

Three methods for QoC estimation including stability and transparency are discussed here.

- **On-line Criteria:** Challenges include online identification and reconfiguration which is very computational expensive. A single criterion is not sufficient. Contact reaction changes with type of surface, air in the wheels and speed of the car.
- **Error based Transparency and Control Performance:** This can be done easily online. The transparency measure can be weighted between different contributing factors. However, the

challenge is posed in case of no command. The question arises as *What value should be assigned to QoC in that condition?* Because, as soon as the video data rate is increased for a better resolution, some bandwidth must be reserved for the control flow.

- **Off-line H-matrix coefficients Analysis:** This is an interesting method for analyzing the delay effect on transparency. The effect of delay variation can be arranged in terms of look up tables (LUT) for the gain and bandwidth measure. Limitations include that it needs a number of test scenarios for a good resolution. Single test condition could provide a limited accuracy. This method is similar to the impedance (Z-width) monitoring.

It has been discussed earlier that for an ideal transparency (which is not possible with passivity based control scheme), master's impedance (h_{11}) and slave admittance (h_{22}) should be zero. Similarly, h_{12} and h_{21} represent the force and velocity gain, which should have some positive value. It can be observed from Fig. 5.12(a) that h_{11} has fairly low magnitude till 35 ms, however, for higher delay values it rises abruptly. For h_{22} , the return of slave velocity due to environmental force is large. This may be due to the weak force feedback (dissipation in the mechanical non-linearities) available in the NeCS-Car. The effect of delay on bandwidth is shown in Fig. 5.12(c). The bandwidth is closed to zero Hz up to 150 ms delay with sudden jumps at higher delays.

The velocity and force gain is shown in Fig. 5.12(b) where velocity gain is more pronounced at lower delays than the force gain. Ideally it should be 1, so that what force and velocity is sent by the master should be received and sent back by the slave. The gain descends at higher delays and the system is less transparent as the gain departs from unity. From Fig. 5.12(c), the bandwidth of velocity gain h_{21} can be seen superior as opposed to h_{12} .

As mentioned in Chapter 4, the NeCS-Car test bench is used to validate the results of our co-design approach. The co-design architecture discussed in Chapter 5 is implemented on NeCS-Car for evaluation of real time performance.

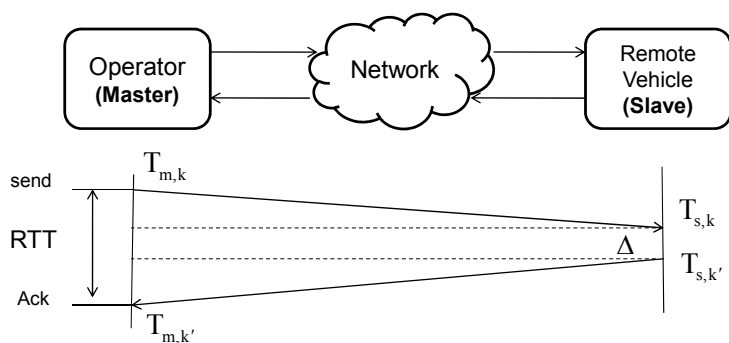

Figure 5.13: Round trip time (RTT) and synchronization in NT

Fig. 5.13 shows the round trip time (RTT) measurement between the master and slave. The packet sent at $T_{m,k}$ reaches at the slave at time $T_{s,k}$. While the packet sent at $T_{s,k'}$ reaches at the master station at $T_{m,k'}$. These time stamps are read (at each sampling instant) at the operator station to update the delay measurement. For simplicity, 'send' and 'receive' time is taken as symmetric, so that it can be halved to get delay in each direction.

In Fig. 5.14(a), NeCS-Car ground tests were conducted for the measurement of SNR at different points of the trajectory. The trajectory map shown in the figure, highlights the points and corresponding communication channels. Channel 2 was found as a free channel, chosen for the communication between

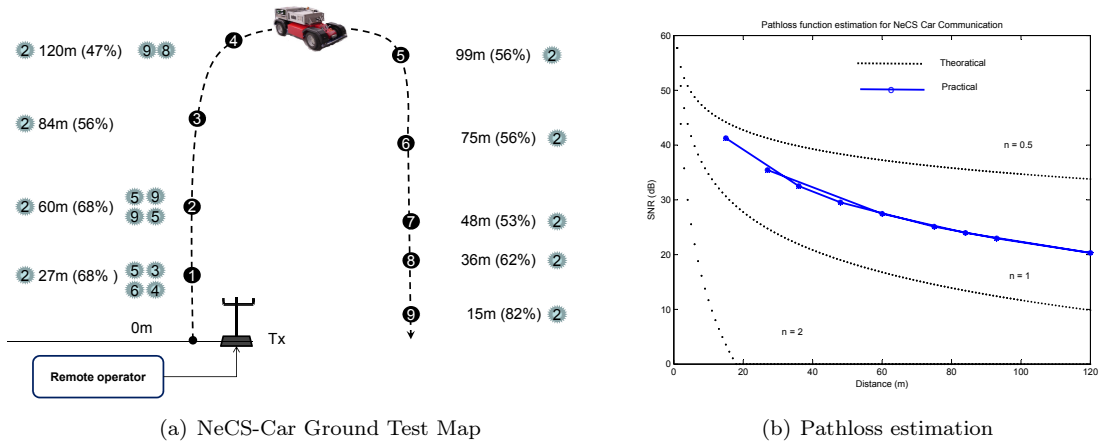

Figure 5.14: NeCS-Car Ground Test Map and Pathloss Estimation

master and slave. In Fig. 5.14(b), the path loss curve obtained from the measured values is shown with the theoretical curves. It shows a close match for a path loss exponent value between $n = 0.5$ and 1.

The fuzzy based co-adaptation module is added to NeCS-Car. The 3-input QoS module is shown to exhibit better performance in estimating QoS as shown in Fig. 5.15(a) which shows the adaptation of video data rate with variation in delay and packet losses. Fig. 5.15(b) shows the corresponding variation in SNR as the distance between the master and slave system increases. The FIS estimates the relative quality of service of the WLAN. It can be noted that at 60 sec and 120 sec, two external video flows of $\Phi_1 = \Phi_2 = 3.1$ Mbps over TCP/IP are added to simulate the network perturbations. This results in low QoS, due to increased delay and packet loss detected by the QoS module. Thus, the QoS controller generates the corresponding gain K and video packet rate for the bilateral teleoperation. The results prove the corresponding decrease in gain and video rate as per network QoS. The filter used in this simulation has a time constant $\tau_{filt} = 5s$ which smooths the packet switching. However, the packet loss is calculated on the raw delay vector.

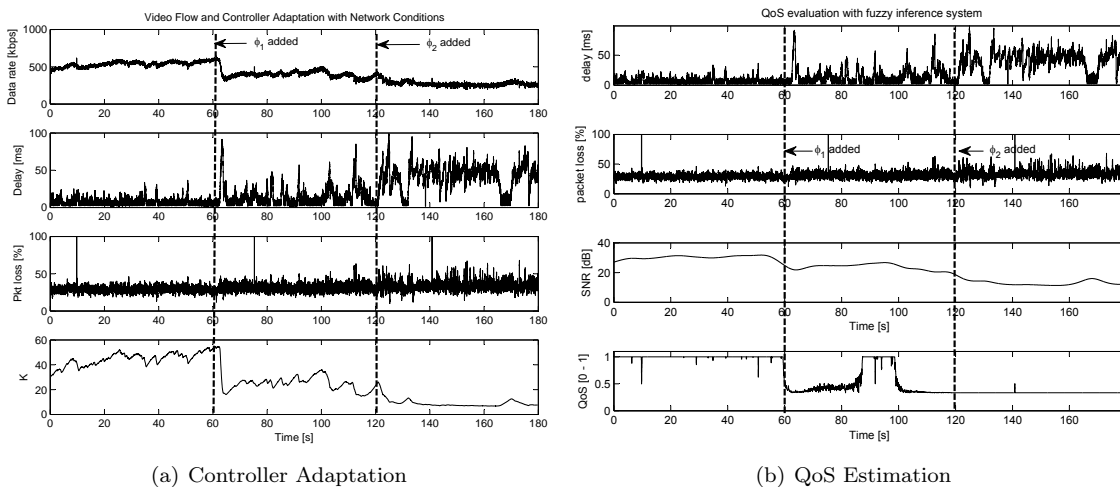

Figure 5.15: QoS Estimation with 3 input Fuzzy Inference (Off-line Test)

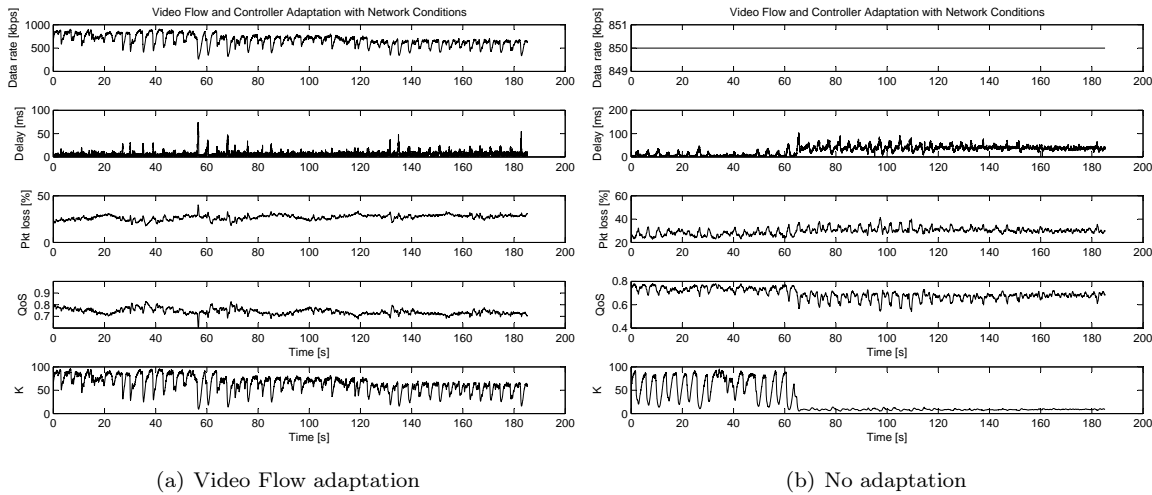

Figure 5.16: Comparison of Fuzzy QoS adaptation and No adaptation cases

In Fig. 5.16, two cases are presented i.e. with and without video adaptation. Fig. 5.16(b), shows no reconfiguration in the case of low network QoS as a fixed video data rate is sent over the WLAN from slave to master station. Thus, control performance deteriorates as soon as the network QoS decreases. However, in Fig. 5.16(a), QoS and QoC are managed with controlled packet rate over the network. When an external flow of 3.1 Mbps is introduced in the network, the perturbation introduces increased delay and packet losses which results in decreased control performance due to low QoS. It is interesting to note that the decreased gain corresponds to the passivity but as the steady state error increases, it deteriorates the control performance.

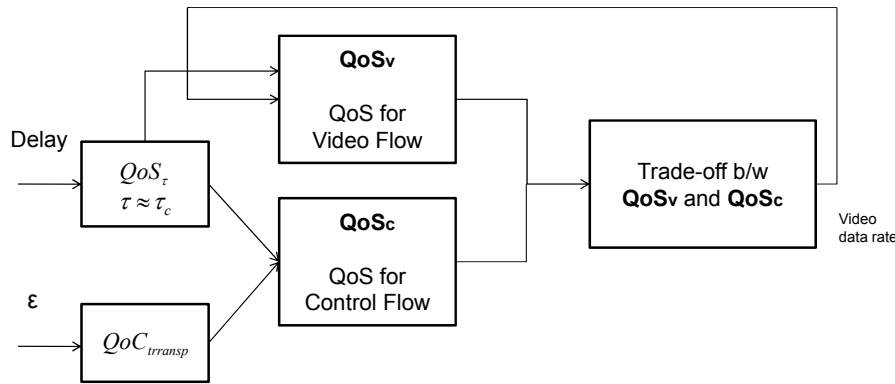

Figure 5.17: Simplified Co-design Architecture

5.4.3 Simplified Co-design Architecture

The simplified co-design architecture for implementation is shown in Fig. 5.17. The delay is taken as $\tau_v = \tau_c + \tau_p$, where τ_v and τ_c are the delays in video and control flow respectively. τ_p is the fixed delay in the video flow due to processing except the communication delay on the network i.e. video acquisition, coding, packetization, reception of packets, decoding and display on the screen as shown in Fig. 4.4.

This is because τ_c is easy to measure on the master station. The QoC function is a performance measure for the control and tracking performance as well as the time domain on-line transparency which is given as:

$$QoC_\epsilon = 1 - (Gqos_F * \epsilon_F) + (Gqos_x * \epsilon_x) + (Gqos_{\dot{x}} * \epsilon_{\dot{x}}) \quad (5.4.3)$$

where $Gqos_F$, $Gqos_x$, $Gqos_{\dot{x}}$ are weights experimentally chosen for an identical scaling of errors in position, velocity and force as per design objectives and for our experiments, they are taken as 0.001, 1 and 0.1 respectively. $\epsilon_x = X_s - X_m$, $\epsilon_{\dot{x}} = \dot{X}_s - \dot{X}_m$ and $\epsilon_F = F_e - \tau_m$ are the tracking errors. The QoS_c is given as:

$$QoC = p * QoS_\tau + (1 - p) * QoC_\epsilon \quad (5.4.4)$$

where $p = \frac{1}{1+|\dot{X}_m|^2}$ and \dot{X}_m is the master's velocity. When $\dot{X}_m \rightarrow 0$, QoS_τ will have a unitary value while QoC_ϵ will approach to zero. QoS_τ is the QoS of the control flow dominated by the delay, while QoC_ϵ is based on scaled control errors. This is important to consider because in steady driving, when there is no command applied from the driver, there is no need to evaluate QoC with emphasis on QoS only, which is a direct function of delay (τ). The time varying gain which is the output of controller block is normalized ($K = K/100$) and passed through a low pass filter $G_k = \frac{1}{5*s+1}$, to avoid noisy switching of the controller. The time constant of the controller has double frequency as compared to the highest frequency of the slave dynamics to avoid aliasing (Slave pole (p_s) = -0.0907 rad/sec [ref: Appendix C] as compared to the controller filter pole (p_k) = 0.2 rad/sec).

5.4.4 Application to Networked Teleoperation

The new architecture is based on the delay, packet loss and SNR prediction to generate QoS. It should apparently improve the results. In NT, the operator is manipulating an autonomous vehicle via communication link with sufficient reliability and bandwidth [Anderson & Spong, 1989], [Ghostine et al., 2006]. This implies that some of the constraints mentioned above in Eq. (5.4.4) should be followed depending upon the network architecture. If the communication architecture is ad hoc, infrastructure based or a mix of two, the requirements on the QoS will be different to ensure an acceptable QoC. For example, in mobile ad hoc networks, there is no fixed structure, the nodes move as per mission requirements e.g. in formation or random trajectories [Naimi, 2005]. In such cases, a cooperative communication plan can also be considered, which will be robust to packet loss and delays. The optimization parameters are constrained by battery utilization, routing and packet loss rate. In infrastructure based teleoperation, the topology is well defined and QoS policies can be easily configured. Typical constraints include link capacity, data rate and end to end delay guarantees.

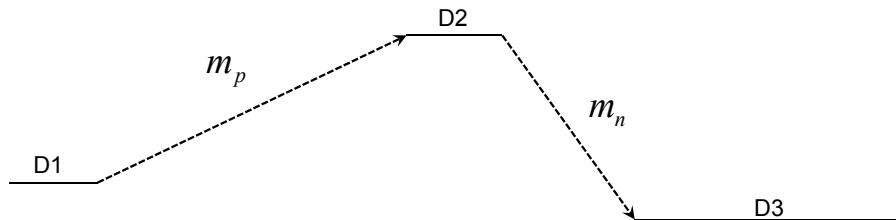

Figure 5.18: Video rate ascend and descend dynamics

5.5 Implementation Results

The Co-design strategy is implemented on the NeCS-Car test bench. The tests are performed by enabling and disabling the QoS adaptation. It has been found that the data rate change (positive or negative) is related to the network bandwidth and the buffer size. Fast alterations introduces oscillations over the network and result in degraded performance. Thus, the controlled data rate has different positive ($m_p = 0.005$) and negative slope ($m_n = 0.1$) in order to avoid non-linear oscillations due to limited buffer and processing power of the network hardware. These slopes are chosen experimentally because it is the added data rate (δ_R) over the minimum data rate necessary for teleoperation. An illustration of this phenomenon is shown in Fig. 5.18.

Three test cases considered in over all experimentation to evaluate the success of co-design strategy. First two cases were confined to static observations while the third one with six subcases was considered. All test scenarios with coded names are listed in Table 5.1:

Test	Status	Video rate Adaptation	Control Excitation
STA01a	Static	No	No
STA01b	Static	Yes	No
STA02a	Static	No	Yes
STA02b	Static	Yes	Yes
DYN03a	Dynamic	Yes	Yes
DYN03b	Dynamic	No	Yes
DYN03c	Dynamic	Yes	Yes
DYN03d	Dynamic	No	Yes
DYN03e	Dynamic	Yes	Yes
DYN03f	Dynamic	No	Yes

Table 5.1: NeCS-Car Test Configuration

5.5.1 Case-1: Static lab Tests

The test cases **STA01(a,b)** and **STA02(a,b)** were performed inside the lab to validate the architecture. In STA01(a,b), no input excitation is applied from the driver, so that the QoS_c will only be influenced by the time delay. While in STA02(a,b), a square wave signal is applied to the steering in order to simulate a control action by the driver. This will influence the error part of the QoS_c formulation as well as indicated in the Eq. 5.4.4. In both of these scenarios, video signals ($\Phi_1 = \Phi_2 = 3.1$ Mbps each) are added to simulate the perturbations over the network, which actually influence the QoS as well as QoC.

In Fig. 5.19 which represents **STA01(a)**, a fixed video flow of 1000 pkts/sec is sent over UDP ($S \rightarrow M$) in addition to the control flow ($M \rightarrow S$) of 1 Mbps. At around 50 and 100 sec, network perturbation (Φ_1, Φ_2 represented by the arrows) are added. It can be noted that the QoS_v is not much affected, however, QoS_c descends greatly and stabilizes to 10% after the second perturbation. The packet loss is more or less constant at 20%, as seen in previous experiments. The video QoS is also not affected because the network capacity has accommodated the perturbations. In addition, the control errors are close to zero in the presence of no excitation from the Master.

In Fig. 5.20 which represents **STA01(b)**, the FIS based adaptation loop is activated. QoS_c is maintained at 70% after the two perturbations from the external video flows. This has affected video QoS to a smaller

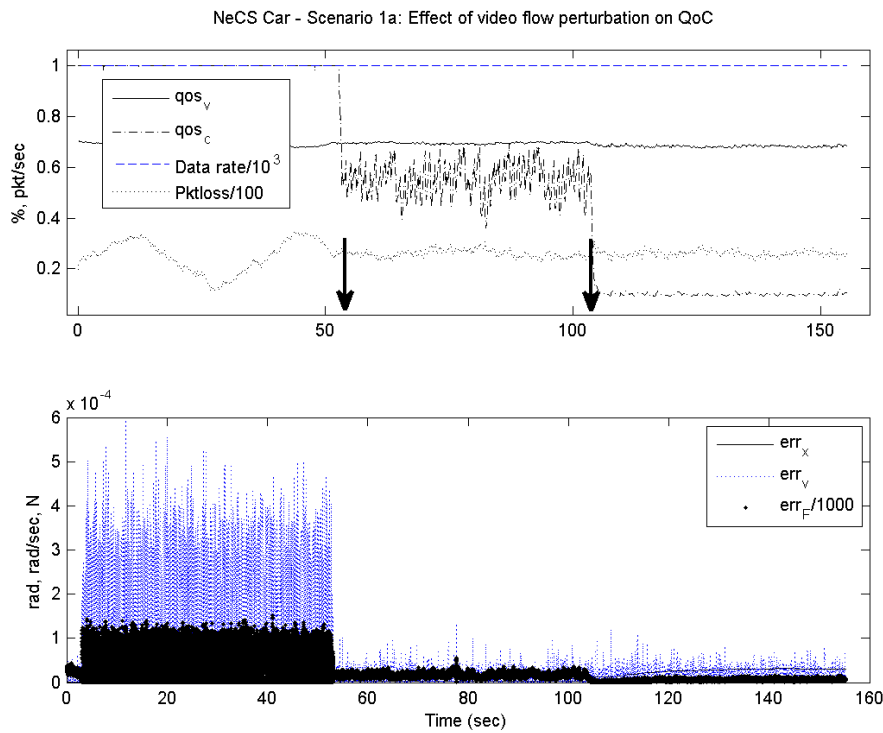

Figure 5.19: STA01a: Static, Fixed video rate, No control excitations, No Adaptation

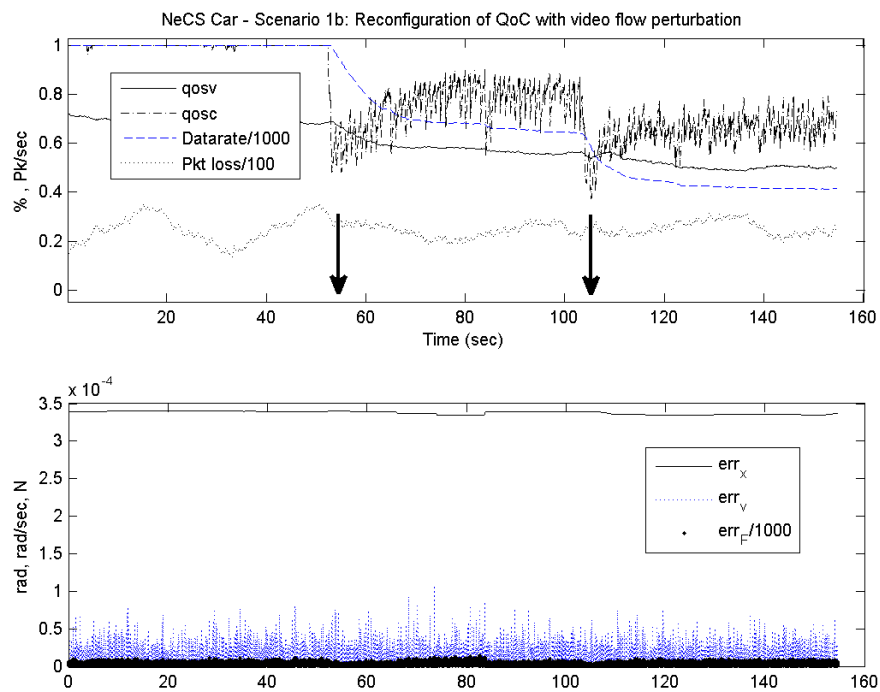

Figure 5.20: STA01b: Static, Adaptation of video flow with perturbations, No control excitations

extent, however, it can be noted that the packet loss has been increased to 30%. The control errors are close to zero in the presence of no excitation from the Master.

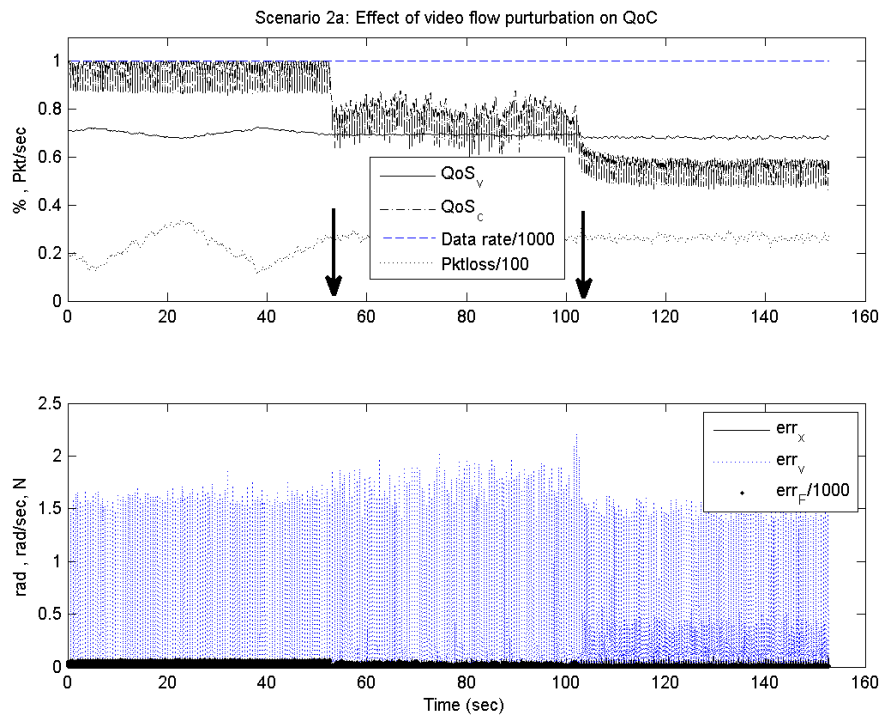

Figure 5.21: STA02a: Static, Fixed video rate, With control excitations

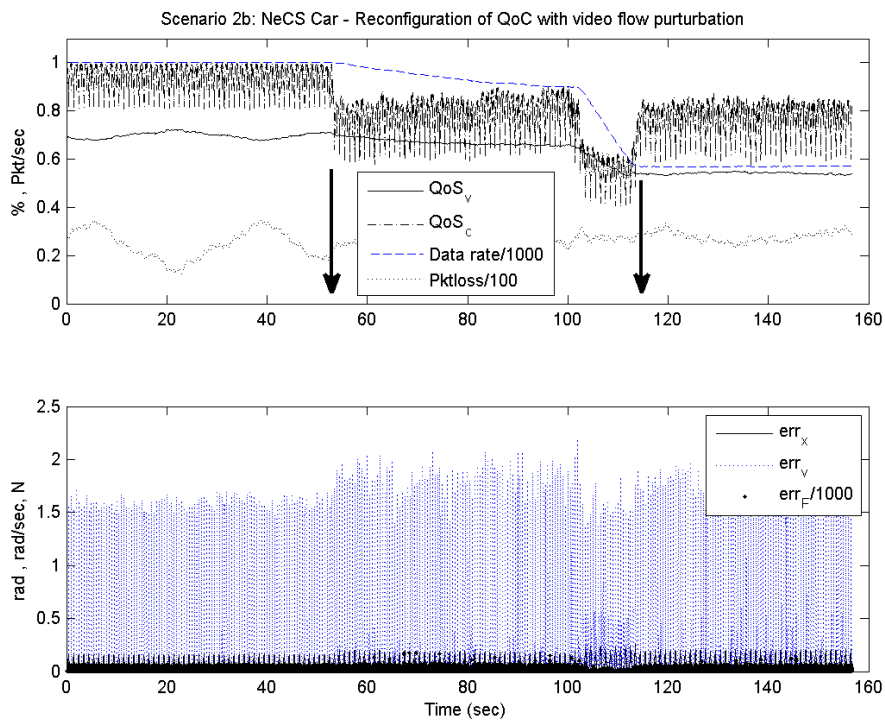

Figure 5.22: STA02b: Static, Adaptation of video flow with perturbations, With control excitations

For the **STA02a,b**, an excitation is applied repeatedly from the master station. The results with and

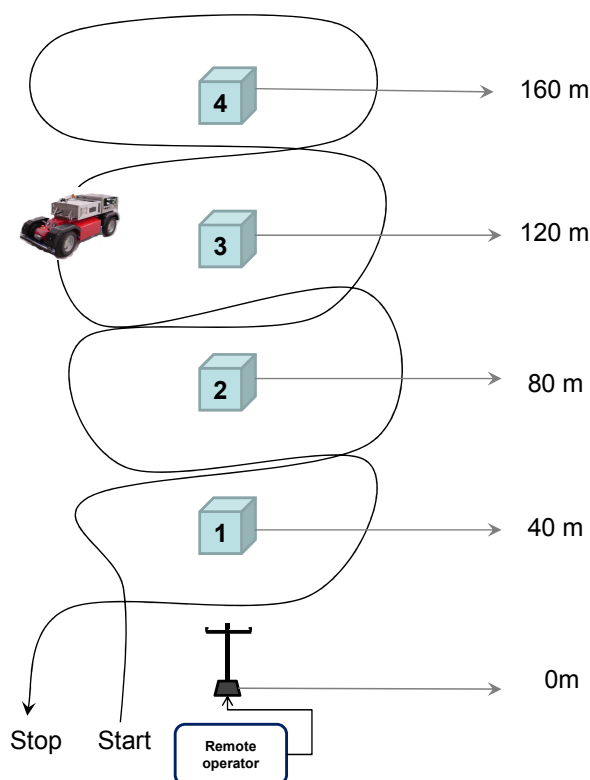

Figure 5.23: NeCS-Car trajectory for external tests

without reconfiguration of the control quality are shown in Fig. 5.21 and Fig. 5.22 respectively. In the first case, when no adaptation is used, it can be seen that control performance is degraded due to increased delay and control errors (in particular the velocity and force errors). The packet losses exceeds from 20% and settles at approximately 30%. In the adaptation case (STA02b), we can observe that the QoS_c is well maintained at 80% even after the two perturbations resulting into lesser available bandwidth. The control errors are significant in this case. It is interesting to note that as opposed to the case of STA01b, more gain in QoS_c is achieved. This is because of the additional weightage added by the control error part in the QoS_c equation as can be observed in Eq. 5.4.4.

5.5.2 Case-2: Dynamic Tests

These tests are carried out in the open environment outside lab and vehicle is run over a zigzag trajectory as shown in the Fig. 5.22. The dynamic tests are carried out in a pair of three sets under similar conditions. These can be analyzed in pairs a,b, then c,d and finally e,f. Whereas, the first one of these three sets considers video rate adaptation while in the second one a fixed video flow is sent. We present only DYN03c and DYN03f for discussion which presents with and without adaptation respectively.

The results shows that packet losses increases so much that even when the vehicle comes in proximity it is around 40%. The explanation can be drawn from multiple phenomenon that are contributing. These are:

- Mobility of the vehicle.

- Interference from other WLAN networks operating in close proximity. This is not the case when operating inside the building.
- Indoor experimentation showed a good signal strength due to multiple reflection from the walls and roof. Outside environment lacks this property.

In the first scenario **DYN03c**, FIS adaptation is enabled as well as the control excitation from the operator. It can be observed that QoS_v is fluctuating and at 80 sec, when channel conditions are not good and packet losses exceeds to 80% the QoS_v drops to zero. This is because the delay exceeds the 500 ms (RTT) security limit in which case the vehicle stops automatically. The maximum speed of the vehicle was found to be 15 Km/h on the terrain.

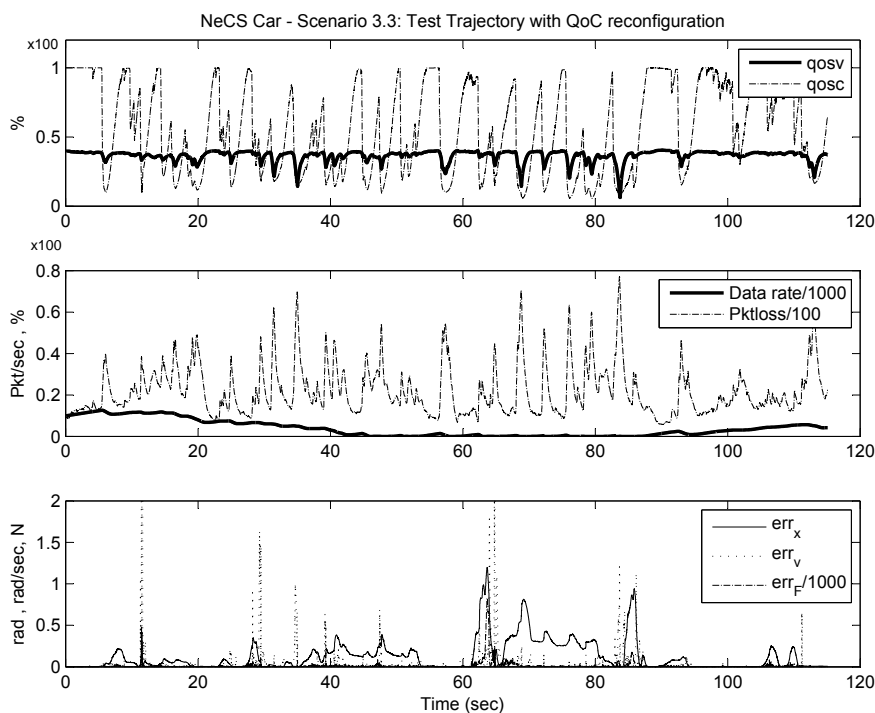

Figure 5.24: DYN03c: Dynamic, Video rate Adaptation, With Control Excitations

In the first part of this scenario, shown in Fig. 5.24, as the distance between the master and slave increases, due to the decreasing QoS_c and increasing delay and packet losses, the change in video data rate (above the nominal data rate) reduces to zero at 50 sec. At this time the return path started and the network QoS starts improving again. While the rising time constant for the data rate is quite larger as compared to the decreasing time constant, the video rate mounts quite slowly, offering lowest possible delay for the control flow. Due to poor network conditions, the vehicle stopped at 100 sec as the delay rises instantly and the safety loop comes into action to stop the car. A v-shaped trend in the video rate can be noted which exactly reflects the NeCS-Car movement away from the base station and towards it when QoS is improved which results in higher video rate. The position, velocity and force errors are presented in the sub-figure which corresponds to the QoS_c as reflected from the packet loss curve.

In the second part shown in Fig. 5.25, the tracking performance is closely shown for the same scenario. It can be seen that the control errors are notable at around 60 sec when a sudden drop in QoS_v was experienced due to the farthest distance between the master and slave. At most of other times the tracking performance is good as the master position is faithfully followed by the slave.

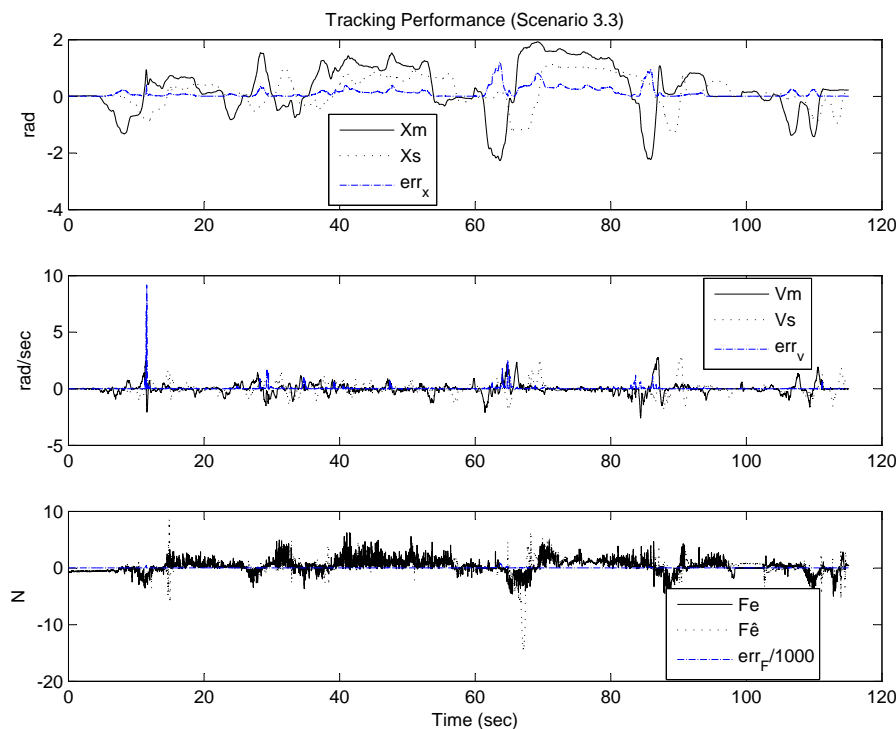

Figure 5.25: DYN03c: Tracking Performance

The scenario **DYN03f** is shown in Fig. 5.26, which is the case without adaptation whereas, a constant video rate of 300 pk/sec is sent throughout the experiment. As noticed from the Figure, the QoS is excellent in the start till 18 sec, however, it drops down at 20 sec and rises again at 40 sec. The packet loss has an average value of 40% which seems to be optimal and not much affected by the changing distance between master and slave. At about 60 sec, due to the poor QoS, the vehicle stops and regains the connection at 65 sec. The corresponding change in QoS_c can also be observed. The disconnection occurs near the farthest distance between the master and slave and is initiated by augmented delay which triggers the safety loop, resulting in emergency brakes for NeCS-Car.

In Fig. 5.27, the tracking performance is presented. The position error (err_x) is minimal before the disconnection at 65 sec, which then settles after the reconnection of the slave with the master. The master position X_m is well tracked by slave X_s but the velocity error err_v and force error (err_f) are noisy most of the time.

These experiments reflect the comparison of scenarios with and without co-adaptation strategy. Fig. 5.24 and Fig. 5.26 can be compared to note the differences. It can be highlighted that in case of no adaptation, control performance is only good when the slave is in close proximity of the master. Otherwise, it is very difficult for the operator to drive the car. However, with the video flow management, appropriate levels of QoC (qos_c) and QoS (qos_v) are achieved throughout the mission despite the fact that more packet losses are observed in the case when QoS is managed.

5.5.3 QoS Oriented Network Architecture

The hybrid architecture shown above uses the default best effort communication. We need to optimize the link usage with QoS preference in order to improve teleoperation and telepresence effects. Consider-

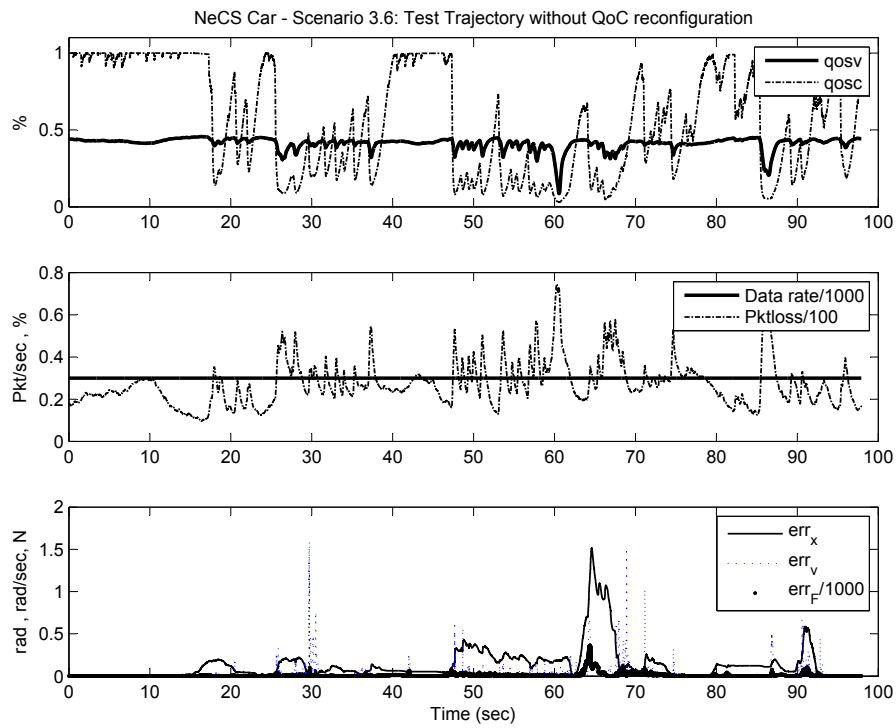

Figure 5.26: DYN03f: Dynamic, Without Adaptation, With Control Excitations

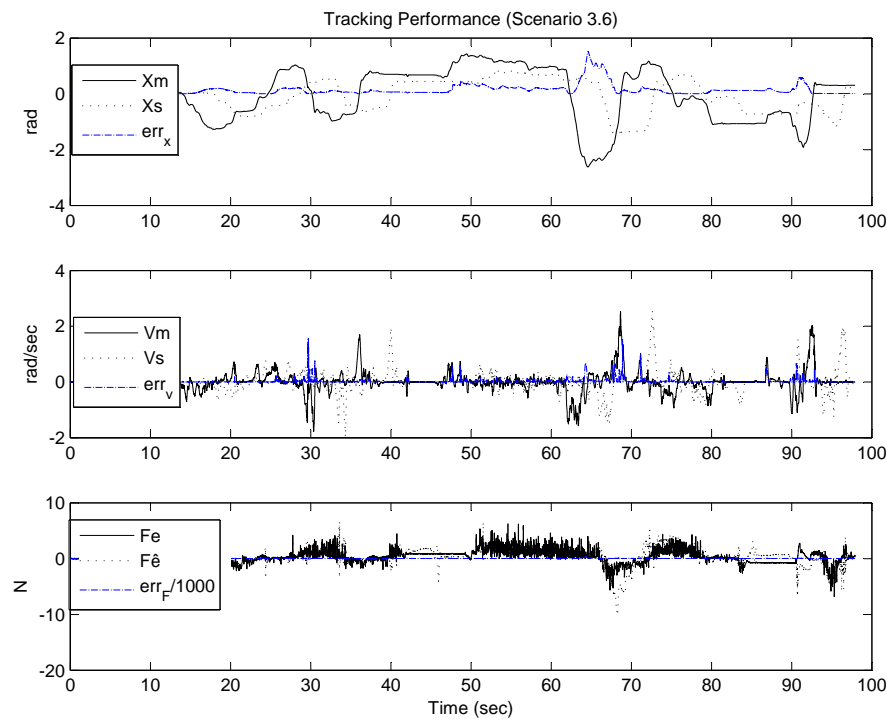

Figure 5.27: DYN03f: Tracking Performance

ing the wireless link as a possible bottleneck, the 802.11e is simulated between the operator node (fixed) and the NeCS-Car (mobile) in OPNET Modeler which offers graphical discrete event network simulation and user interface. In [Habib et al., 2009], an effort is made to estimate maximum and minimum delays for wireless networked control systems using 802.11e quality of service. Video data traffic with access category offering greater transmission opportunity window (TXOP) and shorter arbitrary inter frame spaces (AIFS) and contention window (CW) is scheduled for QoS flow.

It is interesting to conclude that while HCF offers an augmented flow, the corresponding delay also increases. However, packet size can be reduced to reduce delays with sufficiently high data rate as compared to DCF. The 802.11e supports the default DCF mode for backward compatibility, so it is advisable to use QoS enabled frames as per need. The co-design approach thus concludes that when high data rate video is needed to send as a priority, HCF is the mode of choice; whereas, for control data which requires minimum delay, DCF is sufficient.

5.6 Conclusion

This chapter discusses the steer-by-wire teleoperation benchmark available at GIPSA-lab. In the first part, modeling and simulation is described with some discussion on stability and control part. In the next section, the transparency and its significance in teleoperation is described. A co-design formulation is presented to adapt network flows as per network QoS in order to maintain a good QoC. After that a QoS oriented architecture is discussed to emphasize the fact that by managing some control over network resources and allocating bandwidth to flows which are more important, we can improve the performance in bilateral teleoperation. Some problems related to the realtime control requirements are highlighted for future research.

General Conclusion and Perspectives

The present work describes a co-design methodology for teleoperation over network. In the beginning, our motivation was to model the network architecture (specially wireless network) as accurately as possible to visualize a clear picture and find out optimized mechanisms in order to control network resources afterwards as per long range teleoperation requirements. In this struggle, an extended research was made to choose network architectures and protocols which were then simulated in some of the best available network simulators e.g. QualNet, OPNET, NS2 etc. These long distance, heterogeneous/hybrid network architectures were analyzed and end-to-end performance was simulated from QoS perspective. However, it was soon realized that perhaps the complete network dynamics are not accessible for simulation and even if they are simulated, implementation is not realizable due to the proprietary and license issues. In addition, constrained optimization needed from control view point specially with a large number of network parameters and constraints (which increases exponentially as the network size increases) can result in an NP hard problem leaving it computationally infeasible.

Thus, in order to study interconnected networks for long range teleoperation, QoS policies must be maintained from one end to another. It is done by mapping MAC layer QoS options from one protocol to another. IP network was originally meant for best effort services, so QoS mechanisms which were added later on can only prioritize flows over one another. To ensure end-to-end QoS in existing internet can be achieved by using DiffServ, IPv6/MPLS mechanisms as well as RSVP signaling protocol. However, IPv6 is not available everywhere and if one of the long range network segment is non-IPv6, the quality of service objectives are difficult to realize. Thus, our concentration was derived towards a general problem instead of looking at each of the existing QoS mechanism that is available in different protocols. This means that our approach is not limited to consider some specific QoS signaling and handshake procedure, rather the application is adapted to support and modify QoS in an indirect fashion.

Chapter 1 gives the necessary startup by presenting a detailed literature review on the long range teleoperation types, mechanisms, communication systems and applications. The requirement analysis is supplemented by the choice of control and communication system which poses challenges in an isolated design case. These problems can be rectified up to a greater extent through incorporation of these individual limits into the initial design and control/communication adaptation throughout the operation.

In Chapter 2, the requirements of quality of service for teleoperation needs is evaluated. QoS classification for bilateral teleoperation is presented with the contribution of several factors from end-to-end perspective. Network QoS is found to be playing a crucial role as a key contributor in subjective QoS. The basic network operation and types including fieldbuses are analyzed for the QoS options. Different architectures are evaluated with their advantages and shortcomings whereas, the OSI model is described from the point of view of QoS contribution in various network architectures. The wireless network offers limited resources with compromised reliability, so our study was particularly meant to analyze, which part of controller must be embedded and which one can be closed over wireless network.

The control and performance in networked teleoperation is described in Chapter 3 with emphasis on passivity based architecture due to its simple implementation. Many passivity based techniques are application specific, so a good choice is found to be dependent on the user requirements. It is also pointed out that despite some interesting features, passivity control techniques are over stable resulting in compromised transparency for teleoperation. In addition, digital implementation of the controller needs special care as passivity can be lost due to inappropriate sampling period and unsupervised data reconstruction. All time energy monitoring is stressed for all time passive teleoperation in the case of packet loss. Some key performance criteria is highlighted to measure transparency of teleoperation. By sensing transparency, a valuable compromise can be made between stability and transparency for improved results.

The co-design approach for networked teleoperation is presented in Chapter 4 which is a result of inspiration received from similar development for networked control systems. For networked bilateral teleoperation, the quality of control as our objective could be imagined to translate into transparency quality. This raises a requirement that how much haptic information is enough from the slave side. If degradation is necessary in the haptic quality due to lowered QoS, what should be its bounds so that it will remain acceptable to the operator while respecting the passivity conditions. Indeed, it is a promising area of technology and is conceptually very close to the fault detection and fault tolerance control (FDI/FTC) in engineering systems. The co-design approach emphasizes more rigorous testing to robustly perform at every operating point of the system in order to verify the adaptation in control/network parameters throughout operation. We have shown that QoS/link availability prediction using machine learning techniques is reasonably accurate, which can be improved. It can also be extended to multi link analysis to switch the network in case of low QoS or for handover purpose.

One of the design objective is to use a QoS oriented architecture to perform teleoperation by assigning different classes to teleoperation flows as per their preference. For this matter 802.11e analysis is carried out. From implementation perspective, different network cards and routers were searched to experiment with, but unfortunately, the current market lacks in programmable wireless routers which can be modified as per application needs. Only DD-WRT can provide an open source Linux firmware (for WLAN only), where additional functionalities can be added.

Thus, our work addresses the general problem of co-adaptation of control and communication for long range teleoperation of an autonomous system in case of best effort services. The results in Chapter 5 shows the effectiveness of the proposed method where QoS based telepresence effects can be adapted as per network quality. The test bench results can be improved by implementing 802.11n with QoS features as offered by 802.11e traffic classification. It is, therefore mandatory to throw light on the present work in a critical manner to highlight the strength of our approach and at the same time propose some improvements that can be made in our future work. Augmented autonomy of the benchmark can effectively reduce the network bandwidth required for the teleoperation. For the moment, embedded algorithms include a reversibility controller and a safety loop to ensure emergency brakes when command link delay exceeds the 500 ms (RTT). In the future work, scenario based controlled video flow is under study for implementation. This refers to increased frame rate at higher speeds and changing attitude as compared to unaccelerated motion in a straight line. The degree of autonomy of NeCS-Car can also be increased by integrating online obstacle avoidance and intelligent decision for semi-autonomous or fully autonomous operation. In that case, teleoperation will be limited to mission programming and way point navigation only.

Bibliography

- 3GPP, T. . [2003], Feasibility study on 3gpp system to wireless local area network (wlan) interworking, Technical report, 3GPP, <http://www.3gpp.org/ftp/Specs/html-info/22934.htm>.
- A.B.Watson & Malo, J. [2002], ‘Video quality measures based on the standard spatial observer’, *IEEE International Conference on Image Processing* .
- Ahmad, A. [2005], *Wireless and Mobile Data Networks*, Wiley Interscience Publication.
- Akyildiz, I. F., Pompili, D. & Melodia, T. [2004], ‘Challenges for efficient communication in underwater acoustic sensor networks’, *Special Issue on Embedded Sensor Networks and wireless Computing* **1**, 3–8.
- Anderson, R. J. [1996], ‘Autonomous, teleoperated, and shared control of robot systems’, *IEEE International Conference on Robotics and Automation* **3**, 2025–2032.
- Anderson, R. J. & Spong, M. W. [1989], ‘Bilateral control of teleoperation with time delay’, *IEEE Transactions on Automatic Control* **34**, 494–501.
- Andrews, J. G., Ghosh, A. & Muhamed, R. [2007], *Fundamentals of WiMAX- Understanding Broadband Wireless Networking*, Prentice Hall Inc.
- Anttalainen, T. [2003], *Introduction to Telecommunications Network Engineering*, Artech House telecommunications library.
- Arcak, M. [2007], ‘Passivity as a design tool for group coordination’, *IEEE Transactions on Automatic Control* **8**, 1380–1390.
- Avcibas, I., Sankur, B. & Sayood, K. [2002], ‘Statistical evaluation of image quality measures’, *Journal of Electronic Imaging* **11**, 206–223.
- Bajracharya, M., Maimone, M. W. & Helmick, D. [2008], ‘Autonomy for mars rovers: Past, present, and future’, *Control Systems Magazine* pp. 44–50.
- Barger, P., Thiriet, J. & Robert, M. [2003], ‘Safety analysis and reliability estimation of a networked control system’, *IFAC SafeProcess 2003, Washington* pp. 1047–1052.
- Barolli, L., Koyama, A., Yamada, T., Yokoyama, S., Sukanuma, T. & Shiratori, N. [2001], ‘A fuzzy admission control scheme for high-speed networks’, *Proceedings of 12th International Workshop on Database and Expert Systems Application* pp. 157–161.
- Barry, M., Campbell, A. T. & Veres, A. [2001], ‘Distributed control algorithms for service differentiation in wireless packet networks’, *INFOCOM* pp. 582–590.

Bibliography

- Barton, J. E., Cohn, T. E. & Tomizuka, M. [2006], ‘Towards a complete human driver model: The effect of vision on driving performance’, *Proceedings of the American Control Conference, Minneapolis, Minnesota* pp. 2591–2598.
- Bayart, M. [2008], ‘Distributed diagnosis of networked embedded system’, *17th IFAC World congress, Seoul, Korea* .
- Bayart, M., Benoit, G., Benoit, E., Cauffriez, L., Robert, M., Chovin, A., Ciccotelli, J., Conrard, B., Mauris, G., Planade, R. & Weexsteen, J. [1999], *Réseaux de terrain*, HERMES.
- Behzad, M., Asghari, K. & Coppola, E. A. [2010], ‘Comparitive study of svms and anns in aquifer water level prediction’, *Journal of Computing in Civil Engineering* **24**, 408–413.
- Benoit, E., Chovin, A., Foulloy, L., Chatenay, A. & Mauris, G. [2006], ‘Towards a safe design of canopen distributed instruments’, *IEEE Transactions on Instrumentation and Measurement* **55**, 771–777.
- Berestesky, P., Chopra, N. & Spong, M. W. [2004], ‘Discrete time passivity in bilateral teleoperation over the internet’, *IEEE International Conference on Robotics and Automation* **5**, 4557–4564.
- Biaz, S. & Vaidya, N. H. [2003], ‘Is the roundtrip time correlated with the number of packets in flight ?’, *Internet Measurement Conference (IMC)* .
- Biesiadecki, J. J., Leger, C. & Maimone, M. W. [2005], ‘Tradeoffs between directed and autonomous driving on the mars exploration rovers’, *International Symposium of Robotics Research, San Francisco, California, USA* .
- Birk, A. & Kenn, H. [2002], ‘Roboguard, a teleoperated mobile security robot’, *Control Engineering Practice* **10**, 1259–1264.
- Boughanmi, N., Cruz-Sanchez, H., Song, Y., Al-Salami, I. & Yame, J. [2009], ‘Case study of wireless networked control system, conecs and cownecs platform’, *3SGS’09* .
- Branicky, M. S. [1998], ‘Multiple lyapunov functions and other analysis tools for switched and hybrid systems’, *IEEE Transactions on Automatic Control* **43**, 475–482.
- Branicky, M. S., Liberatore, V. & Phillips, S. M. [2003], ‘Networked control system co-simulation for co-design’, *American Control Conference* .
- Branicky, M. S., Phillips, S. M. & Zhang, W. [2000], ‘Stability of networked control systems, explicit ananalysis of delay’, *Proceedings of American Control Conference* .
- Brockett, R. W. [1995], ‘Stabilization of motor networks’, *Proceedings of 34th Conference on Decision and Control* pp. 1484–1488.
- Brockett, R. W. & Liberzon, D. [2000], ‘Quantized feedback stabilization of linear systems’, *IEEE Transactions on Automatic Control* **45**, 1279–1289.
- Bruzzone, G., Bono, R., Bruzzone, G., Caccia, M., Cini, M., Coletta, P., Maggiore, M., Spirandelli, E. & Veruggio, G. [2002], ‘Internet based satellite teleoperation of the romeo rov in antartica’, *10th Mediterranean Conference on Control and Automation - MED2002 Lisbon, Portugal* .
- Burdea, G. [1996], *Force and Touch Feedback for Virtual Reality*, John Wiley and Sons, New York, USA.
- Cao, L. J., Francis, E. & Tay, H. [2003], ‘Support vector machine with adaptive parameters in financial time series forecasting’, *IEEE Transactions on Neural Networks* **14**.

Bibliography

- Carvalho, P., Santos, C., Ferreira, M. J., Silva, L. F. & Afonso, J. A. [2008], *Design and Development of a Fly-by-Wireless UAV Platform*, I-Tech Education and Publishing, Vienna, Austria, chapter Intelligent Aerial Vehicles.
- Cavusoglu, M. C., Sherman, A. & Tendick, F. [2002], 'Design of bilateral teleoperation controllers for haptic exploration and telemanipulation of soft environments', *IEEE Trans. on Robotics and Automation* **18**, 641–647.
- Cervin, A. & Eker, J. [2005], 'Control-scheduling codesign of real-time systems: The control server approach', *Journal of Embedded Computing* **1**, 209–224.
- Cervin, A., Henriksson, D., Lincoln, B., Eker, J. & n, K. E. A. [2003], 'How does control timing affect performance?', *IEEE Control Systems Magazine* **23**, 16–30.
- Chen, J., Irwin, G. W., McKernan, A. & Scanlon, W. G. [2008], 'A model predictive approach to wireless networked control', *International Conference on Control, Manchester, UK*.
- Chen, L., Zhang, Q., Li, M. & Jia, W. [2007], 'Joint topology control and routing in ieee 802.11-based multiradio multichannel mesh networks', *Vehicular Technology, IEEE Transactions on* **56**(5), 3123–3136.
- Cheng, R. & Chang, C. [1996], 'Design of a fuzzy traffic controller for atm networks', *IEEE/ACM Transactions* **4**, 460–469.
- Chiang, M., O'Neill, D., Julian, D. & Boyd, S. [2001], 'Resource allocation for qos provisioning in wireless ad hoc networks', *Proceedings of IEEE Globecom* pp. 2911–2915.
- Chitre, M., Freitag, L., Sozer, E., Shahabudeen, S., Stojanovic, M. & Potter, J. [2006], 'An architecture for underwater networks', *IEEE Asia Pacific Conference OCEANS 06*.
- Chopra, N., Spong, M., Ortega, R. & Barabanov, N. E. [2006], 'On tracking performance in bilateral teleoperation', *IEEE transaction on Robotics* **22**.
- Chopra, N. & Spong, M. W. [2007], 'Adaptive synchronization of bilateral teleoperation with time delay', *Advances in Telerobotics* pp. 257–270.
- Chow, M. Y. & Tipsuwan, Y. [2001], 'Network-based control adaptation for network qos variation', *IEEE Military Communications Conference, MILCOM 1*, 257–261.
- CISCO [1992], *Internetworking Technology handbook*, CISCO.
- Clarke, M. M., Hamel, W. R. & Draper, J. V. [1983], 'Human factors in remote control engineering development activities', *31st Conference on Remote Systems Technology, Detroit, Michigan* pp. 8–16.
- Coelho, T. E., Macedo, R., Carvalho, P., Afonso, J. A., Silva, L. F., Almeida, H., Ferreira, M. J. & Santos, C. [2006], 'A fly-by-wireless uav platform based on a flexible and distributed system architecture', *IEEE International Conference on Industrial Technology, ICIT2006, Mumbai, India*.
- Colandairaj, J., Irwin, G. & Scanlon, W. [2005], 'Analysis of an ieee 802.11b wireless networked control system', *1st Workshop on Networked Control System and Fault Tolerant Control, Ajaccio, France*.
- Colgate, J. [1991], 'Power and impedance scaling in bilateral manipulation', *Proceedings of the IEEE Conference on Robotics and Automation* pp. 2292–2297.

Bibliography

- Colgate, J. E. & Brown, J. M. [1994], ‘Factors affecting the z-width of a haptic display’, *IEEE Int. Conf. on Robotics and Automation* pp. 3205–3210.
- Colgate, J. E. & Schenkel, G. G. [1997], ‘Passivity of a class of sampled data systems: Application to haptic interfaces’, *Journal of Robotic Systems* **14**, 37–47.
- Colgate, J. E., Stanley, M. C. & Brown, J. M. [1995], ‘Issues in the haptic display of tool use’, *IEEE/RSJ International Conference on Intelligent robots and systems* pp. 140–145.
- Cristianini, N. & Taylor, J. S. [2000], ‘An introduction to support vector machines and other kernel-based learning methods’.
- Cruz, R. [1991a], ‘A calculus for network delay. i. network elements in isolation’, *Information Theory, IEEE Transactions on* **37**(1), 114–131.
- Cruz, R. [1991b], ‘A calculus for network delay. ii. network analysis’, *Information Theory, IEEE Transactions on* **37**(1), 132–141.
- D. Hopper, C. B. & Reilly, D. [1996], ‘Advanced teleoperation test bed- a system you can see through’, *Robotica* **14**, 457–461.
- Dai, Z., Fracchia, R., Gosteau, J., Pellati, P. & Vivier, G. [2008], ‘Vertical handover criteria and algorithm in ieee802.11 and 802.16 hybrid networks’, pp. 2480–2484.
- Daniel, R. W. & McAree, P. R. [1998], ‘Fundamental limits of performance for force reflecting teleoperation’, *Int. J. Robotics Research* **17**, 811–830.
- De Mil, P., Allemeersch, T., Moerman, I., Demeester, P. & De Kimpe, W. [2008], ‘A scalable low-power wsan solution for large-scale building automation’, pp. 3130–3135.
- de Wit, C. C., Estern, F. G. & Rubio, F. R. [2009], ‘Delta modulation coding redesign for feedback controlled systems’, *IEEE transactions on Industrial Electronics* **56**, 1–20.
- Dede, M. I. C. & Tosunoglu, S. [2007], ‘Parallel position/force controller for teleoperation systems’, *5th IFAC Workshop on Technology Transfer in Developing Countries: Automation in Infrastructure Creation, DECOM-TT, Izmir, Turkey*.
- Deflaugergues, V., Cocquempot, V., Bayart, M. & Pengov, M. [2009], ‘Analysis for fdi: a modified, invertibility-based canonical decomposition’, *20th International Workshop on Principles of Diagnosis DX’09. Stockholm*.
- Delchamps, D. F. [1990], ‘Stabilizing a linear system with quantized state feedback’, *IEEE Transactions on Automatic Control* **35**, 916–924.
- Deodhar, A., Shiakolas, P. & Belligundu, S. [2005], ‘An ai based controller for temperature control for a hot embossing system’, *Intelligent Control, 2005. Proceedings of the 2005 IEEE International Symposium on, Mediterrean Conference on Control and Automation* pp. 113–118.
- Din, N. M. & Faisal, N. [2008], ‘Fuzzy logic bandwidth prediction and policing in a diffserv aware network’, *Journal of Computers* **3**, 18–23.
- Diolaiti, N., Niemeyer, G., Barbagli, F., Salisbury, J. K. & Melchiorri, C. [2005], ‘The effect of quantization and coulomb friction on the stability of haptic rendering’, *World haptics Conference* pp. 237–246.
- Dote, Y. [1998], ‘Soft computing (immune networks) in artificial intelligence’, *Industrial Electronics, 1998. Proceedings. ISIE ’98. IEEE International Symposium on* **1**, 1–7 vol.1.

Bibliography

- El-Sayed, H., Mellouk, A., George, L. & Zeadally, S. [2008], 'Quality of service models for heterogeneous networks: overview and challenges', *Annales des Télécommunications* **63**, 639–668.
- Elia, N. & Mitter, S. K. [2001], 'Stabilization of linear systems with limited information', *IEEE Transactions on Automatic Control* **46**, 1384–1400.
- Engeldrum, P. [2000], 'Psychometric scaling: A toolkit for imaging systems development', *Imcotek Press*.
- Eriksson, L. M. & Johansson, M. [2007], 'Pid controller tuning rules for vaying time delay systems', *Proceedings of A American Control Conference, New York, USA* pp. 619–625.
- Fang, X. & Ghosal, D. [2003], 'Performance modeling and qos evaluation of mac/rlc layer in gsm/gprs networks', *ICC 03*.
- Fang, Y., Tan, T. & Wang, Y. [2002], 'Fusion of global and local features for face verification', *16th International Conference on Pattern Recognition* **2**, 382–385.
- Fax, J. & Murray, R. [2004], 'Information flow and cooperative control of vehicle formations', *Automatic Control, IEEE Transactions on* **49**(9), 1465–1476.
- Feng, H., Shu, Y., Wang, S. & Ma, M. [2006], 'Svm-based models for predicting wlan traffic'.
- Ferrell, W. R. [1965], 'Remote manipulative control with transmission delay', *IEEE Transacions on Human Factors in Electronics* **6**, 24–32.
- Fiche, G. & Hebuterne, G. [2004], *Communicating Systems and Networks, Traffic and Performance*, Kogan Page Science.
- Finlayson, R. [1999], 'Ip multicast and firewalls'.
- Fite, K. B., Goldfarb, M. & Rubio, A. [2004], 'Loop Shaping for Transparency and Stability Robustness in Time Delayed Bilateral Telemanipulation', *ASME Journal of Dynamic Systems* **126**, 650–656.
- Fite, K. B., Shao, L. & Goldfarb, M. [2004], 'Loop Shaping for Transparency and Stability Robustness in Bilateral Telemanipulation', *IEEE Transaction on Robotics and Automation* **20**, 620–624.
- Fite, K. B., Speich, J. E. & Goldfarb, M. [2001], 'Transparency and stability robustness in two-channel bilateral telemanipulation', *ASME Journal of Dynamic System, Measurement, and Control* **123**, 400–407.
- Fitzek, F. H. P., Can, B., Prasad, R. & Katz, M. [2005], 'Traffic analysis and video quality evaluation of multiple description coded video services for fourth generation wireless ip networks', *Special Issue of the International Journal on Wireless Personal Communications*.
- Flemmer, H. & Wikander, J. [2003], 'Transparency and stability analysis of a surgical teleoperator system', *11th IEEE Symposium on Haptic Interfaces for Virtual Environment and Teleoperator Systems*.
- Flickenger, R. [2007], *Wireless Networking in the Developing World*, Hacker Friendly.
- Fong, T. [2001], Collaborative Control: A robot centric model for vehicle teleoperation, PhD thesis, Robotics Institute, Carnegie Mellon University, Pittsburg, PA.
- Fong, T., Thrope, C. & Baur, C. [2003], 'Multi robot remote driving with collaborative control', *IEEE Transactions on Industrial Electronics* **50**, 699–705.

Bibliography

- Forum, W. [2006], Mobile wimax- part i: A technical overview and performance evaluation, Technical report, WiMAX Forum.
- Franklin, G., Powell, J. & Workman, M. [1994], *Digital Control of Dynamic Systems*, Second edn, Addison Wesley, Reading, MA.
- Friedman, E., Suret, A. & Richard, J. P. [2004], 'Robust sampled data stabilization of linear systems: an input delay approach', *Automatica* **40**, 1141–1446.
- Fukushima, M., Nakamura, H. & Nomoto, S. [2004], 'A playout-buffer-sensitive time slot scheduling for integration of real-time and elastic traffic in wireless networks', **2**, 1188 – 1192 Vol.2.
- Gamez, R. C. L., Marti, P., Velasco, M. & Fuertes, J. M. [2006], Wireless network delay estimation for time-sensitive applications, Technical report, Automatic Control Department, Technical University of Catalonia.
- Ghostine, R., Thiriet, J. M. & Aubry, J. F. [2006], 'Dependability evaluation of networked control systems under transmission faults', *6th IFAC Symposium on Fault detection, Supervision and Safety of Technical Processes (SAFEPROCESS 06)* pp. 1129–1134.
- Goldsmith, A. J. & Chua, S. G. [1998], 'Adaptive coded modulation for fading channels', *IEEE Transactions on Communications* **46**, 595–602.
- Gong, X. & A.Kuh [1999], 'Support vector machine for multiuser detection in cdma communications'.
- Goodrich, M. A. & Boer, E. R. [2003], 'Model based human centered task automation: A case study in acc system design', *IEEE Transactions on Systems, Man and Cybernetics* **33**, 325–336.
- G.P.Liu, J.B.Yang & J.F.Whidborne [2003], 'Multiobjective optimisation and control', *Baldock: Research Studies Press Ltd* .
- Green, M. [2000], 'How long does it takes to stop? methodological analysis of driver perception-brake time', *Transportation Human Factors* **2**, 195–216.
- Grilo, A., Macedo, M. & Nunes, M. [2003], 'A scheduling algorithm for qos support in ieee 802.11e networks', *IEEE Wireless Communications* **10**, 36–43.
- Gross, J., Klaue, J., Karl, H. & Wolisz, A. [2004], 'Cross-layer optimization of ofdm transmission systems for mpeg-4 video streaming', *Computer Communications* **27**, 1044–1055.
- Gu, D., Guangyu, P. L., Gerla, H. & Hong, M. X. [2002], 'Hierarchical routing for multi-layer ad-hoc wireless networks with uavs', *Proceedings of 21st Century Military Communications Conference, MILCOM 2000, Los Angeles* pp. 310–314.
- Gupta, G. S., Paddison, R., Messom, C. & Demidenko, S. [2006], 'Wireless master slave embedded controller for a teleoperated anthropomorphic robotic arm with gripping force sensing', *International Conference on Networking (ICN)* pp. 164–169.
- Habib, G., Divoux, T. & Petin, J.-F. [2009], 'Estimating maximum and minimum delays for wireless discrete networked control systems', *Wireless Telecommunications Symposium, Prague* .
- Haffajee, H. & Chan, H. A. [2006], 'Low-cost qos-enabled wireless network with interworked wlan and wimax', *First IEEE International Conference on Wireless Broadband and Ultra Wideband Communications (AusWireless 2006), Sydney* .
- Halevi, Y. & Ray, A. [1988], 'Integrated communication and control systems: Part 1- analysis', *ASME Journal of Dynamic System, Measurement, and Control* **110**, 367–373.

Bibliography

- Hannaford, B. & Ryu, J. H. [2002], ‘Time domain passivity control of haptic interfaces’, *IEEE Transactions on Robotics and Automation* **18**.
- Hardy, W. C. [2001], *Measurement and evaluation of telecommunication QoS*, Wiley.
- Hartman, J. R. [2004], Networked control system co-simulation for co-design: Theory and experiments, Master’s thesis, Dept. of Electrical Engineering and Computer Science, Case Western Reserve University.
- Hauske, G., T.Stockhammer & Hofmaier, R. [2003], ‘Quality of low rate and low resolution video sequence’, *MoMuC2003* .
- Hawkeye, H., Hannaford, B., Kammerl, J. & Steinbach, E. [2010], ‘Establishing multimodal telepresence sessions using the session initiation protocol (sip) and advanced haptic codecs’, *IEEE Haptics Symposium* .
- Hawkeye, H., Tadano, K., Donlin, R., Friedman, D. & Lum, M. J. H. [2009], ‘Preliminary protocol for interoperable telesurgery’, *17th international conference on Advanced Robotics* .
- Haykin, S. S. [1970], *Active Network Theory*, Addison Wesley.
- Herndon, J. N., Babcock, S. M., Butler, P. L., Costello, H. M., Glassell, R. L., Kress, R. L., Kuban, D. P., Rowe, J. C. & Williams, D. W. [1989], ‘Telerobotic manipulator developments for ground based space research’, *Third ANS Topical meeting on Robotics and remote systems* .
- Herndon, J. N., Martin, H. L., Satterlee, P. E., Jelatis, D. G. & Jennrich, C. E. [1984], ‘The state of the art model m-2 maintenance system’, *Second ANS Topical meeting on Robotics and Remote handling in hostile environments, Gatlinburg, TN* pp. 147–154.
- Hespanha, J., Naghshtabrizi, P. & Xu, Y. [2007], ‘A survey of recent results in networked control systems’, *Proceedings of the IEEE* **95**(1), 138 –162.
- Hespanha, J. P. & Morse, A. S. [1998], ‘Input-output gains of switched linear systems’, *Open Problems in mathematical systems theory and control* pp. 45–47.
- Hirche, S. [2005], Haptic Telepresence in Packet Switched Communication Networks, PhD thesis, TU Munich, Germany.
- Hirche, S., Bauer, A. & Buss, M. [2005], ‘Transparency of haptic telepresence systems with constant time delay’, *IEEE Conf. on Control Applications* pp. 328–333.
- Ho, J. [2008], ‘Qos, queue and channel-aware packet scheduling for multimedia services in multiuser sdma/tdma wireless systems’, *Mobile Computing, IEEE Transactions on* **7**(6), 751 –763.
- Hogan, N. [1985], ‘Impedance control : An approach to manipulation, part i-iii’, *ASME Journal of Dynamic Systems, Measurement and Control Engineering Practice* **107**, 1–24.
- Hokayem, P. F. & Spong, M. W. [2006], ‘Bilateral teleoperation: An historical survey’, *Automatica* **Vol. 42, Issue 12**, 2035–2057.
- Hou, C., Jia, S. & Takase, K. [2003], ‘Real time multimedia applications in a web based robotic telecare system’, *Journal of Intelligent and Robotic Systems* **38**, 135–153.
- Hu, X., Xu, R., Wei, W., Liu, J. & Xie, Y. [2008], ‘A novel scheme of timing synchronization for ofdm underwater communication system’, *OCEANS 2008* pp. 1–5.

Bibliography

- Iancu, B., Dadarlat, V. & Peculea, A. [2008], ‘End-to-end qos frameworks for heterogeneous networks - a survey’, *7th RoEduNet International Conference 08* .
- IDC, T. [2004], *Practical Fieldbus, DeviceNet and Ethernet for Industry*, IDC technologies.
- IEEE [2003], ‘Wireless lan medium access control (mac) and physical layer (phy) specification: High speed physical layer extension to ieee 802.11b’, *IEEE* .
- IEEE Standards for Local and Metropolitan Area Networks: Media Access Control (MAC) Bridges* [1991], *IEEE Std 802.1D-1990* p. 1.
- Iniewski, K., Mccrosky, C. & Minoli, D. [2008], *Network Infrastructure and Architecture*, Wiley Interscience.
- ITU [1998], ‘Subjective audiovisual quality assessment methods for multimedia applications, itu-t recommendation p.911’.
- Jansen, J. F. & Kress, R. L. [1996], ‘Controller design for a hydraulically powered dissimilar teleoperated system’, *IEEE international conference on Robotics and Automation, Minneapolis, MN* pp. 2482–2491.
- Jia, H., Zhang, Z., Cheng, P., Chen, H. H. & Li, S. [2006], ‘Study on network selection for next-generation heterogeneous wireless networks’, *IEEE 17th International Symposium on Personal, Indoor and Mobile Radio Communications* pp. 1–5.
- Jordan, J. R. [1995], *Serial Networked Field Instrumentation*, Wiley, New York.
- Jurdak, R., Lopes, C. & P.Baldi [2004], ‘A survey, classification and comparative analysis of medium access control protocols for ad hoc networks’, *IEEE Communication Surveys and Tutorials* **6**.
- Kasiolas, A. & Makrakis, D. [1999], ‘A fuzzy-based traffic controller for high-speed atm networks using realistic traffic models’, *IEEE Transactions on Multimedia Computing and Systems* **2**, 389–394.
- Khan, Z., Genon-Catalot, D. & Thiriet, J. M. [2009a], ‘Hierarchical wireless network architecture for distributed applications’, *The Fifth International Conference on Wireless and Mobile Communications, Cannes, France* .
- Khan, Z. H., Genon-Catalot, D. & Thiriet, J. M. [2009b], ‘Co-design in heterogeneous wireless networked control systems’, *4th IEEE International Workshop on Real-Time Software, Poland* .
- Khan, Z. H., Genon-Catalot, D. & Thiriet, J. M. [2010], ‘A co-design approach for bilateral teleoperation over hybrid networks’, *18th Mediterranean Conference on Control and Automation (MED), Marakesh, Morocco* .
- Khanna, G., Cheng, M. Y., Varadharajan, P., Bagchi, S., Correia, M. & Verissimo, P. [2007], ‘Automated rule-based diagnosis through a distributed monitor system’, *IEEE Transactions on Dependable and Secure Computing* **4**, 266–279.
- Kim, J. & Chang, P. H. [2007], ‘Extended transparency as a quantitative performance measure in bilateral teleoperation’, *IEEE/RSJ International conference on Intelligent Robots and Systems San Diego, CA, USA* .
- Kim, K., Cavusoglu, M. C. & Chung, W. K. [2007], ‘A framework for quantitative comparison of bilateral teleoperation systems using mu synthesis’, *IEEE International Conference on Robotics and Automation* pp. 1637–1644.
- Kim, K. & Davis, L. [n.d.], ‘A fine structure image/video quality measure using local statistics’.

Bibliography

- Kim, W. S. [1990], ‘Shared compliant control: A stability analysis and experiments’, *Proceedings of IEEE international conference on Systems, Man and Cybernetics* pp. 620–623.
- K.Knightson, N.Morita & T.Towle [2005], ‘Ngn architecture: Generic principles, functional architecture, and implementation’, *IEEE Communications Magazine* pp. 49–55.
- Klaue, J., Rathke, B. & Wolisz, A. [2003], ‘Evalvid- a framework for video transmission and quality evaluation’, *13th International Conference on Modeling Techniques and Tools for COmputer Performance* .
- Knoche, H. & de Meer, H. [1997], ‘Quantitative qos-mapping: A unifying approach’, pp. 347–358.
- Kommineni, J. & Malinowski, A. [2005], ‘Study of time delay distribution in ip protocol family for ip-network based control applications’, p. 4 pp.
- Kosuge, K., Takeo, K. & Fukuda, T. [1995], ‘Unified approach for teleoperation of virtual and real environment manipulation based on reference dynamics’, *IEEE inernational conference on Robotics and Automation* pp. 938–943.
- Kottenstette, N. & Antsaklis, P. J. [2007], ‘Stable digital control networks for continous passive plants subject to delays and data dropouts’, *46th IEEE Conference on Decision and Control* pp. 4433–4440.
- Kottenstette, N. & Antsaklis, P. J. [2008], ‘Communication in automation, including networking and wireless’, *Springer Handbook of Automation* .
- Kottenstette, N., Koutsoukos, X., Hall, J. & Sztipanovits, J. [2008], ‘Passivity based design of wireless networked control systems for robustness to time varying delays’, *Real time systems symposium (RTSS)* pp. 15–24.
- Kragic, D. & Christensen, H. I. [2002], Survey on visual servoing for manipulation, Technical report, ISRN KTH/NA/P-02/01-SE.
- Kress, R. L., Jansen, J. F., Noakes, M. W. & Herndon, J. N. [1997], The evolution of teleoperated manipulators at ornl, Technical report, Oak Ridge National Laboratory.
- Kron, A. & Schmidt, G. [2006], ‘Stability and performance analysis of kinesthetic control architectures for bimanual telepresence systems’, *Journal of Intelligent Robotic System* **46**, 1–26.
- Kuban, D. P., Noakes, M. W. & Bradley, E. C. [1987], ‘The advanced servomanipulator system: Development status and preliminary test results’, *The ANS Topical Meeting on Remote Systems and Robotics in Hostile environments, Pasco, Washington* pp. 638–644.
- Kuchenbecker, K. J. & Niemeyer, G. [2006], ‘Induced master motion in force-reflecting teleoperation’, *ASME Journal of Dynamic System, Measurement, and Control* .
- Kwitowski, A. J., Mayercheck, W. D. & Brautigam, A. L. [1992], ‘Teleoperation for continous miners and haulage equipment’, *IEEE Transactions on Industry Applications* **28**, 1118–1115.
- Lai, Y. C., Lin, Y. D., Chen, C. Y. & Wey, H. Y. [2002], ‘Guaranteed versus controlled load: Implications for service subscribers and providers in rsvp networks’, *15th International Conference on Information Networking* .
- LAMBORAY, E. C. [2004], A Communication Architecture for Telepresence in Virtual Environments, PhD thesis, ETH, Switzerland.

Bibliography

- Lawrence, D. A. [1993], ‘Stability and transparency in bilateral teleoperation’, *IEEE Transaction in Robotics and Automation* **9**, 624–637.
- Lawrenz., W. [1997], *CAN System Engineering - From Theory to Practical Applications*.
- Le, A.-N., Kum, D.-W. & Cho, Y.-Z. [2009], *Advances in Information Security and Assurance*, chapter An Efficient Hybrid Routing Approach for Hybrid Wireless Mesh Networks, pp. 532–542.
- Lee, S. H. & Lim, J. T. [2000], ‘Switching control of h-inf gain scheduled controllers in uncertain non-linear systems’, *Automatica* **36**, 1067–1074.
- Leeraphan, S., Maneewarn, T. & Laowattana, D. [2002], ‘Stable adaptive bilateral control of transparent teleoperation through time varying delay’, *International Conference on Intelligent Robots and Systems, 2002. IEEE/RSJ* **3**, 2979–2984.
- Lepage, F., Divoux, T. & Michaut, F. [2006], ‘Adaptation of control parameters based on qos monitoring’, *Mini-Symposium "Control Over Networks", 17th International Symposium on Mathematical Theory of Networks and Systems, Kyoto, Japan* .
- Leven, J., Burschka, D., Kumar, R. & Zhang, G. [2005], ‘Da vinci canavas: A telerobotic surgical system with integrated, robot assisted, laproscopic ultrasound capability’, *LNCS 3749, Springer-Verlag Berlin* pp. 811–818.
- Li, Y., Chen, C. S., Song, Y.-Q. & Wang, Z. [2007], ‘Real time qos suport in wireless sensor networks: A survey’, *7th IFAC International Conference on Fieldbuses & Networks in Industrial & Embedded Systems - FeT'2007, France* .
- Li, Z., Wang, W. & Jiang, Y. [2009], ‘Managing quality-of-control and requirement-of-bandwidth in networked control systems via fuzzy bandwidth scheduling’, *International Journal of Control, Automation, and Systems* **7(2)**, 289–296.
- Liberatore, V. [2006], ‘Integrated play back, sensing, and networked control’, *25th IEEE International Conference on Computer Communications, INFOCOM 06* .
- Liberzon, D. & Morse, A. [1999], ‘Basic problems in stability and design of switched systems’, *IEEE Control Systems Magazine* **19**, 59–70.
- Lin, Y. & Hsu, Y. [2000], ‘Multihop cellular: A new architecture for wireless communication’, *IEEE INFOCOM* p. 1273–1282.
- Liu, B., Liu, Z. & Towsley, D. [2003], ‘On the capacity of hybrid wireless networks’, *IEEE Infocom* .
- Liu, X. & Goldsmith, A. [2004], ‘Wireless medium access control in networked control systems’, *Proceedings of the 2004 American Control Conference (ACC-04)* pp. 3605–3610.
- Lozano, R., Chopra, N. & Spong, M. [2002], ‘Passivation of force reflecting bilateral teleoperators with time varying delay’, *Journal of Mechatronics Engineering* pp. 24–26.
- Luo, H., Ramjee, R., Sinha, P., Li, L. E. & Lu, S. [2003], ‘Ucan: A unified cellular and ad hoc network architecture’, *ACM Mobicom* .
- Mackay, S., Wright, E. & Park, J. [2003], *Practical Data Communication for Instrumentation and Control*, Elsevier.
- Maimone, M. W., Leger, P. C. & Biesiadecki, J. J. [2007], ‘Overview of the mars exploration rover’s autonomous mobility and vision capabilities’, *IEEE International Conference on Robotics and Automation (ICRA) Space Robotics Workshop, Roma, Italy* .

Bibliography

- Majima, S. & Matsushima, K. [1991], ‘On a micro-manipulator for medical application- stability consideration of its bilateral controller’, *Mechatronics* **1**, 293–309.
- Malysz, P. & Sirouspour, S. [2009], ‘Dual master teleoperation control of kinematically redundant robotic slave manipulators’, *IEEE/RSJ international conference on intelligent robots and systems* pp. 5115–5120.
- Marchese, M. [2007], *QoS Over Heterogeneous Networks*, Wiley.
- Marescaux, J., Leroy, J., Rubino, F., Vix, M., Simone, M. & Mutter, D. [2002], ‘Transcontinental Robot Assisted Remote Telesurgery: Feasibility and Potential Applications’, *Annals of Surgery* pp. 235–487.
- Marshall, J. [1992], *Time-delay systems: Stability and Performance Criteria with Applications*, Ellis Horwood Limited, Chichester, England.
- Marti, P., Fuertes, J., Fohler, G. & Ramamritham, K. [2002], ‘Improving quality-of-control using flexible timing constraints: metric and scheduling’, *23rd IEEE Real-Time Systems Symposium, RTSS 2002* pp. 91–100.
- Marti, P., Yez, J., Velasco, M. & Fuertes, J. M. [2004], ‘Managing quality of control in network based control systems by controller and message scheduling co- \tilde{U} design’, *IEEE transactions on Industrial Electronics* **51**.
- Mathis, M., Semke, J., Mahdavi, J. & Ott, T. [July 1997], ‘The macroscopic behavior of the tcp congestion avoidance algorithm’, *ACM SIGCOMM Computer Communication Review* **3**, 67–82.
- Mathworks [2009], *System Identification toolbox, User’s Manual (Matlab 7.1)*, Mathworks Inc.
- McGovern, D. [1990], Experiences and results in teleoperation of land vehicles, Technical report, Sandia Nat Lab, Albuquerque, NM.
- Mechraoui, A., Khan, Z. H., Thiriet, J. & Gentil, S. [2009], ‘Co-design for wireless networked control of an intelligent mobile robot’, *International Conference on Informatics in Control, Automation and Robotics (ICINCO), Milan, Italy* .
- Mendel, J. [1995], ‘Fuzzy logic systems for engineering: a tutorial’, *Proceedings of the IEEE* **83**, 345–377.
- Michaut, F. & Lepage, F. [2002], ‘An architecture for application adaptation based on qos monitoring’, *IEEE International Conference on Systems, Man and Cybernetics* **2**, 273–278.
- Microsystems, S. [1999], ‘Java media framework api guide’.
- Miller, D. E. & Davison, E. J. [1989], ‘An adaptive controller which provides lyapunov stability’, *IEEE Transactions on Automatic Control* **34**, 599–609.
- Miller, J. [2008], ‘Vehicle-to-vehicle-to-infrastructure (v2v2i) intelligent transportation system architecture’, *IEEE 4th Intelligent Vehicles Symposium, Eindhoven, The Netherlands* .
- Miller, M. J., List, W. D. & Vaidya, N. H. [2003], ‘A hybrid network implementation to extend infrastructure reach’.
- Mitter, S. & Sahai, A. [1999], ‘Information and control: Witsenhausen revisited’, *Learning, Control and Hybrid Systems* pp. 281–293.
- Mogul, J. [n.d.], ‘Broadcasting internet datagrams’.

Bibliography

- Mukherjee, S., Osuna, E. & Girosi, F. [1997], 'Nonlinear prediction of chaotic time series using support vector machine'.
- Mulder, M. [2006], Stability in haptic teleoperation - literature review, Technical report, TU Delft - Mechanical Engineering - Biomechanical Design.
- Muller, D. & Werner, M. [2009], 'Communication protocols for real-time systems: Time vs. events revisited', *30th IFAC workshop on Real-Time Programming and 4th international workshop on Real Time Software, Poland* pp. 139–144.
- Munaretto, A., Badis, H., Al-Agha, K. & Pujolle, G. [September 2002], 'A link state qos routing protocol for adhoc networks', *IEEE MWCN 02, International Workshop on Mobile and Wireless Communications Networks, Sweden* .
- Munir, S. A., Bin, Y., Biao, R. & Jian, M. [2007], 'Fuzzy logic based congestion estimation for qos in wireless sensor network', *IEEE International Symposium on Wireless Communications and Networking* pp. 4336 – 4341.
- Murakami, N., Ito, A., Will, J. D. & Steffen, M. [2008], 'Development of a teleoperation system for agricultural vehicles', *ELSEVIER* **63**, 81–88.
- Nagaraju, C. & Sarkar, M. [2009], 'A packet scheduling to enhance quality of service in ieee 802.16', *Proceedings of the World Congress on Engineering and Computer Science* **Vol. 1**.
- Naghshtabrizi, P. & Hespanha, J. P. [2005], 'Designing an observer based controller for a networked control system', *Proceedings of 44th IEEE Conference on Decision and Control* .
- Naimi, A. [2005], Delay and Routing in the adhoc network 802.11, PhD thesis, University of Versaille, Saint Quentin-En-Yvelines, France.
- Nair, G. N. & Evans., R. J. [1997], 'State estimation via a capacity-limited communication channel', *Proceedings of 36th Conference on Decision and Control* pp. 866–871.
- Nangopal, T., Lu, S. & Bharghavan, V. [1999], 'A unified architecture for the design and evaluation of wireless fair queuing algorithms', *ACM Mobicom99, Seattle, WA* .
- Nguyen, X., Juanole, G., Mouney, G. & Calmettes, C. [2009], Ncs on a network CAN: on the QoS and QoC provided by different message scheduling schemes based on hybrid prioritites, Technical report, LAAS Nř09406, Toulouse, France.
- Niculescu, S. I. [2001], *Delay Effects on Stability, A Robust Control Approach*, Springer Verlag, New York.
- Niemeyer, G. [1996], Using Wave Variables in Time Delayed Force Reflecting Teleoperation, PhD thesis, Departement of Aeronautics and Astronautics, MIT.
- Niemeyer, G. & Slotine, J. [2004], 'Telemanipulation with time delays', *International Journal of Robot Research* **23**, 873–890.
- Niemeyer, G. & Slotine., J. E. [1998], 'Towards force reflecting teleoperation over the internet', *IEEE International Conference on Robotics and Automation* pp. 1909–1915.
- Niemeyer, G. & Slotine, J. J. E. [1991], 'Stable adaptive teleoperation', *IEEE Journal of Oceanic Engineering* **16**, 152–162.
- Nuno, E., Basanez, L. & Ortega, R. [2007], 'Passive bilateral teleoperation framework for assisted robotic tasks', *IEEE International Conference on Robotics and Automation, Rome, Italy* .

Bibliography

- Nuno, E., Basanez, L. & Prada, M. [2009], ‘Asymptotic stability of teleoperators with variable time delays’, *IEEE Conference on Robotics and Automation* pp. 4332–4335.
- Nuno, E., Ortega, R. & Basanez, L. [2010], ‘An adaptive controller for nonlinear teleoperators’, *Automatica* **46**, 155–159.
- Nusairat, A., Li, X.-Y. & Makki, S. K. [2008], *Sensors and Adhoc Networks*, Springer, chapter Heterogeneous Wireless Networks: QoS-Aware Integration Architecture, pp. 123–146.
- Oboe, R. & Fiorini, P. [1997], ‘Issues on internet based teleoperation’, *Syroco* pp. 611–617.
- Ortega, R., Chopra, N. & Spong, M. [2003], ‘A new passivity formulation for bilateral teleoperation with time delays’, *Proceedings of CNRS-NSF Workshop: Advances in time delay systems, La defense, Paris*.
- Ouferhat, N. & Mellouk, A. [2010], ‘Inductive routing based on energy and delay metrics in wireless sensor networks’, *IWCMC* pp. 1121–1125.
- Park, K. I. [2005], *QoS in Packet Networks*, Springer.
- Park, S., Kim, K., Kim, D. C., Choi, S. & Hong, S. [2003], ‘Collaborative qos architecture between diffserv and 802.11e wireless lan’, *The 57th IEEE Semiannual Vehicular Technology Conference* **2**, 945–949.
- Partan, J., Kurose, J. & Levine, B. N. [2006], ‘A survey of practical issues in underwater networks’, *International Conference on Mobile Computing and Networking, Proceedings of Ist ACM international workshop on Underwater networks (WUWNet 06)* pp. 17–24.
- Partridge, C., Mendez, T. & Milliken, W. [1993], ‘Host anycasting service’.
- Perahia, E. [2008], ‘Ieee 802.11n development: History, process, and technology’, *Communications Magazine, IEEE* **46**(7), 48–55.
- Pirmez, L., Delicato, F. C., Pires, P., Mostardinha, A. & de Rezende, N. [2007], ‘Applying fuzzy logic for decision-making on wireless sensor networks’, *IEEE International Symposium on Fuzzy Systems* p. 156.
- Pollard, A., von Hafen, J., Dottling, M., Schultz, D., Pabst, R. & Zimmerman, E. [2006], ‘Winner - towards ubiquitous wireless access’, **1**, 42–46.
- Prado, J. D. & Choi, S. [2003], ‘Link adaptation strategy for ieee 802.11 wlan via received signal strength measurement’, *International Conference on Communication ICC-03* pp. 1108–1113.
- Prokkola, J. & Hanski, M. [2005], Qos measurement methods and tools, Technical report, Thales.
- Pubill, D. & Perez-Neira, A. I. [2006], ‘Handoff optimization with fuzzy logic in 802.11 networks’.
- Quaritsch, M., Kruggl, K., Wischounig-Struel, D., Bhattacharya, S., Shah, M. & Rinner, B. [2010], ‘Networked uavs as aerial sensor network for disaster management applications’, *Elektrotechnik & Informationstechnik* **127/3**.
- Quazi, A. & Konard, W. [1982], ‘Underwater acoustic communications’, *IEEE Communication Magazine* pp. 24–29.
- Rackley, S. [2007], *Wireless Networking Technology: From Principles to Successful Implementation*, Elsevier.

Bibliography

- Roberts, R. A. & Mullis, C. T. [1987], *Digital Signal Processing*, Addison-Wesley, Reading, MA.
- Robotics, O. [2001], *Standardized Teleoperation System (STS)*, OMNITECH Robotics, 2640 South Raritan Circle Englewood, Colorado, 80110.
- Ryu, J. H., Preusche, C., Hannaford, B. & Hirzinger, G. [2005], 'Time domain passivity control with reference energy following', *IEEE Transactions on System Technology* **13**.
- Salamah, M. & Lababidi, H. [2001], 'Fbllb: a fuzzy-based traffic policing mechanism for atm networks', *ACS/IEEE International Conference* **3**, 31–35.
- Salcudean, S. E. & Yan, J. [1994], 'Towards a force reflecting motion scaling system for microsurgery', *IEEE conference on robotics and automation* pp. 2296–2301.
- Salcudean, S. E., Zhu, M., Zhu, W.-H. & Hashtrudi-Zaad, K. [2000], 'Transparent bilateral teleoperation under position and rate control', *International Journal of Robotics Research* **19**, 1185–1202.
- Salvucci, D. D., Boer, E. R. & Liu, A. [2001], 'Towards an integrated model of driver behaviour in cognitive architecture', *Transportation research record 1779, Paper no. 01-2869* pp. 9–16.
- Samsudin, R., Shabri, A. & Saad, P. [2010], 'A comparison of time series forecasting using support vector machine and artificial neural network model', *Journal of Applied Science* **10**, 950–958.
- Sano, A., Fujimura, H. & Tanaka, M. [1998], 'Gain schedules compensation for time delay of bilateral teleoperation systems', *IEEE International Conference on Robotics and Automation* pp. 1916–1923.
- Santi, P. [2008], *Topology Control in Wireless Ad Hoc and Sensor Networks*, Wiley.
- Sarkimaki, V., Tiainen, R., Ahola, J. & Lindh, T. [2005], 'Wireless technologies in condition monitoring and remote diagnosis of electric drives; requirements and applications', *European Conference on Power Electronics and Applications* p. 101–105.
- Schiffbauer, W. H. [1986], 'An intelligent remotely operated controller for mining machines', *Third Conference Use Comput Coal Industry* pp. 27–30.
- Schulzrinne, H. & Casner, S. [July 2003], 'Rtp profile for audio and video conferences with minimal control, rfc 3551'.
- Schulzrinne, H., Casner, S., Frederick, R. & Jacobson, V. [2003], 'Rtp: A transport protocol for realtime applications (rfc 3550)'.
- Schwartz, M. [1988], *Telecommunication Networks*, Addison-Wesley, Reading, Massachusetts, USA.
- Seitz, N. B. [1994], 'User-oriented measures of telecommunication quality', *IEEE Communications Magazine*.
- Sheridan, T. [1992a], 'Musings on telepresence and virtual presence', *Presence* **1**, 120–125.
- Sheridan, T. [1993], 'Space teleoperation through time delay: Review and prognosis', *IEEE Transactions on Robotics and Automation* **9** (5), 592–606.
- Sheridan, T. B. [1992b], *Telerobotics, automation, and human supervisory control*, MIT Press.
- Shiratsuchi, K., Kawata, K., Poorten, E. & Yokokohji, Y. [2007], 'Design and evaluation of a telepresence vision system for manipulation tasks', *IEEE International Conference on Robotics and Automation* pp. 4313–4318.
- Siljak, D. D. [1991], *Decentralized Control of Complex Systems*, Academic Press, Boston.

Bibliography

- Silmane, J. B., Song, Y.-Q., Koubâa, A. & Firkha, M. [2009], ‘Three tiered architecture for large scale wireless hospital sensor network’, *2nd International Joint conference on Biomedical Engineering Systems and Technologies, Portugal* .
- Simek, M., Mica, I., Kacalek, J. & Burget, R. [2007], ‘Bandwidth efficiency of wireless networks of wlan, wlan, wman and wwan’, *elektrorevue* .
- Singh, B. & Tepe, K. [2009], ‘Feedback based real-time mac (rt-mac) protocol for wireless sensor networks’, *Global Telecommunications Conference, 2009. GLOBECOM 2009. IEEE* pp. 1–6.
- Singh, J. & Pesch, D. [2010], ‘A energy efficient tdma scheduling scheme for large-scale wsan’, **6**, V6–383–V6–388.
- Siripongwutikorn, P., Banerjee, S. & Tipper, D. [2002], ‘Adaptive bandwidth control for efficient aggregate qos provisioning’, *SIGCOMM Comput. Commun. Rev.* **32**(3).
- Siripongwutikorn, P., Banerjee, S. & Tipper, D. [2003], ‘A survey of adaptive bandwidth control algorithms’, *IEEE Communication Surveys* **5**, 14–26.
- Sklar, B. [2001], *Digital Communications, Fundamentals and Applications*, Prentice Hall.
- Steinbach, E., Hirche, S., Kammerl, J., Vittorias, I. & Chaudhari, R. [2010], ‘Haptic data compression and communication for telepresence and teleaction’, *IEEE Signal Processing Magazine, Special Issue on Immersive Communications* .
- Surmann, H., Holz, D. & Blumenthal, S. [2008], ‘Teleoperated visual inspection and surveillance with unmanned ground and aerial vehicles’, *International Journal of Online Engineering* .
- Suykens, J., van Gestel, T., de Brabanter, J., de Moor, B. & Vandewalle, J. [2002], ‘Least squares support vector machines’.
- Tafazolli, R. [2006], *Technologies For the Wireless Future*, John Wiley and Sons, Ltd.
- Takai, S. & Ushio, T. [2000], ‘Reliable decentralized supervisory control of discrete event systems’, *Systems, Man, and Cybernetics, Part B: Cybernetics, IEEE Transactions on* **30**(5), 661–667.
- te Sun, M., Huang, L., Arora, A. & hwang Lai, T. [2002], ‘Reliable mac layer multicast in ieee 802.11 wireless networks’, pp. 527–536.
- Tee, C. & Lee, A. [2009], ‘Adaptive reactive routing for vanet in city environments’, *Pervasive Systems, Algorithms, and Networks (ISpan), 2009 10th International Symposium on* pp. 610–614.
- Thiem, L., Goldacker, G., Schuster, M., Luckenbach, T. & Kim, B. K. [2010], ‘Demonstration abstract: Globally interconnected wsan testbeds’, pp. 751–752.
- Thomesse, J. P. [2005], ‘Fieldbus technology in industrial automation’, *Proceedings of the IEEE* **93**, 1073–1101.
- Udwadia, F., Hosseini, M. & Chen, Y. [1996], ‘Robust control of uncertain systems with time varying delays in control input’, *American Control Conference, New Mexico* pp. 3641–3645.
- Ushio, T. & Hirai, K. [1984], ‘Chaotic rounding error in digital control systems’, *IEEE Transactions on Circuits and Systems* **34**, 133–139.
- Vannucci, G., Leigh, D. & Katz, J. [2005], ‘Wide-area long-range unidirectional sensor (walrus) network’, pp. 9 pp. –404.

Bibliography

- Vasilescu, I., Detweiler, C. & Rus, D. [2007], ‘Aquanodes: an underwater sensor network’, *International Conference on Mobile Computing and Networking, Proceedings of the second workshop on Underwater networks* pp. 85–88.
- Verdone, R. [1996], ‘Performance evaluation of r-aloha for inter-vehicle communications at millimeter waves’, *Personal, Indoor and Mobile Radio Communications, 1996. PIMRC’96., Seventh IEEE International Symposium on* **2**, 658–662 vol.2.
- Vidales, P., Patanapongpibul, L., Mapp, G. & Hopper, A. [2004], ‘Experiences with heterogeneous wireless networks, unveiling the challenges’, *Second International Working Conference on Performance Modelling and Evaluation of Heterogeneous Networks (HET-NETs04)* .
- Waharte, S. & Boutaba, R. [2005], ‘Tree based wireless mesh network architecture: Topology analysis’, *First International Workshop on Wireless Mesh Networks (MeshNets), Budapest, Hungary* .
- Wang, S. H. & Davison., E. J. [1978], ‘Minimization of transmission cost in decentralized control systems’, *International Journal of Control* **28**, 889–896.
- Wang, Z., Lu, L. & Bovik, A. C. [2004], ‘Video quality assessment based on structural distortion measurement’, *Signal Processing: Image Communication* **19**, 121–132.
- Watson, A. B. [1993], ‘Det quantization matrices visually optimized for individual images’, *Human Vision, visual processing and digital display, Proceedings SPIE* pp. 202–216.
- Webb, W. [2007], *Wireless Communications - The Future*, John Wiley & Sons.
- Weinmann, A. [2002], ‘Admissible short time uncertainty in networked control systems’, *E & I Elektrotechnik und Informationstechnik* **119**, 301–303.
- Wenjuan, J. [2009], Contribution à la commande et à l’observation des systèmes en réseaux, PhD thesis, Ecole centrale de Lille, France.
- Wilson, A. L., Lenaghan, A. & Malyan, R. [2005], ‘Optimizing wireless access network selection to maintain qos in heterogeneous wireless environments’, *Proceedings of the Wireless Personal Multimedia Communications (WPMC 05), Aalborg, Denmark* .
- Winkler, S. [2005a], ‘Digital video quality - vision models and metrics’, *John Wiley and Sons* .
- Winkler, S. [2005b], ‘Perceptual video quality metrics- a review’, *Digital Video Image Quality and Perceptual Coding* .
- Winkler, S. & Mohandas, P. [2008], ‘The evolution of video quality measurement: From psnr to hybrid metrics’, *IEEE Transactions on Broadcasting* **54**.
- Wisspeintner, T., Nowak, W. & Bredenfeld, A. [2006], ‘Volksbot- a flexible component based mobile robot system’, *RoboCup 2005: Robot Soccer World Cup IX, Springer Berlin Heidelberg* **4020**, 716–723.
- Wolf, S. & Pinson, M. [2002], Video quality measurement techniques, Technical report, National Telecommunication and Information Administration.
- Wong, C.-C., Wang, W.-W., Lee, Y.-L. & Wu, C.-H. [2005], ‘Remote controlled game platform by usb joysticks’, *IEEE International Conference on Mechatronics* pp. 136–139.
- Wong, W. S. & Brockett, R. W. [1999], ‘Systems with finite communication bandwidth constraints ii: Stabilization with limited information feedback’, *IEEE Transactions on Automatic Control* **44**, 1049–1053.

- WorldFIP, Meudon-la-Forêt, F. [1998], ‘The FIP protocol’.
- Wu, H., Qiao, C., De, S. & Tonguz, O. [2001], ‘An integrated cellular and ad hoc relaying system: icar’, *IEEE Journal on Selected Areas in Communications* **19**, 2105–2115.
- Wu, X., Chan, S. & Mukherjee, B. [2000], ‘Madf: A novel approach to add an ad hoc overlay on a fixed cellular infrastructure’, *IEEE WCNC*.
- Wu, X.-X., Mukerjee, B. & Chan, S.-H. G. [2000], ‘Maca – an efficient channel allocation scheme in cellular networks’, *IEEE Global Telecommunications Conference (Globecom 00)* **3**, 1385–1389.
- Xia, F. [2008], ‘Qos challenges and opportunities in wireless sensor/actuator networks’, *Sensors* **8**, 1099–1110.
- Xia, F., Li, S. & Sun, Y. [2005], ‘Neural network based feedback scheduler for networked control system with flexible workload’, *Lecture Notes in Computer Science, Springer-Verlag, Berlin* **3611**, 242–251.
- Xie, J. [2009], Optimal control of chaotic system based on ls-svm with mixed kernel, Vol. 1, pp. 622–625.
- Xu, L. [1994], Theories for unsupervised learning: Pca and its nonlinear extensions, Vol. 2, pp. 1252a, 1253–1257 vol.2.
- Yamano, I., Takemura, K., Endo, K. & Maeno, T. [2002], ‘Method for controlling master slave robots using switching and elastic elements’, *Proceedings of the IEEE International Conference on Robotics and Automation, Washington DC* pp. 1717–1722.
- Yang, L., Chao, Z., Jianhua, L. & Xiaokang, L. [2007], ‘A mac queue aggregation scheme for voip transmission in wlan’, *IEEE Wireless Communications and Networking Conference, WCNC07* pp. 2121–2125.
- Yang, L., Huan, Z. & Wang, W. [2005], ‘Fuzzy logic based handover in MC-CDMA system’.
- Yang, S. & Cao, Y. [2008], ‘Networked control systems and wireless sensor networks: theories and applications’, *International Journal of Systems Science, Special Issue: Networked Control Systems and Wireless Sensor Networks* **39**, 1041–1044.
- Yang, X., Liu, L., N.H., V. & Zhao, F. [2004], ‘A vehicle-to-vehicle communication protocol for cooperative collision warning’, *The First Annual International Conference on Mobile and Ubiquitous Systems: Networking and Services, MOBIQUITOUS 04* p. 114–123.
- Ye, F., Sheu, S. T., Chen, T. & Chen, J. [2006], ‘The impact of rts threshold on ieee 802.11 MAC protocol’, *Tamkang Journal of Science and Engineering* **6**, 57–63.
- Yokokohji, Y., Imaida, T. & Iida, Y. [2001], ‘Bilateral teleoperation: Towards fine manipulation with large time delay’, *Springer-Verlag Berlin*.
- Yokokohji, Y., Imaida, T. & Yoshikawa, T. [1999], ‘Bilateral teleoperation under time varying communication delay’, *Proceedings of IEEE International Conference on Intelligent Robots and Systems* pp. 1854–1859.
- Yokokohji, Y., Tsujioka, T. & Yoshikawa, T. [2002], ‘Bilateral control with time-varying delay including communication blackout’, pp. 285–273.
- Yokokohji, Y. & Yoshikawa, T. [1994], ‘Bilateral control for master-slave manipulators for ideal kinesthetic coupling - formulation and experiment’, *IEEE Transactions on Robotics and Automation* pp. 605–620.

Bibliography

- Yook, J. K., Tilbury, D. M. & Soparkar, N. R. [2001], 'A design methodology for distributed control systems to optimize performance in the presence of time delays', *International Journal of Control* **74**, 58–76.
- Zadeh, L. A. [1983], 'A computational approach to fuzzy quantifiers in natural languages', *Computers and Mathematics* **9**, 149 – 184.
- Zadeh, L. A. [2002], *Fuzzy Logic Toolbox, User Guide*, Mathworks Inc.
- Zampieri, S. [2008], 'Trends in networked control systems', *17th IFAC World Congress, Seoul, Korea* pp. 2886–2894.
- Zhang, R. & Phillis, Y. [2001], 'Admission control and scheduling in simple series parallel networks using fuzzy logic', *IEEE Transactions on Fuzzy Systems* **9**, 307–314.
- Zhang, W. [2001], *Stability Analysis of Networked Control Systems*, PhD thesis, Dept. of Electrical Engineering and Computer Science, Case Western Reserve University.
- Zhang, Y., Feng, W. & Hurley, R. [2006], 'Integration of qos queuing schedules to qos caching schemes', *Computer and Information Science, 2006 and 2006 1st IEEE/ACIS International Workshop on Component-Based Software Engineering, Software Architecture and Reuse. ICIS-COMSAR 2006. 5th IEEE/ACIS International Conference on* pp. 479–484.
- Zhao, J. & Hill, D. J. [2008], 'Passivity and stability of switched systems: A multiple storage function method', *Systems and Control Letters* **57**, 158–164.
- Zhu, M. & Salcudean, S. [1995], 'Achieving transparency for teleoperator systems under position and rate control', *IEEE International Conference On Robotics and Automation* pp. 7–12.
- Zhu, X. [2005], 'Semi-supervised learning literature survey', (1530).
- Ziegler, J. G. & Nichols, N. [1942], 'Optimum settings for automatic controllers', *ASME Transactions* **64**, 759–768.

Appendix A

NeCS-Car Parameters

The NeCS-Car parameters used in the simulation are as follows:

Parameter	Symbol	Value
Master Inertia	M_m	0.0284 $N.m.s^2/rad$
Master Damping	B_m	0.0817 $N.m.s/rad$
Gearbox and Wheel Inertia	$M_{GB} + M_{WH}$	1.25 $N.m.s^2/rad$
Gearbox and Wheel Damping	$B_{GB} + B_{WH}$	1.82 $N.m.s/rad$
Wheel Damping	B_{WH}	1.07 $N.m.s/rad$
Gearbox Damping	B_{GB}	0.75 $N.m.s/rad$
Wheel Inertia	M_{WH}	0.1 $N.m.s^2/rad$
Gearbox Inertia	M_{GB}	1.15 $N.m.s^2/rad$
Slave Inertia	M_{s1}	3.25 $N.m^2/rad$
Positive Constant	b	8 $N.m.s/rad$
Variable Master Damping	b_m	3 $N.m.s/rad$
Control Gain	K	50
Reversibility Controller (Gain)	K_p	9.8
Reversibility Controller (Time Constant)	T_i	0.43
Viscous Friction 1	B_{s1}	5.6833 $N.m.s/rad$
Viscous Friction 2	B_{s2}	9 $N.m.s/rad$
Slave Damping 2	B_{s2m}	3 $N.m.s/rad$

Appendix B

Estimation of worst case M_s and Bs_2

From the relation:

$$F_e + T_s = Ms\ddot{x}_s + Bs_2\dot{x}_s \quad (\text{B.0.1})$$

We can write the transfer function as:

$$\frac{V_s}{\tau_s} = \frac{1}{Ms p + Bs_2} = \frac{\frac{1}{Bs_2}}{\frac{Ms}{Bs_2} p + 1}$$

$M_s = 0.1191$, $K = \frac{3.8}{5} = 0.76 = \frac{1}{Bs_2}$ implies $Bs_2 = 1.3134$ which gives , $p_s = -0.0907 \text{rad/sec}$

Settling time $t_s = 3*\tau = 32.978 - 32.706 = 0.272$. $\tau = 90.7 \text{ ms}$

$$M_s = \tau.Bs_2 = 90.7.10^{-3} * 1.3134 = 0.1197 \text{N.m/rd/s}^2 \quad (\text{B.0.2})$$

$$\hat{F}_e = Ms\ddot{x}_s + Bs_2\dot{x}_s - \tau_s \quad (\text{B.0.3})$$

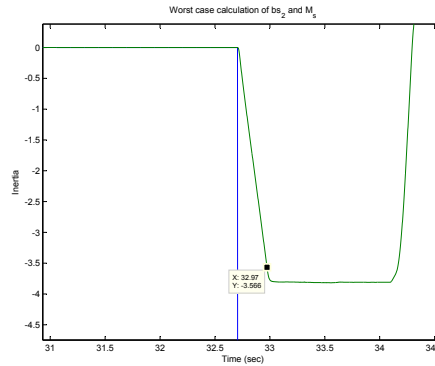

Figure B.1: Worst case approximation of M_s and Bs_2 (without wheels)

Appendix C

Identification of TF

System identification is an experimental approach to determine the transfer function for the dynamic system by using an enriched signal. By enriched signal, it is meant to include all frequencies with sufficient magnitude in order to excite all modes of the system. A PRBS is an ideal signal in such applications which is a deterministic and periodic sequence ($T = N \cdot \Delta t$) of length N (integer) that switches between two levels e.g. $+l$ and $-l$. A PRBS has similar properties as that of white noise but it is not truly random as the sequence repeats itself every $2^n - 1$ bit intervals for an n -bit shift register [Mathworks, 2009].

Pre-processing

After an appropriate PRBS is applied to the system, the output is captured and transformed in *idobject* to be further processed with matlab system identification toolbox graphical user interface (GUI). The data object is preprocessed to remove means and trends in order to fit an accurate model.

Model Structure Selection

We only consider parametric models in our work. The model structure determines the input to output mapping. The complexity of the model structure affects the accuracy with which the model can approximate the real process. The general parametric model structure used in the System identification toolbox is given as:

$$A(q)y(t) = \frac{B(q)}{F(q)}u(t - n_k) + \frac{C(q)}{D(q)}e(t) \quad (\text{C.0.1})$$

where y and u are the output and input sequences respectively, and e is the white noise sequence with zero mean value. The polynomials A, B, C, D, F are defined in terms of backward shift operator as:

$$\begin{aligned} A(q) &= 1 + a_1q^{-1} + \dots + a_naq^{-na} \\ B(q) &= b_1 + b_2q^{-1} + \dots + b_n bq^{-nb+1} \\ C(q) &= 1 + c_1q^{-1} + \dots + c_n cq^{-nc} \end{aligned}$$

$$\begin{aligned} D(q) &= 1 + d_1q^{-1} + \dots + d_{nd}q^{-nd} \\ F(q) &= 1 + f_1q^{-1} + \dots + f_{nf}q^{-nf} \end{aligned} \tag{C.0.2}$$

The choice of model structure results in

- AR Model $A(q)y(t) = e(t)$ which is a time series model without any exogenous input (u).
- ARX Model $A(q)y(t) = B(q)u(t - n_k) + e(t)$
- ARMAX Model $A(q)y(t) = B(q)u(t - n_k) + C(q)e(t)$
- OE Model $y(t) = \frac{B(q)}{F(q)}u(t - n_k) + e(t)$
- BJ Model $y(t) = \frac{B(q)}{F(q)}u(t - n_k) + \frac{C(q)}{D(q)}e(t)$

This choice of model is dependent on the noise sequence w.r.t its estimation as faithfully as possible.

Model Estimation

The model estimation using system identification toolbox of Matlab aims to find a parametric model in terms of input output relationship. Linear model estimation requires no prior model structure and it is found by correlation or spectral analysis. For parametric model, a model structure and order is required. After a successful choice, model reduction techniques (e.g. balanced state space realization) are used for less computational complexity. The model polynomial coefficients which have a low magnitude order, can be discarded easily.

Model Validation

A part of the data set is conserved for the validity test later on. Model validation is performed by frequency domain analysis and residual analysis. Ideally, the residuals should be white and independent of the input signal. If this is not the case, the model order, structure or the length of the data sequence should be revised. The residual tests can be done in several ways. For example, autocorrelation test, cross correlation between the residuals and the input or the distribution of residual zero crossings. These tests give an indication whether the identified model captures the dominating dynamics of the true system or not. Cross validation test considers the correspondence between the simulated and the measured output.

Appendix D

Reversibility Improvement in NeCS-Car

It is important to improve the reversibility of the system so that applied force on the steering will generate sufficient torque to move the wheels in the steer by wire system. We consider the transfer function of the transparenance at the slave side which is equal to the ratio between the measured force and the command T_s on the slave as shown in the Fig. D.1.

We take the model as:

$$\frac{X_s}{T_s} = \frac{1}{s.(J_{s1} + B_{s1})} \quad (D.0.1)$$

$$Z_e = \frac{F_{em}}{X_s} = s.(J_{e1}.s + B_{e1})$$

PI Controller design

A simple PI regulator is proposed to improve the reversibility of the torque motor. The controller is given as:

$$K_p * (1 + \frac{1}{s.T_i}) \quad (D.0.2)$$

where, K_p and T_i are the controller gains, Z_e is the impedance of the environment, J_{e1} is the total inertia of the system, wheels and environment, while B_{e1} is the total friction of the system.

$$J_{e1} = J_{vehicle} + J_{environment} \quad (D.0.3)$$

$$B_{e1} = B_{vehicle} + B_{environment}$$

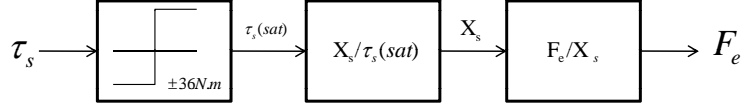
 Figure D.1: Identification of transfer function F_e/T_s

For slave, J_{s1} and B_{s1} are defined as:

$$J_{s1} = J_{motor} + J_{environment} \quad (D.0.4)$$

$$B_{s1} = B_{motor} + B_{environment}$$

The transfer function of the system with PI controller is thus:

$$\frac{F_e}{T_s} = \frac{(T_i \cdot J_{e1} \cdot K_p) \cdot s^2 + K_p \cdot (J_{e1} + T_i \cdot B_{e1}) \cdot s + K_p \cdot B_{e1}}{(T_i \cdot J_{e1} \cdot K_p + J_{s1} \cdot T_i) \cdot s^2 + (T_i \cdot B_{s1} + K_p \cdot (J_{e1} + T_i \cdot B_{e1})) \cdot s + K_p \cdot B_{e1}} \quad (D.0.5)$$

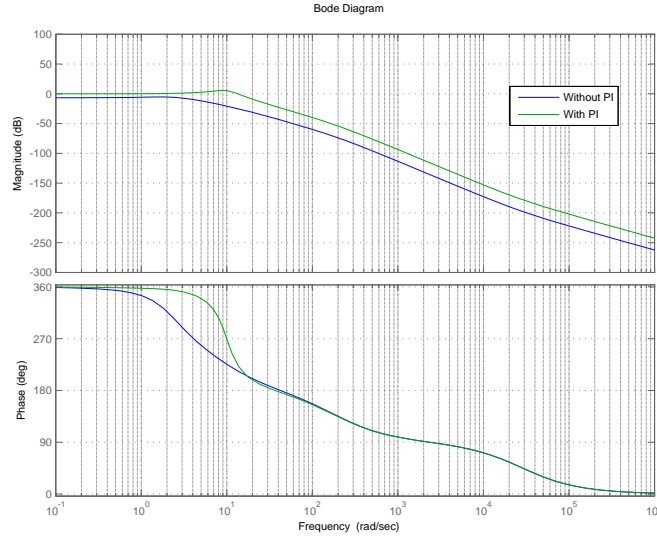
 Figure D.2: PI controller for reversibility improvement ($K_p = 9.8$, $T_i = 0.43$)

We conclude that the cutoff frequency increases when T_i is reduced and that attenuation decreases with the increase in the K_p . Now, adding PI into the system, the Bode diagram of the transfer function $\frac{F_e}{T_s}$ with and without PI is compared in Fig. D.2.

This Bode plot gives a greater cutoff frequency (hence a larger bandwidth) and also a greater trans-
 parence margin. Practically, with the frequency injection to the platform by using a series of sinusoidal
 of 0.5 rad/sec to 40 rad/sec results in the response as shown in Fig. D.3. We conclude that the model
 used above is sufficient as the simulation results and the practical response are quite close.

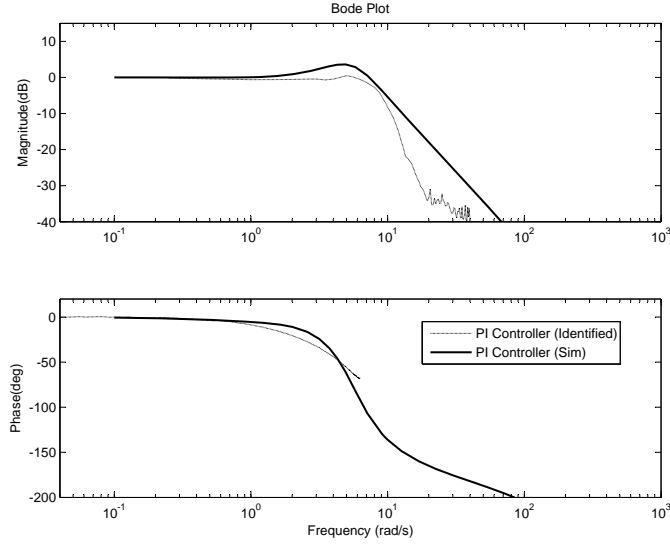

Figure D.3: Comparison of simulated and practical frequency response

Improved Modeling

In this approach we have identified the transfer function of the measured force F_e on the position X_s and that of the position X_s on the command T_s at the slave side.

Identification of the transfer function $\frac{F_e}{X_s}$: This identification is obtained by ARMAX method. We find a signal at 53,96% of the confidence interval as compared to the signal F_{em} measured and a transfer function identified as:

$$\frac{F_e}{X_s} = \frac{4418s + 8163}{s^2 + 194s + 1762} \quad (D.0.6)$$

Identification of the transfer function $\frac{X_s}{T_s}$: This identification is used by utilizing the method ARMAX, which permits us to identify a signal X_s with a confidence interval of 58,3% with respect to the signal X_s already measured and the simplified transfer function identified is given as:

$$\frac{X_s}{T_s} = \frac{0.4889}{s^2 + 2.038s + 3.009} \quad (D.0.7)$$

The required transfer function $\frac{F_{em}}{X_s}$ is therefore the product of the two transfer functions. For $K_p = 9.8$ and $T_i = 4.3$, this gives us the modified response and justifies the use of PI controller for the reversibility of the system.

Robust Control for reversibility improvement

A robust controller is proposed for improved reversibility. The objective is to ensure that the input sensitivity function (Sup) should be small in medium and high frequencies. The robust loop shaping design approach is used here with the objective of adding controllers and gain to shape the loop function

Appendix D. Reversibility Improvement in NeCS-Car

steeply in the low frequency region $\omega \ll \omega_0$ (i.e. maximizing the sensitivity function S), and limiting the slope to -20 dB/decade around the crossover point $\omega \approx \omega_0$ for stability and transient response. This provides a good phase margin. By shaping the loop function steeply in the high frequency region $\omega \gg \omega_0$ to minimize the complementary sensitivity function T avoid problems with uncertainties.

In Fig. D.4, the robust loop shaping design bounds are shown. The bounds show the open loop and the target loop shape.

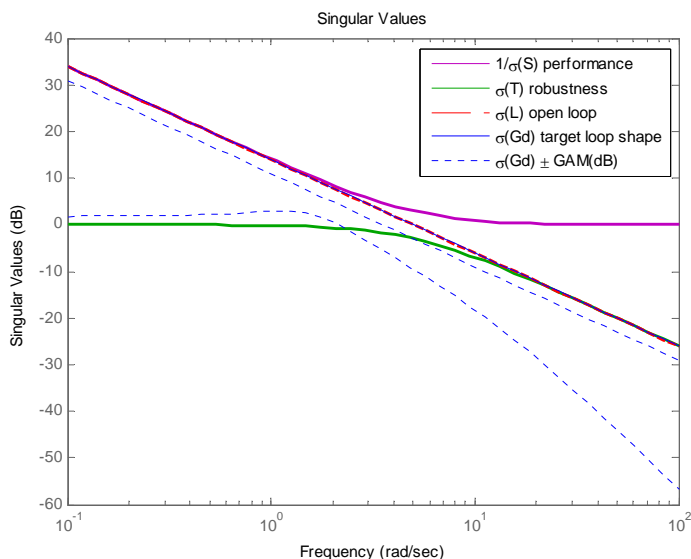

Figure D.4: Robust loop Shaping Design Bounds

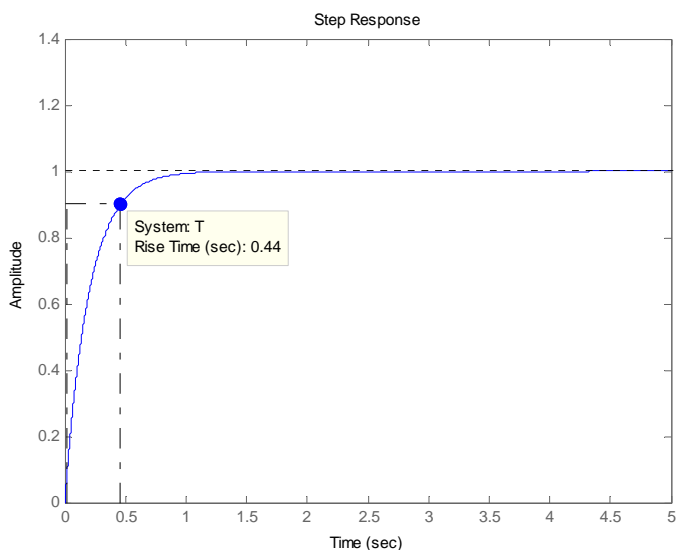

Figure D.5: Step Response with the Robust Controller

By respecting these bounds the robust controller obtained has the step response as shown in Fig. D.5 with a rise time $t_r = 0.4$ sec. The 8th order controller obtained should be reduced to a lower order equivalent by observing the Hankel norm in Fig. D.6. It can be noted that the 4th order controller is

Appendix D. Reversibility Improvement in NeCS-Car

sufficient as the energy modes are well included in it. The response comparison of full and reduced order controllers is shown in Fig. D.7.

The robust controller obtained is given as:

$$G_{robust} = \frac{2.794 * 10^8 s^3 + 54.27 s^2 + 5.027 * 10^{11} s + 6.982 * 10^{11}}{s^4 + 1.179 * 10^4 + s^3 4.634 * 10^7 s^2 + 6.102 * 10^{10} s + 1575} \quad (D.0.8)$$

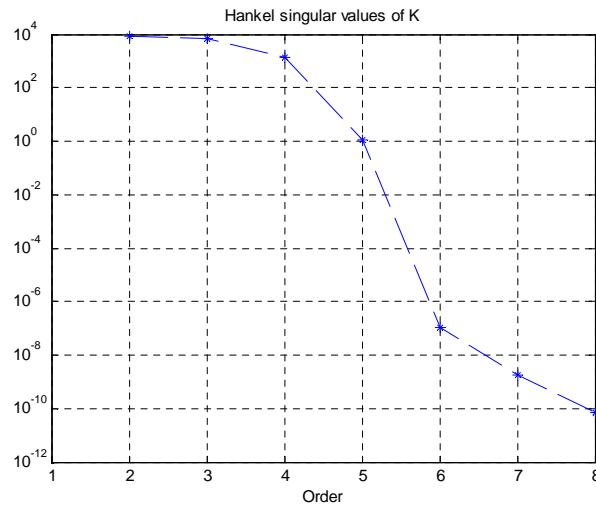

Figure D.6: Singular Values of K and $K - K_r$

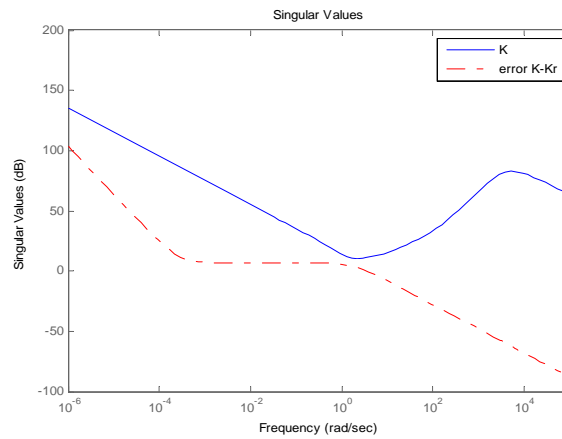

Figure D.7: Response with full order and reduced order controller

Appendix E

Introduction to Fuzzy Inference

A fuzzy logic inference engine has the advantage of preserving the simplicity of rule-based logic, while handling unreliable and imprecise numeric information from the sensor. Fuzzy logic systems are in general non-linear input-output mappings [Mendel, 1995].

The four step fuzzy process can be described as follows:

Fuzzifier: The fuzzifier maps the crisp inputs into set of certainties (fuzzy sets) by using the membership functions.

Rule Base: The fuzzified values activate the rules, which are provided by experts or extracted from numerical data. The rules are expressed as a set of IF-THEN rules used to decide outcome. It is designer dependent whereas different conclusions can be drawn from the same data. For n fuzzy input variables and m fuzzy sets for each fuzzy variables, the maximum possible number of rules in the rule base is m^n .

Fuzzy Inference: The fuzzy inference engine combines the rules to obtain an aggregated fuzzy output. It determines which rules from the IF-THEN rules apply and which conclusions are drawn based on rules.

Defuzzifier: The defuzzifier maps the fuzzy output into a quantitative (crisp) number which is the union of fuzzy sets that can be used for making decisions or control actions.

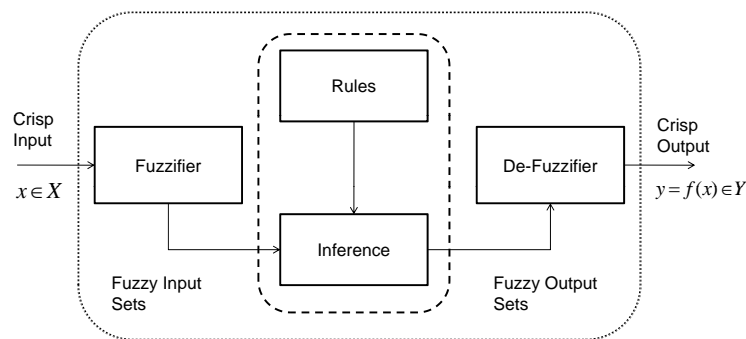

Figure E.1: Fuzzy logic Control Sequence

Appendix E. Introduction to Fuzzy Inference

Fuzzy inference system (FIS) operate with fuzzy sets, which extend the ordinary notion of crisp sets. A fuzzy set F is characterized by a membership function $\mu_F(x)$, which gives the degree of similarity of x to F . Thus FIS is capable of approximating any continuous function with an arbitrary bound B . In engineering, the most widely used are the rule-based FIS. Mamdani and Sugeno are two mostly used inference methods in Fuzzy logic. Mamdani method is widely accepted for capturing the expert knowledge as it allows to describe the expertise in more intuitive, more human-like manner. However, Mamdani-type fuzzy inference entails a substantial computational burden. On the other hand, Sugeno method is computationally effective and works well with optimization and adaptive techniques, which makes it very attractive in control problems, particularly for dynamic nonlinear systems.

Fuzzy logic offers the possibility to transfer the expressions of the human language into mathematical models in the form of linguistic if-then rules which can be applied for the control of nonlinear systems, such as mobile robots. Every rule has two parts: the antecedent part (premise), expressed by *If* and the consequent part, expressed by *then*. The general form of a linguistic if-then rule is: *If a set of conditions is satisfied then a set of consequences can be inferred*. The antecedent part is the description of the state of the system which is used to activate one rule, while the consequent part is the action that the operator who controls the system must take. The process states and control variables are called linguistic variables. A linguistic variable can take several linguistic values. For example, the linguistic variable temperature can be labeled as: POSITIVE BIG (PB), POSITIVE MEDIUM (PM), etc. These linguistic values are expressed by continuous functions, called membership functions (MFs) which represent fuzzy sets. Each membership functions is defined by two parameters namely, its center and width [Zadeh, 2002].

A fuzzy controller is composed of four principal modules as shown in Fig. E.1. The fuzzification interface performs the transformation of crisp values into fuzzy sets. The knowledge base supplies the fuzzification module, the inference engine, and the defuzzification interface with necessary information (parameters of membership functions and rules) for their proper functioning. The decision making unit, or inference engine, computes the meaning of the set of linguistic rules. The defuzzification interface transforms the union of fuzzy sets (individual contributions of each rule in the rule base) into a crisp output.

Appendix F

Background on Support Vector Machines (SVM)

Given a training set of instance label pairs (x_i, y_i) , $i = 1, \dots, l$, where $x_i \in R^n$ and $y_i \in [1, -1]^l$, the SVM requires the solution of the optimization problem:

$$\min_{\omega, b, \xi} \frac{1}{2} w^T w + C \sum_{i=1}^l \xi_i$$

subject to $y_i(w^T \phi(x_i) + b) \geq 1 - \xi_i$ $\xi_i \geq 0$.

The training vectors x_i are mapped into a higher dimensional space by the function ϕ . The SVM algorithm finds a linear separating hyperplane with the maximal margin in this higher dimensional space. $C > 0$ is the penalty parameter of the error term. In addition, $K(x_i, x_j) \equiv \phi(x_i)^T \phi(x_j)$ is called the kernel function or covariance function. Some basic SVM kernels, frequently in use are:

- Linear: $K(x_i, x_j) = x_i^T x_j$.
- Polynomial: $K(x_i, x_j) = (\gamma x_i^T x_j + r)^d, \gamma > 0$.
- Gaussian/Radial Basis Function (RBF): $K(x_i, x_j) = \exp(-\gamma \|x_i - x_j\|^2), \gamma > 0$.
- Sigmoid: $K(x_i, x_j) = \tanh(\gamma x_i^T x_j + r)$.

where γ , r and d are kernel parameters.

Practically, the RBF kernel is commonly used as it handles the case when the relation between class labels and attributes is non-linear. However, the choice of kernel is application dependent. If there are more features in the data set, it is useless to transform the data in higher dimensions with RBF. So in such cases, linear or polynomial kernels are sufficient.

Performance Metrics

We require a performance metric to assess if the prediction is quite close to actual measured output. Mean square error (MSE) is one of such index that can be utilized here. With lower MSE values, prediction error converges. However, a threshold is set over the MSE value, in order to retrain the

model in case MSE diverges. An optimized horizon of past measurements is used to predict one future value.

Prediction quality and performance

There are several hyper parameters of SVM learning machine module that need to be arbitrary chosen in order to ensure the best possible quality and performance of prediction. Those parameters are:

- **Kernel type** RBF (Radial Basis Function) kernel was used since other studies in [Cristianini & Taylor, 2000], [Suykens et al., 2002] and [Cao et al., 2003] have shown that it is the most suitable one for the prediction problem.
- c – Cost parameter , is a tradeoff between model flatness against tolerance of deviations larger than epsilon in optimization formulation.
- ϵ – Epsilon parameter, it determines the zone of insensitivity of cost function, in our case (integer values) 0.1 value is sufficient.
- κ – MSE check horizon, since the proposed module constantly adapts it selves to current network conditions, it is necessary to choose an appropriate horizon of past samples which will be used to calculate current MSE error.
- α – MSE (Mean Square Error) check threshold, past samples determined by MSE check horizon are compared with the same (in terms of time) predicted samples and the SVM model is retrained if MSE is bigger than the MSE check threshold value.
- λ – Training horizon, is a number of past samples used to train the SVM model.

