



**HAL**  
open science

# Tropical orbit spaces and moduli spaces of tropical curves

Matthias Herold

► **To cite this version:**

Matthias Herold. Tropical orbit spaces and moduli spaces of tropical curves. Mathematics [math]. Université de Strasbourg; Technische Universität Kaiserslautern, 2011. English. NNT: 2011STRA6001 . tel-00550370

**HAL Id: tel-00550370**

**<https://theses.hal.science/tel-00550370>**

Submitted on 27 Dec 2010

**HAL** is a multi-disciplinary open access archive for the deposit and dissemination of scientific research documents, whether they are published or not. The documents may come from teaching and research institutions in France or abroad, or from public or private research centers.

L'archive ouverte pluridisciplinaire **HAL**, est destinée au dépôt et à la diffusion de documents scientifiques de niveau recherche, publiés ou non, émanant des établissements d'enseignement et de recherche français ou étrangers, des laboratoires publics ou privés.

FACHBEREICH  
MATHEMATIK

Kaiserslautern

&

INSTITUT DE  
RECHERCHE  
MATHÉMATIQUE  
AVANCÉE

UMR 7501

Strasbourg

# Thesis

presented to receive the degree of doctor of  
philosophy at Technische Universität Kaiserslautern  
and l'Université de Strasbourg  
specialty MATHEMATICS

**Matthias Herold**

**Tropical orbit spaces and moduli spaces of  
tropical curves**

Defended on January 25, 2011  
in front of the jury

Mr. A. Gathmann, supervisor

Mr. I. Itenberg, supervisor

Mr. J-J. Risler, reviewer

Mr. E. Shustin, reviewer

Mr. A. Oancea, scientific member

Mr. G. Pfister, scientific member

[www.mathematik.uni-kl.de](http://www.mathematik.uni-kl.de)  
[www-irma.u-strasbg.fr](http://www-irma.u-strasbg.fr)

## Abstract

A main result of this thesis is a conceptual proof of the fact that the weighted number of tropical curves of given degree and genus, which pass through the right number of general points in the plane (resp., which pass through general points in  $\mathbb{R}^r$  and represent a given point in the moduli space of genus  $g$  curves) is independent of the choices of points. Another main result is a new correspondence theorem between plane tropical cycles and plane elliptic algebraic curves.

## Résumé

Un principal résultat de la thèse est une preuve conceptionnelle du fait que le nombre pondéré de courbes tropicales de degré et genre donnés qui passent par le bon nombre de points en position générale dans  $\mathbb{R}^2$  (resp., qui passent par le bon nombre de points en position générale dans  $\mathbb{R}^r$  et représentent un point fixé dans l'espace de modules de courbes tropicales abstraites de genre  $g$ ) ne dépend pas du choix de points. Un autre principal résultat est un nouveau théorème de correspondance entre les cycles tropicaux plans et les courbes algébriques elliptiques planes.

## Keywords

Tropical geometry, tropical curves, enumerative geometry, metric graphs, moduli spaces, elliptic curves,  $j$ -invariant.

## Mots clés

Géométrie tropicale, courbes tropicales, géométrie énumérative, graphe métrique, espaces de modules, courbes elliptiques,  $j$ -invariant.

Fachbereich Mathematik  
Universität Kaiserslautern  
Postfach 3049  
67653 Kaiserslautern  
Germany

Institut de Recherche Mathématique Avancée  
UMR 7501, Université de Strasbourg et CNRS  
7 rue René-Descartes  
67084 Strasbourg Cedex  
France

# Contents

|  |             |
|--|-------------|
| <b>Preface</b>   | <b>v</b>    |
| <b>Introduction en français</b>  | <b>xiii</b> |
| <b>1 Polyhedral complexes</b>  | <b>1</b>    |
| <b>2 Moduli spaces</b>   | <b>7</b>    |
| 2.1 Moduli space of $n$ -marked tropical curves . . . . .                          | 7           |
| 2.2 Moduli space of parameterized labeled $n$ -marked tropical curves . . . . .    | 9           |
| <b>3 Local orbit spaces</b>  | <b>11</b>   |
| 3.1 Tropical local orbit space . . . . .   | 11          |
| 3.2 Morphisms of local orbit spaces . . . . .                                      | 15          |
| <b>4 One-dimensional local orbit spaces</b>  | <b>25</b>   |
| <b>5 Moduli spaces for curves of arbitrary genus</b>                               | <b>29</b>   |
| 5.1 Moduli spaces of abstract tropical curves . . . . .                            | 29          |
| 5.2 Moduli spaces of parameterized tropical curves . . . . .                       | 39          |
| 5.3 The number of curves is independent of the position of points . . . . .        | 42          |
| <b>6 Orbit spaces</b>  | <b>47</b>   |
| 6.1 Tropical orbit space . . . . .   | 47          |
| 6.2 Morphisms of orbit spaces . . . . .  | 51          |
| <b>7 Moduli spaces of elliptic tropical curves</b>                                 | <b>57</b>   |
| 7.1 Moduli spaces of abstract tropical curves of genus 1 . . . . .                 | 57          |
| 7.2 Moduli spaces of parameterized tropical curves of genus 1 . . . . .            | 62          |
| 7.3 Counting elliptic tropical curves with fixed $j$ -invariant . . . . .          | 66          |
| <b>8 Correspondence theorems</b>   | <b>69</b>   |
| 8.1 Mikhalkin's correspondence theorem . . . . .                                   | 69          |
| 8.2 Correspondence theorem for elliptic curves with given $j$ -invariant . . . . . | 78          |
| <b>Bibliography</b>  | <b>85</b>   |



# Preface

## Tropical geometry

Tropical geometry is a relatively new mathematical domain. The roots of tropical geometry go back to the seventies (see [Be] and [BG]), but only ten years ago it became a subject on its own. Tropical geometry has applications in several branches of mathematics such as enumerative geometry (e.g. [IKS], [M1]), symplectic geometry (e.g. [A]), number theory (e.g. [G]) and combinatorics (e.g. [J]). A powerful tool in enumerative geometry are the so-called correspondence theorems. These theorems establish an important correspondence between complex algebraic curves satisfying certain constraints and tropical analogs of these curves. One of the first results concerning correspondence theorems was achieved by G. Mikhalkin (see [M1]). This theorem was proved again in slightly different form in [N], [NS], [Sh], [ST], [T]. These results initiated the study of enumerative problems in tropical geometry (see for example [GM1], [GM2], [GM3]). Dealing with counting problems, it is naturally to work with moduli spaces. The first step in this direction was the construction of the moduli spaces of rational curves given in [M2] and [GKM]. In [GKM] the authors developed some tools to deal with enumerative problems for rational curves, using the notion of tropical fan. They introduced morphisms between tropical fans and showed that, under certain conditions, the weighted number of preimages of a point in the target of such a morphism does not depend on the chosen point. After showing that the moduli spaces of rational tropical curves have the structure of a tropical fan, they used this result to count rational curves passing through given points.

## Results

In the first part of this thesis we follow the approach of [GKM] and introduce similar tools for enumerative problems concerning curves of positive genus. In the second part we establish a new correspondence theorem. The main results of this thesis are as follows.

- We develop the definitions of (tropical) orbit spaces and (tropical) local orbit spaces which are counterparts of a stack in algebraic geometry.
- We introduce morphisms between (tropical) orbit spaces and (tropical) local orbit spaces.

- For tropical (local) orbit spaces we show that the weighted number of preimages of a point in the target of such a morphism does not depend on the chosen point.
- We equip the moduli spaces of tropical curves with the structure of a tropical local orbit space.
- For the special case of moduli spaces of elliptic tropical curves we equip the moduli spaces as well with the structure of a tropical orbit space.
- Using our results on tropical local orbit spaces, we give a more conceptual proof than the authors of [KM] of the fact that the weighted number of plane tropical curves of a given degree and genus which pass through the right number of points in general position in  $\mathbb{R}^2$  is independent of the choice of a configuration of points.
- In the same way we prove that the weighted number of tropical curves of given degree and genus in  $\mathbb{R}^r$  which pass through the right number of points in  $\mathbb{R}^r$  and which represent a fixed point in the moduli space of abstract genus  $g$  tropical curves is independent of the choice of a configuration of points in general position.
- In the case of plane elliptic tropical curves of degree  $d$  we prove the independence of the choice of a configuration of points and the choice of a type (which is the  $j$ -invariant in this case) as well by using our results on tropical orbit spaces.
- We prove a correspondence between plane tropical cycles (of elliptic curves with big  $j$ -invariant satisfying point constraints) and elliptic plane algebraic curves (satisfying corresponding constraints).

The chapters 1 and 2 recall definitions and do not contain new results. The chapters 3, 4, 5, 6 and 7 are based on [H]. New results in chapter 8 are proposition 8.34, theorem 8.45 and the conjecture 8.50.

## Motivation

A relationship between tropical geometry and complex geometry was conjectured in 2000 by M. Kontsevich and was made precise by the so-called correspondence theorem by G. Mikhalkin in [M1]. In the cases where such a connection is established, it suffices to count tropical curves to get the number of corresponding algebraic objects. Therefore tropical geometry became a powerful tool for enumerative geometry. In algebraic geometry one uses moduli spaces in enumerative problems. Because of the mentioned relation, it would be reasonable to construct moduli spaces in tropical geometry as well. For the construction of moduli spaces in algebraic geometry one needs, in many cases, the notion of a stack. Put simply, a stack is the quotient of a scheme by a group action. In this thesis we want to make an attempt for the definition of a “tropical stack”. Since it is a first approach, we call these objects tropical (local) orbit spaces (instead of calling them stacks). The definition of a tropical orbit space avoids many technical problems. Therefore it is a useful definition to get a first impression on the problems one wants to handle with a “tropical stack”. Nevertheless it seems to be not general enough for the problems we want to deal with. Furthermore the price we have to pay for the simplicity is losing finiteness. Because of this, we give the definition of a tropical local orbit space which is more technical but more appropriate for our

purposes. To show the usefulness of our definition, we equip the moduli spaces of tropical curves with the structure of a tropical local orbit space and use this structure to show that the weighted number of tropical curves through given points does not depend on the position of points.

As mentioned above, one motivation for tropical geometry are the correspondence theorems. Therefore, it is of great interest to enlarge the number of cases where a correspondence is established. The hope is to understand better the algebraic objects and to get a more efficient way to count them (see for example Mikhalkin's lattice path algorithm in [M1]). Our goal is to enlarge the correspondence theorem to the case of elliptic non-Archimedean curves with a  $j$ -invariant of sufficiently big valuation.

## Chapter synopsis

This thesis contains eight chapters, which can be divided into four parts. Chapters 1 and 2 are essential for the first seven chapters. Chapters 3, 4 and 5 belong together as well as chapters 6 and 7. Chapter 8 can be read separately.

- **Chapter 1: Polyhedral complexes**

We start the chapter by defining general cones, which are non-empty subsets of a finite-dimensional  $\mathbb{R}$ -vector space and are described by finitely many linear integral equalities, inequalities and strict inequalities. A union of these cones, which satisfy some properties, is a *general fan*. We equip each top-dimensional cone in the fan with a number in  $\mathbb{Q}$  called *weight*. If these weights together with the cones fulfill a certain condition (the balancing condition) we call the fan a *general tropical fan*. These objects are the local building blocks of tropical varieties (in particular each tropical curve is locally a one-dimensional fan). After this, we define a *general polyhedron*, which is a non-empty subset of a finite-dimensional  $\mathbb{R}$ -vector space and is described by finitely many affine linear integral equalities, inequalities and strict inequalities. *Polyhedral complexes* are certain unions of general polyhedra (locally a polyhedral complex looks like a fan thus, we can define weights for the top-dimensional cones and consider the balancing condition). We end the chapter by defining morphisms between polyhedral complexes.

- **Chapter 2: Moduli spaces**

In this chapter we define moduli spaces of tropical curves. For this we give a definition of  $n$ -marked abstract tropical curves and parameterized labeled  $n$ -marked tropical curves. As in algebraic geometry we can define the genus of a curve. An  *$n$ -marked abstract tropical curve* of genus  $g$  is a connected graph with first Betti number equal to  $g$  and  $n$  labeled edges connected to exactly one one-valent vertex (we consider the curves up to isomorphism) such that the graph without one-valent vertices has a complete metric. Each edge connecting two vertices of valence greater than one has a length defined by the metric. Thus an  $n$ -marked abstract tropical curve can be encoded by these lengths, which give as well a polyhedral structure to the moduli spaces of  $n$ -marked abstract tropical curves. After doing this we consider the special case



of genus one. The underlying graph of an  $n$ -marked abstract tropical curve of genus one contains exactly one simple cycle and we call its length *tropical  $j$ -invariant*. *Parameterized labeled  $n$ -marked tropical curves* are  $n$ -marked abstract tropical curves together with a map from the graph without one-valent vertices to some  $\mathbb{R}^r$  fulfilling some conditions.

- **Chapter 3: Local orbit spaces**

In the first section we introduce tropical local orbit spaces. *Local orbit spaces* are finite polyhedral complexes in which we identify certain polyhedra with each other. These identifications are done with the help of isomorphisms between subsets of the polyhedral complexes. For technical reasons the set of isomorphisms has to fulfill some properties. If the polyhedral complex was equipped with weights which are the same for identified polyhedra, we can equip the local orbit space with weights as well. The word tropical refers again to a balancing condition which the local orbit space with weights has to fulfill. After showing that the balancing condition of the local orbit space and of the underlying polyhedral complex are equivalent we start the second section by defining morphisms between tropical orbit spaces. These morphisms are defined to be morphisms of the underlying polyhedral complexes which respect the properties of the set of isomorphisms (the properties which we have because of the technical reasons). The morphisms allow us to define the image of a tropical local orbit space. Under some conditions on the image we can prove that the number of preimages of a general point in the target space (counted with certain multiplicities) is independent of the chosen point (corollary 3.41). Afterwards, we define rational functions on tropical local orbit spaces and the corresponding divisors.

- **Chapter 4: One-dimensional local orbit spaces**

For a better understanding of the local orbit spaces defined in chapter 3 we study the one-dimensional case more explicitly. The main result of this chapter is a theorem concerning the local structure of a local orbit space. In this chapter we treat as well non-Hausdorff local orbit spaces in the one-dimensional case which we avoid in the other chapters (the non-Hausdorffness).

- **Chapter 5: Moduli spaces for curves of arbitrary genus**

In the first section we equip the moduli spaces of  $n$ -marked abstract tropical curves of genus  $g$  and exactly  $n$  one-valent vertices such that the underlying graph has no two-valent vertices with the structure of local orbit space. As mentioned above we can equip the moduli spaces with a polyhedral structure. The underlying graph (forgetting the metric) of two  $n$ -marked abstract tropical curves might be different. The encoding of the curve by the lengths of the bounded edges does not give a useful global description, since the cones encoding all curves with the same underlying graph are spanned by unit vectors (one vector for each edge). Therefore, we do not get a tropical structure with this description. Thus, instead of the lengths of the bounded edges we take the distances between the  $n$  markings. To get a global description of a moduli space it seems reasonable to take these distances. This idea was used for  $n$ -marked abstract rational tropical curves in [GKM]. Unfortunately, the distance between two markings for curves of higher genus is not well-defined; because of the cycles, there is no unique path from one point to the other. To get rid of this problem, we cut each

cycle at one point such that the curve stays connected and insert a new marked edge at each endpoint of the cut. Now, all distances between markings are well-defined (we are in a case similar to the case of rational curves). Since we made non-canonical choices, we take all possibilities for such a cut and we get rid of the choices by an identification of cones. Thus, we end up with a tropical local orbit space which turns out to be homeomorphic to the moduli space. In section 2 we construct moduli spaces of parameterized labeled  $n$ -marked tropical curves of genus  $g$  in  $\mathbb{R}^r$ . A parameterized tropical curve is an abstract tropical curve with a map to  $\mathbb{R}^r$  where the map satisfies certain properties (in particular it is affine on each edge). Using moduli spaces of abstract curves we only need to encode the map. We consider only curves with fixed directions of the marked edges and therefore it is enough to encode the position of one fixed point to have all information needed for a map (the directions of the edges are fixed and the distances of two points are already encoded, thus the map is fixed by the position of one point). In our construction of the moduli spaces of abstract curves we made a cut on each cycle and inserted two new edges. To make sure that the images of the cut cycles are cycles again we use rational functions for the definition of the moduli spaces we are interested in. In the last section we introduce the condition that a curve passes through given points and the condition that a curve represent a fixed point in the moduli space of 0-marked abstract tropical curves of genus  $g$ . Using the structure of a local orbit space we show that the number of parameterized labeled  $n$ -marked tropical curves of given genus and given direction of marked ends counted with the multiplicity defined by corollary 3.41 fulfilling the mentioned conditions does not depend on a general choice of a configuration of points.

- **Chapter 6: Orbit spaces**

This chapter is relatively similar to chapter 3. In the first section we define tropical orbit spaces and in the second section we define morphisms between these objects. As for tropical local orbit spaces we define tropical orbit spaces to be polyhedral complexes in which we identify polyhedra by using isomorphisms. The difference in this construction is that we weaken the conditions on the polyhedral complex and tighten the condition on the set of isomorphisms. This time we allow the polyhedral complex to be infinite but we ask the set of isomorphisms to be a group. Since the conditions of the set of isomorphisms in chapter 3 are technical but satisfied if the set is a group, we can simplify some problems. Unfortunately, the price we have to pay for this is an infinite polyhedral complex. This is due to the fact that it would be too restrictive for our problems to consider only finite groups. Because of the similarities we can develop the same theory for orbit spaces as for local orbit spaces.

- **Chapter 7: Moduli spaces of elliptic tropical curves**

In the first section we equip the moduli spaces of  $n$ -marked abstract tropical curves of genus 1 and exactly  $n$  one-valent vertices such that the underlying graph has no two-valent vertices with the structure of local orbit space. As in chapter 5 we cut the cycle of the genus-one curve. Since this case is a special case of chapter 5 most of the calculations are similar to those in that chapter but easier. In the second section we build moduli spaces of parameterized labeled  $n$ -marked elliptic tropical curves in  $\mathbb{R}^r$  using rational functions. We end the section with a calculation of weights in the case  $r = 2$ . In this case M. Kerber and H. Markwig have already constructed the moduli

spaces as weighted polyhedral complex [KM]. It turns out that the weights defined by our construction are the same except for the case when the image of the cycle of the curve is zero-dimensional. If the cycle is zero-dimensional our weights differ from the weights of M. Kerber and H. Markwig by  $\frac{1}{2}$ . In particular, it follows that the moduli spaces we constructed are reducible. In the third section of this chapter we show that the number of plane elliptic tropical curves of degree  $d$  with fixed  $j$ -invariant which pass through a given configuration of points does not depend on a general choice of the configuration.

- **Chapter 8: Correspondence theorems**

Since we want to prove a correspondence theorem we recall some correspondence theorems in the first section. Especially theorem 8.30 by I. Tyomkin, which is the first one stating a correspondence for elliptic curves with given  $j$ -invariant, is related to our work. For a correspondence theorem, the multiplicity of a tropical curve is the number of algebraic curves corresponding to it. By recalling some correspondence theorems, we observe that the multiplicity of a curve depends in particular on the problem. We end the section by proving a statement which expresses the multiplicities of theorem 8.30 in a tropical way. These multiplicities agree with those defined by M. Kerber and H. Markwig (resp., calculated in the thesis). In the second section we prove a correspondence between elliptic non-Archimedean curves which have a given  $j$ -invariant with big valuation and tropical cycles which are the images of parameterized elliptic tropical curves with big tropical  $j$ -invariant. The multiplicities we are using for this are those defined by M. Kerber and H. Markwig. Since I. Tyomkin uses the same multiplicities we conjecture that the multiplicities of M. Kerber and H. Markwig are the right ones in each case.

## Financial support

Parts of this work have been done during the *special semester on tropical geometry* at the Mathematical Sciences Research Institute in Berkeley, CA. I thank the MSRI for the hospitality and excellent working conditions.

Financial support was provided by the state of Rheinland-Pfalz via a graduate fellowship, the German Academic Exchange Service (DAAD), the University of Kaiserslautern, the University of Strasbourg and the MSRI.

I was a member of the European Doctoral College of Strasbourg during the preparation of the PhD, from 2007 to 2010, class name Marco Polo. I have benefited from specific financial supports offered by the College and, along with my mainstream research, have followed a special course on topics of general European interests presented by international experts. This PhD research project has been led with the collaboration of two universities: the University of Kaiserslautern, Germany and the University of Strasbourg, France.

## Acknowledgement

I am grateful to my advisors Andreas Gathmann and Ilia Itenberg for introducing me to the problems, for sharing their ideas and generally for an excellent supervision.

I am grateful to my beloved wife for her love, time and motivation.

I am grateful to Johannes Rau for the introduction to the problem of orbit spaces and for proofreading.

I am grateful to Ilya Tyomkin and Annette Werner for many helpful discussions.

I am grateful to Cédric Bujard and Rémi Coulon for their help with the French parts.

I am grateful to Lars Allermann, Georges François, Marina Franz, Michael Kerber, Henning Meyer, Dennis Ochse and Carolin Torchiani for their help when needed and a good working atmosphere.

I am grateful to the PhD students in Strasbourg for their help.

I am grateful to my parents for their love and support.



# Introduction en français

## Géométrie tropicale

La géométrie tropicale est un domaine relativement nouveau des mathématiques. Ses débuts remontent aux années soixante-dix (voir [Be] et [BG]), mais il y a seulement dix ans qu'elle est devenue un sujet à part entière. La géométrie tropicale a des applications dans plusieurs branches des mathématiques comme la géométrie énumérative (cf. [IKS], [M1]), la géométrie symplectique (voir, par exemple [A]), la théorie des nombres (voir, par exemple [G]) et la combinatoire (cf. [J]). Les théorèmes de correspondance sont un outil puissant en géométrie énumérative. Ces théorèmes établissent une correspondance importante entre les courbes algébriques complexes qui satisfont certaines contraintes et leurs analogues tropicaux. Un des premiers résultats concernant les théorèmes de correspondance est dû à G. Mikhalkin (voir [M1]). Ce théorème a été redémontré dans une forme légèrement différente dans [N], [NS], [Sh], [ST], [T]). Ces résultats sont à l'origine de l'étude de problèmes en géométrie tropicale énumérative (voir par exemple [GM1], [GM2], [GM3]). Face à des problèmes de dénombrement, il est naturel de travailler avec des espaces de modules. La première étape dans cette direction a été la construction des espaces de modules de courbes tropicales rationnelles proposée dans [M2] et [GKM]. Dans [GKM], les auteurs utilisent la notion d'un éventail tropical pour développer des outils qui permettent d'étudier des problèmes énumératifs concernant des courbes rationnelles. Ils introduisent des morphismes entre éventails tropicaux et montrent le fait suivant : sous certaines conditions, le nombre pondéré d'antécédents d'un point, pour un tel morphisme, ne dépend pas du point choisi à l'arrivée. Après avoir montré que les espaces de modules de courbes tropicales rationnelles ont la structure d'un éventail tropical, les auteurs de [GKM] utilisent ce résultat pour dénombrer les courbes rationnelles passant par des points donnés.

## Résultats

Dans la première partie de cette thèse, nous suivons l'approche de [GKM] et introduisons des outils similaires pour aborder des problèmes énumératifs concernant les courbes de genre strictement positif. Dans la deuxième partie, nous établissons un nouveau théorème de correspondance. Les principaux résultats de la thèse sont les suivants.

- Nous proposons des définitions d'espaces d'orbites (tropicaux) et d'espaces d'orbites locaux (tropicaux) (une tentative de définition d'un «champ tropical»).
- Nous introduisons des morphismes entre espaces d'orbites (tropicaux) et espaces d'orbites locaux (tropicaux).
- Pour un morphisme d'espaces d'orbites (locaux) tropicaux, nous montrons que le nombre d'antécédents d'un point dans l'image, comptés avec leurs poids, ne dépend pas du point choisi.
- Nous équipons les espaces de modules de courbes tropicales d'une structure d'espace d'orbites local tropical.
- Dans le cas particulier des espaces de modules de courbes tropicales elliptiques, nous équipons aussi les espaces de modules d'une structure d'espace d'orbites tropical.
- En utilisant nos résultats sur les espaces d'orbites locaux tropicaux, nous donnons une preuve plus conceptuelle que les auteurs de [KM] du fait suivant. Le nombre pondéré de courbes tropicales planes de degré et genre donnés qui passent par le bon nombre de points en position générale dans  $\mathbb{R}^2$  est indépendant du choix de la configuration de ces points.
- De la même manière, nous montrons que le nombre pondéré de courbes tropicales de degré et genre donnés dans  $\mathbb{R}^r$  qui passent par le bon nombre de points en position générale dans  $\mathbb{R}^r$  et ayant un type général fixé dans l'espace de modules de courbes tropicales abstraites de genre  $g$  est indépendant du choix de la configuration de ces points ainsi que du type.
- Dans le cas de courbes tropicales elliptiques planes de degré  $d$ , nous prouvons que le nombre pondéré de ces courbes qui passent par le bon nombre de points en position générale et ayant un  $j$ -invariant fixé est indépendant du choix d'une configuration des points et du choix du  $j$ -invariant, et ce, à nouveau, à l'aide de nos résultats sur les espaces d'orbites tropicaux.
- Nous montrons une correspondance entre les courbes tropicales elliptiques planes de degré  $d$  ayant un gros  $j$ -invariant  $j$  (qui satisfont des contraintes données par des points) et les courbes non archimédiennes elliptiques planes de degré  $d$  ayant un  $j$ -invariant fixé de valuation  $j$  (satisfaisant les contraintes correspondantes).

Les chapitres 1 et 2 sont un rappel des définitions et ne contiennent pas de nouveaux résultats. Les chapitres 3, 4, 5, 6 et 7 sont basés sur [H]. Les nouveaux résultats dans le chapitre 8 sont la proposition 8.34, le théorème 8.45 et la conjecture 8.50.

## Motivation

Les connexions avec la géométrie algébrique énumérative fournissent une motivation importante pour le développement de la géométrie tropicale. Une relation entre la géométrie tropicale et la géométrie complexe, conjecturée en 2000 par M. Kontsevich, a été précisée grâce au théorème de correspondance de G. Mikhalkin dans [M1]. Ainsi, dans chaque cas où une telle connexion est établie, il suffit de dénombrer les courbes tropicales pour connaître le nombre

d'objets algébriques correspondants. Par conséquent, la géométrie tropicale devient un puissant outil pour la géométrie énumérative. En géométrie algébrique, on utilise les espaces de modules pour effectuer un dénombrement. Étant donné la relation conjecturée par M. Kontsevich, il serait raisonnable de construire des espaces de modules en géométrie tropicale. En géométrie algébrique, on a besoin, dans de nombreux cas, de la notion de champ pour construire des espaces de modules. Dit simplement, un champ est le quotient d'un schéma par une action de groupe. Dans cette thèse, nous voulons faire une tentative de définition d'un «champ tropical». Puisque cette définition n'est qu'une première approche, nous appellerons ces objets des espaces d'orbites (locaux) tropicaux (au lieu de les appeler des champs tropicaux). La définition d'un espace d'orbites tropical évite de nombreux problèmes techniques. Elle est donc utile pour se donner une première idée des problèmes que l'on voudrait traiter avec un «champ tropical». Néanmoins, il semble que cette définition ne soit pas suffisamment générale pour les problèmes que nous aimerions aborder. En outre, le prix à payer pour la simplicité est la perte de la finitude. Par conséquent, nous donnons la définition d'espace d'orbites local tropical qui est plus technique mais plus appropriée dans notre cas. Pour illustrer l'utilité de la définition, nous équipons les espaces de modules de courbes tropicales de la structure d'espace d'orbites local tropical. Nous utilisons celle-ci pour montrer que le nombre de courbes tropicales qui passent par des points fixés ne dépend pas de leurs positions.

Comme mentionné ci-dessus, une des motivations pour la géométrie tropicale provient de théorèmes de correspondances. C'est pourquoi on a un grand intérêt à étendre les cas où une correspondance est établie. On a ainsi l'espoir d'obtenir une meilleure compréhension d'objets algébriques et un moyen plus efficace pour les dénombrer (voir par exemple l'algorithme de Mikhalkin dans [M1]). Notre objectif est d'élargir le théorème de correspondance au cas des courbes non archimédiennes elliptiques dont la valuation du  $j$ -invariant est suffisamment grande.

## Résumé des chapitres

Cette thèse contient huit chapitres qui peuvent être divisés en quatre parties. Les chapitres 1 et 2 sont essentiels pour les sept premiers chapitres. Les chapitres 3, 4 et 5 forment un tout, ainsi que les chapitres 6 et 7. Le chapitre 8 peut être lu séparément.

- **Chapitre 1: Polyhedral complexes** (complexes polyédraux). Nous commençons ce chapitre par la définition générale de cônes qui sont des sous-ensembles non vides d'un  $\mathbb{R}$ -espace vectoriel de dimension finie décrits par un nombre fini d'égalités et d'inégalités larges ou strictes, linéaires à coefficients entiers. Une union de ces cônes qui satisfait certaines propriétés est un *éventail général*. Nous équipons chaque cône de dimension maximal dans l'éventail d'un nombre rationnel baptisé *poids*. Si ces poids conjointement avec les cônes remplissent une certaine condition (la condition d'équilibre) nous appelons cet éventail, un *éventail tropical général*. Une variété tropicale est localement décrite par de tels objets (en particulier chaque courbe tropicale est localement un éventail de dimension 1). Ensuite, nous définissons les *polyèdres généraux* qui sont des sous-ensembles non vides d'un  $\mathbb{R}$ -espace vectoriel de dimen-



sion finie décrits par un nombre fini d'égalités et d'inégalités larges ou strictes, affines et à coefficients entiers. Les *complexes polyédraux* sont des réunions certaines de polyèdres (localement un complexe polyédral ressemble à un éventail. C'est pourquoi, sous de bonnes conditions, nous pouvons lui associer des poids). Nous terminons le chapitre par la définition de morphismes entre complexes polyédraux.

- **Chapitre 2: Moduli spaces** (espaces de modules). Dans ce chapitre, nous définissons les espaces de modules de courbes tropicales. Pour cela, nous introduisons la définition de courbes tropicales abstraites  $n$ -marquées et de courbes tropicales paramétrées  $n$ -marquées étiquetées. Comme en géométrie algébrique, une courbe tropicale possède un genre. Une *courbe tropicale abstraite  $n$ -marquée* de genre  $g$  est un couple  $(\bar{\Gamma}, \delta)$  où  $\bar{\Gamma}$  est un graphe connexe dont le premier nombre de Betti est égal à  $g$  et ayant  $n$  arêtes marquées chacune de ces arêtes étant reliée à exactement un sommet de valence 1 (nous considérons les courbes à isomorphisme près) tel que le graphe privé de ses sommets de valence 1 soit muni de la métrique de longueur  $\delta$  soit complet. Chaque arête reliant deux sommets de valence strictement supérieure à 1 a une longueur définie par la métrique. Ainsi, une courbe tropicale abstraite  $n$ -marquée peut être codée par ces longueurs, conférant ainsi une structure polyédrale à l'espace de modules de courbes tropicales abstraites  $n$ -marquées. Ensuite, nous considérons le cas particulier des courbes de genre 1. Le graphe sous-jacent d'une courbe tropicale abstraite  $n$ -marquée de genre 1 contient exactement un cycle simple nous appelons sa longueur  $j$ -invariant tropical. Une *courbe tropicale paramétrée  $n$ -marquée étiquetée* est une courbe tropicale abstraite  $n$ -marquée équipée d'une application du graphe privé de ses sommets de valence 1 dans  $\mathbb{R}^r$  satisfaisant de bonnes conditions.
- **Chapitre 3: Local orbit spaces** (espaces d'orbites locaux). Dans la première partie, nous introduisons les espaces d'orbites locaux tropicaux. Les *espaces d'orbites locaux* sont des complexes polyédraux finis dans lesquels nous identifions certains polyèdres. Ces identifications sont données par des isomorphismes entre des sous-ensembles des complexes polyédraux. Pour des raisons techniques, l'ensemble des isomorphismes doit satisfaire certaines propriétés. Si le complexe polyédral est équipé de poids qui coïncident sur les polyèdres identifiés, l'espace d'orbites local hérite de la structure de poids. Le mot tropical se réfère de nouveau à une condition d'équilibre que les espaces d'orbites locaux conjointement avec les poids doivent remplir. Après avoir montré que la condition d'équilibre pour l'espace d'orbites locaux et celle pour les complexes polyédraux sont équivalentes, nous commençons la deuxième partie par la définition de morphisme entre espaces d'orbites locaux tropicaux. Ces morphismes sont définis comme des morphismes entre les complexes polyédraux sous-jacents qui respectent les propriétés de l'ensemble des isomorphismes (les propriétés nous avons à cause des raisons techniques). Ils nous permettent de définir l'image d'un espace d'orbites local tropical. Sous certaines conditions sur l'image, on peut prouver que le nombre d'antécédents d'un point général dans l'espace image (comptés avec multiplicités donnent par poids) est indépendant du point (corollaire 3.41). Enfin, nous définissons les fonctions rationnelles sur les espaces d'orbites locaux tropicaux et les diviseurs correspondants.

- **Chapitre 4: One-dimensional local orbit spaces** (espaces d'orbites locaux de dimension 1). Pour une meilleure compréhension de l'espace d'orbites locaux défini au chapitre 3, nous étudions plus précisément le cas de la dimension 1. Le résultat principal de ce chapitre est un théorème concernant la structure locale d'un espace d'orbites local. Dans ce chapitre, nous traitons aussi les espaces d'orbites locaux non-Hausdorff dans le cas unidimensionnel, cas que nous laisserons de côté dans les autres chapitres (d'être non-Hausdorff).
- **Chapitre 5: Moduli spaces for curves of arbitrary genus** (espace de modules de courbes de genre quelconque). Dans la première partie, nous équipons de la structure d'espaces d'orbites locaux l'espace de modules de courbes tropicales abstraites  $n$ -marquées de genre  $g$  ayant exactement  $n$  sommets de valence 1, telles que les graphes sous-jacents à ces courbes n'aient pas de sommet bivalent. Comme mentionné ci-dessus, nous pouvons munir celui-ci d'une structure polyédrale. Si l'on oublie la métrique, les graphes sous-jacents de deux courbes tropicales abstraites  $n$ -marquées pouvant être différents, l'encodage par les longueurs des arêtes n'en donne pas une description globale. Ainsi, au lieu de considérer des longueurs d'arêtes bornées, nous prenons les distances entre les  $n$  arêtes marquées. Puisque chaque courbe est munie de ces arêtes, ce choix semble raisonnable. Cette idée a été utilisée pour les courbes tropicales abstraites  $n$ -marquées dans [GKM]. Malheureusement, la distance entre deux arêtes marquées n'est pas bien définie pour les courbes de genre strictement positif. Du fait de la présence de cycles, il n'y a pas unicité du chemin entre deux points. Pour s'acquitter de ce problème, nous coupons chaque cycle en un point tel, que la courbe reste connexe et nous insérons une nouvelle arête marquée à chacune des deux nouvelles extrémités introduites. Ainsi, toutes les distances entre des arêtes marquées sont bien définies. Étant donné que nous avons fait des choix non-canoniques, nous devons nous en débarrasser, se qui revient à identifier des cônes. Ainsi, nous nous retrouvons avec un espace d'orbites local tropical homéomorphe à l'espace de modules. Dans la deuxième partie, nous construisons un espace de modules de courbes tropicales paramétrées,  $n$ -marquées et étiquetées de genre  $g$ . Puisque nous voulons utiliser l'espace de modules de courbes abstraites, nous avons besoin d'encoder une application dans  $\mathbb{R}^r$ . Nous nous restreignons au seul cas où la direction des arêtes marquées est fixée. Il suffit donc de préciser la position d'un point fixe pour avoir toutes les informations nécessaires pour définir une application (les directions des arêtes sont fixées et les distances entre des arêtes marquées sont déjà définies, donc l'application est entièrement déterminée par la position d'un point). Dans notre construction des espaces de modules de courbes abstraites, nous avons fait une coupe dans chaque cycle et inséré deux nouvelles arêtes. Pour être sûr que les images des cycles coupés soient de nouveau des cycles, nous utilisons des fonctions rationnelles dans la définition des espaces de modules. Dans la dernière partie, nous demandons que la courbe passe par des points donnés et qu'elle représente un point fixé de l'espace de modules de courbes tropicales abstraites 0-marquées de genre  $g$ . Grâce à la structure d'espace d'orbites local, nous montrons que le nombre (compté avec la multiplicité définie dans le corollaire 3.41) de courbes tropicales paramétrées  $n$ -marquées et étiquetées de genre donné, dont la direction des extrémités marquées est donnée, remplissant en outre les conditions mentionnées, ne dépendent pas du choix d'une configuration de points si

celles-ci restent générales.

- **Chapitre 6: Orbit spaces** (espaces d'orbites). Ce chapitre est relativement similaire au chapitre 3. Dans la première partie, nous définissons les espaces d'orbites tropicaux et dans la deuxième partie, les morphismes entre ces objets. Comme dans le chapitre 3, les espaces d'orbites tropicaux sont des complexes polyédraux dont nous identifions certains polyèdres à l'aide d'isomorphismes. Toutefois, nous relâchons ici les conditions sur le complexe polyédral et nous renforçons la condition sur l'ensemble des isomorphismes. Plus précisément, nous autorisons le complexe polyédral être infini, mais demandons à l'ensemble des isomorphismes d'avoir une structure de groupe. Étant donné que les conditions techniques sur l'ensemble des isomorphismes introduites au chapitre 3 sont satisfaites pour un groupe, nous pouvons simplifier certains problèmes. Malheureusement, le prix à payer est d'avoir un complexe polyédral infini. Cela est dû au fait qu'il serait trop restrictif dans notre contexte de ne considérer que des groupes finis. En raison des similitudes, nous pouvons développer pour les espaces d'orbites la même théorie que pour les espaces d'orbites locaux.
- **Chapitre 7: Moduli spaces of elliptic tropical curves** (espaces de modules de courbes tropicales elliptiques). Dans la première partie nous équipons d'une structure d'espace d'orbites local l'espace de modules de courbes tropicales abstraites  $n$ -marquées de genre 1 ayant exactement  $n$  sommets de valence 1 et telles que les graphes sous-jacents n'aient pas de sommet bivalent. Comme dans le chapitre 5 nous coupons les cycles de chaque courbe. Puisque nous sommes dans un cas particulier du chapitre 5, la plupart des calculs sont similaires, mais plus faciles. Dans la deuxième partie, nous construisons un espace de modules de courbes tropicales paramétrées  $n$ -marquées et étiquetées dans  $\mathbb{R}^r$  à l'aide de fonctions rationnelles. Nous terminons cette partie par un calcul de poids dans le cas  $r = 2$ . Dans ce cas, M. Kerber et H. Markwig ont déjà construit les espaces de modules comme des complexes polyédraux avec des poids [KM]. Nous montrons que les poids définis dans notre construction sont les mêmes, excepté dans le cas où l'image du cycle de la courbe est de dimension nulle. Dans ce cas, nos poids diffèrent de ceux de M. Kerber et H. Markwig de  $\frac{1}{2}$ . En particulier, les espaces de modules que nous avons construit sont réductibles. Dans la troisième partie de ce chapitre, nous montrons que le nombre de courbes tropicales elliptiques planes de degré  $d$  dont le  $j$ -invariant est fixé et qui passent par une configuration donnée de points ne dépend pas du choix d'une configuration générale.
- **Chapitre 8: Correspondence theorems** (théorèmes de correspondance). Puisque nous voulons démontrer un théorème de correspondance, nous rappelons dans la première partie quelques-uns d'entre eux. Le théorème 8.30 démontré par I. Tyomkin, premier théorème de correspondance pour les courbes elliptiques dont le  $j$ -invariant est donné, est particulièrement lié à notre travail. Dans un théorème de correspondance, la multiplicité d'une courbe tropicale est le nombre de courbes algébriques qui lui correspondent. En rappelant quelques théorèmes, nous observons que ces multiplicités varient d'un problème à l'autre. Nous terminons cette partie en montrant que l'on peut exprimer les multiplicités du théorème 8.30 de manière tropicale. Ces poids sont les mêmes que ceux utilisés par M. Kerber et H. Markwig (resp., que ceux que nous avons calculés). Dans la deuxième partie nous montrons une correspondance entre les

courbes non archimédiennes elliptiques dont la valeur du  $j$ -invariant est très grande et dont les cycles tropicaux sont les images d'une courbe tropicale elliptique paramétrée ayant un grand  $j$ -invariant tropical. Pour cela, nous utilisons les multiplicités de M. Kerber et H. Markwig. Étant donné que I. Tyomkin utilise les mêmes multiplicités nous conjecturons que l'on peut utiliser ces multiplicités dans chaque cas (par exemple pas seulement pour un  $j$ -invariant très grande).



# 1 Polyhedral complexes

In this chapter we give the definitions of polyhedral complexes and morphisms between them. These objects are the building blocks for orbit spaces and local orbit spaces. In contrast to the definitions given in tropical geometry so far, we take a more general definition of polyhedra and allow them to be open. The purpose of the definition is to parameterize tropical curves with genus greater than zero. Since we are interested in genus  $g$  curves we consider curves with positive cycle lengths. Therefore some of the polyhedra of the parameterizing space of those curves need to be open. In this part we denote a finitely generated free abelian group by  $\Lambda$  and the corresponding real vector space  $\Lambda \otimes_{\mathbb{Z}} \mathbb{R}$  by  $V$ . So we can consider  $\Lambda$  as a lattice in  $V$ . The dual lattice in the vector space  $V^\vee$  is denoted by  $\Lambda^\vee$ .

**Definition 1.1** (General and closed cone). A *general cone* in  $V$  is a non-empty subset  $\sigma \subseteq V$  that can be described by finitely many linear integral equalities, inequalities and strict inequalities, i.e. a set of the form

$$\sigma = \{x \in V \mid f_1(x) = 0, \dots, f_r(x) = 0, f_{r+1}(x) \geq 0, \dots, f_{r+s}(x) \geq 0, \\ f_{r+s+1}(x) > 0, \dots, f_N(x) > 0\} \quad (*)$$

for some linear forms  $f_1, \dots, f_N \in \Lambda^\vee$ . We denote by  $V_\sigma$  the smallest linear subspace of  $V$  containing  $\sigma$  and by  $\Lambda_\sigma$  the lattice  $V_\sigma \cap \Lambda$ . We define the *dimension* of  $\sigma$  to be the dimension of  $V_\sigma$ . We call  $\sigma$  a *closed cone* if it has a presentation (\*) with no strict inequalities (i.e. if  $N = r + s$ ).

**Definition 1.2** (Face). A *face* (or *subcone*) of  $\sigma$  is a general cone  $\tau \subset \sigma$  which can be obtained from  $\sigma$  by changing some of the non-strict inequalities in (\*) to equalities.

**Definition 1.3** (Fan and general fan). A *fan* in  $V$  is a finite set  $X$  of closed cones in  $V$  such that

- (a) each face of a cone in  $X$  is also a cone in  $X$ ;
- (b) the intersection of any two cones in  $X$  is a face of each of them.

A *general fan* in  $V$  is a finite set  $\tilde{X}$  of general cones in  $V$  satisfying the following property: there exists a fan  $X$  and a subset  $R \subset X$  such that  $\tilde{X} = \{\tau \setminus U \mid \tau \in X\}$ , where  $U = \bigcup_{\sigma \in R} \sigma$ . We put  $|\tilde{X}| = \bigcup_{\tilde{\sigma} \in \tilde{X}} \tilde{\sigma}$ . A (general) fan is called *pure-dimensional* if all its inclusion-maximal cones are of the same dimension. In this case we call the highest dimensional cones *facets*. The set of  $n$ -dimensional cones of a (general) fan  $X$  is denoted by  $X^{(n)}$ .

**Construction 1.4** (Normal vector). If  $\emptyset \neq \tau, \sigma$  are cones in  $V$  and  $\tau$  is a face of  $\sigma$  such that  $\dim \tau = \dim \sigma - 1$ , then there is a non-zero linear form  $g \in \Lambda^\vee$ , which is zero on  $\tau$  and positive on  $\sigma \setminus \tau$ . Then  $g$  induces an isomorphism  $V_\sigma/V_\tau \cong \mathbb{R}$ . There exists a unique generator  $u_{\sigma/\tau} \in \Lambda_\sigma/\Lambda_\tau$ , lying in the same half-line as  $\sigma/V_\tau$  and we call it the *primitive normal vector* of  $\sigma$  relative to  $\tau$ . In the following we write  $\tau \leq \sigma$  if  $\tau$  is a face of  $\sigma$  and  $\tau < \sigma$  if  $\tau$  is a proper face of  $\sigma$ .

**Definition 1.5** (General weighted and general tropical fan). A *general weighted fan*  $(X, \omega_X)$  in  $V$  is a pure-dimensional general fan  $X$  of dimension  $n$  with a map  $\omega_X : X^{(n)} \rightarrow \mathbb{Q}$ . The numbers  $\omega_X(\sigma)$  are called *weights* of the general cones  $\sigma \in X^{(n)}$ . By abuse of notation we also write  $\omega$  for the map and  $X$  for the weighted fan.

A *general tropical fan* in  $V$  is a weighted fan  $(X, \omega_X)$  fulfilling the balancing condition

$$\sum_{\sigma > \tau} \omega_X(\sigma) \cdot u_{\sigma/\tau} = 0 \quad \in V/V_\tau$$

for any  $\tau \in X^{(\dim X - 1)}$ .

**Definition 1.6** (Open fan). Let  $\tilde{F}$  be a general fan in  $\mathbb{R}^n$  and  $0 \in U \subseteq \mathbb{R}^n$  an open subset. The set  $F = \tilde{F} \cap U = \{\sigma \cap U \mid \sigma \in \tilde{F}\}$  is called an *open fan* in  $\mathbb{R}^n$ . As in the case of fans, put  $|F| = \bigcup_{\sigma' \in F} \sigma'$ .

If  $\tilde{F}$  is a general weighted fan, we call  $F$  a *weighted open fan*.

**Remark 1.7.** Since  $0 \in U$  and  $U$  is open,  $\tilde{F}$  is determined by  $F$ .

**Definition 1.8** (General polyhedron). A *general polyhedron* is a non-empty set  $\sigma \subset \mathbb{R}^n$  such that there exists a rational polyhedron  $\tilde{\sigma}$  and a union  $u$  of faces of  $\tilde{\sigma}$  such that  $\sigma = \tilde{\sigma} \setminus u$ . (This definition is equivalent to saying that a general polyhedron has the following form  $\{x \in \mathbb{R}^n \mid f_1(x) = p_1, \dots, f_r(x) = p_r, f_{r+1}(x) \geq p_{r+1}, \dots, f_{r+s}(x) \geq p_{r+s}, f_{r+s+1}(x) > p_{r+s+1}, \dots, f_N(x) > p_N\}$  for some linear forms  $f_1, \dots, f_N \in \mathbb{Z}^n$  and numbers  $p_1, \dots, p_N \in \mathbb{R}$ .)

**Definition 1.9** (General polyhedral precomplex). A *(general) polyhedral precomplex* is a topological space  $|X|$  and a set  $X$  of subsets of  $|X|$  equipped with embeddings  $\varphi_\sigma : \sigma \rightarrow \mathbb{R}^{n_\sigma}$  for all  $\sigma \in X$  such that

- (a) every image  $\varphi_\sigma(\sigma)$ ,  $\sigma \in X$  is a general polyhedron, not contained in a proper affine subspace of  $\mathbb{R}^{n_\sigma}$ ,
- (b)  $X$  is closed under taking intersections, i.e.  $\sigma \cap \sigma' \in X$  is a face of  $\sigma$  and of  $\sigma'$  for any  $\sigma, \sigma' \in X$  such that  $\sigma \cap \sigma' \neq \emptyset$ ,
- (c) for every pair  $\sigma, \sigma' \in X$  the composition  $\varphi_\sigma \circ \varphi_{\sigma'}^{-1}$  is integer affine-linear on  $\varphi_{\sigma'}(\sigma \cap \sigma')$ ,
- (d)  $|X| = \bigcup_{\sigma \in X} \varphi_\sigma^{-1}(\varphi_\sigma(\sigma)^\circ)$ , where  $\varphi_\sigma(\sigma)^\circ$  denotes the interior of  $\varphi_\sigma(\sigma)$  in  $\mathbb{R}^{n_\sigma}$ .

We call the open set  $\varphi_\sigma^{-1}(\varphi_\sigma(\sigma)^\circ)$  the *relative interior* of  $\sigma$  and denote it by  $\sigma^{ri}$ .

**Definition 1.10** (General polyhedral complex). A *(general) polyhedral complex* is a (general) polyhedral precomplex  $(X, |X|, \{\varphi_\sigma \mid \sigma \in X\})$  such that for every  $\sigma \in X$  we are given an

open fan  $F_\sigma$  (denoted as well by  $F_\sigma^X$  to underline that it belongs to the complex  $X$ ) in some  $\mathbb{R}^{N_\sigma}$  and a homeomorphism

$$\Phi_\sigma : S_\sigma = \bigcup_{\sigma' \in X, \sigma' \supseteq \sigma} (\sigma')^{ri} \xrightarrow{\sim} |F_\sigma|$$

satisfying:

- for all  $\sigma' \in X, \sigma' \supseteq \sigma$  one has  $\Phi_\sigma(\sigma' \cap S_\sigma) \in F_\sigma$  and  $\Phi_\sigma$  is compatible with the  $\mathbb{Z}$ -linear structure on  $\sigma'$ , i.e.  $\Phi_\sigma \circ \varphi_{\sigma'}^{-1}$  and  $\varphi_{\sigma'} \circ \Phi_\sigma^{-1}$  are integer affine linear on  $\varphi_{\sigma'}(\sigma' \cap S_\sigma)$ , resp.  $\Phi_\sigma(\sigma' \cap S_\sigma)$ ,
- for every pair  $\sigma, \tau \in X$ , there is an integer affine linear map  $A_{\sigma, \tau}$  such that the following diagram commutes:

$$\begin{array}{ccc} S_\sigma \cap S_\tau & \xrightarrow[\sim]{\Phi_\tau} & \Phi_\tau(S_\sigma \cap S_\tau) \\ \Phi_\sigma \downarrow \sim & \nearrow A_{\sigma, \tau} & \\ \Phi_\sigma(S_\sigma \cap S_\tau) & & \end{array}$$

For simplicity we usually drop the embeddings  $\varphi_\sigma$  or the maps  $\Phi_\sigma$  in the notation and denote the polyhedral complex  $(X, |X|, \{\varphi_\sigma | \sigma \in X\}, \{\Phi_\tau | \tau \in X\})$  by  $(X, |X|, \{\varphi_\sigma | \sigma \in X\})$  or by  $(X, |X|, \{\varphi\}, \{\Phi_\tau | \tau \in X\})$  or by  $(X, |X|)$  or just by  $X$  if no confusion can occur. The subsets  $\sigma \in X$  are called the *general polyhedra* or *faces of*  $(X, |X|)$ . The *dimension* of  $(X, |X|)$  is the maximum of the dimensions of its general polyhedra. We call  $(X, |X|)$  *pure-dimensional* if all its inclusion-maximal general polyhedra are of the same dimension. We denote by  $X^{(n)}$  the set of polyhedra in  $(X, |X|)$  of dimension  $n$ . Let  $\tau, \sigma \in X$ . As in the case of fans we write  $\tau \leq \sigma$  (or  $\tau < \sigma$ ) if  $\tau \subseteq \sigma$  (or  $\tau \subsetneq \sigma$ , respectively). By abuse of notation we identify  $\sigma$  with  $\varphi_\sigma(\sigma)$ .

A (general) polyhedral complex  $(X, |X|)$  of pure dimension  $n$  together with a map  $\omega_X : X^{(n)} \rightarrow \mathbb{Q}$  is called *weighted polyhedral complex* of dimension  $n$ , and  $\omega_X(\sigma)$  is called the *weight* of the polyhedron  $\sigma \in X^{(n)}$ , if all  $F_\sigma$  are weighted open fans and

- $\omega_X(\sigma') = \omega_{F_\sigma}(\Phi_\sigma(\sigma' \cap S_\sigma))$  for every  $\sigma' \in (X)^{(n)}$  with  $\sigma' \supseteq \sigma$ ,

The empty complex  $\emptyset$  is a weighted polyhedral complex of every dimension. If  $((X, |X|), \omega_X)$  is a weighted polyhedral complex of dimension  $n$ , then put

$$X^* = \{\tau \in X | \tau \subseteq \sigma \text{ for some } \sigma \in X^{(n)} \text{ with } \omega_X(\sigma) \neq 0\}, |X^*| = \bigcup_{\tau \in X^*} \tau \subseteq |X|.$$

Note that  $((X^*, |X^*|), \omega_X|_{(X^*)^{(n)}})$  is again a weighted polyhedral complex of dimension  $n$ . This complex is called the *non-zero part* of  $((X, |X|), \omega_X)$ . We call a weighted polyhedral complex  $((X, |X|), \omega_X)$  *reduced* if  $((X, |X|), \omega_X) = ((X^*, |X^*|), \omega_{X^*})$ . Since all polyhedral complexes considered are general we skip the word general from now on.

*Example 1.11.* Figure 1.1 represents a weighted polyhedral complex together with the maps  $\varphi_\sigma$ , and figure 1.2 represents the same complex together with the maps  $\Phi_\sigma$  and its weights (we only label weights non-equal to one).



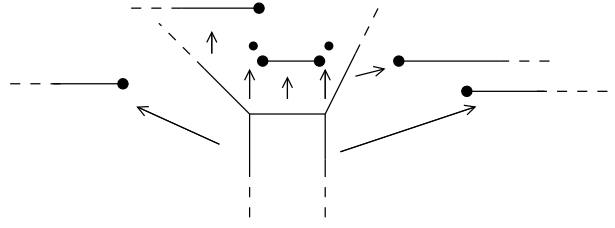

Figure 1.1: A weighted polyhedral complex together with the maps  $\varphi_\sigma$ .

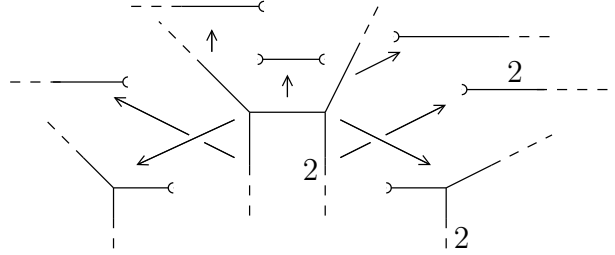

Figure 1.2: A weighted polyhedral complex together with the maps  $\Phi_\sigma$ .

**Definition 1.12** (Subcomplex and refinement). Let  $(X, |X|, \{\varphi_\sigma | \sigma \in X\})$  and  $(Y, |Y|, \{\psi_\tau | \tau \in Y\})$  be two polyhedral complexes. We call  $X$  a *subcomplex* of  $Y$  if

- (a)  $|X| \subseteq |Y|$ ,
- (b) for every  $\sigma$  in  $X$  there exists a  $\tau \in Y$  with  $\sigma \subseteq \tau$ ,
- (c) for a pair  $\sigma$  and  $\tau$  from (b) the maps  $\varphi_\sigma \circ \psi_\tau^{-1}$  and  $\psi_\tau \circ \varphi_\sigma^{-1}$  are integer affine linear on  $\psi_\tau(\sigma)$ , resp.  $\varphi_\sigma(\sigma)$ .

We write  $(X, |X|) < (Y, |Y|)$  in this case, and define a map  $C_{X,Y} : X \rightarrow Y$  that maps a cone in  $X$  to the inclusion-minimal cone in  $Y$  containing it.

We call a polyhedral complex  $(X, |X|)$  a *refinement* of  $(Y, |Y|)$ , if

- (a)  $(X, |X|) < (Y, |Y|)$
- (b)  $|X| = |Y|$

We call a weighted polyhedral complex  $(X, |X|)$  a *refinement* of a weighted polyhedral complex  $(Y, |Y|)$  if in addition the following condition holds:

- $\omega_X(\sigma) = \omega_Y(C_{X^*,Y^*}(\sigma))$  for all  $\sigma \in (X^*)^{(\dim(X))}$ .

**Definition 1.13** (Morphism of (general) polyhedral complexes). Let  $X$  and  $Y$  be two (general) polyhedral complexes. A *morphism of (general) polyhedral complexes*  $f : X \rightarrow Y$  is a continuous map  $f : |X| \rightarrow |Y|$  with the following properties: there exist refinements  $(X', |X'|, \{\varphi\}, \{\Phi_\sigma | \sigma \in X'\})$  and  $(Y', |Y'|, \{\psi\}, \{\Psi_\tau | \tau \in Y'\})$  of  $X$  and  $Y$ , respectively, such that

- (a) for every general polyhedron  $\sigma \in X'$  there exists a general polyhedron  $\tilde{\sigma} \in Y'$  with  $f(\sigma) \subseteq \tilde{\sigma}$ ,

- (b) for every pair  $\sigma, \tilde{\sigma}$  from (a) the map  $\Psi_{\tilde{\sigma}} \circ f \circ \Phi_{\sigma}^{-1} : |F_{\sigma}^{X'}| \rightarrow |F_{\tilde{\sigma}}^{Y'}|$  induces a morphism of fans  $\tilde{F}_{\sigma}^{X'} \rightarrow \tilde{F}_{\tilde{\sigma}}^{Y'}$ , where  $\tilde{F}_{\sigma}^{X'}$  and  $\tilde{F}_{\tilde{\sigma}}^{Y'}$  are the general fans given in definition 1.6 (a morphism of fans is a  $\mathbb{Z}$ -linear map, see [GKM] definition 2.22).

A morphism of *weighted polyhedral complexes* is a morphism of polyhedral complexes (i.e. there are no conditions on the weights). If  $X = Y$  and if there exists a morphism  $g : X \rightarrow X$  such that  $g \circ f = f \circ g = id_X$  we call  $f$  an *automorphism* of  $X$ .



## 2 Moduli spaces

In this chapter we give the definition of the moduli spaces we will equip later on with a structure of a (local) orbit space.

### 2.1 Moduli space of n-marked tropical curves

**Definition 2.1** (*n*-marked abstract tropical curves). An *abstract tropical curve* is a pair  $(\bar{\Gamma}, \delta)$  such that  $\bar{\Gamma}$  is a connected graph, and  $\Gamma = \bar{\Gamma} \setminus \{1\text{-valent vertices}\}$  has a complete inner metric  $\delta$  (i.e. the edges adjacent to two vertices of  $\Gamma$  are isometric to a segment, the edges adjacent to one vertex of  $\Gamma$  are isometric to a ray or a loop and the edges adjacent to no vertex of  $\Gamma$  are isometric to a line). The edges adjacent to at least one 1-valent vertex of  $\bar{\Gamma}$  are called *unbounded*, the other edges are called *bounded*. The unbounded edges have length infinity. The bounded edges have a finite positive length. For simplicity we denote an abstract tropical curve by  $\Gamma$ . An *n*-marked abstract tropical curve is a tuple  $(\Gamma, x_1, \dots, x_n)$  formed by an abstract tropical curve  $\Gamma$  and distinct rays  $x_1, \dots, x_n$  of  $\Gamma$ . Two such marked tropical curves  $(\Gamma, x_1, \dots, x_n)$  and  $(\tilde{\Gamma}, \tilde{x}_1, \dots, \tilde{x}_n)$  are called *isomorphic* (and will from now on be identified) if there exists an isometry from  $\Gamma$  to  $\tilde{\Gamma}$ , mapping  $x_i$  to  $\tilde{x}_i, i = 1, \dots, n$  (i.e. after choosing orientations on the edges of  $\Gamma$  and  $\tilde{\Gamma}$ , there exists a homeomorphism  $\Gamma \rightarrow \tilde{\Gamma}$  identifying  $x_i$  and  $\tilde{x}_i$  and such that the edges of  $\Gamma$  are mapped to edges of  $\tilde{\Gamma}$  by an affine map of slope  $\pm 1$ ).

The unbounded edges are called *leaves* as well.

*Remark 2.2.* We can parameterize each edge  $E$  of a curve  $\Gamma$  by an interval  $[0, l(E)]$  for bounded edges and by  $[0, \infty)$  or  $(-\infty, \infty)$  for unbounded edges, where  $l(E)$  is the length of the edge (for the choice of the direction in the bounded case we choose which vertex of  $E$  is parameterized by 0). Such a parameterization is called *canonical*. We do not distinguish between the unbounded edge  $x_i$  and the vertex of valence strictly greater than 1 adjacent to it and call the vertex also  $x_i$ . Since different edges can be adjacent to the same vertex, a vertex can have several labels.

**Definition 2.3** (Genus). We define the *genus*  $g$  of an abstract tropical curve  $(\bar{\Gamma}, \delta)$  to be the first Betti number  $b_1(\Gamma)$  of  $\Gamma$ .

**Definition 2.4** (Combinatorial type). The *combinatorial type* of an abstract tropical curve  $(\bar{\Gamma}, \delta)$  is the (combinatorial) graph  $\bar{\Gamma}$ .

**Definition 2.5** (Contraction). Let  $\bar{\Gamma}$  be a connected graph. The procedure of removing an edge  $e \in \bar{\Gamma}$  and identifying the endpoints of  $e$  is called *contraction*.

**Definition 2.6.** It is not difficult to see that for a combinatorial type  $\bar{\Gamma}$  the set of all curves given by definition 2.1 with the combinatorial type  $\bar{\Gamma}$  or the combinatorial types one gets by contracting bounded edges of  $\bar{\Gamma}$  can be embedded in a suitable  $\mathbb{R}^m$  by the lengths of the bounded edges and therefore this set of curves has a topological structure (this subset of  $\mathbb{R}^m$  is called *combinatorial cone*). Note, that for combinatorial types with symmetries we take as set of curves (in the beginning of this definition),  $n$ -marked abstract tropical curves with an ordering of the bounded edges. Afterwards we take a connected subspace of this set which contains exactly one representative of each  $n$ -marked abstract tropical curve. Thus, the set of all  $n$ -marked abstract tropical curves of genus  $g$  with this induced topological structure on each combinatorial cone (the cones are glued together along faces representing the same curves) is a topological space.

*Example 2.7.* We consider a 5-marked tropical curve  $(\bar{\Gamma}, \delta)$  with edge lengths  $a$  and  $b$  (see on the left hand side of figure 2.1). The combinatorial cone parameterizing all curves with the combinatorial type  $\bar{\Gamma}$  or with the combinatorial type one gets by contractions of  $\bar{\Gamma}$  is drawn on the right hand side of figure 2.1.

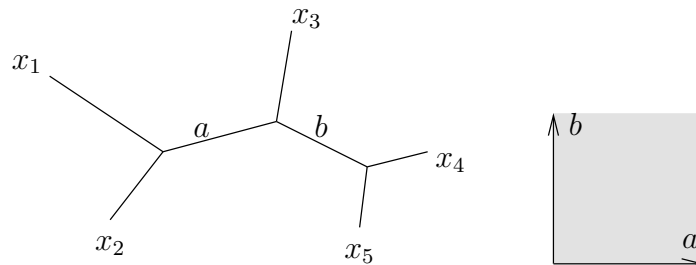

Figure 2.1: A 5-marked abstract tropical curve and its combinatorial cone.

**Definition 2.8** (abstract  $\mathcal{M}_{g,n}$ ). The space  $\mathcal{M}_{g,n}$  is defined to be the topological space of all  $n$ -marked abstract tropical curves (modulo isomorphism) with the following properties:

- (a) each curve has exactly  $n$  leaves,
- (b) the curves have no vertices of valence 2, and
- (c) the genus of each curve is  $g$ .

The topology of this space is the one defined by its combinatorial cones. We call the space  $\mathcal{M}_{g,n}$  a *moduli space*.

*Example 2.9.* The moduli space of 2-marked abstract tropical curves of genus 1 and the curves corresponding to the faces are given in the following picture:

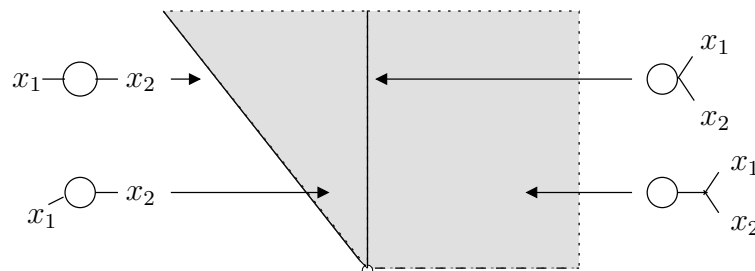

The left cone parameterizes the curves where the two edges of the cycle have the same length. The appearance of this cone is due to the fact that the curves corresponding to the curve on the lower left side are the same if we swap the lengths of the two bounded edges. Thus, the left cone is in the boundary of the second cone from left.

Let  $(\bar{\Gamma}, \delta)$  be a curve of genus 1. As a tropical counterpart of the  $j$ -invariant, we take the length of the cycle as it was suggested in [M3], [V] and [KM]. Motivations for this choice can be found, for example, in [KMM1], [KMM2] and [Sp2].

**Definition 2.10** ( $j$ -invariant). For an  $n$ -marked curve  $\Gamma$  of genus 1, the sum of the lengths of all edges forming the simple cycle is called the  $j$ -invariant of  $\Gamma$ .

## 2.2 Moduli space of parameterized labeled $n$ -marked tropical curves

**Definition 2.11** (Tropical  $\widetilde{\mathcal{M}}_{g,n}^{\text{lab}}(\mathbb{R}^r, \Delta)$ ). A parameterized labeled  $n$ -marked tropical curve of genus  $g$  in  $\mathbb{R}^r$  is a tuple  $(\Gamma, x_1, \dots, x_N, h)$ , where  $N \geq n$  is an integer,  $(\Gamma, x_1, \dots, x_N)$  is an abstract  $N$ -marked tropical curve of genus  $g$ , and  $h : \Gamma \rightarrow \mathbb{R}^r$  is a continuous map satisfying the following conditions.

- (a) On each edge  $E$  of  $\Gamma$  the map  $h$  is of the form  $h(t) = a + t \cdot v$  for some  $a \in \mathbb{R}^r$  and  $v \in \mathbb{Z}^r$ . The integral vector  $v$  occurring in this equation if we pick for  $E$  the canonical parameterization starting at  $V \in \partial E$  is denoted  $v(E, V)$  and is called the *direction* of  $E$  (at  $V$ ). If  $E$  is an unbounded edge and  $V$  is its only boundary point we write  $v(E)$  instead of  $v(E, V)$  for simplicity.
- (b) For every vertex  $V$  of  $\Gamma$  we have the *balancing condition*

$$\sum_{E|V \in \partial E} v(E, V) = 0.$$

- (c)  $v(x_i) = 0$  for  $i = 1, \dots, n$  (i.e. each of the first  $n$  leaves is contracted by  $h$ ), whereas  $v(x_i) \neq 0$  for  $i > n$  (i.e. the remaining  $N - n$  ends are “non-contracted ends”).

Two parameterized labeled  $n$ -marked tropical curves  $(\Gamma, x_1, \dots, x_N, h)$  and  $(\tilde{\Gamma}, \tilde{x}_1, \dots, \tilde{x}_N, \tilde{h})$  in  $\mathbb{R}^r$  are called isomorphic (and will from now on be identified) if there is an isomorphism  $\varphi : (\Gamma, x_1, \dots, x_N) \rightarrow (\tilde{\Gamma}, \tilde{x}_1, \dots, \tilde{x}_N)$  of the underlying abstract curves such that  $\tilde{h} \circ \varphi = h$ .

Let  $m = N - n$ . The *degree* of a parameterized labeled  $n$ -marked tropical curve  $\Gamma$  of genus  $g$  as above is defined to be the  $m$ -tuple  $\Delta = (v(x_{n+1}), \dots, v(x_N)) \in (\mathbb{Z}^r \setminus \{0\})^m$  of directions of its non-contracted ends. The *combinatorial type* of  $\Gamma$  is given by the data of the combinatorial type of the underlying abstract marked tropical curve  $(\Gamma, x_1, \dots, x_N)$  together with the directions of all its (bounded and unbounded) edges. From now on, the number  $N$  will always be related to  $n$  and  $\Delta$  by  $N = n + \#\Delta$  and thus will denote the total number of (contracted or non-contracted) ends of an  $n$ -marked curve of genus  $g$  in  $\mathbb{R}^r$  of degree  $\Delta$ .

Fix a combinatorial type  $T$  of a parameterized labeled  $n$ -marked tropical curve with  $n > 0$ . The set of curves with combinatorial type  $T$  or with the combinatorial type one gets by

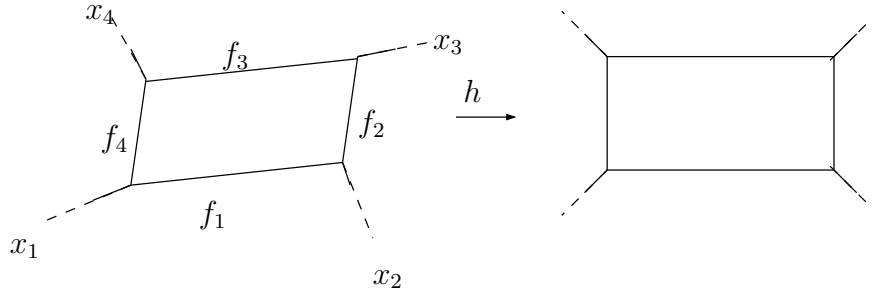

Figure 2.2: A parameterized tropical curve.

contractions of  $T$  can be embedded in a suitable  $\mathbb{R}^b$  by the lengths of all bounded edges together with the point  $h(x_1)$ . As in the case of abstract tropical curves this gives a topology on the set of parameterized labeled  $n$ -marked tropical curves of genus  $g$  in  $\mathbb{R}^r$ .

The space (of the isomorphism classes) of all parameterized labeled  $n$ -marked tropical curves of genus  $g$  and of a given degree  $\Delta$  in  $\mathbb{R}^r$ , such that all vertices have valence at least 3 will be denoted  $\widetilde{\mathcal{M}}_{g,n}^{\text{lab}}(\mathbb{R}^r, \Delta)$  and will be called *moduli space*. Let  $(e_1, \dots, e_r)$  be the canonical basis of  $\mathbb{R}^r$ . For the special choice

$$\Delta = (-e_0, \dots, -e_0, \dots, -e_r, \dots, -e_r)$$

with  $e_0 = -e_1 - \dots - e_r$  and where each  $e_i$  occurs exactly  $d$  times, we will also denote this space by  $\widetilde{\mathcal{M}}_{g,n}^{\text{lab}}(\mathbb{R}^r, d)$  and say that these curves have degree  $d$ .

We now consider an example of a parameterized labeled 4-marked tropical curve and use the notation of the previous definition.

*Example 2.12.* Let  $X$  be the polyhedral complex given by four bounded edges  $(f_1, f_2, f_3, f_4)$  forming a cycle and four rays  $(x_1, x_2, x_3, x_4)$  attached to the four meeting points of two of them, such that  $f_{i-1}, f_i$  and  $x_i$  meet at one point for  $i \in \{2, \dots, 4\}$  (and therefore  $f_1, f_4$  and  $x_1$  meet at one point) which we call  $p_i$  for  $i \in \{1, \dots, 4\}$ . Say the vectors  $v(x_1) = \begin{pmatrix} -1 \\ -1 \end{pmatrix}$ ,  $v(x_2) = \begin{pmatrix} 1 \\ -1 \end{pmatrix}$ ,  $v(x_3) = \begin{pmatrix} 1 \\ 1 \end{pmatrix}$ ,  $v(x_4) = \begin{pmatrix} -1 \\ 1 \end{pmatrix}$ ,  $l(f_1) = l(f_3) = 2$  and  $l(f_2) = l(f_4) = 1$ . We put  $h(p_1) = \begin{pmatrix} 0 \\ 0 \end{pmatrix}$ ,  $h(p_2) = \begin{pmatrix} 2 \\ 0 \end{pmatrix}$ ,  $h(p_3) = \begin{pmatrix} 2 \\ 1 \end{pmatrix}$  and  $h(p_4) = \begin{pmatrix} 0 \\ 1 \end{pmatrix}$  and get a parameterized tropical curve  $(X, x_1, \dots, x_4, h) \in \widetilde{\mathcal{M}}_{1,0}^{\text{lab}}(\mathbb{R}^2, ((-1), \begin{pmatrix} 1 \\ -1 \end{pmatrix}, \begin{pmatrix} 1 \\ 1 \end{pmatrix}, \begin{pmatrix} -1 \\ 1 \end{pmatrix}))$ . A picture of  $(X, x_1, \dots, x_4, h)$  is given in figure 2.2.

# 3 Local orbit spaces

The purpose of this chapter is to define local orbit spaces and to establish some properties for them. In the first part we define local orbit spaces and in the second part we introduce morphisms between them. After this we prove our main result for tropical local orbit spaces (see corollary 3.41).

## 3.1 Tropical local orbit space

**Definition 3.1** (Local orbit space). Let  $X$  be a finite polyhedral complex and  $G$  a finite set of isomorphisms  $g : U_g \rightarrow V_g$  between open polyhedral subcomplexes  $U_g$  and  $V_g$  of  $X$  (open in  $X$ ), such that the following conditions hold:

- (a) the identity morphism of  $X$  is in  $G$ ,
- (b)  $g^{-1} \in G$  for all  $g \in G$ ,
- (c) for all  $F = \{f_1, \dots, f_n\} \subset G$ ,  $g \in G$  with  $g^{-1}(|U_{f_i}|) \neq \emptyset$ , for all  $1 \leq i \leq n$  there exists  $H = \{h_1, \dots, h_n\} \subset G$  with  $|F| = |H|$  such that  $U_{h_i} \supset g^{-1}(|U_{f_i}|)$  and  $h_i|_{g^{-1}(|U_{f_i}|)} = f_i \circ g|_{g^{-1}(|U_{f_i}|)}$  for  $1 \leq i \leq n$ ,
- (d) for all  $g \in G$  the maximal subset  $U \subset U_g$  with  $g|_U = \text{id}|_U$  is closed in  $X$ .

We denote the induced maps on the topological space  $|U_g|$  by  $g$  as well. We identify points of  $|X|$  which are identified by elements of  $G$  and denote the topological space one gets by these identifications by  $|X/G|$ . The conditions (a) to (c) define an equivalence relation of polyhedra. For a polyhedron  $\sigma \in U_g$  with  $g \in G$  let us denote by  $\sigma_{X/G}$  the image of  $|\sigma|$  in  $|X/G|$ . By  $\bar{S}^{|X/G|}$  we denote the closure of  $S \subset |X/G|$  in  $|X/G|$ . We put  $[\sigma] = \bar{\sigma}_{X/G} \subset |X/G|$  and call it a class. After refinement we can assume that for all  $g \in G$  and for all  $\sigma \in U_g$  we have that  $\bar{\sigma}^X \in X$  is a polyhedron. Let  $g \in G$  and  $\sigma \in U_g$ . We call the set  $\{\tau \in X, [\tau] = [\sigma]\}$  *orbit* of  $X$ . The set of orbits of  $X$  together with  $G$  is called a *local orbit space* and is denoted by  $X/G$ . Sometimes we denote the maps  $g$  by  $g_X$  to show that  $g$  is an isomorphism between two polyhedral subcomplexes of  $X$ .

*Remark 3.2.* The conditions on the set  $G$  are fulfilled if  $G$  is a group.

*Example 3.3.* Figure 3.1 shows the polyhedral complex  $X = \{\mathbb{R}_{\leq 0} \times \mathbb{R}_{>0}, 0 \times \mathbb{R}_{>0}, \mathbb{R}_{\geq 0} \times \mathbb{R}_{>0}\}$  and the topological space of the local orbit space  $X/G = (\{\{\mathbb{R}_{\leq 0} \times \mathbb{R}_{>0}, \mathbb{R}_{\geq 0} \times \mathbb{R}_{>0}\}, \{0 \times \mathbb{R}_{>0}\}\}, G)$ . The set of isomorphisms  $G$  consists of the identity, the map  $g : \mathbb{R}_{<0} \times \mathbb{R}_{>0} \rightarrow \mathbb{R}_{>0}^2$ ,  $\begin{pmatrix} x \\ y \end{pmatrix} \mapsto \begin{pmatrix} y \\ -x \end{pmatrix}$  and  $g^{-1}$ .



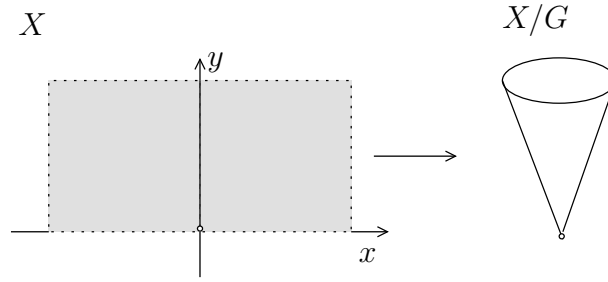

Figure 3.1: A polyhedral complex and a local orbit space.

**Lemma 3.4.** *Let  $X/G$  be a local orbit space and let  $Y$  be a subcomplex of  $X$ . For any  $g \in G$  the topological space  $|U_g| \cap |Y|$  has a canonical structure of an open polyhedral complex, such that  $\tilde{g} : |U_g| \cap |Y| \rightarrow |V_g|$ ,  $x \mapsto g(x)$  defines a morphism of polyhedral complexes.*

*Proof.* By definition there exist refinements  $R$  and  $S$  of  $U_g$  and of  $V_g$ , respectively, such that conditions (a) and (b) of definition 1.13 hold. Since  $Y$  is a subcomplex of  $X$  one gets that  $R \cap Y$  (the set of polyhedra given by the intersection of a polyhedron of  $R$  and a polyhedron of  $Y$  which is non-empty) is a subcomplex of  $R$  and of  $Y$ . For each  $\sigma \in R \cap Y$  we have a  $\sigma' \in U_g$  with  $\sigma \subset \sigma'$ . Thus,  $\tilde{g}(\sigma) = g(\sigma) \subseteq g(\sigma') \subseteq \tilde{\sigma} \in S$  and condition (a) of definition 1.13 holds for  $\tilde{g}$ . Since  $|F_\sigma^{R \cap Y}| \subseteq |F_{\sigma'}^R|$ , condition (b) of a morphism holds as well.  $\square$

**Definition 3.5** (Stabilizer,  $G_\tau$ -orbit of  $\sigma$ ). For  $X$  and  $G$  as above and  $\tau, \sigma \in X$  we call  $G_\tau = \{g \in G \mid \tau \subset U_g \text{ with } g(x) = x \text{ for any } x \in \tau\}$  the *stabilizer* of  $\tau$ . We define  $X_{\sigma/\tau} = \{\overline{g(\sigma^\circ)} \mid g \in G_\tau\}$  to be the  $G_\tau$ -orbit of  $\sigma$ .

**Lemma 3.6.** *Let  $X/G$  be a local orbit space and take  $\sigma, \sigma' \in X$  with  $[\sigma] = [\sigma']$ . One has  $|G_\sigma| = |G_{\sigma'}|$ .*

*Proof.* By symmetry it suffices to show that  $|G_{\sigma'}| \leq |G_\sigma|$ . Let  $\{f_1, \dots, f_n\} = G_{\sigma'}$ . By assumption we have  $[\sigma] = [\sigma']$ . Thus, there exists a  $g \in G$  with  $g(\sigma^\circ) = \sigma'$ . By condition (c) of definition 3.1 there exist  $h_1, \dots, h_n \in G$  with  $h_i|_{\sigma^\circ} = f_i \circ g|_{\sigma^\circ}$  for  $1 \leq i \leq n$ . By (b) of definition 3.1 there exists  $h_i^{-1}$  for  $1 \leq i \leq n$ . Again by condition (c) of definition 3.1 there are  $k_1, \dots, k_n \in G$  such that  $k_i|_{\sigma^\circ} = h_i^{-1} \circ g|_{\sigma^\circ}$  for  $1 \leq i \leq n$ . Since  $h_i^{-1} \circ g|_{\sigma^\circ} = g^{-1} \circ f_i^{-1} \circ g|_{\sigma^\circ} = \text{id}|_{\sigma^\circ}$  and since the maximal subset of  $X$  where  $k_i$  is the identity is closed we have  $|G_{\sigma'}| \leq |G_\sigma|$  by (c) of definition 3.1.  $\square$

**Definition 3.7** (Weighted local orbit space). Let  $(X, \omega_X)$  be a weighted polyhedral complex of pure dimension  $n$ , and  $X/G$  a local orbit space. If

- for any  $g \in G$  and for any  $\sigma \in X^{(n)}$  with  $\sigma^\circ \subseteq |U_g|$ , one has  $\omega_X(\sigma) = \omega_X(\overline{g(\sigma^\circ)})$ ,

we call  $X/G$  a *weighted local orbit space*. The classes  $[\sigma] \subset |X/G|$  are called *weighted classes*.

The weight function on the weighted classes of  $X/G$  is denoted by  $[\omega]$  and defined by  $[\omega]([\sigma]) = \omega(\sigma)/|G_\sigma|$ , for all  $[\sigma] \in X/G$ .

**Lemma 3.8.** *For a weighted local orbit space  $X/G$  of dimension  $m$  and  $\sigma, \tau \in X$  with  $\tau < \sigma$  and  $\dim(\tau) + 1 = \dim(\sigma) = m$ , one has  $|X_{\sigma/\tau}| \cdot |G_\sigma| = |G_\tau|$ .*

*Proof.* For each  $\sigma' \in X_{\sigma/\tau}$  there exists a  $g \in G_\tau$  with  $\sigma = \overline{g(\sigma' \circ)}$ . Put  $\{f_1, \dots, f_n\} = G_\sigma$  with  $|G_\sigma| = n$ . By (c) of definition 3.1 we have  $n$  different elements of  $G$  mapping  $\sigma$  to  $\sigma'$ . By injectivity of the morphisms of  $G$  those elements have to be different for each element of  $X_{\sigma/\tau}$  and therefore  $|X_{\sigma/\tau}| \cdot |G_\sigma| \leq |G_\tau|$ . For each  $g$  in  $G_\tau$  there exists a  $\sigma' \in X_{\sigma/\tau}$  with  $\overline{g(\sigma' \circ)} = \sigma$ . Let  $T \subset G_\tau$  be the set of all elements  $g \in G_\tau$  with  $\overline{g(\sigma' \circ)} = \sigma$ . Since for each  $g$  in  $G_\tau$  there exists a  $\tilde{\sigma} \in X_{\sigma/\tau}$  with  $\overline{g(\tilde{\sigma} \circ)} = \sigma$  it suffices to show that  $|T| \leq n$ . But for an arbitrary  $g \in T$  it follows that  $f \circ g^{-1}|_{\sigma^\circ} = \text{id}|_{\sigma^\circ}$ . Thus, by (c) of definition 3.1 one has  $|T| \leq n$ .  $\square$

**Definition 3.9.** Let  $X/G$  be a local orbit space and  $Y$  be a subcomplex of  $X$ . We denote the set  $\{g|_{|Y| \cap |U_g| \cap g^{-1}(|V_g| \cap |Y|)}, \text{ such that } g \in G\}$  by  $G|_Y$  and consider them as isomorphisms between open polyhedral subcomplexes of  $Y$ . For an element  $g \in G$  we denote the restriction to  $|Y| \cap |U_g| \cap g^{-1}(|V_g| \cap |Y|)$  by  $g_Y$ . (Remark: for  $g \neq h \in G$  we distinguish as well between  $g_Y$  and  $h_Y$  even if  $g|_{|Y| \cap |U_g| \cap g^{-1}(|V_g| \cap |Y|)} = h|_{|Y| \cap |U_h| \cap h^{-1}(|V_h| \cap |Y|)}$ .)

**Corollary 3.10** (of lemma 3.4). *Take the same notation as in the previous definition. The topological spaces  $|Y| \cap |U_g| \cap g^{-1}(|V_g| \cap |Y|)$  and  $g_Y(|Y| \cap |U_g| \cap g^{-1}(|V_g| \cap |Y|))$  have a canonical polyhedral structure such that the map  $g_Y$  from  $|Y| \cap |U_g| \cap g^{-1}(|V_g| \cap |Y|)$  to  $g_Y(|Y| \cap |U_g| \cap g^{-1}(|V_g| \cap |Y|))$  is an isomorphism of polyhedral complexes.*

*Proof.* By lemma 3.4,  $|U_g| \cap |Y|$  and  $|V_g| \cap |Y|$  are canonically polyhedral complexes. Thus,  $|Y| \cap |U_g| \cap g^{-1}(|V_g| \cap |Y|)$  is an intersection of two polyhedral complexes and therefore a polyhedral complex as well. Since  $g$  is an isomorphism, the restriction of  $g$  to a subset and the restriction of the image of  $g$  to the image of this subset gives an isomorphism.  $\square$

*Remark 3.11.* By corollary 3.10 the set  $G|_Y$  is a set of isomorphisms.

**Lemma 3.12.** *Let  $X/G$  be a local orbit space and let  $Y$  be a subcomplex of  $X$ , then  $G|_Y$  fulfills all conditions from definition 3.1.*

*Proof.* The restriction of the identity is the identity as well, thus (a) holds. Since the topology of  $Y$  is the subspace topology, condition (d) holds as well. Furthermore, (b) holds since  $U_{g_Y} = (g^{-1})_Y(V_{g_Y})$  for every  $g \in G$ . Condition (c) holds by the definition of  $G|_Y$ .  $\square$

**Definition 3.13** (Local suborbit space). Let  $X/G$  be a local orbit space. A local orbit space  $Y/H$  is called a *local suborbit space* of  $X/G$  (notation:  $Y/H \subset X/G$ ) if  $Y < X$  and  $H = G|_Y$  (as sets). In this case we denote by  $C_{Y,X} : Y \rightarrow X$  the map which sends a general polyhedron  $\sigma \in Y$  to the (unique) inclusion-minimal general polyhedron of  $X$  that contains  $\sigma$ . Note that for a local suborbit space  $Y/H \subset X/G$  we obviously have  $|Y| \subset |X|$  and  $\dim C_{Y,X}(\sigma) \geq \dim \sigma$  for all  $\sigma \in Y$ . Let  $X/G$  be a weighted local orbit space of dimension  $n$  and let  $Y/H \subset X/G$  be a local suborbit space. If  $\omega_Y(\sigma) = \omega_X(C_{Y,X}(\sigma))$  for all  $\sigma \in Y^{(n)}$ , we write as well  $\omega_X(\sigma)$  for  $\omega_Y(\sigma)$ .

*Example 3.14.* The upper part of figure 3.2 presents an example of the local orbit space  $(-1, 1)$  as local suborbit space of  $\mathbb{R}$ . The lower part of the figure presents the same polyhedral complexes as local orbit spaces, but we take as set of isomorphisms  $G$  the map  $g : x \mapsto -x$  and the identity ( $g$  is defined on  $(-1, 1)$  and on  $\mathbb{R}$ ).

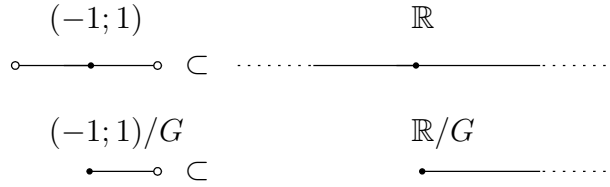

Figure 3.2: Two local suborbit spaces.

**Definition 3.15 (Refinement).** Let  $((Y, |Y|), \omega_Y)/H$  and  $((X, |X|), \omega_X)/G$  be two weighted local orbit spaces. We call  $((Y, |Y|), \omega_Y)/H$  a *refinement* of  $((X, |X|), \omega_X)/G$ , if

- (a)  $((Y, |Y|), \omega_Y)/H \subset ((X, |X|), \omega_X)/G$ ,
- (b)  $|Y^*| = |X^*|$ ,
- (c)  $\omega_Y(\sigma) = \omega_X(C_{Y,X}(\sigma))$  for all  $\sigma \in (Y^*)^{\dim(Y)}$ ,
- (d) each  $\sigma \in Y$  is closed in  $|X|$ .

We say that two weighted local orbit spaces  $((X, |X|), \omega_X)/G$  and  $((Y, |Y|), \omega_Y)/H$  are equivalent (notation:  $((X, |X|), \omega_X)/G \cong ((Y, |Y|), \omega_Y)/H$ ) if they have a common refinement.

*Remark 3.16.* Let  $X/G$  and  $Y/H$  be two local orbit spaces. If  $Y/H$  is a refinement of  $X/G$  then for all  $g \in G$  the complex  $U_{(gY)}$  is a refinement of  $U_g$  and  $H = G$ .

**Definition 3.17 (Tropical local orbit space).** Let  $(X, \omega_X)/G$  be a weighted local orbit space. If for any  $\tau \in X^{(n-1)}$ , one has  $\sum_{\sigma > \tau} \frac{1}{|X_{\sigma/\tau}|} [\omega_X]([\sigma])(u_{\sigma/\tau}) \in V_\tau$ , then  $X/G$  is called a *tropical local orbit space*.

**Proposition 3.18.** *The balancing condition for weighted local orbit spaces  $(X/G, \omega_X)$  holds if and only if the balancing condition of the underlying weighted complex  $(X, \omega_X)$  holds.*

*Proof.* Let  $(X/G, \omega_X)$  be a weighted local orbit space.

"  $\Rightarrow$  ": By assumption the balancing condition of the weighted local orbit space holds. Thus, for every  $\tau \in X$  of codimension one we have  $\sum_{\sigma > \tau} \frac{1}{|X_{\sigma/\tau}|} [\omega_X]([\sigma]) \cdot u_{\sigma/\tau} = t \in V_\tau$ . To verify the balancing condition we have to check it for the fans  $F_\sigma$  (see definition 1.10) of  $X$ . We denote the cones of this fan by the same letters as for the complex. By condition (b) of definition 1.13 the elements of  $G$  are linear on these fans. Thus, we get

$$\begin{aligned}
 |G_\tau| \cdot t &= \sum_{g \in G_\tau} g(t) \\
 &= \sum_{g \in G_\tau} g\left(\sum_{\sigma > \tau} \frac{1}{|X_{\sigma/\tau}|} [\omega_X]([\sigma]) \cdot u_{\sigma/\tau}\right) \\
 &= \sum_{g \in G_\tau} \sum_{\sigma > \tau} \frac{1}{|X_{\sigma/\tau}|} [\omega_X]([\sigma]) \cdot g(u_{\sigma/\tau}) \\
 &= \sum_{\sigma > \tau} |G_\sigma| \cdot [\omega_X]([\sigma]) \cdot u_{\sigma/\tau} \\
 &= \sum_{\sigma > \tau} \omega_X(\sigma) \cdot u_{\sigma/\tau}.
 \end{aligned}$$

”  $\Leftarrow$  ” Put  $n = \dim(X)$ . For any  $\tau \in X^{(n-1)}$  one has  $\sum_{\sigma>\tau} \frac{1}{|G_\tau|} \omega_X(\sigma) \cdot v_{\sigma/\tau} = t \in V_\tau$ , because the balancing condition holds for  $(X, \omega_X)$ . Thus, we have

$$\begin{aligned} \sum_{\sigma>\tau} \frac{1}{|X_{\sigma/\tau}|} [\omega_X](\sigma) \cdot v_{\sigma/\tau} &= \\ \sum_{\sigma>\tau} \frac{|G_\sigma|}{|G_\tau|} [\omega_X](\sigma) \cdot v_{\sigma/\tau} &= \\ \sum_{\sigma>\tau} \frac{1}{|G_\tau|} \omega_X(\sigma) \cdot v_{\sigma/\tau} &= t \in V_\tau \end{aligned}$$

□

**Definition 3.19** (Reduced weighted local orbit spaces). Let  $(X/G, \omega)$  be a weighted local orbit space. Since the weight of a polyhedron  $\sigma$  plays the role of the multiplicity of points in  $\sigma^{r_i}$ , the weight zero stands for multiplicity zero. Since these polyhedra do not contribute to the balancing condition we can delete them without changing the balancing condition. Therefore, if we use weighted local orbit spaces we directly consider the non-zero part of them (see definition 1.10). Weighted local orbit spaces without weight-zero facets are called *reduced*.

*Observation 3.20.* Let  $X'/G'$  and  $X''/G''$  be local orbit spaces, then  $X/G = (X' \times X'')/(G' \times G'')$ , given by the product of the sets, is a local orbit space as well.

If  $X'/G'$  and  $X''/G''$  are weighted local orbit spaces of dimension  $n$  and  $m$ , then we make  $X/G$  into a weighted local orbit space by  $\omega_X(\sigma' \times \sigma'') = \omega_{X'}(\sigma') \cdot \omega_{X''}(\sigma'')$  for  $\sigma' \in X'^{(n)}$  and  $\sigma'' \in X''^{(m)}$ .

If  $X'/G'$  and  $X''/G''$  are tropical local orbit spaces, then  $X/G$  is a tropical local orbit space as well, since a codimension 1 face of  $X$  is the product of a codimension 0 and a codimension 1 face. Thus, the balancing condition around a codimension 1 face is the same as the balancing condition around the corresponding codimension 1 face in  $X'/G'$  (resp.  $X''/G''$ ).

## 3.2 Morphisms of local orbit spaces

Now we have a first understanding of local orbit spaces and we can give the definition of morphisms between them. For a detailed investigation on one dimensional local orbit spaces see chapter 4.

The definition of morphisms should respect the structure of the set of isomorphisms (conditions (a)-(d) of definition 3.1) and the local fan structure of the local orbit spaces (proposition 3.18). The necessary conditions for this are (a) to (f) in the following definition. Furthermore, we want to define images of pure-dimensional local orbit spaces. Only the codimension-one and codimension-zero strata are important for the balancing condition. Thus, we add a further condition which ensures that the morphism is ”well-behaved” in codimension smaller than 2. Since this condition (g) is not as easy to understand as the others we will consider an example regarding this property after the definition.

**Definition 3.21** (Morphism of local orbit spaces). Let  $(X, |X|, \{\varphi\}, \{\Phi_\sigma | \sigma \in X\})/G$  and  $(Y, |Y|, \{\psi\}, \{\Psi_\tau | \tau \in Y\})/H$  be two local orbit spaces and put  $n = \dim(X)$ . A *morphism of local orbit spaces*  $e : X/G \mapsto Y/H$  is a pair  $(e_1, e_2)$  consisting of a continuous map  $e_1 : |X| \rightarrow |Y|$  and a map  $e_2 : G \rightarrow H$  with the following properties:

- (a)  $e_2(id_G) = id_H$
- (b)  $e_2(g^{-1}) = e_2(g)^{-1}$
- (c) if  $h$  fulfills condition (c) of definition 3.1 for elements  $f, g \in G$  (here we have  $|F| = 1$ ), then

$$e_2(h)|_{e_1(g^{-1}(|U_f|))} = e_2(f) \circ e_2(g)|_{e_1(g^{-1}(|U_f|))}$$

- (d) there exists a refinement  $X'$  of  $X$  such that for every general polyhedron  $\sigma \in X'$  there exists a general polyhedron  $\tilde{\sigma} \in Y$  with  $e_1(\sigma) \subseteq \tilde{\sigma}$ ,
- (e) for every pair  $\sigma, \tilde{\sigma}$  from (d) there exist  $\tilde{F}_\sigma^X$  and  $\tilde{F}_{\tilde{\sigma}}^Y$  such that the map  $\Psi_{\tilde{\sigma}} \circ e_1 \circ \Phi_\sigma^{-1} : |F_\sigma^X| \rightarrow |F_{\tilde{\sigma}}^Y|$  induces a morphism of fans  $\tilde{F}_\sigma^X \rightarrow \tilde{F}_{\tilde{\sigma}}^Y$  (a morphism of fans is a  $\mathbb{Z}$ -linear map, see [GKM] definition 2.22), where  $\tilde{F}_\sigma^X$  and  $\tilde{F}_{\tilde{\sigma}}^Y$  are suitable weighted general fans associated to  $F_\sigma^X$  and  $F_{\tilde{\sigma}}^Y$ , respectively (cf. definition 1.6),
- (f)  $e_1(g(x)) = e_2(g)(e_1(x))$  for all  $g \in G$  and  $x \in U_g$ .

If  $X$  is pure-dimensional we ask a morphism to fulfill the following condition as well:

- (g) Let  $\tilde{e}_1$  be the induced map from  $|X/G|$  to  $|Y/H|$ . After a refinement of  $X'$  from condition (d) one has that for any  $\sigma, \tilde{\sigma} \in X$ , with  $\dim(\tilde{e}_1([\sigma]) \cap \tilde{e}_1([\tilde{\sigma}])) = n$  one has  $\dim(\tilde{e}_1([\sigma]) \setminus \tilde{e}_1([\tilde{\sigma}])) \leq \dim(\tilde{e}_1([\sigma])) - 2$  and  $\dim(\tilde{e}_1([\tilde{\sigma}]) \setminus \tilde{e}_1([\sigma])) \leq \dim(\tilde{e}_1([\tilde{\sigma}])) - 2$ .

A *morphism of weighted local orbit spaces* is a morphism of local orbit spaces (i.e. there are no conditions on the weights).

We consider an example to understand condition (g) in the previous definition. Since (g) is a condition only on the polyhedra we take trivial isomorphism sets (i.e.  $G = H = \{id\}$ ).

*Example 3.22.* Let  $X (= X/\{id\})$  be the disjoint union of the cone  $X_1 = \{(x, y) \in \mathbb{R}^2 | y > 0\}$  and the cone  $X_2 = \mathbb{R}^2$  (we label the directions by  $w$  and  $z$ ) and let  $Y (= Y/\{id\})$  be  $\mathbb{R}^2$  (labeled by  $x'$  and  $y'$ ). The map  $e : X \rightarrow Y$  is given by the identity map of the cone  $X_1$  and  $\mathbb{R}^2$  to  $\mathbb{R}^2$  such that  $e(x) = e(w) = x'$ , and  $e(y) = e(z) = y'$  (see figure 3.3). It is easy to see that the conditions (a) to (f) are fulfilled. Let  $X_2$  be any refinement of  $\mathbb{R}^2$  and let  $C$  be a 2-dimensional subcone of  $X_1$  such that the border of  $C$  contains a segment  $I$  of the  $x$ -axis. Since  $\dim(e^{-1}(e(C)) \cap X_2) = 2$ , but  $e^{-1}(e(I)) \cap X_2 = \emptyset$ , there exists a 2-dimensional cone in  $X_2$  contradicting (g) together with  $C$  (there must be a cone containing a part of  $I$  and elements with  $y' > 0$ ). Thus the map  $e$  is not a morphism.

*Remark 3.23.* The problem we are handling in case (g) is, that we would like to have the image to be a local suborbit space. In particular condition (b) of definition 1.9 should hold.

The next two propositions provide a better understanding of condition (g). In particular, the second proposition gives a criterion for the failure of (g).

**Proposition 3.24.** *Let  $X/G$  and  $Y/H$  be local orbit spaces and  $X/G$  be of pure dimension  $n$ . Let  $e$  be a morphism from  $X/G$  to  $Y/H$  and  $X'$  a refinement from (g) in definition 3.21.*

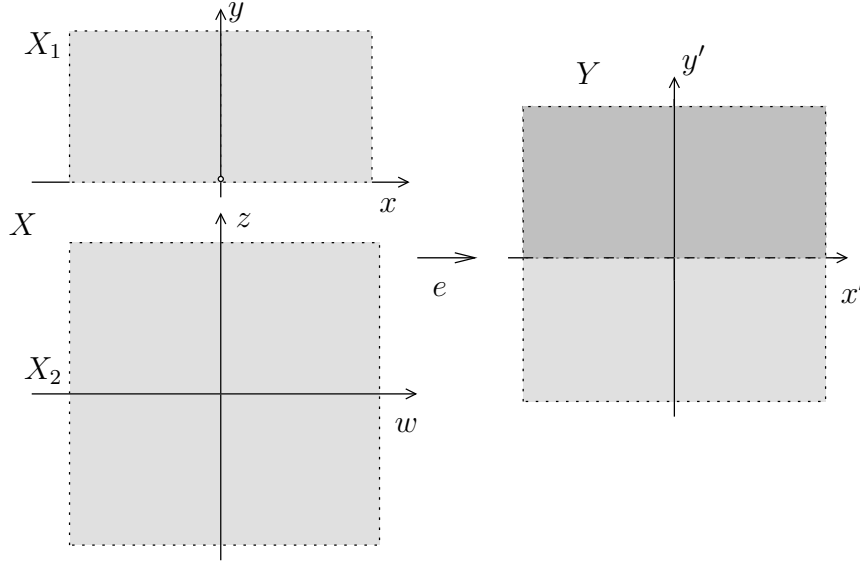

Figure 3.3: A map, but not a morphism between two local orbit spaces.

For every refinement  $X''$  of  $X'$  there exists a refinement  $W$  of  $X''$  such that (g) holds for  $W$  as well.

*Proof.* By refining  $X''$  we can assume that for all  $\sigma, \tilde{\sigma} \in X''$  with  $\dim(\tilde{e}_1([\sigma]) \cap \tilde{e}_1([\tilde{\sigma}])) = n$  one has  $\dim(\tilde{e}_1([\sigma]) \setminus \tilde{e}_1([\tilde{\sigma}])) \leq n - 1$  and  $\dim(\tilde{e}_1([\tilde{\sigma}]) \setminus \tilde{e}_1([\sigma])) \leq n - 1$ . We put  $\tau = \tilde{e}_1([\sigma]) \setminus \tilde{e}_1([\tilde{\sigma}])$ . Let  $\sigma'$  (resp.  $\tilde{\sigma}'$ ) be the polyhedron from  $X'$  which contains  $\sigma$  (resp.  $\tilde{\sigma}$ ). Since  $e_1$  is a linear map on the interior of the polyhedra (see definition 3.21 (e)) and it is continuous everywhere,  $\tau$  cannot be in  $\tilde{e}_1([\tilde{\sigma}'])$ . Since  $\sigma' \supset \sigma$  we have that  $\tilde{e}_1([\sigma'])$  contains  $\tau$  and therefore  $\dim \tau \leq n - 2$ . Thus, g holds for the above mentioned refinement of  $X''$  as well.  $\square$

**Proposition 3.25.** *Let  $X/G$  be a pure  $n$ -dimensional local orbit space and  $Y/H$  be a local orbit space of arbitrary dimension. Let  $e$  be a map from  $X/G$  to  $Y/H$  fulfilling conditions (a) to (f) of definition 3.21. Then  $e$  is a morphism iff for every refinement of  $X'$  ( $X'$  as in condition (d)) and any  $\sigma, \tilde{\sigma} \in X'^{(n)}$  the following holds:  $\dim(\tilde{e}_1([\tilde{\sigma}]) \setminus \tilde{e}_1([\sigma])) \leq n - 2$  or  $\dim(\tilde{e}_1([\tilde{\sigma}]) \setminus \tilde{e}_1([\sigma])) = n$ .*

*Proof.* "  $\Leftarrow$  ": After refinement we can assume that  $\dim(\tilde{e}_1([\tilde{\sigma}]) \setminus \tilde{e}_1([\sigma])) = n$  does not occur and thus (g) is fulfilled.

"  $\Rightarrow$  ": Let  $Z$  be the refinement of (g). Assume, that there exist  $\sigma, \tilde{\sigma} \in X'^{(n)}$  such that  $\dim(\tilde{e}_1([\tilde{\sigma}]) \setminus \tilde{e}_1([\sigma])) = n - 1$ . In this case the intersection has to be  $n$ -dimensional. Take a common refinement  $X''$  of  $X'$  and  $Z$ . Then by proposition 3.24 one has a refinement  $W$  of  $X''$  fulfilling g. Let  $\tilde{\sigma}'$  be a polyhedron of  $W^{(n)}$  such that  $[\tilde{\sigma}']$  contains an  $(n - 1)$ -dimensional part of  $\tilde{e}_1([\tilde{\sigma}]) \setminus \tilde{e}_1([\sigma])$ . Since  $W$  is a refinement of  $X'$  as well, there exists at least one polyhedron  $\sigma' \subset \sigma$  with  $\dim(\tilde{e}_1([\tilde{\sigma}']) \cap \tilde{e}_1([\sigma'])) = n$ . We have  $\tilde{e}_1([\sigma']) \subset \tilde{e}_1([\sigma])$  and  $\dim(\tilde{e}_1([\tilde{\sigma}']) \setminus \tilde{e}_1([\sigma])) = n - 1$ . Thus, we get a contradiction and our assumption has to be false.  $\square$

*Example 3.26.* Let us reconsider example 3.22. If we subdivide  $X_2$  along the  $w$ -axis, the resulting subdivision of  $X$  does not fulfill the condition of the previous proposition and (g) does not hold.

**Lemma 3.27.** *Let  $X/G$ ,  $Y'/H'$  and  $Y''/H''$  be local orbit spaces and  $e' : X/G \rightarrow Y'/H'$  and  $e'' : X/G \rightarrow Y''/H''$  be morphisms. Then  $e : X/G \rightarrow (Y' \times Y'')/(H' \times H'')$ , given by  $e_1 : |X| \rightarrow |Y' \times Y''|$ ,  $e_1(x) = (e'_1(x), e''_1(x))$  and  $e_2 : G \rightarrow H' \times H''$ ,  $e_2(f) = (e'_2(f), e''_2(f))$ , is a map fulfilling conditions (a) till (f) of definition 3.21.*

*Proof.* Since the operations  $e_1$  and  $e_2$  are defined coordinate-wise the lemma follows from the definition of  $e'$  and  $e''$ .  $\square$

Our next goal is to define an image local orbit space. In particular it should be a local orbit space. To make sure that the conditions of a polyhedral complex are fulfilled we need a technical construction.

**Definition 3.28.** Let  $X/G$  and  $Y/H$  be two local orbit spaces, let  $X/G$  be pure by  $n$ -dimensional, and let  $e$  be a morphism of  $X/G$  to  $Y/H$ . Put

$$u(e) = \left\{ \lim_{n \rightarrow \infty} \tilde{e}_1(x_n) \mid (x_n)_{n \in \mathbb{N}} \subset [\sigma] \text{ is a Cauchy sequence with } \lim_{n \rightarrow \infty} (x_n) \notin |X/G| \right. \\ \left. \text{but } \lim_{n \rightarrow \infty} \tilde{e}_1(x_n) \in |Y/H|, \sigma \in X^{(n)} \text{ and } e \text{ is injective on } \sigma \right\}.$$

We denote the natural map from  $|X|$  to  $|X/G|$  by  $\text{Mod}_G$  and put  $u_e = \text{Mod}_H^{-1}(u(e))$ .

*Remark 3.29.* Locally  $X/G$  is a general fan. To make it into a fan we have to add some lower dimensional faces  $\tau$  of some polyhedra  $\sigma$ . Since a morphism  $e$  from  $X/G$  to  $Y/H$  is linear on polyhedra one could define the image of  $\tau$  on the level of fans. If the image of  $\tau$  has a meaning in  $Y/H$ , then it is a polyhedron  $\tau'$ . The set  $u(e)$  is the union of the images of all those  $\tau$ 's.

The following proposition gives a useful characterization of  $u(e)$ .

**Proposition 3.30.** *Take the notation of the previous definition and assume that  $X$  is already refined to fulfill condition (d) of definition 3.21. Let  $X_I$  be the union of all polyhedra  $\sigma$  in  $X^{(n)}$  such that  $e_1$  is injective on  $\sigma$ . Then*

$$u(e) = \bigcup_{\sigma \in X_I} \overline{\tilde{e}_1([\sigma])}^{Y/H} \setminus \tilde{e}_1([\sigma]).$$

*Proof.* For each  $x \in u(e)$  we find a sequence in  $[\sigma]$  such that the images converge to  $x$  but the sequence does not converge in  $X/G$  and hence not in  $[\sigma]$ . By condition (d) we have that  $\tilde{e}_1$  is an injective linear map on  $[\sigma]$  and thus  $x \notin \tilde{e}_1([\sigma])$ . Therefore, the point  $x$  is in  $\bigcup_{\sigma \in X_I} \overline{\tilde{e}_1([\sigma])} \setminus \tilde{e}_1([\sigma])$ .

Now let  $x \in \bigcup_{\sigma \in X_I} \overline{\tilde{e}_1([\sigma])} \setminus \tilde{e}_1([\sigma])$ . Since  $x$  is in the closure of the image of a closed set  $T$  there exists a sequence  $(y_n)_{n \in \mathbb{N}} \subset \tilde{e}_1(T)$  converging to  $x$ . Consider a sequence  $(x_n)_{n \in \mathbb{N}}$  with  $x_i$  a preimage of  $y_i$ . Since  $X$  contains only finitely many polyhedra, one has a polyhedron  $\sigma' \in X^{(n)}$  such that infinitely many  $x_i$  are in  $\text{Mod}_G(\sigma')$ . By changing to this subsequence we

can assume that  $(x_n)_{n \in \mathbb{N}} \subset \text{Mod}_G(\sigma') \subset [\sigma']$ . Each polyhedral complex consists of finitely many polyhedra, thus, condition (d) of definition 1.9 ensures that infinitely many elements of  $(x_n)_{n \in \mathbb{N}}$  lie in the interior of the same polyhedron  $\text{Mod}_G(\tau)$ ,  $\tau \in X$ . By condition (e) of definition 3.21 morphisms are linear maps in the interior of polyhedra. Thus,  $e_1$  is injective and  $(x_n)_{n \in \mathbb{N}}$  converges. Since  $T \cap [\sigma']$  is closed,  $(x_n)_{n \in \mathbb{N}}$  does not converge in  $X/G$  and thus  $x \in u(e)$ .  $\square$

*Construction 3.31.* From now on we consider only Hausdorff local orbit spaces if not stated otherwise. As in the case of orbit spaces (construction 6.26) we can define the image local orbit space. Let  $X/G$  be a purely  $n$ -dimensional local orbit space, and let  $Y/H$  be any local orbit space. For any morphism  $e : X/G \rightarrow Y/H$  we make the following construction: Take a refinement of  $X$  such that condition (d) of definition 3.21 holds and define

$$\tilde{Z} = \{ \text{Mod}_H^{-1}(\tilde{e}_1([\sigma])), \sigma \text{ is contained in a polyhedron } \tilde{\sigma} \text{ of } X^{(n)} \text{ and } e \text{ is injective on } \tilde{\sigma} \}$$

By intersections of the polyhedra in  $\tilde{Z}$  with the polyhedra in  $Y$  we get a set of polyhedra  $Z'$ . Now we have to modify  $Z'$  to make it into a polyhedral complex. Therefore, the non-empty intersection of two polyhedra has to be a face of each of them. For this we modify the set and take

$$Z = \{ \sigma \setminus u_e \mid \sigma \in Z', \sigma \setminus u_e \neq \emptyset \}.$$

We will see that the set  $Z$  is (after refinement) a polyhedral complex, and therefore  $Z/(H|_Z)$  is a local orbit space. If moreover  $X/G$  is a weighted local orbit space, we turn  $e(X/G)$  into a weighted local orbit space. After choosing a refinement for  $X$  and  $Y$  such that  $\overline{e_1(\sigma)}^Y$  is a polyhedron in  $Y$  for each  $\sigma \in X$ , we set

$$\omega_{e(X/G)}(\sigma') = \sum_{[\sigma] \in |X/G^{(n)}| : [e_1(\sigma)] = [\sigma']} \omega_X(\sigma) \cdot |\Lambda'_{[\sigma']} / \tilde{e}_1(\Lambda_{[\sigma]})|$$

for any  $\sigma' \in (Z)^{(n)}$  (for  $\Lambda_{[\sigma]}$  see definition 1.1 and remark that  $[\sigma]$  is a polyhedron as well). Since the weights are defined by their classes, the condition on the weights is fulfilled. We call  $Z/H$  the image of  $e$ .

**Lemma 3.32.** *Let us use the notation of the previous construction. Then, after refinement, the set  $Z$  is a polyhedral complex.*

*Proof.* By conditions (d) and (e) of definition 3.21 the images of polyhedra are polyhedra. Since  $Z$  is a subset of  $Y$ , the conditions on the embeddings and the homomorphisms (see definition 1.9 and definition 1.10) are fulfilled. Thus, we only have to prove (a) of definition 1.9. Let  $\sigma, \sigma' \in Z$  such that  $\emptyset \neq \tau = \sigma \cap \sigma'$  and put  $k = \dim \tau$ . After a refinement, the polyhedra  $\sigma$  and  $\sigma'$  have a  $k$ -dimensional face containing  $\tau$ . Assume that  $\sigma$  and  $\sigma'$  are these faces and thus, they are in  $Z^{(k)}$  already. We can take a refinement to get  $\dim((\sigma \setminus \sigma') \cup (\sigma' \setminus \sigma)) < k$ . Assume that  $(\sigma \setminus \sigma') \cup (\sigma' \setminus \sigma) \neq \emptyset$ . Without loss of generality we can take

$$y \in \sigma \setminus \sigma'. \quad (*)$$

By the definition of  $\tilde{Z}$ , there exist  $\tilde{\sigma}$  and  $\tilde{\sigma}'$  in  $X^{(n)}$  such that  $e$  is injective on  $\tilde{\sigma}$  and  $\tilde{\sigma}'$ ,  $\tilde{e}_1([\tilde{\sigma}]) \supseteq \text{Mod}_H(\sigma)$ ,  $\tilde{e}_1([\tilde{\sigma}']) \supseteq \text{Mod}_H(\sigma')$  and  $\text{Mod}_H(y) \notin \tilde{e}_1([\tilde{\sigma}'])$  (since  $Y/H$  is defined



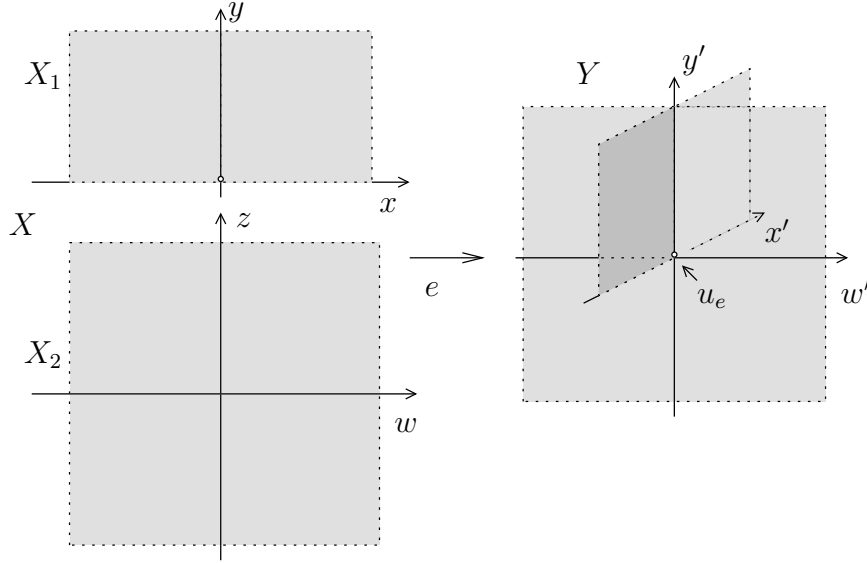

Figure 3.4: A morphism between two local orbit spaces.

by gluing, the subsets can be strict). Let  $(y_n)_{n \in \mathbb{N}} \subset \text{Mod}_H(\sigma') \setminus \text{Mod}_H(y)$  be a sequence which converges to  $\text{Mod}_H(y)$ . Since  $k > 0$  and  $\text{Mod}_H(\sigma')$  is connected such a sequence exists. By condition (e) of definition 3.21 (morphism of fans are linear) there exists a convergent sequence  $(x_n)_{n \in \mathbb{N}} \subset [\tilde{\sigma}']$  such that  $\tilde{e}_1(x_i) = y_i$  for all  $i \in \mathbb{N}$ . Since  $\text{Mod}_H(y) \notin \tilde{e}_1([\tilde{\sigma}'])$  the sequence  $(x_n)_{n \in \mathbb{N}}$  does not converge in  $X/G$ . This is due to the facts that  $[\tilde{\sigma}']$  is closed in  $X/G$  and  $\tilde{e}_1$  is continuous. Thus  $\text{Mod}_H(y) \in u(e)$ ,  $y \in u_e$  and  $y \notin Z$  in contradiction to (\*). Therefore  $(\sigma \setminus \sigma') \cup (\sigma' \setminus \sigma) = \emptyset$  and the non-empty intersection of two polyhedra is a face of both.  $\square$

*Example 3.33.* Let  $X (= X/\{id\})$  be the disjoint union of the cone  $X_1 = \{(x, y) \in \mathbb{R}^2 \mid y > 0\}$  and of  $X_2 = \mathbb{R}^2$  (we label the axes by  $w$  and  $z$ ) and let  $Y (= Y/\{id\})$  be  $\mathbb{R}^3$  (labeled by  $x', y'$  and  $w'$ ). The map  $e : X \rightarrow Y$  is defined by the projection of  $X_1$  and  $X_2$  to  $\mathbb{R}^3$  such, that  $x$  is mapped to  $x'$ ,  $y$  and  $z$  to  $y'$  and  $w$  to  $w'$  (see figure 3.4). It is easy to see that the conditions (a) to (f) are fulfilled. Since  $X_1$  and  $X_2$  are the only cones and the intersection of the image is one-dimensional condition (g) is fulfilled. The origin is not part of  $X_1$ , and there exists a sequence converging to the origin. Since the image of this sequence converges to the origin in  $Y$  the set  $u_e$  contains the origin. With proposition 3.30 we obtain  $u_e = x'$ -axis and thus the origin is the only point of the image under  $\tilde{e}_1$  which lies in  $u_e$ .

**Proposition 3.34.** *Let  $X/G$  be an  $n$ -dimensional tropical local orbit space,  $Y/H$  a local orbit space, and  $e : X/G \rightarrow Y/H$  a morphism. Then  $e(X/G)$  is an  $n$ -dimensional tropical local orbit space (provided that  $e(X/G)$  is not empty).*

*Proof.* Due to the construction of  $\tilde{Z}$  in construction 3.31 the image local orbit space is a pure-dimensional local orbit space. By proposition 3.18 the balancing condition can be checked by proving the balancing condition for the polyhedral complex. Condition (e) of definition 3.21 tells us that for the open fans defined by the homeomorphisms  $\Phi_\sigma$  of definition 1.10, the morphism is a morphism of fans. Let  $\tau' \in e(X/G)^{(n-1)}$  be a face around which we have to

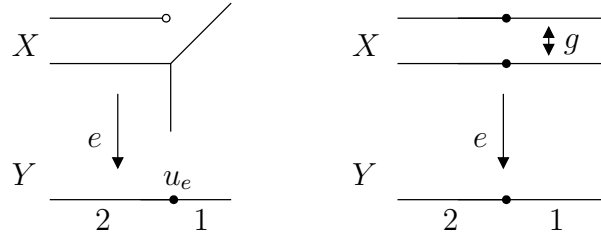

Figure 3.5: Problems which motivate the definition of morphisms.

check the balancing condition. First we need that for each summand  $\omega_X(\sigma) \cdot |\Lambda'_{[\sigma]}/\tilde{e}_1(\Lambda_{[\sigma]})|$  in the weight of a face  $\sigma' > \tau', \sigma' \in e(X/G)$  there exist a  $\tau \in X^{(n-1)}$  with  $\tau < \sigma$  and  $\tilde{e}_1([\tau]) \subset [\tau']$ . If such a face  $\tau$  does not exist,  $\tau' \notin e(X/G)$  by the construction of  $u_e$  which is a contradiction and thus  $\tau$  exists. From this we can conclude that the weighted facets around  $\tau'$  are the union of images of fan morphisms, where all image fans contain  $\tau'$ . Since  $X/G$  is Hausdorff the fans are disjoint after identification with  $G$  or equal. Since the image polyhedral complex is built out of these fans it suffices to prove the proposition for fans. The balancing condition has to be checked around each codimension 1 face (equivalent to this is verifying the balancing condition on the star around this face). Since this (the star fan) is a closed fan (or a fan in the sense of [GKM]) we can apply proposition 2.25 of [GKM] and we are done.  $\square$

*Remark 3.35.* The two problems we handle with in the previous proof (and which therefore motivate the definition) are shown in figure 3.5. The map in each case is given by a projection to  $\mathbb{R}$  and all weights on the source are 1. On the left hand side of the picture we take for  $X$  the union of a tropical curve with an open ray and for  $G$  the trivial set  $\{id_X\}$ . This is not a morphism since  $(g)$  is not fulfilled.

On the right hand side  $X$  is a union of two copies of  $\mathbb{R}$  and the set  $G$  is the set given by the identification of the strict positive part of these copies. Therefore  $X/G$  is not Hausdorff and applying the construction 3.31 word by word for non-Hausdorff spaces would lead to a non-balanced image of a tropical local orbit space.

**Definition 3.36** (Irreducible tropical local orbit space). Let  $X/G$  be a non-empty tropical local orbit space of pure dimension  $n$ . We call  $X/G$  *irreducible* if for any non-empty tropical local orbit space  $Y/H \subset X/G$  with  $\dim(Y/H) = n$  the following holds: if there exists a refinement  $\tilde{X}/G$  of  $X/G$  such that

$$\text{for all } \sigma \in Y^{(n)} \text{ one has a } \sigma' \in \tilde{X}^{(n)} \text{ with } \dim(\sigma' \setminus \sigma) \leq n - 2 \quad (*)$$

then  $\dim(|\tilde{X}| \setminus |Y|) \leq n - 2$ . We call  $X/G$  *strongly irreducible* if  $X/G$  is irreducible and each weighted open fan  $F_\sigma$  of  $X/G$  (see definition 1.10) is irreducible as a tropical local orbit space (the set of isomorphisms is trivial and the balancing condition holds by proposition 3.18).

**Proposition 3.37.** *A tropical local orbit space  $X/G$  of dimension  $n$  is irreducible if and only if for any tropical local orbit space  $Y/H \subset X/G, Y \neq \emptyset$  such that  $\dim(Y/H) = n$  and  $Y$  is closed in  $X$ , one has  $|Y| = |X|$ .*

*Proof.* We start with an irreducible local orbit space and take a tropical local suborbit space  $Y/H \subset X/G$  with the given properties. The polyhedral complex  $Y$  is closed in  $X$  and thus  $\sigma' \setminus \sigma = \emptyset$  in the definition above. Therefore we have  $\dim(|\tilde{X}| \setminus |Y|) \leq n - 2$  and since  $Y$  is closed in  $X$ , one has  $|X| = |Y|$  (here we need the assumption that  $Y$  is pure-dimensional and thus every point lies in an  $n$ -dimensional polyhedron).

Assume, that  $X/G$  has the properties as stated in the if part of the proposition. Let  $Y/H \subset X/G$  be a tropical local suborbit space of dimension  $n$  such that for every  $\sigma \in Y^{(n)}$  one has a  $\sigma' \in \tilde{X}^{(n)}$  with  $\dim(\sigma' \setminus \sigma) \leq n - 2$ . Since the closure of each  $\sigma$  in  $Y^{(n)}$  is  $\sigma'$  (and  $\sigma'$  is closed in the topology of  $X$ ) the polyhedral complex  $\bar{Y}$  is the union of the  $\sigma'$  in  $X$ . The local orbit space  $Y/H$  is weighted and therefore we can make  $\bar{Y}/G|_{\bar{Y}}$  to a weighted local orbit space by taking the same weights. Since we only added faces of dimension  $n - 2$  or smaller, the balancing condition holds for  $\bar{Y}/G|_{\bar{Y}}$  as well. By the proposition, we get  $|\bar{Y}| = |X|$ . Thus we have  $\dim(|\tilde{X}| \setminus |Y|) \leq n - 2$ .  $\square$

*Remark 3.38.* In the case of closed fans (fans considered in [GKM]) our definition of irreducibility is equivalent to definition 2.16 in [GKM].

**Proposition 3.39.** *Let us take  $X/G$  and  $Y/H$  as in the definition of irreducibility in 3.36. Then, there exists a  $\lambda \in \mathbb{Q} \setminus \{0\}$  such that  $\omega_Y(\sigma) = \lambda \cdot \omega_X(\bar{\sigma})$  for all  $\sigma \in Y$ .*

*Proof.* As in the proof of proposition 3.37 we can take the closure of  $Y/H$  and make it into a tropical local orbit space with  $\omega_{\bar{Y}}(\bar{\sigma}) = \omega_Y(\sigma)$  for all  $\sigma \in Y$ . Thus, assume right away that  $Y$  is closed in  $X$ . By proposition 3.37, one has  $|Y| = |X|$ . Take  $\sigma \in Y^{(n)}$  such that  $|\omega_Y(\sigma)/\omega_X(\sigma)|$  is minimal and put  $\lambda = \omega_Y(\sigma)/\omega_X(\sigma)$ . Since the balancing condition is linear in the weights, we get that the weighted local orbit space  $(Y/H, \omega_Y - \lambda \cdot \omega_X)$  is a tropical local orbit space as well. Since the polyhedron  $\sigma$  is removed from the new local orbit space (see construction 3.19),  $Y$  must be empty due to proposition 3.37 and  $\omega_Y = \lambda \cdot \omega_X$ .  $\square$

**Proposition 3.40.** *Let  $X/G$  be a tropical local orbit space of dimension  $n$ ,  $Y/H$  a strongly irreducible tropical local orbit space of dimension  $n$  as well, and  $e$  a morphism from  $X/G$  to  $Y/H$ . In the notation of construction 3.31 the polyhedral complex  $Z' \setminus Z$  has dimension less than or equal to  $n - 2$ .*

*Proof.* Take the notation of construction 3.31 and proposition 3.30. Assume that  $\dim(Z' \setminus Z) = n - 1$ . Since  $Z' \setminus Z \subset u_e$ , there exists (by proposition 3.30)  $\sigma \in X_I$  with  $\dim((\tilde{e}_1([\sigma]) \setminus \tilde{e}_1([\sigma])) \cap (Z' \setminus Z)) = n - 1$ . Let  $\tau$  be an  $(n - 1)$ -dimensional polyhedron of  $\text{Mod}_H^{-1}((\tilde{e}_1([\sigma]) \setminus \tilde{e}_1([\sigma])) \cap (Z' \setminus Z))$ . Since  $Y/H$  is strongly irreducible, the open fan around  $\tau$  is irreducible as well. Furthermore  $Z' \setminus Z$  contains  $\tau$ . Thus, after a refinement, there exist an  $(n - 1)$ -dimensional subpolyhedron  $\tau' \subset \tau$  and  $\sigma' \in X^{(n)}$  such that  $e_1$  is injective on  $\sigma'$  and  $\text{Mod}_H(\tau') \subset \tilde{e}_1(\text{Mod}_G(\sigma'))$ . By (e) of definition 3.21, the morphism  $e$  induces a morphism of fans. By the balancing condition and since the open fan around  $\tau$  is irreducible, there exists a polyhedron  $\tilde{\sigma} \in X$  with  $\tilde{e}_1([\tilde{\sigma}]) \supset \text{Mod}_H(\tau')$  and  $\dim(\tilde{e}_1([\tilde{\sigma}]) \cap \tilde{e}_1([\sigma])) = n$ . This is a contradiction to (g) in definition 3.21 and we are done.  $\square$

**Corollary 3.41.** *Let  $X/G$  and  $Y/H$  be tropical local orbit spaces of the same dimension  $n$  in  $V = \Lambda \otimes \mathbb{R}$  and  $V' = \Lambda' \otimes \mathbb{R}$ , respectively, and let  $e : X/G \rightarrow Y/H$  be a morphism. Assume that  $Y/H$  is strongly irreducible and  $\dim(|Y/H| \setminus \tilde{e}_1(|X/G|)) \leq n - 2$ . Then there is a local orbit space  $Y_0/H|_{Y_0}$  in  $V'$  of dimension smaller than  $n$  with  $|Y_0| \subset |Y|$  such that*

- (a) each point  $Q \in |Y| \setminus |Y_0|$  lies in the interior of a polyhedron  $\sigma'_Q \in Y$  of dimension  $n$ ;
- (b) each point  $P \in e_1^{-1}(|Y| \setminus |Y_0|)$  lies in the interior of a polyhedron  $\sigma_P \in X$  of dimension  $n$ ;
- (c) for  $Q \in |Y| \setminus |Y_0|$  the sum

$$\sum_{[P], P \in |X| : e_1([P]) = [Q]} \text{mult}_{[P]} e$$

does not depend on  $Q$ , where the multiplicity  $\text{mult}_{[P]} e$  of  $e$  at  $[P]$  is defined to be

$$\text{mult}_{[P]} e = \frac{\omega_X(\sigma_P)}{\omega_Y(\sigma'_Q)} \cdot |\Lambda'_{[\sigma'_Q]} / \tilde{e}_1(\Lambda_{[\sigma_P]})|.$$

*Proof.* Consider the tropical local orbit space  $e(X/G)$ . Since  $\dim(|Y/H| \setminus \tilde{e}_1(|X/G|)) \leq n-2$  by assumption we can take a refinement of  $(\text{Mod}_H^{-1}(\tilde{e}_1(|X/G|)) / H)_{|\text{Mod}_H^{-1} \tilde{e}_1(|X/G|), w_Y}$  fulfilling condition  $(*)$  of definition 3.36. Thus  $(*)$  holds also for the polyhedra in  $Z'$  (see construction 3.31). By proposition 3.40 the condition  $(*)$  holds for  $e(X/G)$  as well. This means that we can refine  $e(X/G)$  and  $Y/H$  such that  $e(X/G)$  fulfills condition  $(*)$  (note that the roles of  $X$  and  $Y$  are changed in the definition). From now on we work with these refinements. Since  $Y/H$  is irreducible we can apply proposition 3.39 and  $e(X/G) = \lambda \cdot Y/H$  for some  $\lambda \in \mathbb{Q} \setminus \{0\}$ . Let  $Y_0$  be the polyhedral complex defined by the union of polyhedra of  $Y$  of dimension less than  $n$ . Then (a) and (b) hold because of the way we constructed  $Y_0$ . Each  $Q \in |Y| \setminus |Y_0|$  lies in the interior of a unique  $n$ -dimensional polyhedron  $\sigma'$ . By the 1:1 correspondence between points  $[P] \in \tilde{e}_1^{-1}([Q])$  and  $n$ -dimensional classes  $[\sigma]$  with  $\sigma$  in  $X$  which fulfill  $[e_1(|\sigma|)] = [\sigma']$  we can conclude that

$$\begin{aligned} \sum_{[P], P \in |X| : e_1([P]) = [Q]} \text{mult}_{[P]} e &= \sum_{[\sigma] \in |X/G^{(n)}| : [e_1(\sigma)] = [\sigma']} \frac{\omega_X(\sigma)}{\omega_Y(\sigma')} \cdot |\Lambda'_{[\sigma]} / \tilde{e}_1(\Lambda_{[\sigma]})| \\ &= \frac{\omega_{e(X/G)}(\sigma')}{\omega_Y(\sigma')} = \lambda \end{aligned}$$

does not depend on  $Q$ . □

To see why we need the assumption that  $Y/H$  is strongly irreducible in the preceding corollary (and not just irreducible), we consider an example.

*Example 3.42.* Let us take as sets  $G$  and  $H$  the sets consisting only of the identity element. Let  $X$  be the disjoint union of two polyhedral complexes  $X_1$  and  $X_2$ , where  $X_1$  is an open interval and  $X_2$  is a tropical curve in  $\mathbb{R}^3$  (see figure 3.6). The edge  $E_2$  (resp.,  $E_3$ ) is an edge with direction vector  $(0, 1, 1)$  (resp.,  $(-1, -1, -1)$ ). The other edges of  $X_2$  lie in the plane as drawn in the figure. The complex  $Y$  is a tropical curve in  $\mathbb{R}^2$  as in the figure. The map  $e$  between  $X$  and  $Y$  is given as projection to  $\mathbb{R}^2$  with  $e(E_i) = F_i$ . If we choose the weights  $\omega_{X_1} = 2$ ,  $\omega_{X_2} = 1$  and  $\omega_Y = 1$  we have a morphism between tropical local orbit spaces, but the sum of preimages is different for points  $x \in F_1$  and  $y \in Y \setminus F_1$ .

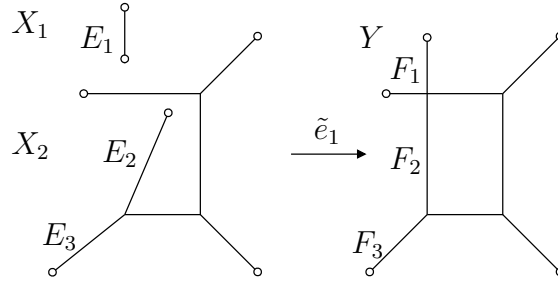

Figure 3.6: A morphism between two local orbit spaces, where all the assumptions of corollary 3.41 are fulfilled except for  $Y$  being strongly irreducible.

**Definition 3.43** (Rational function). Let  $Y/G$  be a tropical local orbit space. We define a *rational function*  $\varphi$  on  $Y/G$  to be a continuous function  $\varphi : |Y| \rightarrow \mathbb{R}$  such that there exists a refinement  $((X, |X|, \{m_\sigma\}_{\sigma \in X}), \{\omega_\sigma\}_{\sigma \in X})$  of  $Y$  which fulfills the following conditions: for each face  $\sigma \in X$  the map  $\varphi \circ m_\sigma^{-1}$  is locally integer affine-linear and  $\varphi \circ g|_{U_g} = \varphi|_{U_g}$ , for all  $g \in G$ . (Remark: by refinements we can directly assume that  $\varphi$  is affine linear on each polyhedron.)

**Definition 3.44** (Local orbit space divisor). Let  $X/G$  be a tropical local orbit space of dimension  $k$ , and  $\phi$  a rational function on  $X/G$ . We define a divisor of  $\phi$  to be  $\text{div}(\phi) = \phi \cdot X/G = [(\bigcup_{i=-1}^{k-1} X^{(i)}, \omega_\phi)] / G$ , where  $\omega_\phi$  is as follows:

$$\begin{aligned} \omega_\phi : X^{(k-1)} &\rightarrow \mathbb{Q}, \\ \tau &\mapsto \sum_{\substack{\sigma \in X^{(k)} \\ \tau < \sigma}} \phi_\sigma \left( \frac{1}{|X_{\sigma/\tau}|} \omega(\sigma) v_{\sigma/\tau} \right) - \phi_\tau \left( \sum_{\substack{\sigma \in X^{(k)} \\ \tau < \sigma}} \frac{1}{|X_{\sigma/\tau}|} \omega(\sigma) v_{\sigma/\tau} \right) \end{aligned}$$

**Proposition 3.45.** *The divisor  $\phi \cdot X/G$  is a tropical local orbit space.*

*Proof.* By definition, the map  $\phi$  is a rational function on the tropical local orbit space  $X/\{\text{id}\}$ . In particular it fulfills the definition of rational functions given in definition 6.1 of [AR] except for  $X$  being a closed polyhedral complex. Nevertheless, the balancing condition around a codimension-1 face of  $X$  is the same as the condition around the closure of the involving polyhedra. Therefore we can apply construction 6.4 of [AR] and  $\phi \cdot X$  is balanced. We only need to show that the weights for identified facets are the same. This is clear since the elements of  $G$  are defined on open sets and therefore the weights are the same for  $\sigma, \sigma' \in \phi \cdot X/G$  with  $[\sigma] = [\sigma']$ .  $\square$

**Proposition 3.46.** *Let  $\phi_1$  and  $\phi_2$  be two rational functions on the tropical local orbit space  $X/G$ . Then  $\phi_1 \cdot (\phi_2 \cdot X/G) = \phi_2 \cdot (\phi_1 \cdot X/G)$ .*

*Proof.* As in the previous proof, the statement follows from the polyhedral case. The corresponding result is proposition 6.7 in [AR].  $\square$

# 4 One-dimensional local orbit spaces

To get a better understanding of the definition of a local orbit space given in chapter 3, we study the one-dimensional case.

Let  $X/G$  be a pure by one-dimensional local orbit space. After a refinement we can assume that all polyhedra in  $X$  are of one of the following two forms. Either a polyhedron in  $X$  is a closed interval or a half open (and half closed) interval. The half open interval can be bounded or unbounded. Around a zero-dimensional face (the codimension one faces) the polyhedral structure is given by fans.

Each element  $g$  of  $G$  gives a morphism of a union of intervals in  $|X|$  to another union of intervals such that the fan structure of  $X$  is respected.

*Example 4.1.* Let  $X$  be the disjoint union of

$$X_1 = \{(x, y) \in \mathbb{R}^2 \mid \max\{0, x, y\} \text{ is attained at least twice and } |x| < 1, |y| < 1\}$$

and

$$X_2 = \{(x, y) \in \mathbb{R}^2 \mid \max\{0, -x, y\} \text{ is attained at least twice and } |x| < 2\}.$$

The isomorphisms of polyhedral complexes for the set  $G$  in definition 3.1 are

$$\begin{aligned} g_1 & : \{(x, y) \in X_1 \mid |x| < 0\} \rightarrow \{(x, y) \in X_2 \mid |x| > 1\} : (x, y) \mapsto (2 + x, y), \\ g_2 & : \{(x, y) \in X_2 \mid |x| < 0\} \rightarrow \{(x, y) \in X_2 \mid |x| < 0\} : (x, y) \mapsto (-2 - x, 2 - y) \end{aligned}$$

together with  $g_1^{-1}$  and  $id_X$  (note that  $g_2^{-1} = g_2$ ). A picture of  $X$  and  $|X/G|$  is shown in figure 4.1.

Since we glue along open sets, the space  $|X/G|$  may be non-Hausdorff.

*Example 4.2.* Let  $X$  be the disjoint union of  $X_1 = \mathbb{R}$  and  $X_2 = \mathbb{R}$ . We put

$$G = \{id_X, g : \{x > 0 \mid x \in X_1\} \rightarrow \{x > 0 \mid x \in X_2\} : x \mapsto x, g^{-1}\}.$$

The resulting local orbit space is non-Hausdorff (see figure 4.2).

**Proposition 4.3.** *A one-dimensional local orbit space  $X$  is a  $T_1$  space such that there exists a collection  $P \subset |X/G|$  of finitely many points with  $|X/G| \setminus P$  Hausdorff.*

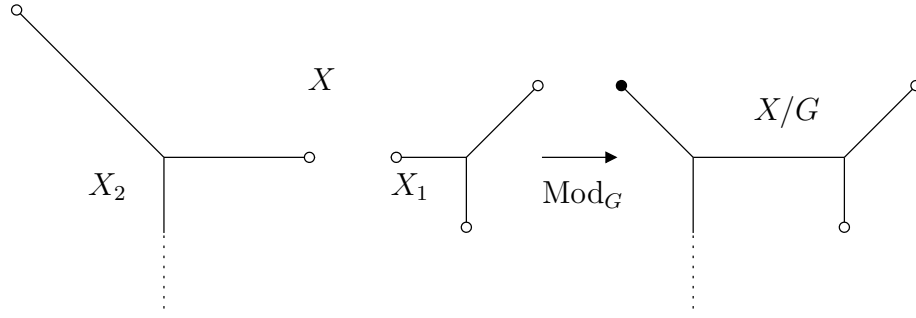

Figure 4.1: The polyhedral complex and the topological space of a one-dimensional local orbit space.

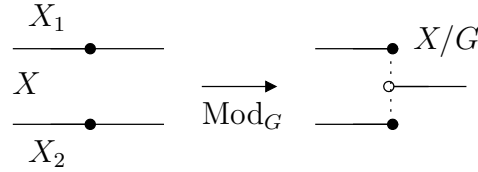

Figure 4.2: A local orbit space which is not Hausdorff.

*Proof.* Local orbit spaces are topological spaces defined by gluing subspaces of  $\mathbb{R}^n$ . Thus, each finite set of points is closed and therefore  $T_1$  holds. Put  $P = \{p \in |X/G| \mid p \in \text{Mod}_g(\overline{U_g} \setminus U_g) \text{ for } g \in G\}$ . The number of elements of  $G$  is finite and  $U_g$  is a finite union of intervals, thus the number of elements of  $P$  is finite. Let  $x', y' \in |X/G| \setminus P$  be two distinct points, and let  $x, y \in X$  be two arbitrary preimages of them under  $\text{Mod}_G$ . By definition of  $P$ , the points  $x$  and  $y$  lie either in the open sets  $U_g$  or in the interior of  $X \setminus U_g$  for all  $g \in G$ . Let  $W_x$  (resp.  $W_y$ ) be the intersection of all sets  $U_g$  and  $(X \setminus U_f)^\circ$ ,  $f, g \in G$  with  $x \in U_g$  and  $x \in (X \setminus U_f)^\circ$  (resp.  $y \in U_g$  and  $y \in (X \setminus U_f)^\circ$ ). For each  $g \in G$  with  $W_x \subset U_g$  and  $W_y \subset V_g$  there exist open sets  $W_x^g \subset W_x$  and  $W_y^g \subset V_g$  with  $x \in W_x^g, y \in W_y^g$  and  $W_x^g \cap W_y^g = \emptyset$  because  $X$  is Hausdorff. The set  $G$  is finite and thus the intersection of all  $W_x^g$  and all  $W_y^g$  are open. Furthermore  $\text{Mod}_G(\bigcap W_x^g) \cap \text{Mod}_G(\bigcap W_y^g) = \emptyset$  and thus  $|X/G| \setminus P$  is Hausdorff.  $\square$

**Definition 4.4** (Non-Hausdorff pair, Non-Hausdorff point). Let  $X/G$  be a local orbit space. We call a pair  $\{x, y\}$  with  $x, y \in |X/G|$  *non-Hausdorff* if for all open sets  $W_x, W_y \subset |X/G|$  with  $x \in W_x$  and  $y \in W_y$  one has  $W_x \cap W_y \neq \emptyset$ . We call a point  $x \in |X/G|$  *non-Hausdorff* if there exists a point  $y \in |X/G|$  such that  $\{x, y\}$  is a non-Hausdorff pair.

**Definition 4.5** (Non-Hausdorff fan). Let  $X$  be a finite set of half open intervals of finite length. Take  $k \in \mathbb{N}$  with  $k > 1$  and let  $Y_1, \dots, Y_k$  be (not necessarily different) subsets of  $X$  such that identifying the elements of  $Y_i$  for all  $i \in \{1, \dots, k\}$  gives a single element (this condition assures connectedness of the resulting space). For each  $i \in \{1, \dots, k\}$  we take a point  $P_i$  and insert it at the open end of all intervals in  $Y_i$ . The resulting space is called *Non-Hausdorff fan* (see figure 4.3).

*Remark 4.6.* A Non-Hausdorff fan is a topological space we get by taking a one-dimensional fan  $X$ , intersect  $X$  with a closed neighborhood at the origin, remove the origin and glue back at least two points connecting some of the edges, such that the result is connected.

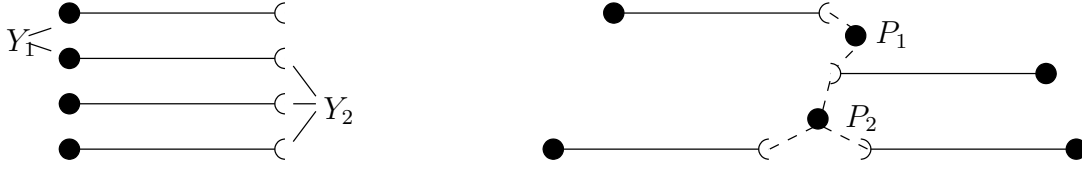

Figure 4.3: A non-Hausdorff fan.

**Proposition 4.7.** *Let  $X/G$  be a one-dimensional local orbit space. Let  $P \subset |X/G|$  be an inclusion maximal set with at least 2 elements, such that for all  $x, y \in P$  there exists a chain  $x = x_1, \dots, x_n = y$  with  $\{x_i, x_{i+1}\}$  non-Hausdorff for all  $i \in \{1, \dots, n\}$ , and let  $V_P$  be a sufficiently small closed neighborhood of  $P$ . Then, the space  $V_P \setminus P$  is Hausdorff and  $V_P$  is homeomorphic to a non-Hausdorff fan.*

*Proof.* Since the interior of the  $U_g$  is Hausdorff only the boundary points of the images of  $U_g$  can be non-Hausdorff. Since  $G$  is finite and  $P$  is inclusion maximal, we can take  $V_P$  sufficiently small such that all points which are elements of a non-Hausdorff pair lie in  $P$ . Thus  $V_P \setminus P$  is Hausdorff. By taking possibly a smaller set we can assume that the border of the images of all sets  $U_g$  for  $g \in G$  intersected with  $V_P$  are in  $\text{Mod}_G(P)$ . Since we glue the set  $X$  along  $U_g$  one has that  $V_P$  is a non-Hausdorff fan.  $\square$

By the previous proposition we know how the one dimensional local orbit spaces look like in the neighborhood of non-Hausdorff pairs. Thus, we now consider the neighborhoods of points which do not belong to non-Hausdorff pairs.

**Proposition 4.8.** *Let  $X/G$  be a one-dimensional local orbit space and  $x \in |X/G|$  such that  $x$  does not belong to a pair  $\{x, y\} \subset |X/G|$  which is non-Hausdorff. Then, there exists a closed neighborhood  $U_x \subset |X/G|$  of  $x$  with  $U_x$  homeomorphic to the closure of an open fan in  $\mathbb{R}^2$  with  $x$  mapped to the origin under this homeomorphism (in particular  $U_x$  is Hausdorff).*

*Proof.* For the proof of the proposition we take a preimage of  $x$  in  $X$  and see how  $G$  changes this preimage. Let  $x' \in X$  be a preimage of  $x$  under  $\text{Mod}_G$ . By the definition of a polyhedral complex (see definition 1.10) there exists an open fan  $x' \in \tilde{U}_{x'} \subset X$ . Since  $G$  is finite, we can assume that  $U_g \cap \tilde{U}_{x'}$  is a union of interiors of faces of  $\tilde{U}_{x'}$ . Let  $g \in G$  be an isomorphism with  $x' \in U_g$ . Since  $U_g$  and  $V_g$  are open the fans  $\tilde{U}_{x'}$  and  $g(\tilde{U}_{x'})$  are isomorphic to each other by the isomorphism  $g|_{\tilde{U}_{x'}}$ . Therefore, by identifying via  $g$ , we keep a closure of an open fan. Thus, we now consider elements  $g \in G$  such that  $x' \notin U_g$ . Since  $x$  does not belong to a non-Hausdorff pair, either  $\tilde{U}_{x'}$  stays the same after gluing along  $g$  or  $g$  identifies faces of  $\tilde{U}_{x'}$ . In the latter case, the space one gets by identification along  $g$  is still homeomorphic to a fan. Thus we can take the closure  $U_x$  of a subset of  $\text{Mod}_G(\tilde{U}_{x'})$  which fulfills the conditions.  $\square$

*Remark 4.9.* The space  $X$  is a metric space. Thus, by gluing along  $G$  we get a pseudometric on  $|X/G|$  induced by the metric on  $X$ . Therefore we can speak about balls in  $|X/G|$ .

**Lemma 4.10.** *Let  $X/G$  be a one-dimensional local orbit space and  $x \in P$  from proposition 4.7. Then we can take for  $V_P$  a set of the form  $\overline{B_\epsilon(x)} \subset |X/G|$ , where  $B_\epsilon(x)$  is the ball around  $x$  of radius  $\epsilon$ .*



*Proof.* All non-Hausdorff pairs have pseudo-distance zero. Thus, we can take a small ball  $B_\epsilon(x)$  for  $V_P$ .  $\square$

**Lemma 4.11.** *Let  $X/G$  be a one-dimensional local orbit space and  $x \in |X/G|$  be as in proposition 4.8. Then, one can take for  $U_x$  a set of the form  $B_\epsilon(x) \subset |X/G|$ .*

*Proof.* For  $U_x$  as in the proposition 4.8 we can intersect this set with a small ball  $B_\epsilon(x)$ . The resulting set fulfills the lemma.  $\square$

**Theorem 4.12.** *Let  $X/G$  be a one-dimensional local orbit space,  $x$  a vertex of  $|X/G|$  and  $\epsilon \in \mathbb{R}_{>0}$  sufficiently small. The neighborhood  $B_\epsilon(x)$  is of one of the following two forms:*

- (a) *a non-Hausdorff fan and  $B_\epsilon(x)$  contains exactly  $|P|$  different points which belong to a non-Hausdorff set, where  $P$  as in proposition 4.7.*
- (b) *an open fan.*

*Proof.* Follows from the previous lemmata.  $\square$

To understand the Hausdorff restriction in chapter 3 we consider a proposition regarding Hausdorffness.

**Proposition 4.13.** *Let  $X/G$  be a one-dimensional local orbit space. The local orbit space  $|X/G|$  is Hausdorff if the quotient map  $e : X \rightarrow X/G$  is a morphism.*

*Proof.* Assume that  $|X/G|$  is not Hausdorff. By theorem 4.12 there exist an element  $x \in |X/G|$  and a real number  $\epsilon > 0$  such that  $B_\epsilon(x)$  is a non-Hausdorff fan. Thus, there exist a half open interval in definition 4.5 at which we insert at least two points. This interval is constructed by identifying two closed intervals  $\sigma, \tilde{\sigma}$  in  $X$  except for one endpoint. Therefore one has  $\dim(\tilde{e}_1(\sigma) \cap \tilde{e}_1(\tilde{\sigma})) = 1$  and  $|\tilde{e}_1(\sigma) \setminus \tilde{e}_1(\tilde{\sigma})| = 1$ . By proposition 3.25,  $e$  is not a morphism.  $\square$

# 5 Moduli spaces for curves of arbitrary genus

In this chapter we show that the moduli spaces of tropical curves of genus  $g$  have a structure of tropical local orbit space. We use this structure to prove two facts. First we show, that the weighted number of tropical curves of degree  $\Delta$  and genus  $g$  in  $\mathbb{R}^r$ , which pass through the right number of points and which are mapped to a given point in the moduli space of genus  $g$  curves with no unbounded ends, is independent of the choices of points. Secondly we show that the number of curves of degree  $\Delta$  and genus  $g$  in  $\mathbb{R}^2$  passing through the right number of points is independent of the position of the points. The chapter is divided in three parts. In the first (resp., the second) section we equip the moduli space of abstract tropical curves of fixed genus (resp., the parameterized tropical curves of fixed genus and degree in  $\mathbb{R}^r$ ) with a structure of tropical local orbit space. In the last part we prove the two statements mentioned above.

## 5.1 Moduli spaces of abstract tropical curves

*Construction 5.1.* We construct a map from  $\mathcal{M}_{g,n}$  to a tropical local orbit space in the following way. For each curve  $C \in \mathcal{M}_{g,n}$  let  $P_g = \{a_1, \dots, a_g\}$  be an arbitrary collection of  $g$  points of  $C$  such that  $C \setminus P_g$  is a tree. We define a new curve  $\tilde{C}$  which we get by cutting  $C$  along  $P_g$  and inserting two leaves  $A_i = x_{n+2i-1}$  and  $B_i = x_{n+2i}$  at the resulting endpoints of each cut  $a_i$ . This curve is an  $(n + 2g)$  marked curve (of genus 0) with up to  $2g$  two-valent vertices (at the ends  $A_i$  and  $B_i$  for  $i \in \{1, \dots, g\}$ ). In the case we choose a marking  $a_i$  to be at a 3-valent or higher valent vertex, either the vertex adjacent to  $A_i$  or to  $B_i$  has valence greater than two.

In order to embed  $\mathcal{M}_{g,n}$  into a tropical local orbit space such that the underlying polyhedral complex lies in  $\mathbb{R}^{\binom{n+2g}{2}}$  we need a map. Since the target of this map will be a tropical local orbit space, let us construct a polyhedral complex  $X_{g,n}$  and the set of isomorphisms  $G_{g,n}$  we need for it.

*Notation 5.2.* For  $b \in \mathbb{R}^t$  we denote by  $b_i, 0 < i \leq t$ , the  $i$ th entry of  $b$ .

Let  $\mathcal{T}$  be the set of all subsets  $S \subset \{1, \dots, n + 2g\}$  with  $|S| = 2$ . For the construction we need the vector space  $V_{g,n}$  which is isomorphic to  $\mathbb{R}^{\binom{n+2g}{2}-n-g}$  and which is given by  $V_{g,n} = \mathbb{R}^{\binom{n+2g}{2}} / (\Phi_n^g(\mathbb{R}^n) + \langle z_1, \dots, z_g \rangle)$ , where

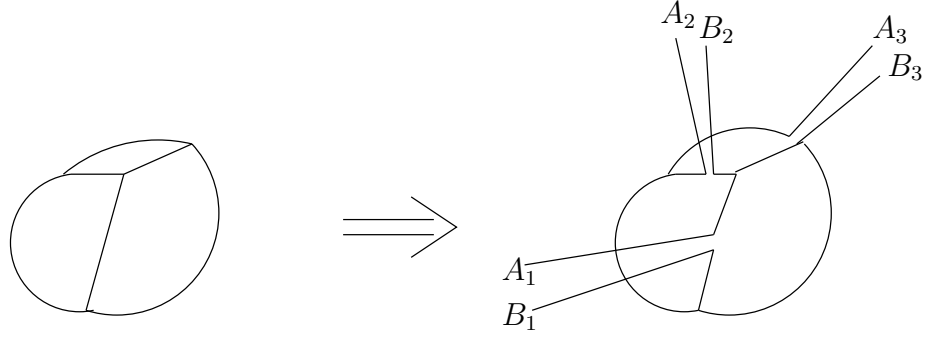

Figure 5.1: Construction of a 6-marked curve of genus 0 from a 0-marked genus-3 curve.

$$\begin{aligned} \Phi_n^g : \mathbb{R}^n &\longrightarrow \mathbb{R}^{n+2g} && \longrightarrow \mathbb{R}^{\binom{n+2g}{2}} \\ b &\longmapsto (b, 0) = \tilde{b} && \longmapsto (\tilde{b}_i + \tilde{b}_j)_{\{i,j\} \in \mathcal{T}}, \end{aligned}$$

and  $z_l \in \mathbb{R}^{\binom{n+2g}{2}}$ ,  $l \in \{1, \dots, g\}$  is a vector such that

$$(z_l)_{i,j} = \begin{cases} 1 & \text{if } (i = n + 2l - 1 \text{ or } j = n + 2l - 1) \text{ and } i \neq n + 2l \neq j, \\ -1 & \text{if } (i = n + 2l \text{ or } j = n + 2l) \text{ and } i \neq n + 2l - 1 \neq j, \\ 0 & \text{otherwise.} \end{cases}$$

Let us now recall the definition of the tropical Grassmanian  $\mathcal{G}_{2,n+2g}$  from [SS]. Put  $\mathbb{Z}[p] = \mathbb{Z}[p_{i_1, \dots, i_d}]$ ,  $(1 \leq i_1 < i_2 < \dots < i_d \leq n)$  and let  $I_{d,n}$  be the homogeneous ideal in  $\mathbb{Z}[p]$  which consists of the algebraic relations among the  $d \times d$ -minors of any  $n \times n$  matrix. The tropicalization of the ideal  $I_{2,n+2g}$  (see the first pages of [SS]), is the tropical Grassmanian  $\mathcal{G}_{2,n+2g}$ . By theorem 2.5.1 of [Sp1] this is a tropical fan. We define the following subset of  $V_{g,n}$ . Put

$$\begin{aligned} \Phi_{n,g} : \mathbb{R}^{n+2g} &\longrightarrow \mathbb{R}^{\binom{n+2g}{2}} \\ b &\longmapsto (b_i + b_j)_{\{i,j\} \in \mathcal{T}}. \end{aligned}$$

It is known that  $\mathcal{G}_{2,n+2g}$  contains the linear space  $\Phi_{n,g}(\mathbb{R}^{n+2g})$  (see [SS]). We denote by  $e_1, \dots, e_{n+2g}$  the canonical basis of  $\mathbb{R}^{n+2g}$  and we subdivide the cones of  $\mathcal{G}_{2,n+2g}$  along the hyperplane  $\langle \Phi_{n,g}(e_i), x \rangle = 0$ ,  $1 \leq i \leq n + 2g$ . The fan  $\mathcal{G}_{2,n+2g} / \Phi_{n,g}(\mathbb{R}^{n+2g})$  is simplicial by theorem 4.2 [SS]. Since  $\Phi_{n,g}(\mathbb{R}^{n+2g})$  is the lineality space of  $\mathcal{G}_{2,n+2g}$  we have that  $\mathcal{G}_{2,n+2g}$  is a simplicial fan as well. Thus, each point  $x$  of a cone  $\sigma$  has a unique representation  $\sum x_i \cdot v_i$  as linear combination of the minimal  $\mathbb{Z}$ -vectors  $v_i$  contained in the one-dimensional faces of  $\sigma$ . Since  $\Phi_{n,g}(\mathbb{R}^{n+2g})$  is the lineality space of  $\mathcal{G}_{2,n+2g}$  there exists a cone  $\sigma'$  with  $\sigma \subset \sigma'$  such that one of those vectors  $v_i$  of  $\sigma'$  is  $\Phi_{n,g}(e_k)$  or  $-\Phi_{n,g}(e_k)$  and  $k \leq n + 2g$  (for  $\sigma$  it might be that for some  $k \leq n + 2g$  neither  $\Phi_{n,g}(e_k)$  nor  $-\Phi_{n,g}(e_k)$  is in  $\sigma$ . In the definition which follows we need  $\sigma'$  to have a well-defined  $P_k(x)$ ). Without loss of generality assume that we ordered the vectors  $v_i$  such that  $i = k$  for  $i \leq n + 2g$ . We define  $P_k(x)$  to be the projection of  $x$  to the line  $\Phi_{n,g}(\mathbb{R} \cdot e_k)$  given by  $P_k(x) = x_k$  (resp.,  $-x_k$ ) for  $v_k = \Phi_{n,g}(e_k)$

(resp.,  $v_k = -\Phi_{n,g}(e_k)$ ). Then we put

$$X_{g,n} = \{x \in \mathcal{G}_{2,n+2g} \mid P_{n+2i-1}(x) + P_{n+2i}(x) > 0, \forall i \in \{1, \dots, g\}\} / (\Phi_n^g(\mathbb{R}^n) + \langle z_1, \dots, z_g \rangle). \quad (5.1)$$

To describe a polyhedral structure on  $X_{g,n}$ , we take the cones in  $\mathcal{G}_{2,n+2g}$ , intersect them with  $\{x \in \mathcal{G}_{2,n+2g} \mid P_{n+2i-1}(x) + P_{n+2i}(x) > 0, \forall i \in \{1, \dots, g\}\}$  and project them to  $V_{g,n}$ . The set  $(\Phi_n^g(\mathbb{R}^n) + \langle z_1, \dots, z_g \rangle)$  is the remaining lineality space of  $\mathcal{G}_{2,n+2g}$ .

*Example 5.3.* We consider the space  $X_{1,1}$ . The Grassmanian  $\mathcal{G}_{2,3}$  is the space  $\mathbb{R}^3$ . The set  $\{x \in \mathcal{G}_{2,3} \mid P_2(x) + P_3(x) > 0\}$  is equal to the set  $\{\Phi_{1,1}(\{(x_1, x_A, x_B) \in \mathbb{R}^3 \mid x_A + x_B > 0\})\}$ . After dividing out the lineality space  $(\Phi_1^1(\mathbb{R}) + \langle (1, -1, 0)^t \rangle)$  we get a ray without the initial point.

*Definition 5.4.* Let  $(C, x_1, \dots, x_n) \in \mathcal{M}_{g,n}$  and let  $(\tilde{C}, x_1, \dots, x_n, x_{n+1}, \dots, x_{n+2g})$  be a curve obtained by cutting  $C$ . We define

$$\text{dist}_\Gamma(\tilde{C}) = (\text{dist}_\Gamma(x_i, x_j))_{\{i,j\} \in \mathcal{T}} \in \mathbb{R}^{\binom{n+2g}{2}},$$

where  $\text{dist}_\Gamma(x_i, x_j)$  is the distance between  $x_i$  and  $x_j$  (that is the sum of the lengths of all edges in the unique path from  $x_i$  to  $x_j$ ) in  $\tilde{C}$ . Set  $x_{n+2i-1} = A_i$  and  $x_{n+2i} = B_i$ , for all  $i \in \{1, \dots, g\}$ . The symbol  $\Gamma$  indicates that we consider the distances of ( $n$ -marked abstract or parameterized labeled  $n$ -marked) tropical curves.

*Lemma 5.5.* Let  $\tilde{C}$  be a curve which we obtain by cutting a curve  $C \in \mathcal{M}_{g,n}$ . Then  $\text{dist}_\Gamma(\tilde{C}) \in \{x \in \mathcal{G}_{2,n+2g} \mid P_{n+2i-1}(x) + P_{n+2i}(x) > 0, \forall i \in \{1, \dots, g\}\}$ .

*Proof.* Put  $y = \text{dist}_\Gamma(\tilde{C})$ . Since each cycle has a positive length the point  $y$  lies in the interior of a cone spanned either by  $\Phi_{n,g}(e_{n+2i-1})$  or by  $\Phi_{n,g}(e_{n+2i})$  for all  $i \in \{1, \dots, g\}$ . Furthermore all edges have a positive length and thus,  $y$  does not lie in a cone spanned by  $-\Phi_{n,g}(e_{n+2i-1})$  or by  $-\Phi_{n,g}(e_{n+2i})$ , and the condition  $P_{n+2i-1}(y) + P_{n+2i}(y) > 0, \forall i \in \{1, \dots, g\}$  is fulfilled. We only have to show that  $y \in \mathcal{G}_{2,n+2g}$ . Theorem 3.4 of [SS] states that the fan  $\mathcal{G}_{2,n+2g} / \Phi_{n,g}(\mathbb{R}^{n+2g})$  is equal to the space  $\mathcal{M}_{0,n+2g}$ . The curve  $\tilde{C}$  does correspond to a point in  $\mathcal{M}_{0,n+2g}$  since the only two-valent vertices are at the ends  $x_{n+1}, \dots, x_{n+2g}$ . These lengths are encoded in  $\Phi_{n,g}(\mathbb{R}^{n+2g})$  and therefore  $[y] \in \mathbb{R}^{\binom{n+2g}{2}} / \Phi_{n,g}(\mathbb{R}^{n+2g})$  lies in  $\mathcal{M}_{0,n+2g}$ . Thus  $y \in \mathcal{G}_{2,n+2g}$ .  $\square$

The set  $G_{g,n}$  is a set of morphisms induced by the following  $\binom{n+2g}{2}$  square matrices.

For all  $s \in \{1, \dots, g\}$ , put

$$(I_s)_{(i,j),(k,l)} = \begin{cases} 1 & \text{if } (\{i, j\}, \{k, l\}) = (\{m, n+2s-1\}, \{m, n+2s\}), \\ & \text{or } (\{i, j\}, \{k, l\}) = (\{m, n+2s\}, \{m, n+2s-1\}), \\ & \text{or } \{i, j\} = \{k, l\} \text{ and } i, j \notin \{n+2s-1, n+2s\}, \\ & \text{or if } \{i, j\} = \{n+2s-1, n+2s\} = \{k, l\}, \\ 0 & \text{otherwise.} \end{cases}$$

For all  $s \in \{2, \dots, g\}$ , put

$$(T_s)_{(i,j)(k,l)} = \begin{cases} 1 & \text{if } (\{i, j\}, \{k, l\}) = (\{m, n + 2s - 1\}, \{m, n + 1\}), \\ & n + 2 \neq m \neq n + 2s, \\ & \text{or } (\{i, j\}, \{k, l\}) = (\{m, n + 1\}, \{m, n + 2s - 1\}), \\ & n + 2 \neq m \neq n + 2s, \\ & \text{or } (\{i, j\}, \{k, l\}) = (\{m, n + 2\}, \{m, n + 2s\}), \\ & n + 1 \neq m \neq n + 2s - 1, \\ & \text{or } (\{i, j\}, \{k, l\}) = (\{m, n + 2s\}, \{m, n + 2\}), \\ & n + 1 \neq m \neq n + 2s - 1, \\ & \text{or } \{i, j\} = \{k, l\} \text{ and } i, j \notin \{n + 1, n + 2, n + 2s - 1, n + 2s\}, \\ & \text{or } (\{i, j\}, \{k, l\}) = (\{n + 2s - 1, n + 2s\}, \{n + 1, n + 2\}), \\ & \text{or if } (\{i, j\}, \{k, l\}) = (\{n + 1, n + 2\}, \{n + 2s - 1, n + 2s\}) \\ 0 & \text{otherwise.} \end{cases}$$

For all  $s \in \{1, \dots, g\}$  and  $p \in \{1, \dots, n + 2g\} \setminus \{n + 2s - 1, n + 2s\}$ , put

$$(M_p^s)_{(i,j)(k,l)} = \begin{cases} 1 & \text{if } \{i, j\} = \{k, l\}, \\ & \text{or } (\{i, j\}, \{k, l\}) = (\{p, n + 2s\}, \{n + 2s - 1, n + 2s\}), \\ & \text{or } (\{i, j\}, \{k, l\}) = (\{p, j\}, \{j, n + 2s - 1\}), j \neq n + 2s, \\ & \text{or } (\{i, j\}, \{k, l\}) = (\{p, j\}, \{p, n + 2s\}), j \neq n + 2s, \\ & \text{or } (\{i, j\}, \{k, l\}) = (\{p, j\}, \{n + 2s - 1, n + 2s\}), \\ & n + 2s - 1 \neq j \neq n + 2s, \\ -1 & \text{if } (\{i, j\}, \{k, l\}) = (\{p, n + 2s - 1\}, \{n + 2s - 1, n + 2s\}), \\ & \text{or } (\{i, j\}, \{k, l\}) = (\{p, j\}, \{j, n + 2s\}), j \neq n + 2s - 1, \\ & \text{or } (\{i, j\}, \{k, l\}) = (\{p, j\}, \{p, n + 2s - 1\}), j \neq n + 2s - 1, \\ 0 & \text{otherwise.} \end{cases}$$

Before going on with our construction, let us understand the defined matrices by the following observation and propositions.

*Observation 5.6.* The main idea in our definition comes from the rational case (see [GKM]). After cutting the curve we get a new curve without cycles. Thus, the distance between any two points in the new curve is well-defined. Then, as in the rational case we have to mod out the image of  $\Phi_n^g$ . In addition, we have to get rid of all the choices we made during the construction of the  $A_i$  and  $B_i$  for  $1 \leq i \leq g$ . These choices can be expressed by the following four operations.

- (a) The shift of the point  $a_i$  on one edge of the cycle (which corresponds to the addition of an element of  $\langle z_i \rangle$ ).
- (b) Interchanging  $A_i$  and  $B_i$ , which corresponds to the matrix  $I_i$ .
- (c) Interchanging  $a_i$  and  $a_1$ , which corresponds to  $T_i$  (interchanging  $a_i$  and  $a_j$  can be done by a product of matrices  $T_l, l \in \{1, \dots, g\}$ ).
- (d) The point  $a_i$  jumps over the vertex adjacent to an unbounded edge  $p$ . The matrix corresponding to this operation is either  $M_p^i$  or  $(M_p^i)^{-1}$  depending on the position of  $A_i$  and  $B_i$ . If the point  $a_i$  jumps over a bounded edge  $E$ , the matrix corresponding

to this operation is the product of all matrices  $(M_p^i)^{\pm 1}$  where  $p$  is connected with  $E$  by edges not intersecting the cycle. (If we want to change the cut  $a_3$  of the curve in figure 5.1 from the upper edge to the right edge we have to apply  $M_1^3 \cdot M_4^3$  to the corresponding point in the parameter space).

*Proposition 5.7.* *Let us fix  $n, g$  and  $s$  in  $\mathbb{N}$ , with  $s \leq g$ . The group  $\langle M_p^s | p \in \{1, \dots, n + 2g\} \setminus \{n + 2s - 1, n + 2s\} \rangle$  is commutative.*

*Proof.* To prove the commutativity, it is enough to show that any two generators of the group commute. Denote by  $p, p'$  two different elements of  $\{1, \dots, n + 2g\} \setminus \{n + 2s - 1, n + 2s\}$ , by  $A$  (resp.,  $B$ ) the element  $n + 2s - 1$  (resp.,  $n + 2s$ ), and by  $o$  and  $o'$  arbitrary elements of  $\{1, \dots, n + 2g\} \setminus \{n + 2s - 1, n + 2s, p, p'\}$ . Denote by  $x_{l,m}$  the coordinates in  $\mathbb{R}^{\binom{n+2g}{2}}$ . The matrices  $M_p^s$  and  $M_{p'}^s$  are defined in the following way.

The matrix  $M_p^s$  is given by

$$\begin{pmatrix} x_{p,p'} & x_{p,o} & x_{p,A} & x_{p,B} & x_{p',o} & x_{p',A} & x_{p',B} & x_{o,o'} & x_{o,A} & x_{o,B} & x_{A,B} \\ \left( \begin{array}{cccccccccccc} 1 & 0 & -1 & 1 & 0 & 1 & -1 & 0 & 0 & 0 & 1 \\ 0 & 1 & -1 & 1 & 0 & 0 & 0 & 0 & 1 & -1 & 1 \\ 0 & 0 & 1 & 0 & 0 & 0 & 0 & 0 & 0 & 0 & -1 \\ 0 & 0 & 0 & 1 & 0 & 0 & 0 & 0 & 0 & 0 & 1 \\ 0 & 0 & 0 & 0 & 1 & 0 & 0 & 0 & 0 & 0 & 0 \\ 0 & 0 & 0 & 0 & 0 & 1 & 0 & 0 & 0 & 0 & 0 \\ 0 & 0 & 0 & 0 & 0 & 0 & 1 & 0 & 0 & 0 & 0 \\ 0 & 0 & 0 & 0 & 0 & 0 & 0 & 1 & 0 & 0 & 0 \\ 0 & 0 & 0 & 0 & 0 & 0 & 0 & 0 & 1 & 0 & 0 \\ 0 & 0 & 0 & 0 & 0 & 0 & 0 & 0 & 0 & 1 & 0 \\ 0 & 0 & 0 & 0 & 0 & 0 & 0 & 0 & 0 & 0 & 1 \end{array} \right) \end{pmatrix} \begin{matrix} x_{p,p'} \\ x_{p,o} \\ x_{p,A} \\ x_{p,B} \\ x_{p',o} \\ x_{p',A} \\ x_{p',B} \\ x_{o,o'} \\ x_{o,A} \\ x_{o,B} \\ x_{A,B} \end{matrix}$$

and the matrix  $M_{p'}^s$  by

$$\begin{pmatrix} x_{p,p'} & x_{p,o} & x_{p,A} & x_{p,B} & x_{p',o} & x_{p',A} & x_{p',B} & x_{o,o'} & x_{o,A} & x_{o,B} & x_{A,B} \\ \left( \begin{array}{cccccccccccc} 1 & 0 & 1 & -1 & 0 & -1 & 1 & 0 & 0 & 0 & 1 \\ 0 & 1 & 0 & 0 & 0 & 0 & 0 & 0 & 0 & 0 & 0 \\ 0 & 0 & 1 & 0 & 0 & 0 & 0 & 0 & 0 & 0 & 0 \\ 0 & 0 & 0 & 1 & 0 & 0 & 0 & 0 & 0 & 0 & 0 \\ 0 & 0 & 0 & 0 & 1 & -1 & 1 & 0 & 1 & -1 & 1 \\ 0 & 0 & 0 & 0 & 0 & 1 & 0 & 0 & 0 & 0 & -1 \\ 0 & 0 & 0 & 0 & 0 & 0 & 1 & 0 & 0 & 0 & 1 \\ 0 & 0 & 0 & 0 & 0 & 0 & 0 & 1 & 0 & 0 & 0 \\ 0 & 0 & 0 & 0 & 0 & 0 & 0 & 0 & 1 & 0 & 0 \\ 0 & 0 & 0 & 0 & 0 & 0 & 0 & 0 & 0 & 1 & 0 \\ 0 & 0 & 0 & 0 & 0 & 0 & 0 & 0 & 0 & 0 & 1 \end{array} \right) \end{pmatrix} \begin{matrix} x_{p,p'} \\ x_{p,o} \\ x_{p,A} \\ x_{p,B} \\ x_{p',o} \\ x_{p',A} \\ x_{p',B} \\ x_{o,o'} \\ x_{o,A} \\ x_{o,B} \\ x_{A,B} \end{matrix}$$

Since  $M_p^s \cdot M_{p'}^s = M_{p'}^s \cdot M_p^s$ , the group under consideration is commutative.  $\square$

*Proposition 5.8.* *With the above notation,  $M_p^s$  acts as identity on the elements of  $(\Phi_n^g(\mathbb{R}^n) + \langle z_1, \dots, z_g \rangle)$ . The matrix  $T_s$  interchanges  $z_1$  and  $z_s$  and is the identity on  $(\Phi_n^g(\mathbb{R}^n) + \langle z_2, \dots, \hat{z}_s, \dots, z_g \rangle)$ . The matrix  $I_s$  acts as identity on  $(\Phi_n^g(\mathbb{R}^n) + \langle z_1, \dots, \hat{z}_s, \dots, z_g \rangle)$ , and one has  $I_s(z_s) = -z_s$ .*

*Proof.* The statement for  $M_p^s$  can be proved using the presentation of  $M_p^s$  given in the previous proof. Since  $I_s$  and  $T_s$  only interchange entries of the vectors, one can conclude that the proposition holds.  $\square$

The set  $H = \langle T_s, I_s, M_p^s \rangle$  is a linear group and since  $I_s \cdot M_p^s \cdot I_s \cdot M_p^s = T_s^2 = I_s^2 = Id$  the elements of  $H$  are  $\mathbb{Z}$ -invertible. Thus, they define isomorphisms on  $\mathbb{R}^{\binom{n+2g}{2}}$ . By proposition 5.8 they define morphisms on  $V_{g,n}$  as well. Now we take the subset of matrices  $h \in H$  for which there exists a non-empty open polyhedral subcomplex  $\tilde{U}$  of  $X_{g,n}$  such that for all  $x \in \tilde{U}$ , the vectors  $x$  and  $h(x)$  are the distance vectors of curves resulting from cuts of the same curve, and we denote this set by  $G$ . We label the set of induced morphisms (for  $h \in G$  and  $\tilde{U}$  from above we have a morphism from  $\tilde{U}$  to  $h(\tilde{U})$ ) by  $\tilde{G}$ . (Remark: for each  $h$  there are many different choices of  $|\tilde{U}|$ .) This set has the following (partial) order:  $h_1 \leq h_2$  if  $|U_{h_1}| \subset |U_{h_2}|$  and  $h_2|_{|U_{h_1}|} = h_1$  ( $U_h$  is defined in 3.1). Let  $\tilde{G}_{g,n}$  be the set of maximal elements of  $\tilde{G}$  with respect to this order. The elements we need are the morphisms induced by  $\{T_s, I_s, M_p^s\}$  together with the elements of  $\tilde{G}_{g,n}$  such that conditions (a), (b), (c) and (d) of definition 3.1 hold. Note, that the morphisms are induced by matrices and therefore the conditions for the set of isomorphisms in definition 3.1 can be fulfilled by elements of  $\tilde{G}_{g,n}$ . We denote this set by  $G_{g,n}$  and want to use it as set of isomorphisms for the construction of a local orbit space. Therefore, we have to show that  $G_{g,n}$  is finite. Take  $X_{g,n}$  with the polyhedral structure mentioned above. First we need to show, that only finitely many points in  $X_{g,n}$  represent the same curve  $C$ . Each of the  $g$  cuts has to be at a different edge of  $C$ . Thus, the number of possibilities we have for the choice on which edges we cut is finite. The position of a cut  $a_i$  on an edge  $\mathcal{E}$  is divided out by the vector  $s_i$ . Thus we have at most two possibilities to insert  $A_i$  and  $B_i$  on  $\mathcal{E}$  to get a different representative of the same curve. Therefore, the number of points representing  $C$  is finite and bounded by the number  $\binom{|E|}{g} \cdot 2^g$ , with  $|E|$  the number of edges in  $C$ . If  $h \in G_{g,n}$  is defined on  $x \in \sigma$ ,  $\sigma \in X_{g,n}$ , then  $U_h \supset \sigma^\circ$ , because  $h$  is linear and  $U_h$  is open. Since the number of cones is finite and the number of represents is bounded we get, that  $G_{g,n}$  is finite.

*Lemma 5.9.* *Let  $\tilde{C}$  and  $\tilde{C}'$  be two curves resulting from two different cuts of a curve  $C$ . The images of  $\tilde{C}$  and  $\tilde{C}'$  in  $X_{g,n}$  are identified by elements of  $G_{g,n}$ .*

*Proof.* During the proof we will denote by  $\tilde{C}$  (resp.  $\tilde{C}'$ ) the curve and the corresponding point in  $X_{g,n}$  given by the distances. Since  $\tilde{C}$  and  $\tilde{C}'$  are results of cuts of the same curve  $C$ , there exist  $i, j \in \{1, \dots, g\}$  such that the path from  $A_i$  to  $B_i$  in  $\tilde{C}$  and the path  $A'_j$  to  $B'_j$  in  $\tilde{C}'$  contain an edge  $S$  (resp.,  $S'$ ) coming from the same edge  $E$  in  $C$ . First of all we can use the matrices  $T_i$  and  $T_j$  for the curve  $\tilde{C}'$  to assume  $i = j$ . Let  $K$  be the set of marked points adjacent to the (unique) path from  $B_i$  to the middle of  $S$ . The curve  $\prod_{p \in K} M_p^i \cdot (\tilde{C}')$  comes from a cut with  $a'_i$  on  $E$  (for this we need proposition 5.7). Without loss of generality we can directly assume that  $a'_i \in E$ . Similarly, we can also assume that  $a_i \in E$ . By applying  $I_i$  if

necessary we can further assume  $a_i = a'_i$ . Denote by  $W$  the curve we get by cutting  $C$  at  $a_i$  and inserting new edges  $A_i$  and  $B_i$  at the new ends. Since the curves  $\tilde{C}$  and  $\tilde{C}'$  are results of cuts of the same genus- $(g - 1)$  curve, we can repeat our arguments and show that the images are the same under elements of  $G_{g,n}$ .  $\square$

*Remark 5.10.* Let  $\sigma$  be a facet of  $X_{g,n}$  where a point in the interior corresponds to a curve which has exactly  $r$  loops (a loop is an edge forming a cycle). The set  $G_{g,n}$  contains at least  $2^r$  elements which are the identity on  $\sigma$ . (If  $A_i$  and  $B_i$  be on one of those loops for  $1 \leq i \leq r$ , then we get that  $I_i$  is the identity on  $\sigma$ . Since the group generated by  $\{I_1, \dots, I_r\}$  has  $2^r$  elements the statement follows.)

*Remark 5.11.* For a better understanding, we describe the morphisms from  $G_{g,n}$ . Let  $C$  be a curve of genus  $g$  with  $n$  marked ends, and let us orient each edge of  $C$ . Let  $a$  and  $a'$  be two cuts of  $C$  as stated above (cutting  $g$  cycles). By contracting all edges from  $C$  except for those cut by either  $a$  or  $a'$  (and not by both) we get a new curve  $\tilde{C}$ . Each such  $\tilde{C}$ , together with the position of  $a$  and  $a'$  on  $\tilde{C}$ , the information which  $A_i$  and  $A'_j$  lie on the same edge and whether their orientation agrees, describes and is described uniquely by an element of  $G_{g,n}$  if  $n$  or  $g$  are greater than one. We begin by defining a morphism  $g$  corresponding to this data. Let  $A_i$  and  $A'_j$  be cuts on the same edge. Using  $T_s$  and  $I_s$  first define a matrix which swaps  $A_i$  and  $A_j$  such that  $A_j$  lies on the same edge as  $A'_j$  and such that  $A_j$  and  $A'_j$  have the same orientation on the edge. Following the idea from lemma 5.9 we then multiply this matrix by the matrix which identifies the curve  $C$  cut by the changed  $a$  with the curve  $C$  cut by  $a'$ . As source  $U_g$  of the corresponding morphism we take all points which correspond to curves containing the edges of  $\tilde{C}$  and the unchanged cut  $a$  (where the cuts of  $a$  are on edges of  $\tilde{C}$  as well; for this remember that we probably removed edges where  $a'$  has cuts at the same edge). The target  $V_g$  (see definition 3.1) are all points which correspond to a curve containing the edges of  $\tilde{C}$  and the cut  $a'$ . By commutativity (see proposition 5.7)  $g$  is well defined for all those points (the products  $\prod_{p \in K} M_p^i$  in the proof of lemma 5.9 are defined if the elements of  $K$  are all marked ends of one component of the curve cut at  $a$  and  $A'_i$  or equivalently if the curve contains the edges of  $\tilde{C}$ ). Furthermore  $U_g$  is open since we take all points where the edges of  $\tilde{C}$  are positive. Finally the set of points where  $g$  is the identity is closed since being the identity is a closed condition and since  $g$  changes positions of cuts and therefore can not be the identity for elements where one of the edges of  $\tilde{C}$  becomes 0. We take the set of morphisms such that definition 3.1 is fulfilled and the morphisms we constructed fulfill this definition. Thus, it remains to show that the above construction is one-to-one. Since the elements of  $U_f$  and  $V_f$  correspond to cut curves we can construct  $C$ ,  $a$  and  $a'$  for an element  $f \in G_{g,n}$ . For  $n$  or  $g$  greater than one there exist curves with at least two bounded edges for each cycle (for  $g = 1$  and  $n \leq 1$  we have  $I_1 = \text{id}$  and  $\text{id} = M_1^1$  if  $n = 1$ ). Thus the construction is unique. If a cycle contains only one edge the orientation makes no difference. In particular, if  $A_i$  lies on this cycle one gets  $I_s = \text{id}$  for this point.

To illustrate the construction of the previous remark we consider the matrix  $M_1^1$ .

*Example 5.12.* Each point corresponding to a cut curve which contain the edges shown on the left hand side of figure 5.2 are mapped under  $M_1^1$  to a point corresponding to a curve with the edges shown on the right hand side of figure 5.2.

*Lemma 5.13.* The set  $G_{g,n}$  described above fulfills all conditions of definition 3.1.



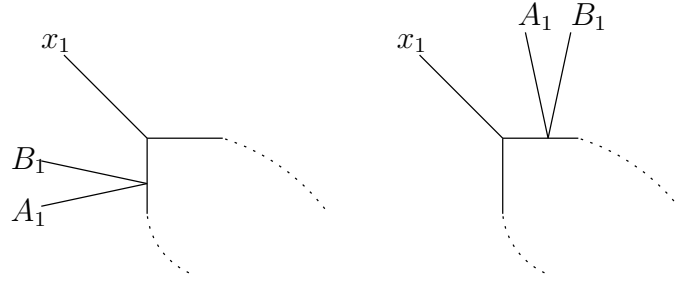

Figure 5.2: A curve cut two times at neighboring edges.

*Proof.* The elements of  $G_{g,n}$  are restrictions of group elements such that the source and the image are in  $X_{g,n}$ . Thus, conditions (a) and (b) are satisfied. Let  $g \in G_{g,n}$  and let  $F = \{f_1, \dots, f_n\} \subset G_{g,n}$ ,  $g \in G_{g,n}$  with  $g^{-1}(|U_{f_i}|) \neq \emptyset$ , for all  $1 \leq i \leq n$ . We have to show that there exists a  $H = \{h_1, \dots, h_n\} \subset G_{g,n}$  with  $|F| = |H|$  such that  $U_{h_i} \supset g^{-1}(|U_{f_i}|)$  and  $h_i|_{g^{-1}(|U_{f_i}|)} = f_i \circ g|_{g^{-1}(|U_{f_i}|)}$  for  $1 \leq i \leq n$ . Since by construction of  $G_{g,n}$  there exists always an element  $h_i$  with  $h_i|_{g^{-1}(|U_{f_i}|)} = f_i \circ g|_{g^{-1}(|U_{f_i}|)}$  it suffices to prove the case where  $V_g \cap U_{f_1} = V_g \cap U_{f_i}$  and  $f_1 \circ g|_{g^{-1}(|U_{f_1}|)} = f_i \circ g|_{g^{-1}(|U_{f_i}|)}$  for  $1 \leq i \leq n$  (we have to show that different  $f_i$  lead to different  $h_i$ ; if one of those equations does not hold, then either the domain or the image of  $h_i$  differs from the domain or image of  $h_1$ ). The set  $G_{g,n}$  is induced by matrices, thus  $g$  and  $f_i$  correspond to matrices  $G$  and  $F_i$ . We define  $h_i$  to be the isomorphism defined by the matrix  $H_i = F_i \circ G$ . Since all matrices are elements of a group all  $H_i$  are different for different  $1 \leq i \leq n$ . Thus, by definition all  $h_i$  are different and therefore (c) holds. Condition (d) holds since we take  $U_g$  as big as possible.  $\square$

Let us make  $X_{g,n}/G_{g,n}$  into a weighted local orbit space by setting all weights in  $X_{g,n}$  to be 1.

*Definition 5.14.* With the notations as before we put

$$\begin{aligned} S : \mathcal{M}_{g,n} &\longrightarrow X_{g,n}/G_{g,n} \\ (C, x_1, \dots, x_n) &\longmapsto [(\text{dist}_\Gamma(\tilde{C}))] \end{aligned}$$

where  $\tilde{C}$  is a curve we get by cutting  $C$ .

*Remark 5.15.* By lemmata 5.5 and 5.9 the map  $S$  is well defined.

*Proposition 5.16.* Let  $X_{g,n}, G_{g,n}$  and  $\mathcal{M}_{g,n}$  be as above. Then  $S : \mathcal{M}_{g,n} \longrightarrow X_{g,n}/G_{g,n}$ ,  $(C, x_1, \dots, x_n) \longmapsto [(\text{dist}_\Gamma(x_i, x_j))]_{\{i,j\} \in \mathcal{I}}$  is a homeomorphism.

*Proof.* The map  $S$  is defined by taking the distances of marked points, thus it is a continuous map. Since the metric on  $\mathcal{M}_{g,n}$  is given by the lengths of edges, the map  $S$  is open and closed. Thus it remains to show that  $S$  is bijective.

Let us first prove the injectivity of  $S$ . For this we take  $C$  and  $\tilde{C}$  in  $\mathcal{M}_{g,n}$  with  $S(C) = S(\tilde{C})$ . By definition the curves in  $\mathcal{M}_{g,n}$  are uniquely defined by the lengths of their bounded edges. Therefore, the curves are uniquely defined if we fix the lengths of the edges of the cut curve (but not the other way round). Thus, the curve is uniquely defined by fixing its image in

$\mathcal{G}_{2,n+2g}$ . Since  $G_{g,n}$  only identifies elements which come from the same curve we can take cut curves  $C'$  of  $C$  (resp.  $\tilde{C}'$  of  $\tilde{C}$ ) such that  $\text{dist}_\Gamma(C') = \text{dist}_\Gamma(\tilde{C}')$  in  $X_{g,n}$ . Thus the difference of the two elements has to be in  $\Phi_n^g(\mathbb{R}^n)_+ < z_1, \dots, z_g >$ . All curves which differ by elements of  $< z_1, \dots, z_g >$  come from the same curve by moving the  $g$  points  $\{a_1, \dots, a_g\}$ . The elements of  $\Phi_n^g(\mathbb{R}^n)$  only insert a new length at the marked ends  $\{x_1, \dots, x_n\}$ . Thus, one has  $C = \tilde{C}$ .

To prove the surjectivity note that  $\mathcal{M}_{0,n+2g}$  is homeomorphic to  $\mathcal{G}_{2,n+2g}/\Phi_{n,g}(\mathbb{R}^{n+2g})$ . Let  $x \in X_{g,n}/G_{g,n}$ . We take a representative  $\tilde{x}$  of  $x$  in  $X_{g,n}$  and denote its image in  $X_{g,n}/\Phi_{n,g}(\mathbb{R}^{n+2g})$  by  $[x]$ . By the mentioned homeomorphism we can construct a unique curve  $\tilde{C} \in \mathcal{M}_{0,n+2g}$  which is identified with  $[x]$ . Now we connect the points  $[x]_{n+2i-1}$  and  $[x]_{n+2i}$  for  $i \in \{1, \dots, g\}$  with an edge  $e_i$  of length  $x_{n+2i-1, n+2i-1} - [x]_{n+2i-1, n+2i}$  and remove the edges  $[x]_{n+2i-1}$  and  $[x]_{n+2i}$ . The resulting curve belongs to  $\mathcal{M}_{g,n}$  and is mapped to  $x$  under  $S$ . Thus  $S$  is surjective.  $\square$

*Proposition 5.17.* *The weighted local orbit space  $X_{g,n}/G_{g,n}$  is a tropical local orbit space.*

*Proof.* By proposition 3.18 the balancing condition is clear, since  $\mathcal{G}_{2,n+2g}$  is a balanced fan.  $\square$

*Example 5.18.* We consider the moduli space  $\mathcal{M}_{1,2}$ . To compare it with the construction of an orbit space see remark 7.6. The polyhedral complex underlying the moduli space consists of the following cones (the entries of the vectors are  $d(x_1, x_2)$ ,  $d(x_1, A)$ ,  $d(x_1, B)$ ,  $d(x_2, A)$ ,  $d(x_2, B)$ ,  $d(A, B)$ ).

$$C_1 = \left\{ a \cdot \begin{pmatrix} 1 \\ 1 \\ 1 \\ 2 \\ 0 \\ 2 \end{pmatrix} + b \cdot \begin{pmatrix} 1 \\ 0 \\ 1 \\ 1 \\ 0 \\ 1 \end{pmatrix} \mid a, b \in \mathbb{R}_{\geq 0}, a > 0 \right\}, C_2 = \left\{ a \cdot \begin{pmatrix} 1 \\ 1 \\ 1 \\ 2 \\ 0 \\ 2 \end{pmatrix} \mid a > 0 \right\},$$

$$C_3 = \left\{ a \cdot \begin{pmatrix} 1 \\ 1 \\ 1 \\ 2 \\ 0 \\ 2 \end{pmatrix} + b \cdot \begin{pmatrix} 0 \\ 1 \\ 0 \\ 1 \\ 0 \\ 1 \end{pmatrix} \mid a, b \in \mathbb{R}_{\geq 0}, a + b > 0 \right\}, C_4 = \left\{ b \cdot \begin{pmatrix} 0 \\ 1 \\ 0 \\ 1 \\ 0 \\ 1 \end{pmatrix} \mid b > 0 \right\},$$

$$C_5 = \left\{ a \cdot \begin{pmatrix} 0 \\ 1 \\ 1 \\ 1 \\ 1 \\ 0 \end{pmatrix} + b \cdot \begin{pmatrix} 0 \\ 1 \\ 0 \\ 1 \\ 0 \\ 1 \end{pmatrix} \mid a, b \in \mathbb{R}_{\geq 0}, b > 0 \right\}, C_6 = \left\{ a \cdot \begin{pmatrix} 1 \\ 2 \\ 0 \\ 1 \\ 1 \\ 2 \end{pmatrix} \mid a > 0 \right\},$$

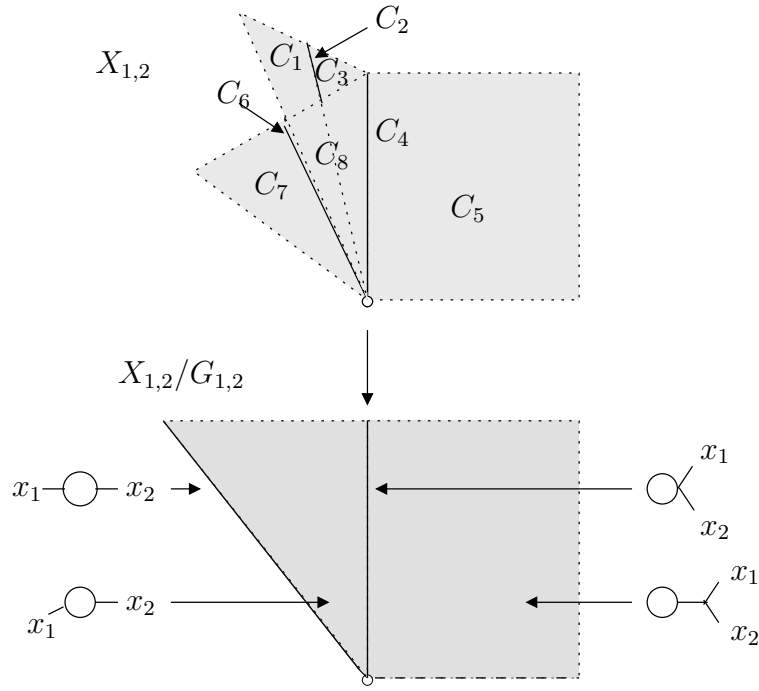
 Figure 5.3: The polyhedral complex and the topological space of  $\mathcal{M}_{1,2}$ .

$$C_7 = \left\{ a \cdot \begin{pmatrix} 1 \\ 2 \\ 0 \\ 1 \\ 1 \\ 2 \end{pmatrix} + b \cdot \begin{pmatrix} 1 \\ 1 \\ 0 \\ 0 \\ 1 \\ 1 \end{pmatrix} \mid a, b \in \mathbb{R}_{\geq 0}, a > 0 \right\},$$

$$C_8 = \left\{ a \cdot \begin{pmatrix} 1 \\ 2 \\ 0 \\ 1 \\ 1 \\ 2 \end{pmatrix} + b \cdot \begin{pmatrix} 0 \\ 1 \\ 0 \\ 1 \\ 0 \\ 1 \end{pmatrix} \mid a, b \in \mathbb{R}_{\geq 0}, a + b > 0 \right\},$$

Since the space  $\Phi_2^1(\mathbb{R}^2) + \langle z_1 \rangle$  which we mod out is three-dimensional the actual picture is three-dimensional. A picture of the polyhedral complex is given in figure 5.3. The set of morphisms in the tropical local orbit space identifies the cones  $C_2$  and  $C_6$  as well as the cones  $C_1, C_3, C_7$  and  $C_8$ . Thus the topological space underlying the tropical local orbit space is the same as the union of the cones  $C_2, C_3, C_4$  and  $C_5$  (in figure 5.3 one can see the topological space of the quotient).

## 5.2 Moduli spaces of parameterized tropical curves

Put  $\tilde{X}_{g,n,\Delta,r}^{\text{lab}} = X_{g,N} \times \mathbb{R}^r \times \mathbb{Z}_1^r \times \dots \times \mathbb{Z}_g^r$ , where  $\mathbb{Z}_i^r$ ,  $i \in \{1, \dots, g\}$  denotes a copy of  $\mathbb{Z}^r$  (for the connection between  $n$  and  $N$  see chapter 2,  $X_{g,N}$  is defined in equation 5.1). We define  $G_{g,N}^{\text{lab}}$  to be as set in bijection with  $G_{g,N}$ . For each  $f \in G_{g,N}^{\text{lab}}$ , we denote the corresponding element in  $G_{g,N}$  by  $f^*$ , and we put  $U_f = U_{f^*} \times \mathbb{R}^r \times \mathbb{Z}_1^r \times \dots \times \mathbb{Z}_g^r$ . Now we want to define a map for each  $f \in G_{g,N}^{\text{lab}}$ . Since  $f$  is induced by a matrix, it suffices to define operations on the generators of  $H$ , mentioned above ( $H$  is defined after the proof of proposition 5.8). We then take the operation defined by the product. We denote the operation on the component  $\mathbb{Z}_1^r \times \dots \times \mathbb{Z}_g^r$  by  $t_f$  and define it for  $(v^1, \dots, v^g) \in \mathbb{Z}_1^r \times \dots \times \mathbb{Z}_g^r$  as follows:

$$I_i(v^1, \dots, v^{i-1}, v^i, v^{i+1}, \dots, v^g) = (v^1, \dots, v^{i-1}, -v^i, v^{i+1}, \dots, v^g)$$

$$T_i(v^1, v^2, \dots, v^{i-1}, v^i, v^{i+1}, \dots, v^g) = (v^i, v^2, \dots, v^{i-1}, v^1, v^{i+1}, \dots, v^g)$$

$$M_p^i(v^1, \dots, v^{i-1}, v^i, v^{i+1}, \dots, v^g) = (v^1, \dots, v^{i-1}, v^i - v(x_p), v^{i+1}, \dots, v^g)$$

( $v(x_p)$  is the direction of  $x_p$ , see chapter 2) Let  $(x, b, v^1, \dots, v^g) \in \tilde{X}_{g,n,\Delta,r}^{\text{lab}}$ , then we put  $f(x, b, v^1, \dots, v^g) = (f^*(x), b, t_f(v^1, \dots, v^g))$ . As topology on  $\tilde{X}_{g,n,\Delta,r}^{\text{lab}}$ , we take the product topology of  $X_{g,N}$ , of the  $\mathbb{Z}_i^r$  and of  $\mathbb{R}^r$ , where we consider  $\mathbb{Z}_i^r$  with the discrete topology and  $\mathbb{R}^r$  with the standard Euclidean topology. Since we need a finite set of polyhedra we refine  $\tilde{X}_{g,n,\Delta,r}^{\text{lab}}$  to be the subset of  $X_N \times \mathbb{R}^r \times \mathbb{Z}_1^r \times \dots \times \mathbb{Z}_g^r$  given by  $|(v^i)_s| \leq \sum_{v \in \Delta} |v_s|$  for  $1 \leq i \leq g$ ,  $1 \leq s \leq r$ .

*Remark 5.19.* The point  $b$  is the image of  $x_1$  under  $h$  in  $\mathbb{R}^r$ , i.e.  $b = h(x_1)$  (see definition 2.11).

In the case of rational curves it was possible to define the moduli space of stable maps to be the product of  $\mathbb{R}^r$  and the moduli space of abstract curves (see [GKM]). In the case of higher genus this is not any longer possible. The cycles cause the problem (see chapter 7). Take a curve  $C$  and cut it at  $g$  points as above. We want to map the abstract tropical curve under  $h$  in  $\mathbb{R}^r$ . Therefore, we have to fix a direction vector in  $\mathbb{Z}^r$  for each cut (the directions of the vectors at  $A_i$  and  $B_i$  are opposite each other). Now we can define the image under  $h$  of the cut curve. Unfortunately the image of the cut cycle do not need to be a cycle, since we allowed arbitrary lengths for the edges. To ensure the closing of the cycles we take rational functions. These functions are given in the following proposition.

**Proposition 5.20.** *For all  $0 < i \leq r$ ,  $1 < d \leq g$ , we have a function*

$$\begin{aligned} \phi_i^d : \tilde{X}_{g,n,\Delta,r}^{\text{lab}} &\rightarrow \mathbb{R} \\ (a, b, v^1, \dots, v^g) &\mapsto \frac{1}{2} \cdot \max\left\{\pm \frac{1}{2} \left( \sum_{k=2}^N (a_{\{k,N+2d\}} - a_{\{k,N+2d-1\}}) v_k(i) \right. \right. \\ &\quad \left. \left. + \sum_{k=1}^g (a_{\{N+2k-1,N+2d\}} - a_{\{N+2k-1,N+2d-1\}} \right. \right. \\ &\quad \left. \left. - a_{\{N+2k,N+2d\}} + a_{\{N+2k,N+2d-1\}} \right) \cdot v^k(i) \right\} \end{aligned}$$

which is rational ( $a = [a_{\{1,2\}}, \dots, a_{\{N+2g-1,N+2g\}}]$ ) and we put  $a_{m,m} = 0$  and  $v_k = v(x_k)$ ).

*Proof.* The only thing we have to do is to show that  $\phi_i^d$  is well defined. Thus, we have to show that  $\phi_i^d([x, b, v]) = \phi_i^d([x + s + t, b, v])$ , for all  $[x, b, v] \in \tilde{X}_{g,n,\Delta,r}^{\text{lab}}$ ,  $s \in \langle s_1, \dots, s_g \rangle$  and  $t \in \Phi_n^g(\mathbb{R}^n)$ . Note, that  $\phi_i^d([x, b, v]) = \phi_i^d([x + s, b, v])$ , because  $\sum_{k=2}^N v_k(i) = 0$  and

$$(a_{\{N+2k-1, N+2d\}} - a_{\{N+2k-1, N+2d-1\}} - a_{\{N+2k, N+2d\}} + a_{\{N+2k, N+2d-1\}}) = 0$$

for each vector  $a$  in  $\langle s_1, \dots, s_g \rangle$ . Furthermore we have

$$\begin{aligned} (a_{\{k, N+2d\}} - a_{\{k, N+2d-1\}}) v_k(i) &= a_{\{N+2k-1, N+2d\}} = a_{\{N+2k-1, N+2d-1\}} = \\ &= a_{\{N+2k, N+2d\}} = a_{\{N+2k, N+2d-1\}} = 0 \end{aligned}$$

for all  $a \in \Phi_n^g(\mathbb{R}^n)$ . Thus,  $\phi_i^d([x, b, v]) = \phi_i^d([x + s + t, b, v])$  for all  $[x, b, v] \in \tilde{X}_{g,n,\Delta,r}^{\text{lab}}$ ,  $s \in \langle s_1, \dots, s_g \rangle$  and  $t \in \Phi_n^g(\mathbb{R}^n)$ .  $\square$

**Remark 5.21.** Let  $x \in \tilde{X}_{g,n,\Delta,r}^{\text{lab}}$ . The value  $\phi_i^d(x)$  is equal to  $\max\{\pm((\text{ev}_{A_d})_i(x) - (\text{ev}_{B_d})_i(x))\}$  where  $\text{ev}_{A_d}(x)$  (resp.  $\text{ev}_{B_d}(x)$ ) are the positions of  $A_d$  and  $B_d$  in  $\mathbb{R}^r$  (see proposition 5.23).

Now we want to show that  $\prod_{d=1}^g \prod_{i=1}^r \phi_i^d \cdot (\tilde{X}_{g,n,\Delta,r}^{\text{lab}} / G_{g,N}^{\text{lab}})$  is well defined. For this we have to show that  $\prod_{d=1}^g \phi_i^d \cdot (U_h) = \prod_{d=1}^g \phi_i^d \cdot (h(U_h))$ .

**Proposition 5.22.** For all  $i \in \{1 \dots r\}$ ,  $x \in \tilde{X}_{g,n,\Delta,r}^{\text{lab}}$  and  $h \in G_{g,N}^{\text{lab}}$  one has  $\prod_{d=1}^g \phi_i^d \cdot (U_h) = \prod_{d=1}^g \phi_i^d \cdot (h(U_h))$ .

*Proof.* Since the elements of  $G_{g,N}^{\text{lab}}$  act as matrices on the component  $X_N$  we can, instead of proving the proposition, show that for all  $f \in H$  and  $x \in V = V_{g,n} \times \mathbb{R}^r \times \mathbb{Z}_1^r \times \dots \times \mathbb{Z}_g^r$  one has  $\prod_{d=1}^g \phi_i^d \cdot (V) = \prod_{d=1}^g \phi_i^d \cdot (f(V))$  ( $f$  and  $\phi_i^d$  are defined canonically on  $V$ , because  $f$  is a matrix on  $V_{g,n}$  and the  $\phi_i^d$  are as well rational maps on  $V$ ). Since the matrices  $I_s, T_s, M_p^s$  generate  $H$ , it suffices to prove it for these matrices.

Thus, let us see how these matrices change the result. Put  $([a_{\{1,2\}}, \dots, a_{\{N+2g-1, N+2g\}}], b, v^1, \dots, v^g) = x$ . First, we consider the matrix  $I_s$  and  $d \neq s$ :

$$\phi_i^d(I_s([a_{\{1,2\}}, \dots, a_{\{N+2g-1, N+2g\}}], b, v^1, \dots, v^g))$$

$$\begin{aligned}
 &= \frac{1}{2} \cdot \max \left\{ \pm \frac{1}{2} \left( \sum_{k=2}^N (a_{\{k, N+2d\}} - a_{\{k, N+2d-1\}}) v_k(i) \right. \right. \\
 &\quad + \sum_{k=1, k \neq s}^g (a_{\{N+2k-1, N+2d\}} - a_{\{N+2k-1, N+2d-1\}} \\
 &\quad - a_{\{N+2k, N+2d\}} + a_{\{N+2k, N+2d-1\}}) \cdot v^k(i) \\
 &\quad + (a_{\{N+2s-1, N+2d-1\}} - a_{\{N+2s-1, N+2d\}} \\
 &\quad \left. \left. - a_{\{N+2s, N+2d-1\}} + a_{\{N+2s, N+2d\}}) \cdot (-v^s(i)) \right) \right\} \\
 &= \frac{1}{2} \cdot \max \left\{ \pm \frac{1}{2} \left( \sum_{k=2}^N (a_{\{k, N+2d\}} - a_{\{k, N+2d-1\}}) v_k(i) \right. \right. \\
 &\quad + \sum_{k=1}^g (a_{\{N+2k-1, N+2d\}} - a_{\{N+2k-1, N+2d-1\}} \\
 &\quad \left. \left. - a_{\{N+2k, N+2d\}} + a_{\{N+2k, N+2d-1\}}) \cdot v^k(i) \right) \right\} \\
 &= \phi_i^d([a_{\{1,2\}}, \dots, a_{\{N+2g-1, N+2g\}}], b, v^1, \dots, v^g).
 \end{aligned}$$

For  $d = s$  it is the same as the genus 1 case, considered in chapter 7.

Now we consider the matrix  $T_s$ . For  $1 \neq d \neq s$  only the order in the second big sum of  $\phi_i^d$  changes which does not effect the result. Further  $\phi_i^1$  and  $\phi_i^s$  are interchanged by  $T_s$ . Since the intersection of a product of rational functions does not depend on the order (see proposition 3.46), one gets  $\prod_{d=1}^g \phi_i^d \cdot (V) = \prod_{d=1}^g \phi_i^d \cdot (T_s(V))$ .

At last consider the matrix  $M_p^s$ . The calculations for  $N + 2d - 1 \neq p \neq N + 2d$  are the same as for genus 1. Thus, as in chapter 7 we get the equality

$$\begin{aligned}
 &\phi_i^d(M_p^s([a_{\{1,2\}}, \dots, a_{\{N+2g-1, N+2g\}}], b, v^1, \dots, v^g)) \\
 &\quad - \phi_i^d([a_{\{1,2\}}, \dots, a_{\{N+2g-1, N+2g\}}], b, v^1, \dots, v^g) = 0.
 \end{aligned}$$

It remains to show the cases  $N + 2d - 1 = p$  or  $N + 2d = p$ . Since the product is invariant under  $I_d$  we only consider  $N + 2d - 1 = p$ . We put

$$\begin{aligned}
 \sum_i^d &= \sum_{k=2}^N (a_{\{k, N+2d\}} - a_{\{k, N+2d-1\}}) v_k(i) + \sum_{k=1}^g (a_{\{N+2k-1, N+2d\}} \\
 &\quad - a_{\{N+2k-1, N+2d-1\}} - a_{\{N+2k, N+2d\}} + a_{\{N+2k, N+2d-1\}}) \cdot v^k(i)
 \end{aligned}$$

and get

$$\begin{aligned}
 &\phi_i^d(M_p^s([a_{\{1,2\}}, \dots, a_{\{N+2g-1, N+2g\}}], b, v^1, \dots, v^g)) \\
 &\quad - \phi_i^d([a_{\{1,2\}}, \dots, a_{\{N+2g-1, N+2g\}}], b, v^1, \dots, v^g)
 \end{aligned}$$

$$\begin{aligned}
 &= \frac{1}{2} \cdot \max \left\{ \pm \frac{1}{2} \left( \sum_i^d + \sum_{k=2}^N - (a_{\{k, N+2s-1\}} + a_{\{N+2d-1, N+2s\}} + a_{\{N+2s-1, N+2s\}} \right. \right. \\
 &\quad \left. \left. - a_{\{k, N+2s\}} - a_{\{N+2d-1, N+2s-1\}} \right) \cdot v_k(i) \right. \\
 &\quad + \sum_{k=1, d \neq k \neq s}^g \left( - (a_{\{N+2k-1, N+2s-1\}} + a_{\{N+2d-1, N+2s\}} + a_{\{N+2s-1, N+2s\}} \right. \\
 &\quad \left. - a_{\{N+2k-1, N+2s\}} - a_{\{N+2d-1, N+2s-1\}}) + a_{\{N+2k, N+2s-1\}} + a_{\{N+2d-1, N+2s\}} \right. \\
 &\quad \left. + a_{\{N+2s-1, N+2s\}} - a_{\{N+2k, N+2s\}} - a_{\{N+2d-1, N+2s-1\}} \right) \cdot v^k(i) \\
 &\quad + 2 \left( a_{\{N+2d, N+2s-1\}} + a_{\{N+2d-1, N+2s\}} + a_{\{N+2s-1, N+2s\}} \right. \\
 &\quad \left. - a_{\{N+2d, N+2s\}} - a_{\{N+2d-1, N+2s-1\}} \right) \cdot (v^d(i)) \\
 &\quad \left( a_{\{N+2s-1, N+2d\}} - a_{\{N+2s-1, N+2d-1\}} \right. \\
 &\quad \left. - a_{\{N+2s, N+2d\}} + a_{\{N+2s, N+2d-1\}} \right) \cdot (-v^d(i)) \\
 &\quad \left. + 2a_{\{N+2s-1, N+2s\}} \cdot (v^s(i) - v^d(i)) \right) \left. \right\} - \frac{1}{2} \cdot \max \left\{ \pm \frac{1}{2} \sum_i^d \right\} \\
 &= \frac{1}{2} \cdot \max \left\{ \pm \frac{1}{2} \left( \sum_i^s + \sum_i^d \right) \right\} - \frac{1}{2} \cdot \max \left\{ \pm \frac{1}{2} \sum_i^d \right\}.
 \end{aligned}$$

The last expression is equal to 0 for  $\prod_{d=1}^g \phi_i^d$  for the following reason. Since the intersection of a product does not depend on the order (see proposition 3.46) we can first intersect with  $\phi_s$ . For points in this intersection the sum  $\sum_i^s$  is equal to 0 and we are done.  $\square$

Now we can define the tropical local orbit space we are interested in by constructing the tropical local orbit space cut out by the rational functions  $\phi_i$ :

$$\mathcal{M}_{g,n,\text{trop}}^{\text{lab}}(\mathbb{R}^r, \Delta) = \prod_{d=1}^g \prod_{i=1}^r \phi_i^d \cdot (\tilde{X}_{g,n,\Delta,r}^{\text{lab}} / G_{g,N}^{\text{lab}}).$$

The set of cones of  $\mathcal{M}_{g,n,\text{trop}}^{\text{lab}}(\mathbb{R}^r, \Delta)$  is denoted by  $X_{g,n,\Delta,r}^{\text{lab}}$ . The rational functions assure that  $A^i$  and  $B^i$  are mapped to the same point for all  $i \in \{1, \dots, g\}$ .

### 5.3 The number of curves is independent of the position of points

In this section we use corollary 3.41 to prove that the number of certain tropical curves passing through given points is independent of the position of points. Therefore we have to define a map fulfilling the requirement of corollary 3.41.

**Proposition 5.23.** *For  $j = 1, \dots, n$  the map*

$$\begin{aligned}
 \text{ev}_j : X_{g,n,\Delta,r}^{\text{lab}} &\rightarrow \mathbb{R}^r \\
 (\Gamma, x_1, \dots, x_N, h) &\longmapsto h(x_j)
 \end{aligned}$$

is invariant under the set  $G_{g,N}$ .

*Proof.* The map  $\text{ev}_j$  is given by

$$\begin{aligned} \text{ev}_j(x) = & b + \frac{1}{2} \left( \sum_{k=2}^N (a_{\{1,k\}} - a_{\{k,j\}}) v_k + \sum_{k=1}^g (a_{\{1,N+2k-1\}} \right. \\ & \left. - a_{\{N+2k-1,j\}} - a_{\{1,N+2k\}} + a_{\{j,N+2k\}}) \cdot (v^k) \right). \end{aligned} \quad (5.2)$$

Since  $I_s$  and  $T_s$  only change the order of the sum, we only have to prove invariance for  $M_p^s$ . The maps are defined for the curves cut along  $a_1, \dots, a_g$ . Thus, let us take a point  $C \in X_{g,n,\Delta,r}^{\text{lab}}$  which represents a curve with cuts at each cycle and prove that the evaluation maps are invariant for those (i.e.  $\text{ev}_j(C) = \text{ev}_j(M_p^s(C))$ ). We can treat such a curve as a genus 1 curve cut at  $a_s$ . For this case the equation is the same as the equation for genus 1 curves in chapter 7 with  $N + 2(g - 1)$  ends and thus the proposition follows.  $\square$

**Definition 5.24** (Evaluation map). For  $j = 1, \dots, n$  the map

$$\begin{aligned} \text{ev}_j : \mathcal{M}_{g,n,\text{trop}}^{\text{lab}}(\mathbb{R}^r, \Delta) & \rightarrow \mathbb{R}^r \\ (\Gamma, x_1, \dots, x_N, h) & \mapsto h(x_j) \end{aligned}$$

is called the  $j$ -th evaluation map (note that this is well-defined for the contracted ends since for them  $h(x_j)$  is a point in  $\mathbb{R}^r$ ).

**Proposition 5.25.** *With the tropical local orbit space structure given above, the evaluation maps  $\text{ev}_j : \mathcal{M}_{g,n,\text{trop}}^{\text{lab}}(\mathbb{R}^r, \Delta) \rightarrow \mathbb{R}^r$  are morphisms of local orbit spaces ( $\mathbb{R}^r$  is equipped with the trivial local orbit space structure).*

*Proof.* We have to show that for  $e = \text{ev}_j$  the conditions in definition 3.21 are fulfilled ( $e_1 = e$  and  $e_2$  the constant map). The conditions (a) - (c) are clear, since  $e_2$  is a constant map. The map  $e_1$  is continuous and conditions (d) and (g) follows, because the image of each cone is the whole  $\mathbb{R}^r$ . Furthermore, (e) is the same as in the case of fans treated in [GKM]. Finally, proposition 5.23 proves (f) and we are done.  $\square$

**Definition 5.26** (Forgetful map). Let  $n \geq 1$  and  $g > 0$ . We define the *forgetful map*  $ft_n : \mathcal{M}_{g,n} \rightarrow \mathcal{M}_{g,0}$  to be the projection given by  $V_{g,n} \rightarrow V_{g,0}$  (projection to the last  $\binom{2g}{2}$  coordinates). The induced forgetful map of  $\mathcal{M}_{g,n,\text{trop}}^{\text{lab}}(\mathbb{R}^r, \Delta)$  to  $\mathcal{M}_{g,0}$  is denoted by  $ft_N$  as well.

**Proposition 5.27.** *The map  $ft_n : \mathcal{M}_{g,n,\text{trop}}^{\text{lab}}(\mathbb{R}^r, \Delta) \rightarrow \mathcal{M}_{g,0}$  is a morphism of tropical local orbit spaces.*

*Proof.* It follows from the fact that  $ft_n$  is a projection, respecting the polyhedral structure.  $\square$

**Proposition 5.28.** *The map  $e = \text{ev}_1 \times \dots \times \text{ev}_n \times ft_N : \mathcal{M}_{g,n,\text{trop}}^{\text{lab}}(\mathbb{R}^r, \Delta) \rightarrow \mathbb{R}^{rn} \times \mathcal{M}_{g,0}$  is a morphism of local orbit spaces.*



*Proof.* By propositions 5.25 and 5.27 the evaluation maps and the forgetful maps are morphisms. By lemma 3.27 the conditions  $a$  till  $f$  of definition 3.21 are fulfilled. We only have to show that condition  $g$  is fulfilled as well. By definition,  $\tilde{e}_1([\tilde{\sigma}]) \setminus \tilde{e}_1([\sigma]) \subset u(e)$ . Thus, the points in  $\tilde{e}_1([\tilde{\sigma}]) \setminus \tilde{e}_1([\sigma])$  are only in the boundary of non-closed faces (see proposition 3.30). The points in the boundary of non-closed faces are the points for which cycle-lengths are zero. Since these points do not lie in  $\mathcal{M}_{g,0}$  one has that  $\tilde{e}_1([\tilde{\sigma}]) \setminus \tilde{e}_1([\sigma])$  is empty and thus condition  $g$  holds.  $\square$

If we fix a degree  $\Delta$  and a genus  $g > 0$  and count tropical curves in  $\mathbb{R}^r$  we want to count a finite (non-zero) number of curves (i.e. the space of the considered curves passing through given points should be 0-dimensional). Thus, we have to take the right number  $n$  of markings such that  $\mathcal{M}_{g,n,\text{trop}}^{\text{lab}}(\mathbb{R}^r, \Delta)$  and  $\mathbb{R}^{rn} \times \mathcal{M}_{g,0}$  have the same dimension. The dimension of  $\mathcal{M}_{g,n,\text{trop}}^{\text{lab}}(\mathbb{R}^r, \Delta)$  is given by the number of inner edges (each inner edge has a length) plus  $r$  (position of  $h(x_1)$ ) minus  $rg$  (because of the  $rg$  rational functions). The dimension of  $\mathbb{R}^{rn} \times \mathcal{M}_{g,0}$  is  $rn + 3g - 3$  (resp.  $rn + 1$ ) for  $g > 1$  (resp.  $g = 1$ ). Thus,  $n$  has to satisfy the following equality:

$$\begin{aligned} \#\Delta + n + 3g - 3 + r - rg = rn + 3g - 3 &\Leftrightarrow r + n + \#\Delta - rg = rn \\ (\#\Delta + n + r - r = rn + 1 &\Leftrightarrow \#\Delta - 1 = (r - 1)n, \text{ for } g = 1.) \end{aligned}$$

**Theorem 5.29.** *Let  $r \geq 2$ , let  $\Delta$  be the degree of a genus  $g > 0$  tropical curve in  $\mathbb{R}^r$ , and let  $n \in \mathbb{Z}_{>0}$  with  $g + n \geq 2$  be such that  $r + n + \#\Delta - rg = rn$  for  $g > 1$  (resp.,  $\#\Delta - 1 = (r - 1)n$  for  $g = 1$ ). The number of parameterized labeled  $n$ -marked tropical curves of genus  $g$  with fixed type  $T \in \mathcal{M}_{g,0}$  which pass through  $n$  points in general position in  $\mathbb{R}^r$ , counted with the multiplicities of corollary 3.41, is independent of the choice of the configuration of points and the choice of  $T$ .*

*Proof.* The map  $\text{ev}_1 \times \dots \times \text{ev}_n \times ft_N$  is by proposition 5.28 a morphism between local orbit spaces. By definition the domain and the target space are of the same dimension. The space  $\mathbb{R}^{rn} \times \mathcal{M}_{g,0}$  is strongly irreducible since all codimension-1 faces of  $\mathcal{M}_{g,0}$  are attached to three codimension-0 faces and  $\mathcal{M}_{g,0}$  is irreducible. The morphism is surjective because of the balancing condition. Thus we can apply corollary 3.41 to get the statement.  $\square$

Let us fix the notation as above. To have a finite count of certain curves passing through  $n$  points,  $n$  has to fulfill the following equality:

$$\#\Delta + n + 3g - 3 + r - rg = rn \Leftrightarrow \#\Delta + (1 - g)(r - 3) = (r - 1)n.$$

**Theorem 5.30** (Theorem 1 in [M1], Theorem 4.8 in [GM1]). *Let  $\Delta$  be the degree of a genus  $g > 0$  tropical curve in  $\mathbb{R}^2$  and let  $n \in \mathbb{Z}_{>0}$  be such that  $\#\Delta + g - 1 = n$ . The number of parameterized labeled  $n$ -marked tropical curves of genus  $g$  (counted with multiplicities) which pass through  $n$  points in general position in  $\mathbb{R}^2$  is independent of the choice of the configuration of points (the multiplicity of a curve is defined to be the weight of the corresponding cone in  $\mathcal{M}_{g,n,\text{trop}}^{\text{lab}}(\mathbb{R}^2, \Delta)$ ).*

*Proof.* By proposition 5.25 the evaluation maps are morphisms and lemma 3.27 implies that conditions *a* till *f* of definition 3.21 are fulfilled for the map  $e = ev_1 \times \cdots \times ev_n : \mathcal{M}_{g,n,\text{trop}}^{\text{lab}}(\mathbb{R}^2, \Delta) \rightarrow \mathbb{R}^{2n}$ . By dimensional reasons the image is  $2n$ -dimensional. Thus, to apply corollary 3.41 we have to show that condition *g* of definition 3.21 holds for  $e$  and that  $\dim(\mathbb{R}^{2n} \setminus \tilde{e}_1(|\mathcal{M}_{g,n,\text{trop}}^{\text{lab}}(\mathbb{R}^2, \Delta)|)) \leq 2n - 2$ . The tropical local orbit space  $\mathbb{R}^{2n}$  (we put all weights to be one) is irreducible and thus it suffices to show that for  $\sigma \in X_{g,n,\Delta,2}^{\text{lab}}$  one has  $\dim(\overline{\tilde{e}_1([\sigma])} \setminus \tilde{e}_1([\sigma])) \leq 2n - 2$  (the image is a tropical fan. If  $\dim(\overline{\tilde{e}_1([\sigma])} \setminus \tilde{e}_1([\sigma])) \leq 2n - 2$ , then by irreducibility  $\dim(\mathbb{R}^{2n} \setminus \tilde{e}_1(|\mathcal{M}_{g,n,\text{trop}}^{\text{lab}}(\mathbb{R}^2, \Delta)|)) \leq 2n - 2$  holds as well. Furthermore  $\overline{\tilde{e}_1([\sigma])} \setminus \tilde{e}_1([\sigma])$  contains the sets in (*g*) of definition 3.21 which must have dimension less than or equal to  $2n - 2$ ). The map is linear on each cone. Therefore, a point  $x$  can only be in  $\overline{\tilde{e}_1([\sigma])} \setminus \tilde{e}_1([\sigma])$  if there exists a Cauchy sequence  $(x_i)_{i \in \mathbb{N}} \subset \mathcal{M}_{g,n,\text{trop}}^{\text{lab}}(\mathbb{R}^2, \Delta)$  with  $\lim_{i \rightarrow \infty} x_i \notin \mathcal{M}_{g,n,\text{trop}}^{\text{lab}}(\mathbb{R}^2, \Delta)$  and  $\lim_{i \rightarrow \infty} \tilde{e}_1(x_i) = x$ . Thus, we have to study the case where we diminish the cycle length to zero. Thus let us consider a sequence  $(C_i)_{i \in \mathbb{N}}$  of curves through arbitrary points where we move the points to shrink the cycle to a point  $p$ . These curves are represented by points in the moduli space  $\mathcal{M}_{g,n,\text{trop}}^{\text{lab}}(\mathbb{R}^2, \Delta)$ . Since  $\mathcal{M}_{g,n,\text{trop}}^{\text{lab}}(\mathbb{R}^2, \Delta)$  consists of finitely many cones,  $(C_i)_{i \in \mathbb{N}}$  contains a subsequence which lies in the interior of one cone  $\sigma$ . Either  $\dim(\sigma) = 2n$  or  $\dim(\overline{\tilde{e}_1([\sigma])} \setminus \tilde{e}_1([\sigma])) \leq 2n - 2$  is fulfilled. Assume that the cone  $\sigma$  is of dimension  $2n$ . Thus, the cycle of each such curve  $(C, h, x_1, \dots, x_n)$  has to be seen in the image  $h(C)$ . For the sake of contradiction, assume that  $\dim(\overline{\tilde{e}_1([\sigma])} \setminus \tilde{e}_1([\sigma])) = 2n - 1$ . Then no marked point can be on the cycle we are shrinking, because this would lead to a codimension 2 face. The edges adjacent to  $p$  have the same direction as the edges which have been adjacent to the shrinking cycle before. Thus, the dual polytope of  $p$  in the limit curve has an interior lattice point and we can insert again a cycle at  $p$ . All curves we get by inserting a small cycle at  $p$  are mapped to the same point under  $e_1$ . Hence, the map is not injective on the face with the shrinking cycle (which is a contradiction to  $\dim(\overline{\tilde{e}_1([\sigma])} \setminus \tilde{e}_1([\sigma])) = 2n - 1$ ) and we are done.  $\square$

*Remark 5.31.* In the previous proof we need the assumption  $r = 2$  since we use the dual polytope in our argumentation. For  $r > 2$  the tropical curve is not a hypersurface and thus the proof does not work in this case.

*Example 5.32.* Let us consider two examples to see why we need the assumption  $r = 2$  in the proof of theorem 5.30. Figure 5.4 shows a curve in  $\mathbb{R}^2$  and shrinking of the cycle of

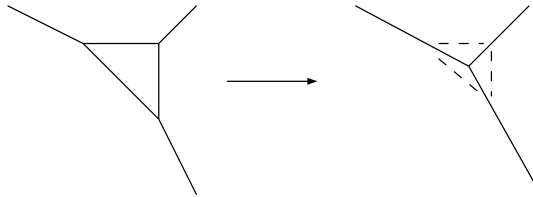

Figure 5.4: A curve in  $\mathbb{R}^2$  where we shrink the cycle length to 0.

this curve. The right hand side represents the limit curve and a possibility to insert again a cycle. All curves with a cycle congruent to the dashed one have the same image under the evaluation map.

Figure 5.5 shows a curve in  $\mathbb{R}^3$  where we shrink again the cycle to a point  $P$ . The directions of the curve are  $x_1 = (-4, 1, -1)$ ,  $x_2 = (1, -2, 0)$ ,  $x_3 = (2, 1, -1)$ ,  $x_4 = (1, 0, 2)$ . Fixing

one more direction determines all directions (because of the balancing condition). Thus, let us choose the direction of  $E$  to be  $(-2, 1, 0)$ . The continuous lines lie in the  $xy$ -plane and the others do not. It is impossible to insert a cycle at  $P$  similar to the case in figure 5.4 (without moving  $x_1$  up to  $x_4$  in  $\mathbb{R}^3$ ).

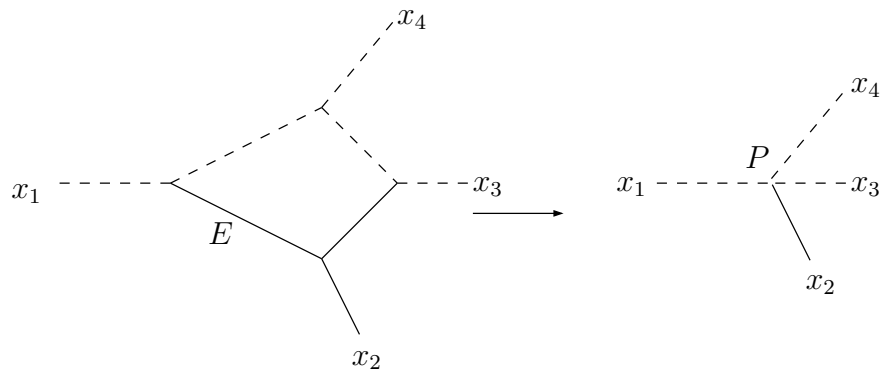
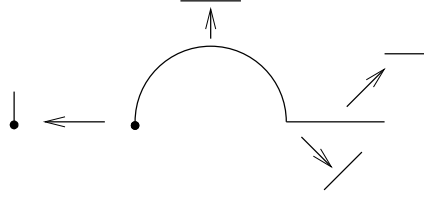

Figure 5.5: A curve in  $\mathbb{R}^3$  where we shrink the cycle length to 0.



Take for  $G$  the group with two elements, consisting of the identity and the map which maps the upper half circle to the lower half circle and vice versa and which let the ray fixed. The picture of  $|X|/G$  is as follows:



**Definition 6.4** (Weighted orbit space). Let  $(X, \omega_X)$  be a weighted polyhedral complex of dimension  $n$ , and  $G$  a group acting on  $X$ . If  $X/G$  is an orbit space such that

- for any  $g \in G$  and for any  $\sigma \in X^{(n)}$ , one has  $\omega_X(\sigma) = \omega_X(g(\sigma))$ ,

we call  $X/G$  a *weighted orbit space*. The classes  $[\sigma] \in X/G$ , for  $\sigma \in X^{(n)}$ , are called *weighted classes*.

**Definition 6.5** (Stabilizer,  $G_\tau$ -orbit of  $\sigma$ ). Let  $X$  and  $G$  be as above and  $\tau, \sigma \in X$ . We call  $G_\tau = \{g \in G | g\{x\} = x \text{ for any } x \in \tau\}$  the *stabilizer* of  $\tau$ . We define  $X_{\sigma/\tau} = \{g(\sigma) | g \in G_\tau\}$  to be the  $G_\tau$ -*orbit* of  $\sigma$ . By  $|G_\tau|$  (resp.,  $|X_{\sigma/\tau}|$ ) we denote the number of elements in  $G_\tau$  (resp.,  $X_{\sigma/\tau}$ ).

The weight function on the weighted classes of  $X/G$  is denoted by  $[\omega]$  and defined by  $[\omega]([\sigma]) = \omega(\sigma)/|G_\sigma|$ , for all  $\sigma \in X^{(n)}$ .

*Remark 6.6.* We could define a weighted orbit space as well by giving an orbit space and a weight for each class instead of defining the weights of the orbit space by the weights of the complex and the group action.

**Definition 6.7** (Suborbit space). Let  $X/G$  be an orbit space. An orbit space  $Y/H$  is called a *suborbit space* of  $X/G$  (notation:  $Y/H \subset X/G$ ) if each general polyhedron of  $Y$  is contained in a general polyhedron of  $X$ ,  $G = H$  and each element of  $G$  acts on the faces of  $Y$  in the same way as for  $X$  (i.e. for all  $g \in G$ ,  $\sigma \in Y$  we have  $g_{|Y|}\{x\} = g_{|X|}\{x\}$  for  $x \in \sigma$ ). In this case we denote by  $C_{Y,X} : Y \rightarrow X$  the map which sends a general polyhedron  $\sigma \in Y$  to the (unique) inclusion-minimal general polyhedron of  $X$  that contains  $\sigma$ . Note that for a suborbit space  $Y/H = Y/G \subset X/G$  we obviously have  $|Y| \subset |X|$  and  $\dim C_{Y,X}(\sigma) \geq \dim \sigma$  for all  $\sigma \in Y$ .

**Definition 6.8** (Refinement). Let  $((Y, |Y|), \omega_Y)/G$  and  $((X, |X|), \omega_X)/G$  be two weighted orbit spaces. We call  $((Y, |Y|), \omega_Y)/G$  a *refinement* of  $((X, |X|), \omega_X)/G$ , if

- $((Y, |Y|), \omega_Y)/G \subset ((X, |X|), \omega_X)/G$ ,
- $|Y^*| = |X^*|$ ,
- $\omega_Y(\sigma) = \omega_X(C_{Y,X}(\sigma))$  for all  $\sigma \in (Y^*)^{(\dim(Y))}$ ,
- each  $\sigma \in Y$  is closed in  $|X|$ .

We say that two weighted orbit spaces  $((X, |X|), \omega_X)/G$  and  $((Y, |Y|), \omega_Y)/G$  are equivalent (notation:  $((X, |X|), \omega_X)/G \cong ((Y, |Y|), \omega_Y)/G$ ) if they have a common refinement.

**Definition 6.9** (Tropical orbit space). Let  $(X, \omega_X)/G$  be a weighted orbit space of dimension  $n$  with finitely many different classes and  $|G_\sigma| < \infty$  for any  $\sigma \in X^{(n)}$ . If for any  $\tau \in X^{(n-1)}$  there exists  $\lambda_{\sigma/\tau} \geq 0$  for any  $\sigma > \tau$  such that  $\sum_{\tilde{\sigma} > \tau, \tilde{\sigma} \in X_{\sigma/\tau}} \lambda_{\tilde{\sigma}/\tau} = 1$  and  $\sum_{\sigma > \tau} \lambda_{\sigma/\tau} [\omega_X]([\sigma]) u_{\sigma/\tau} \in V_\tau$ , then  $X/G$  is called a *tropical orbit space*. (Remark: one has  $\#\{\sigma > \tau\} < \infty$  since  $S_\tau$  in definition 1.10 is homeomorphic to an open fan.)

*Remark 6.10.* For a finite group  $G$  the definitions of tropical orbit space and tropical local orbit space do agree.

**Proposition 6.11.** *Let  $(X, \omega_X)$  be a general weighted fan in  $V$  and  $G \subset Gl(V)$  such that  $X/G$  is a weighted orbit space ( $G$  is finite since  $(X, \omega_X)$  is finite). Then  $(X, \omega_X)$  is a general tropical fan if and only if  $X/G$  is a tropical orbit space.*

*Proof.* "  $\Rightarrow$  ": Put  $n = \dim(X)$  and let  $\tau \in X^{(n-1)}$  and  $\sigma > \tau$ . Then we define  $\lambda_{\sigma/\tau} = \frac{|\{g \in G_\tau, \text{ such that } g(\sigma) = \sigma\}|}{|G_\tau|} = \frac{|G_\sigma|}{|G_\tau|} = \frac{1}{|X_{\sigma/\tau}|}$ . The sets  $X/G$  and  $G$  are finite thus  $X$  is finite. In particular, for any  $\tau \in X^{(n-1)}$  one has  $\#\{\sigma > \tau\} < \infty$ . For any  $\sigma > \tau$  one has  $\lambda_{\sigma/\tau} \geq 0$  and  $\sum_{\tilde{\sigma} > \tau, \tilde{\sigma} \in X_{\sigma/\tau}} \lambda_{\tilde{\sigma}/\tau} = 1$ . Furthermore,

$$\sum_{\sigma > \tau} \frac{1}{|G_\tau|} \omega_X(\sigma) \cdot v_{\sigma/\tau} = t \in V_\tau,$$

because  $(X, \omega_X)$  is a tropical fan. Thus, we have

$$\sum_{\sigma > \tau} \frac{|G_\sigma|}{|G_\tau|} [\omega_X]([\sigma]) \cdot v_{\sigma/\tau} = \sum_{\sigma > \tau} \frac{1}{|G_\tau|} \omega_X(\sigma) \cdot v_{\sigma/\tau} = t \in V_\tau.$$

"  $\Leftarrow$  ": Let  $X/G$  be a tropical orbit space. Thus, there exists  $\lambda_{\sigma/\tau}$  with  $\sigma > \tau$  and  $\tau \in X^{(n-1)}$  such that

$$\sum_{\sigma > \tau} \lambda_{\sigma/\tau} [\omega_X]([\sigma]) \cdot u_{\sigma/\tau} = t \in V_\tau.$$

Therefore, because of the linearity of  $g \in G_\tau$ , we get:

$$\begin{aligned} |G_\tau| \cdot t &= \sum_{g \in G_\tau} g(t) \\ &= \sum_{g \in G_\tau} g\left(\sum_{\sigma > \tau} \lambda_{\sigma/\tau} [\omega_X]([\sigma]) \cdot u_{\sigma/\tau}\right) \\ &= \sum_{g \in G_\tau} \sum_{\sigma > \tau} \lambda_{\sigma/\tau} [\omega_X]([\sigma]) \cdot g(u_{\sigma/\tau}) \\ &= \sum_{\sigma > \tau} |G_\sigma| \cdot [\omega_X]([\sigma]) \cdot u_{\sigma/\tau} \\ &= \sum_{\sigma > \tau} \omega_X(\sigma) \cdot u_{\sigma/\tau}. \end{aligned}$$

□

*Example 6.12.* The following picture is an example of a tropical fan  $X$  and a tropical orbit space  $X/G$  with this fan as underlying polyhedral complex. Let  $X$  be the standard tropical line with its vertex at the origin, the directions  $\begin{pmatrix} -1 \\ 0 \end{pmatrix}$ ,  $\begin{pmatrix} 0 \\ -1 \end{pmatrix}$  and  $\begin{pmatrix} 1 \\ 1 \end{pmatrix}$ , and all the weights are equal to one. The group  $G$  consists of two elements and is generated by the matrix  $\begin{pmatrix} 0 & 1 \\ 1 & 0 \end{pmatrix}$ .

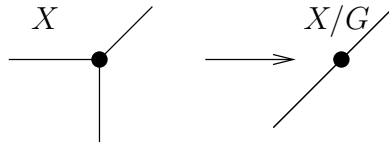

The balancing condition for the fan is

$$\begin{pmatrix} -1 \\ 0 \end{pmatrix} + \begin{pmatrix} 0 \\ -1 \end{pmatrix} + \begin{pmatrix} 1 \\ 1 \end{pmatrix} = \begin{pmatrix} 0 \\ 0 \end{pmatrix}$$

and for the orbit space

$$\frac{1}{2} \cdot \begin{pmatrix} -1 \\ 0 \end{pmatrix} + \frac{1}{2} \cdot \begin{pmatrix} 0 \\ -1 \end{pmatrix} + \frac{1}{2} \cdot \begin{pmatrix} 1 \\ 1 \end{pmatrix} = \begin{pmatrix} 0 \\ 0 \end{pmatrix},$$

where the first two  $(1/2)$ 's come from the splitting of 1 (see definition 6.9), and the third  $1/2$  comes from the invariance of the last vector under  $G$ .

**Corollary 6.13** (of proposition 6.11). *The balancing condition for tropical orbit spaces holds if and only if the balancing condition of the underlying weighted complex holds.*

*Proof.* For tropical orbit spaces with infinite group  $G$  there are only finitely many facets around a codim-1 face. Thus, as in the proof of proposition 6.11 the balancing condition can be checked on the polyhedral complex as well (without group action).  $\square$

*Example 6.14.* To show that there are tropical orbit spaces which do not come from a tropical fan we consider the following orbit space. Let  $|X|$  be the topological space  $\{(x, y) \in \mathbb{R}^2 | y > 0\}$ , and let  $X$  be the set of cones spanned by the vectors  $\begin{pmatrix} x \\ 1 \end{pmatrix}$  and  $\begin{pmatrix} x+1 \\ 1 \end{pmatrix}$  for  $x \in \mathbb{Z}$ . If we define all weights to be one and  $G = \langle \begin{pmatrix} 1 & 1 \\ 0 & 1 \end{pmatrix} \rangle$ , we get the following tropical orbit space  $X/G$ :

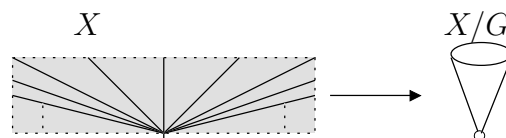

It can easily be seen, that  $X/G$  is a tropical orbit space (see definition 6.9), while  $X$  has infinitely many cones and thus it can not be a tropical fan.

**Definition 6.15** (Global orbit space). Let  $F$  be a finite set of orbit spaces and let  $E$  be a set of isomorphisms of polyhedral complexes fulfilling the following properties. Each element  $g_{X/G, Y/H} \in E$  is labeled by a pair  $X/G, Y/H \in F$  such that  $g_{X/G, Y/H} : X' \rightarrow Y'$  with  $X' \subset X, Y' \subset Y$  subcomplexes, is an isomorphism. Furthermore, for each  $g \in G$  and  $\sigma \subset |X'|$  such that  $g(\sigma) \subset |X'|$  there exists a  $h \in H$  such that  $g_{X/G, Y/H}(g(\sigma)) = h(g_{X/G, Y/H}(\sigma))$ . We call the pair  $(F, E)$  a *global orbit space*.

*Remark 6.16.* The global orbit space is a topological space which locally is an orbit space. In the same way one could define a weighted global and later on a tropical global orbit space. For weighted global orbit spaces one would need the condition that the weights of the glued cones coincide.

## 6.2 Morphisms of orbit spaces

After becoming more familiar with the notion of orbit spaces we now introduce morphisms between them.

**Definition 6.17** (Morphism of orbit spaces). Let  $(X, |X|, \{\varphi\}, \{\Phi_\sigma | \sigma \in X\})/G$  and  $(Y, |Y|, \{\psi\}, \{\Psi_\tau | \tau \in Y\})/H$  be two orbit spaces. A *morphism of orbit spaces*  $f : X/G \rightarrow Y/H$  is a pair  $(f_1, f_2)$  consisting of a continuous map  $f_1 : |X| \rightarrow |Y|$  and a group morphism  $f_2 : G \rightarrow H$  with the following properties:

- (a) for every general polyhedron  $\sigma \in X$  there exists a general polyhedron  $\tilde{\sigma} \in Y$  with  $f_1(\sigma) \subseteq \tilde{\sigma}$ ,
- (b) for every pair  $\sigma, \tilde{\sigma}$  from (a) the map  $\Psi_{\tilde{\sigma}} \circ f_1 \circ \Phi_\sigma^{-1} : |F_\sigma^X| \rightarrow |F_{\tilde{\sigma}}^Y|$  induces a morphism of fans  $\tilde{F}_\sigma^X \rightarrow \tilde{F}_{\tilde{\sigma}}^Y$ , where  $\tilde{F}_\sigma^X$  and  $\tilde{F}_{\tilde{\sigma}}^Y$  are the weighted general fans associated to  $F_\sigma^X$  and  $F_{\tilde{\sigma}}^Y$ , respectively (cf. definition 1.6),
- (c) there exists a refinement of  $X$  such that for any  $\sigma, \tilde{\sigma} \in X$  with  $\dim(f_1(\sigma) \cap f_1(\tilde{\sigma})) = \dim(f_1(\sigma)) = \dim(f_1(\tilde{\sigma}))$ , one has  $f_1(\sigma) = f_1(\tilde{\sigma})$ ,
- (d)  $f_1(g(\sigma)) = f_2(g)(f_1(\sigma))$  for all  $g \in G$  and  $\sigma \in X$ .

A morphism of *weighted orbit spaces* is a morphism of orbit spaces (i.e. there are no conditions on the weights).

*Remark 6.18.* The conditions (a) and (b) of definition 6.17 are equivalent to  $f_1$  being a morphism of general polyhedral complexes.

*Remark 6.19.* For  $G$  being a finite group the concepts of tropical local orbit spaces and tropical orbit spaces are the same. Nevertheless the definitions of morphisms of those objects do not agree. This is due to the fact that we use orbit spaces to treat easier problems than the problems we deal with by using local orbit spaces. In particular we do not need morphisms from open cones to closed cones as in the case of local orbit spaces (cf. theorem 5.30). Thus, we can ask for condition (c) instead of condition (g) in definition 3.21.

*Explanation 6.20.* The motivation for asking a morphism to fulfill conditions (a), (b) and (d) is clear, but to ask for condition (c) is not. Thus, we consider an example where condition (c) is not fulfilled.



Let us consider the map  $f$ , given by the projection of two intervals on a third one (see the following picture). We take  $G$  and  $H$  to be trivial, thus  $X/G = X$  and  $Y/H = Y$ , where  $X$  is the disjoint union of two open intervals of different length and  $Y$  is one open interval with the same length as the longest interval of  $X$ .

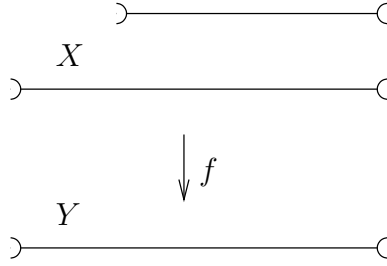

After any possible refinement, the facet  $\sigma$ , which is the most left in the upper interval of  $X$ , is open on the left side, but will be mapped on a left closed facet  $\tau$ . We call  $\tilde{\sigma}$  the intersection of the preimage of  $\tau$  with the longest interval of  $X$ . Then  $f_1(\sigma) \cap f_1(\tilde{\sigma})$  is a line segment as well as  $f_1(\sigma)$  and  $f_1(\tilde{\sigma})$ , but the images are not the same which contradicts (c). The reason is that  $\sigma$  is a half open interval but  $\tilde{\sigma}$  is a closed interval. Thus  $f$  is not a morphism.

*Example 6.21.* If we take the tropical orbit space  $X/G$  from example 6.12, then the canonical map to the diagonal line in  $\mathbb{R}^2$  is a morphism of orbit spaces. But the homeomorphism which goes in the opposite direction is not a morphism, because locally at the origin it cannot be expressed by a linear map.

*Remark 6.22.* The reason we ask condition (c) to be fulfilled is to define images of the polyhedra later on. Thus, after refinement, each polyhedron should map to one polyhedron and the image of the polyhedral complex should be a polyhedral complex as well. In particular condition (b) of definition 1.9 has to be fulfilled. Therefore, images of polyhedra of the same dimension should intersect in lower dimension or should be equal. In other words, (c) ensures (b) in definition 1.9.

To get more familiar with the definition of a morphism we prove the following proposition.

**Proposition 6.23.** *Let  $X/G$  and  $Y^1/H^1, Y^2/H^2$  be orbit spaces and  $f^1, f^2$  be two morphisms,  $f^1 : X/G \rightarrow Y^1/H^1$  and  $f^2 : X/G \rightarrow Y^2/H^2$ . Assume that for each refinement  $X^1$  of  $X$  there exists a refinement  $X^2$  of  $X^1$  such that condition (c) of definition 6.17 is fulfilled for  $f^1$  and  $f^2$ . Then  $f : X/G \rightarrow Y^1/H^1 \times Y^2/H^2, f([x]) \mapsto (f^1([x]), f^2([x]))$  is a morphism.*

*Proof.* Conditions (a), (b) and (d) of definition 6.17 hold since they follow from the conditions of  $f^1$  and  $f^2$ . Thus it remains to prove condition (c). Assume that (c) does not hold. In this case there exist  $\sigma, \tilde{\sigma} \in X$  with  $\dim(f_1(\sigma) \cap f_1(\tilde{\sigma})) = \dim(f_1(\sigma)) = \dim(f_1(\tilde{\sigma}))$  such that  $f_1(\sigma) \neq f_1(\tilde{\sigma})$ . After refinement of  $X^1$  we can assume that  $\sigma, \tilde{\sigma} \in X^{(1)}$  with  $|f_1(\sigma) \setminus f_1(\tilde{\sigma})| = 1$  and  $f$  is injective on  $\sigma$  and  $\tilde{\sigma}$ . Therefore either  $f^1$  or  $f^2$  is injective on  $\sigma$  and  $\tilde{\sigma}$  (if not, then  $\dim(f_1(\sigma) \cap f_1(\tilde{\sigma})) = 0$ ). Without loss of generality we can assume that  $f^1$  is injective. One has  $\dim(f_1^1(\sigma) \cap f_1^1(\tilde{\sigma})) = \dim(f_1^1(\sigma)) = \dim(f_1^1(\tilde{\sigma}))$ , but  $|f_1^1(\sigma) \setminus f_1^1(\tilde{\sigma})| = 1$ . Since  $f^1$  is continuous, every refinement  $X^2$  of  $X^1$  contains  $\sigma$  and  $\tilde{\sigma}$  with  $\dim(f_1^1(\sigma) \cap f_1^1(\tilde{\sigma})) = \dim(f_1^1(\sigma)) = \dim(f_1^1(\tilde{\sigma}))$ , but  $|f_1^1(\sigma) \setminus f_1^1(\tilde{\sigma})| = 1$ . This is a contradiction to our assumption, and (c) holds.  $\square$

To see, why the assumption of the existence of a refinement  $X^2$  for each refinement  $X^1$  of  $X$  is necessary we consider the following example.

*Example 6.24.* Let  $X$  be the disjoint union of a copy of  $\mathbb{R}^2$  (which will be denoted by  $X_1$ ) and a copy of  $\mathbb{R}^2$  where we remove the diagonal  $\{(x, y) \in \mathbb{R}^2 | x = y\}$  (we denote by  $X_2$  the space  $\mathbb{R}^2 \setminus \{(x, y) \in \mathbb{R}^2 | x = y\}$ ). For the image complexes we take  $Y^1 = \mathbb{R}$  and  $Y^2 = \mathbb{R}$ . The groups are defined to be the groups which contain only the trivial element. We define the map  $f^1 : X \rightarrow Y^1$  to be the orthogonal projection of  $X_1$  and  $X_2$  onto the  $x$ -axes, and we define  $f^2 : X \rightarrow Y^2$  to be the projection onto the  $y$ -axes. Each of the three cones of  $X_1$ ,  $\{(x, y) \in X_2 | x < y\}$  and  $\{(x, y) \in X_2 | x > y\}$  are mapped surjectively to  $Y^1$  and  $Y^2$ , thus (c) holds for this refinement. The product  $f^1 \times f^2$  is the identity on  $X_1$  and  $X_2$  and condition (c) can not hold since the diagonal is missing in  $X_2$ .

*Remark 6.25.* This example shows that a product of morphisms is not necessarily a morphism again.

*Construction 6.26.* As in the case of fans (construction 2.24 [GKM]) we can define the image orbit space. Let  $X/G$  be a purely  $n$ -dimensional orbit space, and let  $Y/H$  be any orbit space. For any morphism  $f : X/G \rightarrow Y/H$  consider the following set:

$$Z = \{f(\sigma), \sigma \text{ is contained in a cone } \tilde{\sigma} \text{ of } X^{(n)} \text{ with } f \text{ injective on } \tilde{\sigma}\}$$

Note, that  $Z$  is in general not a polyhedral complex. Since  $Y$  is a polyhedral complex, it satisfies all conditions of definition 1.9 and definition 1.10 except possibly (b) and (d) of definition 1.9 (since there might be overlaps of some regions). Condition (b) is fulfilled by condition (c) of definition 6.17. Furthermore, we can choose a proper refinement (which satisfies (d) of definition 1.9) to turn  $Z$  into a polyhedral complex. We denote the weighted polyhedral complex defined by all representatives of all classes  $[\sigma]$  with  $\sigma \in Z$  by  $H(Z)$ . By condition (a) in definition 6.17 the group action of  $H$  on  $H(Z)$  is well defined. Thus, we get an orbit space  $H(Z)/H$ , which will be the *image orbit space*  $f(X/G)$ .

If moreover  $X/G$  is a weighted orbit space, we turn  $f(X/G)$  into a weighted orbit space. After choosing a refinement for  $X$  and  $Y$  such that  $f(\sigma)$  is a cone in  $Y$  for each  $\sigma \in X$ , we set

$$\omega_{f(X/G)}(\sigma') = \sum_{[\sigma] \in X/G^{(n)} : [f(\sigma)] = [\sigma']} \omega_X(\sigma) \cdot |\Lambda'_{[\sigma]} / f(\Lambda_{[\sigma]})|$$

for any  $\sigma' \in (H(Z))^{(n)}$ .

**Proposition 6.27.** *Let  $X/G$  be an  $n$ -dimensional tropical orbit space,  $Y/H$  an orbit space, and  $f : X/G \rightarrow Y/H$  a morphism. Then  $f(X/G)$  is an  $n$ -dimensional tropical orbit space (provided that  $f(X/G)$  is not empty).*

*Proof.* By construction,  $f(X/G)$  is an  $n$ -dimensional weighted orbit space. It remains to show the balancing condition. The proof works in the same way as for fans in [GKM] (notice that by corollary 6.13 the balancing condition can be checked without taking into account the group operation).  $\square$

**Definition 6.28** (Irreducible tropical orbit space). Let  $X/G$  be a tropical orbit space of dimension  $n$ . We call  $X/G$  *irreducible* if for any refinement  $\tilde{X}/G$  of  $X/G$  and any  $Y/G \subset$

$X/G, Y \neq \emptyset$  with  $\dim(Y/G) = n$  the following holds: if for all  $\sigma \in Y^{(n)}$  one has  $\sigma \in \tilde{X}^{(n)}$ , then  $Y$  and  $\tilde{X}$  are equal. (The equality holds on the level of orbit spaces, the weights can be different. In the case of different weights one has  $\omega_X = \lambda \cdot \omega_Y$  for  $\lambda \in \mathbb{Q} \neq 0$ .) Equivalent to this definition is to say that  $X/G$  is *irreducible*, if for any  $Y/G \subset X/G, Y \neq \emptyset$  with  $\dim(Y/G) = n$  and  $|Y|$  is closed in  $|X|$  one has  $Y = X$ .

**Corollary 6.29** (of proposition 6.27). *Let  $X/G$  and  $Y/H$  be tropical orbit spaces of the same dimension  $n$  in  $V = \Lambda \otimes \mathbb{R}$  and  $V' = \Lambda' \otimes \mathbb{R}$ , respectively, and let  $f : X/G \rightarrow Y/H$  be a morphism. Assume that  $Y/H$  is irreducible and  $f(|X/G|) = |Y/H|$  (as topological spaces). Then there is an orbit space  $Y_0/H \subset Y/H$  of dimension smaller than  $n$  with  $|Y_0| \subset |Y|$  such that*

- (a) *each point  $Q \in |Y| \setminus |Y_0|$  lies in the interior of a cone  $\sigma'_Q \in Y$  of dimension  $n$ ;*
- (b) *each point  $P \in f^{-1}(|Y| \setminus |Y_0|)$  lies in the interior of a cone  $\sigma_P \in X$  of dimension  $n$ ;*
- (c) *for  $Q \in |Y| \setminus |Y_0|$  the sum*

$$\sum_{[P], P \in |X|: f([P]) = [Q]} \text{mult}_{[P]} f$$

*does not depend on  $Q$ , where the multiplicity  $\text{mult}_{[P]} f$  of  $f$  at  $[P]$  is defined to be*

$$\text{mult}_{[P]} f := \frac{\omega_{X/G}(\sigma_P)}{\omega_{Y/H}(\sigma'_Q)} \cdot |\Lambda'_{[\sigma'_Q]} / f(\Lambda_{[\sigma_P]})|.$$

*Proof.* If we can show that  $f(X/G) = \lambda(Y/H)$  (i.e. the image of  $X/G$  is  $Y/G$  and the weights differ by the multiplication of  $\lambda \in \mathbb{Q}$ ) the proof works as in [GKM] for fans.

By assumption we have, that  $f(|X/G|) = |Y/H|$ , as topological spaces. Further, by proposition 6.27,  $f(X/G)$  is a tropical orbit space. Because of irreducibility we have  $f(X/G) = \lambda Y/H$  as tropical orbit spaces.  $\square$

In contrast to the case of fans we need in corollary 6.29 the assumption  $f(|X/G|) = |Y/H|$ . This is due to the fact, that we use non-closed polyhedra. Let us see what happens if we do not assume the above equality.

*Example 6.30.* Let  $G$  be the trivial group and  $X \subset \mathbb{R}$  and  $Y \subset \mathbb{R}$  be open intervals of weight one with  $X \subsetneq Y$ . Let  $f : X \hookrightarrow Y$  be the inclusion.

$$\begin{array}{c} X \\ \text{)-----} \\ \downarrow f \\ Y \\ \text{)-----} \end{array}$$

Then, all conditions of corollary 6.29 but the equality  $f(|X/G|) = |Y/H|$  are fulfilled and the statement of the corollary does not hold.

*Remark 6.31.* Instead of assuming  $f(|X/G|) = |Y/H|$  in corollary 6.29, it suffices to assume that  $f(|X/G|)$  is closed in  $|Y/H|$ .

**Definition 6.32** (Rational function). Let  $Y/G$  be a tropical orbit space. We define a *rational function*  $\varphi$  on  $Y/G$  to be a continuous function  $\varphi : |Y| \rightarrow \mathbb{R}$  such that there exists a refinement  $((X, |X|, \{m_\sigma\}_{\sigma \in X}), \omega_X, \{M_\sigma\}_{\sigma \in X})$  of  $Y$  fulfilling that for each face  $\sigma \in X$  the map  $\varphi \circ m_\sigma^{-1}$  is locally integer affine-linear (i.e. by refinements we can assume that  $\varphi \circ m_\sigma^{-1}$  is affine linear on each general cone of  $Y$ ). Furthermore, we demand that  $\varphi \circ g = \varphi$ , for all  $g \in G$ .

**Definition 6.33** (Orbit space divisor). Let  $X/G$  be a tropical orbit space, and  $\phi$  a rational function on  $X/G$ . We define a divisor of  $\phi$  to be  $\text{div}(\phi) = \phi \cdot X/G = [(\bigcup_{i=-1}^{k-1} X^{(i)}, \omega_\phi)] / G$ , where  $\omega_\phi$  is given as follows:

$$\begin{aligned} \omega_\phi : X^{(k-1)} &\rightarrow \mathbb{Q}, \\ \tau &\mapsto \sum_{\substack{\sigma \in X^{(k)} \\ \tau < \sigma}} \phi_\sigma(\lambda_{\sigma/\tau} \omega(\sigma) v_{\sigma/\tau}) - \phi_\tau \left( \sum_{\substack{\sigma \in X^{(k)} \\ \tau < \sigma}} \lambda_{\sigma/\tau} \omega(\sigma) v_{\sigma/\tau} \right) \end{aligned}$$

(the  $\lambda_{\sigma/\tau}$  are described in definition 6.9).

*Remark 6.34.* The following two statements can be proved analogously to the proof of proposition 6.11.

- 1 The definition above is independent of the chosen  $\lambda_{\sigma/\tau}$  (i.e. if we have different sets of  $\lambda$ 's fulfilling the definition of a tropical orbit space, the divisor will be the same for both sets of  $\lambda$ 's).
- 2 Since  $|X_{\sigma/\tau}| \cdot |G_\sigma| = |G_\tau|$  we have that  $|G_\tau| < \infty$  and thus  $\phi \cdot X/G$  is a tropical orbit space.



# 7 Moduli spaces of elliptic tropical curves

In this chapter we show that the moduli spaces of tropical curves of genus 1 with  $j$ -invariant greater than 0 have a structure of tropical (non-local) orbit space. We use this structure to prove the known fact that the weighted number of plane elliptic tropical curves of degree  $d$  with fixed  $j$ -invariant which pass through  $3d - 1$  points in general position in  $\mathbb{R}^2$  is independent of the choice of a configuration of points. The chapter consists of three parts. In the first part we equip the moduli space of abstract tropical curves of genus 1 with a structure of tropical orbit space. In the second part we do the same for the moduli space of parameterized tropical curves of genus 1. In the last section we use corollary 6.29 to show the mentioned independence of the point configuration.

As mentioned before, a difference between local orbit spaces and orbit spaces lies in the set of isomorphisms (see chapter 3 and chapter 6). In chapter 5 the sets of isomorphisms we used for the construction of the moduli spaces are induced by matrices. This time we take as sets of isomorphisms the groups generated by these matrices. Unfortunately, these groups are infinite and thus it is much more difficult to handle the sets of isomorphisms and we have to restrict ourselves to the case of elliptic curves.

## 7.1 Moduli spaces of abstract tropical curves of genus 1

We construct a map from  $\mathcal{M}_{1,n}$  to a tropical orbit space in the following way. For each curve  $C \in \mathcal{M}_{1,n}$  let  $a$  be an arbitrary point of the cycle of  $C$ . We define a new curve  $\tilde{C}$  which we get by cutting  $C$  along  $a$  and inserting two leaves  $A = x_{n+1}$  and  $B = x_{n+2}$  at the resulting endpoints (if we cut along a vertex we have to decide if the edges adjacent to the vertex which are not in the cycle are adjacent to  $A$  or to  $B$ ). This curve is an  $n + 2$  marked curve (of genus 0) with up to 2 two-valent vertices (at the ends  $A$  and  $B$ ).

By  $\mathcal{T}$  we denote the set of all subsets  $S \subset \{1, \dots, n + 2\}$  with  $|S| = 2$ . In order to embed  $\mathcal{M}_{1,n}$  into a quotient of  $\mathbb{R}^{\binom{n+2}{2}}$  we consider the following map:

$$\begin{aligned} \text{dist}_n : \mathcal{M}_{1,n} &\longrightarrow V_n/G_n \\ (C, x_1, \dots, x_n) &\longmapsto [(\text{dist}_\Gamma(x_i, x_j))_{\{i,j\} \in \mathcal{T}}] \end{aligned}$$

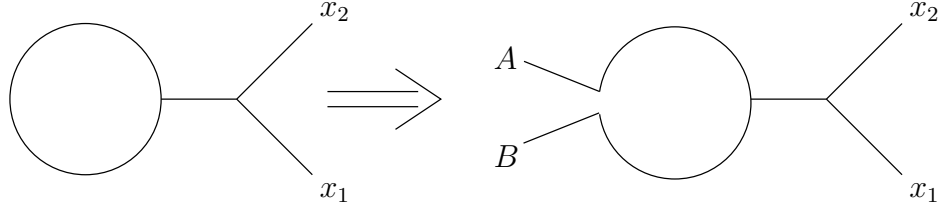
 Figure 7.1: Construction of an  $n + 2$ -marked curve from an  $n$ -marked genus-1 curve.

where  $V_n$ ,  $G_n$ , and  $\text{dist}_\Gamma(x_i, x_j)$  are defined as follows. We denote by  $\text{dist}_\Gamma(x_i, x_j)$  the distance between  $x_i$  and  $x_j$  (that is the sum of the lengths of all edges in the unique path from  $x_i$  to  $x_j$ ) in  $\tilde{C}$ , where  $x_{n+1} = A$  and  $x_{n+2} = B$ .

The vector space  $V_n$  is isomorphic to  $\mathbb{R}^{\binom{n+2}{2}-n-1}$  and is given by  $V_n = \mathbb{R}^{\binom{n+2}{2}} / (\Phi_n^1(\mathbb{R}^n) + \langle s \rangle)$  (Recall  $\Phi_n^1$  from construction 5.1) where

$s \in \mathbb{R}^{\binom{n+2}{2}}$  is a vector such that

$$s_{i,j} = \begin{cases} 1 & \text{if } i = n + 1 \text{ or } j = n + 1 \text{ and } i \neq n + 2 \neq j, \\ -1 & \text{if } i = n + 2 \text{ or } j = n + 2 \text{ and } i \neq n + 1 \neq j, \\ 0 & \text{otherwise.} \end{cases}$$

The group  $G_n$  is generated by the matrix  $I$  and the matrices  $M_p$ ,  $p \in \{1, \dots, n\}$ , where

$$I_{(i,j),(k,l)} = \begin{cases} 1 & \text{if } (\{i, j\}, \{k, l\}) = (\{m, n + 1\}, \{m, n + 2\}), m \leq n, \\ & \text{or } (\{i, j\}, \{k, l\}) = (\{m, n + 2\}, \{m, n + 1\}), m \leq n, \\ & \text{or } \{i, j\} = \{k, l\} \text{ and } i, j \notin \{n + 1, n + 2\}, \\ & \text{or if } \{i, j\} = \{n + 1, n + 2\} = \{k, l\}, \\ 0 & \text{otherwise.} \end{cases}$$

(In particular  $I_{(i,j),(k,l)} = \text{id}$  for  $i, j, k, l \leq n$  and  $I_{(i,n+1),(i,n+2)} = \begin{pmatrix} 0 & 1 \\ 1 & 0 \end{pmatrix}$ )

$$M_{p,(i,j),(k,l)} = \begin{cases} 1 & \text{if } \{i, j\} = \{k, l\} \\ & \text{or } (\{i, j\}, \{k, l\}) = (\{p, n + 2\}, \{n + 1, n + 2\}), \\ & \text{or } (\{i, j\}, \{k, l\}) = (\{p, j\}, \{j, n + 1\}), j \neq n + 2, \\ & \text{or } (\{i, j\}, \{k, l\}) = (\{p, j\}, \{p, n + 2\}), j \neq n + 2, \\ & \text{or } (\{i, j\}, \{k, l\}) = (\{p, j\}, \{n + 1, n + 2\}), \\ & \quad n + 1 \neq j \neq n + 2, \\ -1 & \text{if } (\{i, j\}, \{k, l\}) = (\{p, n + 1\}, \{n + 1, n + 2\}), \\ & \text{or } (\{i, j\}, \{k, l\}) = (\{p, j\}, \{j, n + 2\}), j \neq n + 1, \\ & \text{or } (\{i, j\}, \{k, l\}) = (\{p, j\}, \{p, n + 1\}), j \neq n + 1, \\ 0 & \text{otherwise.} \end{cases}$$

( $M_p$  written as a matrix can be found in the proof of proposition 5.7 for  $s = 1$ .)

The orbits of all elements of  $\langle \Phi_n^1(\mathbb{R}^n) \rangle$  under  $G_n$  are trivial,  $M_p(s) = s$  and  $I(s) = -s$ . Thus  $V_n/G_n$  is well defined. By the following lemma, the map  $\text{dist}_n$  is also well defined.

**Lemma 7.1.** *Let  $\tilde{C}$  and  $\tilde{C}^*$  be two curves resulting from two different cuts of a curve  $C$ . Then, the images of  $\tilde{C}$  and  $\tilde{C}^*$  are the same in  $V_n/G_n$ .*

*Proof.* Let us fix an orientation  $o$  of the simple cycle in  $C$  and let  $\text{dist}(\tilde{C})$  and  $\text{dist}(\tilde{C}^*)$  be the images under  $\text{dist}_\Gamma$  of  $\tilde{C}$  and  $\tilde{C}^*$ . The orientation  $o$  induces an orientation of the edges connecting  $A$  and  $B$  of  $\tilde{C}$  and  $\tilde{C}^*$ . By applying the map  $I$  to  $\text{dist}(\tilde{C})$  and  $\text{dist}(\tilde{C}^*)$  if necessary we can assume that the induced orientation goes from  $A$  to  $B$ . Denote by  $\tilde{a}, \tilde{A}, \tilde{B}$  (resp.  $\tilde{a}^*, \tilde{A}^*, \tilde{B}^*$ ) the cut and the inserted edges corresponding to curve  $\tilde{C}$  (resp.  $\tilde{C}^*$ ). We denote by  $d$  the distance of  $\tilde{B}$  to  $\tilde{A}^*$  in the curve cut at  $\tilde{a}$  and  $\tilde{a}^*$ . Let  $L$  be the subset of marked points of the component containing  $\tilde{B}\tilde{A}^*$ . Then the following equality holds:

$$\text{dist}(\tilde{C}^*) = \prod_{p \in L} M_p \cdot \text{dist}(\tilde{C}) + d \cdot s.$$

□

*Remark 7.2.* The main idea in our definition comes from the rational case (see [GKM]). After cutting the curve we get a new curve without cycles. Thus, the distance of two points in the new curve is well defined. Then, as in the rational case we have to mod out the image of  $\Phi_n^1$ . In addition we have to get rid of all the choices we made during the construction of a rational curve. These choices can be expressed by the following three operations.

- (a) The shift of the point  $a$  on one edge of the cycle (which corresponds to the addition of an element of  $\langle s \rangle$ ).
- (b) Interchanging  $A$  and  $B$ , which corresponds to the matrix  $I$ .
- (c) The point  $a$  jumps over the vertex adjacent to an unbounded edge  $p$ . The matrix corresponding to this operation is  $M_p$ . If the point  $a$  jumps over a bounded edge  $E$ , the matrix corresponding to this operation is the product of all matrices  $M_i$  with  $i$  connected with  $E$  by edges not intersecting the cycle.

To get a polyhedral complex we put

$$\begin{aligned} \Psi_n : V_n &\longrightarrow V_n/G_n \\ x &\longmapsto [x] \end{aligned}$$

and

$$X_n = \Psi_n^{-1}(\text{dist}_n(\mathcal{M}_{1,n})).$$

*Remark 7.3.* Let  $X_{1,n}$  be as in construction 5.1. Then  $X_n = \Psi_n^{-1}(\Psi_n(X_{1,n}))$ .

As general polyhedrons we take the cones induced by the combinatorial cones in  $\mathcal{M}_{1,n}$ , defined in Remark and definition 2.6. Thus,  $G_n$  is a group acting on  $X_n$  and we can consider the quotient topology on the orbit space  $X_n/G_n$  (see definition 6.1). To have a weighted orbit space we choose all weights to be equal to one. To show that the spaces  $\mathcal{M}_{1,n}$  have a structure of tropical orbit space, we have to show that  $\mathcal{M}_{1,n}$  and  $X_n/G_n$  are homeomorphic and that  $X_n/G_n$  fulfills the balancing condition.

**Proposition 7.4.** *Let  $X_n, G_n$  and  $\mathcal{M}_{1,n}$  be as above. Then  $S : \mathcal{M}_{1,n} \longrightarrow X_n/G_n, (C, x_1, \dots, x_n) \longmapsto [(\text{dist}_\Gamma(x_i, x_j))]_{\{i,j\} \in \mathcal{T}}$  is a homeomorphism.*



*Proof.* Surjectivity is clear from the definition, and  $S$  is a continuous closed map. Thus, it remains to show that  $S$  is injective. To show this, we prove that out of each representative of an element  $[x]$  in the target we can construct some numbers which are the same for all representatives of  $[x]$ . If these numbers determine a unique preimage, the injectivity follows. For this we take the following number  $j$  and the set  $d_{i,k}$  which are independent of the representative:

$$j = x_{n+1,n+2} = \text{length of the cycle,}$$

$$d_i = (x_{i,n+1} + x_{i,n+2} - j)/2 = \text{distance from } i \text{ to the cycle (not well-defined mod } \Phi_n^1(\mathbb{R}^n)),$$

$$d_{i,k} = \{|(x_{i,n+1} + x_{k,n+2}) - d_i - d_k - j|, |j - (x_{i,n+1} + x_{k,n+2}) - d_i - d_k - j|\} = \text{distances of } i \text{ and } k \text{ on the cycle.}$$

If there are marked edges  $i_1, \dots, i_r$  with  $d_{i_s, i_t}$  equals  $\{0, j\}$  for all  $1 \leq s, t \leq r$ , then we have to determine the distances these edges have one to each other. But, since these distances do not depend on the cycle, the edges in  $X_n$  encoding these distances are invariant under  $G_n$ . Thus, we can reconstruct these distances, by considering the projection (not necessarily orthogonal) of  $[x]$  to the fixed part of the cone (and thus the fixed part of each representative) in which  $[x]$  lies. The same can be done for two edges  $i_1, i_2$  which have distance zero from each other to determine their distance to the cycle. Thus, all distances are given, injectivity follows and we are done.  $\square$

**Proposition 7.5.** *The weighted orbit space  $X_n/G_n$  is a tropical orbit space.*

*Proof.* To show the balancing condition we have to consider the codim-1 cones and the facets adjacent to them. If there is more than one vertex on the cycle of a curve corresponding to a point on a codimension 1 face  $F$ , then either the stabilizers of the adjacent facets are trivial and we are in the same case as for the  $\mathcal{M}_{0,n}$ , or the cycle of each curve in the face  $F$  consists of two edges of the same length. In the second case there are exactly two facets adjacent to  $F$  which are opposite to each other. Since the stabilizers are trivial the balancing condition holds. If there is only one vertex on the cycle of a curve corresponding to a point in  $F$ , then the stabilizer of  $F$  is  $\{I, 1\}$ , the identity and  $I$  (see above). The curves corresponding to the points in the interior of the codim-1 face have exactly one 4-valent vertex. This vertex can be adjacent to the cycle or not. Let us consider these two cases separately. The second case is trivial (the stabilizers are the same for all three facets and the balancing condition is the same as for  $\mathcal{M}_{0,n}$ ), thus assume, that the 4-valent vertex is at the cycle. Qualitatively, the codim-1 face, which we call  $\tau$ , corresponds to a curve as in the following picture:

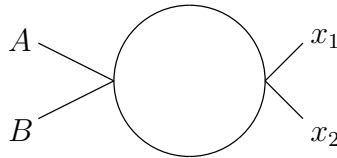

Figure 7.2: A tropical curve with 4-valent vertex.

By assumption, there is only one vertex on the cycle. We only consider the case with two ends  $x_1$  and  $x_2$ , because if we have a tree instead of  $x_i$  the calculation is the same for each leaf of the tree. To verify the balancing condition for tropical orbit spaces given in definition

6.9, we have to consider the three facets around the face  $\tau$ . Let  $\sigma_1$  (resp.  $\sigma_2$ ) belong to the insertion of the edge with  $A$  and  $x_1$  (resp.  $A$  and  $x_2$ ) on the same side. Then,  $\sigma_1$  and  $\sigma_2$  lie in the same  $G_\tau$ -orbit. Thus, if we use the same notation as in the picture we get the following condition:

there exists  $\lambda_{\sigma_1/\tau}, \lambda_{\sigma_2/\tau} \geq 0$ ,  $\lambda_{\sigma_1/\tau} + \lambda_{\sigma_2/\tau} = 1$  such that

$$\begin{pmatrix} d(x_1, x_2) \\ d(x_1, A) \\ d(x_1, B) \\ d(x_2, A) \\ d(x_2, B) \\ d(A, B) \end{pmatrix}, \lambda_{\sigma_1/\tau} \cdot \begin{pmatrix} 1 \\ 0 \\ 1 \\ 1 \\ 0 \\ 1 \end{pmatrix} + \lambda_{\sigma_2/\tau} \cdot \begin{pmatrix} 1 \\ 1 \\ 0 \\ 0 \\ 1 \\ 1 \end{pmatrix} + \frac{1}{2} \cdot \begin{pmatrix} 0 \\ 1 \\ 1 \\ 1 \\ 1 \\ 0 \end{pmatrix} \in V_\tau.$$

This condition is fulfilled for  $\lambda_{\sigma_1/\tau} = \lambda_{\sigma_2/\tau} = \frac{1}{2}$ . Thus we have indeed a tropical orbit space.  $\square$

*Remark 7.6.* In example 2.9 we have seen the topological picture of the moduli space  $\mathcal{M}_{1,2}$ . Unfortunately it is difficult to give a picture of the corresponding polyhedral complex since  $X_2$  has infinitely many cones. Here is a description of it. Let the vector entries be labeled as in the previous proof, and let  $C_1, C_2, C_3, C_4$  be the cones corresponding to the four different combinatorial cones in the picture of example 2.9, where  $C_1$  is the left,  $C_2$  the second left,  $C_3$  the third left and  $C_4$  the right combinatorial type. The group and representatives of the cones  $C_1, C_2, C_3, C_4$  (labeled by the same name) are the following:

$$G = \left\langle \begin{pmatrix} 1 & 0 & 0 & 0 & 0 & 0 \\ 0 & 0 & 1 & 0 & 0 & 0 \\ 0 & 1 & 0 & 0 & 0 & 0 \\ 0 & 0 & 0 & 0 & 1 & 0 \\ 0 & 0 & 0 & 1 & 0 & 0 \\ 0 & 0 & 0 & 0 & 0 & 1 \end{pmatrix}, \begin{pmatrix} 1 & 1 & -1 & -1 & 1 & 1 \\ 0 & 1 & 0 & 0 & 0 & 1 \\ 0 & 0 & 1 & 0 & 0 & -1 \\ 0 & 0 & 0 & 1 & 0 & 0 \\ 0 & 0 & 0 & 0 & 1 & 0 \\ 0 & 0 & 0 & 0 & 0 & 1 \end{pmatrix} \right\rangle,$$

$$C_1 = \left\{ a \cdot \begin{pmatrix} 1 \\ 1 \\ 1 \\ 2 \\ 0 \\ 2 \end{pmatrix} \mid b > 0 \right\}, C_2 = \left\{ a \cdot \begin{pmatrix} 1 \\ 1 \\ 1 \\ 2 \\ 0 \\ 2 \end{pmatrix} + b \cdot \begin{pmatrix} 0 \\ 1 \\ 0 \\ 1 \\ 0 \\ 1 \end{pmatrix} \mid a, b \in \mathbb{R}_{\geq 0}, a + b > 0 \right\},$$

$$C_3 = \left\{ b \cdot \begin{pmatrix} 0 \\ 1 \\ 0 \\ 1 \\ 0 \\ 1 \end{pmatrix} \mid b > 0 \right\}, C_4 = \left\{ a \cdot \begin{pmatrix} 0 \\ 1 \\ 1 \\ 1 \\ 1 \\ 0 \end{pmatrix} + b \cdot \begin{pmatrix} 0 \\ 1 \\ 0 \\ 1 \\ 0 \\ 1 \end{pmatrix} \mid a, b \in \mathbb{R}_{\geq 0}, b > 0 \right\}.$$

All other cones of the underlying polyhedral complex are given by  $g\{C_i\}$  for  $g \in G$  and  $i \in \{1, 2, 3, 4\}$ .

## 7.2 Moduli spaces of parameterized tropical curves of genus 1

Now we define a tropical orbit space corresponding to the parameterized genus 1 tropical curves in  $\mathbb{R}^r$ .

In the case of rational tropical curves we can simply take  $\widetilde{\mathcal{M}}_{0,n}^{\text{lab}}(\mathbb{R}^r, \Delta) = \mathcal{M}_{0,N}^{\text{lab}} \times \mathbb{R}^r$  because to build the moduli spaces of rational tropical curves in  $\mathbb{R}^r$  it suffices to fix the coordinate of one of the marked ends (for example  $x_1$ ). For the case of genus 1 curves the situation is more complicated. If we fix the combinatorial type of the curve, the cycle imposes some conditions on the lengths. In order to get a closed cycle in the image, the direction vectors of the cycle edges multiplied by their lengths have to sum up to zero. Furthermore, we have to get rid of cells which are of higher dimension than expected. We will see that these operations (closing of the cycle and getting rid of higher dimensional cells) can be expressed by some rational functions.

Let  $V_{n,\Delta,r}^{\text{lab}} = V_N \times \mathbb{R}^r \times \mathbb{Z}^r$ . We define  $G_N^{\text{lab}}$  to be  $G_N$ , acting on  $V_N$  as  $G_N$  before, on  $b \in \mathbb{R}^r$  (that is the image of  $x_1$ ) as identity and on  $v \in \mathbb{Z}^r$  (the direction of the edge  $A$ ) as follows:

$$I(v) = -v, M_p(v) = v - v(p).$$

As topology on  $V_{n,\Delta,r}^{\text{lab}}$ , we take the product topology of  $V_N$ ,  $\mathbb{Z}^r$  and  $\mathbb{R}^r$ , where we consider  $\mathbb{Z}^r$  with the discrete topology and  $\mathbb{R}^r$  with the standard Euclidean topology. We define  $Z_\Delta^r$  to be the subset of  $\mathbb{Z}^r$  given by  $|v_s| \leq \sum_{w \in \Delta} |w_s|$ , and put

$$\begin{aligned} \Psi_{n,\Delta,r} : V_{n,\Delta,r}^{\text{lab}} &\longrightarrow V_{n,\Delta,r}^{\text{lab}}/G_N \\ x &\longmapsto [x] \end{aligned}$$

and

$$\tilde{X}_{n,\Delta,r}^{\text{lab}} = \Psi_{n,\Delta,r}^{-1}([X_N \times \mathbb{R}^r \times Z_\Delta^r]).$$

The purpose of the rational functions  $\phi_i$  in the next proposition is to make sure that the  $i$ th coordinate of  $A$  is mapped to the  $i$ th coordinate of  $B$ .

**Proposition 7.7.** *For all  $0 < i \leq r$ , we have a function*

$$\begin{aligned} \phi_i : \tilde{X}_{n,\Delta,r}^{\text{lab}} &\longrightarrow \mathbb{R} \\ (a_{\{1,2\}}, \dots, a_{\{N+1,N+2\}}, b, v) &\longmapsto \frac{1}{2} \cdot \max\left\{\pm\left(\frac{1}{2}\left(\sum_{k=2}^N (a_{\{1,k\}} - a_{\{k,N+1\}}) v_k(i)\right.\right.\right. \\ &\quad \left.\left.\left.+ (a_{\{1,N+2\}} - a_{\{N+1,N+2\}}) (-v(i))\right.\right.\right. \\ &\quad \left.\left.\left.+ (a_{\{1,N+1\}}) v(i)\right.\right.\right. \\ &\quad \left.\left.\left.- \frac{1}{2}\left(\sum_{k=2}^N (a_{\{1,k\}} - a_{\{k,N+2\}}) \cdot v_k(i)\right.\right.\right. \\ &\quad \left.\left.\left.+ (a_{\{1,N+1\}} - a_{\{N+1,N+2\}}) v(i)\right.\right.\right. \\ &\quad \left.\left.\left.+ (a_{\{1,N+2\}}) \cdot (-v(i))\right)\right)\right\} \end{aligned}$$

which is rational and invariant under  $G_N^{\text{lab}}$  ( $v(i)$  =  $i$ -th coordinate of  $v$ ,  $v_k = v(x_k)$ , see definition 2.11).

*Remark 7.8.* The maps  $\phi_i$  defined in proposition 7.7 are given by  $\frac{1}{2} \max \{ \text{ev}(A)_i - \text{ev}(B)_i, \text{ev}(B)_i - \text{ev}(A)_i \}$  (see proposition 7.13).

*Proof of proposition 7.7.* We have to show, that  $\phi_i$  is invariant under the addition of  $c \cdot (s, 0, 0)$  (we identify  $(s, 0, 0)$  with  $s$ ) for  $c \in \mathbb{R}$  and the actions of  $I$  and  $M_p$ . Let  $x \in \tilde{X}_{n,\Delta,r}^{\text{lab}}$  and  $d = \phi_i(x)$ .

For  $c \in \mathbb{R}$ , the value of  $c \cdot s + x$  under  $\phi_i$  is  $d \pm \sum_{k=2}^N (-c) \cdot v_k(i)$ . The second part ( $\sum_{k=2}^N (-c) \cdot v_k(i)$ ) is 0 due to the balancing condition, thus the value of  $x$  and  $c \cdot s + x$  is the same as before.

For  $I$  we get the same, because

$$\begin{aligned}
 & \phi_i(I(a_{\{1,2\}}, \dots, a_{\{N+1,N+2\}}, b, v)) \\
 = & \frac{1}{2} \cdot \max \left\{ \pm \left( \frac{1}{2} \left( \sum_{k=2}^N (a_{\{1,k\}} - a_{\{k,N+2\}}) v_k(i) \right) \right. \right. \\
 & + (a_{\{1,N+1\}} - a_{\{N+1,N+2\}}) (-(-v(i))) + (a_{\{1,N+2\}}) \cdot -v(i) \\
 & - \frac{1}{2} \left( \sum_{k=2}^N (a_{\{1,k\}} - a_{\{k,N+1\}}) v_k(i) \right) \\
 & \left. \left. + (a_{\{1,N+2\}} - a_{\{N+1,N+2\}}) (-v(i)) + (a_{\{1,N+1\}}) \cdot (-(-v(i))) \right) \right\} \\
 = & \frac{1}{2} \cdot \max \left\{ \pm \left( - \left( \frac{1}{2} \left( \sum_{k=2}^N (a_{\{1,k\}} - a_{\{k,N+1\}}) v_k(i) \right) \right. \right. \right. \\
 & + (a_{\{1,N+2\}} - a_{\{N+1,N+2\}}) (-v(i)) + (a_{\{1,N+1\}}) \cdot v(i) \\
 & - \frac{1}{2} \left( \sum_{k=2}^N (a_{\{1,k\}} - a_{\{k,N+2\}}) v_k(i) \right) \\
 & \left. \left. \left. + (a_{\{1,N+1\}} - a_{\{N+1,N+2\}}) v(i) + (a_{\{1,N+2\}}) \cdot (-v(i)) \right) \right) \right\} \\
 = & \phi_i(a_{\{1,2\}}, \dots, a_{\{N+1,N+2\}}, b, v).
 \end{aligned}$$

It remains to show the invariance with respect to  $M_p$ . Let us consider first the case  $p \neq 1$ .

We get:

$$\begin{aligned}
 & d \pm \frac{1}{4} \left( (a_{\{1,N+1\}} + a_{\{p,N+2\}} + a_{\{N+1,N+2\}} - a_{\{1,N+2\}} - a_{\{p,N+1\}}) \right. \\
 & + (a_{\{N+1,N+2\}}) \cdot v_p(i) + (a_{\{1,N+2\}} - a_{\{N+1,N+2\}}) (v_p(i)) + (a_{\{1,N+1\}}) \\
 & \cdot (-v_p(i)) - ((a_{\{1,N+1\}} + a_{\{p,N+2\}} + a_{\{N+1,N+2\}} - a_{\{1,N+2\}} - a_{\{p,N+1\}}) \\
 & - (a_{\{N+1,N+2\}})) \cdot v_p(i) + (a_{\{1,N+1\}} - a_{\{N+1,N+2\}}) (v_p(i)) - (a_{\{1,N+2\}}) \cdot (v_p(i)) \left. \right) \\
 & = d.
 \end{aligned}$$

In the case  $p = 1$ , we have:

$$d \pm \frac{1}{4} \left( \sum_{k=2}^N (a_{k,N+1} + a_{1,N+2} + a_{\{N+1,N+2\}} - a_{\{k,N+2\}} - a_{\{1,N+1\}}) \cdot v_k(i) + \right.$$

$$\begin{aligned}
 & (a_{N+1,N+2}) \cdot (-v(i)) + (a_{N+1,N+2}) \cdot (-v(i)) \\
 & - \sum_{k=2}^N (a_{k,N+1} + a_{1,N+2} + a_{\{N+1,N+2\}} - a_{\{k,N+2\}} - a_{\{1,N+1\}}) \cdot v_k(i) - \\
 & (-a_{N+1,N+2}) \cdot (v(i)) - (a_{N+1,N+2}) \cdot (-v(i)) = d.
 \end{aligned}$$

Thus,  $\phi_i$  is invariant.  $\square$

*Remark 7.9.* We multiply the function by  $\frac{1}{2}$ , because locally the condition that the cycle closes leads to the function  $\max \{(\frac{1}{2} \sum_{k=2}^N (a_{\{1,k\}} - a_{\{k,N+1\}}) v_k(i) + (a_{\{1,N+2\}} - a_{\{N+1,N+2\}}) (-v(i)) + (a_{\{1,N+1\}}) \cdot v(i), 0\}$ . We changed the function slightly because of the symmetry we need for the orbit space structure.

Now we can define the tropical orbit space we are interested in by constructing the tropical orbit space cut out by the rational functions  $\phi_i$ :

$$\mathcal{M}_{1,n,\text{trop}}^{\text{lab}}(\mathbb{R}^r, \Delta) = \phi_1 \cdots \phi_r(\tilde{X}_{n,\Delta,r}^{\text{lab}}/G_N^{\text{lab}}), \text{ see definition 6.33.}$$

The set of cones of  $\mathcal{M}_{1,n,\text{trop}}^{\text{lab}}(\mathbb{R}^r, \Delta)$  is denoted by  $X_{n,\Delta,r}^{\text{lab}}$ . The rational functions assure that  $A$  and  $B$  are mapped to the same point.

*Example 7.10.* We consider the following map:

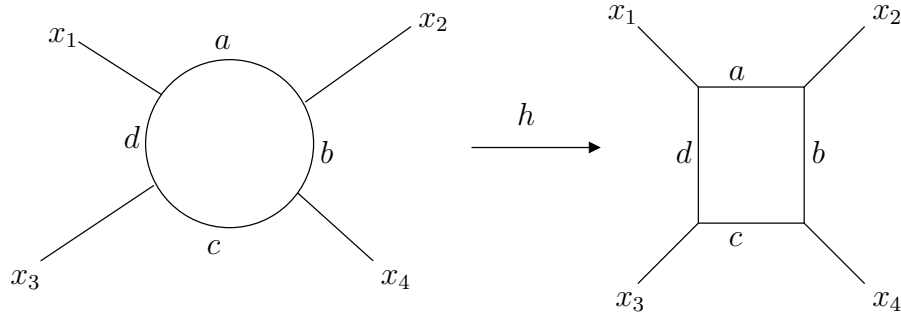

To ensure that  $h$ , defined by  $h(x_3) = \begin{pmatrix} 0 \\ 0 \end{pmatrix}$ ,  $h(x_1) = d \cdot \begin{pmatrix} 0 \\ 1 \end{pmatrix}$ ,  $h(x_2) = d \cdot \begin{pmatrix} 0 \\ 1 \end{pmatrix} + a \cdot \begin{pmatrix} 1 \\ 0 \end{pmatrix}$  and  $h(x_4) = c \cdot \begin{pmatrix} 1 \\ 0 \end{pmatrix}$ , is the map of a tropical curve  $(\Gamma, x_1, \dots, x_4, h)$  we need  $a = c$  and  $b = d$ , which is the case for elements of  $\mathcal{M}_{1,n,\text{trop}}^{\text{lab}}(\mathbb{R}^r, \Delta)$  due to the fact that the direction vectors multiplied by the lengths sum up to zero.

The rational functions  $\phi_i$  define weights on the resulting facets on the divisor. Since the stabilizers are finite, the divisor is a tropical orbit space as well. Consider the case  $r = 2$ . The weights we get from the definition of the rational function are the following (afterwards we consider one of the three cases more explicitly).

(a) The image of the cycle is two-dimensional.

The condition, that the cycle closes up in  $\mathbb{R}^2$  is given by two independent linear equations  $a_1$  and  $a_2$  on the lengths of the edges of the cycle (which is a subset of the bounded edges which we denote by  $\Gamma_0^1$ ); thus, the weight is given by the index of the map:

$$\begin{pmatrix} a_1 \\ a_2 \end{pmatrix} : \mathbb{Z}^{2+\#\Gamma_0^1} \mapsto \mathbb{Z}^2.$$

(b) The image of the cycle is one-dimensional.

Because of the chosen rational function, there has to be one four-valent vertex on the cycle. Otherwise, the weight would be zero on the corresponding face. Let  $m \cdot u$  and  $n \cdot u$  with  $u \in \mathbb{Z}^2$ ,  $m, n \in \mathbb{Z}$ , and  $\gcd(n, m) = 1$  be the direction vectors of the cycle. If we denote by  $v \in \mathbb{Z}^2$  the direction of another edge adjacent to the 4-valent vertex, the weight is  $|\det(u, v)|$ . If  $n = m = 1$  and no point lies on the cycle, the stabilizer of the corresponding face consists of two elements. Thus, the weight of the facet has to be divided by 2 in this case.

(c) The image of the cycle is 0-dimensional. Due to the rational function we get the weight  $\frac{1}{2} \cdot |\det(u, v)|$  if there is a 5-valent vertex adjacent to the cycle,  $u, v$  are two of the three non-cycle directions outgoing from the vertex. If there is no 5-valent vertex the weight would be zero by the definition of the rational function.

*Example 7.11.* Let us consider (b) more explicitly. First we show that if there is no four-valent vertex on the cycle, the weight is 0. The curve corresponds to a face  $F$  in  $\tilde{X}_{n,\Delta,2}^{\text{lab}}$  which is contained in some facets. The points in those facets correspond to curves. Since the vertices are three-valent, all edges of the cycles in this curves are in a one-dimensional affine linear subspace of  $\mathbb{R}^2$ . Since we intersect by two rational functions the weight we get is 0 (let  $X$  be the star build by the faces containing  $F$  in  $\tilde{X}_{n,\Delta,2}^{\text{lab}}$ . The map  $\Phi_1$  (resp.,  $\Phi_2$ ) assures that for all points of  $\Phi_1(X)$  (resp.,  $\Phi_2(X)$ )  $h(A) = h(B)$ . Since rational functions commute, we have that  $\Phi_1$  is constant on  $\Phi_2(X)$ ). Thus, we consider the case where one of the vertices has valence four (see upper figure in figure 7.3) and denote the corresponding face  $F$ . The

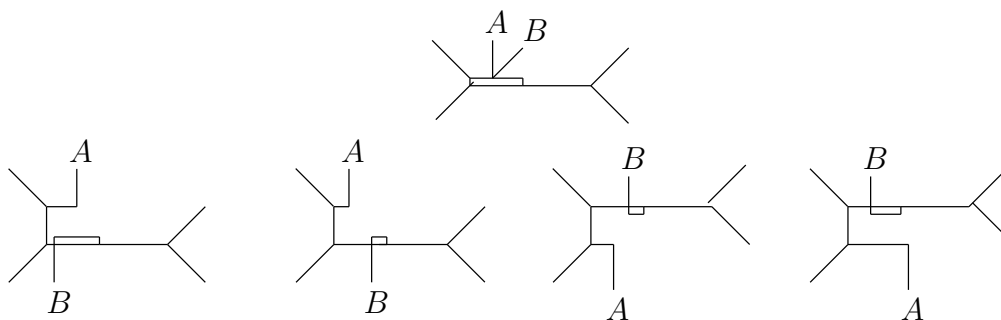

Figure 7.3: The weight of a curve with one-dimensional cycle.

lower pictures in this figure are the curves corresponding to the four facets in  $\tilde{X}_{n,\Delta,2}^{\text{lab}}$  which contain  $F$ . Let  $d$  be the direction vector of the left edge of the cycle and let  $u$  be as in (b). For simplicity assume that  $u = \begin{pmatrix} u_1 \\ 0 \end{pmatrix}$ . Applying  $\Phi_1$  on the left two facets in figure 7.3 leads to a face of weight  $|\gcd(u_1, d_1)|$  where  $\Phi_1$  ensures that  $A_1 = B_1$  on this face. One can calculate that applying  $\Phi_2$  leads to  $F$  with weight  $\left| \frac{u_1}{\gcd(u_1, d_1)} \cdot d_2 \right|$  times the weight  $|\gcd(u_1, d_1)|$ . By the balancing condition, one has  $|\det(u, v)| = |\det(u, d)|$  and we get the stated weight for (b) (in particular the length of the left cycle edge becomes 0).

*Remark 7.12.* The numbers calculated with the help of rational functions differ from those stated in [KM]. The difference lies in (c). The weights proposed in [KM] are  $\frac{1}{2} \cdot (|\det(u, v)| - 1)$ . Since both weights lead to a balanced complex, the union of the facets where the image of the cycle is 0-dimensional (together with its faces) is a tropical orbit space if we define all weights to be  $\frac{1}{2}$ .

## 7.3 Counting elliptic tropical curves with fixed $j$ -invariant

To achieve our goal of proving independency of the position of the points, when one counts certain elliptic tropical curves with fixed  $j$ -invariant, we want to use corollary 6.29. Thus, we first give the definition of evaluation maps which are used to impose the point conditions.

**Proposition 7.13.** *For  $i = 1, \dots, n$  the map*

$$\begin{aligned} \text{ev}_i : X_{n,\Delta,r}^{\text{lab}} &\rightarrow \mathbb{R}^r \\ (\Gamma, x_1, \dots, x_N, h) &\longmapsto h(x_i) \end{aligned}$$

*is invariant under the group  $G_N^{\text{lab}}$ .*

*Proof.* The map  $\text{ev}_i$  is given by

$$\begin{aligned} \text{ev}_i(x) = & b + \frac{1}{2} \left( \sum_{k=2}^N (a_{\{1,k\}} - a_{\{k,i\}}) v_k + (a_{\{1,N+1\}} - a_{\{N+1,i\}}) (v) \right. \\ & \left. + (a_{\{1,N+2\}} - a_{\{i,N+2\}}) \cdot (-v) \right). \end{aligned} \quad (7.1)$$

Recall that  $b = h(x_1)$ . It is invariant under  $s$ , because the value added by  $s$  to the differences  $a_{\{1,N+1\}} - a_{\{N+1,i\}}$  and  $a_{\{1,N+2\}} - a_{\{i,N+2\}}$  is 0.

The map  $I$  changes only the order of the two last summands.

Thus, it remains to consider the map  $M_p$ . We have three cases:  $p = 1, p = i, 1 \neq p \neq i$ . The sum we get differs from (7.1) by the following expressions. Case  $1 \neq p \neq i$ :

$$\begin{aligned} & \frac{1}{2} (a_{\{1,N+1\}} + a_{\{p,N+2\}} + a_{\{N+1,N+2\}} - a_{\{1,N+2\}} - a_{\{p,N+1\}} - \\ & (a_{\{i,N+1\}} + a_{\{p,N+2\}} + a_{\{N+1,N+2\}} - a_{\{i,N+2\}} - a_{\{p,N+1\}})) \cdot v_p \\ & + \frac{1}{2} (a_{\{1,N+1\}} - a_{\{N+1,i\}}) (-v_p) + \frac{1}{2} (a_{\{1,N+2\}} - a_{\{i,N+2\}}) \cdot (v_p) = 0. \end{aligned}$$

Case  $p = 1$ :

$$\begin{aligned} & \sum_{k=2}^N \frac{1}{2} (a_{\{k,N+1\}} + a_{\{1,N+2\}} + a_{\{N+1,N+2\}} - a_{\{k,N+2\}} - a_{\{1,N+1\}}) \cdot v_k + \\ & \frac{1}{2} (-a_{\{N+1,N+2\}}) \cdot (v - v_1) + \frac{1}{2} (a_{\{1,N+1\}} - a_{\{N+1,i\}}) (-v_1) \\ & + \frac{1}{2} (a_{\{N+1,N+2\}}) \cdot (-v + v_1) + \frac{1}{2} (a_{\{1,N+2\}} - a_{\{i,N+2\}}) \cdot (v_1) = 0. \end{aligned}$$

The last equation is true, because

$$\sum_{k=2}^N (a_{1,N+2} + a_{N+1,N+2} - a_{1,N+1}) v_k = 0, v_1 = 0$$

and the rest of the sum

$$\left( \sum_{k=2}^N \frac{1}{2} (a_{\{k,N+1\}} - a_{\{k,N+2\}}) \cdot v_k + \frac{1}{2} (-a_{\{N+1,N+2\}}) \cdot (v) \right. \\ \left. + \frac{1}{2} (a_{\{N+1,N+2\}}) \cdot (-v) \right)$$

is equal to

$$-\frac{1}{2} \left( \sum_{k=2}^N (a_{\{1,k\}} - a_{\{k,N+1\}}) v_k + (a_{\{1,N+2\}} - a_{\{N+1,N+2\}}) (-v) \right. \\ \left. + (a_{\{1,N+1\}}) \cdot v \right) + \left( \frac{1}{2} \left( \sum_{k=2}^N (a_{\{1,k\}} - a_{\{k,N+2\}}) v_k \right. \right. \\ \left. \left. + (a_{\{1,N+1\}} - a_{\{N+1,N+2\}}) v + (a_{\{1,N+2\}}) \cdot (-v) \right) \right)$$

which is 0 because of the rational function which we have used to construct  $X_{n,\Delta,r}^{\text{lab}}$  (see proposition 7.7).

Case  $p = i$ :

$$\frac{1}{2} \sum_{k=2}^N - (a_{\{k,N+1\}} + a_{\{i,N+2\}} + a_{\{N+1,N+2\}} - a_{\{k,N+2\}} - a_{\{i,N+1\}}) \cdot v_k + \\ \frac{1}{2} (a_{\{N+1,N+2\}}) \cdot (v - v_i) + \frac{1}{2} (a_{\{1,N+1\}} - a_{\{N+1,i\}}) (-v_i) \\ + \frac{1}{2} (-a_{\{N+1,N+2\}}) \cdot (-v + v_i) + \frac{1}{2} (a_{\{1,N+2\}} - a_{\{i,N+2\}}) \cdot (v_i) = 0.$$

(Same reason as above.) □

**Definition 7.14** (Evaluation map). For  $i = 1, \dots, n$  the map

$$\text{ev}_i : \mathcal{M}_{1,n,\text{trop}}^{\text{lab}}(\mathbb{R}^r, \Delta) \rightarrow \mathbb{R}^r \\ (\Gamma, x_1, \dots, x_N, h) \mapsto h(x_i)$$

is called the  $i$ -th evaluation map.

**Proposition 7.15.** *With the tropical orbit space structure given above the evaluation maps  $\text{ev}_i : \mathcal{M}_{1,n,\text{trop}}^{\text{lab}}(\mathbb{R}^r, \Delta) \rightarrow \mathbb{R}^r$  are morphisms of orbit spaces (in the sense of definition 6.17 and  $\mathbb{R}^r$  equipped with the trivial orbit space structure).*

*Proof.* Continuity is clear, thus we have to check conditions  $a - d$  in definition 6.17. Condition  $a$  is clear since  $\mathbb{R}^r$  is the unique cone of the target space. Condition  $b$  is the same as the case of fans treated in [GKM]. Condition  $c$  is clear since each cone is mapped to the whole  $\mathbb{R}^r$  and the last condition follows from proposition 7.13. □



**Proposition 7.16.** *The map  $f = \text{ev}_1 \times \cdots \times \text{ev}_n \times j : \mathcal{M}_{1,n,\text{trop}}^{\text{lab}}(\mathbb{R}^r, \Delta) \rightarrow \mathbb{R}^{(rn+1)}$  is a morphism of orbit spaces.*

*Proof.* For each cone in  $\mathcal{M}_{1,n,\text{trop}}^{\text{lab}}(\mathbb{R}^r, \Delta)$  one has that the strict inequalities given in definition 1.1 are coming from the limit of the  $j$ -invariant to 0. Therefore, condition  $c$  of definition 6.17 is fulfilled. Thus, the statement follows from proposition 7.15 and the fact that  $j$  is the projection on the coordinate  $\mathbb{R}_{\{A,B\}}$ .  $\square$

**Theorem 7.17** (Theorem 5.1, [KM]). *Let  $d \geq 1$  and  $n = 3d - 1$ . Then the number of parameterized labeled  $n$ -marked tropical curves of genus 1 and of degree  $d$  with fixed  $j$ -invariant which pass through  $n$  points in general position in  $\mathbb{R}^2$  is independent of the choice of the configuration of points (the multiplicity of a curve is defined to be the weight of the corresponding cone in  $\mathcal{M}_{1,n,\text{trop}}^{\text{lab}}(\mathbb{R}^2, d)$ ).*

*Proof.* For  $n = 3d - 1$  points  $\mathcal{M}_{1,n,\text{trop}}^{\text{lab}}(\mathbb{R}^2, d)$  has the same dimension as  $\mathbb{R}^{(rn)} \times \mathbb{R}_{>0}$ . Since all open ends are mapped to  $j$ -invariant equal 0, surjectivity follows by the balancing condition in  $\mathbb{R}^{(rn)} \times \mathbb{R}_{>0}$ . Thus, proposition 7.16 and corollary 6.29 imply the theorem.  $\square$

When we construct the orbit space structure of the moduli space of parameterized curves we need the component  $\mathbb{Z}^r$  for technical reasons. But, in fact, the direction  $v$  of the edge  $A$  is unique for given lengths of the edges.

**Proposition 7.18.** *Let  $(a_{1,2}, \dots, a_{N+1,N+2}, b, v)$  be in  $\mathcal{M}_{1,n,\text{trop}}^{\text{lab}}(\mathbb{R}^r, \Delta)$ . One has that  $(a_{1,2}, \dots, a_{N+1,N+2}, b, v^*)$  in  $\mathcal{M}_{1,n,\text{trop}}^{\text{lab}}(\mathbb{R}^r, \Delta)$  if and only if  $v = v^*$ .*

*Proof.* Assume that  $(a_{1,2}, \dots, a_{N+1,N+2}, b, v^*) \in \mathcal{M}_{1,n,\text{trop}}^{\text{lab}}(\mathbb{R}^r, \Delta)$ . The closing up of the cycle is given by the equalities (compare with proposition 7.7)

$$\begin{aligned} & \sum_{k=2}^N (a_{\{1,k\}} - a_{\{k,N+1\}}) v_k(i) + (a_{\{1,N+2\}} - a_{\{N+1,N+2\}}) (-v^*(i)) + (a_{\{1,N+1\}}) v^*(i) \\ &= \sum_{k=2}^N (a_{\{1,k\}} - a_{\{k,N+2\}}) \cdot v_k(i) + (a_{\{1,N+1\}} - a_{\{N+1,N+2\}}) v^*(i) + (a_{\{1,N+2\}}) \cdot (-v^*(i)) \end{aligned}$$

Put  $w = v - v^*$ . Since the equality holds for  $v$  as well, we get

$$\begin{aligned} & (a_{\{1,N+2\}} - a_{\{N+1,N+2\}}) (-w(i)) + (a_{\{1,N+1\}}) w(i) \\ &= (a_{\{1,N+1\}} - a_{\{N+1,N+2\}}) w(i) + (a_{\{1,N+2\}}) \cdot (-w(i)) \end{aligned}$$

which is equivalent to

$$2a_{\{N+1,N+2\}} w(i) = 0.$$

Since the cycle length is positive one has  $w(i) = 0$  and therefore  $v = v^*$ .  $\square$

# 8 Correspondence theorems

In the previous parts of the thesis we introduced a theory of (local) orbit spaces and used this theory to build moduli spaces of tropical curves. The aim in constructing moduli spaces is to get a better understanding of the parameterized objects. Besides studying a mathematical domain for its own, it is always interesting to find connections between different domains. This chapter gives a hint on a connection between certain algebraic and tropical objects. In particular, we are interested in the connection between elliptic algebraic curves and elliptic tropical curves.

We start the chapter by stating some known facts. For our purpose, the correspondence theorems are of great interest. These theorems provide bijections between algebraic curves which satisfy certain properties and tropical curves which satisfy corresponding properties and are counted with multiplicities. (Corresponding properties mean for example that the genus of the algebraic and the tropical curves are the same.) Since G. Mikhalkin was the first who discovered a correspondence theorem, we state his result first and then give as well some other results which we need for our work. In the second section we prove a new correspondence theorem for elliptic curves with given big  $j$ -invariant. In contrast to Mikhalkin's correspondence theorem, it is a correspondence between embedded tropical curves and algebraic curves instead of parameterized tropical curves and algebraic curves. The first correspondence theorem for elliptic curves with fixed  $j$ -invariant was obtained by I. Tyomkin [T].

## 8.1 Mikhalkin's correspondence theorem

In correspondence theorems we associate to each tropical curve a multiplicity. This multiplicity is the number of algebraic curves which correspond to a given tropical curve. In particular, the multiplicities depend on the problem. Therefore, we start this section by defining a multiplicity we need.

In this chapter all parameterized tropical curves are in  $\mathbb{R}^2$ .

**Definition 8.1** (multiplicity of a vertex). Let  $(\Gamma, x_1, \dots, x_N, h)$  be a parameterized tropical curve and let  $C = h(\Gamma)$ . For a 3-valent vertex  $V$  of  $C$  with  $|h^{-1}(V)| = 1$ , denote by  $e_1$  and  $e_2$  two different edges adjacent to  $h^{-1}(V)$ . The *multiplicity* of  $C$  at  $V$  is defined to be  $|v(e_1, V) \wedge v(e_2, V)|$  (the area of the parallelogram spanned by the two vectors  $v(e_1, V)$  and  $v(e_2, V)$ ).

*Remark 8.2.* By the balancing condition the multiplicity of a vertex  $V$  in definition 8.1 is independent of the choices of  $e_1$  and  $e_2$ .

**Definition 8.3** (multiplicity of a curve). Let  $(\Gamma, x_1, \dots, x_N, h)$  be a parameterized tropical curve and let  $C = h(\Gamma)$ . We define  $\text{mult}(\Gamma)$  to be the product over the multiplicities of all 3-valent vertices of  $C$  from definition 8.1.

*Example 8.4* (multiplicity). Let  $C$  be the image shown in figure 8.1 of a parameterized tropical curve  $(\Gamma, x_1, \dots, x_4)$ . The multiplicity of vertex  $V_1$  is 1 and the multiplicity of  $V_2$  is 3. Thus,  $\text{mult}(\Gamma) = 3$ .

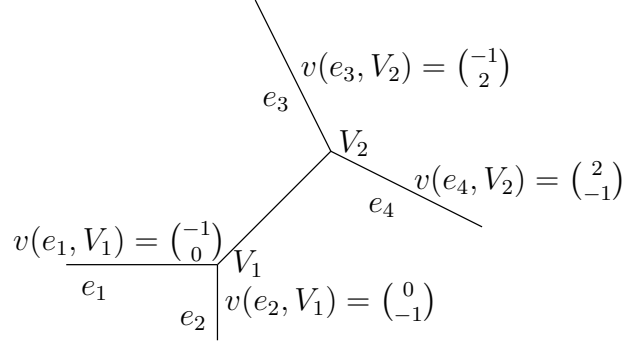

Figure 8.1: The image of a parameterized tropical curve.

A correspondence theorem provides a bijection between curves which satisfy given properties. In particular the number of tropical curves and the number of corresponding algebraic curves do agree. In the following we define those numbers.

**Definition 8.5.** Let  $g \in \mathbb{N}_{\geq 0}$ , and let  $\Delta = (v_1, \dots, v_s) \in (\mathbb{Z}^2 \setminus \{0\})^s$  be the degree of a parameterized tropical curve. For a configuration  $P = \{p_1, \dots, p_{s+g-1}\} \subset \mathbb{R}^2$  of general points we define the numbers  $N_{\text{trop}}^{\text{irr}}(g, \Delta, P)$  to be the number of parameterized tropical curves of degree  $\Delta$  and genus  $g$  passing through  $P$  and counted with the multiplicity of definition 8.3. (Remark: Each parameterized tropical curve in  $N_{\text{trop}}^{\text{irr}}(g, \Delta, P)$  has only 3-valent vertices.)

*Remark 8.6.* A purely tropical proof of the fact that the numbers  $N_{\text{trop}}^{\text{irr}}(0, \Delta, P)$  do not depend on  $P$  is given in the proof of theorem 5.1 in [GKM]. For arbitrary genus the independence of  $P$  follows from theorem 8.19.

To define the algebraic numbers we first give the definition of the degree of an algebraic curve.

**Definition 8.7** (complex degree). A complex algebraic curve  $Z \subset (\mathbb{C}^*)^2$  is defined by a Laurent polynomial  $f : (\mathbb{C}^*)^2 \rightarrow \mathbb{C}$ ,  $f(x) = \sum_{i \in A} a_i x^i$ , with  $A \subset \mathbb{Z}^2$  finite and  $a_i \in \mathbb{C}^*$  for  $i \in A$ . The Newton polygon of  $f$  is called the *degree* of  $Z$ . If the Newton polygon is the convex hull of  $(0, 0)$ ,  $(d, 0)$  and  $(0, d)$  we say that  $f$  has degree  $d$ .

*Remark 8.8.* Our definition of degree is not standard, but it is chosen to have a correspondence to the tropical degree.

*Example 8.9.* Figure 8.2 represents the Newton polygon of the complex algebraic curve given by the polynomial  $f = 2x^3 - 4x^2y + 3x^2 + xy^2 - 2xy - x + 4y^3 + 1$  in  $(\mathbb{C}^*)^2$ .

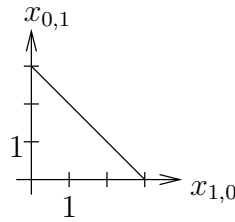

Figure 8.2: The Newton polygon of  $f = 2x^3 - 4x^2y + 3x^2 + xy^2 - 2xy - x + 4y^3 + 1$ .

**Definition 8.10** (Dual vectors). Let  $\Delta = (v_1, \dots, v_n)$  be a multiset of vectors in  $\mathbb{Z}^2$ , where  $\mathbb{Z}^2 \subset \mathbb{R}^2$  is oriented. By the *dual vectors* of  $\Delta$  we mean the multiset  $(v'_1, \dots, v'_n)$  of vectors in  $\mathbb{Z}^2$  where the angle between  $v_i$  and  $v'_i$  is  $-\pi/2$  (not  $\pi/2$ ) and the lattice lengths of  $v_i$  and  $v'_i$  are the same for  $1 \leq i \leq n$ .

**Lemma and Definition 8.11.** Let  $\Delta$  be the degree of a parameterized tropical curve. The dual vectors to  $\Delta$  form a unique (up to translation) oriented cycle which describe a convex polygon  $D$  with vertices in  $\mathbb{Z}^2$ ; we call  $D$  the Newton polygon dual to  $\Delta$ .

*Proof.* By the balancing condition the dual vectors sum up to zero and therefore we can construct a polygon out of them. Since we require the polygon to be convex, it is unique up to translation.  $\square$

*Example 8.12.* Let  $(\Gamma, x_1, \dots, x_9, h)$  be a parameterized tropical curve and let  $h(\Gamma)$  be the figure shown in 8.3 (all weights are 1). The Newton polygon dual to the degree of  $\Gamma$  is the same as shown in figure 8.2.

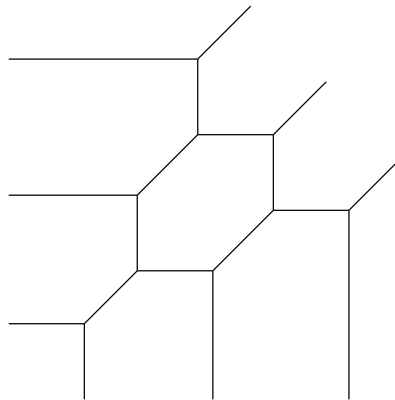

Figure 8.3: A tropical curve of degree 3.

*Notation 8.13.* For the degree  $\Delta$  of a parameterized tropical curve we denote the dual Newton polygon by  $\Delta^\vee$ .

The goal is to have a correspondence between curves which satisfy some properties. Besides the genus and the degree the property the curves have to fulfill is to pass through given points. In definition 8.5 we defined the numbers of tropical curves satisfying given properties. Thus, we now define their algebraic counterparts.

From now on assume that the tropical degree consists only of primitive vectors.

**Definition 8.14.** Let  $\Delta^\vee$  be a convex polygon with vertices in  $\mathbb{Z}^2$ . We define  $\#\Delta^\vee = \partial\Delta^\vee \cap \mathbb{Z}^2$ .

*Remark 8.15.* If the degree of a tropical curve consists only of primitive vectors then  $\#\Delta$  (see chapter 2) is the same as  $\#\Delta^\vee$  for  $\Delta$  being the degree of a tropical curve and for  $\Delta^\vee$  being its dual Newton polygon.

**Definition 8.16.** Let  $Q = (q_1, \dots, q_{\#\Delta^\vee + g - 1}) \subset (\mathbb{C}^*)^2$  be a configuration of points in general position. We define  $N^{\text{irr}}(g, \Delta^\vee, Q)$  to be the number of irreducible complex curves of genus  $g$  and degree  $\Delta^\vee$  passing through  $Q$ .

Those numbers a priori depend on  $Q$ . The following proposition is a useful fact and can be found for example in [CH].

**Proposition 8.17.** *Take the notation of definition 8.16. For generic  $Q$  the numbers  $N^{\text{irr}}(g, \Delta^\vee, Q)$  are finite and independent of  $Q$ . Therefore we get invariants  $N^{\text{irr}}(g, \Delta^\vee)$ .*

By now we defined the objects in algebraic and in tropical geometry we want to connect by a correspondence. To state the correspondence it lacks only a connection between the point conditions in algebraic geometry and those in tropical geometry. For this we use the function given in the following definition.

**Definition 8.18 (Log).** Let  $\text{Log}$  be the map from  $(\mathbb{C}^*)^2$  to  $\mathbb{R}^2$  given by  $\text{Log}(x) = (\log|x_1|, \log|x_2|)$  for all  $x \in (\mathbb{C}^*)^2$ .

**Theorem 8.19 (Mikhalkin, [M1], theorem 1).** *For a generic configuration  $P$  of  $n = \#\Delta + g - 1$  points we have  $N_{\text{trop}}^{\text{irr}}(g, \Delta, P) = N^{\text{irr}}(g, \Delta^\vee)$ . Furthermore, there exists a configuration  $Q \subset (\mathbb{C}^*)^2$  of  $\#\Delta + g - 1$  points in general position such that  $\text{Log}(Q) = P$  and for a parameterized tropical curve  $(\Gamma, x_1, \dots, x_N, h)$  of genus  $g$  and degree  $\Delta$  passing through  $P$  we have  $\text{mult}(\Gamma)$  distinct complex curves of genus  $g$  and degree  $\Delta^\vee$  passing through  $Q$ . The curves are distinct for different  $h(\Gamma)$  and irreducible. (Recall: We assume that the degree of the tropical curve consists of primitive vectors and thus  $\#\Delta$  and  $\#\Delta^\vee$  are equal.)*

The notable fact stated in theorem 8.19 can be used for counting algebraic curves. After translating the algebraic problem into tropical geometry one can use for example lattice paths (see [M1]) or floor diagrams (see [BM]) to count tropical curves. By the correspondence the algebraic problem is solved as well.

*Example 8.20.* There is one parameterized tropical curve of degree 2 and genus 0, passing through 5 general points. This curve correspond to one algebraic curve, which is the only curve of degree 2 passing through given 5 points (see figure 8.4).

*Remark 8.21.* In fact, the proof by G. Mikhalkin of theorem 8.19 contains as well the information how to assign a tropical curve to an algebraic one. He calculated certain Hausdorff limits of curves. For this one defines for  $t > 1$  the following map from  $(\mathbb{C}^*)^2$  to  $(\mathbb{C}^*)^2$

$$H_t : (x, y) \mapsto (|x|^{\frac{1}{\log(t)}} \frac{x}{|x|}, |y|^{\frac{1}{\log(t)}} \frac{y}{|y|}).$$

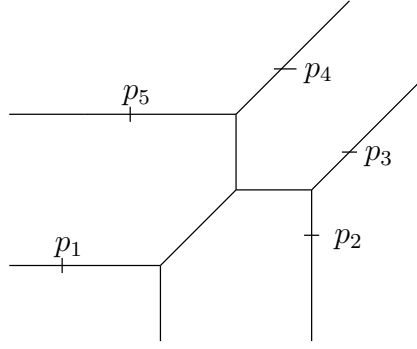

Figure 8.4: The degree 2 and genus 0 parameterized tropical curve passing through the points  $P = \{p_1, \dots, p_5\}$ .

Take the assumptions and notations from theorem 8.19 and let  $\epsilon > 0$  be sufficiently small. For sufficiently big  $t$  there are  $\text{mult}(\Gamma)$  algebraic curves mapped to the  $\epsilon$ -neighborhood of  $h(\Gamma)$  under  $\text{Log} \circ H_t$ .

Besides the correspondence theorem found by G. Mikhalkin there are some other correspondence theorems. To state one of them we change our base field to the field given in the next definition.

**Definition 8.22** (valuation). The field of locally convergent Puiseux series is by definition the field  $\mathbb{K}$  of locally convergent power series which is a subfield of  $\bigcup_{n=1}^{\infty} \mathbb{C}((t^{1/n}))$  (i.e. for  $\sum_{r \in \mathbb{R}} c_r t^r \in \mathbb{K}$  with  $c_r \in \mathbb{C}$  one has  $\sum_{r \in \mathbb{R}} |c_r| t^r < \infty$  for sufficiently small  $t$ ). We define  $\text{val} : (\mathbb{K}^*)^n \rightarrow \mathbb{R}^n$  to be the Cartesian product of the valuations  $\text{val} : (\mathbb{K}^*) \rightarrow \mathbb{R}$ ,  $\sum_{k=k_0}^{\infty} c_k t^{k/n} \mapsto -k_0/n$ , where  $c_k \in \mathbb{C}$  and  $c_{k_0} \neq 0$ . If  $Z$  is an algebraic curve in  $\mathbb{K}^2$  we define  $\text{val}(Z)$  to be the closure of the valuation of  $Z \cap (\mathbb{K}^*)^2$ .

**Theorem 8.23** (Mikhalkin, Shustin). Let  $\mathbb{K}$  be the field of locally convergent Puiseux series, and  $\Delta$  be the degree of a plane tropical curve. Let  $P$  be a set of  $\#\Delta + g - 1 = n$  generic points in  $\mathbb{R}^2$  and let  $Q \subset (\mathbb{K}^*)^2$  be a set of  $n$  different points in general position such that  $\text{val}(Q) = P$ . For each plane parameterized tropical curve  $(\Gamma, x_1, \dots, x_n, h)$  of genus  $g$  and degree  $\Delta$  passing through  $P$ , there exist  $\text{mult}(\Gamma)$  distinct plane algebraic curves in  $\mathbb{K}^2$  of genus  $g$  and degree  $\Delta^\vee$ , which pass through  $Q$  and are mapped to  $h(\Gamma)$  under  $\text{val}$ .

A proof can be found in [Sh] (Theorem 3).

Particularly related to our work is a work done by I. Tyomkin. Since we need again some preparations to quote the result we state the necessary definitions.

**Definition 8.24** (special curves). Let  $(\Gamma, x_1, \dots, x_N, h)$  be a parameterized tropical curve. If  $\Gamma$  has only vertices of valence three and if the lengths of all bounded edges and the position of all vertices are rational we call the parameterized tropical curve *special*. By multiplying these rational numbers by the least common multiple of the divisors of all fractions we assume that all vertices of  $h(\Gamma)$  (resp., lengths of edges of  $\Gamma$ ) are in  $\mathbb{Z}^2$  (resp., in  $\mathbb{Z}$ ).

The aim of definition 8.24 is on one side to use the affine structure of the edges for the definition of a multiplicity. On the other side, if an elliptic tropical curve is special, we have

a correspondence between its  $j$ -invariant and the  $j$ -invariant of the corresponding algebraic curves.

**Definition 8.25.** Let  $(\Gamma, x_1, \dots, x_N, h)$  be a special curve, let  $e$  be an edge of  $\Gamma$ , and let  $V$  be a vertex of  $e$ . The lattice of the tangent space of  $h(e)$  is denoted by  $N_e$ . The lattice length of  $v(e, V)$  in  $N_e$  is denoted by  $l(e)$ .

**Definition 8.26.** Let  $(\Gamma, x_1, \dots, x_N, h)$  be a special parameterized  $n$ -marked tropical curve of genus 1 and fix an arbitrary orientation for each bounded edge such that the cycle in  $\Gamma$  with this directions gives an oriented cycle. We denote by  $W$  the set of vertices of  $\Gamma$ , by  $W^n$  the set of vertices adjacent to  $x_1, \dots, x_n$ , by  $E^b$  the set of bounded edges and we put  $W^f = W \setminus W^n$ . Define  $\epsilon(e, V)$  to be  $-1$  (resp.,  $1$ , resp.,  $0$ ) if  $V \in W$ ,  $e \in E^b$  and  $V$  is the initial point of  $e$  (resp.,  $V$  is the end point of  $e$ , resp.,  $V$  is not a vertex of  $e$ ). Let  $\beta$  be the group morphism  $\bigoplus_{V \in W} (\mathbb{K}^*)^2 \oplus \bigoplus_{e \in E^b} (N_e) \otimes \mathbb{K}^* \rightarrow \bigoplus_{e \in E^b} (\mathbb{K}^*)^2$  given by  $\beta(y_V) = \begin{pmatrix} y_{V_1}^{\epsilon(e, V)} \\ y_{V_2}^{\epsilon(e, V)} \end{pmatrix}$  and  $\beta(y_e) = \begin{pmatrix} y_{e_1}^{-l(e)} \\ y_{e_2}^{-l(e)} \end{pmatrix}$  (the labels  $V$  and  $e$  denote the entry in the direct sum for  $V \in W$  and  $e \in E^b$ ). Let  $\{e_1, \dots, e_m\}$  be the set of edges forming the cycle. We put  $\delta : \bigoplus_{V \in W} (\mathbb{K}^*)^2 \oplus \bigoplus_{e \in E^b} (N_e) \otimes \mathbb{K}^* \rightarrow \mathbb{K}^*$  with  $\delta(y_V) = 1$ ,  $\delta(y_e) = y_e$  ( $N_e \otimes \mathbb{K}^* \cong \mathbb{K}^*$ ) if  $e \in \{e_1, \dots, e_m\}$  and  $\delta(y_e) = 1$  otherwise. Furthermore, we define a map  $\text{id}_n : \bigoplus_{V \in W} (\mathbb{K}^*)^2 \oplus \bigoplus_{e \in E^b} (N_e) \otimes \mathbb{K}^* \rightarrow \bigoplus_{V \in W^n} (\mathbb{K}^*)^2$ , given by  $\text{id}_n(y_V) = y_V$  for  $V \in W^n$  and  $\text{id}_n(y_V) = \text{id}_n(y_e) = 1_{(\mathbb{K}^*)^2} \in (\mathbb{K}^*)^2$  for  $V \in W^f, e \in E^b$ . Put

$$E = \beta \times \delta \times \text{id}_n : \bigoplus_{V \in W} (\mathbb{K}^*)^2 \oplus \bigoplus_{e \in E^b(\Gamma)} (N_e) \otimes \mathbb{K}^* \rightarrow \bigoplus_{e \in E^b(\Gamma)} (\mathbb{K}^*)^2 \times \mathbb{K}^* \times \bigoplus_{V \in W^n} (\mathbb{K}^*)^2$$

and denote by  $K(\Gamma, P, j)$  the kernel of  $E$ . We denote by  $\beta, \delta$  and  $\text{id}_n$  as well the  $\mathbb{Z}$ -linear maps of the underlying lattices ( $\mathbb{Z} \subset \mathbb{Z} \otimes \mathbb{K}^* = \mathbb{K}^*$ ).

The multiplicity of the tropical curves is the number of algebraic curves corresponding to it. To see how the multiplicity  $|K(\Gamma, P, j)|$  is related to point conditions consider the following remark.

*Remark 8.27.* Let us use the notations of definition 8.26 and let  $\{q_1, \dots, q_n\} = Q \subset (\mathbb{K}^*)^2$  be a set of  $n$  points in general position such that  $\text{val}(Q) = P$ , for  $P = \{h(x_1), \dots, h(x_n)\}$ . Since  $E$  is a group morphism, the number  $|K(\Gamma, P, j)|$  equals the number of preimages of an element of the image. Thus,  $|K(\Gamma, P, j)|$  equals for example the number of preimages of  $((1_{(\mathbb{K}^*)^2}, \dots, 1_{(\mathbb{K}^*)^2}), 1, (q_1, \dots, q_n))$ .

Before stating the theorem of Tyomkin we consider an example.

*Example 8.28.* Let  $(\Gamma, x_1, \dots, x_5, h)$  be the parameterized tropical curve with  $h(\Gamma)$  shown in figure 8.5 and equipped with the orientation such that  $e_1$  is directed from  $x_1$  to  $V_1$  and  $e_2 \dots e_5$  form a clockwise oriented cycle; let  $P = \{(-2, -1); (1, 1)\}$ , let  $Q = \{(t^2, t); (1/t, 1/t)\}$  and let the degree  $\Delta$  be  $((\begin{smallmatrix} -2 \\ -1 \end{smallmatrix}), (\begin{smallmatrix} 1 \\ 2 \end{smallmatrix}), (\begin{smallmatrix} 1 \\ -1 \end{smallmatrix}))$ . The map  $E$  from definition 8.26 is a map from a 15-dimensional space to a 15-dimensional space. By abuse of notation we use the same notation as in the previous definition for slightly different objects ( $y_V$  is the value  $(\mathbb{K}^*)^2_V$  as before, but  $y_e$  is the value in  $\mathbb{K}^* \cong N_e \otimes \mathbb{K}^*$  instead of the value in  $N_e \otimes \mathbb{K}^*$ ). To count the elements of the kernel of  $E$  we can solve the following equations:

$$\frac{(y_{V_1})_1}{t^2 \cdot y_{e_1}^2} = 1, \quad \frac{(y_{V_1})_2}{t \cdot y_{e_1}} = 1, \quad \frac{1}{t \cdot (y_{V_1})_1 \cdot y_{e_2}} = 1, \quad \frac{1}{t \cdot (y_{V_1})_2 \cdot y_{e_2}} = 1,$$

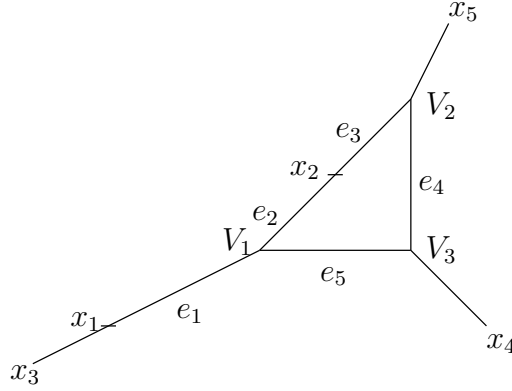

Figure 8.5: An elliptic curve with 5 marked ends.

$$\frac{(y_{V_2})_1 \cdot t}{y_{e_3}} = 1, \frac{(y_{V_2})_2 \cdot t}{y_{e_3}} = 1, \frac{(y_{V_3})_1}{(y_{V_2})_1} = 1, \frac{(y_{V_3})_2}{(y_{V_2})_2 \cdot y_{e_4}} = 1,$$

$$\frac{(y_{V_1})_1}{(y_{V_3})_1 \cdot y_{e_5}} = 1, \frac{(y_{V_1})_2}{(y_{V_3})_2} = 1, y_{e_2} \cdot y_{e_3} \cdot y_{e_4} \cdot y_{e_5} = 1.$$

Since it can be calculated, that these equations have a unique solution, the kernel contains exactly one element.

*Notation 8.29.* Let  $Z$  be an algebraic curve of genus one. We denote by  $J$  the  $j$ -invariant of  $Z$ .

**Theorem 8.30** (Tyomkin, [T], theorem 6.3). *Let  $(\Gamma, x_1, \dots, x_n, h)$  be a parameterized tropical curve of genus one and degree  $d$ . Let  $P$  be a set of  $3d-1$  generic points and let  $Q \subset (\mathbb{K}^*)^2$  be a set of  $3d-1$  points in general position such that  $\text{val}(Q) = P$ . Let further  $j \in \mathbb{R}_{>0}$  be the  $j$ -invariant of  $\Gamma$ . (Recall: The  $j$ -invariant is the sum of all lengths forming the cycle of  $\Gamma$ .) If  $\Gamma$  is special,  $P = \{h(x_1), \dots, h(x_n)\}$ ,  $j(\Gamma) = j$  and  $J \in \mathbb{K}$  with  $\text{val}(J) = j$  then there exist  $|K(\Gamma, P, j)|$  elliptic algebraic curves of degree  $d$  and  $j$ -invariant  $J$  in  $(\mathbb{K}^*)^2$  which pass through  $Q$  and are mapped to  $h(\Gamma)$  by  $\text{val}$ .*

The next proposition gives a tropical interpretation of  $|K(\Gamma, P, j)|$ .

**Definition 8.31.** Take the assumptions and notations of theorem 8.30. For each  $x_i$ ,  $i \in \{1, \dots, n\}$  we can write

$$h(x_i) = h(x_1) + \sum_{e \in R} l(e)v_e$$

for a subset  $R \subset E^b(\Gamma)$  and  $v_e$  a generator of  $N_e$  (see example 8.33). For a fixed subset  $R$  and a fixed vector  $v_e$ , these equalities define the linear map

$$\tilde{e}v_i : \mathbb{R}^2 \oplus \mathbb{R}^{\#E^b} \rightarrow \mathbb{R}^2, (x, \oplus_{e \in E^b} y_e) \mapsto x + \sum_{e \in R} y_e v_e.$$

We denote the product  $\tilde{e}v_1 \times \dots \times \tilde{e}v_n$  by  $\tilde{e}v$ .



*Remark 8.32.* The parameterized tropical curve  $\Gamma$  has a cycle and thus the maps  $e\tilde{v}_i$  from definition 8.31 do depend on  $R$ . Nevertheless we only need those maps to calculate the absolute value of a determinant (proposition 8.34) which will be independent of the choice of  $R$  and  $v_e$ . This is the reason why we denote the map by  $e\tilde{v}_i$  instead of  $(e\tilde{v}_i)_{R,v_e}$ .

*Example 8.33.* The evaluation  $h(x_i)$  of the vertex  $x_i$  of the parameterized tropical curve in figure 8.6 can be written as

$$h(x_i) = h(x_1) + l(e_1) \begin{pmatrix} 1 \\ 0 \end{pmatrix} + l(e_2) \begin{pmatrix} 1 \\ 1 \end{pmatrix} + l(e_3) \begin{pmatrix} 0 \\ 1 \end{pmatrix} + l(e_4) \begin{pmatrix} -1 \\ 1 \end{pmatrix} + l(e_5) \begin{pmatrix} 0 \\ 1 \end{pmatrix} + l(e_6) \begin{pmatrix} 1 \\ 1 \end{pmatrix}.$$

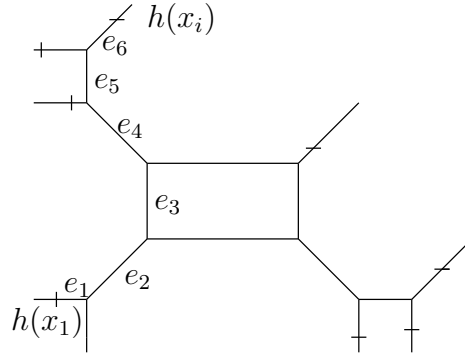

Figure 8.6: Evaluation of  $x_2$ .

**Proposition 8.34.** *Take the same assumptions and notations as in theorem 8.30. The number  $|K(\Gamma, P, j)|$  coincides with the absolute value of the determinant of the linear map*

$$D = e\tilde{v} \times j \times a_1 \times a_2 : \mathbb{R}^{2+\#E^b} \rightarrow \mathbb{R}^{6d-2} \times \mathbb{R} \times \mathbb{R}^2.$$

*Recall:  $j$  is the  $j$ -invariant and  $a_1, a_2$  are the equations for the closing cycle at the end of section 7.2. The space  $\mathbb{R}^{2+\#E^b}$  encodes the position of the vertex  $V_1 = h(x_1)$  and the lengths of the bounded edges of the curve. (In particular the absolute value of the determinant is independent of the choice of  $R$  in definition 8.31.)*

*Proof.* The map  $D$  is a linear map. Thus, the absolute value of the determinant of  $D$  is the same as the numbers of elements of the cokernel of the map

$$D' = e\tilde{v} \times j \times a_1 \times a_2 : \mathbb{Z}^{2+\#E^b} \rightarrow \mathbb{Z}^{6d-2} \times \mathbb{Z} \times \mathbb{Z}^2.$$

The idea of the proof is to replace the matrix  $D'$  with a matrix  $\begin{pmatrix} D' & 0 \\ \star & f|_{V_1=0} \end{pmatrix}$ , where  $(\star \ f|_{V_1=0}) = \tilde{f}$  (see below) and then to use row operations to get  $E|_{\mathbb{Z}}$ . After this we use the tensor product to prove the statement.

Let  $e_1$  be an edge of the cycle. This cokernel is isomorphic to the cokernel of the map

$$D' \times f : \mathbb{Z}^{2+\#E^b} \oplus \bigoplus_{V \in W \setminus \{V_1\}} \mathbb{Z}^2 \rightarrow \mathbb{Z}^{6d-2} \times \mathbb{Z} \times \mathbb{Z}^2 \times \bigoplus_{e \in E^b \setminus \{e_1\}} \mathbb{Z}^2$$

where for each  $e \in E^b \setminus \{e_1\}$  the image of  $f$  in the coordinate  $\mathbb{Z}_e^2$  is the sum  $\sum_{V \in W} \epsilon(e, V) y_V$  with  $y_V \in \mathbb{Z}_V^2$ . The cokernel of  $D'$  is isomorphic to the cokernel of  $D' \times f$  due to the fact, that after fixing  $V_1$  the map  $f$  is a bijective map from the group  $\bigoplus_{V \in W \setminus \{V_1\}} \mathbb{Z}^2$  to  $\bigoplus_{e \in E^b \setminus \{e_1\}} \mathbb{Z}^2$ . (The inverse  $f^{-1}$  is defined recursively starting with vertices connected with  $V_1$  by an edge from  $\Gamma \setminus \{e_1\}$ . For  $e$  an edge connecting  $V$  and  $V'$  we define  $y_{V'} = y_V + \epsilon(e, V) y_e$ . Since  $\Gamma \setminus \{e_1\}$  is connected and  $V_1$  is fixed we can do this to define  $f^{-1}$ .) For each  $e \in E^b \setminus \{e_1\}$  we now change the  $\mathbb{Z}_e^2$ -component of  $f$ . Let the  $\mathbb{Z}_e^2$ -component of  $f$  be  $y_{V_i} - y_{V_k}$ . We change the image by adding the product of the integer corresponding to  $e$  in  $\mathbb{Z}^{2+\#E^b}$  and the direction  $v(e, V_i)$  of  $e$  pointing from  $V_i$  to  $V_k$ . Since  $f$  was bijective, the number of elements of the cokernel stays the same after changing the map  $f$  to this new map  $\tilde{f}$ .

The map  $D' \times \tilde{f}$  is a linear map and therefore it can be written as a matrix  $M$ . The maps  $a_1$  and  $a_2$  refer to the closing of the cycle and are given as a sum of  $v(e, V_i) v_e$  with  $v_e \in \mathbb{Z}_e$  and  $e$  is an edge of the cycle. By adding the rows of  $\mathbb{Z}_e^2$ , in the matrix corresponding to the map  $D' \times \tilde{f}$ , to the rows  $(a_1, a_2)$  we can change the maps  $a_1, a_2$  to get the map  $\beta$  to  $\bigoplus_{e \in E^b} \mathbb{Z}^2$  instead of a map  $a_1 \times a_2 \times \tilde{f}$  to  $\mathbb{Z}^2 \bigoplus_{e \in E^b \setminus \{e_1\}} \mathbb{Z}^2$ . Since these are linear row operations, the determinant and the number of elements in the cokernel stays the same. So far we got the map

$$\tilde{v} \times j \times \beta : \mathbb{Z}^{2+\#E^b} \bigoplus_{V \in W \setminus \{V_1\}} \mathbb{Z}^2 \rightarrow \mathbb{Z}^{6d-2} \times \mathbb{Z} \times \bigoplus_{e \in E^b} \mathbb{Z}^2.$$

The image of a point in  $\mathbb{Z}^{2+\#E^b} \bigoplus_{V \in W \setminus \{V_1\}} \mathbb{Z}^2$  under  $\tilde{v}_l$  be  $x_{V_1} + \sum_{e \in R} y_e v_e$  (see definition 8.31). Let  $\tilde{e} \in R$  and let the map  $\beta$  at coordinate  $\mathbb{Z}_{\tilde{e}}$  be  $x_{V_i^{\tilde{e}}} - x_{V_k^{\tilde{e}}} \pm y_{\tilde{e}} v_{\tilde{e}}$ . By adding the rows corresponding to  $\tilde{e}$  with a suitable sign we can change the row of  $\tilde{v}_l$  to get the image

$$x_{V_1} + \sum_{e \in R \setminus \{\tilde{e}\}} y_e v_e \pm (x_{V_i^{\tilde{e}}} - x_{V_k^{\tilde{e}}}).$$

After doing this for all  $e \in R$  we get the sum

$$x_{V_1} + \sum_{e \in R} \pm (x_{V_i^e} - x_{V_k^e}).$$

Since the edges of  $R$  build a path from  $x_{V_1}$  to  $x_{V_l}$  this sum is equal to  $x_{V_l}$ . Thus we can change the evaluation maps to identity maps of  $\mathbb{Z}_{V_1}^2$  to  $\mathbb{Z}_{V_l}^2$  by row operations which do not change the determinant and thus get a  $(6d-2)$ -identity matrix. Therefore the cokernel of the map  $D$  has the same number of elements as the cokernel of the map

$$E|_{\mathbb{Z}} = \beta \times \delta \times \text{id}_n : \bigoplus_{V \in W} \mathbb{Z}^2 \oplus \bigoplus_{e \in E^b(\Gamma)} \mathbb{Z} \rightarrow \bigoplus_{e \in E^b(\Gamma)} \mathbb{Z}^2 \times \mathbb{Z} \times \bigoplus_{V \in W^n} \mathbb{Z}^2.$$

Thus, it remains to show that the cokernel  $C$  of  $E|_{\mathbb{Z}}$  has the same number of elements as the kernel  $K$  of  $E$ . The map  $E|_{\mathbb{Z}}$  is injective, thus we have the following exact sequence

$$0 \rightarrow \mathbb{Z}^m \xrightarrow{E|_{\mathbb{Z}}} \mathbb{Z}^m \rightarrow C \rightarrow 0,$$

for suitable  $m \in \mathbb{N}$ . The map  $E$  is  $E|_{\mathbb{Z}} \otimes \mathbb{K}^*$ . Thus, by tensorizing with  $\mathbb{K}^*$  we get the exact sequence

$$0 \rightarrow K \rightarrow \mathbb{Z}^m \otimes \mathbb{K}^* \xrightarrow{E} \mathbb{Z}^m \otimes \mathbb{K}^* \rightarrow C \otimes \mathbb{K}^* \rightarrow 0,$$

where

$$\mathbb{Z}^m \otimes \mathbb{K}^* \cong \bigoplus_{V \in W} (\mathbb{K}^*)^2 \oplus \bigoplus_{e \in E^b(\Gamma)} N_e \otimes \mathbb{K}^* \cong \bigoplus_{e \in E^b(\Gamma)} (\mathbb{K}^*)^2 \times \mathbb{K}^* \times \bigoplus_{V \in W^n} (\mathbb{K}^*)^2.$$

Since  $C$  is finite  $C \otimes \mathbb{K}^*$  is 0. Furthermore  $K = \text{Tor}(\mathbb{K}^*, C)$ . It is known that  $\text{Tor}$  commutes with direct sums. Since  $C$  is an abelian group the problem reduces to the case where  $C = \mathbb{Z}_s$  and  $m = 1$ . Thus, it remains to show that  $\mathbb{Z}_s$  and  $K = \text{Tor}(\mathbb{K}^*, C)$  from the exact sequences

$$0 \rightarrow \mathbb{Z} \xrightarrow{\cdot s} \mathbb{Z} \rightarrow \mathbb{Z}_s \rightarrow 0,$$

and

$$0 \rightarrow K \rightarrow \mathbb{K}^* \xrightarrow{(\cdot)^s} \mathbb{K}^* \rightarrow 0$$

with  $s \in \mathbb{N}_{>0}$  have the same number of elements. But  $K$  and  $\mathbb{Z}_s$  are isomorphic and thus the proposition holds.  $\square$

*Remark 8.35.* By remark 4.7 in [KM] the numbers in proposition 8.34 are the same as the multiplicities we calculated for those tropical curves in chapter 7 with the help of corollary 6.29.

## 8.2 Correspondence theorem for elliptic curves with given $j$ -invariant

After stating some known correspondence theorems, we now want to treat the case of elliptic curves with fixed  $j$ -invariant. Therefore, let us do some preparation before we are able to prove our results. For this, we start with a fact about algebraic curves.

**Theorem 8.36** (Pandharipande,[P]). *Let  $K$  be an algebraically closed field of characteristic 0. The number  $E(d, J)$  of irreducible nodal degree  $d$   $K$ -plane elliptic curves with  $j$ -invariant  $J$  which pass through fixed  $3d - 1$  points in general position is independent of the choice of the points. Furthermore,  $E(d, J)$  is independent of the choice of  $J$  for  $J \neq 0, 1728, \infty$ . In this case  $E(d, J) = \binom{d-1}{2} N^{\text{irr}}(0, d)$ .*

In the theorems we stated in the first section of this chapter, we considered curves satisfying some point conditions. To establish a correspondence it was necessary to have a correspondence of the conditions as well. Since we consider elliptic tropical curves with fixed  $j$ -invariant we want to start with a fact about this invariant.

**Theorem 8.37** (Tyomkin, [T], (Theorem 2.32)). *Let  $(\Gamma, x_1, \dots, x_n, h)$  be the special tropical curve corresponding to an algebraic curve  $Z$  (i.e.  $\text{val}(Z) = h(\Gamma)$ , for further details see [T]). If  $g(Z) = g(\Gamma) = 1$ , if  $h$  is injective on the cycle and if  $J$  is the algebraic  $j$ -invariant of  $Z$  then the tropical  $j$ -invariant of  $\Gamma$  is equal to  $\text{val}(J)$ .*

**Corollary 8.38.** *Let  $(\Gamma, x_1, \dots, x_n, h)$  be the special tropical curve corresponding to an algebraic elliptic curve  $Z$  of degree  $d$  passing through given  $3d - 1 = n$  points in general position. If  $\text{val}(J) \gg 0$  (for  $J$  being the  $j$ -invariant of  $Z$ ), then  $h(\Gamma)$  allows rational parameterizations of degree  $d$ .*

*Proof.* Since  $Z$  is of degree  $d$ , we can find a parameterization of  $h(\Gamma)$  of degree  $d$  as well. Therefore it remains to show that  $h(\Gamma)$  allows a rational parameterization. In a parameterization each point which is locally an intersection of two lines can be resolved (see figure 8.7). Take a parameterization  $(\Gamma, h)$  which has resolved all crossings of two lines (and therefore

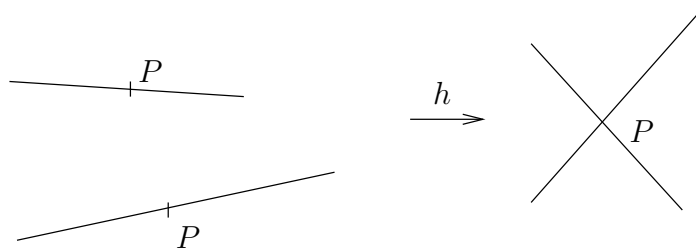

Figure 8.7: Resolving a crossing of two lines.

all vertices of  $\Gamma$  are three-valent). Assume that  $\Gamma$  has genus 1. By theorem 8.37 the cycle length has to be  $\text{val}(J)$  if  $\Gamma$  has no contracted bounded edge. Let us first assume that  $\Gamma$  has a contracted bounded edge  $e$  (i.e.  $h(e)$  is a point). By the balancing condition  $h(\Gamma)$  has a crossing at  $h(e)$  which is a contradiction since we resolved all crossings. Thus,  $(\Gamma, h)$  has no contracted bounded edge. Therefore the cycle length has to be  $\text{val}(J)$ . But this is a contradiction to proposition 5.1 in [GM3] (every elliptic tropical curve of degree  $d$  with a very big  $j$ -invariant and passing through the  $3d - 1$  fixed points has a contracted bounded edge).  $\square$

**Definition 8.39** (tropical cycle). Let  $(\Gamma, x_1, \dots, x_N, h)$  be a parameterized tropical curve. We call the image  $h(\Gamma)$  of a tropical curve a *tropical cycle*. If the tropical cycle of a parameterized tropical elliptic curve can not be parameterized by a rational curve we call the tropical cycle an *elliptic cycle* (for example figure 8.8) and a *rational cycle* otherwise (for example figure 8.9).

*Example 8.40.* The image of a special parameterized tropical curve of genus one, degree 3, and passing through given 8 points looks for example as is figure 8.8. But, if we fix a big

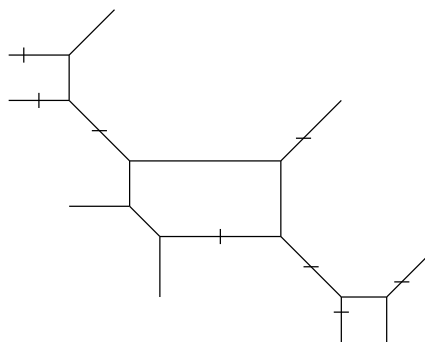

Figure 8.8: Elliptic curve passing through 8 points.

$j$ -invariant, the curve having this  $j$ -invariant has to look like in figure 8.9.

*Remark 8.41.* D. Speyer gives in proposition 9.2 [Sp2] some conditions, when the tropicalization of the  $j$ -invariant of an algebraic curve is the cycle length of the tropical curve. In

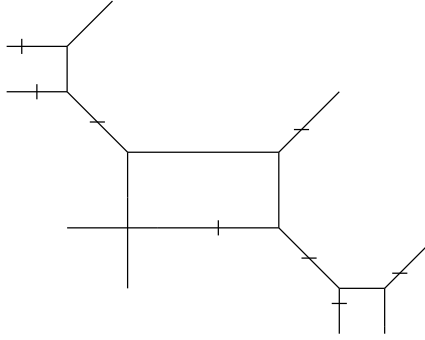

Figure 8.9: The tropical cycle of an elliptic curve passing through 8 points and with given big  $j$ -invariant (therefore the curve has a contracted edge).

particular he needs an injectivity condition to show that the tropicalization is the same as the length of the loop. In example 8.40 this injectivity condition is violated for figure 8.9. Thus, the elliptic curve  $(\Gamma, x_1, \dots, x_9, h)$  with  $h(\Gamma)$  being the tropical cycle from figure 8.9 has a contracted edge at the 4-valent vertex.

**Definition 8.42** (Multiplicity of an elliptic tropical curve). Let  $C_\Gamma = (\Gamma, x_1, \dots, x_n, h)$  be an elliptic tropical curve in  $\mathbb{R}^2$ , let  $P_C$  be the corresponding point in  $\mathcal{M}_{1,n,\text{trop}}^{\text{lab}}(\mathbb{R}^2, d)$  and let  $f = \text{ev}_1 \times \dots \times \text{ev}_n \times j$ . Furthermore, put  $\tilde{f} = f$  as continuous map, but redefine the weights of  $\mathcal{M}_{1,n,\text{trop}}^{\text{lab}}(\mathbb{R}^2, d)$  to be  $\frac{1}{2}$  (resp., 0) for curves with contracted cycle (resp., with the cycle which is not contracted). We define  $\text{mult}_j(C_\Gamma)$  to be  $\text{mult}_{[P_C]} f - \text{mult}_{[P_C]} \tilde{f}$  (see corollary 6.29, end of section 7.2 and theorem 7.17).

*Remark 8.43.* The multiplicity defined in the previous definition agrees with the multiplicity of [KM] (see definition 3.5 and chapter 4 in [KM]).

**Definition 8.44.** Let  $E_{\text{trop}}(d, j, P)$  be the number of irreducible nodal degree  $d$  plane elliptic tropical curves with fixed  $j$ -invariant and passing through  $3d - 1$  points  $P$  counted with the multiplicity from definition 8.42.

Now we can state a main result of this chapter, a correspondence theorem for elliptic curves with given  $j$ -invariant. Note, that it is a correspondence between tropical cycles and parameterized algebraic curves.

**Theorem 8.45.** *Let  $d > 2$  and let us fix as a ground field the field  $\mathbb{K}$ . For a generic configuration  $P$  of  $3d - 1$  points, sufficiently big tropical  $j$ -invariant  $j$  and  $J \in \mathbb{K}$  with  $\text{val}(J) = j$  we have  $E_{\text{trop}}(d, j, P) = E(d, J)$ . Furthermore, let  $Q \subset (\mathbb{K}^*)^2$  be a configuration of  $3d - 1$  points in general position with  $\text{val}(Q) = P$ , and  $C$  be the tropical cycle  $h(\Gamma)$  of a parameterized tropical curve  $(\Gamma, x_1, \dots, x_{3d-1}, h)$  of genus 1, degree  $d$  and  $j$ -invariant  $j$  such that  $P = \{h(x_1), \dots, h(x_{3d-1})\}$ . Then, there exist  $\binom{d-1}{2} \text{mult}(C)$  (remember that  $C$  is rational since  $j$  is sufficiently big, thus the parameterization of  $C$  as a rational parameterized tropical curve of degree  $d$  is unique and by abuse of notation we write  $\text{mult}(C)$  for the multiplicity of this curve) distinct algebraic curves  $Z$  of genus 1, with  $j$ -invariant  $J$  and degree  $d$  such that  $Z$  passes through  $Q$ . These curves are irreducible and the image of each of these curves under  $\text{val}$  is  $C$ .*

Before proving the theorem we quote some facts for Berkovich spaces. For an introduction to the theory of Berkovich spaces we recommend [Ba], [Be3] or [D]. For a general study of this theory we recommend [Be1] and [Be2].

**Fact 8.46.** *Let  $k$  be a non-Archimedean field. There exists a functor  $F$  such that for each  $k$ -algebraic variety  $X$  one can associate a  $k$ -analytic space  $X^{an}$  to it. This space is called the Berkovich  $k$ -analytic space associated to  $X$ .*

See for example section 1.4 in [D] (or §3.4.1 in [Be1] and §2.6 in [Be2]).

To get a first idea of analytic spaces let us consider a remark.

*Remark 8.47.* Let  $\mathbb{A}^n$  be the space of multiplicative seminorms of  $\mathbb{K}[T_1, \dots, T_n]$  (in particular each  $x \in \mathbb{K}^n$  defines a seminorm by  $|f|_x = |f(x)|$ , where  $|\cdot|$  is the norm induced by the valuation). The topology of  $\mathbb{A}^n$  is defined to be the weakest topology such that the map  $\mathbb{A}^n \rightarrow \mathbb{R}_{\geq 0} : |\cdot|_x \mapsto |f|_x$  is continuous for all  $f \in \mathbb{K}[T_1, \dots, T_n]$ . An analytic function is a local limit of rational functions. Denote by  $\mathcal{O}$  the sheaf of analytic functions on open subsets  $U \subset \mathbb{A}^n$ .

A local model for a  $k$ -analytic space is a locally ringed space  $(X, \mathcal{O}_X)$  given by an open set  $U \subset \mathbb{A}^n$  and a finite set of analytic functions  $f_1, \dots, f_n \in \mathcal{O}(U)$  such that  $X = \{x \in U \mid f_i(x) = 0 \forall 1 \leq i \leq n\}$  and  $\mathcal{O}_X = (\mathcal{O}_U / \langle f_1, \dots, f_n \rangle)|_X$ .

Let  $E = E(a, r)$  be a closed disk in  $\mathbb{K}$  with center  $a \in \mathbb{K}$  and radius  $r > 0$ . The function defined by  $f = \sum_{i=1}^n \alpha_i (T - a)^i$  is mapped to  $\max_{1 \leq i \leq n} |\alpha_i| r^i$  is a multiplicative norm  $|\cdot|_E$  on  $k[T]$ . It is a fact, that the set of seminorms on  $\mathbb{K}$  is given by  $f \mapsto \inf_{E \in \mathcal{E}} |f|_E$ , where  $\mathcal{E}$  is a family of nested closed disks. Each point of  $\mathbb{A}^1$  corresponds to  $E = E(a, 0) = a$  (called points of type (1)) or a closed disk with  $r \in |\mathbb{K}^*|$  (type (2)) or a closed disk with  $r \notin |\mathbb{K}^*|$  (type (3)) or to a  $\mathcal{E}$  with  $\bigcap_{E \in \mathcal{E}} E = \emptyset$  (type (4)). The analytification functor from fact 8.46 maps  $\mathbb{K}$  to  $\mathbb{A}^1$ .

**Fact 8.48** (Fact 4.1.3 in [Be3], proposition 3.4.6 und 3.4.7 in [Be1]). *Let  $\varphi : X \rightarrow Y$  be a morphism of schemes of finite type over  $k$ , and let  $\varphi^{an} : X^{an} \rightarrow Y^{an}$  be the corresponding morphism of  $k$ -analytic spaces. The morphism  $\varphi$  is étale, smooth, separated, an open immersion and an isomorphism if and only if  $\varphi^{an}$  possesses the same property. Suppose that  $\varphi$  is of finite type. Then  $\varphi$  is a closed immersion, finite, and proper if and only if  $\varphi^{an}$  possesses the same property.*

**Fact 8.49** (Fact 4.1.4 in [Be3], theorem 3.4.8 in [Be1]). *One has  $X$  is proper  $\Leftrightarrow |X^{an}|$  is compact.*

*Proof of theorem 8.45.* R. Pandharipande has shown that  $E(d, J) = \binom{d-1}{2} N^{irr}(0, d)$  (see [P]). By theorem 8.23 we know that the numbers  $N_{trop}^{irr}(0, d, P)$  and  $N^{irr}(0, d)$  agree. Thus, the first part of the theorem ( $E_{trop}(d, j, P) = E(d, J)$ ) follows from the second part if we can show that the set of tropical cycles of tropical curves of genus 1, with  $j$ -invariant  $j$  and degree  $d$  passing through  $P$  is the same as the set of tropical cycles of rational curves of degree  $d$  passing through  $P$ . Each tropical cycle of a rational curve has at least one node or a vertex of multiplicity greater than 1 because  $d > 2$ . For a node we can make the parameterized tropical curve elliptic by inserting a contracted edge. Since  $j$  is very big we can choose the length of

the contracted edge of this parameterized elliptic tropical curve such that the  $j$ -invariant of this curve is  $j$ . At a vertex of valence greater than one we can insert a cycle of length  $j$  and thus we get a curve which fulfill the requirement. Therefore it remains to show the second part.

Let  $V_{d,1}$  be the Severi variety which is the closure (in the variety of all curves of degree  $d$ ) of the reduced and irreducible plane elliptic nodal algebraic degree  $d$  curves. It is known that  $V_{d,1}$  has dimension  $3d$  (see for example [HM]). Let  $V$  be the intersection of  $V_{d,1}$  with the codimension  $3d - 1$  subspace formed by the curves passing through  $Q$ . By [P] the curve  $V$  is a branched cover of  $\mathbb{P}^1$  by the  $j$ -invariant. The ramification points are  $0$ ,  $1728$ , and  $\infty$ . Since  $V$  is a closed subset of  $\mathbb{P}^N$  for some  $N$ , one gets that  $V$  is proper.

Since  $V$  is an algebraic variety fact 8.46 applies and we can associate the analytic space  $V^{an}$  to  $V$ . Since the points of  $V$  can be identified with points of  $V^{an}$  (those points are the rigid points of  $V^{an}$ ) we can speak of  $V$  being a subset of  $V^{an}$  (see for example proposition 2.1.15 [Be1]). Let  $r \in V$  be a point parameterizing a rational curve and let  $U$  be a neighborhood of  $\infty$  in  $(\mathbb{P}^1)^{an}$ . By  $J$  we denote as well the map  $V \rightarrow \mathbb{P}^1$  given by the  $j$ -invariant. Since  $J^{an}$  is continuous, there exists a neighborhood  $W$  of  $r$  such that  $J^{an}(W) \subset U$  (the topology of  $(\mathbb{P}^1)^{an}$  is induced by the valuation, see for example section 1.3 in [Ba]). Assume now that  $W$  is a closed subset of  $V^{an}$  such that  $J^{an}(W) \cap \mathbb{P}^1$  contains elements with arbitrary big valuation (remark: By 2.1.15 of [Be1]  $\mathbb{P}^1$  is dense in  $(\mathbb{P}^1)^{an}$ ). Since  $V$  is proper and therefore  $V^{an}$  is compact by fact 8.49 we get that  $U$  contains a preimage of  $\infty$ . By definition, this preimage is a point of  $V \subset V^{an}$  ( $J^{an}$  is finite and thus, the preimage of a  $\mathbb{K}$  point is the spectrum of a  $\mathbb{K}$ -algebra of finite dimension. Since  $\mathbb{K}$  is algebraically closed it follows that the preimage lies in  $V$ . For example see section 3.3 in [Be1] or for an idea of this fact see remark 2.1.4 [Ba]) and thus it corresponds to a rational curve. Thus, all curves which have a sufficiently big  $j$ -invariant are in a neighborhood of a rational curve. By [DH] the normalization  $\Pi : V^{no} \rightarrow V$  near a rational curve  $r$  is the union of  $(d - 1)(d - 2)/2$  separated smooth sheets (in particular  $V^{no} \rightarrow V \rightarrow \mathbb{P}^1$  is unramified at infinity). Thus, by fact 8.48  $(V^{no})^{an}$  admits local isomorphisms (in the neighborhood of  $\Pi^{-1}(r)$ ) from each of the  $(d - 1)(d - 2)/2$  sheets to  $\mathbb{P}^1$ . Let  $\epsilon$  be greater 0. By the local isomorphisms, for each  $j$ -invariant  $J$  with sufficiently big valuation, there are exactly  $(d - 1)(d - 2)/2$  curves which have distance  $\epsilon$  ( $\mathbb{P}^1$  has a distance and each sheet is isomorphic to it) or smaller from  $r$  and which have  $j$ -invariant  $J$ .

Let  $C$  be the tropical cycle  $h(\Gamma)$  of a parameterized tropical curve  $(\Gamma, x_1, \dots, x_{3d-1}, h)$  of genus 1, degree  $d$  and  $j$ -invariant  $j$  such that  $P = \{h(x_1), \dots, h(x_{3d-1})\}$ . The tropical cycle  $C$  is a rational cycle by corollary 8.38 (if  $C$  contains a cycle it has a contracted edge since  $j \gg 0$  or see proposition 5.1 in [GM3]). By theorem 8.23 there are  $\text{mult}(C)$  plane rational algebraic curves of degree  $d$ , passing through  $Q$  and which have valuation  $C$ . Let  $r$  be one of those rational curves. A local chart  $U$  at  $r$  is  $\text{Spec}(\mathbb{K}[x_1, \dots, x_N]/I)$  for some ideal  $I$ . Since  $U \rightarrow \mathbb{R}_{\geq 0} : |\cdot|_x \mapsto |f|_x$  is continuous for all  $f \in \mathbb{K}[x_0, \dots, x_N]$  we can define distances to  $r$  using  $f$  ( $d(r, s) = |f(x - r)|_s$ ). In particular we can define  $\epsilon$ -neighborhoods of  $r$ . (Remark: For different choices of  $f$  we get different neighborhoods.) In the following, a point is in the  $\epsilon$ -neighborhood of  $r$  if it is in the  $\epsilon$ -neighborhood for  $f = x_i$  for each  $0 \leq i \leq N$  (notice that this is a neighborhood of  $r$ ). For  $j$  sufficiently big, we find  $(d - 1)(d - 2)/2$  elliptic algebraic curves passing through  $Q$  and with  $j$ -invariant  $J$  such that each of these curves is in an  $\epsilon$ -

neighborhood of  $r$ . Let  $e$  be one of those elliptic curves. The distance of the coefficients of the polynomials parameterized by  $r$  and  $e$  is less than  $\epsilon$ . Thus we get that the valuation of the difference of the coefficients  $(\text{val}(r - e)_i, 0 \leq i \leq N)$  is much less than 0 and therefore the tropicalizations of the curves  $r$  and  $e$  do agree. For each tropical cycle  $C$  of a curve of genus 1, with  $j$ -invariant  $j$  and degree  $d$  passing through  $P$  we have  $\binom{d-1}{2}$  distinct algebraic curves of genus  $g$ , with  $j$ -invariant  $J$  and degree  $d$  passing through  $Q$  and which are mapped to  $C$  under  $\text{val}$ .

□

**Conjecture 8.50.** *Let us fix as a ground field the field  $\mathbb{K}$ . For a generic configuration  $P$  of  $3d - 1$  points, sufficiently big tropical  $j$ -invariant  $j$  and  $J \in \mathbb{K}$  with  $\text{val}(J) = j$  we have  $E_{\text{trop}}(d, j, P) = E(d, J)$ . Let  $S$  be the set of parameterized tropical curves which pass through  $P$ , are of degree  $d$ , genus 1 and which have  $j$ -invariant  $j$ . For each configuration  $Q \subset (\mathbb{K}^*)^2$  of  $3d - 1$  points in general position with  $\text{val}(Q) = P$  one has that for  $C$  being the tropical cycle  $h(\Gamma)$  of a parameterized tropical curve  $(\Gamma, x_1, \dots, x_{3d-1}, h)$  of genus 1, degree  $d$  and  $j$ -invariant  $j$  such that  $P = \{h(x_1), \dots, h(x_{3d-1})\}$  we have*

$$\sum_{(\Gamma, x_1, \dots, x_n, h) \in S, h(\Gamma) = C} \text{mult}_{K, M}((\Gamma, x_1, \dots, x_n, h))$$

*distinct algebraic curves of genus  $g$ , with  $j$ -invariant  $J$  and degree  $d$  passing through  $Q$ . The multiplicity  $\text{mult}_{K, M}$  is the same as in [KM]. The curves are irreducible and the image of these curves under  $\text{val}$  is  $C$ .*

*Remark 8.51.* By proposition 8.34 the numbers stated in the conjecture 8.50 for tropical cycles of special parameterized tropical curves are the same as in theorem 8.30.

The numbers stated in conjecture 8.50 for tropical cycles of elliptic curves with big  $j$ -invariant agree with those in theorem 8.45 by lemma 6.2 from [KM].

These two remarks give a hint why the conjecture might be true. In the proof of theorem 8.45 we used the Berkovich space to make small deformations and used the understanding of the rational case. Our last remark gives a hint why a deformation in other cases might be helpful as well.

*Remark 8.52.* To see why a deformation could help to prove a correspondence we examine the deformation of tropical curves. Since we are interested in the deformation of the  $j$ -invariant we take a plane elliptic parameterized tropical curve  $C$  of degree  $d$  and passing through  $3d - 1$  points in general position. Thus, the image of the curve in  $\mathbb{R}^2$  has to be a rational tropical curve or an elliptic tropical curve. Fix a  $j$ -invariant  $j$  and consider the case, in which the curve is rational. If we can deform the tropical curves continuously we can deform it by making the  $j$ -invariant bigger and bigger. As long as the image of the curve stays rational it cannot change since the  $3d - 1$  points are in general position. Let us consider the case where the image of the curve changes by deforming the  $j$ -invariant. In this case the parameterization of the curve has a 4-valent vertex. Therefore the two other parameterizations have to be elliptic or the same rational curve. Since we know the number of algebraic curves mapped to the tropical cycle of an elliptic tropical curve with sufficiently big  $j$ -invariant or where the cycle is elliptic we can deduce the number of algebraic curves



which are mapped to the cycle of  $C$  by the balancing condition in the moduli space of elliptic tropical curves of genus 1 and degree  $d$ .

We consider an example of a deformation of tropical curves.

*Example 8.53.* Assume that a parameterized tropical curve  $(\Gamma, x_1, \dots, x_n, h)$  has the tropical cycle shown in figure 8.10. If we change the  $j$ -invariant continuously, the tropical cycle either



Figure 8.10: Rational cycle

stays the same or transforms to a tropical cycle similar to the one shown in figure 8.11. Let  $j_0$

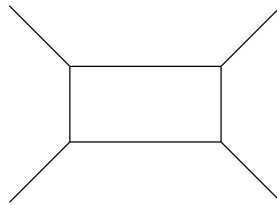

Figure 8.11: Elliptic cycle with changed  $j$ -invariant.

be the value of the  $j$ -invariant where the tropical cycle changes, and assume that the tropical cycle shown in figure 8.10 does not change for bigger  $j$ -invariants. Thus, the multiplicity of the tropical cycle in figure 8.10 with  $j$ -invariant smaller than  $j_0$  has the same multiplicity as the sum of the multiplicity of the tropical cycle in figure 8.10 with big  $j$ -invariant and of the multiplicity of the tropical cycle in figure 8.11.

# Bibliography

- [A] M. Abouzaid, *Morse Homology, Tropical Geometry, and Homological Mirror Symmetry for Toric Varieties*, *Selecta Math. (N.S.)* 15 (2009), no. 2, 189–270; also at preprint math.AG/0610004.
- [AR] L. Allermann, J. Rau, *First Steps in Tropical Intersection Theory*, *Mathematische Zeitschrift*, Volume 264 (2010), Number 3, 633–670; also at preprint math.AG/0709.3705.
- [Ba] M. Baker, *An introduction to Berkovich analytic spaces and non-archimedean potential theory on curves* (2007). Available at <http://math.arizona.edu/~swc/aws/07/BakerNotesMarch21.pdf>
- [Be] G. M. Bergman, *The logarithmic limit set of an algebraic variety*, *Trans. AMS*, Volume 157, (1971), 459–469.
- [Be1] V. G. Berkovich, *Spectral theory and analytic geometry over non-Archimedean fields*, volume 33 of *Mathematical Surveys and Monographs*. AMS, Providence, RI, (1990).
- [Be2] V. G. Berkovich, *Étale cohomology for non-Archimedean analytic spaces*, *Inst. Hautes Études Sci. Publ. Math* 78 (1993), 5–161.
- [Be3] V. G. Berkovich, *Non-Archimedean Analytic space*, Notes of lectures at the Advanced School on p-adic Analysis and Applications, ICTP, Trieste, 31 August-11 September 2009. preprint. Available at [http://www.wisdom.weizmann.ac.il/~vova/Trieste\\_2009.pdf](http://www.wisdom.weizmann.ac.il/~vova/Trieste_2009.pdf)
- [BG] R. Bieri, J. R. J. Groves, *The geometry of the set of characters induced by valuations*, *J. Reine Angew. Math.*, Volume 347 (1984), 168–195.
- [BM] E. Brugallé, G. Mikhalkin, *Enumeration of curves via floor diagrams*, *C. R. Math. Acad. Sci. Paris* 345 (2007), no. 6, 329–334.
- [CH] L. Caporaso, J. Harris, *Counting plane curves of any genus*, *Invent. Math.* 131 (1998), 345–392.
- [D] A. Ducros, *Espaces analytiques p-adiques au sens de Berkovich*. Available at <http://math.unice.fr/~ducros/asterisque.pdf> (2006).
- [DH] S. Diaz, J. Harris, *Geometry of the Severi variety*, *Trans. Amer. Math. Soc.* 309 (1988), 1–34.
- [G] W. Gubler, *Tropical varieties for non-archimedean analytic spaces*, *Invent. Math.*, Volume 169 (2007), 321–376; also at preprint math.NT//0609383.

- [GKM] A. Gathmann, M. Kerber, H. Markwig, *Tropical fans and the moduli spaces of tropical curves*, Compos. Math. 145 (2009), no. 1, 173–195.
- [GM1] A. Gathmann, H. Markwig, *The numbers of tropical plane curves through points in general position*, J. Reine Angew. Math. 602 (2007), 155–177.
- [GM2] A. Gathmann, H. Markwig, *The Caporaso-Harris formula and plane relative Gromov-Witten invariants in tropical geometry*, Math. Ann. 338 (2007), 845–868.
- [GM3] A. Gathmann, H. Markwig, *Kontsevich’s formula and the WDVV equations in tropical geometry*, Adv. Math. 217 (2008), 537–560.
- [H] M. Herold, *Tropical stacks and the moduli spaces of tropical elliptic curves*, preprint math.AG/0911.1491.
- [HM] J. Harris, I. Morrison *Moduli of curves*, Springer Verlag (1998).
- [IKS] I. Itenberg, V. Kharlamov, E. Shustin, *Welschinger invariant and enumeration of real plane rational curves*, Intern. Math. Research Notices, Volume 49 (2003), 2639–2653; also at preprint math.AG/0303378.
- [J] M. Joswig, *Tropical Convex Hull Computations*, Proceedings of the International Conference on Tropical and Idempotent Mathematics, Volume 495 of Contemp. Math. AMS (2009), 193–212; also at preprint math.AG/0809.4694.
- [KM] M. Kerber, H. Markwig, *Counting tropical elliptic plane curves with fixed  $j$ -invariant*, Comment. Math. Helv., 84 (2), (2009), 387–427; also at preprint math.AG/0608472.
- [KMM1] E. Katz, H. Markwig, T. Markwig, *The  $j$ -invariant of a plane tropical cubic*, J. Algebra 320 (2008), no. 10, 3832–3848 .
- [KMM2] E. Katz, H. Markwig, T. Markwig, *The tropical  $j$ -invariant*, LMS J. Comput. Math. 12 (2009), 275–294; also at preprint math.AG/0803.4021.
- [M1] G. Mikhalkin, *Enumerative tropical geometry in  $\mathbb{R}^2$* , J. Amer. Math. Soc. 18 (2005), 313–377.
- [M2] G. Mikhalkin, *Moduli spaces of rational tropical curves*, Proceedings of the 13th Gökova Geometry-Topology Conference 2006, Gökova (2007), 39–51; also at preprint arXiv/0704.0839.
- [M3] G. Mikhalkin, *Tropical geometry and its applications*, International Congress of Mathematicians, volume II, Eur. Math. Soc. (2006), 827–852.
- [N] T. Nishinou, *Correspondence theorems for tropical curves*, preprint arXiv/0912.5090.
- [NS] T. Nishinou, B. Siebert, *Toric degenerations of toric varieties and tropical curves*, Duke Math. J. 135 (2006), no. 1, 1–51.
- [P] R. Pandharipande, *Counting elliptic plane curves with fixed  $j$ -invariant*. Proc. AMS 125 (1997), 3471–3479.
- [Sh] E. Shustin, *A tropical approach to enumerative geometry*, Algebra i Analiz 17 (2005), no. 2, 170–214 (English translation: St. Petersburg Math. J. 17 (2006), 343–375).

- [Sp1] D. Speyer, *Tropical Geometry*, Phd thesis, University of California, Berkeley (2005).
- [Sp2] D. Speyer, *Uniformizing tropical curves i: Genus zero and one*, preprint math.AG/0711.2677.
- [SS] D. Speyer, B. Sturmfels, *The tropical Grassmannian*, Adv. Geom. 4 (2004), 389–411.
- [ST] E. Shustin, I. Tyomkin, *Patchworking singular algebraic curves I*, Israel J. Math. 151 (2006), 125–144.
- [T] I. Tyomkin, *Tropical geometry and correspondence theorems via toric stacks*, preprint math.AG/1001.1554.
- [V] M. Vigeland, *The group law on a tropical elliptic curve*, preprint math.AG/0411485.



## Academic profile

|               |  |
|---------------|--|
| 11/09/1983    | Born in Lima, Peru   |
| 2003          | University-entrance diploma (Abitur) at Privates Gymnasium Abtei Mariensatt, Streithausen, Germany                     |
| since 04/2004 | Study of Mathematics at the TU Kaiserslautern, Germany   |
| 08/2007       | Diplom in Mathematics, TU Kaiserslautern   |
| since 09/2007 | Study of Mathematics at the Université de Strasbourg, France   |
| since 10/2007 | Ph.D. studies with Prof. Dr. Andreas Gathmann, TU Kaiserslautern and Prof. Dr. Ilia Itenberg, Université de Strasbourg |