

Geometric representations of the braid groups

Fabrice Castel

January 2010

Abstract:

Let us denote by $\Sigma_{g,b}$ the orientable connected compact surface of genus g with b boundary components. In this paper, we study the morphisms from the braid group with $n \geq 6$ strands \mathcal{B}_n in the mapping class group $\mathcal{PMod}(\Sigma_{g,b})$ (preserving each boundary component) with the conditions $g \leq n/2$ and $b \geq 0$.

We prove that under these conditions, the morphisms are either *cyclic morphisms*, that is to say, their images are cyclic groups, or *transvections of monodromy morphisms*, that is to say, up to multiplication by an element in the centralizer of the image, the image of a standard generator of \mathcal{B}_n is a Dehn twist, and the images of two consecutive standard generators are two Dehn twists along two curves intersecting in one point.

As a corollary, we get different results for three families of groups: the braid groups \mathcal{B}_n for all integers n greater than or equal to 6, the mapping class groups $\mathcal{PMod}(\Sigma_{g,b})$ (preserving each boundary component) and the mapping class groups $\mathcal{Mod}(\Sigma_{g,b}, \partial\Sigma_{g,b})$ (preserving pointwise the boundary), for all $g \geq 2$ and all $b \geq 0$. For each statement involving the mapping class group, we shall study both cases: when the boundary is fixed pointwise, and when each boundary component is fixed setwise.

Thus for each of these three families, we will describe precisely the structure (always remarkable) of the endomorphisms, we will determine the injective endomorphisms, the automorphisms and the outer automorphism group. We will also describe the set of morphisms between braid groups $\mathcal{B}_n \rightarrow \mathcal{B}_m$ with $m \leq n + 1$ and the set of all morphisms between mapping class groups of surfaces (possibly with boundary) whose genus (greater than or equal to 2) differ by at most one.

Keywords: surface, mapping class group, braid group, representation, group action, surface diffeomorphism, Nielsen Thurston's classification, graph theory.

Mathematics Subject Classification 20F38, 57M99, (primary) 57N05, 20F36, 20E36 (secondary).

Contents

1	Introduction	5
1.1	Presentation of the main notions	5
1.2	Statements of the theorems	7
1.3	Outline	8
1.4	Corollaries	9
1.4.1	Injectivity of the morphisms from \mathcal{B}_n in the mapping class group	9
1.4.2	Morphisms between braid groups	10
1.4.3	Morphisms between mapping class groups	11
1.4.4	Endomorphisms of the mapping class group	16
I	PRELIMINARIES	18
2	Surfaces, curves and subsurfaces	18
2.1	Isotopy classes of sets of curves	19
2.2	Definitions	23
3	Mapping class group	28
3.1	Some different definitions of the mapping class group	28
3.2	Dehn twists	29
3.3	The periodic mapping classes	34
3.3.1	The periodic mapping classes on surfaces with nonempty boundary	35
3.3.2	Maximal order of periodic mapping classes and of finite groups according to the surface.	38
3.4	Pseudo-Anosov mapping classes	42
3.5	The theory of Pseudo-Anosov diffeomorphisms.	43
3.6	The reducible mapping classes: Thurston's theory and the essential reduction system	47
4	Braid groups	54
4.1	The braid group seen in a geometric way	54
4.2	The braid group as an Artin group	55
4.3	The braid group as the mapping class group of the punctured disk; the braid twists	58
4.4	The braid group as the symmetric mapping class group; an embedding from \mathcal{B}_n in $\mathcal{M}od(\Sigma, \partial\Sigma)$	60
II	GEOMETRIC MORPHISMS FROM THE BRAID GROUP AND COROLLARIES	69
5	The morphisms between braid groups and mapping class groups, Theorem 1	70
5.1	Cyclic morphisms, monodromy morphisms and transvections	70
5.2	Statement of the main theorem	73
5.3	From $\text{Hom}(\mathcal{B}_n, \mathcal{P}\mathcal{M}od(\Sigma))$ to $\text{Hom}(\mathcal{B}_n, \mathcal{M}od(\Sigma, \partial\Sigma))$	73
5.4	Transvections of monodromy morphisms	77

6	Corollaries of Theorem 1	80
6.1	Injectivity of the morphisms from \mathcal{B}_n in the mapping class group	80
6.2	Morphisms between braid groups.	84
6.3	Morphisms between mapping class groups	89
6.4	Endomorphisms of the mapping class group	118
III PROOF OF THE MAIN THEOREM		123
7	Morphisms from \mathcal{B}_n in the mapping class group of a holed sphere; peripheral curves	125
7.1	Morphisms from \mathcal{B}_n in the mapping class group of a genus-0 surface	126
7.2	Peripheral curves	127
8	Irreducible morphisms from \mathcal{B}_n in $\mathcal{PMod}(\Sigma)$ with $n \geq 6$	130
8.1	Cardinalities of some abelian subgroups of $\rho(\mathcal{B}_n)$	131
8.2	Periodic morphisms from \mathcal{B}_n in $\mathcal{PMod}(\Sigma_{g,b})$, $b \geq 0$	135
8.3	Pseudo-Anosov morphisms from \mathcal{B}_n in $\mathcal{PMod}(\Sigma_{g,b})$, $b \geq 0$	138
9	Properties of the curves of $\sigma(\mathcal{G})$; the special curves $\sigma_s(\mathcal{G})$	142
9.1	Outline of the section and proved results	142
9.2	Action of \mathcal{B}_n on the simplexes of curves	144
9.3	Specificities of the action of \mathcal{J} on \mathcal{G}	147
9.4	Partition of $\sigma(\mathcal{G})$: Proposition 9.4	160
9.5	Stability and existence results	162
9.6	Summary of the present section	166
10	The special curves are not separating	168
10.1	Outline of the section	168
10.2	The subgroup \mathcal{H} of \mathcal{B}_n and its action on the subset \mathcal{X} of \mathcal{G}	168
10.3	Proof of Proposition 10.1	169
11	Description of $\sigma(\mathcal{X})$ in Σ	176
11.1	Outline of the section	176
11.2	Action of \mathcal{H} on \mathcal{X} and \mathcal{H} -colorations	179
11.3	Description of the embedding of $\sigma_s(\mathcal{X})$ in Σ	181
11.4	Description of $\sigma_n(\mathcal{G})$ and of $\sigma(\mathcal{X})$ in Σ	188
12	Expression of the mapping classes of \mathcal{G}	193
12.1	Outline of the section	193
12.2	The morphism $\hat{\rho}$ is a transvection of monodromy morphism	194
12.3	The morphism ρ is a transvection of monodromy morphism	203
13	Proof of Theorem 1	206
14	Discussion on the hypotheses of Theorem 1	208
14.1	Case where $n = 3$ and $\Sigma = \Sigma_{1,1}$	208
14.2	Case where $n = 3$ and $\Sigma = \Sigma_{1,b}$ with $b \geq 2$	209
14.3	Case where $n = 4$	210
14.4	Case where $n = 5$	212

14.5 When the integer g is greater than $\frac{n}{2}$ 212

IV REFERENCES 214

15 References 214

1 Introduction

1.1 Presentation of the main notions

Mapping class groups

The *mapping class group* $\mathcal{M}\text{od}(\Sigma)$ of an orientable surface Σ , is defined as the group of isotopy classes of orientation-preserving diffeomorphisms of Σ , so that we can write:

$$\mathcal{M}\text{od}(\Sigma) = \pi_0(\text{Diff}^+(\Sigma)).$$

If Σ has several connected components, then they may be permuted by elements of $\mathcal{M}\text{od}(\Sigma)$. Several closely related groups can be derived from this first definition:

- The *extended mapping class group* of Σ , denoted by $\mathcal{M}\text{od}^\diamond(\Sigma)$, is the group of isotopy classes of *all* diffeomorphisms of Σ (they may inverse Σ 's orientation). The group $\mathcal{M}\text{od}(\Sigma)$ is an index two normal subgroup of $\mathcal{M}\text{od}^\diamond(\Sigma)$.
- The *mapping class group of Σ that preserves each boundary component*, denoted by $\mathcal{P}\mathcal{M}\text{od}(\Sigma)$, is defined as the group of isotopy classes of all orientation-preserving diffeomorphisms preserving each boundary component of Σ setwise and preserving each connected component of Σ setwise.
- The *mapping class group of Σ relatively to the boundary*, denoted by $\mathcal{M}\text{od}(\Sigma, \partial\Sigma)$, is defined as the group of isotopy classes of all orientation-preserving diffeomorphisms preserving pointwise each boundary component of Σ . In this definition, isotopies are required to preserve pointwise each boundary component, too.
- Some other groups close to these ones will be introduced in the text.

Throughout this paper, $\Sigma = \Sigma_{g,b}$ will be an orientable connected surface of genus g with b boundary components. We will be mainly interested by the mapping class group $\mathcal{P}\mathcal{M}\text{od}(\Sigma)$. A lifting lemma (namely Proposition 5.12) in Section 5 will allow us to adapt these results to the mapping class groups $\mathcal{M}\text{od}(\Sigma, \partial\Sigma)$.

Historical context

The study of the mapping class groups was initiated in the 1920s by M. Dehn [D], [D1], [D2] and J. Nielsen [Ni1], [Ni2], [Ni3]. Although their work had some common themes, in general their approaches were fairly different. M. Dehn was interested in the properties of the mapping class group as a whole, addressing, for example, such questions as the existence of a finite set of generators. He developed and exploited an important tool for this purpose: the action of the mapping class group on the set of isotopy classes of all circles on the surface. J. Nielsen, in the other hand, was mainly interested in understanding the fine structure of the individual elements of the mapping class group. His methods draw heavily on hyperbolic geometry (a tool also favored by M. Dehn). For quite a while, the work of both M. Dehn and J. Nielsen was apparently forgotten. The ideas of M. Dehn related to the arithmetic field of a surface found a natural continuation in the ideas of W. Harvey [Ha1], [Ha2] about the *complex of curves* of a surface, which is nothing else but the arithmetic field turned into a simplicial complex in a natural way. A closely related object was considered in an influential article of A. Hatcher and W. Thurston [HatT]. The ideas of J. Nielsen were partially rediscovered, extended and brought to an essentially complete form by W. Thurston in his theory of surface diffeomorphisms [T],

[BiCa], [FLP]. Later on, his theory was applied also to the structure of the mapping class group and not only to its individual elements.

J. Birman, A. Lubotski and J. McCathy (cf. [BiLuMc]) as well as N.V. Ivanov (cf. [Iv]) have given to Thurston's theory its final form thanks to a new helpful definition: the *canonical reduction system* for every abelian subgroup of the mapping class group. For instance the canonical reduction system allowed them to determine the maximal rank of the abelian subgroups of the mapping class group of a connected surface, which is equal to $3g - 3 + b$ where g is the genus of the surface and b is the number of boundary components.

The braid group

A way to go forward in this field is to look for other classic groups that would be included in the mapping class group. Let us consider the braid group on n strands, which we define through its *classic presentation* as follows:

$$\langle \tau_1, \tau_2, \dots, \tau_{n-1} \mid \begin{cases} \tau_i \tau_j = \tau_j \tau_i & \text{if } |i - j| \neq 1 \\ \tau_i \tau_j \tau_i = \tau_j \tau_i \tau_j & \text{if } |i - j| = 1 \end{cases} \rangle$$

The generators of this presentation are called the *standard generators of the group* \mathcal{B}_n . Because of this, we say that two elements a and b of any group satisfy a *braid relation* if the equality $aba = bab$ holds.

Geometric representations

A *geometric representation* of a group G (in this paper, G will always be a braid group) is a morphism from G to the mapping class group of some surface $\Sigma_{g,b}$. The aim of this paper is to describe all geometric representations of the braid group. The only hypothesis is that the number n of strands of the braid group \mathcal{B}_n and the genus g of a surface $\Sigma_{g,b}$ must satisfy:

$$g \leq \frac{n}{2}$$

whereas b is any positive integer, possibly zero, as long as the surface $\Sigma_{g,b}$ is of negative Euler characteristic.

One family of mapping classes plays a crucial role in the description of the representations of \mathcal{B}_n in $\mathcal{PMod}(\Sigma_{g,b})$: the *Dehn twists*.

Dehn twists

Given a non-homotopically trivial curve a in $\Sigma \setminus \partial\Sigma$, let \mathcal{V} be a compact tubular neighbourhood of a in Σ and ϕ be a positive homeomorphism from \mathcal{V} to the annulus $\mathbb{A} = [0, 1] \times S^1$ with the product orientation. Let us define the homeomorphism

$$D : \begin{array}{ccc} \mathbb{A} = [0, 1] \times S^1 & \longrightarrow & \mathbb{A} = [0, 1] \times S^1 \\ (t, e^{i\theta}) & \longmapsto & (t, e^{i(\theta+2\pi t)}) \end{array} .$$

The *Dehn twist along the curve* a , denoted by T_a , is the isotopy class of the homeomorphism equal to the identity outside from \mathcal{V} and equal to $\phi^{-1}D\phi$ on \mathcal{V} . As ϕ is unique up to isotopy, T_a is well defined (cf. Figure 1). Moreover, the definition of T_a depends only on the isotopy class of a . By abuse of language, when d is a boundary component of Σ , we speak about the *Dehn twist along* d although we mean actually a Dehn twist along a curve homotopic to d and included in $\Sigma \setminus \partial\Sigma$.

Dehn twists verify the well-known following property (cf. for example [FaMa], section 2.3):

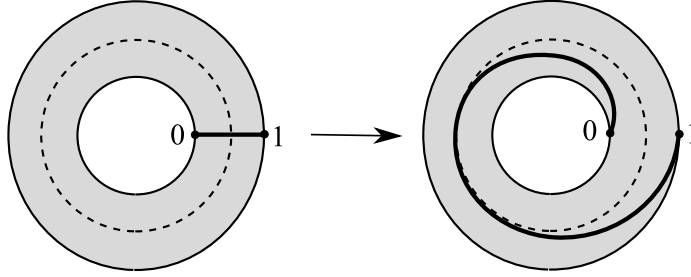

Figure 1: Definition of the (left) Dehn twist.

Lemma 1.1. *Let a and b be two non-homotopically trivial and non-homotopic curves. Then (i) the Dehn twists T_a and T_b commute if and only if there exist two disjoint curves a' and b' isotopic to a and b respectively; (ii) the Dehn twists T_a and T_b verify a braid relation if and only if there exist two curves a' and b' , isotopic to a and b respectively, that intersect transversally in exactly one point. \square*

We will show that all the geometric representations of \mathcal{B}_n whose images are noncyclic can be expressed using the *monodromy representations*.

1.2 Statements of the theorems

Cyclic representations and monodromy representations of \mathcal{B}_n

Definition 1.2 (Cyclic representations of \mathcal{B}_n).

A representation of \mathcal{B}_n (or a morphism from \mathcal{B}_n) in a group is said to be *cyclic* if its image is cyclic.

It is easy to see that a representation of \mathcal{B}_n is cyclic if and only if all the standard generators of \mathcal{B}_n have the same image.

Definition 1.3 (Monodromy representations of \mathcal{B}_n).

A *monodromy representation* of \mathcal{B}_n (or a *monodromy morphism* from \mathcal{B}_n in the mapping class group of a surface) will be a geometric representation of \mathcal{B}_n which sends the different standard generators of \mathcal{B}_n on distinct Dehn twists.

In accordance with Lemma 1.1, a monodromy representation of \mathcal{B}_n can be characterized by the data of an ordered $(n-1)$ -tuple of curves $(a_1, a_2, \dots, a_{n-1})$ such that for all $i, j \in \{1, \dots, n-1\}$, the curves a_i and a_j are disjoint when $|i-j| \neq 1$, and intersect in exactly one point when $|i-j| = 1$.

We would like to answer to the following questions, where we take $\mathcal{PMod}(\Sigma)$ or $\mathcal{Mod}(\Sigma, \partial\Sigma)$ as definitions for the mapping class group: Which are the braid groups that can be embedded in the mapping class of a given surface? How are these braid groups embedded? What about non-injective morphisms from braid groups to mapping class groups? We completely answer to these questions when the genus g of the surface Σ and the number n of strands of the considered braid group satisfy $g \leq \frac{n}{2}$. Section 14 deals with situations that escape from these conditions.

We first answer to the third question by Theorems 1 and 2 (see below), whose statements employs the concept of *transvection*.

Definition 1.4 (Transvection of a representation of \mathcal{B}_n).

Let n be an integer greater than or equal to 3. Let G be any group, ρ a morphism from \mathcal{B}_n to G and w an element lying in the centralizer of $\rho(\mathcal{B}_n)$ in G . The *transvection of ρ with direction w* is the morphism denoted by $L_w(\rho)$ and defined on the standard generators τ_i , $i \in \{1, 2, \dots, n-1\}$ of the braid group by setting:

$$L_w(\rho)(\tau_i) = \rho(\tau_i) w.$$

Theorem 1 (Morphisms from \mathcal{B}_n to $\mathcal{P}\text{Mod}(\Sigma)$ with $n \geq 6$).

Let n be an integer greater than or equal to 6 and Σ a surface $\Sigma_{g,b}$ with $g \leq \frac{n}{2}$. Any morphism ρ from \mathcal{B}_n to $\mathcal{P}\text{Mod}(\Sigma)$ is either cyclic, or is a transvection of monodromy morphism. In addition, such transvections of monodromy morphisms exist if and only if $g \geq \frac{n}{2} - 1$.

This result still holds when we consider $\text{Mod}(\Sigma, \partial\Sigma)$ instead of $\mathcal{P}\text{Mod}(\Sigma)$:

Theorem 2 (Morphisms from \mathcal{B}_n to $\text{Mod}(\Sigma, \partial\Sigma)$ with $n \geq 6$).

Let n be an integer greater than or equal to 6 and Σ a surface $\Sigma_{g,b}$ with $g \leq \frac{n}{2}$. Then any morphism $\tilde{\rho}$ from \mathcal{B}_n to $\text{Mod}(\Sigma, \partial\Sigma)$ is cyclic, or it is a transvection of monodromy morphism. Moreover, such transvections of monodromy morphisms exist if and only if $g \geq \frac{n}{2} - 1$.

Remark. This way to systematically look for all the morphisms from \mathcal{B}_n to another family of groups has already been undertaken by E. Artin (cf. [At3]) and V. Lin (cf. [Ln2]), where the target group was the symmetric group \mathfrak{S}_m with $m \leq n$ (Artin, 1947) and then with $m \leq 2n$ (Lin, 1970-2004).

1.3 Outline

This paper contains three parts:

Part 1: Sections 2-4.

In this preliminary part, we present the objects and the main tools that we will need. We have gathered here some general results about isotopy classes of curves and of subsurfaces (Section 2), on the mapping class groups (Section 3) and on braid groups (Section 4). Many results that are presented in this part are known by experts but do not exist in the literature; some have been adapted or completed; some are new. The reader familiar with mapping class groups for example can skip the concerned section and come back punctually to it later when necessary.

Part 2: Sections 5-6.

These two sections are devoted to the corollaries of the main theorem (Theorem 1). In Section 5, we introduce different types of geometric morphisms from the braid groups, and we establish some links between them, in order to prepare the ground for Section 6. In Section 6, corollaries of Theorem 1 will be stated and proved.

Part 3: Sections 7-14.

This is the main part of this paper. It is devoted to the demonstration of Theorem 1. We prove it first when the number n of strands of B_n is even. Then, the case when n is odd can be deduced easily. Our main tools are the canonical reduction system (see Definitions 3.37 and 3.39) of the images of the standard generators of B_n in the mapping class group, and the simultaneous action of B_n on itself and on these curve systems. We end this part with a discussion on the hypotheses of Theorem 1 and provide some counter-examples when we modify them.

1.4 Corollaries

After having stated Theorems 1 and 2, let us present their corollaries:

- description of injective morphisms from B_n to $\mathcal{M}od(\Sigma, \partial\Sigma)$ or to $\mathcal{P}\mathcal{M}od(\Sigma)$;
- description of morphisms from B_n to B_m with $m \leq n + 1$;
- description of morphisms between mapping class groups of two possibly different surfaces;
- endomorphisms and automorphisms of the mapping class group of a surface.

All these results are new. However, they have similarities with already existing theorems due to Ivanov and McCarthy (injective morphisms between mapping class groups), Dyer and Grossman (automorphisms of the braid groups), Bell and Margalit (injective endomorphisms of the braid groups). We will carefully detail the differences between existing theorems and our results. One of the interests of this paper is to gather these results as consequences of one single main result. The major improvement of our results is that we deal with morphisms instead of injective morphisms.

1.4.1 Injectivity of the morphisms from B_n in the mapping class group

The first natural question coming after having stated Theorems 1 and 2 consists in asking which morphisms are injective.

Definition 1.5 (The surface $\Sigma(\rho)$ included in Σ).

Let ρ be a transvection of monodromy morphism from B_n in the mapping class group of a surface Σ . Then, there exists a $(n - 1)$ -chain of curves $(a_i, 1 \leq i \leq n - 1)$ in Σ , an integer $\varepsilon \in \{\pm 1\}$ and a mapping class W of Σ fixing each curve a_i so that for all i , W commutes with T_{a_i} and we have $\rho(\tau_i) = T_{a_i}^\varepsilon W$. We denote the tubular neighbourhood of the union $\bigcup_{i \leq n-1} a_i$ by $\Sigma(\rho)$.

The surface $\Sigma(\rho)$ allow us to characterize the injectivity of the transvections of monodromy morphisms.

Theorem 3 (Injectivity of the morphisms from braid groups in the mapping class group).

Let n be an integer greater than or equal to 6 and Σ a surface $\Sigma_{g,b}$ with $g \leq \frac{n}{2}$. Let ρ be a morphism from \mathcal{B}_n in $\text{Mod}(\Sigma, \partial\Sigma)$ or in $\mathcal{P}\text{Mod}(\Sigma)$.

(i) Case of $\text{Mod}(\Sigma, \partial\Sigma)$. The morphism ρ is injective if and only if it is a transvection of monodromy morphism such that the boundary components of $\Sigma(\rho)$ do not bound any disk in Σ .

(ii) Case of $\mathcal{P}\text{Mod}(\Sigma)$. The morphism ρ is injective if and only if it is a transvection of monodromy morphism such that boundary components of $\Sigma(\rho)$ do not bound any disk in Σ and at least one boundary component of $\Sigma(\rho)$ is not isotopic to any boundary component of Σ .

1.4.2 Morphisms between braid groups

One of the corollaries of Theorem 1 consists in describing all morphisms from \mathcal{B}_n to itself or to \mathcal{B}_{n+1} . This is a new result. Historically, the first result in this direction was found in 1981: Dyer and Grossman computed the outer automorphisms group of \mathcal{B}_n . We show again this result for $n \geq 6$.

Theorem 1.6 (Dyer & Grossman, [DyGr], 1981).

Let n be an integer greater than or equal to 6. We have: $\text{Out}(\mathcal{B}_n) = \mathbb{Z}/2\mathbb{Z}$.

In 2000, R. Bell and D. Margalit (cf. [BeMa]) have shown better: they described not only the automorphisms of \mathcal{B}_n but all injective endomorphisms of \mathcal{B}_n as well as the injective morphisms from \mathcal{B}_n to \mathcal{B}_{n+1} . The description of these morphisms requires the definition of some special involution that we denote by Inv :

Notation 1.7 (The involution Inv). Given a group \mathcal{B}_n together with its standard presentation, the involutive automorphism that sends each standard generator on its inverse will be denoted by Inv .

Theorem 1.8 (R. Bell, D. Margalit, [BeMa], 2000). Let n be an integer greater than or equal to 4 and ρ an injective endomorphism of \mathcal{B}_n . Then, either ρ or $\text{Inv} \circ \rho$ is a transvection of some inner automorphism of \mathcal{B}_n . If ρ is now an injective endomorphism from \mathcal{B}_n to \mathcal{B}_{n+1} , then either ρ or $\text{Inv} \circ \rho$ is a transvection of the following morphism: an inner automorphism of \mathcal{B}_{n+1} precomposed by the canonical injection $\mathcal{B}_n \rightarrow \mathcal{B}_{n+1}$.

Their proof uses an algebraic characterization of the Dehn twists. The maximal rank of the abelian subgroups of \mathcal{B}_n plays a central role. That is why the considered morphisms have to be injective.

In this paper, we show that the noncyclic morphisms from \mathcal{B}_n to \mathcal{B}_m where $m \in \{n, n+1\}$, are the injective morphisms from \mathcal{B}_n to \mathcal{B}_m that R. Bell and D. Margalit have described. We also prove a theorem due to Lin in 1982, cf. [Ln1] page 765: if m is smaller than n , then the morphisms from \mathcal{B}_n to \mathcal{B}_m are cyclic.

These results are summed up in Theorem 4. Its statement mentions a specific element Δ of \mathcal{B}_n : it is defined by $\Delta = \tau_1(\tau_2\tau_1) \dots (\tau_{n-1} \dots \tau_2\tau_1)$ and it is well-known that its square spans the center of \mathcal{B}_n (see Definition 4.6 and Theorem 4.7).

Theorem 4 (Morphisms between braid groups).

Let n and m be two integers such that $n \geq 6$ and $3 \leq m \leq n + 1$.

- (i) ([Ln1], 1982) Case where $m < n$: any morphism φ from \mathcal{B}_n in \mathcal{B}_m is cyclic.
- (ii) Case where $m = n$: any noncyclic morphism φ from \mathcal{B}_n in \mathcal{B}_n is a transvection of inner automorphism possibly precomposed by the involution Inv : there exist $\gamma, v \in \mathcal{B}_n$ and $\varepsilon = \pm 1$ such that for all $i \leq n - 1$, we have:

$$\varphi(\tau_i) = \gamma \tau_i^\varepsilon \gamma^{-1} v.$$

Moreover, v is a multiple of Δ^2 .

- (iii) Case where $m = n + 1$: let us consider the group \mathcal{B}_n as the subgroup of \mathcal{B}_{n+1} spanned by the $n - 1$ first standard generators of \mathcal{B}_{n+1} . Then, any morphism φ from \mathcal{B}_n in \mathcal{B}_{n+1} is the restriction to \mathcal{B}_n of a morphism from \mathcal{B}_{n+1} in itself, up to transvection. According to item (ii), if φ is not cyclic, then there exist $\gamma, v \in \mathcal{B}_{n+1}$ and $\varepsilon = \pm 1$ such that for all $i \leq n - 1$, we have:

$$\varphi(\tau_i) = \gamma \tau_i^\varepsilon \gamma^{-1} v.$$

Moreover, v belongs to the centralizer of $\{\gamma \xi \gamma^{-1}, \xi \in \mathcal{B}_n\}$ in \mathcal{B}_{n+1} .

- (iv) All the above noncyclic morphisms are injective.

1.4.3 Morphisms between mapping class groups

From Theorems 1 and 2, we can also deduce some results about morphisms between mapping class groups. So far, the main result in this topic was given by N.V. Ivanov and J. McCarthy in 1999:

Theorem 1.9 (Ivanov, McCarthy, [IvMc], 1999).

Let Σ be a surface $\Sigma_{g,b}$ and Σ' be a surface $\Sigma_{g',b'}$ with $g \geq 2$ and $(g', b') \neq (2, 0)$, and such that the inequality

$$|(3g - 3 + b) - (3g' - 3 + b')| \leq 1$$

holds. If there exists an injective morphism ρ from $\text{Mod}(\Sigma)$ in $\text{Mod}(\Sigma')$, then Σ' is homeomorphic to Σ and ρ is an automorphism induced by a possibly not orientation-preserving diffeomorphism from Σ in Σ' .

They have also completed this theorem by dealing with some cases when $(g', b') = (2, 0)$ or when $g = 1$. When $\Sigma' = \Sigma$, this theorem tells us that the mapping class group is co-Hopfian, that is, any injective endomorphism of $\text{Mod}(\Sigma)$ is an automorphism. The computation of $\text{Out}(\text{Mod}(\Sigma))$ also follows from this theorem.

The proof of this theorem is based on an algebraic characterization of the Dehn twists, which is possible only if the maxima of the ranks of the abelian subgroups of $\text{Mod}(\Sigma)$ and $\text{Mod}(\Sigma')$ differ from at most one. The proof then also requires that the considered morphisms are rank-preserving, hence the considered morphisms have to be injective.

In this paper, instead of using the rank of abelian sub-groups embedded in the mapping class group, we have used braid groups embedded in the mapping class group. Since braid groups and mapping class groups are very similar (in a mysterious and still not well understood way),

we get strong results: morphisms do not need anymore to be injective and the hypotheses are reasonably weak. Let us compare the results of Ivanov and McCarthy with ours.

Results of Ivanov and McCarthy (1999) that are not covered in this paper:

- For any nonnegative integer m and for any ε in $\{0, 1\}$, there does not exist any injective morphism from $\mathcal{M}\text{od}(\Sigma_{g, b+3m})$ in $\mathcal{M}\text{od}(\Sigma_{g+m, b+\varepsilon})$, where $g \geq 2$ and $b \geq 0$. It is noticeable that the hypotheses allow the genus of the surface at the target to be arbitrary large with respect to the genus of the surface at the source!
- The elements of the considered mapping class groups can permute the boundary components.

Our results (2010) that are not covered by Ivanov and McCarthy:

- Full description of the morphisms from $\mathcal{M}\text{od}(\Sigma_{g, b}, \partial\Sigma_{g, b})$ in $\mathcal{M}\text{od}(\Sigma_{g', b'}, \partial\Sigma_{g', b'})$ where $g' < g$ and $g \geq 2$, whatever b and b' are. Precisely, all these morphisms are trivial or cyclic.
- Full description of the morphisms from $\mathcal{M}\text{od}(\Sigma_{g, b}, \partial\Sigma_{g, b})$ in $\mathcal{M}\text{od}(\Sigma_{g', b'}, \partial\Sigma_{g', b'})$ where $g' = g$ or $g' = g + 1$, and $g \geq 2$, whatever b and b' are. In these cases, there exist noncyclic morphisms, and only some of them are injective.
- We also prove these results in a slightly different frame: when the elements of mapping class group preserve each boundary component setwise instead of pointwise.

More precisely, in this paper, we focus on morphisms between two mapping class groups associated to the surfaces Σ and Σ' with genera g and g' such that $g \geq 2$ and $g' \leq g + 1$, and whatever their numbers of boundary components are. We shall thus describe the following sets:

- all the morphisms from $\mathcal{M}\text{od}(\Sigma, \partial\Sigma)$ in $\mathcal{M}\text{od}(\Sigma', \partial\Sigma')$ (cf. Theorems 5 and 6),
- all the morphisms from $\mathcal{P}\mathcal{M}\text{od}(\Sigma)$ in $\mathcal{P}\mathcal{M}\text{od}(\Sigma')$ (cf. Theorems 7 and 8),
- all the injective morphisms from $\mathcal{M}\text{od}(\Sigma, \partial\Sigma)$ in $\mathcal{M}\text{od}(\Sigma', \partial\Sigma')$ (cf. Theorem 9),
- all the injective morphisms from $\mathcal{P}\mathcal{M}\text{od}(\Sigma)$ in $\mathcal{P}\mathcal{M}\text{od}(\Sigma')$ (cf. Theorem 10).

Like Ivanov and McCarthy, we will mainly show that the non-trivial morphisms between mapping class groups are *induced by some embeddings* (the result is however slightly different when the genus of the surface Σ equals 2). Let us make our point clear:

Definition 1.10 (Morphisms from $\mathcal{M}\text{od}(\Sigma, \partial\Sigma)$ in $\mathcal{M}\text{od}(\Sigma', \partial\Sigma')$ induced by an embedding, and outer conjugations).

Let Σ and Σ' be two connected oriented surfaces. Let F be the isotopy class of a possibly non-orientation-preserving embedding from Σ in Σ' . Let Σ'' be the subsurface $F(\Sigma)$ of Σ' . We denote by \bar{F} a representative of F ; \bar{F} is a diffeomorphism of Σ in Σ'' . For any $A \in \mathcal{M}\text{od}(\Sigma, \partial\Sigma)$ and any representative $\bar{A} \in \text{Diff}^+(\Sigma, \partial\Sigma)$ of A , the product $\bar{F}\bar{A}\bar{F}^{-1}$ preserves the orientation of Σ'' and induces the identity on $\partial\Sigma''$ (which is equal to $\bar{F}\bar{A}\bar{F}^{-1}(\partial\Sigma)$), so $\bar{F}\bar{A}\bar{F}^{-1}$ belongs to $\text{Diff}^+(\Sigma'', \partial\Sigma'')$. The isotopy class of $\bar{F}\bar{A}\bar{F}^{-1}$ in $\mathcal{M}\text{od}(\Sigma'', \partial\Sigma'')$ depends only on F and A . However, there exists a canonical extension of $\mathcal{M}\text{od}(\Sigma'', \partial\Sigma'')$ in $\mathcal{M}\text{od}(\Sigma', \partial\Sigma')$. Let us denote by $\widetilde{\text{Ad}}_F(A)$ the image of the isotopy class of $\bar{F}\bar{A}\bar{F}^{-1}$ by this extension. The map $\widetilde{\text{Ad}}_F$ defined by:

$$\begin{array}{ccc} \widetilde{\text{Ad}}_F : \text{Mod}(\Sigma, \partial\Sigma) & \longrightarrow & \text{Mod}(\Sigma', \partial\Sigma') \\ & A & \longmapsto & \widetilde{\text{Ad}}_F(A) \end{array}$$

is a group morphism. Such a morphism will be called *the morphism from $\text{Mod}(\Sigma, \partial\Sigma)$ in $\text{Mod}(\Sigma', \partial\Sigma')$ induced by the embedding F* .

Let us insist on the fact that nothing is assumed on the embedding F : the image by F of a boundary component of Σ may bound a disk in Σ' , and the images by F of two boundary components of Σ may be isotopic in Σ' . Moreover, this embedding is allowed not to respect the orientations of Σ and Σ' .

When $\Sigma'' = \Sigma'$, we can identify Σ' and Σ so that the embedding F becomes an element of $\text{Mod}^\circ(\Sigma)$. The morphism $\widetilde{\text{Ad}}_F$ that we get is then an automorphism of $\text{Mod}(\Sigma, \partial\Sigma)$. In this case, $\widetilde{\text{Ad}}_F$ will be called an *outer conjugation by F* .

Before stating the theorems on morphisms between mapping class groups, we need to set some additional definitions. When necessary, we shall justify in Section 6 that they are valid definitions.

Definition 1.11 (Hyper-elliptic Involution).

In $\Sigma_{2,0}$, let \bar{H} be the angle π rotation over the axis δ in Figure 2. We denote by H the isotopy class of \bar{H} . This mapping class is called *the hyper-elliptic involution of $\text{Mod}(\Sigma_{2,0})$* .

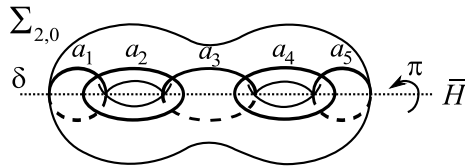

Figure 2: The mapping class H of $\text{Mod}(\Sigma_{2,0})$.

Definition 1.12 (Cyclic morphisms from $\text{Mod}(\Sigma_{2,b})$ in any given group).

A morphism from $\text{Mod}(\Sigma_{2,b})$ in any given group, with $b \geq 0$, is said to be *cyclic* if its image is cyclic.

Definition 1.13 (Transvection of a morphism from the mapping class group in any group).

Let Σ be a genus-2 surface, \mathcal{M} one of the mapping class groups $\mathcal{P}\text{Mod}(\Sigma)$ or $\text{Mod}(\Sigma, \partial\Sigma)$, and G any group. For any morphism Ψ from \mathcal{M} in G and for any element g belonging to the centralizer of $\Psi(\mathcal{M})$ in G such that $g^{10} = 1_G$, we will call *transvection of Ψ with direction g* the morphism Ψ' that associates $\Psi(T_a)g$ to any Dehn twist T_a along a non-separating curve a .

This definition is coherent, as we will see it in Section 6. Notice that a transvection with direction 1_G of a morphism is equal to this morphism.

We now turn to the statements of the theorems. We first deal with the mapping class group relatively to the boundary. Theorem 5 is an existence theorem about non-trivial morphisms between mapping class groups. It is completed by a Theorem 6 which provides a description of these morphisms.

Theorem 5 (Existence of non-trivial morphisms from $\text{Mod}(\Sigma, \partial\Sigma)$ in $\text{Mod}(\Sigma', \partial\Sigma')$).
Let Σ be a surface $\Sigma_{g,b}$ and Σ' a surface $\Sigma_{g',b'}$ with $g \geq 2$ and $g' \leq g + 1$.

- When $g = 2$, there exist some cyclic non-trivial morphisms from $\text{Mod}(\Sigma_{2,b}, \partial\Sigma_{2,b})$ in any mapping class group admitting a subgroup isomorphic to $\mathbb{Z}/2\mathbb{Z}$, $\mathbb{Z}/5\mathbb{Z}$ or $\mathbb{Z}/10\mathbb{Z}$. When $g \geq 3$, there does not exist any cyclic non trivial morphism.
- When $g \geq 2$, there exist some noncyclic morphisms from $\text{Mod}(\Sigma, \partial\Sigma)$ in $\text{Mod}(\Sigma', \partial\Sigma')$ if and only if one of the two following conditions is satisfied: $b \neq 0$ and $g' \geq g$, or $b = 0$ and Σ' is homeomorphic to Σ .

Theorem 6 (Morphisms from $\text{Mod}(\Sigma, \partial\Sigma)$ in $\text{Mod}(\Sigma', \partial\Sigma')$).

Let Σ be a surface $\Sigma_{g,b}$ and Σ' a surface $\Sigma_{g',b'}$ with $g \geq 2$ and $g' \in \{g, g + 1\}$, and such that $\Sigma' = \Sigma$ if $b = 0$. Any noncyclic morphism from $\text{Mod}(\Sigma, \partial\Sigma)$ in $\text{Mod}(\Sigma', \partial\Sigma')$ is a morphism induced by the isotopy class of an embedding from Σ in Σ' , or possibly a transvection with direction H (the hyper-elliptic involution of $\text{Mod}(\Sigma_{2,0})$) of such a morphism if $g = 2$ and $(g', b') = (2, 0)$. Moreover, if $b = 0$, the morphism induced by the isotopy class of an embedding from Σ in Σ' (up to transvection when $\Sigma = \Sigma' = \Sigma_{2,0}$) is an outer conjugation.

Let us now focus on the morphisms from $\mathcal{P}\text{Mod}(\Sigma)$ in $\mathcal{P}\text{Mod}(\Sigma')$. In most of the cases, they also can simply be expressed from *morphisms induced by an embedding*. We have first to define this term in the case of the morphisms from $\mathcal{P}\text{Mod}(\Sigma)$ in $\mathcal{P}\text{Mod}(\Sigma')$.

Definition 1.14 (Morphisms from $\mathcal{P}\text{Mod}(\Sigma)$ in $\mathcal{P}\text{Mod}(\Sigma')$ induced by an embedding, and outer conjugations).

Let Σ be a surface $\Sigma_{g,b}$ and Σ' a surface $\Sigma_{g',b'}$ with $g = g'$ and $b \geq b'$. Let F be the isotopy class of an embedding from Σ in Σ' such that F sends the boundary components of Σ on some boundary components of Σ' or on some trivial curves of Σ' (*trivial* means here isotopic to a point). We refer to these conditions on F by the symbol $(*)$. Let us emphasize on the fact that F may not respect the orientations of Σ and Σ' . Let $\Sigma'' = F(\Sigma)$. Let us denote by \bar{F} a representative of F which is then a diffeomorphism from Σ in Σ'' . For all $A \in \mathcal{P}\text{Mod}(\Sigma)$ and all representative $\bar{A} \in \text{Diff}^+(\Sigma)$ of A , the product $\bar{F}\bar{A}\bar{F}^{-1}$ preserves the orientation of Σ'' , so $\bar{F}\bar{A}\bar{F}^{-1}$ belongs to $\text{Diff}^+(\Sigma'')$. Since $g = g'$ and $b \geq b'$ and according to $(*)$, the complement of Σ'' in Σ' is a disjoint union of disks. Hence according to Alexander's Lemma, $\bar{F}\bar{A}\bar{F}^{-1}$ induces canonically, and up to isotopy, a diffeomorphism of Σ' . Let us denote by $\text{Ad}_F(A)$ the isotopy class of this diffeomorphism. Since \bar{A} preserves the boundary components of Σ , $\bar{F}\bar{A}\bar{F}^{-1}$ preserves the boundary components of Σ'' . But according to $(*)$, the set of boundary components of Σ'' is included in the set of boundary components of Σ' , so the boundary components of Σ' are preserved by $\text{Ad}_F(A)$. Finally, $\text{Ad}_F(A)$ belongs to $\mathcal{P}\text{Mod}(\Sigma')$. The map Ad_F defined by

$$\text{Ad}_F : \begin{array}{ccc} \mathcal{P}\text{Mod}(\Sigma) & \longrightarrow & \mathcal{P}\text{Mod}(\Sigma') \\ A & \longmapsto & \text{Ad}_F(A) \end{array}$$

is a group morphism. Such a morphism will be called *the morphism from $\mathcal{P}\text{Mod}(\Sigma)$ in $\mathcal{P}\text{Mod}(\Sigma')$ induced by the embedding F* .

When $\Sigma' = \Sigma$, according to $(*)$, we get $\Sigma'' = \Sigma'$, so the isotopy class F is invertible. Hence in this case, F is an element of $\text{Mod}^\circ(\Sigma)$. The obtained morphism Ad_F is then an automorphism of $\mathcal{P}\text{Mod}(\Sigma)$ that we will call the *outer conjugation by F* .

When each boundary component is not fixed pointwise but only setwise, Theorems 5 and 6 become Theorems 7 and 8.

Theorem 7 (Existence of noncyclic morphisms from $\mathcal{P}\text{Mod}(\Sigma)$ in $\mathcal{P}\text{Mod}(\Sigma')$).

Let Σ be a surface $\Sigma_{g,b}$ and Σ' a surface $\Sigma_{g',b'}$ with $g \geq 2$ and $g' \leq g + 1$.

- When $g = 2$ and only in this case, there exist some cyclic non-trivial morphisms from $\mathcal{P}\text{Mod}(\Sigma_{2,b})$ in any mapping class group that admits a subgroup isomorphic to $\mathbb{Z}/2\mathbb{Z}$, $\mathbb{Z}/5\mathbb{Z}$ or $\mathbb{Z}/10\mathbb{Z}$.
- When $g \geq 2$, there exist some noncyclic morphisms from $\mathcal{P}\text{Mod}(\Sigma)$ in $\mathcal{P}\text{Mod}(\Sigma')$ if and only if $g' = g$ and $b' \leq b$.

According to this statement, studying all noncyclic morphisms from $\mathcal{P}\text{Mod}(\Sigma)$ in $\mathcal{P}\text{Mod}(\Sigma')$ when $g' \leq g + 1$ can be reduced to studying them when $g' = g$ and $b' \leq b$. This is the aim of Theorem 8 below.

Theorem 8 (Morphisms from $\mathcal{P}\text{Mod}(\Sigma)$ in $\mathcal{P}\text{Mod}(\Sigma')$).

Let Σ be a surface $\Sigma_{g,b}$ and Σ' a surface $\Sigma_{g',b'}$ with $g \geq 2$, $g' = g$ and $b' \leq b$. Let Ψ be a noncyclic morphism from $\mathcal{P}\text{Mod}(\Sigma)$ in $\mathcal{P}\text{Mod}(\Sigma')$. Then there exists an embedding F from Σ in Σ' such that F sends the boundary components of Σ on some boundary components of Σ' or on some trivial curves of Σ' , and such that Ψ is the morphism Ad_F induced by the embedding F , or possibly the transvection by H (see Definition 1.11) of the morphism Ad_F if $g = 2$ and $(g', b') = (2, 0)$.

Among the morphisms between mapping class groups provided by Theorems 6 and 8, let us determine the injective ones.

Theorem 9 (Injections from $\text{Mod}(\Sigma, \partial\Sigma)$ in $\text{Mod}(\Sigma', \partial\Sigma')$).

Let Σ be a surface $\Sigma_{g,b}$ and Σ' a surface $\Sigma_{g',b'}$ with $g \geq 2$ and $g' \leq g + 1$. Then, a morphism from $\text{Mod}(\Sigma, \partial\Sigma)$ in $\text{Mod}(\Sigma', \partial\Sigma')$ is injective if and only if:

- when $b \neq 0$: if it is induced, up to transvection when $g = 2$, by an embedding F of Σ in Σ' such that F sends the boundary components of Σ on pairwise distinct curves in Σ' ;
- when $b = 0$ and $\Sigma' = \Sigma$: if it is not cyclic (it is then an outer conjugation, or possibly a transvection of an outer conjugation when $g = 2$).

Theorem 10 (Injections of $\mathcal{P}\text{Mod}(\Sigma)$ in $\mathcal{P}\text{Mod}(\Sigma')$).

Let Σ be a surface $\Sigma_{g,b}$ and Σ' a surface $\Sigma_{g',b'}$ with $g \geq 2$ and $g' \leq g + 1$. Then, a morphism from $\mathcal{P}\text{Mod}(\Sigma)$ in $\mathcal{P}\text{Mod}(\Sigma')$ is injective if and only if the two following conditions hold:

- the surfaces Σ and Σ' are homeomorphic,
- the morphism is an outer conjugation (i.e. an automorphism of the form Ad_F with $F \in \text{Mod}^\diamond(\Sigma)$ cf. Definition 6.5), or possibly the transvection with direction H of an outer conjugation when Σ' and Σ are homeomorphic to $\Sigma_{2,0}$.

1.4.4 Endomorphisms of the mapping class group

We complete the previous subsection by focusing on the injective morphisms from $\mathcal{M}\text{od}(\Sigma, \partial\Sigma)$ in $\mathcal{M}\text{od}(\Sigma', \partial\Sigma')$ when $\Sigma' = \Sigma$. In particular, we prove Ivanov and McCarthy's theorem stating that $\mathcal{P}\mathcal{M}\text{od}(\Sigma)$ is co-Hopfian (cf. [IvMc]). In addition, we give a complete proof of $\mathcal{M}\text{od}(\Sigma, \partial\Sigma)$ being co-Hopfian (cf. Theorem 11). We will see that when $b = 0$, the group $\mathcal{M}\text{od}(\Sigma, \partial\Sigma)$ satisfies a much stronger property (cf. item (i) of Theorems 11 and 12). As in the previous subsection, and since the center of $\mathcal{M}\text{od}(\Sigma_{2,0})$ is non-trivial, the case of the surface $\Sigma_{2,0}$ is special, and an independent theorem (cf. Theorem 12) is devoted to it.

Theorem 11 (Co-Hopfian property of $\mathcal{M}\text{od}(\Sigma, \partial\Sigma)$ and structure of $\text{Aut}(\mathcal{M}\text{od}(\Sigma, \partial\Sigma))$, where $\Sigma \neq \Sigma_{2,0}$).

Let Σ be a surface $\Sigma_{g,b}$ where $g \geq 2$ and $(g,b) \neq (2,0)$.

- (i) *The mapping class group $\mathcal{M}\text{od}(\Sigma, \partial\Sigma)$ is co-Hopfian, that is, the injections are automorphisms. Moreover, when $b = 0$, all the nontrivial morphisms from $\mathcal{M}\text{od}(\Sigma)$ are automorphisms.*
- (ii) *The map $\text{Ad} : \mathcal{M}\text{od}^\diamond(\Sigma) \rightarrow \text{Aut}(\mathcal{M}\text{od}(\Sigma, \partial\Sigma))$ is an isomorphism.*
- (iii) *The outer automorphism group $\text{Out}(\mathcal{M}\text{od}(\Sigma, \partial\Sigma))$ of $\mathcal{M}\text{od}(\Sigma, \partial\Sigma)$ is isomorphic to the direct product $\mathbb{Z}/2\mathbb{Z} \times \mathfrak{S}_b$, where \mathfrak{S}_b is the symmetric group on b elements.*

We turn now to the case of the surface $\Sigma_{2,0}$. The result is very different because of the exceptional non-trivial center of $\mathcal{M}\text{od}(\Sigma_{2,0})$. Indeed, the morphism $\text{Ad} : \mathcal{M}\text{od}^\diamond(\Sigma) \rightarrow \text{Aut}(\mathcal{M}\text{od}(\Sigma_{2,0}))$ is not injective anymore, nor surjective.

Theorem 12 (Co-Hopfian property of $\mathcal{M}\text{od}(\Sigma)$ and structure of $\text{Aut}(\mathcal{M}\text{od}(\Sigma))$, where $\Sigma = \Sigma_{2,0}$, McCarthy¹ [Mc1]).

Let Σ be the surface $\Sigma_{2,0}$. Let us recall that we denote by H the hyper-elliptic involution of $\mathcal{M}\text{od}(\Sigma)$ (cf. Definition 1.11). Let us denote by ℓ_H the transvection (cf. Definition 1.13) of the identity of $\text{Aut}(\mathcal{M}\text{od}(\Sigma))$ with direction H . Then:

- (i) *The mapping class group $\mathcal{M}\text{od}(\Sigma)$ is co-Hopfian. We have even better: all the noncyclic endomorphisms are automorphisms.*
- (ii) *The morphism ℓ_H of $\mathcal{M}\text{od}(\Sigma)$ is an involution, and any transvection with direction H of an outer conjugation coincides with the (commutative) composition of this outer conjugation with ℓ_H .*
- (iii) *There exists an orientation reversing involution K of $\mathcal{M}\text{od}^\diamond(\Sigma)$. The group spanned by Ad_K and ℓ_H is isomorphic to $\mathbb{Z}/2\mathbb{Z} \times \mathbb{Z}/2\mathbb{Z}$ and contains only outer automorphisms (except the identity of course).*
- (iv) *The restriction of the canonical morphism $\text{Aut}(\mathcal{M}\text{od}(\Sigma)) \rightarrow \text{Out}(\mathcal{M}\text{od}(\Sigma))$ to $\langle \text{Ad}_K, \ell_H \rangle$ is an isomorphism. In particular, $\text{Out}(\mathcal{M}\text{od}(\Sigma)) = \mathbb{Z}/2\mathbb{Z} \times \mathbb{Z}/2\mathbb{Z}$.*

¹In [Mc1], McCarthy shows items (ii) - (v) of this theorem. Item (i) however handles with endomorphisms of $\mathcal{M}\text{od}(\Sigma_{2,0})$. This approach is new.

(v) The map $\text{Ad} : \text{Mod}^\diamond(\Sigma) \rightarrow \text{Aut}(\text{Mod}(\Sigma))$ has the following kernel and cokernel, given in the following exact sequence:

$$1 \rightarrow \langle H \rangle \rightarrow \text{Mod}^\diamond(\Sigma) \xrightarrow{\text{Ad}} \text{Aut}(\text{Mod}(\Sigma)) \rightarrow \langle \overline{\ell_H} \rangle \rightarrow 1,$$

where $\overline{\ell_H}$ is the image of ℓ_H in the quotient of $\text{Aut}(\text{Mod}(\Sigma))$ by $\text{Ad}(\text{Mod}^\diamond(\Sigma))$.

I. Preliminaries

We present in this part the main notions that we will use through out this paper:

- curves, surfaces and subsurfaces in Section 2,
- the mapping class group in Section 3,
- the braid group in Section 4.

2 Surfaces, curves and subsurfaces

Let us begin by specifying what we mean with *surface*.

Definition 2.1 (Surfaces).

In this paper, a *surface* is a compact, orientable and oriented manifold of dimension 2 whose each connected component is of negative Euler characteristic. It may have or not boundary components. We define by $\partial\Sigma$ the topological boundary of Σ , that is to say Σ minus its interior. We define by $\Sigma_{g,b}$ the connected surface of genus g with b boundary components. Implicitly, g and b satisfy $2 - 2g - b \leq -1$.

Outline:

This section aim to present the main topological ingredients associated with surfaces: curves and subsurfaces. We will be mostly interested by isotopy classes of curves and subsurfaces instead of curves and subsurfaces themselves.

- In Subsection 2.1, we show that some objects associated with curves and subsurfaces actually depend only on their isotopy classes. Propositions 2.12 and 2.14 go in this sens. Using definitions of Subsection 2.2, we can sum them up by the following proposition (accessible to the reader familiar with definitions of Subsection 2.2):

Proposition 2.2. *Let Σ be a surface. Given a set \mathcal{A} of (isotopy classes of) curves, there exists a set of representatives of the curves of \mathcal{A} which are in tight position. Moreover, if \mathcal{A} is without triple intersection, such a set of representatives is unique up to strong isotopy.*

- In Subsection 2.2, we give new definitions of curves, subsurfaces, isotopies which will be used through out this paper.

2.1 Isotopy classes of sets of curves

Let us begin by defining what *curve* means for us (cf. Definition 2.3). Actually, this first definition is temporary: from Subsection 2.2 on, it will be replaced by Definition 2.15 which will be used in the next sections.

Definition 2.3 (Temporary definitions). Let Σ be a surface.

- A *curve* will be in this subsection a compact, connected smooth 1-manifold in Σ that is not the boundary of any disk in Σ .
- Two curves a and b are said to be *isotopic* if there exists a continuous path of curves from a to b . When a and b are included in $\Sigma \setminus \partial\Sigma$, this is equivalent to say that there exists a path of diffeomorphisms of Σ , which we denote by $(H_t)_{0 \leq t \leq 1}$ and that satisfies $H_0 = \text{Id}$ and $H_1(a) = b$. Being isotopic for curves is an equivalence relation.
- The *geometric intersection number of two curves a and b* , denoted by $I(a, b)$, is the minimum number of intersection points between a and a curve b' that is transversal to a and isotopic to b :

$$I(a, b) = \min\{|a \cap b'|, b' \simeq b\}.$$

- Let \mathcal{A} be a finite set of curves in Σ . We will say that the curves of \mathcal{A} are in *tight position* if, for any pair (a, b) of distinct curves in \mathcal{A} , the number of intersection points between a and b verify $|a \cap b| = I(a, b)$.

Two different notions of *isotopy class of set of curves* can be derived from the definition of isotopy class of curve:

Definition 2.4 (Strong and weak isotopy between sets of curves).

Let Σ be a surface, r an integer greater than or equal to 1, and $\mathcal{A} = \{a_1, a_2, \dots, a_r\}$ a set of pairwise non-isotopic, disjoint curves. Let $\mathcal{B} = \{b_1, b_2, \dots, b_r\}$ be another set of curves having the same properties. Then \mathcal{A} and \mathcal{B} are said to be:

- *weakly isotopic* if, up to permutation, for each $i \leq r$, the curves a_i and b_i are isotopic. The weak isotopy class of \mathcal{A} will be denoted by $[\mathcal{A}]$, so we have $[\mathcal{A}] = \{[a_1], [a_2], \dots, [a_r]\}$.
- *strongly isotopic* if there exists a path of diffeomorphisms of Σ which we denote by $(H_t)_{0 \leq t \leq 1}$ such that $H_0 = \text{Id}$ and such that, up to permutation, for each integer i smaller than or equal to r , we have $H_1(a_i) = b_i$. The strong isotopy class of \mathcal{A} will be denoted by $\llbracket \mathcal{A} \rrbracket$ or $\llbracket a_1, a_2, \dots, a_r \rrbracket$.

Case of simplexes.

Definition 2.5 (Temporary definition: curve simplex).

Let Σ be a surface. A set of pairwise non-homotopic, disjoint curves in Σ will be called a *curve simplex* (with reference to the curve complex defined later).

Given a surface Σ , an integer r greater than or equal to 1 and a set $\mathcal{A} = \{a_1, a_2, \dots, a_r\}$ such that each pair $\{a_i, a_j\}$ of curves in \mathcal{A} satisfies $I(a_i, a_j) = 0$, we show easily by induction on r that for all integers i smaller than or equal to r , there exists a curve a'_i isotopic to a_i such that the curves a'_1, a'_2, \dots, a'_r are pairwise disjoint. In other words, we have the following lemma:

Lemma 2.6. *Let Σ be a surface. Let \mathcal{A} be a set of pairwise non-isotopic curves in Σ such that each pair of curves a and b in \mathcal{A} satisfy $I(a, b) = 0$. Then the weak isotopy class of \mathcal{A} contains a simplex.*

We do not prove Lemma 2.6 now because we'll prove later in this section a more general result (see Proposition 2.12). We can complete Lemma 2.6 by a uniqueness result which will also be proved later in a more general frame in Proposition 2.14:

Lemma 2.7. *Let Σ be a surface. Let \mathcal{A} be a set of pairwise non-isotopic curves in Σ , such that each pair of curves a and b in \mathcal{A} satisfy $I(a, b) = 0$. Then all simplexes included in the weak isotopy class of \mathcal{A} are strongly isotopic.*

In order to generalize both preceding lemmas to more general sets of curves than simplexes, we recall the definition of bigon, introduced by Epstein in [E].

Bigons.

Definition 2.8 (Bigon, Epstein [E]).

Let Σ be a surface and a and b two curves in Σ . A *bigon cobounded by a and b* is a disk included in Σ whose boundary is the union of an arc included in a denoted by \hat{a} and an arc included in b denoted by \hat{b} (cf. Figure 3).

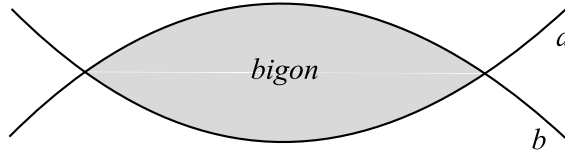

Figure 3: Bigon cobounded by a and b

Proposition 2.9 (Paris, Rolfsen [PaRo]). *Let Σ be a surface and a and b two transversely intersecting curves in Σ . Then a and b are in tight position if and only if a and b do not cobound any bigon. \square*

Let us set up the vocabulary related to bigons.

Definition 2.10 (Edges of a bigon, enter in and exiting a bigon).

Let Σ be a surface, a and b two curves in Σ , and D a cobounded bigon by a and b . We denote by \hat{a} and \hat{b} the two arcs included in a and b whose union is the boundary of the bigon. We call *edge of the bigon* each of these two arcs. We shall say that an oriented path $p : [0, 1] \rightarrow \Sigma$ *enters in the bigon D at time t_0* if $p(t_0)$ belongs to the boundary of D and if there exists $\varepsilon > 0$ such that:

$$p(]t_0 - \varepsilon, t_0]) \cap D = \emptyset \quad \text{and} \quad p(]t_0, t_0 + \varepsilon[) \subset D.$$

In the same way, we shall say that an oriented path $p : [0, 1] \rightarrow \Sigma$ *goes out of D at time t_0* if $p(t_0)$ belongs to the boundary of D and if there exists $\varepsilon > 0$ such that:

$$p(]t_0 - \varepsilon, t_0]) \subset D \quad \text{and} \quad p(]t_0, t_0 + \varepsilon[) \cap D = \emptyset.$$

Generalization of the case of simplexes.

Definition 2.11 (Intersection number of two sets of curves).

Let Σ be a surface. Let \mathcal{A} (respectively \mathcal{B}) be a set of pairwise non-isotopic curves in Σ . The *intersection number* $I(\mathcal{A}, \mathcal{B})$ is by definition:

$$I(\mathcal{A}, \mathcal{B}) = \sum_{(a,b) \in \mathcal{A} \times \mathcal{B}} I(a, b).$$

Let us notice that in this definition, there may exist a and a' in \mathcal{A} such that $I(a, a') \neq 0$ (same thing in \mathcal{B}), but these intersections do not come into account in $I(\mathcal{A}, \mathcal{B})$.

The next proposition generalize Lemma 2.6.

Proposition 2.12. *Let Σ be a surface, r an integer greater than or equal to 1, and $\mathcal{A} = \{a_1, a_2, \dots, a_r\}$ a set of r pairwise non-isotopic curves in Σ . Then there exists in Σ a set $\mathcal{B} = \{b_1, b_2, \dots, b_r\}$ of r curves that are pairwise in tight position and such that, for all $i \leq r$, the curves b_i and a_i are isotopic.*

Proof. By induction on r . The case $r = 2$ is true by definition of the intersection number. Let r be an integer greater than or equal to 3 and let us assume that the proposition is true for $r - 1$: there exist some curves $\{b_1, b_2, \dots, b_{r-1}\}$, lying in tight position, such that for all $i \leq r - 1$, the curves a_i and b_i are isotopic. One can also assume that the curves $\{b_1, b_2, \dots, b_{r-1}\}$ and a_r intersect transversely only in double points. Then, from Proposition 2.9, in the set $\{b_1, b_2, \dots, b_{r-1}, a_r\}$, all the bigons are cobounded by a curve b_i , $i \leq r - 1$, and by a_r . Let us call D_i such a bigon and \hat{b}_i and \hat{a}_r its two edges. Let us show that one can kill one after the other the bigons D_i , $i \leq r - 1$, just by using an isotopy on a_r , without creating other bigons elsewhere. This will prove Proposition 2.12.

Let us consider an innermost bigon D_i . No curve b_k ($k \leq r - 1$, $k \neq i$) entering in D_i through the arc \hat{a}_r can exit again through \hat{a}_r because we would have a bigon D_k strictly included in D_i . The same matter holds with the edge \hat{b}_i , for there does not exist any bigon cobounded by b_k and b_i . So any b_k entering in D_i exits by intersecting the opposite edge. So, if we push a_r through the bigon D_i , the bigon D_i disappears (cf. Figure 4). During this isotopy, a_r and b_k remain transversal and no bigon cobounded by a_r and b_k has occurred. However, $|a_r \cap b_i|$ has decreased by two. Let us repeat this process until $|a_r \cap b_i| = I(a_r, b_i)$ for all $i \leq r - 1$. At the end, the last bigon disappears and the curve b_r is defined as the resulting curve coming from a_r after all these isotopies. \square

In Proposition 2.12, we have given an existence result. In order to get a uniqueness result, we have to consider sets of curves having a property that we call the *without triple intersection* property (see Definition 2.13 below). This property appears in Proposition 2.14), which is a generalization of Lemma 2.7.

Definition 2.13 (Set of curves without triple intersection).

Let Σ be a surface. We shall say that a set of curves \mathcal{A} is *without triple intersection* if for any triple of curves $\{a_i, a_j, a_k\}$ in \mathcal{A} , one of the following intersections $a_i \cap a_j$, $a_i \cap a_k$ or $a_j \cap a_k$ is empty.

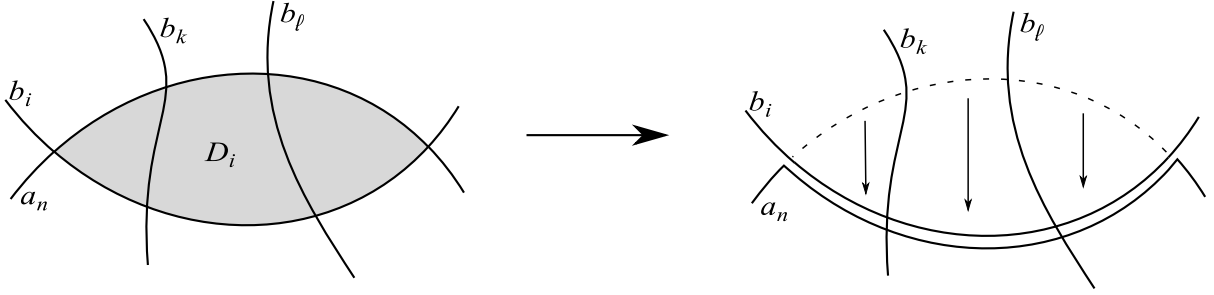

Figure 4: Pushing a_n through the bigon D_i (proof of Proposition 2.12).

Proposition 2.14. *Let Σ be a surface, r an integer greater than or equal to 1, and $\mathcal{B} = \{b_1, b_2, \dots, b_r\}$ a set of pairwise non-isotopic curves, in tight position and without triple intersection. Let $\mathcal{B}' = \{b'_1, b'_2, \dots, b'_r\}$ another set of curves having the same properties and such that b_i and b'_i are isotopic for all $i \leq r$. Then there exists a path of diffeomorphisms of Σ denoted by $(H_t)_{0 \leq t \leq 1}$ such that $H_0 = \text{Id}$ and such that for all $i \leq r$, we have $H_1(b_i) = b'_i$.*

Proof. By induction on r . The case $r = 1$ is classic. Let $r \geq 2$ and let us assume that the result holds for $r - 1$: there exists an isotopy H sending $\{b_1, b_2, \dots, b_{r-1}\}$ on $\{b'_1, b'_2, \dots, b'_{r-1}\}$ and sending b_r on a curve x isotopic to b'_r and in tight position with the curves b'_i , $i \leq r - 1$. We look for an isotopy G that leaves the b'_i invariant, $i \leq r - 1$, and that sends x on b'_r .

If x and b'_r do not intersect, then x and b'_r cobound an annulus. So the isotopy G consists only to make x slide through this annulus in order to bring it on b'_r , and G coincides with the identity outside of a neighbourhood of this annulus (cf. Figure 5). Let us examine this isotopy G . Let us fix an integer $i \leq r - 1$. Recall that the curve b'_i is in tight position with x and with b'_r , so it does not bound any bigon with x nor with b'_r . Hence, if b'_i meets this annulus by intersecting one of the two curves x or b'_r , it can only exit this annulus by intersecting the other curve among x and b'_r . If we now consider another different integer $k \leq r - 1$ such that b'_i and b'_k meet the annulus, we have just shown they must both intersect b'_r . But \mathcal{B}' is without triple intersection, so $I(b'_i, b'_k) = 0$. As the curves in \mathcal{B}' are in tight position, this implies that they are disjoint. In particular, they do not intersect in the annulus. Hence, for $i \leq r - 1$, the curves b'_i are all pairwise isotopic in the annulus and the isotopy G fixes each curve b'_i while it maintains x transversal to these curves b'_i .

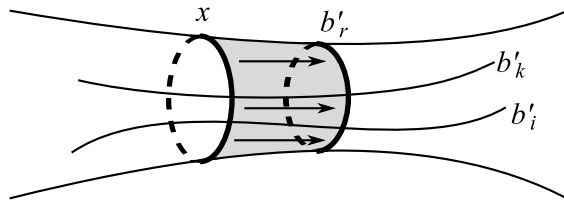

Figure 5: Making x slide through an annulus (proof of Proposition 2.14).

If x and b'_r intersect, they bound a bigon. Let us consider an innermost bigon, and let us show that, by an isotopy, we can move x outside of this bigon while preserving the other curves b'_i for all $i \leq r - 1$. Actually, it is enough to see that, as in the previous case, all the curves b'_i which

enter in the bigon can only exit it by intersecting the opposite edge and so are pairwise isotopic in the bigon. Thus, the isotopy consists only, as in the previous case, to push x outside of the bigon. We can repeat this argument until the image of x by these isotopies does not intersect b'_r , and then conclude as in the previous case. \square

2.2 Definitions

Definitions concerning curves:

Definition 2.15 (Curves).

Let Σ be a surface.

- Two closed, smooth, connected, compact 1-submanifolds \bar{a} and \bar{b} of Σ are said to be *isotopic* if there exists a continuous path of 1-submanifolds with extremities \bar{a} and \bar{b} . When \bar{a} and \bar{b} are included in $\Sigma \setminus \partial\Sigma$, this is equivalent to say that there exists a path of diffeomorphisms of Σ , denoted by $(H_t)_{0 \leq t \leq 1}$, such that $H_0 = \text{Id}$ and $H_1(\bar{a}) = \bar{b}$. In the set of closed, smooth, connected, compact 1-submanifold of Σ , being isotopic is an equivalence relation.
- A *curve* will be an isotopy class of a closed, smooth, connected, compact 1-submanifold of Σ that does not bound any disk in Σ .
- We denote by $\text{Bndy}(\Sigma)$ the set of isotopy classes of the connected components of $\partial\Sigma$.
- We denote by $\mathcal{C}\text{urv}(\Sigma, \partial\Sigma)$ the set of all the curves in Σ and by $\mathcal{C}\text{urv}(\Sigma)$ the set $\mathcal{C}\text{urv}(\Sigma, \partial\Sigma)$ minus $\text{Bndy}(\Sigma)$.
- A *representative of a curve* $a \in \mathcal{C}\text{urv}(\Sigma)$ is a smooth 1-submanifold of Σ that belongs to a .
- The *geometric intersection* between two curves a and b is the minimum number $I(a, b)$ of intersection points between two transversal representatives \bar{a} and \bar{b} of a and b . We shall say that two curves a and b *intersect* or *meet each other* if they satisfy $I(a, b) \neq 0$.
- A *set of curves*, by definition of *set*, contains each element once. Moreover, they will always be finite.
- The *geometric intersection* of two sets of curves \mathcal{A} and \mathcal{B} is the integer $I(\mathcal{A}, \mathcal{B})$ defined by:

$$I(\mathcal{A}, \mathcal{B}) = \sum_{(a,b) \in \mathcal{A} \times \mathcal{B}} I(a, b).$$

- A *representative of a set \mathcal{A} of curves* is a set of representatives of the curves of \mathcal{A} (one representative per curve).
- A *representative in tight position of a set \mathcal{A} of curves* is a representative of the set \mathcal{A} such that for each pair (a, b) of curves in \mathcal{A} , their representatives \bar{a} and \bar{b} are in tight position.

- Harvey introduced in [Ha] the *curve complex*² where the vertices are the curves of $\mathcal{C}\text{urv}(\Sigma, \partial\Sigma)$ and for each integer $k \geq 0$, the k -simplexes are the sets \mathcal{A} of $k + 1$ distinct curves, such that $I(\mathcal{A}, \mathcal{A}) = 0$. We will widely use the *curve simplex* concept.
- A set of curves *without triple intersection* will be a set of curves such that for any three curves a, b and c in it, the product $I(a, b)I(b, c)I(c, a)$ is zero.

The following two propositions will be often used in this paper. The first one is well known and comes from cutting the surface in pairs of pants.

Proposition 2.16. *Let Σ be a surface and c, g, b the number of connected components, the genus and the number of boundary components of Σ respectively. Then, any curve simplex included in $\mathcal{C}\text{urv}(\Sigma)$ contains at most $3g - 3c + b$ curves. Moreover, any curve simplex containing less than $3g - 3c + b$ curves can be completed in a simplex of exactly $3g - 3c + b$ curves. \square*

Propositions 2.12 and 2.14 can be restated as follows:

Proposition 2.2. *Let Σ be a surface. Given a set of curves \mathcal{A} , there exists a set of representatives of the curves of \mathcal{A} that are in tight position. Moreover, if \mathcal{A} is without triple intersection, such a set of representatives is unique up to strong isotopy. \square*

Definitions concerning subsurfaces:

Let Σ be a surface.

Definition 2.17 (Isotopy between 2-submanifolds).

Two nonempty, smooth, compact 2-submanifolds V and W in Σ are said to be *isotopic* if there exists a continuous path of smooth, compact 2-submanifolds with extremities V and W . If V and W are included in $\Sigma \setminus \partial\Sigma$, this is equivalent to say that there exists a continuous path of diffeomorphisms of Σ , which we denote by $(H_t)_{0 \leq t \leq 1}$, such that $H_0 = \text{Id}$ and $H_1(V) = W$.

The term *subsurface* is devoted to a specific class of 2-submanifolds. In order to state clearly the definitions, we first distinguish two types of subsurfaces: the *non-marked subsurfaces* whose boundary curves are pairwise non-isotopic in Σ , and the *marked subsurfaces* that generalize the definition.

Definition 2.18 (Non-marked subsurfaces).

- A *non-marked subsurface* S in Σ will be an isotopy class of a nonempty, connected 2-submanifold V in Σ whose boundary consists in representatives of pairwise non-isotopic curves of $\mathcal{C}\text{urv}(\Sigma, \partial\Sigma)$.
- Let S be a non-marked subsurface in Σ , a *representative of S* is a 2-submanifold in Σ isotopic to V , and ∂S is the isotopy class of the 1-submanifold ∂V .
- Let S be a non-marked subsurface in Σ and V a representative of S . We denote by $\text{Bndy}(S)$ the set of isotopy classes in $\mathcal{C}\text{urv}(\Sigma, \partial\Sigma)$ of the different connected components of ∂V .

²the dimension of the complex $C(\mathcal{C}\text{urv}(\Sigma, \partial\Sigma))$ is $3g - 3c + 2b - 1$, after Proposition 2.16 see below. The curve complex automorphisms group has been studied by Ivanov [Iv2], Korkmaz [Ko1], and Luo [Lu].

When a 2-submanifold contains pairs of isotopic boundary components, we use the definition of *marked subsurface* described below:

Definition 2.19 (Marked subsurfaces).

- When V is a nonempty connected 2-submanifold, different from a disk or a cylinder, and whose each boundary component either is equal to a boundary component of Σ , or is a representative of a curve of $\mathcal{C}urv(\Sigma)$, we associate to V the *marked subsurface* (T, \mathcal{A}) where T is the non-marked subsurface (as described above) associated to the 2-manifold W obtained from V by gluing together each pair of isotopic boundary components, and where \mathcal{A} is a curve simplex in $\mathcal{C}urv(\Sigma)$ called the *mark* and containing for each pair of isotopic boundary components of V their isotopy class. Thus, V and W have the same Euler characteristic, but the genus of W is equal to the sum of the genus of V and the cardinality of \mathcal{A} (cf. Figure 6).

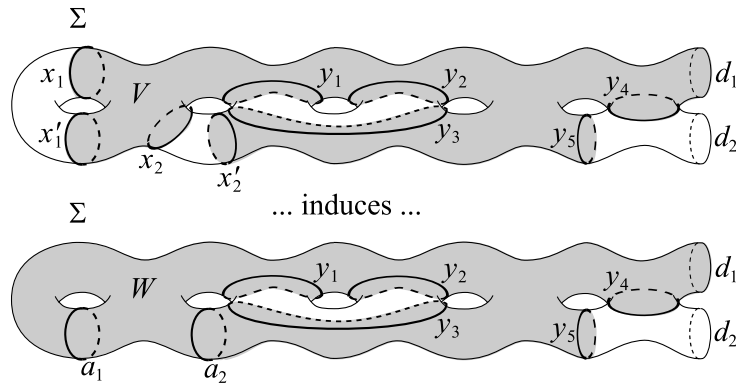

Figure 6: Example of a marked subsurface (S, \mathcal{A}) associated to the 2-submanifold V , where S is the isotopy class of W and where $\mathcal{A} = \{a_1, a_2\}$.

- Let (T, \mathcal{A}) be a marked surface denoted by S , let W be a representative of T , let \mathcal{N} be an open tubular neighbourhood of a 1-submanifold representing \mathcal{A} . Thus \mathcal{N} is included in W . A *representative of S* is a 2-submanifold of Σ isotopic to $W \setminus \mathcal{N}$, and ∂S is the union of the isotopy class of the 1-submanifold ∂W and the curves of \mathcal{A} .
- Let (T, \mathcal{A}) be a marked surface denoted by S . The curve simplex $\text{Bndy}(S)$ is by definition the union $\text{Bndy}(T) \cup \mathcal{A}$.
- Let (T, \mathcal{A}) be a marked surface denoted by S . The curves in $\text{Bndy}(S)$ that are in $\text{Bndy}(\Sigma)$ are called the *natural boundary components* and their set is denoted by $\text{Bndy}^{\text{nat}}(S)$, while the other curves of $\partial(S)$ are called the *inner boundary components* of S and their set is denoted by $\text{Bndy}^{\text{int}}(S)$. Thus, by definition,

$$\begin{aligned} \text{Bndy}^{\text{nat}}(S) &= \text{Bndy}(S) \cap \text{Bndy}(\Sigma), \\ \text{Bndy}^{\text{int}}(S) &= \text{Bndy}(S) \cap \mathcal{C}urv(\Sigma) \text{ and } \mathcal{A} \subset \text{Bndy}^{\text{int}}(S). \end{aligned}$$

For instance, in Figure 6, $\text{Bndy}^{\text{nat}}(S) = \{d_1\}$ and $\text{Bndy}^{\text{int}}(S) = \{a_1, a_2, y_1, y_2, y_3, y_3, y_4, y_5\}$.

- Let (T, \mathcal{A}) be a marked surface denoted by S . We denote by $\mathcal{C}urv(S)$ the set of curves c in $\mathcal{C}urv(T) \setminus \mathcal{A}$ such that $I(c, \mathcal{A}) = 0$ (if \mathcal{A} is empty, we forget this last definition). We denote by $\mathcal{C}urv(S, \partial S)$ the union $\mathcal{C}urv(S) \cup \text{Bndy}(S)$.
- We denote by $\mathcal{S}ub(\Sigma)$ the set of marked (nonempty) subsurfaces in Σ . The elements of $\mathcal{S}ub(\Sigma)$ will be called either marked subsurfaces or simply *subsurfaces*. Notice that a non-marked subsurface is a marked subsurface with an empty mark.

Remark. This definition of subsurface allows us to establish a canonical bijection between the curve simplexes in $\mathcal{C}urv(\Sigma)$ and the partitions of Σ in subsurfaces (cf. Definition 2.23 of $\mathcal{S}ub_{\mathcal{A}}(\Sigma)$).

The following lemma will often be used implicitly. Its proof comes straight from the definition of subsurface, it is left to the reader.

Lemma 2.20 (Sum of Euler characteristic of disjoint subsurfaces).

Given a surface Σ , the sum of the Euler characteristics of some disjoint subsurfaces of Σ is greater than or equal to the Euler characteristic of Σ . \square

Definition 2.21 (Subsurface complex).

The *subsurface complex*³ is the simplicial complex whose vertices are the subsurfaces of $\mathcal{S}ub(\Sigma)$ and whose k -simplexes (for any integer $k \geq 0$) are the sets of $k + 1$ distinct subsurfaces $\mathcal{A} = \{S_0, S_1, \dots, S_k\}$ such that any pair of subsurfaces (S_i, S_j) in \mathcal{A} satisfies $S_i \cap S_j = \emptyset$. The subsurface complex in this paper differ from the domain complex defined by McCarthy and Papadopoulos [McPp], since we consider isotopy classes instead of real embedded subsurfaces, and do not authorize annuli.

Definition 2.22 (Inclusion between curves and subsurfaces or between subsurfaces).

Let Σ be a surface.

- (i) Given a curve $a \in \mathcal{C}urv(\Sigma)$ and a subsurface $S \in \mathcal{S}ub(\Sigma)$, we shall say that a is included in S if there exist a representative \bar{a} of a and a representative \bar{S} of S such that \bar{a} is included in \bar{S} .
- (ii) Let S and T be two subsurfaces in Σ . We shall say that S is included in T if there exist two representatives \bar{S} and \bar{T} of S and of T such that \bar{S} is included in \bar{T} .

Remark. The intersection between subsurfaces is well-defined, for the union of the sets of the boundary components of each surface is a set of curves without triple intersection. However, the connected components of the intersection may be homeomorphic to disks or cylinders, so the intersection of subsurfaces is not in general a subsurface as defined in Definition 2.19.

Surface and curve simplex:

³Because of the additivity of the Euler characteristic and the fact that subsurfaces in $\mathcal{S}ub(\Sigma)$ have a negative Euler Characteristic, the cardinality of any set of disjoint subsurfaces is bounded by $-\chi(\Sigma)$. As this number is reached by any pants-decomposition of Σ , the dimension of the subsurface complex equals $-\chi(\Sigma) - 1$.

Definition 2.23. Let Σ be a surface and let \mathcal{A} be a curve simplex included in $\mathcal{C}urv(\Sigma)$. We introduce some definitions and notation:

- $\mathcal{S}ub_{\mathcal{A}}(\Sigma)$ is the set of subsurfaces S in Σ such that $\text{Bndy}(S)$ is included in $\mathcal{A} \cup \text{Bndy}(\Sigma)$ and such that $\mathcal{C}urv(S) \cap \mathcal{A}$ is empty. We exclude \emptyset (the empty set) from $\mathcal{S}ub_{\mathcal{A}}(\Sigma)$.
- $\Gamma(\Sigma, \mathcal{A})$ is the graph having one vertex for each subsurface in $\mathcal{S}ub_{\mathcal{A}}(\Sigma)$, and having one edge for each curve in \mathcal{A} , so that extremities of an edge associated to a curve x are the two vertices associated to the two subsurfaces whose boundaries contain x , cf. Figure 7.

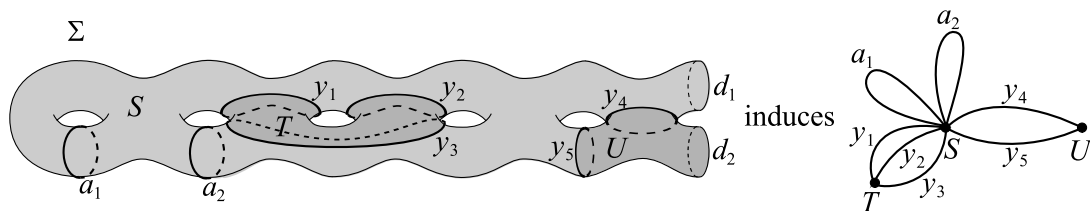

Figure 7: Let \mathcal{A} be the simplex $\{a_1, a_2, y_1, y_2, y_3, y_4, y_5\}$ as illustrated in Figure 6. We represent the associated graph $\Gamma(\Sigma, \mathcal{A})$ by giving to vertices and edges the names of the associated subsurfaces and curves.

- $\Sigma_{\mathcal{A}}$ is the surface Σ blown up along the curves of \mathcal{A} .
- $rec_{\mathcal{A}} : \Sigma_{\mathcal{A}} \rightarrow \Sigma$ is the canonical *gluing* map from $\Sigma_{\mathcal{A}}$ to Σ .

3 Mapping class group

We begin this section by a subsection dedicated to different definitions of the mapping class group and links between them (Subsection 3.1). Then during the next three subsections, we present three fundamental types of mapping classes: Dehn twists (Subsection 3.2), periodic mapping classes (Subsection 3.3), and pseudo-Anosov mapping classes (Subsection 3.4). These three types of mapping classes are central in the diffeomorphisms classification after Nielsen-Thurston, which we present at the end of this section in Subsection 3.6 and which will be our main tool while studying morphisms from the braid group in the mapping class group.

3.1 Some different definitions of the mapping class group

We already gave in the introduction various possible definitions of the mapping class group and the corresponding notation. We give them again below, and in addition all the definitions that will occur later in this paper. Then, we shall explain the links between them.

Definition 3.1. Let Σ be an orientable compact surface, possibly not connected, and with a possibly empty boundary.

- The *mapping class group* of Σ , denoted by $\mathcal{M}od(\Sigma)$, is the group of isotopy classes of orientation-preserving diffeomorphisms of Σ . If Σ has several connected components, then they may be permuted by elements of $\mathcal{M}od(\Sigma)$.
- The *extended mapping class group* of Σ , denoted by $\mathcal{M}od^\diamond(\Sigma)$, is the group of isotopy classes of *all* diffeomorphisms of Σ (they may inverse Σ 's orientation). When Σ is connected, the group $\mathcal{M}od(\Sigma)$ is an index two normal subgroup of $\mathcal{M}od^\diamond(\Sigma)$.
- The *mapping class group of Σ that preserves each boundary component*, denoted by $\mathcal{P}Mod(\Sigma)$, is defined as the group of isotopy classes of all orientation-preserving diffeomorphisms preserving each boundary component of Σ setwise and preserving each connected components of Σ setwise.
- Let X be the disjoint union in Σ of a possibly not connected subsurface and a possibly not connected 1-submanifold. The *mapping class group of Σ relatively to X* , denoted by $\mathcal{M}od(\Sigma, X)$, is the group of isotopy classes of the orientation-preserving diffeomorphisms of Σ that fix X pointwise. The isotopies are required to fix X point-wise at any time. We denote by $for_X : \mathcal{M}od(\Sigma, X) \rightarrow \mathcal{M}od(\Sigma)$ the canonical morphism. The name “for” stands for “forget”. As an example, the *mapping class group of Σ relatively to the boundary*, denoted by $\mathcal{M}od(\Sigma, \partial\Sigma)$, is defined as the group of isotopy classes of all orientation-preserving diffeomorphisms preserving pointwise all boundary components of Σ , and we have a natural morphism $for_{\partial\Sigma} : \mathcal{M}od(\Sigma, \partial\Sigma) \rightarrow \mathcal{P}Mod(\Sigma)$.
- Let \mathcal{A} be a curve simplex in $\mathcal{C}urv(\Sigma)$. We denote by $\mathcal{M}od_{\mathcal{A}}(\Sigma)$ the group of isotopy classes of diffeomorphisms of Σ preserving \mathcal{A} setwise. If we require in addition that each boundary component is preserved, we will denote this group by $\mathcal{P}Mod_{\mathcal{A}}(\Sigma)$. We have a canonical morphism $cut_{\mathcal{A}} : \mathcal{M}od_{\mathcal{A}}(\Sigma) \rightarrow \mathcal{M}od(\Sigma_{\mathcal{A}})$.

- With the same definition of \mathcal{A} , we denote by $\mathcal{P}_{\mathcal{A}}\text{Mod}(\Sigma)$ the subgroup of $\text{Mod}_{\mathcal{A}}(\Sigma)$ that is equal to $\text{cut}_{\mathcal{A}}^{-1}(\mathcal{P}\text{Mod}(\Sigma_{\mathcal{A}}))$. Thus, $\mathcal{P}_{\mathcal{A}}\text{Mod}(\Sigma)$ is the group of isotopy classes of diffeomorphisms of Σ preserving each curve of \mathcal{A} setwise, preserving $\partial\Sigma$ componentwise, and preserving each subsurface in $\text{Sub}_{\mathcal{A}}(\Sigma)$.

The various statements in the following proposition establish links between the mapping class groups defined above. Proofs are left to the reader. This proposition will be completed by Proposition 3.9 where *Dehn twists*, defined in the next subsection, come into play.

Proposition 3.2.

- (i) Let Σ' be a subsurface of Σ and let Σ'' be the closure of the complement of Σ' in Σ . We have then the isomorphism:

$$\text{Mod}(\Sigma, \Sigma' \cup \partial\Sigma) \cong \text{Mod}(\Sigma'', \partial\Sigma'').$$

- (ii) For all curve simplex \mathcal{A} , the following two mapping class groups are isomorphic:

$$\text{Mod}(\Sigma, \partial\Sigma \cup (\bigcup_{a \in \mathcal{A}} a)) \cong \text{Mod}(\Sigma_{\mathcal{A}}, \partial(\Sigma_{\mathcal{A}})).$$

- (iii) Let Σ' and Σ'' in $\text{Sub}(\Sigma)$ such that Σ'' is the closure of the complement of Σ' in Σ . Then $\text{Mod}(\Sigma, \Sigma')$ and $\text{Mod}(\Sigma, \Sigma'')$ are two subgroups of $\text{Mod}(\Sigma)$ such that each of them is included in the centralizer of the other. \square

3.2 Dehn twists

Dehn twists form a major family of mapping classes, for Dehn twists are elementary mapping classes which generate $\text{Mod}(\Sigma, \partial\Sigma)$ (cf. Theorem 3.8). Besides, Dehn twists can satisfy braid relations in the mapping class group (cf. Proposition 3.4). Such relations allow the existence of interesting morphisms from braid groups to mapping class groups, which we will study in this paper.

Definition 3.3 (Dehn twists along curves of $\mathcal{C}\text{urv}(\Sigma, \partial\Sigma)$).

Let Σ be an oriented surface. We give the product-orientation to the annulus $\mathbb{A} = [0, 1] \times S^1$. Given a curve a belonging to $\mathcal{C}\text{urv}(\Sigma)$, let \bar{a} be a smooth 1-submanifold of $\Sigma \setminus \partial\Sigma$ representing a . Let \mathcal{V} be a tubular compact neighbourhood of \bar{a} and let ϕ be a positive homeomorphism of \mathcal{V} in \mathbb{A} . Let us define the homeomorphism

$$D : \begin{array}{ccc} \mathbb{A} = [0, 1] \times S^1 & \longrightarrow & \mathbb{A} = [0, 1] \times S^1 \\ (t, e^{i\theta}) & \longmapsto & (t, e^{i(\theta+2\pi t)}) \end{array} .$$

Let us consider the homeomorphism t_a that equals the identity outside of the tubular neighbourhood \mathcal{V} and equals $\phi^{-1} \circ D \circ \phi$ on \mathcal{V} . By a classic result in differential topology in dimension two, the isotopy class of any homeomorphism contains a unique isotopy class of diffeomorphisms. Thus t_a defines a unique isotopy class of diffeomorphisms, in other words a unique mapping class of $\text{Mod}(\Sigma, \partial\Sigma)$. We denote it by T_a and we call it the *Dehn twist along the curve a* . Notice that *a priori*, T_a depends on the isotopy class of the positive homeomorphism ϕ , but there exists only

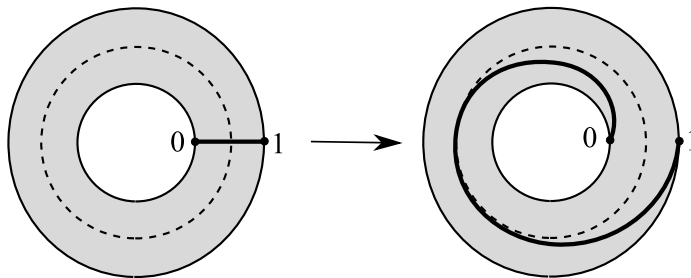

Figure 8: Definition of a Dehn twist.

one such isotopy class since the mapping class group of the cylinder is trivial. In the same way, the choices of the representative \bar{a} and the neighbourhood \mathcal{V} are indifferent, and the Dehn twist T_a depends only on the curve a . In other words, T_a is well-defined. The mapping class induced by T_a in $\text{Mod}(\Sigma)$ is still denoted by T_a and is still called the *Dehn twist along the curve a* .

We define also in a similar way the Dehn twist along a curve of $\text{Bndy}(\Sigma)$: given a curve $a \in \text{Bndy}(\Sigma)$, we choose a representative \bar{a} in $\Sigma \setminus \partial\Sigma$ of a . We define then T_a as before. The Dehn twist T_a in the group $\text{Mod}(\Sigma, \partial\Sigma)$ is not trivial, whereas it is trivial in $\text{Mod}(\Sigma)$.

When Σ is embedded in the 3-sphere \mathbb{S}^3 and when we look at it from outside (*inside* and *outside* depends on the orientation of Σ), a Dehn twist along the curve a changes a curve b intersecting a into a curve following b and turning once to the left round a each time b crosses a .

First Dehn twists' properties.

The following proposition is classic. It plays a great role in this paper.

Proposition 3.4 (Dehn twists' properties, N.V. Ivanov, J.D. McCarthy [Mc1]).

Dehn twists satisfy the following properties:

- For all F in $\text{Mod}(\Sigma)$, we have $FT_a = T_a F$ if and only if $F(a) = a$.
- Let T_a and T_b be two Dehn twists, and i and j two nonzero integers. The relation $T_a^i T_b^j = T_b^j T_a^i$ holds if and only if $I(a, b) = 0$.
- Let T_a and T_b be two Dehn twists, and i and j two nonzero integers. The braid relation $T_a^i T_b^j T_a^i = T_b^j T_a^i T_b^j$ holds if and only if $I(a, b) = 1$ and $i = j = \pm 1$. \square

The proof of this proposition is classic (cf. [FLP]). Let us just recall that it comes from the intersection formula given in Lemma 3.5. We won't prove this lemma either, but we will use it again in this paper.

Lemma 3.5 (Fathi, Laudenbach, Poénaru, cf. [FLP]).

If a, b, c are three curves such that $I(b, c) = 0$, then for all integers k ,

$$I(T_a^k(b), c) = |k|I(a, b)I(a, c).$$

In the general case, when we do not assume that $I(b, c) = 0$, we have the following inequality:

$$|I(T_a^k(b), c) - |k|I(a, b)I(a, c)| \leq I(b, c).$$

\square

Chain of curves.

There exist other relations of great importance in this paper that are satisfied by Dehn twists: the relations involving *chains of curves*.

Definition 3.6 (Chain of curves).

Given a surface Σ , for all integers $k \geq 2$, a k -chain of curves is an ordered sequence of pairwise distinct curves (a_1, a_2, \dots, a_k) such that for all $i, j \leq k$, we have $I(a_i, a_j) = 0$ if $|i - j| \neq 1$ and $I(a_i, a_j) = 1$ if $|i - j| = 1$ (cf. Figure 9).

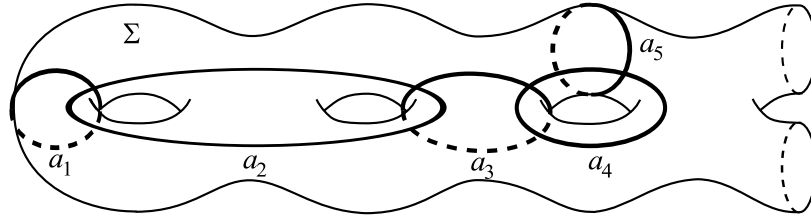

Figure 9: Example of a chain of curves.

The relations between Dehn twists along curves included in a chain of curves are given in Lemma 3.7 below. It is classic, we will not prove it, but we come back to it in Section 4 when we present the braid group in Proposition 4.16.

Lemma 3.7 (C. Labruère, L. Paris, cf. [LaPa]).

Let (c_1, c_2, \dots, c_k) be a k -chain of curves where k is an integer greater than or equal to 2. Then,

- if k is even, the tubular neighbourhood of $c_1 \cup c_2 \cup \dots \cup c_k$ is a surface S of genus $\frac{k}{2}$ with one boundary component which we call d , and the product $(T_{c_1}(T_{c_2}T_{c_1}) \dots (T_{c_k} \dots T_{c_2}T_{c_1}))^2$ is the mapping class α that preserves each curve c_i , $1 \leq i \leq k$, whose restriction outside of S coincides with the identity, and such that $\alpha^2 = T_d$ (cf. Figure 10). Notice that after having given orientations to the curves c_i , $1 \leq i \leq k$, the mapping class α inverse them.

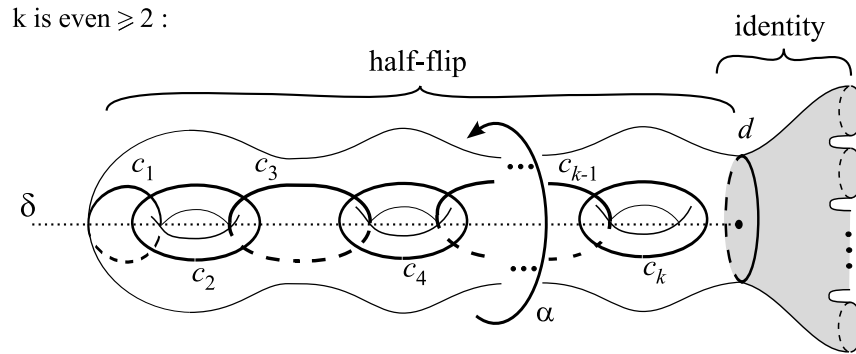

Figure 10: The product $(T_{c_1}(T_{c_2}T_{c_1}) \dots (T_{c_k} \dots T_{c_2}T_{c_1}))^2$ when k is even.

- if k is odd, the tubular neighbourhood of $c_1 \cup c_2 \cup \dots \cup c_k$ is a surface S of genus $\frac{k-1}{2}$ with two boundary components d_1 and d_2 , and the product $(T_{c_1}(T_{c_2}T_{c_1}) \dots (T_{c_k} \dots T_{c_2}T_{c_1}))^2$ equals the product $T_{d_1}T_{d_2}$ (cf. Figure 11). \square

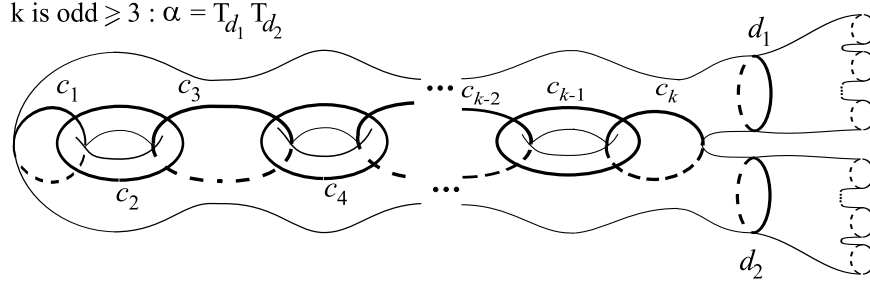

Figure 11: The product $T_{c_1}(T_{c_2}T_{c_1}) \dots (T_{c_k} \dots T_{c_2}T_{c_1})$ when k is odd.

Dehn twists as generators of the mapping class group.

Let us recall the following Theorem due to M. Dehn [D] and rediscovered by W.B.R. Lickorish [Lk]. For the proof of Part 1, the reader can refer to [Bi], Theorem 4.1. Part 2 is a consequence of Part 1, using *lantern relations* (cf. [FaMa] section 5.1) in order to obtain the Dehn twists along the boundary curves.

Theorem 3.8 (The mapping class group is spanned by Dehn twists).

1. Let $\Sigma_{g,b}$ be a surface whose genus satisfies $g \geq 1$. The group $\mathcal{P}\text{Mod}(\Sigma_{g,b})$ is spanned by the Dehn twists along the non-separating curves of $\Sigma_{g,b}$. Actually, one can for instance consider only the curves drawn in Figure 12.

2. The same Dehn twists can be seen as lying in $\text{Mod}(\Sigma_{g,b}, \partial\Sigma_{g,b})$; in this case they span $\text{Mod}(\Sigma_{g,b}, \partial\Sigma_{g,b})$. \square

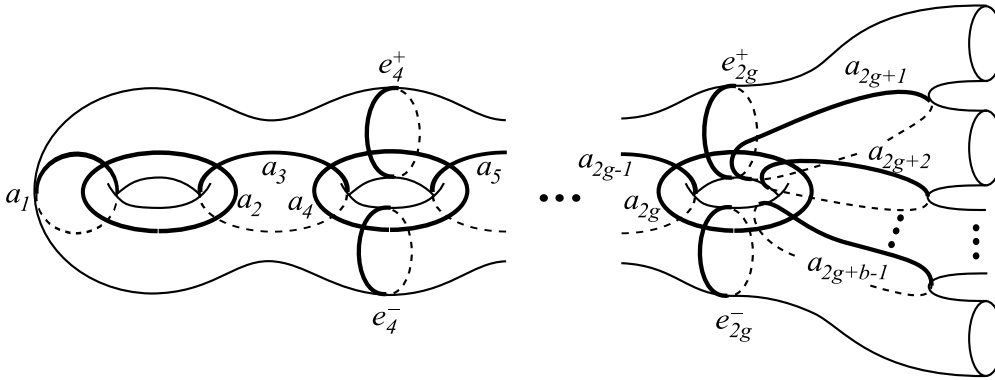

Figure 12: Curves in $\Sigma_{g,b}$ span $\mathcal{P}\text{Mod}(\Sigma_{g,b})$.

Links between mapping class groups and Dehn twists.

We give first three classic results and a Theorem of Paris and Rolfsen where Dehn twists emerge when we compare some specific mapping class groups.

Proposition 3.9 (Central exact sequences between mapping class groups).

The three sequences below are central exact sequences.

(i) For any connected surface Σ , the below sequence is exact:

$$1 \rightarrow \langle T_d, d \in \text{Bndy}(\Sigma) \rangle \rightarrow \text{Mod}(\Sigma, \partial\Sigma) \xrightarrow{\text{for}\partial\Sigma} \mathcal{P}\text{Mod}(\Sigma) \rightarrow 1.$$

(ii) For any curve simplex $\mathcal{A} \subset \text{Curv}(\Sigma)$, the below sequence is exact:

$$1 \rightarrow \langle T_a, a \in \mathcal{A} \rangle \rightarrow \mathcal{P}_{\mathcal{A}}\text{Mod}(\Sigma) \xrightarrow{\text{cut}\mathcal{A}} \mathcal{P}\text{Mod}(\Sigma_{\mathcal{A}}) \rightarrow 1.$$

(iii) Let \mathcal{A} be a curve simplex not isotopic to any boundary component of Σ . For all curve $a \in \mathcal{A}$, let us denote by a^+ and a^- the two boundary components in $\Sigma_{\mathcal{A}}$ coming from a (no matter how the signs are shared out). When we glue in $\Sigma_{\mathcal{A}}$ each boundary component a^+ ($a \in \mathcal{A}$) with its associated boundary component a^- , we get the surface Σ back. Such a gluing operation induces a canonical morphism $\text{rec}_{\mathcal{A}} : \text{Mod}(\Sigma_{\mathcal{A}}, \partial\Sigma_{\mathcal{A}}) \rightarrow \mathcal{P}_{\mathcal{A}}\text{Mod}(\Sigma, \partial\Sigma)$ which satisfies the following exact sequence:

$$1 \rightarrow \langle T_{a^+} T_{a^-}^{-1}, a \in \mathcal{A} \rangle \rightarrow \text{Mod}(\Sigma_{\mathcal{A}}, \partial\Sigma_{\mathcal{A}}) \xrightarrow{\text{rec}\mathcal{A}} \mathcal{P}_{\mathcal{A}}\text{Mod}(\Sigma, \partial\Sigma) \rightarrow 1.$$

□

The concept of *parabolic subgroup of the mapping class group* has been introduced by L. Paris and D. Rolfsen in [PaRo]: given a surface Σ , the *parabolic subgroups of the mapping class group* of Σ are the subgroups induced by the inclusion of subsurfaces in Σ . The next Theorem, due to Paris and Rolfsen, deals with some kernels associated with parabolic subgroups of the mapping class group.

Theorem 3.10 (Paris and Rolfsen, [PaRo]).

Let Σ be a surface and Σ' a subsurface in Σ such that $\partial\Sigma'$ and $\partial\Sigma$ are disjoint. We denote by a_1, a_2, \dots, a_r the boundary components of Σ' that bound a disk in Σ ; we denote by b_j, b'_j for $1 \leq j \leq s$ the pairs of boundary components of Σ' that cobound an annulus in Σ . Then the inclusion $\iota : \Sigma' \rightarrow \Sigma$ induces a morphism $\iota_* : \text{Mod}(\Sigma', \partial\Sigma') \rightarrow \text{Mod}(\Sigma, \partial\Sigma)$ whose kernel is the abelian group \mathcal{T} of rank $r + s$ spanned by $T_{a_i}, 1 \leq i \leq r$ and by $T_{b_j}^{-1} T_{b'_j}, 1 \leq j \leq s$.

Some special products of Dehn twists: the multitwists.

To end this subsection on the Dehn twists, we present the multitwists. They are special products of Dehn twists which often emerge in the kernel of morphisms between different mapping class groups, as they do in Proposition 3.9.(ii).

Definition 3.11 (Multitwists).

A *multitwist along the curves of \mathcal{A}* where \mathcal{A} is a curve simplex is the product of nonzero powers of Dehn twists along the curves of \mathcal{A} .

A multitwist can only be written in a single way as a product of nonzero powers of Dehn twists (up to reordering the factors):

Lemma 3.12 (Uniqueness of the factorisation of a multitwist in product of Dehn twists).

Let \mathcal{A} and \mathcal{B} be two curve simplexes⁴ and let $(k_a)_{a \in \mathcal{A}}$ and $(\ell_b)_{b \in \mathcal{B}}$ two families of nonzero integers indexed by \mathcal{A} and \mathcal{B} . If

⁴Let us recall that a curve simplex is a set of pairwise disjoint curves: no curve can appear twice.

$$\prod_{a \in \mathcal{A}} T_a^{k_a} = \prod_{b \in \mathcal{B}} T_b^{\ell_b},$$

Then $\mathcal{A} = \mathcal{B}$ and for any pair of curves (a, b) in $\mathcal{A} \times \mathcal{B}$, the equality $a = b$ implies the equality $k_a = \ell_b$.

The right frame to prove this lemma is Thurston's theory and the introduction of the *canonical reduction system* σ , see Subsection 3.6 in this section. For this reason, Lemma 3.12 will be proved in Subsection 3.6.

3.3 The periodic mapping classes

Definition 3.13 (Periodic mapping classes, order and period).

- (i) A mapping class $F \in \mathcal{M}\text{od}(\Sigma)$ is said to be *periodic* if there exists a nonzero integer k such that $F^k = \text{Id}$ (where Id is the isotopy class of the identity of Σ). The smallest integer k such that $F^k = \text{Id}$ is called *the order* of F .
- (ii) A mapping class $F \in \mathcal{M}\text{od}(\Sigma, \partial\Sigma)$ is said to be *periodic* if its projection \bar{F} in $\mathcal{M}\text{od}(\Sigma)$ is a periodic mapping class in the previous sens. The smallest integer k such that $\bar{F}^k = \text{Id}$ will be called *the period of F* instead of the *order of F* for F^k is not the identity. However, the period of F is equal to the order of \bar{F} .

As an example, here is a classic lemma:

Lemma 3.14. *Dehn twists are not periodic.*

Proof. Let Σ be a connected surface such that $\mathcal{C}\text{urv}(\Sigma)$ is nonempty (hence Σ is not a pair of pants), and let a be a curve in $\mathcal{C}\text{urv}(\Sigma)$. If a is non-separating, it is easy to construct a curve b that belongs to $\mathcal{C}\text{urv}(\Sigma)$ and that intersects a in one point, indeed it is enough to consider a path in Σ_a joining two boundary components coming from the curve a . In the same way, we can construct a curve b that belongs to $\mathcal{C}\text{urv}(\Sigma)$ and that intersects a in two points, when a is separating. Then, for all nonzero integer k , T_a^k is not trivial, for according to Lemma 3.5,

$$I(T_a^k(b), b) = |k|I(a, b)^2 \neq 0,$$

whereas $I(\text{Id}(b), b) = 0$. □

The following theorem states that every periodic mapping class is the isotopy class of an isometry of the surface with a specific metric depending on the mapping class. Given a connected surface Σ together with a hyperbolic metric g , let us denote by $\text{Isom}^+(\Sigma, g)$ the group of positive isometries of (Σ, g) , which is a subgroup of $\text{Diff}^+(\Sigma)$. According to the Nielsen realization theorem, if $\partial\Sigma = \emptyset$, for every periodic mapping class $F \in \mathcal{M}\text{od}(\Sigma)$ of order m , there exists a hyperbolic metric g on Σ and an isometry $f \in \text{Isom}^+(\Sigma, g)$ such that F is the isotopy class of f and f satisfies $f^m = \text{Id}$. This Theorem has been generalized by Kerckhoff to finite subgroups of $\mathcal{M}\text{od}(\Sigma)$ where $\partial\Sigma$ is possibly nonempty (cf. [Ke1] and [Ke2]):

Theorem 3.15 (“Nielsen realisation problem”, Kerckhoff, cf. [Ke2]).

Let Σ be a surface with a possibly nonempty boundary. Let Γ be a finite subgroup of $\mathcal{M}\text{od}(\Sigma)$. Then, there exists a finite group $\bar{\Gamma}$ of $\text{Diff}^+(\Sigma)$ such that the natural morphism $\text{Diff}^+(\Sigma) \rightarrow \mathcal{M}\text{od}(\Sigma)$ sends isomorphically $\bar{\Gamma}$ on Γ . Moreover, we can choose $\bar{\Gamma}$ as a subgroup of the isometry group of Σ equipped with a metric of constant curvature, where the boundary components are geodesics.

As soon as $\partial\Sigma$ is nonempty, there is no equivalent to Kerckhoff's Theorem on $\text{Mod}(\Sigma, \partial\Sigma)$, since the group $\text{Mod}(\Sigma, \partial\Sigma)$ is torsion-free. Indeed, if $F \in \text{Mod}(\Sigma, \partial\Sigma)$ is periodic of period m , F^m is a non-trivial multitwist along the boundary curves. Lemma 3.17 clarifies this situation.

3.3.1 The periodic mapping classes on surfaces with nonempty boundary

In this subsection, we consider a surface Σ with a nonempty boundary, we choose a boundary component d , and look only at the mapping class group of Σ preserving globally d . All the results that are coming are based on a classic result coming from the theory of Riemannian manifolds (we won't prove it):

Lemma 3.16. *Let M a Riemannian manifold and f an isometry on M . If f fixes a point x and if the differential of f in x is the identity, then f is the identity. We have the same conclusion when f fixes a boundary curve of M point-wise. \square*

Corollaries of Lemma 3.16. Lemma 3.16 is fundamental to the comprehension of the periodic mapping classes and induces many essential corollaries in this paper:

- Lemma 3.17: “If $\partial\Sigma$ is nonempty, then $\text{Mod}(\Sigma, \partial\Sigma)$ is torsion-free.”
- Corollary 3.18 of Lemma 3.17, which allows us to deduce the existence of some periodic mapping classes from the existence of some other periodic mapping classes lying in “smaller” subsurface (i.e. of smaller genus or of greater Euler characteristic).
- Lemma 3.19: “If $\partial\Sigma$ is nonempty and if d belongs to $\text{Bndy}(\Sigma)$, then any finite subgroup of $\text{Mod}_d(\Sigma)$ is cyclic.”

Lemma 3.17 (Behaviour of periodic mapping classes in the neighbourhood of $\partial\Sigma$).

Let Σ be a connected surface such that $\partial\Sigma \neq \emptyset$. Let d be a boundary curve of Σ and let $\text{Mod}(\Sigma, d)$ be the group of the mapping classes of Σ that fix d point-wise. Then the group $\text{Mod}(\Sigma, d)$ is torsion-free. Moreover, let F be a periodic mapping class of period $m \geq 2$ and belonging to $\text{Mod}(\Sigma, d)$. Then there exists an integer ℓ coprime to m such that $F^m = T_d^\ell$ (in particular, ℓ is nonzero).

Proof. Remember that a mapping class in $\text{Mod}(\Sigma, d)$ is said to be periodic if one of its nonzero power induces the trivial mapping class in $\text{Mod}(\Sigma)$. So any mapping class that would belong to the torsion of $\text{Mod}(\Sigma, d)$ is by definition a periodic mapping class. However if we show that any nonzero power of any periodic mapping class is non-trivial in $\text{Mod}(\Sigma, d)$, we will have shown that $\text{Mod}(\Sigma, d)$ is torsion-free. So the second part of Lemma 3.17 implies the first part. Hence, by showing the second part, we will be done.

Let \bar{F} be a diffeomorphism in $\text{Diff}^+(\Sigma, d)$ which represents F and fixes d pointwise. Let d' be a curve isotopic to d in Σ that lies outside of $\partial\Sigma$. Let us call \mathcal{V} the compact cylinder included in Σ whose both boundary components are d and d' . Let Σ' be the closure of the complement of \mathcal{V} in Σ (cf. Figure 13).

Let us apply the Nielsen - Kerckhoff realization theorem: there exist a hyperbolic metric g on Σ' and an isometry \bar{F}_1 of (Σ', g) representing the restriction of F to Σ' . Let us denote by

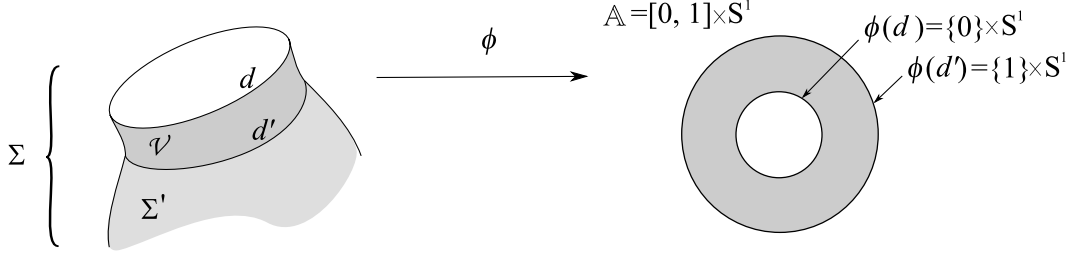

Figure 13: The situation described in proof of Lemma 3.17.

f the restriction of \bar{F}_1 to d' . Since \bar{F}_1 is a periodic isometry of order m , there exists an integer k such that f is a rotation of angle $\frac{2k\pi}{m}$ on d' equipped with the induced metric. But for all $p \in \{1, 2, \dots, m-1\}$, the mapping class $(\text{for}_d(F))^p$ (where $\text{for}_d(F)$ is the mapping class induced by F in $\text{Mod}(\Sigma)$) is different from the identity, so according to Lemma 3.16, f^p is different from the identity. Hence k is coprime to m .

Let \mathbb{A} be the annulus $[0, 1] \times S^1$ and ϕ a positive diffeomorphism of \mathcal{V} in \mathbb{A} such that $\phi(d) = \{0\} \times S^1$ and $\phi(d') = \{1\} \times S^1$ (cf. Figure 13). Moreover, we can construct ϕ so that the map $\phi \circ f \circ \phi^{-1}$ from $\{1\} \times S^1$ to $\{1\} \times S^1$ coincides with the function $(1, e^{i\theta}) \mapsto (1, e^{i(\theta + \frac{2k\pi}{m})})$, for f is an angle $\frac{2k\pi}{m}$ rotation on d' . We extend f on \mathcal{V} (cf. Figure 14) by setting for all $t \in [0, 1]$ and $\theta \in [0, 2\pi[$:

$$f(\phi^{-1}((t, e^{i\theta}))) = \phi^{-1}((t, e^{i(\theta + \frac{2k\pi}{m}t)})).$$

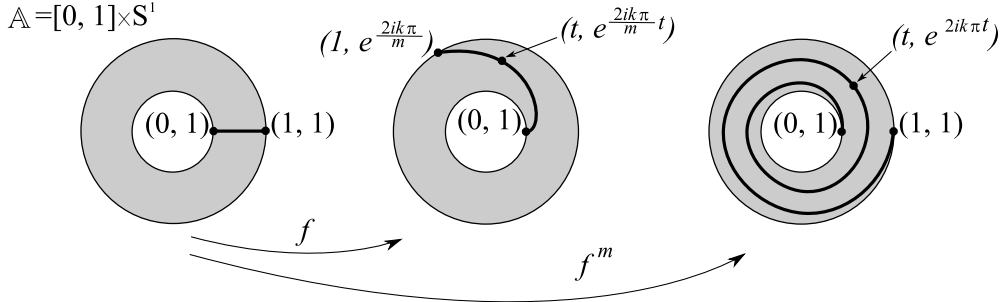

Figure 14: Image of the segment $[0, 1] \times \{1\}$ by f and f^m .

In this way, f fixes d point-wise and coincides with \bar{F}_1 on d' . Let \bar{F}_2 be the homeomorphism of Σ fixing d point-wise and coinciding with f on \mathcal{V} and with \bar{F}_1 on Σ' . By definition of a Dehn twist, the isotopy class of the homeomorphism \bar{F}_2^m is equal to $T_d^k \in \text{Mod}(\Sigma, d)$. Let G be the mapping class of $\text{Mod}(\Sigma, d)$ containing the homeomorphism $\bar{F}\bar{F}_2^{-1}$. By construction, we have $\text{for}_d(\bar{F}) = \text{for}_d(\bar{F}_2)$, so, according to the following central exact sequence:

$$1 \rightarrow \langle T_d \rangle \rightarrow \text{Mod}(\Sigma, d) \xrightarrow{\text{for}_d} \text{Mod}_d(\Sigma) \rightarrow 1,$$

the isotopy classes of \bar{F} and \bar{F}_2^{-1} in $\text{Mod}(\Sigma, d)$ commute, so the homeomorphisms $(\bar{F}\bar{F}_2^{-1})^m$ and $\bar{F}^m\bar{F}_2^{-m}$ are isotopic, hence $G^m = F^m T_d^{-k}$. But $\text{for}_d(\bar{F}) = \text{for}_d(\bar{F}_2)$, so, according to the same exact sequence, there exists an integer j such that $G = T_d^j$. These two last equalities imply that $F^m = G^m T_d^k = T_d^{jm+k}$, and $jm+k$ is coprime to m . \square

Let us give a corollary of Lemma 3.17 that will allow us to show the existence of some

periodic mapping classes from periodic mapping classes defined on “smaller” surfaces (i.e. of smaller genus or of greater Euler characteristic).

Corollary 3.18 (Rebuilding a periodic mapping class).

Let Σ be a connected surface. Let I be a finite set and let $\mathcal{A}_I = \{a_i, i \in I\}$ be a curve simplex in Σ . For all $i \in I$, we denote by a_i^+ and a_i^- the boundary components of $\Sigma_{\mathcal{A}_I}$ coming from the cut of \mathcal{A}_I along the curve a_i . Let \tilde{F} be a periodic mapping class of $\text{Mod}(\Sigma_{\mathcal{A}_I})$ of order two that preserves $\{a_i^+, a_i^-\}$ for all $i \in I$. Then there exists a unique periodic mapping class $F \in \text{Mod}(\Sigma)$ of order two such that F induces \tilde{F} in $\text{Mod}(\Sigma_{\mathcal{A}_I})$.

Proof.

1. *Notation*

Let J and K be two subsets of I such that $J \sqcup K$ forms a partition of I and such that for all $j \in J$, the boundary components a_j^+ and a_j^- of $\Sigma_{\mathcal{A}_I}$ are swapped by \tilde{F} , whereas for all $k \in K$, the boundary components a_k^+ and a_k^- of $\Sigma_{\mathcal{A}_I}$ are not. Let $\mathcal{A}_J = \{a_j, j \in J\}$ and $\mathcal{A}_K = \{a_k, k \in K\}$.

2. *Existence of F*

Let \bar{F}_1 be a diffeomorphism of $\text{Diff}^+(\Sigma_{\mathcal{A}_I})$ of order 2 representing \tilde{F} . We construct a diffeomorphism \bar{F}_2 of $\text{Diff}^+(\Sigma_{\mathcal{A}_K})$ by identifying in $\Sigma_{\mathcal{A}_I}$ a_j^+ and a_j^- thanks to the following relation in $\Sigma_{\mathcal{A}_I}$: for all pairs of points $(x, y) \in \Sigma_{\mathcal{A}_I}$,

$$x \sim y \text{ if and only if } \begin{cases} x = y, \\ \text{or} \\ x, y \in a_j^+ \cup a_j^- \text{ and } y = \bar{F}_1(x). \end{cases}$$

The differential structure of $\Sigma_{\mathcal{A}_K}$ induced by the one of $\Sigma_{\mathcal{A}_I}$ is well-defined up to conjugation by a diffeomorphism (cf. [Hi] page 184: *Gluing Manifolds Together*); and by construction, \bar{F}_2 is a diffeomorphism of $\Sigma_{\mathcal{A}_K}$. Let F_2 be the mapping class of $\text{Mod}(\Sigma_{\mathcal{A}_K})$ containing \bar{F}_2 . It is clear that F_2 is periodic of order two. Notice that F_2 preserves each boundary a_k^ε , $k \in K$, $\varepsilon \in \{+, -\}$. One can then define F_3 as being a representative of F_2 in $\text{Mod}(\Sigma_{\mathcal{A}_K}, \{a_k^+, a_k^-, k \in K\})$. According to Lemma 3.17, for all $k \in K$, there exist two odd integers m_k^+ and m_k^- such that:

$$F_3^2 = \prod_{k \in K} T_{a_k^+}^{m_k^+} T_{a_k^-}^{m_k^-}.$$

Let F_4 be the mapping class of $\text{Mod}(\Sigma)$ obtained by identifying the boundary components a_k^+ and a_k^- for all $k \in K$. Thus F_4 satisfies the equality:

$$F_4^2 = \prod_{k \in K} T_{a_k}^{(m_k^+ + m_k^-)}.$$

Let us set $F_5 = F_4 \left(\prod_{k \in K} T_{a_k}^{\ell_k} \right)^{-1}$, where, for all $k \in K$, the rational ℓ_k defined by $\ell_k = \frac{m_k^+ + m_k^-}{2}$ is an integer since m_k^+ and m_k^- are both odd. Since this product is commutative, we have $F_5^2 = \text{Id}$. By construction, the mapping class F_5 fixes the curves of \mathcal{A}_I and induces in $\text{Mod}(\Sigma_{\mathcal{A}_I})$ the mapping class \tilde{F} . So the mapping class F_5 plays the role of F in the statement of Corollary 3.18.

3. *Uniqueness of F*

Let us assume that there exist two mapping classes F and F' in $\text{Mod}_{\mathcal{A}_I}(\Sigma)$ such that $F^2 = F'^2 = \text{Id}$ and such that F and F' induce \tilde{F} in $\text{Mod}(\Sigma_{\mathcal{A}_I})$. According to the following exact sequence:

$$1 \rightarrow \langle T_{a_i}, i \in I \rangle \rightarrow \text{Mod}_{\mathcal{A}_I}(\Sigma) \rightarrow \text{Mod}(\Sigma_{\mathcal{A}_I}) \rightarrow 1,$$

there exist some integers p_i , $i \in I$ and a mapping class $W = \prod_{i \in I} T_{a_i}^{p_i}$ such that $F' = FW$. But F and F' fix the curves of \mathcal{A}_I , so these two mapping classes commute with W and we have $(FF'^{-1})^2 = W^2$. However, FF'^{-1} is periodic of order two as a commutative product of two periodic mapping classes of order two, so the mapping class $W^2 = \prod_{i \in I} T_{a_i}^{2p_i}$ is trivial. Then for all $i \in I$, we have $2p_i = 0$, so W is trivial. Eventually, after Lemma 3.12, we get $F = F'$. \square

Lemma 3.16 allows us to study the periodic mapping classes when Σ has a nonempty boundary and when these mapping classes preserve at least one boundary component, say d . This lemma leads to two results:

- one about $\mathcal{M}od(\Sigma, d)$, where d is fixed point-wise, cf. Lemma 3.17 above: “ $\mathcal{M}od(\Sigma, d)$ is torsion-free.”;
- and another about $\mathcal{M}od_d(\Sigma)$, where d is preserved set-wise, cf. Lemma 3.19 below: “Any finite subgroup of $\mathcal{M}od_d(\Sigma)$ is cyclic.”.

Lemma 3.19. *Let Σ be a connected surface with a nonempty boundary and let d be a boundary component. Any finite subgroup of $\mathcal{M}od_d(\Sigma)$ is cyclic.*

Proof. Let Γ be a finite group included in $\mathcal{M}od_d(\Sigma)$. According to Kerckhoff’s Theorem (cf. Theorem 3.15) there exist a hyperbolic metric g on Σ and a finite group $\bar{\Gamma}$ of $\text{Isom}^+(\Sigma, g)$ that is sent isomorphically on Γ by the natural morphism $\text{Diff}^+(\Sigma) \rightarrow \mathcal{M}od(\Sigma)$. Let us give an orientation to d and define the map

$$\theta : \bar{\Gamma} \rightarrow \mathbb{R}/2\pi\mathbb{Z}$$

that sends an isometry \bar{K} to the angle of the induced rotation by \bar{K} on d . It is clear that θ is a morphism. According to Lemma 3.16, any isometry that fixes d point-wise is the identity, so θ is an injective morphism. Thus Γ is isomorphic to a finite subgroup of $\mathbb{R}/2\pi\mathbb{Z}$, hence Γ is cyclic. \square

3.3.2 Maximal order of periodic mapping classes and of finite groups according to the surface.

Given a surface Σ , looking for the maximal order obtained by the periodic mapping classes of $\mathcal{P}\mathcal{M}od(\Sigma)$, or looking for the order of the greatest finite subgroup in $\mathcal{P}\mathcal{M}od(\Sigma)$ amounts to the same thing when $\partial\Sigma$ is nonempty, after Lemma 3.19. When $\partial\Sigma$ is empty, things are a bit more complicated. We will be interested by both cases. We recall Riemann-Hurewicz Formula (Lemma 3.20), which is a computation of Euler characteristic. We will deduce from it the maximal order

- of a periodic mapping class in a genus-0 surface (cf. Corollary 3.23),
- of a periodic mapping class in a surface with a non-trivial boundary (cf. Corollaries 3.24 and 3.25),
- of the finite subgroups in a surface without boundary (cf. Corollary 3.26).

The following Lemma, due to Hurwitz, is classic and its proof is left to the reader.

Lemma 3.20 (Riemann-Hurwitz Formula).

Let Σ be a surface with a possibly trivial boundary and let Γ be a finite subgroup of order m of $\text{Diff}^+(\Sigma)$, such that $m \geq 1$. Then Σ/Γ is a surface and the quotient map $\pi : \Sigma \rightarrow \Sigma/\Gamma$ is a ramified covering. Let Q_1, \dots, Q_ℓ the ramification points of π , and, for $1 \leq i \leq \ell$, let $o(Q_i)$ be the number of preimages of Q_i by π . Then the Euler characteristics of Σ and Σ/Γ (as a surface) are linked by the formula:

$$\chi(\Sigma) + \sum_{i=1}^{\ell} (m - o(Q_i)) = m \cdot \chi(\Sigma/\Gamma).$$

□

Definition 3.21 (Ramification points and singular points).

The points of Σ/Γ whose number of preimages by π is smaller than $|\Gamma|$ are called *ramification points*. Their preimages in Σ are called *singular points*.

Remark.

- For all i , the group Γ acts transitively on $\pi^{-1}(\{Q_i\})$. For this reason, the cardinality of $\pi^{-1}(\{Q_i\})$, denoted by $o(Q_i)$, divides m .
- When Γ is spanned by a unique element f , for all $i \leq \ell$, the action of f on $\pi^{-1}(\{Q_i\})$ is cyclic, so $\pi^{-1}(\{Q_i\})$ belongs to $\text{Fix}(f^{o(Q_i)})$, the set of fixed points of $f^{o(Q_i)}$. However, according to Lefschetz Theorem, the number of fixed points of f and of its powers depends only on the isotopy class of f (let us make clear that in Lefschetz Theorem, the number of fixed points takes into account the multiplicity of each fixed point, but in the case of non-trivial isometries, this integer always equals 1). Hence the data of ℓ and $\{o(Q_i), 1 \leq i \leq \ell\}$ is an invariant of the isotopy class of f . Since $\chi(\Sigma/\langle f \rangle)$ and the number of boundary components of $\Sigma/\langle f \rangle$ are also invariant by isotopy on f , the surface $\Sigma/\langle f \rangle$ itself is an invariant of the isotopy class of f .
- This lemma together with Kerckhoff's Theorem have a lot of corollaries and here are some of them that we will use in this paper.

The maximal order of periodic mapping classes on a surface and the sum of the number of fixed boundary components and the number of fixed points in this surface vary in opposite direction. More precisely:

Corollary 3.22 (Fixed points and boundary components preserved by a periodic mapping class).

Let Σ be a surface $\Sigma_{g,b}$ and let F be a periodic mapping class of $\text{Mod}(\Sigma)$ of order m . Then, the sum of the number of boundary components preserved by F and the number of fixed points of F is bounded by $2 + \frac{2g}{m-1}$.

Proof. Let \bar{F} be a diffeomorphism of order m representing F . Let b' be the number of boundary components preserved by \bar{F} and let ℓ' be the number of fixed points of \bar{F} . Let \mathcal{D} be the set of boundary components of Σ that are not fixed by \bar{F} . Let Σ' be the surface obtained from Σ where each boundary components of \mathcal{D} have been filled. Let \bar{F}' the diffeomorphism induced by \bar{F} on Σ' . Let us apply Lemma 3.20 to \bar{F}' , and let us adopt the notation of the statement. The order m of \bar{F}' (equal to the order of \bar{F}) coincides with the order of the group $\Gamma = \langle \bar{F}' \rangle$. In addition, notice that:

- $\chi(\Sigma') = 2 - 2g - b'$;
- for all fixed point Q , we have $o(Q) = 1$;
- $\sum_{i=1}^{\ell} (m - o(Q_i)) \geq \ell'(m - 1)$;
- $\chi(\Sigma'/\Gamma) \leq 2 - b'$.

Finally, we get:

$$(2 - 2g - b') + \ell'(m - 1) \leq m \cdot (2 - b'),$$

whence:

$$(m - 1)b' + \ell'(m - 1) \leq 2(m - 1) + 2g,$$

whence the formula: $b' + \ell' \leq 2 + \frac{2g}{m-1}$. □

The following corollary is the special case $g = 0$.

Corollary 3.23 (Periodic mapping classes on a sphere).

Let S be a holed sphere and F a periodic mapping class of $\text{Mod}(S)$. If there exist at least three boundary components in S preserved by F , then F is the identity of $\text{Mod}(S)$. □

Corollary 3.24 (Order of a periodic mapping class in a surface with boundary).

The order of a periodic mapping class in $\mathcal{PMOD}(\Sigma_{g,b})$ with $g \geq 1$ and $b \geq 1$ is:

- smaller than or equal to $6|\chi(\Sigma)|$ when $b = 1$,
- smaller than or equal to $2|\chi(\Sigma)|$ when $b = 2$,
- smaller than or equal to $|\chi(\Sigma)|$ when $b \geq 3$.

Proof. Let us apply Riemann-Hurewicz formula (Lemma 3.20) to a periodic mapping class F of order m in $\mathcal{PMOD}(\Sigma_{g,b})$:

$$\chi(\Sigma) + \sum_{i=1}^{\ell} \left(m - \frac{m}{q_i} \right) = m \cdot \chi(\Sigma') \quad (1)$$

where $q_i = \frac{m}{o(Q_i)}$ and where $\Sigma' = \Sigma / \langle F \rangle$. Notice that since F belongs to $\mathcal{PMOD}(\Sigma)$, the surface Σ' has got as many boundary components as Σ . If $\chi(\Sigma') < 0$, then we deduce from (1) that $m \leq |\chi(\Sigma)|$. When $b \geq 3$, the surface Σ' has got at least three boundary components, so $\chi(\Sigma') < 0$, so $m \leq |\chi(\Sigma)|$ and we are done.

When $b = 1$ or $b = 2$, if $\chi(\Sigma') < 0$, the result is proved in the same way. Let us assume that $b = 1$ or $b = 2$ and that $\chi(\Sigma') \geq 0$. Since F is an orientation-preserving mapping class and since we have $\chi(\Sigma') \geq 0$, then Σ' is a disk if $b = 1$ or an annulus if $b = 2$. Let us distinguish the cases $b = 1$ and $b = 2$.

- Case $b = 1$. Let us divide equality (1) by $-m$, and let us replace $\chi(\Sigma')$ by 1. We get:

$$\frac{|\chi(\Sigma)|}{m} + \sum_{i=1}^{\ell} \frac{1}{q_i} = \ell - 1. \quad (2)$$

We can then deduce:

- if $\ell \in \{0, 1\}$, then (2) cannot be satisfied;
- if $\ell = 2$, then $\frac{|\chi(\Sigma)|}{m} + \frac{1}{q_1} + \frac{1}{q_2} = 1$ implies that $\frac{|\chi(\Sigma)|}{m} \geq \frac{1}{6}$, for $\frac{1}{q_1} + \frac{1}{q_2} \geq 1$ or $\frac{1}{q_1} + \frac{1}{q_2} \leq \frac{1}{2} + \frac{1}{3} = \frac{5}{6}$ for all integers q_1 and q_2 . Hence $m \leq 6|\chi(\Sigma)|$;
- if $\ell \geq 3$, we have $\frac{|\chi(\Sigma)|}{m} + \frac{\ell}{2} \geq \frac{|\chi(\Sigma)|}{m} + \sum_{i=1}^{\ell} \frac{1}{q_i} = \ell - 1$, whence $\frac{|\chi(\Sigma)|}{m} \geq \frac{1}{2}$ (the extreme case happens when $\ell = 3$ and $q_1 = q_2 = q_3 = 2$). Hence $m \leq 2|\chi(\Sigma)|$.

Finally, when $b = 1$, the inequality $m \leq 6|\chi(\Sigma)|$ always holds.

- Case $b = 2$. Equality (1) becomes:

$$\frac{|\chi(\Sigma)|}{m} + \sum_{i=1}^{\ell} \frac{1}{q_i} = \ell. \quad (3)$$

Hence:

- if $\ell = 0$, then the equation (3) cannot be satisfied;
- if $\ell \geq 1$, we have $\frac{|\chi(\Sigma)|}{m} + \frac{\ell}{2} \geq \frac{|\chi(\Sigma)|}{m} + \sum_{i=1}^{\ell} \frac{1}{q_i} = \ell$, whence $\frac{|\chi(\Sigma)|}{m} \geq \frac{1}{2}$ (the extreme case happens when $\ell = 1$ and $q_1 = 2$). Hence $m \leq 2|\chi(\Sigma)|$.

Finally, when $b = 2$, the inequality $m \leq 2|\chi(\Sigma)|$ always holds. □

When the genus of Σ is 1 instead of zero, we get:

Lemma 3.25 (Order of periodic mapping classes in $\mathcal{PMod}(\Sigma_{1,b})$, $b \geq 1$).

The maximal order of periodic mapping classes of $\mathcal{PMod}(\Sigma_{1,b})$ when $b \geq 1$ is 6.

Proof. Let us denote by m the order of a mapping class lying in $\mathcal{PMod}(\Sigma_{1,b})$. When $b = 1$, we have $m \leq 6|\chi(\Sigma_{1,1})|$ according to Corollary 3.24, so $m \leq 6$. When $b = 2$, we have $m \leq 2|\chi(\Sigma_{1,2})|$ according to Corollary 3.24, so $m \leq 4$. Hence, when $b \geq 3$, the equation $b \leq 2 + \frac{2g}{m-1}$ coming from Lemma 3.22 implies that $m \leq 3$ (recall that $g = 1$). Finally, for all b greater than or equal to 1, we have $m \leq 6$.

The case $m = 6$ is achieved by the following example. Recall that if Σ is the torus with one hole, matrices of $SL_2(\mathbb{Z})$ preserve \mathbb{Z}^2 and so induce diffeomorphisms of the torus, which preserve the point $(0, 0)$. Recall that the induced map from $SL_2(\mathbb{Z})$ to $\mathcal{Mod}(\Sigma)$ is one-to-one.

Then, the matrix $\begin{pmatrix} 1 & 1 \\ -1 & 0 \end{pmatrix}$ of order 6 in $SL_2(\mathbb{Z})$ induces a mapping class of order 6 in $\mathcal{Mod}(\Sigma)$. □

Finally the following result is a technical corollary of Lemma 3.20 which gives a bound to the cardinality of a finite subgroup of the mapping class group of a surface Σ of genus g . It is due to Hurwitz. For a proof, see [FaMa], section 6.2.

Corollary 3.26 (“84($g - 1$)” Theorem).

Let Σ be a connected surface of genus at least 2 without boundary. The order of a finite subgroup of the mapping class group is bounded by $42|\chi(\Sigma)|$ (which is equal to $84(g - 1)$). □

3.4 Pseudo-Anosov mapping classes

In the next sections, the only things about pseudo-Anosov mapping classes that we are going to use are Definition 3.27 and the two following results (Proposition 3.30 and Theorem 3.32). However, the proof of Proposition 3.30 involves the theory of *pseudo-Anosov diffeomorphisms* which we present below in Subsection 3.5. If the reader accepts Proposition 3.30, he can skip Subsection 3.5 and continue the reading at Subsection 3.6.

The following definition of pseudo-Anosov mapping classes is equivalent to the historical definition of pseudo-Anosov mapping classes; it has the advantage of proposing a very simple statement. It can be seen as a consequence of Thurston's theory.

Definition 3.27 (Pseudo-Anosov mapping classes).

For any connected surface Σ non-homeomorphic to a pair of pants, a mapping class $F \in \mathcal{M}\text{od}(\Sigma)$ that verifies $F^k(a) \neq a$ for any curve a in $\mathcal{C}\text{urv}(\Sigma)$ and any nonzero integer k is said to be *pseudo-Anosov*.

Remark. In accordance with this definition, there exists no pseudo-Anosov mapping class on a pair of pants. We can prove directly that the mapping classes on a pair of pants are all periodic if the boundary components may be permuted, or are trivial if they may not. For a mapping class, being periodic and being pseudo-Anosov correspond to two opposite situations and a mapping class cannot be both.

Next proposition involves the following definition:

Definition 3.28 ($\widetilde{\text{Centr}}(F)$).

Given a surface Σ , for any pseudo-Anosov mapping class F belonging to $\mathcal{M}\text{od}(\Sigma)$, we denote by $\widetilde{\text{Centr}}(F)$ the subgroup of $\mathcal{M}\text{od}(\Sigma)$ of all the mapping classes G that commute with some nonzero power of F .

The following properties are immediate.

Lemma 3.29. *For all integers $k \neq 0$, $k' \neq 0$ and all pseudo-Anosov mapping classes $F, F' \in \mathcal{M}\text{od}(\Sigma)$, the following statements hold:*

- (i) $\widetilde{\text{Centr}}(F^k) = \widetilde{\text{Centr}}(F)$;
- (ii) if $F^k = (F')^{k'}$, then $\widetilde{\text{Centr}}(F) = \widetilde{\text{Centr}}(F')$. □

Subsection 3.5 is devoted to the proof of the following proposition.

Proposition 3.30 (Structure of $\widetilde{\text{Centr}}(F)$).

Let Σ be a connected surface without boundary and let F be a pseudo-Anosov mapping class in $\mathcal{M}\text{od}(\Sigma)$. There exists a surjective morphism $\ell_F : \widetilde{\text{Centr}}(F) \rightarrow \mathbb{Z}$ satisfying the following properties:

- (i) The kernel $\text{Ker}(\ell_F)$ coincides with the set of all the finite order mapping classes of $\widetilde{\text{Centr}}(F)$.
- (ii) The kernel $\text{Ker}(\ell_F)$ is a group of order smaller than or equal to $6|\chi(\Sigma)|$.

(iii) The morphism ℓ_F does not depend on F , but only on $\widetilde{\text{Centr}}(F)$ up to the sign. If for two pseudo-Anosov F and F' there exist two positive integers p and q such that $F^p = F'^q$, then $\widetilde{\text{Centr}}(F) = \widetilde{\text{Centr}}(F')$ and $\ell_F = \ell_{F'}$.

As a corollary comes the following result, historically due to McCarthy: “the centralizer of a pseudo-Anosov in $\text{Mod}(\Sigma)$ is virtually infinitely cyclic”. This is not only true for the centralizer, but for $\widetilde{\text{Centr}}(F)$ too, where F is a pseudo-Anosov mapping class. We recall the definition of a *virtually cyclic group*, then we give a formal statement of this corollary.

Definition 3.31 (Virtually infinitely cyclic group).

A group is said to be *virtually infinitely cyclic* if it is finite or if it contains an infinite cyclic subgroup of finite index.

Theorem 3.32 (J.D. McCarthy [Mc2]). *Let Σ be a connected surface and F a pseudo-Anosov mapping class of $\text{Mod}(\Sigma)$. Then $\widetilde{\text{Centr}}(F)$ is virtually infinitely cyclic.*

Proof. Let M be a mapping class of $\widetilde{\text{Centr}}(F)$ such that $\ell(M) = 1$. Then the quotient set $\widetilde{\text{Centr}}(F)/\langle M \rangle$ is in bijection with $\text{Ker}(\ell)$, so we have $[\widetilde{\text{Centr}}(F) : \langle M \rangle] = |\text{Ker}(\ell)|$. Thus $\langle M \rangle$ is an infinite cyclic subgroup of finite index of $\widetilde{\text{Centr}}(F)$. \square

The aim of the next subsection is to (superficially) develop the pseudo-Anosov theory, in order to prove Proposition 3.30.

3.5 The theory of Pseudo-Anosov diffeomorphisms.

We will now recall the fundamental results of the theory of the *pseudo-Anosov diffeomorphisms* on surfaces without boundary, in order to prove Proposition 3.30. There exists a very rich literature concerning this theory. In this subsection, we will lean mainly on the article of C. Bonatti and L. Paris [BoPa], section 2. The classic references are [FLP], [Th], [BlCa], [Iv1]. Let us begin by a remark on the terminology concerning the “pseudo-Anosov diffeomorphisms”. In this subsection, Σ is a surface without boundary.

Pseudo-Anosov diffeomorphisms and homeomorphisms. Let us recall that the “pseudo-Anosov diffeomorphisms” on a surface Σ are actually both homeomorphisms on Σ , and diffeomorphisms on the surface Σ minus a finite number of points. In the neighbourhood of these points, called *singular points*, the homeomorphisms are not differentiable although they are perfectly known, cf. [BoPa]. For this reason C. Bonatti and L. Paris [BoPa] speak about “pseudo-Anosov homeomorphisms” when we speak about “pseudo-Anosov diffeomorphisms”, but we deal with the same objects. Let us recall that there exist true diffeomorphisms in the isotopy class of a “pseudo-Anosov diffeomorphism” (isotopic means here linked by a path of homeomorphisms) and a “pseudo-Anosov diffeomorphism” defines always a unique isotopy class of true diffeomorphisms, so it defines a unique mapping class.

Properties of pseudo-Anosov diffeomorphisms. The fundamental theorem of the pseudo-Anosov theory, due to Thurston (cf. [BlCa], [Th]), is the following:

A mapping class $F \in \mathcal{M}(\Sigma)$ is pseudo-Anosov in the sens of Definition 3.27, if and only if there exists a “pseudo-Anosov diffeomorphism” (cf. below) $\bar{F} \in \text{Diff}(\Sigma)$ representing F .

Instead of a definition of “*pseudo-Anosov diffeomorphism*”, we describe some of their properties. This will be enough for our purpose. Let \bar{F} be any “*pseudo-Anosov diffeomorphism*” in $\text{Diff}(\Sigma)$. By definition, \bar{F} satisfies the following properties:

The foliations \mathcal{F}^s , \mathcal{F}^u , Singular points, separatrices and indexes. There exist a finite set \mathcal{S} of points in Σ preserved by \bar{F} and a pair of transverse measured regular foliations on $\Sigma \setminus \mathcal{S}$. We say we have a unique pair of transverse measured singular foliations \mathcal{F}^s and \mathcal{F}^u invariant by \bar{F} on Σ that are preserved by Σ . These foliations are called the *stable and unstable foliations* (cf. [BoPa]). An integer $k \geq 3$ is associated to each singular point $P \in \mathcal{S}$ and corresponds to the number of leaves of \mathcal{F}^s that end in P (taking \mathcal{F}^u instead of \mathcal{F}^s would have lead to the same number). These leaves ending in a singular point will be called *separatrices* (cf. [BoPa]). The integer k associated to a singular point P will be denoted by $\text{Ind}(\mathcal{F}^s, \mathcal{F}^u : P)$ and called *the index of $(\mathcal{F}^s, \mathcal{F}^u)$ at the singular point P* . Let us put the emphasis on the fact that for any $P \in \mathcal{S}$, we have $\text{Ind}(\mathcal{F}^s, \mathcal{F}^u : P) \geq 3$. Furthermore, each separatrix contains a unique singular point (cf. [BoPa] proposition 2.1, assertion (3)). The indices and the Euler characteristic of Σ satisfy the following (see [FLP], Exposé 5):

Proposition 3.33.

$$\chi(\Sigma) = \sum_{P \in \mathcal{S}} \left(1 - \frac{\text{Ind}(\mathcal{F}^s, \mathcal{F}^u : P)}{2} \right).$$

The group $\text{Norm}(\mathcal{F}^s, \mathcal{F}^u)$ and the morphism L . Let us denote by $\text{Norm}(\mathcal{F}^s, \mathcal{F}^u)$ the set of diffeomorphisms of $\text{Diff}(\Sigma)$ that preserve \mathcal{F}^s and \mathcal{F}^u . The elements of $\text{Norm}(\mathcal{F}^s, \mathcal{F}^u)$ send the singular points on singular points of same index. They are either pseudo-Anosov or periodic. Proposition 3.34 gives the main properties of the *dilatation coefficient* $\lambda^u(\cdot)$ (cf. [BoPa]) of the diffeomorphisms of $\text{Norm}(\mathcal{F}^s, \mathcal{F}^u)$, using the morphism

$$L : \begin{array}{ccc} \text{Norm}(\mathcal{F}^s, \mathcal{F}^u) & \longrightarrow & \mathbb{R} \\ \bar{G} & \longmapsto & \log(\lambda^u(\bar{G})) \end{array} .$$

We won't use the definition of the dilatation coefficient, but only the existence of the morphism L and Proposition 3.34 below.

Proposition 3.34 (Properties of L).

The morphism $L : \text{Norm}(\mathcal{F}^s, \mathcal{F}^u) \rightarrow \mathbb{R}$ (depending on the pseudo-Anosov diffeomorphism \bar{F}) satisfies the five following properties:

- (i) *the real number $L(\bar{F})$ satisfies $L(\bar{F}) > 0$,*
- (ii) *the image of L is isomorphic to \mathbb{Z} ,*
- (iii) *the kernel $\text{Ker}(L)$ acts freely on the set of separatrices of \mathcal{F}^u ,*
- (iv) *the kernel $\text{Ker}(L)$ is a finite group.*

Proof.

- (i) By definition of the dilatation coefficient, $L(F) = \log(\lambda^u(F))$ satisfies $L(F) > 0$ for $\lambda^u(F) > 1$ (cf. [FLP], Exposé 9).

- (ii) We refer to [ArYo] for this result.
- (iii) Since $\text{Ker}(L)$ is included in $\text{Norm}(\mathcal{F}^s, \mathcal{F}^u)$, the elements of $\text{Ker}(L)$ preserve \mathcal{F}^u and permute the separatrices. According to Lemma 2.11 of [BoPa], the induced action by $\text{Ker}(L)$ on the set of separatrices of \mathcal{F}^u is free (the group $\text{Ker}(L)$ is denoted by $\text{Sym}(\mathcal{F}^s, \mathcal{F}^u)$ in [BoPa]).
- (iv) Since \mathcal{S} is finite and since only a finite number of separatrices end in each singular point, the set of separatrices is finite. But $\text{Ker}(L)$ acts freely on it, hence $\text{Ker}(L)$ is a finite group. \square

Let us recall that for all pseudo-Anosov mapping classes $F \in \text{Mod}(\Sigma)$, we have defined $\widetilde{\text{Centr}}(F)$ as being the set of mapping classes $G \in \text{Mod}(\Sigma)$ such that for some nonzero integer m , the mapping classes G and F^m commute (cf. Definition 3.28).

Let us make clear that the group $\widetilde{\text{Centr}}(F)$ contains the centralizer of F , but is not equal to it in general. The aim of this definition is to prepare the following proposition which establishes an isomorphism between $\widetilde{\text{Centr}}(F)$ and $\text{Norm}(\mathcal{F}^s, \mathcal{F}^u)$.

Proposition 3.35 (Realisation of $\widetilde{\text{Centr}}(F)$ in $\text{Norm}(\mathcal{F}^s, \mathcal{F}^u)$).

Let F be a pseudo-Anosov mapping class of $\text{Mod}(\Sigma)$ and let \mathcal{F}^s and \mathcal{F}^u be the stable and unstable foliations of a pseudo-Anosov diffeomorphism \bar{F} representing F . Then there exists a unique isomorphism

$$\psi : \begin{array}{ccc} \widetilde{\text{Centr}}(F) & \longrightarrow & \text{Norm}(\mathcal{F}^s, \mathcal{F}^u) \\ G & \longmapsto & \bar{G} \end{array}$$

where for all $G \in \widetilde{\text{Centr}}(F)$, \bar{G} is a representative of G in $\text{Norm}(\mathcal{F}^s, \mathcal{F}^u)$.

Proof. We show actually the existence of the inverse isomorphism of ψ that we denote by ϕ in this proof:

$$\phi : \begin{array}{ccc} \text{Norm}(\mathcal{F}^s, \mathcal{F}^u) & \longrightarrow & \widetilde{\text{Centr}}(F) \\ \bar{G} & \longmapsto & G \end{array},$$

where G is the isotopy class of \bar{G} . There exists a nonzero integer k such that \bar{F}^k fixes all the separatrices.

Let us first show that ϕ is well-defined. For any diffeomorphism \bar{G} belonging to $\text{Norm}(\mathcal{F}^s, \mathcal{F}^u)$, $\bar{G}\bar{F}^k\bar{G}^{-1}\bar{F}^{-k}$ belongs to $\text{Norm}(\mathcal{F}^s, \mathcal{F}^u)$ and fixes all the separatrices. But since L is a morphism in \mathbb{R} , $L(\bar{G}\bar{F}^k\bar{G}^{-1}\bar{F}^{-k}) = 0$, so $\bar{G}\bar{F}^k\bar{G}^{-1}\bar{F}^{-k} = \text{Id}$. Hence \bar{G} commutes with \bar{F}^k , hence G belongs to $\widetilde{\text{Centr}}(F)$.

Let us show that the morphism ϕ is injective. For any diffeomorphism $\bar{A} \in \text{Ker}(\phi)$, \bar{A} is isotopic to the identity. Then \bar{A} preserves the isotopy class of curves, hence \bar{A} cannot be pseudo-Anosov, hence \bar{A} is a diffeomorphism of finite order, isotopic to the identity. According to [FLP], Exposé 12, this implies that \bar{A} is the identity.

At last, let us show that the morphism ϕ is surjective. Let G be an element of $\widetilde{\text{Centr}}(F)$: there exists a nonzero integer ℓ such that G and F^ℓ commute. Let \bar{G}' be a representative of G in $\text{Diff}(\Sigma', \mathcal{P})$; then $\bar{G}'\bar{F}^\ell\bar{G}'^{-1}$ is isotopic to \bar{F}^ℓ , so according to Theorem III, Exposé 12 in [FLP] (see also Theorem 2.14 in [BoPa]), there exists a diffeomorphism \bar{H} isotopic to the identity such that $\bar{H}\bar{G}'\bar{F}^\ell(\bar{H}\bar{G}')^{-1} = \bar{F}^\ell$. Let us set $\bar{G} = \bar{H}\bar{G}'$. We get then $\bar{G}\bar{F}^\ell\bar{G}^{-1} = \bar{F}^\ell$. Hence \bar{G}

preserves the stable and unstable foliations of \bar{F}^ℓ , hence \bar{G} belongs to $\text{Norm}(\mathcal{F}^s, \mathcal{F}^u)$. Thus any G of $\widetilde{\text{Centr}}(F)$ has an preimage in $\text{Norm}(\mathcal{F}^s, \mathcal{F}^u)$. \square

We are now ready to prove Proposition 3.30.

Proposition 3.30 (Structure of $\widetilde{\text{Centr}}(F)$).

Let Σ be a connected surface without boundary and let F be a pseudo-Anosov mapping class in $\text{Mod}(\Sigma)$. There exists a surjective morphism $\ell_F : \widetilde{\text{Centr}}(F) \rightarrow \mathbb{Z}$ satisfying the following properties:

- (i) The kernel $\text{Ker}(\ell_F)$ coincides with the set of all the finite order mapping classes of $\widetilde{\text{Centr}}(F)$.
- (ii) The kernel $\text{Ker}(\ell_F)$ is a group of order smaller than or equal to $6|\chi(\Sigma)|$.
- (iii) The morphism ℓ_F does not depend on F , but only on $\widetilde{\text{Centr}}(F)$ up to the sign. If for two pseudo-Anosov F and F' there exist two positive integers p and q such that $F^p = F'^q$, then $\widetilde{\text{Centr}}(F) = \widetilde{\text{Centr}}(F')$ and $\ell_F = \ell_{F'}$.

Proof. Let Σ be a surface without boundary. According to Proposition 3.35, there exists an isomorphism $\psi : \widetilde{\text{Centr}}(F) \rightarrow \text{Norm}(\mathcal{F}^s, \mathcal{F}^u)$, $G \mapsto \bar{G}$, such that \bar{G} is a representative of G . Let ℓ_F be the morphism $L \circ \psi$, that we normalize, so that $\text{Im}(\ell_F) = \mathbb{Z}$. Let us prove items (i), (ii) and (iii).

(i) It is clear that for all $G \in \widetilde{\text{Centr}}(F)$, if $\ell_F(G) \neq 0$, then for all integers m different from 1, $\ell_F(G^m) \neq \ell_F(G)$, so G is not of finite order. In the contrary, $\text{Ker}(\ell_F)$ is equal to $\psi^{-1}(\text{Ker}(L))$ which is finite, so the elements of $\text{Ker}(\ell_F)$ are of finite order.

(ii) According to Proposition 3.35, the morphism ψ is an isomorphism, so $\text{Ker}(\ell)$, which is equal to $\text{Ker}(L \circ \psi)$, is isomorphic to $\text{Ker}(L)$. Let us compute the cardinality of $\text{Ker}(L)$. According to Proposition 3.34.(iv), we know it is finite.

Let us recall that all the indices of the singular points are greater than or equal to 3. We lean on Proposition 3.33:

$$\chi(\Sigma) = \sum_{P \in \mathcal{S}} \left(1 - \frac{\text{Ind}(\mathcal{F}^s, \mathcal{F}^u : P)}{2} \right).$$

The surface Σ is of negative Euler characteristic, so the set of singular points is nonempty. Let X be the set of all the separatrices of \mathcal{F}^u . Let P be a singular point and let k be the index $\text{Ind}(\mathcal{F}^s, \mathcal{F}^u : P)$. The k separatrices ending at P bring together a $(1 - \frac{k}{2})$ -contribution to the Euler characteristic of Σ , so each of them bring a contribution of $\frac{1}{k} - \frac{1}{2}$. Since $k \geq 3$, the contribution per separatrix ending at P to the Euler characteristic of Σ is smaller than or equal to $-\frac{1}{6}$. This is also true for all the separatrices of \mathcal{F}^u , so the cardinality of X , the set of separatrices of \mathcal{F}^u , must equal at most $6|\chi(\Sigma)|$. Now the action of $\text{Ker}(L)$ on X is free according to Proposition 3.34.(iii), so the cardinality of $\text{Ker}(L)$ is smaller than or equal to the cardinality of X , whence:

$$|\text{Ker}(L)| \leq 6|\chi(\Sigma)|.$$

But $\text{Ker}(L)$ is isomorphic to $\text{Ker}(\ell_F)$ via ψ , so:

$$|\text{Ker}(\ell_F)| \leq 6|\chi(\Sigma)|.$$

(iii) Let G be a pseudo-Anosov mapping class such that $\widetilde{\text{Centr}}(G) = \widetilde{\text{Centr}}(F)$ and let ℓ_G and ℓ_F be the two morphisms associated to G and F . The periodic elements of $\widetilde{\text{Centr}}(G)$ and

$\widetilde{\text{Centr}}(F)$ are the same, so $\text{Ker}(\ell_G) = \text{Ker}(\ell_F)$. Hence we have the following commutative diagram where the lines are exact and the vertical full arrows are equalities. It follows that the dotted arrow is an isomorphism.

$$\begin{array}{ccccccc} 1 & \longrightarrow & \text{Ker}(\ell_G) & \longrightarrow & \widetilde{\text{Centr}}(G) & \xrightarrow{\ell_G} & \mathbb{Z} \longrightarrow 1 \\ & & \downarrow = & & \downarrow = & & \downarrow \text{dotted} \\ 1 & \longrightarrow & \text{Ker}(\ell_F) & \longrightarrow & \widetilde{\text{Centr}}(F) & \xrightarrow{\ell_F} & \mathbb{Z} \longrightarrow 1 \end{array}$$

But ℓ_F (respectively ℓ_G) is the quotient map $\widetilde{\text{Centr}}(G) \rightarrow \widetilde{\text{Centr}}(G)/\text{Ker}(\ell_G) \cong \mathbb{Z}$ (resp. $\widetilde{\text{Centr}}(F) \rightarrow \widetilde{\text{Centr}}(F)/\text{Ker}(\ell_F) \cong \mathbb{Z}$). Hence ℓ_G and ℓ_F coincide up to an isomorphism of \mathbb{Z} , so ℓ_F and ℓ_G are equal up to multiplication by -1 .

Let F and F' be two pseudo-Anosov mapping classes such that there exist two positive integers p and q such that $F^p = F'^q$, let ℓ_F and $\ell_{F'}$ be the two morphisms associated to F and F' . Since $F^p = F'^q$, we have $\widetilde{\text{Centr}}(F) = \widetilde{\text{Centr}}(F')$, so according to what precedes, $\ell = \ell'$ or $\ell = -\ell'$. Let u and v be two positive integers such that $\ell_F(F) = u$ and $\ell_{F'}(F') = v$. Then $\ell_F(F^p) = pu$ and $\ell_{F'}(F'^q) = qv$, so $\ell_F(F^p)$ and $\ell_{F'}(F'^q)$ have the same sign, hence $\ell_F = \ell_{F'}$. \square

Remark. In the general case, $\widetilde{\text{Centr}}(F)$ is a semi-direct product $\text{Per} \rtimes \mathbb{Z}$ where Per is the finite subgroup of $\widetilde{\text{Centr}}(F)$ consisting of finite order elements of $\widetilde{\text{Centr}}(F)$. Indeed, the exact sequence

$$1 \rightarrow \text{Per} \xrightarrow{\text{incl.}} \widetilde{\text{Centr}}(F) \xrightarrow{\ell_F} \mathbb{Z} \rightarrow 1$$

is split since the last but one term of the sequence is \mathbb{Z} . This is a direct product if and only if there exists a pseudo-Anosov mapping class belonging to $\ell_F^{-1}(\{1\})$, whose action on the separatrices is trivial.

3.6 The reducible mapping classes: Thurston's theory and the essential reduction system

Birman, Lubotsky and McCarthy, and Ivanov independently, have classified the mapping classes by means of sets of characteristic curves called *essential reduction curves*, see Definition 3.37. Given a mapping class F , the set of essential reduction curves of F is called the *canonical reduction system*, see Definition 3.39.

Definition 3.36 (Reduction curves).

Given a surface Σ and a mapping class F in $\mathcal{M}\text{od}(\Sigma)$, a curve a in $\mathcal{C}\text{urv}(\Sigma)$ is called a *reduction curve of F* if the set $\{F^i(a), i \in \mathbb{N}\}$ is a curve simplex (hence a finite set) of $\mathcal{C}\text{urv}(\Sigma)$.

From the definition of reduction curves, given a reduction curve a of a mapping class F , there exists a nonzero integer m such that $F^m(a) = a$. If \mathcal{A} is a simplex of reduction curves of F that is F -stable, then the mapping class F induces a mapping class \widehat{F} in $\mathcal{M}\text{od}(\Sigma_{\mathcal{A}})$. Recall that for any curve simplex \mathcal{A} , we denote by $\mathcal{M}\text{od}_{\mathcal{A}}(\Sigma)$ the group of the mapping classes F preserving \mathcal{A} . We then have the following canonical morphism:

$$\wedge : \begin{array}{ccc} \mathcal{M}\text{od}_{\mathcal{A}}(\Sigma) & \longrightarrow & \mathcal{M}\text{od}(\Sigma_{\mathcal{A}}) \\ F & \longmapsto & \widehat{F} \end{array} .$$

The following definition was given in [BiLuMc] and [Iv]:

Definition 3.37 (Essential reduction curves).

A reduction curve of a mapping class F is said to be *essential* if no other reduction curve of F intersects it.

In the light of Definition 3.37, the following lemma is obvious.

Lemma 3.38. *The set of all the essential reduction curves of a mapping class F is an F -stable simplex.* □

Definition 3.39 (The canonical reduction system σ).

The set of essential reduction curves of a mapping class F is denoted by $\sigma(F)$ and is called the *canonical reduction system* of F .

The canonical reduction system owns the following properties, which we will use throughout this article. Proofs can be found in [BiLuMc] and in [Iv] and come from Nielsen and Thurston's theory, see [BlCa].

Proposition 3.40 (Properties of σ).

Let F and G be two mapping classes. Then, the following holds:

- (i) $G(\sigma(F)) = \sigma(GFG^{-1})$;
- (ii) for any nonzero integer m , then $\sigma(F^m) = \sigma(F)$;
- (iii) if F and G commute, then the curves of $\sigma(F)$ are reduction curves of G . Consequently, $I(\sigma(F), \sigma(G)) = 0$;
- (iv) $\sigma(F)$ is empty if and only if F is periodic or pseudo-Anosov. □

Definition 3.41 (Reducible and irreducible mapping classes).

A mapping class F is said to be *reducible* if $\sigma(F)$ is empty. In the opposite case, F is said to be *irreducible*.

Thus, the irreducible mapping classes are exactly the pseudo-Anosov mapping classes and the periodic mapping classes. The reducible mapping classes are all the others.

As a first example, the following lemma decides whether a reduction curve is essential or not, just by the behavior of the restriction of the mapping class to a subsurface containing this curve. As a corollary, we shall prove Lemma 3.12 stated above, as well as a proposition giving relations between the canonical reduction systems of two mapping classes and their product when they commute (see Proposition 3.45).

Lemma 3.42 (Canonical reduction system on subsurfaces).

Let Σ be a surface and Σ' be a subsurface of Σ non-homeomorphic to a pair of pants. Let F be a mapping class of $\text{Mod}(\Sigma)$ that preserves Σ' and let F' in $\text{Mod}(\Sigma')$ be the restriction of F to Σ' .

- (i) If there exists a reduction curve of F in $\text{Curv}(\Sigma)$ that is not included in $\Sigma \setminus \Sigma'$, then there exists a reduction curve of a nonzero power of F' in $\text{Curv}(\Sigma')$.
- (ii) Let x be a curve belonging to $\text{Curv}(\Sigma')$. If there exists a reduction curve of F in $\text{Curv}(\Sigma)$ that intersects x , then there exists a reduction curve of a nonzero power of F' in $\text{Curv}(\Sigma')$ that intersects x .
- (iii) Any curve of $\sigma(F)$ non-isotopic to a boundary component of Σ' is included either in Σ' or in $\Sigma \setminus \Sigma'$.
- (iv) Moreover, $\sigma(F') = \sigma(F) \cap \text{Curv}(\Sigma')$.

Proof. Item (ii) implies item (i): it is indeed enough to choose a curve x in Σ' that intersects a reduction curve of F . Then, according to item (ii), there exists a reduction curve of F' included in Σ' .

Let us show item (ii). Let x be a reduction curve of $\text{Curv}(\Sigma')$, let c be a reduction curve of F that intersects x . We are going to show that there exists a reduction curve c' of F' that intersects x .

If c is included in Σ' , there is nothing to be shown. Let us now assume that c is not included in Σ' . As the curve c intersects the curve x , which is included in Σ' , then c must intersect $\partial\Sigma'$. Consequently, the intersection $c \cap \Sigma'$ consists in a finite nonzero number of paths with extremities in $\partial\Sigma'$. Then there exists a nonzero integer m such that F^m preserves each boundary of Σ' and preserves each connected component of $c \cap \Sigma'$. Since $I(c, x) \neq 0$, at least one of these paths cuts the curve x . Let us choose one such path which we call d . The extremities of d lie in one or two boundary components of Σ' . In both cases, let P be the pair of pants corresponding to the intersection of Σ' with the tubular neighbourhood of the union of d and the boundary components of Σ' containing the extremities of d (darkened in Figures 15 and 16). Then F^{2m} preserves each boundary component of P . Notice that no boundary component of P can bound any disk:

- if P has only one boundary component a in $\partial\Sigma'$, then both of the other boundary components are isotopic to the union of a path included in a and a path included in d , but a and d do not cobound any bigon, so both boundary components of P different from a cannot bound any disk;

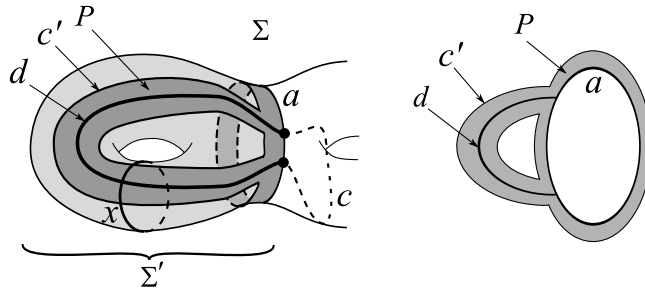

Figure 15: The pair of pants P in Σ' , when both extremities of d belong to the same boundary a of Σ' .

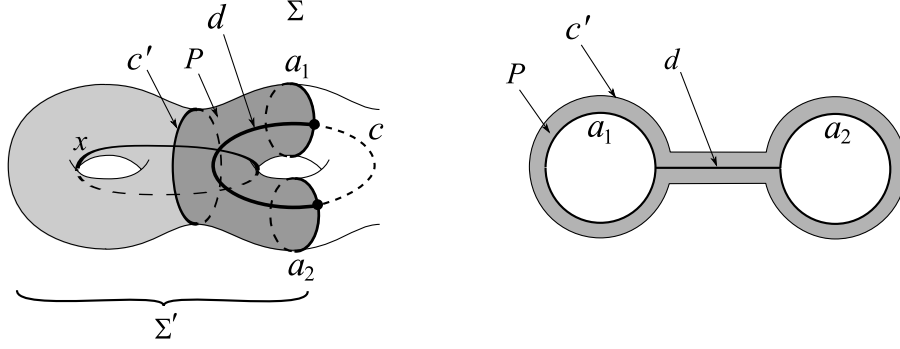

Figure 16: The pair of pants P in Σ' when both extremities of d belong to two distinct boundary components a_1 and a_2 of Σ' .

- and if P has two boundary components in $\partial\Sigma'$, both of these boundary components do not bound any disk. Moreover, as they are not isotopic in Σ , they do not cobound any cylinder. So the third boundary component of P cannot bound any disk.

Notice also that the curve x cannot be one of the boundary components of P , for x and d intersect. The curve x cannot be included in P for any curve that is included in a pair of pants is isotopic to one of its boundary components. Consequently, there exists a boundary of P , say c' , that intersects x . This boundary c' cannot be a boundary component of Σ' because the boundary components of Σ' do not intersect x . Hence c' belongs to $\mathcal{C}\text{urv}(\Sigma')$, is stable by F^{2m} , so is stable by $(F')^{2m}$, and intersects the curve x . We have proved item (ii).

Let us show item (iii). The mapping class F preserves Σ' , so $F(\text{Bndy}(\Sigma')) = \text{Bndy}(\Sigma')$, so the curves of $\text{Bndy}(\Sigma')$ are reduction curves of F . But no curve of $\sigma(F)$ intersects any reduction curve of F , hence any curve of $\sigma(F)$ that is not isotopic to a boundary component of Σ' is included either in Σ' or in $\Sigma \setminus \Sigma'$.

Let us show item (iv). Let x be a reduction curve of F' . If x is not an essential reduction curve of F , then there exists a reduction curve c of F in $\mathcal{C}\text{urv}(\Sigma)$ that intersects x . Then according to item (ii), there exists a nonzero integer m and a reduction curve c' of $(F')^m$ in $\mathcal{C}\text{urv}(\Sigma')$ that intersects x . Hence x is not an essential reduction curve of $(F')^m$. But $\sigma(F') = \sigma((F')^m)$, so x is not an essential reduction curve of F' . In other words, we have $\sigma(F') \subset \sigma(F) \cap \mathcal{C}\text{urv}(\Sigma')$. The converse inclusion is obvious: if a curve belongs to $\sigma(F)$, it belongs *a fortiori* to $\sigma(F')$. \square

Lemma 3.43 (Characterization of the essential reduction curves).

Let Σ be a surface and let F be a mapping class in $\text{Mod}(\Sigma)$. Let a be an oriented curve such that F preserves a and its orientation. Then, there exist two connected subsurfaces S_1 and S_2 (they may be equal) in Σ such that:

- the curve a bounds S_1 (respectively S_2) on the left (rep. on the right),
- both surfaces S_1 and S_2 are stable by F ,
- for all $i \in \{1, 2\}$, the mapping class induced by F in $\text{Mod}(S_i)$, denoted by $F|_{S_i}$, is either periodic or pseudo-Anosov.

Let us denote by S_{12} the union of S_1 and S_2 along a . Let us denote by $F|_{S_{12}}$ the mapping class induced by F in $\text{Mod}(S_{12})$. Then a belongs to $\sigma(F)$ if and only if we are in one of the three following cases:

- a) $F|_{S_1}$ or $F|_{S_2}$ is pseudo-Anosov;
- b) $F|_{S_1}$ and $F|_{S_2}$ are both periodic of the same order $m \geq 1$, and $F^m|_{S_{12}}$ is a non-trivial power of a Dehn twist along the curve a ;
- c) $F|_{S_1}$ and $F|_{S_2}$ are periodic with orders m_1 and m_2 respectively such that $m_1 \neq m_2$.

Proof. Let Γ be the set of curves $\sigma(F) \cup \{a\}$. Let us give to a an orientation and let us denote by S_1 (respectively S_2) the connected component of Σ_Γ bounding a on the left (resp. on the right). For all $i \in \{1, 2\}$, notice that $\sigma(F|_{S_i}) = \emptyset$, so $F|_{S_i}$ is either pseudo-Anosov, or periodic. Moreover, the surface S_{12} cannot be a pair of pants, so there exist some curves in $\mathcal{C}urv(S_{12})$ that intersect a .

Let us show first that if a belongs to $\sigma(F)$, then one of the cases a), b) or c) is satisfied. The cases a), b), c) describe all the possibles cases except the one where $F|_{S_1}$ and $F|_{S_2}$ are both periodic of order $m \geq 1$ and where $F^m|_{S_{12}}$ coincides with the identity. Let c be a curve of $\mathcal{C}urv(S_{12})$ which intersects a . But this curve c is preserved by F^m , so c is a reduction curve of F^m . Therefore a cannot belong to $\sigma(F^m)$. So a does not belong to $\sigma(F)$.

Conversely, let us show now that each case a), b), or c) implies that $a \in \sigma(F)$ (or that there exists a nonzero integer p such that $a \in \sigma(F^p)$, which is equivalent).

In the case a), let us denote by Σ' the subsurface S_1 or S_2 on which F induces a pseudo-Anosov mapping class. Then Σ' is not a pair of pants. If there existed a reduction curve c of F that intersected a , it would not be included in $\Sigma \setminus \Sigma'$, so we could apply item (i) of Lemma 3.42: there would exist a reduction curve c' of a nonzero power of F that would be included in Σ' (cf. Figure 17). This is absurd for the restriction of F (and of its nonzero powers) to Σ' is pseudo-Anosov. Hence any curve c of $\mathcal{C}urv(\Sigma)$ such that $I(a, c) \neq 0$ is not a reduction curve of F , so the reduction curve a of F is an essential reduction curve of F .

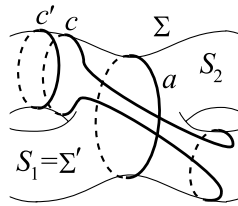

Figure 17: Description of the case a) in the proof of Lemma 3.43.

In the case b), there exists a nonzero integer ℓ such that $(F|_{S_{12}})^m = T_a^\ell$. But then for any integer p and any curve c in $\mathcal{C}urv(S_{12})$ intersecting a , we have:

$$I((F|_{S_{12}})^{mp}(c), c) = I(T_a^{\ell p}(c), c) = |\ell p| I(a, c)^2 \neq 0$$

according to Lemma 3.5. Hence no curve c that intersect a can be preserved by some power of $(F|_{S_{12}})^m$, hence a belongs to $\sigma((F|_{S_{12}})^m)$. Hence a belongs to $\sigma(F^m)$ according to item (iv) of Lemma 3.42.

In the case c), S_1 and S_2 cannot be equal. For all $i \in \{1, 2\}$, let $\mathcal{M}\text{od}(S_i, a)$ be the set of isotopy classes of diffeomorphisms of S_i fixing (a representative of) the curve a pointwise, and let F_i be a mapping class in $\mathcal{M}\text{od}(S_i, a)$ such that F_i induces the mapping class $F|_{S_i}$ in $\mathcal{M}\text{od}(S_i)$. Let us introduce some notation:

- For two integers k and ℓ , let us denote their greatest common divisor by $k \wedge \ell$ and their least common multiple by $k \vee \ell$.
- For all $i \in \{1, 2\}$, let d_i be an integer such that $F_i^{m_i} = T_a^{d_i}$ with $d_i \wedge m_i = 1$ according to Lemma 3.17.
- Let us set $m'_1 = \frac{m_1}{m_1 \wedge m_2} = \frac{m_1 \vee m_2}{m_2}$.
- Let us set $m'_2 = \frac{m_2}{m_1 \wedge m_2} = \frac{m_1 \vee m_2}{m_1}$; thus, m'_1 and m'_2 are coprime.

Then for all $i \in \{1, 2\}$, we have

$$F_i^{(m_1 \vee m_2)} = T_a^{\left(\frac{m_1 \vee m_2}{m_i} d_i\right)} = T_a^{m'_{(3-i)} d_i}.$$

Hence there exists an integer q such that:

$$(F|_{S_{12}})^{(m_1 \vee m_2)} = T_a^{(m'_2 d_1 + m'_1 d_2)} T_a^{q(m_1 \vee m_2)}.$$

Since m_1 and m_2 are different, one of them, by instance m_2 , is not equal to $m_1 \vee m_2$, so m'_1 is different from 1. But d_1 and m'_2 are both coprime with m'_1 , so $m'_2 d_1$ is coprime with m'_1 . Now m'_1 divides $m'_1 d_2 + q(m_1 \vee m_2)$, so m'_1 is coprime with $m'_2 d_1 + m'_1 d_2 + q(m_1 \vee m_2)$, so $m'_2 d_1 + m'_1 d_2 + q(m_1 \vee m_2)$ is nonzero. Hence $(F|_{S_{12}})^{(m_1 \vee m_2)}$ is a nonzero power of T_a . Thus, if we set $p = (m_1 \vee m_2)$ and if we consider F^p instead of F , then we are back to the case b) with $m = 1$. \square

As a corollary, we establish the link between a multitwist and its canonical reduction system.

Corollary 3.44 (Canonical reduction system of a multitwist).

Let \mathcal{A} be a curve simplex. Let $\prod_{a \in \mathcal{A}} T_a^{k_a}$ be a multitwist denoted by A along the curves of \mathcal{A} . Then $\sigma(A) = \{a \in \mathcal{A} \mid k_a \neq 0\}$. In particular, if A is a multitwist such that $\sigma(A) = \emptyset$, then $A = \text{Id}$.

Proof. This is a direct corollary of Lemma 3.43 where we apply the case b) to the neighbourhood of each curve of \mathcal{A} . \square

We are now ready to prove Lemma 3.12. Let us recall the statement.

Lemma 3.12 (Uniqueness of the factorisation of a multitwist in a product of Dehn twists). *Let \mathcal{A} and \mathcal{B} two curve simplexes and let $(k_a)_{a \in \mathcal{A}}$ and $(\ell_b)_{b \in \mathcal{B}}$ be two families of nonzero integers indexed by \mathcal{A} and \mathcal{B} . If*

$$\prod_{a \in \mathcal{A}} T_a^{k_a} = \prod_{b \in \mathcal{B}} T_b^{\ell_b},$$

then $\mathcal{A} = \mathcal{B}$ and for any pair of curves (a, b) in $\mathcal{A} \times \mathcal{B}$, the equality $a = b$ implies the equality $k_a = \ell_b$.

Proof. Let us set $A = \prod_{a \in \mathcal{A}} T_a^{k_a}$ and $B = \prod_{b \in \mathcal{B}} T_b^{\ell_b}$. Since $A = B$, we have $\sigma(A) = \sigma(B)$. Now, according to Lemma 3.44, we have $\sigma(A) = \mathcal{A}$ and $\sigma(B) = \mathcal{B}$ (recall that by hypothesis, the powers k_a , $a \in \mathcal{A}$, and ℓ_b , $b \in \mathcal{B}$, are nonzero), so $\mathcal{A} = \mathcal{B}$. Let us consider the sequence of integers $(j_a)_{a \in \mathcal{A}}$ defined by $j_a = k_a - \ell_a$. We have:

$$\prod_{a \in \mathcal{A}} T_a^{j_a} = \text{Id}.$$

Hence $\sigma\left(\prod_{a \in \mathcal{A}} T_a^{j_a}\right) = \sigma(\text{Id}) = \emptyset$, so according to Corollary 3.44, for all $a \in \mathcal{A}$, we have $j_a = 0$. \square

Here is a last corollary of Lemma 3.43, which establish a link between the canonical reduction systems of F , of G , and of FG , assuming that F and G are two commuting mapping classes.

Proposition 3.45. *Let F and G be two commuting mapping classes. Then,*

$$\sigma(FG) \subset \sigma(F) \cup \sigma(G).$$

Proof. Let a be a curve belonging to $\sigma(FG)$. Since FG commutes with F and with G , we have $I(a, \sigma(F) \cup \sigma(G)) = 0$. Let us set $\mathcal{A} = \sigma(F) \cup \sigma(G)$. Let us assume that a does not belong to \mathcal{A} and let us show that this is absurd.

Let m be a nonzero integer such that F and G preserve each subsurface in $\text{Sub}_{\mathcal{A}}(\Sigma)$. According to Lemma 3.42.(iv), the restrictions of the mapping classes induced by F and G on each subsurface in $\text{Sub}_{\mathcal{A}}(\Sigma)$ have empty canonical reduction systems, so they are either pseudo-Anosov or periodic. We can even assume that they are either pseudo-Anosov or the identity mapping class, provided that the integer m is large enough.

Since a does not belong to \mathcal{A} although $I(a, \mathcal{A}) = 0$, there exists a subsurface S belonging to $\text{Sub}_{\mathcal{A}}(\Sigma)$ such that a is included in S . Since F and G commute with FG , they preserve $\sigma(FG)$, so we can assume that F^m and G^m preserve a , even if it means multiplying m by some positive integer. Therefore a is a reduction curve of F^m and G^m . So the restrictions of F^m and G^m to S cannot be pseudo-Anosov, so they are the identity mapping class. Hence the restriction of $(FG)^m$ to S is equal to the identity mapping class, hence according to Lemma 3.43, the reduction curve a of FG cannot be essential. This is the expected contradiction. \square

4 Braid groups

The braid group \mathcal{B}_n emerges in various domains in mathematics and consequently can be defined in many ways. Here are some possibilities:

- in a purely geometric way (as did Artin in 1925, cf. [Bi]);
- as the fundamental group of a configuration space, (after Fadell and Neuwirth cf. [FaNe]);
- as an Artin group by generators and relations, cf. below;
- as the mapping class group of a punctured disk, (discovered by Artin, cf. [At2], [Bi] and [BiBd]);
- as the symmetric mapping class group of a surface of positive genus having one or two boundary components, (this theorem is due to Birman, and has been generalized later by Perron and Vannier, cf. [BiHi] or [PeV]);
- as a subgroup of the automorphism group of the free group with n generators (cf. [At1]);

Outline: In Subsection 4.1, we quickly state our conventions to draw braids, but we truly define the braid group only in Subsection 4.2. We will see it as the Artin group of type A_{n-1} . In Subsection 4.3, we give an equivalent definition of \mathcal{B}_n , seen as the mapping class group of a punctured disk. This will help us in Subsection 4.4 to interpret Birman and Hilden's Theorem, making the link between \mathcal{B}_n and the *symmetric mapping class group* of a surface of nonzero genus. This theorem allows us to consider \mathcal{B}_n as a subgroup of a mapping class group of a surface of nonzero genus relatively to its boundary and has inspired the main theorem of this paper.

4.1 The braid group seen in a geometric way

We won't develop this point of view. However we assume that the reader is already familiar with it and we simply fix the conventions (we have chosen the ones of Kassel and Turaev in [KaTu]) to draw braids of \mathcal{B}_n where n is an integer greater than or equal to 2.

- The strands are drawn from top to bottom;
- the strands are implicitly numbered from 1 to n from left to right;
- a *positive* crossing between the strands i and $i + 1$ is a crossing where the strand $i + 1$ goes in front of the strand i ; in the opposite case, the crossing is said to be *negative*;
- for all integers i such that $1 \leq i \leq n - 1$, we denote by τ_i (respectively τ_i^{-1}) the braid consisting in a positive (resp. negative) crossing of the strands i and $i + 1$ (cf. Figure 18);
- Given α and β two braids, the product $\alpha\beta$ is the braid that begins with α and then that follows the braid β (cf. Figure 18).



Figure 18: Examples of some braids in \mathcal{B}_5 .

4.2 The braid group as an Artin group

Artin showed in 1925 that any geometric braid of \mathcal{B}_n , where n is an integer greater than or equal to 2, can be expressed by a product on the geometric braids τ_i defined in the previous subsection and on their inverses. He even proved that the group \mathcal{B}_n has the presentation described in Definition 4.1). In this paper, we will think of the braid group \mathcal{B}_n with n strands as the group having this presentation.

Definition 4.1 (The braid group \mathcal{B}_n).

The *braid group with n strands* \mathcal{B}_n is the group having the following presentation, which we will call the *classic presentation of the braid group*:

- generators: $\tau_i, 1 \leq i \leq n - 1,$
- relations: for all $i, j \leq n - 1$:
$$\begin{cases} \tau_i \tau_j = \tau_j \tau_i & \text{when } |i - j| \neq 1 \\ \tau_i \tau_j \tau_i = \tau_j \tau_i \tau_j & \text{when } |i - j| = 1 . \end{cases}$$

Notation 4.2 (The set of standard generators).

The set $\{\tau_1, \tau_2, \dots, \tau_{n-1}\}$ will be called the *set of standard generators* and will be denoted by $\text{Gen}_{\mathcal{B}_n}^{cl}$. The set of relations will be denoted by \mathcal{R}_{cl} . We define:

$$\delta = \tau_1 \tau_2 \dots \tau_{n-1} .$$

In this presentation, τ_1 and τ_{n-1} have special roles. In order to make symmetric the roles of the standard generators, we add an n^{th} generator τ_0 (cf. Figure 19):

$$\tau_0 = \delta \tau_{n-1} \delta^{-1} .$$

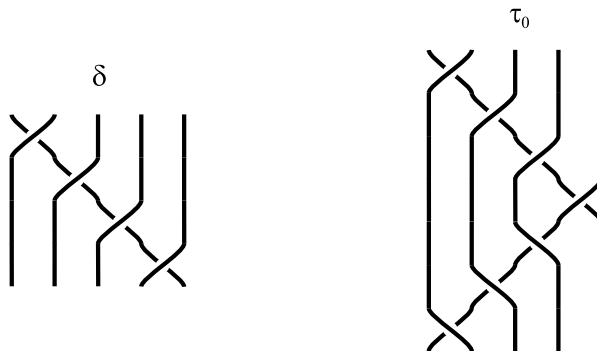

Figure 19: The braids δ and τ_0 in \mathcal{B}_5 .

Notation 4.3 (The augmented set of standard generators).

The set $\{\tau_0, \tau_1, \dots, \tau_{n-1}\}$ will be called the *augmented set of standard generators* and will be denoted by $\text{Gen}_{\mathcal{B}_n}^{\text{aug}}$, where $\tau_0 = \delta\tau_{n-1}\delta^{-1}$. We adopt the following convention: for all integers k , τ_k is the standard generator τ_ℓ where ℓ is the remainder of the euclidian division of k by n . Moreover, for all pairs of integers (i, j) , we denote by $|i-j|_n$ the integer $\min(\{|i-j+kn|, k \in \mathbb{Z}\})$.

When we add the element τ_0 to the set $\text{Gen}_{\mathcal{B}_n}^{\text{cl}}$ in the presentation $\langle \text{Gen}_{\mathcal{B}_n}^{\text{cl}} \mid \mathcal{R}_{\text{cl}} \rangle$, we have to add the following relation r_0 :

$$\tau_0\tau_1 \dots \tau_{n-2} = \tau_1\tau_2 \dots \tau_{n-1} \tag{r_0}$$

to have a new presentation of the same group. We will then show that the following relations are satisfied in \mathcal{B}_n and may therefore be added in the presentation $\langle \text{Gen}_{\mathcal{B}_n}^{\text{aug}} \mid \mathcal{R}_{\text{cl}} \cup \{r_0\} \rangle$ of \mathcal{B}_n .

Lemma 4.4.

- (i) For all integers i such that $0 \leq i \leq n-1$, we have $\delta\tau_i\delta^{-1} = \tau_{i+1}$.
- (ii) For all integers i such that $0 \leq i \leq n-1$, the braids τ_i and τ_j satisfy a braid relation if and only if $|i-j|_n = 1$. Otherwise they commute.
- (iii) For all integers i such that $0 \leq i \leq n-1$, let us set $\delta_i = \tau_{i+1}\tau_{i+2} \dots \tau_{i+n-1}$ (cf. Figure 20). We then have $\delta = \delta_0 = \delta_1 = \dots = \delta_{n-1}$.

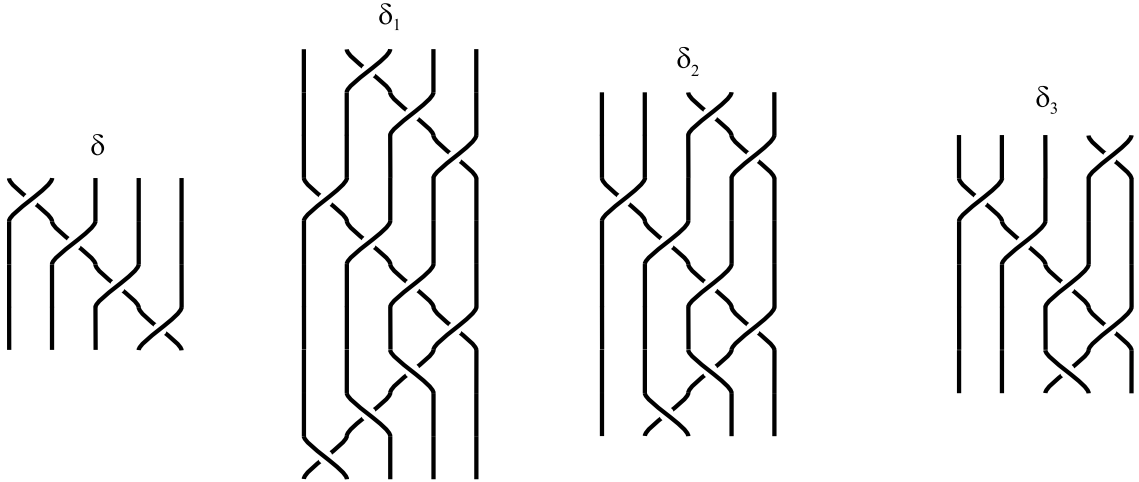

Figure 20: The braids δ_i (here in \mathcal{B}_5) all represent the braid δ .

We can now deduce the following:

Corollary 4.5. *The braid group with n strands \mathcal{B}_n admits the following presentation that we will call the cyclic presentation of the braid group:*

- generators: $\tau_i, i \in \{0, 1, \dots, n-1\}$,
- relations: for all $i, j \in \{0, 1, \dots, n-1\}$:

$$\begin{cases} \tau_{i+1}\tau_{i+2} \dots \tau_{i+n-1} = \tau_{j+1}\tau_{j+2} \dots \tau_{j+n-1} \\ \tau_i\tau_j = \tau_j\tau_i \text{ when } |i-j|_n \neq 1 \\ \tau_i\tau_j\tau_i = \tau_j\tau_i\tau_j \text{ when } |i-j|_n = 1 \end{cases}$$

Proof of Lemma 4.4.

Let us show item (i). When $1 \leq i \leq n - 2$, we have:

$$\begin{aligned} \delta \tau_i &= (\tau_1 \dots \tau_{i-1}) \tau_i \tau_{i+1} (\tau_{i+2} \dots \tau_{n-1}) \tau_i \\ &= (\tau_1 \dots \tau_{i-1}) \tau_i \tau_{i+1} \tau_i (\tau_{i+2} \dots \tau_{n-1}) \\ &= (\tau_1 \dots \tau_{i-1}) \tau_{i+1} \tau_i \tau_{i+1} (\tau_{i+2} \dots \tau_{n-1}) \\ &= \tau_{i+1} (\tau_1 \dots \tau_{i-1}) \tau_i \tau_{i+1} (\tau_{i+2} \dots \tau_{n-1}) \\ &= \tau_{i+1} \delta. \end{aligned}$$

When $i = n - 1$, we have $\delta \tau_{n-1} \delta^{-1} = \tau_0$ by definition of τ_0 . When $i = 0$, the equality $\delta \tau_0 \delta^{-1} = \tau_1$ comes from this other equality $\delta^2 \tau_{n-1} = \tau_1 \delta^2$, which holds in the braid group since:

$$\begin{aligned} \delta^2 \tau_{n-1} &= \tau_1 \tau_2 \dots \tau_{n-2} \tau_{n-1} \delta \tau_{n-1} \\ &= \tau_1 \tau_2 \dots \tau_{n-2} \delta \tau_{n-2} \tau_{n-1} \\ &= \tau_1 \delta \tau_1 \tau_2 \dots \tau_{n-2} \tau_{n-1} \\ &= \tau_1 \delta^2. \end{aligned}$$

Let us show item (ii). Notice that for all $i \in \{1, 2, \dots, n - 2\}$, the pair (τ_0, τ_i) is conjugate by the element δ to the pair (τ_1, τ_{i+1}) . Besides, the pair (τ_0, τ_{n-1}) is conjugate by the element δ^{-1} to the pair (τ_{n-1}, τ_{n-2}) . So for all $i, j \in \{0, 1, \dots, n - 1\}$, the relations between τ_i and τ_j depend only on $|i - j|_n$.

Let us show item (iii). For all $i \in \{1, 2, \dots, n - 1\}$, according to (i), we have:

$$\begin{aligned} \delta_i &= \tau_{i+1} \tau_{i+2} \dots \tau_{i+n-1} \\ &= (\delta^i \tau_1 \delta^{-i}) (\delta^i \tau_2 \delta^{-i}) \dots (\delta^i \tau_{n-1} \delta^{-i}) \\ &= \delta^i \delta \delta^{-i} \\ &= \delta. \end{aligned} \quad \square$$

Remark. If we arrange the strands of \mathcal{B}_n in \mathbb{R}^3 along a cylinder, the generator τ_0 is the crossing between the first and the n^{th} strand. This kind of presentation of the braid group has been studied in a more general frame by V. Sergiescu (cf. [S]). The conventions of V. Sergiescu represent each strand by a point whereas the chosen generators (single crossings between two strands) are represented by an edge linking the two corresponding points, cf. Figure 21.

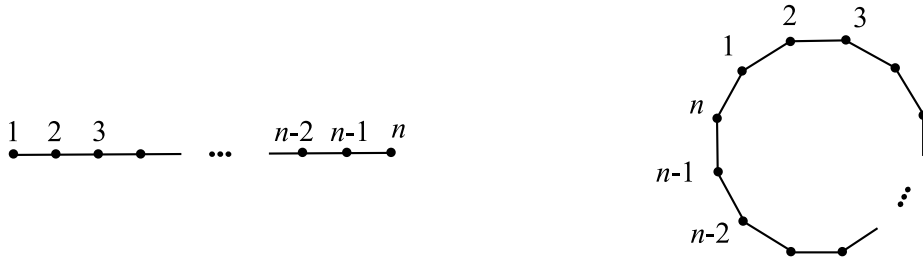

Figure 21: Graphs of V. Sergiescu associated to the group \mathcal{B}_n : on the left hand, the graph associated to the classic presentation; on the right hand, the graph associated to the cyclic presentation.

There exists in \mathcal{B}_n a noticeable element, called the *Garside-element* and denoted by Δ , such that one of its powers spans the center of \mathcal{B}_n :

Definition 4.6 (The Garside-element of the braid group).

The *Garside-element* Δ of the braid group \mathcal{B}_n is:

$$\Delta = \tau_1(\tau_2\tau_1)(\tau_3\tau_2\tau_1)\dots(\tau_{n-1}\tau_{n-2}\dots\tau_1)$$

This element satisfies the following properties.

Theorem 4.7 (Properties of Δ).

- For all integers $i \in \{1, \text{dir}, \dots, n-1\}$, we have $\Delta \tau_i = \tau_{n-i} \Delta$;
- $\Delta^2 = (\tau_1\tau_2\dots\tau_{n-1})^n = (\tau_{n-1}\tau_{n-2}\dots\tau_1)^n$;
- the center of \mathcal{B}_n is an infinite cyclic group spanned by Δ^2 . □

4.3 The braid group as the mapping class group of the punctured disk; the braid twists

Definition 4.8. Let \mathbb{D}_n be a disk in \mathbb{C} containing the points $\{1, 2, \dots, n\}$. Let us consider the group $\text{Diff}_{\mathcal{P}_n}^+(\mathbb{D}_n, \partial\mathbb{D}_n)$ of the orientation-preserving diffeomorphisms of \mathbb{D}_n that stabilize the set $\mathcal{P}_n = \{1, 2, \dots, n\}$ and fix the boundary $\partial\mathbb{D}_n$. We can quotient this group by the following isotopy relation: two diffeomorphisms are said to be *isotopic* if they are the extremities of a continuous path of diffeomorphisms of $\text{Diff}_{\mathcal{P}_n}^+(\mathbb{D}_n, \partial\mathbb{D}_n)$. The quotient group is isomorphic to the braid group with n strands (Artin, 1925, cf. Theorem 4.13, below). One may therefore define the braid group in this way:

$$\mathcal{B}_n = \pi_0(\text{Diff}_{\mathcal{P}_n}^+(\mathbb{D}_n, \partial\mathbb{D}_n)).$$

There exists a set of $n-1$ generators satisfying the same relations as the family τ_i , $i \leq n-1$, does. These generators are the *braid twists* defined as follows.

Definition 4.9 (Braid twists).

Let p and q be two points belonging to \mathcal{P}_n and let a be an arc of extremities p and q , whose interior avoids \mathcal{P}_n and $\partial\mathbb{D}$. Let \mathcal{V} be a compact tubular neighbourhood of a and let ϕ be a positive homeomorphism from \mathcal{V} to \mathbb{D} , the disk in \mathbb{C} with radius 1 and centered in 0 such that $\phi(p) = -\frac{1}{2}$, $\phi(q) = \frac{1}{2}$ and $\phi(a) = [-\frac{1}{2}, \frac{1}{2}]$. Let us define the homeomorphism:

$$h : \begin{array}{ccc} \mathbb{D} & \longrightarrow & \mathbb{D} \\ z & \longmapsto & ze^{2i\pi|z|} \end{array} .$$

Let h_a be the homeomorphism that equals the identity map outside of \mathcal{V} and that equals $\phi^{-1}h\phi$ on \mathcal{V} . A *braid twist along the arc a* , denoted by H_a is the unique isotopy class of diffeomorphisms contained in the isotopy class of homeomorphisms of h_a . Since ϕ is unique up to isotopy, H_a is well-defined.

Definition 4.10. We will denote by \mathcal{T}_n the set of all braid twists.

Remark. The set \mathcal{T}_n coincides with the conjugacy classes of the standard generators of \mathcal{B}_n . Two elements of \mathcal{T}_n can satisfy braid relations or commutation relations. These two cases can be geometrically characterized; this motivates the next definition. In the other cases, two elements of \mathcal{T}_n span a group free, according to a theorem of Crisp and Paris (cf. [CrPa]).

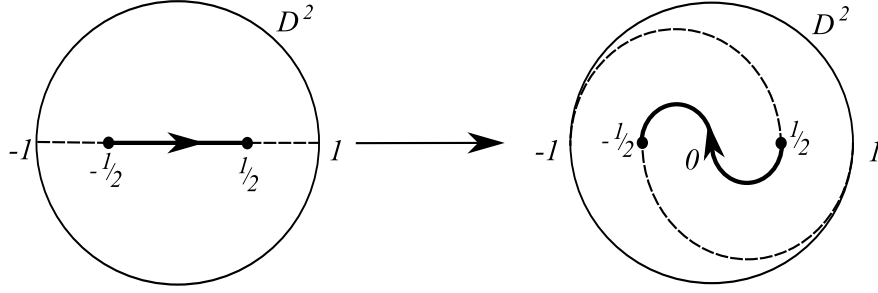

Figure 22: Definition of the braid twist.

Definition 4.11 (Adjacency and independence).

Given two arcs a_1 and a_2 of $\mathbb{D}_n \setminus (\mathcal{P}_n \cup \partial\mathbb{D}_n)$ with extremities in \mathcal{P}_n , the braid twists H_{a_1} and H_{a_2} will be said to be *adjacent* (respectively *independent*) if the intersection of these two arcs a_1 and a_2 is reduced to one single extremity, (resp. if the two arcs a_1 and a_2 are disjoint) cf. Figure 23.

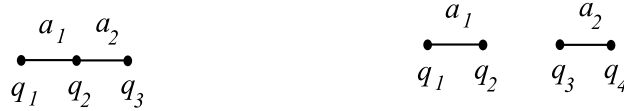

Figure 23: On the left hand, two adjacent arcs; on the right hand, two independent arcs.

The two following results are due to Artin and motivate these definitions.

Proposition 4.12 (Relations between braid twists).

Two braid twists commute if and only if they are independent. Two braid twists satisfy a braid relation if and only if they are adjacent. \square

The following Theorem was first stated by Artin in 1925. A proof can be found in [Bi], Theorem 1.8 page 18.

Theorem 4.13 (\mathcal{B}_n is isomorphic to the group $\text{Mod}(\mathbb{D}_n, \partial\mathbb{D}_n)$, Artin, 1925).

Let a_1, \dots, a_{n-1} be $n-1$ arcs in $\mathbb{D}_n \setminus (\mathcal{P}_n \cup \partial\mathbb{D}_n)$ with extremities in \mathcal{P}_n such that for all integers i and j smaller than or equal to $n-1$, the arcs a_i and a_j are adjacent if $i-j = \pm 1$, and are disjoint if $|i-j| \geq 2$ (cf. Figure 24). Then the family $\{H_{a_i}, i \leq n-1\}$ span $\text{Mod}(\mathbb{D}_n, \partial\mathbb{D}_n)$. Moreover, the presentation of $\text{Mod}(\mathbb{D}_n, \partial\mathbb{D}_n)$ with the family $\{H_{a_i}, i \leq n-1\}$ as set of generators coincides with the standard presentation:

- generators: $H_{a_i}, 1 \leq i \leq n-1$,
- relations: for all $i, j \leq n-1$: $\begin{cases} H_{a_i}H_{a_j} = H_{a_j}H_{a_i} & \text{if } |i-j| \neq 1 \\ H_{a_i}H_{a_j}H_{a_i} = H_{a_j}H_{a_i}H_{a_j} & \text{if } |i-j| = 1 \end{cases}$.

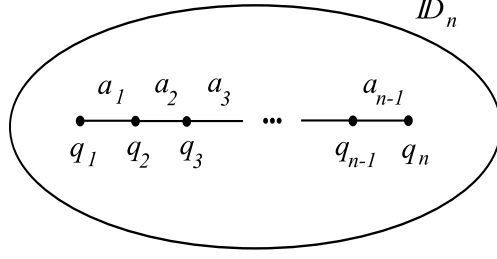

Figure 24: The H_{a_i} with $i \leq n - 1$ span $\mathcal{M}od(\mathbb{D}_n, \partial\mathbb{D}_n)$.

4.4 The braid group as the symmetric mapping class group; an embedding from \mathcal{B}_n in $\mathcal{M}od(\Sigma, \partial\Sigma)$

This aspect of the braid group will be fundamental in this paper. A special morphism from the braid group to the mapping class group, which we will denote by ρ_{ref} , comes with this aspect. We will prove later (cf. Theorems 1 and 2) that all the non-trivial morphisms from the braid group are derived from ρ_{ref} , provided that the genus of the surface is not too large.

Definition 4.14 (Reference surfaces $\Sigma(\mathcal{B}_n)$ and reference representations ρ_{ref} and $\tilde{\rho}_{\text{ref}}$).

For any integer n smaller than or equal to 3, let us denote by $\Sigma(\mathcal{B}_n)$ the surface $\Sigma_{\frac{n-1}{2}, 1}$ if n is odd, or $\Sigma_{\frac{n-2}{2}, 2}$ if n is even. Let us denote by $(c_i)_{1 \leq i \leq n-1}$ the $(n-1)$ -chain of curves represented in Figures 25 and 26, and let $\tilde{\rho}_{\text{ref}}$ be the following morphism:

$$\tilde{\rho}_{\text{ref}} : \begin{array}{ccc} \mathcal{B}_n & \longrightarrow & \mathcal{M}od(\Sigma(\mathcal{B}_n), \partial\Sigma(\mathcal{B}_n)) \\ \tau_i & \longmapsto & T_{c_i} \end{array}$$

for all integers $i \in \{1, 2, \dots, n-1\}$. We denote by ρ_{ref} the projection of $\tilde{\rho}_{\text{ref}}$ in $\mathcal{M}od(\Sigma(\mathcal{B}_n))$. These morphisms (or representations) ρ_{ref} and $\tilde{\rho}_{\text{ref}}$ will be called reference morphisms (or representations). They are unique up to conjugation.

In order to better describe ρ_{ref} , we define the symmetric mapping class group $\mathcal{S}Mod(\Sigma(\mathcal{B}_n))$. Theorem 4.17 below justifies this definition.

Definition 4.15 (The symmetric mapping class group $\mathcal{S}Mod(\Sigma(\mathcal{B}_n))$ associated to ρ_{ref}).

Let n be an integer greater than or equal to 3. Let ρ_{ref} be a reference morphism. We set the following definitions:

- let \bar{s} be the periodic diffeomorphism of order 2 of $\text{Diff}^+(\Sigma(\mathcal{B}_n))$ that coincides with the symmetry with respect to the axis δ represented in Figures 25 and 26;
- let $\text{SDiff}^+(\Sigma(\mathcal{B}_n), \partial\Sigma(\mathcal{B}_n))$ be the set of the diffeomorphisms of $\text{Diff}^+(\Sigma(\mathcal{B}_n), \partial\Sigma(\mathcal{B}_n))$ that commute with \bar{s} ;
- let $\mathcal{S}Mod(\Sigma(\mathcal{B}_n), \partial\Sigma(\mathcal{B}_n))$ be the group of the isotopy classes of diffeomorphisms of $\text{SDiff}^+(\Sigma(\mathcal{B}_n), \partial\Sigma(\mathcal{B}_n))$ this is a subgroup of $\mathcal{M}od(\Sigma(\mathcal{B}_n), \partial\Sigma(\mathcal{B}_n))$;
- let $\mathcal{S}Mod(\Sigma(\mathcal{B}_n))$ be the subgroup of $\mathcal{P}Mod(\Sigma(\mathcal{B}_n))$ induced by $\mathcal{S}Mod(\Sigma(\mathcal{B}_n), \partial\Sigma(\mathcal{B}_n))$;

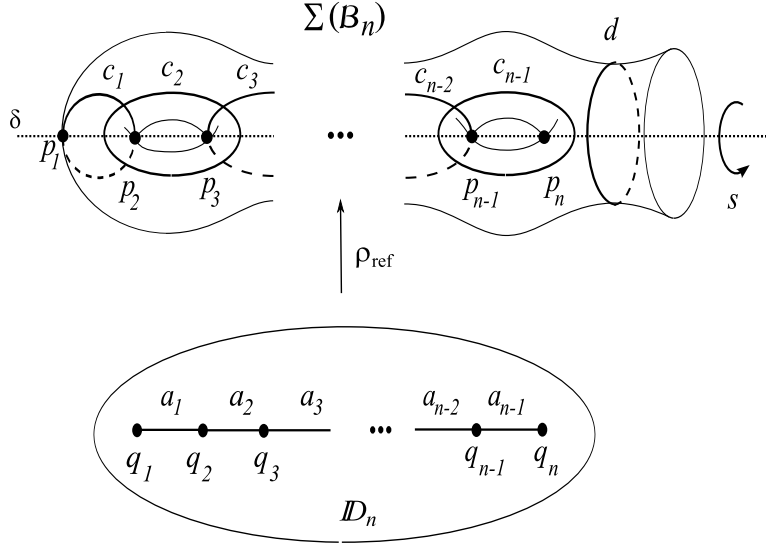

Figure 25: The reference morphism $\rho_{\text{ref}} : \mathcal{B}_n \rightarrow \text{Mod}(\Sigma(\mathcal{B}_n))$ when n is odd.

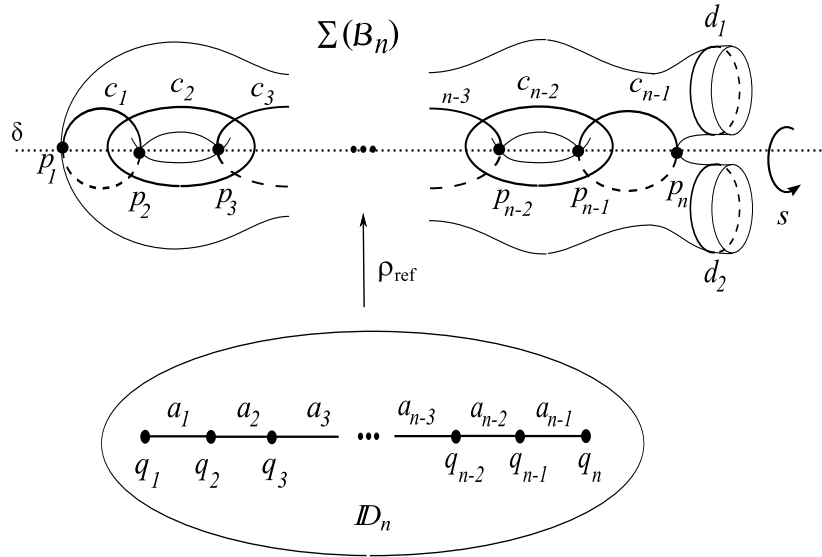

Figure 26: The reference morphism $\rho_{\text{ref}} : \mathcal{B}_n \rightarrow \text{Mod}(\Sigma(\mathcal{B}_n))$ when n is even.

- when n is odd, let s be the mapping class $\rho_{\text{ref}}(\Delta^2)$ in $\text{Mod}(\Sigma(\mathcal{B}_n))$; when n is even, s is not defined;
- when n is odd, let \tilde{s} be the lift of s in $\text{Mod}(\Sigma(\mathcal{B}_n), \partial\Sigma(\mathcal{B}_n))$, such that $\tilde{s}^2 = T_d$ where d is the unique boundary component of $\Sigma(\mathcal{B}_n)$; when n is even, \tilde{s} is not defined.

In the light of these new definitions, Lemma 3.7 becomes:

Proposition 4.16 (C.Labruère, L.Paris, [LaPa]).

For all integers n greater than or equal to 3, in $\text{Mod}(\Sigma(\mathcal{B}_n), \partial\Sigma(\mathcal{B}_n))$,

- when n is odd, $\tilde{\rho}_{\text{ref}}(\Delta^2) = \tilde{s}$ (cf. Figure 25 and Definition 4.15);
- when n is even, $\tilde{\rho}_{\text{ref}}(\Delta^2) = T_{d_1}T_{d_2}$ (cf. Figure 26). □

According to Theorem 4.17 below, the group \mathcal{B}_n is isomorphic to a subgroup of the mapping class group.

Theorem 4.17 (\mathcal{B}_n as subgroup of $\text{Mod}(\Sigma(\mathcal{B}_n), \partial\Sigma(\mathcal{B}_n))$, Birman-Hilden, [BiHi]).

Let n be an integer greater than or equal to 3. The image of $\tilde{\rho}_{\text{ref}}$ in $\text{Mod}(\Sigma(\mathcal{B}_n), \partial\Sigma(\mathcal{B}_n))$ is exactly the symmetric mapping class group $\mathcal{SMod}(\Sigma(\mathcal{B}_n), \partial\Sigma(\mathcal{B}_n))$ associated to $\tilde{\rho}_{\text{ref}}$. □

Let us make clear the links between \mathcal{B}_n and $\mathcal{SMod}(\Sigma, \partial\Sigma)$ where $\Sigma = \Sigma(\mathcal{B}_n)$. The isomorphism $\tilde{\rho}_{\text{ref}}$ sends the conjugacy class of the braid twists on the conjugacy class of the Dehn twists of $\mathcal{SMod}(\Sigma, \partial\Sigma)$ along non-separating curves, and transforms Proposition 3.4 which deals with some relations between Dehn twists, in Proposition 4.12 about relations between braid twists. These results are summed up in Proposition 4.18.

Proposition 4.18 (Links between Dehn twists and braid twists).

Let n be an integer greater than or equal to 3 and let Σ be the surface $\Sigma(\mathcal{B}_n)$. Let \mathcal{T}_n be the conjugacy class of the braid twists of \mathcal{B}_n .

- (i) The images of the braid twists of \mathcal{B}_n by ρ_{ref} are exactly the Dehn twists of $\mathcal{SMod}(\Sigma)$ along non-separating curves.
- (ii) The set of Dehn twists in $\mathcal{SMod}(\Sigma)$ along non-separating curves is a conjugacy class in $\mathcal{SMod}(\Sigma)$ which coincides with the image of \mathcal{T}_n by ρ_{ref} .
- (iii) The morphism ρ_{ref} sends two independent braid twists on two Dehn twists T_a and T_b along two non-intersecting curves a and b ; and ρ_{ref} sends two adjacent braid twists on two Dehn twists T_a and T_b along two curves a and b intersecting in one point.

Proof.

Let us show item (i). The inclusion $\rho_{\text{ref}}(\mathcal{T}_n) \subset \{\text{Twists of Dehn}\}$ is easy: a conjugate of H_{a_1} is sent on a conjugate of T_{a_1} , hence a Dehn twist along a non-separating curve, which must belong to $\mathcal{SMod}(\Sigma)$ according to Theorem 4.17. Conversely, let us show that the Dehn twists belonging to $\mathcal{SMod}(\Sigma)$ along non-separating curves belong to $\rho_{\text{ref}}(\mathcal{T}_n)$.

Let us recall that $\mathcal{SMod}(\Sigma)$ is the set of mapping classes that commute with α (cf. Definition 4.15). Let π be the covering morphism from Σ in \mathbb{D}_n where the n punctures are the singular points of the ramified covering (cf. for example [PeVa]). It is a classic result to show that ρ_{ref} coincides with the lift in $\mathcal{SMod}(\Sigma)$ of the mapping classes of $\text{Mod}(\mathbb{D}_n, \partial\mathbb{D}_n)$ representing the elements of \mathcal{B}_n . We also know the following: let $\bar{\alpha}$ be a representative of α and \bar{e} a representative of a curve e of $\text{Curv}(\Sigma)$ that is invariant by $\bar{\alpha}$ and that has two fixed points by $\bar{\alpha}$; then T_e is sent via π on a braid twist in $\text{Mod}(\mathbb{D}_n, \partial\mathbb{D}_n)$. Then, in order to show item (i), it is enough to show that all the non-separating curves of Σ that are stable by α own a representative preserved by a representative $\bar{\alpha}$ and have two fixed points by $\bar{\alpha}$.

Let us check this. Let c be a non-separating curve of Σ stable by α . According to Kerckhoff's Theorem (cf. Theorem 3.15), there exists a hyperbolic metric on Σ such that α is represented by an isometry $\bar{\alpha}$. Let \bar{c} be the geodesic (well-defined and unique, according to a classic result of hyperbolic geometry) in the isotopy class of c . The restriction of $\bar{\alpha}$ to \bar{c} is an isometry of the

circle, hence a symmetry or a rotation. In the first case, \bar{c} contains exactly two fixed points by $\bar{\alpha}$, just as desired. In the second case, \bar{c} contains no fixed point by $\bar{\alpha}$, and we are going to show that this is absurd. Let us assume that \bar{c} has no fixed point by $\bar{\alpha}$ and that in the neighbourhood of \bar{c} , the isometry $\bar{\alpha}$ is a rotation. Then the restriction of $\bar{\alpha}$ to an $\bar{\alpha}$ -stable compact tubular neighbourhood of \bar{c} preserves each boundary component of this cylinder. Hence, if we consider the surface Σ minus an $\bar{\alpha}$ -stable open tubular neighbourhood of \bar{c} , we get a surface Σ' that has two new boundary components preserved by $\bar{\alpha}$. But $\bar{\alpha}$ had already $2g + 2$ fixed points and preserved boundary components ($2g + 1$ fixed point and one boundary preserved when n is odd, and $2g + 2$ fixed points when n is even). Now, $\bar{\alpha}$ induces on Σ' a mapping class of order 2 such that the number of fixed points plus the number of the preserved boundary components equal $2g + 4$. This is too much if Σ' was connected, according to Corollary 3.22, so Σ' is not connected and c was a separating curve. This is in contradiction with our hypotheses. Hence item (i) is proved.

Let us show Step (ii). We already know that \mathcal{T}_n is the conjugacy class of the braid twists of $\text{Mod}(\mathbb{D}_n, \partial\mathbb{D}_n)$. Since the morphism ρ_{ref} from $\text{Mod}(\mathbb{D}_n, \partial\mathbb{D}_n)$ to $\mathcal{SMod}(\Sigma)$ is surjective, the set $\rho_{\text{ref}}(\mathcal{T}_n)$ is a conjugacy class in $\mathcal{SMod}(\Sigma)$. But $\rho_{\text{ref}}(\mathcal{T}_n)$ is exactly the set of Dehn twists of $\mathcal{SMod}(\Sigma)$ along non-separating curves. Therefore the set of Dehn twists in $\mathcal{SMod}(\Sigma)$ along non-separating curves is a conjugacy class in $\mathcal{SMod}(\Sigma)$ which coincides with the image of \mathcal{T}_n by ρ_{ref} .

Let us show item (iii). This result comes from Propositions 3.4 concerning the Dehn twists and 4.12 concerning the braid twists. \square

Centralizers and normalizers associated to the image of ρ_{ref} , respectively $\tilde{\rho}_{\text{ref}}$.

We now compute the centralizer of the image of \mathcal{B}_n by special morphisms derived from ρ_{ref} , going from \mathcal{B}_n into different mapping class groups. Then we shall compute the normalizer of $\rho_{\text{ref}}(\mathcal{B}_n)$ in $\text{Mod}(\Sigma(\mathcal{B}_n))$.

Proposition 4.19 (Centralizer of the image of \mathcal{B}_n when n is odd by some special morphisms). *Let n be an odd integer greater than or equal to 5. Let Σ be a surface $\Sigma_{g,b}$ where $g \geq \frac{n-1}{2}$ and $b \geq 0$. Let $(a_1, a_2, \dots, a_{n-1})$ be a $(n-1)$ -chain of curves⁵. Let \mathcal{M} be one of the groups $\text{Mod}(\Sigma)$, $\mathcal{PMod}(\Sigma)$ or $\text{Mod}(\Sigma, \partial\Sigma)$. Let ρ be the morphism from \mathcal{B}_n in \mathcal{M} defined by*

$$\rho(\tau_i) = T_{a_i}$$

for all $i \in \{1, \dots, n-1\}$. Let us denote by $\Sigma(\rho)$ the compact tubular neighbourhood of the union of the curves a_i , $1 \leq i \leq n-1$. Let $\mathcal{M}^{\Sigma(\rho)}$ be the subgroup of \mathcal{M} consisting of the mapping classes that preserve $\Sigma(\rho)$ and induce the identity mapping class in $\text{Mod}(\Sigma(\rho))$. Finally, let Z be the mapping class $\rho(\Delta^2)$. Then:

- (i) *the centralizer of $\rho(\mathcal{B}_n)$ in \mathcal{M} is the group spanned by Z and by $\mathcal{M}^{\Sigma(\rho)}$;*
- (ii) *for any mapping class V belonging to the centralizer of $\rho(\mathcal{B}_n)$ in \mathcal{M} , V^2 belongs to $\mathcal{M}^{\Sigma(\rho)}$.*

Proof. Let us show item (i). It is clear that the group $\mathcal{M}^{\Sigma(\rho)}$ defined in the statement of Proposition 4.19 is in the centralizer of $\rho(\mathcal{B}_n)$, and that according to the properties of Δ^2 in \mathcal{B}_n , Z is also in the centralizer of $\rho(\mathcal{B}_n)$. Hence the group spanned by $\mathcal{M}^{\Sigma(\rho)}$ and Z is in the centralizer of $\rho(\mathcal{B}_n)$. Conversely, let us show that any element in the centralizer of $\rho(\mathcal{B}_n)$ coincides

⁵Notice that the assumption $g \geq \frac{n-1}{2}$ implies that $(n-1)$ -chains of curves exist in Σ .

with an element of $\mathcal{M}^{\Sigma(\rho)}$ possibly composed by Z . In this purpose, let us start from a mapping class F lying in the centralizer of $\rho(\mathcal{B}_n)$. We will first set some definitions in Σ , then we will study F .

a) *Definitions of some curves in Σ .*

For all integers $i \in \{2, 3, \dots, n-1\}$, let us set:

$$\Delta_i = \tau_1(\tau_2\tau_1) \dots (\tau_i\tau_{i-1} \dots \tau_1).$$

For any even i in $\{4, \dots, n-1\}$, let e_i^+ and e_i^- be the two curves such that $\rho(\Delta_{i-1}^2) = T_{e_i^+}T_{e_i^-}$.

By induction on the odd integer i in $\{3, \dots, n-2\}$, we define the pairs of pants P_i^+ and P_i^- (cf. Figure 27) in such a way that:

- when $i = 3$, let us denote by P_3^+ and P_3^- respectively the pairs of pants included in Σ whose boundaries are $\{a_1, a_3, e_4^+\}$ and $\{a_1, a_3, e_4^-\}$ respectively,
- when i is an odd integer in $\{5, \dots, n-2\}$ and when P_{i-2}^+ and P_{i-2}^- have been defined, even if it means swapping e_{i+1}^+ and e_{i+1}^- , we can assume that $\{e_{i-1}^+, a_i, e_{i+1}^+\}$ and $\{e_{i-1}^-, a_i, e_{i+1}^-\}$ are the boundary components of two pairs of pants that we denote by P_i^+ and P_i^- respectively.

Let d be the curve such that $\rho(\Delta_{n-1}^4) = T_d$. We denote by P_∂ the pair of pants whose boundary is $\{e_{n-2}^+, e_{n-2}^-, d\}$ (cf. Figure 27). We denote by \mathcal{A}^0 the union of the curves a_i where i is even in $\{2, \dots, n-1\}$, and we denote by \mathcal{A}^1 the union of the curves a_i where i is odd in $\{1, 2, \dots, n-2\}$ and of the curves e_j^+ and e_j^- where j is even in $\{4, \dots, n-1\}$.

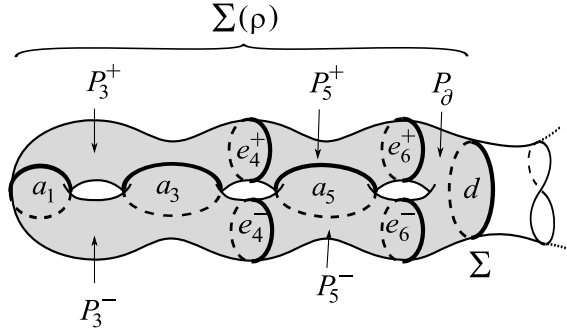

Figure 27: Cutting $\Sigma(\rho)$ in pairs of pants; the curve d and the simplex \mathcal{A}^1 (case where n is odd).

b) *A mapping class F in the centralizer of $\rho(\mathcal{B}_n)$.*

The mapping class F commutes with T_{a_i} for any odd i in $\{1, \dots, n-2\}$, so $F(a_i) = a_i$. The mapping class F commutes also with $T_{e_j^+}T_{e_j^-}$ for any even j in $\{4, \dots, n-1\}$, so $F(\{e_j^+, e_j^-\}) = \{e_j^+, e_j^-\}$. Hence F preserves the set of subsurfaces $\{P_i^+, P_i^-\}$ for any odd i in $\{3, \dots, n-2\}$. Finally, F commutes with T_d for T_d belongs to $\rho(\mathcal{B}_n)$, so F preserves the curve d , preserves the pair of pants P_∂ and preserves the surface $\Sigma(\rho)$ included in Σ with d as boundary, and containing the curve a_1 . Notice that for any odd i in $\{3, \dots, n-4\}$, the pairs of pants P_i^+ and P_{i+2}^+ have e_{i+1}^+ as common boundary component, so the pairs of pants $F(P_i^+)$ and $F(P_{i+2}^+)$ have $F(e_{i+1}^+)$ as common boundary component. Then two situations can happen concerning $F(P_i^+)$ and $F(P_{i+2}^+)$:

- either $F(e_{i+1}^+) = e_{i+1}^+$, and then $F(P_i^+) = P_i^+$ and $F(P_{i+2}^+) = P_{i+2}^+$,

- or $F(e_{i+1}^+) = e_{i+1}^-$, and then $F(P_i^+) = P_i^-$ and $F(P_{i+2}^+) = P_{i+2}^-$.

Finally, by induction, only two situations can happen concerning F :

- First alternative: for all odd integers $i \in \{3, \dots, n-2\}$, $F(P_i^+) = P_i^+$. Then F fixes e_j^+ and e_j^- for all even integers $j \in \{4, \dots, n-1\}$. We define $F' \in \mathcal{M}\text{od}(\Sigma(\rho))$ as being the restriction of F to $\Sigma(\rho)$.
- Second alternative: for any odd i in $\{3, \dots, n-2\}$, we have $F(P_i^+) = P_i^-$. Then for any even j in $\{4, \dots, n-1\}$, the mapping class F swaps e_j^+ and e_j^- . But for any odd i in $\{1, \dots, n-1\}$, the mapping class Z fixes the curves a_i , and for any even j in $\{4, \dots, n-1\}$, the mapping class Z swaps the curves e_j^+ and e_j^- . Hence FZ fixes all the curves of \mathcal{A}^1 . Since F and Z preserve the surface $\Sigma(\rho)$ included in Σ , we can define $F' \in \mathcal{M}\text{od}(\Sigma(\rho))$ as being the restriction of FZ to $\Sigma(\rho)$.

Let us examine F' . The mapping class F' fixes all the curves of \mathcal{A}^1 , hence preserves each subsurface of $\text{Sub}_{\mathcal{A}^1}(\Sigma(\rho))$, which are pairs of pants, and preserves each of their boundary components. So F' induces in $\mathcal{P}\text{Mod}((\Sigma(\rho))_{\mathcal{A}^1})$ a trivial mapping class, where $(\Sigma(\rho))_{\mathcal{A}^1}$ is the surface we get after having cut $\Sigma(\rho)$ along the curves of \mathcal{A}^1 . Then, according to the following exact sequence:

$$1 \rightarrow \langle T_a, a \in \mathcal{A}^1 \rangle \rightarrow \mathcal{P}_{\mathcal{A}^1}\text{Mod}(\Sigma(\rho)) \rightarrow \mathcal{P}\text{Mod}((\Sigma(\rho))_{\mathcal{A}^1}) \rightarrow 1,$$

the mapping class F' is a multitwist along the curves of \mathcal{A}^1 . However, F' commutes with T_a , $a \in \mathcal{A}^0$, so according to Proposition 3.4, the curves \mathcal{A}^0 are reduction curves of F' . But each curve of \mathcal{A}^1 intersects one of the curves of \mathcal{A}^0 , so no curve in \mathcal{A}^1 can be an essential reduction curve of F' . So, according to Corollary 3.44, the mapping class F' is the identity.

Let us come back to the mapping class F . The restriction of F to $\Sigma(\rho)$, or the restriction of FZ to $\Sigma(\rho)$, equals Id in $\mathcal{M}\text{od}(\Sigma(\rho))$. Hence the centralizer of $\rho(\mathcal{B}_n)$ in \mathcal{M} is the group spanned by Z and by $\mathcal{M}^{\Sigma(\rho)}$, the subgroup of \mathcal{M} of the mapping classes inducing the identity mapping class on $\Sigma(\rho)$.

Let us now show item (ii). According to item (i), for all V belonging to the centralizer of $\rho(\mathcal{B}_n)$, there exist $\varepsilon \in \{0, 1\}$ and $V' \in \mathcal{M}^{\Sigma(\rho)}$ such that $V = Z^\varepsilon V'$. Let us compute V^2 . The mapping class Z can be seen as an element of \mathcal{M} that induces the identity outside of $\Sigma(\rho)$, so Z commutes with any element of $\mathcal{M}^{\Sigma(\rho)}$, so $V^2 = Z^2(V')^2$. On the other hand, $Z^2 = T_d$ where d is the boundary of $\Sigma(\rho)$, so Z^2 can be seen as an element of $\mathcal{M}^{\Sigma(\rho)}$. Since V' belongs to $\mathcal{M}^{\Sigma(\rho)}$, we can conclude that V^2 belongs to $\mathcal{M}^{\Sigma(\rho)}$. \square

Proposition 4.20 (Centralizer of the image of \mathcal{B}_n when n is even by some special morphisms). *Let n be an even integer greater than or equal to 6. Let Σ be a surface $\Sigma_{g,b}$ where $g \geq \frac{n}{2} - 1$ and $b \geq 0$. Let \mathcal{M} be one of the groups $\text{Mod}(\Sigma)$, $\mathcal{P}\text{Mod}(\Sigma)$, or $\mathcal{M}\text{od}(\Sigma, \partial\Sigma)$. Let $(a_1, a_2, \dots, a_{n-1})$ be a $(n-1)$ -chain of curves. Let ρ be the morphism from \mathcal{B}_n in \mathcal{M} defined by:*

$$\rho(\tau_i) = T_{a_i}$$

for all integers i in $\{1, 2, \dots, n-1\}$. We call $\Sigma(\rho)$ the compact tubular neighbourhood of the union of the curves a_i where $i \in \{1, 2, \dots, n-1\}$. Let $\mathcal{M}^{\Sigma(\rho)}$ be the subgroup of \mathcal{M} of the mapping classes that preserve $\Sigma(\rho)$ and induce the identity mapping class in $\text{Mod}(\Sigma(\rho))$. Then:

- (i) the centralizer of $\rho(\mathcal{B}_n)$ in \mathcal{M} is reduced to the group $\mathcal{M}^{\Sigma(\rho)}$, except in the following cases (a) and (b) below where it is equal to the group spanned by $\mathcal{M}^{\Sigma(\rho)}$ and by Z , where Z is any extension in Σ of the mapping class $s \in \text{Mod}(\Sigma(\rho))$ defined in Definition 4.15 (where $\Sigma(\mathcal{B}_n)$ is homeomorphic to $\Sigma(\rho)$).
- (a) The set of curves $\{a_1, a_3, \dots, a_{n-1}\}$ is non-separating,
- (b) the cut surface $\Sigma_{\{a_1, a_3, \dots, a_{n-1}\}}$ consists in two homeomorphic connected components and $\mathcal{M} = \text{Mod}(\Sigma)$.
- (ii) for any mapping class V belonging to the centralizer of $\rho(\mathcal{B}_n)$ in \mathcal{M} , the mapping class V^2 belongs to $\mathcal{M}^{\Sigma(\rho)}$.

Proof. The proof of Proposition 4.20 is almost the same as the proof of Proposition 4.19. We only explain what has to be changed.

We begin with the proof of item (i). It is clear that the centralizer of $\rho(\mathcal{B}_n)$ in \mathcal{M} contains the groups given in item (i) of the statement of Proposition 4.20. Let us show the converse inclusion. Similarly to the proof of Proposition 4.19, we define the following topological objects in $\Sigma(\rho)$, drawn in Figure 28:

- a $(n - 1)$ -chain of curves $(a_i)_{1 \leq i \leq n-1}$,
- some curves e_j^+ and e_j^- for any even integer $j \in \{4, \dots, n - 2\}$,
- some curves d^+ and d^- ,
- some pairs of pants P_i^+ and P_i^- for any odd integer $i \in \{3, \dots, n - 1\}$,
- a set \mathcal{A} of the curves a_i where i is odd in $\{1, \dots, n - 1\}$,
- a set \mathcal{A}^1 of the curves of \mathcal{A} and of the curves e_j^+ and e_j^- for any even j in $\{4, \dots, n - 2\}$.

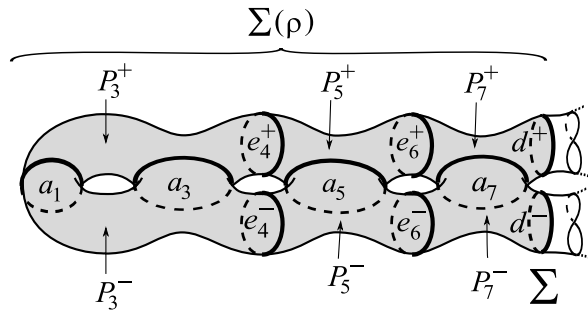

Figure 28: Cutting $\Sigma(\rho)$ in pairs of pants; the curves d^+ , d^- and the simplex \mathcal{A}^1 (case where n is even).

Let us start from a mapping class F belonging to the centralizer of $\rho(\mathcal{B}_n)$. Notice that $\Sigma(\rho) = \Sigma(\mathcal{B}_n)$ and let us define s as we did in Definition 4.15 (remember that s belongs to $\text{Mod}(\Sigma(\rho))$). The action of s on the curves of \mathcal{A}^1 consists in fixing the curves a_i for any odd i in $\{1, \dots, n - 1\}$, in swapping the curves e_j^+ and e_j^- for any even j in $\{4, \dots, n - 2\}$, and in swapping the curves

d^+ and d^- . As in the proof of Proposition 4.19, by considering the action of F on the set of pairs of pants of $\text{Sub}_{\mathcal{A}^1(\Sigma(\rho))}$, we see that the restriction of F to $\Sigma(\rho)$ coincides either with s or with the identity of $\Sigma(\rho)$, depending on whether F fixes or swaps the boundary components d^+ and d^- .

Assume that we are in case (a) or (b). Then the mapping class $s \in \mathcal{M}\text{od}(\Sigma(\rho))$ can be extended on Σ . We denote by Z this extension, which is a mapping class of \mathcal{M} . In all the other cases (different from (a) and (b)), the curves d^+ and d^- do not belong to the same orbit under the action of $\mathcal{P}\mathcal{M}\text{od}(\Sigma)$ on $\mathcal{C}\text{urv}(\Sigma, \partial\Sigma)$, so in these case, F cannot swap d^+ and d^- and cannot coincide with s on $\Sigma(\rho)$, so F induces in $\mathcal{M}\text{od}(\Sigma(\rho))$ the identity mapping class. To conclude,

- when one of the conditions (a) or (b) is satisfied, the centralizer of $\rho(\mathcal{B}_n)$ in \mathcal{M} is the group spanned by Z and $\mathcal{M}^{\Sigma(\rho)}$,
- if none of the conditions (a) or (b) is satisfied, the centralizer of $\rho(\mathcal{B}_n)$ in \mathcal{M} is the subgroup $\mathcal{M}^{\Sigma(\rho)}$.

This shows item (i).

Let us show item (ii). When (a) and (b) are not satisfied, there is nothing left to prove. In the case (a) or (b), according to item (i), for all V lying in the centralizer of $\rho(\mathcal{B}_n)$, there exist $\varepsilon \in \{0, 1\}$ and $V' \in \mathcal{M}^{\Sigma(\rho)}$ such that $V = Z^\varepsilon V'$. If $\varepsilon = 0$, there is nothing left to prove. Otherwise, notice that the mapping class Z preserves the set of curves $\{d_+, d_-\}$, and preserves $\Sigma \setminus \Sigma(\rho)$, so $Z^{-1}V'Z$ belongs to $\mathcal{M}^{\Sigma(\rho)}$. Now, $V^2 = ZV'ZV' = Z^2(Z^{-1}V'Z)V'$ and Z^2 belongs to $\mathcal{M}^{\Sigma(\rho)}$, hence V^2 belongs to $\mathcal{M}^{\Sigma(\rho)}$, too. \square

In the next proposition, we compute the normalizer of $\rho_{\text{ref}}(\mathcal{B}_n)$ and of $\tilde{\rho}_{\text{ref}}(\mathcal{B}_n)$ in $\mathcal{M}\text{od}(\Sigma(\mathcal{B}_n))$ and $\mathcal{M}\text{od}(\Sigma(\mathcal{B}_n), \partial\Sigma(\mathcal{B}_n))$ respectively. We need the following lemma:

Lemma 4.21. *Any automorphism of \mathcal{B}_n that preserves the braid twists is inner.*

Proof. Let φ be an automorphism of \mathcal{B}_n preserving the braid twists. Let $(a_i)_{1 \leq i \leq n-1}$ be a sequence of arcs in \mathbb{D}_n^2 such that we have the equalities $\tau_i = H_{a_i}$ in the identification $\mathcal{B}_n = \mathcal{M}\text{od}(\mathbb{D}_n^2)$. Let us denote by $(b_i)_{1 \leq i \leq n-1}$ the sequence of arcs in \mathbb{D}_n^2 such that $\varphi(\tau_i) = H_{b_i}$. Since the family of the H_{b_i} , $1 \leq i \leq n-1$, and the family of the H_{a_i} , $1 \leq i \leq n-1$, satisfy the same relations, it comes from Proposition 4.12 that the family of the b_i is the underlying set of a chain of arcs. Hence, there exists a homeomorphism of \mathbb{D}_n^2 that sends the chain $(a_i)_{1 \leq i \leq n-1}$ on the chain $(b_i)_{1 \leq i \leq n-1}$ and that preserves \mathcal{P} . The isotopy class of such a homeomorphism is an element γ of \mathcal{B}_n that acts by conjugation on the standard generators of \mathcal{B}_n , as φ does. Therefore, the automorphism φ is the conjugation by γ in \mathcal{B}_n . \square

Proposition 4.22 (Normalizer of $\rho_{\text{ref}}(\mathcal{B}_n)$ and of $\tilde{\rho}_{\text{ref}}(\mathcal{B}_n)$).

The normalizer of $\rho_{\text{ref}}(\mathcal{B}_n)$ in $\mathcal{M}\text{od}(\Sigma(\mathcal{B}_n))$ is the group spanned by $\rho_{\text{ref}}(\mathcal{B}_n)$ and by the centralizer of $\rho_{\text{ref}}(\mathcal{B}_n)$ (i.e. the group of order 2 spanned by s according to Propositions 4.19 and 4.20 in the case where $\Sigma = \Sigma(\rho) = \Sigma(\mathcal{B}_n)$).

The normalizer of $\tilde{\rho}_{\text{ref}}(\mathcal{B}_n)$ in $\mathcal{M}\text{od}(\Sigma(\mathcal{B}_n), \partial\Sigma(\mathcal{B}_n))$ is the group $\tilde{\rho}_{\text{ref}}(\mathcal{B}_n)$ when n is odd, and is the group spanned by $\tilde{\rho}_{\text{ref}}(\mathcal{B}_n)$ and by the Dehn twist T_{d_+} when n is even, where d_+ is one of the two boundary components of $\Sigma(\mathcal{B}_n)$.

Proof. Let us start by computing the normalizer of $\rho_{\text{ref}}(\mathcal{B}_n)$ in $\text{Mod}(\Sigma(\mathcal{B}_n))$. For all $F \in \text{Mod}(\Sigma(\mathcal{B}_n))$, the inner automorphism Ad_F that sends any element G on FGF^{-1} preserves the Dehn twists along non-separating curves. Hence for all $F \in \text{Norm}_{\text{Mod}(\Sigma(\mathcal{B}_n))}(\rho_{\text{ref}}(\mathcal{B}_n))$, the inner automorphism Ad_F preserves the Dehn twists of $\mathcal{S}\text{Mod}(\Sigma(\mathcal{B}_n))$ along non-separating curves, so according to Proposition 4.18, Ad_F induces in \mathcal{B}_n an automorphism that preserves the braid twists. Now, according to Lemma 4.21, such automorphisms are inner. In other words, there exists $\xi \in \mathcal{B}_n$ such that $\text{Ad}_{\rho_{\text{ref}}(\xi)}$ and Ad_F coincides on $\rho_{\text{ref}}(\mathcal{B}_n)$, so $\text{Ad}_{\rho_{\text{ref}}(\xi)^{-1}F}$ fixes the elements of $\rho_{\text{ref}}(\mathcal{B}_n)$. Hence $\rho_{\text{ref}}(\xi)^{-1}F$ is in the centralizer of $\rho_{\text{ref}}(\mathcal{B}_n)$, and the result follows.

We now turn to the normalizer of $\tilde{\rho}_{\text{ref}}(\mathcal{B}_n)$ in $\text{Mod}(\Sigma(\mathcal{B}_n), \partial\Sigma(\mathcal{B}_n))$. We have the following central exact sequence:

$$1 \rightarrow \langle T_d, d \in \text{Bndy}(\Sigma(\mathcal{B}_n)) \rangle \rightarrow \text{Mod}(\Sigma(\mathcal{B}_n), \partial\Sigma(\mathcal{B}_n)) \rightarrow \mathcal{P}\text{Mod}(\Sigma(\mathcal{B}_n)) \rightarrow 1.$$

Hence, the normalizer of $\tilde{\rho}_{\text{ref}}(\mathcal{B}_n)$ in $\text{Mod}(\Sigma(\mathcal{B}_n), \partial\Sigma(\mathcal{B}_n))$ is included in the set of lifts in $\mathcal{P}\text{Mod}(\Sigma(\mathcal{B}_n))$ of the elements of the normalizer of $\rho_{\text{ref}}(\mathcal{B}_n)$.

- When n is odd, the lifts of s are already in $\tilde{\rho}_{\text{ref}}(\mathcal{B}_n)$, and the Dehn twist T_d where d is the unique boundary component of $\Sigma(\mathcal{B}_n)$ is also already in $\tilde{\rho}_{\text{ref}}(\mathcal{B}_n)$, so the normalizer of $\tilde{\rho}_{\text{ref}}(\mathcal{B}_n)$ in $\text{Mod}(\Sigma(\mathcal{B}_n), \partial\Sigma(\mathcal{B}_n))$ is $\tilde{\rho}_{\text{ref}}(\mathcal{B}_n)$, which coincides with the set of lifts in $\mathcal{P}\text{Mod}(\Sigma(\mathcal{B}_n))$ of the elements of the normalizer of $\rho_{\text{ref}}(\mathcal{B}_n)$.
- When n is even, the normalizer of $\rho_{\text{ref}}(\mathcal{B}_n)$ in $\mathcal{P}\text{Mod}(\Sigma(\mathcal{B}_n))$ is reduced to $\rho_{\text{ref}}(\mathcal{B}_n)$, for the mapping class s does not belong to $\mathcal{P}\text{Mod}(\Sigma(\mathcal{B}_n))$. Hence the normalizer of $\tilde{\rho}_{\text{ref}}(\mathcal{B}_n)$ in $\text{Mod}(\Sigma(\mathcal{B}_n), \partial\Sigma(\mathcal{B}_n))$ is the group spanned by $\tilde{\rho}_{\text{ref}}(\mathcal{B}_n)$, T_{d_+} and T_{d_-} where d_+ and d_- are the two boundary components of $\Sigma(\mathcal{B}_n)$. But the product $T_{d_+}T_{d_-}$ belongs already to $\tilde{\rho}_{\text{ref}}(\mathcal{B}_n)$, hence the normalizer of $\tilde{\rho}_{\text{ref}}(\mathcal{B}_n)$ in $\text{Mod}(\Sigma(\mathcal{B}_n), \partial\Sigma(\mathcal{B}_n))$ is the group spanned by $\tilde{\rho}_{\text{ref}}(\mathcal{B}_n)$ and T_{d_+} . \square

II. Geometric morphisms from the braid group and corollaries

In this part, we prove the corollaries of Theorem 1. It is divided into two sections. The first one describes the frame whereas we state and prove the corollaries in the second one. More precisely:

Section 5:

This section aim to present different types of geometric morphisms from the braid group and to set some definitions in order to state the main theorem (Theorem 1) in an adequate context.

We will also give some results linking different types of geometric morphisms between them. These results will help us notably in the second section of this part, when we prove the corollaries of Theorem 1, but they will also help us later in the demonstration of Theorem 1.

Section 6:

In this section, we prove all the corollaries of Theorem 1 presented in this paper. Some of them are very closed to theorems of Ivanov and McCarthy, Bell and Margalit, Dyer and Grossman:

- we study the injectivity of the morphisms from \mathcal{B}_n in both families of mapping class groups: $\mathcal{M}od(\Sigma, \partial\Sigma)$ and $\mathcal{P}\mathcal{M}od(\Sigma)$;
- we study the morphisms from \mathcal{B}_n in \mathcal{B}_n and \mathcal{B}_{n+1} , the injectivity of such morphisms and the automorphisms of \mathcal{B}_n ;
- at last we study the morphisms from the mapping class group of a surface of genus $g \geq 2$ in the one of a surface of genus $g' \leq g + 1$, the injectivity of such morphisms and the automorphisms of the mapping class group.

5 The morphisms between braid groups and mapping class groups, Theorem 1

In this section, we pursue the following goals:

1. setting the main definitions concerning the morphisms from the braid group in some mapping class groups (*cyclic morphisms*, *monodromy morphisms*, *transvections*), and giving some basic facts;
2. stating the main theorem of this paper concerning morphisms from \mathcal{B}_n in $\mathcal{P}\text{Mod}(\Sigma)$ and in $\text{Mod}(\Sigma, \partial\Sigma)$;
3. showing the relations between $\text{Hom}(\mathcal{B}_n, \mathcal{P}\text{Mod}(\Sigma))$ and $\text{Hom}(\mathcal{B}_n, \text{Mod}(\Sigma, \partial\Sigma))$;
4. presenting some results on transvections of monodromy morphisms and computing the centralizer of the image of a monodromy morphism.

The four subsections of this section will follow this outline.

5.1 Cyclic morphisms, monodromy morphisms and transvections

We give in this subsection the main definitions related to the morphisms from the braid group in the mapping class group: the *cyclic morphisms*, the *monodromy morphisms*, the *transvections of monodromy morphisms*.

Cyclic morphisms.

Definition 5.1 (Cyclic morphisms).

Let n be an integer greater than or equal to 3, G any group and φ a morphism from \mathcal{B}_n in G . The morphism φ is said to be *cyclic* if:

$$\varphi(\tau_1) = \varphi(\tau_2) = \cdots = \varphi(\tau_{n-1}).$$

Lemma 5.2. *Let n be an integer greater than or equal to 5, G any group and φ a morphism from \mathcal{B}_n in G . If there exist two distinct integers i and j in $\{0, 1, \dots, n-1\}$ such that $\varphi(\tau_i) = \varphi(\tau_j)$, then φ is a cyclic morphism.*

Proof. Let us recall that by convention, for any integer ℓ , τ_ℓ is the standard generator τ_k where k is the remainder of the euclidian division of ℓ by n . Furthermore, for all integers i and j , we denote by $|i-j|_n$ the integer $\min(\{|i-j+kn|, k \in \mathbb{Z}\})$.

Let i and j be two distinct integers in $\{0, 1, \dots, n-1\}$ such that $\varphi(\tau_i) = \varphi(\tau_j)$.

a) If $|i-j|_n = 1$, for example if $j = i+1$, the equality $\varphi(\tau_i) = \varphi(\tau_{i+1})$ implies that $\varphi(\delta\tau_i\delta^{-1}) = \varphi(\delta\tau_{i+1}\delta^{-1})$, in other words $\varphi(\tau_{i+1}) = \varphi(\tau_{i+2})$. By induction, we get:

$$\varphi(\tau_1) = \varphi(\tau_2) = \cdots = \varphi(\tau_{n-1}).$$

b) If $|i - j|_n > 1$ and $|(i + 1) - j|_n > 1$, let us set $\beta_i = \tau_i \tau_{i+1} \tau_i$. The equality $\varphi(\tau_i) = \varphi(\tau_j)$ implies that $\varphi(\beta_i \tau_i \beta_i^{-1}) = \varphi(\beta_i \tau_j \beta_i^{-1})$, whence $\varphi(\tau_{i+1}) = \varphi(\tau_j)$, and finally $\varphi(\tau_i) = \varphi(\tau_{i+1})$. We are back to a).

c) If $|i - j|_n > 1$ and $|(i + 1) - j|_n = 1$, then we have either $j = i + 2$ or $j = i + 2 - n$, hence $|i - j|_n > 1$ and $|i - (j + 1)|_n > 1$. Let us swap i and j : we are back to b). \square

Since the abelianization of \mathcal{B}_n is infinite cyclic, we have the following lemma:

Lemma 5.3. *Let n be an integer greater than or equal to 3. Any morphism from \mathcal{B}_n in an abelian group is cyclic.* \square

Monodromy morphisms.

Definition 5.4 (Monodromy morphisms).

For any integer n greater than or equal to 3 and any surface Σ , a morphism from \mathcal{B}_n in a subgroup \mathcal{M} of $\text{Mod}(\Sigma)$ or of $\text{Mod}(\Sigma, \partial\Sigma)$ is called a *monodromy morphism* if the standard generators of the braid group are sent on Dehn twists, or on their inverses, along pairwise distinct curves.

This definition was inspired by Proposition 3.4 (properties of Dehn twists) and Definition 3.6 (chain of curves), so that we now can state the following:

Lemma 5.5. *Let n be an integer greater than or equal to 3, Σ a surface and ρ a monodromy morphism from \mathcal{B}_n in $\text{Mod}(\Sigma)$ or $\text{Mod}(\Sigma, \partial\Sigma)$, there exists a $(n-1)$ -chain of curves $(a_1, a_2, \dots, a_{n-1})$ and an integer $\varepsilon \in \{\pm 1\}$ such that for all integers i in $\{1, \dots, n-1\}$, we have:*

$$\rho(\tau_i) = T_{a_i}^\varepsilon.$$

\square

As a corollary, we get a necessary and sufficient condition on the existence of monodromy morphisms.

Lemma 5.6 (Criterion regarding the existence of monodromy morphisms).

Let n be an integer greater than or equal to 3 and Σ a surface $\Sigma_{g,b}$. There exist monodromy morphisms from \mathcal{B}_n in $\mathcal{P}\text{Mod}(\Sigma)$ if and only if $g \geq \frac{n}{2} - 1$.

Proof. *Sufficient condition:* it is enough to consider an embedding from $\Sigma(\mathcal{B}_n)$ in Σ . Then the reference morphism $\tilde{\rho}_{\text{ref}} : \mathcal{B}_n \rightarrow \mathcal{P}\text{Mod}(\Sigma(\mathcal{B}_n))$ induces a monodromy morphism in $\mathcal{P}\text{Mod}(\Sigma)$.

Necessary condition: notice that the existence of monodromy morphisms only depends on the existence of $(n-1)$ -chains of curves. Now, if there exists a $(n-1)$ -chain in Σ , according to Proposition 2.2, there exists a representative in tight position of such a $(n-1)$ -chain. The compact tubular neighbourhood compact of such a representative (they are all homeomorphic, so it is enough to check it on an example) is a surface embedded in Σ whose genus equals the integral part of $\frac{n}{2} - 1$. Hence $g \geq \frac{n}{2} - 1$. \square

Transvections.

Definition 5.7 (Transvections).

Let n be an integer greater than or equal to 3, let G be any group and let ρ and ρ' be two morphisms from \mathcal{B}_n in G . We shall say that ρ' is a transvection of ρ if there exists an element g in the centralizer of $\rho(\mathcal{B}_n)$ in G such that for all integers i in $\{1, \dots, n-1\}$, we have:

$$\rho'(\tau_i) = \rho(\tau_i)g.$$

The following lemma shows how transvections arise naturally from central exact sequences of groups. Such sequences are frequent between mapping class groups. See for instance Proposition 3.9.

Lemma 5.8. *Let $1 \rightarrow N \rightarrow G \xrightarrow{\psi} \widehat{G} \rightarrow 1$ be a central exact sequence of groups, let n be an integer greater than or equal to 3 and let ρ and ρ' be two morphisms from \mathcal{B}_n in G such that $\psi \circ \rho = \psi \circ \rho'$. Then*

- (i) ρ' is a transvection of ρ ,
- (ii) ρ is cyclic if and only if $\psi \circ \rho$ is cyclic.

Proof. Let us prove item (i). For all integers i in $\{1, \dots, n-1\}$, there exists $g_i \in N$ such that $\rho'(\tau_i) = \rho(\tau_i)g_i$. We have then the following equalities, true for all integers i in $\{1, \dots, n-1\}$:

$$\begin{aligned} \rho'(\tau_i) \rho'(\tau_{i+1}) \rho'(\tau_i) &= \rho(\tau_i) \rho(\tau_{i+1}) \rho(\tau_i) g_i g_{i+1} g_i, \\ \rho'(\tau_{i+1}) \rho'(\tau_i) \rho'(\tau_{i+1}) &= \rho(\tau_{i+1}) \rho(\tau_i) \rho(\tau_{i+1}) g_{i+1} g_i g_{i+1}. \end{aligned}$$

The braid relations in \mathcal{B}_n imply that the four members in these two equalities must be all equal. Therefore for any integer i in $\{1, 2, \dots, n-1\}$, we have:

$$g_i g_{i+1} g_i = g_{i+1} g_i g_{i+1}.$$

But for all i and j in $\{1, 2, \dots, n-1\}$, the elements g_i and g_j commute, so they all are equal. Hence ρ' is a transvection of ρ .

Let us prove now item (ii). If ρ is cyclic, then $\psi \circ \rho$ is cyclic. Conversely, if $\psi \circ \rho$ is cyclic, then it is clear that there exists a cyclic morphism ρ' such that $\psi \circ \rho' = \psi \circ \rho$. According to item (i), this implies that ρ is a transvection of ρ' . Hence ρ is cyclic. \square

The most frequently, the transvections that we will meet will be transvections of monodromy morphisms. To make things clear, we give below the definition of a *transvection of monodromy morphism* although it is unnecessary since the words *transvection* and *monodromy morphism* have already been defined. We will prove that under some conditions, all the morphisms from \mathcal{B}_n in $\mathcal{PMod}(\Sigma)$ where Σ is a connected surface are transvections of monodromy morphisms.

Definition 5.9 (Transvection of monodromy morphism).

Let n be an integer greater than or equal to 3, Σ a surface, \mathcal{M} a subgroup of $\mathcal{Mod}(\Sigma)$ or of $\mathcal{Mod}(\Sigma, \partial\Sigma)$. A *transvection of monodromy morphism* is a morphism ρ such that there exist:

- a $(n-1)$ -chain of curves $(a_i)_{1 \leq i \leq n-1}$ in $\mathcal{Curv}(\Sigma)$,
- an integer $\varepsilon \in \{\pm 1\}$,
- a mapping class $V \in \mathcal{M}$ that commutes with T_{a_i} for all $i \leq n-1$,

and that satisfies for all integers i in $\{1, 2, \dots, n-1\}$:

$$\rho(\tau_i) = T_{a_i}^\varepsilon V.$$

Finally, we adopt the following definition:

Definition 5.10 (Morphisms of the same nature).

Let n be an integer greater than or equal to 3, Σ a surface, and ρ_1 and ρ_2 two morphisms from \mathcal{B}_n in a subgroup of $\mathcal{M}\text{od}(\Sigma)$ or $\mathcal{M}\text{od}(\Sigma, \partial\Sigma)$. We will say that ρ_1 and ρ_2 are of the same nature if they both are cyclic morphisms, or if they both are transvections of monodromy morphisms. Otherwise, we will say that they are of different natures.

5.2 Statement of the main theorem

Let us recall the statement of Theorem 1 (proved during Section 13):

Theorem 1 (Morphisms from \mathcal{B}_n in $\mathcal{P}\mathcal{M}\text{od}(\Sigma)$, $n \geq 6$).

Let n be an integer greater than or equal to 6 and Σ a surface $\Sigma_{g,b}$ with $g \leq \frac{n}{2}$. Let ρ be a morphism from \mathcal{B}_n in $\mathcal{P}\mathcal{M}\text{od}(\Sigma)$. If ρ is not cyclic, ρ is a transvection of monodromy morphism. Moreover, such transvections of monodromy morphisms exist if and only if $g \geq \frac{n}{2} - 1$.

Actually, we will first prove Theorem 1 in the case where n is an even integer, cf. Sections 7 to 12. We will prove the general case with n even or odd in Section 13.

As we will see it later in this section in Subsection 5.3, from Theorem 1 we can deduce Theorem 2 in which we consider morphisms from \mathcal{B}_n in $\mathcal{M}\text{od}(\Sigma, \partial\Sigma)$ instead of $\mathcal{P}\mathcal{M}\text{od}(\Sigma)$.

Theorem 2 (Morphisms from \mathcal{B}_n in $\mathcal{M}\text{od}(\Sigma, \partial\Sigma)$, $n \geq 6$).

Let n be an integer greater than or equal to 6 and Σ a surface $\Sigma_{g,b}$ with $g \leq \frac{n}{2}$. Let $\tilde{\rho}$ be a morphism from \mathcal{B}_n in $\mathcal{M}\text{od}(\Sigma, \partial\Sigma)$. Then $\tilde{\rho}$ is cyclic or is a transvection of monodromy morphism. Moreover such transvections of monodromy morphisms exist if and only if $g \geq \frac{n}{2} - 1$.

5.3 From $\text{Hom}(\mathcal{B}_n, \mathcal{P}\mathcal{M}\text{od}(\Sigma))$ to $\text{Hom}(\mathcal{B}_n, \mathcal{M}\text{od}(\Sigma, \partial\Sigma))$

In this subsection, we show the links that exist between the sets $\text{Hom}(\mathcal{B}_n, \mathcal{P}\mathcal{M}\text{od}(\Sigma))$ and $\text{Hom}(\mathcal{B}_n, \mathcal{M}\text{od}(\Sigma, \partial\Sigma))$. In particular, we show two results:

- Proposition 5.12: Let n be an integer greater than or equal to 3 and let Σ be a surface. Any morphism from \mathcal{B}_n in $\mathcal{P}\mathcal{M}\text{od}(\Sigma)$ can be lifted in exactly one way, up to transvections, in a morphism from \mathcal{B}_n in $\mathcal{M}\text{od}(\Sigma, \partial\Sigma)$.
- Theorem 2: Let n be an integer greater than or equal to 6 and let Σ be a surface of genus $g \leq \frac{n}{2}$. Any morphism from \mathcal{B}_n in $\mathcal{M}\text{od}(\Sigma, \partial\Sigma)$ is either cyclic, or is a transvection of monodromy morphism (this theorem is similar to Theorem 1, but the codomain of the considered morphisms is now $\mathcal{M}\text{od}(\Sigma, \partial\Sigma)$).

Lemma 5.11. Let Σ be a surface with a nonempty boundary. Let F and G be mapping classes in $\mathcal{P}\mathcal{M}\text{od}(\Sigma)$ such that F and G commute. Let \tilde{F} and \tilde{G} be the lifts in $\mathcal{M}\text{od}(\Sigma, \partial\Sigma)$ of respectively F and G . Then \tilde{F} and \tilde{G} commute.

Remark. This lemma is not obvious. If a and b are commuting elements of a group G and if H is a central extension of G , it can happen that two lifts of a and b do not commute.

Proof. Let us start from the following central exact sequence linking $\mathcal{M}\text{od}(\Sigma, \partial\Sigma)$ and $\mathcal{P}\mathcal{M}\text{od}(\Sigma)$:

$$1 \rightarrow \langle T_d, d \in \text{Bndy}(\Sigma) \rangle \rightarrow \mathcal{M}\text{od}(\Sigma, \partial\Sigma) \rightarrow \mathcal{P}\mathcal{M}\text{od}(\Sigma) \rightarrow 1. \quad (*)$$

Then two lifts in $\mathcal{M}\text{od}(\Sigma, \partial\Sigma)$ of a same element of $\mathcal{P}\mathcal{M}\text{od}(\Sigma)$ differ from a central element. Therefore, in order to show the lemma, it is enough to show that, given two elements F and G in $\mathcal{P}\mathcal{M}\text{od}(\Sigma)$ that commute, there exist two lifts \tilde{F} and \tilde{G} of F and G in $\mathcal{M}\text{od}(\Sigma, \partial\Sigma)$ that commute. So we start from two mapping classes F and G in $\mathcal{P}\mathcal{M}\text{od}(\Sigma)$ that commute.

1. If F and G are periodic, since Σ has a nonempty boundary, according to Lemma 3.19 there exists $H \in \mathcal{M}\text{od}(\Sigma)$ such that F and G are both some powers of H . Let p and q be two integers such that $F = H^p$ and $G = H^q$. Let \tilde{H} be a lift of H in $\mathcal{M}\text{od}(\Sigma, \partial\Sigma)$. Then \tilde{H}^p and \tilde{H}^q are some lifts of F and G that commute.

2. We now turn to the case where F is pseudo-Anosov and G is periodic. Let us denote by \tilde{F} and \tilde{G} some lifts in $\mathcal{M}\text{od}(\Sigma, \partial\Sigma)$ of F and G respectively. Since $FGF^{-1} = G$, there exists a central mapping class $V \in \mathcal{M}\text{od}(\Sigma, \partial\Sigma)$ such that $\tilde{F}\tilde{G}\tilde{F}^{-1} = \tilde{G}V$. Let p be the order of G and let W be the central mapping class of $\mathcal{M}\text{od}(\Sigma, \partial\Sigma)$ such that $\tilde{G}^p = W$. Then, we have on one hand:

$$(\tilde{F}\tilde{G}\tilde{F}^{-1})^p = \tilde{F}\tilde{G}^p\tilde{F}^{-1} = \tilde{F}W\tilde{F}^{-1} = W, \quad (1)$$

and we have on the other hand:

$$(\tilde{F}\tilde{G}\tilde{F}^{-1})^p = (\tilde{G}V)^p = WV^p. \quad (2)$$

When we compare (1) and (2), it comes out that V is trivial for $\mathcal{M}\text{od}(\Sigma, \partial\Sigma)$ is torsion-free. So \tilde{F} and \tilde{G} commute.

3. If F and G are pseudo-Anosov, according to Theorem 3.32 there exist two nonzero integers p and q such that $F^p = G^q$. Let ℓ and k be two integers such that $\ell p + kq = p \wedge q = d$. Let us set

- $H = F^k G^\ell$ (so H satisfies $H^p = G^d$ and $H^q = F^d$; hence H is pseudo-Anosov),
- $P = F(H^{-1})^{(q/d)}$ (so $P^d = 1$ and $F \in \langle P, H \rangle$),
- $Q = G(H^{-1})^{(p/d)}$ (so $Q^d = 1$ and $G \in \langle Q, H \rangle$).

According to Lemma 3.19, since P and Q are two periodic mapping classes that commute, there exists a mapping class $R \in \langle P, Q \rangle$ such that $\langle P, Q \rangle = \langle R \rangle$. Thus F and G belong to the abelian group spanned by H and R . Then according to step 2., two lifts \tilde{H} and \tilde{R} of H and R in $\mathcal{M}\text{od}(\Sigma, \partial\Sigma)$ span an abelian group, too. Moreover, the latter contains two lifts \tilde{F} and \tilde{G} of F and G in $\mathcal{M}\text{od}(\Sigma, \partial\Sigma)$. In particular, F and G admit two lifts \tilde{F} and \tilde{G} that commute.

4. Let F and G be any two mapping classes of $\mathcal{P}\mathcal{M}\text{od}(\Sigma)$ that commute. Let \mathcal{A} be the set of curves $\sigma(F) \cup \sigma(G)$. Notice that \mathcal{A} is a simplex according to Proposition 3.40.

4.a) Let us assume that F and G belong to $\mathcal{P}_{\mathcal{A}}\mathcal{M}\text{od}(\Sigma)$ (i.e. F and G preserve each curve of the set $\mathcal{A} = \sigma(F) \cup \sigma(G)$). We are going to describe for any $H \in \mathcal{P}_{\mathcal{A}}\mathcal{M}\text{od}(\Sigma)$ a construction of a lift of H in $\mathcal{P}_{\mathcal{A}}\mathcal{M}\text{od}(\Sigma, \partial\Sigma)$, then we will apply it to F and G . First, let us consider the following commutative diagram where all the arrows are canonical ($rec_{\mathcal{A}}$ comes from Proposition 3.9, the three other morphisms have been introduced in Subsection 3.1 Definition 3.1):

$$\begin{array}{ccccc}
H_3 \in & \mathcal{P}_A \text{Mod}(\Sigma, \partial\Sigma) & \xleftarrow{\text{rec}_A} & \text{Mod}(\Sigma_A, \partial\Sigma_A) & \ni H_2 \\
& \downarrow \text{for}_{\partial\Sigma} & & \downarrow \text{for}_{\partial\Sigma_A} & \\
H_4, H \in & \mathcal{P}_A \text{Mod}(\Sigma) & \xrightarrow{\text{cut}_A} & \mathcal{P} \text{Mod}(\Sigma_A) & \ni H_1, H_5
\end{array}$$

For any $H \in \mathcal{P}_A \text{Mod}(\Sigma)$, let us denote by H_i , $1 \leq i \leq 5$, the following mapping classes, derived from H when following the diagram above:

- $H_1 = \text{cut}_A(H)$, so $H_1 \in \mathcal{P} \text{Mod}(\Sigma_A)$,
- H_2 a lift of H_1 in $\text{Mod}(\Sigma_A, \partial\Sigma_A)$, so $H_2 \in \text{Mod}(\Sigma_A, \partial\Sigma_A)$,
- $H_3 = \text{rec}_A(H_2)$, so $H_3 \in \text{Mod}(\Sigma_A, \partial\Sigma_A)$,
- $H_4 = \text{for}_{\partial\Sigma}(H_3)$, so $H_4 \in \mathcal{P}_A \text{Mod}(\Sigma, \partial\Sigma)$,
- $H_5 = \text{cut}_A(H_4)$, so $H_5 \in \mathcal{P} \text{Mod}(\Sigma_A)$.

The diagram is commutative: $\text{for}_{\partial\Sigma_A} = (\text{cut}_A)(\text{for}_{\partial\Sigma})(\text{rec}_A)$, so $H_1 = H_5$. But we have the following central exact sequence:

$$1 \rightarrow \mathcal{T} \rightarrow \mathcal{P}_A \text{Mod}(\Sigma) \xrightarrow{\text{cut}_A} \mathcal{P} \text{Mod}(\Sigma_A) \rightarrow 1, \quad (**)$$

where $\mathcal{T} = \langle T_d, d \in \mathcal{A} \rangle$. Hence H and H_4 , the preimages of H_1 and H_5 by cut_A , differ from a multitwist along some curves of \mathcal{A} . Hence, up to elements in \mathcal{T} , the mapping class H_3 is a lift of H .

Let us apply this to F and G . As F and G commute, F_1 and G_1 commute. But on each connected component of Σ_A , the restrictions of F_1 and G_1 are periodic or pseudo-Anosov, so we can apply what was shown above in steps 1., 2. and 3., and deduce from it that F_2 and G_2 commute. Hence F_3 and G_3 commute as well. Now, as we just saw it with H , there exist T and T' belonging to \mathcal{T} such that $\tilde{F} = F_3 T$ and $\tilde{G} = G_3 T'$ are some lifts of F and G . Moreover T and T' are central in $\mathcal{P}_A \text{Mod}(\Sigma, \partial\Sigma)$ and in addition, F_3 and G_3 commute, so \tilde{F} and \tilde{G} commute.

4.b) In the general case, if F and G are any two mapping classes that commute, let us denote by \tilde{F} and \tilde{G} some lifts of F and G in $\text{Mod}(\Sigma, \partial\Sigma)$. *a priori*, there exists a multitwist W along the boundary components such that $\tilde{F}\tilde{G}\tilde{F}^{-1} = \tilde{G}W$. Once again, let us set $\mathcal{A} = \sigma(F) \cup \sigma(G)$. Since F and G commute, they preserve globally \mathcal{A} , so there exists a nonzero integer m such that F^m and G^m preserve \mathcal{A} curve-wise. In other words, F^m and G^m belong to $\mathcal{P}_A \text{Mod}(\Sigma)$. So, according to 4.a),

$$\tilde{F}^m \tilde{G}^m \tilde{F}^{-m} = \tilde{G}^m.$$

Now, the equality $\tilde{F}\tilde{G}\tilde{F}^{-1} = \tilde{G}W$ implies that $\tilde{F}\tilde{G}^m\tilde{F}^{-1} = \tilde{G}^m W^m$, then

$$\tilde{F}^m \tilde{G}^m \tilde{F}^{-m} = \tilde{G}^m W^{m^2}.$$

So W^{m^2} is trivial. But $\text{Mod}(\Sigma, \partial\Sigma)$ is torsion-free, hence W is trivial and \tilde{G} and \tilde{F} commute. \square

Proposition 5.12 (Lifting from $\text{Hom}(\mathcal{B}_n, \mathcal{P} \text{Mod}(\Sigma))$ in $\text{Hom}(\mathcal{B}_n, \text{Mod}(\Sigma, \partial\Sigma))$).

Let n be an integer greater than or equal to 3, let Σ be a surface and $\rho : \mathcal{B}_n \rightarrow \mathcal{P} \text{Mod}(\Sigma)$ a morphism. Let us recall that we denote by $\text{for}_{\partial\Sigma}$, or for , the canonical epimorphism from $\text{Mod}(\Sigma, \partial\Sigma)$ in $\mathcal{P} \text{Mod}(\Sigma)$. Then:

1. There exists a morphism $\tilde{\rho} : \mathcal{B}_n \rightarrow \text{Mod}(\Sigma, \partial\Sigma)$ such that $\text{for} \circ \tilde{\rho} = \rho$.
2. Such a morphism $\tilde{\rho}$ is unique up to transvection, that is, if $\tilde{\rho}_1$ and $\tilde{\rho}_2$ satisfy $\text{for}(\tilde{\rho}_1) = \text{for}(\tilde{\rho}_2) = \rho$, then there exists $V \in \text{Mod}(\Sigma, \partial\Sigma)$ such that V is in the centralizer of $\tilde{\rho}_1(\mathcal{B}_n)$ and of $\tilde{\rho}_2(\mathcal{B}_n)$ and satisfies for all $i \in \{1, \dots, n-1\}$:

$$\tilde{\rho}_2(\tau_i) = \tilde{\rho}_1(\tau_i) V.$$

3. Such a morphism $\tilde{\rho}$ is cyclic if and only if ρ is cyclic.

4. Such a morphism $\tilde{\rho}$ is a transvection of monodromy morphism if and only if ρ is a transvection of monodromy morphism.

Proof.

1. Let us start from the following central exact sequence:

$$1 \rightarrow \langle T_d, d \in \text{Bndy}(\Sigma) \rangle \rightarrow \mathcal{M}\text{od}(\Sigma, \partial\Sigma) \xrightarrow{\text{for}} \mathcal{P}\mathcal{M}\text{od}(\Sigma) \rightarrow 1. \quad (*)$$

For all $i \in \{1, \dots, n-1\}$, let A_i be a mapping class of $\mathcal{M}\text{od}(\Sigma, \partial\Sigma)$ such that $\text{for}(A_i) = \rho(\tau_i)$. Then for all $i \in \{1, \dots, n-2\}$, we have:

$$\text{for}(A_i A_{i+1} A_i) = \text{for}(A_{i+1} A_i A_{i+1}),$$

hence, according to the exact sequence (*), for all $i \in \{1, \dots, n-2\}$, there exists a multitwist denoted by W_i along some boundary components of Σ such that

$$A_i A_{i+1} A_i = A_{i+1} A_i A_{i+1} W_i.$$

Let us set:

$$\begin{cases} A'_1 := A_1, \\ A'_i := A_i W_1 W_2 \cdots W_{i-1} \text{ when } 2 \leq i \leq n-1. \end{cases}$$

Let us recall that the W_i are central. Hence for all $i \in \{1, \dots, n-2\}$, we have:

$$A'_i A'_{i+1} A'_i = A'_{i+1} A'_i A'_{i+1}.$$

Besides, for all integers i and j smaller than or equal to $n-1$ such that $|i-j| \geq 2$, the mapping classes A_i and A_j commute, so according to Lemma 5.11, the mapping classes A'_i and A'_j commute as well. Finally the map $\tilde{\rho}$ defined by

$$\tilde{\rho}(\tau_i) = A'_i$$

is a morphism from \mathcal{B}_n in $\mathcal{M}\text{od}(\Sigma, \partial\Sigma)$. Moreover, by construction, we have $\text{for}(\tilde{\rho}) = \rho$.

2. Let $\tilde{\rho}_1$ and $\tilde{\rho}_2$ be two morphisms from \mathcal{B}_n in $\mathcal{M}\text{od}(\Sigma, \partial\Sigma)$ that satisfy $\text{for}(\tilde{\rho}_1) = \text{for}(\tilde{\rho}_2)$. According to the central exact sequence (*), we can apply Lemma 5.8: $\tilde{\rho}_2$ is a transvection of $\tilde{\rho}_1$.

3. According to Lemma 5.8, $\tilde{\rho}$ is cyclic if and only if ρ is cyclic.

4. If $\tilde{\rho}$ is a transvection of monodromy morphism, it is clear that $\text{for} \circ \tilde{\rho}$ is still a transvection of monodromy morphism. Conversely, if ρ is a transvection of monodromy morphism, there exist:

- a $(n-1)$ -chain of curves $(a_i)_{1 \leq i \leq n-1}$,
- an integer $\varepsilon \in \{\pm 1\}$,
- a mapping class V commutant with T_{a_i} for all $i \leq n-1$,

such that for all integers i in $\{1, 2, \dots, n-1\}$, we have:

$$\rho(\tau_i) = T_{a_i}^\varepsilon V.$$

Let \tilde{V} be a lift of V in $\mathcal{M}\text{od}(\Sigma, \partial\Sigma)$. For all $i \in \{1, \dots, n-1\}$, the mapping class V commutes with T_{a_i} , so V fixes a_i and \tilde{V} fixes a_i . Hence \tilde{V} commutes with T_{a_i} in $\mathcal{M}\text{od}(\Sigma, \partial\Sigma)$. Then the morphism $\tilde{\rho}$, satisfying for all integers i in $\{1, 2, \dots, n-1\}$ the equality

$$\tilde{\rho}(\tau_i) = T_{a_i}^\varepsilon \tilde{V},$$

is a transvection of monodromy morphism. □

Next proposition will help us proving Theorem 2, which was announced in Subsection 5.2:

Theorem 2 (Morphisms from \mathcal{B}_n in $\mathcal{M}\text{od}(\Sigma, \partial\Sigma)$).

Let n be any integer greater than or equal to 6. Let Σ be a surface $\Sigma_{g,b}$ where $g \leq n/2$. Let $\tilde{\rho}$ a morphism from \mathcal{B}_n in $\mathcal{M}\text{od}(\Sigma, \partial\Sigma)$. Then $\tilde{\rho}$ is cyclic or is a transvection of monodromy morphism. Moreover such transvections of monodromy morphisms exist if and only if $g \geq \frac{n}{2} - 1$.

Proof. The second part of Theorem 2 is clear: the existence of such morphisms is equivalent to the existence of a $(n - 1)$ -chain of curves in Σ , and so is equivalent to $g \geq \frac{n}{2} - 1$.

It remains to be shown that all the morphisms from \mathcal{B}_n in $\mathcal{M}\text{od}(\Sigma, \partial\Sigma)$ are either cyclic, or transvections of monodromy morphisms. Let $\tilde{\rho}$ be a noncyclic morphism from \mathcal{B}_n in $\mathcal{M}\text{od}(\Sigma, \partial\Sigma)$. If we compose $\tilde{\rho}$ with the projection $\mathcal{M}\text{od}(\Sigma, \partial\Sigma) \xrightarrow{\text{for}} \mathcal{P}\mathcal{M}\text{od}(\Sigma)$, we get a morphism ρ from \mathcal{B}_n in $\mathcal{P}\mathcal{M}\text{od}(\Sigma)$. According to Proposition 5.12.3., ρ is not cyclic, so according to Theorem 1, ρ is a transvection of monodromy morphism, so according to Proposition 5.12 item 3., $\tilde{\rho}$ is a transvection of monodromy morphism. \square

5.4 Transvections of monodromy morphisms

In this paper, we will handle transvections of monodromy morphisms. This is the reason why we start this part with some lemmas that will help us to “compare” such transvections.

Let Σ be a surface and let \mathcal{M} be a subgroup of $\mathcal{M}\text{od}(\Sigma)$ or of $\mathcal{M}\text{od}(\Sigma, \partial\Sigma)$. Any transvection of monodromy morphism from \mathcal{B}_n in \mathcal{M} can be described by the data of a $(n - 1)$ -chain (a_1, \dots, a_{n-1}) of curves in Σ , of an integer $\varepsilon \in \{\pm 1\}$, and of a mapping class V that commutes with T_{a_i} for all $i \in \{1, \dots, n-1\}$. We are going to show that such a triple $((a_1, \dots, a_{n-1}), \varepsilon, V)$ is unique. In the next chapter, we will use this result for $n = 4$ (see Theorem 6). That is why we are going to prove it for any integer n greater than or equal to 4 instead of 5, which makes the proof a bit more complicated.

Lemma 5.13. (*Uniqueness of the triple representing a transvection*)

Let n be an integer greater than or equal to 4, let Σ be a surface, and let \mathcal{M} be a subgroup of $\mathcal{M}\text{od}(\Sigma)$ or of $\mathcal{M}\text{od}(\Sigma, \partial\Sigma)$. Let ρ be a transvection of monodromy morphism from \mathcal{B}_n in \mathcal{M} such that there exist two triples $((a_1, \dots, a_{n-1}), \varepsilon, V)$ and $((c_1, \dots, c_{n-1}), \eta, W)$ satisfying the following for all $i \in \{1, \dots, n-1\}$:

$$\rho(\tau_i) = T_{a_i}^\varepsilon V = T_{c_i}^\eta W.$$

Then, these two triples are equal.

Proof. Given the properties of V and W , the computation of $\rho(\tau_1\tau_3^{-1})$ leads to:

$$(T_{a_1} T_{a_3}^{-1})^\varepsilon = (T_{c_1} T_{c_3}^{-1})^\eta . \quad (1)$$

This is an equality between multitwists (for $I(a_1, a_3) = I(c_1, c_3) = 0$), so one of the following cases holds:

- either $\varepsilon = \eta$, $a_1 = c_1$ and $a_3 = c_3$ (2)

- or $\varepsilon = -\eta$, $a_1 = c_3$ and $a_3 = c_1$. (3)

Let us focus on case (3) in order to prove it cannot occur. Case (3) implies that:

$$\rho(\tau_1) = T_{c_1}^\eta W = T_{a_3}^{-\varepsilon} W. \quad (4)$$

Now, we also have $\rho(\tau_1) = T_{a_1}^\varepsilon V$, whence:

$$W = (T_{a_3} T_{a_1})^\varepsilon V. \quad (5)$$

In a similar way, the equalities

$$\begin{cases} \rho(\tau_2) = T_{a_2}^\varepsilon V, \\ \rho(\tau_2) = T_{c_2}^\eta W = T_{c_2}^{-\varepsilon} W, \end{cases} \quad (6)$$

imply that

$$W = (T_{c_2} T_{a_2})^\varepsilon V. \quad (7)$$

By comparing (5) and (7), we get:

$$T_{c_2} T_{a_2} = T_{a_3} T_{a_1}. \quad (8)$$

Given (8), we have reached the expected contradiction, provided that we show that

$$I(a_2, c_2) = 0. \quad (9)$$

Indeed, (8) becomes an equality between multitwists, which, according to Lemma 3.12, leads to:

$$\{c_2, a_2\} = \{a_3, a_1\}, \quad (10)$$

then we have $a_2 = a_1$ or $a_2 = a_3$!

Let us show equality (9). Since V commutes with T_{a_3} and T_{a_1} , it also commutes with $(T_{a_3} T_{a_1})^\varepsilon V$, and so with W as well according to (5). Hence V commutes with W , V and T_{a_2} , therefore according to (7), V also commutes with T_{c_2} . Finally, T_{c_2} commutes with W , V and T_{c_2} , so according to (7), it commutes with T_{a_2} . In other words, equality (9) holds.

Finally, between case (2) and case (3), the case to be retained is case (2). So $a_1 = c_1$, $\varepsilon = \eta$, and $V = W$. Since for all $i \in \{1, \dots, n-1\}$, we have $T_{a_i}^\varepsilon V = T_{c_i}^\eta W$, we then deduce the equality $T_{a_i} = T_{c_i}$, and eventually the equality $(a_1, a_2, \dots, a_{n-1}) = (c_1, c_2, \dots, c_{n-1})$. \square

We deduce from Lemma 5.13 the following definitions:

Definition 5.14 (Characteristic elements of a transvection of monodromy morphism).

Let n be an integer greater than or equal to 4, Σ a surface, \mathcal{M} a subgroup of $\text{Mod}(\Sigma)$ or of $\text{Mod}(\Sigma, \partial\Sigma)$. Let ρ be a transvection of monodromy morphism from \mathcal{B}_n to \mathcal{M} .

- The *triple characteristic* of ρ is the *unique* (according to Lemma 5.13) triple $((a_1, \dots, a_{n-1}), \varepsilon, V)$ such that for all $i \leq n-1$, we have:

$$\rho(\tau_i) = T_{a_i}^\varepsilon V.$$

- We define:

- the *characteristic $(n-1)$ -chain* of the transvection ρ , as being the $(n-1)$ -chain (a_1, \dots, a_{n-1}) ,
- the *characteristic sign* of the transvection ρ , as being the integer ε ,
- the *direction* of the transvection ρ , as being the mapping class V .

- We denote by $\Sigma(\rho)$ the tubular neighbourhood of $\bigcup_{i \leq n-1} a_i$ where $(a_i)_{i \leq n-1}$ is the characteristic $(n-1)$ -chain of ρ . Take care: $\Sigma(\rho)$ does not necessarily belong to $\text{Sub}(\Sigma)$, for the boundary components of $\Sigma(\rho)$ can bound some disks in Σ .
- The transvection ρ determines a unique pair (ρ^*, φ) of morphisms such that for all $\xi \in \mathcal{B}_n$, we have:

$$\rho(\xi) = \rho^*(\xi)\varphi(\xi),$$

where, for all $i \leq n-1$, we have:

$$\begin{cases} \rho^*(\tau_i) &= T_{a_i}^\varepsilon, \\ \varphi(\tau_i) &= V. \end{cases}$$

The monodromy morphism ρ^* and the cyclic morphism φ will be called respectively the *monodromy morphism* and the *cyclic morphism associated to the transvection ρ* .

Thus, the decomposition of a transvection of monodromy morphism gives rise to two morphisms: a monodromy morphism ρ^* determined by a $(n-1)$ -chain of curves and a cyclic morphism determined by the direction of the transvection, which is a mapping class V belonging to the centralizer of $\rho^*(\mathcal{B}_n)$ in \mathcal{M} . Therefore the computation of this centralizer is essential in the remainder of this section, and the surface $\Sigma(\rho)$ plays a crucial role.

Let us reformulate Propositions 4.19 and 4.20:

Proposition 5.15 (Centralizer of the image of a monodromy morphism).

Let n be an integer greater than or equal to 5. Let Σ be a surface $\Sigma_{g,b}$ where $g \geq \frac{n}{2} - 1$ and $b \geq 0$. Let \mathcal{M} be one of the groups $\text{Mod}(\Sigma)$, $\mathcal{P}\text{Mod}(\Sigma)$, or $\text{Mod}(\Sigma, \partial\Sigma)$. Let ρ be a monodromy morphism from \mathcal{B}_n in \mathcal{M} . Let $\mathcal{M}^{\Sigma(\rho)}$ be the groupe of the mapping classes in \mathcal{M} that preserve the subsurface $\Sigma(\rho)$ and induce the identity in $\text{Mod}(\Sigma(\rho))$. Then:

- (i) the centralizer of $\rho(\mathcal{B}_n)$ in \mathcal{M} is reduced to the group $\mathcal{M}^{\Sigma(\rho)}$, except in the below cases (a), (b) or (c) below where it is equal to the group spanned by $\mathcal{M}^{\Sigma(\rho)}$ and by Z , where Z is any extension in $\text{Mod}(\Sigma)$ of the mapping class $s \in \text{Mod}(\Sigma(\rho))$ defined in Definition 4.15 (where $\Sigma(\mathcal{B}_n)$ is homeomorphic to $\Sigma(\rho)$);

Cases (a), (b) and (c) are the following:

- (a) the integer n is odd,
- (b) the curve simplex $\{a_1, a_3, \dots, a_{n-1}\}$ is non-separating,
- (c) $\Sigma_{\{a_1, a_3, \dots, a_{n-1}\}}$ consists in two homeomorphic connected components and $\mathcal{M} = \text{Mod}(\Sigma)$.

- (ii) for any mapping class V belonging to the centralizer of $\rho(\mathcal{B}_n)$ in \mathcal{M} , the mapping class V^2 belongs to $\mathcal{M}^{\Sigma(\rho)}$.

□

6 Corollaries of Theorem 1

In this section, we prove the corollaries of Theorem 1 announced in the introduction. Let us recall Theorem 1 (Section 13 is devoted to its proof):

Theorem 1 (Morphisms from \mathcal{B}_n in $\mathcal{P}\text{Mod}(\Sigma)$, $n \geq 6$).

Let n be any integer greater than or equal to 6. Let Σ be a surface $\Sigma_{g,b}$ with $g \leq \frac{n}{2}$ and $b \geq 0$. Let ρ be a morphism from \mathcal{B}_n in $\mathcal{P}\text{Mod}(\Sigma)$. If ρ is not cyclic, then ρ is a transvection of monodromy morphism. Moreover, such transvections of monodromy morphisms exist if and only if $g \geq \frac{n}{2} - 1$.

Outline of this section:

- In Subsection 6.1, we focus on the injectivity of the morphisms from \mathcal{B}_n in both mapping class groups $\text{Mod}(\Sigma, \partial\Sigma)$ and $\mathcal{P}\text{Mod}(\Sigma)$;
- in Subsection 6.2, we focus on the morphisms from \mathcal{B}_n in itself and in \mathcal{B}_{n+1} ;
- in Subsection 6.3, we focus on the morphisms between the mapping class groups of two possibly different surfaces;
- in Subsection 6.4, we focus on the endomorphisms of the mapping class group.

6.1 Injectivity of the morphisms from \mathcal{B}_n in the mapping class group

According to Theorems 1 and 2, when the genus of Σ is bounded by $\frac{n}{2}$, the morphisms from \mathcal{B}_n in the mapping class group associated to the surface Σ are either cyclic, or are some transvections of monodromy morphisms. Consequently, the issue of the injectivity of the morphisms from \mathcal{B}_n in the mapping class group is reduced to the issue of the injectivity of the monodromy morphisms (cf. Proposition 6.1) and of the transvections of the monodromy morphisms (cf. Proposition 6.2), for the cyclic morphisms obviously cannot be injective. These different results are gathered in Theorem 3.

Given ρ , a transvection of monodromy morphism from \mathcal{B}_n in the mapping class group of a surface Σ , the surface $\Sigma(\rho)$ (described in Definition 5.14) will help us in characterizing the injectivity of the transvections of monodromy morphisms.

Proposition 6.1 (Injectivity of the monodromy morphisms).

(i) *Case of $\text{Mod}(\Sigma, \partial\Sigma)$. For any integer n greater than or equal to 6 and any surface Σ , a monodromy morphism $\tilde{\rho}$ from \mathcal{B}_n in $\text{Mod}(\Sigma, \partial\Sigma)$ is injective if and only if $\text{Bndy}(\Sigma(\tilde{\rho})) \subset \text{Curv}(\Sigma, \partial\Sigma)$ (in other words, the boundary components of $\Sigma(\tilde{\rho})$ do not bound any disk in Σ).*

(ii) *Case of $\mathcal{P}\text{Mod}(\Sigma)$. For any integer n greater than or equal to 6 and any surface Σ , a monodromy morphism ρ from \mathcal{B}_n in $\mathcal{P}\text{Mod}(\Sigma)$ is injective if and only if $\text{Bndy}(\Sigma(\rho)) \subset \text{Curv}(\Sigma, \partial\Sigma)$ and $\text{Bndy}(\Sigma(\rho)) \not\subset \text{Bndy}(\Sigma)$ (in other words, the boundary components of $\Sigma(\rho)$ do not bound any disk in Σ and at least one of them is not isotopic to a boundary component of Σ).*

Proof.

Let us show item (i).

Let θ be the morphism induced by $\tilde{\rho}$ in $\mathcal{M}\text{od}(\Sigma(\tilde{\rho}), \partial\Sigma(\tilde{\rho}))$. According to Theorem 4.17, θ is injective. Let ι be the inclusion of $\Sigma(\tilde{\rho})$ in Σ and ι_* the morphism induced, going from $\mathcal{M}\text{od}(\Sigma(\tilde{\rho}), \partial\Sigma(\tilde{\rho}))$ into $\mathcal{M}\text{od}(\Sigma, \partial\Sigma)$, so that $\tilde{\rho} = \iota_* \circ \theta$.

- *Necessary condition.* If $\tilde{\rho}$ is injective, then $\tilde{\rho}(\Delta^4)$ is not trivial. However when n is odd, $\tilde{\rho}(\Delta^4)$ coincides with $T_d^{\pm 1}$ where d is the unique boundary component of $\Sigma(\tilde{\rho})$, hence T_d must be non-trivial. In other words, $d \in \mathcal{C}\text{urv}(\Sigma, \partial\Sigma)$. When n is even, $\tilde{\rho}(\Delta^4)$ coincides with $(T_{d_1}T_{d_2})^{\pm 2}$ where d_1 and d_2 are the two boundary components of $\Sigma(\tilde{\rho})$, so at least one of the curves d_1 or d_2 has to be non-trivial. Moreover, if one of them is trivial in Σ , say d_1 for example (cf. Figure 29), then $\iota_* \circ \theta((\tau_{a_1} \dots \tau_{a_{n-2}})^{2(n-1)}) = \iota_* \circ \theta((\tau_{a_1} \dots \tau_{a_{n-1}})^n)$, since $(T_{a_1} \dots T_{a_{n-2}})^{2(n-1)} = (T_{a_1} \dots T_{a_{n-1}})^n = T_{d_2}$. But this contradicts the injectivity of $\tilde{\rho}$, for in \mathcal{B}_n , a product of $n(n-1)$ standard generators can be equal to a product of $2(n-1)(n-2)$ standard generators only if $n(n-1) = 2(n-1)(n-2)$, hence only if $n \in \{1, 4\}$. Therefore, $\{d_1, d_2\} \subset \mathcal{C}\text{urv}(\Sigma, \partial\Sigma)$.

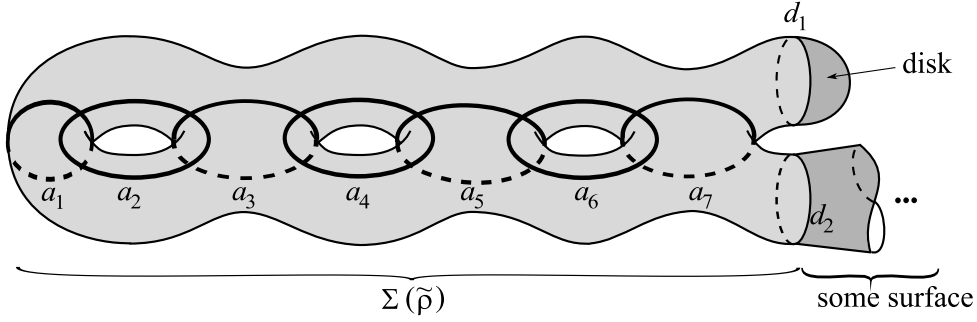

Figure 29: Example with $n = 8$.

- *Sufficient condition.* We assume that $\text{Bndy}(\Sigma(\tilde{\rho})) \subset \mathcal{C}\text{urv}(\Sigma, \partial\Sigma)$. Then according to Theorem 3.10, in the case where n is odd, or in the one where n is even and where the two boundary components of $\Sigma(\tilde{\rho})$ are not isotopic in Σ , ι_* is injective. In the case where n is even and where the two boundary components d_1 and d_2 of $\Sigma(\tilde{\rho})$ are isotopic in Σ , according to Theorem 3.10 again, we have $\text{Ker}(\iota_*) = \langle T_{d_1}T_{d_2}^{-1} \rangle$. Now, according to Theorem 4.17, $\theta(\mathcal{B}_n)$ coincides with $\mathcal{S}\text{Mod}(\Sigma(\tilde{\rho}), \partial\Sigma(\tilde{\rho}))$ whereas $T_{d_1}T_{d_2}^{-1}$ does not belong to $\mathcal{S}\text{Mod}(\Sigma(\tilde{\rho}), \partial\Sigma(\tilde{\rho}))$. Hence $\text{Ker}(\iota_*) \cap \text{Im}(\theta) = \{1\}$, so $\iota_*(\theta)$ is injective. Finally, in all the cases, $\iota_* \circ \theta$ is injective, and hence $\tilde{\rho}$, too.

Let us show item (ii).

Again, let θ be the morphism induced by ρ in $\mathcal{M}\text{od}(\Sigma(\rho), \partial\Sigma(\rho))$. According to Theorem 4.17, θ is injective. Let ι be the inclusion of $\Sigma(\rho)$ in Σ and ι_* the induced morphism from $\mathcal{M}\text{od}(\Sigma(\rho), \partial\Sigma(\rho))$ in $\mathcal{P}\text{Mod}(\Sigma)$, so that $\rho = \iota_* \circ \theta$. The morphism ι_* is not necessarily injective.

- *Necessary condition.* As in the case of item (i) with $\tilde{\rho}$, it is necessary that $\text{Bndy}(\Sigma(\rho)) \subset \mathcal{C}\text{urv}(\Sigma, \partial\Sigma)$, but since the Dehn twists along boundary components are trivial in $\mathcal{P}\text{Mod}(\Sigma)$, it is necessary that $\text{Bndy}(\Sigma(\rho)) \not\subset \text{Bndy}(\Sigma)$.

- *Sufficient condition.* Let us assume that $\text{Bndy}(\Sigma(\rho)) \subset \mathcal{C}\text{urv}(\Sigma, \partial\Sigma)$ and that $\text{Bndy}(\Sigma(\rho)) \not\subset \text{Bndy}(\Sigma)$, and let us check that ρ is injective. Let us denote by Σ' the complement of $\Sigma(\rho)$ in Σ ; we assume that if a boundary component of $\Sigma(\rho)$ is isotopic to a boundary component of Σ , these two boundary components coincide. With this assumption, all the connected components of Σ' are of negative Euler characteristic. Now, since $\text{Bndy}(\Sigma(\rho)) \not\subset \text{Bndy}(\Sigma)$, the surface Σ' is nonempty and $\partial^{\text{inn}}\Sigma(\rho) \neq \emptyset$. The image of ρ lies in $\mathcal{P}\text{Mod}(\Sigma, \Sigma')$, which is isomorphic to $\text{Mod}(\Sigma(\rho), \partial^{\text{inn}}(\Sigma(\rho)))$. If $\partial^{\text{inn}}(\Sigma(\rho)) = \partial(\Sigma(\rho))$, Theorem 4.17 can be applied and ρ is then injective. This is always what happens in the case when n is odd, but when n is even, it can happen that $\partial^{\text{inn}}(\Sigma(\rho)) = \{d\} \neq \partial(\Sigma(\rho))$, where d is one of the two boundary components of $\Sigma(\rho)$. In this case, $\mathcal{P}\text{Mod}(\Sigma, \Sigma')$ is isomorphic to $\text{Mod}(\Sigma(\rho), d)$, and ρ induces a morphism ς from \mathcal{B}_n in $\text{Mod}(\Sigma(\rho), d)$, which is injective if and only if ρ is injective itself. Let us denote by pr the canonical projection of $\text{Mod}(\Sigma(\rho), \partial\Sigma(\rho))$ in $\text{Mod}(\Sigma(\rho), d)$. Then $\varsigma = pr \circ \theta$. Moreover, we have $\text{Ker}(\varsigma) = \text{Ker}(pr) \cap \theta(\mathcal{B}_n) = \{1\}$, for $\text{Ker}(pr) = \langle T_{d'} \rangle$ where d' is the boundary component of $\Sigma(\rho)$ different from d , but $T_{d'}$ does not belong to $\theta(\mathcal{B}_n)$. Hence ς is injective, so ρ is injective. \square

Proposition 6.2 (Injectivity of the transvections).

(i) Let n be an integer greater than or equal to 3, G any group, ρ a morphism from \mathcal{B}_n in G and ρ_1 a transvection of ρ . If G is torsion-free (for example, if $G = \text{Mod}(\Sigma, \partial\Sigma)$ with $\partial\Sigma \neq \emptyset$), then ρ is injective if and only if ρ_1 is injective.

(ii) Let n be an integer greater than or equal to 6 and Σ a surface of genus $g \leq \frac{n}{2}$. Then for any monodromy morphism ρ from \mathcal{B}_n in $\mathcal{P}\text{Mod}(\Sigma)$, any transvection of ρ is injective if and only if ρ is injective.

Proof.

Let us show item (i).

Let ρ be an injective morphism from \mathcal{B}_n in G and let ρ_1 be a transvection of ρ . We show by contradiction that ρ_1 is injective, then we will have shown item (i) of Proposition 6.2, for ρ can also be seen as a transvection of ρ_1 . Let us then assume that there exists ξ , a non-trivial element of \mathcal{B}_n such that $\rho_1(\xi) = 1$. By definition of transvection, there exists a cyclic morphism $\varphi : \mathcal{B}_n \rightarrow G$ such that for all $\zeta \in \mathcal{B}_n$, we have $\rho_1(\zeta) = \rho(\zeta)\varphi(\zeta)$. So, we have $\rho(\xi) = \varphi(\xi)^{-1}$, but by definition of transvection, $\varphi(\xi)$ lies in the centralizer of $\rho(\mathcal{B}_n)$ in G , hence so does $\rho(\xi)$. Since ρ is injective, ξ belongs to the center of \mathcal{B}_n , so ξ is a power of Δ^2 . Therefore, there exists a nonzero integer k such that $(\rho(\Delta)\varphi(\Delta))^{2k} = 1$. As G is torsion-free, we have $\rho(\Delta)\varphi(\Delta) = \rho_1(\Delta) = 1$. Then, as above, $\varphi(\Delta)$ lies in the centralizer of $\rho(\mathcal{B}_n)$ in G , hence so does $\rho(\Delta)$. Now, since ρ is injective, Δ must belong to the center of \mathcal{B}_n , hence must be a power of Δ^2 , which is absurd.

Let us show item (ii).

1. Let us show that if the morphism ρ is injective, then the transvection ρ_1 is injective.

Let $n \geq 6$. Let ρ be an injective monodromy morphism from \mathcal{B}_n in $\mathcal{P}\text{Mod}(\Sigma)$ and ρ_1 a transvection of ρ . We show by contradiction that ρ_1 is injective. Let us assume that there exists a non-trivial element ξ of \mathcal{B}_n such that $\rho_1(\xi) = 1$. As in item (i), we deduce the existence of a nonzero integer k such that $\rho(\Delta^{-2k}) = \varphi(\Delta^{2k})$. Now, Δ is a product of $\frac{n(n-1)}{2}$ generators, so $\varphi(\Delta^2)$ is the $n(n-1)$ -th power of a mapping class V belonging to the centralizer of $\rho(\mathcal{B}_n)$ in $\mathcal{P}\text{Mod}(\Sigma)$. Let us denote by W the mapping class V^2 which lies in $\mathcal{M}^{\Sigma(\rho)}$, according to

Proposition 5.15, where $\mathcal{M}^{\Sigma(\rho)}$ is the group of the mapping classes in $\mathcal{PMod}(\Sigma)$ that preserve $\Sigma(\rho)$ and induce the identity in $\mathcal{PMod}(\Sigma(\rho))$. Let us sum up: on one hand, we have $\varphi(\Delta^2) = W^{\frac{n(n-1)}{2}}$, on the other hand, we have $\varphi(\Delta^{2k}) = \rho(\Delta^{-2k})$. We have also the following: if n is odd, then $\rho(\Delta^4) = T_d^{\pm 1}$ where d is the unique boundary component of $\Sigma(\rho)$, whereas if n is even, then $\rho(\Delta^2) = (T_{d_1}T_{d_2})^{\pm 1}$ where d_1 and d_2 are the two boundary components of $\Sigma(\rho)$. Then the mapping class W lying in $\mathcal{M}^{\Sigma(\rho)}$ satisfies:

- a) $W^{kn(n-1)} = T_d^{\mp k}$ if n is odd, where $\{d\} = \text{Bndy}(\Sigma(\rho))$;
- b) $W^{\frac{kn(n-1)}{2}} = (T_{d_1}T_{d_2})^{\mp k}$, if n is even, where $\{d_1, d_2\} = \text{Bndy}(\Sigma(\rho))$.

Let us recall that since ρ is injective by assumption, then according to Proposition 6.1, at least one of the the boundary components of $\Sigma(\rho)$ is not trivial in Σ , hence the mapping classes T_d in case a) and $T_{d_1}T_{d_2}$ in case b) are not trivial.

Let us show that case a) leads to a contradiction. The curve d is a separating curve of Σ . Let us call Σ' the connected component of Σ_d different from $\Sigma(\rho)$. According to Proposition 3.2.(i), $\mathcal{PMod}(\Sigma, \Sigma(\rho))$ is isomorphic to $\mathcal{PMod}(\Sigma', d)$. The mapping class W can thus be seen as a periodic mapping class in $\mathcal{PMod}(\Sigma', d)$. Let us call m its order. According to Lemma 3.17, there exists an integer p coprime with m such that $W^m = T_d^p$, so the equality $W^{kn(n-1)} = T_d^{\mp k}$ implies $W^{n(n-1)} = T_d^{\mp 1}$. Therefore the period of W is $n(n-1)$, so it is greater than or equal to 42 since $n \geq 7$. But $\Sigma(\rho)$ is of genus $\frac{n}{2} - 1$ and Σ is of genus at most $\frac{n}{2}$ hence Σ' is of genus at most 1. But there does not exist any nontrivial periodic mapping class in a genus-0 surface whose boundary components are fixed, according to Corollary 3.23, and the order of periodic mapping classes on a genus-1 surface with a nonempty boundary and whose boundary components are fixed is bounded by 6, according to Corollary 3.25. This is a contradiction.

Let us show that case b) leads also to a contradiction. If Σ is the gluing of $\Sigma(\rho)$ on itself by identifying both of its boundary components d_1 and d_2 and if we call d the image of d_1 in Σ , then $\mathcal{M}^{\Sigma(\rho)}$ is the cyclic group spanned by T_d , so there exists an integer m such that $W = T_d^m$. But on the other hand, $W^{\frac{kn(n-1)}{2}} = (T_{d_1}T_{d_2})^{\mp k} = T_d^{\mp 2k}$, whence $(T_d^m)^{\frac{kn(n-1)}{2}} = T_d^{\mp 2k}$. This is absurd, for T_d is not a torsion element. Now, if we assume that d_1 and d_2 are two distinct curves in $\text{Curv}(\Sigma, \partial\Sigma)$, we know that at least one is not a boundary component of Σ . Notice that V used to preserve $\{d_1, d_2\}$, so W (which is equal to V^2) preserves d_1 and d_2 . Finally, as previously in case a), W can be seen as a periodic mapping class of period at least 15 (for $\frac{n(n-1)}{2}$ equals at least 15 when $n \geq 6$), on a surface of genus zero or one. As explained above, this is absurd.

2. *Let us show that if the morphism ρ is not injective, then the transvection ρ_1 is not injective either.*

Let ρ be a non-injective monodromy morphism from \mathcal{B}_n in $\mathcal{PMod}(\Sigma)$ and let ρ_1 be a transvection of ρ . Let us show that ρ_1 is not injective. According to Proposition 6.1.(ii), it can exist several reasons for ρ not being injective. We distinguish two cases, whether $\text{Bndy}(\Sigma(\rho)) \cap \text{Curv}(\Sigma)$ is empty or not.

- If $\text{Bndy}(\Sigma(\rho)) \cap \text{Curv}(\Sigma)$ is empty, then $\mathcal{M}^{\Sigma(\rho)}$ is trivial. Hence according to Proposition 5.15, when n is odd, the centralizer of $\rho(\mathcal{B}_n)$ is spanned by $\rho(\Delta^2)$ which is of order 2, and when n is even, this centralizer is trivial. So, in both cases, we have $\rho_1(\Delta^4) = 1$, and ρ_1 is not injective.

- If $\text{Bndy}(\Sigma(\rho)) \cap \text{Curv}(\Sigma)$ is not empty, whereas ρ is not injective, then necessarily, n is even and the boundary component of $\text{Bndy}(\Sigma(\rho))$ that is not in $\text{Curv}(\Sigma)$ bounds a disk. In this case, we are going to exhibit two elements of \mathcal{B}_n that do not commute although their images do. This will show that ρ_1 is not injective. Let us set $\Delta_{n-2} = \tau_1(\tau_2\tau_1) \dots (\tau_{n-2}\tau_{n-3} \dots \tau_1)$. We have seen in the proof of Proposition 6.1 that in our situation, we have $\rho(\Delta^2) = \rho(\Delta_{n-2}^4)$ (cf. Figure 29). Hence in particular $\rho(\Delta_{n-2}^4)$ commutes with $\rho(\tau_{n-1})$, so $\rho_1(\Delta_{n-2}^4)$ commutes with $\rho_1(\tau_{n-1})$. But Δ_{n-2}^4 do not commute with τ_{n-1} . Therefore, ρ_1 is not injective. \square

We can deduce Theorem 3 from Theorems 1 and 2, and from Propositions 6.1 and 6.2.

Theorem 3 (Injectivity of the morphisms from the braid group in the mapping class group).

Let n be an integer greater than or equal to 6 and let Σ be a surface $\Sigma_{g,b}$ such that $g \leq \frac{n}{2}$. Let ρ be a morphism from \mathcal{B}_n in $\text{Mod}(\Sigma, \partial\Sigma)$ or in $\mathcal{P}\text{Mod}(\Sigma)$.

(i) Case of $\text{Mod}(\Sigma, \partial\Sigma)$. The morphism ρ is injective if and only if it is a transvection of monodromy morphism such that $\text{Bndy}(\Sigma(\rho)) \subset \text{Curv}(\Sigma, \partial\Sigma)$ (in other words, the boundary components of $\Sigma(\rho)$ do not bound any disk in Σ).

(ii) Case of $\mathcal{P}\text{Mod}(\Sigma)$. The morphism ρ is injective if and only if it is a transvection of monodromy morphism such that $\text{Bndy}(\Sigma(\rho)) \subset \text{Curv}(\Sigma, \partial\Sigma)$ and $\text{Bndy}(\Sigma(\rho)) \not\subset \text{Bndy}(\Sigma)$ (in other words, the boundary components of $\Sigma(\rho)$ do not bound any disk in Σ and at least one boundary component of $\Sigma(\rho)$ is not isotopic to any boundary component of Σ). \square

6.2 Morphisms between braid groups.

In 2000, R.Bell and D.Margalit have shown (cf. [BeMa]) that all the injective morphisms from \mathcal{B}_n in itself were transvections with direction Δ^{2k} , $k \in \mathbb{Z}$, of inner automorphisms, possibly composed by Inv (cf. Definition 6.3 below). They have shown in a similar way that the injective morphisms from \mathcal{B}_n in \mathcal{B}_{n+1} were transvections of restrictions to \mathcal{B}_n of inner automorphisms of \mathcal{B}_{n+1} , possibly composed by Inv .

We are going to prove that *all* the noncyclic morphisms have the shape indicated by R.Bell and D.Margalit. In the meantime, we show the following theorem, due to Lin in 1982, cf. [Ln1]: if m is smaller than n , the morphisms from \mathcal{B}_n in \mathcal{B}_m are cyclic.

To simplify the notation, we consider that we have the following inclusions:

$$\mathcal{B}_2 \subset \mathcal{B}_3 \subset \mathcal{B}_4 \subset \dots$$

so that for any $k \geq 2$ and any $i \in \{1, 2, \dots, k-1\}$, the element τ_i belonging to \mathcal{B}_k is sent by the inclusion $\mathcal{B}_k \rightarrow \mathcal{B}_{k+1}$ on the element τ_i belonging to \mathcal{B}_{k+1} . Thus, given any two different braid groups, the smaller one is seen as a subgroup of the bigger one.

Let us introduce a specific automorphism of \mathcal{B}_n :

Definition 6.3 (The involution Inv of \mathcal{B}_n).

Let Inv be the involutive automorphism of \mathcal{B}_n that sends τ_i on τ_i^{-1} for all $i \leq n-1$.

Theorem 4 (Morphisms between braid groups).

Let n and m be two integers such that $n \geq 6$ and $3 \leq m \leq n+1$.

(i) Case where $m < n$: any morphism φ from \mathcal{B}_n in \mathcal{B}_m is cyclic.

(ii) Case where $m = n$: any noncyclic morphism φ from \mathcal{B}_n in \mathcal{B}_n is a transvection of inner automorphism possibly precomposed by the involution Inv : there exist $\gamma, v \in \mathcal{B}_n$ and $\varepsilon = \pm 1$ such that for all $i \leq n - 1$, we have:

$$\varphi(\tau_i) = \gamma \tau_i^\varepsilon \gamma^{-1} v.$$

Moreover, v is a multiple of Δ^2 .

(iii) Case where $m = n + 1$: let us consider the group \mathcal{B}_n as the subgroup of \mathcal{B}_{n+1} spanned by the $n - 1$ first standard generators of \mathcal{B}_{n+1} . Then, any morphism φ from \mathcal{B}_n in \mathcal{B}_{n+1} is the restriction to \mathcal{B}_n of a morphism from \mathcal{B}_{n+1} in itself, up to transvection. According to item (ii), if φ is not cyclic, then there exists $\gamma, v \in \mathcal{B}_{n+1}$ and $\varepsilon = \pm 1$ such that for all $i \leq n - 1$, we have:

$$\varphi(\tau_i) = \gamma \tau_i^\varepsilon \gamma^{-1} v.$$

Moreover, v belongs to the centralizer of $\{\gamma \xi \gamma^{-1}, \xi \in \mathcal{B}_n\}$ in \mathcal{B}_{n+1} .

(iv) All the noncyclic morphisms above are injective.

Proof. Let us first set some definitions:

- Let n and m be two integers such that $n \geq 6$ and $m \geq n - 1$,
- φ a morphism from \mathcal{B}_n in \mathcal{B}_m ,
- Σ the surface $\Sigma(\mathcal{B}_m)$, of genus g where g is the integral part of $\frac{m-1}{2}$,
- $\tilde{\rho}_{\text{ref}}$ the reference morphism from \mathcal{B}_m in $\mathcal{M}\text{od}(\Sigma, \partial\Sigma)$,
- s the mapping class of $\mathcal{M}\text{od}(\Sigma)$ introduced in Definition 4.15, relatively to $\tilde{\rho}_{\text{ref}}$,
- $\widetilde{\text{Ad}}_s$ the automorphism of $\mathcal{M}\text{od}(\Sigma, \partial\Sigma)$ that associates to a mapping class F the isotopy class in $\mathcal{M}\text{od}(\Sigma, \partial\Sigma)$ of $\bar{s} F \bar{s}^{-1}$ where \bar{s} and \bar{F} are some diffeomorphisms representing s and F ,
- $\mathcal{S}\text{Mod}(\Sigma, \partial\Sigma)$ the set of fixed points of $\widetilde{\text{Ad}}_s$ (according to Definition 4.15),
- c_i the curve such that $\tilde{\rho}_{\text{ref}}(\tau_i) = T_{c_i}$, for all $i \in \{1, \dots, m - 1\}$.

Furthermore, if $\tilde{\rho}_{\text{ref}} \circ \varphi$ is a transvection of monodromy morphism, we set the following:

- let $((a_1, \dots, a_{n-1}), \varepsilon, V)$ be the characteristic triple of $\tilde{\rho}_{\text{ref}} \circ \varphi$, so that for all $i \in \{1, 2, \dots, n - 1\}$, we have:

$$\tilde{\rho}_{\text{ref}} \circ \varphi(\tau_i) = T_{a_i}^\varepsilon V. \tag{1}$$

Let us start by showing a fact that we will use several times in this proof.

When $\tilde{\rho}_{\text{ref}} \circ \varphi$ is a transvection of monodromy morphism, let us show that the curves a_i , $1 \leq i \leq n - 1$, are s -stable. For all $i, j \leq n - 1$, we have $\tilde{\rho}_{\text{ref}} \circ \varphi(\tau_i \tau_j^{-1}) = (T_{a_i} T_{a_j}^{-1})^\varepsilon$. But, when $|i - j| \geq 2$, $T_{a_i} T_{a_j}^{-1}$ is a multitwist belonging to $\tilde{\rho}_{\text{ref}} \circ \varphi(\mathcal{B}_n)$, included in $\tilde{\rho}_{\text{ref}}(\mathcal{B}_m)$, which is equal to $\mathcal{S}\text{Mod}(\Sigma, \partial\Sigma)$. Hence $T_{a_i} T_{a_j}^{-1}$ is a fixed point of $\widetilde{\text{Ad}}_s$. Now, $\widetilde{\text{Ad}}_s(T_{a_i} T_{a_j}^{-1}) = T_{s(a_i)} T_{s(a_j)}^{-1}$, then

$T_{a_i} T_{a_j}^{-1} = T_{s(a_i)} T_{s(a_j)}^{-1}$, hence according to Lemma 3.12, we get $s(a_i) = a_i$ and $s(a_j) = a_j$. Finally, for all $i \leq n-1$, we have $s(a_i) = a_i$.

Now, we can start the proof of the several parts of Theorem 4.

Let us show item (i).

We distinguish the cases according to the parity of n . If n is odd, the genus g of Σ is equal to the integral part of $\frac{m-1}{2}$, then is smaller than $\frac{n-1}{2}$ (remember that $m < n$ and n is odd). Hence, according to Theorem 1, any morphism from \mathcal{B}_n in $\text{Mod}(\Sigma, \partial\Sigma)$ is cyclic. In particular, $\tilde{\rho}_{\text{ref}} \circ \varphi$ is cyclic. Since $\tilde{\rho}_{\text{ref}}$ is injective, φ must be cyclic, too.

In the case where n is an even integer greater than or equal to 6 and where $m \leq n-2$, the previous reasoning works. On the other hand, when $m = n-1$, the genus g , which is equal by assumption to the integral part of $\frac{m-1}{2}$, which is equal to $\frac{m-1}{2}$ for m is odd, and hence to $\frac{n}{2} - 1$. Then according to Theorem 1, it can exist some noncyclic morphisms from \mathcal{B}_n in $\text{Mod}(\Sigma, \partial\Sigma)$. Let us assume that $\tilde{\rho}_{\text{ref}} \circ \varphi$ is not cyclic. We sum up the situation by the following commutative diagram, where $r = \frac{n}{2}$.

$$\begin{array}{ccc} \mathcal{B}_{2r} & \xrightarrow{\tilde{\rho}_{\text{ref}} \circ \varphi} & \text{Mod}(\Sigma_{r-1,1}, \partial\Sigma_{r-1,1}) \\ & \searrow \varphi & \nearrow \tilde{\rho}_{\text{ref}} \\ & & \mathcal{B}_{2r-1} \end{array}$$

We want to obtain a contradiction. Let Σ' be the surface equal to the tubular neighbourhood of the curves a_i for $1 \leq i \leq m-2$. This surface is of genus $g-1$ and owns two boundary components which we denote by e^+ and e^- (cf. Figure 30). Since s preserves the curves a_i , s

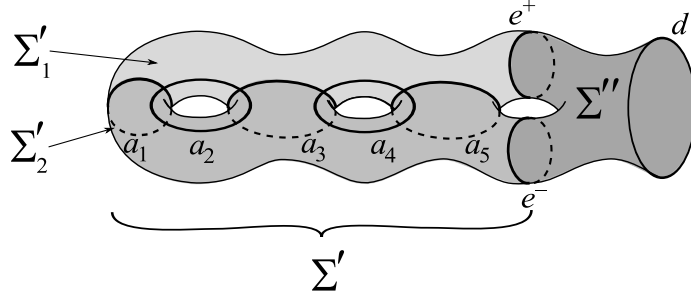

Figure 30: Proof of Theorem 4: The marked surface Σ and its two subsurfaces Σ' and Σ'' , case where $n = 8$, $r = 4$.

preserves the surface Σ' , and also preserves the cut of Σ' along the curves a_i , $i \in \text{Imp}(m-2)$. This cut of Σ' is the disjoint union of two genus-0 subsurfaces: the subsurfaces Σ'_1 and Σ'_2 in Figure 30. If s preserved each of them, s would fix each of their boundary components and hence would be the identity mapping class on Σ' . This is absurd, so s swap Σ'_1 and Σ'_2 , whence:

$$s(e^+) = e^- \text{ and } s(e^-) = e^+.$$

Let us denote by Σ'' the complement of Σ' in Σ . Thus Σ'' is a pair of pants whose boundary components are d , e^+ and e^- . Now, the curve a_m intersects a_{m-1} but not the curves a_i with indices $i \leq m-2$, so a_m is included in Σ'' , hence a_m is one of the curve e^+ , e^- , or d . However, a_m cannot be equal to d since d does not intersect a_{m-1} whereas a_m does. Furthermore a_m cannot either be equal to e^+ or e^- since these two curves are not s -stable, whereas a_m is. This is a contradiction.

Let us show items (ii) and (iii).

The morphism φ from \mathcal{B}_n in \mathcal{B}_m is assumed to be noncyclic, so the morphism $\tilde{\rho}_{\text{ref}} \circ \varphi$ from \mathcal{B}_n in $\text{Mod}(\Sigma, \partial\Sigma)$ is not cyclic since $\tilde{\rho}_{\text{ref}}$ is injective according to Theorem 4.17, so according to Theorem 1, the morphism $\tilde{\rho}_{\text{ref}} \circ \varphi$ is a transvection of monodromy morphism. Let us recall equality (1): for all $i \in \{1, 2, \dots, n-1\}$, we have:

$$\tilde{\rho}_{\text{ref}} \circ \varphi(\tau_i) = T_{a_i}^\varepsilon V. \quad (1)$$

First, we are going to show that in (1), we can replace T_{a_i} by $\tilde{\rho}_{\text{ref}}(\gamma\tau_i\gamma^{-1})$ where γ is an element of \mathcal{B}_m independent of i , then we will show that V belongs to $\tilde{\rho}_{\text{ref}}(\mathcal{B}_m)$. We distinguish two cases:

- If $m = n$, we have two $(m-1)$ -chains of curves: $(c_i)_{1 \leq i \leq m-1}$ and $(a_i)_{1 \leq i \leq m-1}$. By assumption, $\Sigma = \Sigma(\mathcal{B}_m)$. But $\Sigma(\mathcal{B}_m)$ is by definition the tubular neighbourhood of the union of the curves of $(c_i)_{1 \leq i \leq m-1}$. In the same way, Σ is the tubular neighbourhood of the union of the curves of $(a_i)_{1 \leq i \leq m-1}$. Indeed, when m is odd, this is true for any $(m-1)$ -chain of curves. When m is even, there exists an embedding of $(m-1)$ -chains of curves in Σ whose tubular neighbourhood does not coincide with Σ , see Figure 31. This case cannot happen.

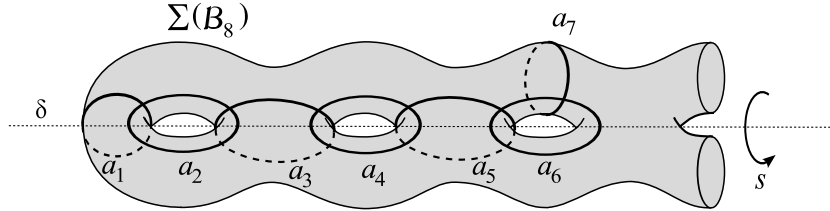

Figure 31: Case of a $(m-1)$ -chain of curves (m even) in a surface $\Sigma(\mathcal{B}_m)$, which is by definition homeomorphic to $\Sigma_{\frac{m-2}{2}, 2}$.

Indeed, if it happened, we would show, as we did in item (i) about the curves e^+ and e^- , that the so-defined curve a_{m-1} would not be s -stable, which is absurd. So Σ is a tubular neighbourhood of both $(m-1)$ -chains of curves $(c_i)_{1 \leq i \leq m-1}$ and $(a_i)_{1 \leq i \leq m-1}$. Then, these $(m-1)$ -chains of curves are topologically equivalent in $\text{Mod}(\Sigma, \partial\Sigma)$, namely, there exists a mapping class F in $\text{Mod}(\Sigma, \partial\Sigma)$ that satisfies $F(c_i) = a_i$ for all $i \in \{1, \dots, m-1\}$. Hence for all $i \in \{1, \dots, m-1\}$, we have $FT_{c_i}F^{-1} = T_{a_i}$. Besides, the Dehn twists along the curves c_i , $1 \leq i \leq m-1$, span $\tilde{\rho}_{\text{ref}}(\mathcal{B}_m)$, but the curves a_i , $1 \leq i \leq m-1$, are s -stable, so T_{a_i} belongs to $\tilde{\rho}_{\text{ref}}(\mathcal{B}_m)$. Therefore F belongs to the normalizer of $\tilde{\rho}_{\text{ref}}(\mathcal{B}_m)$ in $\text{Mod}(\Sigma, \partial\Sigma)$. Then according to Proposition 4.22, even if it means composing F by a power of a (central) Dehn twist along a boundary component of Σ , we can assume that F belongs to $\tilde{\rho}_{\text{ref}}(\mathcal{B}_m)$. Let then γ be an element of \mathcal{B}_m such that $F = \tilde{\rho}_{\text{ref}}(\gamma)$. For all $i \in \{1, \dots, m-1\}$, we have $T_{a_i} = T_{F(c_i)} = FT_{c_i}F^{-1} = \tilde{\rho}_{\text{ref}}(\gamma)\tilde{\rho}_{\text{ref}}(\tau_i)\tilde{\rho}_{\text{ref}}(\gamma)^{-1} = \tilde{\rho}_{\text{ref}}(\gamma\tau_i\gamma^{-1})$. In other words, we have shown that:

$$\text{for all } i \in \{1, \dots, m-1\}, T_{a_i} = \tilde{\rho}_{\text{ref}}(\gamma\tau_i\gamma^{-1}). \quad (2)$$

- If $m = n+1$, Σ is not any more a tubular neighbourhood of the union of the curves of $(a_i)_{1 \leq i \leq m-2}$. We can always find, as we previously did, a mapping class F sending the curves of $(c_i)_{1 \leq i \leq m-2}$ on the curves of $(a_i)_{1 \leq i \leq m-2}$, but *a priori*, this mapping class F

does not belong to $\tilde{\rho}_{\text{ref}}(\mathcal{B}_m)$ and we cannot conclude as we previously did. To surmount this difficulty, we are going to construct an s -stable curve a_{m-1} , such that $(a_i)_{1 \leq i \leq m-1}$ is a $(m-1)$ -chain of curves, and we will be in the previous case where $m = n$ and equality (2) will be satisfied. So, let us construct this curve a_{m-1} . Let Σ' be the tubular neighbourhood of the union of the curves a_i , $1 \leq i \leq m-2$. Since all the curves a_i , $1 \leq i \leq m-2$ are s -stable, the surface Σ' is s -stable. We are going to construct the curve a_{m-1} in four steps as described below. We will refer to Figures 32 and 33. Let x be a path in Σ' whose one

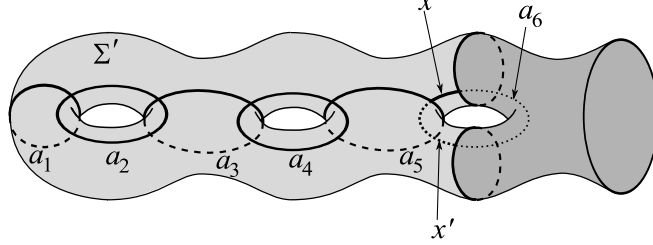

Figure 32: Construction of the curve a_{m-1} when m is odd (here, $n = 6$ and $m = 7$).

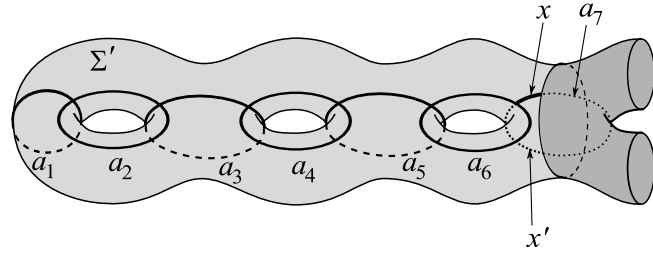

Figure 33: Construction of the curve a_{m-1} when m is even (here, $n = 7$ and $m = 8$).

of its extremities belongs to a_{m-2} and the other belongs to the boundary of Σ' , and such that the interior of x does not intersect any curve a_i , $1 \leq i \leq m-2$. Let x' be the image of x by s . The union $x \cup x'$ is a s -stable path with extremities in $\partial\Sigma'$, which intersects a_{m-2} once and does not intersect the curves a_i , $1 \leq i \leq m-3$. It is easy to close the path $x \cup x'$ on the side of the complement of Σ' in Σ , in such a way that the obtained curve a_{m-1} is s -stable, intersects a_{m-2} once, and does not intersect the curves a_i , $1 \leq i \leq m-3$. Then the $(m-1)$ -chain of curves $(a_i)_{1 \leq i \leq m-1}$ so-defined is s -stable.

We have shown that it exists $\gamma \in \mathcal{B}_m$ such that (2) holds. Let us show now that in (1), the mapping class V belongs to $\tilde{\rho}_{\text{ref}}(\mathcal{B}_m)$. For all $i \leq n-1$, we have $T_{a_i}^\varepsilon V = \tilde{\rho}_{\text{ref}} \circ \varphi(\tau_i)$ so $T_{a_i}^\varepsilon V$ belongs to $\tilde{\rho}_{\text{ref}}(\mathcal{B}_m)$. But T_{a_i} belongs to $\tilde{\rho}_{\text{ref}}(\mathcal{B}_m)$ as we saw it at the beginning of this proof, so V itself belongs to $\tilde{\rho}_{\text{ref}}(\mathcal{B}_m)$, hence there exists $v \in \mathcal{B}_m$ such that $V = \tilde{\rho}_{\text{ref}}(v)$. Finally, for all $i \in \{1, \dots, n-1\}$, we get:

$$\tilde{\rho}_{\text{ref}} \circ \varphi(\tau_i) = \tilde{\rho}_{\text{ref}}(\gamma \tau_i^\varepsilon \gamma^{-1}) \tilde{\rho}_{\text{ref}}(v) = \tilde{\rho}_{\text{ref}}(\gamma \tau_i^\varepsilon \gamma^{-1} v). \quad (3)$$

Since $\tilde{\rho}_{\text{ref}}$ is injective, the following holds for all $i \in \{1, \dots, n-1\}$:

$$\varphi(\tau_i) = \gamma \tau_i^\varepsilon \gamma^{-1} v. \quad (4)$$

Moreover, V commutes with T_{a_i} for all $i \leq n-1$, hence belongs to the centralizer of $\langle \tilde{\rho}_{\text{ref}}(\gamma \tau_i \gamma^{-1}), i \leq n-1 \rangle$, hence belongs to the centralizer of $\{\tilde{\rho}_{\text{ref}}(\gamma \xi \gamma^{-1}), \xi \in \mathcal{B}_n\}$ in $\tilde{\rho}_{\text{ref}}(\mathcal{B}_m)$.

Since $\tilde{\rho}_{\text{ref}}$ is injective, v belongs to the centralizer of $\{\gamma\xi\gamma^{-1}, \xi \in \mathcal{B}_n\}$ in \mathcal{B}_m . When $m = n$, we have $\gamma \in \mathcal{B}_n$, so $\{\gamma\xi\gamma^{-1}, \xi \in \mathcal{B}_n\} = \mathcal{B}_n$ and v belongs to the center of \mathcal{B}_n , hence is a multiple of Δ^2 , according to Theorem 4.7.

Let us show item (iv).

Since the relations are homogeneous in the standard presentation of \mathcal{B}_n , the group \mathcal{B}_n is torsion free. So according to Proposition 6.1, transvections of inner automorphisms of \mathcal{B}_n are injective. Composing by Inv preserves the injectivity. Therefore, the noncyclic morphisms are injective. \square

Theorem 6.4 (Dyer & Grossman, [DyGr], 1981).

Let n be an integer greater than or equal to 6. We have: $\text{Out}(\mathcal{B}_n) = \mathbb{Z}/2\mathbb{Z}$.

Proof. Let φ be an automorphism of \mathcal{B}_n . According to Theorem 4, there exists Φ , an inner automorphism possibly composed by Inv, and an even integer k , such that for all $i \leq n - 1$,

$$\varphi(\tau_i) = \Phi(\tau_i) \Delta^k. \tag{1}$$

As φ and Φ are automorphisms, they preserve the center of \mathcal{B}_n , which is spanned by $\Delta^{\pm 2}$. Hence $\varphi(\Delta^2) = \Delta^{\pm 2}$ and $\Phi(\Delta^2) = \Delta^{\pm 2}$. We have then two possibilities:

$$\varphi(\Delta^2) = \Phi(\Delta^2), \tag{2}$$

$$\text{or } \varphi(\Delta^2) = \Phi(\Delta^2) \Delta^{\pm 4}. \tag{3}$$

But Δ^2 is a product of $n(n - 1)$ standard generators, so equality (1) implies:

$$\varphi(\Delta^2) = \Phi(\Delta^2) \Delta^{kn(n-1)}. \tag{4}$$

The equalities (3) and (4) are incompatible, so (2) takes place, $k = 0$, $\varphi = \Phi$ and, all the automorphisms of \mathcal{B}_n are inner, up to precomposition by Inv. \square

6.3 Morphisms between mapping class groups

In this section, we focus on the morphisms between two mapping class groups associated to two surfaces $\Sigma = \Sigma_{g,b}$ and $\Sigma'_{g',b'}$ such that $g \geq 2$ and $g' \leq g + 1$. We do not assume anything on their numbers of boundary components b and b' . We will also consider:

- the morphisms from $\mathcal{M}\text{od}(\Sigma, \partial\Sigma)$ in $\mathcal{M}\text{od}(\Sigma', \partial\Sigma')$ (cf. Theorems 5 and 6),
- the morphisms from $\mathcal{P}\mathcal{M}\text{od}(\Sigma)$ in $\mathcal{P}\mathcal{M}\text{od}(\Sigma')$ (cf. Theorems 7 and 8),
- the injective morphisms from $\mathcal{M}\text{od}(\Sigma, \partial\Sigma)$ in $\mathcal{M}\text{od}(\Sigma', \partial\Sigma')$ (cf. Theorem 9),
- the injective morphisms from $\mathcal{P}\mathcal{M}\text{od}(\Sigma)$ in $\mathcal{P}\mathcal{M}\text{od}(\Sigma')$ (cf. Theorem 10).

We will mainly show that, up to one exception (when Σ is of genus 2 and Σ' is homeomorphic to $\Sigma_{2,0}$), the non-trivial morphisms between mapping class groups are *induced by embeddings* (see Theorems 5 and 6). Let us make clear what we mean by “*induced by embeddings*”:

Definition 6.5 (Morphisms from $\mathcal{M}od(\Sigma, \partial\Sigma)$ in $\mathcal{M}od(\Sigma', \partial\Sigma')$ induced by an embedding, and outer conjugations).

Let Σ and Σ' be two connected oriented surfaces. Let F be the isotopy class of a possibly non-orientation-preserving embedding from Σ in Σ' . Let Σ'' be the subsurface $F(\Sigma)$ of Σ' . We denote by \bar{F} a representative of F ; \bar{F} is a diffeomorphism of Σ in Σ'' . For any $A \in \mathcal{M}od(\Sigma, \partial\Sigma)$ and any representative $\bar{A} \in \text{Diff}^+(\Sigma, \partial\Sigma)$ of A , the product $\bar{F}\bar{A}\bar{F}^{-1}$ preserves the orientation of Σ'' and induces the identity on $\partial\Sigma''$ ($= \bar{F}\bar{A}\bar{F}^{-1}(\partial\Sigma)$), so $\bar{F}\bar{A}\bar{F}^{-1}$ belongs to $\text{Diff}^+(\Sigma'', \partial\Sigma'')$. The isotopy class of $\bar{F}\bar{A}\bar{F}^{-1}$ in $\mathcal{M}od(\Sigma'', \partial\Sigma'')$ depends only on F and A . However, there exists a canonical extension of $\mathcal{M}od(\Sigma'', \partial\Sigma'')$ in $\mathcal{M}od(\Sigma', \partial\Sigma')$. Let us denote by $\widetilde{\text{Ad}}_F(A)$ the image of the isotopy class of $\bar{F}\bar{A}\bar{F}^{-1}$ by this extension. The map $\widetilde{\text{Ad}}_F$ defined by:

$$\begin{aligned} \widetilde{\text{Ad}}_F : \mathcal{M}od(\Sigma, \partial\Sigma) &\longrightarrow \mathcal{M}od(\Sigma', \partial\Sigma') \\ A &\longmapsto \widetilde{\text{Ad}}_F(A) \end{aligned}$$

is a groupe morphism. Such a morphism will be called *the morphism from $\mathcal{M}od(\Sigma, \partial\Sigma)$ in $\mathcal{M}od(\Sigma', \partial\Sigma')$ induced by the embedding F* .

Let us insist on the fact that nothing is assumed on the embedding F : the image by F of a boundary component of Σ may bound a disk in Σ' , and the images by F of two boundary components of Σ may be isotopic in Σ' . Moreover, this embedding is allowed not to respect the orientations of Σ and Σ' .

When $\Sigma'' = \Sigma'$, we can identify Σ' and Σ so that the embedding F becomes an element of $\mathcal{M}od^\circ(\Sigma)$. The morphism $\widetilde{\text{Ad}}_F$ that we get is then an automorphism of $\mathcal{M}od(\Sigma, \partial\Sigma)$. In this case, $\widetilde{\text{Ad}}_F$ will be called an *outer conjugation by F* .

Before stating the theorems of this section, let us first give two basic facts.:

- the existence of a non-trivial center in $\mathcal{M}od(\Sigma_{2,0})$,
- the computation of the abelianizations of the mapping class groups of the surfaces of genus $g \geq 2$ with $b \geq 0$ boundary components (these abelianized groups are trivial if and only if $g \geq 3$).

We give also some definitions that will allow us to present some specific morphisms that will occur in the theorems:

- the cyclic morphisms in the frame of the mapping class groups,
- the transvections of morphisms.

Definition 6.6 (Hyper-elliptic Involution).

In $\Sigma_{2,0}$, let \bar{H} be the angle π rotation over the axis δ in Figure 34. We denote by H the isotopy class of \bar{H} . This mapping class is called *the hyper-elliptic involution of $\mathcal{M}od(\Sigma_{2,0})$* .

Proposition 6.7 (Center of $\mathcal{M}od(\Sigma_{2,0})$, Dehn, [De2]).

In $\Sigma_{2,0}$, the hyper-elliptic involution H is the only mapping class distinct from the identity that preserves the orientation and preserves all the curves of $\mathcal{C}urv(\Sigma_{2,0})$. It is periodic of order 2 and span the center of $\mathcal{M}od(\Sigma_{2,0})$. \square

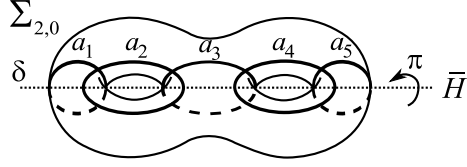

Figure 34: The mapping class H of $\mathcal{M}\text{od}(\Sigma_{2,0})$.

Theorem 6.8 (Abelianization of the mapping class group, Korkmaz, [Ko2]).

For any surface $\Sigma_{g,b}$ with $g \geq 3$ and $b \geq 0$, the abelianization of the mapping class groups $\mathcal{P}\text{Mod}(\Sigma)$ and $\mathcal{M}\text{od}(\Sigma, \partial\Sigma)$ is trivial. When $g = 2$ and $b \geq 0$, the abelianization of the mapping class group $\mathcal{P}\text{Mod}(\Sigma)$ and $\mathcal{M}\text{od}(\Sigma, \partial\Sigma)$ is isomorphic to $\mathbb{Z}/10\mathbb{Z}$ and by this isomorphism, the conjugacy class of the Dehn twists along the non-separating curves is sent on the class of 1.

Proof. The computation of the abelianization of the different mapping class groups (including the mapping class groups with and without boundary $\mathcal{M}\text{od}(\Sigma)$, $\mathcal{P}\text{Mod}(\Sigma)$ and $\mathcal{M}\text{od}(\Sigma, \partial\Sigma)$) has been driven by Korkmaz, cf. [Ko2], page 109 Theorem 5.1. We prove below that the conjugacy class of the Dehn twists span the abelianization of the mapping class group when $g = 2$. First, let us examine the case when $\Sigma = \Sigma_{2,0}$. We start from the presentation of $\mathcal{M}\text{od}(\Sigma)$. We choose as generators the Dehn twists along the five curves a_1, a_2, a_3, a_4 and a_5 in Σ of Figure 34. Let us denote by x_1, x_2, x_3, x_4 and x_5 the generators of the non-commutative free group \mathbb{F}_5 . The morphism $\mathbb{F}_5 \rightarrow \mathcal{M}\text{od}(\Sigma)$ defined by $x_i \mapsto T_{a_i}$ for all $i \in \{1, 2, \dots, 5\}$ leads to the following presentation of $\mathcal{M}\text{od}(\Sigma)$ given by Waynrib (cf. [Bi] page 184):

$$\langle x_1, x_2, x_3, x_4, x_5 \mid \mathcal{R}, \begin{cases} (x_5 x_4 x_3 x_2 x_1 x_1 x_2 x_3 x_4 x_5)^2 = 1 \\ (x_1 x_2 x_3 x_4 x_5)^6 = 1 \\ [x_5 x_4 x_3 x_2 x_1 x_1 x_2 x_3 x_4 x_5, x_5] = 1 \end{cases} \rangle$$

where \mathcal{R} is the set of commutation relations $[x_i, x_j] = 1$ when $|j-i| \geq 2$ for all $i, j \in \{1, 2, \dots, 5\}$ and of the braid relations $x_i x_{i+1} x_i = x_{i+1} x_i x_{i+1}$ for all $i \in \{1, 2, 3, 4\}$. If we add the relations $[x_i, x_{i+1}] = 1$ for all $i \in \{1, 2, 3, 4\}$, we can deduce the following relations $x_1 = x_2 = \dots = x_5$. The other relations becomes then $x_1^{20} = 1, x_1^{30} = 1$ and $x_1^0 = 1$. Finally, the abelianization of $\mathcal{M}\text{od}(\Sigma)$ has the presentation $\langle x_1 \mid x_1^{10} = 1 \rangle$, so the abelianization of $\mathcal{M}\text{od}(\Sigma)$ is isomorphic to $\mathbb{Z}/10\mathbb{Z}$ and by this isomorphism, the conjugacy class of the Dehn twists along the non-separating curves is sent on the class of 1. In the case of the surfaces of genus 2 with $b > 0$, we have a canonical surjective morphism $\mathcal{M}\text{od}(\Sigma_{2,b}) \rightarrow \mathcal{M}\text{od}(\Sigma_{2,0})$ by which the Dehn twists along non-separating curves are sent on some Dehn twists along non-separating curves. So here again, by the abelianization morphism, the conjugacy class of the Dehn twists along non-separating curves is sent on the class of 1. \square

Definition 6.9 (Cyclic morphisms from $\mathcal{M}\text{od}(\Sigma_{2,b})$ in any group).

A morphism from $\mathcal{M}\text{od}(\Sigma_{2,b})$ in any group, with $b \geq 0$, is said to be *cyclic* if its image is cyclic.

Remark. This definition concerns only the genus-2 surfaces. Indeed, for any surface of genus greater than or equal to 3, according to Theorem 6.8 due to Korkmaz, the abelianization of the mapping class group is trivial, so any morphism from the mapping class group of these surfaces in a cyclic group is trivial. Hence the definition of cyclic morphism is empty as soon as the group at the source is the mapping class group of a surface of genus greater than or equal to 3.

Lemma 6.10. *Let b be a nonnegative integer and let \mathcal{M} be one of the two mapping class groups $\mathcal{P}\text{Mod}(\Sigma_{2,b})$ or $\text{Mod}(\Sigma_{2,b}, \partial\Sigma_{2,b})$. Given a morphism Ψ of \mathcal{M} in $\text{Mod}(\Sigma_{2,0})$, there exists a morphism Ψ' of \mathcal{M} in $\text{Mod}(\Sigma_{2,0})$ defined by $\Psi'(T_a) = \Psi(T_a)H$ for any non-separating curve a of $\text{Curv}(\Sigma_{2,b})$, where H is the hyper-elliptic involution of $\text{Mod}(\Sigma_{2,0})$.*

Proof. The abelianization of \mathcal{M} is isomorphic to $\mathbb{Z}/10\mathbb{Z}$ according to Theorem 6.8 due to Korkmaz, and is spanned by the conjugacy class of the Dehn twists along the non-separating curves. Hence since $H^{10} = \text{Id}$, the morphism φ of \mathcal{M} in $\text{Mod}(\Sigma_{2,0})$ sending each Dehn twist along a non-separating curve on the mapping class H is well-defined. Moreover, H is central, so for all $F \in \mathcal{M}$, the mapping classes $\Psi(F)$ and $\varphi(F)$ commute. Hence for all $F_1, F_2 \in \mathcal{M}$, we have:

$$(\Psi(F_1)\varphi(F_1))(\Psi(F_2)\varphi(F_2)) = \Psi(F_1F_2)\varphi(F_1F_2).$$

In other words, the map $\mathcal{M} \rightarrow \text{Mod}(\Sigma_{2,0})$, $F \mapsto \Psi(F)\varphi(F)$ is a morphism. \square

Definition 6.11 (Transvection of a morphism from the mapping class group in any group).

Let Σ be a genus-2 surface, \mathcal{M} one of the mapping class groups $\mathcal{P}\text{Mod}(\Sigma)$ or $\text{Mod}(\Sigma, \partial\Sigma)$, and G any group. For any morphism Ψ from \mathcal{M} in G and for any element g belonging to the centralizer of $\Psi(\mathcal{M})$ in G such that $g^{10} = 1_G$, we will call *transvection of Ψ with direction g* the morphism Ψ' that sends any Dehn twist T_a along a non-separating curve a on the element $\Psi(T_a)g$ of G . A transvection with direction 1_G of a morphism is equal to this morphism.

Remark. Lemma 6.10 shows an example of such transvections. Notice that the proof of this lemma uses a cyclic morphism and thus shows that the abelianization of \mathcal{M} needs to be non-trivial. That is why when the genus of the involved surface Σ is greater than or equal to 3, there does not exist any transvection of morphism from \mathcal{M} in G , whatever G is.

Both following theorems determine the morphisms between mapping class groups. We prove them together. The first one gives a necessary and sufficient condition of the existence of some non-trivial or noncyclic morphisms between two mapping class groups. The second one determines these morphisms.

Theorem 5 (Existence of non-trivial morphisms from $\text{Mod}(\Sigma, \partial\Sigma)$ in $\text{Mod}(\Sigma', \partial\Sigma')$).

Let Σ be a surface $\Sigma_{g,b}$ and Σ' a surface $\Sigma_{g',b'}$ with $g \geq 2$ and $g' \leq g + 1$.

- *When $g = 2$, there exist some cyclic non-trivial morphisms from $\text{Mod}(\Sigma_{2,b}, \partial\Sigma_{2,b})$ in any mapping class group admitting a subgroup isomorphic to $\mathbb{Z}/2\mathbb{Z}$, $\mathbb{Z}/5\mathbb{Z}$ or $\mathbb{Z}/10\mathbb{Z}$. When $g \geq 3$, there does not exist any cyclic non trivial morphisms.*
- *When $g \geq 2$, there exist some noncyclic morphisms from $\text{Mod}(\Sigma, \partial\Sigma)$ in $\text{Mod}(\Sigma', \partial\Sigma')$ if and only if one of the two following conditions is satisfied: $b \neq 0$ and $g' \geq g$, or $b = 0$ and Σ' is homeomorphic to Σ .*

With Theorem 5, we determine in which cases noncyclic morphisms from $\text{Mod}(\Sigma, \partial\Sigma)$ in $\text{Mod}(\Sigma', \partial\Sigma')$ do exist. In Theorem 6, we assume that cyclic morphisms do exist and we describe them.

Theorem 6 (Morphisms from $\text{Mod}(\Sigma, \partial\Sigma)$ in $\text{Mod}(\Sigma', \partial\Sigma')$).

Let Σ be a surface $\Sigma_{g,b}$ and Σ' a surface $\Sigma_{g',b'}$ with $g \geq 2$, with $g' \in \{g, g + 1\}$, and such that $\Sigma' = \Sigma$ if $b = 0$. Any noncyclic morphism from $\text{Mod}(\Sigma, \partial\Sigma)$ in $\text{Mod}(\Sigma', \partial\Sigma')$ is a morphism

induced by the isotopy class of an embedding from Σ in Σ' , or possibly a transvection with direction H (the hyper-elliptic involution of $\text{Mod}(\Sigma_{2,0})$) of such a morphism if $g = 2$ and $(g', b') = (2, 0)$. Moreover, if $b = 0$, the morphism induced by the isotopy class of an embedding from Σ in Σ' (up to transvection when $\Sigma = \Sigma' = \Sigma_{2,0}$) is an outer conjugation.

Proof of Theorems 5 and 6. Notice that in Theorem 5 we state some existence and non-existence results. The existence results are easy to check. Indeed, it is enough to consider one of the morphisms which we are talking about in Theorem 6. The difficult part of Theorem 5 is the non-existence result, which will be shown in step 4. of what follows. Theorem 6 will be shown in step 11..

1. *Definitions.*

Let us begin with associating to the surface Σ an Artin group G and a morphism $\rho_0 : G \rightarrow \text{Mod}(\Sigma, \partial\Sigma)$. First, let us associate to the surface $\Sigma = \Sigma_{g,b}$ the graph $\Gamma_{g,b}$ described in Figure 35. We denote by G the Artin group of type $\Gamma_{g,b}$, and S the system of generators described on

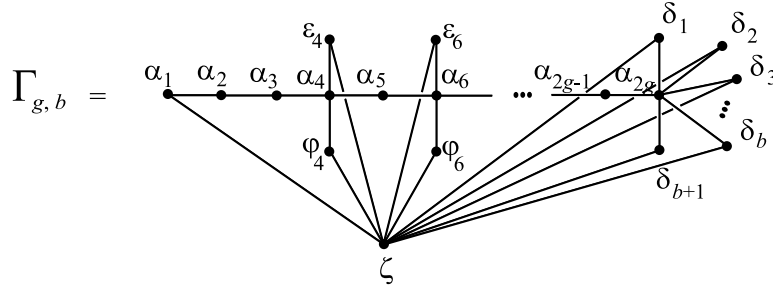

Figure 35: Step 1.: The graph $\Gamma_{g,b}$ associated to the surface $\Sigma_{g,b}$.

the same figure. This set S contains $4g + b - 2$ elements:

- $\alpha_i, 1 \leq i \leq 2g$, and ζ
- ε_{2i} and $\varphi_{2i}, 2 \leq i \leq g - 1$,
- $\delta_i, 1 \leq i \leq b + 1$.

Let us call \mathcal{A} the collection of the following curves :

- the curves $\alpha_i, 1 \leq i \leq 2g$, drawn in Figure 36,
- the curves ε_{2i} and $\varphi_{2i}, 2 \leq i \leq g - 1$, drawn in Figure 36,
- the curves $\delta_i, 1 \leq i \leq b + 1$, drawn in Figure 36.

Let us denote by z the curve described in Figure 36, let us denote by ρ_0 the (non-injective) morphism from the Artin group (G, S) in $\text{Mod}(\Sigma, \partial\Sigma)$ defined by:

- $\rho_0(\alpha_i) = T_{a_i}, 1 \leq i \leq 2g$, and $\rho_0(\zeta) = T_z$
- $\rho_0(\varepsilon_{2i}) = T_{e_{2i}}$ and $\rho_0(\varphi_{2i}) = T_{f_{2i}}, 2 \leq i \leq g - 1$,
- $\rho_0(\delta_i) = T_{d_i}, 1 \leq i \leq b + 1$.

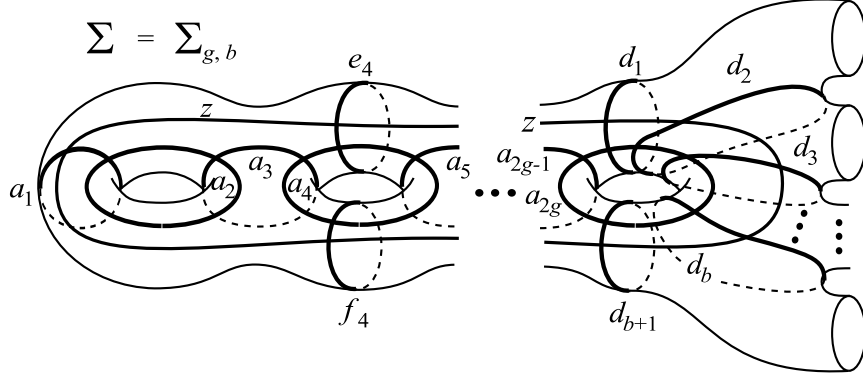

Figure 36: Step 1.: The curves of \mathcal{A} and the curve z .

Let Ψ be a morphism from $\text{Mod}(\Sigma, \partial\Sigma)$ in $\text{Mod}(\Sigma', \partial\Sigma')$ and let Φ be the morphism from G in $\text{Mod}(\Sigma', \partial\Sigma')$ equal to $\Psi \circ \rho_0$. We are going to study Ψ by means of Φ .

2. Let us focus on the special case, when $\Phi(\alpha_1) = \Phi(\alpha_2)$.

by conjugation, the equality $\Phi(\alpha_1) = \Phi(\alpha_2)$ implies that all the elements of S have the same image by Φ . Hence the image of G by Φ is a cyclic group. Hence the image of $\rho_0(G)$ by Ψ is a cyclic group. But according to Theorem 3.8, the Dehn twists along the curves of \mathcal{A} span $\text{Mod}(\Sigma, \partial\Sigma)$, so $\rho_0(G) = \text{Mod}(\Sigma, \partial\Sigma)$ and the image of Ψ is a cyclic group. In other words, Ψ is a morphism from $\text{Mod}(\Sigma, \partial\Sigma)$ in an abelian group. But, according to Theorem 6.8 due to Korkmaz, the abelianization of the mapping class group $\text{Mod}(\Sigma, \partial\Sigma)$ is trivial as soon as the genus of Σ is greater than or equal to 3. Hence under the assumption $\Phi(\alpha_1) = \Phi(\alpha_2)$, we conclude that Ψ is trivial as soon as $g \geq 3$. When $g = 2$, according to the same theorem, for all $b \geq 0$, the abelianization of $\text{Mod}(\Sigma_{2,b}, \partial\Sigma_{2,b})$ equals $\mathbb{Z}/10\mathbb{Z}$. Then under the assumption $\Phi(\alpha_1) = \Phi(\alpha_2)$, when $g = 2$, the image of Ψ is a subgroup of $\mathbb{Z}/10\mathbb{Z}$. In other words, under the assumption $\Phi(\alpha_1) = \Phi(\alpha_2)$, there exist some non-trivial morphisms from $\text{Mod}(\Sigma_{2,b}, \partial\Sigma_{2,b})$ in $\text{Mod}(\Sigma', \partial\Sigma')$ if and only if there exists a subgroup isomorphic to $\mathbb{Z}/2\mathbb{Z}$, $\mathbb{Z}/5\mathbb{Z}$ or $\mathbb{Z}/10\mathbb{Z}$ in $\text{Mod}(\Sigma', \partial\Sigma')$. These non-trivial morphisms are cyclic morphisms.

In what follows, we assume that $\Phi(\alpha_1) \neq \Phi(\alpha_2)$.

3. Let us show that Φ is a transvection of monodromy morphism.

Let us generalize the notion of monodromy morphism to the Artin group G (i.e. the images of the elements of S are Dehn twists or inverses of Dehn twists), we are going to show that Φ is a transvection of monodromy morphism.

Any pair $(\xi, \xi') \in S \times S$ satisfying a braid relation is conjugate to the pair (α_1, α_2) . Since we have assumed that $\Phi(\alpha_1) \neq \Phi(\alpha_2)$, by conjugation, any pair $(\xi, \xi') \in S \times S$ satisfying a braid relation satisfies $\Phi(\xi) \neq \Phi(\xi')$. Let us begin with introducing the following distinct subsets of S (cf. Figure 37):

- $S(\alpha_1) = \{\alpha_i, 1 \leq i \leq 2g\} \cup \{\delta_1\}$,
- $S(\alpha_2) = \{\alpha_i, 2 \leq i \leq 2g\} \cup \{\delta_1, \zeta\}$,

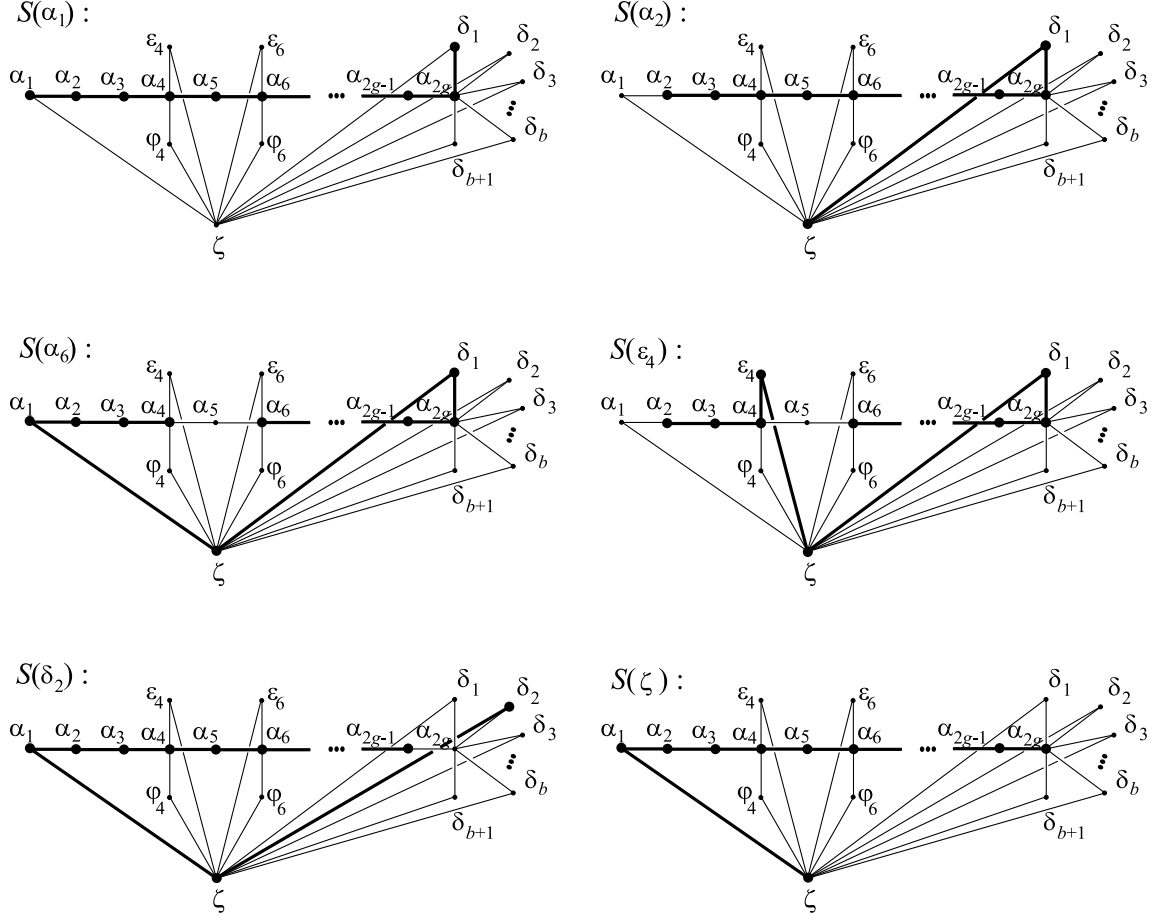

Figure 37: Step 3.: For all $\xi \in S$, the set $S(\xi)$ is the set of generators associated to the vertices in bold on the corresponding graph.

- $S(\alpha_j) = \{\alpha_i, j \leq i \leq 2g\} \cup \{\delta_1, \zeta\} \cup \{\alpha_i, 1 \leq i \leq j-2\}$, $j \in \{3, \dots, 2g\}$,
- $S(\varepsilon_{2j}) = \{\alpha_i, 2 \leq i \leq 2j\} \cup \{\varepsilon_{2j}, \zeta, \delta_1\} \cup \{\alpha_i, 2g \geq i \geq 2j+2\}$, $j \in \{2, \dots, g-1\}$,
- $S(\varphi_{2j}) = \{\alpha_i, 2 \leq i \leq 2j\} \cup \{\varphi_{2j}, \zeta, \delta_1\} \cup \{\alpha_i, 2g \geq i \geq 2j+2\}$, $j \in \{2, \dots, g-1\}$,
- $S(\delta_j) = \{\delta_j, \zeta\} \cup \{\alpha_i, 1 \leq i \leq 2g-2\}$, $j \in \{1, \dots, b+1\}$,
- $S(\zeta) = \{\zeta\} \cup \{\alpha_i, 1 \leq i \leq 2g-1\}$.

For all $\xi \in S$, let us denote by $G(\xi)$ the subgroup of G spanned by the elements of $S(\xi)$. Any subgroup G' of G spanned by the elements of a subset S' of S (called *parabolic subgroup of G* in the literature) is itself an Artin group, according to a theorem of Van der Leek (cf. [The, Chap II, Theorem 4.13]). Hence for all $\xi \in S$, the group $G(\xi)$ is isomorphic to \mathcal{B}_{2g+2} . For all $\xi \in S$, let us denote by Φ_ξ the restriction of Φ to $G(\xi)$. By hypothesis, $g' \leq g+1$, so $g' \leq \frac{2g+2}{2}$ and Theorem 2 can be applied: for all $\xi \in S$, either Φ_ξ is cyclic, or Φ_ξ is a transvection of monodromy morphism. But we have seen that if $\Phi(\alpha_1) \neq \Phi(\alpha_2)$, then for any $\xi \in S$, the morphism Φ_ξ is not cyclic.

Let us consider the set of morphisms Φ_ξ for all $\xi \in S$. Since for all $\xi \in S$, the morphism Φ_ξ is a transvection of monodromy morphism, we can speak about the *characteristic sign* and about the *direction* of Φ_ξ , seen as a transvection (cf. Definition 5.14). We shall say that two morphisms Φ_ξ and $\Phi_{\xi'}$, ξ and ξ' belonging to S , are *compatible* if they have same characteristic signs and same directions. It is clear that being compatible is an equivalence relation. Now, according to Lemma 5.13, for all ξ and ξ' belonging to S , if $S(\xi)$ and $S(\xi')$ contain at least three adjacent elements in common, the morphisms Φ_ξ and $\Phi_{\xi'}$ are compatible. Therefore, we have:

- Φ_{α_i} and $\Phi_{\alpha_{i+1}}$ are compatible for all $i \in \{1, \dots, 2g\}$,
- $\Phi_{\varepsilon_{2i}}$ and Φ_{α_1} are compatible for all $i \in \{2, \dots, g-1\}$, as are $\Phi_{\varphi_{2i}}$ and Φ_{α_1} ,
- Φ_{δ_i} and Φ_{α_1} are compatible for all $i \in \{1, \dots, b+1\}$,
- Φ_ζ and Φ_{α_1} are compatible.

So, there exists only one equivalence class: all the morphisms Φ_ξ are compatible when ξ takes all possible values in S . Therefore, there exist in Σ' some curves

- a'_i for all $i \in \{1, \dots, 2g\}$,
- e'_{2i} and f'_{2i} for all $i \in \{2, \dots, g-1\}$,
- d'_i for all $i \in \{1, \dots, b+1\}$,

whose set will be denoted by \mathcal{A}' , an integer $\eta \in \{\pm 1\}$ and a mapping class $W \in \mathcal{M}od(\Sigma', \partial\Sigma')$ such that:

- $\Phi(\alpha_i) = T_{a'_i}^\eta W$ for all $i \in \{1, \dots, 2g\}$,
- $\Phi(\varepsilon_{2i}) = T_{e'_{2i}}^\eta W$ and $\Phi(\varphi_{2i}) = T_{f'_{2i}}^\eta W$ for all $i \in \{2, \dots, g-1\}$,
- $\Phi(\delta_i) = T_{d'_i}^\eta W$ for all $i \in \{1, \dots, b+1\}$,

where W commutes with the Dehn twists along the curves of \mathcal{A}' .

Let us consider the reflection in \mathbb{R}^3 with respect to a hyperplane containing the curves a_{2j} , $1 \leq j \leq g$ and intersecting the other curves of \mathcal{A} in two points. This reflection preserves all the curves of \mathcal{A} , preserves Σ , and reverses the orientation of Σ . We denote by K the isotopy class in $\mathcal{M}od^\circ(\Sigma)$ of this reflection. Let V be the mapping class equal to Id if $\eta = 1$ or to K if $\eta = -1$, and let $\widetilde{\text{Ad}}_V$ be the outer conjugation of $\mathcal{M}od(\Sigma, \partial\Sigma)$ by V (cf. Definition 6.5). Let us set

$$\dot{\Psi} = \Psi \circ \widetilde{\text{Ad}}_V.$$

After having replaced W by W^η , we get:

- $\dot{\Psi}(T_{a_i}) = T_{a'_i} W$ for all $i \in \{1, \dots, 2g\}$,
- $\dot{\Psi}(T_{e_{2i}}) = T_{e'_{2i}} W$ and $\dot{\Psi}(T_{f_{2i}}) = T_{f'_{2i}} W$ for all $i \in \{2, \dots, g-1\}$,
- $\dot{\Psi}(T_{d_i}) = T_{d'_i} W$ for all $i \in \{1, \dots, b+1\}$.

We still have to determine W and the curves of \mathcal{A}' in order to determine the morphism $\dot{\Psi}$, and hence the morphism Ψ , when Ψ is not cyclic.

4. We assume that Ψ is not cyclic. Let us show that the curves of $\mathcal{A}' \setminus \{d'_j, 2 \leq j \leq b\}$ are arranged in Σ' as illustrated in Figure 38. In particular:

- the genera of Σ' and Σ satisfy $g' \geq g$;
- for all $i \in \{2, \dots, g-1\}$, the two curves e'_{2i} and f'_{2i} are distinct, they cobound a surface of genus $i-1$ containing the curves a'_j , $1 \leq j \leq 2i-1$, and they do not meet the curves a'_j , $j \geq 2i+1$;
- if $\Sigma' \neq \Sigma_{g,0}$, then the curves d'_1 and d'_{b+1} cobound a surface of genus $g-1$, and if $\Sigma' = \Sigma_{g,0}$, then we have $d'_1 = d'_2 = \dots = d'_{b-1}$;
- if $\partial\Sigma$ is empty, then $\Sigma' = \Sigma_{g,0}$ (and we will have shown Theorem 5);
- for all $i \in \{2, \dots, g-2\}$, we know that e'_{2i} and a'_{2i+1} cobound a pair of pants with e'_{2i+2} or with f'_{2i+2} , but we do not know precisely with which of the two. Same thing with e'_{2g-2} , a'_{2g-1} , d'_1 and d'_{b+1} .

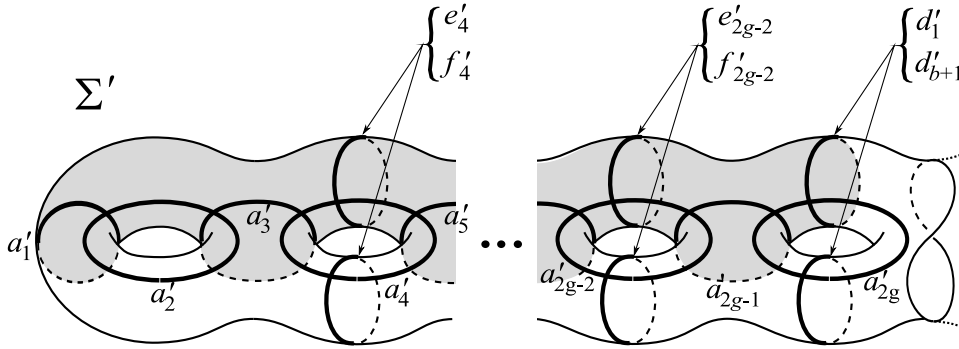

Figure 38: Step 4.: the curves a'_i , $1 \leq i \leq 2g$, e'_{2j} and f'_{2j} , $2 \leq j \leq g-1$, d'_1 and d'_{b+1} .

4.a) *The pairs of curves of \mathcal{A}' without any intersection point.*

Since Ψ is a morphism, if two preimages commute, their images commute. Let x and y be two curves belonging to \mathcal{A} such that $I(x, y) = 0$, and let x' and y' be some curves in Σ' such that $\dot{\Psi}(T_x) = T_{x'}W$ and $\dot{\Psi}(T_y) = T_{y'}W$. Since $I(x, y) = 0$, then T_x and T_y commute, so $T_{x'}W$ and $T_{y'}W$ commute. Since W centralizes the image of $\dot{\Psi}$, $T_{x'}$ and $T_{y'}$ commute, so x' and y' satisfy $I(x', y') = 0$.

4.b) *The pairs of curves of \mathcal{A}' intersecting in one point; the genus g' of Σ' .*

Since Ψ is a morphism, if two preimages satisfy a braid relation, their images do as well. Let x and y be two curves belonging to \mathcal{A} such that $I(x, y) = 1$, and let x' and y' be some curves in Σ' such that $\dot{\Psi}(T_x) = T_{x'}W$ and $\dot{\Psi}(T_y) = T_{y'}W$. If $x' = y'$, then, according to the step 2., the morphism Ψ would be cyclic, which contradicts our assumption. So $x' \neq y'$. Since W centralizes the image of $\dot{\Psi}$, it comes that $T_{x'}$ and $T_{y'}$ satisfy a braid relation without being equal, so $I(x', y') = 1$.

We deduce from what precedes and from step 4.a) that, starting from the $(2g)$ -chain of curves $(a_i)_{i \leq 2g}$ in \mathcal{A} , the curves $(a'_i)_{i \leq 2g}$ in \mathcal{A}' form also a $(2g)$ -chain of curves, so Σ' is of genus $g' \geq g$. Since $g' \leq g + 1$ by hypothesis, we have then $g' \in \{g, g + 1\}$.

4.c) *The pairs of curves of \mathcal{A}' possibly equal.*

Since we have assumed that Ψ is not cyclic and according to the step 2., we have the following: for all pairs of adjacent standard generators ξ and ξ' in S , the mapping classes $\Phi(\xi)$ and $\Phi(\xi')$ are pairwise distinct. Hence the curves a'_i , $1 \leq i \leq 2g$ are pairwise distinct. Therefore, as soon as two elements of S do not satisfy exactly the same relations with each α_i , $1 \leq i \leq 2g$, their images by Φ are distinct. Hence the only pairs of curves of Σ' that are possibly equal are the pairs of the following type:

$$\begin{aligned} & \{e'_{2i}, f'_{2i}\} \text{ with } i \in \{2, 3, \dots, g-1\}, \\ & \text{and } \{d'_j, d'_k\} \text{ with } j, k \in \{1, 2, \dots, b+1\}. \end{aligned}$$

4.d) *Let us show that for all $i \in \{2, 3, \dots, g-1\}$, the curves e'_{2i} and f'_{2i} are distinct and cobound in Σ' a surface homeomorphic to $\Sigma_{i-1,2}$ which contains the curves a'_j , $1 \leq j \leq 2i-1$, but which does not contain the curves a'_j , $j \geq 2i+1$.*

Let i be an integer in $\{2, \dots, g-1\}$ which is fixed once and for all during all step 4.d). The curves a'_k , $1 \leq k \leq 2i-1$ form a $(2i-1)$ -chain, so there exist two disjoint curves e''_{2i} and f''_{2i} that cobound a surface homeomorphic to $\Sigma_{i-1,2}$ in Σ' and such that:

$$\left(\prod_{k=1}^{2i-1} T_{a'_k} \right)^{2i} = T_{e''_{2i}} T_{f''_{2i}}. \quad (1)$$

We have the same type of relation in $\text{Mod}(\Sigma, \partial\Sigma)$:

$$\left(\prod_{k=1}^{2i-1} T_{a_k} \right)^{2i} = T_{e_{2i}} T_{f_{2i}}. \quad (2)$$

By composing (2) by $\dot{\Psi}$, we get:

$$\left(\prod_{k=1}^{2i-1} T_{a'_k} W \right)^{2i} = T_{e'_{2i}} T_{f'_{2i}} W^2, \quad (3)$$

and since W is in the centralizer of $\dot{\Psi}(\rho_0(G))$, we get:

$$T_{e''_{2i}} T_{f''_{2i}} = T_{e'_{2i}} T_{f'_{2i}} W^{(2-2i)(2i-1)}. \quad (4)$$

Now, $I(e''_{2i}, f''_{2i}) = 0$, hence $\sigma(T_{e''_{2i}} T_{f''_{2i}}) = \{e''_{2i}, f''_{2i}\}$. Then, according to equality (4) and since $T_{e'_{2i}}, T_{f'_{2i}}$ and W commute, Proposition 3.45 implies that:

$$\{e''_{2i}, f''_{2i}\} \subset \sigma(T_{e'_{2i}}) \cup \sigma(T_{f'_{2i}}) \cup \sigma(W). \quad (5)$$

For all $i \in \{2, 3, \dots, g-1\}$, the curves $a'_1, a'_3, \dots, a'_{2i-1}$ and e''_{2i} cobound a sphere with $i+1$ holes. Similarly, the curves $a'_1, a'_3, \dots, a'_{2i-1}$ and f''_{2i} cobound a sphere with $i+1$ holes (cf. Figure 39). Since the curve a'_{2i} intersects a'_{2i-1} in only one point, and does not intersect the curves $a'_1, a'_3, \dots, a'_{2i-3}$, then by a connectedness argument (cf. Figure 39), a'_{2i} must intersect the curves e''_{2i} and f''_{2i} .

On the contrary, the curve a'_{2i} does not intersect the curves of $\sigma(W)$ since W is in the centralizer of $\dot{\Psi}(\rho_0(G))$. Therefore

$$\{e''_{2i}, f''_{2i}\} \cap \sigma(W) = \emptyset. \quad (6)$$

Hence, according to (5),

$$\{e''_{2i}, f''_{2i}\} \subset \{e'_{2i}, f'_{2i}\}. \quad (7)$$

But since e''_{2i} and f''_{2i} are distinct, we deduce that e'_{2i} and f'_{2i} are distinct. Finally,

$$\{e''_{2i}, f''_{2i}\} = \{e'_{2i}, f'_{2i}\}. \quad (8)$$

and e'_{2i} and f'_{2i} cobound in Σ' a surface homeomorphic to $\Sigma_{i-1,2}$ that contains the curves a'_j , $1 \leq j \leq 2i-1$. Moreover, the curves a'_j , $j \geq 2i+1$, do not intersect the surface $\Sigma_{i-1,2}$. Indeed,

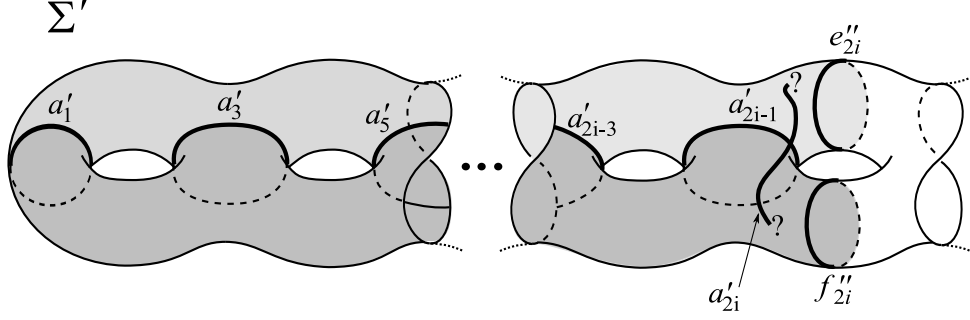

Figure 39: Step 4.d): let us show that $I(e''_{2i}, a'_{2i})$ and $I(f''_{2i}, a'_{2i})$ are nonzero.

they are distinct from the curves a'_j , $j \leq 2i - 1$, do not intersect them, and there is no room for such curves in $\Sigma_{i-1,2}$ since $\Sigma_{i-1,2}$ is a tubular neighbourhood of the union of the curves a'_j , $j \leq 2i - 1$.

4.e) When $\partial\Sigma$ is nonempty, let us show that:

- if $\Sigma' = \Sigma_{g,0}$, then $d'_1 = d'_2 = \dots = d'_{b+1}$,
- if $\Sigma' \neq \Sigma_{g,0}$, then the curves d'_1 and d'_{b+1} are distinct and cobound in Σ' a surface homeomorphic to $\Sigma_{g-1,2}$ that contains the curves a'_j , $1 \leq j \leq 2g - 1$.

Let us denote by u' and v' the two curves of Σ' such that

$$\left(\prod_{k=1}^{2g-1} T_{a'_k} \right)^{2g} = T_{u'} T_{v'}. \quad (9)$$

As in line (7) in step 4.d), where $(e''_i, f''_i, e'_i, f'_i)$ is replaced now by (u', v', d'_1, d'_{b+1}) , we can show that:

$$\{u', v'\} \subset \{d'_1, d'_{b+1}\}.$$

We separate the cases, whether $\Sigma' = \Sigma_{g,0}$ or not.

If $\Sigma' = \Sigma_{g,0}$, then $u' = v'$. The set of curves

$$\{a'_{2j-1}, 1 \leq j \leq g\} \cup \{e'_{2i}, f'_{2i}\} \cup \{2 \leq j \leq g-1\} \cup \{u'\}$$

form a simplex of $3g - 3$ curves, hence a maximal simplex in Σ' . But the curves d'_k , $1 \leq k \leq b+1$, do not intersect the curves of this simplex. They are therefore included in this simplex. Now, on one hand, $I(d'_k, a'_{2g}) = 1$ for all $k \in \{1, 2, \dots, b+1\}$, and on the other hand, u' and a'_{2g-1} are the only curves of this simplex that intersect a'_{2g} . So $d'_k \in \{u', a'_{2g-1}\}$. But d'_k does not intersect a'_{2g-2} , so $d'_k = u'$.

If $\Sigma' \neq \Sigma_{g,0}$, then $u' \neq v'$, so we can conclude as we did in step 4.d): the curves d'_1 and d'_{b+1} are distinct and cobound in Σ' a surface homeomorphic to $\Sigma_{g-1,2}$ containing the curves a'_j , $1 \leq j \leq 2g - 1$.

4.f) When $\partial\Sigma$ is empty, let us show that Σ' is homeomorphic to Σ , and we will have shown Theorem 5.

When $\partial\Sigma$ is empty, we have $d_1 = d_{b+1}$ and $d'_1 = d'_{b+1}$. Let us consider again equality (9): there exist two curves u' and v' in Σ'' that cobound a surface of genus $g - 1$ such that:

$$\left(\prod_{k=1}^{2g-1} T_{a'_k} \right)^{2g} = T_{u'} T_{v'}.$$

We deduce as above that $\{u', v'\} \subset \{d'_1\}$, and so $u' = v'$. But u' and v' cobounded a surface homeomorphic to $\Sigma_{g-1,2}$. Since the two boundary components of this surface are isotopic in Σ' ,

there exists in Σ' a genus- g surface without boundary. Hence Σ' is this genus- g surface without boundary.

5. Let us determine the mapping class W introduced in step 3..

5.a) Let us show that when $g \geq 3$, W is the identity.

Let Σ be a surface of genus at least 3. Let Q be a subsurface of Σ of genus 3 defined as follows: if $g = 3$ and $b \leq 1$, we set $Q = \Sigma$. Otherwise Q is the subsurface of Σ containing the curve a_1 and bounded by the separating curve x defined by $(T_{a_1}(T_{a_2}T_{a_1}) \dots (T_{a_6} \dots T_{a_1}))^4 = T_x$. Let \mathcal{E} be the set of curves $\{a_1, a_2, a_3, a_4, a_5, a_6\} \cup \{e_4, e_6, f_4, f_6\}$, where the curves e_6 and f_6 are the curves d_1 and d_{b+1} when $g = 3$ and are possibly equal (cf. Figure 40). The Dehn twists along the curves of \mathcal{E} belong to a unique conjugacy class in $\text{Mod}(Q, x)$ and span $\text{Mod}(Q, x)$ according to Theorem 3.8. Hence, *a priori*, the abelianization of $\text{Mod}(Q, x)$ is a cyclic group, spanned by the conjugacy class of the Dehn twists along the non-separating curves. However, according to Theorem 6.8 due to Korkmaz, it is trivial. Hence there exists a product P of Dehn twists along some curves of \mathcal{E} such that the sum of the powers of each term in P equals 1, and such that this product P is equal to the identity in $\text{Mod}(Q, x)$. The image by $\dot{\Psi}$ of P has the form $P'W$ where P' looks like the product P except that the Dehn twists along the curves of \mathcal{E} have been replaced by the Dehn twists along the curves $a'_1, a'_2, a'_3, a'_4, a'_5, a'_6, e'_4, f'_4, e'_6, f'_6$. Let us denote by x' the curve of Σ' defined by $(T_{a'_1}(T_{a'_2}T_{a'_1}) \dots (T_{a'_6} \dots T_{a'_1}))^4 = T'_x$ and Q' the subsurface of Σ' containing a'_1 and bounded by x' (if x' is trivial, we set $Q' = \Sigma'$). We saw that P equals the identity in $\text{Mod}(Q, x)$. The same relation takes place in $\text{Mod}(Q', x')$ and the product P' equals the identity in $\text{Mod}(Q', x')$. But $\text{Mod}(Q', x')$ is a subgroup of $\text{Mod}(\Sigma', \partial\Sigma')$, so P' equals the identity in $\text{Mod}(\Sigma', \partial\Sigma')$. Then we conclude from the equality $\dot{\Psi}(P) = P'W$ that W is the identity mapping class.

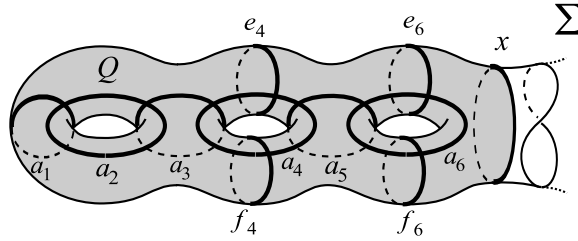

Figure 40: Step 5.a): The surface Σ and the subsurface Q .

5.b) Let us show that when $g = 2$, W satisfies $W^{10} = \text{Id}$ and that W can be different from Id only if $b' = 0$.

We follow the same line of argument as we previously used, except that we set $Q = \Sigma$ if $b \leq 1$, whereas if $b \geq 2$, Q is the genus-2 surface bounded by x and containing a_1 , where x is the curve defined by $(T_{a_1}(T_{a_2}T_{a_1}) \dots (T_{a_4} \dots T_{a_1}))^4 = T_x$. We define Q' in Σ' in an equivalent way. Since the abelianization of $\text{Mod}(Q, x)$ is isomorphic to $\mathbb{Z}/10\mathbb{Z}$, there exists in $\text{Mod}(Q, x)$ a product P of Dehn twists along the curves of $\mathcal{E} = \{a_1, a_2, a_3, a_4\} \cup \{d_1, d_{b+1}\}$ such that the sum of the powers of each term of the product equals 10, and such that this product is equal to the identity in $\text{Mod}(Q, x)$. The same argument as we previously used shows that $\dot{\Psi}(P) = P'W^{10}$ where P' is a trivial product in $\text{Mod}(\Sigma', \partial\Sigma')$. Hence $W^{10} = \text{Id}$. Since $\text{Mod}(\Sigma', \partial\Sigma')$ is torsion-free as soon as $b' > 0$, W can be non-trivial only if $b' = 0$.

5.c) Let us show that when $g = 2$, W is trivial except if $(g', b') = (2, 0)$. If $(g', b') = (2, 0)$, then $W \in \{\text{Id}, H\}$, where H is the hyper-elliptic involution H (cf. Definition 6.6).

Let us recall that W commutes with the Dehn twists along the curves of \mathcal{A}' , so W fixes each of these curves. According to step 5.b), and since $g = 2$ and $g' \in \{2, 3\}$, two cases have to be treated, whether $\Sigma' = \Sigma_{2,0}$ or $\Sigma' = \Sigma_{3,0}$. When $\Sigma' = \Sigma_{2,0}$, we have $\mathcal{A}' = \{a'_i, 1 \leq i \leq 4\} \cup \{d'_1\}$, cf. Figure 41, left hand side. Since the Dehn twists along the curves of \mathcal{A}' span $\text{Mod}(\Sigma')$, W is in the center of $\text{Mod}(\Sigma')$, so $W \in \{\text{Id}, H\}$ where H is the hyper-elliptic involution. When $\Sigma' = \Sigma_{3,0}$, we have $b \neq 0$ according to step 4.f), so \mathcal{A}' contains the curves $a'_i, 1 \leq i \leq 4$, and the two distinct curves d'_1 and d'_{b+1} (distinct, for $b+1 \neq 1$), cf. Figure 41, right hand side. Let us recall that according to step 4.e), the curves d'_1 and d'_{b+1} are distinct and cobound in Σ' a surface of genus $g-1 = 1$ that contains the curve a'_1 . Let R be this subsurface. Let us recall that W is periodic, fixes the curves of \mathcal{A}' and hence preserves R and induces a mapping class W' in $\text{Mod}(R)$. The mapping class W' belongs even to $\mathcal{P}\text{Mod}(R)$ for W' must fix the curves d'_1 and d'_{b+1} . Notice that the Dehn twists along the curves a'_1, a'_2 and a'_3 span $\mathcal{P}\text{Mod}(R)$. Since W' fixes these curves, W' commutes with the Dehn twists along these curves, so W' is central in $\mathcal{P}\text{Mod}(R)$. But the center of $\mathcal{P}\text{Mod}(R)$ is trivial (cf. [De2]), hence W' is the identity mapping class of $\mathcal{P}\text{Mod}(R)$. At last, it is easy to see that a periodic mapping class that coincides with the identity on a subsurface is the identity mapping class (see for instance Lemma 3.43). Hence W is the identity mapping class of $\text{Mod}(\Sigma')$.

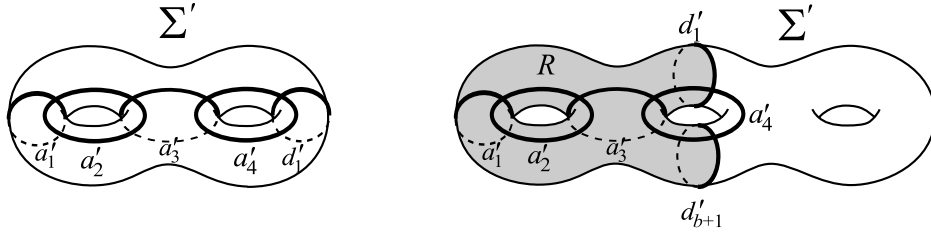

Figure 41: Step 5.c): The surface Σ' and the curves of \mathcal{A}' that W must fix: the case $g' = 2$ on the left, the case $g' = 3$ on the right.

Definition: If $W = \text{Id}$, we define $\ddot{\Psi}$ as been equal to the morphism $\ddot{\Psi}$, and if $W = H$ (cf. 6.11), we define $\ddot{\Psi}$ as been equal to the transvection of $\ddot{\Psi}$ with direction H . Notice that W can be equal to H precisely only if $g = 2$ and $(g', b') = (2, 0)$ and under these conditions and since H is central, such a transvection is well-defined.

6. We show that $\ddot{\Psi}$ sends the Dehn twists along non-separating curves on Dehn twists along non-separating curves. Then we show that if c_1 and c_2 are two non-separating curves of Σ such that $I(c_1, c_2) = 0$, then $I(c'_1, c'_2) = 0$ where c'_1 and c'_2 are the curves of Σ' such that $\ddot{\Psi}(T_{c_1}) = T_{c'_1}$ and $\ddot{\Psi}(T_{c_2}) = T_{c'_2}$.

Let us recall that two Dehn twists along two non-separating curves are conjugate, and that the conjugacy class of a Dehn twist along a non-separating curve contains only such Dehn twists. Hence, having shown that the image of T_{a_1} by $\ddot{\Psi}$ was a Dehn twist along a non-separating curve, we have shown that the image of every Dehn twist along a non-separating curve is a Dehn twist along a non-separating curve.

Let c_1, c_2, c'_1 and c'_2 be some curves defined as in the statement of step 6.. Since $I(c_1, c_2) = 0$, the Dehn twists T_{c_1} and T_{c_2} commute, so their images by $\ddot{\Psi}$, which are equal to $T_{c'_1}$ and $T_{c'_2}$, have to commute. Hence $I(c'_1, c'_2) = 0$.

7. Let us show that when $g \geq 4$, the curves e'_{2i} , $i \in \{2, \dots, g-2\}$, are located on the same connected component of the surface Σ' cut along the curves a'_{2j-1} , $j \in \{1, \dots, g\}$, d'_1 and d'_{b+1} , (in Figure 38, the curves e'_{2i} are in the shadowed part and the curves f'_{2i} are in the unshadowed part).

Let us introduce the curve w on Σ defined as in Figure 42: the curve w is non-separating, intersects the curves a_2 and a_{2g} in one point, the curves of $\{e_{2i}, 2 \leq i \leq g-1\}$ in two points, and does not intersect the other curves of \mathcal{A} . The curve w is non-separating, so, according to step 6., there exists a curve w' in Σ' such that $\ddot{\Psi}(T_w) = T_{w'}$.

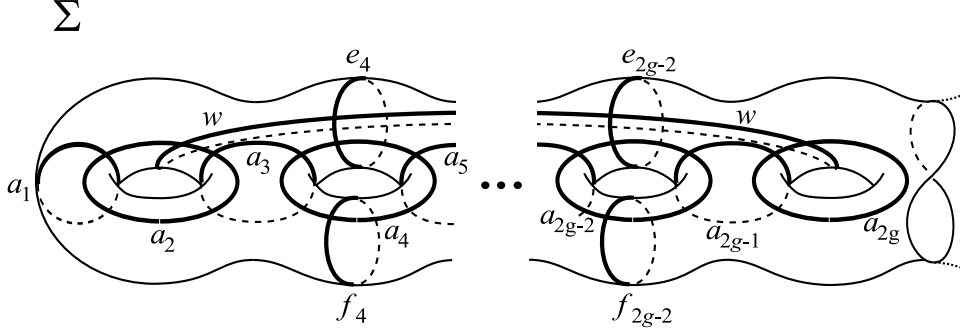

Figure 42: Step 7.: the curve of w in the surface Σ .

Since we have $I(w, a_2) = 1$, then T_w and T_{a_2} satisfy a braid relation. Since $\ddot{\Psi}$ is a morphism, $T_{w'}$ and $T_{a'_2}$ satisfy a braid relation as well, which implies that either $w' = a'_2$ or $I(w', a'_2) = 1$ holds. Since we have $I(w, a_{2g}) = 1$, we also have that either $w' = a'_{2g}$ or $I(w', a'_{2g}) = 1$ holds. However the curves w' and a'_2 are distinct, for $T_{a'_{2g}}$ does not satisfy the same relations with $T_{w'}$ and with $T_{a'_2}$ (we know that $T_{a'_{2g}} \neq T_{a'_2}$ and $I(a'_{2g}, a'_2) = 0$). In the same way, $T_{w'}$ and $T_{a'_{2g}}$ are distinct. Hence the braid relations that $T_{w'}$ satisfies with $T_{a'_2}$ and $T_{a'_{2g}}$ are not trivial, and we have:

$$I(w', a'_2) = I(w', a'_{2g}) = 1.$$

But for all $i \in \{2, \dots, g-1\}$, we have $I(w, f_{2i}) = 0$, so according to step 6., since all the involved curves are non-separating, we have $I(w', f'_{2i}) = 0$ for all $i \in \{2, \dots, g-1\}$. By the same argument, we have $I(w', a'_{2j-1}) = 0$ for all $j \in \{1, \dots, g\}$, and also $I(w', d'_1) = 0$ and $I(w', d'_{b+1}) = 0$.

Let us recall that according to step 4.d), for all $i \in \{2, \dots, g-1\}$, the two curves e'_{2i} and f'_{2i} are distinct and cobound a surface of genus $i-1$ containing the curve a'_2 , but not the curve a'_{2g} . Then, by a connectedness argument in Σ' , the fact that $I(w', a'_2) = I(w', a'_{2g}) = 1$ implies that for any $i \in \{2, \dots, g-1\}$, w' intersects at least one of the curves e'_{2i} and f'_{2i} . But we have seen that for all $i \in \{2, \dots, g-1\}$, we have $I(w', f'_{2i}) = 0$, so $I(w', e'_{2i}) \neq 0$. Hence the curves e'_{2i} , $i \in \{2, \dots, g-1\}$, are all located on the same side with respect to the curve w' , that is to say they all are located on the same connected component of the surface Σ cut along the curves a'_{2j-1} , $j \in \{1, \dots, g\}$, d'_1 and d'_{b+1} .

Definition: The curves w and w' , defined in step 7. when $g \geq 4$, will still be useful in step 8.. Furthermore, we will need to extend their definition when $g = 3$, which is easy: w is the curve drawn in Figure 43, and w' is the only curve of $\text{Curv}(\Sigma')$ such that $\ddot{\Psi}(T_w) = T_{w'}$. From this

definition, we can describe the curve w' as we did in step 7.: Indeed, w' satisfies the following (cf. Figure 43):

- $I(w', a'_{2'}) = I(w', a'_{2g}) = 1$,
- $I(w', a'_k) = 0$ for all $k \in \{1\} \cup \{3, 4, \dots, 2g-1\}$,
- $I(w', d'_j) = 0$ for all $j \in \{1, 2, \dots, b+1\}$,
- $I(w', f'_{2i}) = 0$ for all $i \in \{2, 3, \dots, g-1\}$,
- $I(w', e'_{2i}) \neq 0$.

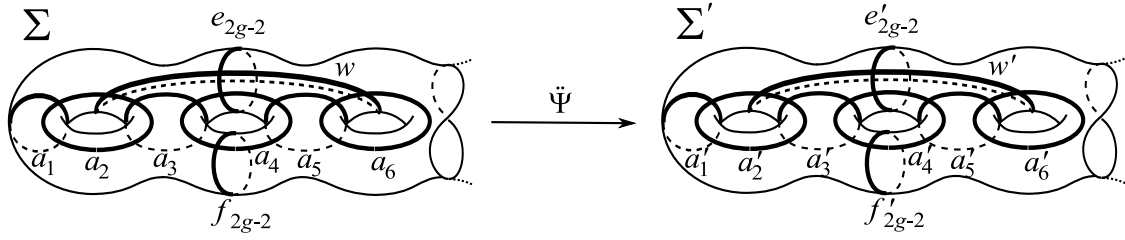

Figure 43: The curve w in the case $g = 3$, and the curve w' such that $\ddot{\Psi}(T_w) = T_{w'}$.

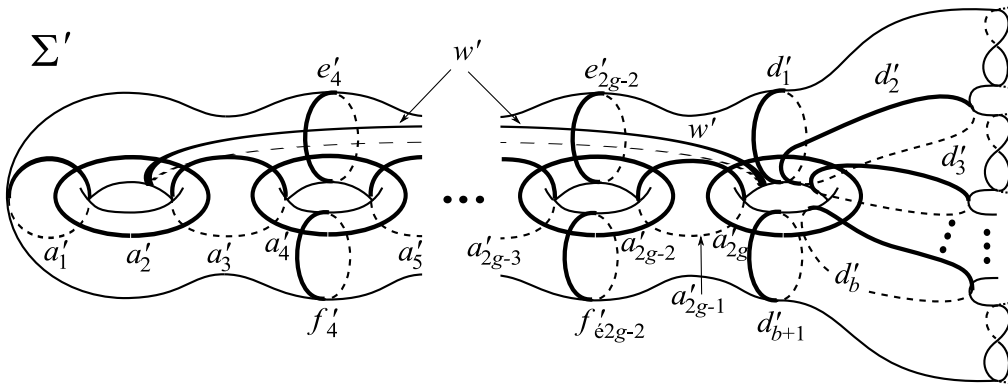

Figure 44: Step 8.: let us show that the curves of \mathcal{A}' (notably the curves d'_j , $1 \leq j \leq b+1$) in the surface Σ' are arranged in this way.

8. Let us show that, when $\partial\Sigma \neq \emptyset$ and $g \geq 3$, the curves of $\mathcal{A}' \cup \{w'\}$ are arranged in Σ' as in Figure 44. In particular, the curves d'_i , $i \in \{1, \dots, b+1\}$, are ordered in Σ' in the following way. For all $i, j \in \{1, \dots, b+1\}$, we will say that:

$$d'_j \leq d'_i$$

if the curves d'_i and d'_j are isotopic, or if there exists a representation of the involved curves in tight position such that when we follow the curve a'_{2g} in one of the two possible directions, we meet the curves a'_{2g-1} , w' , d'_j , d'_i in this order. Then, with this definition, we will prove that:

$$d'_1 \leq d'_2 \leq \dots \leq d'_{b+1}.$$

Notice first that the case where Σ' is homeomorphic to $\Sigma_{g,0}$ is trivial for the curves d'_j , $1 \leq j \leq b+1$, would then be equal. In what follows, we assume that:

$$\Sigma' \neq \Sigma_{g,0}. \quad (H)$$

8.a) *Let us begin by setting some notation.*

We refer to Figure 45 for the following definitions. Let i be any integer in $\{1, 2, \dots, b+1\}$ that we fix once and for all during all step 8.. We will show that for all $j \in \{1, \dots, i\}$, we have $d'_j \leq d'_i$. The following definitions depend on i but to reduce clutterness for the reader, the index i will be omitted.

We define the following curves, lying in Σ and Σ' :

- let \mathcal{V} (respectively \mathcal{V}') be the compact tubular neighbourhood of the $(2g-1)$ -chain $(a_3, a_4, \dots, a_{2g}, d_i)$ (resp. $(a'_3, a'_4, \dots, a'_{2g}, d'_i)$), cf. Figure 45;

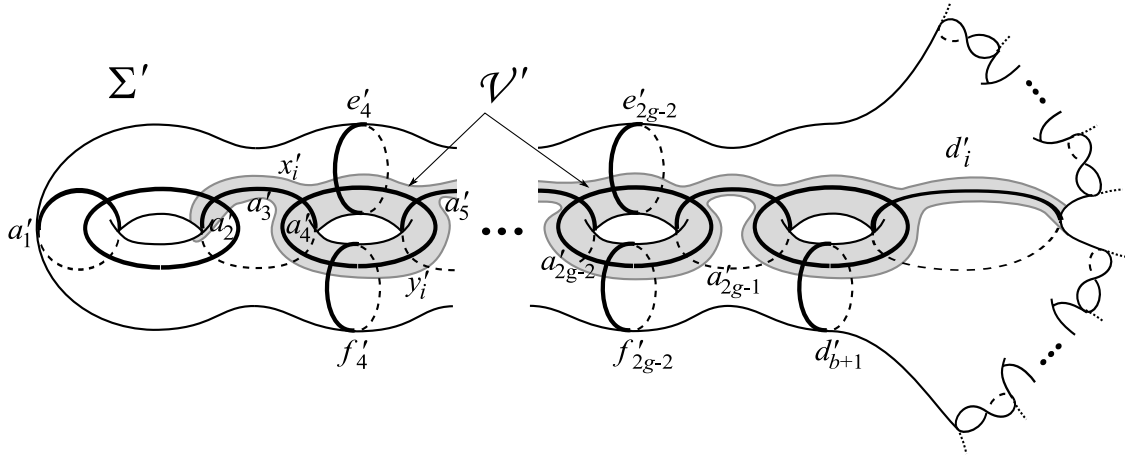

Figure 45: Step 8.a): the subsurface \mathcal{V}' of Σ' .

- let \mathcal{V}_T and \mathcal{V}_B be the two subsurfaces of \mathcal{V} bounded by the curves $(a_3, a_5, \dots, a_{2g-1}, d_i)$ such that \mathcal{V}_T contains w and \mathcal{V}_B does not meet w ; the letters T and B stand for “top” and “bottom” by referring to Figure 46;
- let \mathcal{V}'_T and \mathcal{V}'_B be the two subsurfaces of \mathcal{V}' bounded by the curves $(a'_3, a'_5, \dots, a'_{2g-1}, d'_i)$ such that \mathcal{V}'_T contains w' and \mathcal{V}'_B does not meet w' , cf. Figure 46;
- let x_T and x_B be the two boundary components of \mathcal{V} , so that $x_T \subset \partial\mathcal{V}_T$ and $x_B \subset \partial\mathcal{V}_B$;
- x'_T and x'_B be the two boundary components of \mathcal{V}' , so that $x'_T \subset \partial\mathcal{V}'_T$ and $x'_B \subset \partial\mathcal{V}'_B$, cf. Figure 46.

8.b) *Let us show that $\ddot{\Psi}(T_{x_T}) = T_{x'_T}$ and that $\ddot{\Psi}(T_{x_B}) = T_{x'_B}$.*

First, the sets of curves $\{x_T, x_B\}$ and $\{x'_T, x'_B\}$ satisfy:

$$\begin{cases} T_{x_T} T_{x_B} = \left(\left(\prod_{3 \leq k \leq 2g} T_{a_k} \right) d_i \right)^{2g} \\ T_{x'_T} T_{x'_B} = \left(\left(\prod_{3 \leq k \leq 2g} T_{a'_k} \right) d'_i \right)^{2g} \end{cases},$$

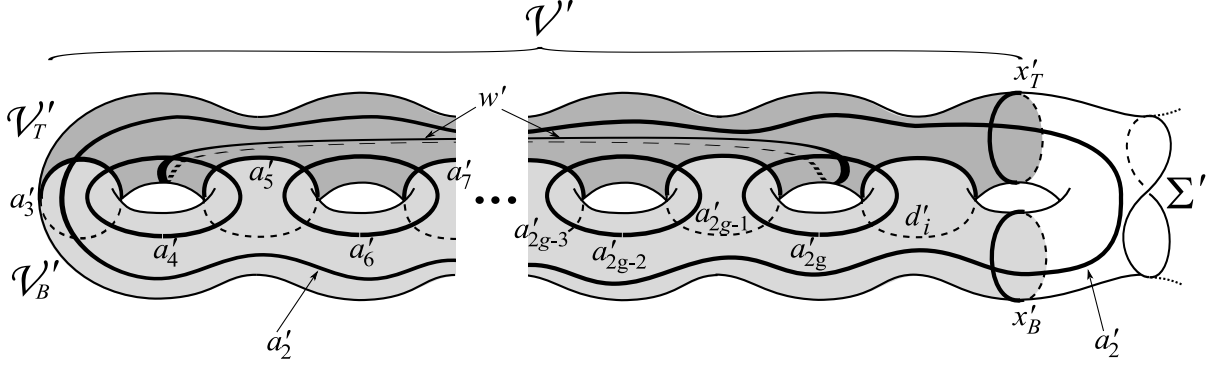

Figure 46: Step 8.a): the subsurface \mathcal{V}'_T and \mathcal{V}'_B of Σ' , and the boundary components x'_T and x'_B of \mathcal{V}' .

however for all $j \in \{1, \dots, 2g\}$, we have $\check{\Psi}(T_{a_j}) = T_{a'_j}$, and $\check{\Psi}(T_{d_i}) = T_{d'_i}$, so $\check{\Psi}(T_{x_T} T_{x_B}) = T_{x'_T} T_{x'_B}$. The involved curves are non-separating. Since $\check{\Psi}$ sends the Dehn twists along non-separating curves on Dehn twists along non-separating curves, according to step 6., it then follows that:

$$\{\check{\Psi}(T_{x_T}), \check{\Psi}(T_{x_B})\} = \{T_{x'_T}, T_{x'_B}\}. \quad (10)$$

To continue the proof of step 8.b), we first have to define some curves. Let y_T and y_B be the curves in Σ corresponding to the boundary of the tubular neighbourhood of the curves a_{2g-1} , a_{2g} and d_i , such that y_T lies in \mathcal{V}_T and y_B lies in \mathcal{V}_B . Analogously, we define the curves y'_T and y'_B in Σ' , cf. Figure 47.

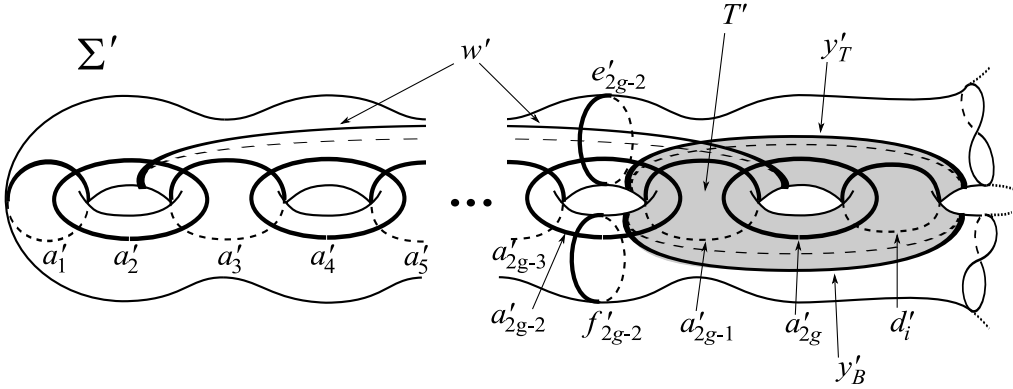

Figure 47: Step 8.b): the curves y'_T and y'_B in Σ' .

As we showed equality (10), we can show that:

$$\{\check{\Psi}(T_{y_T}), \check{\Psi}(T_{y_B})\} = \{T_{y'_T}, T_{y'_B}\}. \quad (11)$$

Let us show now that $\check{\Psi}(T_{y_T}) = T_{y'_T}$ and $\check{\Psi}(T_{y_B}) = T_{y'_B}$. The curve w' intersects a'_{2g} , so w' has to intersect the torus T' with two holes, bounded by y'_T and y'_B and containing a'_{2g} , cf. Figure 47. But w' intersects a'_2 , too, hence w' cannot be included in T' , so w' has to intersect y'_B or y'_T . Since w' does not meet \mathcal{V}'_B by definition of \mathcal{V}'_B , and since y'_B is included in \mathcal{V}'_B by definition of y'_B , it follows that w' does not intersect y'_B . Hence w' has to intersect y'_T , so $T_{w'}$ and $T_{y'_T}$ do not

commute. Since we have $I(w, y_B) = 0$, the Dehn twist T_w commutes with T_{y_B} . Then $\ddot{\Psi}(T_w)$, which is equal to $T_{w'}$ as we saw it in step 7., has to commute with $\ddot{\Psi}(T_{y_B})$. Hence $\ddot{\Psi}(T_{y_B})$ is different from $T_{y'_T}$. And thanks to (11), we get:

$$\ddot{\Psi}(T_{y_T}) = T_{y'_T} \text{ and } \ddot{\Psi}(T_{y_B}) = T_{y'_B}. \quad (12)$$

Let us show that $\ddot{\Psi}(T_{x_T}) = T_{x'_T}$ and that $\ddot{\Psi}(T_{x_B}) = T_{x'_B}$. Let us consider the curve e'_{2g-2} . It intersects a'_{2g-2} in one point, but intersects neither d'_i nor any curve a'_k with $k \neq 2g-2$. Therefore, if e'_{2g-2} was included in \mathcal{V}'_T , according to Figure 48, equality (13) would hold:

$$e'_{2g-2} = y'_T. \quad (13)$$

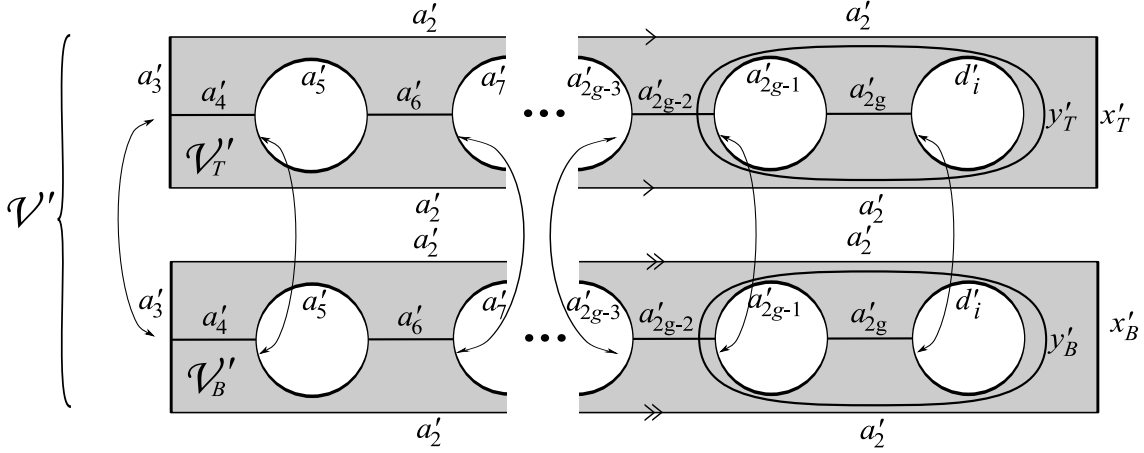

Figure 48: Step 8.b): in Σ' , the curves y'_T and y'_B cannot both coincide with the curves e'_{2g-2} and f'_{2g-2} .

Similarly, if f'_{2g-2} was included in \mathcal{V}'_B , we would have:

$$f'_{2g-2} = y'_B. \quad (14)$$

However, it is impossible that (13) or (14) happen simultaneously, for (according to Figure 47) the sets $\{e'_{2g-2}, f'_{2g-2}\}$ and $\{y'_T, y'_B\}$ are the boundary components of two distinct subsurfaces of Σ' : one is isomorphic to $\Sigma_{g-2,2}$ and the other is isomorphic to $\Sigma_{1,2}$. It would follow from the equality $\{e'_{2g-2}, f'_{2g-2}\} = \{y'_T, y'_B\}$ that there would exist a subsurface without boundary included in Σ' and isomorphic to $\Sigma_{g,0}$. However such a surface without boundary can be included in another connected surface only if they are equal. But here, $\Sigma' \neq \Sigma_{g,0}$ since according to our hypotheses (cf. (H)), we have $\Sigma' \neq \Sigma_{g,0}$. It follows that either (13) or (14) is wrong and consequently, either e'_{2g-2} is not included in \mathcal{V}'_T , or f'_{2g-2} is not included in \mathcal{V}'_B . Hence, either $I(e'_{2g-2}, x'_T) \neq 0$ or $I(f'_{2g-2}, x'_B) \neq 0$. Hence, either $T_{e'_{2g-2}}$ does not commute with $T_{x'_T}$, or $T_{f'_{2g-2}}$ does not commute with $T_{x'_B}$. But $T_{e'_{2g-2}}$ commutes with T_{x_B} and $T_{f'_{2g-2}}$ commutes with T_{x_T} so $T_{e'_{2g-2}}$ commutes with $\ddot{\Psi}(T_{x_B})$ and $T_{f'_{2g-2}}$ commutes with $\ddot{\Psi}(T_{x_T})$. Hence, it would be absurd that $\ddot{\Psi}(T_{x_T}) = T_{x'_B}$ and $\ddot{\Psi}(T_{x_B}) = T_{x'_T}$. Hence

$$\ddot{\Psi}(T_{x_T}) = T_{x'_T} \text{ and } \ddot{\Psi}(T_{x_B}) = T_{x'_B}.$$

8.c) Let us show that for any given integer $j \in \{1, \dots, b+1\}$, one and only one of the three following situations can occur:

$$I(d'_j, x'_T) \neq 0, \text{ or } I(d'_j, x'_B) \neq 0, \text{ or } d'_j = d'_i.$$

- First, it is clear that if $d'_j = d'_i$, then $I(d'_j, x'_T) = 0$, or $I(d'_j, x'_B) = 0$.
- Let us show now that the inequalities $I(d'_j, x'_T) \neq 0$ and $I(d'_j, x'_B) \neq 0$ cannot hold simultaneously. Let us fix an integer $j \in \{1 \dots, b+1\}$ different from i . Then, in Σ , we have $I(d_j, x_T) = 0$ or $I(d_j, x_B) = 0$, so according to step 6., since these three curves are non-separating, we have either $I(d'_j, x'_T) = 0$, or $I(d'_j, x'_B) = 0$. Thus, we have shown that the each assertion in the statement excludes the two others.

- We still have to show that at least one of them holds. Let us fix again an integer $j \in \{1 \dots, b+1\}$ different from i . We assume that $I(d'_j, x'_T) = 0$ and $I(d'_j, x'_B) = 0$, and we want to show that $d'_j = d'_i$. Since $I(d'_j, x'_T) = 0$ and $I(d'_j, x'_B) = 0$, the curve d'_j is included in \mathcal{V}' , is of intersection 1 with a'_{2g} , but does not intersect any other curve a'_k for $k \in \{2, \dots, 2g-1\}$, and does not intersect the curve d'_i either. However, as we can see it in Figure 49, the surface \mathcal{V}' cut along the curves $\{a'_k, 3 \leq k \leq 2g-1\} \cup \{d'_i\}$ and along the path $a'_2 \cap \mathcal{V}'$ is homeomorphic to the disjoint union of two annuli in which the curve d'_i induces a boundary component. Concerning the curve d'_j , it does not bound any disk in Σ' , so its image in this cut is isotopic to the boundary components of one of these two annuli. Hence in Σ' , the isotopy classes of d'_j and d'_i are equal.

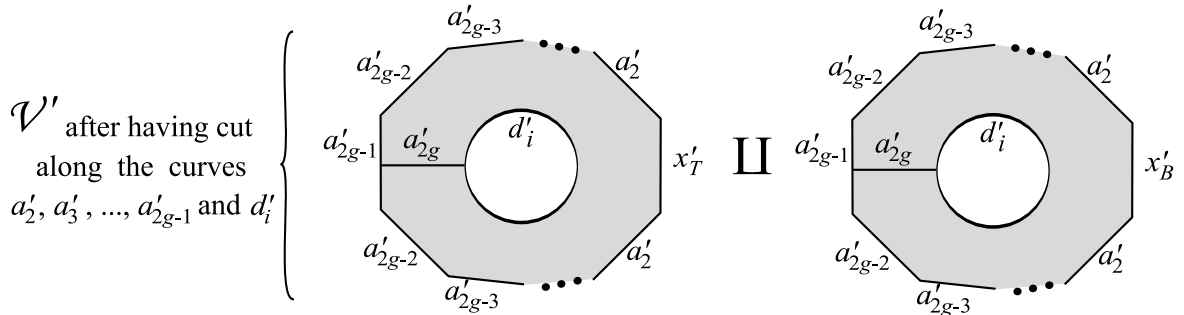

Figure 49: Step 8.c): the surface \mathcal{V}' cut along the curves $\{a'_k, 3 \leq k \leq 2g-1\} \cup \{d'_i\}$ and along the path $a'_2 \cap \mathcal{V}'$ is homeomorphic to the disjoint union of two annuli in which the curve d'_i induces a boundary component.

8.d) *Let us show that for all $j \in \{1, \dots, b+1\}$, if $j \leq i$ then $d'_j \leq d'_i$, in the sense defined in the above statement of step 8.. Since the roles of i and j are symmetric, we will have shown the equivalence.*

Let j be an integer in $\{1, \dots, i-1\}$. Then in Σ we have $I(d_j, x_B) = 0$, so according to step 6., since all the involved curves are non-separating, we have $I(d'_j, x'_B) = 0$. Then according to step 8.c), we deduce that either $d'_j = d'_i$ or $I(d'_j, x'_T) \neq 0$. If $d'_j = d'_i$, the result is shown: by definition $d'_j \leq d'_i$. Let us then assume that $I(d'_j, x'_T) \neq 0$ and let us show that this also implies that $d'_j \leq d'_i$. First, we have $I(d'_j, x'_B) = 0$ and $I(d'_j, a'_{2k-1}) = 0$ for all $k \in \{2, 3, \dots, g\}$, so $I(d'_j, \text{Bndy}(\mathcal{V}'_B)) = 0$. Now, d'_j intersects the curve x'_T located outside of \mathcal{V}'_B , so d'_j does not meet \mathcal{V}'_B . Let us recall that $I(d'_j, a'_{2g}) = 1$ and that the curve a'_{2g} is included in $\mathcal{V}' = \mathcal{V}'_T \cup \mathcal{V}'_B$. Therefore:

$$d'_j \text{ intersects } a'_{2g} \text{ in } \mathcal{V}'_T. \quad (15)$$

We have almost shown that $d'_j \leq d'_i$. To terminate the proof, let us consider the subsurface \mathcal{V}'_T , cf. Figure 50. The curve w' is included in \mathcal{V}'_T that is of genus 0, so w' separates \mathcal{V}'_T in two connected components, one is homeomorphic to a pair of pants which we call P and which contains a boundary isotopic to d'_i in Σ' , the other containing the boundary components isotopic

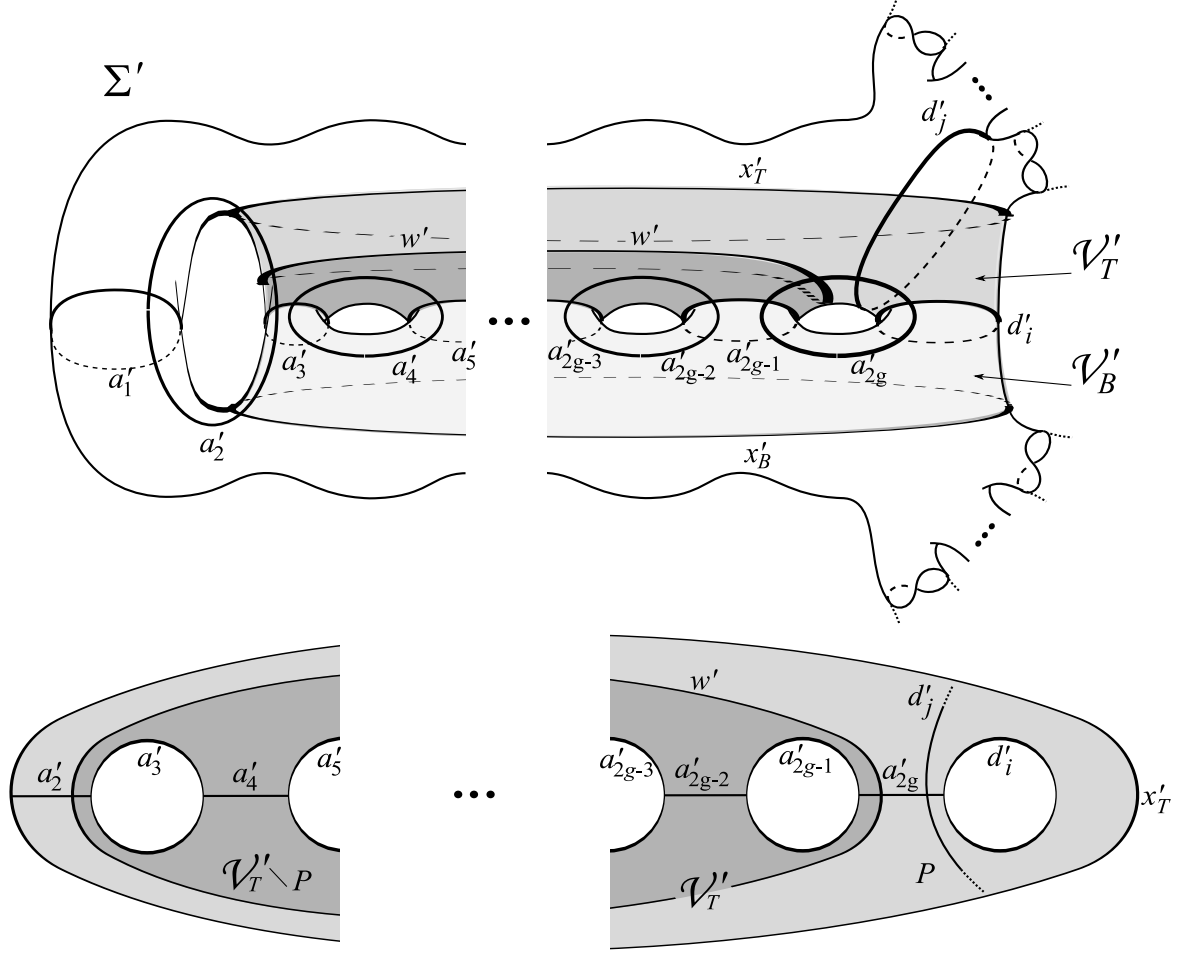

Figure 50: Step 8.d): the subsurface \mathcal{V}'_T of \mathcal{V}' .

to $a'_3, a'_5, \dots, a'_{2g-1}$ in Σ' . The curve d'_j does not intersect any of the boundary components of $\mathcal{V}'_T \setminus P$ (let us recall that we had seen in step 7. that $I(w', d'_j) = 0$), but it intersects x'_T that is a boundary of P . Hence by connectedness, d'_j does not intersect $\mathcal{V}'_T \setminus P$, so (15) becomes:

$$d'_j \text{ intersects } a'_{2g} \text{ in } P. \quad (16)$$

Consequently, the curve a'_{2g} intersects, in this order,

- the curve a'_{2g-1} (one of the boundary components of $\mathcal{V}'_T \setminus P$),
- the curve w' (that separates P and $\mathcal{V}'_T \setminus P$ in \mathcal{V}'_T),
- the curve d'_j (partially included in P),
- and at last the curve d'_i (one of the boundary of P).

Hence by definition, $d'_j \leq d'_i$.

9. Let us show the result of step 8. in the case where $g = 2$. More precisely, when $\partial\Sigma \neq \emptyset$ and $g = 2$, the curves of \mathcal{A}' are arranged in Σ' as in Figure 44 (except the curve w' that is not

defined in the case where $g = 2$). In particular, the curves d'_i , $i \in \{1, \dots, b+1\}$, are ordered in Σ' in the following way. For all $i, j \in \{1, \dots, b+1\}$, we will say that:

$$d'_j \leq d'_i$$

if the curves d'_i and d'_j are isotopic, or if in a representation in tight position of the involved curves, when we follow the curve a'_4 in one of the two possible directions, we meet the curves a'_3 , d'_1 , d'_j , d'_i in this order. Then with this definition, we prove that:

$$d'_1 \leq d'_2 \leq \dots \leq d'_{b+1}.$$

First, notice that the case where Σ' is homeomorphic to $\Sigma_{2,0}$ is trivial for the curves d'_j , $1 \leq j \leq b+1$, would then be equal. Moreover, if $b = 1$, it follows automatically with this definition that $d'_1 \leq d'_2$ and the result is shown. In what follows, we then assume that:

$$b \geq 2 \text{ and } \Sigma' \neq \Sigma_{2,0}. \quad (H2)$$

To show step 9., we proceed as we did in step 8., with the following adaptations. Let us recall that d'_1 and d'_{b+1} cobound a genus-1 surface containing the curves a'_1 , a'_2 and a'_3 according to step 4.. Let i be an integer belonging to $\{1, \dots, b+1\}$. Let us set the following definitions (we refer to Figure 51).

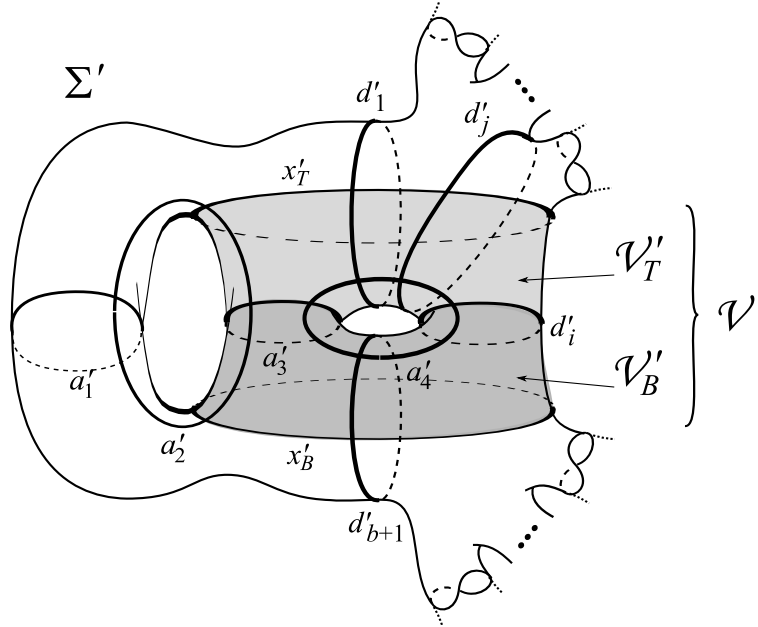

Figure 51: Step 9.: the case $g = 2$.

Let:

- \mathcal{V} (respectively \mathcal{V}') be the compact tubular neighbourhood of the 3-chain (a_3, a_4, d_i) (resp. (a'_3, a'_4, d'_i));
- \mathcal{V}_T and \mathcal{V}_B be the two subsurfaces of \mathcal{V} bounded by the curves a_3 and d_i such that \mathcal{V}_T does not meet d_{b+1} and that \mathcal{V}_B does not meet d_1 ;
- \mathcal{V}'_T and \mathcal{V}'_B be the two subsurfaces of \mathcal{V}' bounded by the curves a'_3 and d'_i such that \mathcal{V}'_T does not meet d'_{b+1} and \mathcal{V}'_B does not meet d'_1 ;

- x_T and x_B be the two boundary components of \mathcal{V} , such that $x_T \subset \partial\mathcal{V}_T$ and $x_B \subset \partial\mathcal{V}_B$;
- x'_T and x'_B be the two boundary components of \mathcal{V}' , such that $x'_T \subset \partial\mathcal{V}'_T$ and $x'_B \subset \partial\mathcal{V}'_B$.

The subsurfaces \mathcal{V}'_T and \mathcal{V}'_B are well-defined, for it is impossible that neither \mathcal{V}'_T , nor \mathcal{V}'_B meets at least one of the curves d'_1 and d'_{b+1} . Indeed, if it happened, the curves d'_1 and d'_{b+1} would be equal to the curve d'_i and the surface Σ' would not have any boundary, which would contradict the hypotheses (H2).

As in 8.b), let us show first that $\ddot{\Psi}(T_{x_T}) = T_{x'_T}$ and $\ddot{\Psi}(T_{x_B}) = T_{x'_B}$. According to the definitions of \mathcal{V}'_T and \mathcal{V}'_B and the remark that we have just made, it follows that one of the two intersections $I(x'_T, d'_1)$ or $I(x'_B, d'_{b+1})$ is nonzero. Hence

$$T_{x'_T} \text{ and } T_{d'_1} \text{ do not commute, or } T_{x'_B} \text{ and } T_{d'_{b+1}} \text{ do not commute.} \quad (17)$$

Now, by definition of x'_T and x'_B , we have:

$$\begin{aligned} T_{x'_B} T_{x'_T} &= (T_{a'_3} T_{a'_3} T_{d'_i})^4 \\ &= (\ddot{\Psi}(T_{a_3}) \ddot{\Psi}(T_{a_3}) \ddot{\Psi}(T_{d_i}))^4 \\ &= \ddot{\Psi}((T_{a_3} T_{a_3} T_{d_i})^4) \\ &= \ddot{\Psi}(T_{x_T} T_{x_B}) \\ &= \ddot{\Psi}(T_{x_T}) \ddot{\Psi}(T_{x_B}), \end{aligned}$$

but x_T and x_B are non-separating curves, so $\ddot{\Psi}(T_{x_T})$ and $\ddot{\Psi}(T_{x_B})$ are some Dehn twists according to step 6., hence the obtained equality above is an equality between multitwists, so according to Lemma 3.12,

$$\{T_{x'_B}, T_{x'_T}\} = \{\ddot{\Psi}(T_{x_B}), \ddot{\Psi}(T_{x_T})\}. \quad (18)$$

Now, by definition of x_B , we have $I(x_B, d_1) = 0$, so T_{x_B} and T_{d_1} commute, so $\ddot{\Psi}(T_{x_B})$ and $T_{d'_1}$ commute. Similarly, $\ddot{\Psi}(T_{x_T})$ and $T_{d'_{b+1}}$ commute. Then, according to (17) and (18), we have:

$$\ddot{\Psi}(T_{x_T}) = T_{x'_T} \text{ and } \ddot{\Psi}(T_{x_B}) = T_{x'_B}. \quad (19)$$

We can then continue the proof of the step 9. as we did in step 8.. Thus, we show that:

- for all $j \in \{1, \dots, b+1\}$, the curve d'_j satisfies exactly one of the three following conditions: $I(d'_j, x'_T) \neq 0$, $I(d'_j, x'_B) \neq 0$, or $d'_j = d'_i$ (cf. 8.c));
- and finally, for all integers $j \in \{1, 2, \dots, i-1\}$, we have $d'_j \leq d'_i$ (cf. 8.d)).

This concludes step 9..

10. *Let us show that $\ddot{\Psi}$ (recall we have supposed it was noncyclic) is induced by an embedding from Σ in Σ' .*

Let $\mathcal{N}(\mathcal{A})$ (respectively $\mathcal{N}(\mathcal{A}')$) be the tubular neighbourhood of the union of the curves of \mathcal{A} (resp. \mathcal{A}') in Σ (resp. Σ'). If the curves d'_j , $1 \leq j \leq b+1$, are pairwise distinct, $\mathcal{N}(\mathcal{A}')$ is well-defined. If there exists $j \in \{1, 2, \dots, b\}$ such that $d'_j = d'_{j+1}$, we can all the same choose a set of representatives of the curves of \mathcal{A}' in tight position, so that when we follow the curve a'_{2g} , we meet the curves d'_j , $1 \leq j \leq b+1$, in the order of their indices. Using this and the results of steps 4., 7. and 8., we conclude that there exists a positive diffeomorphism \bar{F} from $\mathcal{N}(\mathcal{A})$ to $\mathcal{N}(\mathcal{A}')$. We denote by F its isotopy class. This mapping class satisfies the following:

- $F(a_i) = a'_i$, $1 \leq i \leq 2g$,

- $F(e_{2i}) = e'_{2i}$ and $F(f_{2i}) = f'_{2i}$, $2 \leq i \leq g-1$,
- $F(d_i) = d'_i$, $1 \leq i \leq b+1$.

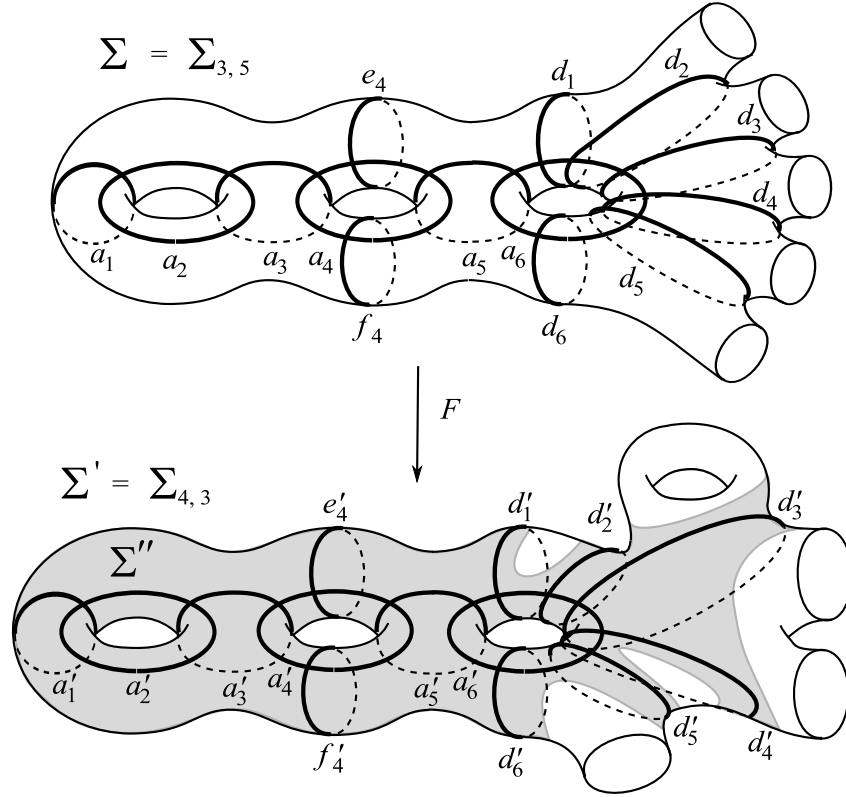

Figure 52: Step 10.: example of the construction of F and of the surface $\Sigma'' = F(\Sigma)$, included in Σ' . We have represented in this example different possibilities:

- $d'_1 \cup d'_2$ bounds an annulus,
- $d'_2 \cup d'_3$ bounds a genus-1 surface,
- $d'_3 \cup d'_4$ bounds a genus-0 surface with 4 boundary components.

Let us call Σ'' the compact tubular neighbourhood of the union of the representatives of the curves a'_i , $i \in \{1, 2, \dots, 2g\}$ and d'_j , $j \in \{2, 3, \dots, b\}$. The surface Σ'' is homeomorphic to Σ and is included in Σ' (cf. Figure 52). Still according to steps 4., 7., 8. and 9., we can extend F on all the open disks of $\Sigma \setminus \mathcal{V}(A)$, so that we obtain a diffeomorphism of Σ in Σ'' that we still call F . Let us compare $\check{\Psi}$ and the morphism $\widetilde{\text{Ad}}_F : \mathcal{M}\text{od}(\Sigma, \partial\Sigma) \rightarrow \mathcal{M}\text{od}(\Sigma', \partial\Sigma')$ (cf. Definition 6.5 for the definition of $\widetilde{\text{Ad}}_F$). Since F is the isotopy class of a positive diffeomorphism, and consequently to what precedes, for any curve $a \in \mathcal{A}$, we have:

$$\check{\Psi}(T_a) = T_{a'} = T_{F(a)} = FT_aF^{-1} = \widetilde{\text{Ad}}_F(T_a).$$

Thus $\check{\Psi}$ and $\widetilde{\text{Ad}}_F$ coincide on $\{T_a, a \in \mathcal{A}\}$. According to Theorem 3.8, such a set span $\mathcal{M}\text{od}(\Sigma, \partial\Sigma)$, so we have the equality:

$$\check{\Psi} = \widetilde{\text{Ad}}_F. \quad (20)$$

11. *End of the proof.*

Let us recall that when Ψ is not cyclic, we had defined $\dot{\Psi} = \Psi \circ \widetilde{\text{Ad}}_V$ at the end of the step 3., where $V \in \{\text{Id}, K\}$. Then just before step 6., except if $W = H$ we had set $\ddot{\Psi} = \dot{\Psi}$. Hence, according to (20), except if $W = H$, we have:

$$\Psi = \widetilde{\text{Ad}}_F \circ \widetilde{\text{Ad}}_{V^{-1}} = \widetilde{\text{Ad}}_{FV^{-1}}.$$

In other words, except if $W = H$, the morphism Ψ is induced by an embedding from Σ in Σ' . When $W = H$, the morphism Ψ is a transvection with direction H of a morphism induced by an embedding from Σ in Σ' (cf. Definition 6.11 for the definition of transvection). This terminates the proof of Theorem 6. The proof of Theorem 5 has been terminated at step 4.f). \square

Let us now focus on the morphisms from $\mathcal{P}\text{Mod}(\Sigma)$ in $\mathcal{P}\text{Mod}(\Sigma')$. In most of the cases, they also can simply be expressed from *morphisms induced by an embedding*. We have first to define this term in the case of the morphisms from $\mathcal{P}\text{Mod}(\Sigma)$ in $\mathcal{P}\text{Mod}(\Sigma')$.

Definition 6.12 (Morphisms from $\mathcal{P}\text{Mod}(\Sigma)$ in $\mathcal{P}\text{Mod}(\Sigma')$ induced by an embedding, and outer conjugations).

Let Σ be a surface $\Sigma_{g,b}$ and Σ' a surface $\Sigma_{g',b'}$ with $g = g'$ and $b \geq b'$. Let F be the isotopy class of an embedding from Σ in Σ' such that F sends the boundary components of Σ on some boundary components of Σ' or on some trivial curves of Σ' (isotopic to a point). We sum up these conditions by:

$$F(\text{Bndy}(\Sigma)) \cap \text{Curv}(\Sigma') = \emptyset. \quad (*)$$

Let us emphasize on the fact that F may not respect the orientations of Σ and Σ' . Let $\Sigma'' = F(\Sigma)$. Let us denote by \bar{F} a representative of F which is then a diffeomorphism from Σ in Σ'' . For all $A \in \mathcal{P}\text{Mod}(\Sigma)$ and all representative $\bar{A} \in \text{Diff}^+(\Sigma)$ of A , the product $\bar{F}\bar{A}\bar{F}^{-1}$ preserves the orientation of Σ'' , so $\bar{F}\bar{A}\bar{F}^{-1}$ belongs to $\text{Diff}^+(\Sigma'')$. Since $g = g'$, $b \geq b'$ and according to (*), the complement of Σ'' in Σ' is a disjoint union of disks. Hence according to Alexander's Lemma, $\bar{F}\bar{A}\bar{F}^{-1}$ induces canonically, and up to isotopy, a diffeomorphism of Σ' . Let us denote by $\text{Ad}_F(A)$ the isotopy class of this diffeomorphism. And since \bar{A} preserves the boundary components of Σ , $\bar{F}\bar{A}\bar{F}^{-1}$ preserves the boundary components of Σ'' . But according to (*), the set of boundary components of Σ' is included in the set of boundary components of Σ'' , so the boundary components of Σ' are preserved by $\text{Ad}_F(A)$. Finally, $\text{Ad}_F(A)$ belongs to $\mathcal{P}\text{Mod}(\Sigma')$. The map Ad_F defined by

$$\text{Ad}_F : \begin{array}{ccc} \mathcal{P}\text{Mod}(\Sigma) & \longrightarrow & \mathcal{P}\text{Mod}(\Sigma') \\ A & \longmapsto & \text{Ad}_F(A) \end{array}$$

is a group morphism. Such a morphism will be called *the morphism from $\mathcal{P}\text{Mod}(\Sigma)$ in $\mathcal{P}\text{Mod}(\Sigma')$ induced by the embedding F* .

When $\Sigma' = \Sigma$, according to (*), we get $\Sigma'' = \Sigma'$, so the isotopy class F is invertible. Hence in this case, F is an element of $\text{Mod}^\circ(\Sigma)$. The obtained morphism Ad_F is then an automorphism of $\mathcal{P}\text{Mod}(\Sigma)$ that we will call the *outer conjugation by F* .

The proof of Theorems 5 and 6 can almost be entirely adapted to the case of the morphisms from $\mathcal{P}\text{Mod}(\Sigma)$ in $\mathcal{P}\text{Mod}(\Sigma')$ where Σ and Σ' satisfy the same hypotheses as in Theorem 6. However, the statements are slightly different. Instead of a complete proof, we only justify these differences.

Theorem 7 (Existence of noncyclic morphisms from $\mathcal{P}\text{Mod}(\Sigma)$ in $\mathcal{P}\text{Mod}(\Sigma')$).

Let Σ be a surface $\Sigma_{g,b}$ and Σ' a surface $\Sigma_{g',b'}$ with $g \geq 2$ and $g' \leq g + 1$.

- When $g = 2$ and only in this case, there exist some cyclic non-trivial morphisms from $\mathcal{P}\text{Mod}(\Sigma_{2,b})$ in any mapping class group that admits a subgroup isomorphic to $\mathbb{Z}/2\mathbb{Z}$, $\mathbb{Z}/5\mathbb{Z}$ or $\mathbb{Z}/10\mathbb{Z}$.
- When $g \geq 2$, there exist some noncyclic morphisms from $\mathcal{P}\text{Mod}(\Sigma)$ in $\mathcal{P}\text{Mod}(\Sigma')$ if and only if $g' = g$ and $b' \leq b$.

According to this statement, studying all noncyclic morphisms from $\mathcal{P}\text{Mod}(\Sigma)$ in $\mathcal{P}\text{Mod}(\Sigma')$ when $g' \leq g + 1$, can be reduced to studying them when $g' = g$ when $g' = g$ and $b' \leq b$. This is the object of Theorem 8 below.

Theorem 8 (Morphisms from $\mathcal{P}\text{Mod}(\Sigma)$ in $\mathcal{P}\text{Mod}(\Sigma')$).

Let Σ be a surface $\Sigma_{g,b}$ and Σ' a surface $\Sigma_{g',b'}$ with $g \geq 2$, $g' = g$ and $b' \leq b$. Let Ψ be a noncyclic morphism from $\mathcal{P}\text{Mod}(\Sigma)$ in $\mathcal{P}\text{Mod}(\Sigma')$. Then there exists an embedding F of Σ in Σ' such that

$$F(\text{Bndy}(\Sigma)) \cap \text{Curv}(\Sigma') = \emptyset$$

and such that Ψ is the morphism Ad_F induced by the embedding F , or possibly the transvection by H of the morphism Ad_F if $g = 2$ and $(g', b') = (2, 0)$.

Proof of Theorems 7 and 8. Let Σ be a surface $\Sigma_{g,b}$ and Σ' a surface $\Sigma_{g',b'}$ with $g \geq 2$ and $g' \leq g + 1$, and such that there exists a morphism $\Psi : \mathcal{P}\text{Mod}(\Sigma) \rightarrow \mathcal{P}\text{Mod}(\Sigma')$. We follow the proof of Theorems 5 and 6. We define the same set of non-separating curves \mathcal{A} that spans $\mathcal{P}\text{Mod}(\Sigma)$ (or $\text{Mod}(\Sigma, \partial\Sigma)$ according to the mapping class group that we consider). We distinguish the case where Ψ sends T_{a_1} and T_{a_2} on the same image, from the one where Ψ differentiates them.

- If $\Psi(T_{a_1}) = \Psi(T_{a_2})$, then the image of Ψ is necessarily cyclic. According to Theorem 6.8, as soon as $g \geq 3$, the abelianization of $\mathcal{P}\text{Mod}(\Sigma)$ is trivial. So no quotient of $\mathcal{P}\text{Mod}(\Sigma)$ can be cyclic except the trivial group, and Ψ has to be trivial. Again according to Theorem 6.8, if $g = 2$, the abelianization of $\mathcal{P}\text{Mod}(\Sigma)$ equals $\mathbb{Z}/10\mathbb{Z}$, hence the morphism Ψ is trivial or possibly cyclic. In this case, its image is isomorphic to $\mathbb{Z}/2\mathbb{Z}$, $\mathbb{Z}/5\mathbb{Z}$ or $\mathbb{Z}/10\mathbb{Z}$, depending on the group $\mathcal{P}\text{Mod}(\Sigma')$.
- If $\Psi(T_{a_1}) \neq \Psi(T_{a_2})$, according to the proofs of Theorems 5 and 6, there exists an embedding from Σ in Σ' (hence $g' \geq g$), that may or may not respect the orientation. Let us denote by F its isotopy class. There exists a mapping class $W \in \mathcal{P}\text{Mod}(\Sigma')$ that preserves each curve $F(a)$, $a \in \mathcal{A}$, and such that for all $a \in \mathcal{A}$, we have:

$$\Psi(T_a) = T_{F(a)} W. \tag{1}$$

Let us make clear that even if W is trivial, we cannot argue that Ψ coincides with Ad_F on a set that span $\text{Mod}(\Sigma)$ and thus conclude that $\Psi = \text{Ad}_F$, for Ad_F is not a well-defined morphism. We first have to show that:

$$F(\text{Bndy}(\Sigma)) \cap \text{Curv}(\Sigma') = \emptyset. \tag{*}$$

From now on, we assume to be in the case where $\Psi(T_{a_1}) \neq \Psi(T_{a_2})$ and hence where (1) holds. We distinguish the cases $b = 0$ and $b \neq 0$.

1. *Case where $b = 0$. Let us show that Σ' must be isomorphic to Σ .*

We repeat the proof that we followed in the proof of Theorems 5 and 6, step 4.. We describe the situation in Figure 53. When $b = 0$, we have:

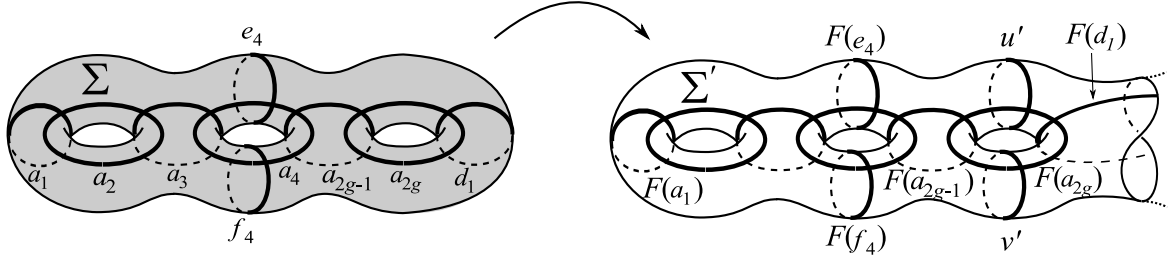

Figure 53: Proof of Theorems 7 and 8, step 1.: case where $b = 0$ and $g = 3$.

$$(T_{a_1} T_{a_2} \dots T_{a_{2g-1}})^{2g} = T_{d_1} T_{d_{b+1}} = T_{d_1}^2.$$

If we compose it by Ψ , we get

$$(T_{F(a_1)} T_{F(a_2)} \dots T_{F(a_{2g-1})})^{2g} W^{(2g-1)2g} = T_{F(d_1)}^2 W^2.$$

Since there exist two curves u' and v' in Σ' such that:

$$(T_{F(a_1)} T_{F(a_2)} \dots T_{F(a_{2g-1})})^{2g} = T_{u'} T_{v'},$$

we then have:

$$T_{u'} T_{v'} = T_{F(d_1)}^2 W^{2-2g(2g-1)}.$$

Hence according to Lemma 3.45, by considering the canonical reduction systems in this last equality, we have:

$$\{u', v'\} \subset \{F(d_1)\} \cup \sigma(W).$$

Let us show that $u' = v' = F(d_1)$. Since $(F(a_1), \dots, F(a_{2g}))$ is a $(2g)$ -chain of curves, the definition of u' and v' implies that $I(u', F(a_{2g})) \neq 0$ and $I(v', F(a_{2g})) \neq 0$ (cf. Figure 53). On the other hand, $I(\sigma(W), F(a_{2g})) = 0$, for W commutes with $T_{F(a_{2g})}$. Therefore $\{u', v'\} \cap \sigma(W) = \emptyset$ and finally $u' = v' = F(d_1)$. Hence Σ' is homeomorphic to $\Sigma_{g,0}$, and hence to Σ .

Thus, when $b = 0$, Theorem 7 is shown. Moreover, since $b' = b = 0$, we have $\mathcal{M}od(\Sigma, \partial\Sigma) = \mathcal{M}od(\Sigma) = \mathcal{P}Mod(\Sigma)$, and the same equalities hold with Σ' , so we can apply Theorem 6. Therefore, when $b = 0$, Theorem 8 is shown.

2. *Case where $b \neq 0$. Let us show that in (1), W is trivial, except if the following holds.*

$$g = 2 \text{ and } (g', b') = (2, 0)$$

If the above assertion holds, then $W \in \{\text{Id}, H\}$.

We distinguish the case depending on the pair (g, b) :

- When $g \geq 3$, the abelianization of $\mathcal{P}Mod(\Sigma)$ is trivial, according to Theorem 6.8. We have seen in step 5.a) of the proof of Theorems 5 and 6 that in this case, W is trivial.
- When $g = 2$ and $b \neq 0$, the abelianization of $\mathcal{P}Mod(\Sigma)$ equals $\mathbb{Z}/10\mathbb{Z}$ and we have seen in step 5.b) of the proof of Theorems 5 and 6 that in this case, W^{10} is trivial. We know also that W fixes the curves $F(a)$ for any curve a in \mathcal{A} . According to step 5.c) of the proof of

Theorems 5 and 6 there does not exist any periodic mapping class in Σ' distinct from the identity that fixes the curves $F(a_1), F(a_2), F(a_3), F(a_4), F(d_1), F(d_{b+1})$ when $g' = 3$ and $b' = 0$. In this proof, everything came from the fact that the curves $F(d_1)$ and $F(d_{b+1})$ were distinct and cobounded a genus-1 surface containing the curves $F(a_1), F(a_2)$ and $F(a_3)$. This fact subsists for all pair (g', b') as long as $g' \geq 2$ and $(g', b') \neq (2, 0)$. Thus, no mapping class, except the identity, can satisfy the conditions fulfilled by W when $g = 2$, $b \neq 0$ and $(g', b') \neq (2, 0)$. On the other hand, when $(g', b') = (2, 0)$, we have seen in step 5.b) of the proof of Theorem 6 that W belongs to $\{\text{Id}, H\}$, where H is the hyper-elliptic involution.

Definition: if $W = \text{Id}$, then we define $\ddot{\Psi}$ as being the morphism Ψ , and if $W = H$, we define $\ddot{\Psi}$ as being the transvection (cf. Definition 6.11) of Ψ with direction H . Notice that W can be equal to H precisely only if $g = 2$ and $(g', b') = (2, 0)$. Under these conditions and since H is central, such a transvection is well-defined.

Notice that according to (1), for any curve $a \in \mathcal{A}$, we get:

$$\ddot{\Psi}(T_a) = T_{F(a)}. \quad (2)$$

3. Case where $b \neq 0$. Let us show that $g' = g$, $b' \leq b$ and that the condition $(*)$ takes place.

Let us set some definitions:

- For any curve x in $\text{Curv}(\Sigma)$ (resp. in $\text{Curv}(\Sigma')$), let us denote by T_x the Dehn twist in $\mathcal{P}\text{Mod}(\Sigma)$ (resp. in $\mathcal{P}\text{Mod}(\Sigma')$) and \tilde{T}_x the Dehn twist in $\text{Mod}(\Sigma, \partial\Sigma)$ (resp. in $\text{Mod}(\Sigma', \partial\Sigma')$).
- Let $\tilde{\Psi}$ be the morphism from $\text{Mod}(\Sigma, \partial\Sigma)$ in $\text{Mod}(\Sigma', \partial\Sigma)$ induced by the isotopy class of the embedding F .
- Let $\text{for}_{\partial\Sigma}$ be the canonical morphism from $\text{Mod}(\Sigma, \partial\Sigma)$ in $\mathcal{P}\text{Mod}(\Sigma)$ and $\text{for}_{\partial\Sigma'}$ the canonical morphism from $\text{Mod}(\Sigma', \partial\Sigma')$ in $\mathcal{P}\text{Mod}(\Sigma')$.

Since the Dehn twists \tilde{T}_a along the curves $a \in \mathcal{A}$ span $\text{Mod}(\Sigma, \partial\Sigma)$ and since for all $a \in \mathcal{A}$, we have $\text{for}_{\partial\Sigma'} \circ \tilde{\Psi}(\tilde{T}_a) = \ddot{\Psi} \circ \text{for}_{\partial\Sigma}(\tilde{T}_a)$, then the following commutative diagram holds:

$$\begin{array}{ccc} \text{Mod}(\Sigma, \partial\Sigma) & \xrightarrow{\text{for}_{\partial\Sigma}} & \mathcal{P}\text{Mod}(\Sigma) \\ \tilde{\Psi} \downarrow & & \downarrow \ddot{\Psi} \\ \text{Mod}(\Sigma', \partial\Sigma') & \xrightarrow{\text{for}_{\partial\Sigma'}} & \mathcal{P}\text{Mod}(\Sigma') \end{array}$$

We are going to use the commutativity of this diagram. Let d be a boundary of Σ . On one hand, we have:

$$\ddot{\Psi} \circ \text{for}_{\partial\Sigma}(\tilde{T}_d) = \ddot{\Psi}(\text{Id}) = \text{Id}. \quad (3)$$

On the other hand, we have:

$$\text{for}_{\partial\Sigma'} \circ \tilde{\Psi}(\tilde{T}_d) = \text{for}_{\partial\Sigma'}(\tilde{T}_{F(d)}) = T_{F(d)}. \quad (4)$$

By commutativity of the diagram, the lines (3) and (4) must be equal, so $T_{F(d)} = \text{Id}$. Hence $F(d)$ is either a trivial curve of Σ' , or a boundary component of Σ' . This is to be true for all boundary components d of Σ , therefore, we have shown that the condition $(*)$ holds. Hence, *a fortiori*, we have: $g' \leq g$ and $b' \leq b$. But the fact that F exists shows that $g' \geq g$ (cf. step 4.b) of the proof of Theorem 6). So $g' = g$ and $b' \leq b$, and step 3. is shown.

Finally, since $g' = g$ and $b' \leq b$, then for any embedding F' satisfying the condition (*), the morphism $\text{Ad}_{F'} : \mathcal{P}\text{Mod}(\Sigma) \rightarrow \mathcal{P}\text{Mod}(\Sigma')$ is well-defined. This terminates the proof of Theorem 7. Furthermore, the assertion (2) shows that all the noncyclic morphisms from $\mathcal{P}\text{Mod}(\Sigma)$ in $\mathcal{P}\text{Mod}(\Sigma')$ are either morphisms induced by an embedding from Σ in Σ' , or transvections of such morphisms when $g = 2$ and $(g', b') = (2, 0)$. Hence Theorem 8 is shown, as well. \square

Injective morphisms between mapping class groups

Among all the morphisms between mapping class groups relatively or not to the boundary, we want to know which are injective. We answer this question in Theorems 9 and 10.

Theorem 9 (Injections from $\text{Mod}(\Sigma, \partial\Sigma)$ in $\text{Mod}(\Sigma', \partial\Sigma')$).

Let Σ be a surface $\Sigma_{g,b}$ and Σ' a surface $\Sigma_{g',b'}$ with $g \geq 2$ and $g' \leq g + 1$. Then, a morphism from $\text{Mod}(\Sigma, \partial\Sigma)$ in $\text{Mod}(\Sigma', \partial\Sigma')$ is injective if and only if:

- when $b \neq 0$: if it is induced, up to transvection when $g = 2$, by an embedding F from Σ in Σ' such that F sends the curves of $\text{Bndy}(\Sigma)$ on some pairwise distinct curves of $\text{Curv}(\Sigma', \partial\Sigma')$;
- when $b = 0$ and $\Sigma' = \Sigma$: if it is not cyclic (it is then an outer conjugation, or possibly a transvection of an outer conjugation when $g = 2$).

Proof. Since the cyclic morphisms are not injective, according to Theorem 6, the only morphisms which may be injective are the morphisms induced by an embedding, and perhaps their transvections when they are defined. First of all, we will consider the morphisms induced by an embedding (including the outer conjugations). Then, we consider the transvections of these morphisms with a non-trivial direction. Let us recall that such transvections exist only if $g = 2$ and $(g', b') = (2, 0)$ and that their direction is H .

1. *Morphisms induced by an embedding.*

When $b \neq 0$, any morphism induced by an embedding F is injective if and only if F sends the curves of $\text{Bndy}(\Sigma)$ on pairwise distinct curves of $\text{Curv}(\Sigma', \partial\Sigma')$ according to Theorem 3.10. When $b = 0$, the outer conjugations are automorphisms, hence are injective.

2. *Transvections of morphisms induced by an embedding*

We consider noncyclic morphisms from $\text{Mod}(\Sigma, \partial\Sigma)$ in $\text{Mod}(\Sigma_{2,0})$, where Σ is of genus 2 with b boundary components, $b \geq 0$. We are going to show that, if $\dot{\Psi}$ is a transvection with direction H of an injective morphism Ψ , then $\dot{\Psi}$ is also injective. Since Ψ can be itself viewed as a transvection with direction H of $\dot{\Psi}$, we will have actually shown that $\dot{\Psi}$ is injective if and only if Ψ is injective. Thus, the injectivity property remains unchanged when we go from a morphism to the transvection with direction H of this morphism. So, according to the first point, Theorem 9 will be then shown.

So, let us show that, in the frame that we have fixed, if $\dot{\Psi}$ is a transvection with direction H of an injective morphism Ψ , then $\dot{\Psi}$ is injective. Since the abelianization of $\text{Mod}(\Sigma, \partial\Sigma)$ is isomorphic to $\mathbb{Z}/10\mathbb{Z}$, and since the conjugacy class of a Dehn twist along a separating curve is sent on 1 according to Theorem 6.8, there exists a morphism $v : \text{Mod}(\Sigma, \partial\Sigma) \rightarrow \mathbb{Z}/2\mathbb{Z}$ that sends any Dehn twist along a non-separating curve on 1, and that sends any product of an even number of such Dehn twists on 0. Let us compute $\text{Ker}(\dot{\Psi})$. Let A be a non-trivial mapping

class of $\mathcal{M}\text{od}(\Sigma, \partial\Sigma)$ such that $\dot{\Psi}(A) = \text{Id}$. Since $\dot{\Psi}$ is a transvection of Ψ with direction H , we have $\dot{\Psi}(A) = \Psi(A)H^{v(A)}$, where $H^{v(A)}$ denote either H if $v(A) = 1$ or Id if $v(A) = 0$. But $\dot{\Psi}(A) = \text{Id}$, so $\Psi(A) = H^{v(A)}$. Since $A \neq \text{Id}$ and since Ψ is injective, it follows that $\Psi(A) \neq \text{Id}$. So $\Psi(A) = H$ and $v(A) = 1$. We are going to show that such a mapping class A cannot exist. Recall the notation defined in the proofs of Theorems 6 and 8 about the curves a_1, a_2, a_3, a_4, d_1 , in $\Sigma = \Sigma_{2,b}$, and $a'_1, a'_2, a'_3, a'_4, d'_1$ in $\Sigma' = \Sigma_{2,0}$. We set:

$$A_0 = T_{d_1}T_{a_4}T_{a_3}T_{a_2}T_{a_1}^2T_{a_2}T_{a_3}T_{a_4}T_{d_1}.$$

Then there exists an integer $\varepsilon \in \{0, 1\}$ such that:

$$\Psi(A_0) = (T_{d'_1}T_{a'_4}T_{a'_3}T_{a'_2}T_{a'_1}^2T_{a'_2}T_{a'_3}T_{a'_4}T_{d'_1}) (H^\varepsilon)^{10}.$$

The first part of this product equals H , whereas the second equals Id , for $H^0 = H^{10} = \text{Id}$. So $\Psi(A_0) = H$. But then for all A_1 such that $\Psi(A_1) = H$, we have $\Psi(A_0A_1) = \text{Id}$. Since Ψ is injective, we have $A_0A_1 = \text{Id}$ in $\mathcal{M}\text{od}(\Sigma, \partial\Sigma)$, so $v(A_0A_1) = 0$, hence $v(A_1) = v(A_0)$, and hence $v(A_1) = 0$. Thus, there does not exist any mapping class $A \in \mathcal{M}\text{od}(\Sigma, \partial\Sigma)$ such that $v(A) = 1$ and $\Psi(A) = H$. Hence $\text{Ker}(\dot{\Psi}) = \{\text{Id}\}$ and $\dot{\Psi}$ is injective. \square

Theorem 10 (Injections from $\mathcal{P}\mathcal{M}\text{od}(\Sigma)$ in $\mathcal{P}\mathcal{M}\text{od}(\Sigma')$).

Let Σ be a surface $\Sigma_{g,b}$ and Σ' a surface $\Sigma_{g',b'}$ with $g \geq 2$ and $g' \leq g + 1$. Then, a morphism from $\mathcal{P}\mathcal{M}\text{od}(\Sigma)$ in $\mathcal{P}\mathcal{M}\text{od}(\Sigma')$ is injective if and only if the two following conditions hold:

- the surfaces Σ and Σ' are homeomorphic,
- the morphism is an outer conjugation (i.e. an automorphism of the form Ad_F with $F \in \text{Mod}^\diamond(\Sigma)$ cf. Definition 6.5), or possibly the transvection with direction H of an outer conjugation when Σ' and Σ are homeomorphic to $\Sigma_{2,0}$.

Proof. When Σ is a surface without boundary, the result is contained in the statement of Theorem 9. When Σ is a surface with a nonempty boundary, the non-trivial morphisms from $\mathcal{P}\mathcal{M}\text{od}(\Sigma)$ in $\mathcal{P}\mathcal{M}\text{od}(\Sigma')$ are induced by some (isotopy classes of) embeddings F satisfying

$$F(\text{Bndy}(\Sigma)) \cap \mathcal{C}\text{urv}(\Sigma') = \emptyset, \quad (*)$$

according to Theorem 8. Let Ψ be an injective morphism from $\mathcal{P}\mathcal{M}\text{od}(\Sigma)$ in $\mathcal{P}\mathcal{M}\text{od}(\Sigma')$ induced by an embedding F . If F sends a curve d of $\text{Bndy}(\Sigma)$ on a contractible curve in Σ' , this would contradict the injectivity of Ψ . Indeed, let us consider a non-separating path in Σ with extremities in d . The tubular neighbourhood in Σ of the union of this path and d is a pair of pants, and d is a boundary component of it. Let us call x and y the two other boundary components, cf. Figure 54. This pair of pants is sent by F on a pair of pants with boundary components

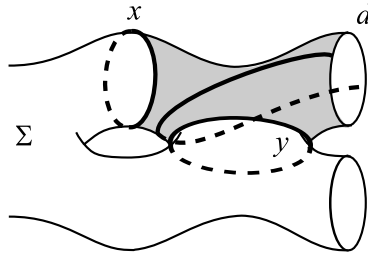

Figure 54: Situation described in the proof of Theorem 10

$\{F(d), F(x), F(y)\}$, but since $F(d)$ is a contractible curve, $F(x)$ and $F(y)$ are the same curve.

Hence $T_{F(x)} = T_{F(y)}$. Thus $\Psi(T_x) = \Psi(T_y)$, although $T_x \neq T_y$. Hence $(*)$ has to be replaced by $F(\text{Bndy}(\Sigma)) \subset \text{Bndy}(\Sigma')$. But $b' \leq b$. Therefore, finally, $(*)$ has to be replaced by:

$$F(\text{Bndy}(\Sigma)) = \text{Bndy}(\Sigma'). \quad (**)$$

This implies that $\Sigma' = \Sigma$ and that F belongs to $\mathcal{M}\text{od}^\diamond(\Sigma)$. \square

6.4 Endomorphisms of the mapping class group

We complete the previous subsection by focusing on the injective endomorphisms of $\mathcal{M}\text{od}(\Sigma, \partial\Sigma)$. In particular, we prove Ivanov and McCarthy's theorem stating that $\mathcal{P}\mathcal{M}\text{od}(\Sigma)$ is co-Hopfian (cf. [IvMc]). In addition, we give a complete proof of $\mathcal{M}\text{od}(\Sigma, \partial\Sigma)$ being co-Hopfian (cf. Theorem 11). We will see that when $b = 0$, the group $\mathcal{M}\text{od}(\Sigma, \partial\Sigma)$ satisfies a much stronger property (cf. item (i) of Theorems 11 and 12). As in the previous subsection, and since the center of $\mathcal{M}\text{od}(\Sigma_{2,0})$ is non-trivial, the case of the surface $\Sigma_{2,0}$ is special, and an independent theorem (cf. Theorem 12) is devoted to it.

Remark. Given two surfaces Σ and Σ' , we have defined in Subsection 6.3 the concept of a morphism from $\mathcal{M}\text{od}(\Sigma, \partial\Sigma)$ in $\mathcal{M}\text{od}(\Sigma', \partial\Sigma')$ induced by the isotopy class F of an embedding from Σ in Σ' , cf. Definition 6.5. When Σ and Σ' are equal, F is not necessarily an isotopic class of a diffeomorphism. However, if this is the case, F belongs to the group $\mathcal{M}\text{od}^\diamond(\Sigma)$.

Theorem 11 (Co-Hopfian property of $\mathcal{M}\text{od}(\Sigma, \partial\Sigma)$ and structure of $\text{Aut}(\mathcal{M}\text{od}(\Sigma, \partial\Sigma))$, where $\Sigma \neq \Sigma_{2,0}$).

Let Σ be a surface $\Sigma_{g,b}$ where $g \geq 2$ and $(g,b) \neq (2,0)$.

- (i) *The mapping class group $\mathcal{M}\text{od}(\Sigma, \partial\Sigma)$ is co-Hopfian, that is, the injective endomorphisms are automorphisms. Moreover, when $b = 0$, all the non-trivial morphisms from $\mathcal{M}\text{od}(\Sigma)$ are automorphisms.*
- (ii) *The map $\text{Ad} : \mathcal{M}\text{od}^\diamond(\Sigma) \rightarrow \text{Aut}(\mathcal{M}\text{od}(\Sigma, \partial\Sigma))$ is an isomorphism.*
- (iii) *The outer automorphism group $\text{Out}(\mathcal{M}\text{od}(\Sigma, \partial\Sigma))$ of $\mathcal{M}\text{od}(\Sigma, \partial\Sigma)$ is isomorphic to the direct product $\mathbb{Z}/2\mathbb{Z} \times \mathfrak{S}_b$, where \mathfrak{S}_b is the symmetric group on b elements.*

Proof.

Let us show item (i).

When $b = 0$ and $g \geq 3$, according to Theorem 9, any non-trivial endomorphism of $\mathcal{M}\text{od}(\Sigma)$ is an outer conjugation, and hence an automorphism.

When $b > 0$ and $g \geq 2$, according to Theorem 9, any injective endomorphism of $\mathcal{M}\text{od}(\Sigma, \partial\Sigma)$ is induced by the isotopy class F of an embedding from Σ in itself and the curves of $\text{Bndy}(\Sigma)$ are sent by F on some pairwise distinct curves of $\mathcal{C}\text{urv}(\Sigma, \partial\Sigma)$. The definition of the complement $(F(\Sigma))^c$ of $F(\Sigma)$ in Σ requires a choice from us: in this proof, for any boundary component of $F(\Sigma)$ that is isotopic to some boundary component of Σ , we will assume that these two boundary components coincide. Thanks to this assumption, $(F(\Sigma))^c$ contains no connected component homeomorphic to a disk or an annulus. Thus, $(F(\Sigma))^c$ is a (possibly empty) union of connected components of negative Euler characteristic. Now, if a curve of $\text{Bndy}(F(\Sigma))$ belongs to $\mathcal{C}\text{urv}(\Sigma)$, then $(F(\Sigma))^c$ is nonempty, hence $\chi(F(\Sigma)) < \chi(\Sigma)$. This would be absurd. Hence $\text{Bndy}(F(\Sigma)) = \text{Bndy}(\Sigma)$, $F(\Sigma) = \Sigma$ and $F \in \mathcal{M}\text{od}^\diamond(\Sigma)$. Therefore, any non-trivial endomorphism of $\mathcal{M}\text{od}(\Sigma)$ is an outer conjugation, hence is an automorphism. This prove item (i).

Let us show item (ii)

We have just shown that any injective endomorphism of $\mathcal{M}\text{od}(\Sigma, \partial\Sigma)$ comes from an outer conjugation by an element of $\mathcal{M}\text{od}^\circ(\Sigma)$, so is an automorphism. Hence the arrow $\text{Ad} : \mathcal{M}\text{od}^\circ(\Sigma) \rightarrow \text{Aut}(\mathcal{M}\text{od}(\Sigma, \partial\Sigma))$ is surjective. Let us now show that the morphism Ad is injective. Let F be in $\mathcal{M}\text{od}^\circ(\Sigma)$ such that Ad_F is the identity of $\text{Aut}(\mathcal{M}\text{od}(\Sigma, \partial\Sigma))$. Let us consider the curves of Figure 55 and set $\mathcal{A} = \{a_1, a_2, \dots, a_{3g-3+b}\}$. Since Ad_F is the identity of

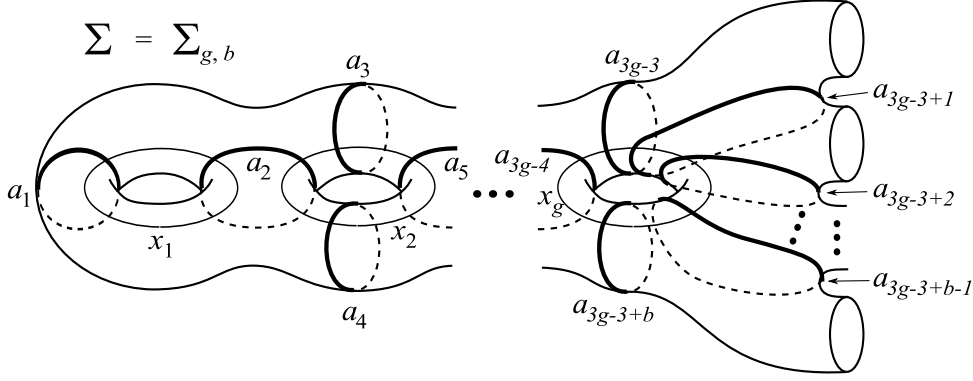

Figure 55: The set of curves $\mathcal{A} = \{a_1, a_2, \dots, a_{3g-3+b}\}$ provides a pants decomposition of Σ .

$\text{Aut}(\mathcal{M}\text{od}(\Sigma, \partial\Sigma))$, Ad_F fixes the Dehn twists along the curves of \mathcal{A} , hence F fixes the curves of \mathcal{A} . Moreover, Ad_F sends the Dehn twists along the curves of \mathcal{A} on themselves instead of their inverses, so F preserves the orientation of Σ . In particular F belongs to $\mathcal{M}\text{od}(\Sigma)$. Moreover, the pants decomposition of Σ by the curves of \mathcal{A} has the following property: if F fixes each curve of \mathcal{A} , then F cannot permute the pairs of pants (notice that the property does not hold in $\Sigma_{2,0}$ but by assumption, Σ is not homeomorphic to $\Sigma_{2,0}$). Hence F induces in $\mathcal{M}\text{od}(\Sigma_{\mathcal{A}})$ a mapping class \widehat{F} that belongs actually to $\mathcal{P}\mathcal{M}\text{od}(\Sigma_{\mathcal{A}})$. Since the mapping class group of a pair of pants whose boundary components are not permuted is trivial, the mapping class \widehat{F} is trivial. Hence F is a multitwist along some curves of \mathcal{A} and $\sigma(F)$ is included in \mathcal{A} . However, Ad_F fixes the Dehn twists along the curves x_1, \dots, x_g , so F fixes these curves. Hence the curves x_1, \dots, x_g are some reduction curves of F , so the essential reduction curves of F cannot intersect these curves. Since each curve of \mathcal{A} intersects one of the curves x_1, \dots, x_g , we conclude that $\sigma(F)$ is empty. Since F is a multitwist, then F has to be trivial. This prove the injectivity of Ad and conclude the proof of item (ii).

Let us show item (iii).

Let us consider the following diagram where \mathcal{M} is the group $\mathcal{M}\text{od}(\Sigma, \partial\Sigma)$, and ε and Act are the following morphisms: for any $G \in \mathcal{M}\text{od}^\circ(\Sigma)$, $\varepsilon(G) = \pm 1$ depending on whether G respects or not the orientation, and $\text{Act}(G)$ is the permutation induced by G on the boundary components of Σ (the group of these permutations is isomorphic to \mathfrak{S}_b , the symmetric group on b elements).

$$\begin{array}{ccccccc}
 1 & \longrightarrow & \mathcal{P}\mathcal{M}\text{od}(\Sigma) & \longrightarrow & \mathcal{M}\text{od}^\circ(\Sigma) & \xrightarrow{(\varepsilon, \text{Act})} & \mathbb{Z}/2\mathbb{Z} \times \mathfrak{S}_b & \longrightarrow & 1 \\
 & & \downarrow \cong & & \downarrow \cong & & \downarrow & & \\
 1 & \longrightarrow & \text{Inn}(\mathcal{M}) & \longrightarrow & \text{Aut}(\mathcal{M}) & \longrightarrow & \text{Out}(\mathcal{M}) & \longrightarrow & 1
 \end{array}$$

The first line is exact by definition of $\mathcal{M}\text{od}^\diamond(\Sigma)$. The second line is exact by definition of $\text{Out}(\mathcal{M})$. The first vertical arrow is an isomorphism for $\text{Inn}(\mathcal{M})$ is isomorphic to the quotient of \mathcal{M} by its center, and this quotient is isomorphic to $\mathcal{P}\mathcal{M}\text{od}(\Sigma)$. The second arrow is an isomorphism according to item (ii) of this theorem. Finally, all the arrows are canonical, so the diagram is commutative. Therefore the third vertical arrow is an isomorphism, too. This prove item (iii) and terminates the proof of this theorem. \square

We turn now to the case of the surface $\Sigma_{2,0}$. The result is very different because of the exceptional non-trivial center of $\mathcal{M}\text{od}(\Sigma_{2,0})$. Indeed, the morphism $\text{Ad} : \mathcal{M}\text{od}^\diamond(\Sigma) \rightarrow \text{Aut}(\mathcal{M}\text{od}(\Sigma_{2,0}))$ is not injective anymore, nor surjective.

Theorem 12 (Co-Hopfian property of $\mathcal{M}\text{od}(\Sigma)$ and structure of $\text{Aut}(\mathcal{M}\text{od}(\Sigma))$, where $\Sigma = \Sigma_{2,0}$, McCarthy⁶ [Mc1]).

Let Σ be the surface $\Sigma_{2,0}$. Let us recall that we denote by H the hyper-elliptic involution of $\mathcal{M}\text{od}(\Sigma)$ (cf. Definition 6.6). Let us denote by ℓ_H the transvection (cf. Definition 6.11) of the identity of $\text{Aut}(\mathcal{M}\text{od}(\Sigma))$ with direction H . Then:

- (i) The mapping class group $\mathcal{M}\text{od}(\Sigma)$ is co-Hopfian. We have even better: all the noncyclic endomorphisms are automorphisms.
- (ii) The morphism ℓ_H of $\mathcal{M}\text{od}(\Sigma)$ is an involution, and any transvection with direction H of an outer conjugation coincides with the (commutative) composition of this outer conjugation with ℓ_H .
- (iii) There exists an orientation reversing involution K of $\mathcal{M}\text{od}^\diamond(\Sigma)$. The group spanned by Ad_K and ℓ_H is isomorphic to $\mathbb{Z}/2\mathbb{Z} \times \mathbb{Z}/2\mathbb{Z}$ and contains only outer automorphisms (except the identity of course).
- (iv) The restriction of the canonical morphism $\text{Aut}(\mathcal{M}\text{od}(\Sigma)) \rightarrow \text{Out}(\mathcal{M}\text{od}(\Sigma))$ to $\langle \text{Ad}_K, \ell_H \rangle$ is an isomorphism. In particular, $\text{Out}(\mathcal{M}\text{od}(\Sigma)) = \mathbb{Z}/2\mathbb{Z} \times \mathbb{Z}/2\mathbb{Z}$.
- (v) The map $\text{Ad} : \mathcal{M}\text{od}^\diamond(\Sigma) \rightarrow \text{Aut}(\mathcal{M}\text{od}(\Sigma))$ has the following kernel and cokernel, given in the following exact sequence:

$$1 \rightarrow \langle H \rangle \rightarrow \mathcal{M}\text{od}^\diamond(\Sigma) \xrightarrow{\text{Ad}} \text{Aut}(\mathcal{M}\text{od}(\Sigma)) \rightarrow \langle \overline{\ell_H} \rangle \rightarrow 1,$$

where $\overline{\ell_H}$ is the image of ℓ_H in the quotient of $\text{Aut}(\mathcal{M}\text{od}(\Sigma))$ by $\text{Ad}(\mathcal{M}\text{od}^\diamond(\Sigma))$.

Proof. Item (i) is an immediate corollary of Theorem 9.

Let us show item (ii).

As in the proof of Theorem 9, let us Define the morphism $v : \mathcal{M}\text{od}(\Sigma) \rightarrow \mathbb{Z}/2\mathbb{Z}$ that sends any Dehn twist along a non-separating curve on 1, and any product of an even number of such Dehn twists on 0. For all $F \in \mathcal{M}\text{od}(\Sigma)$, we have the following (by convention, $H^0 = \text{Id}$ and $H^1 = H$, where 0 and 1 being elements of $\mathbb{Z}/2\mathbb{Z}$):

$$\ell_H(F) = F H^{v(F)}.$$

Let us compute $v(H)$. Since (a_1, x_1, a_2, x_2) is the 4-chain of curves (namely, the one drawn in Figure 56), it follows that $(T_{a_1} T_{x_1} T_{a_2} T_{x_2})^5$ is conjugate to H , hence is equal to H , for H is

⁶In [Mc1], McCarthy shows items (ii) - (v) of this theorem. Item (i) however handles with endomorphisms of $\mathcal{M}\text{od}(\Sigma_{2,0})$. This approach is new.

central. Thus H is equal to a product of 20 Dehn twists along non-separating curves in $\mathcal{M}\text{od}(\Sigma)$, so $v(H) = 0$. Therefore, for all $F \in \mathcal{M}\text{od}(\Sigma)$, we have:

$$\ell_H \circ \ell_H(F) = \ell_H(F H^{v(F)}) = (F H^{v(F)}) H^{v(F H^{v(F)})} = F H^{v(F)} H^{v(F)} = F.$$

Hence ℓ_H is an involution. Moreover, for all $F \in \mathcal{M}\text{od}^\circ(\Sigma)$ and for all $G \in \mathcal{M}\text{od}(\Sigma)$, $FGF^{-1}H = FGHF^{-1}$, hence $\ell_H \circ \text{Ad}_F = \text{Ad}_F \circ \ell_H$. Finally, $\text{Ad}_F \circ \ell_H$ coincides on the Dehn twists along non-separating curves (a set which spans $\mathcal{M}\text{od}(\Sigma)$) with the transvection with direction H of the outer conjugation by F , so this transvection is equal to $\text{Ad}_F \circ \ell_H$. This shows item (ii).

Let us show item (iii).

Let a_1, a_2, a_3, x_1, x_2 be again the five curves in Σ , cf. Figure 56. Let us see the surface Σ as if it was embedded in \mathbb{R}^3 and let us consider the reflection of \mathbb{R}^3 with respect to a plane containing the curves x_1 and x_2 , and intersecting the curves a_1, a_2, a_3 in two points. This reflection reverses the orientation of Σ . Let us denote by K the isotopy class of the restriction of this reflection to Σ : K belongs to $\mathcal{M}\text{od}^\circ(\Sigma)$. The automorphism Ad_K is an outer automorphism of $\mathcal{M}\text{od}(\Sigma)$, for no inner automorphism can send a Dehn twist on the inverse of a Dehn twist. As for the involution ℓ_H , this is also an outer automorphism for it does not send Dehn twists on Dehn twists. Notice that the automorphisms Ad_K and ℓ_H commute for H belongs to the center of $\mathcal{M}\text{od}^\circ(\Sigma)$; notice also that the product $\text{Ad}_K \circ \ell_H$ is an outer automorphism by the same argument.

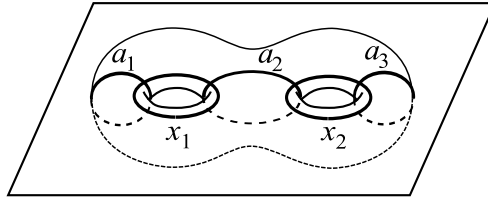

Figure 56: The surface Σ , the curves a_1, a_2, a_3, x_1, x_2 , and the plane containing the curves x_1 and x_2 .

Let us show item (iv).

According to Theorems 6 and 8, the automorphisms of $\mathcal{M}\text{od}(\Sigma)$ are transvections of an outer conjugation with direction Id or H . Hence for any automorphism of $\mathcal{M}\text{od}(\Sigma)$, even if it means composing it adequately with Ad_K and/or with ℓ_H , we get a inner automorphism. Hence the classes of Ad_K and ℓ_H in $\text{Out}(\mathcal{M}\text{od}(\Sigma))$ span $\text{Out}(\mathcal{M}\text{od}(\Sigma))$. Since Ad_K and ℓ_H are outer and cannot be obtained one from the other by any composition by some inner automorphisms, then $\text{Out}(\mathcal{M}\text{od}(\Sigma))$ is not cyclic. Finally, they are involutions that commute, so $\text{Out}(\mathcal{M}\text{od}(\Sigma))$ is isomorphic to $\mathbb{Z}/2\mathbb{Z} \times \mathbb{Z}/2\mathbb{Z}$.

Let us show the part (v).

First, the outer conjugations are automorphisms, hence Ad is a morphism from $\mathcal{M}\text{od}^\circ(\Sigma)$ to $\text{Aut}(\mathcal{M}\text{od}(\Sigma))$. Let us compute the kernel of Ad . Let us come back to the proof of Theorem 11. If an element $F \in \mathcal{M}\text{od}^\circ(\Sigma)$ satisfies $\text{Ad}_F = \text{Id}$ in $\text{Aut}(\mathcal{M}\text{od}(\Sigma))$, then F fixes the curves a_1, a_2, a_3 , and so preserves the pants decomposition of Σ along the curves a_1, a_2, a_3 , even if it means permuting the two pairs of pants in this decomposition, cf. Figure 56. Using the fact that F has to fix the curves x_1 and x_2 , we deduce from it by the same type of argument as in the proof of Theorem 11 that the kernel of Ad is included in $\{\text{Id}, H\}$. Conversely, Ad_{Id} and Ad_H coincide with the identity of $\text{Aut}(\mathcal{M}\text{od}(\Sigma))$. Hence $\text{Ker}(\text{Ad}) = \{\text{Id}, H\}$. Let us compute now the cokernel of Ad . We have seen that any automorphism of $\mathcal{M}\text{od}(\Sigma)$ is the product of an

outer conjugation with Id or with ℓ_H . Since ℓ_H is not an outer conjugation, the cokernel of Ad is isomorphic to $\mathbb{Z}/2\mathbb{Z}$ and is spanned by the image of ℓ_H . \square

Remark. (Comparison between $\text{Aut}(\mathcal{B}_n)$ and $\text{Aut}(\text{Mod}(\Sigma_{2,0}))$).

In the case of the group $\text{Mod}(\Sigma_{2,0})$, the noncyclic endomorphisms are automorphisms. This does not hold with noncyclic endomorphism of \mathcal{B}_n . This comes from the fact that in the case of $\text{Mod}(\Sigma_{2,0})$, the center is contained in the torsion, so the transvections of automorphisms are still automorphisms. On the other hand, in \mathcal{B}_n where the center is infinite, the transvections with non-trivial direction of automorphisms in \mathcal{B}_n are not surjective.

III. Proof of the main theorem 1

In this third part, we prove Theorem 1. The proof ends in Section 13. Actually, Theorem 1 will be a corollary of Theorem 12.2, which seems to be weaker, as it handles only the geometric representations of \mathcal{B}_n when n is even:

Theorem 12.2 (Morphisms from \mathcal{B}_n in $\mathcal{PMod}(\Sigma)$, $n \geq 6$, n even).

Let n be an even integer greater than or equal to 6 and Σ a surface $\Sigma_{g,b}$ with $g \leq \frac{n}{2}$. Then any morphism ρ from \mathcal{B}_n in $\mathcal{PMod}(\Sigma)$ is either cyclic, or a transvection of monodromy morphism. In this case, there exist:

- a $(n-1)$ -chain of curves $(a_i)_{1 \leq i \leq n-1}$,
- an integer $\varepsilon \in \{\pm 1\}$,
- a mapping class V commuting with T_{a_i} for any $i \leq n-1$,

such that for any integer $i \in \{1, \dots, n-1\}$, we have:

$$\rho(\tau_i) = T_{a_i}^\varepsilon V.$$

All our efforts in the upcoming sections until Section 12 will aim to prove Theorem 12.2.

Notation:

Throughout Part III, we adopt the following notation. The two first will be recalled at the beginning of each section:

- n is an even integer greater than or equal to 6,
 g and b are nonnegative integers such that $2 - 2g - b \leq -1$ and $2g \leq n$,
- ρ is a given morphism from \mathcal{B}_n in $\mathcal{PMod}(\Sigma_{g,b})$,
 from Section 9 on, we will assume that ρ is in addition noncyclic,
- τ_i where $i \in \{0, 1, \dots, n-1\}$ is the i^{th} standard generator of \mathcal{B}_n ; when the indice i satisfies $i < 0$ or $i > n-1$, τ_i is the j^{th} standard generator of \mathcal{B}_n where j is the remainder of the euclidian division of i by n ;
 we denote by $\text{Gen}_{\mathcal{B}_n}$ the set $\{\tau_0, \tau_1, \dots, \tau_{n-1}\}$;
 for all integers i and j , we denote by $|i-j|_n$ the integer $\min(\{|i-j+kn|, k \in \mathbb{Z}\})$,
- for all integers i , $\rho(\tau_i)$ will be denoted by A_i ;
 we denote by \mathcal{G} the set $\{A_0, A_1, \dots, A_{n-1}\}$;
 we denote by $\text{Imp}(n)$ the $\frac{n}{2}$ first odd integers $\{1, 3, \dots, n-1\}$ and we denote by \mathcal{X} the following set of mapping classes: $\{A_i, i \in \text{Imp}(n)\}$.
- $\sigma(\mathcal{G})$ is by definition the union $\bigcup_{i \leq n-1} \sigma(A_i)$ and $\sigma(\mathcal{X})$ is by definition the union $\bigcup_{i \in \text{Imp}(n-1)} \sigma(A_i)$.

Outline of the proof of Theorems 12.2 and 1:

Section 7:

A curve a of $\sigma(\mathcal{G})$ is a *peripheral curve* if a is a separating curve with the following property: one of the connected components of Σ_a is of genus 0. Let $\sigma_p(\mathcal{G})$ be the set of *peripheral curves*. We show that up to transvection, we can assume that $\sigma_p(\mathcal{G})$ is empty, which is a first way to simplify the study of $\sigma(\mathcal{G})$. From Section 8 on, we will assume that $\sigma_p(\mathcal{G})$ is empty. We also show in Section 7 that in many cases, we can assume without loss of generality that Σ is a surface without boundary.

Section 8:

We show that, although $\sigma_p(\mathcal{G})$ is assumed to be empty, if ρ is not cyclic, then $\sigma(\mathcal{G})$ is nonempty. From Section 9 on, we will assume that ρ is not cyclic, so that $\sigma(\mathcal{G})$ is nonempty.

Section 9:

We prove that there exists a partition of $\sigma(\mathcal{G})$ in two sets of curves: $\sigma_s(\mathcal{G})$ and $\sigma_n(\mathcal{G})$, both of them satisfying each interesting properties. For instance, for any curve a of $\sigma_s(\mathcal{G})$, there exists a unique $i \in \{0, 1, \dots, n-1\}$ such that $a \in \sigma(A_i)$. As for the set of curves $\sigma_n(\mathcal{G})$, it is stable by the action of \mathcal{B}_n induced by ρ on $\mathcal{C}urv(\Sigma)$.

Section 10:

We show that $\sigma(\mathcal{G})$ contains only non-separating curves.

Section 11:

We describe the set of curves $\sigma(\mathcal{X})$ in the surface Σ , where $\mathcal{X} = \{A_i, i \in \{1, 3, 5, \dots, n-1\}\}$.

Section 12:

We gather the results of the previous sections and we show that ρ is a transvection of monodromy morphism: Theorem 12.2 is shown.

Section 13:

We extend Theorem 12.2 to the case where n is an odd integer greater than or equal to 7. Thus, we prove Theorem 1.

Section 14:

We discuss about the hypotheses of Theorem 1. We state some conjectures and we present some surprising examples when the hypotheses are not satisfied.

7 Morphisms from \mathcal{B}_n in the mapping class group of a holed sphere; peripheral curves

This section is divided into two subsections:

- In Subsection 7.1, we are interested by morphisms from the braid group in the mapping class group of genus-0 surfaces. We will show the following:

Theorem 7.1 (Morphisms from \mathcal{B}_n in $\text{Mod}(\Sigma_{0,b}, \partial\Sigma_{0,b})$ and in $\mathcal{P}\text{Mod}(\Sigma_{0,b})$).

Let Σ be a genus-0 surface. For all integers n greater than or equal to 3, any morphism from \mathcal{B}_n in $\text{Mod}(\Sigma, \partial\Sigma)$, respectively in $\mathcal{P}\text{Mod}(\Sigma)$, is cyclic.

- In Subsection 7.2, we are interested by morphisms from the braid group to the mapping class group of a surface of genus $g \geq 1$ with $b \geq 2$ boundary components. Given such a morphism ρ , we focus on some curves related to ρ which will be called *peripheral curves*.

Definition 7.2 (Peripheral curves, $\sigma_p(\mathcal{G})$).

A curve of $\sigma(\mathcal{G})$ is said to be *peripheral* if it separates Σ in two connected components and one of them is of genus zero. The set of peripheral curves is denoted by $\sigma_p(\mathcal{G})$. For all $A \in \mathcal{G}$, we denote by $\sigma_p(A)$ the set $\sigma_p(\mathcal{G}) \cap \sigma(A)$.

As a corollary of Theorem 7.1, we will show that peripheral curves are fixed by the action of \mathcal{B}_n on $\text{Curv}(\Sigma)$ via ρ :

Proposition 7.3 (Stability of peripheral curves).

- (i) *We have the equalities: $\sigma_p(A_0) = \sigma_p(A_1) = \dots = \sigma_p(A_{n-1}) = \sigma_p(\mathcal{G})$.*
- (ii) *The group $\rho(\mathcal{B}_n)$ is included in $\mathcal{P}_{\sigma_p(\mathcal{G})}\text{Mod}(\Sigma)$ (the subgroup of $\mathcal{P}\text{Mod}(\Sigma)$ that fixes each curve of $\sigma_p(\mathcal{G})$ and that preserves each subsurface of $\text{Sub}_{\sigma_p(\mathcal{G})}(\Sigma)$).*

This will help to simplify the study of ρ , for we can cut the surface along the peripheral curves and the morphism ρ respect this cut (see Proposition 7.4):

Proposition 7.4 (Killing the peripheral curves).

Let Σ' be the connected component of nonzero genus of $\Sigma_{\sigma_p(\mathcal{G})}$. Then:

- (i) *For all $\xi \in \mathcal{B}_n$, $\rho(\xi)$ induced a mapping class in $\mathcal{P}\text{Mod}(\Sigma')$ that we denote by $\rho'(\xi)$. The obtained map $\rho' : \mathcal{B}_n \rightarrow \mathcal{P}\text{Mod}(\Sigma')$ is a morphism.*
- (ii) *The morphisms ρ and ρ' are of the same nature: one is cyclic (respectively is a transvection of monodromy morphism) if and only if the other is.*

As a corollary, we show that in some case, everything happens as if Σ was a surface without boundary (see Proposition 7.5).

Proposition 7.5. *Let \mathcal{A} be a curve simplex and \mathcal{K} a subgroup of $\mathcal{P}\text{Mod}(\Sigma)$ such that \mathcal{A} is \mathcal{K} -stable and such that the cardinality of any curve orbit in \mathcal{A} under the action of \mathcal{K} is at least 3. Then the canonical surjective continuous map $\text{sq} : \Sigma \rightarrow \Sigma_{g,0}$ (see Definition 7.10) induces an isomorphism between the graphs $\Gamma(\Sigma, \mathcal{A})$ and $\Gamma(\Sigma_{g,0}, \text{sq}(\mathcal{A}))$. In particular, the cardinality of $\text{Sub}_{\mathcal{A}}(\Sigma)$ is smaller than or equal to $2g - 2$, and the cardinality of \mathcal{A} is smaller than or equal to $3g - 3$. Moreover, if we denote by $\text{sq}^* : \mathcal{P}\text{Mod}(\Sigma) \rightarrow \text{Mod}(\Sigma_{g,0})$ the epimorphism induced by sq , we have the following: for any mapping class $F \in \mathcal{K}$, for any curve $a \in \mathcal{A}$ and for any subsurface $S \in \text{Sub}_{\mathcal{A}}(\Sigma)$, we have:*

$$\begin{aligned}\text{sq}(F(a)) &= \text{sq}^*(F)(\text{sq}(a)), \\ \text{sq}(F(S)) &= \text{sq}^*(F)(\text{sq}(S)).\end{aligned}$$

7.1 Morphisms from \mathcal{B}_n in the mapping class group of a genus-0 surface

We will show that the morphisms from \mathcal{B}_n ($n \geq 3$) in the mapping class group of a genus-0 surface (whose boundary components are not permuted) are cyclic. For this purpose, we are going to use the fact that some mapping class groups are *bi-orderable*.

Definition 7.6 (Bi-orderable group). A group G is *bi-orderable* if there exists a linear ordering \leq on G invariant by left and right multiplications (namely, if $f \leq g$, then $h_1 f h_2 \leq h_1 g h_2$ for all $f, g, h_1, h_2 \in G$). In what follows, we will denote by \leq the ordering of all the bi-orderable groups that we are going to meet, and by $<$ the strict order associated to \leq .

Proposition 7.7. *Any morphism from \mathcal{B}_n in a bi-orderable group is cyclic.*

Proof. Let G be an orderable group and let φ be a morphism from \mathcal{B}_n in G . Let us assume that $\varphi(\tau_1) < \varphi(\tau_2)$. Let γ be the element $\tau_1 \tau_2 \tau_1$. Then $\varphi(\gamma \tau_1 \gamma^{-1}) < \varphi(\gamma \tau_2 \gamma^{-1})$. Since $\gamma \tau_1 \gamma^{-1} = \tau_2$ and $\gamma \tau_2 \gamma^{-1} = \tau_1$ we have $\varphi(\tau_2) < \varphi(\tau_1)$, which is absurd. In the same way, assuming that $\varphi(\tau_2) < \varphi(\tau_1)$ leads to a contradiction. Hence $\varphi(\tau_1) = \varphi(\tau_2)$, so φ is cyclic. \square

Thanks to Proposition 7.8 below, we will be able to apply Proposition 7.7 to the mapping class groups and so prove Theorem 7.1.

Proposition 7.8 (Bonatti, Paris). *For any genus-0 surface Σ , the mapping class group $\text{Mod}(\Sigma, \partial\Sigma)$ is bi-orderable.* \square

As a corollary, we get:

Theorem 7.1 (Morphisms from \mathcal{B}_n in $\text{Mod}(\Sigma_{0,b}, \partial\Sigma_{0,b})$ and in $\mathcal{P}\text{Mod}(\Sigma_{0,b})$.)

Let Σ be a genus-0 surface. For all integers n greater than or equal to 3, any morphism from \mathcal{B}_n in $\text{Mod}(\Sigma, \partial\Sigma)$, respectively in $\mathcal{P}\text{Mod}(\Sigma)$, is cyclic.

Proof. Any morphism from \mathcal{B}_n in $\text{Mod}(\Sigma, \partial\Sigma)$ is cyclic, for according to Proposition 7.8, $\text{Mod}(\Sigma, \partial\Sigma)$ is bi-orderable. As for the morphisms from \mathcal{B}_n in $\mathcal{P}\text{Mod}(\Sigma)$, according to Proposition 5.12, they can be lifted in morphisms from \mathcal{B}_n in $\text{Mod}(\Sigma, \partial\Sigma)$, which are cyclic. Hence again, according to Proposition 5.12, the morphisms from \mathcal{B}_n in $\mathcal{P}\text{Mod}(\Sigma)$ are cyclic. \square

7.2 Peripheral curves

In this subsection, we are going to prove the propositions 7.3, 7.4 and 7.5. The two last propositions will be some consequences of the first one. Moreover, Proposition 7.5 utilizes Theorem 7.1.

Let n be an integer greater than or equal to 6, let Σ be a surface $\Sigma_{g,b}$ where $g \geq 1$ and $b \geq 2$. Let ρ be a morphism from \mathcal{B}_n in $\mathcal{PMod}(\Sigma)$. Recall Definition 7.2:

Definition 7.2 (Peripheral curves, $\sigma_p(\mathcal{G})$).

A curve a of $\sigma(\mathcal{G})$ is said to be *peripheral* if it separates Σ in two connected components and if the genus of one of them is zero (cf. Figure 57). The set of peripheral curves will be denoted by $\sigma_p(\mathcal{G})$. We will denote by $\sigma_p(A)$ the set of curves $\sigma_p(\mathcal{G}) \cap \sigma(A)$.

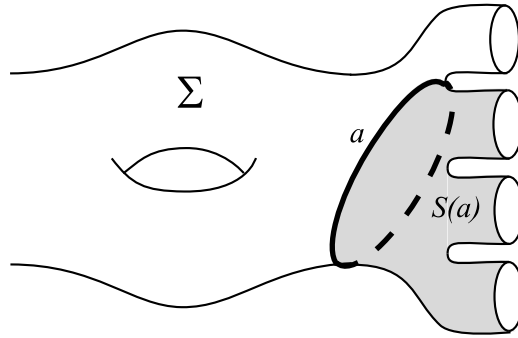

Figure 57: Example of peripheral curve.

Proposition 7.3 (Stability of the peripheral curves).

- (i) We have the equalities: $\sigma_p(A_0) = \sigma_p(A_1) = \dots = \sigma_p(A_{n-1}) = \sigma_p(\mathcal{G})$.
- (ii) The group $\rho(\mathcal{B}_n)$ is included in $\mathcal{P}_{\sigma_p(\mathcal{G})}\text{Mod}(\Sigma)$ (the subgroup of $\mathcal{PMod}(\Sigma)$ that fixes each curve of $\sigma_p(\mathcal{G})$ and that preserves each subsurface of $\text{Sub}_{\sigma_p(\mathcal{G})}(\Sigma)$).

Lemma 7.9. For any peripheral curve x and any mapping class F such that $I(F(x), x) = 0$, F fixes the curve x and does not swap its two side-neighbourhoods.

Proof of Lemma 7.9. Let S be the holed sphere bounded by x . Since $I(F(x), x) = 0$, if $F(x)$ is distinct from x , then either $F(x)$ is in S and $F(S)$ is included in S , or $F(x)$ is outside of S and S is included in $F(S)$ (recall that $\text{Bndy}(F(S)) \cap \text{Bndy}(\Sigma) = \text{Bndy}(S) \cap \text{Bndy}(\Sigma)$ for F belongs to $\mathcal{PMod}(\Sigma)$). Since S and $F(S)$ are homeomorphic, these two hypotheses are absurd. Finally, $F(x) = x$. Moreover, S and $F(S)$ are located on the same side of x , so F does not swap the two side-neighbourhoods of x . \square

Proof of Proposition 7.3.

(i) Let A and C be two mapping classes of \mathcal{G} that commute, x a curve of $\sigma_p(A)$ and Z a mapping class such that $ZAZ^{-1} = C$. Then $Z(x) \in \sigma_p(C)$, and since $AC = CA$, we have $I(\sigma(A), \sigma(C)) = 0$, so $I(x, Z(x)) = 0$. Now, according to Lemma 7.9 which we apply to the curve x and the mapping class Z , we get $Z(x) = x$, and hence $x \in \sigma(C)$. This shows that for

all $i, j \in \{0, 1, \dots, n-1\}$ such that $|i-j|_n > 1$, we have $\sigma_p(A_i) = \sigma_p(A_j)$. We then easily can deduce that

$$\sigma_p(A_0) = \sigma_p(A_1) = \dots = \sigma_p(A_{n-1}) = \sigma_p(\mathcal{G}).$$

(ii) For all $x \in \sigma_p(\mathcal{G})$, all $A \in \mathcal{G}$, we have just seen that $x \in \sigma(A)$, so $I(x, A(x)) = 0$, hence according to Lemma 7.9, $A(x) = x$ and A does not swap the two connected components of Σ_x . Hence A belongs to $\mathcal{P}_x\text{Mod}(\Sigma)$. Since \mathcal{G} span $\rho(\mathcal{B}_n)$, this proves the second part of Proposition 7.3. \square

Proposition 7.4 (Killing the peripheral curves).

Let Σ' be the connected component of nonzero genus of $\Sigma_{\sigma_p(\mathcal{G})}$. Then:

- (i) *For any $\xi \in \mathcal{B}_n$, the mapping class $\rho(\xi)$ of $\mathcal{P}\text{Mod}(\Sigma)$ induces a mapping class in $\mathcal{P}\text{Mod}(\Sigma')$ that we denote by $\rho'(\xi)$. The obtained map $\rho' : \mathcal{B}_n \rightarrow \mathcal{P}\text{Mod}(\Sigma')$ is a morphism.*
- (ii) *The morphisms ρ and ρ' are of the same nature: one is cyclic (respectively is a transvection of monodromy morphism) if and only if the other is.*

Proof.

(i) Let Σ' be the connected component of nonzero genus of $\Sigma_{\sigma_p(\mathcal{G})}$ and let \mathcal{U} be the subset of curves of $\sigma_p(\mathcal{G})$ that bound the subsurface of Σ isomorphic to Σ' . According to Proposition 7.3 on the stability of the peripheral curves, $\rho(\mathcal{B}_n)$ is included in $\mathcal{P}_{\mathcal{U}}\text{Mod}(\Sigma)$. Let us denote by π' the morphism from $\mathcal{P}\text{Mod}(\Sigma_{\mathcal{U}})$ in $\mathcal{P}\text{Mod}(\Sigma')$. Then $\rho' = \pi' \circ \text{cut}_{\mathcal{U}} \circ \rho$, so ρ' is indeed a morphism.

(ii) According to Proposition 5.12, there exists a lift $\tilde{\rho}'$ of ρ' in $\text{Hom}(\mathcal{B}_n, \text{Mod}(\Sigma', \partial\Sigma'))$, which is of the same nature as ρ' . For all $\xi \in \mathcal{B}_n$, if we extend the mapping class $\tilde{\rho}'(\xi)$ by the identity on Σ , and if we then postcompose it by the morphism $\text{sq}_{\partial\Sigma} : \text{Mod}(\Sigma, \partial\Sigma) \rightarrow \mathcal{P}\text{Mod}(\Sigma)$, we get a morphism ρ_1 from \mathcal{B}_n in $\mathcal{P}\text{Mod}(\Sigma)$ such that $\pi' \circ \text{cut}_{\mathcal{U}} \circ \rho_1 = \rho'$. By construction, ρ_1 is of the same nature as ρ' .

Let Σ'' be the union of the subsurfaces of $\text{Sub}_{\mathcal{U}}(\Sigma)$ distinct from Σ' . Let us denote by π'' the morphism from $\mathcal{P}\text{Mod}(\Sigma_{\mathcal{U}})$ in $\mathcal{P}\text{Mod}(\Sigma'')$. According to Theorem 7.1, $\pi'' \circ \text{cut}_{\mathcal{U}} \circ \rho$ is a cyclic morphism. Let W the mapping class $\pi'' \circ \text{cut}_{\mathcal{U}} \circ \rho(\tau_1)$ of $\mathcal{P}\text{Mod}(\Sigma'')$ and \widetilde{W} the mapping class $\rho(\tau_1)(\rho_1(\tau_1))^{-1}$ of $\mathcal{P}\text{Mod}(\Sigma, \Sigma')$. Notice that \widetilde{W} induces W on $\mathcal{P}\text{Mod}(\Sigma'')$. Let ρ_2 the transvection of ρ_1 with direction \widetilde{W} (i.e. for all integers i in $\{1, 2, \dots, n-1\}$, we have $\rho_2(\tau_i) = \rho_1(\tau_i)\widetilde{W}$). Notice that ρ_2 and ρ_1 are of the same nature, so ρ_2 and ρ' are of the same nature.

On the other hand, we have the following central exact sequence:

$$1 \rightarrow \langle T_u, u \in \mathcal{U} \rangle \rightarrow \mathcal{P}_{\mathcal{U}}\text{Mod}(\Sigma) \xrightarrow{\text{cut}_{\mathcal{U}}} \mathcal{P}\text{Mod}(\Sigma_{\mathcal{U}}) \rightarrow 1.$$

Since $\text{cut}_{\mathcal{U}} \circ \rho_2 = \text{cut}_{\mathcal{U}} \circ \rho$, it comes that, according to Lemma 5.8, ρ_2 is a transvection of ρ , hence ρ_2 and ρ are of the same nature.

Finally, ρ' and ρ are of the same nature. \square

Definition 7.10 (The “squeeze map” of a surface with a nonempty boundary).

Starting from the surface $\Sigma_{g,b}$ with $b > 0$, let $\Sigma_{g,0}$ be the surface without boundary obtained from $\Sigma_{g,b}$ by squeezing each boundary component to a point. We get a surface which exceptionally can be a sphere or a torus. There is a canonical surjective continuous map from $\Sigma_{g,b}$ to $\Sigma_{g,0}$

that we will denote by $\text{sq} : \Sigma_{g,b} \rightarrow \Sigma_{g,0}$. The map sq induces a canonical morphism between mapping class groups that we denote by:

$$\text{sq}^* : \mathcal{P}\text{Mod}(\Sigma_{g,b}) \rightarrow \mathcal{M}\text{od}(\Sigma_{g,0}).$$

Proposition 7.5. *Let \mathcal{A} be a curve simplex and \mathcal{K} a subgroup of $\mathcal{P}\text{Mod}(\Sigma)$ such that \mathcal{A} is \mathcal{K} -stable and such that the cardinality of any curve orbit in \mathcal{A} under the action of \mathcal{K} is at least 3. Then the map $\text{sq} : \Sigma \rightarrow \Sigma_{g,0}$ induces a graph isomorphism from the graph $\Gamma(\Sigma, \mathcal{A})$ (cf. Definition 2.23) to the graph $\Gamma(\Sigma_{g,0}, \text{sq}(\mathcal{A}))$. In particular, the cardinality of $\mathcal{S}\text{ub}_{\mathcal{A}}(\Sigma)$ is smaller than or equal to $2g - 2$, and the cardinality of \mathcal{A} is smaller than or equal to $3g - 3$. Moreover, for any mapping class $F \in \mathcal{K}$, for any curve $a \in \mathcal{A}$ and any subsurface $S \in \mathcal{S}\text{ub}_{\mathcal{A}}(\Sigma)$, we have:*

$$\begin{aligned} \text{sq}(F(a)) &= \text{sq}^*(F)(\text{sq}(a)), \\ \text{sq}(F(S)) &= \text{sq}^*(F)(\text{sq}(S)). \end{aligned}$$

(see Definition 7.10 for a description of sq and sq^*).

Proof.

1. Let us show that no subsurface of $\mathcal{S}\text{ub}_{\mathcal{A}}(\Sigma)$ can be sent by sq on a sphere minus one or two disks. Hence no curve of \mathcal{A} is sent on a contractible curve by sq , and for any two curves of \mathcal{A} , they cannot be sent on the same isotopy class in Σ' . Once we have shown this, we have shown that the sets \mathcal{A} and $\text{sq}(\mathcal{A})$ of curves have the same cardinality.

a) By assumption, the set \mathcal{A} does not contain any fixed point under the action of \mathcal{K} . Hence \mathcal{A} does not contain any peripheral curve, according to Lemma 7.9. Hence no subsurface of $\mathcal{S}\text{ub}_{\mathcal{A}}(\Sigma)$ can be sent by sq on a sphere minus a disk. Hence no curve of \mathcal{A} is sent on a contractible curve.

b) Let us show that no subsurface of $\mathcal{S}\text{ub}_{\mathcal{A}}(\Sigma)$ can be sent by sq on a sphere minus two disks, which is equivalent to say that for any two curves of \mathcal{A} , they cannot be sent on the same isotopy class in Σ' . If there did exist two distinct curves a and a' of \mathcal{A} such that $\text{sq}(a) = \text{sq}(a')$, then it would exist in $\mathcal{S}\text{ub}_{\mathcal{A}}(\Sigma)$ a genus-0 subsurface S whose boundary would consists in some natural boundary components and exactly two inner boundary components: a and a' , (see Definition 2.19 for the definition of *inner boundary components*). But any mapping class of $\mathcal{P}\text{Mod}(\Sigma)$ which globally preserves \mathcal{A} should preserve the surface S , since S contains some natural boundary components, and hence should preserve the pair $\{a, a'\}$. This is in contradiction with our hypotheses, since the cardinality of the orbit of a under the action of \mathcal{K} must be greater than or equal to 3.

According to a) and b), the cardinalities of the sets \mathcal{A} and $\text{sq}(\mathcal{A})$ are equal.

2. Since \mathcal{A} and $\text{sq}(\mathcal{A})$ have the same cardinality, the map sq induces a graph isomorphism Ψ from the graph $\Gamma(\Sigma, \mathcal{A})$ to the graph $\Gamma(\Sigma_{g,0}, \text{sq}(\mathcal{A}))$. Moreover, as the map sq and the morphism sq^* are canonical, the action of \mathcal{K} on $\Gamma(\Sigma, \mathcal{A})$ induces an action of $\text{sq}^*(\mathcal{K})$ on $\Gamma(\Sigma_{g,0}, \text{sq}(\mathcal{A}))$ and the expected commutation properties hold. \square

8 Irreducible morphisms from \mathcal{B}_n in $\mathcal{PMod}(\Sigma)$ with $n \geq 6$

In this section and the followings, n is an even integer greater than or equal to 6, Σ is a surface $\Sigma_{g,b}$ where $g \leq \frac{n}{2}$ and $b \geq 0$ and ρ is a morphism from \mathcal{B}_n in $\mathcal{PMod}(\Sigma)$ such that $\sigma_p(\mathcal{G}) = \emptyset$.

To prove Theorem 12.2, the idea is to prove first that up to an element in the centralizer of \mathcal{G} , the elements of \mathcal{G} are Dehn Twists. In this purpose, focusing on $\sigma(\mathcal{G})$ will be efficient, but we first need to prove that $\sigma(\mathcal{G})$ is not empty! This is precisely the aim of this section. We argue by contradiction. We assume that $\sigma(\mathcal{G})$ is empty (we say that ρ is *irreducible*) and we prove that ρ is then cyclic (cf. Theorem 8.2). Let us recall some basic facts on cyclic morphisms.

Recall on cyclic morphisms. (cf. Definition 5.1 and Lemmas 5.2 and 5.3)

Let n be an integer greater than or equal to 5 and φ a morphism from \mathcal{B}_n in any group.

- (i) The morphism φ is said to be *cyclic* if we have: $\varphi(\tau_1) = \varphi(\tau_2) = \dots = \varphi(\tau_{n-1}) = \varphi(\tau_0)$.
- (ii) If there exist two distinct integers i and j in $\{0, 1, \dots, n-1\}$ such that $\varphi(\tau_i) = \varphi(\tau_j)$, then the morphism φ is cyclic.
- (iii) If the image of φ is an abelian group, the morphism φ is cyclic.

Definition 8.1 (Irreducible morphisms, periodic morphisms, pseudo-Anosov morphisms).

We will say that ρ is an *irreducible morphism from \mathcal{B}_n* if $\rho(\tau_1)$ is an irreducible mapping class (equivalently, if $\sigma(\rho(\tau_1)) = \emptyset$). If $\rho(\tau_1)$ is periodic (respectively pseudo-Anosov), we will say that ρ is *periodic* (respectively *pseudo-Anosov*).

Let us recall that in \mathcal{B}_n , the standard generators are conjugate, so they are all reducible, all periodic or all pseudo-Anosov. Moreover, the assertions $\sigma(\rho(\tau_1)) = \emptyset$ and $\sigma(\mathcal{G}) = \emptyset$ are equivalent. According to Definition 8.1, the key theorem of this section is Theorem 8.2:

Theorem 8.2. *Any irreducible morphism from \mathcal{B}_n in $\mathcal{PMod}(\Sigma)$ is cyclic.*

We will distinguish the case of the periodic morphisms (cf. propositions 8.8 and 8.9) from the one of the pseudo-Anosov morphisms (cf. Proposition 8.11). The proof of this theorem is short when Σ has a nonempty boundary but the involved methods are inefficient when the boundary of Σ is empty. When $\partial\Sigma = \emptyset$, we argue by contradiction: we assume that ρ is not cyclic, we exhibit a finite subgroup of $\rho(\mathcal{B}_n)$ and we show that its cardinality exceeds the theoretical maximal cardinality of a finite subgroup of $\mathcal{Mod}(\Sigma)$.

In the first subsection, we present some results on the relations in $\rho(\mathcal{B}_n)$, which will be useful to fix a lower bound to the cardinality of some subgroups of $\rho(\mathcal{B}_n)$. The second and third subsections (8.2 and 8.3) are devoted to the proof of Theorem 8.2 in the case of the periodic morphisms and of the pseudo-Anosov morphisms, respectively.

8.1 Cardinalities of some abelian subgroups of $\rho(\mathcal{B}_n)$

Notation 8.3.

- Let φ be a morphism from \mathcal{B}_n in some group. For any element ξ in \mathcal{B}_n , we write $\bar{\xi}$ instead of $\varphi(\xi)$.
- For all even positive integers positif N , let us denote by $\text{Imp}(N) = \{1, 3, \dots, N-1\}$ the set of odd positive integers smaller than N . Let r be the integer $\frac{n}{2}$. Thus $\text{Imp}(n)$ contains the r first odd positive integers.
- Let \mathcal{L}_n be the free abelian subgroup $\langle \tau_i, i \in \text{Imp}(n) \rangle_{\mathcal{B}_n}$ of \mathcal{B}_n .

The group \mathcal{L}_n is isomorphic to \mathbb{Z}^r . The aim of this subsection is to study the algebraic structure of the abelian group $\varphi(\mathcal{L}_n)$, that is to say to study the structure of the quotients of \mathcal{L}_n , cf. Lemma 8.5, and then to compute the cardinality of $\varphi(\mathcal{L}_n)$, cf. Lemma 8.7. Let us begin by stating an elementary case.

Lemma 8.4. *If there exist two distinct integers i and j smaller than or equal to $n-1$ and a nonzero integer ℓ such that $\bar{\tau}_i^\ell = \bar{\tau}_j^\ell$, then we have:*

$$\bar{\tau}_1^\ell = \bar{\tau}_2^\ell = \dots = \bar{\tau}_{n-1}^\ell.$$

Proof. Let us distinguish the cases whether $|i-j|_n$ is equal to 1 or greater than 1.

1. Let us assume that $|i-j|_n = 1$, for example $j = i+1$. Then, by conjugating the equality $\bar{\tau}_i^\ell = \bar{\tau}_{i+1}^\ell$ by the k^{th} power of $\bar{\delta}$, where $k \in \{0, 1, \dots, n-1\}$, we get: $\bar{\tau}_k^\ell = \bar{\tau}_{k+1}^\ell$. Whence the conclusion.

2. Let us assume that $|i-j|_n \geq 2$. Since $n \geq 6$, there exists $\varepsilon \in \{\pm 1\}$ such that $|i-(j+\varepsilon)|_n \geq 2$. Hence:

$$(\bar{\tau}_j \bar{\tau}_{j+\varepsilon} \bar{\tau}_j) \bar{\tau}_i (\bar{\tau}_j \bar{\tau}_{j+\varepsilon} \bar{\tau}_j)^{-1} = \bar{\tau}_i \quad \text{and} \quad (\bar{\tau}_j \bar{\tau}_{j+\varepsilon} \bar{\tau}_j) \bar{\tau}_j (\bar{\tau}_j \bar{\tau}_{j+\varepsilon} \bar{\tau}_j)^{-1} = \bar{\tau}_{j+\varepsilon}.$$

Then $\bar{\tau}_i^\ell = \bar{\tau}_j^\ell$ implies $\bar{\tau}_i^\ell = \bar{\tau}_{j+\varepsilon}^\ell$, whence $\bar{\tau}_j^\ell = \bar{\tau}_{j+\varepsilon}^\ell$, and we are back to the preceding case. \square

Lemma 8.5. *There exist four nonnegative integers M, m, d, s such that the group $\varphi(\mathcal{L}_n)$ is isomorphic to the quotient of \mathcal{L}_n by the three following relations:*

$$\tau_1^M = \tau_3^M = \dots = \tau_{n-1}^M = 1, \quad \text{R1}(M)$$

$$\tau_1^m = \tau_3^m = \dots = \tau_{n-1}^m, \quad \text{R2}(m)$$

$$(\tau_1 \tau_3 \dots \tau_{2r-1})^d = \tau_1^s. \quad \text{R3}(d, s)$$

When M is nonzero, m and d are also nonzero and the integers M, m, d, s satisfy the following divisibility relations:

- m divides M ;
- d divides m and m divides s ;
- M divides $(r - \frac{s}{d})m$;

Finally, $d = 1$ if and only if φ is cyclic (that is to say if $m = 1$).

Remark. In the following subsection, we will apply this lemma to the image of ρ where ρ will be a morphism from \mathcal{B}_n in a mapping class group. The integer M will be then the order of $\rho(\tau_1)$ and the integer m will be the order of $\rho(\tau_1\tau_3^{-1})$.

Proof.

0. Before starting, notice that if we choose $M = m = d = s = 0$, the quotient of \mathcal{L}_n by $(R1(0), R2(0), R3(0, 0))$ is equal to \mathcal{L}_n .

1. Let us show that any relation that holds in $\varphi(\mathcal{L}_n)$ is equivalent to a set of relations of type R1, R2 and R3.

Since \mathcal{L}_n is abelian, any relation in $\varphi(\mathcal{L}_n)$ can be written as follows:

$$\bar{\tau}_1^{k_1} \bar{\tau}_3^{k_3} \dots \bar{\tau}_{n-1}^{k_{n-1}} = 1, \quad (1)$$

where the k_i , $i \in \text{Imp}(n)$, are not all zero. We are going to show that relation (1) is equivalent to a set of relations of type R1(M), R2(m), R3(d, s) where M, m, d, s are some integers. We distinguish three cases: a), b) and c) below.

a) If the k_i are all equal, (1) is exactly the relation R3($k_1, 0$).

b) Suppose now that the k_i are not all equal. Let us consider the differences $|k_i - k_j|$, $i, j \in \text{Imp}(n)$. They are not all zero. Let us assume for example that $k_1 - k_3 \neq 0$. Then after having conjugated (1) by $\bar{\tau}_1 \bar{\tau}_2 \bar{\tau}_1 \bar{\tau}_3 \bar{\tau}_2 \bar{\tau}_1$, we get:

$$\bar{\tau}_3^{k_1} \bar{\tau}_1^{k_3} (\bar{\tau}_5^{k_5} \dots \bar{\tau}_{n-1}^{k_{n-1}}) = 1. \quad (2)$$

Now, if we compare (1) and (2), we have:

$$\bar{\tau}_1^{k_1} \bar{\tau}_3^{k_3} = \bar{\tau}_3^{k_1} \bar{\tau}_1^{k_3}, \quad (3)$$

whence $\bar{\tau}_1^{k_1 - k_3} = \bar{\tau}_3^{k_1 - k_3}$, and hence, according to Lemma 8.4:

$$\bar{\tau}_1^{|k_1 - k_3|} = \bar{\tau}_2^{|k_1 - k_3|} = \dots = \bar{\tau}_{n-1}^{|k_1 - k_3|}. \quad (4)$$

We repeat this argument for all the pairs $(i, j) \in \text{Imp}(n)^2$, $i \neq j$. Let p be the greatest common divisor of $\{|k_i - k_j|, i, j \in \text{Imp}(n)\}$. We get relation (5), which is equal to R2(p):

$$\bar{\tau}_1^p = \bar{\tau}_2^p = \dots = \bar{\tau}_{n-1}^p. \quad (5)$$

For all $i \in \text{Imp}(n)$, the euclidian division of k_i by p provides two integers q_i and k'_i such that

$$k_i = q_i p + k'_i \text{ where } 0 \leq k'_i < p.$$

Since the k_i , $i \in \text{Imp}(n)$, differ one from the other by a multiple of p , the k'_i , $i \in \text{Imp}(n)$, are all equal. Let us call k' this integer. Thanks to relation (5), relation (1) implies:

$$\bar{\tau}_1^{k'} \bar{\tau}_3^{k'} \dots \bar{\tau}_{n-1}^{k'} = \bar{\tau}_1^{(-p \sum q_i)}. \quad (6)$$

In $\varphi(\mathcal{L}_n)$, relation (6) is equivalent to R1($-p \sum q_i$) if $k' = 0$, and is equivalent to R3($k', -p \sum q_i$) if $k' \neq 0$. Hence if the k_i are not all equal, then relation (1) implies R2(p) and R1($-p \sum q_i$), or R2(p) and R3($k', -p \sum q_i$). And conversely, the set of the relations R2(p) and R1($-p \sum q_i$) implies relation (1), as does the set of the relations R2(p) and R3($k', -p \sum q_i$).

Finally, any relation in $\varphi(\mathcal{L}_n)$ is equivalent to a set of relations of type R1, R2 and R3. This terminates the proof of step 1..

2. Let us now show that there exist four integers M, m, d, s such that $\varphi(\mathcal{L}_n)$ is isomorphic to the quotient of \mathcal{L}_n by the three relations R1(M), R2(m) and R3(d, s).

Let us define M, m, d, s as follows:

$$E_1 = \{k \in \mathbb{N}^* \mid \bar{\tau}_1^k = 1\} \text{ and } M = \begin{cases} \min(E_1) & \text{if } E_1 \neq \emptyset \\ 0 & \text{if } E_1 = \emptyset, \end{cases}$$

$$E_2 = \{ k \in \mathbb{N}^* \mid \bar{\tau}_1^k = \bar{\tau}_3^k \} \text{ and } m = \begin{cases} \min(E_2) & \text{if } E_2 \neq \emptyset \\ 0 & \text{if } E_2 = \emptyset, \end{cases}$$

$$E_3 = \{ k \in \mathbb{N}^* \mid (\bar{\tau}_1 \bar{\tau}_3 \dots \bar{\tau}_{n-1})^k \in \langle \bar{\tau}_1 \rangle \} \text{ and } d = \begin{cases} \min(E_3) & \text{if } E_3 \neq \emptyset \\ 0 & \text{if } E_3 = \emptyset, \end{cases}$$

$$s \text{ is chosen arbitrarily in } \{ k \in \mathbb{N}^* \mid (\bar{\tau}_1 \bar{\tau}_3 \dots \bar{\tau}_{n-1})^d = \bar{\tau}_1^k \}.$$

Then by definition of M , m , d and s , the three relations $R1(M)$, $R2(m)$ and $R3(d,s)$ hold in $\varphi(\mathcal{L}_n)$. According to step 1., any relation like (1) comes from some relations of type $R1(M)$, $M \in \mathbb{Z}$, $R2(m)$, $m \in \mathbb{Z}$ and $R3(d,s)$, $d, s \in \mathbb{Z}$, that take place in $\varphi(\mathcal{L}_n)$. Let us then show that any relation R of type $R1$, $R2$ or $R3$ that holds in $\varphi(\mathcal{L}_n)$ comes from the three relations $R1(M)$, $R2(m)$ and $R3(d,s)$.

- If R is of type $R1$: Let M' be a nonzero integer such that the relation $R1(M')$ is satisfied in $\varphi(\mathcal{L}_n)$. Then E_1 is nonempty, hence M is nonzero. Notice that the union of both relations $R1(M)$ and $R1(M')$ is equivalent to the relation $R1(M \wedge M')$, where $a \wedge b$ is the greatest common divisor of a and b . However, by definition of M , we have $M \leq M \wedge M'$, so $M = M \wedge M'$, hence M divides M' . Consequently, $R1(M)$ implies $R1(M')$.
- If R is of type $R2$: Similarly, any relation of type $R2(m')$ where m' is a nonzero integer is induced by $R2(m)$.
- If R is of type $R3$: If there exist two nonzero integers d' and s' with $d' \neq 0$ such that $R3(d', s')$ takes place in $\varphi(\mathcal{L}_n)$, then E_3 is nonempty. So d is nonzero and the conjunction of $R3(d', s')$ and $R3(d, s)$ induces $R3(kd' + \ell d, ks' + \ell s)$, for all integers k and ℓ . Let us choose k and ℓ such that $kd' + \ell d = d' \wedge d$. By definition of d , we have $d \leq (d' \wedge d)$, so $d = (d' \wedge d)$ and d divides d' . Let p be the integer d'/d . We have:

$$\begin{cases} R3(d, s) \\ R3(d', s') \end{cases} \iff \begin{cases} R3(d, s) \\ R3(pd, ps) \\ R3(pd, s') \end{cases} \iff \begin{cases} R3(d, s) \\ R3(pd, ps) \\ R1(|ps - s'|) \end{cases} \iff \begin{cases} R3(d, s) \\ R1(|ps - s'|) \end{cases}$$

Again, the definition of M implies that $|ps - s'|$ is a multiple of M . Hence $R3(d', s')$ comes from the three relations $R1(M)$, $R2(m)$ and $R3(d,s)$.

3. Let M , m , d and s be the integers defined in step 2.. According to step 2., $\varphi(\mathcal{L}_n)$ is isomorphic to the group \mathcal{L}_n quotiented by the three relations $R1(M)$, $R2(m)$, and $R3(d,s)$. Let us show that if M is nonzero, then m and d are also nonzero. Then let us determine the divisibility relations that link these four integers.

- If M is nonzero, then $R1(M)$ implies $R2(M)$ and $R3(M,0)$, so by definition of m and d , we have that m and d are nonzero.
- Since $R1(M)$ implies $R2(M)$, the relations $R2(M)$ and $R2(m)$ coexist in $\varphi(\mathcal{L}_n)$, so $R2(M \wedge m)$ is satisfied, too. Then, by definition of m , m is smaller than or equal to $M \wedge m$, so we have $m = M \wedge m$. Hence m divides M .
- Similarly, the relation $R2(m)$ implies $R3(m,rm)$. Now, $R3(m,rm)$ and $R3(d, s)$ imply a third relation $R3(u, v)$ where $u = m \wedge d$, and v is an integer determined by r, m, d and s . But by definition of d , d is smaller than or equal to u . Hence d divides m .

- As for the integer s in $R3(d, s)$, we have seen in step 1. that $R3(d, s)$ implies $R2(s)$, so m divides s .
- We still have to show that M divides $(r - \frac{s}{d})m$. Let us start from the relation $R3(d, s)$ in which we remplace $\bar{\tau}_1^s$ by $\bar{\tau}_1^{kd}$ where $k = \frac{s}{d}$. We get:

$$[(\bar{\tau}_1 \bar{\tau}_3 \bar{\tau}_5 \dots \bar{\tau}_{n-1}) \bar{\tau}_1^{-k}]^d = 1, \quad (7)$$

then:

$$[(\bar{\tau}_3 \bar{\tau}_1^{-1})(\bar{\tau}_5 \bar{\tau}_1^{-1}) \dots (\bar{\tau}_{n-1} \bar{\tau}_1^{-1}) \bar{\tau}_1^{(r-k)}]^d = 1. \quad (8)$$

Since m is a multiple of d , we get:

$$[(\bar{\tau}_3 \bar{\tau}_1^{-1})(\bar{\tau}_5 \bar{\tau}_1^{-1}) \dots (\bar{\tau}_{n-1} \bar{\tau}_1^{-1}) \bar{\tau}_1^{(r-k)}]^m = 1. \quad (9)$$

Now, according to $R2(m)$, for all $i \in \text{Imp}(n) \setminus \{1\}$, we have $(\bar{\tau}_i \bar{\tau}_1^{-1})^m = 1$. Hence (9) implies:

$$\bar{\tau}_1^{(r-k)m} = 1.$$

In other words, $R1((r-k)m)$ takes place in $\varphi(\mathcal{L}_n)$. Then, as before, we deduce from definition of M that M divides $(r-k)m$.

4. Let us show that φ is cyclic if and only if $d = 1$.

If φ is cyclic, then $R2(1)$ holds, and so does $R3(1, r)$. Conversely, if $d = 1$, let us show that $m = 1$. Let ξ be the element τ_1^s . If $d = 1$, we have:

$$\bar{\tau}_1 \bar{\tau}_3 \bar{\tau}_5 \dots \bar{\tau}_{n-1} = \bar{\xi}, \quad (10)$$

whence:

$$\bar{\tau}_1^{-1} \bar{\tau}_3^{-1} = \bar{\tau}_5 \dots \bar{\tau}_{n-1} \bar{\xi}^{-1}. \quad (11)$$

Since $\bar{\xi} = \bar{\tau}_1^s$ and m divides s , then $\bar{\xi}$ is a multiple of $\bar{\tau}_1^m$. But according to the relation $R2(m)$ and Lemma 8.4, we have $\bar{\tau}_1^m = \bar{\tau}_2^m = \dots = \bar{\tau}_{n-1}^m$, so $\bar{\tau}_1^m$ is central in $\varphi(\mathcal{B}_n)$, so $\bar{\xi}$ is central in $\varphi(\mathcal{B}_n)$. According to equality (11), it follows that $\bar{\tau}_2$ commutes with the right hand side, hence $\bar{\tau}_2$ commutes with the left hand side. So we get:

$$\bar{\tau}_2 \bar{\tau}_1^{-1} \bar{\tau}_3^{-1} = \bar{\tau}_1^{-1} \bar{\tau}_3^{-1} \bar{\tau}_2,$$

whence

$$\bar{\tau}_1 \bar{\tau}_2 \bar{\tau}_1^{-1} = \bar{\tau}_3^{-1} \bar{\tau}_2 \bar{\tau}_3,$$

but

$$\bar{\tau}_3^{-1} \bar{\tau}_2 \bar{\tau}_3 = \bar{\tau}_2 \bar{\tau}_3 \bar{\tau}_2^{-1},$$

so

$$\bar{\tau}_1 \bar{\tau}_2 \bar{\tau}_1^{-1} = \bar{\tau}_2 \bar{\tau}_3 \bar{\tau}_2^{-1},$$

and by conjugating by $\bar{\delta}$:

$$\bar{\tau}_2 \bar{\tau}_3 \bar{\tau}_2^{-1} = \bar{\tau}_3 \bar{\tau}_4 \bar{\tau}_3^{-1},$$

whence

$$\bar{\tau}_1 \bar{\tau}_2 \bar{\tau}_1^{-1} = \bar{\tau}_3 \bar{\tau}_4 \bar{\tau}_3^{-1},$$

then

$$\bar{\tau}_2 = (\bar{\tau}_1 \bar{\tau}_2 \bar{\tau}_1^{-1}) \bar{\tau}_1 (\bar{\tau}_1 \bar{\tau}_2 \bar{\tau}_1^{-1})^{-1} = (\bar{\tau}_3 \bar{\tau}_4 \bar{\tau}_3^{-1}) \bar{\tau}_1 (\bar{\tau}_3 \bar{\tau}_4 \bar{\tau}_3^{-1})^{-1} = \bar{\tau}_1,$$

so $\bar{\tau}_2 = \bar{\tau}_1$. Hence φ is cyclic. \square

Definition 8.6 ($\mathcal{L}_n(M, m, d, s)$).

For all quadruples of integers (M, m, d, s) , as soon as this definition makes sens (i.e. when m is a multiple of d and M is a multiple of m , according to Lemma 8.5), let us denote by $\mathcal{L}_n(M, m, d, s)$ the group $\langle \tau_i, i \in \text{Imp}(n) \rangle$ quotiented by the relations $(R1(M))$, $(R2(m))$, $(R3(d, s))$. For example, $\mathcal{L}_n(0, 0, 0, 0) \cong \mathbb{Z}^r$ and $\mathcal{L}_n(M, M, M, rM) \cong (\mathbb{Z}/M\mathbb{Z})^r$.

Lemma 8.7 (Cardinality of $\mathcal{L}_n(M, m, d, s)$).

For all $M > 0$, $m \geq 2$, d and s , the cardinality of $\mathcal{L}_n(M, m, d, s)$ is equal to qdm^{r-1} where $q = \frac{M}{m}$ and $r = \frac{n}{2}$.

Proof. The group $\mathcal{L}_n(0, 0, 0, 0)$ is spanned by:

$$\tau_1, \tau_3, \tau_5, \dots, \tau_{n-3}, \tau_{n-1}. \quad (1)$$

Let us set $u_i = \tau_i \tau_1^{-1}$ for all $i \in \text{Imp}(n) \setminus \{1\}$. We set $k = \frac{s}{d}$ (k is an integer for, according to Lemma 8.5, d divides m which divides s). Then we set $w = (u_3 u_5 \dots u_{n-3} u_{n-1}) \tau_1^{(r-k)}$. Thanks to a change of variables, we go from the set (1) spanning $\mathcal{L}_n(0, 0, 0, 0)$ to the below set (2) still spanning $\mathcal{L}_n(0, 0, 0, 0)$:

$$\tau_1, u_3, u_5, \dots, u_{n-3}, w. \quad (2)$$

With this change of variables, the relation $R1(M)$ is now equivalent to:

$$\tau_1^M = 1, u_3^M = 1, u_5^M = 1, \dots, u_{n-3}^M = 1, w^M = 1. \quad (3)$$

Let us denote by $\xi \mapsto \bar{\xi}$ the canonical morphism from $\mathcal{L}_n(0, 0, 0, 0)$ in $\mathcal{L}_n(M, M, M, rM)$, which is the quotient of $\mathcal{L}_n(0, 0, 0, 0)$ by $R1(M)$. According to Lemma 8.5, M divides $(r - k)m$, so in $\mathcal{L}_n(M, M, M, rM)$, we have:

$$\bar{w}^m = (\bar{u}_3 \bar{u}_5 \dots \bar{u}_{n-3} \bar{u}_{n-1})^m \bar{\tau}_1^{(r-k)m} = (\bar{u}_3 \bar{u}_5 \dots \bar{u}_{n-3} \bar{u}_{n-1})^m.$$

Hence the relation $R2(m)$ in $\mathcal{L}_n(M, M, M, rM)$ is equivalent to:

$$\bar{u}_3^m = 1, \bar{u}_5^m = 1, \dots, \bar{u}_{n-3}^m = 1, \bar{w}^m = 1. \quad (4)$$

Finally, in $\mathcal{L}_n(M, M, M, rM)$, the relation $R3(d, s)$ is: $(\bar{\tau}_1 \bar{\tau}_3 \dots \bar{\tau}_{n-1})^d = \bar{\tau}_1^s$. Let us replace τ_1^s by τ_1^{kd} , the relation $R3(d, s)$ is equivalent to $[(\tau_1 \bar{\tau}_3 \bar{\tau}_5 \dots \bar{\tau}_{n-1}) \tau_1^{-k}]^d = 1$, and then to

$$[(\bar{\tau}_3 \bar{\tau}_1^{-1})(\bar{\tau}_5 \bar{\tau}_1^{-1}) \dots (\bar{\tau}_{n-1} \bar{\tau}_1^{-1}) \bar{\tau}_1^{(r-k)}]^d = 1,$$

so the relation $R3(d, s)$ in $\mathcal{L}_n(M, M, M, rM)$ is equivalent to:

$$\bar{w}^d = 1. \quad (5)$$

Finally, since m divides M and since d divides m , the set of relations $R1(M)$, $R3(m)$ and $R3(d, s)$ is equivalent in $\mathcal{L}_n(0, 0, 0, 0)$ to:

$$\tau_1^M = 1, u_3^m = 1, u_5^m = 1, \dots, u_{n-3}^m = 1, w^d = 1. \quad (6)$$

Therefore a presentation by generators and relations of the group $\mathcal{L}_n(M, m, d, s)$ can be obtained from the lines (2) and (6). Therefore $\mathcal{L}_n(M, m, d, s)$ is isomorphic to $\mathbb{Z}/M\mathbb{Z} \times (\mathbb{Z}/m\mathbb{Z})^{r-2} \times \mathbb{Z}/d\mathbb{Z}$. So its cardinality is $Mm^{r-2}d = qdm^{r-1}$ where $q = \frac{M}{m}$. \square

8.2 Periodic morphisms from \mathcal{B}_n in $\mathcal{PMod}(\Sigma_{g,b})$, $b \geq 0$

In the first proposition, we deal with the case where the boundary of Σ is non-trivial ($\Sigma = \Sigma_{g,b}$ with $b > 0$). The remainder of this subsection is devoted to the case without boundary ($b = 0$), which is harder. For all morphisms ρ from \mathcal{B}_n in $\mathcal{PMod}(\Sigma)$ and for all $i \leq n - 1$, we denote by A_i the mapping class $\rho(\tau_i)$.

Proposition 8.8 (The periodic morphisms from \mathcal{B}_n in $\mathcal{PMod}(\Sigma_{g,b})$, $b > 0$, are cyclic).
Any periodic morphism ρ from \mathcal{B}_n in $\mathcal{PMod}(\Sigma_{g,b})$ where $g \leq \frac{n}{2}$ and $b > 0$ is cyclic.

Proof. Let ρ be a periodic morphism from \mathcal{B}_n in $\mathcal{PMod}(\Sigma)$. Notice that the mapping classes A_i for all $i \leq n - 1$ are conjugate. So they are periodic and have the same order. Let us call m this order.

Since the boundary of Σ is nonempty, according to Lemma 3.19, A_1 and A_4 span a cyclic group that we denote by Γ . Any generator of Γ is a product of powers of A_1 and A_4 , so Γ is a cyclic group of order m . Now, the subgroups of Γ spanned on one hand by A_1 and on the other hand by A_4 have the same order m , so each of A_1 and A_4 spans independently Γ . Thus, in \mathcal{G} , any two standard generators that commute span the same cyclic group. Hence A_2 span the same cyclic group as A_4 , that is, the same cyclic group as A_1 . In particular A_2 and A_1 commute. But A_2 and A_1 satisfy a braid relation, so they have to be equal. Then, according to Lemma 5.2, ρ is cyclic. \square

Proposition 8.9 (The periodic morphisms from \mathcal{B}_n in $\mathcal{Mod}(\Sigma_{g,0})$ are cyclic).
Let n be an integer greater than or equal to 6 and Σ the surface $\Sigma_{g,0}$ such that $g \leq \frac{n}{2}$. Any periodic morphism ρ from \mathcal{B}_n in $\mathcal{Mod}(\Sigma)$ is cyclic.

Let us recall a classic lemma in the finite group theory:

Lemma 8.10. *For all integers n greater than or equal to 5, the only quotients of \mathfrak{S}_n are $\{1\}$, $\mathbb{Z}/2\mathbb{Z}$ and \mathfrak{S}_n .*

Proof. Let Q be a quotient group of \mathfrak{S}_n by a normal subgroup N . Since N is normal in \mathfrak{S}_n , $N \cap \mathfrak{A}_n$ is normal in the alternating group on n letters \mathfrak{A}_n . But \mathfrak{A}_n is simple, so $N \cap \mathfrak{A}_n$ is one of the two groups $\{1\}$ or \mathfrak{A}_n . Then if $N \cap \mathfrak{A}_n = \mathfrak{A}_n$, we have $N \in \{\mathfrak{A}_n, \mathfrak{S}_n\}$, and then $Q \in \{\mathbb{Z}/2\mathbb{Z}, \{1\}\}$. And if $N \cap \mathfrak{A}_n = \{1\}$, then $N = \{1\}$ as we will see it, so $Q = \mathfrak{S}_n$.

Assume that $N \cap \mathfrak{A}_n = \{1\}$. The kernel of the restriction to N of the signature $\varepsilon : \mathfrak{S}_n \rightarrow \{\pm 1\}$ is $N \cap \mathfrak{A}_n$, hence the restriction to N of the signature is injective, so $N = \{1\}$ or N is a group with two elements: $\{1, a\}$. Since N is normal in \mathfrak{S}_n , the conjugate elements of a in \mathfrak{S}_n are equal to a , hence a is central. But the center of \mathfrak{S}_n is trivial, so N is not a group with two elements. So $N = \{1\}$. \square

We can now attack the proof of Proposition 8.9.

Proof of Proposition 8.9. We argue by contradiction. Let ρ be a periodic morphism. We assume that ρ is not cyclic. We separate the cases according to the orders of A_1 and $A_3A_1^{-1}$ (the order of $A_3A_1^{-1}$ is different from 1 since ρ is not cyclic).

1. When A_1 is of order 2.

If for all $i \leq n - 1$, the mapping class A_i is of order 2, then $\rho(\mathcal{B}_n)$ is isomorphic to a quotient of the symmetric group \mathfrak{S}_n . But, according to Lemma 8.10, the only non-trivial quotient of \mathfrak{S}_n with $n \geq 6$ is $\mathbb{Z}/2\mathbb{Z}$, however we assume that ρ is not cyclic, so $\rho(\mathcal{B}_n)$ has to be isomorphic to the group \mathfrak{S}_n . In particular, $\rho(\mathcal{B}_n)$ is finite, and its cardinality is:

$$n! = (n - 1)! \times n \geq 5! \times n = 120n \geq 240g.$$

Now, according to Corollary 3.26, the cardinality of a finite subgroup of $\mathcal{Mod}(\Sigma)$ is bounded by $42|\chi(\Sigma)| = 84g - 84$, whence a contradiction.

2. When A_1 is not of order 2, but $A_3A_1^{-1}$ is of order 2.

If $(A_3A_1^{-1})^2 = 1$, then $A_3^2 = A_1^2$, so according to Lemma 8.4, we have $A_1^2 = A_2^2 = \cdots = A_{n-1}^2$. Let \mathcal{Z} be the centralizer $\mathcal{Z}_{\text{Mod}(\Sigma)}(A_1^2)$ of A_1^2 in $\text{Mod}(\Sigma)$ and let p be the canonical morphism from \mathcal{Z} in $\mathcal{Z}/\langle A_1^2 \rangle$. Notice that $\rho(\mathcal{B}_n)$ is included in \mathcal{Z} , so we can consider the morphism $p \circ \rho$ from \mathcal{B}_n in $\mathcal{Z}/\langle A_1^2 \rangle$. It is not cyclic, for $A_3A_1^{-1}$ is not a power of A_1^2 : indeed, if it existed an integer k such that $A_3 = A_1^{(1+2k)}$, by conjugation, we would have $A_5 = A_1^{(1+2k)}$, and so $A_3 = A_5$. But this is absurd for ρ is not cyclic. Thus, the morphism $p \circ \rho$ is not cyclic, but $p \circ \rho(\tau_1^2) = p(A_1^2) = 1$. Then, as we have seen it in step 1., $p \circ \rho(\mathcal{B}_n)$ is isomorphic to the group \mathfrak{S}_n and hence contains at least 240g elements. But $\rho(\mathcal{B}_n)$ is a (central) extension of $p \circ \rho(\mathcal{B}_n)$ by the finite group $\langle A_1^2 \rangle$, in other words, the following sequence is exact:

$$1 \rightarrow \langle A_1^2 \rangle \rightarrow \rho(\mathcal{B}_n) \xrightarrow{p} p \circ \rho(\mathcal{B}_n) \rightarrow 1.$$

Hence $\rho(\mathcal{B}_n)$ is a finite group that contains at least 480g elements. As in step 1., this is absurd.

3. Where A_1 is of order $M \geq 3$ and $A_3A_1^{-1}$ is of order m with $3 \leq m \leq M$.

According to Kerckhoff's Theorem (cf. 3.15), the abelian group $\langle A_i, i \in \text{Imp}(n) \rangle$ being finite, there exist a hyperbolic metric g on Σ and an injective morphism from $\langle A_i, i \in \text{Imp}(n) \rangle$ in $\text{Isom}(\Sigma; g)$. Let us denote by \mathcal{F} its image and \bar{A}_i the image of A_i for all $i \in \text{Imp}(n)$. Let us recall that we assume that ρ is not cyclic, so $\bar{A}_1 \neq \bar{A}_3$. We will show that the action of \mathcal{F} on the points of Σ is free, for if an element of \mathcal{F} had a fixed point in Σ , it would automatically have many, actually too much compared with Corollary 3.22. We will conclude by showing that if the elements of \mathcal{F} do not have any fixed point, the inequality linking $\chi(\Sigma)$ and $\chi(\Sigma/\langle \mathcal{F} \rangle)$ given by Lemma 3.20 cannot be satisfied, whence the contradiction.

a) Let us show that the action of \mathcal{F} on Σ is free.

Let x be a point of Σ and let $\text{Stab}(x)$ be the subgroup of \mathcal{F} that fixes the point x . Let us assume that $\text{Stab}(x)$ is not reduced to $\{1\}$. Let us recall that two isometries that fixes a same point and that have the same differential in this point are equal (cf. Lemma 3.16). But the differential of an isometry in a fixed point is a rotation. Therefore $\text{Stab}(x)$ is a cyclic group. Let G be an isometry spanning $\text{Stab}(x)$, let M' be its order, with $2 \leq M' \leq M$, for on one hand G is not the identity, on the other hand G belongs to the abelian group \mathcal{F} spanned by elements of order M . We are going to count the number ℓ of fixed points of G . On one hand, according to Corollary 3.22, we have:

$$\ell \leq 2 + \frac{2g}{M' - 1}. \quad (1)$$

On the other hand, if G commutes with another isometry G' , then the images by G' of all fixed points of G are again fixed points of G . Since the group \mathcal{F} is abelian, the set of fixed points of G contains the orbit of x by the group \mathcal{F} , so:

$$|\text{Orb}(x)| \leq \ell, \quad (2)$$

where $\text{Orb}(x)$ is the orbit of x . By definition of \mathcal{F} and according to Lemma 8.5, there exist four integers M', m', d and s such that \mathcal{F} is isomorphic to $\mathcal{L}_n(M', m', d, s)$. Now, since M is the order of A_1 and m is the order of $A_3A_1^{-1}$, we have $M' = M$ and $m' = m$. Hence \mathcal{F} is isomorphic to $\mathcal{L}_n(M, m, d, s)$ and according to Lemma 8.7, the cardinality of \mathcal{F} is $qd(m)^{r-1}$ where $q = \frac{M}{m}$ and $r = \frac{n}{2}$. We can then compute the cardinality of the orbit of x :

$$|\text{Orb}(x)| = \frac{|\mathcal{F}|}{|\text{Stab}(x)|} = \frac{qd(m)^{r-1}}{M'}. \quad (3)$$

From (1), (2) and (3), we get:

$$\frac{qd(m)^{r-1}}{M'} = |\text{Orb}(x)| \leq \ell \leq 2 + \frac{2g}{M'-1}. \quad (4)$$

By multiplying all by $\frac{M'}{q}$, we get:

$$d(m)^{r-1} \leq 2\frac{M'}{q} + 2g\frac{1}{q}\frac{M'}{M'-1}. \quad (5)$$

Since $\frac{M'}{q} \leq \frac{M}{q} = m$, we can bound $\frac{M'}{q}$ by m . We bound g by r , $\frac{1}{q}$ by 1, and $\frac{M'}{M'-1}$ by 2. Then (5) becomes:

$$d(m)^{r-1} \leq 2m + 4r, \text{ with } \begin{cases} r = \frac{n}{2} \geq 3, \\ d \geq 2 \text{ and } d \text{ divides } m, \text{ according to Lemma 8.5,} \\ m \geq 3 \text{ by hypothesis.} \end{cases} \quad (6)$$

When $m = 3$, we have $d = 3$, so (6) becomes:

$$3^r \leq 6 + 4r, \quad (7)$$

but this equation is never satisfied for $r \geq 3$ (for $r = 3$, we get $27 \leq 6 + 12$ which is absurd, and for $r > 3$, this is even more flagrant). When $m \geq 4$, let us consider equation (6), we bound $4r$ by mr in the right hand side, we divide the left hand side and the right hand side by m , then in the left hand side, we replace m by its lower bound: 4, and d by its lower bound: 2. We get:

$$2 \times 4^{(r-2)} \leq 2 + r, \quad (8)$$

that is not satisfied for $r = 3$ and certainly not for $r > 3$. Thus, it was absurd to assume that $\text{Stab}(x) \neq \{1\}$. Hence the action of \mathcal{F} on Σ is free.

b) Let us apply the Riemann-Hurwitz' formula (cf. Lemma 3.20) to the finite group \mathcal{F} :

$$\chi(\Sigma) + \sum(|\mathcal{F}| - o(Q_i)) = |\mathcal{F}| \cdot \chi(\Sigma/\mathcal{F}). \quad (9)$$

The surface Σ satisfies $\chi(\Sigma) = 2 - 2g$. Besides, as the action of \mathcal{F} on Σ is free, there is no point of ramification Q_i in the surface Σ/\mathcal{F} hence $\sum(|\mathcal{F}| - o(Q_i)) = 0$. So the two terms of equality (9) are negative. Since the elements of \mathcal{F} preserve the orientation, Σ/\mathcal{F} is an orientable closed surface with $\chi(\Sigma/\mathcal{F}) \leq -2$. But the order of \mathcal{F} is $qd(m)^{r-1}$ with $q \geq 1$, $d \geq 2$, $m \geq 2$ and $r \geq g$, so $|\mathcal{F}| \geq 2^g$, so the equality (9) implies $2 - 2g \leq 2^g(-2)$, i.e.:

$$g \geq 1 + 2^g, \text{ with } g \geq 0, \quad (10)$$

which is absurd. \square

8.3 Pseudo-Anosov morphisms from \mathcal{B}_n in $\mathcal{PMod}(\Sigma_{g,b})$, $b \geq 0$

Proposition 8.11 (The pseudo-Anosov morphisms from \mathcal{B}_n in $\mathcal{PMod}(\Sigma)$ are cyclic).

Let n be an integer greater than or equal to 6 and let Σ be a surface $\Sigma_{g,b}$ where $g \leq \frac{n}{2}$. Any pseudo-Anosov morphism from \mathcal{B}_n in $\mathcal{PMod}(\Sigma)$ is cyclic.

Proof. Let $\rho : \mathcal{B}_n \rightarrow \mathcal{PMod}(\Sigma)$ be a pseudo-Anosov morphism. For all $i \leq n-1$, we set again $A_i = \rho(\tau_i)$.

1. The mapping class A_1 is pseudo-Anosov, so according to Theorem 3.32, its centralizer is virtually infinite cyclic. Since the mapping class A_3 commutes with A_1 , there exist two nonzero integers p and p' such that $A_1^{p'} = A_3^p$. By conjugating this equality by $A_3A_4A_3$, we get $A_1^{p'} = A_4^p$. Hence $A_3^p = A_4^p$, so according to Lemma 8.4:

$$A_1^p = A_2^p = A_3^p \cdots = A_{n-1}^p. \quad (1)$$

Let us exploit this. We separate the cases whether $b > 0$ (cf. 2.) or $b = 0$ (cf. 3. - 5.).

2. When $b > 0$, we produce a direct proof. According to Proposition 5.12, there exists $\tilde{\rho}$, a lift of $\rho \in \text{Hom}(\mathcal{B}_n, \mathcal{P}\text{Mod}(\Sigma))$ in $\text{Hom}(\mathcal{B}_n, \text{Mod}(\Sigma, \partial\Sigma))$. For all $i \leq n-1$, let us denote by \tilde{A}_i the mapping class $\tilde{\rho}(\tau_i)$, so that \tilde{A}_i is a lift of A_i . Let us set then $W = \tilde{A}_3\tilde{A}_1^{-1}$. Since $A_1^p = A_3^p$, the mapping class W^p is a multitwist along the boundary components. Let Z be the mapping class $(\tilde{A}_1\tilde{A}_2\tilde{A}_3)^2$. Then $Z\tilde{A}_1Z^{-1} = \tilde{A}_3$ and $Z\tilde{A}_3Z^{-1} = \tilde{A}_1$, so $ZW^pZ^{-1} = W^{-p}$. Since W is central in $\text{Mod}(\Sigma, \partial\Sigma)$, Z and W^p commute, so we have $W^{2p} = \text{Id}$. But $\text{Mod}(\Sigma, \partial\Sigma)$ is torsion-free according to Lemma 3.17, so $W = \text{Id}$. Hence $\tilde{A}_1 = \tilde{A}_3$ and $\tilde{\rho}$ is cyclic, hence ρ is cyclic.

3. When $b = 0$, we argue by contradiction and we assume that ρ is not cyclic. Then, according to Lemma 8.4, the A_i , $1 \leq i \leq n-1$, are pairwise distinct. Let us consider the group $\widetilde{\text{Centr}}(A_1^p)$ (cf. Definition 3.28 of Subsection 3.4). According to (1), $\rho(\mathcal{B}_n) \subset \widetilde{\text{Centr}}(A_1^p)$. Let ℓ be the morphism associated to A_1^p defined by Proposition 3.30. According to this proposition, the cardinality of $\text{Ker}(\ell)$ satisfies:

$$|\text{Ker}(\ell)| \leq 6|\chi(\Sigma)|. \quad (2)$$

Since all the A_i , $i \leq n-1$, are conjugate in $\widetilde{\text{Centr}}(A_1^p)$, $\ell(A_i)$ is independent of the index i when i ranges from 1 to $n-1$. Hence the group spanned by $A_jA_k^{-1}$ where $j, k \leq n-1$ is included in $\text{Ker}(\ell)$. Yet, we are going to show that its cardinality is greater than $6|\chi(\Sigma)|$, whence the contradiction.

4. Let us assume that $(A_1A_3^{-1})$ is of order $p = 2$. Recall that ρ is not cyclic, so A_1 and A_3 are different. Then the subgroup \mathcal{F} of $\text{Ker}(\ell)$ defined by:

$$\mathcal{F} := \langle A_iA_{n-1}^{-1}; 1 \leq i \leq n-3 \rangle$$

is isomorphic to a quotient \mathfrak{S}_{n-2} by the morphism: (12) $\mapsto A_1A_{n-1}^{-1}$, (23) $\mapsto A_2A_{n-1}^{-1}$, \dots , $(n-3, n-2) \mapsto A_{n-3}A_{n-1}^{-1}$. However, $A_1 \neq A_3$, so this quotient is neither $\{1\}$ nor $\mathbb{Z}/2\mathbb{Z}$. Then, when $n \geq 8$, according to Lemma 8.10, this quotient is \mathfrak{S}_{n-2} . When $n = 6$, the only quotient of \mathfrak{S}_4 different from $\{1\}$, $\mathbb{Z}/2\mathbb{Z}$ and \mathfrak{S}_4 is the quotient of \mathfrak{S}_4 by the normal closure of the element (12)(34). The image of (12)(34) in \mathcal{F} is $(A_1A_5^{-1})(A_3A_5^{-1})$, which is equal to $A_1A_3A_5^{-2}$, hence equal to $A_1A_3^{-1}$, for $A_3^{-2} = A_5^{-2}$ according to (1). Since $A_1 \neq A_3$, $A_1A_3^{-1}$ is not trivial. Hence \mathcal{F} is not isomorphic to the above quotient of \mathfrak{S}_4 . Then, even when $n = 6$, \mathcal{F} is isomorphic to \mathfrak{S}_{n-2} . Hence $\text{Ker}(\ell)$ contains \mathcal{F} that owns $(n-2)!$ elements. When $n \geq 8$, we get:

$$|\text{Ker}(\ell)| \geq |\mathcal{F}| = (n-2)! \geq 5!(n-2) > 6(n-2) \geq 6(2g-2) = 6|\chi(\Sigma)|. \quad (3)$$

But (2) and (3) lead to a contradiction, this is the expected contradiction.

The case $n = 6$ implies $|\mathcal{F}| = |\mathfrak{S}_4| = 4! = 24 \geq 6|\chi(\Sigma)|$, since $n = 6$ implies that $g \leq \frac{n}{2} = 3$, and then $|\chi(\Sigma)| \leq 4$. However $\text{Ker}(\ell)$ contains the element $A_{n-2}A_{n-1}^{-1}$, too, which is different from any element of \mathcal{F} , for \mathcal{F} is in the centralizer of A_{n-1} , whereas $A_{n-2}A_{n-1}^{-1}$ is not. Indeed, if $A_{n-2}A_{n-1}^{-1}$ was in the centralizer of A_{n-1} , then A_{n-2} and A_{n-1} would commute. However they satisfy a braid relation, so they would be equal and ρ would be cyclic: this is absurd. Thus $\text{Ker}(\ell)$ contains \mathcal{F} and the element $A_{n-2}A_{n-1}^{-1}$, which does not belong to \mathcal{F} . Since the cardinality of \mathcal{F} satisfies $|\mathcal{F}| \geq 6|\chi(\Sigma)|$, then the cardinality of $\text{Ker}(\ell)$ satisfies $|\text{Ker}(\ell)| > 6|\chi(\Sigma)|$, which contradicts (2). This is the expected contradiction.

5. Let us assume that $(A_1A_3^{-1})$ is of order $p \geq 3$ and let us consider the abelian groups \mathcal{H} and \mathcal{H}' defined by:

$$\begin{aligned} \mathcal{H} &:= \langle A_i, i \in \text{Imp}(n) \rangle_{\text{Mod}(\Sigma)} \\ \text{and } \mathcal{H}' &:= \langle A_iA_{n-1}^{-1}, i \in \text{Imp}(n-2) \rangle_{\text{Mod}(\Sigma)}. \end{aligned}$$

Let us apply Lemma 8.5 to these two groups:

- *Concerning the group \mathcal{H} .* It is clear that there exist two integers d and s such that \mathcal{H} is isomorphic to $\mathcal{L}_n(0, p, d, s)$, where $d \neq 1$, d divides p , and p divides s , according to Lemma 8.5. Moreover, since $\ell(A_1) = \dots = \ell(A_{n-1}) > 0$, all these relations have to be homogeneous, so by considering the relation $R3(d, s)$, it follows $s = rd$. The relation $R3(d, s)$ then becomes:

$$\left(\prod_{i \in \text{Imp}(n)} A_i \right)^d = A_1^{rd}, \quad (4)$$

and it implies:

$$\left(\prod_{i \in \text{Imp}(n-3)} A_i A_{n-1}^{-1} \right)^d = (A_1 A_{n-1}^{-1})^{rd}, \quad (5)$$

- *Concerning the group \mathcal{H}' .* It is clear that \mathcal{H}' is isomorphic to $\mathcal{L}_{n-2}(p, p, d', s')$ where d' and s' are to be determine. The relation $(R3(d', s'))$ is equivalent to:

$$\left(\prod_{i \in \text{Imp}(n-3)} A_i A_{n-1}^{-1} \right)^{d'} = (A_1 A_{n-1}^{-1})^{s'}, \quad (6)$$

and implies:

$$\left(\prod_{i \in \text{Imp}(n)} A_i \right)^{d'} = A_1^{s'} A_{n-1}^{(rd' - s')}. \quad (7)$$

Since p divides s' , according to Lemma 8.5, we have $A_1^{s'} = A_{n-1}^{s'}$ and (7) becomes:

$$\left(\prod_{i \in \text{Imp}(n)} A_i \right)^{d'} = A_{n-1}^{rd'}. \quad (8)$$

In (8), by conjugation, we can replace $A_{n-1}^{rd'}$ by $A_1^{rd'}$. Let us compare the equalities (4) and (8). By definition of d , it follows from that comparison that d divides d' . Moreover, by comparing (5) and (6), it follows by definition of d' that d' divides d . Thus $d' = d$, so \mathcal{H}' is isomorphic to $\mathcal{L}_{n-2}(p, p, d, s')$, and according to Lemma 8.5, the following holds:

$$d \geq 2, \quad d \text{ divides } p. \quad (9)$$

Then according to Lemma 8.7, $|\mathcal{H}'| = dp^{r-2}$. The only pairs (p, d) that respect (9) and such that $p < 6$ are (3,3), (4,2), (4,4) and (5,5). However, if $(p, d) = (4, 2)$, then r is even. Indeed, as we saw it in the lines preceding (4), p divides s and s is equal to rd . We check in the following table all the possible values of dp^{r-2} for the pairs (p, d) where $p < 6$, as a function of r , and we give a lower bound to the values dp^{r-2} for the pairs (p, d) with $p \geq 6$, as a function of r .

$r \setminus (p, d)$	(3, 3)	(4, 2)	(4, 4)	(5, 5)	(p, d) with $p \geq 6$
$r = 3$	9	–	16	25	$dp^{r-2} \geq 2 \times 6 = 12$
$r = 4$	27	32	64	125	$dp^{r-2} \geq 2 \times 6^2 = 72$
$r \geq 5$	$27 \times 3^{r-4}$	$32 \times 4^{r-4}$	$64 \times 4^{r-4}$	$125 \times 5^{r-4}$	$dp^{r-2} \geq 2p^{r-2} = 72 \times 6^{r-4}$

Table 1 – Computation of dp^{r-2} as a function of d , p and r .

According to Table 1, for all $r \geq 3$, the expression dp^{r-2} achieves its lower bound when $p = d = 3$, hence:

$$|\mathcal{H}'| \geq 3^{r-1}. \quad (11)$$

However, $\text{Ker}(\ell)$ contains also the element $A_2A_{n-1}^{-1}$, which is of order p , too. And $A_2A_{n-1}^{-1}$ does not commute with A_1 (otherwise, A_2 would commute with A_1 , we would have $A_1 = A_2$ and ρ would be cyclic). Since \mathcal{H}' is in the centralizer of A_1 , the mapping class $A_2A_{n-1}^{-1}$ cannot belong to \mathcal{H}' . Similarly $(A_2A_{n-1}^{-1})^{-1}$ cannot belong to \mathcal{H}' . But $A_2A_{n-1}^{-1}$ and its inverse are distinct, for $p \geq 3$. Then the group $\langle \mathcal{H}' \cup A_2A_{n-1}^{-1} \rangle$ contains the following set:

$$\{ H(A_2A_{n-1}^{-1})^k, H \in \mathcal{H}', k \in \{-1, 0, 1\} \}.$$

Its cardinality is $3|\mathcal{H}'|$. Hence $|\text{Ker}(\ell)| \geq 3^r$. But for all integers of $r \geq 3$, the number 3^r is greater than $6(2r - 2)$, which is greater than or equal to $6|\chi(\Sigma)|$. Thus:

$$|\text{Ker}(\ell)| > 6|\chi(\Sigma)|. \tag{12}$$

This contradicts assertion (2). This is the expected contradiction and the end of the proof. \square

9 Properties of the curves of $\sigma(\mathcal{G})$; the special curves $\sigma_s(\mathcal{G})$

Let us recall that n is an even integer greater than or equal to 6, Σ is a surface $\Sigma_{g,b}$ where $g \leq \frac{n}{2}$ and $b \geq 0$, and ρ is a morphism from \mathcal{B}_n in $\mathcal{PMod}(\Sigma)$ such that $\sigma_\rho(\mathcal{G}) = \emptyset$. It will be practical to adopt the following convention:

Notation 9.1. For all integers k and all nonzero integer d , let us denote by $[k]_d$ the remainder of the euclidian division of k by d . Moreover, recall that to simplify the notation, we write A_k instead of $A_{[k]_n}$, and τ_k instead of $\tau_{[k]_n}$.

Moreover, we assume that ρ is not cyclic, so according to Theorem 8.2, $\sigma(\mathcal{G})$ is nonempty. We will use the canonical reduction systems $\sigma(A_0), \sigma(A_1), \dots, \sigma(A_{n-1})$ to study A_0, A_1, \dots, A_{n-1} , and deduce some information on ρ .

However, we have to face several difficulties. For example a curve of $\sigma(\mathcal{G})$ can belong to the canonical reduction systems of several elements of \mathcal{G} . In the extreme case, the elements of \mathcal{G} might all have the same canonical reduction system, without ρ being cyclic. Another difficulty would be that, *a priori*, $\sigma(\mathcal{G})$ is not preserved by the action of \mathcal{B}_n via ρ .

We will show in this section that the set $\sigma(\mathcal{G})$ admits a partition in two subsets denoted by $\sigma_n(\mathcal{G})$ and $\sigma_s(\mathcal{G})$. They answer to the above raised difficulties: the curves of $\sigma_n(\mathcal{G})$ are stable by the action of \mathcal{B}_n on $\text{Curv}(\Sigma)$ and are included in the canonical reduction system of all the mapping classes of \mathcal{G} , whereas each curve of $\sigma_s(\mathcal{G})$ belongs to the canonical reduction system of a unique mapping class of \mathcal{G} .

9.1 Outline of the section and proved results

The two first subsections present technical results which are essential to this section and will be used again in the next sections:

- In Subsection 9.2, we study the \mathcal{B}_n -stable curve simplex and show Proposition 9.2 (where the term of *cyclic action*, recurrent in the sequence of this paper, is made precise by Definition 9.11) :

Proposition 9.2 (Any action of \mathcal{B}_n on a \mathcal{B}_n -stable curve simplex is cyclic).

Let \mathcal{A} be a curve simplex in $\text{Curv}(\Sigma)$ stable by the action of \mathcal{B}_n via ρ on $\text{Curv}(\Sigma)$. Then the actions of \mathcal{B}_n induced by ρ on \mathcal{A} , on $\text{Sub}_{\mathcal{A}}(\Sigma)$ and on $\text{Bndy}(\Sigma_{\mathcal{A}})$ are cyclic, i.e. the elements of $\tau_i, i \in \{0, 1, \dots, n-1\}$ have the same actions.

- In Subsection 9.3, we present the action of the cyclic subgroup \mathcal{J} of \mathcal{B}_n spanned by δ on $\sigma(\mathcal{G})$ where δ is the element $\tau_1\tau_2 \dots \tau_{n-1}$ of \mathcal{B}_n , and we show Proposition 9.3:

Proposition 9.3. *Let a be a curve of $\sigma(\mathcal{G})$. Then $\mathcal{J}.a$ contains at most n curves. The limit case $|\mathcal{J}.a| = n$ can be achieved only when $\mathcal{J}.a$ is not a simplex.*

- During the subsections 9.4 - 9.5, we will be interested by properties that some curves of $\sigma(\mathcal{G})$ satisfy, see Proposition 9.4. These properties are related to the *spectrum* of a curve a , which we denote by $\text{sp}(a)$ and wich we define by:

$$\text{sp}(a) = \{A \in \mathcal{G} \mid a \in \sigma(A)\}.$$

One of the goals of this section is to completely describe the map $\text{sp} : \text{Curv}(\Sigma) \rightarrow \mathcal{P}(\mathcal{G})$ (the power set of \mathcal{G}) that we will call *the spectrum of a* , (cf. Subsection 9.3). In Subsection 9.4, we aim to show the following proposition.

Proposition 9.4. *Any curve a belonging to $\sigma(\mathcal{G})$ satisfies either all the left hand side properties (1g) - (6g), or all the right hand side properties (1d) - (6d).*

$$(1g) \quad I(a, \delta.a) = 0 \quad ; \quad I(a, \delta.a) \neq 0 \quad (1d)$$

$$(2g) \quad |\text{sp}(a)| \geq 2 \quad ; \quad |\text{sp}(a)| = 1 \quad (2d)$$

$$(3g) \quad I(a, \sigma(\mathcal{G})) = 0 \quad ; \quad I(a, \sigma(\mathcal{G})) \neq 0 \quad (3d)$$

$$(4g) \quad \forall k, \text{sp}(a) \not\subset \{A_k, A_{k+2}\} \quad ; \quad \exists k \mid \text{sp}(a) \subset \{A_k, A_{k+2}\} \quad (4d)$$

$$(5g) \quad |\mathcal{J}.a| < n \quad ; \quad |\mathcal{J}.a| = n \quad (5d)$$

$$(6g) \quad \mathcal{J}.a \text{ is a simplex} \quad ; \quad \mathcal{J}.a \text{ is not a simplex} \quad (6d)$$

This proposition prompts us to set the following definitions:

Definition 9.5 (Normal curves, special curves).

– A curve a belonging to $\sigma(\mathcal{G})$ will be said to be *special* if it satisfies $I(a, \sigma(\mathcal{G})) \neq 0$, in other words if it satisfies the right-and side assertions of Proposition 9.4. We denote by $\sigma_s(\mathcal{G})$ the set of special curves and we set $\sigma_s(A) = \sigma_s(\mathcal{G}) \cap \sigma(A)$.

– A curve a belonging to $\sigma(\mathcal{G})$ will be said to be *normal* if it satisfies $I(a, \sigma(\mathcal{G})) = 0$, in other words if it satisfies the left hand side assertions of Proposition 9.4. We denote by $\sigma_n(\mathcal{G})$ the set of normal curves and we set $\sigma_n(A) = \sigma_n(\mathcal{G}) \cap \sigma(A)$.

Example. Let Σ be the surface $\Sigma_{4,2}$ and ρ the morphism from \mathcal{B}_8 in $\mathcal{P}\text{Mod}(\Sigma)$ such that for all integers $i \in \{1, \dots, n-1\}$, we have:

$$\rho(\tau_i) = T_{a_i} V,$$

where V is a mapping class that commutes with the T_{a_i} and such that $\sigma(V) = \{x_1, x_2, x_3, x_4\}$, where the curves a_i and the curves x_k are the ones drawn in Figure 58. In this example, for all i , we have:

$$\sigma(A_i) = \underbrace{\sigma_s(A_i)}_{\{a_i\}} \cup \underbrace{\sigma_n(A_i)}_{\{x_k, 1 \leq k \leq 4\}} .$$

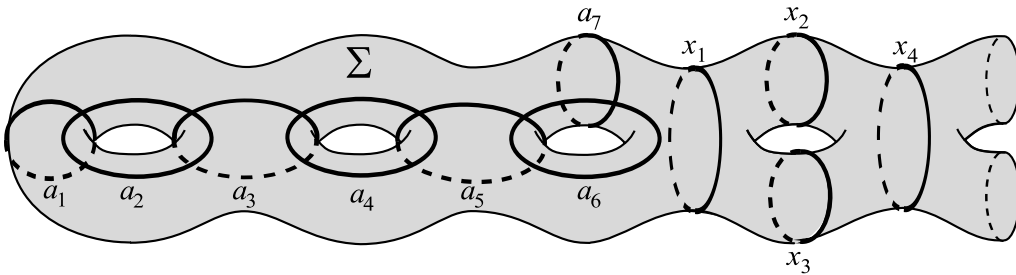

Figure 58: Example of special curves and normal curves.

• Then in Subsection 9.5, we will show the following stability and existence results:

Proposition 9.6 (Stability of the special curves).

(i) The set $\sigma_s(\mathcal{G})$ is \mathcal{J} -stable.

(ii) For all i , $\sigma_s(A_i)$ is stable by any element of $\mathcal{G} \setminus \{A_{i-1}, A_{i+1}\}$.

Proposition 9.7 (Stability of the normal curves).

The set $\sigma_n(\mathcal{G})$ is \mathcal{B}_n -stable and the actions of \mathcal{B}_n via ρ on $\sigma_n(\mathcal{G})$, on $\text{Sub}_{\sigma_n(\mathcal{G})}(\Sigma)$ and on $\text{Bndy}(\Sigma_{\sigma_n(\mathcal{G})})$ are cyclic.

The spectrum in \mathcal{G} of the special curves is reduced to one single mapping class, according Proposition 9.4. The following proposition is a consequence of the preceding one and states the situation concerning the normal curves.

Proposition 9.8 (Spectrum of the normal curves).

The spectrum of a normal curve is always equal to \mathcal{G} .

Proposition 9.9 (Existence of the special curves).

The set $\sigma_s(\mathcal{G})$ is not empty.

We can bring some precisions:

Proposition 9.10 (Cardinality of $\sigma_s(\mathcal{G})$). The set $\sigma_s(\mathcal{G})$ contains n or $2n$ curves.

- Finally in Subsection 9.6, we gather the results of the preceding subsections concerning the normal and special curves in Proposition 9.23.

9.2 Action of \mathcal{B}_n on the simplexes of curves

In this subsection, we show the following proposition. It involves the concept of *cyclic action* defined below.

Proposition 9.2 (All action of \mathcal{B}_n on a \mathcal{B}_n -stable curve simplex is cyclic).

Let \mathcal{A} be a curve simplex in $\text{Curv}(\Sigma)$ stable by the action of \mathcal{B}_n via ρ on $\text{Curv}(\Sigma)$. Then the actions of \mathcal{B}_n induced by ρ on \mathcal{A} , on $\text{Sub}_{\mathcal{A}}(\Sigma)$ and on $\text{Bndy}(\Sigma_{\mathcal{A}})$ are cyclic.

Definition 9.11 (Cyclic action).

- An action of a group G on a set \mathcal{E} will be said to be *cyclic* if the morphism φ of G in $\mathfrak{S}(\mathcal{E})$ associated to this action is such that the quotient $G/\text{Ker}(\varphi)$ is a cyclic group.
- A *cyclic action on a set \mathcal{E}* will be an action of a cyclic group (\mathbb{Z} or one of its quotients) on \mathcal{E} .
- A *cyclic action on a graph Γ* will be the data of a morphism from \mathbb{Z} or one of its quotients in $\text{Aut}(\Gamma)$. Let us make clear that an *automorphism* of Γ is a pair of bijections, one is acting on the vertices, the other on the edges, such that the images of the extremities of an edge are the extremities of the image of this edge.

This definition is compatible with the one of *cyclic action of \mathcal{B}_n* in the mapping class group.

The existence of cyclic actions of \mathcal{B}_n encourages us to define the following subgroups of \mathcal{B}_n :

Definition 9.12. There exists a morphism from \mathcal{B}_n in \mathbb{Z} called *the degree*, traditionally denoted by λ and defined by $\lambda(\tau_i) = 1$ for all $i \in \{1, 2, \dots, n-1\}$. We define the following subgroups of \mathcal{B}_n :

$$\begin{aligned}\mathcal{F}_n &:= \langle\langle \tau_i \tau_1^{-1}, 3 \leq i \leq n-1 \rangle\rangle_{\mathcal{B}_n}, \\ \mathcal{F}_n^* &:= \langle \tau_i \tau_1^{-1}, 3 \leq i \leq n-1 \rangle_{\mathcal{B}_n}.\end{aligned}$$

where $\langle\langle \ \ \ \rangle\rangle_{\mathcal{B}_n}$ refers to the normal closure in \mathcal{B}_n , so that $\mathcal{F}_n = \text{Ker}(\lambda)$.

The definition of \mathcal{F}_n is justified by the following lemma. The one of \mathcal{F}_n^* is justified by the fact that \mathcal{F}_n^* is isomorphic to the group \mathcal{B}_{n-2} while it is included in \mathcal{F}_n .

Lemma 9.13. *Given a set \mathcal{E} on which \mathcal{B}_n acts, the action of \mathcal{B}_n is cyclic if and only if the action restricted to \mathcal{F}_n is trivial, if and only if the action restricted to \mathcal{F}_n^* is trivial*

Proof. Let \mathcal{E} be a set on which \mathcal{B}_n acts and let Φ be the morphism $\mathcal{B}_n \rightarrow \text{Aut}(\mathcal{E})$ associated to this action. According to the definition of λ , any morphism from \mathcal{B}_n is cyclic if and only if its kernel contains $\text{Ker}(\lambda)$. Since \mathcal{F}_n coincides with $\text{Ker}(\lambda)$, the action of \mathcal{B}_n in \mathcal{E} is cyclic if and only if the kernel of Φ contains \mathcal{F}_n , in other words if and only if the action restricted to \mathcal{F}_n on \mathcal{E} is trivial.

Moreover, if the action of \mathcal{F}_n^* on \mathcal{E} is trivial, then τ_1 and τ_3 have the same action on \mathcal{E} . Then the action of \mathcal{B}_n on \mathcal{E} is given by a morphism from \mathcal{B}_n in $\text{Bij}(\mathcal{E})$ that sends τ_1 and τ_3 on the same image, where $\text{Bij}(\mathcal{E})$ is the group of the bijections of \mathcal{E} . Hence according to Lemma 5.2, this morphism is cyclic, so the action of \mathcal{B}_n on \mathcal{E} is cyclic. The converse is obvious. \square

The main result that we will use, allowing us to declare that an action is cyclic, is the following, due to Artin.

Proposition 9.14 (Artin, cf. [At3]). *For all integers n greater than or equal to 5, any action of \mathcal{B}_n on a given set \mathcal{E} having strictly less than n elements is cyclic, and the action restricted to \mathcal{F}_n is trivial.* \square

Thanks to Lemma 9.13 and of Proposition 9.14, we can show Proposition 9.2.

Proof of Proposition 9.2. Let us recall the statement. Let n be an even integer greater than or equal to 6, Σ a surface $\Sigma_{g,b}$ where $g \leq \frac{n}{2}$ and ρ a morphism from \mathcal{B}_n in $\mathcal{P}\text{Mod}(\Sigma)$. Let \mathcal{A} be a curve simplex in $\text{Curv}(\Sigma)$ stable by the action of \mathcal{B}_n via ρ on $\text{Curv}(\Sigma)$. We want to show that the actions induced by \mathcal{B}_n on \mathcal{A} , on $\text{Sub}_{\mathcal{A}}(\Sigma)$ and on $\text{Bndy}(\Sigma_{\mathcal{A}})$ are cyclic.

1. *Let us show that the action of \mathcal{B}_n on $\text{Sub}_{\mathcal{A}}(\Sigma)$ is cyclic.*

Since the action of \mathcal{B}_n on $\text{Curv}(\Sigma)$ preserves \mathcal{A} , the action of \mathcal{B}_n on $\text{Sub}(\Sigma)$ preserves $\text{Sub}_{\mathcal{A}}(\Sigma)$. Let us then consider the action of \mathcal{B}_n on $\text{Sub}_{\mathcal{A}}(\Sigma)$.

The subsurfaces whose natural boundary is nonempty are fixed points of the action of \mathcal{B}_n . Let \mathcal{C} be the set of the subsurfaces of $\text{Sub}_{\mathcal{A}}(\Sigma)$ that have no natural boundary. For all $S \in \mathcal{C}$, we have $\chi(S) = \chi(\text{for}_{\partial\Sigma}(S))$. Now, the sum $\sum_{S \in \mathcal{C}} \chi(\text{for}_{\partial\Sigma}(S))$ is greater than or equal to $\chi(\Sigma_{g,0}) = 2 - 2g$. Moreover, for all $S \in \mathcal{C}$, $\chi(\text{for}_{\partial\Sigma}(S)) \leq -1$, hence the cardinality of \mathcal{C} satisfies $|\mathcal{C}| \leq 2g - 2$, and finally $|\mathcal{C}| \leq n - 2$. Hence according to Proposition 9.14, \mathcal{B}_n acts cyclicly on the surfaces of \mathcal{C} . Finally, \mathcal{B}_n acts cyclicly on $\text{Sub}_{\mathcal{A}}(\Sigma)$.

2. *Let us show that the action of \mathcal{F}_n on \mathcal{A} is trivial. Then, according to Lemma 9.13, the action of \mathcal{B}_n on \mathcal{A} is cyclic.*

Let a be a curve of \mathcal{A} . We are going to study the action of \mathcal{F}_n on $\mathcal{B}_n.a$. We distinguish two cases, whether $|\mathcal{F}_n.a| < n - 2$ or not. In both cases, we will show that the action of \mathcal{F}_n on $\mathcal{B}_n.a$ is trivial. This will be enough for \mathcal{A} is a union of orbits of curves under the action of \mathcal{B}_n .

2.a) *Case where the curve a satisfies $|\mathcal{F}_n.a| < n - 2$.*

Let c be a curve in $\mathcal{B}_n.a$ and let γ be an element of \mathcal{B}_n such that $c = \gamma.a$. Since \mathcal{F}_n is normal in \mathcal{B}_n , it follows that $\mathcal{F}_n = \{\gamma\varphi\gamma^{-1}, \varphi \in \mathcal{F}_n\}$. Then we have:

$$|\mathcal{F}_n.c| = |\{\gamma\varphi\gamma^{-1}.c, \varphi \in \mathcal{F}_n\}| = |\{\gamma\varphi.a, \varphi \in \mathcal{F}_n\}| = |\{\varphi.a, \varphi \in \mathcal{F}_n\}| = |\mathcal{F}_n.a| < n - 2. (*)$$

Let us distinguish two sub-cases, whether $n \geq 8$ or $n = 6$:

- When $n \geq 8$, we can apply Proposition 9.14 to the action of \mathcal{F}_n^* on $\mathcal{F}_n.c$. In particular, $\rho(\tau_3\tau_1^{-1})$ and $\rho(\tau_5\tau_1^{-1})$ have the same action on the curves of $\mathcal{F}_n.c$.
- When $n = 6$, we cannot apply Proposition 9.14 to \mathcal{F}_n^* for \mathcal{F}_n^* is isomorphic to a braid group of rank 4 only. We have seen that the orbit of c under \mathcal{F}_n contained at most three elements according to (*). Hence the action of \mathcal{F}_n^* on $\mathcal{F}_n.c$ is described by a morphism from \mathcal{B}_4 in \mathfrak{S}_3 . Since such a morphism sends the standard generators τ_1, τ_2 and τ_3 of \mathcal{B}_4 on three conjugate elements in \mathfrak{S}_3 , they must be three transpositions, three 3-cycles, or three times the identity.
 - If τ_1, τ_2 and τ_3 are sent on three transpositions, since τ_1 and τ_3 commute, then they are sent on the same element;
 - If τ_1, τ_2 and τ_3 are sent on three 3-cycles, then the morphism is cyclic for the set of 3-cycles span in \mathfrak{S}_3 a subgroup isomorphic to $\mathbb{Z}/3\mathbb{Z}$;
 - If τ_1, τ_2 and τ_3 are sent on three times the identity, then the morphism is trivial.

So whatever this morphism from \mathcal{B}_4 to \mathfrak{S}_3 is, the elements τ_1 and τ_3 have the same image. This means that in the group \mathcal{F}_n^* , the mapping classes $\rho(\tau_3\tau_1^{-1})$ and $\rho(\tau_5\tau_1^{-1})$ have the same action on $\mathcal{F}_n.c$.

Finally, for any $c \in \mathcal{B}_n.a$ and for any even integer n greater than or equal to 6, the mapping classes $\rho(\tau_3\tau_1^{-1})$ and $\rho(\tau_5\tau_1^{-1})$ have the same action on $\mathcal{F}_n.c$, so their difference $\rho(\tau_5\tau_3^{-1})$ (equal to $\rho(\tau_5\tau_1^{-1})\rho(\tau_3\tau_1^{-1})^{-1}$) fixes each curve of $\mathcal{F}_n.c$. Since this is true for all $c \in \mathcal{B}_n.a$, we conclude that $\rho(\tau_5\tau_3^{-1})$ fixes each curve of $\mathcal{B}_n.a$. Then for all $\xi \in \mathcal{B}_n$, the mapping class $\rho(\xi\tau_5\tau_3^{-1}\xi^{-1})$ fixes each curve of $\{\xi.(\beta.a), \beta \in \mathcal{B}_n\}$. Now, on one hand, the normal closure of $\tau_5\tau_3^{-1}$ in \mathcal{B}_n is \mathcal{F}_n , on the other hand, the set $\{\xi.(\beta.a), \beta \in \mathcal{B}_n\}$ coincides with $\mathcal{B}_n.a$. Therefore, we have just shown that \mathcal{F}_n acts trivially on $\mathcal{B}_n.a$ via ρ .

2.b) *Case where the curve a satisfies $|\mathcal{F}_n.a| = m \geq n - 2$.*

Let S and S' be the two subsurfaces (possibly equal) of $\text{Sub}_{\mathcal{A}}(\Sigma)$ containing the curve a in their boundary. Since the action of \mathcal{F}_n is trivial on $\text{Sub}_{\mathcal{A}}(\Sigma)$, the set of curves $\mathcal{F}_n.a$ is included in $\text{Bndy}(S) \cap \text{Bndy}(S')$, so:

- if $S \neq S'$, S and S' are two subsurfaces glued together along at least m curves in Σ , so the surface resulting from the gluing is a subsurface of Σ of genus at least $m - 1$, so $g \geq m - 1$,
- and if $S = S'$, then S is a marked surface and its mark contains m curves, so the surface resulting from the gluing is a subsurface of Σ of genus at last m , so $g \geq m$.

Hence in both cases, $g \geq m - 1$. However on one hand $g \leq \frac{n}{2}$, on the other hand, $m \geq n - 2$. So we get $\frac{n}{2} \geq n - 3$. The only possible integer $n \geq 6$ that satisfies this condition is $n = 6$. Then $g = 3$, $m = n - 2 = 4$, $S \neq S'$, and $\text{Bndy}(S) \cap \text{Bndy}(S')$ is reduced to $\mathcal{F}_n.a$. Moreover, the whole genus of Σ comes from the gluing of S and S' along the curves of $\mathcal{F}_n.a$, so it cannot exist in $\text{Sub}_{\mathcal{A}}(\Sigma)$ another pair of subsurfaces (T, T') such that $\text{Bndy}(T) \cap \text{Bndy}(T')$ contains m curves of \mathcal{A} . Hence $\mathcal{B}_n.a = \mathcal{F}_n.a$. We can then apply Proposition 9.14 to the action of \mathcal{B}_n (a braid group of order 6) on $\mathcal{B}_n.a$ (a simplex of 4 curves) and deduce that the action of \mathcal{F}_n on $\mathcal{B}_n.a$ is trivial. This is what we wanted to show.

3. *Let us show that the action of \mathcal{F}_n on $\text{Bndy}(\Sigma_{\mathcal{A}})$ is trivial. Then, according to Lemma 9.13, the action of \mathcal{B}_n on $\text{Bndy}(\Sigma_{\mathcal{A}})$ is cyclic.*

Let a be a curve of \mathcal{A} and let a^+ and a^- be the two boundary components of $\Sigma_{\mathcal{A}}$ coming from the cut along of the curve a . According to step 2., the action of \mathcal{F}_n on \mathcal{A} is trivial, so the action of \mathcal{F}_n^* on $\text{Curv}(\Sigma)$ via ρ fixes the curve a , so the action of \mathcal{F}_n^* on $\text{Bndy}(\Sigma_{\mathcal{A}})$ via ρ preserves $\{a^+, a^-\}$. But \mathcal{F}_n^* is isomorphic to \mathcal{B}_{n-2} and $n - 2 > 2$, so according to Proposition 9.14, the action of \mathcal{F}_n^* on $\{a^+, a^-\}$ is cyclic. Then $\tau_3\tau_1^{-1}$ and $\tau_5\tau_1^{-1}$ have the same action on $\{a^+, a^-\}$, so the action of $\tau_5\tau_3^{-1}$ on $\{a^+, a^-\}$ is trivial. Since this is true for all curve a of the set \mathcal{A} , $\tau_5\tau_3^{-1}$ acts trivially on $\text{Bndy}(\Sigma_{\mathcal{A}})$. Since the set of curves \mathcal{A} is \mathcal{B}_n -stable, the action of the normal closure of $\tau_5\tau_3^{-1}$ in \mathcal{B}_n (equal to \mathcal{F}_n) on $\text{Bndy}(\Sigma_{\mathcal{A}})$ is trivial. \square

9.3 Specificities of the action of \mathcal{J} on \mathcal{G}

Let us recall that n is an even integer greater than or equal to 6, Σ is a surface $\Sigma_{g,b}$ where $g \leq \frac{n}{2}$ and $b \geq 0$, and ρ is a noncyclic morphism from \mathcal{B}_n in $\mathcal{P}\text{Mod}(\Sigma)$.

Definition 9.15 (The group \mathcal{J} and its action on \mathcal{G}).

Let δ be the element $\tau_1\tau_2 \dots \tau_{n-1}$ of \mathcal{B}_n and let \mathcal{J} be the subgroup of \mathcal{B}_n spanned by δ . For all integers $i \in \{0, \dots, n - 1\}$, we have:

$$\delta\tau_i\delta^{-1} = \tau_{i+1}.$$

We deduce from it an action of \mathcal{J} on \mathcal{G} defined as follows: for all integers $i \in \{0, \dots, n - 1\}$, we set:

$$\delta.A_i = \rho(\delta)A_i\rho(\delta)^{-1} = A_{i+1}.$$

We define also an action of \mathcal{J} on $\mathcal{P}(\mathcal{G})$, the power set of \mathcal{G} , by setting for all subsets \mathcal{K} of \mathcal{G} :

$$\delta.\mathcal{K} = \{\delta.A, A \in \mathcal{K}\} = \{\rho(\delta)A\rho(\delta)^{-1}, A \in \mathcal{K}\}.$$

The \mathcal{J} -coloration σ and the associated spectrum sp .

Definition 9.16 (\mathcal{J} -coloration and associated spectrum).

A \mathcal{J} -coloration on a \mathcal{J} -set \mathcal{E} (i.e. a set \mathcal{E} together with an action of \mathcal{J} on \mathcal{E}) is a map col of \mathcal{G} in $\mathcal{P}(\mathcal{E})$ (the power set of \mathcal{E}) compatible with the actions of \mathcal{J} on \mathcal{G} and on \mathcal{E} , i.e. such that for any $A \in \mathcal{G}$, we have:

$$\text{col}(\delta.A) = \delta.\text{col}(A).$$

Given a \mathcal{J} -coloration col , we call *spectrum* associated to col the map of \mathcal{E} in $\mathcal{P}(\mathcal{G})$ that associates to any element $e \in \mathcal{E}$ the following set $\{A \in \mathcal{G}, | e \in \text{col}(A)\}$.

Proposition 9.17. *The restriction of the map σ from \mathcal{G} in $\text{Curv}(\Sigma)$, which associates to any mapping class $A \in \mathcal{G}$ its canonical reduction system $\sigma(A) \subset \text{Curv}(\Sigma)$, is a \mathcal{J} -coloration.*

Proof. The map σ is a \mathcal{J} -coloration, since, for all $A \in \mathcal{G}$, we have:

$$\begin{aligned} \delta.\sigma(A) &= \{\delta.a, a \in \sigma(A)\} \\ &= \{\rho(\delta)(a), a \in \sigma(A)\} \\ &= \{a', a' \in \sigma(\rho(\delta)A\rho(\delta)^{-1})\} \\ &= \sigma(\delta.A). \end{aligned}$$

□

Notation 9.18. In this section, we will denote by sp the spectrum associated to the \mathcal{J} -coloration σ . Thus by definition, for all $a \in \text{Curv}(\Sigma)$,

$$\text{sp}(a) = \{A \in \mathcal{G} \mid a \in \sigma(A)\}.$$

By considering the action of \mathcal{J} on \mathcal{G} , on $\sigma(\mathcal{G})$ and on $\text{Sub}_{\sigma(\mathcal{G})}(\Sigma)$, we will show the following result.

Proposition 9.3. *Let a be a curve of $\sigma(\mathcal{G})$. Then $\mathcal{J}.a$ contains at most n curves. The limit case $|\mathcal{J}.a| = n$ can be achieved only when $\mathcal{J}.a$ is not a simplex.*

Proof. The proof of this proposition calls for:

- a lemma on the graphs together with a cyclic action (cf. Lemma 9.19),
- a lemma proposing a first version of Proposition 9.3 (cf. Lemma 9.20),
- a lemma treating a special case (cf. Lemma 9.21),
- a corollary proposing a second version of Proposition 9.3 (cf. Corollary 9.22).

The proof of Proposition 9.3 is on page 160.

Lemma 9.19. *Let Γ be a connected non-oriented graph whose number of edges is m . We assume that there exists an action of \mathbb{Z} on Γ , which is compatible with its structure of graph, and which is transitive on the set of edges. Then the pair graph-action (Γ, \cdot) is one of the following pairs:*

- (a) *The graph Γ consists in k vertices and m edges where k is equal to 2 or to a divisor of m (cf. Figure 59):*

$$\left\{ \begin{array}{l} \text{vertices: } \mathcal{S} = \{P_i; 0 \leq i \leq k-1\}, \\ \text{edges: } \mathcal{A} = \{a_0, \dots, a_{m-1}\} \text{ and there exists an integer } p \text{ coprime with } k \\ \text{(} p = 1 \text{ if } k = 1 \text{) such that for all integers } i \in \{0, \dots, m-1\}, \\ \text{the edge } a_i \text{ joins the vertices } P_{[i]_k} \text{ and } P_{[i+p]_k}. \text{ Thus, for all integers} \\ i \in \{0, \dots, k-1\}, \text{ the vertices } P_i \text{ and } P_{[i+p]_k} \text{ are joined by the } d \text{ edges} \\ a_{[i]_m}, a_{[i+k]_m}, \dots, a_{[i+(d-1)k]_m}, \text{ where } d = m \text{ if } k = 2 \text{ and } d = \frac{m}{k} \text{ other-} \\ \text{wise.} \end{array} \right.$$

The action associated to this graph Γ is given by $1.P_i = P_{[i+1]_k}$ and $1.a_i = a_{[i+1]_m}$ for all integers $i \in \{0, \dots, k-1\}$.

(b) The graph Γ consists in $k + \ell$ vertices and m edges where k and ℓ are two integers greater than or equal to 1 and coprime and m is a multiple of $k\ell$ (cf. Figure 59):

$$\left\{ \begin{array}{l} \text{vertices: } \mathcal{S} = \mathcal{S}_1 \sqcup \mathcal{S}_2 \text{ where } \mathcal{S}_1 = \{P_0, \dots, P_{k-1}\} \text{ and } \mathcal{S}_2 = \{Q_0, \dots, Q_{\ell-1}\}, \\ \text{edges: } \mathcal{A} = \{a_0, \dots, a_{m-1}\} \text{ such that for all integers } i \in \{0, \dots, m-1\}, \text{ the edge} \\ a_i \text{ joins the vertices } P_{[i]_k} \text{ and } Q_{[i]_\ell}. \text{ Thus, for all integers } i \in \{0, \dots, k- \\ 1\} \text{ and } j \in \{0, \dots, m-1\}, \text{ the vertices } P_i \text{ and } Q_j \text{ are joint by } d \text{ edges} \\ \text{where } d = \frac{m}{k\ell}. \end{array} \right.$$

The action associated to this graph Γ is given by $1.P_i = P_{[i+1]_k}$, by $1.Q_i = Q_{[i+1]_\ell}$ and by $1.a_i = a_{[i+1]_m}$ for all integers $i \in \{0, \dots, k-1\}$ and $j \in \{0, \dots, m-1\}$.

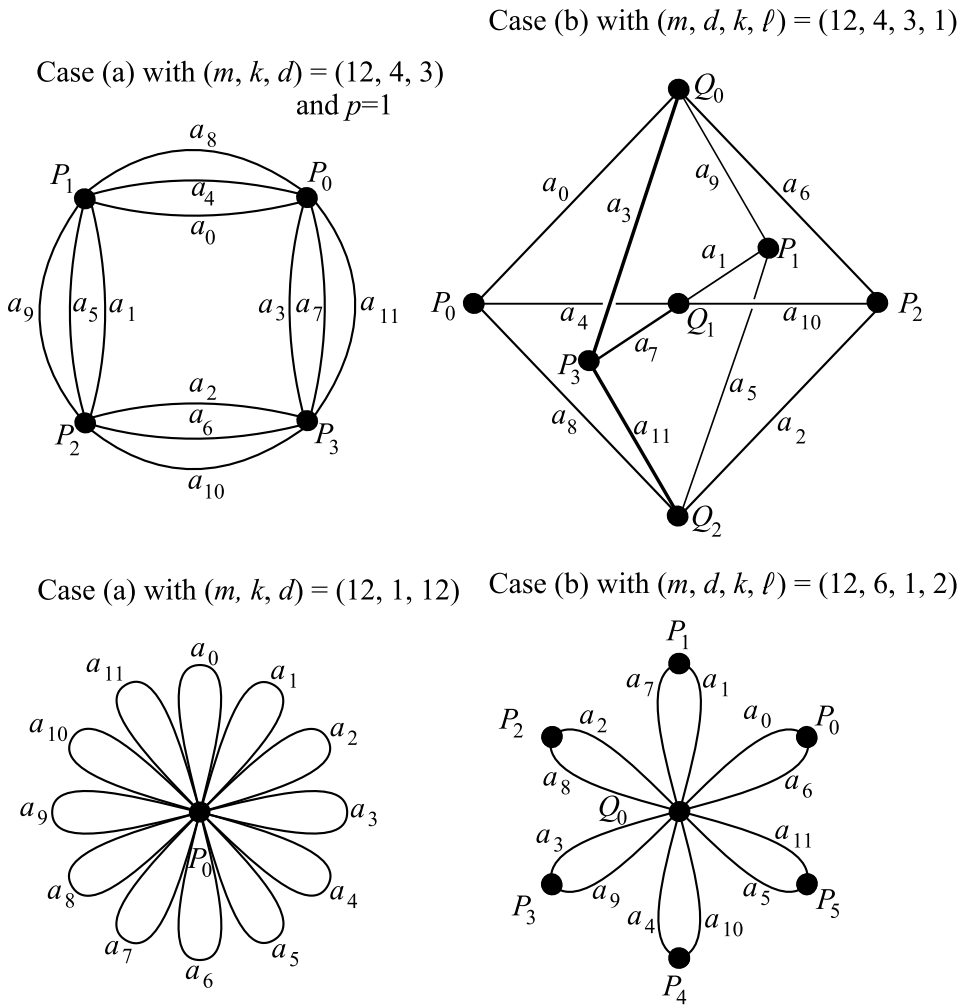

Figure 59: Four examples of graphs with 12 edges, together with a transitive \mathbb{Z} -action on the edges.

Proof. We check easily that the proposed graphs together with the \mathbb{Z} -actions described in the statement exist (cf. Figure 59) and that the actions are transitives on the edges. Conversely, let us show that under these assumptions, Γ is necessarily one of the announced graphs. We begin by the graphs with just one or two vertices:

- if Γ has only one vertex and consists in a bouquet of m circles, then this is a special of case (a) with $k = 1$;
- if Γ has exactly two vertices and if they are swapped by the \mathbb{Z} -action, then we are in case (a) with $k = 2$;
- if Γ has exactly two vertices and if they are fixed by the \mathbb{Z} -action, then we are in case (b) with with $(k, \ell) = (1, 1)$.

Let us focus on the graphs together with a transitive \mathbb{Z} -action on the vertices, having at least 3 vertices. Let m be the number of edges. Since the action is cyclic, $m\mathbb{Z}$ acts trivially on the edges. Notice that any vertex P can be identified by the set of edges ending in P . Indeed, if two distinct vertices were the extremities of the same edges, then by connectedness, the set of vertices of the graph would be reduced to these two vertices, which contradicts our hypotheses. Hence any trivial action on the edges induces a trivial action on the vertices. Thus $m\mathbb{Z}$ acts trivially on the set of vertices. Hence, We can quotient the action of \mathbb{Z} by $m\mathbb{Z}$ and thus get an action of $\mathbb{Z}/m\mathbb{Z}$ on Γ that acts freely and transitively on the edges. The action of $\mathbb{Z}/m\mathbb{Z}$ on the non-ordered pairs of vertices $\{p, q\}$ where p and q are the extremities of a same edge is hence transitive as well. We deduce that there exist one or two orbits of vertices under the action of $\mathbb{Z}/m\mathbb{Z}$, whether the extremities of a same edge belong to a same orbit or not.

Case (a): one single orbit of vertices. Let k be the number of vertices with $k \geq 3$. Since the vertices form a single orbit under the action of $\mathbb{Z}/m\mathbb{Z}$, k must divide m , so the $k\mathbb{Z}/m\mathbb{Z}$ -action on Γ must fix the vertices; and for each pair of vertices (S_1, S_2) linked by some edge, $k\mathbb{Z}/m\mathbb{Z}$ acts freely and transitively on the $d = m/k$ edges whose extremities are S_1 and S_2 . Let $\tilde{\Gamma}$ be the graph obtained from the graph Γ when we identify the edges having the same extremities. The quotient of $\mathbb{Z}/m\mathbb{Z}$ by $k\mathbb{Z}/m\mathbb{Z}$, isomorphic to $\mathbb{Z}/k\mathbb{Z}$, acts on $\tilde{\Gamma}$ and acts transitively on the k edges and the k vertices of the graph $\tilde{\Gamma}$. Let us call P_0, P_1, \dots, P_{k-1} the k vertices of $\tilde{\Gamma}$ so that for all $\ell \in \mathbb{Z}/k\mathbb{Z}$, we have $\ell.P_0 = P_\ell$. Let p be an integer in $\{1, \dots, k-1\}$ such that the vertices P_0 and P_p are joined by an edge. We obtain the left hand side graph in Figure 60. Notice that k and p are coprime, because the graph $\tilde{\Gamma}$ (and consequently the graph Γ) would not be connected. Let us come back to the graph Γ , we denote its vertices in the same way: we denote by a_0 one of the d edges ending in P_0 and P_p , and for all $\ell \in \{1, 2, \dots, m-1\}$, we denote by a_ℓ the edge $\ell.a_0$ of extremities $P_{[\ell]_k}$ and $P_{[\ell+p]_k}$. We get the right hand side graph in Figure 60.

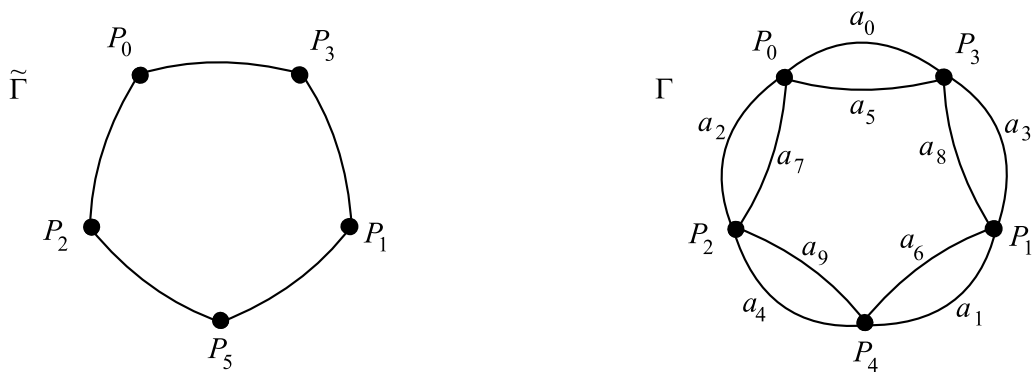

Figure 60: Example of a graph of type (a) where $k = 5$, $\ell = 3$, $d = 2$, $m = 10$.

Case (b): two orbits of vertices.

Let \mathcal{A} be the set of edges. We assume now that, for all edges $a \in \mathcal{A}$:

$$\text{the extremities of } a \text{ belong to two different orbits.} \quad (1)$$

Let a_0 be an edge, P_0 and Q_0 the extremities of a_0 . Let \mathcal{S}_1 be the orbit of P_0 and let k be the cardinality of \mathcal{S}_1 . Similarly, let \mathcal{S}_2 be the orbit of Q_0 and let ℓ be the cardinality of \mathcal{S}_2 . We name the vertices of \mathcal{S}_1 and of \mathcal{S}_2 so that for all $i \in \{0, \dots, k-1\}$, $j \in \{0, \dots, \ell-1\}$, and $p \in \mathbb{Z}$,

$$p.P_i = P_{[i+p]_k}, p.Q_i = Q_{[i+p]_\ell}, \text{ and } p.a_i = a_{[i+p]_m}. \quad (2)$$

We have then $\mathcal{S}_1 = \{P_0, \dots, P_{k-1}\}$ and $\mathcal{S}_2 = \{Q_0, \dots, Q_{\ell-1}\}$. The integers k and ℓ must divide m , for the action of the integer m on the vertices is trivial. Since the cardinality of the orbit of P_0 is k , the stabilizer of P_0 is $k\mathbb{Z}/m\mathbb{Z}$. Similarly the stabilizer of Q_0 is $\ell\mathbb{Z}/m\mathbb{Z}$. We deduce the following equalities between sets:

$$\begin{cases} \{a \in \mathcal{A} \mid P_0 \text{ is an extremity of } a\} = (k\mathbb{Z}/m\mathbb{Z}).a_0, \\ \{a \in \mathcal{A} \mid Q_0 \text{ is an extremity of } a\} = (\ell\mathbb{Z}/m\mathbb{Z}).a_0, \end{cases} \quad (3)$$

We will say that two edges are *adjacent* if they share at least one extremity in commun. Then:

$$\{a \in \mathcal{A} \mid a \text{ is adjacent to } a_0\} = (k\mathbb{Z}/m\mathbb{Z} \cup \ell\mathbb{Z}/m\mathbb{Z}).a_0. \quad (4)$$

Since the action of $\mathbb{Z}/m\mathbb{Z}$ is transitive on the edges, equality (4) holds not only for a_0 , but for all the edges in Γ . Then, given a path of edges starting with the edge a_0 , namely a finite sequence of edges $(a'_0 = a_0, a'_1, \dots, a'_r)$, $r \geq 1$, such that $a'_i \cap a'_{i+1} \neq \emptyset$ for all $i \leq r-1$, the last edge a'_r must satisfy:

$$a'_r \in (k\mathbb{Z}/m\mathbb{Z} + \ell\mathbb{Z}/m\mathbb{Z}).a'_0.$$

But Γ is connected, hence any edge of Γ can be seen as the last edge of some path of edges starting with a , hence $k\mathbb{Z}/m\mathbb{Z} + \ell\mathbb{Z}/m\mathbb{Z} = \mathbb{Z}/m\mathbb{Z}$. Since $k < m$ and $\ell < m$, it follows that:

$$k \text{ and } \ell \text{ are coprime.} \quad (5)$$

Let us determine d , the number of edges having the same extremities as a_0 (cf. Figure 61). According to (3), the set of edges is $(k\mathbb{Z}/m\mathbb{Z}).a \cap (\ell\mathbb{Z}/m\mathbb{Z}).a$, so, using (5) we get:

$$\{\text{edges of extremities } P_0 \text{ and } Q_0\} = ((k\ell)\mathbb{Z}/m\mathbb{Z}).a_0, \quad (6)$$

Hence we count exactly $d = \frac{m}{k\ell}$ edges (including a_0) having the same extremities as a_0 .

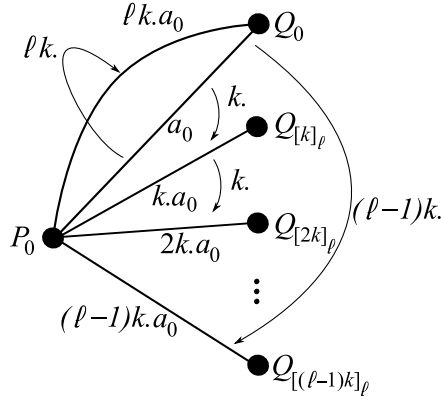

Figure 61: Action of \mathbb{Z} on a . The points Q_1, Q_2, \dots, Q_ℓ form the orbit of Q_1 .

From m, k, ℓ , we can now describe completely Γ and the action of $\mathbb{Z}/m\mathbb{Z}$ on Γ . For all $i \in \{0, \dots, k-1\}$ and all $j \in \{0, \dots, \ell-1\}$, according to the Chinese theorem, there exists a unique integer $u \in \{0, \dots, k\ell-1\}$ such that u is congruent to i modulo k and to j modulo ℓ . Then according to (6):

$$\begin{aligned} \{\text{edges of extremities } P_i \text{ and } Q_j\} &= \{(u + pk\ell).a_0, 0 \leq p \leq d-1\} \\ &= \{a_u, a_{u+k\ell}, \dots, a_{u+(d-1)k\ell}\}. \end{aligned} \quad (7)$$

Thus we get the $m = dk\ell$ edges of Γ . Such a graph is characterized by the triple (m, k, ℓ) or equivalently by the triple (d, k, ℓ) . \square

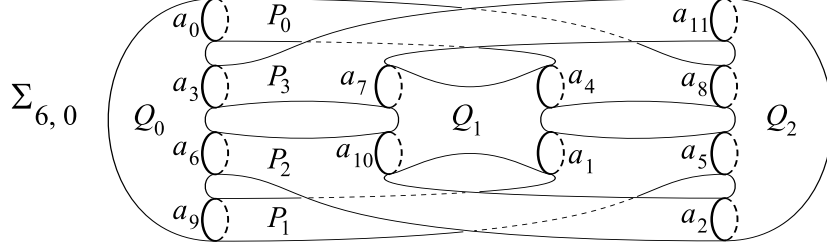

Figure 62: A simplex of 12 curves $\{a_i, i \in \mathbb{Z}/12\mathbb{Z}\}$ in $\Sigma_{6,0}$, and a \mathbb{Z} -action in $\text{Mod}(\Sigma_{6,0})$ such that for all $k \in \mathbb{Z}$ and all $i \in \{0, \dots, 11\}$:

$$\begin{aligned} k.a_i &= a_{[i+k]_{12}}, \\ k.P_i &= P_{[i+k]_4}, \\ k.Q_i &= Q_{[i+k]_3}. \end{aligned}$$

Lemma 9.20. *Let Σ be a surface $\Sigma_{g,b}$. Let \mathcal{A} be a simplex of at least three curves in Σ . We assume that there exists a morphism $\mathbb{Z} \rightarrow \mathcal{P}\text{Mod}(\Sigma)$ whose image preserves \mathcal{A} and that induces a transitive action on the curves of \mathcal{A} . Then the cardinality of \mathcal{A} is smaller than or equal to $2g$. The equality $|\mathcal{A}| = 2g$ can happen only if $g = 6$ and $b = 0$. In this case, the position of the curves of \mathcal{A} and the action of \mathbb{Z} on these curves are unique, up to homeomorphism; this case is represented in Figure 62, where the action of \mathbb{Z} is given as follows: let us denote by $\{a_i, 0 \leq i \leq 11\}$ the set of curves \mathcal{A} , and by $\{P_0, P_1, P_2, P_3\}$ and $\{Q_0, Q_1, Q_2\}$ the seven subsurfaces of $\text{Sub}_{\mathcal{A}}(\Sigma)$, then for all $k \in \mathbb{Z}$ and all $i \in \{0, \dots, 11\}$, we have $k.a_i = a_{[i+k]_{12}}$, $k.P_i = P_{[i+k]_4}$, $k.Q_i = Q_{[i+k]_3}$.*

Proof.

1. *Let us show Lemma 9.20 in the case where $b = 0$.*

Let Γ be the graph $\Gamma(\Sigma; \mathcal{A})$. The action of \mathbb{Z} on Σ induces an action of \mathbb{Z} on Γ that is transitive on the edges. Then Γ is one of the graphs described by Lemma 9.19. We are going to bound the cardinality $|\mathcal{A}|$ as a function of g , the genus of Σ . To do so, according to Lemma 9.19, we denote by:

- $m = |\mathcal{A}|$ the number of curves of \mathcal{A} , also equal to the number of edges of Γ ,
- \mathcal{S} the set of vertices of Γ ,
- c the number of independent cycles of Γ , we have: $c = 1 + |\mathcal{A}| - |\mathcal{S}|$,
- h the number of vertices in Γ of degree 1 or 2.

Let us recall that $b = 0$, hence the vertices of degree 1 or 2 correspond in Σ to connected components having only one or two boundary components. Therefore, these connected components must be of nonzero genus, whence $g \geq c + h$. Moreover, by hypothesis, $m \geq 3$.

In the case (a) of Lemma 9.19, we set $k = |\mathcal{S}|$. Then:

- if $k = 1$, then $c = m$, but $g \geq c$, so $m \leq g$. Therefore, $m < 2g$;
- if $k = 2$, then $c = 1 + m - 2 = m - 1$, whence $g \geq c = m - 1 > \frac{m}{2}$, so $m < 2g$;
- if $k \geq 3$, we then set $d = \frac{m}{k}$. We have $c = 1 + m - k = 1 + \frac{(d-1)m}{d}$. Hence:
 - if $d = 1$, all the vertices are of degree 2, hence $h = k = m$ and we have: $g \geq c + k = 1 + m$, so $m < 2g$;
 - if $d \geq 2$, then: $g \geq c \geq 1 + \frac{m}{2}$, so $m < 2g$.

In the case (b) of Lemma 9.19, let k and ℓ be the cardinalities of the two orbits \mathcal{S}_1 and \mathcal{S}_2 of vertices and $d = \frac{m}{k\ell}$. Even if it means swapping \mathcal{S}_1 and \mathcal{S}_2 , we can assume that $k \leq \ell$. Let us recall that k and ℓ are coprime. For each triple (d, k, ℓ) that respects these two conditions, let us compare m and $2g$.

- if $(d, k, \ell) = (1, 1, m)$, then the ℓ vertices of \mathcal{S}_2 are of degree 1, so $h = \ell = m$, so $g \geq h = \ell = m$, so $m < 2g$;
- if $(d, k, \ell) = (1, 2, \frac{m}{2})$, then $c = 1 + m - (2 + \frac{m}{2}) = \frac{m}{2} - 1$. Now, the $\ell = \frac{m}{2}$ vertices of \mathcal{S}_2 are of degree 2, so $h = \frac{m}{2}$ and $g \geq c + h = m - 1$, so $m < 2g$;
- if $(d, k, \ell) = (1, 3, 4)$, then $c = 6$ and $m = 12$, so $g \geq \frac{m}{2}$, so $m \leq 2g$;
- if $(d, k, \ell) = (1, 3, 5)$, then $c = 8$ and $m = 15$, so $g \geq \frac{m+1}{2}$, so $m < 2g$;
- if $(d, k, \ell) = (1, k, \ell)$ with $k = 3$ and $\ell \geq 7$, or $k \geq 4$ and $\ell \geq 5$ (recall that k and ℓ are coprime), then $c = 1 + m(1 - \frac{1}{\ell} - \frac{1}{k})$. Then $\frac{1}{\ell} + \frac{1}{k} \leq \frac{1}{2}$, so $g \geq c \geq 1 + \frac{m}{2}$, so $m < 2g$;
- if $(d, k, \ell) = (2, 1, \frac{m}{2})$, then a vertex is of degree m and $\frac{m}{2}$ vertices are of degree 2, so $h = \frac{m}{2}$ and $c = 1 + m - (1 + \frac{m}{2})$, so $g \geq h + c = m$, so $m < 2g$;
- if $(d, k, \ell) = (d, 1, \frac{m}{d})$ with $d \geq 3$, then we have $d + 1$ vertices and dm edges. So $c = 1 - (1 + \frac{m}{d}) + (dm) = \frac{d-1}{d}m$. But $\frac{d-1}{d} > \frac{1}{2}$, so $g \geq c \geq \frac{m}{2}$ and finally, $m < 2g$;
- if $(d, k, \ell) = (m, 1, 1)$, then $g \geq c = 1 + m - 2 = m - 1$. But $m \geq 3$, so $m < 2g$;
- if (d, k, ℓ) satisfies $d \geq 2$, $k \geq 2$ and $\ell \geq 2$, we have $c = 1 + m - (k + \ell)$. But $k\ell = \frac{m}{d} \leq \frac{m}{2}$, so $k + \ell \leq \frac{m}{2}$ (indeed, a sum of integers is always smaller than or equal to a product of these two integers as soon as they are greater than or equal to 2), so $g \geq c \geq 1 + \frac{m}{2}$, so $m < 2g$.

Finally, in all the cases, $m \leq 2g$. The equality case comes only in the case (b), when the triple (d, k, ℓ) equals $(1, 3, 4)$, cf. Figure 59, top-right hand graph. The corresponding surface together with the curves of \mathcal{A} , indexed in a self-understanding way with respect to the action of \mathbb{Z} , is the surface $\Sigma_{6,0}$ depicted in Figure 62.

2. *Let us show Lemma 9.20 in the case where $b > 0$.*

Let us assume that we have a surface Σ together with a simplex \mathcal{A} of at least three curves, and a morphism φ of \mathbb{Z} in $\mathcal{P}\text{Mod}(\Sigma)$ whose image preserves \mathcal{A} and induces on its curves a transitive action. Then, after having applied the map sq to Σ and \mathcal{A} , and after having replaced φ by $\text{sq}^* \circ \varphi$, we have boiled down to the case without boundary. Since the simplex \mathcal{A} contains at least three curves and since the action of \mathbb{Z} induced by φ is transitive on \mathcal{A} , we can apply

Proposition 7.5: \mathcal{A} and $\text{sq}(\mathcal{A})$ consist in the same number of curves. Hence $|\mathcal{A}| \leq 2g$, and if $|\mathcal{A}| = 2g$, then $|\text{sq}(\mathcal{A})| = 2g$, so according to what we just saw in the case without boundary, the only pair $(\text{sq}(\Sigma), \text{sq}(\mathcal{A}))$ satisfying $|\text{sq}(\mathcal{A})| = 2g$ is the one of Figure 62. Now, according to Proposition 7.5, for all subsurface $S \in \text{Sub}_{\mathcal{A}}(\Sigma)$, we have:

$$\text{sq}(\varphi(1)(S)) = \text{sq}^*(\varphi(1))(\text{sq}(S)).$$

In the case without boundary, no subsurface is preserved by $\text{sq}^*(\varphi(1))$, so no subsurface is preserved by $\varphi(1)$ in the case with boundary. This is absurd for a subsurface of $\text{Sub}_{\mathcal{A}}(\Sigma)$ whose natural boundary is nonempty is preserved by any mapping class of $\mathcal{P}\text{Mod}_{\mathcal{A}}(\Sigma)$. Hence in a surface of genus 6 with boundary, the curves of \mathcal{A} cannot be arranged as in Figure 62. Therefore, when the boundary is not empty, we have $|\mathcal{A}| < 2g$. \square

In order to better understand the situation depicted in Figure 62, when the role of \mathcal{A} is played by the set of curves $\sigma(\mathcal{G})$, coming from a morphism ρ from \mathcal{B}_{12} in $\text{Mod}(\Sigma_{6,0})$, we prove the following lemma:

Lemma 9.21. *Let Σ be the surface $\Sigma_{6,0}$ and let ρ be a morphism from \mathcal{B}_{12} in $\text{Mod}(\Sigma)$. We assume that there exists a simplex \mathcal{A} of 12 curves in $\sigma(\mathcal{G})$ such that a subgroup of \mathcal{J} acts transitively on \mathcal{A} . Then ρ is cyclic.*

Proof. Let \mathcal{A} be a simplex of 12 curves in $\sigma(\mathcal{G})$ such that a subgroup \mathcal{K} of $\mathcal{J} = \langle \delta \rangle_{\mathcal{B}_{12}}$ acts transitively on it. We want to show that ρ is then cyclic. To do so, we assume that ρ is not cyclic and we look for a contradiction (actually, we will use the fact that ρ is not cyclic to show that ρ is cyclic! This is the expected contradiction).

Let γ be a generator of \mathcal{K} and let k be an integer such that $\gamma = \delta^k$. Even if it means replacing \mathcal{A} by $\delta^\ell \mathcal{A}$ where ℓ is an integer, we can assume that $\mathcal{A} \cap \sigma(A_0)$ is not empty. Let a_0 be one of the curves of $\mathcal{A} \cap \sigma(A_0)$. For all $i \in \{1, \dots, 11\}$, let us denote by a_i the curve $\gamma^i \cdot a_0$. It belongs to $\sigma(A_{ki})$. Then \mathcal{A} is the set $\{a_j, 0 \leq j \leq 11\}$, and the surface Σ together with the curves of \mathcal{A} and with the action of \mathcal{K} on Σ and on \mathcal{A} is (up to homeomorphism) the surface together with the 12 curves and with the \mathbb{Z} -action depicted in Figure 62.

1. *Let us show that k is coprime with 3.*

Let us argue by contradiction. Let us assume that k is a multiple of 3 and let us set $k' = \frac{k}{3}$. Let us then set $\mathcal{L} = \langle \delta^{2k'} \rangle$. We are going to show that $\mathcal{L} \cdot a_0$ contains 18 curves, then to show that this is absurd. First, we check that:

- $a_6 = \gamma^6 \cdot a_0 \neq a_0$, so $\delta^{6k} \cdot a_0 \neq a_0$, so $(\delta^{2k'})^9 \cdot a_0 \neq a_0$;
- $a_8 = \gamma^8 \cdot a_0 \neq a_0$, so $\delta^{8k} \cdot a_0 \neq a_0$, so $(\delta^{2k'})^{12} \cdot a_0 \neq a_0$;
- $\gamma^{12} \cdot a_0 = a_0$, so $\delta^{12k} \cdot a_0 = a_0$, so $(\delta^{2k'})^{18} \cdot a_0 = a_0$.

Consequently, $\mathcal{L} \cdot a_0$ contains 18 curves. Furthermore, $\mathcal{L} \cdot a_0$ is included in $\sigma(A_0) \cup \sigma(A_2) \cup \dots \cup \sigma(A_{n-2})$, which is a simplex, for the group $\langle A_0, A_2, \dots, A_{n-2} \rangle$ is abelian. Finally, $\mathcal{L} \cdot a_0$ is a simplex of 18 curves in Σ , but this is absurd because the greatest simplex in Σ contains $3g - 3 + b = 15$ curves. Hence k is coprime with 3.

2. *Let us show that $I(\mathcal{A}, \sigma(\mathcal{G})) = 0$.*

Let us argue by contradiction. We assume that there exists a curve c of $\sigma(\mathcal{G})$ that intersects a curve of \mathcal{A} . Since $\sigma(\mathcal{G})$ is stable by \mathcal{K} , we can assume without loss of generality that c belongs

to $\sigma(A_{\pm 1})$ and intersects a_0 . According to Figure 62, there exists a pair of pants P in Σ whose boundary components are a_0 , $a_4 = \gamma^4.a_0$ and $a_8 = \gamma^8.a_0$. But the curves a_4 and a_8 belong to $\sigma(\gamma^4.A_0) \cup \sigma(\gamma^{8k}.A_0)$, hence belong to $\sigma(\delta^{4k}.A_0) \cup \sigma(\delta^{8k}.A_0)$. Now, k is coprime with 3 according to step 1., so $4k$ and $8k$ belong to $4\mathbb{Z} \setminus 12\mathbb{Z}$. Hence $\sigma(\delta^{4k}.A_0) \cup \sigma(\delta^{8k}.A_0) \subset \sigma(A_4) \cup \sigma(A_8)$. Moreover $A_{\pm 1}$ commutes with A_4 and A_8 , so the only boundary component of P that c intersects is a_0 , and neither a_4 nor a_8 . Let us consider now the image of this situation by γ^4 . The pair of pants P is stable by γ^4 , but c is sent on a curve $\gamma^4.c$ that intersects only a_4 , cf. Figure 63. Because of a lack of room in the pair of pants P , these two curves c and $\gamma^4.c$ must intersect. Yet c and $\gamma^4.c$ belong respectively to $\sigma(A_{\pm 1})$ and $\sigma(A_{4k\pm 1}) \cup \sigma(A_{8k\pm 1})$. Since $A_{\pm 1}$ commutes with $A_{4k\pm 1}$ and $A_{8k\pm 1}$, the curves c and $\gamma^4.c$ cannot intersect: this is a contradiction.

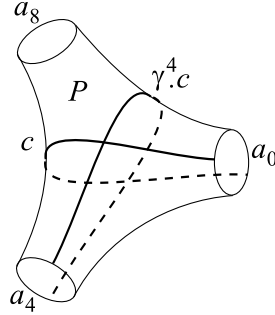

Figure 63: The curves c and $\gamma^4.c$ must intersect in P .

3. Let us show that $\mathcal{A} = \mathcal{J}.a_0$; in other words, everything happens as if $\mathcal{K} = \mathcal{J}$.

Let us denote by $\delta\mathcal{K}$ the set $\{\delta\xi, \xi \in \mathcal{K}\}$ and by $\delta\mathcal{A}$ the set $\{\delta.x, x \in \mathcal{A}\}$. Let us assume that $\mathcal{K} \neq \mathcal{J}$. Then it is clear that \mathcal{K} and $\delta\mathcal{K}$ do not share any element in common. Since \mathcal{A} and $\delta\mathcal{A}$ are the orbits of curves under the action of \mathcal{K} , we have $\mathcal{A} = \delta\mathcal{A}$ or $\mathcal{A} \cap \delta\mathcal{A} = \emptyset$. If $\mathcal{A} \cap \delta\mathcal{A} = \emptyset$, then $\mathcal{A} \cup \delta\mathcal{A}$ contains 24 curves. In addition, according to step 2., we have $I(\sigma(\mathcal{G}), \mathcal{A}) = 0$, so $\delta\mathcal{A} \subset \sigma(\mathcal{G})$, so $I(\delta\mathcal{A}, \mathcal{A}) = 0$, so $\mathcal{A} \cup \delta\mathcal{A}$ is a simplex. Finally, $\mathcal{A} \cup \delta\mathcal{A}$ is a simplex of 24 curves. But this is absurd for in Σ , the largest simplex contains $3g - 3 + b = 15$ curves. Hence $\mathcal{A} = \delta\mathcal{A}$. Then \mathcal{A} is stable by \mathcal{J} , so \mathcal{A} (namely $\mathcal{K}.a_0$) is equal to $\mathcal{J}.a_0$. So $\mathcal{K}.a_0 = \mathcal{J}.a_0$. So everything happens as if $\mathcal{K} = \mathcal{J}$ (actually we have proven that k is coprime with 12).

Notation.

- Let D be the mapping class $\rho(\delta)$.
- For all integers $i \in \{1, \dots, 11\}$, let a_i be the curve $D^i(a_0)$ so that $a_i \in \sigma(A_i)$. According to step 3., we have the equality $\mathcal{A} = \{a_i, 0 \leq i \leq 11\}$.
- Let Q_0 (respectively Q_1 , resp. Q_2) be the subsurface of $\text{Sub}_{\mathcal{A}}(\Sigma)$ that is bounded by the curves a_0, a_3, a_6 and a_9 (resp. a_1, a_4, a_7 and a_{10} , resp. a_2, a_5, a_8 and a_{11}), cf. Figure 62.

4.a) Let us show that $\sigma(\mathcal{G}) \subset \mathcal{A} \cup \text{Curv}(Q_0 \cup Q_1 \cup Q_2)$ and for all $x \in \sigma(\mathcal{G}) \setminus \mathcal{A}$, we have $D^3(x) = x$.

If there exists a curve x belonging to $\sigma(\mathcal{G}) \setminus \mathcal{A}$, the curve x does not intersect any curve of \mathcal{A} according to step 2.. Now, all the subsurfaces of $\text{Sub}_{\mathcal{A}}(\Sigma)$, except Q_0, Q_1 and Q_2 , are some pairs of pants, so x belongs to $\text{Curv}(Q_0)$, $\text{Curv}(Q_1)$, or $\text{Curv}(Q_2)$. Even if it means considering $D(x)$ or $D^2(x)$ instead of x , we can assume that x belongs to $\text{Curv}(Q_0)$. Then $D^3(x)$ belongs to

$\text{Curv}(Q_0)$ as well. Let i be an integer of $\{0, \dots, 11\}$ such that $x \in \sigma(A_i)$. Then $D^3(x)$ belongs to $\sigma(A_{i+3})$. Since A_i and A_{i+3} commute, x and $D^3(x)$ cannot intersect. But $\text{Curv}(Q_0)$ does not contain any simplex of two curves, so $D^3(x) = x$.

4.b) *Let us show that $\sigma(D) \subset \mathcal{A} \cup \text{Curv}(Q_0 \cup Q_1 \cup Q_2)$ and for all $x \in \sigma(D) \setminus \mathcal{A}$, we have $D^3(x) = x$.*

According to step 3., $\mathcal{A} = \mathcal{J}.a_0$, so \mathcal{A} is stable by the mapping class D , so the curves of \mathcal{A} are reduction curves of D . Hence the curves of $\sigma(D)$ do not intersect the curves of \mathcal{A} . Since all the subsurfaces of $\text{Sub}_{\mathcal{A}}(\Sigma)$ except Q_0, Q_1 and Q_2 are pairs of pants, the curves of $\sigma(D)$ belong to $\mathcal{A} \cup \text{Curv}(Q_0) \cup \text{Curv}(Q_1) \cup \text{Curv}(Q_2)$. Moreover, for all $i \in \{0, 1, 2\}$, the surface Q_i does not contain any simplex of more than one curve, since in the case of Q_i , we have $3g - 3 + b = 1$. Hence $\sigma(D) \cap \text{Curv}(Q_i)$ is empty or is reduced to one curve. Now, D^3 preserves $\sigma(D) \cap \text{Curv}(Q_i)$, so D^3 must preserve this curve.

5. *Let us show that $\sigma(\mathcal{G}) \setminus \mathcal{A} \subset \sigma(D) \setminus \mathcal{A}$, and let us describe $\sigma(D) \setminus \mathcal{A}$: if $\sigma(D) \setminus \mathcal{A}$ is not empty, then $\sigma(D) \setminus \mathcal{A}$ contains three curves, one included in Q_0 which we denote by c_0 , and two other curves $c_1 = D(c_0)$ and $c_2 = D^2(c_0)$ included respectively in Q_1 and Q_2 .*

According to the action of D on \mathcal{A} , D permutes Q_0, Q_1 and Q_2 , whereas D^3 preserves each of them. Let us denote by $\widehat{D^3}$ the restriction of D^3 on Q_0 : $\widehat{D^3}$ belongs to $\text{Mod}(Q_0)$. Let us focus on $\sigma(D) \setminus \mathcal{A}$, depending on the nature of $\widehat{D^3}$, and let us show that $\sigma(\mathcal{G}) \setminus \mathcal{A} \subset \sigma(D) \setminus \mathcal{A}$.

- If $\widehat{D^3}$ is pseudo-Anosov, then so is $(\widehat{D^3})^4$. But D^{12} is in the center of $\rho(\mathcal{B}_{12})$, so all the curves of $\sigma(\rho(\mathcal{B}_{12}))$ are some reduction curves of D^{12} . Therefore Q_0 do not contain any curve of $\sigma(\rho(\mathcal{B}_{12}))$. Thus,

$$\sigma(\mathcal{G}) \setminus \mathcal{A} \subset \sigma(D) \setminus \mathcal{A} = \emptyset.$$

- If $\widehat{D^3}$ is periodic, then $\widehat{D^3}$ would be the isotopy class of a positive diffeomorphism of finite order according to Kerckhoff's Theorem. Now, according to Kerékjártó's Theorem (cf. [Kj]), such a diffeomorphism is conjugate to a rotation of the sphere. But if such a rotation, of order 4 here, preserves a curve c , it preserves also each of both hemispheres bounded by this curve. Hence one of these two hemispheres contains the orbit of a_0 , that is to say the four boundary components a_0, a_3, a_6, a_9 , so the other hemisphere is homeomorphic to a disk. Hence the curve c bounds a disk. Hence $\widehat{D^3}$ does not preserve any curve of $\text{Curv}(Q_0)$. Hence according to step 4.a) step 4.b),

$$\sigma(\mathcal{G}) \setminus \mathcal{A} \subset \sigma(D) \setminus \mathcal{A} = \emptyset.$$

- If $\widehat{D^3}$ is reducible, let us denote by c_0 an essential reduction curve of $\widehat{D^3}$. Then $\sigma(\widehat{D^3}) = \{c_0\}$ according to step 4.b). Hence $\mathcal{J}.c_0$ is a set of three curves, one in Q_0 , one in Q_1 and one in Q_2 . Now, any curve of $\text{Curv}(Q_0)$ different from c_0 intersects c_0 , so by definition of $\sigma(\widehat{D^3})$, this curve is not a reduction curve of $\widehat{D^3}$, hence it cannot be preserved by $\widehat{D^3}$. So according to step 4., $\sigma(\mathcal{G}) \cap \text{Curv}(Q_0) \subset \{c_0\}$. Hence if $\widehat{D^3}$ is reducible, we have:

$$\sigma(\mathcal{G}) \setminus \mathcal{A} \subset \sigma(D) \setminus \mathcal{A} = \mathcal{J}.c_0 = \{c_0, c_1, c_2\},$$

where $c_1 = D(c_0)$ and $c_2 = D^2(c_0)$.

In order to discuss later (in steps 7. and 8.) about the stability of \mathcal{A} under the action of \mathcal{B}_{12} , we are going to study in step 6. the stability of $\mathcal{J}.c_0$ under the action of \mathcal{B}_{12} . Of course the set

$\mathcal{J}.c_0$ has some meaning if the curve c_0 is defined, that is to say when $\sigma(D) \setminus \mathcal{A} \neq \emptyset$ according to step 5..

6. Let us show that if $\sigma(D) \setminus \mathcal{A} \neq \emptyset$, then the action of \mathcal{B}_{12} via ρ on $\text{Curv}(\Sigma)$ preserves $\mathcal{J}.c_0$.

By definition of c_0 according to step 5., c_0 belongs to $\sigma(D)$. Since $\sigma(D)$ is stable by D , $\sigma(D)$ contains $\mathcal{J}.c_0$, and if a_0 belongs to $\sigma(D)$, then $\sigma(D)$ contains $\mathcal{J}.a_0$ that is equal to \mathcal{A} , whereas if a_0 does not belong to $\sigma(D)$, then $\sigma(D) \cap \mathcal{A} = \emptyset$. Now, according to step 5., $\sigma(D)$ is included in $\mathcal{J}.c_0 \cup \mathcal{A}$. Hence $\sigma(D) = \mathcal{J}.c_0$ or $\sigma(D) = \mathcal{J}.c_0 \cup \mathcal{A}$. But, for all $\xi \in \mathcal{B}_{12}$, the mapping class $\rho(\xi)$ commutes with D^{12} , so $\rho(\xi)(\sigma(D^{12})) = \sigma(D^{12})$, and so $\rho(\xi)(\sigma(D)) = \sigma(D)$, since $\sigma(D^{12}) = \sigma(D)$. Hence the action of \mathcal{B}_{12} via ρ on $\text{Curv}(\Sigma)$ preserves the curves of $\sigma(D)$. Then if $\sigma(D) = \mathcal{J}.c_0$, we have shown that the action of \mathcal{B}_{12} via ρ on $\text{Curv}(\Sigma)$ preserves $\mathcal{J}.c_0$. We still have to study the case where $\sigma(D) = \mathcal{J}.c_0 \cup \mathcal{A}$. We are going to show that:

Any mapping class that preserves $\mathcal{J}.c_0 \cup \mathcal{A}$ preserves $\mathcal{J}.c_0$ and preserves \mathcal{A} . (1)

Since the action of \mathcal{B}_{12} via ρ on $\text{Curv}(\Sigma)$ preserves $\sigma(D) = \mathcal{J}.c_0 \cup \mathcal{A}$, it preserves $\mathcal{J}.c_0$. So, proving (1) is enough to show step 6..

Let us show assertion (1). The curve c_0 lies in Q_0 , is separating in Q_0 and so induces a partition of $\text{Bndy}(Q_0)$ in two subsets: the boundary components located on an edge of c_0 and the boundary components located on the other one. Since the curve c_0 is stable by D^3 , this partition must be stable by D^3 . The boundary components of Q_0 are the curves a_0, a_3, a_6, a_9 , and their images by D^3 are respectively a_3, a_6, a_9, a_0 , so this partition can only be $\{a_0, a_6\} \sqcup \{a_3, a_9\}$. Indeed, it is clear that the two other partitions $\{a_0, a_3\} \sqcup \{a_6, a_9\}$ and $\{a_0, a_9\} \sqcup \{a_3, a_6\}$ are not stable by D^3 . Let us consider the graph $\Gamma(\Sigma, \sigma(D))$, cf. Figure 64 on the right hand side. We see that the smallest injective cycle of edges containing a_0 contains four edges, for example

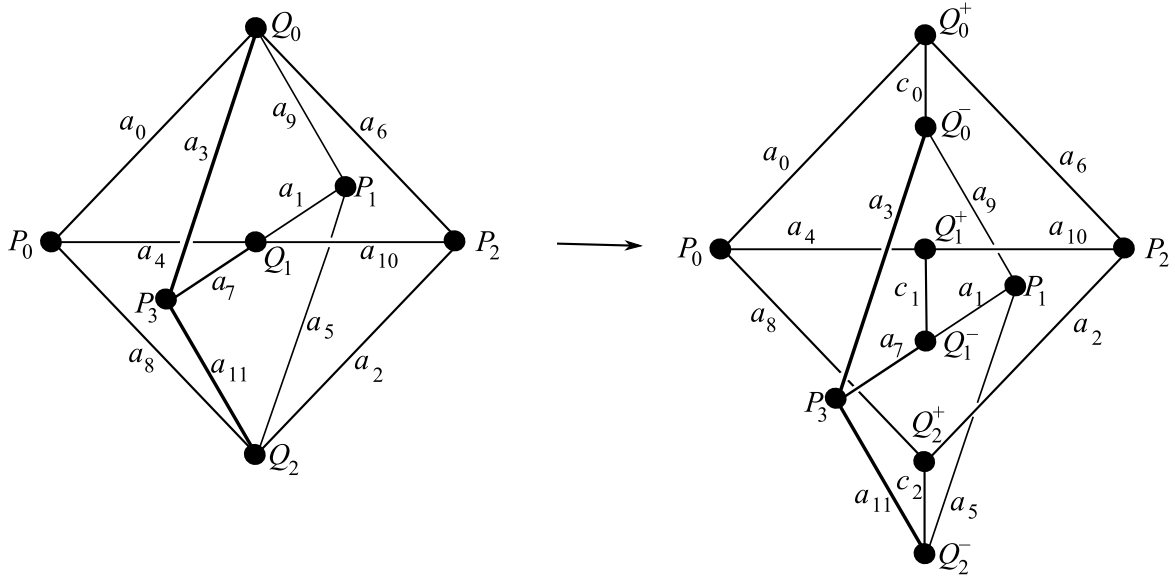

Figure 64: The graph $\Gamma(\Sigma, \mathcal{A})$ on the left hand side, the graph $\Gamma(\Sigma, \mathcal{J}.c_0 \cup \mathcal{A})$ on the right hand side.

the cycle a_0, a_4, a_{10}, a_6 , whereas the smallest injective cycles of edges containing c_0 contains six edges, for example the cycle $a_0, c_0, a_3, a_{11}, c_2, a_8$. Then, any mapping class preserving $\mathcal{J}.c_0 \cup \mathcal{A}$

induces an action on the graph $\Gamma(\Sigma, \mathcal{J}.c_0 \cup \mathcal{A})$, but cannot swap in this graph two edges such that a_0 and c_0 , since they have different combinatoric properties, as we have just seen it. Hence any mapping class that preserves $\mathcal{J}.c_0 \cup \mathcal{A}$ preserves $\mathcal{J}.c_0$ and preserves \mathcal{A} : the statement (1) is proved.

7. *Let us show that if the action of \mathcal{B}_{12} on $\text{Curv}(\Sigma)$ preserves \mathcal{A} , then ρ is cyclic.*

Since we assume that the action of \mathcal{B}_{12} on $\text{Curv}(\Sigma)$ preserves the curve simplex \mathcal{A} , we can apply Proposition 9.2 and conclude that \mathcal{B}_{12} acts cyclicly on \mathcal{A} , and so \mathcal{F}_{12} acts trivially on \mathcal{A} . Let us consider the subgroup \mathcal{F}_{12}^* of \mathcal{F}_{12} which is isomorphic to \mathcal{B}_{10} . Then for any surface $S \in \text{Sub}_{\mathcal{A}}(\Sigma)$, the morphism ρ restricted to \mathcal{F}_{12}^* induces a morphism in $\mathcal{P}\text{Mod}(S)$. Since S is of genus zero and \mathcal{F}_{12}^* is isomorphic to \mathcal{B}_{10} , we can apply Theorem 7.1 and conclude that the restriction of ρ to \mathcal{F}_{12}^* induces in $\mathcal{P}\text{Mod}(S)$ a cyclic morphism. Hence the restriction of ρ to \mathcal{F}_{12}^* induces in $\mathcal{P}\text{Mod}(\Sigma_{\mathcal{A}})$ a cyclic morphism. Thus the group $\rho(\mathcal{F}_{12}^*)$ included in $\mathcal{P}_{\mathcal{A}}\text{Mod}(\Sigma)$ is sent in $\mathcal{P}\text{Mod}(\Sigma_{\mathcal{A}})$ on an abelian subgroup \widehat{G} . Let us consider the below diagram.

$$\begin{array}{ccccc} \rho(\mathcal{F}_{12}^*) \subset \mathcal{P}_{\mathcal{A}}\text{Mod}(\Sigma) & \xrightarrow{\text{cut}_{\mathcal{A}}} & \mathcal{P}\text{Mod}(\Sigma_{\mathcal{A}}) & \supset & \widehat{G} \\ & \nearrow \text{cut}_{\mathcal{A}} & \uparrow \text{for}_{\partial\Sigma_{\mathcal{A}}} & & \\ G \subset \mathcal{P}_{\mathcal{A}}\text{Mod}(\Sigma) & \xleftarrow{\text{rec}_{\mathcal{A}}} & \text{Mod}(\Sigma_{\mathcal{A}}, \partial\Sigma_{\mathcal{A}}) & \supset & \widetilde{G} = \text{for}_{\partial\Sigma_{\mathcal{A}}}^{-1}(\widehat{G}) \end{array}$$

Starting from \widehat{G} , we successively define the groups:

- $\widetilde{G} = \text{for}_{\partial\Sigma_{\mathcal{A}}}^{-1}(\widehat{G})$ where $\text{for}_{\partial\Sigma_{\mathcal{A}}} : \text{Mod}(\Sigma_{\mathcal{A}}, \partial\Sigma_{\mathcal{A}}) \rightarrow \mathcal{P}\text{Mod}(\Sigma_{\mathcal{A}})$ is the canonical “forget” morphism. According to Lemma 5.11, \widetilde{G} is abelian,
- $G = \text{rec}_{\mathcal{A}}(\widetilde{G})$ where $\text{rec}_{\mathcal{A}} : \text{Mod}(\Sigma_{\mathcal{A}}, \partial\Sigma) \rightarrow \mathcal{P}_{\mathcal{A}}\text{Mod}(\Sigma)$ is the gluing morphism along the curves of \mathcal{A} . The group G is abelian since \widetilde{G} is.

By construction, $\rho(\mathcal{F}_{12}^*)$ is included in G , an abelian group, so $\rho(\mathcal{F}_{12}^*)$ is abelian. Since \mathcal{F}_{12}^* is isomorphic to \mathcal{B}_{10} and since the abelianization of \mathcal{B}_{10} is cyclic, it follows that $\rho(\mathcal{F}_{12}^*)$ is cyclic. So the mapping class $\rho(\tau_3\tau_4^{-1}) = \rho(\tau_3\tau_1^{-1})(\rho(\tau_4\tau_1^{-1}))^{-1}$ coincides with the identity. Hence $\rho(\tau_3) = \rho(\tau_4)$, so according to Lemma 5.2, the morphism ρ is cyclic.

8. *Let us show that if $\rho(\mathcal{B}_{12})$ does not preserve \mathcal{A} , then, again, ρ is cyclic.*

If $\rho(\mathcal{B}_{12})$ does not preserve \mathcal{A} , it is clear that there exists a curve $a' \in \mathcal{A}$ and a mapping class $F \in \mathcal{G}$ such that $F(a')$ does not belong to \mathcal{A} . Even if it means conjugating F by a power of D , we can assume without loss of generality that $a' = a_0$. For all $i \in \{0\} \cup \{2, 3, \dots, 10\}$, the mapping class A_i commutes with A_0 , hence preserves $\sigma(A_0)$, hence sends a_0 in $\sigma(\mathcal{G})$. But, according to step 5., $\sigma(\mathcal{G})$ is included in $\mathcal{A} \cup \sigma(D)$, that is to say that $\sigma(\mathcal{G})$ is included in \mathcal{A} if $\sigma(D) \setminus \mathcal{A} = \emptyset$, or in $\mathcal{A} \cup \mathcal{J}.c_0$ if $\sigma(D) \setminus \mathcal{A} \neq \emptyset$. If $\sigma(D) \setminus \mathcal{A} \neq \emptyset$, then $\mathcal{J}.c_0$ is stable by $\rho(\mathcal{B}_{12})$ according to step 6., so A_i cannot send a_0 in $\mathcal{J}.c_0$. Hence in all the cases, A_i sends a_0 in \mathcal{A} . But we have seen that $F(a_0)$ did not belong to \mathcal{A} , so F must belong to $\{A_1, A_{11}\}$. Even if it means conjugating F by $A_{11}(A_0A_{11})(A_1A_0A_{11})$, we can assume without loss of generality that $F = A_1$. Let us sum up: we have shown that

$$\text{if } \rho(\mathcal{B}_{12}) \text{ does not preserve } \mathcal{A}, \text{ then } A_1(a_0) \text{ does not belong to } \mathcal{A}. \quad (2)$$

This implies that

$$\text{sp}(a_0) \subset \{A_0, A_2\}, \quad (3)$$

for otherwise, it would exist $j \in \{3, 4, \dots, 11\}$ such that $a_0 \in \sigma(A_j)$ and as we have just seen it, we would deduce that $A_1(a_0)$ would belong to \mathcal{A} , which would contradict (2). Remember that by definition of a_0 , A_0 belongs to $\text{sp}(a_0)$. Hence (3) implies that $\text{sp}(a_0) \in \{\{A_0\}, \{A_0, A_2\}\}$, whence by conjugation,

$$\text{or } \left. \begin{array}{l} \text{for all } i \in \{0, 1, \dots, n-1\}, \text{ we have } \text{sp}(a_i) = \{A_i\} \\ \text{for all } i \in \{0, 1, \dots, n-1\}, \text{ we have } \text{sp}(a_i) = \{A_i, A_{i+2}\}. \end{array} \right\} \quad (4)$$

For all $\ell \in \{4, 5, \dots, 11\}$ and all $\varepsilon \in \{1, 2\}$, A_ε and A_ℓ commute, so $A_\varepsilon(a_\ell)$ belongs to $\sigma(A_\ell)$, which is itself included in $\sigma(\mathcal{G})$. According to step 5., $\sigma(\mathcal{G})$ is included in $\mathcal{A} \cup \sigma(D)$, so $A_\varepsilon(a_\ell)$ belongs to \mathcal{A} or possibly to $\mathcal{J}.c_0$ if $\sigma(D) \setminus \mathcal{A} \neq \emptyset$. But we have seen that $\mathcal{J}.c_0$ (if it exists) is stable by the action of \mathcal{B}_{12} according to step 6., hence $A_\varepsilon(a_\ell)$ belongs to \mathcal{A} . Let us show that $A_\varepsilon(a_\ell) = a_\ell$. We argue differently, depending on the two cases mentioned by (4).

- If $\text{sp}(a_\ell) = \{A_\ell\}$, then the spectrum of each curve of \mathcal{A} is reduced to a singleton, and the canonical reduction system of each mapping class of \mathcal{G} contains only one element of \mathcal{A} . Since $A_\varepsilon(a_\ell) \in \mathcal{A} \cap \sigma(A_\ell)$, it follows that $A_\varepsilon(a_\ell) = a_\ell$.
- If $\text{sp}(a_\ell) = \{A_\ell, A_{\ell+2}\}$, then a_ℓ and $a_{\ell-2}$ are the only curves of \mathcal{A} in $\sigma(A_\ell)$. Hence $A_\varepsilon(a_\ell) = a_\ell$ or $A_\varepsilon(a_\ell) = a_{\ell-2}$. If $A_\varepsilon(a_\ell) = a_{\ell-2}$, we would have $\text{sp}(A_\varepsilon(a_\ell)) = \{A_{\ell-2}, A_\ell\}$. But A_ε commutes with at least one of the two mapping classes $A_{\ell-2}$ or $A_{\ell+2}$. If A_ε commutes with $A_{\ell-2}$, the fact that $A_{\ell-2} \notin \text{sp}(a_\ell)$ implies that $A_{\ell-2} \notin \text{sp}(A_\varepsilon(a_\ell))$; whereas if A_ε commutes with $A_{\ell+2}$, the fact that $A_{\ell+2} \in \text{sp}(a_\ell)$ implies that $A_{\ell+2} \in \text{sp}(A_\varepsilon(a_\ell))$. In the two cases, the fact that $\text{sp}(A_\varepsilon(a_\ell)) = \{A_{\ell-2}, A_\ell\}$ is contradicted, so $A_\varepsilon(a_\ell) \neq a_{\ell-2}$, so $A_\varepsilon(a_\ell) = a_\ell$.

Hence A_ε preserves each curve a_ℓ , $4 \leq \ell \leq 11$. Let us set

$$\mathcal{A}' = \{a_\ell, 4 \leq \ell \leq 11\}.$$

Let us consider the surface $\Sigma_{\mathcal{A}'}$ Figure 65. Since A_ε preserves each curve of \mathcal{A}' , A_ε cannot permute the connected components of $\Sigma_{\mathcal{A}'}$. Hence A_ε (recall that ε ranges over $\{1, 2\}$) induces a mapping class \tilde{A}_ε in $\mathcal{P}\text{Mod}(\Sigma_{\mathcal{A}'})$. But we have the following canonical isomorphism:

$$\mathcal{P}\text{Mod}(\Sigma_{\mathcal{A}'}) = \prod_{S \in \text{Comp}(\Sigma_{\mathcal{A}'})} \mathcal{P}\text{Mod}(S),$$

where $\text{Comp}(\Sigma_{\sigma(\mathcal{G})})$ denotes the set of all connected components of $\Sigma_{\sigma(\mathcal{G})}$. In other words, $\mathcal{P}\text{Mod}(\Sigma_{\mathcal{A}'})$ is a direct product of mapping class groups of surfaces of genus zero (cf. Figure 65). For any connected component S of $\Sigma_{\mathcal{A}'}$, the images of \tilde{A}_1 and \tilde{A}_2 induced in $\mathcal{P}\text{Mod}(S)$ satisfy a braid relation. But S is of genus zero, so we can apply Theorem 7.1. Hence $\tilde{A}_1 = \tilde{A}_2$. Finally, A_1 and A_2 induce the same mapping class in $\mathcal{P}\text{Mod}(\Sigma_{\mathcal{A}'})$, so according to the following central exact sequence:

$$1 \rightarrow \langle T_{a_i}, 0 \leq i \leq n-1 \rangle \rightarrow \mathcal{P}\text{Mod}_{\mathcal{A}'}(\Sigma) \rightarrow \mathcal{P}\text{Mod}(\Sigma_{\mathcal{A}'}) \rightarrow 1,$$

the mapping classes A_1 and A_2 differ from a multitwist that is central in $\mathcal{P}\text{Mod}_{\mathcal{A}'}(\Sigma)$, so A_1 and A_2 commute in Σ . But A_1 and A_2 satisfy also a braid relation, so A_1 and A_2 have to be equal. In other words, ρ is cyclic. \square

Corollary 9.22. *Let n be an integer greater than or equal to 6, Σ a surface $\Sigma_{g,b}$ where $g \leq \frac{n}{2}$ and ρ a noncyclic morphism from \mathcal{B}_n in $\mathcal{P}\text{Mod}(\Sigma)$. Then, any curve simplex on which a subgroup of \mathcal{J} acts transitively contains strictly less than $2g$ curves.*

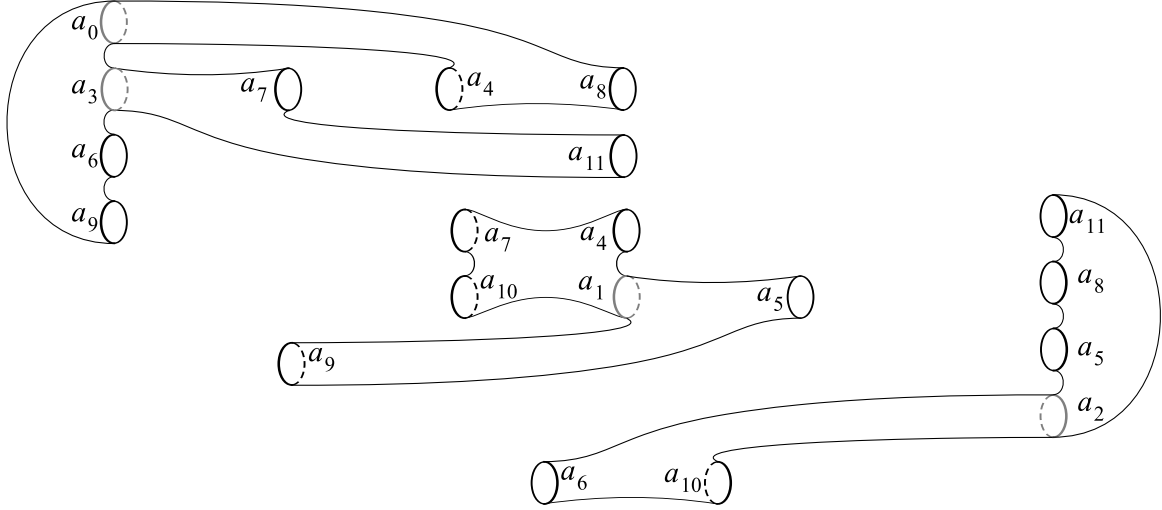

Figure 65: The surface $\Sigma_{\mathcal{A}'}$ is a disjoint union of genus-0 surfaces.

Proof. According to Lemma 9.20, such a simplex \mathcal{A} contains strictly less than $2g$ curves, except if $g = 6$ and $b = 0$ where \mathcal{A} can contain 12 curves. But according to Lemma 9.21, the fact that ρ is not cyclic forbids that \mathcal{A} contains 12 curves. This proves the corollary. \square

We can now prove Proposition 9.3. Let us recall that $n \geq 6$, $\Sigma = \Sigma_{g,b}$ where g and b are some integers such that $g \leq n/2$, and ρ is a noncyclic morphism from \mathcal{B}_n in $\mathcal{PMod}(\Sigma)$.

Proposition 9.3. *Let a be a curve of $\sigma(\mathcal{G})$. Then $\mathcal{J}.a$ contains at most n curves. The limit case $|\mathcal{J}.a| = n$ takes place if and only if $\mathcal{J}.a$ is not a simplex.*

Proof. Let a be a curve of $\sigma(\mathcal{G})$. If the orbit $\mathcal{J}.a$ is a curve simplex, Corollary 9.22 can be applied: $\mathcal{J}.a$ contains strictly less than $2g$ curves, hence strictly less than n curves.

If $\mathcal{J}.a$ is not a simplex, let us show that $|\mathcal{J}.a| \leq n$. We can assume without loss of generality that $a \in \sigma(A_0)$, in other words, $\text{sp}(a) \supset \{A_0\}$. For all $k \in \{0\} \cup \{2, \dots, n-2\}$, the mapping classes A_0 and A_k commute, so according to Proposition 3.40, $I(\sigma(A_0), \sigma(A_k)) = 0$, so $I(a, \delta^k.a) = 0$. But $\mathcal{J}.a$ is not a simplex. Hence a intersects one of the curves of $\mathcal{J}.a$ that belongs necessarily to $\sigma(A_{n-1})$ or to $\sigma(A_1)$. These two cases are symmetric and we can assume without loss of generality that $I(a, \sigma(A_1)) \neq 0$. Then, since A_0 and A_2 are the only mapping classes that do not commute with A_1 , and since $I(a, \sigma(A_1)) \neq 0$, we deduce that $\text{sp}(a) \subset \{A_0, A_2\}$. Let k be the least positive integer such that $\delta^k.a = a$. The integer k satisfies $\delta^k.\text{sp}(a) = \text{sp}(a)$, but since $\text{sp}(a) \subset \{A_0, A_2\}$, then k must be a multiple of n . Let p be the integer $\frac{k}{n}$, so that $|\mathcal{J}.a| = pn$.

Let us denote by $\mathcal{K} = \langle \delta^2 \rangle$. Since $|\mathcal{J}.a| = pn$, we have $|\mathcal{K}.a| = p\frac{n}{2} \geq pg$. But the set $\mathcal{K}.A_0 = \{A_i, i \in \text{Pair}(n)\}$ consists on elements that commute, so $\sigma(\mathcal{K}.A_0)$ is a simplex. Hence $\mathcal{K}.a$, that is included in $\sigma(\mathcal{K}.A_0)$, is a simplex, too. In other words, $\mathcal{K}.a$ is a curve simplex on which \mathcal{K} , a subgroup of \mathcal{J} , acts transitively. Hence according to Corollary 9.22, $|\mathcal{K}.a| < 2g \leq n$. Hence $p = 1$ and $|\mathcal{J}.a| = n$. \square

9.4 Partition of $\sigma(\mathcal{G})$: Proposition 9.4

We are going to show Proposition 9.4. Let us recall its statement.

Proposition 9.4 (Partition of $\sigma(\mathcal{G})$).

Any curve a belonging to $\sigma(\mathcal{G})$ satisfies either all the left hand side properties (1g) - (6g), or all the right hand side properties (1d) - (6d).

$$(1g) \quad I(a, \delta.a) = 0 \quad ; \quad I(a, \delta.a) \neq 0 \quad (1d)$$

$$(2g) \quad |\text{sp}(a)| \geq 2 \quad ; \quad |\text{sp}(a)| = 1 \quad (2d)$$

$$(3g) \quad I(a, \sigma(\mathcal{G})) = 0 \quad ; \quad I(a, \sigma(\mathcal{G})) \neq 0 \quad (3d)$$

$$(4g) \quad \forall k, \text{sp}(a) \not\subset \{A_k, A_{k+2}\} \quad ; \quad \exists k \mid \text{sp}(a) \subset \{A_k, A_{k+2}\} \quad (4d)$$

$$(5g) \quad |\mathcal{J}.a| < n \quad ; \quad |\mathcal{J}.a| = n \quad (5d)$$

$$(6g) \quad \mathcal{J}.a \text{ is a simplex} \quad ; \quad \mathcal{J}.a \text{ is not a simplex} \quad (6d)$$

Notice that each of the six lines of this table contains two opposite assertions (knowing that $|\mathcal{J}.a| \leq n$, as seen in Proposition 9.3), so that any curve a satisfies exactly one assertion per line. We are going to show that all the right hand side assertions are equivalent. Let us first show the cycle of implications (1d) \Rightarrow (3d) \Rightarrow (4d) \Rightarrow (5d) \Rightarrow (6d) \Rightarrow (1d).

The first implication is trivial.

Step 1: (1d) \Rightarrow (3d). Any curve $a \in \sigma(\mathcal{G})$ such that $I(a, \delta.a) \neq 0$ satisfies a fortiori $I(a, \sigma(\mathcal{G})) \neq 0$. \square

Step 2: (3d) \Rightarrow (4d). For any curve $a \in \sigma(\mathcal{G})$, let us show that if $I(a, \sigma(\mathcal{G})) \neq 0$, then there exists an integer k such that $\text{sp}(a) \subset \{A_k, A_{k+2}\}$.

Proof. Since $I(a, \sigma(\mathcal{G})) \neq 0$, there exists an integer k such that $I(a, \sigma(A_{k+1})) \neq 0$. But for all $i \in \{0, \dots, n-1\} \setminus \{k, k+2\}$, the mapping classes A_{k+1} and A_i commute, so according to Proposition 3.40, $I(\sigma(A_1), \sigma(A_i)) = 0$. Hence $a \notin \sigma(A_i)$. Thus $\text{sp}(a) \subset \{A_k, A_{k+2}\}$. \square

Step 3: (4d) \Rightarrow (5d). For any curve $a \in \sigma(\mathcal{G})$, let us show that if there exists an integer k such that $\text{sp}(a) \subset \{A_k, A_{k+2}\}$, then $|\mathcal{J}.a| = n$.

Proof. Let us assume for example that there exists an integer k such that $\text{sp}(\delta^k.a) = \{A_0, A_2\}$ (the situation is even more simple if $\text{sp}(\delta^k.a)$ is a singleton). Then for all integers i , we have $\text{sp}(\delta^{k+i}.a) = \{A_i, A_{i+2}\}$. But $\delta^i.a = a$ only if $\text{sp}(\delta^{k+i}.a) = \text{sp}(\delta^k.a)$, hence only if i is a multiple of n . Hence $|\mathcal{J}.a| \geq n$. Hence, according to Proposition 9.3, $|\mathcal{J}.a| = n$. \square

Step 4 comes from Proposition 9.3.

Step 4: (5d) \Rightarrow (6d). For any curve $a \in \sigma(\mathcal{G})$, if $|\mathcal{J}.a| = n$, then $\mathcal{J}.a$ is not a simplex. \square

Step 5: (6d) \Rightarrow (1d). Any curve $a \in \sigma(\mathcal{G})$ such that $\mathcal{J}.a$ is not a simplex satisfies $I(a, \delta.a) \neq 0$.

Proof. Let us start from a curve $a \in \sigma(\mathcal{G})$, and let us denote by \mathcal{A} its orbit $\mathcal{J}.a$. We have:

$$\begin{aligned}
I(\mathcal{A}, \mathcal{A}) &= \sum_{0 \leq i, j \leq n-1} I(\delta^i.a, \delta^j.a) && \text{by definition of } I(\mathcal{A}, \mathcal{A}), \\
&= \sum_{0 \leq i, k \leq n-1} I(\delta^i.a, \delta^{i+k}.a) && \text{by change of variables,} \\
&= \sum_{0 \leq i, k \leq n-1} I(a, \delta^k.a) && \text{since for all } i, k, \text{ we have } I(\delta^i.a, \delta^{i+k}.a) = I(a, \delta^k.a), \\
&= n \sum_{0 \leq k \leq n-1} I(a, \delta^k.a) \\
&= n (I(a, \delta.a) + I(a, \delta^{-1}.a)) && \text{since all the other terms are zero in the above sum.} \\
&&& \text{Indeed, if } k \neq \pm 1, \text{ the curves } a \text{ and } \delta^k.a \text{ belong to the} \\
&&& \text{canonical reduction systems of two mapping classes} \\
&&& \text{that commute, so they cannot intersect,} \\
&= 2n I(a, \delta.a) && \text{for } I(a, \delta.a) = I(a, \delta^{-1}.a).
\end{aligned}$$

Hence if \mathcal{A} is not a simplex, in other words if $I(\mathcal{A}, \mathcal{A}) \neq 0$, then $I(a, \delta.a) \neq 0$. \square

We terminate the proof of Proposition 9.4 by showing the implications

$$(1d) \Rightarrow (2d) \Rightarrow (4d).$$

Step 6: (1d) \Rightarrow (2d). Any curve $a \in \sigma(\mathcal{G})$ such that $I(a, \delta.a) \neq 0$ satisfies $|\text{sp}(a)| = 1$.

Proof. If $I(a, \delta.a) \neq 0$, then the action of δ^{-1} on the pair $(a, \delta.a)$ implies that $I(\delta^{-1}.a, a) \neq 0$. Let i be an integer in $\{0, \dots, n-1\}$ such that $a \in \sigma(A_i)$. Then we have $\delta.a \in \sigma(A_{i+1})$ and $\delta^{-1}.a \in \sigma(A_{i-1})$. Hence according to Proposition 3.40, the inequality $I(a, \delta.a) \neq 0$ implies the inclusion $\text{sp}(a) \subset \{A_i, A_{i+2}\}$ and similarly, the inequality $I(\delta^{-1}.a, a) \neq 0$ implies the inclusion $\text{sp}(a) \subset \{A_{i-2}, A_i\}$. Finally, we have $\text{sp}(a) = \{A_i\}$. \square

The last implication is trivial.

Step 7: (2d) \Rightarrow (4d). For any curve $a \in \sigma(\mathcal{G})$ such that $|\text{sp}(a)| = 1$, there exists an integer k such that we have $\text{sp}(a) \subset \{A_k, A_{k+2}\}$. \square

We recall Definition 9.5, which is central for the following sections.

Definition 9.5 (Normal curves, special curves).

– A curve a belonging to $\sigma(\mathcal{G})$ will be said to be *special* if it satisfies $I(a, \sigma(\mathcal{G})) \neq 0$, in other words if it satisfies the right-and side assertions of Proposition 9.4. We denote by $\sigma_s(\mathcal{G})$ the set of special curves and we set $\sigma_s(A) = \sigma_s(\mathcal{G}) \cap \sigma(A)$.

– A curve a belonging to $\sigma(\mathcal{G})$ will be said to be *normal* if it satisfies $I(a, \sigma(\mathcal{G})) = 0$, in other words if it satisfies the left hand side assertions of Proposition 9.4. We denote by $\sigma_n(\mathcal{G})$ the set of normal curves and we set $\sigma_n(A) = \sigma_n(\mathcal{G}) \cap \sigma(A)$.

9.5 Stability and existence results

This subsection is devoted to Propositions 9.6, and 9.7 concerning the stability of the normal and the special curves, and to Propositions 9.9 and 9.10 concerning the existence of special curves.

Proposition 9.6 (Stability of the special curves).

(i) The set $\sigma_s(\mathcal{G})$ is \mathcal{J} -stable.

(ii) For all integers $i \in \{0, \dots, n-1\}$, the set $\sigma_s(A_i)$ is stable by any element of $\mathcal{G} \setminus \{A_{i-1}, A_{i+1}\}$.

Proof.

Let us show item (i).

For all $a \in \sigma_s(\mathcal{G})$, we have $I(a, \delta.a) \neq 0$. From the point of view of the curve $\delta.a$, we have $I(\delta.a, \sigma(\mathcal{G})) \neq 0$. As \mathcal{G} is stable by the action of δ via ρ by conjugation on $\mathcal{P}\text{Mod}(\Sigma)$, the curve $\delta.a$ belongs to $\sigma(\mathcal{G})$. Finally, $\delta.a$ belongs to $\sigma_s(\mathcal{G})$. Hence $\sigma_s(\mathcal{G})$ is \mathcal{J} -stable.

Let us show item (ii).

To simplify the proof, we set $i = 0$. Let a be a special curve of $\sigma_s(A_0)$. Let j be an integer in $\{3, \dots, n-2\}$ so that A_j commutes with A_0 and A_1 . Then $A_j(a) \in \sigma(A_0)$ and $A_j(\delta.a) \in \sigma(A_1)$. By hypothesis, a is special, so $I(a, \delta.a) \neq 0$. Then, when we apply A_j to the pair $(a, \delta.a)$, we get $I(A_j(a), \sigma(A_1)) \neq 0$, so $A_j(a) \in \sigma_s(A_0)$.

Symmetrically, when $j = 2$, if we replace $\delta.a$ by $\delta^{-1}.a$, we show that $I(A_2(a), \sigma(A_{n-1})) \neq 0$, so $A_2(a) \in \sigma_s(A_0)$.

We have one more case to deal with, when $j = 0$. Let us start again from $a \in \sigma_s(A_0)$. Then $A_0(a) \in \sigma(A_0)$. We want to show that $A_0(a)$ is a special curve. We are going to show that $|\mathcal{J}.(A_0(a))| = n$, which is enough according to Proposition 9.4. Since a is special, we have $\text{sp}(a) = \{A_0\}$. Now, for all $\ell \in \{2, \dots, n-2\}$, the mapping class A_ℓ commutes with A_0 and $a \notin \sigma(A_\ell)$, so $A_0(a) \notin \sigma(A_\ell)$. Hence we have:

$$\{A_0\} \subset \text{sp}(A_0(a)) \subset \{A_{n-1}, A_0, A_1\}.$$

So for all integers k , $\delta^k.\text{sp}(A_0(a)) = \text{sp}(A_0(a))$ if and only if k is a multiple of n . So, if $\delta^k.A_0(a) = A_0(a)$ then k is a multiple of n , so $|\mathcal{J}.(A_0(a))| \geq n$. Hence according to Proposition 9.3, we have $|\mathcal{J}.(A_0(a))| = n$. So $A_0(a)$ is a special curve. \square

Proposition 9.7 (Stability of the normal curves).

The set $\sigma_n(\mathcal{G})$ is \mathcal{B}_n -stable and the actions of \mathcal{B}_n via ρ on $\sigma_n(\mathcal{G})$, on $\text{Sub}_{\sigma_n(\mathcal{G})}(\Sigma)$ and on $\text{Bndy}(\Sigma_{\sigma_n(\mathcal{G})})$ are cyclic.

Proof. Let us recall that according to Proposition 9.4, $\sigma_n(\mathcal{G})$ is a simplex. Then if we show that $\sigma_n(\mathcal{G})$ is \mathcal{B}_n -stable, we can apply Proposition 9.2 (according to which any action of \mathcal{B}_n on a curve simplex \mathcal{B}_n -stable is cyclic) and deduce from it Proposition 9.7. Let a be a normal curve. We proceed as follows:

1. We show that $A_1(a)$ belongs to $\sigma(\mathcal{G})$.
2. We show that $A_1(a)$ is not special, hence is normal.
3. Therefore $\sigma(\mathcal{G})$ is \mathcal{B}_n -stable.

1. Let a be a normal curve. According to assertion (2g) of Proposition 9.4, $\text{sp}(a)$ contains at least two elements A_i and A_j with $0 \leq i < j \leq n-1$, and according to assertion (4g) of the same proposition, we can assume that $j \notin \{i+2, i+n-2\}$. In particular $\{i, j\} \neq \{0, 2\}$. Therefore A_1 commutes with at least one of the two mapping classes A_i and A_j , so $A_1(a) \in \sigma(\mathcal{G})$.

2. Let us assume that $A_1(a)$ is special. If $A_1(a)$ did not belong to $\sigma_s(A_0)$ or to $\sigma_s(A_2)$, then according to Proposition 9.6.(ii), $A_1^{-1}(A_1(a))$ would still be a special curve. But $A_1^{-1}(A_1(a)) = a$, which is a normal curve. Therefore $A_1(a)$ belongs to $\sigma_s(A_0)$ or $\sigma_s(A_2)$. The situation being symmetric, we can assume that

$$A_1(a) \in \sigma_s(A_0). \quad (1)$$

Having assumed that $A_1(a)$ was special, we have $I(A_1(a), \delta.A_1(a)) \neq 0$, so

$$I(a, A_1^{-1}(\delta.A_1(a))) \neq 0. \quad (2)$$

Now, according to (1), $A_1(a) \in \sigma(A_0)$, so $\delta.A_1(a) \in \sigma(A_1)$ and $A_1^{-1}(\delta.A_1(a)) \in \sigma(A_1)$. Then (2) implies:

$$I(a, \sigma(\mathcal{G})) \neq 0,$$

which is absurd since a is a normal curve.

3. Let us conclude: we have just shown that $A_1(\sigma_n(\mathcal{G})) = \sigma_n(\mathcal{G})$. But $\sigma_n(\mathcal{G}) = \sigma(\mathcal{G}) \setminus \sigma_s(\mathcal{G})$ and the two sets $\sigma(\mathcal{G})$ and $\sigma_s(\mathcal{G})$ are \mathcal{J} -stable (for $\sigma_s(\mathcal{G})$, this comes from Proposition 9.6), so $\sigma_n(\mathcal{G})$ is \mathcal{J} -stable. Hence for all integers $i \in \{1, \dots, n-1\}$, we have $(\rho(\delta^i)A_1\rho(\delta^i)^{-1})(\sigma_n(\mathcal{G})) = \sigma_n(\mathcal{G})$, in other words, $A_i(\sigma_n(\mathcal{G})) = \sigma_n(\mathcal{G})$. Since \mathcal{G} spans $\rho(\mathcal{B}_n)$, it follows that $\sigma_n(\mathcal{G})$ is stable by $\rho(\mathcal{B}_n)$. \square

Proposition 9.8 (Spectrum of the normal curves).

The spectrum of a normal curve is always equal to \mathcal{G} .

Proof. Let a be a normal curve. There exists an integer k such that the curve $a' = \rho(\delta^k)(a)$ belongs to $\sigma(A_0)$. Then the curve $(A_0A_1A_0A_3^{-3})(a')$ belongs to $\sigma(A_1)$ for $(A_0A_1A_0A_3^{-3})A_0(A_0A_1A_0A_3^{-3})^{-1} = A_1$. But since the action of \mathcal{B}_n is cyclic on the normal curves according to Proposition 9.7, the action of $(A_0A_1A_0A_3^{-3})$ is trivial and $(A_0A_1A_0A_3^{-3})(a') = a'$, so the curve a' belongs to $\sigma(A_1)$. For all $i \in \{0, 1, \dots, n-1\}$, the same argument can be repeated, so a' belongs to $\sigma(A_i)$ for all $i \in \{0, 1, \dots, n-1\}$. By conjugating this by $\rho(\delta^{-k})$, it follows that the curve $a = \rho(\delta^{-k})(a')$ belongs to $\sigma(A_i)$ for all $i \in \{0, 1, \dots, n-1\}$. The proposition is proved. \square

Proposition 9.9 (Existence of the special curves). *The set $\sigma_s(\mathcal{G})$ is not empty.*

Proof. Let us recall that the morphism ρ is assumed to be noncyclic. We argue by contradiction: we assume that all the curves of $\sigma(\mathcal{G})$ are normal.

First, since ρ is not cyclic and according to Theorem 8.2, $\sigma(\mathcal{G})$ is not empty. Then the set $\sigma(\mathcal{G})$ of curves (being all normal by assumption) is a simplex, according to Proposition 9.4. Moreover, this simplex is \mathcal{B}_n -stable according to Proposition 9.7. The Proposition 9.2 can be applied to the simplex $\sigma(\mathcal{G})$, so the action of \mathcal{B}_n on $\text{Bndy}(\Sigma_{\sigma(\mathcal{G})})$ is cyclic and the one of \mathcal{F}_n on $\text{Bndy}(\Sigma_{\sigma(\mathcal{G})})$ is trivial. Hence the morphism ρ induces a morphism $\bar{\rho}$ from \mathcal{F}_n in $\mathcal{P}\text{Mod}(\Sigma_{\sigma(\mathcal{G})})$. Recall that we have the following canonical isomorphism:

$$\mathcal{P}\text{Mod}(\Sigma_{\sigma(\mathcal{G})}) = \prod_{S \in \text{Comp}(\Sigma_{\sigma(\mathcal{G})})} \mathcal{P}\text{Mod}(S),$$

where $\text{Comp}(\Sigma_{\sigma(\mathcal{G})})$ denotes the set of all connected components of $\Sigma_{\sigma(\mathcal{G})}$. Let S be one of these components and let $\bar{\rho}_S$ be the morphism induced by ρ on $\mathcal{P}\text{Mod}(S)$. The morphism $\bar{\rho}_S$ is irreducible, that is, for all $i \in \{3, \dots, n-1\}$, the element $\tau_i\tau_1^{-1}$ is sent on a irreducible mapping class. Indeed, according to Proposition 3.45, $\sigma(\rho(\tau_i\tau_1^{-1})) \subset \sigma(\rho(\tau_i)) \cup \sigma(\rho(\tau_1^{-1}))$, but these two sets $\sigma(\rho(\tau_i))$ and $\sigma(\rho(\tau_1^{-1}))$ do not contain any curve in S , so $\sigma(\bar{\rho}_S(\tau_i\tau_1^{-1})) = \emptyset$. We will say that $\bar{\rho}_S$ is *periodic* or *pseudo-Anosov* whether $\bar{\rho}_S(\tau_3\tau_1^{-1})$ is periodic or pseudo-Anosov. Let us denote by $A = \bar{\rho}_S(\tau_3\tau_1^{-1})$, $B = \bar{\rho}_S(\tau_4\tau_1^{-1})$, $C = \bar{\rho}_S(\tau_5\tau_1^{-1})$, and $Z = ABACBA$.

Case where $\bar{\rho}_S$ is pseudo-Anosov⁷: According to Theorem 3.32, the centralizer of a pseudo-Anosov mapping class is virtually infinite cyclic. Then, since C is in the centralizer of A , there exist two nonzero integers p and q such that $A^p = C^q$. By conjugating this equality by Z , we get $C^p = A^q$. Hence $A^{p^2} = C^{qp} = A^{q^2}$. We deduce that $p = q$ or $p = -q$. We are going to show that both of these two equalities are absurd. For this purpose, we set $\gamma_{13} = \tau_1\tau_2\tau_1\tau_3\tau_2\tau_1$ and $\gamma_{35} = \tau_3\tau_4\tau_3\tau_5\tau_4\tau_3$. Notice that:

$$\begin{aligned}\gamma_{13}\tau_1\gamma_{13}^{-1} &= \tau_3 \text{ and } \gamma_{35}\tau_1\gamma_{35}^{-1} = \tau_1, \\ \gamma_{13}\tau_3\gamma_{13}^{-1} &= \tau_1 \text{ and } \gamma_{35}\tau_3\gamma_{35}^{-1} = \tau_5, \\ \gamma_{13}\tau_5\gamma_{13}^{-1} &= \tau_5 \text{ and } \gamma_{35}\tau_5\gamma_{35}^{-1} = \tau_3.\end{aligned}$$

Hence, if we set $v = \gamma_{13}\gamma_{35}^{-1}$, then the element v belongs to \mathcal{F}_n and satisfies:

$$\begin{aligned}v\tau_1v^{-1} &= \tau_3, & v\tau_3v^{-1} &= \tau_5, & v\tau_5v^{-1} &= \tau_1, \\ v(\tau_3\tau_1^{-1})v^{-1} &= \tau_5\tau_3^{-1}, & v(\tau_5\tau_3^{-1})v^{-1} &= \tau_1\tau_5^{-1}, & v(\tau_1\tau_5^{-1})v^{-1} &= \tau_3\tau_1^{-1}.\end{aligned}$$

Then if we set $U = \rho_S(v)$, then:

$$\begin{aligned}\text{we have:} & & UAU^{-1} &= CA^{-1}, & U(CA^{-1})U^{-1} &= C^{-1}, & UC^{-1}U^{-1} &= A, \\ \text{so if } C^p = A^p: & & UAPU^{-1} &= \text{Id}, & U(\text{Id})U^{-1} &= A^{-p}, & UA^{-p}U^{-1} &= A^p, \\ \text{and if } C^p = A^{-p}: & & UAPU^{-1} &= A^{-2p}, & U(A^{-2p})U^{-1} &= A^p, & UA^pU^{-1} &= A^p.\end{aligned}$$

So if $C^p = A^p$, then A^p is equal to Id, which is absurd for A is pseudo-Anosov; whereas if $C^p = A^{-p}$, then we have $UAPU^{-1} = A^p$ and $UA^pU^{-1} = A^{-2p}$ whence $A^p = A^{-2p}$ and so $A^{3p} = \text{Id}$, which is also absurd. Hence $\bar{\rho}_S$ is not pseudo-Anosov.

Case where $\bar{\rho}_S$ is periodic. Notice that the mapping classes A, B, C are conjugate. There are then periodic of same order. Let us call m this order. We restrict the domain of the morphism $\bar{\rho}_S$ to \mathcal{F}_n^* , which is isomorphic to \mathcal{B}_{n-2} . According to Proposition 5.12, we can lift this new morphism from \mathcal{F}_n^* in $\mathcal{PMod}(S)$ into a morphism $\tilde{\rho}_S$ from \mathcal{F}_n^* in $\mathcal{Mod}(S, \partial S)$. Let us denote by $\tilde{A}, \tilde{B}, \tilde{C}$, the images by $\tilde{\rho}_S$ of $\tau_3\tau_1^{-1}, \tau_4\tau_1^{-1}, \tau_5\tau_1^{-1}$. Then \tilde{A}^m and \tilde{C}^m are multitwists along some curves of $\text{Bndy}(S)$. Since these multitwists are in the center of $\mathcal{Mod}(S, \partial S)$ and since $\tilde{Z}\tilde{A}^m\tilde{Z}^{-1} = \tilde{C}^m$ (where $\tilde{Z} = (\tilde{A}\tilde{B}\tilde{C})^2$), we have $\tilde{A}^m = \tilde{C}^m$. Therefore, $\tilde{A}\tilde{C}^{-1}$ satisfies $(\tilde{A}\tilde{C}^{-1})^m = 1$ in $\mathcal{Mod}(S, \partial S)$. But $\mathcal{Mod}(S, \partial S)$ is torsion-free, so $\tilde{A}\tilde{C}^{-1}$ is trivial and $\tilde{A} = \tilde{C}$. This implies that in $\mathcal{PMod}(S)$, we have $\bar{\rho}_S(\tau_3\tau_1^{-1}) = \bar{\rho}_S(\tau_5\tau_1^{-1})$.

This last equality holds for any connected components S of $\Sigma_{\sigma(\mathcal{G})}$. Hence, by considering the morphism $\bar{\rho} : \mathcal{F}_n \rightarrow \mathcal{PMod}(\Sigma_{\sigma(\mathcal{G})})$, we have shown that $\bar{\rho}(\tau_3\tau_1^{-1}) = \bar{\rho}(\tau_5\tau_1^{-1})$. Then $\bar{\rho}(\tau_5\tau_3^{-1})$ coincides with the identity of $\mathcal{PMod}(\Sigma_{\sigma(\mathcal{G})})$. Let us recall that \mathcal{B}_n stabilizes $\Sigma_{\sigma(\mathcal{G})}$. Then by conjugation in \mathcal{B}_n , we deduce that the morphism $\bar{\rho} : \mathcal{F}_n \rightarrow \mathcal{PMod}(\Sigma_{\sigma(\mathcal{G})})$ is trivial. Hence the image of the restriction of the morphism ρ to \mathcal{F}_n^* in $\mathcal{PMod}(\Sigma)$ is included in the abelian group spanned by the Dehn twists along the curves of $\sigma(\mathcal{G})$. Hence, according to Lemma 5.3, the restriction of ρ to \mathcal{F}_n^* is a cyclic morphism. Therefore $\rho(\tau_5\tau_3^{-1})$ is the identity, so $\rho(\tau_3) = \rho(\tau_5)$. Hence, according to Lemma 5.2, ρ is a cyclic morphism. This contradicts our hypotheses, so the proposition is proved. \square

Proposition 9.10 (Cardinality of $\sigma_s(\mathcal{G})$).

The set $\sigma_s(\mathcal{G})$ contains n or $2n$ curves, depending on whether $|\sigma_s(A_1)| = 1$ or $|\sigma_s(A_1)| = 2$.

Proof. First, according to Proposition 9.6, we have $\delta.\sigma_s(A_i) = \sigma_s(A_{i+1})$, so the cardinality of $\sigma_s(\mathcal{G})$ is equal to n times the one of $\sigma_s(A_1)$. But $\sigma_s(A_1)$ contains one or two curves for one

⁷We cannot apply the results of Section 8 for \mathcal{F}_n^* can be isomorphic to \mathcal{B}_4 and this case is not treated in Section 8. On the other hand, the techniques involved here would have appeared quite complicated in Section 8 when the boundary of Σ is nonempty, and simply do not work when the boundary is empty.

hand, it cannot be empty since $\sigma_s(\mathcal{G})$ is not empty, and on the other hand, it cannot contain three curves or more as we are going to show it. This prove the proposition.

Let us then show that $|\sigma_s(A_1)| < 3$. Notice that the elements $A_1, A_3, A_5, \dots, A_{n-1}$ pairwise commute, so the set of curves $\sigma_s(A_1) \cup \sigma_s(A_3) \cup \dots \cup \sigma_s(A_{n-1})$ is a simplex. If $\sigma_s(A_1)$ contained at least three curves, the set of curves $\sigma_s(A_1) \cup \sigma_s(A_3) \cup \dots \cup \sigma_s(A_{n-1})$ would be a simplex \mathcal{A} of at least $\frac{3n}{2}$ curves that would be stable by the action of $\langle \delta^2 \rangle$ on $\text{Curv}(\Sigma)$. However, the orbits included in \mathcal{A} under the action of $\langle \delta^2 \rangle$ contain at least $\frac{n}{2}$ curves, which is greater than or equal to 3, so we can apply Proposition 7.5: after having squeezed the boundary components of Σ , the simplex \mathcal{A} still contains at least $\frac{3n}{2}$ distinct curves. But $\frac{3n}{2} \geq 3g$ whereas the cardinality of all simplex in a surface without boundary of genus g is bounded by $3g - 3$. This is the expected contradiction. \square

9.6 Summary of the present section

Definition 9.5 (Normal curves, special curves).

We say that a curve a belonging to $\sigma(\mathcal{G})$ is *special* if it satisfies $I(a, \sigma(\mathcal{G})) \neq 0$, and that it is normal if it satisfies $I(a, \sigma(\mathcal{G})) = 0$. We denote by $\sigma_s(\mathcal{G})$ the set of special curves, and by $\sigma_n(\mathcal{G})$ the set of normal curves. Moreover, for all $A \in \mathcal{G}$, we set

$$\begin{aligned}\sigma_n(A) &= \sigma_n(\mathcal{G}) \cap \sigma(A), \\ \sigma_s(A) &= \sigma_s(\mathcal{G}) \cap \sigma(A).\end{aligned}$$

Proposition 9.23 (Characterizations and properties of the normal curves and the special curves). *Let a be a curve of $\sigma(\mathcal{G})$. Then:*

(i) *The following statements are equivalent:*

- a is special,
- $|\text{sp}(a)| = 1$ (in particular, we have the partition $\sigma_s(\mathcal{G}) = \bigsqcup_{i=0}^{n-1} \sigma_s(A_i)$),
- $I(a, \delta.a) = I(a, \delta^{-1}.a) \neq 0$,
- $|\mathcal{J}.a| = n$.

(ii) *The following statements are equivalent:*

- a is normal,
- $\text{sp}(a) = \mathcal{G}$ (in particular, for all $i \in \{0, 1, \dots, n-1\}$, we have $\sigma_n(A_i) = \sigma_n(\mathcal{G})$),
- $I(a, \sigma(\mathcal{G})) = 0$,
- $|\mathcal{J}.a| < n$.

(iii) *The curves of $\sigma(\mathcal{G})$ split as follows:*

- $\sigma(\mathcal{G})$ admits the partition: $\sigma(\mathcal{G}) = \sigma_s(\mathcal{G}) \sqcup \sigma_n(\mathcal{G})$,
- $\sigma_s(\mathcal{G})$ is nonempty and contains n or $2n$ curves, depending on whether $|\sigma_s(A_1)| = 1$ or $|\sigma_s(A_1)| = 2$.

(iv) *The curves of $\sigma(\mathcal{G})$ satisfy the following properties of stability:*

- $\sigma_n(\mathcal{G})$ is stable by the action of \mathcal{B}_n on $\text{Curv}(\Sigma)$ and the restriction of this action on $\sigma_n(\mathcal{G})$ is cyclic: for all $a \in \sigma_n(\mathcal{G})$ and all integers $i, j \in \{0, \dots, n-1\}$, we have $A_i(a) = A_j(a)$.
- $\sigma_s(\mathcal{G})$ is stable by the action of \mathcal{J} on $\text{Curv}(\Sigma)$.

10 The special curves are not separating

Let us recall that n is an even integer greater than or equal to 6, Σ is a surface $\Sigma_{g,b}$ where $g \leq \frac{n}{2}$ and $b \geq 0$, and ρ is a noncyclic morphism from \mathcal{B}_n in $\mathcal{PMod}(\Sigma)$ such that $\sigma_p(\mathcal{G})$ is empty. According to Proposition 9.9, the set $\sigma_s(\mathcal{G})$ is not empty.

10.1 Outline of the section

In this section, we are going to show the following proposition:

Proposition 10.1. *The curves of $\sigma_s(\mathcal{G})$ are not separating.*

- In Subsection 10.2, we present a subset \mathcal{X} of \mathcal{G} , stable under the action of \mathcal{H} via ρ , where \mathcal{H} is a subgroup of \mathcal{B}_n . The set \mathcal{X} is smaller than \mathcal{G} , but the action of \mathcal{H} on \mathcal{X} is r times transitive, where r is the cardinality of \mathcal{X} . Moreover, \mathcal{X} will consist in elements of \mathcal{G} which pairwise commute, so the union of their canonical reduction systems will be a simplex. These aspects will be very useful.
- Subsection 10.3 is devoted to the proof of Proposition 10.1. The proof will be topological and the bound of $\frac{n}{2}$ on the genus of Σ is essential here. If we wanted to replace the bound $\frac{n}{2}$ by $\frac{n}{2} + 1$, our method would fail. However, the bound $\frac{n}{2}$ is maybe not the best one.

10.2 The subgroup \mathcal{H} of \mathcal{B}_n and its action on the subset \mathcal{X} of \mathcal{G}

Definition 10.2 (The subset $\text{Imp}(n)$ of $\{0, 1, \dots, n-1\}$ and the subset \mathcal{X} of \mathcal{G}).

For all positive integers m , let $\text{Imp}(m)$ be the set of the first odd integers smaller than or equal to m . Let $\mathcal{X} = \{A_i, i \in \text{Imp}(n)\}$ be the subset of \mathcal{G} . We set $\sigma(\mathcal{X}) = \cup_{i \in \text{Imp}(n)} \sigma(A_i)$.

Remark. The elements of \mathcal{X} commute pairwise, so the curves in $\sigma(\mathcal{X})$ cannot intersect each other. Thus $\sigma(\mathcal{X})$ is a curve simplex.

Definition 10.3 (The subgroup \mathcal{H} of \mathcal{B}_n).

For all integers i belonging to $\text{Imp}(n)$, we set

$$\gamma_i = \tau_i \tau_{i+1} \tau_i \tau_{i+2} \tau_{i+1} \tau_i,$$

where for all integers k , we denote by τ_k the standard generator τ_ℓ where ℓ is the remainder of the euclidian division of k by n . The group \mathcal{H} is the subgroup of \mathcal{B}_n defined by

$$\mathcal{H} := \langle \gamma_i, i \in \text{Imp}(n) \rangle.$$

Proposition 10.4 (Properties of the group \mathcal{H}).

- The action of \mathcal{H} by conjugation via ρ on $\mathcal{PMod}(\Sigma)$ preserves \mathcal{X} .
- The morphism $\mathcal{H} \rightarrow \mathfrak{S}(\mathcal{X})$ of the action of \mathcal{H} on \mathcal{X} , where $\mathfrak{S}(\mathcal{X})$ is the symmetric group on the elements of \mathcal{X} , is surjective. Consequently, this action is $\frac{n}{2}$ times transitive.

(iii) The action of \mathcal{H} on $\mathcal{C}urv(\Sigma)$ preserves $\sigma_s(\mathcal{X})$.

Proof. Let us first remark that for all $i \in \text{Imp}(n)$, the element γ_i acts by conjugation on the subset $\{\tau_j, j \in \text{Imp}(n)\}$ of \mathcal{B}_n in the following way:

$$\gamma_i \tau_j \gamma_i^{-1} = \begin{cases} \tau_j & \text{if } j \notin \{i, i+2\} \\ \tau_{j-2} & \text{if } j = i+2 \\ \tau_{j+2} & \text{if } j = i. \end{cases}$$

We deduce the following:

- (i) The group \mathcal{H} acts by conjugation on \mathcal{B}_n and preserves the set $\{\tau_j, j \in \text{Imp}(n)\}$, so the group \mathcal{H} acts via ρ on $\mathcal{P}Mod(\Sigma)$ and preserves \mathcal{X} .
- (ii) For all $i \in \text{Imp}(n)$, the morphism $\phi : \mathcal{H} \rightarrow \mathfrak{S}(\mathcal{X})$, where $\mathfrak{S}(\mathcal{X})$ is the symmetric group on the elements of \mathcal{X} , sends γ_i on the transposition that swaps A_i and A_{i+2} . Then $\phi(\mathcal{H})$ is a subgroup of $\mathfrak{S}(\mathcal{X})$ containing $\frac{n}{2} - 1$ transpositions with disjoint supports, so ϕ is surjective.
- (iii) The action of \mathcal{H} on $\mathcal{C}urv(\Sigma)$ preserves $\sigma(\mathcal{X})$, since the action of \mathcal{H} on $\mathcal{P}Mod(\Sigma)$ preserves \mathcal{X} . Now, according to Proposition 9.7, the action of \mathcal{B}_n on $\mathcal{C}urv(\Sigma)$ preserves $\sigma_n(\mathcal{G})$, so the action of \mathcal{H} on $\mathcal{C}urv(\Sigma)$ preserves $\sigma_n(\mathcal{G})$. So the action of \mathcal{H} on $\mathcal{C}urv(\Sigma)$ also preserves the complement of $\sigma_n(\mathcal{G})$ in $\sigma(\mathcal{X})$, which is $\sigma_s(\mathcal{X})$. \square

10.3 Proof of Proposition 10.1

We are going to show the proposition:

Proposition 10.1. *The curves of $\sigma_s(\mathcal{G})$ are not separating.*

We will need the definition of *special boundary* of a subsurface. We will also recall what is the *natural boundary* of a subsurface:

Definition 10.5 (Natural boundary and special boundary).

Let n be an even integer greater than or equal to 6, let Σ be a surface and ρ a morphism from \mathcal{B}_n in $\mathcal{P}Mod(\Sigma)$. Let \mathcal{A} be a curve simplex included in $\mathcal{C}urv(\Sigma)$. For any subsurface S of $\mathcal{S}ub_{\mathcal{A}}(\Sigma)$, a boundary component d of S will be said to be *natural* if it belongs to $\text{Bndy}(\Sigma)$, and will be said to be *special* if it belongs to $\sigma_s(\mathcal{G})$. The union of the natural boundary components will be called the natural boundary, and the union of the special boundary components will be called the special boundary.

We are going to proceed in five steps.

Step 1. *If there exists in $\sigma_s(\mathcal{G})$ a separating curve, then for all $i \in \{0, 1, \dots, n-1\}$, the set of curves $\sigma_s(A_i)$ contains exactly a separating curve that bounds a torus with one hole (cf. Figure 66). Thus, Σ is a surface of genus $g = \frac{n}{2}$.*

Proof of step 1. If there exists a separating curve in $\sigma_s(\mathcal{G})$, then there exists at least one separating curve in $\sigma_s(A_1)$. Let us call it a_1 . Let \mathcal{A} be the set of curves $\mathcal{H}.a_1$. Since we have $a_1 \in \sigma(\mathcal{X})$ and since \mathcal{X} is \mathcal{H} -stable, the set \mathcal{A} is included in $\sigma(\mathcal{X})$, hence is a simplex. Let us consider the graph $\Gamma(\Sigma, \mathcal{A})$. Since the curves of \mathcal{A} are separating, if we remove from $\Gamma(\Sigma, \mathcal{A})$ one of its edges, we get a disconnected graph. Hence the graph $\Gamma(\Sigma, \mathcal{A})$ contains no cycle: this graph

is a finite tree. So it contains leaves (vertices of degree 1). Let T be a subsurface of $\text{Sub}_{\mathcal{A}}(\Sigma)$ corresponding to a leaf in $\Gamma(\Sigma, \mathcal{A})$. Since exactly one curve of \mathcal{A} bounds T , T is not stable by the action of \mathcal{H} , so T contains no natural boundary component. Hence T has only one boundary component, so T is of nonzero genus. Each subsurface in the orbit $\mathcal{H}.T$ can be identified by the curve $a \in \mathcal{A}$ that bounds it. Since the number of curves in \mathcal{A} is at least equal to the cardinality of \mathcal{X} , there exists at least $\frac{n}{2}$ disjoint subsurfaces homeomorphic to T in $\text{Sub}_{\mathcal{A}}(\Sigma)$. But Σ is of genus $g \leq \frac{n}{2}$, so:

- there exist exactly $\frac{n}{2}$ such subsurfaces,
- these subsurfaces are tori with one hole,
- and Σ is of genus $g = \frac{n}{2}$.

So, there exist exactly $\frac{n}{2}$ curves in \mathcal{A} , hence one separating curve in each set $\sigma_s(A_i)$, $i \in \text{Imp}(n)$. Moreover, the complement of these $\frac{n}{2}$ tori is a genus-0 surface having $\frac{n}{2}$ special boundary components and b natural boundary components (cf. Figure 66). \square

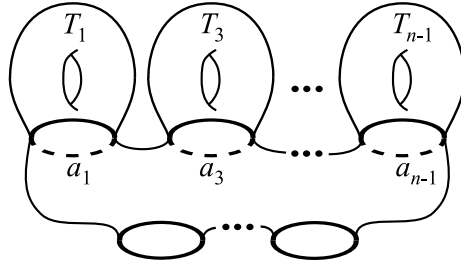

Figure 66: The surface Σ and the separating curves a_i , $i \in \text{Imp}(n)$ of $\sigma(\mathcal{X})$.

From now on, we are in the situation described by step 1 and we adopt the following notation.

Notation 10.6 (Situation described by step 1).

For all $i \in \{0, 1, \dots, n-1\}$, let us denote by a_i the unique separating curve of $\sigma_s(A_i)$ and by T_i the torus with one hole, included in Σ and bounded by a_i . Let us denote by S the genus-0 surface obtained from Σ minus the tori T_i where i ranges over $\text{Imp}(n)$ (cf. Figure 66). Finally, we set $\text{Pair}(n) = \{0, 1, \dots, n-1\} \setminus \text{Imp}(n)$.

Notation 10.7 (Representatives of the isotopy classes).

Let us choose some representatives \bar{a}_i , $i \in \{0, 1, \dots, n-1\}$ in tight position, of the curves a_i , $i \in \{0, 1, \dots, n-1\}$ (such a system of representatives is unique up to isotopy, according to Proposition 2.2). From these representatives of curves, we deduce the representatives \bar{S} and \bar{T}_i for all $i \in \{0, 1, \dots, n-1\}$, of the subsurfaces S and T_i for all $i \in \{0, 1, \dots, n-1\}$.

Step 2. *There exists an orientation preserving diffeomorphism \bar{F} of Σ that preserves the boundary components of Σ such that*

- for all $i \in \{1, 2, 3\}$, we have $\bar{F}(\bar{a}_i) = \bar{a}_{4-i}$,
- and for all $i \in \{5, 6, \dots, n-1\}$, we have $\bar{F}(\bar{a}_i) = \bar{a}_i$.

Proof of step 1. Let \bar{G} be a diffeomorphism representing the mapping class $\rho(\gamma_1)$ where γ_1 is defined by:

$$\gamma_1 := \tau_1\tau_2\tau_1\tau_3\tau_2\tau_1.$$

Let us denote by $\bar{\mathcal{A}}$ the set of representatives of curves $\{\bar{a}_2\} \cup \{\bar{a}_i, i \in \text{Imp}(n)\}$ and $\bar{\mathcal{A}}'$ the set $\{\bar{G}(\bar{a}_2)\} \cup \{\bar{G}(\bar{a}_i), i \in \text{Imp}(n)\}$. According to Proposition 10.4,

- for any $i \in \{1, 2, 3\}$, we have $\rho(\gamma_1)A_i\rho(\gamma_1)^{-1} = A_{4-i}$,
- and for any $i \in \{5, 6, \dots, n-1\}$, we have $\rho(\gamma_1)A_i\rho(\gamma_1)^{-1} = A_i$.

Besides, for any $i \in \{0, 1, \dots, n-1\}$, the curve a_i is the unique separating curve belonging to $\sigma_s(A_i)$, so:

- for any $i \in \{1, 2, 3\}$, the curve $\bar{G}(\bar{a}_i)$ is isotopic to \bar{a}_{4-i} ,
- and for any $i \in \{5, 6, \dots, n-1\}$, the curve $\bar{G}(\bar{a}_i)$ is isotopic to \bar{a}_i .

Then, the sets of curves $\bar{\mathcal{A}}$ and $\bar{\mathcal{A}}'$ are both weakly isotopic. Let us recall that $\bar{\mathcal{A}}$ is a set of representatives of curves in tight position. Hence the representatives of curves of $\bar{\mathcal{A}}$ do not bound any bigon. But $\bar{\mathcal{A}}'$ is the image of $\bar{\mathcal{A}}$ by \bar{G} . So the representatives of curves of $\bar{\mathcal{A}}'$ do not bound any bigon either. Hence $\bar{\mathcal{A}}'$ is a set of representatives of curves in tight position. Moreover $\bar{\mathcal{A}}$ is without triple intersection, hence so is $\bar{\mathcal{A}}'$. Then, according to Proposition 2.14, $\bar{\mathcal{A}}$ and $\bar{\mathcal{A}}'$ are in the same strong isotopy class. In other words, there exists a diffeomorphism isotopic to the identity \bar{H} such that $\bar{H}(\bar{\mathcal{A}}) = \bar{\mathcal{A}}'$. Then the diffeomorphism \bar{F} defined by $\bar{F} := \bar{H}^{-1}\bar{G}$ satisfies the assertions of the statement. \square

Definition 10.8 (Arcs).

For all i, j, k in $\{1, 2, 3\}$, let us denote by $\text{Arc}_j^k(i)$ the set of closures of the connected components of $\bar{a}_i \setminus (\bar{a}_j \cup \bar{a}_k)$. We will say that an element of $\text{Arc}_j^k(i)$ is an *arc included in \bar{a}_i with extremities in \bar{a}_j and \bar{a}_k* .

Step 3. *The arcs of $\text{Arc}_1^1(2)$ and $\text{Arc}_3^3(2)$ are included respectively in \bar{T}_1 and \bar{T}_3 . In other words, the only arcs included in $\bar{a}_2 \cap \bar{S}$ belong to $\text{Arc}_1^3(2)$.*

Proof of step 3. Let us argue by contradiction. Let us consider an arc $\bar{\ell}$ belonging to $\text{Arc}_1^1(2)$ and included in \bar{S} . Since \bar{S} is of genus zero, $\bar{\ell}$ separates \bar{S} in two connected components. One of them contains the boundary \bar{a}_3 . Since the curves \bar{a}_1 and \bar{a}_2 do not cobound any bigon, the other component is not a disk, so it contains a special boundary component or a natural boundary component. In both cases, let us call d this boundary component. Finally, we have a path $\bar{\ell}$ which separates \bar{S} in two components, one containing \bar{a}_3 , the other containing d . Similarly $\bar{F}(\bar{\ell})$ belongs to $\text{Arc}_3^3(2)$ (for $\bar{\ell}$ belongs to $\text{Arc}_1^1(2)$), is included in \bar{S} and separates \bar{S} in two components, one containing $\bar{F}(\bar{a}_3)$ that is equal to \bar{a}_1 , the other containing $\bar{F}(d)$ that is equal to d . We deduce from it Figure 67 where it is clear that $\bar{\ell}$ and $\bar{F}(\bar{\ell})$ intersect, which is absurd: $\bar{F}(\bar{\ell})$ and $\bar{\ell}$ cannot intersect, for they are both included in the same curve. \square

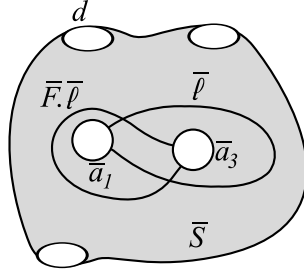

Figure 67: The existence of an arc $\bar{\ell}$ in $\text{Arc}_1^1(2)$ induces the existence of an arc $\bar{F}(\bar{\ell})$ in $\text{Arc}_3^3(2)$ intersecting $\bar{\ell}$.

Definition 10.9 (Arc paths, rectangles, hexagons, octagons).

We call *arc path* a union of arcs such that this union is homeomorphic to a segment or to a circle. In the first case, the arc path will be said to be *open*, in the second it will be said to be *closed*.

If a connected component D of $\bar{T}_2 \cap \bar{T}_1$, of $\bar{T}_2 \cap \bar{S}$, or of $\bar{T}_2 \cap \bar{T}_3$ is homeomorphic to a disk whose boundary is a closed arc path, each of the arcs of this arc path will be called *edge of D* . Such a connected component with four edges will be called a *rectangle*, with six edges a *hexagon*, and with eight edges an *octagon*.

Step 4. *The connected components of $\bar{T}_2 \cap \bar{S}$ are rectangles. The connected components of $\bar{T}_2 \cap \bar{T}_1$ (respectively $\bar{T}_2 \cap \bar{T}_3$) consist in exactly one hexagon and some rectangles.*

Proof of step 4.

1. *connected components of $\bar{T}_2 \cap \bar{S}$.*

We can see \bar{S} as an annulus whose boundary components are \bar{a}_1 and \bar{a}_3 , minus $\frac{n}{2} - 2 + b$ open disks, corresponding to the curves a_i , $i \in \text{Imp}(n) \setminus \{1, 3\}$ and to the boundary components of Σ (cf. Figure 68). The torus \bar{T}_2 contains none of these curves and none of these boundary components so the connected components of $\bar{T}_2 \cap \bar{S}$ are simply connected and of genus zero, hence are homeomorphic to disks. All the boundary components of a component C of $\bar{T}_2 \cap \bar{S}$ are some arc paths leaning on the curves \bar{a}_1 , \bar{a}_2 and \bar{a}_3 . But we have seen that the arcs included in $\bar{a}_2 \cap \bar{S}$ belong to $\text{Arc}_1^3(2)$. It is easy to see that in such an annulus, the only injective arc paths that contain some arcs of $\text{Arc}_1^3(2)$ and that bound disks are rectangles: two edges belong to $\text{Arc}_1^3(2)$, one edge to $\text{Arc}_2^2(1)$ and one edge to $\text{Arc}_2^2(3)$.

2. *Connected components of $\bar{T}_2 \cap (\bar{T}_1 \cup \bar{T}_3)$.*

We can see \bar{T}_2 as the gluing along arcs included in \bar{a}_1 and \bar{a}_3 of the connected components of $\bar{T}_2 \cap \bar{T}_1$, $\bar{T}_2 \cap \bar{S}$ and $\bar{T}_2 \cap \bar{T}_3$. In this proof, we call *domains* these connected components. A domain of $\bar{T}_2 \cap \bar{T}_1$ is bounded by some arcs belonging to $\text{Arc}_2^2(1)$ and to $\text{Arc}_1^1(2)$. Notice that in \bar{T}_1 (as in any such torus with one hole), there exist at most three pairwise disjoint, non-isotopic arcs, whose extremities belong to $\partial\bar{T}_1$. So the set of arcs in $\text{Arc}_1^1(2)$ contains at most three isotopy classes (cf. Figure 69).

But the arcs of $\text{Arc}_1^1(2)$ and of $\text{Arc}_2^2(1)$ constitute the boundary components of the domains of $\bar{T}_1 \cap \bar{T}_2$. We deduce that there exist only four possible types of domains in \bar{T}_1 : rectangles, hexagons, octagons and *cylinders with bigonal boundary components*, that is to say spheres with two boundary components, such that each is a path of two arcs (cf. Figure 70).

The connected components of $\bar{T}_3 \cap \bar{T}_2$ satisfy the same properties, since they are the images by the diffeomorphism \bar{F} of step 2 of the connected components of $\bar{T}_1 \cap \bar{T}_2$.

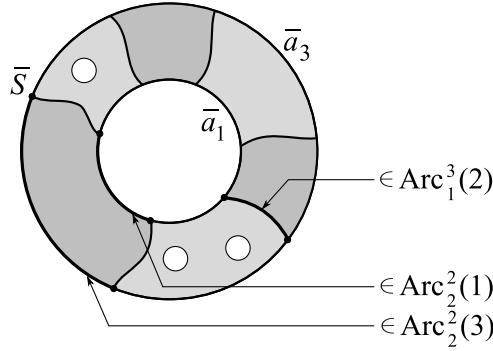

Figure 68: The surface \bar{S} is seen as an annulus, the dark grey parties are the connected components of $\bar{T}_2 \cap \bar{S}$.

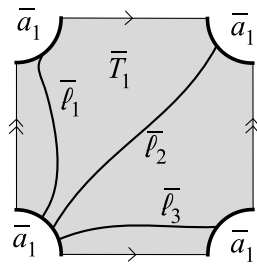

Figure 69: An example of three disjoint, non-isotopic arcs belonging to $\text{Arc}_1^1(2)$, in \bar{T}_1 .

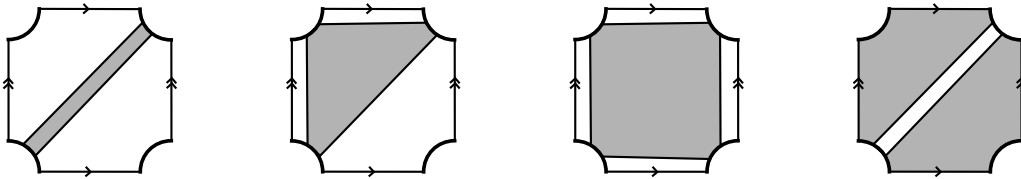

Figure 70: The four types of domains: from left to right: the rectangle, the hexagon, the octagon, the cylinder with bigonal boundary components.

3. Euler characteristic computation.

We are going to determine the contribution of each domain to the Euler characteristic of \bar{T}_2 (equal to -1 since \bar{T}_2 is a torus with one hole). Let us recall that \bar{T}_2 is the gluing of the domains along the arcs of $\text{Arc}_2^2(1) \cup \text{Arc}_2^2(3)$ included in \bar{T}_2 . Hence if a domain D has exactly k edges belonging to $\text{Arc}_2^2(1) \cup \text{Arc}_2^2(3)$, then its contribution to $\chi(\bar{T}_2)$ amounts to $\chi(D) - \frac{k}{2}$. Indeed, when we add up the Euler characteristics of all the domains, each of the gluing arcs has been counted twice. To compute the contribution of a domain to the Euler characteristic of \bar{T}_2 , we hence need to add to its own Euler characteristic $-\frac{1}{2}$ as a corrective term for each gluing arc included in the boundary of D . Thus,

- the rectangles have a 0-contribution;
- the hexagons have a $(-\frac{1}{2})$ -contribution;

- the cylinders with bigonal boundary components have a (-1) -contribution;
- the octagons have a (-1) -contribution.

But according to step 2, the domains of $\bar{T}_2 \cap \bar{T}_3$ are diffeomorphic to the ones of $\bar{T}_2 \cap \bar{T}_1$. Besides, the contribution of the domains of $\bar{T}_2 \cap \bar{S}$ is zero, since all the domains of $\bar{T}_2 \cap \bar{S}$ are rectangles (as we have seen it in step 1.). Hence the global contribution of the domains of $\bar{T}_2 \cap \bar{T}_1$ and the global contribution of the domains of $\bar{T}_2 \cap \bar{T}_3$ must both equal $-\frac{1}{2}$. Therefore $\bar{T}_2 \cap \bar{T}_1$ contains exactly one hexagon and some rectangles. Same thing for $\bar{T}_2 \cap \bar{T}_3$. \square

Example 10.10. An example of the torus \bar{T}_2 built up from two hexagons and some rectangles, according to the conclusion of step 4, is given Figure 71.

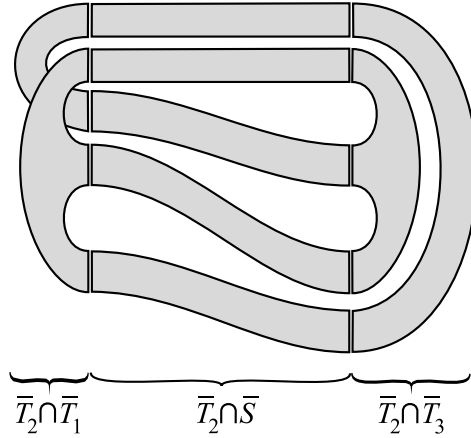

Figure 71: The torus \bar{T}_2 , built up from two hexagons and some rectangles.

Step 5. *We end in a contradiction.*

Proof of step 5 and end of the proof of Proposition 10.1. The torus \bar{T}_3 contains the connected components of $\bar{T}_2 \cap \bar{T}_3$ and of $\bar{T}_4 \cap \bar{T}_3$, which are pairwise disjoint since $\bar{T}_2 \cap \bar{T}_4 = \emptyset$. There are two hexagons among them, one included in $\bar{T}_2 \cap \bar{T}_3$, the other included in $\bar{T}_4 \cap \bar{T}_3$. Each of them contains three edges included in \bar{a}_3 (cf. Figure 72).

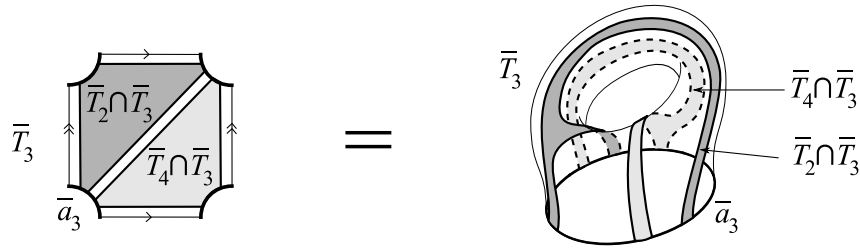

Figure 72: Two disjoint hexagons, one included in $\bar{T}_2 \cap \bar{T}_3$, the other included in $\bar{T}_4 \cap \bar{T}_3$.

Let us recall that it is possible to include in a torus with one hole only three pairwise disjoint and non-isotopic arcs with extremities in the boundary. Therefore our two hexagons are arranged as in Figure 72. In particular, let us remember that:

the six edges included in the boundary of the torus \bar{T}_3 belong alternatively to one and to the other of the two tori \bar{T}_2 and \bar{T}_4 . (1)

Let us describe how the tori \bar{T}_2 and \bar{T}_4 are embedded in Σ . The following description is depicted in Figure 73.

1. Since $\bar{T}_2 \cap \bar{T}_3$ contains a hexagon, $\bar{T}_2 \cap \bar{a}_3$ contains at least three connected components.

2. These at least three connected components extend in $\bar{T}_2 \cap \bar{S}$ in at least three rectangles. Indeed, let us recall that the rectangles of $\bar{T}_2 \cap \bar{S}$ have only one edge in \bar{a}_3 , so two distinct connected components of $\bar{T}_2 \cap \bar{a}_3$ are the edges of two distinct rectangles of $\bar{T}_2 \cap \bar{S}$. Now, there are at least three such rectangles in $\bar{T}_2 \cap \bar{S}$. Each of them has an edge in \bar{a}_1 and an edge in \bar{a}_3 . Since \bar{S} is of genus zero, we deduce that $\bar{S} \setminus \bar{T}_2$ contains at least three connected components. We will name by *region* each of these connected components.

3. For instance, consider the regions R_1, R_2, R_3 , in Figure 73. Since the two tori \bar{T}_2 and \bar{T}_4 are disjoint, the rectangles of $\bar{T}_4 \cap \bar{S}$ are inside some of these regions. However, all the rectangles of $\bar{T}_4 \cap \bar{S}$ have an edge included in \bar{a}_5 , so they should all be located in the region containing the curve \bar{a}_5 .

4. But this is impossible, for according to statement (1), there exist rectangles of $\bar{T}_4 \cap \bar{S}$ in at least three distinct regions (cf. Figure 73). □

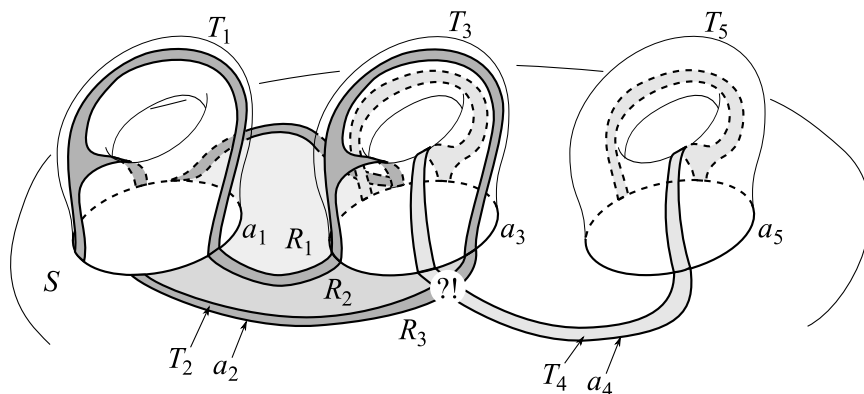

Figure 73: In this configuration where the hexagons $\bar{T}_2 \cap \bar{T}_3$ and $\bar{T}_4 \cap \bar{T}_3$ are “nested” in \bar{T}_3 , the tori \bar{T}_2 and \bar{T}_4 intersect, which should not happen yet.

11 Description of $\sigma(\mathcal{X})$ in Σ

Let us recall that n is an even integer greater than or equal to 6, Σ is a surface $\Sigma_{g,b}$ where $g \leq \frac{n}{2}$ and $b \geq 0$, and ρ is a noncyclic morphism from \mathcal{B}_n in $\mathcal{PMod}(\Sigma)$ such that:

the set $\sigma_p(\mathcal{G})$ is empty.

According to Proposition 9.9, the set $\sigma_s(\mathcal{G})$ is not empty. We even know that $|\sigma_s(A_1)| \in \{1, 2\}$ according to 9.10. Recall that $\mathcal{X} = \{A_1, A_3, A_5, \dots, A_{n-1}\}$.

In this section, we will determine the arrangement of the curves of $\sigma(\mathcal{X})$ in Σ while distinguishing the special curves and the normal curves. In other words, we will be able to describe the graphs $\Gamma(\Sigma; \sigma_s(\mathcal{X}))$ (cf. Definition 2.23) and $\Gamma(\Sigma; \sigma(\mathcal{X}))$. Our main tool will be the action of the subgroup \mathcal{H} of \mathcal{B}_n on the subset \mathcal{X} of \mathcal{G} .

11.1 Outline of the section

- In Subsection 11.2, we state a result concerning the action of \mathcal{H} on \mathcal{X} . We define notably the \mathcal{H} -colorations. They are \mathcal{H} -equivariant functions which will help us to express the constraints coming from the structure of \mathcal{B}_n on the characteristic elements of the mapping classes of \mathcal{G} .
- In Subsection 11.3 we determine the graph $\Gamma(\Sigma, \sigma_s(\mathcal{X}))$. Especially, we will prove the proposition:

Proposition 11.1 (Arrangement of the curves of $\sigma_s(\mathcal{X})$ in Σ).

- (i) *The set $\sigma_s(\mathcal{G})$ contains n curves (hence for all $A \in \mathcal{G}$, we have $|\sigma_s(A)| = 1$).*
- (ii) *The set $\sigma_s(\mathcal{X})$ is non-separating in Σ , or it is separating but for any $a \in \sigma_s(\mathcal{X})$, the set of curves $\sigma_s(\mathcal{X}) \setminus \{a\}$ is non-separating. In other words, the graph $\Gamma(\Sigma, \sigma_s(\mathcal{X}))$ is one of those depicted in Figure 74.*

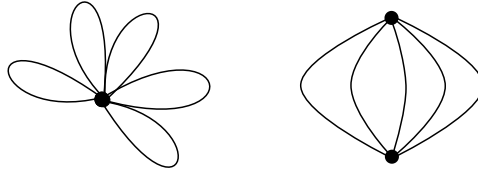

Figure 74: The two possible embeddings of $\sigma_s(\mathcal{X})$ in Σ (here $n = 10$).

- After having described $\sigma_s(\mathcal{X})$, we turn in Subsection 11.4 to the description of the set $\sigma(\mathcal{X}) = \sigma_s(\mathcal{X}) \cup \sigma_n(\mathcal{X})$ with Propositions 11.2 and 11.4.

Proposition 11.2 (Existence of the surface $\widehat{\Sigma}$).

- (i) *There exists a unique subsurface $\widehat{\Sigma}$ in $\mathcal{Sub}_{\sigma_n(\mathcal{G})}(\Sigma)$ that contains the curves of $\sigma_s(\mathcal{G})$.*
- (ii) *The boundary of each subsurface belonging to $\mathcal{Sub}_{\sigma_s(\mathcal{X})}(\widehat{\Sigma})$ contains $\sigma_s(\mathcal{X})$.*

(iii) The surface $\widehat{\Sigma}$ is of genus $\widehat{g} \in \{\frac{n}{2} - 1, \frac{n}{2}\}$.

(iv) The surface Σ is of genus $g \in \{\frac{n}{2} - 1, \frac{n}{2}\}$.

(v) The set $\text{Sub}_{\sigma_s(\mathcal{X})}(\widehat{\Sigma})$ is reduced to a connected component of genus zero, or to two connected components, one of them is of genus zero and the other is of genus zero or one.

Example. Here are three situations described in Figure 75 and illustrating Proposition 11.2.(v). On each of these three cases, we have represented the special curves of $\sigma(\mathcal{X})$, the possible normal curves of $\sigma(\mathcal{G})$, and the surface $\widehat{\Sigma}$, associated to three morphisms from \mathcal{B}_6 in $\mathcal{PMod}(\Sigma_{3,2})$:

- on the left hand side, $\text{Sub}_{\sigma_s(\mathcal{X})}(\widehat{\Sigma})$ is reduced to a connected component of genus zero,
- in the center, $\text{Sub}_{\sigma_s(\mathcal{X})}(\widehat{\Sigma})$ consists in two subsurfaces of genus zero,
- on the right hand side, $\text{Sub}_{\sigma_s(\mathcal{X})}(\widehat{\Sigma})$ consists in two subsurfaces, one of genus zero, the other of genus one.

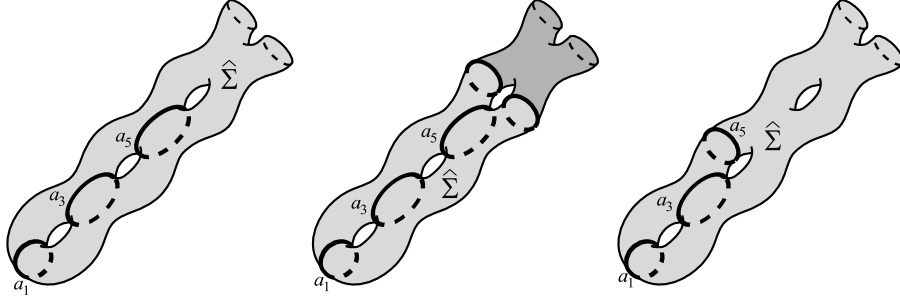

Figure 75:

Proposition 11.2 allow us to set the following definitions that will still be useful in the following section.

Definition 11.3 ($\widehat{\Sigma}$, $\check{\Sigma}$ and \mathcal{U}).

- Let $\widehat{\Sigma}$ be the subsurface of $\text{Sub}_{\sigma_n(\mathcal{G})}(\Sigma)$ that contains the special curves.
- Let us set $\mathcal{U} = \text{Bndy}(\widehat{\Sigma}) \cap \sigma_n(\mathcal{G})$.
- Let $\check{\Sigma}$ be the union of the subsurfaces of $\text{Sub}_{\mathcal{U}}(\Sigma)$ different from $\widehat{\Sigma}$. If $\widehat{\Sigma}$ is the only subsurface of $\text{Sub}_{\mathcal{U}}(\Sigma)$, we will say that $\check{\Sigma}$ is empty.

Example. Let us consider the morphism ρ from \mathcal{B}_8 in $\mathcal{PMod}(\Sigma_{4,2})$ such that for all $i \in \{1, \dots, n-1\}$, we have $\rho(\tau_i) = T_{a_i} V$, where the curves a_i are the ones drawn in Figure 76, and where V is a mapping class that commutes with the T_{a_i} and such that $\sigma(V) = \{x_1, x_2, x_3\}$, where the curves x_k are the ones drawn in Figure 76. Then we have the equalities: $\sigma_n(\mathcal{G}) = \{x_1, x_2, x_3\}$ and $\mathcal{U} = \{x_1, x_2\}$. Moreover, $\widehat{\Sigma}$ is the subsurface of $\Sigma_{\mathcal{U}}$ that contains the curves a_i (drawn in light grey in Figure 76), and $\check{\Sigma}$ is the subsurface of $\Sigma_{\mathcal{U}}$ that does not contains the curves a_i (drawn in dark grey in Figure 76).

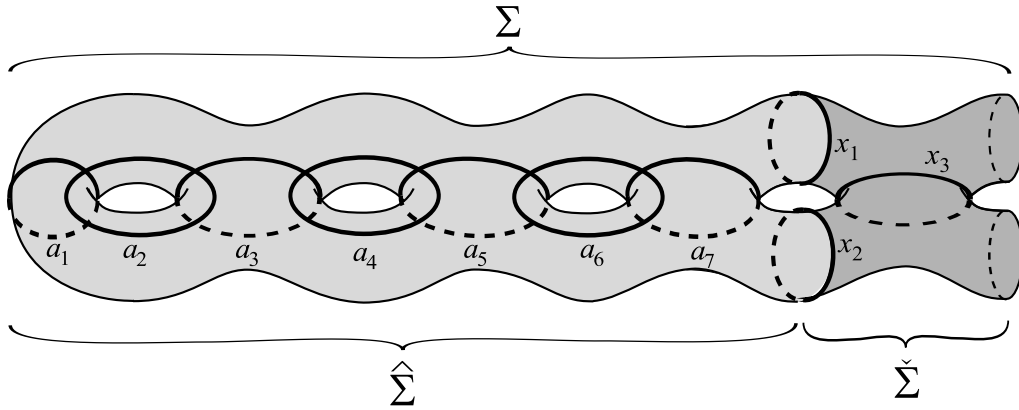

Figure 76:

For the following proposition, recall that we have assumed in this section that $\sigma_p(\mathcal{G})$ was empty. In other words, the separating curves belonging to $\sigma_n(\mathcal{G})$ separate Σ in two surfaces, each of them being of nonzero genus.

Proposition 11.4 (Description of $\text{Sub}_{\mathcal{U}}(\Sigma)$).

We have $|\mathcal{U}| \leq 2$, and $\text{Sub}_{\mathcal{U}}(\Sigma)$ satisfies the following properties:

- if \mathcal{U} is empty, then $\Sigma = \widehat{\Sigma}$; if $\widehat{\Sigma}$ is of genus $\frac{n}{2}$, then \mathcal{U} is empty,
- if \mathcal{U} is reduced to a non-separating curve u , then $\check{\Sigma}$ is empty and $\{u\}$ is the mark of $\widehat{\Sigma}$,
- if \mathcal{U} is reduced to a separating curve u , then $\check{\Sigma}$ is a connected subsurface of genus 1,
- if \mathcal{U} contains two curves, then they are non-separating and $\check{\Sigma}$ is connected, of genus zero.

These assertions can be summed up as follows: the graph $\Gamma(\Sigma, \mathcal{U})$ is one of the four graphs depicted in Figure 77 where:

- the circled vertices represent the subsurfaces of nonzero genus of $\text{Sub}_{\mathcal{U}}(\Sigma)$,
- the integer placed beside the circled vertices indicates the genus,
- the edges are drawn as dotted so as to be coherent with Remark 11.9 at the end of the present section.



Figure 77: The four possible graphs for $\Gamma(\Sigma, \mathcal{U})$ (cf. Proposition 11.4).

We then could easily deduce from it the different possible graphs corresponding to $\Gamma(\Sigma; \sigma(\mathcal{X}))$. We do it only as a remark (cf. Remark 11.9 in end of section), because such a detailed description will be useless in the following of the proof of Proposition 12.1. Indeed, Propositions 11.1, 11.2 and 11.4 are enough for this purpose.

11.2 Action of \mathcal{H} on \mathcal{X} and \mathcal{H} -colorations

Recalls. Let us recall the definitions of the group \mathcal{H} and of the subset \mathcal{X} of \mathcal{G} (cf. Subsection 10.2, Definitions 10.2 and 10.3). For any nonzero integer m , let $\text{Imp}(m)$ be the set of the first odd integers smaller than or equal to m . Let \mathcal{X} be the subset $\{A_i, i \in \text{Imp}(n)\}$ of \mathcal{G} consisting in $\frac{n}{2}$ elements which pairwise commute. We denote by $\sigma(\mathcal{X})$ the curve simplex $\cup_{i \in \text{Imp}(n)} \sigma(A_i)$. We set $\sigma_s(\mathcal{X}) = \sigma(\mathcal{X}) \cap \sigma_s(\mathcal{G})$. The group \mathcal{H} is the subgroup $\langle \gamma_i, i \in \text{Imp}(n) \rangle$ of \mathcal{B}_n where for all $i \in \text{Imp}(n)$, the element γ_i is the product $\tau_i \tau_{i+1} \tau_i \tau_{i+2} \tau_{i+1} \tau_i$.

Let us also recall the main properties of \mathcal{H} (see Proposition 10.4):

i) The action of \mathcal{H} on $\mathcal{P}\text{Mod}(\Sigma)$ via ρ preserves \mathcal{X} . Indeed, for all $i, j \in \text{Imp}(n)$, we have:

$$\gamma_i \cdot A_j = \rho(\gamma_i) A_j \rho(\gamma_i)^{-1} = \begin{cases} A_j & \text{if } i \notin \{j, j-2\} \\ A_{j-2} & \text{if } i = j-2 \\ A_{j+2} & \text{if } i = j. \end{cases}$$

(ii) The morphism $\mathcal{H} \rightarrow \mathfrak{S}(\mathcal{X})$ describing the action of \mathcal{H} on \mathcal{X} , where $\mathfrak{S}(\mathcal{X})$ is the symmetric group on the elements of \mathcal{X} , is surjective. In particular, this action is $\frac{n}{2}$ times transitive.

(iii) The action of \mathcal{H} on $\mathcal{C}\text{urv}(\Sigma)$ preserves $\sigma_s(\mathcal{X})$.

We have already given the definition of \mathcal{J} -coloration (cf. Definition 9.16). We define what is a \mathcal{H} -coloration in the same way.

Definition 11.5 (\mathcal{H} -colorations on \mathcal{X}).

Let \mathcal{E} be an \mathcal{H} -set (i.e. a set together with an action of \mathcal{H}) and $\mathcal{P}(\mathcal{E})$ the power set of \mathcal{E} . An \mathcal{H} -coloration is a function $\text{col}_{\mathcal{X}} : \mathcal{X} \rightarrow \mathcal{P}(\mathcal{E})$ that is \mathcal{H} -equivariant, which means that for all $\xi \in \mathcal{H}$ and all $A \in \mathcal{X}$, we have:

$$\xi \cdot \text{col}_{\mathcal{X}}(A) = \text{col}_{\mathcal{X}}(\xi \cdot A).$$

The integers of $\text{Imp}(n)$, in bijection with \mathcal{X} , are called *colors*. We will say that an element $e \in \mathcal{E}$ is of color i if $e \in \text{col}_{\mathcal{X}}(A_i)$. An element $e \in \mathcal{E}$ can be of several colors in the meantime or possibly of none color.

Conversely, starting from a \mathcal{H} -coloration $\text{col}_{\mathcal{X}} : \mathcal{X} \rightarrow \mathcal{P}(\mathcal{E})$, let us define the map called \mathcal{H} -spectrum:

$$\text{sp}_{\mathcal{X}} : \begin{array}{ccc} \mathcal{E} & \longrightarrow & \mathcal{P}(\mathcal{X}) \\ e & \longmapsto & \{A \in \mathcal{X} \mid e \in \text{col}_{\mathcal{X}}(A)\} \end{array} .$$

The map $\text{sp}_{\mathcal{X}}$ is \mathcal{H} -equivariant: for all $\xi \in \mathcal{H}$ and all $e \in \mathcal{E}$, we have:

$$\xi \cdot \text{sp}_{\mathcal{X}}(e) = \text{sp}_{\mathcal{X}}(\xi \cdot e).$$

Proposition 11.6. *The map $\sigma_s : \mathcal{X} \rightarrow \mathcal{C}\text{urv}(\Sigma)$ is an \mathcal{H} -coloration.*

Proof. According to Proposition 3.40.(i), we have $\sigma(\gamma.A) = \gamma.\sigma(A)$ for any $\gamma \in \mathcal{B}_n$ and any $A \in \mathcal{P}\text{Mod}(\Sigma)$, so the function Σ is an \mathcal{H} -coloration on $\sigma(\mathcal{X})$. Moreover, $\sigma_s(\mathcal{X})$ is \mathcal{H} -stable, according to Proposition 10.4). Then for all $i, j \in \text{Imp}(n)$, we have:

$$\begin{aligned}\sigma_s(\gamma_i.A_j) &= \sigma(\gamma_i.A_j) \cap \sigma_s(\mathcal{X}) \\ &= \gamma_i.\sigma(A_j) \cap \sigma_s(\mathcal{X}) \\ &= \gamma_i.\sigma(A_j) \cap \gamma_i.\sigma_s(\mathcal{X}) \\ &= \gamma_i.(\sigma(A_j) \cap \sigma_s(\mathcal{X})) \\ &= \gamma_i.\sigma_s(A_j).\end{aligned}$$

So the restriction of the function σ on \mathcal{X} is an \mathcal{H} -coloration. \square

Lemma 11.7. *Let \mathcal{E} be an \mathcal{H} -set. Let $\text{col}_{\mathcal{X}} : \mathcal{X} \rightarrow \mathcal{P}(\mathcal{E})$ be an \mathcal{H} -coloration and $\text{sp}_{\mathcal{X}} : \mathcal{E} \rightarrow \mathcal{P}(\mathcal{X})$ the associated \mathcal{H} -spectrum. Let e be an element of \mathcal{E} such that the \mathcal{H} -spectrum of e contains k mapping classes ($0 \leq k \leq \frac{n}{2}$). Then there exists an integer $\ell \geq 1$ such that $|\mathcal{H}.e| = \ell C_r^k$ where $r = \frac{n}{2}$.*

Proof. This is an easy application of general principles about group actions. In a general way, if \mathcal{F} is a finite set on which \mathcal{H} acts, if we choose an element $f_0 \in \mathcal{F}$ and if we denote by $S = \text{Stab}_{\mathcal{H}}(f_0)$ the subgroup of \mathcal{H} that fixes f_0 , and by \mathcal{Z} a transversal of \mathcal{H}/S , then,

- we have the disjoint union $\mathcal{H} = \bigsqcup_{\gamma \in \mathcal{Z}} \gamma.S$
- if the action of \mathcal{H} on \mathcal{F} is transitive, we have $|\mathcal{Z}| = |\mathcal{H}/S| = |\mathcal{F}|$.

Given an element e of \mathcal{E} such that $\text{sp}_{\mathcal{X}}(e)$ is a set of k mapping classes of \mathcal{X} with $0 \leq k \leq r$ where $r = \frac{n}{2}$, let us consider the set $\mathcal{P}_k(\mathcal{X})$ of the subsets of \mathcal{X} containing k elements. We replace \mathcal{F} by $\mathcal{P}_k(\mathcal{X})$ and f_0 by $\text{sp}_{\mathcal{X}}(e)$. Notice that the action of \mathcal{H} on $\mathcal{P}_k(\mathcal{X})$ is transitive for the action of \mathcal{H} on \mathcal{X} is k times transitive. We get then:

$$\mathcal{H} = \bigsqcup_{\gamma \in \mathcal{Z}} \gamma.\text{Stab}_{\mathcal{H}}(\text{sp}_{\mathcal{X}}(e)), \quad (1)$$

$$\text{and } |\mathcal{Z}| = |\mathcal{H}/\text{Stab}_{\mathcal{H}}(\text{sp}_{\mathcal{X}}(e))| = |\mathcal{P}_k(\mathcal{X})| = \binom{r}{k}. \quad (2)$$

Now for all distinct γ' and γ'' belonging to \mathcal{Z} , the elements $\gamma'.\text{sp}_{\mathcal{X}}(e)$ and $\gamma''.\text{sp}_{\mathcal{X}}(e)$ are different, so the elements of $\gamma'.(\text{Stab}_{\mathcal{H}}(\text{sp}_{\mathcal{X}}(e)).e)$, that all have the same spectrum, which is different from the spectrum of the elements of $\gamma''.(\text{Stab}_{\mathcal{H}}(\text{sp}_{\mathcal{X}}(e)).e)$. Hence the two sets $\gamma'.(\text{Stab}_{\mathcal{H}}(\text{sp}_{\mathcal{X}}(e)).e)$ and $\gamma''.(\text{Stab}_{\mathcal{H}}(\text{sp}_{\mathcal{X}}(e)).e)$ are disjoint. Therefore, the assertion (1) implies:

$$\mathcal{H}.e = \bigsqcup_{\gamma \in \mathcal{Z}} \gamma.(\text{Stab}_{\mathcal{H}}(\text{sp}_{\mathcal{X}}(e)).e), \quad (3)$$

We set $\ell = |(\text{Stab}_{\mathcal{H}}(\text{sp}_{\mathcal{X}}(e)).e)|$. Then, we deduce from (2) and (3) the following equality:

$$|\mathcal{H}.e| = \ell \binom{r}{k}. \quad (4)$$

\square

11.3 Description of the embedding of $\sigma_s(\mathcal{X})$ in Σ

In this subsection, we are going to show the following proposition:

Proposition 11.1 (Arrangement of the curves of $\sigma_s(\mathcal{X})$ in Σ).

- (i) The set $\sigma_s(\mathcal{G})$ contains n curves (hence for all $A \in \mathcal{G}$, we have $|\sigma_s(A)| = 1$).
- (ii) The set $\sigma_s(\mathcal{X})$ is non-separating in Σ , or it is separating but for any $a \in \sigma_s(\mathcal{X})$, the set of curves $\sigma_s(\mathcal{X}) \setminus \{a\}$ is non-separating. In other words, the graph $\Gamma(\Sigma, \sigma_s(\mathcal{X}))$ is one of those depicted in Figure 78.

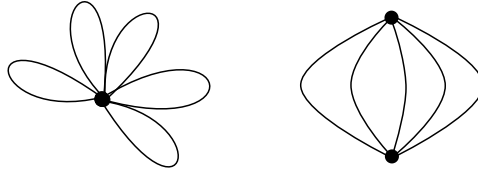

Figure 78: The two possible embeddings of $\sigma_s(\mathcal{X})$ in Σ (here $n = 10$).

Proof. According to Proposition 9.10, $\sigma_s(\mathcal{G})$ contains n or $2n$ curves, depending on whether $\sigma_s(A_1)$ contains one or two curves. Since \mathcal{X} contains only the mapping classes with odd indices, $\sigma_s(\mathcal{X})$ contains $\frac{n}{2}$ or n curves. While showing item (ii) we will show that $\sigma_s(\mathcal{X})$ contains $\frac{n}{2}$ curves, which will prove item (i).

Let us show that if we prove this proposition in the case where $\partial\Sigma$ is empty, then the proposition in the case where $\partial\Sigma$ is not empty can be deduced easily. So, we assume that $\partial\Sigma$ is not empty. Let us consider the graph $\Gamma(\Sigma, \sigma_s(\mathcal{X}))$ and the subgroup \mathcal{H} preserving the simplex $\sigma_s(\mathcal{X})$. Since the cardinality of each orbit of curves of $\sigma_s(\mathcal{X})$ under \mathcal{H} is greater than or equal to $\frac{n}{2} \geq 3$, we can apply Proposition 7.5. In other words, $\Gamma(\Sigma, \sigma_s(\mathcal{X}))$ is canonically isomorphic to $\Gamma(\text{sq}(\Sigma), \text{sq}(\sigma_s(\mathcal{X})))$ that is the graph associated to the morphism $\text{sq}^* \circ \rho : \mathcal{B}_n \rightarrow \mathcal{M}\text{od}(\text{sq}(\Sigma))$, in the same way as the graph $\Gamma(\Sigma, \sigma_s(\mathcal{X}))$ is associated to the morphism $\rho : \mathcal{B}_n \rightarrow \mathcal{P}\mathcal{M}\text{od}(\Sigma)$. Thanks to this isomorphism, in order to prove Proposition 11.1, it is enough to show the parts (i) and (ii) when $\partial\Sigma$ is empty.

From now on, we assume that $\partial\Sigma$ is empty. We are going to use the action of \mathcal{H} on the graph $\Gamma(\Sigma, \sigma_s(\mathcal{X}))$. In order to make the action of \mathcal{H} on the graph $\Gamma(\Sigma, \sigma_s(\mathcal{X}))$ more obvious, we “color in” the different edges and the different vertices as follows:

The graph $\Gamma = \Gamma(\Sigma, \sigma_s(\mathcal{X}))$.

We denote by Γ the graph $\Gamma(\Sigma, \sigma_s(\mathcal{X}))$. Its vertices are in bijection with $\text{Sub}_{\sigma_s(\mathcal{X})}(\Sigma)$ and its edges are in bijection with $\sigma_s(\mathcal{X})$. The action of \mathcal{H} on $\text{Sub}_{\sigma_s(\mathcal{X})}(\Sigma)$ induces an action of \mathcal{H} on the set of vertices of Γ and the action of \mathcal{H} on $\sigma_s(\mathcal{X})$ induces an action of \mathcal{H} on the set of edges of Γ . Moreover, these two actions are compatible with the graph structure of Γ . In addition, we also have two \mathcal{H} -colorations:

- the \mathcal{H} -coloration $\sigma_s : \mathcal{X} \rightarrow \sigma_s(\mathcal{X})$, that can be seen as an \mathcal{H} -coloration on the edges of Γ . In this way, the \mathcal{H} -spectrum of each edge of Γ contains a unique color $i \in \text{Imp}(n)$;

- the \mathcal{H} -coloration $\omega_{\mathcal{X}} : \begin{array}{l} \mathcal{X} \longrightarrow \text{Sub}_{\sigma_s(\mathcal{X})}(\Sigma) \\ A \longmapsto \{S \in \text{Sub}_{\sigma_s(\mathcal{X})}(\Sigma) \mid \text{Bndy}(S) \cap \sigma_s(A) \neq \emptyset\} \end{array}$, that can be seen as an \mathcal{H} -coloration on the vertices of Γ . Thus the \mathcal{H} -spectrum of each vertex contains exactly the colors of the edges incident to this vertex.

Since σ_s and $\omega_{\mathcal{X}}$ are \mathcal{H} -colorations, the action of \mathcal{H} on the vertices and on the edges of Γ is compatible with the action of \mathcal{H} on their colors. Finally, the group \mathcal{H} acts on the graph Γ together with its colors.

The cycles and the degrees in Γ .

Let us denote by c the number of independent cycles which exist in Γ . Then, we have of course:

Fact 1: $c \leq g$.

The vertices of degree 1 correspond to the subsurfaces bounded by some separating curves. However, according to Proposition 10.1, there does not exist in $\sigma_s(\mathcal{X})$ any separating curve in Σ , so:

Fact 2: *The degree of each vertex is at least 2.*

Hence the graph Γ contains some cycles:

Fact 3: $c \geq 1$.

Notice that the vertices of degree 2 correspond to the connected components having only two boundary components. Remember that $\partial\Sigma$ is empty, so such connected components must be of nonzero genus. We deduce:

Fact 4: *The number of vertices of degree 2 is bounded by $g - c$.*

Moreover, if there exists a vertex p of degree 2, such that i and j in $\text{Imp}(n)$ are the colors of the two edges having an extremity in p , the orbit of p under the action of \mathcal{H} is of cardinality at least $\frac{n}{2}$ if $i = j$, and of cardinality at least $\binom{\frac{n}{2}}{2} \geq \frac{n}{2}$ if $i \neq j$, according to Lemma 11.7. But according to Facts 3 and 4, this number should be bounded by $g - 1$. However, $g - 1 < \frac{n}{2}$, so finally:

Fact 5: *There does not exist any vertex of degree 2.*

We are going to treat separately the graphs containing some edges whose both extremities are equal, from the graphs where both extremities of each edges are distinct.

Definition 11.8 (Petals). Let us call *petal* an edge whose both extremities are equal.

Graphs with petals. If there exist some petal in Γ , then there exist some in each color, so there exist at least $\frac{n}{2}$ petals. But each petal produces an independent cycle of Γ , and the number of independent cycles is bounded by g , and so by $\frac{n}{2}$. So we have $c = g = \frac{n}{2}$. Therefore, if there exist some petals in Γ , then there exist exactly $\frac{n}{2}$ petals and $g = \frac{n}{2}$. Moreover, since the maximal number of independent cycles is achieved just because of the petals, it follows that if we remove these $\frac{n}{2}$ petals from Γ , we get a tree. Since each edge is *separating* in a tree (we say that an edge is *separating* in a connected graph if removing this edge from the graph makes it disconnected), then all the edges in Γ that are not a petal are separating. But according to Proposition 10.1, $\sigma_s(\mathcal{X})$ does not contain any separating curves, so Γ contains no other edge but the $\frac{n}{2}$ petals. Therefore, the graph Γ is a rose, that is, a graph with only one vertex (cf. graph of gauche Figure 78).

Graphs without petals. Let us assume now that Γ is a graph without petals.

According to Proposition 9.10, for each $A \in \mathcal{G}$, the cardinality $|\sigma_s(A)|$ equals 1 or 2. In other words, for each $i \in \{0, 1, \dots, n-1\}$, there are only one or two curves in $\sigma_s(\mathcal{G})$ that are in $\sigma_s(\mathcal{A}_i)$. In the graph Γ , this implies that:

Fact 6: *There exist at most two edges of a same color.*

If there is only one edge per color:

According to Facts 2 and 5, all the vertices are at least of degree 3. Since there is no petal, at least three distinct edges are incident to each vertex.

- When $n = 6$, since there is only one edge per color, Γ contains only three edges. Hence in the case $n = 6$, there exists exactly 2 vertices of degree 3 and the graph is drawn in Figure 78, left hand side.
- Suppose now that $n \geq 8$. We take $j = n - 1$ and we set $\mathcal{H}_{n-2} = \langle \gamma_i, i \in \text{Imp}(n-2) \rangle$ so that \mathcal{H}_{n-2} is a subgroup of \mathcal{H} that fixes the color $n-1$ and acts $\frac{n}{2} - 1$ times transitively on the set of the $\frac{n}{2} - 1$ other colors of $\text{Imp}(n)$. Given a vertex q of degree v and an edge of color $n-1$ incident to q , according to Lemma 11.7, there should exist at least $\binom{\frac{n}{2} - 1}{v - 1}$ distinct vertices in the orbit of q under the action of \mathcal{H}_{n-2} . But there is only one edge of color $n-1$ in Γ , so there should be at most two vertices in the orbit of q under \mathcal{H}_{n-2} , including q . So $\binom{\frac{n}{2} - 1}{v - 1}$ must be equal to 1 or 2. Since $\frac{n}{2} - 1 \geq 3$ and $v - 1 \geq 2$, v must be equal to $\frac{n}{2}$. So the graph Γ is fully determined: there are exactly two vertices and $\frac{n}{2}$ edges incident to these two vertices: the graph is drawn in Figure 78, right hand side.

If there are exactly two edges per color:

We suppose from now on that there exist two curves in each color.

We want to show that this case is absurd.

Notice that we have the following:

Fact 7: *Two edges of the same color cannot have the same extremities.*

Proof. Assume that two edges of a same color have the same extremities. Then they would form a cycle, and we can associate their color to this cycle. We would obtain $\frac{n}{2}$ independent cycles of distinct colors, hence the equalities $c = g = \frac{n}{2}$ would hold and it would not exist other independent cycles in Γ , according to Fact 1. It would not exist either other edges than the n edges constituting these $\frac{n}{2}$ cycles, according to Fact 6. Let us identify in Γ two edges if they have the same color and let us call Γ' this new graph (cf. Figure 79). The graph Γ' is a tree, so it contains leaves (vertices of degree 1). These leaves correspond in Γ to vertices of degree 2. But this is forbidden, according to Fact 5. Hence Fact 7 is shown. \square

Let us go further:

Fact 8: *Two edges of the same color cannot share an extremity in common.*

Proof. We argue again by contradiction. We suppose that two edges of the same color share an extremity in common (if this is true for one color, this must be true for each color). Let us recall that there exist only two edges of the same color, according to Fact 6. Let us also recall that two

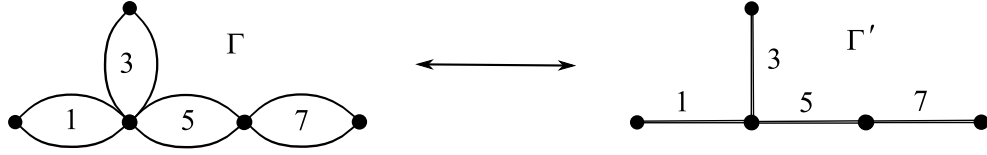

Figure 79: Case $g \geq 4$, when two edges of a same color have the same extremities.

such edges cannot have the same extremities, according to Fact 7. So for all $i \in \text{Imp}(n)$, there exists only one vertex that is a common extremity the two edges of color i . We will call it p_i . By symmetry of the action of \mathcal{H} on \mathcal{X} , the p_i are all distinct or all equal.

- a) **The vertices p_i , $i \in \text{Imp}(n)$, coincide.** We keep in mind Figure 80. Let us call p the vertex $p_1 = p_3 = \dots = p_{n-1}$. The vertex p is at least of degree n . It cannot be of a greater degree, for there is no petal in Γ , by assumption. Thus, each on the n edges in Γ has an extremity in p . The number of the other extremities is n , and they are incident to vertices distinct from p . But since these vertices are of degree greater than or equal to 3 according to Facts 2 and 5, their number is at most $\frac{n}{3}$. So, Γ contains n edges and at most $1 + \frac{n}{3}$ vertices, so its number of independent cycles is at least of $1 + n - (\frac{n}{3} + 1) = \frac{2n}{3}$. But this is absurd for $\frac{2n}{3} > \frac{n}{2} \geq g$.

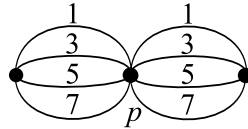

Figure 80: Example of graph where all the p_i coincide.

- b) **The vertices p_i , $i \in \text{Imp}(n)$, are pairwise distinct.** We keep in mind Figure 81. As the p_i are not of degree 2, according to Fact 5, each p_i is the extremity of the two edges of color i and of at least an edge of color $j \neq i$. But the subgroup of \mathcal{H} that fixes the color i acts transitively on the other colors, so p_i is also the extremity of an edge of color k for all $k \in \text{Imp}(n) \setminus \{i\}$. Thus p_i is of degree at least $\frac{n}{2} + 1$ (actually, this must be an equality with our assumptions). As we know that there is at least $\frac{n}{2}$ vertices in Γ (think of the p_i , $i \in \text{Imp}(n)$), we deduce that the degrees of all the vertices in Γ sum to at least $\frac{n}{2}(\frac{n}{2} + 1)$. Now, this sum should be equal to two times the number of edges. Since there are exactly n edges in Γ , we have the equality:

$$\frac{n}{2}(\frac{n}{2} + 1) \leq 2n. \quad (*)$$

We get then $n^2 + 2n \leq 8n$, hence $n \leq 6$. By hypothesis, $n \geq 6$, so $n = 6$ and $(*)$ is an equality and becomes: $\frac{n}{2}(\frac{n}{2} + 1) = 12$. That means that the vertices in Γ is reduced to the set $\{p_1, p_3, p_5\}$. The graph now is perfectly determined, and drawn in Figure 81. But this graph contains $c = 1 + 6 - 3 = 4$ independent cycles, which is absurd for $c \leq g \leq \frac{n}{2} = 3$.

Thus, Fact 8 is shown. \square

Now, with these eight facts, we can terminate the proof of Proposition 11.1. Remember that we assume that $|\sigma_s(\mathcal{X})| = n$. We prove separately the cases $n = 6$ and $n \geq 8$. We start by the case $n \geq 8$ which is the easiest one.

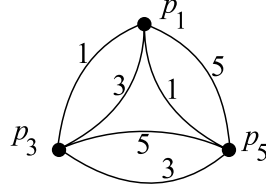

Figure 81: Example of a graph where the p_i are distinct.

Let us show that the conditions $|\sigma_s(\mathcal{X})| = n$ and $n \geq 8$ lead to a contradiction.

Let us denote by S the number of vertices. Since Γ has n edges, the number of independent cycles must satisfy $c = 1 + n - S \leq \frac{n}{2}$. Hence:

$$S \geq \frac{n}{2} + 1.$$

Let v be the minimum degree among the vertices of Γ . We have seen, according to Facts 2 and 5 that $v \geq 3$. But the sum of the degrees of all the vertices of Γ is at least equal to vS . On the other hand, it must be equal to two times the number of vertices. Hence we have $2n \geq vS$, so:

$$S \leq \frac{2n}{v}.$$

It is then absurd that $v \geq 4$ for we would have $\frac{n}{2} + 1 \leq S \leq \frac{n}{2}$. Now, suppose that $v = 3$. Thanks to Fact 8, we know that all the edges incident to a vertex are of pairwise distinct colors, so when $v = 3$, to each vertex corresponds a choice of three colors among $\frac{n}{2}$. According to Lemma 11.7, we have then at least $\binom{\frac{n}{2}}{3}$ vertices in Γ . When $n \geq 10$, we check that $\binom{\frac{n}{2}}{3} \geq n$, so this leads to the following contradiction:

$$n \leq \binom{\frac{n}{2}}{3} \leq S \leq \frac{2n}{3}.$$

When $n = 8$, since $v = 3$, there exists an orbit of vertices of degree 3. The cardinality of this orbit is a multiple of 4 vertices, according to Lemma 11.7. But as there exists 8 edges in Γ and consequently 16 half-edges, there must exist in Γ exactly 4 vertices of degree 3 and one vertex of degree 4 (replace the vertex of degree 4 by two vertices of degree 2 is forbidden by Fact 5) to satisfy the equality: $16 = 3 \times 4 + 1 \times 4$. We thus get a graph similar to those depicted in Figure 82. Let us call P_1, P_3, P_5 and P_7 the four vertices of degree 3 and Q the vertex of degree 4, as in Figure 82. The subgroup of \mathcal{H} that fixes the color 1 does not preserve such a graph, for it fixes the vertices P_1 and Q but modifies the color of the unique edge that joint the vertices P_1 and Q : this edge can be of color 3, 5 or 7, and gives rise to different graphs (in Figure 82, we give two examples with 7 and 5). Hence this case $n = 8$ is absurd. Finally, the conditions $|\sigma_s(\mathcal{X})| = n$ and $n \geq 8$ lead only to contradictions.

Let us show that the conditions $|\sigma_s(\mathcal{X})| = n$ and $n = 6$ lead to a contradiction.

According to Facts 2, 5 and 8, all the vertices are of degree 3, each being the extremity of three edges of colors 1, 3 and 5. We get the graph represented on Figure 83. Let us recall that according to Proposition 9.4 (5d) describing the equivalent properties of the special curves, each orbit of edges of $\sigma_s(\mathcal{X})$ under the action of $\mathcal{J} = \langle \delta \rangle$ is of cardinality $n = 6$, and each orbit of edges of $\sigma_s(\mathcal{X})$ under the action of $\langle \delta^2 \rangle$ is of cardinality $\frac{n}{2} = 3$. So we distinguish two orbits among the 6 curves of $\sigma_s(\mathcal{X})$, and the action of δ^2 on the graph Γ is periodic of order three. Then one of the vertices is preserved whereas the three others are cyclicly permuted. Let us call P the preserved vertex. Its boundary components form an orbit under the action of δ^2 , we will call them $a'_1, a'_3,$

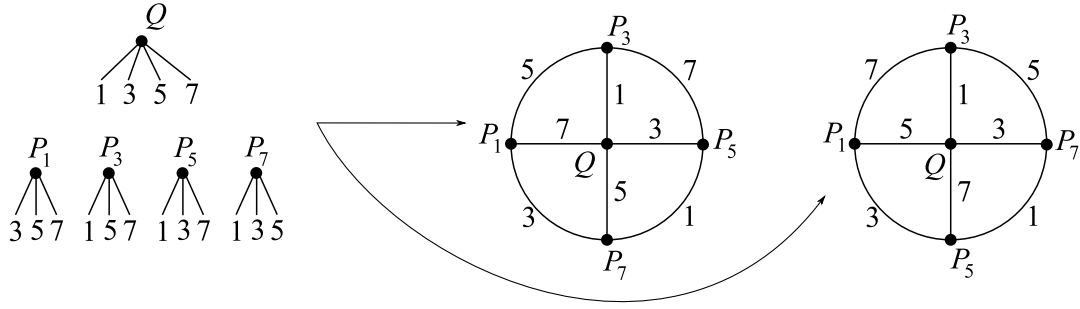

Figure 82: Two examples of *a priori* possible graphs with $n = 8$ and $|\sigma_s(\mathcal{X})| = 8$. (They are different, for Q and P_1 are joined by an edge of color 7 in one case, and 5 in the other. But, none of them is \mathcal{H} -stable since the action of γ_5 swap them.)

a'_5 , where the indices respect the color of each curve. Let us call the other curves a_1, a_3, a_5 , where the indices respect the color of each curve. For all $i \in \{1, 3, 5\}$, let us denote by P_i the subsurface different from P that contains the curve a'_i in its boundary, see Figure 83.

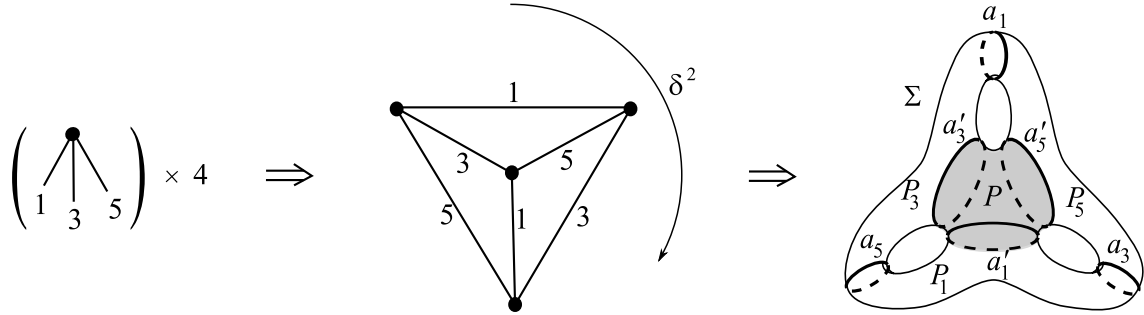

Figure 83: Case $n = 6$: the surface $\Sigma_{3,0}$ together with the curves of $\sigma_s(\mathcal{X})$ when $|\sigma_s(\mathcal{X})| = 6$.

We are going to show, by means of the special curves of $\mathcal{Y} = \mathcal{G} \setminus \mathcal{X} = \{A_0, A_2, A_4\}$, that such a configuration cannot happen. Notice that $\sigma_s(\mathcal{G})$ is a set of curves without triple intersection, so according to Proposition 2.2, there exists a unique system of representatives of the curves of $\sigma_s(\mathcal{G})$ in tight position, up to isotopy. Moreover, any representative of the mapping class $\rho(\delta)$ sends such a system of representatives on itself, up to isotopy. Moreover, we have, $\sigma_s(\mathcal{Y}) = \delta.\sigma_s(\mathcal{X})$, and we denote by $a_0, a_2, a_4, a'_0, a'_2, a'_4$ the curves of $\sigma_s(\mathcal{Y})$, so as to be coherent with their colors, as we did with the curves of $\sigma_s(\mathcal{X})$. Let us consider the subsurface P_1 . Then:

- $a'_2 = \delta.a'_1$ and $a'_0 = \delta^{-1}.a'_1$, so according to Proposition 9.23, $I(a'_1, a'_2) = I(a'_1, a'_0) \neq 0$, hence $a'_0 \cap P_1$ and $a'_2 \cap P_1$ are not empty.
- Similarly if we consider the curves a_3 and a_5 , it follows that $I(a_3, a_4) = I(a_3, a_2) \neq 0$ and $I(a_5, a_0) = I(a_5, a_4) \neq 0$, so $a_0 \cap P_1, a_2 \cap P_1$ and $a_4 \cap P_1$ are not empty.
- Let x be a curve of $\sigma_s(\mathcal{Y})$ whose restriction to P_1 is a path with extremities in a same boundary component, and y another curve of $\sigma_s(\mathcal{Y})$ whose restriction to P_1 is a path with extremities in the two other boundary components of P_1 . Then x and y must intersect,

as illustrated in Figure 84 (two cases are to be considered, depending on whether the extremities of y belong to the same boundary of P_1 or not). But $\sigma_s(\mathcal{Y})$ is a curve simplex, so this situation cannot happen.



Figure 84: Case $n = 6$: the curve x and the curve y have to intersect.

- Let us apply the last point to the curves $x = a'_0$ and $y = a_4$. Suppose that the extremities of one of the connected components of $a'_0 \cap P_1$ lie in a'_1 . Notice that a_4 cannot intersect a'_1 , so the extremities of any connected component of $a_4 \cap P_1$ lie in $a_3 \cup a_5$. This leads to a contradiction as we just have seen it above. Therefore $a'_0 \cap P_1$ cannot contain any path with extremities in a'_1 . Hence $a'_0 \cap P_1$ consists in paths joining the boundary components a'_1 and a_5 . Similarly, $a'_2 \cap P_1$ consists in paths joining the boundary components a'_1 and a_3 .
- Let us now apply the last-but-one point to the curves $x = a_2$ and $y = a_0$. We conclude just as before that $a_2 \cap P_1$ cannot contain any path with extremities in a_3 . Similarly, if we take the curves $x = a_4$ and $y = a_0$, we see that $a_4 \cap P_1$ cannot contain any path with extremities in a_3 . The reader can check that in fact, no curve of $\sigma_s(\mathcal{Y})$ can contain some path in P_1 with extremities in a same boundary of P_1 . The situation is summed up in Figure 85.

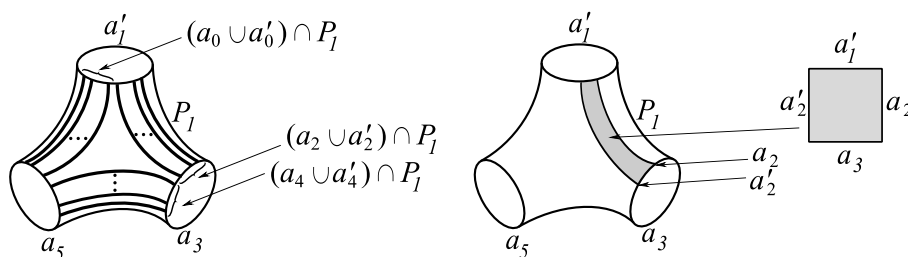

Figure 85: Case $n = 6$: the intersection of the curves of $\sigma_s(\mathcal{Y})$ and P_1 .

- Then, there exists in $\Sigma_{\sigma_s(\mathcal{G})}$ a connected component homeomorphic to a disk whose boundary consists in four arcs of curves, each arc being included in a'_1 , a_2 , a'_2 and a_3 respectively. We then deduce that there exists in $\mathcal{S}ub_{\sigma_s(\mathcal{Y})}(\Sigma)$ a subsurface bounded altogether by a_2 and a'_2 . Then, taking the image of this situation by $\rho(\delta^{-1})$, we deduce that there should exist in $\mathcal{S}ub_{\sigma_s(\mathcal{X})}(\Sigma)$ a subsurface bounded altogether by a_1 and a'_1 . However, this is not the case. This is the expected contradiction.

Finally, the conditions $|\sigma_s(\mathcal{X})| = n$ and $n = 6$ lead to a contradiction. This concludes the proof of Proposition 11.1. \square

11.4 Description of $\sigma_n(\mathcal{G})$ and of $\sigma(\mathcal{X})$ in Σ

According to Proposition 11.1, for all integers $i \in \{0, \dots, n-1\}$, the set of curves $\sigma_s(A_i)$ is reduced to a unique curve. We denote it by a_i . Since we know that the set $\sigma_s(\mathcal{X})$ is equal to $\{a_1, a_3, \dots, a_{n-1}\}$ and since we know how these curves are arranged in Σ (cf. Proposition 11.1), we turn now to the simplex $\sigma(\mathcal{X})$. Let us recall that according to Proposition 9.23, we have $\sigma_n(A_1) = \sigma_n(\mathcal{G})$, whence the equality

$$\sigma(\mathcal{X}) = \sigma_s(\mathcal{X}) \cup \sigma_n(\mathcal{G}).$$

Recall that $\sigma(\mathcal{X})$ is a simplex since \mathcal{X} span an abelian group. Consequently, $\sigma_s(\mathcal{X})$ and $\sigma_n(\mathcal{G})$ are also simplexes. Moreover, $I(\sigma_s(\mathcal{X}), \sigma_n(\mathcal{G})) = 0$. Actually, we have the following, which is stronger, and which comes from the properties of the normal curves (see Proposition 9.23.(ii)):

$$I(\sigma_s(\mathcal{G}), \sigma_n(\mathcal{G})) = 0.$$

Proposition 11.2 (Existence and description of the surface $\widehat{\Sigma}$).

- (i) *There exists a unique subsurface $\widehat{\Sigma}$ in $\text{Sub}_{\sigma_n(\mathcal{G})}(\Sigma)$ containing the curves of $\sigma_s(\mathcal{G})$.*
- (ii) *The boundary of each subsurface belonging to $\text{Sub}_{\sigma_s(\mathcal{X})}(\widehat{\Sigma})$ contains $\sigma_s(\mathcal{X})$.*
- (iii) *The surface $\widehat{\Sigma}$ is of genus $\widehat{g} \in \{\frac{n}{2} - 1, \frac{n}{2}\}$.*
- (iv) *The surface Σ is of genus $g \in \{\frac{n}{2} - 1, \frac{n}{2}\}$.*
- (v) *The set $\text{Sub}_{\sigma_s(\mathcal{X})}(\widehat{\Sigma})$ is reduced to one genus-0 connected component, or to two connected components, one being of genus 0 and the other being of genus 0 or 1.*

Proof.

Let us show item (i).

Let us recall that the normal curves do not intersect any curve of $\sigma(\mathcal{G})$ and hence any special curve. For all $i \in \{0, 1, \dots, n-1\}$, let $\widehat{\Sigma}_i$ be the subsurface of $\text{Sub}_{\sigma_n(\mathcal{G})}(\Sigma)$ that contains the curve a_i . Let us recall that for all $i \in \{0, 1, \dots, n-1\}$, the curve $\delta.a_i$ is a special curve of $\sigma_s(A_{i+1})$, so $\delta.a_i = a_{i+1}$. But $I(a_i, \delta.a_i) \neq 0$ according to Proposition 9.23 for a_i is special, so $I(a_i, a_{i+1}) \neq 0$, hence $\widehat{\Sigma}_i = \widehat{\Sigma}_{i+1}$. Thus all the special curves are included in a unique subsurface $\widehat{\Sigma}$ of $\text{Sub}_{\sigma_n(\mathcal{G})}(\Sigma)$.

Let us show item (ii).

Let S be a subsurface belonging to $\text{Sub}_{\sigma_s(\mathcal{X})}(\widehat{\Sigma})$. If none of the boundary components of S is a normal curve, then S belongs to $\text{Sub}_{\sigma_s(\mathcal{X})}(\Sigma)$ and according to Proposition 11.1, the boundary of S contains $\sigma_s(\mathcal{X})$ and item (ii) is proved in this case.

Let us then assume that $\sigma_n(\mathcal{G})$ is nonempty and let us focus on the surfaces of $\text{Sub}_{\sigma_s(\mathcal{X})}(\widehat{\Sigma})$ such that at least one of the boundary components is a normal curve. We define a subgroup \mathcal{H}^* of \mathcal{H} (\mathcal{H} was defined in Definition 10.3) by:

$$\mathcal{H}^* := \langle \gamma_i \gamma_j^{-1}, i, j \in \text{Imp}(n) \rangle$$

It acts via ρ on $\text{Curv}(\Sigma)$ and notably on $\sigma(\mathcal{X})$ so that:

- *Action of \mathcal{H}^* via ρ on $\sigma_s(\mathcal{X})$.* We have seen that the action of \mathcal{H} via ρ on $\mathcal{C}urv(\Sigma)$ preserves $\sigma_s(\mathcal{X})$, hence so does the action of \mathcal{H}^* on $\mathcal{C}urv(\Sigma)$, since \mathcal{H}^* is included in \mathcal{H} . Moreover, the morphism $\mathcal{H} \rightarrow \mathfrak{S}(\mathcal{X})$ sends \mathcal{H}^* on $\mathfrak{A}(\mathcal{X})$, the alternating group on the elements of \mathcal{X} . Indeed, for all $i \in \text{Imp}(n)$, this morphism sends $\gamma_i \gamma_{i+2}^{-1}$ on the circular permutation on the three elements A_i, A_{i+2}, A_{i+4} . But $\mathfrak{A}(\mathcal{X})$ acts transitively on \mathcal{X} (recall that \mathcal{X} contains at least three elements). Hence the action of \mathcal{H}^* on $\mathcal{P}Mod(\Sigma)$ preserves \mathcal{X} and is transitive on \mathcal{X} . Therefore \mathcal{H}^* acts transitively on $\sigma_s(\mathcal{X})$.
- *Action of \mathcal{H}^* via ρ on $\sigma_n(\mathcal{G})$.* Let us recall that according to Proposition 9.7, the action of \mathcal{B}_n on $\sigma_n(\mathcal{G})$ and on $\text{Bndy}(\Sigma_{\sigma_n(\mathcal{G})})$ is cyclic. Then the action of \mathcal{F}_n (cf. Definition 9.12) on $\sigma_n(\mathcal{G})$ and on $\text{Bndy}(\Sigma_{\sigma_n(\mathcal{G})})$ is trivial according to Lemma 9.13. Since \mathcal{H}^* is a subgroup of \mathcal{F}_n , the action of \mathcal{H}^* on $\mathcal{C}urv(\Sigma)$ fixes each curve of $\sigma_n(\mathcal{G})$ and each boundary component of $\Sigma_{\sigma_n(\mathcal{G})}$.
- *Action of \mathcal{H}^* via ρ on $\text{Sub}_{\sigma_n(\mathcal{G})}(\widehat{\Sigma})$.* According to the action of \mathcal{H}^* on $\sigma_n(\mathcal{G})$, the action of \mathcal{H}^* via ρ on $\text{Sub}(\Sigma)$ preserves $\widehat{\Sigma}$ and preserves the set $\text{Sub}_{\sigma_s(\mathcal{X})}(\widehat{\Sigma})$ of subsurfaces. Let S be a surface belonging to $\text{Sub}_{\sigma_s(\mathcal{X})}(\widehat{\Sigma})$ such that at least one of the boundary components is a normal curve. According to the action of \mathcal{H}^* via ρ on $\sigma_n(\mathcal{G})$, the action of \mathcal{H}^* via ρ on $\text{Sub}(\Sigma)$ preserves the surface S .

Let us exploit this. For any subsurface S belonging to $\text{Sub}_{\sigma_s(\mathcal{X})}(\widehat{\Sigma})$ such that $\text{Bndy}(S)$ contains a normal curve, S must be stable by \mathcal{H}^* . Hence $\text{Bndy}(S)$ is \mathcal{H}^* -stable, and so is $\text{Bndy}(S) \cap \sigma_s(\mathcal{X})$. So $\text{Bndy}(S)$ must contain all $\sigma_s(\mathcal{X})$ since \mathcal{H}^* acts transitively on $\sigma_s(\mathcal{X})$.

Let us show items (iii) and (iv).

According to item (ii), each subsurface belonging to $\text{Sub}_{\sigma_s(\mathcal{X})}(\widehat{\Sigma})$ contains at least $\frac{n}{2}$ special curves in its boundary. Since $\sigma_s(\mathcal{X})$ contains $\frac{n}{2}$ curves, $\text{Sub}_{\sigma_s(\mathcal{X})}(\widehat{\Sigma})$ contains one only connected component having n special boundary components, or $\text{Sub}_{\sigma_s(\mathcal{X})}(\widehat{\Sigma})$ contains two connected components having each $\frac{n}{2}$ special boundary components. In the first case $\widehat{\Sigma}$ contains a non-separating set of $\frac{n}{2}$ curves, so $\widehat{\Sigma}$ is of genus $\widehat{g} \geq \frac{n}{2}$. In the second case $\widehat{\Sigma}$ contains a non-separating set of $\frac{n}{2} - 1$ curves, so $\widehat{\Sigma}$ is of genus $\widehat{g} \geq \frac{n}{2} - 1$. Let us recall that by hypothesis, $g \leq \frac{n}{2}$. Since Σ contains $\widehat{\Sigma}$, we have $\widehat{g} \leq g$. So finally, we have:

$$\frac{n}{2} - 1 \leq \widehat{g} \leq g \leq \frac{n}{2}$$

Let us show item (v).

We have just seen in items (iii) and (iv) that $\text{Sub}_{\sigma_s(\mathcal{X})}(\widehat{\Sigma})$ is a set of exactly one or two subsurfaces.

- If $\text{Sub}_{\sigma_s(\mathcal{X})}(\widehat{\Sigma})$ contains only one subsurface, let us denote it by S . The surface $\widehat{\Sigma}$ is the gluing of S on itself by making coincide the n boundary components between them. The difference between the genera of $\widehat{\Sigma}$ and S is then $\frac{n}{2}$, but $\widehat{\Sigma}$ is already of maximal genus $\frac{n}{2}$, so S is a genus-0 surface.
- If $\text{Sub}_{\sigma_s(\mathcal{X})}(\widehat{\Sigma})$ contains two subsurfaces, let us denote them by S_1 and S_2 . The gluing of S_1 on S_2 along the n special boundary components brings a contribution of $\frac{n}{2} - 1$ to the genus of $\widehat{\Sigma}$. Since the genus of $\widehat{\Sigma}$ is at most $\frac{n}{2}$, the sum of the genera of S_1 and of S_2 is at most 1.

□

We turn now to describe precisely the set $\sigma_n(\mathcal{G})$. Let us first recall Definition 11.3 of $\widehat{\Sigma}$, $\check{\Sigma}$ and \mathcal{U} given in the introduction.

Definition 11.3 ($\widehat{\Sigma}$, $\check{\Sigma}$ and \mathcal{U}).

- Let $\widehat{\Sigma}$ be the subsurface of $\text{Sub}_{\sigma_n(\mathcal{G})}(\Sigma)$ containing the special curves.
- Let us set $\mathcal{U} = \text{Bndy}(\widehat{\Sigma}) \cap \sigma_n(\mathcal{G})$.
- Let $\check{\Sigma}$ be the union of the subsurfaces of $\text{Sub}_{\mathcal{U}}(\Sigma)$ different from $\widehat{\Sigma}$. If $\widehat{\Sigma}$ is the only subsurface of $\text{Sub}_{\mathcal{U}}(\Sigma)$, we will say that $\check{\Sigma}$ is empty.

Attention: *Let us recall that we have supposed in this section that $\sigma_p(\mathcal{G})$ was empty, in other words, the separating curves belonging to $\sigma_n(\mathcal{G})$ separate Σ in two surfaces of nonzero genus. Without this hypothesis, Proposition 11.4 would be false.*

Remark. If $\check{\Sigma}$ is nonempty, we have $\text{Bndy}(\widehat{\Sigma}) \cap \text{Bndy}(\check{\Sigma}) = \mathcal{U}$. In the following section, the only information about $\sigma_n(\mathcal{G})$ that will help us concerns \mathcal{U} . That is why we focus only on \mathcal{U} . According to this remark, the next proposition deals only with \mathcal{U} instead of $\sigma_n(\mathcal{G})$. All the same, we terminates this section by giving all the possible graphs of $\Gamma(\Sigma, \sigma(\mathcal{X}))$.

Proposition 11.4 (Description of $\text{Sub}_{\mathcal{U}}(\Sigma)$).

We have $|\mathcal{U}| \leq 2$, and $\text{Sub}_{\mathcal{U}}(\Sigma)$ satisfies the following properties:

- *if \mathcal{U} is empty, then $\Sigma = \widehat{\Sigma}$; if $\widehat{\Sigma}$ is of genus $\frac{n}{2}$, then \mathcal{U} is empty,*
- *if \mathcal{U} is reduced to a non-separating curve u , then $\check{\Sigma}$ is empty and $\{u\}$ is the mark of $\widehat{\Sigma}$,*
- *if \mathcal{U} is reduced to a separating curve u , then $\check{\Sigma}$ is a connected subsurface of genus 1,*
- *if \mathcal{U} contains two curves, then they are non-separating and $\check{\Sigma}$ is connected, of genus zero.*

These assertions can be summed up as follows: the graph $\Gamma(\Sigma, \mathcal{U})$ is one of the four graphs depicted in Figure 86 where:

- *the circled vertices represent the subsurfaces of nonzero genus of $\text{Sub}_{\mathcal{U}}(\Sigma)$,*
- *the integer placed beside the circled vertices indicates the genus,*
- *the edges are drawn as dotted so as to be coherent with Remark 11.9 at the end of the present section.*

Proof. The proof comes from a genus computation. Let us recall that g is the genus of Σ . Let us denote by \widehat{g} the genus of $\widehat{\Sigma}$ and by \check{g} the genus of $\check{\Sigma}$ (which is zero by convention when $\check{\Sigma}$ is empty). According to Proposition 11.2, we have:

$$g \in \left\{ \frac{n}{2} - 1, \frac{n}{2} \right\}, \quad \widehat{g} \in \left\{ \frac{n}{2} - 1, \frac{n}{2} \right\}, \quad \check{g} \in \{0, 1\}.$$

Notice that each (nonempty) connected component of $\check{\Sigma}$, that is separated from $\widehat{\Sigma}$ by a separating curve of \mathcal{U} , is of nonzero genus, for we have assumed that there exists no peripheral curve in $\sigma(\mathcal{G})$. Hence it can exist only one nonempty connected component of $\check{\Sigma}$ separated from $\widehat{\Sigma}$ by

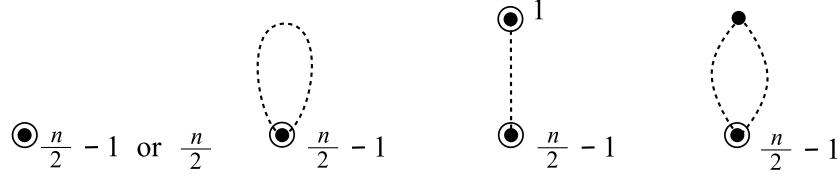

Figure 86: The four possible graphs for $\Gamma(\Sigma, \mathcal{U})$ (cf. Proposition 11.4).

a separating curve. Besides, if a (nonempty) connected component of $\check{\Sigma}$ is of genus zero, it is separated from $\widehat{\Sigma}$ by at least two curves of \mathcal{U} (again because the curves of \mathcal{U} are not peripheral curves). So the gluing of $\widehat{\Sigma}$ and of a genus-0 connected component of $\check{\Sigma}$ brings also a nonzero contribution to the genus of Σ . Hence $\check{\Sigma}$ contains only one connected component. In other words, $\check{\Sigma}$ is connected. Hence the following formula holds as soon as $\check{\Sigma}$ is nonempty:

$$g - \widehat{g} - \check{g} = |\mathcal{U}| - 1.$$

This number must be equal to zero or one. Hence $|\mathcal{U}| \in \{1, 2\}$ (still under the hypothesis: $\check{\Sigma}$ is nonempty). If $|\mathcal{U}| = 2$, then $\check{g} = 0$. We have seen that conversely, if $\check{g} = 0$ whereas $\check{\Sigma}$ is nonempty, we have $|\mathcal{U}| \geq 2$, so $|\mathcal{U}| = 2$. Similarly, if $\check{\Sigma}$ is nonempty, $|\mathcal{U}| = 1$ if and only if $\check{g} = 1$. These two last cases correspond to the two graphs drawn in Figure 86, right hand side. When $\check{\Sigma}$ is empty, we get obviously the two graphs in Figure 86, left hand side. \square

Remark 11.9. To conclude this section, we draw in Figure 87 the different graphs of $\Gamma(\Sigma, \sigma(\mathcal{X}))$ compatible with the propositions 11.1, 11.2 and 11.4. We do not prove that these graphs are the only possible ones, but this can be easily deduced from the previously quoted propositions. The legend of this Figure is the following:

- the full edges represent the special curves,
- the dotted edges represent the normal curves,
- the circled vertices represent the subsurfaces of nonzero genus of $\mathcal{S}ub_{\mathcal{U}}(\Sigma)$,
- the integer placed beside the circled vertices indicates the genus,
- the non-circled vertices of degree 2 correspond to genus-0 subsurfaces whose boundaries contain some boundary components of Σ .

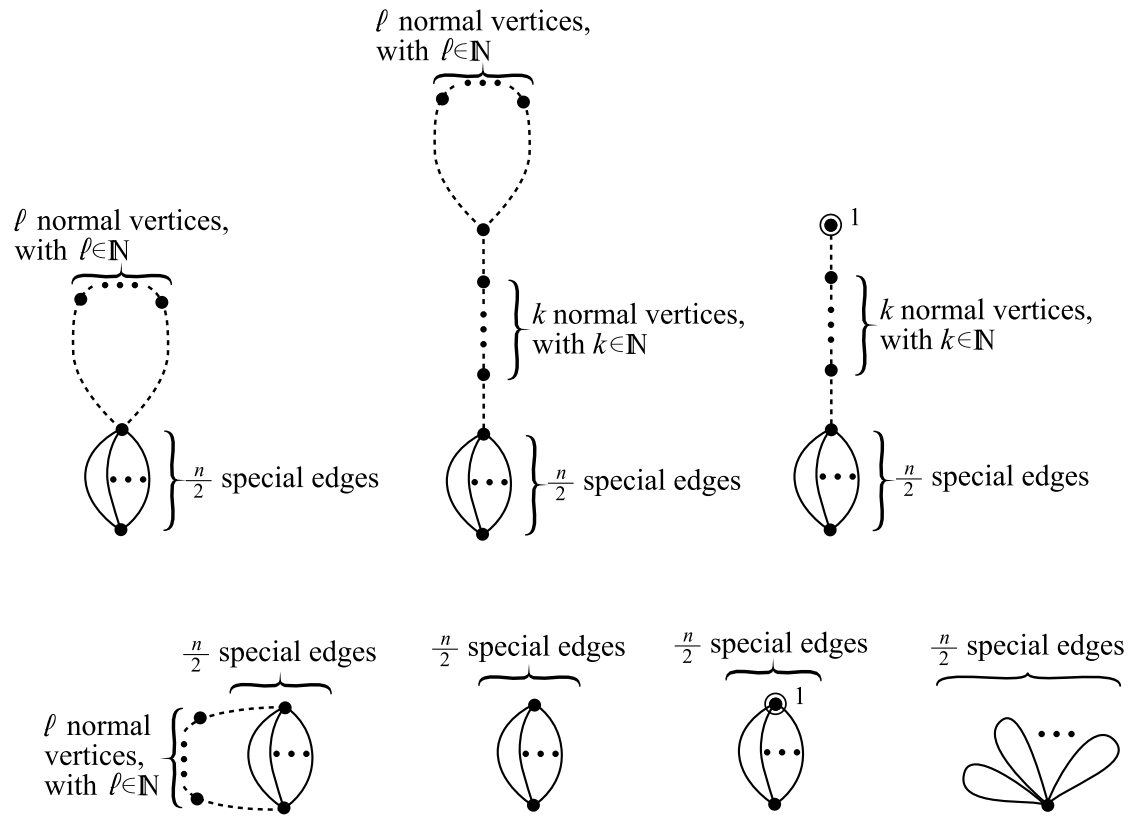

Figure 87: -

12 Expression of the mapping classes of \mathcal{G}

Let us recall our hypotheses:

- n is an even integer greater than or equal to 6,
- Σ is a surface $\Sigma_{g,b}$ where $g \leq \frac{n}{2}$ and $b \geq 0$,
- ρ is a noncyclic morphism from \mathcal{B}_n in $\mathcal{PMod}(\Sigma)$ such that $\sigma_p(\mathcal{G})$ is empty.

According to Proposition 11.1, for all $i \in \{0, 1, \dots, n-1\}$, the canonical reduction system of each mapping class A_i is reduced to a special curve that we denote by a_i , up to the normal curves. We want to show that ρ is a transvection of monodromy morphism.

12.1 Outline of the section

In this section, we show the proposition:

Proposition 12.1. *Under the hypotheses of this section (stated above), the morphism ρ is a transvection of monodromy morphism.*

We have then proved the following theorem:

Theorem 12.2 (Theorem 1 when n is even).

Let n be an even integer greater than or equal to 6, and Σ a surface $\Sigma_{g,b}$ where $g \leq \frac{n}{2}$. Then any morphism ζ from \mathcal{B}_n in $\mathcal{PMod}(\Sigma)$ is either cyclic, or is a transvection of monodromy morphism.

Proof of Theorem 12.2. If ζ is cyclic, then there is nothing left to be proved. Let us then assume that ζ is not cyclic. Let Σ' be the connected component of $\Sigma_{\sigma_p(\mathcal{G})}$ of genus g (recall that $\sigma_p(\mathcal{G})$ is the set of peripheral curves which were introduced in Section 7). According to Proposition 7.4.(i) and (ii), the morphism ζ induces a noncyclic morphism $\zeta' : \mathcal{B}_n \rightarrow \mathcal{PMod}(\Sigma')$. Then according to Proposition 12.1, ζ' is a transvection of monodromy morphism. Then, according to Proposition 7.4.(ii), the morphism ζ was a transvection of monodromy morphism. \square

Outline of the section: To determine the morphism ρ and prove Proposition 12.1, we consider its restriction to the surface $\widehat{\Sigma}$ that was defined in Section 11, Definition 11.3 (recall that $\widehat{\Sigma}$ is a subsurface of $\mathcal{Sub}_{\sigma_n(\mathcal{G})}(\Sigma)$, stable under the action of \mathcal{B}_n and containing the special curves, but not the normal curves). We then define the morphism

$$\wedge : \begin{array}{ccc} \mathcal{PMod}_{\sigma_n(\mathcal{G})}(\Sigma) & \longrightarrow & \mathcal{Mod}(\widehat{\Sigma}) \\ A & \longmapsto & \widehat{A} \end{array} .$$

We denote by $\widehat{\rho}$ the composition $\wedge \circ \rho : \mathcal{B}_n \rightarrow \mathcal{Mod}(\widehat{\Sigma})$. This morphism is well-defined for $\rho(\mathcal{B}_n)$ preserves $\sigma_n(\mathcal{G})$ according to Proposition 9.7. Then we will use what we know about the special curves to identify the mapping classes \widehat{A}_i , $i \in \{0, 1, \dots, n-1\}$. This is possible since, according to Lemma 3.42, for all $i \in \{0, 1, \dots, n-1\}$, we have:

$$\sigma(\widehat{A}_i) = \sigma(A_i) \cap \mathcal{Curv}(\widehat{\Sigma}) = \{a_i\}.$$

Thus, Subsection 12.2 is devoted to the study of the morphism $\widehat{\rho}$ via the mapping classes \widehat{A}_i , $i \in \{0, 1, \dots, n-1\}$. We will show that $\widehat{\rho}$ is a transvection of monodromy morphism, cf. Proposition 12.4. Then, in Subsection 12.3, we will use these results to determine the morphism ρ and thus prove Proposition 12.1.

12.2 The morphism $\hat{\rho}$ is a transvection of monodromy morphism

In this subsection, we are going to show that the morphism $\hat{\rho}$ is a transvection of monodromy morphism. We denote by $\hat{\mathcal{G}}$ and $\hat{\mathcal{X}}$ the images of \mathcal{G} and \mathcal{X} by \wedge , where $\mathcal{X} = \{A_i, i \in \text{Imp}(n)\} = \{A_1, A_3, \dots, A_{n-1}\}$. In order to study the morphism $\hat{\rho}$, we focus on the mapping classes induced by those belonging to $\hat{\mathcal{X}}$, in $\text{Mod}(\hat{\Sigma})$, where $\hat{\Sigma}$ is the surface $\hat{\Sigma}_{\sigma_s(\hat{\mathcal{X}})}$. Notice that, according to Lemma 3.42, we have:

$$\begin{cases} \sigma_s(\hat{\mathcal{X}}) = \sigma_s(\mathcal{X}) \cap \text{Curv}(\hat{\Sigma}) = \{a_i, i \in \text{Imp}(n)\}, \\ \sigma_n(\hat{\mathcal{X}}) = \sigma_n(\mathcal{X}) \cap \text{Curv}(\hat{\Sigma}) = \emptyset. \end{cases}$$

Cutting $\hat{\Sigma}$ along the curves of $\sigma_s(\hat{\mathcal{X}})$

- Let $\tilde{\Sigma}$ be the surface $\hat{\Sigma}_{\sigma_s(\hat{\mathcal{X}})}$. According to Proposition 11.2.(v), $\tilde{\Sigma}$ is a connected genus-0 surface, or contains two connected components such that one is of genus zero and the other is of genus at most one.
- Let \sim be the canonical morphism $\sim: \text{Mod}_{\sigma_s(\hat{\mathcal{X}})}(\hat{\Sigma}) \longrightarrow \text{Mod}(\tilde{\Sigma})$, where $\text{Mod}_{\sigma_s(\hat{\mathcal{X}})}(\hat{\Sigma})$ is the group of the mapping classes of $\text{Mod}(\hat{\Sigma})$ preserving $\sigma_s(\hat{\mathcal{X}})$. We will denote by $\tilde{\mathcal{X}}$ the image of $\hat{\mathcal{X}}$.
- For all $i \in \text{Imp}(n)$, let us denote by a_i^+ and a_i^- the two boundary components coming from cutting $\hat{\Sigma}$ along a_i . We set $\text{Bndy}^+(\tilde{\Sigma}) = \{a_i^+, i \in \text{Imp}(n)\}$ and $\text{Bndy}^-(\tilde{\Sigma}) = \{a_i^-, i \in \text{Imp}(n)\}$. When $\tilde{\Sigma}$ is not connected, the boundary components a_i^+ and a_i^- are such that $\text{Bndy}^+(\tilde{\Sigma})$ is included in the boundary of one connected components of $\tilde{\Sigma}$ and $\text{Bndy}^-(\tilde{\Sigma})$ is included in the boundary of the other connected components of $\tilde{\Sigma}$. For these definitions, see Figure 88 that represents the case where $\tilde{\Sigma}$ is connected.

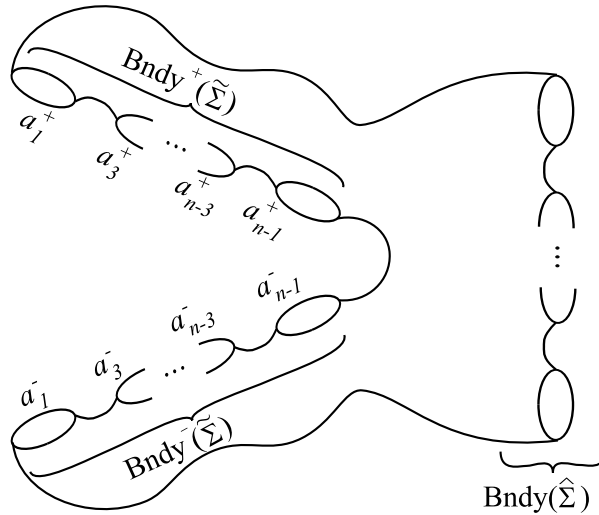

Figure 88: The surface $\tilde{\Sigma}$ (case where $\tilde{\Sigma}$ is connected).

- Recall that the subgroup \mathcal{H} of \mathcal{B}_n (see Subsection 10.2, Definition 10.3) is the subgroup $\langle \gamma_i, i \in \text{Imp}(n) \rangle$ of \mathcal{B}_n where for all $i \in \text{Imp}(n)$, the element γ_i is the product $\tau_i \tau_{i+1} \tau_i \tau_{i+2} \tau_{i+1} \tau_i$.
- Let us also recall the main properties of \mathcal{H} (see Proposition 10.4):

(i) The action of \mathcal{H} on $\mathcal{P}\text{Mod}(\Sigma)$ via ρ preserves \mathcal{X} . Indeed, for all $i, j \in \text{Imp}(n)$, we have:

$$\gamma_i \cdot A_j = \rho(\gamma_i) A_j \rho(\gamma_i)^{-1} = \begin{cases} A_j & \text{if } i \notin \{j, j-2\} \\ A_{j-2} & \text{if } i = j-2 \\ A_{j+2} & \text{if } i = j. \end{cases}$$

- (ii) The morphism $\mathcal{H} \rightarrow \mathfrak{S}(\mathcal{X})$ describing the action of \mathcal{H} on \mathcal{X} , where $\mathfrak{S}(\mathcal{X})$ is the symmetric group on the elements of \mathcal{X} , is surjective. In particular, this action is $\frac{n}{2}$ times transitive.
- (iii) The action of \mathcal{H} on $\mathcal{C}\text{urv}(\Sigma)$ preserves $\sigma_s(\mathcal{X})$.

- For all $\xi \in \mathcal{H}$, the mapping class $\rho(\xi)$ preserves $\sigma_s(\mathcal{X})$, so the element $\sim \circ \wedge (\rho(\xi))$ is well-defined. Thus, we can define an action of \mathcal{H} on $\tilde{\mathcal{X}}$ as follows. For all $\xi \in \mathcal{H}$ and all $A \in \mathcal{X}$, we set:

$$\xi \cdot \tilde{A} = \sim \circ \wedge (\rho(\xi) A \rho(\xi)^{-1}).$$

Notice that the action of \mathcal{H} on $\tilde{\mathcal{X}}$ can be deduced from the action of \mathcal{H} on \mathcal{X} . Then, for all $i, j \in \text{Imp}(n)$, we have:

$$\gamma_i \cdot \tilde{A}_j = \begin{cases} \tilde{A}_j & \text{if } i \notin \{j, j-2\} \\ \tilde{A}_{j-2} & \text{if } i = j-2 \\ \tilde{A}_{j+2} & \text{if } i = j. \end{cases}$$

Lemma 12.3 (The mapping classes $\tilde{A}_i, i \in \text{Imp}(n)$).

All the mapping classes $\tilde{A}_i, i \in \text{Imp}(n)$, coincide. Either they are trivial, or there are periodic of order 2 and swap a_j^+ and a_j^- for all $j \in \text{Imp}(n)$.

Proof.

Action of \mathcal{H} on $\text{Bndy}^+(\tilde{\Sigma}) \sqcup \text{Bndy}^-(\tilde{\Sigma})$:

Notice that each mapping class of $\tilde{\mathcal{X}}$ preserves $\sigma_s(\hat{A}_i)$ for all $i \in \text{Imp}(n)$, so each mapping class of $\tilde{\mathcal{X}}$ preserves $\{a_i^+, a_i^-\}$ for all $i \in \text{Imp}(n)$. If \tilde{A}_1 fixes both boundary components a_3^+ and a_3^- , then \tilde{A}_1 fixes both boundary components a_i^+ and a_i^- for all $i \in \text{Imp}(n) \setminus \{1\}$, as we are going to show it right now. Let us recall that according to Proposition 10.4, \mathcal{H} acts $\frac{n}{2}$ times transitively on \mathcal{X} , hence on $\tilde{\mathcal{X}}$. So, for all $i \in \text{Imp}(n) \setminus \{1\}$, there exists $\xi \in \mathcal{H}$ such that $\xi \cdot \tilde{A}_1 = \tilde{A}_i$ and $\xi \cdot \tilde{A}_3 = \tilde{A}_i$. Then if \tilde{A}_1 fixes the boundary components a_3^+ and a_3^- , $\xi \cdot \tilde{A}_1$ fixes the boundary components $\xi \cdot a_3^+$ and $\xi \cdot a_3^-$ (\mathcal{H} acts canonically via ρ on $\text{Bndy}(\tilde{\Sigma})$), so \tilde{A}_i fixes both boundary components a_i^+ and a_i^- . So there exist *a priori* four possible actions of $\tilde{\mathcal{X}}$ on $\text{Bndy}^+(\tilde{\Sigma}) \sqcup \text{Bndy}^-(\tilde{\Sigma})$:

- a) the mapping classes of $\tilde{\mathcal{X}}$ fixes the curves of $\text{Bndy}^+(\tilde{\Sigma}) \sqcup \text{Bndy}^-(\tilde{\Sigma})$;

- b) the mapping classes of $\tilde{\mathcal{X}}$ swap a_i^+ and a_i^- for all $i \in \text{Imp}(n)$;
- c) for all $i \in \text{Imp}(n)$, \tilde{A}_i swaps a_i^+ and a_i^- , and fixes a_j^+ and a_j^- for all $j \in \text{Imp}(n) \setminus \{i\}$;
- d) for all $i \in \text{Imp}(n)$, \tilde{A}_i fixes a_i^+ and a_i^- , and swaps a_j^+ and a_j^- for all $j \in \text{Imp}(n) \setminus \{i\}$.

Both cases a) and b) correspond to the situations described in the statement of Lemma 12.3. In the remainder of this proof, we assume to be in the case c) or d) and we expect to find some contradiction. Let us show first the below assertion (1), stating that $\tilde{\Sigma}$ must be connected. Notice that in the cases c) and d), \tilde{A}_1 sends some boundary components of $\text{Bndy}^+(\tilde{\Sigma})$ in $\text{Bndy}^+(\tilde{\Sigma})$ and some other boundary components of $\text{Bndy}^+(\tilde{\Sigma})$ in $\text{Bndy}^-(\tilde{\Sigma})$. Yet, on one hand the boundary components of $\text{Bndy}^+(\tilde{\Sigma})$ belong to a same connected component of $\tilde{\Sigma}$ and so do the boundary components of $\text{Bndy}^-(\tilde{\Sigma})$. On the other hand, \tilde{A}_1 sends the connected components of $\tilde{\Sigma}$ on the connected components of $\tilde{\Sigma}$. Hence there exists a connected component in $\tilde{\Sigma}$ that contains some boundary components of $\text{Bndy}^+(\tilde{\Sigma})$ and some other boundary components of $\text{Bndy}^-(\tilde{\Sigma})$. By a transitivity argument, the boundary components of $\text{Bndy}^+(\tilde{\Sigma})$ and of $\text{Bndy}^-(\tilde{\Sigma})$ belong to a same connected component, hence:

$$\text{the surface } \tilde{\Sigma} \text{ is connected.} \tag{1}$$

We pursue the proof of Lemma 12.3 by studying the nature of the mapping classes of $\tilde{\mathcal{X}}$, (reducible, periodic or pseudo-Anosov). We will show that they are periodic and we will determine their order.

The nature of the mapping classes of $\tilde{\mathcal{X}}$:

The mapping class \tilde{A}_1 is pseudo-Anosov or periodic, for $\sigma(\tilde{A}_1) = \emptyset$. Remember that $\tilde{\Sigma}$ is the cut of $\hat{\Sigma}$ along the curves $\sigma_s(\hat{X})$. So, if \tilde{A}_1 was pseudo-Anosov in $\text{Mod}(\tilde{\Sigma})$, the mapping class \hat{A}_1 in $\text{Mod}(\hat{\Sigma})$ would satisfy $\sigma(\hat{A}_1) = \sigma_s(\hat{X})$, according to Lemma 3.43. However $\sigma_s(\hat{A}_1) = \{a_1\}$, whence a contradiction. So \tilde{A}_1 is periodic. Now, notice that \tilde{A}_1^2 fixes each curve of $\text{Bndy}^+(\tilde{\Sigma}) \sqcup \text{Bndy}^-(\tilde{\Sigma})$, so \tilde{A}_1^2 is a periodic mapping class that fixes more than three boundary components in a genus-0 surface. Hence, according to Corollary 3.23, \tilde{A}_1^2 is the identity. Hence \tilde{A}_1 is the identity or is periodic of order two. The same argument can be held for \tilde{A}_i for all $i \in \text{Imp}(n)$. Hence:

$$\begin{aligned} &\text{either the mapping classes of } \tilde{\mathcal{X}} \text{ all are the identity,} \\ &\text{or they all are periodic of order two.} \end{aligned} \tag{2}$$

We are now ready to focus on the case c) and then on the case d), in order to find some contradiction.

Refutation of the case c):

In the case c), \tilde{A}_1 fixes at least $n - 2$ boundary components of $\tilde{\Sigma}$. But as we saw it in (1), $\tilde{\Sigma}$ is a connected genus-0 surface. Furthermore, \tilde{A}_1 is periodic according to (2), so we can apply Corollary 3.23 and conclude that \tilde{A}_1 is the identity. But then \tilde{A}_1 must fix a_1^+ and a_1^- , which contradicts the hypotheses of the case c).

Study and refutation of the case d):

A following simple argument allows us to reject the case d) when $n \geq 8$. Let us consider the mapping class $\tilde{A}_1\tilde{A}_3$. It is periodic of order 2, for \tilde{A}_1 and \tilde{A}_3 commute. According to Corollary 3.23, a periodic mapping class that fixes three or more boundary components of a genus-0 surface is the identity. Here, $\tilde{A}_1\tilde{A}_3$ fixes all the special boundary components except

the boundary components a_1^+ , a_1^- , a_3^+ and a_3^- . So, when $n \geq 8$, the mapping class $\tilde{A}_1\tilde{A}_3$ fixes at least four boundary components. Then $\tilde{A}_1\tilde{A}_3$ must be the identity. But this is absurd, for $\tilde{A}_1\tilde{A}_3$ does not fix the boundary components a_1^+ , a_1^- , a_3^+ and a_3^- . Hence the case d) can *a priori* happen only if $n = 6$.

Let us consider the case $n = 6$ and let us describe the situation. Recall that according to (1), $\tilde{\Sigma}$ is connected. Let $\text{Bndy}^0(\tilde{\Sigma})$ be the set of boundary components of $\tilde{\Sigma}$ that do not belong to $\text{Bndy}^+(\tilde{\Sigma}) \sqcup \text{Bndy}^-(\tilde{\Sigma})$. Again, the mapping class $\tilde{A}_1\tilde{A}_3$ is periodic and fixes the boundary components a_5^+ , a_5^- , whereas it permutes the boundary components a_1^+ , a_1^- , a_3^+ and a_3^- non-trivially. According to Corollary 3.23, such a mapping class fixes at most two boundary components. Hence $\tilde{A}_1\tilde{A}_3$ fixes no boundary component of $\text{Bndy}^0(\tilde{\Sigma})$. Yet, on one hand, $\text{Bndy}^0(\tilde{\Sigma})$ is included in $\text{Bndy}(\Sigma) \cup \mathcal{U}$, and on the other hand the mapping classes of $\tilde{\mathcal{X}}$ fixes the curves of $\text{Bndy}(\Sigma) \cap \text{Bndy}^0(\tilde{\Sigma})$ and have all the same action on the curves of $\mathcal{U} \cap \text{Bndy}^0(\tilde{\Sigma})$. So $\text{Bndy}(\Sigma) \cap \text{Bndy}^0(\tilde{\Sigma})$ must be empty. Concerning \mathcal{U} , notice that in each of the three cases $|\mathcal{U}| \in \{0, 1, 2\}$ which are authorized by Proposition 11.4, the mapping class $\tilde{A}_1\tilde{A}_3$ fixes the curves of \mathcal{U} . Thus $\mathcal{U} \cap \text{Bndy}^0(\tilde{\Sigma})$ and $\text{Bndy}(\Sigma) \cap \text{Bndy}^0(\tilde{\Sigma})$ are finally empty sets. Hence \mathcal{U} , $\text{Bndy}(\Sigma)$ and $\text{Bndy}^0(\tilde{\Sigma})$ are all empty sets. Hence:

$$\hat{\Sigma} = \Sigma = \Sigma_{3,0}, \text{ and } \tilde{\Sigma} = \Sigma_{0,6}.$$

We have represented the surface $\tilde{\Sigma}$ in Figure 89 and we have described in it an example of an *a priori* possible set of the three periodic mapping classes \tilde{A}_1 , \tilde{A}_3 , and \tilde{A}_5 , such that their action on $\text{Bndy}(\tilde{\Sigma})$ is coherent with the case d).

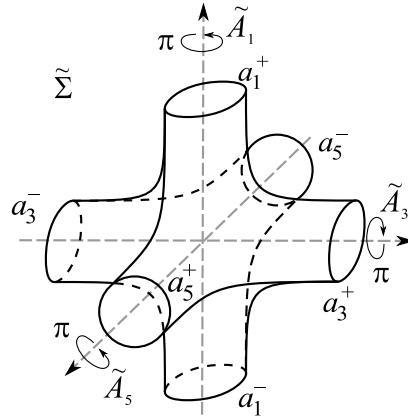

Figure 89: The case $n = 6$ where \tilde{A}_1 fixes a_1^+ and a_1^- , and permute a_3^+ with a_3^- , and a_5^+ with a_5^- . We see $\tilde{\Sigma}$ in \mathbb{R}^3 and the mapping classes \tilde{A}_1 , \tilde{A}_3 and \tilde{A}_5 are isotopy classes of rotations.

Now, since \mathcal{U} is empty (and hence since $\sigma_n(\mathcal{G})$ is empty), the morphism \wedge is trivial so we can forget it. The contradiction we aim will comes from a study on the mapping class $Z = (A_3A_4A_5)^2$: we will see that it induces on a subsurface of Σ a periodic mapping class of order 4 and that the square of Z coincides with A_1 modulo a power of Dehn twist along the curve a_1 . But as we will see it, such a mapping class has no square root. This is absurd since Z is a square itself.

1. *First attempt to describe $\sigma(Z)$.*

Let us recall that $\sigma(Z) = \sigma(Z^2)$. Since A_1 commutes with A_1 , A_3 , A_4 and A_5 , the mapping classes Z and A_1 commute. Hence Z fixes the curve a_1 . Moreover, $ZA_3Z^{-1} = A_5$ and $ZA_5Z^{-1} =$

A_3 , so Z swaps the curves a_3 and a_5 . Hence Z induces a mapping class \tilde{Z} in $\text{Mod}(\tilde{\Sigma})$. Moreover, let us justify that Z^2 commutes with A_3, A_4 and A_5 . In \mathcal{B}_4 , the element $\delta = \tau_1\tau_2\tau_3$ acts cyclically on the set $\{\tau_1, \tau_2, \tau_3, \tau_0\}$ by conjugation, so $(\tau_1\tau_2\tau_3)^4$ acts trivially on this set by conjugation. Now, the fact that Z^2 commutes with A_3, A_4 and A_5 comes from an obvious morphism from \mathcal{B}_4 to $\langle A_3, A_4, A_5 \rangle$ that sends τ_1, τ_2 and τ_3 respectively on A_3, A_4 and A_5 , and that sends $(\tau_1\tau_2\tau_3)^4$ on Z^2 . Hence:

$$Z^2 \text{ commutes with } A_1, A_3, A_4, A_5. \quad (3)$$

So,

$$Z^2 \text{ fixes the curves } a_1, a_3, a_4 \text{ and } a_5. \quad (4)$$

Hence the curves a_1, a_3, a_4, a_5 are some reduction curves of Z^2 , so we have $I(\sigma(Z^2), \{a_1, a_3, a_4, a_5\}) = 0$. Hence, if we see $\tilde{\Sigma}$ as a subsurface of Σ , we have:

$$\sigma(Z^2) \subset \mathcal{C}\text{urv}(\tilde{\Sigma}) \cup \{a_1, a_3, a_5\}. \quad (5)$$

But a_4 , which is a reduction curve of Z^2 , intersects a_3 and a_5 , so neither a_3 nor a_5 can belong to $\sigma(Z^2)$. So (5) can be replaced by (6):

$$\sigma(Z^2) \subset \mathcal{C}\text{urv}(\tilde{\Sigma}) \cup \{a_1\}. \quad (6)$$

We are interested in $\sigma(Z)$ which is equal to $\sigma(Z^2)$. According to (6), we should investigate the set $\sigma(Z) \cap \mathcal{C}\text{urv}(\tilde{\Sigma})$. To do so, we focus on \tilde{Z} , which we define as being $\sim (Z)$, the induced mapping class by Z in $\text{Mod}(\tilde{\Sigma})$. Notice that $\sim (Z)$ is well-defined, since Z preserves the set $\{a_1, a_3, a_5\}$. According to Lemma 3.42, we have:

$$\sigma(\tilde{Z}) = \sigma(Z) \cap \mathcal{C}\text{urv}(\tilde{\Sigma}). \quad (7)$$

Let us then describe the surface $\tilde{\Sigma}_{\sigma(\tilde{Z})}$. In the remainder of step 1., we refer to Figure 90.

- (i) Since a_4 intersects a_3 and a_5 but does not intersect the curves of $\sigma(Z)$, there exists in $\tilde{\Sigma}_{\sigma(\tilde{Z})}$ a path ω included in a_4 such that ω has one of its extremities in $a_3^+ \cup a_3^-$ and the other extremity in $a_5^+ \cup a_5^-$. Even if it means renaming the curves, we can assume that this path is with extremities in a_3^+ and a_5^+ . So we can assume without loss of generality that a_3^+ and a_5^+ belong to a same connected component of $\tilde{\Sigma}_{\sigma(\tilde{Z})}$. Let us denote this connected component by C^+ .
- (ii) Since A_1 commutes with Z^2 according to (3), it preserves the curves of $\sigma(Z)$ and induces an action on the boundary components of $\tilde{\Sigma}_{\sigma(\tilde{Z})}$. According to the hypotheses of the case d), \tilde{A}_1 sends a_3^+ and a_5^+ respectively on a_3^- and a_5^- . So \tilde{A}_1 sends ω on a path joining a_3^- and a_5^- . Therefore a_3^- and a_5^- belong to a same connected component of $\tilde{\Sigma}_{\sigma(\tilde{Z})}$. Let us denote this connected component by C^- .
- (iii) Since A_3 commutes with Z^2 according to (3), it preserves the curves of $\sigma(Z)$ and induces an action on the boundary components of $\tilde{\Sigma}_{\sigma(\tilde{Z})}$. According to the hypotheses of the case d), \tilde{A}_3 sends a_3^+ and a_5^+ respectively on a_3^+ and a_5^- . So \tilde{A}_3 sends ω on a path joining a_3^+ and a_5^- . Therefore a_3^+ and a_5^- belong to a same connected component of $\tilde{\Sigma}_{\sigma(\tilde{Z})}$. So $C^+ = C^-$. Let us denote by C this connected component.

2. We show that the set $\sigma(Z)$ is included in $\{a_1\}$.

We argue by contradiction. Let us assume that there exists a curve x in $\sigma(Z)$ different from a_1 . According to (6), the curve x lies in $\sigma(\tilde{Z})$. It is a separating curve of $\tilde{\Sigma}$ for $\tilde{\Sigma}$ is a genus-0

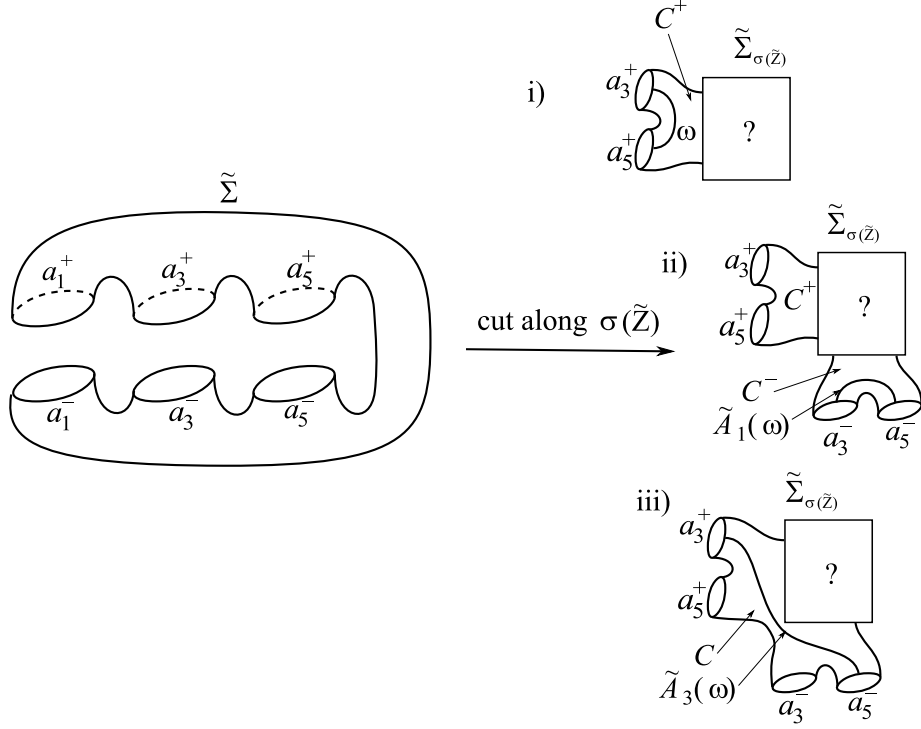

Figure 90: Following the argument of step 1. of the proof of Lemma 12.3.

surface. Let x^+ and x^- be the two boundary components of $\tilde{\Sigma}_\sigma(\tilde{Z})$ coming from the cut along x . We can assume that x^- is a boundary component of C whereas x^+ belongs to another connected component of $\tilde{\Sigma}_\sigma(\tilde{Z})$ that we call P . Notice that $\chi(\tilde{\Sigma}_\sigma(\tilde{Z})) = \chi(\tilde{\Sigma}) = -4$, whereas $\chi(C) \leq -3$ since it has at least five boundary components: $a_3^+, a_3^-, a_5^+, a_5^-$ and x^- , and $\chi(P) \leq -1$. Since $-4 = -3 - 1$, the connected component C is a sphere with five holes, P is a sphere with three holes, and C and P are the only connected components of $\tilde{\Sigma}_\sigma(\tilde{Z})$. So

$$x \text{ is the only curve in } \sigma(\tilde{Z}). \quad (8)$$

Notice that $\text{Bndy}(P)$ is equal to $\{x^+, a_1^+, a_1^-\}$. This situation is summed up in Figure 91.

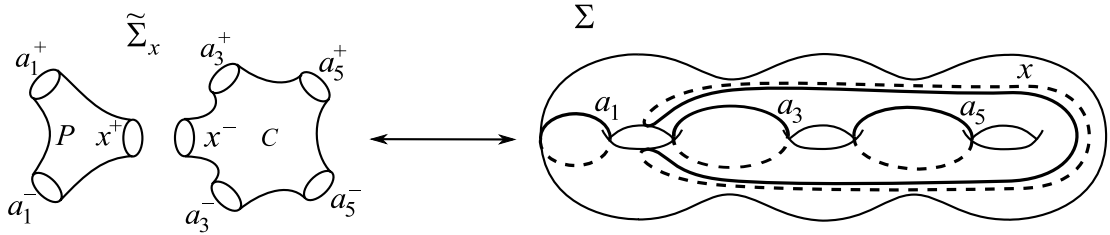

Figure 91: The curve x such that $\sigma(\tilde{Z}) = \{x\}$.

Now, \tilde{A}_3 commutes with \tilde{Z}^2 , so \tilde{A}_3 fixes the curve x . Then \tilde{A}_3 induces a mapping class in $\text{Mod}(\tilde{\Sigma}_x)$. But $\tilde{\Sigma}_x$ contains two non-homeomorphic connected components, so \tilde{A}_3 induces a mapping class on each connected component. Let F be the so induced mapping class by \tilde{A}_3 on C . It is periodic of order two on the surface C (for \tilde{A}_3 was periodic of order two, according

to (2)). However, F fixes x^- , a_3^+ and a_3^- . This is in contradiction with Corollary 3.23, since C is a genus-0 surface, and any periodic mapping class on a genus-0 surface that fixes three boundary components is the identity. This is the expected contradiction. We have then shown that $\sigma(Z) \subset \{a_1\}$.

3. Let us show that Z^2 and A_1 coincide, up to a power of a Dehn twist along the curve a_1 .

Let us recall that, according to (2), \tilde{A}_1 is periodic of order two. The mapping class \tilde{Z} satisfies $\sigma(\tilde{Z}) = \emptyset$, so it is either pseudo-Anosov, or periodic. If it was pseudo-Anosov, the curves a_1 , a_3 and a_5 would be essential reduction curves of Z , but we saw in step 1. that a_3 and a_5 were not. Hence \tilde{Z} is periodic. Then the mapping classes \tilde{Z} and \tilde{A}_1 are periodic and commute, so they span a finite group. Notice that according to the hypotheses of the case d), \tilde{A}_1 fixes the curves a_1^+ and a_1^- . Concerning \tilde{Z} , remember that A_3 , A_4 and A_5 fix the curve a_1 , hence so does the mapping class $A_3A_4A_5$. So the mapping class $Z = (A_3A_4A_5)^2$ fixes the curve a_1 and does not permute the two connected components of $\mathcal{V} \setminus a_1$ where \mathcal{V} is a tubular neighbourhood of a_1 , so \tilde{Z} fixes the curves a_1^+ and a_1^- . Hence \tilde{Z} and \tilde{A}_1 are periodic mapping classes and both fix the curves a_1^+ and a_1^- , so according to Lemma 3.19, \tilde{Z} and \tilde{A}_1 span a cyclic group. Since the order of \tilde{Z} is even (for \tilde{Z} swaps $\{a_3^+, a_3^-\}$ with $\{a_5^+, a_5^-\}$) and since the order of \tilde{A}_1 is two, then there exists an integer $k \geq 1$ such that $\tilde{A}_1 = \tilde{Z}^k$. But \tilde{Z}^4 has a trivial action on the boundary components of $\tilde{\Sigma}$, so it is the identity, hence $k \in \{1, 2, 3\}$. But \tilde{Z} and \tilde{Z}^3 swap $\{a_3^+, a_3^-\}$ and $\{a_5^+, a_5^-\}$ whereas \tilde{A}_1 preserves each of these sets, so $k \notin \{1, 3\}$. Finally,

$$\tilde{A}_1 = \tilde{Z}^2.$$

Let us consider the product $Z^2A_1^{-1}$. We just have seen that $\sim(Z^2A_1^{-1})$ is trivial in $\mathcal{M}\text{od}(\tilde{\Sigma})$, so according to the following exact sequence:

$$1 \rightarrow \langle T_{a_1}, T_{a_3}, T_{a_5} \rangle \rightarrow \mathcal{M}\text{od}_{\sigma_s(\mathcal{X})}(\Sigma) \xrightarrow{\sim} \mathcal{M}\text{od}(\tilde{\Sigma}) \rightarrow 1,$$

the mapping class $Z^2A_1^{-1}$ is a multitwist along the curves a_1 , a_3 and a_5 . But $\sigma(A_1)$ is equal to $\{a_1\}$ and according to step 2., $\sigma(Z^2)$ is included in $\{a_1\}$, so according to Proposition 3.45, $\sigma(Z^2A_1^{-1})$ is included in $\{a_1\}$.

3. We get a contradiction when we examine on the mapping class $Y = A_3A_4A_5$.

We can see $\tilde{\Sigma}$ as a punctured sphere where each boundary component has been replaced by a puncture. The mapping class \tilde{Z} of $\mathcal{M}\text{od}(\tilde{\Sigma})$ is periodic so according to Kerckhoff's Theorem, \tilde{Z} can be represented by a periodic diffeomorphism of $\tilde{\Sigma}$. According to Kerékjártó's Theorem, this periodic diffeomorphism is conjugate to a rotation on the sphere $\tilde{\Sigma}$ by a diffeomorphism isotopic to the identity. Since \tilde{Z} is of order 4, $\tilde{\Sigma}$ is the isotopy class of an angle $\pm\pi/2$ rotation over an axis containing two punctures that correspond to the boundary components a_1^+ and a_1^- . The square of this rotation is in the isotopy class of \tilde{A}_1 . This justifies Figure 92 in which we have represented the genus-2 surface Σ_{a_1} with two boundary components a_1^+ and a_1^- , and the periodic mapping classes A'_1 and Z' induced by A_1 and Z in $\mathcal{P}\mathcal{M}\text{od}(\Sigma_{a_1})$. We can see that A'_1 has exactly four fixed points, namely P_1, P_2, P_3 and P_4 , in Figure 92. Therefore:

- (1) Z' has no fixed points,
- (2) $Z'^2 = A'_1$ has four fixed points.

Let us set $Y := A_3A_4A_5$. According to Proposition 9.6, A_3 , A_4 and A_5 fix $\sigma_s(A_1)$, hence fix a_1 . So Y induces a mapping class in $\mathcal{M}\text{od}(\Sigma_{a_1})$, which we will call Y' . Since Z' is periodic of order 4, the mapping class Y' is periodic of order 8. Assertions (1) and (2) imply assertions (3)-(5) below. Only assertion (5) needs to be proved.

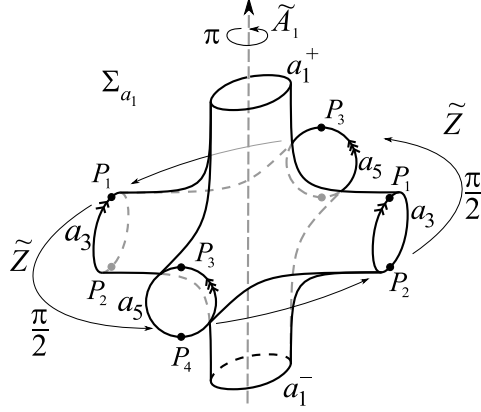

Figure 92: The periodic mapping class \tilde{A}_1 induced by A_1 in Σ_{a_1} (the arrows along the curves a_3 and a_5 stand for a gluing along these curves, so that Σ_{a_1} is indeed a genus-2 surface with two boundary components: a_1^+ and a_1^-).

- (3) Y' is periodic of order 8 without fixed points,
- (4) $Y'^2 = Z'$ is periodic of order 4 without fixed points,
- (5) Y'^4 has four fixed points belonging to a same orbit under Y' .

Let us justify assertion (5). If Y' preserved $\{P_1, P_3\}$, then Y'^2 would fix P_1 and P_3 . But it does not, so the cardinality of the orbit of P_1 under Y' is at least 4. But Y'^2 preserves $\{P_1, P_3\}$, so the cardinality of the orbit of P_1 under Y' is at most 4. Hence the orbit of P_1 and P_3 and the orbit of P_2 and of P_4 contain exactly 4 points. Since Y'^4 contains 4 fixed points instead of 8, the orbit of P_1 and the orbit of P_2 coincide. Thus assertion (5) is proved. We are then ready to apply Lemma 3.20, linking the Euler characteristics of Σ_{a_1} and of the quotient surface $\Sigma_{a_1}/\langle Y' \rangle$. To do this, let us compute $\chi(\Sigma_{a_1}/\langle Y' \rangle)$. The mapping classes A'_3, A'_4 and A'_5 induced by A_3, A_4 and A_5 in $\text{Mod}(\Sigma_{a_1})$ swap a_1^+ and a_1^- (we knew it already for A_3 and A_5 by hypothesis, we deduce it easily for A_4). So Y' swaps a_1^+ and a_1^- , so the surface $\Sigma_{a_1}/\langle Y' \rangle$ must have a unique boundary component. Since Y' preserves the orientation, $\Sigma_{a_1}/\langle Y' \rangle$ is a disk, a torus with one hole, or a genus-2 surface with one hole. So $\chi(\Sigma_{a_1}/\langle Y' \rangle) \in \{1, -1, -3\}$. The ramification points of the covering $\Sigma_{a_1} \rightarrow \Sigma_{a_1}/\langle Y' \rangle$ come also into account. According to (5), there is only one ramification point Q that has 4 preimages P_1, P_2, P_3 and P_4 in Σ_{a_1} . So, with the notation of Lemma 3.20, we have $o(Q) = 4$. Let us recall that in Lemma 3.20, the cardinality of $\langle Y' \rangle$ is denoted by m , then here, $m = 8$. We get:

$$\underbrace{\chi(\Sigma_{a_1})}_{-4} + \underbrace{(m - o(Q))}_{8-4} = \underbrace{m}_{8} \cdot \underbrace{\chi(\Sigma_{a_1}/\langle Y' \rangle)}_{1, -1 \text{ or } -3}.$$

This equality cannot be satisfied, since the left hand side is zero whereas the right hand side is nonzero. This is the expected contradiction and terminates the proof of Lemma 12.3. \square

We now can prove the following proposition:

Proposition 12.4 (Description of $\hat{\rho}$).

There exist an integer $\varepsilon \in \{\pm 1\}$ and a mapping class α of $\text{Mod}(\hat{\Sigma})$ that is either the identity or

the periodic mapping class of order two that fixes the curves a_i , $i \in \{1, 2, \dots, n-1\}$ such that, for all $i \in \{0, 1, \dots, n-1\}$, the morphism $\widehat{\rho}$ satisfies:

$$\widehat{\rho}(\tau_i) = T_{a_i}^\varepsilon \alpha.$$

Proof.

1. Let us begin to deal with the case where \widetilde{A}_1 is trivial. In this case, \widehat{A}_1 is a multitwist along the curves of $\sigma(\widehat{\mathcal{X}})$. But $\sigma(\widehat{A}_1) = \sigma_s(A_1) \cap \text{Curv}(\widehat{\Sigma}) = \{a_1\}$, so there exists a nonzero integer ε such that $\widehat{A}_1 = T_{a_1}^\varepsilon$. Then, by applying the conjugation by the elements of $\widehat{\rho}(\mathcal{J})$, for all $i \in \{0, 1, \dots, n-1\}$, we get:

$$\widehat{\rho}(\tau_i) = \widehat{A}_i = T_{a_i}^\varepsilon. \quad (1)$$

Now, for all $i \in \{0, 1, \dots, n-1\}$, \widehat{A}_i and \widehat{A}_{i+1} satisfy a braid relation, so according to Proposition 3.4, ε belongs to $\{\pm 1\}$. Thus, in the case where \widetilde{A}_1 is trivial, the proof is over.

2. When \widetilde{A}_1 is not the identity, we have $\widetilde{A}_1 = \widetilde{A}_3 = \dots = \widetilde{A}_{n-1}$ according to Lemma 12.3. According to Corollary 3.18, these periodic mapping classes of order 2 all induce a unique mapping class α of order 2 on $\text{Mod}(\widehat{\Sigma})$. According to Proposition 3.45, for all $i \in \text{Imp}(n)$, we have the inclusions $\sigma(\widehat{A}_i \alpha) \subset \sigma(\widehat{A}_i) \cup \sigma(\alpha)$ and $\sigma(\widehat{A}_i) \subset \sigma(\widehat{A}_i \alpha) \cup \sigma(\alpha^{-1})$, but $\sigma(\alpha) = \sigma(\alpha^{-1}) = \emptyset$, so we get the equality $\sigma(\widehat{A}_i \alpha) = \sigma(\widehat{A}_i) = \{a_i\}$. By definition of α , the mapping class $\widehat{A}_i \alpha$ induces a trivial mapping class in $\text{Mod}(\widehat{\Sigma})$. Hence, for all $i \in \text{Imp}(n)$, there exists an integer k_i such that:

$$\widehat{A}_i \alpha = T_{a_i}^{k_i}. \quad (2)$$

Notice that for all $\xi \in \mathcal{H}$, the mapping class $\widehat{\rho}(\xi) \alpha \widehat{\rho}(\xi)^{-1}$ is periodic of order 2 and induces in $\text{Mod}(\widehat{\Sigma})$ a mapping class that coincides with $\xi \cdot \widehat{A}_1$. But $\xi \cdot \widehat{A}_1 = \widetilde{A}_1$ according to Lemma 12.3, so by uniqueness of the construction of α (cf. Corollary 3.18), we have the equality $\widehat{\rho}(\xi) \alpha \widehat{\rho}(\xi)^{-1} = \alpha$. Then, by conjugation by the elements of $\widehat{\rho}(\mathcal{H})$, the k_i are all equal to an integer which we denote by ε . Hence for all $i \in \text{Imp}(n)$, we have:

$$\widehat{A}_i \alpha = T_{a_i}^\varepsilon. \quad (3)$$

Since $\widehat{A}_3 \widehat{A}_4 \widehat{A}_3(\sigma_s(\widehat{A}_3)) = \sigma_s(\widehat{A}_4)$, then $\widehat{A}_3 \widehat{A}_4 \widehat{A}_3(a_3) = a_4$. Hence the product $\widehat{A}_3 \widehat{A}_4 \widehat{A}_3$ sends by conjugation T_{a_3} on T_{a_4} . Moreover, $\widehat{A}_3 \widehat{A}_4 \widehat{A}_3$ sends also by conjugation \widehat{A}_3 on \widehat{A}_4 . Hence, by conjugating the equality $\widehat{A}_1 T_{a_1}^{-\varepsilon} = \widehat{A}_3 T_{a_3}^{-\varepsilon}$ by $\widehat{A}_3 \widehat{A}_4 \widehat{A}_3$, we get $\widehat{A}_1 T_{a_1}^{-\varepsilon} = \widehat{A}_4 T_{a_4}^{-\varepsilon}$. Hence $\widehat{A}_4 T_{a_4}^{-\varepsilon} = \widehat{A}_3 T_{a_3}^{-\varepsilon}$. Now, let us make δ act on this last equality. We get (4):

$$\widehat{A}_1 T_{a_1}^{-\varepsilon} = \widehat{A}_2 T_{a_2}^{-\varepsilon} = \dots = \widehat{A}_{n-1} T_{a_{n-1}}^{-\varepsilon} = \widehat{A}_0 T_{a_0}^{-\varepsilon}. \quad (4)$$

Therefore α (equal to $\widehat{A}_1 T_{a_1}^{-\varepsilon}$) is stable by the action of δ . In other words, α commutes with $\widehat{\rho}(\delta)$. Then, since $\alpha(a_1) = a_1$, it follows that for all $i \in \{0, 1, \dots, n-1\}$, we have $\alpha(a_i) = a_i$. Hence, for all $i \in \{0, 1, \dots, n-1\}$, the mapping class α commutes with T_{a_i} , hence with $T_{a_i}^\varepsilon \alpha$. That is, α commutes with \widehat{A}_i . Therefore, the transvection of $\widehat{\rho}$ with direction α is well-defined. Let us denote it by $L_\alpha(\widehat{\rho})$. Thus, for all $i \in \{0, 1, \dots, n-1\}$, we have:

$$L_\alpha(\widehat{\rho})(\tau_i) = \widehat{A}_i \alpha = T_{a_i}^\varepsilon. \quad (5)$$

This kind of equality (5) is very similar to (1). We can then prove, exactly as in the case where \widetilde{A}_1 is trivial, that $\varepsilon \in \{\pm 1\}$. \square

12.3 The morphism ρ is a transvection of monodromy morphism

At last, we prove in this subsection Proposition 12.1: we know that the morphism $\widehat{\rho}$ induced by ρ is a transvection of monodromy morphism. We have now to check that the morphism ρ itself is a transvection of monodromy morphism.

Let us gather the main informations on $\widehat{\Sigma}$, $\check{\Sigma}$ and \mathcal{U} contained in Definition 11.3 and Proposition 11.4.

Recalls (The Definition 11.3 and the propositions 11.2 and 11.4).

- Let $\widehat{\Sigma}$ be the subsurface of $\mathcal{S}ub_{\sigma_n(\mathcal{G})}(\Sigma)$ containing the special curves. The surface $\widehat{\Sigma}$ is of genus $\frac{n}{2} - 1$ or $\frac{n}{2}$.
- We set $\mathcal{U} := \text{Bndy}(\widehat{\Sigma}) \cap \sigma_n(\mathcal{G})$. The set of curves \mathcal{U} can be empty and contains at most two curves.
- Let $\check{\Sigma}$ be the subsurface of $\mathcal{S}ub_{\mathcal{U}}(\Sigma)$ different from $\widehat{\Sigma}$ (well-defined according to Proposition 11.4). If $\widehat{\Sigma}$ is the only subsurface of $\mathcal{S}ub_{\mathcal{U}}(\Sigma)$, we will say that $\check{\Sigma}$ is empty.

The links between $\widehat{\Sigma}$, $\check{\Sigma}$ and \mathcal{U} are the following:

- if \mathcal{U} is empty, $\Sigma = \widehat{\Sigma}$; if $\widehat{\Sigma}$ is of genus $\frac{n}{2}$, then \mathcal{U} is empty,
- if \mathcal{U} is reduced to a non-separating curve u , then $\check{\Sigma}$ is empty and $\{u\}$ is the mark of $\widehat{\Sigma}$,
- if \mathcal{U} is reduced to a separating curve u , then $\check{\Sigma}$ is of genus 1,
- if \mathcal{U} contains two curves, then they are non-separating and $\check{\Sigma}$ is a nonempty genus-0 surface.

Proposition 12.5. *There exists a mapping class $W \in \mathcal{P}Mod(\Sigma)$ such that for all $i \in \{1, 2, \dots, n-1\}$, the following holds:*

- in $\mathcal{M}od(\widehat{\Sigma})$, $\wedge(W)$ commutes with $\wedge(T_{a_i})$ and $\wedge(A_i)$,
- in $\mathcal{M}od(\widehat{\Sigma})$, $\wedge(A_i W^{-1}) = \wedge(T_{a_i}^\varepsilon)$,
- in $\mathcal{M}od(\widehat{\Sigma})$, $\vee(W)$ commutes with $\vee(A_i)$,
- in $\mathcal{M}od(\check{\Sigma})$, $\vee(A_i W^{-1}) = \vee(T_{a_i}^\varepsilon)$.

Proof. Let us distinguish the case according to \mathcal{U} .

a) If \mathcal{U} is empty, then $\widehat{\Sigma} = \Sigma$, so $A_1 T_{a_1}^{-1}$ coincides with α , the mapping class defined in Proposition 12.4. According to this last proposition, α satisfies the four assertions that W must satisfy. Then in this case, Proposition 12.5 is proved.

b) If \mathcal{U} is reduced to a non-separating curve u , then, if α is the identity, we set $W = \text{Id}$ in the group $\mathcal{P}Mod(\Sigma)$. And if α is not the identity, according to Corollary 3.18, there exists a unique mapping class W of $\mathcal{P}Mod(\Sigma)$, periodic of order two, fixing the curve u and such that $\text{cut}_u(W) = \alpha$. Then, again according to Proposition 12.4, this definition of W suits.

c) If \mathcal{U} is separating in Σ , which gathers all the cases not treated by a) and b) above, then we are going to show that the mapping class $W = A_1 T_{a_1}^{-1}$ belonging to $\mathcal{P}Mod(\Sigma)$ suits. Let us start by showing that the morphism $\vee \circ \rho$ is cyclic.

The set of curves \mathcal{U} is stable by the mapping classes of \mathcal{G} , for the curves of \mathcal{U} are topologically different from the other curves of $\sigma_n(\mathcal{G})$: they are the only ones that separate $\widehat{\Sigma}$ from $\check{\Sigma}$. Let us distinguish two cases, depending on whether $\check{\Sigma}$ is of genus 1, or of genus 0.

- If $\check{\Sigma}$ is of genus 1, according to Proposition 11.4, \mathcal{U} is reduced to one only curve, that is hence stable by the action of $\rho(\mathcal{B}_n)$. Hence the image of the morphism $\vee \circ \rho$ is included in $\mathcal{P}\text{Mod}(\check{\Sigma})$ (the boundary components are not permuted). Then we can apply Proposition 11.2: since $\check{\Sigma}$ is of genus 1, hence smaller than $\frac{n}{2} - 1$, then the morphism $\vee \circ \rho$ is cyclic.
- If $\check{\Sigma}$ is of genus zero, then \mathcal{U} can contain two curves. They can be swapped by the elements of \mathcal{G} , but according to the proposition 9.7, the action of \mathcal{B}_n on \mathcal{U} is cyclic. Then, according to the definition 9.12, we set

$$\mathcal{F}_n := \langle\langle \tau_i \tau_1^{-1}, 2 \leq i \leq n-1 \rangle\rangle_{\mathcal{B}_n},$$

$$\mathcal{F}_n^* := \langle \tau_i \tau_1^{-1}, 3 \leq i \leq n-1 \rangle_{\mathcal{B}_n},$$

where $\langle\langle \cdot \rangle\rangle_{\mathcal{B}_n}$ is the normal closure in \mathcal{B}_n . According to Lemma 9.13, \mathcal{F}_n acts trivially on \mathcal{U} . Then \mathcal{F}_n^* is a group isomorphic to \mathcal{B}_{n-2} . According to Theorem 7.1, the action of \mathcal{B}_{n-2} on $\mathcal{P}\text{Mod}(\check{\Sigma})$ via $\vee \circ \rho$ is cyclic. Hence $\vee(A_3 A_1^{-1}) = \vee(A_4 A_1^{-1})$, whence $\vee(A_3) = \vee(A_4)$ and by conjugation by some powers of $\vee \circ \rho(\delta)$, we get:

$$\vee(A_1) = \vee(A_2) = \cdots = \vee(A_{n-1}).$$

Hence again, the morphism $\vee \circ \rho$ is cyclic.

Then, according to Proposition 12.4, the mapping class $W = A_1 T_{a_1}^{-\varepsilon}$ belonging to $\mathcal{P}\text{Mod}(\Sigma)$ satisfies for all $i \in \{1, 2, \dots, n-1\}$ the following facts (where α is the mapping class of $\text{Mod}(\widehat{\Sigma})$ introduced in Proposition 12.4):

- in $\text{Mod}(\widehat{\Sigma})$, $\wedge(W)$ is equal to α and then commutes with T_{a_i} ,
- in $\text{Mod}(\widehat{\Sigma})$, $\wedge(T_{a_i}^\varepsilon W) = \widehat{A}_i$,
- in $\text{Mod}(\check{\Sigma})$, $\vee(A_i T_{a_i}^{-\varepsilon}) = \vee(A_i) = \vee(W)$.

This terminates the proof of Proposition 12.5. □

Proposition 12.1. *The morphism $\rho : \mathcal{B}_n \rightarrow \mathcal{P}\text{Mod}(\Sigma)$ is a transvection of monodromy morphism.*

Proof. Let W be the mapping class of $\mathcal{P}\text{Mod}(\Sigma)$ defined in Proposition 12.5. Notice that according to this same proposition, $\wedge(A_i W^{-1})$ belongs to $\mathcal{P}\text{Mod}(\widehat{\Sigma})$ for all $i \in \{1, \dots, n-1\}$, since $\wedge(A_i W^{-1}) = \wedge(T_{a_i}^\varepsilon)$. Similarly, when $\check{\Sigma}$ is nonempty, $\vee(A_i W^{-1})$ belongs to $\mathcal{P}\text{Mod}(\check{\Sigma})$ since $\vee(A_i W^{-1}) = \vee(T_{a_i}^\varepsilon)$. Hence $A_i W^{-1}$ and $T_{a_i}^\varepsilon$ belong to $\mathcal{P}_{\mathcal{U}}\text{Mod}(\Sigma)$. Let us consider then the following central exact sequence:

$$1 \rightarrow \langle T_u, u \in \mathcal{U} \rangle \rightarrow \mathcal{P}_{\mathcal{U}}\text{Mod}(\Sigma) \xrightarrow{\text{cut}_{\mathcal{U}}} \mathcal{P}\text{Mod}(\Sigma_{\mathcal{U}}) \rightarrow 1 \quad (1)$$

where $\text{cut}_{\mathcal{U}}$ is the canonical morphism. For any $i \in \{1, \dots, n-1\}$, both mapping classes $A_i W^{-1}$ and $T_{a_i}^\varepsilon$ induce the same mapping classes in $\mathcal{P}\text{Mod}(\Sigma_{\mathcal{U}})$. So $A_i W^{-1}$ and $T_{a_i}^\varepsilon$ differ by a central element. Consequently, W commutes with A_i . We can then define a morphism $\rho' : \mathcal{B}_n \rightarrow \mathcal{P}\text{Mod}(\Sigma)$ by setting:

$$\rho'(\tau_i) = A_i W^{-1} = \rho(\tau_i) W^{-1}$$

for all integers $i \in \{1, \dots, n-1\}$. Let $\rho'' : \mathcal{B}_n \rightarrow \mathcal{P}\text{Mod}(\Sigma)$ be the monodromy morphism defined by

$$\rho''(\tau_i) = T_{a_i}^\varepsilon$$

for all $i \in \{1, \dots, n-1\}$. The morphisms ρ' and ρ'' satisfy $\text{cut}_{\mathcal{U}}(\rho') = \text{cut}_{\mathcal{U}}(\rho'')$ according to Proposition 12.5. Let us apply Lemma 5.8 to the central exact sequence (1). It follows that

ρ' and ρ'' are of the same nature, hence ρ' is a transvection of monodromy morphism. So by construction, ρ is also a transvection of monodromy morphism. \square

13 Proof of Theorem 1

In this section, we use Theorem 12.2 that was proved in the previous section, in order to deduce Theorem 1.

Theorem 1 (Morphisms from \mathcal{B}_n in $\mathcal{PMod}(\Sigma)$, $n \geq 6$).

Let n be an integer greater than or equal to 6 and Σ a surface $\Sigma_{g,b}$ with $g \leq \frac{n}{2}$. Any morphism ρ from \mathcal{B}_n to $\mathcal{PMod}(\Sigma)$ is either cyclic, or is a transvection of monodromy morphism. In addition, such transvections of monodromy morphisms exist if and only if $g \geq \frac{n}{2} - 1$.

Proof. Let n be an integer greater than or equal to 6. Let Σ be a surface $\Sigma_{g,b}$ where $g \leq \frac{n}{2}$ and $b \geq 0$. Let ρ be a noncyclic morphism from \mathcal{B}_n in $\mathcal{PMod}(\Sigma)$. We start by showing that ρ is a transvection of monodromy morphism.

When n is even, this is exactly Theorem 12.2.

Let us then assume that n is odd. Notice that in this case, the condition $g \leq \frac{n}{2}$ is equivalent to $g \leq \frac{n-1}{2}$. If ρ is cyclic, there is nothing to be shown. Let us then assume that ρ is not cyclic. We adopt the following notation:

$$\begin{aligned}\mathcal{B}_{n-1}^{(1)} &= \langle \tau_1, \tau_2, \dots, \tau_{n-2} \rangle_{\mathcal{B}_n}, \\ \mathcal{B}_{n-1}^{(2)} &= \langle \tau_2, \tau_3, \dots, \tau_{n-1} \rangle_{\mathcal{B}_n}.\end{aligned}$$

The morphism ρ from \mathcal{B}_n in $\mathcal{PMod}(\Sigma)$ induces by restriction to $\mathcal{B}_{n-1}^{(1)}$ and $\mathcal{B}_{n-1}^{(2)}$ the morphisms $\rho^{(1)} : \mathcal{B}_{n-1}^{(1)} \rightarrow \mathcal{PMod}(\Sigma)$ and $\rho^{(2)} : \mathcal{B}_{n-1}^{(2)} \rightarrow \mathcal{PMod}(\Sigma)$. The morphism ρ is not cyclic, so the mapping classes $\rho(\tau_2)$ and $\rho(\tau_3)$ are distinct according to Lemma 5.2. So the morphisms $\rho^{(1)}$ and $\rho^{(2)}$ are not cyclic either. Then, according to Theorem 12.2, $\rho^{(1)}$ and $\rho^{(2)}$ are transvections of monodromy morphisms. According to Theorem 12.2, there exist two $(n-2)$ -chains: $(a_i, 1 \leq i \leq n-2)$ and $(c_i, 2 \leq i \leq n-1)$; two mapping classes: V belonging to the centralizer of $\langle T_{a_i}, 1 \leq i \leq n-2 \rangle$ in $\mathcal{PMod}(\Sigma)$ and W belonging to the centralizer of $\langle T_{c_i}, 2 \leq i \leq n-1 \rangle$ in $\mathcal{PMod}(\Sigma)$; and two integers ε and η belonging to $\{\pm 1\}$, such that for all $i \in \{1, \dots, n-2\}$:

$$\begin{cases} \rho^{(1)}(\tau_i) = T_{a_i}^\varepsilon V, \\ \rho^{(2)}(\tau_{i+1}) = T_{c_{i+1}}^\eta W. \end{cases}$$

The morphisms $\rho^{(1)}$ and $\rho^{(2)}$ coincide on the standard generators τ_i with $2 \leq i \leq n-2$, so they coincide on at least four consecutive standard generators (four when $n=7$). Then according to Lemma 5.13, we have $V = W$, $\varepsilon = \eta$, and $a_i = c_i$ for all $i \in \{2, 3, \dots, n-2\}$. Let us denote by a_{n-1} the curve c_{n-1} . Then, we have for all $i \in \{1, \dots, n-1\}$:

$$\rho(\tau_i) = T_{a_i}^\varepsilon V.$$

We just have to check that this is a transvection of monodromy morphism.

- On one hand, the mapping class V is in the centralizer of $\langle T_{a_i}, 1 \leq i \leq n-1 \rangle$, since the equality $V = W$ implies that V commutes with $T_{a_{n-1}}$ as well;
- On the other hand, the ordered list of curves $(a_i, 1 \leq i \leq n-1)$, is an $(n-1)$ -chain, since the curve a_{n-1} intersects a_{n-2} in one point, does not intersect the curves a_i for $i \in \{2, \dots, n-3\}$, and does not intersect either a_1 . Let us justify this last point: τ_1 and τ_{n-1} commute, so $\rho(\tau_1)$ and $\rho(\tau_{n-1})$ commute, so $T_{a_1}V$ and $T_{a_{n-1}}V$ commute. But V commutes with T_{a_1} and $T_{a_{n-1}}$, so finally, T_{a_1} and $T_{a_{n-1}}$ commute, so we have $I(a_1, a_{n-1}) = 0$.

Thus, ρ is a transvection of monodromy morphism.

It remains to show that such transvections of monodromy morphisms exist if and only if $g \geq \frac{n}{2} - 1$. But there exist some if and only if there exist monodromy morphisms, and according to Lemma 5.6, monodromy morphisms exist if and only if $g \geq \frac{n}{2} - 1$. \square

14 Discussion on the hypotheses of Theorem 1

With Theorem 1, we aim to describe morphisms from the braid group \mathcal{B}_n into the mapping class group $\mathcal{PMod}(\Sigma_{g,b})$ where b is any nonnegative integer whereas the integers n and g satisfy the hypotheses:

- $n \geq 6$,
- $g \leq \frac{n}{2}$.

Obviously, the smallest n is and the largest g is, the more difficult it becomes to “control” the morphisms from \mathcal{B}_n in $\mathcal{PMod}(\Sigma_{g,b})$. Another difficulty appears when n is small: when n is equal to 3, 4 or 5, we have very few grips on \mathcal{B}_n : the actions of subgroups of \mathcal{B}_n on itself are less rich, the commutation relations are rarer, etc. The aim of this section is essentially to present some counter-examples to the main result when we overstep the hypotheses on n and g .

We will also describe the morphisms from \mathcal{B}_n in $\mathcal{PMod}(\Sigma_{g,b})$ with $g \leq \frac{n}{2}$ when n is small, but without proof. We reject the proofs of these results to upcoming publications, because the techniques are specific and need several additional preliminaries (notably on the periodic mapping classes, pseudo-Anosov and even on multitwists, on the symmetric groups \mathfrak{S}_4 and \mathfrak{S}_6 and on some properties of the morphisms between braid groups and symmetric groups). In this paper, we leave these results as conjectures

Concerning the case where the genus of the surface Σ is greater than $\frac{n}{2}$, we have not yet any proof. We will only ask some questions and expose some counter-examples.

14.1 Case where $n = 3$ and $\Sigma = \Sigma_{1,1}$

Let us recall that any morphism from \mathcal{B}_3 in $\mathcal{PMod}(S)$ where S is a sphere minus at least three open disks is cyclic (cf. Theorem 7.1). So, we will investigate surfaces of genus $g \geq 1$.

Proposition 14.1. *Let Σ be the surface $\Sigma_{1,1}$ and let ℓ and m be two curves in Σ such that $I(\ell, m) = 1$. The morphism ρ from \mathcal{B}_3 in $\mathcal{Mod}(\Sigma)$ given by $\rho(\tau_1) = T_\ell^{-1}T_m^2$ and $\rho(\tau_2) = T_m^{-1}T_\ell^2$ is well-defined. Yet, it is neither cyclic nor a transvection of monodromy morphism. Indeed, $\rho(\tau_1)$ is pseudo-Anosov.*

Proof.

1. Let us show that the morphism ρ is well-defined. To do so, it is enough to see that $\rho(\tau_1)$ and $\rho(\tau_2)$ satisfy a braid relation. And indeed:

$$(T_\ell^{-1}T_m^2)(T_m^{-1}T_\ell^2)(T_\ell^{-1}T_m^2) = T_\ell^{-1}T_mT_\ell T_m^2 = T_\ell^{-1}T_\ell T_m T_\ell T_m = T_m T_\ell T_m,$$

and symmetrically,

$$(T_m^{-1}T_\ell^2)(T_\ell^{-1}T_m^2)(T_m^{-1}T_\ell^2) = T_\ell T_m T_\ell = T_m T_\ell T_m.$$

2. Let us show that the mapping class $\rho(\tau_1)$, equal to $T_\ell^{-1}T_m^2$, is pseudo-Anosov. To do so, we use the classic isomorphism between $\mathcal{Mod}(\Sigma)$ and $SL_2(\mathbb{Z})$. We won't prove that this is indeed an isomorphism, but we will define it carefully. We give to the curves ℓ and m an orientation in such a way that at the unique intersection point, the product orientation of the pair (ℓ, m) coincides with the orientation of Σ (cf. Figure 93). Let us denote by $[\ell]$ and $[m]$ the homology classes (with integral coefficients) of the curves ℓ and m . The first homology group

$H_1(\Sigma; \mathbb{Z})$ is then isomorphic to $\mathbb{Z}[\ell] \oplus \mathbb{Z}[m]$. Moreover, we have an isomorphism Φ from $\text{Mod}(\Sigma)$ in the group $\text{Aut}(H_1(\mathbb{T}^2; \mathbb{Z}))$ identified with $SL_2(\mathbb{Z})$, the group of matrices of determinant 1 with integral entries. The image of T_ℓ by Φ is the automorphism $(T_\ell)_*$ of $H_1(\Sigma; \mathbb{Z})$ that sends $[\ell]$ on $[\ell]$, and $[m]$ on $[m] - [\ell]$ (cf. Figure 93), and such that its matrix in the base $([\ell], [m])$ is $\begin{pmatrix} 1 & -1 \\ 0 & 1 \end{pmatrix}$. Similarly, the image of T_m by Φ is the automorphism $(T_m)_*$ of $H_1(\Sigma; \mathbb{Z})$ that sends $[\ell]$ on $[\ell] + [m]$, and $[m]$ on $[m]$, and such that its matrix in the base $([\ell], [m])$ is $\begin{pmatrix} 1 & 0 \\ 1 & 1 \end{pmatrix}$.

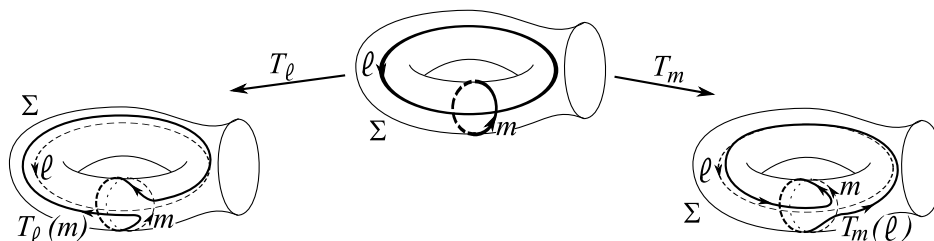

Figure 93: The curves ℓ , m and $T_\ell(m)$ and $T_m(\ell)$ in Σ .

Now, thanks to a second classic result concerning the isomorphism Φ , for any $M \in SL_2(\mathbb{Z})$ such that $|\text{tr}(M)| > 2$, the mapping classes $\Phi^{-1}(M)$ is pseudo-Anosov⁸, where $\text{tr}(M)$ is the trace of M . But, with our conventions, the matrix $\Phi(T_\ell^{-1}T_m^2)$ is equal to the product $\begin{pmatrix} 1 & 0 \\ 0 & 1 \end{pmatrix} \begin{pmatrix} 1 & 0 \\ 1 & 1 \end{pmatrix}$, hence is equal to $\begin{pmatrix} 3 & 1 \\ 2 & 1 \end{pmatrix}$ that is of trace 4. So $T_\ell^{-1}T_m^2$ is a pseudo-Anosov mapping class. \square

This example of morphism is one of the first of an infinite family of morphisms sharing the same properties. More precisely, we make the following conjecture:

Conjecture 14.2. *There exists an infinite family of conjugacy classes of pairwise distinct injective but not surjective morphisms (we say that two morphisms ϕ_1 and ϕ_2 are conjugate if there exists an inner automorphism ψ such that $\phi_1 = \psi \circ \phi_2$) from \mathcal{B}_3 in $\text{Mod}(\Sigma_{1,1})$, such that the braid twists in \mathcal{B}_3 are sent on pseudo-Anosov mapping classes in $\text{Mod}(\Sigma_{1,1})$. Any morphism from \mathcal{B}_3 in $\text{Mod}(\Sigma_{1,1})$ is cyclic, or is a transvection of monodromy morphism, or is conjugate to a morphism of this infinite family.*

14.2 Case where $n = 3$ and $\Sigma = \Sigma_{1,b}$ with $b \geq 2$

Under the hypotheses of this subsection, the situation gets more complicated. Here is a example.

Proposition 14.3. *Let Σ be the surface $\Sigma_{1,2}$ and let a_1 , a_2 and a_3 be the curves in Σ drawn in Figure 94. The morphism ρ from \mathcal{B}_3 in $\text{Mod}(\Sigma)$ given by the formulae $\rho(\tau_1) = T_{a_2}T_{a_3}$ and $\rho(\tau_2) = T_{a_2}T_{a_1}$ is well-defined. Yet, it is neither a cyclic morphism and nor a transvection of*

⁸Here is a sketch of the proof of this result. The matrices M of $SL_2(\mathbb{Z})$ such that $|\text{tr}(M)| > 2$ have two irrational real eigenvalues. These eigenvalues are associated to eigenvectors whose coordinates have an irrational ratio. Since the closed curves of Σ are associated in \mathbb{R}^2 to lines with a rational slope, the mapping classes associated via Φ to matrices M satisfying $|\text{tr}(M)| > 2$ do not preserve any curve of Σ . Neither do their iterates, since any iterate N of such a matrix M satisfies also $|\text{tr}(N)| > 2$. That is why such matrices M are pseudo-Anosov).

monodromy morphism. Indeed, $\sigma(\rho(\tau_1))$ contains a unique separating curve x . The surface Σ_x consists in a pair of pants P and a torus T with one hole. The restriction of $\rho(\tau_1)$ to P is the identity, and its restriction to T is periodic of order 3. Let y be the unique curve of $\rho(\tau_2)$. We have $I(x, y) = 4$.

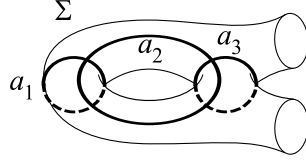

Figure 94: The curves a_1, a_2, a_3 in Σ .

Proof.

1. Let us check that ρ is well-defined. Let us set $S := T_{a_1}T_{a_2}T_{a_3}T_{a_1}$ and $T := (T_{a_2}T_{a_3}T_{a_1})^2$. It is easy to check with a drawing of braids in \mathcal{B}_4 that S is periodic of order 3 and T is periodic of order 2 in $\mathcal{PMod}(\Sigma)$. Let us set then $A = S^{-1}T = T_{a_2}T_{a_3}$ and $B = T^{-1}S^2 = T_{a_2}T_{a_1}$. We have $ABA = S^{-1}TT^{-1}S^2S^{-1}T = T$ and $BAB = T^{-1}S^2S^{-1}TT^{-1}S^2 = T^{-1}S^3 = T$. Hence the morphism ρ is well-defined.

2. In $\mathcal{PMod}(\Sigma_{1,2})$, the mapping classes A and B are reducible: each of the sets $\sigma(A)$ and $\sigma(B)$ contains exactly one separating curve. Let us set $\{x\} = \sigma(A)$ and $\{y\} = \sigma(B)$. The curve x (respectively y) separates $\Sigma_{1,2}$ in a holed torus, and the restriction of A (resp. B) to this holed torus is a periodic mapping class of order six, whereas the restriction of A (resp. B) to the complement of this holed torus is the identity mapping class. Moreover, the curves x and y satisfy $I(x, y) = 4$ (cf. Figure 95).

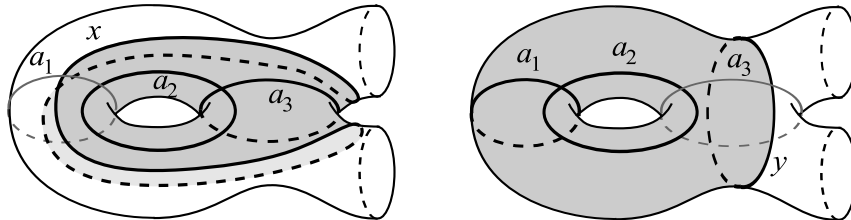

Figure 95: An unusual braid relation: $A = T_{a_2}T_{a_3}$ and $B = T_{a_2}T_{a_1}$. The shadowed parts are the “supports” of A and B . Defined as they are, A and B satisfy a braid relation.

14.3 Case where $n = 4$

Definition 14.4 (Degenerate morphisms).

We shall say that a morphism ρ from \mathcal{B}_4 in any group is *degenerate* if it satisfies $\rho(\tau_1) = \rho(\tau_3)$.

Let us begin by a conjecture on the morphisms from \mathcal{B}_4 in $\mathcal{Mod}(\Sigma_{1,b})$ with $b \geq 1$.

Conjecture 14.5 (Morphisms from \mathcal{B}_4 in $\text{Mod}(\Sigma_{1,b})$ with $b \geq 1$).

Let b be a positive integer and Σ the surface $\Sigma_{1,b}$. Any morphism ρ from \mathcal{B}_4 in $\mathcal{P}\text{Mod}(\Sigma)$ is degenerate.

Let us focus now on the morphisms from \mathcal{B}_4 in genus-2 surfaces.

Definition 14.6 (Exceptional morphisms).

Let Σ be the surface $\Sigma_{2,0}$. A morphism ρ from \mathcal{B}_4 in $\text{Mod}(\Sigma)$ is said to be *exceptional* if there exists a 5-chain of curves $(a_i, i \leq 5)$ such that ρ is one of the two following morphisms ρ_1^{exp} or ρ_2^{exp} :

$$\begin{aligned} \rho_1^{exp}(\tau_1) &= T_{a_1}^2 T_{a_2} T_{a_3} T_{a_4}, & \rho_2^{exp}(\tau_1) &= T_{a_1}^2 T_{a_2} T_{a_3} T_{a_4} \alpha, \\ \rho_1^{exp}(\tau_2) &= T_{a_5} T_{a_4} T_{a_2}^{-1} T_{a_1} T_{a_2} T_{a_3} T_{a_4}, & \rho_2^{exp}(\tau_2) &= T_{a_5} T_{a_4} T_{a_2}^{-1} T_{a_1} T_{a_2} T_{a_3} T_{a_4} \alpha, \\ \rho_1^{exp}(\tau_3) &= (T_{a_1}^2 T_{a_2} T_{a_3} T_{a_4})^{-1} \alpha, & \rho_2^{exp}(\tau_3) &= (T_{a_1}^2 T_{a_2} T_{a_3} T_{a_4})^{-1}, \end{aligned}$$

where α is the (central, hence independent from the chosen 5-chain of curves) mapping class represented in Figure 96.

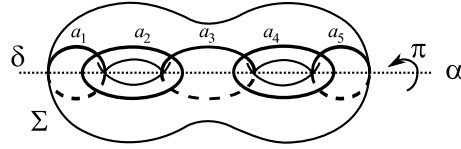

Figure 96: The non-trivial central mapping class α of $\text{Mod}(\Sigma_{2,0})$.

In the following proposition, we make clear some specificities of the exceptional morphisms. The proof is a simple check.

Proposition 14.7. *The image of any exceptional morphism from \mathcal{B}_4 in $\text{Mod}(\Sigma)$, where Σ is the surface $\Sigma_{2,0}$, is a central index-2 extension of the group \mathfrak{S}_4 , precisely the second extension of Schur, denoted by S_4^{**} and having the number 29 in the classification of the finite groups of low cardinality by the software GAP 4. This is a finite group of order 48 that can be presented as follows:*

$$\tilde{\mathfrak{S}}_4 := \langle u, v \mid u^8 = 1, u^4 = v^4, uvu = vuv, (uvu)^2 = 1, \rangle.$$

where the roles u, v, u^3 are played here by the images of the generators τ_1, τ_2, τ_3 . □

Remark. We can prove, by some raffinement of Theorem 84($g - 1$) (cf. Corollary 3.26) and by showing that there does not exist periodic mapping class of order 7 in $\text{Mod}(\Sigma_{2,0})$ that 48 is the maximal order of any finite subgroup of $\text{Mod}(\Sigma_{2,0})$.

We make then the following conjectures:

Conjecture 14.8 (Morphisms from \mathcal{B}_4 in $\text{Mod}(\Sigma_{2,0})$).

Any non-degenerate morphism from \mathcal{B}_4 into $\mathcal{P}\text{Mod}(\Sigma_{2,0})$ is either a transvection of monodromy morphism, or an exceptional morphism. Moreover, there exist exactly two conjugacy classes of exceptional morphisms from \mathcal{B}_4 in $\mathcal{P}\text{Mod}(\Sigma_{2,0})$. We go from one to the other by applying the transvection with direction α .

Conjecture 14.9 (Morphisms from \mathcal{B}_4 in $\text{Mod}(\Sigma_{2,b})$ with $b > 0$).

Any non-degenerate morphism from \mathcal{B}_4 in $\mathcal{P}\text{Mod}(\Sigma_{2,b})$ with $b > 0$ is a transvection of monodromy morphism.

14.4 Case where $n = 5$

Remember that we have deduced Theorem 1 from Theorem 12.2 where the number of strands n of \mathcal{B}_n is even. Similarly, the case $n = 5$ can be deduced from the case $n = 4$. So we expect the following conjecture to be true.

Conjecture 14.10. *Let Σ be a surface $\Sigma_{g,b}$ where $g \leq 2$ and $b \geq 0$. If $g = 2$, any morphism from \mathcal{B}_5 in $\mathcal{P}\text{Mod}(\Sigma)$ is either cyclic, or is a transvection of monodromy morphism. If $g = 1$, all the morphisms from \mathcal{B}_5 in $\mathcal{P}\text{Mod}(\Sigma)$ are cyclic.*

The result for the case $n = 5$ is similar to the cases $n \geq 6$, and is different from the case $n \in \{3, 4\}$. However, the involved techniques of the preceding sections cannot be adapted to the group \mathcal{B}_5 and some specific arguments are needed. We reject hence the writing of the case $n = 5$ in upcoming publications, as a corollary of the case $n = 4$.

14.5 When the integer g is greater than $\frac{n}{2}$

All over the third part, we have used the inequality $g \leq \frac{n}{2}$. Here are some key points where we used it:

- We have used it in order to bound the order of some finite subgroups of the mapping class group. This allowed us to prove that the morphisms such that the images of the standard generators are periodic or pseudo-Anosov elements are actually cyclic.
- We have also used several times the inequality $g \leq \frac{n}{2}$ to prove the existence of curves in $\sigma(A_1)$ that would intersect some curves in $\sigma(A_2)$, namely, the *special* curves. We have even used it to show that these special curves should intersect their own image by $\rho(\delta)$. This becomes wrong when $g = n - 1$. We have in mind two constructions illustrating this, one of them is a transvection of the morphism from the example developed below in the subsection called “Situation when $g \geq n - 1$ ” with direction the involution hyper-elliptic “obvious” when n is even.
- We have used the inequality $g \leq \frac{n}{2}$ to show that these special curves have to be non-separating. We have counterexamples as soon as $g = n$: it is enough to consider the standard isomorphism from \mathcal{B}_n in the mapping class group of a n -punctured disk $\text{Mod}(\mathbb{D}_n, \partial\mathbb{D}_n)$, then we omit little disks centered in each puncture and we glue along the new boundary curves holed tori. Then, the common braid twists that swap the punctures become mapping classes that swap holed tori. The curves that bounded the support of the braid twists are now separating curves that play the role of special curves.

- At last, we have used the inequality $g \leq \frac{n}{2}$ to show that the images of the standard generators, about which we know only their canonical reduction system, were actually Dehn twists, (up to transvection).

However, this bound $g \leq \frac{n}{2}$ is arbitrary! The result still is interesting and easier to show if we had tried the inequality $g < \frac{n}{2}$ instead. We could have thus avoided some complications like dealing with some “exceptions”. We could have also deduce the description of the endomorphisms of the braid groups from such weakened main result. But we could not have deduced the description of the endomorphisms of the mapping class groups. The bound $g \leq \frac{n}{2}$ is finally a compromise between the strength of the corollaries and the complexity of the proof. For instance, if we had chosen the bound $g \leq \frac{n}{2} + 1$, Section 10 would have been much more complicated, since our topological argument would have failed, and we should have looked for a deeper proof.

It seems to us that the larger bound allowing an reasonable generalization of our main theorem is $g \leq n - 2$. In other words, we ask the following question:

Question: Let n be an integer greater than or equal to 5 and Σ a surface $\Sigma_{g,b}$ where $g \leq n - 2$ and $b \geq 0$. Is it still true that the morphisms from \mathcal{B}_n in $\mathcal{P}\text{Mod}(\Sigma_{g,b})$ are either cyclic, or are transvections of monodromy morphisms ?

Situation when $g \geq n - 1$. The answer is no when $g \geq n - 1$. Indeed, let us consider the following example. Let S be an n -punctured sphere. Let us remove n little disks centered in the punctures. Let us double the surface S . We obtain a closed $(n - 1)$ -genus surface DS . When doubling the surface S , a braid twist on the punctured sphere S becomes a reducible mapping class A in DS whose support T , which is homeomorphic to a torus with two holes, is bounded by two non-separating curves x and y . We have $\sigma(A) = \{x, y\}$ and the restriction of A in $\text{Mod}(T)$ is periodic of order 2 (cf. the example depicted in Figure 97 where T_2 plays the role of T and x_2 and y_2 play the roles of x and y). Consequently, the classic, noncyclic morphism from \mathcal{B}_n in $\text{Mod}(S)$ that sends the standard generators on braid twists permuting punctures induces a morphism from \mathcal{B}_n in DS such that the images of the standard generators are some mapping classes conjugate to A .

For example, with $n = 5$, let Σ be the surface $\Sigma_{4,0}$. According to the above process, we get a morphism from \mathcal{B}_5 in $\text{Mod}(\Sigma)$ such that $\sigma\rho(\tau_i) = \{x_i, y_i\}$ for all $i \leq 4$, where the curves x_i and the curves y_i are drawn in Figure 97.

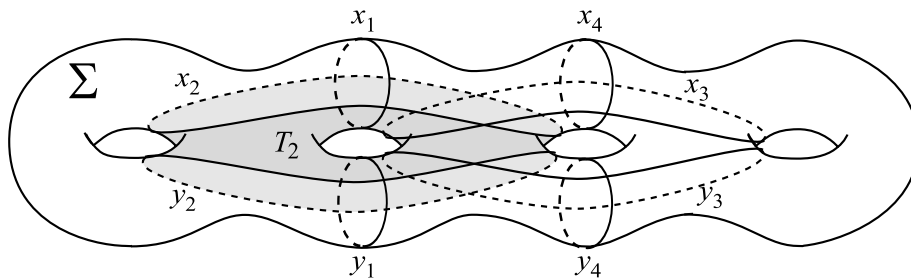

Figure 97: A noncyclic morphism, different from the transvections of monodromy morphisms, from \mathcal{B}_5 in $\text{Mod}(\Sigma_{4,0})$.

15 References

- [ArYo] P. Arnoux, J.-C. Yoccoz. *Construction de difféomorphismes pseudo-Anosov* C. R. Acad. Sci. Paris Sér. I Math. (1) **292** (1981), pp 75 - 78.
- [At1] E. Artin, *Theorie der Zöpfe*, Abhandlungen Hamburg **4** (1925), pp 47 - 72, (JMF 51.0450.01).
- [At2] E. Artin. *Theory of braids*, Annals of Math. (2) **48** (1947), pp 101 - 126.
- [At3] E. Artin, *Braids and permutations*, Annals of Math. (2) **48** (1947), pp 643 - 649.
- [BeMa] R. Bell, D. Margalit, *Braid groups and the co-Hopfian property*, Journal of Algebra **303** (2006), pp 275 - 294.
- [Bi] J. Birman, *Braids, Links and Mapping Class Groups*, Annals of Mathematics Studies, Princeton University Press **82** (1975), Princeton.
- [BiBr] J. Birman, T. Brendel, *Braids: A survey*, in Handbook of Knot Theory (Ed. W. Menasco and T. Thistlethwaite) (2005), Elsevier.
- [BiHi] J. Birman, H. Hilden, *On isotopies of homeomorphisms of Riemann surfaces*, Annals of Math. (2) **97** (1973), pp 424 - 439.
- [BiLuMc] J. Birman, A. Lubotzky, J. McCarthy, *Abelian and Solvable Subgroups of the Mapping Class Group*, Duke Mathematical Journal (4) **50** (1983), pp 1007 - 1020.
- [BlCa] S.A. Bleiler, A.J. Casson, *Automorphisms of surfaces after Nielsen and Thurston*, London Mathematical Society Students Texts **9** (1988), Cambridge University Press, Cambridge.
- [BoPa] C. Bonatti, L. Paris, *Roots in the mapping class groups*, Proc. Lond. Math. Soc. (Third Series) (2) **98** (2009), pp 471 - 503.
- [Bri] E. Brieskorn, *Sur les groupes de tresses*, Séminaire Bourbaki, exposé **401**, Lecture Notes Math. **317** (1971/72), Springer, Berlin Heidelberg New York, pp 1 - 24.
- [Bro] L.E.J. Brouwer, *Über die periodischen Transformationen der Kugel*, Math. Ann. **80** (1919), pp 39 - 41.
- [BrSa] E. Brieskorn, K. Saito, *Artin Gruppen und Coxeter-Gruppen*, Invent. Math. **17** (1972), pp. 245 - 271.
- [CaTu] C. Cassel, V. Turaev, *Braid groups*, Graduate Texts in Mathematics, **247** (2008), Springer, New York.

- [ChCr] R. Charney, J. Crisp, *Automorphism groups of some affine and finite type Artin groups*, Mathematical Research Letters **12** (2005), pp 321 - 333.
- [CrPa1] J. Crisp, L. Paris, *The solution to a conjecture of Tits on subgroups generated by the squares of the generators of an Artin group*, Inventiones mathematicae **145** (2001), pp 19 - 36.
- [CrPa2] J. Crisp, L. Paris, *Artin groups of type B and D*, Advances in Geometry **5** (2005), pp 607 - 636.
- [De1] M. Dehn, *On curve systems on two-sided surfaces, with application to the mapping problem*, Lecture (supplemented) to the math. colloquium, Breslau 11-2-1922, translated in English in [De3], pp 234 - 252.
- [De2] M. Dehn, *Die Gruppe der Abbildungsklassen*, Acta Math. **69**, pp 135 - 206; translated in English in [De3], pp 256 - 362.
- [De3] M. Dehn, *Papers in Group Theory and Topology*, Springer-Verlag, New York (1987), translated from the German and introduced by John Stillwell.
- [DyGr] J.L.Dyer, E.K. Grossman. *The automorphism groups of the braid groups*, Amer. J. Math. (6) **103** (1981), pp 1151 - 1169.
- [Ei] S. Eilenberg, *Sur les transformations périodiques de la surface de sphère*, Fund. Math. **22** (1934), pp 28 - 41.
- [Ep] D.B.A. Epstein, *Curves on 2-manifolds and isotopies*, Acta Math. **115** (1966), pp 83 - 107.
- [Fa] B. Farb, *Problems on Mapping Class Groups and Related Topics*, Proceedings of Symposia in Pure Mathematics **74** (2006), American Mathematical Society, AMS Bookstore.
- [FaMa] B. Farb, D. Margalit *A Primer on Mapping Class Group*, version 3.1 (June 2009) is available on the web page: <http://www.math.uchicago.edu/~margalit/mcg/mcgv31.pdf>
- [FdNe] E. Fadell, L. Neuwirth, *Configuration spaces*, Math. Scand. **10** (1962), pp 111 - 118.
- [FLP] A. Fathi, F. Laudenbach, V. Poénaru, *Travaux de Thurston sur les surfaces*, Séminaire Orsay, Astérisque **66** et **67** (1979), Société Mathématique de France, Paris.
- [Hi] Morris W. Hirsch, *Differential topology*, Graduate texts in Mathematics **33** (1976), Springer-Verlag, New York Inc.
- [Hv1] W.J. Harvey, *Geometric structure of surface mapping class groups*, Homological group theory (Proc. Durham, 1977), London Math.Soc. Lecture Note Ser. **36** (1979), pp 255 - 269, Cambridge Univ. Press, Cambridge New York.

- [Hv2] W.J. Harvey, *Boundary structure of the modular group*, in *Riemann surfaces and related topics: Proceedings of the 1978 Stony Brook Conference*, edited by I. Kra and B. Maskit, Annals of Math. Studies **97** (1981), Princeton University Press, pp 245 - 251.
- [HtTh] A. Hatcher, W. Thurston, *A presentation for the mapping class group of a closed orientable surface*, Topology (3) **19** (1980), pp 221 - 237.
- [Iv1] N.V. Ivanov, *Subgroups of Teichmüller Modular Groups*, translated from the Russian by E.J.F. Primrose, Translations of Mathematical Monographs **115** (1992), American Mathematical Society, Providence, RI.
- [Iv2] N.V. Ivanov, *Automorphisms of complexes of curves and of Teichmüller Spaces*, Math. Res. Notices **14** (1997), pp 651 - 666; also in: *Progress in knot theory and related topics*, Travaux en cours **56** (1997), Hermann, Paris, pp 113 - 120.
- [IvMc] N.V. Ivanov, J. McCarthy, *On injective homomorphisms between Teichmüller Modular Groups I*, Inventiones mathematicae **135** (1999), pp 425 - 486, Springer-Verlag.
- [J] D. Johnson, *The structure of Torelli group I: A finite set of generators for \mathcal{I}* , Annals of Mathematics **118** (1983), pp 423 - 442.
- [Ke1] S.P. Kerckhoff, *The Nielsen realisation problem*, Bull. AMS (3) **2** (1980), pp 452 - 454.
- [Ke2] S.P. Kerckhoff, *The Nielsen realisation problem*, Ann. of math. (2), **117** (1983), pp 235 - 265.
- [Kj] B. de Kerékjártó. *Über die periodischen Transformationen der Kreisscheibe und der Kugelfläche*, Math. Annalen **80** (1919), pp 3 - 7.
- [Ko1] M. Korkmaz, *Automorphisms of complexes of curves on punctured spheres and on punctured tori*, Topology and its Applications (2) **95** (1999), pp 85 - 111.
- [Ko2] M. Korkmaz, *Low-dimensional homology groups of mapping class groups: a survey*, Turkish Journal of Mathematics (1) **26**, (2002).
- [LaPa] C. Labruère, L. Paris, *Presentations for the punctured mapping class groups in terms of Artin groups*, Algebr. Geom. Topol. **1** (2001), pp 73 - 114.
- [Le] H. Van der Leek, *The Homotopy Type of Complex Hyperplane Complements*, Ph.D. Thesis, Utrecht (1994).
- [Lk] W.B.R. Lickorish, *A finite set of generators for the homeotopy group of a 2-manifold*, Proc. Cambridge Philos. Soc., **60** (1964), pp 769 - 778.
- [Ln1] V. Lin, *Artin braids and the groups and spaces connected with them*, Plenum Publishing Corporation (1982), pp 736 - 788.

- [Ln2] V. Lin, *Braids and Permutations*, arXiv:math.GR/0404528 v1, 29 Apr 2004.
- [Lu] F. Luo, *Automorphisms of complexes of curves*, *Topology* (2) **39** (2000), pp 283 - 298.
- [Mc1] J.D. McCarthy, *Automorphisms of surface mapping class groups. A recent theorem of N. Ivanov*, *Invent. Math.* **84** (1986), pp 49 - 71.
- [Mc2] J.D. McCarthy, *Normalizers and Centralizers of pseudo-Anosov mapping classes*, Preprint, 1982 (This constitutes a part of the author's Ph. D thesis in Columbia University).
- [McPp] J.D. McCarthy, A. Papadopoulos *Automorphisms of the complex of domains*, preprint, Max-Plank Institut, Bonn (2006).
- [Ni1] J. Nielsen, *Untersuchungen zur Theorie der geschlossenen zweiseitigen Flächen I*, *Acta Math.* **50** (1927), pp 189 - 358.
- [Ni2] J. Nielsen, *Untersuchungen zur Theorie der geschlossenen zweiseitigen Flächen II*, *Acta Math.* **53** (1929), pp 1 - 76.
- [Ni3] J. Nielsen, *Untersuchungen zur Theorie der geschlossenen zweiseitigen Flächen III*, *Acta Math.* V. **58** (1932), pp 87 - 167.
- [Ni] J. Nielsen, *Abbildungsklassen endlicher Ordnung*, [J] *Acta Math.* **73** (1942), pp. 23 - 115, [ISSN 0001-5962].
- [Pa] L. Paris, *From braid groups to mapping class groups*, *Proceedings of Symposia in Pure Mathematics* **74** (2006), Amer. Math. Soc., Providence, RI, pp 355 - 371
- [PaRo] L. Paris, D. Rolfsen, *Geometric subgroups of mapping class groups*, *Journal für die reine und angewandte Mathematik* **521** (2000), pp 47 - 83, Walter de Gruyter, Berlin - New York.
- [PeV] B. Perron, J.P. Vannier, *Groupe de monodromie géométrique des singularités simples*, *Mathematische Annalen* **306** (1996), pp 231 - 245, Springer-Verlag.
- [Ro] D. Rolfsen, *Knots and links*, Publish or Perish, Berkeley 1976.
- [Se] V. Sergiescu, *Graphes planaires et présentations des groupes de tresses*, *Mathematische Zeitschrift*, vol. **214** (1993), pp 477 - 490, Springer-Verlag.
- [Th] W.P. Thurston, *On the geometry and dynamics of surfaces.*, *Bull. Amer. Math. Soc. (N.S.)* (2) **19** (1988), pp 417 - 431.
- [Ti] J. Tits, *Normalisateurs de tores. I. Groupes de Coxeter étendus*, *J. Algebra* vol **4** (1966), pp 96 - 116.