

Thèse de doctorat

Soutenue publiquement le 26 novembre 2010

Etude de la conduction électrique dans les diélectriques à forte permittivité utilisés en microélectronique

Jean Coignus

Directeur de thèse :
M. Raphaël CLERC
IMEP-LAHC

Co-encadrant :
M. Charles LEROUX
CEA-LETI Minatec

Fundamental limits of SiO₂ thickness downscaling

- Conventional bulk MOSFET scaling

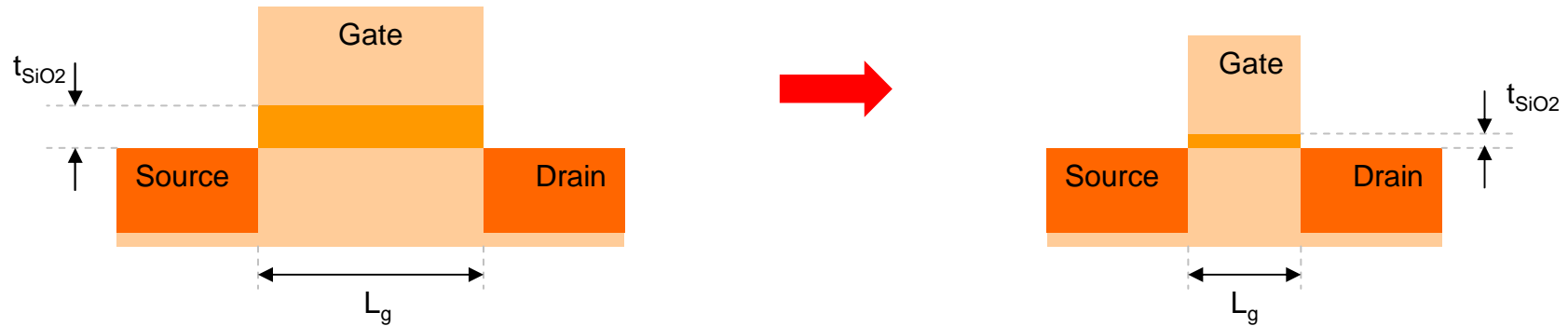

Fundamental limits of SiO₂ thickness downscaling

- Conventional bulk MOSFET scaling

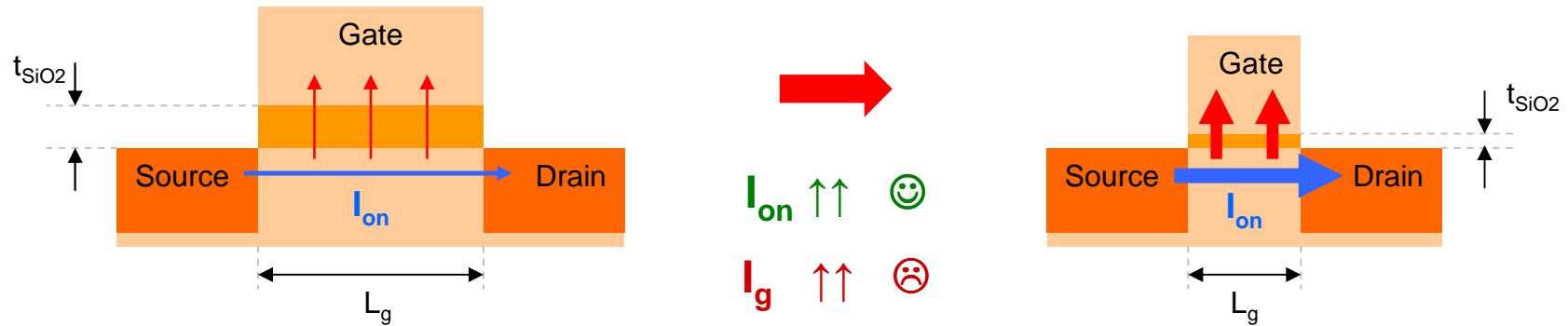

Fundamental limits of SiO₂ thickness downscaling

- Conventional bulk MOSFET scaling

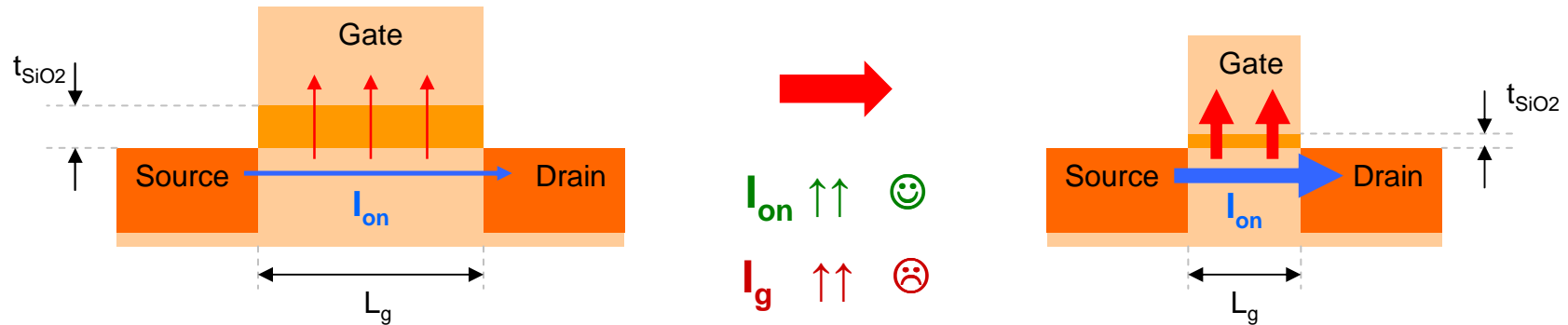

- High-k dielectrics : mandatory for HP 45nm node and beyond

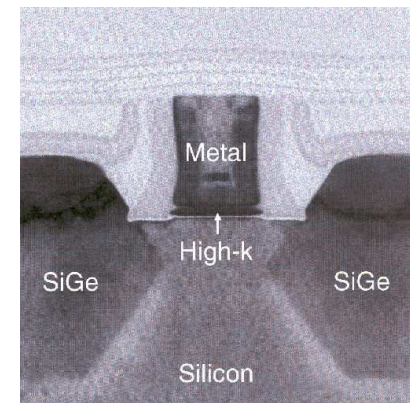

© Intel corp. '07

Fundamental limits of SiO₂ thickness downscaling

- Conventional bulk MOSFET scaling

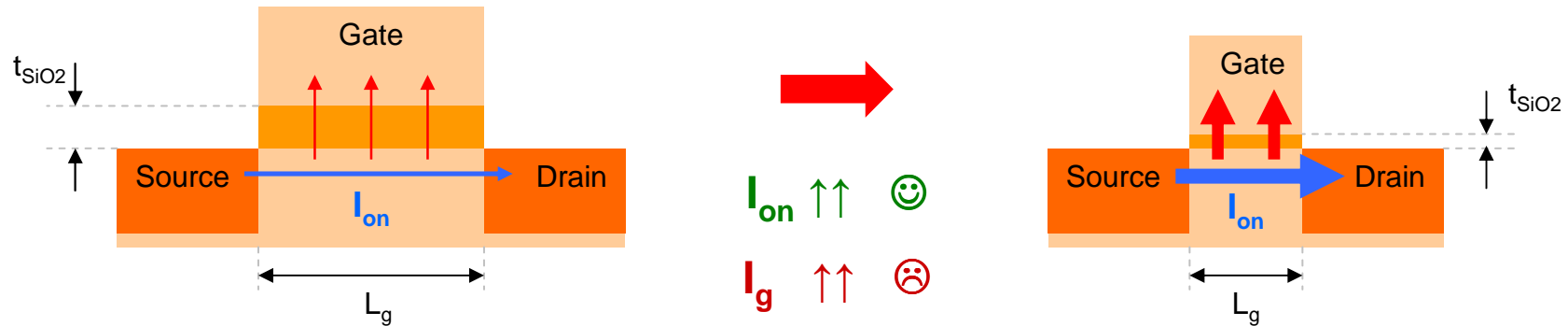

- High-k dielectrics : mandatory for HP 45nm node and beyond

Basics :
higher permittivity = higher t_{phys} @ constant C_{ox}

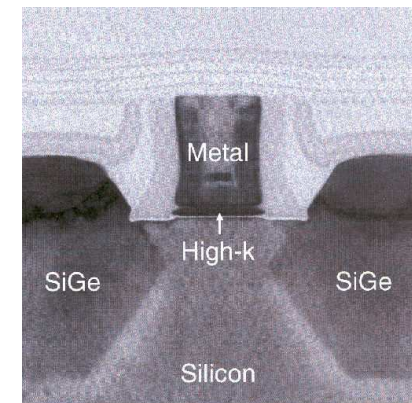
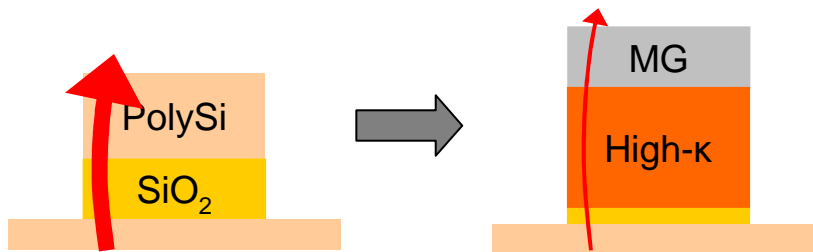

© Intel corp. '07

High- κ dielectrics integration

- What about effective leakage reduction ?

High-k dielectrics integration

- What about effective leakage reduction ?

- **Dielectric parameters**

I_g strongly correlated to m / Φ : high-k dielectrics appear more conductive

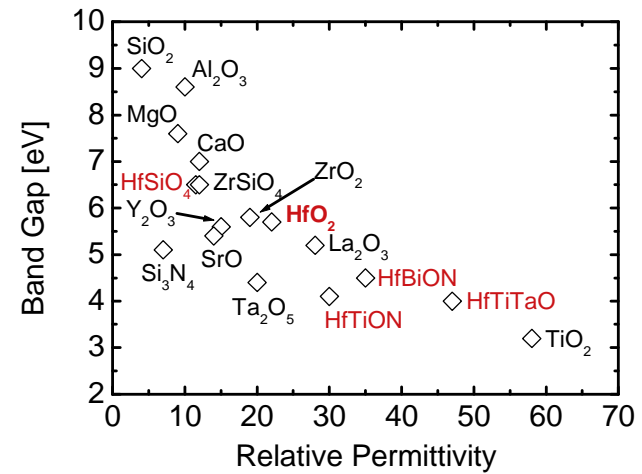
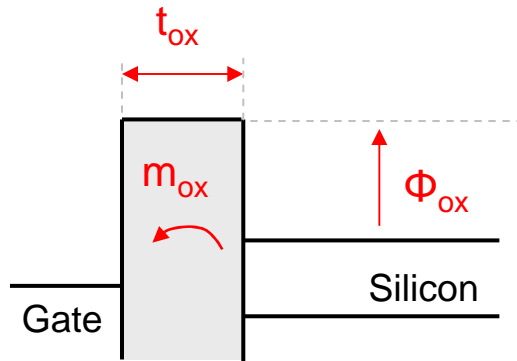

Huang VLSI '09

High-k dielectrics integration

- What about effective leakage reduction ?

- **Dielectric parameters**

I_g strongly correlated to m / Φ : high-k dielectrics appear more conductive

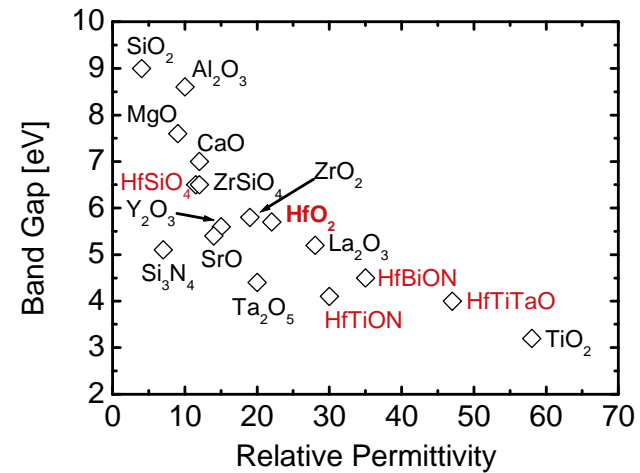
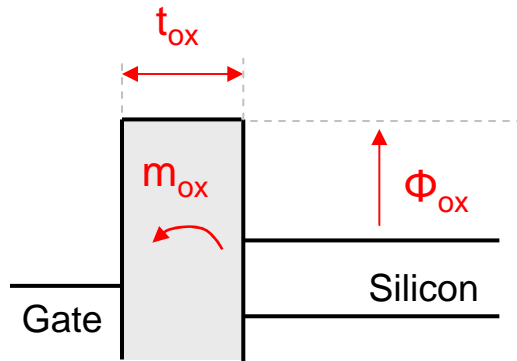

Huang VLSI '09

- **Transport mechanisms**

SiO₂ → Direct Tunneling

high-k → Presence of Trap-Assisted mechanisms ?

High-k dielectrics integration

- What about effective leakage reduction ?

- **Dielectric parameters**

I_g strongly correlated to m / Φ : high-k dielectrics appear more conductive

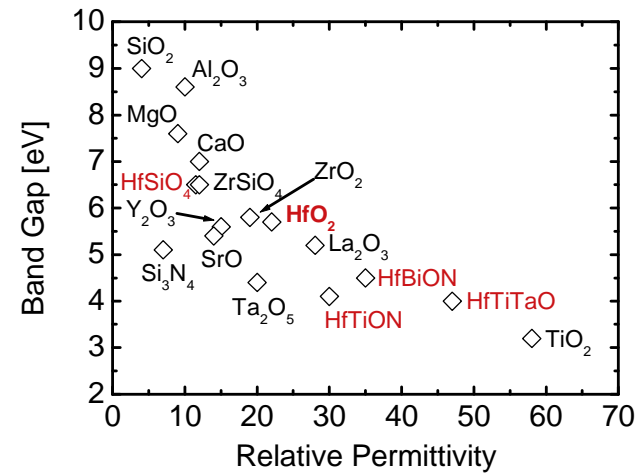
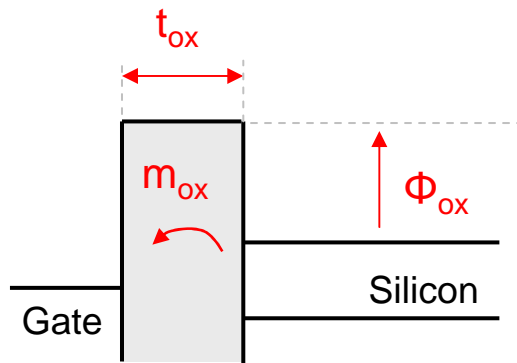

Huang VLSI '09

- **Transport mechanisms**

SiO₂ → Direct Tunneling

high-k → Presence of Trap-Assisted mechanisms ?

- **Integration limitations (HfO₂ case) : presence of an Interfacial Layer**

State of the art

- Gate leakage current modeling has already been studied

[Lo EDL '97, Li TED '06, Palestri TED '07...]

State of the art

- Gate leakage current modeling has already been studied

[Lo EDL '97, Li TED '06, Palestri TED '07...]

- However, this topic remains controversial

- I_g @300K

- Direct Tunneling ?

[Hou EDL '03, Govoreanu SSE '04]

- Additional transport mechanisms ?

[Xu APL 2002, Blank JAP 2005, Houssa JAP 2000]

- Interfacial Layer may differ from pure SiO_2

[Damlencourt SSE '03]

- Effective Mass Approximation in high- κ ?

[Sacconi TED '09]

State of the art

- Gate leakage current modeling has already been studied

[Lo EDL '97, Li TED '06, Palestri TED '07...]

- However, this topic remains controversial

– I_g @300K

- Direct Tunneling ?

[Hou EDL '03, Govoreanu SSE '04]

- Additional transport mechanisms ?

[Xu APL 2002, Blank JAP 2005, Houssa JAP 2000]

– Interfacial Layer may differ from pure SiO_2

[Damlencourt SSE '03]

– Effective Mass Approximation in high- κ ?

[Sacconi TED '09]

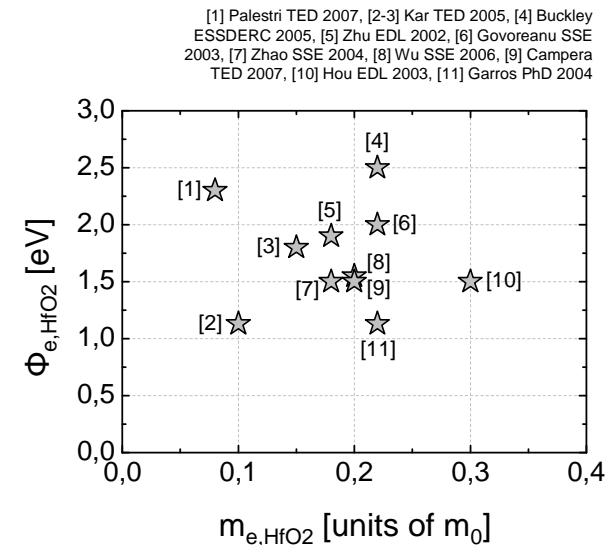

→ Lack of complete experimental studies

State of the art

- Gate leakage current modeling has already been studied

[Lo EDL '97, Li TED '06, Palestri TED '07...]

- However, this topic remains controversial

– I_g @300K

- Direct Tunneling ?

[Hou EDL '03, Govoreanu SSE '04]

- Additional transport mechanisms ?

[Xu APL 2002, Blank JAP 2005, Houssa JAP 2000]

– Interfacial Layer may differ from pure SiO_2

[Damlencourt SSE '03]

– Effective Mass Approximation in high- κ ?

[Sacconi TED '09]

Aim of this work :

Re-investigate transport mechanisms in high- κ gate stacks by mean of a complete experimental study performed :

- at low temperature (transport mechanisms)
- on various HKGS showing thickness variants (IL nature investigation, EMA validity)

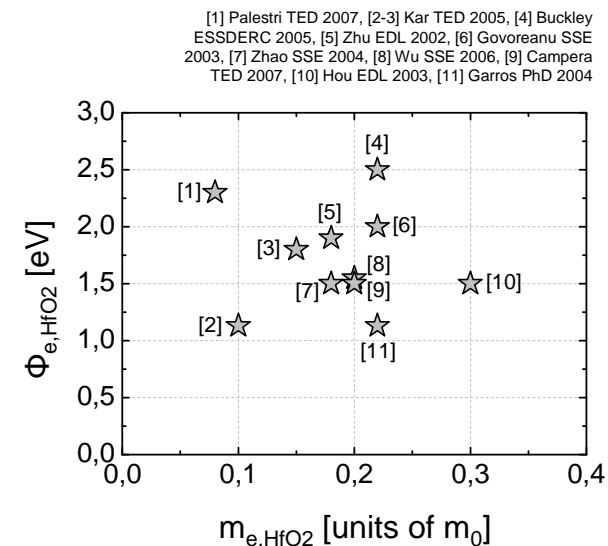

Outline

- **Tunneling current modeling**
 - Self-consistent Poisson-Schrödinger simulation
 - Transmission probability
- **Experimental investigation of leakage current in HfO₂ gate stacks**
 - Transport mechanisms
 - Dielectric thicknesses extraction
 - Tunneling parameters extraction
 - Dipole effect in Mg-capped HfO₂ gate stacks
- **Conclusions**

Outline

- **Tunneling current modeling**
 - Self-consistent Poisson-Schrödinger simulation
 - Transmission probability
- **Experimental investigation of leakage current in HfO₂ gate stacks**
 - Transport mechanisms
 - Dielectric thicknesses extraction
 - Tunneling parameters extraction
 - Dipole effect in Mg-capped HfO₂ gate stacks
- **Conclusions**

Tunneling current modeling

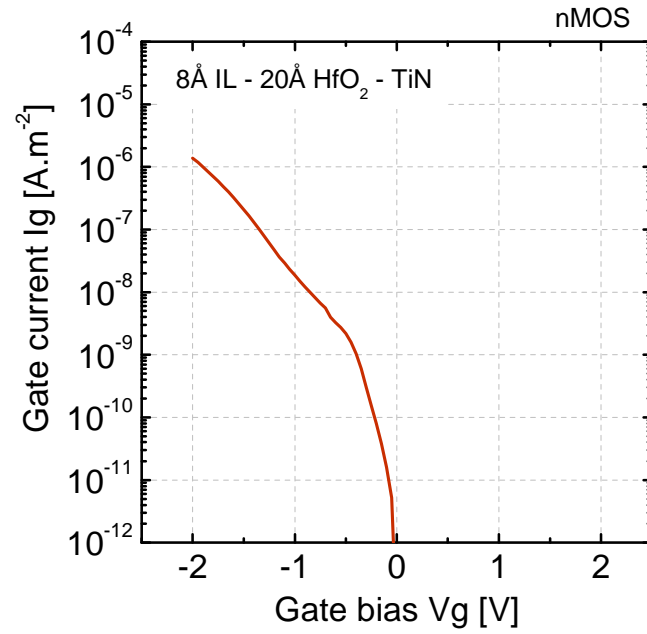
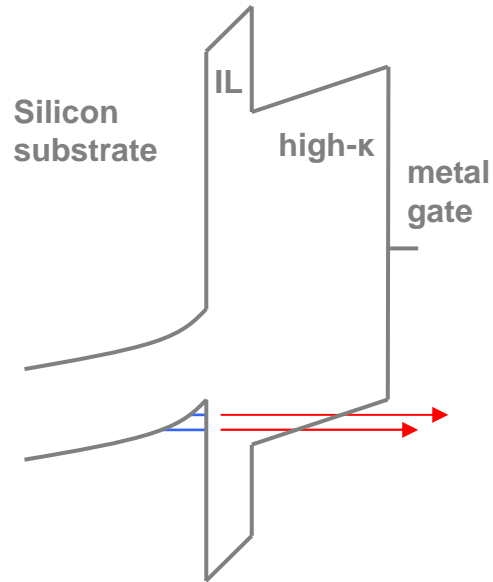

Tunneling current modeling

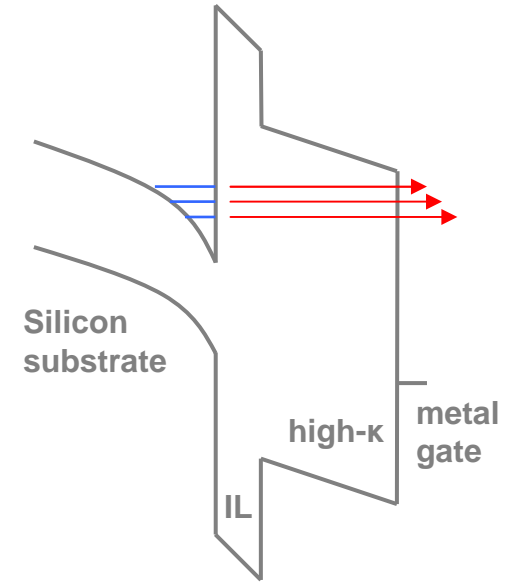
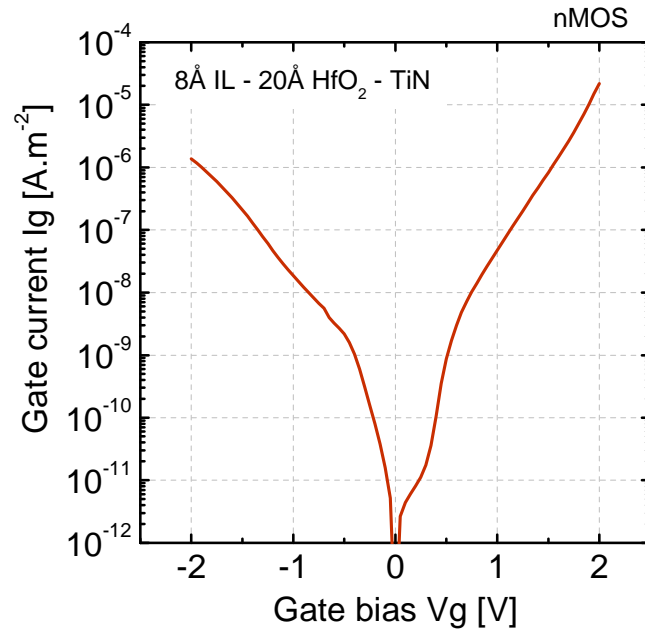
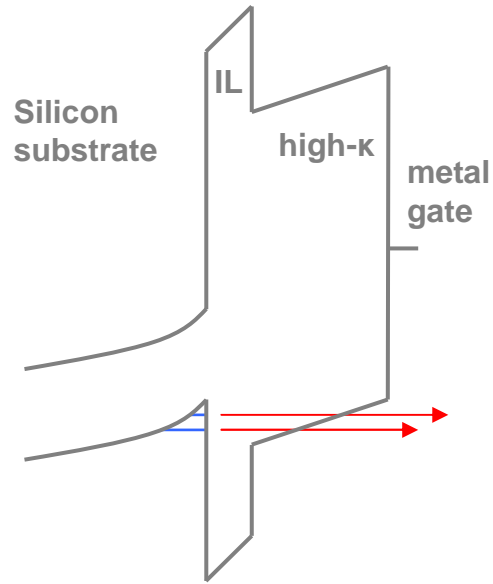

Tunneling current modeling

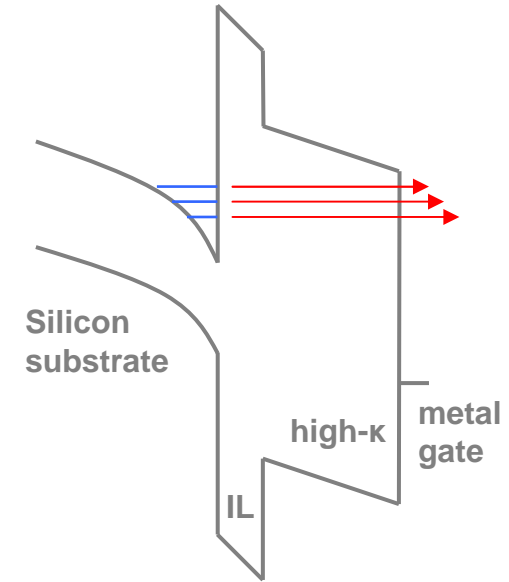
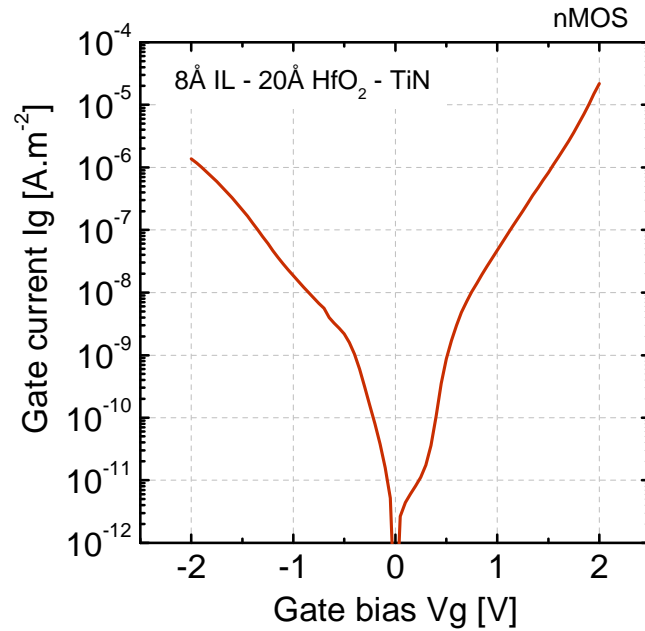
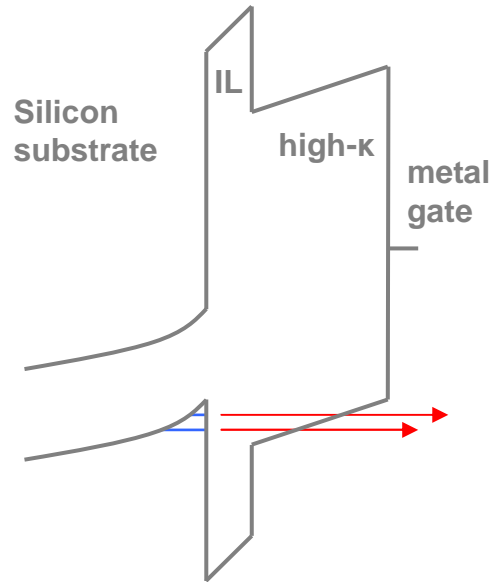

- Tunneling current from 2D gas :
$$I_g = \sum_i Q_i(E_i) \cdot f_i(E_i) \cdot T_i(E_i)$$

Tunneling current modeling

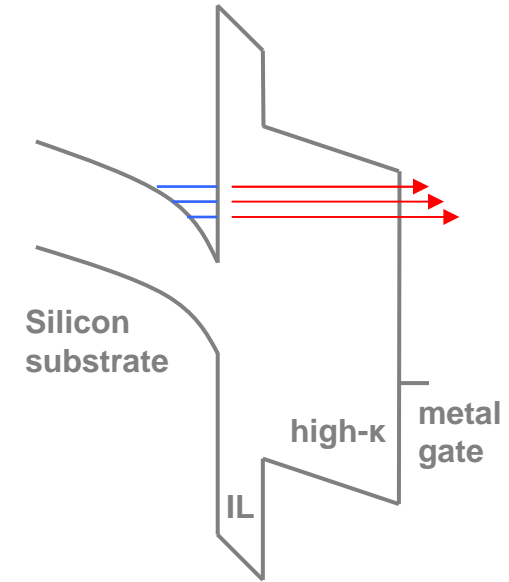
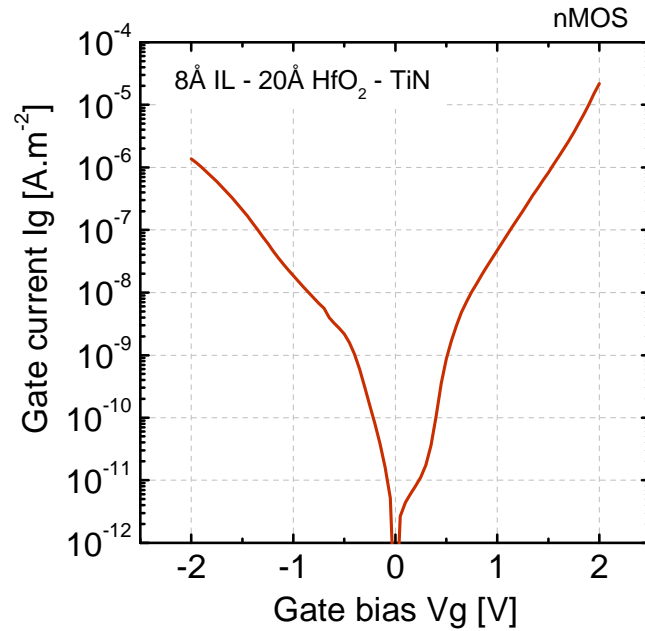
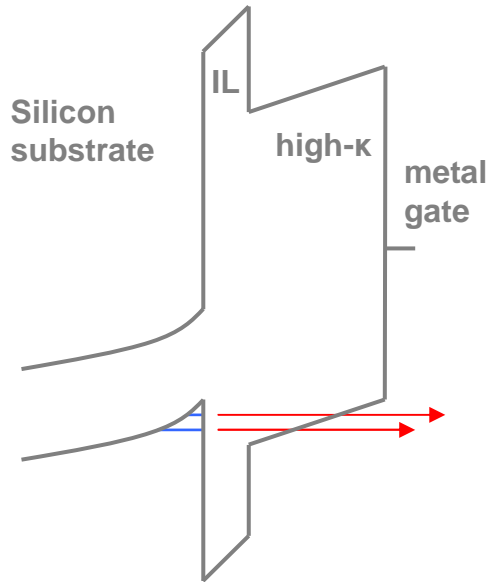

- Tunneling current from 2D gas : $I_g = \sum_i Q_i(E_i) \cdot f_i(E_i) \cdot T_i(E_i)$
- 1. $Q_i(V_g)$ and $E_i(V_g)$: Poisson-Schrödinger simulation

Tunneling current modeling

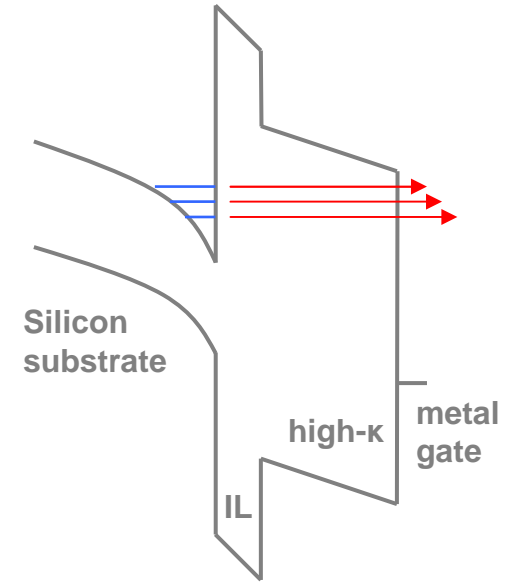
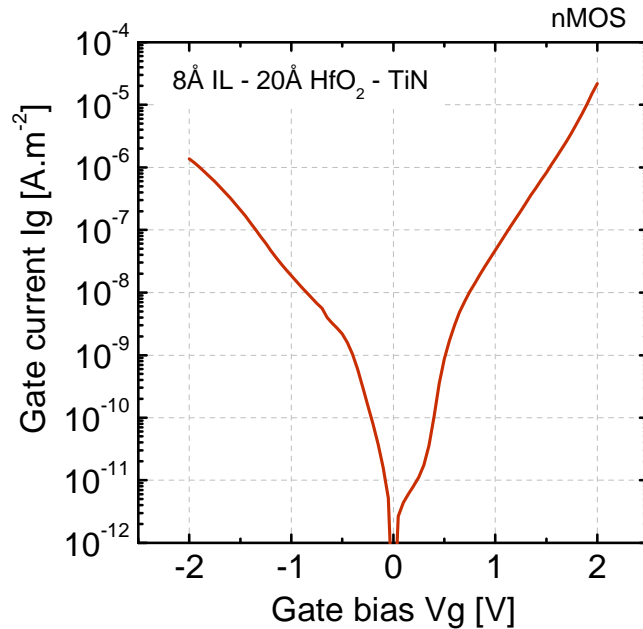
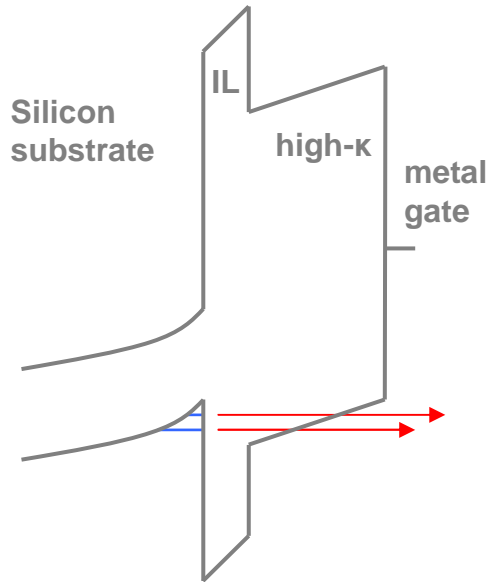

- Tunneling current from 2D gas : $I_g = \sum_i Q_i(E_i) \cdot f_i(E_i) \cdot T_i(E_i)$
 1. $Q_i(V_g)$ and $E_i(V_g)$: Poisson-Schrödinger simulation
 2. $T_i(E_i)$: transmission probability modeling
 $= \text{fct} (m_{IL} / \Phi_{IL} / m_{high-k} / \Phi_{high-k})$

Outline

- **Tunneling current modeling**
 - Self-consistent Poisson-Schrödinger simulation
 - Transmission probability
- **Experimental investigation of leakage current in HfO₂ gate stacks**
 - Transport mechanisms
 - Dielectric thicknesses extraction
 - Tunneling parameters extraction
 - Dipole effect in Mg-capped HfO₂ gate stacks
- **Conclusions**

Poisson-Schrödinger simulation

- Principle

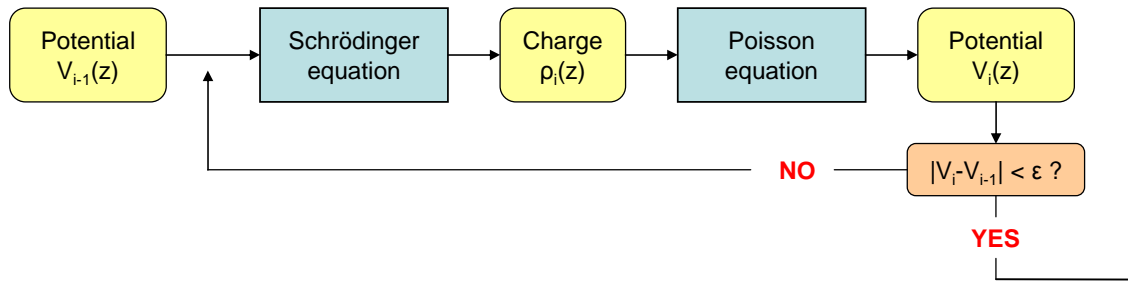

eg. : nMOS, 0.8nm IL – 2nm HfO₂ @Vg = 3V

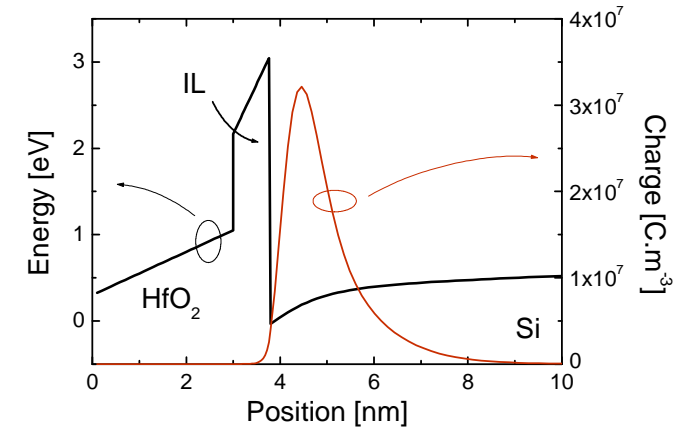

Poisson-Schrödinger simulation

- Principle

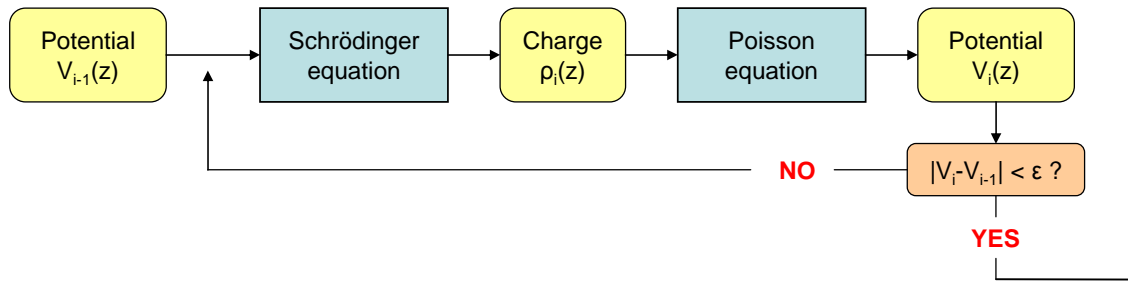

- Dedicated to...

- ... gate current modeling

eg. : nMOS, 0.8nm IL – 2nm HfO₂ @V_g = 3V

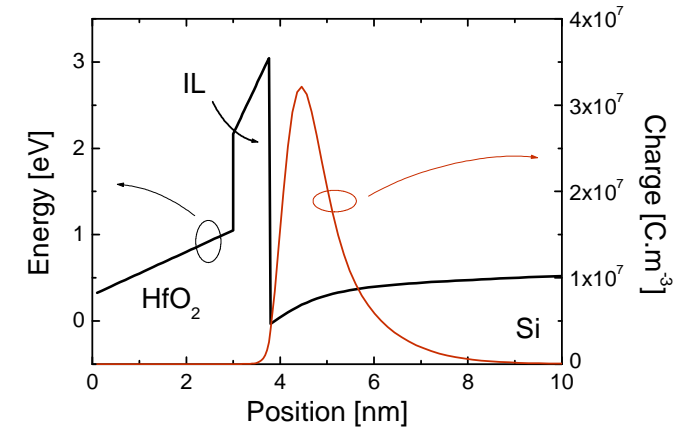

Poisson-Schrödinger simulation

- Principle

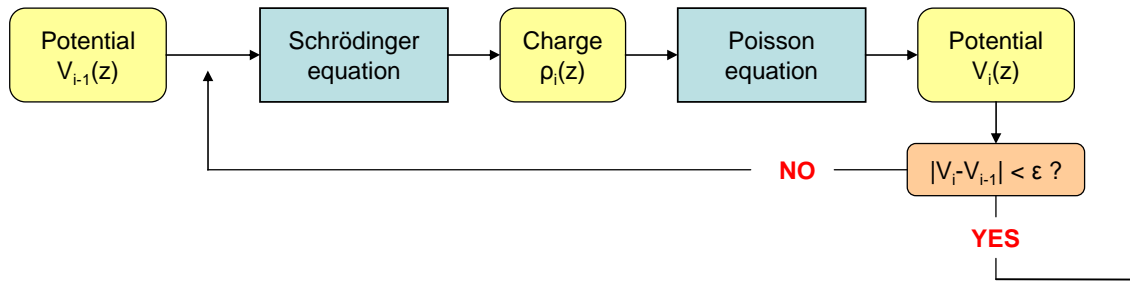

eg. : nMOS, 0.8nm IL – 2nm HfO₂ @V_g = 3V

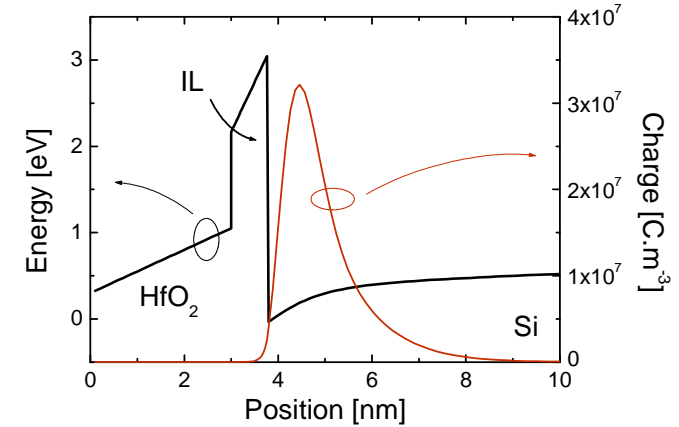

- Dedicated to...

- ... gate current modeling
- ... parameter extraction from C(V_g) measurements

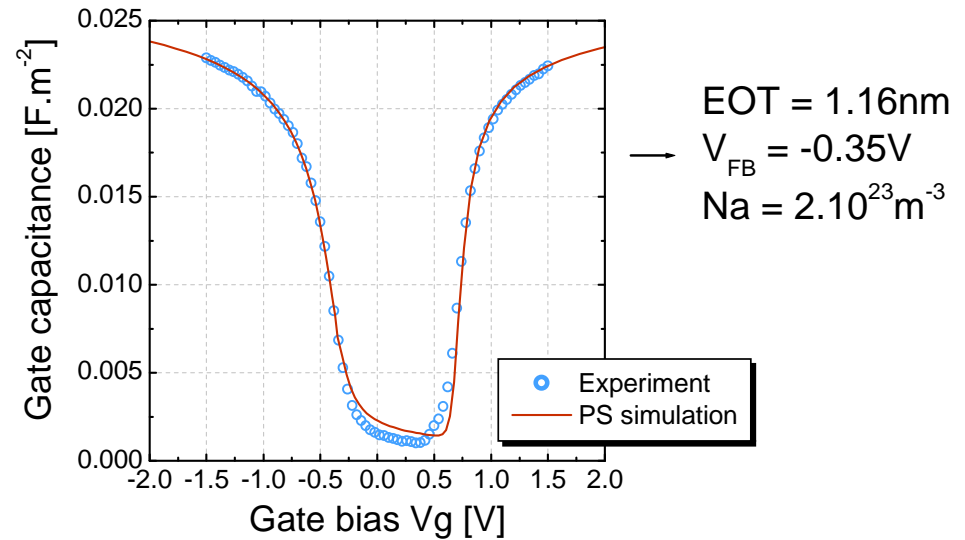

Poisson-Schrödinger simulation

- Main features
 - 1D simulation with closed boundaries

Poisson-Schrödinger simulation

- Main features
 - 1D simulation with closed boundaries
 - Simulation of dielectrics + whole substrate

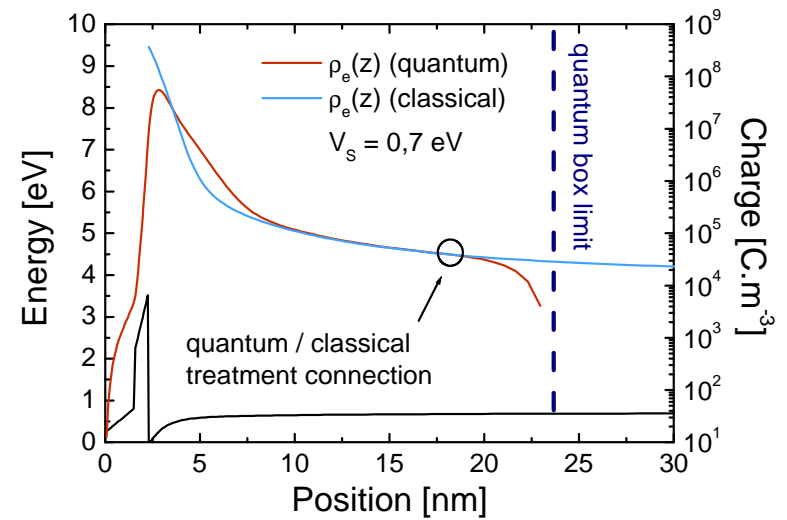
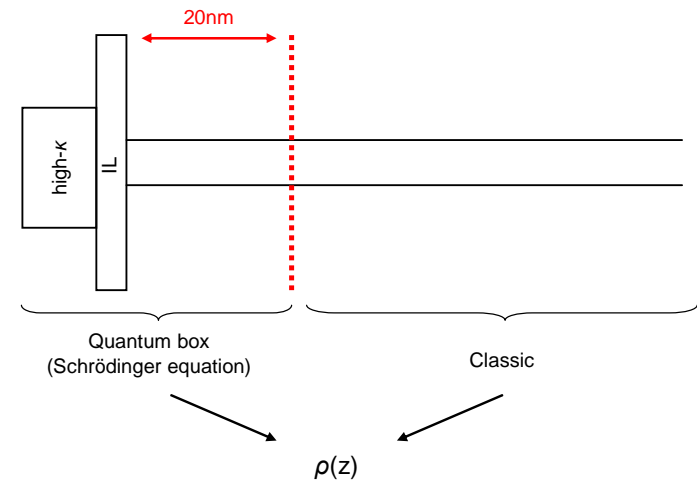

Poisson-Schrödinger simulation

- Main features
 - 1D simulation with closed boundaries
 - Simulation of dielectrics + whole substrate
 - Newton-Raphson convergence procedure

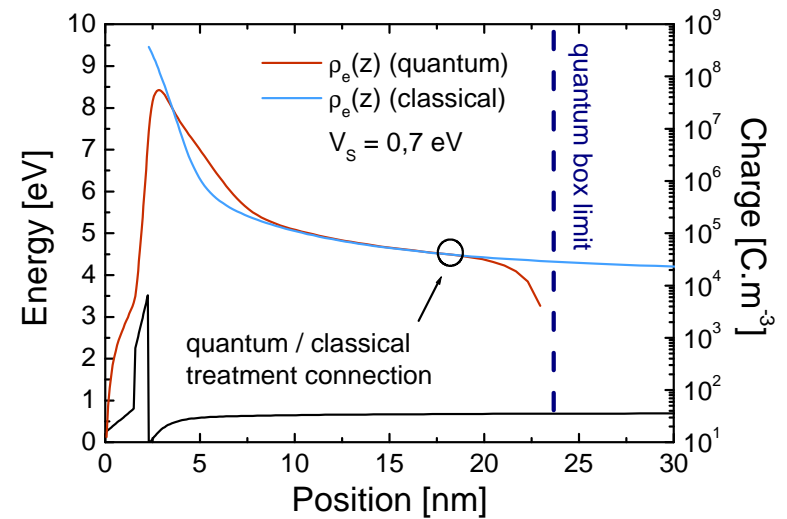
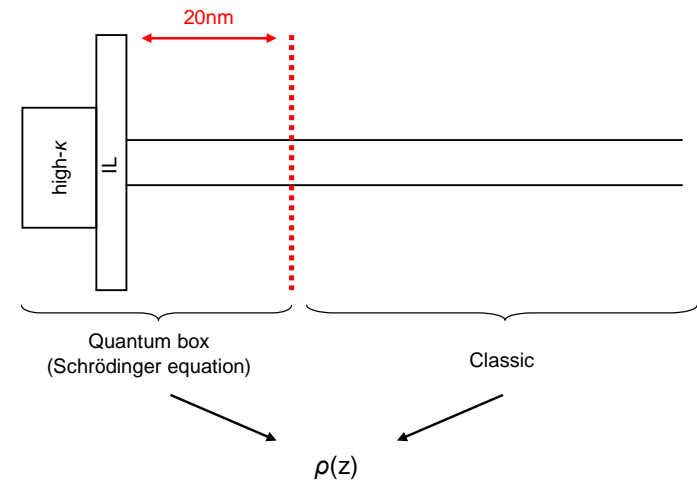

Poisson-Schrödinger simulation

- Main features

- 1D simulation with closed boundaries
- Simulation of dielectrics + whole substrate
- Newton-Raphson convergence procedure
- Non-uniform mesh

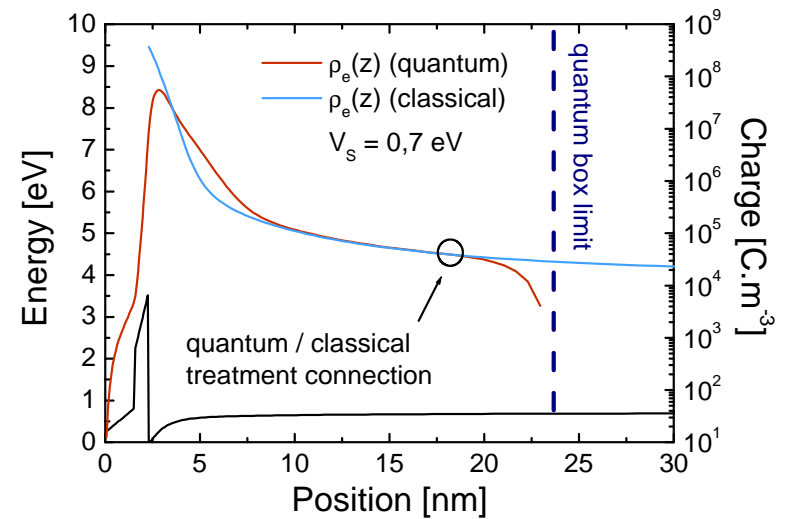
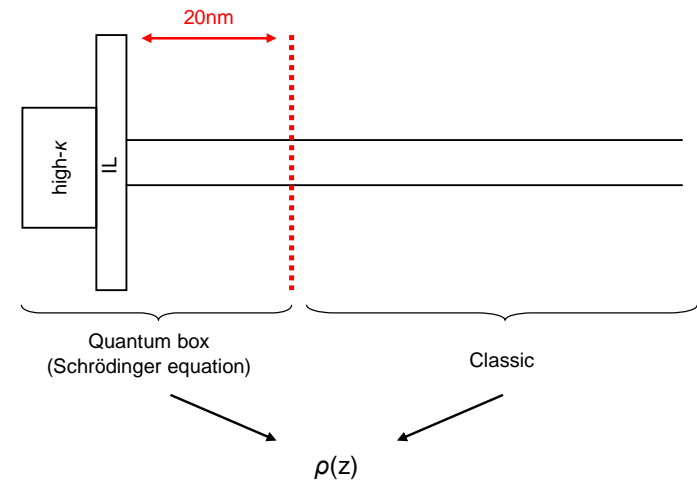

Poisson-Schrödinger simulation

- Main features
 - 1D simulation with closed boundaries
 - Simulation of dielectrics + whole substrate
 - Newton-Raphson convergence procedure
 - Non-uniform mesh
 - Electrons + holes both considered

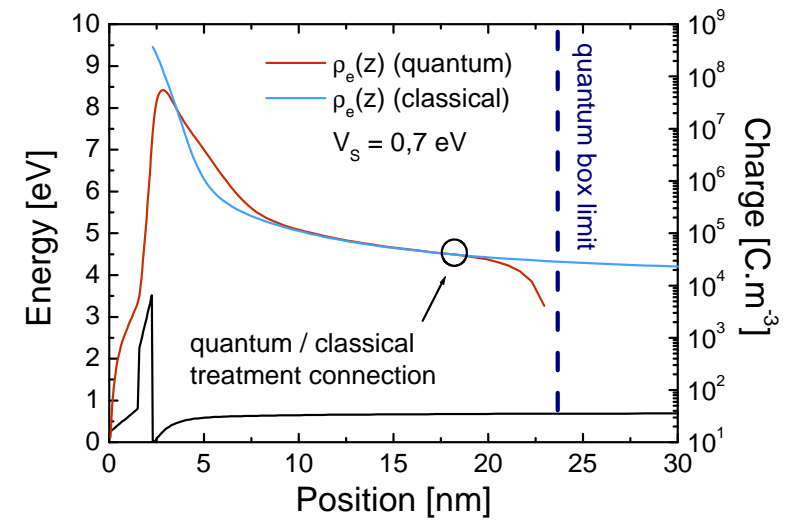
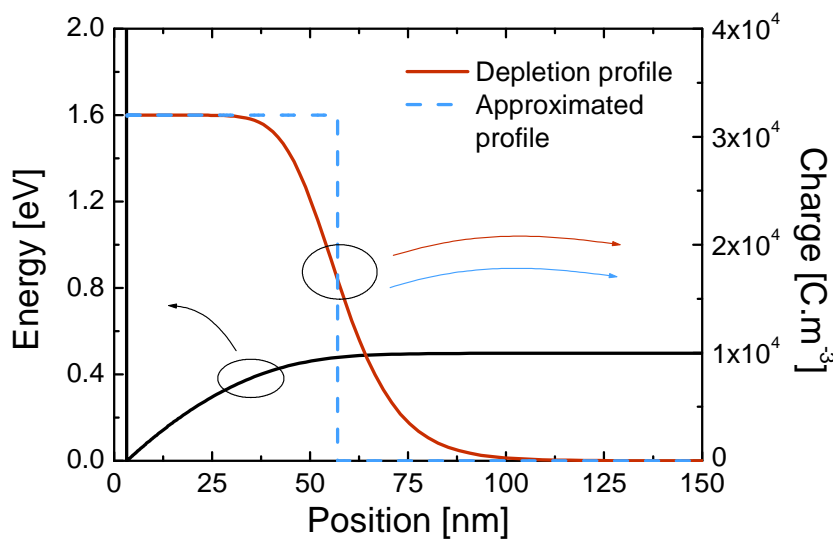
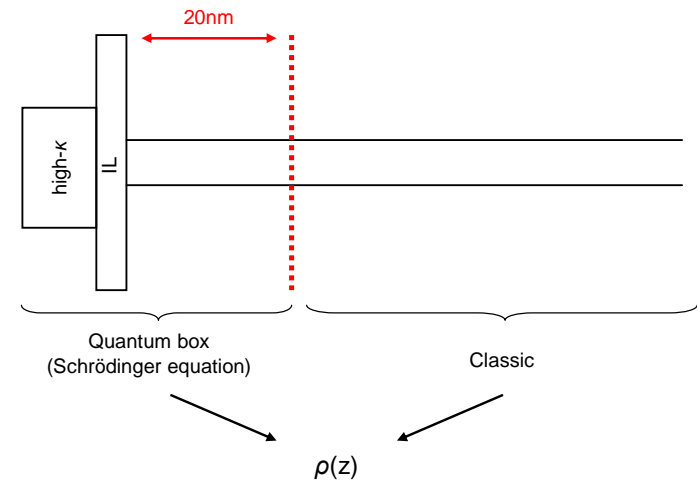

Poisson-Schrödinger simulation : WFP

- Conventional PS resolution : simulation of Silicon substrate only

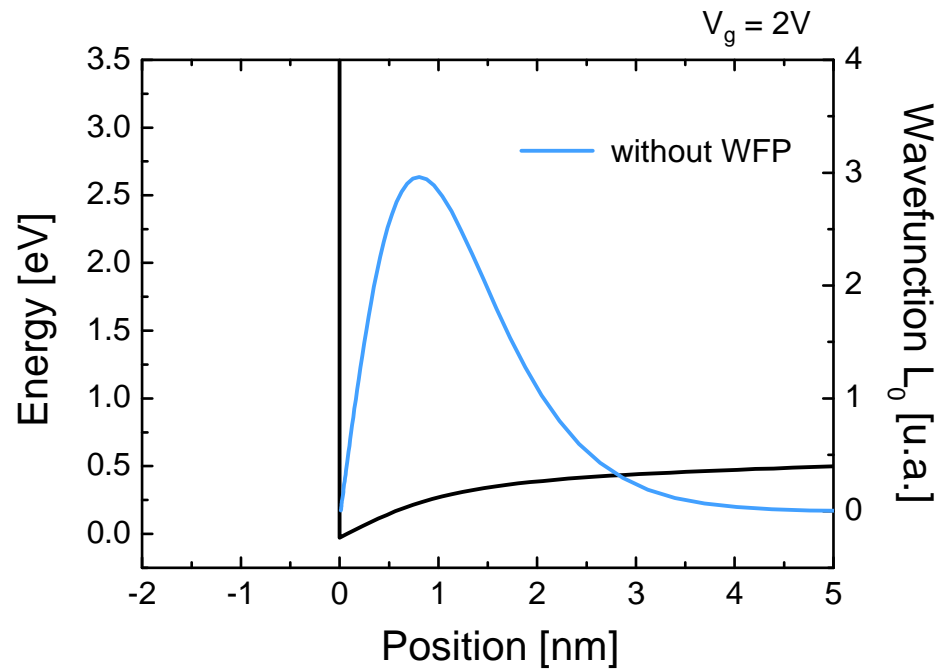

Poisson-Schrödinger simulation : WFP

- Conventional PS resolution : simulation of Silicon substrate only
- **This work : Silicon substrate + gate dielectrics both included**

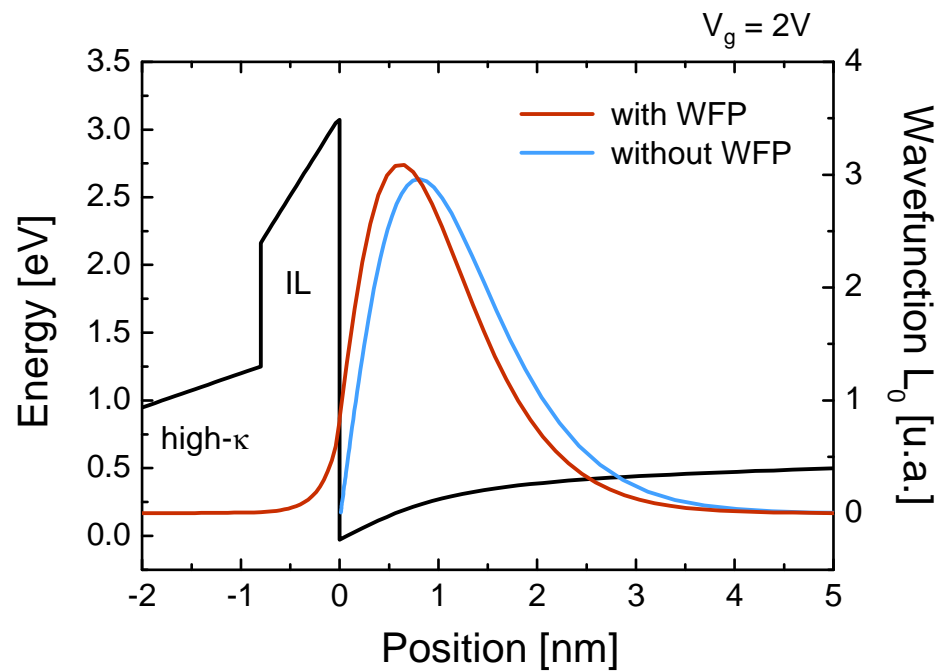

Poisson-Schrödinger simulation : WFP

- Conventional PS resolution : simulation of Silicon substrate only
- This work : Silicon substrate + gate dielectrics both included

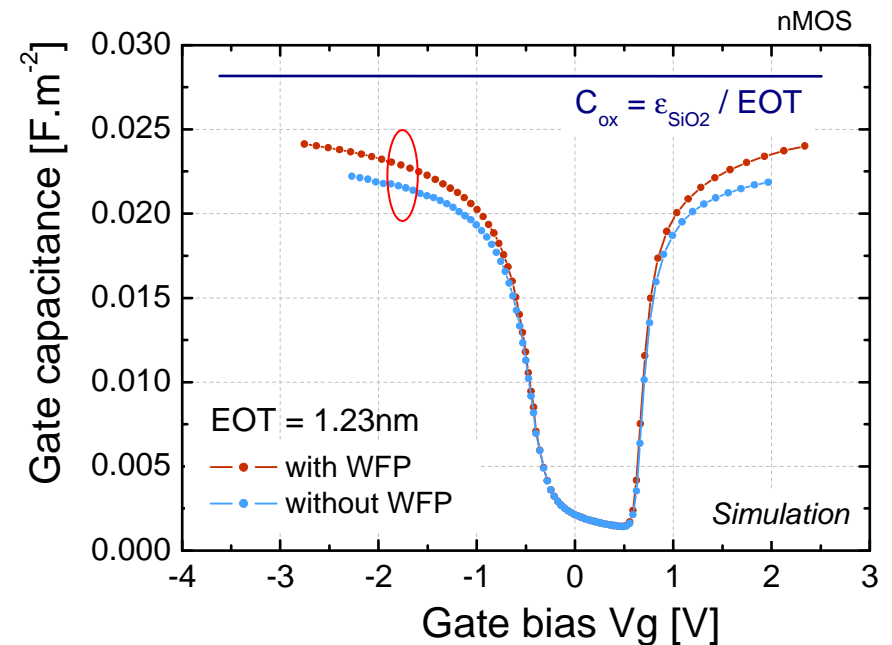
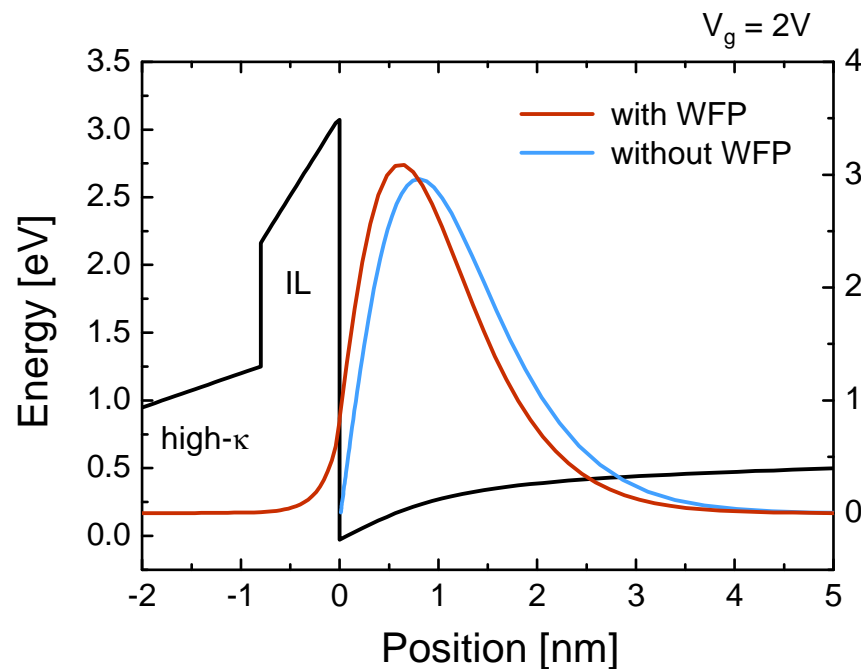

➔ Without WFP : 1Å error in EOT extraction

Poisson-Schrödinger simulation : VB description

- Conduction band description : **Effective Mass Approximation OK**

Poisson-Schrödinger simulation : VB description

- Conduction band description : **Effective Mass Approximation OK**
- Holes description : **bands centered around $k=0$**
 - degeneracy
 - anisotropy
 - non-parabolicity

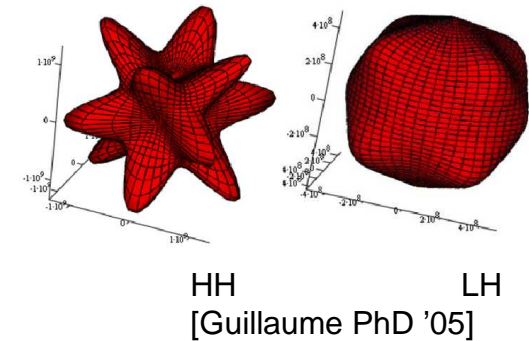
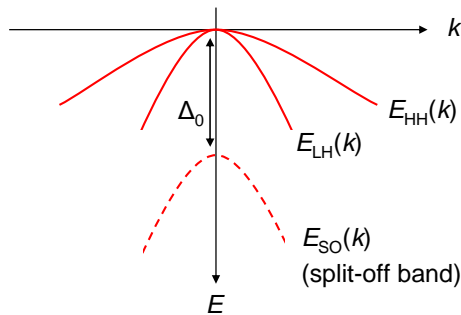

Poisson-Schrödinger simulation : VB description

- Conduction band description : **Effective Mass Approximation OK**
- Holes description : **bands centered around $k=0$**

- degeneracy
- anisotropy
- non-parabolicity

→ VB non-parabolicity
integrated in PS simulation

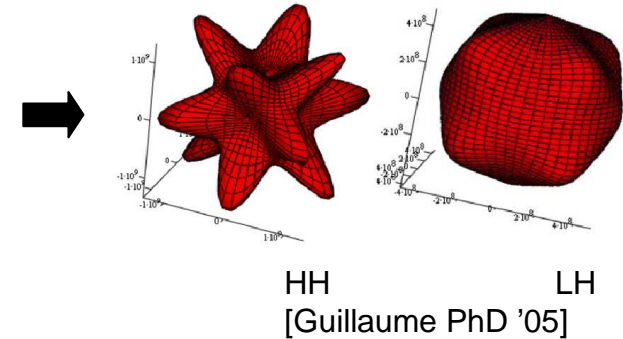
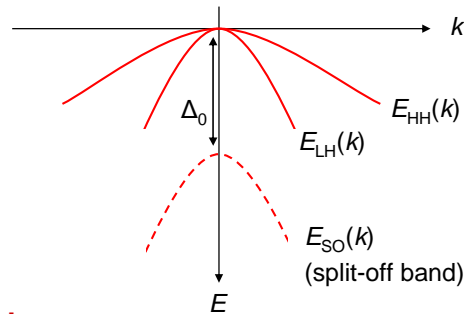

Poisson-Schrödinger simulation : VB description

- Conduction band description : **Effective Mass Approximation OK**
- Holes description : **bands centered around $k=0$**

- degeneracy
- anisotropy
- non-parabolicity

→ **VB non-parabolicity integrated in PS simulation**

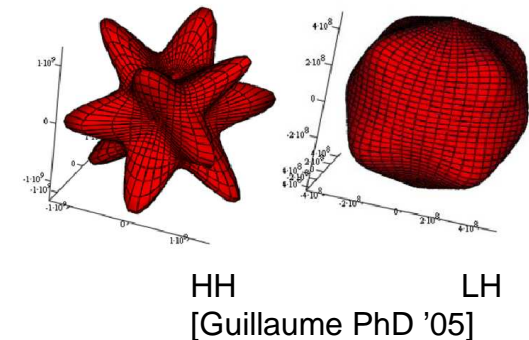
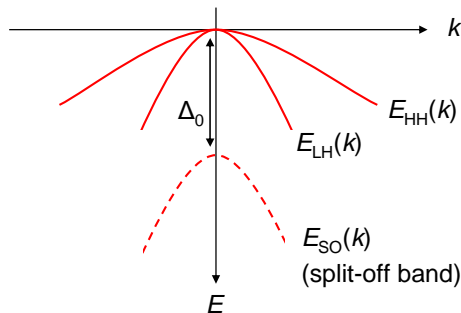

- Main idea: advanced 2D-holes description using analytical E-k fitted on 6x6 k.p results

[DeMichielis et al., IEEE TED **54**, 2008]

→ Analytical 2D-holes Density-of-States

Poisson-Schrödinger simulation : VB description

- Impact on EOT extraction ?

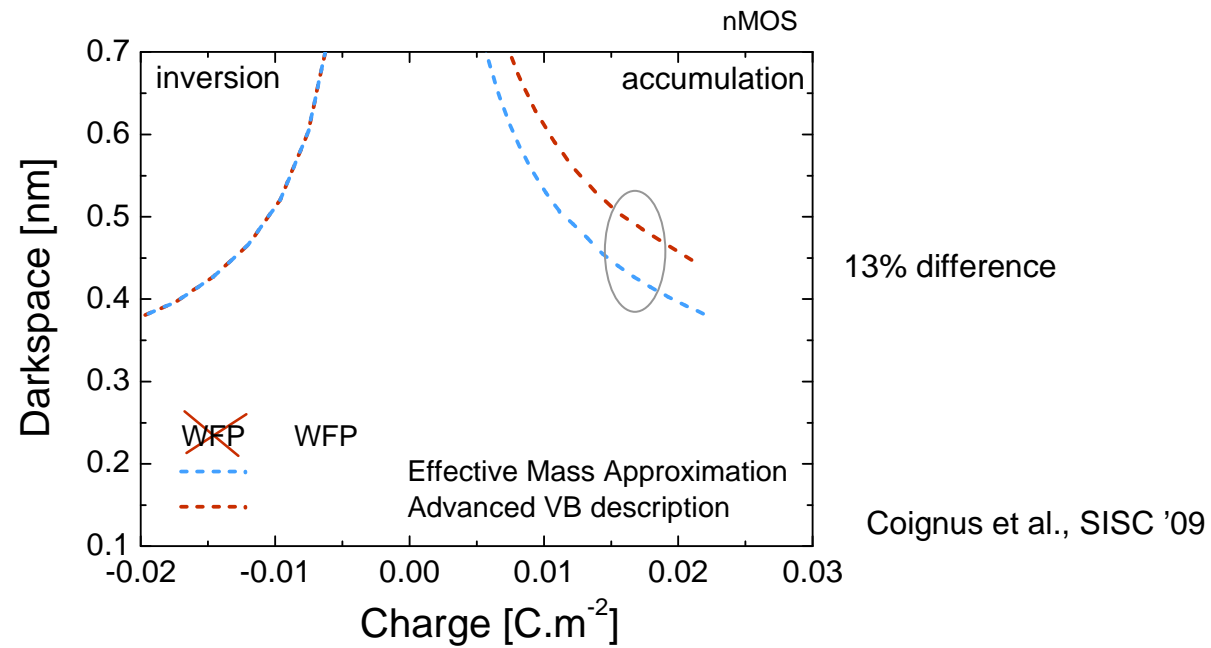

Poisson-Schrödinger simulation : VB description

- Impact on EOT extraction ?

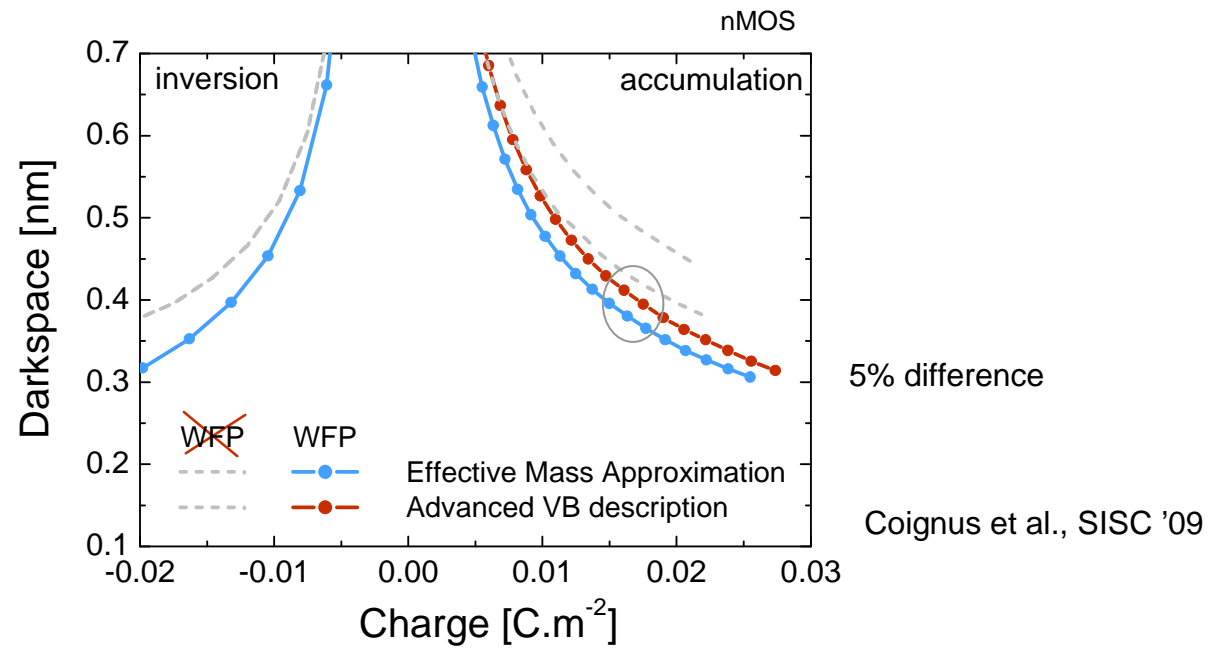

Poisson-Schrödinger simulation : VB description

- Impact on EOT extraction ?

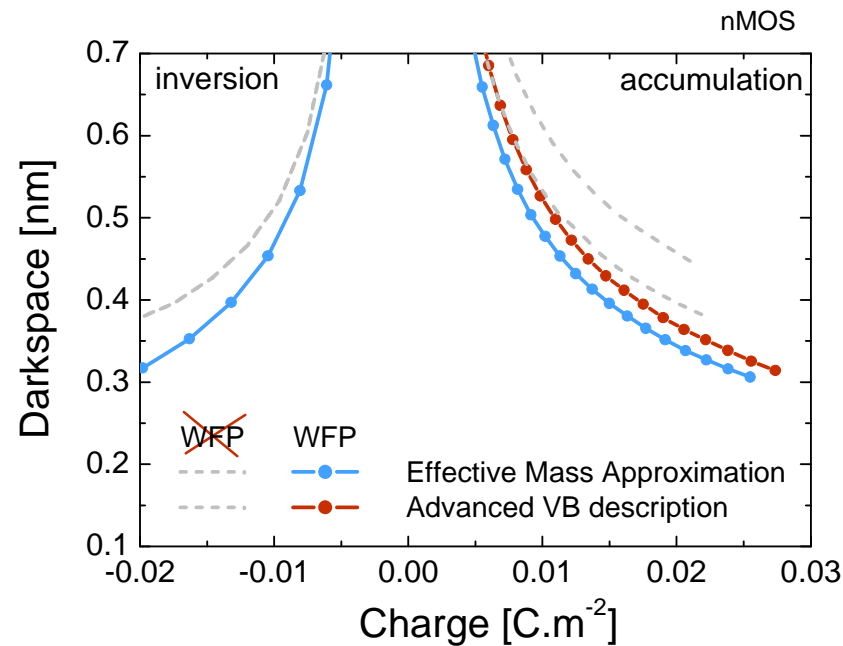

Coignus et al., SISC '09

➔ This advanced approach does not significantly impact EOT extraction

Outline

- **Tunneling current modeling**
 - Self-consistent Poisson-Schrödinger simulation
 - Transmission probability
- **Experimental investigation of leakage current in HfO₂ gate stacks**
 - Transport mechanisms
 - Dielectric thicknesses extraction
 - Tunneling parameters extraction
 - Dipole effect in Mg-capped HfO₂ gate stacks
- **Conclusions**

Transmission probability modeling

- Transmission probability parameters :

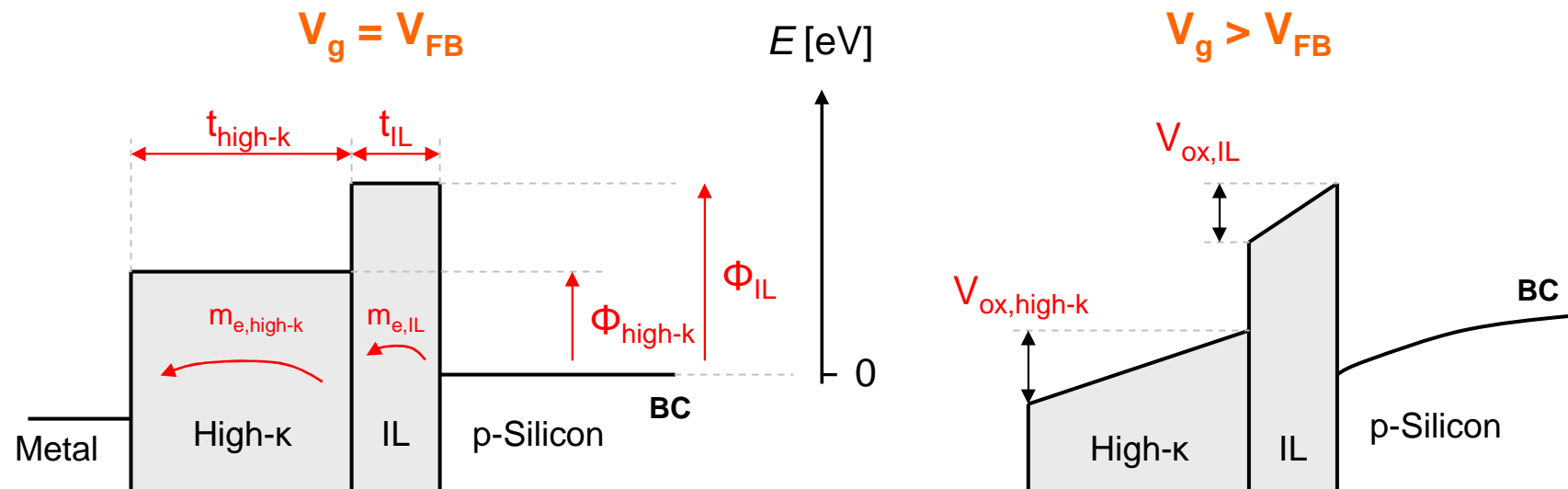

- Several approaches in literature, differing by their accuracy and nature (analytical or numerical)

Transmission probability modeling

- Airy formalism [Allen JAP '96]
 - Exact solution of Schrödinger equation in a triangular barrier
 - Solving wavefunction continuity at each triangular barrier transition provides T
- ↑↑ **exact solution**
- ↓↓ use of Airy function, inadequate to standard compact model libraries

	Analytical approach ?	« Exact » solution
Airy formalism	x	✓

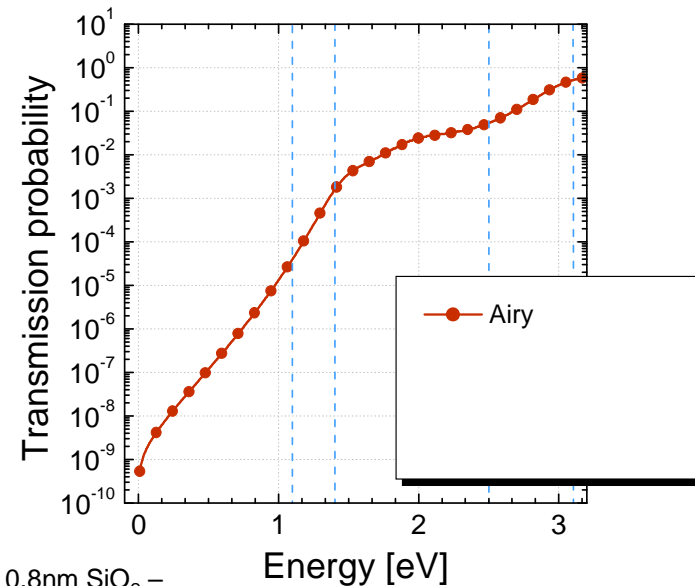
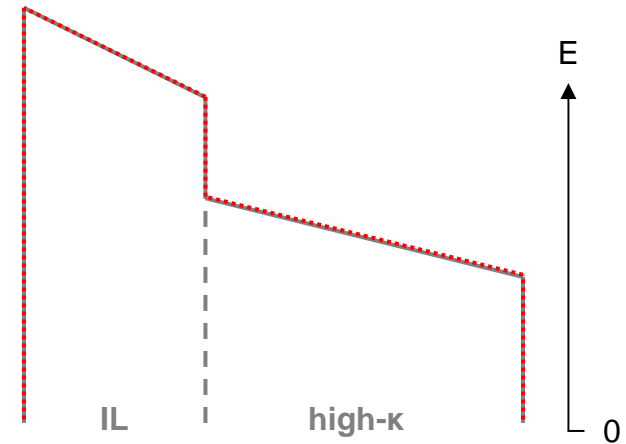

eg. : 0.8nm SiO₂ –
2nm HfO₂

Transmission probability modeling

- WKB (1926)
 - Analytical method
 - Valid only for smoothly varying potential barriers
- ↑↑ **analytical approach**
 ↓↓ **poor accuracy (reflections on potential discontinuities at interfaces not included)**

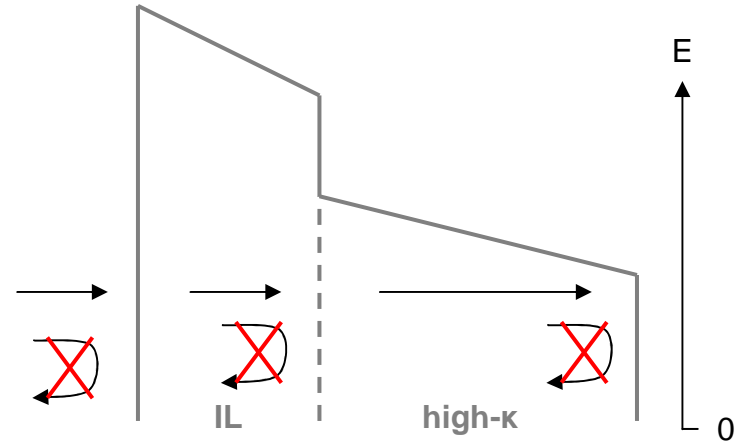

	Analytical approach ?	« Exact » solution
Airy formalism	x	√
WKB	√	x

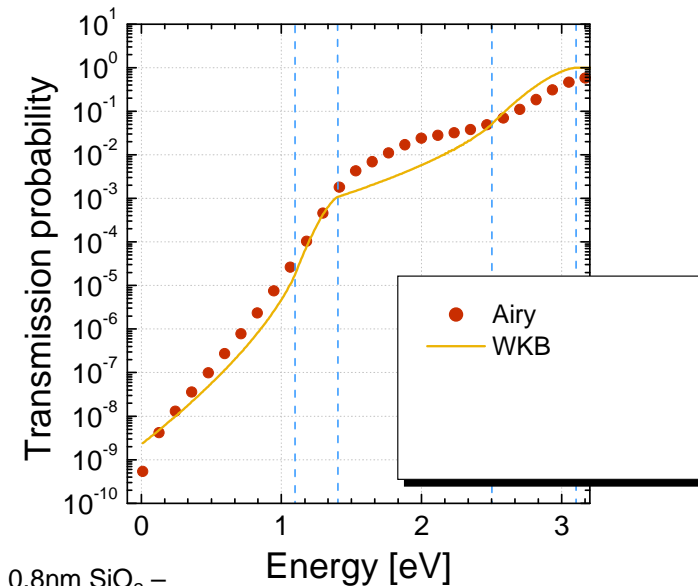

eg. : 0.8nm SiO₂ –
2nm HfO₂

Transmission probability modeling

- Transfer matrix [Ando JAP '87]
 - Computational method: discretization of an arbitrary barrier by N square barriers
 - Solving wavefunction continuity at each square barrier transition provides T
 - ↑↑ **accuracy (N > 20)**
 - ↓↓ **numerical approach, computational time**

	Analytical approach ?	« Exact » solution
Airy formalism	x	✓
WKB	✓	x
Transfer matrix	x	≈

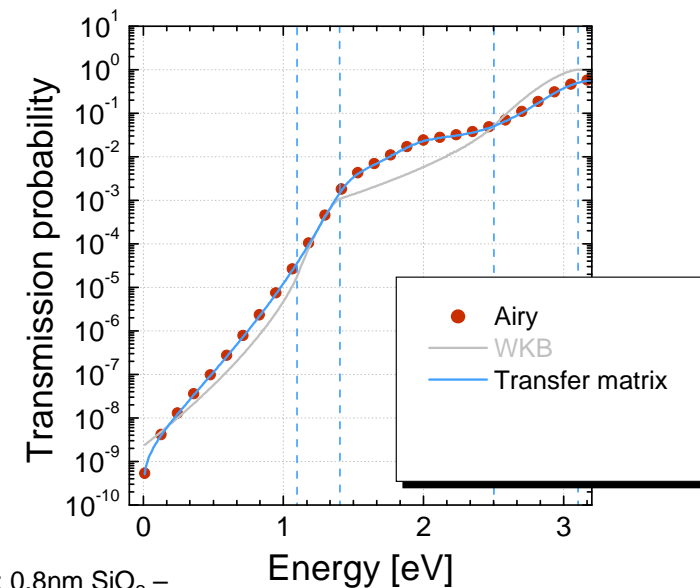
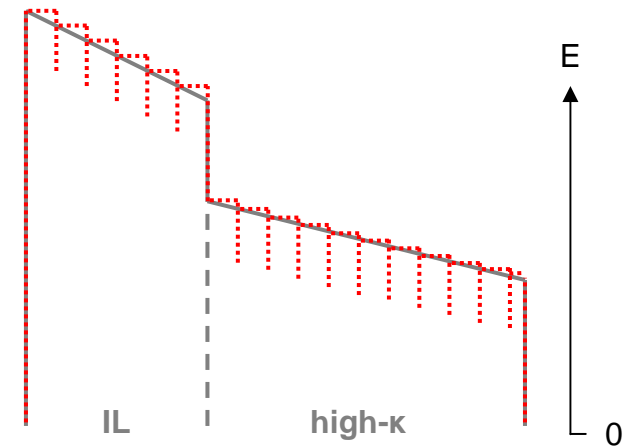

eg. : 0.8nm SiO₂ –
2nm HfO₂

Transmission probability modeling

- Advanced WKB
 - Extended from WKB analytical formula
 - Provides multiplicative factor correcting for potential discontinuities
 - ↑↑ **analytical approach**
 - ↑↑ **accuracy**
 - ↓↓ **validity : Direct Tunneling only**

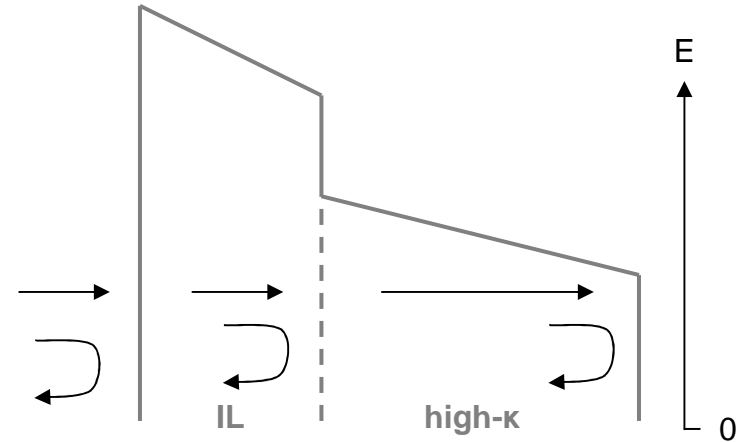

	Analytical approach ?	« Exact » solution
Airy formalism	x	✓
WKB	✓	x
Transfer matrix	x	≈
Advanced WKB	✓	≈

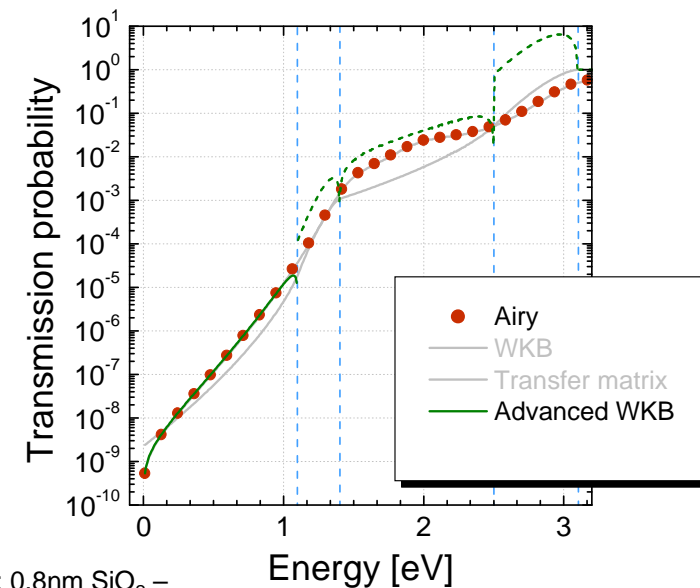

eg. : 0.8nm SiO₂ –
2nm HfO₂

Transmission probability modeling

- Effective barrier height approximation

- Exact solution of Schrödinger equation in a squares barriers
- Solving wavefunction continuity at each triangular barrier transition provides T

↑↑ **analytical approach**

↑↑ **accuracy in DT regime**

↓↓ **may lead to important error around TD – FN transitions**

	Analytical approach ?	« Exact » solution
Airy formalism	x	✓
WKB	✓	x
Transfer matrix	x	≈
Advanced WKB	✓	≈
Effective barrier	✓	≈

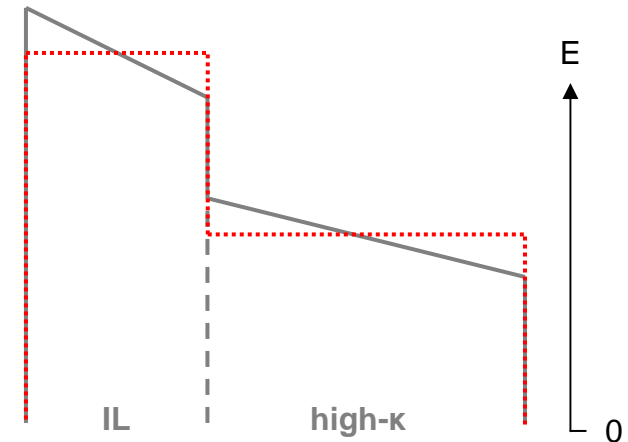

Coignus et al., JVST B '09

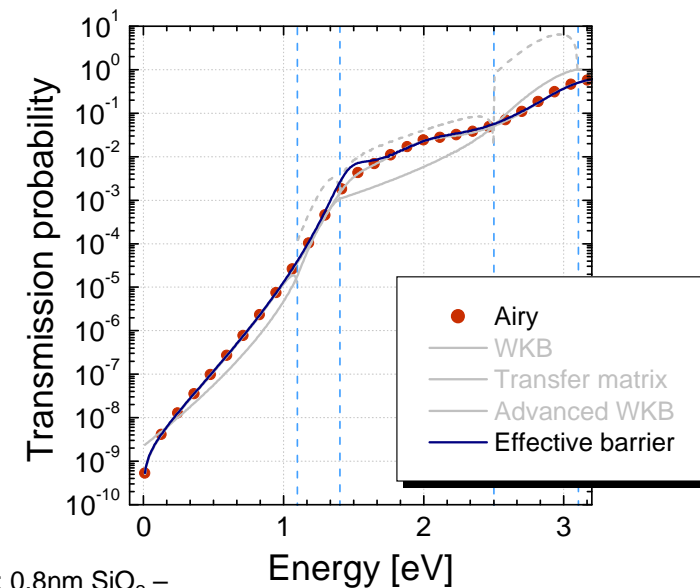

eg. : 0.8nm SiO₂ –
2nm HfO₂

Outline

- **Tunneling current modeling**
 - Self-consistent Poisson-Schrödinger simulation
 - Transmission probability
- **Experimental investigation of leakage current in HfO₂ gate stacks**
 - Transport mechanisms
 - Dielectric thicknesses extraction
 - Tunneling parameters extraction
 - Dipole effect in Mg-capped HfO₂ gate stacks
- **Conclusions**

Gate leakage mechanisms in HfO₂ gate stacks

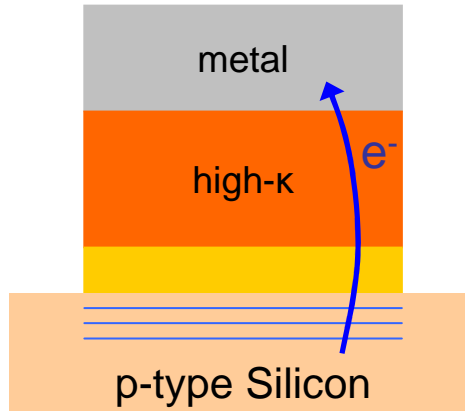

Gate leakage mechanisms in HfO₂ gate stacks

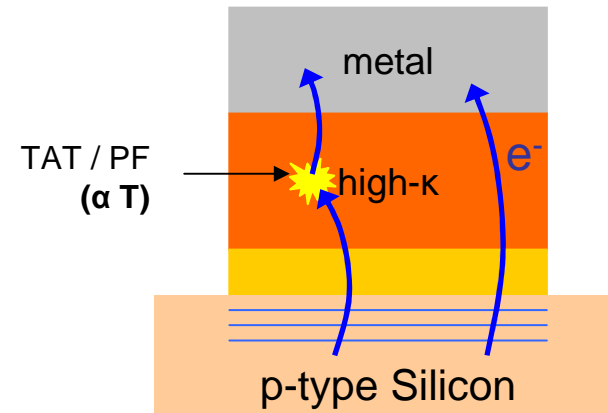

Gate leakage mechanisms in HfO₂ gate stacks

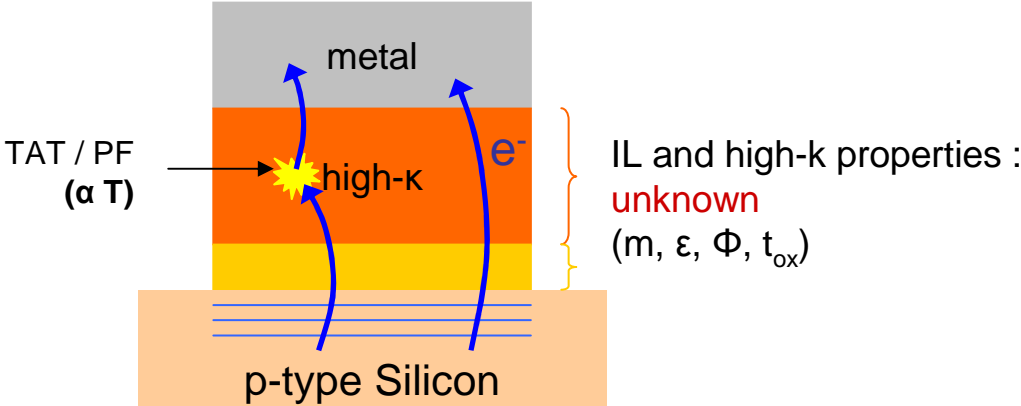

Gate leakage mechanisms in HfO₂ gate stacks

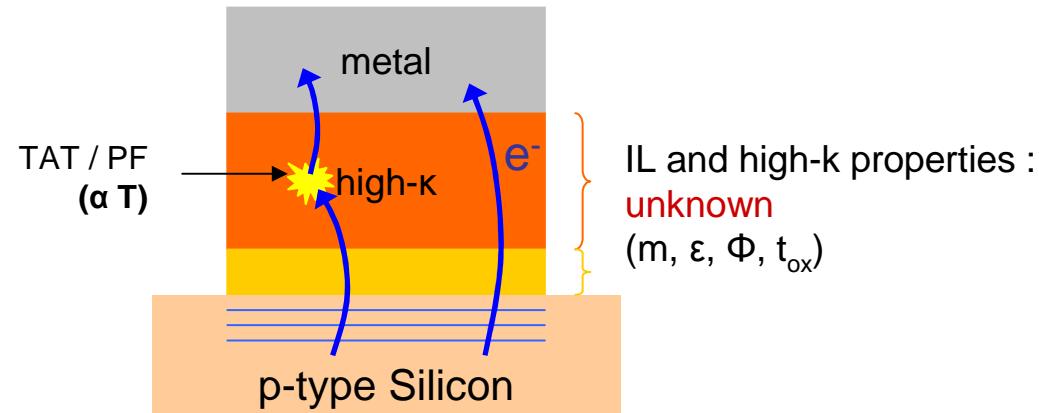

- **Issue 1** : Identification of transport mechanisms

$$J_{total} = \underbrace{J_{direct\ tunneling\ current}}_{\substack{\text{Depends on } T \\ \text{only via } Q_{sc}(T)}} + \underbrace{J_{temperature/trap\ assisted\ current}}_{\substack{Q_{sc}(T)\ \text{dependant} + \\ \text{temperature assisted}}}$$

Gate leakage mechanisms in HfO₂ gate stacks

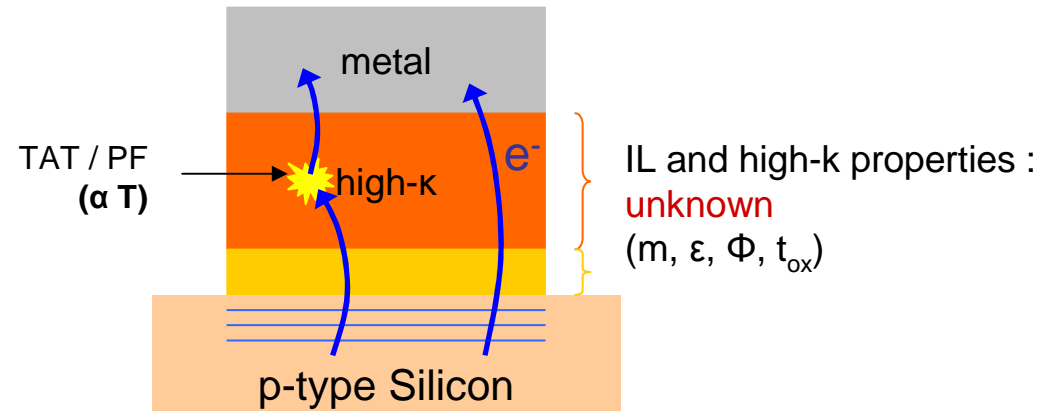

- **Issue 1** : Identification of transport mechanisms

$$J_{total} = \underbrace{J_{direct\ tunneling\ current}}_{\substack{\text{Depends on } T \\ \text{only via } Q_{sc}(T)}} + \underbrace{J_{temperature/trap\ assisted\ current}}_{\substack{Q_{sc}(T)\ \text{dependant} + \\ \text{temperature assisted}}}$$

→ low / high temperature measurements at constant Q_{sc} (i.e. field)

Transport mechanisms : methodology

1. Several nMOS transistors tested

- p Silicon / RTO **SiO₂** / n+ Polysilicon
(*ref. samples*)

$$t_{\text{SiO}_2} = 1.5 / 2.5 \text{ nm}$$

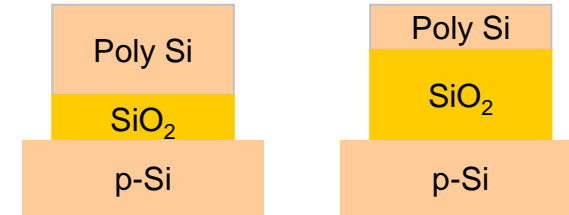

Transport mechanisms : methodology

1. Several nMOS transistors tested

- p Silicon / RTO SiO_2 / n+ Polysilicon
(*ref. samples*)

$$t_{\text{SiO}_2} = 1.5 / 2.5 \text{ nm}$$

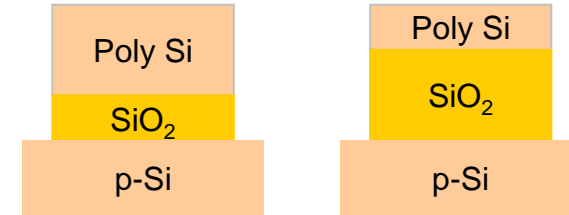

- p Silicon / **IL** / ALD HfO_2 / CVD TiN

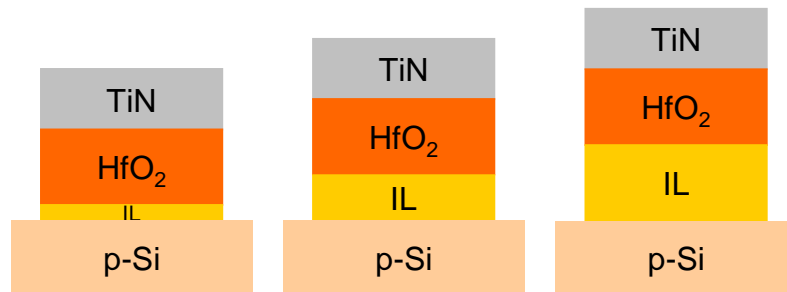

$$t_{\text{IL}} (\text{RTO}) = 1.2 / 1.5 / 2.0 \text{ nm}$$

$$t_{\text{HfO}_2} = \text{cte} = 3 \text{ nm}$$

Transport mechanisms : methodology

1. Several nMOS transistors tested

- p Silicon / RTO SiO_2 / n+ Polysilicon
(*ref. samples*)

$$t_{\text{SiO}_2} = 1.5 / 2.5 \text{ nm}$$

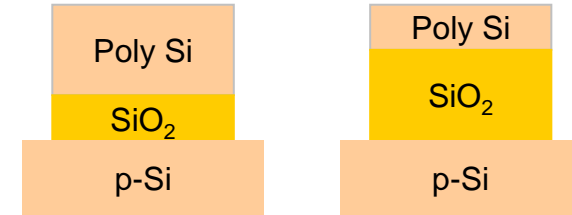

- p Silicon / **IL** / ALD HfO_2 / CVD TiN

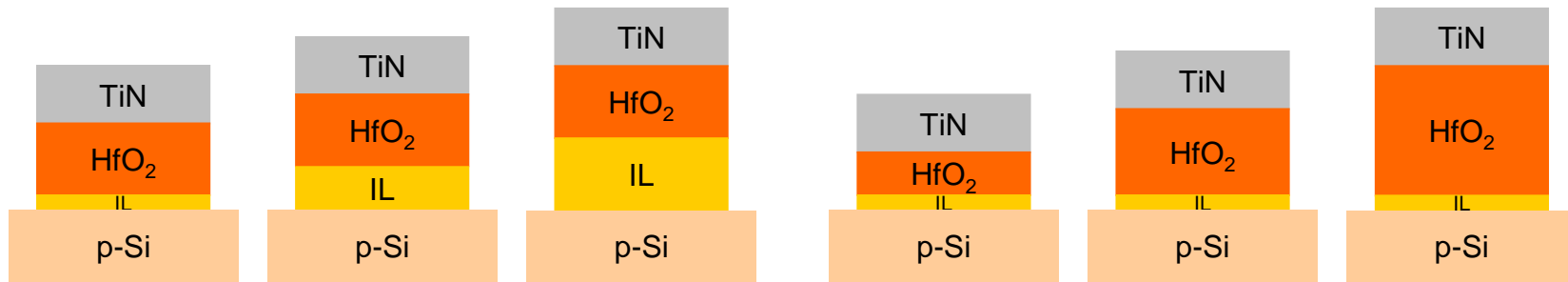

$$t_{\text{IL}} (\text{RTO}) = 1.2 / 1.5 / 2.0 \text{ nm}$$

$$t_{\text{HfO}_2} = \text{cte} = 3 \text{ nm}$$

$$t_{\text{IL}} (\text{chem.}) = \text{cte} = 0.8 \text{ nm}$$

$$t_{\text{HfO}_2} = 2.0 / 3.0 / 4.5 \text{ nm}$$

Transport mechanisms : methodology

2. $C(V_g)$ measurements from 80 to 400K

- Parameters extraction by fitting Poisson-Schrödinger results : EOT, Na, V_{FB}
- Experimental charge extraction $Q(V_g) = \int_{V_{fb}}^{V_g} C(u) du$

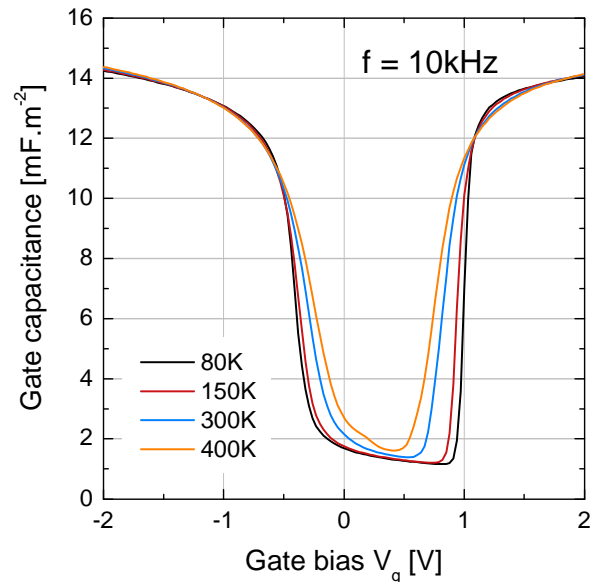

example :
 12\AA IL - 30\AA
 HfO_2 gate
stack

Transport mechanisms : methodology

2. $C(V_g)$ measurements from 80 to 400K

- Parameters extraction by fitting Poisson-Schrödinger results : EOT, Na, V_{FB}
- Experimental charge extraction $Q(V_g) = \int_{V_{FB}}^{V_g} C(u) du$

3. $I_g(V_g)$ measurements from 80 to 400K

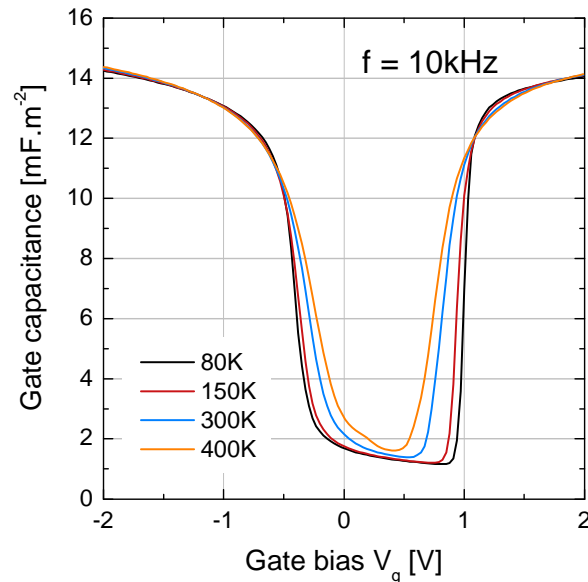

example :
 12\AA IL - 30\AA
 HfO_2 gate
stack

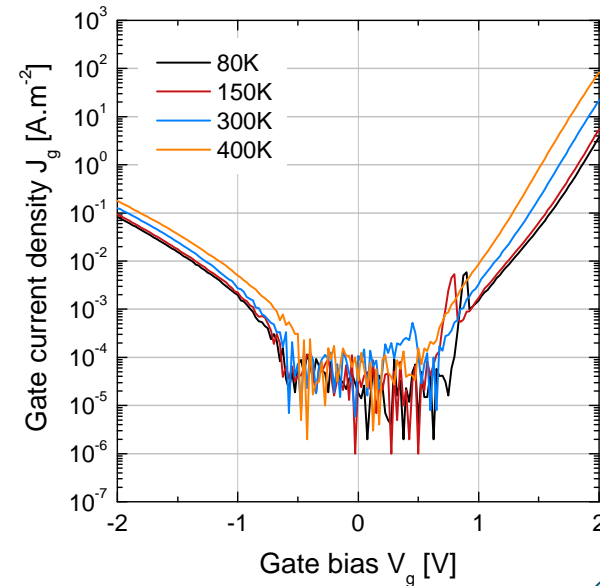

Transport mechanisms : methodology

2. $C(V_g)$ measurements from 80 to 400K

- Parameters extraction by fitting Poisson-Schrödinger results : EOT, Na, V_{FB}
- Experimental charge extraction $Q(V_g) = \int_{V_{FB}}^{V_g} C(u) du$

3. $I_g(V_g)$ measurements from 80 to 400K

→ $I_g(Q_{sc})$ plots

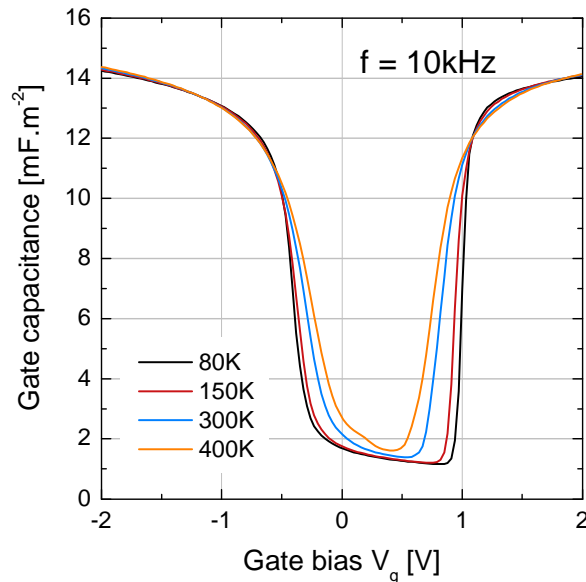

example :
12Å IL - 30Å
HfO₂ gate
stack

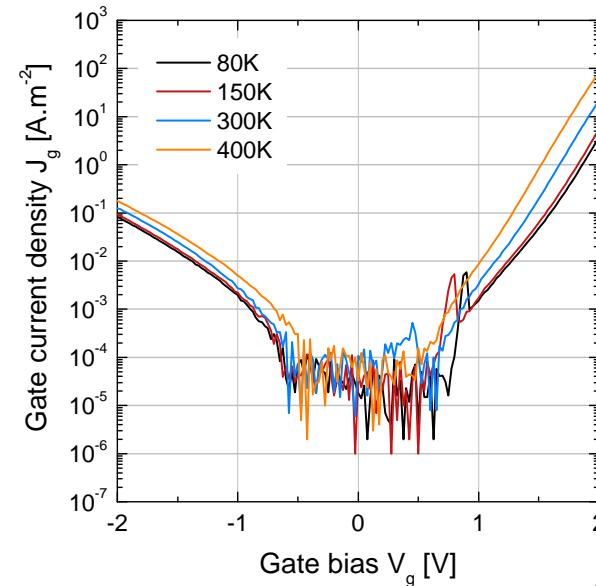

Transport mechanisms : electrical results

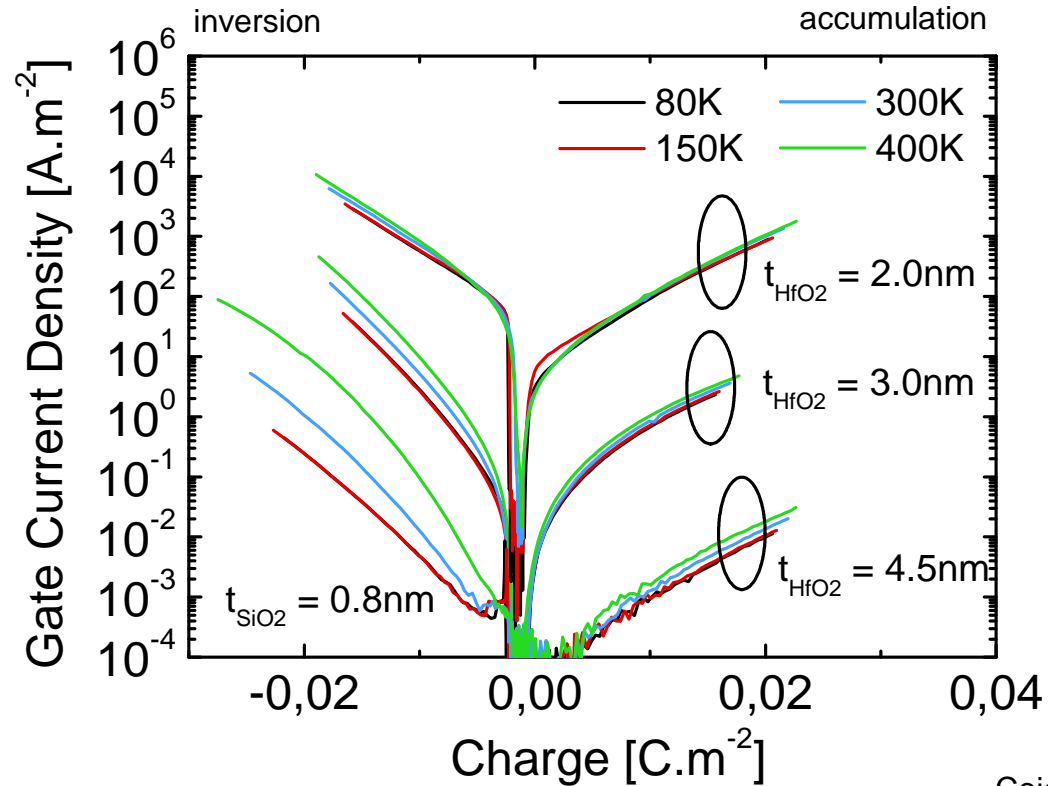

Coignus et al., ESSDERC '09

- Accumulation regime ($Q > 0$) : no temperature activation...
- Inversion regime ($Q < 0$) : thermally-assisted current for thick stacks

Transport mechanisms : electrical results

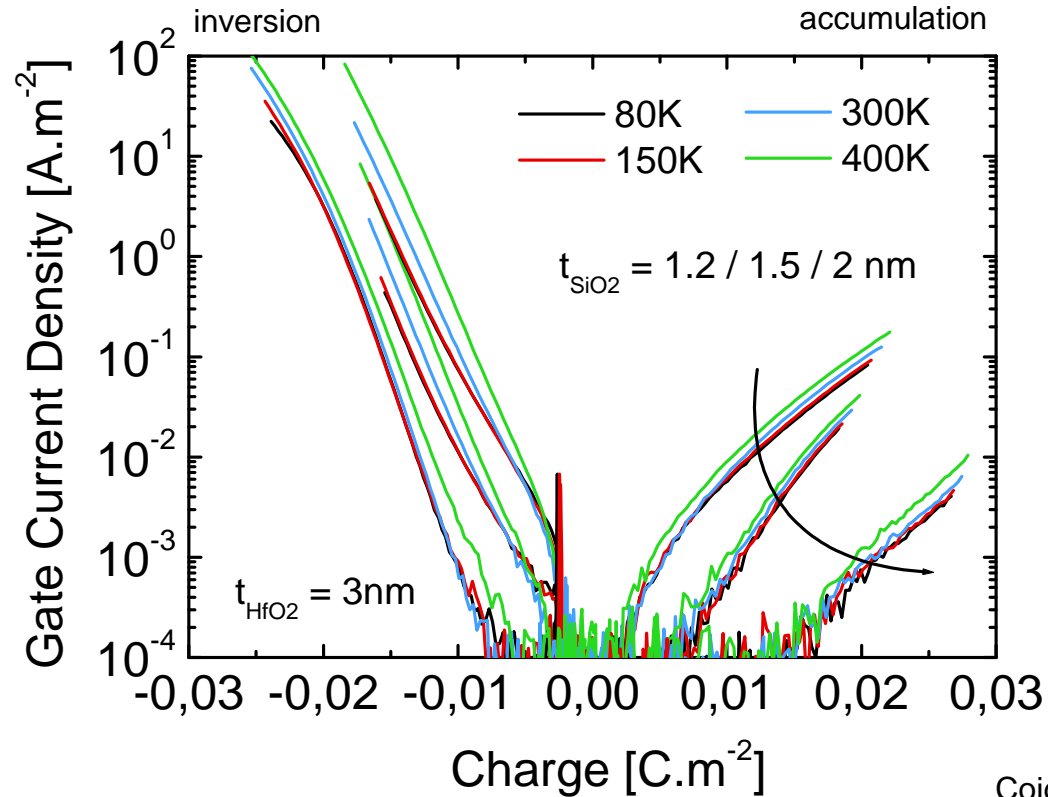

Coignus et al., ESSDERC '09

- Accumulation regime ($Q > 0$) : no temperature activation...
- Inversion regime ($Q < 0$) : constant thermally-assisted component

Transport mechanisms

- **Conclusion on Issue 1** : Identification of transport mechanisms

Presence of a thermally-assisted contribution in HfO_2

- In nMOS inversion regime (electrons)
- On thick layers ($t_{\text{HfO}_2} > 3\text{nm}$) (due to volume trap)

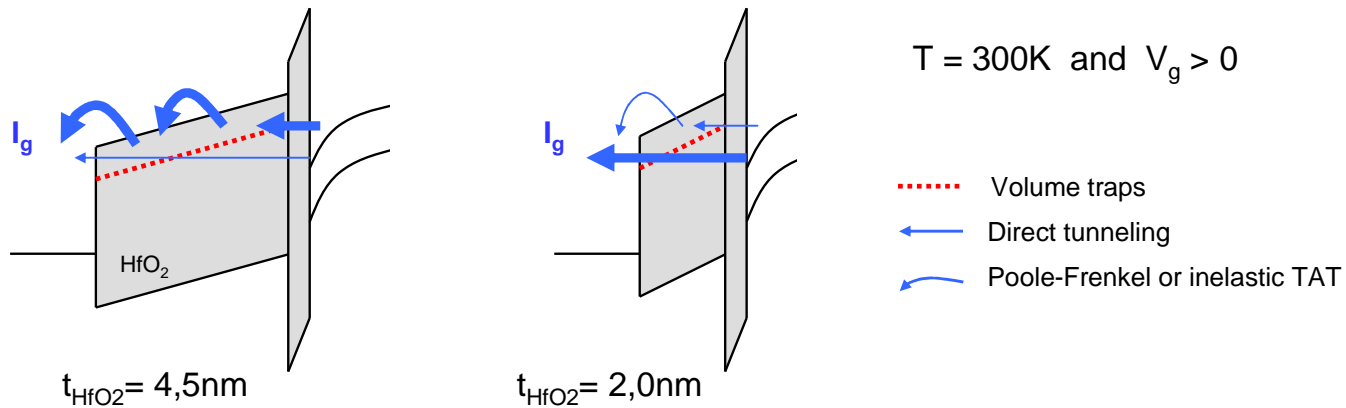

Transport mechanisms

- **Conclusion on Issue 1** : Identification of transport mechanisms

Presence of a thermally-assisted contribution in HfO_2

- In nMOS inversion regime (electrons)
- On thick layers ($t_{\text{HfO}_2} > 2.5\text{nm}$) (due to volume trap)

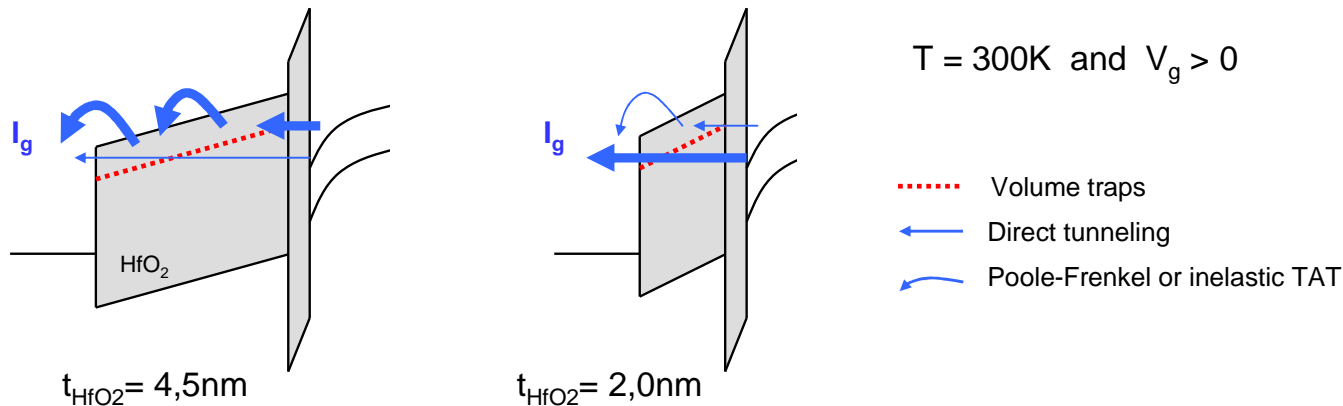

- **Issue 2** : Can current @ low temperature be explained by DT model ?

→ Comparison with simulation, accurate extraction of dielectric parameters

Purpose : explain the **whole** set of experiments with a **single** set of parameters

Outline

- **Tunneling current modeling**
 - Self-consistent Poisson-Schrödinger simulation
 - Transmission probability
- **Experimental investigation of leakage current in HfO₂ gate stacks**
 - Transport mechanisms
 - Dielectric thicknesses extraction
 - Tunneling parameters extraction
 - Dipole effect in Mg-capped HfO₂ gate stacks
- **Conclusions**

Dielectric thicknesses extraction

$$\text{EOT} = \epsilon_{\text{SiO}_2} \cdot \left(\frac{t_{\text{IL}}}{\epsilon_{\text{IL}}} + \frac{t_{\text{HfO}_2}}{\epsilon_{\text{HfO}_2}} \right)$$

Dielectric thicknesses extraction

$$\text{EOT} = \epsilon_{\text{SiO}_2} \cdot \left(\frac{t_{\text{IL}}}{\epsilon_{\text{IL}}} + \frac{t_{\text{HfO}_2}}{\epsilon_{\text{HfO}_2}} \right)$$

↓
**Extracted from C(V_g)
measurements**

Dielectric thicknesses extraction

$$\text{EOT} = \epsilon_{\text{SiO}_2} \cdot \left(\frac{t_{\text{IL}}}{\epsilon_{\text{IL}}} + \frac{t_{\text{HfO}_2}}{\epsilon_{\text{HfO}_2}} \right)$$

Extracted from $C(V_g)$ measurements

ALD deposition : assumed equal to target value

Dielectric thicknesses extraction

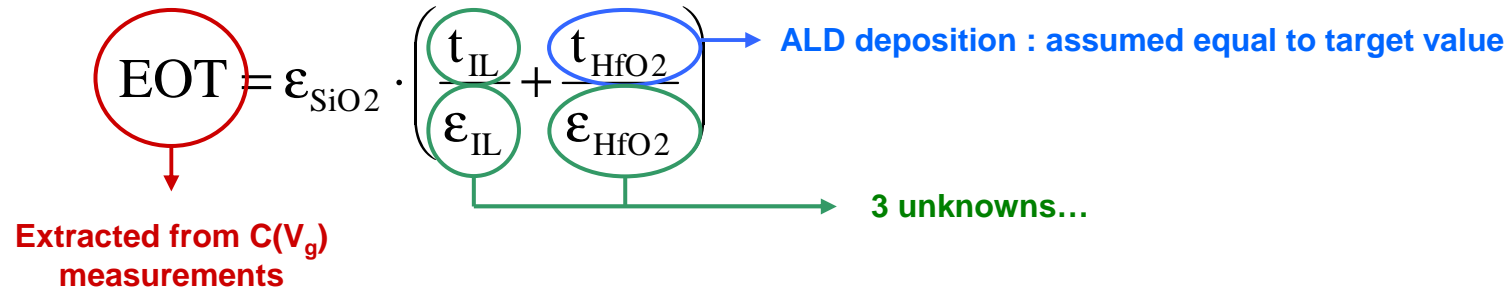

→ samples with IL/HfO₂ thickness variants : permittivity extraction

Dielectric thicknesses extraction

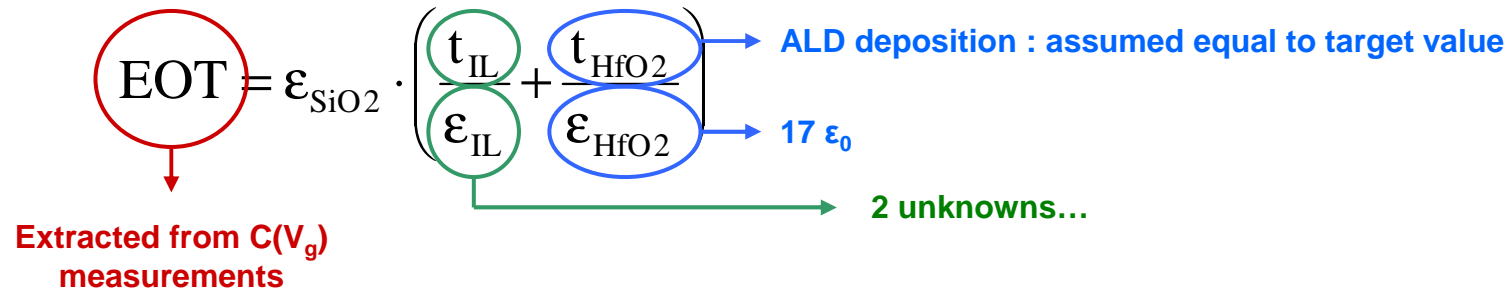

→ samples with IL/HfO₂ thickness variants : permittivity extraction

- HfO₂ permittivity extraction

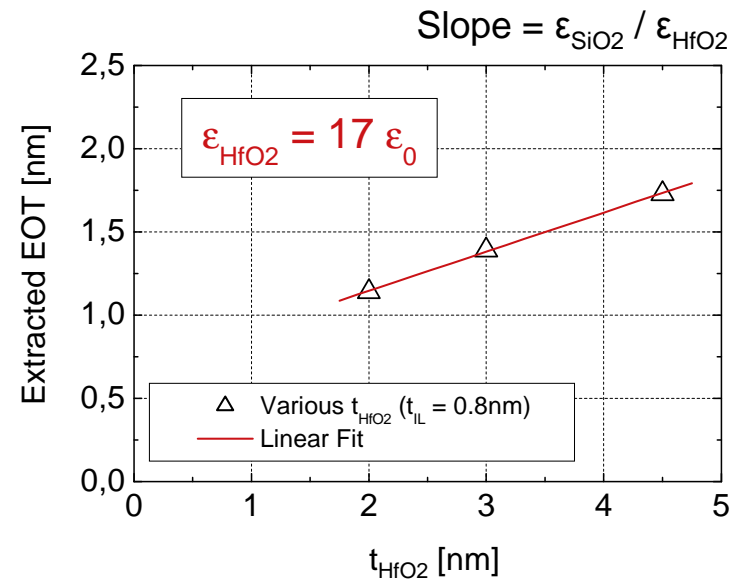

Dielectric thicknesses extraction

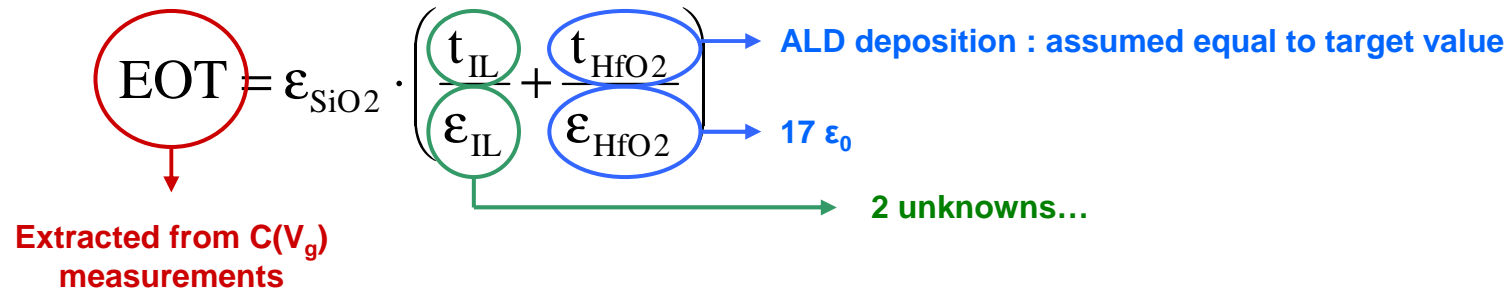

→ samples with IL/HfO₂ thickness variants : permittivity extraction

- HfO₂ permittivity extraction
- IL issue :
 - permittivity may differ from $\epsilon_{SiO_2} = 3.9\epsilon_0$
 - thickness may be different from target value...

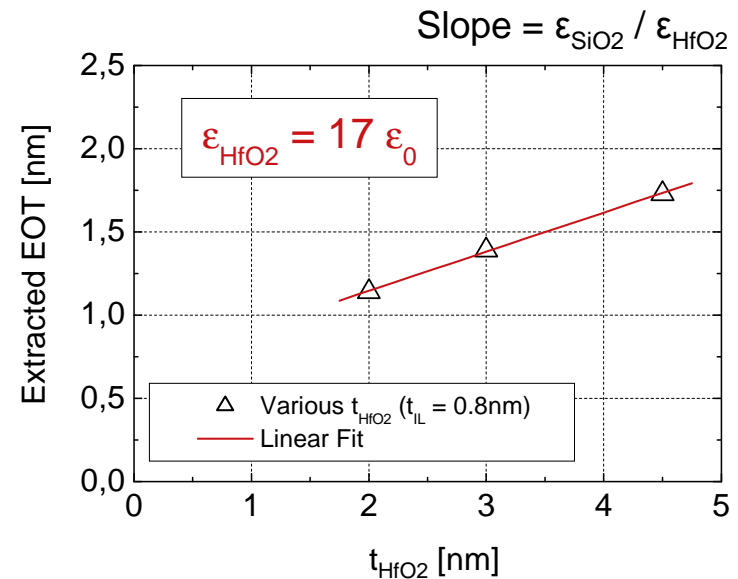

Dielectric thicknesses extraction

- TEM observations on RTO IL devices

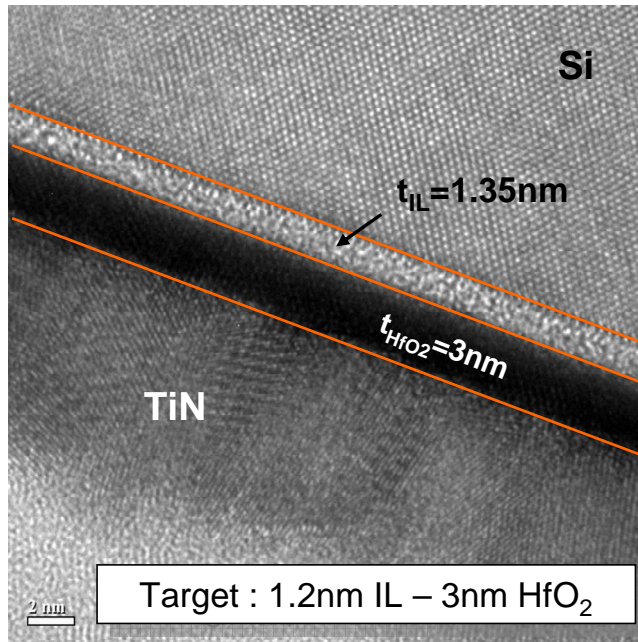

$$t_{\text{target}} \neq t_{\text{measured}}$$

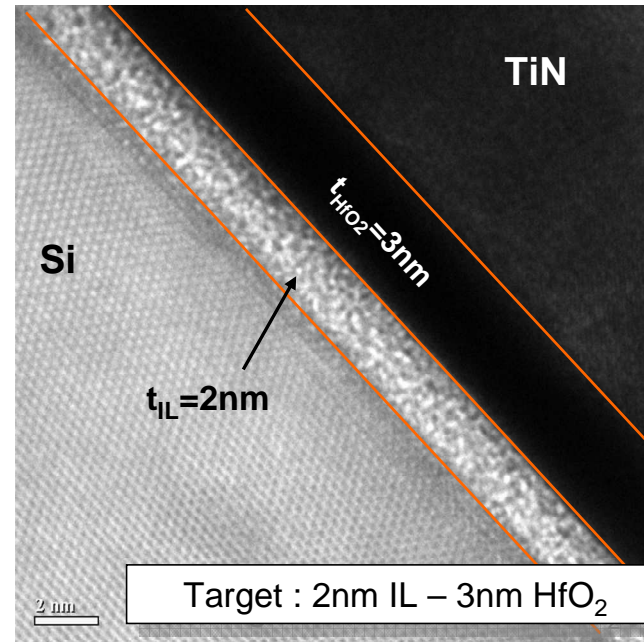

$$t_{\text{target}} = t_{\text{measured}}$$

Dielectric thicknesses extraction

- TEM observations on RTO IL devices

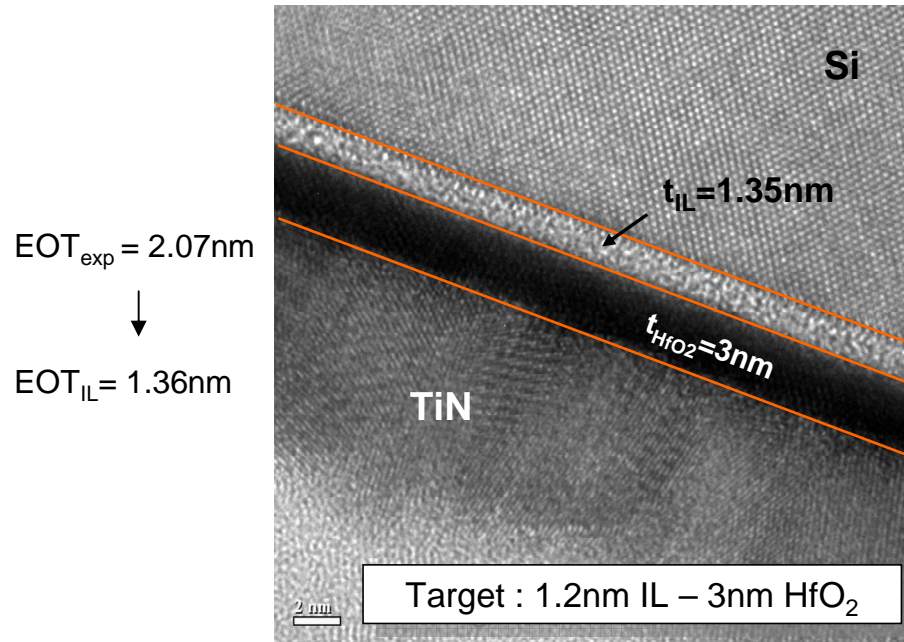

$$t_{target} \neq t_{measured}$$

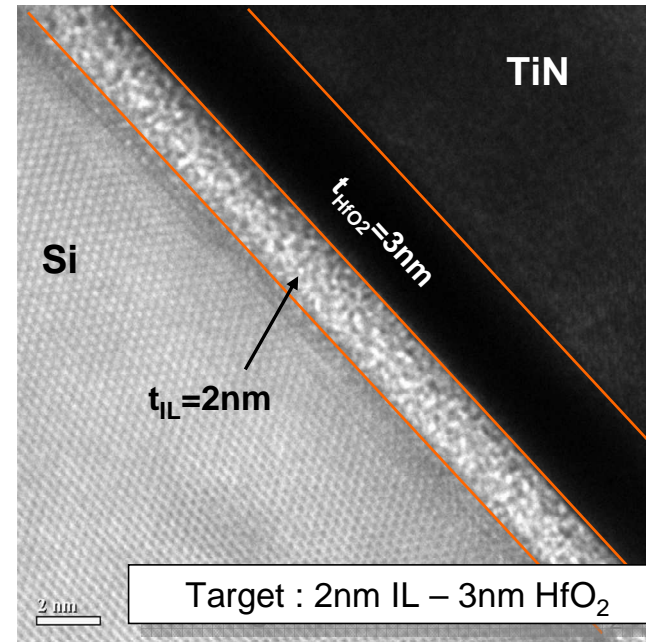

$$t_{target} = t_{measured}$$

Dielectric thicknesses extraction

- TEM observations on RTO IL devices

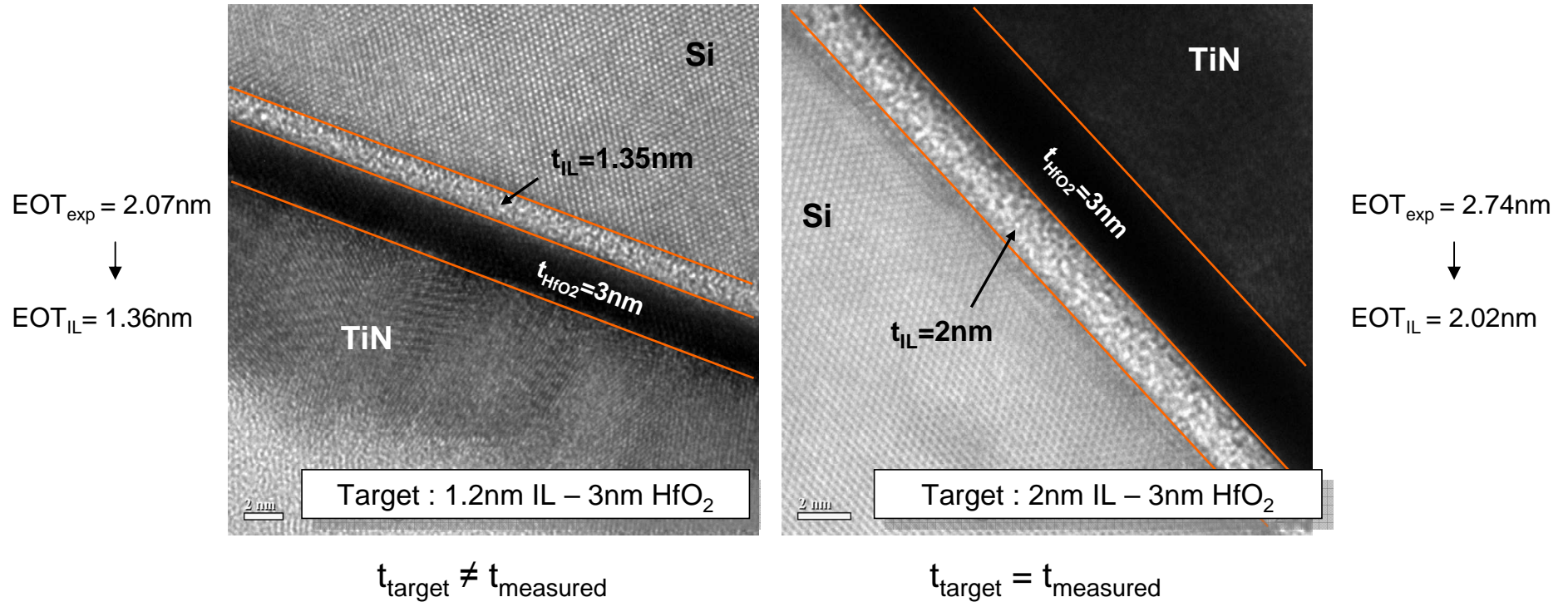

→ RTO IL devices : IL = SiO₂

→ $\epsilon_{IL,RTO} = 3.9\epsilon_0$

Coignus et al., SSE '10

Dielectric thicknesses extraction

- IL regrowth mechanism
[Damlencourt SSE '03]

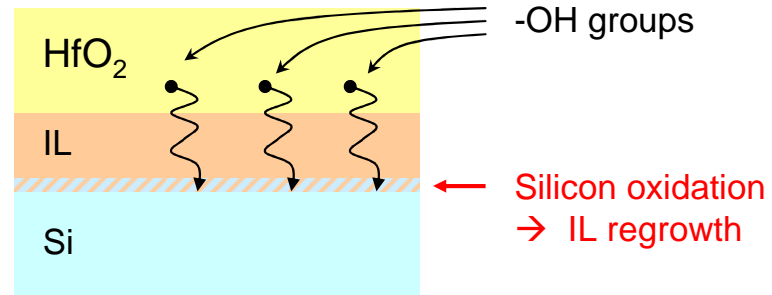

Dielectric thicknesses extraction

- IL regrowth mechanism [Damlencourt SSE '03]

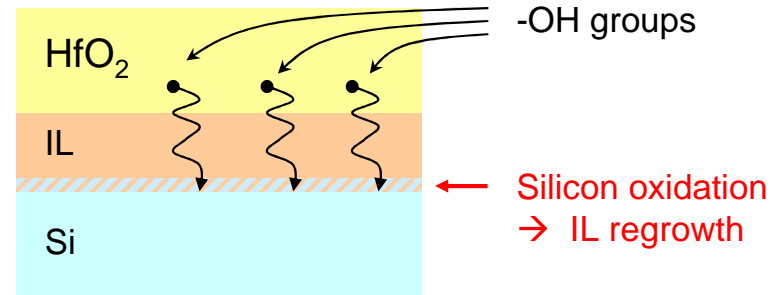

- TEM observations on chemical IL devices

→ target = 8Å $EOT_{IL,exp} \approx 6-7\text{\AA}$ TEM observation $\approx 1\text{nm}$

→ $\epsilon_{IL,chem} > \epsilon_{SiO_2}$

→ **Chemical IL devices :**
IL = silicate or SiO_x

device 8Å IL – 2nm HfO₂

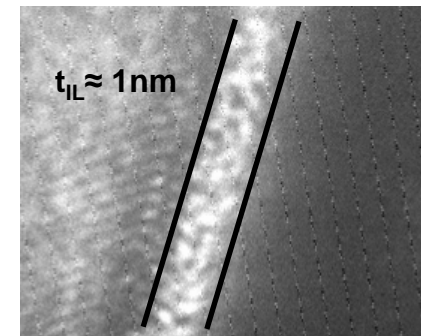

Dielectric thicknesses extraction

- IL regrowth mechanism [Damlencourt SSE '03]

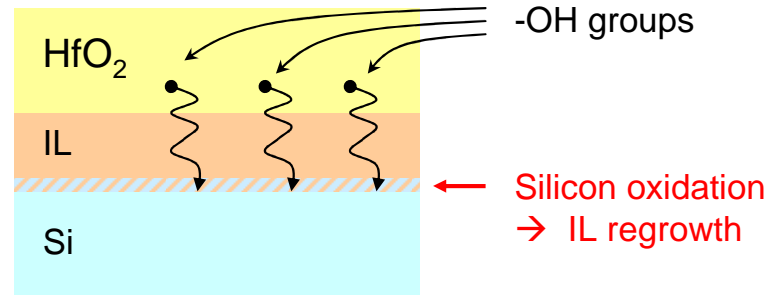

- TEM observations on chemical IL devices

→ target = 8Å $EOT_{IL,exp} \approx 6-7\text{\AA}$ TEM observation $\approx 1\text{nm}$

→ $\epsilon_{IL,chem} > \epsilon_{SiO_2}$

→ **Chemical IL devices :**
IL = silicate or SiO_x

device 8Å IL – 2nm HfO₂

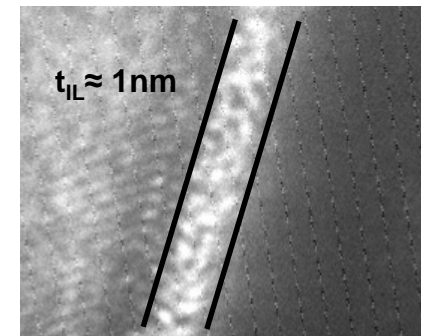

$$EOT_{exp} \rightarrow t_{phys}$$

Outline

- **Tunneling current modeling**
 - Self-consistent Poisson-Schrödinger simulation
 - Transmission probability
- **Experimental investigation of leakage current in HfO₂ gate stacks**
 - Transport mechanisms
 - Dielectric thicknesses extraction
 - Tunneling parameters extraction
 - Dipole effect in Mg-capped HfO₂ gate stacks
- **Conclusions**

Tunneling parameters extraction @80K

- **Inversion regime**

1. SiO_2 – Polysilicon reference samples

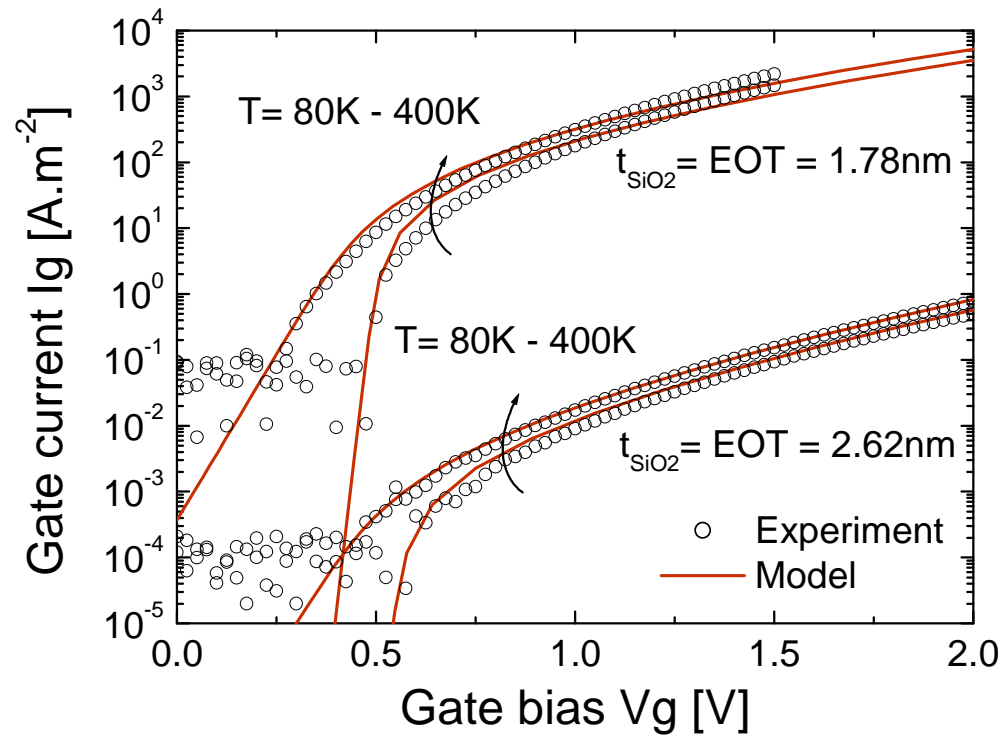

→ $m_{e,\text{SiO}_2} = 0.5m_0$
 $\Phi_{e,\text{SiO}_2} = 3.1\text{eV}$

Tunneling parameters extraction @80K

- **Inversion regime**

1. SiO₂ – Polysilicon reference samples
2. HfO₂ gate stacks : HfO₂ thickness variants

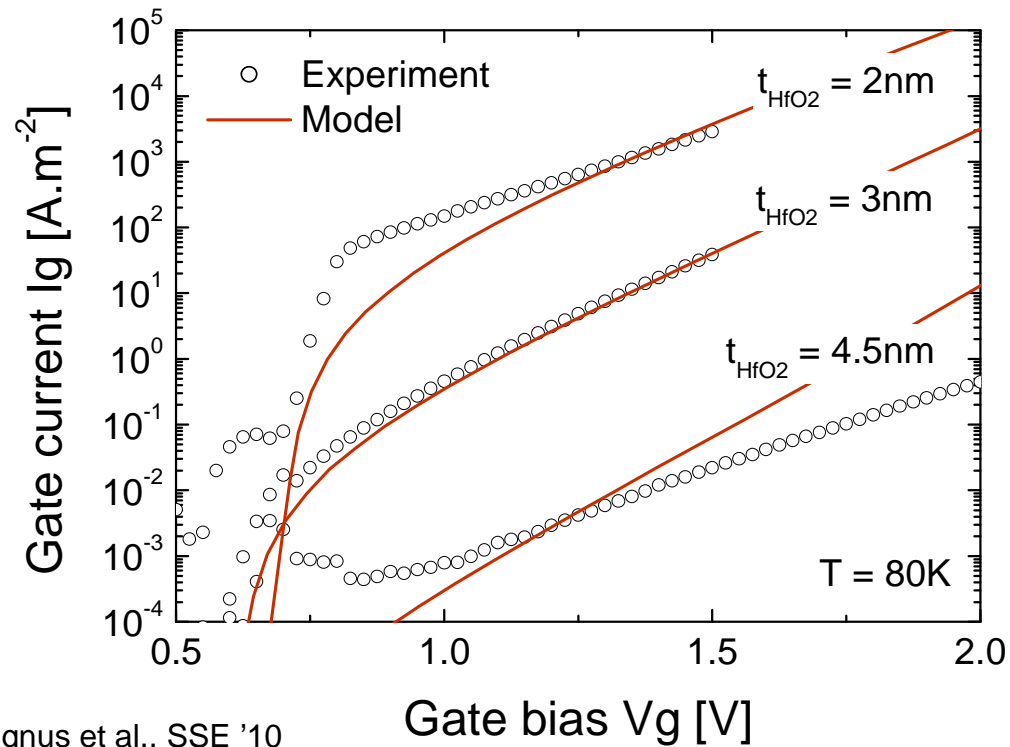

→ $m_{e,IL} = 0.5m_0$
 $\Phi_{e,IL} = 3.1eV$

→ $m_{e,HfO_2} = 0.165m_0$
 $\Phi_{e,HfO_2} = 1.9eV$

Tunneling parameters extraction @80K

- **Inversion regime**

1. SiO₂ – Polysilicon reference samples
2. HfO₂ gate stacks : HfO₂ thickness variants
3. HfO₂ gate stacks : IL thickness variants

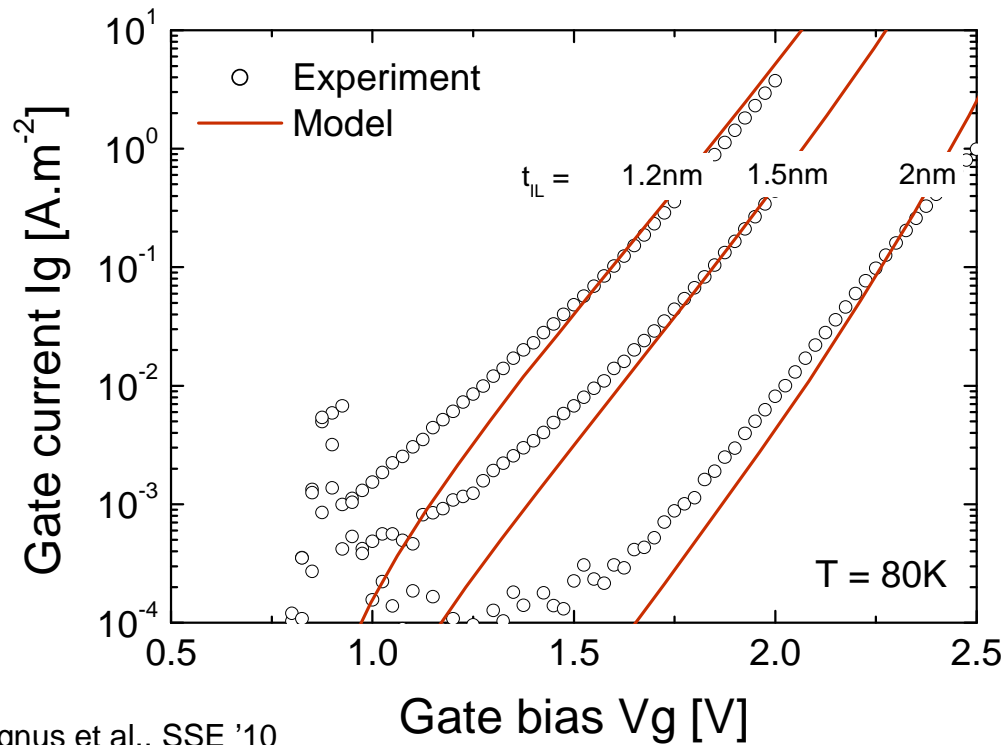

← $m_{e,IL} = 0.5m_0$
← $\Phi_{e,IL} = 3.1eV$

← $m_{e,HfO_2} = 0.165m_0$
← $\Phi_{e,HfO_2} = 1.9eV$

Tunneling parameters extraction @80K

- Accumulation regime**

$\Phi_{h,IL} = 4.78\text{eV}$ and $\Phi_{h,HfO_2} = 2.83\text{eV}$ obtained from experimental extraction of bandgap

Charbonnier, TED '10
Martinez, ECS '09

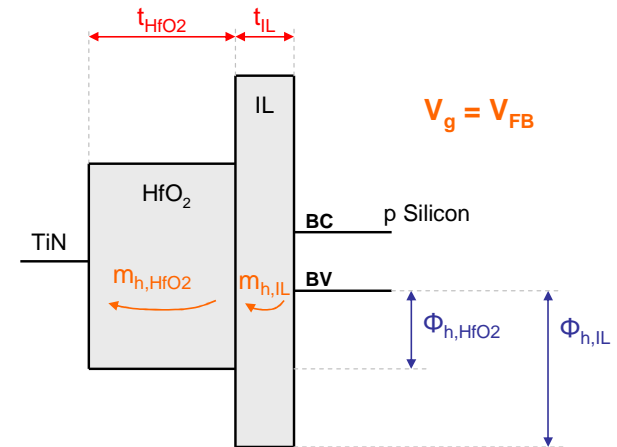

Tunneling parameters extraction @80K

- **Accumulation regime**

$\Phi_{h,IL} = 4.78\text{eV}$ and $\Phi_{h,HfO2} = 2.83\text{eV}$ obtained from experimental extraction of bandgap

Charbonnier, TED '10
Martinez, ECS '09

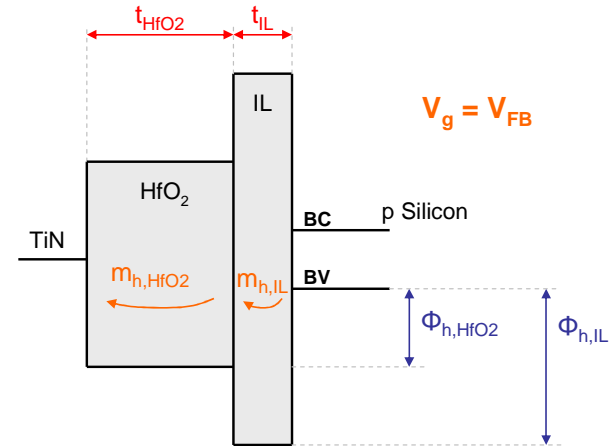

- **Best fit obtained :**

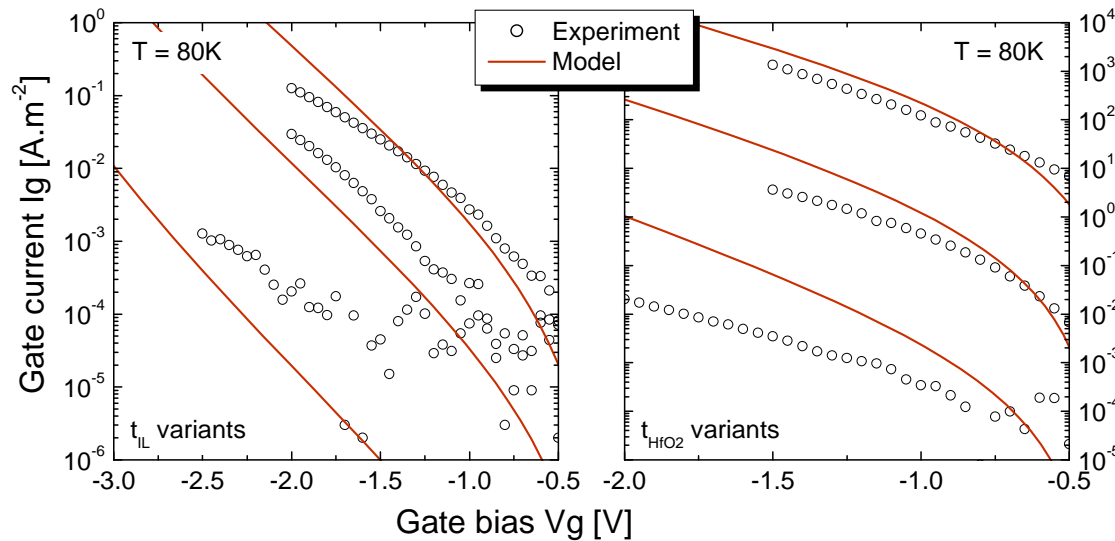

→ 2D tunneling model fails to reproduce experiment

**($m_{h,IL}=0.5m_0$, $m_{h,HfO2}=0.06m_0$,
 $\Phi_{h,IL}=4.78\text{eV}$, $\Phi_{h,HfO2}=2.83\text{eV}$)**

Tunneling parameters extraction @80K

- This model assumes a parabolic description of IL and HfO₂ band structure

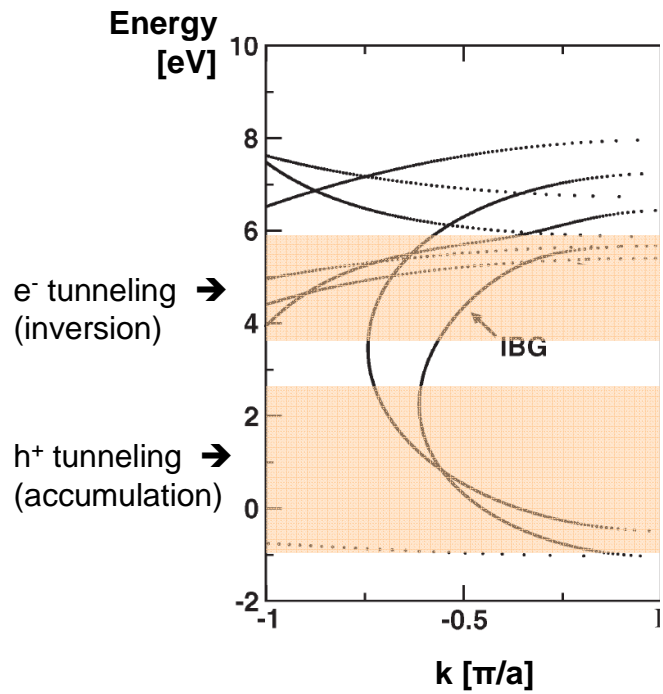

Sacconi TED '07

Tunneling parameters extraction @80K

- This model assumes a parabolic description of IL and HfO₂ band structure

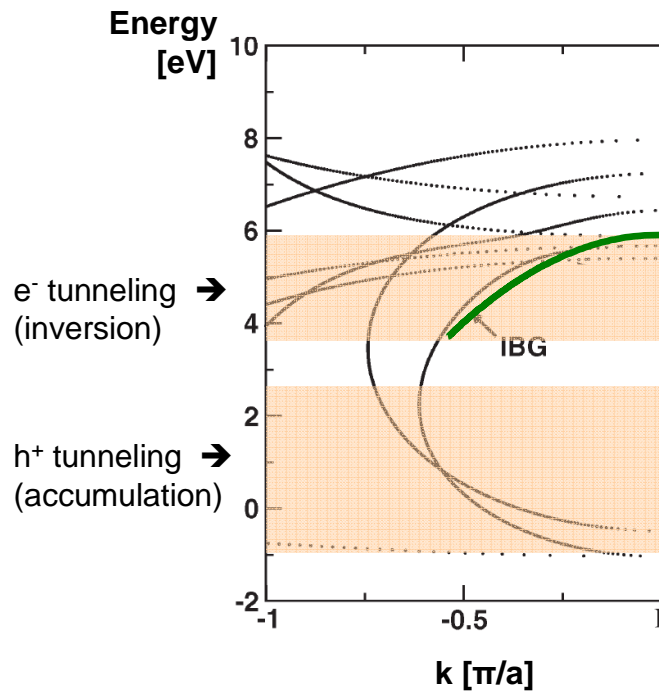

Sacconi TED '07

- Inversion regime :

parabolic description with $m_{\text{HfO}_2} = 0.165m_0$ **OK**

$$k_z(E) = \frac{1}{\hbar} \sqrt{2m_e E},$$

Tunneling parameters extraction @80K

- This model assumes a parabolic description of IL and HfO₂ band structure

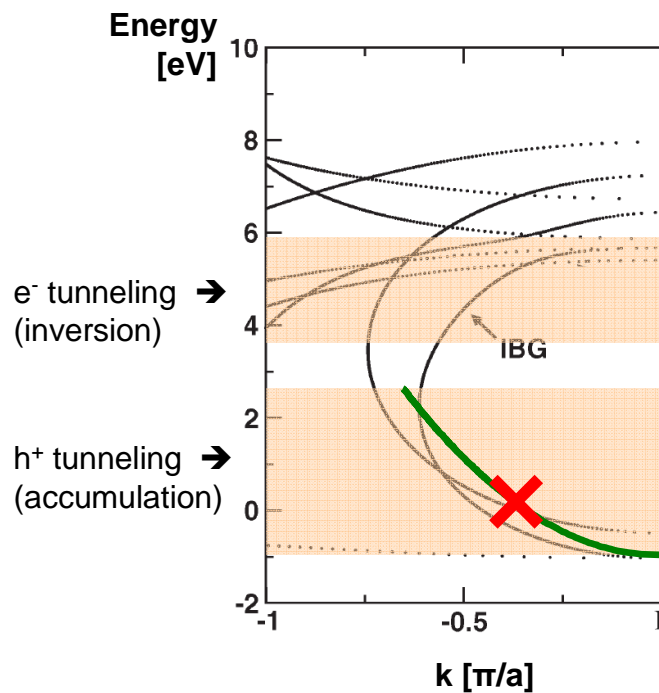

Sacconi TED '07

- Inversion regime :
parabolic description with $m_{\text{HfO}_2} = 0.165m_0$ **OK**
- Accumulation regime
parabolic description fails to reproduce band structure
→ new description needed

Tunneling parameters extraction @80K

- This model assumes a parabolic description of IL and HfO₂ band structure

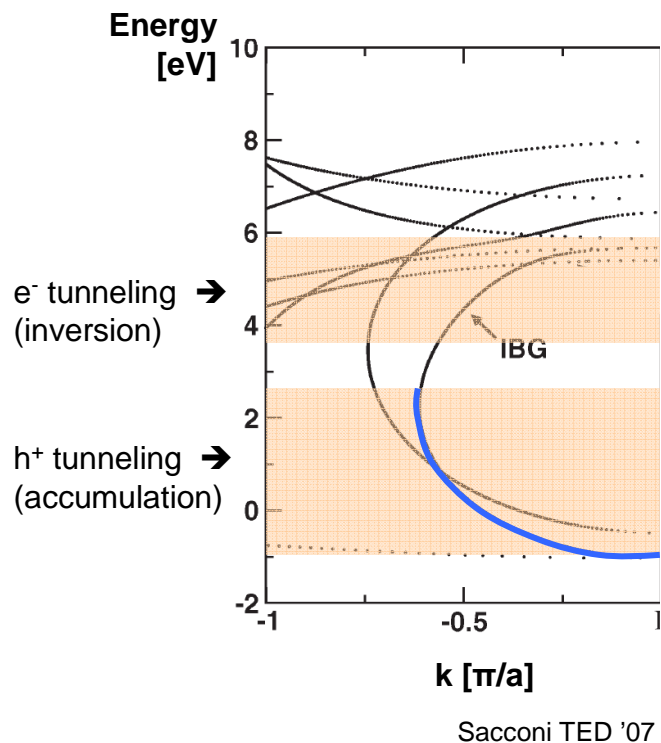

- Inversion regime :
parabolic description with $m_{\text{HfO}_2} = 0.165m_0$ **OK**

- Accumulation regime
parabolic description fails to reproduce band structure
→ new description needed

Franz-type description introduced (fitting parameter m_f : Franz-type tunneling mass)

$$k_z(E) = \frac{1}{\hbar} \sqrt{2m_f E \left(1 - \frac{E}{E_g}\right)}$$

Tunneling parameters extraction @80K

- Accumulation regime

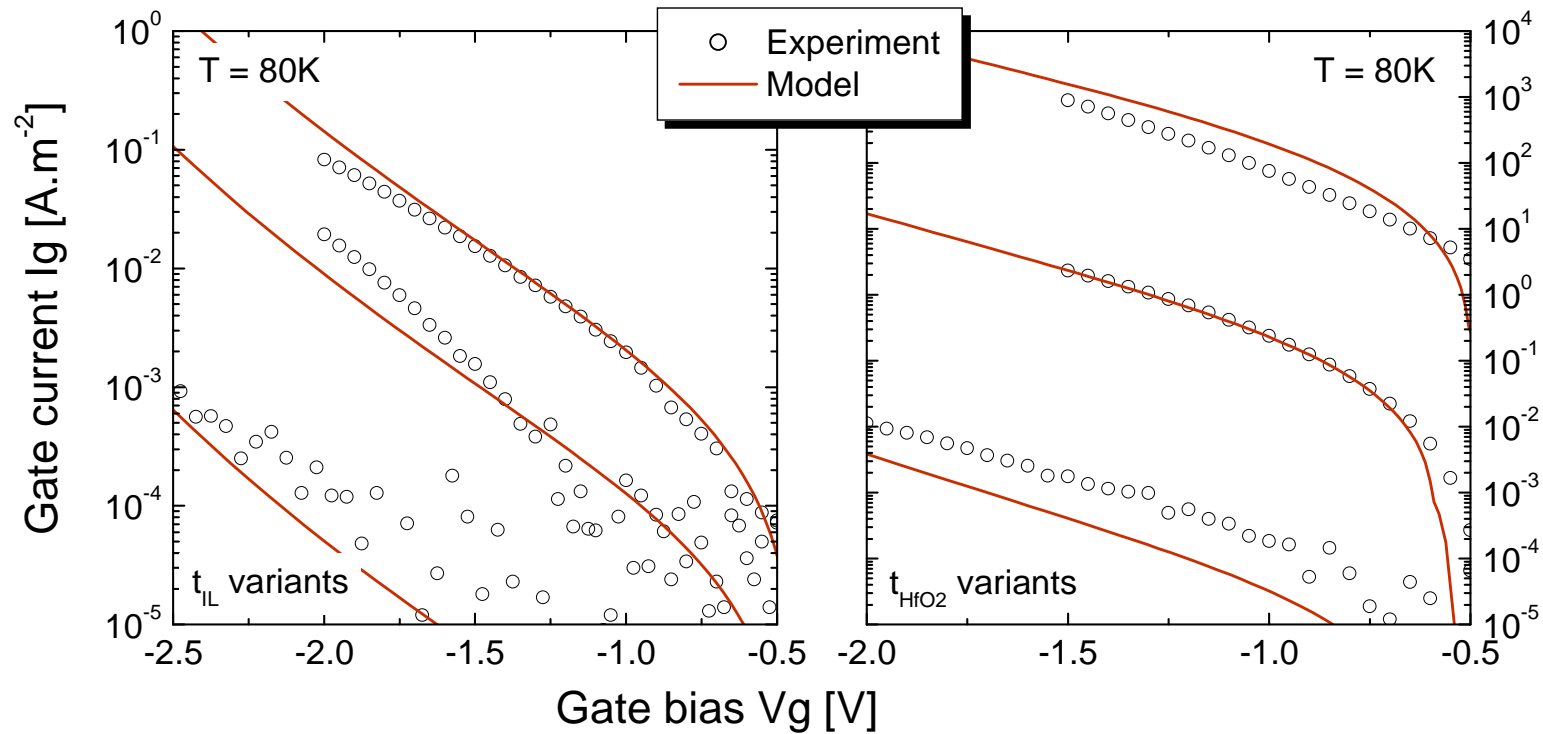

Best fit obtained with :

$m_{f,IL} = 0.5m_0$ $\Phi_{h,IL} = 4.78eV$

$m_{f,HfO2} = 0.22m_0$ $\Phi_{h,HfO2} = 2.83eV$

Tunneling parameters extraction : conclusions

- **Issue 2** : One **single** set of tunneling parameters explains the **whole** set of experiments
→ exception : $t_{\text{HfO}_2} = 4.5\text{nm}$

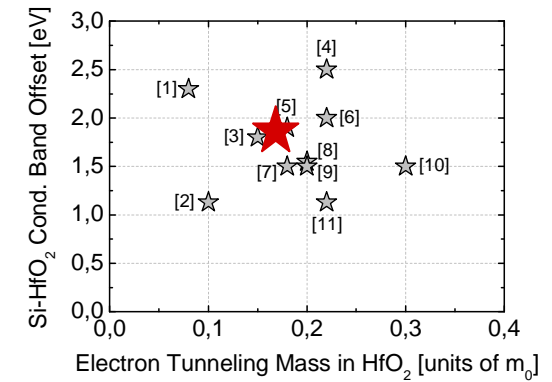

Tunneling parameters extraction : conclusions

- **Issue 2** : One **single** set of tunneling parameters explains the **whole** set of experiments
 - ➔ exception : $t_{\text{HfO}_2} = 4.5\text{nm}$
- Current @80K is a pure tunneling mechanism
 - ➔ experiments @low T are mandatory for $t_{\text{high-k}} > 2.5\text{nm}$

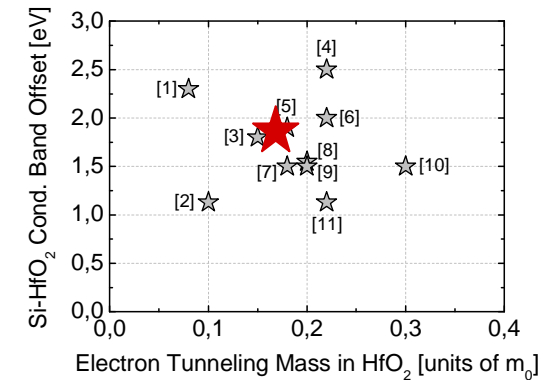

Tunneling parameters extraction : conclusions

- **Issue 2** : One **single** set of tunneling parameters explains the **whole** set of experiments

→ exception : $t_{\text{HfO}_2} = 4.5\text{nm}$

- Current @80K is a pure tunneling mechanism

→ experiments @low T are mandatory for $t_{\text{high-k}} > 2.5\text{nm}$

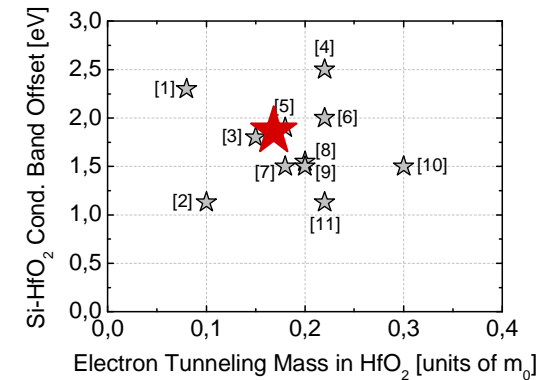

- HfO₂ and IL band structures have been electrically extracted

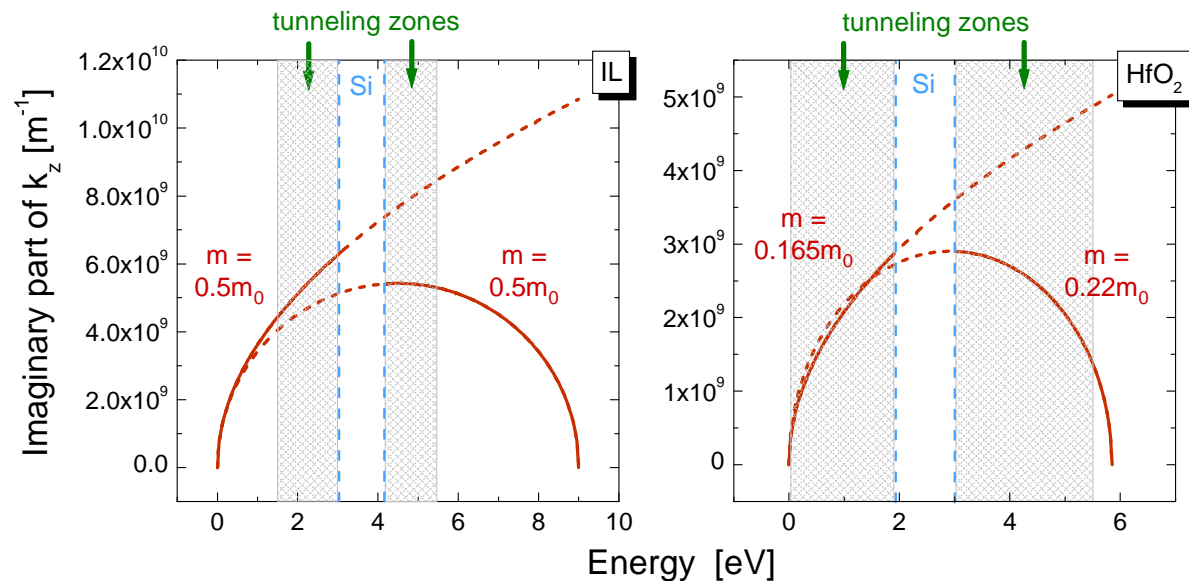

Outline

- **Tunneling current modeling**
 - Self-consistent Poisson-Schrödinger simulation
 - Transmission probability
- **Experimental investigation of leakage current in HfO₂ gate stacks**
 - Transport mechanisms
 - Dielectric thicknesses extraction
 - Tunneling parameters extraction
 - Dipole effect in Mg-capped HfO₂ gate stacks
- **Conclusions**

Dipole effect in Mg-capped HfO₂ gate stacks

- V_{TH} - tuning for 32nm HP devices

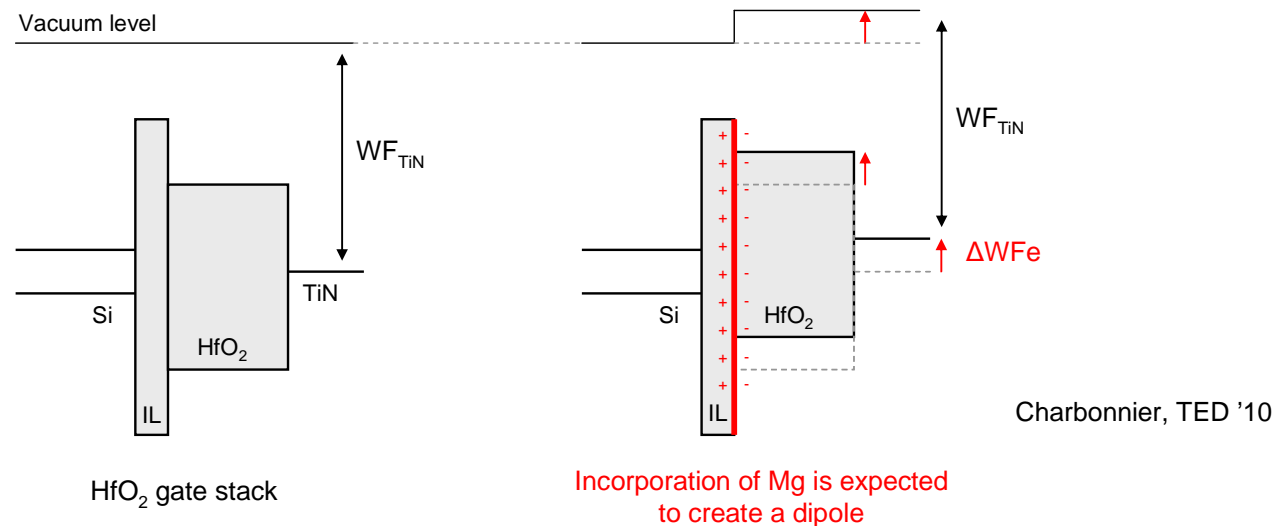

V_{fb} shift is usually observed
→ due to fixed charges ?
→ due to dipole ?

→ gate leakage study : investigation of barrier height shifts

Dipole effect in Mg-capped HfO₂ gate stacks

- Incorporation of 0.3nm MgO in standard HfO₂ gate stack

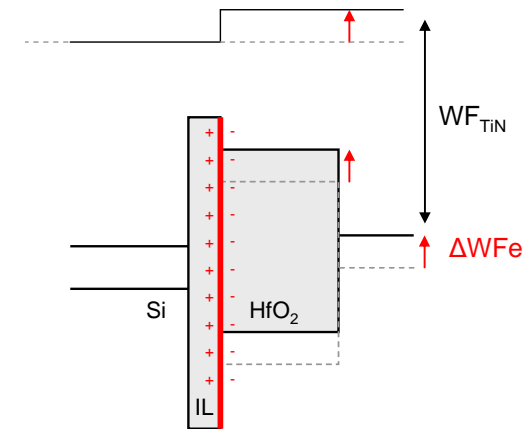
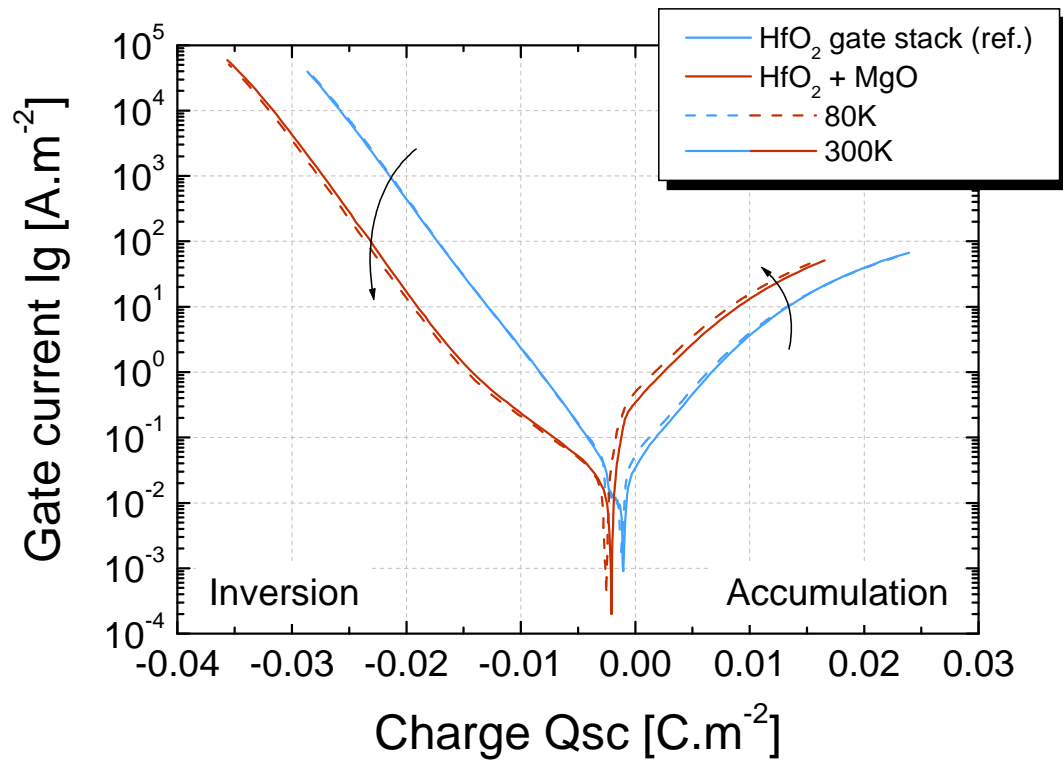

→ Coherent with barrier height shifts

Dipole effect in Mg-capped HfO₂ gate stacks

- Simulation of HfO₂ ref. sample + Mg-capped gate stack

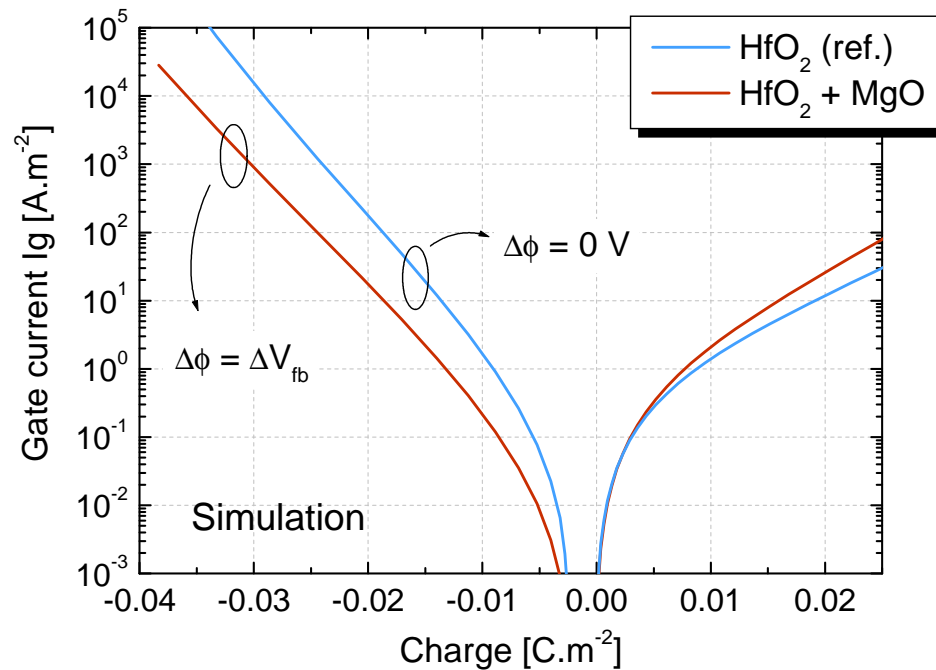

Tunneling parameters extraction suffer from uncertainties in gate stack materials

Investigation of gate leakage appears mandatory for V_{fb} shift study in capped gate stacks.

Additional samples and measurements should be considered for accurate quantitative results.

Outline

- **Tunneling current modeling**
 - Self-consistent Poisson-Schrödinger simulation
 - Transmission probability
- **Experimental investigation of leakage current in HfO₂ gate stacks**
 - Transport mechanisms
 - Dielectric thicknesses extraction
 - Tunneling parameters extraction
 - Dipole effect in Mg-capped HfO₂ gate stacks
- **Conclusions**

Conclusions

- Gate leakage mechanisms in high- κ gate stacks have been investigated, by mean of :
 - quantum models for tunneling and quantization simulation
 - Accounting for wavefunction penetration in PS simulation appears mandatory for ultra-thin gate stacks
 - Advanced VB description does not significantly impact EOT extraction
 - WKB formalism inaccuracy has been highlighted
 - An original approach for transmission probability modeling is proposed
 - a complete experimental study performed
 - @ low temperature (transport mechanisms discrimination)
 - on various high- κ gate stacks (dielectrics parameters evaluation)

Conclusions

- Transport mechanisms in HfO₂
 - In inversion :
 - Direct tunneling for thin layers (<2.5nm, eg. 32nm node)
 - Poole Frenkel or inelastic TAT for thick HfO₂ layers (>2.5nm) (@80K : tunneling)
 - In accumulation : pure tunneling
- IL parameters have been shown to differ from target values
 - RTO IL : regrowth
 - Chemical IL : silicate or substoechiometry
- Effective Mass Approximation in dielectrics :
 - **OK** for electrons
 - **Not valid** for holes : Franz-type E-k
- Carefull experimental study allowed to reach a better consensus on HfO₂ band structure and tunneling parameters

Thank you for your attention