

Cosmologie et modifications à grandes distances de l'interaction gravitationnelle

Cosmology and modifications of gravity at large distances

Riad ZIOUR

APC, Université Paris 7 Diderot

Sous la direction de
C. Deffayet



Laboratoire APC, Mardi 19 Janvier 2010

Outline of the presentation

- The acceleration of the Universe: Dark Energy or new gravity?
- Massive gravity and the Vainshtein's mechanism
- Observations: the confrontation with reality

The acceleration of the Universe:
Dark Energy or new gravity?

The expansion of the Universe

- What does “expansion” mean?

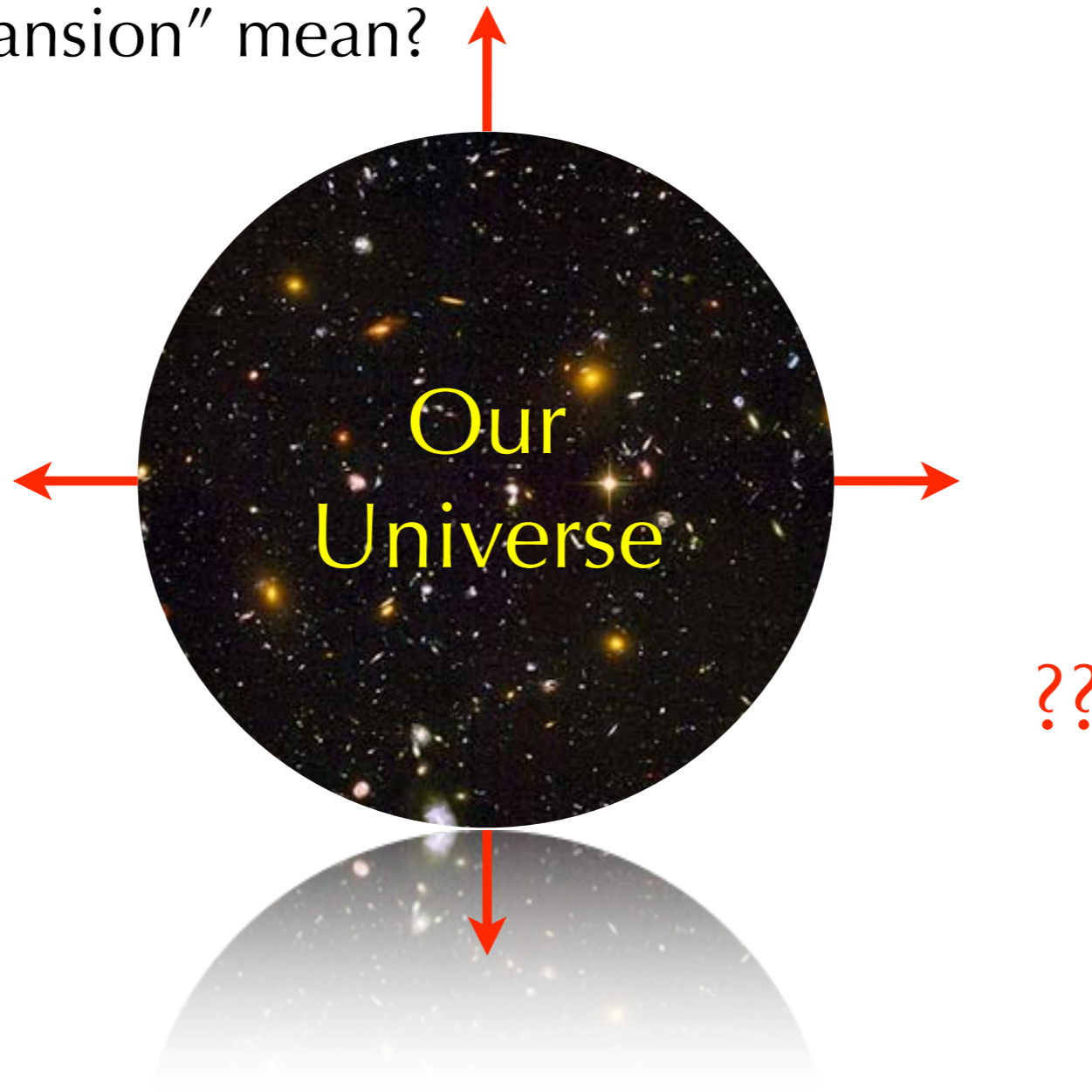

The expansion of the Universe

- What does “expansion” mean?

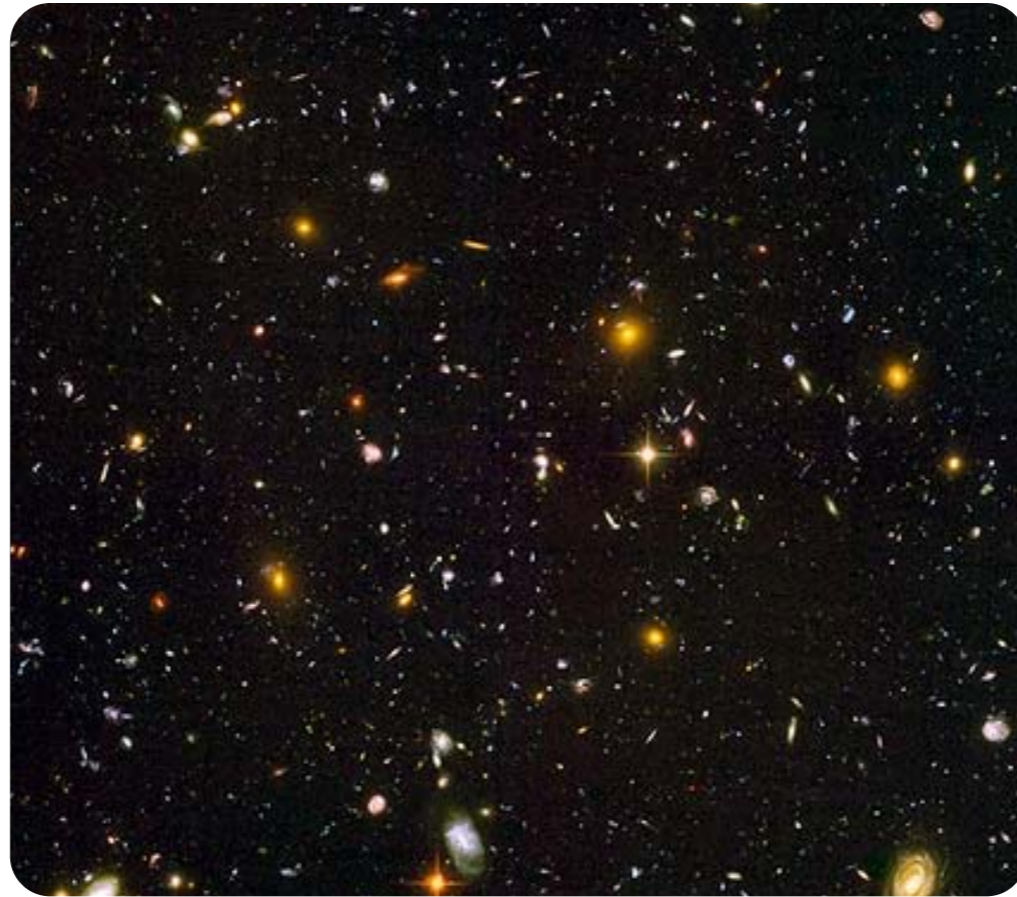

The expansion of the Universe

- What does “expansion” mean?

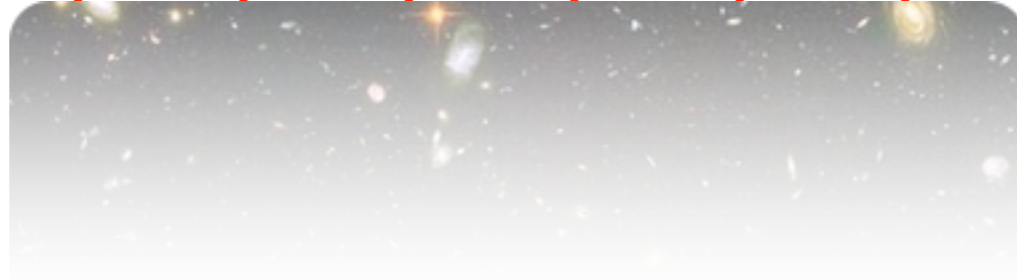
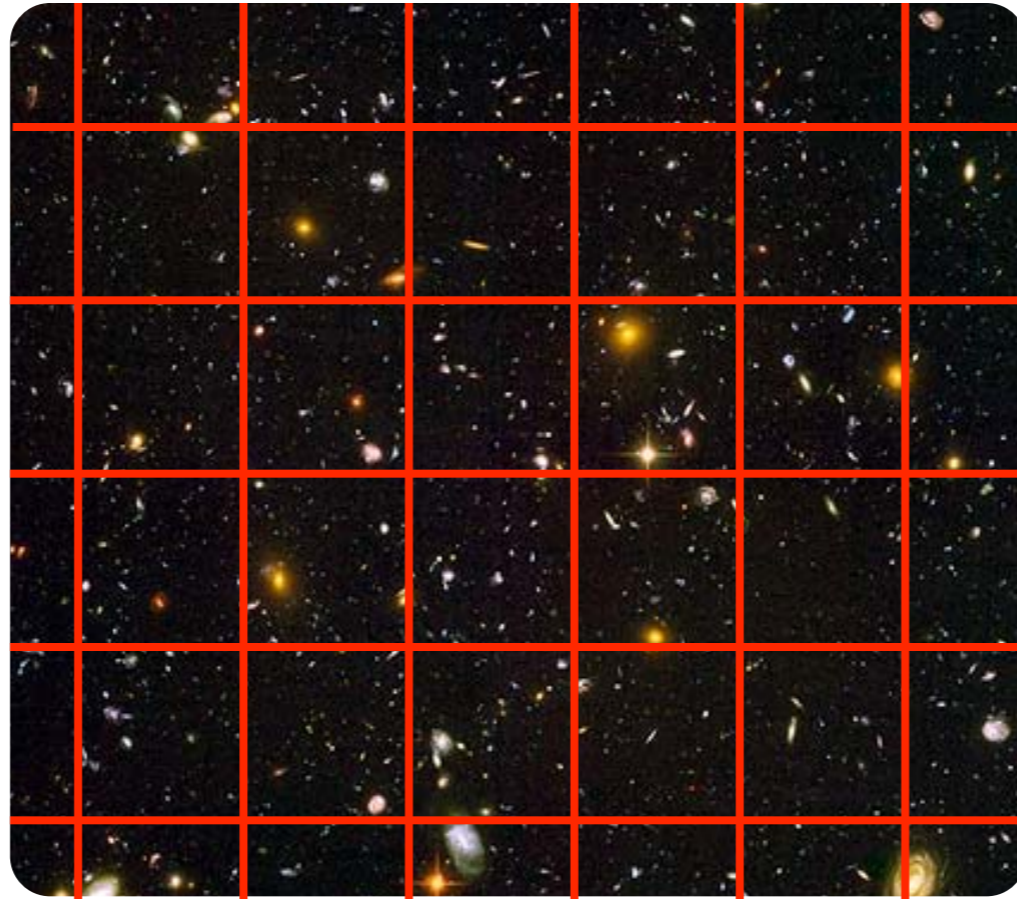

The expansion of the Universe

- What does “expansion” mean?

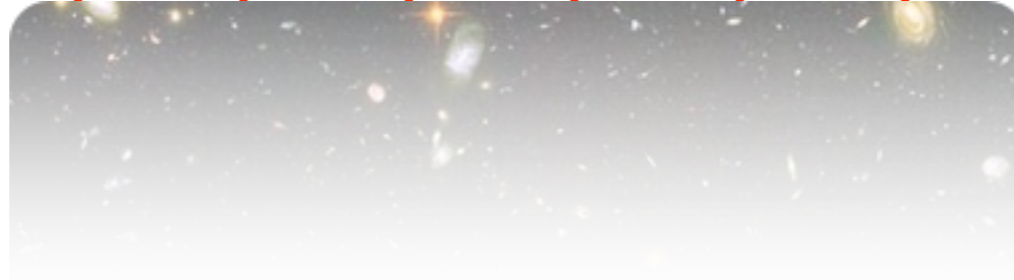
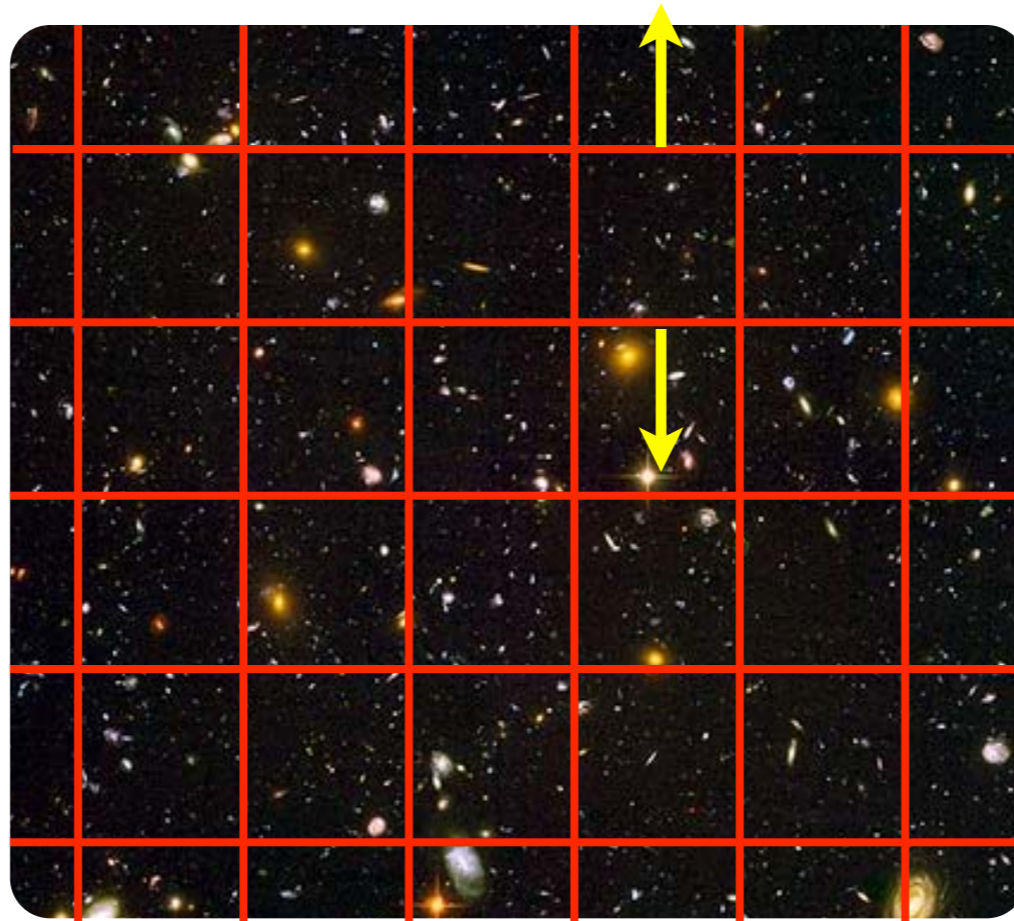

The expansion of the Universe

- What does “expansion” mean?

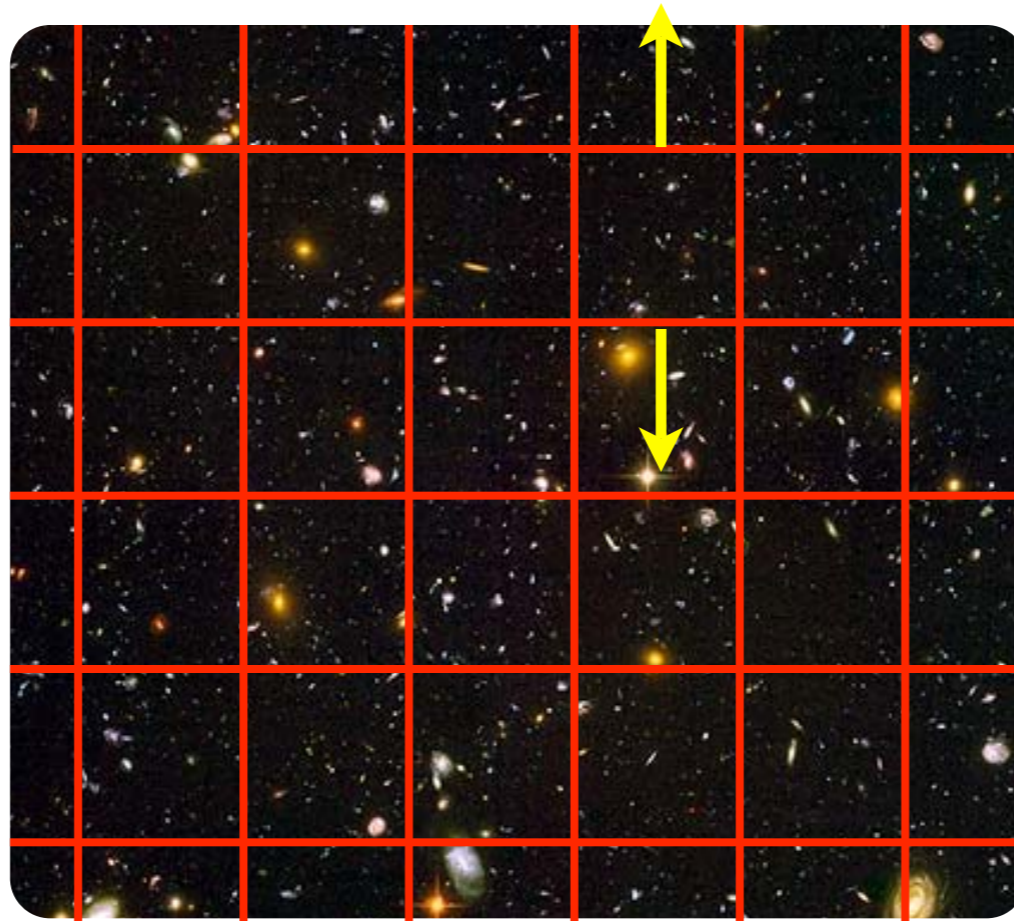

Two types of units of distances:

The expansion of the Universe

- What does “expansion” mean?

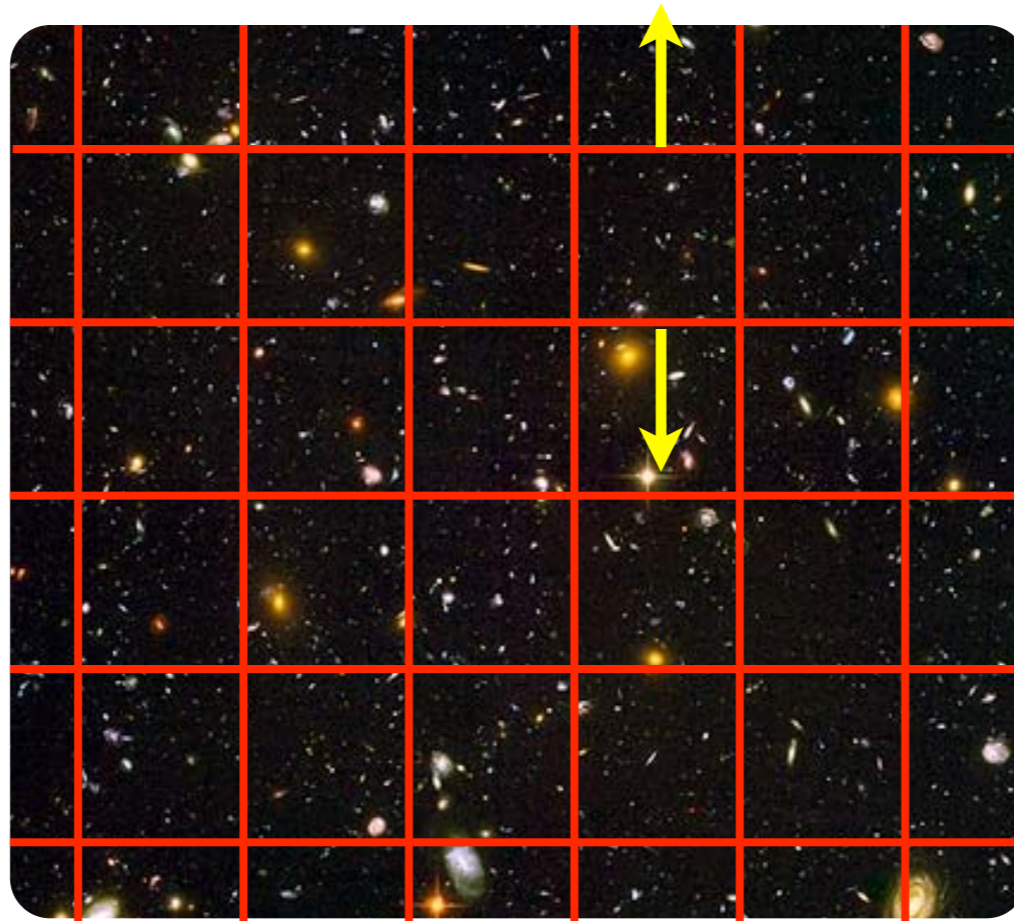

Two types of units of distances:

✓ grid units

The expansion of the Universe

- What does “expansion” mean?

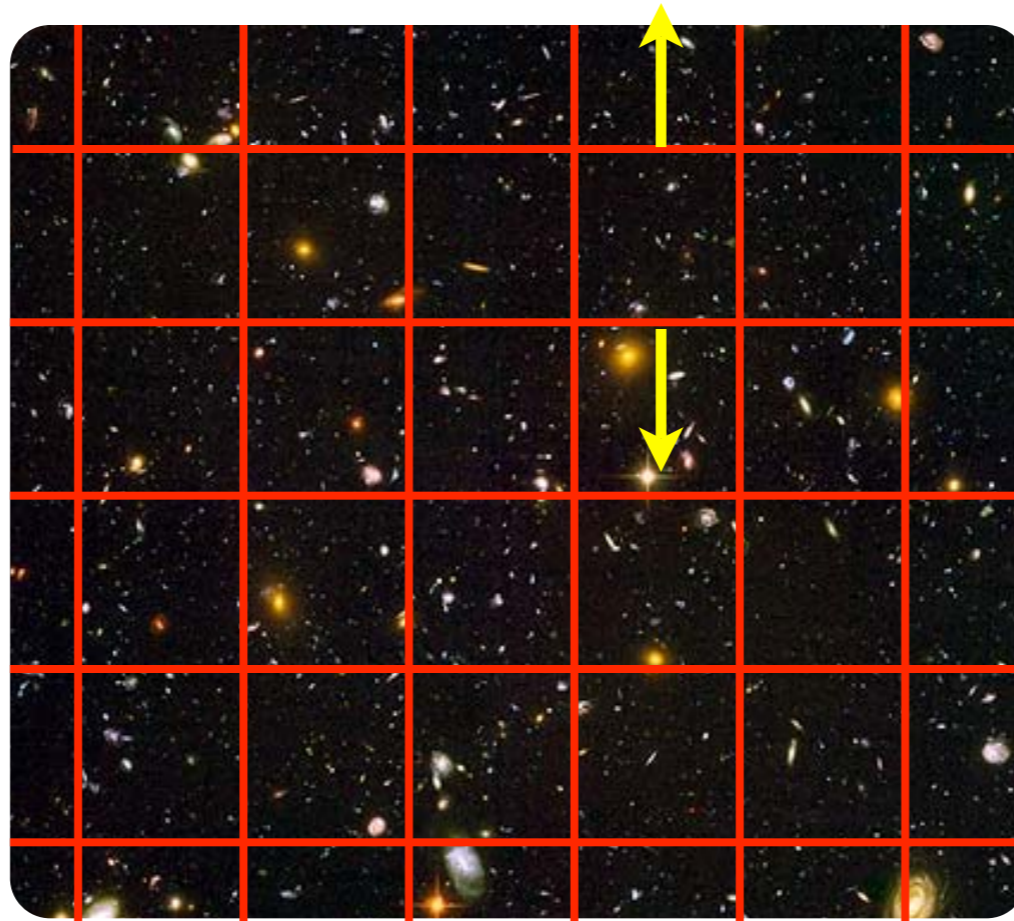

Two types of units of distances:

✓ grid units

✓ physical units

The expansion of the Universe

- What does “expansion” mean?

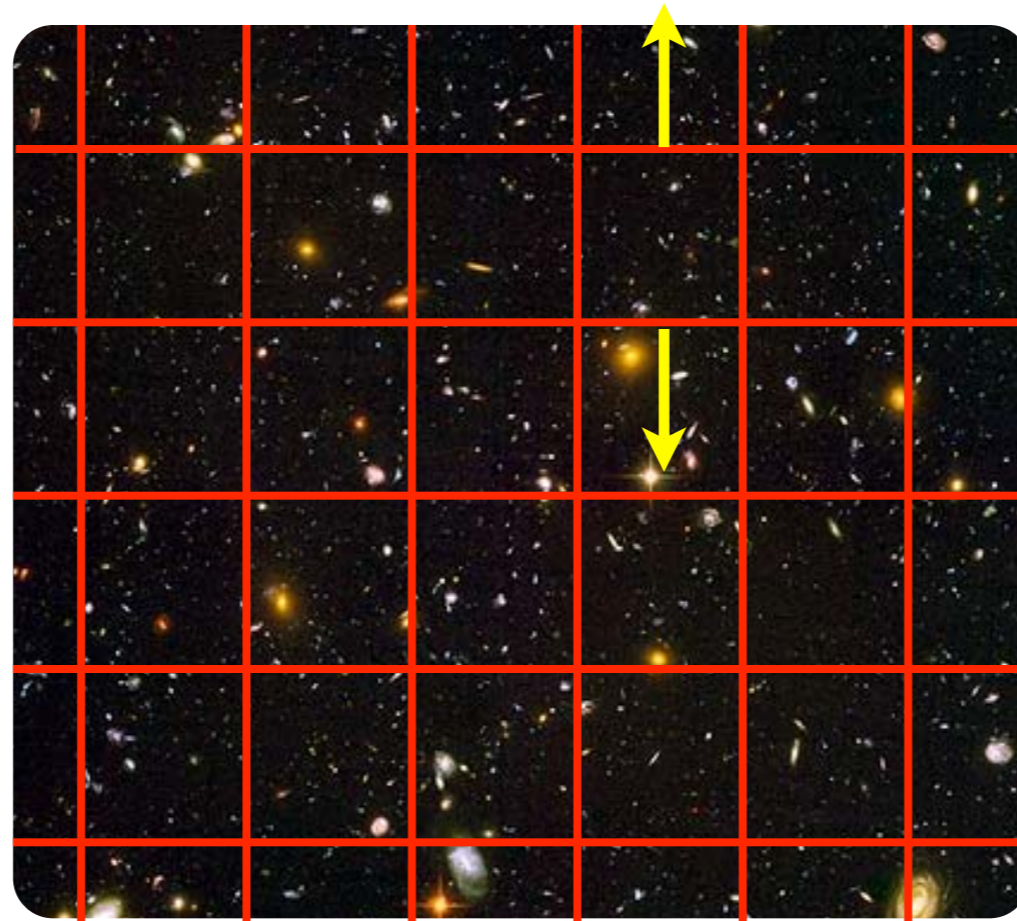

Two types of units of distances:

✓ grid units



The metric
 $g_{\mu\nu}$



✓ physical units

The expansion of the Universe

- What does “expansion” mean?

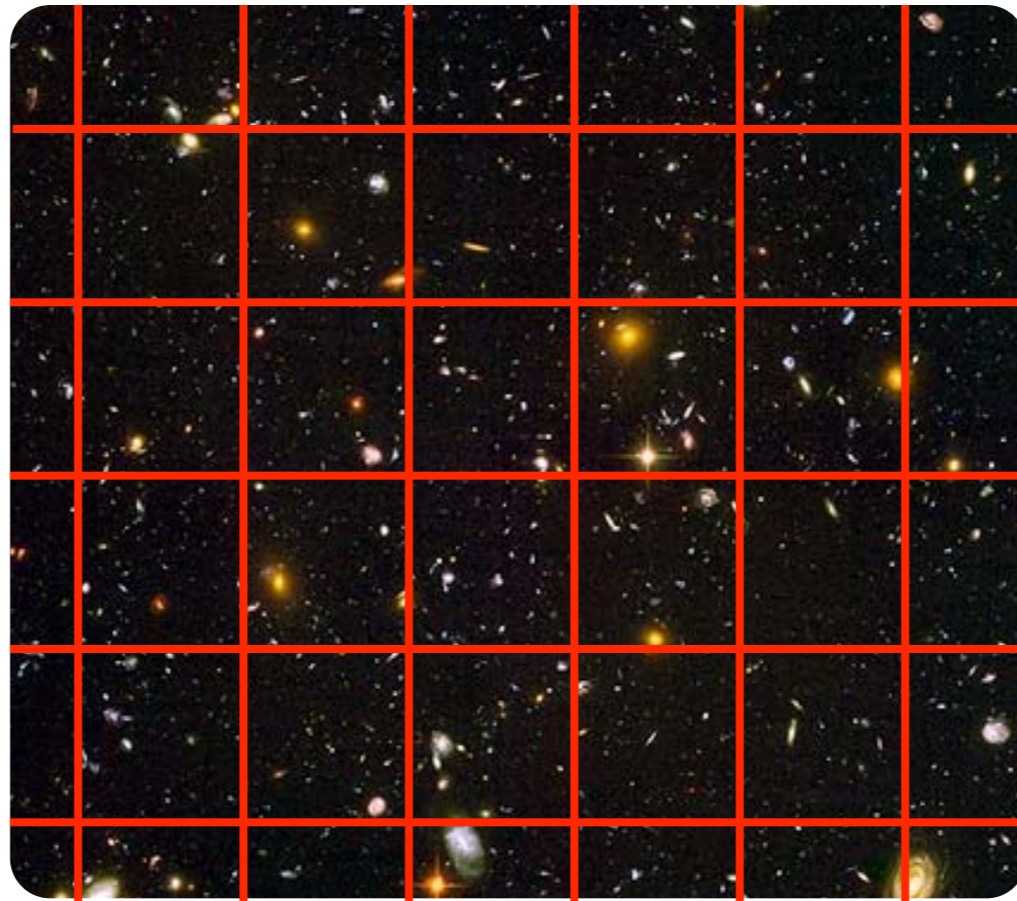

Two types of units of distances:

✓ grid units



The metric

$$g_{\mu\nu}$$



✓ physical units

encodes the space-time

The acceleration of the Universe

The acceleration of the Universe

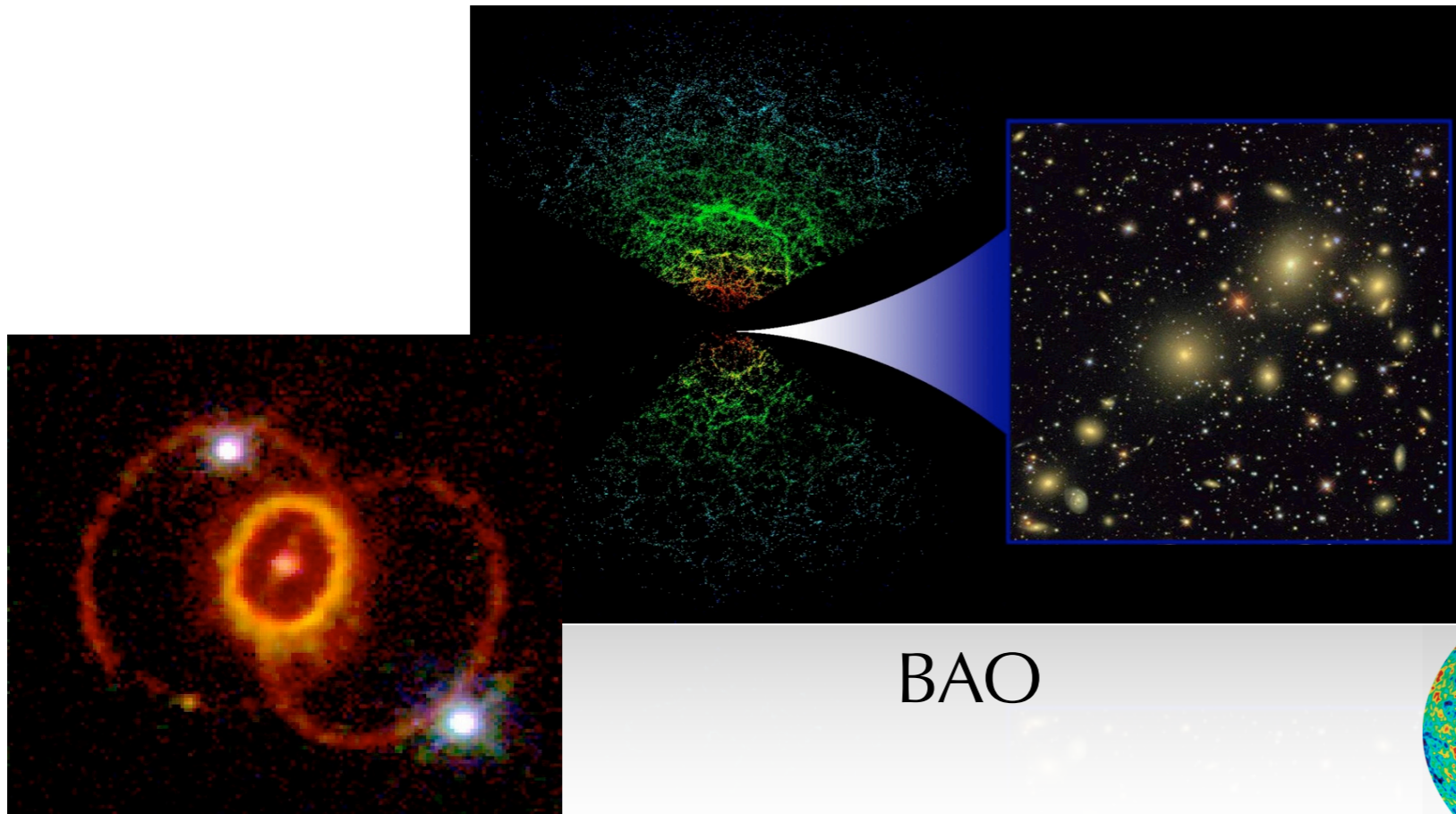

SN Ia

BAO

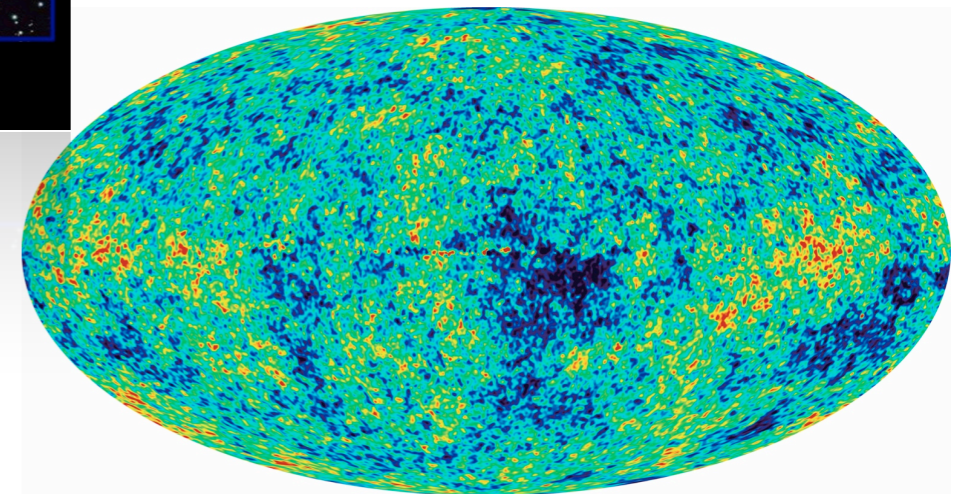

CMB

The acceleration of the Universe

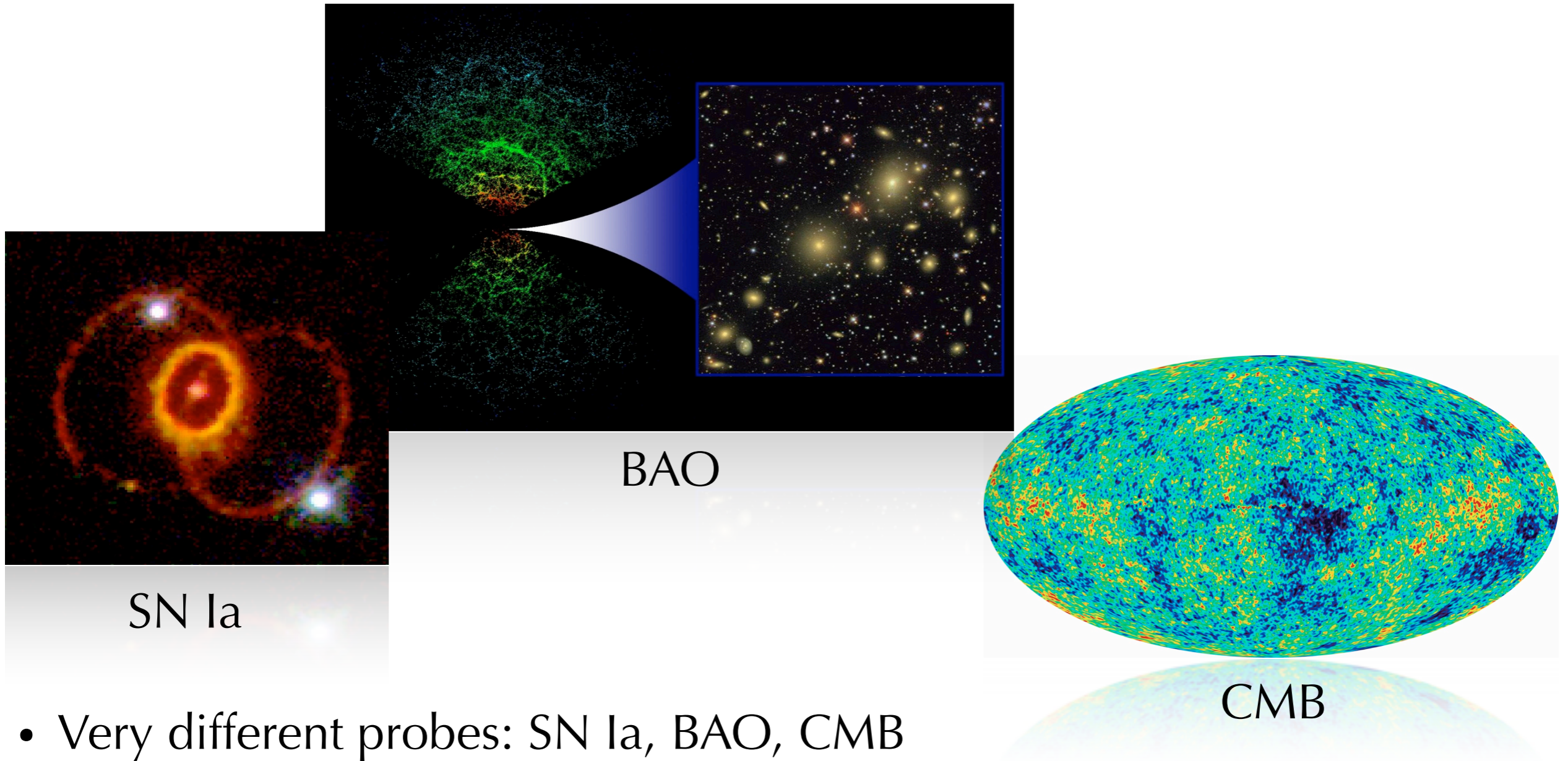

The acceleration of the Universe

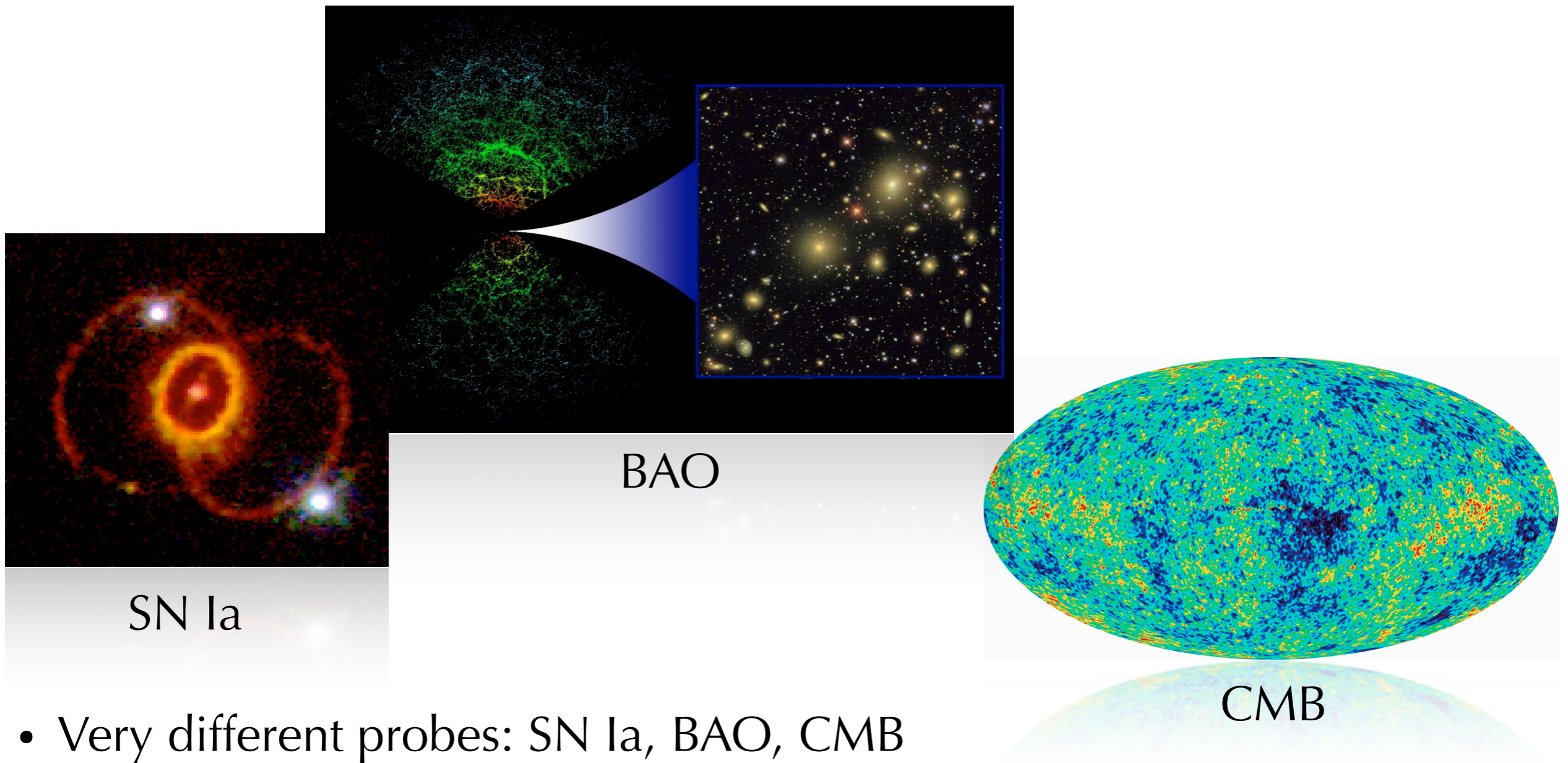

They all show that the Universe is accelerating!

The source of the acceleration

The source of the acceleration

- Einstein's equations

$$G_{\mu\nu} = 8\pi G T_{\mu\nu}^{(m)} - \Lambda g_{\mu\nu}$$

The source of the acceleration

- Einstein's equations

$$G_{\mu\nu} = 8\pi G T_{\mu\nu}^{(m)} - \Lambda g_{\mu\nu}$$

Geometry

The source of the acceleration

- Einstein's equations

$$G_{\mu\nu} = 8\pi G T_{\mu\nu}^{(m)} - \Lambda g_{\mu\nu}$$

Geometry

Matter

The source of the acceleration

- Einstein's equations

$$\text{Geometry} \rightarrow G_{\mu\nu} = 8\pi G T_{\mu\nu}^{(m)} \rightarrow \Lambda g_{\mu\nu} \leftarrow \text{Dark Energy}$$

Geometry

Matter

Dark Energy

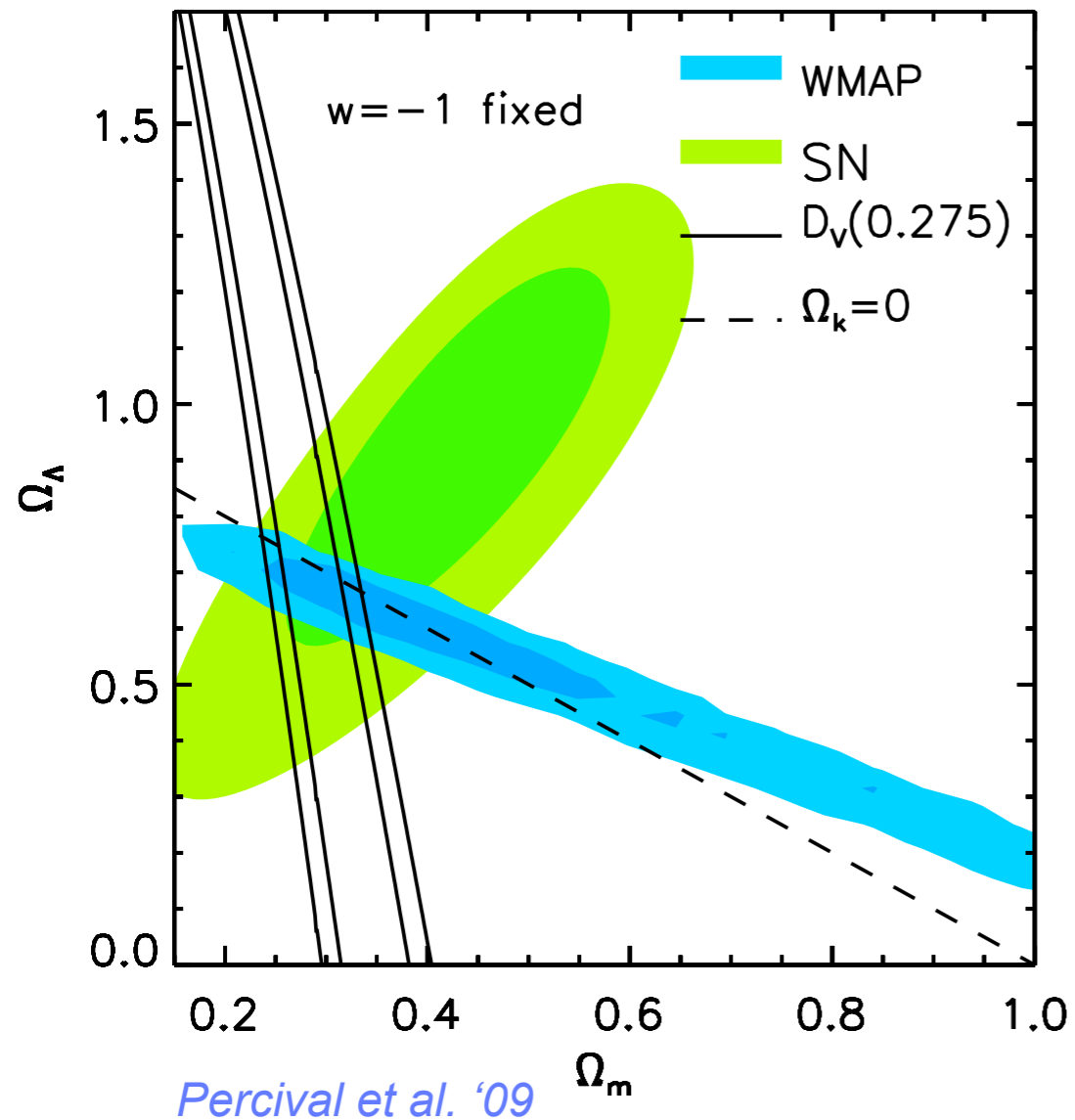

The source of the acceleration

- Einstein's equations

$$\text{Geometry} \rightarrow G_{\mu\nu} = 8\pi G T_{\mu\nu}^{(m)} + \Lambda g_{\mu\nu} \rightarrow \text{Dark Energy}$$

Geometry Matter Dark Energy

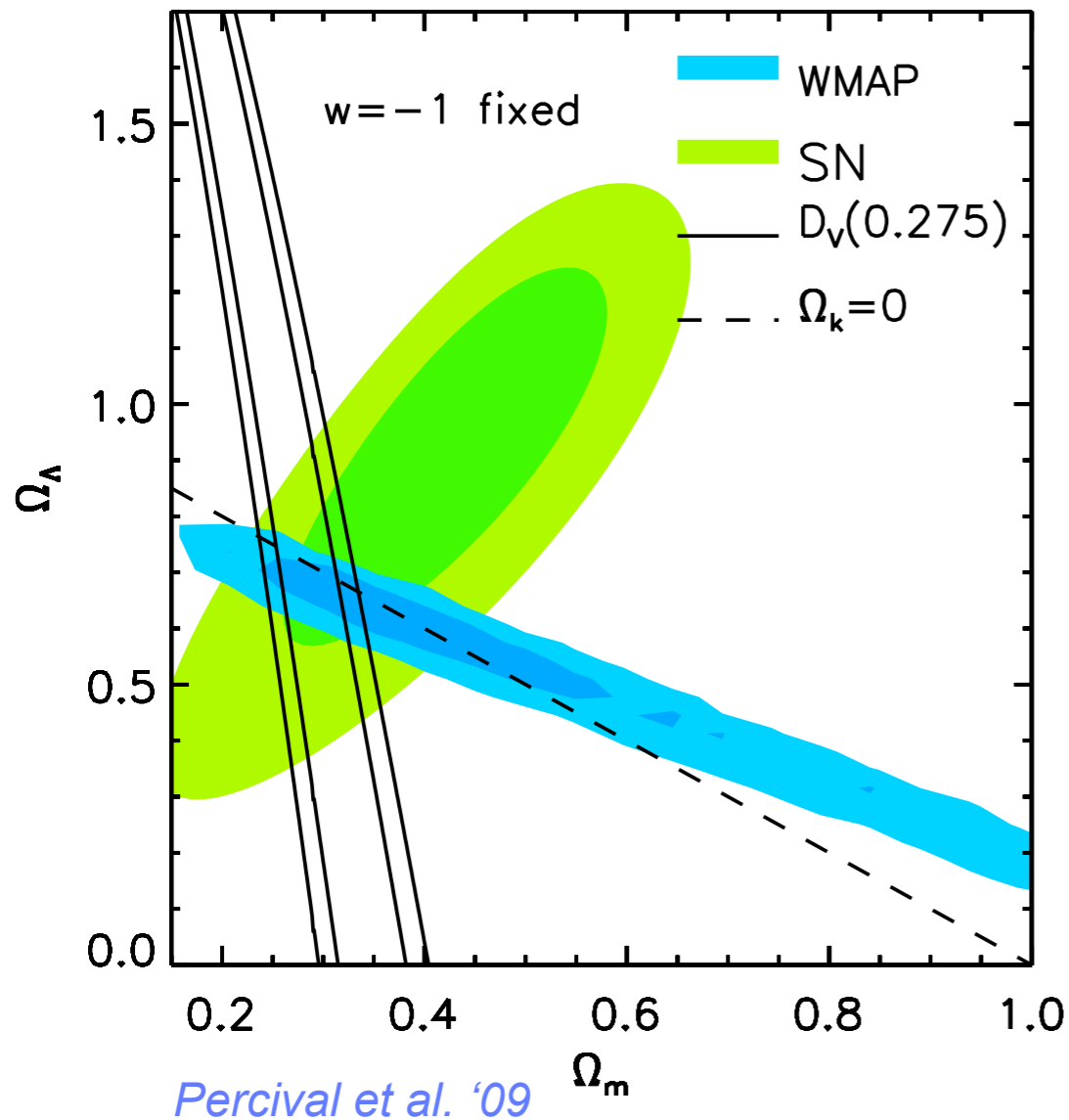

- Coincidence problem

The source of the acceleration

- Einstein's equations

$$\text{Geometry} \rightarrow G_{\mu\nu} = 8\pi G T_{\mu\nu}^{(m)} - \Lambda g_{\mu\nu} \leftarrow \text{Dark Energy}$$

Matter

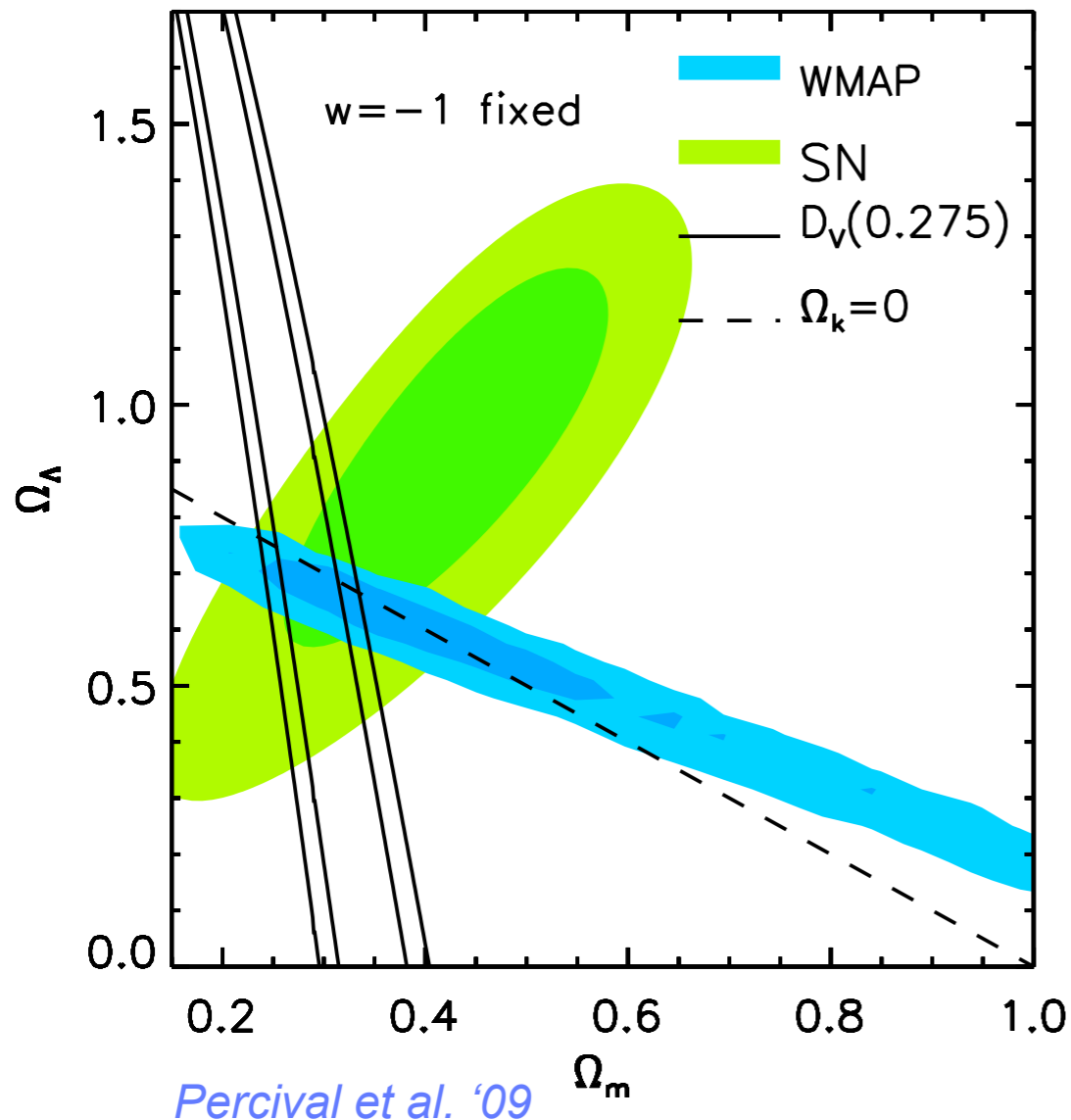

- Coincidence problem
- Fine tuning problem

The source of the acceleration

- Einstein's equations

$$\text{Geometry} \rightarrow G_{\mu\nu} = 8\pi G T_{\mu\nu}^{(m)} - \Lambda g_{\mu\nu} \leftarrow \text{Dark Energy}$$

Matter

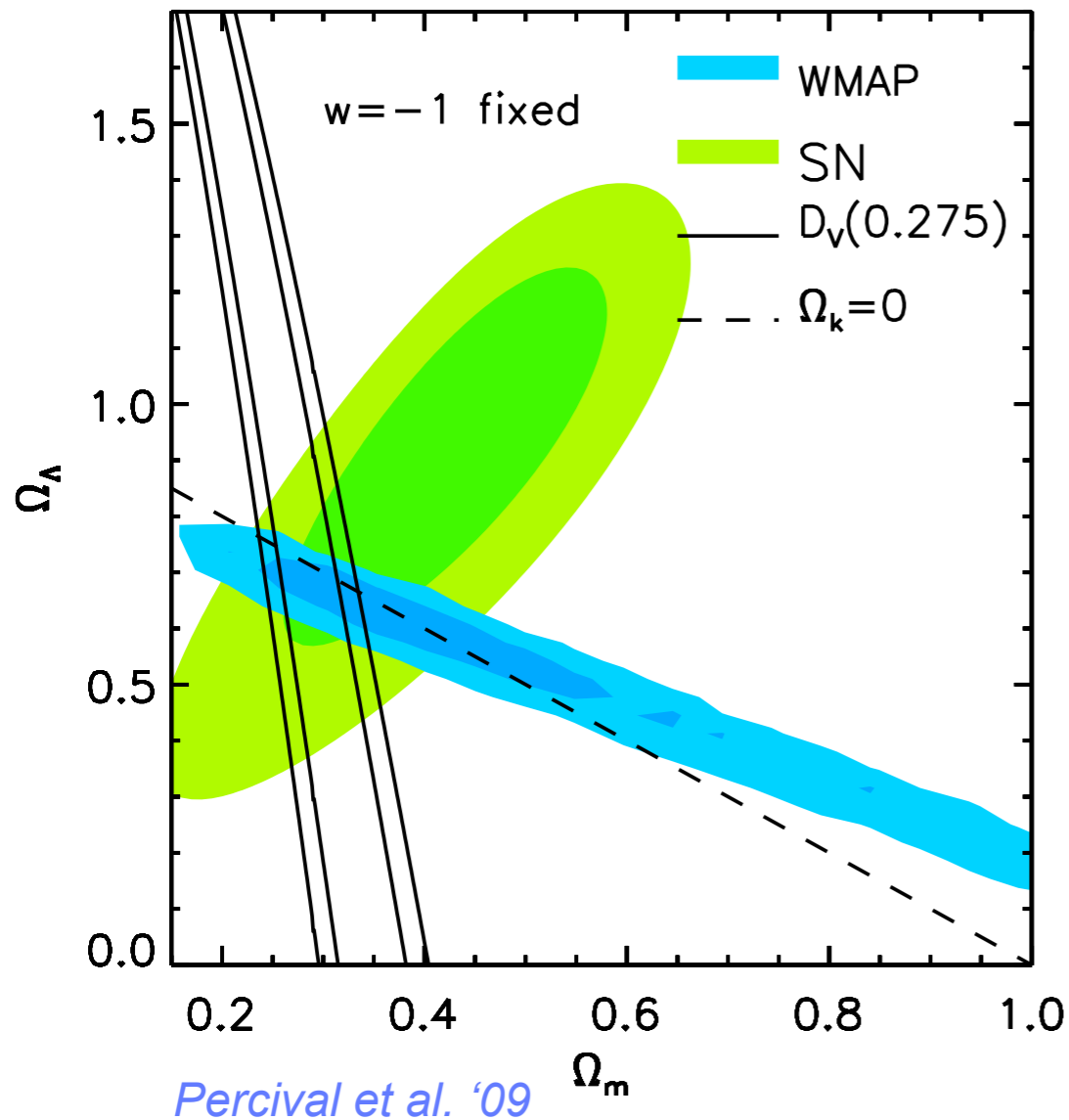

- Coincidence problem
- Fine tuning problem

What is the nature of the Dark Energy?

Modified gravity theories

Modified gravity theories

Aim: to generalize Einstein's equations to explain the acceleration of the Universe without Dark Energy

Modified gravity theories

Aim: to generalize Einstein's equations to explain the acceleration of the Universe without Dark Energy

How: by adding extra fields

Modified gravity theories

Aim: to generalize Einstein's equations to explain the acceleration of the Universe without Dark Energy

How: by adding extra fields

Problem: we want to recover GR at short distances (inside the solar system) while modifying gravity at large distances

Modified gravity theories

Aim: to generalize Einstein's equations to explain the acceleration of the Universe without Dark Energy

How: by adding extra fields

Problem: we want to recover GR at short distances (inside the solar system) while modifying gravity at large distances

Suppressing the role of these extra fields at short distances:

Modified gravity theories

Aim: to generalize Einstein's equations to explain the acceleration of the Universe without Dark Energy

How: by adding extra fields

Problem: we want to recover GR at short distances (inside the solar system) while modifying gravity at large distances

Suppressing the role of these extra fields at short distances:

→ Chameleon mechanism

Modified gravity theories

Aim: to generalize Einstein's equations to explain the acceleration of the Universe without Dark Energy

How: by adding extra fields

Problem: we want to recover GR at short distances (inside the solar system) while modifying gravity at large distances

Suppressing the role of these extra fields at short distances:

➡ Chameleon mechanism

➡ Vainshtein's mechanism

Modified gravity theories: a (short) review

Modified gravity theories: a (short) review

➔ Chameleon mechanism

Khoury & Veltman '00

Modified gravity theories: a (short) review

➔ Chameleon mechanism

Khoury & Veltman '00

- scalar-tensor theories (and $f(R)$ models)

Modified gravity theories: a (short) review

➔ Chameleon mechanism

- scalar-tensor theories (and $f(R)$ models)

Khoury & Veltman '00

➔ Vainshtein's mechanism

Vainshtein '72

Deffayet et al. '02

Modified gravity theories: a (short) review

➡ Chameleon mechanism

- scalar-tensor theories (and $f(R)$ models)

Khoury & Veltman '00

➡ Vainshtein's mechanism

- Massive Gravity

Vainshtein '72

Deffayet et al. '02

Modified gravity theories: a (short) review

➔ Chameleon mechanism

Khoury & Veltman '00

- scalar-tensor theories (and $f(R)$ models)

➔ Vainshtein's mechanism

Vainshtein '72

Deffayet et al. '02

- Massive Gravity
- Models with extra dimensions, e.g. DGP

Modified gravity theories: a (short) review

➔ Chameleon mechanism

Khoury & Veltman '00

- scalar-tensor theories (and $f(R)$ models)

➔ Vainshtein's mechanism

Vainshtein '72

Deffayet et al. '02

- Massive Gravity
- Models with extra dimensions, e.g. DGP

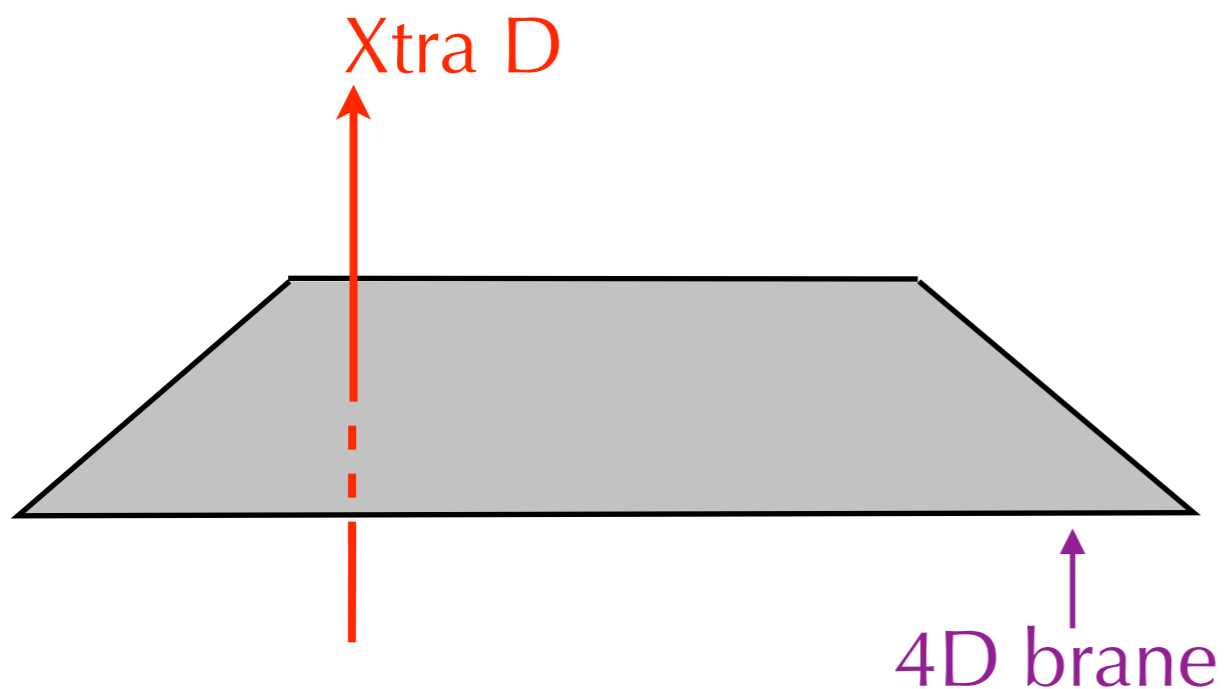

Dvali, Gabadadze and Porrati '00

Modified gravity theories: a (short) review

➔ Chameleon mechanism

Khoury & Veltman '00

- scalar-tensor theories (and $f(R)$ models)

➔ Vainshtein's mechanism

Vainshtein '72

Deffayet et al. '02

- Massive Gravity
- Models with extra dimensions, e.g. DGP

✓ matter stays on the brane

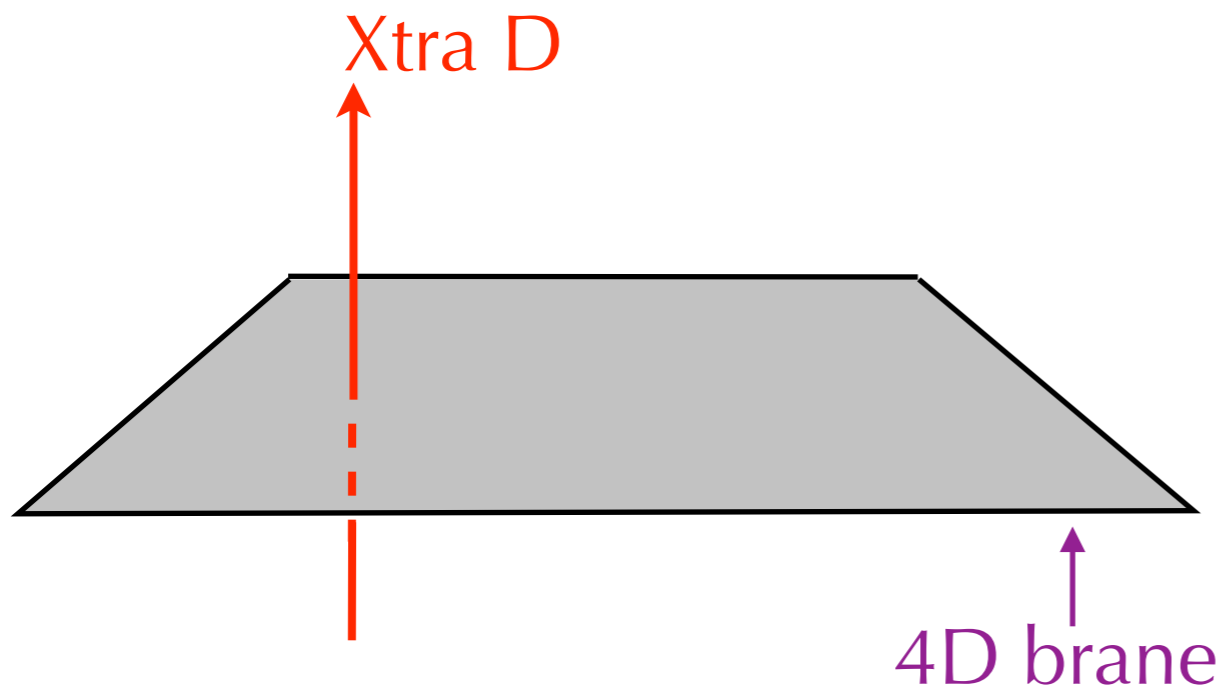

Dvali, Gabadadze and Porrati '00

Modified gravity theories: a (short) review

➔ Chameleon mechanism

- scalar-tensor theories (and $f(R)$ models)

Khoury & Veltman '00

➔ Vainshtein's mechanism

- Massive Gravity
- Models with extra dimensions, e.g. DGP

Vainshtein '72

Deffayet et al. '02

- ✓ matter stays on the brane
- ✓ 5D + 4D gravity

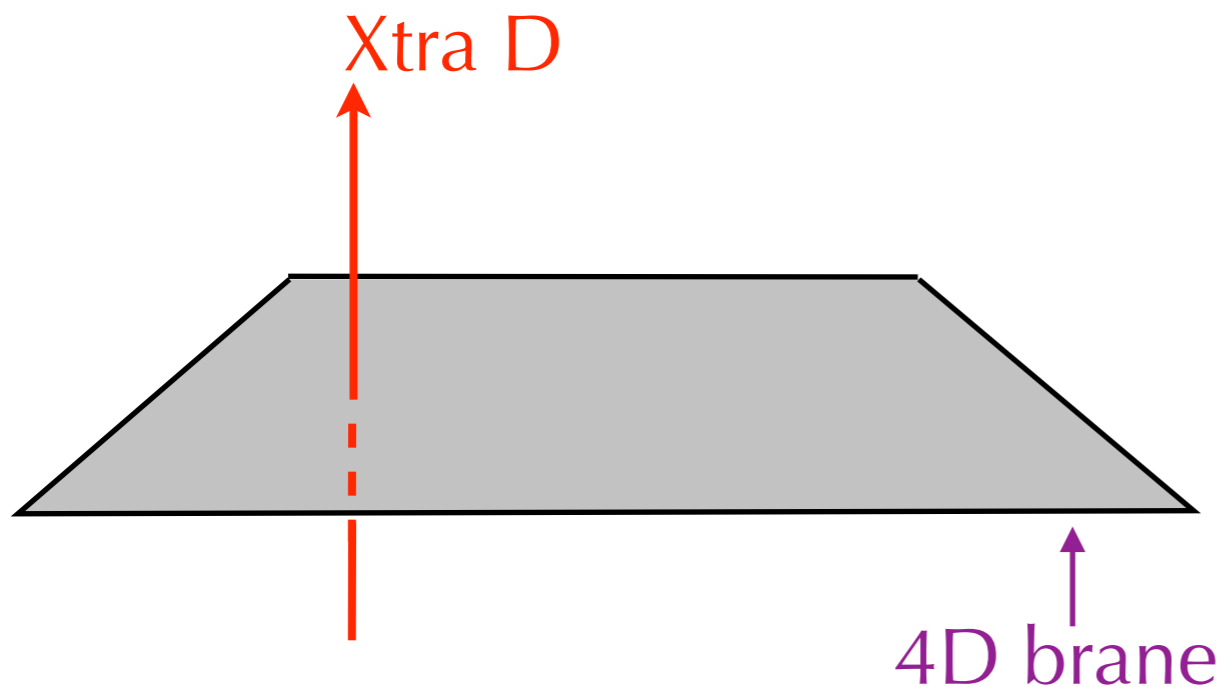

Dvali, Gabadadze and Porrati '00

Modified gravity theories: a (short) review

➔ Chameleon mechanism

- scalar-tensor theories (and $f(R)$ models)

Khoury & Veltman '00

➔ Vainshtein's mechanism

- Massive Gravity
- Models with extra dimensions, e.g. DGP

Vainshtein '72

Deffayet et al. '02

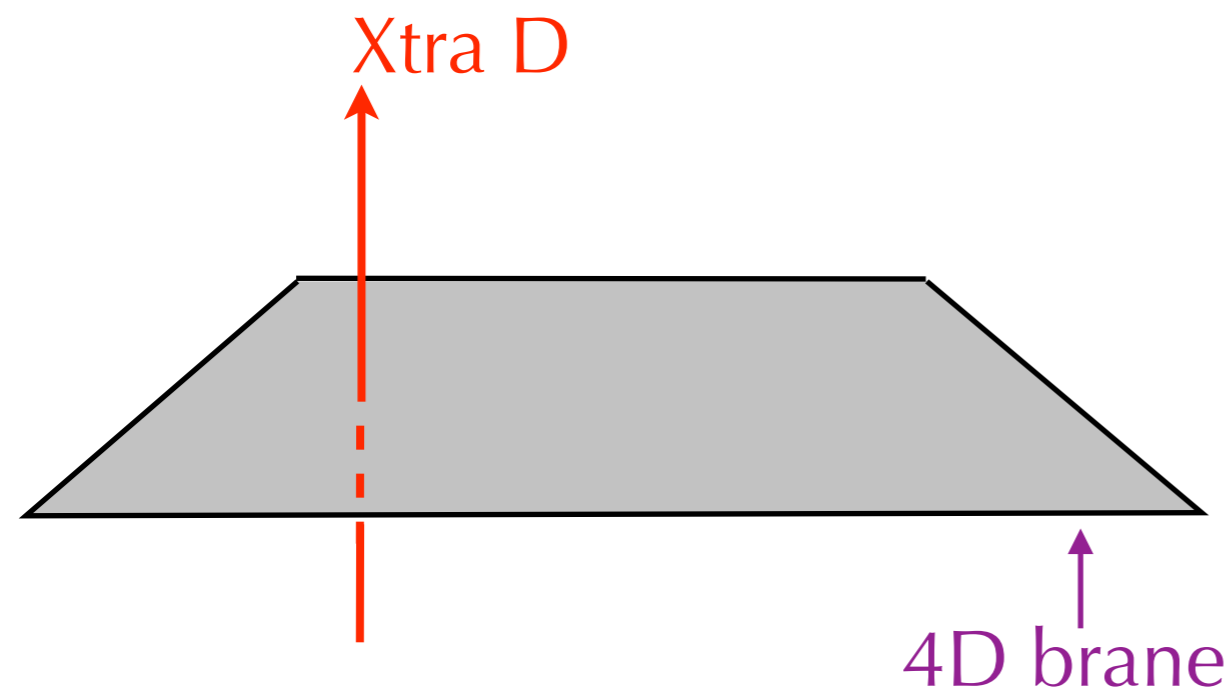

- ✓ matter stays on the brane
- ✓ 5D + 4D gravity
- ✓ can provide an explanation for the cosmic acceleration

Dvali, Gabadadze and Porrati '00

Modified gravity theories: a (short) review

➔ Chameleon mechanism

- scalar-tensor theories (and $f(R)$ models)

Khoury & Veltman '00

➔ Vainshtein's mechanism

- Massive Gravity
- Models with extra dimensions, e.g. DGP

Vainshtein '72

Deffayet et al. '02

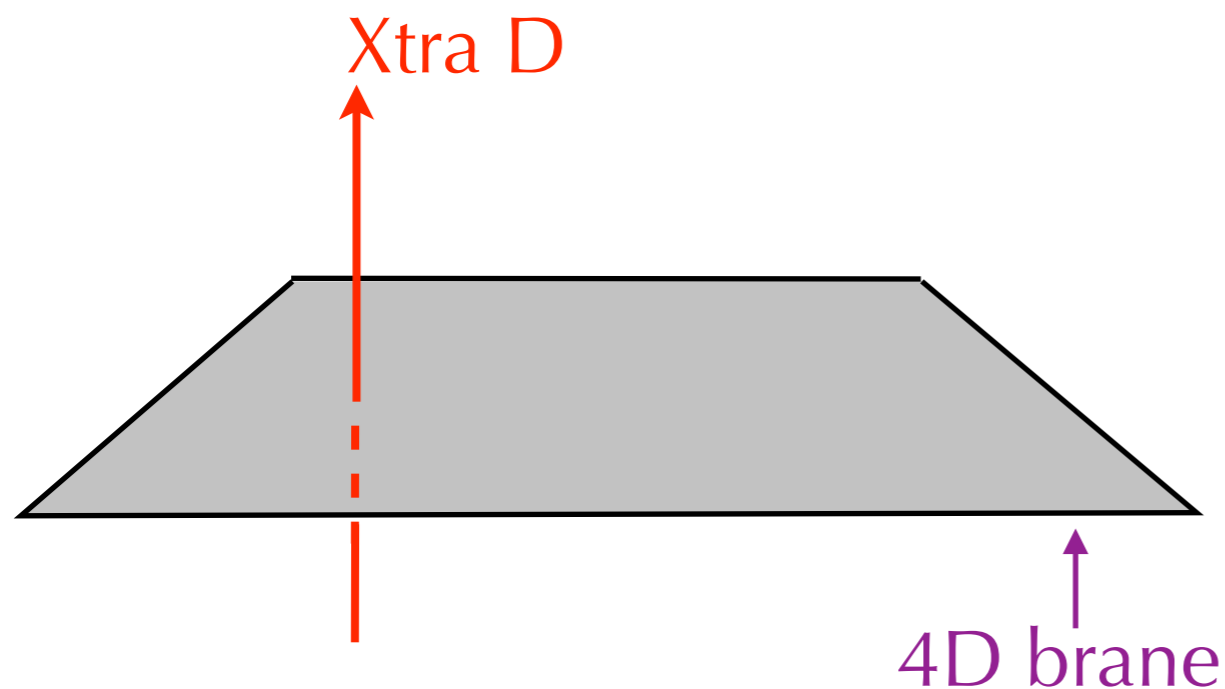

✓ matter stays on the brane

✓ 5D + 4D gravity

✓ can provide an explanation for the cosmic acceleration

✓ 5D massless graviton = infinite tower of 4D gravitons

Dvali, Gabadadze and Porrati '00

Publications

Publications

- [E. Babichev, C. Deffayet, RZ](#), JHEP 05 (2009) 098 [[arXiv:0901.0393](#)]
The Vainshtein mechanism in the Decoupling Limit of massive gravity
- [E. Babichev, C. Deffayet, RZ](#), PRL 103 (2009) 201102 [[arXiv:0907.4103](#)]
Recovering general relativity from massive gravity
- [E. Babichev, C. Deffayet, RZ](#), in preparation [[arXiv:1001.xxxx](#)]
Spherically symmetric solutions of massive gravity and the Vainshtein mechanism
- [E. Babichev, C. Deffayet, RZ](#), International Journal of Modern Physics D (accepted for publication) (2010) [[arXiv:0905.2943](#)],
Awarded a honorable mention at the 2009 Awards for “Essays on gravitation”
k-Mouflage gravity
- [RZ, L. Hui](#), PRD, 78 (2008) 123517 [[arXiv:0809.3101](#)]
Magnification bias corrections to galaxy-lensing cross-correlations

Publications

Massive gravity

- [E. Babichev, C. Deffayet, RZ](#), JHEP 05 (2009) 098 [[arXiv:0901.0393](#)]
The Vainshtein mechanism in the Decoupling Limit of massive gravity
 - [E. Babichev, C. Deffayet, RZ](#), PRL 103 (2009) 201102 [[arXiv:0907.4103](#)]
Recovering general relativity from massive gravity
 - [E. Babichev, C. Deffayet, RZ](#), in preparation [[arXiv:1001.xxxx](#)]
Spherically symmetric solutions of massive gravity and the Vainshtein mechanism
-
- [E. Babichev, C. Deffayet, RZ](#), International Journal of Modern Physics D (accepted for publication) (2010) [[arXiv:0905.2943](#)],
Awarded a honorable mention at the 2009 Awards for “Essays on gravitation”
k-Mouflage gravity
 - [RZ, L. Hui](#), PRD, 78 (2008) 123517 [[arXiv:0809.3101](#)]
Magnification bias corrections to galaxy-lensing cross-correlations

Publications

Massive gravity

- [E. Babichev, C. Deffayet, RZ](#), JHEP 05 (2009) 098 [[arXiv:0901.0393](#)]
The Vainshtein mechanism in the Decoupling Limit of massive gravity
- [E. Babichev, C. Deffayet, RZ](#), PRL 103 (2009) 201102 [[arXiv:0907.4103](#)]
Recovering general relativity from massive gravity
- [E. Babichev, C. Deffayet, RZ](#), in preparation [[arXiv:1001.xxxx](#)]
Spherically symmetric solutions of massive gravity and the Vainshtein mechanism

k-Mouflage

- [E. Babichev, C. Deffayet, RZ](#), International Journal of Modern Physics D (accepted for publication) (2010) [[arXiv:0905.2943](#)],
Awarded a honorable mention at the 2009 Awards for “Essays on gravitation”
k-Mouflage gravity
- [RZ, L. Hui](#), PRD, 78 (2008) 123517 [[arXiv:0809.3101](#)]
Magnification bias corrections to galaxy-lensing cross-correlations

Publications

Massive gravity

- [E. Babichev, C. Deffayet, RZ](#), JHEP 05 (2009) 098 [[arXiv:0901.0393](#)]
The Vainshtein mechanism in the Decoupling Limit of massive gravity
- [E. Babichev, C. Deffayet, RZ](#), PRL 103 (2009) 201102 [[arXiv:0907.4103](#)]
Recovering general relativity from massive gravity
- [E. Babichev, C. Deffayet, RZ](#), in preparation [[arXiv:1001.xxxx](#)]
Spherically symmetric solutions of massive gravity and the Vainshtein mechanism

k-Mouflage

- [E. Babichev, C. Deffayet, RZ](#), International Journal of Modern Physics D (accepted for publication) (2010) [[arXiv:0905.2943](#)],
Awarded a honorable mention at the 2009 Awards for “Essays on gravitation”
k-Mouflage gravity

Observations

- [RZ, L. Hui](#), PRD, 78 (2008) 123517 [[arXiv:0809.3101](#)]
Magnification bias corrections to galaxy-lensing cross-correlations

Massive gravity & the Vainshtein's mechanism

Context & Motivations

- Naive idea: give a mass to the graviton with $m \sim 1/H_0$
- Massive gravity = basic ingredient for models with extra-dimensions (like DGP):
 - in 5D, the gravity is massless,
 - viewed from the 4D brane, the gravity is mediated by a tower a massive Kaluza-Klein gravitons with no massless mode.
- Pathologies: non-bounded by below Hamiltonian and ghosts [Boulware & Deser '72; Creminelli, Nicolis, Papucci, Trincherini '05; Deffayet & Rombouts '05], singular solutions (?) [Damour et al. '03], but interesting toy model for more realistic theories.

What is Massive gravity?

What is Massive gravity?

- The quadratic action for the massive graviton:

f : background metric (often flat) $H_{\mu\nu}$: spin 2 excitation over f

$$S = \frac{M_P^2}{2} \int d^4x \left(\underbrace{\text{“}H\partial^2 H + \dots\text{”}}_{\text{Kinetic term}} - \frac{m^2}{4} \underbrace{[H_{\mu\nu}H^{\mu\nu} - (H^\mu_\mu)^2]}_{\substack{\text{Pauli-Fierz} \\ \text{Mass term}}} \right) + \int d^4x \frac{1}{2} \underbrace{T_{\mu\nu}H^{\mu\nu}}_{\text{Matter coupling}}$$

What is Massive gravity?

- The quadratic action for the massive graviton:

f : background metric (often flat) $H_{\mu\nu}$: spin 2 excitation over f

$$S = \frac{M_P^2}{2} \int d^4x \left(\underbrace{\text{"}H\partial^2 H + \dots\text{"}}_{\text{Kinetic term}} - \frac{m^2}{4} \underbrace{[H_{\mu\nu}H^{\mu\nu} - (H^\mu_\mu)^2]}_{\text{Pauli-Fierz Mass term}} \right) + \int d^4x \frac{1}{2} \underbrace{T_{\mu\nu}H^{\mu\nu}}_{\text{Matter coupling}}$$

- Non-linear completion: dynamical metric $g = f + H$

$$S = \frac{M_P^2}{2} \int d^4x \left(\sqrt{-g}R[g] - \frac{m^2}{4} \underbrace{\mathcal{V}^{(a)}[\mathbf{g}^{-1}\mathbf{f}]}_{\text{Scalar density}} \right) + S_m[g]$$

What is Massive gravity?

- The quadratic action for the massive graviton:

f : background metric (often flat) $H_{\mu\nu}$: spin 2 excitation over f

$$S = \frac{M_P^2}{2} \int d^4x \left(\underbrace{\text{“}H\partial^2 H + \dots\text{”}}_{\text{Kinetic term}} - \frac{m^2}{4} \underbrace{[H_{\mu\nu}H^{\mu\nu} - (H^\mu_\mu)^2]}_{\text{Pauli-Fierz Mass term}} \right) + \int d^4x \frac{1}{2} \underbrace{T_{\mu\nu}H^{\mu\nu}}_{\text{Matter coupling}}$$

- Non-linear completion: dynamical metric $g = f + H$

$$S = \frac{M_P^2}{2} \int d^4x \left(\sqrt{-g}R[g] - \frac{m^2}{4} \underbrace{\mathcal{V}^{(a)}[\mathbf{g}^{-1}\mathbf{f}]}_{\text{Scalar density}} \right) + S_m[g]$$

- Examples:

$$\mathcal{V}^{(BD)}[\mathbf{g}^{-1}\mathbf{f}] = \sqrt{-f} H_{\mu\nu}H_{\sigma\tau} (f^{\mu\sigma}f^{\nu\tau} - f^{\mu\nu}f^{\sigma\tau})$$

Boulware and Deser '72

$$\mathcal{V}^{(AGS)}[\mathbf{g}^{-1}\mathbf{f}] = \sqrt{-g} H_{\mu\nu}H_{\sigma\tau} (g^{\mu\sigma}g^{\nu\tau} - g^{\mu\nu}g^{\sigma\tau})$$

Arkani-Hamed, Georgi and Schwartz '03

Static Spherically Symmetric solutions



Static Spherically Symmetric solutions

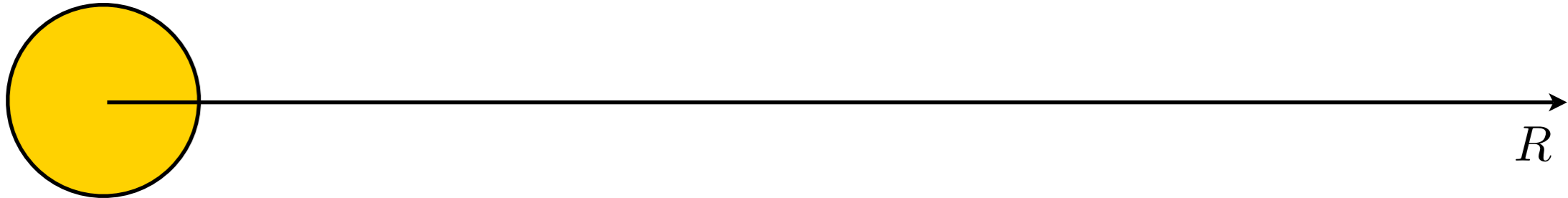

- “Schwarzschild Gauge” (bi-diagonal, asymptotically flat):

$$g_{\mu\nu} dx^\mu dx^\nu = -e^{\nu(R)} dt^2 + e^{\lambda(R)} dR^2 + R^2 d\Omega^2 \quad : \text{“Schwarzschild” like}$$

$$f_{\mu\nu} dx^\mu dx^\nu = -dt^2 + \left(1 - \frac{R\mu'(R)}{2}\right)^2 e^{-\mu(R)} dR^2 + e^{-\mu(R)} R^2 d\Omega^2 \quad : \text{flat}$$

Static Spherically Symmetric solutions

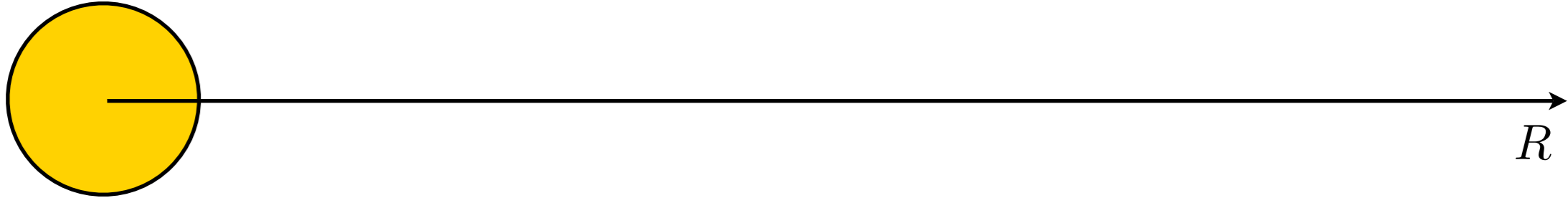

- “Schwarzschild Gauge” (bi-diagonal, asymptotically flat):

$$g_{\mu\nu} dx^\mu dx^\nu = -e^{\nu(R)} dt^2 + e^{\lambda(R)} dR^2 + R^2 d\Omega^2 \quad : \text{“Schwarzschild” like}$$

$$f_{\mu\nu} dx^\mu dx^\nu = -dt^2 + \left(1 - \frac{R\mu'(R)}{2}\right)^2 e^{-\mu(R)} dR^2 + e^{-\mu(R)} R^2 d\Omega^2 \quad : \text{flat}$$

- Equations of motion:

$$e^{\nu-\lambda} \left(\frac{\lambda'}{R} + \frac{1}{R^2} (e^\lambda - 1) \right) = 8\pi G_N (T_{tt}^g + \rho e^\nu),$$

$$\frac{\nu'}{R} + \frac{1}{R^2} (1 - e^\lambda) = 8\pi G_N (T_{RR}^g + P e^\lambda),$$

$$\nabla^\mu T_{\mu R}^g = 0.$$

Static Spherically Symmetric solutions

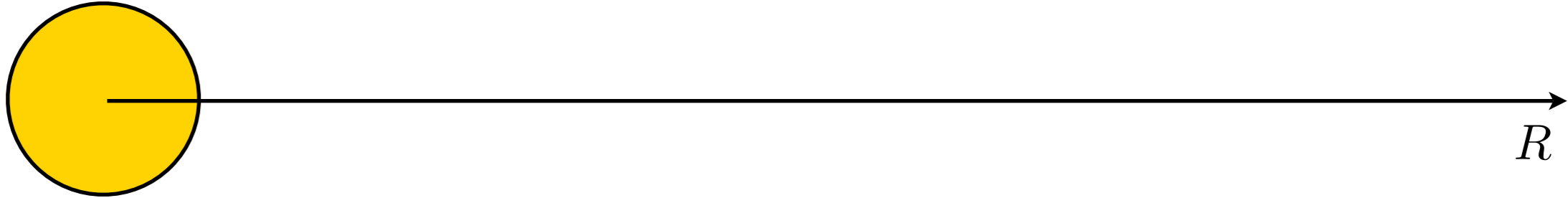

- “Schwarzschild Gauge” (bi-diagonal, asymptotically flat):

$$g_{\mu\nu} dx^\mu dx^\nu = -e^{\nu(R)} dt^2 + e^{\lambda(R)} dR^2 + R^2 d\Omega^2 \quad : \text{“Schwarzschild” like}$$

$$f_{\mu\nu} dx^\mu dx^\nu = -dt^2 + \left(1 - \frac{R\mu'(R)}{2}\right)^2 e^{-\mu(R)} dR^2 + e^{-\mu(R)} R^2 d\Omega^2 \quad : \text{flat}$$

- Equations of motion:

$$\begin{aligned} e^{\nu-\lambda} \left(\frac{\lambda'}{R} + \frac{1}{R^2} (e^\lambda - 1) \right) &= 8\pi G_N (T_{tt}^g + \rho e^\nu), \\ \frac{\nu'}{R} + \frac{1}{R^2} (1 - e^\lambda) &= 8\pi G_N (T_{RR}^g + P e^\lambda), \\ \nabla^\mu T_{\mu R}^g &= 0. \end{aligned}$$

Is it possible to
find a solution
regular
everywhere?

Solution far from the source (I)

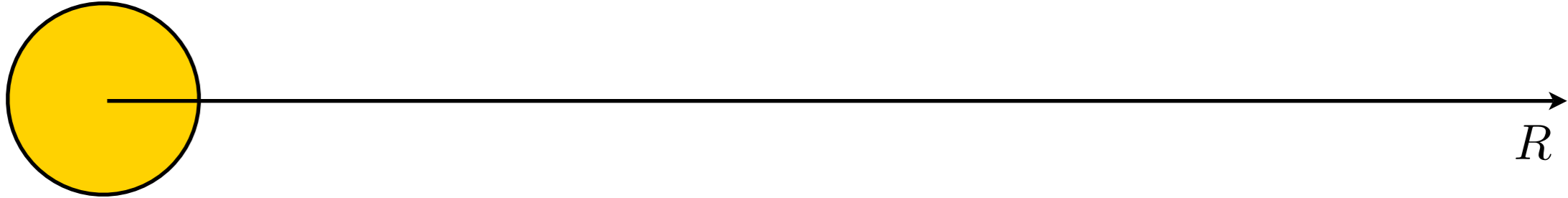

Solution far from the source (I)

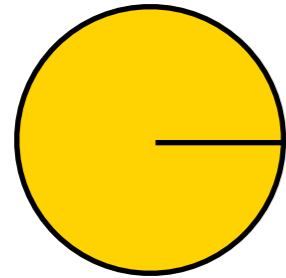

Linear massive gravity

R

Solution far from the source (I)

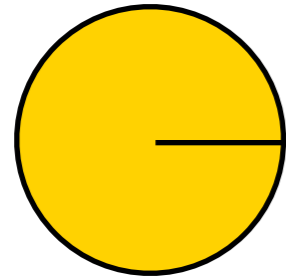

Linear massive gravity

R

- Expansion in the Newton's constant:

$$\lambda = \lambda_0 + \lambda_1 + \dots \text{ etc. , with } \lambda_i, \nu_i, \mu_i \propto G_N^{i+1}$$

Solution far from the source (I)

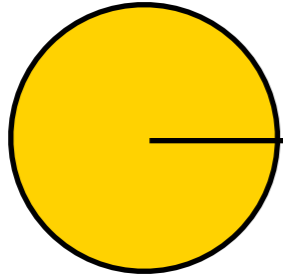

Linear massive gravity

- Expansion in the Newton's constant:

$$\lambda = \lambda_0 + \lambda_1 + \dots \text{ etc. , with } \lambda_i, \nu_i, \mu_i \propto G_N^{i+1}$$

- Linearized solution:

$$\nu_0 = -\mathcal{C} \times \frac{R_S}{R} e^{-mR}$$

$$\lambda_0 = \mathcal{C} \times \frac{R_S}{2R} (1 + mR) e^{-mR}$$

$$\mu_0 = \mathcal{C} \times \frac{R_S}{2(mR)^2 R} (1 + mR + (mR)^2) e^{-mR}$$

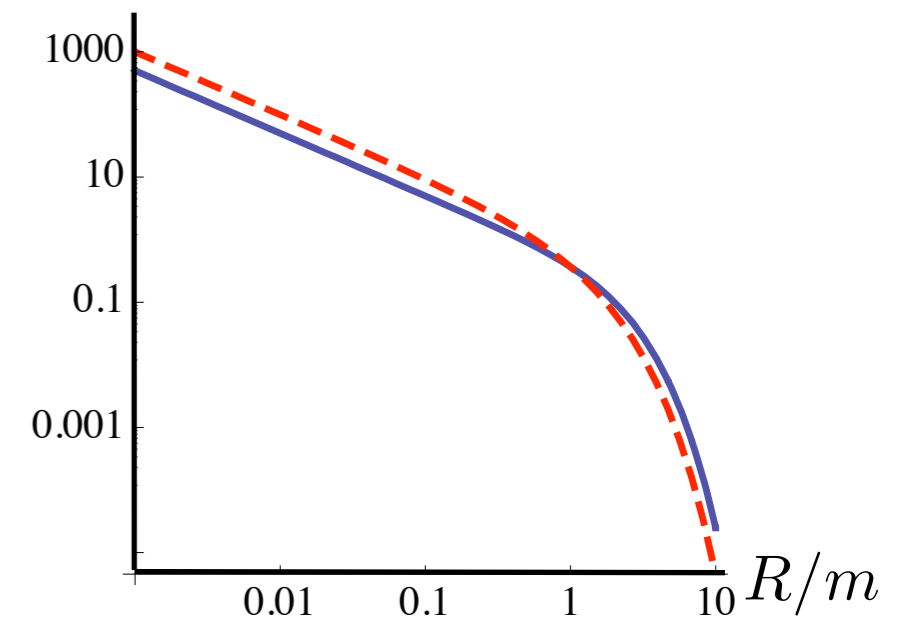

Solution far from the source (I)

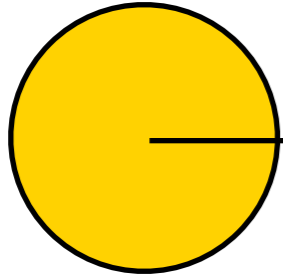

Linear massive gravity

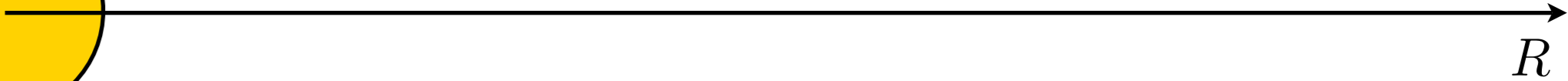

- Expansion in the Newton's constant:

$$\lambda = \lambda_0 + \lambda_1 + \dots \text{ etc. , with } \lambda_i, \nu_i, \mu_i \propto G_N^{i+1}$$

- Linearized solution:

$$\nu_0 = -C \times \frac{R_S}{R} e^{-mR}$$

$$\lambda_0 = C \times \frac{R_S}{2R} (1 + mR) e^{-mR}$$

$$\mu_0 = C \times \frac{R_S}{2(mR)^2 R} (1 + mR + (mR)^2) e^{-mR}$$

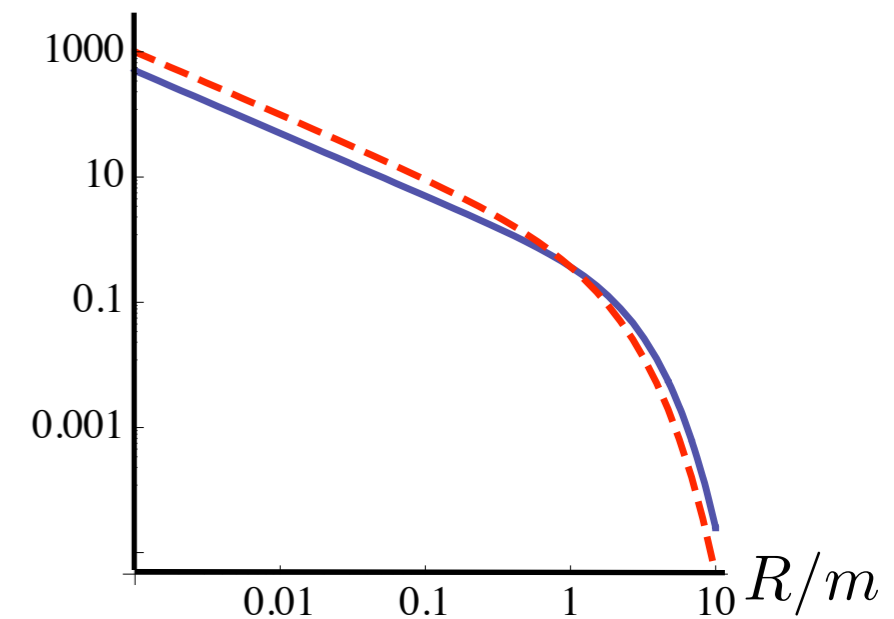

- for $R \ll m^{-1}$: $\lambda_0 = \frac{C_1}{2R}$, $\nu_0 = -\frac{C_1}{R}$, $\mu_0 = \frac{1}{(mR)^2} \frac{C_1}{2R}$.

Solution far from the source (I)

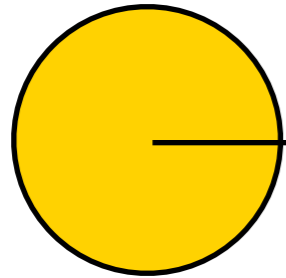

Linear massive gravity

Non GR

R

- Expansion in the Newton's constant:

$$\lambda = \lambda_0 + \lambda_1 + \dots \text{ etc. , with } \lambda_i, \nu_i, \mu_i \propto G_N^{i+1}$$

- Linearized solution:

$$\nu_0 = -C \times \frac{R_S}{R} e^{-mR}$$

$$\lambda_0 = C \times \frac{R_S}{2R} (1 + mR) e^{-mR}$$

$$\mu_0 = C \times \frac{R_S}{2(mR)^2 R} (1 + mR + (mR)^2) e^{-mR}$$

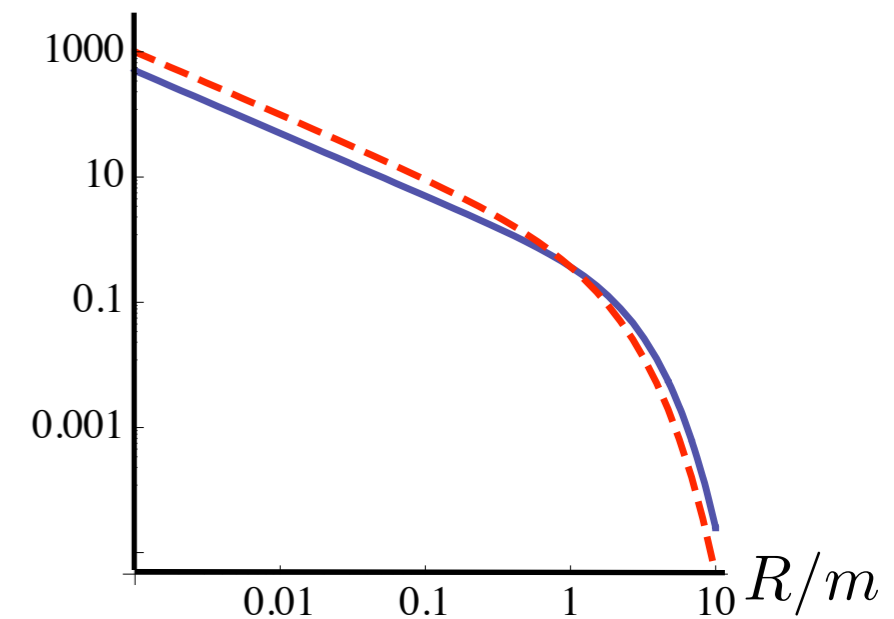

- for $R \ll m^{-1}$: $\lambda_0 = \frac{C_1}{2R}$, $\nu_0 = -\frac{C_1}{R}$, $\mu_0 = \frac{1}{(mR)^2} \frac{C_1}{2R}$.

vDVZ
discontinuity

Solution far from the source (II)

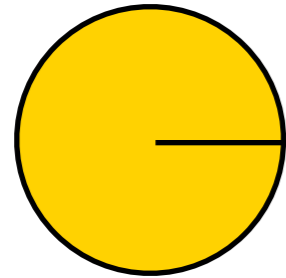

Linear massive gravity

Non GR

R



Solution far from the source (II)

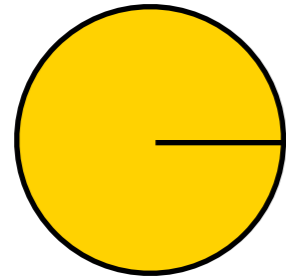

Linear massive gravity

Non GR

R

- Nonlinear corrections:

$$\nu = -\frac{2 R_S}{3 R} + \frac{R_S^2}{R^2} \frac{n_1}{(mR)^4} + \mathcal{O}(R_S^3)$$

$$\lambda = \frac{1 R_S}{3 R} + \frac{R_S^2}{R^2} \frac{l_1}{(mR)^4} + \mathcal{O}(R_S^3)$$

$$\mu = \frac{1}{3(mR)^2} \frac{R_S}{R} + \frac{R_S^2}{R^2} \frac{m_1}{(mR)^6} + \mathcal{O}(R_S^3)$$

Solution far from the source (II)

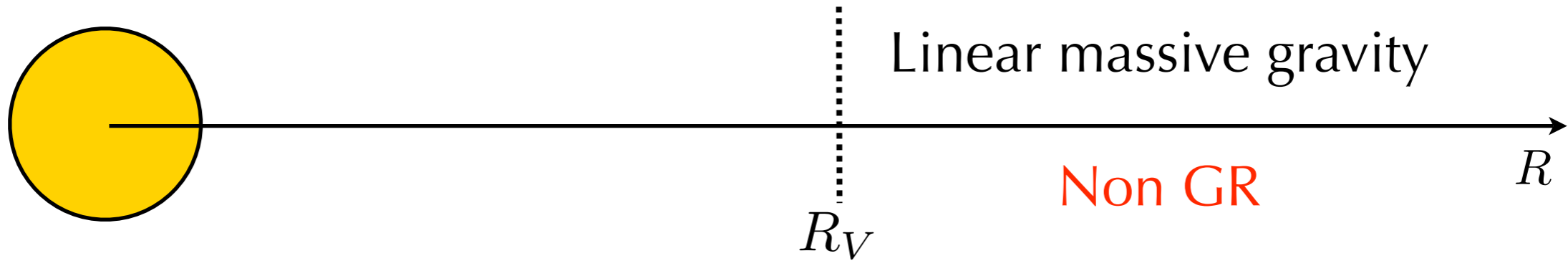

- Nonlinear corrections:

Vainshtein '72

$$\nu = -\frac{2 R_S}{3 R} + \frac{R_S^2}{R^2} \frac{n_1}{(mR)^4} + \mathcal{O}(R_S^3)$$

$$\lambda = \frac{1 R_S}{3 R} + \frac{R_S^2}{R^2} \frac{l_1}{(mR)^4} + \mathcal{O}(R_S^3)$$

$$\mu = \frac{1}{3(mR)^2} \frac{R_S}{R} + \frac{R_S^2}{R^2} \frac{m_1}{(mR)^6} + \mathcal{O}(R_S^3)$$

Relevant at

$$R_V = \left(\frac{R_S}{m^4} \right)^{1/5}$$

New scale:
Vainshtein's radius

Solution far from the source (II)

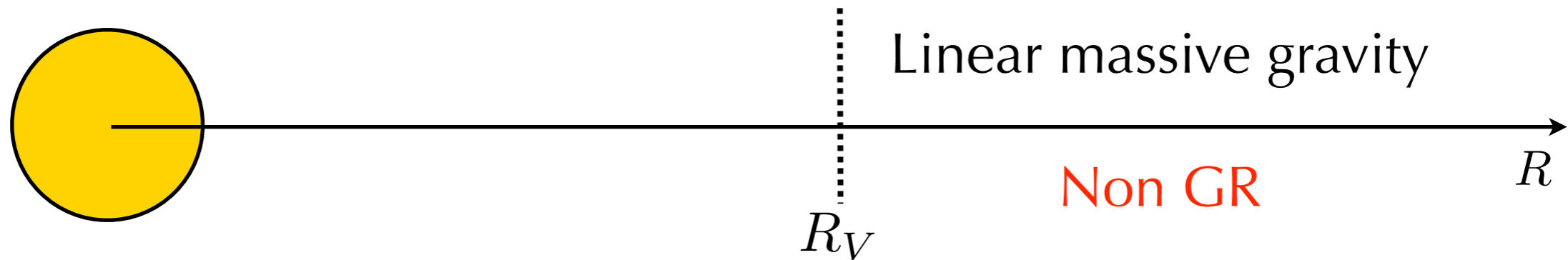

- Nonlinear corrections:

Vainshtein '72

$$\nu = -\frac{2 R_S}{3 R} + \frac{R_S^2}{R^2} \frac{n_1}{(mR)^4} + \mathcal{O}(R_S^3)$$

$$\lambda = \frac{1 R_S}{3 R} + \frac{R_S^2}{R^2} \frac{l_1}{(mR)^4} + \mathcal{O}(R_S^3)$$

$$\mu = \frac{1}{3(mR)^2} \frac{R_S}{R} + \frac{R_S^2}{R^2} \frac{m_1}{(mR)^6} + \mathcal{O}(R_S^3)$$

Relevant at

$$R_V = \left(\frac{R_S}{m^4} \right)^{1/5}$$

New scale:
Vainshtein's radius

What happens inside the Vainshtein's radius?

Solution close to the source

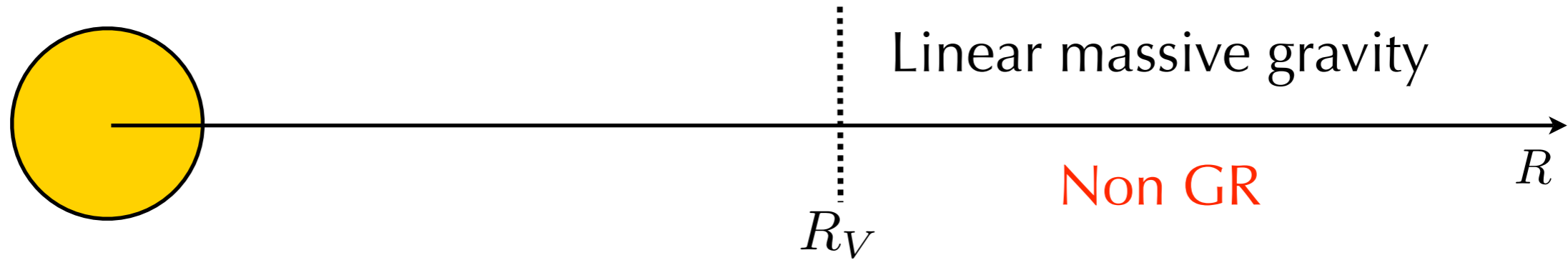

Solution close to the source

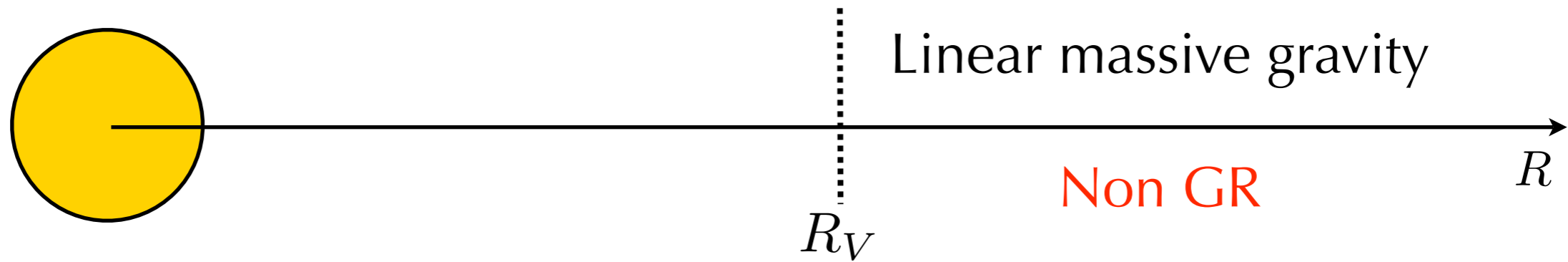

- The functions λ, ν, μ are expanded in m :
$$f(R) = \sum_{n=0}^{\infty} m^{2n} f_n(R)$$

Solution close to the source

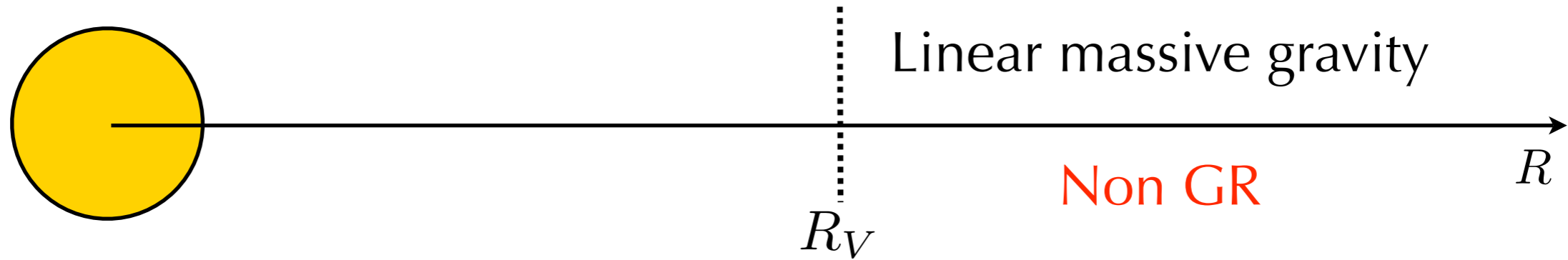

- The functions λ , ν , μ are expanded in m : $f(R) = \sum_{n=0}^{\infty} m^{2n} f_n(R)$
- Order 0 = GR: $\lambda_0 = -\nu_0 = -\ln \left(1 - \frac{R_S}{R} \right)$

Solution close to the source

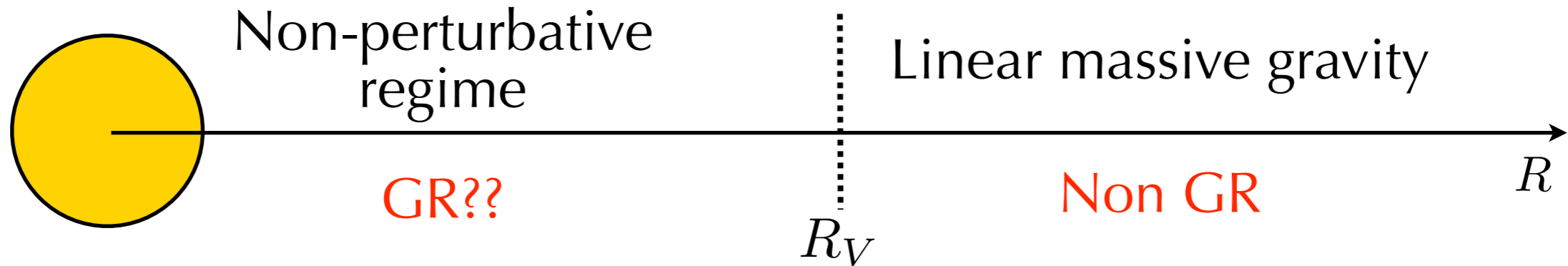

- The functions λ, ν, μ are expanded in m : $f(R) = \sum_{n=0}^{\infty} m^{2n} f_n(R)$

- Order 0 = GR: $\lambda_0 = -\nu_0 = -\ln\left(1 - \frac{R_S}{R}\right)$

- Expansion:

$$\nu = -\frac{R_S}{R} + n_1 (mR)^2 \sqrt{\frac{R_S}{R}} + \mathcal{O}(m^4)$$

$$\lambda = \frac{R_S}{R} + l_1 (mR)^2 \sqrt{\frac{R_S}{R}} + \mathcal{O}(m^4)$$

$$\mu = m_0 \sqrt{\frac{R_S}{R}} + m_1 (mR)^2 + \mathcal{O}(m^4)$$

Vainshtein '72

Relevant at

$$R_V = \left(\frac{R_S}{m^4}\right)^{1/5}$$

Existence of a regular solution?

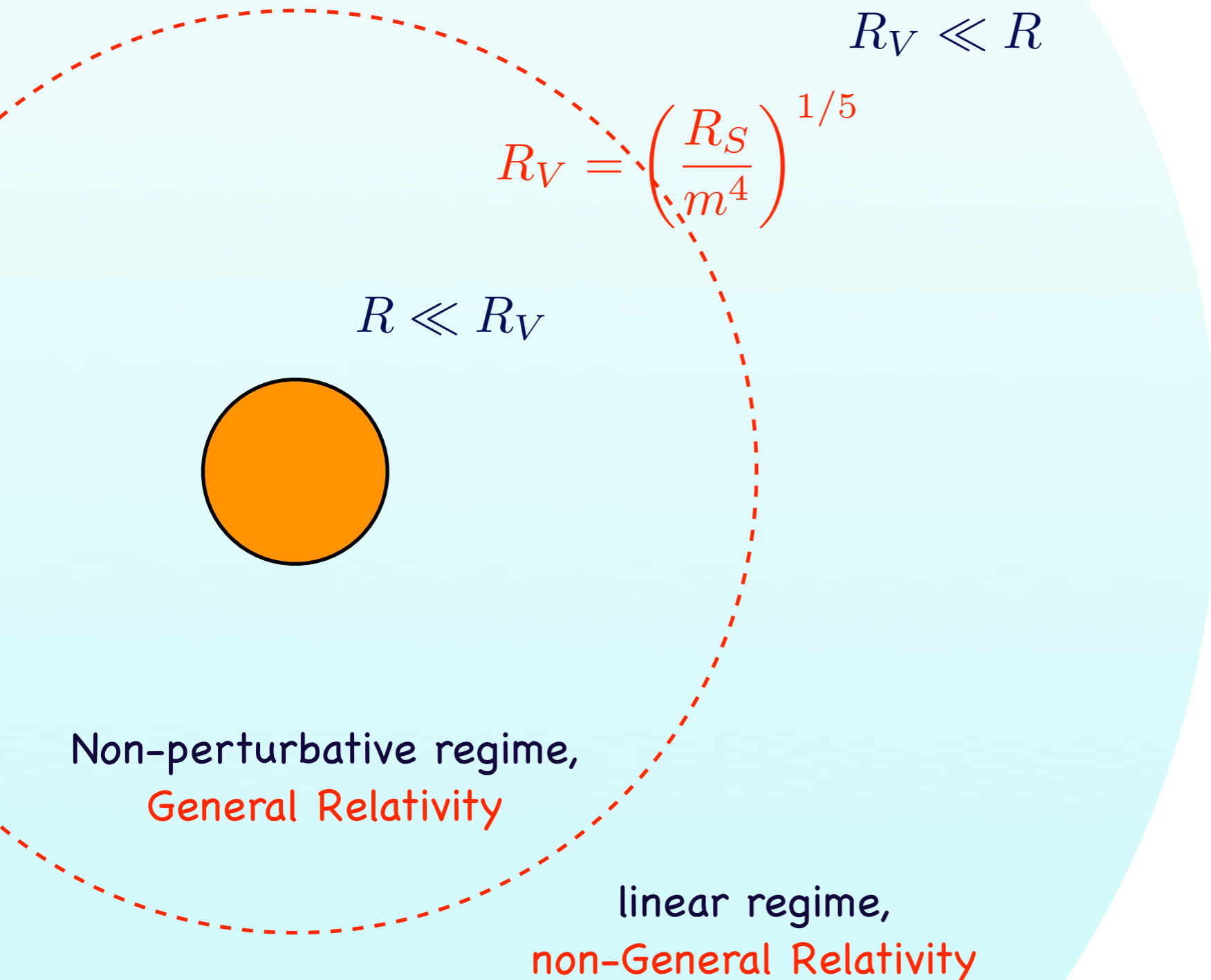

Existence of a regular solution?

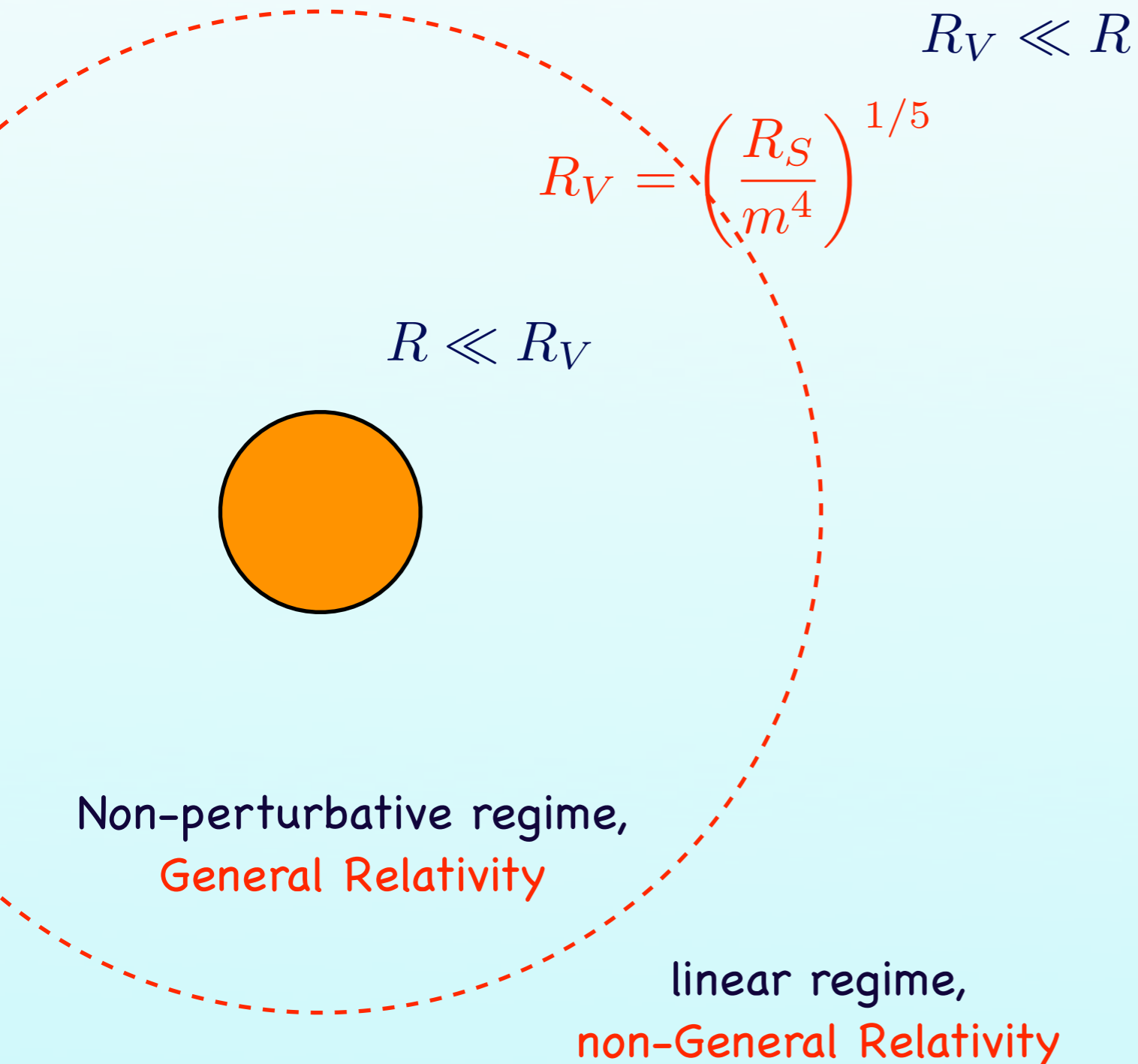

Is the Vainshtein's mechanism valid?

Is it possible to find a solution regular everywhere?

Existence of a regular solution?

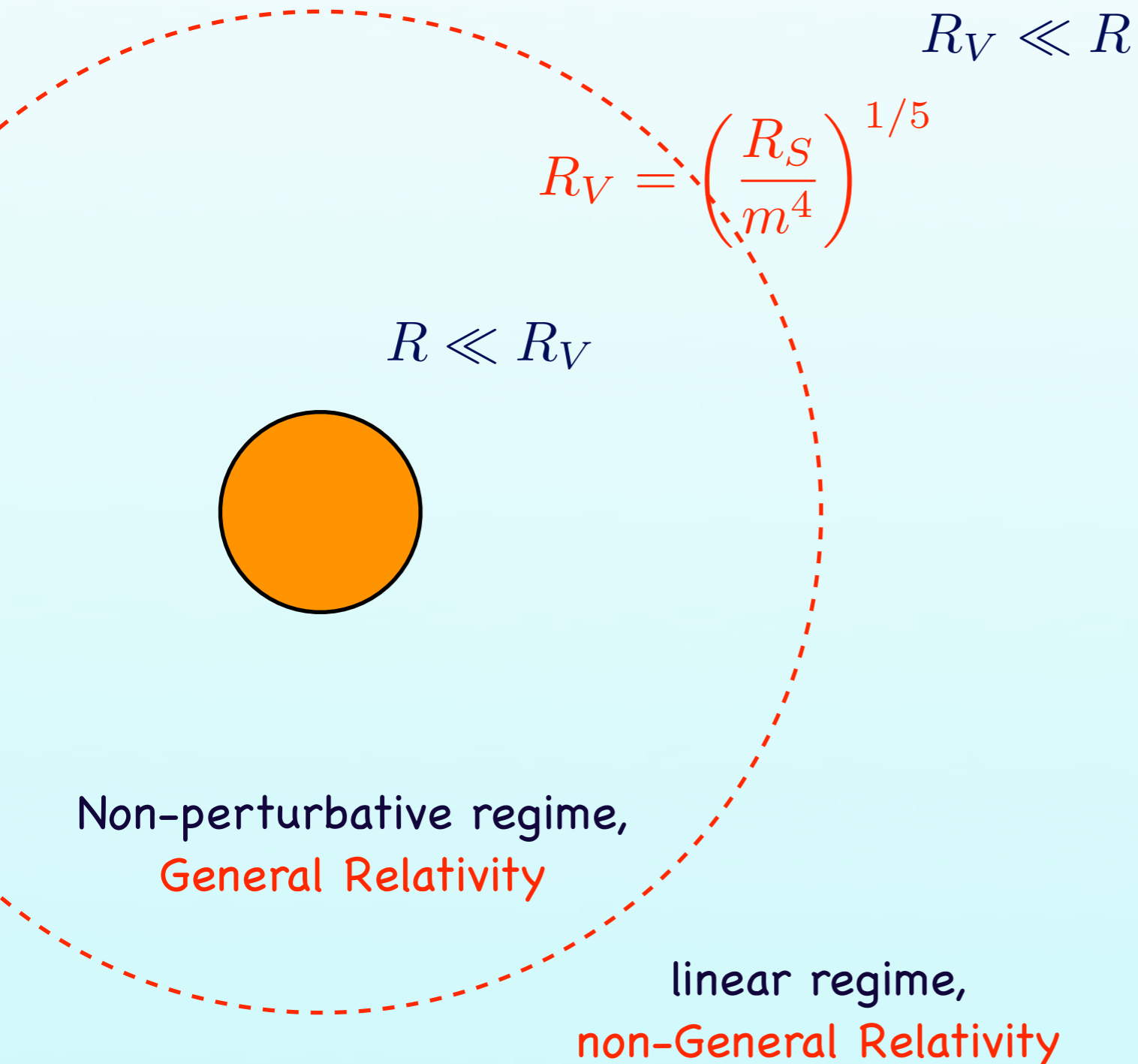

Is the Vainshtein's mechanism valid?

Is it possible to find a solution regular everywhere?

*Vainshtein '72,
Boulware & Deser '72,
Jun & Kang '86*

Existence of a regular solution?

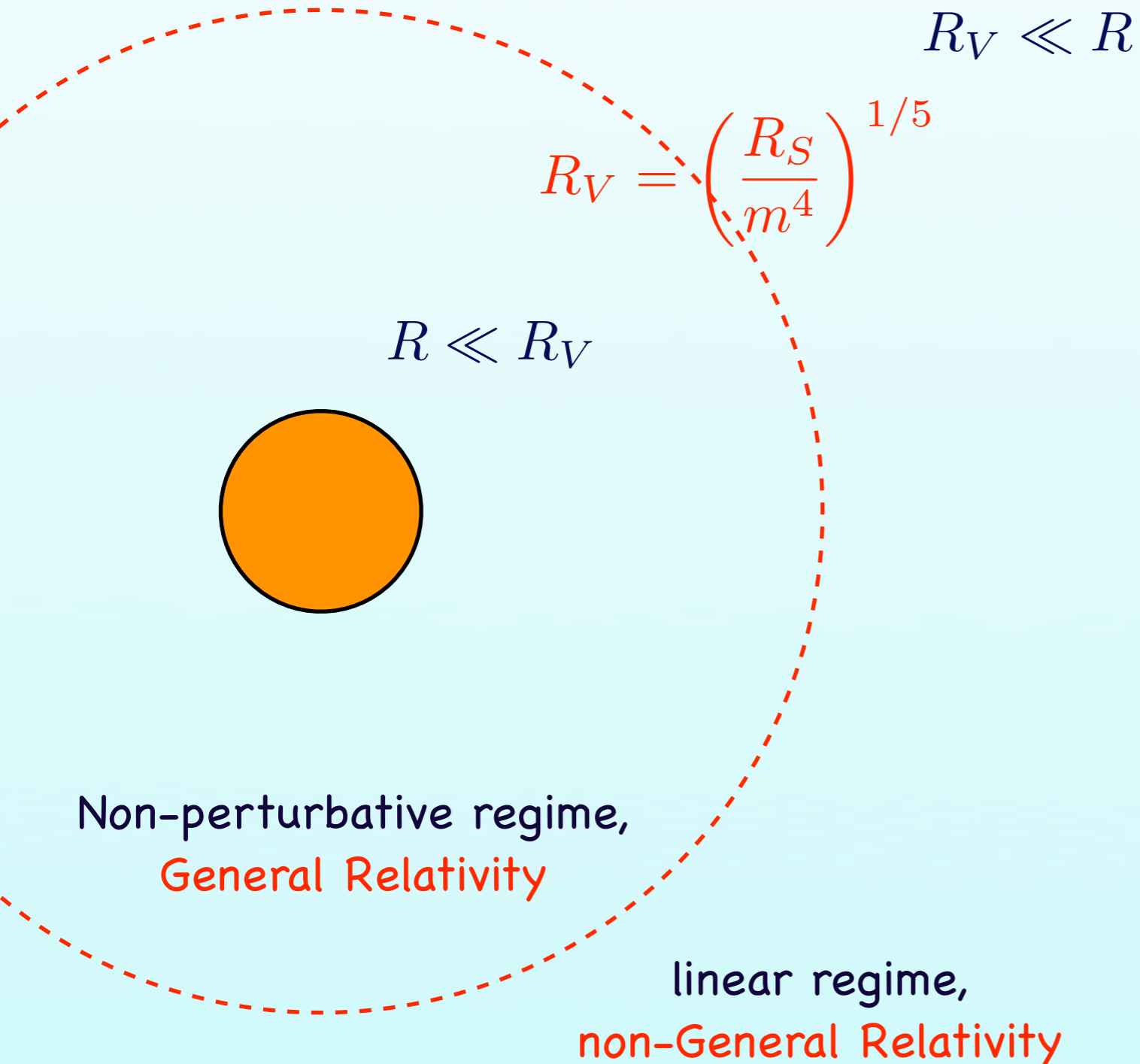

Is the Vainshtein's mechanism valid?

Is it possible to find a solution regular everywhere?

*Vainshtein '72,
Boulware & Deser '72,
Jun & Kang '86*

Damour, Kogan, Papazoglou '03

Existence of a regular solution?

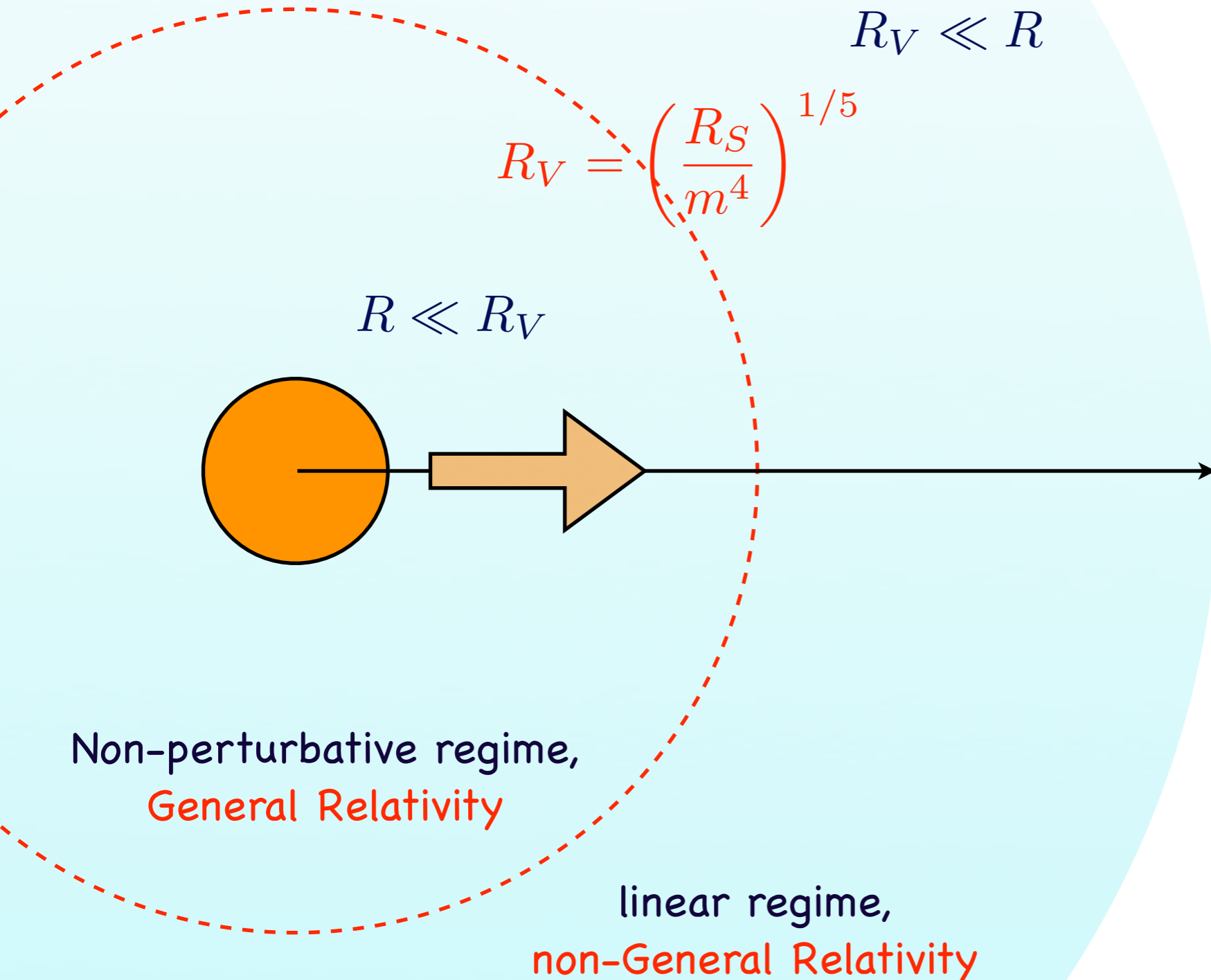

Is the Vainshtein's mechanism valid?

Is it possible to find a solution regular everywhere?

*Vainshtein '72,
Boulware & Deser '72,
Jun & Kang '86*

Damour, Kogan, Papazoglou '03

Existence of a regular solution?

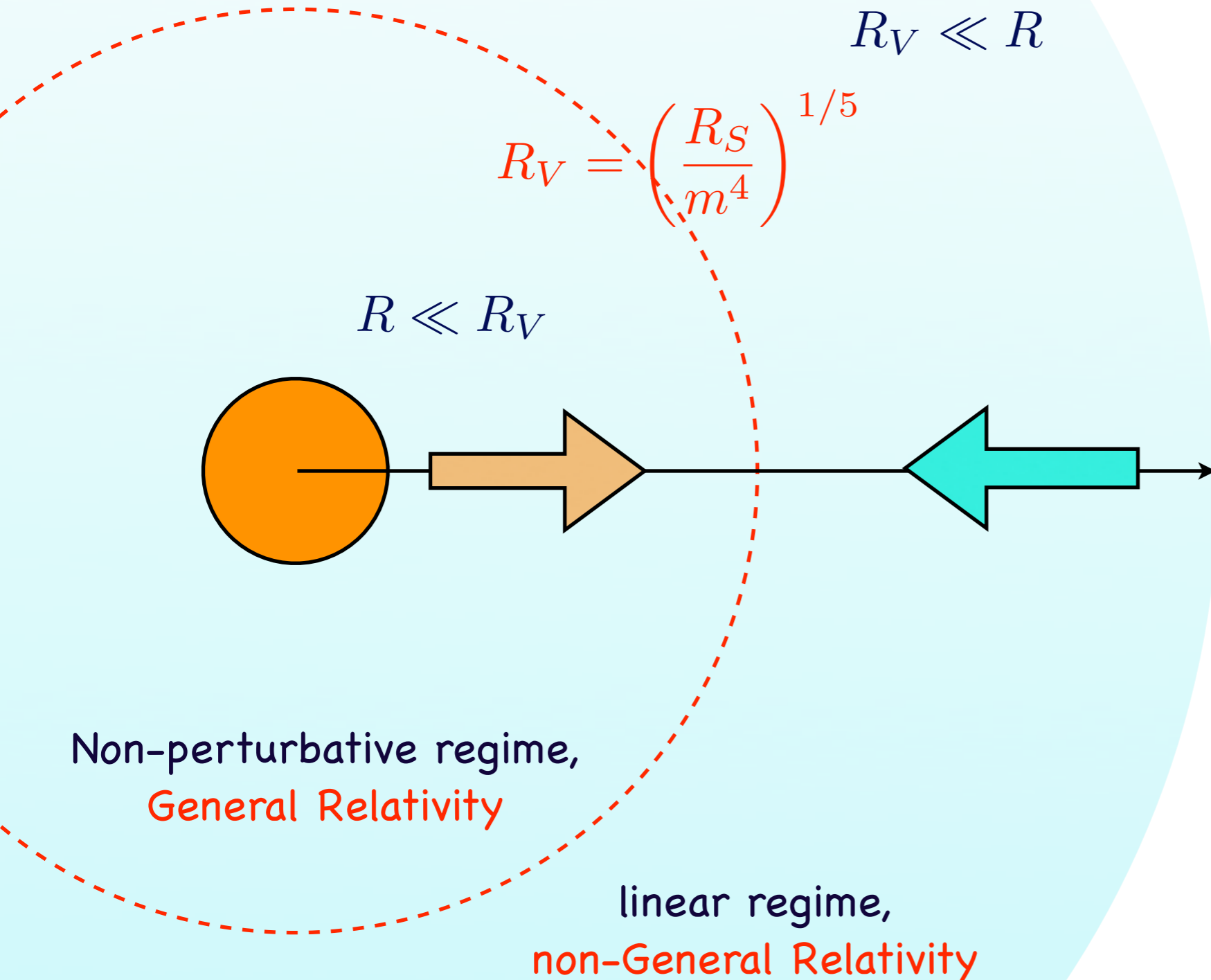

Is the Vainshtein's mechanism valid?

Is it possible to find a solution regular everywhere?

*Vainshtein '72,
Boulware & Deser '72,
Jun & Kang '86*

Damour, Kogan, Papazoglou '03

Existence of a regular solution?

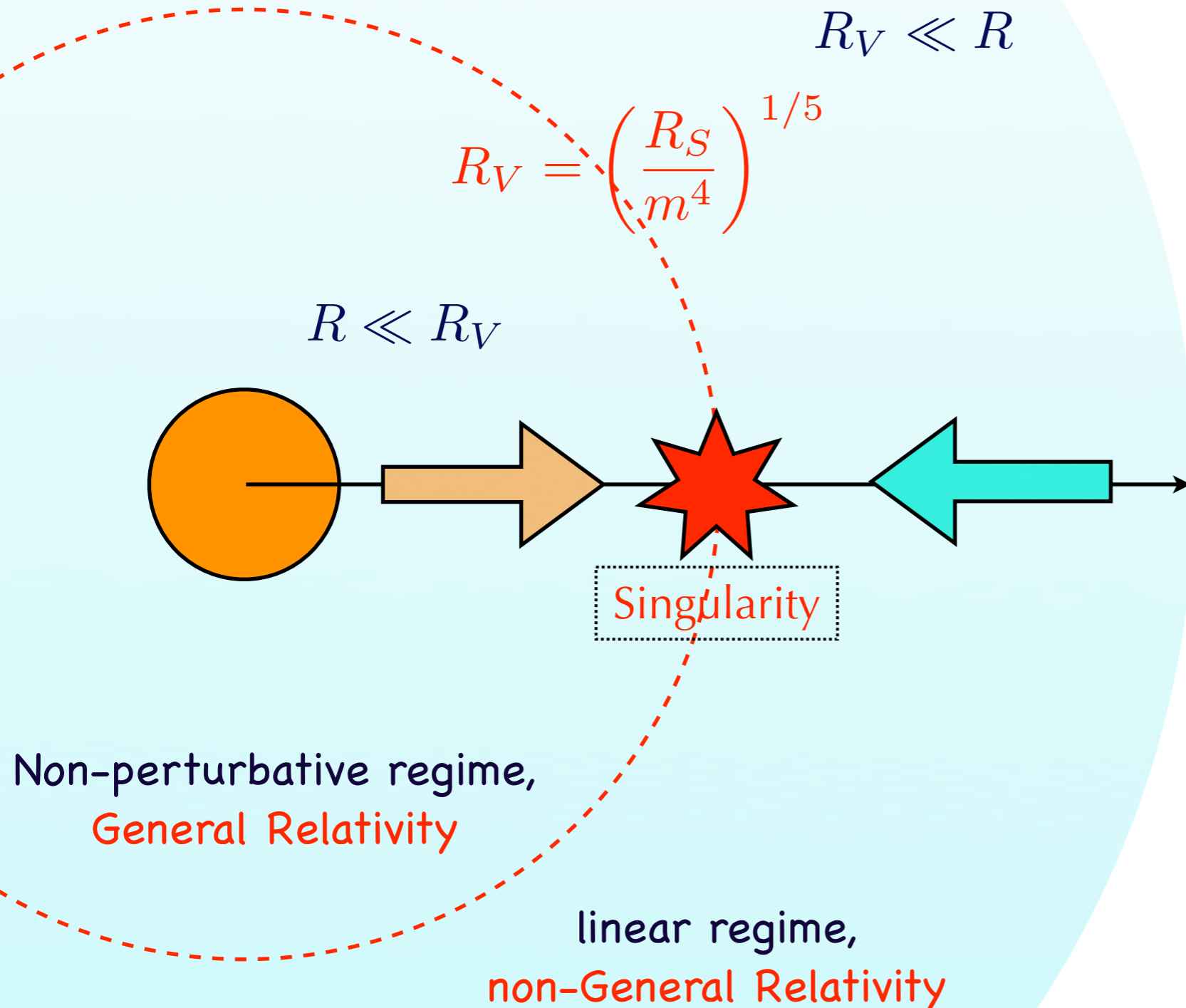

Is the Vainshtein's mechanism valid?

Is it possible to find a solution regular everywhere?

*Vainshtein '72,
Boulware & Deser '72,
Jun & Kang '86*

Damour, Kogan, Papazoglou '03

Our approach

Our approach

Decoupling Limit

*[E. Babichev, C. Deffayet, RZ,](#)
JHEP 05 (2009) 098*

Our approach

Decoupling Limit

*[E. Babichev, C. Deffayet, RZ,](#)
JHEP 05 (2009) 098*

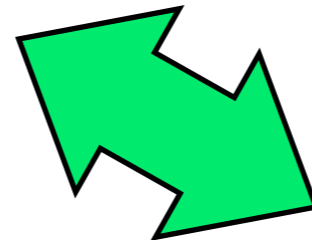

Analytical
expansions
+
adapted numerical
methods

Our approach

Decoupling Limit

*[E. Babichev, C. Deffayet, RZ,](#)
JHEP 05 (2009) 098*

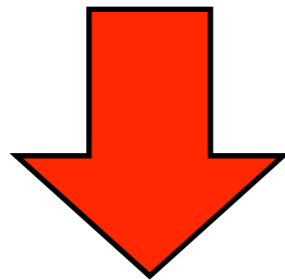

General case

*[E. Babichev, C. Deffayet, RZ,](#)
PRL 103 (2009) 201102*

*[E. Babichev, C. Deffayet, RZ,](#)
in preparation (2010)*

Analytical
expansions
+
adapted numerical
methods

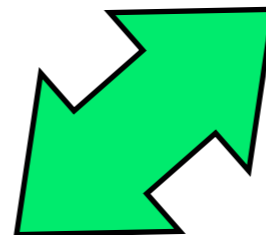
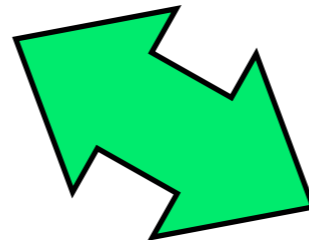

The Decoupling Limit: definition

The Decoupling Limit: definition

Main idea: to focus on the physics around the Vainshtein scale R_V

The Decoupling Limit: definition

Main idea: to focus on the physics around the Vainshtein scale R_V

- Remove the GR nonlinearities: $M_P \rightarrow \infty$, $M/M_P \sim \text{const}$

The Decoupling Limit: definition

Main idea: to focus on the physics around the Vainshtein scale R_V

- Remove the GR nonlinearities: $M_P \rightarrow \infty$, $M/M_P \sim \text{const}$
- Remove the Yukawa behavior: $m \rightarrow 0$

The Decoupling Limit: definition

Main idea: to focus on the physics around the Vainshtein scale R_V

- Remove the GR nonlinearities: $M_P \rightarrow \infty$, $M/M_P \sim \text{const}$
- Remove the Yukawa behavior: $m \rightarrow 0$
- Keep the Vainshtein scale constant: $R_V = (R_S m^{-4})^{1/5}$
 $\sim \left(\frac{M}{M_P} \frac{1}{M_P m^4} \right)^{1/5} \sim \text{const}$

The Decoupling Limit: definition

Main idea: to focus on the physics around the Vainshtein scale R_V

- Remove the GR nonlinearities: $M_P \rightarrow \infty$, $M/M_P \sim \text{const}$
- Remove the Yukawa behavior: $m \rightarrow 0$
- Keep the Vainshtein scale constant: $R_V = (R_S m^{-4})^{1/5} \sim \left(\frac{M}{M_P} \frac{1}{M_P m^4} \right)^{1/5} \sim \text{const}$

Decoupling Limit

$$\begin{aligned} M_P &\rightarrow \infty \\ m &\rightarrow 0 \\ \Lambda \equiv (M_P m^4)^{1/5} &\sim \text{const} \\ T_{\mu\nu}/M_P &\sim \text{const} \end{aligned}$$

The Decoupling Limit: definition

Main idea: to focus on the physics around the Vainshtein scale R_V

- Remove the GR nonlinearities: $M_P \rightarrow \infty$, $M/M_P \sim \text{const}$
- Remove the Yukawa behavior: $m \rightarrow 0$
- Keep the Vainshtein scale constant: $R_V = (R_S m^{-4})^{1/5}$
 $\sim \left(\frac{M}{M_P} \frac{1}{M_P m^4} \right)^{1/5} \sim \text{const}$

Decoupling Limit

$$\begin{array}{lcl} M_P & \rightarrow & \infty \\ m & \rightarrow & 0 \\ \Lambda \equiv (M_P m^4)^{1/5} & \sim & \text{const} \\ T_{\mu\nu}/M_P & \sim & \text{const} \end{array}$$

Arkani-Hamed, Georgi and Schwartz '03

Other point of view:

$$\begin{aligned} h_{\mu\nu} \rightarrow & h_{\mu\nu} - \partial_\mu A_\nu - \partial_\nu A_\mu - 2\partial_\mu \partial_\nu \phi \\ & - \partial_\mu A_\sigma \partial_\nu A^\sigma - \partial_\mu \partial_\sigma \phi \partial_\nu \partial^\sigma \phi \\ & - \partial_\nu A^\sigma \partial_\mu \partial_\sigma \phi - \partial_\mu A^\sigma \partial_\nu \partial_\sigma \phi \end{aligned}$$

$\Lambda =$ strong coupling scale of ϕ

The Decoupling Limit: equations

The Decoupling Limit: equations

$$e^{\nu-\lambda} \left(\frac{\lambda'}{R} + \frac{1}{R^2} (e^\lambda - 1) \right) = 8\pi G_N (T_{tt}^g + \rho e^\nu),$$

$$\frac{\nu'}{R} + \frac{1}{R^2} (1 - e^\lambda) = 8\pi G_N (T_{RR}^g + P e^\lambda),$$

$$\nabla^\mu T_{\mu R}^g = 0.$$

Equations of motion

$$g_{\mu\nu} dx^\mu dx^\nu = -e^\nu dt^2 + e^\lambda dR^2 + R^2 d\Omega^2$$

$$f_{\mu\nu} dx^\mu dx^\nu = -dt^2 + (1 - R\mu'/2)^2 e^{-\mu} dR^2 + e^{-\mu} R^2 d\Omega^2$$

The Decoupling Limit: equations

$$e^{\nu-\lambda} \left(\frac{\lambda'}{R} + \frac{1}{R^2} (e^\lambda - 1) \right) = 8\pi G_N (T_{tt}^g + \rho e^\nu),$$

$$\frac{\nu'}{R} + \frac{1}{R^2} (1 - e^\lambda) = 8\pi G_N (T_{RR}^g + P e^\lambda),$$

$$\nabla^\mu T_{\mu R}^g = 0.$$

Equations of motion

$$g_{\mu\nu} dx^\mu dx^\nu = -e^\nu dt^2 + e^\lambda dR^2 + R^2 d\Omega^2$$

$$f_{\mu\nu} dx^\mu dx^\nu = -dt^2 + (1 - R\mu'/2)^2 e^{-\mu} dR^2 + e^{-\mu} R^2 d\Omega^2$$

• but $T_{tt}^g = m^2 M_P^2 f_t$, $T_{RR}^g = m^2 M_P^2 f_R$, $\nabla^\mu T_{\mu R}^g = -m^2 M_P^2 f_g$,

with

$$f_t = \frac{e^{-\lambda-2\mu}}{4}$$

$$\times \left[(3e^{\mu+\nu} + e^\mu - 2e^\nu) \left(1 - \frac{R\mu'}{2}\right)^2 + e^\lambda (2e^\mu - e^\nu) - 3e^{\lambda+\mu} (2e^{\mu+\nu} + e^\mu - 2e^\nu) \right],$$

$$f_R = \frac{e^{-\nu-2\mu}}{4}$$

$$\times \left[(3e^{\mu+\nu} - e^\mu - 2e^\nu) \left(1 - \frac{R\mu'}{2}\right)^2 + e^\lambda (2e^\mu + e^\nu) - 3e^{\lambda+\mu} (-2e^{\mu+\nu} + e^\mu + 2e^\nu) \right],$$

$$f_g = - \left(1 - \frac{R\mu'}{2}\right) \frac{e^{-\lambda-2\mu-\nu}}{8R}$$

$$\times \left[8(e^\lambda - 1) (3e^{\mu+\nu} - e^\mu - e^\nu) + 2R ((3e^{\mu+\nu} - 2e^\nu) (\lambda' + 4\mu' - \nu') - e^\mu (\lambda' + 4\mu' + \nu')) \right. \\ \left. - R^2 \left((3e^{\mu+\nu} - 2e^\nu) (\lambda'\mu' - 2\mu'' - \mu'\nu' + (\mu')^2) - e^\mu (\lambda'\mu' - 2\mu'' + \mu'\nu' + (\mu')^2) - 2e^\nu (\mu')^2 \right) \right].$$

For AGS
potential

The Decoupling Limit: equations

$$e^{\nu-\lambda} \left(\frac{\lambda'}{R} + \frac{1}{R^2} (e^\lambda - 1) \right) = 8\pi G_N (T_{tt}^g + \rho e^\nu),$$

$$\frac{\nu'}{R} + \frac{1}{R^2} (1 - e^\lambda) = 8\pi G_N (T_{RR}^g + P e^\lambda),$$

$$\nabla^\mu T_{\mu R}^g = 0.$$

Equations of motion

$$g_{\mu\nu} dx^\mu dx^\nu = -e^\nu dt^2 + e^\lambda dR^2 + R^2 d\Omega^2$$

$$f_{\mu\nu} dx^\mu dx^\nu = -dt^2 + (1 - R\mu'/2)^2 e^{-\mu} dR^2 + e^{-\mu} R^2 d\Omega^2$$

• but $T_{tt}^g = m^2 M_P^2 f_t$, $T_{RR}^g = m^2 M_P^2 f_R$, $\nabla^\mu T_{\mu R}^g = -m^2 M_P^2 f_g$,

with

$$f_t = \frac{e^{-\lambda-2\mu}}{4}$$

$$\times \left[(3e^{\mu+\nu} + e^\mu - 2e^\nu) \left(1 - \frac{R\mu'}{2}\right)^2 + e^\lambda (2e^\mu - e^\nu) - 3e^{\lambda+\mu} (2e^{\mu+\nu} + e^\mu - 2e^\nu) \right],$$

$$f_R = \frac{e^{-\nu-2\mu}}{4}$$

$$\times \left[(3e^{\mu+\nu} - e^\mu - 2e^\nu) \left(1 - \frac{R\mu'}{2}\right)^2 + e^\lambda (2e^\mu + e^\nu) - 3e^{\lambda+\mu} (-2e^{\mu+\nu} + e^\mu + 2e^\nu) \right],$$

$$f_g = -\left(1 - \frac{R\mu'}{2}\right) \frac{e^{-\lambda-2\mu}}{8R}$$

$$\times \left[8(e^\lambda - 1) (3e^{\mu+\nu} - e^\mu - e^\nu) + 2R ((3e^{\mu+\nu} - 2e^\nu) (\lambda' + 4\mu' - \nu') - e^\mu (\lambda' + 4\mu' + \nu')) \right. \\ \left. - R^2 \left((3e^{\mu+\nu} - 2e^\nu) (\lambda'\mu' - 2\mu'' - \mu'\nu' + (\mu')^2) - e^\mu (\lambda'\mu' - 2\mu'' + \mu'\nu' + (\mu')^2) - 2e^\nu (\mu')^2 \right) \right].$$

Simplification of the equations

For AGS potential

The Decoupling Limit: equations

$$e^{\nu-\lambda} \left(\frac{\lambda'}{R} + \frac{1}{R^2} (e^\lambda - 1) \right) = 8\pi G_N (T_{tt}^g + \rho e^\nu),$$

$$\frac{\nu'}{R} + \frac{1}{R^2} (1 - e^\lambda) = 8\pi G_N (T_{RR}^g + P e^\lambda),$$

$$\nabla^\mu T_{\mu R}^g = 0.$$

Equations of motion

$$g_{\mu\nu} dx^\mu dx^\nu = -e^\nu dt^2 + e^\lambda dR^2 + R^2 d\Omega^2$$

$$f_{\mu\nu} dx^\mu dx^\nu = -dt^2 + (1 - R\mu'/2)^2 e^{-\mu} dR^2 + e^{-\mu} R^2 d\Omega^2$$

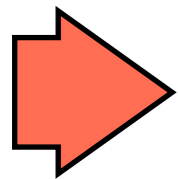

$$\frac{\lambda'}{R} + \frac{\lambda}{R^2} = -\frac{m^2}{2} (3\mu + R\mu') + \frac{\rho}{M_P^2}$$

$$\frac{\nu'}{R} - \frac{\lambda}{R^2} = m^2 \mu$$

$$\frac{\lambda}{R^2} = \frac{\nu'}{2R} + Q(\mu),$$

$$\text{with } Q = -\frac{1}{2} \left(\frac{\mu'^2}{2} + \mu\mu'' + \frac{4\mu\mu'}{R} \right)$$

*E. Babichev, C. Deffayet, RZ,
JHEP 05 (2009) 098*

The Decoupling Limit: equations

$$e^{\nu-\lambda} \left(\frac{\lambda'}{R} + \frac{1}{R^2} (e^\lambda - 1) \right) = 8\pi G_N (T_{tt}^g + \rho e^\nu),$$

$$\frac{\nu'}{R} + \frac{1}{R^2} (1 - e^\lambda) = 8\pi G_N (T_{RR}^g + P e^\lambda),$$

$$\nabla^\mu T_{\mu R}^g = 0.$$

Equations of motion

$$g_{\mu\nu} dx^\mu dx^\nu = -e^\nu dt^2 + e^\lambda dR^2 + R^2 d\Omega^2$$

$$f_{\mu\nu} dx^\mu dx^\nu = -dt^2 + (1 - R\mu'/2)^2 e^{-\mu} dR^2 + e^{-\mu} R^2 d\Omega^2$$



$$\frac{\lambda'}{R} + \frac{\lambda}{R^2} = -\frac{m^2}{2} (3\mu + R\mu') + \frac{\rho}{M_P^2}$$

$$\frac{\nu'}{R} - \frac{\lambda}{R^2} = m^2 \mu$$

$$\frac{\lambda}{R^2} = \frac{\nu'}{2R} + Q(\mu),$$

with $Q = -\frac{1}{2} \left(\frac{\mu'^2}{2} + \mu\mu'' + \frac{4\mu\mu'}{R} \right)$

*E. Babichev, C. Deffayet, RZ,
JHEP 05 (2009) 098*

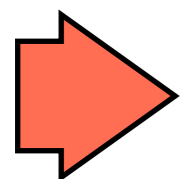

$$2Q(\mu) + \frac{3}{2} m^2 \mu = \frac{R_S}{R^3}$$

Only one equation!

The Decoupling Limit: solution

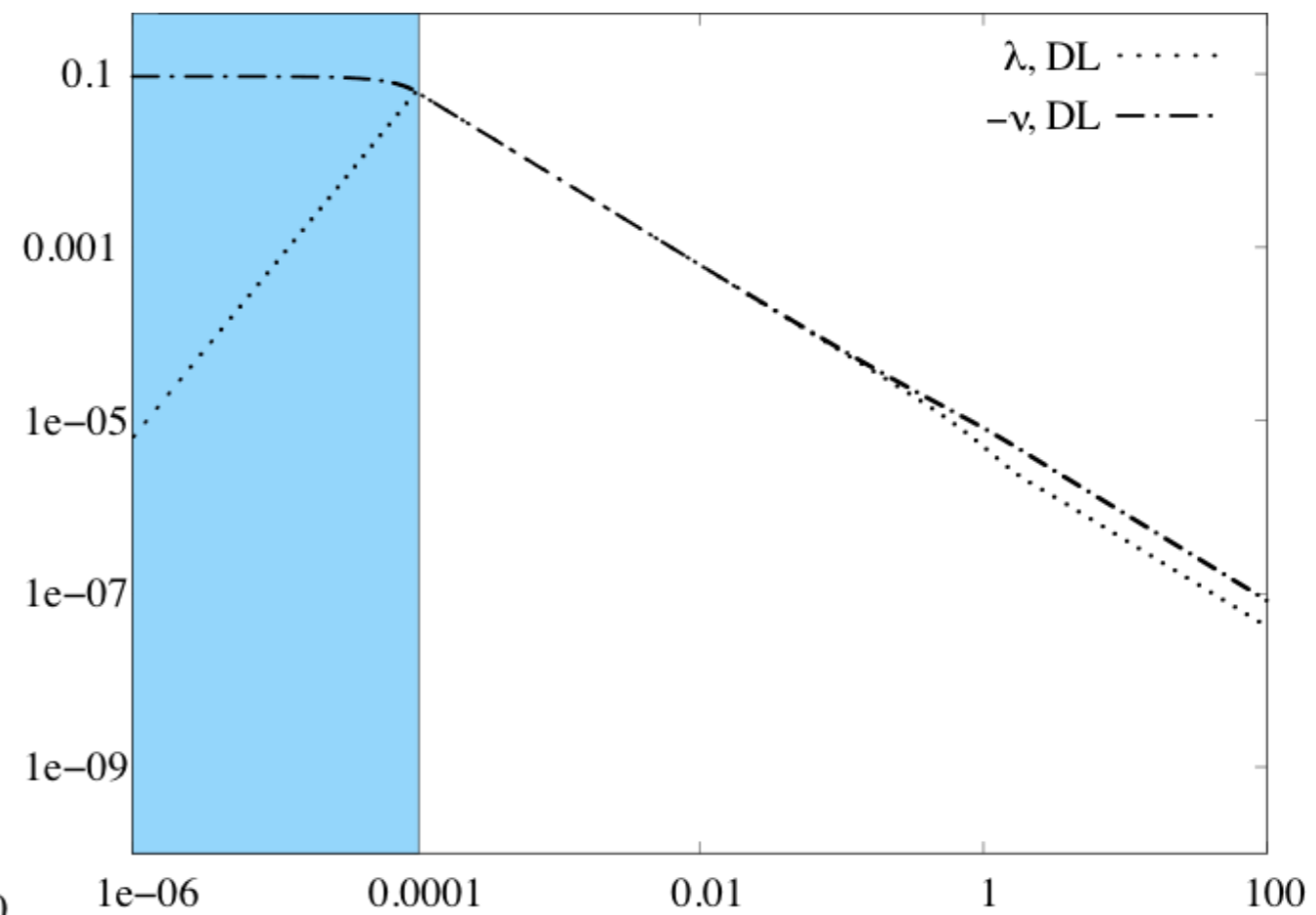
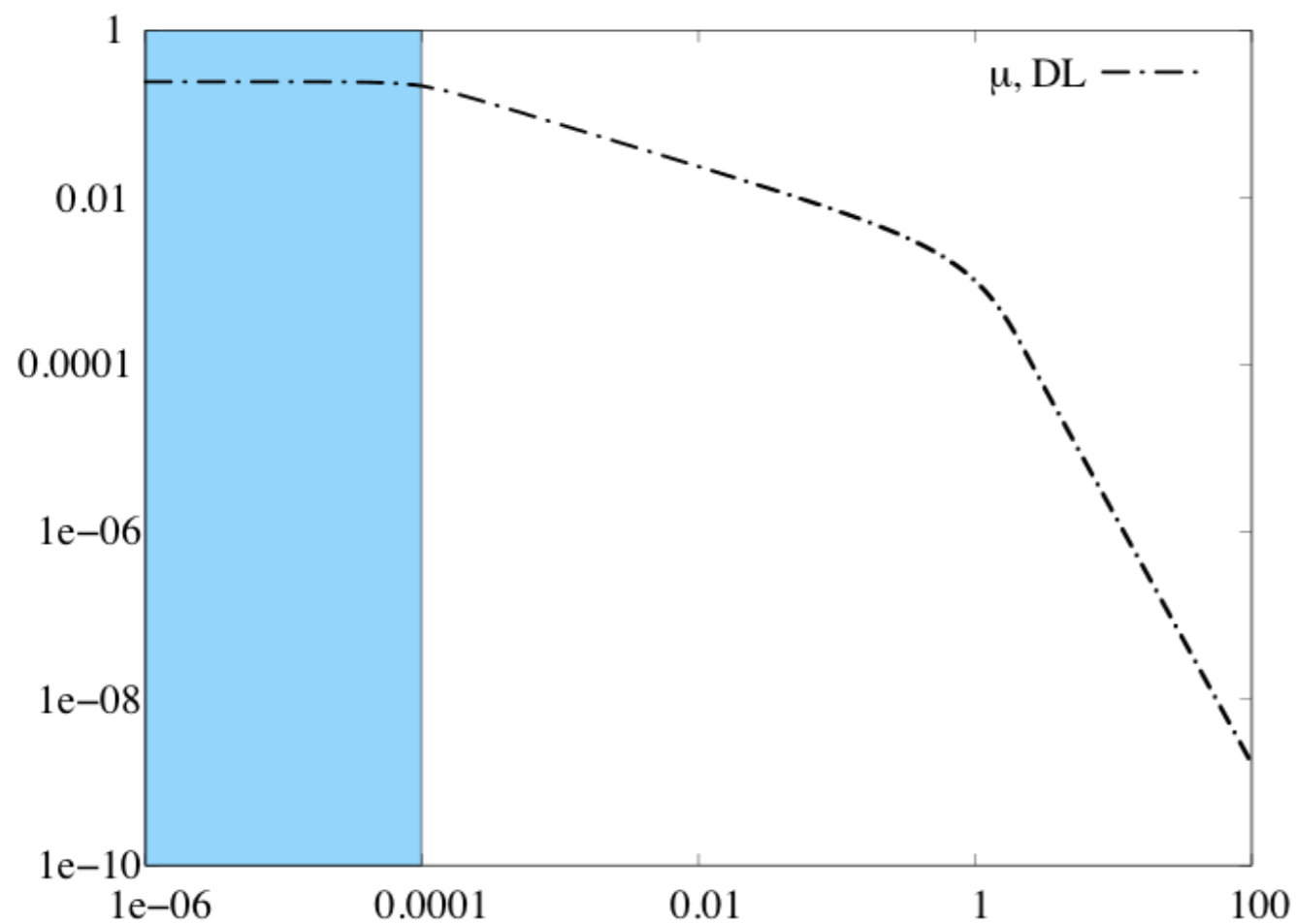

The Decoupling Limit: solution

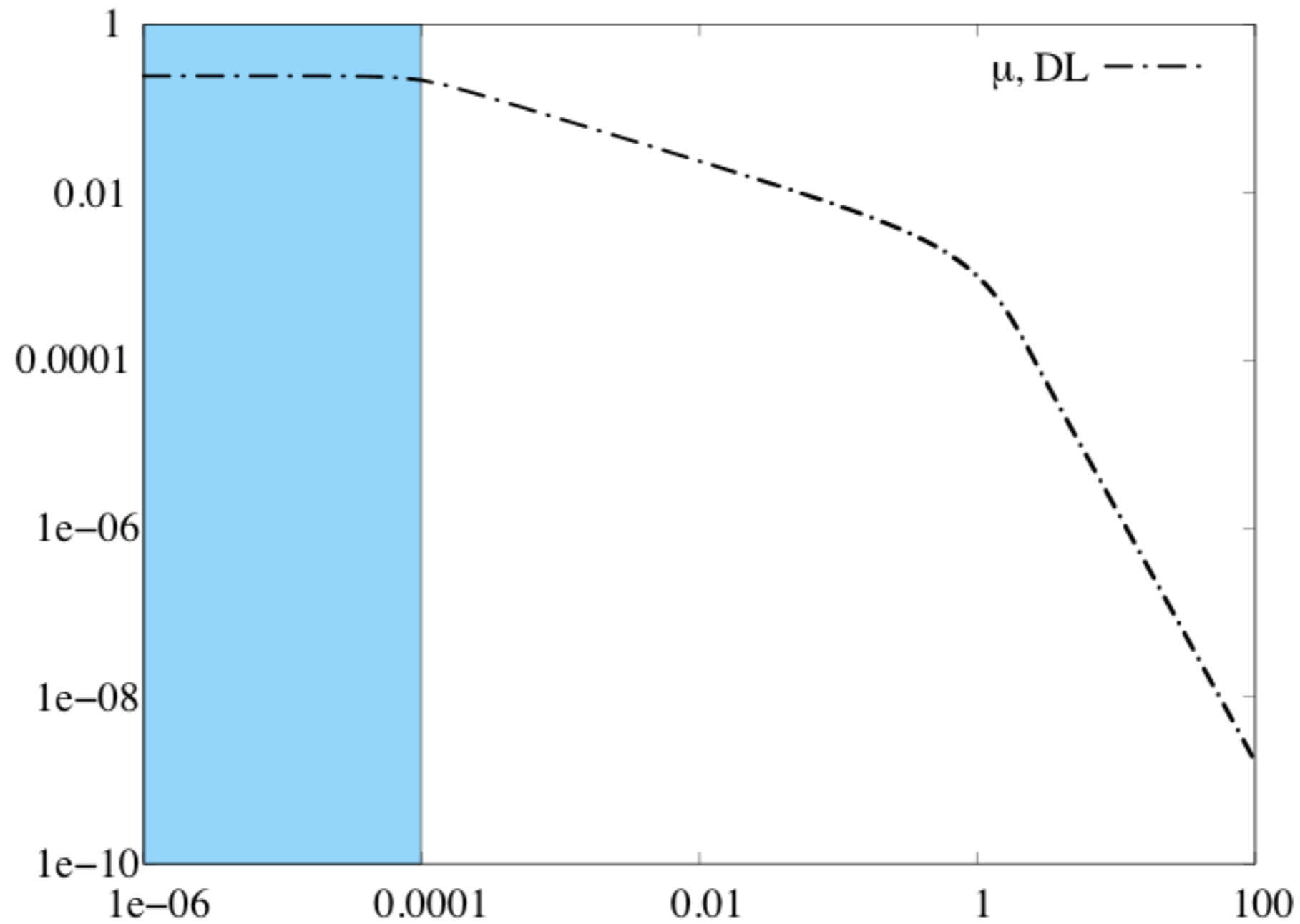

The Decoupling Limit: solution

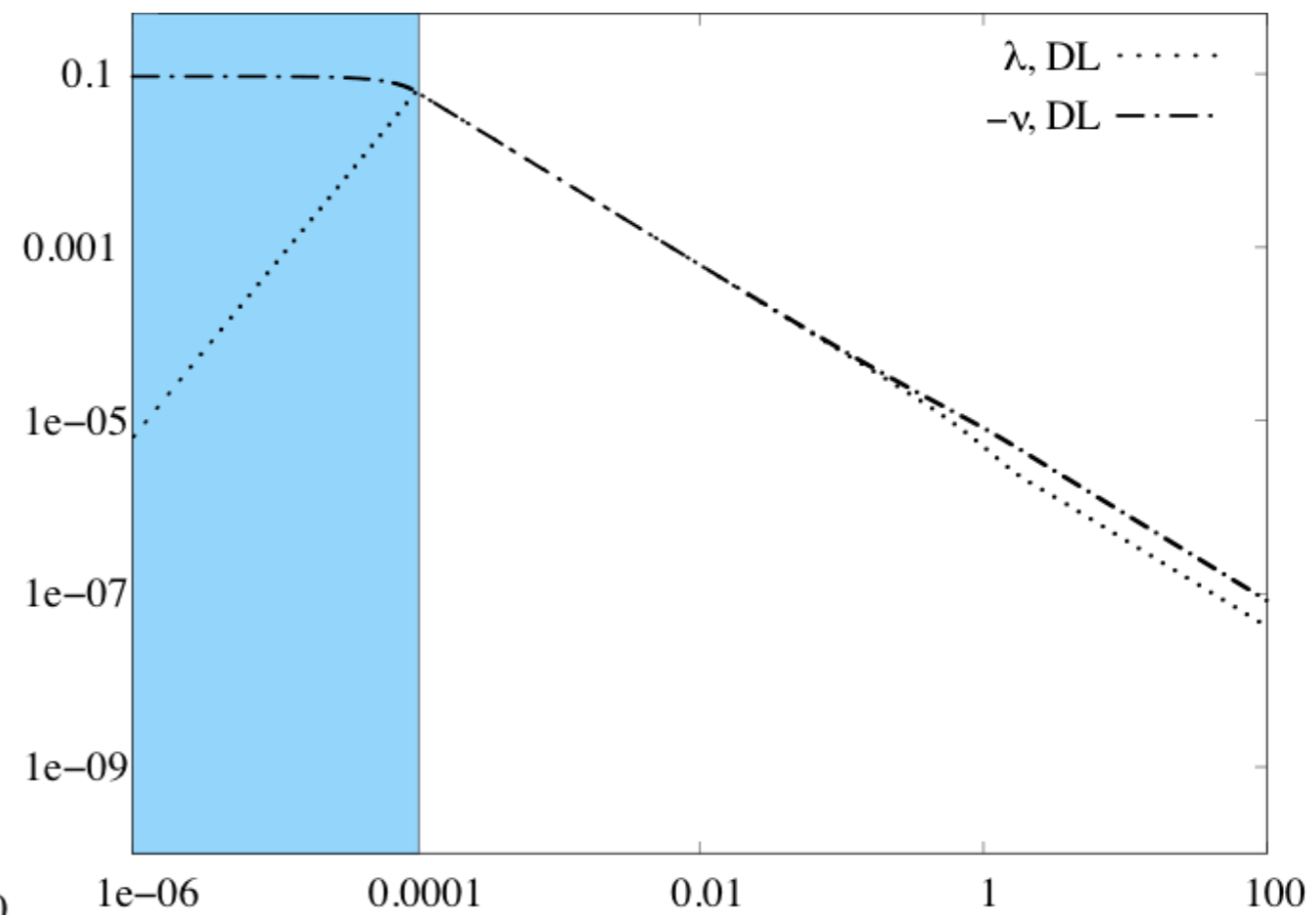
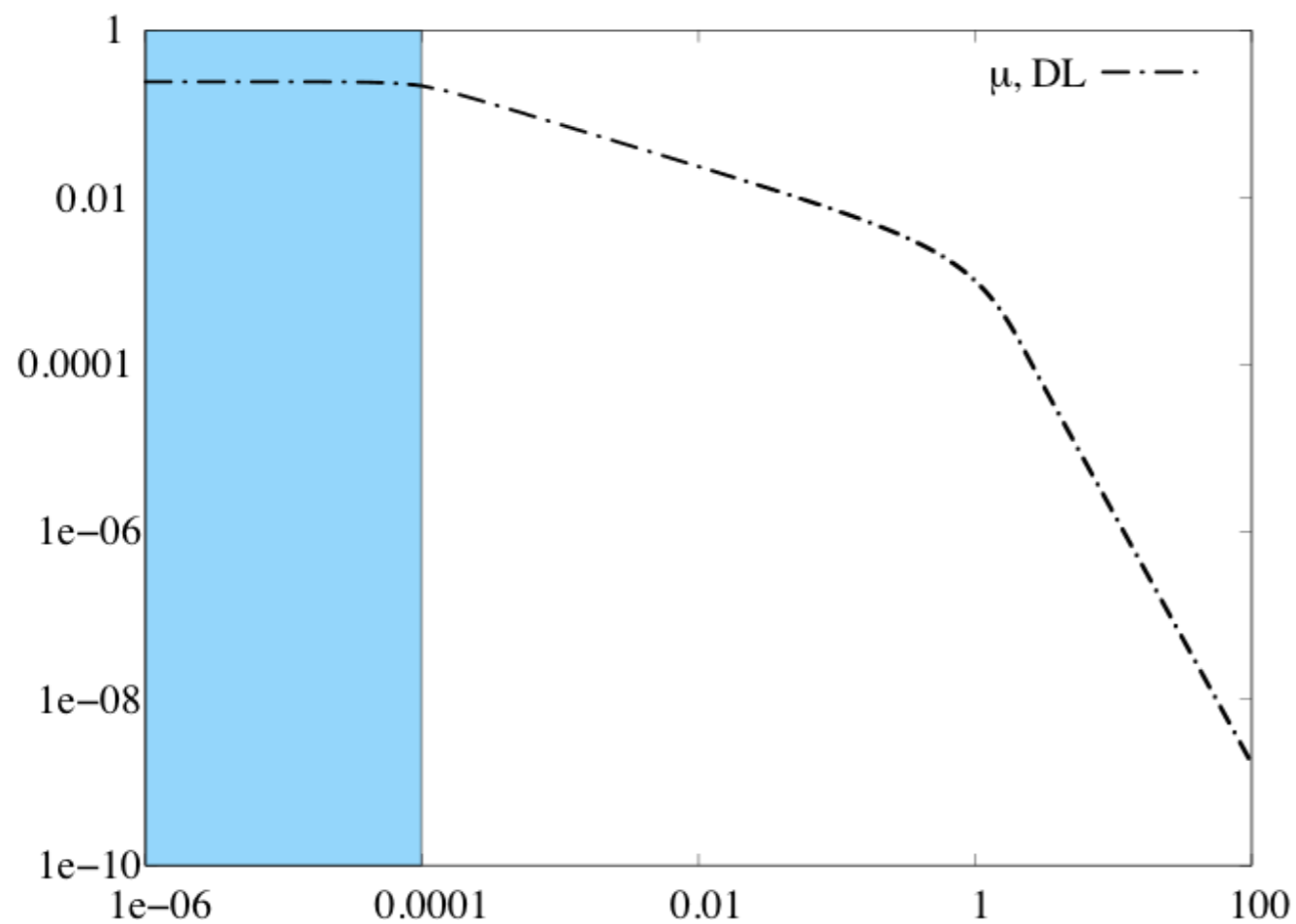

The Decoupling Limit: solution

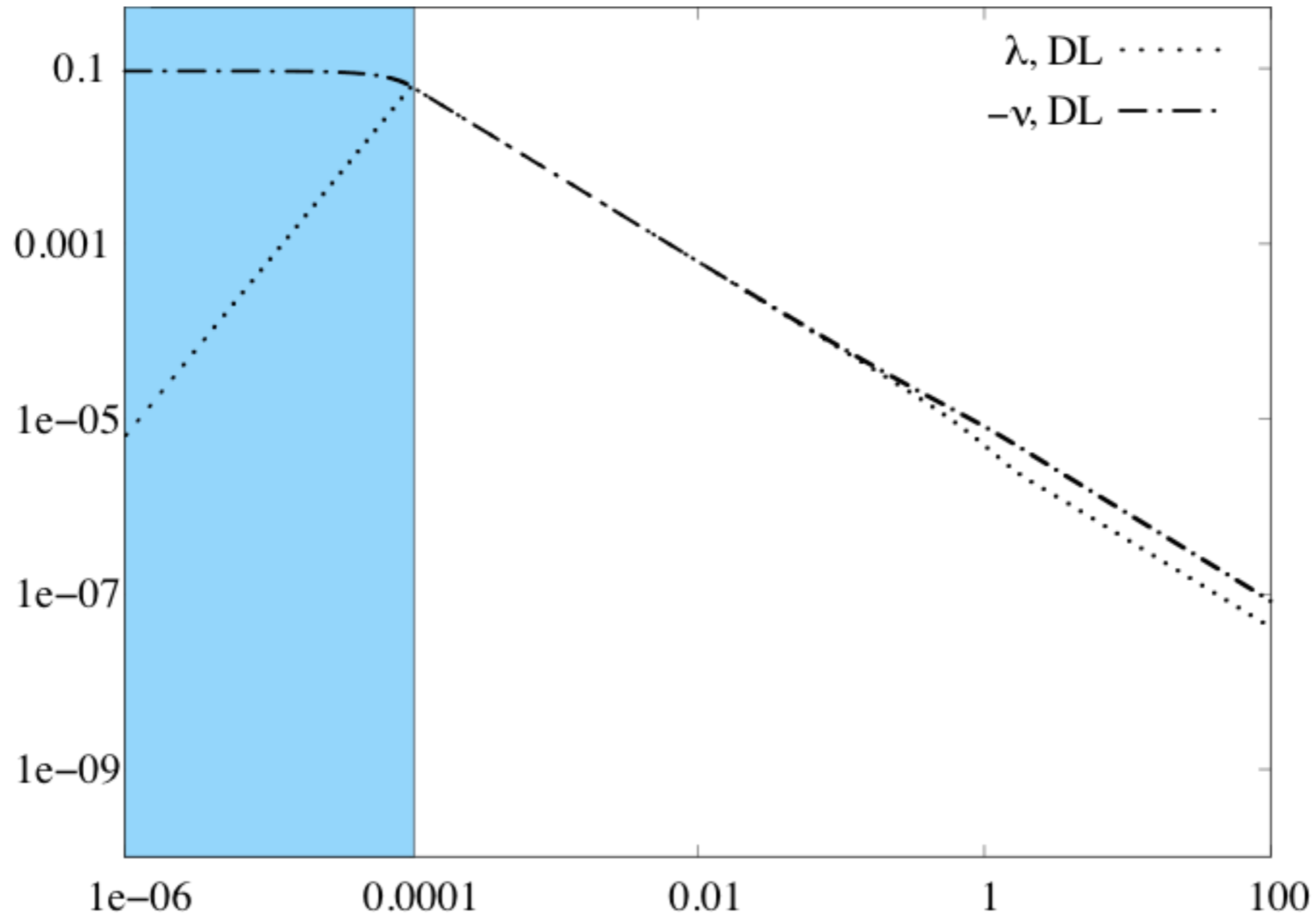

The Decoupling Limit: solution

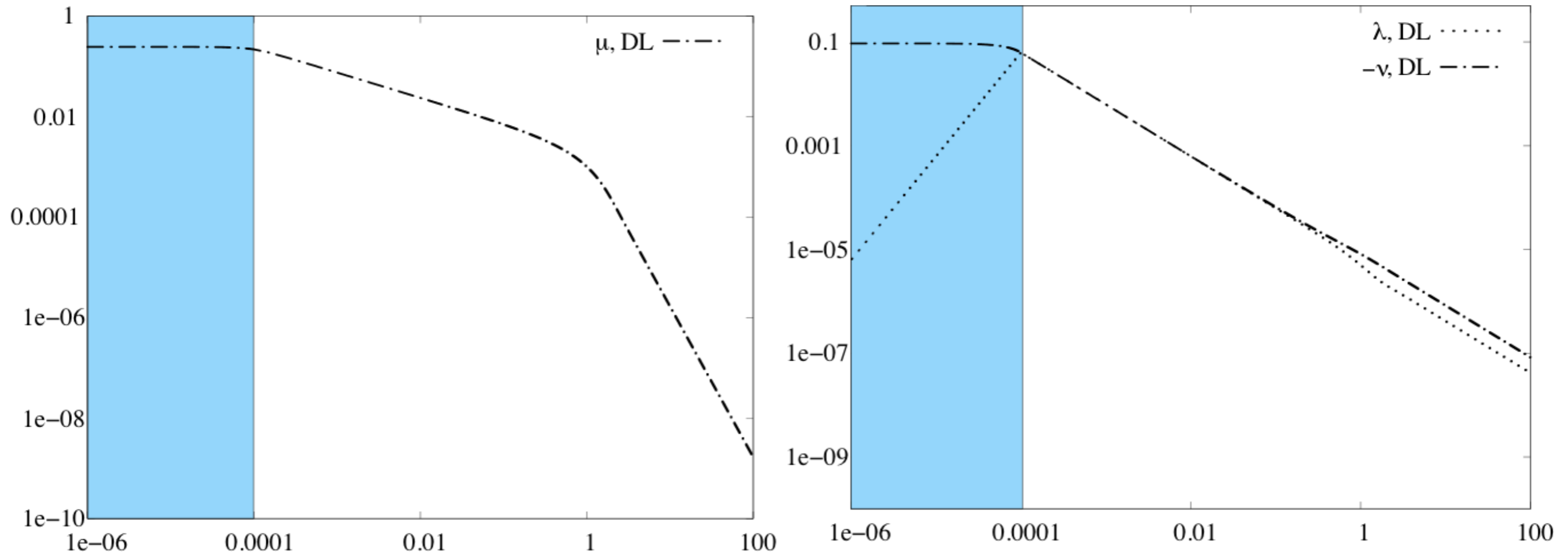

The Decoupling Limit: solution

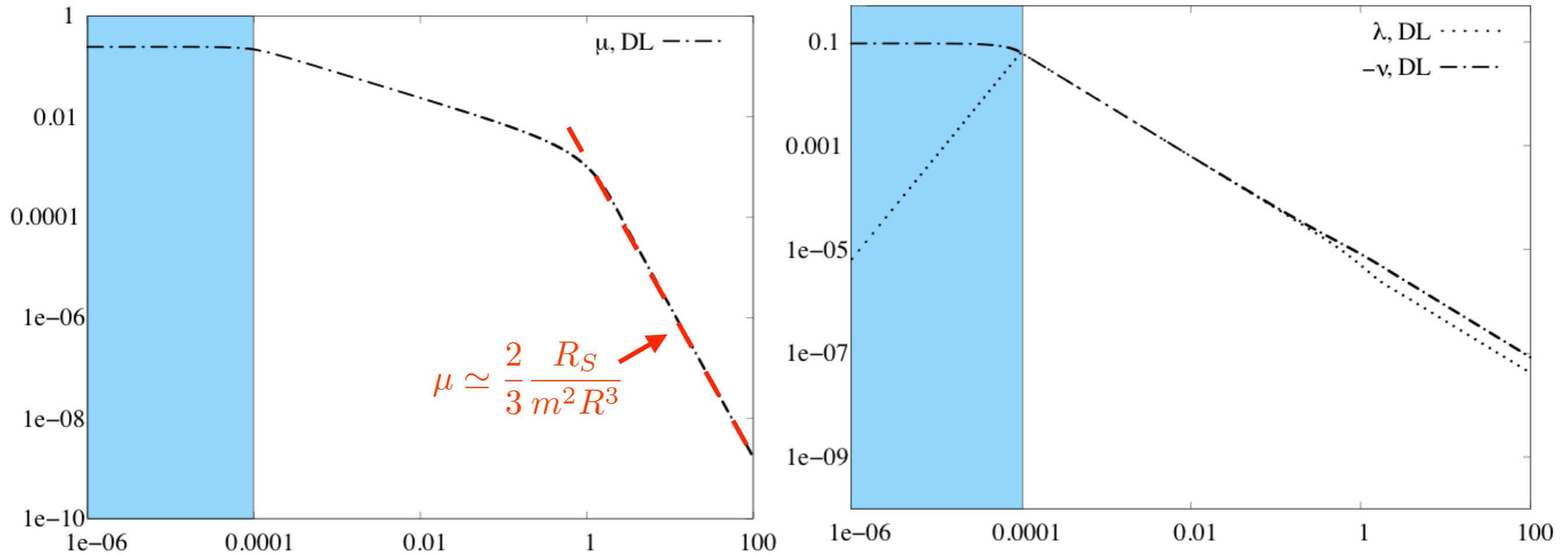

The Decoupling Limit: solution

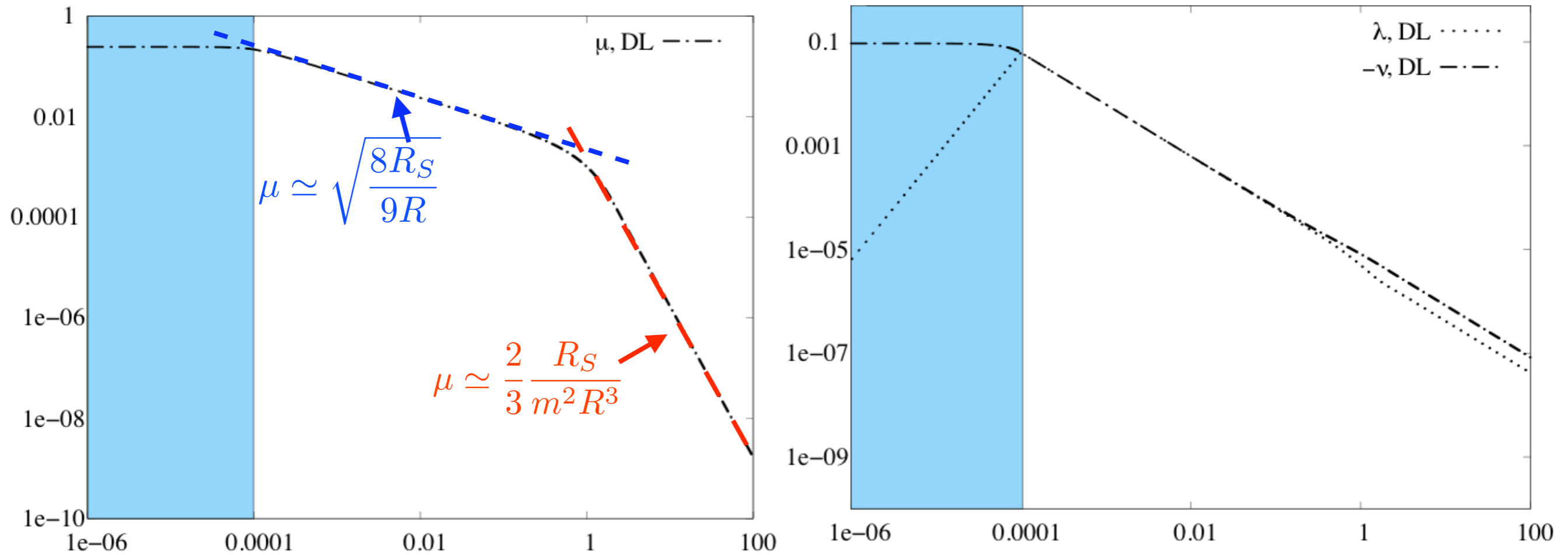

The Decoupling Limit: solution

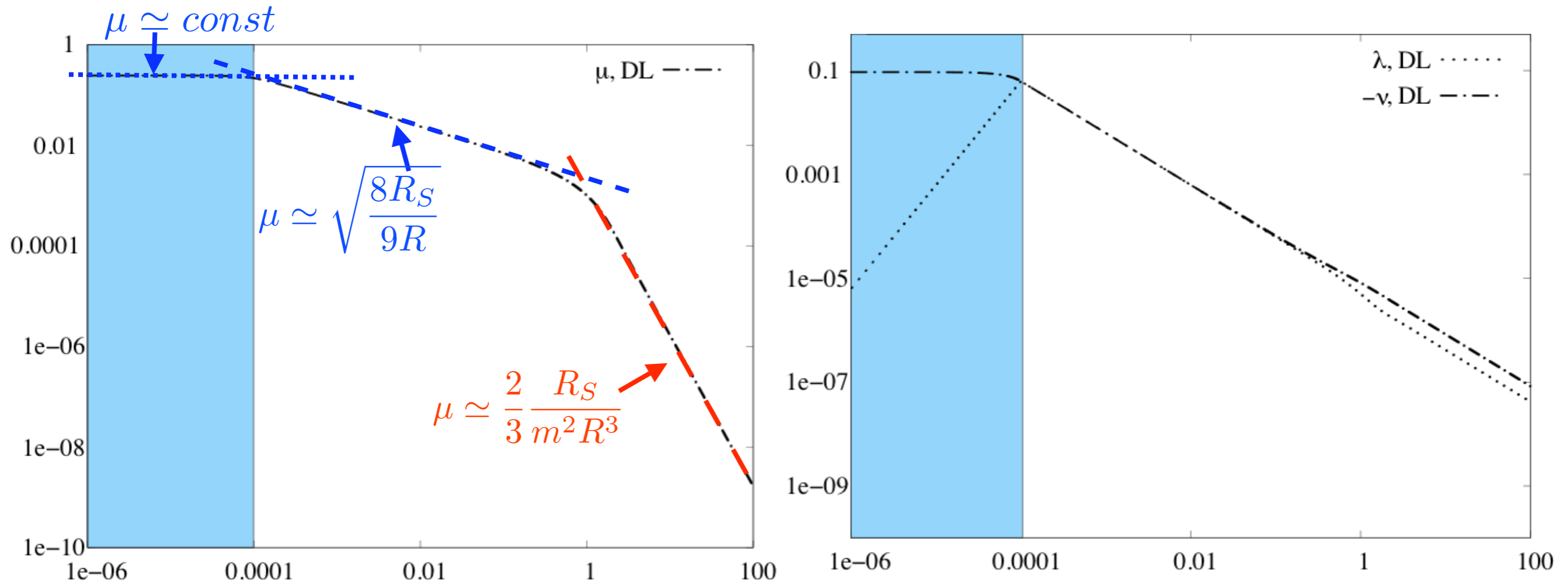

The Decoupling Limit: solution

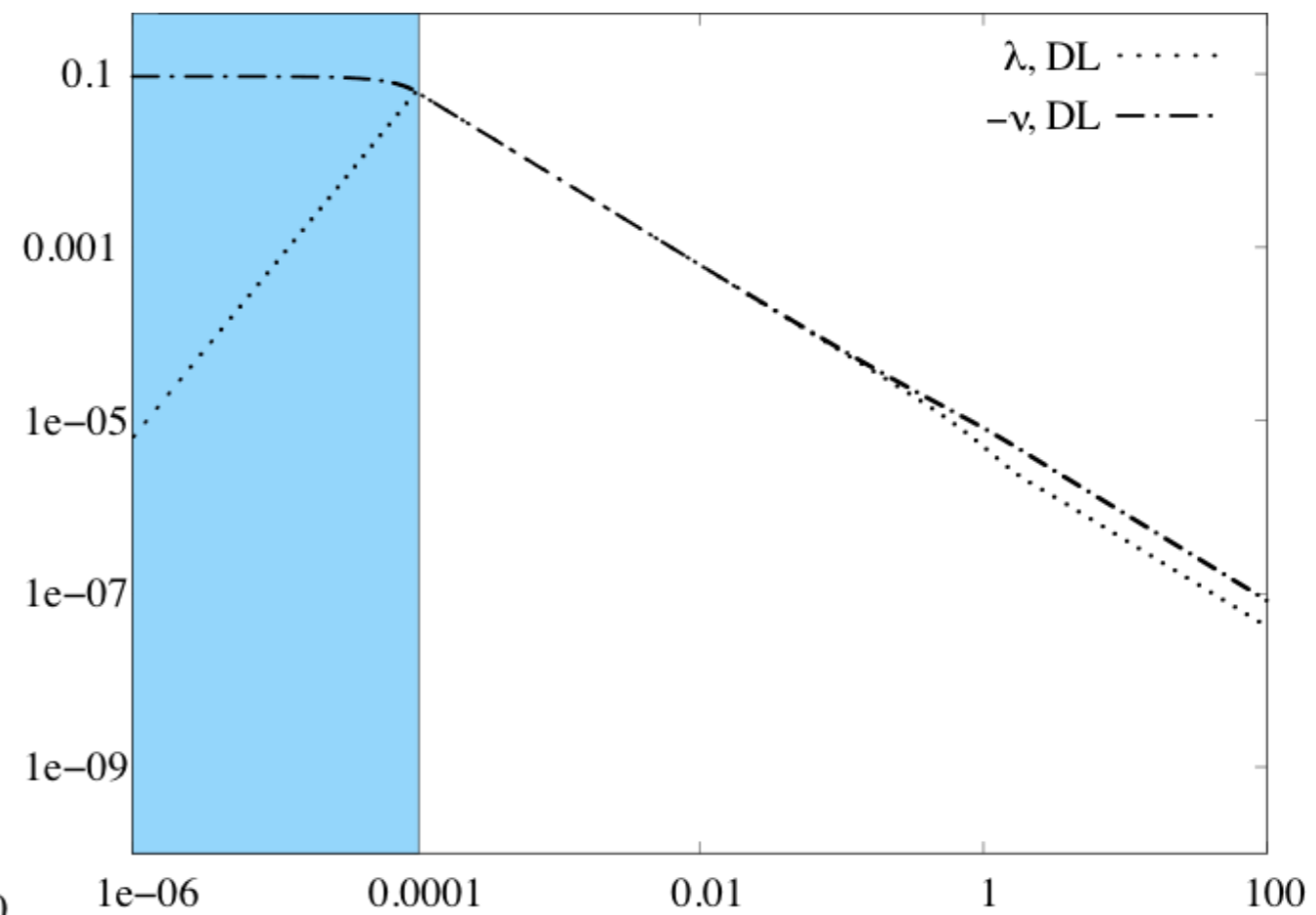
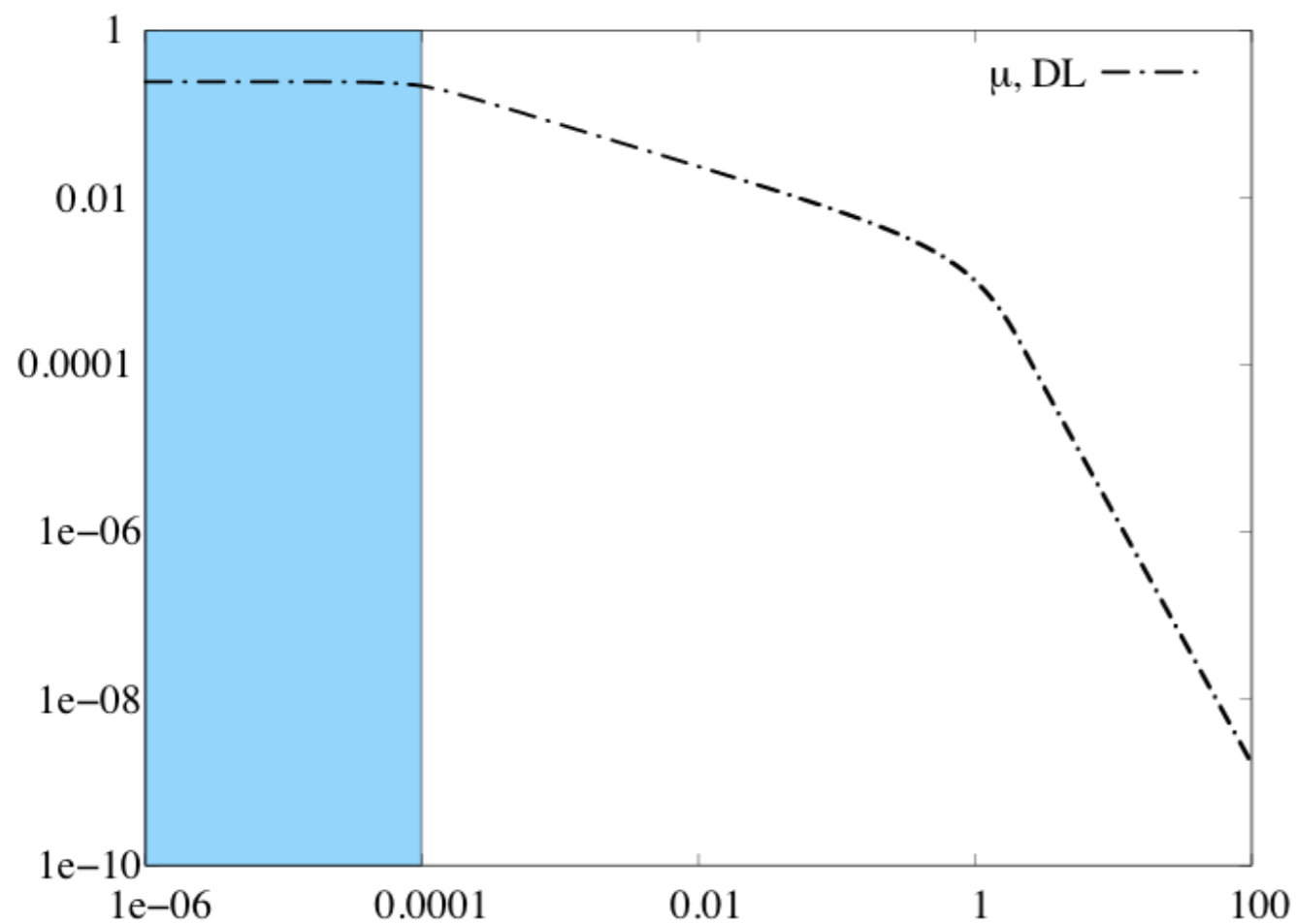

The Decoupling Limit: solution

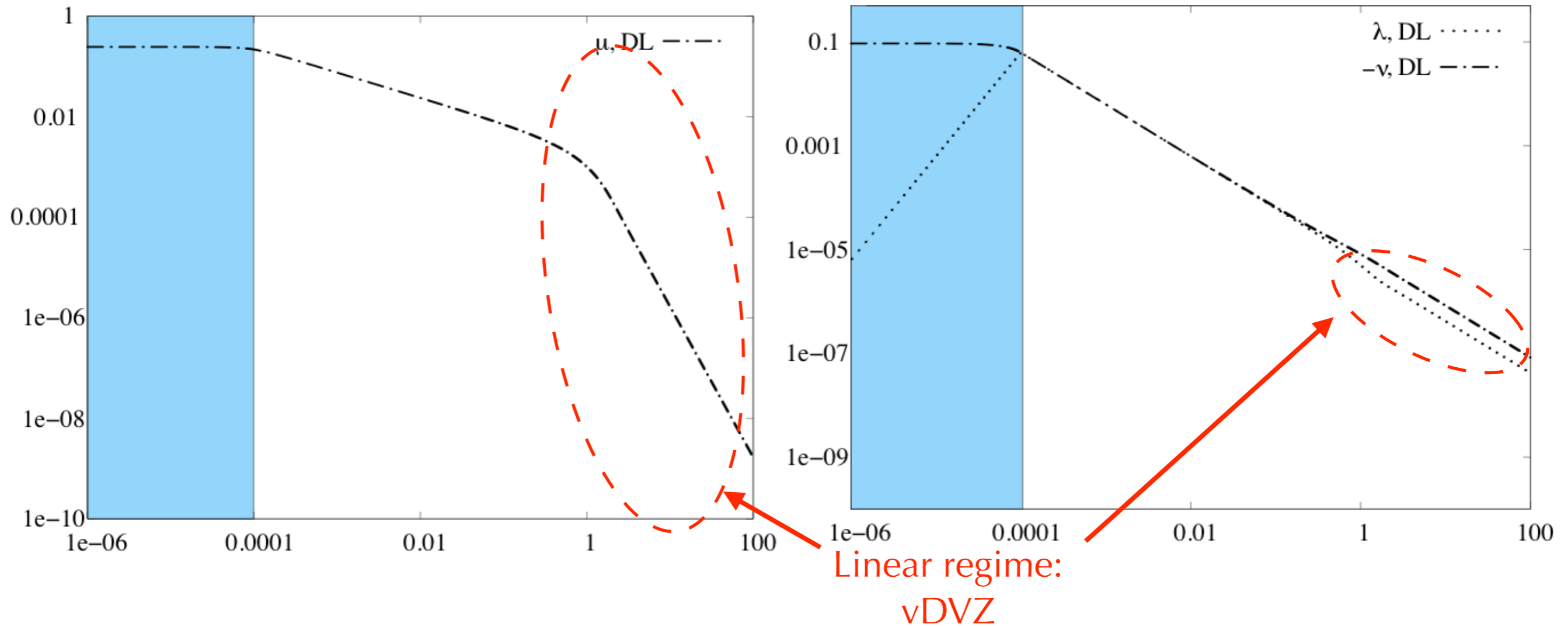

The Decoupling Limit: solution

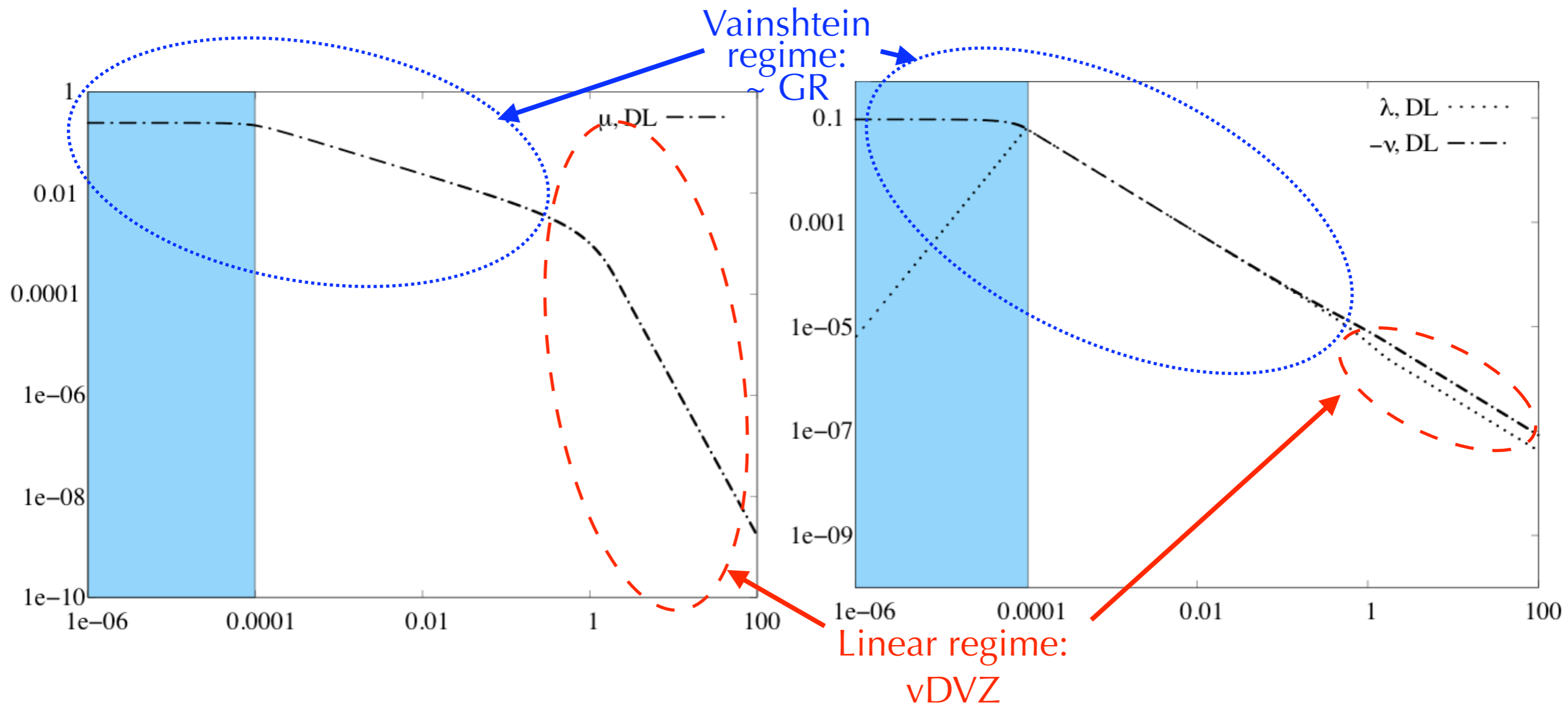

The Decoupling Limit: solution

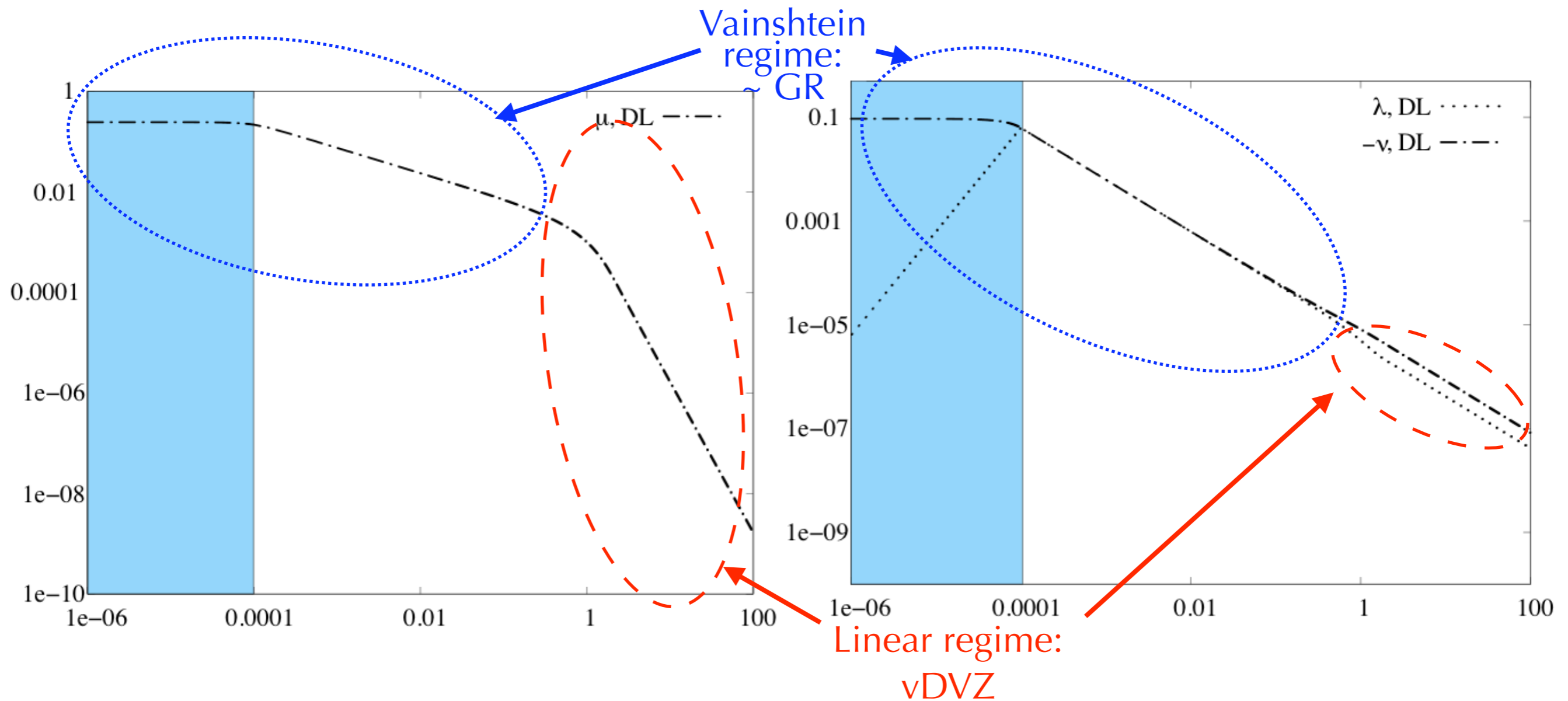

- Rôle of the nonlinearities not taken into account by the DL?

The Decoupling Limit: solution

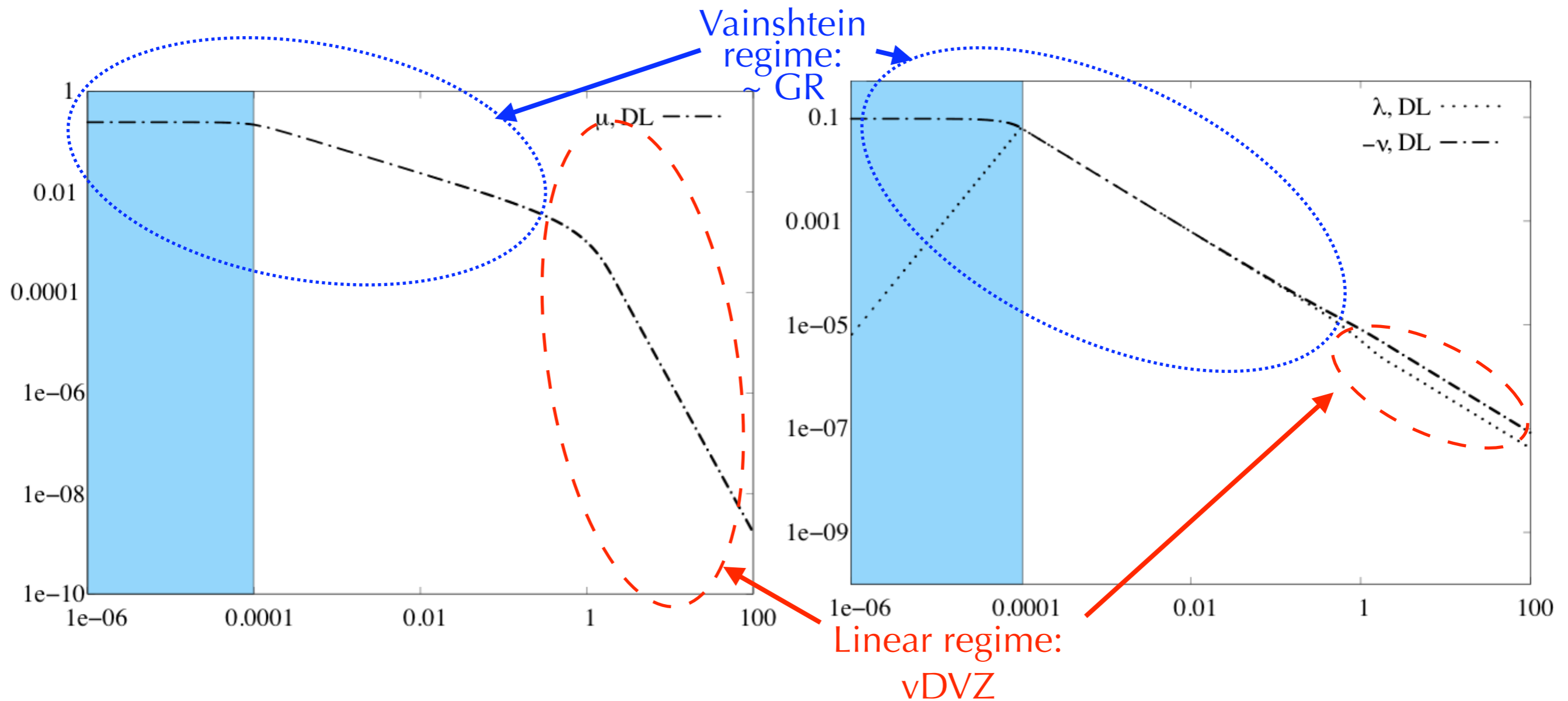

- Rôle of the nonlinearities not taken into account by the DL?
 - ▶ Domain of validity of the DL: between $R = 0$ and $R = m^{-1}$ for non compact sources

The Decoupling Limit: solution

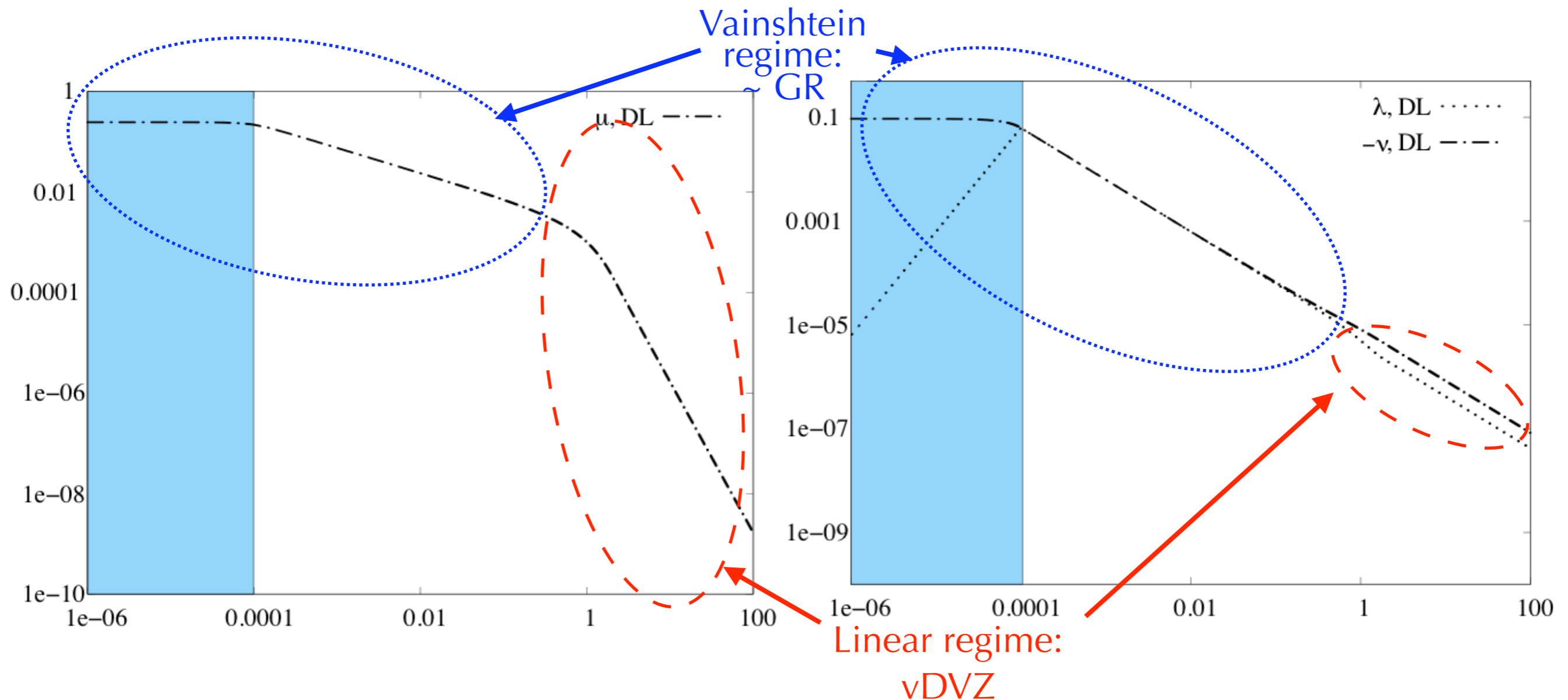

- Rôle of the nonlinearities not taken into account by the DL?
 - ▶ Domain of validity of the DL: between $R = 0$ and $R = m^{-1}$ for non compact sources

Is it possible to generalize this solution?

The full system solution (I)

The full system solution (I)

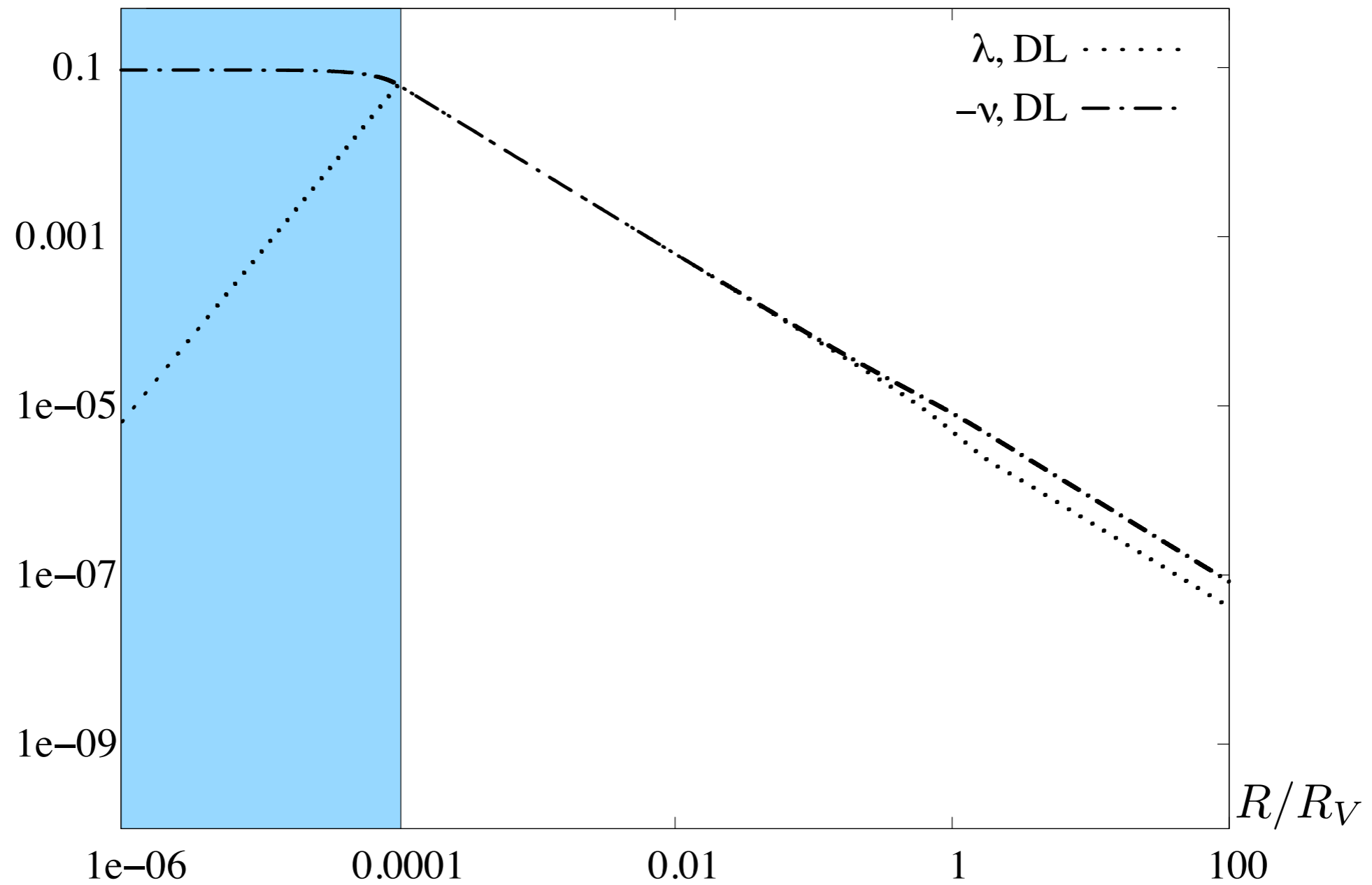

The full system solution (I)

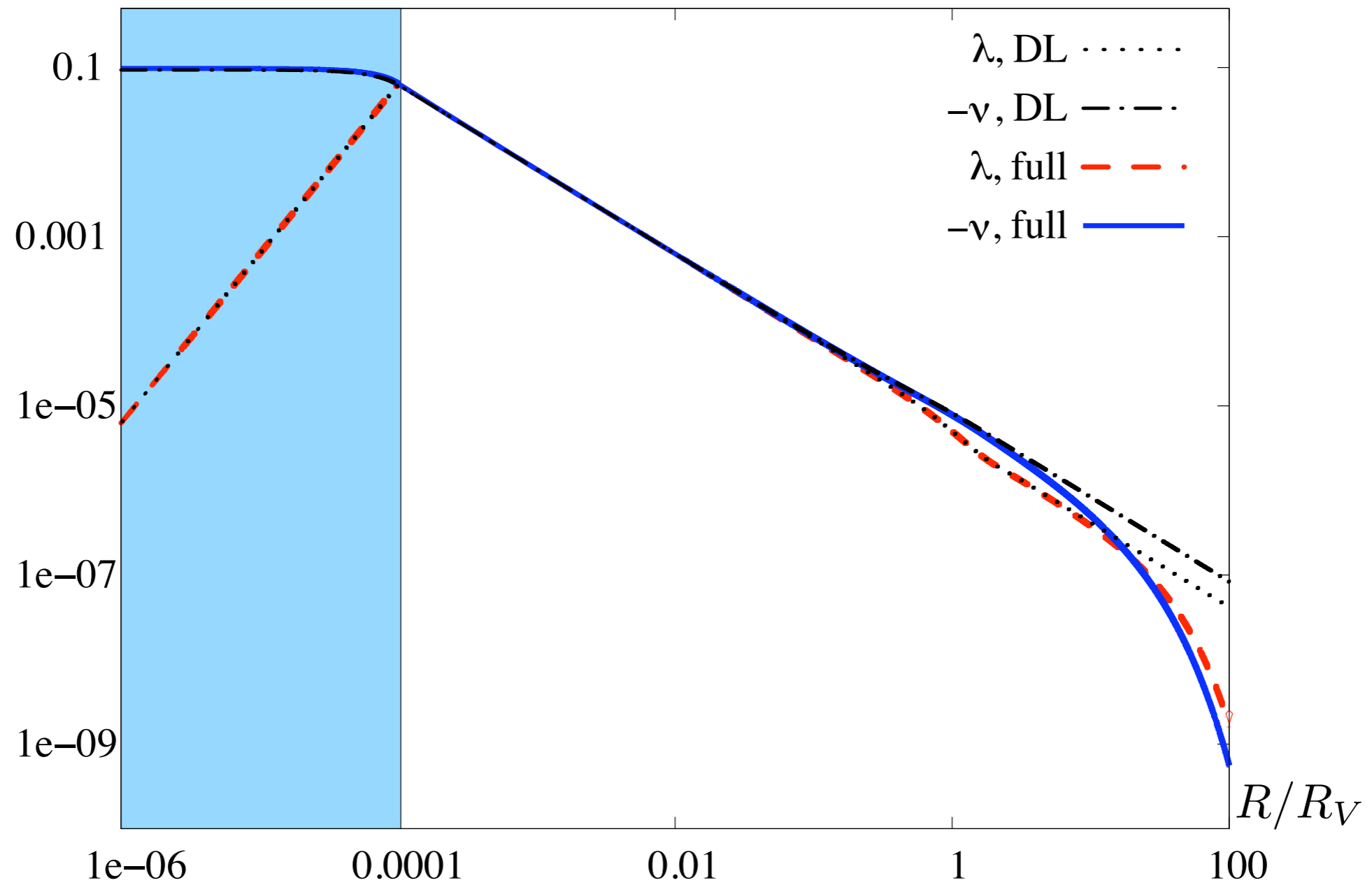

The full system solution (I)

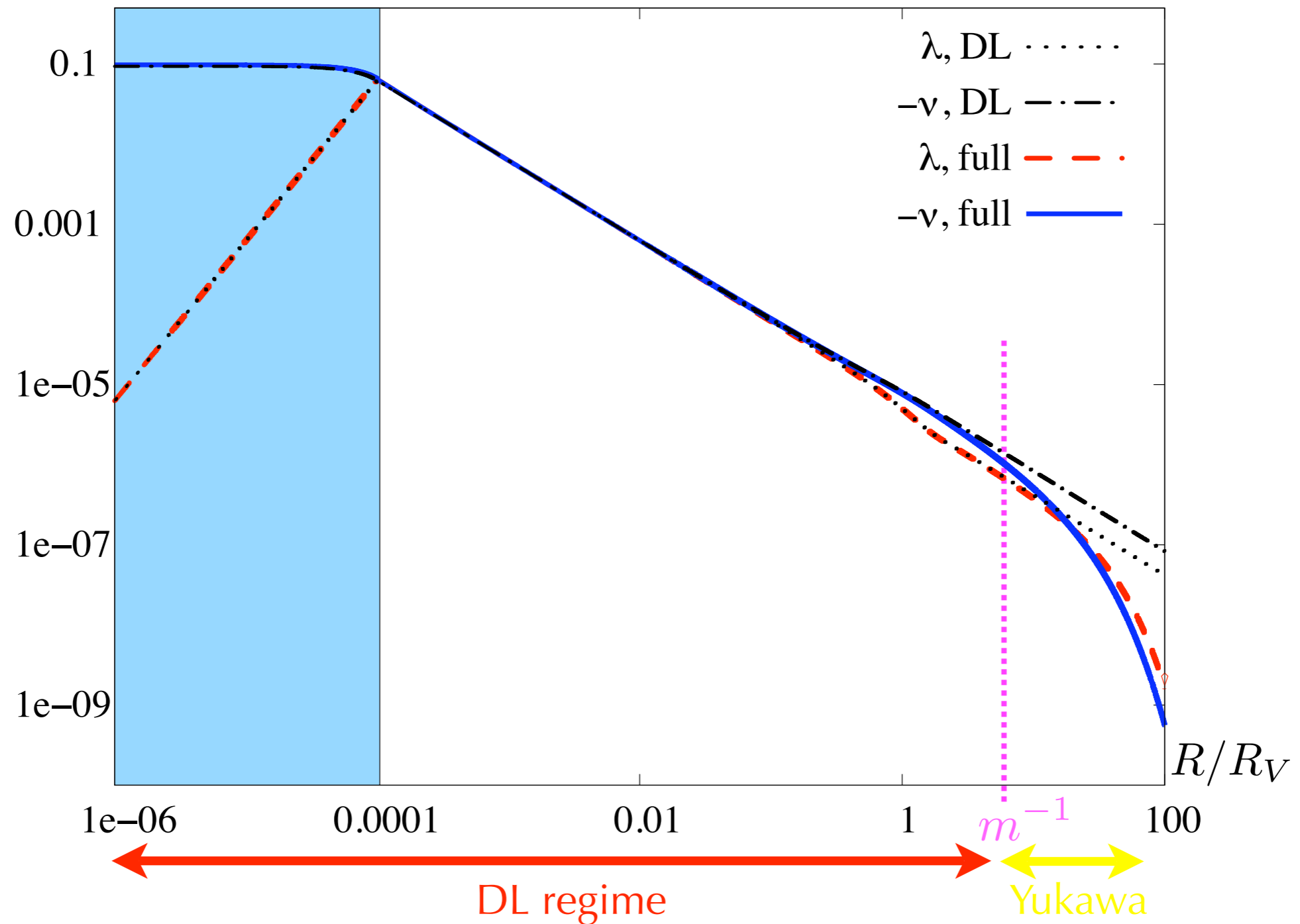

The full system solution (I)

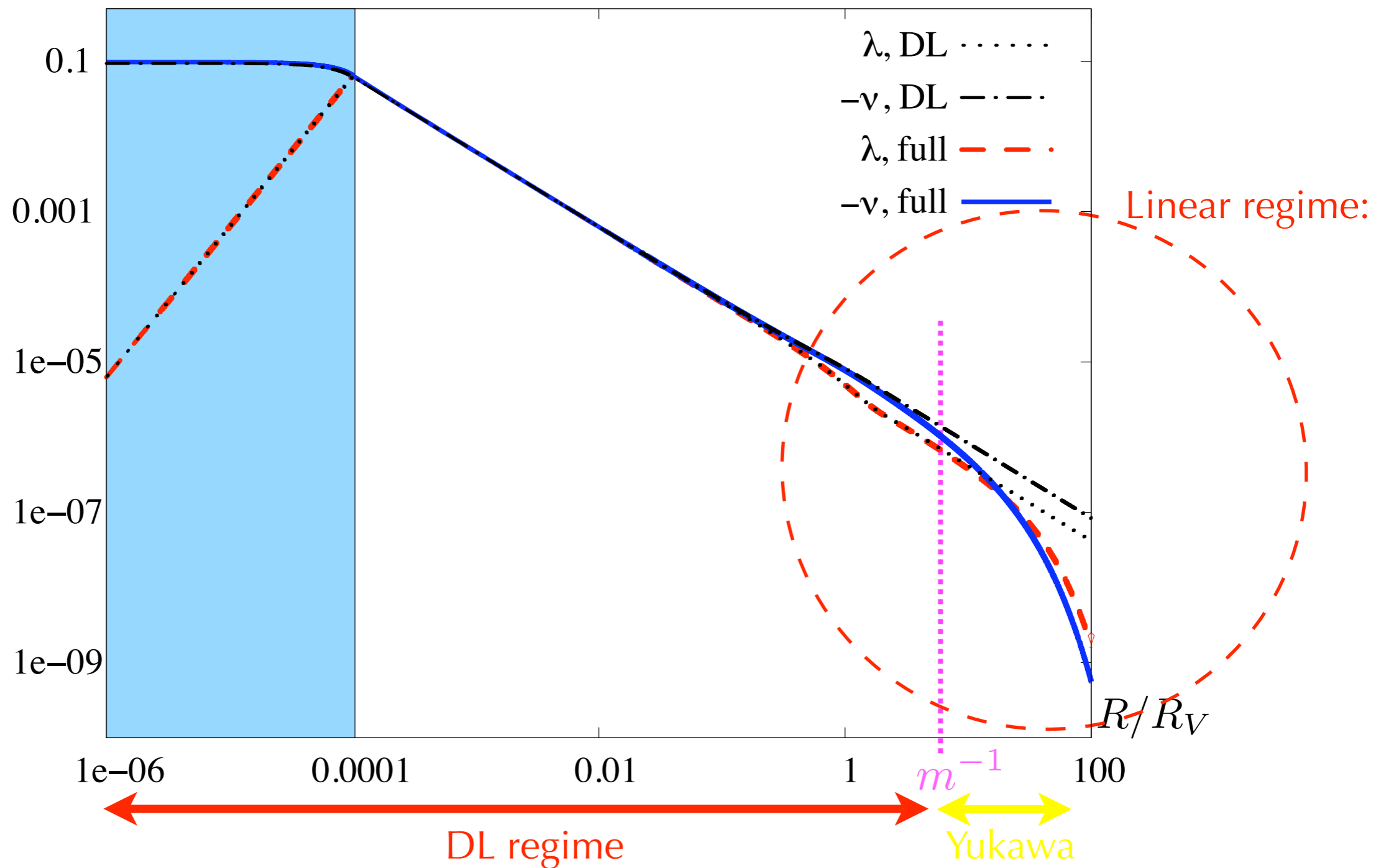

The full system solution (I)

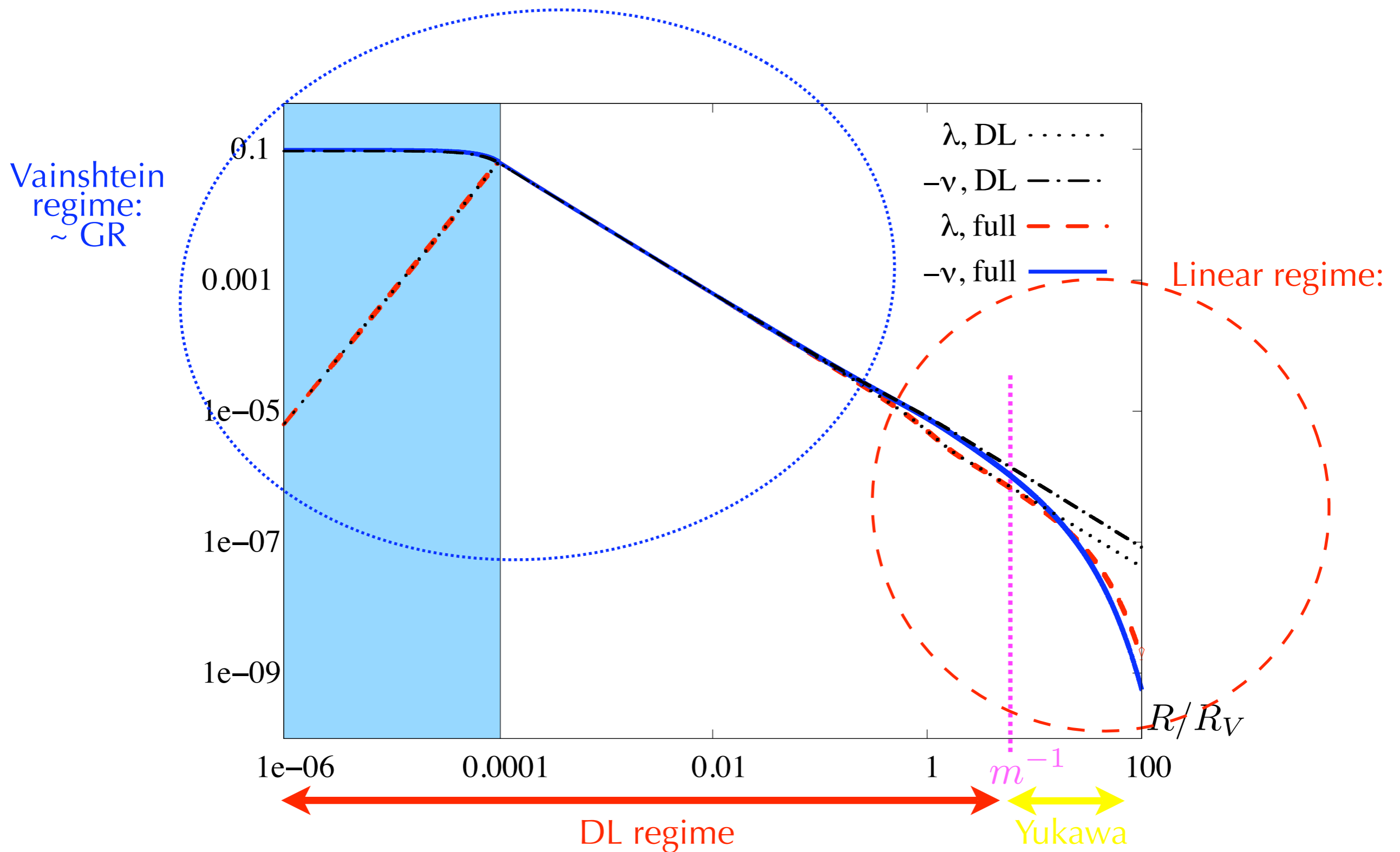

The full system solution (II)

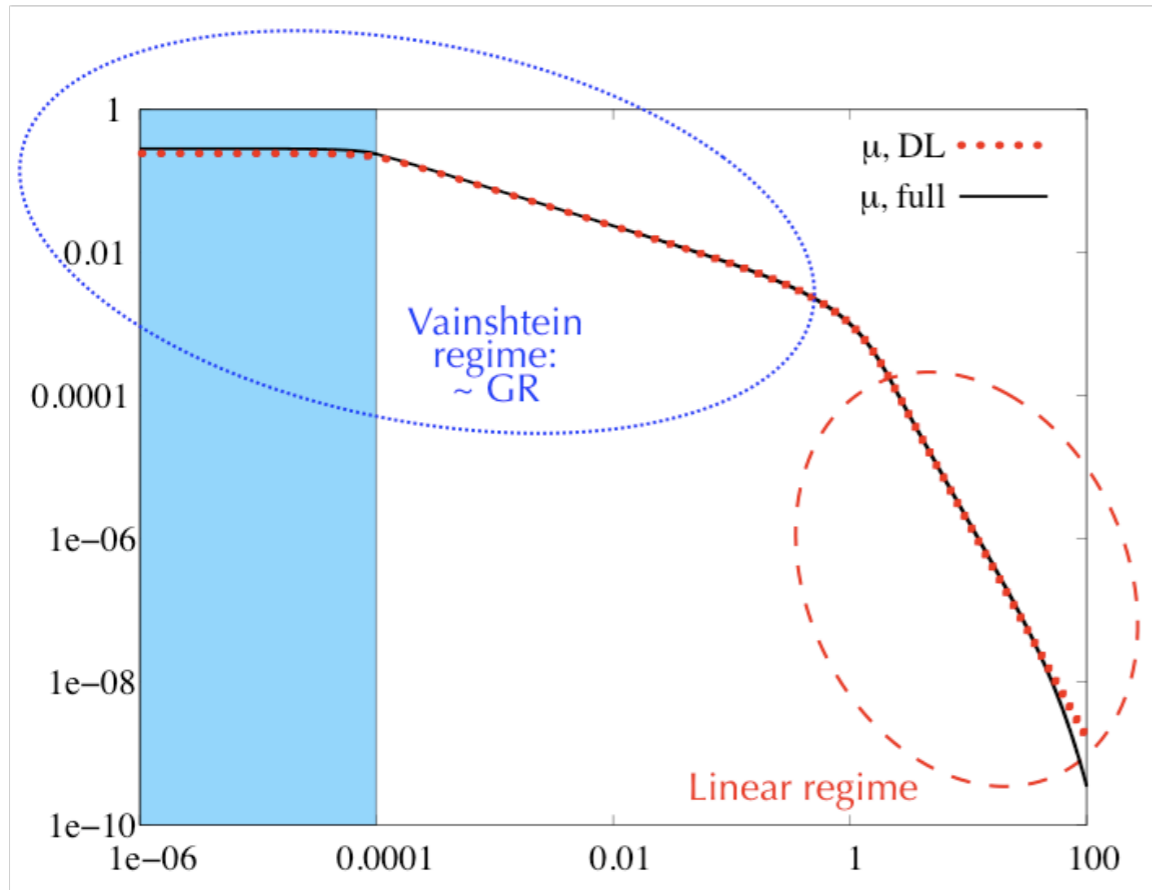

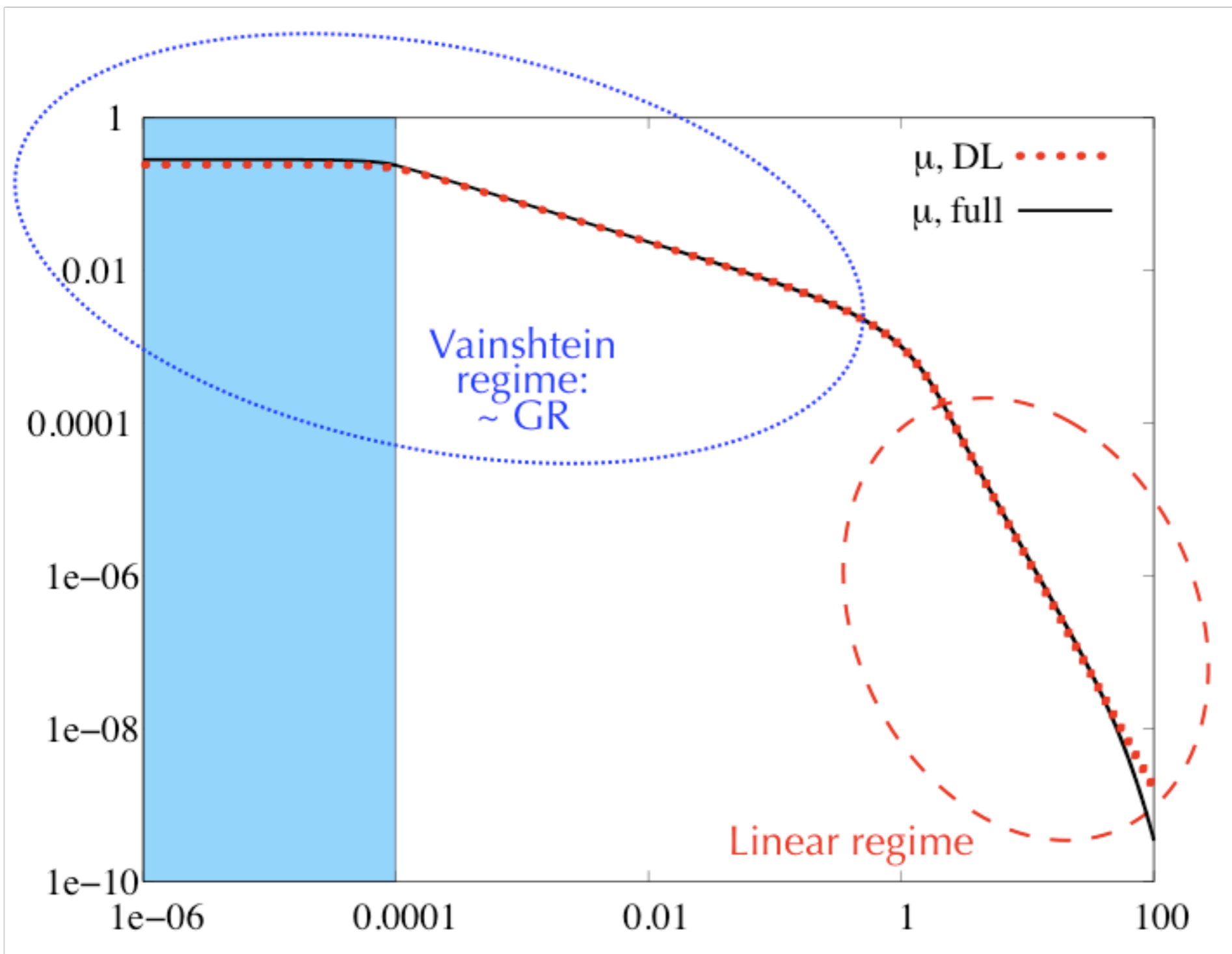

The full system solution (II)

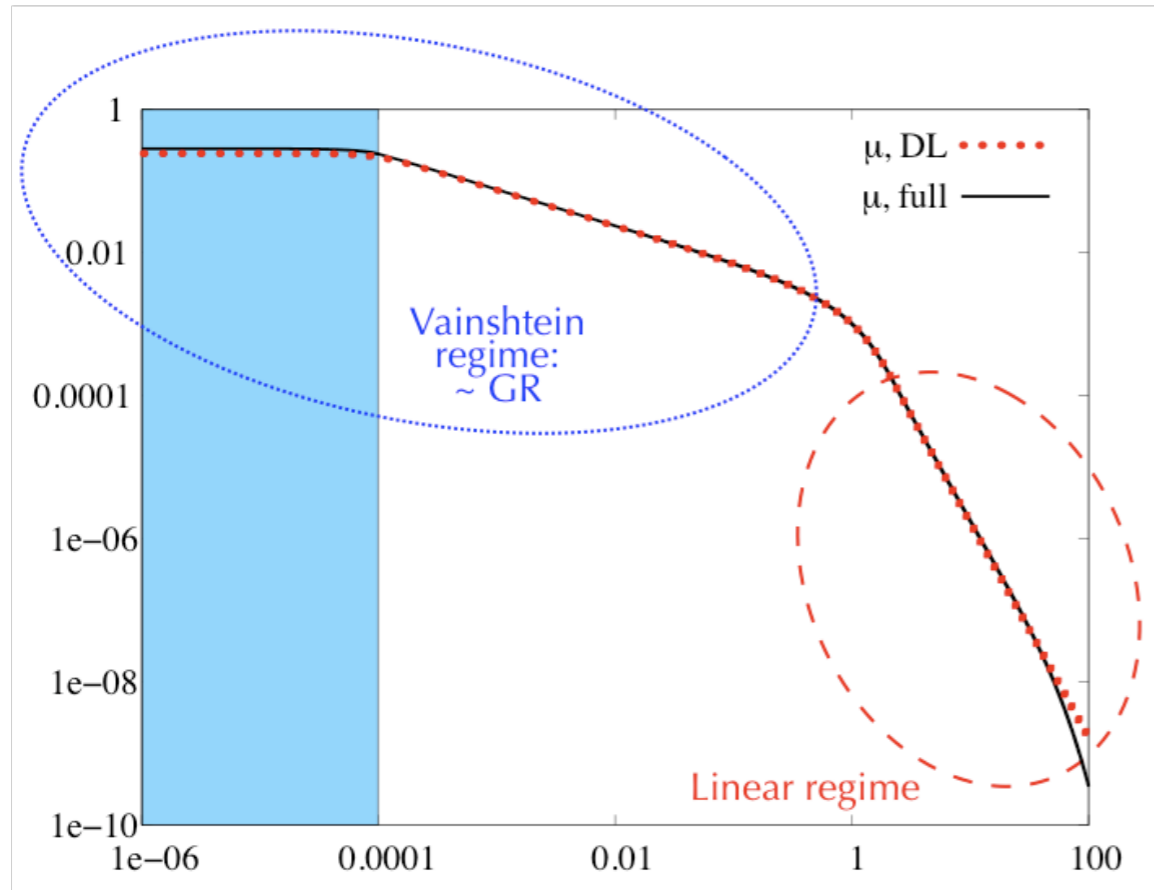

ν inside

The full system solution (II)

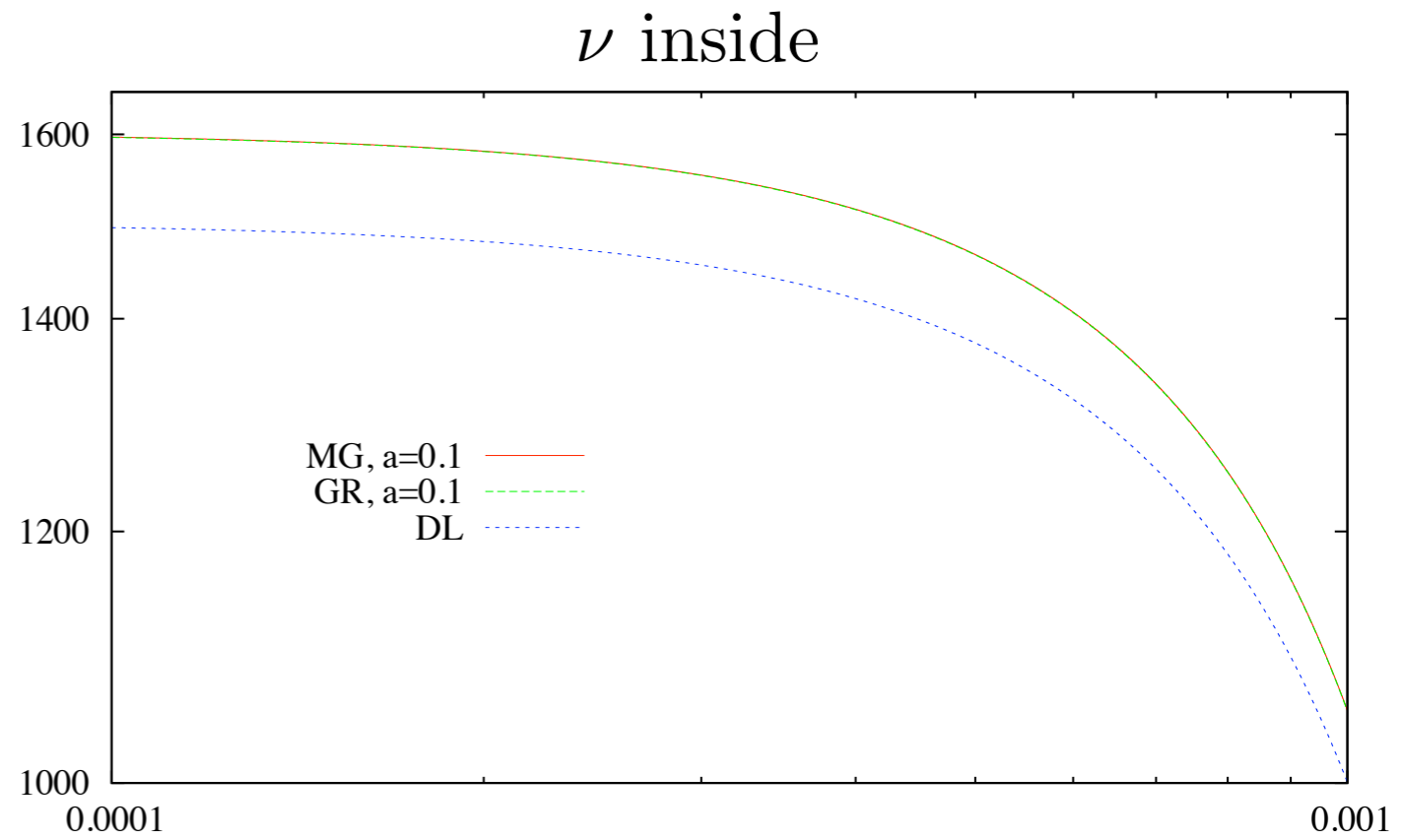
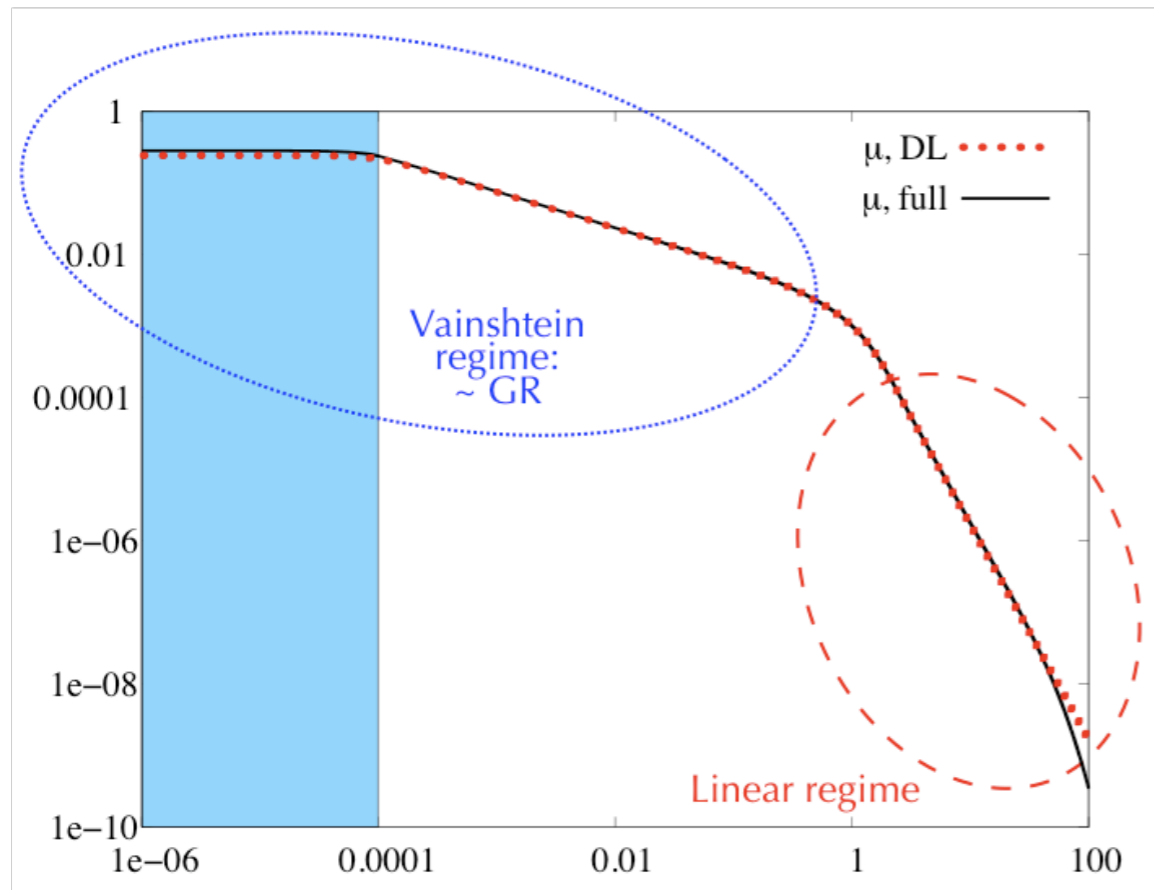

The full system solution (II)

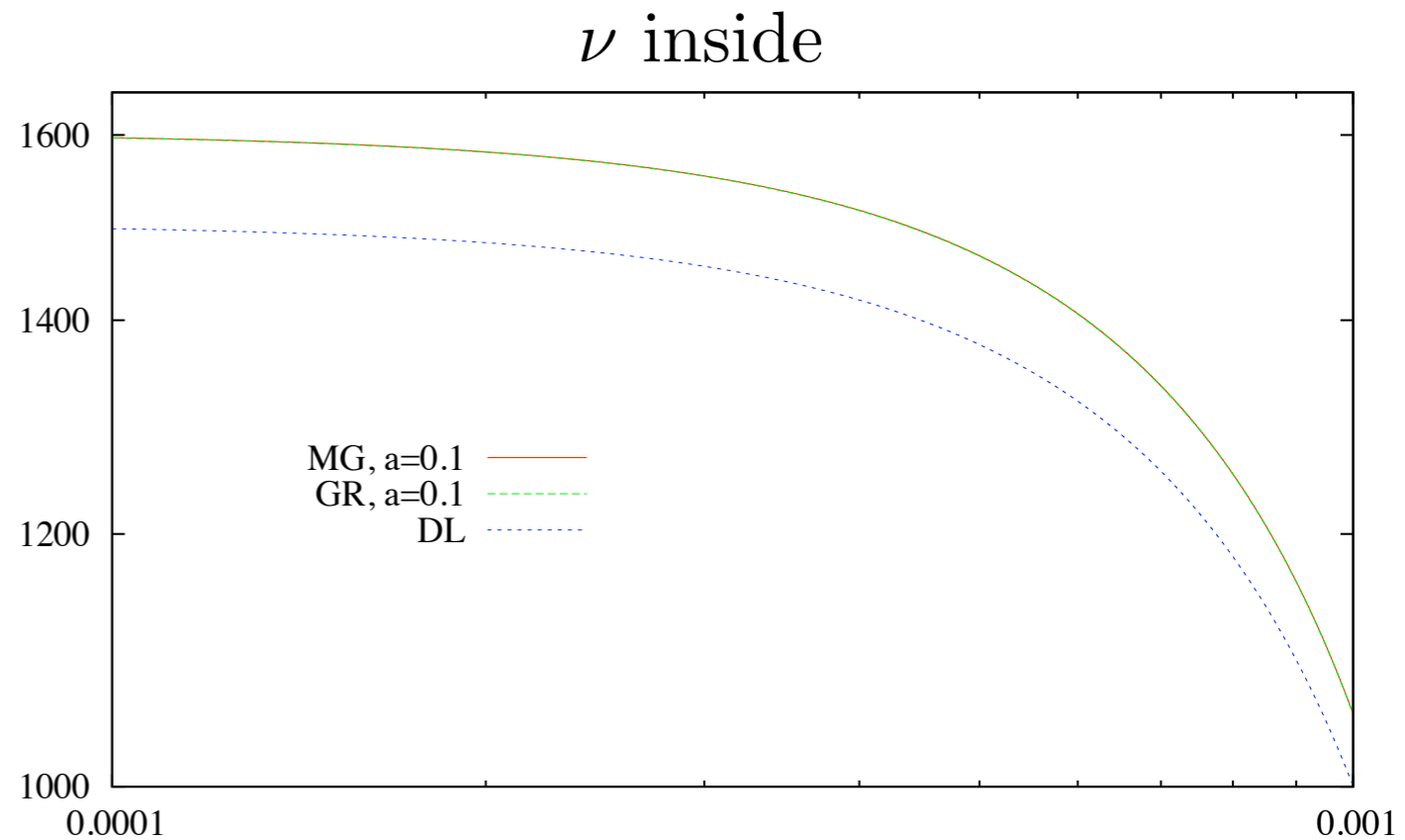
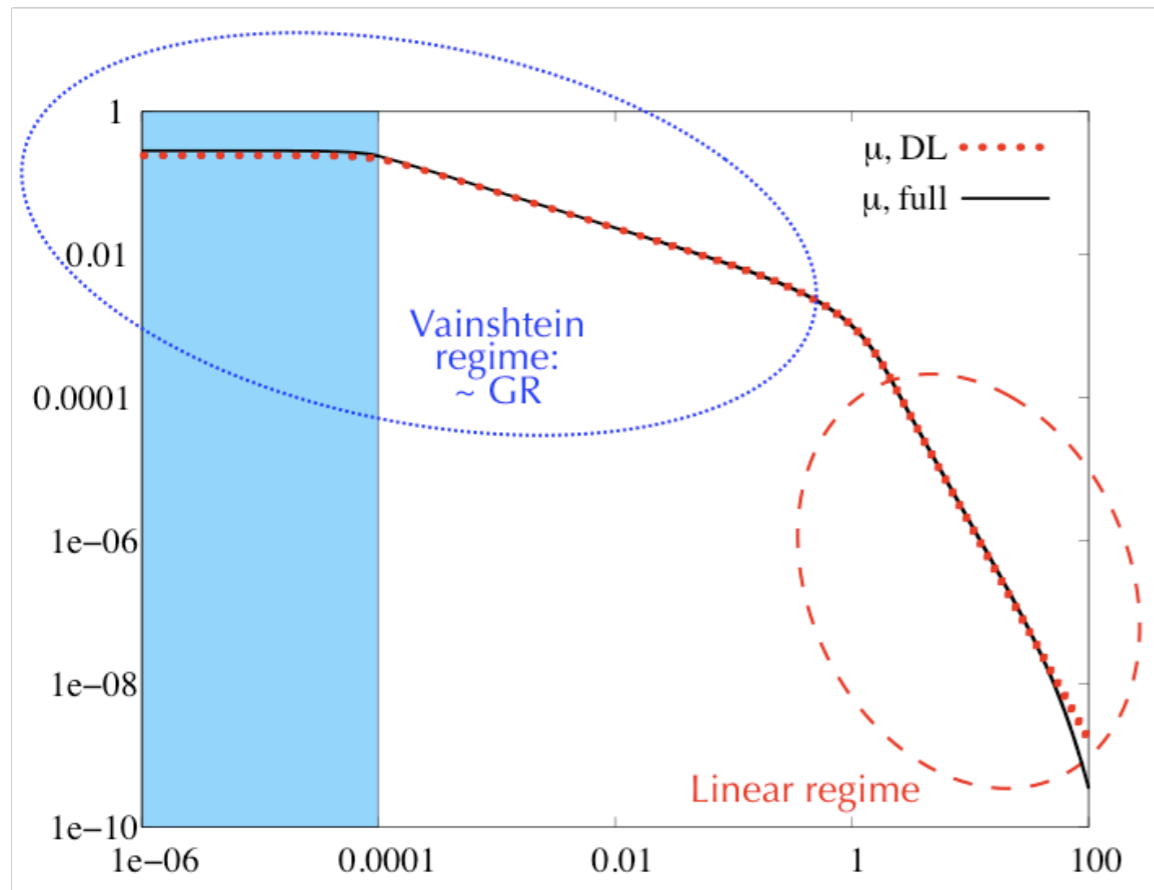

Difference between MG and GR:

$$\Delta\lambda \sim \frac{\sqrt{2}}{3} (mR)^2 \sqrt{\frac{R_S}{R}}$$

The full system solution (II)

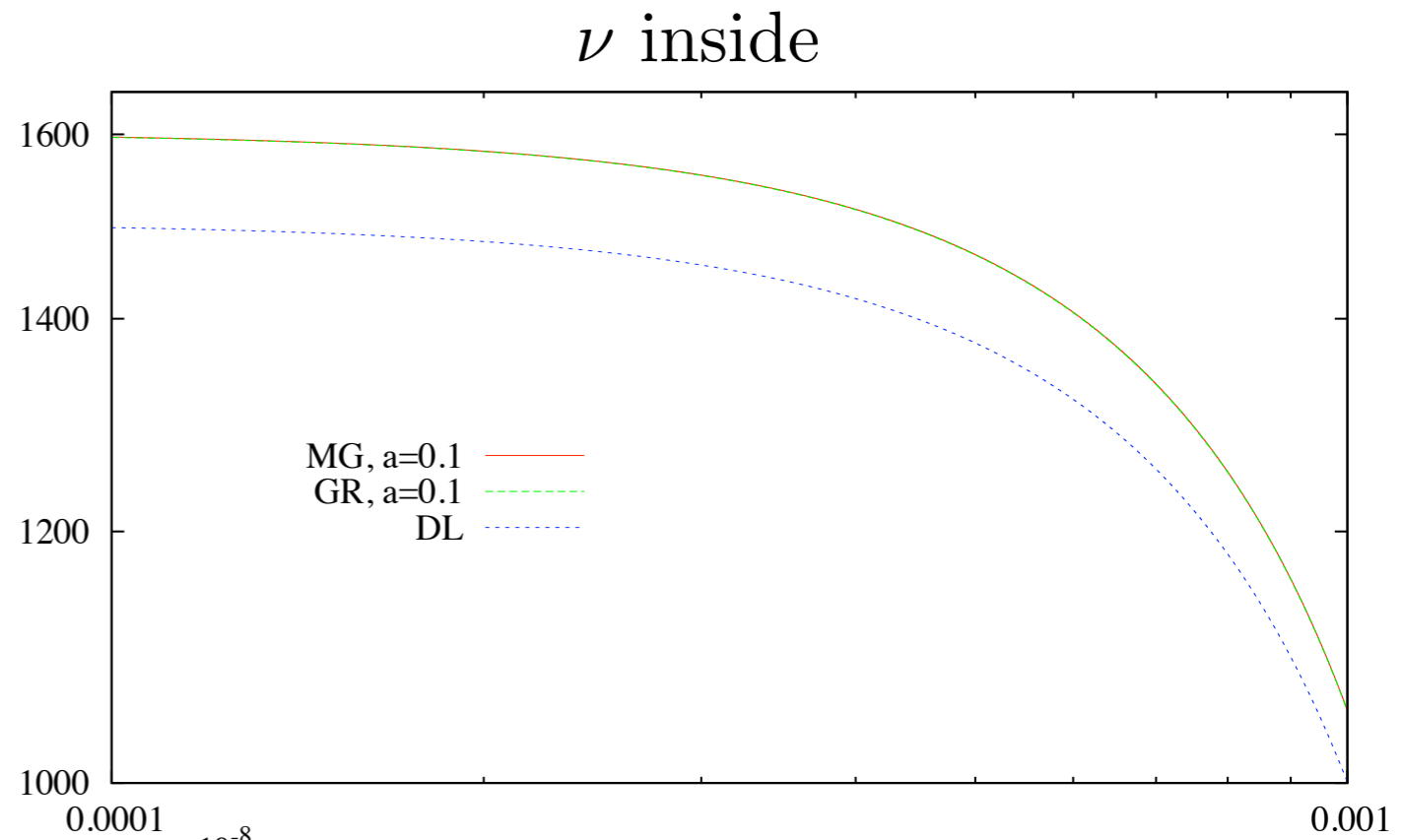
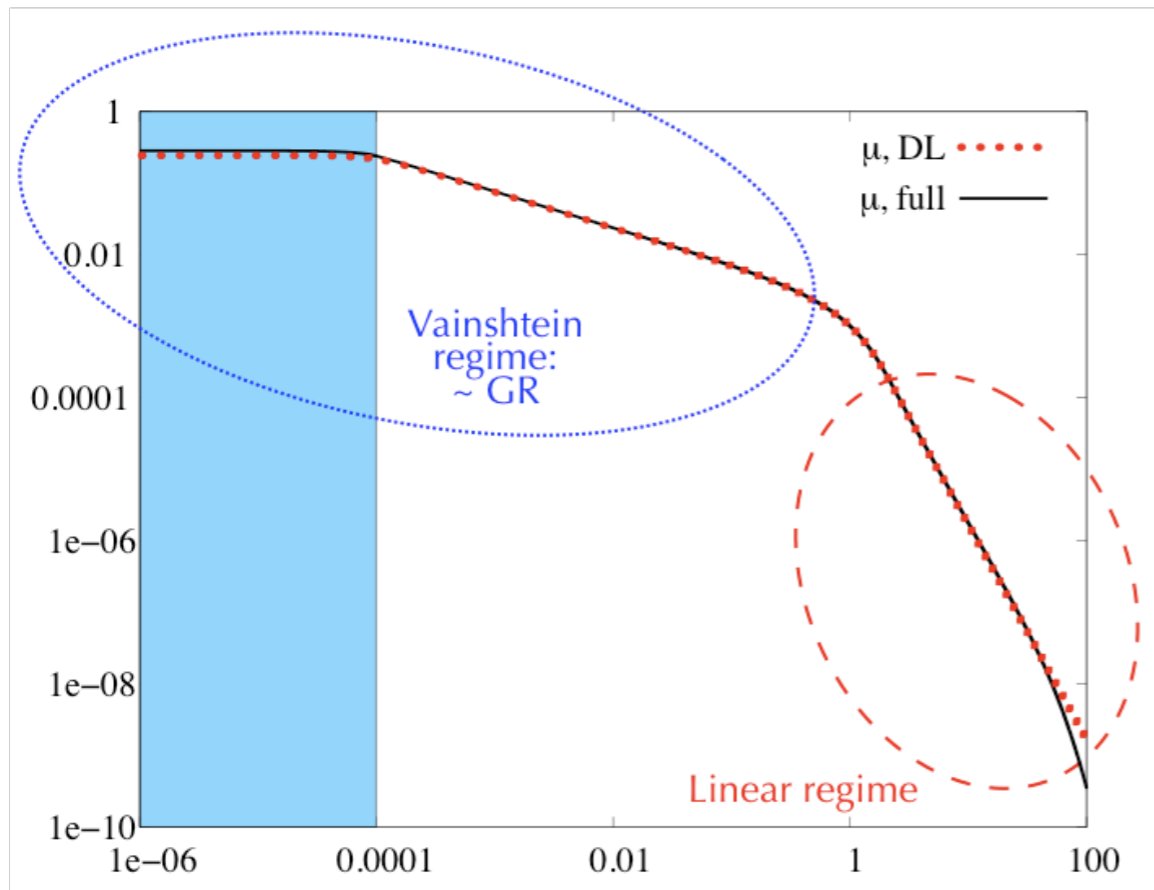

Difference between MG and GR:

$$\Delta\lambda \sim \frac{\sqrt{2}}{3} (mR)^2 \sqrt{\frac{R_S}{R}}$$

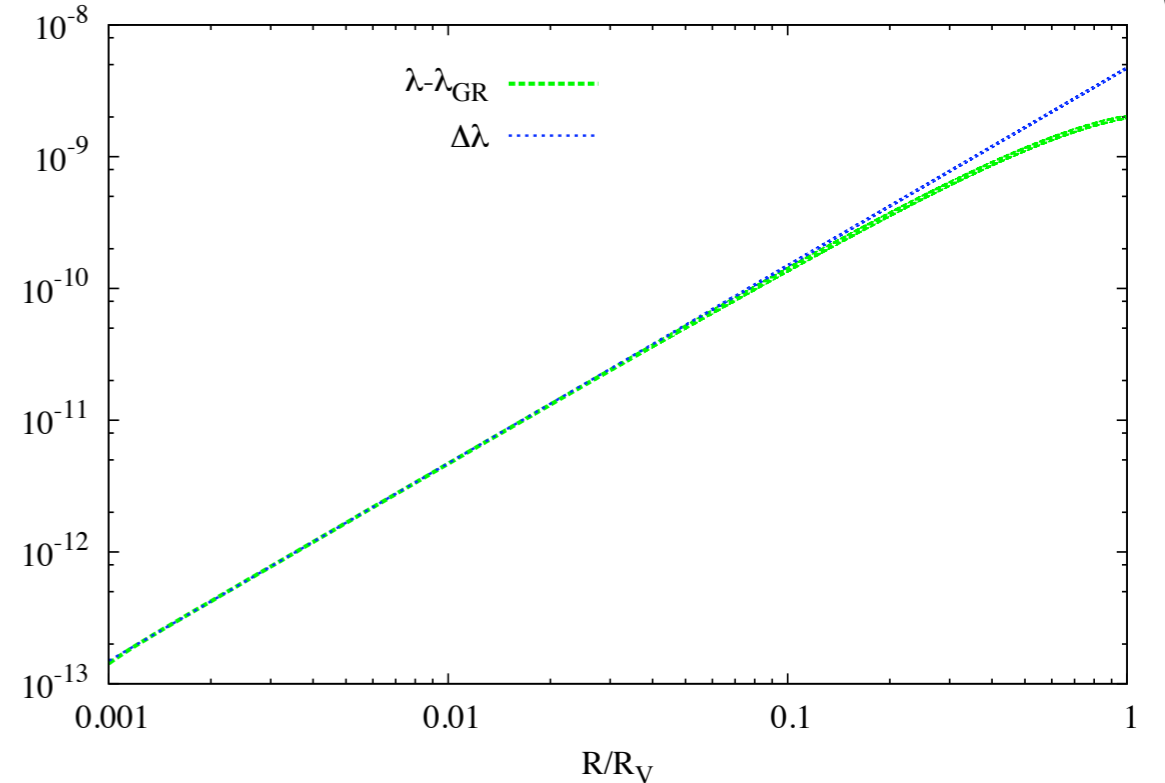

The full system solution (II)

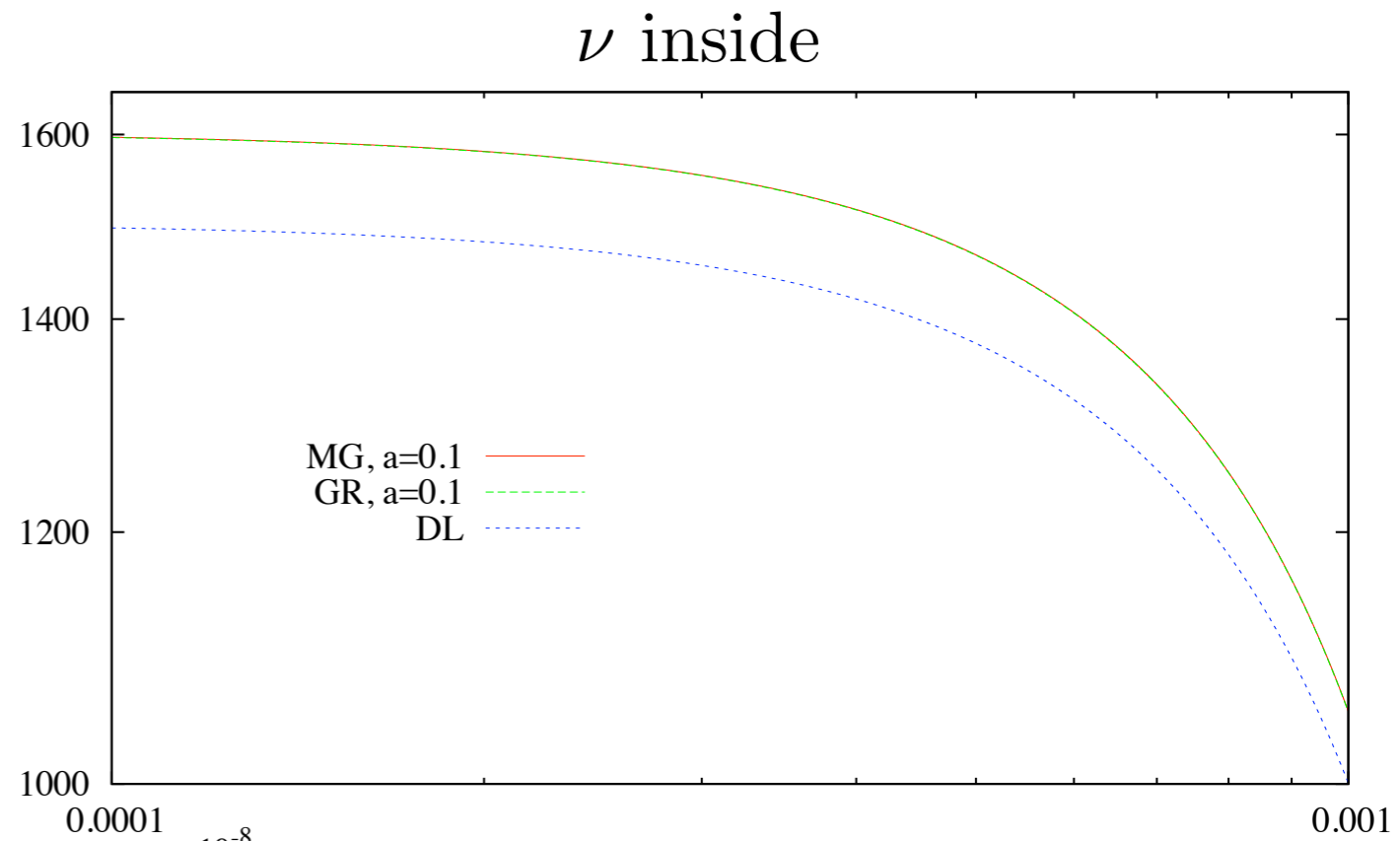
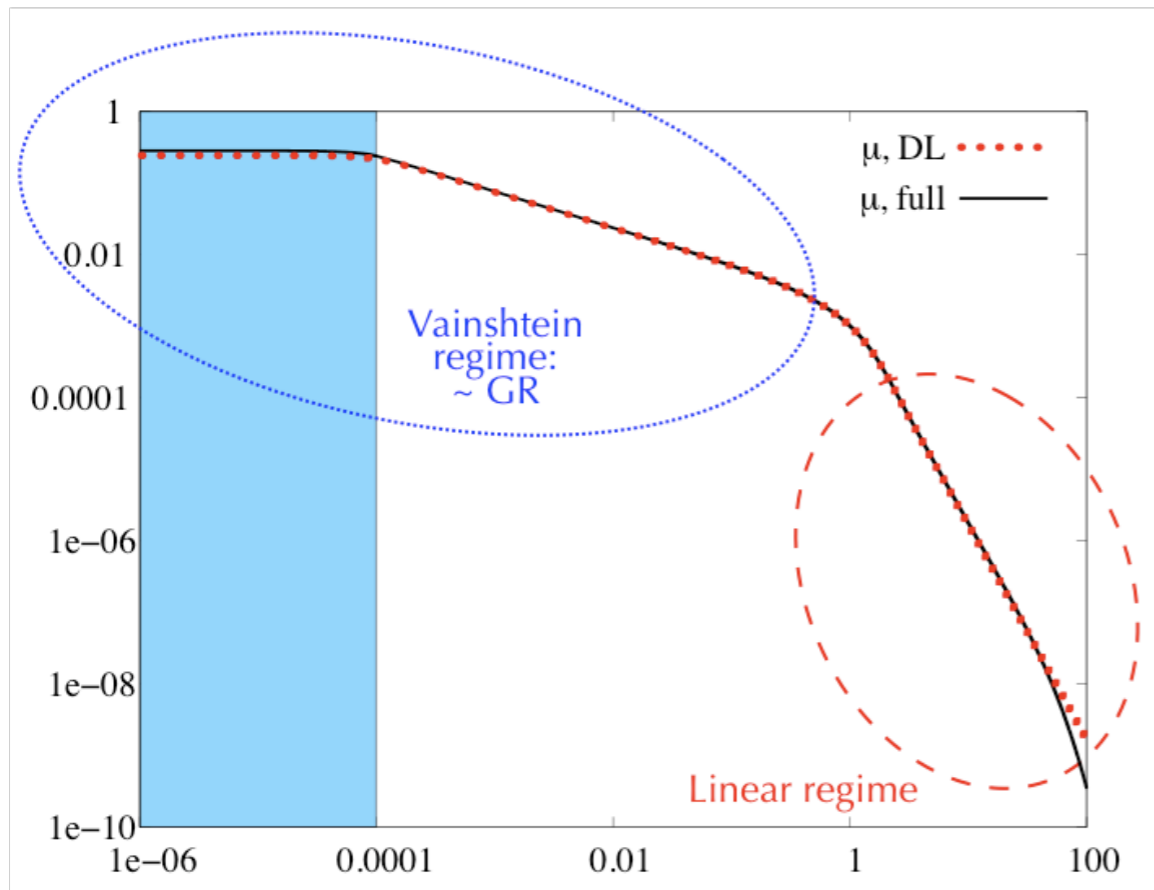

Difference between MG and GR:

$$\Delta\lambda \sim \frac{\sqrt{2}}{3} (mR)^2 \sqrt{\frac{R_S}{R}}$$

Excellent agreement with numerics

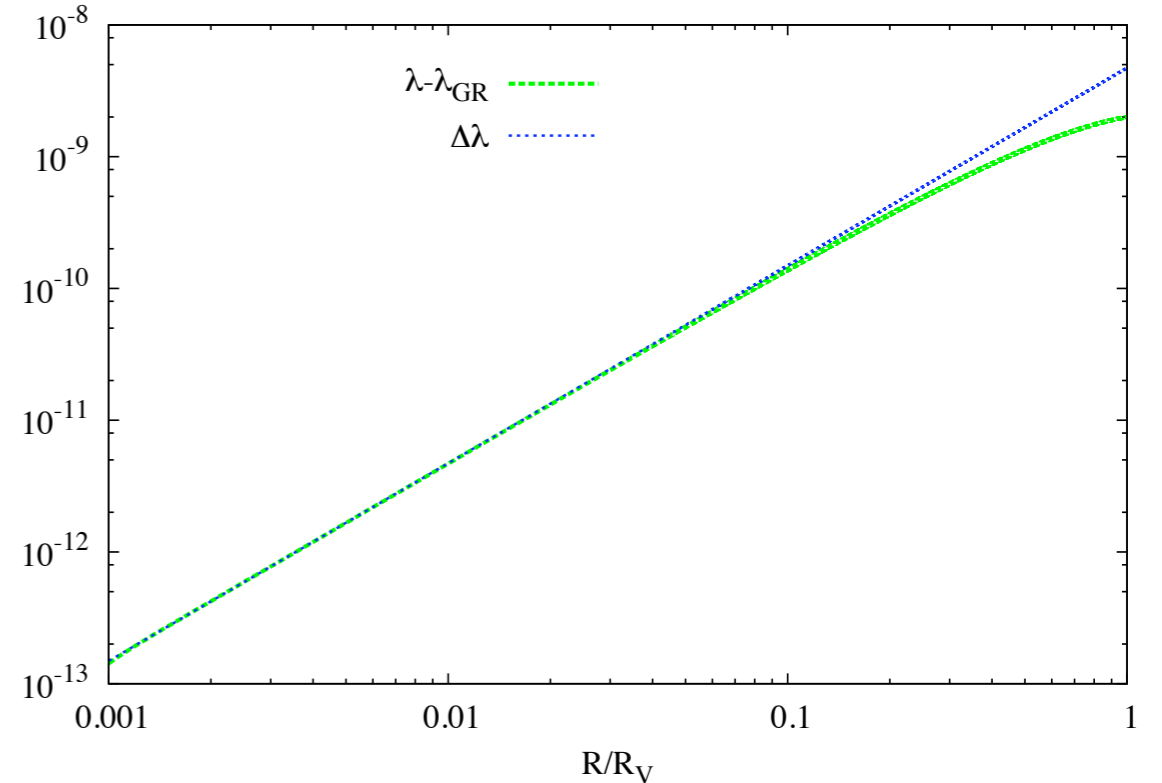

Analytical and numerical tools

Analytical and numerical tools

- Series expansions: far and inside the source

Analytical and numerical tools

- Series expansions: far and inside the source
- Cauchy problem at infinity: evidence for the existence of infinite number of solutions with the same asymptotic behavior (collaboration with J. Ecalle)

Analytical and numerical tools

- Series expansions: far and inside the source
- Cauchy problem at infinity: evidence for the existence of infinite number of solutions with the same asymptotic behavior (collaboration with J. Ecalle)
- Simplified model (weak field)

Analytical and numerical tools

- Series expansions: far and inside the source
- Cauchy problem at infinity: evidence for the existence of infinite number of solutions with the same asymptotic behavior (collaboration with J. Ecalle)
- Simplified model (weak field)
- Numerics: relaxation method
 - ✓ Decoupling Limit
 - ✓ Full system (Decoupling Limit as a starting guess)

Analytical and numerical tools

- Series expansions: far and inside the source
- Cauchy problem at infinity: evidence for the existence of infinite number of solutions with the same asymptotic behavior (collaboration with J. Ecalle)
- Simplified model (weak field)
- Numerics: relaxation method
 - ✓ Decoupling Limit
 - ✓ Full system (Decoupling Limit as a starting guess)
- Numerics: shooting method

Analytical and numerical tools

- Series expansions: far and inside the source
- Cauchy problem at infinity: evidence for the existence of infinite number of solutions with the same asymptotic behavior (collaboration with J. Ecalle)
- Simplified model (weak field)
- Numerics: relaxation method
 - ✓ Decoupling Limit
 - ✓ Full system (Decoupling Limit as a starting guess)
- Numerics: shooting method

All the methods agree: robustness of the results

Beyond Massive Gravity

Beyond Massive Gravity

- k -Mouflage models

[E. Babichev, C. Deffayet, RZ,](#)
“ k -Mouflage gravity”, *IJMP* (2010)

Beyond Massive Gravity

- k -Mouflage models

[E. Babichev, C. Deffayet, RZ,](#)
“ k -Mouflage gravity”, *IJMP* (2010)

$$S = M_P^2 \int d^4x \sqrt{-g} \left(\frac{R}{2} + \frac{\gamma}{2} m^2 \phi R + m^2 H(\phi) \right) + S_m$$

Beyond Massive Gravity

- k -Mouflage models

[E. Babichev, C. Deffayet, RZ,](#)
“ k -Mouflage gravity”, *IJMP* (2010)

$$S = M_P^2 \int d^4x \sqrt{-g} \left(\frac{R}{2} + \frac{\gamma}{2} m^2 \phi R + m^2 H(\phi) \right) + S_m$$

with

$$H(\phi)_{MG} = \frac{\alpha}{2} (\square\phi)^3 + \frac{\beta}{2} (\square\phi \phi_{;\mu\nu} \phi^{;\mu\nu}),$$
$$H(\phi)_{DGP} = m^2 \square\phi \phi_{;\mu} \phi^{;\mu},$$
$$H(\phi)_K = K(X), \quad \text{with} \quad X = m^2 \phi_{;\mu} \phi^{;\mu}$$

Beyond Massive Gravity

- k -Mouflage models

[E. Babichev, C. Deffayet, RZ,](#)
 “ k -Mouflage gravity”, *IJMP* (2010)

$$S = M_P^2 \int d^4x \sqrt{-g} \left(\frac{R}{2} + \frac{\gamma}{2} m^2 \phi R + m^2 H(\phi) \right) + S_m$$

with

$$H(\phi)_{MG} = \frac{\alpha}{2} (\square\phi)^3 + \frac{\beta}{2} (\square\phi \phi_{;\mu\nu} \phi^{;\mu\nu}),$$

$$H(\phi)_{DGP} = m^2 \square\phi \phi_{;\mu} \phi^{;\mu},$$

$$H(\phi)_K = K(X), \quad \text{with} \quad X = m^2 \phi_{;\mu} \phi^{;\mu}$$

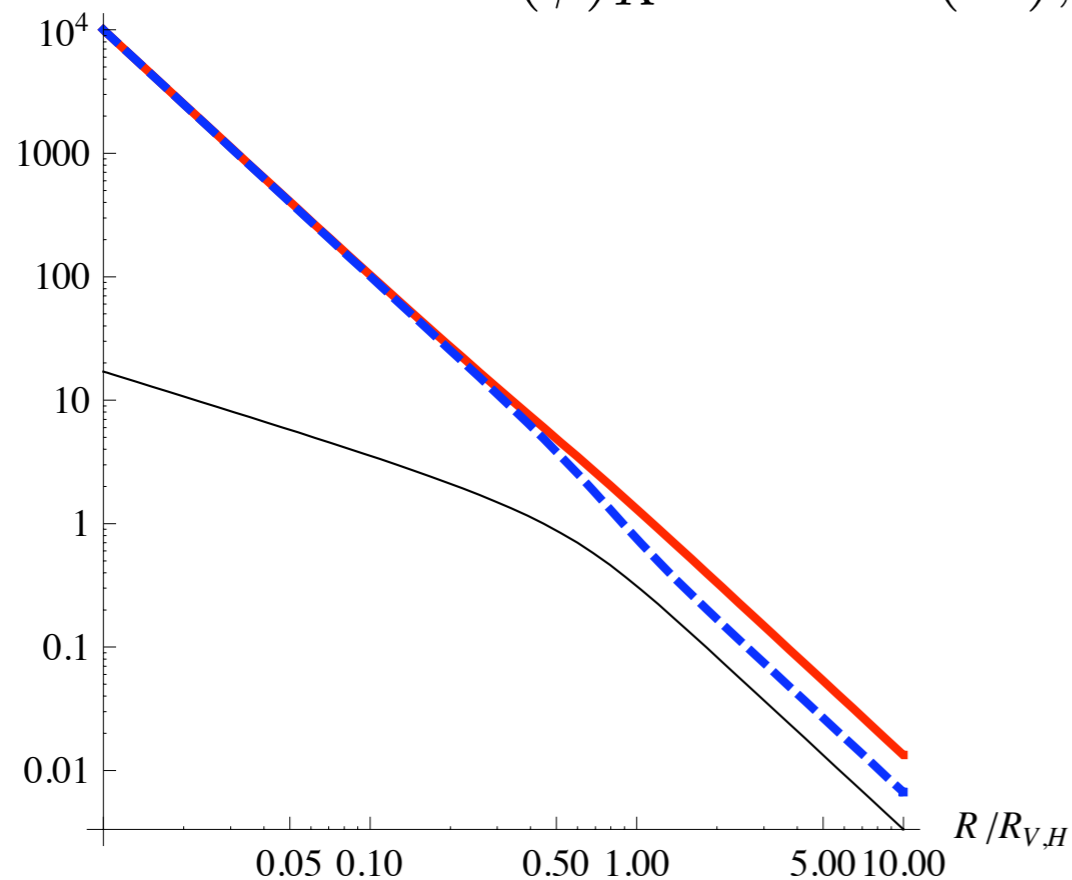

Beyond Massive Gravity

- k -Mouflage models

[E. Babichev, C. Deffayet, RZ,](#)
 “ k -Mouflage gravity”, *IJMP* (2010)

$$S = M_P^2 \int d^4x \sqrt{-g} \left(\frac{R}{2} + \frac{\gamma}{2} m^2 \phi R + m^2 H(\phi) \right) + S_m$$

with

$$H(\phi)_{MG} = \frac{\alpha}{2} (\square\phi)^3 + \frac{\beta}{2} (\square\phi \phi_{;\mu\nu} \phi^{;\mu\nu}),$$

$$H(\phi)_{DGP} = m^2 \square\phi \phi_{;\mu} \phi^{;\mu},$$

$$H(\phi)_K = K(X), \quad \text{with} \quad X = m^2 \phi_{;\mu} \phi^{;\mu}$$

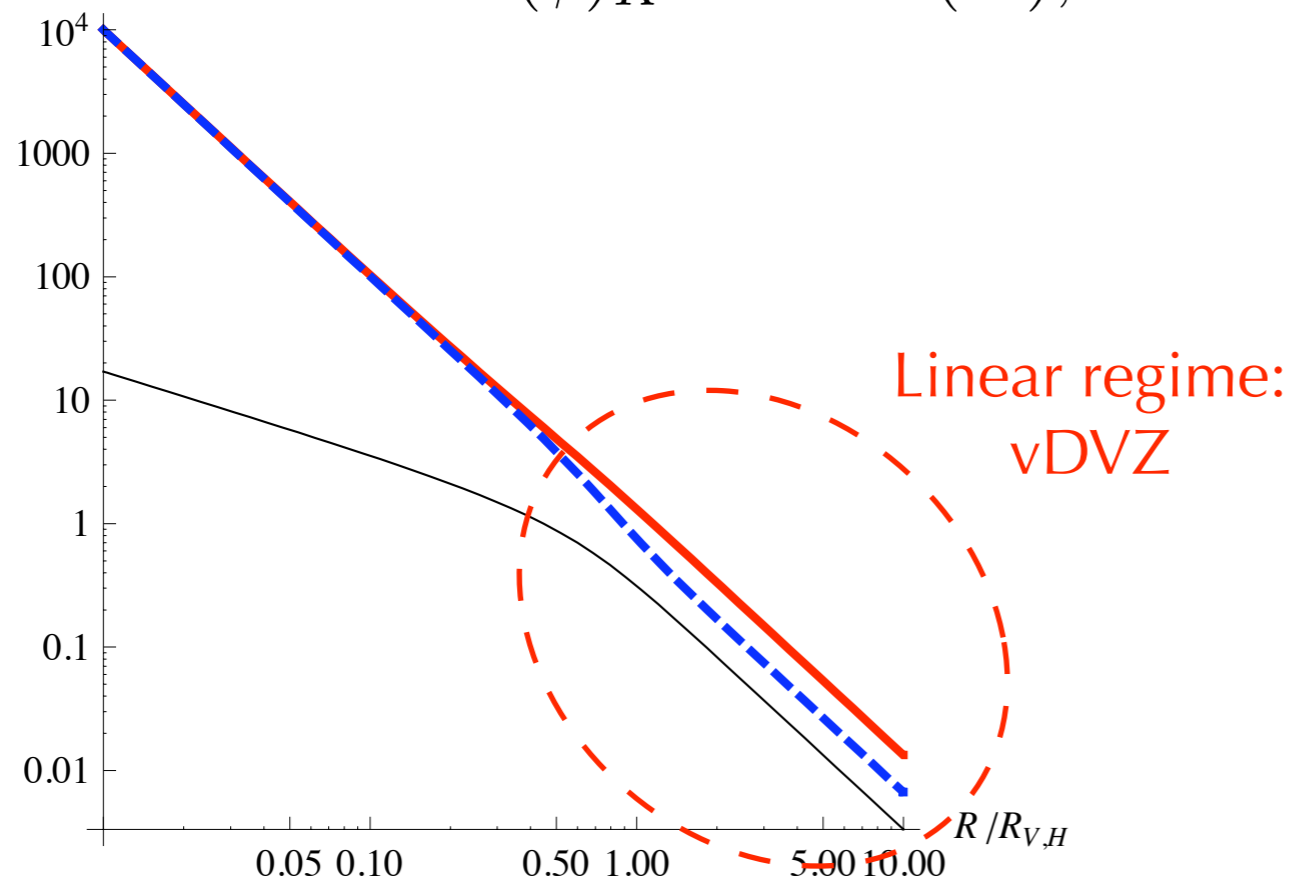

Beyond Massive Gravity

- k -Mouflage models

[E. Babichev, C. Deffayet, RZ,](#)
 “ k -Mouflage gravity”, *IJMP* (2010)

$$S = M_P^2 \int d^4x \sqrt{-g} \left(\frac{R}{2} + \frac{\gamma}{2} m^2 \phi R + m^2 H(\phi) \right) + S_m$$

with $H(\phi)_{MG} = \frac{\alpha}{2} (\square\phi)^3 + \frac{\beta}{2} (\square\phi \phi_{;\mu\nu} \phi^{;\mu\nu}),$

$$H(\phi)_{DGP} = m^2 \square\phi \phi_{;\mu} \phi^{;\mu},$$

$$H(\phi)_K = K(X), \quad \text{with} \quad X = m^2 \phi_{;\mu} \phi^{;\mu}$$

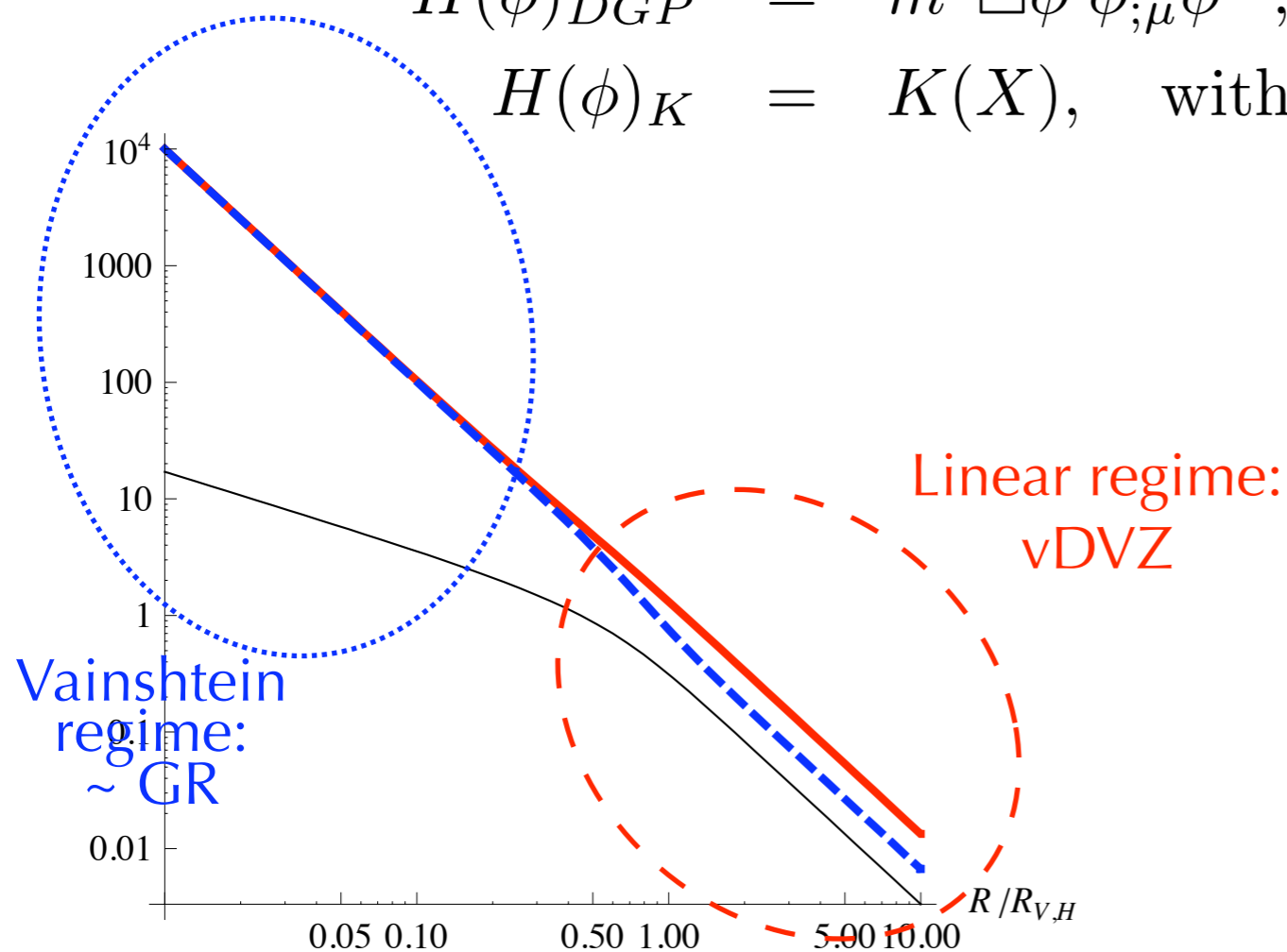

Beyond Massive Gravity

- k -Mouflage models

*E. Babichev, C. Deffayet, RZ,
"k-Mouflage gravity", IJMP (2010)*

$$S = M_P^2 \int d^4x \sqrt{-g} \left(\frac{R}{2} + \frac{\gamma}{2} m^2 \phi R + m^2 H(\phi) \right) + S_m$$

with $H(\phi)_{MG} = \frac{\alpha}{2} (\square\phi)^3 + \frac{\beta}{2} (\square\phi \phi_{;\mu\nu} \phi^{;\mu\nu}),$

$$H(\phi)_{DGP} = m^2 \square\phi \phi_{;\mu} \phi^{;\mu},$$

$$H(\phi)_K = K(X), \quad \text{with} \quad X = m^2 \phi_{;\mu} \phi^{;\mu}$$

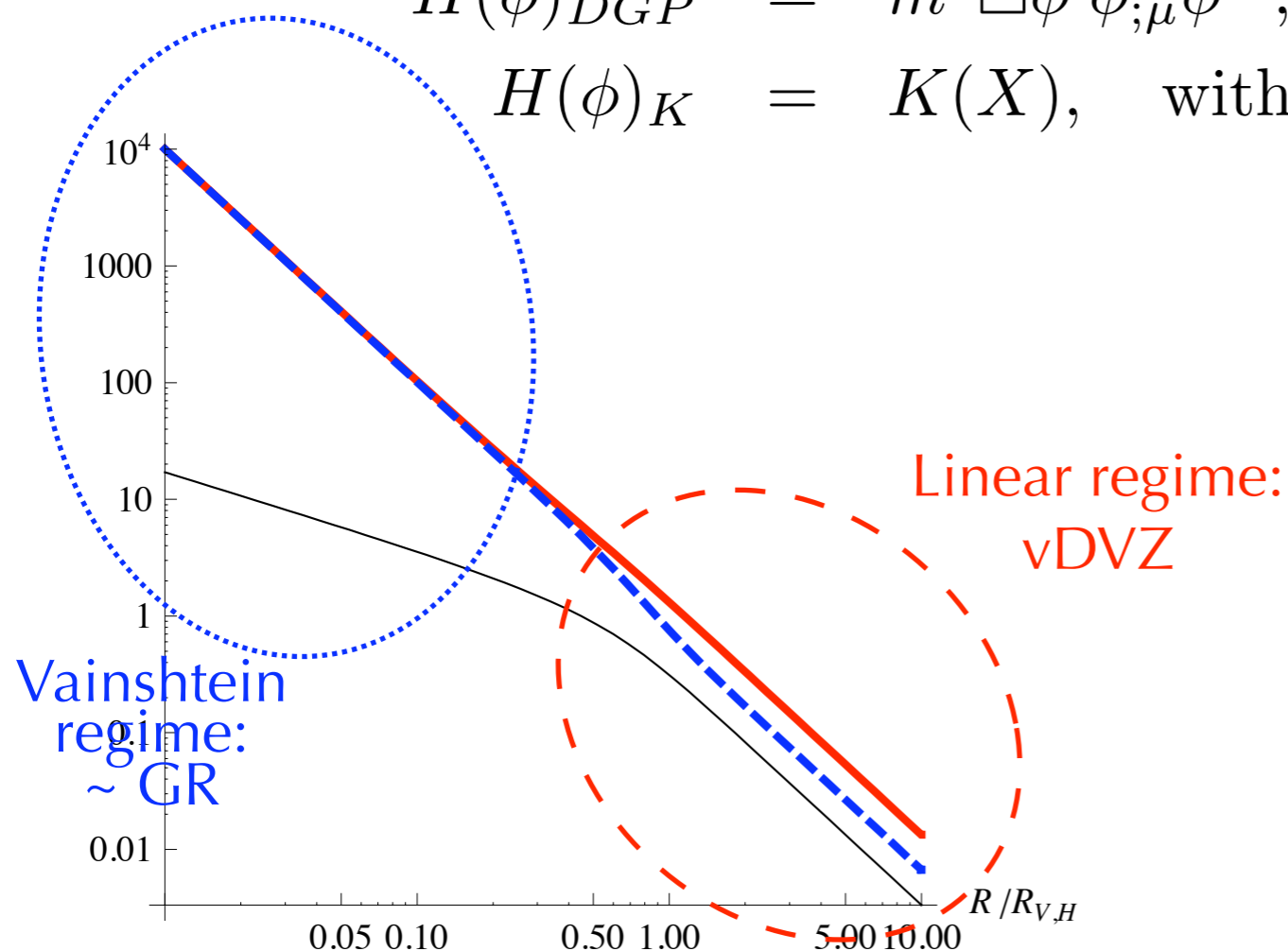

The Vainshtein mechanism is valid for a broad class of models

Observational constraints

Observational probes

Observational probes

- Laboratory and Solar system tests, and PPN parameters

Observational probes

- Laboratory and Solar system tests, and PPN parameters
- Galactic scales

Observational probes

- Laboratory and Solar system tests, and PPN parameters
- Galactic scales
- Cosmological evolution
 - ✓ SN Ia
 - ✓ CMB
 - ✓ BAO
 - ✓ galaxy density
 - ✓ velocity field
 - ✓ weak lensing

Observational probes

- Laboratory and Solar system tests, and PPN parameters
- Galactic scales
- Cosmological evolution
 - ✓ SN Ia
 - ✓ CMB
 - ✓ BAO
 - ✓ galaxy density
 - ✓ velocity field
 - ✓ weak lensing
- Gravitational waves

Observational probes

- Laboratory and Solar system tests, and PPN parameters
- Galactic scales
- Cosmological evolution
 - ✓ SN Ia
 - ✓ CMB
 - ✓ BAO
 - ✓ galaxy density
 - ✓ velocity field
 - ✓ weak lensing
- Gravitational waves

Combination of all these observations: best constraints

Weak lensing

Weak lensing

- The presence of matter bends the light rays trajectories

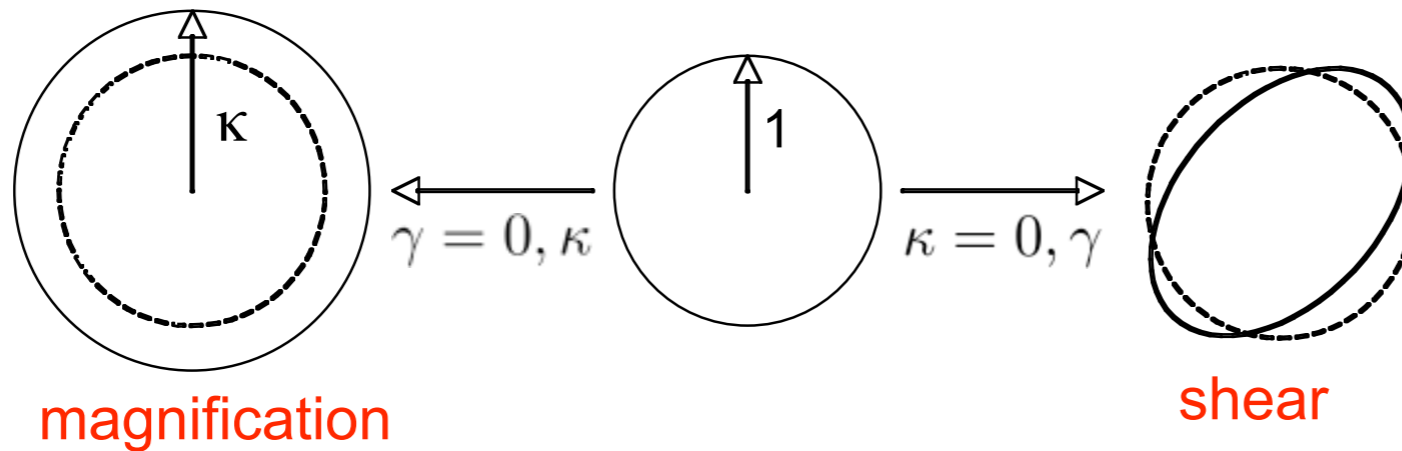

Weak lensing

- The presence of matter bends the light rays trajectories

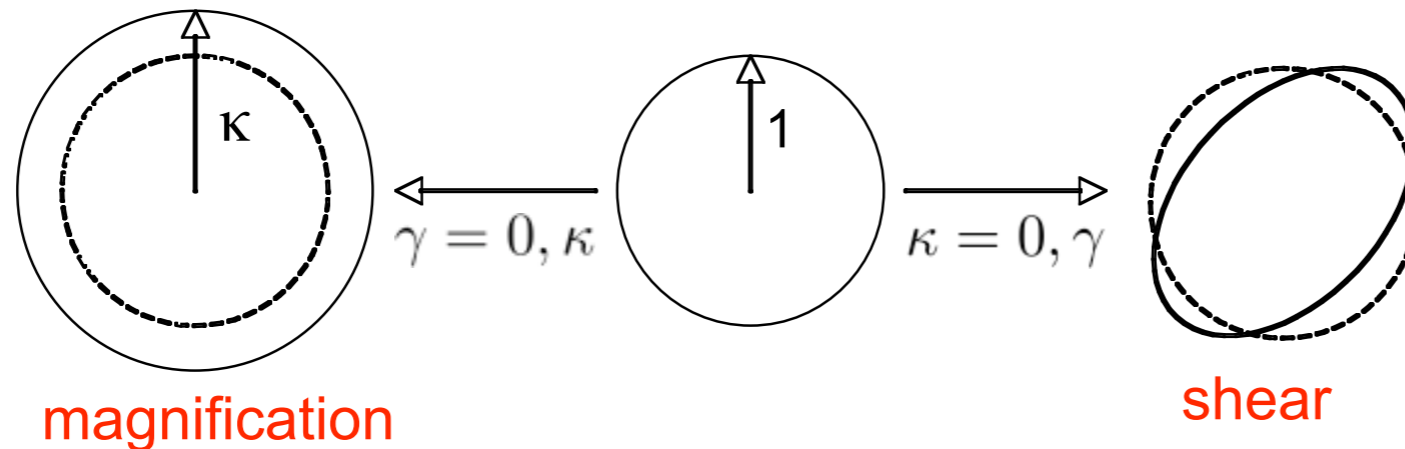

- Galaxy-lensing correlations

$\langle \delta_g(z_f) \kappa(z_b) \rangle \Rightarrow$ Informations on the foreground matter power spectrum

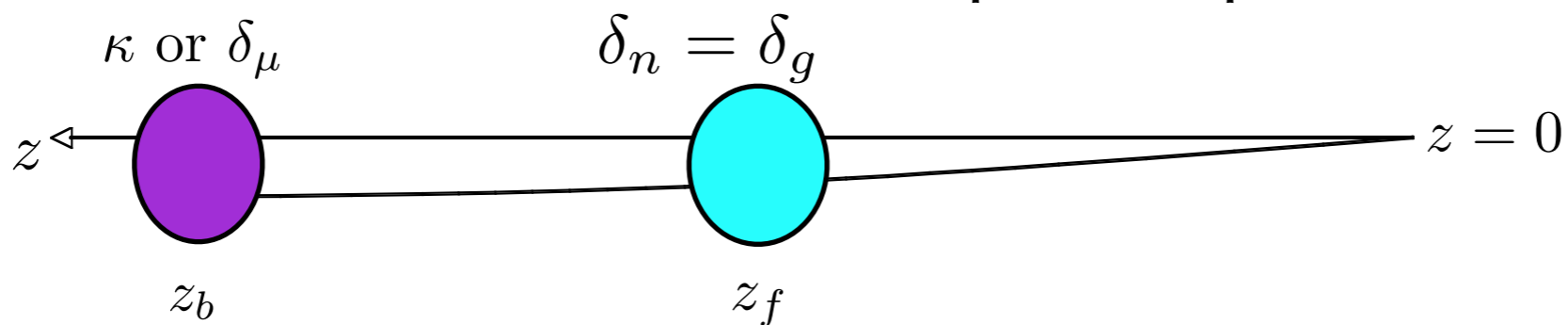

Weak lensing

- The presence of matter bends the light rays trajectories

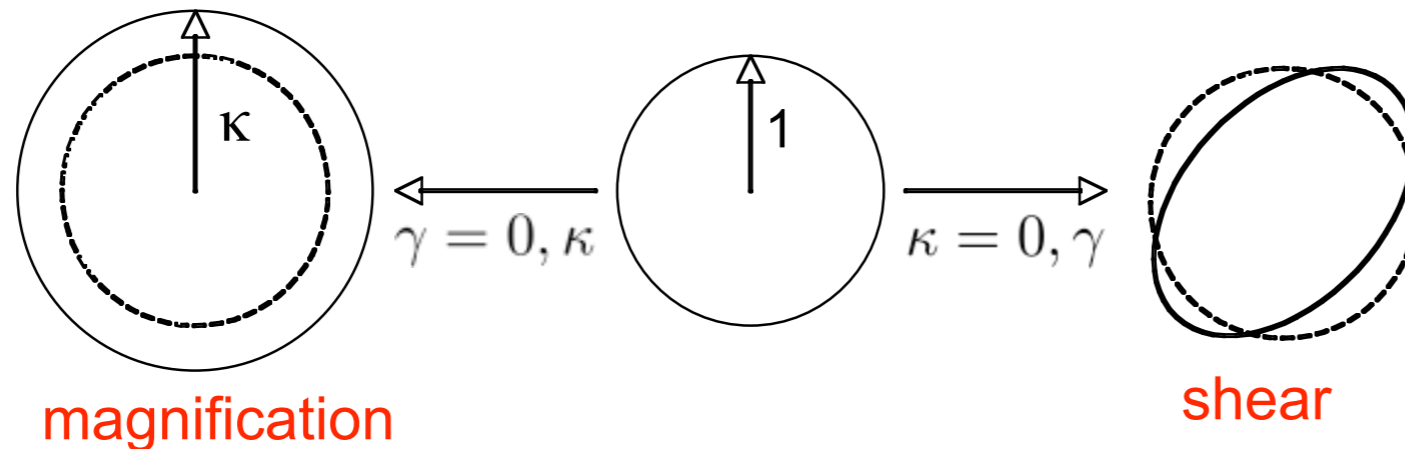

- Galaxy-lensing correlations

$\langle \delta_g(z_f) \kappa(z_b) \rangle \Rightarrow$ Informations on the foreground matter power spectrum

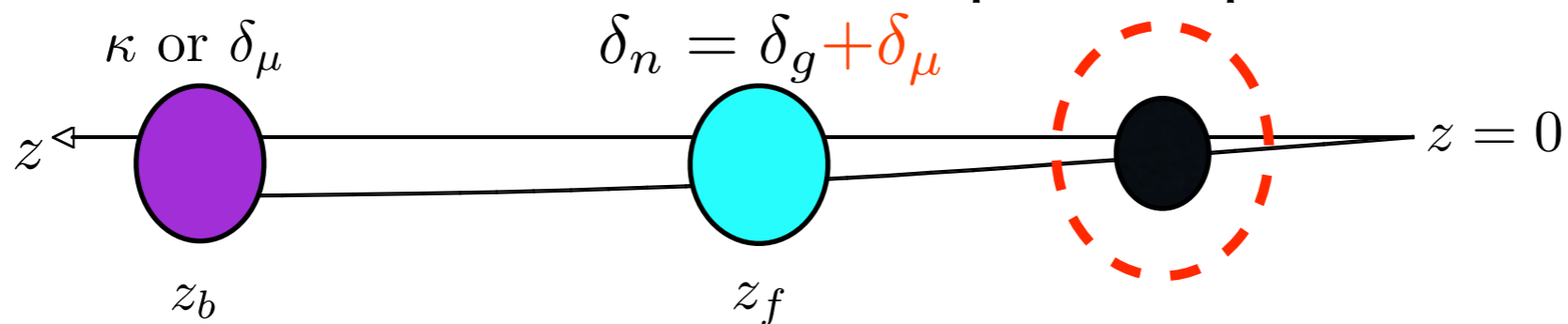

Corrections that need to be taken into account

Conclusions

Conclusions

- New results on Massive Gravity
 - ✓ Decoupling Limit for Spherically Symmetric solutions
 - ✓ demonstration of the existence of a solution regular everywhere
 - ✓ demonstration of the validity of the Vainshtein mechanism
 - ✓ new model: k -Mouflage theories

Conclusions

- New results on Massive Gravity
 - ✓ Decoupling Limit for Spherically Symmetric solutions
 - ✓ demonstration of the existence of a solution regular everywhere
 - ✓ demonstration of the validity of the Vainshtein mechanism
 - ✓ new model: k -Mouflage theories
- Magnification bias corrections to galaxy-lensing correlations

Conclusions

- New results on Massive Gravity
 - ✓ Decoupling Limit for Spherically Symmetric solutions
 - ✓ demonstration of the existence of a solution regular everywhere
 - ✓ demonstration of the validity of the Vainshtein mechanism
 - ✓ new model: k -Mouflage theories
- Magnification bias corrections to galaxy-lensing correlations
- A lot of interesting open questions
 - ✓ compact sources?
 - ✓ stability of the found solutions
 - ✓ phenomenology of the k -Mouflage theories

Thank you