



**HAL**  
open science

# Spatial dynamics of the population in the Czech Republic (1989 - 2007)

Jana Vobecka Vobecká

► **To cite this version:**

Jana Vobecka Vobecká. Spatial dynamics of the population in the Czech Republic (1989 - 2007). Economics and Finance. Université de Bourgogne; Univerzita Karlova (Prague), 2010. English. NNT : 2010DIJ0E006 . tel-00575624

**HAL Id: tel-00575624**

**<https://theses.hal.science/tel-00575624>**

Submitted on 10 Mar 2011

**HAL** is a multi-disciplinary open access archive for the deposit and dissemination of scientific research documents, whether they are published or not. The documents may come from teaching and research institutions in France or abroad, or from public or private research centers.

L'archive ouverte pluridisciplinaire **HAL**, est destinée au dépôt et à la diffusion de documents scientifiques de niveau recherche, publiés ou non, émanant des établissements d'enseignement et de recherche français ou étrangers, des laboratoires publics ou privés.

**CHARLES UNIVERSITY IN PRAGUE**

Faculty of Science

Departement of Demography and Geodemography

**UNIVERSITÉ DE BOURGOGNE IN DIJON**

UMR INRA-AgroSup DIJON



**SPATIAL DYNAMICS OF THE POPULATION  
IN THE CZECH REPUBLIC,  
1989-2007**

Ph.D. Thesis

**JANA VOBECKÁ**

Thesis directors:

Doc. RNDr. Ludmila Fialová, CSc.

Bertrand Schmitt, Research Director I.N.R.A.

2010



This bi-nationally supervised doctoral thesis (doctorat en cotutelle) was written under the joint supervision scheme between Charles University in Prague and Université de Bourgogne in Dijon.

I declare on my honour that this thesis is my own work under the joint tuition of Ludmila Fialová and Bertrand Schmitt. Where other sources of information have been used, they have been acknowledged.

I agree to lend this thesis for study reasons and agree that the thesis will be added to the borrower's database.

In Prague, 5<sup>th</sup> March 2010

## **Abstract**

The aim of the thesis is to describe, analyse and discuss the development of spatial population dynamics in the Czech Republic between 1989 and 2007. Demographic structure and migration, the two components of spatial population dynamics, are analysed using two spatial dimensions, the urban-suburban-rural gradient and the core-periphery region distinction, using quantitative analyses, including gravity regression modelling of migration. The analysis primarily focuses on domestic migration as the main vehicle of spatial population dynamics. It discusses the structure, determinants, and temporal evolution of migration and its consequences on the population structure in different spatial categories. The thesis indicates that suburbanisation has recently become the main factor influencing Czech spatial population dynamics. The key factor determining migration destination is the social status of migrants, whereas age has only secondary importance. However, since Czechs are not very mobile, population dispersal is less large-scale than in Western-Europe. This explains why recent domestic migration patterns have had only a small measurable influence on the social or demographic structures of the population across spatial categories.

Key words: suburbanisation, domestic migration, gravity modelling, population structures, Czech regions, transformation

## **Abstrakt**

Cílem této disertační práce je popsat, analyzovat a diskutovat vývoj prostorové dynamiky obyvatel v České republice mezi lety 1989 a 2007. Demografická struktura a migrace, dvě komponenty prostorové dynamiky obyvatel, jsou analyzovány ve dvou prostorových dimenzích, v gradientu město-suburbium-venkov a v regionálním rozlišení jádrových a periferních regionů, prostřednictvím kvantitativní analýzy, včetně gravitačního regresního modelu migrace. Analýza se zaměřuje především na vnitřní migraci jako hlavního hybatele prostorové dynamiky obyvatel. Zabývá se strukturou, determinanty migrace a jejím vývojem v čase a také jejími dopady na strukturu obyvatel v jednotlivých prostorových kategoriích. V disertaci je ukázáno, že suburbanizace se v poslední době stala nejdůležitějším faktorem ovlivňujícím prostorovou dynamiku obyvatel v České republice. Hlavním faktorem určujícím směr migrace je sociální status migrantů, zatímco jejich věk má pouze druhořadý význam. Nicméně, tím, že Češi nejsou příliš migračně aktivní, populační dekoncentrace dosahuje menších rozměrů a objemů než v západoevropských zemích. To vysvětluje, proč novodobé migrační trendy měly zatím jen malý měřitelný dopad na sociální a demografické struktury obyvatel jednotlivých prostorových kategorií.

Klíčová slova: suburbanizace, vnitřní migrace, gravitační regresní model, populační struktura, české regiony, transformace

## Résumé

L'objectif central de la thèse est de décrire, analyser et discuter la dynamique spatiale de la population tchèque entre 1989 et 2007. La structure démographique et les migrations, les deux composantes de cette dynamique spatiale, sont analysées par le biais de deux articulations de l'espace : le gradient urbain-périurbain-rural et la distinction régionale centre-périphérie. Des outils quantitatifs sont utilisés, avec en particulier un modèle gravitaire explicatif des migrations. L'orientation principale de l'analyse repose sur les migrations internes, comme étant l'agent majeur de la dynamique spatiale de la population. La structure, les déterminants, et l'évolution dans le temps de ces migrations sont étudiés, ainsi que leurs conséquences sur la structure démographique des ensembles spatiaux. La thèse indique que le processus de périurbanisation est récemment devenu un facteur majeur, influençant la dynamique spatiale de la population tchèque. Il est également établi que le facteur explicatif clé de la destination des migrations est le statut social du migrant, tandis que son âge ne présente qu'une importance secondaire. Cependant, étant donné que les Tchèques sont généralement peu mobiles, la déconcentration de la population s'opère à une échelle plus modeste que dans les pays d'Europe de l'Ouest. Cette constatation permet d'expliquer en quoi les tendances récentes des migrations résidentielles ont un impact mesuré relativement faible sur les structures sociales et démographiques de la population dans les catégories d'espace.

Mots clés : périurbanisation, migrations internes, modèle gravitaire, structures de la population, régions tchèques

## TABLE OF CONTENTS

Table of contents	1
List of tables	4
List of figures	7
List of annexes	8
INTRODUCTION	10
P A R T I. Theoretical concept, societal context and research questions	15
1. Theoretical background	16
1.1 Terminological note	18
1.2 Towards a general description and explanation of agglomeration mechanisms – New Economic Geography Perspective	19
1.3 Observations in population spatial dynamics – toward a common pattern?	24
2. General context of societal development in the Czech Republic	34
2.1. Pre-1989 shifts in economic orientation, policies and their repercussions on regional development	34
2.2. Post-1989 societal transformation and its repercussions on regional development	38
3. Research questions, hypothesis and outline of the thesis	48
3.1 Research questions and hypothesis	49
3.2 Outline of the thesis	55
P A R T II. Quantitative conceptualisation of space and definition of spatial categories	56
4. Existing approaches to definitions of the urban-rural gradient and core-periphery regions	57

4.1 Urban – rural approach	57
4.1.1 Existing approaches in the Czech Republic	57
4.1.2. Existing approaches in Europe	61
4.2 Core-periphery regional approach in the Czech Republic	65
5. Commuting based classification: a new approach to the urban-rural gradient definition in the Czech Republic	69
5.1 Method	70
5.2 Discussion	75
P A R T III. Analysis of the spatial population dynamics in the Czech Republic	77
6. Descriptive analysis of population structure and dynamics in spatial categories	78
6.1. General characteristics of space and population	78
6.2 Demographic and socio-economic characteristics of the population from a regional and urban-rural gradient perspective	89
6.2.1 Structural-geographical analysis: analytical tool description	90
6.2.2 Population change differentiation	95
6.2.3 Family and fertility patterns differentiation	98
6.2.4 Differentiation of social and economic characteristics of the population	107
6.2.5 Spatial differentiation of demographic, social and economic characteristics of the population – general remarks	114
7. Analysis of migration flows as the main component of spatial population dynamics	115
7.1 Residential migration data set	116
7.2 General patterns of residential migration in the Czech Republic	120
7.3 Description of residential migration across the spatial categories and data reduction	127
7.3.1 Protocol	127
7.3.2 Social status, life cycle or sex? Findings about the main determinants of residential migration from descriptive analysis	133
8. Structure and determinants of residential migration: explorative analysis	138
8.1. Gravity model	138
8.2 Results	146
CONCLUSIONS: A tale of conservative commuters and population not-very-dynamics in the Czech Republic after 1989	156



References	169
Annexes	180

## LIST OF TABLES

Table 1: Number of municipalities in the Czech Republic.....	38
Table 2: Municipalities and population by size of municipalities in France and in the Czech Republic, in %.....	70
Table 3: Municipalities and population by commuting approach classes, 2001 .....	79
Table 4: Population change by residential categories between 1991 and 2001 and between 2001 and 2007 .....	84
Table 5: Components of population change by residential category, 2001 - 2005 .....	86
Table 6: Population change in regions between 1991 and 2001 and between 2001 and 2007 .....	88
Table 7: Coefficient of determination ( $R^2$ ) and Fischer statistics for the shift-share analysis of two factors .....	95
Table 8: Total population change rate between 1991 - 2001 and 2001 - 2007, regional and gradient effects, decomposition for gradient effect .....	96
Table 9: Total population change rate between 2001 - 2007, regional and gradient effects, decomposition for regional effect .....	97
Table 10: Coefficient of determination ( $R^2$ ) and Fischer statistics for shift-share analysis of two factors .....	97
Table 11: Natural increase and net migration rates between 2001 and 2005, regional and gradient effects.....	98
Table 12: Coefficient of determination ( $R^2$ ) and Fischer statistics for shift-share analysis of two factors .....	99
Table 13: Proportion of households with dependent children in 2001, regional and gradient effects, decomposition for gradient effect .....	99
Table 14: Proportion of households with dependent children in 2001, regional and gradient effects, decomposition for regional effect .....	100
Table 15: Coefficient of determination ( $R^2$ ) and Fischer statistics for shift-share analysis of two factors .....	100
Table 16: Proportion of one-parent families out of all families with dependent children in 2001, regional and gradient effects, decomposition for gradient effect .....	101

Table 17: Proportion of one-parent families out of all families with dependent children in 2001, regional and gradient effects, decomposition for regional effect .....	102
Table 18: Coefficient of determination ( $R^2$ ) and Fischer statistics for shift-share analysis of four factors.....	104
Table 19: Average number of children ever born per 1 000 women (cohort fertility) in 2001, regional and gradient effects, effects of age and education, decomposition for gradient effect .....	104
Table 20: Coefficient of determination ( $R^2$ ) and Fischer statistics for shift-share analysis of four factors.....	105
Table 21: Proportion of divorced in population in 2001, regional and gradient effects and effect of age, decomposition for gradient effect .....	106
Table 22: Proportion of divorced in population in 2001, regional and gradient effects and effect of age, decomposition for age effect.....	106
Table 23: Proportion of divorced in population in 2001, regional and gradient effects and effect of age, decomposition for regional effect .....	107
Table 24: Coefficient of determination ( $R^2$ ) and Fischer statistics for shift-share analysis of two factors .....	108
Table 25: Proportion of 15+ population with A-levels and higher education in 1991 and 2001, regional and gradient effects, decomposition for gradient effect .....	108
Table 26: Proportion of population aged 15+ and 25-34 with A-levels and higher education and its differences from national average in 1991 and 2001.....	109
Table 27: Coefficient of determination ( $R^2$ ) and Fischer statistics for shift-share analysis of two factors .....	110
Table 28: Service/industry index in 1991 and in 2001, regional and gradient effects, decomposition for gradient effect .....	110
Table 29: Coefficient of determination ( $R^2$ ) and Fischer statistics for shift-share analysis of two factors .....	111
Table 30: Unemployment rate in 2001, regional and gradient effects, decomposition for regions.....	111
Table 31: Coefficient of determination ( $R^2$ ) and Fischer statistics for shift-share analysis of two factors .....	112
Table 32: Proportion of low income households in 2003 (households receiving housing allowances with an income of between 1.0 and 1.4 of the life minimum), regional and gradient effects, decomposition for urban-rural gradient categories .....	113
Table 33: Proportion of low income households in 2003 (households receiving housing allowances with an income of between 1.0 and 1.4 of the life minimum), regional and gradient effects, decomposition for regions.....	113
Table 34: Population by level of education in 2001 and migrants by level of education in 2004, in % .....	127

Table 36: Definition of the variables used in the gravity model analysis.....	141
Table 37: Model 1-3: Estimates of the model of inter-municipal migration $m_{ij}$ without specification of the age or level of education of migrants .....	148
Table 37: Model 1-3: Estimates of the model of inter-municipal migration $m_{ij}$ without specification of the age or level of education of migrants .....	148
Table 38: Estimates of the model of inter-municipal migration $m_{ij}^d$ including specification of the age and level of education of migrants .....	150
Table 39: Estimated significant beta coefficients of model of inter-municipal migration $m_{ij}^{dmn}$ for each demographic group.....	152

## LIST OF FIGURES

Figure 1: Development of housing construction between 1971 and 2007 by type of dwellings.....	44
Figure 2: Regions (NUTS 3) of the Czech Republic with their capital cities .....	66
Figure 3: Urban, suburban and rural areas in the Czech Republic according to the urban-rural gradient commuting approach.....	73
Figure 4: Population change rates (A), natural increase rates (B) and net migration rates (C) in urban-rural gradient categories in selected years between 1980 and 2007, in %.	81
Figure 5: Classification of Czech regions into one core and three peripheral regions as used in the core-periphery regional classification .....	119
Figure 6: Migration flows between and within urban-rural gradient categories and net migration, in absolute numbers, in thousands, 1995 and 2004.....	122
Figure 7: Migration flows between and within groups of regions and net migration, in absolute numbers, in thousands, 1995 and 2004 .....	125
Figure 8: Visualisation of the demographic and geographic dimensions of migration flows.....	134
Figure 9: Proportion of migrants aged 20+ from Prague-city to spatial categories within Prague region by level of education in 2004 .....	162

## LIST OF ANNEXES

Annex 1: List of agglomerations used in the commuting approach classification .....	181
Annex 2: List of municipalities which did not accomplish the condition that the primary centres .....	182
Annex 3: One-Way analysis of variance (ANOVA) testing the hypothesis of significant difference of migration rates between urban-rural gradient categories in 2004.....	183
Annex 4: Total population change, natural increase and net migration in urban-rural gradient categories in the selected years between 1980 and 2007, absolute and in rates per 1 000 inhabitants.....	185
Annex 5a: Number of migration flows by sex and age of migrants, departures, arrivals and net migration for urban-rural gradient categories in 1995 .....	186
Annex 5b: Number of migration flows by sex and age of migrants, departures, arrivals and net migration for urban-rural gradient categories in 2004 .....	187
Annex 5c: Number of migration flows by sex and age of migrants, departures, arrivals and net migration for four regions in 1995 .....	188
Annex 5d: Number of migration flows by sex and age of migrants, departures, arrivals and net migration for four regions in 2004 .....	189
Annex 6: Intra- and inter-regional migration flows structured by urban-rural gradient categories, 2004 .....	190
Annex 7: Visualisation of the relationship between spatial dimension of migration and demographic characteristics of migrants separately in seven zones, results of correspondence analysis .....	191
Annex 8: Reduction of spatial dimensions of migration flows based, cluster analysis based on the previous correspondence analysis.....	207
Annex 9: Estimates of the model of inter-municipal migration $m_{ij}^{dmn}$ with specification of the age and level of education of migrants .....	215
Annex 10: List of municipalities representing “Primary centres” .....	216
Annex 11: List of municipalities representing “Secondary centres” .....	218
Annex 12: Descriptive analysis on age structure and crude death rate .....	220

Annex 13: Estimated significant beta coefficients of the model of inter-municipal migration  $m_{ij}^{dm}$  for each demographic group with spatial dimension clustering according to similar migration orientation ..... 222

## INTRODUCTION

Today, just over twenty years after the fall of communist regimes in Central and Eastern Europe, we can look back to the period of transformation to assess our current situation and the path that has led to it. Twenty years is a period long enough to overview not only the initial systemic reforms from totalitarian states with central planned economy to democracies with market economies, but also their repercussions. It invites reflections on where the reforms are leading and whether post-communist societies still represent distinct political, economic and social systems or to what extent they share common features with their Western neighbours. What is the result of the mixing up the communist heritage with the capitalist regimes on the forms and structures of the inevitably path-dependent societal evolution? The spatial population dynamics in the Czech Republic after 1989 can be included into the broad categories of studies of transformation effects.

The concept of spatial population dynamics is twofold. First, it assumes that there exist differences in demographic reproduction which are created or reproduced by two factors: on one hand by differences in the population structure, or on the other hand by local specificities of the demographic behaviour. Second, migration influences demographic structures as an exogenous factor and contributes to the spatial population differentiation as well. Demographic reproduction and migration can mutually influence each other and act together in remoulding existing demographic structures.

Czech demographic behaviour has changed sharply as a reaction to the post-communist societal changes. The number of newborns has fallen to unprecedented low levels and the average age of women giving birth is rising quickly. Cohabitations, extra-marital births and modern means of contraception are transforming family models. Life



expectancy is rising and the population is ageing. In general, life cycle trajectories are changing. Domestic and international migration has evolved as well. The Czech Republic has now become an immigration rather than an emigration country. Economic restructuring, with its unequal regional repercussions, and halts in housing construction at the beginning of 1990s were the main factors causing the decline in the volume and change in the orientation of domestic migration. Suburbanisation and counterurbanisation are phenomena witnessed since 1990s as never before at such a scale. All these processes have led to a remoulding of population structures that has been uneven across space and novel in its patterns. The detailed description, analysis and discussion of the demographic reproduction and domestic migration over the past two decades are the main aims of this thesis. To widen the geographical scope, the Czech analysis is framed within a broader context of patterns in other post-communist countries and of patterns of spatial population dynamics in developed democracies.

I argue in this thesis that:

1. In the Czech Republic, population *concentration* under socialism changed to population *dispersal* after 1995 as the main tendency of population dynamics. This finding itself justifies the detailed study of spatial population dynamics as a process integrally connected to and caused by post-communist transformation.
2. The main changes in spatial differentiation of population not only after 1989 are due to domestic *residential* migration and not due to fertility and mortality changes. That is why domestic migration forms the focus of the analysis in the thesis.
3. The main driver of residential migration is *social position* (education) and not the life cycle stage. This is analysed in Chapters 7 and 8. It has important policy implications as it indicates a new differentiation of human capital.
4. More specifically, *well educated* people especially after 1995 are overrepresented in moving to the suburbs and *low educated* people are overrepresented in moving to more remote suburban areas and to the rural areas.

5. However, since these new patterns of residential migration are new and still relatively small, it has *not* yet affected demographic structures very much at least from a macro-level observation, but it can be expected to do so in the future.

6. The features of Western model of spatial population dynamics are clearly present twenty years after the beginning of the post-communist transformation. At the same time, four decades of socialism have deeply altered some mechanisms driving population mobility, and their consequences are still shaping spatial population dynamics today.

To develop these arguments, the thesis is structured into three parts divided into chapters. First part is an introduction into the topic and covers theoretical concept, societal context and research questions. It contains Chapter 1 which gives a theoretical background and presents two different approaches to the emergence and evolution of spatial agglomeration and the dispersal of the population. First, New Economic Geography presents a theoretical framework to explain the mechanisms underlying the emergence and perpetuation of uneven spatial economic and demographic location patterns. Second, empirical research on components of population concentration and dispersal in Western European and other developed countries, as exemplified by Champion (1991), are confronted with empirical research findings on Central and Eastern Europe. Chapter 2 briefly describes the broad societal context of spatial population dynamics, including the pre-1989 economic and political context (Section 2.1) and the social, economic and territorial repercussion of the reforms of the post-communist transformation (Section 2.2). Chapter 3 gives the outline of the thesis and detailed research questions. It also presents the concept of two spatial perspectives of the analysis. The first is the urban-rural gradient perspective, which enables the analyst to distinguish the urban, suburban and rural areas. The second is the core-periphery regional perspective, which subdivides the Czech Republic into one core and three peripheral regions.

Second part includes a discussion on quantitative conceptualisation of space and definition of spatial categories. Chapter 4 discusses the spatial perspective adopted for

studying population dynamics in various European countries and in the Czech Republic. Section 4.1 focuses on the urban-rural approaches and Section 4.2 on the regional ones. Chapter 5 presents the original approach of urban-rural gradient spatial classification, elaborated for the purposes of the thesis (Section 5.1 and 5.2) and discusses possible fields of application and limitations of the approach.

Third part contains the analysis of the spatial population dynamics in the Czech Republic, the core empirical contributions of the thesis. Chapter 6 is devoted to the descriptive analysis of spatial differentiation of demographic and socio-economic characteristics of population. Structural-geographical analysis used there allows to distinguish the structural and the separate effects of spatial categories (Section 6.2). Chapter 7 focuses on the descriptive analysis of residential migration as the most important component influencing spatial population dynamics. It discusses the evolution in migration patterns between 1995 and 2004 (Section 7.2), the common patterns in residential migration between different socio-demographic groups, and data reduction by means of correspondence analysis (Section 7.3). Chapter 8 continues the analysis of migration by means of an explorative analysis using gravity regression modelling. The analysis unveils the prioritized residential destinations of distinct socio-demographic groups of migrants, as well as the importance of local socio-demographic characteristics for the decision to migrate.

Finally, the Conclusions synthesize the findings and the answers to the main research questions. The findings about spatial population dynamics in the Czech Republic are placed in the broader international context.

## Acknowledgements

The wide thematic scope and overlap with multiple scientific disciplines during the work on this thesis enabled me to get into touch with research traditions I was not initially trained in; especially social and regional geography and spatial economics. I am most grateful to my supervisor, Bertrand Schmitt, for help with the specification of the thesis outline, theoretical framing, and fruitful discussions throughout the different stages of my work. I am also grateful to Virginie Piguet for her excellent advice on statistical methods and collaboration on data analysis. My thanks go to Mohamed Hilal and Daniel Čermák for their help with certain technical and methodological steps in my work. I also want to thank Ludmila Fialová for her tolerant supervision. An excellent research environment was provided by Centre d'Economie et Sociologie Appliquées à l'Agriculture et aux Espaces Ruraux (UMR INRA-AgroSup) in Dijon. I would like to thank Francis Aubert and Cecile Détang-Dessendre, the Centre's Directors, and all its members for their hospitality. My thanks also go to the Institute of Sociology of the Czech Academy of Sciences, specifically to its director Marie Čermáková, to Tomáš Kostelecký, and the members of the research group of Local and Regional Studies for being patient and understanding in providing me the possibility to combine work and study duties. I thank very much Mary Bouley for her careful linguistic proofreading.

For financial support and scholarships, I would like to thank: Faculty of Science, Charles University in Prague, French Government and Embassy of France in the Czech Republic, Centre d'Economie et Sociologie Appliquées à l'Agriculture et aux Espaces Ruraux (UMR INRA-AgroSup) in Dijon, the Institute of Sociology of Czech Academy of Sciences, CEFRES (USR 3138 CNRS-MAEE) and Komerční Banka.

Finally, I would like to thank my parents and Pieter for their constant support.

## **PART I.**

### **THEORETICAL CONCEPT, SOCIETAL CONTEXT AND RESEARCH QUESTIONS**

## 1. THEORETICAL BACKGROUND

Population development and its dynamics are conditioned by many factors. These include, notably, previous demographic development, the economic and political contexts and the socio-cultural context in the sense of the traditions, attitudes and values of individuals and of the society as a whole. When considering an open population, we can add to these factors the influence of migration and cultural and business exchanges. The general context of these conditions is geospatial location. Population is distributed unevenly in space and its characteristics differ among localities. This is true on an international level, but also within a single country (Rees, Kupiszewski 1999, Kulu et al. 2008, Michelin 2002). Beginning with the industrial revolution, affected countries witnessed significant urbanisation - population concentration in municipalities where the manufacturing industry was located. These municipalities therefore grew in size and were characterised by dense population and economic concentration. But this tendency toward concentration has changed and since the 1960s and 1970s, a tendency towards a decentralisation and a relative deconcentration of population has been dominant in most developed countries. This movement takes the form of suburbanisation, meaning a residential and employment dispersion to the outskirts of the administrative boundaries of urban cores while conserving at the same time a close functional interconnection with these cores. But it further proceeded to a significant development of more remote areas and local centres outside the urban cores and their suburban areas. Such areas had for many previous decades seen their population decrease. This process, called counter-urbanisation, does not stand in opposition to suburbanisation but is the continuation of it (Champion 2001). The degree of economic connectivity with the metropolitan areas maintained by migrants is a crucial factor distinguishing suburbanisation and counter-urbanisation (Ford 1999). Counter urbanites do not usually maintain economic connections with the metropolitan area, either because they find jobs in the local centres

or because they are self-employed, home-working or have even ceased economic activity. The pre-retired and retired population account for a large number of in-migrants to these areas. Some describe this process as the “cascading of population down the settlement hierarchy” with the most rural areas experiencing the highest rates of net in-migration and the most urban areas seeing the highest rates of net out-migration (Champion 1989, 2001). This deconcentration has affected different socio-demographic groups unevenly. Differences are discernable according to age group, marital status and size of the family, ethnicity or immigration status (Champion 1989).

Former communist countries, including the Czech Republic, went through a distinct evolution in their overall societal organisation, urbanisation and economic system for at least four decades in the second half of the twentieth century. During the period in which suburbanisation and counter urbanisation processes were observed in the “Western” non-communist, highly developed parts of the world, none of these processes were observable in countries of real socialism. The regional arrangements and the pace of urbanisation in socialist countries, as long as they remained under the hegemony of public ownership and redistributive or central planning, did not converge with the trajectory followed by Western societies during the 1950s and 1960s (Szelenyi 1996). Some support the idea that socialist spatial organisation were perhaps delayed but followed the same paths as in Western countries (Enyedi 1996), others argue that the socialist societies produced new types of regional arrangements (Szelenyi 1996, Sjöberg, 1999, Tammaru 2001). Today, twenty years after the fall of communist regimes in Europe, the moment is propitious to examine how spatial population dynamics have been affected by the transformation in these countries and whether it has led to forms of spatial population organisation comparable to those observed in developed countries since the 1960s or whether the heritage of socialist specificities continues to mould the spatial organisation of these societies.

There exist general preconditions which incite the evolution of spatial arrangements as well as country specific factors which are usually path-dependent. The search for the influencing factors may be carried out either by an inductive or by a deductive approach. The first studies specific cases of spatial arrangements and a general explanation is constructed on their basis. The latter investigates general conditions in a rather abstract

world where only a few variables are taken into account and generally valid mechanisms are revealed. In the following section, based on the example of theories arising from inductive, as well as deductive approaches, I will introduce the theories of agglomeration, suburbanisation and counter-urbanisation. Their “argumentation” represents the theoretical framework of my theses and also serves as background for my hypothesis.

## 1.1 Terminological note

Before going ahead, it is necessary to clearly define certain terms used in the following thesis. The first of these is *spatial population dynamics*. This term refers to three main components of population in space: demographic structure, migration and change over time. All three components are interconnected, as demographic structure is a result of fertility and mortality levels and of the structure and volume of migration. Altogether, it evolves over time. Spatial population dynamics is analysed in different *spatial categories*. Spatial categories are defined below (Chapters 5 and 7.1). They do not represent any existing administrative unit as they have been defined especially for the purposes of the thesis. I decided to define the spatial categories to be able to distinguish suburban areas and more remote areas. For that purpose, I aggregate municipal units. The level of districts (NUTS 4) or higher is not suitable because it is not detailed enough and the processes I am analysing in my thesis would be blurred by the heterogeneity inside these larger units. All the categories defined and used below, both in the urban-rural perspective and the core-periphery regional perspective, are referred to as spatial categories when talking generally about them.

A central issue in my thesis is the analysis of *migration*. If not specified, I use the word *migration* to indicate domestic residential migration. It refers to the sum of the migration of individuals changing their permanent resident address within the Czech Republic. Finally, I focus on the processes of spatial population dynamics in the period after 1989. This period is commonly called the *post-communist* transformation (Kornai 1992) although none of the Central and Eastern European countries ever reached the stage of real communism. I consider the term post-communist more accurate than that of post-



socialist because even some non-totalitarian societies may be called socialist (led by social-democratic parties etc.).

## **1.2 Towards a general description and explanation of agglomeration mechanisms – New Economic Geography Perspective**

Assuming that all individuals have a place of residence which corresponds to a combination of their personal or familial situation, economic constraints and professional specialisation, we should be able to discover a logic in how people are organised in space. A theoretical model borrowed from New Economic Geography (Krugman 1991) can provide us with a functional reference. The model theorises the internal mechanisms of how it happens that an unequal distribution of economic activity and labour force occurs in space. Thus, in the context of my thesis, it serves as a theoretical foundation for the expectation that there exists a logic in population organisation in space which pulls some people to concentrate and the others to remain dispersed and still others to deconcentrate.

New Economic Geography is a mainstream neo-classical theory, initially constructed to answer the questions of why and when manufacturing activities and people became concentrated in a few regions, leaving others relatively underdeveloped. It tries to explain the appearance and variety of economic agglomerations in geographical space. Toward that purpose, its proponents search for a model which is able to explain the formation of agglomerations and the dynamics in the context of the whole economy, that is, in the general equilibrium. It allows them to talk simultaneously about the centripetal forces that pull economic activity together and the centrifugal forces that push it apart. The geographical structure of an economy is then shaped by the tensions between these forces. Moreover, it explains these forces in terms of more fundamental micro decisions (Fujita, Krugman 2004). The core and periphery model can be considered on various levels: on the level of urban spatial organisation (Fujita, Krugman 1995, Fujita, Mori 1997), on the level of a country between regions belonging to the same country (Krugman 1991) or in the global international perspective (Krugman, Venables 1996).

The approaches differ between each other in terms of the variables considered. It should be underlined here that the model of New Economic Geography is primarily intended to explain the localisation of economic activities and not for population localisation. Population initially enters the model in a limited sense in the forms of a labour force and consumers. Its explanation force for spatial population organisation is therefore limited. It can explain population behaviour in the limited conditions of economic motivations considered in that model. Three main variables enter into the core-periphery model: specific competition structure, mobility and consumption behaviour of labour force and transportation costs. An agglomeration emerges or not depending on the type of the economic activity, the specialisation and mobility of the labour force, the consumers' behaviour and transportation costs. Krugman (1991) explains the process of economic agglomeration as follows: there exist in a country two regions characterised by two kinds of production: agriculture and manufacturing. Agriculture is according to Krugman (1991) characterised by constant returns to scale and by the extensive use of immobile land. Its location is therefore largely dependent on the distribution of the suitable land. The workers employed in agriculture are then immobile. Manufactures are, on the other hand, characterised by increasing returns to scale, low use of land and a mobile labour force. Manufacturing tends to be concentrated in a limited number of sites, distributing its products to the agricultural sector. Its concentration is possible because of monopolistic competition and the economy of scale. The first means that firms do not compete with identical products, and therefore their competition does not mainly concern price but type of produced goods and share of market. Monopolistic competition leads the local firms close to the consumers (Chamberlain, 1933). The latter term refers to the fact that the more pieces that are produced, the lower the cost of any new piece produced. This situation stands in opposition to competition in agriculture, where producers compete with the same goods. In order to increase their profits, they therefore tend to disperse them in space to widen their market catchment area without competitors (competition for homogeneous goods). This is also not new, and is reported in traditional works of geography (Christaller, 1933 and Lösch, 1940). But Krugman (1991) continues his reasoning thus: the products of manufacturing are not only marketed in agricultural areas; some part of the demand also comes from the

manufacturing sector itself. This creates what Myrdal (1957) called “circular causation”. It is characterised by backward and forward linkages which mean, other things being equal, that higher concentrations are more profitable in terms of living and producing. Consumers are attracted by high variety of products and services and workers by relatively higher salary and choice of job opportunities. The salaries can be relatively higher because of low transportation cost of products. This attracts new firms to come (circular causation). If one site’s manufacturing sector is larger than that of the others (the initial advantage may be the result of favourable physical-geographical conditions or may be path-dependent), it also offers a larger market for intermediate goods<sup>1</sup> and thus makes this site more attractive for other production of such goods (backward linkages). But if one region produces a greater variety of intermediate goods, then, other things being equal, it will offer lower production costs of final goods (forward linkages). In addition, this process is cumulative, but up to what point? Krugman (1991) answers that this depends on the proportion of manufacturing employment in the country and on transportation costs. If the share of manufacturing employment and production is small, demand is small and transportation costs are high, agglomeration and rising profits will not be possible. This was the case in countries before the industrial revolution. Nowadays, agglomeration forces are strongest in those countries where manufacturing employs a high proportion of inhabitants, and where the transportation costs are low. In this case, firms benefit from the high concentration of other firms and intermediate goods, they have no transportation costs for consumers living in that agglomeration and, at the same time, transportation costs are low enough to enable distribution of necessary goods to rural areas. The growth and diversity of manufacturing results in a greater variety in the labour force attracting still other firms. In such a situation, households and population concentrates and the core and periphery diverge.

Krugman (1991) modelled general laws of economic activity and labour force organisation in space and, given the variables he used, constructed a functional economic model. The search for equilibrium among access to employment, amenities, housing market price and transportation cost leads individuals or households to localise in space between centres and peripheries. They make decisions according to their family

---

<sup>1</sup> Refers to a product intended for other producers and not for the final consumer.

and professional situation, life cycle position and present place of residence. The resulting geography of residence and residents is thus, according to the logic of New Economic Geography, inevitably unequal, as centres and peripheries attract different types of economic activities and therefore workers and therefore residents. From this postulate of inevitable and natural spatial inequality emerges the possibilities of specialisation, variability and a favourable environment for spatial mobility. Spatial inequality further leads to a distinct socio-economic structure of residents but also influences the demographic structure; more specifically, age structure as well as mortality and fertility levels are known to be highly correlated with socio-economic characteristics (Rychtaříková, 2007, 2004, Klasen, Launov, 2006). In this context, geographical determinants are of secondary importance because differences among social classes determine the social, economic and demographic differences in a more significant manner. Regional differences are important to the extent that they influence the choices people have at their disposal according to their place of residence. Free mobility of economic activities and labour can thus help to minimise these spatial traps.

Like all theoretical approaches, New Economic Geography has met with criticism, mainly from the position of economic geography. The gist of this criticism was expressed by Krugman himself, when he remarked: "I am having a terrible time with my current work on economic geography. Referees tell me: 'It's obvious, it's wrong and anyway they said it years ago'" (Gans, Shepherd, 1994, p. 178). The concept of New Economic Geography is criticised as an attempt to simply revamp regional science and regional economics and is said to contain 'too little region and too much mathematics' (Martin, 1999). "The spatial agglomeration models may well predict that, under specific assumptions, industrial localisation and specialisation will occur, but they are unable to tell us where it actually occurs, or why in particular places and not in others" (Ibid, p. 78). The annoying elements for geographers appear in the very name of the approach "new economic geography", because in their point of view it is neither new, nor geography. It in fact represents a conflict of paradigms. Geography in its mainstream abandoned formal logical positivism in the 1970s for discursive forms of theorising and more realistic approaches in empirical investigation where explanations are built "from below" (Martin, 1999). The cleavage between mainstream economic geography and new

economic geography is therefore of a fundamental methodological and epistemological nature. Geographers are convinced that a more suitable name and a more accurate respective ranking for the theory would be “new geographical economy”, because of its use of econometric tools and because it is a new approach in economics (which for a long time neglected space as an active factor in economic organisation) but not in geography. Krugman does not deny that reality is more colourful than provided for in his models, but particular empirical cases are not in his focus. He tries to reveal under what conditions core-periphery organisation can appear. The explanation of the initial moment of change is often a weak point of empirically based theories.

When Krugman considers economies of scale and transportation costs as main explicative variables of agglomeration forces, he does not really explain suburbanisation and counter urbanisation processes. This need may be filled by the theories borrowed from urban economic and urban studies explaining the hierarchy of urban systems and their inner organisation (Hoyt 1939, Alonso 1964, Fujita 1989). These approaches highlight the importance of real estate competition. The inclusion of this variable may explain dispersal processes. These refer to the deconcentration which appears at a certain stage of the agglomeration process because of agglomeration diseconomies. It does not signify a let-up of the agglomeration tendency as such, but it transforms its character into a deconcentrating sprawl. This may happen at a moment in time when further concentration holds no new added advantage and may even be costly for certain agents. The reason may be found in the fact that the higher the concentration of population and activities is, the higher land and estate prices climb. Other negative externalities emerge as well, such as environmental pollution, traffic congestion, etc. The areas outside the centres are spared these negative externalities. “Without modification, the environment of the areas on the periphery of centres witnesses a relative improvement in quality. Positive rural amenities would seem therefore to be initiated by the negative externalities of the urban centres.” (Blanc 1997, pp. 6). In this situation, the periphery becomes attractive to those households and economic activities for which the equilibrium between accessibility to the urban centre amenities (jobs, services), transportation costs, price of land and other environmental amenities is reached on the periphery. The peripheral region and rural areas differ from urban centres not only in terms of population density

and number of employment possibilities, but also in terms of their structure (only certain economic subjects and households prefer to be localised on the periphery). The further away from the urban centres, the more the structure of economic activities and population differs. The space requiring economic subjects who use the land less intensively, with a limited demand on the variety of qualifications in different working activities will most likely be located in rural areas or peripheral regions. They exploit natural resources, which are by definition immobile, and tend to their primary processing. Other economic activities in rural areas are connected with the services provided to the resident population. The social composition of the population therefore issues from the specialisation of production in the rural areas and is marked by a higher proportion of less qualified people and by a higher proportion of non-active residents. (Blanc 1997).

### **1.3 Observations in population spatial dynamics – toward a common pattern?**

Studies of social geographers, sociologists and spatial economists concerning Western European and North American societies as well as other highly economically developed regions have revealed the existence of important changes in the spatial distribution of population with important repercussions for demographic structure. According to them towns and cities develop according to a fixed pattern with three main stages urbanization, suburbanization and counterurbanization (Berg, Braun 1999, Champion 1989, Champion 2001). Urbanisation occurred in the period of transition from agricultural to industrial societies and is characterised by economic and population concentration when the larger the town the higher net migration occurs (Champion 2001). This stage was transformed into deconcentration of residential areas behind the boundaries of the core towns into its hinterlands fed massively by both upper and middle class. In the United States, the process of residential suburbanisation was observed from the late 1950s, leading to growing urban sprawl and functional agglomerations with the urban core as the centre of employment surrounded by its residential suburban areas. Later, residential suburbanisation was followed by employment decentralisation

resulting in multi-central agglomeration. This was a process of “decentralisation” but still concentrated around large centres. Remote rural areas and local centres were losing population attracted to large urban agglomerations. Some therefore consider this transformation to be another form of urbanisation (Berry 1976). Since 1970, places outside US metropolitan areas have recorded relatively high rates of population growth, representing firstly a part of the extension of the decentralisation process. Yet a significant proportion of this growth also occurred in remote rural areas and their local centres on the periphery of the American urban system, therefore referred to as deconcentration or “counter-urbanisation” (Ibid). During the same period, inter-regional movements took place, with the major trend of leaving the traditional urban and industrial areas of the north and east in favour of the south and west. Since the 1980s, certain dynamic cities have witnessed “back to the city” migration movements on the part of young adults and white collar workers. The case of USA spatial population dynamics is presented as an extreme in scope as well as in the avantgarde timing of these trends. Examining the studies of Western European countries, Canada, Japan and Australia, we note that these trends were at least observed in these places as well, although they might differ in scope and certainly timing. Researchers agree that such trends consist of common patterns (Champion 1989, Robert, Randolph 1983, Ford 1999, Détang-Dessendre et al. 2000, Schmitt, Goffette-Nagot. 2000, Détang-Dessendre et al. 2008). As the metropolitan areas are expanding and widening their functional diversity the population disperses to even further areas in the form of ‘cascade down the settlement hierarchy’ (Cahmpion, Shepherd 2006). As Champion (1989) concludes on the basis of case studies undertaken in the United States, Great Britain, Norway, Denmark, France, Italy, the Federal Republic of Germany, Japan and Australia, “the differences between countries in the extent and timing of counterurbanisation seem relatively insignificant. It therefore seems highly inconceivable that the events in each country should be caused by completely different sets of factors, but much more likely that the processes involved vary in strength and impact between countries under the influence of conditioning factors such as the geographical layout of national territory, the previous history of urbanization and the recent pace of economic growth” (Champion, 1989, p. 233). Centrifugal tendencies in population redistribution have been observed in these countries

since the 1960s or 1970s in the form of intensified suburbanisation and counter urbanisation. These tendencies are generally termed “dispersal”<sup>2</sup> by Champion (1989). When answering the question “who” was concerned by population shifts, Champion’s conclusions, drawn from the nine nation case studies, are as follows:

*Natural change*, represented by the decline in birth rate in the observed countries since the 1960s through the 1970s, has certainly contributed to the fall in the actual growth rate in major cities. On the other hand, “it has not played an important role in promoting counterurbanisation, because the natural change rates in the cities has not tended to be greater than nationally, except in Italy and Japan. If anything, there has been a tendency toward the convergence in birth rates between the more urban and more rural parts of most countries, which has worked against population deconcentration because rural areas have traditionally been characterised by higher fertility” (Ibid, p. 234).

*International migration* caused an acceleration of migration out of urban places, mainly in the major metropolitan centres of the New World (USA, Australia) as a result of congestion or ethnic conflicts. In Europe, generally speaking, the concentration of immigrants to urban centres diminished the apparent population dispersal. But all case studies made it clear that “it is the switches in the patterns and rates of domestic migration that have been very largely responsible for the observed tendency towards population deconcentration” (Ibid, p. 235).

Concerning the *age structure of migrants*, there has not emerged a prevailing opinion concerning the dominance of retirement migration behind the centrifugal tendencies. Retirement migration was already a well established phenomenon before the 1970s. “Instead, the major change from the 1960s appears to be the increasing tendency for younger age groups to take on a “retirement pattern” in their net migration flows” (Ibid, p. 235). The main in-comers are in productive but pre-retirement age or retired but the recent observation in Britain have shown that even the “quintessential suburbanisers” (families with children) are moving there (Champion, Shepherd 2006). The case studies conducted in the developed countries provided enough evidence to refute another suggestion which is that “the rural population turnaround was largely caused, if not by

---

<sup>2</sup> He considers it a better word than deconcentration because it can encompass in its sense a larger variety of spatial arrangements, e.g. redistribution of population from larger to smaller places.



the elderly, by others who were not gainfully employed, including early retirees, those dependent on unemployment benefits or other welfare payments, and drop-outs or hippies in search of alternative life-styles” (Ibid, p. 235-236).

Much harder than finding the demographic components of population dispersal is identifying the underlying factors of that change and proving them or estimating the relative importance of each of the factors. Among the conclusive remarks wrapping up the chapters devoted to the national case studies (Champion 1989, p. 236-237), the following explanatory factors of migration turnaround were detailed. They are not the result of rigorous empirical analysis, but are rather based on expert observation of the respective cases and on previous research:

- a) The expansion of commuting fields around employment centres.
- b) The emergence of scale diseconomies and social problems in large centres.
- c) The concentration of the rural population in local urban centres.
- d) The reduction in the stock of potential out-migrants living in rural areas.
- e) The availability of government subsidies for rural activities.
- f) The growth of employment in particular localized industries like mining, defence and tourism.
- g) The restructuring of the manufacturing industry and the associated growth of branch plants.
- h) Improvements in transport and communication technology.
- i) The improvement in education, health and other infrastructure in rural areas.
- j) The growth of employment in the public sector and personal services.
- k) The success of explicitly spatial government policies.
- l) The growth of state welfare payments, private pensions and other benefits.
- m) The acceleration of retirement migration.
- n) The change in the residential preferences of working-age people and entrepreneurs.

- o) Changes in age structure and household size and composition.
- p) The effect of economic recession on rural-urban and return migration.
- q) The first round in a new cyclic pattern of capital investment in property and business.

The impossible nature of a proper “proof” of these explanatory factors discredits them in the view of exact science. Nevertheless, they will serve as a source of a hypothesis whose plausibility will be discussed in the following analysis of spatial population arrangements in the Czech Republic. Moreover, certain explanatory points cited above from Champion are in compliance with the modelled centripetal and centrifugal tendencies governing centre-periphery spatial arrangements in New Economic Geography (Krugman, 1991, Détang-Dessendre, C. et al. 2002, Bessy-Pietry, P. et al. 2001). These especially include points a), b), g), h), j), m), and p).

In the Czech context, it must be verified whether the spatial population distribution follows a logic comparable to that presented above by the New Economic Geography model or observed in the developed countries or if the mechanisms differ. In urban geography, there exists a long standing debate on whether differences between socialist urbanisation (including all the further phases of decentralisation and deconcentration) and the capitalist version are systemic or solely the result of delayed development. The majority of urban researchers from the East and West agree on the baseline that there were important differences. They also agree that they “originated from collective (mainly state) ownership of urban and land infrastructure, from the centrally planned allocations of development funds, and from the existence of comprehensive strategies for development of the national settlement network in the socialist countries. By contrast, capitalist urbanisation is led by market competition, private property, real-estate profitability, local decision making and physical planning on the city-by-city basis” (Enyedi 1996, 101). Enyedi (1996) argues that there are common fundamental characteristics in socialist and capitalist urbanisation. This common process was more significant than the varying social structures that carried it (p. 103). He enumerates the main characteristics of global urbanisation, all of which were also shared by socialist

societies, as follows: rural to urban migration and concentration of the population; the spatial separation of place of work and place of residence; the growing importance of tertiary and quaternary employment which changes the locational pattern of workplaces; and finally, suburbanisation and the increasing importance of small and local centres (Ibid).

There are, on the other hand, opponents of this global urbanisation view. They are convinced that the differences between socialist and capitalist urbanisation are fundamental and systemic. The socialist societal organisation resulted in a settlement system in which industrial concentration in urban areas was not followed by adequate population concentration and thus led to under-urbanization (Szelenyi 1996). The socialist societies did not share the trajectory followed by Western societies during the 1950s and 1960s and in the post-industrial phase; instead, they produced qualitatively different arrangements from those observable in the West (Szelenyi, 1996, 299).

In conclusion, a debate exists on whether the spatial organisation of socialist society shared the general patterns observed in Western society or whether it led to qualitatively new arrangements. The answer to this question also determines one's view on and interpretation of the post-socialist settlement and spatial population changes. In my thesis, I will return to this discussion when concluding the analysis of spatial population dynamics. Based on empirical findings for the case of the Czech Republic, I will discuss the possible system specific features on one hand and similarities with Western features on the other.

Relevant studies concerning spatial population dynamics in other post-communist transforming societies may serve as an initial clue to identify tendencies which might be expected in the Czech context. Although one has to bear in mind the different historical contexts, settlement structures, sizes and densities of population of the countries of Central and Eastern Europe, some common features influencing spatial population dynamics did exist. The commonalities were mainly centrally planned economies, emphasis on large scale industry and its urban concentration, non-meritocratic social systems and the general effort toward the equalisation of social cleavages. Studies concerning spatial population dynamics in post-communist countries are rather rare.

Nevertheless, some exist for Hungary (Brown, Schafft. 2002), for Russia (Ioffe, Nefedova 1998), for Poland (Kupiszewski 2005) and for Romania (Kupiszewski et al. 1998).

Ioffe and Nefedova (1998) describe the particular case of the development of the Russian urban hinterland. In the 1990s, the typical process of suburbanisation characterised by the outgrowth or extension of urban realms was not the case. Russian urban hinterland (*prigorod*) did not experience economically determined urban sprawl; instead, its transformation rather reflected a restrictive policy governing residents' permits (*propiska*<sup>3</sup>) in large cities and rarity in the real estate market. In that situation, *prigorod* has thus become a stepping stone into the city and not out of it as observed in Western European countries and the USA. Suburbanisation of the Western-cut was still rather marginal at the end of the 1990s and concerned mainly the richest individuals (the *new rich*). The reason for this may be found 1) in the fact that a majority of economic activities, wealth and resident population is concentrated in large towns; 2) the administrative borders of Russian cities have undergone numerous changes as a response to expansion necessities. Very often, residential complexes of multi-storey housing developed in the newly acquired rural hinterland. In the Western countries, urban borders were more stable over time and urban planning approaches were different. 3) In Russia, there exist sharp divisions between residential sectors. Densely populated towns create "islands" in the sea of very sparsely populated rural areas. Deep peripheries exist not only in the Far East but also between the two largest cities, Moscow and Sankt Petersburg. Depopulation of the rural hinterland precedes irrespective of the quality of the agricultural soil. Agricultural use of the land in Russian provinces reassembles that of von Thünen's rings in the classic location model of agricultural activity in which a town is surrounded by concentric rings with land use intensity declining outwards. These von Thünen's rings are sustained not only, and in many cases not as much by, transport costs as by the polarisation of the countryside, conditioned by socio-demographic

---

<sup>3</sup> Propiska was the authorisation of residence in the Soviet era, aimed at controlling population migration. It was approved by local or regional authorities. Although *propiska* was officially abolished in 1991, many post-Soviet states are still applying this rule. In Russia, it is still a common way to control unwanted immigration, although it has been condemned as unconstitutional. Its accordance was usually on an exaggerated fee, which attained, for example, 300 times the minimal salary in Moscow-city at the end of the 1990s (Ioffe, Nefedova, 1998).

factors. (Ibid, p. 1330). 4) In Russia, there is a strong tradition of the possession of recreational second dwellings. Many urban inhabitants are owners of second dwellings in the urban hinterland both for uses of recreation and small scale farming. The desire of numerous urbanites is not to move to the urban hinterland, but to own a second dwelling there. Some people use the second residence for year-round living while renting apartments in town. This fact can distort the real scope of population suburbanisation. 5) The demographic decline of rural areas is an ongoing fact. The stage of population redistribution in which larger settlements lose their population due to emigration and smaller towns and rural areas increase in population through net migration gains has never actually arrived in Russia. Although the 1992-95 period, during which the rural population experienced a sudden growth, stands as an exception, it was a short-lived phenomenon exclusively driven by the acute crisis in cities in the wake of the removal of state price controls and stalling industry. However, by 1995 the situation had already returned to what had been normal for Russia for over a century: a positive relationship between a settlement's growth rate and size, although the overall negative rate of the Russian population's natural increase has suppressed growth everywhere it takes place at all. (Ibid, p.1328)

Brown and Schafft (2002) observed population deconcentration in Hungary as a new phenomenon beginning in the 1990s after the steady growth of urban population concentration in the previous decades. They looked for the explanation for such deconcentration, expecting it to be a multi-causal phenomenon. The traditional motivations for deconcentration as identified in Western Europe and the USA, namely the search for amenities and increased economic opportunities, do not seem to them a convincing explanation of deconcentration movements in Hungary. There, high amenity values or employment opportunities do not characterise most rural areas. Already Ládanyi and Szélényi (1998) observed that in the 1990s, rural villages became resettlement destinations for economically marginal populations after the dissolution of much of the manufacturing industry, mainly localised in urban areas. Based on the analysis of inter-municipal migrations, Brown and Shafft (2002) interpreted observed migration movements in the 1990s in Hungary as two distinct types of deconcentration. "For people moving to the suburbs it is quite likely a positively selected search for

amenities, better housing and residential proximity to jobs in new service industries. In contrast, given the wide-scale economic dislocation that has occurred in Hungary since 1990 as a result of its fundamental economic restructuring, it seems likely that much post-1990 domestic migration involves out-migrants from Budapest and other large cities who were displaced from industrial jobs, and who are seeking enhanced economic opportunities in suburban areas or lower costs of living and opportunities for self-provisioning in rural locales.”

Kupiszewski (2005) concludes that the main features of the recent migration changes in Poland are a decrease in residential migration volume, a decrease in commuting intensity, population decentralisation and deconcentration and the growth of international emigration. Population concentration in urban centres motivated by centrally planned industrialisation as observed in other communist countries was already slowing down in the 1980s in Poland, due to the economic crisis. It triggered the return migration to rural areas, which overtook rural to urban migration in the 1990s. Kupiszewski (2005) explains this firstly by the dissolution of industry in urban centres and especially their system of housing and transportation subsidies, secondly by the increasing differences in the incomes of low-skilled and higher-skilled or better educated employees, thirdly by a decline after 1989 in the regularity with which migration was recorded and fourth, by the increase in transitional forms of residence. Without subsidies for housing, the revenues of the low-skilled population were not adequate to the new, higher costs. This population therefore returned to family farms or stopped commuting regularly. These workers preferred to take temporary jobs or other forms of employment. Moreover, with the maturing of the economy, the educational requirements demanded of the labour force in towns and the low educational level of the rural population made it increasingly difficult for rural dwellers to find jobs in urban areas (Kupiszewski 2005, p. 8). There results a situation of concentration of the surpluses of the underskilled population in eastern and south-eastern provincial Poland and in Silesia. The outflow of the young and better educated population to more dynamic parts of Poland or abroad also characterises these regions. International migration then serves as a substitution for domestic migration and commuting (Ibid, p. 22). At the same time,

suburbanisation is a phenomenon which has been evolving since the mid-1990s around all the larger towns and which concerns the wealthier segments of the urban population.

In Romania, the dominant flow toward urban centres persisted in the first half of the 1990s, nevertheless, the intensity of migration was slowing down in general, and toward large centres in particular (Kupiszewski et al. 1998). At the same time, new migration patterns were observable. The main migration gains were seen in smaller and middle sized towns, migration towards rural areas was increasing, and migration distance was shortening. Nevertheless, the depopulation of rural areas was still going on at the time of observation (1994), and selective emigration had deteriorated the demographic structures in rural areas with the exodus of young active inhabitants (Ibid).

Generally speaking, these authors report an important turnaround in spatial population dynamics in post-communist countries. First, the incentives for migration are no longer determined by centrally planned policies but by the economic motivation of individuals and families and character of the emerging market economy. Secondly, despite economic reforms with uneven regional repercussions, the overall domestic migration of the population was slowing down in the Central and Eastern European countries (Fidrmuc 2004, Svejnar 2002). Fidrmuc (2004), on the basis of analysis of migration between regions in the Czech Republic, Slovak Republic, Poland and Hungary, concludes that “prosperous regions tend to have relatively large inflows and outflows whereas depressed regions have largely immobile population” (p. 246). Thirdly, the obvious dominance of rural to urban migration observed in Central and Eastern Europe prior to 1989 loses its primacy, while decentralisation (suburbanisation) and deconcentration (urban to rural migration) emerge and grow in relative importance. The scarcity of the urban housing is one reason, the search for larger and more representative dwellings is another, each of them being relevant for different social groups.

## **2. GENERAL CONTEXT OF SOCIETAL DEVELOPMENT IN THE CZECH REPUBLIC**

To understand the recent development of spatial population organisation, at least the general contours of the previous development and broader societal context should be presented. In the first part of this chapter, I will present the main processes which led to the spatial organisation of Czech society at the end of the 1980s and present the situation as it was at the beginning of the transformation. The key factors of economic restructuring after 1989 and its spatial repercussions will be outlined in section 2.2.

### **2.1. Pre-1989 shifts in economic orientation, policies and their repercussions on regional development**

Illner and Andrlé (1994) articulate some of the main features of the communist heritage of regional development as follows:

1. After World War II the Czech lands, a relatively little damaged and, at the same time, highly industrialised region, were a provider of goods and services for the post-war reconstruction and modernisation of the more damaged and backward Slovakia as well as of the USSR and other Soviet block trading area countries (CMEA<sup>4</sup>). A massive redistribution of resources took place in Slovakia's favour, while at the same time the renewal of capital assets in the Czech lands lagged behind. In the long run, levels of economic and social development of the two parts of Czechoslovakia converged.
2. The regional policy of the socialist state, which practised a directed inter-regional equalisation (based on the territorial redistribution of resources), moderated some of the

---

<sup>4</sup> Council for Mutual Economic Assistance



deepest economic and social regional differences and imbalances within the Czech lands, while leaving some of them unchanged and creating several new ones.

The long-lasting division of the Czech Republic along approximately the 50th parallel (more precisely, along a north-west to south-east axis), into the more industrial and urbanised north and the less developed south has not disappeared, nor has the strong centrality of the capital city of Prague been balanced. The existing industrial centres remained engines of economic development; indeed their role was strengthened. „Socialist“ industrialisation, oriented mostly toward heavy, defence and capital construction-oriented industries, supported and strengthened the monostructural character of many industrial agglomerations, making them extremely vulnerable to shifting external influences and creating a host of social problems, especially in northwest Bohemia and north Moravia (Kostelecký 1993). However, the most relevant of the newly emerging imbalances was the marginalisation of the regions along the West German and Austrian borders following the expulsion of the frontier belt's German population in the years immediately after the close of World War II. The loss of its original population, its insufficient (in many districts) replacement by new settlers, its special military and security regime, the disruption of former trans-border routes and relationships, the strategic interest of the Warsaw Pact military in freezing economic development along the „Iron Curtain“, all led to the overall marginalisation and stagnation of some of the border regions, especially in west, south-west and south Bohemia, and south Moravia (Hampl, Kühnl 1993). Some of the regions in north Bohemia and north Moravia neighbouring with East Germany or Poland shared a similar fate. Besides the marginalised border regions, „inner peripheries“ also developed, mostly among the inland agricultural areas with low population densities, ageing population, negative net migration, low per capita incomes, stagnating infrastructures and housing construction (Musil 1988). Such peripheries lie mostly on the perimeter of the administrative regions, e.g. on the north-east reaches of Central Bohemia or on the eastern side of the Brno area.

3. An obsolete industrial infrastructure, a one-sided concentration on heavy industry and negligence contributed to harsh environmental damage in some industrial

agglomerations and urban centres as well as in their hinterlands (north and north-west Bohemia, north Moravia and the cities of Prague, Brno and Plzeň being the worst hit).

4. Full employment was imposed by the law and non-working was a crime. Officially, there was no unemployment during the communism. It concerned both men and women (except for those on the maternity leave). Before 1989 the economic activity of Czech women was the highest in Europe (Hraba et al. 1997). This situation led inevitably to the existence of redundant jobs and workers. Work efficiency as well as work motivation was low. Moreover the wages were not based on meritocratic basis and the equalisation of salaries was the goal of the system (Večerník 1996).

5. The collectivisation of agriculture, which liquidated family farming and established increasingly large state farms and agricultural co-operatives, fundamentally changed employment structure and land use in rural areas (Majerová 2000). Workers freed from collectivized agriculture converted into industrial workers commuting to the plants and factories or moving to the towns. The collectivisation also contributed to the change in the settlement system. Many small rural settlements which did not find any function within the large-scale socialised agriculture lost permanent residents and were transformed into recreational villages. In some place, like in the border regions resettled after the World War II, the big state farming companies, although heavily subsidized helped to retain and stabilize the population. From the 1970s onwards a recreational housing hobby flourished among Czechs. Thanks to that a part of traditional rural architectural heritage was saved, even though the “popular creativity” often had destructive effects.

6. Housing construction predominantly took the form of new developments (multi-storey apartment blocks) on city perimeters, while the inner cities and especially city centres (many of them historical treasures) have remained in urgent need of renovation. Suburbanisation was slowed down or entirely halted by the legal protection of agricultural lands and by the economic impossibility for the vast majority of the population to acquire family homes. Urban growth took the form of changing urban borderline. On the newly built land with countryside character multi-storey apartment

blocks were built. So rather than urban sprawl, there existed expansion within the urban borderline.

7. Urban infrastructure and transport and telecommunications systems (highways, railways, airports, telephone and other networks) across the country were neglected. All routes and links connecting the Czech lands internationally, especially with the West, were underdeveloped. The industrial bias of the official economic policy led to the chronic neglect of services which were considered „non-productive“ and, therefore, of secondary importance.

8. Central planning, administrative centralisation and political control by the Communist party extinguished most of the elements of territorial self-government and deprived regional authorities of genuine decision-making powers (see also Kornai 1992). Regional governments were further weakened by the increasing economic and political influence of large industrial enterprises and by the subordination of regional development to their interests. The sector-branch system prevailed over the territorial organisation (Illner, 1992). Regional policies lost importance and became subordinated components of central economic planning.

The socialist urbanisation was designed mainly by collective ownership centrally planned allocation of development funds and decision making (Enyedi 1996) whereas in capitalist countries private ownership, retail price competition and local governance deconcentration were the main factors shaping urbanisation. The socialist model of urbanisation resulted in the Central and Eastern Europe including the Czech Republic in over-industrialised cities and towns with underdeveloped infrastructure and residential areas, known as “underurbanization” (Szelenyi 1996). The centrally planned settlement organisation led to a design of the “hierarchy of municipalities”. Higher levels of that hierarchy were fate for further development of housing, services and employment and the lower levels (mainly small municipalities) to a progressive die off. This system led to prioritizing municipalities which later in the conditions of capitalist market economy were not able to maintain their artificially made position and were losing importance (Hampl 1996, 2005).

Traditionally fragmented settlement structure of the Czech Republic underwent important changes as well. Already since the end of 1940s and in the 1950s some small municipalities disappeared after the expulsion of ethnic Germans from the frontier areas. The resettlement of these areas did not replace fully the lost German population and the tough iron curtain border protection underlined this trend. In the 1970s a large programme of forced unification of municipalities was introduced. Thousands of municipalities were forced to connect with the “centre municipalities” chosen according to centrally defined “hierarchy of municipalities” (Table 1). This extremely unpopular measure led to the dissolution of these forced entities after 1989 as soon as it was legally possible (Vajdová 2003, Illner 2003c).

*Table 1: Number of municipalities in the Czech Republic*

	1955	1961	1970	1980	1991	2001
No. of municipalities	10 877	8 724	7 511	4 778	5 768	6 258

Note: The data are for 1.1. 1955 and for the following years to the date of population censuses.

Source: Czech Statistical Office

## **2.2. Post – 1989 societal transformation and its repercussions on regional development**

At the end of the 1980s, the whole socialist block of countries, including Czechoslovakia, was facing economic slowdown, progressive ideological burnout and a lack of innovations and competitiveness (Kornai 1992). The attempt for systemic reforms (perestroika) came late and finally could not stop popular movements which turned into revolutions ending radically with the communist regimes in almost all communist countries in Central and Eastern Europe between 1989 and 1991.

Czechoslovakia, where the communist regime collapsed in November 1989, entered the period of post-communist transformation with a polarised regional structure, over-industrialised urban agglomerations, an underdeveloped infrastructure, a polluted environment, and a weak and over-centralised territorial administration. Spatial patterns were changed (intentionally or not) considerably during the communist era when the developmental dynamics in the Czech lands have been gradually shifting toward their

east (Moravian) part to the detriment of the west (Bohemian) part, historically the economically stronger of the two macro-regions. (Illner, Andrlé, 1994: p. 110-111). At the beginning of transformation the policymakers strategy was to focus on macroeconomic stabilisation, microeconomic restructuring and introduction of social safety net along with institutional and political reforms (Horovitz and Petras, 2003; Orenstein, 2001; Svejnar, 2002). Svejnar (2002) distinguishes qualitatively different Type I and Type II reforms. Type I reforms goal was to cut off state subsidies and to reduce centrally planned regulation. Given the shortage of budget revenues due to the lessen tax revenues at the beginning of transformation, most of the post-communist states were forced to implement these reforms (see also Kornai 1993; 1999). Type I reforms consisted mainly in macro stabilization, dismantling the institutions of communist system, privatization and price liberalization, although a number of key prices like those of energy and housing often remained controlled (de Melo et al. 1996; Vanhuysse 1999). Type II reforms depended on the ability of the state to collect the taxes and on its level of domination of corruption and special interests. These softer reforms consist of the creation of a reliable state apparatus and institutions that would provide a level playing field for the market economy (e.g. appropriate regulatory infrastructure, labour market regulations, institutions related to public unemployment and retirement systems). Although Type I reforms were implemented in all post-communist countries, the Type II reforms are still in process and vary widely across the transition countries (Svejnar 2002; Vanhuysse 2008). The following part characterizes shortly the essence of reforms undertaken in various societal aspects with the emphasis to their repercussions on spatial population structure and dynamics.

1. Democratic Czechoslovakian federation lasted for a relatively short time. Important political tensions between the representatives of Czech and Slovak political parties led to the separation of the two states by political decision, without civic referendum. In January 1993, Czech Republic and Slovak Republic were founded as two independent states after more than seven decades of co-existence. The separation was peaceful and did not create any great national animosities or conflicts about the new established border or interruption of the economic collaboration. Nevertheless, the border regions with Slovakia, which used to be in the heart of Czechoslovakia, were situated now on a

periphery accentuated by economic restructuring and decline of local industry. Due to the better economic development in the Czech Republic than in Slovakia during the whole decade following the separation and due to the virtually inexistent language barrier, there was an important inflow of Slovak migrants (Uherek 2003).

2. The regional policy's first task was to re-establish the authority and rights to self governing units. It had to be ensured legally by delegation of powers to local bodies as well as by appropriate revision of local budget financing. Because it consisted of a complex and politically sensitive issue, the accomplishment of the reform took longer than a decade. The first step on the way to democratize and decentralize public administration and to increase its effectiveness was the reform of municipal governance and the abolition of the existing regional bodies, which had been discredited by the previous regime. This step was done between 1990 and 1993. Although municipal governments received a wide array of self-governing competencies and a large legal independence, their position was much more restricted in terms of finance (Illner 2003a). The tough central control over the finance of municipalities is partly inherited from the Communist regime and partly an intentional measure aimed at preventing the rise of social inequalities among municipalities. Municipalities' per capita income differentiation is thus mainly a function of their size (when larger and hierarchically more important municipalities receive higher per capita contributions) (Vobecká, Kostelecký 2008). The execution of the second step of the reform which created the intermediary governments of the regions came much later, in 1999-2002 (Illner 2003b, 2003c). 14 new regions (NUTS 3) were established within which Prague has a unique status of municipality and region at the same time. Generally, although being self governing units with elected representatives, the regions are quite weak and, moreover, they are completely dependent on redistribution of the resources from the state budget. In general, the post-1989 transformation of regional organization is characterised by persisting and further fragmented municipal structure with a wide scope of competencies but limited financial independence. There are more than 6 200 municipalities, of which 79 % have a population of less than one thousand. More than 2 thousand regained their independence shortly after 1989 released from the forced unification of municipalities prioritized during the two previous decades (Vajdová 2003). In such a situation,

competent governance in the smallest municipalities is problematic. The redistributive and equalizing municipal financing is a practical tool to prevent collapse of incompetent or too small municipalities. The 14 regions are new entities with limited capacities to design their own policies. This can partially explain the relatively low interregional disparities in the Czech Republic, although the striking dominance of Prague contrasts with other regions.

3. An obsolete industrial infrastructure and trade orientation needed an in-depth transformation. The old Soviet bloc trading area (CMEA) was abolished and industry had to face the open market and competition of Western production (Kornai 1992; 1994). In the Czech context many big companies continued to receive state subsidies. In the worse case, they collapsed later, in the better case, they were privatized, sometimes only subsequent to the massive state restructuration subsidies. Other state owned companies went to privatisation directly. The smaller and middle sized ones were sold in auctions which established a group of small entrepreneurs (Orenstein 2001; Myant 2003). The newly established private owned companies absorbed a part of labour force from the dissolved big industrial firms. The privatisation scheme did not simultaneously set up legal barriers (Type II) to reduce or to make impossible large scale frauds. The lack of appropriate legal frame and insufficient regulations was striking especially in the context of small and large scale privatisation and de-monopolisation of banking system (Kornai 1999). The latter led to a quick emerging of dozens of small banks, many of which quickly collapsed. Large banks accumulated a large number of non-performing loans and were on the point to collapse at the end of 1990s. Only because they were “too large to fail” did the government bail them out. The need for repeated bailouts of banks has led in the late 1990s to sell off virtually all domestic banks to large western banks (Horowitz and Petras 2003; Myant 2003; Svejnar, 2002). Foreign direct investments started to be important player in the restructuration of Czech industry only since 1998 when the political and legal environment became favourable to it. Since then, the Czech Republic has been a leading country in the amount of foreign direct investments among post-communist countries (Drahokoupil 2008). With already privatised and well restructured Škoda car company other car plants installed in the Czech Republic creating a demand for multiple sub-contractors, other type of industrial manufacturing installed

and only recently there started to grow up investment with higher value added of workforce in IT and technologies (Drahokoupil 2008). The foreign investment plays more and more important role in the Czech economy. Blažek (2002) assesses that one quarter of the 200 biggest firms in the Czech Republic are in hands of non-domestic owners.

The regional disparities in economic prosperity widened after 1989 (Blažek, Csank 2007). In general, the regions with initial most favourable economic structure and human capital were the ones where the prosperity and economic growth were the most dynamic. On the other hand, regions with mono-structural economy (mainly mining and heavy industry) were the most hit. The regional differentiation in prosperity was growing during the 1990s and after the year 2000 it stabilised (Ibid). The main prosperity driver was Prague-city whose GDP level is still growing relatively quicker than that of other regions. It is also a dominant place of concentration of headquarters of big firms, services, progressive services and High-tech (Blažek 2002, Blažek 1996).

On the local level, by local authorities and in the depressed regions by national bodies as well, there were made attempts to incite investment, industrial parks with infrastructure were constructed, incentives for foreign investors were provided and many new industries on the “green field” were supported sometimes losing the possibility to offset the existing industrial brownfields.

4. New social phenomena such as unemployment, contractual work and also higher estimation of skills and level of education arose in the transformation. Svejnar (2002, p. 16) states that the initial reduction in industrial employment was rather mild in the Czech Republic (9 %). On the other hand, he estimates the downward adjustment in industrial wages amounted to 24 % (see also Ham et al. 1998; Boeri 1994; Boeri et al. 1998). Until 1997 approximately, there was a rather low unemployment rate in the Czech Republic staying under 5 %<sup>5</sup> (in contrast with other Central European countries). Unemployment rose to more than 8 % due to the economic recession of 1997 and 1998 and declined since 2005. Real wages renewed also its rising tendency after the decline in the same period. The economic transformation incited important labour mobility, from

---

<sup>5</sup> General unemployment rate levels.



former state owned firms either to private ones or to unemployment or to early retirement (Ham et al. 1998; Vanhuyse 2006). Much of the labour mobility consisted of occupational rather than geographic change with individuals moving from one occupation to another within the regions. This observation from Central European countries is in contrast with that from western countries, mainly United States where individuals move more geographically than occupationally (Svejnar 2002; also Boeri et al. 1998). Together with the rise of inequality and job insecurity, the social safety net was created consisting mainly of support of families with low income and of unemployment benefits and unemployment allowances. The social safety net together with only slow decline of employment, relatively low income differentiation and recent recovery of economic prosperity are the main reasons why the social and economic inequality within the Czech population does not seem dramatic (Vanhuyse 2006; Potůček 2001).

5. Similarly to macroeconomic transformation, also housing policy needed to find a way from an administratively rationed system to a liberal market one. Housing policy is clearly an example of a still unaccomplished field of transformation. The key reforms were done early between 1991 and 1995. They included restitutions, non-profit transfer of state-owned dwellings to municipalities, the start of privatisation of rental municipal dwellings, the deregulation of rents and the introduction of some new tools of housing policy such as building savings (in the 1993) and mortgage credits (in the 1995). (Sunega 2005) The withdrawal of the state as main "developer" and the transfer of its competencies to municipalities caused the virtual interruption of housing construction between 1991 and 1995. In this period, dwelling construction dropped from 61 thousand new construction projects in 1990 to less than 20 thousand per year between 1991 and 1995, reaching the lowest level since 1950s. The recovery of construction activities started in 1996 and recently reached 44 000 new projects (in 2007)<sup>6</sup>, which is still less than in 1970s and 1980s (Figure 1). Not only the structure of investors changed, but also the type of the newly built dwellings. Whereas in previous decades apartment construction in multi-storey houses largely dominated (by 70 %), family houses

---

<sup>6</sup> Data are about newly started dwelling constructions per year. The source of data is Czech Statistical Office.

constructions dominated the sector after 1990. The restitutions, transfer of housing property to municipalities followed by its partial privatisation combined with state regulations caused a situation of “multi-speed” market of dwellings. Some dwelling occupants could buy their flat in privatisation. Others were living in regulated rental segment of the market with legally regulated progression of rent to market levels. A third group of real estate owners or seekers acquired their new flat on the free but (by the previously mentioned points) distorted market. The housing market in the Czech Republic is not completely liberalised until now and not very flexible due to slow administration procedures and rather high levels of risks during ownership changes (Lux, Sunega 2007). The extension of use of mortgage credits had very modest beginnings. The reason was mainly the high interest rates of mortgages (which were in 2000 still more than 8 %) but also a general popular fear about long-term debt combined with economic uncertainty (Sunega 2005). The important growth of mortgage credits has risen considerably since 2003 due to better economic situation and lower interest rates and a higher affordability for middle class.

*Figure 1: Development of housing construction between 1971 and 2007 by type of dwellings*

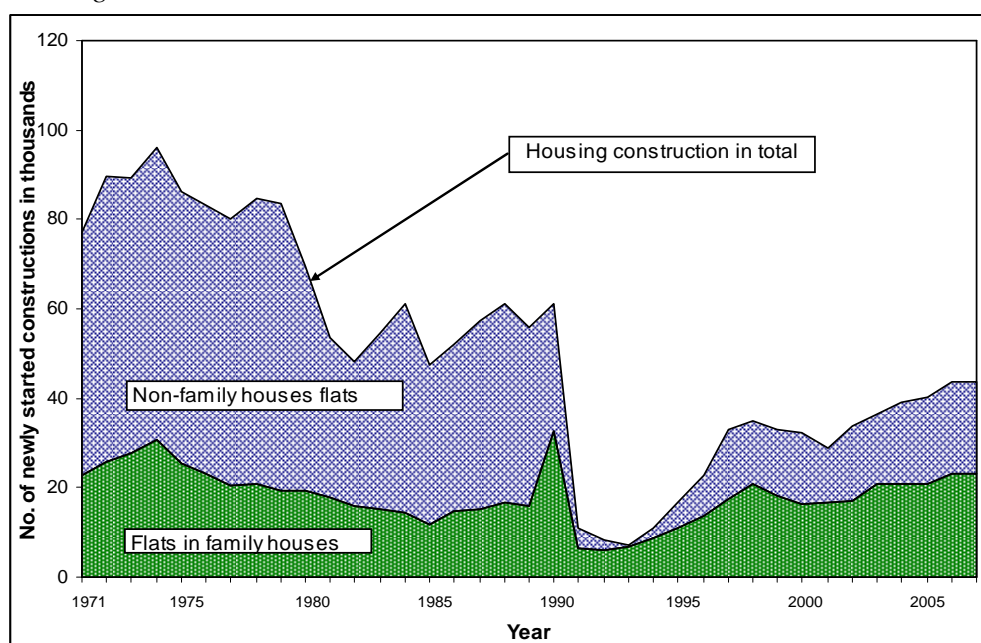

Source: Czech statistical office.

6. Transformation of agricultural firms and privatisation of land started shortly after 1989. The privatisation led to an extremely fragmented ownership of agricultural land but did not bring people back to farming or to a massive sale of their property. The former state farms and agricultural cooperatives continued their factual existence legally transformed and privatized, but working on the leased land. This situation naturally does not lead to long-term land use sustainability, but to intensive profit oriented agricultural undertaking. Therefore now, enterprises with more than 50 ha of agricultural land account for 92 % of the entire area of agricultural land under cultivation (the average size of agricultural enterprise is 71 hectares) (Majerová 2000). Employment in agriculture and forestry witnessed a sharp reduction. 65 % of employees have lost their jobs during the 1990s and now the primary sector accounts only for 4 % of all economically actives (instead of 11% in 1991). Nevertheless, neither the job losses in agricultural employment nor other consequences of transformation led to return to subsistence agriculture as it was observed in Romania, Hungary or to certain extent in Poland (Rees, Kupiszewski 1999). At the same time, the typical Czech phenomenon of recreational housing hobby survived the transformation unharmed. For some people, typically those entering retirement, it has become permanent or seasonal full-time dwelling.

Important change into rural areas brought new self-governing competencies. Accordingly, municipalities now have a wide possibility to influence the land use on their territory. The strict protection of arable land against their conversion to build up area was modified and new residential as well as industrial construction started to transform the face of Czech countryside. Mainly in residentially attractive localities the combination of investors' pressures, low experience of local authorities or other unofficial interests have led to constructions with little respect to landscape, environment or reasonable urban planning.

7. The underdeveloped infrastructure, transport and telecommunication systems underwent a step by step renovation. The borders with western neighbours were opened and main highway connecting Prague and Pilsen to western Germany (Bavaria) was built, other highway via Dresden is almost accomplished. The railway communication system is still awaiting modernisation and despite the high density of railways in the

Czech Republic, their obsolete state and low speed causes an outflow of passengers. The heritage of a very good net of public transport in the country was considerably modified and many lines of public transport were abolished as non-rentable. This was particularly painful for inhabitants of more remote regions and small municipalities when the accessibility of jobs, amenities and services provided by town decreased. Car ownership rose partially also as a reaction to that. Investment into the infrastructure was, and for many smaller municipalities still is, the main issue and investment goal (Majerová 2003).

This overview of the main milestones of societal evolution in the past few decades has indicated some important consequences for regional development and spatial dynamics as well. From the regional perspective, it is clear that Prague as a capital city has never ceased to have a prominent position in economic development potential despite the socialist attempts for equalisation. This potential transformed into the most dynamic economic growth (measured by the GDP) relatively to all other Czech regions. Regional differentiation in the Czech Republic is generally driven by the path-dependent factors such as traditional sector orientation of economy or macro-regional geographical localisation. In general the Northern regions were more industrialized and therefore more severely hit by economic restructuring than southern regions. There where is better educational profile of workforce with higher variety of skills the economic restructuring went on more successfully than in the regions with monostructural economy. The regional self-governance as a factor influencing the regional differentiation plays only a minor role. It is because the present 14 regional self-government units exist only relatively short time (since 2000) and the scope of their authority as well as financial independence is very limited. Similar is the situation on the municipal level. Although the municipalities have relatively vast independent responsibilities, they have little space to control the financial flows to fulfill their legal duties, both on a side of revenues, as well as expenditures. The redistributive role of the state in financial affairs is very strong. The tough central control over the finance of municipalities is partly inherited consequence of the Communist regime and partly an intentional measure aimed at preventing rise of social inequalities among municipalities (Vobecká, Kostelecký 2007).

That is why the present strategies of governance on the local and regional level have relatively small impact on spatial differentiation of economic performance and social capital (Kostelecký et al. 2007) and are more driven by path dependent factors.

In general, regional differentiation of economic performance grew up during the 1990s (Blažek, Csank 2007) but recently it is rather narrowing. The mobility of labour force and residential migration in general was surprisingly decreasing in the two past transformation decades and its recent mild growth is still not surpassing the levels from pre-1989 period. It might be that there is lower quality of evidence or residential migration (as it is based on self-declaration of) and emergence of temporal work or other migrations. But it might be as described by Svejnar (2002) that the labour mobility in the transformation period was more occupational than regional.

### **3. RESEARCH QUESTIONS, HYPOTHESIS AND OUTLINE OF THE THESIS**

It is evident from the examples of changing spatial patterns of population redistribution in Russia, Hungary, Poland and Romania, that although these processes are motivated by economic factors, they do not result in qualitatively similar movements as in the “long-term” democratic countries. The major task of my thesis will be to describe the spatial population dynamics in the Czech Republic and discuss to what extent it follows the logic of agglomeration and counterurbanisation observed in Western European countries and whose origins can be explained by theories of New Economic Geography and theories of organisation of urban systems. If the pattern is different, we will then need to examine whether this represents the result of a specific Czech constellation of path dependency, regulation, geographical arrangements, etc. or if it may be a general pattern, that of a society morphing from a centrally planned economy and regime of regional development to one which is less or better regulated by other means.

These rather general concerns about the logic of spatial population organisation are conditioned by a detailed analysis of population migratory movements, demographic structure and socio-economic characteristics, as well as their evolution over time. A general remark concerning the mobility of the Czech population formulated by Dostál and Hampl (2004) already indicates that the situation in the Czech Republic may represent a different pattern or a modification of the situation observed in Western Europe and other developed countries. Dostál and Hampl state that:

“Despite the new circumstances and conditions of the post-communist transformation and the clear regional differences in the localisation of resources and job opportunities,

there did not take place an increase in interregional migration, but a decrease of migration flows. An important factor explaining the decreased migration intensity is the strong inertia of the Czech welfare state provisions and some consequences of the former equalising tendencies (so-called 'nivelisation'). A specific factor has been the impact of housing policies of the central government orientated to the abolition of subsidies for house building, but maintaining highly regulated housing rents. In consequence, a combined result of these policies has been the decreasing geographical mobility of labour force. From the geographical viewpoint, this is one of the main deficiencies of the post-communist transformation in the Czech Republic. Only in the case of suburbanisation processes one can establish a beginning of 'natural' tendencies in this respect..." (Dostál, Hampl, 2004, p. 16)

This claim in a sense encourages further research because it mentions the emerging pattern of suburbanisation which has not been followed by further "natural" moves. The issue which arises is to explain the reasons for this and demonstrate how this emerging tendency evolved over time. The existence of such new patterns in population dynamics, if observed, has repercussions on population structure. In that case, we could speak of new modes of spatial population dynamics in the post-transformation Czech Republic.

### **3.1 Research questions and hypothesis**

Inspired by the theoretical approaches, I will structure my research questions around two dimensions. The first will be the core-periphery regional approach, supported by the theory of New Economic Geography and the second will be the urban-rural gradient approach inspired by the theories of urban hierarchy and urban structure. My research questions are the following:

How has spatial population dynamics evolved in the Czech Republic? What are its patterns and are they comparable to those observed in Western Europe or are they "Czech specific" or specific to the post-communist transformation period?

I will compare my results with observations from other countries already published. The connected questions then are: are the population structures different through spatial

categories?, who is moving where?, what is the relative importance (intensity) of these flows?, do they influence population structure?, do they lead to the constitution of new inequalities along spatial dimensions, both core-periphery and urban-rural?

I expect that the main factor moulding spatial population differentiation will be migration. Factors of demographic change are expected to have only secondary influence on the spatial population differentiation within the Czech Republic. This will be tested in the following chapters, devoted to descriptive analysis.

If this is the case, the main focus of the analysis will be centred on migration and thus give rise to the following hypotheses. Nevertheless, certain hypotheses about demographic characteristic differentiation will be formulated as well. The analysis will be conducted on the two spatial dimensions, namely, the core-periphery regional dimension and urban-rural gradient dimension. The definitions of both these terms is provided in Chapter 5 and Section 7.1.

The hypotheses tested in my thesis are as follows:

A. The hypothesis concerning spatial differentiation of domestic residential migration

1.1 Hypothesis about migration to suburban areas:

H 1.1.1 *Suburbanisation occurred only after 1989.*

Suburbanisation as residential decentralisation was inexistent before 1989 (Kupiszewski et al. 1998, Andrusz et al. 1996, Čermák 1999). Before 1989, the priority of the planned economy of the centralised state was given to a high urban concentration of industry. It led to the urbanisation of the population, although taking on specific forms of under-urbanisation (Szelenyi 1996). Suburban fringes as well as rural areas were underdeveloped and losing population. “Suburbanisation was slowed down or entirely halted by the legal protection of agricultural lands and by the economic impossibility for the vast majority of the population acquiring family homes. ” (Illner, Andrlé 1994)

H 1.1.2 *Upper social classes suburbanised earlier than the middle and lower classes.* Assuming that, after 1989, some of the “newly rich” were first searching for more spacious housing possibilities in suburban areas. It is expected that it was only after 1998, when mortgages became more widely available and that suburbanisation



started to develop into a large scale phenomenon. The main motivations for suburbanisation are expected to be the same as those influencing Western suburbanisers: the search for amenities (space, nature, accessibility to urban centres – “the house of one’s dreams”, “the dream of house-ownership”), lower real estate prices and commuting distance from the urban centres.

H 1.1.3 The *middle class suburbanised later*; only in recent years and to slightly different locations than the upper classes (either multi-storey housing or suburban areas located further from urban centres), assuming that the same motivations instigated this migration as for the previous group, but its realization had to be postponed to the period when mortgages were widely available and economic growth allowed a wider variety of households access to mortgages.

H 1.1.4 *Who is moving to suburban areas from rural areas?* Can we talk about suburban zones as being buffers to inaccessible towns as observed by Ioffe and Nefedova in large Russian towns (1998)?

## 1.2 Hypothesis about migration to rural areas:

H 1.2.1 The *lower social classes are stable or are moving to rural areas* because of high rent pressure in towns, as observed in Hungary by Brown and Schafft (2002) and others. This would not seem to be the case in the Czech Republic because of the central government’s commitment to maintaining highly regulated housing rents and the specific, non-dramatic-leap evolution of unemployment. At the same time the agriculture of subsistence is only of minor importance and the employment opportunities in Czech rural are scarce. Therefore the hypothesis here is that Czech post-communist circumstances did not lead to a significantly higher outflow of the lower social classes from urban to rural areas. At the same time, it is known that lower educated and lower skilled population is less mobile (Fidrmuc 2005) and is less vulnerable to respond flexibly on economic or other incentives for residential change. For that reason, the number of migrants originating from lower social groups limited, too. Therefore the hypothesis is that in rural areas may exist pockets of immobile residents of lower class, low skilled people.

H 1.2.2 *Families with more children are moving to rural areas* because of high rents and spatial pressure in the towns. This is a possible scenario, but must be proven by analysis if the data allow.

H 1.2.3 *Retired people are moving to rural areas*. I assume that when they do not need to be close to their places of employment, they prioritise rural amenities such as nature and smaller neighbourhoods, or that they obey other motivations connected to family ties or permanent residence in their summer homes. On the other hand, they may prefer to be close to health care and other services, motivations which would therefore support the inverse hypothesis that retired people tend to move to towns, even smaller ones. Nevertheless, the general opinion is the first one; I will therefore test whether this belief is in fact supported by the data.

### 1.3 Hypothesis about migration to urban centres:

H 1.3.1 *People are returning from suburban and rural areas to urban centres*.

Only very recently, there may also exist a return migration of some of the suburbanisers, mainly well off, middle aged people fed up with commuting to urban areas and able to afford good urban housing. This population may also consist of the divorced and widowed who move to towns. Nevertheless, this particular query can be answered only partially because of the unavailability of the necessary data.

H 1.3.2 *Well educated people are moving from rural areas*. The job attractiveness of the urban centres for highly skilled and well educated people counterbalances the higher housing costs. This is expected to concern all the age groups of economically actives and most prominently migration toward the largest urban centres or core regions. It can be also expected because of relatively higher mobility of better skilled and better educated population.

H 1.3.3 *Young people move to urban centres from all the other spatial categories*.

I assume that due to their position in the life cycle, young people are looking for the “bright city lights” of their independence, first jobs and careers.

H 1.3.4 *Retired people move to urban centres.* As explained in H 2.2.4.

B. The hypothesis concerning spatial differentiation of demographic characteristics and of natural change:

H 2.1 *Hypothesis about natural increase:* it is expected to differ between urban, suburban and rural areas because of the distinct impact of migration on the age structures in different urban-rural gradient categories.

H 2.2 *Hypothesis about fertility and marital status and size of household:* the main differentiation is expected to be between urban and non-urban spatial categories. Suburban areas are not expected to have any distinct pattern. Regional differentiation will be important as well.

C. The hypothesis about regional differentiation

These hypotheses refer to the distinction of regions in the Czech Republic to the core and peripheral ones. This distinction is done on the NUTS 3 level. As it is described further in the Chapter 7 in more details, core is represented by Prague and Central Bohemian region and all other 12 regions belong to one of the three categories of peripheral regions.

H 3.1 *Migration attractiveness of the core region will be high and will attract a specific group of migrants. At the same time it will repel more intensively other groups of people.*

More specifically, I assume that core region will be particularly attractive for high skilled people of all ages and young people. On the other hand, it will repel lower social classes and retired people. Further, I assume that the migration attractiveness of the core region will be higher recently than at the mid-1990s as the relative economic strenght of the regions is still growing faster than that of other regions (see part 2.2.).

*H 3.2 In- and Out-migration in the peripheral regions will be more balanced in its structure than in the core region. The least economically attractive regions will lose population by net migration, mainly young people and high skilled inhabitants.*

*H 3.3 The main trends in the structure of urban, suburban and rural migration within the regions will be comparable in all the regions. However, in the core region the urban-rural gradient migration is expected to have distinct characteristics.*

I assume that despite the existence of structurally comparable migration flows to urban, suburban and rural areas in all regions, the dynamics in the core region will be different. I expect that choice of migration destination will be determined more strongly by the social status of the migrant.

### **3.2 Outline of the thesis**

To respond to the research questions and to test the hypotheses, my thesis will adopt the following structure: In Chapter 4, I will focus on the definitions of the core-periphery regional approach and the urban-rural gradient approach. To begin, I will discuss various approaches to the definition of the urban-rural gradient used in the study of population dynamics in the Czech Republic and in other European countries. Secondly, I will introduce a definition of both the urban-rural gradient as well as the core-periphery which I construct and use in my work (Chapter 5 and Section 7.1). A descriptive analysis of population structure and dynamics since the beginning of the 1990s using the previously defined spatial categories follows in Chapter 6. This description consists mainly of the analysis of population change and its components: natural increase and migration, age structure, family structure, and fertility differences, and of an examination of socioeconomic characteristics such as differences in education, economic activity and poverty. For this purpose, shift and share analysis will be used together with simple descriptive tools. In Chapters 7 and 8, the main motor of spatial population dynamics - domestic migration – will be analysed in detail. Using the data on residential migration by age and education, descriptive analysis will reveal the main tendencies and their evolution between the mid-1990s and the first years of the new century (Chapter 7). The explorative analysis undertaken in Chapter 8 will unveil the complex network of relationships between life cycle and social status and migration orientation in the Czech Republic. Conclusions will provide answers to the research questions and hypotheses in the light of the results and indicate additional questions for further research.

## **PART II.**

### **QUANTITATIVE CONCEPTUALISATION OF SPACE AND DEFINITION OF SPATIAL CATEGORIES**

## **4. EXISTING APPROACHES TO DEFINITIONS OF THE URBAN-RURAL GRADIENT AND CORE-PERIPHERY REGIONS**

To be able to proceed in the analysis of spatial population dynamics, we must define the spatial dimensions within which the analysis will be carried out. The two spatial dimensions framing my research are the urban-rural gradient and the core-periphery regional perspective. In this chapter, I will first focus on the definition of the urban-rural gradient. I will give an overview of existing approaches used to analyse the situation in the Czech Republic and approaches currently used in the study of other European countries. I will then present the approach adopted in my thesis. The general outline of the core-periphery regional approach will be presented as well. However, the definition of core-periphery regions as used in my thesis will only be treated after the descriptive analysis of demographic and socio-economic characteristics in Section 7.1.

### **4.1 Urban – rural approach**

#### **4.1.1 Existing approaches in the Czech Republic**

The need to distinguish urban zones from rural ones arises for a variety of researchers and policy makers, but also architects or ethnologists. Thus, there is not and cannot be one single definition of what is urban and what is rural. For the needs of the present thesis, we must look for a quantitative definition, as it should categorise localities in the whole country. The definition of the categories should be based primarily on population characteristics, as the focal point here is spatial population dynamics. Secondly,

economic indicators need to be taken into account as well, as spatial population dynamics is largely determined by the economic characteristics of localities, the distance to an important employment (urban centre) and commuting accessibility and intensity (for more details see Chapter 1). Commuting intensity and especially work commuting is an important proxy for assessment of functional connection and dependence of municipalities and their inhabitants on other larger and economically stronger (urban) centres. The definition used in my thesis can therefore be categorised as belonging to the group of quantitative, statistical-economic commuting based approach.

Although the study of the spatial differentiation of urban and rural populations in the Czech Republic is a subject of long-lasting concern for sociologists (University of Life Sciences), social geographers (Charles University) and spatial planning and developmental policy makers, it suffers from a lack of consensus on an appropriate definition enabling the study of general trends in the settlement and population transformation from an urban-rural perspective. Binary-size classifications are most commonly used to define urban and rural areas in the Czech context. Municipalities of more than 2000 inhabitants are considered as urban and those of less than 2000 as rural. This definition is used in the research of the Institute of Agricultural Economics and Information (ÚZEI) or in the Sociological laboratory at University of Life Sciences. But even these institutions do not use this binary definition alone, and they are searching for alternatives (Perlín 2003b, Maříková 2005, Pavlík 2005). Certain inconsistencies may arise in the approaches adopted in research projects and very often choices are neither explained nor justified sufficiently. For instance, research on the rural population conducted by the research team of Věra Majerová in 2001 (Majerová 2001) involved the populations in municipalities numbering less than 2000 inhabitants with no further justification of this measure (Majerová 2001, p. 12 in the English online version). Moreover, this approach is inconsistent with the typology adopted in the previous chapter of the same text, where the density of population in the studied municipalities is the essential element (Majerová 2001, p. 8 in the English online version). Another example of this problematic is the use of the term rural areas for the purpose of policy strategy elaborated by the Programme of rural development in the Czech Republic for the period 2004-2006 and for the following period 2007-2013. There, a clear definition



of a rural area is not given at all (further discussion of the consequences of this in Vobecká 2009b).

Radim Perlín remarks that authors concerned with recent rural development and rural municipalities in the Czech context do not discuss the question of the definition of rural municipalities, but instead concentrate on their derived characteristics, such as social problems and participation, architectural and urban structure, sustainable development and ecology or socio-economic living conditions in the rural areas (Perlín 2003, p. 3). Perlín himself is interested in rural settlement structure, and defined rural areas on the basis of a multicriterial analysis, taking into account a complex network of historical, social, economic and geographical criteria. The resulting definition distinguishes six types of rural areas: suburban areas, rural in the rich agricultural areas, rich Sudeten, poor Sudeten, inner peripheries and the Moravian-Slovak borderland (Perlín, 1999, 2003a). The distinction of rich and poor Sudeten in this typology had an undubiously important historical foundation. However today, more than a half a century after the resettlement of these former German settlement areas by new inhabitants from the Czechoslovak in-land, distinction on the historical basis is not so relevant for the studies of social and demographic structures and economic differentiation. Analysis of social-economic differences and social mobility based on Perlín's typology fails to reveal any significant differences between the types (Tuček 2003). Elsewhere, Perlín comes to the conclusion that the most suitable approach to the study of rural areas in the Czech context is, finally, the approach based on population count in the municipalities. He suggests that the breaking point between 2000 and 3000 inhabitants is suitable. Furthermore, he proves that administratively defined towns match closely with those municipalities numbering more than 2500 inhabitants. For Perlín, multicriterial classifications of the rural or urban character of municipalities are only applicable on the micro-level of observation (Perlín 2003b, p. 14).

It has often been the concern of the Czech Statistical Office to come up with new definitions of urban and rural areas. Before each population census since 1960, the categories of urban and rural areas have been revised. Commonly, the units used to define them have been municipalities. In 1961, a classification was created dividing municipalities into five distinct categories according to a complex of criteria (e.g.

proportion of population employed in agriculture, urban attributes, presence of higher service facilities).<sup>7</sup> The resulting division consisted of five categories: regional and departmental towns, other towns, small towns, agglomerated municipalities and rural municipalities.<sup>8</sup> The first four categories were counted as urban and included 457 towns. A very similar classification was used in the population census of 1970, although the definition of respective categories was considerably changed. 602 municipalities were defined as towns. For the 1980 census, a new classification was established which stressed the departmental importance of municipalities. According to its calculations, 345 municipalities were considered as towns. A similar classification was used in the census of 1991 when 348 towns were thus defined (Rozmístění a koncentrace... 2004). The criteria have changed from one census to another, making comparison difficult. For the occasion of the latest census in 2001, no such definition was established. The Czech Statistical Office now uses a very simple definition of rural areas. Rural areas consist of municipalities which do not have the status of a town. Town status is politically and historically determined and is not related to any socio-geographic limitation<sup>9</sup>. At the same time, data sorted by the population size of the municipalities are also published, thus making the binary classification based analysis possible. The Czech Statistical Office considers the present urban-rural classification as insufficient and is searching for a new one. A large variety of alternative classifications is being considered for the analysis of population dynamics, socio-economic characteristics and land use. The proposed variants range from the simple ones based on population size to those involving multiple criteria combining number of inhabitants, density of built-up areas or distance from regional centres. A public debate was initiated in 2008 in the aim of finding the best fitting definition.

The most commonly used classifications of urban and rural areas in the Czech Republic presented above are mainly quantitative definitions based on the binary distinction between municipalities according to population size or predicated on municipal administrative status. These classifications do not take into account the spatial

---

<sup>7</sup> The classification was finalised by Milan Kučera.

<sup>8</sup> For more details about this classification, see Pavlík (2005).

<sup>9</sup> Although a population size limit of 3000 inhabitants minimum for newly designated towns was introduced in 2000 (by law No. 128/2000 col.).

organisation of the population, settlement or economic activities. They do not distinguish between core and periphery in the sense I am looking for to further my analysis. The agglomeration power of the core urban areas cannot be deduced from them nor can a delimitation of more remote areas be drawn up.

#### **4.1.2. Existing approaches in Europe**

Approaches to urban-rural delimitation in other European countries are more varied. Still considering solely the family of classifications targeted to quantitative statistical studies of population or related matters, the common feature of the quasi-totality of these approaches is that their point of departure is the definition of urban areas. The rural is then defined as what is not urban or under urban influence. Generally speaking, in Europe, there exist two types of delimitation of urban and rural areas: conceptual or based on government decision. The latter are simply based on legislation defining which municipalities or regions will be considered as urban and which as rural. The decision may be based on scientific expertise, but more often than not it is a simple decision resulting from traditional legal status or based simply on the number of inhabitants. These approaches are dominant in the countries of Central and Eastern Europe (according to ESPON (2003); they are thus used in the Baltic states, Hungary, Poland and Slovakia). The Czech Republic is not considered in the ESPON document as using the government decision definition, although this is how urban and rural areas are officially defined by the Czech Statistical Office. In Western Europe, on the other hand, all countries use conceptual definitions.

In the EU, an OECD definition for policy purposes and for international comparison is used. Rural areas are defined therein according to population density and the construction of categories consists of two steps. On the local (municipal) level, rural municipalities are defined as those with a population density under 150 inhabitants per km<sup>2</sup>. The second step is a definition of significantly rural regions, predominantly rural regions and predominantly urban regions. Significantly rural regions are those in which more than 50 % of the population lives in rural municipalities; predominantly rural regions are those in which 15 to 50 % of the inhabitants live in rural municipalities and predominantly urban regions count less than 15 % of its inhabitants living in rural

municipalities. In the Czech context, all regions except for Prague and the Moravskoslezský region are defined as predominantly or significantly rural. This definition is very useful to maximise the area and population eligible for benefits from EU funds which are distributed according to this criterion. On the other hand, it is rather unsuitable for the analysis of the differentiation of populations between urban and rural areas.

Here, I will direct my attention to those classifications which make an attempt to cover the functional interconnection of urban cores and their hinterlands. I will do so in the aim of developing an approach which can then lead to the construction of an appropriate functional classification for the Czech Republic. I will discuss approaches adopted in the Netherlands, Belgium, Germany, Great Britain and France, mainly with the help of the comprehensive overview published by Caruso (2002).

The Statistical Office of the Netherlands has adopted a classification which divides municipalities into three general categories: rural, urbanised rural and urban. Rural areas are divided into sub-categories according to the proportion of the population working in agriculture. Urbanised rural areas are defined according to the proportion of inhabitants employed in agriculture and the proportion of the economically active population which commutes to work. Urban areas are divided to subcategories according to population size. There exist also an alternative definition according to which rural areas have less than 1 000 addresses per km<sup>2</sup> and urban areas have at least 1 500 addresses per km<sup>2</sup>.<sup>10</sup> The densely populated and urbanised Netherlands has few rural municipalities. Suburbanisation is a longstanding tradition begun in the 1950s and continuing for two decades. It was a process which affected even the smallest towns of a few thousand inhabitants. Town centres deteriorated because of the loss of the resident population. Therefore, in the 1980s, a programme of “compact towns” was launched in the aim of revitalising the urban cores and regulating urban sprawl. In the Netherlands, there is a strong tradition of municipal and state intervention in spatial planning and therefore the application of policy visions is reflected in the organisation of the population in space.

---

<sup>10</sup> Source: <http://www.cbs.nl/en-GB/menu/themas/dossiers/nederland-regionaal/publicaties/artikelen/archief/2005/2005-1651-wm.htm> (cit. 2.2.2010)

In Belgium, the definition of core and periphery combines morphologic variables (population density and built-up area) with functional ones (economic interconnection, school and work commuting) (Mérenne, B. et al. 1998)<sup>11</sup>. Based on the cluster analysis of the two variable groups, nine municipality types are identified which combine the characteristics of strong, moderate or weak morphologic functional interconnection with urban agglomerations. A strong suburbanisation flow has taken place in Belgium since the 1960s, when urban cores were losing and hinterlands were gaining in population and the construction of family houses. Since the 1980s, there have been signs of a slow down in urban population losses, partly because of the effects of foreign immigration and partly because of the increasing attractiveness of urban cores for residence.

In Germany, the Federal Office of Building and Regional Planning (Bundesamt für Bauwesen und Raumordnung<sup>12</sup>) defines urban regions (Stadtregion). They comprise central cities (44 in Germany) which number more than 80 000 inhabitants and suburban areas which are functional environs defined according to the intensity of work-commuting. According to this authority, suburban areas are further divided into narrow suburban areas and wider suburban areas. Residential suburban flows have gained in force since the 1960s. Since the 1980s, the suburbanisation of employment has taken place as well and direct dependence on the central city is decreasing, although the tide of dependence on the functional complex agglomeration remains unchanged.

In Great Britain, there exist a wide range of urban-rural definitions which vary according to purpose. Their overview is given for example in "A review of urban and rural area definitions" (2002). The definition used by British National Statistics for the delimitation of functional regions is called "Travel to Work Areas". The fundamental criterion is that at least 75 % of the resident economically active population actually works in the area, and also that at least 75 % of everyone working in the area actually lives in the area<sup>13</sup>. This delimitation is therefore based on work commuting data. Its prime purpose is not to define urban cores and more remote areas. Nevertheless, the definition of functional

---

<sup>11</sup> Cited from Bengs, Christer, Schmidt-Thomé, Kaisa (eds.).

<sup>12</sup> Source:

[http://www.bbr.bund.de/nm\\_26208/BBSR/EN/Publications/Forschungen/1999\\_\\_2006/114abstract.html](http://www.bbr.bund.de/nm_26208/BBSR/EN/Publications/Forschungen/1999__2006/114abstract.html)  
(cit. 2.2. 2010)

<sup>13</sup> More about the definition on <http://www.statistics.gov.uk/geography/ttwa.asp>, or in Coombes, Bond (2007) Travel-to-Work Areas: the 2007 review

labour regions allows for the definition, in a second step, of its core, with job concentration and periphery. Concerning state and regional intervention in urban planning, there are strict limitations on urban sprawl introduced by the establishment of “green belts areas” since the 1950s in Britain. These consist of areas around towns which are supposed to block urban sprawl to the rural land.

In France, the statistical office (INSEE, Institut national de la statistique et des études économiques), uses a geographical classification called ZAUER (Le zonage en aires urbaines et en aires d’emploi de l’espace rural)<sup>14</sup> (for more information, see Schmitt 1998). It defines urban cores according to the number jobs they provide. The suburban areas are then defined according to work commuting intensity to urban cores. Rural areas consist of municipalities which are not under strong commuting influence from urban cores and of small, secondary, local centres which provide a smaller number of jobs.

All of the approaches detailed above (except in part for the British case) have in common the aim of reflecting a functional interconnection between the core, concentrating economic activities, and the suburban areas and more remote areas. To this end, all of them make use of work commuting flows into the cores. Many of these classifications (Netherlands, Germany, Belgium, France) use for that purpose the NUTS 5 municipal level. For the definition of urban cores, the Netherlands and Germany use population size; in France, it is the number of employment opportunities and in Belgium, the population size of the agglomeration. These countries differ, of course, in their setting of the breaking point in the classification according to diverse settlement organisations, densities of population or commuting patterns particular to each country. Urban sprawl and suburbanisation took place in all of the above countries starting in the 1950s or 1960s. Initially, it consisted of residential suburbanisation oriented toward access to individual housing and was followed, to different extents, by the deconcentration of economic activities. Trends toward the return to urban cores have been noted in certain countries since the 1980s (Belgium, Netherlands, Germany). But this movement has concerned only certain social or age groups and the tendency of

---

<sup>14</sup> For more detail, see Schmitt (1998).

residential deconcentration continues to be a dominant flow. Finally, settlement planning on municipal, regional or state levels plays a distinct role in each of the observed countries. In the Netherlands and in Great Britain, settlement settings are more influenced by these policies than in the other observed countries. For the Czech context, the inspiring model may be that which defines a functional region according to work commuting intensity on the municipal NUTS 5 level. I will discuss this issue in more detail in the next chapter.

## **4.2 Core-periphery regional approach in the Czech Republic**

Another approach to assessing the agglomeration power of an urban core is via the establishment of hierarchical settlement systems. Hierarchically higher settlement units have more intense agglomeration power and serve as superior centres of economic activities and services for units lower in the hierarchy. Again, we can study this hierarchy on different scales: global, national, local... Here, we will focus on the national level in compliance with the scale of study adopted in this thesis. A systematic study of settlement hierarchy, its theory and concrete manifestation in the Czech Republic is provided by geographer Martin Hampl (Hampl et al. 1978, 1987, 1996 and Hampl 2005). Regionalisation is in a permanent process of evolution and the attractiveness of regional centres changes over time. Hampl studies this evolution on the basis of census data. The latest update therefore followed the Census of 2001. Work commuting catchment areas are the starting point of regionalisation. They are established according to the hierarchical composition of the dominant orientation of commuting flows toward hierarchically higher units (more details in Hampl 2005). The final result of this procedure is the establishment of regions and their centres on macro-, mezzo- and micro levels. Macro-level regions are of importance to the whole country and in the Czech Republic, there is only one such centre – Prague. The mezzo-level represents centres and areas on the sub-national regional level of regional importance. According to Hampl's analysis, there are eleven urban cores on the mezzo-level in the Czech Republic: Brno, Ostrava, Plzeň, Olomouc, České Budějovice, Zlín, Hradec

Králové, Ústí nad Labem, Pardubice, Liberec and Karlovy Vary. They were determined according to their population size, the size of their commuting catchment area and its relative autonomy. They all represent regional capitals of NUTS 3 regions (see Figure 2). Of the fourteen NUTS 3 regional capitals, Jihlava, a centre in the Vysočina region, is missing because its power of attractiveness is diminished due to its position between the two most important centres in the Czech Republic: Prague and Brno. The Středočeský region, situated around Prague, does not have a regional centre because of the dominance of Prague. The administrative borders of NUTS 3 regions are only partially in compliance with geographical regionalisation. The dominance of Prague's influential zone results in the weakening of almost all the neighbouring regions. Finally, the lowest, micro-regional level is represented by the other 132 regions, determined by the population size of their respective regions as between approximately 15 000 and 40 000 inhabitants.

Figure 2: Regions (NUTS 3) of the Czech Republic with their capital cities



Note: Praha: Prague; capital city and NUTS 3 region at the same time  
 “Středočeský kraj” means “Central Bohemian region”  
 “Kraj” means “region”  
 Thin white lines are NUTS 4 (district) borderlines.



The principal dynamics of regional organisation during the period of major societal transformation between 1991 and 2001 further accentuated the dominance of Prague (Hampl 2005, Blažek, Csank 2007). This dominance is reflected in the further spread of its commuting catchment area and a reduction in the number of regions on the micro-level, as some of them close to Prague have lost their relative micro-level autonomy (e.g. the micro-regions of Kladno, Beroun, Nymburk). On the mezzo-level, the growing dominance of Prague caused the Olomouc and Zlín regions to be dominantly oriented toward Prague and no longer toward the geographically closer Brno. Eleven mezzo-level centres therefore lost ground relative to dominating Prague in the hierarchical scale, but their positions were strengthened vis à vis the centres on the lower hierarchical level. Centres on the micro-level (generally NUTS 4 centres) lost their regional importance. Commuting mobility underwent an intensifying tendency. As Hampl claims (2005, p. 78), the intensity of work commuting outside the municipality of residence rose to almost 40 % of all economically active individuals. This figure also reflects the increase in the economic importance of commuting due to regional disparities in wages and unemployment. The high proportion of non-daily commuting suggests that it is somehow a compensation for the proper migration process in a context of rent regulations and a therefore deformed housing market. This hypothesis is also supported by the decline in residential migration witnessed in the 1990s.

In my study, the core-periphery distinction will be done on the NUTS 3 regional level. As is clear from the studies of Hampl (2005), Prague has an outstanding position and therefore should be considered as core. Further descriptive analysis will show how the other regions will be classified. Such a classification will be drawn up according to the analysis in part 6.1. and 6.2. of regions' attractive power as measured by migration flows and other demographic and socio-economic characteristics. This will lead me in Chapter 7 to decisions on whether another region may be classified as core, which of them will be considered as periphery and how refined the clustering will be. I am aware of the fact that NUTS 3 regions are rather large and heterogeneous units and that such a level of generalisation can hide some intra-regional differences. That is why the regional approach is combined with the urban-rural gradient one which enables the inside into the

regional structure. At the same time, I am convinced that working with NUTS 3 region is supported by the findings about the laws of macroregional hierarchies and their evolutions as described by Hampl (2005).

## **5. COMMUTING BASED CLASSIFICATION: A NEW APPROACH TO THE URBAN-RURAL GRADIENT DEFINITION IN THE CZECH REPUBLIC**

Definition of core and peripheral areas used to study population dynamics cannot be based on any definitions which already exist in the Czech Republic (Section 4.1.1 and Vobecká 2009a). The appropriate approach, which needs to be quantitative and applicable on the municipal level to the territory of the whole country, must therefore be constructed here. The inspiration for such a definition was sought among definitions used in other European countries (Section 4.1.2). All of the above-mentioned approaches used commuting flows as an indicator of the functional interconnection between urban core, its hinterlands and more remote areas. Commuting can be seen as an approximation for the agglomeration forces of urban cores. The definition of urban, suburban and rural areas can be interpreted as the result of particular agglomeration and dispersion forces relating to the labour market, the land market and the area's attributes (Schmitt, Goffette-Nagot 1999, Schmitt, 1999). The cornerstones of the spatial organisation are urban centres as the places of population concentration and concentration of firms and employment. Urban centres' micro as well as macroregional strengths influences their hinterlands. The definition most relevant to the case of the Czech Republic is the ZAUER definition used in France.

There are several reasons for this:

1. The definition is used as a framework for the study of spatial population dynamics in France.

2. French settlement structure is quite similar to that of the Czech Republic and therefore the parallel between the two countries can be made more easily (see table 2). This is particularly true for the proportion of municipalities of less than 2 000 inhabitants and the proportion of inhabitants living there.

*Table 2: Municipalities and population by size of municipalities in France and in the Czech Republic, in %*

Municipality pop. size	France		Czech Republic	
	Municipalities	Population	Municipalities	Population
	in %	in %	in %	in %
to 199	29,7	2,3	26,5	2,0
200 - 499	29,1	6,0	32,6	6,5
500 - 999	16,5	7,4	20,5	8,7
1 000 - 1 999	8,4	7,4	10,4	8,8
<i>Sub-total</i>	83,7	23,0	90,0	26,1
2 000 - 19 999	9,5	19,4	9,0	29,1
20 000 - 99 999	2,6	13,2	0,9	24,0
100 000 plus, incl. capital	4,2	44,3	0,1	20,8
Paris/ Prague alone	1,0	16,5	0,0	11,4
<i>Sub-total</i>	16,3	77,0	10,0	73,9
Total	100,0	100,0	100,0	100,0

Note: Paris also includes the agglomerated municipalities.

Source: France: Insee, Population census 1990. Cited from Schmidt et al. (1998)

Czech Republic: ČSÚ Population census 2001, author's computations.

The inspiration of the French ZAUER classification is evident in the choice of criteria for the definition of urban cores and the number of spatial categories with which I will operate. On the other hand, the scale for the definition of the respective categories was elaborated according to expert decision to best fit the Czech settlement structure.

## 5.1 Method

Our classification consists of three main spatial categories: centres, their suburban areas and more remote rural areas. The starting point of the classification construction was data concerning inter-municipal commuting flows and the work size of municipalities<sup>15</sup>. Municipalities in which more than one third of employed inhabitants commute to work in centres are considered as suburban. Municipalities in which less than one third of employed inhabitants commute to centres are considered as more remote rural areas.

<sup>15</sup> This refers to the approximate number of jobs. More detailed explanation is provided in the text below.

In order to define the spatial categories, data from the latest population census of 2001 were used. More precisely, the data concerning employed populations according to the place of work for all municipalities in the Czech Republic and the work size of municipalities were exploited. The source of the first was the Czech Statistical Office; the latter represents a composite measure representing an estimation of the number of jobs in municipalities. It was calculated as the sum of economically active employed residents and the balance of in and out work commuting in each of the municipalities<sup>16</sup>.

In the first step (1) primary and secondary centres were defined as municipalities and agglomerations whose work size exceeds 5000 for the first and 2000 for the second measurement. For this purpose, agglomerations were defined as consisting of two or more municipalities characterised by a continuity in their built-up areas and a strong functional interconnection. Following Hampl's definition (Hampl 2005, p. 139), 31 agglomerations counting 75 municipalities exist in the Czech Republic (see their list in Appendix 1). Using these criteria, 127 primary centres having 5 000 and more employment posts were identified. In the next step, those with a low attractive force were excluded. The attractive force of a large centre was defined as the fact of having a larger work size than the number of economically active employed residents. It was used to approximate the autonomy of primary centres and to exclude the large residential municipalities with relatively a weak economic base. By applying this condition, 12 units were excluded from the primary centres group (see their list in Annex 2). The final number of large centres thus fell to 115, comprised of 147 municipalities (when counting individually the municipalities considered as agglomerated) (see their list in Annex 10).

Next (2) 159 *small centres* with more than 2 000 but less than 5 000 employment posts were identified. 10 municipalities excluded from the group of large centres were added to them, bringing their number up to 169. Later, 20 small centres were excluded from the group because they fell into the category of the outer fringe of large centres. Finally therefore, we were left with 139 small centres accounting for 147 municipalities.

---

<sup>16</sup> The data were kindly provided by Professor Martin Hampl.

Around the primary centres (3) municipalities in the inner fringe, in the outer fringe and polycentric municipalities were defined, as well as the suburban areas of secondary centres (4). Finally, the rural municipalities were the remaining ones (5).

Figure 3: Urban, suburban and rural areas in the Czech Republic according to the urban-rural gradient commuting approach

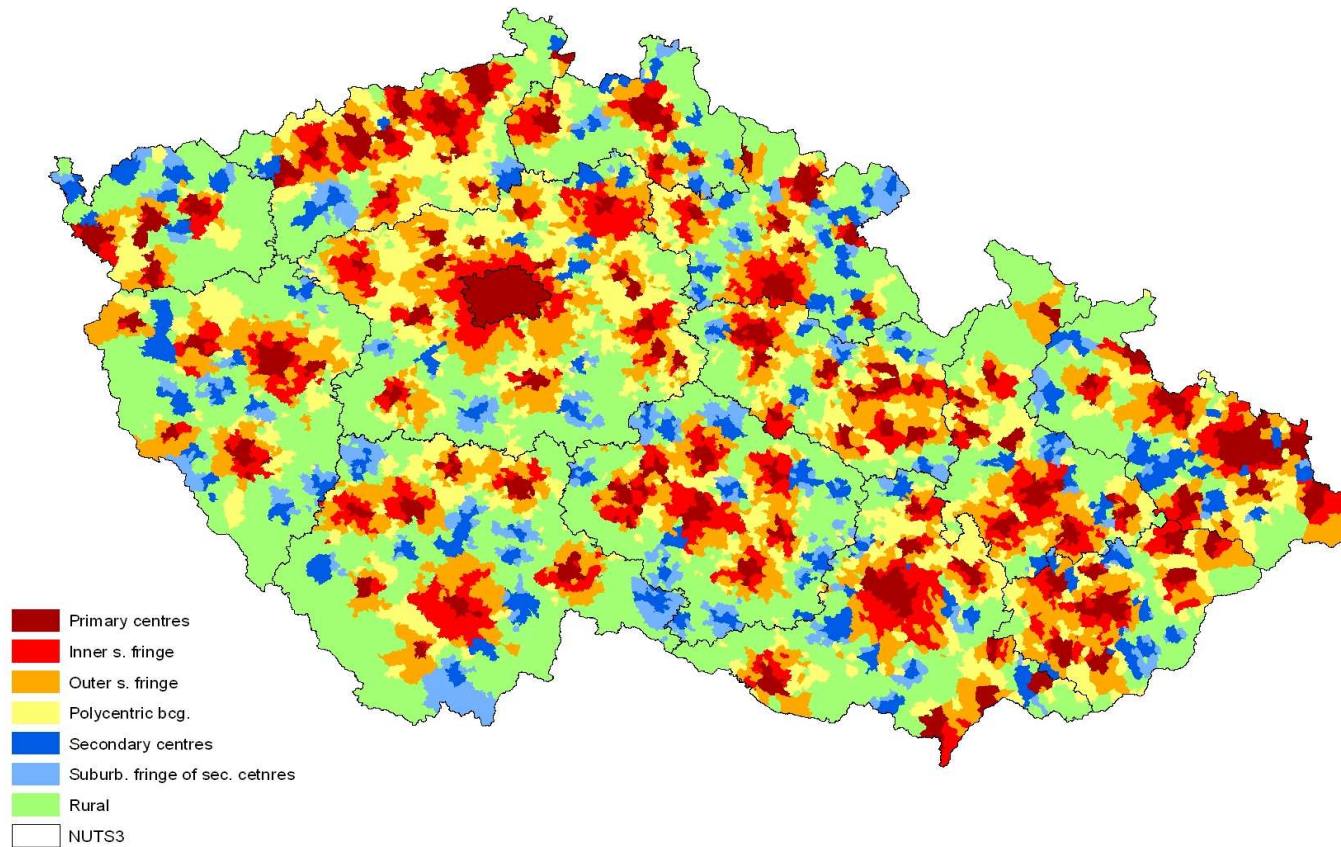

Source: Author. Based on the 2001 Census data.

The review of defined urban-rural gradient categories is given here:

*Primary centres* are defined as towns and agglomerations<sup>17</sup> whose work size is more than 5 000 employment posts that have more employment posts than resident employees and that do not belong to the fringe of another large centre. We identified 115 primary centres, among which the smallest town, Stříbro, numbered 7 781 inhabitants in 2001.

The *inner suburban fringe* consists of municipalities in which at least 50 % of employed inhabitants commute to primary centres. They numbered 1 054.

The *outer suburban fringe* consists of municipalities in which the workers commuting to primary centres account for more than one third (33.3 %) but less than a half of all employed residents. We identified 1 390 such municipalities.

The *polycentric background* consists of municipalities in which more than one third (33.3 %) of employed inhabitants commute to work to two or more primary centres but none of these centres draws more than one third of all commuters. This stipulation is the reason why these municipalities are not counted in the category of the suburban fringe. There are 1 103 municipalities in this category.

The polycentric background together with the fringe forms the suburban area of the primary centres. They represent an area in which the inhabitants live in relatively close economic connection with primary centres (by intensive work commuting) although they are outside their administrative boundaries.

In the areas characterised by a lower intensity of interconnection with primary centres, we defined:

*Secondary centres* as municipalities and their agglomerations whose work size is between 2 000 and 5 000 and which belong neither to an inner nor to an outer suburban fringe. They account for 139 occurrences and only two of them (Dukovany and Temelín, atomic plants localities) number less than 2 800 inhabitants.

---

<sup>17</sup> Agglomerations are defined according to the list of agglomerations in the Czech Republic in Hampl 2005.



The *suburban fringe of secondary centres* consists of municipalities in which at least one third (33.3 %) of employed inhabitants commute to secondary centres. There are only 465 municipalities in this category.

Municipalities and inhabitants which do not belong to any of the above defined categories are considered as *rural*. They account for 1 951 municipalities.

Secondary centres, their suburban fringes and rural municipalities form a counterweight to the primary centres and their suburban areas.

## 5.2 Discussion

The breaking values of work size for the definition of primary and secondary centres, as well as the breaking points for commuting zones defining suburban areas are the result of expert decision and based on the character of settlement structure, settlement hierarchy and municipality population size. Among the primary centres, are included all of the former district capitals (NUTS 4 units) in addition to those centres which are attractive from the viewpoint of their work size, providing more jobs than economically active residents. Secondary centres are centres of local importance. Classification is based on the functional interconnection between defined centres and other municipalities. The stress is therefore not placed on settlement hierarchy definitions. Commuting based definitions of urban and rural areas here provide a novel tool in the study of spatial population dynamics. They represent an alternative to the quantitative approaches currently used in the Czech Republic. Contrary to other approaches, the method elaborated here allows for the definition of suburban areas and more remote rural areas. Its relatively simple construction technique, requiring only a few input variables, is one advantage of our method. It also allows for relatively simple updating by new data when available; in our context, by data from the forthcoming population census in 2011. The threshold values used in the definitions of classes are the result of expert decision. These values were established after testing for different threshold values and after consultation with Czech geographers and examination of the literature concerning the Czech settlement system.

In spite of its convenience, certain limitations of the commuting approach need to be pointed out. Like other quantitative methods, it is very sensitive to the choice of defining variables and to the thresholds and intervals defining each category. Definitions drawn up using a limited number of variables represent a compromise, one which omits other variables which might lead to different decisions. The commuting approach is meant as a framework for the study of spatial population dynamics; it serves to classify the population into spatial categories by means of which further study will proceed. The classification units themselves do not predestine the population characteristics of the respective spatial category; they are thus categories and not types. The danger of mistaken utilisation and interpretation of the classification might lie in the assumption that the sociological characteristics of a population can be “read ” according to the spatial category in which it is situated (Newby 1985: 211). The commuting approach is a spatial classification which does not assume the homogeneity of social, demographic, cultural or other characteristics of the populations within the categories. It represents a tool in the study of spatial population differentiation and an alternative to the classifications of urban and rural areas which have been widely used in the Czech Republic until now.

## **PART III.**

### **ANALYSIS OF THE SPATIAL POPULATION DYNAMICS IN THE CZECH REPUBLIC**

## **6. DESCRIPTIVE ANALYSIS OF POPULATION STRUCTURE AND DYNAMICS IN SPATIAL CATEGORIES**

Population characteristics will here be described according to the urban-rural gradient approach whose categories are defined in chapter 5 and according to regional appurtenance.

First, I will overview the population dynamics and its natural components and migration movements from the urban-rural gradient perspective. In a second stage, I will distinguish the effect of regional appurtenance on one hand, and of the urban-rural gradient on the other, on demographic and socio-economic characteristics. This will allow for a comparison of the explanatory power of both urban-rural and regional spatial approaches for the respective variables. Shift and share analysis will be used for that purpose. Finally, on the basis of the results of descriptive analysis, I will finalize the classification of regions as belonging to the core or periphery. This will represent the second axis of spatial perspective (with the first being the urban-rural gradient) developed in further analysis.

### **6.1. General characteristics of space and population**

The population is unevenly spread over the Czech territory. Three quarters of the population live in primary centres and suburban areas of which more than a half, 52.7 %, in primary centres (see table 2). Almost one quarter of the population, 23.8 %, lives in secondary centres and rural areas. Suburban areas of large centres cover a large part of the territory (43.8 %) and include 56.6 % of all Czech municipalities. This reflects the

important and far-reaching functional interconnection of large centres with their outlying areas and the habit of intensive work commuting. 148 secondary centres account only for 10.2 % of the population and their suburban areas are rather small in surface as well as in number of residents (1.6 % in total). Rural areas account for 12 % of the population, spread over more than one third of the territory (36.2%). In rural areas, together with suburban areas of secondary centres, we note the lowest population density (43, resp. 38 inhabitants per km<sup>2</sup>).

*Table 3: Municipalities and population by commuting approach classes, 2001*

	Number of municipalities		Surface, in km <sup>2</sup>		Population		Pop. density
	abs.	in %	abs.	in %	abs.	in %	per km <sup>2</sup>
Primary centres	147	2,3	6 624	8,4	5 393 076	52,7	814
Inner suburban fringe	1 054	16,8	8 166	10,4	640 554	6,3	78
Outer suburban fringe	1 390	22,2	14 273	18,1	1 019 890	10,0	71
Polycentric background	1 103	17,6	12 080	15,3	744 747	7,3	62
<i>Primary c. and suburban</i>	<i>3 694</i>	<i>59,0</i>	<i>41 143</i>	<i>52,2</i>	<i>7 798 267</i>	<i>76,3</i>	<i>190</i>
Secondary centres	148	2,4	4 891	6,2	1 043 858	10,2	213
Suburban fringe of sec. c.	465	7,4	4 291	5,4	163 341	1,6	38
Rural	1 951	31,2	28 541	36,2	1 224 594	12,0	43
<i>Secondary c. and rural</i>	<i>2 564</i>	<i>41,0</i>	<i>37 723</i>	<i>47,8</i>	<i>2 431 793</i>	<i>23,8</i>	<i>65</i>
<i>Czech Republic</i>	<i>6 258</i>	<i>100,0</i>	<i>78 865</i>	<i>100,0</i>	<i>10 230 060</i>	<i>100,0</i>	<i>130</i>

Source: Census 2001, ČSÚ (Czech Statistical Office), author's computations.

Population growth has evolved in the past three decades from slightly positive in the 1980s to negative in the 1990s to slightly positive again in recent years. It is important to look at this evolution from a wider time perspective, that is, since 1980, because there occurred a change in tendencies in the processes of spatial population modification as a result of overall societal changes (Rychtaříková et al. 2007, Sobotka et al. 2003, see also Sections 2 and 4.2). The elements of population change, natural increase and net migration rate, were shaping both the particular form of this evolution and its intensity. Migration, which plays an extremely important role in spatial population differentiation

and dynamics turned from positive net in-flows to urban centres to negative ones in the scope of the few years between 1991 and 1995 (see Figure 4 and Annex 4). The recent revival of the attractiveness of migration to primary centres is mainly due to the positive net migration to Prague, caused mainly by foreign immigrants. Other urban centres still have negative net migration rates. On the other hand, the previously non-attractive suburban areas have experienced population growth since the beginning of the 1990s marked by an intensifying tendency from about 2000 onwards. Natural increase differentiation is of much smaller scope but moving in the same direction as net migration. The positive natural increase of urban centres became negative in the 1990s, with a decreasing differentiation between the urban-rural gradient categories. Only recently, suburbanisation has brought slight growth in natural increase into the inner fringes. In general, the population change differentiation between urban, suburban and rural areas has recently become more important, due mainly to differentiated migration flows, which will probably only later be accompanied by higher differentiation of natural increase with the first signs given by the natural increase in inner fringes of primary centres. The most dynamic evolution in net migration and recently in natural increase as well, is clearly in suburban areas. This evolution means that rural and suburban categories no longer belong to a single cluster. Migration losses and natural decrease clearly follow the logic of proximity to important centres of employment, with inner fringes being the most dynamic, largely outdistancing more remote suburbs and rural areas.

Figure 4: Population change rates (A), natural increase rates (B) and net migration rates (C) in urban-rural gradient categories in selected years between 1980 and 2007, in ‰

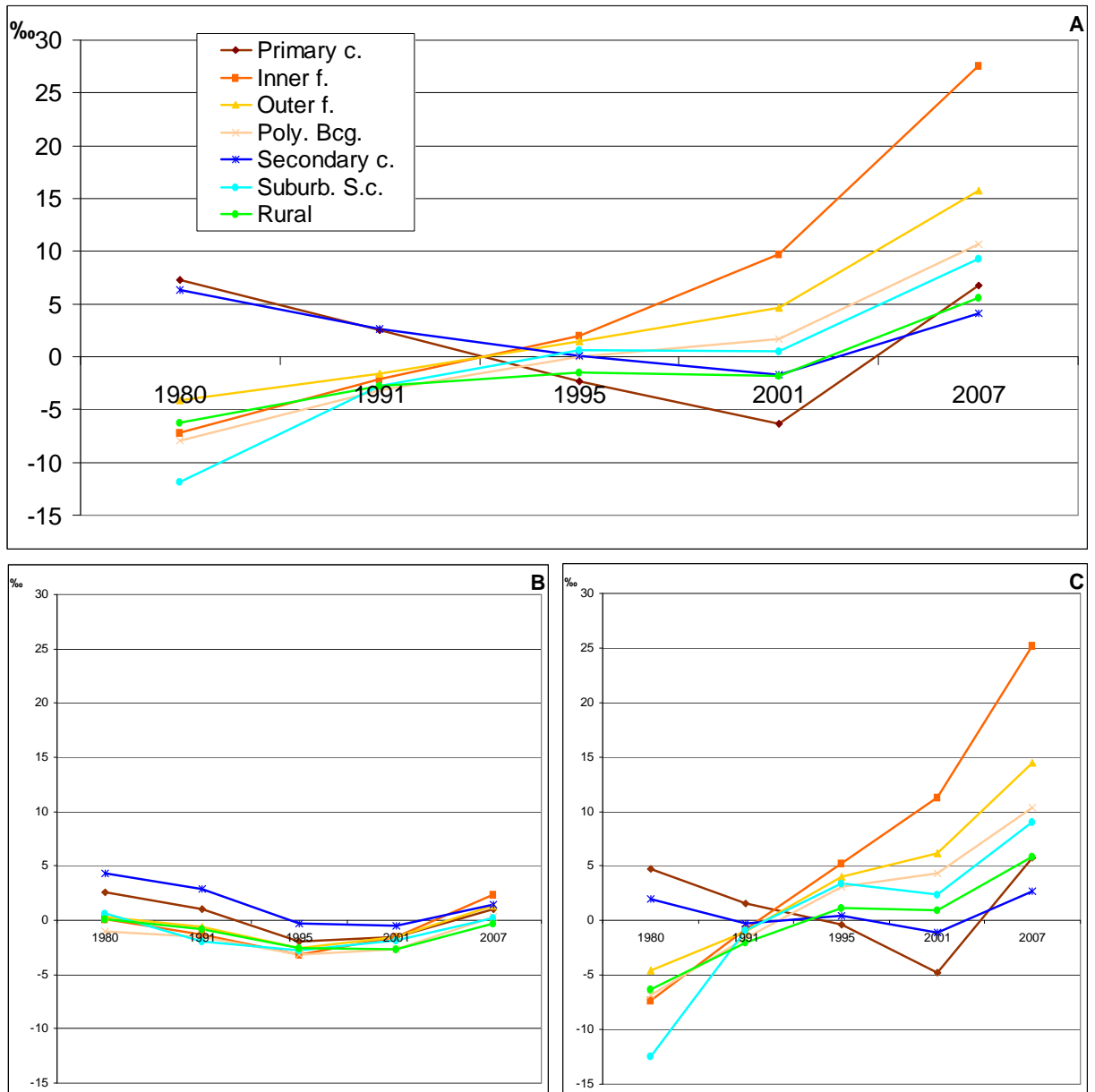

Source: Czech Statistical Office (CSO), author's computation.

The number of municipalities in the Czech Republic was changing considerably. Therefore also the capacity to identify their appurtenance in the urban-rural gradient classification (created using the 2001 data) was complicated. For the years 1980, 1991 and 1995 only the municipalities with the ID still existing in 2001 were taken into account:  $N_{1980} = 5127$ ,  $N_{1991} = 5738$ ,  $N_{1995} = 6215$ ,  $N_{2001} = 6258$ ,  $N_{2007} = 6247$

Note: For the table of absolute numbers and rates see Annex 4.

When we look in detail at the evolution over the last two decades, we see that the primary centres massively lost population in the decade between 1991 and 2001; secondary centres and rural areas also slightly lost population. In total, the population of the Czech Republic was decreasing. The losses between 1991 and 2001 numbered 72 thousand, or -0.7 % of the total population. Suburban areas were the only ones to increase in population during this period. The highest levels of growth were in the inner fringes, the areas of closest interconnection to primary centres. The growth of Prague's inner fringe reached 10 % and was significantly higher than that of the inner fringes of other primary centres (4.1 %; Table 4). The growth of outer fringes was less intensive, with, again, significantly higher growth in Prague's outer fringe. Backgrounds of primary centres achieved only moderate growth. The dynamic growth of the Prague suburbs at that time coincides with an important population decline in Prague itself (-3.7 %), a much more intensive decrease than in other primary centres (1,8 %; Table 4). Therefore, the suburbanisation process was more intensive and far-reaching in the Prague metropolitan area than elsewhere, and that the major losses of population in Prague between the 1991 and 2001 censuses were due to the relatively high outflow of the population to suburban areas, combined with negative natural increase. In the context of general population decrease in the Czech Republic, the population growth in suburban areas was a result of positive net migration rate rather than of positive natural increase.

Between 2001 and 2007, the situation had already changed. The year 2001 is taken here as a "rational" break point. "Rational" because it was a year of a new population census and a year of a new definition of foreign citizens who are counted among Czech population. From 2001 onwards all the foreigners with a longterm permission of stay (more than 3 month) are counted between the total number of population. Before 2001 only the foreigners with permanent residence were counted. This change in definition led to the increase of the total number of population and the rates of its relative growth. At the same time, after 2001 a steady economic growth went on, together with dynamic development of residential suburbanisation and only very recently (after 2004) growth of fertility rates and return to a positive natural increase (from 2006 onwards).



In Prague-city and its suburban areas the total population growth was far most dynamic and positive compared to all other regions and spatial categories between 2001 and 2007. Prague-city total population growth became positive and the population of Prague grew by 3,7 % between 2001 and 2007. The new definition of population after 2001 and increasing number of foreign in-migrants is the main cause of population growth in Prague<sup>18</sup>. We do not dispose of the structure of residential migrants by their Czech or foreign nationality, however given the intensified suburban residential growth around Prague and the negative natural growth of Prague population and due to the prominent position of Prague in the attractiveness for foreigners, I expect that most of Prague-city total population growth in this period is due to the foreigners. Suburban fringes around Prague knew particularly high population gains. The inner and outer Prague fringes grew by 33.0 %, and 21.5 % respectively in six years (Table 4). Population of Prague city and its two suburban fringes grew in total by 6 % in six years between 2001 and 2007. In the decade between 1991 and 2001 the same territory have lost 2,2 % of population. Although the new definition of population complicate a comparasion of these two numbers, the conclusion that attractiveness of Prague region have been growing is undeniable.

The other primary centres and their suburban fringes were stagnating in their total population growth. Their total growth was however slightly positive (0,4 %) compared to the previous decade 1991-2001 when it was slightly negative (-0,7 %; Table 4). Fringes around other primary centres witnessed higher population increases than in the 1991-2001 period, growing by 9.4 % and 4.3 % respectively. Suburbanisation seemed to spread out, reaching areas further away from the primary centres. This is discernable not only on the level of the growth of outer fringes, but also in the increased growth in the polycentric background population by almost 25 thousand inhabitants or 3.3 %.

Rural areas and secondary centres' population growth was modest. Secondary centres were slightly losing population (-0,19 %) whereas its suburban areas and rural areas had a slight population gain (2,9 % and 0,9 % respectively). Although the population growth in rural areas was moderate, it represent a turning point in the long lasting

---

<sup>18</sup> One third of resident foreigners living in the Czech Republic are concentrated in Prague. (136 thousand from 424 thousand in 2008)

tendency in population losses in rural areas. For the first time after many decades or even a more than a century rural areas knew a positive population growth due to the positive net migration gains (Table 5).

*Table 4: Population change by residential categories between 1991 and 2001 and between 2001 and 2007*

	1991	2001	2007 (a)	Population Change 1991-2001		Population Change 2001-2007	
	Population	Population	Population	Total	Rate, in %	Total	Rate, in %
Prague - city	1 214 174	1 169 106	1 212 097	-45 068	-3,71	42 991	3,68
Inner fringe of Prg.	72 693	80 029	106 403	7 336	10,09	26 374	32,96
Outer fringe of Prg.	90 806	98 201	119 272	7 395	8,14	21 071	21,46
<i>Prague city and fringes</i>	1 377 673	1 347 336	1 437 772	-30 337	-2,20	90 436	6,71
Primary centres - other	4 301 830	4 223 970	4 153 971	-77 860	-1,81	-69 999	-1,66
Inner suburban fringe	538 413	560 525	613 447	22 112	4,11	52 922	9,44
Outer suburban fringe	904 094	921 689	961 599	17 595	1,95	39 910	4,33
<i>Other primary c. and fringes</i>	5 744 337	5 706 184	5 729 017	-38 153	-0,66	22 833	0,40
Polycentric background	740 061	744 747	769 391	4 686	0,63	24 644	3,31
<i>All primary c. and suburban areas</i>	7 862 071	7 798 267	7 936 180	-63 804	-0,81	137 913	1,77
Secondary centres	1 052 855	1 048 910	1 046 958	-3 945	-0,37	-1 952	-0,19
Suburban fringe of secondary c.	156 890	158 289	162 885	1 399	0,89	4 596	2,90
Rural	1 230 399	1 224 594	1 235 107	-5 805	-0,47	10 513	0,86
<i>Secondary c. and rural</i>	2 440 144	2 431 793	2 444 950	-8 351	-0,34	13 157	0,54
<i>Czech Republic</i>	10 302 215	10 230 060	10 381 130	-72 155	-0,70	151 070	1,48

(a) The number of municipalities on 31.12.2007 was 6249. Two municipalities newly founded in 2006 (558419 Držovice and 558443 Lahná) were considered as part of the inner suburban fringe.

Source: ČSÚ: Census 2001, data from Census 1991 recounted to the settlement structure of 2001, population balance for 31.12. 2007, author's calculations.

The only categories to lose population in the period 2001-2007 were urban centres, Prague excluded. This period was therefore marked by on-going, intensified and outward spreading suburbanisation, and at the same time by overall population growth. This growth was mainly due to positive net migration from abroad. In the period 2001-2005, large population losses caused by negative natural increase (-65,3 thousand) were compensated for by positive net migration (84,3 thousand; Table 5). Since 2006, there has been a slightly positive natural increase in population for the first time since 1993. Nevertheless, the increasing number of foreign in-migrants is the main cause of population growth<sup>19</sup>.

The components of total population change, natural increase and net migration played unequal roles in the population dynamics of the spatial categories. On average during the years 2001-2005, the natural increase in population was much less variable between the categories than net migration (Table 5). Generally negative, natural increase varied between an average annual level of - 0.23 % in rural areas and 0.02 % in the Prague outer fringes. Apart from rural areas, the lowest natural increase levels were recorded in Prague and in the polycentric background. This may result from an older age structure, lower fertility levels or higher death rates in these areas. On the other hand, the only category in which the natural increase registered slightly positive or very close to zero is Prague's inner and outer fringes. It seems that the more intensive suburbanisation process brought in a higher proportion of people of childbearing age who, moreover, realized their reproductive capacities. Nevertheless, negative natural increase reached comparable levels in both primary centres (excluding Prague-city) and their suburbs. Negative natural increase is compensated for by positive net migration and turned into a positive total population change in all spatial categories except for urban centres (with the exception of Prague-city). The highest population increases caused by net migration gains are expectedly in suburban fringes, around Prague but also around other primary centres. Between 2001 and 2005 Prague suburban fringes have gained almost 27 000 inhabitants (Table 5) and by 2007 it was approximately other 20 000 more<sup>20</sup>. Suburban areas around other primary centres gained by net migration approximately as much as

---

<sup>19</sup> In 2006 there was a natural increase of 1 390 inhabitants and in 2007 it was 9 996, in the same years the in-migration numbered 34 720 in 2006 and 83 945 in 2007, according to Czech Statistical Office data.

<sup>20</sup> Roughly estimated from Table 4 from the total population gain 2001-2007.

population (60,9 thousand) as the primary centres have lost (-63,5 thousand) in the period 2001-2005. Rural areas gained 15 512 (0,13 % annually) inhabitants by net migration in the period 2001-2005 and it was enough to compensate for the population losses by the natural increase, not at all common situation in the rural areas in the previous decades. Rapid growth of suburban population by migration is a proof of ongoing process of residential suburbanisation. It is certainly remoulding the population structures in the suburban areas as well as in the areas of the departures of migrants,

*Table 5: Components of population change by residential category, 2001 - 2005*

	Population change 2001-2005		Natural increase 2001-2005		Net Migration 2001-2005	
	Total	Rate, in %*	Total	Rate, in %*	Total	Rate, in %*
Prague - city	11 134	0,19	-13 051	-0,22	24 185	0,42
Inner fringe of Prg.	14 691	3,44	-88	-0,02	14 779	3,46
Outer fringe of Prg.	12 084	2,35	102	0,02	11 982	2,33
Primary centres - other	-81 370	-0,39	-17 838	-0,09	-63 532	-0,30
Inner suburban fringe	30 430	1,06	-2 342	-0,08	32 772	1,15
Outer suburban fringe	22 247	0,48	-5 851	-0,13	28 098	0,60
Polycentric background	12 347	0,33	-8 165	-0,22	20 512	0,55
<i>Primary c. and suburb.</i>	21 563	0,06	-47 233	-0,12	68 796	0,18
Secondary centres	-5 978	-0,11	-2 387	-0,05	-3 591	-0,07
Suburban fringe of sec. c.	2 268	0,29	-1 363	-0,17	3 631	0,46
Rural	1 133	0,02	-14 339	-0,23	15 472	0,25
<i>Secondary c. and rural</i>	-2 577	-0,02	-18 089	-0,15	15 512	0,13
<i>Czech Republic</i>	18 986	0,04	-65 322	-0,13	84 308	0,17

Note: The number of considered municipalities is 6248, only municipalities existing during the whole period 2001-2005 are taken into account.

One-way analysis of variance between the urban-rural gradient group means of net migration rate is presented in Annex 3.

\* All rates are annualized.

Source: ČSÚ: population balance for 1.7. 2001 - 1.7.2005, author's calculations.

mainly urban areas. Therefore, the migration is the main factor of population differentiation within the Czech territory. The recent total population growth of rural areas signals a further spread of population dispersal and deconcentration. Further analysis will unveil who are the migrants to these areas.

Relatively important difference in the population change in the spatial categories between 2001-2005 and 2001-2007 showed in Tables 5 and 4 reveals a very dynamic evolution of the number of inhabitants of the Czech Republic between 2005 and 2007. Quick economic growth brought a large number of immigrants, this is visible mainly on the population change of Prague-city, the accentuated process of suburbanisation and turn into positive natural increase are playing important role as well in increasing the population gains in suburban areas and partially also in the rural areas.

The above description of population change and its components has provided a general overview of the tendencies in spatial population dynamics. The observed period, between 1991 and 2007, was cut into two parts according to data availability<sup>21</sup> but also according to changing tendencies in spatial dynamics. Population deconcentration from urban to suburban areas was observable around primary centres in the period between censuses 1991 and 2001 but was further accentuated between 2001 and 2007. Outstanding dynamics in that respect were observed in the suburban Prague area. Population losses were generally not the most pronounced in rural areas, as could be expected because of their relative remoteness, but in primary and secondary centres. When comparing the two large spatial categories of primary centres and their suburban areas on one hand, and secondary centres and rural areas on the other, we see that between 1991 and 2001 the population losses were more important in the first spatial category, whereas in the period 2001-2007 this trend reversed and the former category exhibited higher positive population growth than the latter (see Table 4). In this context, further research into the structure of migration and the socio-economic characteristics of residents is needed.

---

<sup>21</sup> I had to purchase the data held by the Czech Statistical Office (ČSÚ). Financial limitations and complicated communication meant that some data were simply not acquired or were acquired in a format which was compromise between the author's resources and the helpfulness of the ČSÚ.

*Table 6: Population change in regions between 1991 and 2001 and between 2001 and 2007*

Region	1991		2001		2007 (a)		Population Change 1991-2001		Population Change 2001-2007	
	Population	Population	Population	Population	Total	Rate, in %	Total	Rate, in %		
Praha	1 214 174	1 169 106	1 212 097		-45 068	-3,7	42 991	3,7		
Středočeský	1 112 882	1 122 473	1 201 827		9 591	0,9	79 354	7,1		
Jihočeský	622 889	625 267	633 264		2 378	0,4	7 997	1,3		
Plzeňský	558 307	550 688	561 074		-7 619	-1,4	10 386	1,9		
Karlovarský	301 985	304 343	307 449		2 358	0,8	3 106	1,0		
Ústecký	824 461	820 219	831 180		-4 242	-0,5	10 961	1,3		
Liberecký	425 120	428 184	433 948		3 064	0,7	5 764	1,3		
Královéhradecký	552 809	550 724	552 212		-2 085	-0,4	1 488	0,3		
Pardubický	508 718	508 281	511 400		-437	-0,1	3 119	0,6		
Vysočina	521 068	519 211	520 749		-1 857	-0,4	1 538	0,3		
Jihomoravský	1 136 832	1 127 718	1 132 249		-9 114	-0,8	4 531	0,4		
Olomoucký	642 796	639 369	636 221		-3 427	-0,5	-3 148	-0,5		
Zlínský	596 903	595 010	590 780		-1 893	-0,3	-4 230	-0,7		
Moravskoslezský	1 283 271	1 269 467	1 254 186		-13 804	-1,1	-15 281	-1,2		
Czech Republic	10 302 215	10 230 060	10 381 130		-72 155	-0,7	151 070	1,5		

Source: ČSÚ: Census 2001, data from Census 1991 recounted to the settlement structure of 2001, population balance for 31.12. 2007, author's calculations.

The population growth between 1991 and 2001 of a majority of the Czech regions was slightly negative or close to zero (Table 6). The regions with the highest population losses were Prague-city (Praha), Plzeňský and Moravskoslezský region. Prague-city was losing the population not only by negative natural increase but also by residential suburbanisation to its hinterland within Středočeský region (Central Bohemia). This is also reflected in the positive population growth of Středočeský region (0,9 %). Plzeňský and Moravskoslezský regions are both having large industrial centres (the city of Pilsen in the first case and Ostrava in the latter) which went through a deep restructuring of its economy in the 1990s. That might probably explain a part of the regional population losses. Moreover Plzeňský region cover also some peripheral areas where continued the longlasting trend of population losses (mainly in the north and west from Pilsen). In the recent period 2001-2007, the regions are more diversified in the population growth stays negative or close to zero in all Moravian regions and in Eastern-Bohemian ones (Pardubický and Královéhradecký). The regions Moravskoslezský and Zlínský are the

having even higher negative decrease of population in the period 2001-2007 compared to the 1991-2001. All the rest Czech regions have positive population change in the recent period. The most striking is the population increase in Prague-city (discussed above) and in Středočeský region (7,1 %). Středočeský region is a relatively large region surrounding Prague and therefore profiting well from Prague residential suburbanisation as well as from other regional consequences of Prague economic attractiveness. Moreover, in Středočeský region lies other economically important towns such as Mladá Boleslav and Kolín where are large car plants (Škoda and TPCA) attracting Czech and foreign workforce and residents as well.

The regional view on population change shows an outstanding position of Prague and the surrounding region and relatively stabilised and slightly positive growth of population in Bohemian region whereas population stagnation in Moravian regions or even deepening losses in Silesian Moravskoslezský region.

## **6.2 Demographic and socio-economic characteristics of the population from a regional and urban-rural gradient perspective**

In this chapter, further descriptive analysis will be undertaken in order to understand the structural differences of the population in the urban-rural gradient categories. At the same time, the importance of the regional determinant will be measured. Where the availability of data allowed, variables were controlled for differentiation in the age structure or the educational structure of the population. The tool of shift and share analysis has been employed for that purpose. This spacial type of regression model will help to assess the importance of different factors (independent variables) in explaining the spatial differentiation of demographic and socio-economic characteristics under study.

### 6.2.1 Structural-geographical analysis: analytical tool description

Population change, educational structure and fertility levels may differ by spatial categories in simple descriptive analysis. But such simple comparisons may omit certain important structural differences underlying the differentiation between spatial categories. For instance, the population growth rate over the time interval 0-1 may differ between spatial categories. But we do not know from simple descriptive analysis whether these differences are statistically important. We also do not know whether the differences are due to the characteristics of the spatial categories themselves or whether it is due to the difference of structures within the categories. Or another example, levels of fertility in rural areas may be higher than those in urban areas, but we do not know if this difference is a structural effect (eg. caused by differences in age structure or education) or an effect of the spatial category itself. To distinguish the structural effect from the spatial effect, we will use structural-geographical analysis (shift and share), which is in fact a special type of regression. In its description below, I will cite the explanation as presented in Gaigné et al. (2005) and Piguet (2005).

To be able to carry out our analysis, we need to have at least two quantitative variables and two qualitative variables. The quantitative variables serve to create the observed variable: growth rate proportion (over the time interval 0-1) or average. The qualitative variables serve to classify the population into sub-populations. I will describe here the shift and share analysis method applied to the example of population change between 1991 and 2001. Population change is composed of two quantitative variables, namely population in 1991 and population in 2001. The two qualitative variables are represented in this particular case by regions  $i$  where  $i$  ( $i = 1-14$ ) and by urban-rural gradient categories where  $j$  ( $j = 1-7$ ). Then, the decomposition of the shift and share analysis takes the form of three change ratios:

$$r_{ij} = r + (r_i - r) + (r_{ij} - r_i) \quad (1)$$



where  $r_{ij}$  is the population change rate in region  $i$  and gradient category  $j$ ,  $r$  is the total population change rate and  $r_i$  is the population change rate in region  $i$ . Given that  $P_{ijt}$  is the number of inhabitants in region  $i$  and gradient category  $j$  at a given time  $t$ ,  $t(t = 1991$  or  $2001)$ ,  $P_{it} = \sum_j P_{ijt}$ , the total population in region  $i$  at time  $t$  and  $P_t = \sum_i \sum_j P_{ijt}$ , the national sum of population at time  $t$ , these three change ratios can be expressed as follows:

$$r_{ij} = (P_{ij2001} - P_{ij1991})/P_{ij1991}$$

$$r = (P_{2001} - P_{1991})/P_{1991} = \sum_i \sum_j \frac{P_{ij1991}}{P_{1991}} r_{ij}$$

$$r_i = (P_{i2001} - P_{i1991})/P_{i1991} = \sum_j \frac{P_{ij1991}}{P_{j1991}} r_{ij}$$

If we now turn to the population change rate in the urban-rural gradient category  $j$  (not distinguishing the region), then  $r_j$  can be written as:

$$r_j = (P_{j2001} - P_{j1991})/P_{j1991} = \sum_i \frac{P_{ij1991}}{P_{j1991}} r_{ij} \quad \text{where} \quad \sum_i P_{ijt} = P_{jt}$$

From equation (1) we obtain the population change in gradient category  $j$  in the following structural-geographic equation:

$$r_j = r + s_j + g_j$$

$$\text{with} \quad s_j = \sum_i \frac{P_{ij1991}}{P_{j1991}} (r_i - r) \quad \text{and} \quad g_j = \sum_i \frac{P_{ij1991}}{P_{j1991}} (r_{ij} - r_i)$$

Total population change rate in gradient category  $j$ ,  $r_j$ , is then equal to the sum of three elements: (I)  $r$ , total population change rate in the whole country; (II)  $s_j$ , regional effect,

explaining the differences among rates  $r_j$  by differences in the regional distribution of each gradient category,  $(r_i - r)$  being identical for all gradient categories  $j$  (and therefore representing the deviation of population change in region  $i$  from the total population change ( $r$ )); (III)  $g_j$ , gradient effect, explaining the disparities between the gradient categories' levels of population change rate  $r_j$  by the differences between average population change rate in the region  $r_i$  and its gradient specific rate  $r_{ij}$ .

However, the classical method of shift-share analysis as presented above includes two disadvantages. Firstly, it mixes gradient effect and residual effect, with the result that the gradient effect is not clearly distinguished. Secondly, it does not allow for a test of significance of regional and gradient effects, because it is formulated as a tautology. To overcome these limitations, an analysis of variance based on Berzeg (1978) can be adopted. This involves an estimable stochastic formulation and consists in rewriting equation (1) as a linear model given by:

$$r_{ij} = \alpha + \beta_i + \gamma_j + \varepsilon_{ij} \quad (2)$$

where  $\alpha$  is a constant,  $\beta_i$  (resp.  $\gamma_j$ ) is a fixed effect of the  $i$ -th region (resp. the  $j$ -th urban-rural gradient category) and  $\varepsilon_{ij}$  is a random error term. In order to define the model, the two following constraints were introduced in model (2):

$$\sum_i \left( \sum_j w_{ij} \right) \beta_i = \sum_i \frac{P_{i1991}}{P_{1991}} \beta_i = 0$$

$$\sum_j \left( \sum_i w_{ij} \right) \gamma_j = \sum_j \frac{P_{j1991}}{P_{1991}} \gamma_j = 0$$

where  $w_{ij} = P_{ij1991}/P_{1991}$  is a weight coefficient necessary to achieve identical expressions with the descriptive model presented in (1), in this case,  $\hat{\alpha} = r$ . Because of

the introduction of the weight into the model, the variance of residuals is no longer homoscedastic (of equal variance). It is inversely proportional to the weight coefficients:

$$V(\boldsymbol{\varepsilon}_{ij}) = \frac{\sigma^2}{w_{ij}}$$

Testing the significance of the regional and gradient effects can therefore be accomplished. The significance of the regional effect is tested with the help of the null hypothesis that  $\beta_1 = \beta_2 = \dots = \beta_{I-1} = 0$ . The Fisher test of  $(I-1, N-I-J+1)$  degrees of freedom is applied. Statistical significance of the gradient effect with the help of the null hypotheses that  $\gamma_1 = \gamma_2 = \dots = \gamma_{J-1} = 0$  is likewise carried out. The Fisher test of  $(J-1, N-I-J+1)$  degrees of freedom is applied.

Finally, the calculation of regional and gradient effects for each gradient category can be calculated as the following linear combination of the estimates  $\hat{\beta}_i$  and  $\hat{\gamma}_j$  from model (2), respectively:

$$s_j = \sum_i \frac{P_{ij1991}}{P_{j1991}} \hat{\beta}_i \quad \text{and} \quad g_j = \hat{\gamma}_j$$

Thus, we can calculate their variance and determine whether these effects are significant or not (Jayet, 1993).

The analysis whose procedure is presented above and whose results are provided below was executed on selected data on population change and demographic and socio-economic characteristics of the population of the Czech Republic. Seven urban-rural gradient categories (variables  $j$ ) as defined by the commuting approach and detailed in

Chapter 5 were entered in the analysis. Regions *i* were considered to be NUTS 3 regions. The Central Bohemian region surrounding Prague and Prague itself were merged, therefore finally creating 13 regions entered in the analysis<sup>22</sup>. The shift and share analysis was executed by means of a macro in the SAS programme in the research laboratory of the Centre d'économie et de sociologie appliquées à l'agriculture et aux espaces ruraux (Centre for economy and sociology as applied to agriculture and rural areas, CESAER UMR INRA ENESAD) in Dijon, thanks to the expertise of Virginie Piguet.

Variables for the analysis were chosen following the results of descriptive analysis including a larger group of demographic and socio-economic characteristics of population. Some of these data showed little variability such as population differentiation by age, some of them were not detailed enough to make a reasonable analysis, such as data on mortality. The analysis was processed on the municipal level and that brought certain constraint concerning the data structure and detail. That was particularly the case of data on age structure and mortality. The age structure is published in greater detail only from population censuses on municipal level (the last was in 2001) and the yearly population evidence is not published in detail. Therefore the descriptive analysis was done on the 2001 data using the dependency ratio, young-old ratio and proportion of population 80+ (data are available in Annex 12)<sup>23</sup>. Mortality data on municipal level are scarce as well and only crude death rates can be calculated. However, the crude rates are biased by uneven age structure and are not suitable for the analysis of spatial differentiation (Annex 12). The importance of the urban-rural gradient and of regional effects is studied here on the demographic characteristics of population growth, family composition and fertility. These characteristics do not fully account for all the processes by which we can describe a population, but they were chosen for their

---

<sup>22</sup> The fusion of Prague and the Central Bohemian region was effected in order to avoid the extreme situation whereby Prague-city, as an independent region, would consist solely of the primary centre's gradient category. Such an extreme case would have distorted the significance of the results and the results themselves.

<sup>23</sup> Czech Statistical Office could maybe provide more detailed data on request but given the fact that I had to buy a majority of the data for the analysis, the financial constraints led me to buy only the essential data which would provide most interesting informations.

capacity to differentiate and because the combination of these factors informs us about the structural characteristics of the population living in the various spatial categories.

In general, the spatial effect of the urban - rural gradient exhibited stronger explanatory power than regional effect for almost all the observed characteristics. Regional effect played a role mainly in “outstanding regional cases”; outstanding either in terms of their dynamism (very often the case of Prague and the Central Bohemian region) or in terms of a concentration of rather unfavourable characteristics (often the case in the western Bohemian regions). Another distinct feature is the rather systematic differentiation between Bohemian and Moravian regions. The exceptions from the explanatory dominance of the urban-rural gradient effect are unemployment rate and poverty, whose differences are better explained by regional factors.

### 6.2.2 Population change differentiation

Regarding the result of the Fischer statistics, dominant factor explaining the *total population change rates* between 1991 and 2007 was the effect of the urban-rural gradient (table 7). Nevertheless, the explanatory force of regional appurtenance increased in more recent years. The clear-cut differences in population change rates highlight three spatial groups; primary centres, their suburban areas and more peripheral areas (secondary centres and rural areas). Between 1991 and 2001, the primary centres were losing population whatever the region they were located. This tendency was further accentuated in the more recent period (2001 - 2007), despite their localisation in the regions of positive population growth.

*Table 7: Coefficient of determination ( $R^2$ ) and Fischer statistics for the shift-share analysis of two factors*

	Population change rate 1991-2001	Population change rate 2001-2007
$R^2$	0,738	0,848
F Regional effect	1,38 <sup>n</sup>	14,91
F Gradient effect	30,46	61,82

*n* at the F statistics means that the effect is non-significant in the model,  $p > 0,05$

*Table 8: Total population change rate between 1991 - 2001 and 2001 - 2007, regional and gradient effects, decomposition for gradient effect*

	1991 - 2001					2001 - 2007				
	Change rate	Regional effect	Sig.	Gradient effect	Sig.	Change rate <sup>1)</sup>	Regional effect	Sig.	Gradient effect	Sig.
National average	-0,70					1,45				
Primary centres	-2,23	-0,04		-1,48	***	-0,5	0,32	***	-2,28	***
Inner fringe	4,82	-0,07	*	5,59	***	11,99	-0,26	***	10,79	***
Outer fringe	2,51	-0,04		3,26	***	5,98	-0,30	***	4,83	***
Polycentric bcg.	0,63	-0,04		1,37	**	3,31	0,05		1,81	***
Secondary centres	-0,37	0,17	**	0,16		-0,19	-0,67	***	-0,97	*
Suburb. fringe of sc	0,89	0,11		1,48		2,9	-0,60	***	2,05	
Rural	-0,47	0,13		0,10		0,86	-0,42	***	-0,17	

\*, \*\* and \*\*\* : significant on the level of resp. 10 %, 5 % and 1 %

Source: Census ČSÚ, author's computation.

Rates and effects are in %.

Whatever the demographic situation in the regions, suburban areas witnessed dynamic and, over time, accentuated positive population growth. The intensity of suburban area population growth diminishes with increasing distance from primary centres. This growth is directly connected to net migration gains (table 11). Natural growth was relatively less important and only slightly influenced population growth in the inner fringes. There it had a positive effect accentuating the total growth between 2001 and 2005 (Table 11). In rural areas and secondary centres, the population growth dynamics is rather sluggish. They were losing the population by natural decrease and only in rural areas these losses were compensated by migration gains (Table 11), secondary centres were losing the population by net migration, as well (Table 11). Regional localisation of rural areas contributes to their population losses (table 8) as well as to their negative natural increase (table 11). Nevertheless, the negative development is outweighed by net migration gains in rural areas as well as in suburban areas of secondary centres. Secondary centres together with primary centres are the only spatial categories to lose population, despite the country population growth of 1.45 % between 2001 and 2007.

When focussing on regional effect (significant only for the period 2001-2007), interesting cleavages appear (table 9). There is a clear opposition between Moravian (Vysočina, Jihomoravský, Zlínský, Olomoucký and Moravskoslezský) and Bohemian

regions (Prague and Středočeský). In all Moravian regions the regional effect significantly contributes to their population decrease, whereas in Czech regions this effect is not significant. Only in Central Bohemia and the Prague region, is there a strongly positive effect of regional appurtenance. Further decomposition of the population change rate into natural and migration components shows that it is caused by significant migration losses in Moravian regions on one hand and significant migration gains in Prague and Central Bohemian regions on the other hand. Moravian region population losses accentuated in the period between 2001 and 2007 compared to the previous period when the regional effect did not play a significant role (Table 7 and 9).

*Table 9: Total population change rate between 2001 - 2007, regional and gradient effects, decomposition for regional effect*

Regions	Change rate	Regional effect	Sig.	Gradient effect	Sig.
Praha and Středočeský	5,34	4,27	***	-0,38	***
Jihočeský	1,28	-0,47		0,3	***
Plzeňský	1,89	0,29		0,14	**
Karlovarský	1,02	0,17		-0,6	***
Ústecký	1,34	0,28		-0,39	***
Liberecký	1,35	0,33		-0,43	***
Královéhradecký	0,27	-1,1		-0,08	
Pardubický	0,61	-1,07		0,23	***
Vysočina	0,3	-1,54	*	0,39	***
Jihomoravský	0,4	-1,44	***	0,39	***
Olomoucký	-0,49	-2,63	***	0,68	***
Zlínský	-0,71	-2,79	***	0,62	***
Moravskoslezský	-1,2	-2,47	***	-0,18	***

\*, \*\* and \*\*\* : significant on the level of 10 %, 5 % and 1 % respectively

Source: Census ČSÚ, author's computation.

Rates and effects are in %.

*Table 10: Coefficient of determination ( $R^2$ ) and Fischer statistics for shift-share analysis of two factors*

	Natural increase 2001-2005	Net migration rate 2001 – 2005
$R^2$	0,738	0,848
F Regional effect	5,07	14,77
F Gradient effect	16,15	61,82

Table 11: Natural increase and net migration rates between 2001 and 2005, regional and gradient effects

	Change rate <sup>1)</sup>	Regional effect	Sig.	Gradient effect	Sig.	Change rate <sup>1)</sup>	Regional effect	Sig.	Gradient effect	Sig.
Natural increase 2001-2005						Net migration rate 2001 – 2005				
National average	-0,13					0,17				
Primary centres	-0,12	-0,01	***	0,02	***	-0,15	0,04	***	-0,35	***
Inner fringe	-0,07	0,00		0,06	**	1,45	-0,02	***	1,30	***
Outer fringe	-0,11	0,00		0,02		0,78	-0,03	***	0,64	***
Polycentric bcg.	-0,22	0,00	*	-0,09	***	0,55	0,01		0,38	***
Secondary centres	-0,05	0,02	***	0,07	***	-0,07	-0,08	***	-0,15	**
Suburb. fringe of sc	-0,17	0,01	***	-0,06		0,46	-0,08	***	0,37	**
Rural	-0,23	0,01	***	-0,12	***	0,25	-0,06	***	0,15	***

\*, \*\* and \*\*\* : significant on the level of 10 %, 5 % and 1 % respectively

(1) All rates are annualized.

Source: Census ČSÚ, author's computation.

Rates and effects are in %.

*Net migration* as well as *natural increase* rate differentiation is explained by the urban-rural gradient effect much more strongly than by the regional effect (table 10). Net migration rate between 2001 and 2005 is positive in all non-urban spatial categories, whatever the region in which they are situated. This helps to compensate the negative natural increase. The regional effect, although its explanatory power is low, sharply divides the Moravian regions, with a negative regional effect, from the Prague region where it is positive. It influences the trend of total population growth mentioned above (table 9). The most marked natural decrease occurs in rural areas (-0.23 % per annum between 2001-2005). Regional effect in natural increase is significant and positive only in the Karlovarský, the Liberecký and the Vysočina regions, whereas it is negative in Prague and the Central Bohemian region; the effect is non-significant in all other regions.

### 6.2.3 Family and fertility patterns differentiation

In explaining the spatial differentiation of the *proportion of families with dependent children*, both the regional and the urban rural-gradient effects have the same



explanatory power (table 12). The proportion of families with dependent children is the lowest in the primary centres (32.2 %) creating a major cleavage between them and the rest of the spatial categories (table 13). The highest proportion of households with dependent children is in secondary centres (36.1 %), most probably due to the lower proportion of the population aged 65+ living there. From the regional perspective, there is an important difference between the Bohemian and Moravian regions in terms of the proportion of families with dependent children . The lowest proportions are recorded in Prague and Central Bohemia (30.3 %, table 14) and in the Plzeňský region, with strong negative regional effects in both cases. On the other hand, in the Pardubický region, Vysočina and all the Moravian regions, there is strong positive regional effect as well as a positive gradient effect. The highest proportion of families with dependent children is recorded in Vysočina (36.8 %).

*Table 12: Coefficient of determination ( $R^2$ ) and Fischer statistics for shift-share analysis of two factors*

	Proportion of households with dependent children, 2001
$R^2$	0,885
F Regional effect	27,22
F Gradient effect	25,75

*Table 13: Proportion of households with dependent children in 2001, regional and gradient effects, decomposition for gradient effect*

	Proportion	Regional effect	Sig.	Gradient effect	Sig.
National average	33,58				
Primary centres	32,15	-0,24	***	-1,20	***
Inner fringe	35,27	0,25	***	1,44	***
Outer fringe	35,62	0,24	***	1,80	***
Polycentric bcg.	34,76	-0,01		1,19	***
Secondary centres	36,07	0,48	***	2,01	***
Suburb. fringe of sc	35,18	0,60	***	1,00	
Rural	34,93	0,34	***	1,02	***

\*, \*\* and \*\*\* : significant on the level of 10 %, 5 % and 1 % respectively

Source: Census ČSÚ, author's computation

Proportion is in %.

Table 14: Proportion of households with dependent children in 2001, regional and gradient effects, decomposition for regional effect

Regions	Proportion	Regional effect	Sig,	Gradient effect	Sig,
National average	33,58				
Praha and Středočeský	30,25	-2,94	***	-0,39	***
Jihočeský	34,86	0,96	**	0,31	***
Plzeňský	32,40	-1,44	***	0,26	***
Karlovarský	32,75	-1,12	*	0,3	***
Ústecký	32,99	-0,41		-0,19	***
Liberecký	33,77	0,15		0,04	
Královéhradecký	33,95	-0,02		0,39	***
Pardubický	35,07	1,3	***	0,18	***
Vysočina	36,77	2,69	***	0,5	***
Jihomoravský	34,65	1	***	0,07	***
Olomoucký	35,39	1,64	***	0,16	***
Zlínský	36,47	2,68	***	0,22	***
Moravskoslezský	35,41	1,96	***	-0,14	***

\*, \*\* and \*\*\* : significant on the level of 10 %, 5 % and 1 % respectively

Source: Census ČSÚ, author's computation

Proportion is in %.

The *proportion of one parent families* shows a very similar spatial pattern as that of the proportion of families with dependent children. The urban-rural gradient effect has much stronger explanatory power than the regional effect (table 15). There appears a main cleavage between primary centres and the rest of the categories and between Bohemia and Moravia in the regional dimension. The highest proportion of one-parent families is found in the Karlovarský region (27.5 %) followed by Prague and Central Bohemia, then the Ústecký and Liberecký regions. The proportion of one parent families in all the other regions is below the national average.

Table 15: Coefficient of determination ( $R^2$ ) and Fischer statistics for shift-share analysis of two factors

	Proportion one-parent families with dependent children, 2001
$R^2$	0,964
F Regional effect	53,47
F Gradient effect	176,75

The decomposition of the proportion of one parent families into gradient and regional effects allows us to determine how strong the regional effect is. In the Liberecký and Ústecký regions, the effect specific to the regions greatly increases the proportion of one-parent families; this is furthermore accentuated by the structure of the urban-rural gradient categories (higher proportion of urban centres) (table 17).

*Table 16: Proportion of one-parent families out of all families with dependent children in 2001, regional and gradient effects, decomposition for gradient effect*

	Proportion	Regional effect	Sig.	Gradient effect	Sig.
National average	21,05				
Primary centres	25,33	0,41	***	3,87	***
Inner fringe	16,45	-0,40	***	-4,19	***
Outer fringe	15,81	-0,44	***	-4,80	***
Polycentric bcg.	15,28	0,00		-5,77	***
Secondary centres	19,58	-0,47	***	-1,00	***
Suburb. fringe of sc	13,02	-1,22	***	-6,81	***
Rural	15,91	-0,56	***	-4,59	***

\*, \*\* and \*\*\* : significant on the level of 10 %, 5 % and 1 % respectively

Source: Census ČSÚ, author's computation

Proportion is in %.

The Karlovarský region shows a more favourable gradient effect, but a very strong regional effect raises the proportion of one-parent families. It seem therefore that there is a specific regional effect of the western Bohemian regions which distinguishes their family characteristics from other regions. The reason for that may be a specific socio-professional profile of inhabitants of these regions, which are mainly workers, mine workers and lower educated inhabitants. But to be able to recognise the reasons better a special detailed analysis would have to be done.

Table 17: Proportion of one-parent families out of all families with dependent children in 2001, regional and gradient effects, decomposition for regional effect

Regions	Proportion	Regional effect	Sig,	Gradient effect	Sig,
National average	21,05				
Praha and Středočeský	26,04	4,03	***	0,96	***
Jihočeský	19,00	-1,24	**	-0,81	***
Plzeňský	20,55	0,28		-0,77	***
Karlovarský	27,48	6,7	***	-0,27	***
Ústecký	24,89	3,11	***	0,73	***
Liberecký	23,3	2,13	***	0,12	***
Královéhradecký	19,51	-0,92	*	-0,61	***
Pardubický	17,47	-2,9	***	-0,68	***
Vysočina	14,17	-5,66	***	-1,21	***
Jihomoravský	19,38	-1,2	***	-0,47	***
Olomoucký	18,35	-2,07	***	-0,63	***
Zlínský	15,66	-4,76	***	-0,62	***
Moravskoslezský	20,07	-1,77	***	0,79	***

\*, \*\* and \*\*\* : significant on the level of 10 %, 5 % and 1 % respectively

Source: Census ČSÚ, author's computation

Proportion is in %.

More complex analysis was effectuated on the *cohort fertility*<sup>24</sup> data from the population census of 2001. Cohort fertility looks at fertility longitudinally, that is at all births occurring to a specific group of women, in this case to those born during a particular ten years intervals. One is looking here in the year 2001 at their reproductive histories. This data allowed us to take four effects into account; in addition to regional and gradient effects, the effects of age and education of women were examined. Women aged 15+ in 2001 were divided into six age groups (15-24, 25-34, 35-44, 45-54, 55-64 and 65+), four categories of education (basic and none, professional without A-levels, with A-levels and university) and into regional and urban-rural gradient categories. This allowed us to control the strength of the effect of each respective spatial dimension for age and educational bias. Here again, the gradient effect revealed stronger explanatory force than the regional one (table 18). The marked explicative power of age and education is not surprising. The high explicative power of the age effect reflects the importance of

<sup>24</sup> Cohort fertility looks at fertility longitudinally, that is at all births occurring to a specific group of women, in this case to those born during a particular ten years intervals. One is looking over time at their reproductive histories.

differences in cohort fertility between very young women and older women out of their fertile age. The level of this effect in the general model has therefore no particular interest.

The marked explicative power of the education effect confirms the well known pattern of decreasing fertility levels with higher levels of educational accomplishment of women. The analysis shows that, even after controlling the cohort fertility levels for age and education, there remained an important residual gradient effect which strongly divides urban-rural categories, creating the main cleavage between primary centres and the rest of the spatial categories. The cohort fertility level in primary centres was the lowest and registered 1564 children ever born to 1000 women (table 19). The analysis shows that between two women of the same age, the same level of education and the same region of residence, the one living in a primary centre would show a lower cohort fertility on average than the one living in any other spatial category. The second most important effect contributing to the low fertility levels in primary centres is level of education, showing that the higher education level of women in primary centres contributes significantly to the lower fertility levels. The negative effect of spatial category and education is partially compensated by a favourable age effect. This means that women in the age groups with the most children, de facto older women, are overrepresented in primary centres.

The highest levels of fertility are recorded in rural areas and in the suburbs of secondary centres (1894 children ever born to 1000 women in rural areas). Here, the gradient effect is positive and the most important contributing factor to what is the highest cohort fertility of all the spatial categories. The education effect is the second most important contributing factor to the higher fertility levels, reflecting the lower level of education among rural women. Here again, the gradient effect amplifies the effect of education, so that not only being less educated, but also living in a rural area implies even higher fertility levels.

Table 18: Coefficient of determination ( $R^2$ ) and Fischer statistics for shift-share analysis of four factors

Cohort fertility, 2001	
$R^2$	0,967
F Regional effect	57,48
F Age effect	11056,30
F Education effect	1013,39
F Gradient effect	234,77

Table 19: Average number of children ever born per 1 000 women (cohort fertility) in 2001, regional and gradient effects, effects of age and education, decomposition for gradient effect

	Cohort fertility <sup>1)</sup>	Regional effect	Sig.	Gradient effect	Sig.	Age effect	Sig.	Education effect	Sig.
National average	1 684,3								
Primary centres	1563,8	-8,2	***	-98,0	***	12,3	***	-26,6	***
Inner fringe	1779,7	5,0	***	72,8	***	-5,2	***	22,9	***
Outer fringe	1825,4	5,8	***	113,6	***	-10,4	***	32,1	***
Polycentric bcg.	1851,7	-1,9	**	141,2	***	-9,8	***	37,9	***
Secondary centres	1727,8	21,0	***	33,8	***	-21,6	***	10,3	***
Suburb. fringe of sc	1947,0	15,9	***	211,8	***	-16,8	***	51,8	***
Rural	1893,7	11,0	***	172,6	***	-18,2	***	44,0	***

\*, \*\* and \*\*\* : significant on the level of 10 %, 5 % and 1 % respectively

(1) Women of unknown age and education are excluded

Rates and effects are per 1000 women.

Source: Census ČSÚ, author's computation

The age effect negatively influences the cohort fertility level of rural women. The explanatory effects on cohort fertility levels in other spatial categories are in line with those observed in rural areas and therefore stand in opposition to those at work in primary centres, although they are less extreme. Interestingly, the inner fringes of primary centres have the lowest cohort fertility levels of all non-urban spatial categories. There, the gradient effect as well as the education effect are still positive, but much less so than in other non-urban spatial categories. This distinguishes them from other suburban categories, in which cohort fertility levels and levels of explanatory effects are closer to those recorded in rural areas. In general, the model shows that the gradient effect is strong and that it amplifies the effect of education. More about the analysis of

fertility and urban, suburban and rural disparities in fertility in the post-communist transition context on the case of the Czech Republic can be found in (Vobecká, Piguet 2010 manuscript).

The *proportion of divorced* in the population was expected to differentiate between urban and rural areas, and this was indeed confirmed by shift and share analysis after controlling for age structure and regional effects. The main opposition revealed is between urban and non-urban areas, when the proportion of divorced is below 6 % in all non-urban categories, 7.7 % in secondary centres and 9.6 % in primary centres. Apart from the gradient effect, which contributes most strongly to this differentiation, there is also a distinct age structure which raises the proportion of divorced in primary centres and moderates it in other gradient categories (table 21). The highest proportion of divorced people is between the ages of 30 and 59, and these age groups are also overrepresented in primary centres (table 22). From the regional perspective, the highest proportion of divorced is found in the western Bohemian regions (Karlovarský (10.8 %), Ústecký and Liberecký) and in Prague and Central Bohemia, whereas the southern and eastern regions register a lower proportion of divorced in their populations, with the lowest level observed in Vysočina (5.2 %, table 23). These figures fit well with the picture of the distribution of one-parent families.

*Table 20: Coefficient of determination ( $R^2$ ) and Fischer statistics for shift-share analysis of four factors*

	Proportion of divorced, 2001
$R^2$	0,931
F Regional effect	20,80
F Gradient effect	95,68
F Age effect	1210,35

*Table 21: Proportion of divorced in population in 2001, regional and gradient effects and effect of age, decomposition for gradient effect*

	Proportion of divorced <sup>1)</sup>	Regional effect	Sig.	Gradient effect	Sig.	Age structure effect	Sig.
National average	7,93						
Primary centres	9,55	0,10	***	1,39	***	0,13	***
Inner fringe	5,48	-0,17	***	-2,23	***	-0,06	***
Outer fringe	5,72	-0,16	***	-1,91	***	-0,14	***
Polycentric beg.	5,66	-0,04	**	-2,09	***	-0,14	***
Secondary centres	7,74	-0,01		-0,08		-0,11	***
Suburb. fringe of sc	4,72	-0,39	***	-2,60	***	-0,23	***
Rural	5,91	-0,13	***	-1,70	***	-0,20	***

\*, \*\* and \*\*\* : significant on the level of 10 %, 5 % and 1 % respectively

Source: Census ČSÚ, author's computation

(1) Individuals of unknown age are excluded.

Rates and effects are in %.

*Table 22: Proportion of divorced in population in 2001, regional and gradient effects and effect of age, decomposition for age effect*

Age group	Proportion of divorced <sup>1)</sup>	Regional effect	Sig.	Gradient effect	Sig.	Age structure effect	Sig.
National average	7,93						
0 - 19	0,00	-0,01	***	-0,06	***	-7,86	***
20 - 29	3,54	0,00	***	0,00	***	-4,39	***
30 - 39	13,14	0,00		0,03	***	5,17	***
40 - 49	15,90	0,00	***	0,02	***	7,94	***
50 - 59	13,75	0,03	***	0,06	***	5,72	***
60 - 69	8,73	-0,01	***	0,00		0,81	***
70 - 79	6,43	-0,01		0,00		-1,49	***
80 +	4,41	-0,04	***	-0,02	***	-3,46	***

\*, \*\* and \*\*\* : significant on the level of 10 %, 5 % and 1 % respectively

Source: Census ČSÚ, author's computation

(1) Individuals of unknown age are excluded.

Rates and effects are in %.



Table 23: Proportion of divorced in population in 2001, regional and gradient effects and effect of age, decomposition for regional effect

Regions	Proportion of divorced <sup>1)</sup>	Regional effect	Sig,	Gradient effect	Sig,	Age effect	Sig,
Praha and Středočeský	8,99	0,51	***	0,35	***	0,19	***
Jihočeský	7,03	-0,53	**	-0,34	***	-0,04	***
Plzeňský	7,70	-0,03		-0,28	***	0,08	***
Karlovarský	10,85	2,90	***	-0,01		0,02	***
Ústecký	9,65	1,54	***	0,24	***	-0,05	***
Liberecký	9,43	1,52	***	0,04	**	-0,06	***
Královéhradecký	7,66	-0,02		-0,21	***	-0,04	***
Pardubický	6,76	-0,79	***	-0,25	***	-0,13	***
Vysočina	5,22	-2,01	***	-0,48	***	-0,22	***
Jihomoravský	7,13	-0,60	***	-0,18	***	-0,03	***
Olomoucký	7,21	-0,36		-0,27	***	-0,09	***
Zlínský	6,01	-1,58	***	-0,25	***	-0,09	***
Moravskoslezský	7,94	-0,25		0,29	***	-0,04	***

\*, \*\* and \*\*\* : significant on the level of 10 %, 5 % and 1 % respectively

Source: Census ČSÚ, author's computation

(1) Individuals of unknown age are excluded.

Rates and effects are in %.

#### 6.2.4 Differentiation of social and economic characteristics of the population

The importance of the urban-rural gradient and of regional effects is studied here on the socio-economic characteristics of education and employment by sector of the economy, unemployment rate and poverty.

*The level of education* was determined by measuring the proportion of 15+ with secondary (A-levels) and higher education, both in the year 1991 and in 2001. On different levels, the cleavages follow the same lines in both years of observation. In both 1991 and 2001, we note the very strong explanatory force of the gradient effect (Table 24). The main differentiation occurs between primary centres and the rest of the spatial categories (Table 25). Secondary centres lie between the two extremes, but are still below the national average. In 2001, 44 % of the 15 + population with A-levels and higher education lived in primary centres, whereas in the rural areas the total was less than 26 %. Between 1991 and 2001 the gap between primary centres and inner fringes in

terms of the A-level-plus educated population slightly decreased from 15 % to 13 %. This gap gets even smaller if we focus solely on the population aged 25-34: there the gap is “only” 11 % (Table 26). We may interpret this change as an effect of suburbanisation, when more highly educated people suburbanize and thus raise the level of education of the local population. This effect is not observable in secondary centres nor in rural areas. There, the “lagging behind” in the level of education of 25-34 year olds remains almost unchanged when compared to primary centres and becomes even more profoundly marked, compared to the national average. So, although the absolute number of A-levels and higher diplomas increased at this time in the young generation living in rural areas and secondary centres, it did not increase as quickly as in other spatial categories.

*Table 24: Coefficient of determination ( $R^2$ ) and Fischer statistics for shift-share analysis of two factors*

	Proportion of 15+ population with A-levels and higher, 1991	Proportion of 15+ population with A-levels and higher, 2001
$R^2$	0,951	0,940
F Regional effect	17,13	20,30
F Gradient effect	187,15	136,44

*Table 25: Proportion of 15+ population with A-levels and higher education in 1991 and 2001, regional and gradient effects, decomposition for gradient effect*

	1991					2001				
	Educ. A-levels and higher	Regional effect	Sig.	Gradient effect	Sig.	Educ. A-levels and higher	Regional effect	Sig.	Gradient effect	Sig.
National average	28,15					37,24				
Primary centres	35,16	0,12	**	6,88	***	44,29	0,21	***	6,84	***
Inner fringe	20,12	0,04		-8,08	***	31,11	0,11	*	-6,24	***
Outer fringe	19,28	0,01		-8,88	***	28,92	0,03		-8,36	***
Polycentric bcg.	18,07	0,20	***	-10,28	***	27,26	0,29	***	-10,27	***
Secondary centres	26,23	-0,84	***	-1,08		34,39	-1,11	***	-1,74	**
Suburb. fringe of sc	15,12	0,11		-13,14	***	24,26	-0,03		-12,96	***
Rural	17,54	-0,02		-10,59	***	25,93	-0,24	*	-11,07	***

\*, \*\* and \*\*\* : significant on the level of 10 %, 5 % and 1 % respectively

Source: Census ČSÚ, author's computation

Rates and effects are in %.

Table 26: Proportion of population aged 15+ and 25-34 with A-levels and higher education and its differences from national average in 1991 and 2001

	Proportion A-levels +	Variation from national average	Proportion A-levels +	Variation from national average	Proportion A-levels +	Variation from national average
	Population 15 + in 1991		Population 15 + in 2001		Population 25-34 in 2001	
Primary centres	35,2	7,0	44,3	7,0	54,8	6,7
Inner fringe	20,1	-8,0	31,1	-6,1	43,5	-4,7
Outer fringe	19,3	-8,9	28,9	-8,3	40,4	-7,7
Polycentric bcg.	18,1	-10,1	27,3	-10,0	38,9	-9,3
Secondary centres	26,2	-1,9	34,4	-2,9	45,4	-2,7
Suburb. fringe of sc	15,1	-13,0	24,3	-13,0	35,6	-12,6
Rural	17,5	-10,6	25,9	-11,3	36,8	-11,4
Czech Republic	28,2	0,0	37,2	0,0	48,1	0,0

Proportions are in %.

Source: Census ČSÚ, author's computation

The *service/ industry index* provides information about the proportion of the economically active population employed in services compared to those employed in industry. This data reveals the very important changes which occurred between 1991 and 2001. In 1991, employment in services was less than industrial employment in all spatial categories including primary centres, attaining a level of only 83 % of industry employment in the national average. In 2001, the national average was already at 144 persons employed in services to one hundred employed in industry, and in primary centres this number reached 188. Only rural areas and suburban areas of secondary centres registered a lower proportion of active residents in services than in industry (index below 100). Nevertheless, the biggest gap was recorded between primary centres and the rest of the spatial categories. The residents of suburban areas clearly participate in the concentration of services in and nearby primary centres, as proven by the fact that in 2001, as well as in 1991, the level of the service/industry index there was closest to the levels in primary centres. Secondary centres lag behind and their development in terms of a service economy is much less dynamic than that in primary centres. The prevailing industrial economic orientation of rural residents correlates with their lagging educational level. Both of these characteristics (education and the service/industry index) show that rural areas and secondary centres lag behind the dynamics of other urban-rural categories more markedly in 2001 than in 1991.

The explanatory force of regional effect is relatively weak in 2001 as well as in 1991 (Table 27). Nevertheless, attention should be drawn to the outstandingly high service/industry index in Prague and Central Bohemia (230 in 2001). Prague itself most probably considerably raised the whole average level of primary centres. A negative regional effect significantly diminishes the service/industry index in the Liberecký, Zlínský and Vysočina regions, where its level oscillates around 100 but also in Moravskoslezsko, a traditional region of heavy industry.

Table 27: Coefficient of determination ( $R^2$ ) and Fischer statistics for shift-share analysis of two factors

	Service/industry index, 1991	Service/ industry index, 2001
$R^2$	0,844	0,874
F Regional effect	19,18	18,60
F Gradient effect	22,19	36,84

Table 28: Service/industry index in 1991 and in 2001, regional and gradient effects, decomposition for gradient effect

	Service - Industry index					Service - Industry index				
	Regional effect	Sig.	Gradient effect	Sig.		Regional effect	Sig.	Gradient effect	Sig.	
	1991					2001				
National average	83,03					143,62				
Primary centres	99,98	1,2	***	15,75	***	188,05	3,85	***	40,59	***
Inner fringe	72,81	-0,42		-9,80	*	123,24	0,69		-21,07	**
Outer fringe	65,95	-0,85	**	-16,23	***	108,87	-1,52	**	-33,23	***
Polycentric bcg.	63,04	2,72	***	-22,72	***	101,82	5,05	***	-46,85	***
Secondary centres	60,98	-4,19	***	-17,86	***	107,91	-8,08	***	-27,62	***
Suburb. fringe of sc	54,46	-1,86	*	-26,71	**	83,16	-8,92	***	-51,54	***
Rural	61,37	-1,71	**	-19,95	***	91,93	-7,09	***	-44,60	***

\*, \*\* and \*\*\* : significant on the level of 10 %, 5 % and 1 % respectively

Source: Census ČSÚ, author's computation

The Index is computed per 100 economically active residents working in industry.

The *unemployment rate*, which reached 9.3 % according to 2001 census data, reveals a very important regional differentiation. Gradient effect accounts for only very little explicative power (Table 29) and it is regional effect which boasts far higher explicative power. The highest unemployment rates were recorded in the regions most seriously hit

by economic restructuring, the regions with heavy industry, coal mines and a relatively less flexible labour force; namely the Ústecký (15.5 %) and Karlovarský regions in western Bohemia and the Moravskoslezský and Olomoucký regions in Moravia. In general, all Moravian regions registered higher unemployment rates than Czech regions (with the exception of western Bohemian ones). More recent data concerning unemployment should be analysed to test whether certain structural changes have occurred recently.

*Table 29: Coefficient of determination ( $R^2$ ) and Fischer statistics for shift-share analysis of two factors*

Unemployment rate, 2001	
$R^2$	0,959
F Regional effect	140,71
F Gradient effect	5,24

*Table 30: Unemployment rate in 2001, regional and gradient effects, decomposition for regions*

Regions	Unempl. rate	Regional effect	Sig,	Gradient effect	Sig,
National average	9,27				
Praha and Středočeský	6,12	-3,09	***	-0,05	*
Jihočeský	6,34	-3,01	***	0,08	**
Plzeňský	7,04	-2,33	***	0,1	***
Karlovarský	10,75	1,37	***	0,11	**
Ústecký	15,51	6,25	***	-0,01	
Liberecký	6,97	-2,38	***	0,09	***
Královéhradecký	6,11	-3,24	***	0,08	**
Pardubický	7,94	-1,38	***	0,05	***
Vysočina	6,94	-2,44	***	0,11	**
Jihomoravský	9,68	0,43	*	-0,01	
Olomoucký	11,81	2,58	***	-0,04	*
Zlínský	8,80	-0,42		-0,05	**
Moravskoslezský	15,50	6,31	***	-0,08	***

\*, \*\* and \*\*\* : significant on the level of 10 %, 5 % and 1 % respectively

Source: Census ČSÚ, author's computation

Rates and effects are in %.

The *level of poverty* is measured here by the proportion of low income households receiving the housing allowances<sup>25</sup>. This is again differentiated significantly by region and not by urban-rural gradient categories. An interesting general message resulting from our figures is that the cleavages of social ills lie between regions more than between urban-rural categories. The regions with a significantly higher proportion of poverty are also the regions plagued by higher unemployment: the Ústecký, Moravskoslezský and Olomoucký regions (table 33). Despite the overall non-significant gradient effect, our decomposition reveals that rural areas are the only ones that register significantly higher poverty levels (table 32). This tells us that families living in rural areas are more likely to receive the housing allowance for low income families than families living in other spatial categories. Together with the facts that rural areas are home to populations with the lowest average educational level, and that the employment orientation toward dynamic sectors is changing rather slowly in these areas, it is evidence favouring the hypothesis of the prevailing concentration of a socially weaker population in rural areas. From the regional perspective, the concentration of poverty and of socially weaker populations is observed in the regions in the midst of profound economic restructuring, that is, in western Bohemia and northern Moravia.

*Table 31: Coefficient of determination ( $R^2$ ) and Fischer statistics for shift-share analysis of two factors*

	Proportion of low income households, 2003
$R^2$	0,776
F Regional effect	19,56
F Gradient effect	2,21 <sup>n</sup>

*n* in the F statistics means that the effect is non-significant in the model,  $p > 0,05$

<sup>25</sup> Eligibility for the allowances does not differ among regions because it is set by the Ministry of Social Affairs. Families with an income of below 1.4 times the life minimum were deemed eligible (according to the act applicable in 2003).

*Table 32: Proportion of low income households in 2003 (households receiving housing allowances with an income of between 1.0 and 1.4 of the life minimum), regional and gradient effects, decomposition for urban-rural gradient categories*

	Poverty rate	Regional effect	Sig.	Gradient effect	Sig.
National average	5,79				
Primary centres	5,59	-0,05		-0,15	
Inner fringe	5,13	0,11	***	-0,77	
Outer fringe	5,33	0,03		-0,49	
Polycentric bcg.	5,43	-0,05		-0,31	
Secondary centres	6,52	0,37	***	0,36	
Suburb. fringe of sc	7,17	-0,14		1,52	
Rural	6,9	-0,13		1,24	***

\*, \*\* and \*\*\* : significant on the level of 10 %, 5 % and 1 % respectively

(1) Number of low income households in 2003 is divided by the total number of households from the 2001Census

Source: Ministry of Labour and Social Affairs, Census ČSÚ, author's computation.

Rates and effects are in %.

*Table 33: Proportion of low income households in 2003 (households receiving housing allowances with an income of between 1.0 and 1.4 of the life minimum), regional and gradient effects, decomposition for regions*

Regions	Poverty rate	Regional effect	Sig.	Gradient effect	Sig.
National average	5,79				
Praha and Středočeský	2,92	-2,75	***	-0,12	**
Jihočeský	4,90	-1,05	*	0,17	***
Plzeňský	3,99	-1,95	***	0,15	***
Karlovarský	6,31	0,35		0,17	**
Ústecký	9,49	3,75	***	-0,05	**
Liberecký	5,27	-0,64		0,11	***
Královéhradecký	4,74	-1,22	*	0,18	**
Pardubický	6,81	0,95		0,07	**
Vysočina	6,61	0,57		0,25	***
Jihomoravský	5,96	0,18		-0,01	
Olomoucký	6,88	1,15	**	-0,06	
Zlínský	5,72	0,02		-0,08	*
Moravskoslezský	9,18	3,48	***	-0,09	**

\*, \*\* and \*\*\* : significant on the level of 10 %, 5 % and 1 % respectively

(1) Number of low income households in 2003 is divided by the total number of households from the 2001Census

Source: Ministry of Labour and Social Affairs, Census ČSÚ, author's computation.

Rates and effects are in %.

### **6.2.5 Spatial differentiation of demographic, social and economic characteristics of the population – general remarks**

In conclusion, the analysis has shown that there are distinct patterns of spatial differentiation in demographic and socio-economic terms in most of the analysed characteristics, both from the viewpoint of the urban-rural gradient categories, as well as from the regional viewpoint. The main cleavages in demographic characteristics, notably in fertility levels, family arrangements and divorce rates, are found between primary centres and the rest of the spatial categories. The characteristics of suburban areas do not show any tangible consequences of suburbanisation and are rather close to those of rural areas. This may be explained by the fact that the suburbanisation process, which might be the carrier of new differentiation, is only a very recent phenomenon; it did not yet influence structural demographic characteristics, notably as they were observed in 2001. A different picture is obtained from the analysis of population change rates and their natural and migratory components. Urban area losses and suburban area gains are the characteristics of recent dynamics. In comparison, rural areas are marked by a rather stagnating tendency, although they are nonetheless gaining population by means of net-migration after decades. There is also a clear regional divide between migration losses in the Moravian regions and the strong gains in Prague and the Central Bohemian region. On the level of education and in terms of service and industry employment, there is a much clearer cut between urban, suburban and rural areas. Suburban areas are affected by the economic influence of primary centres, whereas rural areas are less dynamic and lagging behind. Unemployment rates and poverty, on the other hand, differ along clearly regional lines. Regions with structural problems are mainly located in western Bohemia and northern Moravia. The analysis has shown some systematic patterns in regional differentiation. Therefore, the results were used for clustering the regions into the groups of core and periphery regions. The classification is described in Section 7.1.

The differentiation on urban-rural gradient is more important for demographic and social characteristics whereas the economic differentiation runs more importantly along regional lines. These patterns are not unique for the Czech Republic but are also observable in other Western-European countries.



## **7. ANALYSIS OF MIGRATION FLOWS AS THE MAIN COMPONENT OF SPATIAL POPULATION DYNAMICS**

In the previous chapter, we focused on the description of selected demographic and socio-economic characteristics of spatial and geographical categories, stressing their distinct features both from the perspective of the urban-rural gradient and using the regional approach. The descriptive analysis of general population change and its natural and migration components have indicated that, firstly, the spatial differentiation in population growth is far more an issue of urban-rural gradient differentiation than a regional issue. Secondly, the differentiation is far more the effect of migration than of natural increase. Therefore, thirdly, the main differentiation in population growth within the Czech Republic is a result of migration flow intensity between urban, suburban and rural areas. The regional aspect of migration flow differentiation is less pronounced, but nevertheless important from the viewpoint of the evolution of regional dominance or attractiveness. The highest imbalances are between Moravian regions and the Prague (Praha) and Central Bohemian (Středočeský) region, where the first is losing population to the advantage of the latter with an intensified tendency since the turn of the century.

Migration flows influence not only population quantity but also its structure. Descriptive analysis provides only a partial understanding of the composition of migrants and their subsequent impact on the demographic structure in the spatial categories. The descriptive analysis in Section 6.2.4 revealed that suburban areas are getting closer to the urban centres in terms of level of education and professional structure, but we were unable to conclude any significant influence on demographic behaviour such as fertility, family structure or divorce rates. To understand the impact of migration, I will focus in

this chapter on migration flow itself; its direction, volume and composition. Section 7.1 presents the data set and present the core-periphery regional approach classification. Section 7.2 contains a review of migration flows between regions and urban rural gradient categories in absolute numbers. In Section 7.3, the procedure of data reduction is applied (correspondence analysis) to uncover some commonalities and general tendencies in the vast combinations of possible migration flows and to reduce the data set for further explorative analysis (Chapter 8).

## **7.1 Residential migration data set**

The data set used for the analysis in Chapter 7 contains data for all individuals changing their place of residence in the two selected years 1995 and 2004. Although, the data set does not contain panel data, the choice of these two years enable the observation of the possible evolution over time. Year 1995 was one of the years with the lowest migration intensity in the last three decades. At the same time it was a year when the process of population deconcentration and mainly residential suburbanisation was at the very beginning. Therefore the migration in 1995 reflects the transition from the pre-1989 domestic migration patterns to the new one in a situation of an important downturn of migration. Last but not least reason for choosing 1995 was that the wave of municipal dissolution and re-appearance of newly founded municipalities as a massive process begun at the beginning of the 1990s was already over and municipal structure resembled that of 2001<sup>26</sup>. By 2004, the migration volume had been growing again for a few years. This upsurge was connected with economic growth, the increase in housing construction and the number of newly contracted mortgages. Therefore, new patterns of spatial population dynamics are already expected to be visible in the 2004 data. At the same time, a more prosaic reason led to the choice of the year 2004. It was the most recent year for which the evidence of migrants by their level of education was available. Since

---

<sup>26</sup> The referential year for the definition of urban-rural gradient spatial categories.

2005, unfortunately, no information about the education of migrants has been collected<sup>27</sup>.

The data set includes information about all individuals who changed their permanent residence from one municipality to another within the Czech Republic in the respective year. The information concerning municipality departure and arrival, sex, age and level of education are available for each individual migrant. We take into account only the domestic migration of Czech citizens and foreigners with permanent residence; other migration of foreign residents is omitted. This is because the evidence of foreign citizens' residence is generally quite poor and because the rules for their evidence changed considerably between 1995 and 2004. That makes the comparability of the data impossible. The cross-border migration of Czech citizens was omitted as well, because the information concerning such migration is unreliable and incomplete. Czech citizens are obliged to declare a permanent residence but they are not obliged to inform municipalities nor other institutions of population evidence when they move. Therefore, a person who has been living in a municipality for a couple of years need not have his permanent residence there and may have a declared permanent residence somewhere else (e.g. at his parents' home; at a dwelling which is now rented out, etc.). This situation biases the statistical evidence, as well as other important governance related issues (such as tax collection and redistribution etc.) and nobody is able to estimate the scope of the distortion.

In the analysis, the combinations of five main variables are used. Two of them, region and urban-rural gradient are "geographical and spatial dimensions", identifying the migration flows in differentiated space. Three of them, sex, age and education are "demographic" ones. Although education is not a demographic characteristic in the narrow sense of the word, we include it here in the group of characteristics of the individuals, using the wider meaning of the term demography. At the same time education serves as a proxy of the social status of the individual. To reduce the number of possible combinations resulting from crosstabulation of all variables, an initial aggregation of certain dimensions of variables was made. Here is given their overview:

---

<sup>27</sup> The Ministry of the Interior which is newly in charge of migration evidence no longer wishes to collect it.

*Regions*: classification into one core and three peripheral regions on the basis of NUTS 3 regions was used. The classification resulted from results of the analysis of spatial and regional differentiation of demographic, social and economic characteristics of the population of Section 6.2. The analysis have shown that the main and systematic distinction on the regional level is between Prague together with Central Bohemia and the rest. Therefore, for the purposes of the following regional spatial dimension analysis, we will consider Prague and Central Bohemian regions as the *core*. All of the other twelve regions will be considered as the *periphery*. Nevertheless, we can more or less systematically distinguish outstanding regions. On one hand there are the Ústecký, Liberecký and Karlovarský regions, characterised by high poverty and unemployment rates (Section 6.2.3) as well as a high divorce rate and a large proportion of one-parent families (Section 6.2.2). On the other hand, there are the Moravian regions marked by negative population growth, a low proportion of divorced residents and one parent families (Section 6.2.1 and 6.2.2). The rest of the Bohemian regions are not systematically outstanding and thus form a middle category.

For the purposes of further analysis along regional dimensions we will therefore distinguish four regional categories, one core and three peripheral (see also Figure 5):

- *Prague core region* including Prague and the Central Bohemian regions
- *North-West Bohemia (NW Bohemia)* including the Liberecký, Ústecký and Karlovarský regions
- *East-South-West Bohemia (ESW Bohemia)* including the Plzeňský, Jihočeský, Královehradecký and Pardubický regions
- *Moravia* including the Vysočina, Jihomoravský, Zlínský, Olomoucký and Moravskoslezský regions.

Figure 5: Classification of Czech regions into one core and three peripheral regions as used in the core-periphery regional classification

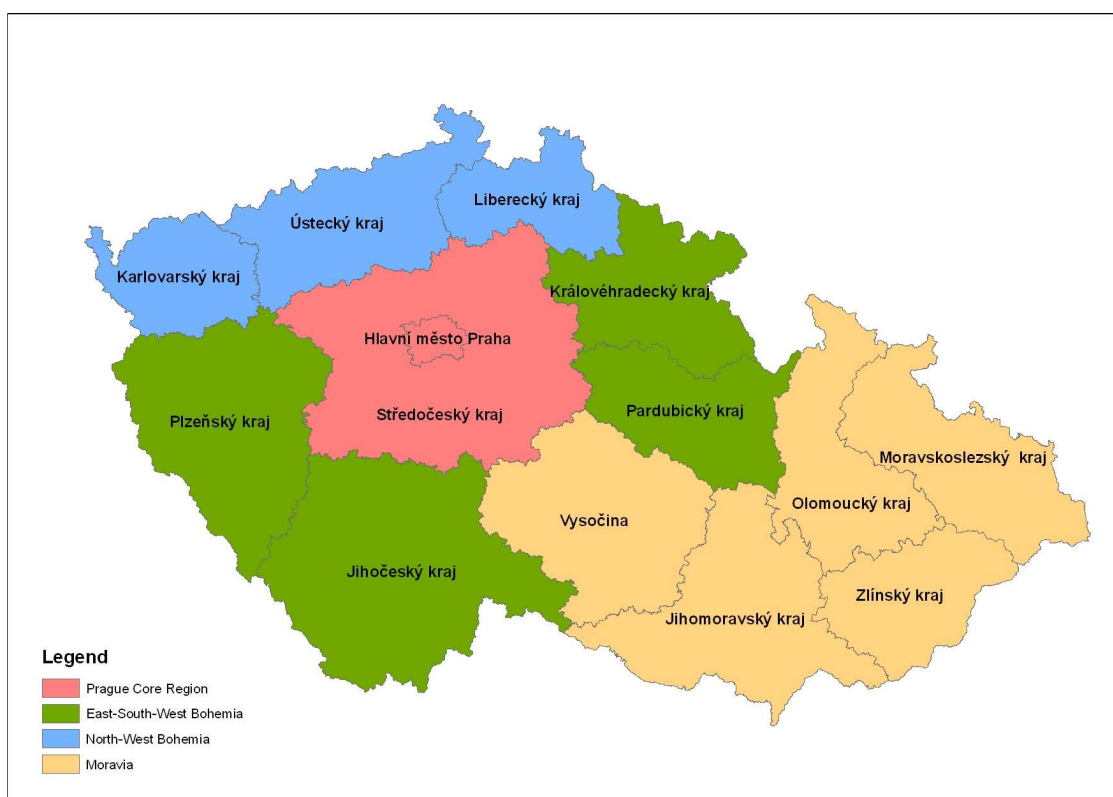

Source: Author.

*Urban-rural gradient:* six spatial categories will be used below, instead of the seven used previously (Figure 3, Section 5). The rural areas are merged with suburban areas of secondary centres because the latter represent only a very small portion of the population (Table 3) and therefore the migration flows would be too insignificant. Moreover, the descriptive analysis in Chapter 6 revealed systematic resemblance between the two categories in demographic as well as socioeconomic characteristics.

*Sex:* at this stage, the distinction between the two sexes is preserved and only if the variable proves to be unimportant in differentiation, will it be omitted further on.

*Age:* an aggregation of flows in five age categories was established according to histograms of migration flows to and from all six urban-rural gradient categories by five year age groups. The number of flows and the homogeneity of each age group were

taken into account when defining the categories. The age groups are as follows: 0-19, 20-29, 30-44, 45-59, 60+.

*Education:* according to histograms of migration flows to and from all six urban-rural gradient categories, four levels of education were defined: “basic and none” for those whose highest level of education is finished or unfinished primary school, “without A-levels” for those with a professional level of education without A-levels, “with A-levels” for those who acquired A-levels (maturita) or other non-university diplomas, “university” for university educated with Bc. level or higher.

## **7.2 General patterns of residential migration in the Czech Republic**

From a long-term perspective, the volume of migration diminished in the Czech Republic with a steep decline after 1989 and only a mild recovery after 1995. It declined from 250 000 in the year 1980 to 164 000 in 1996 and rose slowly to surpass 200 000 after 2004<sup>28</sup>. Nowadays, only 2 % of the population changes the municipality of residence annually, which means that one would change residence once in 40-50 years which de facto means once in lifetime (Polášek 2005). Moreover, the decline would be steeper, if the number of municipalities had not risen by one third in the early 1990s. The essential factors in the decline of mobility were the halt in subsidised dwelling construction leading to a steep decline in housing construction in the early 1990s (see Section 2.2 and Figure 1 for more details), a decline in centrally planned industrial production and therefore the diminished attractiveness of some towns and regions for migrants, the collapse of the socialist habit of housing provision for newly arrived workers and the financial inaccessibility of new dwellings on the free-market for a majority of the population, at least during the whole first decade of transformation. Given these transformation related elements, families' attachment to their present dwellings as often the most valuable asset owned increased yet further. People prioritized housing accessibility before employment attractiveness, accepting longer commuting distances or less attractive jobs before moving elsewhere (Lux, Sunega

---

<sup>28</sup> These figures include all migrants, including foreign immigrants.

2007). In 2001, 40 % of all employed persons were commuting out of the municipality of their residence (Hapl 2005). Part of them can be people living in reality elsewhere but without official change of residence which can cause a non-estimable overvalue of that number.

The growth in the domestic population migration from 171 959 in 1995 to 179 946 in 2004<sup>29</sup> was mainly due to the increased volume of out-migration from primary centres (from 74 to 85 thousand). The benefits of these migration flows went mainly to the fringes and polycentric backgrounds (see Figure 4, Figure 6). These benefitted from positive net migration flows from primary centres as early as 1995 (inner and outer fringes by approximately 3 000 each and polycentric backgrounds by around 1 500) but these benefits were to increase considerably. In 2004, primary centres were the main “suppliers” of in-coming inhabitants to suburban areas. The inner fringes experienced a net migration gain of around 9 800 of which approximately 9 500 from primary centres alone. Outer fringes saw a total net gain of around 8 200 of which around 7 700 were from primary centres. The total net migration gains in the polycentric backgrounds were about 3 400, of which approximately 3 200 from primary centres. The migration exchange between suburban areas and the remaining spatial categories is balanced.

The net-migration losses in primary centres intensified mainly as a result of increased out-migration (an increase of about 10 000 in 2004 compared to 1995). The in-migration dropped less dramatically, but still considerably (by about 3 000). Secondary centres slightly intensified their migration losses due to the increase in out-migration (by about 500) while in-migration to these secondary centres dropped by approximately 1 100 in 2004 compared to 1995.

---

<sup>29</sup> These figures include only internal migration of Czech citizens and foreigners with long-term residence permit.

Figure 6: Migration flows between and within urban-rural gradient categories and net migration, in absolute numbers, in thousands, 1995 and 2004

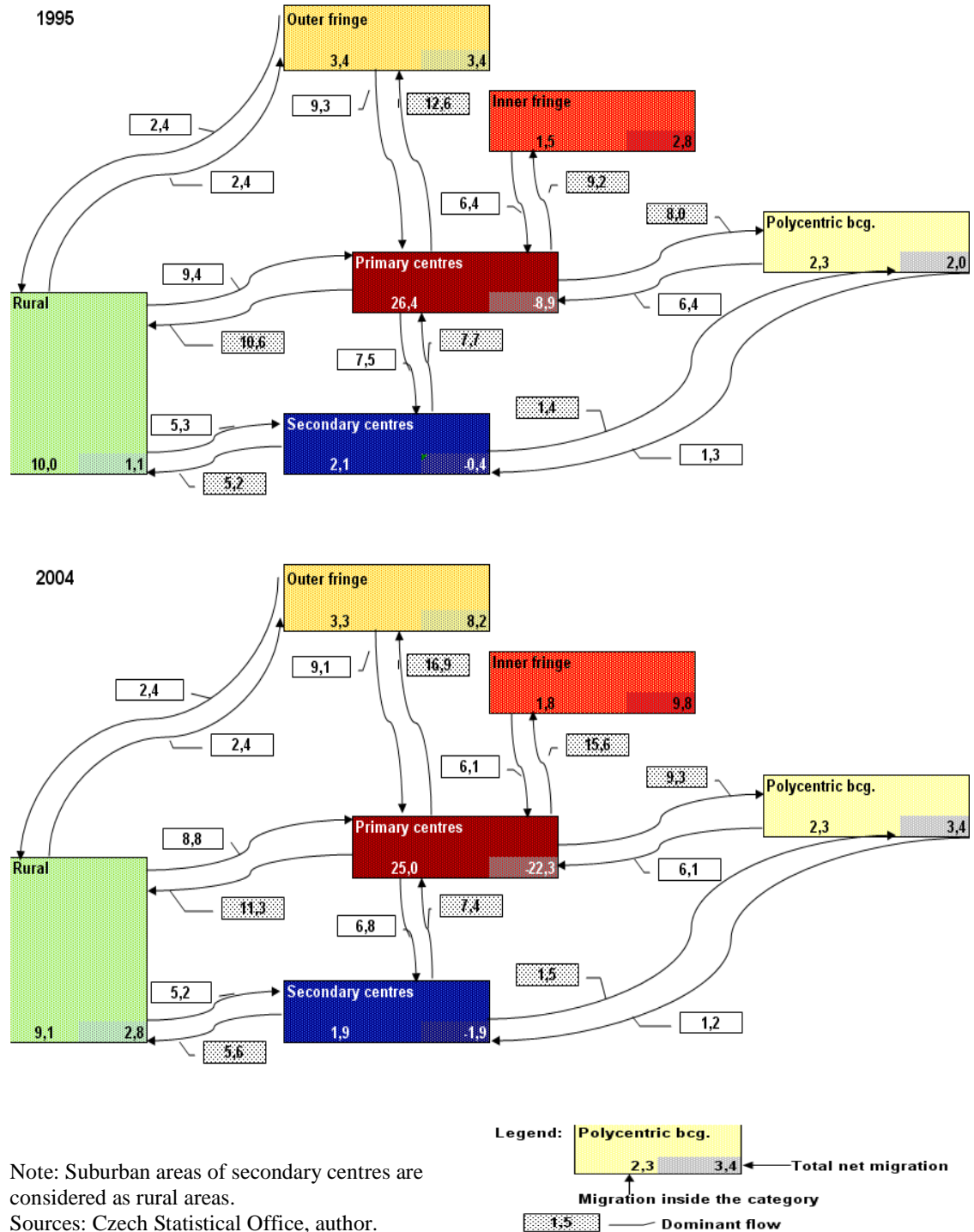



The rural areas experienced higher net migration gains in 2004 than in 1995 (about 2 800 compared to 1 100 in 1995). The gain in 2004 is not due to higher in-migration (difference of -200 between 1995 and 2004) but rather to lower out-migration from rural areas (about 28 800 in 2004 against 30 700 in 1995). The largest volume of migration was with primary centres when almost 9 000 rural inhabitants moved from rural areas to primary centres and more than 11 000 inhabitants left primary centres for urban areas (Figure 6). This migration exchange made the rural net migration gains. Compared to 1995, the immigration from primary centres intensified whereas the rural to primary centres migration diminished (from 9,4 thousand in 1995 to 8,8 thousand in 2004). The same effect was observable on migration between rural areas and secondary centres.

The largest migration volume was however within the spatial category of primary centres. In 2004, around 25 000 citizens moved from one primary centre to another. It was only little less than in 1995. Rural areas have the within migration relatively important (9,1 thousand in 2004) as well with a slightly declining trend between 1995 and 2004. In other spatial categories the within category migration is relatively small. In general, the migration profile observed in 2004 was already relatively similar in the 1995. Only the out-migration from primary centres intensified and the in-migration to primary centres diminished slightly. But in general the intensity of other in and out-migrations flows stayed relatively similar. The rural out-migration was not halted or markedly diminished, nor was out-migration from the suburban areas. The increasing residential suburbanisation was not accompanied by any reversal of already existing domestic migration trends.

From regional perspective, the most striking pattern in the domestic migration is a prevailing occurrence of migration within the regional blocks (Figure 7). More than 80 % of all migrants moved within the regional block of their residence and this figure even increased slightly between 1995 and 2004 (from 80.5 % to 81.6 %). This migration “closing” inside the regions was present in all four regional categories. In the case of Prague region, it was the most striking. In 1995, about 23,2 thousand citizens changed the residence from one municipality to another in the same region, whereas in 2004 it was already 27,4 thousand.

The dynamics of inter-regional spatial population movement between 1995 and 2004 viewed from a regional perspective can be characterised as the imposing attractiveness of the Prague core region over the other regions. Migration flows were more equally distributed and net migration gains were less polarized in 1995 than in 2004. The Moravia region was the one which lost population to all the other regions beginning in 1995; its losses deepened from almost 1 000 to more than 3 000 in 2004 mainly due to high outflow to the Prague core region (see Figure 7). NW Bohemia had a relatively smaller inflow of inhabitants in 2004 compared to 1995 (mainly from ESW Bohemia, but also from the Prague core region). This was the main reason why the migration gains here were four times smaller in 2004 than in 1995. The accentuated losses of the NW Bohemia region in 2004 were therefore not caused by a much more intensive outflow of inhabitants to other regions but by the lower volume of in-migrants. This suggests that the NW Bohemia region, seriously hit by economic restructuring, became less attractive for in-migration but did not witness a growing outflow of the resident population. This is a different pattern from the one observed in Moravia, where diminished in-migration combined with intensified out-migration at the same time.

The attractiveness of migration to ESW Bohemia was clearly higher in 1995, when there was higher absolute in-migration gains from all other regions, than in 2004. Its net migration gains remained positive in 2004 but diminished in absolute terms, due mainly to the diminished in-migration from the Prague core region. The Prague core region was the one which profited most from high in-migration in 2004, much more significantly than in 1995. This intensified in-migration was combined with diminished out-flow from the Prague core region elsewhere. This combined effect resulted in a net migration gain of almost 4 000 inhabitants in the Prague region in 2004. Moravian regions were the main suppliers of the in-migrants to the Prague core region (around 4 700).

Figure 7: Migration flows between and within groups of regions and net migration, in absolute numbers, in thousands, 1995 and 2004

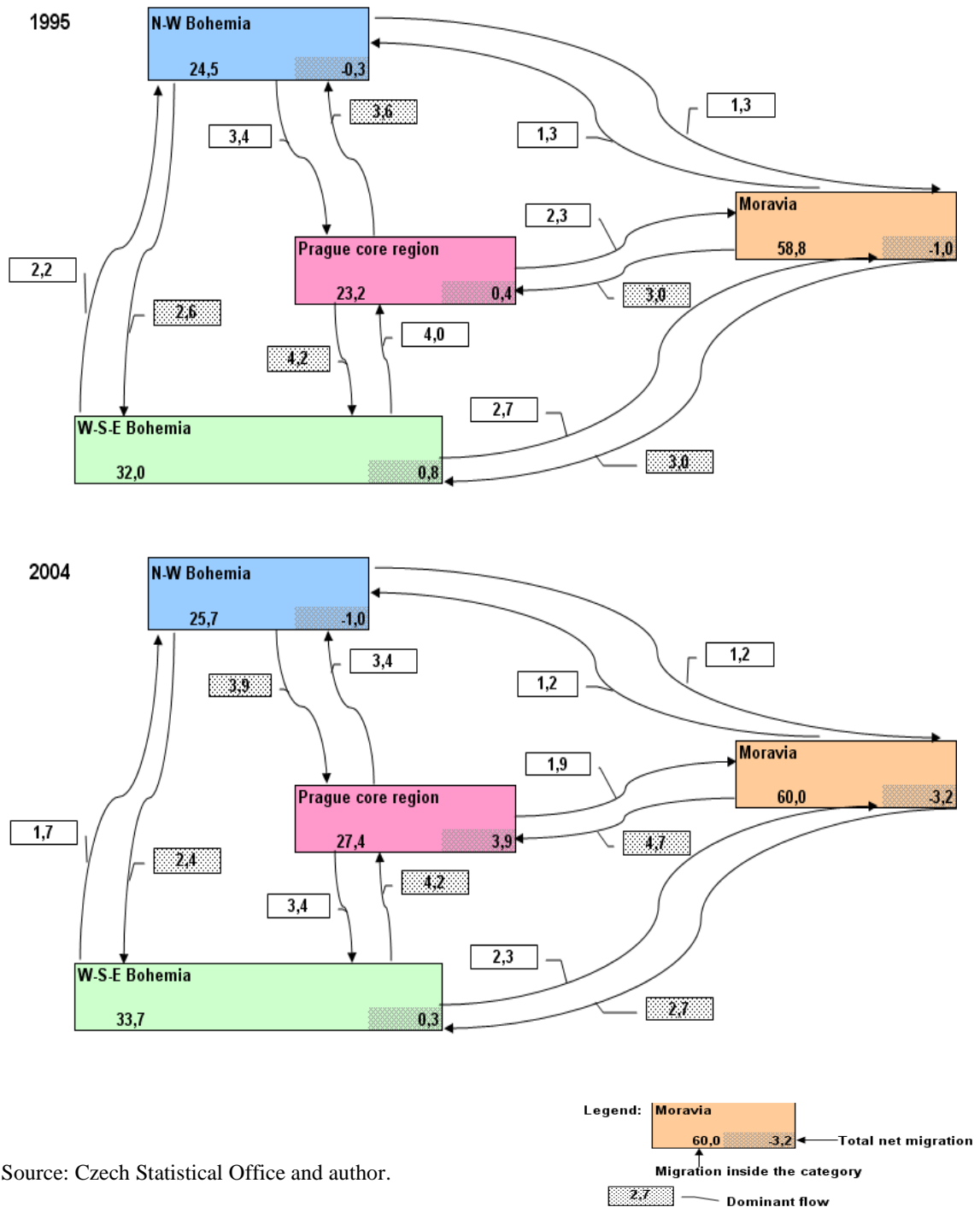

Source: Czech Statistical Office and author.

As a conclusion, we can say that the growing volume of migration flows in total numbers is mainly due to the growth in the volume of out-migration from primary centres towards suburban areas. The trend in the rest of the spatial categories is opposite to that of the primary centres. In suburban and rural areas, the volume of out-migration diminished in 2004 compared to 1995. From the regional viewpoint, the most remarkable feature is the growing volume of migration inside and into the Prague core region, the first caused undoubtedly by suburbanisation, the second by the growing economic dominance of the Prague region and its attractiveness for in-migration from other regions, mainly from Moravia. This finding suggests a changing pattern of migration: on the one hand, a high out-flow from primary centres and diminished mobility from other spatial categories, on the other hand the growing dominance of the Prague core region in its migration attractiveness. The following analysis will reveal these structural differences in more detail.

A first look at the data on age, sex and education of migrants from the perspective of simple crosstabs gives us a first overview which highlights the main tendencies in differentiation of migration by demographic characteristics. Generally speaking, the demographic structure of migrants in the 1995 and 2004 (see the detailed tables in Annex 5) is characterised by balanced migration of males and females according to their proportion in the whole population. There are only slightly more women migrating at the age of 20-29 years. The youngest age group of 0-19 typically moves with their parents and therefore follows their migration patterns. The age of 20-29 is the most frequent for residential change; later in the life cycle it diminishes steadily. The population aged 20-29 especially migrates to urban centres, a characteristic which distinguishes them from all other age groups. Those aged 30-44 most often move to suburban areas. Rural areas and small centres are not so attractive for them. On the other hand, the 45-59 age group is attracted more than the previous groups by more remote suburban and rural areas. Migrants aged 60+ compose the smallest group. They migrate mainly to non-urban destinations or small centres. The higher educated migrate more frequently than the less educated (Table 34). Although the proportion of population without A-levels was almost 69 % in 2001, only 63 % from all migrants were without A-levels. The migrants with A-levels and higher were overrepresented by 6 % compared to their proportion in the

whole population. This trend is in compliance with findings from other countries (Rees, Kupiszewski 1999).

*Table 34: Population by level of education in 2001 and migrants by level of education in 2004, in %*

Level of education	Population in 2001	Migrants in 2004
Without A-levels	68,8	63,0
With A-levels	23,8	26,8
University	7,5	10,2
Total	100,0	100,0

Note: Include all age groups of population.

Sources: Population census 2001, Czech Statistical Office, author's calculations

Further analysis will combine both regional and urban-rural gradient spatial dimensions of municipalities of origin and destination with the demographic characteristics of the migrants. This multi-dimensional analysis will clarify the complexity of migration patterns and help identify those migration flows which show similar characteristics.

### **7.3 Description of residential migration across the spatial categories and data reduction**

The multiple combinations of variables characterizing migration flows pose problems for meaningful interpretation. Therefore, a reduction of combinations will be performed straight off by means of correspondence analysis. This will also serve as a first visualisation of the structure of migration flows.

The analysis will be carried out on the dataset of 2004 because the processes already discernable in 1995 were more pronounced in 2004 and this data gives the most updated snapshot of the spatial dynamics of the population we can have.

#### **7.3.1 Protocol**

The initial working data set provides us with information about the municipality of origin, municipality of destination, sex, age and level of education for each of the 179 746 migrants in 2004. Each of the municipalities of origin and destination is situated in one of the urban-rural gradient spatial categories (primary centre, inner fringes, outer

fringes, polycentric backgrounds, secondary centres or rural areas) and in one of the four regions (Prague core region, ESW Bohemia, NW Bohemia or Moravia). To display all the possible combinations of migration flows, we would need a table of contingency composed of 576 lines and 38 columns. The lines would represent a combination of four regions and their six urban-rural gradient categories (that is,  $4 \times 6 \times 4 \times 6$ ) and the columns would represent the flows according to demographic characteristics of sex, age (0-19, 20-29, 30-44, 45-59 and 60+) and education (basic or none, without A-levels, with A-levels, university), that is,  $2 \times 5 \times 4 \times 2$  (no one aged 0-19 had a university education). Such a table would be impossible to interpret and would likely include boxes in which the number of individuals would be insignificant. It is therefore clear that a reduction in categories, both in terms of the spatial dimension as well as that of the demographic dimension, accompanied by the least possible loss of information (inevitable in the process of data reduction) is necessary. To this end, five steps were followed. Four of them are presented in this section (I-IV) and in Annexes 6-8. The results are described in the next section 7.3.2 as is the fifth and final step in data reduction (V).

The first step in our data reduction was **a reduction in categories of the spatial dimension of migration flows (I)**. To check the frequency of flows within and between the regions, a crosstabulation of four regions of origin with their six urban-rural gradient categories by four regions of destination with their six urban-rural gradient categories, a  $24 \times 24$  table, was created (Annex 6). The majority of migration flows (more than 80 %) occurs within regions, and the flows between regions are much smaller. I therefore decided to merge some of the inter-regional migration flows. As a result, the flows between regions were reduced into seven zones: internal flows within each region (Prague, ESW Bohemia, NW Bohemia, Moravia), and three migration zones between regions: departures from the Prague region (core) and arrival to all other (peripheral) regions, arrival to Prague (core) region from all other (peripheral) regions and all other inter-regional flows. The less frequent flows were therefore aggregated and the distinction between the core and peripheral regions was conserved in compliance with our theory and hypothesis, but also in response to the real distribution of flows (Annex 6).

Secondly, **the relationship between the spatial dimension of migration flows and the demographic characteristics of migrants** was examined (II). Correspondence analysis was used for this purpose. This is a technique for the reduction in the dimensions of data. It supposes nominal variables and can describe the relationships between categories of each variable, as well as the relationships between the variables. It is a geometric technique to display the rows and columns of a two-way contingency table as points in a low-dimensional space, such that the positions of the row and column points are consistent with their associations in the table. The goal is to obtain a global view of the data that is useful for interpretation (more about this standard statistical method in Benzécri, 1973, Greenacre 1984).

Correspondence analysis is applied here to seven contingency tables (one for each of the above defined zones of intra- and inter-regional migration) with 36 lines and 38 columns. The lines represent the combinations of migration between the six urban-rural gradient categories 6x6 and the columns represent the migration flows by sex, the five age groups and the four levels of education 2x5x4-2 (no one aged 0-19 had a university degree). The analysis was executed by the SAS program by means of the CORRESP procedure.<sup>30</sup> The resulting graphics are available in Annex 7 and will be discussed in section 7.3.2.

Following the results of the correspondence analysis, **further reduction in the spatial dimensions of migration flows (III)** was performed for each of the seven zones. The aim here was to identify the migration flows which are similar in their demographic structure (by sex, age and education of migrants) and which therefore could be grouped together. This reduction in dimensions was informed by the theoretical assumptions and the results of cluster analysis.

Cluster analysis graphically displays the distance between migration flows according to the similarity in their structures. It is an iterative procedure which first identifies the closest units and, by grouping them, creates a new unit. This new unit, in turn, enters a new step searching for the closest units, the now total number of units being N-1. The

---

<sup>30</sup> All the computational procedures with SAS, including correspondence analysis and other computations whose results are presented below, were executed by Virginie Piguet from CESAER, UMR INRA-AgroSup Dijon.

axis distance indicator of each of the individuals resulting from correspondence analysis was used to measure distances between the migration flows. The Ward criterion was applied to minimise the inertia in each of the clusters. The analysis was executed by means of the SAS procedure CLUSTER.

The initial number of 252 categories of the spatial dimension of migration flows 6x6x7 (combination of six urban-rural gradient categories for each of the seven zones) was thus reduced to 29 categories. This reduction in migration categories was necessary for another reason. By reducing the number of observed migration flows to 29, the total number of migrants in almost all categories became higher than 2 000. By aggregating the categories with low frequencies of flows, a complication of “small N” in further analysis was avoided. Of the 29 categories of the spatial dimension of migration flows, there were six within the Prague region, six within ESW Bohemia, four within NW Bohemia, four within Moravia and three for migration flows from the Prague region to peripheral regions, from peripheral regions to Prague and between the peripheral regions. Table 35 or the Migration Flow Key gives the keys defining each of the 29 flows. The clustering trees and resulting reduction in the spatial dimensions are presented in Annex 8.

Finally, a **second correspondence analysis (IV)** was processed to reveal the association between the demographic characteristics of the migrants (19 categories: 5 age x 4 education – 1: none of 0-19 was university educated) and the 29 categories of the spatial migration flows in order to reach a general understanding of associations between geography of flows and demography of migrants for the whole of the Czech Republic. These results are presented and described in Section 7.3.2.



Table 35 (part 1): Categories of the spatial dimension of migration flows by four regions and six urban-rural categories with absolute number of migrants in 2004

D_A Region	D_A Gradient cat.	Gradient cat.		ID	No. of Migrants
		D	A		
Prague core region	PS_P	Primary c. Secondary c.	Primary c.	11	2 832
Prague core region	P_F	Primary c.	Fringes	12	8 758
Prague core region	P_BSR	Primary c.	Background Secondary c. Rural	13	4 319
Prague core region	FBR_P	Fringes Background Rural	Primary c.	14	4 373
Prague core region	FBSR_F	Fringes Background Secondary c. Rural	Fringes	15	3 020
Prague core region	FBSR_BSR	Fringe Background Secondary c. Rural	Background Secondary c. Rural	16	4 121
ESW Bohemia	PS_P	Primary c. Secondary c.	Primary c.	21	3 058
ESW Bohemia	P_FBR	Primary c.	Fringe Background Rural	22	9 323
ESW Bohemia	P_S	Primary c.	Secondary c.	23	1 146
ESW Bohemia	FBR_P	Fringes Background Rural	Primary c.	24	5 249
ESW Bohemia	FBSR_FBSR	Fringes Background Secondary c. Rural	Fringe Background Secondary c. Rural	25	12 918
ESW Bohemia	S_R	Secondary c.	Rural	26	2 041
NW Bohemia	PFBSR_P	Primary c. Fringes Background Secondary c. Rural	Primary c.	31	10 097
NW Bohemia	P_FB	Primary c.	Fringe Background	32	5 534
NW Bohemia	P_SR	Primary c.	Secondary c. Rural	33	2 776
NW Bohemia	FBSR_FBSR	Fringes Background Secondary c. Rural	Fringe Background Secondary c. Rural	34	7 278
Moravia	PS_PS	Primary c. Secondary c.	Primary c. Secondary c.	41	10 007
Moravia	FBSR_P	Fringes Background Secondary c. Rural	Primary c.	42	13 267
Moravia	PS_FBR	Primary c. Secondary c.	Fringes Background Rural	43	20 365
Moravia	FBR_FBSR	Fringes Background Rural	Fringes Background Secondary c. Rural	44	16 214

Continues on the next page.

Table 35 (part 2): Categories of the spatial dimension of migration flows by four regions and six urban-rural categories

Departures from Prague region	P_PFBRS	Primary c.	Primary c. Fringes Background Secondary c. Rural	51	6 126
Departures from Prague region	FBSR_P	Fringes Background Secondary c. Rural	Primary c.	52	994
Departures from Prague region	FBSR_FBSR	Fringes Background Secondary c. Rural	Fringes Background Secondary c. Rural	53	1 664
Arrivals to Prague region	PFBSR_P	Primary c. Fringes Background Secondary c. Rural	Primary c.	61	8 260
Arrivals to Prague region	PFBSR_F	Primary c. Fringe Background Secondary c. Rural	Fringes	62	2 417
Arrivals to Prague region	PFBSR_BSR	Primary c. Fringe Background Secondary c. Rural	Background Secondary c. Rural	63	2 046
Other inter-regional flows	PFBSR_P	Primary c. Fringes Background Secondary c. Rural	Primary c.	71	5 100
Other inter-regional flows	PFBSR_F	Primary c. Fringes Background Secondary c. Rural	Fringes	72	1 652
Other inter-regional flows	PFBSR_BSR	Primary c. Fringes Background Secondary c. Rural	Background Secondary c. Rural	73	4 791

Note: D – departure, A – arrival, Fringes – inner and outer fringes, Background – polycentric background  
In column “D\_A Gradient cat.” are abbreviations of categories listed in the following two columns.

### **7.3.2 Social status, life cycle or sex? Findings about the main determinants of residential migration from descriptive analysis**

The correspondence analysis have shown the association between the demographic characteristics of the migrants and the categories of the spatial migration flows in several dimensions and we pay attention here to the first three which explains 90 % of variance in total. The first dimension (Dim 1) can be called “*Dimension of education*” explains 57 % of variance of the data set. The second (Dim 2) can be called “*Dimension of young versus old economically actives*” and explains 25 % of variance and the third dimension (Dim 3) “*Dimension of economically actives versus seniors*” explains only 8 % of variance (Figure 8).

Level of education is the main differentiating factor in migration destination. The age of the migrants plays a less important role and whether the migrant is a man or a woman has negligible differentiating power. These general observations are true for intra- as well as for inter-regional migration in all seven observed zones (Annex 7). In other words, social status (approximated here by the level of education) plays a more determining role in the decision where to migrate than position in the life cycle. This is not the case for example in France where the position in life cycle is more important in migration destination than the level of education (Schmitt ed. 1998, p. 59). This finding may have an important impact on social policy, including an impact on spatial social segregation. A further study of the evolution of this phenomenon over time would surely lead to more insight.

The strongest “*Dimension of education*” (Dim1 in Figure 8A) shows that the migration behaviour of the university educated is clearly different from the behaviour of those with little education (without A-levels). In between the two lies those with a secondary (A-levels) education. The second “*Dimension of young versus old economically actives*” (Dim2 in Figure 8A) represents all subjects aged 45-59 above the horizontal line intersecting zero and all those aged 20-29 below that line.

Figure 8: Visualisation of the demographic and geographic dimensions of migration flows

A

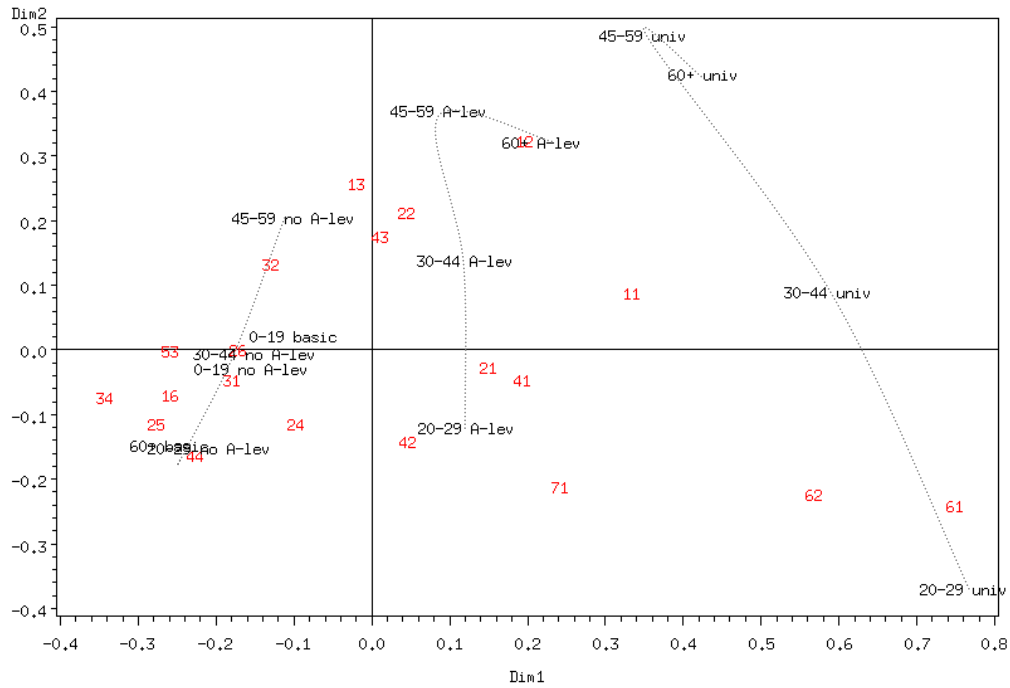

Note: Hand drawn curved lines help in orientation by extracting the most distinct features in the figure.

B

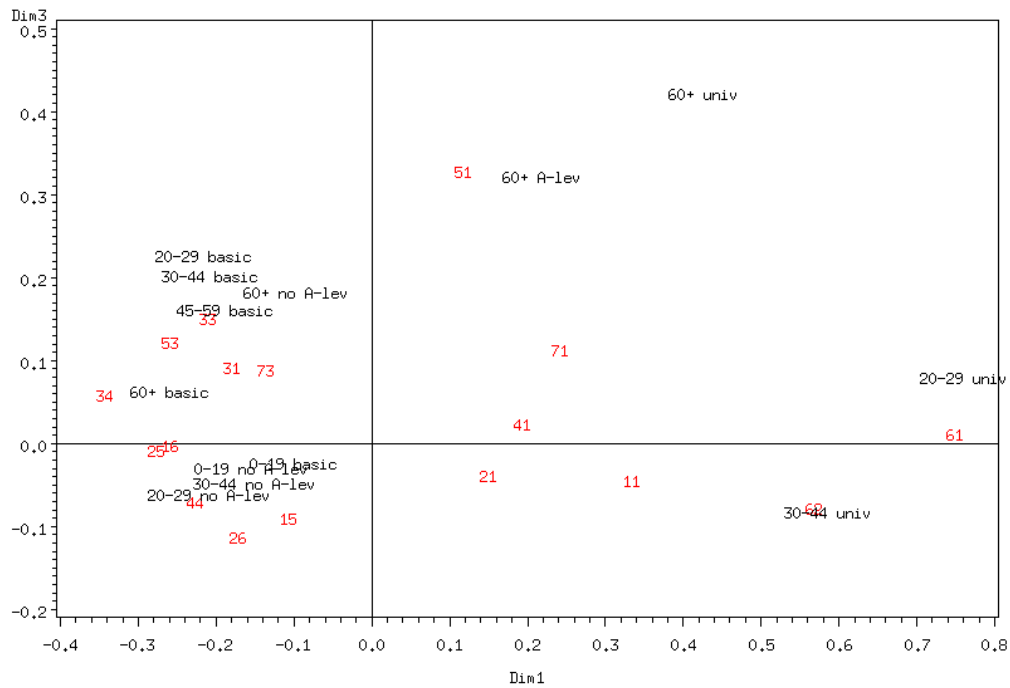

C

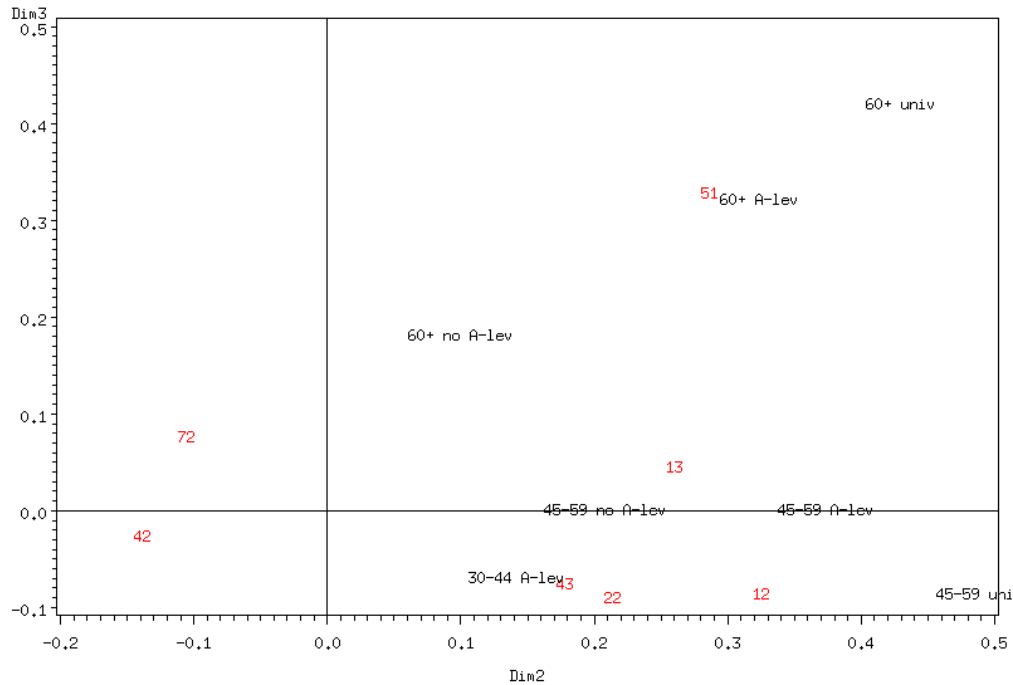

Note: In the results of the correspondence analysis, Dim1 explains 57 % of the variance, Dim2: 25 % and Dim3: explains 8 % of variance. The list of IDs explaining the categories of migration flows in the geographic dimension (11, 13, 22 etc.) is found in Table 35 or in the Migration Flow Key. Only those categories whose sum of the squared cossinuses of displayed axis of the two dimensions was equal to or greater than 0,5 were included in the figures.

Sources: Author.

Migrants moving to primary centres and to the fringes of the Prague core region<sup>31</sup> (Arrivals to Prague region from all other regions (ID 61, PFBSR\_P), to the fringes of Prague region (ID 62, PFBSR\_F) and from urban centres within Prague region to primary centres (ID 11, PS\_P)) exhibit distinct characteristics. Those who move to primary centres of the Prague core region (ID 61, PFBSR\_P) are mainly young and university educated; this same group moves to the Prague region suburban fringes as well (ID 62, PFBSR\_F). Contrary to the situation in the Prague core region, urban immigration in other regions is dominated by the 20-29 age group with a secondary education (ID 21, PS\_P ESW Bohemia; ID 41, PS\_PS Moravia; ID 42, FBSR\_P

<sup>31</sup> The key to the significance of ID numbers is in the attached Migration Flow Key and in Table 35.

Moravia; ID 71, PFBSR\_P Other inter-regional). The suburban areas are attractive mainly for migrants aged 30-44 with A-levels (ID 12, P\_F Prague core region; ID 22, P\_FBR ESW Bohemia; ID 43, PS\_FBR Moravia). The least educated tend to move mainly within the regions and between the non-urban categories, irrespective of their age. The exception to this rule is the case of migration towards more remote suburban areas of the Prague primary centres. It is particularly attractive for subjects aged 45-59 without A-levels. This supports the hypothesis that lower social classes, when wishing to suburbanise, have to move further out because of their financial constraints. This hypothesis will be examined more rigorously following the regression analysis below.

NW Bohemian migration patterns (ID 31, PFBSR\_P; ID 32, P\_FB) seem to have distinct features when compared to ESW Bohemia and Moravia, and even appear to oppose the patterns of migration inside and toward the Prague region. The migration towards the primary centres of NW Bohemia is not very specific in terms of Dimensions 1 (education) or 2 (age). The migration towards NW Bohemian suburban areas is not typical for secondary educated as it is in ESW Bohemia and Moravia. Although the separate correspondence analysis for NW Bohemia revealed differentiation by level of education and age (Annex 7), when included in the model for the whole Czech Republic, this effect was no longer visible. The reason for this may be that dimensions 1 and 2 have only low explicative power for migration in NW Bohemia. In the separate model, the dimension of education (Dim1) explained only 27 % of the variability, whereas for intra-regional migration of all the other regions, it represented approximately 45 %<sup>32</sup> (Annex 7). Therefore, in NW Bohemia other factors explain migration differentiation.

Dimension 3 “*Dimension of economically actives versus seniors*” explains only 8 % of variance of the model and is the least important from all the three dimensions. It opposes economically actives and non-actives (60+) . It also distinguishes the flows of departures from the Prague primary centres to all other regions (ID 51 in Figure 8 B and C). This flow seems to be mainly composed of seniors moving out of the Prague region’s large centres. We have to be cautious with any interpretation at this stage because the

---

<sup>32</sup> The reason was not a small number of observations but rather the stronger influence of other variables on the individual level which were not taken into account.

migration flows of the 60+ are relatively rare (especially the more highly educated) and therefore this association may not be significant.

The results of the correspondence analysis in Figure 8 as well as in Annex 7 show which demographic groups and geographic flows have their strong specificities but they also reveal which demographic characteristics resemble others. We have already mentioned the case of sex, where, when all other demographic characteristics are equal, men and women have similar migration patterns. The age group of 0-19 was rarely included in the figures and if it was, occupies a place close to the age group 30-44. This proves the intuitive expectation that children move with their parents who are mainly in the 30-44 age group. The 60+ demographic group shows more distinct features, but there is a danger that they may be caused by the small number of observations (small N problem).<sup>33</sup> Regarding the structure by education, in general, the migrants with basic education were very often close to those without A-levels of the same age group.

For the purposes of explorative analysis, a further reduction in data was necessary, first of all to increase the readability of the data but also to diminish the problem of insignificant results caused by “small N”. Therefore, the fifth step in data reduction was undertaken by **merging certain demographic groups (V)**. The sex of migrants was no longer distinguished, the age group of children (0-19) was merged with the most probable age group of their parents (30-44) and the age group 60+ was merged with the age group 45-59, mainly for the reasons of “small N” but also because in several observations, their migration flows were close to those of 45-59. Finally, the migrants with basic education were merged with those without A-levels. The resulting demographic dimension with which we will work below contains 6 categories which combine low education (basic + without A-levels), secondary education (with A-levels) and university education with the age groups 20-29, 0-19 plus 30-44 and 45+.

---

<sup>33</sup> The 60+ age group of migrants comprises 16 064 individuals of which 2 328 have A-levels only and 1 095 have a university education.

## **8. STRUCTURE AND DETERMINANTS OF RESIDENTIAL MIGRATION: EXPLORATIVE ANALYSIS**

The descriptive analysis presented in Chapter 7 is a powerful tool for a visualisation of the existing relationship between the phenomena under scrutiny, represented here by the direction and demographic structure of migration flows. It is also helpful for the subsequent data reduction. But it cannot provide us with rigorous information about the determinants of the phenomena in focus. Here, we will measure the importance of some of the socio-economic characteristics of the municipalities and their relative importance as pull or push factors for migrants. This relative importance may be different for different demographic groups and therefore separate models for each of them will be developed. By introducing the spatial and demographic dimension into the gravity model, we can also estimate their relative importance and therefore underpin the results of the descriptive analysis. Finally, we will be able to answer the research question about the character of the recent spatial population dynamics in the Czech Republic.

### **8.1. Gravity model**

A gravity model, a special type of regression, is used here to analyse the impact of socio-economic variables on migration flows between municipalities. This model, borrowed from classical physics, is often used in regional economics to analyze the effects that distance and population size of localities have on migratory forces (Borjas 1989; Greenwood 1975). In this context, migration behaviour is analysed in terms of utility maximization. All else equal, individuals will move to a new location if the perceived utility of doing so is greater than the utility of not moving. Such models are



commonly used to explain the determinants of international migration (Lewer, Van den Berg, 2007, Karemera et al. 2000, Borjas 1989, Faustino, Leitao 2008); for domestic migration, their use is rather rare but some authors have successfully used them in this context, too (Ashby 2006).

An unconstrained gravity equation would be

$$M_{ij} = \frac{GP_i P_j}{D_{ij}} \quad (1)$$

where  $M_{ij}$  denotes gross migration from location  $i$  to location  $j$ ,  $G$  is a constant,  $P_i$  and  $P_j$  represent the population in locations  $i$  and  $j$ , and  $D_{ij}$  is the distance between these two locations. By taking logs on both sides of the equation, a reduced-form of the model is created

$$m_{ij} = a_0 + a_1(p_i \cdot p_j) + a_2(d_{ij}) + u_{ij} \quad (2)$$

where  $(p_i \cdot p_j)$  are natural logs  $\ln(P_i * P_j)$  and  $d_{ij}$  is the natural log of  $\ln(D_{ij})$ .

Often, variables chosen to control for demographic, geographic, ethnic, economic or other conditions are included in the model. Here, when explaining the determinants of domestic migration flows, three groups of control variables and gravitational demographic variables will be employed:

1. *Gravitational demographic variables*: distance  $d_{ij}$  and population  $p_i$ ,  $p_j$ . Distance is expected to be a constraint on migration because the costs of migration may increase in this dimension. These costs increase with the growing distance between localities  $i$  and  $j$ . Since transport costs are not readily available, a common practice is to use the shortest crow fly distance ( $d_{ij}$ ) between origin and destination localities (Borjas 1987). The coefficient  $a_2$  is expected to be  $a_2 < 0$ . The population size  $(p_i \cdot p_j)$  matters as an attractive “mass”; the more people there are in a source locality or in the destination locality, the more people are likely to migrate. The coefficient  $a_1$  is expected to be  $a_1 > 0$ . In the

literature, financial status or average income are considered as major determining pull-push forces influencing migration and are often included in the model as a third gravitational demographic variable (Lewer, Van den Berg, 2007, Karemera et al. 2000, Ashby 2006). In our case, we do not dispose of such information on the municipal level, nor do we have a proxy for that variable. We therefore cannot include this variable in the model.

2. *Characteristics of municipalities*: they are included to identify the social, economic and environmental conditions which may play a role in inciting in- or out-migration. We include in the model the differential of the six following variables. They enter into the model as natural logs of fraction of municipal characteristics of destination to the value of municipality of origin:  $\ln\left(\frac{\text{destination.value}}{\text{origin.value}}\right)$ . Their exact description is in Table 36.

We enter the variables listed bellow and expect that variables' logs will interfere in the model as follows:

- the real estate price differential between municipality i and j (PRICE<sub>i</sub>, PRICE<sub>j</sub>). We expect that the differential will incite migration of at least some demographic groups, therefore we expect  $a_3 < 0$  (equation 3).
- the environmental quality differential between municipality i and j (KES, coefficient of ecological stability) expresses the quality of the natural environment (measured by a proxy of proportion of green to build up area) and is expected to incite positive migration flows, at least in some demographic groups, therefore  $a_4 > 0$  (3).
- the proportion of blue collars differential between municipality i and j (BLUE\_COL) is expected to push away some demographic groups of migrants, mainly those searching for a dynamic urban environment. The  $a_5$  plus/minus sign is expected to vary depending on the social and age group of the migrants.
- the poverty rate differential between municipality i and j (POVERTY) is expected to be generally a push factor, therefore  $a_6 < 0$  is expected (3).
- the unemployment rate differential between municipality i and j (UNEMP), if high is expected to have push effect on economically active migrants and  $a_7 < 0$  is expected (3).

- the proportion of young to old population differential between municipality  $i$  and  $j$  (YOUNG\_OLD); its positive sign is expected to characterize suburban areas and therefore positive migration attractiveness at least for non-senior demographic groups. Therefore  $a_8 > 0$  is expected in equation (3).

*Table 36: Definition of the variables used in the gravity model analysis*

Variables	Names	Description	Year	Source
Migrants	M	Individuals changing permanent residence between municipalities within the Czech Republic	2004	(1)
Population	P	Size of population in both the municipality of origin and destination	2004	(1)
Distance	D	Shortest air distance between the two municipalities	2004	(6)
Real estate price	PRICE	Market price of real estate for a square meter of a standard dwelling (a)	2006	(3)
Environment	KES	Proportion of built-up areas and agricultural land to forest, orchards, meadows and water areas	2007	(1)
Blue collars	BLUE_COL	Proportion of manual workers out of all economically active population	2001	(2)
Poverty	POVERTY	Proportion of families with an income of less than 1,4 times the existence minimum receiving housing allowances	2003	(4)
Unemployment	UNEMP	Unemployment rate in municipalities (estimate)	2004	(4)
Young-old ratio	YOUNG_OLD	Proportion of children (0-14) to seniors (aged 65 plus)	2004	(5)
Spatial dim. of migration	SPACE	Direction of migration flows defined by spatial category of departure and arrival, 29 categories of flows described in Table 35 or Migration Flow Key.	2004	(5)
Demography	DEMO	Demographic characteristics of migrants 9 categories combining sex and age.	2004	(5)

Source: (1) Czech Statistical Office, (2) Czech Statistical Office, Population census 2001, (3) Institute of Regional Informations (IRI), (4) Ministry of Social Affairs of the Czech Republic, (5) Author, on the basis of the data from Czech Statistical Office, (6) Author, on the basis of vector indicators for ArcGIS.

(a) Exact price for primary centres and estimates for four size categories of municipalities per region.

3. *Spatial dimension of migration* (SPACE) enters the analysis as dummy variables of migration direction. Into the analysis enter 28 dummies which allows to capture the 29 possibilities (one dummy is a reference) (see the list in Table 35 or in the Migration Flow Key). Their value in regression indicates the weight they have in explaining the variance of dependent variables when all other variables are equal. Their relative

importance can therefore also be compared to that of all 29 of the other migration categories.

SPACE is the direction of migration in dummy form and DEMO is a dummy for the individual demographic characteristics of the migrants.

4. *Demographic characteristics* (DEMO) of migrants enter as dummy variables for nine combinations of age and education (aged 20-29 with low education, 20-29 with A-levels, 20-29 with university education, aged 0-19 and 30-44 with low education, 0-19 and 30-44 with A-levels, 0-19 and 30-44 with university education, aged 45 plus with low education, 45 plus with A-levels, 45 plus with university education).

These considerations point to the augmented migration gravity equation. Sixteen regression models were executed consecutively, each time including an extra set of variables: firstly, without consideration of the demographic structure of the migrants (Models 1-3), secondly, considering the demographic structure of the migrants (Models 4-7) and thirdly, for the migration of each demographic group separately (Models 8-16). This step by step approach of 16 models lays bare the change in the explanatory power of the model and the significance of its components. The analysis is executed on the domestic migration data from the year 2004 and on the data representing selected socio-economic characteristics of municipalities in the year 2004 or close to it depending on the data availability (Table 36).

Model 1: explains the total migration flow  $M_{ij}$  between the municipalities using gravitational demographic variables only (equation 2). It included 61 520 inter-municipal migration flows.

Model 2: adds to the previous model the characteristics of municipalities (equation 3).

$$m_{ij} = a_0 + a_1(p_i \cdot p_j) + a_2(d_{ij}) + a_3(\text{price}_{ij}) + a_4(\text{kes}_{ij}) + a_5(\text{blue\_col}_{ij}) + a_6(\text{poverty}_{ij}) + a_7(\text{unemp}_{ij}) + a_8(\text{young\_old}_{ij}) + u_{ij} \quad (3)$$

Model 3: adds to Model 2 the dummy variables of the spatial dimension of migration (equation 4).

$$m_{ij} = a_0 + a_1(p_i \cdot p_j) + a_2(d_{ij}) + a_3(\text{price}_{ij}) + a_4(\text{kes}_{ij}) + a_5(\text{blue\_col}_{ij}) + \quad (4)$$

$$+ a_6(\text{poverty}_{ij}) + a_7(\text{unemp}_{ij}) + a_8(\text{young\_old}_{ij}) + a_9(\text{SPACE}_{ij}) + u_{ij}$$

Model 4: explains the inter-municipal migration flow structured by the nine demographic groups  $M_{ij}^d$  using the gravitational variables only (equation 5). It includes 103 997 flows in total.

$$m_{ij}^d = b_0 + b_1(p_i \cdot p_j) + b_2(d_{ij}) + v_{ij} \quad (5)$$

Model 5: adds to Model 4 the characteristics of municipalities (equation 6).

$$m_{ij}^d = b_0 + b_1(p_i \cdot p_j) + b_2(d_{ij}) + b_3(\text{price}_{ij}) + b_4(\text{kes}_{ij}) + b_5(\text{blue\_col}_{ij}) + \quad (6)$$

$$+ b_6(\text{poverty}_{ij}) + b_7(\text{unemp}_{ij}) + b_8(\text{young\_old}_{ij}) + v_{ij}$$

Model 6: adds to Model 5 the dummy variables of the demographic characteristics (equation 7).

$$m_{ij}^d = b_0 + b_1(p_i \cdot p_j) + b_2(d_{ij}) + b_3(\text{price}_{ij}) + b_4(\text{kes}_{ij}) + b_5(\text{blue\_col}_{ij}) + \quad (7)$$

$$+ b_6(\text{poverty}_{ij}) + b_7(\text{unemp}_{ij}) + b_8(\text{young\_old}_{ij}) + b_9(\text{DEMO}) + v_{ij}$$

Model 7: adds to Model 6 the dummy variables of the spatial dimension of migration (equation 8).

$$m_{ij}^d = b_0 + b_1(p_i \cdot p_j) + b_2(d_{ij}) + b_3(\text{price}_{ij}) + b_4(\text{kes}_{ij}) + b_5(\text{blue\_col}_{ij}) + \quad (8)$$

$$+ b_6(\text{poverty}_{ij}) + b_7(\text{unemp}_{ij}) + b_8(\text{young\_old}_{ij}) + b_9(\text{DEMO}) + b_{10}(\text{SPACE}_{ij}) +$$

$$v_{ij}$$

Models 8-16: explain inter-municipal migration flows for each of the nine demographic groups  $M_{ij}^{d11}$ ,  $M_{ij}^{d12}$  etc. using gravitational demographic variables, characteristics of municipalities and dummies for the spatial dimension of migration as independent variables (equation 9).

$$m_{ij}^{dmn} = b_0 + b_1(p_i \cdot p_j) + b_2(d_{ij}) + b_3(\text{price}_{ij}) + b_4(\text{kes}_{ij}) + b_5(\text{blue\_col}_{ij}) + \quad (9)$$

$$+ b_6(\text{poverty}_{ij}) + b_7(\text{unemp}_{ij}) + b_8(\text{young\_old}_{ij}) + b_9(\text{SPACE}_{ij}) + v_{ij}$$

where  $m_{ij}^{dmn}$  stands for the natural log of migration flows for each combination of demographic characteristics of migrants

$m_{ij}^{d11}$  the natural log of migration flows for migrants aged 20-29 with low education

$m_{ij}^{d12}$  the natural log of migration flows for migrants aged 20-29 with A-levels

$m_{ij}^{d13}$  the natural log of migration flows for migrants aged 20-29 with university education

$m_{ij}^{d21}$  the natural log of migration flows for migrants aged 0-19 and 30-44 with low education

$m_{ij}^{d22}$  the natural log of migration flows for migrants aged 0-19 and 30-44 with A-levels

$m_{ij}^{d23}$  the natural log of migration flows for migrants aged 0-19 and 30-44 with university education (de facto considers only migrants aged 30-44)

$m_{ij}^{d31}$  the natural log of migration flows for migrants aged 45 plus with low education

$m_{ij}^{d32}$  the natural log of migration flows for migrants aged 45 plus with A-levels

$m_{ij}^{d33}$  the natural log of migration flows for migrants aged 45 plus with university education

This model may include some bias. One bias is directly connected to its specific field of application. In our case, the gravitation model is applied to the domestic inter-municipal migration in a small country, the Czech Republic. These models are usually used to estimate explaining variables for international migration (Lewer, Van den Berg, 2008, Karemera et al. 2000, Borjas 1989, Faustino, Leitao 2008) or domestic migration inside large federal states like the USA (Ashby 2006). In these cases, the main variable of the gravitational model, distance (D), is more appropriate than in our case. In the Czech Republic, the distance gravitational variable may be biased by the phenomenon of commuting. Its inverse proportion need not be so direct, because people might choose not to move but rather to commute short distances. Nevertheless, we choose to ignore this possible bias, knowing that the majority of residential migration in the Czech Republic is over short distances (Polášek 2005). A second source of bias is related to the fact that only non-zero observations have been taken into account. Immigration between two pairs of localities may be zero in a substantial percentage of observations, and omitting these zero observations biases the regression results. Here we make just the first test and this comment may be taken into consideration in the later phasis of the research. Thirdly, in the case when migration between localities occurs, only the characteristics of the migrating population are under scrutiny. Therefore, we are not able to control for the characteristics of the population which did not migrate. Ashby (2006) notes that, rather than using the total migration flows from one locality to another as a dependent variable, examining migration flows as a percentage of the total population at risk is a common technique. The population at risk is defined as the population at the beginning of the migration period. Typically, the total number of out migrants is added

to the population in a given spatial category, and the number of immigrants is subtracted from the population. Application of this solution is, however, problematic as we do not have information about the education structure of the populations in municipalities in 2004, the year of our observation. Finally, this model is inspired by a labour market model and includes premises about utility maximization. The migration flows observed are in some part motivated by factors which are not economically oriented, since we are not focussing only on labour migrants but on all migrants, including the retired, etc. This bias is of course also reflected in the percentage of explained variance of the dependent variable. In general, it is important to bear in mind that gravity models are meaningful when a probabilistic approach can be adopted and when we are looking to discover or confirm major tendencies. They are not meaningful when we are looking for causal relations in terms of individual behaviour (Termote 2002).

## 8.2 Results

All municipalities which were origins or destinations of domestic migration in 2004 and for which all municipal characteristics were available were included in the analysis.<sup>3435</sup>

Table 37 presents estimation results for Models 1-3. The covariance model estimates were obtained by applying linear regression to variables in natural logs (gravitational variables and municipal characteristics) and to dummies (spatial dimension of migration flows). The colinearity of municipal characteristics was tested beforehand, and no colinearity was found for them (condition index < 15). The models show that gravitational demographic variables have the expected signs and are statistically significant. The estimated results show that distance impairs migration between municipalities. This may be because costs and logistics necessarily increase with distance, but also because people may just want to change residence without wanting to change their place of work (case of suburbanisation). The population “mass” growth

---

<sup>34</sup> Two inter-municipal flows including the municipalities Častolovice (544311) and Hostovice (575020) were excluded because their fusion (Častolovice with Česká Lípa (561380) and Hostovice with Pardubice (555134)) did not allow us to gather all the variables entering into the analysis. In the analysis, they were fused with Česká Lípa and Pardubice, respectively.

<sup>35</sup> All the computational procedures of gravity modelling were done in SAS programme and were executed by Virginie Piguet from CESAER, UMR INRA-AgroSup Dijon.



supports growing migration, which means that in larger municipalities more migration flows occur.

The estimated parameter values of municipal characteristics in Model 2 shows that they are significantly different from zero at the 5 % level in all but two cases. They suggest that migrants prefer to move to municipalities in which there are more blue collar workers than in the municipality of their origin. This counter-intuitive results are caused by the predominant migration from urban areas, mainly towards the suburban areas, where there is a higher proportion of blue collar workers. Migrants prefer to move to places where the levels of unemployment and poverty are lower but not necessarily where the environment is better than in the municipality of their origin. The results in terms of unemployment and poverty seem to support the hypothesis of the economic motivation for migration and the premises of utility maximization. The migrants prefer to move to municipalities where is lower poverty and lower level of unemployment than in the municipality of their origin. The two other variables, young-old ration and real estate price, are still significant on the levels bellow 10 %. Migrants prefer to move to the municipalities where is younger population (higher young-old ratio) than in their municipality of origin. At the same time they prefer to move there where the real estate prices are lower. This could be again the effect of migration to suburban areas which combine the younger age structure with lower real estate prices in comparasion with urban centres (often a place of departure of suburbanisers).

Table 37: Model 1-3: Estimates of the model of inter-municipal migration  $m_{ij}$  without specification of the age or level of education of migrants

Independent variables	Model 1		Model 2		Model 3	
	Parameter Estimate	Sig.	Parameter Estimate	Sig.	Parameter Estimate	Sig.
Constant	-0,709	0,000	-0,708	0,000	-0,7731	0,0000
Population	0,135	0,000	0,135	0,000	0,1366	0,0000
Distance	-0,288	0,000	-0,288	0,000	-0,2981	0,0000
Real estate price			-0,014	0,065	-0,0080	0,3078
Environment			-0,006	0,003	-0,0053	0,0078
Blue collars			0,129	0,000	0,0130	0,2879
Poverty			-0,011	0,000	-0,0047	0,0192
Unemployment			-0,020	0,000	-0,0012	0,7981
Young-old ratio			0,013	0,053	0,0014	0,8264
11_PS_P					0,5575	0,0000
12_P_F					0,4852	0,0000
13_P_BSR					0,2141	0,0000
14_FBR_P					-0,0828	0,0036
15_FBSR_F					-0,0204	0,4039
16_FBSR_BSR					0,0050	0,8332
21_PS_P					0,2249	0,0000
22_P_FBR					0,1954	0,0000
23_P_S					0,1751	0,0023
24_FBR_P					-0,0133	0,6168
25_FBSR_FBSR					0,0724	0,0007
26_S_R					0,1136	0,0005
31_PFBSR_P					0,1616	0,0000
32_P_FB					0,2761	0,0000
33_P_SR					0,1249	0,0004
34_FBSR_FBSR					0,0634	0,0055
41_PS_PS					0,1474	0,0000
42_FBSR_P					-0,0353	0,1366
43_PS_FBR					0,1175	0,0000
44_FBR_FBSR					-0,0018	0,9316
E_51_P_PFBSR					-	-
52_FBSR_P					-0,0618	0,0231
53_FBSR_FBSR					0,3156	0,0000
61_PFBSR_P					-0,0129	0,6474
62_PFBSR_F					0,1958	0,0000
63_PFBSR_BSR					0,1495	0,0000
71_PFBSR_P					-0,0572	0,0087
72_PFBSR_F					0,2725	0,0000
73_PFBSR_BSR					0,2060	0,0000
No. of flows		61 520		61 520		61 520
Adj. R <sup>2</sup>		0,220		0,226		0,242

Note: See the Migration Flow Key to read the dummies of spatial dimension. Variable of reference for dummies is 51\_P\_PFBSR.

Models 1 and 2 are estimations with homoskedasticity of residuals and Model 3 is heteroskedasticity consistent.

Source: Author.

This explanation is supported by Model 3 in which the spatial dimension of migration is introduced. The orientation of migration itself makes the parameter values of municipal characteristics non-significant (with the exception of the Environment and Poverty). This is because the parameter values of the municipal characteristics are impaired by stronger parameter values of spatial dimension. Although the dummies of spatial dimension indicating migration direction in Model 3 had significant coefficients, their introduction did not result in major improvement in the explicative power of the models. The explained variation ( $R^2$ ) rose from 22,0 % in Models 1 to 22,6 % in Model 2. The addition of the dummies of the spatial dimension of migration (Model 3) rose the power of the model to 24,2 %. We can therefore conclude that the gravitational demographic variables are the most important factors in explaining the variability of total inter-municipal migration flows. The explanatory power of spatial dimension as well as of municipal characteristics is low.

Models 4 to 7, which explain migration flows and include specification of the age and level of education of migrants ( $m_{ij}^{dmn}$ ), give a different picture altogether. Here, the explanatory power of the model rises considerably (by 9,4%) when adding demographic variables into the model (Model 6, Table 38). The spatial dimension does not bring much to the explanation of variability of the dependent variable. But at the same time, because of the intervention of demographic variables, it does not undermine the influence of municipal characteristics (Model 7, Table 38). Compared to Model 2 (Table 37) Model 7 once again shows that migrants prefer to move to where the levels of unemployment and poverty are lower, where a younger population lives and where the prices of real estate are lower than in the municipality of origin. On the other hand, the environmental indicator is non-significant and the parameter of the proportion of blue collar workers changes its sign from positive to negative. This indicates that these two last mentioned variables are weak, dependent on small changes in the model and therefore will not be interpreted here.

Table 38: Estimates of the model of inter-municipal migration  $m_{ij}^d$  including specification of the age and level of education of migrants

Independent variables	Model 4		Model 5		Model 6		Model 7	
	Parameter Estimate	Sig.	Parameter Estimate	Sig.	Parameter Estimate	Sig.	Parameter Estimate	Sig.
Constant	-0,4333	0,0000	-0,4323	0,0000	-0,6562	0,0000	-0,8039	0,0000
Population	0,0688	0,0000	0,0685	0,0000	0,0770	0,0000	0,0825	0,0000
Distance	-0,1398	0,0000	-0,1391	0,0000	-0,1434	0,0000	-0,1502	0,0000
Real estate price			-0,0104	0,0212	-0,0089	0,0375	-0,0148	0,0007
Environment			-0,0016	0,2027	-0,0019	0,1249	-0,0008	0,4766
Blue collars			0,0655	0,0000	0,0647	0,0000	-0,0217	0,0016
Poverty			-0,0067	0,0000	-0,0079	0,0000	-0,0029	0,0087
Unemployment			-0,0222	0,0000	-0,0249	0,0000	-0,0068	0,0095
Young-old ratio			0,0209	0,0000	0,0239	0,0000	0,0112	0,0023
11_PS_P							0,3545	0,0000
12_P_F							0,3054	0,0000
13_P_BSR							0,0687	0,0000
14_FBR_P							-0,1010	0,0000
15_FBSR_F							0,0566	0,0000
16_FBSR_BSR							0,0689	0,0000
21_PS_P							0,0570	0,0011
22_P_FBR							0,1180	0,0000
23_P_S							0,0701	0,0043
24_FBR_P							-0,0245	0,0780
25_FBSR_FBSR							0,1066	0,0000
26_S_R							0,0714	0,0000
31_PFBSR_P							0,0916	0,0000
32_P_FB							0,1865	0,0000
33_P_SR							0,0750	0,0000
34_FBSR_FBSR							0,0736	0,0000
41_PS_PS							0,0991	0,0000
42_FBSR_P							-0,0230	0,0668
43_PS_FBR							0,0942	0,0000
44_FBR_FBSR							0,0648	0,0000
E_51_P_PFBSR							-	-
52_FBSR_P							0,0312	0,0425
53_FBSR_FBSR							0,2472	0,0000
61_PFBSR_P							0,0545	0,0005
62_PFBSR_F							0,1843	0,0000
63_PFBSR_BSR							0,1504	0,0000
71_PFBSR_P							-0,0188	0,1071
72_PFBSR_F							0,2385	0,0000
73_PFBSR_BSR							0,1741	0,0000
D_20-29_low					0,0061	0,2540	0,0046	0,2972
D_20-29_A-levels					-	-	-	-
D_20-29_university					-0,0770	0,0000	-0,0828	0,0000
D_0-19_30-44_low					0,3722	0,0000	0,3710	0,0000
D_0-19_30-44_A-levels					-0,0001	0,9899	-0,0033	0,5460
D_0-19_30-44_univ.					-0,0499	0,0000	-0,0632	0,0000
D_45 plus_low					0,0672	0,0000	0,0661	0,0000
D_45 plus_A-levels					-0,0685	0,0000	-0,0722	0,0000
D_45 plus_university					-0,1372	0,0000	-0,1449	0,0000
No. of flows		103 997		103 997		103 997		103 997
Adj. R <sup>2</sup>		0,127		0,131		0,221		0,237

Note: See the Migration flow key to read the dummies of spatial dimension. Variable of reference for spatial dummies is 51\_P\_PFBSR. Variable of reference for demographic dummies is D\_20\_29\_A-levels. Models 4, 5 and 6 are estimations with homoskedasticity of residuals and Model 7 is heteroskedasticity consistent. Source: Author.

A more precise way to understand of the structure of migration flows is to construct migration models for each of the demographic groups defined previously. The nine resulting models (Model 8-16, Table 39, Annex 9, Annex 13) reveal the importance of municipal characteristics on the migration of each demographic group as well as the importance of spatial dimensions. By comparing them, the structure of migration flows can be more precisely visualised. The standardized beta coefficients show that the greatest statistical explanation of variation in migration flows for all the models concerns gravitational demographic characteristics (distance and population “mass”). That is not surprising and serves as a control that the model works in a logic way.

Our main interest was to uncover the prevailing direction of migration flows typical for each demographic category. We were particularly interested in identifying the characteristics of migrants who compose the inter urban migration flows, the urban to suburban flows, migration toward fringes such as buffer zones, migration toward rural areas and all other non-urban migration flows; all of this in the core-periphery regional perspective. The clusters representing each of the groups of migration flows are presented in Annex 13 with bold face type indicating the seven most important variables explaining the variance of the residential migration.

*Inter-urban migration* is the domain of young, economically active migrants aged 20-29 with secondary and university education; in the case of the Prague core region, the 30-34 age group with secondary and higher education are largely present as well. Those with little education are not an important group in the inter-urban flows, nor are those aged 45 and over.

Table 39: Estimated significant beta coefficients of model of inter-municipal migration  $m_{ij}^{dmn}$  for each demographic group

Independent variables	Model 7		Model 8 20-29_low		Model 9 20-29_A-levels		Model 10 20-29_university		Model 11 0-19_30-44_low		Model 12 0-19_30-44_A-levels		Model 13 0-19_30-44_university		Model 14 45 plus_low		Model 15 45 plus_A-levels		Model 16 45 plus_university	
	Beta Coefficient	Rank	Beta Coefficient	Rank	Beta Coefficient	Rank	Beta Coefficient	Rank	Beta Coefficient	Rank	Beta Coefficient	Rank	Beta Coefficient	Rank	Beta Coefficient	Rank	Beta Coefficient	Rank	Beta Coefficient	Rank
Population	0,434	1	0,431	1	0,540	1	0,592	1	0,384	1	0,515	1	0,568	1	0,401	1	0,464	1	0,459	1
Distance	-0,337	2	-0,355	2	-0,398	2	-0,206	2	-0,367	2	-0,398	2	-0,316	2	-0,340	2	-0,309	2	-0,241	2
Real estate price	-0,016	28					0,065	16						-0,051	4	-0,065	7			
Environment																				
Blue collars	-0,016	29															-0,084	4		
Poverty	-0,008	37															-0,034	17		
Unemployment	-0,007	38																	-0,053	8
Young-old ratio	0,008	36							0,018	21			0,043	21	-0,022	15	0,029	18	0,052	9
11_PS_P	<b>0,052</b>	7	0,050	12	<b>0,100</b>	3	0,093	10	0,041	11	0,078	8	0,096	9	0,030	9	0,054	10		
12_P_F	<b>0,085</b>	4	0,061	8	<b>0,084</b>	4	<b>0,124</b>	6	<b>0,075</b>	3	<b>0,145</b>	3	<b>0,179</b>	3	<b>0,069</b>	3	<b>0,120</b>	3	<b>0,169</b>	3
13_P_BSR	0,018	27			0,023	23	0,028	23	0,019	20	0,034	18			0,019	16	0,036	15		
14_FBR_P	-0,029	21							-0,025	17	-0,035	17			<b>-0,047</b>	6	<b>-0,081</b>	5	-0,048	10
15_FBSR_F	0,015	31	0,029	21	0,032	20	0,087	12			0,034	20	0,070	15						
16_FBSR_BSR	0,021	25			0,042	19	0,062	18			0,040	15	0,071	14						
21_PS_P	0,012	33	0,030	20	0,042	18	0,033	22	0,020	19							0,061	8	<b>0,062</b>	5
22_P_FBR	0,044	13	0,037	17	0,057	15	0,087	11	0,047	10	<b>0,080</b>	7	<b>0,137</b>	5						
23_P_S	0,009	35	0,031	19	0,017	24														
24_FBR_P																				
25_FBSR_FBSR	<b>0,055</b>	6	<b>0,080</b>	4	0,074	8	<b>0,126</b>	4	0,051	8	<b>0,082</b>	6	0,117	8					<b>0,059</b>	6
26_S_R	0,014	32					0,042	20	0,021	18	0,027	23	0,048	19	-0,018	17				
31_PFBRSR_P	0,032	20	<b>0,082</b>	3	0,062	13			0,040	12	0,034	19			0,026	11				
32_P_FB	0,049	10	<b>0,077</b>	6	0,049	17	0,035	21	0,047	9	<b>0,090</b>	5	0,070	16	<b>0,048</b>	5	0,047	12		
33_P_SR	0,015	30	0,033	18	0,028	21					0,031	22								
34_FBSR_FBSR	0,027	23	0,045	15	0,025	22	0,052	19	0,036	14	0,032	21	0,047	20						
41_PS_PS	0,034	18	0,060	9	<b>0,076</b>	6	0,078	13	0,036	15	0,039	16	0,068	17	0,025	13				
42_FBSR_P	-0,011	34													-0,031	8	<b>-0,076</b>	6		
43_PS_FBR	0,051	8	0,047	13	0,064	11	0,065	17	<b>0,061</b>	5	<b>0,106</b>	4	<b>0,149</b>	4					<b>0,071</b>	4
44_FBR_FBSR	0,037	16	0,059	10	<b>0,074</b>	7	<b>0,164</b>	3	<b>0,164</b>	3	0,056	13	<b>0,131</b>	6					<b>0,057</b>	7
51_P_PFBRSR	-		-		-		-		-		-		-		-		-		-	
52_FBSR_P																				
53_FBSR_FBSR	0,049	9	<b>0,062</b>	7	0,062	12	0,069	14	<b>0,056</b>	6	0,061	12	0,067	18	0,030	10	0,057	9	0,044	11
61_PFBRSR_P	0,019	26			0,060	14	<b>0,115</b>	7			0,071	13								
62_PFBRSR_F	0,046	12	0,046	14	0,070	10	<b>0,124</b>	5	0,035	16	0,068	11	<b>0,122</b>	7	0,025	12	0,035	16		
63_PFBRSR_BSR	0,034	17	0,042	16	0,053	16	0,069	15	0,036	13	0,047	14	0,094	10			0,033	18		
71_PFBRSR_P															-0,023	14	-0,043	13		
72_PFBRSR_F	0,049	11	0,054	11	0,071	9	0,098	9	<b>0,052</b>	7	0,070	10	0,084	11	0,032	7	0,036	14		
73_PFBRSR_BSR	<b>0,059</b>	5	<b>0,079</b>	5	<b>0,079</b>	5	0,099	8	<b>0,067</b>	4	0,077	9	0,079	12	<b>0,043</b>	7	0,052	11	0,043	12
D_20-29_low																				
D_20_29_A-levels																				
D_20-29_university	-0,033	19																		
D_0-19_30-44_low	<b>0,289</b>	3																		
D_0-19_30-44_A-levels																				
D_0-19_30-44_univ.	-0,023	24																		
D_45 plus_low	0,042	14																		
D_45 plus_A-levels	-0,029	22																		
D_45 plus_university	-0,041	15																		
No. of flows	103 997		17 384		16 177		5 444		26 238		10 223		4 498		15 708		5 639		2 686	
Adj. R <sup>2</sup>	0,237		0,181		0,251		0,242		0,161		0,249		0,253		0,179		0,204		0,180	

Note: See the Migration flow key for reading the dummies of spatial dimension. Variable of reference for spatial dummies is 51\_P\_PFBRSR. Variable of reference for demographic dummies is D\_20\_29\_A-levels. Models are heteroskedasticity consistent. The estimated betas are ranked according to magnitude of absolute significant values. First seven are in **Bold**. Source: Author.

In the *migration towards the urban centres*, the model clearly divides the population into those who are attracted to them and those who are repelled by them. We particularly note the age group of 45plusers of the Prague and Moravia regions who are repelled from migrating to primary centres (inverse proportion of ID 14, FBR\_P; ID 42, FBSR\_P in Model 14-16, Table 39). At the same time, the university educated aged 20-44 are particularly attracted by the Prague region and its primary centres (ID 61, PFBSR\_P in Model 10, 13, table 39) as well as the young migrants with A-levels (ID 11, PS\_P in Model 9; ID 41, PS\_PS in Model 9). The effect clearly manifested here is of Prague as the capital city, attractive for the highly educated from the whole country. On the other hand, the primary centres of NW Bohemia do not attract the university educated, but mainly little educated inhabitants of the region aged between 20 and 44 (ID 31, PFBSR\_P in Model 8),. In general we can say that while the outflow from the Prague region's primary centres continues to increase (referential variable ID 51, Table 39), more university educated young people will migrate toward Prague's primary centres and more less educated migrants will flow into NW Bohemian primary centres while at the same time, fewer 45plusers will be attracted to primary centres.

*Suburbanisation* is the domain of the more educated, namely secondary school educated 30plusers and the university educated of all age groups. Particularly strong is the suburbanisation process in the Prague region where the intensity of suburban migration is the highest and is structurally specific for the fringes compared to more remote suburban and rural areas. The more highly educated of all age groups tend to migrate there more frequently than elsewhere (ID 12 P\_F in Model 10,12,13 but also 15 and 16 compared to ID 13 in the same Models). In ESW Bohemia and Moravia, suburbanisation is less centred on fringes but also includes background and rural areas<sup>36</sup>. Mainly the university and secondary school educated aged 30-44 are attracted to suburban areas there (ID 22, P\_FBR in Model 10, 12, 13; ID 43, PS\_FBR in Model 10-13). NW Bohemia shows a slightly different pattern as suburbanisation is attractive for the less educated aged 20-29, 45plusers and 30-44 with A-levels (ID 32 Models 8, 14 and 12), but the university educated do not

---

<sup>36</sup> This is due to the relatively small distances even between urban centres and more remote areas but also because of the thick fringes around Prague-city in the Prague region, which accentuates the suburban fringe flows in this region.

seem to move predominantly to suburban areas of NW Bohemia (ID 32 Models 10 and 13). This reveals that there is not one single pattern of suburbanisation and that its structure differs among regions, mainly between the core Prague region and other peripheral regions.

The migration *towards the fringes from non-urban areas* may be seen as a “buffer migration” on the part of those who move towards the urban centres because of their economic attractiveness but prefer to reside in its outskirts. This phenomenon is clear in the case of the Prague region suburban areas. Typically, these areas attract the university educated aged 20-44 moving there from all other regions (ID 62 Models 10 and 13) but also from more remote areas of the Prague region itself (ID 15 Models 10 and 13). Such a specific suburban “buffer migration” is not discernable in other regions. It is hard to say whether this is a question of “voluntary buffer migration” chosen for its suburban amenities and increased comfort of residence or rather a decision dictated by budget constraints (“forced buffer migration”). In all likelihood, it is a combination of both, but given the level of education and the expected social status of the prevailing migrants, it is likely rather a sign of the search for comfort at a reasonable price.

Migration *from primary centres toward more remote suburban or rural areas* was not a very specific flow for any demographic group. Within the Prague region, it was mainly seniors with A-levels but also other age groups with secondary education who followed this trajectory (ID 13 Models 12 and 15).

*Flows between non-urban areas* include heterogeneous flows which were not usually represented by many cases and did not come out as specific in the descriptive analysis. The resulting picture of dominant demographic groups in the flows resulting for gravity model is therefore not very consistent. The university educated of the 20–44 age group are often a main component of these flows, especially in ESW Bohemia and Moravia (ID 25 and ID 44 Models 10 and 16). In other non-urban intra- as well as inter-regional flows, it is hard to find specific patterns, given the fact that all demographic groups contribute in a balanced way to these flows. Nevertheless, according to ranking of relative importance within the demographic groups, non-urban migration is more frequent in the group of lower educated migrants.



Municipal characteristics as a second set of independent variables lose their power to explain the parameter values of migration flows for a majority of the demographic groups (Model 8-16 in Table 39) when the spatial dimension of migration is taken into account. The exception is their contribution to the explanation of migration of those aged 45 and over. This is especially the case for real estate prices. For 45plusers with low and secondary education (Model 14 and 15), the difference in real estate prices represents an important pull factor toward the cheaper localities, even after controlling for all other variables. As for the 20-29 age group with university degrees, they move to localities with higher real estate prices (Model 10). This again underlines their strong tendency to move to large centres, especially Prague. For other demographic groups, real estate prices are not significant after controlling for other variables. The economic characteristics of the inhabitants of municipalities of origin and destination such as poverty, unemployment and proportion of manual workers, do not retain their significant explanatory contribution when the spatial dimension of migration is controlled for. The exception again is the 45plus age group; those with secondary and higher education prefer to move to economically less problematic municipalities even after control for the spatial dimension (Model 15, variables Blue collars and Poverty). They also prefer to move to municipalities with a younger population (Models 15 and 16, variable Young-old ratio). The less educated 45plusers are unique in their significant trend of moving to places with an older population (Model 14 and 16, variable Young-old ratio). It may be the rural areas who have both cheaper housing and older population. The quality of the environment does not significantly contribute to the parameter values of migration for any demographic group when controlling for the spatial dimension.

## **CONCLUSIONS**

### **A TALE OF CONSERVATIVE COMMUTERS AND POPULATION**

### **NOT-VERY-DYNAMICS IN THE CZECH REPUBLIC AFTER 1989**

In Chapter 1, I defined a theoretical framework which set the thesis into the context of studies oriented to the analysis of spatial population dynamics and their transformation in post-socialism. In the theoretical models of the New Economic Geography, the centrifugal and centripetal forces driven by economic incentives push the population and economic activities to concentrate or disperse (Masahisa, Krugman 2004). In the empirical world, however, the influence of incentives can be mediated by the concrete societal system – the ensemble of laws, national economy, political institutions, socio-cultural norms and values, and individual idiosyncrasies. The effects of the socialist and capitalist political economies are generally recognised as having led to different spatial population dynamics and settlement structure. There is less agreement on whether the differences are of systemic nature or merely the result of delayed development under socialism, and on whether there will be convergence to capitalist spatial population dynamics. One viewpoint holds that socialist and the capitalist societies both followed a common process, therefore the post-communist development should converge to the Western one (Enyedi 1996). The other viewpoint is based on the conviction that capitalist and socialist evolutions were inherently qualitatively different and therefore will continue to have a distinct impact on the post-communist spatial population dynamics and settlement structure, without full convergence (Szelenyi 1996). This thesis on the spatial population arrangements and their evolution during the last twenty years of post-communist transformation in the Czech Republic represents a case in which system-specific features and similarities with the Western arrangements are studied. In

general, this study can be seen as a contribution to understanding the nature and scope of the societal transformation post-1989.

As the aim of the thesis is to describe, analyse and discuss the modes of spatial population dynamics, it is primarily focused on domestic migration, its structure, determinants and its consequences on the population structure in different spatial categories. For that purpose, the spatial categories were defined within two perspectives. First, the urban-rural gradient perspective distinguishes primary and secondary urban centres, three types of suburban areas, and more remote rural areas. Suburban areas are defined as commuting catchment areas, distinguishing three different zones according to commuting intensity towards the urban centres. Second, the regional perspective, distinguishes one core region (Prague) and three peripheral regions (North-West Bohemia, West-South-East Bohemia, and Moravia). It follows the theoretical assumption about core-peripheral relations with strong agglomeration power of the core and therefore a distinct migration pattern both inside and between the core and peripheral regions. The distinction of three peripheral regions reflects the spatial specificities in demographic and socio-economic characteristics resulting from the descriptive analysis (in Section 6.2).

After the definition of the spatial perspectives, the socio-demographic characteristics of the population were studied using data from the 1990s and 2000s. This has offered important information about the scope of the differences between the spatial categories and their evolution in the transformation period. The main vehicle of spatial population dynamics is clearly *residential migration* and its differentiation between urban-rural gradient categories. However, as new trends in residential migration is both a very recent phenomenon and a small phenomenon relative to already existing population structures, its actual impact on demographic structure is not yet discernable. The main cleavages in demographic characteristics (notably in fertility levels, family arrangements, and divorce rates) still run between primary centres and the rest of the spatial categories. That is, suburban areas as such do not –yet- show in these characteristics any tangible consequence of the net-migration gains they have experienced. As of 2001, suburban areas are still rather close to rural areas. In other words, the suburbanisation process, being very new in the Czech Republic post-1989, could not yet influence the structural

demographic characteristics. In socio-economic characteristics such as the level of education and the proportion of services and industrial employment, there is a much clearer cut between urban, suburban and rural areas. Suburban areas are affected by the economic influence of primary centres, whereas rural areas are less dynamic and lag behind. Unemployment rates and poverty on the other hand differ clearly along regional lines.

The core of this research was formed by the analysis of the structure of domestic residential migration. It took into account the orientation of migration, the characteristics of the municipalities of origin and destination, and socio-demographic characteristics of the migrants themselves. The analysis was done on the basis of residential mobility in 2004, a year when the number of migrants increased from previously very low levels and when the processes of population dispersal became more intense. Purely practically, 2004 is the most recent year for which data about education of migrants as a proxy to social status were available.

Migration during the second decade of transformation has deepened the tendencies from the 1990s. It is characterised by population dispersal and a growing proportion of migration toward suburban areas, which are becoming a dominant migration destination. Suburbanisation has become omnipresent, dominant not only in the core Prague region but also in other Czech regions, around primary centres, as well as around secondary ones (Table 3 and 4, part 6.1). At the same time, population dispersal went well behind the borders of suburban fringes. Rural areas gained population by net migration as well, although the gains were relatively modest. The dispersal processes became a reality only from the beginning of the 1990s. Before, the net migration gains were solely a domain of secondary and primary centres. Suburban and rural areas were losing population universally. The current trends are relatively recent, dating from around 1995 when the net migration gains started to grow steeply in fringes of primary centres and after 2000 in other non-urban areas (Figure 4). The urban centres were until recently (2007) still losing population. The only exception was Prague-city, where net-migration turned to be positive, mainly due to foreign in-migration.

The demographic and social profile of domestic migrants varies according to the category of destination on the urban-rural gradient scale. The analysis has shown some regularities and common patterns valid in both core and periphery regions. First, the more educated and young adults (mainly aged 20-29) migrate more frequently than all other age groups. Second, concerning the migration destination, the choice to leave urban centres for suburban areas is overrepresented among the higher educated than among the little educated. It is particularly true among those in younger age between 20 and 44 (Figure 8 and Annex 7). It shows that mainly the upper and upper-middle classes (approximated by the level of education) prefer the suburban areas and especially the inner fringes, closer to primary centres. This supports the hypothesis H 1.1.2 (from section 3.1) that because budget constraints are less tight among the higher social classes, the inner suburban fringes are prioritized by these social groups (Figure 8 and 9). It does not mean that lower educated do not move to these areas, but their proportion is significantly lower than expected according to their proportion in the sum of migrants.

Although we can trace the structure of migrants, we cannot at this stage say anything about the timing of migration flows. Therefore, we cannot evaluate the hypothesis H 1.1.3 that the middle classes suburbanised only later and that the suburbanisation process was started by higher social classes. From the present analysis, we can only state that the middle class (represented here by migrants with A-levels) is overrepresented in the suburban migration as is the upper-class (university educated). Only in the case of migration towards the suburban inner fringes of Prague-city does the upper-class clearly dominate. The middle and lower classes (with A-levels and less) decide more often to move to remote suburban areas, secondary centres or to rural areas. This socially stratified migration is very clear and it is not an effect of age – it occurs in all age groups above age 20. Brown and Schaft (2002) observed the same in Hungary. They explain it by the high rent pressure in large urban centres (which burdens mainly lower social classes) and the promise of living a more comfortable life in rural environments. There, apart from lower real estate prices, small scale agriculture is still a common way of reducing basic expenses. I did not expect the same effects in the Czech Republic, only because the rental housing did not undergo such a drastic step change as in Hungary. Yet the results give a clear picture of such a pattern. A further study of this phenomenon

should be pursued to understand the motivations of lower educated citizens to move to peripheral localities. Job opportunities are presumably rarer, there, but probably their willingness to commute to work over longer distances is higher.

The hypothesis H 1.2.3 about seniors' migration preferences for non-urban areas was supported by the analysis. Nevertheless, the number of 60plussers migrating is low and therefore it is hard to make any deeper conclusions about their preferred non-urban destinations. Because of their low number, the migration of seniors cannot explain the positive migration gains of rural areas. The latter are more due to migrants aged 45-59, mainly with lower and secondary education, who move to rural areas and secondary centres. For 45plussers with lower education, low real estate prices are an important pull factor. The hypothesis H 1.2.2 about the more frequent incidence of migration to rural areas among families with children could not be supported. The highest proportion of children generally migrates to suburban areas and the size of the family (which could have some impact on prioritizing migration to rural areas) was not available.

Primary centres hold a high attractiveness for secondary and university educated citizens aged 20-29 and university educated citizens aged 30-44 from all other spatial categories, in all regions. Other age and social groups are not particularly attracted by primary centres. It seems that for the young well-educated the expected benefit of a larger job market exceeds the expected cost of high rent pressure. Against expectations, no return migration from suburban areas to urban areas was found by the analysis. Therefore, the hypothesis H 1.3.1 about the return of "empty nesters" to urban centres directed by search for amenities seems unsuitable for the Czech context. On the contrary, the dominant tendency of 45plussers is to move outside primary centres.

As conclusion, the analysis of the socio-demographic structure of migrants has shown that the key factor determining migration destination is the *social status* of migrants, here approximated by the level of education. Age has only secondary importance and sex almost does not differentiate migration at all. This indicates that spatial population dynamics do not just transform the population growth of localities, but might be the main motor transforming their social profiles as well. This is particularly true for suburban areas, where immigration is most intensive, and where the social profile of

immigrants often differs sharply from that of the old residents (Vobecká, Kostelecký 2007). Future studies ought to inquire whether the impact of social status on migration destination decisions rose in the course of transformation. If that was the case, it would imply that spatial mobility has only recently become one of the factors of social inequality manifestation. If not, that is if social status always played a key role, it would mean that an important turning point in residential priorities has arisen leading to a new spatial social inequality distribution.

This thesis has also told a tale of *Prague core and the periphery*. Despite the common patterns in socio-demographic structure of migrants and their residential priorities across Czech regions, the analysis has revealed some important differences that indicate that we cannot talk about one mode of migration patterns (hypothesis H 3.3). Firstly, we cannot talk about similar migration patterns in the core Prague region and other three peripheral regions (NW Bohemia, ESW Bohemia and Moravia). The Prague region, consisting of Prague-city and the surrounding Central Bohemian region, is unique in a number of respects. It has a dominant economic strength and agglomeration power. Especially Prague-city's macro-regional importance as an economic, institutional and services centre has been growing since 1989, so that the gap with other regional centres is still widening (Hampl 2007). Therefore the pull and push factors were more pronounced here, and their effects more visible (hypothesis H 3.1 and H 3.3). The most specific migration pattern of the Prague region was the attractiveness of primary centres (mainly of Prague-city) for higher educated people aged 20-44 from all the other regions.

Secondly, not only primary centres but also the suburban fringes in the Prague region were a destination of young university educated people from all regions. There the suburban fringes in the Prague region serve as "buffer zones" for those who are economically attracted by primary centres but prefer to live in the suburban area. The Prague core region is the only one where this effect is discernable. We cannot prove this effect for peripheral regions. Nor we can make a qualified judgment about the motives of the "buffer" migrants. They may search better amenities or may be motivated by budget constraints, or both. However, given the fact that it concerns mainly university educated Czechs, we cannot confirm the model of buffer suburbanisation by lower social classes as was observed in Russia by Ioffe and Nefedova (1998).

Figure 9: Proportion of migrants aged 20+ from Prague-city to spatial categories within Prague region by level of education in 2004

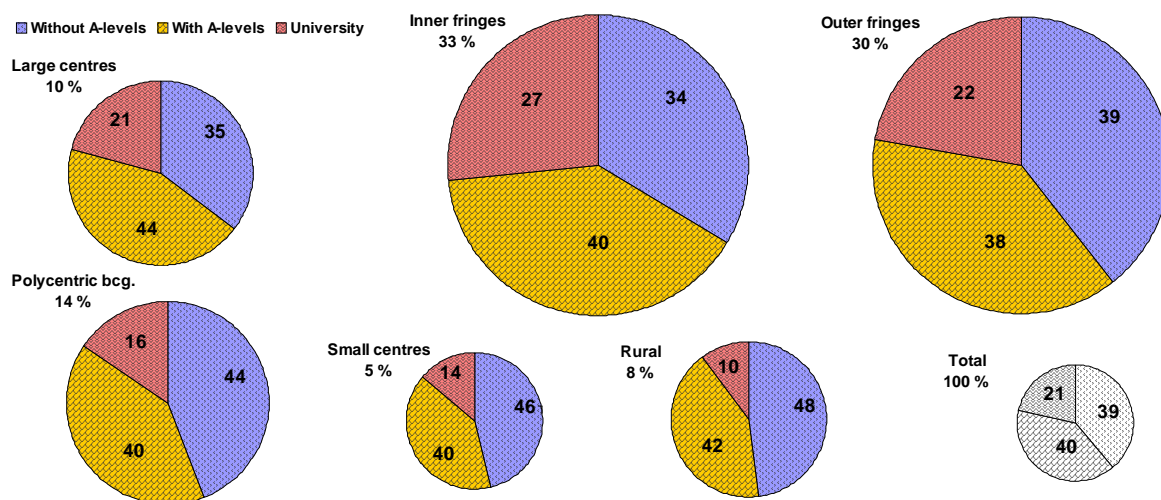

Note: Numbers in the pie are proportions of migrants with respective level of education in %. Figures under the name of spatial category are proportion migrating there from all migrants. N=7 514.  
Source: Author and Czech Statistical Office.

Figure 7: Proportion of migrants aged 20+ from NW Bohemian Primary centres to spatial categories within NW Bohemian region by level of education in 2004

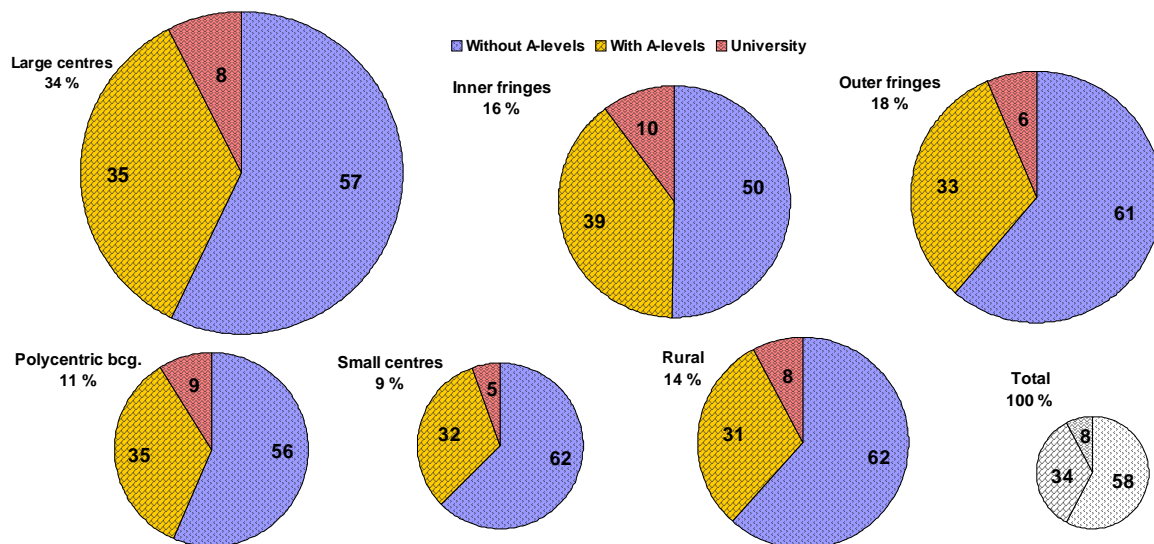

Note: Numbers in the pie are proportions of migrants with respective level of education in %. Figures under the name of spatial category are proportion migrating there from all migrants. N=9 155.  
Source: Author and Czech Statistical Office.



Although the “social selectivity” is present also in the residential migration in all three peripheral regions, the inter-urban migration is more important there and suburban migration is less intensive than in the Prague region (hypothesis H 3.3). The most contrasting is the case of migration within NW Bohemia. There, one third of migrants from primary centres move to another primary centre within the region (Figure 9) and another third move from primary centres to suburban fringes. Suburbanisation is not the dominant flow there. The reason can be that the factors typically present when suburbanisation occurs are less present in NW Bohemia. Firstly, the proportion of secondary and university educated inhabitants in NW Bohemia is relatively low, the lowest of all four regions<sup>37</sup>. As the main actors of suburbanisation, the stock of potential suburban migrants is smaller and therefore suburbanisation is less intensive. Secondly, high real estate prices in urban centres, an important push factor to their outskirts, are less of an issue in NW Bohemia because the real estate prices are constantly very low and housing affordability is relatively high (Kostelecký, Mikeszová 2008). Thirdly, the environmental attractiveness and other amenities motivating potential migrants to move to suburban areas may be relatively low in this heavily industrialized region reducing the pull factor of suburban areas.

In sum, despite the observation of regionally distinct patterns in migration, we can still conclude that a single most dominant trend is migration dispersal to non-urban areas with the dominating flows to suburban areas from the nearby towns. Migration priorities depend mainly on social status and secondly on the position in the life cycle. The Prague core region has a specific position in migration attractiveness given its economic and agglomeration potential and strengths.

What do we see when we place recent Czech spatial population dynamics in a broader European context? Do they resemble the processes observed in Western European countries, or are they post-communist or even Czech specific evolution? The processes

---

<sup>37</sup> In 2001, there was 32 % of inhabitants aged 15+ with A-levels and higher education, whereas the national average was 37 %.

of spatial population dynamics are well described in Western European countries (Champion 1989, Robert, Randolph 1983, Détang-Dessendre et al. 2000, 2002, Caruso, 2002). In Western Europe, a general pattern of suburbanisation has been observed since the 1960s and 1970s in the form of residential deconcentration of young economically active planning or already having a family. Their movements are typically interpreted as a result of a search for the best compromise between amenities (environment, services, etc.), affordable real estate prices, commuting distance to urban centre as places of employment, and affordable transportation costs. This is a lasting phenomenon, still strong around large as well as smaller local urban centres. Together with decentralisation of population, economic activities and jobs also tend to decentralise. Some firms move from urban areas, others establish due to the growing size of the suburban population. The economic dependency of the suburban population on the centre is therefore later weakened and a system of multicentre agglomeration appears. Since the end of the 1970s, a simultaneous process of deconcentration and counter-urbanisation was observed in Western-European countries. This process, characterised by exit from areas of agglomerations further on to rural remote areas and local centres, is the most developed in Great Britain. Research on England and Wales has shown that it is not only seniors moving to these areas but also post-family-aged and most recently also 30plussers with children from middle-class background, which used to be considered as “quintessential suburbanisers” (Champion, Shepherd 2006). Net migration gains of English rural areas are at present higher than in suburban areas (Champion 1999). Typically, school leavers and young adults leave rural as well as suburban areas to move toward the “bright city lights” in urban centres. So do some of the “empty-nesters” who return from suburban areas to enjoy the cultural and other amenities of large towns. This was observed into some extent in Great Britain (Champion, Shepherd 2006).

There are few studies of Central and East-European countries analysing the spatial population dynamics in the post-communist era. Researchers generally agree that the transition towards market capitalism brought population dispersal as a new phenomenon after steady urban population concentration in previous decades. However, the classical motivations of deconcentration known from Western Europe and USA seem to be only a

partial explanation of these processes (Brown, Schafft 2002, Szelenyi 1996). As a result of deep economic restructuring, dissolution of much of the manufacturing industry, the rise of unemployment and the decline of real wages across Central and Eastern Europe in the 1990s (Chapter 2), many people left towns to rural areas for cheaper living and subsistence farming (Ládanyi, Szelényi, 1998, Brown, Schafft 2002, Ioffe, Nefedova 1998). Throughout the 1990s, suburbanisation seemed to be a rather marginal phenomenon concerning mainly the richest individuals. In Russia, the suburban areas became mostly the “buffer zones” of workers attracted by urban centres offering job opportunities but not affordable housing (Ioffe, Nefedova 1998). Despite under-urbanisation in the communist era (Szelenyi 1996, Hampl, Kühnl, 1993), the transition to capitalism did not bring a migration inflow into the urban centres, because economic decline hit the urban centres strongly since the beginning of 1990s. The industries and services which have been newly growing in urban centres offer employment to young and better trained people, and less so to the underskilled population from rural areas (Szelenyi 1996). Moreover, the scarce housing stock did not significantly grow or improve in quality. Therefore, the net migration gains of urban centres became even negative. House owners felt strongly attached to their property because it represented a certain (and often their inmost valuable) asset (Lux, Sunega 2007). The people who had to move faced very non-standard housing markets. Therefore, as under socialism, people preferred to commute to their jobs rather than changing residence. Under-urbanisation and strong commuting habits, a heavily regulated and under-developed real-estate market, and a lack of capital for the majority of the population created obstacles for the occurrence of the spatial population dynamics known from Western Europe since the 1960s and 1970s.

Despite a lack of actual studies about the situation in Central and Eastern Europe, we can conclude that throughout the 1990s, the economic and political circumstances of transformation were not favourable to a fast or full convergence of residential and migration patterns towards Western ones. Under-urbanisation with all its settlement repercussion continued to determine spatial population dynamics. In some respects the thesis has thus told a tale of spatial population *not-very-dynamics*. Yet, having said this, very recent observations about Czech spatial population dynamics do reveal new

patterns of spatial population dynamics that promise to advance existing knowledge based on fast outdated observations from the 1990s.

These most recent trends do appear to indicate a convergence towards the Western European model in some respects, in others it is still driven by the specific features of urbanisation under socialism. Regarding the first, it was shown that decentralisation in the form of suburbanisation takes place around urban centres. “Quintessential suburbanisers” are moving there, meaning young adults with children. Mostly higher and middle social classes can afford this model. The lower social classes move more frequently to further suburban areas. The demographic structure of suburban immigrants should imply a rejuvenation of the local age structure and the rise of natural increase and fertility rates. This could not be proved yet by the present analysis. Neither the data about female fertility and age structure from 2001 nor the average natural increase of 2001-2005 has shown important differences with other spatial categories (Table 6 and Table 19). Suburbanisation is thus a very recent phenomenon with rising volume, and still in mid-2000s, without a measurable impact on demographic structures. It is hard to prove that with the migrants, job opportunities decentralise as well. At the present stage of research, it seems that quasi totality of suburbanisers depends for their jobs on the urban centres and commute there every day. The multi-central agglomerations are not discernable in the Czech context.

Further population dispersal toward the smaller local centres and rural areas present in the Czech context can be only partially compared to counter-urbanisation. Local centres are losing population and are unattractive for migrants of younger ages. Rural areas' migration gains are mainly due to the lower educated, especially those aged 45plus. In the long-term, they will probably not contribute to the economic revival of these territories, although at present they compensate for natural change losses. In the long term, however, the 45plussers will become seniors and will contribute to a faster ageing of rural population. It will have implications for local infrastructure such as social and health care facilities, shops, and public transport. In this respect, the threats are the same as in counter-urbanised territories in the Western countries. Only their scope in Czech context is much smaller. Combined with the outflow of young adults with higher

education, not only the age structure but also social cleavages between more remote rural localities and suburban and urban ones may deepen.

In conclusion, the features of the Western model of the spatial population dynamics are clearly present twenty years after the beginning of the post-communist transformation. They are visible firstly, in suburban deconcentration carried by middle and upper social classes and secondly in the attractiveness of urban centres to higher educated young adults. Counter-urbanisation or a return to urban centres are less prevalent and cannot be considered as being in a similar stage of evolution as in Western-European countries. In general, population dispersal is less massive in the Czech context than in Western-Europe. It is mainly driven by middle and upper social classes, who can afford migration motivated by the search for amenities. The Czech population remain relatively little mobile. Home ownership is highly valued and once people are owners, they try to avoid further migration. The urban centres' socialist blocks of flats districts, which were considered by some as condemned to social and physical degradation (Szelenyi 1996), are often revitalized and stay attractive for a large part of the urban lower and middle class, as well as young families. At the same time, inhabitants of rural areas are used to commute and continue to do so, rather than moving toward their jobs or new opportunities. In many respects, Czechs tend to be *conservative commuters*: they commute to work and stick to the homes they own. It is very important in this regard to underline that Czech Republic is a relatively small country and therefore, commuting can replace migration much more easily than in larger countries.

We can conclude that the processes of urbanisation and population dispersal may be very similar in Central and Eastern and in Western Europe, once the capitalist societal organisation exists in both of them. Four decades of socialism, however, have deeply altered some mechanisms driving population mobility, and their consequences are still shaping spatial population dynamics today. Therefore currently Central and Eastern Europe spatial population dynamics seems to experience the same patterns of suburbanisation as in Western European societies during the 1960s and 1970s, but deformed by factors of post-communist transformation. It is hard to predict whether the other stages of population dispersal will occur and whether further convergence with the Western pattern will happen. The path of the spatial population dynamics is on the most

general level a single one, and sooner or later it will be common for Western as well as for Central and Eastern European countries.

Spatial population dynamics as a tale of conservative commuters and population not-very dynamics, serves as a good example of the general tale about post-1989 transformation. The societal system, as a little fire, was burning gently under communist wooden roof. Till the 1989 when the roof collapsed onto the fire. It temporarily took breath of the fire which became much less strong. However, the fire started eating the wood, first weakly but later becoming strong on the wreck of it. The same way, societal transformation did not turn all institutions, economy, socio-cultural norms and values on the spot and did not start the new life strongly and immediately as with a blow fresh air. On the contrary, the breath of the societal system was taken away by the transformation and only gradually, the new rules of capitalist society visibly took over.

## REFERENCES

- Alonso, William. 1964. *Location and Land Use*. Cambridge, Mass.: Harvard University Press.
- Andrusz, Gregory, Michael Harloe, Ivan Szelenyi (eds.). 1996. *Cities After Socialism: Urban and Regional Change and Conflict in Post-Socialist Societies*. Oxford: Blackwell.
- Ashby, Nathan, J. 2007. "Economic freedom and migration flows between U.S. states". *Southern Economic Journal* 73 (3): 677-697.
- "A review of urban and rural area definitions". 2002. London: Office for National Statistics. (Available at [http://www.statistics.gov.uk/geography/downloads/Project%20Report\\_22%20AugONS.pdf](http://www.statistics.gov.uk/geography/downloads/Project%20Report_22%20AugONS.pdf), cit. 1.2.2009 ). Birkbeck College, Newcastle University and Sheffield University.
- Bengs, Christer, Kaisa ,Schmidt-Thomé (eds.). 2005. „Urban-rural relations in Europe“. Final Report ESPON 1.1.2. [online] [cit. 6.3.2007]. Available from [http://www.espon.eu/mmp/online/website/content/projects/259/649/file\\_1182/fr-1.1.2\\_revised-full\\_31-03-05.pdf](http://www.espon.eu/mmp/online/website/content/projects/259/649/file_1182/fr-1.1.2_revised-full_31-03-05.pdf) .
- Benzécri, J. P. 1973. *L'Analyse des Données: T. 2, l'analyse des correspondances*. Paris, Dunod
- Berg van den, Leo, Braun, Erik. 1999. „Urban competitiveness, marketing and the need for organising capacity“. *Urban Studies* 36 (5-6): 987-999.
- Berry, Brian, J. L. (ed.). 1976. *Urbanization and counterurbanization*. Sage Publications, USA.
- Berzeg, K. (1978). "The empirical content of shift-share analysis". *Journal of Regional Science* 18: 463-469.
- Bessy-Pietry P., Mohamed Hilal., Bertrand Schmitt, 2001. „Des évolutions démographiques rurales contrastées liées à la proximité et aux dynamiques urbaines : le cas de la France“.

*Espace, Populations, Sociétés*, (1-2): 19-36.

Blanc, Michel. 1997. *La ruralité: diversité des approches*. *Economie Rurale* 242, s. 5-12.

Blažek, Jiří. 1996. „Meziregionální rozdíly v České republice v transformačním období“. *Geografie : Sborník České geografické společnosti* 101 (4): 265-277.

Blažek, Jiří, Pavel, Csank. 2007. „Nová fáze regionálního rozvoje v ČR?“ *Sociologický časopis/Czech Sociological Review* 43 (5): 945-965.

Boeri, T. 1994. "Transitional Unemployment". *Economics of Transition* 2 (1): 121-146.

Boeri, T., M. Burda and J. Köllö. 1998. *Mediating the Transition: Labor Markets in Central and Eastern Europe*. New York: CEPR and Centre for EastWest Studies.

Borjas, George. 1987. "Self-selection and the earnings of immigrants". *American Economic Review* 77: 531-53.

Borjas, George. 1989. "Economic theory and international migration". *International Migration Review*, 23: 457-485.

Brown, David, L., Kai. A. Schafft. 2002. „Population deconcentration in Hungary during the post-socialist transformation“. *Journal of Rural Studies* 18: 233-244.

Caruso, Geoffrey . 2002. La diversité des formes de la périurbanisation en Europe. In Perrier-Cornet, P. (dir.): *Repenser les campagnes*. Ed. de l'Aube.

Chaberlain, Edward. 1933. *The Theory of Monopolistic Competition*. Cambridge, Mass.: Harvard University Press.

Champion, Anthony, G. (ed.). 1989. *Counterurbanization: the changing face and nature of population deconcentration*. London.

Champion, Anthony. 1999. "Urbanisation and counterurbanisation". In Pacione, Michael. *Applied Geography: Principles and Practice*. London, Routledge.

Champion, Tony. 2001. "The continuing urban-rural population movement in Britain: trends, patterns, significance". *Espace, Populations, Sociétés* 2001 (1-2): 37-51.

Champion, Tony, John Shepherd. 2006. "Demographic Change in Rural England" in Philip



Lowe and Lydia Speakman (eds) *The Ageing Countryside, the growing older population of rural England*, Age Concern Books, 2006.

Christaller, Walter. 1933. *Die Zentralen Orte in Süddeutschland*. Gustav Fischer Verlag, Jena. English translation: *The central places of southern Germany*. 1966. Prentice-Hall, Englewood Cliffs NJ.

Coombes, Mike, Bond, Steve. 2007. Travel-to-Work Areas: the 2007 review. National Statistics, Great Britain. (Online available from <http://www.statistics.gov.uk/geography/ttwa.asp> (cit. 1.2. 2009)).

De Melo, M., Denizer, C., and Gelb, A. 1997. "From Plan to Market: Patterns of Transition". In Blejer, M., Skreb, M. (eds). *Macroeconomic Stabilization in Transition Economies*. Cambridge: Cambridge University Press, pp. 17-72.

Détang-Dessendre, C., Schmitt B., Piguët, V. 2002. „Life Cycle Variability in the Microeconomic Determinants of Urban-Rural Migration“. *Population*, E-57(1): 31-56.

Détang-Dessendre, Cécile, Florence Goffette-Nagot, Bertrand Schmitt. 2000. „Can Agglomeration Forces Explain Life-cycle migration Flows between Urban and Rural Areas?“, a paper presented at 6th world congress of the Regional Science Association International, Lugano (Switzerland), 16-20 May.

Détang-Dessendre, Cécile, Florence, Goffette-Nagot, Virginie, Piguët. 2008. "Life Cycle and Migration to Urban and Rural Areas: Estimation of a mixed logit model on French data". *Journal of Regional Science* 22/10: 1-36.

Dostál, Petr, Martin, Hampl. 2004. „Geography of post-communist transformation and general cycle of regional development: Experiences of the Czech Republic in a Global Context“. *European Spatial Research and Policy* 11 (1): 9-29.

Drahokoupil, J. 2008. *Globalization and the State in Central and Eastern Europe: The Politics of Foreign Direct Investment*. London: Routledge.

Enyedi, György. 1996. "Urbanization under socialism." Pp. 100–119 in Andrusz, Gregory, Harloe, Michael and Szelenyi, Ivan (Eds) *Cities after Socialism. Urban and Regional Change and Conflict in Postsocialist Societies*. Oxford: Blackwell Publishers.

- Faustino, Horácio, Leitao, Nuno. 2008. *Using the Gravity Equation to Explain the Portuguese Immigration-trade Link*. Working Papers WP 12/2008/DE/SOCIUS. Lisabon, Portugal.
- Fidrmuc, Jan. 2004. "Migration and regional adjustment to asymmetric shocks in transition economies". *Journal of Comparative Economics* 32: 230-247.
- Ford, Tania. 1999. "Understanding population growth in the peri-urban region". *International Journal of Population Geography* 5: 297-311.
- Fujita Masahisa. 1989. *Urban economic theory: Land use and city size*. Cambridge University Press.
- Fujita Masahisa, Mori T. 1997. "Structural stability and evolution of urban systems". *Regional Science and Urban Economics* 27: 399-442.
- Fujita Masahisa, Paul, Krugman. 1995. "When is the economy monocentric? von Thünen and Chamberlin unified". *Regional Science and Urban Economics* 25: 505-528.
- Fujita, Masahisa, Paul, Krugman. 2004. "The New Economic Geography: Past, present and the future". *Papers in Regional Sciences* 83: 139-164.
- Gaigné, Carl, Piguet, Virginie, Schmitt, Bertrand. 2005. "Evolution recente de l'emploi industriel rural versus urbain: une analyse structurel-geographique sur données françaises". *Revue d'Economie Régionale et Urbaine (RERU)*: 3-30.
- Gans Joshua S., George B., Shepherd. 1994. "How are the mighty fallen: Rejected classic articles by leading economists". *Journal of Economic Perspectives* 8: 165-179.
- Greenacre, Michael, J. 1984. *Theory and Application of Correspondence Analysis*. London.
- Greenwood, M. 1975. Research on national migration in the United States: a survey. *Journal of Economic Literature* 13: 397-433.
- Ham J.C., J. Svejnar and K. Terrell. 1998. "Unemployment and the Social Safety Net during Transitions to a Market Economy: Evidence from the Czech and Slovak Republics". *American Economic Review* 88 (5): 117-141.
- Hraba, Joseph, Allan L McCutcheon, Jiří Večerník. 1997. „Životní šance mužů a žen v období transformace“. *Sociologický časopis/ Czech Sociological Review* 33(4): 405-421.

- Hampl, Martin et al. 1996. *Geografická organizace společnosti a transformační procesy v České republice*. Praha.
- Hampl, Martin, J., Ježek, Karel, Kühnl. 1978. *Sociálně geografická regionalizace ČSR*. Praha.
- Hampl, Martin, Karel, Kühnl. 1993. *Migratory Trends in Former Czechoslovakia*. Acta Universitatis Carolinae - Geographica 28 (1): 53-71.
- Hampl, Martin, Václav, Gardavský, Karel, Kühnl. 1987. *Regionální struktura a vývoj systému osídlení ČSR*. Praha: Univerzita Karlova.
- Hampl, Martin. 2005. *Geografická organizace společnosti v České republice: transformační procesy a jejich obecný kontext*. Praha: DemoArt pro Univerzitu Karlovu, Přírodovědecká fakulta.
- Horizontal Rural Development Plan of the Czech Republic 2004-2006*. 2004. Prague: Ministry of Agriculture.
- Horowitz, S., M. Petras. 2003. "Pride and Prejudice in Prague: Understanding Early Policy Error and Belated Reform in the Czech Economic Transition". *East European Politics and Societies* 17 (2): 231-265.
- Hoyt, H. 1939. „The Pattern of Movement of Residential Rental Neighborhoods“. In Fyfe, N. R., J. T. Kenny 2005. *The Urban Geography Reader*. London: Routledge, pp. 28-36.
- Illner, Michal. 1992. „Municipalities and Industrial Paternalism in a ‚Real Socialist‘ Society“. In *Changing Territorial Administration in Czechoslovakia*, ed. by P. Dostál et al. Amsterdam: University of Amsterdam, pp. 39-47.
- Illner, Michal. 2003a. Thirteen years of reforming sub-national government in the Czech Republic (available at <http://www.uni-stuttgart.de/soz/avps/rlg/papers/CZ-Illner.pdf>, cited 27.3.2008).
- Illner, Michal. 2003b. „Thirteen years of reforming sub-national government in the Czech Republic“. Pp.261-281 in: Kersting, Norbert and Angelica Vetter (eds.). *Reforming Local Government in Europe*, Opladen: Leske+Budrich.

- Illner, Michal. 2003c. „The Czech Republic 1990-2001. Successful reform at the municipal level and a difficult birth of the intermediary government“. Pp. 61-90 in Baldersheim, Harald, Illner, Michal and Hellmut Wollmann (eds.). *Local Democracy in Post-Communist Europe*, Opladen: Leske+Budrich.
- Illner, Michal, Alois, Andrlé. 1994. „The Regional Aspect of Post-Communist Transformation in the Czech Republic“. *Sociologický časopis/Czech Sociological Review* 2(1): 107-127.
- Ioffe, Grigory, Tatyana, Nefedova. 1998. „Environs of Russian cities: A case study of Moscow“. *Europe-Asia Studies* 50: 1325-1356.
- Jayet, Hubert. 1993. *Analyse spatiale quantitative*. Paris.
- Karamera, David, Iwuagwu Oguledo, Victor, Davis, Bobby. 2000. "A gravity model analysis of international migration to North America." *Applied Economics* 32: 1745-1755.
- Klasen, S., A. Launov. 2006. „Analysis of the determinants of fertility decline in the Czech Republic“. *Journal of Population Economics* 19(1): 25–54.
- Kornai, J. 1992. *The Socialist System: The Political Economy of Communism*. Oxford: Oxford University Press.
- Kornai, J. 1993. "The Evolution of Financial Discipline under the Postsocialist System". *Kyklos*, 46 (3): 315-336.
- Kornai, J. 1994. "Transformational Recession: The Main Causes". *Journal of Comparative Economics*, 19 (1): 39-63.
- Kornai, J. (1999) *Hardening the Budget Constraint: the Experience of Postsocialist Countries*. Budapest: Collegium Budapest working paper.
- Kostecký, T. 1993. *Regionální diferenciace sociálních problémů v České republice* (The Regional Differentiation of Social Problems in the Czech Republic). Praha: Sociologický ústav AV ČR.
- Kostecký, Tomáš, Martina Mikeszová. 2008. "Regionální rozdíly ve finanční dostupnosti vlastnického bydlení mezi roky 2000-2006." Pp. 65-86 in Lux, M., F. Kuda (eds.). *Regionální rozdíly v dostupnosti bydlení v České republice*. Praha: Sociologický ústav AV ČR.

- Krugman, Paul, Venables, Anthony J. 1995. „Globalization and the inequality of nations”. *Quarterly Journal of Economics* 110(4): 857–880
- Krugman, Paul. 1991. "Increasing returns and economic geography". *Journal of Political Economy* 99: 483–499.
- Krugman, Paul. 1999. "The Role of Geography in Development". *International Regional Science Review* 22: 142–161.
- Kulu Hill, Paul J. Boyle, Gunnar Andersson. 2008. *High suburban fertility: evidence from four Northern European countries*. Max Planck Institute for Demographic Research Working Paper WP 2008-21.
- Kupiszewski, Marek, Helen, Durham, Philip, Rees. 1998. “Internal Migration and Urban Change in Poland”. *European Journal of Population* 14: 265-290.
- Kupiszewski, Marek. 2005. *Migration in Poland in the Period of Transition – the Adjustment to the Labour Market Change*. Warszawa, 2005. Available at: <http://www.ier.hit-u.ac.jp/pie/Japanese/discussionpaper/dp2004/dp266/text.pdf> (August 2009).
- Ladányi, János, Iván, Szelényi. 1998. “Class, ethnicity and urban restructuring in postcommunist Hungary”. Pp. 67-86 in Enyedi, G. (ed.) *Social Change and Urban Restructuring in Central Europe*. Akadémiai Kiado, Budapest.
- Lewer, Joshua J., Van den Berg, Hendrik. 2008. „A gravity model of immigration“. *Economic letters* 99: 164-167.
- Lux, Martin, Petr Sunega. 2007. "Vliv podmínek bydlení na zamýšlenou migraci české populace za prací". *Sociologický časopis/Czech Sociological Review* 43 (2): 305-332.
- Majerová, Věra. 2000. „Four Milestones in the Social and Economic Development of Czech Agriculture“. *Sociologický časopis/Czech Sociological Review* 8 (2): 157-176.
- Majerová, Věra. a kol. 2003. *Český venkov 2003 – Situace před vstupem do EU*. PEF ČZU Praha.
- Majerová, Věra. a kol. 2001. *Český venkov 2000 – Základní údaje*. PEF ČZU Praha.

- Martin, Ron. 1999. „The New „Geographical Turn“ in Economics: Some Critical Reflections.“ Cambridge Journal of Economics 23 (1): 65-91.
- Maříková, Pavlína. 2005. *Venkov v České republice – Teoretické vymezení*. Pp. 35-57 in Majerová, V a kol. *Český venkov 2005 – Rozvoj venkovské společnosti*. PEF ČZU Praha.
- Mérenne, B., Van der Haegen, H., Van Hecke, E. 1998. *België ruimtelijk doorgelicht*, Brussel, DWTC: 14.
- Michielin, Francesca. 2002. *Lowest low fertility in an urban context. When migration plays a key role*. Max Planck Institute for Demographic Research Working Paper WP 2002-050.
- Musil, Jiří, Jan, Müller. 2008. "Vnitřní periferie v České republice jako mechanismus sociální exkluze". *Sociologický časopis* 44 (2): 321-348.
- Musil, Jiří. 1988. „Nové pohledy na regeneraci našich měst a osídlení“ (New Approaches to the Regeneration of Our Towns and the Settlement System). *Územní plánování a urbanismus* 2: 67-72.
- Myant, Martin. 2003. *The Rise and Fall of Czech Capitalism: Economic Development in the Czech Republic since 1989*. Northampton: Edward Elgar.
- Myrdal, Gunnar. 1957. *Economic Theory and Under-developed Regions*. London: Duckworth.
- Newby, Howard. 1985. "Locality and Rurality: The Restructuring of Rural Social Relations". *Regional Studies* 20(3): 209-215.
- Orenstein, M. 2001. *Out of the Red*. Ann Arbor: University of Michigan Press.
- Pavlík, Zdeněk. 2005. "Vymezení venkovského obyvatelstva". Pp. 21-36 in Majerová, V a kol. *Český venkov 2005 – Rozvoj venkovské společnosti*. PEF ČZU Praha.
- Perlín, Radim. 1999. "Typologie venkovského prostoru v Česku". Pp. 87-104 in *Česká etnoekologie, etnoekologické semináře v Liběchově*. Cargo Publishers, Praha.
- Perlín, Radim. 2003a. "Typologie venkova". Pp. 113-119 in Majerová, V. a kol. *Český venkov 2003 – Situace před vstupem do EU*. PEF ČZU Praha.
- Perlín, Radim. 2003b. "Předpoklady rozvoje českého venkova". In Vávra, V. *Funkce politiky v agrárním sektoru a rozvoji venkova v nejdůležitějších typech regionů v období před a po*

*vstupu do EU. Praha. Praha.*

Piguet, Virginie. 2005. *Analyse structurelle-géographique à 2, 3 ou 4 facteurs : notice d'utilisation des macros ss2fact, ss3fact, ss4fact*. Working paper UMR INRA-ENESAD, Dijon.

Polášek, V. 2005. *Vnitřní stěhování v ČR 1991 až 2004*. ČSÚ, Praha.

Potůček, M. 2001. "Czech Social Reform after 1989: Concepts and Reality". *International Social Security Review* 54(2): 81-105.

*Program rozvoje venkova České republiky na období 2007-2013*. 2007. Praha: Ministerstvo zemědělství ČR.

Rees, Philip, Marek, Kupiszewski. 1999. *Internal migration and regional population dynamics in Europe: a synthesis*. Council of Europe.

Robert, S., W. G. Randolph. 1983. "Beyond decentralisation: the evolution of population distribution in England and Wales, 1961-1981". *Geoforum* 14 (1): 75-102.

*Rozmístění a koncentrace obyvatelstva ČR časová řada 1961-2001*. 2004. Český statistický úřad, Praha. Available at [http://www.czso.cz/csu/2003edicniplan.nsf/publ/4120-03-casova\\_rada\\_1961\\_2001](http://www.czso.cz/csu/2003edicniplan.nsf/publ/4120-03-casova_rada_1961_2001) (cit. 16.11.2008).

Rychtaříková, Jitka. 2004. „Změny generační plodnosti v České republice se zaměřením na vzdělání žen“. *Demografie* 46(2): 77-87.

Rychtaříková, Jitka. 2007. „Porodnost v České republice: současný stav a nedávné trendy“. Pp. 79-94 in *Populační vývoj České republiky 2001-2006*. Praha.

Schmitt, B. (et al.). 1998. *Les campagnes et leurs villes*. Paris: INSEE.

Schmitt, B. 1999. "Economic geography and contemporary rural dynamics : an empirical test on some French regions". *Regional Studies* 33: 697-711.

Schmitt, Bertrand, Florence Goffette-Nagot. 1999. "Agglomeration economies and spatial configurations in rural areas". *Environment and Planning A*, 31 (7): 1239-1257.

Schmitt, B., Florence Goffette-Nagot. 2000. „Définir l'espace rural? De la difficulté d'une définition conceptuelle a la nécessité d'une délimitation statistique.“ *Economie Rurale*: 42-55.

- Schmitt, Bertrand et al. 1998. *Les campagnes et leurs villes*. Paris: INSEE.
- Sjöberg, Ö. 1999. "Shortage, priority and urban growth: towards a theory of urbanisation under central planning". *Urban Studies*, 36 (13): 2217–2235.
- Sobotka, Tomáš, Kryštof Zeman, Vladimíra Kantorová. 2003. "Demographic shifts in the Czech Republic after 1989: A Second demographic transition view". *European Journal of Population* 19(3): 249-277.
- Sunega, Petr. 2005. "Efektivnost vybraných nástrojů bytové politiky v České republice". *Sociologický časopis/Czech Sociological Review* 41: 271-299.
- Svejnar, Jan. 2002. Transition Economies: Performance and Challenges. *Journal of Economic Perspectives* 16 (1): 3-28.
- Szelenyi, Ivan. 1996. Cities under socialism—and after. Pp. 286–317 in Andrusz, Gregory, Harloe, Michael and Szelenyi, Ivan (Eds) *Cities after Socialism. Urban and Regional Change and Conflict in Postsocialist Societies*. Oxford: Blackwell Publishers.
- Tammaru, Tiit. 2001. "Suburban Growth and Suburbanisation under Central Planning: The Case of Soviet Estonia". *Urban Studies* 38 (8): 1341-1357.
- Termote, Marc. 2002. „The Explanatory power of migration models“. In Franck, Robert (ed.) *The Explanatory Power of Models*. Kluwer Academic Publishers.
- Tuček, Milan. 2003. "Sociální struktura venkova a mobilita jeho obyvatel". Pp. 197-208 in *Český venkov 200 - Situace před vstupem do EU*. PEF ČZU Praha 2001.
- Uherek, Zdeněk. 2003. "Cizinecké komunity a městský prostor v České republice". *Sociologický časopis/Czech Sociological Review* 39 (2): 193-216.
- Vajdová, Z., 2003. „Local community transformation: the Czech Republic 1990-2000“. Pp. 143-160 in Smith Simon, (ed.). *Local Communities and Post-Communist Transformation*. London and N.Y., RoutledgeCurzon.
- Vanhuyse, P. 1999. "The Political Dynamics of Economic Reforms: Przeworski's Theory and the Case of Hungary and Poland". *East European Quarterly* 33 (4): 491-515.



Vanhuyse, P. 2006. *Divide and Pacify: Strategic Social Policies and Political Protests in Post-Communist Democracies*. Budapest and New York: Central European University Press.

Vanhuyse, Pieter (ed). 2008. "Special Review Section: Advances in the Study of Post-Communist States and Public Administrations". *Czech Sociological Review*, 44(6): 1151-1197.

*Varianty vymezení venkova a jejich zobrazení ve statistických ukazatelích v letech 2000 až 2006*. 2008. Praha: Český statistický úřad.

Večerník, J. 1996. „Incomes in Central Europe: Distributions, Patterns and Perceptions.“ *Journal of European Social Policy* 6: 101-122.

Vobecká, J., Kostecký, T. (eds.). 2007. *Behaviour and Civic Participation in Selected Suburban Localities around Prague and Brno*. Sociologické studie/ Sociological studies 07:8. Prague. In Czech.

Vobecká, Jana. 2009. „Dojížděkový přístup k vymezení městského, příměstského a venkovského obyvatelstva v České republice“. *Demografie* 50 (1): 14-23.

Vobecká, Jana. 2009b. „Czech Rural Development Policies for Human Resources, post-2004: A Tale of Muddled Definitions Preventing Strategic Visions ?“ *Central European Journal of Public Policy*, 3 (1): 44-65.

Vobecká Jana, Tomáš Kostecký. 2008. *Municipal finance and social-spatial inequalities in the Czech metropolitan areas*. ECPR 2008 Joint Session of Workshops: Workshop “Metropolitan governance and social inequality.” Rennes, France, April 11-16 2008.

Vobecká, Jana, Virginie, Piguet. 2010 manuscript. „Urban, suburban and rural disparities in fertility in the post-communist transition context: the case of the Czech Republic“. Institute of Sociology, Academy of Sciences of the Czech Republic, Prague.

## **ANNEXES**

## Annex 1: List of agglomerations used in the commuting approach classification

Agglomeration	NUTS 4 Code	NUTS 5 Code	Municipality
A 1	CZ0212	531057	Beroun
	CZ0212	533203	Králův Dvůr
A 2	CZ0216	535087	Neratovice
	CZ0216	571784	Libiš
A 3	CZ0217	535419	Mladá Boleslav
	CZ0217	570826	Kosmonosy
A 4	CZ0311	544256	České Budějovice
	CZ0311	535206	Dobrá Voda u Č. Budějov.
A 5	CZ0219	538574	Odolena Voda
	CZ0219	539015	Vodochody
A 6	CZ0317	552046	Tábor
	CZ0317	553069	Sezimovo Ústí
A 7	CZ0411	554642	Mariánské Lázně
	CZ0411	539279	Velká Hleďsebe
A 8	CZ0413	560286	Sokolov
	CZ0413	560294	Březová
	CZ0413	538591	Dolní Rychnov
	CZ0413	538434	Svatava
A 9	CZ0413	560383	Chodov
	CZ0413	560685	Vintřov
	CZ0413	560707	Vřesová
A 10	CZ0422	562971	Chomutov
	CZ0422	563099	Jirkov
A 11	CZ0426	567442	Teplice
	CZ0426	567507	Dubí
	CZ0426	567752	Novosedlice
	CZ0426	567787	Proboštov
A 12	CZ0426	567451	Bílina
	CZ0426	567655	Ledvice
A 13	CZ0427	554804	Ústí nad Labem
	CZ0427	553697	Tmice
A 14	CZ0512	563820	Tanvald
	CZ0512	563552	Desná
A 15	CZ0513	563889	Liberec
	CZ0513	544477	Stráž nad Nisou
A 16	CZ0523	574082	Hronov
	CZ0523	547646	Velké Poříčí
A 17	CZ0524	576425	Kvasiny
	CZ0524	576808	Solnice
A 18	CZ0532	555134	Pardubice
	CZ0532	575593	Rybitví
	CZ0532	575704	Staré Hradiště
A 19	CZ0623	583782	Rosice
	CZ0623	584207	Zastávka
A 20	CZ0623	584002	Tišnov
	CZ0623	549746	Předklášteří
A 21	CZ0625	586722	Veselí nad Moravou
	CZ0625	586757	Vnorovy
A 22	CZ0627	593711	Znojmo
	CZ0627	546941	Dobšice
A 23	CZ0627	587729	Nový Šaldorf-Sedleš
	CZ0721	588393	Bystřice pod Hostýnem
	CZ0721	506737	Chvalčov

Source: Hampf (2005, p. 139)

## Annex 2: List of municipalities which did not accomplish the condition that the primary centres

List of municipalities which did not accomplish the condition that the primary centres must have larger work size than number of economically active employed residents. Explanation of the final classification of these municipalities.

Municipality	Note	Categorization
Kladno	It is close to Prague, a residential area for people working in Prague. However, it is large and important centre of attraction for its surrounding.	Primary centre
Frýdek-Místek	Although in the agglomeration it does not fulfil the condition. However, it is a large centre of regional importance in very urbanized area, therefore the work opportunities are more dispersed.	Primary centre
Kopřivnice	-	Secondary centre
Orlová	-	Secondary centre
Český Těšín	-	Secondary centre
Žatec	-	Secondary centre
Neratovice	-	Secondary centre
Ostrov	-	Secondary centre
Šternberk	-	Secondary centre
Vlašim	-	Secondary centre
Aš	-	Secondary centre
Kláštorec nad Ohří	-	Secondary centre
Other excluded municipalities		
Říčany	Fulfil the condition but is situated in the suburban fringe of Prague.	Outer fringe
Kuřim	Fulfil the condition but is situated in the suburban fringe of Brno. With its own suburban municipality, it is classified as Background of the Large centre	Outer fringe

### Annex 3: One-Way analysis of variance (ANOVA) testing the hypothesis of significant difference of migration rates between urban-rural gradient categories in 2004

Graph of the means and standard errors of net migration rates by urban-rural gradient categories in 2004 clearly shows that the mean net migration rates differ between the spatial categories, being the highest in suburban fringes and negative in urban areas. It also shows intervals of standard errors having different variability for each categories. The test of homogeneity of variances (Leven statistics) will prove whether this fact disturbs the results of ANOVA.

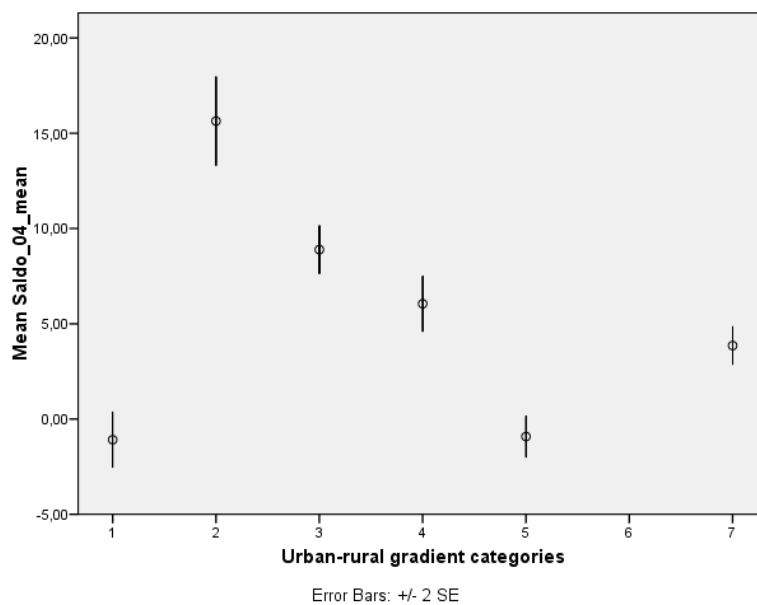

Note: 1–primary centres, 2-inner fringe, 3-outer fringe, 4-polycentric background, 5-secondary centres, 7-rural areas (incl. suburban areas of secondary centres);

y-axis represent the mean values of net migration rates per thousand inhabitants in 2004

Standard error in the table of descriptives shows that their variability is not very high, only for the category of inner fringe, the standard error exceeds other categories. It is therefore a category of the highest internal heterogeneity. It could be expected because this category includes the municipalities with the highest migration dynamics together with the average and under average municipalities. Some of the municipalities might also suffer from extreme values due to their small size.

The Levene statistic rejects the null hypothesis that the group variances are equal. And the two test of equality of means (Welsch and Brown-Forsythe tests) reject the hypothesis of equal means, therefore we can consider the ANOVA results as reliable. Anova test shows that the municipalities in urban-rural gradient categories differ significantly in the mean net-migration rates in 2004. It proves the appropriateness of use of urban-rural gradient spatial classification for the study of migration differentiation.

#### Descriptives

Saldo\_04\_mean

	N	Mean	Std. Deviation	Std. Error	95% Confidence Interval for Mean		Minimum	Maximum
					Lower Bound	Upper Bound		
Primary centres	147	-1,08	8,757	,722	-2,51	,34	-13	39
Inner Fr.	909	15,64	35,061	1,163	13,36	17,92	-62	709
Outer Fr.	1209	8,89	21,870	,629	7,66	10,12	-67	182
Polycentric bcg.	934	6,05	22,106	,723	4,63	7,47	-88	193
Secondary centres	148	-,92	6,531	,537	-1,98	,14	-24	24
Rural	1978	3,86	21,926	,493	2,89	4,82	-225	152
Total	5325	7,13	24,628	,377	6,46	7,79	-225	709

#### Test of Homogeneity of Variances

Saldo\_04\_mean

Levene Statistic	df1	df2	Sig.
25,499	5	5319	,000

#### Robust Tests of Equality of Means

	Statistic(a)	df1	df2	Sig.
Welch	60,191	5	990,594	,000
Brown-Forsythe	50,375	5	3197,979	,000

a. Asymptotically F distributed.

#### ANOVA

	Sum of Squares	df	Mean Square	F	Sig.
Between Groups	111344,624	5	22268,925	37,991	,000
Within Groups	3117837,329	5319	586,170		
Total	3229181,953	5324			

**Annex 4: Total population change, natural increase and net migration in urban-rural gradient categories in the selected years between 1980 and 2007, absolute and in rates per 1 000 inhabitants**

	1980				1991				1995				2001				2007			
	Natural incr.	Net migration	Change total	Total pop.	Natural incr.	Net migration	Change total	Total pop.	Natural incr.	Net migration	Change total	Total pop.	Natural incr.	Net migration	Change total	Total pop.	Natural incr.	Net migration	Change total	Total pop.
Large c.	13 910	25 525	39 435	5 400 481	5 668	8 503	14 171	5 561 588	-11 060	-1 976	-13 036	5 543 358	-8 290	-25 718	-34 008	5 383 473	5 354	30 755	36 109	5 366 068
Inner f.	32	-4 176	-4 144	573 067	-769	-452	-1 221	580 425	-1 956	3 197	1 241	605 994	-994	7 243	6 249	642 720	1 703	18 047	19 750	717 356
Outer f.	357	-4 522	-4 165	1 000 219	-576	-929	-1 505	980 922	-2 541	4 011	1 470	994 106	-1 609	6 309	4 700	1 021 645	1 429	15 600	17 029	1 080 871
Poly. Bcg.	-817	-5 157	-5 974	758 435	-1 163	-1 209	-2 372	738 425	-2 334	2 321	-13	736 766	-1 963	3 246	1 283	745 083	271	7 952	8 223	769 391
Small c.	4 708	2 222	6 930	1 097 063	3 141	-307	2 834	1 084 569	-324	469	145	1 070 130	-561	-1 183	-1 744	1 048 836	1 541	2 817	4 358	1 046 958
Suburb. S.	74	-1 514	-1 440	121 775	-265	-118	-383	138 977	-415	515	100	152 098	-300	376	76	158 257	39	1 476	1 515	162 885
Rural	93	-8 092	-7 999	1 277 681	-941	-2 445	-3 386	1 220 286	-3 181	1 429	-1 752	1 222 420	-3 323	1 176	-2 147	1 224 178	-336	7 246	6 910	1 235 107
Total	18 357	4 286	22 643	10 228 721	5 095	3 043	8 138	10 305 191	-21 811	9 966	-11 845	10 324 871	-17 040	-8 551	-25 591	10 224 192	10 001	83 893	93 894	10 378 636

In ‰

	1980			1991			1995			2001			2007		
	Natural incr. Rate	Net migr. Rate	Total change rate	Natural incr. Rate	Net migr. Rate	Total change rate	Natural incr. Rate	Net migr. Rate	Total change rate	Natural incr. Rate	Net migr. Rate	Total change rate	Natural incr. Rate	Net migr. Rate	Total change rate
Large c.	2,6	4,7	7,3	1,0	1,5	2,5	-2,0	-0,4	-2,4	-1,5	-4,8	-6,3	1,0	5,7	6,7
Inner f.	0,1	-7,3	-7,2	-1,3	-0,8	-2,1	-3,2	5,3	2,0	-1,5	11,3	9,7	2,4	25,2	27,5
Outer f.	0,4	-4,5	-4,2	-0,6	-0,9	-1,5	-2,6	4,0	1,5	-1,6	6,2	4,6	1,3	14,4	15,8
Poly. Bcg.	-1,1	-6,8	-7,9	-1,6	-1,6	-3,2	-3,2	3,2	0,0	-2,6	4,4	1,7	0,4	10,3	10,7
Small c.	4,3	2,0	6,3	2,9	-0,3	2,6	-0,3	0,4	0,1	-0,5	-1,1	-1,7	1,5	2,7	4,2
Suburb. S.	0,6	-12,4	-11,8	-1,9	-0,8	-2,8	-2,7	3,4	0,7	-1,9	2,4	0,5	0,2	9,1	9,3
Rural	0,1	-6,3	-6,3	-0,8	-2,0	-2,8	-2,6	1,2	-1,4	-2,7	1,0	-1,8	-0,3	5,9	5,6
Total	1,8	0,4	2,2	0,5	0,3	0,8	-2,1	1,0	-1,1	-1,7	-0,8	-2,5	1,0	8,1	9,0

Source: Czech statistical office, own computation.

Number of municipalities in denominator differed according to evolution of their number in time and capacity to identify their appurtenance in urban-rural gradient classification (crated on the 2001 data):  $N_{1980} = 5127$ ,  $N_{1991} = 5738$ ,  $N_{1995} = 6215$ ,  $N_{2001} = 6258$ ,  $N_{2007} = 6247$

Note: total population in denominator in the year 1980 is for 31.12., all others are at 1.7.

## Annex 5a: Number of migration flows by sex and age of migrants, departures, arrivals and net migration for urban-rural gradient categories in 1995

### Urban-rural gradient categories

1995												
Departure from:	0-19		20-29		30-44		45-59		60+		Total	
	M	F	M	F	M	F	M	F	M	F	M	F
Large centres	10 094	10 718	9 929	11 501	7 069	6 190	3 759	3 585	2 606	4 551	33 457	36 545
Inner fringes	1 623	1 867	1 996	2 310	1 001	863	434	406	425	941	5 479	6 387
Outer fringes	2 827	3 441	3 340	3 857	1 700	1 355	672	638	691	1 387	9 230	10 678
Polycentric bcg.	2 215	2 641	2 599	3 008	1 268	1 022	540	483	478	1 112	7 100	8 266
Small centres	2 782	3 029	2 967	3 434	1 691	1 459	702	675	513	995	8 655	9 592
Rural	4 620	5 169	5 055	5 832	2 475	2 014	913	894	1 068	2 267	14 131	16 176
<b>Total</b>	<b>24 161</b>	<b>26 865</b>	<b>25 886</b>	<b>29 942</b>	<b>15 204</b>	<b>12 903</b>	<b>7 020</b>	<b>6 681</b>	<b>5 781</b>	<b>11 253</b>	<b>78 052</b>	<b>87 644</b>

1995												
Arrival to:	0-19		20-29		30-44		45-59		60+		Total	
	M	F	M	F	M	F	M	F	M	F	M	F
Large centres	8 457	9 313	10 216	12 152	5 805	4 878	2 399	2 414	2 031	4 143	28 908	32 900
Inner fringes	2 174	2 366	2 087	2 583	1 479	1 280	737	657	438	694	6 915	7 580
Outer fringes	3 401	3 977	3 486	3 868	2 143	1 887	1 063	976	781	1 427	10 874	12 135
Polycentric bcg.	2 572	2 946	2 645	2 820	1 556	1 373	813	715	626	1 166	8 212	9 020
Small centres	2 705	2 877	2 846	3 277	1 558	1 238	646	622	661	1 408	8 416	9 422
Rural	4 848	5 384	4 601	5 243	2 663	2 245	1 362	1 296	1 245	2 417	14 719	16 585
<b>Total</b>	<b>24 157</b>	<b>26 863</b>	<b>25 881</b>	<b>29 943</b>	<b>15 204</b>	<b>12 901</b>	<b>7 020</b>	<b>6 680</b>	<b>5 782</b>	<b>11 255</b>	<b>78 044</b>	<b>87 642</b>

1995												
Net migration	0-19		20-29		30-44		45-59		60+		Total	
	M	F	M	F	M	F	M	F	M	F	M	F
Large centres	-1 637	-1 405	287	651	-1 264	-1 312	-1 360	-1 171	-575	-408	-4 549	-3 645
Inner fringes	551	499	91	273	478	417	303	251	13	-247	1 436	1 193
Outer fringes	574	536	146	11	443	532	391	338	90	40	1 644	1 457
Polycentric bcg.	357	305	46	-188	288	351	273	232	148	54	1 112	754
Small centres	-77	-152	-121	-157	-133	-221	-56	-53	148	413	-239	-170
Rural	228	215	-454	-589	188	231	449	402	177	150	588	409
<b>Total</b>	<b>-4</b>	<b>-2</b>	<b>-5</b>	<b>1</b>	<b>0</b>	<b>-2</b>	<b>0</b>	<b>-1</b>	<b>1</b>	<b>2</b>	<b>-8</b>	<b>-2</b>

## Number of migration flows by education, departures, arrivals and net migration for urban-rural gradient categories in 1995

Departure from:	Education				Total
	Basic and none	Without A-levels	With A-levels	University	
Large centres	26 682	20 522	16 512	6 286	70 002
Inner fringes	4 919	4 018	2 352	577	11 866
Outer fringes	8 340	6 860	3 771	937	19 908
Polycentric bcg.	6 495	5 361	2 810	700	15 366
Small centres	7 283	5 751	3 932	1 281	18 247
Rural	13 174	10 395	5 429	1 309	30 307
<b>Total</b>	<b>66 893</b>	<b>52 907</b>	<b>34 806</b>	<b>11 090</b>	<b>165 696</b>

Arrival to:	Education				Total
	Basic and none	Without A-levels	With A-levels	University	
Large centres	23 037	17 027	15 365	6 379	61 808
Inner fringes	5 613	4 949	3 089	844	14 495
Outer fringes	9 470	8 158	4 325	1 056	23 009
Polycentric bcg.	7 433	5 981	3 104	714	17 232
Small centres	7 503	5 731	3 645	959	17 838
Rural	13 833	11 058	5 276	1 137	31 304
<b>Total</b>	<b>66 889</b>	<b>52 904</b>	<b>34 804</b>	<b>11 089</b>	<b>165 686</b>

Net migration	Education				Total
	Basic and none	Without A-levels	With A-levels	University	
Large centres	-3 645	-3 495	-1 147	93	-8 194
Inner fringes	694	931	737	267	2 629
Outer fringes	1 130	1 298	554	119	3 101
Polycentric bcg.	938	620	294	14	1 866
Small centres	220	-20	-287	-322	-409
Rural	659	663	-153	-172	997
<b>Total</b>	<b>-4</b>	<b>-3</b>	<b>-2</b>	<b>-1</b>	<b>-10</b>

Note: The total net migration in 1995 is not equal to zero because some migration flows are from or to municipalities which did not exist anymore in 2001 (at a moment for which the urban-rural gradient categories were defined). There is 17 such cases with 27 individuals of departure and 37 individuals of arrival.

Source: Czech statistical office, authors calculations.



## Annex 5b: Number of migration flows by sex and age of migrants, departures, arrivals and net migration for urban-rural gradient categories in 2004

### Urban-rural gradient categories

2004												
Departure from:	0-19		20-29		30-44		45-59		60+		Total	
	M	F	M	F	M	F	M	F	M	F	M	F
Large centres	9 524	9 438	9 296	12 291	10 540	9 379	5 847	5 476	3 057	4 328	38 264	40 912
Inner fringes	1 480	1 513	1 647	2 353	1 412	1 314	605	555	375	784	5 519	6 519
Outer fringes	2 464	2 559	2 724	3 920	2 254	2 061	927	933	610	1 236	8 979	10 709
Polycentric bcg.	1 809	1 796	2 090	3 004	1 637	1 452	658	652	468	966	6 662	7 870
Small centres	2 360	2 409	2 486	3 704	2 433	2 088	1 012	935	467	855	8 758	9 991
Rural	3 689	3 797	3 940	5 948	3 122	2 859	1 229	1 229	897	1 839	12 877	15 672
<b>Total</b>	<b>21 326</b>	<b>21 512</b>	<b>22 183</b>	<b>31 220</b>	<b>21 398</b>	<b>19 153</b>	<b>10 278</b>	<b>9 780</b>	<b>5 874</b>	<b>10 008</b>	<b>81 059</b>	<b>91 673</b>

2004												
Arrival to:	0-19		20-29		30-44		45-59		60+		Total	
	M	F	M	F	M	F	M	F	M	F	M	F
Large centres	6 581	6 751	8 366	12 293	7 230	6 590	2 876	2 932	1 875	3 470	26 928	32 036
Inner fringes	2 655	2 646	2 334	3 175	2 911	2 690	1 429	1 304	604	912	9 933	10 727
Outer fringes	3 459	3 417	3 309	4 507	3 535	3 094	1 842	1 687	866	1 340	13 011	14 045
Polycentric bcg.	2 372	2 255	2 086	2 908	2 232	1 935	1 228	1 099	653	1 043	8 571	9 240
Small centres	2 093	2 267	2 263	3 169	1 896	1 739	847	895	631	1 159	7 730	9 229
Rural	4 166	4 176	3 825	5 168	3 594	3 105	2 056	1 863	1 245	2 084	14 886	16 396
<b>Total</b>	<b>21 326</b>	<b>21 512</b>	<b>22 183</b>	<b>31 220</b>	<b>21 398</b>	<b>19 153</b>	<b>10 278</b>	<b>9 780</b>	<b>5 874</b>	<b>10 008</b>	<b>81 059</b>	<b>91 673</b>

2004												
Net migration	0-19		20-29		30-44		45-59		60+		Total	
	M	F	M	F	M	F	M	F	M	F	M	F
Large centres	-2 943	-2 687	-930	2	-3 310	-2 789	-2 971	-2 544	-1 182	-858	-11 336	-8 876
Inner fringes	1 175	1 133	687	822	1 499	1 376	824	749	229	128	4 414	4 208
Outer fringes	995	858	585	587	1 281	1 033	915	754	256	104	4 032	3 336
Polycentric bcg.	563	459	-4	-96	595	483	570	447	185	77	1 909	1 370
Small centres	-267	-142	-223	-535	-537	-349	-165	-40	164	304	-1 028	-762
Rural	477	379	-115	-780	472	246	827	634	348	245	2 009	724
<b>Total</b>	<b>0</b>	<b>0</b>	<b>0</b>	<b>0</b>	<b>0</b>	<b>0</b>	<b>0</b>	<b>0</b>	<b>0</b>	<b>0</b>	<b>0</b>	<b>0</b>

### Number of migration flows by education, departures, arrivals and net migration for urban-rural gradient categories in 1995

Departure from:	Educ groups				
	Basic and none	Without A-levels	With A-levels	University	Total
Large centres	24 380	21 686	22 740	10 370	79 176
Inner fringes	4 057	3 845	3 162	974	12 038
Outer fringes	6 993	6 455	4 842	1 398	19 688
Polycentric bcg.	5 104	4 967	3 466	995	14 532
Small centres	6 201	5 599	5 180	1 769	18 749
Rural	10 518	9 605	6 607	1 819	28 549
<b>Total</b>	<b>57 253</b>	<b>52 157</b>	<b>45 997</b>	<b>17 325</b>	<b>172 732</b>

Arrival to:	Educ groups				
	Basic and none	Without A-levels	With A-levels	University	Total
Large centres	18 240	15 547	17 158	8 019	58 964
Inner fringes	6 324	5 719	5 913	2 704	20 660
Outer fringes	8 688	8 663	7 218	2 487	27 056
Polycentric bcg.	6 172	5 918	4 497	1 224	17 811
Small centres	6 149	5 523	4 029	1 258	16 959
Rural	11 680	10 787	7 182	1 633	31 282
<b>Total</b>	<b>57 253</b>	<b>52 157</b>	<b>45 997</b>	<b>17 325</b>	<b>172 732</b>

Net migration	Educ groups				
	Basic and none	Without A-levels	With A-levels	University	Total
Large centres	-6 140	-6 139	-5 582	-2 351	-20 212
Inner fringes	2 267	1 874	2 751	1 730	8 622
Outer fringes	1 695	2 208	2 376	1 089	7 368
Polycentric bcg.	1 068	951	1 031	229	3 279
Small centres	-52	-76	-1 151	-511	-1 790
Rural	1 162	1 182	575	-186	2 733
<b>Total</b>	<b>0</b>	<b>0</b>	<b>0</b>	<b>0</b>	<b>0</b>

Source: Czech statistical office, authors calculations.

**Annex 5c: Number of migration flows by sex and age of migrants, departures, arrivals and net migration for four regions in 1995**

1995												
Departure from:	0-19		20-29		30-44		45-59		60+		Total	
	M	F	M	F	M	F	M	F	M	F	M	F
Prague core	4 504	4 930	4 515	5 256	2 955	2 726	1 613	1 564	1 330	2 491	14 917	16 967
E-S-W Bohemia	5 950	6 539	6 424	7 549	3 478	2 906	1 515	1 408	1 347	2 752	18 714	21 154
N-W Bohemia	4 509	5 120	4 389	4 962	3 024	2 504	1 474	1 423	1 110	1 950	14 506	15 959
Moravia	9 200	10 281	10 560	12 182	5 750	4 768	2 419	2 289	1 995	4 062	29 924	33 582
Total	24 163	26 870	25 888	29 949	15 207	12 904	7 021	6 684	5 782	11 255	78 061	87 662

1995												
Arrival to:	0-19		20-29		30-44		45-59		60+		Total	
	M	F	M	F	M	F	M	F	M	F	M	F
Prague core	4 361	4 852	5 036	5 844	3 067	2 687	1 472	1 453	1 123	2 185	15 059	17 021
E-S-W Bohemia	5 963	6 783	6 342	7 430	3 530	3 060	1 620	1 533	1 528	2 962	18 983	21 768
N-W Bohemia	4 615	5 031	4 284	4 900	2 921	2 442	1 517	1 426	1 101	2 021	14 438	15 820
Moravia	9 224	10 204	10 226	11 775	5 689	4 715	2 412	2 272	2 030	4 087	29 581	33 053
Total	24 163	26 870	25 888	29 949	15 207	12 904	7 021	6 684	5 782	11 255	78 061	87 662

1995												
Net migration	0-19		20-29		30-44		45-59		60+		Total	
	M	F	M	F	M	F	M	F	M	F	M	F
Prague core	-143	-78	521	588	112	-39	-141	-111	-207	-306	142	54
E-S-W Bohemia	13	244	-82	-119	52	154	105	125	181	210	269	614
N-W Bohemia	106	-89	-105	-62	-103	-62	43	3	-9	71	-68	-139
Moravia	24	-77	-334	-407	-61	-53	-7	-17	35	25	-343	-529
Total	0	0	0	0	0	0	0	0	0	0	0	0

Note: M: male, F: female

**Number of migration flows by education, departures, arrivals and net migration for four regions in 1995**

Departure from:	Education				Total
	Basic and none	Without A-levels	With A-levels	University	
Prague core	12 579	9 571	7 332	2 402	31 884
E-S-W Bohemia	16 140	12 839	8 309	2 580	39 868
N-W Bohemia	13 368	9 518	5 967	1 612	30 465
Moravia	24 817	20 987	13 204	4 498	63 506
Total	66 904	52 915	34 812	11 092	165 723

Arrival to:	Education				Total
	Basic and none	Without A-levels	With A-levels	University	
Prague core	12 042	9 343	7 691	3 004	32 080
E-S-W Bohemia	16 635	13 138	8 479	2 499	40 751
N-W Bohemia	13 580	9 599	5 709	1 370	30 258
Moravia	24 647	20 835	12 933	4 219	62 634
Total	66 904	52 915	34 812	11 092	165 723

Net migration	Education				Total
	Basic and none	Without A-levels	With A-levels	University	
Prague core	-537	-228	359	602	196
E-S-W Bohemia	495	299	170	-81	883
N-W Bohemia	212	81	-258	-242	-207
Moravia	-170	-152	-271	-279	-872
Total	0	0	0	0	0

Source: Czech statistical office, authors calculations.

## Annex 5d: Number of migration flows by sex and age of migrants, departures, arrivals and net migration for four regions in 2004

### Regions

2004												
Departure from:	0-19		20-29		30-44		45-59		60+		Total	
	M	F	M	F	M	F	M	F	M	F	M	F
Prague core	3 979	4 058	3 809	5 271	4 455	4 008	2 423	2 388	1 521	2 223	16 187	17 948
E-S-W Bohemia	5 082	5 104	5 475	7 922	5 029	4 423	2 332	2 117	1 255	2 221	19 173	21 787
N-W Bohemia	4 257	4 218	3 919	5 323	3 798	3 510	1 888	1 828	1 061	1 809	14 923	16 688
Moravia	8 008	8 132	8 980	12 704	8 116	7 212	3 635	3 447	2 037	3 755	30 776	35 250
Total	21 326	21 512	22 183	31 220	21 398	19 153	10 278	9 780	5 874	10 008	81 059	91 673

2004												
Arrival to:	0-19		20-29		30-44		45-59		60+		Total	
	M	F	M	F	M	F	M	F	M	F	M	F
Prague core	4 189	4 219	4 850	6 840	5 180	4 563	2 241	2 184	1 219	1 915	17 679	19 721
E-S-W Bohemia	5 184	5 238	5 285	7 616	4 906	4 485	2 497	2 355	1 470	2 424	19 342	22 118
N-W Bohemia	4 157	4 090	3 648	4 990	3 653	3 310	1 932	1 879	1 112	1 931	14 502	16 200
Moravia	7 796	7 965	8 400	11 774	7 659	6 795	3 608	3 362	2 073	3 738	29 536	33 634
Total	21 326	21 512	22 183	31 220	21 398	19 153	10 278	9 780	5 874	10 008	81 059	91 673

2004												
Net migration	0-19		20-29		30-44		45-59		60+		Total	
	M	F	M	F	M	F	M	F	M	F	M	F
Prague core	210	161	1 041	1 569	725	555	-182	-204	-302	-308	1 492	1 773
E-S-W Bohemia	102	134	-190	-306	-123	62	165	238	215	203	169	331
N-W Bohemia	-100	-128	-271	-333	-145	-200	44	51	51	122	-421	-488
Moravia	-212	-167	-580	-930	-457	-417	-27	-85	36	-17	-1 240	-1 616
Total	0	0	0	0	0	0	0	0	0	0	0	0

Note: M: male, F: female

## Number of migration flows by education, departures, arrivals and net migration for four regions in 2004

Departure from:	Educ groups				Total
	Basic and none	Without A-levels	With A-levels	University	
Prague core	10 632	10 127	9 575	3 801	34 135
E-S-W Bohemia	13 401	12 875	10 698	3 986	40 960
N-W Bohemia	12 101	9 697	7 648	2 165	31 611
Moravia	21 119	19 458	18 076	7 373	66 026
Total	57 253	52 157	45 997	17 325	172 732

Arrival to:	Educ groups				Total
	Basic and none	Without A-levels	With A-levels	University	
Prague core	10 674	10 037	10 933	5 756	37 400
E-S-W Bohemia	13 741	13 566	10 701	3 452	41 460
N-W Bohemia	12 135	9 552	7 271	1 744	30 702
Moravia	20 703	19 002	17 092	6 373	63 170
Total	57 253	52 157	45 997	17 325	172 732

Net migration	Educ groups				Total
	Basic and none	Without A-levels	With A-levels	University	
Prague core	42	-90	1 358	1 955	3 265
E-S-W Bohemia	340	691	3	-534	500
N-W Bohemia	34	-145	-377	-421	-909
Moravia	-416	-456	-984	-1 000	-2 856
Total	0	0	0	0	0

Source: Czech statistical office, authors calculations.

## Annex 6: Intra- and inter-regional migration flows structured by urban-rural gradient categories, 2004

Arrival \ Departure	Prague core region							N-W Bohemia							E-S-W Bohemia							Moravia				
	Large centre	Inner s fringe	Outer s. fringe	Polycentric c bcg	Small centre	Rural	Total	Large centre	Inner s fringe	Outer s. fringe	Polycentric c bcg	Small centre	Rural	Total	Large centre	Inner s fringe	Outer s. fringe	Polycentric c bcg	Small centre	Rural	Total	Large centre	Inner s fringe	Outer s. fringe	Polycentric c bcg	Small centre
<b>Prague</b>	2360	4313	4445	2399	678	1242	15437	997	103	190	285	247	471	2293	772	101	251	225	301	828	2478	621	78	136	111	14
Large centre	1094	426	350	167	50	113	2200	55	7	16	14	9	28	129	33	12	8	10	11	36	110	58	1	8	6	
Inner s fringe	1394	322	651	437	207	219	3230	136	8	41	27	40	59	311	54	15	36	14	33	70	222	63	10	21	8	2
Outer s. fringe	1175	179	498	716	154	267	2989	118	14	40	38	35	79	324	61	6	29	23	19	90	228	52	7	14	9	2
Polycentric bcg	472	65	234	191	99	319	1380	70	5	19	15	8	42	159	26	7	16	12	7	25	93	34	15	3	2	
Small centre	710	73	222	252	257	673	2187	104	11	16	5	15	61	212	82	6	41	29	36	107	301	48	15	17	1	1
Rural																										
Total	7205	5378	6400	4162	1445	2833	27423	1480	148	322	384	354	740	3428	1028	147	381	313	407	1156	3432	876	126	199	137	21
<b>N-W Boh.</b>	1387	163	224	209	84	88	2155	4228	1968	2202	1364	1071	1705	12538	445	82	102	68	139	348	1184	344	47	74	46	5
Large centre	59	3	14	10	9	6	101	898	122	137	97	49	112	1415	15	0	4	13	14	11	57	15	4	3	1	
Inner s fringe	154	10	19	19	10	17	229	1576	148	336	257	109	254	2680	44	6	17	8	27	56	158	31	12	2	1	
Outer s. fringe	156	11	28	35	22	18	270	1019	93	233	313	178	290	2126	40	7	18	6	11	37	119	20	0	6	6	1
Polycentric bcg	312	29	42	45	21	26	475	1102	63	157	166	359	1097	2944	159	23	41	35	42	92	392	102	7	16	9	1
Small centre	361	34	106	56	44	48	649	1274	89	176	255	928	1260	3982	154	18	45	60	66	126	469	69	8	20	19	2
Rural																										
Total	2429	250	433	374	190	203	3879	10097	2483	3241	2452	2694	4718	25685	857	136	227	190	299	670	2379	581	78	121	82	10
<b>E-S-W Boh.</b>	1262	136	164	99	40	110	1811	359	12	54	33	76	125	659	1935	2677	3028	1164	1146	2454	12404	486	50	74	43	9
Large centre	92	18	25	11	12	4	162	25	4	10	4	10	15	68	1007	325	350	107	118	290	2197	36	9	10	9	
Inner s fringe	218	33	47	11	7	30	346	79	2	13	2	15	38	149	1581	326	696	310	373	691	3977	64	6	15	10	1
Outer s. fringe	150	29	37	20	13	29	278	55	5	9	11	14	21	115	776	120	297	317	186	523	2219	80	11	21	12	1
Polycentric bcg	390	54	61	49	14	30	598	143	13	16	7	21	37	237	1123	149	362	236	534	2041	4445	139	22	30	32	5
Small centre	579	81	84	88	38	108	978	246	29	35	21	41	111	483	1885	281	685	480	1944	3218	8493	203	50	50	50	6
Rural																										
Total	2691	351	418	278	124	311	4173	907	65	137	78	177	347	1711	8307	3878	5418	2614	4301	9217	33735	1008	148	200	156	24
<b>Moravia</b>	1937	320	244	106	77	56	2740	392	12	49	22	97	87	659	519	53	134	83	169	300	1258	6927	5451	5477	3008	241
Large centre	139	18	39	20	9	18	243	35	1	4	4	5	12	61	51	9	9	10	20	42	141	2502	854	749	362	30
Inner s fringe	229	24	26	42	9	17	347	63	4	15	7	10	17	116	90	14	24	14	24	50	216	3366	721	1387	801	64
Outer s. fringe	132	19	25	8	9	14	207	42	8	3	5	7	14	79	56	28	9	15	27	48	183	2171	335	698	778	51
Polycentric bcg	371	47	73	33	16	27	567	75	1	19	4	34	19	152	140	22	37	27	33	101	360	2735	348	814	662	66
Small centre	332	53	77	50	19	36	567	99	2	9	18	18	31	177	185	30	44	30	90	182	561	2493	397	758	722	160
Rural																										
Total	3140	481	484	259	139	168	4671	706	28	99	60	171	180	1244	1041	156	257	179	363	723	2719	20194	8106	9883	6333	615

Source: Czech statistical office and author.

## **Annex 7: Visualisation of the relationship between spatial dimension of migration and demographic characteristics of migrants separately in seven zones, results of correspondence analysis**

The abbreviations in the charts have the following meaning:

P\_P departure from primary centres, arrival to primary centres

P\_I departure from primary centres, arrival to inner fringes

I\_P etc. departure from inner fringes, arrival to primary centres

P Primary centres

I Inner fringes

O Outer fringes

B Polycentric backgrounds

S Secondary centres

R Rural areas

H 45-59 basic men aged 45-59 with basic education

F 0-19 no A-lev women aged 0-19 without A-levels

F 60+ A-lev women aged 60 and more with A-levels

H 20-29 univ men aged 20-29 university educated

etc. in total 38 combinations (2 sex x 5 age x 4 education – 2 none aged 0-19 with university degree)

The categories displayed are those which contribute the most importantly to the inertia of the respective dimension. Because the quality of the representation of the points on the axis can be misleading, only the points whose sum of squared cosinuses on the two displayed axis exceed 0,5, eg.  $sqcos1 + sqcos2 \geq 0,5$ . This measure prevents the

mistaken interpenetration of nearness of points caused by a misleading projection. The detailed computational tables are not attached but are available upon request.

In the next plot depicting the categories which contributed the most to the first and second axis of migration within the Prague region shows that the first dimension distinguishes well between the migrants by their level of education. All university educated are depicted rather in left, migrants with A-levels in the middle and low educated more on the right side of the axis. The dimension 2 axis distinguishes between the migration patterns of young and older actives, situating all the 20-29 year olds above zero and all the other age group (with the exception of 30-44 university educated) below the zero horizontal line. Above the horizontal zero axis are exclusively situated the flows to primary and secondary centres. Male and female aged 20-29 with university education are probably the most present group which is moving between the urban areas of Prague region, whereas the main age group of people with low education is more connected with flows from rural areas to secondary centres. University educated men and women are rather connected with the movement toward inner suburban fringes, mainly in the age group of aged 45 and plus. The university educated aged 30-44 are clearly in between the flows toward primary centres and their suburban fringes, whereas the same age group of migrants with accomplished secondary education (A-levels) is quite clearly dominant in the flows toward inner and outer fringes. The plot shows quite homogenous behaviour of both sexes when other things equal and a clear distinction between age groups of migrants and their level of education. The first axis of education explains 43 % of variability of the data set.

Further and general description of the correspondence analysis are given in the section 7.3.2.

### Migration flows within the Prague region in 2004

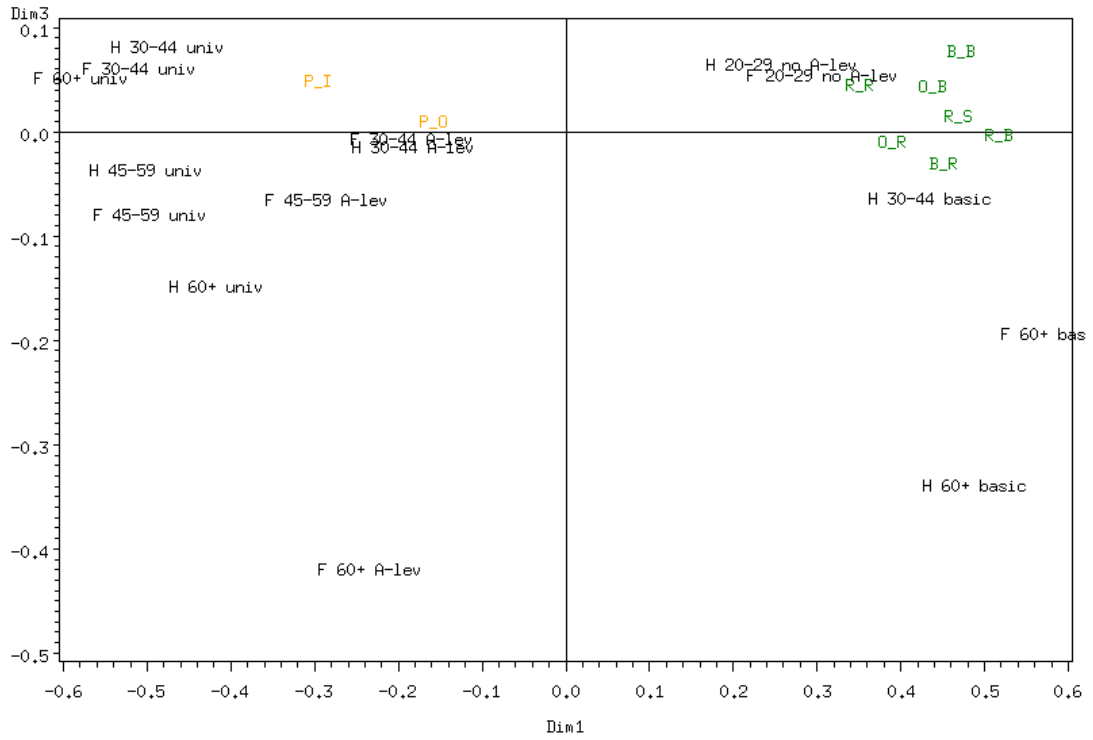
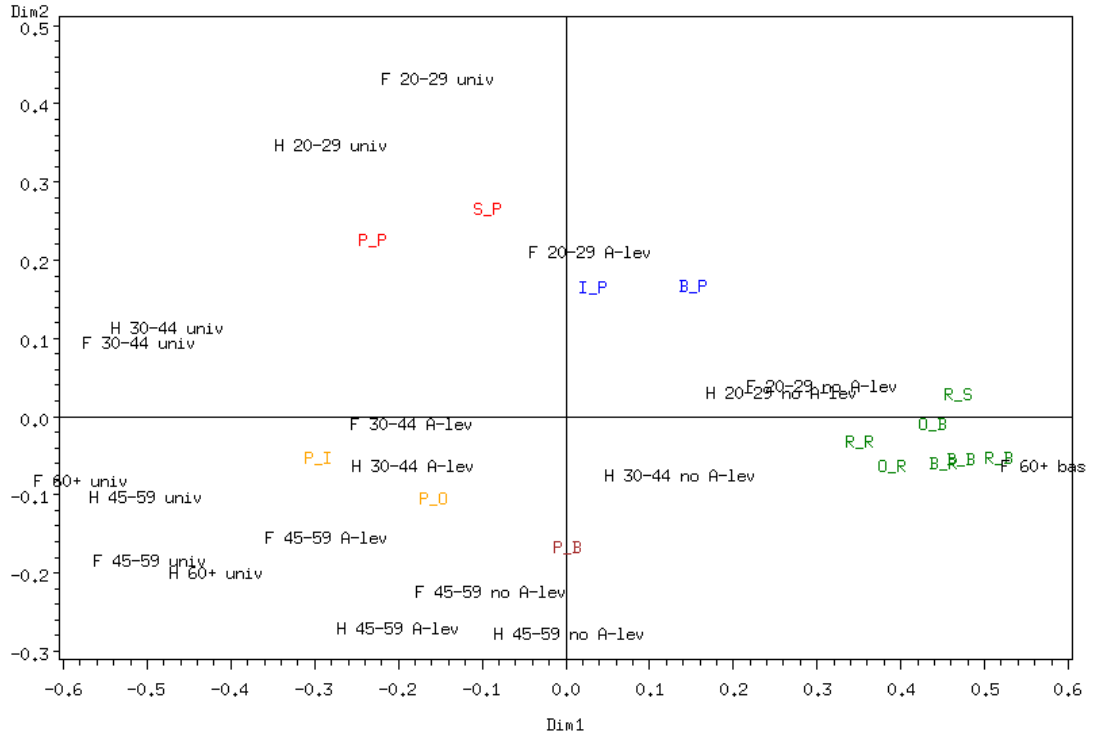

### Migration flows within the Prague en 2004

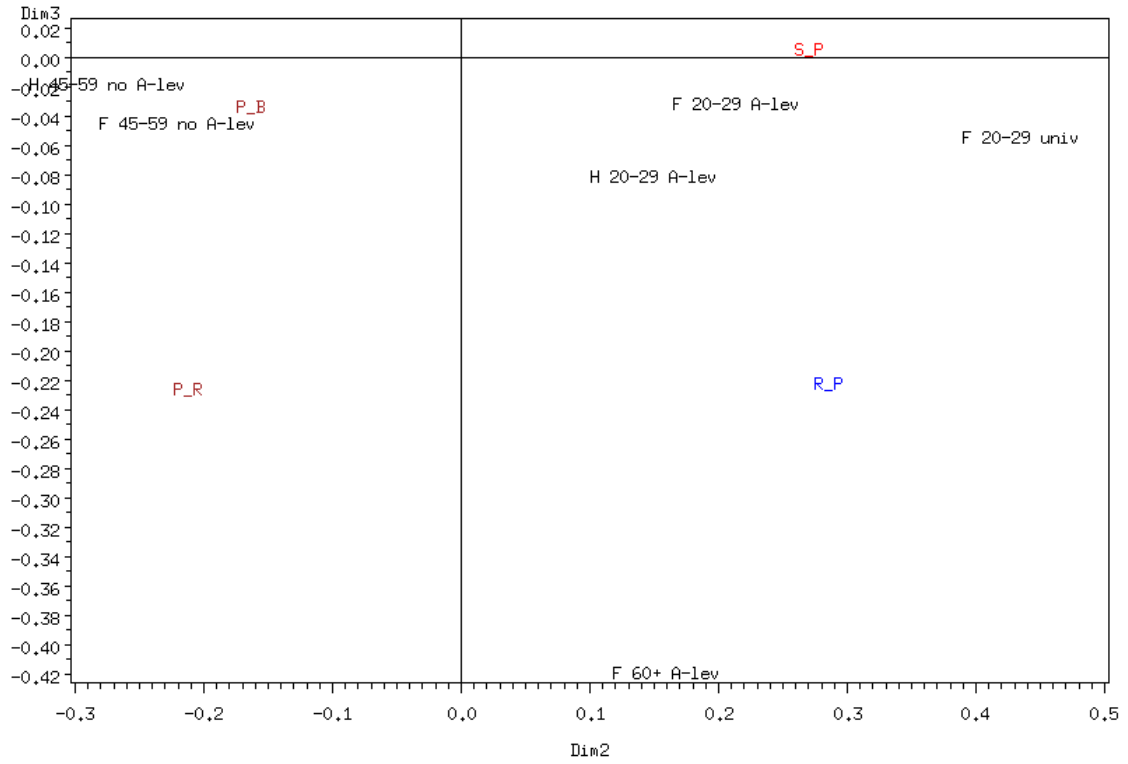

Dimension 1 explains 43 % of the variance within the data, Dim 2: 15 %, Dim 3: 7 %.



### Migration flows within the E-S-W Bohemia in 2004

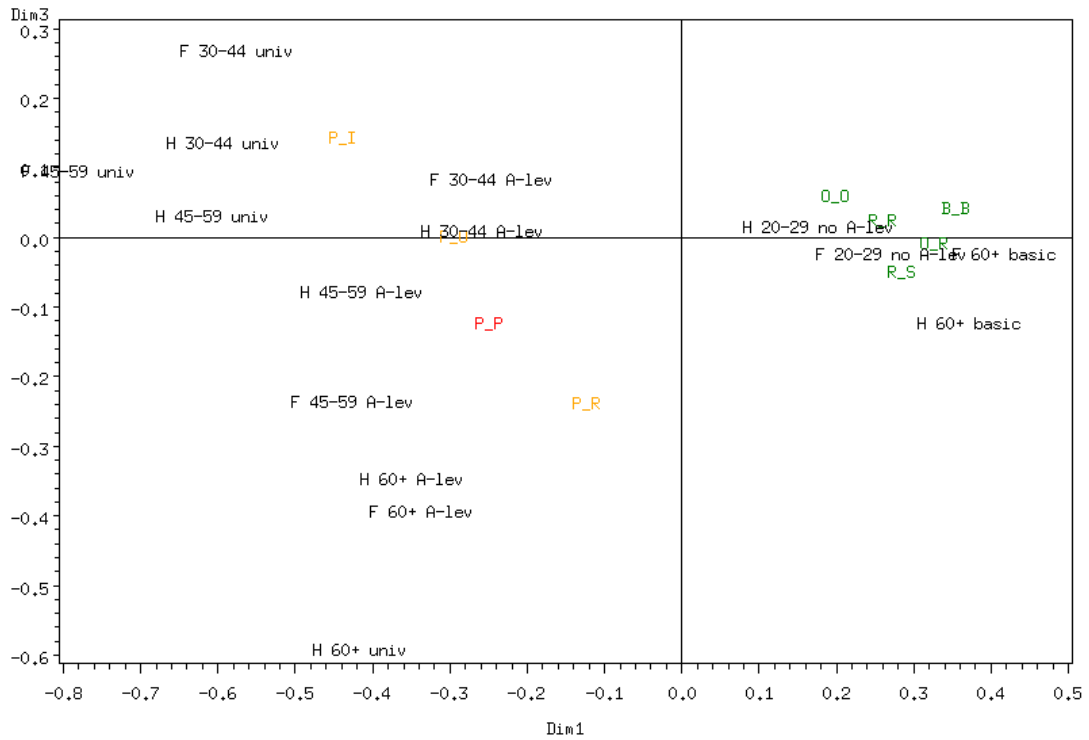
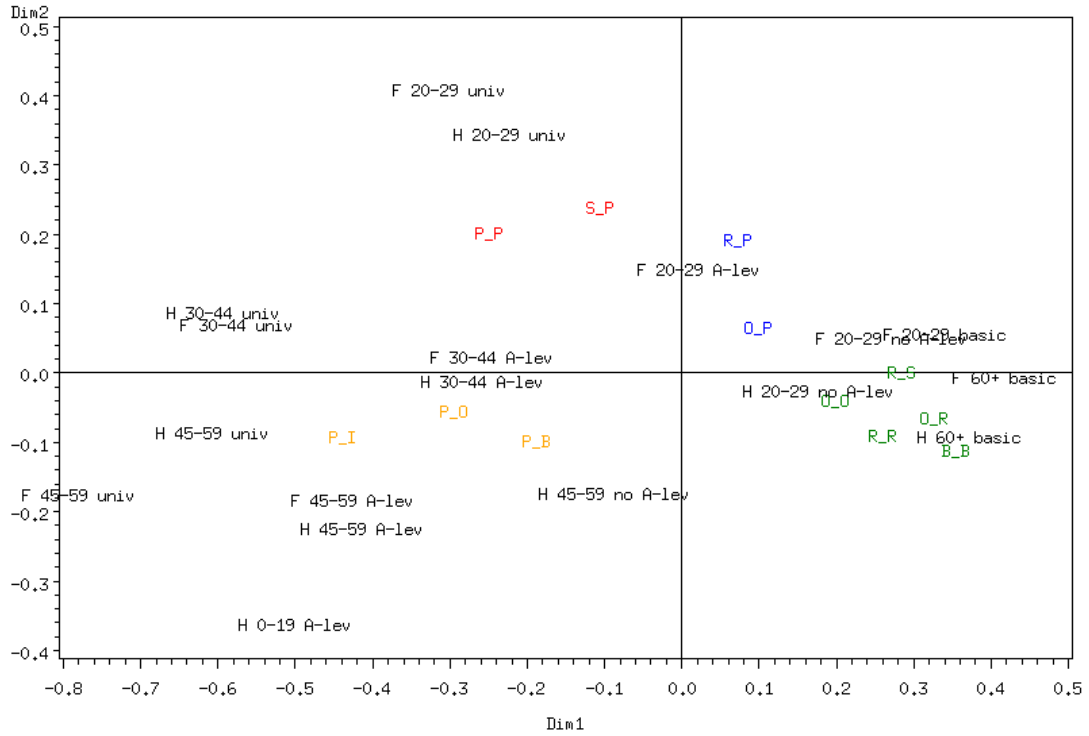

### Migration flows within the E-S-W Bohemia in 2004

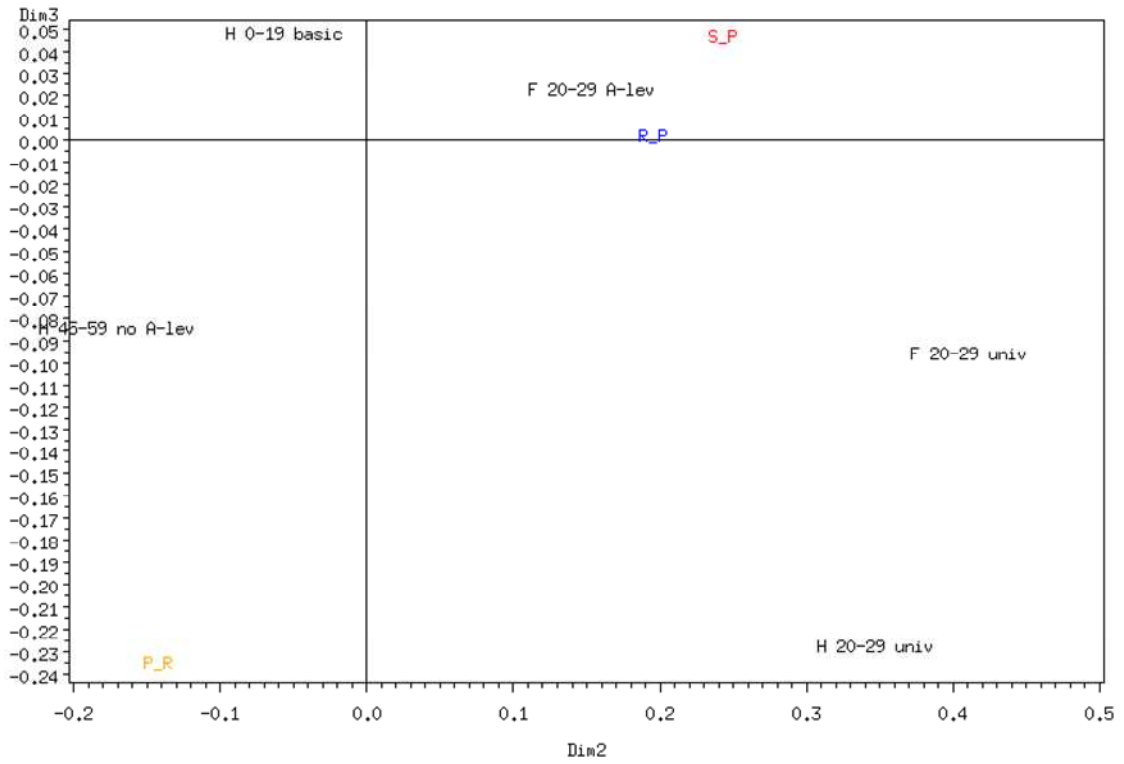

Dim. 1: 48 %, Dim 2: 11 %, Dim 3: 8 %

### Migration flows within the N-W Bohemia in 2004

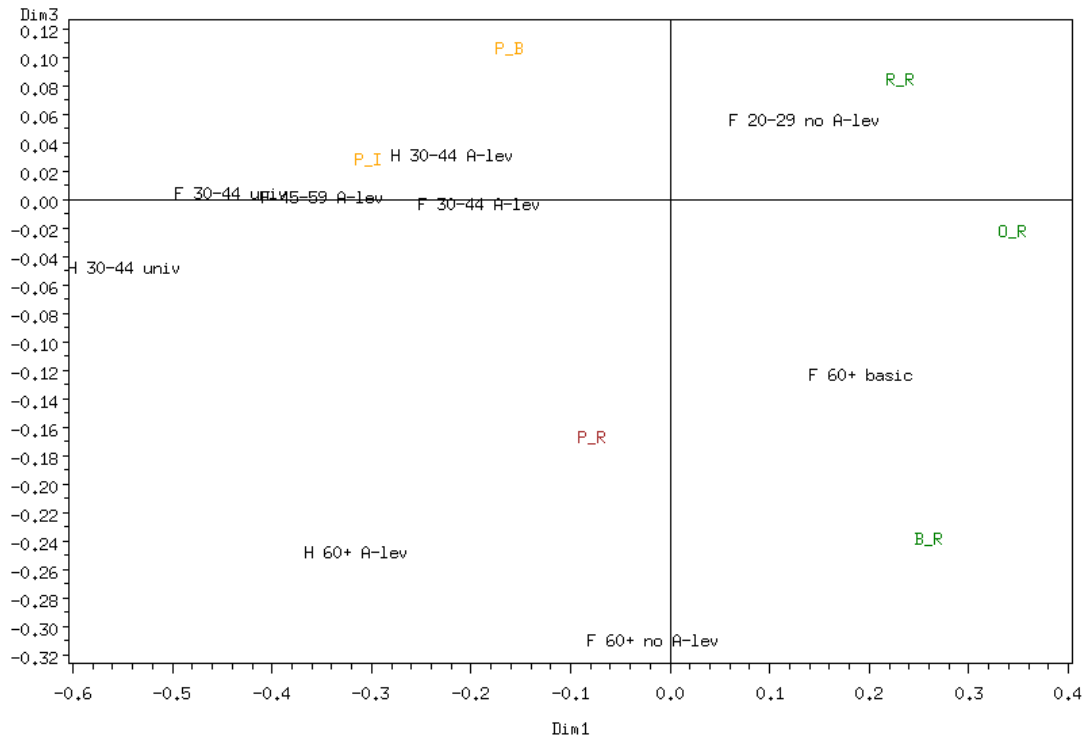
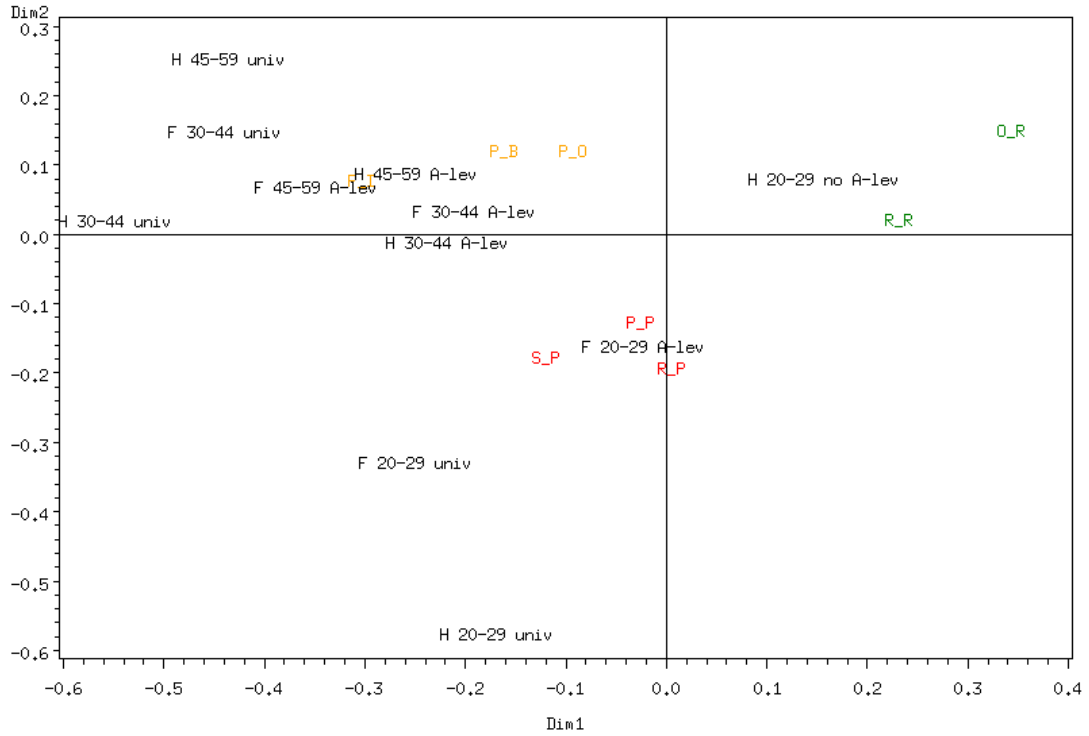

### Migration flows within the N-W Bohemia in 2004

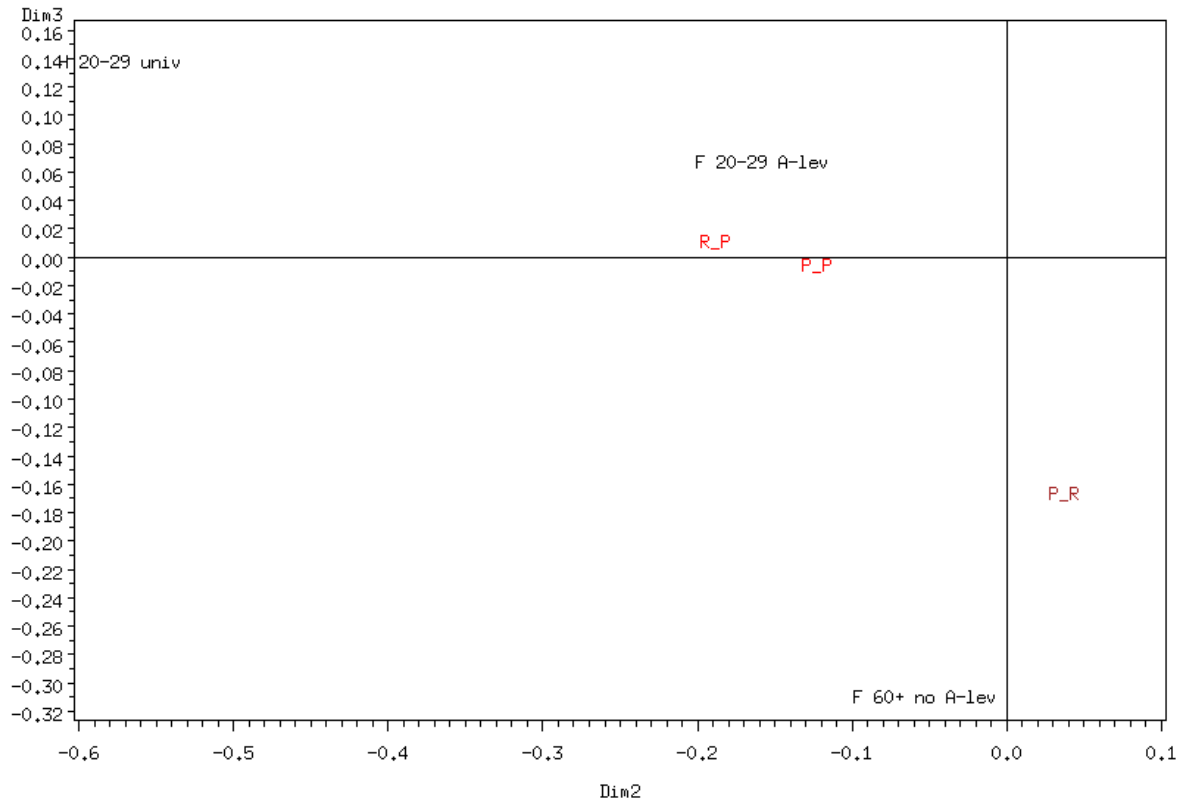

Dim. 1: 27 %, Dim 2: 15 %, Dim 3: 6 %

### Migration flows within the Moravia region in 2004

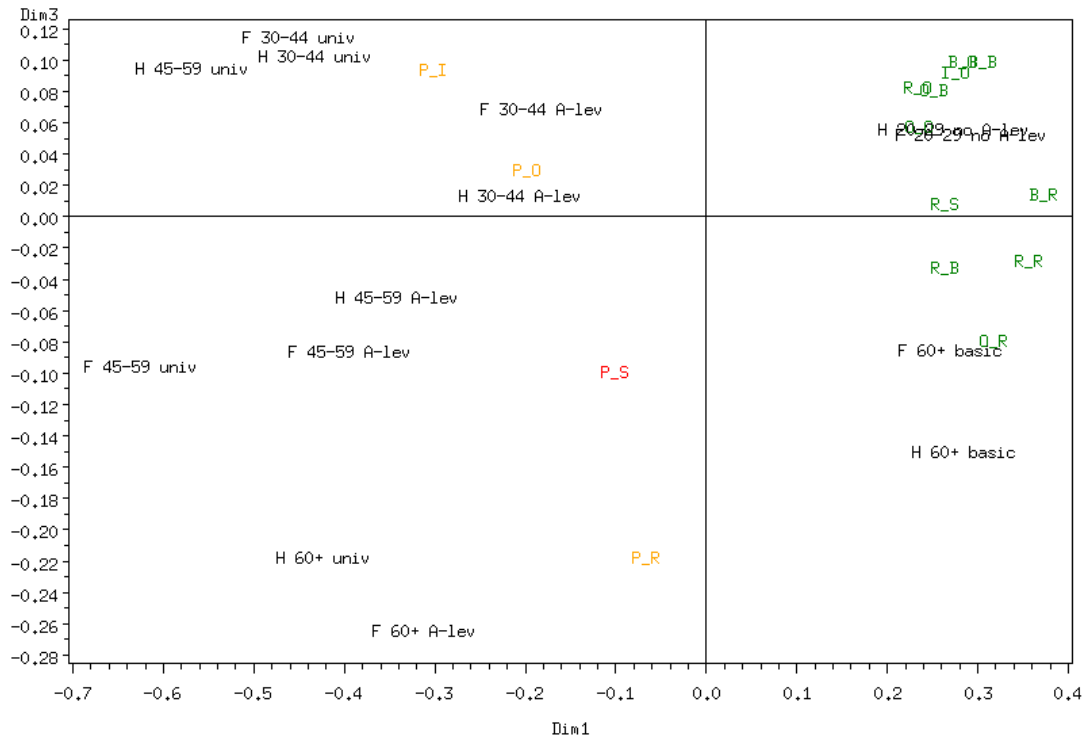
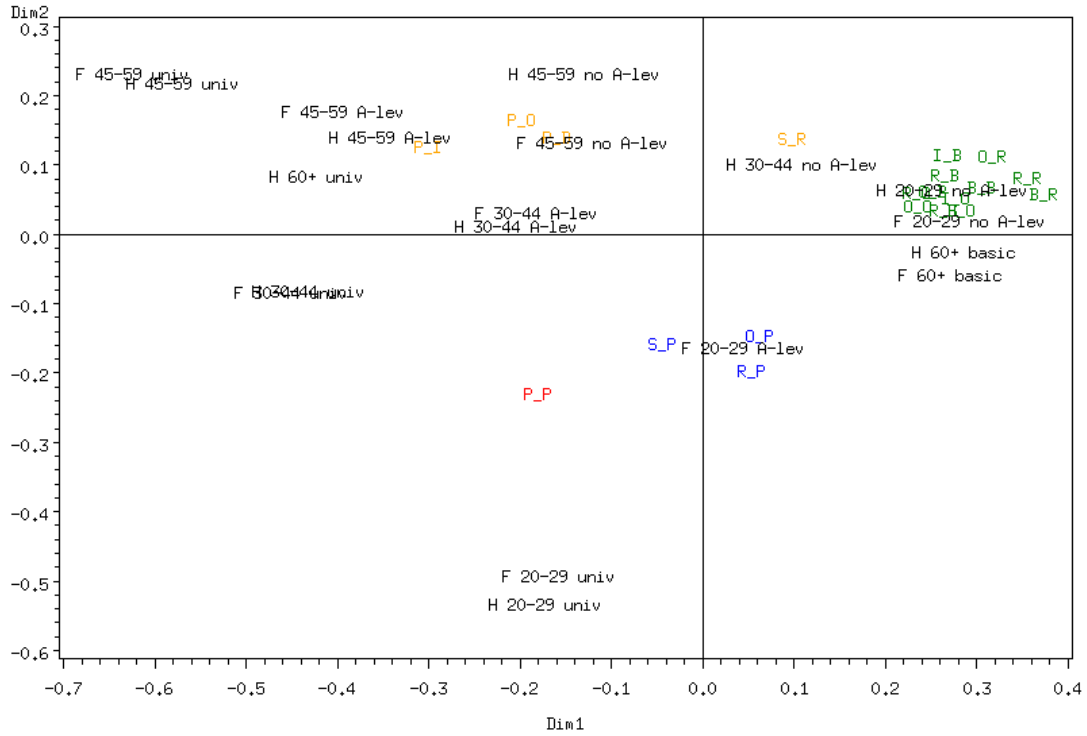

## Migration flows within the Moravia region in 2004

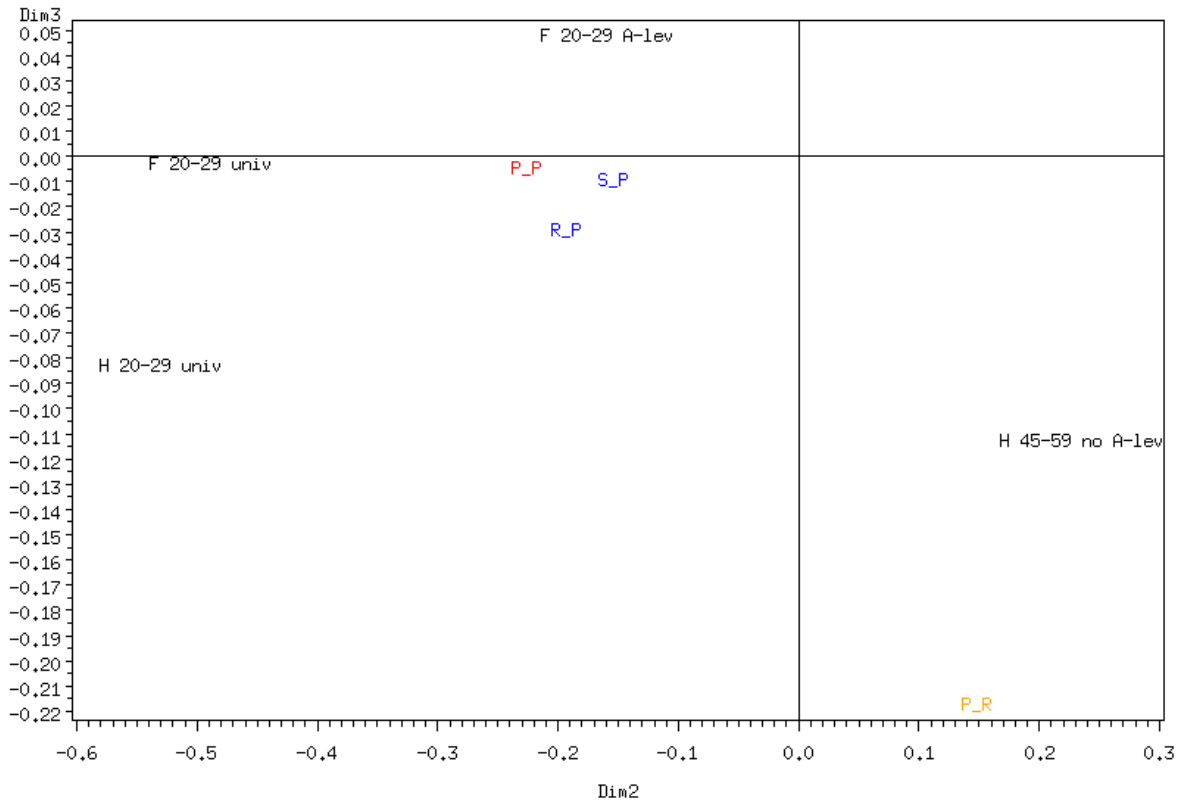

Dim. 1: 46 %, Dim 2: 23 %, Dim 3: 6 %

### Departures from Prague region toward all the other regions in 2004

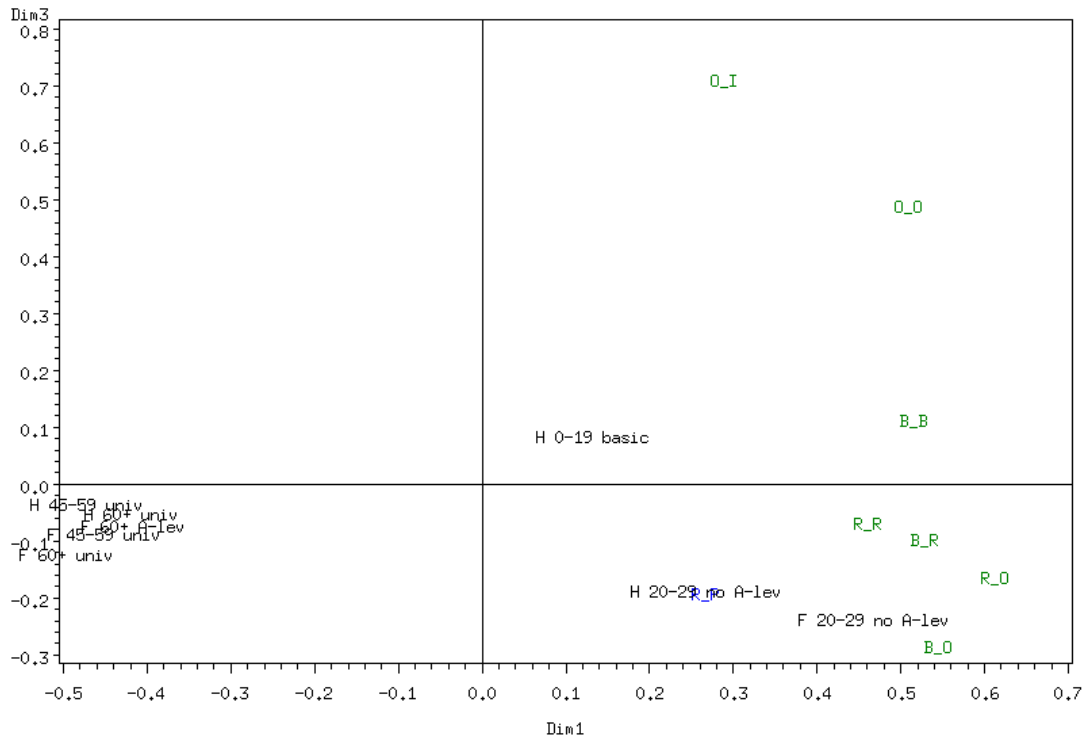
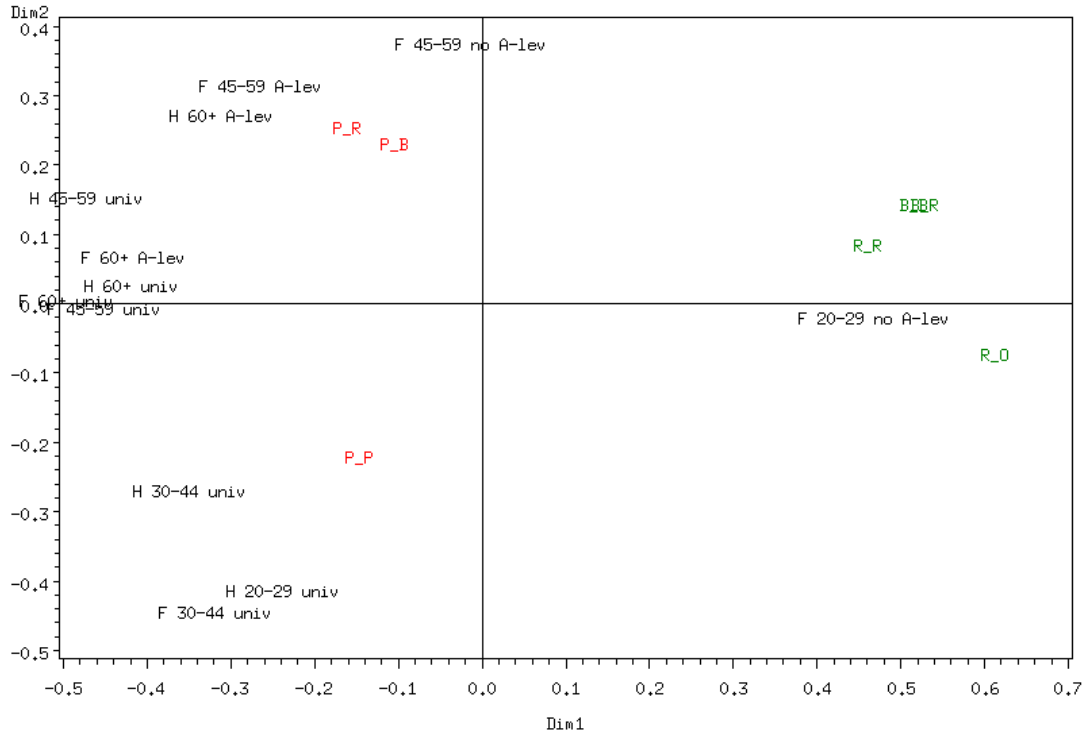

### Departures from Prague region toward all the other regions in 2004

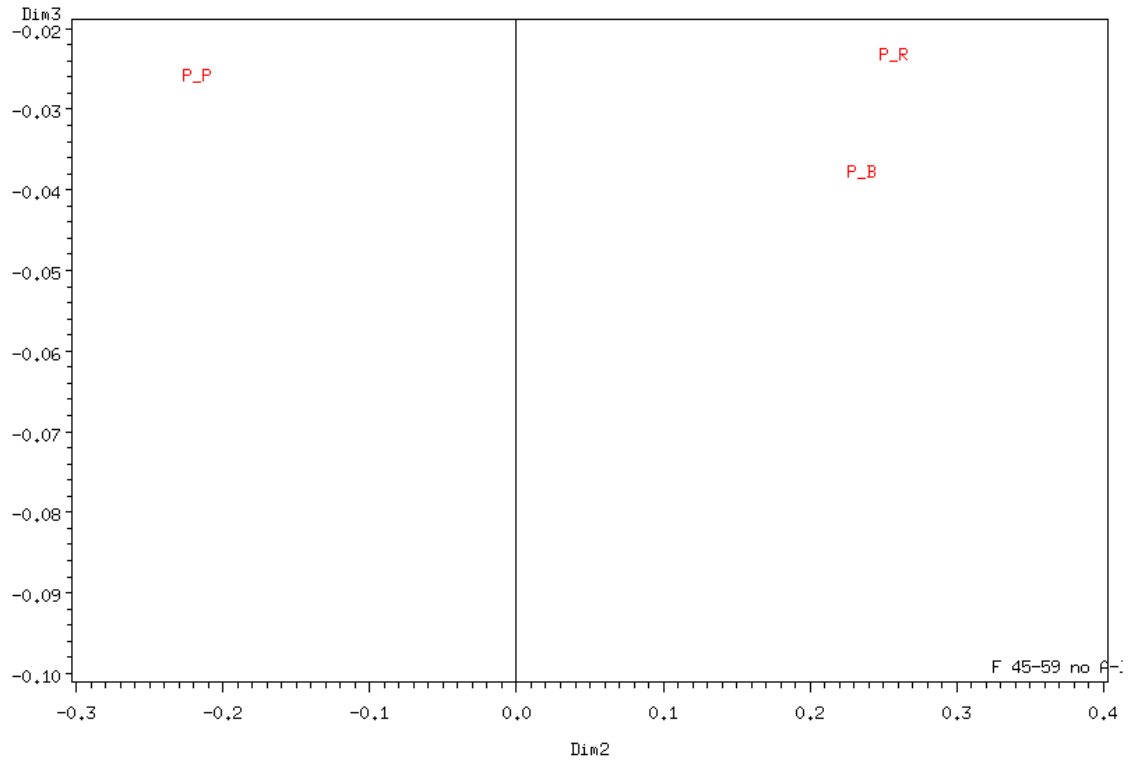

Dim. 1: 24 %, Dim 2: 16 %, Dim 3: 7 %



### Arrivals to Prague region from all the other regions in 2004

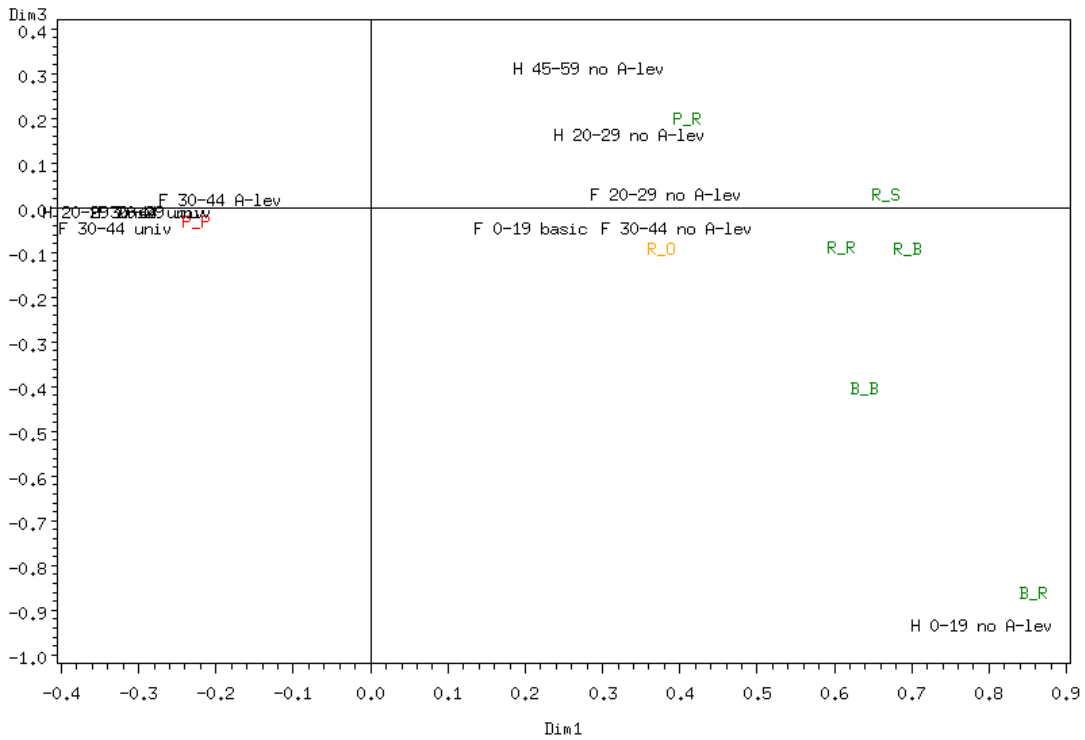
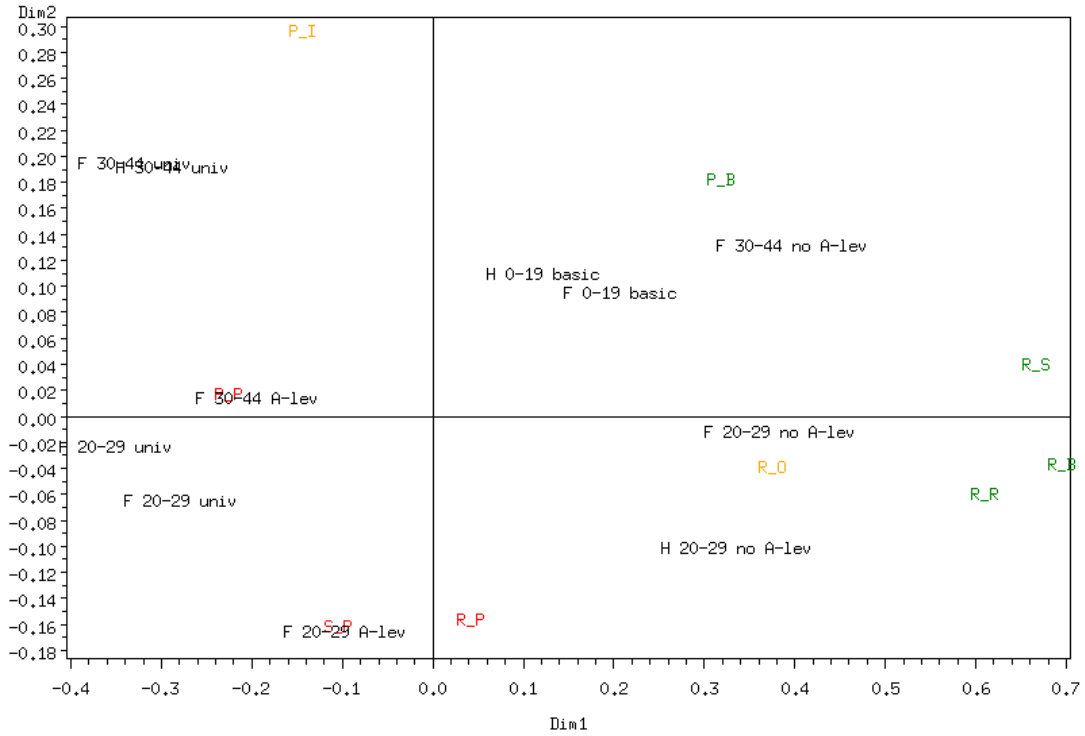

### Arrivals to Prague region from all the other regions in 2004

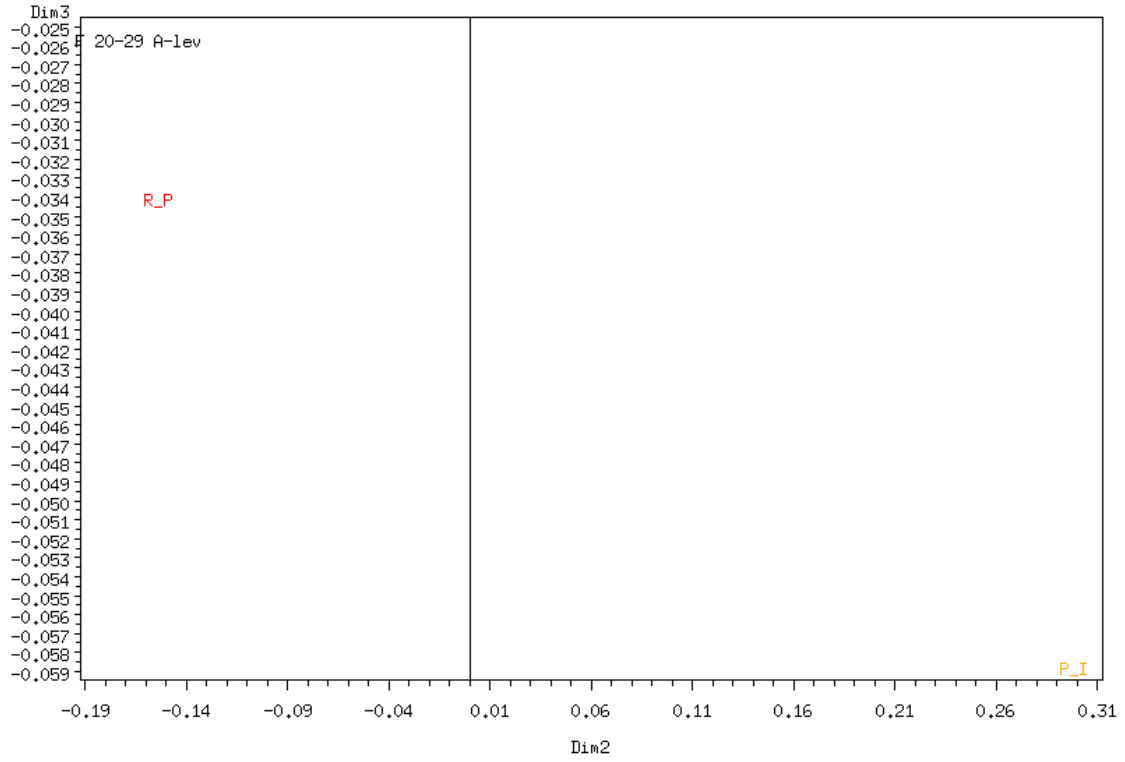

Dim. 1: 36 %, Dim 2: 9 %, Dim 3: 6 %

### Other inter-regional flows in 2004

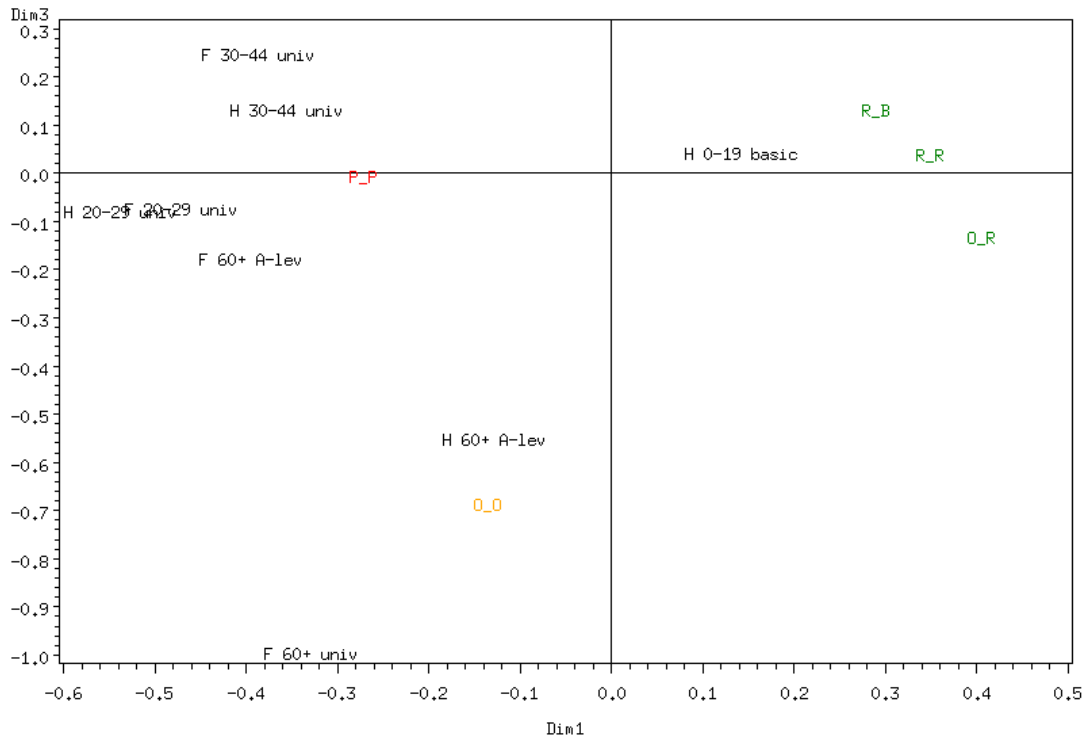
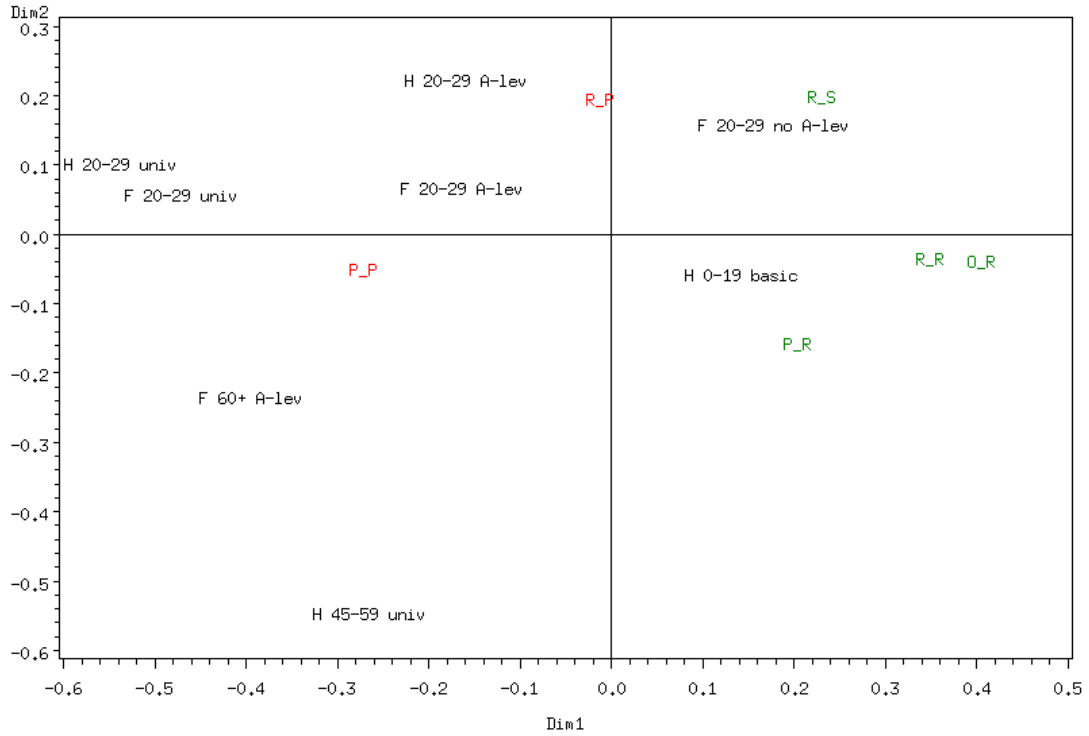

### Other inter-regional flows in 2004

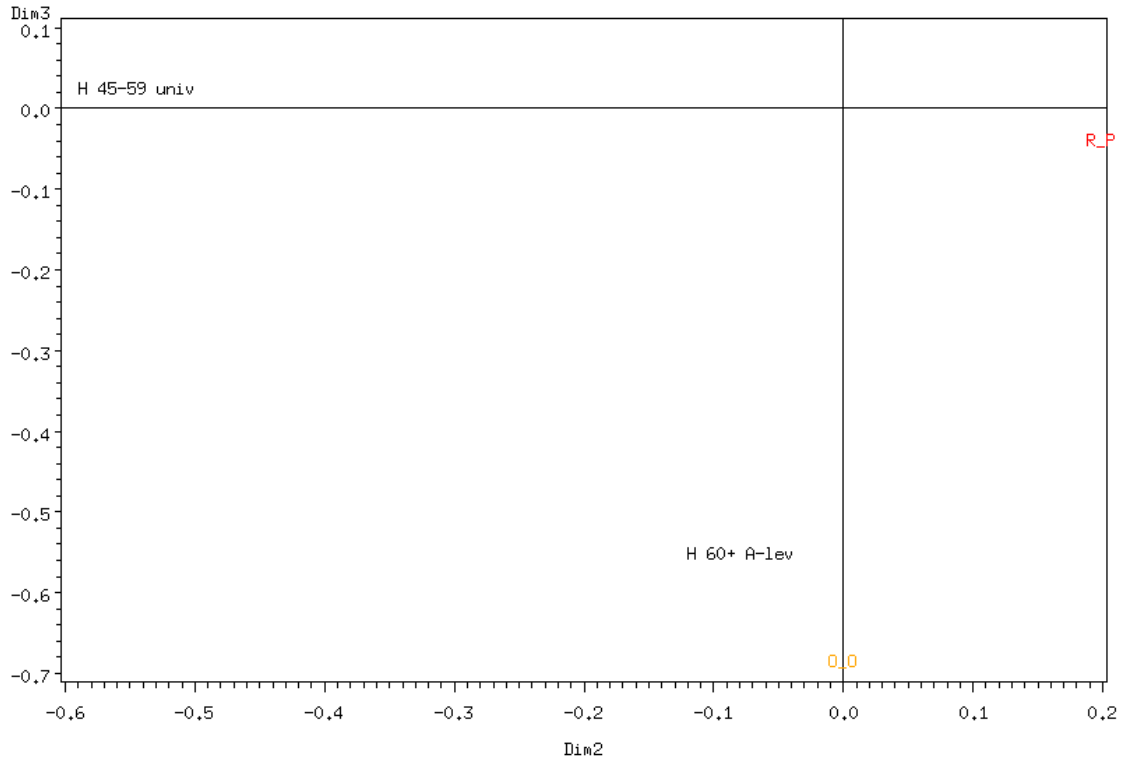

Dim. 1: 28 %, Dim 2: 11 %, Dim 3: 7 %

## **Annex 8: Reduction of spatial dimensions of migration flows based, cluster analysis based on the previous correspondence analysis**

In the lines are urban-rural categories of departure, in the columns of arrival

The tree of clustered migration flows represents the results of cluster analysis. The first number represent the spatial category of departure, the second number, the spatial category of arrival (eg. 31 means migration flow from outer fringes (3) toward primary centres (1)).

Numbers stands for:

- 1 Primary centres
- 2 Inner fringes
- 3 Outer fringes
- 4 Polycentric backgrounds
- 5 Secondary centres
- 6 Rural

## 1. Migration flows within the Prague region in 2004

D \ A	1Primary	2Inner f	3Outer f	4Polyc b	5Second	6 Rural	Total
1 Primary	2360	4313	4445	2399	678	1242	15437
2 Inner f	1094	426	350	167	50	113	2200
3 Outer f	1394	322	651	437	207	219	3230
4 Polyc b	1175	179	498	716	154	267	2989
5 Second.	472	65	234	191	99	319	1380
6 Rural	710	73	222	252	257	673	2187
Total	7205	5378	6400	4162	1445	2833	27423

Flux internes de la région de Prague en 2004

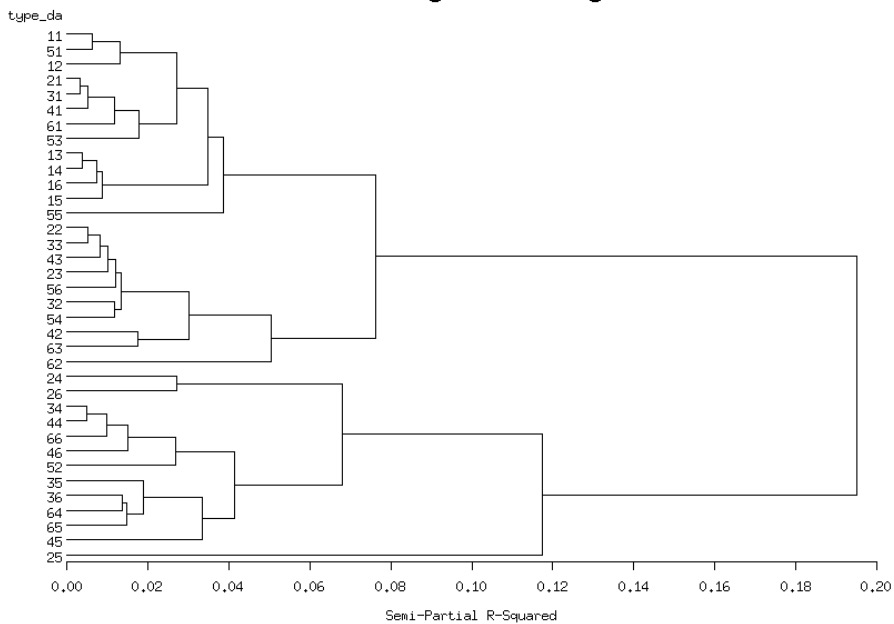

## 2. Migration flows within the E-S-W Bohemia region

D \ A	1 P	2 IF	3 OF	4 B	5 S	6 R	Total
1 P	1935	2677	3028	1164	1146	2454	12404
2 IF	1007	325	350	107	118	290	2197
3 OF	1581	326	696	310	373	691	3977
4 B	776	120	297	317	186	523	2219
5 S	1123	149	362	236	534	2041	4445
6 R	1885	281	685	480	1944	3218	8493
Total	8307	3878	5418	2614	4301	9217	33735

Flux internes de la région E-S-W Bohemia en 2004

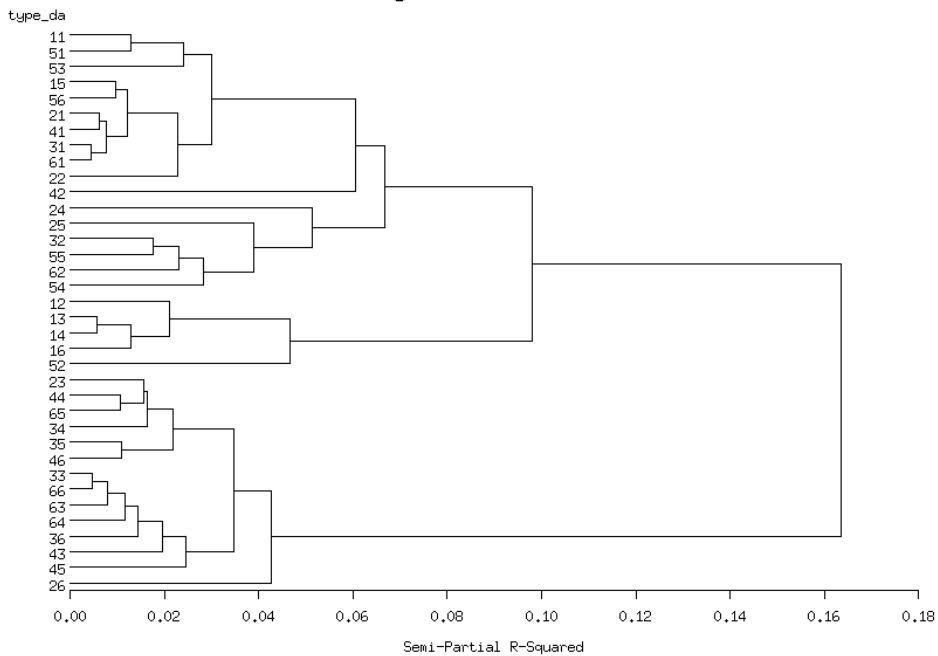

### 3. Migration flows within the N-W Bohemia region in 2004

D \ A	1 P	2 IF	3 OF	4 B	5 S	6 R	Total
1 P	4228	1968	2202	1364	1071	1705	12538
2 IF	898	122	137	97	49	112	1415
3 OF	1576	148	336	257	109	254	2680
4 B	1019	93	233	313	178	290	2126
5 S	1102	63	157	166	359	1097	2944
6 R	1274	89	176	255	928	1260	3982
Total	10097	2483	3241	2452	2694	4718	25685

Flux internes de la région N–W Bohemia en 2004

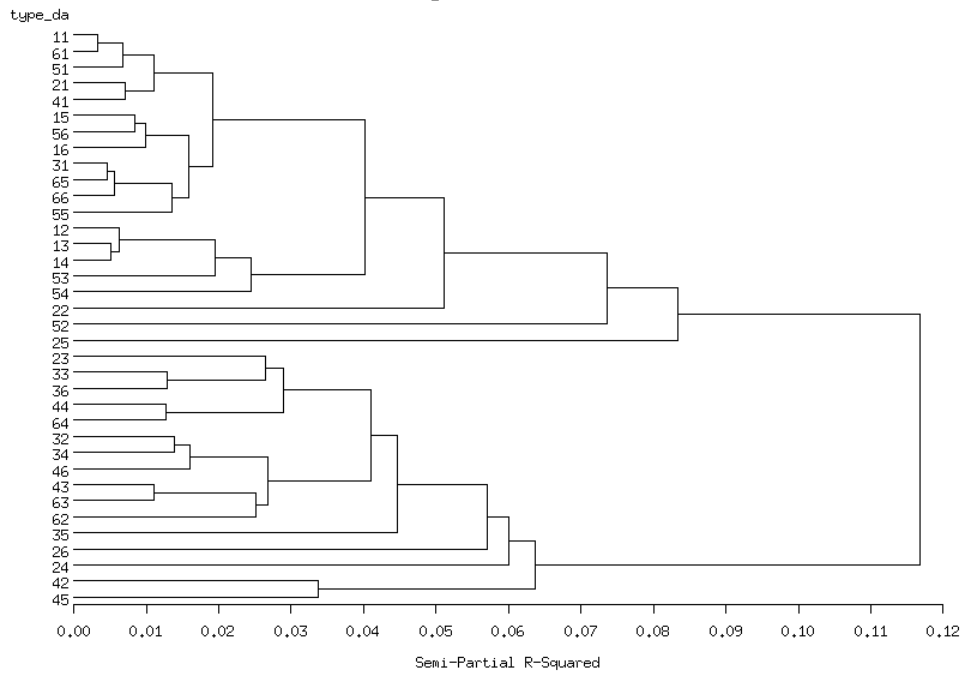



#### 4. Migration flows within the Moravia region in 2004

D \ A	1 P	2 IF	3 OF	4 B	5 S	6 R	Total
1 P	6927	5451	5477	3008	2411	2954	26228
2 IF	2502	854	749	362	302	341	5110
3 OF	3366	721	1387	801	646	746	7667
4 B	2171	335	598	778	519	674	5175
5 S	2735	348	814	662	669	1651	6879
6 R	2493	397	758	722	1603	2821	8794
Total	20194	8106	9883	6333	6150	9187	59853

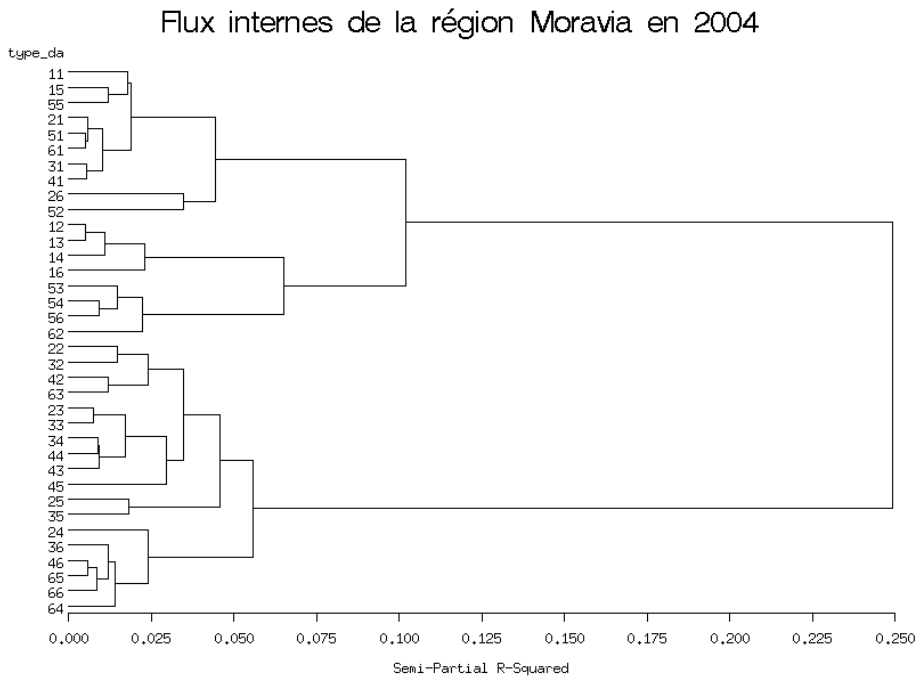

### 5. Departures from Prague region to all the other regions in 2004

D \ A	1 P	2 IF	3 OF	4 B	5 S	6 R	Total
1 P	2390	282	577	621	690	1566	6126
2 IF	146	20	32	30	26	71	325
3 OF	253	33	98	49	93	159	685
4 B	231	27	33	70	74	199	684
5 S	130	27	38	29	22	76	322
6 R	234	32	74	35	68	199	642
Total	3384	421	902	834	973	2270	8784

Départs de la région de Prague en 2004

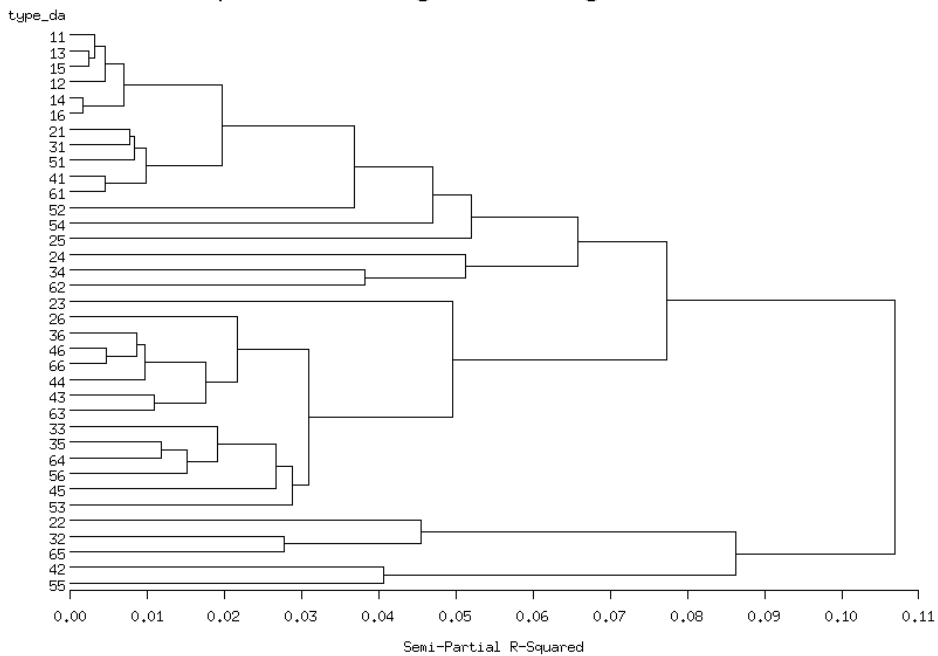

## 6. Arrivals to Prague from all the other regions in 2004

D \ A	1 P	2 IF	3 OF	4 B	5 S	6 R	Total
1 P	4586	619	632	414	201	254	6706
2 IF	290	39	78	41	30	28	506
3 OF	601	67	92	72	26	64	922
4 B	438	59	90	63	44	61	755
5 S	1073	130	176	127	51	83	1640
6 R	1272	168	267	194	101	192	2194
Total	8260	1082	1335	911	453	682	12723

Arrivées dans la région de Prague en 2004

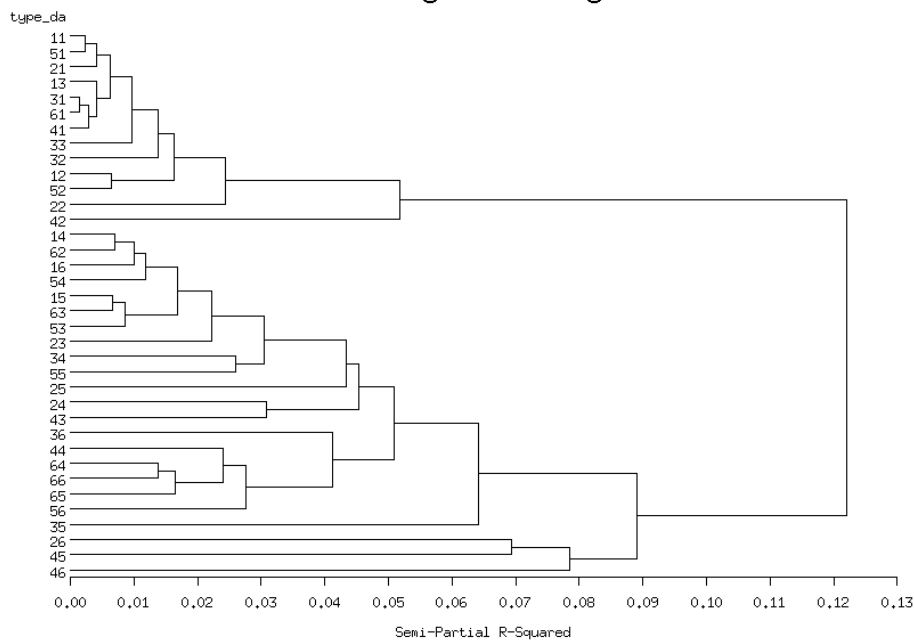

## 7. Other inter-regional flows in 2004

D \ A	1 P	2 IF	3 OF	4 B	5 S	6 R	Total
1 P	2545	256	487	295	631	1168	5382
2 IF	177	27	40	41	62	106	453
3 OF	371	44	86	42	86	223	852
4 B	293	59	66	55	86	148	707
5 S	758	88	159	114	196	348	1663
6 R	956	137	203	198	304	688	2486
Total	5100	611	1041	745	1365	2681	11543

Autres flux entre régions en 2004

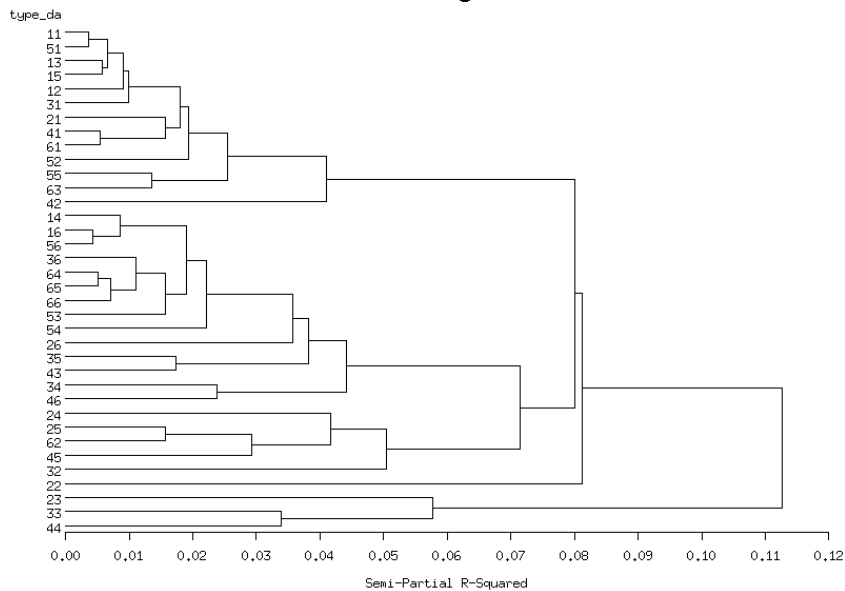

## Annex 9: Estimates of the model of inter-municipal migration $m_{ij}^{dmn}$ with specification of the age and level of education of migrants

Independent variables	Gravit_indiv_04 All		1_1_20_29 low		1_2_20_29 A-lev		1_3_20_29 Univ		2_1_19_30_44 low		2_2_19_30_44 A-lev		2_3_19_30_44 Univ		3_1_45+ low		3_2_45+ A-lev		3_3_45+ Univ	
	Parameter Estimate	Model 7 Sig.	Parameter Estimate	Model 8 Sig.	Parameter Estimate	Model 9 Sig.	Parameter Estimate	Model 10 Sig.	Parameter Estimate	Model 11 Sig.	Parameter Estimate	Model 12 Sig.	Parameter Estimate	Model 13 Sig.	Parameter Estimate	Model 14 Sig.	Parameter Estimate	Model 15 Sig.	Parameter Estimate	Model 16 Sig.
Constant	-0.8039	0.0000	-0.5946	0.0000	-0.9789	0.0000	-1.3276	0.0000	-0.4925	0.0000	-0.9593	0.0000	-1.3566	0.0000	-0.5078	0.0000	-0.7520	0.0000	-0.8792	0.0000
Population	0.0825	0.0000	0.0647	0.0000	0.0903	0.0000	0.0860	0.0000	0.0953	0.0000	0.0914	0.0000	0.0992	0.0000	0.0702	0.0000	0.0726	0.0000	0.0706	0.0000
Distance	-0.1502	0.0000	-0.1247	0.0000	-0.1505	0.0000	-0.0693	0.0000	-0.2055	0.0000	-0.1642	0.0000	-0.1257	0.0000	-0.1404	0.0000	-0.1145	0.0000	-0.0888	0.0000
Real estate price	-0.0148	0.0007	-0.0018	0.8391	-0.0095	0.3033	0.0393	0.0031	-0.0103	0.3748	-0.0168	0.1780	-0.0000	0.9981	-0.0422	0.0000	-0.0414	0.0046	-0.0141	0.5210
Environment	-0.0008	0.4766	-0.0021	0.3227	-0.0041	0.0843	0.0034	0.3204	-0.0027	0.3536	0.0020	0.5503	0.0031	0.4977	-0.0001	0.9648	0.0015	0.6983	0.0122	0.0341
Blue collars	-0.0217	0.0016	0.0042	0.7641	-0.0207	0.1607	0.0055	0.7826	-0.0116	0.5175	-0.0301	0.1211	-0.0344	0.2240	-0.0126	0.4527	-0.0815	0.0006	-0.0544	0.1290
Poverty	-0.0029	0.0087	-0.0005	0.8391	-0.0040	0.0892	-0.0004	0.9286	-0.0039	0.1920	-0.0057	0.0738	-0.0090	0.0753	0.0027	0.2753	-0.0108	0.0036	-0.0050	0.4441
Unemployment	-0.0068	0.0095	-0.0003	0.9538	-0.0068	0.2186	-0.0028	0.7663	-0.0070	0.2998	-0.0064	0.3774	-0.0190	0.1148	-0.0020	0.7413	-0.0093	0.3437	-0.0372	0.0093
Young-old ratio	0.0112	0.0023	0.0051	0.4600	0.0073	0.3528	0.0212	0.1031	0.0301	0.0024	0.0157	0.1392	0.0516	0.0014	-0.0246	0.0021	0.0304	0.0128	0.0568	0.0100
11_PS_P	0.3545	0.0000	0.3105	0.0002	0.6052	0.0000	0.3806	0.0001	0.4252	0.0000	0.4286	0.0000	0.4135	0.0001	0.2073	0.0140	0.2418	0.0080	0.1150	0.2571
12_P_F	0.3054	0.0000	0.1973	0.0000	0.2881	0.0000	0.3732	0.0000	0.3766	0.0000	0.4161	0.0000	0.4674	0.0000	0.2260	0.0000	0.2634	0.0000	0.3055	0.0000
13_P_BSR	0.0687	0.0000	0.0567	0.1160	0.0832	0.0184	0.1225	0.0428	0.0986	0.0137	0.1075	0.0031	0.0319	0.4934	0.0615	0.0988	0.0838	0.0402	-0.0323	0.4747
14_FBR_P	-0.1010	0.0000	-0.0242	0.4409	-0.0188	0.5538	-0.0331	0.4630	-0.1150	0.0039	-0.1043	0.0052	-0.0391	0.4880	-0.1525	0.0000	-0.2089	0.0000	-0.1186	0.5055
15_FBSR_F	0.0566	0.0000	0.0839	0.0035	0.1043	0.0002	0.3197	0.0000	-0.0050	0.8909	0.1171	0.0010	0.2678	0.0000	0.0156	0.6460	0.0330	0.4192	0.1197	0.0449
16_FBSR_BSR	0.0689	0.0000	0.0559	0.0370	0.1227	0.0000	0.2591	0.0000	0.0475	0.1768	0.1258	0.0002	0.3420	0.0000	0.0176	0.5544	0.0402	0.3304	0.1410	0.0222
21_PS_P	0.0370	0.0011	0.1185	0.0056	0.1656	0.0001	0.0941	0.0639	0.1259	0.0089	0.0804	0.0868	-0.0125	0.8090	-0.0363	0.4252	-0.0381	0.5173	-0.1092	0.0684
22_P_FBR	0.1180	0.0000	0.0824	0.0020	0.1341	0.0000	0.2003	0.0000	0.1653	0.0000	0.1759	0.0000	0.3229	0.0000	0.0266	0.3579	0.1018	0.0021	0.1016	0.0204
23_P_S	0.0701	0.0043	0.1948	0.0035	0.1098	0.0549	0.0872	0.1992	0.0799	0.1985	-0.0147	0.8017	0.1044	0.1601	0.0991	0.1133	-0.0050	0.9442	-0.0532	0.6129
24_FBR_P	-0.0245	0.0780	0.0430	0.1602	0.0518	0.0873	0.0424	0.3098	-0.0466	0.2239	-0.0028	0.9393	0.0513	0.3168	-0.0764	0.0219	-0.0683	0.1329	-0.0776	0.1553
25_FBSR_FBSR	0.1066	0.0000	0.1060	0.0000	0.1250	0.0000	0.2801	0.0000	0.1169	0.0002	0.1623	0.0000	0.3042	0.0000	0.0450	0.1003	0.0562	0.1149	0.1394	0.0049
26_S_R	0.0714	0.0000	0.0963	0.0057	0.0705	0.0292	0.2250	0.0000	0.1301	0.0028	0.1204	0.0029	0.0299	0.0000	-0.0813	0.0238	-0.0027	0.9501	0.1388	0.0561
31_PFBRSR_P	0.0916	0.0000	0.1780	0.0000	0.1536	0.0000	0.0357	0.4047	0.1404	0.0002	0.0852	0.0324	-0.0022	0.9652	0.0641	0.0767	-0.0253	0.5597	-0.1005	0.0787
32_P_FB	0.1865	0.0000	0.2414	0.0000	0.1708	0.0000	0.1409	0.0035	0.2306	0.0000	0.2794	0.0000	0.2242	0.0001	0.1559	0.0001	0.1172	0.0074	-0.0095	0.8629
33_P_SR	0.0750	0.0000	0.1246	0.0019	0.1313	0.0015	0.0054	0.9094	0.0763	0.0893	0.1339	0.0058	0.0880	0.1588	0.0611	0.1399	-0.0162	0.7353	-0.0159	0.7805
34_FBSR_FBSR	0.0736	0.0000	0.0812	0.0021	0.0630	0.0184	0.2118	0.0000	0.1108	0.0009	0.0861	0.0083	0.2039	0.0003	0.0146	0.6120	-0.0053	0.8904	0.0584	0.3409
41_PS_PS	0.0991	0.0000	0.1541	0.0000	0.1900	0.0000	0.1286	0.0015	0.1510	0.0002	0.0984	0.0102	0.1442	0.0025	0.0688	0.0611	-0.0293	0.4809	-0.0688	0.1669
42_FBSR_P	-0.0230	0.0668	0.0329	0.2584	0.0512	0.0675	0.0479	0.2176	-0.0175	0.6134	-0.0194	0.5699	0.0129	0.7843	-0.0594	0.0538	-0.1359	0.0005	-0.0806	0.1315
43_PS_FBR	0.0942	0.0000	0.0716	0.0028	0.1040	0.0000	0.1022	0.0029	0.1473	0.0000	0.1694	0.0000	0.2303	0.0000	0.0298	0.2426	0.0544	0.0637	0.0840	0.0273
44_FBR_FBSR	0.0648	0.0000	0.0715	0.0044	0.1093	0.0000	0.2738	0.0000	0.0561	0.0723	0.0973	0.0017	0.2840	0.0000	-0.0006	0.9829	0.0377	0.2863	0.1252	0.0126
52_FBSR_P	0.0312	0.0425	0.0258	0.3770	0.0730	0.0184	0.1134	0.0190	0.0751	0.0856	0.0742	0.0478	0.2381	0.0000	-0.0349	0.2901	-0.0596	0.1519	0.0383	0.5820
53_FBSR_FBSR	0.2472	0.0000	0.2205	0.0000	0.2967	0.0000	0.4027	0.0000	0.3154	0.0000	0.3313	0.0000	0.4855	0.0000	0.1162	0.0001	0.2221	0.0000	0.2389	0.0000
61_PFBRSR_P	0.0545	0.0005	0.0316	0.3797	0.1326	0.0002	0.1534	0.0018	-0.0460	0.2757	0.0713	0.0990	0.1273	0.0374	-0.0605	0.1161	-0.0296	0.5722	0.0001	0.9994
62_PFBRSR_F	0.1843	0.0000	0.1669	0.0000	0.2332	0.0000	0.2343	0.0000	0.1881	0.0000	0.2526	0.0000	0.2653	0.0000	0.1215	0.0004	0.1630	0.0018	0.0628	0.3000
63_PFBRSR_BSR	0.1504	0.0000	0.1436	0.0000	0.2034	0.0000	0.2197	0.0000	0.1898	0.0000	0.1985	0.0000	0.3304	0.0000	0.0418	0.1915	0.1336	0.0027	0.1518	0.0102
71_PFBRSR_P	-0.0188	0.1071	0.0378	0.1561	0.0130	0.6076	0.0294	0.4281	-0.0046	0.8911	0.0106	0.7364	0.0059	0.8955	-0.0627	0.0243	-0.1013	0.0035	-0.1093	0.0195
72_PFBRSR_F	0.2385	0.0000	0.2198	0.0000	0.2912	0.0000	0.3016	0.0000	0.3103	0.0000	0.3443	0.0000	0.3716	0.0000	0.1413	0.0000	0.1395	0.0004	0.1286	0.0301
73_PFBRSR_BSR	0.1741	0.0000	0.1702	0.0000	0.2217	0.0000	0.2466	0.0000	0.2279	0.0000	0.2321	0.0000	0.2458	0.0000	0.1061	0.0000	0.1343	0.0001	0.1179	0.0087
D_20_29_low	0.0046	0.2972																		
D_20_29_university	-0.0828	0.0000																		
D_0_19_30_44_low	0.3710	0.0000																		
D_0_19_30_44_A-levels	-0.0033	0.5460																		
D_0_19_30_44_univ.	-0.0632	0.0000																		
D_45_plus_low	0.0661	0.0000																		
D_45_plus_A-levels	-0.0722	0.0000																		
D_45_plus_university	-0.1449	0.0000																		
No. of flows		103 997		17 384		16 177		5 444		26 238		10 223		4 498		15 708		5 639		2 686
Adj. R <sup>2</sup>		0,237		0,181		0,251		0,242		0,161		0,249		0,253		0,179		0,204		0,180

Note: See the Migration Flow Key for reading the dummies of spatial dimension. Variable of reference for spatial dummies is 51\_P\_PFBRSR. Variable of reference for demographic dummies is D\_20\_29\_A-levels. Models are heteroskedasticity consistent.

Source: Athor.

## Annex 10: List of municipalities representing “Primary centres”

No.	Municipal code	Name of municipality	Region
1	554782	Praha	Praha
2	529303	Benešov	Středočeský
3	531057	Beroun	Středočeský
3	533203	Králův Dvůr	Středočeský
4	532053	Kladno	Středočeský
5	532819	Slaný	Středočeský
6	533165	Kolín	Středočeský
7	533955	Kutná Hora	Středočeský
8	534005	Čáslav	Středočeský
9	534676	Mělník	Středočeský
10	534951	Kralupy nad Vltavou	Středočeský
11	535419	Mladá Boleslav	Středočeský
11	570826	Kosmonosy	Středočeský
12	537004	Nymburk	Středočeský
13	537683	Poděbrady	Středočeský
14	538094	Brandýs nad Labem-St	Středočeský
15	539911	Příbram	Středočeský
16	541656	Rakovník	Středočeský
17	535206	Dobrá Voda u Českých	Jihočeský
17	544256	České Budějovice	Jihočeský
18	545392	Český Krumlov	Jihočeský
19	545881	Jindřichův Hradec	Jihočeský
20	549240	Písek	Jihočeský
21	549576	Milevsko	Jihočeský
22	550094	Prachovice	Jihočeský
23	550787	Strakonice	Jihočeský
24	552046	Tábor	Jihočeský
24	553069	Sezimovo Ústí	Jihočeský
25	553425	Domažlice	Jihočeský
26	555771	Klatovy	Jihočeský
27	554791	Plzeň	Plzeňský
28	559717	Rokycany	Plzeňský
29	560715	Tachov	Plzeňský
30	561215	Stříbro	Plzeňský
31	554481	Cheb	Karlovarský
32	539279	Velká Hleďsebe	Karlovarský
32	554642	Mariánské Lázně	Karlovarský
33	554961	Karlovy Vary	Karlovarský
34	538434	Svatava	Karlovarský
34	538591	Dolní Rychnov	Karlovarský
34	560286	Sokolov	Karlovarský
34	560294	Březová	Karlovarský
35	562335	Děčín	Ústecký
36	562882	Varnsdorf	Ústecký
37	562971	Chomutov	Ústecký
37	563099	Jirkov	Ústecký
38	563102	Kadaň	Ústecký
39	564567	Litoměřice	Ústecký
40	565555	Roudnice nad Labem	Ústecký
41	565229	Lovosice	Ústecký
42	565971	Louny	Ústecký
43	567027	Most	Ústecký
44	567256	Litvínov	Ústecký
45	567442	Teplice	Ústecký
45	567507	Dubí	Ústecký
45	567752	Novosedlice	Ústecký
45	567787	Proboštov	Ústecký
46	567451	Bílina	Ústecký
46	567655	Ledvice	Ústecký
47	553697	Trmice	Ústecký
47	554804	Ústí nad Labem	Ústecký
48	561380	Česká Lípa	Liberecký
49	561860	Nový Bor	Liberecký
50	563510	Jablonec nad Nisou	Liberecký
51	544477	Stráž nad Nisou	Liberecký
51	563889	Liberec	Liberecký
52	577626	Turnov	Liberecký
53	576964	Semily	Liberecký
54	569810	Hradec Králové	Královéhradecký
55	572659	Jičín	Královéhradecký
56	573868	Náchod	Královéhradecký
57	574121	Jaroměř	Královéhradecký
58	576069	Rychnov nad Kněžnou	Královéhradecký

## Annex 10 follow-up: List of municipalities representing “Primary centres”

59	579025 Trutnov	Královéhradecký
60	579858 Vrchlábí	Královéhradecký
61	579203 Dvůr Králové nad Lab	Královéhradecký
62	571164 Chrudim	Pardubický
63	571393 Hlinsko	Pardubický
64	555134 Pardubice	Pardubický
64	575593 Rybitví	Pardubický
64	575704 Staré Hradiště	Pardubický
65	577731 Svitavy	Pardubický
66	578347 Litomyšl	Pardubický
67	578444 Moravská Třebová	Pardubický
68	578576 Polička	Pardubický
69	580511 Lanškroun	Pardubický
70	579891 Ústí nad Orlicí	Pardubický
71	580031 Česká Třebová	Pardubický
72	581186 Vysoké Mýto	Pardubický
73	568414 Havlíčkův Brod	Vysočina
74	586846 Jihlava	Vysočina
75	547492 Pelhřimov	Vysočina
76	547999 Humpolec	Vysočina
77	590266 Třebíč	Vysočina
78	595209 Žďár nad Sázavou	Vysočina
79	597007 Velké Meziříčí	Vysočina
80	581283 Blansko	Jihomoravský
81	581372 Boskovice	Jihomoravský
82	582786 Brno	Jihomoravský
83	584291 Břeclav	Jihomoravský
84	586021 Hodonín	Jihomoravský
85	586307 Kyjov	Jihomoravský
86	586722 Veselí nad Moravou	Jihomoravský
86	586757 Vnorovy	Jihomoravský
87	592889 Vyškov	Jihomoravský
88	546941 Dobšice	Jihomoravský
88	587729 Nový Šaldorf-Sedleš	Jihomoravský
88	593711 Znojmo	Jihomoravský
89	536385 Jeseník	Olomoucký
90	500496 Olomouc	Olomoucký
91	505587 Uničov	Olomoucký
92	589250 Prostějov	Olomoucký
93	511382 Přerov	Olomoucký
94	513750 Hranice	Olomoucký
95	523704 Šumperk	Olomoucký
96	541354 Zábřeh	Olomoucký
97	540471 Mohelnice	Olomoucký
98	588296 Kroměříž	Zlínský
99	588458 Holešov	Zlínský
100	550744 Kunovice	Zlínský
100	550752 Staré Město	Zlínský
100	592005 Uherské Hradiště	Zlínský
101	592731 Uherský Brod	Zlínský
102	545058 Valašské Meziříčí	Zlínský
103	541630 Vsetín	Zlínský
104	544841 Rožnov pod Radhoštěm	Zlínský
105	585068 Zlín	Zlínský
105	585599 Otrokovice	Zlínský
106	597520 Krnov	Moravskoslezský
107	597180 Bruntál	Moravskoslezský
108	552551 Staré Město	Moravskoslezský
108	569631 Sviadnov	Moravskoslezský
108	598003 Frýdek-Místek	Moravskoslezský
109	598810 Třinec	Moravskoslezský
110	598917 Karviná	Moravskoslezský
110	599140 Stonava	Moravskoslezský
111	599051 Bohumín	Moravskoslezský
112	554171 Šenov u Nového Jičína	Moravskoslezský
112	568546 Kunín	Moravskoslezský
112	599191 Nový Jičín	Moravskoslezský
113	599344 Frenštát pod Radhoštěm	Moravskoslezský
114	505927 Opava	Moravskoslezský
115	554821 Ostrava	Moravskoslezský
115	555088 Havířov	Moravskoslezský
115	598798 Šenov	Moravskoslezský
115	598879 Vratimov	Moravskoslezský
115	599085 Petřvald	Moravskoslezský

Source: Author.

## Annex 11: List of municipalities representing “Secondary centres”

No.	Municipal code	Name of municipality	Region
1	530883	Vlašim	Středočeský
2	534382	Sázava	Středočeský
3	531189	Hořovice	Středočeský
4	535087	Neratovice	Středočeský
5	571784	Libiš	Středočeský
6	536326	Mnichovo Hradiště	Středočeský
7	535451	Benátky nad Jizerou	Středočeský
8	535443	Bělá pod Bezdězem	Středočeský
9	537454	Lysá nad Labem	Středočeský
10	538132	Čelákovice	Středočeský
11	541281	Sedlčany	Středočeský
12	540111	Dobříš	Středočeský
13	545155	Temelín	Jihočeský
14	545201	Týn nad Vltavou	Jihočeský
15	545171	Trhové Sviny	Jihočeský
16	545562	Kaplice	Jihočeský
17	546127	Dačice	Jihočeský
18	547336	Třeboň	Jihočeský
19	550647	Vimperk	Jihočeský
20	550850	Blatná	Jihočeský
21	551953	Vodňany	Jihočeský
22	553131	Soběslav	Jihočeský
23	553271	Veselí nad Lužnicí	Jihočeský
24	552054	Bechyně	Jihočeský
25	553671	Horšovský Týn	Plzeňský
26	553786	Kdyně	Plzeňský
27	553654	Holíšov	Plzeňský
28	557153	Sušice	Plzeňský
29	556254	Horažďovice	Plzeňský
30	556831	Nýrsko	Plzeňský
31	558249	Přeštice	Plzeňský
32	558389	Stod	Plzeňský
33	559300	Nýřany	Plzeňský
34	559075	Kralovice	Plzeňský
35	561134	Planá	Plzeňský
36	560758	Bor	Plzeňský
37	554499	Aš	Karlovarský
38	554529	Františkovy Lázně	Karlovarský
39	555428	Ostrov	Karlovarský
40	555380	Nejdek	Karlovarský
41	560383	Chodov	Karlovarský
41	560685	Vintřov	Karlovarský
41	560707	Vřesová	Karlovarský
42	560472	Kraslice	Karlovarský
43	560367	Horní Slavkov	Karlovarský
44	562777	Rumburk	Ústecký
45	563129	Kláštepec nad Ohří	Ústecký
46	565709	Štětí	Ústecký
47	566985	Zátec	Ústecký
48	566616	Podbořany	Ústecký
49	567515	Duchcov	Ústecký
50	562092	Stráž pod Ralskem	Liberecký
51	561835	Mimoň	Liberecký
52	563871	Železný Brod	Liberecký
53	563552	Desná	Liberecký
53	563820	Tanvald	Liberecký
54	564028	Frydlant	Liberecký
55	564095	Hrádek nad Nisou	Liberecký
56	577197	Jilemnice	Liberecký
57	577308	Lomnice nad Popelkou	Liberecký
58	570508	Nový Bydžov	Královéhradecký
59	570109	Chlumec nad Cidlinou	Královéhradecký
60	572926	Hořice	Královéhradecký
61	573248	Nová Paka	Královéhradecký
62	574279	Nové Město nad Metují	Královéhradecký
63	573922	Broumov	Královéhradecký
64	573965	Červený Kostelec	Královéhradecký
65	573990	Česká Skalice	Královéhradecký
66	547646	Velké Poříčí	Královéhradecký
66	574082	Hronov	Královéhradecký
67	574341	Police nad Metují	Královéhradecký
68	576271	Dobruška	Královéhradecký
69	576859	Týniště nad Orlicí	Královéhradecký



## Annex 11 follow-up: List of municipalities representing “Secondary centres”

70	576361	Kostelec nad Orlicí	Královéhradecký
71	576883	Vamberk	Královéhradecký
72	576425	Kvasiny	Královéhradecký
72	576808	Solnice	Královéhradecký
73	579297	Hostinné	Královéhradecký
74	579777	Úpice	Královéhradecký
75	572241	Skuteč	Pardubický
76	575500	Přelouč	Pardubický
77	574988	Holice	Pardubický
78	578193	Jevíčko	Pardubický
79	580350	Choceň	Pardubický
80	581259	Žamberk	Pardubický
81	580538	Letohrad	Pardubický
82	580376	Jablonné nad Orlicí	Pardubický
83	568759	Chotěboř	Vysočina
84	569569	Světlá nad Sázavou	Vysočina
85	568988	Ledeč nad Sázavou	Vysočina
86	588024	Telč	Vysočina
87	588032	Třešť	Vysočina
88	587711	Polná	Vysočina
89	548511	Pacov	Vysočina
90	591181	Moravské Budějovice	Vysočina
91	590576	Dukovany	Vysočina
92	591211	Náměšť nad Oslavou	Vysočina
93	590789	Jemnice	Vysočina
94	596230	Nové Město na Moravě	Vysočina
95	595411	Bystřice nad Pernštejnem	Vysočina
96	596973	Velká Bíteš	Vysočina
97	581917	Letovice	Jihomoravský
98	581291	Adamov	Jihomoravský
99	583120	Ivančice	Jihomoravský
100	549746	Předklášteří	Jihomoravský
100	584002	Tišnov	Jihomoravský
101	583782	Rosice	Jihomoravský
101	584207	Zastávka	Jihomoravský
102	584495	Hustopeče	Jihomoravský
103	584649	Mikulov	Jihomoravský
104	584801	Pohořelice	Jihomoravský
105	586081	Bzenec	Jihomoravský
106	586587	Strážnice	Jihomoravský
107	593583	Slavkov u Brna	Jihomoravský
108	592943	Bučovice	Jihomoravský
109	593559	Rousínov	Jihomoravský
110	594482	Moravský Krumlov	Jihomoravský
111	505188	Šternberk	Olomoucký
112	503444	Litovel	Olomoucký
113	502146	Hlubočky	Olomoucký
114	514705	Lipník nad Bečvou	Olomoucký
115	514055	Kojetín	Olomoucký
116	588393	Bystřice pod Hostýnem	Zlínský
116	506737	Chvalčov	Zlínský
117	588491	Hulín	Zlínský
118	588512	Chropyně	Zlínský
119	592749	Uherský Ostroh	Zlínský
120	592048	Bojkovice	Zlínský
121	585459	Luhačovice	Zlínský
122	585751	Slavičín	Zlínský
123	585939	Vizovice	Zlínský
124	585891	Valašské Klobouky	Zlínský
125	585777	Slušovice	Zlínský
126	597783	Rýmařov	Moravskoslezský
127	597961	Vrbno pod Pradědem	Moravskoslezský
128	598143	Frýdlant nad Ostravou	Moravskoslezský
129	598569	Paskov	Moravskoslezský
130	599069	Orlová	Moravskoslezský
131	598933	Český Těšín	Moravskoslezský
132	599565	Kopřivnice	Moravskoslezský
133	599921	Studénka	Moravskoslezský
134	599701	Odry	Moravskoslezský
135	599808	Příbor	Moravskoslezský
136	599247	Bílovec	Moravskoslezský
137	599352	Fulnek	Moravskoslezský
138	511021	Vítkov	Moravskoslezský
139	506702	Dolní Benešov	Moravskoslezský

Source: Author.

## Annex 12: Descriptive analysis on age structure and crude death rate

	in 2001	in 2001	in 2001	in 2001	2001-05
	Proportion of 0-14	Proportion of 80+	Dependency ratio	Young-old ratio	Crude death rate
					CDR
	in %	in %	in ‰	in ‰	in ‰
Large centres	15,4	2,40	293	1110	10,4
Inner fringes	16,6	2,44	306	1190	10,4
Outer fringes	17,0	2,42	308	1228	10,8
Polycentric Large centres	16,9	2,52	312	1177	11,3
Small centres	17,2	2,08	296	1390	10,0
Suburbium Small centres	17,3	2,47	318	1191	10,8
Rural	17,2	2,55	313	1225	11,5
Czech Republic	16,2	2,40	300	1173	10,6

No of cases                      6258            6258            6258            6258            6258

Source: Athor and Czech Statistical Office

### Proportion of seniors aged 80+ in Czech districts (Nuts 4) in 2001

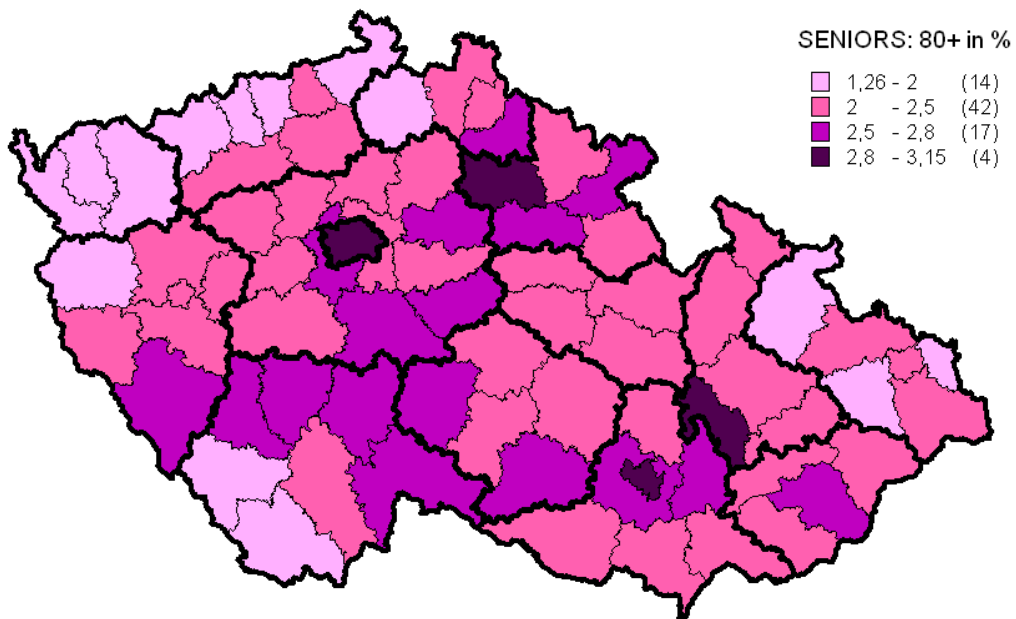

Note: Natural breaks were chosen for the cartograms according to value histograms. Numbers in brackets in the legend are numbers of districts in each category.

Source: Athor.

## Annex 12 follow up: Descriptive analysis on age structure and crude death rate

### Crude death rate in Czech districts (Nuts 4) in 2001-2005

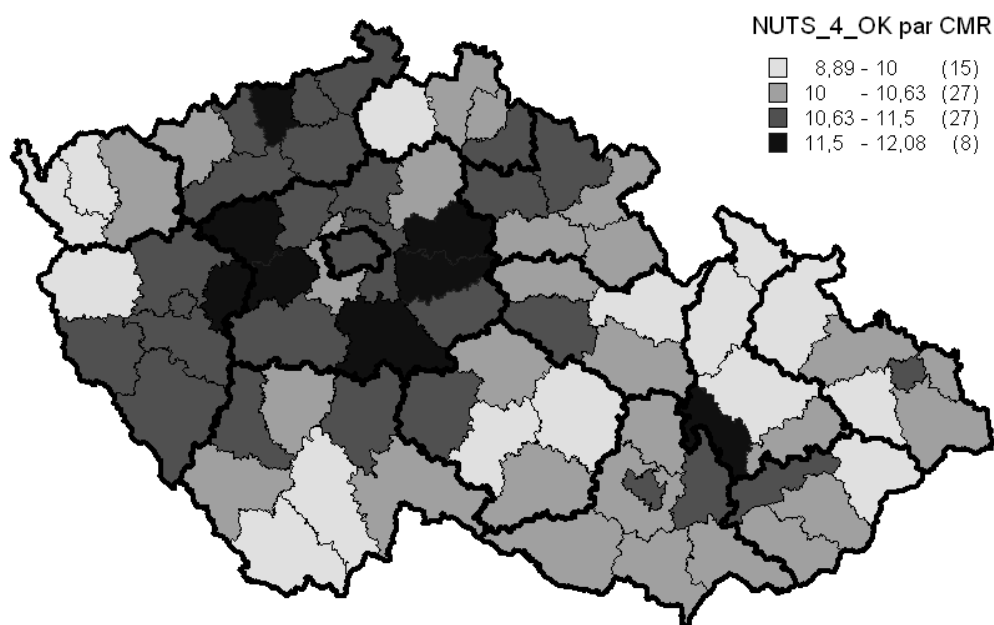

Note: Natural brekas were chosen for the carthograms according to value histograms. Numbers in brackets in the legend are numbers of districts in each cathegory.

Source: Author.

Annex 13: Estimated significant beta coefficients of the model of inter-municipal migration  $m_{ij}^{dmn}$  for each demographic group with spatial dimension clustering according to similar migration orientation

Demographic groups	Model 7	Model 8	Model 9	Model 10	Model 11	Model 12	Model 13	Model 14	Model 15	Model 16
Independent variables	All	20-29 Low	20-29 A-levels	20-29 University	0-19_30-44 Low	0-19_30-44 A-levels	0-19_30-44 University	45 plus Low	45 plus A-levels	45 plus University
	Beta coefficients									
Population	0,434	0,431	0,540	0,592	0,384	0,515	0,568	0,401	0,464	0,459
Distance	-0,337	-0,355	-0,398	-0,206	-0,367	-0,398	-0,316	-0,340	-0,309	-0,241
Real estate price	-0,016			0,065				-0,051	-0,065	
Environment										
Blue collars	-0,016								-0,084	
Poverty	-0,008								-0,034	
Unemployment	-0,007									-0,053
Young-old ratio	0,008				0,018		0,043	-0,022	0,029	0,052
Urban to urban										
11_PS_P	<b>0,052</b>	0,050	<b>0,100</b>	0,093	0,041	0,078	0,096	0,030	0,054	
23_P_S	0,009	0,031	0,017							
41_PS_PS	0,034	0,060	<b>0,076</b>	0,078	0,036	0,039	0,068	0,025		
21_PS_P	0,012	0,030	0,042	0,033	0,020					
All to urban										
14_FBR_P	-0,029				-0,025	-0,035		-0,047	-0,081	-0,048
24_FBR_P										
31_PFBSR_P	0,032	<b>0,082</b>	0,062		0,040	0,034		0,026		
42_FBSR_P	-0,011							-0,031	-0,076	
52_FBSR_P										
61_PFBSR_P	0,019		0,060	<b>0,115</b>			0,071			
71_PFBSR_P								-0,023	-0,043	
Urban to suburban										
12_P_F	<b>0,085</b>	0,061	<b>0,084</b>	<b>0,124</b>	<b>0,075</b>	<b>0,145</b>	<b>0,179</b>	<b>0,069</b>	<b>0,120</b>	<b>0,169</b>
22_P_FBR	0,044	0,037	0,057	0,087	0,047	<b>0,080</b>	<b>0,137</b>		0,061	<b>0,062</b>
26_S_R	0,014			0,042	0,021	0,027	0,048	-0,018		
32_P_FB	0,049	<b>0,077</b>	0,049	0,035	0,047	<b>0,090</b>	0,070	<b>0,048</b>	0,047	
43_PS_FBR	0,051	0,047	0,064	0,065	<b>0,061</b>	<b>0,106</b>	<b>0,149</b>			<b>0,071</b>
Others to suburban										
15_FBSR_F	0,015	0,029	0,032	0,087		0,034	0,070			
62_PFBSR_F	0,046	0,046	0,070	<b>0,124</b>	0,035	0,068	<b>0,122</b>	0,025	0,035	
72_PFBSR_F	0,049	0,054	0,071	0,098	<b>0,052</b>	0,070	0,084	0,032	0,036	
Urban to remote										
13_P_BSR	0,018		0,023	0,028	0,019	0,034		0,019	0,036	
33_P_SR	0,015	0,033	0,028			0,031				
Non-urban flows										
16_FBSR_BSR	0,021		0,042	0,062		0,040	0,071			
25_FBSR_FBSR	<b>0,055</b>	<b>0,080</b>	0,074	<b>0,126</b>	0,051	<b>0,082</b>	0,117			<b>0,059</b>
34_FBSR_FBSR	0,027	0,045	0,025	0,052	0,036	0,032	0,047			
44_FBR_FBSR	0,037	0,059	<b>0,074</b>	<b>0,164</b>		0,056	<b>0,131</b>			<b>0,057</b>
53_FBSR_FBSR	0,049	<b>0,062</b>	0,062	0,069	<b>0,056</b>	0,061	0,067	0,030	0,057	0,044
63_PFBSR_BSR	0,034	0,042	0,053	0,069	0,036	0,047	0,094		0,033	
73_PFBSR_BSR	<b>0,059</b>	<b>0,079</b>	<b>0,079</b>	0,099	<b>0,067</b>	0,077	0,079	<b>0,043</b>	0,052	0,043
D_20-29_low										
D_20-29_university	-0,033									
D_0-19_30-44_low	<b>0,289</b>									
D_0-19_30-44_A-levels										
D_0-19_30-44_univ.	-0,023									
D_45 plus_low	0,042									
D_45 plus_A-levels	-0,029									
D_45 plus_university	-0,041									

Note: See the Migration Flow Key to read the dummies of spatial dimension. Variable of reference for spatial dummies is 51\_P\_PFBSR. Variable of reference for demographic dummies is D\_20\_29\_A-levels. Models are heteroskedasticity consistent. The first seven estimated betas ranked according to magnitude of absolute significant values in columns are in **Bold**. Only significant values are displayed.

Source: Author.