



**HAL**  
open science

# What can optical spectroscopy contribute to understanding protein dynamics ?

Martin Byrdin

► **To cite this version:**

Martin Byrdin. What can optical spectroscopy contribute to understanding protein dynamics ?. Biological Physics [physics.bio-ph]. Université Joseph-Fourier - Grenoble I, 2010. tel-00585252

**HAL Id: tel-00585252**

**<https://theses.hal.science/tel-00585252>**

Submitted on 12 Apr 2011

**HAL** is a multi-disciplinary open access archive for the deposit and dissemination of scientific research documents, whether they are published or not. The documents may come from teaching and research institutions in France or abroad, or from public or private research centers.

L'archive ouverte pluridisciplinaire **HAL**, est destinée au dépôt et à la diffusion de documents scientifiques de niveau recherche, publiés ou non, émanant des établissements d'enseignement et de recherche français ou étrangers, des laboratoires publics ou privés.

**Habilitation à Diriger des Recherches**

**Université Joseph Fourier, Grenoble**

**UFR de Physique**

**2010**

**What can optical spectroscopy contribute  
to understanding protein dynamics ?**

Martin BYRDIN

Institut de Biologie Structurale, Grenoble, France

Members of the thesis committee:

Dr. Dominique BOURGEOIS, Grenoble	examineur
Prof. Antoine DELON, Grenoble	rapporteur
Prof. Rolf DILLER, Kaiserslautern	examineur
Prof. Stefan HAACKE, Strasbourg	rapporteur
Dr. Dimitra MARKOVITSI, Saclay	examinatrice
Dr. Pascal PLAZA, Paris	rapporteur
Dr. Pierre SETIF, Saclay	rapporteur
Prof. Stefan WEBER, Freiburg	examineur

To be defended on September 28<sup>th</sup> 2010 at IBS Grenoble, France

für Ute Annemarie Kleinmichel Richling (1937 - 2008)

## Contents

INTRODUCTION	4
PAST: Transient absorption on a photoactivated protein: picoseconds to milliseconds	5
1. Photolyase and transient absorption	6
2. Photoactivation	9
3. The nanosecond hole	13
4. Photorepair	16
PRESENT: Functional & structural protein dynamics - approaches & parameters	21
5. Proteins move	22
6. Things around the protein also move	24
7. Who sees what, and when?	25
8. The lure of single molecules	29
FUTURE: What can optical spectroscopy contribute to understanding protein dynamics?	30
9. Roles of light in biology	31
10. Role of spectroscopy for dynamics	33
11. Experiments to start with	35
12. Fitting in the IBS context	37
Acknowledgments	40
References	41
Abbreviations	51

## INTRODUCTION

The short answer to the title question is: “a lot”. It was transient absorption spectroscopy on geminate recombination in myoglobin that led Hans Frauenfelder to constructing his picture of protein’s hierarchical energy landscape [1]. And even before that (in 1973), Joseph Lakowicz and Gregorio Weber at UIUC used quenching of tryptophan fluorescence by oxygen diffusing to solvent-inaccessible protein regions to conclude that “proteins, in general, undergo rapid structural fluctuations on the nanosecond time scale “ [2].

The not-so-short answer is that the present text is written at a point where, after a decade of applying transient absorption spectroscopy to understand light induced electron transfer in a variety of enzymes, I am about to change the angle of attack and ask how these techniques and enzymes could be of help to solve some problems that are addressed in the IBS environment, namely protein dynamics, both structural and functional.

It is for this reason that the answer will have to be delayed to the third and final part of this opus, “future”, that deals with the perspectives. Meanwhile, the first part, “past”, will be dedicated to showing on the example of the “paradigm” enzyme –DNA photolyase (the yellow egg hereunder)-, what transient absorption spectroscopy is capable of and the middle part, “present” dresses a short review into various experimental approaches currently used to obtain insight into protein dynamics. In the final section, I will delineate ways how optical spectroscopy could interact with projects existing or emerging in the protein dynamics community at IBS and thus contribute elements of an answer to the title question.

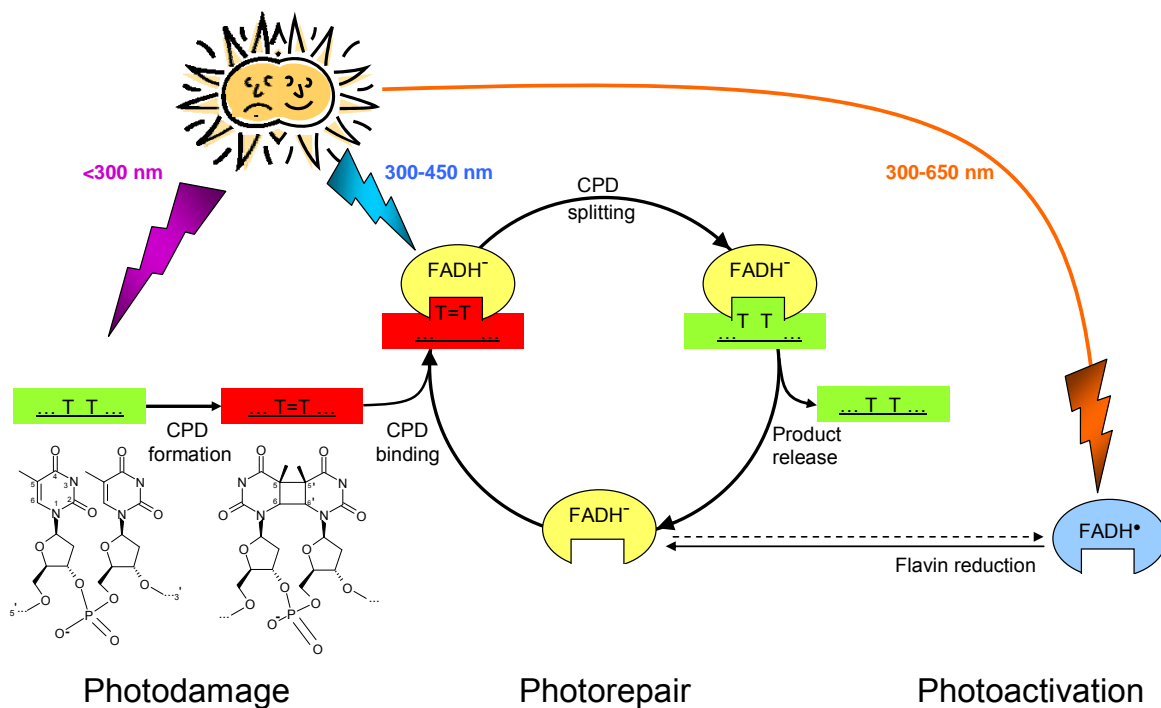

\* Note on timescale semantics \*

For convenience, and to have a common language, by convention we denote by “slow” the part of the scale comprising anything slower than few microseconds but faster than seconds; picoseconds to nanoseconds are conventionally called “fast” and femtoseconds and below-“ultrafast”.

ich was suchen  
ich nicht wissen was suchen  
ich nicht wissen wie wissen was suchen  
ich suchen wie wissen was suchen

ich wissen was suchen  
ich suchen wie wissen was suchen  
ich wissen wie ich suchen wissen was suchen  
ich was wissen

E. Jandl 1978 “suchen & wissen”

## PART I: PAST

Transient absorption on a photoactivated protein: picoseconds to milliseconds

1. Photolyase and transient absorption
2. Photoactivation
3. The nanosecond hole
4. Photorepair

## 1. Photolyase and transient absorption

### What is photolyase ?

*DNA repair enzyme.* DNA photolyase is a special protein: you get two enzymes for the price of one. In fact, it works both as an oxidoreductase and as a lyase, and both reactions are light triggered.

Moreover, DNA photolyase is a flavoprotein, noncovalently binding flavin adenosine dinucleotide (FAD, green hereunder) as catalytic cofactor and it is the redox state of this flavin that decides upon the reaction to perform: if **radical FADH<sup>•</sup>** is excited (visible light), intraprotein electron transfer from a surface exposed tryptophan (red hereunder) will reduce it to form FADH<sup>-</sup> which is active in DNA repair. If **reduced FADH<sup>-</sup>** is excited (UV), electron transfer to damaged DNA will trigger repair. Last but not least, DNA photolyase is a DNA binding protein that recognises with high selectivity the damages it can repair: covalent intrastrand linkages between adjacent pyrimidine bases- so called cyclobutane pyrimidine dimers (CPD), actually the most abundant form of UV-induced lesion to DNA. Curious to note that this most accurate and least expensive of all DNA repair enzymes is found all over the kingdoms of life with the remarkable exception of placental mammals- so humans will have to get along without (and use more complex repair systems).

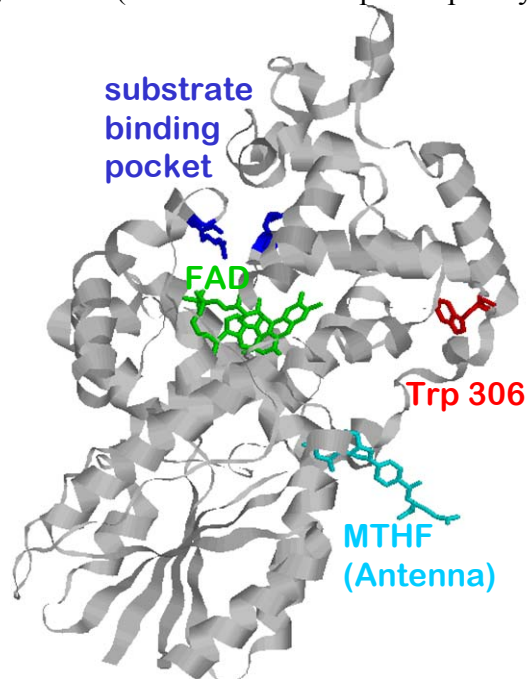

*Figure 1. The crystal structure of photolyase from E. coli has been resolved to 2.3Å resolution (1dnp.pdb) [3]. The antenna cofactor (cyan) serves to increase the absorption cross section and transmits excitation to the flavin within subnanoseconds.*

The standard review on this medium-size, soluble protein (Fig.1) was written by Aziz Sancar in 2003, and it serves still today as a good starting point [4]. However, the work described here contributed to picture some aspects somewhat more consistently.

The enzyme was discovered shortly after the war [5] and the fact that it is **light triggered** very soon made **flash absorption spectroscopy** a method of choice for its study [6].

Alongside, based on the fact that in both catalytic cycles the flavin radical FADH<sup>•</sup> intervenes, EPR has become another important approach [7,8].

### What does photolyase ?

*Light induced electron transfer.* The **oxidoreductase** reaction catalyzed by photolyase is called “**photoactivation**”. It consists of the light-induced reduction of the neutral flavin radical  $\text{FADH}^\bullet$ , upon visible excitation, to the reduced flavin anion  $\text{FADH}^-$  by intraprotein electron transfer over a distance of  $15\text{\AA}$  from the protein surface to the buried cofactor. This reaction is ultrafast ( $<100\text{ ps}$ ), the subsequent deprotonation of the electron-donating tryptophan (Trp, W) takes  $200\text{ ns}$  and if no external donor intervenes, recombination will occur in a pH dependent manner in microseconds to milliseconds. We managed to demonstrate that the ultrafast electron transfer is in fact a hole transfer along a chain of three conserved Trp residues and single hops within this nanowire take few picoseconds (see Fig.2 and chapter 2).

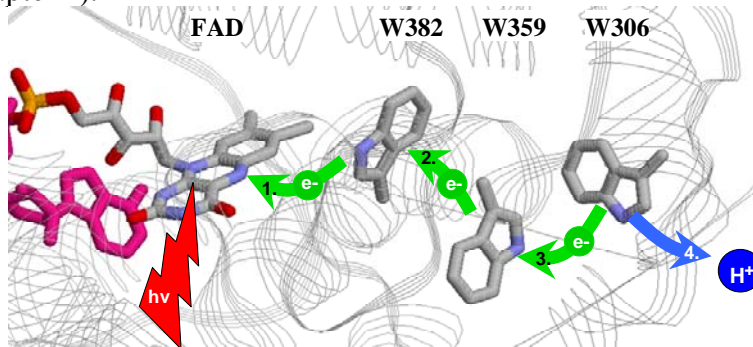

Figure 2. Schematic presentation of hole hopping along a triple Trp chain during photoactivation in *E.coli*

The **lyase** reaction catalyzed by photolyase is called “**photorepair**”. It consists of the light-induced transient oxidation of the reduced flavin anion  $\text{FADH}^-$ , upon UV excitation, to the neutral flavin radical  $\text{FADH}^\bullet$ , the leaving electron being injected into the CPD to trigger its spontaneous splitting and afterwards returning to re-reduce the flavin. The forth and back electron transfer steps in this reaction occur between cofactor and substrate in (sub)nanoseconds (see chapter 4). The full enzymatic cycle implies also substrate binding (milliseconds) and product release (microseconds), summarized in the figure below (Fig.3).

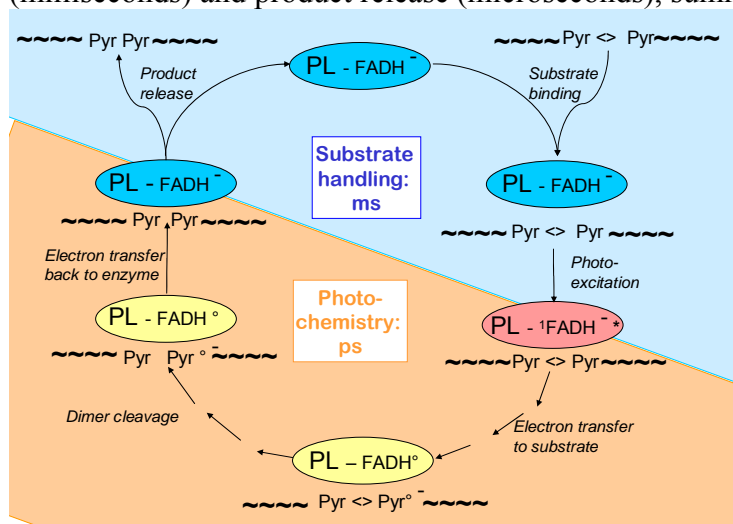

Figure 3. Schematic presentation of the photorepair reaction cycle.  $\langle \rangle$  symbolizes the cyclobutane ring in the CPD.

Thus, both reactions cover functionally important events in the large time window ranging from **picoseconds to milliseconds**, a situation that is rather typical for enzymatic catalysis (see chapter 5).



### What is flash spectroscopy and what can it do ?

*Simple, (relatively) cheap, versatile.* In the following short review of some of our results from the last seven years, the stress will be on the **versatility** of flash spectroscopy and how it could be brought to help deciphering most of photolyase's enzymatic reaction steps. The method in itself is both conceptually and technically extremely simple: a beam of (typically **monochromatic**) monitoring light crosses a cell with the sample under study and its intensity is detected continuously by a photodiode. The output of this diode is followed in time, e.g. by an oscilloscope. An intense **flash triggers** a reaction in the sample cell and if this reaction brings about any changes in the absorption of the participating molecules (reactants, products, solvent), they will be found as a change in the photodiode output. Such setup allows both identifying species (by their spectral signature) and following reaction kinetics (by the time course of absorption changes) (see Fig.4 and chapter 10).

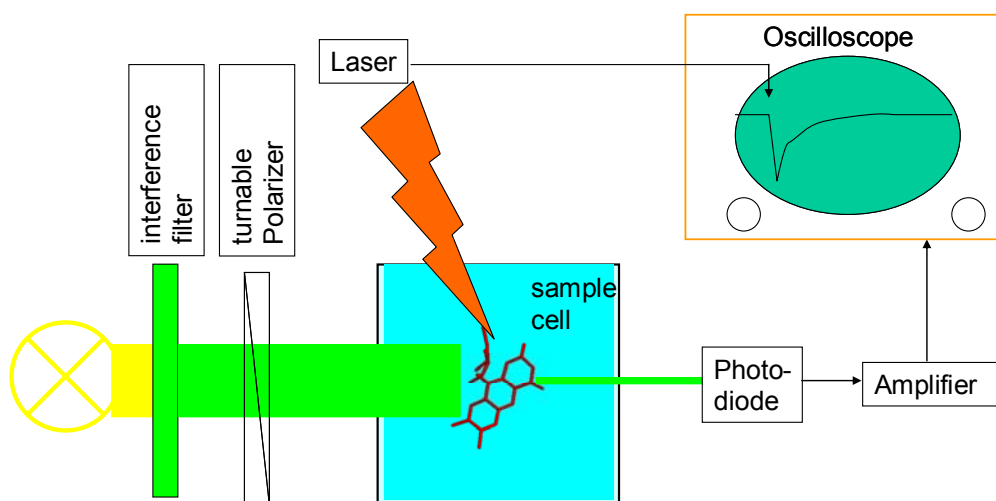

Figure 4. Schematic presentation of a transient absorption (fluorescence) setup

The challenge is to develop setups that have the sensitivity to identify ever smaller changes in wavelength, amplitude or time. In reality, these things are interwoven because in the end it is photons per nm (spectral resolution) per second (temporal resolution) that are detected and if their number drowns in the unavoidable noise of the detection system, there's nothing more to be done [9].

In the case of fluorescence spectroscopy, one can leave either of the light sources out ("Fluorescence induction") - the actinic light will concomitantly serve to trigger the process under study and to excite the fluorescence by which you study it. Alternatively, one can use two pulses ("pump-probe"), one -actinic- to trigger and a second -delayed- for testing. This will put some demands on synchronisation, but except for some filters and lenses, the setup is very similar to that for transient absorption.

## 2. Photoactivation - Reducing an intraprotein flavin radical

Originally, photoreduction of FADH<sup>o</sup> by the solvent exposed tryptophan residue W306 had been found to take ~1  $\mu$ s [10] and was thought to occur in a single step (or via superexchange coupling involving W382 and W359 [11]). Aubert and coworkers [12] later demonstrated by transient absorption that excited FADH<sup>o</sup> in *E. coli* photolyase was reduced in ~30 ps and that the previously observed much slower reaction reflected in fact deprotonation of the W306 cation radical (time constant ~300 ns). To explain the very fast electron transfer, they suggested the involvement of two intervening tryptophan residues as “stepping stones”.

### How to distinguish three tryptophans in an electron transfer chain from each other ?

*Taking them out one by one.* That is what has been accomplished by Andre Eker at Erasmus University in Rotterdam. He replaced the three Trp residues of the putative electron transfer chain –one at a time- by isosteric but redox inert phenylalanine (Phe, F). In *E. coli*, the three mutant proteins can be overexpressed and isolated. The protein with the Trp proximal to the flavin replaced is called W382F, that of the intermediate Trp is W359F and that with the distal (surface exposed) Trp mutated goes under W306F.

### What, if we take out the proximal tryptophan ? ([13], appendix A)

*No electron transfer.* The excited flavin radical won't have the chance of electron abstraction (donor no more available) and hence will have to go back to its ground state with its intrinsic excited state lifetime. This lifetime was not known before for the FADH<sup>o</sup> radical and we measured it to be 80 ps (see Figure 5). If no donor at all is available, the direct decay will happen in 100% of the cases and no resting signal will be detectable after that time. On the picosecond timescale, this is what we observed. However, if some of the excited flavin radicals would manage to pick up an electron, e.g. from the middle Trp 359, the recombination after subsequent electron transfer from W306 is expected to take milliseconds and can be sought for on a slower setup.

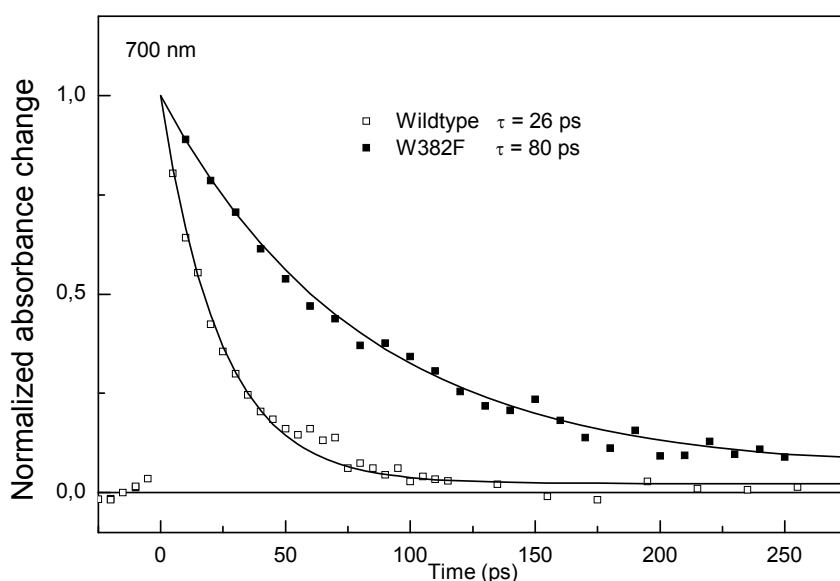

Figure 5. Decay of the excited flavin radical in the presence (empty squares) and absence (filled squares) of an electron donor. Lines are monoexponential fits (26 and 80 ps).

### Why should we see something in milliseconds if there was nothing in picoseconds ?

*Because of the noise.* It is in the order of 1 mOD for the ultrafast measurement. In the case of a slow measurement, we can couple the photodiode to a high-impedance, low-noise, bandwidth-limited preamplifier and thus, with reasonable averaging (128 shots) make appear signals as small as 0.01 mOD. In the case of W382F mutant photolyase, this allowed to find the trace of a residual electron transfer and even determine a spectrum of the donor, leading to the conclusion that it was also a tryptophan, most likely W359 (Fig.6, inset)

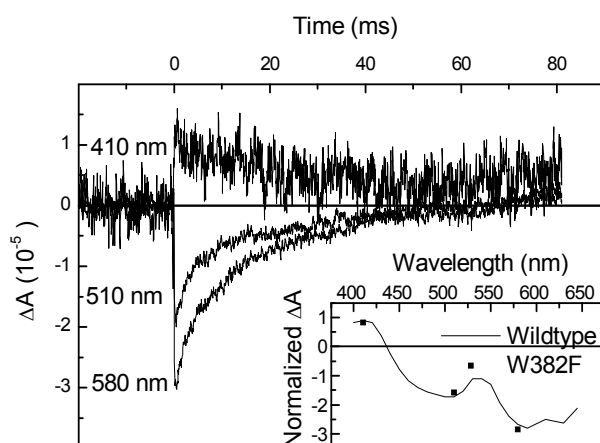

Figure 6. Tiny residual absorbance changes allow to identify the electron donating species as a tryptophan (radical after donation) and estimate the yield as 0.1 %

### What is different between W359 and W306 ? ([14], appendix B)

*Their orientation.* The chain FAD-W382-W359-W306 in DNA photolyase from *E. coli* is a prominent example of a biological electron transfer chain that contains identical molecules so that electron transfer between them does not change net absorbption. The electron transfer between the tryptophan residues could previously not be monitored directly as the absorption changes due to the reduction of W382<sup>o+</sup> and of W359<sup>o+</sup> are compensated by those due to the concomitant oxidation of W359 and W306, respectively.

To overcome this difficulty, we made use of the fact that **polarized excitation** (by a pulsed laser) induces a preferential axis (that of the excited transition of FADH<sup>o</sup>) in the *a priori* unoriented sample (photoselection), and that the transition dipoles of oxidized W359 and W306 form different angles with this axis (known from the crystal structure, see Figure 2). Thus, polarized detection should allow distinguishing between these two chemically identical residues in their transiently oxidized state. To demonstrate this, we replaced W306 by redox inert phenylalanine, thus pruning the electron transfer chain behind W359. On a “classical” setup (time resolution 10 ns), we showed that the resulting transient absorption polarization pattern at ten nanoseconds after excitation is in line with the orientation of W359 but well different from that in wildtype photolyase where W306 is oxidized in the same time scale (Fig.7). Based on the crystal structure, the **measured anisotropy** for mutant and wildtype photolyases allows for an **adjustment** of the **transition dipole moments** within the **molecule frame** for both **flavinyl** and **tryptophanyl** radicals [14]. Subsequently, pump-probe measurements with picosecond resolution demonstrated that the polarization pattern at 100 ps is already that of [FADH<sup>-</sup>, Trp306H<sup>o+</sup>], suggesting that electron transfer along the triple tryptophan chain is limited by the first step [15].

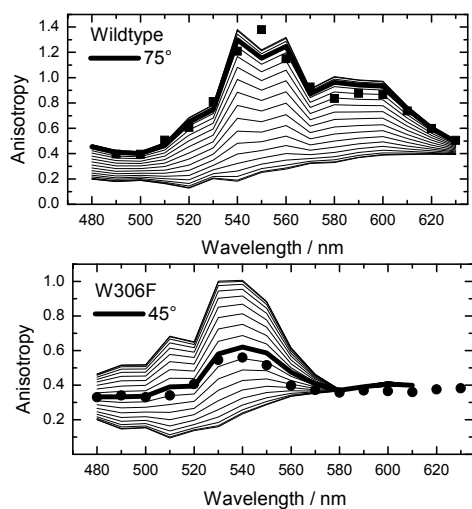

Figure 7. Comparison of measured (symbols) and simulated (lines) anisotropy of initial absorbance change for photolyases with the chain ending with W306 (wt, top) or W359 (mutant, bottom) allows extracting the angle formed by the detected tryptophanyl transition with that of the excited flavin.

### Two more things to keep in mind on polarization

\* On a suitable timescale, the effect of photoselection can be used in transient absorption spectroscopy to obtain **bigger signals**, if detecting parallel to the pump pulse polarization, where the excited population is largest.

\* If depolarization processes intervene on the timescale of interest, they may introduce **kinetic artefacts**. These can be prevented when detecting under the magic angle ( $54.7^\circ$ ), the squared cosine of which is  $1/3$ , thus ensuring that always constant contributions from both polarisation directions reach the detector (meaning that a polarizer is always a good idea if you don't know your timescales in advance).

### What happens between 100 ps and 10 ns ? [16]

*We can't tell.* This question is tantalizing because, with the distal Trp mutant, we see at 300 ps a protonated tryptophanyl radical and at 10 ns we see a deprotonated tryptophanyl radical. In between should happen a deprotonation, but how can we see it? For technical reasons, pump probe spectroscopy becomes unreliable for small signals at times  $\geq 1$  ns and "classical" transient absorption had not yet reached this limit for biological material (see chapter 3). So there was no overlap between the accessible time windows of the two techniques and this prevented us, among others, from knowing the amount of recombination occurring during the "time gap". In this situation, we applied "**kinetic overlap actinometry**". The idea is to find a substance (the "chemical actinometer") of well-characterized behaviour on **both** timescales (in our case, some special red-absorbing ruthenium complex) and to measure it back-to-back with photolyase on both setups. However, complications may arise from differences between setups in experimental parameters such as excitation pulse profiles, beam geometries etc. and also from differences in absorption spectra between samples and actinometers. For this reason, even after careful correction, the accuracy of such "calibration" measurements will rarely exceed 20%. Nevertheless, we could exclude major losses during the "1 ns" time gap and hence extrapolate early yields from the more reliably defined late yields. This link in turn

allowed to draw up a more complete scheme of the electron transfer pathways and energetics during photoactivation in *E. coli* photolyase, as summarized in Fig.8.

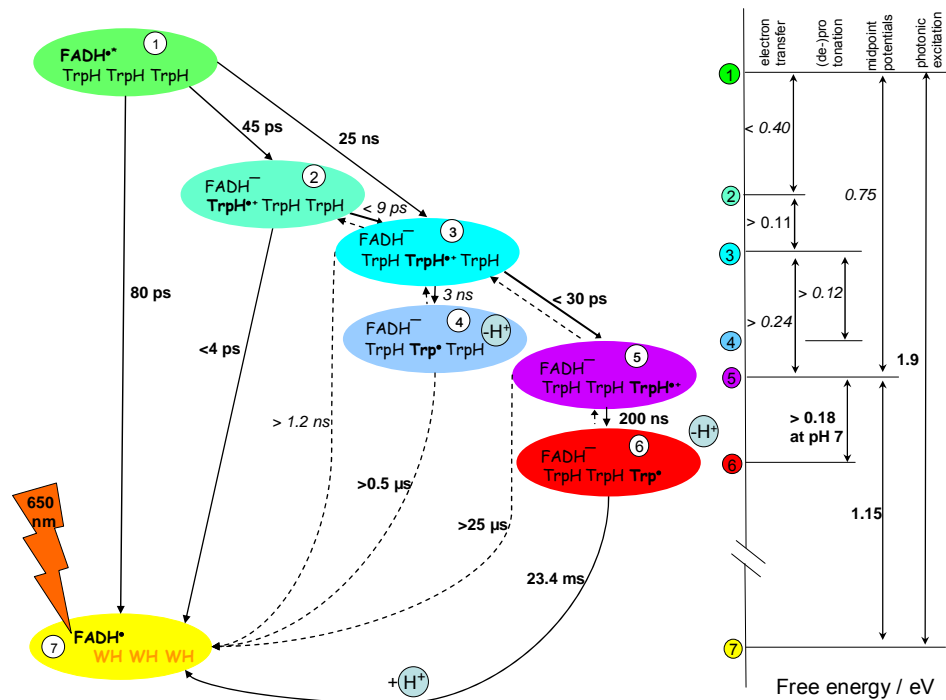

*Figure 8. Overview of electron (proton) transfer pathways during photoactivation of E. coli photolyase and their parameters as revealed by our studies [12-21].*  
*Excitation of the flavin radical with visible light leads to its singlet excited state  $FADH^{\bullet*}$  whose redox potential is such that it abstracts (within 30 ps) an electron from nearby  $Trp_{382}$ . The formed tryptophanyl radical  ${}_{382}TrpH^{\bullet+}$  in turn is unstable and recombines immediately with the reduced flavin  $FADH^-$  to the neutral ground state [ $FADH^{\circ} Trp$ ]. A fraction (about one third) of  ${}_{382}TrpH^{\bullet+}$  however succeeds in abstracting an electron from another close-by tryptophan residue  ${}_{359}TrpH$ . Again, recombination is possible, but as the distance is now much bigger (10 vs 4.2 Å), it competes much poorer with another forward electron abstraction step from a third tryptophan, less than four Ångstroms away, surface exposed  ${}_{306}TrpH$ . As the second and third steps are faster than the first one, the intermediate states ( ${}_{382}TrpH^{\bullet+}$  and  ${}_{359}TrpH^{\bullet+}$ ) are not populated in wildtype to any significant level and escape spectroscopic detection. Direct recombination from the third Trp radical (over 15 Å) is estimated to take microseconds and is by far outcompeted by deprotonation of  ${}_{306}TrpH^{\bullet+}$  to form the neutral radical  ${}_{306}Trp^{\circ}$  in 200 ns. Depending on the availability of external electron donors, this latter can recombine in the millisecond time scale or else undergo further reduction and thus stabilize the reduced flavin. Driving forces are calculated from spectroscopically determined rates and yields, detailed motivations can be found in [16].*

### 3. The nanosecond hole – missing overlap between fast and ultrafast

If, however, one wants to not just exclude losses but really know what goes on around one nanosecond (e.g. the time constant for W359 deprotonation), it is necessary to create an actual overlap between the time windows accessible to fast and ultrafast measurements, respectively.

#### **Should the “nanosecond hole” be fixed ?**

*Yes.* Since its introduction in the fifties [22,23], flash absorption spectroscopy has become a most powerful tool in the study of light induced reactions in many fields. Based on its remarkably simple principle, it found applications in areas all over physics, chemistry and biology. The reaction is triggered by a strong actinic flash, originally created by a flashlamp and of microsecond duration. With the advent of lasers, shorter flashes (nanoseconds) became available and this extended the achievable time resolution, which was now essentially determined by the speed of the detection/recording system. Later on, these limitations were overcome by introduction of the pump/probe technique where a slow detection system was no longer a problem because the detecting light itself was now a short pulse [24,25]. These achievements opened the pico- and femtosecond window to optical absorption spectroscopy with an overwhelming host of new and fascinating insights [26].

It is, however, often overseen that the two complementary methods, “classical” flash absorption spectroscopy and “ultrafast” pump-probe spectroscopy do not fit with each other very neatly. Actually, rare are the cases where the latter method has proven able to detect signals of lifetimes reaching or exceeding a nanosecond, especially if those signals are small. This is due to intrinsic baseline instabilities for the very long delay lines required for achieving nanosecond separation of pump- and probe pulses. On the other hand, “classical” setups’ time resolution has not reached the few-ns region due to both problems increasing the electronic bandwidth and additional noise arising from this increasing bandwidth. Meanwhile, this elusive 0.5-5 ns window represents a whole decade of lifetimes that are typical for electron and energy transfer processes and it is therefore highly desirable to dispose of a method that makes this “nanosecond hole” accessible.

Finally, it may be remarked that even at time scales where classical and ultrafast transient absorption techniques **do overlap**, they can provide **complementary** information as the classical technique is typically applied for multiple wavelengths, capturing all delays at one time whereas the inverse is true for pump/probe setups, thus providing for mutual baseline verification.

#### **Can the “nanosecond hole” be fixed ? ([27], appendix C)**

*If the money is there.* Recently, important advances and developments in detector/ amplifier/ digitizer/ laser techniques have pushed the abovementioned bandwidth limits back to a stage where it became reasonable to design a setup able to meet this challenge. It should be mentioned here that new material at the edge of technology has its price and acquiring the parts that make up the machine presented schematically in the figure below (Fig.9) became possible thanks to the circumstance that at one precise moment in French Science, ANR had started to finance projects and CNRS had not yet ceased to do so.

The transient absorption setup is composed of the following **main elements**:

a) The excitation system based on a Nd/YAG laser (Continuum Leopard SS-10) provides pulses of 100 ps duration and up to 50 mJ energy at either 532 or 355 nm at a repetition rate of 2 Hz. A small fraction of the pulse is used to trigger the detection system via a fast photodiode.

- b) Four alternative continuous wave (cw) lasers provide monitoring light of rather low noise at wavelengths covering the visible spectral range: A laser diode (Nichia NDHB510) emitting up to 50 mW at 448 nm, diode pumped solid state (DPSS) lasers emitting 20 mW at 488 nm (Picarro Cyan-20) and 25 mW at 561 nm (Oxxius 561-25-COL-002), respectively, and an external cavity diode laser system (EOSI 2010) tuneable between 660 and 695 nm that emits 5-10 mW.
- c) A mechanical light pulsing system limits the actinic effect of the monitoring light. A rotating plate with a small hole is placed in the focus of a collimating lens and provides monitoring light pulses of 70  $\mu$ s duration at a repetition rate of 66 Hz. An additional shutter selects one out of 33 pulses to match with the 2 Hz repetition rate of the excitation laser pulses.
- d) A polarization system allows turning the polarization of the monitoring light to any angle with respect to the (vertical) polarization of the excitation pulses. It is composed of an achromatic  $\lambda/2$  waveplate optimized for 400- 700 nm (from Melles Griot) and a Glan laser linear polarizer (CLPA-10.0-425-675 from CVI).
- e) The detection system is optimized for fast response, high fidelity and low noise. It consists of a Si photodiode (Alphas UPD-200-UP; risetime, 200 ps; sensitive area, 0.1 mm<sup>2</sup>), optionally an electronic amplifier (Femto HSA-X-2-20; 20 dB; 10 kHz – 2 GHz), and a digital oscilloscope (Agilent Infinium 81004B; bandwidth, DC – 10 GHz; sampling rate, 40 Gsamples/s). An interference filter with transmission maximum at the wavelength of the monitoring light protects the photodiode against stray light from the excitation beam and against fluorescence.

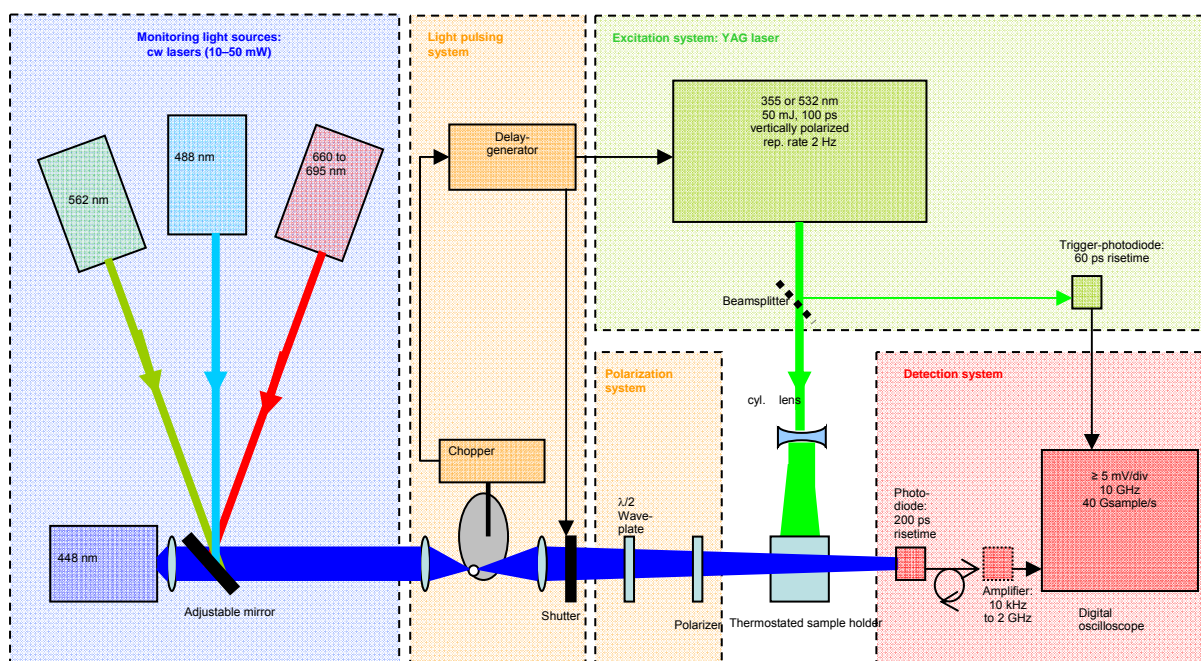

Figure 9. Scheme of a transient absorption setup with sub-ns time resolution. The detector is so small that only a focussed cw- laser can provide sufficient measuring light in the short acquisition time. Such intense measuring light is amenable to degrade the sample and must hence be chopped to minimize exposure to a short ( $\mu$ s) window synchronized with the excitation pulse (100 ps).



### Is the “nanosecond hole” thus fixed ?

*Proof.* Other than constructing a setup that claims to reliably resolve kinetics around one nanosecond, we also need to have a method to verify these claims. Lifetime standards as usually used for this purpose are scarce, exactly for the reason that the time window in question has not been assessed routinely previously. We therefore resort to an *adjustable* lifetime standard as represented by the rotational diffusion of a small chromophore with intrinsic absorption anisotropy. For a sphere of radius R, this anisotropy decreases exponentially with a characteristic lifetime  $\tau$  given by

$$\tau = 4\pi R^3 \eta(T) / 3kT, \text{ where } k \text{ is Boltzmann's constant.}$$

Raising the temperature T of the solvent will decrease the viscosity  $\eta$ , which, for our glycerol-water mixtures, effects  $\tau$  much stronger than the inverse temperature dependence in the denominator and thus we are able to tune the time constant of rotational diffusion quite easily. A reassuring aspect to this method of creating standard signals is that it relies entirely on photophysical principles and is hence free of any whims of high-speed electronics. In order to detect the limits in time and amplitude resolution of the “sub-ultrafast” setup, we first adjust the viscosity (by adding glycerol) of the dye solution such that the parallel signal decays to the isotropic value with well resolved kinetics and amplitude at room temperature. Then, by heating the sample, rotational diffusion becomes faster in a predictable manner and, as our detecting system cannot follow it any longer, the signal will increasingly lose amplitude. Figure 10 shows that application of an exponential fit allows to recover the lost amplitude and thus the system is able to reliably resolve both lifetime and amplitude within an error margin of 10% (grey zones) down to 300 ps of expected lifetime (provided an exponential decay is applicable).

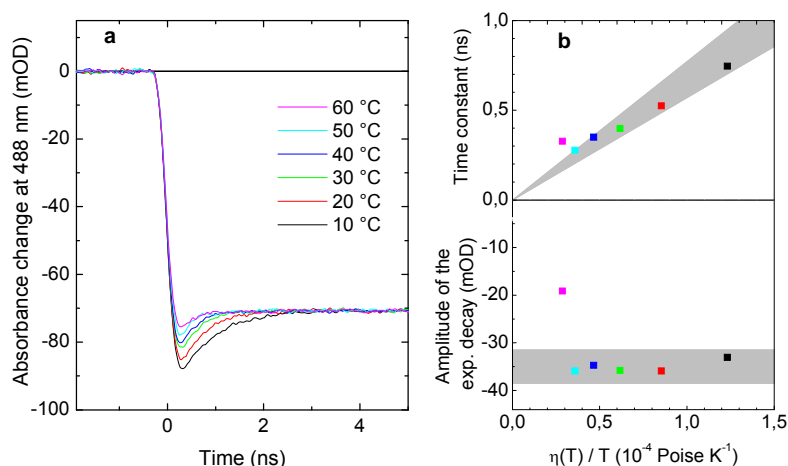

Figure 10. Expected decay times down to 300 ps are reasonably recovered by exponential fitting.



#### 4. Photorepair – the ultimate challenge

##### What was known on photorepair ?

*Structure: yes - kinetics: little.* **Structure** Using a chemical trick (replacement of the internucleotide phosphate by carbon-based formacetal ether), Carell and coworkers [28] managed to produce a CPD analogue with the right stereochemistry (in natural DNA, exclusively cis-syn is found) in sufficient amount for crystallographic studies. The complex of a double stranded DNA oligomer carrying this building block with photolyase from *A.nidulans* was crystallized; and one of the four protein-DNA complexes in the crystal structure actually showed the CPD tightly bound in the protein's binding pocket, flipped out of its DNA strand, as predicted [29] (Figure 11). The only flaw was that the synchrotron radiation used for structure determination had done severe photodamage: it had repaired the cyclobutane ring and restored the intact thymines. So the result of the study was damaged CPD (=intact DNA) in the geometry of intact CPD (=damaged DNA). Presumably, the flipped-out geometry was preserved due to the low temperature (100 K) that prevented release of the DNA from the enzyme's substrate binding pocket. This suggests that this latter process needs some thermal activation, in agreement with earlier measured positive binding energies [30].

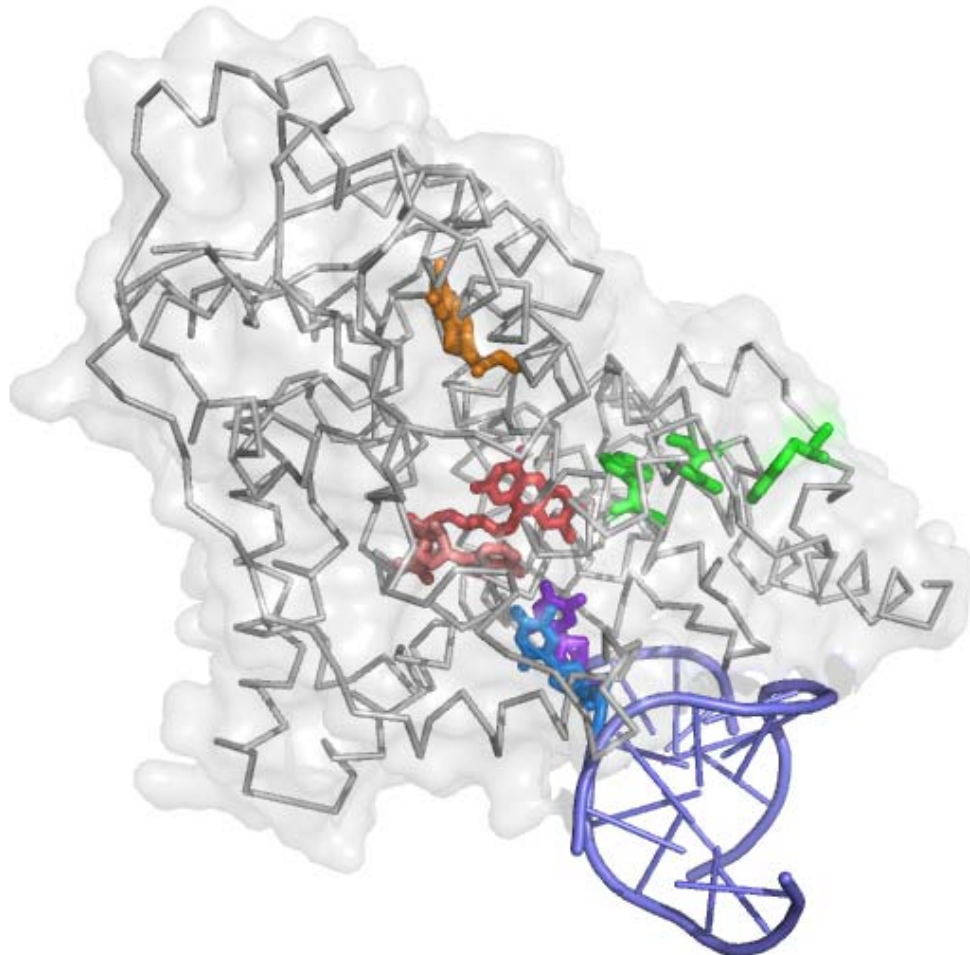

*Figure 11. The overall view of photolyase from *A.nidulans* in complex with a repaired substrate-analogue (1tez.pdb,[28]) shows the dimer flipped out of the double helix. One can also see that the flavin (red) is approached by antenna (orange), triple tryptophan chain (green) and substrate (blue) from different sides- a rather remarkable construction design.*

For photorepair, to date, two relevant **kinetic studies** have been published. MacFarlane & Stanley [31] measured transient absorption at 265 nm on photolyase from *A. nidulans* devoid of antenna cofactor due to overexpression in *E. coli*. Kao et al [32] combined fluorescence upconversion (480-625 nm) with transient absorption studies at four different wavelengths (510, 580, 625, 690 nm) on *E. coli* photolyase with the antenna cofactor depleted by photobleaching.

Whereas both studies agree on the finding of a ca 600 ps-phase and give compatible interpretations: (splitting of the second C-C bond of the CPD in the former case and electron back transfer to the flavin radical in the latter), findings on and interpretations of the events before that (i.e. electron transfer to the CPD and splitting of the first C-C bond) differ and appear rather incompatible with each other. These discrepancies might not be too astonishing in view of the fact that different spectroscopic techniques, wavelength ranges, sample sources and preparation techniques were involved. For these same reasons, the question as to which of the studies comes to the “right” conclusions, is idle - it must rather be concluded that, based on these encouraging attempts, more thorough work is needed in order to understand the mechanistic details of photorepair.

The **UV-studies** [31] were actually designed to choose a particular wavelength (265 nm) where absorption increase due to CPD repair is maximal ( $\Delta\epsilon \approx 17 \text{ mM}^{-1} \text{ cm}^{-1}$ ) whereas FADH<sup>-\*</sup>/FADH<sup>o</sup> difference absorption is minimized ( $\Delta\epsilon \approx 6 \text{ mM}^{-1} \text{ cm}^{-1}$ ). This issue is crucial as both contributions will occur concomitantly and with different sign upon electron transfer to the CPD. Regrettably, these studies failed to reproduce the established lifetimes of FADH<sup>-\*</sup> excited state decay in the absence and presence of CPD-containing substrates (ca 1.3 vs 0.2 ns) [33] and must therefore be suspected of imperfect/incomplete substrate binding. Such binding problems should not come as a surprise here because, in order to avoid the huge background absorption of intact bases, the authors used very short strands whereas it is known that longer strands are better bound.

The studies of Kao et al. [32] concentrated on the **visible wavelength range**, where contributions from FADH<sup>-\*</sup> (induced emission and excited state absorption) and from FADH<sup>o</sup> (formation and decay due to forward and reverse electron transfer) are expected, but CPD repair itself is not seen (marker band around 260 nm).

The resulting kinetic and spectral overlap of various flavin species makes it necessary to recur to a kinetic model in order to extract individual rate constants or spectral shapes. The simplest such model is represented in Figure 12, right. If antenna depletion did not leave any species behind, that could absorb at the excitation wavelength (400 nm), the antenna part of the scheme may not be considered. If, by contrast, other absorbing species are present (CPD-based intermediates, or incompetent enzyme complexes, e.g. without properly bound substrate because rebinding after repair is not yet complete or with partially oxidized cofactor because electron return was incomplete or finally with repaired substrate bound because release takes 50  $\mu\text{s}$  [34], the corresponding branches need to be added to the scheme. The authors of [32] preferred a simplified analysis assuming  $k_{et} = 0$  (no electron back transfer before repair) and obtained  $k_{et} = 170 \text{ ps}$  for the forward electron transfer. The controls presented in that work do not allow judging the degree to which this treatment is justified and the conclusions warranted. On the other hand, recent steady state work on photolyases both from *E. coli* and *A. nidulans* [35] suggests that the actual quantum yield of repair might be lower than previously assumed and hence the  $k_{et}$  process not negligible. Then, the alternative description of the FADH<sup>-\*</sup> decay by a sum of two exponentials with 60 and 335 ps lifetimes might be interpreted as being due to the presence of the  $k_{et}$  and  $k_{-et}$  processes, but the data in [32] are not

sufficient for the assignment of individual rate constants. Again, in the simplest possible homogeneous model, a 50% quantum yield of photorepair would imply comparable rates for the productive ( $k_{split}$  and  $k_{et}$ ) and the unproductive ( $k_{-et}$ ) channels.

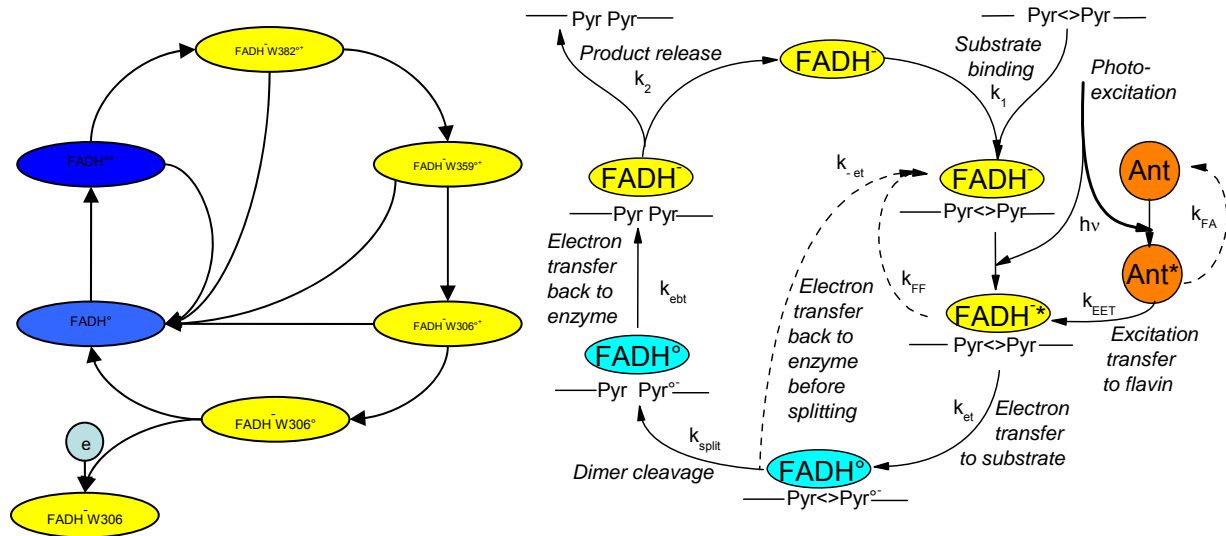

Figure 12. Comparison of reaction schemes for photoactivation (left) and photorepair (right). Radical flavin is blue, reduced flavin is yellow. Photoexcitation happens into the radical during photoactivation (at 9 o'clock) and into the reduced flavin during photorepair (at 3 o'clock).

### Why do we understand photoactivation better than photorepair ?

*Because it is cyclic.* Upon comparison of the reaction schemes for photoactivation and photorepair (Figure 12), a whole range of striking parallels hit the eye:

- both reactions cycle between FADH° and FADH-
- both excitations engage the flavin in ultrafast electron transfer
- both timescales cover events from ultrafast (ps) to slow (ms)
- both schemes show branching points involving back channels at essential reaction steps
- both reactions are essentially cyclic with some external in/output branches

Regardless of all these similarities, it is possible to dress a more or less complete picture of the photoactivation reaction (Figure 8) whereas for photorepair, the presented scheme rests for its better part speculative. The problem is rooted in a technical difficulty that is linked to the last of these common points: The crucial difference for studyability is, that for photoactivation, the interactions with the environment can be eliminated by keeping the medium electron-donor-free, thus ensuring that the reaction is completely cyclic and can be repeated as often as desired. This is not possible in the case of photorepair, where substrate repair is the essential step and cannot reasonably be eliminated if it is photorepair that is to be studied. The severe limitations on the repeatability thus imposed have direct consequences for the attainable signal-to-noise ratio.

### What can be done about it ?

*Keep trying.* What we hence needed to finally see repair, is first a substrate which is well bound by photolyase on the one hand but does not obscure observation at 266 nm by its huge background absorption on the other hand. We could solve this issue by saturation of all but one of the thymines surrounding the CPD in the strand to the dihydro form. The resulting **substrate analogue is virtually UV-transparent** but is bound and repaired equally well as traditional CPD-containing oligonucleotides ([35], appendix D). In passing, we used a chemical actinometer (a dimethylamino benzenediazonium salt with a characteristic absorption peak at 360 nm) to measure the photorepair quantum yield and found that it was about half of the “unity” established in the literature [4].

Now, extending the sub-nanosecond setup for milliOD transient absorption changes described above (see chapter 3) to application on a light-consumed sample in the UV presented in itself only few more reasons to despair. The difficulties outlined in the previous section didn't let sleep Klaus Brettel for more than ten years. It was his unique combination of cleverness and stubbornness (call it wisdom) that let him push on, and allowed him to obtain the means to step further. So, in the fall of 2009, by adding an ultrastable 266 nm UV laser (that Sony had originally developed for their inhouse wafer technology) to the “hole fixing” setup, this **impossible setup came into existence**. This was the moment I left Saclay.

### What does photorepair look like ?

*Noisy.* In the last days of his Saclay postdoc contract (and of the year 2009), Thiagarajan Viruthachalam collected hundreds of individual single flashes on a photolyase sample renewed after each shot. All in all, we have 361 usable photorepair events monitored at 266 nm with 300 ps time resolution and averaging them all allowed us to make the repair signal appear out of the noise (Figure 13).

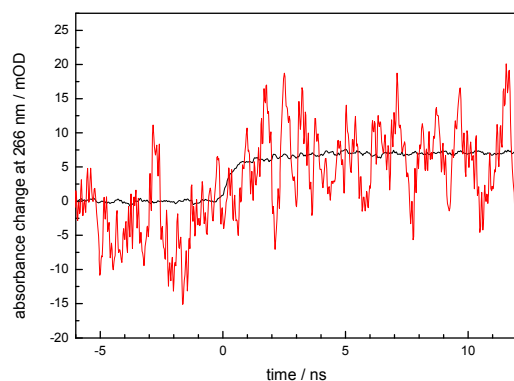
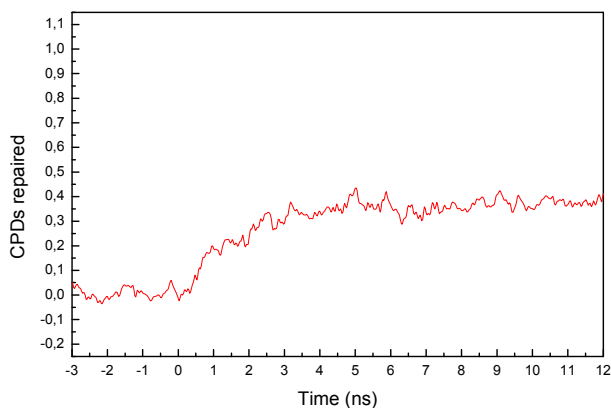

Figure 13. Reasonable averaging gives a usable transient (black) from single shots (red)

Unfortunately, the 266 nm signal is not only -and not even to the larger part- due to re-formation of intact thymine. Three different flavin species: FADH-, FADH\* and FADH° are also involved in photorepair and undergo transient absorption changes at this wavelength, masking the time course of the bond-splitting reactions we are interested in. Therefore, all of these **“parasite” signals need to be characterized separately**, at characteristic wavelengths (in the visible this time). In order to make possible comparison of signal amplitudes at various wavelengths, we again made use of the “actinometric” approach and monitored in parallel a well-defined chemical solution- Ru(bipy)<sub>3</sub> under all conditions. This –elaborate- procedure allowed to correct the 266 nm signal for the flavin contributions and revealed the **first ever real-time trace of enzymatic CPD repair (Figure 14)**.

### What can we learn from it ?

*The experiment was well worth being performed.* This curve features two surprises: its risetime and its amplitude. It is rewarding that we did more than just confirming a plausible scheme that was established so long ago that its justification seemed almost beyond all doubt. Beside bringing the **first solid experimental evidence for the standard scheme**- our findings also introduce **new grounds for discussion on further elaboration** of that same scheme.



*Figure 14. Enzymatic CPD repair is both slower and less efficient than anticipated by the « standard model ».*

Both the slower-than-expected rise and the less-than-expected amplitude can simultaneously be explained by an electron backtransfer reaction before bond splitting is accomplished. This raises a considerable challenge to computer simulations that up to now in unison found CPD splitting upon electron injection to be ultrafast (few picoseconds) [36,37]. Clearly, our repair transient does not show traces of such ultrafast chemistry. This divergence points to the longstanding difficulty of simulation protocols to adequately handle the protein environment and the whole story may serve as a reminder that even the nicest theoretical picture is not really established as long as it has not been confirmed by measurement.

### SUMMARY TO THE PAST

In a review of some papers selected from my recent research activity on enzymatic mechanisms of DNA photolyase (2003 to present, photorepair is unpublished=confidential), I demonstrated that transient absorption techniques can be pushed to reveal information on protein function on the picosecond to millisecond time scales.

« Si la matière mue me montre une volonté, la matière mue selon de certaines lois me montre une intelligence : c'est mon second article de foi. »

J.-J. Rousseau 1762, "Profession de foi du vicaire savoyard"

## PART II: PRESENT

Functional & structural protein dynamics- approaches & parameters

5. Proteins move
6. Things around the protein also move
7. Who sees what, and when?
8. The lure of single molecules

This part deals entirely with schoolbook wisdom that I acquired essentially during the last year. Therefore, it is full of references (two thirds of the total) but does not contain a single picture. The function of this part is to serve as a background for the motivation of the following. No warranty can be given for the correctness of the information provided. In case of doubt, refer to the original literature (or just skip).

## 5. Proteins move

### Why should I care about dynamics ?

*Maybe you shouldn't.* Proteins move because of their **marginal thermodynamic stability** (that is the difference in free energy between unfolded and native state  $\Delta G$  is just 3 to 10 kcal/mol, [38]). And this low stability in turn is a product of all the mutations that accumulated through history - destabilizing but not killing the protein [39].

On the other hand, in condensed media, **overcoming a reaction barrier** becomes possible when the reactants gain the necessary energy from their **coupling to the fluctuations** of the surrounding bath. The last century has witnessed important advances in our understanding of the mechanism of that coupling (Arrhenius 1889 [40], Eyring 1935 [41], Kramers 1940 [42], Hynes 1980 [43]). These theories, differing in the treatment of the bath's contribution to reaching the transition state (top of the barrier), are reasonably successful in predicting reaction rates (for a comprehensive review, see e.g. [44]). However, their application to enzymatic catalysis remains a persisting challenge, mainly due to the proteins' complex dynamic behaviour.

Even if from a naive experimental point of view, it seems clear that enzyme flexibility is necessary for proper function (most catalysis stalls at helium temperature), we still **fail to put hand on the "mechanistic link"** of how the coupling between fluctuations and reactions is actually put to work in proteins. To illustrate this point, suffice it to cite recent statements of two eminent players in the field: On the one hand, Arieh Warshel, who -by introducing QM/MM methods- first managed to approach the problem by computer simulations, in his 2006 exhausting review [45] calls dynamical contributions to enzyme catalysis "a popular hypothesis" but, regardless of a host of simulation techniques mobilized, fails to track down these contributions. And on the other hand, at the same time, Casey Hynes in his 2008 festschrift states that "Grote-Hynes theory could be used to understand and quantify key aspects of the murky issue of dynamical effects on the catalysis" [46].

### How does this show up in live ?

On an intuitive level, the crucial role of protein motion for proper functioning can be illustrated on some **rather general examples**:

\* With enzymes serving as **trans-membrane channels**, it is not uncommon to observe that they function as "gates", i.e. they **open and close selectively** to permit or deny access to desired or undesired molecules, i.e. filtering is done by an active motion rather than by a static "sieve" [47].

\* For proteins with **allosteric** regulation, binding of a substrate on one place triggers a reaction on a different site within the protein. This can be understood if there were two different minima in the free energy surface, corresponding to two different conformational substates. The potential valley of the inactive conformation is preferred by the free enzyme and that of active conformation is preferred by the enzyme-substrate complex and **substrate binding liberates the energy to push the protein over the barrier from the inactive conformation to the active one**. This type of functional control by protein dynamics would be applicable to most proteins with signalling or regulatory function [48].

\* Another way of dynamic control for protein function is at work for the ubiquitous class of electron/proton transferring proteins. Here, a considerable fraction of the transfer may occur through the barrier (tunnelling) and is hence exponentially dependent on distance. If protein dynamics do rapidly enough **sample the conformational space, the transfer rate will be dominated by the few situations with optimal geometries**. In the contrary case of slow sampling, many states with less favourable organization can determine the transfer rate, simply because the "good" ones may not be reached in time [49-51].

\* In the case of proteins catalysing “**just metabolic chemistry**”, it is clear that the “pre-reaction” free enzyme should favour substrate binding and the “post-reaction” enzyme-product complex should favour product release, with a trigger in between achieved by a conformational change sometime in the course of the reaction [52]. For the mechanism of preferential binding of substrate over product, there is discussion between proponents of “induced fit” (first binding, then conformational change) and conformational preselection (the other way round). It turns out, that these two views are two manifestations of the same mechanism if the conformational sampling is shifted from slow to fast [53].

### **How do we get a grip on this mess ?**

*Models. Timescales.* Of these examples, the latter two illustrate directly the importance of the timescales of protein dynamics for the control of the functional mechanism. The underlying dilemma common to these examples, “few good” vs. “many not-so-good”, doesn’t seem to have any general answer to it. By **disrupting an optimized structure** via perturbing mutations, people attempted to demonstrate the importance of a presumably optimized “prearrangement”, but found to their surprise that, although in the mutant protein substrate binding was actually hampered, the catalytic rate did *not* decrease significantly [54], supposedly by compensation of this “grass root” type [55].

By here, it should have become clear that part of the problem is rooted in the fact that, due to the **hierarchical organization of their conformational landscape** [56], **proteins display motions on an extremely wide range of timescales**. The challenge is to understand how these motions are coupled among each other and which of them are important for function. By definition, “fluctuations” are those motions that are rapid with respect to the reaction rate. As, for enzymes, the latter span a window of several orders of magnitude [57], so will do the former and it seems difficult to know *a priori* where and when to look for the functional part of the protein motions. Moreover, the (de-)coupling of the various timescales presents a major technical challenge for experimenters both *in vitro* and *in silico*.

For the time being, it is tempting to stick to a mechanistic picture as put forward by Vern Schramm in his excellent 2005 review [58]. According to this, the (infinitely short lived) transition state is reached when **all critical atoms simultaneously** reach a “near-attack conformation” or “pre-transition state”, which –due to their ps fluctuations- is quite often for any single degree of freedom but occurs only rarely in sync for all of them.

This concept was put into a somewhat more formalized form recently by Sunney Xie and coworkers at Harvard [59]. They consider a two-dimensional problem with a **reaction coordinate R and a dynamic coordinate X** which is *not* fast with respect to the former so it cannot be averaged out but instead is **considered explicitly**. The picture that arises resembles somewhat that of an antenna-reaction center complex of oxygenic photosynthesis, where the exciton has to migrate to the place of photochemistry in order to be transformed into a charge separated state. The analogy is that it is *a priori* not clear whether “migration” (X) or “chemistry”(R) is rate limiting. In nature, both situations can be found and, upon closer study, it often turns out **that both processes’ rates actually are not far from each other**. With respect to photosynthesis, in hindsight, one could say, that this is what could be expected from **evolution, which can exercise pressure only on the slowest process in a chain**. As to the general picture of protein dynamics, the field is wider and therefore a broader spectrum of situations is imaginable.



## 6. Things around the protein also move

### **What role is played by the solvent ?**

*Important. But unclear.* Back in 1959, Walter Kauzmann suggested that protein folding is driven by “hydrophobic interaction”, i.e. the aqueous environment is of vital importance for structural integrity [60]. On the experimental side (as with helium temperature) most protein activity stalls when isolated proteins are dried completely and it restarts when about one layer of surface water (“saturation hydration”, 20-70% of dry protein weight) is added ([61], but see also [62]). Thus water is essential for both structure and function. As to the dynamics, they appear correlated to both of them (depending on what exactly you measure), but it is not easy to establish a cause-effect relationship from these findings ([63,64], see also many others of the papers in Faraday Discuss. 2009, Vol.141).

Single fluorescent proteins flicker in a stochastic manner, their emission goes on and off. These fluctuations stop if the protein is attached to a bare glass surface (no solvent), suggesting that some flexibility is a prerequisite for the fluorescence fluctuations [65].

In 2002, again on their working horse myoglobin, Fenimore and Frauenfelder [66] introduced the concept of “solvent slaving”: essential processes in the protein have a temperature dependence that strongly resembles that of the solvent dielectric relaxation in different solvents, seemingly independent on viscosity [67,68]. On the other hand, by the same techniques, dynamics are found to be different for different macromolecules (protein > tRNA > DNA) in one and the same solvent [69]. These findings suggest that protein/solvent interactions might be more subtle than just between slave and master [70].

Both simulations [71] and experimental studies of water structure and dynamics [72-74] (see chapter 7 for the scopes of various techniques) suggest that there are different “types” of water around the protein: strongly bound, loosely bound, unspecifically bound. The meaning of these types is, however, different: ordered vs disordered in structure and slow vs fast in dynamics, but recent theoretical work suggests that the kinetics of the water movement may not at all be a good indicator of the strength or order with which it is bound to the protein surface [75]. So it seems that water and its role for life will continue to be puzzling for the years to come.

### **Why work under cryo-conditions ?**

*Handle to dynamics and energetics.* If the goal is observation of “living” proteins, why should we apply low temperature, certainly not a very life-near condition? [76]

For certain techniques, like electron microscopy, single molecule spectroscopy, or synchrotron crystallography, low temperature was initially just an unavoidable evil, necessary to be able to “see anything at all”. At low temperatures, vibrations, diffusion, reactions of the samples studied are slowed down- in short; samples are made “more stable”, but this effect can also be used for the direct study of dynamics – by switching them “on” or “off” progressively [77].

With time, techniques became more sophisticated and often low temperature, even if still being key to good resolution, is no longer absolutely necessary. But once the cryostat in place, it is tempting to use temperature as a parameter to steer experimental conditions (e.g. via the temperature dependencies of permittivity or viscosity of the solvent). Alternatively, temperature can be used to selectively overcome a reaction barrier or to stop a reaction in front of it. Finally, measurements of yields as a function of temperature may give an access to the height of activation barriers and thus to the energetic dimension of otherwise purely kinetic measurements. The matter is complicated by the fact that in their “natural environment”, aqueous solution, proteins should denature below zero [78], so there is a whole story of cryo-protection involved [79,80].

## 7. Methods and what they can see

### **The dynamic dimension**

*One corner and two edges.* If you add the dynamical aspect to the classical dualism

structure  $\leftrightarrow$  function,

you end up with a triangle, i.e. ONE new corner, but TWO new arrows: structural dynamics and functional dynamics. Of course, these are two sides to one medal, but what makes it difficult to get a grip on this medal is the fact that the methods of study for structural and functional dynamics are not generally the same. In the most popular example, the “solvent slaving” theory [66], protein function was followed by transient absorption on geminate recombination in myoglobin, while the structural part -solvent dynamics- came from dielectric relaxation. Similarly, in the other -more recent- popular case of adenylate kinase [81,82], structural fluctuations were followed by NMR and functional movements by FRET, and computer simulations had to come to help to put it all together.

Therefore, the following short review of methods is by no means exhaustive but rather meant to underline the fact that if we want to progress in understanding the “murky issue”, we will necessarily have to cover the widest accessible time range by applying as many complementary approaches as possible [83]. In the given case, the broad multi-method approach is facilitated by the on-site presence in Grenoble of excellent expertise and facilities for most of the techniques mentioned.

### **Förster resonance energy transfer (FRET)**

*Persuasive.* The historically probably oldest approach was the 1967 idea of Lubert Stryer to use the steep (sixth power) distance dependence of Förster resonance energy transfer [84] for a “spectroscopic ruler” to measure momentary distances in space between fluorescing entities [85]. The popularity of the method comes from its simple principle, but upon second sight, it may become exceedingly tricky to obtain something reliable. One major problem comes from the strong angular dependence of the underlying dipole-dipole interaction that for unfavourable geometries can lead to complete vanishing of the signal and also introduces large uncertainty if the correct geometry (or its change in time) is not known [86]. Another problem arises if distances approach those comparable to chromophore size because then the dipole-dipole approximation is no longer valid [87,88]. Still other problems are linked to limited knowledge of the refractive index inside a protein (solution) [89]. Finally, for application to single molecule experiments, dye photophysics can pose serious limitations [90,91]. Therefore, this method is of limited value for determination of absolute distances but rather useful for detecting movements, i.e. (transient) changes in distance or angle between donor and acceptor. Thus, regardless of its numerous limitations, FRET is a method widely used for monitoring the effects of external manipulation, like, pushing or pulling a protein or DNA strand by optical or magnetic tweezers (using fluorescent beads) or scanning probe techniques.

### **Kinetic protein crystallography**

*Rare.* As many proteins are functional in crystals, this is the one method that can, in principle, visualize structural dynamics directly, i.e. real movements in real time. The main problem is resolution. Very small movements occur on very fast timescales. And as these fluctuations occur in the typically  $10^{14}$  molecules per crystal not in phase, their direct monitoring is out of reach for this method. Instead, the goal is to follow structural changes that are linked to function by synchronizing the molecules of the sample. There are two strategies to achieve this: “Trapping”: Stop the dynamics (by freezing) and look afterwards (eg [92]) or “Real Time” using a pump-probe scheme: trigger the reaction (e.g. by light) and determine the structure at various delays afterwards by Laue crystallography [93,94]. This puts extreme demands on crystal quality and also requires that the reaction under study can be triggered by light. Successful examples include myoglobin [95], Photoactive Yellow Protein [96], and hemoglobin [97], or -very recently- also a bacterial reaction center [98].

### **Dielectric relaxation**

*Easy.* Dielectric relaxation spectroscopy is a straightforward handle to the spontaneous movements that occur in a sample. The sample is placed inside a capacitor and an external alternating electric field is applied. This field exercises a torque on the molecules of the sample that tends to orient them. Depending on their spontaneous movement, the sample molecules resist and cause a phase shift of the current across the cell with respect to the applied voltage. This reaction will be strongest at frequencies where the external field is in resonance with internal movements, allowing for the extraction of typical relaxation times. These times can then be used to extract the dipole moment or hydrodynamic radius of the probed molecule. More information on the character of a particular relaxation process can be obtained if these measurements are carried out as a function of temperature. For the case of proteins in aqueous solution, typical relaxations occur at room temperature around few picoseconds (20 GHz, “gamma”, ascribed to reorientation of bulk water) and at few nanoseconds (10 MHz, “beta”, ascribed to protein tumbling). Between the two, several other weak relaxations can be found (“delta”) and their relation to the protein-solvent interaction is a matter of debate [99,100].

### **Neutron scattering [101,102] and Nuclear Magnetic Resonance [103] spectroscopies**

*Heavy.* For insight, ask Frank Gabel (04 38 78 95 73).

These two (families of) techniques measure the amount of energy that a sample exchanges with an incident beam of neutrons or with a radiofrequency magnetic field on timescales down to picoseconds. Both can be considered as “standard” techniques for observation of structure *and* dynamics of both protein and solvent. Their importance is partly due to the fact that they are sensitive to protons, which X-ray crystallography is practically unable to see. Moreover, both techniques have in common that directed exchange of protium for deuterium can serve to visualize selectively the (un)labelled portion of the sample or medium. The back side of the medal is that you need an isotope lab, which might not be a minor factor even if you consider the cost of the instruments alone. The enormous infrastructure required for these techniques is probably one reason why people who apply them went further into data extraction strategies than for other techniques. As a consequence, I do not feel qualified to qualify or quantify the scope of these techniques myself in a few words and instead, I rather gave here just the references of some reviews to begin with, that appeared to me particularly readable.

### **Correlation spectroscopy**

*Not really spectroscopy.* You don't watch anything as a function of energy. What you watch is monochromatic light coming from a small spot of the sample during a long time. If the light comes from a laser and is scattered by the sample, the method is called "Photon correlation spectroscopy" (PCS) or "dynamic light scattering", if the light is emitted by the sample itself, we have "fluorescence correlation spectroscopy" (FCS). In both cases, the time trace is compared to copies of itself from various moments in the past and the behaviour of this auto-correlation function is analyzed as function of the delay between original and copy.

Information obtainable are particle size distributions in the former case and concentrations, diffusion coefficients or photophysical behaviour in the latter [104]. Depending on the detector, time resolutions down to picoseconds are possible, for FCS however, milliseconds are more common. Using polarized excitation and detection, rotational diffusion times can be determined that exceed largely the fluorescence lifetime limiting the direct use of fluorescence anisotropy to this end [105]. Extension to two-focus and dual-color mode recently allowed the *in vivo* detection of protein-substrate interaction [106].

### **Terahertz Spectroscopy**

*Phenomenological.* ("T-rays") is the spectroscopic technique that addresses the picosecond time window directly ( $1 \text{ THz} = 1 \text{ ps}^{-1}$ ). Due to difficulties in the development of suitable emitters and detectors, it is only relatively recently that this method came into play [107]. Probably as a consequence, with respect to applying it to protein/water dynamics, there seems to be little theoretical framework for interpretation of its results and this is rather done on a more qualitative basis [108].

### **Computer simulations**

*Impressive.* Computer simulations are the ultimate method to study protein dynamics [45,109]. They allow to observe the system while you pull here and you push there and still keep everything else from unforeseen "collateral damage", a situation the experimenter is never really confronted with. Since the introduction of combined quantum and classical treatment ("QM/MM") by Warshel and Levitt in 1976, it even became possible to reconcile atomistic detailed description (the quantum mechanic part) with large system size (the molecular mechanic part) [110]. Still, it often seems that the best agreement of simulation with experiment is obtained if the experiment has been accomplished beforehand. Sometimes it looks as if a mean deity is not willing to let us have "everding fer noding".

Current simulations suffer from mainly two problems: first how to create huge amounts of data (numerical restrictions) and second how to interpret them afterwards (human restrictions). For both kinds of problem, mediation can be brought about by mutual help between man and machine and new methods are constantly being developed. In the first case, a human bias towards "interesting" events can be introduced ("accelerated dynamics"[111], "metadynamics" [112]), but the "corruption" of the "natural flow" of things raises the problem of synchronization of the various timescales and extraction of quantities comparable to experiment.

For the second problem, getting a grip on the vast amounts of data created, various algorithms of data reduction can be employed to find the "major" changes among an ocean of tiny fluctuations. To name but a few, there may be cited: principal component analysis [113], mezo-analysis by discretizing conformational space onto a Markov network [114], or exploitation of various "moments" (e.g. time averages) [115].

### **Dynamic Stokes shift**

*Industry.* Femtosecond fluorescence upconversion is the counterpart of pump/probe absorption [116]. As in that technique, a trigger (pump) pulse starts the reaction and a delayed monitoring pulse serves to read out the state of the system. This probe pulse is used to “gate” a crystal that, as long as the probe lasts, shifts the fluorescence of the sample to a region where it can be seen by the detector. This technique allows to follow the evolution of fluorescence emission with femtosecond resolution, i.e. faster than detector-limited “classical” real time setups or electronic-limited TCSPC. With such time resolution, it becomes possible to follow the evolution of the emitting state as it is progressively stabilized by the surrounding medium that adapts continuously to the new charge distribution of the excited state, resulting in an increasing red-shift of the emission maximum. Typically, these so-called “solvation” processes proceed in few ps if the solvent molecules are free to rotate. In the vicinity of the protein surface, however, they can be “glued” or “stuck”, resulting in a slowing down that can be followed as long as the fluorescence lifetime lasts (typically nanoseconds). Complemented by anisotropy measurements, information can be derived about the movements at the site of the probe. Zewail’s and other groups perfected the approach to an amazing fertility [117-125]. With respect to proteins, artificial dyes have been complemented and partly replaced by site-directed insertion of Trp via mutagenesis (if there were Trps there before, they need to be removed in order to have a single probe).

### **Femtosecond stimulated raman (FSR)**

*Wonder weapon.* Really good time resolution (faster than fast, i.e. femtoseconds) is (apart from simulations) available only to optical pulses. Atomic displacements, vibrations that is, are probed in the infrared region, e.g. by stimulated Raman [126]. Put the two together and you have the impossible: high resolution in both time and frequency. The price to pay is: you need three pulses, one to trigger the reaction, one to excite the vibration and one to probe it; and two experiments: with and without the middle pulse. By taking the ratio of the probe amplitudes for the two experiments, one obtains the so-called “gain factor” as a function of time after trigger and of vibration frequency, i.e. a three-dimensional map, be it mountain contours or colours. Knowing typical intramolecular vibration band positions, it is possible to study the temporal behaviour of all of them simultaneously [127]. This is a powerful tool that seems suited best to study the fine atomic details of processes previously investigated thoroughly by less demanding apparatus.

## 8. The lure of single molecules (SM)

### Why SM ?

Experimentally observed reaction rates represent a macroscopic ensemble average of individual, fluctuation-guided micro-events. There are two approaches to get beyond the limitations imposed by ensemble averaging: to shrink the ensemble to a single individual ("SM") or to synchronize the ensemble by a highly precise external trigger. Both approaches are quite popular and both have inconvenients. For SM, a macroscopic rate can be obtained if the behaviour of a single molecule is followed over long enough time to accumulate sufficient statistical significance, but there is no warranty that ergodicity holds in a potential glass-like system as an enzyme in a multi-well potential landscape. In fact, at high substrate concentrations, a "molecular memory" phenomenon arises, but, on the average, the basic Michaelis-Menten description seems still to hold [128].

For synchronization by external triggering, the most precise stimulus available is a light pulse, but it is applicable only to a limited variety of systems: 1. absorbing and 2. reacting to excitation. This is a quite general limitation, but for the time being, it may be considered as a chance: Take such an excitable system and make both on it: SM and synchronized ensemble. Comparison should then allow to test whether ergodicity holds and thus ultimately open the possibility to take the SM approach (now justified) on systems that are not easily light triggerable.

Finally, a realistic description of protein function may need to take into account the constant turnover of transient molecular interactions in the cell that can not easily be reproduced *in vitro*. To achieve this, single molecule experiments in the living cell seem to be the way to go [129],[130].

### How SM ?

The system  $\beta$ -galactosidase + fluorogenic substrate (i.e. after processing by the enzyme, the product becomes fluorescent, but the substrate is not) allows to follow the evolution of enzymatic activity directly in the light microscope. Single molecule studies have revealed that periods of intense activity are stochastically followed by periods of leisure that are more or less prolonged [131]. The reasons for such unpredictable switching between "work" and "sleep" phases is unclear. An approach to find out would be to try to "wake up" the enzyme, e.g. by pulling or pushing it (Scanning probe microscope, optical tweezers, magnetic tweezers...) If the beads attached to the protein in order to tweeze it carries a fluorescent label and the supporting slide a suitable acceptor, structural changes can be monitored directly in the microscope by introducing a second detector channel that would allow to follow the relative movements of donor and acceptor via FRET [132].

### SUMMARY TO PRESENT

It can be said that it is a bit surprising that the attraction of protein dynamics has been discovered by different communities separately and, as their fields of expertise do not necessarily overlap a lot, there seems to persist a trace of mutual ignorance which regrettably contributes to slight confusion in terminology (closing the vicious circle).

The other thing that hits the eye is that in the surroundings of the IBS, most of the methods are prominently present, with the exception of the last few: optical spectroscopy. This has certainly to do with the rather recent recognition of the fundamental role the dynamic aspect plays in understanding protein function and the high potential that optical spectroscopy has in unravelling it.

« Not that science explains ‘why’ things are as they are -gravitation does not explain why things fall- but science gives so many details of ‘how’ that we have the feeling we understand ‘why’. Let us be clear about this point; it is by the sea of interrelated details that science seems to say ‘why’ the universe is as it is. »

R. W. Hamming 1980, “The unreasonable effectiveness of mathematics”

## PART III: FUTURE

What can optical spectroscopy contribute to understanding protein dynamics?

9. Roles of light in biology
10. Role of spectroscopy for dynamics
11. Experiments to start with
12. Fitting in the IBS context

In this concluding part III, the case is made how transient absorption -with its potential demonstrated in part I- can be harnessed to meet the challenge evoked in part II.

## 9. Roles of light in biology

### What can light do ?

*Work or spy.* In principle, absorbed light excites molecules. From here, the molecules can return to their ground state more or less directly or they can engage in all kinds of (photo)chemistry, the primary steps of which are often isomerisation and/or charge transfer. Subsequently, a cascade of further events can lead to such diverse results as DNA damage, chlorophyll biosynthesis, a transmembrane proton gradient, stopped hypocotyl elongation or even DNA repair, to name but a few (Fig.15a). All these processes have in common that nature is mean and once she can have workers for free, they'll have to do their job efficiently. Meaning that the role of the light in this case is to **change the system**, not to preserve it.

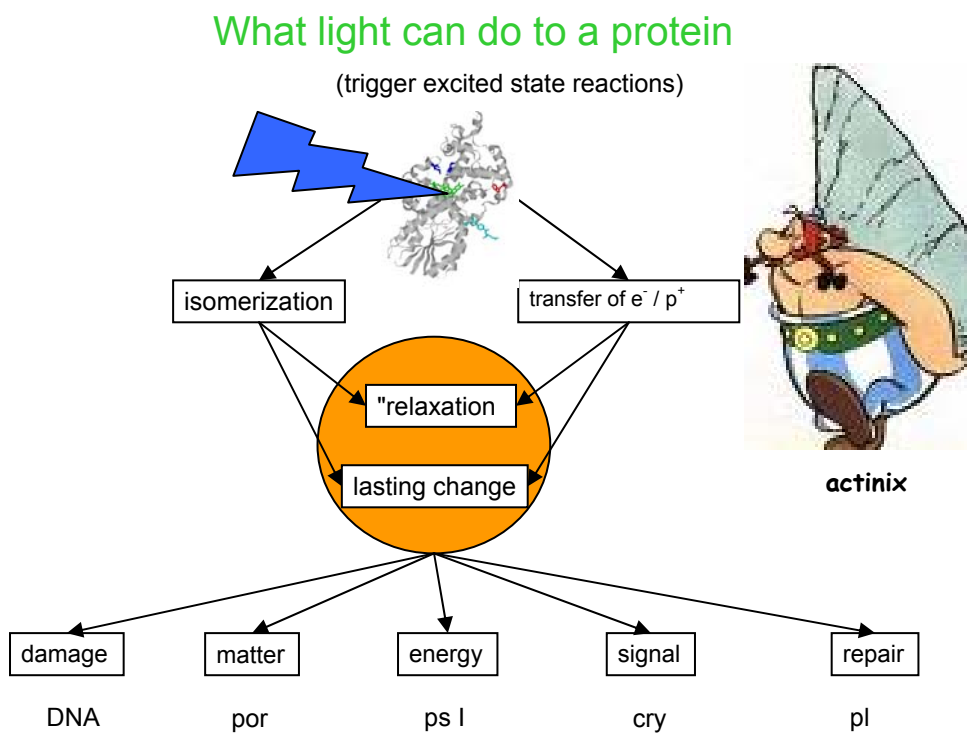

Figure 15a: Light as working horse in biological function (Inset courtesy Uderzo)

This is different in the case of man-made spectroscopy (Fig.15b), where light, thanks to its high speed, low-invasiveness and the supreme subtlety of light-matter interactions serves to get a wealth of information that often otherwise would hardly be accessible **without perturbing the system** excessively. It's the aim of the spy to leave unremarked. This is basically achieved by **the low intensity of the measuring light**.

The listing in the lower panel contains some of the parameters that can be extracted from primary spectroscopic measurements that I happened to deal with but it is by no means exhaustive. A major missing point is dynamics (see above) and we will come back to this shortly (see chapter 10).



## What light can do to a protein (II)

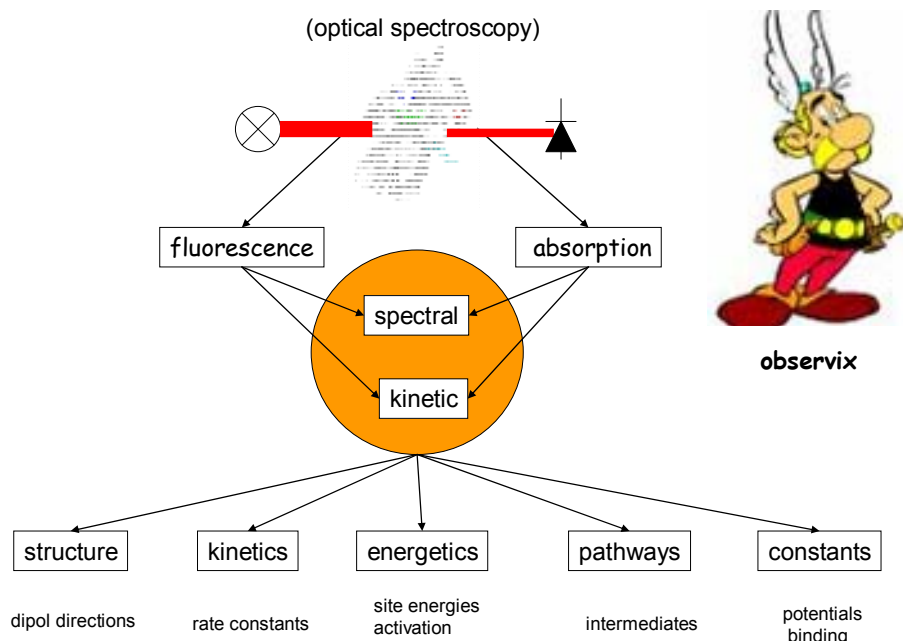

Figure 15b: Light as super-spy into biological function (Inset courtesy Uderzo)

### A superhero with no Achilles' heel ?

*Too nice to be true.* A “third” role of light that is not covered by the figure is exemplified by fluorescent proteins that seem to be “made by nature for man”. Obviously, man is seldom satisfied with what he gets for free and immediately started to fiddle around (all of the three 2008 Nobel lectures are very worth reading [133-135]). Consequently, fluorescent proteins (FP) became incredibly popular this last time for their use as markers in microscopic and nanoscopic imaging. They thus managed to couple both working and spying functions and become something like a superclever Obelix or a superstrong Asterix. But nobody’s perfect, so there should be a drawback here, too.

If microscopy (including nanoscopy) is to yield information on the system under study (and not on artefacts of the marker), we need to know exactly how the marker behaves *in situ*. This requires preliminary characterization *in vitro* under conditions (pH, temperature, viscosity, redox potential, ionic strength) as close as possible to those expected in the living environment. Here, it seems, is the hidden vice of our ASTOBE; the photophysical behaviour of most fluorescent proteins is far from well understood, the more so under constant light stress. Once again, structural studies are necessary and useful but understanding comes from their correlation with function, i.e. spectroscopic studies in our case [125,136-139].

## 10. Role of spectroscopy for dynamics

### **Can spectroscopy save the world ?**

*We can but try.* As we have seen in chapters 5 and 7, the central question is that of the relation between the “functional” reaction coordinate (R) and the “structural” dynamics coordinate (X). In order to be able to say something meaningful on this, we need experiments that follow the two under conditions as close to each other as possible, that is, ideally simultaneously. Unfortunately, among the techniques summarized in chapter 7, rare are those that are sensitive to both at the same time.

If catalysis is governed, as championed vigorously by Arieh Warshel [140], by local electrostatic interaction, its rate should fluctuate with a temporal behaviour that reflects the fluctuations of this interaction energy. On the other hand, these same fluctuations should dictate the behaviour of any chromophore at the catalytic site and thus should be directly detectable via absorption or fluorescence. Prakash and Marcus have recently come up with a theory that actually links fluctuations in enzyme catalysis and spectral diffusion of marker chromophores and they predict an observable correlation in single molecule experiments [141,142]! It could hence be optical spectroscopy -combined with SM techniques- that holds an important key.

### **Which time window is the good one ?**

*Milliseconds.* It is one of the strengths of optical spectroscopy that in principle it can have access to the whole range of time scales from seconds all the way down to attoseconds [143]. As mentioned in the introduction, it was this large dynamical window that opened the first sight on the complex conformational landscape of proteins [1]. Since we are here more concerned with the immediate “functional” dynamics (the “X” coordinate), the timescale of interest is rather that of typical catalysis events, **milliseconds** [144]. This has the undeniable advantage of a technical effort that is easier to handle (“cheaper”). Where necessary, extensions to fast and ultrafast can be envisioned via long-standing cooperations (SB2SM, Saclay- Klaus Brettel) and (LOB, Palaiseau-Marten Vos). Interestingly, ever since the advent of lasers made high time resolution available, the lure of “ULTRAFAST” attracted people to ever faster timescales [145], leaving the “outdated” classical techniques somewhat forlornly aside, even if their potential was far from exhausted. This led to a situation where it is not a big exaggeration to say that the population of transient optical spectroscopy setups scales inversely with their time resolution. In other words, a slow setup is a rare setup and hence is a precious setup.

Moreover, the millisecond time window has the advantage that it is amenable to **synchronization by stopped flow** methods, thus lifting the restriction to light-triggered processes intrinsic to flash spectroscopy.

### **A universal tool for detection of motions in proteins ?**

*Electrochromic Trps.* In fall 2009, I moved from a spectroscopy-centered lab (Ibitech Saclay-SB2SM) to a lab where the center of interest is protein dynamics (IBS Grenoble-LBM). Here, a whole battery of techniques is applied to approach the dynamical link between structure and function of various proteins (chapter 7). For historical reasons, transient absorption spectroscopy is not among them, regardless of its huge potential (high sensitivity and time resolution). In an attempt to put this potential into the service of the questions tackled, I suggest to set up a universal tool for (marker-free) detection of relative motions between intrinsic entities. The “monitor” chromophore is tryptophan (Trp), ubiquitous in proteins and the “probe” can be anything that moves with respect to this monitor and has a charge or dipole

moment to create an electric field in the order of  $10^8$  V/m at the site of the Trp. As a function of mutual orientation, this field will cause an electrochromic shift of the Trp absorption band ( $\geq 1$ nm) and should be spectroscopically detectable. Depending on the distance, such a field can be due to, e.g., the dipole moment of a nucleobase, a substrate molecule or an interacting partner protein few Å away.

### **Dynamics on a nanosecond-to-second timescale via tryptophan absorption bandshifts ?**

*Detectable.* Tryptophan is the one amino acid that absorbs strongest and closest to the visible (in protein,  $\epsilon \approx 5\text{-}6 \text{ mM}^{-1} \text{ cm}^{-1}$  at  $\lambda = 280 \text{ nm}$ ) [146] and has therefore early on deserved much interest by biologically oriented spectroscopists. However, due to contribution from many other small molecules (nucleobases, cofactors, buffers etc) a huge background signal is almost unavoidable so that attention shifted rapidly to the essentially background free complementary technique of fluorescence. Here, it turned out, tryptophan is a tool of immense value because its emission characteristics are extremely sensitive to the local environment it experiences. Numerous are thus the applications that tryptophan fluorescence found as sensor for, e.g., oxygen diffusion [147], polarity changes, solvent accessibility etc [148,149]. On the backside of the medal, the high sensitivity is caused by a rather complicated excited state photochemistry (see, e.g., [150-153]) which often complicates the drawing of quantitative conclusions from the observed signals.

In contrast, absorption transitions are sensitive to the difference dipole moment between ground and excited state ( $\Delta\mu \approx 6 \text{ D}$  for Trp) experienced by the sensor molecule in the ground state geometry and their interpretation can therefore be based on known crystal structures. The expected electrochromic shift of the absorption band can be calculated (in  $\text{cm}^{-1}$ ) by

$$\Delta\nu = -(\Delta\mu \cdot E)/hc$$

where  $(\Delta\mu \cdot E)$  is the scalar product of the vectors of tryptophan difference dipole moment and electric field strength at the monitor position, which in turn, for a permanent probe dipole  $\mu$  would have the form:

$$E = \mu / 4\pi\epsilon\epsilon_0 r^3 (3\cos(r_n\mu_n)r_n - \mu_n)$$

where  $\mu_n$  and  $r_n$  are unit vectors in the direction of the permanent dipole and from it to the monitor position and  $r$  is the distance between dipole and tryptophan monitor. As soon as the probe dipole  $\mu$  moves, all of these three latter quantities will change, having as a consequence a change in  $E$  and hence in  $\Delta\nu$ . Such electrochromic shifts in single absorption bands have the form of a first derivative of the band and can thus attain considerable amplitudes at the edge of the band concerned. It is therefore important to have good wavelength resolution around 280 nm. This can be achieved by turning an interference filter with respect to the beam propagation direction, which will result in a change of the maximal transmission wavelength. Knowing the position of the Trp band peaks from steady state measurements, the wavelength can then be chosen to maximize the transient signal and hence get the possibility to follow the transition in real time.

Examples of successful application of tryptophan absorption as a monitor of functional protein dynamics include femtosecond studies on bacteriorhodopsin, where –upon combination of site-directed mutagenesis with sophisticated data treatment- it became possible to consistently interpret the transient UV-absorption data [154-156].

In the case of most enzymes, the dynamics of interest are expected to happen on the slower timescale of microseconds-milliseconds which, by way of using slower and thus less noisy detection electronics, should be easier to follow.

## 11. Experiments to start with

### And photolyase ?

*Might continue to play its “paradigmatic” role.* It so happens that the “slow” part of the enzymatic cycle (blue zone of figure 3), viz. product-for substrate replacement i) falls (partly) into the millisecond time window [34] and ii) involves the movement of a “recognition loop” (as judged by comparison of the crystal structures with and without substrate in the photolyase binding pocket [28,157] and confirmed by partial digestion [158]). The fact that this recognition loop contains a tryptophan residue inside it may be considered a lucky coincidence. Moreover, the (repaired) substrate will have to move with respect to a second, immobile Trp residue (W286 in *A.nidulans* numbering). During this movement, the electrochromic shift induced by the substrate dipole moment on the absorption band of this bystander tryptophan should change. So we can, in principle, have handles both on protein function (substrate movement) and motion (recognition loop flipping). (Un)fortunately, both of these signatures fall into the same spectral region of tryptophan absorption. This could make things easier to detect, but harder to disentangle. A possibility would be to follow the process also by fluorescence, if it turns out that a wavelength can be found where Trp fluorescence can be isolated from that of the flavin cofactor and the (damaged) nucleobases’ background. In the visible, detectable shifts of absorption bands upon substrate binding have been observed by steady state spectroscopy for photolyase with the flavin in the radical state [159-161].

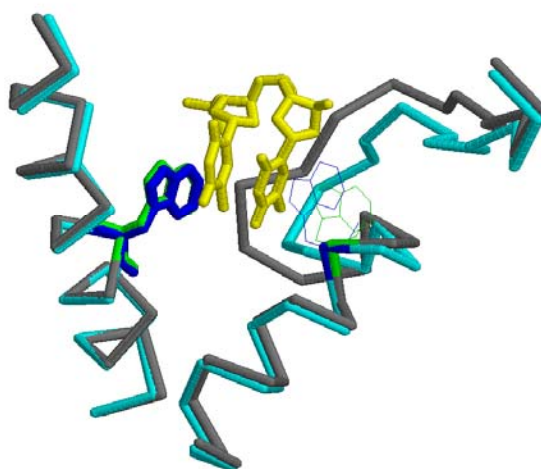

*Figure 16. Overlay of photolyase structures from *A.nidulans* without (grey) and with (cyan) substrate bound [28,157]. Upon binding of the CPD (yellow), the “substrate recognition loop” moves out to accommodate the CPD, but concomitantly Trp 392 (thin wire) moves inwards to form a stack-like configuration with the nearer of the pyrimidines. At the opposite side, Trp286 (sticks) stays put.*

### What’s needed ?

*A setup.* To begin with, all we need is a light source tuneable through the Trp absorption band, a detector (photomultiplier) and filters to limit the detection wavelength interval. As photolyase is light-activated, the reaction could be triggered by an intense UV flash that should be strong enough (>mJ) to be (nearly) saturating and short enough to be trigger just a

single catalytic cycle ( $< \mu\text{s}$ ). Both a flashlamp and a pulsed laser could be considered. Alternatively, if no such source is available, millisecond kinetics could also be seen by stopped flow after rapid mixing of enzyme and substrate. Then a corresponding mixing setup is required instead of a conventional sample holder in the former case.

The pulsed laser source (40k€) is the single element of the setup that makes up the major part of the required investment. Still, this is justified because, ultimately, it is the length of the light pulse triggering the turnover that limits the time resolution that is potentially achievable. Therefore a nanosecond laser is preferable to any mechanic solution that would not allow to go beyond few milliseconds. Our preliminary studies indicated however, that product release might be as fast 50  $\mu\text{s}$  [34].

Moreover, the high output power of the UV pulses makes it possible, in perspective, to use this laser as a pump source for an optical parametric oscillator that would largely widen the spectral range of the attainable pulses (essentially the whole visible range).

Another crucial part is a light source of sufficient output power and stability to provide for measuring light in the UV. A cost efficient and low energy consuming solution is a series of light emitting diodes that recently became available for the deep UV [162]. Coupled with suitable interference filters, covering the spectral area of interest (260-300 nm), this also avoids problems with ozone creation and handling common with other strong UV sources.

### **What proteins are to be considered ?**

*All.* At least those that are available and for which exists a handle, i.e. a spectroscopic signature to be followed. *A priori*, tryptophan is a most interesting chromophore. It is intrinsic to most proteins (no perturbation needed to introduce it) and, as a rule, not too abundant either, facilitating the disentangling of overlapping signals. Nevertheless, site directed mutagenesis can be very useful for engineering Trp probes in and out of proteins (see [122] for an impressive example).

For the beginning, light triggering will limit the applicability to photo-excitable processes, such as DNA repair, primary steps in light signalling by photoreceptors (that are expected to involve conformational changes) or natural and artificial photosynthesis. For the future, insertion of artificial absorbers or photo-decaging of substrate precursors can be envisioned to overcome this limitation.

### **Middle-to-Long term perspectives**

The time scales are not exhausted by slow measurements on the one hand and fancy ultrafast machines on the other hand; there is still the wide region of “ordinary fast”, *viz.* nanoseconds-microseconds that holds the “bridge” between molecular events and biological function. Extension into this “no mans land” is costly in time and money, but certainly rewarding.

## 12. How does all this fit into the IBS context ?

*Quite well.* There exist two laboratories with potential thematic and/or instrumental overlap to the questions raised here. On the one hand, the “cryobench” lab (also called: ESRF beamline ID29s) is dedicated to spectroscopic studies in liquid/crystalline samples mounted in an “ESRF-type” sample holder, i.e. a loop mounted on a goniometer. On the other hand, the joint IRTSV/IBS “pixel” lab (situated in a renewed building on the CEA campus) is dedicated to application of fluorescent proteins in super-resolution imaging of (single) cells.

### **Cryobench: Spectroscopy in the x-ray beam ?**

*Ideally, yes.* Such a possibility is highly desirable for at least two reasons: Often, structural changes between the active and inactive states of an enzyme are so subtle that crystallography alone may miss them easily (e.g.[163]); here a “functional fingerprint” could be provided by a spectroscopic signature. On the other hand, even if tests before X-ray exposure confirmed that the protein was active, this may change during data acquisition due to radiation damage; again a “functional fingerprint” could be provided by a spectroscopic signature during data collection.

The “cryobench” setup is equipped with a programmable Oxford temperature controller that allows exposing the sample to a stream of cold nitrogen gas and thus to establish any desired temperature between 100 K and room temperature. The sample holder is surrounded by three microscope objectives in a way that allows both measurements of transmission (absorbance) and fluorescence (in right-angle geometry). The objectives are fiber coupled and can be connected to light sources (lamp or various cw lasers) or detectors (CCD, PM). The large focal distance of the objectives required by the goniometer geometry and the fiber-borne light transport make the system very flexible [164-166].

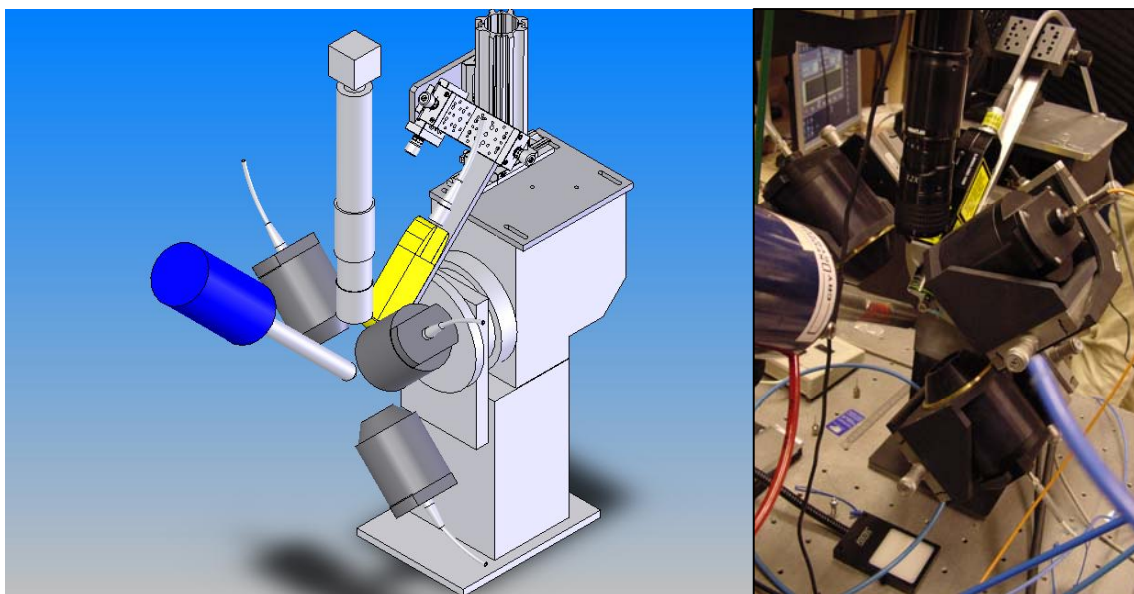

Figure 17 Arrangement for” in-crystallo optics” at the cryobench setup. Figure courtesy of Philippe Carpentier.

### **Protein dynamics on the cryobench ?**

*In stopped-motion.* However, this geometry also severely limits the photon current so that acceptable signal-to-noise ratios can be obtained only with considerable integration times. This limitation makes the cryobench setup essentially a static setup with a time resolution of, at best, seconds. In this context, protein “dynamics” can still be assessed by a detour via

temperature. If the catalytic cycle of a protein involves energetic barriers that are easily overcome at room temperature but prevent progression of the reaction at low temperature, flash freezing of the sample can lead to the observation of an intermediate trapped at the foot of such a barrier [167]. In a manner of speaking, temperature can “stop the time” (see chapter 6). Whether the states thus observable present functional relevant steps in the enzymatic catalysis, or probably dead-end lanes or just simply artefacts needs to be verified and double-checked by time-resolved measurements at room temperature. A straightforward way of such control would be the spectroscopic signature (with all the caveats that comparison of spectra at different temperatures may hold, [168]).

### Pixel: Diffraction unlimited microscopy ?

*Go for it.* The “pixel” lab is a venture to establish in Grenoble the technique that would allow to see relevant things in the (ideally living) cell without being hindered by the diffraction limit of classical light microscopy (200 nm). One trick to cheat around the diffraction limit is known from single molecule techniques and goes “one at a time”. You mark your sample with fluorophores and look on them not all simultaneously but sequentially so that you can separate in time what you cannot separate in space. Afterwards you can take the center of gravity of individual spots, corresponding to the localization of individual fluorophores and overlay everything and –if nothing has moved uncontrolled- that’s it (20 nm would allow to see individual proteins). The whole problem is that you need to be able to switch your fluorophores on (and off) at will. This can be done by light, but in order to do it reliably, the on and off forms need to absorb at different wavelengths [169]. Again, the setup consists of cw-lasers that are fiber-coupled to a microscope objective and, in perspective, a thermostatable sample holder. The difference is; the resolution is aimed at single fluorophores at pixel (and there is also more space in the lab).

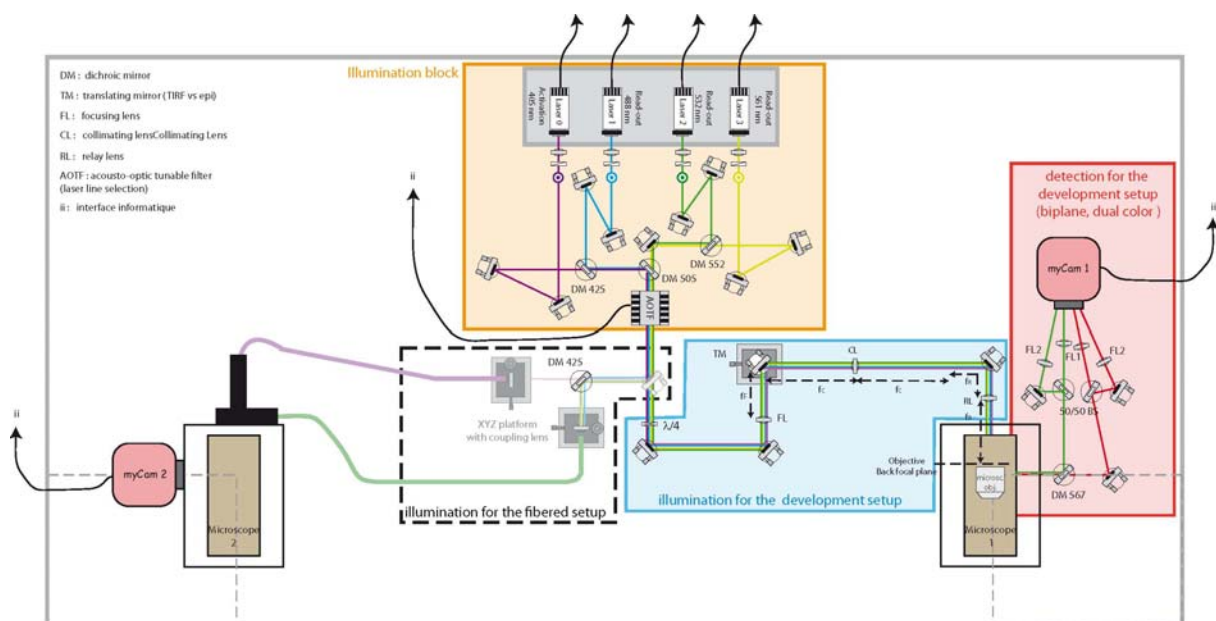

Figure 18 Modular construction of the optical setup in the pixel lab. The yellow block contains the light sources (cw-lasers), the microscope on the left is fiber-coupled for “routine” measurements and the microscope at the right is “open air” for instrumental and methodological development. Figure courtesy of Delphine Arcizet.



### **Spatial resolution or time resolution ?**

*You need tit for tat.* The tricky part is the switching of the chromophores. You want “on” or “off” and not anything third. For that, you need to know your fluorophore and its photophysical behaviour quite well, first in solution, than also attached to the object of your curiosity, i.e. cytoskeleton filaments, cell membrane, protein aggregate...

To find out these “preliminaries”, time resolved absorption and fluorescence spectroscopy is the indispensable counterpart of all imaging attempts. Real-time resolution (view “cells working” is much trickier because we used the time dimension for getting a handle on the space resolution beforehand, so now we have to pay this debt, if only we don’t find a way to replace time multiplexing by frequency multiplexing, i.e. observe more than one fluorophore at a time, but with different colours, if we manage to separate them neatly.

### **And spectral resolution ?**

*Costly.* In imaging, a crucial role is played by effective segregation of wanted from unwanted (« background ») photons arising from sources other than the fluorophore of interest, be it a different type of fluorophore in the detection volume, be it the same type of fluorophore outside the detection volume. For the latter type of background, various schemes limiting the size of the excited volume have been developed in recent years [170-174]. The former type is unavoidable as long as the excitation wavelength is limited by the choice of laser sources available. A significant gain could be envisioned if the excitation wavelength was tuneable in order to maximize the selectivity between desired “signalling” chromophores and undesired “parasites”. Such **wavelength tuneability** today is available via two different technical solutions: supercontinuum lasers that produce a constant beam containing the whole visible spectrum of somewhat limited energy on the one hand and optical parametric oscillators that can produce high peak energies at varying pulse frequencies (but only one colour at a time) on the other hand. It remains to be tested what kind of excitation source results in better noise suppression.

### **OVERALL SUMMARY**

Time resolved absorption spectroscopy is a conceptually straightforward technique that has proven its versatile potential in the study of DNA photolyase function over timescales ranging from picoseconds to milliseconds. For sure, it can play its role in linking protein motion to enzyme function. In principle, it allows to follow both structural and functional dynamics. This shall be primarily demonstrated on substrate binding/product release of DNA photolyase. In tight collaboration with the “pixel” and “cryobench” labs, time-resolved absorption spectroscopy can also contribute to the more efficient use of fluorescent proteins as markers in biological nanoscopy and to corroborate the functional relevance of cryotrapped structural intermediates in kinetic X-ray crystallography.



## ACKNOWLEDGEMENTS

This is the place to warmly thank Klaus Brettel to whom I 'll always be indebted for all that makes a spectroscopist (and not only).

I also would like to thank all the members of the jury for having agreed to play their part, for having come and having contributed to make this project what it is now.

Special thanks go to Delphine Arcizet and Ingmar Bauer for comments on a preliminary version of this opus.

Finally, I thank my “old” and “new” colleagues at Berlin, Saclay and Grenoble for creating the stimulating atmosphere that makes it a pleasure to work on protein spectroscopy.

## REFERENCES

1. Austin RH, Beeson KW, Eisenstein L, Frauenfelder H, Gunsalus IC: **Dynamics of ligand binding to myoglobin.** *Biochemistry* 1975, **14**:5355-5373.
2. Lakowicz JR, Weber G: **Quenching of fluorescence by oxygen. Detection of structural fluctuations in proteins on the nanosecond time scale.** *Biochemistry* 1973, **12**:4171-4179.
3. Park HW, Kim ST, Sancar A, Deisenhofer J: **Crystal structure of DNA photolyase from *Escherichia coli*.** *Science* 1995, **268**:1866-1872.
4. Sancar A: **Structure and function of DNA photolyase and cryptochrome blue-light photoreceptors.** *Chem Rev* 2003, **103**:2203-2237.
5. Kelner A: **Effect of Visible Light on the Recovery of *Streptomyces Griseus* Conidia from Ultra-violet Irradiation Injury.** *Proceedings of the National Academy of Sciences of the United States of America* 1949, **35**:73-79.
6. Harm H, Rupert CS: **Analysis of photoenzymatic repair of UV lesions in DNA by single light flashes: I. In vitro studies with haemophilus influenzae transforming DNA and yeast photoreactivating enzyme.** *Mutation Research/Fundamental and Molecular Mechanisms of Mutagenesis* 1968, **6**:355.
7. Weber S: **Light-driven enzymatic catalysis of DNA repair: a review of recent biophysical studies on photolyase.** *Biochim Biophys Acta* 2005, **1707**:1-23.
8. Schleicher E, Bittl R, Weber S: **New roles of flavoproteins in molecular cell biology: Blue-light active flavoproteins studied by electron paramagnetic resonance.** *FEBS Journal* 2009, **9999**.
9. Tkachenko NV: **Optical Spectroscopy Methods and Instrumentations.** Edited by: Elsevier; 2006:129-149.
10. Heelis PF, Sancar A: **Photochemical properties of *Escherichia coli* DNA photolyase: a flash photolysis study.** *Biochemistry* 1986, **25**:8163-8166.
11. Cheung MS, Daizadeh I, Stuchebrukhov AA, Heelis PF: **Pathways of electron transfer in *Escherichia coli* DNA photolyase: Trp306 to FADH.** *Biophys J* 1999, **76**:1241-1249.
12. Aubert C, Vos MH, Mathis P, Eker APM, Brettel K: **Intraprotein radical transfer during photoactivation of DNA photolyase.** *Nature* 2000, **405**:586-590.
13. Byrdin M, Eker APM, Vos MH, Brettel K: **Dissection of the triple tryptophan electron transfer chain in *Escherichia coli* DNA photolyase: Trp382 is the primary donor in photoactivation.** *Proc Natl Acad Sci U S A* 2003, **100**:8676-8681.
14. Byrdin M, Villette S, Espagne A, Eker APM, Brettel K: **Polarized Transient Absorption To Resolve Electron Transfer between Tryptophans in DNA Photolyase.** *J. Phys. Chem. B* 2008, **112**:6866-6871.
15. Lukacs A, Eker APM, Byrdin M, Brettel K, Vos MH: **Electron Hopping through the 15 Å Triple Tryptophan Molecular Wire in DNA Photolyase Occurs within 30 ps.** *J. Am. Chem. Soc.* 2008, **130**:14394-14395.
16. Byrdin M, Lukacs A, Thiagarajan V, Eker APM, Brettel K, Vos MH: **Quantum Yield Measurements of Short-Lived Photoactivation Intermediates in DNA Photolyase: Toward a Detailed Understanding of the Triple Tryptophan Electron Transfer Chain** *The Journal of Physical Chemistry A* 2010, **114**:3207-3214.
17. Balland V, Byrdin M, Eker APM, Ahmad M, Brettel K: **What Makes the Difference between a Cryptochrome and DNA Photolyase? A Spectroelectrochemical Comparison of the Flavin Redox Transitions.** *Journal of the American Chemical Society* 2009, **131**:426-427.

18. Byrdin M, Sartor V, Eker APM, Vos MH, Aubert C, Brettel K, Mathis P: **Intraprotein electron transfer and proton dynamics during photoactivation of DNA photolyase from E. coli: review and new insights from an "inverse" deuterium isotope effect.** *Biochim Biophys Acta* 2004, **1655**:64-70.
19. Byrdin M, Villette S, Eker APM, Brettel K: **Observation of an Intermediate Tryptophanyl Radical in W306F Mutant DNA Photolyase from Escherichia coli Supports Electron Hopping along the Triple Tryptophan Chain.** *Biochemistry* 2007, **46**:10072-10077.
20. Lukacs A, Eker APM, Byrdin M, Villette S, Pan J, Brettel K, Vos MH: **Role of the Middle Residue in the Triple Tryptophan Electron Transfer Chain of DNA Photolyase: Ultrafast Spectroscopy of a Trp->Phe Mutant.** *J. Phys. Chem. B* 2006, **110**:15654-15658.
21. Pan J, Byrdin M, Aubert C, Eker APM, Brettel K, Vos MH: **Excited-State Properties of Flavin Radicals in Flavoproteins: Femtosecond Spectroscopy of DNA Photolyase, Glucose Oxidase, and Flavodoxin.** *J. Phys. Chem. B* 2004, **108**:10160-10167.
22. Christie MI, Norrish RGW, Porter G: **The Recombination Of Atoms .1. Iodine Atoms In The Rare Gases.** *Proceedings Of The Royal Society Of London Series A- Mathematical And Physical Sciences* 1953, **216**:152-165.
23. Norrish RGW, Porter G: **Chemical Reactions Produced By Very High Light Intensities.** *Nature* 1949, **164**:658-658.
24. Rentzepis PM: **Direct measurements of radiationless transitions in liquids.** *Chemical Physics Letters* 1968, **2**:117-120.
25. Topp MR, Rentzepis PM, Jones RP: **Time-Resolved Absorption Spectroscopy In 10<sup>-12</sup>-Sec Range.** *Journal Of Applied Physics* 1971, **42**:3415-3419.
26. Zewail AH: **Femtochemistry: Recent progress in studies of dynamics and control of reactions and their transition states.** *The Journal of Physical Chemistry* 1996, **100**:12701-12724.
27. Byrdin M, Thiagarajan V, Villette S, Espagne A, Brettel K: **Use of ruthenium dyes for subnanosecond detector fidelity testing in real time transient absorption.** *Review of Scientific Instruments* 2009, **80**:043102.
28. Mees A, Klar T, Gnau P, Hennecke U, Eker APM, Carell T, Essen LO: **Crystal structure of a photolyase bound to a CPD-like DNA lesion after in situ repair.** *Science* 2004, **306**:1789-1793.
29. Vande Berg BJ, Sancar GB: **Evidence for dinucleotide flipping by DNA photolyase.** *J Biol Chem* 1998, **273**:20276-20284.
30. Jordan SP, Alderfer JL, Chanderkar LP, Jorns MS: **Reaction of Escherichia coli and yeast photolyases with homogeneous short-chain oligonucleotide substrates.** *Biochemistry* 1989, **28**:8149-8153.
31. MacFarlane AW, Stanley RJ: **Cis-Syn Thymidine Dimer Repair by DNA Photolyase in Real Time.** *Biochemistry* 2003, **42**:8558-8568.
32. Kao YT, Saxena C, Wang L, Sancar A, Zhong D: **Direct observation of thymine dimer repair in DNA by photolyase.** *Proc Natl Acad Sci U S A* 2005, **102**:16128-16132.
33. Kim ST, Heelis PF, Sancar A: **Energy transfer (deazaflavin-->FADH2) and electron transfer (FADH2-->T <-> T) kinetics in Anacystis nidulans photolyase.** *Biochemistry* 1992, **31**:11244-11248.
34. Espagne A, Byrdin M, Eker APM, Brettel K: **Very Fast Product Release and Catalytic Turnover of DNA Photolyase.** *ChemBioChem* 2009, **10**:1777-1780.
35. Thiagarajan V, Villette S, Espagne A, Eker APM, Brettel K, Byrdin M: **DNA Repair by Photolyase: A Novel Substrate with Low Background Absorption around 265 nm for Transient Absorption Studies in the UV.** *Biochemistry* 2010, **49**:297-303.

36. Chatgililoglu C, Guerra M, Kaloudis P, Houee-Levin C, Marignier JL, Swaminathan VN, Carell T: **Ring opening of the cyclobutane in a thymine dimer radical anion.** *Chemistry-A European Journal* 2007, **13**:8979-8984.
37. Masson F, Laino T, Rothlisberger U, Hutter J: **A QM/MM Investigation of Thymine Dimer Radical Anion Splitting Catalyzed by DNA Photolyase.** *ChemPhysChem* 2009, **10**:400-410.
38. Zeldovich KB, Chen P, Shakhnovich EI: **Protein stability imposes limits on organism complexity and speed of molecular evolution.** *Proc Natl Acad Sci U S A* 2007, **104**:16152-16157.
39. Tokuriki N, Tawfik DS: **Stability effects of mutations and protein evolvability.** *Current Opinion in Structural Biology* 2009, **19**:596-604.
40. Arrhenius S: **Über die Reaktionsgeschwindigkeit bei der Inversion von Rohrzucker durch Säuren.** *Zeit. Phys. Chem (Leipzig)* 1889, **4**:226-248.
41. Eyring H: **The Activated Complex in Chemical Reactions.** *The Journal of Chemical Physics* 1935, **3**:107-115.
42. Kramers HA: **Brownian motion in a field of force and the diffusion model of chemical reactions.** *Physica A: Statistical and Theoretical Physics (Amsterdam)* 1940, **7**:284-304.
43. Grote RF, Hynes JT: **The Stable States Picture of Chemical-Reactions .2. Rate Constants for Condensed and Gas-Phase Reaction Models.** *Journal of Chemical Physics* 1980, **73**:2715-2732.
44. Hänggi P, Talkner P, Borkovec M: **Reaction-rate theory: fifty years after Kramers.** *Reviews of Modern Physics* 1990, **62**:251.
45. Olsson MHM, Parson WW, Warshel A: **Dynamical Contributions to Enzyme Catalysis: Critical Tests of A Popular Hypothesis.** *Chem. Rev.* 2006, **106**:1737-1756.
46. Hynes JT: **Autobiography of James T. (Casey) Hynes.** *The Journal of Physical Chemistry B* 2008, **112**:191-194.
47. Zhou H-X, McCammon JA: **The gates of ion channels and enzymes.** *Trends in Biochemical Sciences* 2010, **35**:179-185.
48. Hilser VJ, Thompson EB: **Intrinsic disorder as a mechanism to optimize allosteric coupling in proteins.** *Proceedings of the National Academy of Sciences of the United States of America* 2007, **104**:8311-8315.
49. Hay S, Johannissen LO, Sutcliffe MJ, Scrutton NS: **Barrier Compression and Its Contribution to Both Classical and Quantum Mechanical Aspects of Enzyme Catalysis.** 2010, **98**:121-128.
50. Wang HY, Lin S, Allen JP, Williams JC, Blankert S, Laser C, Woodbury NW: **Protein dynamics control the kinetics of initial electron transfer in photosynthesis.** *Science* 2007, **316**:747-750.
51. Beratan DN, Skourtis SS, Balabin IA, Balaeff A, Keinan S, Venkatramani R, Xiao D: **Steering Electrons on Moving Pathways.** *Accounts of Chemical Research* 2009, **42**:1669-1678.
52. Jackson CJ, Foo JL, Tokuriki N, Afriat L, Carr PD, Kim HK, Schenk G, Tawfik DS, Ollis DL: **Conformational sampling, catalysis, and evolution of the bacterial phosphotriesterase.** *Proceedings of the National Academy of Sciences of the United States of America* 2009, **106**:21631-21636.
53. Zhou H-X: **From Induced Fit to Conformational Selection: A Continuum of Binding Mechanism Controlled by the Timescale of Conformational Transitions.** *Biophysical Journal* 2010, **98**:L15-L17.

54. Pervushin K, Vamvaca K, Vogeli B, Hilvert D: **Structure and dynamics of a molten globular enzyme.** *Nat Struct Mol Biol* 2007, **14**:1202-1206.
55. Roca M, Messer B, Hilvert D, Warshel A: **On the relationship between folding and chemical landscapes in enzyme catalysis.** *Proceedings of the National Academy of Sciences of the United States of America* 2008, **105**:13877-13882.
56. Frauenfelder H, Sligar SG, Wolynes PG: **The energy landscapes and motions of proteins.** *Science* 1991, **254**:1598-1603.
57. Wolfenden R, Snider MJ: **The Depth of Chemical Time and the Power of Enzymes as Catalysts.** *Acc. Chem. Res.* 2001, **34**:938-945.
58. Schramm VL: **Enzymatic transition states and transition state analogues.** *Current Opinion in Structural Biology* 2005, **15**:604.
59. Min W, Xie XS, Bagchi B: **Two-Dimensional Reaction Free Energy Surfaces of Catalytic Reaction: Effects of Protein Conformational Dynamics on Enzyme Catalysis.** *The Journal of Physical Chemistry B* 2008, **112**:454-466.
60. Kauzmann W: **Some Factors in the Interpretation of Protein Denaturation.** *Advances in Protein Chemistry* 1959, **14**:1-63.
61. Rupley JA, Careri G: **Protein Hydration and Function.** In *Advances in Protein Chemistry*. Edited by C.B. Anfinsen FMR, John T. Edsall and David S. Eisenberg: Academic Press; 1991:37-172. vol 41.]
62. Kurkal V, Daniel RM, Finney JL, Tehei M, Dunn RV, Smith JC: **Enzyme activity and flexibility at very low hydration.** *Biophysical Journal* 2005, **89**:1282-1287.
63. Pérez J, Zanotti J-M, Durand D: **Evolution of the Internal Dynamics of Two Globular Proteins from Dry Powder to Solution.** 1999, **77**:454-469.
64. Frölich A, Gabel F, Jasnin M, Lehnert U, Oesterhelt D, Stadler AM, Tehei M, Weik M, Wood K, Zaccai G: **From shell to cell: neutron scattering studies of biological water dynamics and coupling to activity.** *Faraday Discussions* 2009, **141**:117-130.
65. Schenk A, Ivanchenko S, Rocker C, Wiedenmann JR, Nienhaus GU: **Photodynamics of red fluorescent proteins studied by fluorescence correlation spectroscopy.** *Biophysical Journal* 2004, **86**:384-394.
66. Fenimore PW, Frauenfelder H, McMahon BH, Parak FG: **Slaving: Solvent fluctuations dominate protein dynamics and functions.** *Proceedings of the National Academy of Sciences of the United States of America* 2002, **99**:16047-16051.
67. Beece D, Eisenstein L, Frauenfelder H, Good D, Marden MC, Reinisch L, Reynolds AH, Sorensen LB, Yue KT: **Solvent Viscosity and Protein Dynamics.** *Biochemistry* 1980, **19**:5147-5157.
68. Kleinert T, Doster W, Leyser H, Petry W, Schwarz V, Settles M: **Solvent composition and viscosity effects on the kinetics of CO binding to horse myoglobin.** *Biochemistry* 1998, **37**:717-733.
69. Khodadadi S, Roh JH, Kisliuk A, Mamontov E, Tyagi M, Woodson SA, Briber RM, Sokolov AP: **Dynamics of Biological Macromolecules: Not a Simple Slaving by Hydration Water.** *Biophysical Journal* 2010, **98**:1321-1326.
70. Ball P: **Water as an Active Constituent in Cell Biology.** *Chemical Reviews* 2007, **108**:74-108.
71. Atilgan C, Aykut AO, Atilgan AR: **How a Vicinal Layer of Solvent Modulates the Dynamics of Proteins.** *Biophys. J.* 2008, **94**:79-89.
72. Karplus PA, Faerman C: **Ordered Water in Macromolecular Structure.** *Current Opinion in Structural Biology* 1994, **4**:770-776.
73. Wood K, Plazanet M, Gabel F, Kessler B, Oesterhelt D, Tobias DJ, Zaccai G, Weik M: **Coupling of protein and hydration-water dynamics in biological membranes.** *Proceedings of the National Academy of Sciences* 2007, **104**:18049-18054.

74. Tielrooij KJ, Paparo D, Piatkowski L, Bakker HJ, Bonn M: **Dielectric Relaxation Dynamics of Water in Model Membranes Probed by Terahertz Spectroscopy.** 2009, **97**:2484-2492.
75. Laage D, Hynes JT: **Do more strongly hydrogen-bonded water molecules reorient more slowly ?** *Chemical Physics Letters* 2006, **433**:80-85.
76. Franks F: *Biophysics and Biochemistry at low temperatures.* Cambridge: Cambridge University Press; 1985.
77. Okan OB, Atilgan AR, Atilgan C: **Nanosecond Motions in Proteins Impose Bounds on the Timescale Distributions of Local Dynamics.** *Biophysical Journal* 2009, **97**:2080-2088.
78. Dias CL, Ala-Nissila T, Wong-ekkabut J, Vattulainen I, Grant M, Karttunen M: **The hydrophobic effect and its role in cold denaturation.** *Cryobiology* 2010, **60**:91-99.
79. Wowk B: **Thermodynamic aspects of vitrification.** *Cryobiology* 2010, **60**:11-22.
80. Douzou P: *Cryobiochemistry An Introduction:* Academic Press; 1977.
81. Henzler-Wildman KA, Lei M, Thai V, Kerns SJ, Karplus M, Kern D: **A hierarchy of timescales in protein dynamics is linked to enzyme catalysis.** *Nature* 2007, **450**:913.
82. Henzler-Wildman KA, Thai V, Lei M, Ott M, Wolf-Watz M, Fenn T, Pozharski E, Wilson MA, Petsko GA, Karplus M, et al.: **Intrinsic motions along an enzymatic reaction trajectory.** *Nature* 2007, **450**:838-844.
83. Callender R, Dyer RB: **Advances in Time-Resolved Approaches To Characterize the Dynamical Nature of Enzymatic Catalysis.** *Chem. Rev.* 2006, **106**:3031-3042.
84. Förster T: **Energiewanderung und Fluoreszenz.** *Die Naturwissenschaften* 1946, **6**:166-175.
85. Stryer L, Haugland RP: **Energy transfer: a spectroscopic ruler.** *Proceedings of the National Academy of Sciences of the United States of America* 1967, **58**:719-726.
86. Dale RE, Eisinger J, Blumberg WE: **The orientational freedom of molecular probes. The orientation factor in intramolecular energy transfer.** *Biophysical Journal* 1979, **26**:161-193.
87. Beljonne D, Curutchet C, Scholes GD, Silbey RJ: **Beyond Förster Resonance Energy Transfer in Biological and Nanoscale Systems.** *The Journal of Physical Chemistry B* 2009, **113**:6583-6599.
88. Singh H, Bagchi B: **Non-Förster distance and orientation dependence of energy transfer and applications of fluorescence resonance energy transfer to polymers and nanoparticles: How accurate is the spectroscopic ruler with  $1/R^6$  rule?** *Current Science* 2005, **89**:1710-1719.
89. Knox RS, van Amerongen H: **Refractive Index Dependence of the Forster Resonance Excitation Transfer Rate.** *The Journal of Physical Chemistry B* 2002, **106**:5289-5293.
90. Heilemann M, Margeat E, Kasper R, Sauer M, Tinnefeld P: **Carbocyanine dyes as efficient reversible single-molecule optical switch.** *Journal of the American Chemical Society* 2005, **127**:3801-3806.
91. Chung HS, Louis JM, Eaton WA: **Distinguishing between Protein Dynamics and Dye Photophysics in Single-Molecule FRET Experiments.** *Biophysical Journal* 2010, **98**:696-706.
92. Colletier JP, Bourgeois D, Sanson B, Fournier D, Sussman JL, Silman I, Weik M: **Shoot-and-Trap: Use of specific x-ray damage to study structural protein dynamics by temperature-control led cryo-crystallography.** *Proceedings of the National Academy of Sciences of the United States of America* 2008, **105**:11742-11747.

93. Bourgeois D, Weik M: **Kinetic protein crystallography: a tool to watch proteins in action.** *Crystallography Reviews* 2009, **15**:87-118.
94. Bourgeois D, Royant A: **Advances in kinetic protein crystallography.** *Current Opinion in Structural Biology* 2005, **15**:538-547.
95. Schotte F, Lim M, Jackson TA, Smirnov AV, Soman J, Olson JS, Phillips GN, Jr., Wulff M, Anfinrud PA: **Watching a Protein as it Functions with 150-ps Time-Resolved X-ray Crystallography.** Edited by; 2003:1944-1947. vol 300.]
96. Ihee H, Rajagopal S, Å rاجر V, Pahl R, Anderson S, Schmidt M, Schotte F, Anfinrud PA, Wulff M, Moffat K: **Visualizing reaction pathways in photoactive yellow protein from nanoseconds to seconds.** Edited by; 2005:7145-7150. vol 102.]
97. Knapp JE, Pahl R, Å rاجر V, Royer WE: **Allosteric action in real time: Time-resolved crystallographic studies of a cooperative dimeric hemoglobin.** Edited by; 2006:7649-7654. vol 103.]
98. Wöhri AB, Katona G, Johansson LC, Fritz E, Malmerberg E, Andersson M, Vincent J, Eklund M, Cammarata M, Wulff M, et al.: **Light-Induced Structural Changes in a Photosynthetic Reaction Center Caught by Laue Diffraction.** *Science* 2010, **328**:630-633.
99. Oleinikova A, Sasisanker P, Weingartner H: **What Can Really Be Learned from Dielectric Spectroscopy of Protein Solutions? A Case Study of Ribonuclease A.** *The Journal of Physical Chemistry B* 2004, **108**:8467-8474.
100. Nandi N, Bhattacharyya K, Bagchi B: **Dielectric Relaxation and Solvation Dynamics of Water in Complex Chemical and Biological Systems.** *Chemical Reviews* 2000, **100**:2013-2046.
101. Zaccai G: **How soft is a protein? A protein dynamics force constant measured by neutron scattering.** *Science* 2000, **288**:1604-1607.
102. Gabel F, Bicout D, Lehnert U, Tehei M, Weik M, Zaccai G: **Protein dynamics studied by neutron scattering.** *Quarterly Reviews of Biophysics* 2002, **35**:327-367.
103. Boehr DD, Dyson HJ, Wright PE: **An NMR Perspective on Enzyme Dynamics.** *Chemical Reviews* 2006, **106**:3055-3079.
104. Hausteiner E, Schwille P: **Fluorescence correlation spectroscopy: Novel variations of an established technique.** *Annual Review of Biophysics and Biomolecular Structure* 2007, **36**:151-169.
105. Loman A, Gregor I, Stutz C, Mund M, Enderlein J: **Measuring rotational diffusion of macromolecules by fluorescence correlation spectroscopy.** *Photochemical & Photobiological Sciences* 2010, **9**:627-636.
106. Ries J, Yu SR, Burkhardt M, Brand M, Schwille P: **Modular scanning FCS quantifies receptor-ligand interactions in living multicellular organisms.** *Nat Meth* 2009, **6**:643-645.
107. Schmittenmaier CA: **Exploring Dynamics in the Far-Infrared with Terahertz Spectroscopy.** *Chemical Reviews* 2004, **104**:1759-1780.
108. Born B, Havenith M: **Terahertz Dance of Proteins and Sugars with Water.** *Journal of Infrared, Millimeter and Terahertz Waves* 2009, **30**:1245-1254.
109. Garcia-Viloca M, Gao J, Karplus M, Truhlar DG: **How Enzymes Work: Analysis by Modern Rate Theory and Computer Simulations.** Edited by; 2004:186-195. vol 303.]
110. Warshel A, Levitt M: **Theoretical Studies of Enzymic Reactions - Dielectric, Electrostatic and Steric Stabilization of Carbonium-Ion in Reaction of Lysozyme.** *Journal of Molecular Biology* 1976, **103**:227-249.

111. Markwick PRL, Bouvignies G, Salmon L, McCammon JA, Nilges M, Blackledge M: **Toward a Unified Representation of Protein Structural Dynamics in Solution.** *Journal of the American Chemical Society* 2009, **131**:16968-16975.
112. Barducci A, Bonomi M, Parinello M: **Linking well-tempered Metadynamics simulations with Experiments.** *Biophysical Journal* 2010, **98**:L44-L46.
113. Zhuravlev PI, Materese CK, Papoian GA: **Deconstructing the Native State: Energy Landscapes, Function, and Dynamics of Globular Proteins.** *Journal of Physical Chemistry B* 2009, **113**:8800-8812.
114. Prada-Gracia D, Gomez-Gardenes J, Echenique P, Falo F: **Exploring the Free Energy Landscape: From Dynamics to Networks and Back.** *PLoS Comput Biol* 2009, **5**:e1000415.
115. Klipp E: **Timing matters.** *FEBS letters* 2009, **583**:4013-4018.
116. van Amerongen H, van Grondelle R: **Transient Absorption-Spectroscopy In Study Of Processes And Dynamics In Biology.** In *Biochemical Spectroscopy*. Edited by; 1995:201-226. Methods In Enzymology, vol 246.]
117. Pal SK, Peon J, Zewail AH: **Biological water at the protein surface: Dynamical solvation probed directly with femtosecond resolution.** *Proceedings of the National Academy of Sciences of the United States of America* 2002, **99**:1763-1768.
118. Pal SK, Zewail AH: **Dynamics of Water in Biological Recognition.** *Chemical Reviews* 2004, **104**:2099-2124.
119. Li TP, Hassanali AAP, Kao YT, Zhong DP, Singer SJ: **Hydration dynamics and time scales of coupled water-protein fluctuations.** *Journal Of The American Chemical Society* 2007, **129**:3376-3382.
120. Zhong D: **Hydration Dynamics and coupled water-protein fluctuations probed by intrinsic tryptophan.** In *Advances in chemical physics*. Edited by Rice SA: Wiley; 2009:83-149. vol 147.]
121. Zang C, Stevens JA, Link JJ, Guo L, Wang L, Zhong D: **Ultrafast Proteinquake Dynamics in Cytochrome c.** *Journal of the American Chemical Society* 2009, **131**:2846-2852.
122. Zhang L, Yang Y, Kao Y-T, Wang L, Zhong D: **Protein Hydration Dynamics and Molecular Mechanism of Coupled Water - Protein Fluctuations.** *Journal of the American Chemical Society* 2009, **131**:10677-10691.
123. Stevens JA, Link JJ, Kao Y-T, Zang C, Wang L, Zhong D: **Ultrafast Dynamics of Resonance Energy Transfer in Myoglobin: Probing Local Conformation Fluctuations.** *The Journal of Physical Chemistry B* 2010, **114**:1498-1505.
124. Chang CW, Kao YT, Li J, Tan C, Li TP, Saxena C, Liu ZY, Wang LJ, Sancar A, Zhong DP: **Ultrafast solvation dynamics at binding and active sites of photolyases.** *Proceedings of the National Academy of Sciences of the United States of America* 2010, **107**:2914-2919.
125. Abbyad P, Childs W, Shi X, Boxer SG: **Dynamic Stokes shift in green fluorescent protein variants.** *Proc Natl Acad Sci U S A* 2007, **104**:20189-20194.
126. Carey PR: **Spectroscopic Characterization of Distortion in Enzyme Complexes.** *Chem. Rev.* 2006, **106**:3043-3054.
127. Fang C, Frontiera RR, Tran R, Mathies RA: **Mapping GFP structure evolution during proton transfer with femtosecond Raman spectroscopy.** *Nature* 2009, **462**:200-204.
128. English BP, Min W, van Oijen AM, Lee KT, Luo G, Sun H, Cherayil BJ, Kou SC, Xie XS: **Ever-fluctuating single enzyme molecules: Michaelis-Menten equation revisited.** *Nat Chem Biol* 2006, **2**:87-94.



129. Pinaud F, Clarke S, Sittner A, Dahan M: **Probing cellular events, one quantum dot at a time.** *Nat Meth* 2010, **7**:275-285.
130. Ebbinghaus S, Dhar A, McDonald JD, Gruebele M: **Protein folding stability and dynamics imaged in a living cell.** *Nat Meth* 2010, **7**:319-323.
131. Engelkamp H, Hatzakis NS, Hofkens J, De Schryver FC, Nolte RJ, Rowan AE: **Do enzymes sleep and work?** *Chem Commun (Camb)* 2006:935-940.
132. Deniz AA, Mukhopadhyay S, Lemke EA: **Single-molecule biophysics: at the interface of biology, physics and chemistry.** Edited by; 2008:15-45. vol 5.]
133. Chalfie M: **GFP: Lighting Up Life (Nobel Lecture).** *Angewandte Chemie-International Edition* 2009, **48**:5603-5611.
134. Shimomura O: **Discovery of Green Fluorescent Protein (GFP) (Nobel Lecture).** *Angewandte Chemie-International Edition* 2009, **48**:5590-5602.
135. Tsien RY: **Constructing and Exploiting the Fluorescent Protein Paintbox (Nobel Lecture).** *Angewandte Chemie-International Edition* 2009, **48**:5612-5626.
136. Violot S, Carpentier P, Blanchoin L, Bourgeois D: **Reverse pH-Dependence of Chromophore Protonation Explains the Large Stokes Shift of the Red Fluorescent Protein mKeima.** *Journal of the American Chemical Society* 2009, **131**:1035610357.
137. Carpentier P, Violot S, Blanchoin L, Bourgeois D: **Structural basis for the phototoxicity of the fluorescent protein KillerRed.** *Febs Letters* 2009, **583**:2839-2842.
138. Lelimosin M, Adam V, Nienhaus GU, Bourgeois D, Field MJ: **Photoconversion of the Fluorescent Protein EosFP: A Hybrid Potential Simulation Study Reveals Intersystem Crossings.** *Journal of the American Chemical Society* 2009, **131**:16814-16823.
139. Adam V, Carpentier P, Violot S, Lelimosin M, Darnault C, Nienhaus GU, Bourgeois D: **Structural Basis of X-ray-Induced Transient Photobleaching in a Photoactivatable Green Fluorescent Protein.** *Journal of the American Chemical Society* 2009, **131**:18063-+.
140. Warshel A, Sharma PK, Kato M, Xiang Y, Liu H, Olsson MHM: **Electrostatic Basis for Enzyme Catalysis.** *Chem. Rev.* 2006.
141. Prakash MK, Marcus RA: **An interpretation of fluctuations in enzyme catalysis rate, spectral diffusion, and radiative component of lifetimes in terms of electric field fluctuations.** *Proceedings of the National Academy of Sciences of the United States of America* 2007, **104**:15982-15987.
142. Prakash MK, Marcus RA: **Dielectric Dispersion Interpretation of Single Enzyme Dynamic Disorder, Spectral Diffusion, and Radiative Fluorescence Lifetime** *The Journal of Physical Chemistry B* 2008, **112**:399-404.
143. Hentschel M, Kienberger R, Spielmann C, Reider GA, Milosevic N, Brabec T, Corkum P, Heinzmann U, Drescher M, Krausz F: **Attosecond metrology.** *Nature* 2001, **414**:509-513.
144. Hammes-Schiffer S, Benkovic SJ: **RELATING PROTEIN MOTION TO CATALYSIS.** *Annual Review of Biochemistry* 2006, **75**:519-541.
145. Dantus M, Zewail A: **Femtochemistry.** *Chemical Reviews* 2004, **104**:1717-1718.
146. Gill SC, von Hippel PH: **Calculation of protein extinction coefficients from amino acid sequence data.** *Analytical Biochemistry* 1989, **182**:319-326.
147. Lakowicz JR, Weber G: **Quenching of fluorescence by oxygen. Probe for structural fluctuations in macromolecules.** *Biochemistry* 1973, **12**:4161-4170.

148. Doose S, Neuweiler H, Sauer M: **Fluorescence Quenching by Photoinduced Electron Transfer: A Reporter for Conformational Dynamics of Macromolecules.** *ChemPhysChem* 2009, **10**:1389-1398.
149. Eftink MR, Ghiron CA: **Exposure of tryptophanyl residues and protein dynamics.** *Biochemistry* 1977, **16**:5546-5551.
150. Callis PR: **Molecular-Orbital Theory Of The 1lb And 1la States Of Indole.** *Journal Of Chemical Physics* 1991, **95**:4230-4240.
151. Callis PR: **L-1(a) and L-1(b) transitions of tryptophan: Applications of theory and experimental observations to fluorescence of proteins.** In *Fluorescence Spectroscopy*. Edited by; 1997:113-150. Methods In Enzymology, vol 278.]
152. Callis PR, Liu T: **Short range photoinduced electron transfer in proteins: QM-MM simulations of tryptophan and flavin fluorescence quenching in proteins.** *Chemical Physics* 2006, **326**:230.
153. Callis PR, Petrenko A, Muino PL, Tusell JR: **Ab Initio Prediction of Tryptophan Fluorescence Quenching by Protein Electric Field Enabled Electron Transfer.** *J. Phys. Chem. B* 2007, **111**:10335-10339.
154. Leonard J, Portuondo-Campa E, Cannizzo A, van Mourik F, van der Zwan G, Tittor J, Haacke S, Chergui M: **Functional electric field changes in photoactivated proteins revealed by ultrafast Stark spectroscopy of the Trp residues.** *Proceedings of the National Academy of Sciences of the United States of America* 2009, **106**:7718-7723.
155. Schenkl S, van Mourik F, Friedman N, Sheves M, Schlesinger R, Haacke S, Chergui M: **Insights into excited-state and isomerization dynamics of bacteriorhodopsin from ultrafast transient UV absorption.** *PNAS* 2006, **103**:4101-4106.
156. Schenkl S, van Mourik F, van der Zwan G, Haacke S, Chergui M: **Probing the Ultrafast Charge Translocation of Photoexcited Retinal in Bacteriorhodopsin.** *Science* 2005, **309**:917-920.
157. Tamada T, Kitadokoro K, Higuchi Y, Inaka K, Yasui A, deRuiter PE, Eker APM, Miki K: **Crystal structure of DNA photolyase from *Anacystis nidulans*.** *Nature Structural Biology* 1997, **4**:887-891.
158. McLeod NR, Brolich MA, Damiani MJ, O'Neill MA: **Distinct recognition loop dynamics in cryptochrome-DASH and photolyase revealed by limited proteolysis.** *Biochemical and Biophysical Research Communications* 2009, **385**:424-429.
159. Jorns MS, Wang BY, Jordan SP, Chanderkar LP: **Chromophore function and interaction in *Escherichia coli* DNA photolyase: reconstitution of the apoenzyme with pterin and/or flavin derivatives.** *Biochemistry* 1990, **29**:552-561.
160. MacFarlane AWt, Stanley RJ: **Evidence of powerful substrate electric fields in DNA photolyase: implications for thymidine dimer repair.** *Biochemistry* 2001, **40**:15203-15214.
161. Schelvis JPM, Ramsey M, Sokolova O, Tavares C, Cecala C, Connell K, Wagner S, Gindt YM: **Resonance Raman and UV-Vis Spectroscopic Characterization of FADH° in the Complex of Photolyase with UV-Damaged DNA.** *J. Phys. Chem. B* 2003, **107**:12352-12362.
162. Gaska R, Zhang J: **Deep-UV LEDs: physics, performance, and applications.** Edited by Jung-Chih C, Andrew SD, Chennupati J, David VT: SPIE; 2005:603706. vol 6037.]
163. Coureux P-D, Fan ZP, Stojanoff V, Genick UK: **Picometer-Scale Conformational Heterogeneity Separates Functional from Nonfunctional States of a Photoreceptor Protein.** 2008, **16**:863-872.
164. Royant A, Carpentier P, Ohana J, McGeehan J, Paetzold B, Noirclerc-Savoye M, Vernède X, Adam V, Bourgeois D: **Advances in spectroscopic methods for**

- biological crystals. 1. Fluorescence lifetime measurements.** *Journal of Applied Crystallography* 2007, **40**:1105-1112.
165. Carpentier P, Royant A, Ohanaa J, Bourgeois D: **Advances in spectroscopic methods for biological crystals. 2. Raman spectroscopy.** *Journal of Applied Crystallography* 2007, **40**:1113-1122.
166. Bourgeois D, Vernede X, Adam V, Fioravanti E, Ursby T: **A microspectrophotometer for UV-visible absorption and fluorescence studies of protein crystals.** *Journal of Applied Crystallography* 2002, **35**:319-326.
167. Durin G, Delaunay A, Darnault C, Heyes DJ, Royant A, Vernede X, Hunter CN, Weik M, Bourgeois D: **Simultaneous Measurements of Solvent Dynamics and Functional Kinetics in a Light-Activated Enzyme.** *Biophysical Journal* 2009, **96**:1902-1910.
168. Meyer B: *Low temperature spectroscopy.* New York: American Elsevier Publishing Company, Inc.; 1971.
169. Heilemann M, Dedecker P, Hofkens J, Sauer M: **Photoswitches: Key molecules for subdiffraction-resolution fluorescence imaging and molecular quantification.** *Laser & Photonics Reviews* 2009, **3**:180-202.
170. Shao L, Isaac B, Uzawa S, Agard DA, Sedat JW, Gustafsson MGL: **I5S: Wide-Field Light Microscopy with 100-nm-Scale Resolution in Three Dimensions.** *Biophys. J.* 2008, **94**:4971-4983.
171. Gustafsson MGL, Shao L, Carlton PM, Wang CJR, Golubovskaya IN, Cande WZ, Agard DA, Sedat JW: **Three-Dimensional Resolution Doubling in Wide-Field Fluorescence Microscopy by Structured Illumination.** *Biophys. J.* 2008, **94**:4957-4970.
172. Hell SW: **Microscopy and its focal switch.** *Nature Methods* 2009, **6**:24-32.
173. Westphal V, Kastrop L, Hell SW: **Lateral resolution of 28 nm ( $\lambda/25$ ) in far-field fluorescence microscopy.** *Applied Physics B-Lasers and Optics* 2003, **77**:377-380.
174. Hell SW: **Toward fluorescence nanoscopy.** *Nature Biotechnology* 2003, **21**:1347-1355.

## Abbreviations

ANR	Agence Nationale de Recherche
CEA	Commissariat à l'Energie Atomique et Energies Alternatives
CNRS	Centre National de la Recherche Scientifique
CPD	Cyclobutane Pyrimidine Dimer
DNA	Desoxyribo Nucleic Acid
$\Delta A$	Absorbance change
ESRF	European Synchrotron Radiation Facility
FADH-	Flavin Adenine Dinucleotide (reduced anion)
FADH <sup>°</sup>	Flavin Adenine Dinucleotide (neutral radical, one electron less)
FCS	Fluorescence Correlation Spectroscopy
FP	Fluorescent Protein
FRET	Förster Resonance Energy Transfer
FSR	Femtosecond Stimulated Raman
GFP	Green Fluorescent Protein
IBS	Institut de Biologie Structurale
LBM	Laboratoire de Biophysique Moléculaire
LOB	Laboratoire d'Optique et Bioscience
PCS	Photon Correlation Spectroscopy
PM	Photo Multiplier
SB2SM	Service de Bioénergétique, Biologie Structurale et Mécanismes
SM	Single Molecule
Trp	Tryptophan
UV	Ultra Violet
WT	Wild Type