



HAL
open science

Stratégie de lutte contre les catastrophes pétrolières et risque environnemental associé: évaluation de la toxicité d'un dispersant en milieu côtier chez *Liza* sp

Thomas Milinkovitch

► To cite this version:

Thomas Milinkovitch. Stratégie de lutte contre les catastrophes pétrolières et risque environnemental associé: évaluation de la toxicité d'un dispersant en milieu côtier chez *Liza* sp. Sciences agricoles. Université de La Rochelle, 2011. Français. NNT: 2011LAROS322 . tel-00589750

HAL Id: tel-00589750

<https://theses.hal.science/tel-00589750v1>

Submitted on 1 May 2011

HAL is a multi-disciplinary open access archive for the deposit and dissemination of scientific research documents, whether they are published or not. The documents may come from teaching and research institutions in France or abroad, or from public or private research centers.

L'archive ouverte pluridisciplinaire **HAL**, est destinée au dépôt et à la diffusion de documents scientifiques de niveau recherche, publiés ou non, émanant des établissements d'enseignement et de recherche français ou étrangers, des laboratoires publics ou privés.

UNIVERSITÉ DE LA ROCHELLE
ÉCOLE DOCTORALE DE LA ROCHELLE
UMR6250 LITTORAL, ENVIRONNEMENT ET SOCIÉTÉS

STRATÉGIE DE LUTTE CONTRE LES CATASTROPHES PETROLIÈRES
ET RISQUE ENVIRONNEMENTAL ASSOCIÉ : ÉVALUATION DE LA
TOXICITÉ D'UN DISPERSANT EN MILIEU CÔTIER CHEZ *LIZA SP*

THÈSE DE DOCTORAT

Soutenue le 21 janvier 2011

Pour l'obtention du grade de docteur de l'université de La Rochelle

Discipline : Océanologie biologique et environnement marin

Par

Thomas Milinkovitch

Composition du jury :

Thierry Caquet , Directeur de recherche, INRA, Rennes	Rapporteur
Michel Warnau , Directeur de recherche, IAEA, Vienne	Rapporteur
Paco Bustamante , Professeur, UMR6250 LIENSs, La Rochelle	Examineur
Eric Feunteun , Professeur, MNHN, Dinard	Examineur
Véronique Loizeau , Chargée de recherche, Ifremer, Plouzané	Examineur
Lionel Camus , Professeur associé, Polar Environmental Center, Tromsø	Examineur
Stéphane Le Floch , Service Recherche & Développement, Cedre, Brest	Examineur
Hélène Thomas-Guyon , Maître de Conférences, UMR6250 LIENSs, La Rochelle	Directeur de thèse

Cette thèse a été financée par le Conseil Général de Charente-Maritime sous forme d'une
allocation de recherche doctorale

Remerciements

Je tiens tout d'abord à remercier les membres du Jury qui ont accepté de juger ce travail : Monsieur Thierry Caquet et Monsieur Michel Warnau pour avoir accepté d'être rapporteur.

Madame Véronique Loizeau, Madame Hélène Thomas-Guyon, Monsieur Paco Bustamante, Monsieur Eric Feunteun, Monsieur Lionel Camus et Monsieur Stéphane Le Floch pour avoir accepté de juger ce travail en tant qu'examinateur. Pour leur accueil durant cette thèse, j'exprime également ma gratitude envers le Cedre et l'UMR LIENSs 6250 et à leur directeur respectif Gilbert Le Lann et Sylvain Lamare. Mes remerciements s'adressent également à Hélène Thomas-Guyon pour la direction de cette thèse et surtout pour avoir été un véritable moteur « avec le sourire et le rire » pendant toute cette période. Mes remerciements vont également à Stéphane Le Floch au Cedre pour m'avoir toujours aidé pendant cette année et demi au Cedre. Merci à toi pour l'encadrement de la partie chimie, les dissections où tu étais désigné à l'improviste, les passages le week-end au labo et bien sur ton humour et ton attitude positive. Merci également à Nathalie Imbert pour m'avoir encadré sur cette matière si intéressante qu'est la cardiologie, merci également pour ton aide sur cette fin de thèse.

Je souhaite également remercier Christel Lefrançois. Merci à toi pour beaucoup : tes innombrables conseils scientifique et aide au sein de cette thèse mais aussi pour ton amitié, pour m'avoir logé quand on était en galère entre deux apparts, pour les soirées sur La Rochelle (d'ailleurs je te dois toujours 1743 verres) et j'en passe ! Je remercie également les stagiaires et maintenant amis qui m'ont aidé dans cette thèse : Morgane, Julie et Joachim. De manière exhaustive, à tous les amis de Lyon (Tchoïb, Ofl, Momo, Marion, Damien, Ben, Dim, Rouky, Zip), de Brest (Gilles et Caro, MAAxime, Marie, Claire et Sylvain), de La Rochelle comme Matéo, Julie et Joachim (pour ces innombrables soirées dont on ne se souvient plus !), aux ritales Marcella, Serena, Tarek (un peu ritale) et Fabrizio (dit Teletubbies bleu). Mes remerciements vont également à tous ceux avec qui j'ai partagé le quotidien à l'ILE (Fred, Chalumette, Camille, Julien, Jeremy, Andrea, Marion, Pascaline, Aurore, Ricard, Luc et les autres). Bien sur ! Bien sur ! Merci à ma Super poulette pour m'avoir aidé, supporté, avoir écouté mes plaintes et toujours être là malgré ça. Je vais maintenant prendre le temps de te rendre tout ça (oui, en jus d'orange pressé si tu veux !).

Enfin mes plus vifs remerciements vont à mes parents et mon frère pour leur soutien et pour m'avoir toujours encouragé dans ces études en m'offrant toutes les opportunités possibles. Merci à vous!

SOMMAIRE

SOMMAIRE.....	3
LISTE DES ABREVIATIONS	5
AVANT PROPOS	9
INTRODUCTION GENERALE.....	15
1. Contexte sociétal	17
2. Contexte scientifique.....	26
3. Approche écotoxicologique expérimentale.....	34
CHAPITRE 1 - TOXICITE LETALE AIGUE ET PHENOMENE DE BIOACCUMULATION DES HAP	45
1. Introduction	48
2. Materials and methods	51
3. Results	58
4. Discussion	63
5. Conclusion.....	67
Synthèse du Chapitre 1	69
CHAPITRE 2 - EFFETS SUBLETAUX D'UNE NAPPE DE PETROLE DISPERSEE SUR LES PERFORMANCES DE NAGE ET LA CAPACITE METABOLIQUE AEROBIE.....	71
1. Introduction	74
2. Material and Methods.....	76
3. Results	84
4. Discussion	89
5. Conclusion.....	92
Synthèse du Chapitre 2	93

CHAPITRE 3 - EFFETS SUBLETAUX D'UNE NAPPE DE PETROLE DISPERSEE : APPROCHE MULTIMARQUEUR SUR DEUX ORGANES CIBLES (LE FOIE ET LES BRANCHIES).....95

CHAPITRE 3 - 1^{ÈRE} PARTIE : UNE APPROCHE MULTIMARQUEUR AUX NIVEAUX HEPATIQUE ET PLASMATIQUE..... 97

1.	Introduction	100
2.	Materials and methods	102
3.	Results	108
4.	Discussion	115
5.	Conclusion.....	121

CHAPITRE 3 - 2^{ÈME} PARTIE : UNE APPROCHE MULTIMARQUEUR AU NIVEAU BRANCHIAL..... 123

1.	Introduction	126
2.	Materials and methods	128
3.	Results	133
4.	Discussion	138
5.	Conclusion.....	142

Synthèse du Chapitre 3

DISCUSSION GENERALE 147

1.	Synthèse des résultats.....	150
2.	Conclusion et perspectives	164

BIBLIOGRAPHIE..... 169

ANNEXE - EXPOSITION A DES SEDIMENTS CONTAMINES PAR UNE NAPPE DE PETROLE DISPERSEE : VALIDATION D'UNE APPROCHE EXPERIMENTALE 189

1.	Introduction	192
2.	Materials and methods	194
3.	Results	200
4.	Discussion	202

LISTE DES ABREVIATIONS

- ACH 50** : haemolytic activity of the alternative complement pathway
- AchE** : acetylcholine esterase
- ADN** : acide desoxyribonucléique
- AhR** : aryl hydrocarbon receptor
- AMS** : aerobic metabolic scope
- AMR** : active metabolic rate
- AMSA** : australian maritime safety authority
- ANOVA** : analysis of variance
- ANSES** : Agence Nationale de Sécurité Sanitaire
- ANR** : agence national de la recherche
- API** : american petroleum institute
- ARN** : acide ribonucléique
- ARNT** : Aryl hydrocarbon receptor nuclear translocator
- BAF** : bioaccumulation factor
- BAL** : brut arabian light
- C** : control
- CAT** : catalase
- CCO** : cytochrome C oxydase
- CD** : chemical dispersion
- CEDRE** : centre de documentation et de recherche sur les pollutions accidentelles des eaux
- CEWAF** : chemical enhanced water accomodated fraction
- CG17** : conseil général de charentes maritimes
- CL₅₀** : concentration létale induisant la mort de 50% de la population
- CNRS** : centre national de la recherche
- CPER** : contrat plan état région
- Cyp1A1** : cytochrome P450 1A1
- D** : dispersant
- DC** : dispersion chimique
- DM** : dispersion mécanique
- DCM** : dichloromethane

DDAC : didecyldimethylammonium
DISCOBIOL : dispersant et techniques de luttres en milieu côtier : effets biologique et apports à la réglementation
DM : dispersion mécanique
DNA : desoxyribo nucleic acid
DTNB : 5,5'-dithiobis-(2-nitrobenzoic) acid
DW : dry weight
EGTA-Mg-GVB : ethylene glycol tetraacetic acid
EROD : ethoxyrésurufine-O-dééthylase
FF : fixed wavelengh fluorescence
FREDD : federation de recherche en développement durable
GC-MS : gaz chromatography-mass spectrometry
GSH : glutathione
(GSH+GSSG) : total glutathione
GSSG : oxidized glutathione
GST : glutathione-S-transferase
GPx : glutathione peroxidase
HAP : hydrocarbures aromatiques polycyclique
HC : hydrocarbure totaux
HSD : honestly significant difference
IFREMER : institut français de recherche pour l'exploitation de la mer
IMO : international maritime organization
ITOPF : international tanker owners pollution federation
LDH : lactate deshydrogenase
LIENSs : Littoral environnemental
LPO : lipid peroxydation
MD : mechanical dispersion
MDA : malondialdehyde
MFO : mixed-function oxidase
MO₂ : oxygen consumption
MSD : mass selective detector
n.c. : not calculated
n.d. : not detected
NADH : nicotinamide adénine dinucléotide

NADPH : nicotinamide adenine dinucleotide phosphate-oxidase
NEBA : net environmental benefits analysis
NETCEN : UK national environmental technology centre
NF.T. : norme française
nom. : nominal
NRC : US national research council
OD : optical density
ΣPAH : sum of PAH
P : polluted
PAH : polycyclic aromatic hydrocarbon
PDMS : polydimethylsiloxane
POLMAR : pollution maritime
PRECODD : programme ecotechnologies et développement durable
REACH : Registration, evaluation and authorisation of chemicals)
ROS : reactive oxygen species
RRC : red rabbit blood cell
SBSE : stir bar sorptive
SDS : sodium dodecyl sulfate
SMR : standard metabolic rate
SOD : superoxyde dismutase
TCA : trichloroacetic acid
TNB : thiobis-(2-nitrobenzoic) acid
TPH : total petroleum hydrocarbon
TR : treatment
UBO : université de bretagne occidentale
U_{crit} : critical swimming speed
ULR : université de La Rochelle
UMR : unité mixte de recherche
USEPA : united states environmental protection agency
UV : ultra violet
WAF : water accomodated fraction
WSF : water soluble fraction
XRE : xenobiotic regulatory element

AVANT PROPOS

Avant propos

Suite à la catastrophe de l'Amoco Cadiz en 1978, le gouvernement français a institué les plans POLMAR (POLution MARitime). Ces plans POLMAR (faisant actuellement partie des plans ORSEC, décret n° 2005-1157) constituent des plans d'intervention en cas de pollutions accidentelles des milieux marins. Ils permettent la mobilisation et la coordination des moyens de luttés au niveau national. Les deux principales techniques de luttés en mer décrites dans ces plans POLMAR sont (i) la récupération mécanique de la nappe de pétrole et (ii) la dispersion chimique de celle-ci par l'application de dispersants (produits à base tensioactive). Cette dernière méthode permet le transfert de la nappe de pétrole de la surface vers la colonne d'eau, sous forme de gouttelettes d'hydrocarbures. Ainsi, la dispersion chimique évite un échouage de la nappe sur le littoral mais augmente transitoirement le risque d'exposition des écosystèmes aquatiques côtiers aux hydrocarbures. Afin d'évaluer l'impact environnemental de cette technique de lutte en milieu côtier et, par là, de contribuer à sa réglementation, le projet DISCOBIOL (DISpersant et techniques de luttés en milieu CÔtier : effets BIOLogique et apports à la réglementation) a été mis en place. Ce projet, d'une durée de 3 ans, a répondu à une offre de l'agence nationale de la recherche (ANR) dans le cadre du PRogramme ECOTEchnologies et Développement Durable (PRECODD) et a impliqué les partenaires suivants : l'Université de Bretagne Occidentale (UBO), le Centre de Documentation et de Recherche sur les pollutions accidentelles des eaux (Cedre), l'Agence Nationale de Sécurité Sanitaire (Anses), L'Université de La Rochelle (ULR) et les groupes pétroliers Total et Innospech.

Ce projet se divisait en trois phases principales :

- (i) La première phase consistait en une caractérisation de la toxicité d'une nappe de pétrole dispersée dans la colonne d'eau.
- (ii) La deuxième phase permettait de transposer la problématique dans son contexte environnemental notamment en évaluant la toxicité d'une nappe de pétrole dispersée en interaction avec le sédiment.
- (iii) La troisième phase de ce projet consistait en la création d'un réseau d'experts sur la thématique des dispersants en zone côtière. Aux vues des résultats obtenus dans les deux premières phases, ce groupe de travail avait pour but de réglementer l'utilisation des

dispersants en zones côtières mais également d'harmoniser les politiques d'utilisation des dispersants à l'échelle européenne.

Cette thèse de doctorat, effectuée dans le cadre d'une convention tripartite entre le Cedre, l'Université de La Rochelle et le Conseil Général de Charentes Maritimes (CG17), intègre la première phase de ce programme de recherche puisqu'elle a pour but d'évaluer la toxicité de l'application de dispersant sur un organisme pélagique des écosystèmes aquatiques côtiers, le mullet (*Liza sp.*).

Ces travaux de recherche ont été financés par le CG 17, l'UMR6250 LIENSs et l'ANR PRECODD DISCOBIOL.

Les résultats de ces travaux de Doctorat ont fait l'objet d'articles scientifiques et de communications scientifiques présentées dans des congrès nationaux et internationaux sous forme de conférences et d'affiches:

Articles scientifiques

Liver antioxidant and plasmatic immune responses in juvenile golden grey mullet (*Liza aurata*) exposed to dispersed crude oil. **T. Milinkovitch**, A. Ndiaye, W. Sanchez, S. Le Floch, H. Thomas-Guyon. *Publié dans Aquatic Toxicology (if: 3,1)*

Acute lethal toxicity and bioaccumulation of polycyclic aromatic hydrocarbons following dispersed oil exposure. **T. Milinkovitch**, R. Kanan, H. Thomas-Guyon, S. Le Floch. *Publié dans Science of the total environment (if: 2,9)*

Toxicity of dispersant application: antioxidant response in gills of juvenile golden grey mullet (*Liza aurata*). **T. Milinkovitch**, J. Godefroy, H. Thomas-Guyon. *Accepté avec révision dans Environmental pollution (if: 3,4) et sous forme révisé*

Effect of dispersed crude oil exposure upon the metabolic scope in juvenile golden grey mullet (*Liza aurata*). **T. Milinkovitch**, J. Lucas, S. Le Floch, H. Thomas-Guyon, C. Lefrançois. *Soumis dans Ecotoxicology and environmental safety (if: 2,2)*

Exposure of golden grey mullets to mudflats contaminated with dispersed oil using intertidal mesocosms. M. Richard, **T. Milinkovitch**, M. Prineau, F. Caupos, J. Godefroy, H. Thomas-Guyon. *Soumis dans Environmental Pollution (if: 3,4)*

Présentation orales

Antioxidant responses in gill and liver of golden grey mullet (*Liza aurata*) following exposure to chemically dispersed crude oil. **T. Milinkovitch**, J. Godefroy, W. Sanchez and H. Thomas-Guyon. *Fish Biology Congress*, Barcelone, Espagne (2010).

Effects of a chemically dispersed crude oil upon the cardiovascular physiology, the metabolic scope and the innate immune function of Juvenile golden grey mullet (*Liza Aurata*). **T. Milinkovitch**, N. Imbert, C. Lefrançois and H. Thomas-Guyon. *Workshop ANR PRECODD Discobiol*, Brest, France (2010).

Discobiol Program: Investigation of Dispersant use in Coastal and Estuarine Waters. F-X. Merlin, S. Le Floch, J. Arzel, M. Théron, G. Claireaux, M. Dussauze, C. Quentel, **T. Milinkovitch**, H. Thomas-Guyon, T. Crowe, P. Lemaire, D. Desmichels. *Interspill Conference*, Marseille, France (2009)

In vivo effects of bioaccumulated polychlorinated biphenyl (PCBs) on immune function in common sole, *Solea solea* (Linné). **T. Milinkovitch**, V. Loizeau, D. Mazurais, E. Durieux, M. L. Bégout, H. Thomas-Guyon. *Congrès de l'Union des Océanographes de France*, La Rochelle, France (2009).

Présentation par affiche

Influence of contaminated mudflat with dispersed oil on the health of golden grey mullet (*Liza aurata*): Preliminary in mesocosm experiment. *Fish Biology Congress*, Barcelone, Espagne (2010). M. Richard, **T. Milinkovitch**, A. Luna-Acosta, J. Godefroy, F. Caupos, H. Thomas-Guyon.

Toxicological effects of Dispersed Crude Oil on Golden Grey Mullet (*Liza aurata*) innate immune function. *Society of Experimental Biology*, Glasgow, UK (2009). **T. Milinkovitch**, C. Quentel, W. Sanchez, S. LeFloch, and H. Thomas-Guyon.

Effects of dispersed crude oil upon the cardiovascular physiology and the metabolic scope of Juvenile Golden Mullet (*Liza Aurata*). *Society of Experimental Biology*, Glasgow, UK (2009). **T. Milinkovitch**, C. Le François, J. Lucas, H. Thomas Guyon, S. LeFloch and N. Imbert.

Fast start performance in golden grey mullet, *Liza aurata*, exposed to sub-lethal concentrations of dispersed oil. *Society of Experimental Biology*, Glasgow, UK (2009). C. Lefrançois, J. Lucas, **T. Milinkovitch**, S. Lefloch.

Bioavailability and Toxicological effects of Two Dispersant on Juvenile Golden Grey Mullet. *Primo*, Bordeaux, France (2009). **T. Milinkovitch**, H. Thomas-Guyon, M. Danion, A. Bado-Nilles, N. Imbert and S. LeFloch.

A New Experimental System to study Toxicological Effects of Dispersants and Dispersed Oil on Fish juvenile Species. *Society of Experimental Biology*, Marseille, France (2008). **T. Milinkovitch**, M. Danion, A. Bado-Nilles, H. Thomas-Guyon and S. LeFloch.

Le présent manuscrit est organisé suivant le modèle d'une thèse sur publication, à savoir, quatre articles constituant les trois principaux chapitres de la thèse et un autre article méthodologique présenté en annexe. Une introduction générale, des synthèses pour chaque chapitre et une discussion générale viendront consolider ce manuscrit.

INTRODUCTION GENERALE

Introduction générale

1. Contexte sociétal

1.1. Les catastrophes pétrolières : « Drill baby, drill »¹

La demande actuelle croissante en énergie a considérablement augmenté le flux des transports maritimes pétroliers ainsi que le développement de prospections en mer comme le confirme le slogan très controversé « Drill, baby, drill! » du politicien américain Michael Steele. En effet, l'énergie pétrolière reste la source d'énergie dominante (plus de 40% des énergies consommées en 2010). Cette « course à l'or noir » a entraîné, depuis les années soixante, de nombreux **accidents pétroliers**. Le premier accident couvert médiatiquement a été celui du pétrolier Torrey Canyon (1967) qui déversa 123 000 tonnes de pétrole brut qui souillèrent 180 km de côtes anglaises et françaises. De nombreuses catastrophes pétrolières s'en suivirent, issues à la fois du transport et de la prospection du pétrole. En 1978, l'Amoco Cadiz déversa 220 000 tonnes de pétrole au large des côtes françaises. La catastrophe pétrolière de l'Exxon Valdez (1989) aura certainement été l'une des plus grandes catastrophes environnementales du 20^{ème} siècle puisque sur les 180 000 tonnes de pétrole déversées en mer, 40 000 s'échouèrent sur 1 700 km de côtes en Alaska. Récemment, la plateforme Deep Water Horizon déversa entre 318 et 636 millions de tonnes de pétrole brut dans le golfe du Mexique atteignant les littoraux de 4 états américains (Louisiane, Mississippi, Alabama, Floride) sur plusieurs centaines de kilomètres de côtes.

Ces catastrophes pétrolières auront fortement marqué la conscience collective, et par là mobilisé les pouvoirs publics. En effet, de nombreuses organisations ont été mises en place afin de **répondre aux risques environnementaux représentés par les catastrophes pétrolières** : US National Research Council (NRC), International Maritime Organization (IMO), International Tanker Owners Pollution Federation (ITOPF), UK National Environmental Technology Centre (NETCEN), Australian Maritime Safety Authority (AMSA), Centre de Documentation et de REcherche sur les pollutions accidentelles des eaux (CEDRE). Ces organisations, outre leurs implications dans des programmes de recherche et

¹ to drill (*angl.*): forer

développement nationaux et internationaux, disposent de cellules d'intervention capables de répondre dans les délais les plus rapides aux déversements de pétrole en mer. Lors de ces opérations trois principales méthodes sont préconisées : la récupération mécanique du pétrole, la combustion de la nappe de pétrole (« *in situ burning* ») et la dispersion de la nappe de pétrole.

1.2. Méthodes d'intervention lors d'un déversement de pétrole en mer

Le naufrage du pétrolier Erika l'illustre : le **risque environnemental** est fortement augmenté lorsque la nappe de pétrole s'échoue en **zone côtière**. Si l'on compare aux autres marées noires, celle de l'Erika est caractérisée par une quantité de fioul déversée en mer relativement faible (18 000 tonnes) lorsqu'on l'a comparé à d'autres catastrophes pétrolières (Exxon Valdez, 180 000). En revanche, l'importante longueur de côtes souillées (400 km) par l'échouage de la nappe de pétrole, et la dégradation des habitats qui en a découlé a entraîné une véritable **catastrophe environnementale**.

En effet, une diminution de l'abondance ou même une disparition complète d'espèces intertidales de décapodes, gasteropodes, bivalves et/ou isopodes (Le Hir & Hily 2002) a pu être observée. Conjointement, l'échouage de la nappe de pétrole a entraîné la mort de plus de 80 000 oiseaux marins (Cadiou et al. 2004). Le naufrage de l'Erika a eu également des conséquences environnementales à long terme puisque les concentrations en hydrocarbures polycycliques aromatiques étaient encore élevées chez les bivalves filtreurs, 4 ans après le naufrage (Laubier et al. 2004).

Ainsi, considérant l'impact environnemental consécutif à l'échouage de la nappe de pétrole, trois méthodes d'intervention mises en œuvre en cas d'avarie pétrolière ont pour but d'éviter ce « scénario du pire ».

➤ La récupération mécanique

Une des méthodes la plus couramment employée est la **récupération mécanique** qui consiste à **confiner** la nappe à l'aide de barrages flottants tractés par des navires avant de la pomper. Cette technique est généralement retenue lorsque les **conditions d'agitation de la surface de la mer sont appropriées** (de 0 à 2 Beaufort) et pour un pétrole relativement visqueux, >500

Cst² (Merlin 2005). Lorsque les conditions d'agitation de la surface de la mer sont supérieures à 2 Beaufort le confinement de la nappe devient impossible du fait d'une dispersion naturelle de la nappe de pétrole.

➤ Le « *in situ burning* »

Une méthode alternative à la récupération mécanique, le « *in situ burning* », permet la **combustion** quasi-complète **de la nappe de pétrole**. Employée lors des catastrophes du Torrey Canyon et de l'Exxon Valdez, cette technique est néanmoins rarement utilisée, sa mise en œuvre se heurtant à de nombreux **facteurs limitants** : (i) la nappe de pétrole doit être d'une épaisseur minimum de 2 mm et d'une viscosité faible (<500 Cst) pour être enflammée (Faiferlick 1997), (ii) les conditions météorologiques doivent être appropriées (moins de 20 nœuds de vent, une houle inférieure à 1 mètre) pour permettre la combustion de la nappe (Faiferlick 1997), et (iii) une distance vis-à-vis des habitations est à respecter puisque 1 à 3% du pétrole brûlé forme un nuage composé de dioxyde d'azote, de dioxyde de soufre, de monoxyde de carbone, d'hydrocarbures aromatiques polycycliques et d'autres produits de combustion toxiques (Ferek & Kucklick 1997). De plus, comparée à la technique de récupération mécanique, l'importante toxicité des déchets de combustion (Gunderson et al. 1996; Cohen et al. 2001), impose aux cellules d'intervention de grandes précautions et une connaissance de la sensibilité des écosystèmes environnant. Ainsi cette technique **très controversée** reste **peu souvent employée**.

➤ L'application de dispersants

De manière moins anecdotique, l'application de dispersants sur la nappe de pétrole est une méthode d'intervention **couramment employée** (18% des catastrophes pétrolières mondiales, Chapman et al. 2007). Cette méthode est complémentaire de la récupération mécanique ; son efficacité étant optimale pour un état de la mer entre 2 et 4 Beaufort (Merlin 2005). Le **dispersant** est un solvant contenant des **surfactants** (*surface active agents*), molécules à propriété tensioactive. Le dispersant permet le transfert de la nappe de pétrole de la surface de la mer vers la colonne d'eau, sous forme de **gouttelettes d'hydrocarbures**. Judicieusement appliqué, les avantages environnementaux du dispersant sont nombreux. L'utilisation de

² Cst (centiStoke) : unité de viscosité cinématique

dispersant permet, en premier lieu, d'éliminer la nappe en surface et par là supprime le risque de mazoutage des oiseaux et mammifères marins ainsi que sa dérive vers la côte, et donc, la contamination des écosystèmes côtiers. De plus, la formation de gouttelettes d'hydrocarbures, en augmentant le ratio surface/volume, permet de potentialiser l'attaque microbienne et par là, la dégradation de ces hydrocarbures (Thiem 1994; Churchill et al. 1995; Swannell & Daniel 1999).

Ce phénomène de dispersion du pétrole et les **bénéfices environnementaux** qui en découlent sont essentiellement dus à la composition chimique des dispersants, à leur mode d'action ainsi qu'à leurs conditions d'utilisation

1.3. Composition chimique, mode d'action et limites d'utilisation des dispersants

➤ Composition chimique

La composition chimique des dispersants a évolué depuis les premiers dispersants extrêmement toxiques utilisés lors de la catastrophe du Torrey Canyon (Mulkins-Phillips & Stewart 1974). Les dispersants utilisés à l'heure actuelle sont concernés par le règlement REACH (Registration, evaluation and authorisation of chemicals). Ces dispersants dits « de troisième génération » ou « concentrés » sont composés de **mélange de surfactants dans des solvants** (glycols et/ou éthers de glycol) miscibles à l'eau. Les surfactants, composés actifs, comportent une partie lipophile et une partie hydrophile. La balance hydrophile-lipophile (Becher 1957; Fiocco & Lewis 1999) est fréquemment utilisée pour déterminer la solubilité des dispersants dans l'eau et dans le pétrole. Les dispersants les plus efficaces sont ceux dont la balance hydrophile-lipophile est équilibrée (Fiocco & Lewis 1999). Ainsi, judicieusement épanchés à l'interface eau de mer/pétrole, ils entraîneront une diminution de la tension de surface pétrole – eau favorisant ainsi la solubilisation de la phase hydrophobe : ils augmentent ainsi la **stabilité des gouttelettes de pétrole en suspension dans la colonne d'eau** limitant ainsi les processus de coalescence du pétrole en surface.

➤ Mode d'action des dispersants

Les différentes étapes du mode d'action des dispersants sur une nappe de pétrole sont détaillées en **Figure 1**. Les dispersants (surfactants + solvants) sont généralement appliqués sur la nappe de pétrole **(a)** en pluie de fine gouttelettes (0,4 -1 mm, Fiocco & Lewis 1999), en respectant un ratio pétrole/dispersant de 1/20. **(b)** Les solvants vont diffuser dans la nappe de pétrole pour délivrer les surfactants. Les surfactants peuvent alors se positionner à l'interface pétrole-eau. **(c)** Sur leur partie lipophile, les molécules de surfactants entrent en contact avec le pétrole et sur leur partie hydrophile avec l'eau de mer. **(d)** Des micelles, d'une taille inférieure à 100 µm de diamètre, sont alors formées. Elles sont composées d'une gouttelette d'hydrocarbure entourée de molécules de surfactants.

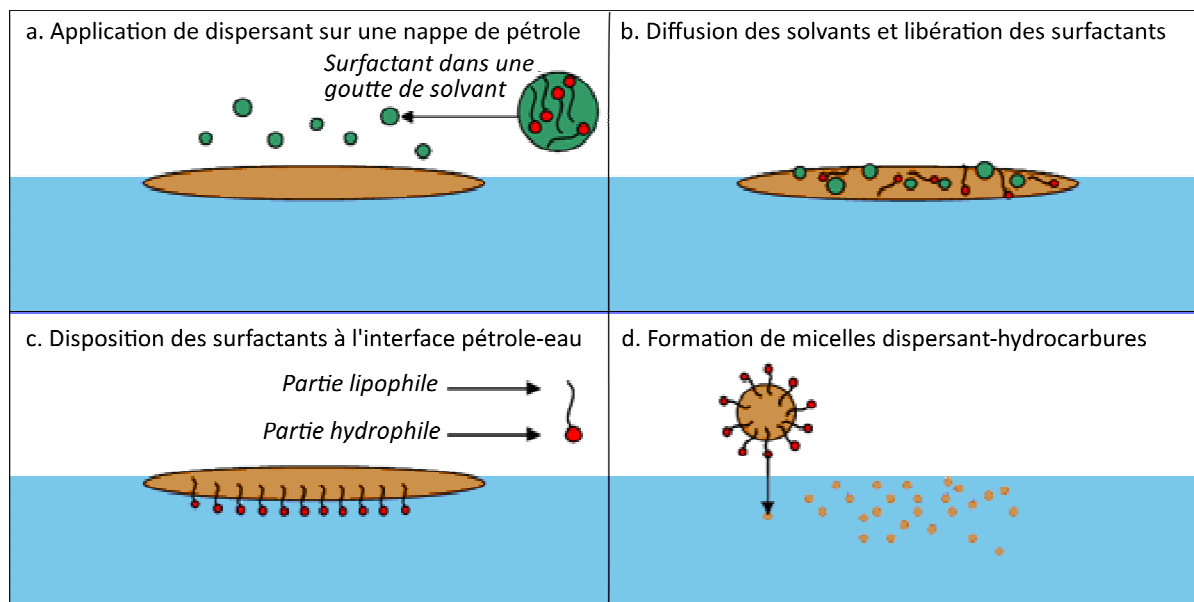

Figure 1. Mode d'action des dispersants, modifié d'après Fiocco (1995).

Lors de catastrophes en pleine mer (taille de la colonne d'eau importante), ces micelles seront rapidement diluées dans toute la colonne d'eau sous l'influence des courants et les **concentrations en hydrocarbures diminueront rapidement, limitant ainsi l'impact environnemental**. Cette vitesse de dilution a été observée (**Figure 2**) au travers des résultats obtenus par Lewis and Daling (2001).

De part leur mode d'action, l'application des dispersants semble donc permettre de transférer les hydrocarbures dans la colonne d'eau. Cependant, l'efficacité de cette méthode dépend de

la nature et du site de la catastrophe pétrolière : seules certaines conditions d'utilisation sont appropriées.

➤ Limites d'utilisation des dispersants

Lors d'une catastrophe pétrolière, les équipes d'intervention devront considérer plusieurs facteurs avant de tenter une dispersion de la nappe de pétrole, notamment la **viscosité** du pétrole déversé et les **conditions météorologiques** sur le site du déversement.

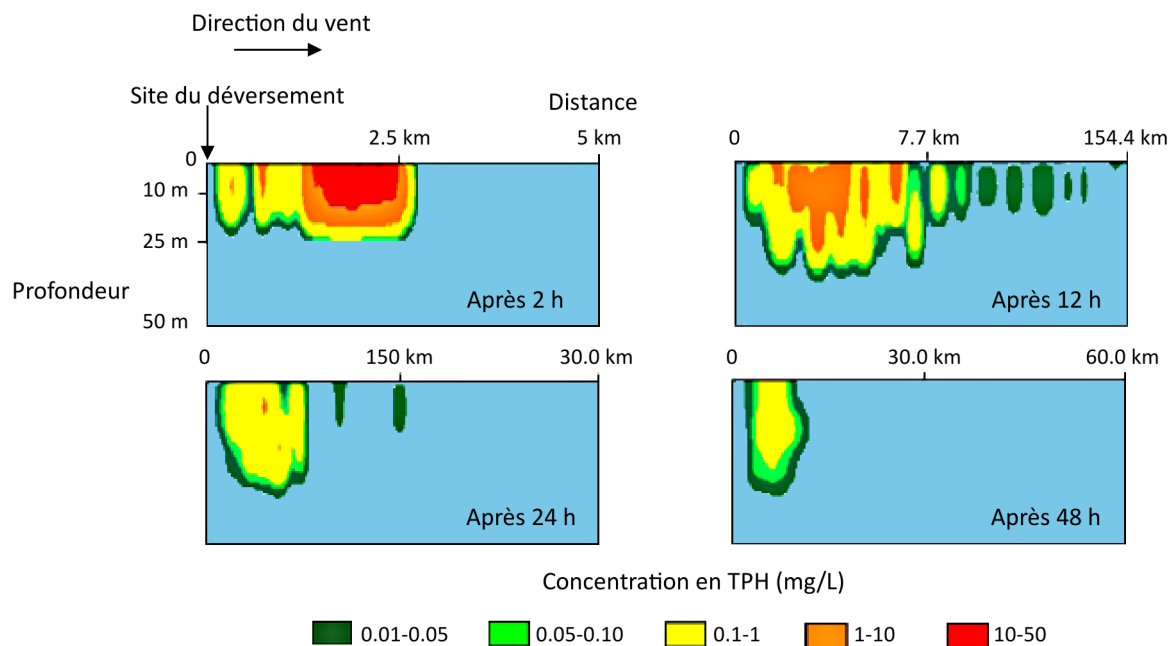

Figure 2. Vue en section verticale de la dilution d'une nappe de pétrole (100 m^3) dans la colonne d'eau après traitement par des dispersants (vent = 10m/s). Observation après 2 h, 12 h, 24 h et 48 h. Modifié d'après Lewis & Daling (2001).

La viscosité du pétrole est un des premiers facteurs à prendre en compte puisque elle régit le phénomène de dispersion. En effet, **l'efficacité d'un dispersant va être inversement corrélée à la viscosité du pétrole** : les polluants visqueux (supérieur à 5000 cSt) seront très difficilement dispersés alors que les polluants d'une viscosité inférieure à 500 cSt seront dispersés très facilement (Merlin 2005). Ainsi, lors de la catastrophe de l'Erika, la viscosité importante du pétrole empêchait la dispersion. Dans le cas d'un pétrole faiblement visqueux, la dispersion doit se faire dès les premiers jours post-catastrophe. En effet la viscosité du pétrole augmente lorsque celui-ci vieillit en mer. Ce phénomène de vieillissement est essentiellement dû à la perte par volatilisation/photo-dégradation des composés légers (Huang

et al. 2004). Cette augmentation de viscosité par vieillissement va ainsi définir un créneau de temps appelé « fenêtre de dispersibilité » pendant lequel la nappe est dispersible.

Outre leurs effets sur la viscosité du pétrole, les conditions météorologiques peuvent également directement influencer la dispersion de la nappe puisqu'une **agitation minimum de la surface de la mer est nécessaire**. Lorsque les conditions météorologiques provoquent une agitation de la mer faible (de 0 à 2 Beaufort) la dispersion de la nappe de pétrole est impossible car le polluant reviendra inévitablement à la surface de l'eau (un brassage mécanique de la nappe peut être effectué artificiellement en utilisant des dispositifs spéciaux : lances incendies, chaînes tractées, etc...). A l'inverse, si les conditions météorologiques sont supérieures à 7 Beaufort, l'application de dispersant qu'elle soit par avion, hélicoptère ou bateau devient imprécise et donc inefficace.

Des conditions météorologiques appropriées semblent donc nécessaires à l'application des dispersants. Ces conditions météorologiques réunies, la décision de l'application de dispersant reste encore sous restriction législative et notamment dans les zones côtières. En effet, bien que le bénéfice environnemental de la dispersion d'une nappe de pétrole en haute mer soit consensuel (Bocard et al. 1987; Lessard & DeMarco 2000; Daling et al. 2002), **l'utilisation de dispersants sur les eaux littorales reste controversée**.

1.4. Utilisation des dispersants en milieu côtier : une problématique environnementale

L'épandage de dispersant sur une nappe de pétrole provoque la formation d'un « nuage » d'hydrocarbures dont la concentration, dans les 10 premiers mètres de la colonne d'eau, se situe à des valeurs maximum de 30 à 50 mg/L (**Figure 3**).

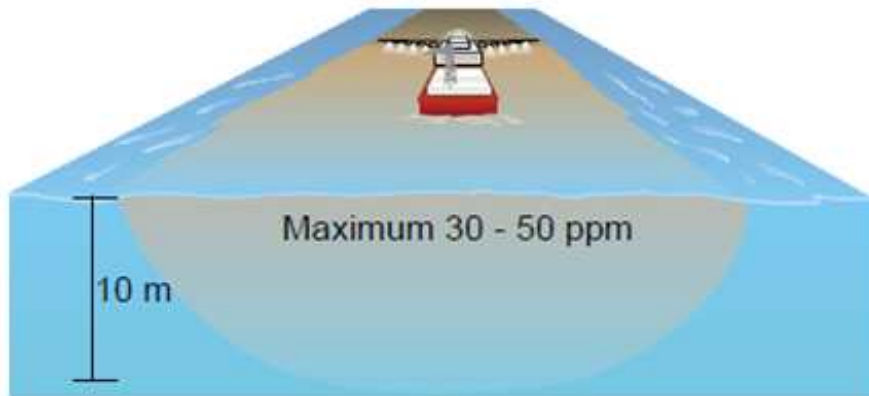

Figure 3. Schéma de la dilution d'une nappe de pétrole dans la colonne d'eau (ppm=mg/L) après épandage de dispersants par bateau, d'après Lewis & Daling (2001).

En **pleine mer**, la profondeur de la colonne d'eau, et par là le phénomène de **dilution-dissémination qui s'y produit**, permettent une diminution rapide (24 heures) de cette concentration vers des valeurs situées en dessous d'1 mg/L (décrit en 1.3.). En **milieu côtier**, la faible profondeur de la colonne d'eau **réduit ce phénomène de dilution-dissémination** augmentant ainsi le potentiel toxique d'une nappe de pétrole dispersée.

De plus, il apparaît que la **biodiversité des écosystèmes côtiers** est très forte, relativement aux écosystèmes hauturiers (Gray 1997). La dispersion d'une nappe de pétrole en zone côtière, contrairement à la dispersion en zone hauturière, est donc susceptible d'avoir des conséquences environnementales lourdes.

La prise en compte de ces risques environnementaux a donc imposé des **limites géographiques à l'utilisation des dispersants**. Ce cadre législatif permet à la fois de garantir des conditions de dilution des hydrocarbures suffisantes pour que les concentrations soient inoffensives, mais permet également une **protection des zones côtières** écologiquement sensibles. Ces limites sont définies, dans toute l'Europe, en fonction de la profondeur d'eau sur le site et en fonction de l'éloignement par rapport au littoral. En France il existe quatre zones d'utilisation des dispersants définies par le Cedre : trois zones de libre utilisation,

applicables à des pollutions d'ampleur croissante et une limite à l'intérieur de laquelle la dispersion est proscrite (**Figure 4**). Bien que chaque pays européen ait des réglementations différentes, il apparaît qu'aucune dispersion de la nappe de pétrole ne soit possible dans les zones littorales les plus proches du continent (Chapman et al. 2007).

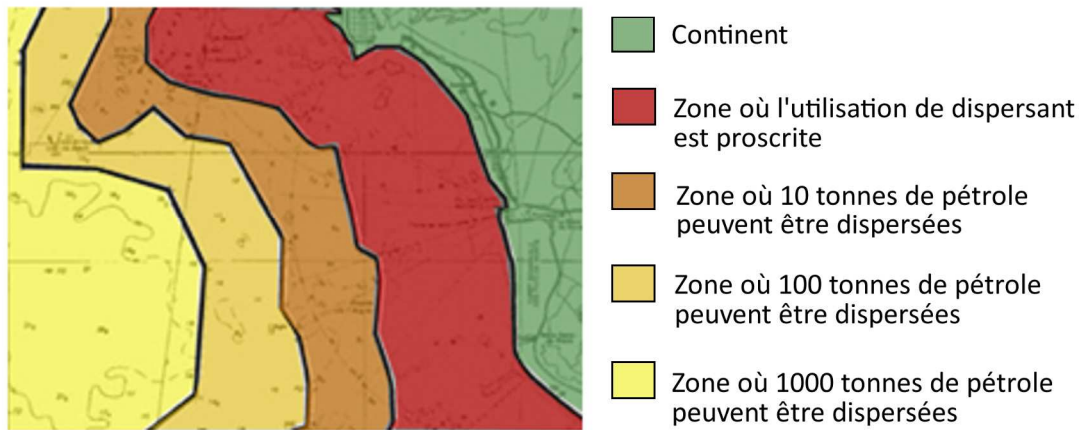

Figure 4. Limites géographiques d'utilisation des dispersants en zone côtière, 4 zones littorales sont définies : une zone entre 0 et 5 mètres de profondeur où l'utilisation de dispersant est proscrite; une zone entre 5 et 10 mètres de profondeur où la dispersion est interdite au dessus de 10 tonnes de pétrole déversé; une zone entre 10 et 15 mètres de profondeur où la dispersion est interdite au dessus de 100 tonnes de pétrole déversé; une zone au dessus de 15 mètres de profondeur où la dispersion est interdite au dessus de 1000 tonnes de pétrole déversé. Au dessus de ce tonnage la décision de l'utilisation de dispersant appartient au poste de commandement des pollutions maritimes (PC POLMAR). Figure modifiée d'après Merlin (2005).

Ainsi, contrairement à une dispersion de la nappe dans les zones hauturières, qui ne semble présenter que des avantages environnementaux (décrit en 1.2.), **la dispersion en zones côtières oppose risques à avantages environnementaux**, ce qui a conduit à la proscription de cette méthode dans les zones littorales proches, au titre du principe de précaution.

Cependant, conjointement au développement de nouvelles formules de dispersants biodégradables (test NF. T. 90-346) et de plus en plus efficaces (test NF. T. 90-345), des études ont montré un bénéfice environnemental positif à l'utilisation de dispersant dans certaines zones littorales comme la mangrove (Duke et al. 2000; Baca et al. 2005). De ce fait, il semble intéressant de **reconsidérer l'utilisation de cette technique en milieu côtier**. C'est dans ce cadre que le projet DISCOBIOL (DISpersant et techniques de luttés en milieu COtiers : effets BIOLogique et apports à la réglementation), soutenu par l'ANR PRECODD (PRogramme ECOtechnologies et Développement Durable), a été élaboré. Ce projet a pour but de fournir des informations sur l'impact environnemental consécutif à l'utilisation des dispersants en milieu côtier. Ce projet constitue un préalable indispensable à l'utilisation de dispersant comme stratégie d'intervention en zone côtière. Cette thèse a été réalisée au sein de

ce projet et visait à évaluer la toxicité d'une nappe de pétrole dispersée dans la frange côtière la plus proche du littoral (zone rouge en **figure 4**). Le modèle biologique retenu dans cette thèse est le mulot (*Liza sp.*), une espèce côtière considérée comme cible potentielle des pollutions de type anthropique (Bruslé 1981).

2. Contexte scientifique

2.1. Généralités

L'application de dispersants lors du naufrage du Torrey Canyon en 1967, a été l'origine d'une véritable catastrophe environnementale : tous les niveaux de l'écosystème ont été impactés depuis les communautés planctoniques jusqu'aux oiseaux marins (Smith 1968). La toxicité induite par ce moyen de lutte fut essentiellement due à la composition des dispersants utilisés, dont les solvants contenaient un dérivé du kérozène (Southward & Southward 1978; Power 1983; Cotou et al. 2001).

De nombreuses études furent alors conduites afin d'évaluer au mieux la toxicité des dispersants sur les communautés littoral tel que les échinidés ou les téléostéens (Crapp 1971b, a; Lönning & Hagström 1975a, b; Wilson 1976; Greenwood 1983). Ces études ne prenaient en compte que la toxicité intrinsèque du dispersant, c'est-à-dire la toxicité de la formulation chimique pure.

La recherche de nouvelles formules chimiques a permis de mettre sur le marché des dispersants significativement moins toxiques (Perkins et al. 1973), si bien qu'actuellement, un dispersant n'est utilisable que si sa toxicité intrinsèque est considérée comme nulle, i.e. comme dix fois inférieure à celle d'un toxique de référence (test d'homologation NF 90-349 réalisé pour des durées d'exposition courtes chez les invertébrés *Palaemonetes varians* ou *Crangon crangon*).

Cependant, bien que les dispersants utilisés à l'heure actuelle (dits de « troisième génération ») soient considérés comme non toxiques, l'écotoxicité du mélange pétrole-dispersant a été démontrée chez de nombreuses espèces aquatiques (Gulec et al. 1997; Long & Holdway 2002; Otitoloju 2005; Lin et al. 2009; Mendonça Duarte et al. 2010).

Ainsi, au-delà d'une étude écotoxicologique visant à déterminer la toxicité intrinsèque des dispersants, ce travail, s'est focalisé sur la toxicité de l'application de dispersants en milieu côtier, en **considérant l'interaction pétrole-dispersant**.

Cette toxicité est essentiellement due à la formation de gouttelettes de pétrole lors de la dispersion d'une nappe (décrit en 1.3.). En plus de la toxicité due à leur présence dans la colonne d'eau, la formation de gouttelettes augmente considérablement la surface d'échange pétrole-eau (le ratio surface/volume des gouttelettes étant supérieur à celui de la nappe). Par là ce phénomène accélère les processus de **diffusion des composés chimiques du pétrole au sein de la colonne d'eau** (Lessard & DeMarco 2000). Afin de mieux comprendre la toxicité d'une nappe de pétrole dispersée, il semble donc important dans un premier temps de définir la composition chimique d'un pétrole.

2.2. Composition chimique d'un pétrole

Bien que des composés oxygénés, azotés et sulfurés, ainsi que des traces de métaux lourds - majoritairement le vanadium et le nickel (Salar Amoli et al. 2006) - soient détectés dans le pétrole, trois familles d'hydrocarbures dominent : les hydrocarbures saturés, les composés polaires et les hydrocarbures aromatiques.

➤ Les hydrocarbures saturés

Ils peuvent être divisés en 3 groupes établis sur leur structure chimique :

- **les n-alcane**s sont les composés les plus abondants. Ils sont formés de chaînes linéaires de groupements méthyles (CH₃),
- **les alcanes ramifiés** sont composés de chaînes linéaires branchées de groupements méthyles,
- **les cycloalcanes** sont des composés cycliques essentiellement composés des cyclopentanes et des cyclohexanes.

Cette famille d'hydrocarbures est **très abondante** en particulier dans les pétroles bruts légers où elle peut représenter près de 60 % des hydrocarbures totaux. Cependant leur **hydrosolubilité** est **faible**.

➤ Les composés polaires

Les composés polaires représentent la fraction lourde des hydrocarbures. Ils sont essentiellement **composés de résines et d'asphaltènes**. Ces composés sont **peu abondants** dans les pétroles bruts légers mais leur proportion augmente dans les pétroles lourds (jusqu'à 25%).

➤ Les hydrocarbures aromatiques polycycliques (HAP)

Les hydrocarbures aromatiques polycycliques sont composés de 1 à 6 cycles aromatiques, les composés monocycliques (e.g. benzène) étant prédominant dans les pétroles légers. Les HAP légers sont considérés comme relativement **hydrosoluble** : par exemple le log Kow du naphthalène, *i.e.* sont coefficient de partage octanol eau est de 3,0 (Neff 1979). De ce fait, la **diffusion à l'interface pétrole-eau de mer de ces composés légers est importante**. De plus les HAP possèdent une haute affinité pour les particules solides ce qui les rend très présents dans les sédiments côtiers (Fowler et al. 1993). Enfin ces composés sont **considérés comme toxiques**, si bien que l'USEPA (United States Environmental Protection Agency) a défini une liste de 16 HAP prioritaires (**Figure 5**), qu'il est nécessaire de quantifier dans toute étude écotoxicologique. Cette préoccupation est née du fait de leurs propriétés cancérigènes ; c'est le cas tout particulièrement du benzo[*a*]pyrène, du benzo[*a*]anthracène, du benzo[*b*]fluorantène, de l'indénol[1,2,3-*c,d*]pyrène et du benzo[*g,h,i*]pérylène (Jaouen-Madoulet et al. 2000). Cependant bien que de nombreuses études aient montré la toxicité des HAP pour les organismes aquatiques (Ortiz-Delgado et al. 2007; Almroth et al. 2008; Oliveira et al. 2008; Nahrgang et al. 2009), des études montrent qu'ils ne sont pas les seuls déterminants de la toxicité du pétrole (Barron et al. 1999; González-Doncel et al. 2008). Les études restreintes à l'évaluation de la toxicité des HAP, ne peuvent donc en aucun cas rendre compte de la toxicité d'une nappe de pétrole dispersé. Ainsi des études expérimentales ont été conduites en considérant la totalité des hydrocarbures en solution dans la colonne d'eau.

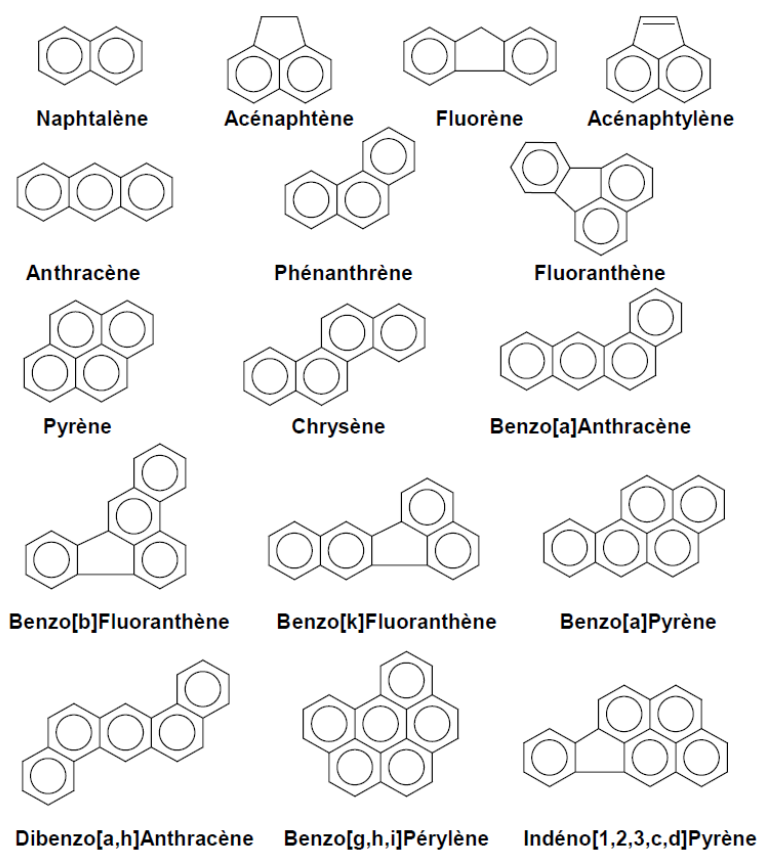

Figure 5. 16 HAP (hydrocarbures aromatiques polycycliques) prioritaires dans la liste de l'US EPA (united states environmental protection agency)

2.3. Evaluation de la toxicité d'un pétrole dispersé

➤ Toxicité létale d'une nappe de pétrole dispersée

De nombreuses études expérimentales ont été conduites, au travers de mesures de CL_{50} (Concentration Létale induisant la mort de 50% des individus exposés) afin de déterminer la **toxicité, en termes de mortalité** consécutive à l'application de dispersant (résumé dans le **tableau 1**).

Ces travaux ont été menés chez de nombreuses espèces des écosystèmes côtiers: poissons téléostéens (Adams et al. 1999; Cohen & Nugegoda 2000; Lin et al. 2009), amphipodes (Gulec et al. 1997), céphalopodes (Long & Holdway 2002), échinodermes (Wells & Keizer 1975) et macro-algues (Thorhaug et al. 1986). Toutes ces approches expérimentales ont montré une augmentation de la mortalité consécutive à l'application de dispersant, et par là, ont permis l'établissement d'un consensus scientifique autour de la toxicité conférée par

Tableau 1. Effets sublétaux d'un pétrole dispersé chimiquement chez différentes espèces aquatiques.

Espèces	Auteurs	Effets sublétaux au niveau de l'organisme	Effets sublétaux au niveau de l'organe
<i>Macquaria novemaculeata</i>	Cohen et al. 2000	Modification d'activité spontanée	
<i>Polinices conicus</i>	Gulec 1997	Suppression du comportement d'enfouissement	
<i>Heteroxenia fuscescense</i> <i>Stylophora pistillata</i>	Esptein et al. 2000	Altération du comportement de nage	
<i>Macquaria novemaculeata</i>	Cohen et al. 2001	Augmentation du métabolisme standard	Augmentation de l'activité enzymatique CCO (branchies) Augmentation de l'activité LDH (foie)
<i>Sebastes schengeni</i>	Jung et al. 2009		Augmentation de l'expression de cyp 1A et de l'activité EROD (foie) Diminution de l'activité AchE (encéphale)
<i>Collossoma macropomum</i>	Mendonça Duarte et al. 2010		Modification les échanges ioniques (branchies) Déséquilibre osmotique (sang)
<i>Scophthalmus maximus</i> <i>Salmo salar</i>	Camus et al. 1998 Gagnon & Holdway 2000		Augmentation de l'activité EROD (cerveau)
<i>Platichthys flesus</i>	Baklien 1986		Déséquilibre osmotique (sang)

l'application de dispersants. Cependant ces approches expérimentales utilisent une méthodologie ne prenant pas en compte la complexité de la réalité. En effet, l'évaluation de la toxicité aiguë d'un contaminant au travers d'une mesure de la mortalité nécessite, dans la plupart des expérimentations, des **concentrations** et/ou des temps d'exposition **supérieurs à ceux rencontrés *in situ*** : Lin et al. (2009) montrent que l'application des dispersants (utilisés à l'heure actuelle) n'entraîne la mort de juvéniles de saumons royaux (*Oncorhynchus tshawytscha*) que pour des expositions de 96 h à des concentrations en hydrocarbures totaux de 155,93 mg/L alors que les concentrations rencontrées *in situ* dans les premiers mètres de la colonne d'eau ne dépassent que très rarement 50 mg/L (Blackman et al. 1978) et chutent rapidement en quelques heures (**Figure 2**).

Les concentrations en hydrocarbures totaux rencontrés *in situ* au sein de la colonne d'eau ne semblent donc pas induire de mortalité immédiate cependant les effets sublétaux sont patents. Ainsi de nombreuses expérimentations ont été conduites afin de déterminer la toxicité sublétales d'un pétrole dispersé.

➤ Effets sublétaux d'un pétrole dispersé

L'évaluation des effets sublétaux du pétrole dispersé a été conduite au travers d'approches expérimentales en comparant la toxicité d'un pétrole non dispersé à la toxicité issue de l'interaction pétrole-dispersant. Le corpus d'articles scientifiques montre, à différents niveaux d'intégration biologique, des effets sublétaux dus à l'application de dispersants (résumé en **Tableau 1**).

Au niveau de l'organisme, des modifications de comportement, notamment en terme d'activité spontanée ont été montrées chez le bar australien, *Macquaria novemaculeata* (Cohen & Nuggeoda 2000). Ces résultats sont confirmés au travers de deux autres études : (i) Gulec (1997) a montré une suppression du comportement d'enfouissement chez le gastéropode *Polinices conicus* et (ii) Epstein et al. (2000) ont montré une altération du comportement de nage chez les larves de deux espèces de coraux (*Heteroxenia fuscescense* et *Stylophora pistillata*). Ces modifications de comportement pourraient être dues à une altération de l'intégrité fonctionnelle du système nerveux. En effet, Jung et al. (2009) montrent, chez le poisson de roche *Sebastes schengeli*, que l'exposition au pétrole dispersé induit une diminution de l'activité de l'acétylcholine-estérase cérébrale, suggérant une dégradation des fonctions neurales. Toujours au niveau de l'organisme, Cohen et al. (2001)

ont constaté que la dispersion du pétrole induit une augmentation du métabolisme standard chez le bar australien (*Macquaria novemaculeata*). Ce phénomène a déjà été observé lors de contaminations aux métaux lourds chez *Oncorhynchus mykiss* (Wilson et al. 1994; Pane et al. 2004) et pourrait être induit par une augmentation du coût métabolique due à la détoxification (Bains & Kennedy 2004). Ce processus de détoxification, est essentiellement observable au niveau hépatique (Camus et al. 1998). Ainsi une **approche au niveau de l'organe** semble donc nécessaire afin de caractériser plus précisément les effets sublétaux dus à l'application de dispersants.

Dans ce but, de nombreuses approches expérimentales utilisent les **biomarqueurs** comme indicateurs de toxicité. Un biomarqueur est, selon la définition de McCarthy & Shugart (1990), une mesure au niveau moléculaire, biochimique ou cellulaire qui indique (i) que l'organisme a été exposé à des toxiques chimiques, et (ii) l'intensité de la réponse de l'organisme au contaminant. Par la suite, la notion de biomarqueurs a évolué et Delafontaine et al. (2000) définissent deux types de biomarqueurs : les biomarqueurs de défense et les biomarqueurs de dommage.

Les biomarqueurs de défense permettent de mettre en évidence les réponses biologiques d'un organisme faisant face à une contamination chimique. **Les biomarqueurs de dommage** traduisent l'altération des fonctions biologiques consécutives à l'exposition aux polluants. Au travers de ces « approches biomarqueurs », la littérature montre que la toxicité d'un pétrole dispersé a été évaluée principalement au sein de deux organes cibles des polluants : les branchies, en tant qu'organe externe donc en contact direct avec les contaminants, et le foie, en tant qu'organe de bioaccumulation (van der Oost et al. 2003).

Au niveau branchial, Cohen et al. (2001) rapportent, chez *Macquaria novemaculeata* exposé à un pétrole dispersé, une augmentation de l'activité enzymatique CCO (cytochrome C oxydase), enzyme impliquée dans les processus de métabolisme aérobie. Outre cette altération d'activité enzymatique, l'application de dispersant sur une nappe de pétrole modifie les échanges ioniques au niveau branchial chez *Colossoma macropomum* (Mendonça Duarte et al. 2010) probablement en réponse au déséquilibre osmotique du milieu intérieur (Baklien et al. 1986; Mendonça Duarte et al. 2010).

Au niveau hépatique, l'utilisation de biomarqueurs de défense a permis de mettre en évidence une augmentation des processus de biotransformation des hydrocarbures suite à la dispersion d'une nappe de pétrole. En effet, il a été observé une augmentation de l'expression protéique du cytochrome P4501A (Jung et al. 2009) et de son activité catalytique EROD (ethoxyrésurufine-O-dééthylase ; Camus et al. 1998 ; Gagnon & Holdway 2000 ; Jung et al.

2009). Conjointement, l'augmentation de l'activité de la lactate-deshydrogénase (LDH) indique une acidose hépatique synonyme de dommages (Cohen et al. 2001).

Les études expérimentales précédemment menées montrent donc que la toxicité d'une nappe de pétrole est potentialisée par l'application de dispersants. La méthodologie employée dans l'ensemble de ces travaux consistait en la comparaison de deux solutions : (i) une solution de contamination appelé **WAF** (Water Accomodated Fraction ; Singer et al. 2000), simulant la toxicité d'un pétrole non dispersé, **comparée à** (ii) une solution de contamination appelée **CEWAF** (Chemical Enhanced Water Accomodated Fraction ; Singer et al., 2001), simulant la toxicité d'un pétrole chimiquement dispersé. Brièvement, ces 2 solutions de contamination étaient obtenues en mixant du pétrole (avec ajout de dispersant pour la CEWAF) dans de l'eau de mer pendant 18 heures puis en décantant cette solution pendant une période de 1 à 6 heures. Cette période de décantation induit une diminution drastique de la concentration des gouttelettes d'hydrocarbures en suspension dans la colonne d'eau (Singer et al. 2000).

Ainsi, cette méthode expérimentale de contamination n'est pas représentative de la toxicité induite par l'application de dispersant en zone côtière et ne pourra donc pas être considérée dans cette étude. En effet, au sein de nos travaux, plusieurs arguments imposent **de considérer la présence de gouttelettes d'hydrocarbures** dans la colonne d'eau :

(i) La présence de gouttelettes de pétrole est déterminante dans la toxicité d'une nappe de pétrole dispersée (Bobra et al. 1989 ; Brannon et al. 2006).

(ii) De plus, la présence de gouttelettes d'hydrocarbures dans la colonne d'eau est un facteur abiotique représentatif des catastrophes pétrolières en zone côtière : les phénomènes de turbulence (*e.g.* vagues) peuvent induire une dispersion totale de la nappe de pétrole sous forme de gouttelettes en suspension dans la colonne d'eau – ceci même en absence de produit dispersant comme le montre les catastrophes du Braer (Lunel 1995) et du Sea Empress (Edwards & White 1999).

Ainsi, afin de déterminer la toxicité d'une nappe de pétrole dispersée en **milieu côtier**, nous privilégierons **une approche prenant en compte ces phénomènes de turbulence** et la présence de gouttelettes d'hydrocarbures qui leur est associée. D'après nos connaissances, cette approche expérimentale n'a jusque là jamais été considérée et nécessite donc une évaluation de la toxicité au travers d'un large spectre de mesures biologiques.

3. Approche écotoxicologique expérimentale

L'approche développée au sein de cette étude a pour but d'évaluer les effets toxiques d'une nappe de pétrole dispersée en milieu côtier chez des organismes exposés. Les modèles biologiques employés dans cette étude étaient des **juvéniles (de 2^{ème} année) de *Liza ramada* et *Liza aurata* (Figure 6)**, deux espèces de poissons téléostéens mugilidés du genre *Liza*, regroupés dans cette thèse sous le terme de *Liza sp.* Plusieurs arguments appuient le choix de ces modèles biologiques :



Figure 6. Mulet doré (*Liza aurata*), téléostéen perciforme de la famille des mugilidés.

(i) La répartition géographique de ces espèces est essentiellement côtière (en Atlantique Nord et Méditerranée, **Figure 7**), en particulier chez les juvéniles qui n'opèrent pas de migration vers la haute mer (Gautier & Hussenot 2005). Ainsi, ces espèces sont considérées comme des **organismes cibles des pollutions côtières** (Bruslé 1981), donc adaptés à nos travaux de recherche.

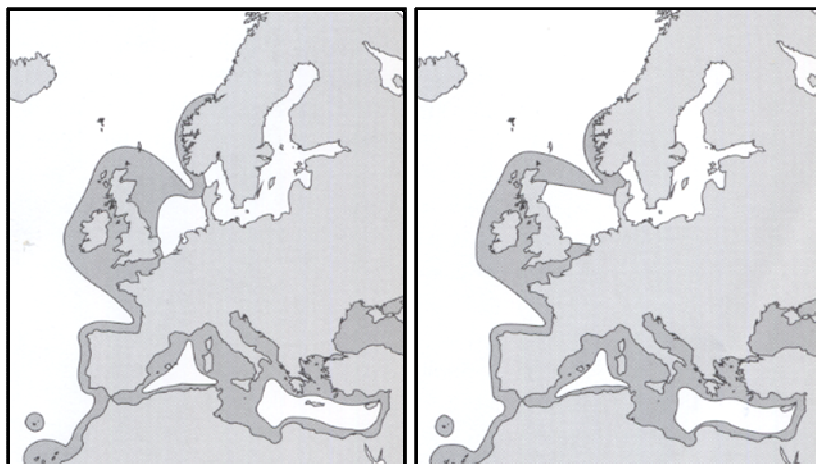

Figure 7. Cartes de la répartition géographique de *Liza aurata* (à gauche) et de *Liza ramada* (à droite) sur le littoral européen, d'après Hussenot et Gautier (2005).

(ii) Ces espèces sont **représentatives** des communautés des écosystèmes côtiers car elles représentent une biomasse animale importante dans les écosystèmes côtiers d'Atlantique Nord (e.g. 81 % de la biomasse des téléostéens dans la baie du Mont Saint-Michel, Laffaille et al. 1998).

(iii) Ces deux espèces de mugilidés sont considérés comme des **espèces clés dans le fonctionnement des écosystèmes côtiers** car elles permettent un transport de matière organique particulière important depuis les marais salés vers les eaux côtières (Laffaille et al. 1998) et sont ainsi nécessaire au maintien d'autres populations. De plus, leur statut de prédateur en fait des acteurs majeurs dans le fonctionnement des écosystèmes (Barbault 1995).

Sur ces modèle biologiques, **trois types d'expositions** réalisés au travers d'une approche expérimentale en laboratoire ont été menés parallèlement : (i) une **nappe de pétrole dispersée mécaniquement** a permis de simuler la dispersion naturelle de la nappe en milieu côtier turbulent ; (ii) l'addition de dispersant à cette précédente condition a permis de simuler la **dispersion chimique** d'une nappe de pétrole en milieu côtier turbulent ; enfin (iii) **une nappe de pétrole non dispersée** et non traitée aux dispersants a permis de simuler le confinement de la nappe avant sa récupération, lorsque la faible turbulence en milieu côtier le permet. **Deux conditions « contrôle »** ont également été établies: une solution d'exposition contenant un dispersant seul (contrôle interne de la dispersion chimique) et une solution d'eau de mer non contaminée.

La toxicité d'un pétrole dispersé étant essentiellement due à la présence des hydrocarbures en suspension dans la colonne d'eau (décrit en 2.1), un **dosage des hydrocarbures totaux** au cours de la période de contamination a été effectué dans les solutions d'exposition. De plus et plus spécifiquement, **un dosage des HAP** solubilisés dans l'eau de mer a été réalisé puisque (i) ces composés solubilisés dans la colonne d'eau sont susceptible de traverser les branchies -une des voies de contamination majeure des hydrocarbures (Thomas & Rice 1981) ; et que parallèlement (ii) ces composés sont considérés comme un des déterminants de la toxicité d'une dispersion chimique de pétrole (Anderson et al. 1974).

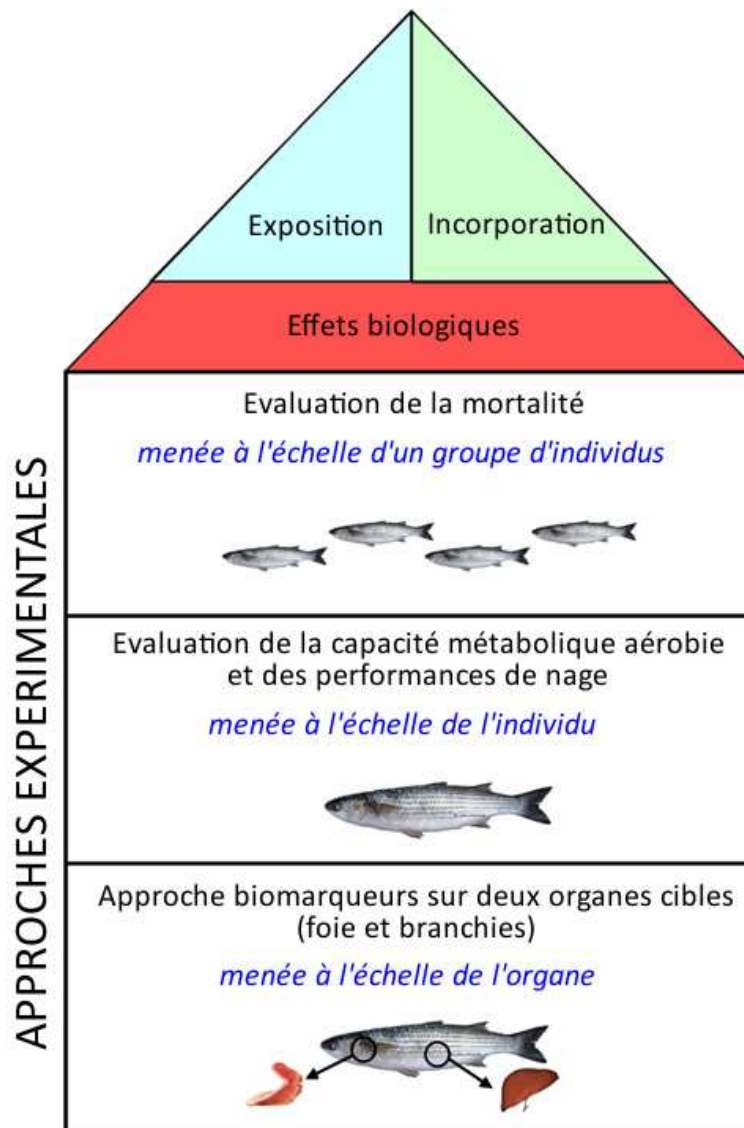

Figure 8. Approche écotoxicologique menée dans cette thèse. Les effets biologiques, en lien avec l'exposition et l'incorporation des contaminants, sont mesurés à trois niveaux d'intégration biologique (groupe d'individus, individu, organe).

En parallèle à ces dosages chimiques visant à révéler l'exposition des organismes aux contaminants, notre étude visait à évaluer **l'incorporation des contaminants** dans le milieu interne ainsi que les **effets biologiques** susceptibles d'être induits. Cette étude a donc permis de mesurer la toxicité d'une nappe de pétrole dispersée, au sein de ce que Amiard et Amiard-Triquet (2008) nomment « la triade de l'écotoxicologie » : exposition-incorporation-effets biologiques. Les effets biologiques ont été observés à **trois niveaux d'intégration biologique** (schématisés en **Figure 8**): (i) au niveau d'un groupe d'individus via une mesure de la CL_{50} (concentration létale pour 50 % du groupe d'individus) couplée à une observation des phénomènes de bioaccumulation ; (ii) au niveau de l'organisme via une mesure de la capacité

métabolique aérobie et des performances de nage de l'individu ; (iii) au niveau de l'organe via la mesure de biomarqueurs sur deux organes cibles : le foie et les branchies.

Cette « approche biomarqueurs » a également été réalisée sur le cœur puisque l'intégrité fonctionnelle de cet organe est susceptible d'être dégradée suite à une pollution de type hydrocarbures (Claireaux & Davoodi 2010). L'acquisition tardive des résultats n'a pas permis de publication au sein de cette thèse ; les résultats sont exposés dans la discussion.

*3.1. Toxicité létale aiguë et phénomène de bioaccumulation des HAP consécutifs à l'application de dispersant chez des juvéniles de mulets porcs (*Liza ramada*)*

L'évaluation de la **toxicité létale** aiguë est effectuée en écotoxicologie, par la détermination de la mortalité au sein d'un groupe d'organismes exposés à des concentrations croissantes de toxique. La mesure la plus couramment employée afin de définir la toxicité d'un contaminant est la **CL₅₀** (concentration létale à 50% des organismes testés). De nombreuses études, chez de nombreuses espèces, ont été menées afin de déterminer la CL₅₀ consécutive à l'interaction pétrole-dispersant (cité en 2.3). Ce corpus d'articles scientifiques permet ainsi la comparaison des méthodes de contamination précédemment employées avec celle utilisée dans notre étude qui reflète plus spécifiquement la dispersion d'une nappe en milieu côtier. La détermination d'une toxicité aiguë peut être interprétée comme prédictive du potentiel d'un toxique à affecter une population. Cependant le caractère expérimental de cette méthode impose une certaine prudence quant à une telle extrapolation. De plus, la toxicité aiguë ne rend compte que des effets à court terme d'un contaminant.

Ainsi, afin de compléter les résultats obtenus en termes de toxicité aiguë, des mesures de **bioconcentration de 21 HAP** (dont les 16 HAP considérés comme prioritaire par l'US EPA) ont été obtenues dans les muscles de l'organisme. Ces valeurs de bioconcentration permettent de renseigner sur une toxicité à plus long terme consécutive à l'application de dispersant (Ramachandran et al. 2004a). Cependant, malgré un stockage dans les compartiments intra- ou extracellulaire, l'incorporation des HAP ne se traduira pas automatiquement par un effet néfaste pour l'organisme -les processus de détoxification biotransformant ces contaminants-. De plus, l'ensemble de cette étude a été conduite en utilisant des concentrations supérieures à celle observé *in situ* lors de catastrophes pétrolières (50 mg/L, d'après Cormack 1977). Ces

deux limites imposent donc, dans la suite de nos travaux, (i) d'évaluer, au niveau de l'organisme, les effets biologiques consécutifs à l'application de dispersant, et ce, (ii) en utilisant des concentrations en hydrocarbures retrouvées *in situ* lors de catastrophe pétrolières. Pour ce faire, l'altération de la capacité métabolique aérobie et des performances de nage a été évaluée chez le mulot doré juvénile exposé à des concentrations sublétales de pétrole dispersé, concentrations représentatives de celles observées *in situ*.

*3.2. Effets sublétaux d'une nappe de pétrole dispersée sur les performances de nage et la capacité métabolique aérobie chez des juvéniles de mulots dorés (*Liza aurata*)*

La **puissance énergétique** d'un organisme correspond à la quantité d'énergie produite par unité de temps. Elle peut être divisée en **trois compartiments (Figure 9)** : (i) **La puissance énergétique de maintenance** permettant le maintien des activités « obligatoires », telles que la ventilation, l'osmorégulation, etc. ; (ii) **La puissance énergétique de routine** correspondant au maintien des activités de routine telles que la nage et la digestion. Ces activités dépendent du niveau d'effort fourni par l'animal (Brett 1971) ; (iii) **Le surplus de puissance énergétique**, qui selon les phases de développement de l'animal est préférentiellement alloué à la croissance somatique (phase larvaire et juvénile) ou gonadique (phase adulte).

Fry (1971) définit la capacité métabolique aérobie comme la différence entre la puissance énergétique totale et la puissance énergétique de maintenance. Conceptuellement, **la capacité métabolique** représente donc une quantité d'énergie globale pouvant être allouée aux **activités dites « non obligatoires » ou discrétionnaires** pour l'animal (croissance, reproduction, nage, digestion etc. cf. **Figure 9**). Ainsi Claireaux et Lefrançois (2007) estiment que la capacité métabolique aérobie peut être considérée comme un indicateur de la fitness de l'animal, c'est-à-dire comme **un indicateur de sa capacité à survivre et se reproduire**.

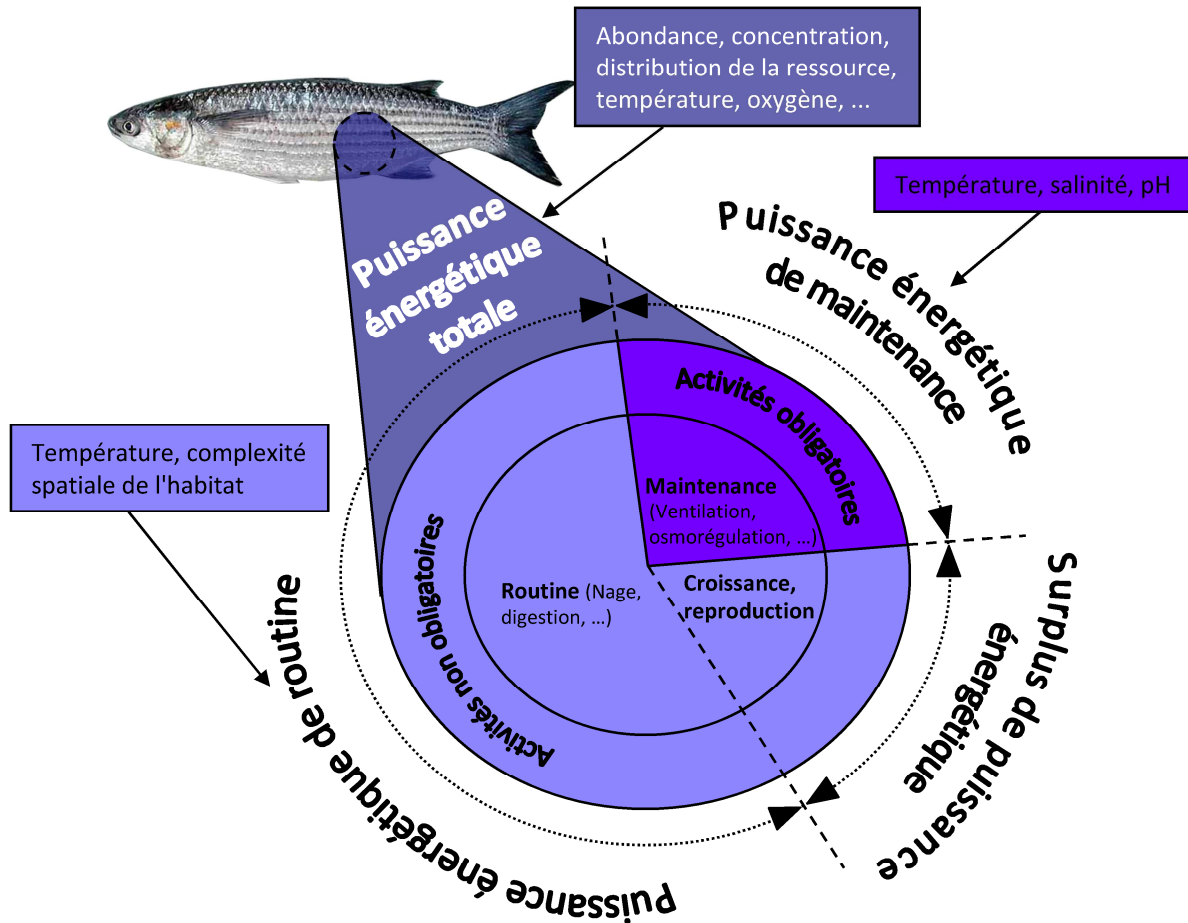

Figure 9. Subdivisions de la puissance énergétique en trois compartiments : la puissance énergétique de maintenance allouée aux activités obligatoires, la puissance énergétique de routine et le surplus de puissance énergétique alloués aux activités non obligatoires ou discrétionnaires, modifié d'après Lefrançois (2001).

En pratique, la capacité métabolique aérobie se calcule par la différence entre le taux métabolique aérobie maximal, représentant la puissance énergétique totale de l'organisme, et son taux métabolique de maintenance, représentant sa puissance énergétique de maintenance. Au sein de notre étude, le taux métabolique aérobie maximal a été mesuré par la consommation d'oxygène du poisson à sa vitesse de nage maximale ; le taux métabolique de maintenance correspond à la consommation d'oxygène de l'animal au repos. **La capacité métabolique** a ainsi pu être calculée et **les performances de nage** (vitesse de nage maximale) du poisson évaluées. Au cours de cette expérimentation les niveaux d'exposition aux HAP ont été évalués en mesurant les concentrations des **métabolites biliaires de 3 HAP** (le naphtalène, le pyrène et le benzo[*a*]pyrène). Cette méthode a été choisie car elle permet de s'affranchir de la disparition par métabolisation intra-tissulaire des HAPs et révèle ainsi

l'incorporation des HAPs même lorsque les concentrations d'exposition sont faibles (Beyer et al. 2010).

De nombreux auteurs ont montré une altération de la capacité métabolique aérobie et des performances de nage due à la présence de contaminants (Nikl & Farrell 1993; Wilson et al. 1994; Pane et al. 2004). Par exemple, Wood et al. (1996) montrent une diminution du taux métabolique actif contribuant à une diminution de la capacité métabolique et des performances de nage chez la truite arc en ciel (*Onchorynchus mykiss*), lorsque celle-ci est exposée au didecyldiméthylammonium (DDAC). Cette altération a été mise en lien avec l'altération morphologique branchiale, susceptible de diminuer l'approvisionnement en oxygène, mais pourrait également être due à une diminution des performances cardiaques (McKenzie et al. 2007).

Les performances de nage et de la capacité métabolique aérobie représentent donc des biomarqueurs pertinents et appropriés à notre étude car ils permettent d'évaluer l'effet des contaminants au niveau de l'organisme et également de prédire un impact sur les processus de croissance et de reproduction de l'animal donc sur sa fitness. Cependant cette approche intégrative ne permet pas de déterminer les cibles affectées par les contaminants. Afin d'évaluer au mieux l'impact d'une nappe de pétrole dispersé chez le mulot doré, une approche multimarqueur a été effectuée sur **deux organes cibles des contaminants: le foie et les branchies**.

3.3. Effets sublétaux d'une nappe de pétrole dispersé, évalués au travers d'une approche multimarqueur au niveau de l'organe, chez des juvéniles de mulets dorés (*Liza aurata*)

Dans cette étude, les effets sublétaux au niveau de l'organe ont été évalués au travers du **stress oxydant, de la réponse antioxydante et des processus de détoxication** mis en place au niveau **branchial et hépatique**.

Le stress oxydant implique la production d'espèces réactives de l'oxygène (*Reactive oxygen species* : ROS) et est synonyme de dommages (Halliwell & Gutteridge 1999).

Bien qu'il puisse représenter un biomarqueur non spécifique des effets néfastes des xénobiotiques (van der Oost et al. 2003), l'implication spécifique des HAP dans l'induction de stress oxydant a été démontrée dans différentes études chez *Carassius auratus* (Sun et al. 2006), *Liza aurata* (Oliveira et al. 2008) et chez *Solea senegalensis* (Oliva et al. 2010).

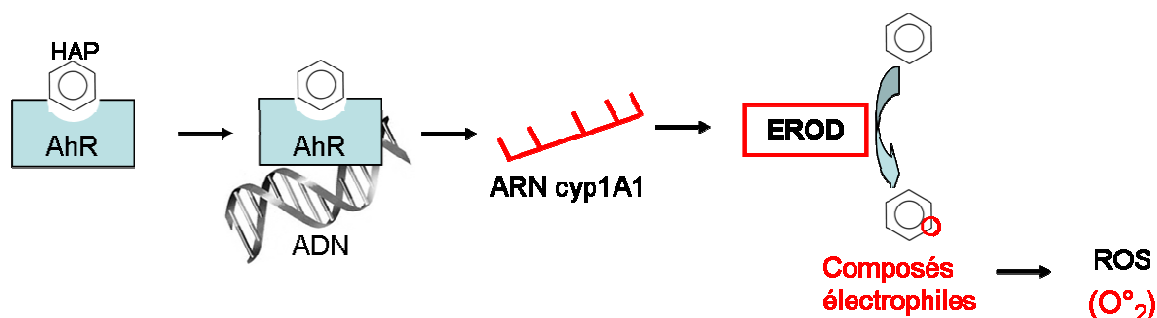

Figure 10. Mécanismes cellulaires amenant à la production de ROS (*Reactive Oxygen Species*) dans la phase 1 de biotransformation des HAP. 1. Fixation des HAP sur le récepteur AhR (*Aryl hydrocarbons receptor*) ; 2. Translocation du récepteur AhR dans le noyau et liaison à l'ADN ; 3. Transcription de l'ARN cyp1A1 ; 4. Traduction de l'enzyme EROD qui catalyse la transformation des HAP en composés hydrosolubles électrophiles et espèces réactives de l'oxygène (ROS : *Reactive oxygen species*).

Les mécanismes cellulaires qui lient exposition aux HAP et stress oxydant sont désormais connus et décrits ici en **Figure 10**. Lors de l'incorporation des HAP dans le milieu interne, la première réponse de défense de l'organisme aux polluants est la biotransformation de phase 1. Cette biotransformation est initiée par la liaison spécifique d'un HAP sur un récepteur cytoplasmique aryl hydrocarbure (AhR). Le récepteur AhR s'associe ensuite avec la protéine ARNT (*Aryl hydrocarbon receptor nuclear translocator*) qui le transporte à l'intérieur du noyau de la cellule. Ce complexe se lie alors à une séquence spécifique de l'ADN : le XRE (*xenobiotic regulatory element*). Cette fixation entraîne une augmentation de transcription des

ARN messager du *cyp1A1* (cytochrome P450 1A1) codant entre autre pour l'enzyme EROD (éthoxyrésorufine-*O*-dééthylase). L'enzyme monooxygénase **EROD** permet la biotransformation des HAP en composés hydrosolubles. Ces **composés hydrosolubles** peuvent être **électrophiles** et donc directement inter-agir avec certaines macromolécules comme l'ADN (Livingstone 2001) ou entraîner la **production de ROS** et notamment d'oxygène singulet (O°_2) (Adler et al. 1999).

Les composés électrophiles pourront être **conjugués avec le glutathion (GSH)**, dans la phase 2 de biotransformation (**Figure 11**), par l'intermédiaire de la **glutathion-S-transférase (GST)**, une enzyme cytosolique. Ces métabolites seront alors excrétés (phase 3) de la cellule puis de l'organisme entre autre par voie biliaire.

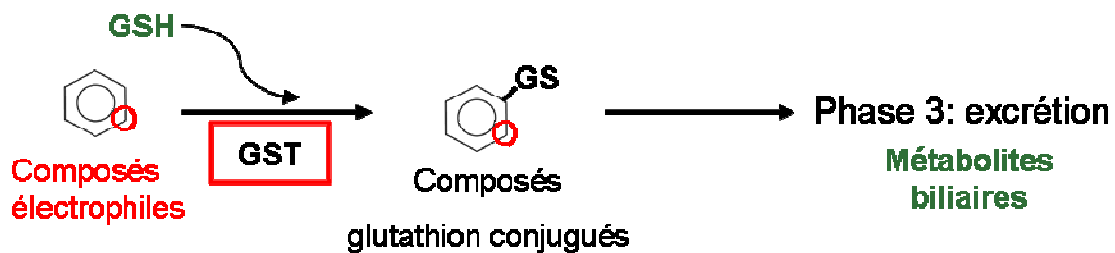

Figure 11. Conjugaison des composés électrophiles au glutathion par l'enzyme GST (Glutathion-S-transférase).

Les ROS, quant à eux, seront éliminés par des **mécanismes de défense antioxydante (Figure 12)** qui mettent en jeu l'enzyme superoxyde dismutase (**SOD**) catalysant la transformation d'oxygène singulet en peroxyde d'hydrogène (H_2O_2). Le peroxyde d'hydrogène est ensuite transformé en oxygène et eau par l'intermédiaire de la catalase (**CAT**) ou par l'intermédiaire de la glutathion peroxidase (**GPx**) qui permet la réduction du H_2O_2 par le glutathion réduit (**GSH**).

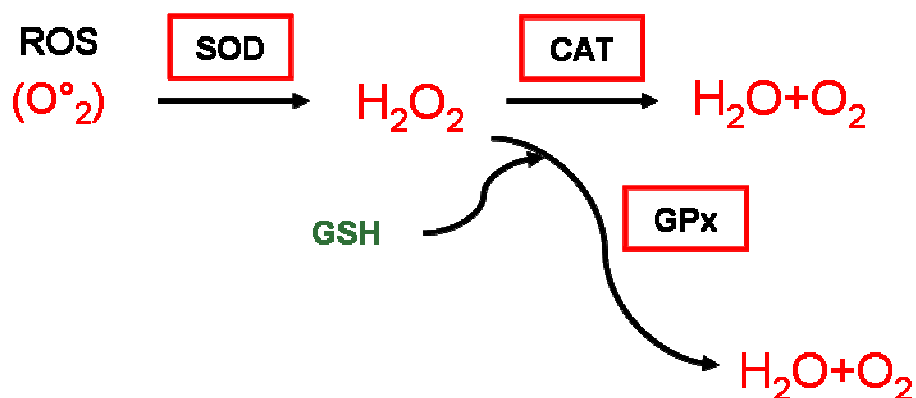

Figure 12. Systèmes de défense antioxydants (SOD : super oxyde dismutase ; CAT : catalase ; GPx : glutathion peroxydase) mis en place dans la transformation des ROS (reactive oxygen species) en molécule non réactive (H_2O et O_2).

Lors d'une contamination aux HAP le **déséquilibre** entre la production de ROS et leur neutralisation par les systèmes antioxydants correspond au **stress oxydant**.

Ce déséquilibre peut être dû (i) soit à une inhibition des défenses antioxydantes par les HAP ou (ii) soit à une production de ROS trop importante pour être éliminée par les mécanismes de défense antioxydante (**Figure 13**). Ce déséquilibre en faveur de la production de ROS peut entraîner des **dommages** notamment au niveau des **membranes cellulaires** puisque les ROS altèrent la structure des lipides membranaires (Winston & Di Giulio 1991). Ce phénomène de dégradation est appelé **lipoperoxydation** ou peroxydation lipidique.

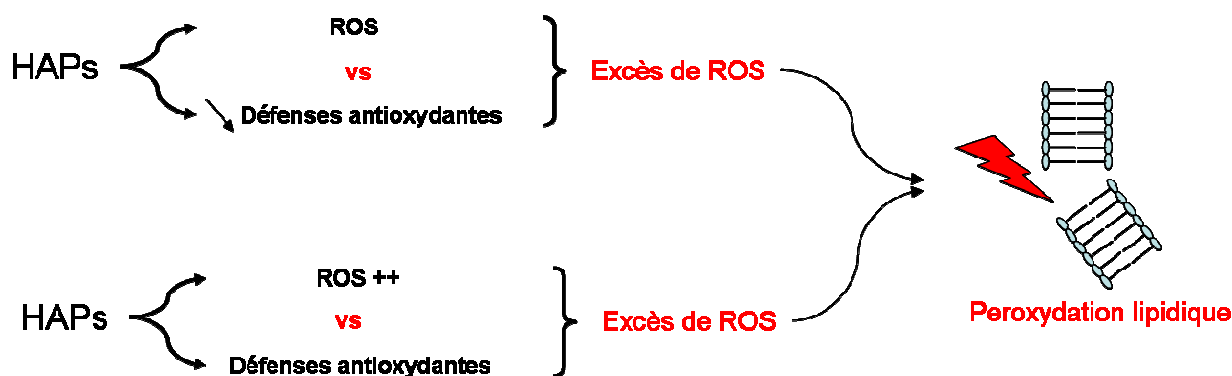

Figure 13. Représentation schématique de l'induction par les HAP du phénomène de peroxydation lipidique.

Au sein de ce travail, l'étude du **processus de détoxication** -impliquant les enzymes **EROD** et **GST** ainsi que le substrat **GSH** et les **métabolites biliaires**- a été menée afin de mieux comprendre la réponse de l'organisme à l'entrée des contaminants. Les taux de glutathion

(GSH) seront tout particulièrement observés au niveau branchial et hépatique, car leur diminution au travers des processus de détoxication a été corrélée à la mortalité chez *Onchorynchus mykiss* (Ferrari et al. 2007).

L'étude du stress oxydant a été évaluée au travers de **biomarqueurs de défense** que sont les **enzymes antioxydantes SOD, CAT, GPx** et au travers du **biomarqueur de dommage** qu'est la **lipoperoxydation**. Au niveau de l'organe, l'étude de ces biomarqueurs permet de révéler de manière précoce les effets d'une nappe de pétrole dispersée exerçant sa toxicité via un stress oxydant (van der Oost et al. 2003).

CHAPITRE 1 - TOXICITE LETALE AIGUE ET PHENOMENE DE BIOACCUMULATION DES HAP

Effects of dispersed oil exposure on the bioaccumulation of polycyclic aromatic hydrocarbons and the mortality of juvenile

Liza ramada

Thomas Milinkovitch, Rami Kanan, H  l  ne Thomas-Guyon, St  phane Le Floch

Abstract

Dispersing an oil slick is considered to be an effective response to offshore oil spills. However, in nearshore areas, dispersant application is a controversial countermeasure: environmental benefits are counteracted by the toxicity of dispersant use. In our study, the actual toxicity of the dispersant response technique in the nearshore areas was evaluated through an experimental approach using juvenile *Liza ramada*. Fish were contaminated via the water column (i) by chemically dispersed oil, simulating dispersant application, (ii) by dispersant, as an internal control of chemical dispersion, (iii) by mechanically dispersed oil, simulating only the effect of natural mixing processes, without dispersant application, and (iv) by the water soluble fraction of oil, simulating the toxicity of an oil slick before recovery. Bioconcentrations of polycyclic aromatic hydrocarbons (PAH) and mortality were evaluated, and related to both total petroleum hydrocarbon (TPH) and polycyclic aromatic hydrocarbon (PAH) concentrations in seawater.

Fish exposed to chemically dispersed oil showed both a higher bioconcentration of PAH and a higher mortality than fish exposed to either the water soluble fraction of oil or the mechanically dispersed oil. These results suggest that (i) dispersion is a more toxic response technique than containment and recovery of the oil slick; (ii) in turbulent mixing areas, dispersant application increases the environmental risk for aquatic organisms living in the water column. Even if the experimental aspects of this study compel us to be cautious with our conclusions, responders could consider these results to establish a framework for dispersant use in nearshore areas.

Keywords: dispersant, chemically dispersed oil, toxicity, polycyclic aromatic hydrocarbons, bioaccumulation, nearshore areas.

1. Introduction

In the last decades, increasing demand for petrochemicals has led to an increase in oil pollution in the sea. Many sources oil pollution, such as industrial wastewater, tanker accidents, and oil leaks from drilling operations (recently Deepwater Horizon) still contaminate the marine ecosystem. Even if oil spills do not represent the major source of pollution (one third of the petroleum hydrocarbons that enter the aquatic environment each year, UNEP/IOC/IAEA, 1992), the consequences of oil spills on local flora and fauna are disastrous (Dauvin 1998; Claireaux et al. 2004; Cadiou et al. 2004). Secondary to mechanical containment and recovery of the oil slick, chemical dispersants can be used to reduce the environmental and economic impact of an oil spill. Chemical dispersants are composed of surface active agents (surfactants), which contain anionic and nonionic molecules that confer hydrophilic and hydrophobic properties, enabling lower interfacial tension between oil and water. This chemical process facilitates the formation of small, mixed oil-surfactant micelles, dispersed into the water column (Canevari 1978). Thus, the application of chemical dispersants shows many advantages, by accelerating dilution of the oil slick (Lessard & Demarco 2000) and consequently accelerating biodegradation of oil compounds (Thiem 1994; Churchill, 1995). However, in nearshore areas, the advantages of dispersant use are counteracted by its toxicity: the low dilution potential of the oil slick in shallow water may expose ecologically sensitive ecosystems to relevant concentrations of petroleum. Therefore, in nearshore areas, the long-term net environmental benefits of dispersant application are counteracted by acute toxicity. A net environmental benefit analysis (NEBA, as conducted by Baca et al. 2005, on a mangrove ecosystem), which considers both the advantages and toxicity of dispersant use, is required in order to establish a comprehensive framework for dispersant use policies for nearshore areas.

In an attempt to do so, past studies have evaluated the acute toxicity of single dispersants (Perkins et al. 1973; Thompson & Wu 1981; Law 1995; Adams et al. 1999; George-Ares & Clark 2000). More recent studies have taken into consideration the toxicity of the petroleum-dispersant interaction (Epstein et al. 2000; Long & Holdway 2002; Lin et al. 2009) using chemical enhanced water accommodated fractions (CEWAF, Singer et al. 2000) as contamination solutions. These exposure solutions do not take into account most of the particulate oil formed during the dispersion of an oil slick.

However, the dispersion of oil provokes the presence of oil droplets, which have been suggested to be a determinant of toxicity (Ramachandran et al. 2004a and Brannon et al. 2006), and does so even more in nearshore areas, where natural dispersion (e.g. waves) can send the whole oil slick from the surface into the water column (as described during the Braer oil spill by Lunel 1995). Thus, in order to simulate actual exposure to dispersed oil in nearshore areas, an experimental approach was designed. This approach, similar to Milinkovitch et al. (2011a), considers the presence of oil droplets in the water column.

Experiments were conducted on juvenile, thin-lipped grey mullets (*Liza ramada*), because this teleost fish species is present in the Atlantic nearshore areas during its early life stage (Gautier & Hussenot 2005), and is consequently considered to be a target organism of anthropogenic contaminants (Bruslé 1981). Moreover, this species is a key species of ecosystems since it plays a significant role in the global energy budgets of coastal environments, by transporting particulate organic matter from the salt marsh to the marine coastal waters (Lafaille et al. 1998). Four exposure conditions were tested on these organisms: (i) chemically dispersed oil solutions, simulating the application of dispersant when turbulent mixing processes (necessary for this response technique) are present; (ii) single dispersant solutions as internal controls of chemically dispersed oil solutions; (iii) a mechanically dispersed oil solution, simulating the natural dispersion of an oil slick due to mixing processes, but without dispersant application; (iv) a water soluble fraction of oil solution, simulating an undispersed oil slick before recovery, when the absence of turbulent mixing processes permits this response technique. Mortality was observed upon increasing exposure concentrations, yielding information on acute toxicity following dispersant application. Moreover, the concentration of 21 polycyclic aromatic hydrocarbons (PAH) was measured in both the sea water and fish muscles, since (i) PAH are considered to be a primary determinant of petroleum toxicity for aquatic organisms (Anderson et al. 1974) and (ii) their bioaccumulation in organisms is enhanced by dispersant application (Wolfe et al. 2001; Ramachandran et al. 2004b; Mielbrecht et al. 2005).

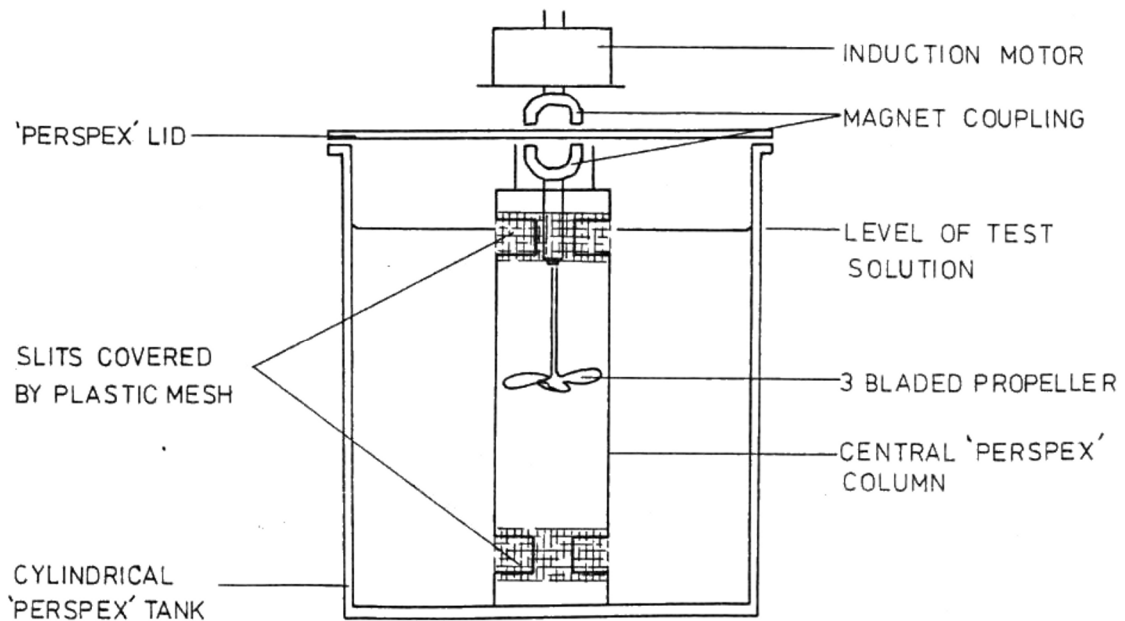

From Blackman et al., 1977

Figure 14. One tank of the experimental system (composed of twelve tanks) devised to maintain a mixture of oil-dispersant droplets throughout the water column.

2. Materials and methods

2.1. Materials and experimental organisms

2.1.1. Experimental system

The experimental system (**Figure 14**) used in this study was adapted from Blackman et al. (1978), and is composed of 12 experimental tanks (units) covered by a lid. Each tank is a 22 L cylinder fitted with a removable central column (77 mm in diameter), that houses a stainless steel shaft and a three-bladed propeller. The central cylinder has two sets of two apertures, located at the top and the bottom. The apertures are covered with a plastic mesh screen to exclude test animals from the propeller housing. The propeller (30 × 25 mm) is rotated (1000 rounds per minute) to produce a small vortex within the central cylinder, drawing the exposure solutions in through the upper apertures and expelling them through the lower ones. Even if residual oil is observed in the experimental system following exposure, the system is devised to maintain a mixture of oil-dispersant droplets throughout the water column. The system is a static water system, stored in a temperature controlled room (19 °C). Physicochemical parameters were measured during exposures (**Table 1**).

Table 1. Fish weight (Values represent mean ± standard error mean; n = 10 per treatment) and physicochemicals parameters measured during organism exposure (Values represent mean ± standard error mean of 6 tanks measurement at T = 0 h and at T = 24 h).

Parameters	MD	CD1	CD2	WSF	D1	D2
Temperature (°C)	19.1 ± 0.1	18.8 ± 0.1	18.6 ± 0.2	19.1 ± 0.1	18.9 ± 0.2	18.6 ± 0.2
pH	7.96 ± 0.03	7.92 ± 0.04	7.90 ± 0.03	8.00 ± 0.01	7.98 ± 0.02	7.93 ± 0.02
Dissolved oxygen (% AS)	95.2 ± 0.8	92.1 ± 0.6	94.6 ± 1.1	95.2 ± 0.8	93.8 ± 0.6	96.8 ± 0.6
Salinity (‰)	35.1 ± 0.1	35.2 ± 0.1	35.2 ± 0.1	35.1 ± 0.1	35.1 ± 0.1	35.2 ± 0.1
Fish weight (g)	1.74 ± 0.11	1.60 ± 0.12	1.65 ± 0.09	1.71 ± 0.12	1.78 ± 0.11	1.87 ± 0.14

2.1.2. Chemicals

A Brut Arabian Light (BAL) oil was selected for this study and the composition of the oil was evaluated by CEDRE (Centre de Documentation de Recherche et d'Expérimentations sur les pollutions accidentelles des eaux), a laboratory certified according to ISO 9001 and ISO 14001. The oil was found to contain 54% saturated hydrocarbons, 36% aromatic hydrocarbons, and 10% polar compounds. Concentrations of 21 PAH (including the 16 priority PAH listed by US-EPA) in the Brut Arabian Light oil are presented in Table 2. Before performing the exposure studies, the oil was weathered by bubbling air through the petroleum in 3 m³ tanks, for 8 days in open air, at a temperature of 12 to 16 °C. This aeration protocol results in a 7 % petroleum weight loss. This, corresponds to the petroleum weight loss occurring in 12 h on a 1 mm oil slick released at sea (personal communication, S. Le Floch). Using this weathered oil, our study simulates a 12 h period of petroleum ageing, i.e. the time it might take for responders to apply dispersant. The composition of the weathered test oil was 54% saturated hydrocarbons, 34% aromatic hydrocarbons and 12% polar compounds and its API (American Petroleum Institute) gravity was 33. Concentrations of 21 PAH (including the 16 US-EPA PAH) are presented in

Table 2.

Two formulations of dispersants (1 and 2), manufactured by Total Fluides and Innospech, were selected. Both were evaluated by CEDRE and were deemed effective enough (determined using the method, NF.T.90-345) for use in marine environments, non-toxic at concentrations recommended by the manufacturer (determined using a standard toxicity test: method NF.T.90-349), and biodegradable. Dispersants 1 and 2 are composed of surfactants (surface active agents) and solvents. Because they are “third generation” dispersants, these surfactants are blends of anionic and non-ionic types (Fiocco & Lewis 1999). The manufacturers state that the chemical compounds in their surfactants which represent a health risk are non-ionic surfactants (24 %) and anionic surfactants (between 12 and 24%) for dispersant 1; and saturated hydrocarbons with a flash point higher than 60 °C for dispersant 2.

Table 2. Concentration of 21 PAH (alkylated and parents) in the Brut Arabian Light (BAL) and in the weathered Brut Arabian Light. The 21 PAH represent the 16 US-EPA PAH and five supplementary PAH (benzo[*b*]thiophene, biphenyl, dibenzothiophene, benzo[*e*]pyrene, perylene). n.d. = not detected.

	Molecular weight (g/mol)	Concentration in BAL (µg/g of petroleum)	Concentration in weathered BAL (µg/g of petroleum)
Naphtalene	128.2	222	211
C1-Naphtalene	143.2	955	854
C2-Naphtalene	158.2	2 099	1 819
C3-Naphtalene	173.2	2 084	1 796
C4-Naphtalene	188.2	1480	1317
Benzo[<i>b</i>]thiophene	134.2	5	5
C1-benzo[<i>b</i>]thiophene	149.2	63	22
C2-benzo[<i>b</i>]thiophene	164.2	298	292
C3-benzo[<i>b</i>]thiophene	179.2	681	1 030
C4-benzo[<i>b</i>]thiophene	209.2	606	537
Acenaphtylene	152.2	30	25
Biphenyl	154.2	15	14
Acenaphtene	154.2	4	3
Fluorene	166.2	45	39
C1-Fluorenes	181.2	132	116
C2-Fluorenes	196.2	269	230
C3-Fluorenes	211.2	304	261
Phenanthrene	178.2	112	95
Anthracene	178.2	112	95
C1-phenanthrenes/anthracenes	193.2	396	335
C2-phenanthrenes/anthracenes	208.2	603	498
C3-phenanthrenes/anthracenes	223.2	493	416
C4-phenanthrenes/anthracenes	238.2	318	273
Dibenzothiophene	184.3	373	330
C1-dibenzothiophenes	199.3	1115	987
C2-dibenzothiophenes	214.3	2021	1759
C3-dibenzothiophenes	229.3	1764	1546
C4-dibenzothiophenes	244.3	1040	936
Fluoranthene	202.3	7	6
Pyrene	202.3	11	9
C1-fluoranthenes/pyrenes	217.3	62	51
C2-fluoranthenes/pyrenes	232.3	137	119
C3-fluoranthenes/pyrenes	247.3	222	191
Benzo[<i>a</i>]anthracene	228.3	19	16
Chrysene	228.3	18	15
C1-chrysenes	243.3	37	29
C2-chrysenes	258.3	57	45
C3-chrysenes	273.3	84	88
Benzo[<i>b+k</i>]fluoranthene	252.3	3	3
Benzo[<i>e</i>]pyrene	252.3	2	2
Benzo[<i>a</i>]pyrene	252.3	11	9
Perylene	252.3	3	7
Benzo(<i>g,h,i</i>)perylene	276.3	2	2
Indeno(<i>1,2,3-cd</i>)pyrene	276.3	n.d.	n.d.
Dibenz(<i>a,h</i>)anthracene	278.4	n.d.	1

2.1.3. Experimental organisms

Juvenile, thin-lipped grey mullets (*Liza ramada*) were caught in Daoulas Bay (France) and acclimatised for 1 month in 300 L flow-through tanks (35 ± 0.5 ‰, 19 ± 0.2 °C, with 12 h light:12 h dark photoperiods) prior to the bioassays. During acclimatisation, no mortality was observed and mullets were fed daily with fish food (Neosupra AL2 from Le Gouessant aquaculture). The fish were not fed 48 h prior to the bioassays, and throughout the exposure period. For each exposure condition, ten fish were weighed prior to the exposure (**Table 1**).

2.2. *Exposure methods*

2.2.1. Preparation of exposure media

Stock solutions were prepared in 22 L glass beakers. All stock solutions were stirred for 24 h as described below. A Water Soluble Fraction of oil (WSF) stock solution was prepared as the Water Accommodated Fraction (WAF) recommended by CROSSERF, with the exception that the WAF preparation used in this study did not have a lid on the glass beaker in order to simulate the evaporation of light compounds which occur during oil slick confinement. Practically, 95 g of BAL (Brut Arabian Light) oil was weighed and gently spread out over 20 L seawater to simulate an oil slick. Then, the solution was stirred using a magnetic agitator (RCT basic IKA) using the low energy method (no vortexing) for a 24 h period. Only the liquid phase of the WSF of oil was used in the subsequent exposure studies. Chemically dispersed oil (CD1 and CD2) stock solutions, using dispersant 1 and 2, were prepared using 20 L of seawater, 95 g BAL oil slick, and 5 g of dispersants 1 and 2 (following the manufacturers' recommended application petroleum:dispersant ratio of 20:1). Dispersant (D1 and D2) stock solutions were prepared using 20 L of seawater and 5 g of dispersant. A mechanically dispersed oil stock solution (MD) was prepared using 20 L of seawater and 95 g BAL oil slick. CD1, CD2, D1, D2 and MD stock solutions were each stirred for 24 h using a propeller mixer (RW 16 Basic IKA), fitted with the same propeller as used in the experimental system. The propeller mixer speed was set higher than during exposure (1400 rounds per minute instead of 1000 rounds per minute) in order to avoid the formation of an oil slick for the MD stock solution.

2.2.2. Exposure conditions

Following the 24 h period of exposure media preparation, each stock solution was diluted in seawater, which was previously placed in the experimental system tanks (described in **2.1.1.**). On the basis of one dilution per tank, 6 dilutions of each stock solution were made: 0%, 2.4%, 12%, 18%, 24%, and 40%. The final volume of each dilution was 16 L. Two exposure conditions were tested simultaneously: CD1 and D1, followed by CD2 and D2, and then WSF of oil and MD, chronologically. Each group of 10 organisms was exposed to one stock solution dilution (16 L) for 24 h in one experimental tank. At the end of the 24 h exposure period, the animals in each tank were gently transferred to a 22 L glass tank with clean seawater flow-through for 24 h, as recommended by Blackman et al. (1978). After 24 h, each tank was inspected and dead animals were counted. Animals were considered to be dead when no gill movement was visible and no response to a caudal pinch was observed. Surviving fish were euthanised using Eugenol (4-allyl-2-methoxyphenol). The whole axial muscle of each fish was removed and stored at -20°C for later assessment of polycyclic aromatic hydrocarbon (PAH) concentrations.

2.3. *Chemical analysis*

2.3.1. Total petroleum hydrocarbon (TPH) seawater concentrations

The TPH concentration, which is the sum of dissolved hydrocarbon concentrations plus the amount of oil droplets, was measured for all exposure media in each tank, at T = 0 h, and at the end of fish exposure (T = 24 h), using the mean of three replicated measurements for each time point. Each sample was removed using a Teflon straw, linked to a pipette filler (VWR), and stored in a 60 mL tinted glass bottle (VWR). The seawater samples were extracted with 10 mL of Pestipur-quality dichloromethane (Carlo Erba Reactifs, SDS). After separation of the organic and aqueous phases, the seawater was extracted two additional times with the same volume of dichloromethane (2×10 mL). The combined extracts were dried on anhydrous sulphate and then analysed using a UV spectrophotometer (UV-Vis spectrophotometer, Unicam) at 390 nm, as described by Fusey & Oudot (1976). The detection limit of this method is dependent on the precision of the spectrophotometer (CEDRE property), and results are not reliable for concentrations under 1 mg/L

2.3.2. Polycyclic aromatic hydrocarbon (PAH) seawater concentrations

PAH concentrations were assessed in each tank, at T = 0 h and following fish exposure (T = 24 h), using the mean of two replicated measurements for each time point. After sampling, a 24 h settling phase was used to separate oil droplets and particulate matter from the seawater. Then, 150 µL of a solution of 5 perdeuterated internal standards (Naphthalene d₈, Biphenyl d₁₀, Phenanthrene d₁₀, Chrysene d₁₂, and Benzo[a]pyrene d₁₂ at concentrations of 210, 110, 210, 40 and 40 µg/mL, respectively in acetonitrile Sigma-Aldrich, France) were diluted in 10 mL of absolute methanol (Sigma-Aldrich, France), and this volume of methanol was added to the liquid phase of the samples. PAH were extracted from the seawater using the stir bar sorptive extraction technique (SBSE, stir bar coated with PDMS, Gerstel), and analysed by thermal desorption coupled to a capillary gas chromatography–mass spectrometer (GC–MS). An HP7890 series II (Hewlett Packard, Palo Alto, CA, USA) GC was used, coupled with an HP5979 mass selective detector (MSD, Electronic Impact: 70eV, voltage: 2 000 V). Twenty-one PAH (alkylated and parents), including the 16 PAH listed by the US-EPA and 5 additional PAH (benzo[b]thiophene, biphenyl, dibenzothiophene, benzo[e]pyrene, perylene), were quantified according to published procedures (Roy et al. 2005). Based on the detection limits of this method, accurate results at concentrations of 1ng/L were possible.

2.3.3. polycyclic aromatic hydrocarbon (PAH) concentrations in fish muscles and bioaccumulation factor (BAF)

The concentrations of 21 PAH (alkylated and parents) in the fish muscles were assessed. The 21 PAH represent the 16 US-EPA PAH and 5 supplementary PAH (benzo[b]thiophene, biphenyl, dibenzothiophene, benzo[e]pyrene, perylene). PAH concentrations in the fish muscles were determined by GC–MS, using a procedure modified from Baumard et al. (1997). Fish samples were pooled according to exposure treatment (one pool per tank). Although most pools contained some fish which survived the exposure experiments, pools were not analysed for exposures to 40 % stock solutions, because there were no surviving fish following CD1 and CD2 exposure.. The mean weight of the fish in the pools was 6.1 ± 0.7 g. Prior to extraction, 150 µL of a solution of 5 perdeuterated internal standards (Naphthalene d₈, Biphenyl d₁₀, Phenanthrene d₁₀, Chrysene d₁₂, and Benzo[a]pyrene d₁₂ at concentrations of 210, 110, 210, 40 and 40 µg/mL, respectively, in acetonitrile Sigma-Aldrich, France) and

50 mL of an ethanolic solution of potassium hydroxide (2 mol L^{-1} , Fisher Chemicals) were added to fish muscles in 250 mL flasks and placed for 3 h in a drying cupboard at $60 \text{ }^{\circ}\text{C}$. After alkaline digestion, 20 mL of demineralised water was added and samples were extracted with $2 \times 20 \text{ mL}$ of pentane (Carlo Erba Reactifs, SDS). The resulting extract was then concentrated using a Turbo Vap 500 concentrator (Zyman, Hopkinton, MA, USA, at 880 mbar and $50 \text{ }^{\circ}\text{C}$) to 1 mL, purified on a silica column (5 g of silica, hydrocarbons were eluted with 50 mL of pentane/dichloromethane 80/20) and concentrated to 200 μL for analysis. Aromatic compounds were analysed by GC–MS, with an approximate quantification limit of $5 \mu\text{g.kg}^{-1}$ of dry weight. PAH levels were quantified relative to the 5 perdeuterated internal standards introduced at the beginning of the sample preparation procedure (one per aromaticity class).

Moreover, as described in Baussant et al. (2009), a bioaccumulation factor (BAF) was calculated using the ratio of the total PAH concentration in fish muscles divided by the total PAH concentration in seawater (2.3.2.).

2.4. Statistical analysis

All correlations were tested using Spearman's correlation test (XL Stat 5.2) and the statistical significance of the results was ascertained at $\alpha = 0.05$. Differences between exposure conditions (CD1, CD2, MD, D1, D2, WSF) concerning seawater PAH concentrations, muscle PAH concentrations, and bioaccumulation factors were evaluated using the Quade test. For the Quade test procedure, exposure conditions were defined as treatment and % of stock solutions defined as blocks. Values obtained for each exposure conditions at several % of stock solutions were considered as repeated measurements. The Quade test was carried out using R statistical software and the statistical significance of the results was ascertained at $\alpha = 0.05$.

3. Results

For all exposure conditions, physicochemical parameters were stable and no difference was observed between them (**Table 1**).

*3.1. Total petroleum hydrocarbon (TPH) seawater concentrations and fish mortality (Erreur ! Source du renvoi introuvable. and **Table 4**)*

No mortality was observed and the TPH concentration was zero for 0% stock solutions of all exposure media. Spearman's test revealed a correlation between TPH concentration (the mean of measurements at T = 0 h and at T = 24 h) and the percent dilution of stock solutions for CD1 and CD2 exposure ($P < 0.05$), but no correlation was found for MD exposure ($P = 0.137$). Because only soluble compounds are present in WSF of oil exposure media, the low TPH concentrations contained in this exposure media cannot be detected using spectrophotometry.

No mortality was observed following WSF of oil and MD exposure. For D1 exposure, 10 % mortality and 30 % mortality was observed for 18 and 40 % stock solution exposures, respectively. Approximately the same pattern was observed for D2 exposure: 10% mortality and 20 % mortality was observed for 12 and 40 % stock solution exposures, respectively.

For CD1 exposure, no mortality was observed following exposure to 0% and 2.4 % of the stock solution. Following exposure to 12, 18 and 24 % of the stock solution, 30 % mortality was observed. Thus, no mortality increase was observed following exposure between 12 and 24 % of the CD1 stock solution, whereas our results show increased TPH concentrations. Following exposure to 40 % of the stock solution, 100 % mortality was observed.

For CD2 exposure, 0 % mortality was observed following exposure between 0 and 18 % of the stock solution. 10% mortality was observed following exposure to 24 % of the stock solution and 100 % mortality was observed following exposure to 40 % of the CD2 stock solution.

Table 3. Mortality and Total petroleum hydrocarbon (TPH) concentration (values represent the concentration at T_{0 h}-T_{24 h}) measured for each % of stock solution, for MD (mechanically dispersed oil), CD1 (chemically dispersed oil using dispersant 1), CD2 (chemically dispersed oil using dispersant 2). n.d. = not detected.

% of stock solution	MD		CD1		CD2	
	[TPH] (mg/L)	Mortality (%)	[TPH] (mg/L)	Mortality (%)	[TPH] (mg/L)	Mortality (%)
0	n. d.	0	n. d.	0	n. d.	0
2.4	67-15	0	55-35	0	111-64	0
12	281-228	0	491-398	30	616-548	0
18	173-158	0	873-605	30	777-625	0
24	383-340	0	1223-1096	30	1203-1055	10
40	374-122	0	1606-1457	100	1641-1438	100

Mortality was not observed and TPH concentration was under the method detection limit (n/a) for 0% stock solution of all exposure media. The Spearman test revealed a correlation between TPH concentration and the percentage of stock solution for CD1 and CD2 exposure ($P < 0.05$) but no correlation was found for MD exposure ($P = 0.137$). Only soluble compounds are present in WSF exposure media so that the low concentrations were under the method detection limit.

Table 4. Mortality and contaminant concentration (TPH for WSF exposure and Dispersant nominal concentration for D1 and D2 exposure). n.d. = not detected.

% of stock solution	WSF		D1		D2	
	[TPH] (mg/L)	Mortality (%)	[Disp] (mg/L)	Mortality (%)	[Disp] (mg/L)	Mortality (%)
0	n.d.	0	0	0	0	0
2.4	n.d.	0	6	0	6	0
12	n.d.	0	30	0	30	10
18	n.d.	0	45	10	45	0
24	n.d.	0	60	0	60	0
40	n.d.	0	100	30	100	20

3.2. Polycyclic aromatic hydrocarbon (PAH) seawater concentration

No polycyclic aromatic hydrocarbons (PAH) were detected for 0% of the stock solutions for all exposure media.

A correlation between the sum of the concentrations of the 21 PAH (**Figure 15**) and the percent dilution of the stock solution was found for CD1, CD2 and WSF of oil exposures ($P < 0.05$), but not for MD exposure ($P = 0.100$). The sum of the concentrations of the 21 PAH in seawater revealed significant differences between exposure conditions. First, PAH concentrations were significantly higher following CD2 exposure than CD1 exposure. Moreover, our results reveal that exposure to chemically dispersed oil solutions (CD1 and CD2) is associated with higher concentrations of PAH than mechanically dispersed oil media. Finally, PAH concentrations following WSF of oil exposure were significantly lower than PAH concentrations measured following other exposure conditions (MD, CD1, CD2).

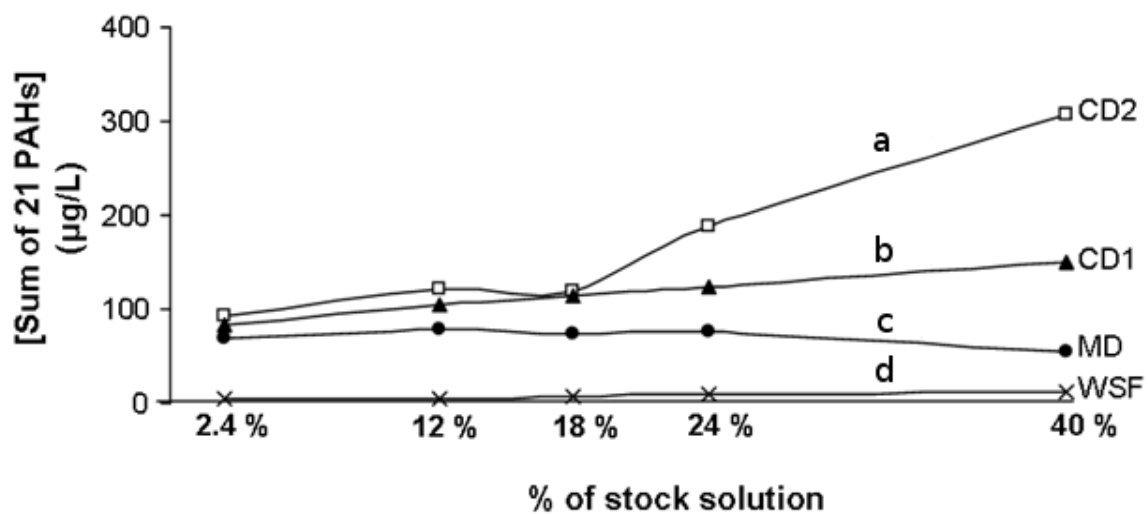

Figure 15. Concentration of the sum of 21 PAH (alkylated and parents) in sea water during CD1 (Chemically Dispersed oil using dispersant 1), CD2 (Chemically Dispersed oil using dispersant 2), MD (Mechanically Dispersed oil) and WSF (Water Soluble Fraction of oil). Values represent means of two measurements (at $T = 0$ h and at $T = 24$ h). The 21 PAHs represent the 16 US-EPA PAHs and five supplementary PAHs (benzo[*b*]thiophene, biphenyl, dibenzothiophene, benzo[*e*]pyrene, perylene). To determine whether the curves differed significantly, Quade test was conducted. Different letters above curves indicates that curves differed significantly ($P < 0.05$).

3.3. Polycyclic aromatic hydrocarbon (PAH) concentrations in fish muscles and bioaccumulation factor (BAF)

Polycyclic aromatic hydrocarbon (PAH) muscles concentration (Table 5) were measured to be zero following exposure to 0% of the stock solutions for all exposure media.

Correlations were found between PAH concentrations in fish muscles and the percent stock solution dilution used for MD, WSF, CD1 and CD2 ($P < 0.05$). PAH concentrations were significantly higher in chemically dispersed oil (CD1 and CD2) than in either mechanically dispersed oil (MD) or WSF of oil. Even though the PAH concentrations appeared to be much higher following mechanically dispersed oil exposure than WSF of oil exposure, statistical analysis did not reveal any significant difference (P -value = 0.115).

No correlation was observed between BAF and the percent stock solution dilution, for all exposure media (**Table 6**). BAF was found to be significantly higher following exposure to chemically dispersed crude oil (CD1 and CD2) than WSF of oil exposure. Although BAF levels appeared to be higher following MD exposure than following WSF of oil exposure, no significant difference was found ($P = 0.064$). No significant difference was found between MD and CD1 exposure ($P = 0.265$). The same is true of MD and CD2 exposure ($P = 0.701$).

4. Discussion

The aim of this study was to evaluate the toxicity due to dispersant application in nearshore areas as an oil spill response technique. Using an experimental approach, this study took into account the turbulent mixing processes inherent in nearshore waters, and also accounted for the presence of oil droplets resulting from oil slick dispersion. Four exposure conditions were tested: (i) chemically dispersed oil solutions, simulating the application of dispersant when turbulent mixing processes permit this response technique; (ii) dispersant alone (D1 and D2) in seawater, as internal controls of chemically dispersed oil solutions; (iii) a mechanically dispersed oil solution, simulating the natural dispersion of an oil slick due to mixing processes but without dispersant application; (iv) a water soluble fraction of oil, simulating an undispersed and untreated oil slick before recovery, when calm weather conditions permit this response technique.

For 0% dilutions of the stock solution of all treatments, mortality did not occur and contaminants were not detected in seawater or fish tissues. These results, coupled with the stability of physicochemical parameters (T °C, pH, dissolved oxygen, salinity) validate the experimental procedure used in this study.

4.1. Mortality, total petroleum hydrocarbon (TPH), and polycyclic aromatic hydrocarbon (PAH) concentrations in seawater

The TPH concentration decrease observed in this study between T = 0 h and T = 24 h, is in agreement with field operation measurements, although the drastic decrease observed in literature (Cormack 1977; Lessard & Demarco 2000) was slighter less in our experiment. Although the experimental system used for this study attempts to simulate natural dispersion at nearshore areas, we admit that the evolution of TPH concentration depends on the turbulent mixing energy of the experimental system.

Correlations between the percentage stock solution used for exposure and total petroleum hydrocarbon concentrations (mean of measurements at T = 0h and at T = 24 h) were observed following CD1 and CD2 exposures, whereas no correlation was found following MD exposure. Indeed, following CD1 and CD2 exposures, TPH concentrations increase linearly

as a function of the percentage stock solution used for exposure, whereas TPH concentrations for MD exposure did not increase between 12% of the stock solution and 40% of the stock solution. Extrapolated to oil spill response techniques, this result shows that, for a given sea energy (in this study, the experimental system energy), a threshold water column concentration cannot be exceeded if the oil slick is dispersed mechanically, whereas this threshold can be exceeded if the oil slick is dispersed chemically.

In parallel, an oil slick was observed following exposure to 12, 18, 24, and 40% MD stock solution dilutions, whereas no oil slick was observed following CD1 and CD2 exposures. Thus we can hypothesise that, following MD exposure, increasing the petroleum quantity led to an increase in oil slick thickness instead of an increase in water column TPH concentration. The formation of an oil slick during mechanical dispersion, but not during chemical dispersion is in agreement with the mode of action of chemical dispersants and with observations made at oil spill sites. Lewis & Daling (2001) gave a complete explanation of this phenomenon: when turbulent mixing energy permits natural dispersion of the oil slick, oil droplets are large (from 0.4 to several mm in diameter) and rise quickly back to the sea surface, where they coalesce and reform the oil slick. In contrast, chemical dispersant application mediates the formation of smaller oil droplets (10 to 50 μm), which have a low rise velocity and are disseminated, for instance by water currents, before they can reform an oil slick.

Regarding to fish mortality, chemically dispersed oil would be more toxic than an untreated and undispersed oil slick (WSF). Indeed, no mortality was found for WSF of oil exposure whereas 100 % fish mortality was observed following exposure to 40% dilutions of CD1 and CD2 exposures. Moreover, mortality due to chemical dispersion of oil (CD1 and CD2) was observed at lower concentrations: at 12 % of the CD1 stock solution and at 24 % of the CD2 stock solution. Note that mortality did not increase between 12 % and 24 % of the CD2 stock solution, whereas actual TPH concentrations increased. This phenomenon is likely due to contamination resistance variability between fish. For example, it is possible that some fish exposed to 24 % of the CD2 stock solution were more resistant to hydrocarbon contamination than other fish exposed to 12 % of the CD2 stock solution. This would result in the same mortality percentage for both groups of fish, even if the exposure concentrations were different. In total, these results are in agreement with many studies (Long & Holdway 2002; Pollino & Holdway 2002; Lin et al. 2009) and suggest, as it was previously proposed by Cohen & Nugegoda (2000), that when meteorological conditions permit it, recovery and containment of the oil slick should be conducted since it is a less toxic response technique

than the application of chemical dispersants. Similarly, chemically dispersed oil seems to be more toxic than mechanically dispersed oil, because no mortality was observed after fish were exposed to this condition. This finding suggests that, when the oil slick is under natural mixing processes, the application of chemical dispersant increases the toxicity of the petroleum, probably by increasing the amount of total petroleum hydrocarbons in the water column (as described above). Moreover, our study results suggest that the toxicity of dispersants (D1 and D2) seems to be too low to be the major determinant of CD1 and CD2 exposure toxicity. This result is in accordance with Otitoluju (2005), who showed that the toxicity of dispersant application is not due to dispersant toxicity alone, but rather to the synergistic toxicity of dispersant and petroleum.

With respect to seawater concentrations of the 21 PAH compounds tested, our results show that PAH concentrations were significantly higher following CD1 and CD2 exposures than WSF of oil exposure. This result is in line with the mode of action of chemical dispersants, which increase the total surface area for the partitioning of PAH from oil to water by increasing the number of droplets and decreasing their size. Mechanical dispersion also increases the number of droplets in the water column, and, logically, based on our results, this phenomenon led to an increase in PAH concentrations (comparing WSF of oil exposure and MD exposure).

Our study results demonstrate that PAH concentrations are higher in chemically dispersed oil than in mechanically dispersed oil. This result could also be due to an increase in surface area available for PAH partitioning, since part of the petroleum is taking part in an oil slick (instead of droplets) in mechanically dispersed oil.

Moreover, our results indicate that, through comparison of both chemical dispersants (CD1 and CD2), dispersant 2 induces higher PAH concentrations in seawater than dispersant 1. However, TPH concentrations in the water column do not seem to be different between both dispersed oil solutions. It is therefore possible to hypothesise that dispersant 1 retards the PAH partitioning from oil droplets to water.

In our study, the sum of 21 PAH concentrations in seawater were never higher than 308 µg/L (following exposure to 40 % of the CD2 stock solution). In a study by Maria et al. (2002), conducted on *Anguilla anguilla*, the exposure period was 9 times longer (216 h) than in our study, and the concentration of benzo[*a*]pyrene -considered to be the most toxic of the 21 PAH (Eisler 1987)- was measured to be 2 times higher (680 µg/L) than the sum of 21 PAH concentrations measured in our study. Nevertheless, in this last study, mortality was not observed. Comparison of these two studies suggests that, in our study, PAH concentration

was not sufficient to induce mortality. Thus, PAH were not the only determinant of acute toxicity. In fact, acute toxicity could be due to other petroleum compounds (such as saturated hydrocarbons), or the presence of oil droplets (Brannon et al. 2006). Therefore, as stated in the introduction of this article, the presence of total petroleum hydrocarbons and/or droplets in the water column seems to be very important for evaluation of the toxicity of chemically dispersed oil.

4.2. Bioaccumulation factor (BAF), PAH concentrations in fish muscles

PAH compounds are considered to be mutagenic and carcinogenic (Ohe et al. 2004) and, consequently, their bioaccumulation is relevant and interesting because it provides information about long-term toxicity (Ramachandran et al. 2004a). In the present study, PAH bioconcentrations were measured following a 24 h period in clean seawater. There is evidence that biological detoxification processes (such as the induction of EROD activity described in Camus et al. 1998) can be induced during this period. However, because the detoxification period was the same for all fish, comparison of results between exposure conditions is reliable.

In a comparison of chemically dispersed oil and the water soluble fraction of oil, our results show that dispersion of the oil slick led to an increase in PAH concentrations in seawater (previously discussed in section 4.1. above). Moreover, our results show that PAH bioaccumulation (via BAF calculation) is higher following CD1 and CD2 exposure conditions than WSF of oil exposure conditions. This phenomenon could be due to other contaminants (such as saturated hydrocarbons or the chemical dispersant), which can induced functional morphology alterations in the gills (as described in Rosety-Rodriguez et al. 2002). This alteration would have induced a decrease of the selective permeability of gills and by the way an increase of PAH bioaccumulation.

Taken together, these results show that dispersant application increases PAH partitioning from oil to water, and moreover, increases PAH bioaccumulation (at the seawater–organism interface). As a result, PAH concentrations were found to be higher in the muscles of fish exposed to chemically dispersed oil than in the muscles of fish exposed to the water soluble fraction of oil. These results are in agreement with many studies that have revealed an increase in PAH uptake due to dispersant application (Wolfe et al. 2001; Mielbrecht et al. 2005).

Similarly, PAH concentration measurements in seawater were found to be higher following MD exposure than WSF of oil exposure. Moreover, these results show that PAH bioaccumulation seems to be higher following MD exposure than WSF of oil exposure ($P = 0.064$). Together, these results suggest that mechanical dispersion seems to increase PAH partitioning from oil to water, and, in addition, increase PAH bioaccumulation (at the seawater–organism interface). As a result, PAH concentrations seem to be higher in the muscles of fish exposed to mechanically dispersed oil (MD) than in the muscles of fish exposed to the water soluble fraction of oil (P value = 0.115).

By comparing chemically and mechanically dispersed crude oil, we have shown that PAH concentrations in seawater were higher following chemically dispersed oil exposure (either CD1 or CD2) than following MD exposure. PAH bioaccumulation (BAF) was not different following these two exposures whereas PAH concentrations were significantly higher in the muscles of fish exposed to chemically dispersed oil than in the muscles of fish exposed to mechanically dispersed oil. These results suggest that, following chemical dispersant application, PAH partitioning from oil to water is the main factor inducing the observed increase in PAH bioconcentrations.

5. Conclusion

By comparing chemically dispersed oil exposure and water soluble fraction of oil exposure, our results demonstrate that chemical dispersion is more toxic than an untreated and undispersed oil slick, both in terms of acute toxicity (i.e. mortality observations) and chronic toxicity (increased PAH bioconcentration in fish muscles). The higher toxicity found for chemically dispersed oil solutions is probably due to the presence of oil droplets and the resulting increase in the concentration of PAH in the water column. Based on these results, responders should consider the increased toxicity due to chemical dispersion before using this response technique. For instance, when an oil spill site is ecologically sensitive, oil dispersion, by applying dispersants and inducing mixing processes (e.g. using a boat propeller as recommended in Merlin 2005), would not be appropriate. In this case, oil slick containment and recovery should be considered if technical facilities and meteorological conditions permit.

Our comparison of chemically and mechanically dispersed oil exposure effects has yielded information on dispersant application toxicity when turbulent mixing processes are present in nearshore areas. Under these conditions, oil slick containment and recovery is impossible, because of natural dispersion of the slick. Our results show that dispersant application increases both fish mortality and PAH bioconcentrations (by increasing the amount of dissolved PAH in the water column). These results suggest that, when the oil slick is under natural mixing processes, such as waves, the application of dispersant increases the environmental risk for aquatic organisms living in the water column.

However, these results were obtained at an experimental given mixing energy and concentrations used were significantly higher than those normally encountered during oil spills (Cormack 1977; Lunel 1995). These limitations of our study compel us to be cautious in our conclusion. Nevertheless, responders must take into account these results and also need more information on potentially sublethal effects, to better evaluate the long-term toxicity of dispersant application. Because of this, our study is part of an on-going project (DISCOBIOL project: DISpersant and response techniques for COastal areas; BIOLogical assessment and contributions to the regulation). Considering both the toxicity of dispersant application and its advantages, this project aims to obtain information about the ecological effects of dispersant application in nearshore areas.

Acknowledgements

This study was supported by a PhD grant from the Conseil Général of the Charente-Maritime. The Agence Nationale de la Recherche and especially Michel Girin and Gilbert Le Lann are acknowledged for financial support from the project 'DISCOBIOL', managed by F. X. Merlin. The authors also acknowledge Total Fluides and Innospech for providing chemicals. Special thanks go to Gwenaël Quaintenne and Benoit Simon-Bouhet for their help and assistance with statistical analysis and to Maxime Richard and Marie Czamanski for their helpful assistance providing the fish.

Synthèse du Chapitre 1

Cette étude constitue un préliminaire nécessaire au sein de ce travail de thèse. En effet, notre approche expérimentale permet à la fois de mesurer la **toxicité aiguë** – au travers de mesure de CL₅₀- due à l'application de dispersant sur une nappe de pétrole, mais permet également d'informer sur la toxicité à plus long terme, au travers des mesures de bioaccumulation. Plus précisément, la mesure des composés chimiques présents dans la colonne d'eau et dans les muscles de poissons permet de renseigner, sur les **processus de solubilisation et d'incorporation des HAP** responsable, en partie, de la toxicité chronique due à l'application des dispersants.

Dans cette étude, **trois conditions expérimentales** simulent trois scénarii possibles lors d'une catastrophe pétrolière : (i) **la dispersion mécanique** de la nappe de pétrole simule la dispersion naturelle d'une nappe de pétrole non traitée en milieu côtier turbulent ; (ii) **la dispersion chimique** d'une nappe de pétrole simule une nappe de pétrole traitée aux dispersants en milieu côtier turbulent ; (iii) **la fraction soluble des hydrocarbures** issue d'un pétrole non traité aux dispersants simule le confinement d'une nappe avant sa récupération. **Deux conditions contrôles** ont également été établies: dispersant seul en solution dans l'eau de mer (contrôle interne d'une dispersion chimique) et eau de mer non contaminée.

La comparaison des résultats de CL₅₀ entre une nappe de pétrole non traitée et la dispersion chimique de celle ci montre que l'application de dispersant augmente la toxicité létale aiguë du pétrole. La bioconcentration des HAP est également augmentée puisque leur diffusion à l'interface pétrole-eau ainsi qu'à l'interface eau-organisme est potentialisée par l'application de dispersant. Ces résultats suggèrent que lorsque l'état d'agitation de la mer est faible et que les moyens techniques permettent un confinement et une récupération de la nappe, la dispersion chimique de la nappe de pétrole -par application de dispersant et induction artificielle de phénomène turbulents (e.g. utilisation d'hélice de bateau)- ne doit pas être envisagée.

La comparaison des résultats entre une nappe de pétrole chimiquement et mécaniquement dispersée montre que l'application de dispersant en milieu côtier turbulent entraîne une augmentation de la mortalité. De plus, l'application de dispersant augmente le transfert des HAP au sein de la colonne d'eau. Ce phénomène est probablement responsable de l'augmentation de la bioconcentration des HAP dans les chairs de poissons. Cette

augmentation de la bioconcentration n'est régie que par le phénomène de diffusion à l'interface pétrole-eau, l'incorporation des HAP (à l'interface eau-organisme) n'étant pas potentialisée par l'application de dispersant en présence de phénomènes de turbulence. Ces résultats suggèrent, qu'**en milieu côtier turbulent, l'application de dispersant augmente la toxicité létale du pétrole et les phénomènes de bioaccumulation.**

Cependant, les conditions expérimentales de cette étude imposent d'être extrêmement prudent quant à nos extrapolations. En effet, afin d'obtenir une évaluation en termes de mortalité, cette étude a été réalisée à des concentrations bien plus élevées que celles rencontrées habituellement lors de catastrophes pétrolières. Il semble donc nécessaire dans un deuxième temps d'évaluer les effets biologiques de l'application d'un dispersant au travers d'une étude expérimentale reflétant les concentrations retrouvées *in situ* lors de catastrophes pétrolières. Pour ce faire, une approche expérimentale visant à déterminer les effets sublétaux d'une nappe de pétrole au niveau de l'organisme a été développée et est présentée dans le chapitre suivant.

CHAPITRE 2 - EFFETS SUBLETAUX D'UNE NAPPE DE
PETROLE DISPERSEE SUR LES PERFORMANCES DE NAGE
ET LA CAPACITE METABOLIQUE AEROBIE

Effect of dispersed crude oil exposure upon the metabolic scope in juvenile golden grey mullet (*Liza aurata*)

Thomas Milinkovitch, Julie Lucas, Stéphane Le Floch,
Hélène Thomas-Guyon, Christel Lefrançois

Abstract

Dispersant application is used as a response technique to minimize the environmental risk of an oil spill. However, in nearshore area this counter measure is controversial. Through an experimental approach in juvenile golden grey mullet (*Liza aurata*), this study evaluated the toxicity of dispersant use. Five exposure conditions were tested: (i) a chemically dispersed oil simulating dispersant application; (ii) a single dispersant as an internal control of chemically dispersed oil; (iii) a mechanically dispersed oil simulating natural dispersion of oil; (iv) a water soluble fraction of oil simulating an undispersed and untreated oil slick and (v) an uncontaminated sea water as a control exposure condition. For each of these exposure conditions, contamination level of polycyclic aromatic hydrocarbons (PAH) was evaluated through the measurement of relative concentration of biliary metabolites. Toxicity, at the organism level, was evaluated measuring the aerobic metabolic scope and the critical swimming speed of exposed fish. PAH biliary metabolites revealed that exposure of fish to PAH was increased if the oil was dispersed, whatever mechanically or chemically. However, aerobic metabolic scope and critical swimming speed did not reveal significant difference between the exposure conditions. These results suggest that further studies must be conducted in order to evaluate dispersant use toxicity in nearshore area: studies focused at the organ level or studies evaluating the long term effects of dispersant application could be of interest.

Key words: Dispersant toxicity, Aerobic metabolic scope, Critical swimming speed, biliary metabolites, nearshore area, golden grey mullet.

1. Introduction

Since the last decades, oil spills are a common occurrence: Amoco Cadiz in 1978, Erika in 1999, Prestige in 2002 and recently Deepwater horizon platform (2010). Nowadays, recovery and dispersion are the two main techniques used to clean up an oil spill. Recovery, and associated containment of the oil slick, are operated when the oil is viscous type, water temperature low, and sea surface flat. On the other hand, dispersant application is operated if the oil is light, water temperature high, and the sea rough enough to permit dispersion of the oil slick (Chapman et al. 2007). Dispersants used are surfactants (surface active agents) with a chemical affinity for both oil and water, enabling to mix the petroleum into the water column in small mixed oil-surfactant micelles (i.e. with a diameter lower than 100 μm) as described by Canevari (1978). By diluting the oil slick in the water column, dispersants prevent the arrival of the petroleum slick on ecological sensitive nearshore habitats and limit the risk of contamination in sea surface-occupying organisms (e.g. seabirds, marine mammals). Moreover, by increasing the surface to volume ratio of the oil, dispersion of the slick accelerates bacteria degradation of hydrocarbons (Tiehm et al. 1994; Churchill et al. 1995; Swannell & Daniel 1999).

In spite of these advantages, dispersant spraying may be considered as a countermeasure in nearshore area. Indeed, because of a limited dilution potential of the oil in shallow waters, use of dispersant may induce high concentrations of petroleum in the water column and thereby raises the toxicity for aquatic organisms. Thus, in order to give a framework to dispersant use policies in nearshore area, it is necessary to evaluate the toxicity of its application. In past studies, toxicity of dispersant spraying technique was determined by evaluating mortality of organisms exposed to a single dispersant solution (e.g. Perkins et al. 1973 in *Solea solea*). Later, studies measured toxicity of chemically enhanced water accommodated fraction, taking into consideration the toxicity of the interaction between dispersant and petroleum. For instance, Lin et al. (2009) and Jung et al. (2009) evaluated respectively LC_{50} in juvenile *Onchorhynchus tshawytscha* and biomarkers responses (acetylcholine esterase in the brain and ethoxyresorufin O-de-ethylase in the liver) in *Sebastes schlegeli*. Most of these studies considered the toxicity of the chemically enhanced water accommodated fraction (CEWAF, described in Singer et al. 2000), a contamination solution which does not take into

consideration the presence of a majority of the oil droplets formed during the dispersion of an oil slick. However, *in situ*, dispersant application provokes the formation of particulate oil (oil-dispersant droplets) which is a phenomenon particularly enhanced in nearshore area because of the mechanical agitation due to natural mixing process (e.g. waves). In addition, oil droplets have been suggested as a determinant of dispersed oil toxicity by Brannon et al. (2006). Therefore, the present study takes in consideration the relevant presence of these droplets in the water column in order to assess the actual toxicity of dispersant use in nearshore area. Through an experimental approach, juvenile of golden grey mullets (*Liza aurata*), a near shore teleost species, were exposed to (i) Chemically Dispersed oil (CD) simulating dispersant application; (ii) single Dispersant (D) as an internal control of CD; (iii) Mechanically Dispersed oil (MD) simulating natural dispersion of oil; (iv) Water Soluble Fraction of oil (WSF) simulating an undispersed and untreated oil slick and (v) uncontaminated sea water as a Control exposure condition (C).

For each condition, the level of exposure was evaluated through the concentration in seawater of total petroleum hydrocarbons (TPH) and through the concentration of the 16 Polycyclic Aromatic Hydrocarbons (PAH) priority pollutants listed by US EPA. In parallel, the concentration in the gallbladder of three biliary metabolites was estimated in order to give information of PAH bioavailability. At the whole organism level, the contamination-related impairments were evaluated by assessing the fish Aerobic Metabolic Scope (AMS, Fry 1947). AMS is the difference between Active Metabolic Rate (AMR) and Standard Metabolic Rate (SMR), *i.e.* the maximal metabolic rate of an organism in a highly active state minus its metabolic rate when at rest, respectively. Thus, AMS estimates an instantaneous rate of metabolism in the organism to cope with energy-demanding activities (e.g. locomotion, digestion, feeding). Environmental factors (e.g. temperature, dissolved oxygen, pollutants) are known to modulate AMS. For instance, in *Solea solea*, temperature together with oxygen is a determinant of metabolic scope (Lefrançois & Claireaux 2003). Specifically to petroleum hydrocarbons exposure, Davoodi & Claireaux (2007) highlighted a 30% decrease of AMS in *Solea solea*. Reduction of AMS illustrates a diminished ability to cope with energy demanding activities, which is likely to result in a prioritization of internal energy flow towards short term survival activities at the detriment of somatic and/or gonadic growth (Claireaux & Lefrançois 2007; Del Toro-Silva et al. 2008; Chabot & Claireaux 2008). As a consequence, AMS is claimed to be a relevant proxy of fitness for an animal coping with changing environmental factors such as temperature, oxygen availability and pollutant

exposure (Claireaux & Lefrançois 2007) and was employed in this study in order to evaluate the environmental risk of dispersant application upon *Liza aurata* population.

2. Material and Methods

2.1. Experimental organisms

Sixty juveniles golden grey mullets (*Liza aurata*) provided by Commercio Pesca Novellame (Srl, Chioggia, Italy) were used. Prior to the exposure studies, fish were acclimatized for at least 3 weeks in 300-l flow-through tanks with the following physico-chemicals parameters: dissolved oxygen: $91 \pm 2\%$ air saturation ; salinity: $35 \pm 1 \text{ ‰}$; temperature: $15 \pm 0.1 \text{ °C}$ (means \pm standard error means). During this period, they were fed daily with commercial food (Neosupra AL3 from Le Gouessant aquaculture). At the end of the acclimation period, average length of fish was $147.70 \pm 0.49 \text{ mm}$ and their average weight was $34.39 \pm 0.50 \text{ g}$ (mean \pm standard error of the mean).

2.2. Pollutants

2.2.1. Oil

An Arabian Crude Oil was selected for this study. Composition was evaluated by Cedre (CEntre of Documentation, Research and Experimentation on accidental water pollution, Brest, France), a laboratory certified according to ISO 9001 and ISO 14001. The oil was found to contain 54% saturated hydrocarbons, 36% aromatic hydrocarbons and 10% polar compounds. To simulate the natural behaviour of the oil after its release at sea (i.e. evaporation of light compounds), the oil was experimentally evaporated under atmospheric conditions. The resulting chemical composition of the oil was thereby 54% saturated hydrocarbons, 34% aromatic hydrocarbons and 12% polar compounds and its API (American petroleum institute) gravity was 33.

2.2.2. Dispersants

Because of its efficiency, a formulation manufactured by Total Fluides was selected. Dispersant is composed of surfactants (blend of anionic and non ionic types) and solvents. It is a third generation dispersant (concentrated surfactant) deemed-effective enough (preliminary determined by Cedre, using the method NF.T.90-345), non-toxic at the concentration recommended by the manufacturer (preliminary determined by Cedre assessing standard toxicity test: method NF.T.90-349) and biodegradable.

2.3. Contamination protocol

The experimental system was previously described in Milinkovitch et al. (2011a). Briefly it is made of five cylindrical tanks (diameter=1.1 m; height=0.4 m). Each tank comprised a funnel connected to a Johnson L450 water pump (**Figure 16**) which permits to maintain mixture of oil-dispersant droplets throughout the water column. The experimental system was set up in a temperature controlled room (15 ± 0.1 °C).

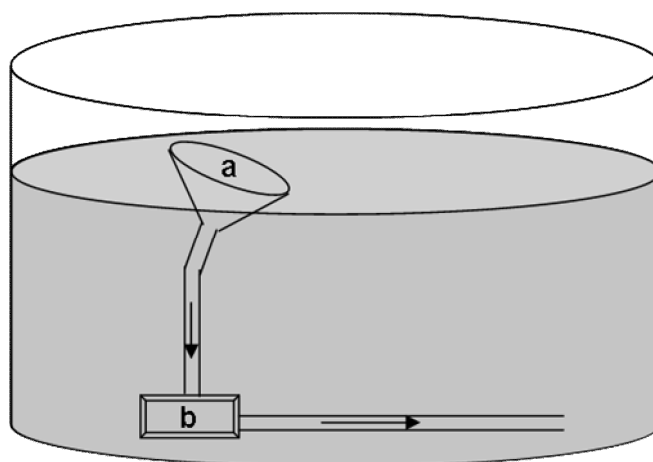

Figure 16. The experimental system constituted of a funnel (a) linked to a water pump (b) in a 300-l sea tank. → indicates the direction of seawater and/or contaminants through the experimental system.

Five exposure conditions were tested. Prior to preparation of exposure conditions, all tanks were filled with 300-l uncontaminated seawater provided by Oceanopolis (Brest, France). Control exposure condition was made up using only seawater. The chemically dispersed (CD) oil exposure medium was made by pouring 20 g of petroleum and 1 g of dispersant into the

funnel of the experimental system. The dispersant alone (D), as a positive control of CD, was made by pouring 1 g of dispersant into the funnel. The mechanically dispersed (MD) oil exposure medium was made by pouring 20 g of petroleum into this funnel. For the medium containing the water-soluble fraction (WSF), in addition to the funnel and the pump, which were only kept to maintain the same experimental conditions as for other treatments, a 20 g oil slick was contained using a plastic circle placed on the surface of the seawater. The oil slick remained at the surface without mixing and the fish were thereby only exposed to the soluble fraction of the oil.

A total of 5 experimental tanks were used for the five exposure conditions. For each exposure condition, 6 replicates of exposure were successively conducted. Two fish were exposed per replicate so that 12 fish were exposed to each of the five conditions. For each replicate, exposure lasted 48 h. Between consecutive exposures, experimental tanks were cleaned using dichloromethane (Carlo Erba Reactifs, SDS, France), a 12 hours phase of evaporation was then conducted and tanks were finally heavily washed with freshwater. The absence of dichloromethane trace was ensured conducting a gas chromatography-mass spectrometry. Fish were starved for 48 h prior to bioassays and throughout the exposure period in order to avoid bile evacuation from the gallbladder. Physicochemicals parameters were measured at the beginning and at the end of the contamination period and are reported in **Table 7**. No fish died and physicochemicals parameters (oxygen, pH, temperature) remained stable during the exposure (**Table 7**).

Table 7. Physicochemical Parameters Monitored over the Experimental Period. Values are the mean of six tank replicates (\pm standard error mean).

	Temperature (°C)	Oxygen (% AS)	pH
C	14.39 \pm 0.15	99.64 \pm 1.4	8.05 \pm 0.01
CD	14.49 \pm 0.13	99.47 \pm 1.6	7.98 \pm 0.02
MD	14.68 \pm 0.11	100.71 \pm 1.95	8.03 \pm 0.03
WSF	14.57 \pm 0.13	98.13 \pm 3.2	8.02 \pm 0.03
D	14.46 \pm 0.12	99.55 \pm 1.5	8.03 \pm 0.02

2.4. Total petroleum hydrocarbon (TPH) and polycyclic aromatic hydrocarbon (PAH) concentrations.

2.4.1. Total petroleum hydrocarbon (TPH) seawater concentrations.

TPH concentrations were measured for the 6 replicates of each exposure conditions. For each replicate, three samples were analyzed at the beginning (T = 0 h) and three at the end of fish exposure (T = 48 h). The mean of the three samples was considered representative of the TPH concentration at each time point. Extraction of samples was conducted with 10 ml of pestipur-quality dichloromethane (Carlo Erba Reactifs, SDS, France) which induced separation of the organic and aqueous phases. Then, water was extracted two additional times with the same volume of dichloromethane (2 x 10 ml). The extracts were dried using anhydrous sulphate and then treated using a UV spectrophotometer (UV-Vis spectrophotometer, Unicam, USA) at 390 nm as described by Fusey & Oudot (1976). According to Cedre and taking into account the precision of the spectrophotometer (Cedre property), results obtained with this method are not reliable under 1mg/L.

2.4.2. Polycyclic aromatic hydrocarbon (PAH) seawater concentrations

Two replicates were analyzed at the beginning (T=0 h) and at the end of fish exposure (T=48 h) for each replicate. Sixteen PAH (alkylated and parents), listed by US-EPA as priority pollutants, were quantified according to the method described by Roy et al. (2005). After sampling, a 24-hours settling phase to separate oil droplets and particulate matter from the seawater, was conducted. Then, 150 µL of a solution of five perdeuterated internal standards (Naphthalene d₈, Biphenyl d₁₀, Phenanthrene d₁₀, Chrysene d₁₂, and Benzo[a]pyrene d₁₂ at concentrations of 210, 110, 210, 40 and 40 µg/mL, respectively, in acetonitrile Sigma-Aldrich, France) were diluted in 10 ml of absolute methanol (Sigma-Aldrich, France) and this volume of methanol was added to the liquid phase of samples. Using the stir bar sorptive extraction technique (SBSE – Stir bar coated with PDMS, Gerstel, USA) and thermal desorption coupled to capillary gas chromatography-mass spectrometry (GC-MS), PAH were extracted from the seawater and treated. The GC was a HP7890 series II (Hewlett Packard, Palo Alto, CA, USA) coupled with a HP5979 mass selective (MS) detector (Electronic

Impact: 70eV, voltage: 2 000 V). According to publish procedure of Roy et al. (2005), detection limit for each PAH was 1 ng/L.

2.5. Evaluation of aerobic metabolic scope and critical swimming speed

2.5.1. Equipment

Two identical swimming tunnels (Loligo ApS., Danemark) were simultaneously employed to control the swimming speed of two fish of each exposure replicates and, at the same time, to measure their oxygen consumption. Swimming tunnels are adapted from those used in Vagner et al (2008), except the reduced size (75 l instead of 150 l). Each swimming tunnels was composed of a swimming respirometer (11 l) and a buffer tank. The swimming respirometer was made of a chamber (40 x 10 x 10 cm) where the fish was placed to be experimented. The water flow was generated by a motor fitted with a three bladed-propeller. Some deflectors and a plastic honeycomb promoted rectilinear flow with uniform profile of velocity (vertical and horizontal). A peristaltic pump promoted a continuous water flow from the respirometer to an oxygen probe placed in a chamber measure. This oxygen probe was connected to an oxymeter which was interfaced to a computer via a RS232 port. A data acquisition program (Oxyview) permitted to record oxygen saturation every ten seconds. The buffer tank, where temperature and oxygen were controlled using a thermoregulator and an air pump respectively, was connected to the swimming respirometer via a flush pump which allowed exchange of water between both compartments. This water flow permitted to renew the oxygen between consecutive measurements and also to maintain temperature in the swimming respirometer.

2.5.2. Experimental protocol

At the end of the 48 h contamination period, fish were gently caught and fork length (L) was measured before the animal was introduced in the swimming respirometer where it recovered during one night prior to the swim challenge. During the recovery period, water flow was maintained at a low swimming speed of $0.5 \text{ L}\cdot\text{s}^{-1}$. When the experiment started, water flow was increased by steps of $1.5 \text{ L}\cdot\text{s}^{-1}$ from 0.5 to $3.5 \text{ L}\cdot\text{s}^{-1}$, and by steps of $0.75 \text{ L}\cdot\text{s}^{-1}$ for further increase. Step duration was 20 min. The fish was considered fatigued if it did not manage to swim against the current but fell against the grid at the rear of the swimming chamber. Then,

the experiment stopped and the speed was decreased to 0.5 L.s⁻¹. Fish was allowed to recover during a couple of hours before it was removed from the swimming respirometer and euthanized with eugenol. Gallbladder was removed for PAH biliary metabolites analysis. Length, mass, width, height were measured. The net oxygen consumption (i.e. the microbial oxygen consumption) was measured to be further subtracted to the measured oxygen consumption of fish.

2.5.3. Calculations

2.5.3.1 Oxygen consumption (MO₂)

The measured oxygen consumption MO_{2(meas)} is expressed in mgO₂.kg⁻¹.h⁻¹ and calculated using the following formula :

$$MO_{2(meas)} = \Delta[O_2] \cdot V \cdot M_{meas}^{-1} \cdot \Delta t^{-1}$$

where $\Delta[O_2]$ in mgO₂.l⁻¹ is the variation of oxygen concentration during the measurement period (Δt in hours), V (L) is the volume of the respirometer minus the volume of the fish, M_{meas} (kg) is the fish mass.

Since an allometric relation exists between oxygen consumption and body mass, MO_{2(meas)} is corrected using the following formula:

$$MO_{2cor} = MO_{2meas} \cdot (M_{meas} \cdot M_{cor}^{-1})^{1-A}$$

where MO_{2cor} (mgO₂.kg⁻¹.h⁻¹) is the oxygen consumption related to a 0.1 kg (M_{cor}) fish, MO_{2meas} (mgO₂.kg⁻¹.h⁻¹) is the oxygen consumption calculated for the organism whose the mass is M_{meas} (kg) and A is the allometric constant describing the relation between oxygen consumption and body mass. In the case of this study, we used A=0.8 as in Vagner et al. (2008).

2.5.3.2 Critical swimming speed (U_{crit})

The critical swimming speed is expressed in $L.s^{-1}$ and calculated using Brett formula (1964):

$$U_{crit} = U_t + t_1 \cdot t^{-1} \cdot U_1$$

where U_t ($L.s^{-1}$) is the highest velocity maintained for an entire swimming step, t_1 (min) is the amount of time spent at the fatigue velocity, t (min) is the prescribed swimming period (20 min) and U_1 is the increment velocity (0.75 or 1.5 $L.s^{-1}$).

2.5.3.3 Standard metabolic rate (SMR), active metabolic rate (AMR) and aerobic metabolic scope (AMS)

As expected, oxygen consumption increased exponentially with swimming speed (Brett 1964) so that SMR can be described by the following equation:

$$MO_2 = SMR \exp^{bU}$$

where SMR is the intercept with the y-axis (i.e. MO_2 when $U=0 L.s^{-1}$), b is a constant, U is the swimming speed and MO_2 is the oxygen consumption ($mgO_2.h^{-1}.kg^{-1}$).

AMR is evaluated as the maximum oxygen consumption measured during the swimming test.

Finally, AMS is the difference between AMR and SMR. U_{crit} , SMR, AMR and AMS were assessed for each individual.

2.6. Fixed wavelength fluorescence analysis

Four μL of bile extracted from the gallbladder of fish were diluted in 996 μL of absolute ethanol (VWR International) in quartz cuvettes. Fixed wavelength fluorescence (FF) was then measured on a spectrofluorimeter (SAFAS Flx-Xenius, Monaco). Excitation:emission wavelength pairs 290:335, 341:383, 380:430 were employed to detect naphthalene-derived metabolites, pyrene-derived metabolites and benzo[*a*]pyrene-derived metabolites, respectively (Aas et al. 2000). The FF values are expressed as arbitrary units of fluorescence and give an

estimation of the relative concentration of metabolites between the five different exposure conditions (C, CD, MD, WSF, D).

2.7. Statistical analysis

The statistical analysis was carried out using Statistica software. Homoscedasticity (using Barlett test) and normality (using Kolmogorov-Smirnoff test) of data were demonstrated for SMR, AMR, AMS and the fixed wavelength fluorescence. Therefore, for each of these variables, a one way analysis of variance (one-way ANOVA) was performed in order to test for significant difference due to exposure conditions. For critical swimming speed, homoscedasticity and normality were not respected therefore a Kruskal-Wallis test was conducted. When necessary a Tukey post-hoc test was conducted to detect significant differences between exposure conditions. Patterns of TPH and PAH concentrations were analysed using a one-way repeated measure ANOVA (coupled to a HSD Tukey post hoc test) with time as a within factor and exposure condition as a between factor; concentration measurements at the beginning and at the end of the exposure were considered as repeated measure. Results were considered significantly different if $P_{\text{value}} < 0.05$. Results were expressed as means \pm standard error means.

3. Results

3.1. Total petroleum hydrocarbon (TPH) and polycyclic aromatic hydrocarbon (PAH) concentrations (Table 8)

Table 8. TPH and concentration of the sum of 16 parents and alkylated US-EPA PAH (Σ PAH) in the five exposure conditions at the beginning (T=0 h) and at the end of the exposure (T=48 h) for C (Control), CD (Chemically Dispersed oil), MD (Mechanically Dispersed oil), WSF (Water Soluble Fraction of oil) and D (Dispersant). For each contaminant measurements (TPH and PAH), different letters in the same row indicate significant difference of concentration between T = 0h and T = 48 h ($p < 0.05$); different symbols in the same column indicate significant difference of concentration between exposure conditions ($p < 0.05$). Values are the mean of six tank replicates (\pm standard error mean). n.d. means non detected PAH or TPH compounds.

	[TPH] _{T=0h} (mg/L)	[TPH] _{T=48h} (mg/L)	[Σ PAH] _{T=0h} (μ g/L)	[Σ PAH] _{T=48h} (μ g/L)
C	n.d.	n.d.	n.d.	n.d.
CD	44.0 \pm 3.0 ^{a,*}	38.2 \pm 2.8 ^{a,*}	60.1 \pm 9.3 ^{a,*}	15.6 \pm 3.3 ^{b,†}
MD	29.2 \pm 5.6 ^{a,*}	14.2 \pm 3.1 ^{b,†}	36.9 \pm 6.3 ^{a,*}	1.8 \pm 0.4 ^{b,†}
WSF	n.d.	n.d.	3.3 \pm 0.6 ^{a,†}	0.5 \pm 0.1 ^{a,†}
D	n.d.	n.d.	n.d.	n.d.

Both TPH and PAH were not detected in C and D exposure conditions. TPH were not detected in WSF exposure conditions while PAH were detected.

At T=0h, even if TPH concentration tended to be higher in CD than in MD exposure, results did not differ significantly. At T=48 h, TPH concentration remained stable in CD while it significantly decreased in MD exposure. Consequently, at T=48 h, TPH concentration was significantly lower in mechanically dispersed oil solution than in chemically dispersed oil.

At T=0 h, the concentration of PAH (sum of the 16) in CD and MD exposure conditions were significantly higher than in WSF. At T=48 h, PAH concentration significantly decreased in CD and MD exposure, while no significant decrease was observed in WSF. Even if not statistically different, concentration of PAH (at T=48 h) is higher in MD and CD than in WSF.

Concerning the 16 US-EPA PAH (**Table 9**), whatever the exposure conditions, naphthalene (alkylated and parents) concentration represents the major proportion of dissolved PAH. While concentration of two and three ring compounds (from naphthalene to fluoranthene) tended to represent the higher proportion of PAH dissolved in seawater, heavier PAH (four rings and more) showed low concentrations. Regarding variation over time, two and three ring compounds concentration tended to decrease during the exposure contrary to the concentration of heavier PAH.

3.2. Fixed wavelength fluorescence analysis (Figure 17)

Fixed wavelength fluorescence analysis did not reveal any significant differences of relative concentration of naphthalene derived metabolites between exposure conditions. On the contrary, a significant increase of relative concentration of pyrene derived metabolites was observed following both MD and CD exposure (when compared to C, D and WSF). The same pattern was obtained for benzo[*a*]pyrene derived metabolites.

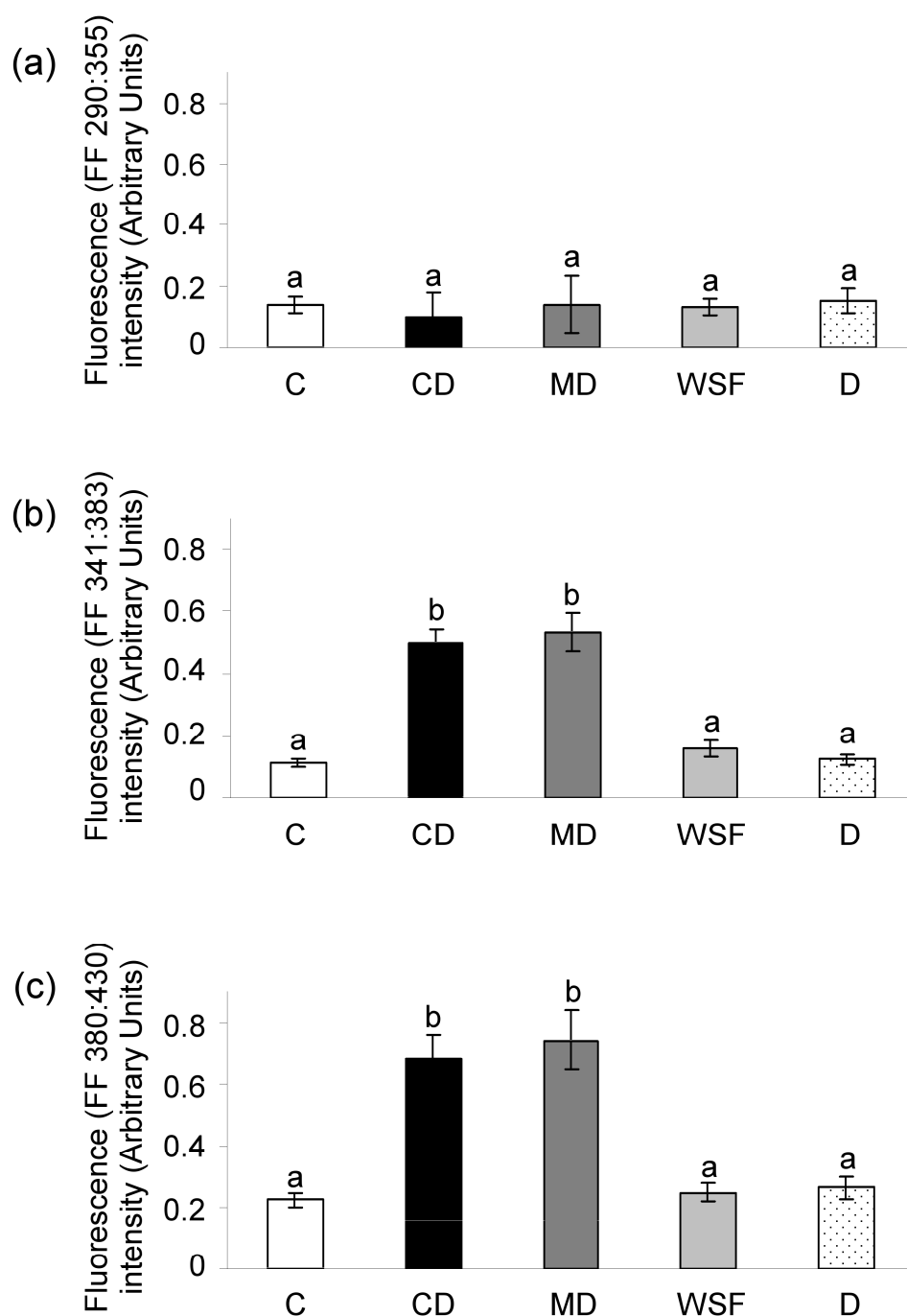

Figure 17. Fixed wavelength fluorescence (FF) of bile reflecting biliary PAH metabolites levels after 48 h exposure to Control (C), Chemically Dispersed oil (CD), Mechanically Dispersed oil solution (MD), Water Soluble Fraction (WSF) and Dispersant (D) solution: (a) FF 290:335 (naphthalene derived type of metabolites); (b) FF 341:383 (benzo[*a*]pyrene type of metabolites); (c) FF 380:430 (pyrene derived type of metabolites). Levels expressed as fluorescence intensity. Values represent mean \pm standard error (n=10 per treatment). Different letters above bars indicate a significant difference, where $P < 0.05$.

Table 9. Concentration of 16 parents and alkylated (C1-, C2-,C3-,C4-) US-EPA PAH in sea water during CD (Chemically Dispersed oil), MD (Mechanically Dispersed oil) and WSF (Water Soluble Fraction of oil) exposures. Values are the mean of six tank replicates (\pm standard error mean). n.d. means non detected PAH compounds.

16 US-EPA PAH (parents and alkylated)	Concentration (ng/L) at T=0h and T=48h					
	T= 0 h			T=48 h		
	CD	MD	WSF	CD	MD	WSF
Naphthalene	526 \pm 149	676 \pm 191	301 \pm 72	469 \pm 43	71 \pm 16	48 \pm 6
C1-Naphthalene	5798 \pm 1064	4451 \pm 1363	1040 \pm 255	1444 \pm 698	150 \pm 37	111 \pm 17
C2-Naphthalene	21948 \pm 4808	12553 \pm 3181	833 \pm 167	3641 \pm 1725	167 \pm 35	105 \pm 15
C3-Naphthalene	23828 \pm 4195	12398 \pm 2436	497 \pm 181	4276 \pm 1204	156 \pm 26	55 \pm 7
C4-Naphthalene	4294 \pm 602	4654 \pm 2441	171 \pm 55	1513 \pm 180	312 \pm 48	23 \pm 4
Acénaphthylene	8 \pm 8	9 \pm 7	1 \pm 0	27 \pm 2	1 \pm 0	n.d.
Acénaphthene	33 \pm 3	32 \pm 3	3 \pm 0	46 \pm 3	1 \pm 0	n.d.
Fluorene	283 \pm 22	202 \pm 12	6 \pm 2	121 \pm 21	2 \pm 1	n.d.
C1-Fluorene	370 \pm 39	206 \pm 31	9 \pm 3	169 \pm 22	10 \pm 3	2 \pm 0
C2-Fluorene	224 \pm 27	128 \pm 19	7 \pm 2	168 \pm 13	29 \pm 7	2 \pm 1
C3-Fluorene	62 \pm 9	27 \pm 10	2 \pm 1	60 \pm 8	29 \pm 4	1 \pm 0
Phenanthrene	600 \pm 29	343 \pm 47	18 \pm 4	477 \pm 66	5 \pm 1	5 \pm 2
Anthracene	153 \pm 82	47 \pm 42	2 \pm 1	141 \pm 56	2 \pm 0	2 \pm 1
C1-Phenanthrenes/Anthracene	868 \pm 45	456 \pm 85	16 \pm 5	591 \pm 122	12 \pm 6	5 \pm 1
C2-Phenanthrenes/Anthracene	472 \pm 41	274 \pm 52	22 \pm 9	530 \pm 37	108 \pm 22	4 \pm 1
C3-Phenanthrenes/Anthracene	183 \pm 25	104 \pm 24	12 \pm 8	241 \pm 33	107 \pm 15	3 \pm 1
C4-Phenanthrenes/Anthracene	4 \pm 3	n.d.	3 \pm 3	3 \pm 4	n.d.	1 \pm 1
Fluoranthene	4 \pm 1	10 \pm 8	4 \pm 2	28 \pm 1	2 \pm 1	1 \pm 0
Pyrene	10 \pm 1	15 \pm 9	6 \pm 3	31 \pm 1	6 \pm 1	1 \pm 0
C1-Fluoranthenes/Pyrenes	17 \pm 5	9 \pm 2	n.d.	26 \pm 4	13 \pm 2	n.d.
C2-Fluoranthenes/Pyrenes	29 \pm 8	15 \pm 4	12 \pm 10	48 \pm 7	26 \pm 3	n.d.
C3-Fluoranthenes/Pyrenes	27 \pm 8	22 \pm 15	22 \pm 17	42 \pm 8	19 \pm 3	1 \pm 1
Benzo[a]anthracene	3 \pm 0	37 \pm 28	3 \pm 2	130 \pm 38	10 \pm 7	2 \pm 2
Chrysene	64 \pm 7	72 \pm 31	11 \pm 5	225 \pm 44	40 \pm 7	7 \pm 4
Benzo[b+k]fluoranthene	33 \pm 15	48 \pm 37	15 \pm 6	474 \pm 177	97 \pm 75	51 \pm 47
Benzo[a]pyrene	32 \pm 13	17 \pm 11	20 \pm 10	225 \pm 80	87 \pm 61	12 \pm 11
Benzo(g,h,i)perylene	91 \pm 25	46 \pm 24	37 \pm 11	231 \pm 36	123 \pm 65	18 \pm 10
Indeno(1,2,3-cd)pyrene	71 \pm 16	29 \pm 8	41 \pm 12	86 \pm 32	105 \pm 71	22 \pm 11
Dibenzo(a,h)anthracene	105 \pm 24	46 \pm 16	56 \pm 17	132 \pm 43	149 \pm 91	33 \pm 17

3.3. Aerobic metabolic scope (AMS) and critical swimming speed (U_{crit}).

For all conditions of exposure, the increasing swimming speed of the fish induced an exponential increase in oxygen demand (results not shown). This exponential increase in oxygen consumption was followed by a plateau as the fish fatigued. Concerning SMR and AMR (**Figure 18**), no significant difference was found between exposure conditions.

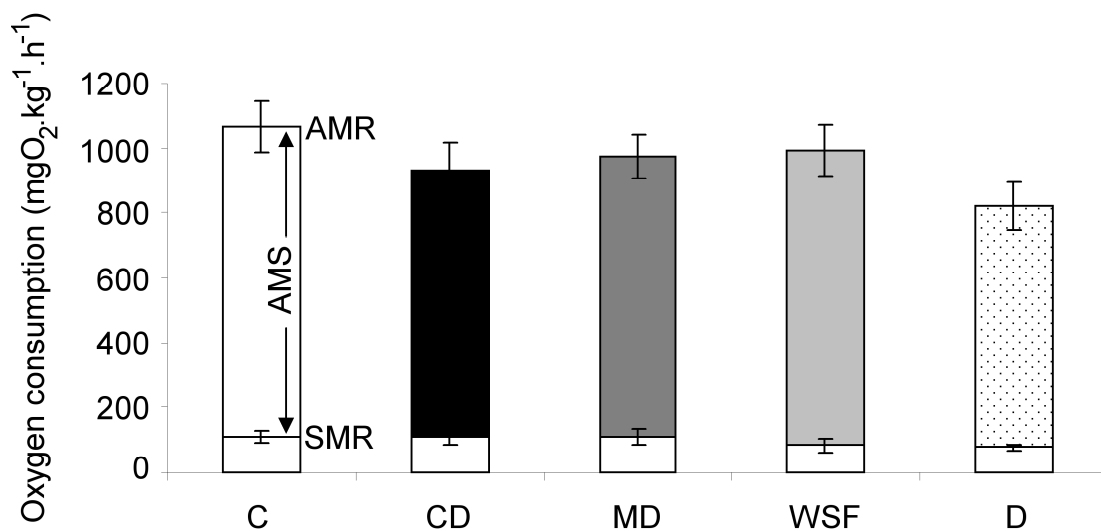

Figure 18. Standard metabolic rate (SMR), Active metabolic rate (AMR) and Aerobic metabolic scope (AMS) of golden grey mullets exposed to Control (C), Chemically Dispersed oil (CD), Mechanically Dispersed oil (MD), Water Soluble Fraction (WSF) and Dispersant (D) solution. Results are expressed as mean values \pm standard error mean.

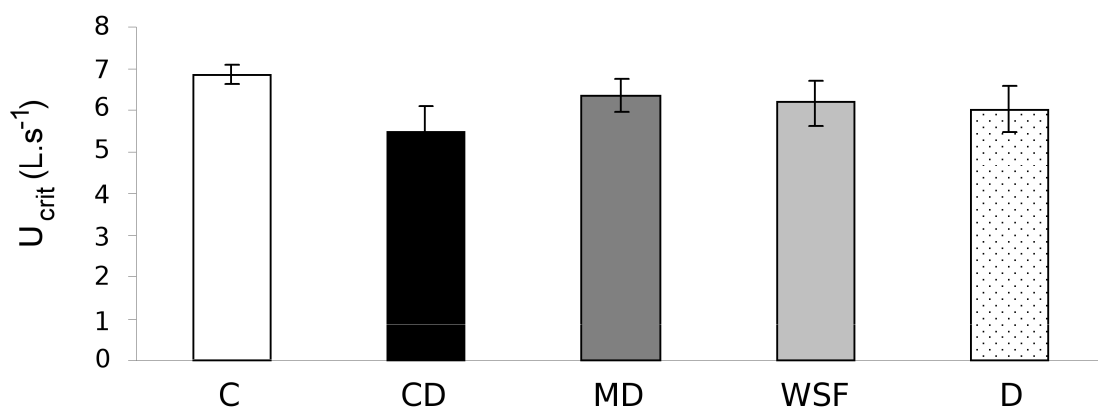

Figure 19. Critical swimming speed (U_{crit}) of golden grey mullets exposed to Control (C), Chemically Dispersed oil solution (CD), Mechanically Dispersed oil solution (MD), Water Soluble Fraction (WSF) and Dispersant (D) solution. Results are expressed as mean values \pm standard error mean.

Due to high AMR values, AMS tended to be higher in Control exposure condition than in contaminants exposure condition even if no significant difference was found between conditions. U_{crit} (**Figure 19**) showed the same pattern as AMS; even if U_{crit} tended to be higher in C exposure condition than in contaminants exposure, no significant difference was found between the conditions.

4. Discussion

The aim of this study was to investigate the toxicity of dispersant use in nearshore area. Our experimental approach aimed at evaluating the toxicity of dispersant application on an oil slick under mixing process since turbulent energy is present in nearshore areas (e.g. waves) and an abiotic condition required for dispersant use (Merlin 2005).

The experimental system was previously used in another study (Milinkovitch et al. 2011a) and described as suitable to conduct this experiment.

4.1. Total petroleum hydrocarbons concentration (TPH), PAH concentration and relative concentration of biliary metabolites

Concentrations of TPH (**Table 8**) in both CD and MD exposure have the same order of magnitude than the concentrations measured on oil spill sites or field studies. For instance, Cormack (1977) measured concentration of 18 mg/L in top 30 cm of the water column after chemical dispersion and Spooner (1970) measured 50 mg/L of naturally dispersed oil after an oil spill in Tarut Bay (Saudi Arabia).

In the present study, TPH concentration was found significantly lower in MD than in CD at the end of the exposure period. This phenomenon was probably due to the observed petroleum adherence to the experimental system (in particular to the funnel) which occurred for MD exposure and not during CD exposure. This reduction of petroleum adherence following dispersant use has even been described in field study (Baca et al. 2006).

With regards to kinetics of hydrocarbons concentration and exposure period, our experimental approach permitted to expose fish to a possible scenario. Indeed, in most of the oil spills in offshore area, TPH concentration decreased drastically after 2-5 hours (Lessard & Demarco

2000) during which a localized oil slick is dispersed and hydrocarbons are disseminated. On the contrary in shallow waters of nearshore area the lower dilution potential can reduce the dissemination speed. Moreover in case of a tanker grounding in coastal area, the continuous release of oil coupled to the turbulent mixing process may contribute to maintain the TPH concentration in the water column. For instance, in Braer oil spill, which was under rough sea conditions (until 10 Beaufort), the dispersion was maintained during more than one week (Lunel 1995). Our experimental approach permitted to expose fish to a halfway scenario (between a drastically decrease and a one week dispersion) in which the concentration was maintained (for CD exposure) or decreases slowly (for MD exposure) on a 48 h period.

With regards to the sum of PAH concentration, a higher concentration was observed for MD exposure and for CD exposure than for WSF exposure. This was probably due to the fact that oil droplets have a larger surface/volume ratio than an oil slick, inducing an enhanced solubilisation of PAH. Among the PAH, results show that mainly naphthalene is solubilized which is probably due to the solubility of this compound. Indeed naphthalene shows a K_{ow} (octanol-water partition coefficient) which is 3.0.

During the exposure (48 h), a decrease of PAH concentration was observed for MD as well as for CD exposure which may be due to volatilization/photolysis of the lighter compounds as described in Huang et al. (2004). Our results confirm this hypothesis since the lighter PAH concentration (from naphthalene to phenanthrene) decreased.

Concerning PAH biliary metabolites, concentration of pyrene and benzo[*a*]pyrene type were relatively higher in MD and CD than for other exposure conditions (WSF, D, C) which suggests a higher exposure to these compounds when the oil was dispersed (mechanically and/or chemically). The similar patterns observed for CD and MD exposure suggest that dispersant application did not increase PAH bioavailability. On the other hand, the invariability of naphthalene type metabolites between all the conditions was probably due to the high turnover of light PAH which were rapidly bioaccumulated (as described in *Mytilus edulis* in Baussant et al. 2001) and metabolized in the tissues so that metabolites may not have been accumulated in the gallbladder of contaminated fish.

4.2. Metabolic scope and critical swimming speed

In accordance with the literature, the increasing swimming speed induced an exponential increase in oxygen demand followed by a plateau before the fish started to fatigue. The values

of AMR and the shape of the curve representing MO_2 as a function of the swimming speed (data not shown) are similar to those obtained in Vagner et al. (2008), at 20°C, in a close species, the flathead grey mullet (*Mugil cephalus*).

Concerning aerobic metabolic scope of fish, previous studies showed that aquatic pollutants can alter it. For instance, Wilson et al. (1994) showed an increase of the standard metabolic rate in rainbow trout (*Oncorhynchus mykiss*) following an exposure to aluminium. This may be due to the fact that onset of defence mechanisms, such as the production of metallothionein (Roméo et al. 1997 in Amiard, 2008), is energetically costly. Focussed on hydrocarbons toxicity, a study of Davoodi & Claireaux (2007) showed that a 5 days exposure to petroleum decreased the active metabolic rate of the common sole (*Solea solea*) while the standard metabolic rate remained unchanged. This phenomenon could be explained by the impairment of heart rate and stroke volume which led to diminished cardio-respiratory performances (as described in Claireaux & Davoodi 2010), but also by the alteration of gill functional integrity which led to a reduced oxygen diffusion across the respiratory epithelium and into the blood (Claireaux et al. 2004).

In our study, measurements of standard and active metabolic rate did not reveal any differences between exposure conditions leading to an unchanged metabolic scope. Since aerobic metabolic scope has been shown, through the measurement of daily growth rate, to be correlated to fitness (Claireaux & Lefrançois 2007), this lack of difference may indicate that the fitness of the fish is not impaired by the exposures of our experiment. Swimming performance, measured by the critical swimming speed, was also not altered by contaminants exposure. This could be interpreted as a consequence of the invariability observed for metabolic scope since authors suggested a correlation between these two parameters (Wilson et al. 1994; Pane et al. 2004)

Precocious exposure biomarkers, such as biliary metabolites revealed significant differences between exposure conditions, so this lack of effect could be due to the low concentration used and/or to a too short exposure period. Indeed, in Davoodi & Claireaux (2007) the decrease of active metabolic rate was observed for a 5 days exposure with a fuel to water ratio which was 76 times fold higher than in our study. However, such experimental conditions should not have been used in our study since they do not simulate actual organism exposure during dispersant application in oil spill.

This lack of difference between conditions could also be due to physiological compensatory effects: the loss of functional integrity of an organ, involved in metabolism processes, should

have been compensated by the plasticity of another organ. For instance, alteration of the functional integrity of gills could have been compensated by cardiac plasticity leading to no impairment on the oxygen providing and consequently to no alterations of aerobic metabolic scope. On this basis it would have been interesting to also investigate effects of dispersed oil on gills and heart following dispersant application.

5. Conclusion

Through an experimental approach, this study intended to evaluate the toxicity of dispersant application. Even if, biliary metabolites revealed an increase exposure to PAH following dispersed oil exposure, no effect was highlighted regarding aerobic metabolic scope nor critical swimming speed. This lack of effect may indicate that the fitness of the fish is not impaired. However, at the organism level, physiological compensatory mechanisms may have hidden potential impairment due to dispersed oil. Thus, an approach conducted at lower levels of biological organisation should be of interest. For instance, evaluating the modulation of biomarkers in target organs (e.g. liver, gills, kidney and heart) would be relevant in order to highlight a loss of functional integrity.

The lack of significance could also be due to a too short time of exposure. Indeed, this study focused on the acute toxicity of oil spill, whereas in nearshore area, the contamination of the sediment and the consequent retention of heavy PAH induce also a chronic exposure. On this basis, it would have been important to develop an approach studying chronic toxicity of organism following an oil spill.

Acknowledgements

This study was supported by a PhD grant from the Conseil Général of the Charente-Maritime. Special thanks go to Sophie Vanganse for her help and assistance during the study. The Agence Nationale de la Recherche and especially Michel Girin and Gilbert Le Lann are acknowledged for financial support for the project 'DISCOBIOL'. The authors also acknowledge Total Fluides and Innospech for providing chemicals.

Synthèse du Chapitre 2

Cette étude expose les effets sublétaux de l'application de dispersant sur la capacité métabolique aérobie du mullet doré, ainsi que sur ses performances de nage. Ces deux variables sont considérées comme des valeurs prédictives de la fitness de l'animal. En effet, les **performances de nage** jouent un rôle fondamental dans le cycle de vie d'un poisson, au travers par exemple, des processus d'acquisition d'énergie, comme la recherche alimentaire. **La capacité métabolique aérobie**, mesure plus intégrative, donne une estimation de l'énergie dont l'animal dispose pour ses activités discrétionnaires, tel que les processus de digestion, mais aussi tel que la croissance gonadique et somatique.

La modification de ces deux variables biologiques traduirait donc des altérations au niveau de l'organisme susceptibles d'affecter sa fitness. Dans cette étude, les mêmes conditions expérimentales que précédemment (chapitre 1) ont été employées **mais les concentrations en hydrocarbures totaux correspondent à celles observées *in situ*** lors de catastrophes pétrolières.

Bien que l'utilisation d'un biomarqueur précoce, **la concentration des métabolites biliaries des HAP, montre une incorporation de ces contaminants** par l'organisme lorsque celui-ci est exposé à une dispersion mécanique et chimique de la nappe de pétrole, **aucune modification de la capacité métabolique aérobie ni des performances de nage** de l'individu n'a été mise en évidence. Si l'on se base uniquement sur ces deux variables, les résultats suggèrent que la fitness de l'animal ne serait pas altérée, et ce, pour toutes les conditions de contamination considérées. Cependant il se peut qu'une perte d'intégrité fonctionnelle à des niveaux d'intégration biologique inférieurs, au niveau de l'organe ou de la cellule, soit non observable au niveau de l'organisme.

Ainsi dans le troisième chapitre de notre étude nous tenterons de mettre en évidence, au travers d'une approche multimarqueur les effets biologiques dans deux organes cibles : foie et branchies. Notre travail se concentrera à l'étude de biomarqueurs de défense et de biomarqueurs de dommage.

CHAPITRE 3 - EFFETS SUBLETAUX D'UNE NAPPE DE
PETROLE DISPERSÉE : APPROCHE MULTIMARQUEUR SUR
DEUX ORGANES CIBLES (LE FOIE ET LES BRANCHIES)

CHAPITRE 3 - 1^{ERE} PARTIE : UNE APPROCHE MULTIMARQUEUR AUX NIVEAUX
HEPATIQUE ET PLASMATIQUE

Liver antioxidant and plasmatic immune responses in juvenile golden grey mullet (*Liza aurata*) exposed to dispersed crude oil

Thomas Milinkovitch, Awa Ndiaye, Wilfried Sanchez,
Stéphane Le Floch, Hélène Thomas-Guyon

Abstract

Dispersant application is an oil spill response technique. To evaluate the environmental cost of this operation in nearshore habitats, the experimental approach conducted in this study exposed juvenile golden grey mullets (*Liza aurata*) for 48 hours to chemically dispersed oil (simulating, *in vivo*, dispersant application), to dispersant alone in sea water (as an internal control of chemically dispersed oil), to mechanically dispersed oil (simulating, *in vivo*, natural dispersion), to the water-soluble fraction of oil (simulating, *in vivo*, an oil slick confinement response technique) and to sea water alone (control condition). Biomarkers such as fluorescence of biliary polycyclic aromatic hydrocarbon (PAH) metabolites, total glutathione liver content, EROD (7-ethoxy-resorufin-O-deethylase) activity, liver antioxidant enzyme activity, liver lipid peroxidation and an innate immune parameter (haemolytic activity of the alternative complement pathway) were measured to assess the toxicity of dispersant application. Significant responses of PAH metabolites and total glutathione liver content to chemically dispersed oil were found, when compared to water-soluble fraction of oil. As it was suggested in other studies, these results highlight that priority must be given to oil slick confinement instead of dispersant application. However, since the same patterns of biomarkers responses were observed for both chemically and mechanically dispersed oil, the results also suggest that dispersant application is no more toxic than the natural dispersion occurring in nearshore areas (e.g. waves). The results of this study must, nevertheless, be interpreted cautiously since other components of nearshore habitats must be considered to establish a framework for dispersant use in nearshore areas.

Keywords: dispersed crude oil; dispersant; oxidative stress; complement system; *Liza aurata*; nearshore areas.

1. Introduction

By accelerating the dispersion of oil from the sea surface into the water column, the use of dispersants (surface active agents) offers the environmental benefits of (i) diluting the oil slick in the water column (Lessard & DeMarco 2000), (ii) reducing the threat of oiling shorelines and (iii) accelerating the bacterial degradation of oil by increasing the available surface of the oil (Thiem 1994; Churchill et al. 1995). However, the use of dispersant is, at the moment, subject to certain restrictions depending mainly on weather conditions, oil type, distance to the shore and/or water depth. For example in European Atlantic coast the minimum permitted water depth is 10 m (Chapman et al. 2007). This restriction of minimum water depths was derived from studies on the dilution of dispersed oil in shallow water and took into consideration the ecological sensitivity of nearshore areas as they are nurseries for many aquatic species. However, a field study conducted by Baca et al. (2005) suggests that, in nearshore tropical ecosystems, dispersant use minimizes the environmental damages arising from an oil spill. This Net Environmental Benefits Analysis (NEBA) highlights a positive environmental role of dispersant use in nearshore areas but it is only applicable to tropical mangroves. To the best of our knowledge no NEBA has ever been conducted in Atlantic coastal ecosystems in order to establish the current restrictions for dispersant use and policies in nearshore areas. To do so, an on-going project (DISCOBIOL project: DISpersant and response techniques for COastal areas; BIOLogical assessment and contributions to the regulation) aims at obtaining informations on the environmental impact of dispersed oil in nearshore areas.

Including in this project, this study aims at assessing the toxicity of chemically dispersed oil at concentration similar to those encountered at oil spill sites. To simulate current operational oil dispersant application, our study uses a third generation dispersant, which is the more recent formulations and is considered as the less toxic, the more concentrated in tensio-active and there by the most commonly used at the moment. While, most experimental studies assessed the toxicity of the dispersant itself (Adams et al. 1999; George-Ares & Clark 2000) or the dispersed oil water-accommodated fraction (Cohen & Nugegoda 2000; Mitchell & Holdway 2000; Ramachandran et al. 2004a; Perkins et al. 2005; Jung et al. 2009), our experimental approach simulates operational oil dispersant application, considering the presence of oil droplets in the water column. Indeed, oil droplets are suggested to be a

determinant of toxicity (Brannon et al. 2006) and does so even more in nearshore areas, where natural dispersion (e.g. waves) can replace the whole oil slick from the surface in the water column (as described during the Braer oil spill by Lunel 1995).

To reveal the toxicity of this chemically dispersed oil, several biomarkers were assessed after exposure of juvenile golden grey mullets (*Liza aurata*). The choice of the species is due to (i) its presence in nearshore areas during its early life stages (Gautier & Hussenot 2005) and consequently its status of pollutants target organism (Bruslé 1981); and to (ii) its significant role in the coastal ecosystems, since this fish species permits an important particulate organic matter transport from the salt marsh to the marine coastal waters (Laffaille et al. 1998).

In this context, the use of biomarkers seems appropriate since they are defined as “a biochemical, cellular, physiological or behavioural variation that can be measured in tissue or body fluid samples or at the level of whole organisms that provides evidence of exposure to and/or effects of one or more chemical pollutants” (Depledge et al. 1995). Hence, these ecotoxicological tools provide integrative informations, linking exposure to pollutants and the health of the monitored organisms (Sanchez & Porcher 2009). As a consequence, other studies evaluate the toxicity to fish of a dispersed crude oil through biomarkers assessment (Cohen & Nugegoda 2000; Jung et al. 2009; Mendonça Duarte et al. 2010) and reveal an increase of toxicity due to dispersant application. In our study, a set of complementary biomarkers, including EROD (7-ethoxy-resorufin-O-deethylase) activity implicated in phase I biotransformation, total glutathione (GSH), enzymatic antioxidant activities (glutathione peroxidase, GPx; catalase, CAT; superoxide dismutase, SOD; glutathione-S-transferase, GST) and lipid peroxidation (LPO) were measured in the liver of golden grey mullet. These biomarkers are known to be sensitive to petroleum compounds and in particular to polycyclic aromatic hydrocarbons (PAH) as described in Pan et al. (2005), Oliveira et al. (2008), Nahrgang et al. (2009) and Hannam et al. (2010). Moreover, the physiological links between the presence of PAH, the production of reactive oxygen species (ROS) and consequently enzymatic and non-enzymatic antioxidant responses have also been described (Stegeman 1987; Livingstone 2001). The haemolytic activity of the alternative complement pathway (ACH 50), an innate immune parameter that is involved in the innate humoral response, was measured in the plasma of the golden grey mullets, since it is a known biomarker of petroleum exposure (Bado-Nilles et al. 2009a). Modulations of the antioxidant system and innate immune function will be discussed with regards to the 16 PAH USEPA priority pollutants, the concentration of total petroleum hydrocarbons (TPH) in seawater and exposure biomarkers: pyrene-derived and benzo[*a*]pyrene-derived biliary metabolites.

2. Materials and methods

2.1. Chemicals

An Arabian Crude Oil containing 54% saturated hydrocarbons, 36% aromatic hydrocarbons and 10% polar compounds, was selected for this study. Before exposure, the oil was evaporated (in a 1m³ tank, during 24 hours) under atmospheric conditions and natural UV-sunlight in order to simulate the natural behaviour of the oil after it is released at sea (evaporation of light compounds and natural photodegradation, respectively). The resulting chemical composition of the oil was 54% saturated hydrocarbons, 34% aromatic hydrocarbons and 12% polar compounds.

With regards to dispersant, a formulation manufactured by Total Fluides was selected based on its efficiency. Dispersant was evaluated by CEDRE (Centre de Documentation de Recherche et d'Expérimentations sur les pollutions accidentelles des eaux, France) and was deemed effective enough to be used in the marine environment (preliminary determined using the method NF.T.90-345), non-toxic at the concentration recommended by the manufacturer (preliminary determined assessing standard toxicity test: method NF.T.90-349) and biodegradable. Its chemical formulation was not available for reasons of confidentiality.

2.2. Experimental animals

The experiment was carried out using 50 juvenile golden grey mullets (*Liza aurata*), which were provided by Commercio Pesca Novellame Srl, Chioggia, Italy. Their average length was 139.0 ± 0.7 mm (mean \pm standard error of the mean) and their average weight was 38.25 ± 1.22 g.

The fish were acclimatized for 3 weeks in 300-L flow-through tanks (dissolved oxygen: $91 \pm 2\%$; salinity: $35 \pm 1\%$; 15 ± 0.1 °C, with a 12 h light:12 h dark photoperiod in seawater free of nitrate and nitrite) prior to the exposure studies. During acclimation, they were fed daily with fish food (Neosupra AL3 from Le Gouessant aquaculture) but were starved for 48 h prior to the bioassays and throughout the exposure period, in order to avoid bile evacuation from the gallbladder.

2.3. Experimental design

2.3.1. Experimental system

The experimental system (**Figure 20**) was devised to maintain the mixture of oil and dispersant as a homogenous solution. The mixture was homogenized using a funnel (at the surface of a 300-L seawater tank), which was linked to a Johnson L450 water pump (at the bottom of the tank) in order to homogenize the mixture despite the hydrophobic nature of the oil. Preliminary tests showed that, after 24 hours of homogenisation, the total petroleum hydrocarbon (TPH) concentrations in the water column do not depend on water column depth, suggesting the homogenous dispersion of small petroleum droplets throughout the water column. The system was a static water system stocked in a temperature controlled room ($15\text{ }^{\circ}\text{C}$), and thus exposure studies were conducted at $15 \pm 0.1\text{ }^{\circ}\text{C}$. Other physico-chemical parameters were also measured: pH (8.02 ± 0.07) and dissolved oxygen ($95 \pm 1\%$) remained constant throughout the study.

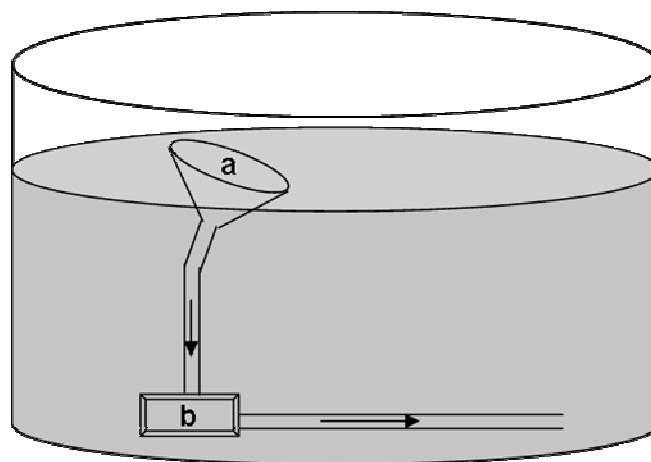

Figure 20. The experimental system constituted of a funnel (a) linked to a water pump (b) in a 300-l sea tank. (→) indicates the direction of seawater and/or contaminants through the experimental system.

2.3.2. Exposure conditions and exposure media

Control exposure medium (C) was made up using seawater provided by Oceanopolis, Brest, France. The chemically dispersed (CD) oil exposure medium was made by pouring 20 g of petroleum and 1 g of dispersant into the funnel of the experimental system. Dispersant alone (D) exposure medium, as an internal control of CD, was made by pouring 1 g of dispersant

into the funnel. The mechanically dispersed (MD) oil exposure medium was made by pouring 20 g of petroleum into this funnel. For the water-soluble fraction of oil (WSF), in addition to the funnel and the pump which were kept to maintain the same level of agitation of the seawater as for other treatments, a 20 g oil slick was contained using a plastic cylinder (21 cm diameter) placed on the surface of the seawater (4 cm below the surface and 8 cm above). A plastic mesh was placed at the bottom of the plastic cylinder. The spreading of the oil slick was not prevented by the plastic cylinder, as the oil slick was smaller in diameter than the plastic cylinder, therefore the experimental approach simulates the actual spreading behaviour of oil at sea. During the entire exposure period, the oil slick remained at the surface without mixing and the fish were only exposed to the soluble fraction of the oil.

None of the fish were exposed for 24 hours, while the solutions remained homogenous. The groups of 5 fish were then randomly distributed in the five experimental tanks, each tank containing an exposure medium (described above). The fish were exposed to the different media for a period of 48 h and the protocol was replicated so that 10 fish were exposed to each exposure medium.

At the end of the exposure period, the fish in each tank (each exposure medium) were euthanized using eugenol (4-allyl-2-methoxyphenol). To collect plasma samples, 0.2 mL of blood was withdrawn from the caudal vein of each fish and centrifuged (12,000 g, 10 min, 4 °C, Jouan). Plasma samples were stored at –80 °C. The liver and gallbladder were removed from each fish and stored at –80 °C prior to analysis.

2.4. TPH and PAH concentrations

2.4.1. TPH seawater concentrations

The TPH concentration, which is the sum of dissolved hydrocarbon concentrations plus the amount of oil droplets, was measured for all exposure media at the beginning (T=0 h) and at the end of fish exposure (T=48 h), using the mean of three replicated measurements for each time point. The seawater samples were extracted with 10 mL of pestipur-quality dichloromethane (99.8 % pure solvent, Carlo Erba Reactifs, SDS). After separation of the organic and aqueous phases, water was extracted two additional times with the same volume of dichloromethane (2 x 10 mL). The combined extracts were dried on anhydrous sulphate

and then analyzed using a UV spectrophotometer (UV-Vis spectrophotometer, Unicam) at 390 nm, as described by Fusey and Oudot (1976).

2.4.2. Seawater concentrations of PAH

PAH concentrations were assessed at the beginning (T=0 h) and at the end of fish exposure (T=48 h), using the mean of three replicated measurements for each time point. After sampling, the first step was a 24-hour settling phase to separate oil droplets and particulate matter from the seawater. Then, PAH were extracted from the seawater using the stir bar sorptive extraction technique (SBSE – Stir bar coated with PDMS, Gerstel), and analyzed using thermal desorption coupled to capillary gas chromatography-mass spectrometry (GC–MS). The GC was a HP7890 series II (Hewlett Packard, Palo Alto, CA, USA) coupled with a HP5979 mass selective detector (MSD, Electronic Impact: 70eV, voltage: 2 000 V). PAH were quantified according to published procedures (Roy et al. 2005).

2.5. *Biochemical analyses*

2.5.1. Fixed wavelength fluorescence analysis

Bile samples were diluted (1:250) in absolute ethanol (VWR International). Fixed wavelength fluorescence (FF) was then measured at the excitation:emission wavelength pairs 341:383 and 380:430 nm. FF 341:383 mainly detects pyrene-derived metabolites and FF 380:430 mainly detects benzo[*a*]pyrene-derived metabolites (Aas et al. 2000). Measurements were performed in quartz cuvettes on a spectrofluorimeter (SAFAS Flx-Xenius). The FF values were expressed as arbitrary units of fluorescence and the signal levels of pure ethanol were subtracted.

2.5.2. Measurement of oxidative stress biomarkers

Livers were homogenized in ice-cold phosphate buffer (100 mM, pH 7.8) containing 20% glycerol and 0.2 mM phenylmethylsulfonyl fluoride as a serine protease inhibitor. The homogenates were centrifuged at 10,000 g, 4 °C, for 15 min and the postmitochondrial fractions were used for biochemical assays. Total protein concentrations were determined

using the method of Bradford (1976) with bovine serum albumin (Sigma-Aldrich Chemicals, France) as a standard. Hepatic biomarkers assays including GSH content and activities of EROD, GST, GPx, SOD and CAT were adapted for use in microplate and, after preliminary test using several dilutions, adapted for samples of liver of juvenile golden grey mullet.

The EROD activity was measured using the fluorimetric assay developed by Flammarion et al. (1998). To summarize, 10 μ L of a 5g proteins/L diluted sample were added to phosphate buffer containing 8 μ M of 7-ethoxyresorufin and 0.5 mM of NADPH. Formed resorufin was quantified by fluorimetric measurement with 530 nm wavelength excitation and 590 nm wavelength emission. Resorufin was used as standard, and results were expressed as nmol resorufin/min/g protein.

The GSH (total glutathione) concentration was measured according to Vandeputte et al. (1994). Briefly, 10 μ L of TCA-deproteinized sample were mixed with phosphate buffer containing 0.3 mM NADPH and 1 mM Ellman reagent. The enzymatic reaction was monitored spectrophotometrically at 405 nm and the results were expressed in μ mol of GSH/g of proteins.

The GST activity assay was conducted according to Habig et al. (1974). Briefly, 10 μ L of a 0.75 g proteins/L diluted sample were mixed with 1 mM chloro dinitro benzene and 1 mM reduced glutathione. The enzymatic reaction was monitored spectrophotometrically at 340 nm and the results were expressed in U of GST/g of proteins.

GPx activity was determined using 15 μ L of a 4.5 g proteins/L diluted sample according to the method of Paglia and Valentine (1967). Cumene hydroperoxide was used as the substrate and enzymatic activity was assessed at 340 nm. The results were expressed in U of GPx/g of proteins.

SOD activity was measured using the assay developed by Paoletti et al. (1986). Briefly, the inhibition of NADH (350 μ M) oxidation by 20 μ L of a 0.25 g proteins/L diluted sample was monitored at 340 nm. The results were presented in U of SOD/mg of proteins.

CAT activity was monitored using the method previously described by Babo and Vasseur (1992). Briefly, 0.08 g proteins/L diluted samples were mixed (v:v) with 28 mM hydrogen peroxide. The kinetics of hydrogen peroxide degradation were assessed at 280 nm and the results were expressed in U of CAT/mg of proteins.

2.5.3. Lipid peroxidation (LPO) determination

Lipid peroxidation levels were assessed via malondialdehyde (MDA) content determined using a commercially available MDA assay kit (Oxis International MDA assay kit). The method was based on the reaction of a chromogenic reagent, N-methyl-2-phenylindole, with MDA at 45 °C. The blue product was quantified by measuring absorbance at 586 nm (Gérard-Monnier et al. 1998).

2.5.4. Determination of the alternative pathway of plasma complement activity

Determination of the alternative pathway of plasma complement activity was carried out by haemolytic assay with rabbit red blood cells (RRC, Biomérieux, France) as described by Yano (1992) and adapted to microtitration plates. Plasma samples, diluted to 1/80 in EGTA-Mg-GVB buffer, were added in increasing amounts, from 10 to 100 µL per well. The wells were then filled with EGTA-Mg-GVB buffer to a final volume of 100 µL. Finally, 50 µL of a suspension containing 2% rabbit red blood cells were added to each well. Control values of 0% and 100% haemolysis were obtained using 100 µL of EGTA-Mg-GVB buffer and 100 µL of non-decomplemented trout haemolytic serum at 1/50 in ultra pure water respectively. Samples were incubated for 1 hour at 20 °C. The microplates were centrifuged (400 g, 5 min, 4 °C, Jouan). Then, 75 µL of supernatant from each well were transferred with 75 µL of phosphate buffer saline (Biomérieux, France) into another 96-well microplate. The absorbance (540 nm) was read in a spectrofluorimeter (SAFAS Flx-Xenius) and the number of ACH 50 units per mL of plasma was determined by reference to 50% haemolysis.

2.6. *Statistical analysis*

The statistical analysis was carried out using XLstat 2007 software. The assumptions of normality and homoscedasticity were verified using the Kolmogorov-Smirnov and Cochran tests, respectively. Firstly, Student's t-tests were conducted, for each variables (fixed wavelength fluorescence, EROD activity, total glutathione concentration, hepatic oxidative stress biomarkers, lipid peroxidation, haemolytic activity of alternative complement pathway) in order to highlight significant differences between both experimental replicates of each exposure media. No significant difference was found, thereby, both replicates were

considered as one homogenous group of ten individuals. A factorial analysis of variance (one-way ANOVA) was performed in order to assess the effects of the several exposure conditions. This statistical analysis was followed by the Tukey post-hoc test to detect significant differences between groups. The significance of the results was ascertained at $\alpha=0.05$. The results were expressed as means \pm s.e.m. (standard error of the mean) corresponding to groups of ten fish (n=10).

3. Results

No fish mortality was observed during the experiments. Moreover no TPH or PAH was detected in the control and dispersant exposure media. The TPH concentration measured in the CD (chemically dispersed oil) and MD (mechanically dispersed oil) groups corresponded to that encountered under oil spill situations (for instance, 1 to 100 mg/L of total petroleum hydrocarbons were measured in coastal waters around Shetland during the Braer oil spill, as reported by Lunel 1995). No oil slick was observed in either the CD or MD exposure media, suggesting that the energy in the experimental system was sufficient to disperse the oil slick. These observations validated the experimental procedure.

3.1. Total petroleum hydrocarbon (TPH) and polycyclic aromatic hydrocarbon (PAH) concentration in seawater

The TPH concentrations of oil were higher in media with dispersant compared to without, and the lowest concentration was observed in the WSF (water soluble fraction of oil) medium, in which only dissolved compounds were present in the seawater column. In the CD medium, the TPH concentration (**Table 10**) was 39 mg/L at the beginning of the exposure period (T=0 h) and 25 mg/L at the end of the exposure period (T=48 h), giving a percentage decrease of 36 %. In the MD medium, the TPH concentration was 13 mg/L at the beginning of the exposure period (T=0 h) and 9 mg/L at the end of the exposure period (T=48 h), giving a percentage decrease of 29 %. The TPH concentration could not be determined in the WSF medium since it was too low to be detected using spectrophotometry.

According to spectrophotometry as well as gas chromatography coupled with mass spectrometry, petroleum compounds and PAH were not detected in the D (Dispersant) or C (Control) media.

Table 10. Dispersant nominal concentration, TPH and sum of 16 parents and alkylated US-EPA PAH (Σ PAH) concentration in the five exposure media at the beginning (T=0 h) and at the end of the exposure (T=48 h) to C (Control), CD (Chemically Dispersed oil), MD (Mechanically Dispersed oil), WSF (Water Soluble Fraction of oil) and D (Dispersant). Values are expressed as mean \pm standard error mean of both experimental replicates. n.d. = not detected. n.a. = not assessed.

	[TPH] _{T=0h} (mg/L)	[TPH] _{T=48h} (mg/L)	[Σ PAH] _{T=0h} (μ g/L)	[Σ PAH] _{T=48h} (μ g/L)	[Dispersant] _{nom.} (mg/L)
C	n.d.	n.d.	n.d.	n.d.	n.a.
CD	39.1 \pm 4.1	25.1 \pm 3.1	43.98 \pm 5.5	26.34 \pm 2.7	3.33
MD	13.15 \pm 2.6	9.30 \pm 0.2	39.09 \pm 0.6	20.63 \pm 0.1	n.a.
WSF	n.d.	n.d.	5.16 \pm 0.6	0.47 \pm 0.07	n.a.
D	n.d.	n.d.	n.d.	n.d.	3.33

In terms of the sum of 16 parent and alkylated USEPA PAH (Σ PAH) concentrations, the CD medium contained 43.98 μ g/L, at the beginning of the experiment, then 26.34 μ g/L after 48 hours, giving a percentage decrease of 40 %. For MD, the percentage decrease was 48 %: the Σ PAH concentration at T=0 h was 39.09 μ g/L and at T=48 h it was 20.63 μ g/L. WSF values were lower when compared to both the CD and MD values, with a Σ PAH concentration at T=0 h of 5.16 μ g/L and at T=48 h of 0.47 μ g/L, corresponding to a drastic decrease (91 %).

Regarding the concentration of 16 USEPA PAH (alkylated and parents) in seawater during CD, MD and WSF exposures (**Table 11**), it appears that two- or three-ring PAH compounds (specifically, naphthalene alkylated compounds) were dominant when compared to heavier PAH (\geq four rings). Regarding the variation over time in PAH concentration, it appears that light PAH such as naphthalene (parent and alkylated) decreased during CD, MD and WSF exposure (with the exception of fluorene for CD exposure) while the concentrations of heavier PAH remained relatively stable or increased (e.g. chrysene).

Table 11. Concentration of 16 US-EPA PAH (alkylated and parents) in sea water during CD (Chemically Dispersed oil), MD (Mechanically Dispersed oil) and WSF (Water Soluble Fraction of oil) exposures. Values are expressed as mean \pm standard error mean of both experimental replicates. n.d. = not detected.

16 US-EPA PAH (parents and alkylated)	Molecular weight (g/mol)	Concentration (ng/L) at T=0h and T=48h					
		T= 0 h			T=48 h		
		CD	MD	WSF	CD	MD	WSF
Naphthalene	128.2	2287 \pm 78	1842 \pm 101	311 \pm 10	335 \pm 14	262 \pm 6	32 \pm 5
C1-Naphthalene	143.2	6936 \pm 1699	7569 \pm 49	987 \pm 22	3244 \pm 61	2658 \pm 53	78 \pm 22
C2-Naphthalene	158.2	15579 \pm 199	12766 \pm 223	1668 \pm 172	7937 \pm 393	6396 \pm 46	95 \pm 9
C3-Naphthalene	173.2	11496 \pm 385	9957 \pm 59	1298 \pm 183	7677 \pm 491	6506 \pm 47	59 \pm 6
C4-Naphthalene	188.2	4488 \pm 129	4081 \pm 21	450 \pm 57	3696 \pm 106	3094 \pm 226	64 \pm 12
Acenaphthylene	152.2	27 \pm 3	16 \pm 3	n.d.	n.d.	n.d.	n.d.
Acenaphthene	154.2	n.d.	n.d.	n.d.	n.d.	n.d.	1 \pm 0
Fluorene	166.2	241 \pm 3	196 \pm 8	53 \pm 9	400 \pm 298	89 \pm 2	1 \pm 0
C1-Fluorene	181.2	336 \pm 5	291 \pm 4	70 \pm 11	663 \pm 480	158 \pm 2	4 \pm 1
C2-Fluorene	196.2	316 \pm 3	284 \pm 9	44 \pm 7	734 \pm 523	187 \pm 3	3 \pm 0
C3-Fluorene	211.2	169 \pm 2	130 \pm 17	16 \pm 1	329 \pm 231	57 \pm 31	3 \pm 0
Phenanthrene	178.2	316 \pm 300	522 \pm 16	79 \pm 4	160 \pm 151	241 \pm 1	5 \pm 0
Anthracene	178.2	3 \pm 0	8 \pm 8	2 \pm 1	n.d.	6 \pm 6	n.d.
C1-Phenanthrenes/Anthracene	193.2	959 \pm 32	818 \pm 17	66 \pm 23	569 \pm 18	467 \pm 3	5 \pm 0
C2-Phenanthrenes/Anthracene	208.2	489 \pm 4	390 \pm 25	34 \pm 4	326 \pm 2	295 \pm 9	n.d.
C3-Phenanthrenes/Anthracene	223.2	136 \pm 1	89 \pm 0	8 \pm 1	75 \pm 0	68 \pm 2	n.d.
C4-Phenanthrenes/Anthracene	238.2	36 \pm 5	29 \pm 4	n.d.	23 \pm 1	17 \pm 3	n.d.
Fluoranthene	202.3	n.d.	2 \pm 2	1 \pm 0	2 \pm 0	1 \pm 1	n.d.
Pyrene	202.3	n.d.	n.d.	n.d.	n.d.	n.d.	n.d.
C1-Fluoranthenes/Pyrenes	217.3	n.d.	n.d.	n.d.	n.d.	3 \pm 3	n.d.
C2-Fluoranthenes/Pyrenes	232.3	n.d.	7 \pm 7	n.d.	9 \pm 1	5 \pm 5	n.d.
C3-Fluoranthenes/Pyrenes	247.3	n.d.	4 \pm 4	n.d.	3 \pm 3	3 \pm 3	n.d.
Benzo[a]anthracene	228.3	n.d.	n.d.	n.d.	1 \pm 0	n.d.	n.d.
Chrysene	228.3	8 \pm 8	9 \pm 9	6 \pm 3	27 \pm 8	19 \pm 5	14 \pm 2
Benzo[b+k]fluoranthene	252.3	3 \pm 1	6 \pm 0	5 \pm 0	10 \pm 6	8 \pm 3	9 \pm 1
Benzo[a]pyrene	252.3	3 \pm 0	3 \pm 0	2 \pm 0	5 \pm 1	5 \pm 0	4 \pm 1
Benzo[g,h,i]perylene	276.3	34 \pm 5	3 \pm 3	32 \pm 3	4 \pm 1	3 \pm 1	4 \pm 4
Indeno[1,2,3-cd]pyrene	276.3	51 \pm 31	31 \pm 0	3 \pm 0	49 \pm 0	37 \pm 0	40 \pm 0
Dibenzo[a,h]anthracene	278.4	63 \pm 3	39 \pm 3	25 \pm 1	57 \pm 4	45 \pm 2	48 \pm 4

3.2. Fixed wavelength fluorescence analysis of biliary PAH metabolites

With regards to the levels of benzo[a]pyrene-type metabolites, which were measured by fluorescence intensity (FF 380:430), CD and MD exposures led to significantly higher values, compared to the values obtained in control fish (C). The intensity of fluorescence did not significantly differ between the C, WSF and D groups of fish, even though WSF exposure seemed to increase the intensity (**Figure 21a**).

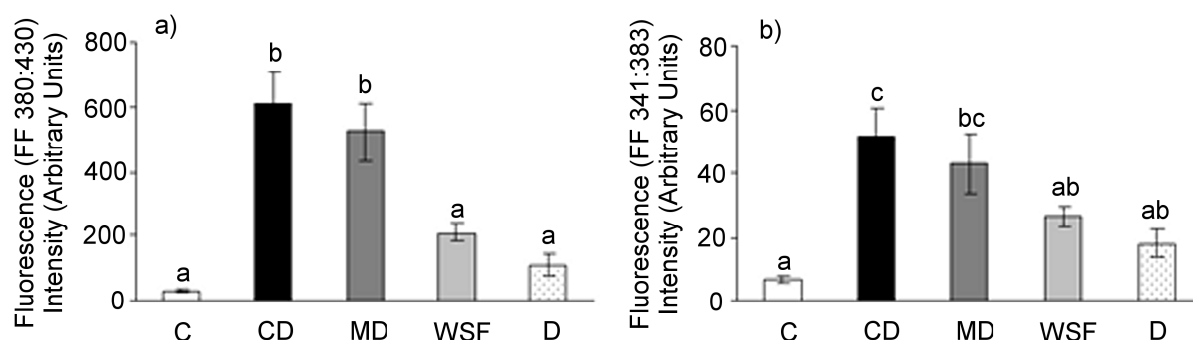

Figure 21. Fixed wavelength fluorescence (FF) of bile reflecting biliary PAH metabolites levels after 48 h exposure to Control solution (C), Chemically Dispersed oil solution (CD), Mechanically Dispersed oil solution (MD), Water Soluble Fraction solution (WSF) and Dispersant solution (D): (a) FF 380:430 (benzo[a]pyrene type of metabolites); (b) FF 341:383 (pyrene derived type of metabolites). Levels are expressed as fluorescence intensity. Values represent mean \pm standard error (n=10 per treatment). Different letters above bars indicate a significant difference, where $P < 0.05$.

With regards to the levels of pyrene-type metabolites (**Figure 21b**), which were measured by fluorescence intensity (FF 341:383), CD and MD exposure led to significantly higher values when compared to values obtained in control fish (C). The intensity of fluorescence did not significantly differ between the C, WSF and D groups of fish, even though WSF exposure seemed to increase the intensity. The intensity of fluorescence following CD exposure was significantly different to that following WSF and D exposure while it appears that MD exposure did not induce an increase in fluorescence compared to WSF and D exposure.

3.3. EROD (7-ethoxy-resorufin-O-deethylase) activity, total glutathione content and hepatic oxidative stress biomarkers

EROD demonstrated no significant difference between the exposure conditions (**Figure 22**) and was characterized by a high intragroup variability that could reflect differences in biotransformation processes between organisms.

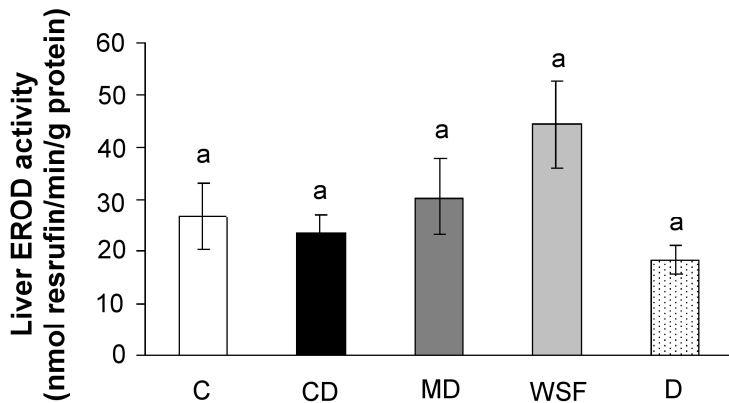

Figure 22. EROD (7-ethoxy-resorufin-O-deethylase) activity in *Liza aurata* after 48 h exposure to Control solution (C), Chemically Dispersed oil solution (CD), Mechanically Dispersed oil solution (MD), Water Soluble Fraction (WSF) solution and Dispersant solution.

The concentration of GSH (total glutathione, **Figure 23**) significantly decreased after exposure to CD (45.35 ± 8.65) and MD (53.18 ± 10.04), compared to the control group (130.50 ± 32.64), while no significant difference was observed after exposure to WSF (90.51 ± 23.11) or D (108.44 ± 22.86). When CD and MD were compared with WSF and D, no significant difference was revealed even though the GSH content in the WSF and D groups seemed higher than in the CD and MD groups.

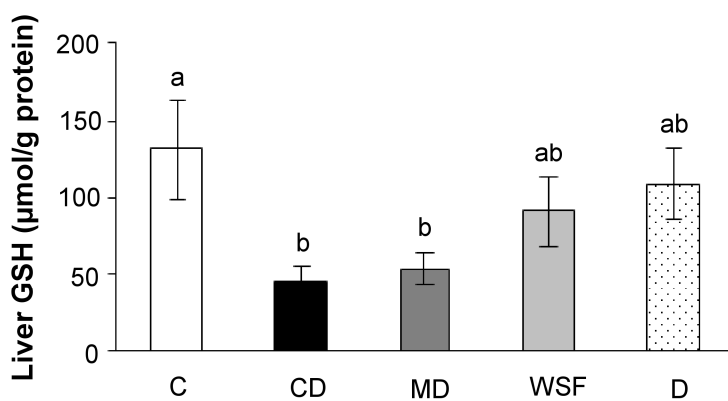

Figure 23. Total glutathione (GSH) content in liver of *Liza aurata* after 48 h exposure to Control solution (C), Chemically Dispersed oil solution (CD), Mechanically Dispersed oil solution (MD), Water Soluble Fraction (WSF) solution and Dispersant solution (D). Values represent mean \pm standard error (n=10 per treatment). Different letters above bars indicate a significant difference, where $P < 0.05$.

No significant difference between exposure conditions was recorded for antioxidant enzyme activities (i.e. GST, GPx, SOD and CAT) (**Figure 24**).

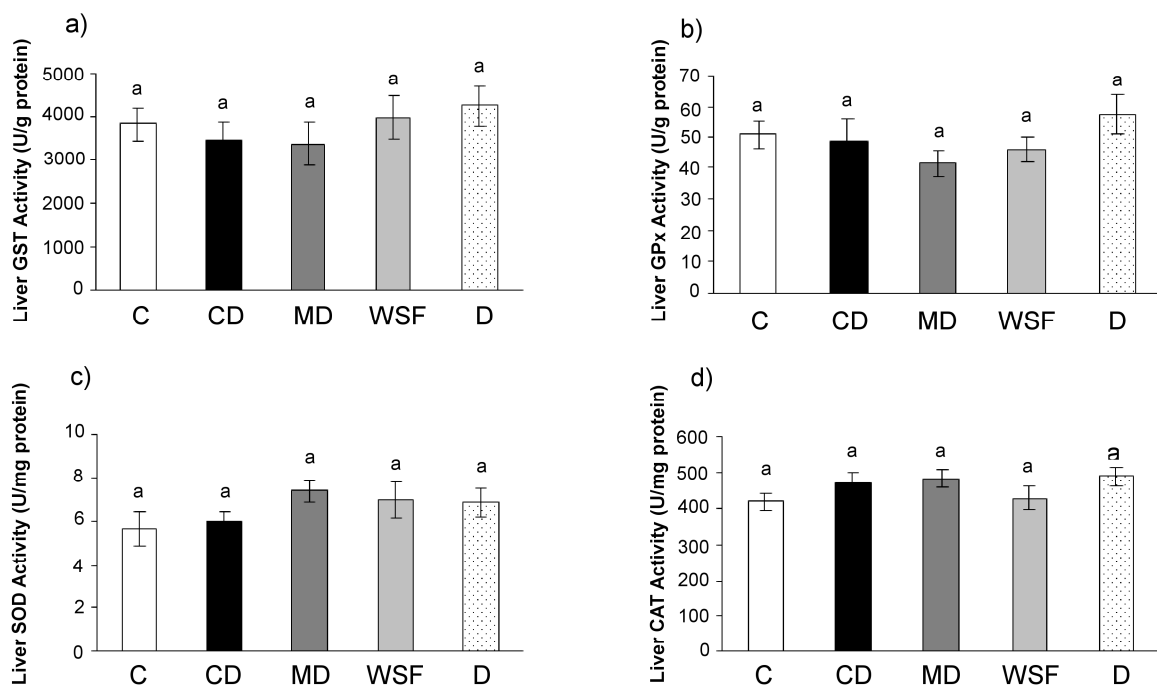

Figure 24. a) Glutathione S-Transferase (GST) activity, b) Glutathione Peroxidase (GPx) activity, c) Superoxide Dismutase (SOD) activity and d) Catalase (CAT) activity in liver of *Liza aurata* after 48 h exposure to Control solution (C), Chemically Dispersed oil solution (CD), Mechanically Dispersed oil solution (MD), Water Soluble Fraction (WSF) solution and Dispersant solution (D). Values represent mean \pm standard error (n=10 per treatment). Different letters above bars indicate a significant difference, where $P < 0.05$.

3.4. Lipid peroxidation (LPO)

As for antioxidant enzymes, LPO demonstrated no significant difference between the exposure conditions (**Figure 25**). However, LPO was characterized by a high intragroup variability (especially for WSF, CD and MD exposure media) that could reflect differences in sensitivity between organisms.

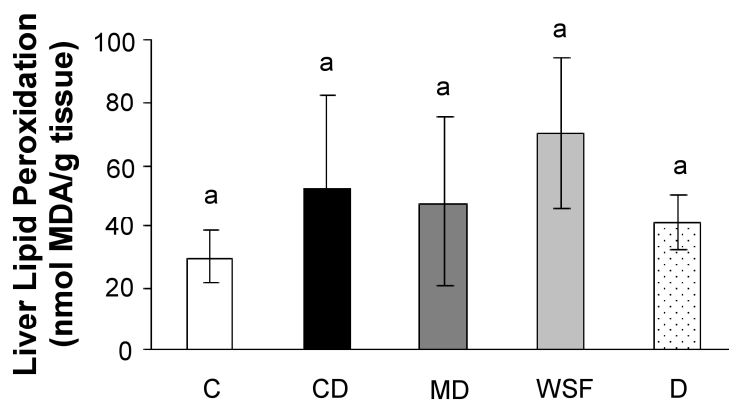

Figure 25. Lipid peroxidation in liver of *Liza aurata* after 48 h exposure to Control solution (C), Chemically Dispersed oil solution (CD), Mechanically Dispersed oil solution (MD), Water Soluble Fraction (WSF) solution and Dispersant solution (D). Values represent mean \pm standard error (n=10 per treatment). Different letters above bars indicate a significant difference, where $P < 0.05$.

3.5. Haemolytic activity of alternative complement pathway (ACH 50)

The results are presented in **Figure 26**. As for antioxidant enzymes, ACH 50 demonstrated no significant difference between the exposure conditions. Haemolytic activity appeared to be lower after CD exposure and higher after MD exposure.

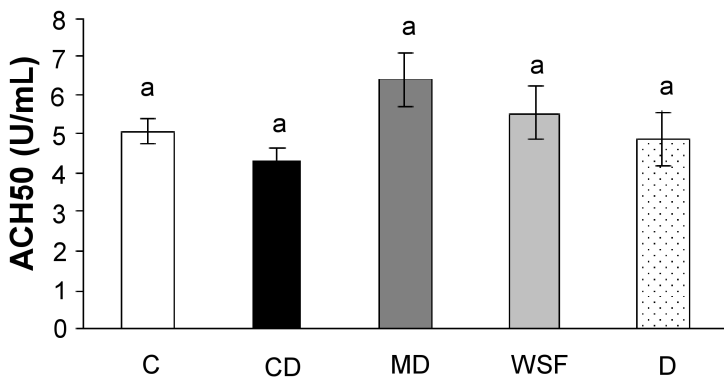

Figure 26. Haemolytic activity of alternative complement pathway (ACH 50) in plasma of *Liza aurata* after 48 h exposure to Control solution (C), Chemically Dispersed oil solution (CD), Mechanically Dispersed oil solution (MD), Water Soluble Fraction (WSF) solution and Dispersant solution (D). Values represent mean \pm standard error (n=10 per treatment). Different letters above bars indicate a significant difference, where $P < 0.05$.

4. Discussion

The aim of this study was to accurately simulate operational oil dispersant application and to assess its toxicity. An experimental system providing mixing energy (described in section 2.3.1) was necessary for this purpose: to achieve the dispersion of crude oil through operational dispersant application, seawater energy is necessary (Merlin 2005). Readers must take into account that the results obtained (and discussed below), through this experimental approach, are available only for a given mixing energy (the mixing energy induces by the waterpump). However, extrapolation of results from the experimental approach to the oil spill operations is possible. Indeed, meteorological conditions during the Braer oil spill (Wind force 7 to 10, Lunel 1995) were the most propitious to dispersed oil, among most of the meteorological conditions during oil spills. While a dispersion of the whole oil was maintained for more than one week, other oil spills, in offshore areas, exposed an unstable dispersion of oil slick with a rapid decrease of concentration in 2-5 hours (Lessard & DeMarco 2000). Our experimental approach is situated between these two opposite scenarios (decrease of concentration on a 48 hours period, discussed in 4.1) and thus can be considered as a possible one. Moreover, according to CEDRE observations during oil spill response in nearshore area, 4 tide cycles (48h) are sufficient to totally disperse the oil slick, so that no petroleum is present after this period. This suggests that an exposure of 48 h seems to be accurate.

The fish were exposed to (i) a chemically dispersed oil (simulating dispersant application), (ii) dispersant alone in sea water (as an internal control of chemically dispersed oil), (iii) mechanically dispersed oil (simulating natural dispersion), (iv) water-soluble fraction of oil (simulating an oil slick confinement response technique) and to (v) sea water alone (control condition).

4.1. Total petroleum hydrocarbon (TPH) and polycyclic aromatic hydrocarbon (PAH) concentrations in seawater

The energy supplied by the experimental system was the same for the five exposure media. However, our results show that the TPH concentration in the water column was higher in CD than in MD at T=0 h and T=48 h. This finding and our observations, suggest that oil adheres

more to the experimental system in the MD exposure medium than in the CD exposure medium. When extrapolated to field operations in the shallow water of nearshore areas, the results show that the application of dispersants would promote higher concentrations of TPH in the water column but would decrease the adherence to substrates (seagrass beds, sediments etc...). This result is in accordance with Baca et al. (2005) and shows that dispersant application increases the exposure to TPH for pelagic organisms living in the water column (as golden grey mullets), while decreases the exposure to TPH for benthic organisms.

Unlikely TPH concentration, the difference of the sum of PAH concentrations between CD and MD exposures is low (slightly higher in CD exposure). The sum of PAH concentration is relevantly lower in WSF exposure medium than in CD and MD exposures (at T=0 h and T=48 h): as a consequence of dispersion, oil droplets have a larger surface-to-volume ratio than an oil slick, and this would accelerate the solubilization of PAH in seawater. Consideration must also be given to the fact that the sum of PAH decreased slightly in the CD and MD exposure media while drastically decreased during the 48 hours of WSF exposure media. The solubilization and volatilization/photolysis of PAH are two opposing processes that determine the distribution and the residence time of PAH in seawater (Schwarzenbach et al. 2003). In this case, it can be hypothesized that the dispersion of oil (CD and MD exposure) triggers the solubilization of PAH from oil droplets into the seawater, which relatively compensates for the volatilization/photolysis of PAH that occurs during the exposure. Inversely the solubilization of PAH from the oil slick to the seawater (WSF exposure) was not high enough to compensate for the loss of PAH due to volatilization/photolysis. Another explanation could be that PAH loss is due to absorption by golden grey mullets as it is suggested in literature for other organisms (LeFloch et al. 2003; Goanvec et al. 2008).

With regards to the 16 USEPA PAH (alkylated and parent), the results show that light PAH (two to three rings) were predominant in the WSF, CD and MD exposure media at T=0 h and T=48 h. This observation is consistent with the current theory that the aqueous solubility increases as the molecular weight of PAH decreases (Neff 1979). Moreover, with the exception of fluorene, the concentrations of light PAH decreased during the experiment while the concentration of heavy PAH remained stable (cf. Indeno[1,2,3-*cd*]pyrene and Dibenzo[*a,h*]anthracene in **Table 11**), a phenomenon probably attributable to the volatilization/photolysis of light PAH (Schroeder & Lane 1988).

4.2. Fixed wavelength fluorescence analysis of biliary PAH metabolites

The fixed wavelength fluorescence of fish biliary metabolites has been used as a PAH exposure biomarker in many studies (Aas et al. 2000; Barra et al. 2001; Insausti et al. 2009; Kopecka-Pilarczyk & Correia 2009).

In our study pyrene-derived fluorescence was significantly higher under MD and CD exposures than under control exposure (C). However, only fluorescence under CD exposure was significantly higher than WSF and D exposures, which show that the exposure to pyrene was higher when the oil was chemically dispersed. These results are consistent with the alkylated fluoranthenes/pyrenes seawater concentration at T=48 h since this was higher under CD exposure. However at T=0 h, no pyrene (alkylated or parent) was detected under CD. Concerning the benzo[a]pyrene-type metabolites, fluorescence was higher under CD and MD exposures than for the other exposure groups (WSF, D, C), indicating a higher bioavailability of this PAH (and its derived type). Even though the relative fluorescence was higher under WSF exposure than in other conditions (D and C), the difference was not significant. These results are consistent with the benzo[a]pyrene concentrations measured in the seawater, since the concentration of this PAH was similar for CD and MD exposures and lower for WSF exposure (at T=0 h and T=48 h). Benzo[a]pyrene is considered carcinogenic and is a reactive oxygen species producer through its role as a P450 mixed-function oxidase (MFO) inducer (Lemaire-Gony & Lemaire 1993). This result is of importance because it reveals the potentially high toxicity of CD and MD exposures when compared to other conditions.

For both metabolite types, the relative fluorescence revealed a higher exposure of fish to PAH under CD exposure (compared to WSF), probably resulting from the higher PAH concentrations in the seawater. The results are consistent with the literature; indeed Ramachandran et al. (2004a) showed that oil dispersant increases PAH uptake by fish exposed to crude oil. Moreover Jung et al. (2009) showed that hydrocarbons metabolites in bile from fish exposed to crude oil treated with dispersant were significantly higher compared with fish exposed to crude oil alone.

To the best of our knowledge no studies have been conducted in order to allow the comparison between the toxicity of an oil slick dispersed with turbulent mixing energy and dispersant (CD) to an oil slick dispersed only with turbulent mixing energy (MD). Even if benzo[a]pyrene derived metabolites levels seem to be slightly lower in MD exposure than in CD exposure, no significant difference was highlighted. This is in accordance with the

benzo[a]pyrene concentrations in seawater (no difference between CD and MD exposure). However, for pyrene derived metabolites, while a significant difference was observed between CD and WSF, no difference was observed between MD and WSF exposure. This finding is in accordance with the pyrene concentration in sea water: alkylated fluoranthenes/pyrenes seawater concentration (at T=48 h) was higher under CD exposure.

4.3. EROD (7-ethoxy-resorufin-O-deethylase) activity

Since the eighties, EROD activity is commonly used to reveal PAH biotransformation (Addison & Payne 1986) and thereby a large body of literature permits comparison of our results to other studies. Furthermore, since EROD activity is involved in phase I biotransformation of xenobiotics, the modulation of this biomarker in response to PAH is more precociously observed than the increase of PAH biliary metabolites (described above). By the way EROD activity measurement gives an idea of organism short term defence against the xenobiotics.

Ramachandran et al. (2004a) and Jung et al. (2009) showed an increase of EROD activity following chemically dispersed oil exposure. However, our study did not show an EROD activity increase while a PAH biliary metabolites increase was observed following dispersed crude oil exposure. A reason for this lack of significance could be the low sensitivity to PAH of EROD activity, when compared to biliary metabolites sensitivity (Camus et al. 1998).

4.4. Total glutathione content

The results obtained for total glutathione content in the liver of *Liza aurata* after 48 h confirmed previous results concerning biliary metabolites contents since a significant difference was found between dispersed oil exposure (CD and MD) and the control condition. These results are consistent with the literature since Almroth et al. (2008) showed a significance decrease in total glutathione in corkwing wrasse (*Symphodus melops*) exposed to contaminated PAH sites. The total glutathione content, which corresponds to reduced plus oxidized glutathione (GSH+GSSG), was lower in both conditions (CD and MD), although GST activity did not change. This finding shows that depletion was not due to glutathione conjugation (phase II detoxification) since an increase in GST should be concomitant with conjugation. Nevertheless, it is possible that the decrease in total glutathione was due to

inhibition of the GSH synthesis rate by contaminants, as suggested in Canesi et al. (1999), in Wang et al. (2008) and in Zhang et al. (2004) on freshwater crabs, mussels and goldfish, respectively. Another explanation could be that, in the process of detoxification, reduced glutathione chelated the heavy metals contained in petroleum (mainly vanadium and nickel) so that GS-V or GS-Ni binding complexes are formed (Sies 1999). These complexes cannot be assessed through biochemical analysis and contributed to the observed reduction in total glutathione content. However, according to low heavy metals concentration in common crude oil (e.g. 109.9 mg/L of Vanadium and 71.5 mg/L of Nickel, Salar Amoli et al. 2006) and the short exposure period of our experiment, this explanation seems to be less accurate.

So, although the mechanism is not fully understood, this study shows that total glutathione is depleted, suggesting, for CD and MD exposures, a reduction in the first line cellular defence, since glutathione is involved in several detoxification reactions. Indeed, conjugation of glutathione to contaminants can prevent them from interacting deleteriously with other cellular components, enabling the organism to cope with the contaminated environment (Maracine & Segner 1998).

Moreover Ringwood and Connors (2000) showed that gonadal depletion of glutathione induces a decrease in reproductive success in oyster. Even if this study was conducted in oyster, this finding suggests that a link between the total glutathione pool and the organism fitness could exist. Since our study demonstrated a depletion of the total glutathione pool in the liver of juveniles golden grey mullets, it would also be interesting to assess the total glutathione in the gonads of adult fish.

4.5. Antioxidant enzyme activity and lipid peroxidation (LPO)

Antioxidant enzyme activity has been shown to be modulated in response to short term (≤ 48 h) contaminants exposure in different targets organs of fish (Ahmad et al. 2004; Sun et al. 2006; Modesto & Martinez 2010) and especially to short term PAH exposure in the liver of golden grey mullet (Oliveira et al. 2008). However, in our study, results concerning antioxidant enzyme activity showed no significant differences between exposure conditions, suggesting that oxidative stress was absent.

LPO was measured via the malondialdehyde content in the liver and revealed the targeting of cell membranes by reactive oxygen species (ROS), thus altering membrane fluidity, compromising membrane integrity, inactivating membrane-bound enzymes and disrupting

surface receptor molecules. In Ahmad et al. (2004) and in Oliveira et al. (2008), a LPO increase was observed in fish gills after 48 h of contamination and in fish livers after 16 h of contamination, respectively. In our study the high intragroup variability, when compared to other studies (Oliveira et al. 2008; Kopecka-Pilarczyk & Correia 2009), induced a lack of significance, confirming the notion that oxidative stress was absent. However it should be stated that, for exposure conditions containing petroleum (CD, MD, WSF) a high intragroup variability was observed whereas a lower variability was observed following Control (C) and single dispersant (D) exposure. This observation suggests a difference of oxidative stress between the individuals exposed to conditions containing petroleum.

Oliveira et al. (2008) evaluated oxidative stress using, as in our study, LPO and antioxidant enzyme activity in the liver of *Liza aurata* exposed to a PAH (phenanthrene). They found a significant difference in these biomarkers, but the concentrations of phenanthrene were 50 to 1300 times higher than in our study.

4.6. Haemolytic activity of alternative complement pathway (ACH 50)

The innate immune function has also been used as a biomarker of PAH toxicity (Seeley & Weeks-Perkins 1997; Carlson et al. 2004). The complement system of teleost fish is a powerful defence system since it is involved in important immune functions that are pivotal to the recognition and clearance of microbes (Boshra et al. 2006). Moreover, the haemolytic activity of the alternative complement pathway has been shown to be a suitable biomarker of PAH contamination in teleost fish (Bado-Nilles et al. 2009a). On this basis, the alternative complement pathway was chosen since its functional modulation by exposure to petroleum compounds could reveal an alteration in fish health.

In our study no significant difference was found between the control condition and contaminant exposures, even though the haemolytic activity seemed to be lower following CD exposure. Bado-Nilles et al. (2009a) found significant differences between contaminated and control fish, for a sum of PAH concentrations that was lower than in our study, but for longer exposure times, suggesting that modulation of haemolytic activity could have been observed after more than 48 h of exposure.

5. Conclusion

Based on fixed wavelength fluorescence analysis of biliary PAH metabolites, the results from this study show higher exposure for dispersed crude oil (CD and MD) than for other types of contaminant exposure. Also, the total glutathione content, described as a first line cellular defence against contaminants, was significantly reduced under dispersed oil exposures. Antioxidant enzymes did not show any responses to the contamination. EROD activity, lipid peroxidation and the haemolytic activity of the complement system also did not respond when fish were exposed to contaminants.

These results demonstrate a significant response of biomarkers to chemically dispersed oil, when compared to a non-dispersed oil slick (water-soluble fraction of oil), suggesting that oil slicks must not be dispersed when containment and recovery can be conducted at the oil spill site (low mixing energy of seawater). This finding is in accordance with an important body of literature: many studies show an increase of PAH toxicity to fish following dispersant application (Perkins et al. 1973; Cohen & Nugegoda 2000; Ramachandran et al. 2004a; Lin et al. 2009). On the other hand, no significant difference in the response of biomarkers was observed between chemically and mechanically dispersed oil. This finding suggests that when containment and recovery cannot be conducted (high mixing energy of seawater) the application of dispersant in nearshore areas is no more toxic than the natural dispersion (wave, current, swell).

To conclude, the results of this study are of interest with regards establishing a framework for dispersant use and policies in nearshore areas since they are part of a current project: DISCOBIOL project (DISpersant and response techniques for COastal areas: BIOLogical assesment and contributions to the regulation). Initially, this project intends to assess the toxicity of chemically dispersed oil to several species living in nearshore areas (*Crassostera gigas*, *Mytilus edulis*, *Scophtalmus maximus*, *Dicentrarchus labrax* and *Liza aurata*). For this reason, organisms were exposed to oil in the water column. However, since dispersed crude oil can interact with other components of nearshore area habitats, such as mudflats, further studies must be conducted in order to better evaluate the net environmental benefits of dispersant application in nearshore areas.

Acknowledgements

This study was supported by a PhD grant from the Conseil Général of the Charente-Maritime. The Agence Nationale de la Recherche and especially Michel Girin and Gilbert Le Lann are acknowledged for financial support for the project 'DISCOBIOL', managed by F. X. Merlin. The authors also acknowledge Total Fluides and Innospech for providing chemicals. Special thanks go to Julie Lucas and Marion Menguy for their help and assistance during the study and during the experimental procedures.

CHAPITRE 3 - 2^{EME} PARTIE : UNE APPROCHE MULTIMARQUEUR AU NIVEAU
BRANCHIAL

Toxicity of dispersant application: antioxidant response in gills of juvenile golden grey mullet (*Liza aurata*)

Thomas Milinkovitch, Joachim Godefroy, H el ene Thomas-Guyon

Abstract

Dispersant use in nearshore areas is likely to increase the exposure of aquatic organisms to petroleum. To measure the toxicity of this controversial response technique, golden grey mullets (*Liza aurata*) were exposed to mechanically dispersed oil, chemically dispersed oil, dispersant alone in seawater, water-soluble fraction of oil and to seawater as a control treatment. Several biomarkers were assessed in the gills (enzymatic antioxidant activities, glutathione content, lipid peroxidation) and in the gallbladder (polycyclic aromatic hydrocarbons metabolites). The significant differences between chemically dispersed oil and water soluble fraction of oil highlight the environmental risk to disperse an oil slick when containment and recovery can be conducted. The lack of significance between chemically and mechanically dispersed oil suggests that dispersant application is no more toxic than the natural dispersion of the oil slick. The results of this study are of interest in order to establish dispersant use policies in nearshore areas.

Keywords: dispersed crude oil; oxidative stress; glutathione; PAH biliary metabolites; gills; *Liza aurata*.

1. Introduction

Dispersant application is an oil spill response technique that permits the transfer of the oil slick from the surface to the water column. When applied on an oil slick, the chemical formulation of the dispersant (surface active agent) induces the formation of oil–surfactant micelles. In offshore areas, dispersion shows many advantages since it accelerates the bacterial degradation of petroleum (Tiehm, 1994; Churchill et al. 1995), reduces the chance of drifting of the oil slick to the shoreline and also limits the risk of contamination to the surface occupying organisms (e.g. seabirds, marine mammals). However, when the oil spill site is in a nearshore area or if an oil slick reaches the coast (as observed recently in the Deep Water Horizon oil spill), slick dispersion is prohibited (Chapman et al. 2007). This environmental precautionary principle is based (i) on the low dilution potential of the oil slick in the shallow waters of nearshore areas and (ii) on the ecological sensitivity of nearshore areas since they are nurseries for many fish species (Martinho et al. 2007). On the other hand, a field study conducted by Baca et al. (2006), but only applicable to nearshore mangroves, seagrass and coral ecosystems, revealed a positive net environmental benefit of dispersant application in nearshore areas. Thus, with regards to the precautionary principle and the recent results of field studies, dispersant application in nearshore areas seems to be a controversial response technique. In this context, in order to contribute to dispersant use policies in nearshore areas, an on-going project is being conducted: the DISCOBIOL project (DISpersant and response techniques for COastal areas; BIOLogical assessment and contributions to the regulation). This study is part of this project and intended to assess the toxicity of a chemically dispersed oil. For this purpose, most studies have evaluated the toxicity of dispersant alone in seawater (Adams et al. 1999; George-Ares & Clark 2000) or the dispersed oil water-accommodated fraction (Cohen & Nugegoda 2000; Mitchell & Holdway 2000; Ramachandran et al. 2004; Perkins et al. 2005; Jung et al. 2009), not taking into account the presence of oil droplets in the water column. However, many field observations have shown the presence of oil droplets in the water column. Their formation can be induced within 2 hours (Cormack 1977) or during a period of more than 1 week, as observed during the Braer oil spill (Lunel 1995). In this context, our experimental approach was conducted in order to evaluate the actual toxicity of a chemically dispersed oil treatment containing oil droplets. Toxicity was measured through the assessment of biomarkers in a target organ of a pelagic fish species.

Oxidative stress and antioxidant defences were considered as suitable biomarkers since they have been shown in many studies to respond to petroleum contamination and especially to the PAH (polycyclic aromatic hydrocarbons) contained in petroleum (Avcı et al. 2005 ; Almroth et al. 2008; Oliveira et al. 2008; Jung et al. 2009; Kopecka Pylarczyk & Correia 2009; Narghang et al. 2009). Moreover, both, oxidative stress and antioxidant defences could give information on the health of the contaminated organisms: (i) oxidative stress, since it is considered as a cause of tissue injury (Halliwell, 1999) and (ii) antioxidant defences, since authors linked modulation of this biological parameter to fish health indicators such as progression of diseases and/or cellular mortality (Allen & Moore 2004).

In our study, oxidative stress and antioxidant defences were assessed by evaluating lipid peroxidation (a marker of lipid degradation due to oxidative stress) and evaluating the response of antioxidant enzymatic activities (catalase, superoxide dismutase and glutathione peroxidase), respectively.

Additionally, total glutathione was measured taking into account the importance of the cellular status of this molecule for the defence of the organism against xenobiotics (Maracine & Segner 1998). Indeed, glutathione is implied in many cellular defence mechanisms such as (i) antioxidant defences, by its conjugation to reactive oxygen species (Amiard-Triquet & Amiard 2008); (ii) heavy metals (such as Vanadium and Nickel present in petroleum, Salar Amoli et al. 2006) chelation, as described in Sies 1999; and (iii) detoxification processes, by its conjugation to xenobiotics such as PAH (van der Oost et al. 2003). In our study, we evaluated the glutathione status through the measurement of the total glutathione content which is the sum of the oxidized and the reduced form of this molecule.

These biomarkers were assessed in fish gills, taking into account their target organ status: several studies have shown an effect of petroleum compounds on gills (McKeown 1981; Oliveira et al. 2008; Mendonça Duarte et al. 2010). In parallel, PAH biliary metabolites were measured in order to evaluate the level of exposure to PAH following dispersant application.

The choice of the golden grey mullet (*Liza aurata*) as a biological model was based on the fact that (i) it represents a relevant biomass in nearshore ecosystems; (ii) it is a commercially important species especially in Europe and Egypt (Gautier & Hussenot 2005) and (iii) this species is present in nearshore areas during its early life stages (Gautier & Hussenot 2005) being consequently a target organism for anthropogenic pollutants (Bruslé 1981).

2. Materials and methods

2.1. Experimental design

2.1.1. Experimental animals

Fifty juvenile golden grey mullets (*Liza aurata*), fished in Venice (Italy) lagoons and provided by Commercio Pesca Novellame Srl (Chioggia, Italy), were used to conduct this study.

For 4 weeks, fish were acclimatized in 300-L flow-through tanks prior to the exposure studies (dissolved oxygen: $94 \pm 2\%$; salinity: $35 \pm 0\%$; temperature: 14.9 ± 0.5 °C, with a 12 h light:12 h dark photoperiod in seawater free of nitrate and nitrite). During acclimation, they were fed daily with fish food (Neosupra AL3, from Le Gouessant aquaculture) which does not contain additives (also called synthetics) antioxidants authorised by the European Union (butyl-hydroxy-anisol, butyl-hydroxy-toluene, ethoxyquin, propyl gallate and octyl gallate). Fish were starved for 48 h prior to bioassays and throughout the exposure period, in order to avoid bile evacuation from the gallbladder. Prior to bioassay, their average length was 136.6 ± 0.1 mm (mean \pm standard error of the mean) and their average weight was 32.33 ± 0.87 g.

2.1.2. Chemicals

A dispersant formulation (Total Fluides) was selected based on its efficiency. The efficiency was preliminary determined in the CEDRE (CEntre de Documentation de Recherche et d'Expérimentations sur les pollutions accidentelles des eaux, France) using the method NF.T.90-345. The dispersant was non-toxic at the concentration recommended by the manufacturer (preliminary determined using standard toxicity test: method NF.T.90-349) and biodegradable.

A Brut Arabian Light (BAL) crude oil was selected for this study. The oil is composed of 54% saturated hydrocarbons, 10% polar compounds and 36% aromatic hydrocarbons.

To simulate the natural behaviour of the oil after it is released at sea (evaporation of light compounds and natural photodegradation, respectively) the oil was evaporated under atmospheric conditions and natural UV-sunlight, prior to fish exposure. The resulting

chemical composition of the oil was 54% saturated hydrocarbons, 12% polar compounds and 34% aromatic hydrocarbons. Among aromatic hydrocarbons, concentration of 21 PAH was measured (the 16 PAH listed by the USEPA as priority pollutants and five supplementary PAH: benzo[*b*]thiophene, biphenyl, dibenzothiophene, benzo[*e*]pyrene, perylene). The sum of the 21 PAH represents 16.4 mg/g of petroleum (1.64 % of the petroleum). More information concerning the composition of the petroleum used in this study is available in (Milinkovitch et al. 2011b).

2.1.3. Experimental system (Figure 27)

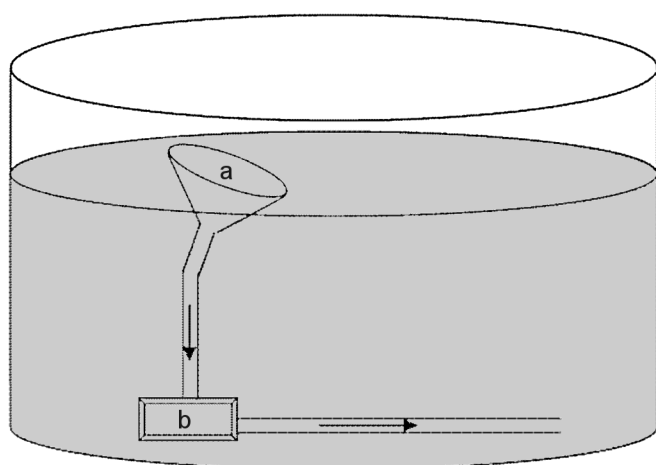

Figure 27. The experimental system constituted of a funnel (a) linked to a water pump (b) in a 300-l sea tank. → indicates the direction of seawater and/or contaminants through the experimental system.

The experimental system comprised five 300-L seawater tanks. Each one contains a funnel (a, at the surface) linked to a Johnson L450 water pump (b, at the bottom of the tank). After 24 h homogenization, this system was set up to maintain a mixture of oil and dispersant as a homogenous solution despite the hydrophobic character of the oil (preliminary tests not shown).

The temperature in this static water system was controlled using two heaters (RENA CAL 300) so that the exposure temperature was 15.3 ± 0.3 °C (mean \pm standard error mean). Other physico-chemical parameters were also measured: seawater was free of nitrate and nitrite, pH (7.99 ± 0.03) and dissolved oxygen ($98 \pm 5\%$) remained constant throughout the study.

2.1.4. Experimental treatments

Each experimental tank contained 300 L seawater provided by Oceanopolis (France). The control treatment (C) was made up using 300 L seawater. The chemically dispersed (CD) oil treatment was made by pouring 20 g of petroleum and 1 g of dispersant into the funnel of the experimental system. The mechanically dispersed (MD) oil treatment was made by pouring 20 g of petroleum into this funnel. The dispersant alone (D) treatment, as an internal control of CD, was made by pouring 1 g of dispersant into the funnel. For the water-soluble fraction

of oil (WSF), a 20 g oil slick was contained using a plastic cylinder (21 cm diameter) placed on the surface of the seawater (in addition to the funnel and the pump, which were kept to maintain the same level of agitation of the seawater as for other treatments). Readers must take into account that the spreading of the oil slick was not prevented by the plastic cylinder since the oil slick was smaller than the diameter of the plastic cylinder. Thereby the experimental approach simulates the actual spreading behaviour of oil at sea. During the entire exposure period, the oil slick remained at the surface without mixing. No droplet was observed in the water column (visual observations) suggesting that the fish were only exposed to the soluble fraction of the oil.

While the solutions remained homogenous (less than 5 % difference between three TPH concentration measurements sampled at three different depths in the experimental tanks), no fish were exposed for 24 hours after making up the solutions. Then, groups of 10 fish were randomly distributed in the five experimental tanks, each tank containing an exposure media (described above). The fish were exposed for 48 h (from T=0 h to T=48 h).

At the end of the exposure period, the fish in each tank (each treatment) were euthanized using eugenol (99 %, Sigma Aldrich chemicals, France). The gallbladder was removed from each fish and stored at -80°C prior to analysis. Gills were rinsed off by dipping them in PBS (Phosphate Buffered Sodium 0.01 M, pH=7.4, Sigma) in order to remove blood. Then, the gills were homogenized in another PBS solution. The homogenates were centrifuged at 10,000 g, 4°C , for 15 min to obtain the post-mitochondrial supernatant. Total protein concentrations in supernatants were determined using the method of Bradford (1976) with bovine serum albumin (Sigma-Aldrich Chemicals, France). Then, supernatants were stored at -80°C prior to biochemical analysis.

2.2. Total petroleum hydrocarbon (TPH) seawater concentrations

The TPH concentration, which is the sum of the dissolved hydrocarbon concentrations plus the amount of oil droplets, was measured for all treatments at the beginning (T=0 h) and at the end of fish exposure (T=48 h), using the mean of three replicated measurements for each time point. The samples were extracted with 10 mL of dichloromethane (Carlo Erba Reactifs, SDS). After separation of the organic and aqueous phases, water was extracted two additional times with the same volume of dichloromethane (2 x 10 mL). The combined extracts were dried on anhydrous sulphate and then analysed using a UV spectrophotometer (UV-Vis

spectrophotometer, Unicam, France) at 390 nm, as described by Fusey & Oudot (1976). Assays were conducted in collaboration with Cedre (Centre de Documentation de Recherche et d'Expérimentations sur les Pollutions Accidentelles des Eaux), a laboratory with agreement ISO 9001 and ISO 14001. In accordance with Cedre, results are not reliable under 1mg/L.

2.3. Biochemical analysis

2.3.1. Fixed wavelength fluorescence analysis of bile

Bile samples were diluted (1:1000) in absolute ethanol (VWR International, France) and assessments were conducted for three fixed wavelength fluorescence (FF). FF 290:335 mainly detects naphthalene-derived metabolites, FF 341:383 mainly detects pyrene-derived metabolites and FF 380:430 mainly detects benzo[*a*]pyrene-derived metabolites (Aas et al. 2000). Measurements were performed in quartz cuvettes (Sigma Aldrich, USA) on a spectrofluorimeter (SAFAS Flx-Xenius, Monaco). The FF values were expressed as arbitrary units of fluorescence and the signal level of pure ethanol was subtracted.

2.3.2. Total glutathione (GSH)

Total (reduced plus oxidized) glutathione was determined spectrophotometrically in gills, according to the procedure of Akerboom & Sies (1981) and using a glutathione assay kit (SIGMA CS0260, Sigma Aldrich, USA). The samples were first deproteinized with 5% 5-sulfosalicylic acid solution. The glutathione content of the sample was then assayed using a kinetic assay in which amounts of glutathione cause a continuous reduction of 5,5'-dithiobis-(2-nitrobenzoic) acid (DTNB) to TNB. The oxidized glutathione formed was recycled by glutathione reductase and NADPH. The product, TNB, was assayed colorimetrically at 412 nm in UV microplates (Greiner Bio One), using a spectrophotometer (SAFAS Flx-Xenius, Monaco). The results are presented in μmol of GSH/g of protein.

2.3.3. Glutathione peroxidase activity (GPx)

GPx activity was determined according to the method of Paglia & Valentine (1967), using a glutathione peroxidase assay kit (RS504/RS 505, RANDOX, France).

Glutathione peroxidase (GPx) catalyses the oxidation of reduced glutathione by cumene hydroperoxide. In the presence of glutathione reductase and NADPH the oxidized glutathione (GSSG) is immediately converted to the reduced form with concomitant oxidation of NADPH to NADP⁺. The decrease in absorbance at 340 nm was measured in UV microplates (Greiner Bio One, Germany), using a spectrophotometer (SAFAS Flx-Xenius, Monaco). The results are presented in units of GPx/g of protein.

2.3.4. Superoxide dismutase activity (SOD)

SOD activity was determined according to the method of Wooliams et al. (1983) and using a superoxide dismutase assay kit (SD125, RANDOX, France).

This method employs xanthine and xanthine oxidase to generate superoxide radicals which react with 2-(4-iodophenyl)-3-(4-nitrophenol)-5-phenyltetrazolium chloride (INT) to form a red formazan dye, assessed at 505 nm in polystyrene microplates (Greiner Bio One, Germany), using a spectrophotometer (SAFAS Flx-Xenius, Monaco). The superoxide dismutase activity was then measured by the degree of inhibition of this reaction. One unit of SOD was that which causes a 50% inhibition of the rate of reduction of INT. The results are presented in units of SOD/mg of protein.

2.3.5. Catalase activity (CAT)

CAT activity was determined according to the method of Deisseroth & Dounce (1970) and using a catalase assay kit (CAT 100, Sigma Aldrich, USA).

Samples were mixed (v:v) with hydrogen peroxide. The kinetics of hydrogen peroxide degradation were assessed at 280 nm in UV microplates (Greiner Bio One, Germany), using a (SAFAS Flx-Xenius, Monaco). The results are expressed in units of CAT/mg of protein.

2.3.6. Lipid peroxidation (LPO)

Lipid peroxidation levels were assessed via malondialdehyde (MDA) contents determined using a commercially available MDA assay kit (MDA assay kit, Oxis International, USA). The method was based on the reaction of a chromogenic reagent, N-methyl-2-phenylindole, with MDA at 45 °C. The blue product was quantified by measuring absorbance at 586 nm

(Gérard-Monnier et al. 1998) in polystyrene cuvettes, using a spectrophotometer (SAFAS Flx-Xenius). The results are presented in nmol of MDA/g of tissue.

2.4. Statistical analysis

The statistical analysis was carried out using XLstat 2007 software. The assumptions of normality and homoscedasticity were verified using the Kolmogorov-Smirnov and Cochran tests, respectively. When homoscedasticity and normality were not respected, a Kruskal Wallis test was conducted to highlight significant differences between treatments. When homoscedasticity and normality were respected, a factorial analysis of variance (one-way ANOVA) was performed in order to assess the effects of the different treatments. This statistical analysis was followed by the Tukey post-hoc test to detect significant differences between groups. Correlations between fixed wavelength fluorescence intensity and other variables (GSH, GPx, SOD, CAT and LPO) were conducted using the Spearman test. The significance of the results was ascertained at $\alpha=0.05$. The results are expressed as means \pm s.e.m. (standard error of the mean) corresponding to groups of 10 fish (n=10).

3. Results

No fish died during the acclimation and exposure period. TPH were not detected in the Control (C) and Dispersant (D) treatments. Moreover no oil slick was observed in the Chemically Dispersed oil (CD) and the Mechanically Dispersed oil (MD) treatments. In the Water Soluble Fraction of oil (WSF) treatment, the oil slick remained at the surface throughout the exposure period and no droplets were observed (visual observations) in the water column.

3.1. Total petroleum hydrocarbons (TPH)

The concentration of TPH (**Table 12**) was slightly higher in the CD than in the MD treatment at T=0 h and at T=48 h. A 68% decrease was observed in the CD treatment (from 46.4 to 14.9

mg/L) and a 73% decrease was observed in the MD treatment (from 39.4 to 10.7 mg/L) during the 48 h exposure period. No TPH were detected in the WSF treatment, probably due to the detection limit of the method.

Table 12. TPH and dispersant nominal concentration in the five exposure media at the beginning (T=0 h) and at the end of the exposure (T=48 h) to C (Control), CD (Chemically Dispersed oil), MD (Mechanically Dispersed oil), WSF (Water Soluble Fraction of oil) and D (Dispersant). Values are expressed as mean \pm standard error mean of both experimental replicates. n.d. = not detected.

	[TPH] _{T=0h} (mg/L)	[TPH] _{T=48h} (mg/L)	[Dispersant] _{nom.} (mg/L)
C	n.d.	n.d.	n.d.
CD	46.4	14.9	3.33
MD	39.2	10.7	n.d.
WSF	n.d.	n.d.	n.d.
D	n.d.	n.d.	3.33

3.2. Fixed wavelength fluorescence analysis of bile

Whatever the fixed wavelength employed (**Figure 28**), no significant difference was found between the fluorescence intensity of the WSF, D and C treatments.

Whatever the fixed wavelength employed, the fluorescence intensity was significantly higher in the CD treatment than in the C, D and WSF treatments.

At FF 380:430 and FF 343:383, the fluorescence intensity was higher in the MD treatment than in the C, D and WSF treatments whereas no significant difference was found at FF 290:335.

At FF 290:335 and FF 343:383, the fluorescence intensity was lower in the MD treatment than in the CD treatment whereas no significant difference was observed at FF 380:430.

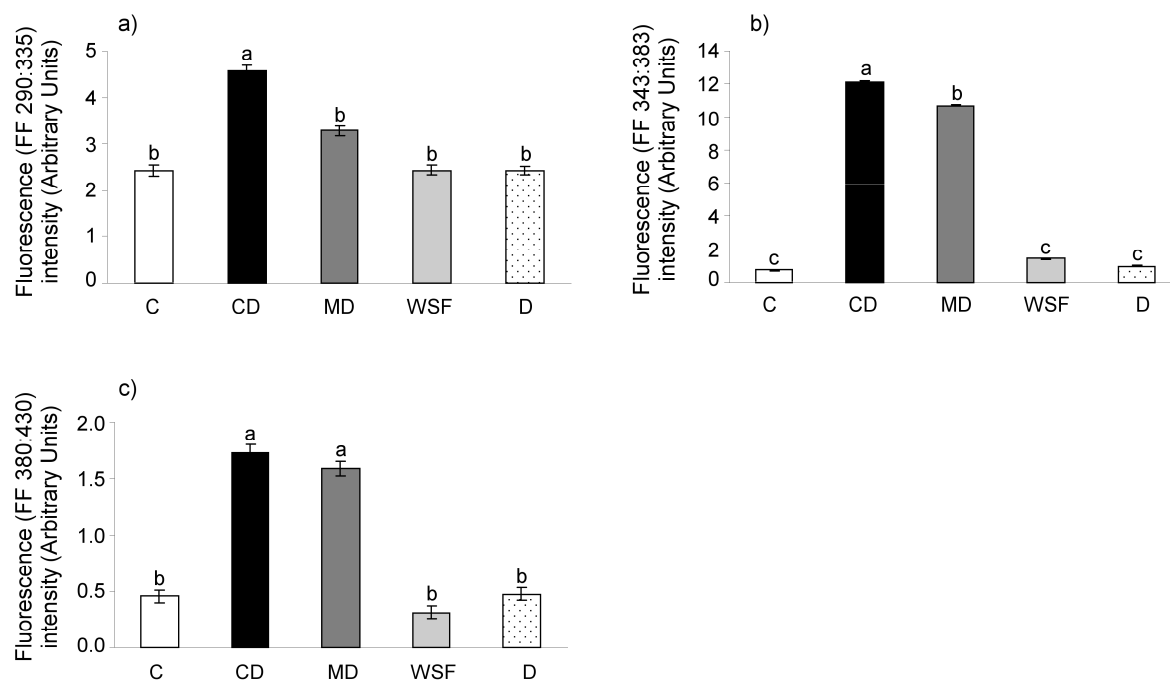

Figure 28. Concentration of biliary PAH metabolites measured by fixed wavelength fluorescence (FF) levels after 48 h exposure to Control solution (C), Chemically Dispersed oil solution (CD), Mechanically Dispersed oil solution (MD), Water Soluble Fraction (WSF) solution and Dispersant solution (D) : (a) FF 290:335 (naphthalene type derived metabolites); (b) FF 343:383 (pyrene derived type of metabolites); (c) FF 380:430 (benzo[a]pyrene type of metabolites). Levels are expressed as fluorescence intensity. Values represent mean \pm standard error (n=10 per treatment). Different letters above bars indicate a significant difference, where $P < 0.05$.

3.3. Total glutathione (GSH)

Gill GSH content (**Figure 29**) was significantly lower in the CD than in the C, D and WSF treatments, whereas no significant difference was observed between the CD and MD treatments. No significant difference was observed between MD and the other treatments (C, D and WSF).

Significant correlations were found between the fluorescence intensities FF 343:383 and FF 380:430 with GSH content ($P = 0.001$ and $P = 0.002$ respectively) whereas there was no correlation between the fluorescence intensity at 290:335 with GSH content ($P > 0.05$).

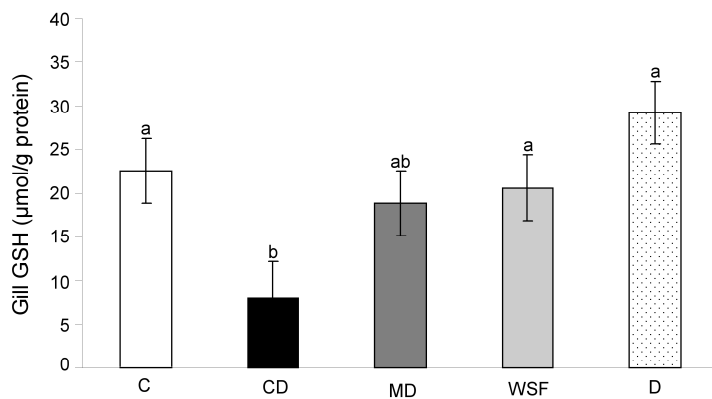

Figure 29. Total glutathione (GSH) content in gills of *Liza aurata* after 48 h exposure to Control solution (C), Chemically Dispersed oil solution (CD), Mechanically Dispersed oil solution (MD), Water Soluble Fraction (WSF) solution and Dispersant solution (D). Values represent mean \pm standard error (n=10 per treatment). Different letters above bars indicate a significant difference, where $P < 0.05$.

Significant correlations were found between the fluorescence intensities FF 343:383 and FF 380:430 with GSH content ($P= 0.001$ and $P=0.002$ respectively) whereas there was no correlation between the fluorescence intensity at 290:335 with GSH content ($P>0.05$).

3.4. Antioxidant enzymatic activity

No significant difference was found between the five treatments ($P>0.05$), in terms of antioxidant enzymatic (SOD, CAT, GPx) activities (**Figure 30**). With regards to SOD activity, the lack of significance could be due to the high intragroup variability. With regards to GPx, the enzymatic activity seemed to be higher in the CD treatment than in the other treatments. No correlation was found between the enzymatic activities and fixed wavelength fluorescence intensity ($P>0.05$).

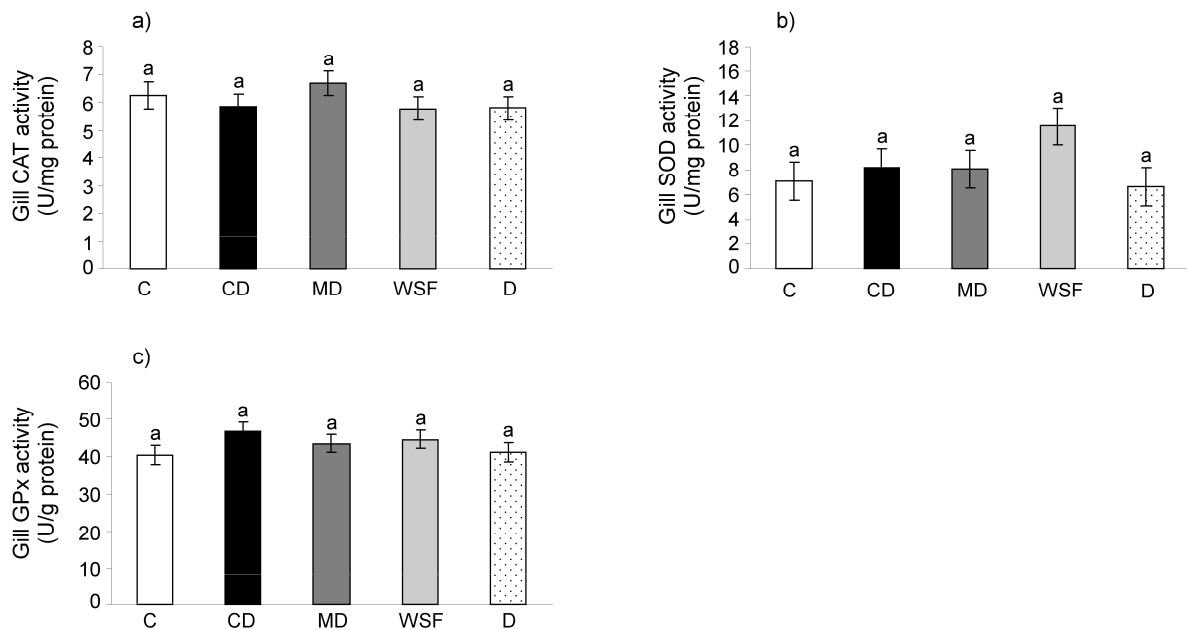

Figure 30. a) Catalase (CAT) activity, b) Superoxide Dismutase (SOD) activity and c) Glutathione Peroxidase (GPx) activity in gills of *Liza aurata* after 48 h exposure to Control solution (C), Chemically Dispersed oil solution (CD), Mechanically Dispersed oil solution (MD), Water Soluble Fraction (WSF) solution and Dispersant solution (D). Values represent mean \pm standard error (n=10 per treatment). Different letters above bars indicate a significant difference, where $P < 0.05$.

3.5. Lipid peroxidation (LPO)

There was no significant difference in LPO (**Figure 31**) between the five treatments ($P > 0.05$) and no correlation was found between LPO and the fixed wavelength fluorescence intensities ($P > 0.05$).

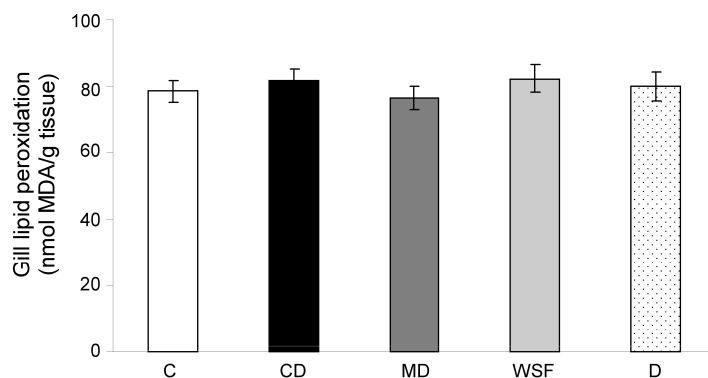

Figure 31. Lipid peroxidation in gills of *Liza aurata* after 48 h exposure to Control solution (C), Chemically Dispersed oil solution (CD), Mechanically Dispersed oil solution (MD), Water Soluble Fraction (WSF) solution and Dispersant solution (D). Values represent mean \pm standard error (n=10 per treatment). Different letters above bars indicate a significant difference, where $P < 0.05$.

4. Discussion

By conducting an experimental approach simulating dispersant application, our study evaluated the toxicity of five exposure treatments: (i) a control treatment with only seawater, (ii) a chemically dispersed oil treatment simulating dispersant application on an oil slick under mixing processes, (iii) dispersant alone in seawater as an internal control of CD, (iv) a mechanically dispersed oil simulating only the effect of mixing processes on the oil slick and (v) a water-soluble fraction of oil simulating contamination due to an undispersed oil slick.

Given observations at oil spill sites (such as during the Braer oil spill, Lunel 1995) and the natural mixing processes in nearshore areas (e.g. waves), the presence of oil droplets in the water column seems to be relevant when evaluating the toxicity of dispersant application in nearshore areas. Thus, the experimental system was devised to maintain oil droplets in the water column throughout the course of exposure.

4.1. Total petroleum hydrocarbons (TPH)

TPH concentrations vary from 46.4 to 14.9 mg/L for CD treatment and from 39.4 to 10.7 mg/L for MD treatment. The concentrations observed at T = 0 h are inferior to the nominal concentrations (66.6 mg/L). This is probably due to the petroleum adherence to the experimental system during the 24 h period of homogenisation (prior to the bioassays, described in 2.1.5.). The concentrations of TPH, measured in this experimental approach, are consistent with those observed at oil spill sites. Indeed, Spooner (1970) observed 50 mg/L of TPH after an oil spill in Tarut Bay (Saudi Arabia) due to a pipeline fracture. This observed concentration was due to the natural dispersion of 16 000 t of light Arabian crude oil in nearshore areas (less than 2 km from the shoreline). In the same way, Lunel (1995) observed concentrations varying between 1 and 100 mg/L during the wreck of the Braer on the Scotland coast. The cargo released 86 000 t of Gullfaks crude oil which were naturally dispersed due to severe wind conditions (Force 6 to 10).

Braer oil spill shows that, in nearshore areas, meteorological conditions could induce dispersion of the oil slick during a period of more than one week. However, at most oil spill sites in offshore areas, a decrease in concentration is observed over a 2 to 5 h period (Lessard and Demarco, 2000). Situated between these two scenarios, our experimental approach

showed a decrease in TPH concentration over a 48 h period. Our observations suggest that this decrease is mainly due to petroleum adherence to the experimental system. This phenomenon of adherence to the experimental system simulates the adherence to the substrate observed in field studies (Baca et al. 2006). In this study, adhered petroleum represents approximately the nominal concentration of the petroleum minus the concentration of petroleum assessed in the water column. Even if adhered petroleum represents a relevant proportion of the petroleum (in particular at T = 48 h), fish were not directly exposed to this fraction of the petroleum since (i) pelagic fish species, such as golden grey mullets, should only be exposed to petroleum present in the water column; (ii) in our study, most of the adhered petroleum was present in the funnel, for which fish do not have access.

4.2. PAH biliary metabolites

The relative concentration of PAH biliary metabolites (evaluated through fixed wavelength fluorescence analysis) has often been used as an exposure biomarker (Camus et al. 1998; Aas et al. 2000; Jung et al. 2009). PAH are well studied since they are considered to be the most toxic compounds of petroleum. In our study we measured the biliary-derived metabolites corresponding to PAH (alkylated and parents) of three different weights (naphthalene: 128.2 g.mol⁻¹, pyrene: 202.3 g.mol⁻¹, benzo[a]pyrene: 252.3 g.mol⁻¹). The results showed a significant increase in the three PAH metabolites following the CD treatment, when compared to WSF. This result is in accordance with many studies (Perkins et al. 1973; Cohen & Nugegoda 2000; Ramachandran et al. 2004; Lin et al. 2009) since it shows that the application of dispersant on an undispersed oil slick increases PAH exposure. The same is true of the MD treatment, when compared to WSF: mechanical dispersion increased pyrene and benzo[a]pyrene exposure (however no significant difference was observed for naphthalene-derived metabolites). This increase in PAH exposure, due to the dispersion (chemical or mechanical), suggests an increase of toxicity for tested organisms. Indeed, PAH are considered as carcinogenic and mutagenic (Eisler 1987). Moreover, studies revealed that PAH induce histopathological effects (Stentiford et al. 2003 ; Ortiz-Delgado et al. 2007), inflammatory responses (Stentiford et al. 2003), oxidative stress (Sun et al. 2006 ; Oliveira et al. 2008) and alterations of DNA integrity (Oliveira et al. 2007 ; Maria et al. 2002) in teleost fish.

With regards to the MD and CD treatment, our results show that the differences in the relative concentration of the metabolites seem to be linked to PAH toxicity: the more toxic a PAH, the lower the difference, in metabolite concentration, between the two treatments. Indeed, naphthalene-derived metabolites (described as low toxicity PAH in Petry et al. 1996 and Bosveld et al. 2002) showed a 40% increase with CD treatment (when compared to MD treatment). Pyrene-derived metabolites showed a 13% increase. No significant difference was observed for benzo[*a*]pyrene-derived metabolites, which is considered as a carcinogenic PAH and induces reactive oxygen species (Lemaire-Gony & Lemaire 1993).

4.3. Total glutathione content (GSH)

When compared to the WSF treatment, the CD treatment induced a significant decrease in total glutathione content in the gills. Several hypotheses may explain the decrease in GSH content, such as the conjugation of glutathione to PAH through the increase in GST activity as observed in Yin et al. (2007) or the decrease in GSH synthesis due to contaminant exposure as described in Canesi et al. (1999). Whatever the physiological mechanism implicated, this study shows that dispersant application induced a depletion of glutathione, which is the first line cellular defence involved in many detoxification processes (Maracine & Segner 1998). Thereby, the chemical dispersion of an oil slick decreases the potential of fish to cope with contaminated environments.

On the contrary, when compared to the MD treatment, the CD treatment did not induce a significant decrease in the total glutathione content in the gills, suggesting that, even when the oil slick is mechanically dispersed (e.g. due to meteorological conditions), the application of dispersant does not significantly decrease the potential of the organism to cope with its environment.

Benzo[*a*]pyrene- and pyrene-derived metabolite concentrations were correlated with the total glutathione content in the gills. However no correlation was found between naphthalene-derived metabolites and total glutathione content. Taken together, these results suggest that glutathione depletion arises due to exposure to heavy PAH whereas light PAH would not be involved in the observed decrease in glutathione.

In Milinkovitch et al. (2011a), a similar experimental approach was conducted with the same exposure treatments as described in this study (C, CD, MD, WSF, D). The total glutathione content in fish liver was evaluated and appeared to follow the same pattern as the total

glutathione content in gills (exposed in this study): CD treatment induced a significant decrease of total glutathione when compared to control treatment; and no significant difference was observed between CD and MD treatments. However, no significant difference was observed concerning the liver total glutathione content between WSF and CD exposure whereas, in the present study, when studying the fish gills, a significant difference was observed between these both conditions. This finding shows that, evaluating dispersant application toxicity, gill seems to be a more sensitive target organ than liver. This relevant sensitivity of gills could be due to the fact that gills are target organs immediately in contact with the external environment and thereby immediately in contact with pollutants presents in the water column.

4.4. *Oxidative stress*

PAH, when incorporated by the organism, are bound to a cellular aryl hydrocarbon receptor (AhR). This binding induces the formation of a complex, the aryl hydrocarbon receptor nuclear translocator (ARNT), which is delocalized in the nucleus of the cell and bound to the xenobiotic regulatory element (XRE). This phenomenon increases the transcription rate of the P4501A cytochrome genes (CYP1A) and by the way increases the synthesis *de novo* of the cytochrome P450 enzymes and the catalytic activity of these enzymes (Stegeman 1987). This increasing activity enhances the cellular production of reactive oxygen species (Livingstone 2001), which is counteracted by the antioxidant response (especially through enzymatic antioxidant activities). When the production of ROS overwhelms the antioxidant response, free reactive oxygen species can interact deleteriously with cellular components. Lipid peroxidation is a marker of this impairment.

Our results showed no modulation of lipid peroxidation, suggesting a lack of free radical attack due to PAH exposure. Moreover, no antioxidant response was observed. The absence of oxidative stress could be due to the composition of the fish food. Indeed, even if fish were fed during four weeks with a fish food free of additives (also called synthetics) antioxidants, natural antioxidants (such as vitamins A, C and E) are presents in the food composition. This consummation of antioxidants could have prevented fish against oxidative stress.

Another explanation concerning this lack of significance could also be due to the fact that the exposure period was too short to induce ROS production. Indeed, although some studies have shown some effects of PAH following a short exposure period (≤ 48 h, Sun et al. 2006;

Oliveira et al. 2008), many studies investigated the effects of contaminants on oxidative stress by exposing animals to longer periods (Kopecka-Pilarczyk & Correia 2009; Jung et al. 2009; Narghang et al. 2009; Hannam et al. 2010).

5. Conclusion

With regards to gill glutathione content and the relative concentration of PAH biliary metabolites, the results of this study firstly demonstrate that WSF exposure would be less toxic than CD exposure. These results are in accordance with an important body of literature (Perkins et al. 1973; Cohen & Nugegoda 2000; Ramachandran et al. 2004; Lin et al. 2009). Extrapolated to field operations, these results mean that containment and recovery, rather than chemical dispersion of the oil slick, must be conducted. However, depending on technical facilities and meteorological conditions, it is not always possible to contain the oil slick. In some oil spill situations (e.g. rough sea and low viscosity petroleum), dispersant is the only appropriated response technique.

Since a minimum sea energy is required before a dispersant functions effectively (Merlin 2005) and since nearshore areas are considered to be turbulent zones (due to waves, wind and swell) it seemed important, in this study, to evaluate the toxicity of dispersant application under a mixing process. Comparison of MD and CD showed a significant difference concerning low toxicity PAH-derived metabolites (naphthalene and pyrene); however, no significant difference was found for benzo[*a*]pyrene-derived metabolites, which are considered to be carcinogenic and to induce reactive oxygen species. Moreover no significant difference was found between the glutathione content following the CD and MD treatments, again suggesting no impairment of the gills due to dispersant application. Taken together these results show that, when an oil slick is naturally dispersed, the application of dispersant seems to not increase its environmental toxicity. These results are in accordance with a similar previous study (Milinkovitch et al. 2011a).

However, several limits of this experimental approach compel us to be cautious in our conclusions. Indeed, the experimental approach is available only for a given turbulent mixing energy (the energy induced by the experimental system). Moreover, this experimental approach only takes into account the toxicity to pelagic teleost fish while other components of the ecosystem are also likely to be impaired by dispersant application. An experimental

approach considering the environmental conditions and other components of an ecosystem (benthic and demersal species) would provide supplementary information. In this context, further studies as part of the DISCOBIOL project will evaluate the impact of dispersed oil on burrowing organisms, demersal organisms (such as oysters) and pelagic species (such as golden grey mullet) within an enclosed ecosystem (mesocosm).

Acknowledgements

This study was supported by a PhD grant from the Conseil Général of the Charente-Maritime. The authors also wish to acknowledge CEDRE (CEntre de Documentation de Recherche et d'expérimentations sur les pollutions accidentelles des eaux), FREDD (Fédération de Recherche en Environnement et pour le Développement Durable), CPER (Contrat de Projet Etat-Région), Sophie Labrut and Jérôme Abadie from UMR 707 INRA-ONIRIS-University of Nantes for financial and technical support. Special thanks go to Marion Richard for her help and assistance during the study and to everybody who helped during Xynthia storm.

Synthèse du Chapitre 3

Ce chapitre expose, au travers de l'utilisation de biomarqueurs, les effets biologiques d'une nappe de pétrole dispersée sur deux organes cibles des contaminants : le foie et les branchies. En effet, **le foie** en tant qu'organe de détoxification majeur est un site de bioconcentration des contaminants ; (ii) **les branchies**, organes externes sont directement en contact avec les contaminants présents dans le milieu.

Au niveau hépatique, les principaux résultats de cette étude ne montrent **pas de réponse de l'organisme au stress oxydant** (aucune modulation d'activité des enzymes antioxydantes) **ni de dommages associés** (lipoperoxydation). Cependant les résultats montrent **une augmentation des métabolites biliaires de type pyrène et benzo[a]pyrène** concomitante d'une **déplétion du glutathion total** lorsque la nappe de pétrole est dispersée chimiquement ou mécaniquement. La diminution du glutathion total est interprétée comme une réduction d'une des premières lignes de défense contre les contaminants, cette molécule étant utilisée par l'organisme dans une multitude de processus de détoxification (chélation des métaux lourds, biotransformation des contaminants organiques). Ainsi, cette déplétion du glutathion suggère que, suite à l'exposition à une nappe de pétrole dispersée (chimiquement ou mécaniquement), la capacité de l'animal à faire face à un environnement contaminé sera diminuée. En revanche, l'absence de différence constatée entre une dispersion mécanique et chimique montre que l'application de dispersant ne diminuerait pas la capacité de l'animal à faire face à un environnement contaminé, lorsque les conditions météorologiques entraînent déjà une dispersion naturelle de la nappe de pétrole.

Au niveau branchial, comme au niveau hépatique, **aucune réponse au stress oxydant ni aucune lipoperoxydation** n'a été constatée. Concernant les taux de glutathion, les résultats obtenus montrent, comme précédemment, que (i) **la dispersion chimique entraîne une diminution du glutathion**, suggérant qu'une nappe de pétrole dispersée chimiquement diminue la capacité de l'animal à faire face à un environnement contaminé. Cependant, contrairement aux résultats obtenus au niveau hépatique, (ii) les taux de glutathion obtenus après la dispersion mécanique semblent se situer à un niveau intermédiaire entre ceux obtenus

lors de l'exposition à une nappe de pétrole non traité et une nappe de pétrole dispersé chimiquement.

Afin de statuer sur la comparaison, en termes de toxicité, d'une nappe de pétrole dispersée chimiquement, mécaniquement ou non dispersée, notre discussion devra prendre en compte la toxicité au niveau de ces 2 organes. Une mesure de la toxicité au niveau d'un autre organe cible, le cœur, pourra également être évoquée.

De plus, ces résultats montrent qu'**une nappe de pétrole dispersé (chimiquement ou mécaniquement) entraîne une diminution de l'animal à faire face, par la suite, à un environnement contaminé.** Or suite à une dispersion de la nappe de pétrole en milieu côtier, une partie des hydrocarbures peut être incorporée aux sédiments. Il semble donc important de développer une approche permettant de déterminer les effets biologique de cette voie d'exposition. Dans ce but, une approche menée en mésocosme a été développée au sein de cette thèse. Une publication scientifique située en annexe (Richard et al. soumis) expose et valide cette approche qui permet l'exposition de *Liza aurata* à des sédiments contaminés par une nappe de pétrole dispersée.

DISCUSSION GENERALE

Discussion générale et Conclusion

L'application de dispersant sur une nappe de pétrole présente de nombreux avantages environnementaux. Cependant, en milieu côtier, cette technique de lutte augmente transitoirement l'exposition des organismes aquatiques aux hydrocarbures. Afin de déterminer **le risque environnemental consécutif à l'application de dispersant dans la frange la plus proche du littoral**, et par là de contribuer à sa réglementation, le projet DISCOBIOL (DISpersant et techniques de luttés en milieu CÔtiers : effets BIOLogique et apports à la réglementation) a été élaboré. Différentes espèces ont été utilisées afin de déterminer la toxicité d'une nappe de pétrole dispersée: 2 espèces de bivalves, l'huître creuse (*Crassostrea gigas*) et la moule commune (*Mytilus edulis*) ; 3 espèces pélagiques de poissons téléostéens, le bar (*Dicentrarchus labrax*) et deux espèces de mullets (*Liza ramada* et *Liza aurata*)

Ces deux dernières espèces, regroupées sous le nom du genre *Liza sp*, ont constitué le **modèle biologique** de ce travail de thèse. L'approche expérimentale exposée dans ce manuscrit a considéré la dispersion d'une nappe de pétrole en tenant compte des phénomènes de turbulences inhérents aux milieux côtiers. La toxicité d'une nappe de pétrole dispersée a été évaluée en fonction des **phénomènes de bioaccumulation** et de **toxicité létale** (Chapitre 1) pour ensuite être mesurée, au travers d'approches sublétales, **au niveau de l'organisme** et **au niveau de l'organe** (respectivement Chapitres 2 et 3). Au sein de ces études, **la concentration en hydrocarbures** dans la colonne d'eau, **l'incorporation des HAP** par l'organisme et les effets biologiques ont été évalués. La synthèse et la discussion des résultats de ce travail de thèse sont présentées ci-dessous.

1. Synthèse des résultats

1.1. Effets de l'application de dispersants sur la concentration en hydrocarbures au sein de la colonne d'eau et incorporation de ces composés par l'organisme

L'application de dispersant sur une nappe de pétrole s'effectue *in situ* lorsque les conditions météorologiques le permettent ; c'est-à-dire lorsque la turbulence du milieu entraîne déjà une dispersion naturelle, partielle ou totale, de la nappe (Lewis & Dailing 2001). Dans le cas d'une dispersion partielle de la nappe, l'application de dispersant va permettre de transférer dans la colonne d'eau, la totalité de la nappe de pétrole sous forme de gouttelettes d'hydrocarbures en empêchant leur « recoalescence ». Dans notre première étude expérimentale (Chapitre 1), cette caractéristique du dispersant a été observée : la dispersion mécanique ne permet pas de transférer la totalité de la nappe de pétrole dans la colonne d'eau alors que l'application de dispersant (dispersion chimique) a permis une homogénéisation totale de la nappe de pétrole sous forme de gouttelettes d'hydrocarbures (vérifiée par une mesure des concentrations en hydrocarbures totaux dans la colonne d'eau). Ainsi les **caractéristiques d'un dispersant observées *in situ* sont conservées** dans cette approche expérimentale permettant par là de simuler les comportements d'une nappe de pétrole dispersée.

De plus, dans le deuxième et le troisième chapitre de cette thèse, notre étude reflétait la volonté de **se rapprocher des conditions de contaminations observées *in situ***, lors de catastrophes pétrolières. En accord avec de nombreuses études menées *in situ* (Spooner 1970; Cormack 1977; Lunel 1995), les concentrations en hydrocarbures totaux dans notre étude montraient des valeurs comprises entre 10 et 50 mg/L lors d'une dispersion chimique et mécanique. Lors de ces expérimentations, la période d'exposition, située entre 2 et 5 heures lors d'une dispersion de la nappe en milieu hauturier (Lessard & DeMarco 2000), a été étendue à une période de 48 heures afin de simuler une dispersion de la nappe en milieu côtier. En effet, dans les eaux peu profondes de la frange littorale, la dilution d'une nappe de pétrole dispersée est ralentie par la faible profondeur de la colonne d'eau : par voie de conséquence, la période d'exposition est augmentée. Lors de cette période d'exposition, une

décroissance des concentrations a été observée et notamment pour la dispersion mécanique d'une nappe de pétrole. Cette décroissance correspond au phénomène d'adhérence du pétrole au dispositif expérimental. Cette adhérence a été diminuée lors de l'application de dispersant. Cette observation est en accord avec celle faite par Baca et al. (2005) qui constate, *in situ*, une diminution de l'adhérence au substrat (sédiment et flore épigée) lors de l'application de dispersant.

La comparaison entre une nappe de pétrole non dispersée et une nappe de pétrole dispersée (chimiquement ou mécaniquement) montre que la **formation de gouttelettes de pétrole entraîne une augmentation des HAP dissous** (Chapitre 1 et chapitre 2), avec une fraction dominante de naphthalène (en accord avec Fucik 1994). Ce résultat peut s'expliquer par le fait que la transformation d'une nappe en gouttelettes entraîne une élévation du ratio surface sur volume du pétrole, augmentant de fait la surface d'échange et donc la diffusion des hydrocarbures au sein de la colonne d'eau.

Notre première étude (Chapitre 1) montre, au travers de la comparaison entre une nappe de pétrole dispersée mécaniquement et une nappe de pétrole dispersée chimiquement, que l'application de dispersant entraîne une augmentation des HAP dissous. Ce phénomène peut s'expliquer par le transfert, sous forme de gouttelettes d'hydrocarbures, de la totalité de la nappe de pétrole lors de l'application de dispersant. En effet, lors de la dispersion mécanique, les phénomènes de turbulence induit par le système expérimental ne suffisent pas à disperser totalement le pétrole au sein de la colonne d'eau. Il y a formation d'une nappe de pétrole en surface aux dépens de gouttelettes d'hydrocarbure dans la colonne d'eau. En revanche, lors d'une dispersion chimique, l'ensemble de la nappe de pétrole est dispersée sous forme de gouttelettes dans la colonne d'eau augmentant le ratio surface sur volume du pétrole ainsi que les processus de diffusion.

Dans le deuxième et le troisième chapitre de cette thèse, du fait des faibles quantités de pétrole employées, la dispersion de la nappe de pétrole sous forme de gouttelettes est totale, quelle que soit la méthode de dispersion employée, chimique ou mécanique. Contrairement à l'étude précédente, la comparaison entre la dispersion mécanique et chimique ne montre pas d'augmentation de la concentration en HAP dissous. Ces résultats suggèrent que, dans les deux conditions d'exposition, la dispersion totale de la nappe a augmenté le ratio surface sur volume du pétrole et les processus de diffusion des HAP. Cependant, bien qu'aucune

différence significative n'ait été observée, la concentration en HAP à 0 et 48 heures était inférieure pour la dispersion mécanique (comparée à la dispersion chimique). Cette différence pourrait s'expliquer (i) par le processus d'adhérence des gouttelettes au dispositif et la diminution de concentration en hydrocarbures totaux associée, mais aussi (ii) par le fait que, lors d'une dispersion mécanique, la taille des gouttelettes est supérieure à celle observée lors d'une dispersion chimique (Singer et al. 2000) réduisant ainsi le ratio surface sur volume du pétrole et par là les processus de diffusion des HAP.

La comparaison des deux expérimentations, exposées au chapitre 1 et au chapitre 2, montre que, **(i) lorsque les seuls phénomènes de turbulence (dispersion mécanique) n'ont pas entraîné la dispersion totale de la nappe de pétrole** (chapitre 1), l'application de dispersant, en provoquant le transfert de la totalité du pétrole dans la colonne d'eau a entraîné une **augmentation de la concentration en HAP** ; (ii) à l'inverse, **lorsque les seuls phénomènes de turbulence ont permis la dispersion totale de la nappe** (chapitre 2), **l'application de dispersant n'a pas entraîné d'augmentation de concentration en HAP** dans la colonne d'eau.

Ces résultats révèlent donc que, lors d'une catastrophe pétrolière en milieu côtier, l'application de dispersant sur une nappe de pétrole, partiellement dispersée par les phénomènes de turbulence, augmenterait l'exposition des organismes aux HAP ; à l'inverse l'exposition aux HAP ne serait pas augmentée par l'application de dispersant, lorsque les conditions de turbulence entraînent déjà une dispersion totale de la nappe de pétrole.

Dans le cas d'une dispersion totale de la nappe par les phénomènes de turbulence, il est important de noter que l'application de dispersant permet la formation de gouttelettes d'hydrocarbure d'un diamètre plus faible que ne le permettent les seuls phénomènes de turbulence (Singer et al, 2001). De ce fait, l'application de dispersant confère un bénéfice environnemental en empêchant la recalescence de la nappe et en augmentant la dégradation bactérienne du pétrole. Il y a donc une véritable « utilité environnementale » à l'application de dispersant même lorsque la nappe de pétrole peut être dispersée totalement par les phénomènes de turbulence.

Les HAP étant considérés comme un déterminant majeur de toxicité (Anderson et al. 1974) et leur processus de diffusion ayant montré une augmentation lors de l'application de dispersant, les phénomènes d'incorporation dans les organismes de ces contaminants ont été mesurés.

1.2. Incorporation des HAP au sein de l'organisme

L'incorporation des HAP a été étudiée dans le premier chapitre au travers d'une mesure de la **bioconcentration dans les muscles des organismes**. Dans le deuxième et troisième chapitre, les phénomènes d'incorporation des HAP ont été évalués en mesurant la **concentration des métabolites biliaires de ces composés**. Cette méthode, bien qu'indirecte, est considérée plus sensible pour des concentrations faibles en hydrocarbures (Beyer et al. 2010).

Les trois chapitres de cette thèse montrent une **augmentation de l'incorporation des HAP lorsque la nappe de pétrole est dispersée chimiquement ou mécaniquement** (au travers d'une mesure des métabolites biliaires du benzo[*a*]pyrène dans les chapitres 2 et 3). Ces résultats sont en accord avec les résultats décrits en *1.1.* puisque la dispersion mécanique ou chimique d'une nappe de pétrole montrait une augmentation de la concentration en HAP dans la colonne d'eau suggérant une augmentation de leur biodisponibilité.

Dans le premier chapitre de cette thèse, la comparaison entre une dispersion mécanique et une dispersion chimique met en évidence une augmentation des bioconcentrations en HAP consécutive à l'application de dispersant. Ces résultats peuvent être interprétés comme une conséquence des processus de solubilisation (décrit en *1.1.*). En effet, les différences observées, en termes de bioconcentration en HAP reflètent les différences observées en termes de concentration en HAP solubilisés dans la colonne d'eau. Cependant il semble que, lors d'une dispersion chimique, cette augmentation de solubilisation ne soit pas le seul phénomène mis en jeu dans l'incorporation des HAP. En effet, une augmentation du facteur de bioaccumulation (ratio de la concentration en HAP dans la colonne d'eau sur la concentration en HAP dans les muscles) est mise en évidence lors d'une dispersion chimique (comparée à une nappe de pétrole non dispersée). Cette augmentation du facteur de bioaccumulation indique une augmentation de diffusion des HAP à l'interface eau-organisme. Plusieurs hypothèses peuvent expliquer cette augmentation de la diffusion :

(i) Ce phénomène pourrait être dû à une altération morpho-fonctionnelle branchiale induite par les surfactants contenus dans les dispersants. Cette altération, déjà décrite dans (Rosety-Rodríguez et al. 2002), est susceptible d'entraîner une diminution de la perméabilité sélective des branchies et par là une entrée massive de HAP dans l'organisme.

(ii) Cette augmentation de la diffusion des HAP pourrait également être due à la présence de microgouttelettes de pétrole à la surface des branchies (Ramachandran et al. 2004b). Ces microgouttelettes de pétrole accélèreraient la diffusion des HAP à travers l'épithélium branchial jusque dans le milieu interne de l'organisme.

Dans les deuxième et troisième chapitres de cette thèse, la concentration relative des métabolites de 3 HAP (naphthalène, pyrène, benzo[*a*]pyrène) a été dosée dans la bile des poissons afin de mettre en évidence des différences en termes d'incorporation des HAP. Les concentrations observées en métabolites de type benzo[*a*]pyrène sont en accord avec les concentrations en HAP mesurées dans la colonne d'eau (*1.1.*) puisque aucune différence significative n'a été mise en évidence entre une dispersion chimique et une dispersion mécanique. Le benzo[*a*]pyrène étant considéré comme un des HAP les plus toxiques (Eisler 1987) du à ses effets carcinogéniques et mutagéniques, il est possible de penser que cette absence de différence de concentration en métabolites reflète une similitude dans les toxicités attribuées aux deux méthodes de dispersion. Cependant, il apparaît que la concentration en métabolites biliaires de type pyrène est significativement plus élevée lors d'une exposition à une dispersion chimique que lors d'une exposition à une dispersion mécanique.

L'ensemble des résultats (résumé en **Figure 32**) montre que **l'incorporation des HAP semble dépendre majoritairement des processus de solubilisation** de ces composés. La comparaison entre une nappe de pétrole non dispersée et une nappe de pétrole dispersée (chimiquement ou mécaniquement) montre que **la formation de gouttelettes de pétrole entraîne une augmentation des HAP dissous** (décrite en *1.1.*). Ce phénomène a pour conséquence **une augmentation des HAP incorporés dans les muscles des organismes. Lorsque les seuls phénomènes de turbulence (dispersion mécanique) ne permettent pas une dispersion totale de la nappe** (Chapitre 1), **l'application de dispersant** entraîne un transfert de toute la nappe sous forme de gouttelettes de pétrole dans la colonne d'eau (dispersion chimique). Ce phénomène **augmente le transfert des HAP dans la colonne d'eau et par là leur incorporation dans les organismes**. A l'inverse lorsque les seuls phénomènes de turbulence permettent une **dispersion totale de la nappe, l'application de dispersant n'entraîne pas d'augmentation de la dissolution des HAP dans la colonne d'eau**. Par voie de conséquences, **aucune différence d'incorporation** n'a été mesurée au niveau du benzo[*a*]pyrène, considéré comme le HAP le plus toxique mesuré dans cette étude.

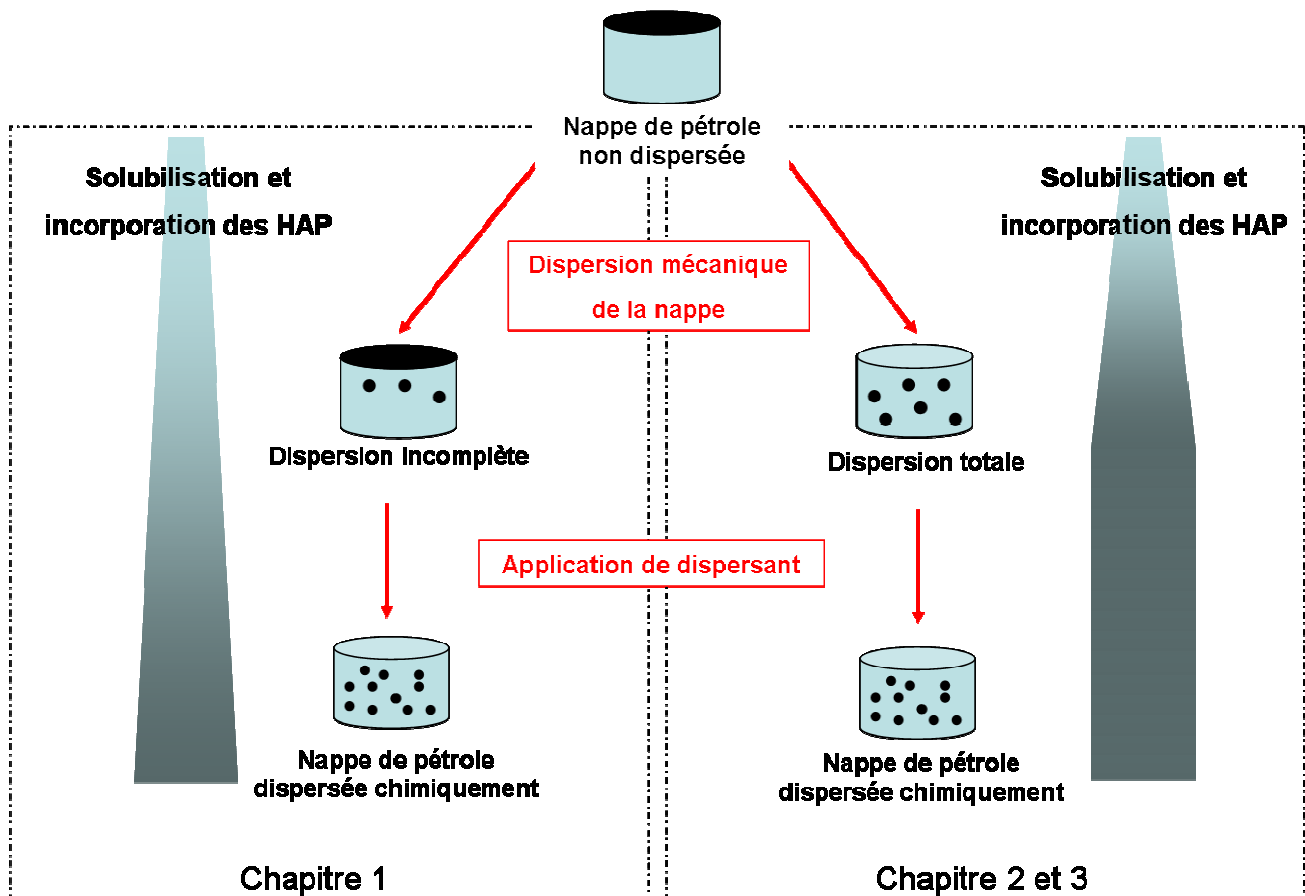

Figure 32. Schéma synthétique des résultats obtenus dans cette thèse illustrant les processus de solubilisation et d'incorporation des HAP consécutif à une dispersion mécanique de la nappe de pétrole et à l'application de dispersant.

Cependant, bien qu'une incorporation des contaminants apparaisse, elle ne va pas se traduire obligatoirement par un effet néfaste pour l'organisme. En effet, la réponse de l'organisme en termes de mécanismes de défense peut empêcher les xénobiotiques d'interférer avec les macromolécules cellulaires (enzymes, ADN, lipides membranaires etc.) et ainsi empêcher les dommages observés au niveau de la cellule, de l'organe ou au niveau de l'organisme.

Dans cette thèse, des dommages potentiels ont été recherchés au niveau de l'organisme et de l'organe. Notre approche expérimentale a permis d'exposer *Liza sp* à l'ensemble des composés présents dans le pétrole (décrits en Introduction). Cependant, les effets biologiques observés pourront être discutés en fonction de la toxicité des HAP puisque ces composés ont montré (i) une augmentation de leur incorporation lors de l'application de dispersant (résultats précédemment discutés) et (ii) une toxicité dans de nombreuses études chez des poissons téléostéens (Sun et al. 2006; Oliveira et al. 2008; Nahrgang et al. 2009).

1.3. Effets biologiques de l'application de dispersants

➤ Toxicité létale d'une nappe de pétrole dispersée

Au cours du premier chapitre de cette thèse les effets biologiques ont été évalués en termes de mortalité sur un groupe d'individus, permettant la détermination d'une CL₅₀ (Concentration Létale pour 50% du groupe d'individus testés). La toxicité évaluée d'après ces expérimentations est qualifiée de **toxicité aiguë** : des concentrations létales et une période courte (24h) d'exposition ont été utilisées. La comparaison entre une nappe de pétrole traitée au dispersant et une nappe de pétrole non dispersée montre que la **dispersion chimique augmente la toxicité du pétrole**. De même, la comparaison entre une nappe de pétrole mécaniquement dispersée et une nappe de pétrole chimiquement dispersée montre, qu'en milieu turbulent, la toxicité aiguë est également augmentée par l'application de dispersant. Ces résultats sont en accord avec de nombreuses études menées sur des poissons téléostéens pélagiques qui montrent une augmentation de la mortalité consécutive à l'application de dispersant (Adams et al. 1999; Cohen & Nugegoda 2000; Lin et al. 2009). Cependant, au sein de notre étude, les conditions de turbulences inhérentes au milieu côtier ont été prises en compte. Ces mesures de la mortalité sur un groupe d'individus pourraient être interprétées comme prédictives d'un impact au niveau populationnel. Les résultats, décrits ci-dessus, suggéreraient donc l'existence d'un impact environnemental de l'application des dispersants en zone côtière. Cependant, le caractère expérimental de cette étude, la prise en compte d'une seule espèce de poisson téléostéen pélagique et les concentrations employées –très supérieures à celles observées *in situ*- nous imposent la plus grande prudence quant à l'interprétation de nos résultats.

Dans ce premier chapitre, les mesures de concentration des HAP dans l'eau (décrites en 1.2.) montrent, comme la mesure de mortalité, des valeurs significativement plus importantes lors d'une dispersion chimique que lors d'une exposition à une nappe de pétrole non dispersée ou à une dispersion mécanique. Ceci suggère que la toxicité létale serait la conséquence de l'exposition à ces composés. Cependant, il semble que dans notre étude, la concentration en HAP dissous ne soit pas suffisante pour induire la mortalité des organismes. En effet, une étude menée par Maria et al. (2002) chez *Anguilla anguilla*, ne montre aucune mortalité après une exposition de 216 heures à des concentrations de 680 µg/L en benzo[*a*]pyrène. Dans cette expérimentation, la durée d'exposition est 9 fois plus élevée que dans notre étude et les

concentrations en benzo[a]pyrène -classifié comme le plus toxique des 21 HAP (Eisler 1987) - 2 fois plus élevées que la valeur maximale de la somme des 21 HAP dosés. Il apparaîtrait donc, dans notre approche expérimentale, que **les HAP dissous dans la colonne d'eau ne soient pas les seuls déterminants de la toxicité aiguë d'une nappe de pétrole dispersée**. D'autres facteurs, par exemple la présence de gouttelettes d'hydrocarbures au niveau branchial (Ramachandran et al. 2004b) mais aussi la présence de métaux lourds (vanadium et nickel), pourraient être responsable de cette mortalité.

Les expérimentations des chapitres 2 et 3, ont donc été conduites en considérant la totalité des composés présents lors de la dispersion chimique d'une nappe de pétrole. Bien qu'inscrits dans le cadre d'une démarche expérimentale, ces deux chapitres reflètent la volonté de se rapprocher des conditions observées lors de l'application de dispersant en situation de catastrophe pétrolière. Les organismes ont ainsi été exposés à des concentrations en hydrocarbures totaux retrouvés *in situ* (concentrations sublétales). L'utilisation de biomarqueurs au niveau de l'organisme et dans des organes cibles a permis d'évaluer la toxicité de la nappe de pétrole dispersé.

- Effets sublétaux d'une nappe de pétrole dispersée sur la capacité métabolique aérobie et les performances de nage

Au sein de notre étude, les effets biologiques de l'application de dispersant ont été mesurés au travers des performances de nage et de la capacité métabolique aérobie des organismes.

Les performances de nage ont été évaluées par une mesure de la vitesse de nage critique. En effet, la vitesse de nage critique, correspondant à la vitesse maximale qu'un poisson peut atteindre lorsqu'il pratique une nage de type prolongé (période de nage entre 15 secondes et quelques heures), est considérée comme un indicateur des performances de l'activité natatoire chez le poisson (Brett 1964). Les performances de nage jouent un rôle fondamental dans le cycle de vie d'un poisson, et notamment pour les processus d'acquisition d'énergie, tel que la recherche de nourriture.

La capacité métabolique aérobie est mesurée par la différence entre le taux métabolique aérobie maximal et son taux métabolique de maintenance. Cette mesure, plus intégrative que la performance de nage, donne une estimation de la puissance énergétique dont l'animal dispose, en premier lieu pour ses activités discrétionnaires telles que les processus de digestion et en second lieu pour la croissance somatique et gonadique. Ainsi Lefebvre et al. (2001) montrent, chez *Dicentrarchus labrax*, une corrélation entre capacité métabolique et

taux de croissance somatique. La croissance somatique étant considérée comme un corrélat de la fitness, Claireaux et Lefrançois (2007) exposent le lien entre capacité métabolique et fitness de l'animal.

Ainsi **l'altération de ces deux variables biologiques** traduirait donc des altérations au niveau de l'organisme susceptibles d'affecter sa **fitness**.

De plus, des études ont montré une diminution de la capacité métabolique aérobie et des performances de nage liée aux contraintes environnementales abiotiques du milieu, tel que l'hypoxie et la diminution de température (Claireaux & Lagardère 1999; Lefrançois & Claireaux 2003), mais aussi tel que la présence de nombreux polluants : métaux lourds (Pane et al. 2004) ou hydrocarbures (Kennedy & Farrell 2006; Davoodi & Claireaux 2007). Ces deux variables biologiques peuvent donc être considérées comme des **biomarqueurs en écotoxicologie**.

Considérant (i) le lien qui existe entre ces deux variables biologiques et la fitness de l'animal ainsi que (ii) leur validation comme bioindicateurs en écotoxicologie, la mesure de la capacité métabolique aérobie et des performances de nage semble pertinente au sein de notre étude : elles permettraient de mettre en évidence, suite à l'exposition à une nappe de pétrole dispersée, des altérations au niveau de l'organisme susceptibles d'affecter la population.

Cependant, dans notre étude, **aucune modification de la capacité métabolique et des performances de nage n'a été observée**, et ce, pour toutes les conditions de contamination établies. Ces résultats donnent à penser qu'aucune altération observable au niveau de l'organisme n'est susceptible d'affecter la fitness du poisson.

Une étude de Kerambrun et al. (2009) a été menée, chez *Dicentrarchus labrax*, dans les mêmes conditions expérimentales qu'au deuxième chapitre de cette thèse. Après 48 h d'exposition aux conditions de contamination, une période de 28 jours de récupération a été conduite suite à laquelle les taux de croissances journaliers (en taille) ont été évalués (**Figure 33**). Bien que cette étude ait été menée chez une autre espèce de poisson téléostéen pélagiques et à un stade de développement plus précoce que dans notre étude (juvéniles de première année), il est envisageable de comparer les résultats obtenus dans cette étude aux résultats de ce deuxième chapitre de thèse. Kerambrun et al. (2009) montrent une diminution de la croissance des individus après une exposition à une dispersion chimique et mécanique. La croissance étant classiquement considérée en écologie comme un indicateur de fitness, cette étude montre que la dispersion de la nappe (mécanique ou chimique) affecte la fitness de l'animal. Ainsi, ces résultats semblent contraster avec ceux obtenus dans ce deuxième chapitre de thèse.

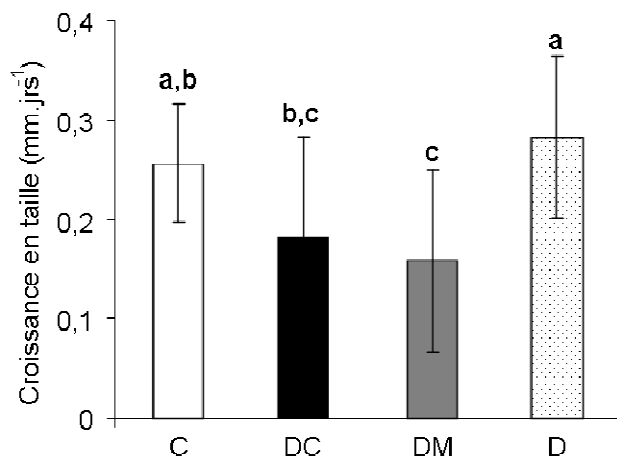

Figure 33: Comparaison des taux de croissance en taille (mm.jrs⁻¹) après exposition de juvéniles de bar, *Dicentrarchus labrax*. La mesure du taux de croissance s'est effectuée sur une période de 28 jours. Ces expérimentations ont été menées dans le cadre du même programme de recherche (DISCOBIOL), les conditions d'expositions ont été réalisées en suivant le même protocole qu'au deuxième chapitre de cette thèse, à l'exception de la condition WSF (« nappe de pétrole non dispersée ») qui n'a pas été envisagée. Les histogrammes représentent la moyenne des valeurs obtenues pour une condition et les barres d'erreurs représentent leur écart type. Modifié d'après Kerambrun et al. (2009).

Il est important de noter que les résultats obtenus par Kerambrun et al. (2009) ont considéré cette mesure intégrative qu'est la croissance sur une échelle de temps différente de notre étude. En effet, la croissance a été mesurée sur 28 jours post contamination alors que la capacité métabolique est une mesure instantanée après 48 h de contamination. Ceci pourrait expliquer la divergence des résultats obtenus entre ces 2 études.

En effet, au sein de notre étude, il est possible de penser que des mécanismes physiologiques compensatoires peu coûteux en énergie ont été mis en place, dissimulant par là les effets des contaminants sur la capacité métabolique : la perte d'intégrité fonctionnelle, au niveau d'un organe impliqué dans le métabolisme de l'organisme est susceptible d'affecter la capacité métabolique mais elle aurait été compensée par la plasticité d'un autre organe. La mise en place de ces mécanismes compensatoires et le coût énergétique faible qu'ils engendrent n'auraient pas pu être détecté au travers de notre approche. En revanche sur une échelle de temps plus longue, donc plus intégrative, ce coût énergétique aurait pu être ressenti d'où la diminution de la croissance observée sur 28 jours par Kerambrun et al. (2009).

Cette hypothèse évoquant des mécanismes physiologiques compensatoires s'appuie sur le fait que dans le cadre de cette thèse, une perte d'intégrité fonctionnelle au niveau du cœur, organe impliqué dans les processus de transport de l'oxygène donc dans le métabolisme aérobie du poisson, a été observée (Milinkovitch et Imbert, résultats non publiés). En effet, une expérimentation sur cœur isolé de mulot doré a été menée dans le programme DISCOBIOL en utilisant le même protocole d'exposition des organismes qu'au deuxième chapitre de cette

thèse. L'objectif était d'évaluer les performances cardiaques telles que la force de contraction et la sensibilité adrénergique. Dans ces conditions d'expérience, une mesure de la tension isométrique d'une bande de muscle cardiaque a été effectuée en présence d'adrénaline 10^{-9} M et 10^{-6} M. La tension isométrique donne une estimation de la force de contraction du muscle cardiaque (Satchell 1991); les concentrations d'adrénaline 10^{-9} M et 10^{-6} M reflètent respectivement la concentration d'adrénaline plasmatique chez un poisson à son métabolisme standard (de repos) et la concentration d'adrénaline plasmatique maximum chez un poisson lors d'une phase d'activité intense (chez *Oncorhynchus mykiss*, Shiels & Farrell 1997). Ainsi, la comparaison de la tension isométrique à 10^{-9} M et à 10^{-6} M donne une estimation de la force de contraction cardiaque que le poisson peut développer lorsqu'il passe du repos à une phase d'activité intense. Une partie des résultats de notre étude, représentée en **Figure 34**, montre qu'en présence d'adrénaline 10^{-6} M, l'exposition à une dispersion chimique, mécanique et à une nappe de pétrole non dispersée n'entraînent pas d'augmentation de la tension isométrique alors qu'une augmentation de la tension isométrique est constatée pour la condition contrôle et l'exposition au dispersant seul. Ces résultats suggèrent donc une incapacité des poissons exposés aux hydrocarbures (dispersion chimique, mécanique et nappe de pétrole non dispersée) à augmenter leur force de contraction cardiaque lors d'activité intense.

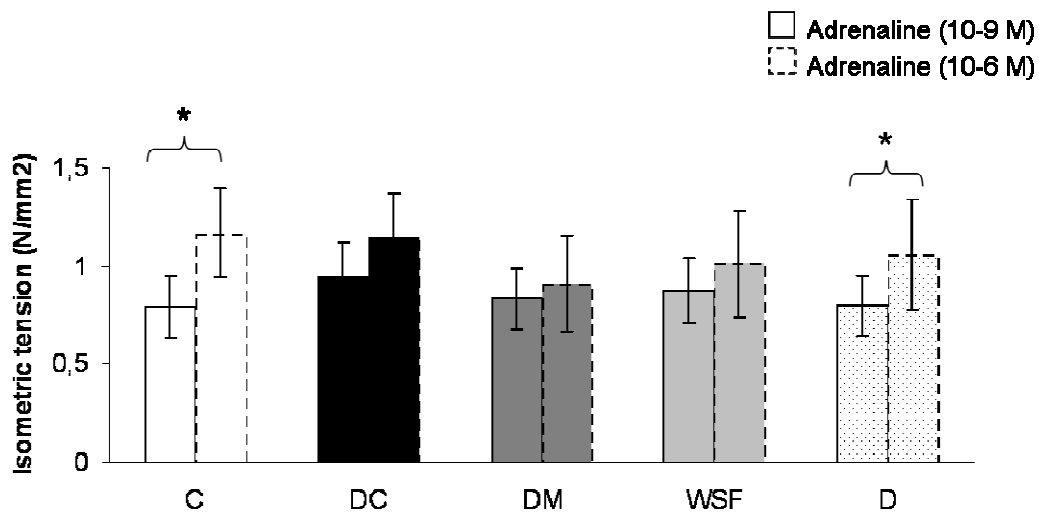

Figure 34: Tension isométrique obtenue sur une bande de muscle cardiaque à 0,2 Hz après application d'adrénaline 10^{-9} M ou 10^{-6} M. Les poissons (*Liza aurata*) ont préalablement été exposés à 5 conditions (C : contrôle ; DC : Dispersion Chimique ; DM : Dispersion Mécanique ; WSF : Water Soluble Fraction ; D : Dispersant seul). * : différence significative ($P < 0,05$) entre la tension isométrique à 10^{-9} M et à 10^{-6} M pour une même condition d'exposition. Les histogrammes représentent la moyenne des valeurs obtenues pour une condition et les barres d'erreurs représentent l'erreur standard à cette moyenne. Le test statistique employé est une ANOVA à mesures répétées.

L'ensemble des résultats exposés dans le deuxième chapitre de cette thèse ne montre **pas d'altération des performances de nage ni d'altération de la capacité métabolique aérobie** chez les organismes exposés aux conditions de contamination de cette étude. Ces deux variables étant considérées comme des valeurs prédictives de la fitness de l'animal, il est possible de penser que cette dernière n'a pas été impactée. Cependant une étude menée en parallèle de la nôtre chez une autre espèce de poisson téléostéen, *Dicentrarchus labrax*, semble prédire, au travers d'une mesure de croissance, un impact sur la fitness de l'animal lorsque celui-ci est exposé à une dispersion chimique et mécanique de la nappe de pétrole. De plus, des effets biologiques apparaissent notamment à des niveaux d'intégration biologique inférieurs, au niveau de l'organe. Ainsi au sein du troisième chapitre de cette thèse, nous nous sommes intéressés à la toxicité d'une nappe de pétrole sur deux organes cibles, le foie et les branchies. Les résultats obtenus au niveau cardiaque (non exposés dans le corps de ce manuscrit) seront également discutés ci-dessous.

- Effets sublétaux d'une nappe de pétrole dispersée, évalués au travers d'une approche multimarqueur au niveau de l'organe.

Au sein de ce troisième chapitre de thèse les **effets biologiques** d'une nappe de pétrole dispersée ont été **évalués au niveau de l'organe** (foie, branchies, cœur). Les effets biologiques ont particulièrement été observés au travers des **processus de détoxication**, de la **réponse antioxydante** et du **stress oxydant** (mesure de lipoperoxydation). De plus, **l'activité du complément** a été mesurée au niveau plasmatique afin de mettre en évidence la présence de processus inflammatoires, déjà observés par Stentiford (2003) au niveau des organes cibles des HAP.

Les processus de détoxication et les systèmes de défenses antioxydantes sont des biomarqueurs de défenses précoces des effets dus aux contaminants. La modulation de ces biomarqueurs peut être considérée comme prédictive de l'état de santé des individus. En effet, Ferrari et al. (2007) montrent que la diminution du taux de glutathion hépatique, substrat essentiel dans les processus de détoxication, est associée à l'augmentation de mortalité chez *Onchorynchus mykiss* exposée à des pesticides. De même Allen et Moore (2004) montrent le lien entre l'activation de l'enzyme antioxydante superoxyde dismutase SOD et la progression des maladies chez *Mytilus edulis*.

Le stress oxydant, au travers de la mesure de lipoperoxydation, est un biomarqueur de dommages traduisant l'inefficacité des systèmes antioxydants à enrayer une agression toxique

même lorsque les activités antioxydantes sont augmentées. Par là, le stress oxydant est témoin d'un niveau supérieur d'agression dû au xénobiotiques.

Au sein de notre étude aucune modification d'activité du complément n'a été observée. En revanche une **diminution des taux de glutathion total** a été constatée : (i) au niveau hépatique, pour la dispersion mécanique et la dispersion chimique; (ii) au niveau branchial, pour la dispersion chimique –une diminution non significative ayant été observée pour la dispersion mécanique-. Ces résultats sont en accord avec l'incorporation des HAP (et notamment du benzo[a]pyrène). Au niveau hépatique cette diminution de glutathion ne semble pas être due aux processus de détoxication puisque l'activité de la glutathion-S-transférase (GST) -enzyme catalysant la conjugaison du glutathion aux xénobiotiques dans les processus de détoxication- n'a pas été augmentée. Cette diminution du glutathion serait due, soit à une inhibition de sa synthèse par les HAP comme le suggèrent Zhang et al. (2004), soit à une chélation des métaux lourds contenus dans le pétrole, phénomène déjà observé par Maracine & Segner (1998). Quoiqu'il en soit, cette diminution des taux de glutathion lors des conditions de dispersion mécanique et chimique suggère une **réduction de la première ligne de défense contre les xénobiotiques**, le glutathion étant impliqué dans de nombreux processus de détoxication. Ainsi, **suite à l'exposition à une nappe de pétrole dispersée (chimiquement ou mécaniquement), la capacité de l'animal à faire face à un environnement contaminé sera diminuée**. Les résultats obtenus au niveau hépatique et branchial sont en accord avec les résultats non publiés (Milinkovitch & Imbert) obtenus au niveau cardiaque chez des mullets dorés ayant été exposés aux mêmes conditions (**Figure 35**).

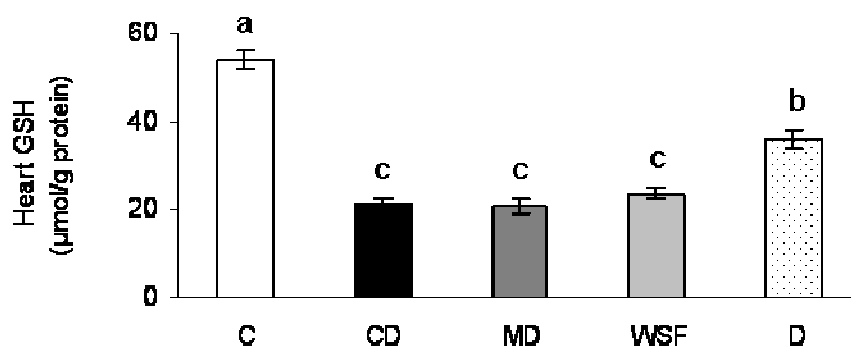

Figure 35: Contenu en glutathion total dans les cœurs de poissons (*Liza aurata*) préalablement exposés à 5 conditions (C : contrôle ; DC : Dispersion Chimique ; DM : Dispersion Mécanique ; WSF : Water Soluble Fraction ; D : Dispersant seul). Des lettres différentes (a, b, c) indiquent des différences significatives entre les conditions ($P < 0,05$). Les histogrammes représentent la moyenne des valeurs obtenues pour une condition et les barres d'erreurs représentent leur écart type. Le test statistique employé est une ANOVA.

Cependant, bien que les taux de glutathion au niveau cardiaque soient les plus bas pour les conditions CD et MD, des différences significatives ont également été mises en évidence lors d'une exposition à une nappe de pétrole non dispersé (WSF) et à un dispersant seul (D) suggérant une toxicité au niveau cardiaque de ces deux conditions d'exposition.

Bien qu'une incorporation des HAP, considérés comme des inducteurs de radicaux libres ait été constatée (décrite en 1.2.), aucune modification du stress oxydant ni de l'activité des enzymes antioxydantes n'a été observée, et ceci aussi bien au niveau branchial qu'hépatique. Ce résultat ne semble pas être dû à une période trop courte d'exposition puisque de nombreuses études montrent une induction de l'activité antioxydante et un stress oxydant pour des périodes d'exposition aux contaminants inférieures à 48h (Ahmad et al. 2004; Sun et al. 2006; Oliveira et al. 2008; Modesto & Martinez 2010). Il est donc possible de penser que ce résultat serait le fait (i) de concentrations d'exposition trop faibles, mais le manque de littérature sur cette thématique ne permet pas de comparaison avec notre étude ou (ii) d'une importante variabilité qui pourrait notamment être due à un impact de l'anesthésique utilisé (eugenol) sur les paramètres biologiques (stress et réponse antioxydante) mesurés (Velisek et al. 2011). Cette absence d'activité antioxydante au niveau hépatique et branchial contraste avec les résultats obtenus au niveau cardiaque (Milinkovitch & Imbert, résultats non publiés) qui montrent une induction de l'activité antioxydante (**Figure 36**) lorsque les poissons sont exposés à une nappe de pétrole non dispersée ainsi qu'à une dispersion mécanique et chimique -une augmentation des activités antioxydantes, plus faible, de la catalase (CAT) et de la superoxyde dismutase (SOD) est également observée lors d'une exposition à un dispersant seul-. Ces résultats sont en accord avec les résultats exposés en **Figure 34** montrant une incapacité des poissons exposés aux hydrocarbures (dispersion chimique, mécanique et nappe de pétrole non dispersée) à augmenter leur force de contraction cardiaque lors d'activité intense. Il est possible d'émettre l'hypothèse que cette induction de l'activité des enzymes antioxydantes est en relation avec la diminution des performances cardiaques de l'organisme, comme le suggèrent Thomaz et al. (2009).

L'ensemble des résultats exposés dans ce troisième chapitre de thèse montre que (i) **la capacité de l'animal à faire face à un environnement contaminé sera diminuée après exposition à une nappe de pétrole dispersée** (chimiquement ou mécaniquement); (ii) **l'activité antioxydante**, considéré comme un biomarqueur de défense précoce ayant une valeur prédictive de l'état de santé de l'individu, **ne semble pas être modulée au niveau**

hépatique et branchial ; cependant (iii) une **induction des enzymes antioxydantes a été observée au niveau cardiaque** en particulier pour les conditions de dispersion chimique et mécanique de la nappe ainsi que pour une exposition à une nappe de pétrole non dispersée.

La synthèse générale de ce travail de thèse, son intégration dans le projet DISCOBIOL en vue d'un apport à la réglementation ainsi que les perspectives qui se dégagent de cette étude sont présentées ci-dessous.

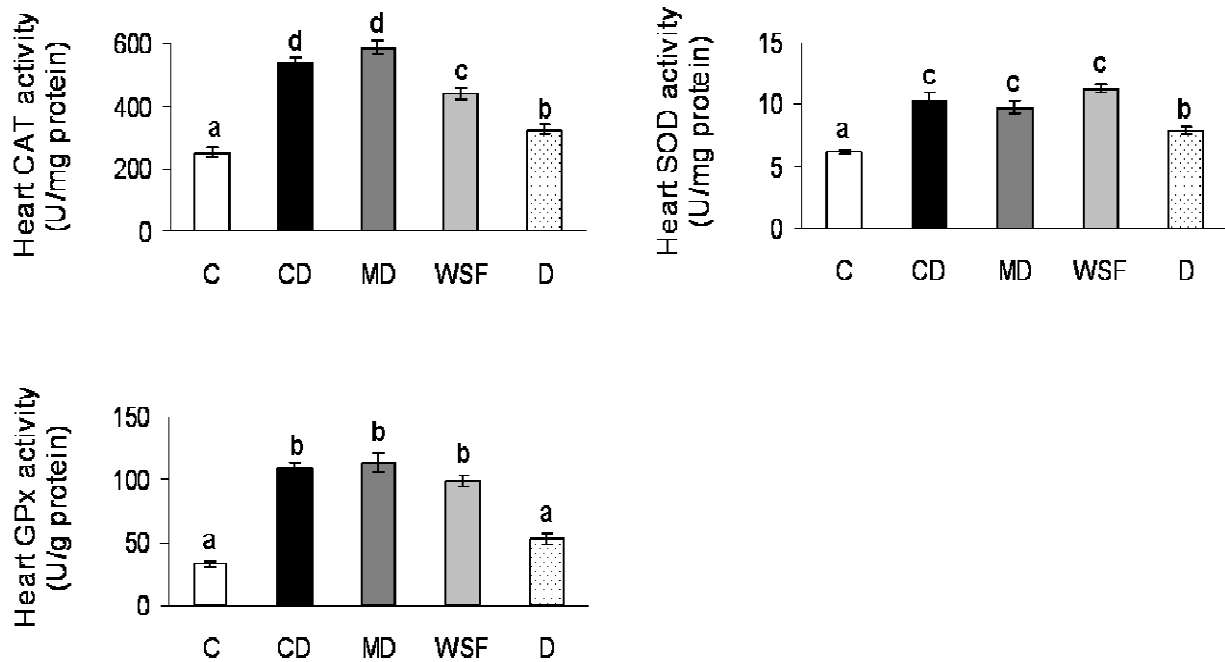

Figure 36 : Activités de trois enzymes antioxydantes (CAT : catalase, SOD : superoxyde dismutase, GPx : glutathion peroxydase) dans les cœurs de poissons (*Liza aurata*) préalablement exposés à 5 conditions (C : contrôle ; DC : Dispersion Chimique ; DM : Dispersion Mécanique ; WSF : Water Soluble Fraction ; D : Dispersant seul). Des lettres différentes (a, b, c, d) indiquent des différences significatives entre les conditions ($P < 0,05$). Les histogrammes représentent la moyenne des valeurs obtenues pour une condition et les barres d'erreurs représentent leur écart type.

2. Conclusion et perspectives

Ce travail de thèse a envisagé trois scénarii possibles lors d'une catastrophe pétrolière en milieu côtier. Ainsi, au sein de notre approche expérimentale, trois conditions de contaminations ont été établies : (i) une **condition de dispersion mécanique** a permis de simuler la présence d'une nappe de pétrole sous l'influence des phénomènes de turbulence

inhérents au milieu côtier (e.g. vagues) ; (ii) une **condition de dispersion chimique** reflète l'application de dispersant sur une nappe de pétrole, en considérant également ces phénomènes de turbulence puisqu'ils sont nécessaires à l'emploi de cette stratégie de lutte; enfin (iii) une **nappe de pétrole non dispersée** a permis de simuler le confinement de la nappe de pétrole avant sa récupération, stratégie de lutte employée lorsque l'intensité de turbulence est faible. Dans ce cadre expérimental, les **phénomènes de solubilisation des HAP** dans la colonne d'eau, d'**incorporation** de ces composés au sein des organismes (*Liza sp*), ainsi que **les effets biologiques** induits par ces trois conditions d'exposition ont été évalués.

Nos résultats montrent que la **dispersion** d'une nappe de pétrole (chimique ou mécanique) entraîne une **augmentation de la solubilisation des HAP dans la colonne d'eau** et par là une **augmentation de leur incorporation** au sein de l'organisme. Parallèlement, des **effets biologiques prédictifs de toxicité** ont été observés pour ses conditions de dispersion : au niveau de l'organe, la dispersion chimique ou mécanique d'une nappe de pétrole induit une **déplétion hépatique, branchiale et cardiaque des stocks de glutathion**. Ces résultats suggèrent que, suite à la dispersion d'une nappe de pétrole, **les capacités de l'animal à faire face à un environnement contaminé seront diminuées**.

Lorsque les phénomènes de turbulence entraînent déjà une dispersion de la nappe de pétrole, **deux cas de figure** se dégagent :

(i) lorsque la nappe de pétrole n'est que partiellement dispersée par les phénomènes de turbulence, l'application de dispersant va provoquer une dispersion complète de la nappe de pétrole dans la colonne d'eau (chapitre 1), et l'on constate une augmentation des phénomènes de solubilisation des HAP et de leur incorporation. Cette augmentation des phénomènes de solubilisation et d'incorporation des HAP est concomitante avec l'augmentation de la mortalité.

A l'inverse, (ii) lorsque la nappe de pétrole est totalement dispersée par les phénomènes de turbulence, l'application de dispersant ne va pas provoquer d'augmentation des phénomènes de solubilisation et d'incorporation des HAP (particulièrement du benzo[*a*]pyrène). Cette absence de différence entre ces deux conditions de dispersion est également observable au travers des effets biologiques. En effet, aucune différence entre les deux conditions de dispersion n'a été observée par la mesure des taux de glutathion hépatiques, branchiaux et cardiaques. De même, aucune augmentation de l'activité des enzymes antioxydantes ni des performances musculaires, au niveau cardiaque, n'a été observée entre ces deux conditions de

dispersion. Ces résultats suggèrent que, lorsque les phénomènes de turbulence entraînent déjà une dispersion de la nappe, l'application de dispersant n'augmente pas la toxicité du pétrole. Par là ces résultats sont en accord avec les résultats obtenus par Kerambrun et al. (non publiés) qui, en utilisant une mesure plus intégrative qu'est la croissance, ne montrent aucune différence entre une dispersion chimique et mécanique. La comparaison de ces deux cas de figure (i et ii) montrent que **l'application de dispersant sur une nappe de pétrole partiellement dispersée par la turbulence du milieu augmente les phénomènes de toxicité ; à l'inverse lorsque la nappe de pétrole est totalement dispersée par les phénomènes de turbulence, l'application de dispersant n'augmente pas la toxicité du pétrole.**

Le but du projet DISCOBIOL était d'évaluer la toxicité de l'application de dispersant dans la frange la plus proche du littoral dans le but de **réglementer cette technique de lutte**. Au sein de cette thématique, les résultats obtenus montrent dans un premier temps que la toxicité d'une nappe de pétrole dispersée est supérieure à la toxicité d'une nappe de pétrole non dispersée. Ainsi, aux vues de nos résultats, **le confinement de la nappe de pétrole** en vue de sa récupération devrait être envisagé comme la **stratégie de lutte prioritaire** lors de catastrophes pétrolières en milieu côtier. Cependant, cette stratégie de lutte n'est pas toujours opérable : par exemple lorsque l'état de la mer est supérieur à 2 Beaufort, une dispersion partielle de la nappe se produit et empêche son confinement. Dans ces conditions météorologiques, l'application de dispersant est envisagée. Nos résultats suggèrent que cette stratégie de lutte devrait prendre en considération ce que nous appellerons le « taux de dispersion naturelle de la nappe », c'est-à-dire la quantité de pétrole dispersée par les phénomènes de turbulence sur la quantité de pétrole totale. En effet, **lors d'une dispersion partielle de la nappe** par les phénomènes de turbulence -taux de dispersion naturelle de la nappe faible-, **l'application de dispersant augmentera la toxicité du pétrole ; à l'inverse lors d'une dispersion totale de la nappe** - taux de dispersion naturelle de la nappe égal à 1- notre étude montre que l'application de dispersant n'augmente pas la toxicité du pétrole. Dans cette dernière situation, la dispersion chimique semblerait conférer un bénéfice environnemental positif si l'on considère (i) la **toxicité faible** induite par cette technique de lutte (évaluée dans cette étude), et (ii) les **avantages environnementaux importants conférés par l'application de dispersants, telle que la formation de gouttelette d'un diamètre faibles empêchant la « recoalescence » de la nappe et permettant la dégradation bactérienne.**

Cependant, plusieurs remarques imposent des **limites** à nos conclusions :

(i) Au cours de cette étude seul *Liza sp*, poisson pélagique téléostéen a été considéré comme modèle biologique. Au sein du projet DISCOBIOL, des espèces bivalves (*Crassostrea gigas* et *Mytilus edulis*) ont également été étudiées. Ces espèces sont considérées comme sentinelles du fait de leur capacité à accumuler les xénobiotiques (notamment par filtration) à des niveaux très supérieurs à ceux du milieu et ainsi à alerter sur un déséquilibre du milieu dommageable pour l'écosystème. L'évaluation de la toxicité d'une nappe de pétrole dispersée devra **intégrer les effets biologiques observés sur ces espèces sentinelles**.

(ii) De plus, dans cette étude, seule la contamination *via* la colonne d'eau a été considérée. Cependant, après dispersion de la nappe, les hydrocarbures, notamment les HAP, s'accumulent dans les sédiments (Page et al. 2002). *Liza sp* de part son comportement de broutage sur la surface sédimentaire se trouve ainsi en contact direct avec ces hydrocarbures. En vue d'observer les effets biologiques de cette contamination, une **approche expérimentale en mésocosme** a été développée. L'article scientifique en annexe (Richard et al. soumis) présente et valide cette approche. En considérant les différents compartiments d'un écosystème de type vasière, notamment les compartiments benthiques, épigé et endogé, cette approche en mésocosme constitue un préliminaire à la deuxième phase du projet DISCOBIOL « Transposition à l'environnement ».

(iii) Au sein de notre approche expérimentale, le comportement des organismes faisant face à une contamination n'a pas été considéré. Cependant, l'étude du comportement semble intéressante afin de comprendre les modalités de la contamination. Par exemple, le comportement d'évitement des hydrocarbures est susceptible d'influencer sur la toxicité aiguë d'une nappe de pétrole dispersée. De même, l'observation du comportement de recherche alimentaire en zone contaminée permettrait d'obtenir des informations essentielles sur la toxicité à long terme consécutive à l'application de dispersant en zone côtière.

(iv) La survie des organismes étant liée à leur capacité à faire face aux changements environnementaux, il aurait été intéressant d'estimer cette capacité, notamment au travers d'expérimentations de « challenge ». Un **challenge** immunologique, consistant en l'infection expérimentale (par un virus) d'organismes préalablement contaminés par une nappe de pétrole dispersée, pourrait être envisagé. De même, un challenge pourrait être mené en considérant la capacité des organismes à faire face à la variation des paramètres abiotiques tels que la température et l'oxygène.

(v) Enfin, dans le but de se rapprocher au mieux des conditions d'exposition *in situ*, une étude de terrain aurait pu être menée. Dans un premier temps, l'impact d'une nappe de pétrole

dispersée au sein de la colonne d'eau pourrait être déterminé, en utilisant des cellules flottantes qui permettent d'isoler une colonne d'eau tout en préservant les paramètres abiotiques (houle, vent et température de l'eau). Dans un deuxième temps, l'impact de sédiments contaminés par une nappe de pétrole dispersée pourrait être étudié en considérant une étude de terrain semblable à celle menée par Baca et al. (2006), c'est-à-dire en contaminant une colonne sédimentaire isolée.

L'ensemble des perspectives évoquées ci-dessus permettront d'approfondir nos connaissances sur le risque environnemental que représente *in situ* l'application de dispersant lors de catastrophe pétrolière en zone côtière.

BIBLIOGRAPHIE

Bibliographie

- Aas, E., Baussant, T., Balk, L., Liewenborg, B. & Andersen, O. K.** (2000) PAH metabolites in bile, cytochrome P4501A and DNA adducts as environmental risk parameters for chronic oil exposure: a laboratory experiment with Atlantic cod. *Aquatic Toxicology*, **51**, 241-258.
- Adams, G. G., Klerks, P. L., Belanger, S. E. & Dantin, D.** (1999) The effect of the oil dispersant omni-clean® on the toxicity of fuel oil no. 2 in two bioassays with the sheepshead minnow cyprinodon variegatus. *Chemosphere*, **39**, 2141-2157.
- Addison, R. F. & Payne, J. F.** (1986) Assessment of hepatic mixed function oxidase induction in winter flounder (*Pseudopleuronectes americanus*) as a marine petroleum pollution monitoring technique, with anthropiques appendix describing practical field measurements of MFO activity. *Canadian Technical Report of Fisheries and Aquatic Sciences*, **1505**, 1-34.
- Adler, V., Yin, Z., Tew, K. D. & Ronai, Z.** (1999) Role of redox potential and reactive oxygen species in stress signaling. *Oncogene*, **18**, 6104-6111.
- Ahmad, I., Pacheco, M. & Santos, M. A.** (2004) Enzymatic and nonenzymatic antioxidants as an adaptation to phagocyte-induced damage in *Anguilla anguilla* L. following in situ harbor water exposure. *Ecotoxicology and Environmental Safety*, **57**, 290-302.
- Akerboom, T. P. & Sies, H.** (1981) Assay of glutathione, glutathione disulfide and glutathione mixed disulfides in biological samples. *Methods in Enzymology*, **77**, 373-382.
- Allen, J. I. & Moore, N. M.** (2004) Environmental prognostics: Is the current use of biomarkers appropriate for environmental risk evaluation? *Marine Environmental Research*, **58**, 227-232.
- Almroth, B. C., Sturve, J., Stephensen, E., Holth, T. F. & Förlin, L.** (2008) Protein carbonyls and antioxidant defenses in corkwing wrasse (*Symphodus melops*) from a heavy metal polluted and a PAH polluted site. *Marine Environmental Research*, **66**, 271-277.
- Amiard-Triquet, C. & Amiard, J. C.** (2008) *Les biomarqueurs dans l'évaluation de l'état écologique des milieux aquatiques*. Paris. pp. 372.

- Anderson, J. W., Neff, J. M., Cox, B. A., Tatem, H. E. & Hightower, G. M.** (1974) Characteristics of dispersions and water-soluble extracts of crude and refined oils and their toxicity to estuarine crustaceans and fish. *Marine Biology*, **27**, 75-88.
- Avci, A., Kaçmaz, M. & Durak, I.** (2005) Peroxidation in muscle and liver tissues from fish in a contaminated river due to a petroleum refinery industry. *Ecotoxicology and Environmental Safety*, **60**, 101-105.
- Babo, S. & Vasseur, P.** (1992) In vitro effects of Thiram on liver antioxidant enzyme activities of rainbow trout (*Oncorhynchus mykiss*). *Aquatic Toxicology*, **22**, 61-68.
- Baca, B., Ward, G. A., Lane, C. H. & Schuler, P. A.** (2005) Net Environmental Benefit Analysis (NEBA) of dispersed oil on nearshore tropical ecosystems derived from the 20 year "TROPICS" field study. *Proceedings of the 2005 International Oil Spill Conference*, pp. 1-4. Miami, Florida, USA.
- Bado-Nilles, A., Quentel, C., Auffret, M., Le Floch, S., Gagnaire, B., Renault, T. & Thomas-Guyon, H.** (2009a) Immune effects of HFO on European sea bass, *Dicentrarchus labrax*, and Pacific oyster, *Crassostrea gigas*. *Ecotoxicology and Environmental Safety*, **72**, 1446-1454.
- Bado-Nilles, A., Quentel, C., Thomas-Guyon, H. & Le Floch, S.** (2009b) Effects of two oils and 16 pure polycyclic aromatic hydrocarbons on plasmatic immune parameters in the European sea bass, *Dicentrarchus labrax* (Linné). *Toxicology in Vitro*, **23**, 235-241.
- Bains, O. S. & Kennedy, C. J.** (2004) Energetic costs of pyrene metabolism in isolated hepatocytes of the rainbow trout, *Oncorhynchus mykiss*. *Aquatic Toxicology*, **67**, 217-226.
- Baklien, Å., Lange, R. & Reiersen, L. O.** (1986) A comparison between the physiological effects in fish exposed to lethal and sublethal concentrations of a dispersant and dispersed oil. *Marine Environmental Research*, **19**, 1-11.
- Barbault, R.** (1995) *Écologie des populations et des peuplements*. Masson, Paris. pp. 200.
- Barra, R., Sanchez-Hernandez, J. C., Orrego, R., Parra, O. & Gavilan, J. F.** (2001) Bioavailability of PAH in the Biobio river (Chile): MFO activity and biliary fluorescence in juvenile *Oncorhynchus mykiss*. *Chemosphere*, **45**, 439-444.
- Barron, M. G., Podrabsky, T., Ogle, S. & Ricker, R. W.** (1999) Are aromatic hydrocarbons the primary determinant of petroleum toxicity to aquatic organisms? *Aquatic Toxicology*, **46**, 253-268.

- Baumard, P., Budzinski, H. & Garrigues, P.** (1997) Analytical procedures for the analysis of PAH in biological tissues: application to mussels. *Fresenius' Journal of Analytical Chemistry*, **359**, 502-509.
- Baussant, T., Bechmann, R. K., Taban, I. C., Larsen, B. K., Tandberg, A. H., Bjørnstad, A., Torggrimsen, S., Nævdal, A., Øysæd, K. B., Jonsson, G. & Sanni, S.** (2009) Enzymatic and cellular responses in relation to body burden of PAH in bivalve molluscs: A case study with chronic levels of North Sea and Barents Sea dispersed oil. *Marine Pollution Bulletin*, **58**, 1796-1807.
- Baussant, T., Sanni, S., Jonsson, G., Skadsheim, A. & Borseth, J. F.** (2001) Bioaccumulation of polycyclic aromatic compounds: 1. Bioconcentration in two marine species and in semipermeable membrane devices during chronic exposure to dispersed crude oil. *Environmental Toxicology and Chemistry*, **20**, 1175-1184.
- Becher, P.** (1957) *Emulsions: theory and practice*. Reinhold Publishing Corporation, New York. pp. 382.
- Beyer, J., Jonsson, G., Porte, C., Krahn, M. M. & Ariese, F.** (2010) Analytical methods for determining metabolites of polycyclic aromatic hydrocarbon (PAH) pollutants in fish bile: a review. *Environmental Toxicology and Pharmacology*, **30**, 224-244.
- Bilbao, E., Raingeard, D., de Cerio, O. D., Ortiz-Zarragoitia, M., Ruiz, P., Izagirre, U., Orbea, A., Marigómez, I., Cajaraville, M. P. & Cancio, I.** (2010) Effects of exposure to Prestige-like heavy fuel oil and to perfluorooctane sulfonate on conventional biomarkers and target gene transcription in the Thicklip grey mullet *Chelon labrosus*. *Aquatic Toxicology*, **98**, 282-296.
- Blackman, R. A. A., Franklin, F. L., Norton, M. G. & Wilson, K. W.** (1978) New procedures for the toxicity testing of oil slick dispersants in the United Kingdom. *Marine Pollution Bulletin*, **9**, 234-238.
- Bobra, A. M., Shiu, W. Y., Mackay, D. & Goodman, R. H.** (1989) Acute toxicity of dispersed fresh and weathered crude oil and dispersants to *Daphnia magna*. *Chemosphere*, **19**, 1199-1222.
- Bocard, C., Castaing, G., Ducreux, J. & Gatellier, C.** (1987) Summary of protecmar experiments, the french dispersant offshore trials program. *Oil & Chemical Pollution*, **3**, 471-484.
- Boshra, H., Li, J. & Sunyer, J. O.** (2006) Recent advances on the complement system of teleost fish. *Fish & Shellfish Immunology*, **20**, 239-262.

- Bosveld, A. T. C., De Bie, P. A. F., van den Brink, N. W., Jongepier, H. & Klomp, A. V.** (2002) In vitro EROD induction equivalency factors for the 10 PAH generally monitored in risk assessment studies in The Netherlands. *Chemosphere*, **49**, 75-83.
- Bradford, M. M.** (1976) A rapid sensitive method for the quantitation of microgram quantities of protein utilizing the principle of protein-dye binding. *Analytical Biochemistry*, **72**, 248-254.
- Brannon, E. L., Collins, K. M., Brown, J. S., Neff, J. M., Parker, K. R. & Stubblefield, W. A.** (2006) Toxicity of weathered *Exxon Valdez* crude oil to Pink salmon embryos. *Environmental Toxicology and Chemistry*, **25**, 962-972.
- Bratbak, G., Heldal, M., Knutsen, G., Lien, T. & Norland, S.** (1982) Correlation of dispersant effectiveness and toxicity of oil dispersants towards the alga *Chlamydomonas reinhardtii*. *Marine Pollution Bulletin*, **13**, 351-353.
- Brett, J. R.** (1964) The respiratory metabolism and swimming performance of young Sockeye salmon. *Journal of the Fisheries Research Board of Canada*, **21**, 1183-1226.
- Brett, J. R.** (1971) Energetic responses of salmon to temperature - Study of some thermal relations in physiology and freshwater ecology of Sockeye salmon (*Oncorhynchus nerka*). *American Zoologist*, **11**, 99-113.
- Bruslé, J.** (1981) Food and feeding in Grey mullets. *Aquaculture of grey mullets* (ed O. H. Oren), pp. 185-217. Cambridge University Press, Cambridge.
- Cadiou, A., Riffaut, L., McCoy, K. D., Cabelguen, J., Fortin, M., Gelinaud, G., Le Roch, A., Tirard, C. & Boulinier, T.** (2004) Ecological impact of the "Erika" oil spill: Determination of the geographic origin of the affected Common guillemots. *Aquatic Living Resources*, **17**, 369-377.
- Camus, L., Aas, E. & Børseth, J. F.** (1998) Ethoxyresorufin-O-deethylase activity and fixed wavelength fluorescence detection of PAH metabolites in bile in Turbot (*Scophthalmus maximus L.*) exposed to a dispersed topped crude oil in a Continuous Flow System. *Marine Environmental Research*, **46**, 29-32.
- Canesi, L., Viarengo, A., Leonzio, C., Filippelli, M. & Gallo, G.** (1999) Heavy metals and glutathione metabolism in mussel tissues. *Aquatic Toxicology*, **46**, 67-76.
- Canevari, G. P.** (1978) Some observations on the mechanism and chemistry aspects of chemical dispersion. *Chemicals dispersants for the control of oil spills* (eds L. T. J. McCarthy, G. P. Lindblom & H. F. Walter), pp. 2-5. American society for testing and materials, Philadelphia.

- Carlson, E. A., Li, Y. & Zelikoff, J. T.** (2004) Suppressive effects of benzo[a]pyrene upon fish immune function: Evolutionarily conserved cellular mechanisms of immunotoxicity. *Marine Environmental Research*, **58**, 731-734.
- Chabot, D. & Claireaux, G.** (2008) Environmental hypoxia as a metabolic constraint on fish: The case of Atlantic cod, *Gadus morhua*. *Marine Pollution Bulletin*, **57**, 287-294.
- Chapman, H., Purnell, K., Law, R. J. & Kirby, M. F.** (2007) The use of chemical dispersants to combat oil spills at sea: A review of practice and research needs in Europe. *Marine Pollution Bulletin*, **54**, 827-838.
- Churchill, P. F., Dudley, R. J. & Churchill, S. A.** (1995) Surfactant-enhanced bioremediation. *Waste Management*, **15**, 371-377.
- Claireaux, G. & Davoodi, F.** (2010) Effect of exposure to petroleum hydrocarbons upon cardio-respiratory function in the Common sole (*Solea solea*). *Aquatic Toxicology*, **98**, 113-119.
- Claireaux, G., Désaunay, Y., Akcha, F., Aupérin, B., Bocquené, G., Budzinski, H., Cravedi, J.-P., Davoodi, F., Galois, R., Gilliers, C., Goanvec, C., Guérault, D., Imbert, N., Mazéas, O., Nonnotte, G., Nonnotte, L., Prunet, P., Sebert, P. & Vétier, A.** (2004) Influence of oil exposure on the physiology and ecology of the common sole *Solea solea* (L.): experimental and field approaches. *Aquatic and Living Resources*, **17**, 335-352.
- Claireaux, G. & Lagardère, J. P.** (1999) Influence of temperature, oxygen and salinity on the metabolism of the European sea bass. *Journal of Sea Research*, **42**, 157-168.
- Claireaux, G. & Lefrançois, C.** (2007) Linking environmental variability and fish performance: integration through the concept of metabolic scope for activity. *Philosophical Transactions of the Royal Society of London B Biological Sciences*, **362**, 2031-2041.
- Cohen, A., Nugegoda, D. & Gagnon, M. M.** (2001) Metabolic responses of fish following exposure to two different oil spill remediation techniques. *Ecotoxicology and Environmental Safety*, **48**, 306-310.
- Cohen, A. M. & Nugegoda, D.** (2000) Toxicity of three oil spill remediation techniques to the Australian Bass *Macquaria novemaculeata*. *Ecotoxicology and Environmental Safety*, **47**, 178-185.
- Cormack, D.** (1977) Oil pollution. *Chemistry and Industry*, **14**, 605-608.

- Cotou, E., Castritsi-Catharios, I. & Moraitou-Apostolopoulou, M.** (2001) Surfactant-based oil dispersant toxicity to developing nauplii of *Artemia*: effects on ATPase enzymatic system. *Chemosphere*, **42**, 959-964.
- Crapp, G. B.** (1971a) The biological consequence of emulsifier cleansing. *Ecological effects of oil pollution on littoral communities* (ed E. B. Cowell), pp. 150-168. Institute of Petroleum, London.
- Crapp, G. B.** (1971b) Laboratory experiments with emulsifiers. *Ecological effects of oil pollution on littoral communities* (ed E. B. Cowell), pp. 129-149. Institute of Petroleum, London.
- Daling, P. S., Singsaas, I., Reed, M. & Hansen, O.** (2002) Experiences in dispersant treatment of experimental oil spills. *Spill Science & Technology Bulletin*, **7**, 201-213.
- Dauvin, J. C.** (1998) The fine sand *Abra alba* community of the bay of morlaix twenty years after the Amoco Cadiz oil spill. *Marine Pollution Bulletin*, **36**, 669-676.
- Davoodi, F. & Claireaux, G.** (2007) Effects of exposure to petroleum hydrocarbons upon the metabolism of the Common sole *Solea solea*. *Marine Pollution Bulletin*, **54**, 928-934.
- De Lafontaine, Y., Gagné, F., Blaise, C., Costan, G., Gagnon, P. & Chan, H. M.** (2000) Biomarkers in Zebra mussels (*Dreissena polymorpha*) for the assessment and monitoring of water quality of the St Lawrence River (Canada). *Aquatic Toxicology*, **50**, 51-71.
- Del Toro-Silva, F. M., Miller, J. M., Taylor, J. C. & Ellis, T. A.** (2008) Influence of oxygen and temperature on growth and metabolic performance of *Paralichthys lethostigma* (Pleuronectiformes: Paralichthyidae). *Journal of Experimental Marine Biology and Ecology*, **358**, 113-123.
- Depledge, M. H., Aagaard, A. & Györkös, P.** (1995) Assessment of trace metal toxicity using molecular, physiological and behavioural biomarkers. *Marine Pollution Bulletin*, **31**, 19-27.
- Duke, N. C., Burns, K. A., Swannell, R. P. J., Dalhaus, O. & Rupp, R. J.** (2000) Dispersant use and a bioremediation strategy as alternate means of reducing impacts of large oil spills on mangroves: the Gladstone field trials. *Marine Pollution Bulletin*, **41**, 403-412.
- Edwards, R. & White, I.** (1999) The Sea Empress Oil Spill: Environmental Impact and Recovery. *Proceedings of the 1999 International Oil Spill Conference*. Seattle, Washington, USA.

- Eisler, R.** (1987) Polycyclic aromatic hydrocarbon hazards to fish, wildlife, and invertebrates: a synoptic review *U.S. Fish and Wildlife Service Biological Report*, **85**, 1.11.
- Epstein, N., Bak, R. P. M. & Rinkevich, B.** (2000) Toxicity of third generation dispersants and dispersed Egyptian crude oil on Red sea coral larvae. *Marine Pollution Bulletin*, **40**, 497-503.
- Faiferlick, D.** (1997) Open-water response strategies: in-situ burning. Oil Spill : Behaviour, Response and Planning. *Proceedings of the 1997 International Oil Spill Conference*. Washington, USA.
- Ferek, R. A. & Kucklick, J. H.** (1997) *Air Quality Considerations Involving In-Situ Burning*. Marine Preservation Association, Scottsdale, Arizona. 29 pp.
- Ferrari, A., Venturino, A. & Pechén de D'Angelo, A. M.** (2007) Effects of carbaryl and azinphos methyl on juvenile Rainbow trout (*Oncorhynchus mykiss*) detoxifying enzymes. *Pesticide Biochemistry and Physiology*, **88**, 134-142.
- Fiocco, R. J. & Lewis, A.** (1999) Oil spill dispersants. *Pure and Applied Chemistry*, **71**, 27-42.
- Fowler, S. W., Readman, J. W., Oregioni, B., Villeneuve, J. P. & McKay, K.** (1993) Petroleum hydrocarbons and trace metals in nearshore Gulf sediments and biota before and after the 1991 war: An assessment of temporal and spatial trends. *Marine Pollution Bulletin*, **27**, 171-182.
- Fry, F. E. J.** (1947) *Effect of the environment on animal activity*. University of Toronto Press, Toronto. pp. 62.
- Fry, F. E. J.** (1971) *The effect of environmental factors on the physiology of fish*. Academic Press. pp. 98.
- Fucik, K.** (1994) Dispersed oil toxicity tests with species indigenous to the Gulf of Mexico. Continental Shelf Associates, Inc., Ventura, México.
- Fusey, P. & Oudot, J.** (1976) Comparaison de deux méthodes d'évaluation de la biodégradation des hydrocarbures in vitro. *Material und Organismen (Berlin)*, **4**, 241-251.
- Gagnon, M. M. & Holdway, D. A.** (2000) EROD induction and biliary metabolite excretion following exposure to the water accommodated fraction of crude oil and to chemically dispersed crude oil. *Archives of Environmental Contamination and Toxicology*, **38**, 70-77.

- Gautier, D. & Hussenot, J.** (2005) *Les mulets des mers d'Europe. Synthèse des connaissances sur les bases biologiques et les techniques d'aquaculture*. Ifremer, Paris. pp. 120.
- George-Ares, A. & Clark, J. R.** (2000) Aquatic toxicity of two Corexit® dispersants. *Chemosphere*, **40**, 897-906.
- Gérard-Monnier, D., Erdelmeier, I., Régnard, K., Moze-Henry, N., Yadan, J. & Chaudière, J.** (1998) Reactions of 1-Methyl-2-phenylindole with Malondialdehyde and 4-Hydroxyalkenals. Analytical Applications to a Colorimetric Assay of Lipid Peroxidation. *Chemical Research in Toxicology*, **11**, 1176-1183.
- Goanvec, C., Theron, M., Lacoue-Labarthe, T., Poirier, E., Guyomarch, J., Floch, S. L., Laroche, J., Nonnotte, L. & Nonnotte, G.** (2008) Flow cytometry for the evaluation of chromosomal damage in turbot *Psetta maximus* (L.) exposed to the dissolved fraction of heavy fuel oil in sea water: a comparison with classical biomarkers. *Journal of Fish Biology*, **73**, 395-413.
- González-Doncel, M., González, L., Fernández-Torija, C., Navas, J. M. & Tarazona, J. V.** (2008) Toxic effects of an oil spill on fish early life stages may not be exclusively associated to PAH: Studies with Prestige oil and medaka (*Oryzias latipes*). *Aquatic Toxicology*, **87**, 280-288.
- Gray, J. S.** (1997) Marine biodiversity: patterns, threats and conservation needs. *Biodiversity and Conservation*, **6**, 153-175.
- Greenwood, P. J.** (1983) the influence of an oil dispersant chemserve ose-DH on the viability of sea urchin gametes. Combined effects of temperature, concentration and exposure time on fertilization. *Aquatic Toxicology*, **4**, 15-29.
- Gulec, I., Leonard, B. & Holdway, D. A.** (1997) Oil and dispersed oil toxicity to amphipods and snails. *Spill Science & Technology Bulletin*, **4**, 1-6.
- Gunderson, D. T., Kristanto, S. W., Curtis, L. R., Al-Yakoob, S. N., Metwally, M. M. & Al-Ajmi, D.** (1996) Subacute toxicity of the water-soluble fractions of Kuwait crude oil and partially combusted crude oil on *Menidia beryllina* and *Palaemonetes pugio*. *Archives of Environmental Contamination and Toxicology*, **31**, 1-8.
- Habig, W. H., Pabst, M. J. & Jakoby, W. B.** (1974) Glutathione S-Transferases. The first enzymatic step in mercapturic acid formation. *The Journal of Biological Chemistry*, **249**, 7130-7139.
- Halliwell, B. & Gutteridge, J. M. C.** (1999) *Free radicals in biology and medicine*. Oxford University Press, Oxford. pp. 192.

- Hannam, M. L., Bamber, S. D., Galloway, T. S., John Moody, A. & Jones, M. B.** (2010) Effects of the model PAH phenanthrene on immune function and oxidative stress in the haemolymph of the temperate scallop *Pecten maximus*. *Chemosphere*, **78**, 779-784.
- Huang, R., Choe, E. & Min, D. B.** (2004) Effects of riboflavin photosensitized oxidation on the volatile compounds of soymilk. *Journal of Food Science*, **69**, 733-738.
- Hussenot, J. & Gautier, D.** (2005) *Les mulets des mers d'Europe, synthèse des connaissances sur l'espèce*. IFREMER, Paris. pp. 120.
- Insausti, D., Carrasson, M., Maynou, F., Cartes, J. E. & Solé, M.** (2009) Biliary fluorescent aromatic compounds (FACs) measured by fixed wavelength fluorescence (FF) in several marine fish species from the NW Mediterranean. *Marine Pollution Bulletin*, **58**, 1635-1642.
- Jaouen-Madoulet, A., Abarnou, A., Le Guellec, A. M., Loizeau, V. & Leboulenger, F.** (2000) Validation of an analytical procedure for polychlorinated biphenyls, coplanar polychlorinated biphenyls and polycyclic aromatic hydrocarbons in environmental samples. *Journal of Chromatography A*, **886**, 153-173.
- Jung, J. H., Yim, U. H., Han, G. M. & Shim, W. J.** (2009) Biochemical changes in rockfish, *Sebastes schlegeli*, exposed to dispersed crude oil. *Comparative Biochemistry and Physiology Part C: Toxicology & Pharmacology*, **150**, 218-223.
- Kennedy, C. J. & Farrell, A. P.** (2006) Effects of exposure to the water-soluble fraction of crude oil on the swimming performance and the metabolic and ionic recovery postexercise in Pacific herring (*Clupea pallasii*). *Environmental Toxicology and Chemistry*, **25**, 2715-2724.
- Kerambrun, E., Le Floch, S., Thomas Guyon, H., Sanchez, W. & Amara, R.** (2009) Relationship study between biomarkers responses and physiological performance of juveniles Sea bass, *Dicentrarchus labrax*, exposed to oil contamination. *Abstract book of the 25th Forum of young oceanographers*, pp. 26. La Rochelle, France.
- Kopecka-Pilarczyk, J. & Correia, A. D.** (2009) Biochemical response in gilthead seabream (*Sparus aurata*) to in vivo exposure to a mix of selected PAH. *Ecotoxicology and Environmental Safety*, **72**, 1296-1302.
- Laffaille, P., Brosse, S., Feunteun, E., Baisez, A. & Lefeuvre, J.-C.** (1998) Role of fish communities in particulate organic matter fluxes between salt marshes and coastal marine waters in the Mont Saint-Michel Bay. *Hydrobiologia*, **374**, 121-133.

- Laubier, L., Le Moigne, M., Flammarion, P., Thybaud, E. & Cossa, D.** (2004) The monitoring programme of the ecological and ecotoxicological consequences of the “Erika” oil spill. *Aquatic Living Resources*, **17**, 239-241.
- Law, A. T.** (1995) Toxicity study of the oil dispersant Corexit 9527 on *Macrobrachium rosenbergii* (de Man) egg hatchability by using a flow-through bioassay technique. *Environmental Pollution*, **88**, 341-343.
- Le Hir, M. & Hily, C.** (2002) First observations in a high rocky-shore community after the Erika oil spill (December 1999, Brittany, France). *Marine Pollution Bulletin*, **44**, 1243-1252.
- Lefebvre, S., Bacher, C., Meuret, A. & Hussenot, J.** (2001) Modelling nitrogen cycling in a mariculture ecosystem as a tool to evaluate its outflow. *Estuarine, Coastal and Shelf Science*, **52**, 305-325.
- LeFloch, S., Guyomarch, J., Merlin, F., Borseth, J., Corre, P. L. & Lee, K.** (2003) Effects of oil and bioremediation on mussel (*Mytilus edulis* L.) growth in mudflats. *Environmental Technology*, **24**, 1211-1219.
- Lefrançois, C.** (2001) Effet de l'environnement abiotique (température et oxygène) sur le métabolisme énergétique, la physiologie cardiaque et le comportement de deux espèces côtières : le bar, *Dicentrarchus labrax*, et la sole, *Solea solea*. UMR 10 CREMA, CNRS-IFREMER, pp. 142. Université de La Rochelle, La Rochelle.
- Lefrançois, C. & Claireaux, G.** (2003) Influence of ambient oxygenation and temperature on metabolic scope and scope for heart rate in the Common sole *Solea solea*. *Marine ecology progress series*, **259**, 273-284.
- Lemaire-Gony, S. & Lemaire, P.** (1993) Interactive effects of cadmium and benzo(a)pyrene on cellular structure and biotransformation enzymes of the liver of the European eel *Anguilla anguilla*. *Aquatic Toxicology*, **22**, 145-160.
- Lessard, R. R. & DeMarco, G.** (2000) The significance of oil spill dispersants. *Spill Science & Technology Bulletin*, **6**, 59-68.
- Lewis, A. & Dailing, P.** (2001) Oil spill dispersants. (ed A. L. O. S. Consultant), pp. 28. SINTEF, Staines.
- Lin, C. Y., Anderson, B. S., Phillips, B. M., Peng, A. C., Clark, S., Voorhees, J., Wu, H.-D. I., Martin, M. J., McCall, J., Todd, C. R., Hsieh, F., Crane, D., Viant, M. R., Sowby, M. L. & Tjeerdema, R. S.** (2009) Characterization of the metabolic actions of crude versus dispersed oil in salmon smolts via NMR-based metabolomics. *Aquatic Toxicology*, **95**, 230-238.

- Livingstone, D. R.** (2001) Contaminant-stimulated reactive oxygen species production and oxidative damage in aquatic organisms. *Marine Pollution Bulletin*, **42**, 656-666.
- Long, S. M. & Holdway, D. A.** (2002) Acute toxicity of crude and dispersed oil to *Octopus pallidus* (Hoyle, 1885) hatchlings. *Water Research*, **36**, 2769-2776.
- Lønning, S. & Hagström, B. E.** (1975a) The effects of crude oils and the dispersant Corexit 8666 on sea urchin gametes and embryos. *Norwegian journal of zoology*, **23**, 121-129.
- Lønning, S. & Hagström, B. E.** (1975b) The effects of oil dispersants on the cell in fertilization and development. *Norwegian journal of zoology*, **23**, 131-134.
- Lunel, T.** (1995) The Braer oil spill: oil fate governed by dispersion. *Proceedings of the 1995 International Oil Spill Conference*. Long Beach, California, USA.
- Maracine, M. & Segner, H.** (1998) Cytotoxicity of metals in isolated fish cells: Importance of the cellular glutathione status. *Comparative Biochemistry and Physiology Part A*, **120**, 83-88.
- Maria, V. L., Correia, A. C. & Santos, M. A.** (2002) *Anguilla anguilla* L. biochemical and genotoxic responses to Benzo[a]pyrene. *Ecotoxicology and Environmental Safety*, **53**, 86-92.
- Martinho, F., Leitao, R., Neto, J. M., Cabral, H. N., Marques, J. C. & Pardal, M. A.** (2007) The use of nursery areas by juvenile fish in a temperate estuary, Portugal. *Hydrobiologia*, **587**, 281-290.
- McCarthy, J. F. & Shugart, L. R.** (1990) *Biomarkers of environmental contamination*. Lewis Publishers, Boca Raton. pp. 472.
- McKenzie, D. J., Campbell, H. A., Taylor, E. W., Micheli, M., Rantin, F. T. & Abe, A. S.** (2007) The autonomic control and functional significance of the changes in heart rate associated with air breathing in the Jeju, *Hoplerythrinus unitaeniatus*. *Journal of Experimental Biology*, **210**, 4224-4232.
- McKeown, B. A.** (1981) Long-term sublethal and short-term high dose effects of physically and chemically dispersed oil on accumulation and clearance from various tissues of juvenile Coho salmon, *Onchorhynchus kitsutch*. *Marine Environmental Research*, **1**, 295-300.
- Mendonça Duarte, R., Tomio Honda, R. & Luis Val, A.** (2010) Acute effects of chemically dispersed crude oil on gill ion regulation, plasma ion levels and haematological parameters in tambaqui (*Colossoma macropomum*). *Aquatic Toxicology*, **97**, 134-141.
- Merlin, F. X.** (2005) Traitement aux dispersants des nappes de pétrole en mer. pp. 54. CEDRE, Brest.

- Mielbrecht, E. E., Wolfe, M. F., Tjeerdema, R. S. & Sowby, M. L.** (2005) Influence of a dispersant on the bioaccumulation of phenanthrene by Topsmelt (*Atherinops affinis*). *Ecotoxicology and Environmental Safety*, **61**, 44-52.
- Milinkovitch, T., Ndiaye, A., Sanchez, W., Le Floch, S., Thomas-Guyon, H.** (2011a) Liver antioxidant and plasma immune responses in juvenile Golden grey mullet (*Liza aurata*) exposed to dispersed crude oil. *Aquatic Toxicology*, **101**,155-164.
- Milinkovitch, T., Kanan, R., Thomas-Guyon, H., Le Floch, S.** (2011b) Effects of dispersed oil exposure on bioaccumulation of polycyclic aromatic hydrocarbons and mortality of juvenile *Liza ramada*. *Science of the total environment*. **409**,1643-1650
- Mitchell, F. M. & Holdway, D. A.** (2000) The acute and chronic toxicity of the dispersants Corexit 9527 and 9500, water accommodated fraction (WAF) of crude oil, and dispersant enhanced WAF (DEWAF) to *Hydra viridissima* (Green hydra). *Water Research*, **34**, 343-348.
- Modesto, K. A. & Martinez, C. B. R.** (2010) Roundup® causes oxidative stress in liver and inhibits acetylcholinesterase in muscle and brain of the fish *Prochilodus lineatus*. *Chemosphere*, **78**, 294-299.
- Mulkins-Phillips, G. J. & Stewart, J. E.** (1974) Effect of four dispersants on biodegradation and growth of bacteria on crude oil. *Applied Microbiology*, **28**, 574-552.
- Nahrgang, J., Camus, L., Gonzalez, P., Goksøyr, A., Christiansen, J. S. & Hop, H.** (2009) PAH biomarker responses in Polar cod (*Boreogadus saida*) exposed to benzo(a)pyrene. *Aquatic Toxicology*, **94**, 309-319.
- Neff, J. M.** (1979) *Polycyclic aromatic hydrocarbons in the aquatic environment: sources, fates and biological effects*. Applied Science Publishers Ltd., London. pp. 262.
- Nikl, D. L. & Farrell, A. P.** (1993) Reduced swimming performance and gill structural changes in juvenile salmonids exposed to 2-(thiocyanomethylthio)benzothiazole. *Aquatic Toxicology*, **27**, 245-263.
- Ohe, T., Watanabe, T. & Wakabayashi, K.** (2004) Mutagens in surface waters: a review. *Mutation Research/Reviews in Mutation Research*, **567**, 109-149.
- Oliva, M., Gonzales de Canales, M. L., Gravato, C., Guilhermino, L. & Perales, J. A.** (2010) Biochemical effects and polycyclic aromatic hydrocarbons (PAH) in Senegal sole (*Solea senegalensis*) from a Huelva estuary (SW Spain) *Ecotoxicology and Environmental Safety*, **73**, 1842-1851.

- Oliveira, M., Pacheco, M. & Santos, M. A.** (2008) Organ specific antioxidant responses in Golden grey mullet (*Liza aurata*) following a short-term exposure to phenanthrene. *Science of The Total Environment*, **396**, 70-78.
- Ortiz-Delgado, J. B., Segner, H., Arellano, M. & Sarasquete, C.** (2007) Histopathological alterations, EROD activity, CYP1A protein and biliary metabolites in Gilthead seabream *Sparus aurata* exposed to Benzo(a)pyrene. *Histology and Histopathology*, **22**, 417-432.
- Otitoluju, A. A.** (2005) Crude oil plus dispersant: always a boon or bane? *Ecotoxicology and Environmental Safety*, **60**, 198-202.
- Page, D. S., Boehm, P. D., Stubblefield, W. A., Parker, K. R., Gilfillan, E. S., Neff, J. M. & Maki, A. W.** (2002) Hydrocarbon composition and toxicity of sediments following the Exxon valdez oil spill in Prince William Sound, Alaska, USA. *Environmental Toxicology and Chemistry*, **21**, 1438-1450.
- Paglia, D. E. & Valentine, W. N.** (1967) Studies on the quantitative and qualitative characterization of erythrocyte glutathione peroxidase. *Journal of Laboratory and Clinical Medicine*, **70**, 158-169.
- Pan, L., Ren, J. & Liu, J.** (2005) Effects of benzo(k)fluoranthene exposure on the biomarkers of Scallop *Chlamys farreri*. *Comparative Biochemistry and Physiology Part C: Toxicology & Pharmacology*, **141**, 248-256.
- Pane, E. F., Haque, A., Goss, G. G. & Wood, C. M.** (2004) The physiological consequences of exposure to chronic, sublethal waterborne nickel in Rainbow trout (*Oncorhynchus mykiss*): exercise vs resting physiology. *Journal of Experimental Biology*, **207**, 1249-1261.
- Paoletti, F., Aldinucci, D., Mocali, A. & Caparrini, A.** (1986) A sensitive spectrophotometric method for the determination of superoxide dismutase activity in tissue extracts. *Analytical Biochemistry*, **154**, 536-541.
- Perkins, E. J., Gribbon, E. & Logan, J. W. M.** (1973) Oil dispersant toxicity. *Marine Pollution Bulletin*, **4**, 90-93.
- Perkins, R. A., Rhoton, S. & Behr-Andres, C.** (2005) Comparative marine toxicity testing: A cold-water species and standard warm-water test species exposed to crude oil and dispersant. *Cold Regions Science and Technology*, **42**, 226-236.
- Petry, T., Schmidz, P. & Slatter, C.** (1996) The use of toxic equivalency factors in assessing occupational and environmental health risk associated with exposure to airborne mixtures of polycyclic aromatic hydrocarbons (PAH). *Chemosphere*, **4**, 639-648.

- Pollino, C. A. & Holdway, D. A.** (2002) Toxicity testing of crude oil and related compounds using early life stages of the crimson-spotted rainbowfish (*Melanotaenia fluviatilis*). *Ecotoxicology and Environmental Safety*, **52**, 180-189.
- Power, F. M.** (1983) Long-term effects of oil dispersants on intertidal benthic invertebrates. I. Survival of barnacles and bivalves. *Oil & Petrochemical Pollution*, **1**, 97-108.
- Ramachandran, S. D., Hodson, P. V., Khan, C. W. & Lee, K.** (2004a) Oil dispersant increases PAH uptake by fish exposed to crude oil. *Ecotoxicology and Environmental Safety*, **59**, 300-308.
- Ramachandran, S. D., Khan, C. W. & Hodson, P. V.** (2004b) Role of droplets in promoting uptake of PAH by fish exposed to chemically dispersed crude oil, Twenty-Seventh Arctic and Marine Oilspill Program (AMOP). *Technical Seminar Edmonton*, pp. 765-772. Environment Canada, Alberta, Canada.
- Ringwood, A. H. & Conners, D. E.** (2000) The effects of glutathione depletion on reproductive success in oysters, *Crassostrea virginica*. *Marine Environmental Research*, **50**, 207-211.
- Roméo, M., Cosson, R. P., Gnassia-Barelli, M., Risso, C., Stien, X. & Lafaurie, M.** (1997) Metallothionein determination in the liver of the Sea bass *Dicentrarchus labrax* treated with copper and B(a)P. *Marine Environmental Research*, **44**, 275-284.
- Rosety-Rodríguez, M., Ordoñez, F. J., Rosety, M., Rosety, J. M., Rosety, I., Ribelles, A. & Carrasco, C.** (2002) Morpho-histochemical changes in the gills of Turbot, *Scophthalmus maximus* L., induced by sodium dodecyl sulfate. *Ecotoxicology and Environmental Safety*, **51**, 223-228.
- Roy, G., Vuillemin, R. & Guyomarch, J.** (2005) On-site determination of polynuclear aromatic hydrocarbons in seawater by stir bar sorptive extraction (SBSE) and thermal desorption GC-MS. *Talanta*, **66**, 540-546.
- Salar Amoli, H., Porgamb, A., Bashiri Sadr, Z. & Mohanazadeh, F.** (2006) Analysis of metal ions in crude oil by reversed-phase high performance liquid chromatography using short column. *Journal of Chromatography A*, **1118**, 82-84.
- Sanchez, W. & Porcher, J.-M.** (2009) Fish biomarkers for environmental monitoring within the Water Framework Directive of the European Union. *Trends in Analytical Chemistry*, **28**, 150-158.
- Satchell, G. H.** (1991) *Physiology and form of fish circulation*. Cambridge University Press, New York. pp. 235.

- Schroeder, W. H. & Lane, D. A.** (1988) The fate of toxic airborne pollutants. *Environmental Science & Technology*, **22**, 240-246.
- Schwarzenbach, R. P., Gschwend, P. M. & Imboden, D. M.** (2003) *Environmental Organic Chemistry*. Wiley InterScience, Hoboken, USA. pp. 1328.
- Seeley, K. R. & Weeks-Perkins, B. A.** (1997) Suppression of natural cytotoxic cell and macrophage phagocytic function in Oyster toadfish exposed to 7,12-dimethylbenz[a]anthracene. *Fish & Shellfish Immunology*, **7**, 115-121.
- Shiels, H. & Farrell, A.** (1997) The effect of temperature and adrenaline on the relative importance of the sarcoplasmic reticulum in contributing Ca^{2+} to force development in isolated ventricular trabeculae from Rainbow trout. *Journal of Experimental Biology*, **200**, 1607-1621.
- Sies, H.** (1999) Glutathione and its role in cellular functions. *Free Radical Biology and Medicine*, **27**, 916-921.
- Singer, M. M., Aurand, D., Bragin, G. E., Clark, J. R., Coelho, G. M., Sowby, M. L. & Tjeerdema, R. S.** (2000) Standardization of the preparation and quantitation of water-accommodated fractions of petroleum for toxicity testing. *Marine Pollution Bulletin*, **40**, 1007-1016.
- Smith, J. E.** (1968) *Torrey Canyon Pollution and Marine Life*. Cambridge University Press, London & New York. pp. 196.
- Southward, A. J. & Southward, E. C.** (1978) Recolonization of rocky shores in Cornwall after the use of toxic dispersants to clean up the Torrey Canyon spill. *Journal of the Fisheries Research Board of Canada*, **35**, 682-706.
- Spooner, M. F.** (1970) Oil spill in Tarut Bay, Saudi Arabia. *Marine Pollution Bulletin*, **1**, 166-167.
- Stegeman, J. J.** (1987) Cytochrome P450 isozymes and monooxygenase activity in aquatic animals. *Environmental Health Perspectives*, **71**, 87-95.
- Stentiford, G. D., Longshaw, M., Lyons, B. P., Jones, G., Green, M. & Feist, S. W.** (2003) Histopathological biomarkers in estuarine fish species for the assessment of biological effects of contaminants. *Marine Environmental Research*, **55**, 137-159.
- Sun, Y., Yu, H., Zhang, J., Yin, Y., Shi, H. & Wang, X.** (2006) Bioaccumulation, depuration and oxidative stress in fish *Carassius auratus* under phenanthrene exposure. *Chemosphere*, **63**, 1319-1327.

- Swannell, R. P. J. & Daniel, F.** (1999) Effect of dispersants on oil biodegradation under simulated marine conditions. *Proceedings of the 1999 International Oil Spill Conference*, pp. 169-176. Seattle, Washington, USA.
- Theodorsson-Norheim, E.** (1987) Friedman and Quade tests: BASIC computer program to perform nonparametric two-way analysis of variance and multiple comparisons on ranks of several related samples. *Computers in Biology and Medicine*, **17**, 85-99.
- Thiem, A.** (1994) Degradation of polycyclic aromatic hydrocarbons in the presence of synthetic surfactants. *Applied and Environment Microbiology*, **60**, 258-263.
- Thomas, R. E. & Rice, S. D.** (1981) Excretion of aromatic hydrocarbons and their metabolites by freshwater and seawater Dolly Varden char. *Biological Monitoring of Marine Pollutants* (eds F. J. Vernberg, A. Calabrese, F. Thurberg & W. Vernberg), pp. 425-448. Academic Press, New York.
- Thomaz, J. M., Martins, N. D., Monteiro, D. A., Rantin, F. T. & Kalinin, A. L.** (2009) Cardio-respiratory function and oxidative stress biomarkers in *Nile tilapia* exposed to the organophosphate insecticide trichlorfon (NEGUVON®). *Ecotoxicology and Environmental Safety*, **72**, 1413-1424.
- Thompson, G. B. & Wu, R. S. S.** (1981) Toxicity testing of oil slick dispersants in Hong Kong. *Marine Pollution Bulletin*, **12**, 233-237.
- Thorhaug, A., Marcus, J. & Booker, F.** (1986) Oil and dispersed oil on subtropical and tropical seagrasses in laboratory studies. *Marine Pollution Bulletin*, **17**, 357-361.
- Vagner, M., Lefrançois, C., Ferrari, R. S., Satta, A. & Domenici, P.** (2008) The effect of acute hypoxia on swimming stamina at optimal swimming speed in Flathead grey mullet *Mugil cephalus*. *Journal Marine Biology*, **155**, 183-190.
- van der Oost, R., Beyer, J. & Vermeulen, N. P. E.** (2003) Fish bioaccumulation and biomarkers in environmental risk assessment: a review. *Environmental Toxicology and Pharmacology*, **13**, 57-149.
- Velisek, J., Stara, A., Li, Z., Silovska, S., Turek, J.** (2011) Comparison of the effects of four anaesthetics on blood biochemical profiles and oxidative stress biomarkers in rainbow trout. *Aquaculture*, **310**, 369-375.
- Wang, L., Yan, B., Liu, N., Li, Y. & Wang, Q.** (2008) Effects of cadmium on glutathione synthesis in hepatopancreas of freshwater crab, *Sinopotamon yangtsekiense*. *Chemosphere*, **74**, 51-56.
- Wells, P. G. & Keizer, P. D.** (1975) Effectiveness and toxicity of an oil dispersant in large outdoor salt water tanks. *Marine Pollution Bulletin*, **6**, 153-157.

- Wilson, K. W.** (1976) Effects of oil dispersants on the developing embryos of marine fish. *Marine Biology*, **36**, 259-268.
- Wilson, R. W., Bergman, H. L. & Wood, C. M.** (1994) Metabolic costs and physiological consequences of acclimation to aluminum in juvenile Rainbow trout (*Oncorhynchus mykiss*). 1. Acclimation specificity, resting physiology, feeding, and growth. *Canadian Journal of Fisheries and Aquatic Sciences*, **51**, 527-535.
- Winston, G. W. & Di Giulio, R. T.** (1991) Prooxidant and antioxidant mechanisms in aquatic organisms. *Aquatic Toxicology*, **19**, 137-161.
- Wolfe, M. F., Schwartz, G. J. B., Singaram, S., Mielbrecht, E. E., Tjeerdema, R. S. & Sowby, M. L.** (2001) Influence of dispersants on the bioavailability and trophic transfer of petroleum hydrocarbons to larval topsmelt (*Atherinops affinis*). *Aquatic Toxicology*, **52**, 49-60.
- Wood, A. W., Johnston, B. D., Farrell, A. P. & Kennedy, C. J.** (1996) Effects of didecyldimethylammonium chloride (DDAC) on the swimming performance, gill morphology, disease resistance, and biochemistry of rainbow trout (*Oncorhynchus mykiss*). *Canadian Journal of Fisheries and Aquatic Sciences*, **53**, 2424-2432.
- Yano, T.** (1992) Assays of hemolytic complement activity. *Techniques in Fish Immunology* (eds J. S. Stolen, T. C. Fletcher, D. P. Anderson, S. L. Kaattari & A. F. Rowley), pp. 131-142. SOS Publications, Pair Haven, New Jersey.
- Yin, Y., Jia, H., Sun, Y., Yu, H., Wang, X., Wu, J. & Xue, Y.** (2007) Bioaccumulation and ROS generation in liver of *Carassius auratus*, exposed to phenanthrene. *Comparative Biochemistry and Physiology Part C: Toxicology & Pharmacology*, **145**, 288-293.
- Zhang, J. F., Wang, X. R., Guo, H. Y., Wu, J. C. & Xue, Y. Q.** (2004) Effects of water-soluble fractions of diesel oil on the antioxidant defenses of the goldfish, *Carassius auratus*. *Ecotoxicology and Environmental Safety*, **58**, 110-116.

**ANNEXE - EXPOSITION A DES SEDIMENTS CONTAMINES
PAR UNE NAPPE DE PETROLE DISPERSÉE : VALIDATION
D'UNE APPROCHE EXPERIMENTALE**

Exposure of golden grey mullets to mudflats contaminated with dispersed oil using intertidal mesocosms

Marion Richard, Thomas Milinkovitch, Michel Prineau, Fanny Caupos, Joachim Godefroy,
Hélène Thomas-Guyon

Abstract

The study objectives were to (i) significantly contaminate sediment with dispersed oil and (ii) to expose mullets to contaminated mudflats in order to study the production speed of biliary metabolites. Thus, a 2 x 3 factorial experiment was carried out using two types of innovative devices (2.4 m²), equipped with a tidal cycle system. Factors were (i) the presence or absence of dispersed oil and (ii) exposure time to the mudflats of 5, 7 and 10 days. Ten fish were randomly caught per mesocosm and per date to analyse the PAH-derived metabolites in bile. In accordance with video observations, and analysis of biliary metabolites, mullets were quickly contaminated by the sediment through their grazing activity. These contamination and exposure mesocosms are adequate tools to study the effect of contaminant spills on sediments and on the health of a large density of organisms, as part of single or multi-species tests.

Key words: PAH, dispersant, sediment, fish, bile

1. Introduction

Numerous accidental oil spills have occurred during the last 40 years near coastal zones (e.g. Torrey Canyon, UK, 1967; Amoco Cadiz, France, 1978; Erika, France, 1999; Prestige, France, 2002; Tasman Spirit, 2003; Mian et al. 2009). Whereas the use of dispersants could be an advantageous oil spill remediation technique in offshore areas (Canevari 1978; Page et al. 1999; Lessard & DeMarco 2000) it is controversial in nearshore areas (Chapman et al. 2007). Indeed, dispersants could increase the bio-availability of polycyclic aromatic hydrocarbons (PAH) to fish in the water (Jung et al. 2009). While most studies have investigated the effects of dispersed oil in the water column (Perkins et al. 1973; Cohen et al. 2001; Ramachandran et al. 2004; Jung et al. 2009; Milinkovitch et al. 2011), no experiments have been done investigating the effects of oil in the sediment. However, it must be taken into account that, after being poured into water, organic compounds such as petroleum hydrocarbons are known to bind to particulates and accumulate in sediments (Fowler et al. 1993; Sauer et al. 1993; Hinkle-Conn et al. 1998). Thus, in shallow water, sediments are considered as repositories and potential sources of anthropogenic contaminants. Since contaminants may better penetrate into the sediment as droplets than in oil form, the use of dispersants at the coast could increase PAH bio-availability in the sediment, and raise the risk of contamination for aquatic organisms, especially benthic species.

Thus, the aim of the DISCOBIOL (Investigation of Dispersant use in Coastal and Estuarine Waters) programme is to test the influence of contaminated sediments with dispersed and non-dispersed oil on the health of several benthic species associated with intertidal mudflats (e.g. microphytobenthos, fish, bivalves and endofauna). As part of this programme, this study focussed on the golden grey mullet (*Liza aurata*). This species is a common European mugilide, widely distributed in Atlantic coastal waters (Gautier & Hussenot 2005; Oliveira et al. 2007). Grey mullets are grazing fish, observed in intertidal mudflats (Degré et al. 2006). Grazing mud, mullets eat microphytobenthos (the primary resource of intertidal mudflats; Degré et al. 2006), organic detritus, bacteria and meiofauna (Bruslé 1981; Crosetti & Cataudella 1994). A significant impact of contaminants on this species could have repercussions on the ecosystem, i.e. via modifications to the food web and particulate organic matter transport between saltmarsh and marine coastal waters (Laffaille et al. 1998; Laffaille et al. 2002).

When fish are exposed to contaminants, the latter are transformed by oxidation and conjugation reactions by the organism in order to facilitate their excretion (Barra et al. 2001). Metabolites are thereby temporarily concentrated and stored in the gallbladder. Biliary metabolites have been used in many ecotoxicology studies (Aas et al. 2000; Shailaja et al. 2006; Insausti et al. 2009; Kopecka-Pilarczyk & Correia 2009) since they are considered as sensitive biomarkers of polycyclic aromatic hydrocarbon (PAH) exposure (Camus et al. 1998).

An increase in PAH metabolites in the fish gallbladder has often been observed with *in situ* methods, by direct collecting (Krahn et al. 1993; Aas et al. 2001; Johnson-Restrepo et al. 2008; Insausti et al. 2009; Kreitsberg et al. 2010; Oliva et al. 2010) or by caging in polluted sites (Beyer et al. 1988; Escartin & Porte 1999; Barra et al. 2001). Many *in vivo* studies have been carried out by exposing animals to contaminated seawater, giving insights into the effects of direct contamination through water (Camus et al. 1998; Sundt et al. 2006; Jung et al. 2009; Milinkovitch et al. 2011). However, few authors have carried out *in vivo* experiments with contaminated sediments to explore indirect pathways of contamination, i.e. via the sediment, which could be the main pathway of contamination for benthic fish and especially for benthic grazers.

To this aim, different methods have been used to contaminate the sediment. Sediment could be (i) collected from *in situ* polluted sites (Eggens et al. 1996; French et al. 1996; Inzunza et al. 2006), (ii) directly mixed with oil (Varanasi & Gmur 1981; Hellou et al. 1994; Hinkle-Conn et al. 1998) or (iii) continuously exposed to a combined discharge of contaminants in seawater (Bakke et al. 1988). Homogenised mixing of oil and sediment is probably not the best method to mimic the *in situ* effect of an oil spill on the coastal sediment since it does not take into consideration the high *in situ* spatial variability of contaminants in sediments (Broman et al. 1988). Moreover, note that no experiments have been carried out with sediments contaminated with dispersed oil. In contrast to Bakke et al. (1988), sediment should be contaminated before fish are exposed to the polluted sediment in order to distinguish the different pathways of contamination and highlight the indirect contamination pathway.

In the literature, the size of exposure devices have ranged from small aquariums (17 L: Varanasi & Gmur 1981; 60 L: Inzunza et al. 2006) to larger tanks, with surfaces which have varied from 0.16 m² (40 x 40 cm: Eggens et al. 1996) to almost 1.2 m² (1.13 m²: 5 sediment units of 47.5 x 47.5 cm: Bakke et al. 1988; 1.17 m²: 122 cm Ø: French et al. 1996). In contrast to small devices, larger devices have the advantage of limiting stress linked to spatial and trophic competition related to a great density of organisms, especially on mobile macro-

organisms, such as fish. Thus, the use of a mesocosm could permit the evaluation of the effects of contaminants in a better way at different levels from the individual to the population, up to the ecosystem level (Cappello & Yakimov 2010). Moreover, taking into consideration the effects of tide on (i) sediment contamination, in terms of penetration and release, and (ii) the feeding behaviour of mullets in an intertidal mudflat (Almeida 2003) is important, and devices investigating contamination and exposure should mimic the tidal cycle.

The aim of this study was (i) to contaminate a mudflat with dispersed oil using large devices (2.4 m²) equipped with a tidal cycle system, and (ii) to expose golden grey mullets to contaminated and non-contaminated mudflats into large mesocosms, in order to study the production speed of several biliary metabolites, such as naphthalene, pyrene and benzo[a]pyrene-derived metabolites in response to indirect contamination of mullets to oil and, more specifically, PAH. The results of this study could validate (i) the efficiency of the contamination and exposure devices and (ii) determine a time-exposure framework for further experiments to compare the effects of contaminated sediments with dispersed and non-dispersed oil on the immune and physiological responses of mullets.

2. Materials and methods

2.1. Experimental devices

2.1.1. Experimental mudflats

Mud was collected at low tide at the mudflats of Esnandes (Charente Maritime, France). Mud was collected up to the first centimetres of the oxic layer with a spade. Thus, twenty 20L-buckets of mud were transferred to the experimental facilities of IFREMER/CNRS in L'Houmeau (France). The mud of each bucket was first mixed with a stick. It was next progressively transferred into twenty plastic trays (60 x 40 x 5 cm) to obtain a homogenised mud among trays. The mean mud weight per tray was above 12 kg. Two experimental mudflats were thus created by the assemblage of 10 trays (5 x 2) on a 2.4 m² array. Note that (i) a cross of twenty holes (7 mm Ø) was made in the bottom of each tray, and (ii) a meshed

tissue was deployed on the tray bottom before the transfer of mud, to permit irrigation of the sediment during low tide, without mud loss.

2.1.2. Pollution device equipped with tidal cycles

Mud trays were transferred into two large devices located under a greenhouse to facilitate the development of microphytobenthos. The two devices were composed of a long principal tank (300 x 80 x 25 cm) and an adjacent water tank (120 x 80 x 65 cm; **Figure 37**). They were equipped with a system of tidal cycles using a controlled pump (Eheim compact 1000L.h⁻¹) with a mechanical timer (IDK PMTF 16A). This pump was located in the adjacent tank that was filled with 400 L of water (Figure 1). In the “On” mode, the pump filled the principal tank via a long hose (16 mm Ø). The circulation of water was created through a hole (7 mm Ø) located at the opposite end of the water arrival, and on the bottom of the principal tank (**Figure 37**). The water level was regulated in the long tank by an evacuation tube (16 mm Ø) 15 cm in height (**Figure 37**). This mimicked high tide. In “OFF” mode, the principal tank was emptied by gravity through the bottom evacuation hole. This mimicked low tide. The tide cycle was composed of 6 hours of low tide and 6 hours of high tide with two tides per day. Low tides were scheduled from 9 am to 3 pm, and from 9 pm to 3 am. In contrast, high tides were scheduled from 3 pm to 9 pm and from 3 am to 9 am.

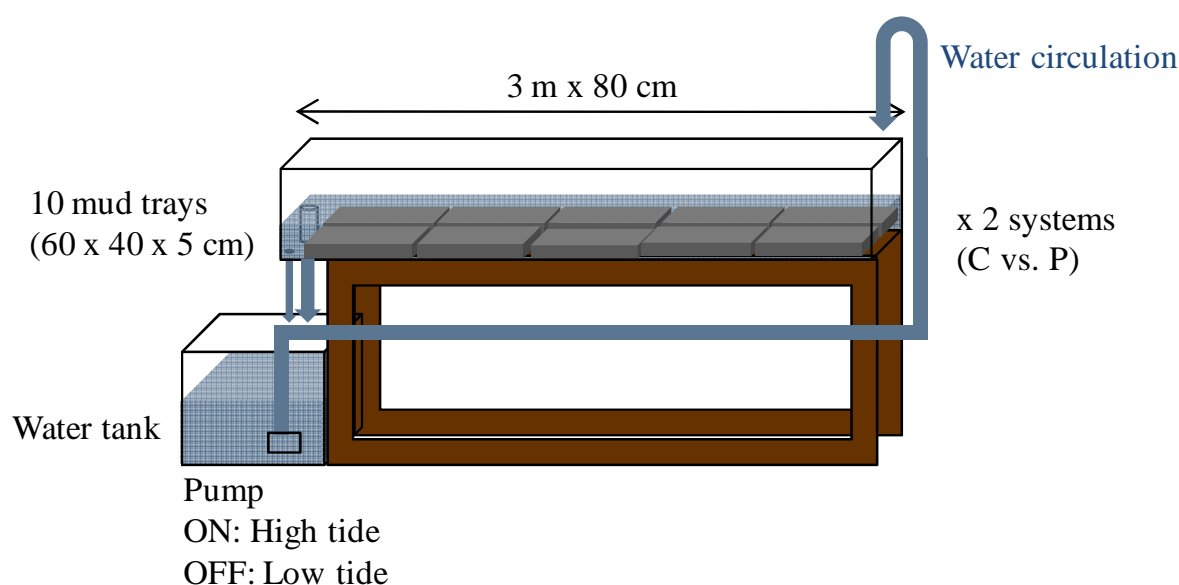

Figure 37. Scheme of the contamination device, equipped with a cyclic intertidal system.

After two days of microphytobenthos production, 106 g of Arabian light crude oil, topped at 110°C (Milinkovitch et al. 2011b) and 5% of dispersant (5.3 g) were mixed into the same bottle. This was added at ebb tide at the water surface of the large tank of one of the two production devices. The duration of contamination was 48 h, corresponding to the average reaction time of antipollution procedures.

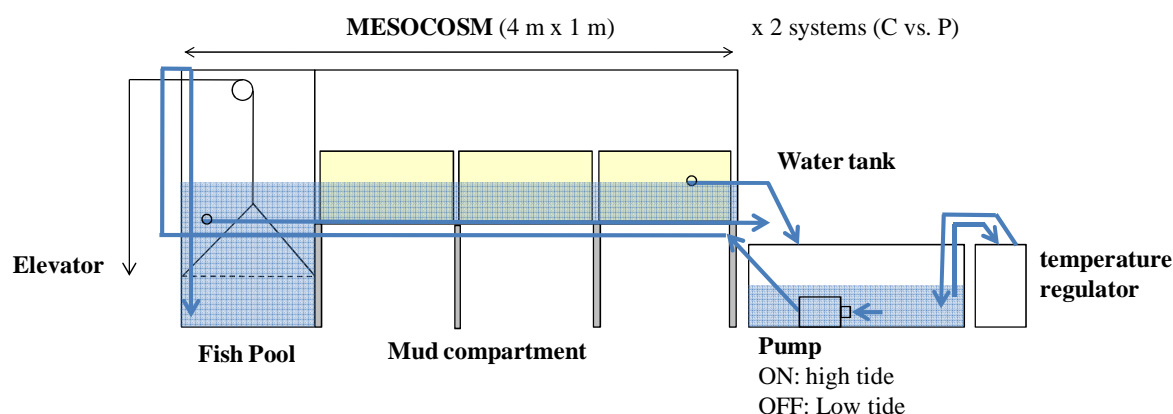

Figure 38. Scheme of the exposure device, i.e. the mesocosm, equipped with a cyclic intertidal system.

2.1.3. Exposure devices: Mesocosms

After the first 48 h period of production and 48 h of contamination in the first devices, mud trays were transferred into the two mesocosms. One of them contained polluted mud trays whereas the other contained non-contaminated mud trays. Mesocosm dimensions were 400 x 220 x 100 cm. The device was composed of (i) a mud compartment (300 x 80 cm) where the mud trays were deployed, and (ii) a 100 x 100 x 50 cm pool the surface level of which corresponded to the level of the mud trays (**Figure 38**). Three windows were installed along the mud compartment to permit visual observations. The mesocosm was linked to an adjacent tank (160 x 100 x 80 cm) via a long 25 mm Ø hose. The mesocosm was equipped with a system of tidal cycles via a controlled pump (Eheim 1262, 3400l.h⁻¹) with a mechanical timer. When the pump was in function, the water passed from the adjacent tank to the mud compartment via the pool to finish in the adjacent tank through an evacuation hole, located at a height of 20 cm (**Figure 38**). Another evacuation hole was located at the surface level of the pool, i.e. at the level of the tray bottom. This hole permitted emptying of the mesocosm when the pump was turned off to mimic low tide. During this period, fish were considered to take refuge in the pool. The schedule of the tidal cycle was the same in the mesocosm as in the

production device. The pool was aerated with two 10 cm diffusers throughout the experiment. Before the use of the mesocosm, the pool and adjacent tank were filled with 1780 L of seawater. Water temperature was regulated to 15°C by a TR 60 TECO (**Figure 38**).

2.2. Experimental design

2.2.1. Sediment

Six sediment samples were collected per (i) treatment TR (TR: C: control, P: polluted mudflat) and (ii) TIME with 0 (corresponding to 48 h of mud contamination), 5 and 10 days of exposure in the both mesocosms, as levels. Thus, 36 samples were collected for this experiment.

2.2.2. Mulletts

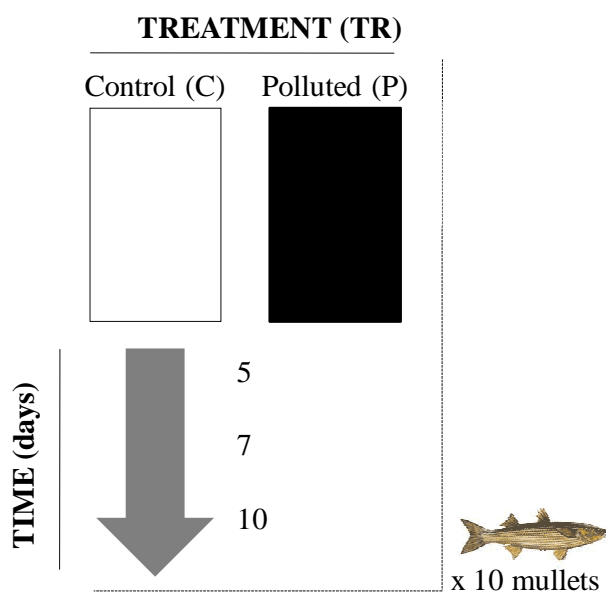

Figure 39. Experimental design composed of two factors (i) pollution treatment (TR; C: control and P: exposed fish) and (ii) TIME (5, 7, 10 days), with 10 replicates.

A 2 x 3 factorial experiment was carried out in the two mesocosms. The first factor was TR, with non-exposed (C) and mullets exposed to the polluted mudflat (P) as levels. The second factor was TIME with 5, 7 and 10 days of exposure to the mudflats (referred to as 5, 7, 10) as levels (Figure 3). Ten fish (mean weight 40 g) were randomly caught per mesocosm and per date. Thus, 60 fish (30 per mesocosm) were used for this experiment.

2.3. *Field sampling*

2.3.1. Sediment collecting

Sediment was collected using a cut off 60 ml disposable syringe to determine the total petroleum hydrocarbon concentration in the top 1 cm of sediments. Samples were stored in a petri-box, covered with aluminium foil and stored at -80°C. Samples were lyophilised at 55°C for 48 h before analysis.

2.3.2. Mulletts: Video and gallbladder collecting

A camera (Panasonic NV-GS400 EG) was installed outside both mesocosms, between the pool and the mud compartment, at the level of the sediment surface and behind the first window. The recording was carried out without human presence for 90 minutes.

On each sampling date, fish were caught with nets in the pool using the elevator in each mesocosm. They were next transferred into a 400 L tank equipped with an Eheim 2075 Pro 3 filter and air diffusers for 48 h without feed. Fish were euthanised using eugenol (4-allyl-2-methoxyphenol, 1 mL per 5 L of seawater) and the gallbladder was removed from each fish and stored in an Eppendorf tube (1 mL) at -80 °C prior to analysis.

2.4. *Sample processing*

2.4.1. Total Petroleum Hydrocarbons

Lyophilised sediments were crushed and homogeneously mixed with a pestle. A subsample of 2.5 g was put in a beaker with 10mL of dichloromethane pestipur quality (DCM; Carlo Erba Reactif, SDS) to extract Total Petroleum Hydrocarbons (TPH), which is the sum of dissolved hydrocarbons plus oil droplets. The duration of extraction was 10 minutes in an Ultrasonic cuvette (Ney). The solution was dried with anhydrous sulphate. The solution was next filtered through paper in a funnel. Optical density (OD) of the sample was measured using a UV spectrophotometer (UV-Vis spectrophotometer, Unicam) at 390 nm as described by Fusey and Oudot (1976). A standard curve was established according to the optical density of ten different concentrations of TPH extracted in 10 ml DCM. The equation of the linear relation

was $OD = 0.122 \times \text{mgHC}/10 \text{ ml}^{-1}$ and the regression coefficient was 0.99. Extracted TPH was reported to the dry weight of the sub-sample sediment and was expressed in mgHC.kg^{-1} of sediment dry weight. The mean concentration observed in the control sediment (C), issued to *Chla* interferences, was subtracted from the concentrations observed in the polluted mudflat (P).

2.4.2. Mulletts: video acquisition and biliary PAH metabolites

Acquisition of video was carried out by a ROI-USB and GrabBee software. Static images were recorded using a screen capture and pasting the image into a Microsoft Word file.

Bile samples were diluted 1:250 in absolute ethanol (VWR International). Fixed wavelength fluorescence (FF) was then measured at the excitation:emission wavelength pairs 290:335, 341:383 and 380:430 nm. Mainly naphthalene, pyrene and benzo[a]pyrene derived metabolites are detected by FF290:335, FF341:383, FF380:430 respectively (Aas et al., 2000). Measurements were performed in a quartz cuvette on a spectrofluorimeter (SAFAS Flx-Xenius). The FF values were expressed as arbitrary units of fluorescence and the signal levels of pure ethanol were subtracted.

2.5. *Statistical analysis*

The assumptions of normality and homoscedasticity of ANOVA were evaluated using the Shapiro-Wilk (Shapiro & Wilk 1965) and Brown-Forsythe (Brown & Forsythe 1974) tests, respectively. When required, data was transformed to satisfy the assumptions of ANOVA. ANOVA were performed to test the effects of (i) pollution treatment (TR: C, P) and (ii) time (TIME: 0, 5 and 10 days or 5, 7, 10 days) and their interactions on Total Petroleum Hydrocarbons for sediment and FF for mullets. Tukey's HSD (honestly significant difference) pairwise multiple comparison tests were used to identify the differences when a source of variation was significant ($P < 0.05$).

3. Results

3.1. Total Petroleum Hydrocarbons (TPH)

ANOVAs showed that TPH varied significantly according to treatment (TR: $p = 0.0003$) but not according to TIME ($p = 0.28$). Mean TPH was higher in polluted mud (P) than in control mud (C). Regardless of the time (0, 5 or 10 days), mean TPH content (\pm SD) was 220 ± 173 mg.DWKg⁻¹ in the first centimetre of contaminated mud. The maximal value was 533 mg.DWKg⁻¹.

3.2. Mullet

Video observations showed that the mullets moved out of the pool during high tide. They moved in groups into the mud compartment and grazed the mud in both mesocosms, starting at the first minutes of recording (**Figure 40**). During the ebb tide, mullets stayed until the last moment in contact with the mud before moving into the pool. They were observed in the mud compartment with only 5 cm of water depth.



Figure 40. Capture of video image representing a group of mullets that grazed the mud in the polluted mesocosm.

The log of the mean fixed wavelength fluorescence (FF) did not vary according to TIME (FF380-430: $p = 0.59$, FF343-383: $p = 0.99$, FF290-335: $p = 0.85$) whatever the TR (C and/or P). In contrast, log mean FF varied significantly according to TR ($p < 0.0001$), whatever the TIME (5, 7 or 10). According to the HSD tests, the mean relative concentration of metabolites was significantly higher in the gallbladder of mullets that were exposed to the contaminated mudflats (P) since the 5th day (**Figure 41**), with a factor of two for benzo[a] pyrene (FF380-430), naphthalene (FF290-335) and three for pyrene (FF341-383).

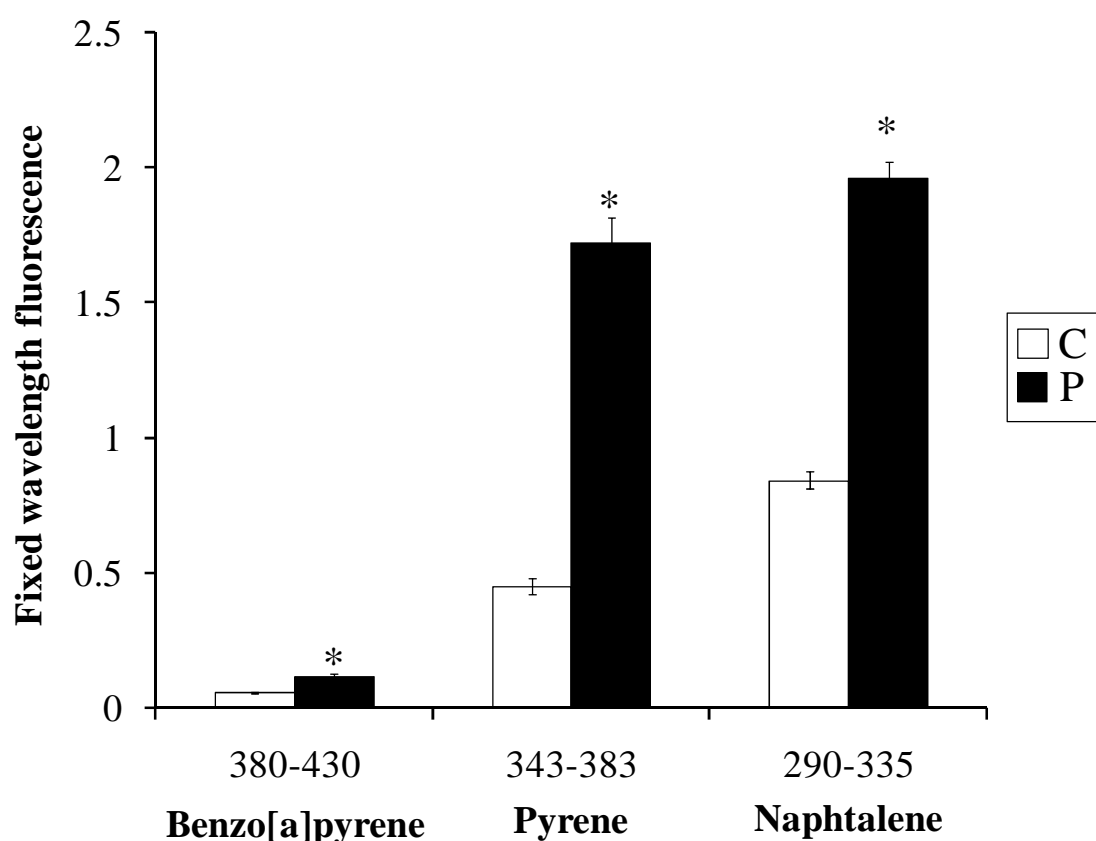

Figure 41. Mean fixed wavelength fluorescence (FF) (\pm SE) measured according to the pollution treatment (TR: exposed and non exposed fish: P vs. C). Stars indicate significant differences between treatments within the excitation:emission wavelength (nm), i.e. the PAH-derived metabolites (benzo[a]pyrene, pyrene, naphthalene).

4. Discussion

The first objective of this study was to significantly contaminate mud with dispersed oil via the water column, using large devices equipped with a tidal cycle system. After 48 h of contamination, total petroleum hydrocarbon was significantly observed in the first centimetre of contaminated mud. The concentration of total hydrocarbons was quite uneven and ranged from 0 to 533 mg.Kg⁻¹ (ppm) with a mean of 220 ppm. This type of range and spatial variability of sediment oil content has often been reported in coastal zones where the total hydrocarbon content in sediment has been found to range from (i) 10 to 520 mg.kg⁻¹ after the North Cape oil spill (Michel et al. 1997), (ii) 100 to 300 mg.Kg⁻¹ after the Tasman Spirit oil spill (Alrai & Rizvi 2003), or from (iii) 62 to 1400 mg.kg⁻¹ after the 1991 Gulf War (Fowler et al. 1993). Thus, the use of large structures equipped with tidal cycles, and an indirect contamination via water, appears to be a good method to mimic the effects of dispersant use during a black tide on mudflats.

The second objective of this study was to expose mullets to contaminated mudflats, in order to study the production speed of several biliary metabolites, such as naphthalene, pyrene and benzo[a]pyrene derived metabolites in response to indirect contamination of mullets to oil.

As expected, mullets moved without stress in both mesocosms. At low tide, they took refuge in the pool, and moved out into the mud compartment at high tide. Video observations confirmed that mullets grazed the mud in groups, even if the mud was contaminated.

In accordance with the video observations, PAH-derived metabolites were significantly increased in the gallbladder of exposed fish from the fifth day, revealing a rapid and significant exposure of mullets to PAH from the contaminated sediment. Aas et al. (2000) obtained similar results in a time-response experiment, where PAH biliary metabolites of cod exposed to oil increased rapidly during the first three days of the experiment. Nevertheless, in contrast to the results of this study, Aas et al. (2000) showed that PAH metabolites continued to increase during the rest of the 30 day exposure period. A similar temporal pattern was observed by (i) Britvić et al. (1993), who exposed carp to both crude and diesel oil dissolved in water for 18 days and French et al. (1996), who exposed English sole to a gradient of contaminated sediment for 15 days. 10 days of exposure may be too short to observe this exposure time-dependent effect, which revealed an increase in the biotransformation efficiency of PAH (Aas et al. 2000).

The aqueous solubility of PAH is known to increase with a decrease in the molecular weight of PAH. Thus, naphthalene is a lighter compound than pyrogenic PAH, such as pyrene and benzo[a]pyrene, which are respectively composed of two, four and five aromatic rings. Medium and higher molecular weight PAH, such as pyrene and benzo[a]pyrene, are highly hydrophobic and readily adsorb to suspended organic or inorganic particulates that settle to the sea floor (Hinkle-Conn et al. 1998).

In this study, these three types of PAH-derived metabolites significantly increased in the bile of exposed mullets. Mullet were expected to be exposed to a) light PAH (naphthalene) via the release of pore-water favoured by sediment resuspension caused by the locomotion and feeding activities of the fish, and to b) heavy PAH (pyrene, benzo[a]pyrene) via the ingestion of PAH adsorbed to sediment and organic particles during their grazing activities.

To distinguish these two pathways of indirect contamination, it would have been interesting to measure the PAH content in water and sediment but also to determine the release of PAH by the sediment using (i) sophisticated benthic chambers, equipped with fluorescence probes (Chen et al. 1997) or (ii) simple chambers and water sampling within the incubation time, as has been previously shown (Richard et al. 2007a; Richard et al. 2007b) in determining benthic nutrient fluxes.

Moreover, as other authors have done (Avci et al. 2005; Jung et al. 2009; Kopecka-Pilarczyk & Correia 2009; Xu et al. 2009; Oliva et al. 2010; Milinkovitch et al. 2011), it will be relevant, in future studies, to also evaluate the variation of other biomarkers of defence (ethoxyresorufin-O-deethylase, catalase, superoxide dismutase, glutathione peroxidase; Amiard-Triquet & Amiard 2008) and damage (malondialdehyde concentration; van der Oost et al. 2003) in different organs, such as the gill and liver. These organs have been selected on the basis of functional criteria which make them preferential targets, i.e., xenobiotic uptake (gill) and xenobiotic metabolism, (liver), as explained by Oliveira et al. (2008).

In conclusion, this study highlights that this kind of innovative mesocosm is an excellent tool to study the effect of contaminated mudflats on the health of a large density of organisms, especially on mobile organisms such as fish. The results confirmed that biliary metabolites are good biomarkers of exposure and that sediment is a significant pathway of contamination for grazing fish. This should be taken into consideration as a part of the development of a contamination model for benthic fish. This study also demonstrated that grey mullets are a good bioindicator for monitoring sediment contamination by PAH, as has been previously shown in water contamination (Pacheco et al. 2005; Oliveira et al. 2007).

As part of the DISCOBIOL Programme, the efficiency of these experimental tools will permit, in further experiments, to compare the effect of contaminated sediments with dispersed and non-dispersed oil on sediments and on the vital functions of mullets. Whereas the response of contaminants was rapid for the exposition biomarker, it could be prolonged for defense and damage biomarkers, thus the time of exposure will be maintained at 10 days and collection throughout the exposure period will also be scheduled. Future results will highlight the effect of the presumably higher bio-availability of dispersed PAH than non-dispersed PAH, which has been reported in water by Ramachadran et al. (2004), Jung et al. (2009) and Milinkovitch et al. (2011). These results will be essential for the recommendation and implementation of dispersants at the coast.

Finally, such innovative devices could also be used for single or multi-species tests with a large panel of species using different types of contaminants such as herbicides or pharmaceutical residuals.

Acknowledgments

This study was funded by the DISCOBIOL ANR, coordinated by F.X. Merlin (CEDRE, Brest) and was possible thanks to the CNRS INEE grant received for the post-doctoral fellowship of Marion Richard. The authors thank C. Dupuy and C. Lefrançois (LIENSs) for lending us the control mesocosms and the associated thermo-regulators that were used during the VASIREMI ANR program. The authors thank D. Vilday and A.L. Acosta for their help in the field. Finally, the authors thank M.-L. Bégout and X. Cousin (IFREMER, INRA, L'Houmeau) for lending us materials linked to fish maintenance and C. LeFrançois, F. Atzori and M. Cannas for the video camera.

References

Aas, E., Baussant, T., Balk, L., Liewenborg, B. & Andersen, O. K. (2000) PAH metabolites in bile, cytochrome P4501A and DNA adducts as environmental risk

- parameters for chronic oil exposure: a laboratory experiment with Atlantic cod. *Aquatic Toxicology*, **51**, 241-258.
- Aas, E., Beyer, J., Jonsson, G., Reichert, W. L. & Andersen, O. K.** (2001) Evidence of uptake, biotransformation and DNA binding of polyaromatic hydrocarbons in Atlantic cod and corkwing wrasse caught in the vicinity of an aluminium works. *Marine Environmental Research*, **52**, 213-229.
- Almeida, P. R.** (2003) Feeding ecology of *Liza ramada* (Risso, 1810) (Pisces, Mugilidae) in a south-western estuary of Portugal. *Estuarine Coastal and Shelf Science*, **57**, 313-323.
- Alrai, I. S. & Rizvi, S. H. N.** (2003) Natural resource damage assessment programme for Tasman Spirit oil spill in Pakistan. pp. 4.
- Amiard-Triquet, C. & Amiard, J. C.** (2008) *Les biomarqueurs dans l'évaluation de l'état écologique des milieux aquatiques*. Paris. pp. 372.
- Avci, A., Kaçmaz, M. & Durak, I.** (2005) Peroxidation in muscle and liver tissues from fish in a contaminated river due to a petroleum refinery industry. *Ecotoxicology and Environmental Safety*, **60**, 101-105.
- Bakke, T., Follum, O. A., Moe, K. A. & Sorensen, K.** (1988) The GEEP Workshop: mesocosm exposures. *Marine ecology progress series*, **46**, 13-18.
- Barra, R., Sanchez-Hernandez, J. C., Orrego, R., Parra, O. & Gavilan, J. F.** (2001) Bioavailability of PAH in the Biobio river (Chile): MFO activity and biliary fluorescence in juvenile *Oncorhynchus mykiss*. *Chemosphere*, **45**, 439-444.
- Beyer, J., Aas, E., Borgenvick, H. K. & Ravn, P.** (1988) Bioavailability of PAH in effluent water from an aluminium works evaluated by transplant caging and biliary fluorescence measurements of Atlantic Cod (*Gadus morhua* L.). *Marine Environmental Research*, **46**, 233-236.
- Britvić, S., Lucić, D. & Kurelec, B.** (1993) Bile fluorescence and some early biological effects in fish as indicators of pollution by xenobiotics. *Environmental Toxicology and Chemistry*, **12**, 765-773.
- Broman, D., Colmsjoe, A., Ganning, B., Naef, C. & Zebuhr, Y.** (1988) A multi-sediment trap study on the temporal and spatial variability of polycyclic aromatic hydrocarbons and lead in an anthropogenic influenced archipelago. *Environmental Science and Technology*, **22**, 1219-1228.
- Brown, M. B. & Forsythe, A. B.** (1974) Robust tests for the equality of variances. *Journal of American Statistical Association*, **69**, 364-367.

- Bruslé, J.** (1981) Food and feeding in Grey mullets. *Aquaculture of grey mullets* (ed O. H. Oren), pp. 185-217. Cambridge University Press, Cambridge.
- Camus, L., Aas, E. & Børseth, J. F.** (1998) Ethoxyresorufin-O-deethylase activity and fixed wavelength fluorescence detection of PAH metabolites in bile in Turbot (*Scophthalmus maximus L.*) exposed to a dispersed topped crude oil in a Continuous Flow System. *Marine Environmental Research*, **46**, 29-32.
- Canevari, G. P.** (1978) Some observations on the mechanism and chemistry aspects of chemical dispersion. *Chemicals dispersants for the control of oil spills* (eds L. T. J. McCarthy, G. P. Lindblom & H. F. Walter), pp. 2-5. American society for testing and materials, Philadelphia.
- Cappello, S. & Yakimov, M. M.** (2010) Mesocosms for oil spill simulation. *Handbook of hydrocarbon and lipid microbiology* (ed K. N. Timmis), pp. 3513-3521. Springer Berlin Heidelberg, New York.
- Chapman, H., Purnell, K., Law, R. J. & Kirby, M. F.** (2007) The use of chemical dispersants to combat oil spills at sea: A review of practice and research needs in Europe. *Marine Pollution Bulletin*, **54**, 827-838.
- Chen, R. F., Chadwick, D. B. & Lieberman, S. H.** (1997) The application of time-resolved spectrofluorometry to measuring benthic fluxes of organic compounds. *Organic Geochemistry*, **26**, 67-77.
- Cohen, A., Nugegoda, D. & Gagnon, M. M.** (2001) Metabolic responses of fish following exposure to two different oil spill remediation techniques. *Ecotoxicology and Environmental Safety*, **48**, 306-310.
- Crosetti, D. & Cataudella, S.** (1994) Production of aquatic animals: fishes. (ed C. E. Nash), pp. 253-268. Elsevier, Amsterdam.
- Degré, D., Leguerrier, D., Armynot du Chatelet, E., Rzeznik, J., Auguet, J.-C., Dupuy, C., Marquis, E., Fichet, D., Struski, C., Joyeux, E., Sauriau, P.-G. & Niquil, N.** (2006) Comparative analysis of the food webs of two intertidal mudflats during two seasons using inverse modelling: Aiguillon Cove and Brouage Mudflat, France. *Estuarine Coastal and Shelf Science*, **69**, 107-124.
- Eggens, M. L., Vethaak, A. D., Leaver, M. J. & Jean Horbach, G. J. M.** (1996) Differences in CYP1A response between Flounder (*Platichthys flesus*) and Plaice (*Pleuronectes platessa*) after long-term exposure to harbour dredged spoil in a mesocosm study. *Chemosphere*, **32**, 1357-1380.

- Escartin, E. & Porte, C.** (1999) Assessment of PAH pollution in coastal areas from the NW Mediterranean through the analysis of fish bile. *Marine Pollution Bulletin*, **38**, 1200-1206.
- Fowler, S. W., Readman, J. W., Oregioni, B., Villeneuve, J. P. & McKay, K.** (1993) Petroleum hydrocarbons and trace metals in nearshore Gulf sediments and biota before and after the 1991 war: An assessment of temporal and spatial trends. *Marine Pollution Bulletin*, **27**, 171-182.
- French, B. L., Reichert, W. L., Hom, T., Nishimoto, M., Sanborn, H. R. & Stein, J. E.** (1996) Accumulation and dose-response of hepatic DNA adducts in English sole (*Pleuronectes vetulus*) exposed to a gradient of contaminated sediments. *Aquatic Toxicology*, **36**, 1-16.
- Fusey, P. & Oudot, J.** (1976) Comparaison de deux méthodes d'évaluation de la biodégradation des hydrocarbures in vitro. *Material und Organismen (Berlin)*, **4**, 241-251.
- Gautier, D. & Hussenot, J.** (2005) *Les mulets des mers d'Europe. Synthèse des connaissances sur les bases biologiques et les techniques d'aquaculture*. Ifremer, Paris. pp. 120.
- Hellou, J., Payne, J. F. & Hamilton, C.** (1994) Polycyclic aromatic compounds in Northwest Atlantic cod (*Gadus morhua*). *Environmental Pollution*, **84**, 197-202.
- Hinkle-Conn, C., Fleeger, J. W., Gregg, J. C. & Carman, K. R.** (1998) Effects of sediment-bound polycyclic aromatic hydrocarbons on feeding behaviour in juvenile Spot (*Leiostomus xanthurus* Lacépède: Pisces). *Journal of Experimental Marine Biology and Ecology*, **227**, 113-132.
- Insausti, D., Carrasson, M., Maynou, F., Cartes, J. E. & Solé, M.** (2009) Biliary fluorescent aromatic compounds (FACs) measured by fixed wavelength fluorescence (FF) in several marine fish species from the NW Mediterranean. *Marine Pollution Bulletin*, **58**, 1635-1642.
- Inzunza, B., Orrego, R., Penalosa, M., Gavilan, J. F. & Barra, R.** (2006) Analysis of CYP4501A1, PAH metabolites in bile, and genotoxic damage in *Oncorhynchus mykiss* exposed to Biobio River sediments, Central Chile. *Ecotoxicology and Environmental Safety*, **65**, 242-251.
- Johnson-Restrepo, B., Olivero-Verbel, J., Lu, S., Guette-Fernandez, J., Baldiris-Avila, R., O'Byrne-Hoyos, I., Aldous, K. M., Addink, R. & Kannan, K.** (2008) Polycyclic

- aromatic hydrocarbons and their hydroxylated metabolites in fish bile and sediments from coastal waters of Colombia. *Environmental Pollution*, **151**, 452-459.
- Jung, J. H., Yim, U. H., Han, G. M. & Shim, W. J.** (2009) Biochemical changes in rockfish, *Sebastes schlegeli*, exposed to dispersed crude oil. *Comparative Biochemistry and Physiology Part C: Toxicology & Pharmacology*, **150**, 218-223.
- Kopecka-Pilarczyk, J. & Correia, A. D.** (2009) Biochemical response in gilthead seabream (*Sparus aurata*) to in vivo exposure to a mix of selected PAH. *Ecotoxicology and Environmental Safety*, **72**, 1296-1302.
- Krahn, M. M., Ylitalo, G. M., Buzitis, J., Bolton, J. L., Wigren, C. A., Chan, S. L. & Varanasi, U.** (1993) Analyses for petroleum-related contaminants in marine fish and sediments following the Gulf Oil Spill. *Marine Pollution Bulletin*, **27**, 285-292.
- Kreitsberg, R., Zemit, I., Freiberg, R., Tambets, M. & Tuvikene, A.** (2010) Responses of metabolic pathways to polycyclic aromatic compounds in flounder following oil spill in the Baltic Sea near the Estonian coast. *Aquatic Toxicology*, **99**, 473-478.
- Laffaille, P., Brosse, S., Feunteun, E., Baisez, A. & Lefevre, J.-C.** (1998) Role of fish communities in particulate organic matter fluxes between salt marshes and coastal marine waters in the Mont Saint-Michel Bay. *Hydrobiologia*, **374**, 121-133.
- Laffaille, P., Feunteun, E., Lefebvre, C., Radureau, A., Sagan, G. & Lefevre, J.-C.** (2002) Can Thin-lipped mullet directly exploit the primary and detritic production of European macrotidal salt marshes? *Estuarine Coastal and Shelf Science*, **54**, 729-736.
- Lessard, R. R. & DeMarco, G.** (2000) The significance of oil spill dispersants. *Spill Science & Technology Bulletin*, **6**, 59-68.
- Mian, S., Arabia, S. & Bennet, S.** (2009) The Tasman Spirit oil spill: implications for regulatory change in Pakistan. *Disasters*, pp. 390-411. Blackwell publishing, Oxford.
- Michel, J., Csulak, F., French, D. & Sperduto, M.** (1997) Natural resource impacts from the North Cape oil spill. *International Oil Spill*, pp. 841-850. American Petroleum Institute Publication, Fort Lauderdale, Florida.
- Milinkovitch, T., Ndiaye, A., Sanchez, W., Le Floch, S. & Thomas-Guyon, H.** (In Press) Liver antioxidant and plasma immune responses in juvenile Golden grey mullet (*Liza aurata*) exposed to dispersed crude oil. *Aquatic Toxicology*, **Corrected Proof**, doi:10.1016/j.aquatox.2010.09.013.
- Oliva, M., Gonzales de Canales, M. L., Gravato, C., Guilhermino, L. & Perales, J. A.** (2010) Biochemical effects and polycyclic aromatic hydrocarbons (PAH) in Senegal

- sole (*Solea senegalensis*) from a Huelva estuary (SW Spain) *Ecotoxicology and Environmental Safety*, **73**, 1842-1851.
- Oliveira, M., Pacheco, M. & Santos, M. A.** (2007) Cytochrome P4501A, genotoxic and stress responses in Golden grey mullet (*Liza aurata*) following short-term exposure to phenanthrene. *Chemosphere*, **66**, 1284-1291.
- Oliveira, M., Pacheco, M. & Santos, M. A.** (2008) Organ specific antioxidant responses in Golden grey mullet (*Liza aurata*) following a short-term exposure to phenanthrene. *Science of The Total Environment*, **396**, 70-78.
- Pacheco, M., Santos, M. A., Teles, M., Oliveira, M., Rebelo, J. E. & Pombo, L.** (2005) Biotransformation and genotoxic biomarkers in mullet species (*Liza sp.*) from a contaminated coastal lagoon (Ria de Aveiro, Portugal). *Environmental Monitoring Assessment*, **107**, 133-153.
- Page, C., Sumner, P., Autenrieth, R., J., B. & McDonald, T.** (1999) Materials balance on a chemically-dispersed oil and a whole oil exposed to an experimental beach front. *Proceedings of the Twenty-second Arctic and Marine Oilspill Program (AMOP)* (ed T. S. i. E. Canada), pp. 645-658. Ottawa.
- Perkins, E. J., Gribbon, E. & Logan, J. W. M.** (1973) Oil dispersant toxicity. *Marine Pollution Bulletin*, **4**, 90-93.
- Ramachandran, S. D., Hodson, P. V., Khan, C. W. & Lee, K.** (2004) Oil dispersant increases PAH uptake by fish exposed to crude oil. *Ecotoxicology and Environmental Safety*, **59**, 300-308.
- Richard, M., Archambault, P., Thouzeau, G. & Desrosiers, G.** (2007a) Summer influence of 1- and 2-yr-old mussel cultures on benthic fluxes in Grande-Entrée lagoon, Îles-de-la-Madeleine (Quebec, Canada). *Marine ecology progress series*, **338**, 131-143.
- Richard, M., Archambault, P., Thouzeau, G., McKindsey, C. W. & Desrosiers, G.** (2007b) Influence of suspended scallop cages and mussel lines on pelagic and benthic biogeochemical fluxes in Havre-aux-Maisons Lagoon, Îles-de-la-Madeleine (Quebec, Canada). *Canadian Journal of Fisheries and Aquatic Sciences*, **64**, 1491-1505.
- Sauer, T., Brown, J. S., Boehm, P. D., Aurand, D. V., Michel, J. & O.Hayes, M. O.** (1993) Hydrocarbon source identification and weathering characterization of intertidal and subtidal sediments along the Saudi Arabian Coast after the Gulf War Oil Spill. *Marine Pollution Bulletin*, **27**, 117-134.

- Shailaja, M. S., Rajamanickam, R. & Wahidulla, S.** (2006) Increased formation of carcinogenic PAH metabolites in fish promoted by nitrite. *Environmental Pollution*, **143**, 174-177.
- Shapiro, S. S. & Wilk, M. B.** (1965) An analysis of variance test for normality (complete samples). *Biometrika*, **52**, 591-611.
- Sundt, R. C., Pampanin, D. M., Larsen, B. K., Brede, C., Herzke, D., Bjørnstad, A. & Andersen, O. K.** (2006) The BEEP stavanger workshop: mesocosm exposures. *Aquatic Toxicology*, **78**, S5-S12.
- van der Oost, R., Beyers, J. & Vermeulen, N. P. E.** (2003) Fish bioaccumulation and biomarkers in environmental risk assessment: a review. *Environmental Toxicology and Pharmacology*, **13**, 57-149.
- Varanasi, U. & Gmur, D. J.** (1981) Hydrocarbons and metabolites in English sole (*Parophrys vetulus*) exposed simultaneously to [³H]Benzo[a]pyrene and [¹⁴C]Naphthalene in oil-contaminated sediment. *Aquatic Toxicology*, **1**, 49-67.
- Xu, W., Li, Y., Wu, Q., Wang, S., Zheng, H. & Liu, W.** (2009) Effects of phenanthrene on hepatic enzymatic activities in tilapia (*Oreochromis niloticus* ♀ × *O. aureus* ♂). *Journal of Environmental Sciences*, **21**, 854-857.

Résumé

Lors de catastrophes pétrolières, deux principales stratégies de lutttes sont envisagées : (i) le confinement de la nappe de pétrole en vue de sa récupération et (ii) l'utilisation de dispersant. Cette dernière technique permet le transfert de la nappe de pétrole de la surface vers la colonne d'eau, sous forme de gouttelettes d'hydrocarbure. En milieu hauturier, cette dispersion de la nappe de pétrole présente un risque environnemental faible puisque les hydrocarbures sont rapidement disséminés dans la colonne d'eau. De plus cette technique de lutte présente de nombreux avantages environnementaux notamment en évitant le mazoutage des oiseaux et mammifères marins et en accélérant la dégradation bactérienne des hydrocarbures. En milieu côtier, la dispersion de la nappe de pétrole est une mesure controversée. En effet, dans les eaux superficielles que représentent les zones littorales, le potentiel de dissémination des gouttelettes d'hydrocarbure est réduit par la profondeur de la colonne d'eau. L'exposition aux hydrocarbures de sites écologiquement sensibles suggère donc un risque environnemental.

Afin d'évaluer la toxicité de l'application de dispersant en zone côtière une approche expérimentale a été menée chez *Liza sp.* Trois conditions de contaminations ont été établies simulant trois scenarii possibles: (i) une condition de dispersion mécanique reflète la toxicité d'une nappe de pétrole sous l'influence des phénomènes de turbulence inhérents au milieu côtier ; (ii) une condition de dispersion chimique a permis de simuler l'application de dispersant sur une nappe de pétrole ; enfin (iii) une nappe de pétrole non dispersée représente le confinement de la nappe avant sa récupération.

La toxicité de chacune de ces conditions de contamination a été évaluée au travers d'une mesure de la mortalité sur un groupe d'individu, par l'estimation des performances de nage et de la capacité métabolique au niveau de l'organisme, et par une approche multimarqueurs au niveau de l'organe.

La comparaison entre une nappe de pétrole non dispersée et une nappe de pétrole dispersée chimiquement montre que l'application de dispersant entraine une augmentation des phénomènes de mortalité et une diminution, au niveau hépatique et branchial, des capacités de défense contre les xénobiotiques. Ces résultats suggèrent que, lorsque l'intensité de turbulence en milieu côtier est faible et, de ce fait, permet la récupération de la nappe de pétrole, cette dernière stratégie de lutte devra être considérée comme prioritaire sur l'utilisation de dispersant.

La comparaison entre une nappe de pétrole dispersée mécaniquement et une nappe de pétrole dispersée chimiquement montre, qu'en milieu côtier turbulent, l'application de dispersant ne semble pas potentialiser la toxicité du pétrole. Ainsi, aux vues des avantages environnementaux conférés par l'application de dispersant cette stratégie de lutte pourra donc être considérée sous restriction de conditions météorologique appropriées.

Le caractère expérimental de ce travail de thèse impose cependant une certaine prudence quant à l'interprétation de nos résultats. Ces derniers seront donc intégrés au sein du projet DISCOBIOL (Dispersant et techniques de lutte en milieu côtier : effets biologiques et apport à la réglementation) afin de statuer sur le risque environnemental consécutif à l'utilisation de dispersants en milieu côtiers.