



**HAL**  
open science

# COMMUNICATION MECHANISMS FOR MESSAGE DELIVERY IN HETEROGENEOUS NETWORKS PRONE TO EPISODIC CONNECTIVITY

Rao Naveed Bin Rais

► **To cite this version:**

Rao Naveed Bin Rais. COMMUNICATION MECHANISMS FOR MESSAGE DELIVERY IN HETEROGENEOUS NETWORKS PRONE TO EPISODIC CONNECTIVITY. Networking and Internet Architecture [cs.NI]. Université Nice Sophia Antipolis, 2011. English. NNT: . tel-00590626

**HAL Id: tel-00590626**

**<https://theses.hal.science/tel-00590626>**

Submitted on 4 May 2011

**HAL** is a multi-disciplinary open access archive for the deposit and dissemination of scientific research documents, whether they are published or not. The documents may come from teaching and research institutions in France or abroad, or from public or private research centers.

L'archive ouverte pluridisciplinaire **HAL**, est destinée au dépôt et à la diffusion de documents scientifiques de niveau recherche, publiés ou non, émanant des établissements d'enseignement et de recherche français ou étrangers, des laboratoires publics ou privés.

Université de Nice - Sophia Antipolis – UFR Sciences  
École Doctorale STIC

## THÈSE

Présentée pour obtenir le titre de :

*Docteur en Sciences de l'Université de Nice - Sophia Antipolis*

Spécialité : INFORMATIQUE

par

**\*Rao Naveed Bin RAIS\***

Équipe d'accueil : Projet-Equipe Planete – INRIA Sophia Antipolis

### **\*COMMUNICATION MECHANISMS FOR MESSAGE DELIVERY IN HETEROGENEOUS NETWORKS PRONE TO EPISODIC CONNECTIVITY\***

Thèse dirigée par \*Thierry TURLETTI\* et \*Katia OBRACZKA\*

Soutenance à l'INRIA le 02 Février, 2011, devant le jury composé de :

Président :	Prof. Michel RIVIELL	University of Nice, Sophia Antipolis, France
Directeurs :	Dr. Thierry TURLETTI	INRIA, Sophia Antipolis, France
	Prof. Katia OBRACZKA	University of California at Santa Cruz, USA
Rapporteurs :	Prof. Isabelle GUERIN-LASSOUS	ENS Lyon/INRIA, France
	Prof. Joerg OTT	Aalto University, Finland
	Prof. Marco CONTI	IIT-CNR, Italy
Examineurs :	Dr. Franck LEGENDRE	ETH Zurich, Switzerland



# COMMUNICATION MECHANISMS FOR MESSAGE DELIVERY IN HETEROGENEOUS NETWORKS PRONE TO EPISODIC CONNECTIVITY

by

\*Rao Naveed Bin Rais\*

Thesis Advisors: Thierry Tuletti (INRIA, Sophia Antipolis), Katia Obraczka (University of California at Santa Cruz)  
Planète, INRIA Sophia Antipolis, France

## ABSTRACT

Today's Internet is characterized by heterogeneity, both at node- (e.g., smart phones, PDAs) and network level (e.g., wired/wireless infrastructure-based and ad-hoc networks, cellular-based networks). As the networks are becoming increasingly heterogeneous, it is expected that future internetworks will interconnect different types of network including wired, infrastructure-based wireless and infrastructure-less wireless networks including multi-hop mobile ad-hoc networks (or MANETs). Additionally, a number of emerging applications such as environmental or habitat monitoring, emergency response, vehicular communication, to name a few, require that future internetworks be tolerant to frequent or long-lived connectivity disruptions. This connectivity disruption is the inherent property of Delay or Disruption Tolerant Networks (DTNs). Interconnecting these heterogeneous networks poses several challenges due to heterogeneity of nodes and networks. These challenges include seamless message delivery and identification of nodes especially when the nodes are mobile. We target these issues in this thesis.

The contributions of this thesis are three fold. First, we present a classification of existing DTN routing protocols by breaking up existing routing strategies into tunable *routing modules* (forwarding, replication, coding). Then, we identify a set of useful *design guidelines* to show how and when a given *routing module* should be used, depending on the set of *network characteristics* exhibited by the wireless application. Second, we propose a new framework called MeDeHa to provide message delivery across heterogeneous networks prone to intermittent connectivity. MeDeHa is able to bridge infrastructure-based and infrastructure-less networks and makes them inter-operate seamlessly, through devices carrying multiple interfaces or part of several networks and by the integration of existing protocols (e.g., MANET protocols). We evaluate MeDeHa through extensive simulations using realistic synthetic and real mobility traces, and by performing hybrid experiments which run partly on simulator and partly on real machines. Third, we propose a naming mechanism called HeNNA for heterogeneous networks prone to connectivity disruptions which aims to provide message delivery to nodes irrespective of their current IP addresses. Henna can accommodate nodes equipped with multiple network interfaces and is compatible with the status-quo Internet routing. We also implement HeNNA within the MeDeHa framework and conduct experiments to showcase the operation of the complete message delivery and naming protocol suite.



TO MY PARENTS, WIFE AND DAUGHTER



# ACKNOWLEDGMENTS

---

---

This thesis would not have been completed without the help and contributions from a number of people who provided me their support both at technical and moral levels. Thus, I would like to take the opportunity to express my gratitude in order to thank them all here. I cannot possibly thank my thesis advisors Dr. Thierry Turetli (INRIA, Sophia Antipolis) and Prof. Katia Obraczka (UCSC, USA) for their continuous guidance, support and invaluable feedback on my work. They really helped me a lot in making the progress in my research, and I have learnt a lot while working under their supervision. I would also like to thank my colleagues in the Planete team at INRIA, Sophia Antipolis, especially Dr. Walid Dabbous, Dr. Chadi Barakat and Dr. Arnaud Legout who repeatedly provided their feedback on my work and helped me in improving it technically. Working in the Planete team at INRIA, Sophia Antipolis has been an unforgettable and very pleasant experience of my life, and I am going to miss the working environment here. Besides, I thank all my friends and colleagues who helped me in improving the thesis manuscript by providing their valuable feedback.

I would particularly like to express my gratitude to a number of colleagues who technically contributed in this thesis. Especially, I have had the honor to work with Dr. Thrasyvoulos Spyropoulos for the taxonomy part of this thesis. His valuable comments and input in the work has really been very helpful. Besides, Marc Mendonca from University of California at Santa Cruz helped me in implementing the MeDeHa framework on Linux machines and to perform hybrid experiments, while Mariem Abdelmoula assisted me in implementing the HeNNA architecture.

Nobody in this world can pay back for the love, affection and support of parents, and I am no exception. I would really like to thank my parents for extending their financial and moral support to me throughout my life. Their prayers and guidance have enabled me to achieve whatever I have attained in my life. Moreover, I would also want to mention the support and love that I have been receiving from my wife Huma, who has been very understanding and her support helped me in a great way to complete my thesis successfully in time. She has been tolerating to live away from me for the past two years, and I thank her for all her understanding.

In the end, I would also like to thank the Higher Education Commission (HEC), Government of Pakistan who provided me the opportunity to come to France in order to get this thesis done. They have been providing me financial support for the last 4 years.





# CONTENTS

<b>Abstract</b>	<b>iii</b>
<b>Acknowledgements</b>	<b>vii</b>
<b>Tables</b>	<b>xv</b>
<b>Figures</b>	<b>xx</b>
<b>I Introduction and Background</b>	<b>1</b>
<b>1 Introduction</b>	<b>3</b>
1.1 Résumé de thèse . . . . .	3
1.2 Context . . . . .	4
1.2.1 L'architecture de l'Internet . . . . .	4
1.2.2 Le besoin de la connectivité universelle . . . . .	5
1.2.3 L'hétérogénéité de réseau et de noeud . . . . .	5
1.2.4 L'interconnexion de réseau . . . . .	6
1.2.5 Le problème de l'identification de noeuds mobiles . . . . .	7
1.2.6 La classification des protocoles DTN . . . . .	8
1.3 Contributions . . . . .	8
1.4 La liste de publications reliées à la thèse . . . . .	9
1.5 Aperçu de la thèse . . . . .	10
<b>1 Introduction</b>	<b>13</b>
1.1 Problem Statement . . . . .	13
1.2 Context . . . . .	14
1.2.1 Background on the Internet Architecture . . . . .	14
1.2.2 Universal Connectivity Requirement . . . . .	15
1.2.3 Nodes and Network Heterogeneity . . . . .	16

1.2.4	Networks interconnection . . . . .	17
1.2.5	Node Identification and Mobility Problem . . . . .	17
1.2.6	DTN Routing Protocols . . . . .	18
1.3	Summary of Motivations . . . . .	18
1.4	Contributions . . . . .	19
1.4.1	DTN Routing Taxonomy . . . . .	20
1.4.2	The Message Delivery Framework . . . . .	20
1.4.3	The Naming Architecture . . . . .	21
1.5	Publications Related to Thesis . . . . .	22
1.6	Outline of the Thesis . . . . .	23
<b>2</b>	<b>Communication in Heterogeneous Networks: A Background</b>	<b>25</b>
2.1	Heterogeneity . . . . .	27
2.1.1	Inter-operation of infrastructure-based and ad-hoc networks . . . . .	27
2.1.2	Networks with Gateway Connectivity . . . . .	28
2.2	Disconnection . . . . .	29
2.2.1	Delay/Disruption Tolerant Networks (DTNs) . . . . .	29
2.2.1.1	Deterministic or Scheduled Forwarding . . . . .	30
2.2.1.2	Enforced Forwarding . . . . .	31
2.2.1.3	Opportunistic Forwarding . . . . .	31
2.2.2	MANETs with Disconnections . . . . .	31
2.3	Node Identification . . . . .	32
2.4	New Communication Architectures . . . . .	33
2.4.1	Content Centric Naming (CCN) . . . . .	33
2.4.2	Pocket Switched Networks (PSN) . . . . .	34
2.4.3	Data Oriented Network Architecture (DONA) . . . . .	34
2.4.4	A Layered Architecture for the Internet . . . . .	34
2.4.5	Persistent Connectivity Management Protocol (PCMP) . . . . .	35
2.4.6	Opportunistic Connection Management Protocol (OCMP) . . . . .	35
2.4.7	Unmanaged Internet Architecture (UIA) . . . . .	35
2.5	Design Objectives . . . . .	35
2.5.1	Assumptions and Limitations . . . . .	36
<b>II</b>	<b>Taxonomy of Routing in Disruption Tolerant Networks</b>	<b>37</b>
<b>3</b>	<b>DTN Routing Taxonomy</b>	<b>39</b>
3.1	Introduction . . . . .	39

---

3.2	Opportunistic Routing Primitives . . . . .	41
3.2.1	Routing as Opportunistic Forwarding . . . . .	41
3.2.2	Message Replication . . . . .	42
3.2.2.1	Greedy Replication . . . . .	43
3.2.2.2	Controlled Replication . . . . .	43
3.2.2.3	Utility-Based Replication . . . . .	44
3.2.3	Message Forwarding . . . . .	45
3.2.4	Message Coding . . . . .	46
3.2.5	Routing as Resource Allocation . . . . .	47
3.2.6	Examples of DTN Routing Protocols . . . . .	48
3.3	DTN Routing Utility Functions . . . . .	49
3.3.1	Destination Dependent (DD) Utility . . . . .	49
3.3.2	Destination Independent (DI) Utility . . . . .	52
3.3.3	Additional Considerations . . . . .	53
3.4	A Taxonomy of DTNs . . . . .	54
3.4.1	Connectivity . . . . .	54
3.4.2	Mobility . . . . .	57
3.4.3	Node Resources . . . . .	59
3.4.4	Application Requirements . . . . .	60
3.5	DTN Routing Design Guidelines . . . . .	61
3.6	Concluding Remarks . . . . .	63
<b>III</b>	<b>MeDeHa - A Message Delivery Framework</b>	<b>65</b>
<b>4</b>	<b>MeDeHa Framework</b>	<b>67</b>
4.1	Introduction . . . . .	67
4.2	Related Work . . . . .	70
4.3	Design Principle . . . . .	72
4.4	MeDeHa Overview . . . . .	73
4.4.1	Functional Components . . . . .	74
4.4.2	Integration of Existing Protocols . . . . .	76
4.4.3	Multi-hop Connectivity . . . . .	76
4.5	MeDeHa's Operation . . . . .	77
4.5.1	MeDeHa State Diagram . . . . .	77
4.5.2	Receive Operation . . . . .	78
4.5.3	Relay/Forward Operation . . . . .	79
4.5.4	Buffer Operation . . . . .	81

4.6	MeDeHa Design Details . . . . .	82
4.6.1	The Notification Protocol . . . . .	82
4.6.1.1	Neighbor Sensing . . . . .	83
4.6.1.2	Neighborhood Information Exchange . . . . .	85
4.6.2	Routing and Contact Table Management . . . . .	88
4.6.3	Relay Node Selection and Forwarding . . . . .	89
4.7	Interaction with MANETs . . . . .	91
4.7.1	MANET Information Exchange . . . . .	91
4.7.2	Gateway Discovery in MANETs . . . . .	92
4.7.3	Proactive vs. Reactive MANET Routing . . . . .	92
4.7.4	Message Delivery to MANETs . . . . .	93
4.7.5	Message Delivery across MANETs . . . . .	93
4.8	Message Delivery in MeDeHa: An Overall Picture . . . . .	94
4.9	Design Assumptions and Limitations . . . . .	96
4.9.1	Node Identification . . . . .	96
4.9.2	Security Issues . . . . .	97
4.10	Concluding Remarks . . . . .	97
<b>5</b>	<b>MeDeHa Implementation and Performance Evaluation</b>	<b>99</b>
5.1	Implementation Approaches . . . . .	99
5.2	Evaluation Platforms . . . . .	101
5.2.1	Simulator Experimentation . . . . .	101
5.2.2	Real Experimentation . . . . .	102
5.2.3	Hybrid Experimentation . . . . .	103
5.3	Simulator Implementation . . . . .	103
5.3.1	NS-3 Implementation . . . . .	106
5.4	Implementation on Real Machines . . . . .	107
5.4.1	Stations Implementation . . . . .	109
5.4.2	AP Implementation . . . . .	110
5.4.3	Intercepting Messages . . . . .	110
5.5	Hybrid Experiments . . . . .	111
5.5.1	Experimental Setup . . . . .	111
5.6	Performance Evaluation . . . . .	112
5.6.1	Performance Metrics . . . . .	113
5.6.2	Wireless Configuration Parameters . . . . .	115
5.6.3	Mobility Model . . . . .	115
5.6.4	Link-Layer Implementation Results . . . . .	115

5.6.4.1	Uniform and Non-uniform AP Distribution . . . . .	116
5.6.4.2	Buffers Size . . . . .	119
5.6.5	NS-3 Results . . . . .	121
5.6.5.1	Relay Selection Strategies . . . . .	122
5.6.5.2	Case 1: Convention Center Type Scenario . . . . .	123
5.6.5.3	Case 2: Communication between Clusters of Nodes . . . . .	127
5.6.5.4	Case 3: Communication between Students across Campuses . . .	133
5.6.5.5	Case 4: Convention Center Type Scenario . . . . .	136
5.6.5.6	Case 5: Community Intercommunication with MANETs . . . . .	139
5.6.6	Real Mobility Traces . . . . .	143
5.6.6.1	MeDeHa with Infrastructure-based and 2-hop Infrastructure-less Networks (Second Phase) . . . . .	144
5.6.6.2	MeDeHa with Infrastructure-based and Multi-hop Infrastructure- less Networks (Third Phase) . . . . .	144
5.6.7	Hybrid Experiment Results . . . . .	146
5.7	Concluding Remarks . . . . .	147
<b>IV</b>	<b>HeNNA - A Naming Mechanism for Heterogeneous Networks</b>	<b>149</b>
<b>6</b>	<b>Naming for Heterogeneous Networks</b>	<b>151</b>
6.1	Introduction . . . . .	151
6.2	Design Guidelines . . . . .	153
6.3	Analysis of Existing Naming Schemes . . . . .	154
6.3.1	Region-based Naming . . . . .	154
6.3.1.1	Interplanetary Internet Naming and Addressing . . . . .	154
6.3.1.2	EDIFY . . . . .	155
6.3.2	Content-based Naming . . . . .	155
6.3.2.1	Content Centric Networking (CCN) . . . . .	156
6.3.2.2	A Layered Architecture for the Internet . . . . .	156
6.3.2.3	Data Oriented Network Architecture (DONA) . . . . .	156
6.3.3	Intentional Naming . . . . .	157
6.3.4	Host-based Naming . . . . .	157
6.3.4.1	Locator/ID Separation Protocol (LISP) . . . . .	157
6.3.4.2	Node Identity Internetworking Architecture . . . . .	158
6.3.4.3	Host Identity Protocol (HIP) . . . . .	158
6.3.4.4	MobileIP . . . . .	158
6.3.4.5	Dynamic DNS . . . . .	158

6.4	The HeNNA Naming Mechanism . . . . .	159
6.4.1	HeNNA Operation . . . . .	160
6.4.2	Location and Management Server (LMS) . . . . .	161
6.4.3	Local Network Operation . . . . .	164
6.4.4	Ad-hoc Network Operation . . . . .	166
6.4.5	GUID as Content Identifiers . . . . .	166
6.4.6	GUID format . . . . .	166
6.4.7	Scalability and Security Issues . . . . .	167
6.5	HeNNA Implementation . . . . .	168
6.5.1	Modifications in MeDeHa implementation . . . . .	169
6.6	Results . . . . .	169
6.6.1	Case 1: File Download Across Campuses . . . . .	169
6.6.2	Case 2: File Transfer across Campuses with Mobile Sources . . . . .	173
6.7	Concluding Remarks . . . . .	174
<b>V</b>	<b>Conclusion and Future Work</b>	<b>175</b>
<b>7</b>	<b>Conclusions and Future Research Perspectives</b>	<b>177</b>
7.1	Opportunistic DTN Routing Taxonomy . . . . .	177
7.2	Message Delivery in Heterogeneous Networks . . . . .	178
7.3	Naming for Heterogeneous Networks . . . . .	182
<b>7</b>	<b>Les Conclusions et les travaux de recherche future</b>	<b>183</b>
7.1	Une taxonomie des protocoles routage DTN . . . . .	183
7.2	La livraison des messages dans les réseaux hétérogènes . . . . .	184
7.3	L'identification des noeuds dans les réseaux hétérogènes . . . . .	188
<b>A</b>	<b>Glossary</b>	<b>191</b>
A.1	List of Acronyms and Abbreviations . . . . .	191
A.2	Basic Definitions . . . . .	193
	<b>Bibliography</b>	<b>195</b>

# TABLES

3.1	DTN Routing primitives and their use by existing DTN routing protocols . . . . .	49
3.2	Routing Module Applicability . . . . .	62
4.1	The Notification Information Exchanged for Ad-hoc Networks . . . . .	87
4.2	The Infrastructure-based Notification Protocol Messages . . . . .	89





# FIGURES

1.1	Un exemple d'un réseau hétérogène qui comprend les réseaux d'infrastructure et d'ad-hoc . . . . .	6
1.1	A glimpse of a heterogeneous internetwork with a wired backbone, wireless infrastructure-based, and ad-hoc networks . . . . .	16
3.1	Expected percentage of total nodes in largest connected component, as a function of the number of nodes ( $M$ ) and transmission range ( $K$ ) ( $200 \times 200$ grid). . .	55
4.1	An example of a heterogeneous internetwork with a wired backbone, wireless infrastructure-based, and ad-hoc networks prone to episodic connectivity. Node13 is disconnected, whereas Node5, Node6, Node8 and Node12 are indirectly connected to the backbone network via the corresponding associated nodes. . . . .	68
4.2	GW nodes connecting two different MANETs . . . . .	76
4.3	MDH-2 is able to communicate with MDH-1 by traversing through MANET using GW-1 and GW-2 . . . . .	77
4.4	State diagram showing MeDeHa's overall operation. A MeDeHa-capable node can be in one of the four states, <i>Idle</i> , <i>Receive</i> , <i>Forward</i> , and <i>Buffer</i> . . . . .	78
4.5	Receive Operation of a MeDeHa-capable Node . . . . .	80
4.6	Forward/Relay Operation of a MeDeHa-capable Node . . . . .	80
4.7	Buffer Operation of a MeDeHa-capable Node . . . . .	83
4.8	Multi-hop message delivery involving infrastructure-based and "ad hoc" nodes that may be intermittently connected. Source $S$ wants to send a message to destination $D$ . This is made possible with the help of node $G$ that acts as gateway between the two networks. $S$ and $D$ do not need to be connected to more than one network nor be part of the same network in order to send or receive messages. . . . .	84
4.9	Hello handshake mechanism between node 10 and node 12. Node 10 wins and sends the NEIGHBOR.INFO notification before Node 12. . . . .	85

4.10	The GW node acts as a bridge to provide communication between MANET nodes and MDH nodes . . . . .	94
4.11	An example of message delivery in heterogeneous networks . . . . .	96
5.1	Total and Effective Coverage Areas of an AP represented respectively by circle with continuous line (green) and circle with dotted line (gray). Node <b>B</b> is at the edge of the dotted line circle and eventually sends the <i>disassociation</i> frame to the AP, while Node <b>A</b> is still <i>associated</i> . . . . .	105
5.2	MeDeHa's implementation in Linux as a user-space daemon. Both Incoming and Outgoing messages are intercepted for processing before being passed to Linux kernel . . . . .	108
5.3	MeDeHa notification header implemented as IP option header . . . . .	109
5.4	Configuration of bridge node using tap-bridge to inter-connect simulated and real networks. . . . .	112
5.5	Hybrid experimentation setup involving real machines acting as APs and stations, and virtual machines running in the NS-3 simulator . . . . .	113
5.6	Hybrid experimentation setup as demonstrated at ACM Mobicom 2010. . . . .	114
5.7	Uniform Deployment of 9 APs (28 Attraction Points). . . . .	117
5.8	CDF of Nodes with Uniform APs Distribution. . . . .	117
5.9	Non-Uniform Deployment of 9 APs (28 Attraction Points). . . . .	118
5.10	CDF of Nodes with Non-Uniform APs Distribution. . . . .	118
5.11	CDF of Nodes with Mobile Sources. Message rate: 5 messages/s . . . . .	119
5.12	Buffer Size Impact on MDR (Non-uniform APs deployment). . . . .	120
5.13	Buffer Size Impact on MDR (Uniform APs deployment). . . . .	121
5.14	Fraction of Nodes vs. Delivery Ratio for uniform deployment of APs . . . . .	125
5.15	Delay vs. message rates for uniform deployment of APs . . . . .	125
5.16	Fraction of Nodes vs. Delivery Ratio for non-uniform deployment of APs . . . . .	126
5.17	Delay vs. message rates for non-uniform deployment of APs . . . . .	126
5.18	Impact of varying buffer sizes on Delivery Ratio for high and low priority messages (message rate: 2 messages/s) . . . . .	127
5.19	Deployment of APs and attraction points in a scenario with 3 disconnected clusters. . . . .	128
5.20	CDF of fraction of nodes vs. delivery ratio showing the comparison between forwarding and 2-copy replication for inter-cluster and intra-cluster traffic. Messages rate is set to 1 message/s . . . . .	129
5.21	CDF of nodes vs. Delivery Ratio for 2-copy Encounter Replication (ER), Social Affiliation Replication (SAR) and Encounter and Social Affiliation-based Replication schemes - (1 message/s) . . . . .	130

5.22	Impact of using different number of copies per message on the average MDR of the nodes using ER and SAR relay selection strategies - (1 message/s) . . . . .	132
5.23	CDF of fraction of nodes vs. delivery ratio showing the comparison between forwarding and 2-copy replication for inter-campus and intra-campus traffic. Message rate is set to 1 message/s . . . . .	134
5.24	CDF of nodes vs. Delivery Ratio for 2-copy Encounter Replication (ER) and Social Affiliation Replication (SAR) - (1 message/s) . . . . .	135
5.25	CDF of nodes vs. Delivery Ratio using 2-copy Community-and-Encounter Replication (ESAR) - (1 message/s) . . . . .	136
5.26	Types and distribution of nodes used in Case 4 . . . . .	137
5.27	Forwarding vs. 2-copy Replication using ER scheme for 1st part of Case 4 (30 MDH, 30 GW, 30 OLSR visitors) . . . . .	138
5.28	Comparison between ER and SAR schemes using 2-copy replication for 1st part of Case 4 (30 MDH, 30 GW, 30 OLSR visitors) . . . . .	139
5.29	Forwarding vs. 2-copy Replication using ER and SAR schemes for 2nd part of Case 4 (60 GW, 30 OLSR visitors) . . . . .	140
5.30	Comparison between ER and SAR schemes using 2-copy replication for 2nd part of Case 4 (60 GW, 30 OLSR visitors) . . . . .	140
5.31	Case 5: Three communities with the GW nodes are joined by three “transit MANETs”. . . . .	141
5.32	Forwarding vs. 2-copy Replication using ER scheme for Case 5 . . . . .	142
5.33	Impact of different encounter parameters on fraction of nodes while comparing forwarding and replication for Case 5 . . . . .	142
5.34	Impact of using different number of copies on delivery ratio using ER. . . . .	143
5.35	CDF of nodes vs. Delivery Ratio for KAIST Campus Traces for two hours using IS only and IS+Adhoc modes (message rate: 1 message/s) . . . . .	145
5.36	Forwarding vs. 2-copy Replication showing a comparison between the <i>second phase</i> and the <i>third phase</i> of the MeDeHa’s implementation using KAIST mobility traces for 40 nodes . . . . .	146
5.37	Forwarding vs. 2-copy Replication comparison resulting from a hybrid scenario involving real and simulated stations. . . . .	147
6.1	Operation of a node running HeNNA mechanism when the node has a message to send. . . . .	162
6.2	An example of message delivery using HeNNA. <b>S</b> which knows <b>GUID(D)</b> sends a message to <b>D</b> by first contacting <b>LMS(D)</b> . . . . .	163
6.3	LMS Operation in HeNNA. . . . .	164

---

6.4	NGW Operation in HeNNA. . . . .	165
6.5	Composition of a GUID. . . . .	167
6.6	GUID header in the protocol stack. . . . .	167
6.7	Three campuses are connected to the Internet via NGWs. . . . .	170
6.8	Comparison of using MeDeHa with HeNNA functionality and regular MeDeHa framework by showing the percentage of messages received in each campus. . . . .	171
6.9	Percentage of messages received in both infrastructure-based and ad-hoc networks. . . . .	172
6.10	Percentage of messages received in each campus for the case of file transfer with mobile sources. . . . .	173

## **Part I**

# **Introduction and Background**



# 1

## INTRODUCTION

---

### 1.1 Résumé de thèse

Au cours de ces dernières années, les différents types de réseaux et d'applications ont évolué et l'Internet actuel est fortement hétérogène au niveau de réseaux qu'il comporte, ainsi qu'au niveau de noeuds qu'il relie. Egalement, il est prévue que l'Internet du futur sera plus hétérogène. Cette hétérogénéité existe au niveau de noeud – (par exemple, les ressources, la batterie, les caractéristiques de mobilité) et au niveau de réseau (par exemple, les réseaux sans fil infrastructure et ad-hoc mobiles). D'ailleurs, la tendance des utilisateurs d'être connecté tout le temps nécessite l'existence d'un réseau omniprésente où les utilisateurs mobiles profitent de tous les opportunités de connexion même lorsque qu'ils déplacent. Comme la connectivité ne peut pas être garantie partout, il est souhaitable que l'Internet du futur gère la perte de connectivité de noeuds intrinsèquement, quand les noeuds se déplacent. Par ailleurs, l'intercommunication de ces différents réseaux pose de nombreux défis scientifiques comme la gestion de la session de communication et l'identité de noeuds mobiles. Malheureusement, l'Internet actuel peut gérer la perte de connectivité de très courte durée. En plus, il n'est pas possible de garder la session de communication dans l'Internet actuel quand les noeuds se déplacent et changent leurs points de connectivité avec du réseau.

Les “Delay/Disruption Tolerant Networks” ont été proposée pour adresser le problème des ruptures fréquentes de connectivité. Plusieurs propositions ont été présentées qui visent principalement des mécanismes de routing/forwarding pour DTNs, mais il n'y a aucun consensus sur des mécanismes spécifiques pour les applications spécifiques. Dans cette thèse, nous présentons d'abord une taxonomie des protocoles existants de DTN afin d'assister aux con-



cepteurs de protocole pour choisir une approche particulière de routing/forwarding pour une application spécifique. Deuxièmement, nous adressons le problème de la livraison de message dans les réseaux hétérogènes à connectivité intermittente, et proposons un framework appelé MeDeHa. Le MeDeHa framework permet à des noeuds mobiles de gérer les ruptures de connectivité et de profiter de la connectivité à différents types de réseaux incluant les réseaux d'infrastructure et ad-hoc afin d'augmenter la possibilité de livraison de message. MeDeHa intègre également des protocoles MANET existants sans n'exiger aucune modification. Nous présentons l'évaluation étendue de MeDeHa en utilisant les traces mobilité des noeuds qui sont synthétique ainsi que réels. Aussi, nous implémentons MeDeHa sur Linux et faisons des expériences hybrides. Troisièmement, nous proposons un mécanisme d'identification, appelé HeNNA pour les réseaux hétérogènes aux ruptures de connectivité qui permet à des noeuds mobiles de communiquer avec d'autres noeuds même lorsqu'ils changent leurs points d'attachement. Le mécanisme sépare l'identification de noeuds de leurs positions et permet la livraison de message dans l'Internet actuel. Nous prouvons également que HeNNA complète le framework MeDeHa en permettant aux noeuds de MeDeHa de changer leurs adresses IP dynamiquement.

## 1.2 Context

### 1.2.1 L'architecture de l'Internet

L'architecture originale d'Internet a été développée pour fournir la communication de bout-en-bout entre un ensemble de noeuds, tout en assumant les routes fixes de réseau entre la source et la destination. Cependant, la conception de l'architecture d'Internet n'a pas considéré l'extensibilité que l'Internet a éprouvée. Le but primaire de l'Internet était la pouvoir de transférer des données à partir d'une machine à l'autre sur un réseau, mais l'Internet a changé son rôle beaucoup de fois depuis son émergence. Par exemple, au début du siècle, presque la moitié du trafic d'Internet a comporté le contenu d'application de pair-à-pair (P2P). Aujourd'hui, la partie la plus signifiante du trafic d'Internet est orientée vers les services de données (services d'enchaînement comprenant audio et visuel) [1].

Grâce à certaines propositions très innovatrices telles que le "Domain Name System" (DNS), le "Classless Interdomain Routing" (CIDR), le "Network Address Translation" (NAT) et le "Dynamic Configuration Control Protocol" (DHCP), l'Internet a survécu des nouvelles applications et leur besoin. En particulier, l'augmentation en service des communications sans fil a fondamentalement douté l'architecture de l'Internet, car elle apporte implicitement la mobilité de noeuds ce qui doit être géré par le réseau. Il y a également quelques autres problèmes que la communication sans fil introduit dans l'Internet. Par exemple, le protocole original de contrôle

de congestion de TCP's traite la perte de paquets comme signe de congestion, supposant qu'un routeur intermédiaire a jeté le paquet dû au débordement de tampon. Cependant, la perte de paquet est la norme dans la communication sans fil due à l'affaiblissement ou aux collisions de canal. Tout en faisant face à ces défis, l'Internet a fondamentalement changé depuis sa naissance. Par ailleurs, beaucoup de différents réseaux et applications ont évolué avec des besoins et des caractéristiques spécifiques.

De plus, l'Internet actuel est basé sur le principe de la présence d'un chemin de bout-en-bout entre une paire de noeuds pour la communication, qui n'est pas toujours possible. Ce principe élimine également l'intégration des réseaux (ou des noeuds) dans l'Internet où la connectivité peut être de courte durée, et les noeuds communiquent dans une manière opportuniste plutôt que dans une manière déterministe, et où les délais de la communication sont très longtemps. Ce dispositif sporadique de connectivité est une caractéristique inhérente de beaucoup d'application actuelle telle que la réponse de secours, réseaux sous-marins, habitat et environnement surveillant, et réseaux véhiculaires. Par ailleurs, les réseaux ad-hoc mobiles (MANET) sont vulnérables aux ruptures de connectivité même si les protocoles conventionnel de MANET (par exemple, AODV [33], DSDV [34], OLSR [32]) sont basés sur l'hypothèse forte de la présence du chemin de bout-en-bout entre tous les noeuds participants pour que la session de communication fonctionne.

### 1.2.2 Le besoin de la connectivité universelle

Le désir d'un réseau omniprésent ce qui a semblé tout à fait futuriste il y a une décennie, devient de plus en plus une réalité. Ce désir comprend la création d'un Inter-network qui relie les différents types de réseaux (par exemple, les réseaux filaire et sans-fil infrastructure et ad-hoc). Cet Inter-network inclura probablement de nouveaux paradigmes de gestion de réseau tels que les réseaux tolérants de déconnexion (DTNs) et le réseau commuté par poche (PSN) [47, 133] en tant que son composant intégral. Un aperçu de l'hétérogénéité de réseau est montré dans le Fig. 1.1.

### 1.2.3 L'hétérogénéité de réseau et de noeud

Grâce à l'avancement en technologie, particulièrement dans les réseaux sans fil, des genres des dispositifs mobiles sont disponibles aujourd'hui pour les utilisateurs, y compris des téléphones cellulaires et PDAs. Aujourd'hui, la nécessité de rester connecté en se déplaçant est devenu une nécessité plutôt qu'un désir. La plupart des dispositifs actuels portent plus d'une interface (par exemple, Wifi, 3G, EDGE, Bluetooth etc.), que les utilisateurs peuvent utiliser pour se relier à l'Internet, ou à d'autres noeuds voisins. D'ailleurs, il est envisagé que l'Internet du futur sera non seulement plus hétérogène dû à la grande variété de dispositifs (en termes de

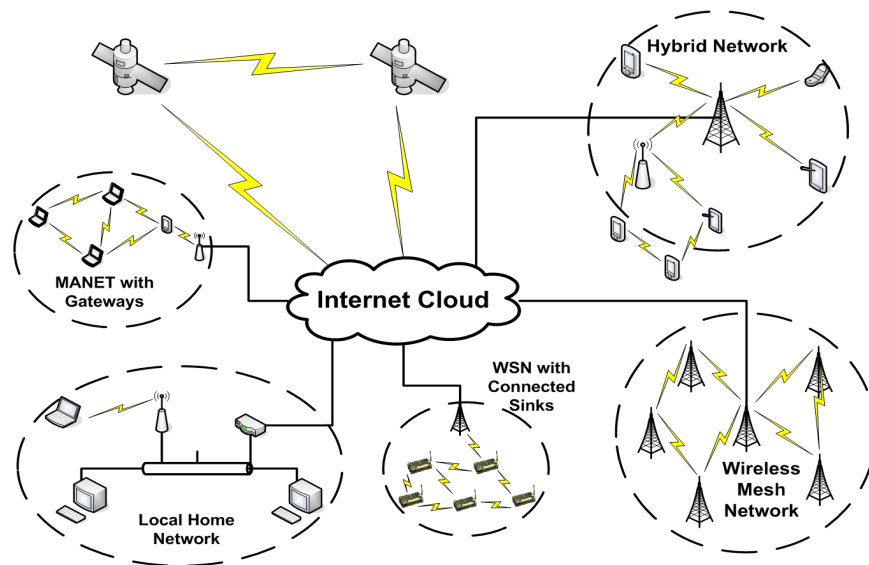

Figure 1.1: Un exemple d'un réseau hétérogène qui comprend les réseaux d'infrastructure et d'ad-hoc

leurs capacités, par exemple, stockage, durée de la transformation, vie de batterie, mobilité, et caractéristiques du trafic), mais également en termes de réseaux fondamentaux (par exemple, infrastructure, ad-hoc, fixée, véhiculaires.) qu'il comporte. L'architecture actuel d'Internet gère ces problèmes d'hétérogénéité dans une certaine mesure en impliquant différents genres de réseaux et en soutenant de divers noeuds, mais l'inter-opération de ces réseaux afin de fournir une meilleur connectivité, continu et omniprésent est toujours un problème à résoudre.

Par conséquent, l'hétérogénéité doit être manipulée aux niveaux de réseau et de noeud. L'hétérogénéité des réseaux devrait être considérée en raison de différents types de réseaux évolués depuis quelques années comprenant les réseaux d'infrastructure et d'ad-hoc (MANETs, VANETs). D'autre part, le concept de la connectivité omniprésente a changé les politiques conventionnelles de routage et de forwarding. Dans le nouveau modèle de réseau, les noeuds peuvent porter des données pour d'autres noeuds tout en se déplaçant d'un endroit à l'autre. Ainsi, l'hétérogénéité des dispositifs tels que l'espace de buffering, la vie de batterie, modèle de mobilité devient importante à être considéré.

#### 1.2.4 L'interconnexion de réseau

L'interopérabilité intégrée parmi les réseaux hétérogènes est un problème assez difficile car les différents réseaux peuvent avoir des caractéristiques très différentes. D'ailleurs, la diversité de noeud peut rendre le routage difficile, car les noeuds doivent également tenir compte des ressources disponibles à d'autres noeuds ainsi que des possibilités de contact afin de prendre

des décisions correctes de routage (étant donné que les liens changent avec du temps à cause de la possibilité de connectivité intermittente). Par exemple, dans un réseau qui a un contrainst sur le tampon où les noeuds participants peuvent avoir différentes possibilités de buffering, il est inutile d'expédier un message à un noeud voisin, si le dernier manque de l'espace de tampon.

De nombreuses propositions ont visé la livraison de message dans les réseaux hétérogènes, mais il n'y a aucune solution complète disponible, jusqu'ici. Nous pouvons classifier les solutions existantes dans quatre catégories différentes.

- MANETs avec support de la connectivité épisodique. Les exemples comprennent "Island Hopping" [2], "DTN-MANET Integration" [3], "Epidemic Routing" [7], et "Spray-and-Wait" [29].
- Augmentation de la region de connectivite de l'AP dans les réseaux sans fil infrastructure pour prolonger la connectivité, par exemple, se servant des radios multi-canales ou com-mutant entre différents modes d'IEEE 802.11 (WLAN [8], MMWLAN [9], Flex-Wifi [10], Multinet [11]).
- Fournissant à MANETs la connectivité de backbone (Internet) avec l'aide des noeuds spéciaux (passerelles), et de proposer des mécanismes de découvrir ces passerelles (par exemple, AODV+ [14]).

### 1.2.5 Le problème de l'identification de noeuds mobiles

Dans le modèle de communication de l'Internet, les adresses IP des noeuds changent avec la mobilité et leurs points d'attachement dans le réseau. Ceci remet les sessions de communication à zéro car ces sessions sont liés aux noeuds spécifiques et aux endroits spécifiques identifiés par les adresses IP. D'ailleurs, les protocoles de la couche transport et de l'application se relient typiquement avec des adresses IP pour définir des points de communication. Ce modèle de communication n'est pas approprié aux scénarios où les noeuds sont mobiles et changent fréquemment leurs endroits. Par conséquent, il est nécessaire que les architectures du futur doivent considérer la distinction entre l'identification de noeuds et leurs localisations. Il y a une longue discussion connue pour séparer l'identification de noeuds de leur locations [94], et des travaux assez considérable ont été déjà effectuée pour réaliser cet séparation [84, 80, 82].

D'ailleurs, dans un environnement d'un réseau hétérogène où les dispositifs mobiles peuvent employer les interfaces multiples pour la connectivité, il devient impraticable que les applications emploient les adresses IP pour la communication avec des autre noeuds. La raison est que le modèle actuel de communication exige des noeuds d'acquérir l'adresse IP d'un autre noeud avant de commencer la communication. Avec la mobilité de noeuds, il n'y a aucune

garantie que l'adresse du noeud demeure accessible avant que le paquet approche une destination, particulièrement en cas d'expédition opportuniste. C'est encore vrai avec l'utilisation des mécanismes comme le protocole dynamique de configuration des adresses (DHCP) qui font des discours d'IP même moins stables, car un noeud peut changer son adresse IP dû à être éteint ou être temporairement débranché même si il ne s'est pas physiquement déplacé.

Les propositions existantes qui visent séparer l'identification de noeuds avec leurs endroits peuvent être classifiées dans deux groupes: (1) les approches *clean-slate* se rapportent à proposer les mécanismes tout à fait nouveaux pour l'identification de noeuds, qui ne fonctionnent pas dans l'architecture actuel de l'Internet. Les exemples incluent Intentional Naming[79], EDIFY [55], and CCN [56]). (2) les approches *status-quo* proposent des mécanismes pour séparer l'identification et la localisation de noeuds dans l'architecture d'Internet tels que les décisions de routage sont encore prises en utilisant des adresses d'IP des noeuds. Les exemples notables sont LISP[82], layered Internet architecture [80], DONA [81], and HIP [84]. Dans cette thèse, nous nous concentrons sur l'approche de statut-quo, car l'objectif est de trouver une solution de nommage qui est réalisable dans le cadre de l'architecture actuel de l'Internet.

### 1.2.6 La classification des protocoles DTN

Depuis la matérialisation des réseaux DTNs [17], une quantité significative de travaux de recherches a été mise dans le domaine, visant la plupart du temps le routage ou les mécanismes de expédition dans DTNs. Malgré l'existence d'un grand nombre des protocoles *opportunistes* de DTN tels que "Epidemic" [7] ou "Spray-and-Wait" [29], il ya peu ou pas de consensus sur quelle protocole convient mieux à quel environnement. Une des raisons est l'existence de la grande diversité des applications sans fil et des réseaux montrant la connectivité *episodique*. Ces réseaux ont souvent des caractéristiques très différentes, qui rendent très difficile, si pas impossible, pour concevoir une solution de routage qui adapte tous.

## 1.3 Contributions

Les contributions de cette thèse sont présentées ci-dessous:

1. Nous passons en revue les protocoles existants de routage DTN et définissons les trois primitifs de base de routage: "*forwarding*", "*replication*" et "*coding*". Puis, nous plaçons chacun des protocoles existants de routage DTN en termes de ces primitifs. Nous visons le routage opportuniste dans les réseaux DTNs et fournissons une classification (taxonomie) des protocoles de routage proposés dans la littérature. Ceci est fait en définissant des catégories de différentes approches de routage et en plaçant des protocoles existants de routage dans chacune de ces catégories. Nous fournissons alors quelques directives de

conception basées sur notre analyse des protocoles existants de routage DTN qui aident des concepteurs de protocole de routage à choisir une catégorie particulière de routage basées sur l'environnement dans lequel le protocole doit fonctionner.

2. Nous développons un framework appelé MeDeHa pour livraison de message, qui permet l'inter-opération de différents réseaux hétérogènes comprenant les réseaux ad-hoc mobiles et infrastructure. Le framework MeDeHa se sert comme un pont pour les réseaux d'infrastructure et d'ad-hoc et permet également l'intégration des protocoles existants de routage MANET dans le framework. Il fournit également des mécanismes à la connectivité intermittente de noeuds en réseau. Les dispositifs qui se relient à différents réseaux par les interfaces multiples se profitent de cette hétérogénéité pour prolonger la livraison de message et pour transmettre par relais le trafic entre différents réseaux, alors que le support des déconnexions temporaires ou longévitaux. Nous implémentons le framework MeDeHa à l'aide du simulateur NS-3 aussi bien qu'avec Linux 2.6. Nous évaluons le framework de la livraison de message avec des simulations étendues en utilisant les scénarios réalistes aussi bien qu'employer de vraies traces de mobilité. En conclusion, nous exécutons également quelques expériences hybrides où une partie de l'expérience fonctionne sur de vraies machines et partie sur des noeuds de simulateur.
3. Nous proposons un mécanisme d'identification, appelé HeNNA, pour permettre la livraison de message dans les réseaux hétérogènes à connectivité intermittente même lorsque les noeuds changent leurs adresses de routage ou leurs points d'attachement en réseau. Le but est de concevoir un mécanisme de nommage qui sépare l'identification de noeuds avec l'endroit et qui est réalisable avec le routage actuel de l'Internet. C'est essentiel pour les environnements dans lesquels les noeuds possèdent les interfaces multiples ou lorsque les noeuds ont une mobilité élevée tels qu'ils continuent à changer leurs endroits (et adresses IP). Dans le mécanisme proposé, les applications se lient aux marques de noeuds au lieu de leurs endroits. Ceci permet aux noeuds de traverser plusieurs réseaux. L'architecture proposée complémente notre framework de la livraison de message et augmente son extensibilité et fonctionnalité. Par conséquent, nous implémentons ce mécanisme d'identification sur notre framework de la livraison de message et le validons employant quelques scénarios réalistes de simulation.

## 1.4 La liste de publications reliées à la thèse

Notre travaux dans cette thèse nous a permit de publier les papiers ci-dessous:

1. T. Spyropoulos, R.N.B. Rais, T. Turletti, K. Obraczka, and A. Vasilakos, *DTN Routing*:

- Taxonomy and Design*, to appear in *Delay Tolerant Networks: Protocols and Applications*, CRC Press, ISBN: 978-1-4398110-8-5, May 2011.
2. R.N.B. Rais, M. Abdelmoula, T. Turetletti, and K. Obraczka, *Naming for Heterogeneous Networks prone to Episodic Connectivity*, to appear in the IEEE WCNC Conference, Mexico, March 2011.
  3. R.N.B. Rais, M. Mendonca, T. Turetletti, and K. Obraczka, *Towards Truly Heterogeneous Networks: Bridging Infrastructure-based and Infrastructure-less Networks*, to appear in the IEEE/ACM 3rd International Conference on Communication Systems and Networks (COMSNETS), India, January 2011.
  4. R.N.B. Rais, T. Turetletti, and K. Obraczka, *Message Delivery in Heterogeneous Networks prone to Episodic Connectivity*, ACM/Springer Wireless Networks (WINET), under revision, 2010.
  5. T. Spyropoulos, R.N.B. Rais, T. Turetletti, K. Obraczka, and A. Vasilakos, *Routing for Disruption Tolerant Networks: Taxonomy and Design*, ACM/Springer Wireless Networks, Vol. 16, No. 8, pages 2349-2370, November 2010.
  6. M. Mendonca, R.N.B. Rais, T. Turetletti, and K. Obraczka, *Message Delivery in Heterogeneous Disruption-prone Networks*, demo presentation in ACM Mobicom, USA, September 2010.
  7. M. Mendonca, R.N.B. Rais, T. Turetletti, and K. Obraczka, *Message Delivery in Heterogeneous Disruption-prone Networks*, demo presentation in ACM S3 Workshop, USA, September 2010.
  8. R.N.B. Rais, T. Turetletti, and K. Obraczka, *MeDeHa - Efficient Message Delivery in Heterogeneous Networks with Intermittent Connectivity*, INRIA Research Report No. 7227, inria-00464085, March 2010.
  9. R.N.B. Rais, T. Turetletti, and K. Obraczka, *Coping with Episodic Connectivity in Heterogeneous Networks*, In Proceedings of the 11th International Symposium on Modeling, Analysis and Simulation of Wireless and Mobile Systems (MSWiM), pp. 211-219, Canada, 2008.

## 1.5 Aperçu de la thèse

L'organisation de cette thèse est la suivante. Dans le chapitre 2, nous présentons un background sur l'état de l'art impliquant les matières couvertes dans la thèse. Le chapitre 3 fournit une taxonomie des protocoles de routage DTN et présente un ensemble de directives à l'aide

en concevant un protocole de routage pour une application et environnement particulière. Le framework MeDeHa pour viser la livraison de message dans les réseaux hétérogènes est présenté dans le chapitre 4, alors que des détails sur l'exécution et son évaluation sont fournis dans le chapitre 5. Dans le chapitre 6, nous présentons un nouveau mécanisme de nommage (HeNNA) pour les réseaux hétérogènes qui considère la mobilité de noeuds et les débranchages temporaires du réseau. À la fin, nous récapitulons les résultats et les contributions principaux de cette thèse dans le chapitre 7 avec quelques directions pour la recherche du futur dans le domaine.

---

---





# 1

## INTRODUCTION

---

### 1.1 Problem Statement

Over the past few years, different types of networks and applications have evolved and the current Internet is highly heterogeneous not only in terms of the networks it comprises, but also the nodes it interconnects. Thus, it is envisioned that the future Internet will be even more heterogeneous. This heterogeneity exists at both node- (e.g., resources, battery, mobility characteristics) and network level (e.g., wired and wireless infrastructure-based and infrastructure-less mobile networks). Moreover, tendency of users to be connected “anytime, anywhere” gives birth to the *ubiquitous* networking where users want to take advantage of any available connection opportunity even when moving, including cellular based networks, Wifi etc. As connectivity cannot be guaranteed everywhere, it is desirable that the future Internet inherently supports disruptions in connectivity when nodes move and change their locations. Also, interconnection of these different networks presents several challenges as users may want to get a continuation of connectivity even using different network interfaces so as to maintain the communication session. Unfortunately, the current Internet architecture can only cope with very short-lived connectivity disruptions and the communication is delay-bound. Furthermore, it is not possible to maintain the communication session in the current architecture when the nodes move and change their locations (and eventually change their IP addresses).

Delay or Disruption Tolerant Networking (DTN) has been proposed to address the problem of frequent or long-lived connectivity disruptions. Several proposals have been presented which mainly target routing/forwarding mechanisms for DTNs, but there is no consensus on which approach suits which scenario or application. In this thesis, we first present a taxonomy of existing

DTN routing protocols to help DTN routing designers choose a particular routing/forwarding approach for a specific application in hand. Second, we address the problem of seamless message delivery in heterogeneous networks prone to intermittent connectivity, and propose a message delivery framework called MeDeHa (Message Delivery in Heterogeneous Disruption-prone Networks) for such environments. The MeDeHa framework allows mobile nodes to cope with connectivity disruptions and to take advantage of connectivity to different types of networks including infrastructure-based and infrastructure-less networks in order to enhance message delivery. The framework also seamlessly integrates existing MANET routing protocols without requiring any modifications. We present extensive evaluation of the MeDeHa framework using synthetic but realistic mobility models and real mobility traces, and by implementing the framework on Linux as a user-space daemon. Third, we propose a naming mechanism, named HeNNA (Heterogeneous Networks Naming Architecture), for heterogeneous networks prone to connectivity disruptions which allows mobile nodes to communicate with other nodes even when they change their locations. The mechanism separates node identification from their locations and allows message delivery in the current Internet architecture. We also show that HeNNA complements the MeDeHa framework by allowing the MeDeHa nodes to change their IP addresses dynamically.

## 1.2 Context

### 1.2.1 Background on the Internet Architecture

Since its emergence, the Internet has experienced tremendous growth. The original Internet architecture was developed to provide end-to-end communication between a set of nodes, while assuming static or rather fixed network routes between a pair of source and destination. However, the design of the original Internet architecture did not consider the scalability that the Internet has experienced. The primary purpose of the Internet was the ability to transfer data from one machine to another over a network, but the Internet has changed its role many times since then. For instance, at the start of the decade, peer-to-peer (P2P) traffic came into action and almost half the Internet traffic comprised P2P application contents. These days, most of the Internet traffic is oriented towards data services (Web services including audio and video) as presented in [1], where the authors found that more than 57% of the Internet traffic comprises HTTP (Web).

The Internet has faced a number of challenges as its growth occurred. Thanks to some very innovative proposals such as Domain Name System (DNS), Classless Inter Domain Routing (CIDR), Network Address Translation (NAT), and Dynamic Host Configuration Protocol (DHCP), the Internet has been living up to the expectations of the emerging applications and the increasing worldwide demand. Especially, the increase in use of wireless communications

has fundamentally questioned the architecture of the Internet, as it implicitly brings the node mobility which the network has to cope with. There are also some other problems that the wireless communication brings into the Internet. For instance, the original TCP's congestion control protocol inherently treats loss of packets as a sign of congestion, assuming that an intermediate router has dropped the packet due to buffer overflow. However, packet loss is the norm in wireless communication due to channel impairment or collisions. While coping with these challenges, the Internet has fundamentally changed since its birth. Besides, many different networks and applications have evolved with specific requirements and characteristics.

Furthermore, the current Internet architecture is based on the principle that a contemporaneous delay-bound end-to-end path exists between a pair of nodes for communication, which may not always be possible. This principle also rules out the integration of networks (or nodes) in the Internet where connectivity can be short-lived, and nodes communicate opportunistically rather than in a deterministic way (e.g., mobile wireless nodes), and where communication delays are very long (e.g., communication between satellites). This sporadic connectivity feature is an inherent characteristic of many recently emerged applications such as emergency response, underwater networks, habitat and environment monitoring, smart environments (e.g., smart offices, homes, museums, etc.), and vehicular networks, to name a few. Besides, regular mobile ad-hoc networks (MANET) are vulnerable to connectivity disruptions even though conventional MANET routing protocols (e.g., AODV [33], DSDV [34], OLSR [32]) are based on the strong assumption of a network with connected graph and on the presence of contemporaneous end-to-end path between all participating nodes for communication session to operate.

### 1.2.2 Universal Connectivity Requirement

The desire of ubiquitous networking which seemed quite futuristic a decade or so ago, is becoming more and more a reality. One of the critical enabling technologies for this “universal connectivity” is the emergence of an internetwork that interconnects different types of networks, ranging from wired, infrastructure-based wireless (e.g., cellular-based networks, wireless mesh networks) to infrastructure-less wireless networks (e.g., mobile ad hoc networks, or MANETs, vehicular networks, or VANETs<sup>1</sup>). This internetwork will likely include new networking paradigms such as disruption/delay tolerant networks (DTNs) and Pocket Switched Network (PSN) [47, 133] as its integral component. A glimpse of the network heterogeneity is shown in Fig. 1.1.

---

<sup>1</sup>While VANETs are generally used for safety purposes to prevent accidents, it is also desirable that vehicles on roads have an Internet connectivity while moving.

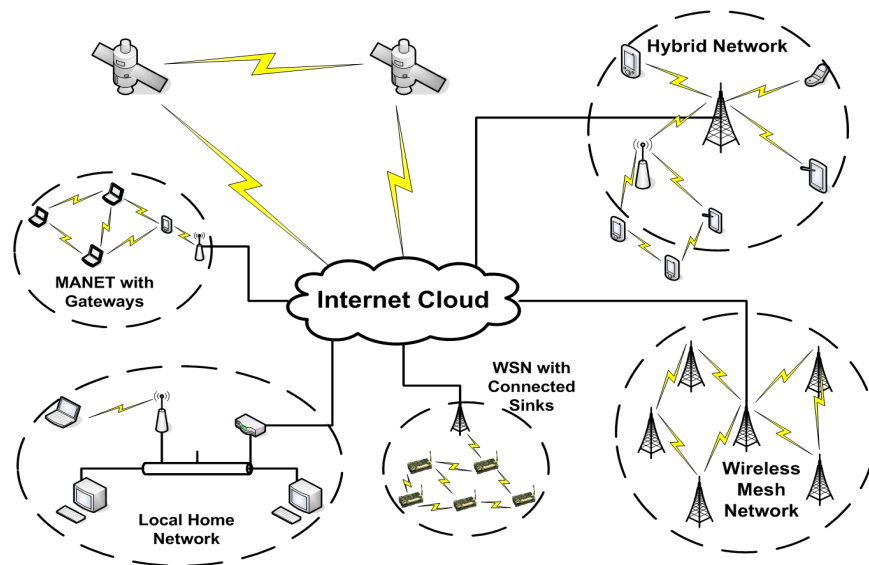

**Figure 1.1:** A glimpse of a heterogeneous internetwork with a wired backbone, wireless infrastructure-based, and ad-hoc networks

### 1.2.3 Nodes and Network Heterogeneity

Thanks to the advancement in technology, especially in wireless networks, diverse kinds of handhelds and mobile devices have come out in the past few years, including smart/cellular phones and PDAs. These days, the need to remain connected while moving has become a necessity rather than a desire. Most of the existing devices carry more than one interface (e.g., Wifi, 3G, EDGE, Bluetooth etc.), which they can use to connect to the Internet, or to other neighboring nodes. Thus, it is envisioned that the Internet of the future will be even more heterogeneous not only due to the wide variety of end devices (in terms of their capabilities, e.g., storage, processing time, battery lifetime, mobility, and traffic characteristics) it interconnects, but also in terms of the underlying networks (e.g., infrastructure-based, infrastructure-less, fixed, vehicular networks etc.) it comprises. The current Internet architecture is coping with these heterogeneity issues to some extent by involving different kinds of networks and supporting various end nodes, but inter-operation of these networks to make connectivity better, continuous and ubiquitous still remains an open issue.

Thus, heterogeneity needs to be handled at both network and node levels. The heterogeneity of networks should be considered because of different types of networks evolved in the past few years including infrastructure-based and infrastructure-less networks such as MANETs, vehicular networks, etc. On the other hand, the concept of ubiquitous connectivity changed the conventional routing and forwarding policies. In the new network model, nodes can carry data

for other nodes while moving from one place to another. Thus, the heterogeneity of devices such as buffering space, battery life, mobility pattern comes into consideration.

#### 1.2.4 Networks interconnection

Seamless interoperability among heterogeneous networks is a challenging problem as different networks may have very different characteristics. Also, node diversity may make routing difficult, as nodes must also take into account available resources at other nodes along with contact opportunities in order to make correct routing decisions (given that links are time-varying due the possibility of intermittent connectivity). For instance, in a buffer-constrained network where participating nodes may have different buffering capabilities, it is useless to forward a message to a neighboring node, if the latter is running out of buffer space.<sup>2</sup>

A few proposals have targeted message delivery in heterogeneous networks, but there are no comprehensive solutions available, to date. We can classify the existing solutions into four different categories.

- Extend MANETs to handle episodic connectivity. Examples include Island hopping [2], DTN-MANET Integration [3], Epidemic Routing [7], and Spray-and-Wait [29].
- Augment the coverage area of APs in infrastructure-based wireless networks to extend connectivity, for example, making use of multi-channel radios or switching between different modes of IEEE 802.11 (WIANI [8], MMWLAN [9], Flex-Wifi [10], Multinet [11]).
- Provide MANETs with backbone (Internet) connectivity with the help of special purpose gateway nodes, and proposing mechanisms to discover these gateways (e.g., AODV+ [14]).

#### 1.2.5 Node Identification and Mobility Problem

In the Internet communication model, IP addresses of nodes generally change with mobility and their points of attachment to the network. This makes the communication sessions to be reset as these sessions are bound to specific hosts and specific locations identified by the IP addresses. Moreover, transport and application protocols typically rely on IP addresses to define communication endpoints. This communication model is not suitable for the scenarios where nodes are mobile and frequently change their locations. Therefore, it is required that the future communication architectures should consider the distinction between node identification and their locations. There is a long known debate of separating node identification from their locations [94], and significant amount of work has been done to realize this [84, 80, 82].

---

<sup>2</sup>Though today's devices may have large storage space thanks to the cheap memories availability, buffer constraints and issues still need to be considered because nodes may not be willing to contribute whole of their available buffer space.

Besides, in a heterogeneous network environment where mobile devices may use multiple interfaces for network connectivity, it becomes unfeasible for applications to use IP address for communication with peer devices. This is due to the fact that the current communication model requires the nodes to acquire IP address of a peer node before starting the communication. With nodes mobility, there is no guarantee that the IP address of a peer node remains reachable by the time the packet approaches a destination, especially in case of opportunistic forwarding. This is even more true with the use of mechanisms like Dynamic Host Configuration Protocol (DHCP) which make IP addresses even less stable, as a node may change its IP address due to being turned off or temporarily disconnected even if it has not physically moved.

The existing proposals that target separating node identification from locations can be classified into two groups: (1) *clean-slate approaches* refer to proposing altogether new mechanisms for node identification, which do not work in the current Internet architecture. Examples include Intentional Naming[79], EDIFY [55], and CCN [56]). (2) *status-quo approaches* propose mechanisms to separate node identification and location within the Internet architecture such that the routing/forwarding decisions are still made using IP addresses of nodes. Notable examples are LISP[82], layered Internet architecture [80], DONA [81], and HIP [84]. These mechanisms propose patches to the current Internet architecture. In this thesis, we focus on the status-quo approach, as the objective is to find a naming solution that is workable within the framework of the current Internet architecture.

### 1.2.6 DTN Routing Protocols

Since the materialization of the delay or disruption tolerance networks (DTNs) [17], a significant amount of research effort has been put in the domain, mostly targeting routing or forwarding mechanisms in DTNs. Despite the existence of a large number of *opportunistic* DTN routing protocols such as Epidemic [7] or Spray-and-Wait [29], there is little or no consensus on which routing protocol is suitable for which environment. One of the reasons is the large diversity of evolving wireless applications and networks exhibiting *episodic* connectivity. These networks often have very different characteristics and requirements, making it very difficult, if not impossible, to design a routing/forwarding solution that fits all.

## 1.3 Summary of Motivations

In the light of the context presented in the previous section, we summarize the main motivations behind the work presented in this thesis as:

1. Classification of existing DTN routing protocols and presentation of a set of guidelines for DTN routing designers.

2. Seamless inter-operation of heterogeneous networks (including infrastructure-based and infrastructure-less networks) in the face of connectivity disruptions.
3. Decoupling node identification from their locations in heterogeneous networks prone to episodic connectivity.

## 1.4 Contributions

The contributions of this thesis are three fold.

1. We review the existing DTN routing protocols and define basic routing primitives: *forwarding*, *replication* and *coding*. Then, we place each of the existing DTN routing protocols in terms of these routing primitives. We target opportunistic routing in disruption tolerant networks (DTN) and provide a classification (taxonomy) of the routing protocols proposed in the literature. This is done by defining categories of different routing approaches and placing existing routing protocols in each of these categories. We then provide some design guidelines based on our analysis of the existing DTN routing protocols that help routing protocol designers choose a particular category of routing policies based on the environment in which the protocol needs to function.
2. We develop a message delivery framework called MeDeHa, which allows seamless inter-operation of different heterogeneous networks including infrastructure-based and multi-hop mobile ad-hoc networks. The MeDeHa framework bridges infrastructure-based and infrastructure-less networks and also allows the integration of existing MANET routing protocols within the framework. It also provides mechanisms to support nodes intermittent connectivity with the network. Devices that connect to different networks through multiple interfaces take advantage of this heterogeneity to extend the message delivery and relay the traffic between different networks, while supporting temporary or long-lived disconnections of nodes and long communication delays. We implement the MeDeHa framework using the NS-3 simulator as well as on a real testbed using Linux 2.6 kernel. We evaluate the message delivery framework with extensive simulations using realistic scenarios as well as using real mobility traces. Finally, we also perform some hybrid experiments where part of the experiment runs on real machines and part on simulator nodes.
3. We propose a naming mechanism, named HeNNA, to allow message delivery in disruption-prone heterogeneous networks even when nodes change their routing addresses or their points of attachment to the network. The purpose is to design a naming mechanism that



separates node identification from location and that is workable with the status-quo Internet routing. This is essential for the environments in which nodes possess multiple interfaces or where nodes have high mobility such that they keep on changing their locations (and IP addresses). In the proposed mechanism, applications bind themselves to node identifiers instead of their locations. This allows seamless roaming of nodes across several networks. The proposed naming architecture complements our message delivery framework and enhances its scalability and functionality. Hence, we implement this naming scheme on top of our message delivery framework and validate it using some realistic simulation scenarios.

We briefly describe each of these contributions in the following.

#### 1.4.1 DTN Routing Taxonomy

We present a classification of existing opportunistic DTN routing protocols by breaking up existing routing strategies into a small number of common and tunable *routing modules* (e.g. message forwarding, replication, coding, etc.), and then show how and when a given *routing module* should be used, depending on the set of *network characteristics* exhibited by the wireless application and environment. We further attempt to create a taxonomy for intermittently connected networks. We try to identify generic *network characteristics* that are relevant to the routing process (e.g., network density, node heterogeneity, mobility patterns) and dissect different *challenged* wireless networks or applications based on these characteristics. The main goal is to identify a set of useful *design guidelines* that will enable one to choose an appropriate routing protocol for the application or network in hand. Details on this classification are presented in Chapter 3.

#### 1.4.2 The Message Delivery Framework

We call our message delivery framework MeDeHa which incorporates node and network heterogeneity and tries to make use of it whenever possible. The framework offers the following advantages:

- Bridging infrastructure-based and infrastructure-less networks.
- Seamless message delivery across heterogeneous networks.
- Ability to work with existing MANET routing protocols without modifying them.
- Ability to work with existing DTN routing mechanisms.
- Partition mending through multi-hop ad-hoc (MANET) “transit networks”.

- Flexibility to operate at different layers of the protocol stack.

The framework design is based on the principle that in order to join two networks, there must be a node that understands the traffic on both networks and acts as a gateway to pass the traffic. In MeDeHa, any node can serve as the gateway node, as long as it has multiple interfaces (e.g., Wifi and 3G on a cellular/smart phone) or it is able to connect to multiple networks simultaneously with a single interface card by, for example, switching frequencies to connect to different networks [11].

A notification protocol has been designed for the MeDeHa framework which plays a key role in seamless message delivery across multiple heterogeneous interconnected networks (including infrastructure-based and infrastructure-less networks). This notification protocol enables the integration of existing MANET routing protocols in the framework. The protocol performs this functionality through neighborhood information exchange across all networks including infrastructure-based and infrastructure-less networks. Using the information obtained from neighborhood information exchange, the nodes are able to build their routing and contact tables. The routing tables are used for nodes that are directly accessible, while the contact tables are used to manage heuristics about nodes (e.g., number of encounters) that are used in relay node selection.

We implemented the MeDeHa framework on NS-3, and conducted extensive simulations using a number of scenarios with synthetic but realistic mobility models and real mobility traces. Furthermore, we implemented the framework as a user-space daemon in Linux and conducted experiments on a real testbed. We then performed some hybrid experiments, in which part of the experiment ran on NS-3 simulator and part of the experiment executed on real machines. These hybrid experiments involved the inter-communication of real machines and simulator nodes, which implicitly validates the simulation implementation. The design of the MeDeHa framework is provided in Chapter 4, whereas the framework's evaluation is presented in Chapter 5.

### 1.4.3 The Naming Architecture

A heterogeneous network comprises nodes that carry devices with multiple interfaces (e.g., a smart phone with Wifi and 3G interface). Hence, while providing message delivery in an environment where nodes are able to connect simultaneously to multiple networks, identification of nodes becomes a challenge, as the sender cannot send a message destined to a particular IP address of a destination. This is especially true in an environment where nodes are highly mobile and remain disconnected for long periods of time; hence, they keep on changing their points of attachment to the networks and eventually their IP addresses. This means that a naming mechanism is indispensable for such networks so that the sender of a message use the

destination identifier to send messages, and the network locates the destination and delivers the message at any interface the destination is using. For this purpose, we propose the HeNNA naming for heterogeneous disruption-prone networks, which allows participating nodes to own a globally unique identifier (GUID), and applications use the GUID to communicate with peer applications.

HeNNA complements the MeDeHa framework and enables the MeDeHa-capable nodes to exchange messages with other nodes in the Internet. For this purpose, we showcased the HeNNA's functionality with the MeDeHa framework. We implemented HeNNA on NS-3 with an extended version of MeDeHa such that the MeDeHa nodes use the GUIDs of peer nodes to communicate instead of their IP addresses. We conducted experiments using some realistic scenarios, and show the effectiveness of HeNNA in practice for delivering messages to mobile nodes despite the change of their IP addresses and the change in their points of attachment to the network. Chapter 6 provides more details on this naming architecture.

## 1.5 Publications Related to Thesis

The work presented in this thesis has resulted in the following publications in international journals and conferences:

1. T. Spyropoulos, R.N.B. Rais, T. Turletti, K. Obraczka, and A. Vasilakos, *DTN Routing: Taxonomy and Design*, to appear in *Delay Tolerant Networks: Protocols and Applications*, CRC Press, ISBN: 978-1-4398110-8-5, May 2011.
2. R.N.B. Rais, M. Abdelmoula, T. Turletti, and K. Obraczka, *Naming for Heterogeneous Networks prone to Episodic Connectivity*, to appear in the IEEE WCNC Conference, Mexico, March 2011.
3. R.N.B. Rais, M. Mendonca, T. Turletti, and K. Obraczka, *Towards Truly Heterogeneous Networks: Bridging Infrastructure-based and Infrastructure-less Networks*, to appear in the IEEE/ACM 3rd International Conference on Communication Systems and Networks (COMSNETS), India, January 2011.
4. R.N.B. Rais, T. Turletti, and K. Obraczka, *Message Delivery in Heterogeneous Networks prone to Episodic Connectivity*, ACM/Springer Wireless Networks (WINET), under revision, 2010.
5. T. Spyropoulos, R.N.B. Rais, T. Turletti, K. Obraczka, and A. Vasilakos, *Routing for Disruption Tolerant Networks: Taxonomy and Design*, ACM/Springer Wireless Networks, Vol. 16, No. 8, pages 2349-2370, November 2010.

6. M. Mendonca, R.N.B. Rais, T. Turletti, and K. Obraczka, *Message Delivery in Heterogeneous Disruption-prone Networks*, demo presentation in ACM Mobicom, USA, September 2010.
7. M. Mendonca, R.N.B. Rais, T. Turletti, and K. Obraczka, *Message Delivery in Heterogeneous Disruption-prone Networks*, demo presentation in ACM S3 Workshop, USA, September 2010.
8. R.N.B. Rais, T. Turletti, and K. Obraczka, *MeDeHa - Efficient Message Delivery in Heterogeneous Networks with Intermittent Connectivity*, INRIA Research Report No. 7227, inria-00464085, March 2010.
9. R.N.B. Rais, T. Turletti, and K. Obraczka, *Coping with Episodic Connectivity in Heterogeneous Networks*, In Proceedings of the 11th International Symposium on Modeling, Analysis and Simulation of Wireless and Mobile Systems (MSWiM), pp. 211-219, Canada, 2008.

## 1.6 Outline of the Thesis

This thesis is organized as follows. In Chapter 2, we present some background of the related work involving the topics covered in the thesis. Chapter 3 provides a taxonomy of DTN routing protocols and presents a set of guidelines to help in designing a routing protocol for a particular environment application. The MeDeHa framework to target message delivery in heterogeneous networks is presented in Chapter 4, while details on MeDeHa's implementation and its evaluation are provided in Chapter 5. In Chapter 6, we present a new naming mechanism (HeNNA) for heterogeneous networks that considers nodes mobility and temporary disconnections from the network. At the end, we summarize the main findings and contributions of this thesis in Chapter 7 along with some future directions.

---

---



## 2

# COMMUNICATION IN HETEROGENEOUS NETWORKS: A BACKGROUND

---

---

Thanks to the evolution of the communication technology, the Internet has experienced incredible growth in the past few years, yet it has been living up to the expectations and the requirements of emerging applications most of the time. The initial idea of the Internet was to provide a communication model for end-to-end connectivity between two endpoint nodes assuming primarily a static network between these nodes. Though, it remains the premier service offered by the today's Internet architecture, the Internet has been evolved enough to cope with some new applications (e.g., peer-to-peer, multi-casting, social network applications) and networks (e.g., vehicular networks, sensor networks). Especially, the introduction of the wireless networks (most specifically mobile) challenged the existing Internet architecture because of the existence of unpredictable and ever changing connection opportunities. Also, in mobile wireless networks, nodes are assumed to provide the routing facilities to the packets which is in contrast to the traditional viewpoint of the Internet architecture, where dedicated machines (nodes) are generally used to serve as routers. While it is acceptable to assume that a path between two endpoint nodes remain persistent during a communication session in case of the traditional Internet backbone, it becomes a very strong assumption if the network involves mobile nodes. This is especially true when the infrastructure network is absent (e.g., MANETs) as there is no guarantee that a contemporaneous path exists between two nodes all the time. MANET routing protocols are generally based on this strong assumption.

These days, users can connect to infrastructure-based networks using portable devices even when moving from one place to another. One of the critical enabling technologies of this *ubiquitous* connectivity is the realization of an internet that attempts to bridge together different

types of networks ranging from infrastructure-based wired and wireless to infrastructure-less networks. This *ubiquitous* connectivity requirement and interconnection of networks of diverse characteristics introduce several challenges such as seamless message delivery, network scalability, continuous connectivity, session persistence identification of nodes and security, to name a few. Moreover, other challenges include heterogeneity of nodes and networks, and nodes temporary or long-lived disconnection from the infrastructure-based network and from each other. In this thesis, we target three main challenges related to the ubiquitous connectivity and inter-operation of heterogeneous nodes and networks, which we describe in the following:

1. **Heterogeneity:** The term *heterogeneity* needs to be carefully defined as it has been used by the research community for different purposes. In the thesis, the term *heterogeneous networks* refers to the heterogeneity both at the network and at the node level. Heterogeneity of networks means that different types of networks with diverse characteristics co-exist in the internetwork and we are interested in their inter-operation to provide *ubiquitous* connectivity, which is an important issue to be considered. For instance, communicating nodes may be member of different types of infrastructure-based and infrastructure-less networks. By heterogeneity of nodes, we mean that the participating nodes can have different and distinct capabilities in terms of their resources (e.g., processing power, memory, battery life) and other characteristics such as mobility or connectivity pattern. Thus the participation of each node to provide connectivity is not homogeneous and depends upon its resources and characteristics. What is more, the participating nodes can use multiple interfaces to connect to the network simultaneously, either to balance the network load or to increase the chances of message delivery. We discuss these issues related to nodes heterogeneity in detail in Chapter 3.
2. **Disconnection:** Another issue to be considered is the nodes temporary or long-lived disconnection from the network. The Internet is not originally designed to handle long-lived disconnections, and even temporary disconnections may break the existing communication sessions. However, this case can often occur especially when the participating nodes are mobile and use wireless connectivity. Besides, it is also important that the network includes the support of storing messages for unavailable (disconnected) destinations, and nodes also carry messages for these unavailable destinations.

Note that we can differentiate between *disconnection* and *disruption* in connectivity [4]. The *disconnection* in connectivity means that the user intentionally leaves the network or shuts down the mobile device she is using, while the *disruption* in connectivity refers to the unintentional loss of connectivity (for instance due to change in network neighborhood, or when the battery of a mobile device is drained). In the thesis, we use the two terms interchangeably and we do not generally distinguish between the them.

3. **Node Identification:** Unique identification of participating nodes is crucial especially when the nodes are multi-homed and mobile. Identifying nodes using their IP addresses may cause the termination of communication sessions as nodes change their points of attachment to the network. In case of multi-homing, nodes can have more than one IP address representing each of their interfaces; thus, using one of the node's IP addresses to communicate, limits the communication to the availability of that particular interface. In case of mobility, solutions like MobileIP [77, 78] only provide partial support for change in IP addresses, and require proper configuration, maintenance and management of the IP addresses of different entities such as *home* and *foreign agents*. Moreover, MobileIP suffers from the problem of address spoofing or ingress filtering in which packets coming from a local mobile node are discarded by the border router as the source address of the packet does not belong to the subnet to which the router belongs. On the other hand, some networks may not allow a *home agent* to intercept packets on behalf of the mobile nodes (by replying to ARP requests). What is more, each node should be assigned a globally routeable permanent address in MobileIP, which is clearly unfeasible for the IPv4 address space.

In the following sections, we describe some existing proposals that have been presented to target each of these challenges.

## 2.1 Heterogeneity

There have been a number of attempts to target heterogeneity partially, each directing towards a specific aspect of network heterogeneity. We present a summary of the existing solutions for heterogeneous networks in the following subsections.

### 2.1.1 Inter-operation of infrastructure-based and ad-hoc networks

In the context of IEEE 802.11 networks, there exists a number of proposals that try to make infrastructure-based and ad-hoc networks inter-operate either by using multiple interface cards or different frequency channels of a single interface card. The aim is either (1) to extend the coverage area (connectivity region) of the infrastructure-based networks (as in Flex-Wifi [10] and WIANI [8]), (2) to increase the network capacity by performing load-balancing between stations and APs such that stations may exchange their messages directly (as in MMWLAN [9], IEEE 802.11e [12], and NUMI [13]), or (3) to use single wireless interface card to connect to multiple networks using infrastructure-based and ad-hoc modes of IEEE 802.11 [11].

Flex-Wifi [10] is aimed at enhancing the coverage area of IEEE 802.11 infrastructure-based networks and augmenting the network capacity by allowing nodes to communicate directly using ad-hoc mode. The study proposes modifications to IEEE 802.11e Direct Link Session (DLS)



mechanism [12]. By default, the DLS mechanism allows the participating stations to exchange messages directly without traversing through the AP. Flex-Wifi modifies the DLS mechanism by using a different wireless channel for direct communication of stations and by making stations work in ad-hoc mode. The stations use the Power Saving Mode (PSM) functionality of IEEE 802.11 standard while switching modes in order to remain connected to both infrastructure-based and ad-hoc networks.

Wireless Infrastructure and Ad-hoc Network Integration (WIANI) [8] proposes a hybrid communication mechanism between infrastructure and ad-hoc modes of IEEE 802.11 based networks. In WIANI, only the APs communicate with each other in the infrastructure mode over the backbone network, while all other communication is performed using the ad-hoc mode, including the communication even between APs and stations. Thus, the stations can have access to the APs (and ultimately to the backbone) through relaying, even when they are outside the coverage range of the APs. The main goal of this study is to enhance network range beyond the connectivity areas of APs.

In Mixed-Mode Wireless LAN (MMWLAN) [9], the stations communicate with the APs in the infrastructure mode and may communicate with each other in the ad-hoc mode, but only under the supervision and direction of the APs. The purpose is to offer some load-balancing to the APs, as well as to improve network capacity by allowing connected nodes to communicate with each other directly, thereby reducing the traffic burden at the APs. While this proposal offers load-balancing to some extent, it does not provide network extension as the participating stations have to be present within the coverage area of the APs. On the other hand, NUMI [13] has been proposed to target data management in heterogeneous networks to improve the efficiency of the network.

Multinet [11] is a software-based solution that facilitates seamless simultaneous connectivity to both infrastructure-based and ad-hoc networks using single interface wireless card. This is done by introducing an intermediate layer between IP and MAC layers of the communication stack. Again, the switching between different modes is performed using the Power Saving Mode (PSM) of IEEE 802.11 standard. This solution requires changes to the data link layer or to the interface driver in the kernel.

### 2.1.2 Networks with Gateway Connectivity

While the absence of infrastructure enables MANETs to be deployed on-the-fly without requiring any centralized configuration, it becomes almost unfeasible for the participating nodes to enjoy any backbone (e.g., the Internet) connectivity. Hence, some efforts have been made to provide backbone connectivity to MANETs. A notable study is AODV+ [14], which is an extension to the Adaptive On-demand Distance Vector (AODV) protocol and proposes a scheme for the backbone connectivity to MANETs by introducing gateway discovering mechanisms in the

AODV protocol. Thus, there are one or more gateways in the network and nodes communicate with these gateways in order to access the backbone network. The authors have proposed three methods of discovering gateways: reactive discovery, proactive discovery and hybrid discovery.

Besides, some other MANET routing protocols, such as the Optimized Link State Routing (OLSR) [32] protocol, provide implicit support for the gateway discovery. In OLSR, the nodes that have connectivity to other networks (including the backbone) may broadcast the Host and Network Association (HNA) control messages in order to announce the networks that are reachable through them. In this way, the participating nodes can reach other networks by contacting the nodes that advertise these HNA announcements. Besides, the Dynamic MANET On-demand (DYMO) routing protocol [35] allows gateways in the network but requires that each node in the MANET belongs to a common subnet.

## 2.2 Disconnection

Many recent emerging applications such as Interplanetary networks, habitat or ecological monitoring, and underwater networks require that the network is tolerant to frequent and long-lived disruptions in connectivity. Even MANETs can be vulnerable to frequent connectivity disruptions due to node mobility and wireless impairments. This has not been under consideration in the era when wireless networks rarely existed and the communication was mostly performed using fixed wired networks infrastructure. The requirement to tolerate long-lived delays or disruptions gave birth to a new type of network, a.k.a. Delay or Disruption Tolerant Networks (DTN) [98]. In the following subsections, we describe DTN networks and their variants that have been proposed in the literature, while Chapter 3 details the state-of-the-art related to the DTN routing protocols.

### 2.2.1 Delay/Disruption Tolerant Networks (DTNs)

Routing or forwarding in DTNs does not assume an end-to-end path between two communicating nodes. These networks also incorporate long communication delays for sending a message from a source (e.g., a node at Earth) to a destination (e.g., another node at Mars). Hence, protocols like TCP do not work (or under-perform) on such networks. These types of networks are first proposed for Interplanetary communication [92], which later applied to other networks such as mobile ad-hoc networks.

The DTN Bundle Architecture [17] employs the *store-carry-and-forward* paradigm which is a diversion from the conventional *store-and-forward* Internet architecture. This architecture (and protocol suite) is intended for networks that are tolerant to disruptions and in which intermittent connectivity is a norm rather than the exception. The DTN Bundle Protocol is mainly suited for asynchronous applications where the source and the destination do not need to have

an end-to-end path for communication and the *bundles* are forwarded by taking advantage of the hop-by-hop *contacts* that nodes experience. Also, it is applicable to scenarios and applications that are subject to long delays. The Bundle Protocol [16] is intended to be compatible with different types of networks through the *convergence layer adapters*. In this way, the protocol supports internetworking by allowing multiple *convergence layers* to be used for different networks. Moreover, the protocol is generally considered to be running on top of different transport layers.

A *bundle* is a higher layer data unit and is comprised of a number of concatenated blocks. The peer applications register with the *bundle agents* and pass the data to the *bundle agents* which then form *bundles* and transmit them on behalf of the applications. The *bundle agents* forward the bundles to other bundle agents using the hop-by-hop reliable *custody transfer* [16]. Note that the *bundle agents* are considered as the endpoints which act as gateways for different networks and these endpoints may form an overlay over different networks. The Bundle protocol uses Endpoint Identifiers (EIDs) as routing identifier for bundle forwarding. These EIDs are mapped to local network routing addresses (e.g., IP address) via *late-binding*. Forwarding in the Bundle Protocol is based on *late-binding* of all identifiers and the DTN architecture does not differentiate between host and content identifiers. Moreover, the *custody transfer* is the only reliability mechanism present so far in the DTN Bundle Architecture, and the end-to-end reliability and error control mechanisms are not supported [18]. What is more, a consensus on using same format of EIDs is required but the DTN Research Group (DTNRG) has not yet agreed upon this.

DTN Bundle Architecture still has some unresolved issues and design considerations. In [18], the author discussed some issues with the architecture and suggested some guidelines to cope with them, while in [4], the author presented a few issues with the architecture along with its position in the future Internet.

A notable amount of research effort has been put to address the efficient forwarding problems in DTNs. Mainly, there are three forwarding variants in DTNs, which we described below:

### 2.2.1.1 Deterministic or Scheduled Forwarding

*Deterministic* or *scheduled* forwarding algorithms can be employed in the presence of little or complete information about the location or mobility of the destination nodes. One of the most significant examples of *deterministic* forwarding is the Interplanetary networks [92], which is aimed to offer communication between different planets. Generally, the encounter time and duration between two planets can easily be estimated as we have the information about their orbits and speed. The same principle can also be applied for routing in urban bus networks [114]. A few algorithms for *deterministic* DTN forwarding are presented in [97]. The performance of *deterministic* forwarding mechanisms can significantly suffer if the schedule of

contacts is changed or disturbed. For instance, a traffic jam may prevent two buses to encounter each other in an urban transport network.

### 2.2.1.2 Enforced Forwarding

In *Enforced* forwarding algorithms, special-purpose nodes are employed in the network to increase connection opportunities, which are either fixed or follow specific paths. For example, a bus can be used to carry traffic from one village to another and vice versa while these villages may not be connected otherwise [43]. These special purpose nodes can either be mobile or are fixed at specific places. Examples of *enforced* DTN routing/forwarding algorithms using mobile nodes include Message Ferries [19] and Data Mules [20], while Throwbox [21] is an example of using static special-purpose nodes for *enforced* forwarding. Placement of static nodes in the network to maximize efficiency, planning of routes for mobile ferries, and number of special purpose nodes in the network are among the main challenges with *enforced* forwarding algorithms.

### 2.2.1.3 Opportunistic Forwarding

*Opportunistic* DTN forwarding refers to the case when no information about node encounters is present and these encounters are not deterministic. Moreover, message forwarding is not aided by special-purpose nodes. This is the most challenging DTN environment as no information about nodes location or mobility is known a priori and forwarding decisions are either made in an epidemic manner [7], or are based on the context information that the nodes learn with the passage of time (e.g., encounter-based routing [48]). In this thesis, we consider only the case of *opportunistic* forwarding when handling disconnections or disruptions of nodes.

## 2.2.2 MANETs with Disconnections

As described earlier, depending upon the density of nodes, MANETs are vulnerable to frequent connectivity disruptions. These disruptions are not handled by the conventional MANET routing protocols, as they require a contemporaneous end-to-end path between a pair of source and destination before any message could be sent. The efficiency of MANET routing protocols can be improved by taking advantage of the *opportunistic* contacts between nodes, and the *context information* that nodes compute and exchange about other nodes. Efforts have been made to cope with connectivity disruptions in MANETs. Context-Aware Routing (CAR) [15] algorithm is one of the premier solutions to handle disruptions in MANETs, which uses DSDV [34] as the MANET protocol. In CAR, all nodes implement the CAR algorithm along with DSDV protocol and exchange both DSDV control information and CAR context information. A more efficient scheme to handle connectivity disruptions in MANETs has been proposed in [3], which employs AODV [33] as the MANET routing protocol. The main advantage of this scheme is that

the disruption tolerance capability does not need to be implemented at each node; rather, this functionality is performed by special-purpose DTN-capable endpoint nodes.

What is more, Island Hopping [2] is based on the heterogeneous mobility patterns of the nodes to form Concentration Points (CP). Thus within a CP, messages may be forwarded either directly or via multiple hops using any routing protocol, while messages are forwarded between disconnected CPs using the mobility of the nodes that move between those CPs. SCA<sub>TR</sub> [37] is another attempt to combine on-demand multi-hop routing with opportunistic forwarding. Nodes in SCA<sub>TR</sub> attempt to deliver messages using the AODV routing protocol and if a destination is not found, they try to find a suitable *proxy* within their cluster that may carry messages to the destination. A recent similar approach to integrate DTN and MANET routing is HY<sub>MAD</sub> [38], which periodically scans the network to identify disjoint groups of nodes and topological changes; thus, a conventional MANET routing is used within each disjoint group while a DTN protocol is employed to enable communication between disjoint groups.

A different approach to use DTN and MANET networks together is presented in Pre<sub>DA</sub> [39], which uses the underlying MANET routing protocol control messages to exchange DTN control information between DTN endpoint nodes that may be multiple hops away. In other words, Pre<sub>DA</sub> provides support for DTN overlay routing control over multi-hop ad-hoc networks. The authors used AODV as the default MANET routing protocol in Pre<sub>DA</sub>.

## 2.3 Node Identification

These days, devices do not usually own permanent IP address and they are assigned a dynamic IP address by a DHCP server (e.g., nodes in a local network behind a firewall, nodes connected to a cellular-based network, nodes using a dial-up connection). Thus, it is not feasible to use devices' IP addresses for communication especially in an environment where nodes are mobile and disconnections are norm rather than the exception. Solutions like MobileIP [77] and HIP [84] cope with change in IP addresses of mobile nodes but they do not work well when mobile nodes are mostly disconnected or only opportunistically connected [41], and solutions like MobileIP still require that each mobile node must have a permanent IP address.

Besides, a significant amount of work has been proposed to separate location of nodes from their identification, and this is a long known problem [94]. In the Internet architecture, applications are supposed to be bound to specific hosts at specific locations, at least for the duration of the session<sup>1</sup>. Thus, the applications use IP addresses of the peer nodes to communicate with them. This is an architectural flaw of the Internet because it makes the applications dependent upon the physical location of the node hosting the content, and eventually upon an IP address of one of the node's interfaces. In contrast, an application should only be concerned about

---

<sup>1</sup>Of course, before the start of a session, an application can learn the current IP address of the endpoint hosting the content using, for example, a DNS lookup against the hostname of the content.

the data content and not the identifier of the endpoint who currently holds the content, and also not on the location of that endpoint. Consequently, the transport layer should only be concerned about the endpoint node and not on its current location (IP address) [80].

While both node and content identification are important for communication in a mobile intermittently connected network, we only consider the problem of node identification in this thesis. However, an analysis of the existing naming schemes is presented in Chapter 6.

## 2.4 New Communication Architectures

A number of new communication architectures for challenged networks have been proposed in relevance to the three challenges mentioned above, heterogeneity, disconnection and node identification. In this section, we provide an overview of some of these architectures.

### 2.4.1 Content Centric Naming (CCN)

The recently proposed Content Centric Naming (CCN) Architecture [56] is built around naming data instead of naming hosts. In CCN, the routing is performed based on the content and not on where the content resides, i.e., the CCN packets name the content and not the hosts. The architecture is based on the client/server communication model in which the host that needs a particular content has to request for the content by sending an *interest* packet, which followed by a *data* packet containing the requested content from a host that has possession of the content. CCN can take advantage of multiple simultaneous connections through different interfaces by broadcasting an *interest* to all available interfaces. Each CCN node keeps three data structures, the forwarding information base (FIB), the content store, and the pending interest table (PIT). The lookup for a content is performed in the following order: (1) Content Store, (2) PIT, (3) FIB.

One important feature of CCN is that only *interest* packets are routed. The *data* packets follow the path taken by the corresponding *interest* packets to reach the holder of the content. For a network where the routes are persistent and do not change very frequently, this works fine. Though, this feature may present a few problems when the environment is highly mobile and nodes change their location frequently. In this case, a node may have to send a number of *interest* packets before it gets the *data* packet because it may have changed its location or neighborhood due to mobility during the time while the node was waiting for the requested content<sup>2</sup>. Moreover, the architecture is based on the assumption that all nodes are willing to cooperate and offer buffer space for holding all the content. In this way, it is assumed that a copy of a data content is stored at a node through which a *data* packet passes. While this

---

<sup>2</sup>This assumes that the time spent at a given location is smaller than the time required to download the content. Also note that a node itself may not change its location but its neighborhood may have changed due to mobility.

increases the content availability and reachability, it raises some privacy concerns and also it may have scalability issues if a lot of data is requested.

### 2.4.2 Pocket Switched Networks (PSN)

Pocket Switched Networks (PSN) [133] have been proposed to take advantage of connection opportunities that mobile users experience. The Huggle architecture [47] presents a *clean-slate* design for nodes communication in the PSN. The architecture enables nodes to benefit from different data transfer opportunities including infrastructure-based connectivity and nodes mobility. It decouples node identification with location and allows the integration of different naming schemes based on the environment. However, the Huggle architecture does not discuss multi-hop communication in infrastructure-less networks, and the inter-operation of different networks.

### 2.4.3 Data Oriented Network Architecture (DONA)

Data Oriented Network Architecture (DONA) [81] is another architecture that proposed a service-oriented communication architecture as opposed to the current host-oriented Internet architecture. DONA proposes a different naming and resolution mechanism than what the Internet currently offers. The resolution process is handled by a hierarchy of resolution handlers (RHs) and it is based on the *FIND* and *REGISTER* primitives. However, the architecture does not provide a comprehensive solution in case of nodes intermittent connectivity. It also requires a lot of management and configuration at the RH level. In case of continuous (or frequent) nodes mobility, DONA does not have a good performance as nodes have to wait till the expiry of the their previous *REGISTER* primitives before registering their new locations.

### 2.4.4 A Layered Architecture for the Internet

Balakrishnan et al. [80] proposed a novel naming architecture for the Internet that is based on a hierarchical resolution of names. The architecture differentiates between content and host identifiers from their locations (i.e., IP addresses) by providing a series of name resolution, i.e., from a user-level descriptor (ULD) to a session identifier (SID), from a SID to an endpoint identifier (EID), and from an EID to an IP address. The resolution from the ULD to SID is supposed to be performed by lookup operation at a centralized server, whereas the application layer performs the resolution from the SID to EID. Consequently, the transport layer resolves the EID to an IP address. The basic assumption of this architecture is that a node always has access to all resolution handlers, but again this may not be true for DTNs and MANETs.

### 2.4.5 Persistent Connectivity Management Protocol (PCMP)

Persistent Connectivity Management Protocol [5] is designed for the Drive-thru Internet architecture [73]. The protocol maintains session persistence for TCP-oriented applications that run on mobile nodes, vehicles or pedestrians, even when they experience connectivity disruptions. This is done using the Drive-thru *proxies* that are present in the Internet and have persistent connectivity. These *proxies* are responsible for maintaining sessions with peers in the absence of the Drive-thru clients. The data is delivered to the clients as soon as they are connected to the Internet.

### 2.4.6 Opportunistic Connection Management Protocol (OCMP)

Opportunistic Connection Management Protocol (OCMP) [44] follows the same principle as PCMP in order to provide session persistence to mobile nodes. Besides, OCMP also takes advantage of multiple connection opportunities of a node through its multiple interfaces (e.g., Wifi, 3G etc.). It defines policies for data communication such that data is forwarded based on its urgency to be delivered and underlying connectivity bandwidth. For example, the bulk of data may be forwarded only on the availability of a Wifi interface while urgent messages could be forwarded using a cellular interface. *Proxies* are used to collect data on behalf of mobile nodes when they are disconnected, and these nodes gather data from their respective proxies when they re-connect. Like PCMP, this proposal only deals with the infrastructure-based networks and does not handle communication in the infrastructure-less networks.

### 2.4.7 Unmanaged Internet Architecture (UIA)

Unmanaged Internet Architecture (UIA) [45] targets communication between personal devices. UIA presents architectural changes at three functional areas of the Internet, i.e., naming, transport and routing. It allows devices to communicate without requiring prior configuration and set-up and even without the availability of an infrastructure-based network. It also allows mobile nodes to securely connect to other nodes in their *personal groups* using the persistent location-independent *identifiers* that are different from the existing DNS based names. This allows the participating nodes to communication with other personal nodes even in the presence of NAT or by traversing ad-hoc networks.

## 2.5 Design Objectives

In general, following are our main design considerations for transparent message delivery in heterogeneous networks that we target in this thesis:

1. **Mobility Transparency:** Nodes should be able to communicate with each other despite their mobility and change in points of attachment to the network (e.g., IP addresses).



2. **Disconnection Transparency:** The network and the communication architecture should be able to cope with frequent and long-lived connectivity disruptions of nodes.
3. **Internet compatibility:** The architecture should be able to fit in the current Internet architecture such that the status-quo routing should be maintained. This will help in quick deployment and an adaptation of the proposed architecture.
4. **Heterogeneity support:** Nodes should be able to successfully use multiple interfaces for communication simultaneously. The architecture should allow multi-homing at nodes while coping with mobility and disruptions in connectivity.

### 2.5.1 Assumptions and Limitations

As the MeDeHa framework can be implemented at different layers of the communication stack, the data unit at each layer can be different (e.g., datagram at transport layer, packet at network layer, frame at link layer). But for consistency, we use the term “message” throughout the thesis, which refers to the application-level data unit (ADU). However, We also assume that all the information that helps the MeDeHa module in routing/forwarding decisions (e.g., number of copies, message priority etc.) is part of the ADU.

Furthermore, we generally consider applications that are asynchronous in nature and inherently provide tolerance to connectivity disruptions, or are able to cope with long end-to-end delays. Examples include email, file transfer, SMS, and chat applications<sup>3</sup>, instant messaging, connectivity to remote villages [43]. Of course, real-time delay-bound applications such as audio chat or video conferencing cannot be used in a disruption-prone network.

However, we do not consider transport layer issues including end-to-end reliability and flow control in this thesis, though the transport related issues are equally important from an application perspective. The application-level session persistence is very important when end-to-end communication is considered. Though, there are TCP alternatives to cope with disconnections such as TCP Migrate [40], we believe that more sophisticated solutions could be used for session persistence such as PCMP [5] and OCMP [42]. This is because solutions like TCP Migrate only handle end-to-end connectivity resumption from disruptions but still require the presence of a contemporaneous end-to-end path between a source and a destination for any communication to take place. On the other hand, we handle the case of opportunistic data forwarding even in environments where no end-to-end path exists between a pair of source and destination.

---

<sup>3</sup>Though the chat applications are interactive but they can afford connectivity disruptions

## **Part II**

# **Taxonomy of Routing in Disruption Tolerant Networks**



# 3

## DTN ROUTING TAXONOMY

---

---

### 3.1 Introduction

Traditionally, communication networks, regardless of whether they are wired or wireless, have always been assumed to be connected almost all the time.<sup>1</sup> When partitions occur, they are considered transitory failures and core network functions such as routing react to these failures by attempting to find alternate paths. However, for some emerging applications like emergency response, special operations, smart environments, habitat monitoring, and VANETs, which are motivated by advances in wireless communications as well as ubiquity of portable computing devices, the assumption of “universal connectivity” among all participating nodes no longer holds. In fact, for some of those scenarios or applications, the network may be disconnected most of the time.

Networked environments which operate under such intermittent connectivity are also referred to as episodically connected, delay tolerant, or disruption tolerant networks (or DTNs). Clearly, traditional routing, including MANET routing protocols like OLSR [32], AODV [96], and DSDV [96] cannot deliver adequate performance in DTNs. Consequently, a number of new routing approaches have been proposed to cope with frequent, arbitrarily long-lived connectivity disruptions. They can be classified into three categories: *deterministic* or *scheduled*, *enforced*, and *opportunistic* routing. Deterministic routing solutions are used when contact information is known a priori. Jain et al. [97] showed how little or full information about contacts, queues, and traffic can be utilized to route messages from a source to a destination in the case of disrup-

---

<sup>1</sup>Here, by connected networks, we mean that there exists at least one end-to-end path between every pair of nodes in the network.

tions. They have presented a modified Dijkstra algorithm based upon information on scheduled contacts and compared the proposed approach against an optimal LP formulation. In order to deliver messages to otherwise disconnected parts of network (islands), enforced routing solutions like message ferries [19] and data mules [20] can be employed, where special-purpose mobile devices move over predefined paths in order to provide connectivity. Epidemic dissemination [7] is the basic form of opportunistic routing and works as follows. When node A encounters node B, it passes to B replicas of messages A is carrying which B does not have. In other words, epidemic routing is to episodically connected environments what flooding is to “traditional”, well-connected networks. While on one hand epidemic routing offers minimum delivery delay, it may be prohibitively expensive since it consumes considerable network resources due to the excessive amount of message duplicates generated.

Our focus here is on opportunistic approaches to DTN routing, i.e., where no contact information is known a priori and no network infrastructure (e.g., special-purpose nodes with controlled trajectories) exists to provide connectivity. Besides the question of when contact opportunities happen between nodes, a number of other factors also affect data forwarding, including available storage at peering nodes, contact duration, available bandwidth, message priority or expiration time, etc.

An ever growing number of protocols addressing these “opportunistic” DTN scenarios have been proposed. However, it is not at all clear how existing solutions can be applied to a variety of DTN applications given their requirements and underlying network characteristics (e.g., connectivity, node mobility and capability).

In this chapter, we address this question and thus help map the design space of opportunistic DTN routing. We can summarize the contributions of this work as follows:

- First, we dissect opportunistic routing solutions identifying their basic *building blocks* in terms of the forwarding scheme employed, namely *message replication*, *forwarding*, and *(source and network) coding* (Section 3.2).
- We also identify a number of features that can be used to classify DTNs. Classifying DTNs according to their connectivity, mobility, and capability (i.e., storage, battery life, processing) of the participating nodes will be key to deciding what routing mechanism(s) to use in order to achieve adequate application-level performance (Section 3.4).
- Finally, we proceed to map the opportunistic routing design space by drawing the correspondence between the proposed DTN taxonomy and the basic opportunistic routing building blocks (Section 3.5).

The remainder of this chapter is organized as follows. Section 3.2 discusses the routing strategies in intermittently connected network by dissecting the existing solutions into a small

number of common and tunable routing primitives. Important utility functions for routing decisions are described in Section 3.3. Section 3.4 presents a DTN taxonomy by detailing the network characteristics that are important in designing a routing protocol. In the end, DTN routing design guidelines and a discussion are presented in Section 3.5. More details on the work presented in this chapter can be found in [27].<sup>2</sup>

## 3.2 Opportunistic Routing Primitives

The basic principle governing opportunistic routing is that when two nodes meet one another, they must decide whether to forward a message, or to carry it further. It represents a shift from basic *store-and-forward* to the so-called *store-carry-and-forward* [17]. Due to its inherent characteristic of running without a priori knowledge, opportunistic routing is quite general and is also applicable to both scheduled and enforced connectivity scenarios since they may suffer from some non-determinism and uncertainty. For example, a bus that is scheduled to reach a bus stop at a certain instant may get stuck in a traffic jam, causing a deviation in its schedule, which may ultimately affect deterministic routing. Also, there can be other factors affecting scheduled behavior like weather, radio interference, and system failure.

Even though our focus is on networks or applications exhibiting frequent and long-lasting disruptions in connectivity, we should point out that node mobility has been shown to increase capacity of *connected* wireless networks [116]. Thus, DTN routing approaches can be employed in *connected* networks to harness node mobility for capacity reasons.

### 3.2.1 Routing as Opportunistic Forwarding

In a DTN-like environment, it is possible that a path may never be available between source-destination pairs. Hence, the *store-carry-and-forward* routing paradigm is utilized in such scenarios; this means that a set of *independent, opportunistic<sup>3</sup> forwarding decisions* will attempt to *eventually* deliver messages to destinations.

In the following, we define opportunistic routing based on the evolution of the message vectors at nodes as they encounter other nodes. It is important to note that as energy is a precious resource in mobile nodes, any node can turn to *sleep* mode to conserve battery lifetime. Thus, it is possible that two nodes are within communication range of each other but are unable to exchange any information, if one of them is in *sleep* mode. For clarity, we define the “encounter of two nodes” for the case when two nodes are within communication range of each other and are in *power on* mode.

---

<sup>2</sup>This work has been done in cooperation with Dr. Thrasyvoulos Spyropoulos.

<sup>3</sup>Opportunistic means that there is no certainty about whether there will ever be a path to destination, and the forwarding is generally performed by taking advantage the available information.

**Definition:** If node  $A$  with a set of messages  $S_{\text{msg}}^{(A)}(t)$  and a set of context information<sup>4</sup>,  $S_{\text{ctxt}}^{(A)}(t)$  at time  $t$ , encounters nodes  $B_1, \dots, B_n$ , each with message vectors  $S_{\text{msg}}^{(i)}(t)$ ,  $i \in [1, n]$  and context information  $S_{\text{ctxt}}^{(i)}(t)$ ,  $i \in [1, n]$ . Then opportunistic routing does the following:

- $S_{\text{msg}}^{(i)}(t + \Delta t) = f(S_{\text{msg}}^{(A)}(t), S_{\text{msg}}^{(1)}(t), \dots, S_{\text{msg}}^{(n)}(t), S_{\text{ctxt}}^{(1)}(t), \dots, S_{\text{ctxt}}^{(n)}(t)), \forall i \in \{A, 1, \dots, n\}$ ,
- $S_{\text{ctxt}}^{(i)}(t + \Delta t) = f(S_{\text{ctxt}}^{(A)}(t), S_{\text{ctxt}}^{(1)}(t), \dots, S_{\text{ctxt}}^{(n)}(t)), \forall i \in \{A, 1, \dots, n\}$ ,

where  $\Delta t$  is a random variable and is the time it takes to forward a message (medium access, transmission and propagation delay, etc.), and  $f(\cdot)$  denotes a function that will be applied to the message- and context vectors at the time of the encounter. The function  $f(\cdot)$  will depend on the type of routing primitive, e.g., replication, forwarding, etc.

We use the same notation to define three basic building blocks<sup>5</sup> of mobility-assisted opportunistic routing, namely *replication*, *forwarding*, and *coding*, based upon which, every opportunistic routing protocol can be constructed.

Next, we look into these three primitives in more detail, providing also specific examples. Let us assume that a node  $A$  which has a set of neighbors  $B_j$  encounters node  $B_i$ ,  $j \neq i$ .  $A$  has then to decide whether to forward message  $m$  to  $B_i$ .

### 3.2.2 Message Replication

A relay  $A$  carrying a copy of  $m$  can decide to spawn a new copy of  $m$  and forward it to a newly encountered node, ( $B$ ). This decision will depend on the message vectors of the two nodes (e.g., if the new neighbor does not have a copy of the message in question) as well as on the “context” of the two nodes (e.g., the new neighbor tends to see the message destination often). In other words, if nodes have infinite buffer space and if  $m \notin S_{\text{msg}}^{(B)}(t)$ , then

$$\begin{aligned} S_{\text{msg}}^{(B)}(t + \Delta t) &= S_{\text{msg}}^{(B)}(t) \cup f_{\text{rep}}(S_{\text{ctxt}}^{(A)}(t), S_{\text{ctxt}}^{(B)}(t)), \\ S_{\text{msg}}^{(A)}(t + \Delta t) &= S_{\text{msg}}^{(A)}(t), \end{aligned}$$

where  $f_{\text{rep}}(\cdot)$  is either  $\{m\}$  or  $\{\emptyset\}$  (the empty set). Several studies such as [29, 117, 112] have reported the benefits of replication for DTN routing. Note that in case where more than two nodes encounter each other at the same time,  $f_{\text{rep}}(\cdot)$  would contain context information of all the nodes that meet each other at that time.

<sup>4</sup>The context information comprise of nodes utilities that they keep for other nodes or their own affiliation/status. A number of possible DTN utility functions are described in detail in Section 3.3.

<sup>5</sup>We will use the terms building blocks and primitives interchangeably throughout the chapter.

### 3.2.2.1 Greedy Replication

The simplest version of copy replication is performed in a “greedy” manner. When node  $A$  encounters any node, say  $B$ , and  $B$  does not have a copy of  $m$ ,  $A$  will spawn and forward a copy of  $m$  to  $B$ ; that is,  $f_{\text{rep}}(S_{\text{ctxt}}^{(A)}(t), S_{\text{ctxt}}^{(B)}(t)) = \{m\}$ :

If nodes have infinite buffer space and if  $m \notin S_{\text{msg}}^{(B)}(t)$  then

$$\begin{aligned} S_{\text{msg}}^{(B)}(t + \Delta t) &= S_{\text{msg}}^{(B)}(t) \cup \{m\}, \\ S_{\text{msg}}^{(A)}(t + \Delta t) &= S_{\text{msg}}^{(A)}(t). \end{aligned}$$

This is a fast and robust method to distribute copies, creating a number of “copy custodians” that will look for the destination concurrently. Greedy replication is the basic primitive used by epidemic routing [7]. Epidemic routing has many variants and has been used by researchers as a baseline to evaluate DTN routing protocols, as it offers minimum average message delay at the cost of consuming maximum network resources. Prioritized Epidemic Routing (PREP) [137] is a recent greedy replication based protocol, where the stored bundles are prioritized based upon their expiry time and distance to destination in order to better utilize resources.

Generating and passing a new copy to *every* node encountered may produce considerably high overhead in terms of buffer space for storage and energy spent on transmission and reception. Variants of replication that control the number of copies or custodians of a message circulating in the network at any given point are quite effective in reducing overhead and still achieving adequate performance. They are described below.

### 3.2.2.2 Controlled Replication

In the controlled replication, some *context* is associated with each given message  $m$ . This context keeps track of the number of copies that have been created for  $m$ . If the perceived number of generated copies is smaller than some desired value  $L$ , then  $f_{\text{rep}}(m, S_{\text{ctxt}}^{(A)}(t)) = \{m\}$ . Otherwise,  $f_{\text{rep}}(m, S_{\text{ctxt}}^{(A)}(t)) = \{\emptyset\}$ . Below are some examples of controlled replication strategies:

- In *copy-limited replication*, each message copy generated is accompanied by a number of forwarding tokens ( $\text{fwd}(m) \geq 1$ ). This number indicates how many extra copies of the message the new node can further create itself and replicate.

$$\begin{aligned} \text{fwd}(m) > 1 &\Rightarrow S_{\text{msg}}^{(B)}(t + \Delta t) = S_{\text{msg}}^{(B)}(t) \cup \{m\}, \\ \text{fwd}(m) = 1 &\Rightarrow S_{\text{msg}}^{(B)}(t + \Delta t) = S_{\text{msg}}^{(B)}(t). \end{aligned}$$

- In *time-limited replication*, each new message generated (say at time  $T_s$ ) may be further replicated to nodes other than the destination, only for an amount of time  $T_{\text{rep}}$ . If  $t$  is the



time a node B is encountered and B is not the message destination, then

$$\begin{aligned} t \leq T_s + T_{\text{rep}} &\Rightarrow S_{\text{msg}}^{(B)}(t + \Delta t) = S_{\text{msg}}^{(B)}(t) \cup \{m\}, \\ t > T_s + T_{\text{rep}} &\Rightarrow S_{\text{msg}}^{(B)}(t + \Delta t) = S_{\text{msg}}^{(B)}(t). \end{aligned}$$

- In *probability-limited replication* [113], a node decides to forward a copy of a message to any node it encounters with a specific probability  $p_i$ , where  $i$  indicates the service class to which the message belongs.

Controlled replication has been shown to attain competitive delays with only a small fraction of the copies used by uncontrolled replication policies such as epidemic routing [7]. It is the strategy used in protocols like Spray and Wait [29, 112], more specifically the copy-limited version.

Controlled replication performs especially well when nodes are homogeneous and move frequently around the network. However, if candidate relays have very different capabilities, greedy- and even controlled replication may waste valuable message copies by forwarding them to nodes that are of little use in the delivery process.

### 3.2.2.3 Utility-Based Replication

In the utility-based replication scheme, the forwarding decision depends on the *context* of the current custodian and that of the candidate relay. Specifically, we assume that a set of parameters related to the nodes in question are evaluated to estimate the nodes' *utility* or *fitness* as a relay for a given message bound to a certain destination. This utility may correspond, for example, to the probability of the new node encountering the destination in the future. This and other utility functions will be discussed in detail in Section 3.3.

There are basically two variants of utility-based replication, namely *uncontrolled* and *controlled* replication, both of which are described below using our message vector notation:

- *Uncontrolled utility-based replication*: If  $m \notin S_{\text{msg}}^{(B)}(t)$  AND  $f_{\text{rep}}(S_{\text{ctxt}}^{(A)}(t), S_{\text{ctxt}}^{(B)}(t)) = \{m\} \Rightarrow S_{\text{msg}}^{(B)}(t + \Delta t) = S_{\text{msg}}^{(B)}(t) \cup \{m\}$ .
- *Controlled utility-based replication*: If  $m \notin S_{\text{msg}}^{(B)}(t)$  AND  $f_{\text{rep}}(S_{\text{ctxt}}^{(A)}(t), S_{\text{ctxt}}^{(B)}(t)) = \{m\}$  AND  $\text{fwd}(m) > 1 \Rightarrow S_{\text{msg}}^{(B)}(t + \Delta t) = S_{\text{msg}}^{(B)}(t) \cup \{m\}$ .

Uncontrolled utility-based replication has been used to reduce the overhead of epidemic routing [109, 104]. As an example, rather than handing over a copy to every new node encountered, each node maintains a probability measure of future encounters using the history of past encounters; based on this probability, a node forwards a new copy to a new neighbor only

if the neighbor has a high enough (or higher than the current relay's) probability of a future encounter with the destination.

On the other hand, controlled utility-based replication has been proposed in [28] to improve the quality of forwarding decisions made by Spray and Wait [29] in heterogeneous environments. Encounter-Based Routing (EBR) [136] is another example of controlled, utility-based replication, in which future rate of node encounters is predicted using number of past encounters with nodes, and encounter metric is computed locally at each node. The number of replicas of a message, delivered to a relay node depends upon the ratio of encounter value that the relay advertises.

### 3.2.3 Message Forwarding

Unlike replication, under copy forwarding, a relay  $A$  carrying a message  $m$  may decide to hand that message over to a node  $B$  it encounters; by doing so,  $A$  relinquishes its copy of  $m$  and ceases to be one of its custodians. Clearly, forwarding incurs minimal message duplication overhead. It is beneficial when the initial relay(s) chosen is(are) not the best one(s). Using our message vector evolution notation, we can define forwarding as follows.

If  $m \notin S_{\text{msg}}^{(B)}(t)$ , then

$$\begin{aligned} S_{\text{msg}}^{(B)}(t + \Delta t) &= S_{\text{msg}}^{(B)}(t) \cup f_{\text{fwd}}(S_{\text{ctxt}}^{(A)}(t), S_{\text{ctxt}}^{(B)}(t)), \\ S_{\text{msg}}^{(A)}(t + \Delta t) &= S_{\text{msg}}^{(A)}(t) - f_{\text{fwd}}(S_{\text{ctxt}}^{(A)}(t), S_{\text{ctxt}}^{(B)}(t)), \end{aligned}$$

where  $f_{\text{fwd}}(\cdot)$  takes values either  $\{m\}$  or  $\{\emptyset\}$  (the empty set).

Forwarding a message can be performed either using a utility function or in a probabilistic manner (e.g., tossing a coin to decide, at each contact, if a message should be forwarded or not). If a utility function approach is used, each node  $i$  maintains a value for the utility function  $U_i(j)$  for every other node  $j$  in the network.  $U_i(j)$  which can be interpreted as the probability that node  $i$  will forward a message to node  $j$ , may be based on a number of different parameters (e.g., encounter history, mobility, friendship index with  $j$ , etc.). In general,  $U_i(d)$  is a function of the context  $S_{\text{ctxt}}^{(i)}(t)$  of node  $i$ , and possibly of that of node  $d$ , the destination,  $S_{\text{ctxt}}^{(d)}(t)$ . Hence,

$$U_i(d) = g(S_{\text{ctxt}}^{(i)}(t), S_{\text{ctxt}}^{(d)}(t)).$$

If a node  $i$  carrying a message copy for a destination  $d$  encounters a node  $j$  with no copy of the message, then

- **Rule 1: Absolute utility criterion** If  $U_j(d) > U_{\text{th}}$  for some  $U_{\text{th}}$  threshold value OR

■ **Rule 2: Relative utility criterion** If  $U_j(d) > U_i(d)$  (*relative utility criterion*), then

$$\begin{aligned} S_{\text{msg}}^{(B)}(t + \Delta t) &= S_{\text{msg}}^{(B)}(t) \cup \{m\} \\ S_{\text{msg}}^{(A)}(t + \Delta t) &= S_{\text{msg}}^{(A)}(t) - \{m\} \end{aligned}$$

Scale Free Routing (SFR) [135] is an example of a routing protocol that is based on message forwarding, where single copy per message is used, and there is no replication. Forwarding is based upon some utility function, but if the utility function is lower than a certain threshold, the nodes with the highest mobility are chosen as relays and message is forwarded to these relay, which are called Ballistic Nodes.

### 3.2.4 Message Coding

Messages may be coded and processed at the source, i.e., *source coding* or as they traverse the network, i.e., *network coding*. In the following subsections, both of these coding variants are presented.

**Source Coding:** Source coding aims at increasing delivery reliability and reducing worst-case delay. A notable example is *erasure coding* [118], in which the coding is performed by the source, a coded part of a message is further treated as any other message in the network, and there is no specific implications on routing and forwarding.

A variation of source coding known as *distributed source coding* tries to minimize propagating redundant information in the network, and thus reduce overhead. Sensor networks, which are aimed at a variety of monitoring applications (e.g., environmental and habitat monitoring), are the typical target scenario for distributed source coding [119]. The basic idea behind distributed source coding is to take advantage of the data's inherent spatial and temporal locality to suppress propagation of unnecessary information. For example, in a sensor network tasked to measure the temperature field of a given region, nodes that are in close proximity to one another are expected to report similar temperature values. Through DSC strategies, nodes can identify such redundancies and perform *in-network aggregation* to reduce the volume of data transmitted in the network [120]. Another example of DSC is growth codes [121], which use coding redundancy at neighbors to avoid the impact of loss.

**Network Coding:** Network coding has been proposed as a way to increase the capacity of wireless network [122], [102]. The main idea behind network coding is to allow mixing of messages at intermediate nodes in the network. In this way, a receiver reconstructs original message, once it receives enough encoded messages. Linear network coding has been shown to achieve the capacity of information networks [123]. This coding scheme permits a node to apply a linear transformation to a vector (a block of messages over a certain base field) before passing it further in the network. It can be used to reduce the time to deliver a given flow,

maximize the throughput, reduce the number of transmissions (and thus energy expended), etc.

Random network coding, where coding coefficients are chosen by each node randomly from a large enough field (often  $Z^8$ ), and in a distributed manner, is an efficient method to implement network coding in practice (coding coefficients are sent as part of the packet, with only a small overhead) [124]. To take advantage of the benefits of network coding in a wireless, often “challenged”, environment, the following modification of greedy replication have been proposed [122]: instead of transmitting single packets, linear combinations of packets are generated and transmitted; assume a node A has a set of linear combinations of N packets  $S_{\text{msg}}^{(A)} = \{\hat{m}_1, \hat{m}_2, \dots, \hat{m}_m\}$  and encounters another node B. Then, it creates a linear combination of all its messages in the queue

$$\hat{m}_{\text{new}} = \sum_{i=1}^m c_i \hat{m}_i. \quad (3.1)$$

Here, the addition is *modulo* the given base field chosen for network coding. Finally, depending on the context of nodes A and B,  $f_{\text{code}}(S_{\text{ctxt}}^{(A)}(t), S_{\text{ctxt}}^{(B)}(t)) = \{\hat{m}_{\text{new}}\}$  or  $\{\emptyset\}$ , and

$$S_{\text{msg}}^{(B)}(t + \Delta t) = S_{\text{msg}}^{(B)}(t) \cup f_{\text{code}}(S_{\text{ctxt}}^{(A)}(t), S_{\text{ctxt}}^{(B)}(t)). \quad (3.2)$$

When enough independent combinations ( $\geq N$ ) of the N messages, belonging to a given coding generation, have been received, a node can *decode* them to get the original N messages. Finally, the forwarding function  $f_{\text{code}}(\cdot)$  might be for example:

- a random coin toss, i.e.  $f_{\text{code}}(S_{\text{ctxt}}^{(A)}(t), S_{\text{ctxt}}^{(B)}(t)) = \{\hat{m}_{\text{new}}\}$  with some probability  $p \leq 1$  [122].
- based on a utility function as described in Section 3.3.

One key problem with the network coding approach described above is that coding *every* single message together may result in never collecting enough independent combinations of messages to successfully decode, especially when the network is sparse or when the nodes’ degree is low. Some control is needed on how many and which messages will be coded together. This is known as generation control. Coding messages from many different sessions and from large time or sequence number windows (large generations) might result in high delivery delays. On the other hand, using small generations limits the amount of gains achievable by network coding. Finally, even controlling the generations in a distributed manner, might pose significant challenges.

### 3.2.5 Routing as Resource Allocation

In this subsection, we look into DTN routing from a resource allocation point of view. In traditional DTN routing, routing is mostly performed based upon some utility function(s). The

main aim is always to find a path to a destination with the available information. Almost all routing strategies are no exception to this, and thus they have an incidental effect on routing metrics (maximizing average delay or delivery ratio). Another angle to look at DTN routing is to treat it as a resource allocation problem. The purpose is to have an intentional effect on the DTN routing, rather than an incidental one, in order to maximize the performance of specific routing metrics. The idea is to forward or replicate a message to a relay, based upon the available resources in order to maximum the likelihood of message delivery, when two nodes meet. Note that resource allocation based routing is not a basic primitive of DTN routing, and can use any of the three basic primitives described in the previous subsections.

RAPID [132] is the first protocol which treats DTN routing as a resource allocation problem. In RAPID, messages are ordered with respect to their utilities, keeping in view the goal of maximizing specific metrics (e.g. delay), which allows computation of more sophisticated and desired metrics such as worst-case delivery delay and packet delivery ratio. The protocol translates a routing metric to per-packet utilities, and at every transfer opportunity, it is verified if the marginal utility of replication justifies the resources used. In a way, it is a replication-based protocol, but what differs it with the traditional replication scheme is resource allocation.

Erramilli et al. [138] have done a study that is based upon prioritizing messages to better manage network resources in a resource-constrained environment, where they use delegation forwarding [141] as their forwarding algorithm. ORWAR (Opportunistic Routing with Window-Aware Replication) [139] is another protocol based upon the resource allocation concept that uses message utility based differentiation mechanism. This allows allocation of more resources for messages with high utilities. Thus, it replicates messages in order of high utilities first, and removes messages in the reverse order, if needed. Again, this is a replication routing scheme, but the delivery of number of copies depends upon evaluation of the contact window.

### 3.2.6 Examples of DTN Routing Protocols

In Section 3.2, we have described three basic primitives based on which DTN routing can be built. We now proceed to identify the use of these primitives in some existing DTN routing protocols. Table 3.1 summarizes this correspondence between DTN building blocks, their variants and existing DTN solutions. The table shows examples of DTN-routing protocols and categorizes them in terms of the three main building blocks (i.e., replication, forwarding and coding). The first column represents the properties based on which the routing protocols are built, and the second column shows the routing protocol examples.

Take for example Epidemic Routing [7]: it is a typical case of “uncontrolled”, i.e., with no constraints on the number of copies generated, message replication using a greedy approach; on the other hand, Spray and Wait [29] is an example of “controlled” greedy replication as it limits the number of copies for each message. Replication can also be made “smart” by

using some utility functions as in [28]. Spray and Focus [30] is an example of a protocol that combines greedy replication with smart forwarding mechanisms. Performance and efficiency can further be improved if smart forwarding is used with smart replication. On the other hand, smart forwarding mechanisms can be used with source coding schemes such as Erasure Coding [118], and replication can be used with coding schemes [102], [121].

**Table 3.1:** DTN Routing primitives and their use by existing DTN routing protocols

	<b>Forwarding</b>	<b>Replication</b>	<b>Coding</b>
<b>Greedy</b>		Epidemic [7] PREP [137]	
<b>Controlled</b>		Spray and wait [29] SWIM [112]	
<b>Utility Based</b>	FRESH [125] Scale-free [135] Spray and Focus [30]	History-based Epidemic [104] Probabilistic flooding (Prophet) [109] Smart Replication [28] MV Routing [134] Encounter-based [136]	
<b>Resource-allocation</b>		RAPID [131], [132] ORWAR [139]	
<b>Mobility Characteristics</b>	Mobyspace [108], [128] Solar [105] Scale-free [135]	Maxprop [114]	
<b>Routing Table Entry</b>	Island hopping [2]		
<b>Network (end-to-end)</b>			LeBoudec [122]
<b>Opportunistic</b>			COPE [102]
<b>Distributed source coding</b>			Growth codes [121]

### 3.3 DTN Routing Utility Functions

We now turn our attention to utility functions that can be used in message replication (or forwarding) by the DTN routing primitives previously discussed. Candidate utility functions could be broadly categorized into *destination dependent* (“DD”) and *destination independent* (“DI”) functions. These utility functions are very useful especially when the network as well as the participating nodes are heterogeneous. Many utility functions have been presented in [28], and are thoroughly investigated and applied to heterogeneous environments in [22] and [23].

#### 3.3.1 Destination Dependent (DD) Utility

One node may be the best relay for one destination ( $d_1$ ), and another node may be the best relay for a different destination ( $d_2$ ). In other words, for DD utility functions, it is possible that

the following is true:

$$U_i(d_1) > U_j(d_1) \text{ but } U_i(d_2) < U_j(d_2), d_1 \neq d_2. \quad (3.3)$$

Below we describe a number of parameters that can be used to build destination dependent utility functions.

- **Age of Last Encounter:** It has been suggested that keeping track of past encounters with a given node can be helpful in successfully predicting future encounters. For example, each node could maintain a timer for every other node in the network that records the time elapsed since the two nodes last “saw” each other [125]. These timers could then act as indirect location information. Additionally, a node can keep a record of its encounters with another node by noting the last encounter time and the node’s position at the time of encounter [36]. Although keeping the last encounter time for nodes does not provide any guarantee that a node would meet a destination in the future, yet it can be useful in predicting the current location of a destination.

Because, nodes tend to move in a continuous manner (i.e., they don’t ordinarily perform jumps in space), often, a smaller timer value implies a smaller distance to the destination, if we assume that the average speed of nodes does not vary too much. In case nodes are heterogeneous in terms of their characteristics and capabilities, some other parameters should be used in combination with age of last encounter in order to choose a “suitable” relay node. Note that the age of last encounter with a destination is related to the *instantaneous* fitness of a node as a candidate relay for that destination.

- **History of Past Encounters:** The age of last encounter is only a single “snapshot” of the history of past encounters and may not necessarily predict future encounters successfully. Instead, a node could maintain a “richer” set of information about past encounters with another node, like *frequency of encounters*, *average inter-encounter time*, *higher moments of inter-encounter time*, *average encounter duration*, etc. Such information could help identify more accurately good candidate next hops; on the other hand, keeping more information about encounters increases the overhead in terms of context data that needs to be stored. Also, depending upon the application requirements, a combination of past encounter parameters can be used to choose the best possible relay for a destination. Another consideration is how long to keep this history about a certain destination at a node as it may not be useful, or even misleading after a certain threshold of time depending upon the dynamics and mobility pattern of participating nodes. An example of this kind of utility function is Encounter Based Routing (EBR) [136], in which future rate of node encounter is predicted using information about past encounters with node.

- **Pattern of Locations Visited:** In the real world, mobile users move with certain purposes in mind (e.g., going to work, going to a class, going from work to lunch, etc.). Additionally, they may follow specific paths in between these locations due to geographical constraints. As a result, people tend to follow a *movement pattern* in their daily activities. These patterns are a function of a variety of parameters including professional activity, work and home location, etc. What is more, most people also tend to spend the majority of their time in a small subset of *preferred* locations, as opposed to indiscriminately roaming everywhere (unless, this is part of their job, e.g., taxi driver, salesman, etc). “Location preference” as well as the periodic nature of human mobility (diurnal and weekly patterns) have been consistently demonstrated in a variety of real mobility traces [103]. Mobility patterns (known a priori or “learned” online by collecting appropriate statistics) could help identify a *profile* for a given node; nodes with a matching or similar mobility profile as the destination could be considered good candidate relays for messages to that destination [108], [128], [105].
  
- **Social Networks:** Humans are involved in complex social relationships (networks), and people who are socially-related to each other (e.g. friends, students in the same class, and colleagues in the same department) are expected to interact more often with each other. These social features can have important implications for networks formed by communication devices operated or carried by humans (e.g., vehicles, PDAs, laptops). Knowledge about existing social links could allow one to choose a “data relay” that has a much better chance of encountering the destination soon. Note that one way to gather information about social networks is by keeping a history of past encounters. However, there is additional data that is relevant in the context of social networks. For example, suppose that it is known a priori that A is a good friend of D, but B hardly knows D; then, even with no past encounter information of D at A or B, A can be considered a *better* relay for D than B. The social network information about nodes can also be gathered by observing and estimating their mobility pattern.

Bubble [140] is one of the recent social-based forwarding protocol, in which forwarding is based upon identifying “hubs” and “centrality points” in the network. Having no information about a destination, a message is forwarded towards a more “popular” area or node, and then the forwarding mechanism tries to find the destination itself, or a node having the same “community” as the destination node. The logic behind finding a popular node first is that in a social network, some nodes tend to see other nodes more often than others.



### 3.3.2 Destination Independent (DI) Utility

In case of Destination Independent (DI) utility, the *utility* of a given node is independent of any destination; rather, it depends on some characteristic(s) exhibited by a node. This implies that one node may be the best relay for most or all destinations. In other words, for DI functions it holds in general that:

$$U_i(d_1) \geq U_j(d_1) \Rightarrow U_i(d) \geq U_j(d), \text{ for most or all } j, d. \quad (3.4)$$

Examples of nodes which are highly preferable as relays for any destination could be nodes with high and frequent mobility (e.g., vehicles), nodes with many “friends” (e.g., *hubs* [140] in scale-free networks), nodes with more resources (e.g., buses [114]), or nodes with high cooperative behavior (e.g., APs, routers or gateways, ferries). Below, we describe in more detail some destination independent parameters that should be considered when making forwarding decisions.

- **Amount of Mobility:** In some wireless network deployments, some nodes might be more mobile than others. In the case of a campus environment, nodes carried by humans may tend to be more static, while nodes attached to campus transportation vehicles (e.g., [114]) move around the campus periodically, some of which following regular trajectories. These more mobile nodes tend to traverse a wider portion of the network in the same amount of time than the more static nodes, and thus encounter a larger subset of other wireless nodes. As a result, they represent highly desirable relays, if a DTN-like routing strategy is employed. One way to identify such relays could be, for example, to use *labels* that represent the type of mobility exhibited by nodes, e.g. “BUS”, “TAXI”, “PEDESTRIAN”, “BASE STATION”, etc. In some scenarios, it would not be too burdensome to manually configure a label (e.g., by setting some software parameter when installing a radio, say, on the top of a bus). Nevertheless, algorithms that estimate the “degree of mobility” *online* could also be deployed in self-organized, more dynamic environments [28].
- **Node Resources:** When forwarding a message to a node, the resources and capabilities of that node should be considered. Even if a certain node has some ties to the destination (e.g., close friendship), giving a message copy to that node might be a waste of resources, if it is almost out of battery. Chances are it will either turn itself off or run out of battery before it gets a chance of delivering the message. Similarly, if a candidate relay has its buffer almost full, it might be more prudent to prefer another node instead. This may not only result in smaller queuing delays, but may also reduce the probability of the message getting dropped later. Consequently, nodes may maintain the current status of their resources, which can be used to identify nodes that are “good” (or “bad”) relays independent of the destination.

- **Cooperative Behavior:** Message forwarding is not free and consumes node resources including battery life and buffer space. So, it is possible that some nodes refuse to forward messages on behalf of others because either they have limited resources, or they are pre-configured with specific forwarding policies, or because they have been either compromised or are owned by an attacker. So, forwarding a message to such nodes would be disadvantageous. Consequently, forwarding decisions should also consider how cooperative nodes are in forwarding messages. Approaches to boosting cooperation among nodes include offering incentives to cooperating nodes, or penalizing non-cooperative ones. This has also implications in building trust among participating nodes, which is the topic of the DI parameter discussed below.
  
- **Trustworthiness:** Securing communication is among the biggest challenges in wireless networks. This is due to a number of factors notably the shared, uncoordinated access to the wireless medium, as well as its inherent unreliability and non-determinism. The peer-to-peer, non-hierarchical nature of many emerging wireless applications requires collaboration among participating nodes so that data delivery can be accomplished. Malicious peers could exploit this to intervene with the network's normal operation or extract sensitive information, such as passwords, credit card numbers, etc., from packet streams. In other cases, malicious users could pretend to carry and forward other nodes' traffic, while in fact, they don't do so, which may create drastic forwarding problem. Thus, non-malicious yet selfish users might be tempted to refuse carrying other's traffic. For these reasons, the utility of a node as a message relay might also be a function of the trust other nodes have in it, a trust which could be based on signed certificates, PGP-like architectures [129], reputation systems [130], etc.

### 3.3.3 Additional Considerations

It is certainly possible (and probably desirable) to define utility functions that take into account both the general, destination independent *fitness* of a node as well as destination specific information. For example, we can combine history of past encounters (DD utility) with nodes' mobility patterns, or their resources (DI utility) in order to define a hybrid utility function that is able to deliver messages to destinations more efficiently.

Most utility functions discussed above are based solely on a snapshot of the past (e.g., the last time node X encountered node Y). However, in real life scenarios node interactions may exhibit rich and intricate structure; it would thus be beneficial to explore learning techniques that try to use history over a window of time or feedback (e.g., from the destination) to make better routing decisions.

## 3.4 A Taxonomy of DTNs

In this section, we classify DTNs according to a set of characteristics relevant to routing. For example, a well-connected network whose nodes exhibit little or no mobility would imply that traditional MANET routing algorithms (e.g. OLSR [32], AODV [96], etc.) might be appropriate. Similarly, a network where nodes have little or no energy limitations (e.g., vehicles) would likely render routing protocols that focus on minimizing energy consumption inadequate. We start by describing the network features used in our DTN taxonomy.

### 3.4.1 Connectivity

Connectivity is an important characteristic of wireless networks. Two well-known definitions of network connectivity are (i) the probability that a path exists between two randomly chosen nodes [99], or (ii) the percentage of nodes connected to the largest connected component [99]. Although these two definitions are slightly different, they have similar implications from a macroscopic point of view.

In multi-hop wireless ad-hoc networks, or MANETs, due to node mobility, wireless channel impairments, limited node capabilities, etc, the assumption that the network is always connected no longer holds and routing had to be re-thought. However, partitions are still considered exceptions to normal operation and routing reacts by trying to find alternate paths. In fact, it is well-known that the so-called reactive (or on-demand) routing protocols such as DSR [96] and AODV [96] perform poorly when disconnections are frequent and persist for arbitrarily long periods of time.

It is well-known from percolation theory that, in networks consisting of randomly placed (or randomly moving) nodes, connectivity exhibits a *phase transition* behavior [100] as depicted in Fig. 3.1.<sup>6</sup> Specifically, if connectivity is scaled by changing the nodes' transmission range, then the following can be observed [101]: (i) for (a large number of) low transmission range values, connectivity values are quite low: no large cluster exists, but rather very small clusters (few with 1 node), whose sizes are exponentially distributed, are found; (ii) when transmission range crosses some threshold value, connectivity starts increasing rapidly and quickly enters a region where a giant component is formed containing a large percentage of nodes, while the rest of the nodes form smaller clusters (again of exponentially distributed size).

This phase transition behavior has some important implications: *random networks*, i.e., those formed by randomly placing nodes (e.g., sensors scattered uniformly in the field) or randomly moving nodes (e.g., random direction), will be either *sparse* or *almost connected*, in

<sup>6</sup>Note that in DTNs, connectivity will be consistently below 1 (or 100%). As a result, the whole spectrum of possible connectivity values all the way from 0 (very sparse networks) to 1 (connected networks) need to be considered when designing routing algorithms.

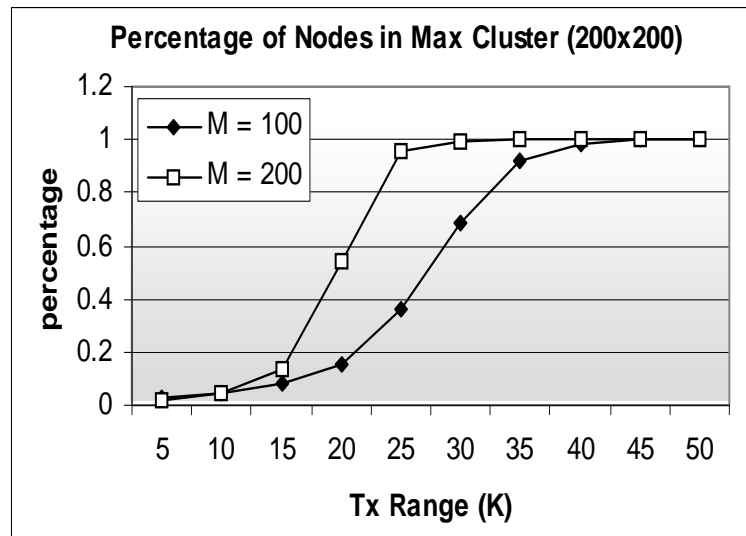

**Figure 3.1:** Expected percentage of total nodes in largest connected component, as a function of the number of nodes ( $M$ ) and transmission range ( $K$ ) ( $200 \times 200$  grid).

most cases. But, if transmission range or number of nodes is low, we can have the case where nodes tend to form clusters (or connectivity islands) due to their mobility patterns. So, in the following, we focus on three different kinds of networks according to their connectivity, namely: *almost connected networks*, *sparse networks*, and *connectivity islands*.

**Almost connected networks:** These networks more closely resemble the traditional MANET viewpoint of a connected graph. However, the graph here often exhibits partitions. A good percentage of end-to-end pairs are connected at any time, even though the paths might not be long-lasting. Traditional proactive– (e.g., link-state) or reactive routing protocols (e.g. DSR, AODV) could still deliver a part of the traffic successfully (although with a higher overhead for route discovery and maintenance). Yet, they are unable to deliver any traffic between nodes that lie in different partitions. Mobility-assisted routing schemes can be beneficial in bridging disconnected parts of the network and are able to deliver traffic between any two nodes. Yet, hybrid protocols that can also take advantage of the existence of large connected clusters are desirable.

**Sparse networks:** In these networks, transmission range is much lower and no large clusters exist. Most nodes have only a few neighbors or are isolated most of the time. Every now and then, two such nodes come into contact, at which time they can exchange data or other useful information, and soon go back to having no neighbors. It is evident that traditional– or even MANET routing protocols would fail to satisfy most end-to-end traffic requests, as very few contemporaneous paths exist. What is more, the small size or non-existence of clusters imply that routing modules that aim at maintaining multi-hop neighborhood information (2-hop,

k-hop, etc.) have not much value to offer.

Instead, a message has to get routed predominantly by being carried using relays. Occasionally a new candidate relay is encountered and the routing protocol needs to decide whether it should hand-over custody, replicate some of its messages, or continue carrying them. Consequently, node mobility is a crucial feature in these sparse networks, both in terms of how mobile nodes are, as well as how structured node mobility is (i.e., whether mobility patterns exist). Similar to network connectivity, mobility is another important feature and will be discussed in detail in Section 3.4.2 below.

Another important implication of sparse networks is that whenever two nodes encounter each other, there is only a small probability that other nodes are also within range. As a result, there is little contention, on average, at the MAC layer for each transmission, and there is also little (in-channel) interference. This suggests that available bandwidth (or buffer space) per contact is the limiting factor as far as performance is concerned. What is more, it suggests that forwarding or scheduling techniques that aim to choose the right neighbor (e.g., transmit to the “best” neighbor according to some utility function) [28] or combine packets for different neighbors (e.g. opportunistic network coding [102]) offer little gain here.

**Connectivity Islands:** It has been observed that in real world deployments, node location does not typically follow a uniform distribution. Similarly, node mobility is usually non-uniform. In fact, it is often the non-uniform mobility process that creates the non-uniform node location distribution. Thus, even though the phase transition phenomenon described earlier might imply that networks are either *sparse* or *almost connected*, in real world different connectivity structures might be observed. For example, in vehicular networks nodes may tend to gather around different concentration points for reasons dependent on the transportation network (e.g., traffic lights, junctions, toll, etc.) or application (e.g., taxi booths at airports, popular locations, etc.) [2]. Other real world examples include *First Mile Solutions* [126] and *VLINK* [127].

This non-uniform placement or mobility of nodes can also be observed in a variety of other scenarios. Consider, for example, a campus with people mostly moving within their own departments [103], or herds of animals mostly moving together in packs [104]. These networks can be seen as a set of separated islands of (full) connectivity, formed around a concentration point, with few or no contemporary paths between concentration points.

*Connectivity Islands* lie in between *almost connected*- and *sparse* networks. On one hand, their sizable clusters imply that proactive routing approaches could help collect and maintain useful information about *immediately reachable* nodes. On the other hand, a large number of nodes outside the local cluster are not immediately reachable using traditional techniques. Instead, mobility-assisted routing should be used to move messages between different “islands”, where no immediate path is available. In these cases, routing can be done hierarchically where at the macroscopic level, relatively stable paths can be constructed and used to route traf-

fic between “islands”, while *store-carry-and-forward* is used on a microscopic level to forward messages when no routes exist, likely between “islands” [2]. Moreover, if the nodes that are associated with a given concentration point are stable over time (e.g. nodes affiliated with a given department), macroscopic information about the mobility pattern [105] or community structure [106] between nodes could be used to route traffic across disconnected parts.

### 3.4.2 Mobility

Node mobility is another important factor to be considered when choosing adequate routing approaches, especially as the network becomes sparser. In particular, we will discuss two aspects related to node mobility as follows:

**Amount of Mobility:** The “amount of mobility” of a node can be defined as the percentage of the network traversed or “covered” by the node within a given amount of time. Alternately, it can also be expressed as the number of new nodes (and thus either destinations or candidate relays) a given node encounters within a given time window. The following characteristics are needed to quantify mobility.

- **Node Speed:** Intuitively, the faster a node is moving, the more new area it should cover in a given amount of time, all other parameters unchanged. Additionally, if nodes move fast, they would have more chances to meet more nodes, thus increasing the number of contacts. On the other hand, if node speed is too high, contact duration is reduced, directly affecting routing protocol performance.
- **Pause Time and Frequency:** Depending upon the environment and the application, mobile nodes may tend to stay at a particular position for extended periods of time. We call this duration as the pause time. For example, in an exposition hall, nodes may move from one place to another and stay at the other place for some time before moving further. Again depending upon the application, the pause time may be used to deliver messages to destinations as it increases the contact duration when the node is in static position, as it has been shown that in some cases, the nodes that are static are more useful to relay messages because of their placement in the area (e.g., throwboxes[21], bus stops etc.). On the other hand, depending upon the scenario, the nodes that have longer pause times may not be as useful in the delivery process as mobile nodes. The nodes’ periodicity of visiting places, or their frequency can also be exploited in the delivery process of messages.
- **Integration Time:** This is essentially the time it takes a node, starting at a given state of a mobility structure, to arrive to its stationary distribution; the higher the integration time, the more time it takes the average node to reach a randomly chosen destination.

In general, the larger the amount of *average* node mobility, the better the performance of routing protocols that rely on such mobility. Furthermore, in a number of situations it holds that the higher the average node mobility, the less sophisticated the design of a protocol needs to be. This seems to be in contrast with the traditional viewpoint that node mobility has a negative effect on routing protocol performance.

**Structure of Mobility:** The structure of the nodes mobility is equally important, and becomes significantly more important for sparser and “less mobile” networks. The following information about the structure of a node’s mobility pattern is particularly important from a routing protocol’s perspective:

- **Homogeneous vs. Heterogeneous Mobility:** Depending on a particular DTN application, participating nodes may all have the same capabilities and behavior. Conversely, in a heterogeneous deployment, nodes mobility may differ from one another. For example, one could reasonably assume that nodes in a sensor network have homogeneous capabilities and behavior (e.g., duty cycle operation). However, people forming a Pocket Switched Network [107] might have largely different mobility patterns from one another.

Nodes heterogeneous mobility affects protocol design in a number of ways. For example, some nodes will be better relays than others for delivering traffic. Some relays might be preferable for any destination<sup>7</sup>, as in the case of nodes that move fast and frequently around the networks (e.g. vehicles). Protocols that are “smart” enough to discover and pick such advantageous relays are expected to perform better the more heterogeneous a network is. Attention is needed though to make sure not to overload a few nodes with relaying responsibilities; this will possibly have detrimental effects due to congestion or battery drainage. Alternatively, if the network is homogeneous, then simple greedy solutions may be adequate to achieve good performance.

- **Spatial and Temporal Correlation:** In addition to differences in the mobility pattern between nodes, individual nodes may exhibit specific mobility patterns which could be leverage to improve routing performance. For instance, a given node may visit some locations (e.g., a person’s home or office) often which exemplifies spatial correlation of movement. Also, a given node may exhibit different mobility behaviors depending on the time of day (temporal correlation). For example, most employees might head to the company’s cafeteria between 12 – 1p.m. Finally, there might also exist correlations between the mobility of different nodes both in space (e.g., nodes that tend to visit the same locations [108]) and time (e.g., nodes that leave their “home” location at around the same times). In such cases, good relays may be *destination specific*, that is, a given

---

<sup>7</sup>There are also cases where some nodes are better relays for certain destinations. Destination dependent and destination independent choice of relays is discussed in detail in Section 3.3.

node may be the best relay to deliver a message to destination X but may never do so for another destination Y. In some other cases, good relays may be *time-specific*, which means that a given node can act as the best relay at a specific time for a destination (or during a specific time interval), and another node would serve as relay for another time interval. Protocols that possess the necessary intelligence to distinguish between relays in general, and more specifically, take advantage of mobility patterns they exhibit, are desirable.

- **Other Considerations:** In addition to the previous generic mobility characteristics, a given set of networked nodes may also exhibit mobility attributes that may result in special structures which should be accounted for by routing. This is the case of *disconnected islands* as discussed in Section 3.4.1. In several applications, a set of mobile nodes can create well-connected clusters (e.g., a military platoon, a nomadic community [109], wildlife herd or pack [104]) which may be far enough away from one another that they cannot communicate among them. It has been shown that, in these cases, hybrid protocols that take explicit advantage of this structure, using regular routing protocols within a cluster and mobility-assisted techniques to bridge such clusters, can achieve good performance [110], [2].

### 3.4.3 Node Resources

Although network and node resources are becoming less and less of an issue in wired networks, it is not typically the case for their wireless counterparts. Depending on the application, node capabilities such as bandwidth, storage, and battery lifetime may vary largely. Resource availability or lack thereof should play an important role in the design and performance of a routing protocol.

- **Bandwidth:** Networks which operate over a common shared wireless medium, the available bandwidth is always a valuable and often scarce resource. If bandwidth is limited, then routing protocols should be efficient, especially in terms of signaling and control information exchange. Furthermore, the more limited the available bandwidth, the more prudent the choice of forwarding opportunities needs to be.
- **Storage:** Sensor networks are the typical case where available memory at nodes might be limited relative to the amount of information that needs to be stored locally. Besides affecting the choice of the routing algorithm to be used, storage limitation also influences relevant routing protocol parameters (e.g., TTL) as well as mechanisms such as buffer replacement policies and garbage collection [111, 112]).
- **Battery Lifetime:** Power awareness is usually an important feature in routing protocols



for wireless networks<sup>8</sup>. In the case of DTNs, it becomes even more critical, especially in the case of deployments in remote, hard to access regions where nodes may be left unattended for extended periods of time. There is also a recent work [147] that considers making throwboxes energy efficient in order to increase their lifetime while maintaining high efficiency of the system in terms of delivery ratio and latency. In order to minimize the energy waste in DTN, optimal searching or probing intervals are calculated using statistical information of contact opportunities in [142], [143], [144] and energy efficient sleep scheduling mechanisms are constructed in [145], [146].

**Heterogeneous Node Capabilities:** In addition to different mobility patterns, nodes may also have largely varying capabilities, like battery life, processing power, storage capability, etc. Imagine, for example, a scenario where some of the wireless nodes are vehicles (with little or no energy and storage limitations) while others are small PDAs carried by pedestrians. In such a scenario, it is important for the routing protocol to be able to identify the more capable nodes as they are possibly better candidates for relaying traffic than nodes that have barely enough resources to handle their own traffic.

### 3.4.4 Application Requirements

The discussion so far focused on network and individual node features and capabilities. In this section, we consider application-specific requirements, which must be taken into account when choosing or designing DTN routing mechanisms.

- **Message Content and Priority:** Despite the inherent delay tolerance of most DTN driving applications, there can be situations where some messages may be more important than others. For example, in a VANET network it is reasonable to assume that an accident notification message will have higher priority than a chat message, or announcements of nearby shops. In some cases, users might be willing to “pay” more for some of their traffic to get through quickly. Under such heterogeneous traffic requirements, different forwarding policies will be needed to serve the different types of traffic. What is more, not only is it important to ensure that a given protocol can deliver the desired performance (this is not always the case in such a partitioned environment), but the coexistence of the different protocols must be harmonic, as well.
- **Reliability:** In addition to different priority requirements, some messages may need to be sent reliably. Unlike conventional networks, acknowledging messages end-to-end in partitioned networks is not a trivial task and may often have a significant performance

---

<sup>8</sup>There are of course some notable exceptions, e.g., VANETs.

overhead (e.g., flooding an ACK message after successful reception at the destination). Furthermore, if a whole session of messages needs to be sent reliably, the considerably large delays of the *loosely* closed feedback loop may significantly reduce the ability to “pipeline” data through the network. What is more difficult in terms of reliability in a disruption-tolerant kind of network, is the ability to reliably deliver data in a certain order.

### 3.5 DTN Routing Design Guidelines

In the previous three sections, we have discussed different properties of DTNs such as connectivity, mobility and node resources, and have dissected DTN-based routing solutions with respect to their characteristics (replication, forwarding and coding). Now, we try to summarize the discussion by providing a correspondence between DTN-based routing solutions and the characteristics of different networks or applications. Having known, a priori, a given set of application characteristics and requirements, we can choose or build a specific kind of routing solution. For example, where connectivity and mobility are low, but the nodes have enough resources in terms of energy, bandwidth, and buffering, and we need a reliable solution, the epidemic routing or any of its variant such as Spray and Wait [29] can be employed. On the other hand, if the connectivity is low in an environment where nodes are highly mobile and nodes’ resources are restricted and expensive (in terms of energy, buffering or processing), message replication schemes are better candidates to be utilized. If reliability is needed by a routing solution, only epidemic routing or message coding can be employed.

Table 3.2 aims at summarizing the correspondence between network characteristics and DTN routing solutions. The rows in the table represents the properties of networks (or applications), whereas each column provides a different routing solution. If read line-by-line (horizontally), it states which routing modules may be *useful* or *necessary* to cope with the given characteristic (one per line). If read column-by-column (vertically), then it describes particular scenarios where the given protocol (one per column) is a better choice. We do not intend that this table is all-inclusive or without exceptions. It is only rather an indication of which routing strategies might match better which DTN environments. It is also important to note that this table characterizes the suitability of a routing solution according to the set of network or application characteristics that we have presented in Section 3.4.

In the following, we take up a few exemplary networks, summarize their characteristics and describe what kind of routing protocol is suitable for each network.

1. A typical Vehicular Ad hoc Network (VANET), where vehicles exchange information when they come into contact of each other. In such a network, at some places the network may

Table 3.2: Routing Module Applicability

		Epidemic	Replicate	Smart replicate	Focus	Manet	Code
<b>Connectivity</b>	low	✓	✓	✓	✓		
	high				✓	✓	
<b>Amount of Mobility</b>	low	✓			✓	✓	✓
	high		✓	✓			
<b>Structure of Mobility</b>	homogeneous		✓		✓		
	heterogeneous			✓	✓		
	correlated			✓	✓		
<b>Resources</b>	low		✓	✓			✓
	high	✓			✓	✓	
<b>Priority</b>		✓				✓	
<b>Reliability</b>		✓					✓

be very dense whereas at other places, it is sparse. The speed of nodes is generally high (from tens to hundreds km/h). Normally, resources are not scarce, especially in terms of power and memory. When choosing a suitable routing strategy in the light of what has been presented in this chapter, one may opt for controlled replication as the routing algorithm because nodes have sufficient resources available and mobility is high.

2. Habitat monitoring such as ZebraNet [104], where animals are equipped with wireless sensors with little memory and limited battery lifetime, and we want to collect information about living conditions and environment. Resources are very precious in such a network, and speed is low (a few m/sec) with large pause times. Animals live most of the time in groups, and different groups occasionally encounter each other, and may exchange information. A coding scheme can be beneficial in such a scenario, as it works better with low resources, and because we can aggregate groups information together in order to save transmissions.
3. A social network in which people belonging to the same social community or interest form a network. People may also move in between different communities depending upon their changing interests, and due to variations in their daily life routines (e.g., workplace, home, market). Nodes in such a network can have diverse variations in terms of connectivity, mobility and resources, which makes this kind of network heterogeneous. In such a network, a hybrid approach of routing may be useful. For instance, controlled replication scheme such as Spray and Wait [29] can be used within a community, while some utility based smart replication scheme could be used for inter-community traffic.

## 3.6 Concluding Remarks

In this chapter, we have presented a taxonomy of opportunistic routing protocols for DTNs. One of the main goals of our taxonomy is to have it serve as a set of guidelines for routing protocol designers and developers. The chapter starts by defining basic building blocks used by existing DTN opportunistic routing schemes. Then, we create a taxonomy for intermittently connected networks based on network characteristics and application requirements, and finally we presented some design guidelines that allows one to choose an appropriate routing protocol based on network characteristics and application in hand. Besides, we have also conducted a few case studies to validate the design principles that can be found in [27].

---

---



## **Part III**

# **MeDeHa - A Message Delivery Framework**



# 4

## MEDEHA FRAMEWORK

---

### 4.1 Introduction

With the advancement of technology, nodes and networks are becoming more and more heterogeneous. Today, a number of devices are available with diverse capabilities and people use these devices in order to stay connected with each other and to enjoy services offered by the backbone (Internet). Examples include laptops, netbooks, tablet PCs, PDAs, smart phones etc. Thus, willingness to be connected “anytime-anywhere” has also increased, as people want to remain connected using these smart portable devices (e.g., users may enjoy connectivity via the 3G interface or may connect to a Wifi network for high data rate whenever available). On the other hand, different types of networks exist ranging from wired- and wireless backbones to wireless infrastructure-based and ad-hoc networks (for instance, MANETs, VANETs, etc.). A glimpse of network heterogeneity is illustrated in Figure 4.1. Despite the existence of these different networks for a long time, not much has been done to make them inter-operate and allow users to take advantage of all the available networks (interfaces) simultaneously, while offering seamless interoperability. Thus, one of the goals is to provide seamless message delivery to users independent of which network they are part of and where they are while taking benefit from connectivity over multiple interfaces. Another goal is to integrate multi-hop mobile ad-hoc networks (or MANETs) to infrastructure-based networks (wired or wireless) that allows network coverage to be extended to regions where infrastructure deployment is sparse or nonexistent as well as a way to cope with intermittent connectivity.

In order to target these challenges, we designed an efficient message delivery mechanism that enables distribution or dissemination of messages in an internet connecting heterogeneous



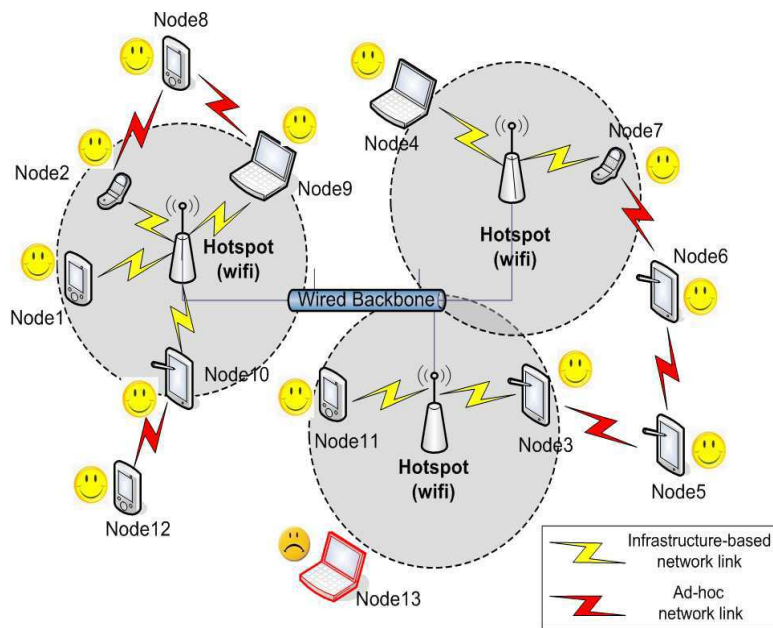

**Figure 4.1:** An example of a heterogeneous internetwork with a wired backbone, wireless infrastructure-based, and ad-hoc networks prone to episodic connectivity. Node13 is disconnected, whereas Node5, Node6, Node8 and Node12 are indirectly connected to the backbone network via the corresponding associated nodes.

networks and prone to disruptions in connectivity. We call our framework MeDeHa for Message Delivery in Heterogeneous, Disruption Tolerant Networks. MeDeHa takes advantage of network heterogeneity (e.g., nodes supporting more than one network and nodes having diverse resources) to improve message delivery. For example, in the case of IEEE 802.11 networks, participating nodes may use both infrastructure- and ad hoc modes to deliver messages to otherwise unavailable destinations. To cope with arbitrarily long-lived connectivity disruptions, we use available storage within the network to save messages for destinations that are currently unreachable. The message storage operation at nodes depends upon current storage availability as well as quality-of-service needs (e.g., delivery delay bounds) imposed by the application; once the destinations re-connect, messages destined to them get delivered. MeDeHa offers additional functionalities to what the Bundle Architecture [17], [16] provides, particularly the fact that it is able to operate at different layers of the communication stack (application, network, link etc.), and bridges infrastructure-based and infrastructure-less networks. Thus, MeDeHa can be supported by any (intermediate) node including ones that do not run higher-layer protocols (e.g., access point bridges, relay nodes, etc.), and is complementary to the Bundle Architecture. MeDeHa is also able to provide different levels of quality-of-service through traffic differentiation and message prioritization by controlling when messages are forwarded and for how long

they are stored.

We use opportunistic routing approach in MeDeHa, i.e., make a best effort to carry messages towards the destination based on the contact opportunities that a message carrier experiences. Also, any node in MeDeHa can act as a relay for any destination, and can serve as a gateway to bridge different networks that it is capable to connect. In MeDeHa, any node can provide backbone connectivity too, and we do not need any special purpose gateway or node to provide this feature. Note that there is a difference between introducing special-purpose nodes in the network to perform the task of relaying (like message ferries [19], data mules [20], and throw-boxes [21]) and making use of existing nodes with special capabilities (e.g., access points, or APs in the case of infrastructure-based wireless networks) that are an integral part of the underlying network. Of course, whenever available, MeDeHa utilizes nodes with more resources and capabilities like APs to perform message delivery more efficiently, but does not count on them. Furthermore, we take advantage of the underlying heterogeneity (e.g., in the context of IEEE 802.11 networks, a node's ability to operate in infrastructure or ad-hoc modes) to enable message delivery across different networks.

MeDeHa allows seamless integration of existing multi-hop (or MANET) routing protocols as well as DTN based forwarding mechanisms, without requiring any modification. It also helps in bridging together the infrastructure-based and the infrastructure-less networks even under intermittent connectivity. In this way, multi-hop MANET connectivity is used to fill in connectivity gaps left by infrastructure-based networks. Moreover, as we show in Chapter 5 (MeDeHa's evaluation), acceptable performance of the MeDeHa framework in terms of message delivery ratio can be achieved (close to 100%) with very few copies per message in the network, unlike conventional DTN routing (forwarding) solutions where more copies of a message increases the message delivery ratio. This helps in reducing control overhead and saving network resources.

To summarize, the MeDeHa framework is design to offer the following advantages:

- Seamless message delivery across heterogeneous networks.
- Ability to run at different layers of the protocol stack.
- Bridging infrastructure-based and infrastructure-less networks.
- Seamless integration of existing MANET routing protocols without requiring modifications.
- Ability to incorporate with existing DTN forwarding mechanisms.
- Partition mending through multi-hop ad-hoc (MANET) "transit networks".

## 4.2 Related Work

Most efforts that target heterogeneity in 802.11 networks aim towards extending network coverage and thus increasing network capacity. To extend network connectivity beyond regions covered by APs, these proposals employ different mechanisms such as: (1) the use of different frequencies in Flex-Wifi [10], and (2) a new layer between IP and link layer in Multi-Net [11]. Flex-Wifi [10] proposes the enhancement of the coverage area of the IEEE 802.11 infrastructure-based networks as well as the increase in the capacity of the network by allowing nodes to communicate directly in ad-hoc mode using IEEE 802.11e Direct Link Session (DLS) mechanism [12]. Flex-Wifi modifies the DLS mechanism by using a different wireless channels for direct communication of stations. The stations use Power Saving Mode (PSM) of IEEE 802.11 standard to switch modes in order to remain connected to both infrastructure-based and ad-hoc networks. On the other hand, Multinet [11] is a software based solution that allows seamless simultaneous connections to both infrastructure-based and infrastructure-less networks using a single interface card. Again, switching between different modes is performed using the PSM of IEEE 802.11 standard. Multinet requires changes to the data link layer or to the interface driver in the kernel. Besides, there are some other studies that target enhancement in network capacity and coverage area. Examples include WIANI [8], NUMI [13] and MMWLAN [9]. All these proposals target specific aspects of network heterogeneity, i.e., either enhancement of network coverage area or increase in network capacity. However, they do not consider nodes intermittent connectivity with the network.

Mobile Ad-hoc Networks (MANETs) are generally considered as lacking an infrastructure; thus, the backbone connectivity in MANETs is not provided by default. Efforts have been made to providing backbone connectivity to MANETs such as AODV+ [14]. AODV+ proposes a scheme to connect MANETs to the backbone by introducing gateway discovering mechanisms. Besides, some MANET routing protocols such as the Optimized Link State Routing (OLSR) [32] and the Dynamic MANET On-demand (DYMO) [35] protocols provide support for gateway discovery. OLSR performs this task by making nodes listen to the Host and Network Association (HNA) control messages announced by the potential gateways to declare the networks that are reachable through these gateways. DYMO provides Internet connectivity by the Internet DYMO Router (IDR), which intercepts route requests for nodes in the Internet and responds on behalf of them. This requires that all DYMO nodes behind IDR must have a common local network prefix, thereby elevating the need of an explicit gateway discovery mechanism. Again, these MANET routing protocols fail to deliver messages in the presence of frequent network partitioning.

The seminal work of the IRTF's Delay-Tolerant Networking Research Group (DTNRG) pioneered research on DTNs with their delay-tolerant network architecture [17] a.k.a. the Bundle

Architecture. Their proposal is based on bundle switching with the ability to store bundles in transit for arbitrarily long periods of time. This is referred to as *store-carry-and-forward*. Storage is generally performed above the transport layer to provide interoperability among networks that support different types of transport layers. The Bundle Protocol [16] is intended to be compatible with different types of networks through the *convergence layer adapters*. In this way, the protocol supports internetworking by allowing multiple *convergence layers* to be used for different networks.

Several studies have been proposed in the past to make MANETs impermeable to connectivity disruptions, which either propose a completely new protocol [2], [50], [51], or patch existing MANET protocols [3], [52], [53]. Ott et al. [3] introduce specialized DTN-capable end point nodes to bridge islands of networks, but this solution doesn't provide backbone connectivity. Natasa et al. [2] use the mobility patterns of the nodes over time to make nodes communicate in between different islands, but the proposal is based on the assumption of the existence of concentration points (CP). Besides, Context-Aware Routing (CAR) [15] protocol is another routing algorithm that aims at providing disruption tolerance to mobile ad-hoc networks (MANETs) using the Destination Sequenced Distance Vector (DSDV) protocol. In CAR, all the participating nodes exchange context information on other nodes along with DSDV control messages. The context information is based on the transmitting node's encounters with other nodes as well as the current battery status of the node. CAR requires all participating nodes to implement the CAR algorithm along with the support of the DSDV protocol. Also, it does not provide a way to connect to the backbone. Other notable examples that targets towards integration of DTNs and MANETs include SCaTR [37], HYMAD [38], and PreDA [39]. While all these solutions offer some disruption tolerance support to MANETs, they do not deal with network heterogeneity, nor they provide backbone connectivity.

Besides, some studies use the concept of node relaying in order to bridge otherwise partitioned networks. These propositions include message ferries [19], throwboxes [21], and use of data mules [20]. They suggest the use of specialized nodes, fixed or mobile that are used as message carriers or forwarders. These specialized nodes are resourceful entities (storage space, battery power etc). The concept is very fruitful in increasing the delivery ratio, and in some cases, reducing the overall delay, but the problem of number of these special-purpose nodes, planning of their routes, and their placement in the network is not trivial.

Some initiatives target relay node selection in a disruption tolerant environment. One notable example is [28], which presents different utility functions to be utilized for intermittently connected networks with different characteristics. Exponential Age Search (EASE) algorithm is presented in [36], where a destination location is estimated using the encounter database maintained locally by each node for every other node. A similar approach is presented in Encounter-based Routing (EBR) [48] where future rate of node encounters is predicted using

number of past encounters with nodes. For this purpose, an encounter metric is computed locally by each node, and is used as utility metric when choosing a relay for a message. Details on utility-based mechanisms in challenged networks have already been presented in Chapter 3.

There are a few architectures that address message delivery in heterogeneous networks. Notable examples include EDIFY [55] and CCN [56]. While EDIFY mainly targets the identification problem in a disruption tolerant environment, and CCN deals with naming the content rather than nodes, both lack true heterogeneous support (treating some specific networks in specific environments). Episodic connectivity and infrastructure supports in EDIFY are provided by mobile message ferries that carry traffic for other nodes, whereas the performance of CCN may suffer in an environment where routes are not persistent and change frequently. This is because in CCN, *data* messages are not routed (only *interests* are routed). So, *data* messages may not reach, if the route to the *interested* peer changes; hence the *interest* has to be resent. This may be due to the continuous movement of the *interested* node or the mobility of its neighbors.

### 4.3 Design Principle

We base our design on the principle that in order to join more than one network, there must be a gateway that is able to understand the traffic on all the networks to which it is a member. This gateway node learns the traffic on all connected networks and may pass each network's information to other networks. This node can either have multiple interfaces (e.g., a cellular phone with a 3G and a Wifi interface), or it can use the same interface card to join more than one network by using different frequency bands to communicate [11]. In the MeDeHa framework, we define gateway nodes (GW) to be MeDeHa nodes (MDH) with interfaces to multiple networks.

For instance, when involving MANETs, the GW is a node that runs the MeDeHa software and is configured with a MANET routing protocol. Thus, when this GW node hears a "hello" message from a MANET node, it learns about the presence of the MANET and passes this information to other connected networks (ad-hoc or infrastructure-based). In this way, nodes in the other networks are able to forward messages to the MANET nodes via the GW node. In a scenario such as Figure 4.1, Node2, Node3, Node7, Node9 and Node10 are examples of the GW nodes.

We define that there are two types of nodes in the networks, MeDeHa (MDH) nodes and non-MeDeHa (regular) nodes. MDH nodes run the MeDeHa framework and support all its functionalities, while non-MeDeHa regular nodes do not implement our framework. We assume that the participating nodes do not know about their own geographical locations and that of other nodes; rather, they can only have information about their logical connectivity. Moreover, we assume that the MeDeHa nodes are willing to cooperate in the network they are connected

to, and that they are able to store and carry network traffic for other MeDeHa or non-MeDeHa nodes. The participating nodes have limited storage capacity except the more resourceful nodes (such as base stations or access points). In this way, when forwarding a message to a relay, a node gives priority to a node with better resources over other nodes.

## 4.4 MeDeHa Overview

MeDeHa allows message delivery across heterogeneous networks by accommodating a diverse set of nodes characteristics in terms of mobility, connectivity, and resources. MeDeHa embraces node- (e.g., in terms of battery power, buffering or mobility characteristics) and network (e.g., co-existence of different types of infrastructure-based and infrastructure-less networks) heterogeneity and tries to make use of it whenever possible. For example, MeDeHa tries to take advantage of more resourceful nodes (e.g., APs in IEEE 802.11 infrastructure-based networks) whenever possible and feasible. Additionally, a node that participates in multiple networks will attempt to find a path (or a suitable relay) to a destination in all networks of which the node is a member. With the use of network heterogeneity, only few copies of a message are sufficient to provide acceptable delivery ratios, especially in the presence of infrastructure-based networks. This is in compliance with the observations found in [115], and we demonstrate this capability of the MeDeHa framework in Chapter 5.

To facilitate message delivery, MeDeHa nodes have several responsibilities:

- Find paths (or suitable relays) to a destination across all connected networks.
- Act as a relay for other nodes to forward or buffer messages.
- Exchange topological and routing information to aid in relay selection.

The MeDeHa framework involves a notification protocol [23] that plays a key role in seamless message delivery across multiple heterogeneous interconnected networks. The notification protocol collects information about a node and its neighborhood and shares that information with other nodes by exchanging the notification messages. Neighborhood information is then used by MeDeHa nodes to construct their routing and contact tables. We can describe the MeDeHa's protocol both in terms of functionality and network operation. With respect to functionality, the MeDeHa's notification protocol has two main components:

- **Neighborhood sensing** is used to detect immediate neighbors, and is performed using periodic broadcast of the *HELLO* notifications (e.g., in ad-hoc networks or MANETs), or using underlying network information (e.g., *association* information in infrastructure-based networks).

- **Neighborhood information exchange** is performed to pass information collected via *neighbor sensing* to currently encountered neighbors.

With respect to network operation, the notification protocol can also be divided into two components:

- **Infrastructure-based network operation** involves collection of nodes' connectivity information (*association* or *disassociation*). This information can be exchanged between infrastructure-based nodes connected in local network, which are also able to act as relays to store messages for unavailable destinations.
- **Infrastructure-less (ad-hoc) network operation** is based on gathering network information from neighboring nodes (using the protocol messages)<sup>1</sup>, and passing this information to an infrastructure-based network through the GW nodes, if possible. A key benefit of ad-hoc networks is the ability to extend the coverage area or act as a "transit" networks to link two disjoint infrastructure network segments.

Using the information obtained from the neighborhood exchange, the MeDeHa nodes build their routing and contact tables. The routing tables contain information of currently reachable nodes, while the contact tables are used to manage heuristics about nodes encounters.

#### 4.4.1 Functional Components

MeDeHa's main functional components are:

**Message Relaying and Forwarding:** In MeDeHa, any node in the network can relay messages under the *store-carry-and-forward* paradigm [17], and can be used to connect to the backbone network. We thus avoid using any explicit discovery mechanism for finding specialized nodes (e.g., gateway to the backbone). Message delivery is improved by taking advantage of network heterogeneity. This is achieved with the help of the GW nodes that are able to connect simultaneously to more than one network. The GW nodes may also switch between multiple networks using the same interface card. For example, 802.11-capable nodes may join different networks by switching between infrastructure- and ad hoc modes by using different frequencies (this can be done, e.g., using the PSM of IEEE 802.11 standard [11]).

**Buffering:** In an environment with intermittent connectivity, it is necessary to use network nodes to store messages if a route to the intended destination(s) is not available. An important question is where to buffer these messages. In MeDeHa any node can act as a relay and therefore store messages whose destination(s) is(are) not available. However, we again try to take advantage of network heterogeneity. For example, Access Points (APs) in infrastructure-based

<sup>1</sup>The protocol messages are defined in Section 4.6.1 and are also presented in [23] and [25].

wireless networks or mesh routers in the case of wireless mesh networks, are usually good candidates to serve as temporary storage for undelivered messages as they exhibit higher resource availability<sup>2</sup>. Another advantage of storing messages at these more resourceful backbone nodes (such as APs) is that it increases the probability of message delivery, as the stored message(s) can be delivered to a destination as soon as it connects to any backbone node if the backbone nodes share connectivity information.

As we will show in Chapter 5, in MeDeHa, buffering can be done at different layers of the communication stack, which enables almost any network-enabled device to relay and buffer messages. This feature allows MeDeHa to be implemented on nodes that run only the lower two or three protocol layers (e.g., AP bridges and routers). This also makes MeDeHa complementary to the Bundle Architecture [16] as MeDeHa can operate on the nodes that do not implement the Bundle Architecture. Moreover, in MeDeHa, quality-of-service is supported by enforcing application specific requirements at the message forwarding and storage level. For instance, data belonging to real-time flows would be discarded after a pre-defined time interval specified by the application.

**Topology and Content Information Exchange:** Nodes periodically exchange information that is used in building their routing and contact tables. This information includes a node's knowledge about the topology (e.g., its own neighborhood as well as what it knows about other nodes). Routing tables are used to keep information on the connected nodes, whereas contact tables are maintained to keep a history of nodes encounters for a pre-defined period of time that may be used in the relay selection process. Entries in the contact tables are removed when expired. Nodes also exchange a summary of their message buffer and their current state in terms of resources (e.g., how much storage left, remaining battery lifetime, etc.). All this information is used in the relay selection process [28], [36], [48], [49] and contributes to the overhead incurred by MeDeHa. Clearly, there is a tradeoff between the overhead incurred by the framework, how fresh paths are, and how well the relay selection performs. Note that if neighborhood information is already made available by the underlying layer-2 protocol (e.g., beaconing, AP *association* or *disassociation* in IEEE 802.11 infrastructure mode), MeDeHa simply makes use of it.

**Traffic Differentiation:** In order to satisfy application specific needs, MeDeHa uses message tags to carry information such as message priority, time-to-live (or TTL, which is the maximum amount of time the message should remain in the network), etc. Besides performing traffic differentiation and supporting quality-of-service, message tags are also used for buffer manage-

---

<sup>2</sup>It is true that most current off-the-shelf APs do not typically come equipped with mass storage. We argue that adding this capability to next-generation APs is viable and will not considerably impact cost, especially if there is market demand. Furthermore, co-locating a general-purpose computing device with APs is another alternative given current AP technology.



ment purposes. For instance, a message that has been stored past its TTL would be discarded.

#### 4.4.2 Integration of Existing Protocols

One of the objectives of the MeDeHa framework is to allow existing protocols and routing/forwarding strategies to be integrated without requiring any modification. In this way, conventional MANET routing protocols can be added to the framework, and the MeDeHa nodes can communicate with non-MeDeHa MANET nodes using the GW nodes. In the infrastructure-based network, the framework relies on the underlying connectivity information, if available (e.g., *association* or *disassociation* at MAC layer in case of IEEE 802.11 based networks). In ad-hoc network, the framework design allows the integration of different existing forwarding algorithms such as Spray and Wait [29] or Spray and Focus [30] for disruption-prone networks and OLSR [32] or AODV [33] for mobile ad-hoc networks.

#### 4.4.3 Multi-hop Connectivity

MeDeHa offers multi-hop connectivity to nodes while coping with nodes intermittent connectivity. Unlike previous proposals (e.g., [52], [53], [3]), MeDeHa does not require any modification to existing MANET routing protocols, as mentioned previously. This serves to provide two advantages:

1. **Connectivity to non-MeDeHa nodes:** The framework extends network connectivity to non-MeDeHa MANET nodes using the GW nodes. In this way, all nodes in the network do not need to implement the MeDeHa framework. For instance, when a MANET is present, the connectivity can be extended beyond the MANET in the presence of at least one GW node. Similarly, when two GWs meet and are part of two different MANETs, nodes in these different MANETs can communicate to each other using the GWs, as shown in Figure 4.2.

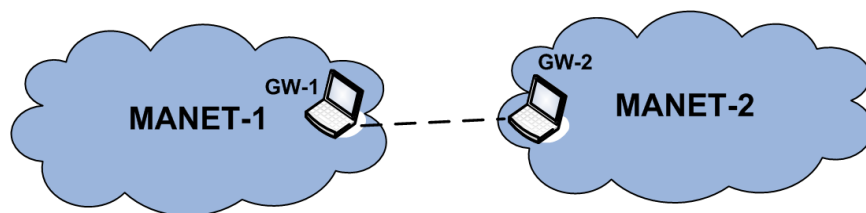
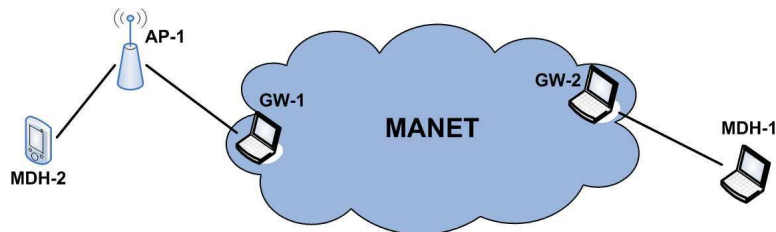

Figure 4.2: GW nodes connecting two different MANETs

2. **Partition mending through multi-hop connectivity:** The framework allows the MeDeHa nodes to use multi-hop MANET connectivity in order to bridge different partitioned networks (including infrastructure-based networks), and to communicate with other MeDeHa

nodes that may be multiple hops away. In this way, the GW nodes can learn about the presence of other GW nodes in a MANET, and can exchange information about the connected networks. This mechanism allows MANETs to act as “transit networks” to bridge disjoint networks, as illustrated in Figure 4.3.



**Figure 4.3:** MDH-2 is able to communicate with MDH-1 by traversing through MANET using GW-1 and GW-2

## 4.5 MeDeHa's Operation

In this section, we present the operation of the MeDeHa framework. We start by showing a state diagram of MeDeHa's functionality.

### 4.5.1 MeDeHa State Diagram

Figure 4.4 illustrates MeDeHa's overall operation.

**Idle:** By default, a node starts in *idle* state. It switches to *receive* state upon reception of a message, or to *forward* state if it has some message to send. This message can either be generated by this node, or can be the message that the node has stored for some unavailable destination. Thus, in *forward* state, if the destination is not found, the node stores the message and goes back to *idle*. Later if the destination is found, the node goes to *forward* state, delivers the message and changes its state to *idle*.

**Forward:** When a node has a message to send either as the message originator or relay, it checks if it has a path to the destination, and if so, sends the message along that path and switches to *idle* state. Otherwise, it tries to find a “suitable” relay. If it does not succeed, it switches to *buffer* state to store the message locally.

A number of destination-dependent and destination-independent heuristics can be used to select a relay for a *(message, destination)* tuple including: (1) when the node last encountered the destination (or age of last encounter), (2) how frequent the destination was encountered, (3) how mobile a node is, and whether the scope of the mobility is “local” or “global”, (4) how

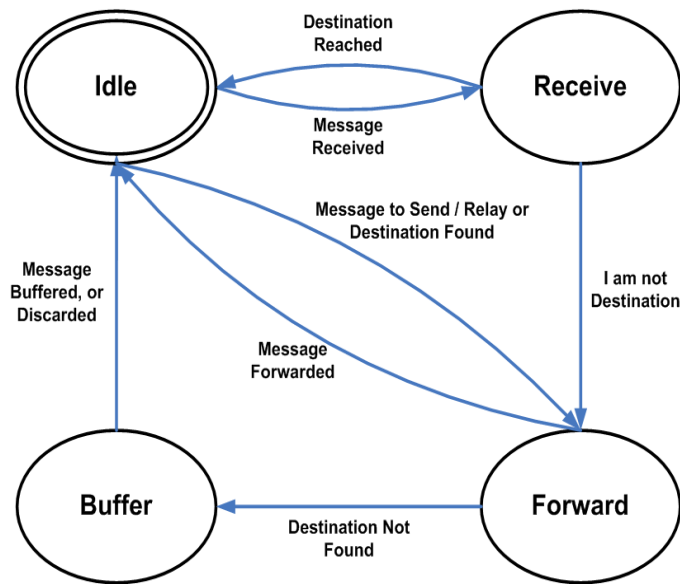

**Figure 4.4:** State diagram showing MeDeHa’s overall operation. A MeDeHa-capable node can be in one of the four states, *Idle*, *Receive*, *Forward*, and *Buffer*

“social” a node is, etc. A number of these heuristics or utility functions has been presented in [28]. MeDeHa’s framework is flexible enough to employ any kind of utility function for choosing a relay to carry a message to a destination. When selecting relays, MeDeHa can also account for the underlying heterogeneity among participating nodes, e.g., the amount of available resources such as storage, processing, and battery lifetime. For instance, more resourceful entities (like APs) may be preferred when messages need to be stored.

**Receive:** When a node receives a message and it is not the message’s intended destination, it switches to *forward* state and follows the steps described above. Otherwise, the message is passed to the application layer.

**Buffer:** A node is in *buffer* state when it has a message to store for an unavailable destination. MeDeHa’s buffering mechanism is based on message priorities and time-to-live (TTL) values. The node goes back to *idle* state whether the message is buffered or discarded. MeDeHa nodes make use of different buffer management strategies based, for example, on the application QoS requirements such as message priority and TTL.

In the following, we detail different components of the MeDeHa framework:

#### 4.5.2 Receive Operation

When a node receives a message from another node, it first checks if it is the intended destination of the message. If it is the intended destination, it passes the message to the application

layer so that the message is consumed (*ConsumeMessage()*). If it is not the destination, it checks whether some information is available in its routing or contact tables about the destination; the message is forwarded to the destination or the next relay in case there is an entry in either the routing or the contact table. At this point, if the node supports a reactive routing protocol (such as AODV or DSR in case of MANETs), the node tries to search for the destination in its neighborhood. Otherwise, the message is buffered locally depending upon the availability of the buffer space and the priority of the message. The pseudo code of the receive operation of the MeDeHa framework is presented below, while the receive mechanism is illustrated in Figure 4.5.

```

1: state ← idle
2: if message received then
3:     state ← receive
4:     if node is destination then
5:         ConsumeMessage()
6:         state ← idle
7:     else
8:         state ← forward
9:         Forward()
10:    end if
11: end if

```

### 4.5.3 Relay/Forward Operation

When a node has a message stored for a destination, and a connection is detected (i.e., another node comes in the vicinity or the node is connected to the backbone network via a base station), the node checks whether it has a path towards the destination or if it can make a better forwarding decision for the stored message based on the current available information by choosing a (another) relay. Choosing a “suitable” relay depends upon the relay selection strategy used. Figure 4.6 describes the relay operation of the MeDeHa nodes.

In other words, the forward function is called either when a message is generated at a source or when a message carrier meets the destination, or encounters another “suitable” relay for that destination. Thus, the forward function is called at each contact opportunity that the message carrier experiences. The function is also called when a node receives a message but it is not the intended destination of the message. In *forward* state, a node first consults its routing table to see if it has an entry for a destination. If the destination information is found, the message is forwarded to the destination (*SendMessageToDestination()*) and the node goes to *idle* state. Otherwise, the node consults in contact table to see if some information is available to select a “suitable” relay or tries to find a route to the destination through its neighborhood, and if the relay is found, the message is forwarded to the relay (*SendMessageToRelay()*), and the current

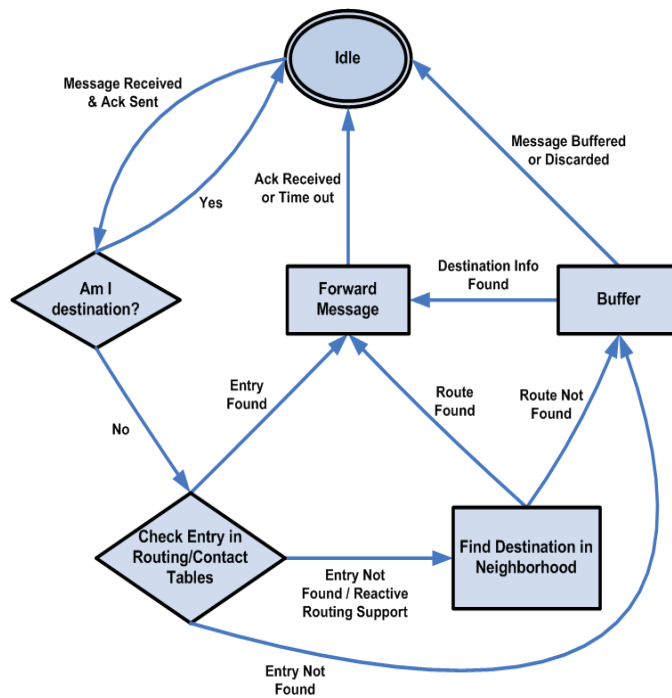

Figure 4.5: Receive Operation of a MeDeHa-capable Node

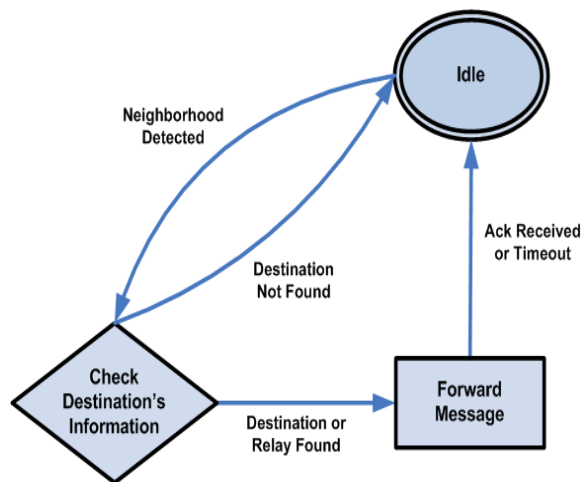

Figure 4.6: Forward/Relay Operation of a MeDeHa-capable Node

node changes its state to *idle*. If no information about the destination is found or no relay is selected and the message is not already buffered locally, the node changes its state to *buffer* and stores the message (*BufferMessage()*). The pseudo code for the forward/relay function is given

below.

```
1: state ← forward
2: ConsultRoutingTable()
3: if destination info is found then
4:     SendMessageToDestination()
5:     state ← idle
6: else
7:     ConsultContactTable()
8:     if destination info is found then
9:         SendMessageToRelay()
10:        state ← idle
11:    else
12:        if message is already buffered then
13:            state ← idle
14:        else
15:            state ← buffer
16:            BufferMessage()
17:        end if
18:    end if
19: end if
```

#### 4.5.4 Buffer Operation

MeDeHa uses message tags to carry information such as message priority, message TTL and scope, in order to fulfill application-level requirements. These message tags are also used for making decisions on which messages to be stored, especially in buffer constrained environments. When a message needs to be stored, the node immediately stores the message if the space is available (*StoreMessage()*). If the space is not available, then the node checks the message tag to look at its priority (*CheckMessagePriority()*). It then removes the oldest message having lower or equal priority in its buffer and stores the incoming message. If the buffer is full with all higher priority messages, the incoming message is discarded. The pseudo code for the buffer operation is given below whereas the MeDeHa buffer operation is illustrated in Figure 4.7.

```
1: state ← buffer
2: if buffer is not full then
3:   StoreMessage()
4: else
5:   CheckMessagePriority()
6:   CheckForOldestLowerPriorityMessage()
7:   if message is found then
8:     RemoveOldestLowerPriorityMessage()
9:     StoreMessage()
10:  else
11:    CheckForEqualPriorityMessage()
12:    if message is found then
13:      RemoveEqualPriorityMessage()
14:      StoreMessage()
15:    else
16:      DiscardMessage()
17:    end if
18:  end if
19: end if
20: state ← idle
```

## 4.6 MeDeHa Design Details

This section details the MeDeHa framework and its notification protocol that implements MeDeHa's functional components presented in Section 4.4. MeDeHa involves a neighbor sensing and neighborhood exchange information mechanism which is implemented via the notification protocol, both in infrastructure-based and infrastructure-less networks.

### 4.6.1 The Notification Protocol

As illustrated in the example of Figure 4.8, the MeDeHa's notification protocol plays a key role in seamless message delivery across multiple heterogeneous interconnected networks. It collects information about a node and its neighborhood and shares that information with other nodes by exchanging the *notification messages* (described below). Neighborhood information is then used by the MeDeHa nodes to construct their routing and contact tables. For the protocol design, we assume that the notification protocol is able to work on more than one interface, where each interface may have a different network identifier (e.g., IP address).

In the specific example of Figure 4.8, the access point (AP) gathers two-hop network infor-

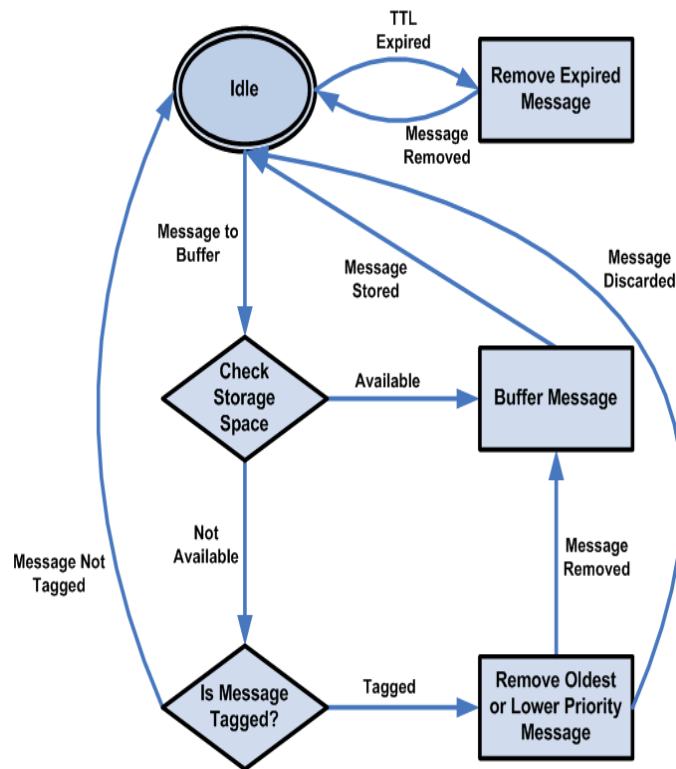

Figure 4.7: Buffer Operation of a MeDeHa-capable Node

mation from the nodes that are *associated* to it; it then can forward a message to a node (in this case, node **D**) that is connected through one of the *associated* nodes (node **G**).<sup>3</sup> This particular example shows that MeDeHa extends message delivery beyond the range of access points in infrastructure-based networks to destinations that can only connect (intermittently) on ad-hoc mode.

The MeDeHa's notification protocol has itself 2 main components, *neighbor sensing* and *neighborhood information exchange*. These components are described in detail below.

#### 4.6.1.1 Neighbor Sensing

If neighbor detection is provided by the underlying network, MeDeHa can take advantage of that information. For instance, in the case of IEEE 802.11 infrastructure mode, a node senses the presence of a nearby AP when it is *associated* with the AP at the link layer. This information is immediately forwarded to the MeDeHa routing component. Similarly, a link disconnection

<sup>3</sup>Note that node **G** can be using single interface card to connect to two different networks [11], or it can be connected to a cellular base station and use 802.11 card to connect to an ad-hoc network.



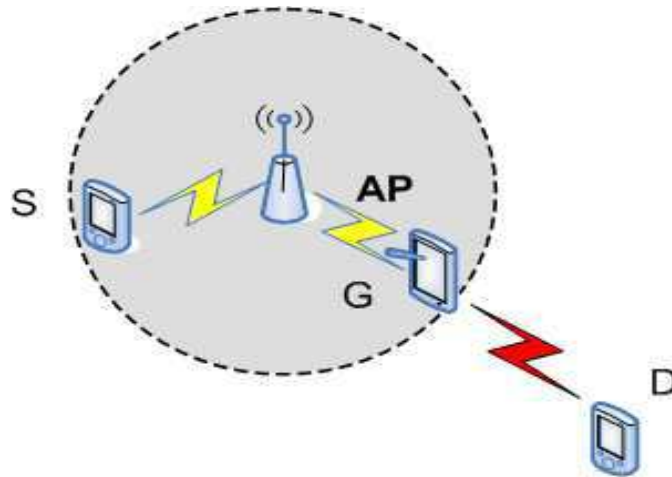

**Figure 4.8:** Multi-hop message delivery involving infrastructure-based and “ad hoc” nodes that may be intermittently connected. Source *S* wants to send a message to destination *D*. This is made possible with the help of node *G* that acts as gateway between the two networks. *S* and *D* do not need to be connected to more than one network nor be part of the same network in order to send or receive messages.

is detected when a node is *disassociated* with an AP. Thus, in infrastructure-based network, neighbor sensing is performed implicitly with the help of underlying link-layer protocol.

In MeDeHa-capable ad-hoc networks, neighbor sensing is done using the *HELLO* notification message exchange. Nodes periodically broadcast the *HELLO* notifications in order to inform other nodes in the neighborhood (if any) about their presence. In MeDeHa’s current implementation, the *HELLO* notification interval is empirically set to 2 seconds, by default. In an effort to minimize the overhead incurred by the protocol, information in the *HELLO* notifications is kept to a minimum and may include:

- **Node identifier(s) (e.g., IP address):** Nodes may announce multiple identifiers if they have more than one.
- **Infrastructure affiliation indicator:** A flag indicating whether transmitting node is currently connected to an infrastructure-based network.
- **Identifier of infrastructure-based node<sup>4</sup>:** In case of affiliation with an infrastructure-based network, identifier of the associated infrastructure-based node (e.g., AP).
- **Memory status:** Available memory in number of bytes.
- **Energy level:** An indication about the status of the node’s current power capacity (e.g., remaining battery life).

<sup>4</sup>We use the term infrastructure-based node to refer to a basestation with backbone connectivity (e.g., an AP)

- **Node Utility:** This metric is used to announce to other nodes for the set of utilities that is supported by the transmitting node. It helps in making better decisions for selecting relays. For instance, this can be an indicator of the node's mobility behavior (e.g., bus, pedestrian, car etc.), or its affiliation to a particular community (e.g., city, village etc.) or an organization. Details are provided in Section 4.6.3.

Note that all fields are optional except the node identifier field.

#### 4.6.1.2 Neighborhood Information Exchange

The *HELLO* notification only contains information about the *HELLO*-originating node, and not about its neighborhood. As previously mentioned, this is done in order to limit protocol overhead; this is especially beneficial in the case of highly partitioned networks. Having received the *HELLO* notification, a “hello handshake” process starts, where two nodes exchange their neighborhood information by sending the *NEIGHBOR\_INFO* unicast notification, as shown in Figure 4.9. In this way, the node with lower ID announced in its *HELLO* sends the *NEIGHBOR\_INFO* notification first. This completes the handshake between two neighboring nodes and also eliminates uni-directional wireless links implicitly. A *NEIGHBOR\_INFO* notification message may contain any combination of the following:

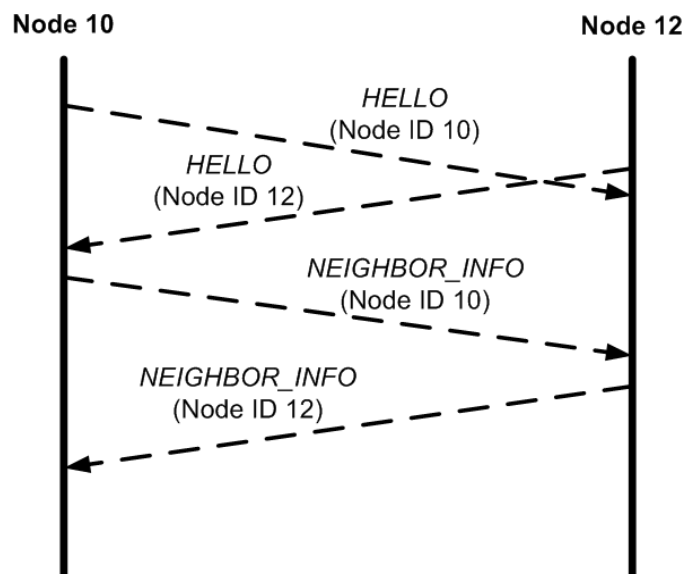

**Figure 4.9:** Hello handshake mechanism between node 10 and node 12. Node 10 wins and sends the *NEIGHBOR\_INFO* notification before Node 12.

- **CURRENT\_NEIGHBORS:** List of one-hop neighbor identifiers minus the identifier(s) of

the node to which the notification is being sent. If the transmitting node has no neighbors except the one to which the *NEIGHBOR\_INFO* is sent, this notification is not included.

- ***RECENT\_NEIGHBORS***: List of node identifiers who have been encountered within a pre-defined period of time. It may also include additional information related to encountered nodes (e.g., number of encounters, encounter time, social affiliation of node, speed of nodes etc.) which are used in computing the *utility functions* employed in relay selection (see details in Section 4.6.3). If the transmitting node has not encountered any node in the specified period of time, or all its contact table entries are expired, this notification is not included.
- ***MSG\_VECTOR***: List of application-level message identifiers (sequence numbers, source-destination identifiers and ports). This notification may be sent to avoid forwarding a message to a relay that already has a copy of it. This is used with a multi-copy replication scheme in order to reduce unnecessary message duplication.<sup>5</sup> If the transmitting node's buffer is empty, this notification is not included.
- ***MANET\_NEIGHBORS***: List of MANET neighbors for which a route is available over multi-hops. This notification is sent by the GW node when it is part of a MANET network. Note that the MeDeHa node that receives this notification treats all MANET neighbors as 2-hops away (direct neighbors of the GW node) even if they are multiple hops away. This is done in order to maintain simplicity so that MeDeHa nodes use the notification protocol to access MANET nodes. If the transmitting node is not part of a MANET, this notification is not included.

The *MSG\_VECTOR* notification contains only a list of message identifiers (described above) for messages stored at the advertising node, instead of actual messages. After exchanging the list of messages, the advertising node decides which message(s) the other node is missing. Then, they exchange only the missing messages that pass the relay selection criteria. Messages could also be identified by message digests which could also be used as a security mechanism to prevent message tempering by intermediate nodes. Note that *MSG\_VECTORS* are generated “on-the-fly” upon an encounter and are not stored at the nodes.

Table 4.1 summarizes different notification messages exchanged in MeDeHa-capable ad-hoc networks. We assume that each MeDeHa node recognizes each control notification, though it is not mandatory to include all control notifications in the *NEIGHBOR\_INFO* message. Note that neighborhood information exchange in ad hoc mode allows each node to keep two-hop neighborhood information.

---

<sup>5</sup>Note that following the epidemic routing replication principle, the two encountered nodes exchange the list of all the messages that they have stored. To prevent waste of memory resources, each stored message has an expiry

**Table 4.1:** The Notification Information Exchanged for Ad-hoc Networks

Notification Name	Includes	Contents	Description
HELLO		Node IDs flagAssociated Affiliated infrastructure node's ID Buffer level Energy level	Broadcasted by each node periodically to inform neighboring nodes about its IDs
NEIGHBOR_INFO	CURRENT_NEIGHBORS	IDs of neighbors	Sent in order to inform receiving node about other neighboring nodes
	RECENT_NEIGHBORS	IDs of encountered nodes Encounter time Number of encounters <i>Any other heuristic</i>	Sent to inform receiving node about the nodes recently seen by the transmitting node
	MSG_VECTOR	Sequence no. of messages Source of messages Destination of messages	Contains sequence numbers of messages stored at transmitting node
	MANET_NEIGHBORS	IDs of MANET neighbors	Sent by a MeDeHa-capable MANET node to inform about the connected MANET nodes

In case of infrastructure-based networks, neighborhood information is exchanged between a node and its *associated* infrastructure-based node (e.g., AP) and among infrastructure-based nodes that are connected within a local scope (either wired or wireless). The notification messages between infrastructure-based nodes are triggered on the reception of a connection or a disconnection event (e.g., *NODE\_PRESENT*, *NODE\_LEAVE* etc.).<sup>6</sup> The notification messages between a node and its *associated* infrastructure-based node may result from a link layer *association* of the node, or based on sensing a neighboring node in ad hoc mode. Nodes that pass their ad-hoc one-hop neighborhood information to their *associated* infrastructure-based nodes act as gateways to connect nodes in infrastructure-based networks with nodes in ad-hoc networks. The notification messages that are exchanged in the infrastructure-based network are presented in Table 4.2. In the specific case of IEEE 802.11, the notification protocol messages exchanged amongst APs are broadcasted but confined to APs within an Extended Service Set (ESS). Simi-

time associated to it.

<sup>6</sup>These notifications are defined in Table 4.2.

larly, there are two other notification messages named as *MANET\_PRESENT* and *LEAVE\_MANET* that could be sent by the GW node to its corresponding *associated* infrastructure-based node. *MANET\_PRESENT* is sent as soon as the GW node joins a new MANET or when there is a change in its MANET routing table (addition or removal of routes to other MANET nodes), whereas *LEAVE\_MANET* is sent to inform the *associated* infrastructure-based node that the GW node is no longer part of the MANET.

#### 4.6.2 Routing and Contact Table Management

Each MeDeHa node maintains routing and contact tables which are built using information collected from the “hello handshake”. MeDeHa routing tables contain forwarding information for nodes that are currently accessible. Using information from the *HELLO* and *CURRENT\_NEIGHBORS* messages allows nodes to maintain 2-hop routing information. Routing information is updated after each “hello handshake”. If a node does not hear an update from a neighboring node (for which it has a routing entry) for as long as two times the period of *HELLO* exchange, it removes the routing entry from its routing table<sup>7</sup> and stops propagating the node’s availability in the subsequent *CURRENT\_NEIGHBORS* notifications. All entries in the routing table for which the departed node was a gateway are also removed at this point. As soon as the entries from the routing table are removed, the corresponding entries in the contact table are updated so that they can be used in the *RECENT\_NEIGHBORS* notifications.

Routes are calculated in such a way that the routing loops are avoided. In this way, a direct hop to a node always has a priority over a 2-hop route to the node. Moreover, as nodes may use multiple interface identifiers (e.g., IP address), the routing table considers the ad-hoc interface identifier of a node as direct hop, and use all its other interfaces as accessible via the ad-hoc identifier of the node.

A node’s contact table comprises information about other nodes that are encountered by this node over a pre-defined period of time. The contact table information is then propagated via the *RECENT\_NEIGHBORS* notifications. The information about a “contact” is entered into the contact table of a node when the node received a *HELLO* notification from a newly connected neighbor. This information contains the time at which the contact occurred as well as an encounter counter. This counter is only incremented once during a contact duration (even if nodes exchange more than one *HELLO* notification), and is an indicator of the number of contact opportunities the two nodes have had with each other. Contact table entries of a node are removed when they time out. This timeout period is configurable, and depends on how long an information remains useful about a “contact” in a specific environment. A node stops propagating a contact information after this timeout.

---

<sup>7</sup>The node does not remove the neighboring node’s entry from its contact table.

**Table 4.2:** The Infrastructure-based Notification Protocol Messages

Notification Name	Originator	Destination	Description
ASSOC	MeDeHa Node	Infrastructure-based node	Notification sent to the MeDeHa routing component as soon as a node is connected to an infrastructure-based node.
NODE_PRESENT	Infrastructure-based node	Infrastructure-based node	Upon arrival of <i>ASSOC</i> , this notification is sent to all other infrastructure-based nodes to inform about a node's connection (association).
NODE_LEAVE	Infrastructure-based node	Infrastructure-based node	This notification may be sent when a disassociation process is completed (implicit or explicit).
FETCH_FRAMES	Infrastructure-based node	Infrastructure-based node	On the arrival of a <i>ASSOC</i> , an infrastructure-based node may send this notification to other infrastructure-based nodes asking about any stored messages.
NEIGHBOR_PRESENT	GW Node	Infrastructure-based node	This notification is sent from a node to its affiliated infrastructure-based node, and contains information about immediate neighbors of the transmitting station.
INDIRECT_ASSOC	Infrastructure-based node	Infrastructure-based node	This notification is sent on the reception of <i>NEIGHBOR_PRESENT</i> to inform other infrastructure-based nodes about an indirect association.
NEIGHBOR_LEAVE	GW Node	Infrastructure-based node	As soon as departure of a neighboring node is detected, this notification is sent from an associated node to its infrastructure-based node.
MANET_PRESENT	GW Node	Infrastructure-based node	This notification is sent by a GW node that is connected to a MANET to inform its associated infrastructure-based node about the MANET neighbors available through the GW node.
LEAVE_MANET	GW Node	Infrastructure-based node	This notification is sent by a GW node to its associated infrastructure-based node, as soon as it detects that it is no more member of the MANET.

### 4.6.3 Relay Node Selection and Forwarding

In MeDeHa, selection of a relay node depends upon the information advertised by candidate relays (propagated as part of “hello handshake”) or by locally collecting the encounter infor-

mation with other nodes. This information is used to compute the *utility* of the node as a relay. The choice of utility metrics for relay selection also depends upon the network environment, node heterogeneity, as well as application's specific requirements.

For instance with IEEE 802.11, considering all APs within an ESS are connected to each other, providing an "almost connected" network, APs may have high utility as relays when compared to other nodes. This is because in such environments handing over a copy of a message to an AP means that the network contains the number of message copies equal to the total number of neighboring APs within the ESS, even though only one AP has stored the message. This increases the probability of message delivery to a destination. Another advantage is that APs are expected to be more resourceful entities in terms of battery and storage space. Now consider an example where connectivity between different villages is only provided using buses that move between them. In this case, buses would be given priority as relays to carry inter-village traffic. The affiliation to a particular community (e.g., village in this case) can also be used to choose a relay for carrying the traffic. The nodes detect the presence of these relays (such as buses) by the *utility* advertised by the relays in the *HELLO* notifications under the field of *Node Utility*. The field *Node Utility* can also include information about the trust rating of the advertising node. This rating may be assigned by a central entity, and helps in avoiding malicious nodes.

Another important parameter in choosing a "suitable" relay is the buffer capacity (e.g. in bytes) advertised by a candidate relay. If a node has more messages to send than the messages that can be accommodated by a candidate relay, it could only forward a subset of stored message to the latter and must look for another relay to carry the other remaining messages. Similarly, a node's energy level is another parameter to be considered when choosing relay nodes as it may be useless to forward messages to a node who is going to die soon.

Two nodes may also exchange a summary of their stored application-level messages (instead of actual messages) using the *MSG\_VECTOR* notification as part of their *NEIGHBOR\_INFO* message exchange. Furthermore, before forwarding a message (or a set of messages) to a relay, the corresponding route for the destination is entered in the routing table of the node that is forwarding the message with next hop set as the chosen relay. This route remains in the node's routing table until it times out, or the relay becomes unfeasible for carrying messages for the destination (for instance, if the relay runs out of buffer or another more suitable relay is found).

To perform data forwarding, MeDeHa employs the hop-by-hop reliability mechanism as specified by the reference DTN architecture [17] which works as follows. When a message carrier encounters a destination or a relay, it forwards the messages and considers that a message is successfully received by the latter when it receives an acknowledgment. This makes sure that the message is transferred reliably and that the number of messages transferred are proportional to the contact duration, thus avoiding any unnecessary message loss. This is even more

beneficial for the scenarios where only one copy of a message exist in the network, as losing the only copy has more drastic effect on the performance as compared to the scenario where multiple copies of a message co-exist in the network. This could also be served as a flow control mechanism.

## 4.7 Interaction with MANETs

As previously mentioned, MeDeHa allows integration of MANET routing protocols without requiring any modification. In this way, the GW nodes get multi-hop connectivity information about MANET nodes when they are connected to a MANET. The GW nodes are also capable of using the multi-hop node information to discover other GW nodes in the MANET and to use the underlying MANET network as a bridge to connect networks that are otherwise disconnected.

The GW node when member of a MANET, can be connected to other infrastructure-based or ad-hoc networks, and learns about the presence of the MANET nodes and passes this information to other connected networks. In this way, nodes in the other networks gather the MANET nodes information and are able to forward messages to the MANET nodes via the GW node.

In the following subsections, the framework functionality with MANETs is described.

### 4.7.1 MANET Information Exchange

The presence of a MANET at the GW node is detected by neighbor sensing procedures of the MANET routing protocols (e.g., receiving a “hello” broadcast), and is notified to the MeDeHa routing component, which starts looking up the MANET routing table to get the information about the available MANET neighbors. Also, each time that the MANET routing table is changed at the GW node, a notification is sent to the routing component. Thus, the GW node consults the MANET routing table to keep information about all available MANET nodes, and treats them as immediate neighbors. Note that nodes form a MANET whenever two or more MANET-capable nodes approach each other.

The GW node sends the *MANET\_NEIGHBORS* notifications to other encountered MeDeHa nodes that are not participating in the MANET. In this way, the MeDeHa’s 2-hop ad-hoc protocol is utilized, and MeDeHa nodes assume that all MANET nodes announced by the GW node are 2-hop away. Thus, they are able to forward any stored messages for MANET nodes via the GW node (e.g., MDH-1 in Fig. 4.10 considers MANET-3 as 2-hop away via GW-1).

Furthermore, the GW node keeps track of history of past encounters for MANET nodes over a period of time and passes this information to other MeDeHa nodes when it meets them using the *RECENT\_NEIGHBORS* notification. This helps the MeDeHa nodes to choose the advertising GW as a relay for stored messages, and forward the messages to the GW node if the latter fulfills



a particular utility function being used as relay selection strategy (e.g., if the GW node has seen a MANET node a specific number of times).

As soon as the GW node is *associated* to an infrastructure-based node (e.g., an AP), it passes information about all MANET nodes to the AP using the *MANET\_PRESENT* notification. As a result, the AP forwards stored messages to the MANET nodes via the GW node, and also sends the *INDIRECT\_ASSOC* notification to all connected APs within the ESS. Moreover, the GW node also sends the *LEAVE\_MANET* notification to the AP, when it leaves a MANET network, so that the AP removes route information of the MANET nodes. When a GW node leaves, the AP will remove routes for all nodes that were accessible through the departed GW node.

### 4.7.2 Gateway Discovery in MANETs

The GW nodes use the MANET nodes connectivity information to discover other GW nodes, and exchange data and control information about other networks. This helps in treating MANETs as “transit networks” to transfer the MeDeHa protocol information across different networks. The discovery is performed by sending the MeDeHa *HELLO* messages periodically to the MANET nodes to inquire if any node supports MeDeHa<sup>8</sup>, and is done on the top of the MANET protocol, so the routing protocol does not require to be modified. Once a GW node discovers another GW, the two GW nodes can talk to each other to exchange other nodes information (e.g., current and past neighbors, messages stored) over multiple hops as if they were direct neighbors, using regular MeDeHa protocol. Exchange of data messages between two GW nodes that are multi-hop away in a MANET cloud is performed using IP encapsulation.

### 4.7.3 Proactive vs. Reactive MANET Routing

A MANET routing protocol does not require any modification while working with MeDeHa, though the performance of the MeDeHa framework may vary with the choice of a particular MANET routing protocol. The MANET routing protocols are generally divided into reactive (such as AODV and DSR) and proactive (e.g., DSDV and OLSR) routing protocols. The reactive protocols attempt to find a route to a destination when there is a message to send to the destination. On the other hand, nodes running the proactive protocols generally keep an updated view of the whole network all the time.

Thus, in the context of MeDeHa, the GW node running a reactive routing protocol such as AODV, may not have complete information about all MANET nodes, at the time when it encounters a MeDeHa node. It only has information about the nodes for which a route request

---

<sup>8</sup>In MANET routing protocols where a mechanism to discover a gateway joining more than one network is already present (e.g., Host and Network Association (HNA) control messages in OLSR, gateways in DYMO [35]), GW discovery overhead can be reduced by contacting only the gateway nodes to check whether they support MeDeHa.

has recently been sent, or about the nodes for which the GW node is a source. Whereas, a proactive protocol does a better job with MeDeHa, because of the availability of the complete route information at the time the two nodes meet. Therefore, a proactive protocol is better suited to the MeDeHa framework. To provide the proof of concept of MeDeHa's functionality with MANETs, we chose the Optimized Link State Routing (OLSR) protocol [32] to incorporate in MeDeHa. In this way, when the GW node joins a MANET, it passes the route information to the MeDeHa routing component as soon as it learns about the MANET nodes. Also, when this GW node encounters a MeDeHa node, it immediately forwards the MANET route information to the latter using the *MANET\_NEIGHBORS* notification. The OLSR protocol also helps in finding the GW nodes in MANETs using Host and Network Association (HNA) messages, which is used to announce non-OLSR interfaces of each node [32].

#### 4.7.4 Message Delivery to MANETs

As mentioned earlier, MeDeHa is able to deliver messages to regular MANET nodes via the GW nodes. Fig. 4.10 shows how a GW node is used to bridge MeDeHa nodes to MANET nodes. The GW node also passes utility function metrics (e.g., encounter history with MANET nodes) to encountered MeDeHa nodes using the *RECENT\_NEIGHBORS* notification. So, if a message carrier encounters a GW node, it may forward stored (or generated) messages to the MANET destination via the GW node if the latter has the destination node in its MANET routing table. The GW nodes may also hand over a stored message to a MeDeHa node, if the latter is selected as a relay for the message. An infrastructure-based node such as AP will forward messages to the MANET via an *associated* GW node. Messages that are stored for a long time at a node are eventually expired.

#### 4.7.5 Message Delivery across MANETs

Multi-hop communication between two GW nodes is performed by using a MANET routing protocol, as presented in Figure 4.3. In this way, a GW node treats another GW node as if they were direct neighbors and both GW nodes exchange information about other networks. This information exchange is performed using the control messages of the MeDeHa notification protocol. These GW nodes can then advertise the availability of other networks (MeDeHa nodes) to the infrastructure-based network to which they are connected or to other MeDeHa nodes they encounter (Fig. 4.3). Besides exchanging the network control information, the nodes can forward/receive data messages using IP encapsulation. This enables MeDeHa to provide message delivery between networks that do not have any connectivity except that they may be joined by MANETs.

When using OLSR, nodes that belong to different networks via multiple interfaces are de-

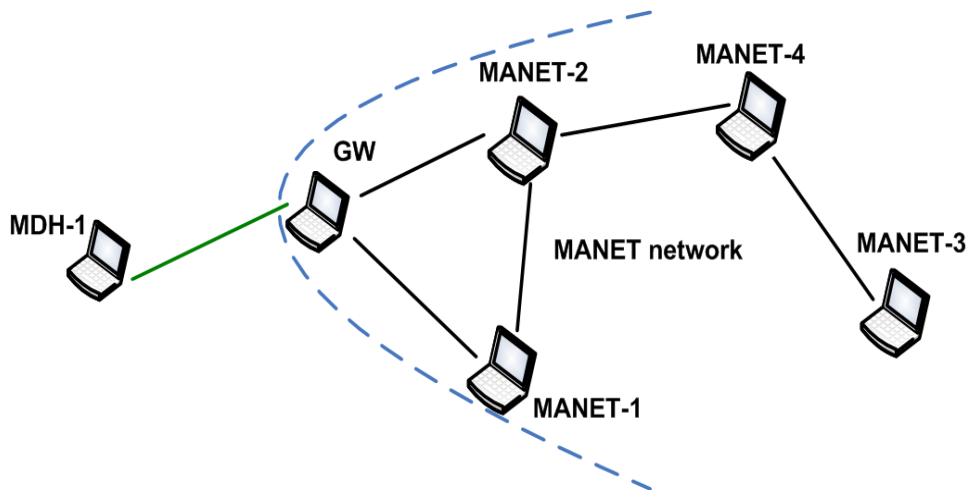

**Figure 4.10:** The GW node acts as a bridge to provide communication between MANET nodes and MDH nodes

ected by the OLSR HNA announcements. Once a GW node receives a HNA announcement, it contacts the node that has transmitted this HNA by sending a MeDeHa *HELLO* message to this node. If the other node is also a GW node, the two nodes may exchange their neighborhood information via the “hello handshake”.

## 4.8 Message Delivery in MeDeHa: An Overall Picture

In this section, we present the overall mechanism of message delivery in MeDeHa by taking an example of IEEE 802.11 based networks for better understanding. Here, we consider APs as infrastructure-based nodes, though any infrastructure-based network can be used without the loss of generality.

At each contact opportunity, the routing and contact tables at nodes are updated. Thus, when a contact opportunity arrives or a message is generated by the application, a message carrier (source or relay) searches for the destination in the following order:

1. It checks whether the available contact is the destination. If it is the message is delivered to the destination.
2. It searches for the destination in its routing table to verify if a multi-hop route to the destination is available. If it finds a route, the message is delivered to the destination.
3. It consults the contact table to check if the available contact is a candidate relay for the destination. In case more than one contacts are available simultaneously, the message

carrier checks which contact has the best utility function. If the message carrier finds a “suitable” relay, the message is forwarded or replicated to the relay.

4. It checks if it is *associated* to an AP that is capable of storing the messages. If it is *associated*, the message is forwarded or replicated to the AP. This is because it is assumed that the infrastructure-based nodes such as APs are more resourceful nodes and are good candidates to store messages. Moreover, as APs can be connected to each other in an ESS, storing a message at an AP increases the chances of message delivery as the message can be delivered as soon as the destination connects with any of the APs. Furthermore, in a network where all APs are connected to each other, and there is only one copy per message, it may be better to keep the message stored at an AP and not forwarding the message from an AP to a relay, as keeping a message stored at an AP increases the chances of message delivery, especially in a scenario where nodes are expected to be connected to the ESS at some point; the message is delivered as soon as the destination’s information is found at any AP within the ESS.

If the message carrier is unable to find the destination information through the four steps presented above, it keeps the message stored locally.

When a message carrier encounters a relay with higher utility metric (with the help of the *RECENT\_NEIGHBORS* exchange), it will add an entry in its routing table for the destination, declaring the relay as its next hop, and forwards messages for that destination to the relay. The routing table entries are refreshed periodically with the help of the *CURRENT\_NEIGHBORS* and *RECENT\_NEIGHBORS* notifications, and all the entries for which there is no update, are removed from the routing table after a timeout. Each node maintains two types of tables, routing table and contact table. Forwarding a message to available nodes is performed by looking up the routing table entries. Contact tables are used to maintain utility function metrics for each encountered node within a specific time window. As soon as a node detects that a neighboring node has left its surrounding (i.e., if it does not hear from the latter for a period of two *HELLO* intervals), it removes the node’s entry from its routing table, and updates its contact table entries for the departing station. The message delivery to MANET nodes is performed in similar fashion. The difference is that the routing and contact table updates are based on the *MANET\_NEIGHBORS*, the *MANET\_PRESENT* and the *MANET\_LEAVE* notifications.

Advertising the addresses of all interfaces of a station in the *HELLO* notification allows message delivery to any of the available interfaces of a destination. Consider the scenario shown in Figure 4.11. A source *S* with two interfaces, I.1 for infrastructure mode and A.1 for ad hoc mode, and a destination *D* has two interface identifiers I.2 and A.2 for infrastructure and ad hoc mode respectively. *S* is *associated* to AP *BS1* and has a message to be sent to I.2 address of *D*, but *D* is not currently *associated* to any of the APs in the network. A relay *R* meets *D* in

ad hoc mode, and is able to deliver message to  $D$  via  $G$ , because in its hello advertisement,  $D$  announces the possession of both I.2 and A.2, and  $G$  advertises to  $R$  that  $G$  is accessible. Thus, in ad hoc mode, the message from  $S$  would be sent to A.2 address of  $D$  via  $R$ .

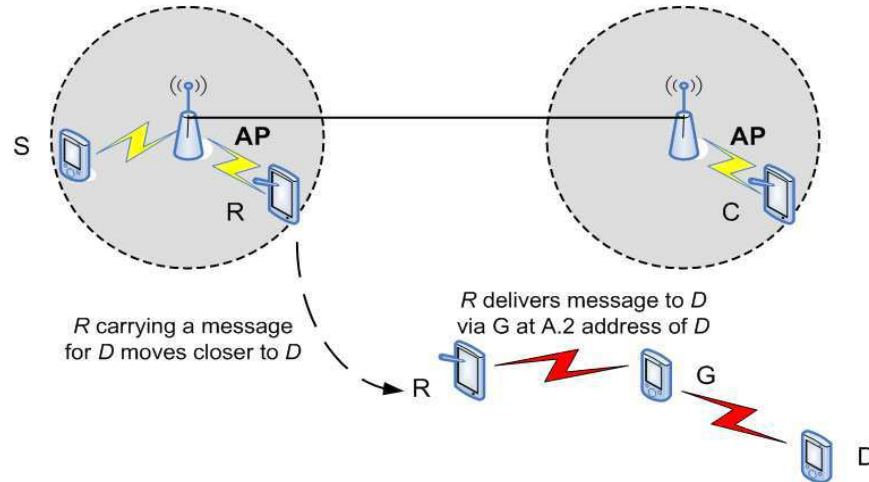

Figure 4.11: An example of message delivery in heterogeneous networks

## 4.9 Design Assumptions and Limitations

In this section, we present the assumptions and limitations of the MeDeHa framework.

### 4.9.1 Node Identification

Till now, we have assumed that each MeDeHa node can have multiple interfaces and thus have multiple IP addresses. We also assumed that nodes use IP addresses of other nodes to communicate, and that these IP addresses do not change during the communication session. This is a very strong assumption, and can prevent the framework from deployment on a large scale, especially in mobile environments where nodes move frequently and change their points of attachment to the network, and eventually their IP address. Also, nodes information cannot be passed beyond the local connected network (e.g., ESS), which means that if a node leaves the local network and joins another network, it is not possible to reach the node. These limitations can be overcome by communicating to nodes using unique identifiers instead of IP addresses. In other words, by separating node identification from their points of attachment to the network. We target this issue in Chapter 6.

### 4.9.2 Security Issues

Securing information is an important component of wireless communication. While application level messages can be secured using end-to-end security mechanisms such as encryption, it is also important to secure routing information exchange (e.g., *HELLO* advertisements and neighborhood information). Although we do not currently have any explicit security mechanisms in place, the MeDeHa framework is flexible and extensible enough that security-related mechanisms can be easily added. For example, using message digests to ensure message integrity and authenticity (as mentioned in Section 4.6.1.2), adding security-specific criteria to the utility function (e.g., the *trustworthiness* of a node assigned by a trusted authority).

## 4.10 Concluding Remarks

In this chapter, we have presented our message delivery framework MeDeHa that helps in bridging infrastructure-less and infrastructure-based networks while tolerating nodes temporary or long-lived disruptions. The framework is flexible enough to incorporate different forwarding mechanisms and MANET routing protocols. We have also presented the detailed design of the MeDeHa framework and its operation in different types of networks including infrastructure-based networks, ad-hoc networks and networks with intermittent connectivity. In the next chapter, we will provide the implementation of MeDeHa and a thorough evaluation using synthetic and real mobility traces using simulations, as well as on a real testbed.

---

---



# 5

## MEDEHA IMPLEMENTATION AND PERFORMANCE EVALUATION

---

---

In Chapter 4, we described the MeDeHa framework, which has been designed to provide seamless message delivery across heterogeneous, disruption-prone networks. In this chapter, we focus on the implementation of the framework, and its performance evaluation. We start with presenting different implementation approaches that we took in order to implement MeDeHa both on simulators as well as on real machines. We then present the performance evaluation of MeDeHa by demonstrating the simulation results, results obtained from the real experiments, as well as some hybrid experiments that involve experiments partly running on a simulator and partly on real machines.

### 5.1 Implementation Approaches

As described earlier in Chapter 4, one of the key features of the MeDeHa framework is the ability to work at different layers of the communication stack. To validate this claim, we implemented the framework on different layers of the communication stack, where each implementation approach offers its own advantages and brings in some disadvantages as well. In this section, we will highlight different implementation approaches that we have used to implement MeDeHa as well as present the pros and cons associated with each.

The implementation of MeDeHa was incremental. The initial implementation the framework included infrastructure-based wired and wireless networks while supporting nodes connectivity disruptions (i.e., infrastructure-based nodes buffer messages for unavailable nodes and as soon as a node is connected to an infrastructure-based node, the messages are delivered).



Later, we added support for infrastructure-less networks including mobile ad-hoc networks (MANET) in the framework.

For an implementation that comprises the infrastructure-based networks, a link-layer implementation approach was the obvious choice. This is because the infrastructure-based network mechanism is based on the link-layer connectivity information of nodes (*association* and *disassociation*). We used IEEE 802.11 [60] as the link-layer wireless technology because it is the most widely used wireless local area network (LAN) standard these days. Hence, the link-layer implementation involved only infrastructure-based wireless and wired networks. The advantage of implementing the framework at the link layer is that the solution could be implemented on nodes that only run two layers of the communication stack (e.g., AP bridges). Furthermore, in an internet involving infrastructure-based networks (e.g., an ESS), it is easy to collect nodes connectivity information (*association* or *disassociation*) at infrastructure-based nodes (e.g., APs). This information can then be exchanged between the infrastructure-based nodes to provide message delivery. The main disadvantage of this approach is that message routing in infrastructure-less networks becomes very challenging. This is because the routing is generally performed at the network layer and nodes do not generally have a multi-hop network view at link layers. Moreover, this requires modifications at the hardware level (at least at the device driver level). These modifications involve maintaining routing information over multiple networks as well as implementing a buffering mechanism at the link-layer, which may not be feasible. As the link-layer is generally specific to a particular interface, a node cannot have access to other interfaces at the link-layer, which is required when the nodes have multiple interfaces. To summarize, the link-layer solution is suitable for infrastructure-based wireless and backbone networks while supporting disruptions in connectivity, but (1) it cannot be extended to infrastructure-less multi-hop networks, and (2) it cannot be incorporated on nodes that run multiple interfaces.

In order to add the support for the infrastructure-less networks in the MeDeHa framework, a network layer implementation was required, as a network layer implementation facilitates the development of the routing function. Moreover, with this implementation approach, it is easy to make the framework communicate with the existing routing protocols (such as MANET routing protocols). Thus, as the next step, we implemented the framework at the network layer. This implementation comprised diverse types of networks including infrastructure-based wired and wireless networks, infrastructure-less networks including MANETs, and while coping with connectivity disruptions. The disadvantage of this approach is that it makes collection of the underlying connectivity information difficult, because the information has to be available to the network layer. To solve this issue, we used a cross-layer approach so that the link layer connection information is passed to the network layer module of MeDeHa, as a connection event (*association* or *disassociation*) is detected. On the other hand, the network layer implementa-

tion approach requires that all nodes in the network must include network layer. For instance, AP routers can be used, but not AP bridges. Of course, the network can still include AP bridges, but the functionality of the MeDeHa framework is implemented only at AP routers.

A compromised approach is to implement the MeDeHa framework at a new sublayer between the link- and the network layers (as layer 2.5 or the *bridge* layer). The advantage for this approach is that the MAC layer implementation does not need to be modified while the collection of the link layer connectivity information is easy. Moreover, handling multiple interfaces at the bridge layer is also possible which helps in collecting multi-hop routing information in the infrastructure-less networks. While this approach seems to solve many drawbacks of the link- or the network layer implementations, it poses several other problems and complexities, as a completely new sublayer needs to be designed and should be supported by all participating nodes; thus, nodes cannot communicate with other nodes in the Internet. Another problem is the identification of nodes at the bridge level as neither the MAC level address nor the IP address of a node can be used for this purpose. Hence, a new identification scheme is required for such a scheme, and it will increase the overhead of the framework. For these reasons, we decided not to use this implementation approach.

Note that an application-layer solution is also possible where application level (overlay) routing could be performed between MeDeHa nodes in infrastructure-less networks, whereas the *association* (and *disassociation*) information could be passed from the link-layer to the application layer, in infrastructure-based networks. Implementing the framework at the application layer is one of the future tasks that we plan to do.

Besides, in order to validate the performance of the framework with real-world scenarios, we have also implemented MeDeHa on Linux machines as a user space daemon. Details on this implementation are presented in Section 5.4.

## 5.2 Evaluation Platforms

In order to implement the MeDeHa framework, we used different evaluation strategies involving different platforms. They are described in the following subsections:

### 5.2.1 Simulator Experimentation

Implementing a new solution in a simulator is generally considered to be the first step towards the performance evaluation of the proposed solution as simulators allow reproduction of experiments. Also, the simulator experiments are flexible in terms of creating scenarios and users mobility. Hence, we implemented the MeDeHa framework in different open-source simulators (OMNET++ [58] and NS-3 [59]). The reason to implement in different simulators

is discussed in Section 5.3. In order to validate the performance of the framework, we carried out experiments using conventional synthetic mobility models (e.g., Random Waypoint Mobility Model [61]), and real mobility traces.

- **Synthetic Mobility Models:** Nodes mobility pattern affects the outcome of an experiment and different scenarios require different mobility patterns for the participating nodes. This is very important for the networks where message forwarding depends upon the contact opportunities of mobile nodes. To simulate nodes mobility, a number of synthetic mobility models have been used by the researchers including Random Walk Mobility Model [62] and Random Waypoint Mobility Model [61, 63]. Among the available mobility models, the RWP model is the most commonly used mobility model as movements of the nodes following the RWP mobility model do not depend upon the movements of other nodes. But it is believed that the RWP model does not provide a realistic mobility behavior because of the fact that in reality, users do not randomly choose their destination point and also that nodes do not generally move independent of one another [133]. Hence, we used a variation of the RWP mobility model known as BonnMotion Mobility Model [65], in which nodes move using the RWP mobility model, but their movements are not pure random. Rather, the movements are based on the attraction points such that nodes choose their next destination among one of the attraction points with a certain specified probability instead of choosing a destination randomly. The attraction points are assigned to the potential destinations for nodes such that mobile nodes move only between these attraction points. The BonnMotion Model is a very simple variation of the RWP model but significantly adds reality of the mobility traces. More details on this model are presented in Section 5.6.3.
- **Real Mobility Traces:** Synthetic mobility models, no matter how well they are defined, do not depict the real mobility pattern of nodes. Hence, to validate the MeDeHa framework against the scenarios where the participating nodes have real connections or disconnections, encounter and inter-contact times, we used real mobility traces acquired from CRAWDAD [67] for the KAIST campus [66]. This data set provides students mobility traces carrying GPS devices across the campus.

## 5.2.2 Real Experimentation

Simulator-based scenarios are normally not equivalent to the real world scenarios, as there are many factors that are generally ignored while performing experiments using simulators. For instance, when wireless networks are involved, parameters such as signal attenuation and communication range are not the same in the simulator as in real scenarios because simulator-based implementations are usually based on simplistic models. Due to these reasons, it is very

important to validate the performance of a proposed solution against its implementation on real machines. Hence, we implemented the MeDeHa framework on real machines as a user-space daemon using Linux kernel 2.6. This implementation enables us to validate the functionality of the framework without modifying the kernel implementation of Linux.

### 5.2.3 Hybrid Experimentation

Although real implementation has many advantages, in practice experimental scenarios are limited by many factors, including size, cost, and limited mobility of the participating nodes. While simulated scenarios do not have these constraints, they allow the reproducibility of the experiment results and provide increased scalability, it is not guaranteed that the simulation results are a representation of what would have happened on real hardware. The advantages of the simulator- and the real implementation can be combined by performing the hybrid experimentation such that the experiments run partly on real machines and partly on simulator. This provides validation of the solution on real machines besides demonstrating the scalability of the solution to some extent. This also validates the simulator implementation as in order to perform such experiments, it is necessary that simulator nodes and real machines are able to communicate with each other. Hence, we have done some experimentation with a hybrid experimental setup involving both simulator nodes and real machines. In Section 5.5, we provide details on the hybrid experimental setup, whereas the experimental results are presented in Section 5.6.7.

In the following sections, we present these different evaluation strategies, and the framework implementation in detail.

## 5.3 Simulator Implementation

As mentioned earlier, we implemented the MeDeHa framework on different simulators (OMNET++ [58] and NS-3 [59]). To start with, we tried implementing the framework in the NS-2 [57] simulator, as NS-2 has been a widely used open-source network simulator. But NS-2 misses out many basic functionalities that are required for the framework's implementation such as roaming capability (hand-off support) of nodes in IEEE 802.11 infrastructure-based network within an ESS and support of multiple interfaces per node.

OMNET++ [58] is another open-source network simulator that provides basic roaming support<sup>1</sup> for IEEE 802.11 infrastructure-based networks through the INET framework. It also provides the possibility to use external mobility traces. We implemented the MeDeHa frame-

---

<sup>1</sup>This roaming support includes active scanning of nodes to search for beacons at different communication channels. It does not include comparing power levels of different APs in order to select the AP with stronger signal.

work using the INET framework (version INET-20061020) of the OMNET++ simulator. As explained in Section 5.1, this implementation was done at the link-layer and only included infrastructure-based wireless and wired networks with disruption tolerance support. To implement the framework, we had to modify the link layer code of OMNET++.<sup>2</sup>

Although IEEE 802.11 standard [60] defines the *disassociation* management frame, it does not precise when a station or an AP should send this frame. In MeDeHa, infrastructure-based nodes (e.g., APs) need to know the up-to-date state of the connected nodes, and the performance of MeDeHa in infrastructure-based networks depends upon the accuracy of this information. To maintain this connectivity information accurately, it is required that a node sends a *disassociation* frame before leaving the network in the infrastructure-based networks. On the other hand, an AP should also send a *disassociation* frame to an *associated* node that remains inactive for a specific period of time. This is necessary to allow the AP to start storing data on behalf of the node that has left without informing the AP (e.g., the device is off due to battery drainage or the AP does not receive its *disassociation* frame). However, the *disassociation* mechanism was missing in the regular OMNET++ simulator which means that a *disassociation* frame was never sent from a station or an AP. Hence, in order to implement MeDeHa in the simulator, we added an *explicit disassociation* mechanism in the OMNET++ simulator. In this way, before leaving the coverage area of an AP, a station explicitly sends a *disassociation* frame to its corresponding AP indicating that it is going to leave the AP. A station can detect that it is at the border of an AP's connectivity region by comparing the received power level in the beacons from the AP with a power threshold; as soon as the station's received power level falls within 10% of the threshold, the *disassociation* frame is sent. While this mechanism reduces the effective coverage area of the APs by 10%, it makes sure that the station sends a *disassociation* frame before leaving, see Figure 5.1.

Then, we extended the OMNET++ simulator to support the *passive scanning* mechanism in order to allow nodes to search a nearby AP over multiple channels. Specifically, a node can select a more suitable AP by comparing the received power levels of the beacon frames. This was also not provided in the base implementation of the OMNET++ simulator, and helps in selecting an AP which has a strong connectivity signal. It also allows a smoother hand-off of a node between two APs (*reassociation* mechanism), as based on the received power level of the two APs, a station may decide to switch to another AP in order to get better connectivity. Some of the results obtained with this implementation were presented in [22], and will be described in Section 5.6.4.

However, as many other contemporary open-source network simulators, the OMNET++ simulator still lacks the support of multiple interfaces per node. Recently, a new network sim-

---

<sup>2</sup>The modified version of the INET Framework of OMNET++ can be found at <http://planete.inria.fr/software/MeDeHa>. Several scripts are also available at this URL.

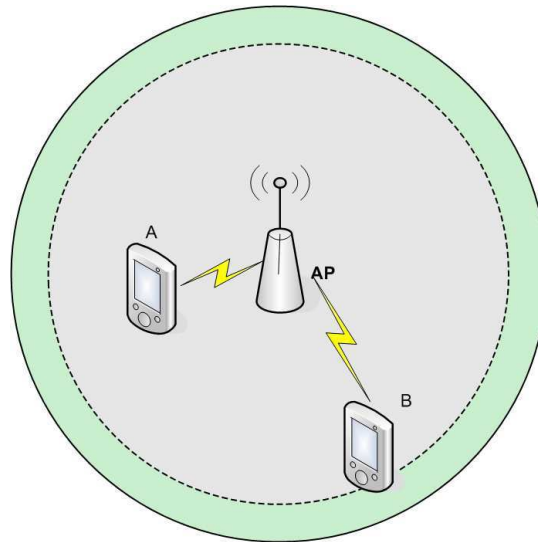

**Figure 5.1:** Total and Effective Coverage Areas of an AP represented respectively by circle with continuous line (green) and circle with dotted line (gray). Node B is at the edge of the dotted line circle and eventually sends the *disassociation* frame to the AP, while Node A is still *associated*.

ulator NS-3 [59] has been released, providing this functionality. NS-3 enables nodes to run multiple routing protocols (and routing tables). It provides a stack implementation that is similar to the Linux kernel 2.6, which makes sure that the simulator implementation can be ported to real machines with little or no modifications. NS-3 also provides a real-time event scheduler which makes the emulation feature of the simulator very strong and allows experiments with real machines. Hence, we switched to the NS-3 simulator and implemented the framework at the network layer of the simulator, due to the reasons mentioned in Section 5.1.<sup>3</sup>

For features related to the link-layer, we ported the MeDeHa implementation of OMNET++ to NS-3 including the *disassociation* functionality as it was not available in NS-3 as well. Besides the *explicit disassociation* feature, we added an *implicit disassociation* mechanism at the link layer of the simulator, in which the AP keeps a timer for nodes associations and removes stations from its association list by sending them a *disassociation* frame when the timer for a particular station expires. This is done to avoid unnecessary message loss in case where a station sends an *explicit disassociation* request to the AP before leaving, but the request fails to reach the AP, or the station is abnormally shutdown. Without the *implicit disassociation* mechanism, the AP would keep a route to a station though the station may actually be disconnected.

Later, the MeDeHa implementation in the NS-3 simulator had been extended to incorporate

<sup>3</sup>We started by porting the OMNET++ at the link layer of NS-3 in order to make sure that the implementation is correctly working in the simulator. Then we proceeded to implement the framework at the network layer.

the infrastructure-less networks, including support for existing MANET routing protocols (as explained in Section 4.6). In order to validate MeDeHa's functionality with existing MANET routing protocols, we integrated the Optimized Link State Routing (OLSR) protocol implementation with the framework's implementation. The choice of the OLSR routing protocol is discussed in Section 4.7.3.

In the following subsection, we provide some details on the MeDeHa's implementation over NS-3, while the performance evaluation is presented in Section 5.6.5.

### 5.3.1 NS-3 Implementation

As the implementation is done at the network layer, a mechanism is necessary to notify the MeDeHa module at the network layer about nodes' *associations* and *disassociations*. The *association* and *disassociation* information is generally available at the link-layer. Hence, we modified the IEEE 802.11 code in NS-3 for both AP and stations in order to send a notification from the link layer to the MeDeHa module at the network layer, as soon as an *association* or *disassociation* event is detected.<sup>4</sup>

Besides, we developed two main modules in the NS-3 simulator, the infrastructure-based wireless network module and the infrastructure-less wireless network module.

- **The infrastructure-based network module** is responsible for operations related to managing nodes *associations* and *disassociations* with the backbone network, and exchanging this information among APs within an ESS.
- **The infrastructure-less network module** handles MeDeHa's operations in ad-hoc networks, and implements the ad-hoc component of the Notification protocol described in Section 4.6.1, including detection of neighborhood, exchange of neighborhood information and relay selection process.

Both of these modules maintain interfaces to the OLSR routing module, and they share some common functions such as buffer management. The buffer module implements the buffer management strategy described in Section 4.5. Another module is implemented to prepare and parse the notification protocol headers which are used in the information exchange.

Besides, the Inverse Address Resolution Protocol (InARP) [68] mechanism has been added to the NS-3 simulator which is used to get the IP address of a station from its MAC address. This mechanism is needed when a station wants to *associate* to an AP, and only knows the MAC address of the AP. At this point, the station uses InARP mechanism to get the IP address of the

---

<sup>4</sup>The link-layer implementation generates an event whenever an *association* or a *disassociation* occur. Any module in the NS-3 simulator can bind itself to this event in order to receive this notification. This allows the link-layer connectivity information to be passed to any layer of the communication stack.

AP before sending a MeDeHa's ASSOC notification to the AP. The ASSOC notification needs to be sent by the station and includes all IP addresses of the station.

## 5.4 Implementation on Real Machines

Figure 5.2 shows the development approach we chose to implement MeDeHa for the physical testbed. To achieve high portability and compatibility with the existing infrastructure, the MeDeHa framework is implemented at the network layer as a user-space daemon in Linux with kernel 2.6.<sup>5</sup> We call this the MeDeHa daemon as represented in Figure 5.2. All required MeDeHa information is included as part of the IP header (as an IP option, illustrated in Figure 5.3) and no transport or application data is modified. This allows MeDeHa nodes to function over any network with unmodified existing protocols.

In Figure 5.2, all the blocks that are bounded by the dashed rectangle are part of the Linux kernel, and we do not modify their implementation; rather, the MeDeHa daemon only uses these blocks. On the other hand, the blocks that are illustrated outside the dashed rectangle represent user-space daemons (MeDeHa daemon, olsrd, hostapd). In the following, we describe each of these blocks:

- **MeDeHa Daemon:** This daemon comprises the MeDeHa's implementation. It interacts with the routing tables in the Linux kernel, and with netfilter [69] modules.
- **Hostapd Daemon[70]:** This daemon implements the IEEE 802.11 access points, and is used to notify the MeDeHa daemon about the connectivity of stations (*associations* or *disassociations*). It also directly interacts with the input and output device modules of the kernel in order to send and receive frames.
- **OLSR Daemon:** The OLSR daemon interacts with the routing table module of the kernel to update the routing information of the MANET nodes. This information is used by the MeDeHa daemon.
- **Routing Tables:** This module is managed by the Linux kernel and maintains the routing tables for all the routing protocols (including MeDeHa and MANET routing protocols).
- **Netfilter Pre-Routing Hook:** This module is kept in the Linux kernel and is used to intercept the incoming messages in order to make a decision whether the messages need to be stored (if the destination is not available). In this way, a copy of the incoming message is

---

<sup>5</sup>The implementation of the MeDeHa framework on Linux machines has been done in cooperation with Marc Mendonca at University of California at Santa Cruz, USA who is a graduate student and working under the supervision of Prof. Katia Obraczka.



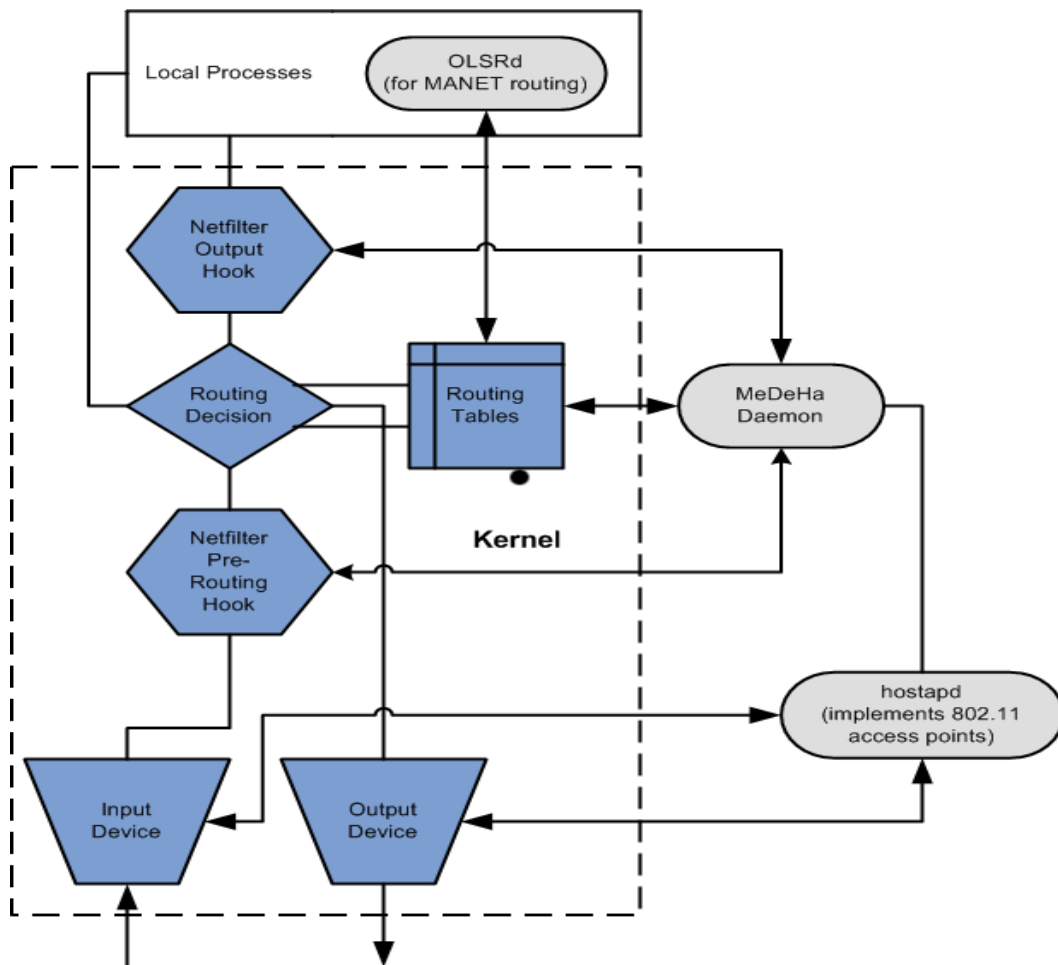
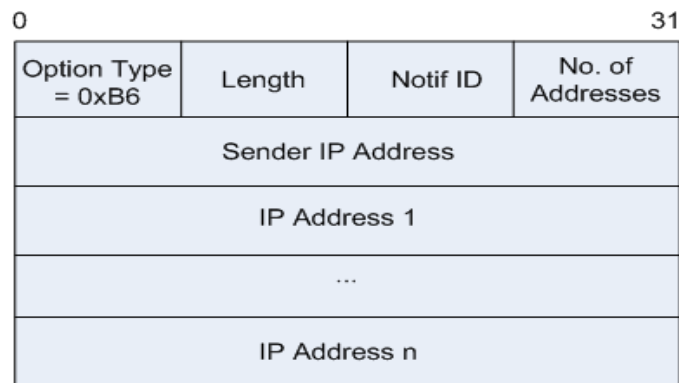

**Figure 5.2:** MeDeHa's implementation in Linux as a user-space daemon. Both Incoming and Outgoing messages are intercepted for processing before being passed to Linux kernel

stored by the MeDeHa daemon and the message is passed to the routing module where it may be dropped.

- Netfilter Output Hook:** This module is used to intercept the outgoing messages so as to make a decision whether the messages need to be stored (e.g., if the destination is not available, or the local interface is disconnected). Thus, a copy of the message is passed to the MeDeHa daemon which may store it; eventually the message is passed to the routing module, which may drop it.

The Linux implementation can be thought of as operating at the network layer. It uses *netfilter* [69] to hook into the Linux protocol stack with a kernel module and passes messages to the user-space daemon for further processing. As shown in Fig. 5.2, all incoming and outgoing



**Figure 5.3:** MeDeHa notification header implemented as IP option header

messages are intercepted before passing through the kernel routing algorithm. The daemon determines whether a message should be buffered or forwarded based on whether a connected next hop destination exists. Connectivity information must also be used to manage the kernel routing table and to continue accepting messages from user applications even if it appears that connections are disrupted. Neighborhood information in infrastructure-based networks is determined through a combination of the MeDeHa control messages and 802.11 management frames. Moreover, the current Linux implementation uses *hostapd* [70] to provide AP service and *ath5k* [76] as the wireless driver.<sup>6</sup> The MeDeHa daemon listens for *association* or *disassociation* information from the *hostapd* daemon.

To showcase the MANET routing protocols integration with MeDeHa in Linux, we used the popular *olsrd* [71] implementation of the OLSR protocol. While there were other implementations available, we choose *olsrd* due to its widespread distribution and high portability. We only had to make a simple change to the source code such that a notification is sent to the MeDeHa daemon whenever a change is made by *olsrd* to the routing table. Thus, the MeDeHa daemon listens for changes made to the *olsrd* routing table to determine which nodes are currently accessible via the MANET. It then exchanges the notification messages with other MeDeHa nodes participating in the MANET and shares this information with networks (such as an infrastructure-based network) on other interfaces.

### 5.4.1 Stations Implementation

The implementation of the stations has been done in an incremental way. It has been carried out in two parts to make sure that we are able to validate each part individually. In the first part, we implemented the infrastructure capability of the MeDeHa framework for the stations.

<sup>6</sup>The *ath5k* driver must be from at least the linux 2.6.31 kernel. The driver is available to download from [76].

In this way, nodes choose their affiliated AP as their default route and forward all messages they have to their respective APs, when *associated*. When they are disconnected, they store the messages in the local buffer.

In the second part, the GW functionality of the stations has been added so that the stations are able to act as a bridge between infrastructure-based networks and OLSR-based MANETs. To learn the information about the nodes present in the MANET, the GW nodes listen for changes made to the MANET routing table by the *olsrd* daemon. These changes are shared by the MeDeHa daemon to other MeDeHa nodes via the notification messages (as described in Section 4.6.1). This allowed the MeDeHa framework to use connectivity information in deciding when and where to forward and buffer messages.

### 5.4.2 AP Implementation

As messages arrive, they are intercepted before the routing table is consulted, and delivered to the MeDeHa daemon. This daemon determines whether the messages should be buffered or forwarded. If they have to be forwarded, the daemon makes necessary modifications to the messages or the routing table before letting the messages continue on their path. If the messages have to be buffered, then all pertinent information is saved before the messages are silently dropped. If the messages are MeDeHa notification messages, then the appropriate action is taken.

While the above is occurring, another process receives information from *hostapd* about *associations* or *disassociations*. When a new station joins or leaves, the appropriate MeDeHa notification messages are sent to other APs and modifications to the routing table are made.

### 5.4.3 Intercepting Messages

The entire implementation of MeDeHa exists outside the Linux kernel in user-space. This is possible through the use of *netfilter/iptables/libipq* [69], which provide a series of hooks into the IP protocol stack as well as a method of controlling these hooks from the user-space. Although it is traditionally used for security purposes, it can also be used to implement our protocol without kernel modification. A brief introduction to the various hooks can be found at [75]. For our implementation, we have utilized hook 1 (pre-routing) for all incoming messages as well as hook 5 (local out) for all outgoing messages.

All messages (incoming/outgoing) have their destination checked against the local routing table prior to passing it on. If the destination does not exist, then the message is saved to the buffer and it is “dropped” by *netfilter*. All incoming messages are also checked for MeDeHa notification headers that are attached as IP-header options.

## 5.5 Hybrid Experiments

Our goal of using hybrid networks is to allow more interesting scenarios as well as validate our simulation results. We integrate the NS-3 MeDeHa implementation with the testbed through the NS-3 emulation and real-time scheduling capabilities. Specifically, we use NS-3 TAP [74] to bridge part of the simulated network to the testbed network. This works by creating a “ghost” node on the NS-3 network that passes all Ethernet frames between a Linux TAP device on the real machine and the simulated links to which the node is connected. Messages can then be routed between the simulated network and the networks to which the real machine is connected. To our knowledge, there are very few studies (only [3] and [39]) that attempt to perform similar kind of hybrid experiments.

When using the tap-bridge option, the real-time scheduler of the NS-3 simulator is used, and the tasks performed by the simulator machines are scheduled in real-time and are synchronized with the real machines (test-bed). While this is an outstanding feature of the simulator, it limits the scalability of the simulator nodes to a particular number only<sup>7</sup>, which is much less than the number when the simulator is used as a discrete-event network simulator. This is especially true when the participating simulator nodes have multiple interfaces. Thus, the simulator cannot schedule the tasks of all the interfaces of all the nodes after a certain limit. This limit also depends upon the processing power of the machine on which the simulator is running. In our experiments, we used the NS-3 simulator on an Intel machine with 2.4 GHz dual-core processor with 4 GB RAM. With this configuration, we could not use more than 30 nodes in the simulator, where each node has 2 to 3 interfaces. Figure 5.4 shows the steps for bridge configuration to inter-connect simulated and real networks.

### 5.5.1 Experimental Setup

The testbed consists of laptops and mobile briefcase devices [72]<sup>8</sup> equipped with 802.11g wireless cards, Linux 2.6, and the MeDeHa framework. Depending on the scenario, a number of laptops are configured as access points connected via Ethernet while the remainder of nodes are set up as wireless infrastructure stations. In addition, some of the laptops are equipped with an additional wireless interface that can be used to connect to a MANET or ad-hoc network. The mobile briefcase devices are configured in ad-hoc mode to connect only to a MANET. We use *hostapd* [70] to implement the wireless AP functionality and *olsrd 0.6.0* [71] to provide MANET routing.

---

<sup>7</sup>In our experiments, we experienced that the scalability of the NS-3 simulator is limited to 30% with real-time scheduler.

<sup>8</sup>Scorpion Testbed has been developed by the Computer Engineering Department at University of California at Santa Cruz, USA.

**Bridge Configuration:**

```
sudo brctl addbr ns-3-bridge
sudo tunctl -t tap
sudo ifconfig ns-3-bridge bridge-ip-address
sudo ifconfig tap 0.0.0.0 promisc up
sudo ifconfig eth0 0.0.0.0 promisc up
brctl addif ns-3-bridge tap
brctl addif ns-3-bridge eth0
```

**Adding Route for Real APs at Bridge Node:**

```
sudo ip route add real-ap-ip-network-number/netmask dev br
```

**Adding Route for Simulated APs at Real APs:**

```
sudo ip route add simulated-ap-ip-network-number/netmask dev eth0
```

**Figure 5.4:** Configuration of bridge node using tap-bridge to inter-connect simulated and real networks.

Finally, a simulated heterogeneous network, involving infrastructure-based and ad-hoc networks, is connected to the testbed with the NS-3 TAP bridge. As shown in Fig. 5.5, this creates a larger hybrid network that allows more interesting scenarios beyond the limitations imposed by a physical testbed.<sup>9</sup> The simulator machine, which is identical to the laptops of the testbed, is configured with an Intel 2.4 Ghz Dual-Core processor and 4 GB of RAM.

Figure 5.6 demonstrates the hybrid experiment setup that we presented in [26].

## 5.6 Performance Evaluation

We showcase MeDeHa's functionality and evaluate its performance through extensive simulations using a wide range of scenarios including traffic of different priorities. We used both synthetic but realistic mobility patterns and real mobility traces [67]. Besides, we also evaluated the framework on the real machines, and by performing some hybrid experiments.

<sup>9</sup>Though the amount of simulated traffic for a hybrid network is more limited than a pure simulation network due to real-time scheduling requirements, we still find them to be a useful supplement to a physical testbed.

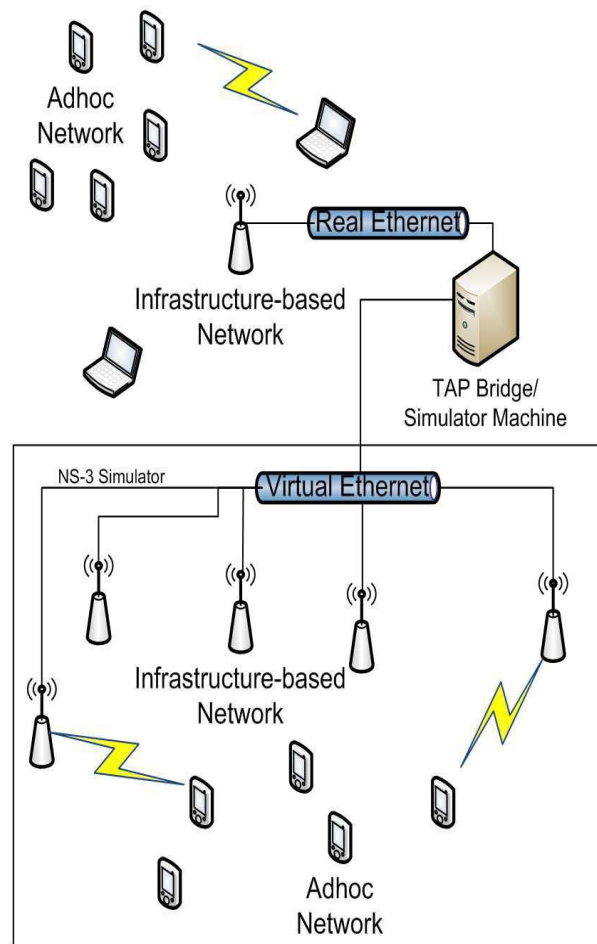

**Figure 5.5:** Hybrid experimentation setup involving real machines acting as APs and stations, and virtual machines running in the NS-3 simulator

### 5.6.1 Performance Metrics

We measure message delivery ratio (MDR) to evaluate MeDeHa’s efficiency in heterogeneous internets subject to connectivity disruptions. Average delivery delay (AD) is also used as a performance metric to show the benefits of embracing network heterogeneity. To this end, we compare different scenarios where nodes have one or more interfaces to communicate. The applications we considered for MeDeHa’s evaluation are transfer of files between nodes and chat messages. The size of messages for file transfer is taken as 1 KB unless otherwise specified. When using multiple destinations in the experiments, we are also interested in fraction of destinations achieving a particular delivery ratio, which we represent by the CDF of destinations.

we compared two different buffering strategies for the APs. In the first one, each AP has a

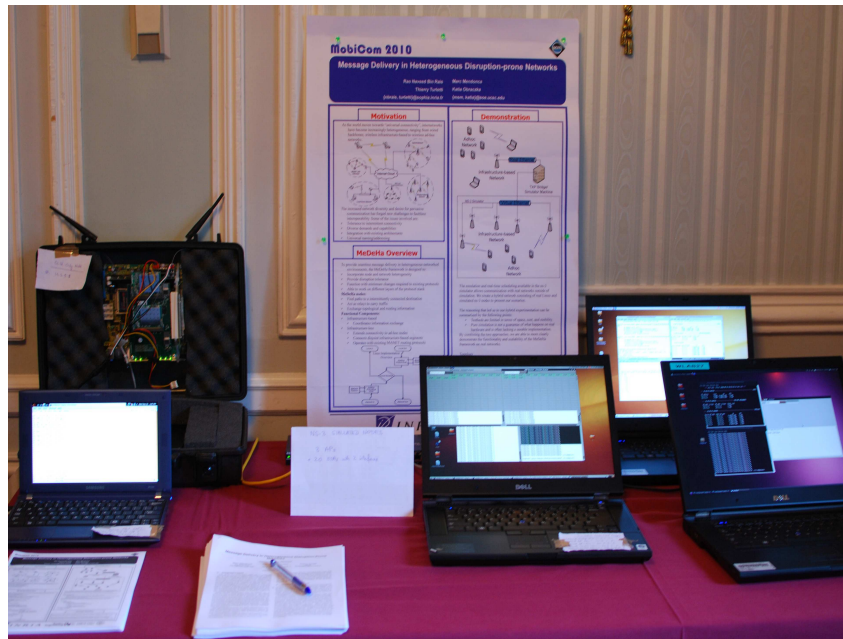

Figure 5.6: Hybrid experimentation setup as demonstrated at ACM Mobicom 2010.

storage space associated to it; thus, it buffers the messages when the destination information is unavailable. We call this as *Distributed Buffering*. In the second strategy which we call as *Centralized Buffering*, we used a dedicated centralized server in the ESS for buffering purposes that is used by all the AP to store the messages. We also evaluated MeDeHa's performance by using different values of buffer sizes and using priority-based data traffic. We also measured the effect of using different relay selection strategies and number of copies per message on MDR and AD.

It is important to note that due to involvement of wireless communication, performance of MeDeHa depends upon how quickly neighborhood changes are detected. The *HELLO* notifications are used for neighborhood detection in ad-hoc networks, while beacons, *associations* and *disassociations* are utilized in infrastructure-based networks for this purpose. Message delivery can be improved by broadcasting *neighbor sensing* notifications such as *HELLO* more frequently, but it also increases the protocol overhead. So, this tradeoff needs to be considered when setting the protocol's parameters. For our experiments, we have used 100ms as beacon interval and 2 seconds as *HELLO* period.

### 5.6.2 Wireless Configuration Parameters

For the wireless experiments, we have used IEEE 802.11a model with a constant rate of 6 Mbps. The APs broadcast the beacons every 100ms, and announce the same ESSID within an ESS. Mobile nodes decide which AP to connect to based on the received power level of the beacons announced from multiple APs. The received power of the frames is calculated using the log-distance propagation loss model.

### 5.6.3 Mobility Model

To have results close to a realistic scenario, we used Random Waypoint (RWP) mobility model with attraction points [63], [64]. The attraction points can be considered as rooms, seminar halls, buildings in communities or departments at campuses, and the nodes move only in between these attraction points. This avoids pure random movement employed by the conventional RWP mobility model. For example, in a scenario where students move between campuses of a university, we can place a few attraction points in each campus and can associate visiting probability to each attraction point by the students. Each attraction point is defined with a specific standard deviation along with an intensity to select the attraction point by the RWP mobility model. The standard deviation is of Gaussian distribution with zero mean and is used to specify the distances of nodes to the attraction point [65]. In other words, the standard deviation acts as a radius of the region of influence for an attraction point. The intensity of an attraction point can also be understood as the probability of choosing that attraction point by a node.

The OMNET++ simulator includes the support for using the BonnMotion Mobility Model traces directly in the simulator. However, to use these traces with the NS-3 simulator, we implemented a specific module in the simulator, which parses the traces generated by the mobility generator. When simulating users mobility, we generally use pedestrian speeds (e.g., 1-2.5 m/s) for users that move within a community or campus, and we assume that users take vehicles to move between communities.

### 5.6.4 Link-Layer Implementation Results

As mentioned before, we first implemented the MeDeHa framework at the link-layer of the communication stack in the OMNET++ [58] simulator. This implementation only involved infrastructure-based wired and wireless networks along with support for disruption tolerance. Thus, a node is considered as unavailable when it is not *associated* to any of the AP within an ESS, and the messages destined to this node are stored in the network. The stored messages are delivered to the node as soon as it is connected to any of the AP within the ESS. We do not consider nodes contacts in infrastructure-less networks, in this case.



To evaluate the link-layer implementation, we consider a museum environment where exhibit rooms/halls are equipped with APs. Visitors carrying portable devices move from one room to another. APs are connected to each other via an Ethernet switch. While moving between rooms, visitors may get disconnected temporarily, and the network stores the messages destined to them. For storing messages, we used the *Centralized* and *Distributed* buffering mechanism as described in Section 5.6.1.

We used the Random Waypoint (RWP) mobility model with attraction points to evaluate visitors mobility, as described in Section 5.6.3. The attraction points can be considered as rooms and the nodes move only between these attraction points at a speed that is uniformly distributed between 1 and 2.5 m/s. Furthermore, a node stays at an attraction point for a time that is uniformly distributed between 10 and 90 seconds. We have chosen a network of 9 APs within a 1.2km x 1.2km area and define 28 attraction points with an effective radius of 10 meters for each, indicating the region of influence. There are 60 nodes in the network and we have run the simulations for a duration of 40 minutes. The results are taken as an average by running the experiment 6 times, with the confidence intervals shown by the error bars.

#### 5.6.4.1 Uniform and Non-uniform AP Distribution

In the first set of experiments, we consider 20 visitors downloading the content from 20 sources, which send messages following an exponential distribution at the rates of 1 message/s and 5 messages/s. We observed similar results with different mean exponential distribution rates, as there is no limit of buffer space for storing messages. The message size is 1 KB.

First, we distributed the APs uniformly across the entire network such that the distance between all the APs is constant. This is done to obtain low disconnection times when nodes move, representing a “almost-connected network” but still showing connectivity “black holes”, as shown in Figure 5.7. The CDF of destinations against delivery ratio is shown in Figure 5.8.

We compared MeDeHa with the case when there is no buffering available. This is a very simple experiment but it helps us understanding how many messages are lost due to disconnections when MeDeHa is not employed. As is clear from the figure, with MeDeHa, 95% of nodes have more than 90% delivery ratio for the average rate of 5 messages/s, and 99% of nodes have more than 90% delivery ratio in case of 1 message/s. On the other hand, in the case where the buffering is not enabled, about 40% of nodes have less than 90% delivery ratio and 10% of nodes have even less than 50% delivery ratio, in case of 5 messages/s rate.

Next, we considered the case when the APs are distributed in the network in such a way that at some places, there is little overlap in APs’ connectivity regions, while at other places, they are very far from one another (Figure 5.9). The idea was to simulate an environment where the average disconnection time is higher. All other simulation parameters are the same as for the previous case. The result in case of non-uniform deployment of APs is shown in Figure 5.10.

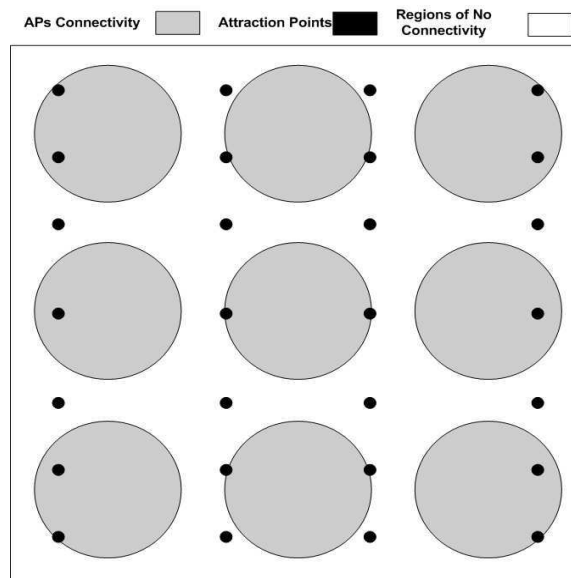

**Figure 5.7:** Uniform Deployment of 9 APs (28 Attraction Points).

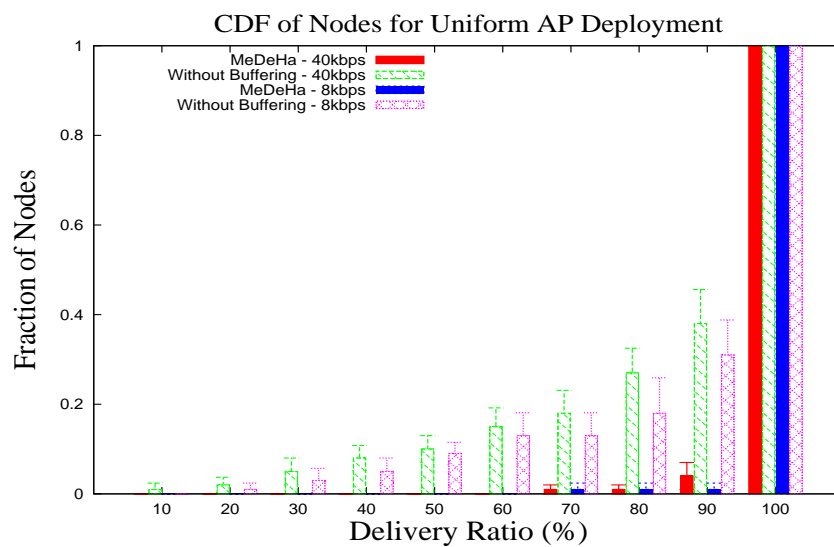

**Figure 5.8:** CDF of Nodes with Uniform APs Distribution.

The impact of non-uniform distribution of APs on the delivery ratio for the case when the messages are not buffered is very high, as 75% of nodes have less than 80% delivery ratio, and 40% of nodes have less than 40% delivery ratio. MeDeHa still achieves good performance, as 97% of nodes have more than 90% delivery ratio, for the average message rate of 5 messages/s. The behavior in case of 1 message/s is also the same.

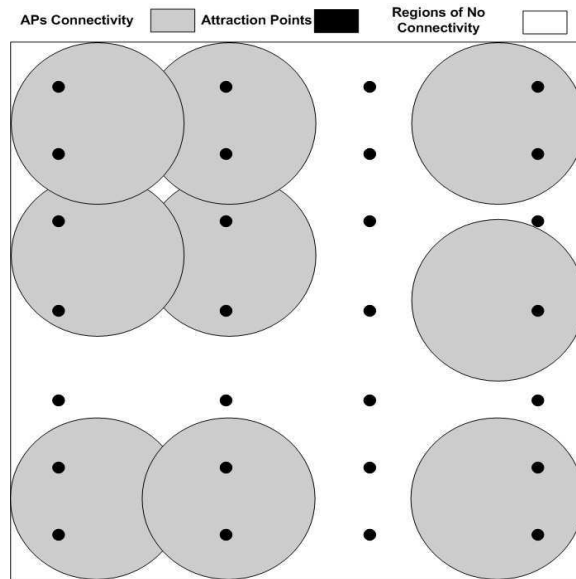

Figure 5.9: Non-Uniform Deployment of 9 APs (28 Attraction Points).

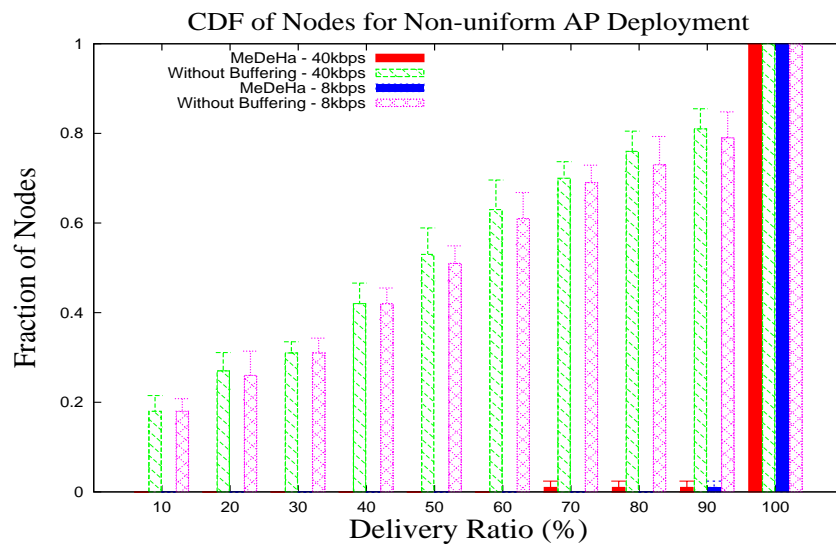

Figure 5.10: CDF of Nodes with Non-Uniform APs Distribution.

We also studied the impact of source mobility on the performance of MeDeHa. If a source is mobile, it can also be disconnected from the network, and hence is not able to send any messages. We used two approaches for this case, namely: (1) caching messages at sources when they are disconnected, along with buffering in the network; and (2) disabling network buffering, and only enabled sources to buffer messages while moving. We made all the 20

sources mobile, and all other parameters remain the same. We evaluated this scenario with non-uniform deployment of APs. The result for the average message rate of 5 messages/s is shown in Figure 5.11.

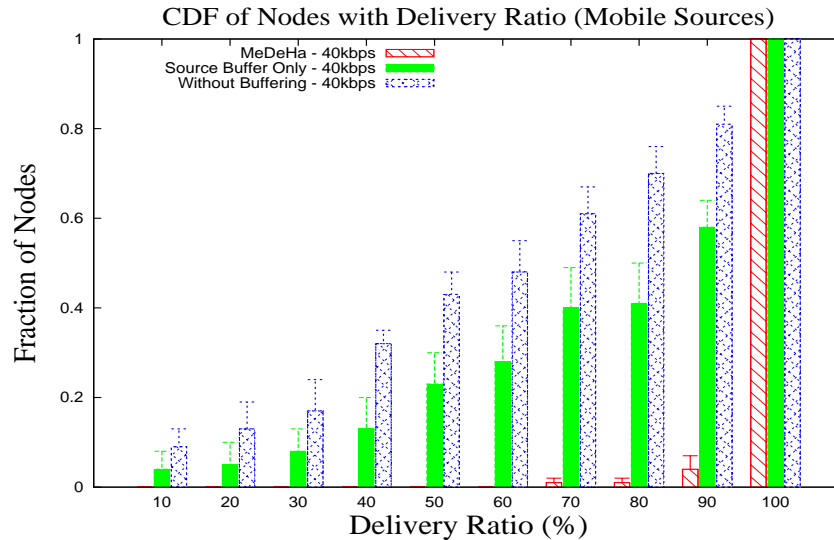

Figure 5.11: CDF of Nodes with Mobile Sources. Message rate: 5 messages/s

We observed that with MeDeHa, when buffering is provided at both sources and in the network, 96% of the nodes have more than 90% delivery ratio. When the buffering is only present at the sources, 40% of the nodes have less than 70% delivery ratio. When no buffering is present, only 20% of the nodes have more than 90% MDR, and 30% of the nodes have even less than 40% MDR.

#### 5.6.4.2 Buffers Size

The choice of the buffer size highly depends on the application's message rates, as well as on the delivery ratio requirements. To provide the proof of concept of MeDeHa's buffering mechanism, we computed the MDR as a function of different buffer sizes, both with *Centralized* and *Distributed* buffering schemes. It is also interesting to observe the impact of buffer sizes on traffic flows of different priorities. For this purpose, we used two flows per source (high and low priority), and the simulation parameters are the same as mentioned before. The impact of buffers sizes on MDR of different traffic flows is also observed for the uniform and non-uniform deployment of APs. As mentioned in the previous subsection, the deployment of APs is directly related to the average disconnection time of mobile nodes; the more the nodes remain disconnected, the more important is the buffer size required to store messages for these nodes. To analyze the impact of buffer sizes in *Centralized* and *Distributed* buffering, we take equal

buffers size. This implies that the size of the buffer at the centralized server is equal to the sum of buffer sizes at all APs in case of *Distributed Buffering*. Thus, we say that:

$$S_c = \sum_i S_{d_i} \quad (5.1)$$

Where,

$S_c$  = The buffer size for *Centralized Buffering* at the central server, and

$S_d$  = The buffer size for *Distributed Buffering* at each AP.

Figure 5.12 shows the impact of buffer size for non-uniform AP deployment. The results are taken for 20 source-destination pairs with mean message rate of 5 messages/s per flow per source, and message rate is exponentially distributed.

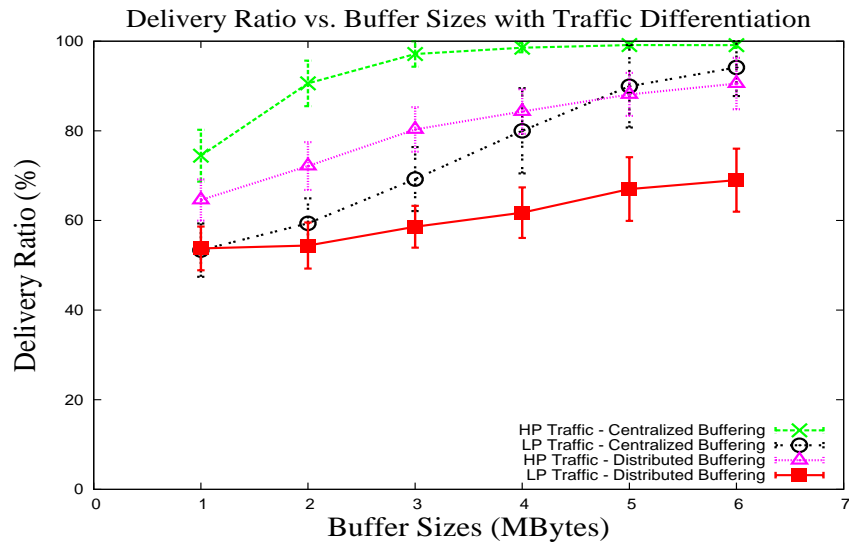

**Figure 5.12:** Buffer Size Impact on MDR (Non-uniform APs deployment).

Here, in case of *Centralized Buffering*, for higher buffer sizes (e.g. 6 MB), both low and high priority flows have obtained more than 95% MDR. But as we reduce the size of the buffer, the low priority traffic gets more affected than high priority traffic, until we reach at a limit (e.g., 3 Mbytes in this case), where the buffering scheme has to drop some messages of high priority; hence a reduction in MDR.

The same simulation is performed using the *Distributed Buffering* scheme, but we can see that the performance is not as good as in case of the *Centralized Buffering*. There are two main reasons behind this change in behavior. One is that the APs are not uniformly deployed.

Hence, for some APs, when they get the responsibility to store messages for a destination that gets disconnected for a longer period of time, it is likely that their buffer gets full and hence, they drop some messages. The impact is higher than what is observed in case of *Centralize Buffering* even at very low buffer sizes (1Mbyte for 9 APs would mean that each AP has only 111 KB storage space, and can store only 111 messages). The second reason is that it is possible that some nodes remain disconnected for longer period of time, and hence they require more storage space at APs than others. So, it is possible that at a given time, one of the APs has more messages to buffer than its capacity while some other APs have a lot of storage space available. This case cannot be avoided in *Distributed Buffering*, and is something that does not happen when the messages are stored at a central server.

Next, the impact of buffer sizes has been observed in case of uniform APs deployment. When comparing *Centralized* and *Distributed* buffering schemes, the same behavior is observed with two main changes. First, the reason described above for the non-uniform AP distribution case is not present in this case. Second, the size of buffers required to store messages is reduced, as the average disconnection time is reduced. The results are shown in Figure 5.13.

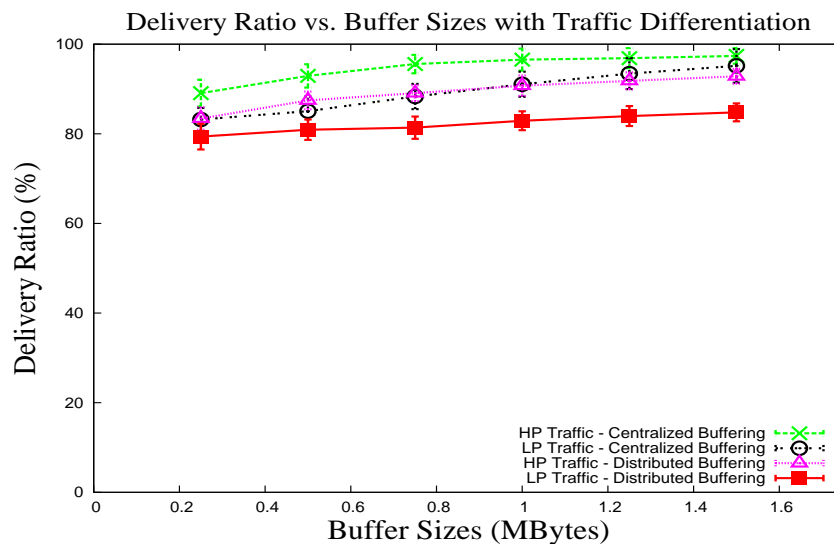

Figure 5.13: Buffer Size Impact on MDR (Uniform APs deployment).

### 5.6.5 NS-3 Results

We have done the NS-3 implementation of MeDeHa in three phases:

- **First Phase:** We ported the link layer implementation of the OMNET++ simulator (targeting only infrastructure-based networks with disruption tolerance support) to the net-

work layer. This allows maintaining multiple interfaces of the participating nodes and offers the possibility to integrate existing routing protocols with the framework, as explained in Section 5.1. Thus, we added the MeDeHa's notification protocol module to the network layer, and design a cross-layer approach to notify the network layer implementation about the link layer connection events (*associations* and *disassociations*). We then proceeded to test the validity of the implementation using a similar scenario that we used to validate the OMNET++ implementation (Case 1 below).

- **Second Phase:** We added the ad-hoc notification protocol to the implementation, in which messages are forwarded towards the intended destinations opportunistically using different *relay selection strategies*. Thus, MeDeHa nodes are able to store-and-carry messages for other nodes, and forward these messages as soon as they meet a *suitable* relay or the destination nodes. Besides, the infrastructure-based nodes (e.g., APs) also store messages for the destinations, as they do in the first phase. The relay selection strategies that we employed are described in the next subsection.
- **Third Phase:** The multi-hop infrastructure-less network support has been added to the simulator. In this way, the existing MANET routing protocols are made to seamless work with the MeDeHa framework. Also, MeDeHa nodes are able to exchange messages with non-MeDeHa MANET nodes via the potential the GW nodes that implement both the MeDeHa framework and the MANET routing protocols. For the MANET routing protocol, we used the OLSR protocol implementation, as it is a proactive routing protocol (see Section 4.7). The GW nodes use the underlying multi-hop connectivity to search for other GW nodes in the MANETs so that the connectivity can be extended using the MANETs as “transit networks”.

#### 5.6.5.1 Relay Selection Strategies

Selecting a *suitable* relay to carry messages is an important component of MeDeHa and can have considerable effect on the performance of the protocol. One can employ different relay selection strategies depending upon a number of factors including network-, node-, and application characteristics as described in Section 4.4. In order to evaluate MeDeHa, we defined and used three relay selection strategies which are described in the following:

1. **Encounter-based Replication (ER):** This strategy is similar in approach to the Last-Seen First (LSF) scheme presented in [28], and falls in the category of the Destination Dependent (DD) utility functions (Section 3.3.1). Following ER, a message carrier hands over a message to a node only if the latter has already encountered a destination at least a number of times, and it has seen the destination more recently. The number of encounters

before a node is chosen as a relay can be set depending upon the scenario.<sup>10</sup> The idea behind this utility metric is that if a node has already seen a destination, there is a strong probability that it will again encounter the destination in the future. Note that, depending on the mobility pattern of nodes, this utility function may not be a good indication of the likelihood of future encounters.

2. **Social Affiliation-based Replication (SAR):** In Social Affiliation-based Replication (SAR) scheme, we choose “community affiliation” as the utility function for relay selection. In this way, a relay is chosen only if it belongs to the community of the destination. This utility function is meaningful in cases where nodes belong to different communities or social groups. Thus, in order to send traffic between different communities, we rely on nodes that visit different communities. In this way, it is useful to forward a message to a node if the node belongs to the same community as destination. This strategy is inspired by the Most-Mobile First (MMF) and the Most-Social First (MSF) strategies presented in [28], and falls in the Destination Independent (DI) category of utility functions (Section 3.3.2).
3. **Encounter and Social-Affiliation-based Replication (ESAR):** This is a hybrid utility function that is obtained by combining the ER and SAR schemes (Section 3.3.3). Thus in ESAR, a relay is chosen to carry a message to a destination only if it belongs to the same community as that of the destination as well as if it has encountered the destination at least a number of times.

Note that when using message replication, the distribution of copies is similar to *source spraying* in Spray-and-Wait [29], in which only source distributes the copies to the encountered nodes. The only difference is that the distribution of copies is based on the qualification of a node to become a relay for a destination, and not in an epidemic fashion.

In the following, we present MeDeHa performance evaluation in the NS-3 simulator using different scenarios.

### 5.6.5.2 Case 1: Convention Center Type Scenario

We consider a convention center type environment with different rooms and seminar halls where connectivity is provided by APs, but connectivity is not guaranteed everywhere (e.g., outside rooms or in hallways). Visitors carrying portable devices may move from one room to another and roam around across multiple AP coverage areas.<sup>11</sup> These APs are connected to each

<sup>10</sup>Unless otherwise specified, we use number of encounters as two in our experiments.

<sup>11</sup>In our simulations, we assume that the APs have circular coverage areas. In practice, APs do not generally provide circular behavior. Changing APs coverage regions may change results obtained in this scenario, but has no effect on the functionality of MeDeHa qualitatively.



other via Ethernet. Without MeDeHa, visitors get disconnected temporarily while moving from one room to another and hence may lose some messages destined to them. With MeDeHa, the network stores messages temporarily, when no destination information is available. When using more than one network, a message can either be delivered to a destination in infrastructure mode, in ad-hoc mode, or the message can be handed over to a relay, which may carry the message to its destination.

This case is similar to the one we used in Section 5.6.4 in which we employed Random Waypoint (RWP) mobility model with attraction points [63], [64]. One of the differences is that in this scenario, instead of comparing with a case where we do not buffer, we provide a comparison between the MeDeHa's implementation in the *first phase* to that in the *second phase*. The other difference is that we only used *Distributed Buffering* for APs in this scenario. Attraction points correspond to rooms and nodes move only in between these attraction points. Nodes are made to move in between these attraction point regions at a speed that is uniformly distributed between 1 and 2.5 m/s. Also, while within the coverage area of an attraction point, a node stays there for a time that is uniformly distributed between 0 and 60 seconds. A network of 9 APs is used spanning a 1km x 1km area; 16 attraction points are set up, each having an effective radius of 20 meters, indicating its region of influence. There are 50 nodes in the network and we have run the simulations for a duration of 40 minutes. The results are obtained by running the simulation 6 times, which are used to compute the confidence intervals of the results.

**Uniform and Non-uniform AP Distribution:** We consider that 20 mobile sources are sending messages to 20 mobile destination using exponential distribution at different average rates (in messages/s). We do not assume buffer constraint at nodes for this scenario. Each visitor sends data traffic for a duration of about 20 minutes, and the average number of messages received by each node is represented by the average MDR for each case. First, we place the APs uniformly across the entire network, and their positions are similar to Figure 5.7.

Here, we compared two cases of MeDeHa: (1) nodes support infrastructure-based networks only (IS only), and (2) nodes are able to connect to infrastructure-based network as well as with other nodes in ad-hoc mode (IS+Adhoc). Our goal is to evaluate the impact on delivery ratio (MDR) and delivery delay (AD). In ad-hoc mode, we use ER relay selection strategy with number of copies per message is set to 1, and the number of encounters is set to 2. CDF of nodes is shown in Figure 5.14, while the average delivery delay is presented in Figure 5.15.

All stations exhibit more than 90% delivery ratio irrespective of whether they are member of one or two networks for the case of both 1 message/s and 4 messages/s.<sup>12</sup> While delivery ratio is not significantly affected, taking advantage of multiple networks decreases the average delivery delay significantly irrespective of the message rate.

Next, we consider the case of non-uniform deployment of APs (similar to Figure 5.9). All

<sup>12</sup>We used message rates from 1 message/s to 20 message/s and observed similar performance trend.

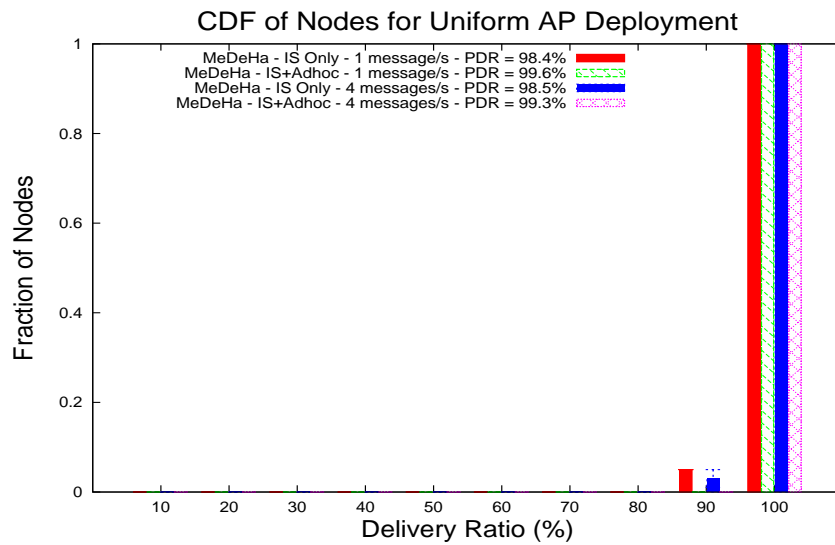

Figure 5.14: Fraction of Nodes vs. Delivery Ratio for uniform deployment of APs

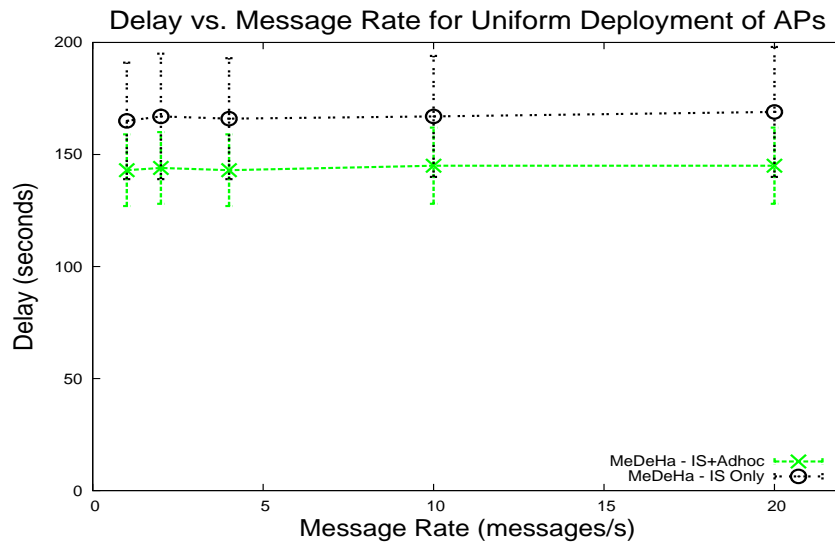

Figure 5.15: Delay vs. message rates for uniform deployment of APs

other simulation parameters are the same as for the uniform deployment. CDF of nodes and AD are shown in Figure 5.16 and Figure 5.17, respectively.

Here, 80% of nodes have more than 90% delivery ratio in case of IS-Only, as compared to more than 90% of nodes having more than 90% delivery ratio when IS+Adhoc scheme is used. Again, we can see that the average delay is higher as compared to the uniform AP deployment scenario, but we still observed an improvement in average delivery delay by using more than

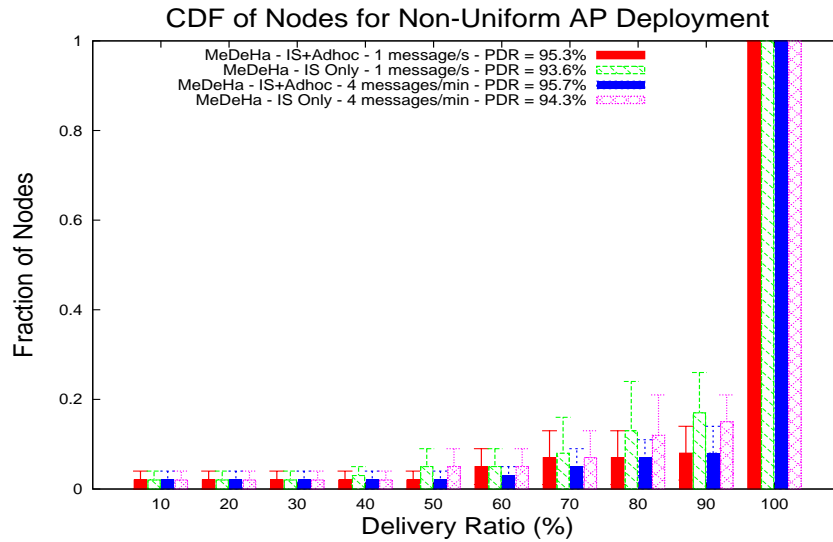

Figure 5.16: Fraction of Nodes vs. Delivery Ratio for non-uniform deployment of APs

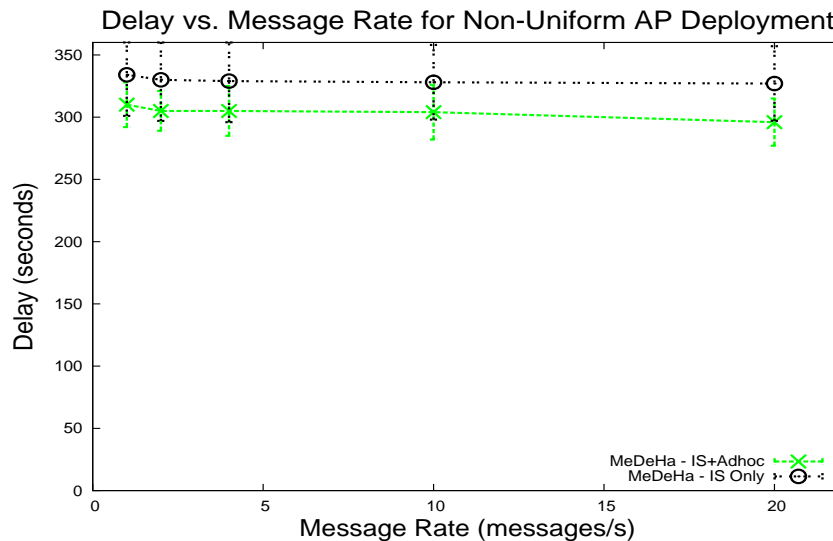
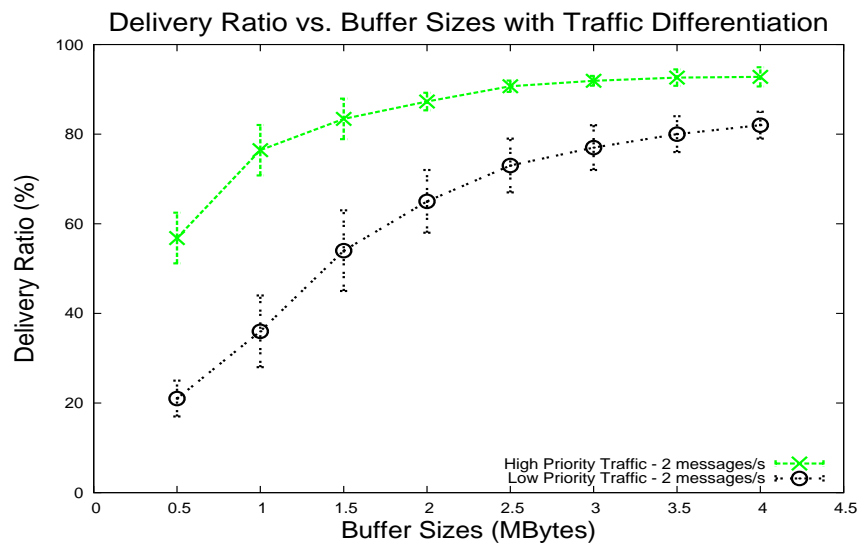

Figure 5.17: Delay vs. message rates for non-uniform deployment of APs

one network. The average delay is higher because the overall disconnection time is high due to non-uniform AP positions. The reason is the same for slightly lower MDR as compared to uniform deployment case.

**Buffers Size:** The goal of these experiments is to evaluate MeDeHa's performance when buffer capacity at nodes is limited. Further, we inject traffic of different priorities. We use a uniform AP deployment leaving all other parameters the same. The results are given for 2 mes-

sages/s and for stations supporting both infrastructure-based and ad-hoc networks. Delivery ratio for different buffer sizes and traffic priorities (high and low) is shown in Figure 5.18.



**Figure 5.18:** Impact of varying buffer sizes on Delivery Ratio for high and low priority messages (message rate: 2 messages/s)

We observed that the average delivery ratio of nodes improve with the increase in buffer sizes, for low and high priority message flows. Moreover, the results confirmed that MeDeHa gives preference to high priority messages, i.e., high priority messages achieve higher delivery ratio as compared to low priority messages; this is especially true for the cases where buffer capacity is more limited.

### 5.6.5.3 Case 2: Communication between Clusters of Nodes

This scenario is used to evaluate the *second phase* of the framework's implementation, in which we simulate 3 clusters, each of which equipped with 3 APs connected to one other as part of an ESS. As shown in Figure 5.19, within each cluster, there may be some regions with no connectivity. The clusters spans an area of 400m x 400m each and are placed well apart so they do not have overlapping coverage areas, i.e., they are disconnected from each other. Each cluster is configured with 20 users carrying mobile devices: 14 of which only move within the boundary of their cluster at pedestrian speeds (3-6 km/h), while 6 users visit other clusters with probability 0.4. These nodes are potential relays to carry the inter-cluster traffic and are assumed to move at vehicle speeds uniformly distributed between 30 and 60 km/h.<sup>13</sup> The

<sup>13</sup>For this scenario, we assume that, while moving, users have their devices *on*. In real scenarios, users may turn their devices *off* while moving. For such cases, message buffering in the nodes must use persistent storage. But

simulation area is set to 3km x 3km, and total simulation time is 120 minutes. The performance metrics used are percentage of nodes that receive a certain delivery ratio, average message delivery ratio (MDR), and average delivery delay (AD). Figure 5.19 shows the map of the scenario and the corresponding AP locations.

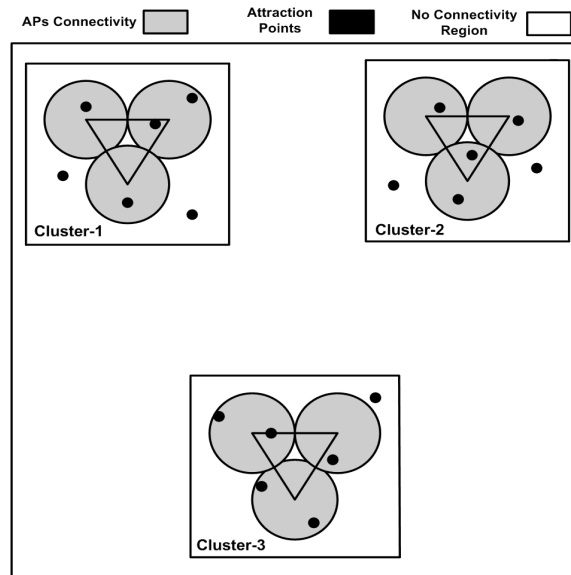
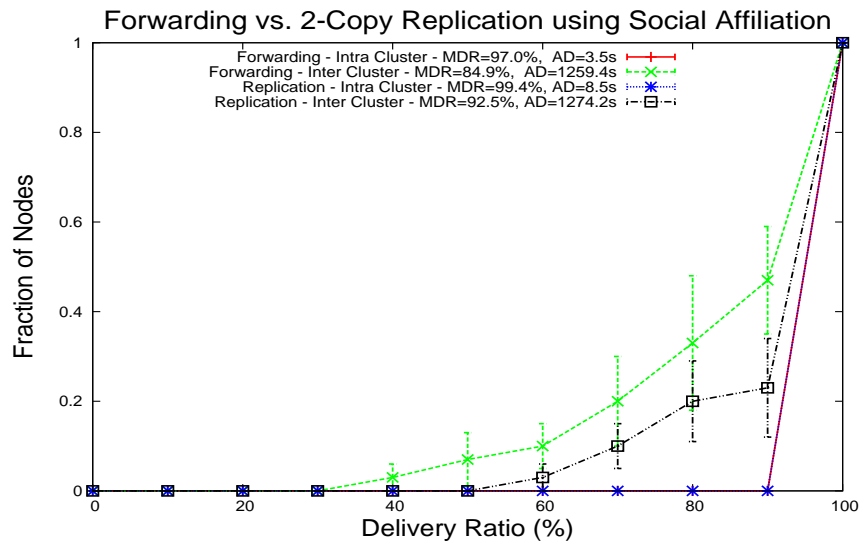

**Figure 5.19:** Deployment of APs and attraction points in a scenario with 3 disconnected clusters.

**Forwarding versus Replication:** For this scenario, we chose “community affiliation” as the relay selection strategy (SAR scheme), where a community corresponds to a cluster. We compare the behavior of forwarding, where there is only one copy of a message, with replication, where multiple copies per message exist in the network. We used 2 copies per message for the replication.

Additionally, traffic is divided into two parts: intra-cluster and inter-cluster traffic. Intra-cluster traffic corresponds to the case where both the source and the destination belong to the same cluster and thus both do not leave the cluster for the duration of simulation. 10 sources are chosen across all clusters to generate intra-cluster traffic which is destined to nodes in their own cluster (more precisely 4 sources in cluster 1, 3 each in cluster 2 and 3). Inter-cluster traffic represents the traffic exchanged by nodes belonging to different clusters. For this traffic, 10 source-destination pairs are selected from all 3 clusters such that both the source and the destination do not move out of their clusters and belong to different clusters. The average message rate is set to 1 message/s (60 messages/mn) and users send messages to other users for a duration of around 80 minutes. Figure 5.20 shows the CDF of the fraction of nodes as a qualitatively, this will not affect the results presented here.

function of delivery ratio using forwarding and replication for both types of traffic. The average number of messages received by each user is represented by the average MDR indicated in Figure 5.23.

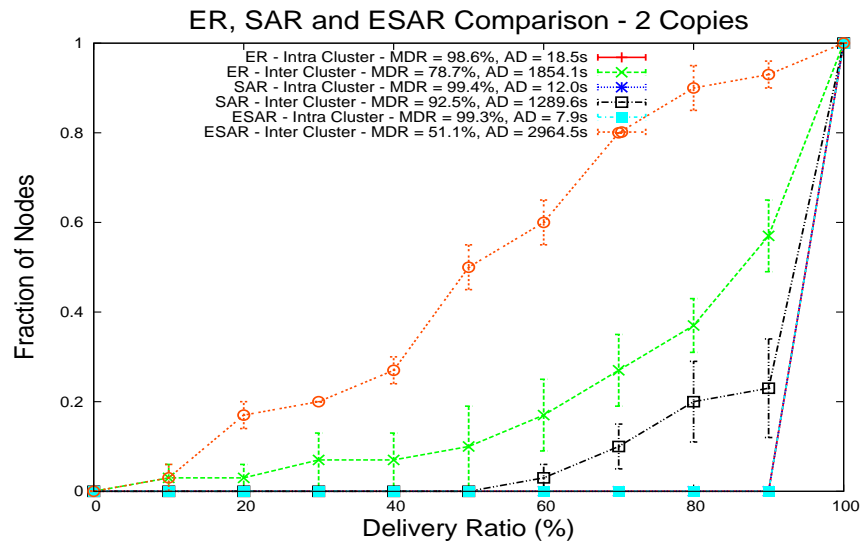

**Figure 5.20:** CDF of fraction of nodes vs. delivery ratio showing the comparison between forwarding and 2-copy replication for inter-cluster and intra-cluster traffic. Messages rate is set to 1 message/s

By comparing the results of forwarding and replication, we observed that in the case of forwarding, 33% of the nodes have less than 80% delivery ratio, whereas using 2-copy replication, only 20% of nodes have less than 80% delivery ratio, which is a significant improvement. A slight improvement is observed in the average MDR in the case of intra-cluster traffic. This slight improvement occurs because the traffic is local and any local node can become a relay node for a message, so the probability of message delivery is high. Hence, increasing the number of copies from 1 to 2 does not help much as forwarding performs quite well, mainly because the nodes tend to see each other more, and the messages are also stored at the local APs. The minor increase in average delivery delay (AD) is due to the increase in MDR from 97.0% to 99.4%. For inter-cluster traffic, average MDR is greatly improved by using 2-copy replication as compared to forwarding (from 84% to 92%), but this increases the average delay as well (from 1259.4 seconds to 1274.2 seconds). The increase in average delay (AD) is due to the significant improvement in MDR, as the messages that get delivered very late contribute towards an increase in AD. These messages do not contribute in forwarding case as they are never delivered. The results are obtained by running the simulation experiments 6 times.

**Relay Selection Strategy:** Now, we focus our attention on providing a comparison between

the three relay selection strategies described earlier (i.e., ER, SAR and ESAR).<sup>14</sup> In Figure 5.21, a comparison is shown between ER, SAR and ESAR selection strategies for 2-copy replication. All other simulation parameters are the same as used for the forwarding versus replication comparison.



**Figure 5.21:** CDF of nodes vs. Delivery Ratio for 2-copy Encounter Replication (ER), Social Affiliation Replication (SAR) and Encounter and Social Affiliation-based Replication schemes - (1 message/s)

From the figure, it is clear that for inter-cluster traffic, SAR performs the best both in terms of average delivery ratio (MDR) and average delivery delay (AD). The reason is that the clusters are far away from each other and are not connected. Hence for message delivery, we relay only on the nodes that move between different clusters. SAR obtains the best results in this scenario because handing over a message to a node that belongs to the same cluster as that of destination increases the chances of message delivery, as compared to ER case which relies on the fact that the relay has to meet at least a few number of times (2 encounters in this case) before becoming a candidate for relay selection. Considering the size of the network and the nodes speed, it is unlikely that nodes in different clusters tend to encounter each other too often. For the same reason, ESAR performs the worst, as the criteria for the relay selection is stricter in ESAR (hand over a message to a relay if the relay belongs to the same cluster as that of the destination and if the relay has seen the destination at least twice). This criteria adds the buffering/waiting delay for a suitable node and results in expiration of a lot of messages while being stored at nodes.

<sup>14</sup>There are also some other relay selection strategies available such as [36], [48], [49]. Here, we use simple strategies as the purpose is to show the validation of the framework functionality. Of course, using more sophisticated strategies may provide better delivery ratios.

Even for the messages that are delivered, ESAR yields the highest delay. So, even increasing the simulation time would not have helped in improving MDR in this case, as the messages are expired while stored at the nodes. Increasing the simulation time can improve the results only when message expiry time is also increased.

On the other hand, for intra-cluster traffic, all relay selection strategies yield similar average delivery ratio (MDR), though ESAR performs slightly better than the other two strategies in terms of average delay (AD). This is because, when both source and destinations are within the same cluster and do not move out, nodes tend to encounter other nodes more often. Hence, ESAR yields the most accurate relay selection as it does not hand over a message to a node that belongs to a different cluster even if the node has already encountered the destination twice. Thus, ESAR results in minimizing end-to-end delay as messages reach the destination in an efficient way.

When comparing the two traffic types, intra-cluster traffic has better MDR values with significantly low delay values, as both the source and the destination are present in the same cluster, whereas MDR of inter-cluster traffic is relatively low and it has very high delivery delays, as the clusters are not directly connected and nodes has to carry the inter-cluster traffic for long periods of time before delivering them to the destinations.

We can conclude the results obtained in this case in the light of the taxonomy presented in Chapter 3, and say that a DD utility based scheme like ER performs better when there are many connection opportunities between participating nodes such that the relay nodes tend to encounter the destinations more frequently. This is the case of the intra-cluster traffic where both source and destination are confined to a small area of 400m x 400m. On the other hand, the performance of SAR (a DI utility-based scheme) is better than the ER scheme when relay nodes do not frequently encounter the destination nodes. Here, this is the case of the inter-cluster traffic.

**Impact of Number of Copies per Message:** Next, we wanted to explore the impact of number of copies per message on the performance of the framework. So far, we have only used either one copy (forwarding) or two copies (replication) per message. It is indeed interesting to compute the average MDR of the nodes with respect to the number of copies per message. In this way, we have used 1 to 6 copies per message for both ER and SAR relay selection strategies, and the impact is shown in Figure 5.22.

We observed a very interesting behavior here. Generally, it is expected that increasing the number of copies should enhance the performance in terms of delivery ratio at the cost of using more network resources, especially in *opportunistic* routing, as in Epidemic Routing [7] and Spray-and-Wait [29]. Here, we did not observe this improvement. Rather, the performance is affected poorly by increasing the number of copies, in case of the ER scheme for inter-cluster traffic. The average MDR of nodes only decreases slightly in case of the SAR scheme. The reason



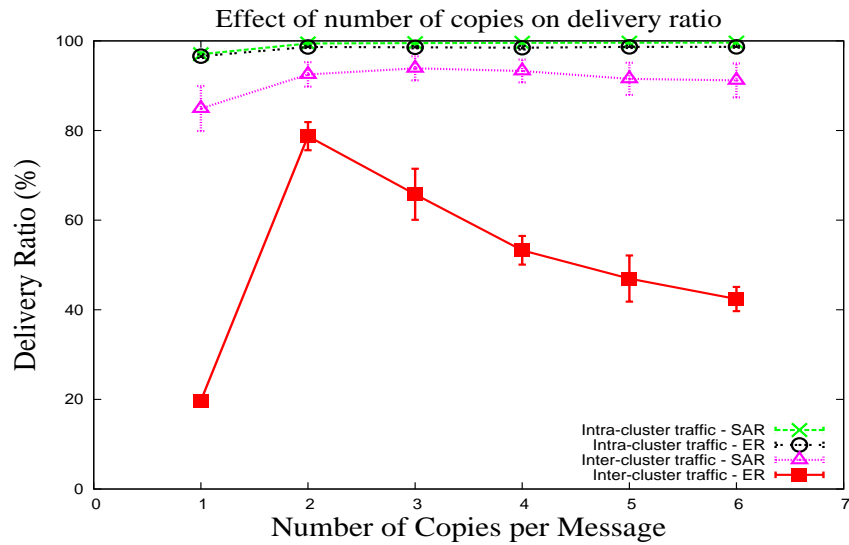

**Figure 5.22:** Impact of using different number of copies per message on the average MDR of the nodes using ER and SAR relay selection strategies - (1 message/s)

for this behavior is the following: As the network only relies on the relay nodes that move in between clusters in order to forward inter-cluster messages, the relay nodes have to buffer more messages as the number of copies per message is increased. But the contact opportunities (and contact duration) remain the same. Hence, bandwidth is wasted in forwarding messages that may already be delivered when the relay node A meets the relay node B, and the two exchange messages based on the utility function. The effect is severe in case of the ER scheme as the nodes need to buffer messages for longer period of time until they find another node that has seen the destination at least twice. Hence, the number of stored messages increases with the increase in number of copies. In case of the SAR scheme, the impact is less, as SAR is based on DI utility function, and nodes do not need to hold message for long duration before finding a relay: hence, the number of stored messages at the relay nodes are less as compared to the case of ER. On the other hand, there is hardly any impact on the average MDR for intra-cluster traffic with the increase in the number of copies.

So, we conclude two important things here. First, increasing the number of copies per message can only help in increasing the average MDR to a certain limit, and after this limit it can even have a devastating effect on the MDR. Second, we generally do not need too many copies per message in the MeDeHa framework as nodes in the framework take advantage of the connection opportunities in many networks simultaneously. In other words, the performance of the MeDeHa framework is acceptable even with low number of copies per message. This is also due to the presence of the APs in the network. For instance, if 3 APs are connected to each

other and a message is stored at one of the APs, it is considered as if 3 copies of the message are stored because the message is delivered to the destination as soon as it is connected to any of the APs. Similar observation regarding message delivery has been made by authors in [115].

#### 5.6.5.4 Case 3: Communication between Students across Campuses

This scenario is similar to the case 2 presented above with the difference that we consider a shorter network area (1km x 1km), and instead of 3 communities, we consider that students move between three campuses of a university. Each campus spans over an area of 400m x 400m, and 20 students belong to each campus, in which 14 move only within their respective campus. Six other students move out of their campuses to visit the other two campuses with a probability of 0.4. We assume that while moving from one campus to another, students take university shuttles that move at a speed uniformly distributed between 30 and 60 km/h. On the other hand, pedestrian students move at a speed that is uniformly distributed between 3 and 6 km/h. The other parameters remain the same as described in Case 2 including the message rates and number of destinations. The traffic is classified into inter-campus traffic and intra-campus traffic, and the duration of the simulation is set to 1 hour, and the results are obtained by taking the average of 6 simulation runs.

**Forwarding versus Replication:** Again, we used SAR as the relay selection strategy, where a community corresponds to a campus. Students advertise the campus they belong to using the *HELLO* notifications. Similar to what we did for Case 2, we compare the behavior of forwarding with 2-copy replication. Figure 5.23 shows the CDF of the fraction of nodes as a function of delivery ratio using forwarding and replication for both kinds of traffic.

By comparing the results of forwarding and replication, we can see that in the case of forwarding, 63% of the nodes have less than 80% delivery ratio, whereas using 2-copy replication, only 33% of nodes have less than 80% delivery ratio, which is a significant improvement. The overall average delivery ratio (MDR) of all the nodes is also greatly improved using replication as compared to forwarding in the case of inter-cluster traffic (from 64% to 82%), and a slight improvement is observed in the MDR in the case of intra-cluster traffic. This improvement is because the traffic is local and any local node can become a relay node for a message, so the probability of message delivery is high. The minor increase in average delivery delay (AD) is due to the increase in MDR from 97.4% to 98.2%. For inter-campus traffic, average MDR is greatly improved by using 2-copy replication, but increases the average delay by 9% as well (from 419 seconds to 488 seconds). This increase in average delay (AD) is due to the significant improvement in MDR, as the messages that get delivered very late contribute towards increase in AD. These messages do not contribute in forwarding case as they are never delivered.

The results discussed above are for a duration of 60 minutes. We observed that increasing the simulation time to 90 minutes increase the average delivery ratio (MDR) of nodes for inter-

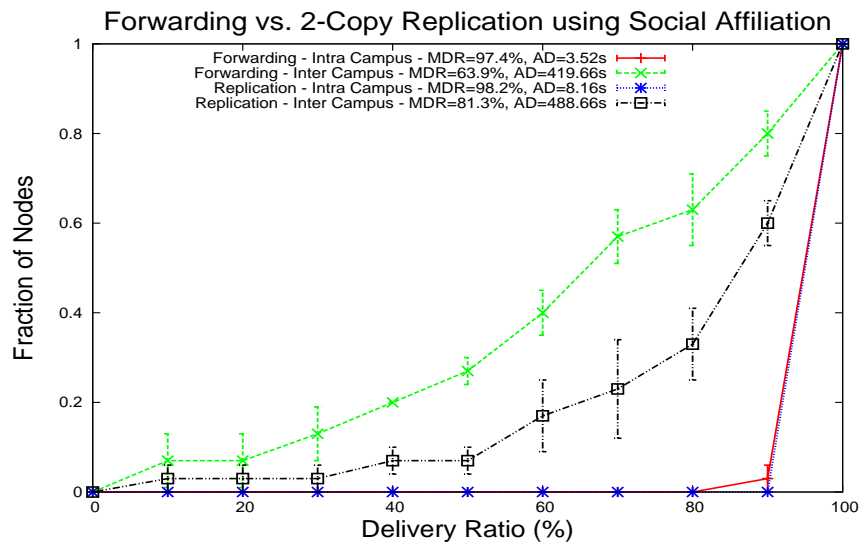
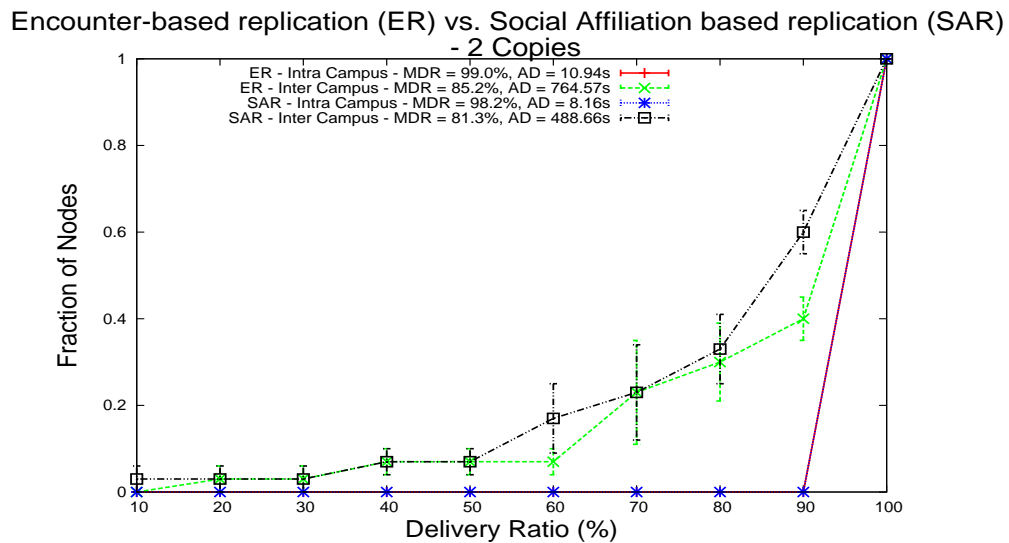

**Figure 5.23:** CDF of fraction of nodes vs. delivery ratio showing the comparison between forwarding and 2-copy replication for inter-campus and intra-campus traffic. Message rate is set to 1 message/s

campus traffic from 81.3% to 98.4% in case of replication, but also increases the average delay (AD) by 68% (from 488 seconds to 712 seconds). This is because more messages are delivered to the destinations by increasing the simulation time to 90 minutes; these messages were undelivered but stored at nodes for the 60-minute case. The increase in MDR also causes the delay (AD) to increase. On the other hand, for forwarding, increasing simulation time improves the MDR from 63.9% to 90.3%, as well as increases the AD from 419 seconds to 822 seconds.

**Relay Selection Strategy:** As in Case 2, we performed simulations to compare ER, SAR and ESAR relay selection strategies. In Figure 5.24, a comparison is shown between ER and SAR selection strategies for 2-copy replication.

From the figure, it is clear that ER performs well in terms of delivery ratio (MDR) while SAR provides lower average delay. The reason for this is that ER only hands over a message to a relay if the relay has seen the destination at least twice. While this adds the buffering/waiting delay for a suitable relay, thereby increasing the overall average delay, it may increase the message delivery because if a node has already encountered a destination twice, it is more probable that it is going to encounter the destination again in the future. The results obtained also favor this principle as is clear from increase in average MDR (from 81.3% to 85.2%). On the other hand, the decrease in average MDR in case of SAR is due to the fact that the “community-based affiliation” metric chooses a relay node only based upon a node’s affiliation with a particular community (campus here). It is not certain that every relay node will encounter a destination when it goes back to its parent campus.



**Figure 5.24:** CDF of nodes vs. Delivery Ratio for 2-copy Encounter Replication (ER) and Social Affiliation Replication (SAR) - (1 message/s)

The delay for intra-campus traffic is very low as compared to the delay for inter-campus traffic. This is because intra-campus traffic does not involve nodes belonging to different campuses, and therefore, a destination is found quickly within the campus. Moreover, for inter-campus traffic, 40% of nodes have less than 90% delivery ratio in case of ER, whereas 60% of nodes have less than 90% of delivery ratio in case of SAR.

The result obtained for 2-copy replication using the hybrid ESAR scheme is shown in Figure 5.25.

The choice of this hybrid utility function improves the average MDR for both types of traffic. The average delay (AD) for intra-campus traffic is increased by using the hybrid function. This is because of the strict condition to choose a relay where a node has to keep on waiting for a suitable relay, and keeps a message stored until it encounters a node that follows the hybrid utility function, thereby adding an additional delay. On the other hand, the advantage of doing that is the improvement in average MDR. Thus, there is a tradeoff between increasing average MDR and decreasing average AD. In terms of fraction of nodes attaining a particular level of delivery ratio, using hybrid utility metric (ESAR), only 30% of nodes attain less than 90% delivery ratio (MDR) as compared to 40% of nodes using ESAR and 60% of nodes using ER (Figure 5.24).

Note that the results obtained in this case are somewhat different from what we obtained in the Case 2 (communication between clusters, Section 5.6.5.3). The reason is that in this case, the size of the network is not too big; hence, nodes tend to see each other more as compared to

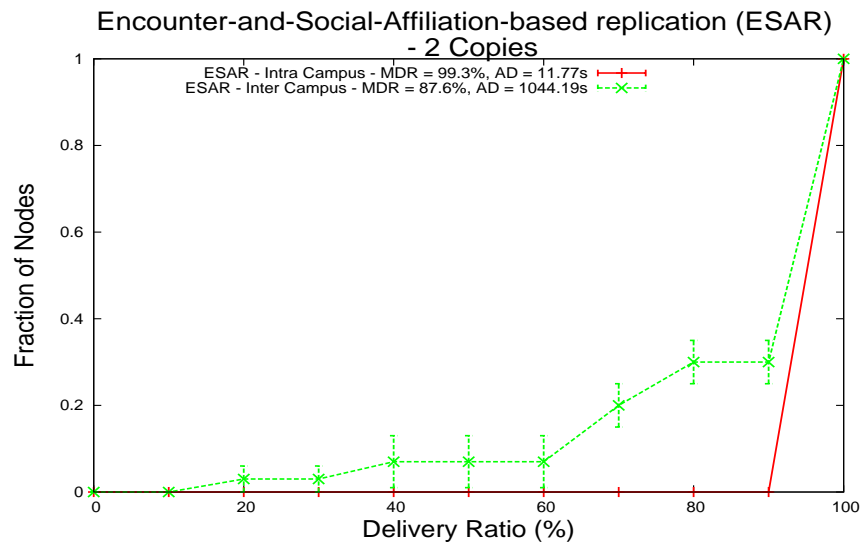

**Figure 5.25:** CDF of nodes vs. Delivery Ratio using 2-copy Community-and-Encounter Replication (ESAR) - (1 message/s)

what we observed in case 2. This decreases the overall AD and consequently, encounter-based replication schemes (ER and ESAR) perform better than SAR.

In this scenario, we observed a different behavior of the utility based schemes (ER, SAR and ESAR) as compared to Case 2 (Section 5.6.5.3). Here, the DD encounter-based schemes performed better in terms of average MDR as compared to DI community-based scheme (SAR). This is because the total network area is smaller (1km x 1km), as compared to what we had in Case 2 (3km x 3km). Hence, as the nodes move at a similar speed, the contact opportunities between the nodes have increased which cause the performance of DD utility functions to perform better.

#### 5.6.5.5 Case 4: Convention Center Type Scenario

This scenario belongs to the *third phase* of the MeDeHa's implementation in which we show the effectiveness of adding support for multi-hop mobile ad-hoc networks (MANET) to the MeDeHa framework and demonstrate that the framework is able to deliver messages to non-MeDeHa MANET nodes. In this scenario, we consider a convention center type environment with different rooms and seminar halls spanned over a region of 1000m x 1000m, and where connectivity is provided by a network of 9 APs that are connected to each other via Ethernet. Each AP has its specific region of connectivity, and the regions of connectivity of different APs may overlap. Almost 60% of the network is under AP connectivity, and the APs are not positioned uniformly (their position is similar to Figure 5.9), which means that at some places,

mobile nodes will have longer periods of disconnection than at some other places. Visitors carrying portable devices move from one room to another. Also, visitors while moving may form MANETs, and can use MANET connectivity to exchange messages where APs do not provide connectivity.

There is a total of 90 visitors in the convention center, moving at a speed that is uniformly distributed between 1 and 2.5m/s. While moving, visitors stay at different places for a duration that is uniformly distributed between 0 and 60 seconds. Attraction points [64] are considered as rooms or seminar halls, and nodes visit these attraction points. For this experiment, 20 MeDeHa (MDH) sources are chosen in the network, which send messages at an average rate of 1 message/s (60 messages/mn)<sup>15</sup> to 20 non-MeDeHa MANET destinations, and the duration of simulation is 1 hour. The results shown here are obtained by running the experiments 6 times in order to compute the confidence intervals which are presented with the results. Among the 90 visitors, 30 visitors are MDH, 30 run the regular OLSR protocol, and the remaining 30 are GW (i.e., nodes that run the MeDeHa software and the OLSR protocol), in the first part of this experiment, as shown in Fig. 5.26(a).

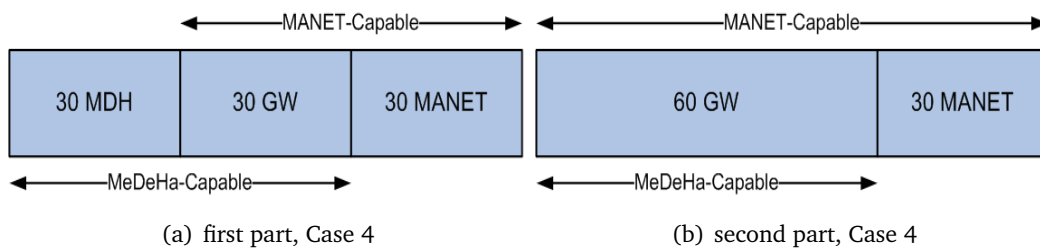
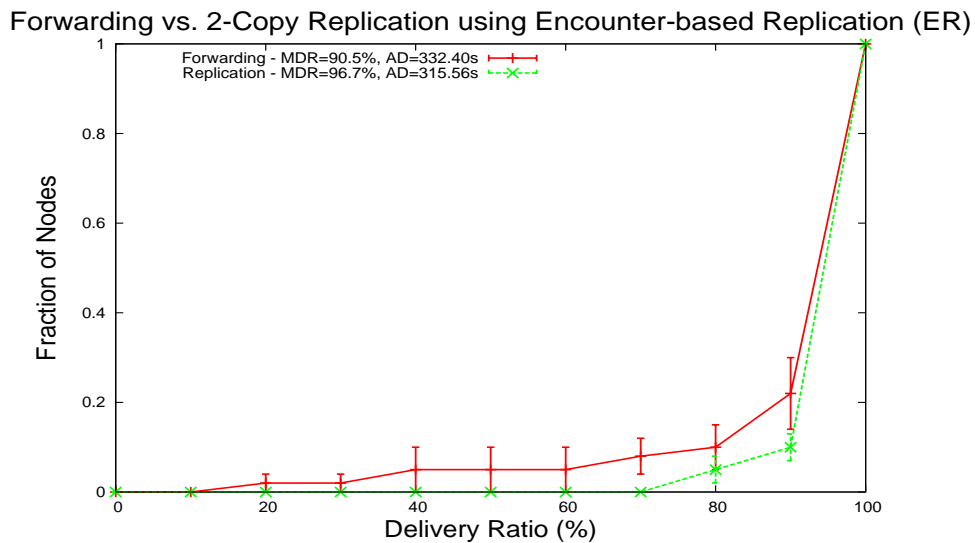

Figure 5.26: Types and distribution of nodes used in Case 4

**Forwarding versus Replication:** First, we want to observe the performance of the protocol by comparing forwarding with replication, as we did for Case 2 and Case 3. For this experiment, we used 2 copies per message and employed Encounter-based Replication (ER) as the relay selection strategy. Fig. 5.27 plots the percentage of nodes against delivery ratio comparing forwarding and 2-copy replication.

We see that with forwarding scheme, about 25% of nodes have less than 90% of delivery ratio, as compared to the replication scheme where only 12% of nodes have less than 90% of delivery ratio. While looking into the overall MDR of all 20 nodes, we observe that replication increases delivery chances (from 90% to 97%), while minimizing average end-to-end delay. This is because using one more copy of a message would increase the likelihood that a source

<sup>15</sup>We used messages rates from 3 messages/mn to 160 messages/mn and observed similar performance when the buffer space is not limited.



**Figure 5.27:** Forwarding vs. 2-copy Replication using ER scheme for 1st part of Case 4 (30 MDH, 30 GW, 30 OLSR visitors)

(or a relay) encounters another relay (or a destination). This is done at the cost of increasing message overhead, thus requires more resources at nodes. Note that the AD shown is only taken for the messages that are received both in forwarding and replication experiments.

**Relay Selection Strategy:** We show a comparison of different relay selection schemes with respect to average delivery ratio and average delivery delay. We divide 60 MANET-capable visitors in 3 groups (20 visitors each) by labeling them with different MANET identifiers, and MANET nodes employ the SAR scheme to announce their groups. This utility function is meaningful here since in order to pass the traffic to MANET nodes that are otherwise inaccessible, we have to rely on nodes that belong to these MANETs, and thus visit them off and on. Thus, it is useful to forward a message to a visiting node for a destination if both the destination and the visiting node belong to the same group (i.e. MANET, in our case). A comparison between ER and SAR relay selection approaches using 2-copy replication is shown in Fig. 5.28.

We observed another interesting behavior here. First, using ER, only 10% of nodes have less than 90% of delivery ratio, whereas about 25% of nodes have less than 90% of delivery ratio in case of using SAR. Second, in terms of average MDR, ER performs slightly better than SAR (an increase from 93.5% to 96.7%). On the other hand, SAR outperforms ER in terms of AD, reducing delay to more than half. Again, note that the AD shown is only taken for the messages that are received using both ER and SAR.

The reason for average delay increase in case of ER over SAR is the strict relay selection metric employed in ER, where a relay is chosen only if it has encountered a destination at least

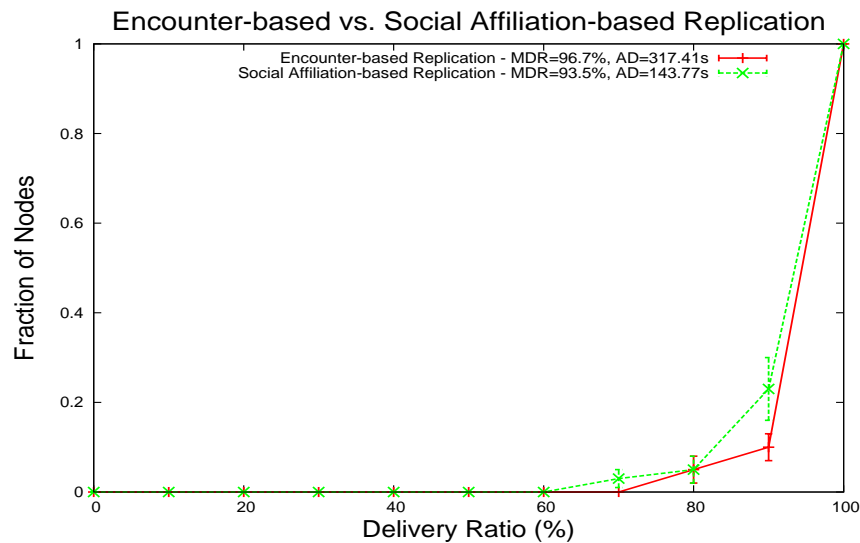

**Figure 5.28:** Comparison between ER and SAR schemes using 2-copy replication for 1st part of Case 4 (30 MDH, 30 GW, 30 OLSR visitors)

twice in the past. This implies an increase in delay but also an increase in average MDR. But on the other hand, there is very little initial delay in forwarding a message to a relay in case of SAR, the message can be forwarded to any node that belongs to the destination's group.

Next, we slightly change this scenario and make all 90 visitors MANET-capable of which 60 nodes are GW, as shown in Fig. 5.26(b). The visitors follow the same mobility pattern as before. The result obtained for a comparison between forwarding and 2-copy replication is shown in Fig. 5.29.

Here, we used both ER and SAR to show a comparison between forwarding and replication. The result is consistent with what we obtained in Fig. 5.27. The only interesting point here is the substantial decrease in AD. This is due to the increase of MANET participating nodes, which form multi-hop connected MANET graphs more often than what we had in the previous case. A comparison between ER and SAR is also shown in Fig. 5.30.

Again, the behavior is consistent with what we obtained in Fig. 5.28, i.e., increase in average MDR and increase in delay while using encounter based replication (ER), as compared to SAR. The only difference is the drop in AD due to the reason mentioned above.

#### 5.6.5.6 Case 5: Community Intercommunication with MANETs

In this scenario, we consider that there are 3 different communities; each community spans over a 600m x 600m area, and has 20 GW mobile nodes and 3 APs. The APs which are in the same community are connected to each other, and thus run MeDeHa notification protocol to



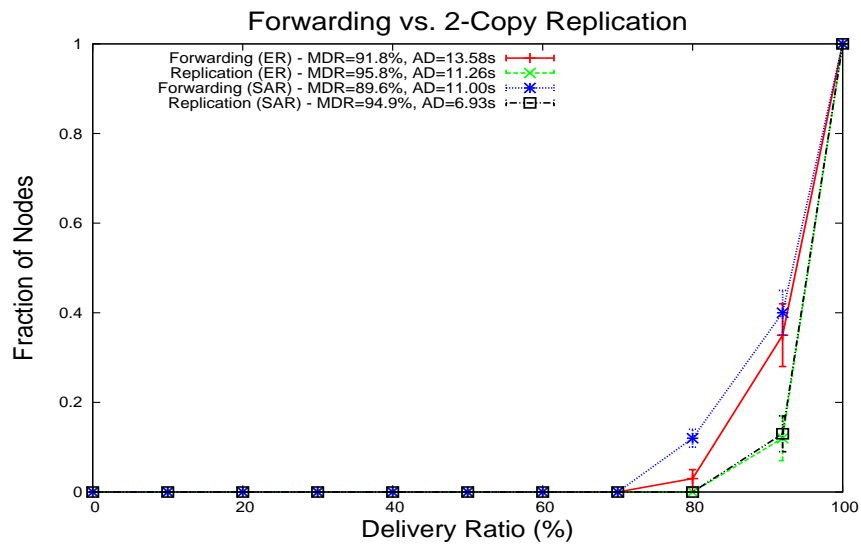

**Figure 5.29:** Forwarding vs. 2-copy Replication using ER and SAR schemes for 2nd part of Case 4 (60 GW, 30 OLSR visitors)

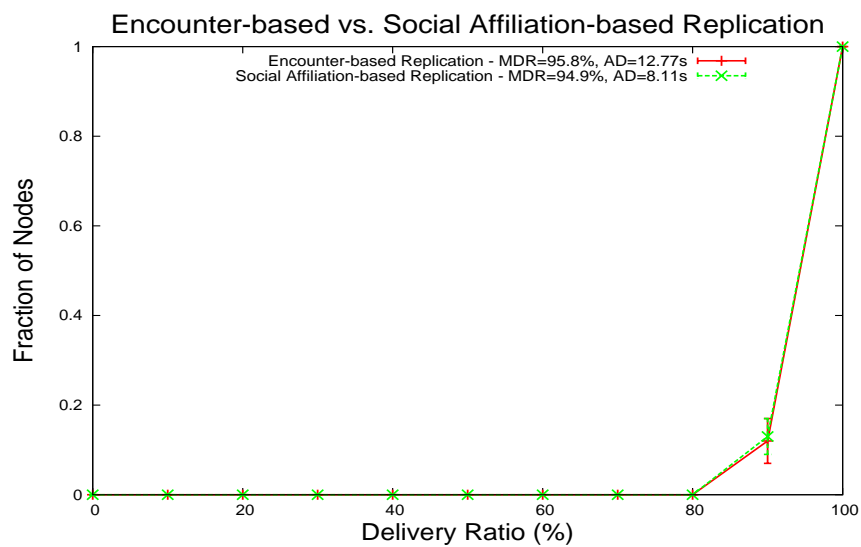

**Figure 5.30:** Comparison between ER and SAR schemes using 2-copy replication for 2nd part of Case 4 (60 GW, 30 OLSR visitors)

exchange connectivity information about nodes. The APs do not provide connectivity everywhere in a community. The GW nodes do not move out of their respected communities, and move according to the mobility model mentioned earlier. These communities are not connected to each other except via three “transit MANETs”, as shown in Fig. 5.31. This implies that if a

source in one community wants to send a message to a destination in another community, it has to rely on the “transit MANET” that joins the two communities. Each “transit MANET” includes 10 nodes, 8 of which are non-MDH mobile nodes and 2 others are GW that are static.

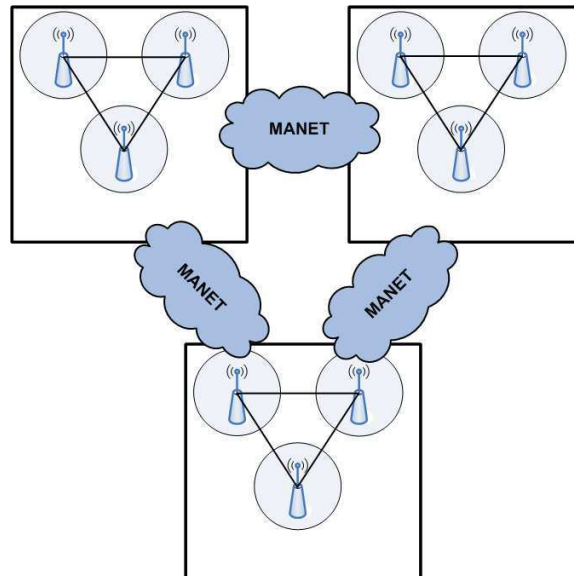

**Figure 5.31:** Case 5: Three communities with the GW nodes are joined by three “transit MANETs”.

We carry out a comparison between forwarding and replication in this environment, and the result obtained for the fraction of nodes attaining a specific amount of delivery ratio is shown in Fig. 5.32. There are 20 sources chosen from all three communities, which send messages to destinations that do not belong to their own communities. It is obvious that the MeDeHa framework would yield 0% MDR in this case if it does not support MANETs, as the source-destination pairs are only connected through MANETs. The simulation time is set to 1 hour, the average message rate is 1 message/s, and message size is 1 KB. The result is obtained by running the experiment 6 times in order to obtain the confidence intervals.

We observed that with forwarding, more than 75% of nodes have less than 80% delivery ratio, as compared to replication which yields that only 40% of nodes have less than 80% of delivery ratio. The average MDR is also improved significantly using replication (82%) over forwarding (71%). Also, AD decreases by almost 3 seconds. We are not close to 100% of MDR in this scenario as the source-destination pairs are only connected through MANETs, and depending upon the mobility of nodes, they may never encounter MANET GWs during the simulation time, which affects the MDR. We verify this by reducing the community areas to 400mx400m, and notice that average MDR is more than 95% for replication and 86% for forwarding. The AD is also reduced quite significantly (Fig. 5.32).

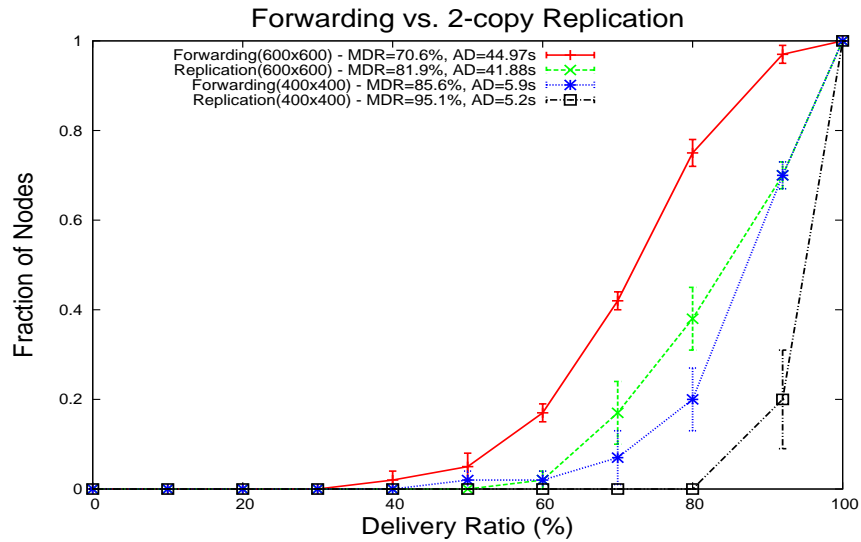

Figure 5.32: Forwarding vs. 2-copy Replication using ER scheme for Case 5

We proceed to play with the ER scheme to analyze the impact of changing the encounter threshold, and used number of encounters as 2 and 4 for both forwarding and 2-copy replication. A comparison of forwarding and 2-copy replication is shown in Fig. 5.33.

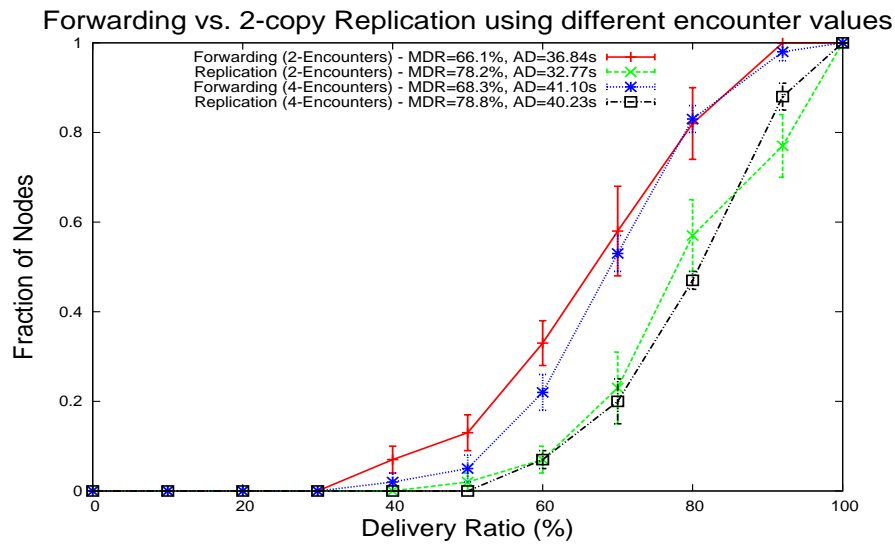

Figure 5.33: Impact of different encounter parameters on fraction of nodes while comparing forwarding and replication for Case 5

The average MDR slightly increases for both forwarding and replication while using en-

counter parameter as 4, but on the other hand, it slightly increases the AD. This is because when choosing encounter parameter as 4, nodes have to wait slightly more to find a suitable relay, which increases the AD but improves the average MDR, as relay selection is more accurate. On the other hand, choosing a high value of encounter parameter also decreases the number of messages forwarded.

Next, we evaluate the impact of number of copies on message delivery. In this way, we choose different number of copies of each message and plot the fraction of nodes that attain a particular delivery ratio. The impact is shown in Figure 5.34.

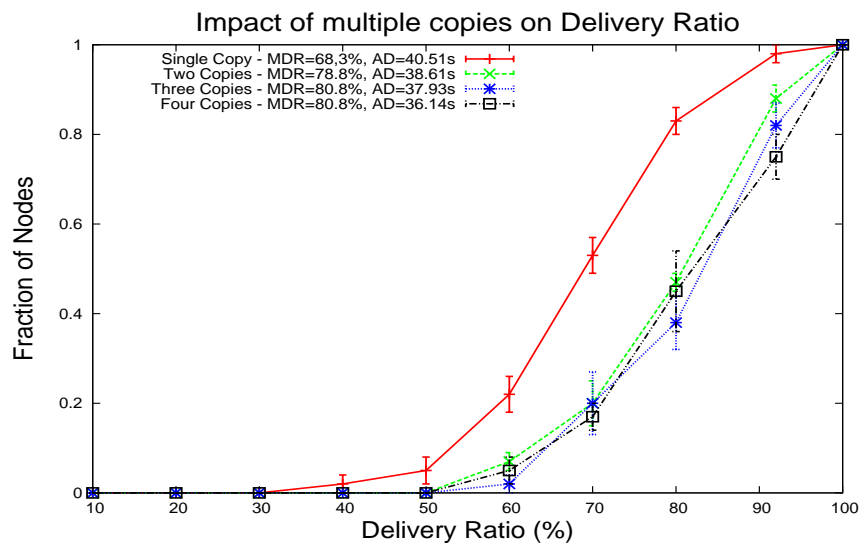

Figure 5.34: Impact of using different number of copies on delivery ratio using ER.

There is a significant improvement when we use 2 copies instead of a single copy, as already shown in forwarding vs. replication comparison. Beyond 2 copies, the delivery ratio does not improve much, though there is still a slight improvement. This is because the message delivery is dependent on the connection opportunities that nodes have with relay nodes that move between different communities, which are limited during the simulation time. Hence, increasing the number of copies per message does not help in improving the average MDR. On the other hand, the AD decreases with the increase in number of copies.

### 5.6.6 Real Mobility Traces

To validate the framework's performance against real mobility of nodes, we used the human mobility traces for the KAIST Campus, which are available for download from CRAWDAD [66]. They correspond to the mobility traces of the students of KAIST campus across different building

(faculties, departments, hostels etc.). We evaluated the *second phase* and the *third phase* of the MeDeHa's implementation using a subset of these traces, which we present in the following.

#### 5.6.6.1 MeDeHa with Infrastructure-based and 2-hop Infrastructure-less Networks (Second Phase)

To test the MeDeHa's performance against real mobility traces, first, we evaluated the MeDeHa framework with the infrastructure-based and the 2-hop infrastructure-less networks implementation (IS+Adhoc), as described in Section 5.6.5. In this experiment, we took a subset of KAIST campus traces that record mobility of 50 students during a day. We took a 2-hour window over the trace from 10 AM to 12 PM, and superimposed this mobility pattern on top of an area of 1.4 km x 2.4 km with 9 APs where all APs are connected to each other and form a local ESS. Students visit different places of campus during the time and their speeds change (students take shuttles while moving from one place to another, and move at pedestrian speed or are static). Again, we evaluated this scenario for 20 source-destination pairs of students, sending each other messages at the average rate of 1 message/s, and obtained the CDF of students attaining a particular delivery ratio (MDR). We consider the cases (1) where students can only connect to infrastructure-based network (MeDeHa-IS only), and (2) where students can use both infrastructure-based and ad-hoc interfaces to communicate (MeDeHa-IS+Adhoc) using both forwarding (1-copy per message) and replication (2-copy per message). We also measured the average MDR and the average delay (AD). The result is shown in Figure 5.35. Here, we used ER for relay selection, and set the number of encounters value to 2. In this scenario, each student sent messages for a duration of 40 minutes to the other student (destination), and the average number of messages received by each student is represented by average MDR achieved for each case.

From the figure, it is clear that using network heterogeneity (IS+Adhoc) improves the performance both in terms of delivery ratio (MDR) and delivery delay (AD). IS+Adhoc *replication* attains the best average MDR and AD. In terms of fraction of nodes, we can see that only 6% of nodes have less than 90% delivery ratio for 2-copy heterogeneous network (IS+Adhoc) as compared to 25% of nodes having less than 90% of delivery ratio when using only infrastructure-based network (IS only).

#### 5.6.6.2 MeDeHa with Infrastructure-based and Multi-hop Infrastructure-less Networks (Third Phase)

Next, we evaluated the complete MeDeHa implementation (*third phase*) including interaction with MANET routing protocols against human mobility traces. Again, we took a subset of student mobility traces across the KAIST campus. This includes 2 hours of mobility from 10

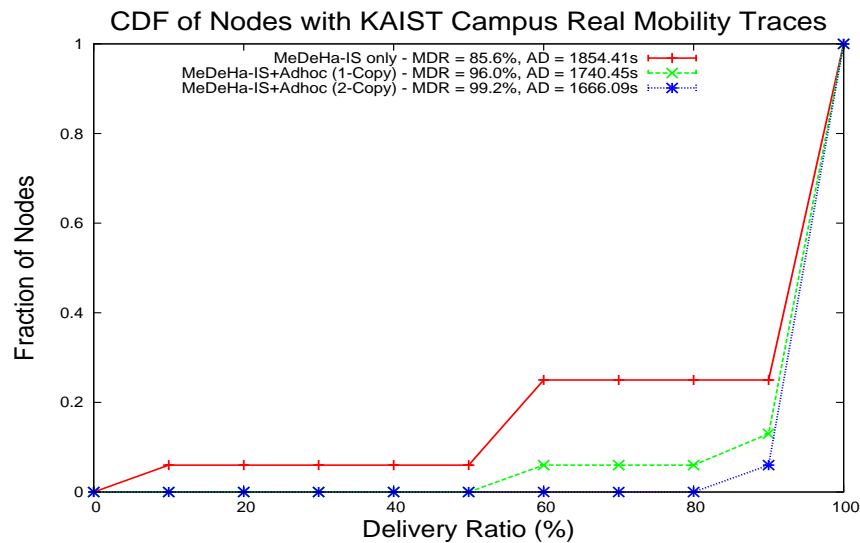
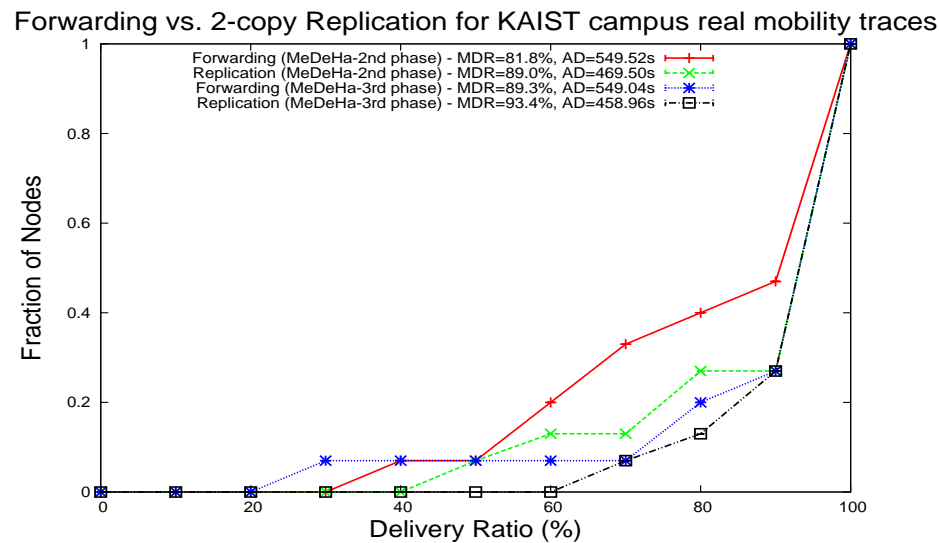

**Figure 5.35:** CDF of nodes vs. Delivery Ratio for KAIST Campus Traces for two hours using IS only and IS+Adhoc modes (message rate: 1 message/s)

A.M. to 12 P.M. of 40 students for an area of 1.2 km x 1.5 km. We placed 9 APs in the area by looking at department positions at KAIST, with all APs connected to each other. Students either take campus shuttles to move from one area to other, move at pedestrian speed, or do not move at all. We chose 15 students sending data at an average rate of 1 message/s to 15 other students across the campus<sup>16</sup>, and we provided a comparison between the results obtained using MeDeHa with and without MANET support (*second* and *third phase*). Using OLSR, students that approach each other form small MANETs when moving across the campus and thus able to exchange data and control messages over multiple hops. The comparison between forwarding and 2-copy replication using the *second phase* and the *third phase* of the MeDeHa implementation is shown in Fig. 5.36.

The behavior is consistent with what we obtained for other scenarios, i.e., there is a marked improvement in MDR and a decrease in AD for replication over forwarding. Moreover, 2-copy replication using the *third phase* implementation yields the best result, where MDR is improved to a great extent, while AD is decreased. This is because students form small MANETs while moving, thereby have a larger view of the network most of the times, which allows them to exchange messages faster and efficiently.

<sup>16</sup>We also observed similar results for file transfer between students. [26]



**Figure 5.36:** Forwarding vs. 2-copy Replication showing a comparison between the *second phase* and the *third phase* of the MeDeHa’s implementation using KAIST mobility traces for 40 nodes

### 5.6.7 Hybrid Experiment Results

Our testbed consists of 7 laptops and 2 mobile briefcases [72] equipped with 802.11g wireless cards: 4 of the laptops are configured as wireless stations and the other 3 laptops are set up as AP routers connected over a wired network, while 2 briefcases and one of the 3 wireless stations (the GW station) run the OLSR protocol. During the experiment, wireless stations move and change connectivity with different APs; Briefcases running the OLSR protocol also move and form OLSR network, and are accessed via the GW station. While moving, stations also remain disconnected for some period of time when they are in a region of no connectivity. All 3 APs are connected to simulated APs via a machine that runs NS-3 and acts as a Tap bridge to the NS-3 nodes. In the simulator, we use 30 stations along with 6 APs. Stations in the simulator use the same mobility pattern as described in Section 5.6.5.5.

In the experiment, there are a total of 15 source-destination pairs sending data at an average rate of 1 message/s, out of which 10 pairs are present inside the simulator, 2 simulator nodes sending data to 2 wireless stations (laptops), and 1 simulator node is sending data to an OLSR briefcase. The two remaining sources are wireless stations that send data to 2 simulator nodes. We compare 1-copy forwarding against 2-copy encounter-based replication and run this experiment for a period of 30 minutes. The results are shown in Fig. 5.37. We also conducted other experiments, and some results are presented in [26].

As observed from earlier simulation results, we see that 2-copy replication performs better than 1-copy forwarding both in terms of MDR and AD. Also, while looking at individual delivery

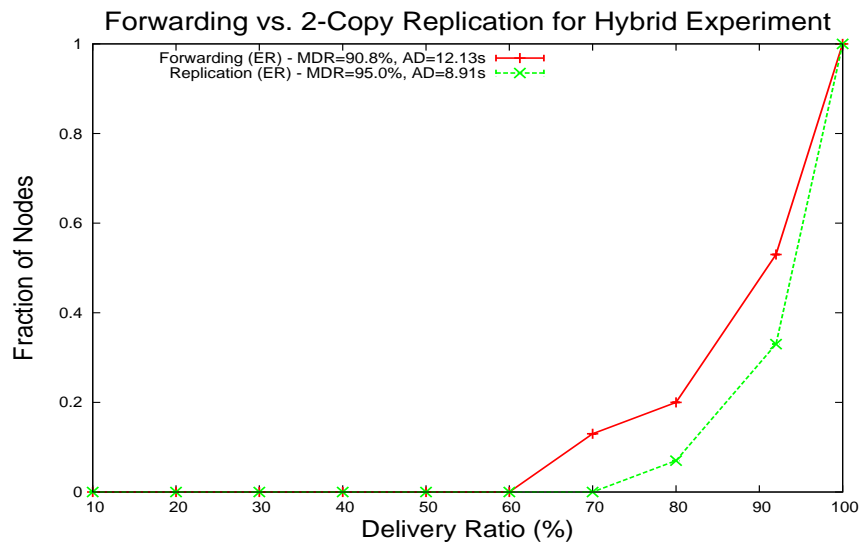

**Figure 5.37:** Forwarding vs. 2-copy Replication comparison resulting from a hybrid scenario involving real and simulated stations.

ratios of nodes, only 6% nodes have less than 80% delivery ratio with 2-copy replication, as compared to 20% nodes having less than 80% delivery ratio. While comparing the results obtained using this “hybrid” experiment, we see that the behavior of MeDeHa is similar to what we got with pure simulation results in previous sections, which validates our simulation results.

## 5.7 Concluding Remarks

In this chapter, we presented the implementation and performance evaluation of the MeDeHa framework. We provided different implementation approaches that we have taken to evaluate the framework under different scenarios and involving different network types. First, we presented a link-layer implementation of the framework which included infrastructure-based wired and wireless networks with disruption tolerance. But it was not possible to include infrastructure-less networks and to maintain multiple interfaces per node in this approach. Hence, we implemented the MeDeHa framework at the network layer of the communication stack. We also implemented the framework on Linux machines as a user-space daemon. Moreover, we have presented the results using a number of diverse scenarios involving different networks and demonstrated that message delivery can be greatly improved by taking advantage of network heterogeneity. In the end, we evaluated the framework using hybrid experimental setup in which the experiments run partly on simulator and partly on real machines.

We learnt that in a network where nodes are subject to connectivity disruptions, perfor-



mance of a particular forwarding approach depends upon a number of factors including nodes mobility and relay selection strategies. For instance, in some case, we observed that destination independent (DI) utility functions performed better than destination dependent (DD) utility functions, while the reverse is true in other cases. This is in compliance with what we proposed in Chapter 3. Also, we experienced that in a framework like MeDeHa, where both infrastructure-based and infrastructure-less networks are involved, high message delivery can be achieved only with a few message copies by taking advantage of the availability of the infrastructure-based networks. Similar observation are found by authors in [115]. Moreover, we found out that encounter-based replication schemes such as ER perform better in terms of delivery ratio, while community affiliation-based replication schemes such as SAR provide better results in terms of delivery delay.

---

---

## **Part IV**

# **HeNNA - A Naming Mechanism for Heterogeneous Networks**



# 6

## NAMING FOR HETEROGENEOUS NETWORKS

---

---

### 6.1 Introduction

In an environment where devices are highly mobile and want to remain connected while moving, mobility poses quite a few challenges, as IP address for nodes generally changes with the change in nodes points of attachment to the network. Hence, communication sessions need to be reset, and data that is sent while the nodes move between the two points of attachment is vulnerable to be lost. This is because, in traditional Internet communication model, data is assumed to be bound to specific hosts at specific locations, identified by IP addresses. Hence, transport and application protocols typically rely on IP addresses to define end-to-end communication endpoints. Conversely, an application should only be concerned about a particular data content, and a transport layer should only know an endpoint host rather than one of interface addresses of a peer host [80]. Unfortunately, this is not the case in the current Internet architecture.

What is more, in a heterogeneous network, where mobile devices may be multi-homed since they possess multiple interfaces for network connectivity (e.g., PDAs, smart phones may use Wifi and 3G for connectivity), applications can no longer use IP address to communicate with these devices. This is because at the time of packet transmission, a sender does not know which IP address of a node is currently available, and even if a specific IP address is known a priori, there is no guarantee that it remains reachable by the time the packet approaches a destination, especially in case of opportunistic forwarding. New communication architectures such

as Hagggle [47] and CCN [56] are based on taking advantage of different connection opportunities using multiple interfaces, and allow applications to use location-independent identifiers instead of IP addresses. Furthermore, while mechanisms like Dynamic Host Configuration Protocol (DHCP) simplify the administration of private IP address spaces, they make IP addresses even less stable, in that a host may change its IP address because of being turned off or a temporary disconnection even if it has not physically moved.

MobileIP [77], [78] targets “last hop” mobility by allocating a globally routeable address to each mobile node (MN), which may not be feasible in many cases (e.g., allocating a routeable IPv4 address to each MN). On the other hand, Shim6 [90] provides mobility solution for multi-homed devices by differentiating upper layer identifiers (ULID) from locators, but requires pre-configuration of all interface addresses of the devices. Moreover, both MobileIP and Shim6 suffer from the very basic problem where endpoints are named using topological identifiers (i.e., IP addresses), so applications have to rely on IP addresses to communicate with peers.

Proposals like [80] and DONA [81] advocate decoupling identification from location so that, instead of an IP address, applications bind to a location-transparent identifier and the network uses this identifier to find the object, e.g., irrespective of the current network interface of the host at the time the request for the object was issued. As described in more detail in Section 6.3, some of the proposed approaches that try to separate object identification from location employ a “clean-slate” design philosophy ([79, 55, 56]), whereas others propose patches to current Internet routing ([82], [80], [81], [84]). Here, we adopt the latter approach; and our aim is to propose a naming solution that accommodates intermittent connectivity. To our knowledge, this is the first proposal that tries to operate with status-quo Internet routing and still accommodates intermittent connectivity.

In this chapter, we present a new naming mechanism, HeNNA (Heterogenous Networks Naming Architecture) for heterogeneous disruption-prone networks.<sup>1</sup> HeNNA decouples object identification from their location, enabling applications to use “universal object identifiers” independent to where the object may be located. It is designed to be used with the current Internet routing, while accommodating node mobility, address changes, as well as temporary or long-lived disconnections. We implemented HeNNA with our framework MeDeHa (Message Delivery in Heterogeneous, Disruption-prone Networks [23], [22]), which allows message delivery across an internet consisting of different networks and involving diverse node capabilities. In MeDeHa, nodes use IP addresses to communicate, which becomes unfeasible when devices are multi-homed and are capable to connect to multiple networks. HeNNA targets this problem of node identification and internetwork communication in MeDeHa by taking care of the change of IP addresses of nodes. We show that HeNNA augments MeDeHa to use location-transparent naming and thus makes MeDeHa better equipped to support network and node

---

<sup>1</sup>This work is published in [24].

heterogeneity.

The rest of the chapter is organized as follows. First, we present some design guidelines that lead us to develop the HeNNA mechanism in Section 6.2. An analysis of existing naming architectures and proposal is provided in Section 6.3. HeNNA and details on its operation are presented in Section 6.4. Section 6.5 presents the current implementation of HeNNA and its interoperability with the MeDeHa framework. At the end, a simulation-based evaluation of HeNNA is presented in Section 6.6.

## 6.2 Design Guidelines

The design on HeNNA is motivated by a set of design guidelines, which we describe in the following:

1. **Decouple identification from location:** Ideally, applications should only be concerned about service or session identifiers (SID) instead of specific IP addresses, unlike today's TCP/IP architecture. The transport layer should in turn be responsible for communication with endpoints rather than one of the interface addresses of an endpoint. This is a long known problem and recognized by the Internet Engineering Task Force [94]. Clearly, solutions like MobileIP do not serve this purpose.
2. **Manage connectivity disruptions:** The naming mechanism should provide a way to handle temporary or long-lived connectivity disruptions of the participating nodes. This involves caching data for nodes in the network or at nodes, when route information is unavailable. Besides, communications between two endpoint nodes should be possible even if there is no contemporaneous end-to-end path available between these nodes.
3. **Maintain status-quo for routing:** It is preferable that the naming scheme should not propose changes to how packets are routed in the current Internet (i.e., packets should be routed using IP addresses of the nodes). This would make a naming scheme workable in the existing Internet without requiring a significant change. It should also work with the support of only a few Internet routers.
4. **Support of heterogeneous networks:** A node can have more than one interface connected to the backbone, resulting in multiple IP addresses per node. The naming mechanism should be able to cope with this heterogeneity. Moreover, it should also support both infrastructure-based and infrastructure-less networks.

## 6.3 Analysis of Existing Naming Schemes

We start with an analysis of the existing naming proposals, and then we describe how they relate to the *design guidelines*. We also provide the pros and cons of each proposal.

We classify the existing naming proposals into four main groups based upon their functionality:

1. Region-based Naming
2. Content-based Naming
3. Intentional Naming
4. Host-based Naming

In the following subsections, we present an analysis of each of these groups and the proposals that fit into each group. Besides, each naming proposal can be categorized as either being a *clean-slate* or a *conventional* approach. The *clean-slate* approaches propose a completely new architecture that involves new routing mechanism and thus, they are not workable with the current Internet architecture. This is in contrast to the *design guideline 3* presented in 6.2. The *conventional* approaches present patches to the status-quo Internet architecture and propose mechanisms to separate node identification from location in the Internet. As our focus is to find a solution for naming that is workable in the current Internet, we are mostly concerned with the *conventional* naming approaches. When describing a naming proposal in the following subsections, we will indicate whether it is a *clean-slate* or a *conventional* approach.

### 6.3.1 Region-based Naming

Region-based naming schemes refer to the mechanisms in which nodes are identified by their respective regions. Thus, each node's identifier has two main parts, region-ID and personal-ID. While this makes routing easy and scalable, it requires proper definition and management of regions, and the schemes may suffer when nodes are mobile. Examples include Interplanetary Internet naming and addressing [91] and EDIFY [55].

#### 6.3.1.1 Interplanetary Internet Naming and Addressing

Interplanetary Internet Naming and Addressing [91] is a *clean-slate* naming proposal. It extends the original Interplanetary Internet design proposed in [17] and [92], which focused

primarily on deep-space communication issues susceptible to very long delays, and where communication endpoints are named by Endpoint Identifier (EIDs) [6]. The scheme proposes two-level hierarchical addressing using absolute Universal Resource Identifiers (URIs) [93] which signifies the EIDs. The DTN EIDs has the following form:

*region-name:region-specific-part*

In this way, the routing between regions is performed by simply looking at the *region-name* of the EID, whereas any other routing scheme can be used for *region-specific-part*. However, the design does not consider nodes mobility between regions.

#### 6.3.1.2 EDIFY

EDIFY [55] is also a region-based naming scheme and is counterpart of Interplanetary Internet naming and addressing scheme for regular networks. It defines groups of nodes and each node has an EID that is a tuple of group ID (GID) and its personal ID (PID). The mobility management of nodes is provided similar to what MobileIP [77] offers, where a node visiting another group informs its home group's DTN Name Registrar (DNR) about its new location. Moreover, when visiting other groups, a node changes its PID but its group ID remains the same. When making temporary ad-hoc networks while moving, nodes do not use their (GID, PID) tuple to communicate. Instead a temporary group ID (TGID) and temporary personal ID (TPID) tuple is created on-the-fly and nodes use this new tuple for communication. EDIFY is a *clean-slate* naming proposal.

While EDIFY tries to solve the mobility issue in the Interplanetary naming scheme, it does so by introducing a lot of complexity where each node may have to maintain multiple identifiers including (GID, PID) tuple, (TGID, TPID) tuple, and a visiting identifier. Also, infrastructure-based support provided by the scheme is only based on message ferries that provides connectivity between different groups. Moreover, the definition of the *group* is not properly provided, and it is assumed that each group has at least one gateway node to which every member has an access. In an intermittently connected environment, this is a very strong assumption.

### 6.3.2 Content-based Naming

In conventional Internet communication model, data is assumed to be bound to specific hosts at specific locations, identified by IP addresses most of the time. Hence, application layer typically relies on IP addresses of peer nodes to define end-to-end communication endpoints, whereas an application should not care where the data content is currently located. Content-based naming architectures are based on this principle, unlike the current Internet



architecture. Examples include Content Centric Networking (CCN [56]) and a layered architecture for the Internet presented in [80], which we highlight in the following subsections.

### 6.3.2.1 Content Centric Networking (CCN)

CCN [56] is a *clean-slate* communication architecture based on naming content such that a data content or a service is identified by a name that is independent from the host that currently owns (hosts) the content. The architecture is based upon two packet types, *Interest* and *Data*. *Interests* are issued to request (find) a particular content and contains the name of the required content. Any node that possesses the content responds with the *Data* packet containing the required content. In CCN, only *Interest* packets are routed, and *Data* packets follow a predefined path that the *Interest* packet used to reach the node that hosts the content. The architecture offers many benefits including scalability, security, support for nodes disconnections and allowing nodes to issue *Interests* over multiple interfaces. On the other hand, the performance of the CCN architecture is questionable in mobile wireless ad-hoc networks which are usually vulnerable to changing routes frequently. For instance, if the initiator of an *Interest* packet is moving, it may not get the requested *Data* packet all the time, and may have to issue many *Interest* packets before receiving the desired content, because the *Data* packets are supposed to follow the same route as their *Interest* packets have taken.

### 6.3.2.2 A Layered Architecture for the Internet

In [80], authors presented a new layered architecture for the Internet that is based on naming the content and endpoints. The proposed architecture is *conventional* and separates content and endpoint identifiers from their locations. The authors proposed this architecture by introducing multiple layers of identification in the communication stack, which requires multiple resolutions of identifiers. More precisely, a user-level descriptor (ULD) is translated into a Session Identifier (SID). This SID is then resolved into Endpoint Identifier (EID) which is eventually translated into IP address. The proposal is very good and can be used as a baseline for naming schemes, but it is a little complex as the resolution process from a ULD to an IP address is very long. The architecture is also based on the assumption that a source has access to all resolvers all the time, which may not always be possible especially in mobile wireless ad-hoc networks. Moreover, support for nodes intermittent connectivity is not discussed.

### 6.3.2.3 Data Oriented Network Architecture (DONA)

Data Oriented Network Architecture (DONA) [81] is also aimed at naming the content instead of naming the content holder, as service-oriented applications are usually interested in the content only. DONA proposes a *clean-slate* design of the Internet naming and addressing,

and nodes in DONA use flat, self-certifying names for service (or content) identification. The resolution process is handled by a hierarchy of resolution handlers (RHs) and it is based on the *FIND* and *REGISTER* primitives. However, the architecture does not provide a comprehensive solution in the case of nodes intermittent connectivity. It also requires a lot of management and configuration at the RH level. Moreover, DONA generally suffers from the scalability problem as each resolution handler has to maintain a forwarding table for each content in the network.

### 6.3.3 Intentional Naming

Intentional naming [79] aims at naming a destination by predicting its attributes (e.g., membership to a group, employee of an organization, spatial coordinates, etc.) instead of its unique personal identifier (EIDs). It is designed to be used for Disruption Tolerant Networks (DTNs). Resolving a destination's name in such a way comes in the category of *late binding*, in which a source may not know a destination's identifier before sending a message, and the destination identifier in a bundle may change as the bundle approaches the destination. This makes the routing easy but the solution is very specific to cases where a source must have some hint about the destination's attributes in advance. The proposed solution also does not define how EID of a destination eventually resolved as the bundle approaches the destination. This is a *clean-slate* naming approach.

### 6.3.4 Host-based Naming

Host-based naming schemes target unique identification of endpoints by separating their identification from locations. This is very important (and becomes essential) when nodes frequently change their IP addresses due to mobility, and when devices use multiple interfaces for network connectivity. In the following subsections, we present and analyze different host-based naming schemes.

#### 6.3.4.1 Locator/ID Separation Protocol (LISP)

LISP [82] presents a naming architecture that separates identification from location by using two different naming identifiers, Routing Locators (RLOC) and Endpoint Identifiers (EID). RLOCs are used to route packets in the backbone and routing is performed by tunneling the packets (containing EIDs) in RLOCs between Egress Tunnel Router (ETR) and Ingress Tunnel Router (ITR) of different domains. EIDs are used to identify nodes and routing is performed within a domain using nodes' EIDs. LISP does not provide a specific mapping system between Endpoint Identifiers (EID) and Routing Locators (RLOC). Also, it does not properly define nodes mobility between domains, though it can be used with MobileIP but it is problematic due to

overhead caused by MobileIP [83]. LISP is categorized as a *conventional* naming approach, though routing in LISP is based on both EIDs and RLOCs.

#### 6.3.4.2 Node Identity Internetworking Architecture

Node Identity Internetworking Architecture [87] is a *clean-slate* naming approach and provides an infrastructure-based solution to separate identification from location by defining locator domains (LD). However, it does not explain the operation in ad-hoc networks and networks with disruptions. The architecture is based on routing hints that are resolved at LDs and serve as source routing. It means that source is responsible for adding the routing hints when sending a message and if the destination moves and changes its LD, the messages are lost.

#### 6.3.4.3 Host Identity Protocol (HIP)

Host Identity Protocol (HIP) [84] is a *conventional* naming approach that uses flat, self-certifying names for identification which are called Host Identifiers (HI). It is designed to be used in the Internet, and enables host mobility and multi-homing across different address families (IPv4 and IPv6). In HIP, both transport and application layers use HI of peer nodes to communicate, and two nodes must establish a HIP association before communication, which is known as the HIP Base Exchange (BEX). This is a strong compulsion of the protocol as it may not be feasible in many scenarios, especially when there is no end-to-end contemporaneous path between the two nodes.

#### 6.3.4.4 MobileIP

MobileIP [77], [78] solves the mobility problem by assigning persistent home address to nodes, but this solution requires that each node has a globally routeable IP address. In MobileIP, a permanent routeable address is assigned to each node, and the Home Agent (HA) implicitly intercepts the messages sent to a MN which means that both HA address and MN home address must belong to the same subnet. Moreover, the MobileIP approach fundamentally differs from the *design guideline 1* defined in Section 6.2 where endpoints are named by topological identifiers. MobileIP is categorized as a *conventional* solution to nodes mobility and naming.

#### 6.3.4.5 Dynamic DNS

Dynamic DNS (DynDNS) [88] allows hosts to cope with the problem of changing their IP addresses by dynamically updating its name record (hostname to IP address mapping) with the service provider whenever hosts change their IP address. But the existing transport sessions still

break at this point, and the host generally remains unreachable whenever it is behind a firewall or NAT. This is because the DynDNS client softwares report the actual interface IP address to the DNS server, and as the IP address is not routeable if it is from a private address space, the DNS server does not know where to route packets. Moreover, the update mechanism for DynDNS is not very efficient and an IP change update may take a few minutes (and sometimes a few hours), as the update needs to be propagated across all DNS servers. Also, frequent updates from a client may be considered as abusive and are not permitted [89]. Thus, it is also not very efficient in case where IP address of hosts change frequently. DynDNS is a *conventional* naming solution to cater for nodes IP address change and mobility.

As our focus is to find a solution for naming that is workable in the current Internet, we are concerned with the *conventional* naming approaches. But none of the *conventional* approaches supports network heterogeneity (*design guideline 4*) and nodes temporary or long-lived disconnections from the network (*design guideline 2*).

## 6.4 The HeNNA Naming Mechanism

HeNNA decouples node identification from location and allows message delivery across heterogeneous networks, including infrastructure-based and ad-hoc networks, while coping with nodes intermittent connectivity. In this way, the source does not have to care about the current location of the destination that may be connected using any interface at the time of message arrival. For this purpose, applications bind to nodes identifier instead of IP addresses to communicate and nodes location information is maintained by their corresponding Location and Management Server (LMS) nodes. The LMS is a node with a globally reachable address and it maintains location information about the registered nodes. It is also responsible for storing messages on behalf of the nodes when they are unavailable. Details on the functionality of the LMS are presented in Section 6.4.2. The idea is that nodes contact the LMS of other nodes to locate them. Nodes in ad-hoc network can also be reached via neighboring gateways that are connected to the infrastructure; this extends message delivery beyond infrastructure-based networks.

In HeNNA, each node has a globally unique identifier (GUID), and we assume that the users will learn about these GUIDs via a variety of ways such as search engines, private communication etc. Otherwise, a global DNS-like service can also be present with which nodes register their GUIDs against their hostnames. This DNS-like service can either have the normal DNS functionality or a Dynamic DNS service [88], except that nodes are registered with their GUIDs instead of their IP address. We do not consider the hostname to GUID resolution.<sup>2</sup> On the

---

<sup>2</sup>A source which has a hostname for a destination can contact the DNS service (distributed or central) to get the

other hand, users have the luxury of having their own private namespace of human-readable names which map to the GUIDs of the nodes [46]. This way of managing namespaces allows independence from centrally maintained nameservers.

GUIDs are persistent identifiers, though a node may change its GUID by registering a new GUID against its hostname in the global DNS-like service. The GUID of a node contains a routeable address of the node's LMS along with the its identifier which is unique within the context of the LMS. A GUID can also be used to identify a content instead of a node without requiring any major change in the architecture (see Section 6.4.5).

We now present the design details of HeNNA and describe its major components.

### 6.4.1 HeNNA Operation

We assume that each mobile node is registered with its corresponding LMS that has a permanently routeable Internet address. To acquire a GUID, a mobile node has to register with its corresponding LMS. In this way, the LMS only entertains the control message for the nodes for which it has the registration. As GUIDs are assumed to be persistent identifiers, this registration does not occur frequently and only happens when a mobile node changes its GUID or its LMS node. Therefore, we only assume an offline registration where a node acquires its GUID identifier offline and associates with its LMS. The registration process needs to be secure if performed online so that the LMS node is able to authenticate (recognize) the mobile node somehow. Moreover, the routeable address of the LMS is used as part of the mobile node's GUID.

HeNNA defines a number of control messages that are used between nodes and the LMS. They are:

**LOC\_UPDATE:** A mobile node sends the *LOC\_UPDATE* to its LMS in order to inform the latter about its current location. This message is sent each time a node changes its location or its IP address is changed. This message can only be sent when the node is either directly or indirectly connected to an infrastructure-based network such that a path to its LMS exist. A node is said to be indirectly connected to an infrastructure-based network, when it is in ad-hoc mode and is connected an infrastructure-based network via a neighboring node. The LMS updates the location information only for the nodes that are registered with it.<sup>3</sup> This message comprises of the GUID of a mobile node and its current IP address.

**LOC\_REQ:** A message carrier may inquire about the current location of a destination by sending this control notification. The sender of this notification must connect to the backbone GUID of the destination before contacting the LMS of the destination.

<sup>3</sup>The registration process can be made secure so as to prevent unauthorized/malicious nodes from providing wrong location information about the nodes to the LMS. However, we do not consider this case currently.

such that it has a route to the LMS of the destination. This message contains the GUID of the destination, and the identification of the inquiring message carrier.

**LOC RESP:** The LMS responds the *LOC\_REQ* with the *LOC\_RESP* notification either by sending the inquired node's (destination) current routeable address, or its own routeable address (if the destination's location is unavailable). The latter case implies that the LMS will store messages for the destination. This message includes the destination's GUID and its IP address.

**STORE:** A node sends this control notification to the LMS, requesting the latter to store a message for a destination. This control message includes the data message to be stored, where the message contains source and destination GUID tuple.

A node locally caches a mapping between the GUID of nodes and their most recent routeable addresses. This mapping is maintained for the nodes for which an inquiry (*LOC\_REQ*) has been sent recently. This mapping is only maintained for the duration of the communication session and there is a timeout associated with each entry in this mapping. Thus, a message carrier first checks in its "local mapping" to get the routeable address of the destination. If the address is found, the message is forwarded to the destination. If the destination information is not found in the "local mapping", the message carrier checks the availability of an infrastructure to send an inquiry to the LMS (*LOC\_REQ*). If the inquiry is timed out (i.e., no response is received from the LMS), the node retransmits the request for a maximum number of 5 times. While this continues, the message carrier tries to find the destination in the ad-hoc network. If no information is present about the destination and the message carrier is not connected to the infrastructure, the message is stored locally. The message is forwarded to the destination, as its location information is found. The operation is illustrated in Figure 6.1.

#### 6.4.2 Location and Management Server (LMS)

The LMS is responsible for keeping track of nodes current routeable address. It is a node that must be connected to the Internet and has a persistent routeable address. The LMS may maintain location information for one or more nodes, and can either be maintained by an Internet Service Provider (ISP), or by a company on behalf of its employees, or by an individual to maintain personal location updates. It is also responsible for storing messages on behalf of a mobile node when the node is unavailable. There is a time to live (TTL) associated with each stored message, and messages pass their TTL are expired at the LMS.

The LMS keeps a list of the registered nodes, and maintains a mapping between the nodes' GUID and their latest routeable address. The mappings are expired if the LMS does not get a *LOC\_UPDATE* from nodes for a pre-defined amount of time. As a mobile node changes its location or IP address, it informs its corresponding LMS by sending the *LOC\_UPDATE* notification, only if it is directly or indirectly connected to the Internet. As a result, the LMS adds a new entry for the node's GUID or updates node's GUID mapping to point to the new IP address, and

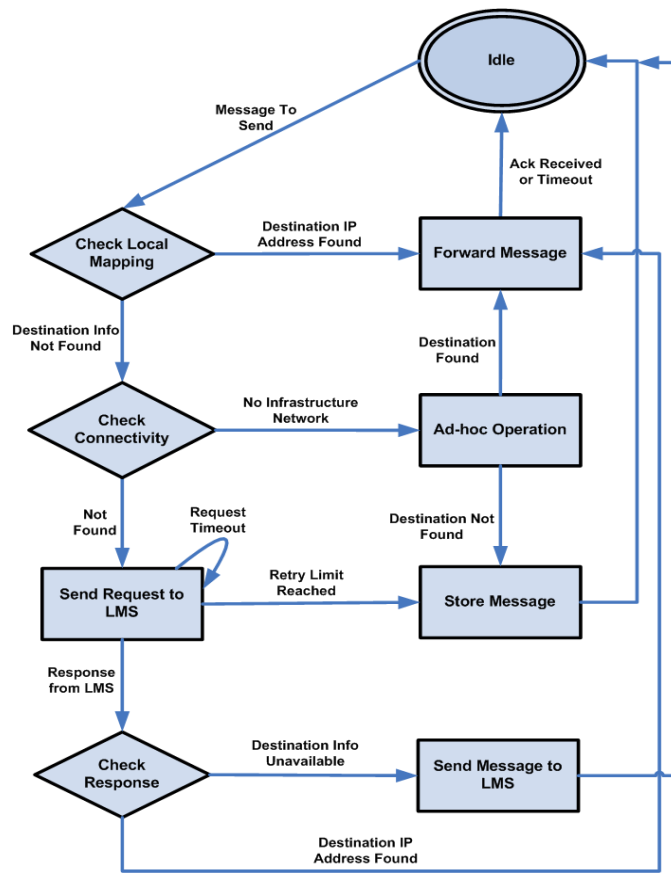
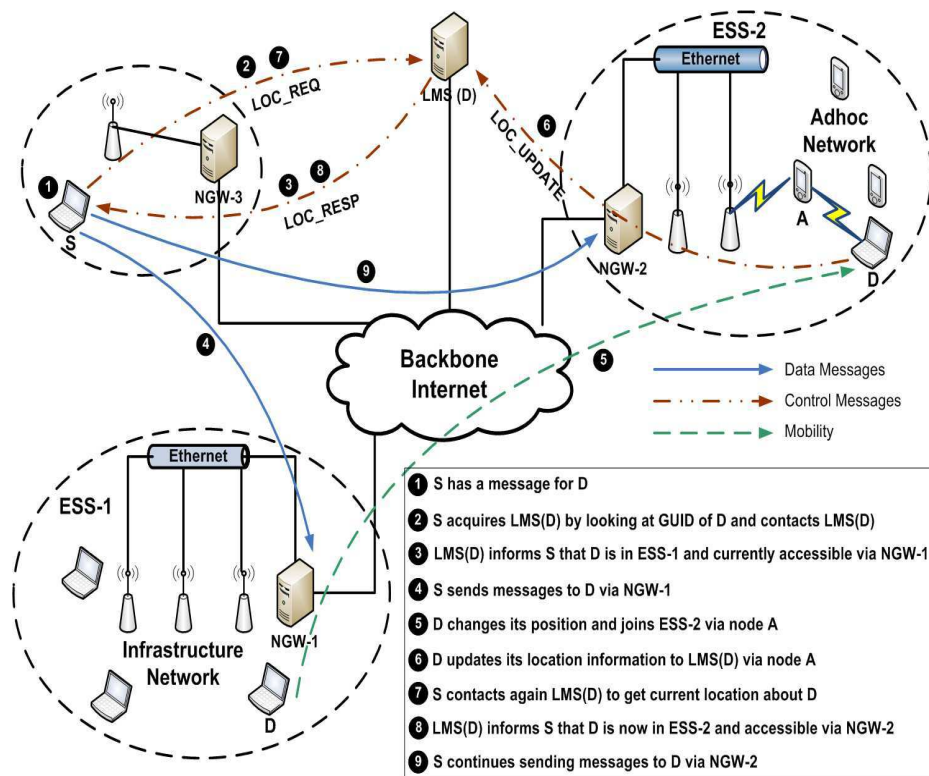

**Figure 6.1:** Operation of a node running HeNNA mechanism when the node has a message to send.

in response, sends all messages that it has stored for the node, during the node's unavailability.

When a message carrier  $S$  has a message to send to a destination  $D$  with identifier  $GUID(D)$ , it consults its local cache to check if it has a corresponding entry of IP address against  $GUID(D)$ . If the node does not have an entry, it contacts the LMS of  $D$  to acquire  $D$ 's current routeable address by sending a  $LOC.REQ$ . As a result, the LMS sends back the current routeable IP address of  $D$  or its own IP address. The latter implies that the LMS is going to store messages for  $D$ .  $S$  then uses the received routeable address to route the message directly to  $D$  or its LMS. An exemplary scenario is shown in Fig. 6.2, in which  $D$  moves from ESS-1 to ESS-2, and is connected to ESS-2 via ad-hoc interface when the  $LOC.REQ$  was sent to its LMS by  $S$ .

The functionality of the LMS can be compared to that of the home agent (HA) in MobileIP, with the following differences. The HA implicitly intercepts the messages sent to a MN, which means that both HA address and MN home address must belong to the same subnet. HeNNA does not have any such constraint. In HeNNA, a request is explicitly sent to the LMS to locate a mobile node before any communication takes place. Also, in HeNNA, the LMS is also



**Figure 6.2:** An example of message delivery using HeNNA. **S** which knows **GUID(D)** sends a message to **D** by first contacting **LMS(D)**.

responsible for storing data for nodes when they are unavailable whereas the HA is expected to have location information about a MN all the time, which may not always be true. Note that if MobileIP infrastructure is already available, the functionality of the HA could be modified to use it as the LMS. Also, MobileIP [77], [78] requires that each node has a globally routeable IP address. HeNNA differs from MobileIP in this respect, i.e., no permanent routeable address is required for nodes; rather a GUID is owned by each node and a routeable address of a node is acquired by a source on-the-fly.

A comparison can also be made between the functionality of the LMS and that of the rendezvous server (RVS) in HIP [86]. Like LMS, a RVS also maintains location information about registered nodes, but unlike LMS, a RVS does not store any messages on behalf of unavailable nodes. Moreover, nodes use the RVS only to exchange HIP base with the mobile nodes, but the data is never routed via the RVS. Implicitly, it requires that both initiator and responder are available for the data exchange to take place. There is no such constraint in HeNNA, as a source can send data even if a destination is unavailable.

Figure 6.3 illustrates the LMS operation in HeNNA.



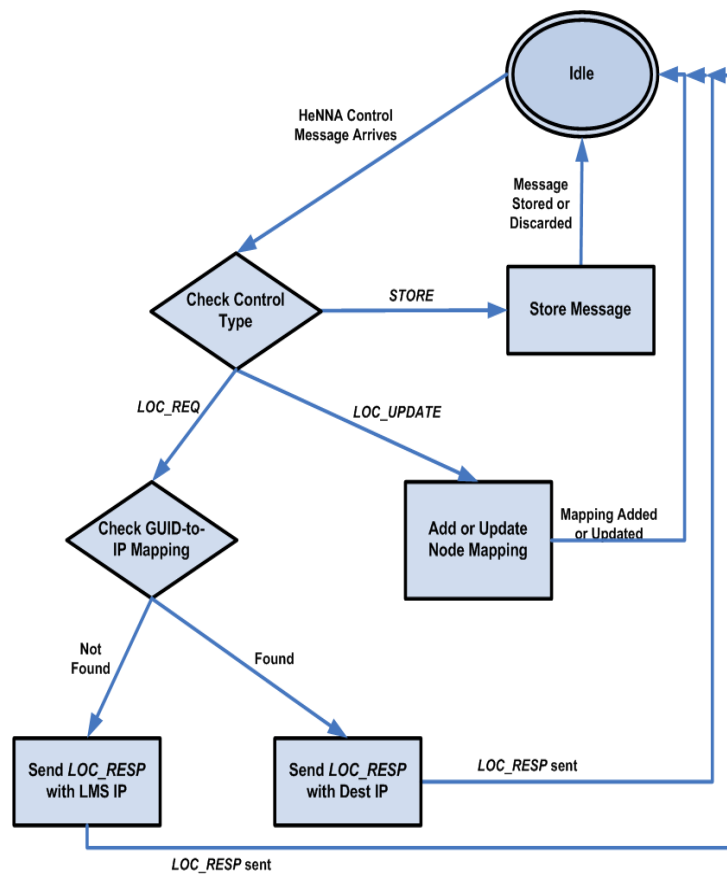

Figure 6.3: LMS Operation in HeNNA.

### 6.4.3 Local Network Operation

When nodes are behind a Network Address Translation (NAT) server, a DHCP server may be assigning addresses to the participating nodes (local nodes) from a private address space. In this case, only the local gateway (e.g., NAT Server) has a globally routeable address. In the context of HeNNA, we call this gateway as the Network Gateway (NGW).

**Network Gateway (NGW):** The NGW comes into operation when a DHCP server is assigning IP addresses to local nodes, or when nodes use private static addresses in an ad-hoc network and are connected to the backbone via a gateway. Besides the regular NAT server operation, the NGW is responsible to keep a mapping between the local nodes' GUID and their local (private) IP addresses. To perform this task, the NGW intercepts location updates (*LOC\_UPDATE*) from the local nodes, replaces the local IP address with its own IP before forwarding the updates to the LMS. The process is transparent to nodes. This also implies that in this case, the *LOC\_UPDATE* notifications do not need to be sent to the LMS for each newly acquired IP ad-

dress, as long as the node is in the same local network. This concept is similar in approach to the Hierarchical MobileIP (HMIP) [85], where local movements are not propagated to the HA. Note that as GUID to IP address mappings at the LMS may often expire, the *LOC\_UPDATE* messages are forwarded to the LMS, before an entry expires at the LMS, even if the node's NGW does not change.

The NGW keeps a mapping of a local node's GUID and the IP address of the node's interface with which it has sent the *LOC\_UPDATE*. In case the node is connected via its ad-hoc interface, the NGW keeps mapping between the node's GUID and its ad-hoc IP address. If the node is simultaneously using its ad-hoc and infrastructure interface, the NGW registers both of its addresses, but prefers the infrastructure-based IP address for communication. Besides, if a message carrier sends a *LOC\_REQ* to the LMS, the NGW may intercept the request to respond on behalf of the LMS, if it already knows the destination. In other words, if destination is available locally, the NGW responds the *LOC\_REQ* with the local IP address of the destination by looking into the local mapping. The operation of the NGW is shown in Figure 6.4.

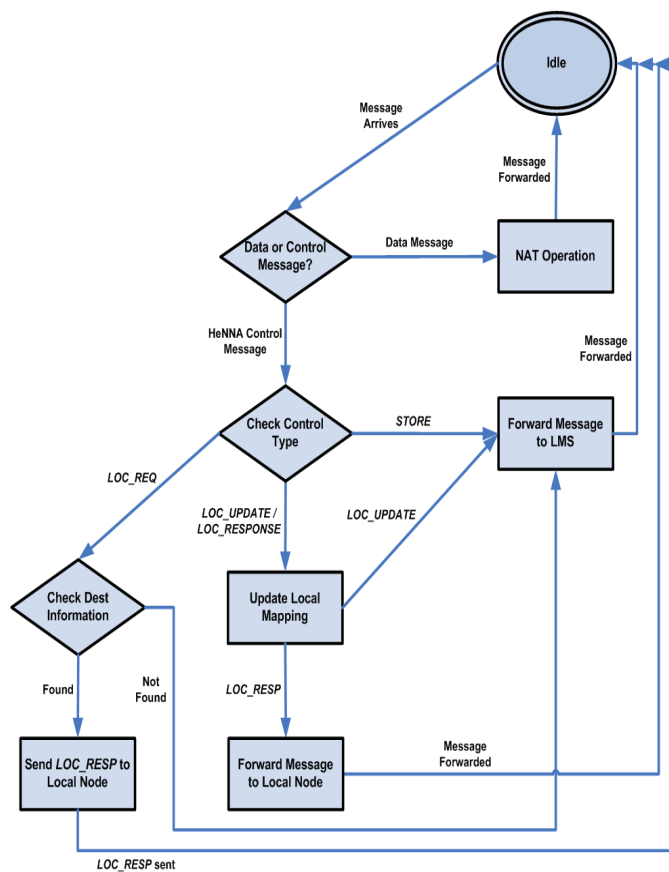

Figure 6.4: NGW Operation in HeNNA.

#### 6.4.4 Ad-hoc Network Operation

Communication operation in ad-hoc networks is performed without involving the LMS or the NGW, as long as the communicating nodes are in the same network. In this way, nodes exchange their GUIDs as part of their neighbor sensing procedures (e.g., using “hello” messages). As a result, this GUID information is propagated to other neighbors, just the same way as the neighbors IP address information is passed in the regular ad-hoc routing protocols for mobile networks. In a network where routing is performed using IP address, nodes also exchange their IP addresses along with GUIDs and nodes keep local mappings between GUID and IP address of all neighboring nodes. Entries in this local mapping are either expired, if a node does not receive an update from a neighboring node for a pre-defined period of time, or refreshed if the neighboring node changes its IP address. Consequently, this mapping is passed to the corresponding LMS of nodes, as soon as one of the participating nodes holding the mapping connects to the Internet via a gateway.

#### 6.4.5 GUID as Content Identifiers

Till now, we assume that GUIDs represent endpoint nodes, and nodes use GUIDs to communicate. Instead of an endpoint identifier, the GUID can also be served as a content identifier without requiring major changes to HeNNA. Thus, applications use the GUIDs as the content identifiers, and users searching for a specific content contact the LMS of the content in order to locate it. The LMS, in return, passes the current routeable address of the node(s) carrying the content. In case where more than one node carry the same content, a mechanism is required at the LMS to maintain one-to-many mappings between GUID and IP addresses of the nodes holding the content. We do not currently deal with one-to-many mappings at the LMS.

#### 6.4.6 GUID format

As shown in Fig. 6.5, a GUID is composed of:

**LMS Address Type:** Indicated by 3-bits 1 for IPv4, 2 for IPv6, 3 for DTN EIDs. Other types are unused.

**ID Length:** 5-bits indicating in how many bytes the ID of a node is represented. A zero value means that the ID value is absent (a personal LMS).

**LMS Address:** Address of the LMS of a node. The length of this field is variable and depends upon the type of address being used (e.g., 4 bytes for IPv4 address).

**ID Value (Optional):** The Node identifier (ID) within the context of the LMS. Length is variable (maximum: 32 bytes). This is the ID with which the LMS locally differentiates between registered mobile nodes.

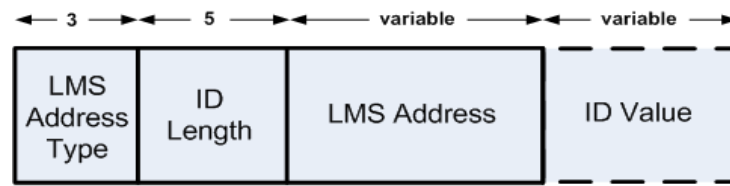

Figure 6.5: Composition of a GUID.

A GUID header is placed between the IP and the transport headers of a message, as in [81], which allows intermediate nodes to get information about a destination's GUID, in case a path is disconnected, and a message needs to be stored. To allow messages to traverse nodes that run regular TCP/IP stack, we insert the GUID header as an IP option. Position of the GUID header is shown in Fig. 6.6, with 5 bytes representing GUIDs (1 byte control, 4 bytes IPv4 address). Note that there is an overhead associated while adding GUID headers to each message. For the IPv4 case of Fig. 6.6, this overhead is 12 bytes per message. Also, there is an overhead related to the exchange of control notifications between nodes and the LMS, and the amount of this overhead depends how frequently the nodes contact their LMS.

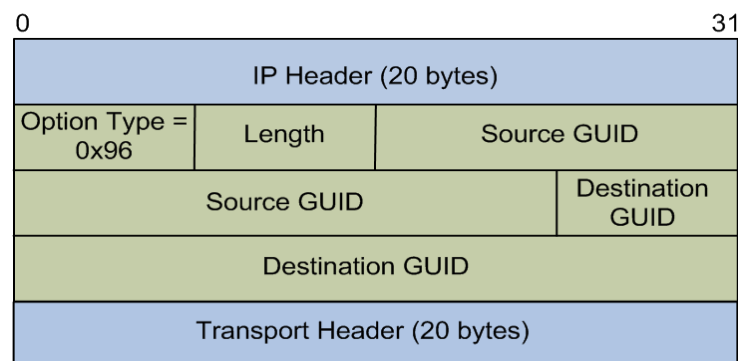

Figure 6.6: GUID header in the protocol stack.

#### 6.4.7 Scalability and Security Issues

The scalability of a new architecture is very important for its deployment. We believe that HeNNA naming mechanism is scalable due to its inherent property that any Internet node with a permanent routeable address can serve the role of a LMS. In this way, we do not assume that there are only a few LMS present in the Internet. Rather, different communities can manage and maintain the functionality of the LMS at different places. Even, the LMS can be managed personally (e.g., a desktop of a user that is permanently connected to the Internet). Moreover,

if anycast addressing is used for the LMS, a number of LMS nodes can be used to maintain the location information for a set of nodes, and a *LOC.REQ* can be routed to and responded by the nearest LMS available. This could also provide load-balancing and resistance to the LMS failures.

However, there are some security issues related to the HeNNA mechanism that, unless resolved, may prevent the scalable deployment of the architecture. We do not treat the security issues in this thesis but we point of a few of them. For instance, the exchange of control messages (e.g., *LOC.UPDATE*, *LOC.REQ*, *LOC.RESP*) is not secure. Any node can use the GUID of a mobile node to misinform the corresponding LMS about the current location of the mobile node. Moreover, the end-to-end communication between a source and a destination using GUIDs needs to be secure.

## 6.5 HeNNA Implementation

In the previous two chapters, we presented MeDeHa – a framework to provide message delivery across heterogeneous networks with diverse nodes capabilities while considering nodes intermittent connectivity. While MeDeHa provides a flexible mechanism for seamless message delivery across heterogeneous networks, it is based on two strong assumptions, (1) a sender knows one of the IP addresses of a destination before sending a message, and (2) the IP address of the destination does not change during the communication session. This limits the application of the MeDeHa framework only to networks with local scope and to networks where nodes IP addresses are static. In practice, this case is not common as mobile nodes change their IP addresses with the change in their network point of attachment. Hence, the communication between two nodes is vulnerable to change in IP addresses of the nodes. Moreover, nodes generally use private address spaces when they are behind a firewall or a NAT server. Thus, their IP addresses are not routeable in the Internet and are assigned temporarily. The MeDeHa framework does not handle this issue.

For all these reasons, an identification based naming mechanism is indispensable for the deployment of the MeDeHa framework, such that the communication between two nodes is independent of their points of connection with the network. Using location-independent identifiers for communication in HeNNA is in contrast to the current Internet architecture in which applications are bound to nodes IP addresses and these IP addresses needs to be acquired before any communication takes place.

We implement HeNNA in the NS-3 [59] simulator and combine it with an extended version of the MeDeHa framework [22], [25]<sup>4</sup>. The modifications that are made to make the MeDeHa framework workable with HeNNA are described in the following subsection.

<sup>4</sup>The implementation of HeNNA in NS-3 can be downloaded from <http://planete.inria.fr/software/MeDeHa>.

### 6.5.1 Modifications in MeDeHa implementation

When operating with HeNNA, the MeDeHa nodes use location-independent GUID as nodes identifiers for communication. A MeDeHa node sends the *LOC\_UPDATE* to its LMS, when it is *associated* to an infrastructure-based node (e.g., an AP or base station), or when it is indirectly connected via a neighboring node that is *associated* to an infrastructure-based network. Besides, the MeDeHa notification protocol [23] has been extended so that APs exchange GUIDs of the *associated* MeDeHa nodes instead of their IP addresses in the Extended Service Set (ESS). In this way, all the notifications, presented in Section 4.6.1, comprise GUID of nodes instead of the IP addresses. Besides in ad-hoc mode, the MeDeHa nodes exchange both their GUIDs and IP addresses using the “hello handshake” (comprising of the *HELLO* and the *NEIGHBOR\_INFO* notifications). In this way, the MeDeHa nodes maintain GUID to IP address mappings of all other neighboring MeDeHa nodes. Besides, nodes also exchange GUID of the nodes that they encountered within a pre-defined period of time. This is done using the *RECENT\_NEIGHBORS* notifications and the information is used in the relay selection process.

When a MeDeHa node *S* wants to send a message to a destination *D*, it first checks *D*'s location information in its cache. The local information about location may be present either because (1) a *LOC\_REQ* notification has recently been sent for *D*, or (2) the information is collected using the neighborhood information exchange mechanism of MeDeHa. If the information is not found locally, *S* checks about *D*'s location using the information collected by the APs within the ESS. If no information is available in the ESS, the LMS of *D* is consulted (contacted by sending a *LOC\_REQ* control message) to get the current location of *D*. Messages are forwarded based on the MeDeHa nodes' GUID rather than their IP addresses in the original MeDeHa framework. This enables the MeDeHa nodes to receive their messages even if their IP addresses are changed due to temporary disconnection or joining a new network. APs may store messages for temporary unavailable destinations within an ESS, but if a destination is not connected to the ESS for a long time, APs transfer the stored messages to destinations' corresponding LMS.

## 6.6 Results

### 6.6.1 Case 1: File Download Across Campuses

We show how HeNNA helps in message delivery to mobile nodes irrespective of their points of attachment to the network and IP addresses. In this scenario, we consider that 40 students move within and between 3 campuses of a university. These campuses do not belong to the same subnet, and are not directly connected, as shown in Figure 6.7. Students carry portable devices that run MeDeHa framework and HeNNA. While traveling between campuses, they remain

disconnected for a long period of time. The time of disconnection when moving between campuses depends upon the nodes' speed, the path followed by the nodes, and their pause time between campuses. Using their devices, the students are also able to connect both in infrastructure and ad-hoc modes. At a campus, the students use the local ESS for connectivity, are behind a NAT, and a DHCP server is assigning IP addresses dynamically from a private address space. Nodes change their IP address due to disconnection or a change of association to APs, even when present in the same ESS. Moreover, connectivity is not guaranteed everywhere within a campus. Two of the campuses comprise 6 APs while the third has 3 APs. Each campus has a NGW that has a globally routeable IP address. We assume that there are two LMS (LMS-1 and LMS-2), each responsible for location information of 20 students. We assume that two students, Bob and Alice are downloading a file from a server in the Internet, and want to continue downloading it while moving. The file contents are sent at an average rate of 5 messages/s (5 KB/s). The mobility traces are obtained using BonnMotion Mobility Model [65] and the students move at a speed that is uniformly distributed between 1 and 3 m/s, and stay at some places for a time that is distributed between 0 and 300 seconds, and total simulation time is 2 hours. Campus 1 and 2 has an area of 600m x 600m, while Campus 3 spans over an area of 600m x 300m, and the total simulation area is 3km x 1.5km.

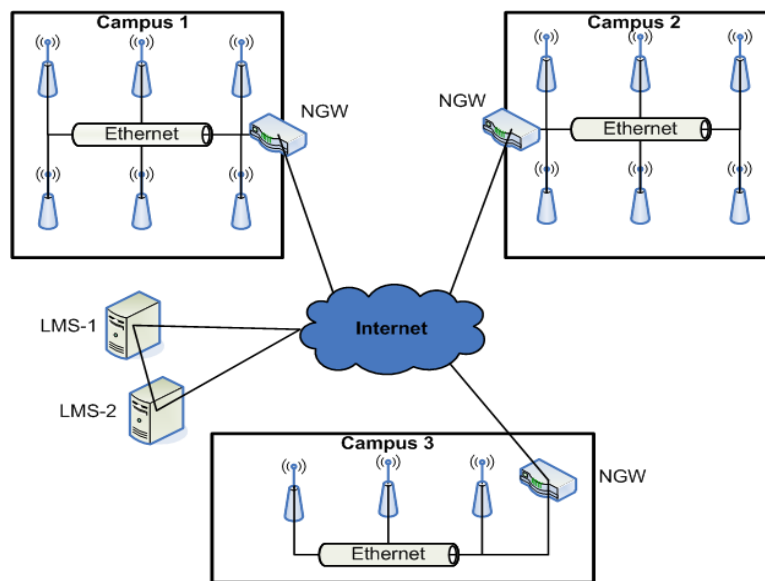

**Figure 6.7:** Three campuses are connected to the Internet via NGWs.

For opportunistic ad-hoc forwarding in MeDeHa, we use Encounter-based Replication mechanism (ER) as described in Section 5.6.5, where a message carrier forwards a message to another relay, if the latter has encountered the destination at least twice and more often than the

former. The number of encounters is set to 2 and the number of copies per message is set to 1. As both Bob and Alice change their IP addresses with the change in their network attachment point, it is interesting to compute what percentage of the file they receive in each network that they visit. This is because according to their mobility pattern, Bob and Alice move between different campuses during the simulation time. So, if both Bob and Alice are able to receive the file content across different campuses they visit, this will validate the functionality of HeNNA. Moreover, measuring the overall delivery delay gives us an estimate about how long they remain disconnected. We compare the performance of HeNNA with 2 cases where HeNNA is not used. Fig. 6.8 provides the distribution of the percentage of messages received and lost in all 3 campuses.

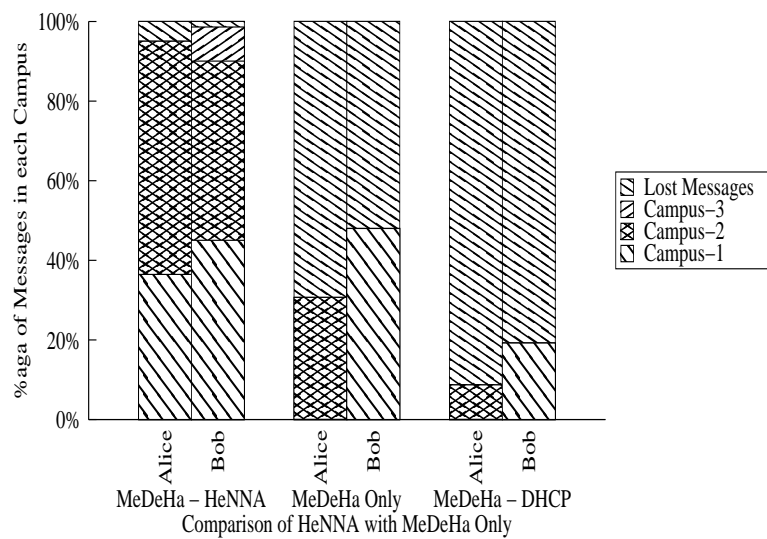

**Figure 6.8:** Comparison of using MeDeHa with HeNNA functionality and regular MeDeHa framework by showing the percentage of messages received in each campus.

With HeNNA (MeDeHa-HeNNA), Bob received data in all 3 campuses, and got 98.5% of the file (45% each in Campus 1 and 2, and 8.5% in Campus 3), while Alice received data in Campus 1 and 2 only and got 95% of the file (36% in Campus 1 and 58.5% in Campus 2).<sup>5</sup> Some messages are expired (expiry time is 40 minutes) while being stored at the LMS. This loss of data can be coped with by adding application level reliability. The average delivery delay for Bob and Alice is 242.3 and 233.6 seconds respectively. When using regular MeDeHa (MeDeHa only) in which nodes IP addresses are static (which is neither practical nor scalable), the delivery ratio is 48% for Bob and 30.7% for Alice. This is because connectivity information is

<sup>5</sup>Note that Bob and Alice receive a few messages off-campus in ad-hoc mode when encountering relays but we consider these messages as being received in the recently visited campus.



not passed beyond the ESS in MeDeHa. Bob was initially in Campus 1, so he could receive data either in Campus 1 or via relays. APs in Campus 1 can keep the messages stored for a long time when Bob is unavailable; hence, a lot of messages are expired. Similarly, Alice was initially in Campus 2, and received all messages in Campus 2. The delivery delay for Bob is 628.4s and for Alice is 25.9s). We also used dynamic addressing mechanism with MeDeHa (MeDeHa-DHCP), in which students change their IP address when moving/reconnecting. This has a drastic effect on MeDeHa's performance (delivery ratio reduces to 19.1% for Bob and 8.67% for Alice). The delivery delay in this case is very low (0.97s and 0.62s respectively) as both students only received messages in the beginning of the simulation before their IP addresses are changed. The message size is 1 kB, and HeNNA control messages and the GUID header included in each message caused an overhead of 1.61%. For this experiment, we measured the total IP addresses that has been used by both Bob and Alice. For the infrastructure-based interfaces, 12 IP addresses are allocated to Bob while Alice used 6 IP addresses during the experiment, while their ad-hoc interface IP addresses are static.

While moving inside and between the campuses, Alice and Bob communicate with other nodes they encounter within or outside campuses in ad-hoc mode, and receive data destined to them either via relays that carry data for them, or when they are indirectly connected to an infrastructure-based node. Hence, it is interesting to analyze what percentage of data both Alice and Bob has received during each mode (infrastructure and ad-hoc) in all three campuses, and even while moving between campuses. Figure 6.9 shows the distribution of file received in both infrastructure and ad-hoc modes.

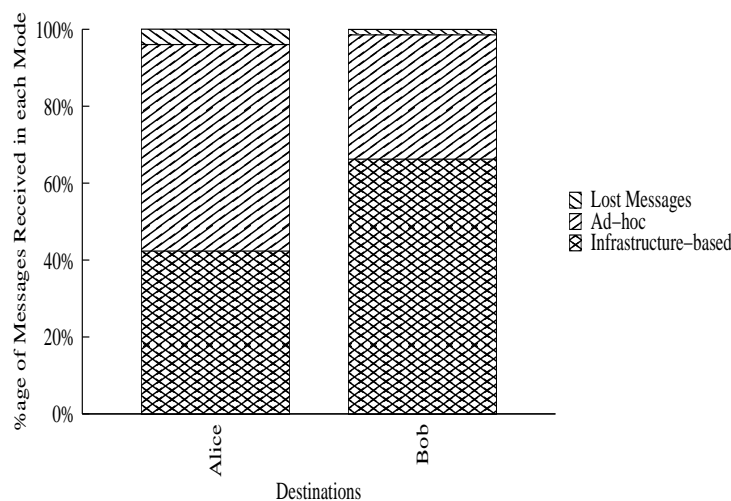
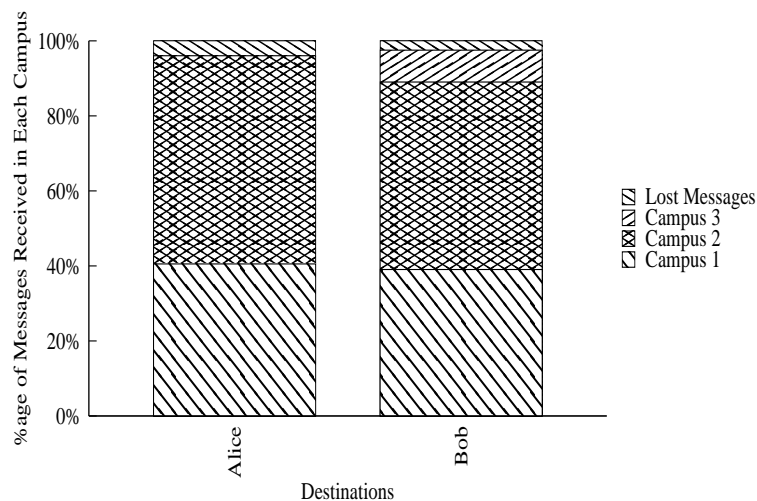

**Figure 6.9:** Percentage of messages received in both infrastructure-based and ad-hoc networks.

We notice that out of total of 98.5% of the file contents, Bob received 66.2% in infrastructure mode (while connected directly to APs), and 32.3% in ad-hoc mode (via relays or by indirectly connecting to an infrastructure-based network). On the other hand, Alice received more data in ad-hoc mode (53.7%) than while connected to the infrastructure-based network (42.3%). This means that Bob used the infrastructure-based interface most of the time to receive the file contents (he is able to connect to the APs mostly), while Alice has mostly received the file contents either via relays or by indirect connection to the infrastructure-based network using its ad-hoc interface.

### 6.6.2 Case 2: File Transfer across Campuses with Mobile Sources

In this experiment, we consider that two students John and Mary are sending two files to Bob and Alice, respectively by dividing the file contents into equally sized messages of 1 KB size each. Both John and Mary are mobile but do not leave their respective campuses (John is in Campus 1 and Mary is in Campus 2). Both move at a speed that is uniformly distributed between 1 and 3 m/s. All other parameter are the same as described in Section 6.6.1. Thus, the difference in this scenario is that the sources are also mobile and may get disconnected from the network. Hence, the message transfer rate is not uniform and depends upon the connection of the sources with the infrastructure. The distribution of the percentage of messages received by Bob and Alice across all three campuses and that of lost messages is shown in Figure 6.10.



**Figure 6.10:** Percentage of messages received in each campus for the case of file transfer with mobile sources.

We see that the results are still comparable with what we obtained in Section 6.6.1. Bob

received 97.5% of the file contents across all three campuses (39% in Campus 1, 50% in Campus 2 and 8.5% in Campus 3), while Alice received 96% of the file contents (40.5% in Campus 1 and 55.5% in Campus 2). On the other hand, the case of mobile sources reduced the average delivery delay to some extent (210.87s for Bob and 216.54s for Alice), which means that there is a 13% decrease in delay for Bob and 8% decrease in delay for Alice. This is because the contact opportunities are increased as the sources are mobile, which caused the delivery delay to decrease slightly.

## 6.7 Concluding Remarks

We have proposed a naming mechanism HeNNA that decouples node identification from location. HeNNA is designed to operate with status-quo Internet routing while coping with nodes temporary disconnections and change of IP address during communication sessions. The proposed mechanism also provides NAT traversal and allows mobile nodes to use private-space IP addresses in local networks. We run experiments to show a proof-of-concept of HeNNA's effectiveness by running it using our framework MeDeHa via simulations in NS-3, and observed that it is able to deliver messages to nodes even with frequent nodes mobility.

---

---

## **Part V**

# **Conclusion and Future Work**



# CONCLUSIONS AND FUTURE RESEARCH PERSPECTIVES

---

---

During the past few years, the current Internet architecture has consistently been challenged by the heterogeneity of emerging smart devices and networks (or applications), and the users eagerness to remain connected all the time. Especially the emergence of the wireless communications has jolted various aspects of the existing communication architecture, as it allows nodes to communicate despite their mobility. The ubiquitous connectivity requirement gives birth to an internetwork that connects different networks together and provides seamless inter-operation. Notable challenges related to inter-operation of different networks include session persistence, seamless message delivery across multiple heterogeneous networks and identification of mobile nodes, which are the three challenges we targeted in this thesis.

The contributions of this thesis can be divided into three parts: (1) DTN routing taxonomy for opportunistic networks, (2) Message delivery framework for heterogeneous networks, and (3) Naming mechanism for heterogeneous networks. In the following subsections, we summarize these contributions. We also provide some possible research perspectives of each part.

## 7.1 Opportunistic DTN Routing Taxonomy

In the first part, we provided a taxonomy of DTN routing protocols by breaking up the existing opportunistic DTN routing protocols into a set of small and tunable routing modules. We identified three main routing modules as *forwarding*, *replication*, and *source or network coding*. We showed in which scenario a given routing module is the most suitable depending upon the network characteristics and environment. We also identified a set of *utility functions* based

on which forwarding decisions can be made in an opportunistic networking environment. We highlighted two types of *utility functions* that can be used in DTNs as *destination dependent* (DD) and *destination independent* (DI) utility functions, and showed when a specific utility function should be used. We further provided a classification of opportunistic networks by identifying a set of *network characteristics* (such as connectivity, mobility and nodes heterogeneity information). This classification and the tunable routing modules help the opportunistic DTN routing designers to choose a specific routing/forwarding approach for a problem in hand, for which we also provided some design guidelines. To our knowledge, no similar work has been done before despite the large number of DTN routing protocols that have been proposed in the past few years.

While presenting a classification on the existing DTN routing protocols, we focused only on the opportunistic routing protocols for delay or disruption tolerant networks. But other types of DTN routing exist as well, as pointed out in Chapter 2: (1) *deterministic* or *scheduled* routing and (2) *enforced* routing. We believe that the classification can further be extended to include these two types of DTN routing protocols in the future. Even the insight of the work we presented can be applicable to these types. For instance, when dealing with *enforced* routing, a network may have a number of message ferries [19] where each ferry follows a specific route and visits some places. In such scenario, the insight from *utility functions* can be used to choose a *suitable* message ferry for a particular destination. In case of *scheduled* and *deterministic* DTN routing, the time and duration of node contacts are generally known a priori and the forwarding decisions are scheduled based on this information (e.g., the communication between two satellites or planets can be scheduled at the time of their contact which is normally known due to the orbits they follow). However, there can be some cases even in the *scheduled* routing where opportunistic routing can be employed. For example, the contact between two buses can be predetermined based on their pre-defined routes, but two buses may not encounter each other due to traffic conditions on roads. Thus, the *scheduled* routing would fail in that case. Hence, we believe that the DTN routing classification that we presented in the thesis can be used even in scenarios where routing is generally *deterministic* or *enforced*.

## 7.2 Message Delivery in Heterogeneous Networks

In the second part of the thesis, we provided a message delivery framework which we named as MeDeHa for Message Delivery in Heterogeneous Disruption-prone Networks. The MeDeHa framework is an attempt to provide seamless inter-operation of infrastructure-based and infrastructure-less networks, while coping with nodes intermittent and sporadic network connectivity. The framework is applicable to scenarios where applications are not strictly delay-bound and where nodes prefer late delivery of messages over complete loss of information

due to nodes intermittent connectivity. With more investigation, the framework can serve as a building block for coping with network heterogeneity in future internetworks. MeDeHa nodes act as relays to carry traffic for other nodes in a *store-carry-and-forward* manner, as opposed to the conventional *store-and-forward* Internet model. Thus, the framework is able to deliver messages to destinations across multiple hops even if there is no contemporaneous end-to-end path between a pair of source and destination. This is done by taking advantage of *opportunistic contacts* that nodes experience while moving.

MeDeHa nodes also take advantage of different *destination dependent* and *destination independent* utility functions (such as history of past encounters, number of encounters, and nodes community or social affiliation), which helps in choosing a *suitable* relay and making forwarding decisions in an opportunistic way. The framework is also able to integrate existing MANET routing protocols so that message delivery is extended to MANET nodes which do not run the MeDeHa software. This is made possible by the *gateway* nodes that run the MeDeHa framework and a MANET routing protocol. The multi-hop connectivity information of MANETs is also used to connect two infrastructure-based networks that are otherwise disconnected. In this way, MANETs act as *transit networks* to bridge these disconnected networks. Moreover, the flexible design of MeDeHa allows it to be implemented at different layers of the communication stack.

We implemented and evaluated the MeDeHa framework at link and network layers using the OMNET++ and the NS-3 simulators. We used realistic synthetic mobility models and real mobility traces to show the effectiveness of the framework in diverse set of scenarios and environments with mobile nodes. We also implemented the framework on Linux machines as a user-space daemon and evaluated it. Finally, we have performed some hybrid experiments where both simulator nodes and real machines inter-communicate and are part of a single experiment. On one hand, it allows the evaluation of the scalability of the framework by having more nodes on the simulator side, while on the other hand, it validates the framework's implementation in the NS-3 simulator. Following are the main findings of the framework's evaluation:

1. Network heterogeneity and nodes cooperation help in increasing the message delivery ratio of mobile nodes. In this way, nodes ability to simultaneously connect to different infrastructure-based and infrastructure-less networks improve the message delivery.
2. Using more copies per message help in reducing the average end-to-end delay at the cost of using more network resources.
3. Using the MeDeHa framework, only a few copies per message (normally 2) are sufficient to provide almost 100% of delivery ratio. This enables the nodes using the framework to achieve acceptable delivery ratios with low overhead.



4. DD utility functions such as ER perform better than DI utility functions when nodes have more contact opportunities (i.e., they encounter each other more often).
5. Encounter-based replication schemes offer better average delivery ratios while community affiliation-based schemes provide better average delivery delays.

Moreover, we evaluated the MeDeHa framework using traffic involving different priority of flows, and showed the basic buffer management performed by the nodes that implement the framework. We have also learnt a few important lessons specific to the hybrid experimentation. The hybrid experiments allow the inter-operation of simulator nodes and real machines, and helps in verifying the simulation implementation as real machines inter-communicate with simulator nodes. On the other hand, due to the real-time scheduler of the NS-3 simulator, the hybrid experiments limit the number of simulator nodes to a certain number, and this number depends upon the processing and scheduling capability of the machine on which we run the simulator. In our hybrid experiments, we could not use more than 30 nodes in the simulator using Intel dual-core with 2.4 GHz processor and 4 GB RAM, where each node has 2 to 3 interfaces.

To conclude, the MeDeHa framework offers the following main advantages:

- Bridge heterogeneous networks involving nodes with diverse set of capabilities and network with different characteristics.
- Provide Seamless message delivery across multiple networks despite nodes mobility.
- Capability to work at different layers of the communication stack.
- Integration of existing MANET routing protocols to provide multi-hop communication whenever possible.
- Integration of existing forwarding/routing mechanisms for opportunistic networks.

However, the MeDeHa framework uses IP address of nodes for communication, and the communication is based on the assumption that IP addresses of the nodes do not change during the communication session. Whereas, IP addresses of the nodes are impermeable to change especially when nodes are mobile and change their points of attachment to the network. Also, when nodes are multihomed, they may possess multiple IP addresses; thus, IP addresses of nodes are not a good candidate to be used for communication with mobile nodes. We addressed this issue in the last part of the thesis.

The current design of the framework only considers point-to-point message delivery to destinations. There may be environments where multi-destination message delivery is required. For instance, in a convention center, an organizer may want to disseminate text, audio or video

messages to the participants. In the future, it will be interesting to explore the capability and feasibility of the MeDeHa framework to provide multi-destination (point-to-multipoint) message delivery. The framework design can be reviewed from a content dissemination point of view to employ content dissemination strategies such as ContentPlace [95] in heterogeneous networks.

Moreover, in the thesis, we put aside the transport layer issues of communication in heterogeneous networks. These issues include flow control, congestion control and reliability. In a way, these issues are handled hop-by-hop at the network layer of the nodes, as the forwarding of messages from one node to another node is performed based on the buffer space available at the latter. Moreover, all the messages are acknowledged when forwarded from one node to another – thus providing hop-by-hop reliability, as in the DTN Bundle Architecture [17]. But we believe that efforts need to be made to handle these transport layer issues end-to-end in heterogeneous disruption-prone networks. Very little effort has been made to address the transport layer issues in DTNs, with notable examples include [148] and [149].

MeDeHa's current buffering mechanism is based on message priorities, and when a message arrives to the MeDeHa module and there is no space available, messages with lower priorities may be dropped. Message priorities can also be used to provide some flow control mechanism such that before exchanging messages, two nodes order the messages based on their priorities. Besides providing flow control, this will also help in quick dissemination for high priority traffic, and is useful when the average contact duration of nodes is lower than average number of messages nodes have to replicate, for instance, due to high speeds. A similar approach for managing buffers in this way is presented in [31] for opportunistic networks.

Another important future research direction for the MeDeHa framework is its interaction with the DTN Bundle Architecture [17]. As already stated in Chapter 4, the MeDeHa framework is complementary to the Bundle Architecture, but we can see that providing support of disruption tolerance is not the only goal of the MeDeHa framework. When working with the DTN Bundle Architecture, a DTN overlay network can be formed where DTN endpoint nodes use bundles as communication data unit to exchange data between them. DTN endpoint nodes in this overlay network can use the MeDeHa-capable nodes to traverse multiple hops in order to communicate with other DTN endpoint nodes. A similar approach has already been proposed in PreDA [39] where DTN endpoint nodes use underlying AODV network to communicate. Conversely, MeDeHa-capable networks can be made to operate with DTN-capable networks. Work is in progress in order to realize this inter-operation.

### 7.3 Naming for Heterogeneous Networks

In the third and last part of the thesis, we presented a naming mechanism, called Heterogeneous Networks Naming Architecture (HeNNA), which decouples node identification with their locations. This allows nodes to roam and to be part of networks with different subnet IP addresses while maintaining their communication session. The MeDeHa framework does not inherently allow this functionality. HeNNA is complementary to the MeDeHa framework and can be used in cooperation with the framework. In Chapter 6, we showed this cooperation of HeNNA and MeDeHa using simulations performed in the NS-3 simulator. HeNNA also allows NAT traversal and enables mobile nodes to use dynamically assigned IP addresses from private address space. Another feature of HeNNA is its ability to work with the status-quo Internet routing, which makes the naming mechanism ready to be deployed and used in the Internet. The mechanism also inherently copes with the disconnection of mobile nodes with the network. In this way, nodes with permanent IP addresses in the Internet, called Location and Management Server (LMS), are responsible for keeping the most recent location information of the mobile nodes and for storing messages on behalf of the unavailable nodes.

We have only presented the proof-of-concept of the naming mechanism. Detailed evaluation of the protocol especially with respect to nodes mobility and its comparison with existing naming schemes is part of the future work. Another future direction is the deployment of the scheme on a real test-bed so that the performance of HeNNA with the actual Internet architecture can be evaluated. Using a mechanism like HeNNA to integrate the Internet with the DTN Bundle architecture [17] is another research direction.

While HeNNA may serve as a building block for communication of mobile nodes in heterogeneous disruption-prone networks, security aspects related to the scheme must be addressed before it is actually deployed in the Internet. The security concerns are mainly related to how control notifications are exchanged between the mobile nodes and the LMS nodes so that the location information present at the LMS nodes is accurate.



## LES CONCLUSIONS ET LES TRAVAUX DE RECHERCHE FUTURE

---

---

Pendant les années récentes, l'architecture actuel de l'Internet a été uniformément défiée par l'hétérogénéité des dispositifs et les nouveaux réseaux (ou les applications), et par le désir d'utilisateurs d'être connecté tout le temps. Particulièrement l'apparition des communications sans fil a secoué de divers aspects de l'architecture actuelle de communication, car elle permet à des noeuds de communiquer même avec la mobilité. Le besoin d'une connectivité omniprésente nécessite un inter-réseau qui relie différents réseaux ensemble et fournit leur inter-opération. Les défis notables liés à l'inter-opération de différents réseaux comprennent la persistance de session, la livraison de message à travers les réseaux hétérogènes multiples et l'identification des noeuds mobiles, qui sont les trois défis que nous avons visés dans cette thèse.

Les contributions de cette thèse peuvent être divisées en trois parties : (1) une taxonomie de routage DTN pour les réseaux opportuniste, (2) un framework de la livraison de message pour les réseaux hétérogènes, et (3) un mécanisme d'identification des noeuds pour les réseaux hétérogènes. Dans les sous-sections suivantes, nous récapitulons ces contributions. Nous fournissons également quelques perspectives possibles de recherches de chaque partie.

### 7.1 Une taxonomie des protocoles routage DTN

Dans la première partie, nous avons fourni une taxonomie des protocoles de routage DTN en divisant les protocoles existants en ensemble de petits et réglables modules de routage. Nous avons identifié trois modules principaux de routage comme *forwarding*, *replication*, et *coding* (source ou réseau). Nous avons montré dans quel scénario un module donné est le

plus approprié pérennant en compte des caractéristiques de réseau et l'environnement. Nous avons également identifié un ensemble de fonctions d'utilité (*utility function*) basées sur quelles décisions de forwarding peuvent être prises dans un environnement de réseau opportuniste. Ensuite, nous avons souligné deux types de fonctions d'utilité qui peuvent être employées dans DTNs comme *destination dépendant* (DD) et *destination indépendant* (DI) fonctions d'utilité, et montré quand une fonction spécifique devrait être employée. De plus, nous avons fourni une classification des réseaux opportuniste en identifiant un ensemble de caractéristiques de réseau (comme l'information de connectivité, de mobilité et d'hétérogénéité de noeuds). Cette classification et les modules réglables de routage aident les concepteurs des protocoles de routage DTN à choisir une approche spécifique de routage pour un problème à disposition, pour lequel nous avons également fourni quelques directives de conception. À notre connaissance, aucun travail similaire n'a été effectué qui ont été proposés jusqu'à aujourd'hui.

Tout en présentant une classification sur les protocoles actuels de routage DTN, nous nous sommes concentrés seulement sur les protocoles opportunistes de routage pour DTNs. Mais d'autres types de routage DTN existent aussi bien, comme précisé dans le chapitre 2: (1) "*deterministic*" ou "*scheduled*" et (2) "*enforced*". Nous croyons que la classification que nous avons présentée dans cette thèse peut être prolongée pour inclure ces deux types de protocoles de routage DTN à l'avenir. Même la classification que nous avons présentée peut être applicable à ces types actuellement. Par exemple, quand traiter le routage "*enforced*", un réseau peut avoir un certain nombre de message ferries [19] où chaque ferry suit un itinéraire spécifique et visite quelques endroits. Dans un tel scénario, les fonctions de utilité peut être employé pour choisir un ferry qui est convient pour une destination particulière. En cas du routage *scheduled* ou *deterministic*, la période et la durée des contacts de noeud sont généralement connus a priori et les décisions de expédition ont basé sur cette information (par exemple, la communication entre deux satellites ou planètes peut être programmée à l'heure de leur contact qui est normalement dû connu aux orbites qu'ils suivent). Cependant, il peut y avoir quelques cas même dans le routage *scheduled* où le routage opportuniste peut être utilisé. Par exemple, le contact entre deux bus peut être prédéterminé a basé sur leurs itinéraires prédéfinis, mais deux bus peuvent ne pas se rencontrer dû aux conditions du trafic sur des routes. Ainsi, le routage *scheduled* échouerait dans ce cas. Par conséquent, nous croyons que la classification de routage DTN que nous avons présentée dans la thèse peut être employée même dans les scénarios où le routage est généralement *deterministic* ou *enforced*.

## 7.2 La livraison des messages dans les réseaux hétérogènes

Dans la deuxième partie de la thèse, nous avons fourni un framework pour la livraison de message dans les réseaux hétérogènes que nous avons appelé MeDeHa. Le framework MeDeHa

est une essaie de fournir l'interopération des réseaux infrastructure et ad-hoc, avec les réseaux qui sont tolérants à la connectivité sporadique. Le framework est applicable aux scénarios où les applications ne manquent pas lorsque les retards sont très élevés et où les noeuds préfèrent la livraison tardive à la perte complète de messages due à la connectivité intermittente de noeuds. Avec plus de recherche, le framework peut servir de module de base pour les réseaux hétérogènes dans les inter-networks de future. Les noeuds de MeDeHa agissent en tant que relais pour porter le trafic pour d'autres noeuds d'une façon "*store-carry-and-forward*" par opposition au modèle "*store-and-forward*" dans l'Internet actuel. Ainsi, le framework peut fournir des messages aux destinations à travers les sauts multiples même s'il n'y a aucun chemin bout-en-bout entre une paire de source et la destination. Ceci est fait en profitant des contacts *opportuniste* des noeuds quand ils se déplacent.

Les noeuds de MeDeHa profitent également des différents fonctions d'utilité (telles que l'histoire de la rencontre passée, le nombre de rencontre, et la communauté de noeuds ou l'affiliation sociale), qui aident en choisissant un mieux relais et en prenant des décisions de expédition d'une manière opportuniste. Le framework peut également intégrer des protocoles existants de routage MANET de sorte que la livraison de message soit prolongée aux noeuds de MANET qui ne courent pas le logiciel de MeDeHa. Ceci est rendu possible par les noeuds *passerelles* qui courent le framework de MeDeHa et un protocole de routage MANET. L'information de connectivité de multi-saute de MANETs est également employée pour relier deux réseaux infrastructure qui sont autrement déconnectés. De cette façon, les reseaux MANETs se servent comme des *réseaux de transits* afin de fournir un pont sur ces réseaux déconnectés. D'ailleurs, la conception flexible de MeDeHa lui permet d'être implémenté sur différentes couches de la pile de communication (*protocol stack*).

Nous avons implémenté et avons évalué le framework MeDeHa à la couche lien et à la couche réseau en utilisant les simulateurs OMNET++ et NS-3. Nous avons employé les modèles synthétiques réalistes de mobilité et la vraie trace de mobilité pour montrer l'efficacité du framework dans l'ensemble divers de scénarios et d'environnements avec des noeuds mobiles. Nous avons également implémenté le framework sur des machines de Linux et l'avons évalué. En conclusion, nous avons exécuté quelques expériences hybrides où les noeuds de simulateur et les vraies machines inter-communicent et font partie d'une expérience. D'une part, elle permet l'évaluation de l'extensibilité du framework en ayant plus de noeuds du côté de simulateur; bien que d'autre part, elle valide l'exécution du framework dans le simulateur NS-3. Les résultats principaux de l'évaluation du framework sont les suivants:

1. L'hétérogénéité de réseau et la coopération de noeuds aident en augmentant le rapport de la livraison de message des noeuds mobiles. De cette façon, la capacité de noeuds de se relier simultanément à différents réseaux infrastructure et ad-hoc améliorent la livraison de message.

2. Le délais moyen de bout-en-bout se réduit en augmentant les nombres de copies par message au coût d'employer plus de ressources de réseau.
3. Seulement quelques copies par message (normalement 2) sont suffisantes pour fournir presque 100% du rapport de la livraison de messages en utilisant le framework MeDeHa. Ceci permet aux noeuds de MeDeHa de réaliser des rapports acceptables de la livraison avec une surcharge faible.
4. Les fonctions d'utilité comme DD exécutent mieux que des fonctions DI quand les noeuds ont plus d'occasions de contact (Quand ils se rencontrent plus souvent).
5. Les mécanismes qui sont basés sur les contacts des noeuds offrent de meilleurs rapports moyens de la livraison, tandis que les mécanismes qui sont bases sur l'affiliation d'une communauté fournissent le meilleur délai moyen.

D'ailleurs, nous avons évalué le framework MeDeHa en utilisant le trafic impliquant la priorité différente, et nous avons montré la gestion de tampon exécutée par les noeuds qui implémentent le framework. Nous avons également appris quelques leçons importantes spécifiques à l'expérimentation hybride. Les expériences hybrides permettent l'interopération des noeuds de simulateur et de vraies machines, et aident en vérifiant l'implémentation de simulation pendant lesquelles les vraies machines inter-communiquent avec des noeuds de simulateur. D'autre part, en raison de l'exécution en temps réel du simulateur NS-3, les expériences hybrides limitent le nombre de noeuds de simulateur à un certain nombre, et ce nombre dépend des capacités de traitement et d'établissement du programme de la machine sur laquelle nous exécutons le simulateur. Dans nos expériences hybrides, nous ne pourrions pas employer plus de 30 noeuds dans le simulateur en utilisant le dual-core Intel avec le processeur de 2.4 gigahertz et la RAM de 4 gigaoctets, où chaque noeud a 2 à 3 interfaces.

Pour conclure, le framework MeDeHa offre les avantages principaux suivants:

- Le framework se sert comme un pont entre les réseaux hétérogènes comprenant des noeuds de capacité divers et de réseau avec différentes caractéristiques.
- Il fournit la livraison de message à travers les réseaux multiples même dans la présence de la mobilité de noeuds.
- MeDeHa est capable de fonctionner sur des différentes couches de la pile de communication.
- Il est possible d'intégrer des protocoles existant de routage MANET afin de fournir la communication de multi-saute autant que possible.

- Le framework intègre des mécanismes existants de routage DTN.

Cependant, le framework MeDeHa emploie l'adresse IP des noeuds pour la communication, et la communication est fondée sur l'hypothèse que les adresses IP des noeuds ne changent pas pendant la session de communication. En fait, les adresses IP des noeuds sont imperméables à changer, particulièrement quand les noeuds sont mobiles et changent leurs points d'attachement en réseau. En plus, quand les noeuds sont multihomed, ils peuvent posséder plusieurs adresses IP; ainsi, les adresses IP des noeuds ne sont pas un bon candidat à employer pour la communication avec des noeuds mobiles. Nous avons abordé cette question dans la dernière partie de la thèse.

La conception actuelle du framework considère seulement la livraison de message aux destinations point-à-point. Il peut y avoir des environnements où la livraison de message de multi-destination est exigée. Par exemple, dans un centre de convention, un organisateur peut vouloir disséminer des messages des textes, d'acoustique ou de vidéo aux participants. Dans le futur, il sera intéressant d'explorer les possibilités et la praticabilité du framework MeDeHa pour fournir la livraison de message de multi-destination (point-à-multipoint). La conception de framework peut être passée en revue d'un point de vue de diffusion de contenu pour utiliser des stratégies telles que ContentPlace [95] dans les réseaux hétérogènes.

D'ailleurs, dans cette thèse, nous avons mis de côté les problèmes de couche transport de communication dans les réseaux hétérogènes. Ces issues incluent le *flow control*, le *congestion control* et la fiabilité. D'une certaine manière, ces issues sont manipulées à la couche réseau des noeuds, comme expédition des messages d'un noeud à un autre noeud est exécutées basé sur l'espace de tampon disponible au dernier. En plus, tous les messages sont acquittés une fois expédiés d'un noeud à l'autre – de ce fait fournissant la fiabilité de saute au saute, comme dans l'Architecture Bundle de DTN [17]. Mais nous croyons que des efforts doivent être faits pour manipuler ces issues de couche transport bout-en-bout dans les réseaux hétérogènes à connectivité épisodique.

Le mécanisme actuel du buffering dans le framework MeDeHa est basé sur des priorités de message. Quand un message arrive au module de MeDeHa et il n'y a aucun espace disponible, des messages avec des priorités inférieures peuvent être lâchés. Des priorités de message peuvent également être employées pour fournir un certain mécanisme du "*flow control*" tels qu'avant d'échanger des messages, deux noeuds trient les messages basés sur leurs priorités. En plus de fournir le contrôle de flux (le "*flow control*"), ceci aidera également dans la diffusion rapide pour le trafic prioritaire élevé, et c'est très utile quand la durée moyenne de contact des noeuds est inférieure que le nombre moyen de messages les noeuds doivent échanger, par exemple, en raison des vitesses élevées. Une approche similaire pour la gestion de tampon de cette façon est présentée dans [31] pour les réseaux opportuniste.

Une autre direction importante de future recherches pour le framework MeDeHa est son



interaction avec l'architecture Bundle de DTN [17]. Comme déjà indiqué dans le Chapitre 4, le framework MeDeHa est complémentaire à l'architecture de Bundle, mais nous pouvons noter que fournir la tolérance de déconnection n'est pas le seul but du framework MeDeHa. En travaillant avec l'architecture Bundle de DTN, un réseau de recouvrement de DTN peut être formé où les "DTN endpoint nodes" emploient des *bundles* en tant qu'unité de données de communication pour échanger des données entre eux. Les DTN endpoint noeuds dans ce réseau de recouvrement peuvent employer les noeuds MeDeHa pour traverser les plusieurs sauts afin de communiquer avec d'autres DTN endpoint noeuds. Une approche similaire a été déjà proposée dans laquelle le protocole AODV est utilisés pour la communications entre les DTN endpoint noeuds (PreDA [39]). Réciproquement, des réseaux MeDeHa peuvent être faits pour fonctionner avec les réseaux DTN. Le travail est en cours afin de réaliser cette interopération.

### 7.3 L'identification des noeuds dans les réseaux hétérogènes

Dans la troisième et la dernière partie de la thèse, nous avons présenté un mécanisme d'identification, appelé HeNNA, qui découple l'identification de noeuds avec leurs positions dans le réseau. Ceci permet à des noeuds de changer leurs points d'attachement avec le réseau tout en maintenant leur session de communication. Le framework MeDeHa ne comprend pas cette fonctionnalité. HeNNA est complémentaire au framework MeDeHa et peut être employé en coopération avec le framework. Dans le chapitre 6, nous avons montré cette coopération de HeNNA et MeDeHa en utilisant des simulations effectuées dans le simulateur NS-3. HeNNA également permet à traverser le NAT et permet à des noeuds mobiles d'employer des adresses IP dynamiquement assignées parmi l'espace adresse privée. Un autre dispositif de HeNNA est son capacité de fonctionner avec le routage de l'Internet d'aujourd'hui, qui permet au mécanisme HeNNA d'être déployé et utilisé dans l'Internet actuel. Le mécanisme support également le déconnection des noeuds mobiles avec le réseau. De cette façon, les noeuds avec des adresses IP permanentes dans l'Internet, appelé le *Location and Management Server (LMS)*, sont responsables de garder l'information de position la plus récente des noeuds mobiles et de stocker des messages des noeuds qui sont indisponibles.

Dans cette thèse, nous avons seulement présenté le *proof-of-concept* du mécanisme HeNNA. L'évaluation détaillée du protocole particulièrement en ce qui concerne la mobilité de noeuds et sa comparaison avec des mécanismes de nommage existants fait partie des travaux futurs. Une autre direction de future est le déploiement du mécanisme sur un vrai test-bed de sorte que l'exécution de HeNNA avec l'architecture de l'Internet puisse être évaluée. L'utilisation d'un mécanisme comme HeNNA pour intégrer l'Internet avec l'architecture Bundle de DTN [17] est une autre direction de recherches.

Tandis que HeNNA peut servir de module à la communication des noeuds mobiles dans les

réseaux hétérogènes à connectivité intermittente, des aspects de sécurité liés à HeNNA doivent être adressés avant qu'il soit déployé réellement dans l'Internet. Les soucis de sécurité sont principalement liés à la façon dont des messages de contrôle sont échangés entre les noeuds mobiles et les noeuds LMS de sorte que l'information d'endroit actuelle aux noeuds de LMS soit précise.

---

---



# Appendix A

## Glossary

### A.1 List of Acronyms and Abbreviations

**AD:**

Average Delivery Delay

**AP:**

Access Point

**CCN:**

Content Centric Networking

**CDF:**

Cumulative Distribution Function

**DHCP:**

Dynamic Host Configuration Protocol

**DNS:**

Domain Name System

**DONA:**

Data Oriented Network Architecture

**DTN:**

Delay or Disruption Tolerant Networks

**DYMO:**

Dynamic MANET On-demand Routing Protocol

**EID:**

Endpoint Identifier

**ER:**

Encounter-based Replication

**ESAR:**

Encounter and Social Affiliation-based Replication

**ESS:**

Extended Service Set

**GUID:**

Globally Unique Identifier

**GW:**

Gateway

**HA:**

Home Agent

**HeNNA:**

Heterogeneous Networks Naming Architecture

**HIP:**

Host Identity Protocol

**HNA:**

Host and Network Association

**LISP:**

Locator/Identifier Separation Protocol

**MANET:**

Mobile Ad-hoc Networks

**MDR:**

Message Delivery Ratio

**MeDeHa:**

Message Delivery in Heterogeneous Disruption-prone Networks

**MN:**

Mobile Node

**NAT:**

Network Address Translation

**OLSR:**

Optimized Link State Routing Protocol

**P2P:**

Peer-to-Peer

**PDA:**

Personal Digital Assistant

**PSM:**

Power Saving Mode

**RWP:**

Random Waypoint Mobility Model

**SAR:**

Social Affiliation-based Replication

**SID:**

Session Identifier

**VANET:**

Vehicular Ad-hoc Networks

## A.2 Basic Definitions

**Association:**

Connection of a node with an infrastructure-based network.

**Delay/Disruption Tolerant Networks:**

Networks that tolerate nodes intermittent connectivity and are not based on end-to-end Internet principle.

**Deterministic Routing:**

The encounters between two nodes can be determined based on their route information.

**Disassociation:**

Disconnection of a node from an infrastructure-based network.

**Enforced Routing:**

Special-purpose nodes are added to the network to enhanced routing.

**Forwarding:**

Only one copy of a message exists in the network.

**Gateway (GW):**

A node that runs the MeDeHa software and has the capability to connect to multiple networks simultaneously.

**Handoff:**

Connection transfer of a mobile node from one AP to another within an ESS.

**Hello Handshake:**

Neighbor sensing mechanism of MeDeHa for ad-hoc networks.

**Hop-by-hop Reliability:**

The data transfer between two neighboring nodes is reliable.

**Infrastructure-based Networks:**

Networks with fixed infrastructure and connectivity to the backbone. Examples include Wifi, WiMax, cellular-based networks.

**Infrastructure-based Node:**

A basestation or an AP providing the backbone connectivity to wireless nodes.

**Infrastructure-less Networks:**

Ad-hoc Networks without any fixed infrastructure including multi-hop mobile ad-hoc networks or MANETs.

**Late Binding:**

The process of acquiring the routing address of a destination from its application-level identifier while the packet is being routed.

**Opportunistic Routing:**

The encounters between two nodes are not known a priori.

**Replication:**

Multiple copies per message exist in the network.

**Ubiquitous Networks:**

Networks that provide continuous connectivity everywhere.

---

---

# BIBLIOGRAPHY

- [1] G. Maier, A. Feldmann, V. Paxson, and M. Allman, *On Dominant Characteristics of Residential Broadband Internet Traffic*, in Proceedings of the Internet Measurement Conference (IMC), Chicago, November 2009. 4, 14
- [2] N. Sarafijanovic-Djukic, M. Piorkowski, and M. Grossglauser, *Island Hopping: Efficient Mobility-Assisted Forwarding in Partitioned Networks*, In Proceedings of IEEE SECON'06, pp. 226-235, 2006. 7, 17, 32, 49, 56, 57, 59, 71
- [3] J. Ott, D. Kutscher, and C. Dwertmann, *Integrating DTN and MANET Routing*, In Proceedings of ACM 3 workshop on Challenged Networks (CHANTS), pp. 221-228, Pisa, Italy, 2006. 7, 17, 31, 71, 76, 111
- [4] J. Ott, *Delay Tolerance and The Future Internet*, In Proceedings of the 11th International Symposium on Wireless Personal Multimedia Communications (WPMC), 2008. 26, 30
- [5] J. Ott and D. Kutscher, *A Disconnection-Tolerant Transport for Drive-thru Internet Environments*, in Proceedings of IEEE Infocom 2005, Miami, March, 2005. 35, 36
- [6] K. Fall, S. Burleigh, A. Doria, J. Ott, and D. Young, *The DTN URI Scheme*, DTNRG Internet draft, 2009. 155
- [7] A. Vahdat and D. Becker, *Epidemic Routing for Partially Connected Ad Hoc Networks*, Technical Report CS-200006, Duke University, 2000. 7, 8, 17, 18, 31, 40, 43, 44, 48, 49, 131
- [8] J.-C. Chen, S. Li, S.-H. Chan, and J.-Y. He, *WIANI: Wireless Infrastructure and Ad-Hoc Network Integration*, In Proceedings of IEEE International Conference on Communications (ICC), pp. 3623-3627, Seoul, Korea, 2005. 7, 17, 27, 28, 70
- [9] J He J. Chen, S.-H. G. Chan, and S.-C. Liew, *Mixed-mode Wlan: The Integration of Ad Hoc Mode with Wireless LAN Infrastructure*, In Proceedings of IEEE Globecom, pp. 231-235, 2003. 7, 17, 27, 28, 70
- [10] C. Parata, G. Convertino, and V. Scarpa, *Flex-WiFi: A Mixed Infrastructure and Ad-Hoc IEEE 802.11 Network for Data Traffic in a Home Environment*, In Proceedings of the First



- IEEE WoWMoM Workshop on Autonomic and Opportunistic Communications (AOC), pp. 1-6, Finland, 2007. 7, 17, 27, 70
- [11] R. Chandra, P. Bahl, and P. Bahl, *MultiNet: Connecting to Multiple IEEE 802.11 Networks Using a Single Wireless Card*, In Proceedings of IEEE Infocom, pp. 882-893, Hong Kong, 2004. 7, 17, 21, 27, 28, 70, 72, 74, 83
- [12] IEEE-802.11e-2005, *IEEE Standard for Information Technology-Telecommunications and Information Exchange between Systems - Local and Metropolitan Area Networks*, ISBN: 0738147885, November, 2005. 27, 28, 70
- [13] O.V. Ratsimor, S.B. Kodeswaran, T. Finin, A. Joshi, and Y. Yesha, *Combining Infrastructure and Ad-hoc Collaboration for Data Management in Mobile Wireless Networks*, In Proceedings of The Workshop on Ad hoc Communications and Collaboration in Ubiquitous Computing Environments (CSCW'2002), Seattle, Washington, USA, 2003. 27, 28, 70
- [14] A. Hamidian, U. Korner, and A. Nilsson, *Performance of Internet Access Solutions in Mobile Ad Hoc Networks*, Wireless Systems and Mobility in Next Generation Internet, pp. 189-201, Springer Berlin, 2005. 7, 17, 28, 70
- [15] M. Musolesi, S. Hailes, and C. Mascolo, *Adaptive Routing for Intermittently Connected Mobile Ad Hoc Networks*, In Proceedings of the sixth IEEE International Symposium on a World of Wireless Mobile and Multimedia Networks (WoWMoM), 2005. 31, 71
- [16] K. Scott and S. Burleigh, *RFC 5050, Bundle Protocol Specifications*, IRTF DTN Research Group, November 2007. 30, 68, 71, 75
- [17] V. Cerf, S. Burleigh, A. Hooke, L. Torgerson, R. Durst, K. Scott, K. Fall, and H. Weiss, *RFC 4838, Delay-Tolerant Networking Architecture*, IRTF DTN Research Group, April 2007. 8, 18, 29, 41, 68, 70, 74, 90, 154, 181, 182, 187, 188
- [18] L. Wood, W.M. Eddy, and P. Holliday, *A Bundle of Problems*, In Proceedings of IEEE Aerospace Conference, pages 1-17, March 2009. 30
- [19] W. Zhao, M. Ammar, and E. Zegura, *A Message Ferrying Approach for Data Delivery in Sparse Mobile Ad Hoc Networks*, In Proceedings of ACM/IEEE MOBIHOC, pp. 187-198, Japan, 2004. 31, 40, 69, 71, 178, 184
- [20] R. Shah, S. Roy, S. Jain, and W. Brunette, *Data MULEs: Modeling a Three-tier Architecture for Sparse Sensor Networks*, In Proceedings of IEEE Workshop on Sensor Network Protocols and Applications (SNPA), pp. 30-41, Seattle, WA, 2003. 31, 40, 69, 71

- [21] W. Zhao, Y. Chen, M. Ammar, M. Corner, B.N. Levine, and E. Zegura, *Capacity Enhancement using Throwboxes in DTNs*, In Proceedings of IEEE International Conference on Mobile Ad hoc and Sensor Systems (MASS), pp. 31-40, Canada, 2006. 31, 57, 69, 71
- [22] R.N.B. Rais, T. Turetletti, and K. Obraczka, *Coping with Episodic Connectivity in Heterogeneous Networks*, In Proceedings of the 11th International Symposium on Modeling, Analysis and Simulation of Wireless and Mobile Systems (MSWiM), pp. 211-219, Canada, October 2008. 49, 104, 152, 168
- [23] R.N.B. Rais, T. Turetletti, and K. Obraczka, *MeDeHa - Efficient Message Delivery in Heterogeneous Networks with Intermittent Connectivity*, INRIA Research Report No. 7227, inria-00464085, March 2010. 49, 73, 74, 152, 169
- [24] R.N.B. Rais, M. Abdelmoula, T. Turetletti, and K. Obraczka, *Naming for Heterogeneous Networks prone to Episodic Connectivity*, to appear in the IEEE WCNC Conference, Cancun, Mexico, March 2011. 152
- [25] R.N.B. Rais, M. Mendonca, T. Turetletti, and K. Obraczka, *Towards Truly Heterogeneous Networks: Bridging Infrastructure-based and Infrastructure-less Networks*, to appear in the IEEE/ACM 3rd International Conference on Communication Systems and Networks (COMSNETS), Bangalore, India, January 2011. 74, 168
- [26] M. Mendonca, R.N.B. Rais, T. Turetletti, and K. Obraczka, *Message Delivery in Heterogeneous Disruption-prone Networks*, demo presentation in ACM Mobicom, Chicago, September 2010. 112, 145, 146
- [27] T. Spyropoulos, R.N.B. Rais, T. Turetletti, K. Obraczka, and A. Vasilakos, *Routing for Disruption Tolerant Networks: Taxonomy and Design*, ACM/Springer Wireless Networks, Vol. 16, No. 8, DOI: 10.1007/s11276-010-0276-9, pages 2349-2370, November 2010. 41, 63
- [28] T. Spyropoulos, T. Turetletti, and K. Obraczka, *Routing in Delay Tolerant Networks Comprising Heterogeneous Node Populations*, IEEE Transactions on Mobile Computing (TMC) Vol. 8, No. 8, pp. 1132-1147, August 2009. 45, 49, 52, 56, 71, 75, 78, 122, 123
- [29] T. Spyropoulos, K. Psounis, and C.S. Raghavendra, *Spray and Wait: Efficient Routing in Intermittently Connected Mobile Networks*, In Proceedings of ACM SIGCOMM workshop on Delay Tolerant Networking (WDTN), 2005. 7, 8, 17, 18, 42, 44, 45, 48, 49, 61, 62, 76, 123, 131
- [30] T. Spyropoulos, K. Psounis, and C.S. Raghavendra, *Spray and Focus: Efficient Mobility-Assisted Routing for Heterogeneous and Correlated Mobility*, In Proceedings of IEEE Percom

- International Workshop on the Intermittently Connected Mobile Ad-hoc Networks (ICMAN), March 2007. 49, 76
- [31] A. Krifa, C. Barakat, and T. Spyropoulos, *Optimal Buffer Management Policies for Delay Tolerant Networks*, in Proceedings of IEEE SECON conference, San Francisco, June 2008. 181, 187
- [32] T. Clausen and P. Jacquet, *Optimized Link State Routing Protocol (OLSR)*, IETF RFC 3626, 2003. 5, 15, 29, 39, 54, 70, 76, 93
- [33] C. Perkins, E. Belding-Royer, and S. Das, *Ad hoc On-Demand Distance Vector (AODV) Routing*, IETF RFC 3561, 2003. 5, 15, 31, 76
- [34] C. Perkins and P. Bhagwat, *Highly Dynamic Destination-Sequenced Distance-Vector routing (DSDV) for Mobile Computers*, In Proceedings of ACM SIGCOMM, 1994. 5, 15, 31
- [35] I. Chakerens and C. Perkins, *Dynamic MANET On-demand (DYMO) Routing*, IETF Internet draft (Work in Progress), draft-ietf-manet-dymo-20, July 2010. 29, 70, 92
- [36] M. Grossglauser and M. Vetterli, *Locating Mobile Nodes with EASE: Learning Efficient Routes from Encounter Histories Alone*, IEEE/ACM Transactions on Networking, Vol. 14, No. 3, pp. 457-469, June 2006. 50, 71, 75, 130
- [37] J. Boice, J.J. Garcia-Luna-Aceves, and K. Obraczka, *Combining On-demand and Opportunistic Routing for Intermittently Connected Networks*, Ad Hoc Networks, Vol. 7, No. 1, pages 201-218, January 2009. 32, 71
- [38] J. Whitbeck and V. Conan, *HYMAD: Hybrid DTN-MANET Routing for Dense and Highly Dynamic Wireless Networks*, Computer Communications, Vol. 33, No. 13, pages 1483-1492, August 2010. 32, 71
- [39] F. Esposito and I. Matta, *PreDA: Predicate Routing for DTN Architectures over MANET*, In Proceedings of IEEE Globecom, Honolulu, USA, December 2009. 32, 71, 111, 181, 188
- [40] A. Snoeren and H. Balakrishnan, *An End-to-End Approach to Host Mobility*, In Proceedings of ACM Mobicom, 2000. 36
- [41] A. Seth, P. Darragh, S. Liang, Y. Lin, and S. Keshav, *An Architecture for Tetherless Communication*, In DTN Workshop, July 2005. 32
- [42] S. Bhattacharyya, S. Keshav, and A. Seth, *Opportunistic Data Transfer over Heterogeneous Wireless Networks*, US Patent No. 7769887, "http://www.freepatentsonline.com/7769887.html", August 2010. 36

- [43] A. Seth, D. Kroeker, M. Zaharia, S. Guo, and S. Keshav, *Low-cost Communication for Rural Internet Kiosks using Mechanical Backhaul*, In Proceedings of ACM Mobicom, 2006. 31, 36
- [44] A. Seth, S. Bhattacharyya, and S. Keshav, *Application Support for Opportunistic Communication on Multiple Wireless Networks*, Manuscript, "<http://blizzard.cs.uwaterloo.ca/keshav/home/Papers/data/05/ocmp.pdf>", November 2005. 35
- [45] B.A. Ford, *Unmanaged Internet Architecture (UIA)*, PhD Thesis, MIT, September 2008. 35
- [46] B.A. Ford, J. Strauss, C. Lesniewski-Laas, S. Rhea, F. Kaashoek, and R. Morris, *Persistent Personal Names for Globally Connected Mobile Devices*, In Proceedings of OSDI, pages 233-248, Seattle, USA, November, 2006. 160
- [47] J. Scott, J. Crowcroft, P. Hui, and C. Diot, *Haggle: a Networking Architecture Designed Around Mobile Users*, in Proceedings of the Third Annual Conference on Wireless On-demand Network Systems and Services, January 2006. 5, 15, 34, 152
- [48] S. Nelson, M. Bakht, and R. Kravets, *Encounter-Based Routing in DTNs*, In Proceedings of IEEE Infocom'09, Brazil, 2009. 31, 71, 75, 130
- [49] A. Lindgren, A. Doria, and O. Schelén, *Probabilistic Routing in Intermittently Connected Networks*, Lecture Notes in Computer Science, Vol. 3126, pp. 239-254, January 2004. 75, 130
- [50] Y. Zhu and X. Wu, *Mobility Assisted Routing Strategy (MARS) for Hybrid Ad Hoc Networks*, in Proceedings of 4th International Wireless Communications and Mobile Computing Conference (IWCMC), 2008. 71
- [51] L. Ding, B. Gu, and X. Hong, *Routing Across Colonies in Delay Tolerant Networks*, Technical Report No. TR-2009-02, Computer Science, University of Alabama, 2009. 71
- [52] C. Liu and J. Wu, *Efficient Adaptive Routing in Delay Tolerant Networks*, in Proceedings of IEEE International Conference of Communications (ICC), 2009. 71, 76
- [53] C. Kretschmer, S. Rieß, and C. Schindelhauer, *DT-DYMO: Delay-tolerant Dynamic MANET On-demand Routing*, in Proceedings of 29th IEEE International Conference on Distributed Computing Systems Workshops, 2009. 71, 76
- [54] T. Matsuda, H. Nakayama, X. Shen, Y. Nemoto, and N. Kato, *Gateway Selection Protocol in Hybrid MANET using DYMO Routing*, Mobile Networks and Applications, Vol. 15, No. 2, pages 205-215, 2010.

- [55] M. Chuah, L. Cheng, and B. Davison, *Enhanced Disruption and Fault Tolerant Network Architecture for Bundle Delivery*, in Proceedings of IEEE Globecom, 2005. 8, 18, 72, 152, 154, 155
- [56] V. Jacobson, D.K. Smetters, J.D. Thornton, M. Plass, N. Briggs, and R.L. Braynard, *Networking Named Content*, in Proceedings of ACM CoNext, 2009. 8, 18, 33, 72, 152, 156
- [57] Network Simulator and Network Animator Project (NSNAM), *Network Simulator 2 (NS-2)*, <http://nnsam.isi.edu/nnsam/index.php>. 103
- [58] *The OMNET++ Network Simulation Framework*, <http://www.omnetpp.org>. 101, 103, 115
- [59] Network Simulator and Network Animator Project (NSNAM), *Network Simulator 3 (NS-3)*, <http://www.nsnam.org>. 101, 103, 105, 168
- [60] IEEE Communications Society, *IEEE 802.11: Wireless LAN Medium Access Control (MAC) and Physical Layer (PHY) Specifications*, (2007 revision). IEEE-SA. 12 June 2007. doi:10.1109/IEEESTD.2007.373646. 100, 104
- [61] C. Bettstetter, *Smooth is Better than Sharp: A Random Mobility Model for Simulation of Wireless Networks*, In Proceedings of the 4th ACM International Symposium on Modeling, Analysis and Simulation of Wireless and Mobile Systems (MSWiM), pages 19-27, Italy, 2001. 102
- [62] T. Camp, J. Boleng, and V. Davies, *A Survey of Mobility Models for Ad Hoc Network Research*, Wireless Communications and Mobile Computing (WCMC), Special Issue on Mobile Ad-hoc Networking, Vol. 2, pages 483-502, 2002. 102
- [63] C. Bettstetter and C. Wagner, *The Spatial Node Distribution of the Random Waypoint Mobility Model*, In Proceedings of the First German Workshop on Mobile Ad-Hoc Networks (WMAN), GI Lecture Notes in Informatics, Vol. 11, pp. 41-58, 2002. 102, 115, 124
- [64] M. Feeley, N. Hutchinson, and S. Ray, *Realistic Mobility for Mobile Ad Hoc Network Simulation*, Ad-Hoc, Mobile, and Wireless Networks, Lecture Notes in Computer Science Vol. 3158, Springer Berlin, 2004. 115, 124, 137
- [65] BonnMotion, University of Bonn, *A Mobility Scenario Generation and Analysis Tool*, <http://web.informatik.uni-bonn.de/IV/Mitarbeiter/dewaal/BonnMotion>. 102, 115, 170
- [66] I. Rhee, M. Shin, S. Hong, K. Lee, S. Kim, and S. Chong, *CRAWDAD Data Set ncsu/mobilitymodels (v. 2009-07-23)*, <http://crawdad.cs.dartmouth.edu/ncsu/mobilitymodels>, July 2009. 102, 143

- [67] *Community Resource for Archiving Wireless Data At Dartmouth (CRAWDAD) Mobility Traces*, <http://www.crowdad.org>. 102, 112
- [68] T. Bradley, C. Brown, and A. Malis, *Inverse Address Resolution Protocol (InARP)*, IETF RFC 2390, 1998. 106
- [69] *Netfilter*, <http://www.netfilter.org/>. 107, 108, 110
- [70] *Hostapd*, <http://hostap.epitest.fi/hostapd/>. 107, 109, 111
- [71] *olsrd*, <http://www.olsr.org/?q=about>. 109, 111
- [72] S. Bromage, J. Koshimoto, C. Engstrom, M. Bromage, V. Petkov, B. Nunes, H. Taylor, K. Obraczka, S. Dabideen, M. Hu, R. Menchaca-Mendez, D. Nguyen, D. Sampath, JJ. Garcia-Luna-Aceves, H. Sadjadpour, and B. Smith, *SCORPION: A Heterogeneous Wireless Networking Testbed*, ACM SIGMOBILE Mobile Computing and Communications Review, 2009. 111, 146
- [73] *Drive-thru Internet Project*, <http://www.drive-thru-internet.org/>. 35
- [74] *NS-3 Tap Bridge*, [http://www.nsnam.org/doxygen-release/group\\_\\_tap\\_bridge\\_model.html](http://www.nsnam.org/doxygen-release/group__tap_bridge_model.html). 111
- [75] *Netfilter Hacking HowTo*, <http://www.iptables.org/documentation/HOWTO/netfilter-hacking-HOWTO-3.html>. 110
- [76] *Ath5k Wireless Driver*, <http://linuxwireless.org/en/users/Download>. 109
- [77] C. Perkins, *IP Mobility Support for IPv4*, RFC 3344, 2002. 27, 32, 152, 155, 158, 163
- [78] D. Johnson, C. Perkins, and J. Arkko, *Mobility Support in IPv6*, IETF 3775, 2004. 27, 152, 158, 163
- [79] P. Basu, D. Brown, S. Polit, and R. Krishnan, *Intentional Naming in DTN*, DTNRG Internet draft, 2009. 8, 18, 152, 157
- [80] H. Balakrishnan, K. Lakshminarayanan, S. Ratnasamy, S. Shenker, I. Stoica, and M. Wal-fish, *A Layered Naming Architecture for the Internet*, In Proceedings of ACM SIGCOMM, 2004. 7, 8, 17, 18, 33, 34, 151, 152, 156
- [81] T. Koponen, M. Chawla, B-G Chun, A. Ermolinskiy, K. Kim, S. Shenker, and I. Stoica, *A Data-Oriented (and Beyond) Network Architecture*, In Proceedings of ACM SIGCOMM, 2007. 8, 18, 34, 152, 156, 167
- [82] D. Farinacci, V. Fuller, D. Meyefr, and D. Lewis, *Locator/ID Separation Protocol*, Internet Draft, Network Working Group, August 2010. 7, 8, 17, 18, 152, 157

- [83] D. Meyer, *The Locator/Identifier Separation Protocol*, The Internet Protocol Journal Vol.11, N.1, 2008. 158
- [84] R. Moskowitz and P. Nikander, *Host Identity Protocol Architecture*, RFC 4423, 2006. 7, 8, 17, 18, 32, 152, 158
- [85] H. Soliman, C. Castelluccia, K. ElMalki, and L. Bellier, *Hierarchical Mobile IPv6 Mobility Management*, RFC 5380, 2008. 165
- [86] J. Laganier and L. Eggert, *Host Identity Protocol (HIP) Rendezvous Extension*, RFC 5204, 2008. 163
- [87] S. Schützb, H. Abrahamssona, B. Ahlgrena, and M. Brunnerb, *Design and Implementation of the Node Identity Internetworking Architecture*, Computer Networks, 54(7), pages 1142-1154, 2010. 158
- [88] P. Vixie, S. Thomson, Y. Rekhter, and J. Bound, *Dynamic Updates in the Domain Name System (DNS UPDATE)*, RFC 2136, 1997. 158, 159
- [89] *DynDNS.com Support*, <http://www.dyndns.com/support/abuse.html>. 159
- [90] E. Nordmark and M. Bagnulo, *Shim6: Level 3 Multihoming Shim Protocol for IPv6*, RFC 5533, 2009. 152
- [91] L. Clare, S. Burleigh, and K. Scott, *Endpoint Naming for Space Delay/Disruption Tolerant Networking*, IEEE Aerospace Conference, 2010. 154
- [92] S. Burleigh, A. Hooke, L. Torgerson, K. Fall, V. Cerf, B. Durst, K. Scott, and H. Weiss, *Delay-Tolerant Networking: An Approach to Interplanetary Internet*, in IEEE Communications Magazine, Vol. 41, Issue 6, June 2003. 29, 30, 154
- [93] T. Berners-Lee, R. Fielding, and L. Masinter, *Universal Resource Identifier (URI): Generic Syntax*, IETF RFC 3986, 2005. 155
- [94] J. Saltzer, *On The Naming and Binding of Network Destinations*, IETF RFC 1498, September 1992. 7, 17, 32, 153
- [95] C. Boldrini, M. Conti, and A. Passarella, *Design and Performance Evaluation of Content-Place, a Social-Aware Data Dissemination System for Opportunistic Networks*, Computer Networks, 2009, doi: 10.1016/j.comnet.2009.09.001. 181, 187
- [96] J. Broch, D.A. Maltz, D.B. Johnson, Y-C. Hu, and J. Jetcheva, *A Performance Comparison of Multi-Hop Wireless Ad Hoc Network Routing Protocols*, In Proceedings of Mobile Computing and Networking, 1998. 39, 54

- [97] S. Jain, K. Fall, and R. Patra, *Routing in a Delay Tolerant Network*, In Proceedings of ACM SIGCOMM, 2004. 30, 39
- [98] K. Fall, *A Delay-Tolerant Network Architecture for Challenged Internets*. In Proceedings of ACM SIGCOMM, August 2003. 29
- [99] D. Yu and H. Li, *On the Definition of Ad Hoc Network Connectivity*, In Proceedings of International Conference on Communications Technologies (ICCT), 2003, pages 990-994. 54
- [100] B. Krishnamachari, S.B. Wicker, and R. Bejar, *Phase Transition Phenomena in Wireless Ad Hoc Networks*, In Proceedings of IEEE Globecom, 2001, pages 2921-2925. 54
- [101] B. Krishnamachari, S.B. Wicker, R. Bejar, and M. Pearlman, *Critical Density Thresholds in Distributed Wireless Networks*, In Proceedings of Communications, Information and Network Security, 2002, pages 1-15. 54
- [102] S. Katti, H. Rahul, W. Hu, D. Katabi, M. Medard, and J. Crowcroft, *XORs In The Air: Practical Wireless Network Coding*, In Proceedings of ACM SIGCOMM, 2006. 46, 49, 56
- [103] T. Henderson, D. Kotz, and I. Abyzov, *The Changing Usage of a Mature Campus-wide Wireless Network*, In Proceedings of the 10th annual international conference on Mobile computing and networking, 2004. 51, 56
- [104] P. Juang, H. Oki, Y. Wang, M. Martonosi, L.S. Peh, and D. Rubenstein, *Energy-efficient Computing for Wildlife Tracking: Design Tradeoffs and Early Experiences with ZebraNet*, In Proceedings of ACM ASPLOS, 2002. 44, 49, 56, 59, 62
- [105] J. Ghosh, S.J. Philip, and C. Qiao, *Sociological Orbit Aware Location Approximation and Routing in MANET*, In Proceedings of 2nd International Conference on Broadband Networks, 2005. 49, 51, 57
- [106] M. Musolesi and C. Mascolo, *A Community Based Mobility Model for Ad Hoc Network Research*, In Proceedings of ACM REALMAN, 2006. 57
- [107] J. Scott, P. Hui, J. Crowcroft, and C. Diot, *Haggle: A Networking Architecture Designed Around Mobile Users*, In Proceedings of IFIP Conference on Wireless On-demand Network Systems and Services (WONS), 2006. 58
- [108] J. Leguay, T. Friedman, and V. Conan, *DTN Routing in a Mobility Pattern Space*, In Proceedings of ACM SIGCOMM workshop on Delay Tolerant Networking (WDTN), 2005. 49, 51, 58



- [109] A. Lindgren, A. Doria, and O. Schelen, *Probabilistic routing in intermittently connected networks*, Lecture Notes in Computer Science, Vol. 3126, pages 239-254, January 2004. 44, 49, 59
- [110] J. Boice, J.J. Garcia-Luna-Aceves, and K. Obraczka, *Disruption-Tolerant Routing with Scoped Propagation of Control Information*, In Proceedings of International Conference on Communications (ICC), 2007, pages 3114-3121. 59
- [111] X. Zhang, G. Neglia, J. Kurose, and D. Towsley, *Performance Modeling of Epidemic Routing*, In Proceedings of IFIP Networking, 2006. 59
- [112] T. Small and Z. Haas, *Resource and Performance Tradeoffs in Delay-Tolerant Wireless Networks*, In Proceedings of ACM SIGCOMM workshop on Delay Tolerant Networking (WDTN), 2005. 42, 44, 49, 59
- [113] P. Ramanathan and A. Singh, *Delay Differentiated Gossiping in Delay Tolerant Networks*, In Proceedings of International Conference on Communications (ICC), 2008, pages 3291-3295. 44
- [114] J. Burgess, B. Gallagher, D. Jensen, and B.N. Levine, *MaxProp: Routing for Vehicle-Based Disruption-Tolerant Networks*, In Proceedings of IEEE Infocom, April 2006. 30, 49, 52
- [115] N. Banerjee, M.D. Corner, D. Towsley, and B.N. Levine, *Relays, Base Stations and Meshes: Enhancing Mobile Networks with Infrastructure*, In Proceedings of ACM Mobicom, September 2008. 73, 133, 148
- [116] M. Grossglauser and D. Tse, *Mobility Increases the Capacity of Ad Hoc Wireless Networks*, IEEE/ACM Transactions on Networking, vol 10, no 4, pages 1360-1369, August 2002. 41
- [117] G. Neglia and X. Zhang, *Optimal Delay-Power Tradeoff in Sparse Delay Tolerant Networks: A Preliminary Study*, In Proceedings of ACM SIGCOMM workshop on Challenged Networks (CHANTS'06), 2006. 42
- [118] Y. Wang, S. Jain, M. Martonosi, and K. Fall, *Erasure Coding Based Routing for Opportunistic Networks*, In Proceedings of ACM SIGCOMM workshop on Delay Tolerant Networking (WDTN), 2005. 46, 49
- [119] X. Zixiang, A.D. Liveris, and S. Cheng, *Distributed Source Coding for Sensor Networks*, IEEE Signal Processing Magazine, Vol. 21, Issue 5, pages 80-94, September 2004. 46
- [120] I. Solis and K. Obraczka, *Efficient Continuous Mapping in Sensor Networks Using Isolines*, In Proceedings of MobiQuitous, 2005, pages 325-332. 46

- [121] A. Kamra, V. Misra, J. Feldman, and D. Rubenstein, *Growth Codes: Maximizing Sensor Network Data Persistence*, In Proceedings of ACM SIGCOMM, 2006. 46, 49
- [122] J. Widmer and J-Y. Le Boudec, *Network Coding for Efficient Communication in Extreme Networks*, In Proceedings of ACM SIGCOMM workshop on Delay Tolerant Networking (WDTN), 2005. 46, 47, 49
- [123] S-Y. R. Li, R.W. Yeung, and N. Cai, *Linear Network Coding*, IEEE Transactions on Information Theory, February 2003, Vol. 49, pages 371-381. 46
- [124] S. Deb, C. Choute, M. Medard, and R. Koetter, *Data Harvesting: A Random Coding Approach to Rapid Dissemination and Efficient Storage of Data*, In Proceedings of the IEEE Infocom, March 2005. 47
- [125] H. Dubois-Ferriere, M. Grossglauser, and M. Vetterli, *Age Matters: Efficient Route Discovery in Mobile Ad Hoc Networks using Encounter Ages*, In Proceedings of ACM MobiHoc, 2003. 49, 50
- [126] First Mile Solutions, <http://www.firstmilesolutions.com>. 56
- [127] KioskNet (VLINK), University of Waterloo, Canada, <http://blizzard.cs.uwaterloo.ca/tetherless/index.php>. 56
- [128] J. Leguay, V. Conan, and T. Friedman, *Evaluating MobySpace-based Routing Strategies in Delay-Tolerant Networks*, Wireless Communications and Mobile Computing, May 2007. 49, 51
- [129] S. Capkun, L. Buttyan, and J. Hubaux, *Self-Organized Public Key Management for Mobile Ad Hoc Networks*, IEEE Transactions on Mobile Computing, Vol. 1, No. 1, pages 52-64, 2002. 53
- [130] P. Resnick, R. Zeckhauser, E. Friedman, and K. Kuwabara, *Reputation Systems, Facilitating Trust in Internet Interactions*, In Proceedings of Communications of the ACM, December 2000, pages 45-48. 53
- [131] A. Balasubramanian, B.N. Levine, and A. Venkataramani, *DTN Routing as a Resource Allocation Problem*, In Proceedings of the ACM SIGCOMM, August 2007. 49
- [132] A. Balasubramanian, B.N. Levine, and A. Venkataramani, *Replication Routing in DTNs: A Resource Allocation Approach*, IEEE/ACM Transactions on Networking, Vol. 18 Issue 2, pages 596-609, 2010. 48, 49

- [133] P. Hui, A. Chaintreau, J. Scott, R. Gass, J. Crowcroft, and C. Diot, *Pocket Switched Networks and Human Mobility in Conference Environments*, In Proceedings of ACM SIGCOMM workshop on Delay Tolerant Networking (WDTN), 2005. 5, 15, 34, 102
- [134] B. Burns, O. Brock, and B.N. Levine, *MV Routing and Capacity Building in Disruption Tolerant Networks*, In Proceedings of the IEEE Infocom, March 2005. 49
- [135] M. Shiny, S. Hongyy, and I. Rhee, *DTN Routing Strategies using Optimal Search Patterns*, In Proceedings of the third ACM Workshop on Challenged Networks (CHANTS), September 15, 2008, San Francisco, California, USA. 46, 49
- [136] S.C. Nelson, M. Bakht, and R. Kravets, *Encounter-Based Routing in DTNs*, In Proceedings of the IEEE Infocom, Rio de Janeiro, Brazil, April 2009. 45, 49, 50
- [137] R. Ramanathan, R. Hansen, P. Basu, R. Rosales-Hain, and R. Krishnan, *Prioritized Epidemic Routing for Opportunistic Networks*, In Proceedings of the 1st International MobiSys Workshop on Mobile Opportunistic Networking, Puerto Rico, 2007. 43, 49
- [138] V. Erramilli and M. Crovella, *Forwarding in Opportunistic Networks with Resource Constraints*, In Proceedings of third ACM Workshop on Challenged Networks (CHANTS), September 15, 2008, San Francisco, CA, USA. 48
- [139] G. Sandulescu and S. Nadjm-Tehrani, *Opportunistic DTN routing with Window-Aware Adaptive Replication*, In Proceedings of the ACM 4th Asian Conference on Internet Engineering (AINTEC), Bangkok, Thailand, November 2008. 48, 49
- [140] P. Hui, J. Crowcroft, and E. Yoneki, *BUBBLE Rap: Social-based Forwarding in Delay Tolerant Networks*, In Proceedings of ACM MobiHoc'08, Hong Kong, May 2008. 51, 52
- [141] V. Erramilli, M. Crovella, A. Chaintreau, and C. Diot, *Delegation Forwarding*, In Proceedings of ACM MobiHoc'08, Hong Kong, May 2008. 48
- [142] H. Jun, M.H. Ammar, and E.W. Zegura, *Power Management in Delay Tolerant Networks: A Framework and Knowledge-Based Mechanisms*, In Proceedings of IEEE SECON, 2005. 60
- [143] W. Wang, V. Srinivasan, and M. Motani, *Adaptive Contact Probing Mechanisms for Delay Tolerant Applications*, In Proceedings of ACM Mobicom, 2007. 60
- [144] E. Altman, A.P. Azad, T. Basar, and F. Pellegrini, *Optimal Activation and Transmission Control in Delay Tolerant Networks*, In Proceedings of IEEE Infocom, 2010. 60
- [145] Y. Xi, M. Chuah, and K. Chang, *Performance Evaluation of a Power Management Scheme for Disruption Tolerant Network*, Lecture Notes in Computer Science, vol. 12, no. 5.6, pages 370-380, December 2007. 60

- [146] B.J. Choi and X. Shen, *Adaptive Asynchronous Clock based Power Saving Protocols for Delay Tolerant Networks*, In Proceedings of IEEE Globecom'09, Honolulu, Hawaii, USA, 2009. 60
- [147] N. Banerjee, M.D. Corner, and B.N. Levine, *Design and Field Experimentation of an Energy-Efficient Architecture for DTN Throwboxes*, IEEE/ACM Transactions on Networking, Vol. 18 Issue 2, pages 554-567, 2010. 60
- [148] P.U. Tournoux, E. Lochin, J. Leguay, and J. Lacan, *Robust Streaming in Delay Tolerant Networks*, In Proceedings of IEEE ICC Conference, May 2010. 181
- [149] K.A. Harras and K.C. Almeroth, *Transport Layer Issues in Delay Tolerant Mobile Networks*, In Proceedings of IFIP Networking, May 2006. 181
- 
-

## RÉSUMÉ

Il est très probable que l'Internet de futur interconnectera des réseaux encore plus hétérogènes qu'ils ne le sont aujourd'hui. Aussi, les nouvelles applications incluant la surveillance de l'environnement, l'intervention d'urgence et la communication véhiculaire nécessitent une plus grande tolérance aux délais ainsi qu'aux pertes de connectivité. L'interconnexion des réseaux hétérogènes robustes aux coupures de connectivité pose de nombreux défis scientifiques. Dans cette thèse nous proposons trois contributions principales dans ce domaine. Premièrement, nous présentons une classification des protocoles de routage DTN qui se base sur les stratégies de routage. Nous proposons des heuristiques pour choisir le meilleur module de routage à utiliser. Deuxièmement, nous proposons un nouveau protocole, appelé MeDeHa, pour disséminer des messages dans les réseaux hétérogènes à connectivité intermittente. MeDeHa permet d'interconnecter des réseaux infrastructures avec des réseaux ad-hoc, en utilisant plusieurs interfaces réseaux et il permet d'utiliser des protocoles de routage existants comme OLSR pour les réseaux MANETs. Nous évaluons MeDeHa par des simulations utilisant des traces de mobilités synthétiques et réelles, mais aussi en effectuant des expérimentations hybrides fonctionnant en partie sur simulateur et en partie sur des machines réelles. Troisièmement, nous proposons un mécanisme de nommage appelé HeNNA pour des réseaux hétérogènes à connectivité épisodique. Ce mécanisme permet de transmettre des messages aux noeuds indépendamment de leurs adresses IP et donc de leur localité. HeNNA est compatible avec le routage actuel de l'Internet. Enfin, nous avons intégré HeNNA dans le protocole MeDeHa afin d'illustrer le fonctionnement de l'ensemble de la pile de communication.

**Mots-clés:** Réseaux hétérogènes, connectivité intermittente, identification de noeud, taxonomie

## ABSTRACT

As the networks are becoming increasingly heterogeneous, it is expected that future internetworks will interconnect different types of network including infrastructure-based and ad-hoc wireless networks including MANETs. Additionally, a number of emerging applications such as environmental monitoring, emergency response, require that future internetworks be tolerant to connectivity disruptions. Interconnecting these heterogeneous networks poses several challenges including seamless message delivery and identification of mobile nodes. The contributions of this thesis are three fold. First, we present a classification of existing DTN routing protocols by breaking up existing routing strategies into tunable routing modules. Then, we identify some design guidelines to show how and when a given routing module should be used. Second, we propose a new framework called MeDeHa to provide message delivery across heterogeneous networks prone to intermittent connectivity. MeDeHa is able to seamlessly bridge infrastructure-based and ad-hoc networks, through devices carrying multiple interfaces and by the integration of existing protocols. We evaluate MeDeHa through extensive simulations using realistic synthetic and real mobility traces, and by performing hybrid experiments which run partly on simulator and partly on real machines. Third, we propose a naming mechanism called HeNNA for heterogeneous networks prone to connectivity disruptions, which provides message delivery to nodes irrespective of their IP addresses. Henna is compatible with the status-quo Internet routing. We also implement HeNNA within MeDeHa to showcase the operation of complete message delivery protocol suite.

**Keywords:** Heterogeneous networks, Intermittent connectivity, Node identification, Routing taxonomy