

Quantum dynamics in a dcSQUID:

From a phase qubit to a 2D quantum oscillator

Florent LECOCQ

11 mai 2011

Soutenance de thèse pour
obtenir le titre de Docteur de
l'Université de Grenoble

Directeur de thèse :

Olivier BUISSON

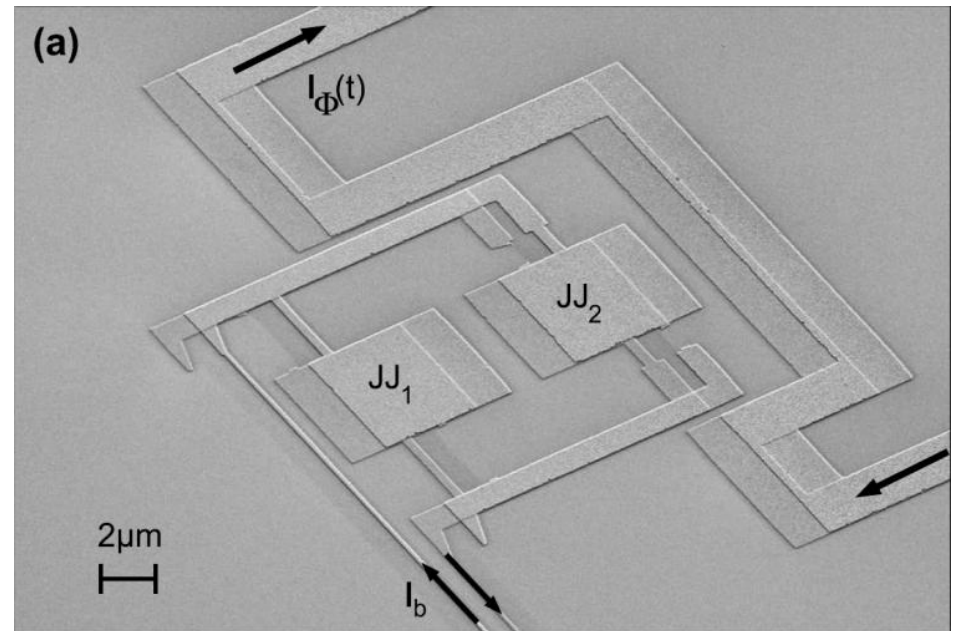

Quantum integrated circuits

- **Ultra-low dissipation** : superconductivity
- **Ultra-low noise** : low temperature
- **Non-linear, non-dissipative element** : Josephson junction

Josephson junction based electronics and superconducting qubits

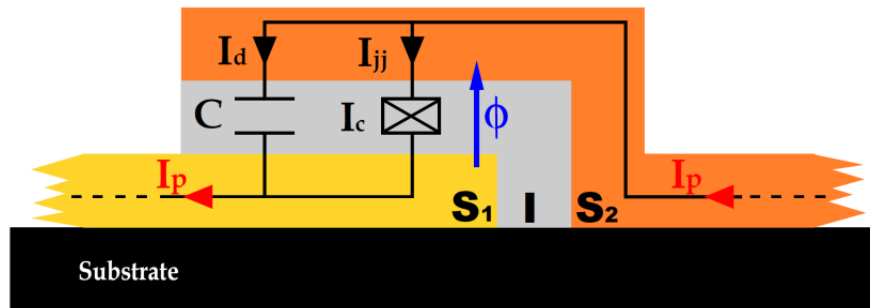

$$E_J = \frac{\Phi_0}{2\pi} I_c$$

$$E_C = \frac{(2e)^2}{2C}$$

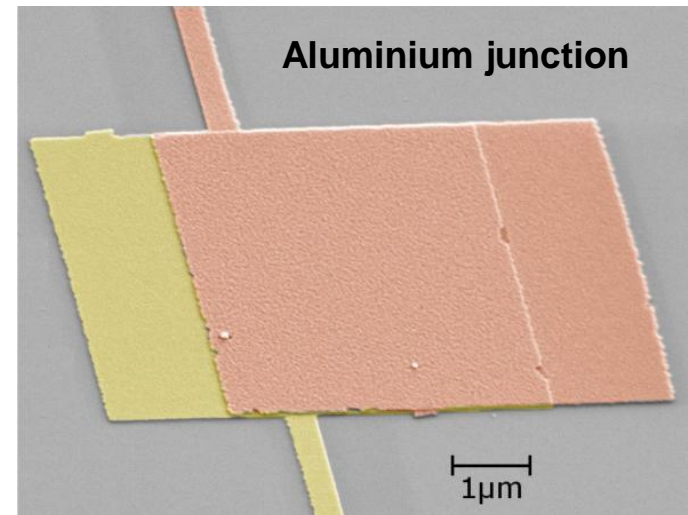

Macroscopic quantum effects...

Voss *et al*, PRL (1981)

Devoret *et al*, PRL (1985)

... and quantized energy levels (microwave frequency regime)

Martinis *et al*, PRL (1985)

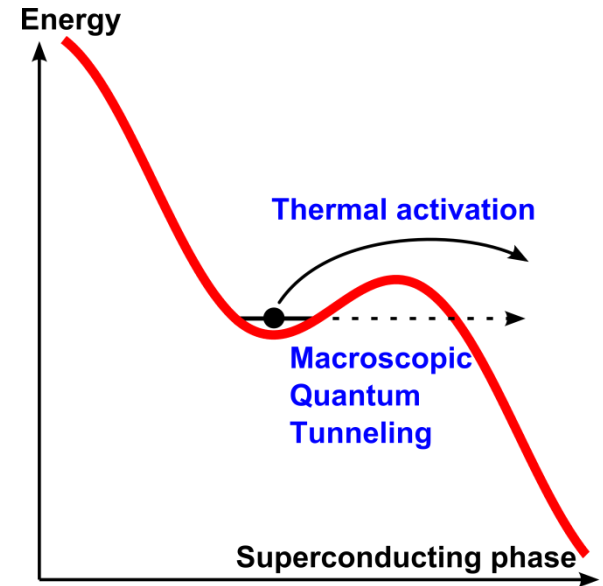

An artificial atom controlled by electronics signals

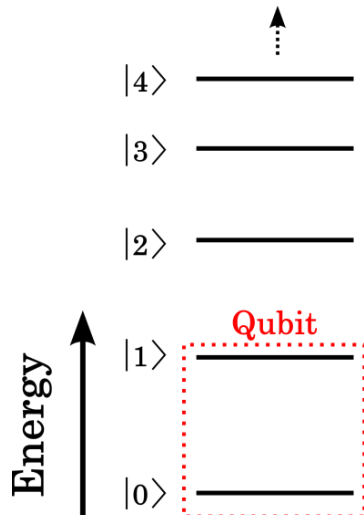

- Non-linear quantum oscillator
- Superconducting qubit

Nakamura *et al*, Nature (1999)

Engineering quantum mechanics

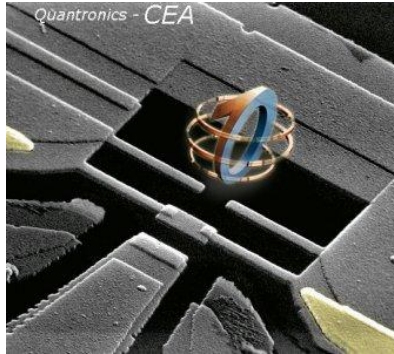

Vion et al, Science (2002)

- Coherence
- Optimal point

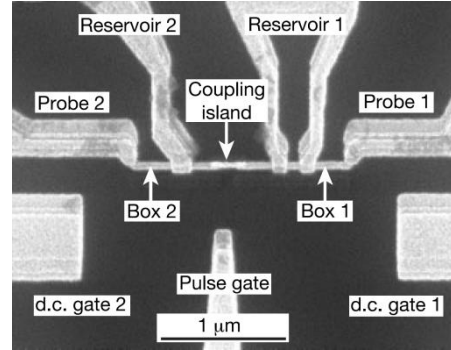

Pashkin et al, Nature (2003)

- Coupling
- Gates
- Algorithm

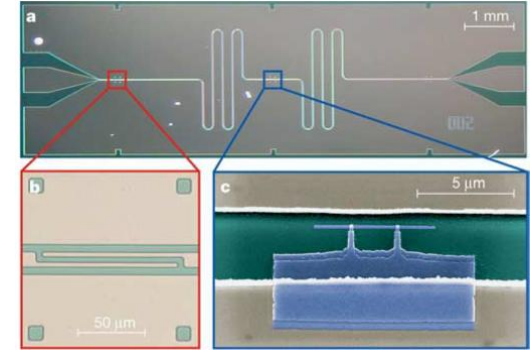

Wallraff et al, Nature (2004)

- Readout
- Memory
- Bus

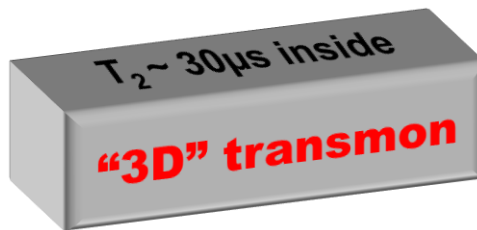

Yale, APS Meeting (2011)

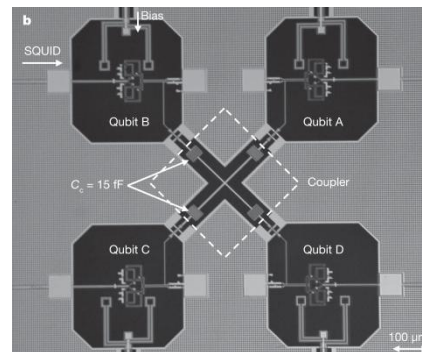

Neelley et al, Nature (2010)

DiCarlo et al, Nature (2010)

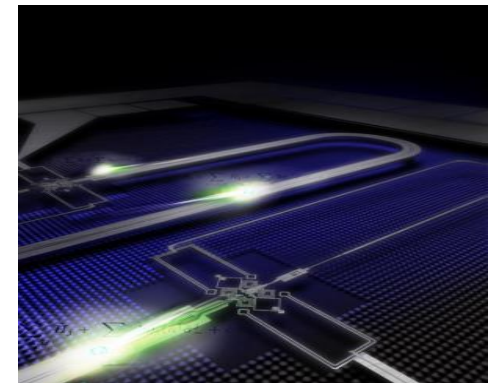

Sillanpaa et al, Nature (2007)

Trapped ion

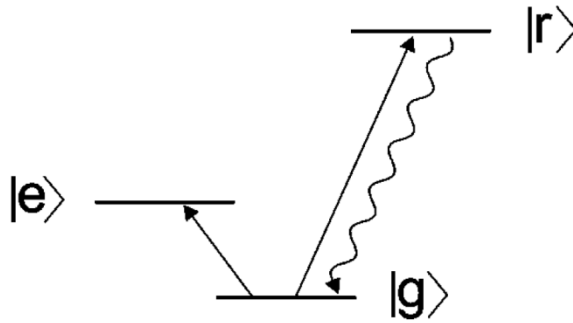
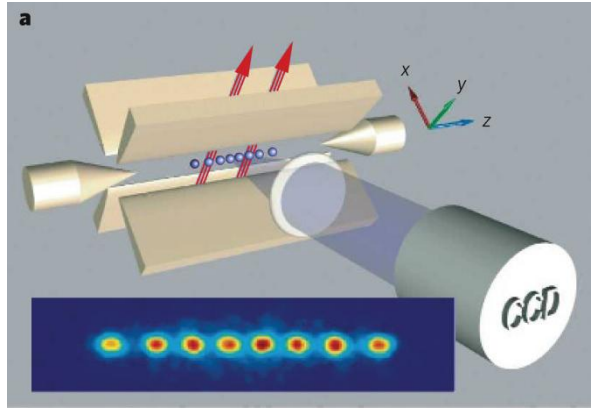

Leibfried, *Rev.Mod.Phys* (2003)
Blatt and Wineland, *Nature* (2008)

NV centers in diamond

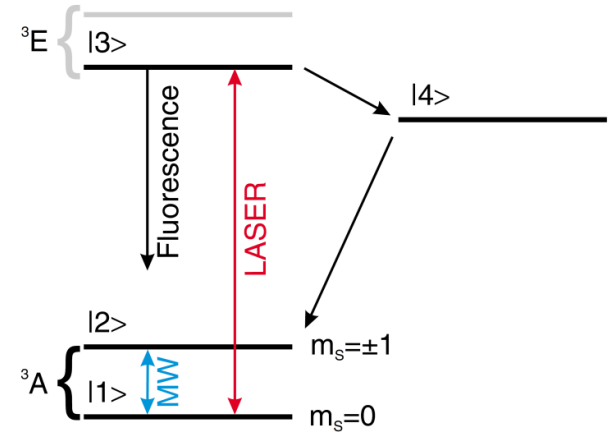
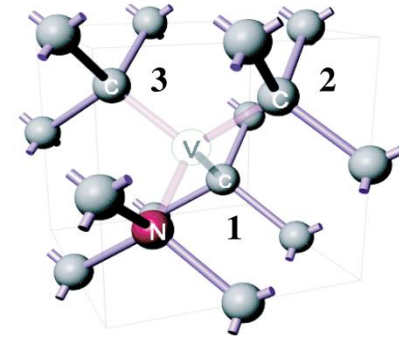

Jelezko et al, *PRL* (2004)

High fidelity readout & Electromagnetically Induced Transparency

**Superconducting artificial atom
with multiple degrees of freedom ?**

1. Quantum dynamics in a dcSQUID

2. Bridge-Free Nanofabrication Technique

3. Sequential junction cooling in dcSQUID

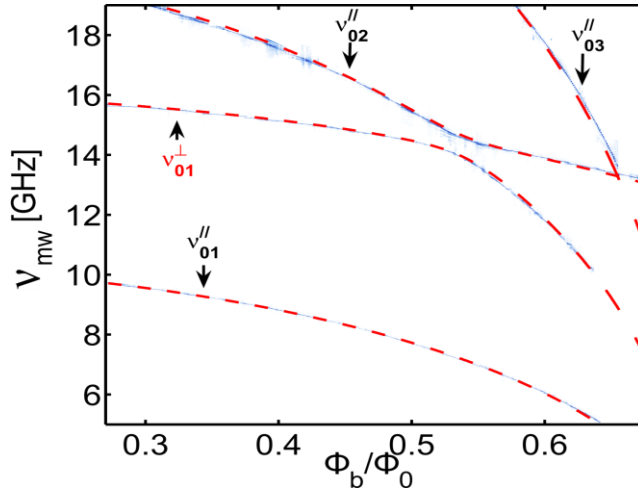

Part 2 Nano-Fabrication: Bridge-Free Technique

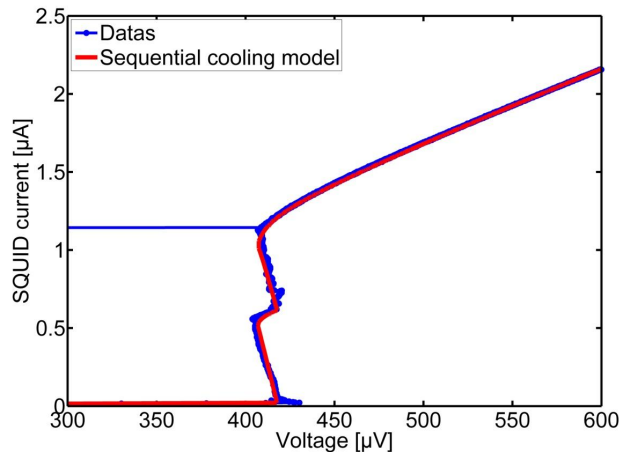

Part 1 Quantum dynamics in a dcSQUID From a phase Qubit to a 2D oscillator

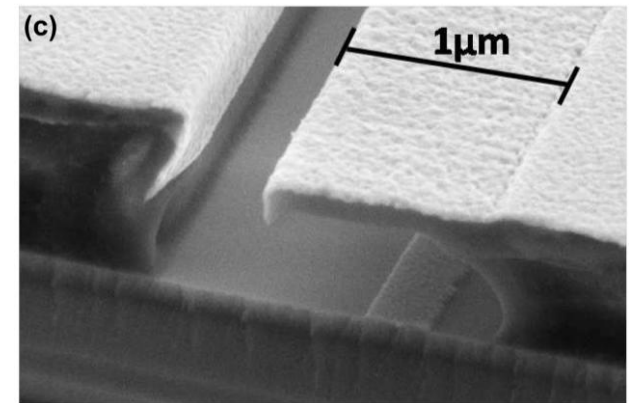

Part 3 Sequential junction cooling in a dcSQUID

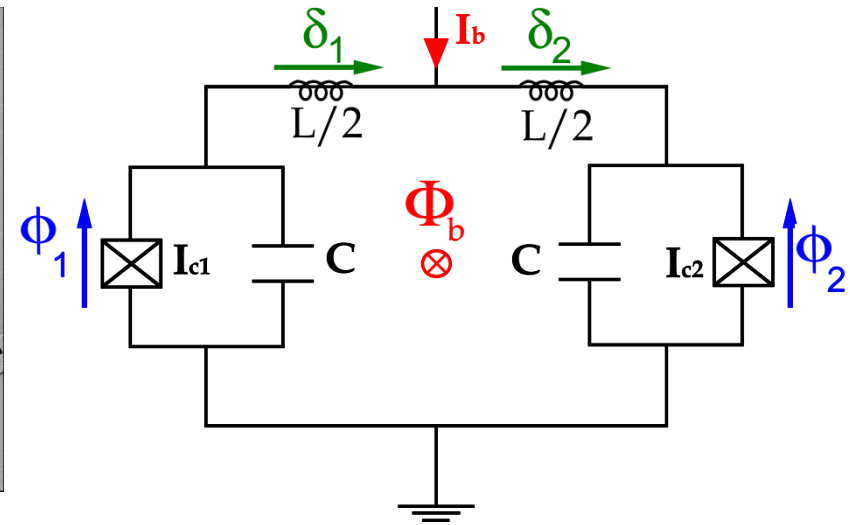
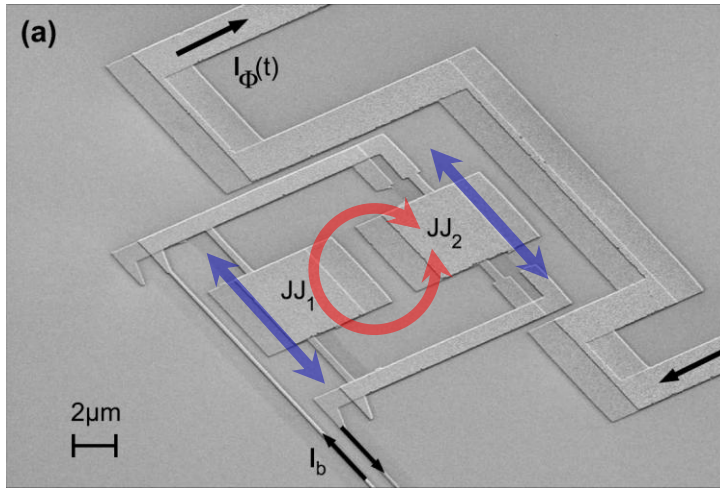

1. Quantum dynamics in a dcSQUID

- Th description

- Spectroscopy

- Coherent control

2. Bridge-Free Nanofabrication Technique

3. Sequential junction cooling in dcSQUID

$$U(\mathbf{x}, \mathbf{y}) = U_0 \left[-\cos x \cos y + b \left(y - \pi \frac{\Phi_b}{\Phi_0} \right)^2 \right] \quad \text{where} \quad \left\{ \begin{array}{l} x = \frac{\phi_1 + \phi_2}{2} \end{array} \right.$$

$$b = \frac{L_J}{L} = \frac{\Phi_0}{2\pi L I_c}$$

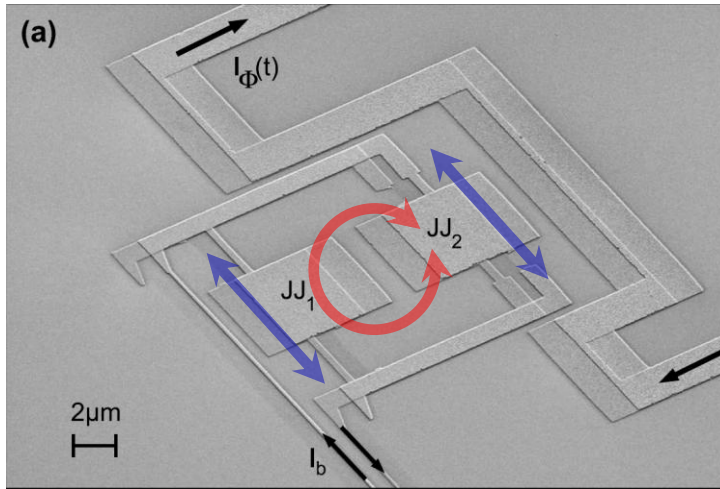

$$U(x, y) = U_0 \left[-\cos x \cos y + b \left(y - \pi \frac{\Phi_b}{\Phi_0} \right)^2 \right]$$



$$\hat{H}_{2D} = \hat{H}_{\parallel} \quad \hat{H}_{\perp}$$

$$\hat{C}_{\parallel\perp} = h\nu_{21}^c \hat{X}^2 \hat{Y} + h\nu_{12}^c \hat{X} \hat{Y}^2 + h\nu_{22}^c \hat{X}^2 \hat{Y}^2$$

- 1. Quantum dynamics in a dcSQUID
- Th description
- Spectroscopy
- Coherent control
- 2. Bridge-Free Nanofabrication Technique
- 3. Sequential junction cooling in dcSQUID

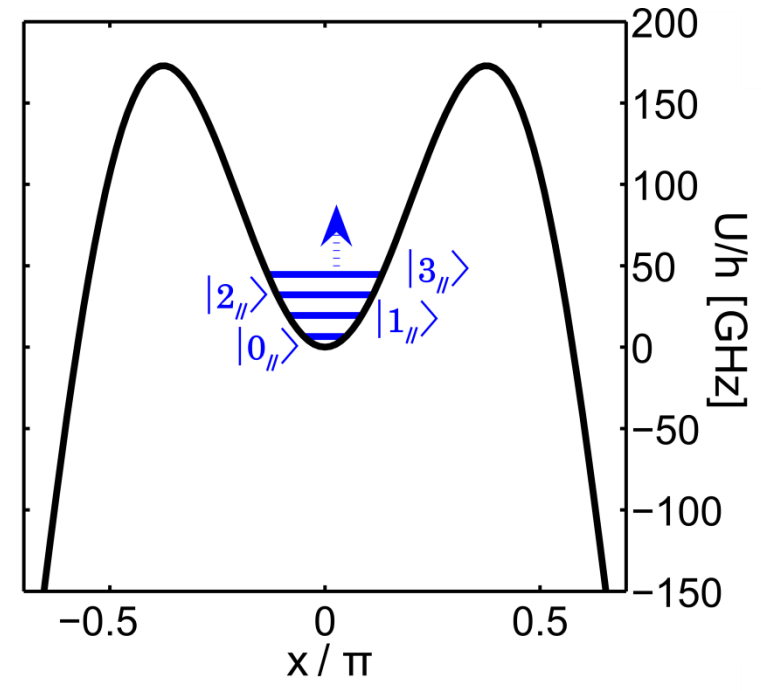
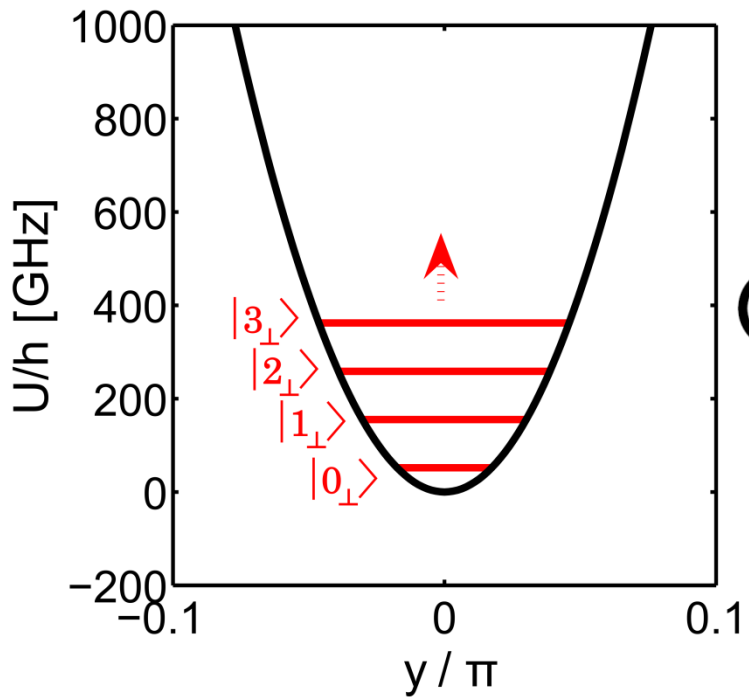

$L < L_{\text{Josephson}}$

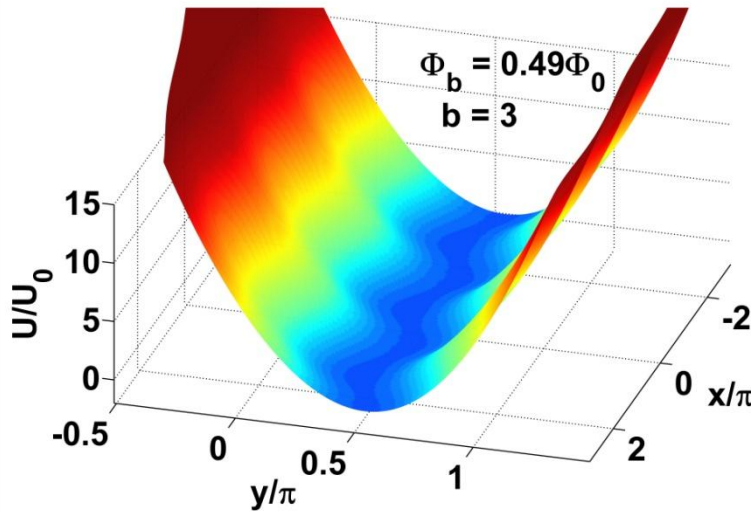

Hoskinson, Lecocq et al, PRL (2009)



Circuit insensitive to current noise @ zero current bias

Transverse mode high in energy



Considered in the ground state



1D dynamics

Quantum anharmonic oscillator

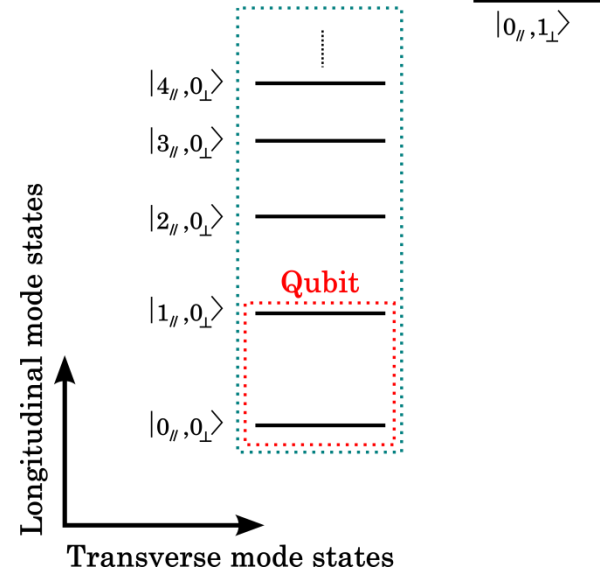

F. Lecocq

Ph.D. Defense
May 11th 2011

1. Quantum dynamics in a dcSQUID

- Th description

- Spectroscopy

- Coherent control

2. Bridge-Free Nanofabrication Technique

3. Sequential junction cooling in dcSQUID

$L > L_{\text{josephson}}$



Transverse mode energy decreased

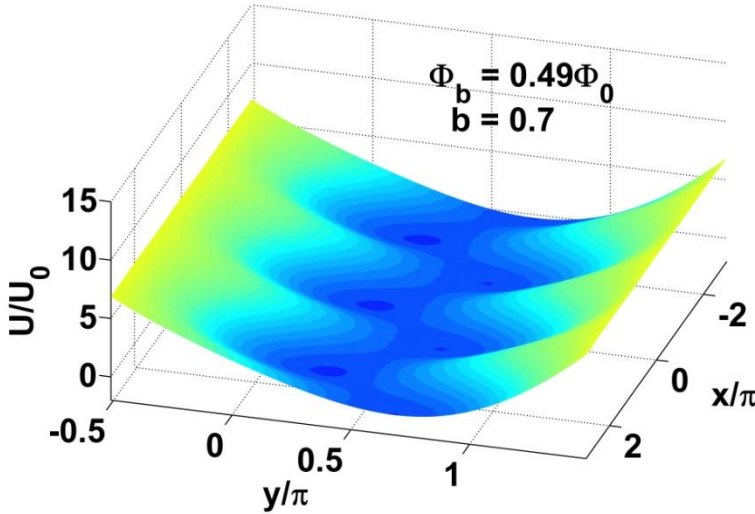

dcSQUID
+
large loop inductance
=
2D oscillator

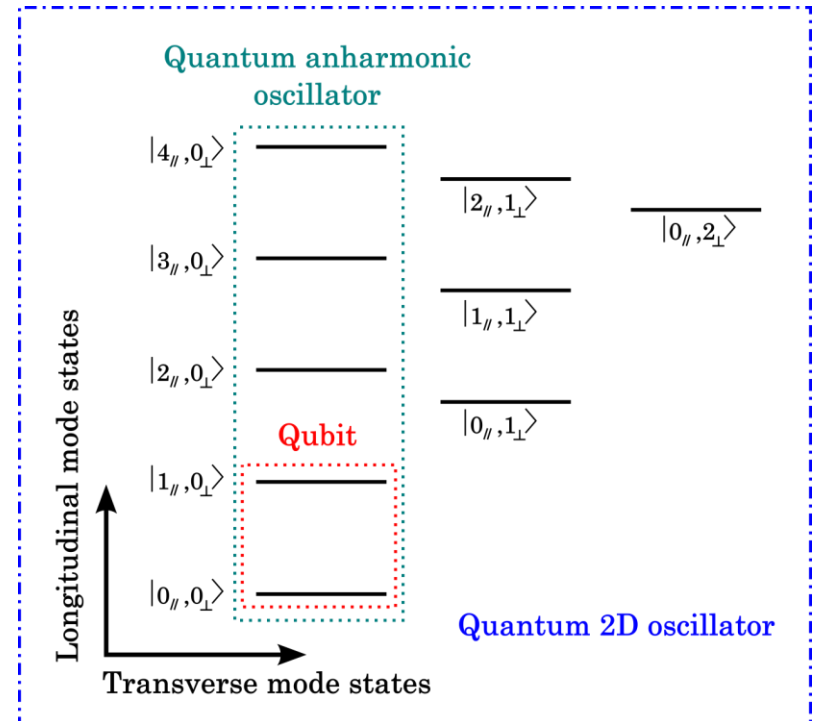

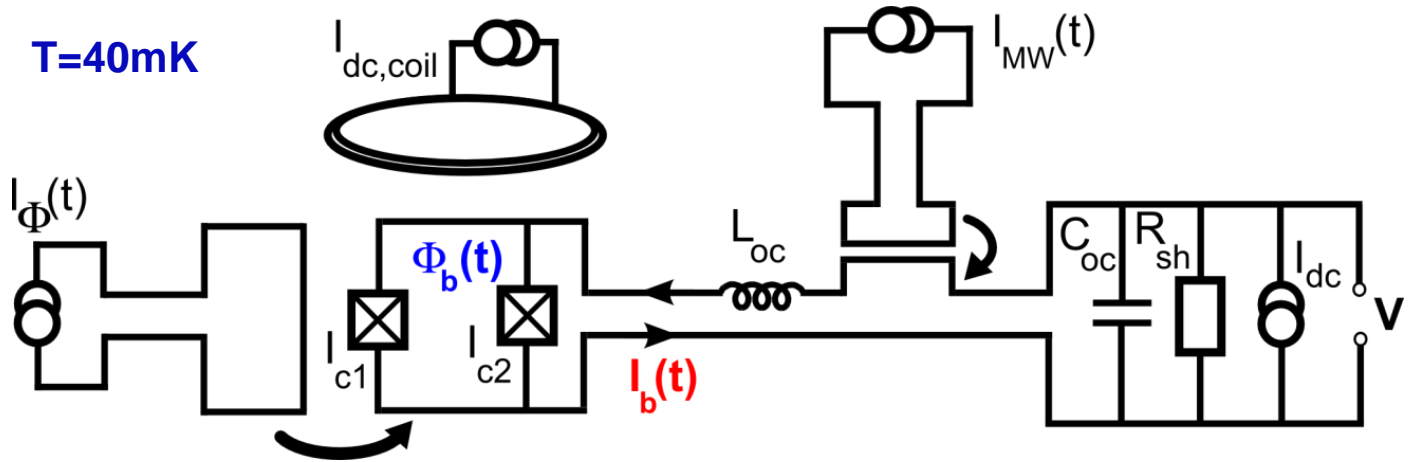

1. Quantum dynamics in a dcSQUID

-Th description

- Spectroscopy

- Coherent control

2. Bridge-Free Nanofabrication Technique

3. Sequential junction cooling in dcSQUID

Critical current per JJ	$0.713 \mu\text{A}$
Capacitance per JJ	510 fF
loop inductance	629.8 pH
JJ's surface	$10 \mu\text{m}^2$
SQUID's surface	$900 \mu\text{m}^2$

$$b = \frac{L_J}{L} = 0.733$$

$$E_J = 17\text{K}$$

$$E_C = 7\text{mK}$$

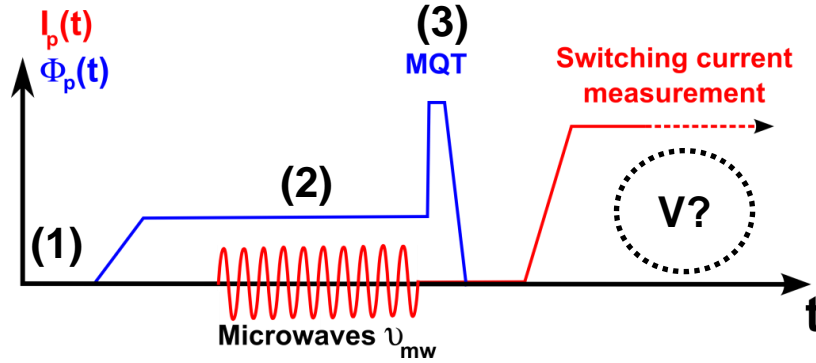

Nanosecond flux pulse and switching current measurement

Hoskinson, Lecocq et al, *PRL* (2009)

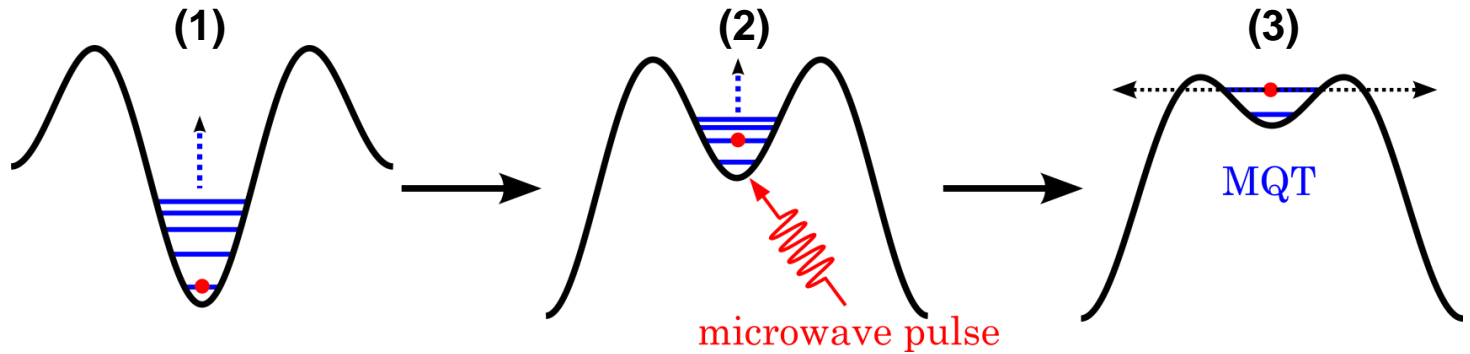

The probability of escape increases when the system is excited

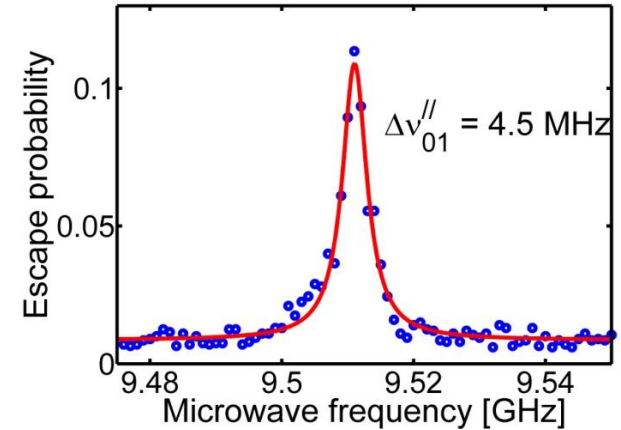

F. Lecocq

Ph.D. Defense
May 11th 2011

1. Quantum dynamics in a dcSQUID

-Th description

- Spectroscopy

- Coherent control

2. Bridge-Free Nanofabrication Technique

3. Sequential junction cooling in dcSQUID

Longitudinal mode

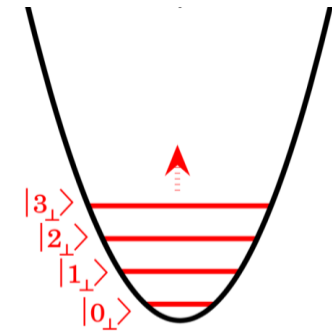
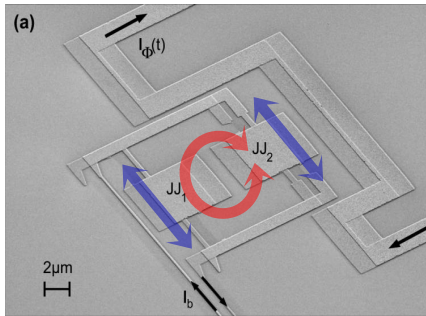
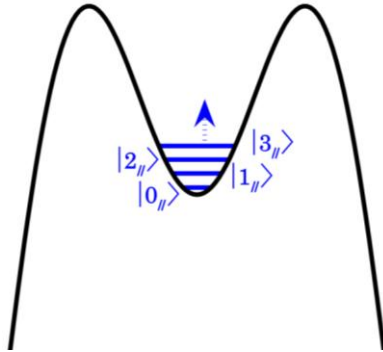

Transverse mode

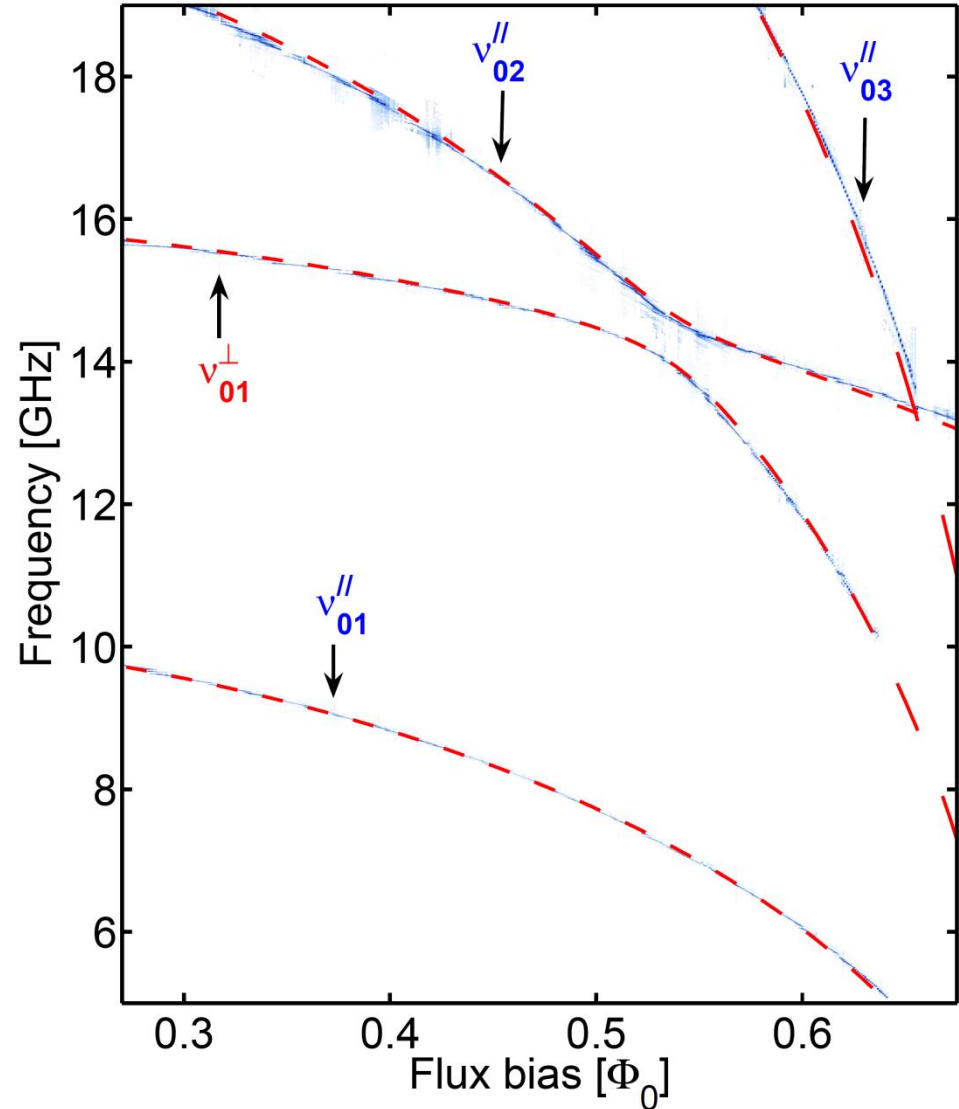

Large anti-crossing at the resonance between ν_{02}^{\parallel} and ν_{01}^{\perp}

Non linear coupling

$$\hat{C}_{\parallel\perp} = h\nu_{21}^c \hat{X}_{\parallel}^2 \hat{Y}_{\perp}$$

Also discussed in quantum optics and ion traps

Bertet et al, PRL (2002)
Vogel and Dematos, PRA (1995)

Strong coupling regime

$$\nu_{21}^c = 700\text{MHz}$$

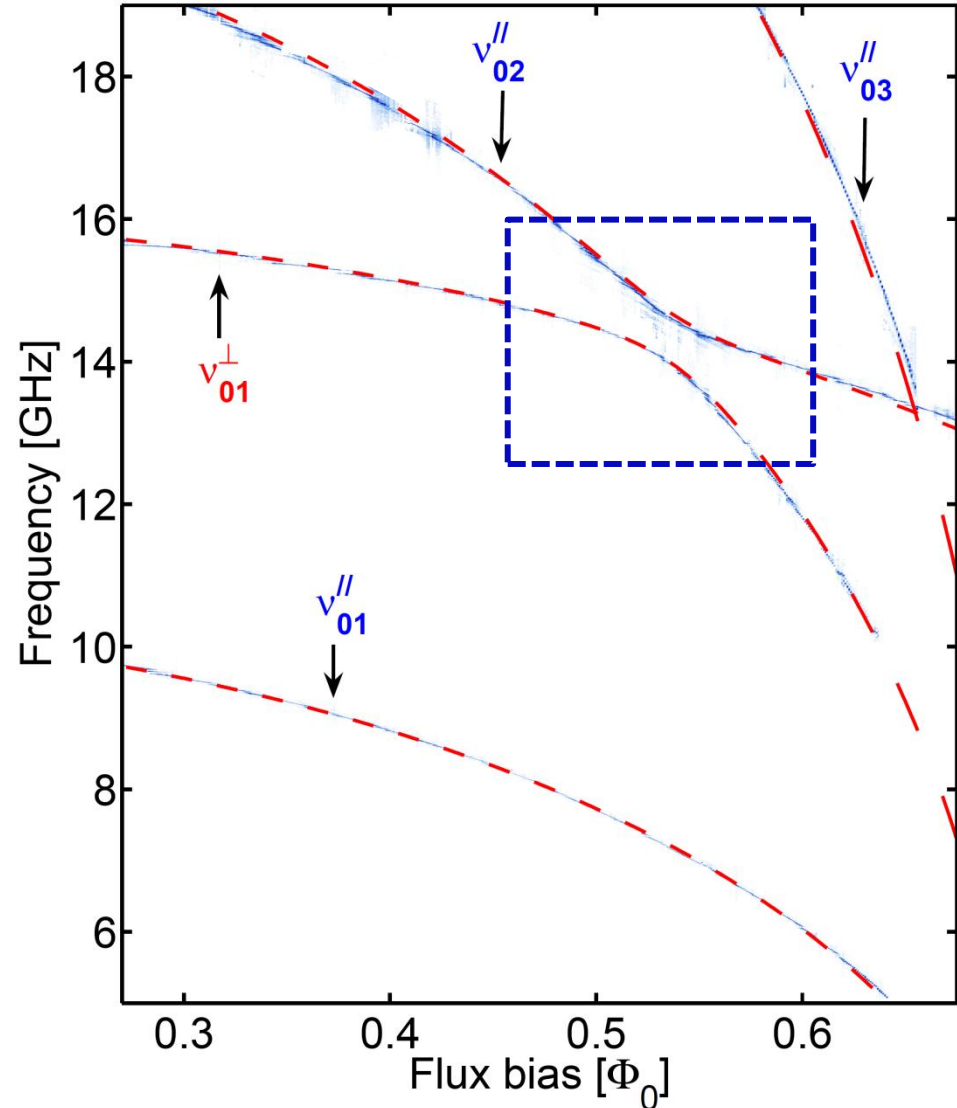

1. Quantum dynamics in a dcSQUID

-Th description

- Spectroscopy

- Coherent control

2. Bridge-Free Nanofabrication Technique

3. Sequential junction cooling in dcSQUID

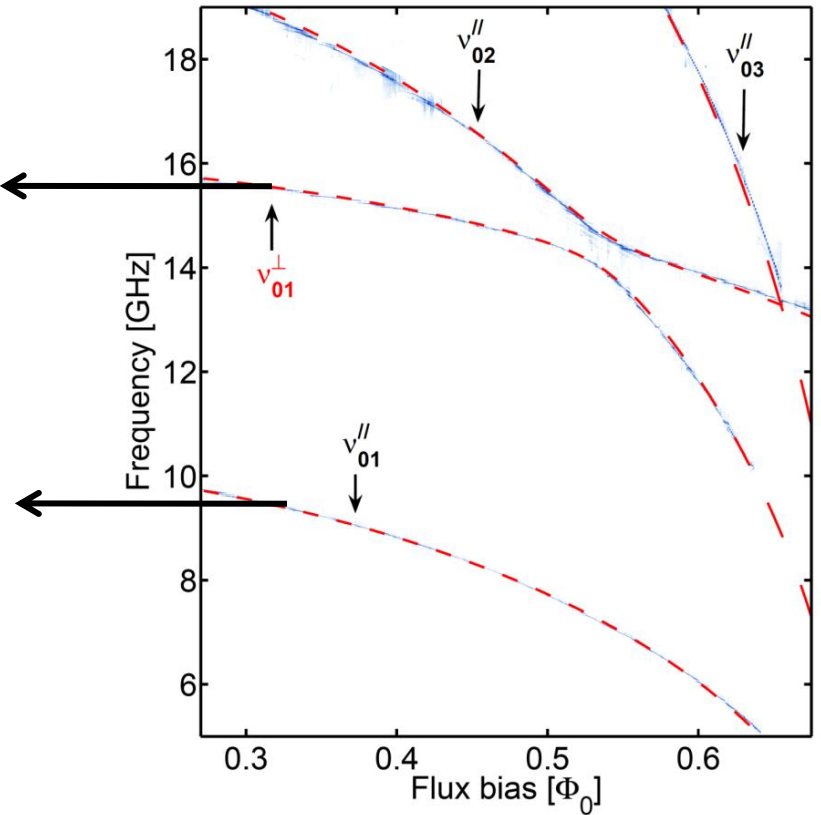
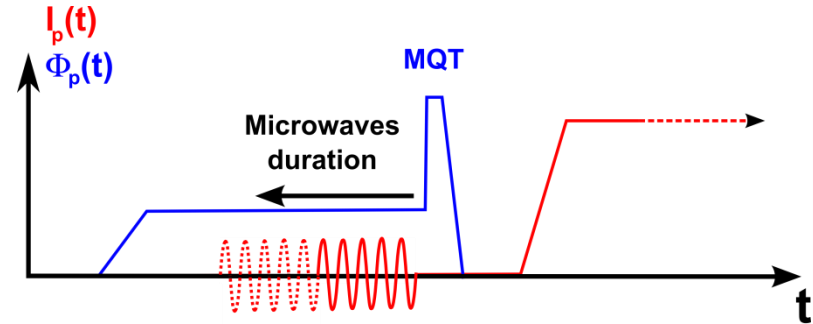
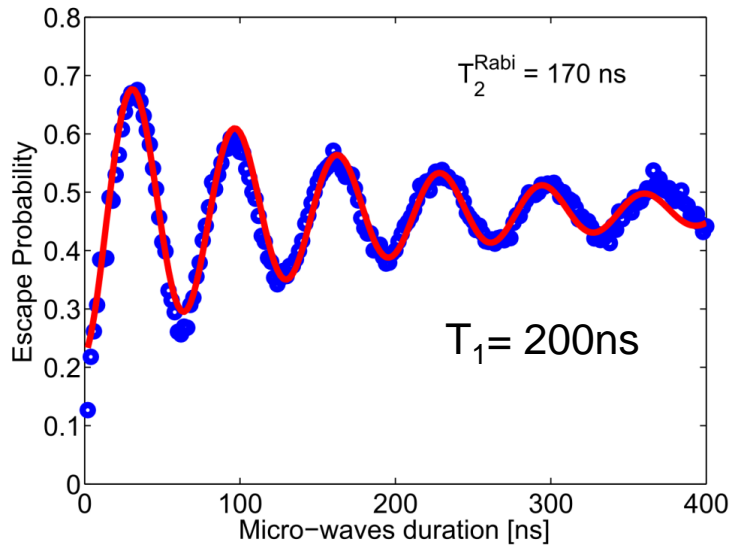
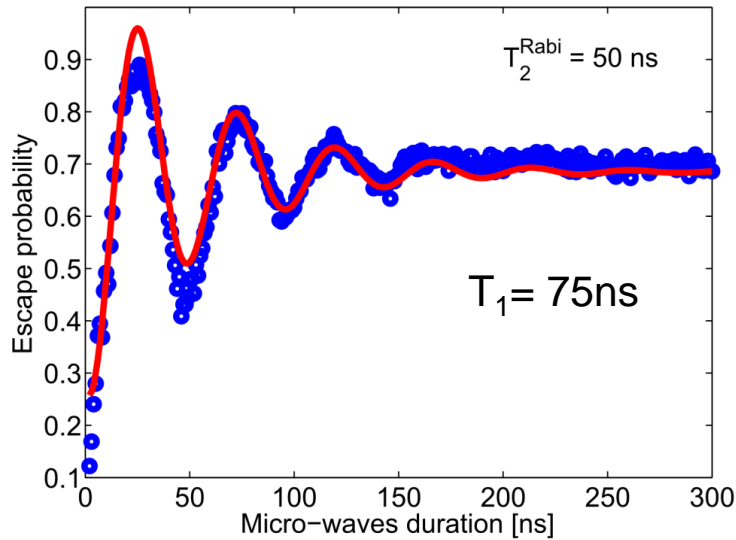



F. Lecocq

Ph.D. Defense
May 11th 2011

1. Quantum dynamics in a dcSQUID

-Th description

- Spectroscopy

- Coherent control

2. Bridge-Free Nanofabrication Technique

3. Sequential junction cooling in dcSQUID

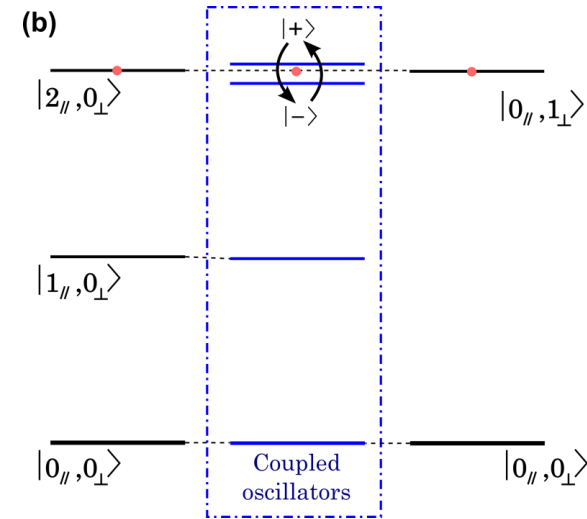
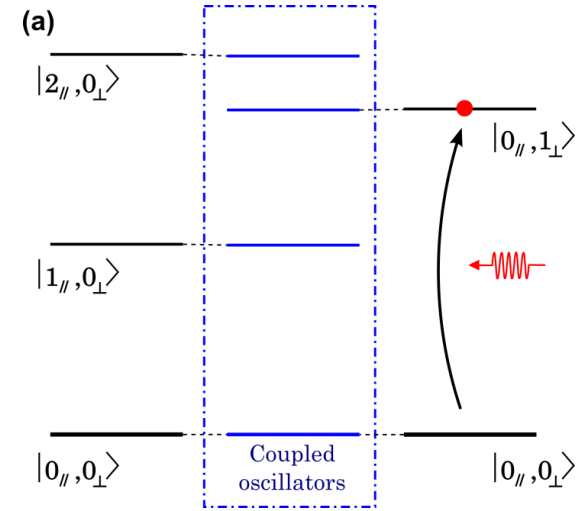
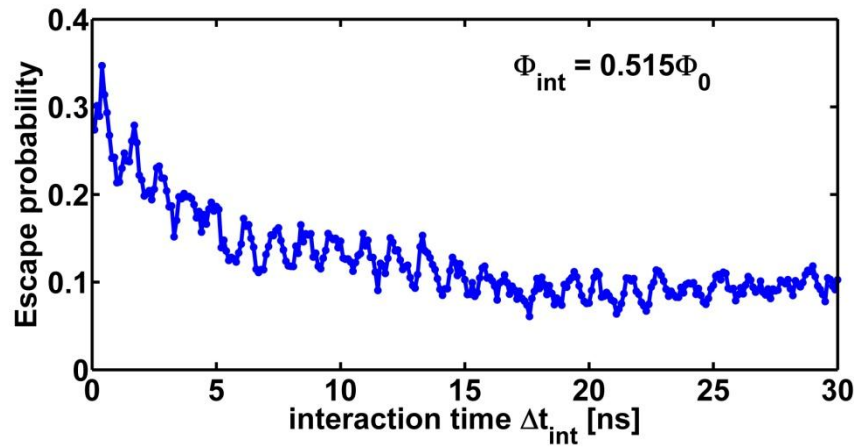
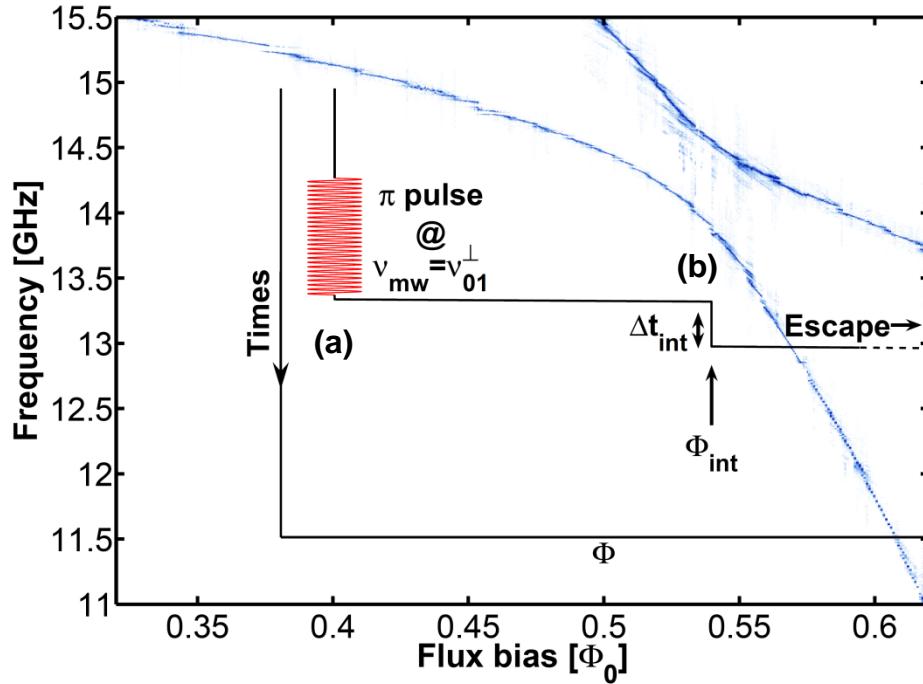

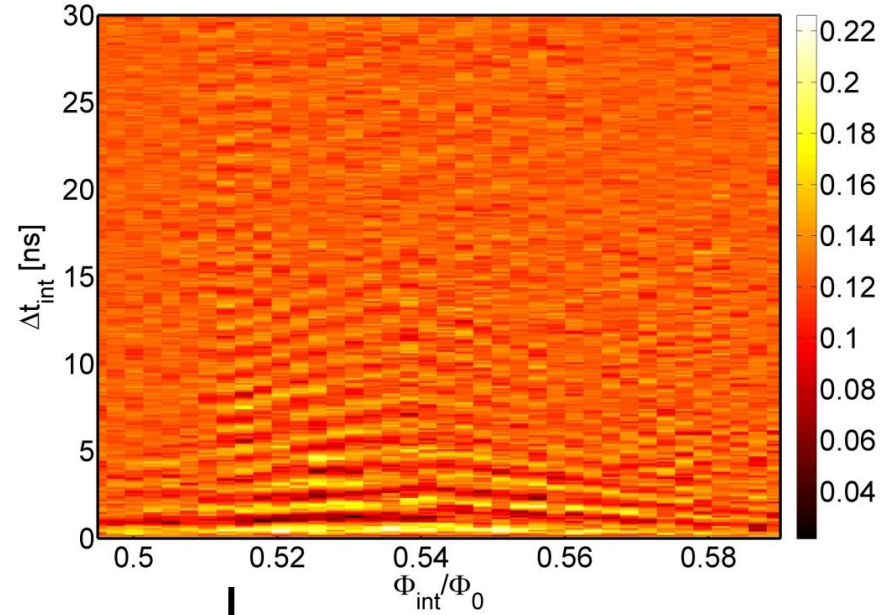
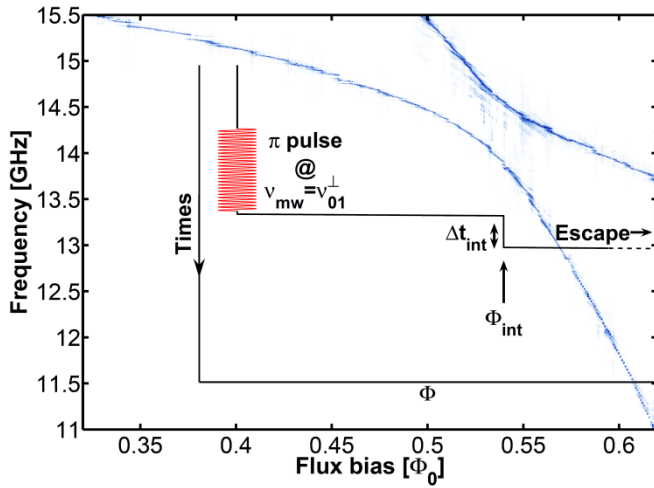

Coherent exchange of quanta between the modes

Frequency conversion back and forth

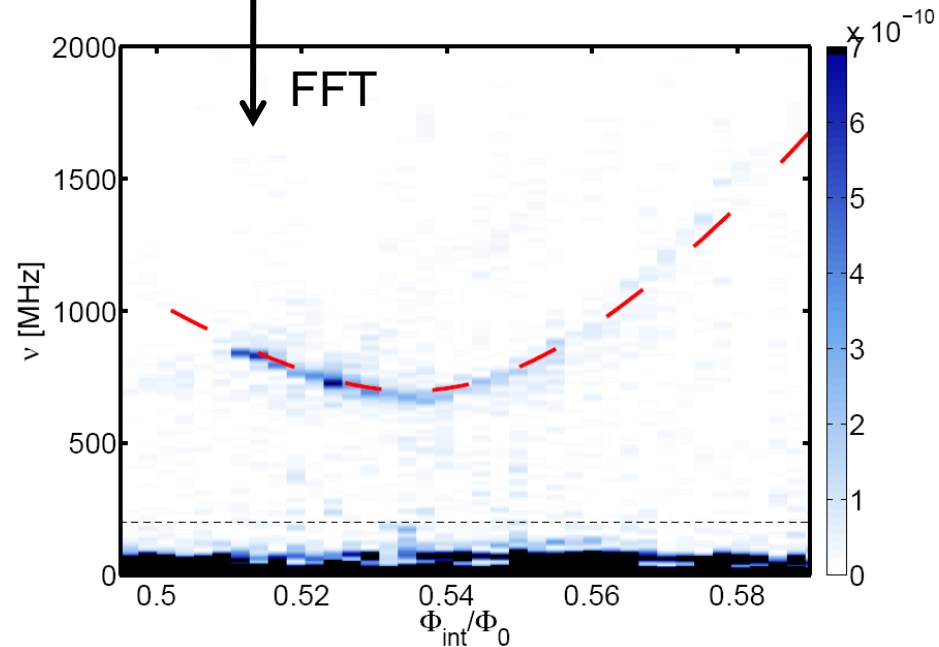
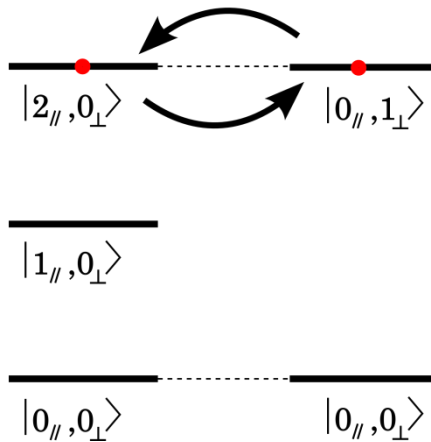

1. Quantum dynamics in a dcSQUID

- Th description

- Spectroscopy

- Coherent control

2. Bridge-Free Nanofabrication Technique

3. Sequential junction cooling in dcSQUID

1. Quantum dynamics in a dcSQUID

-Th description

- Spectroscopy

- Coherent control

2. Bridge-Free Nanofabrication Technique

3. Sequential junction cooling in dcSQUID

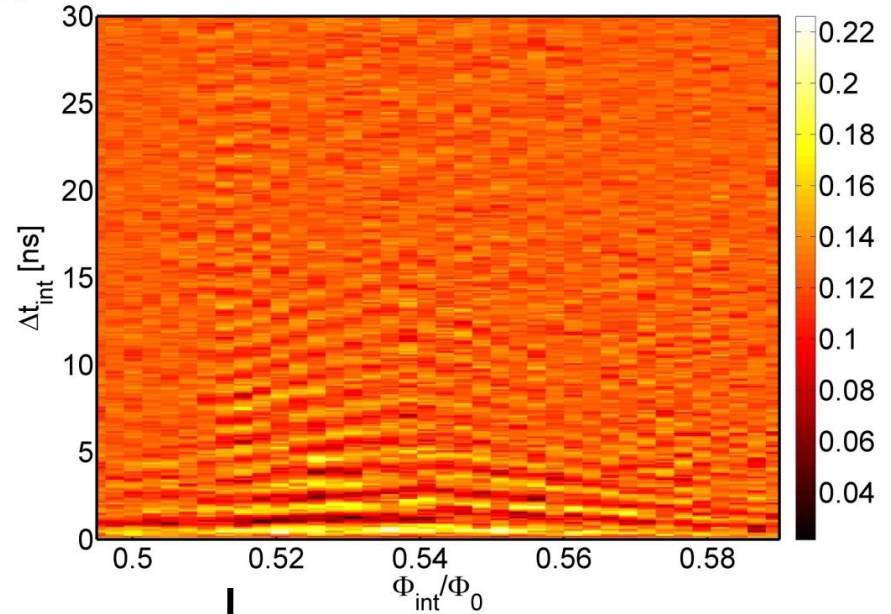
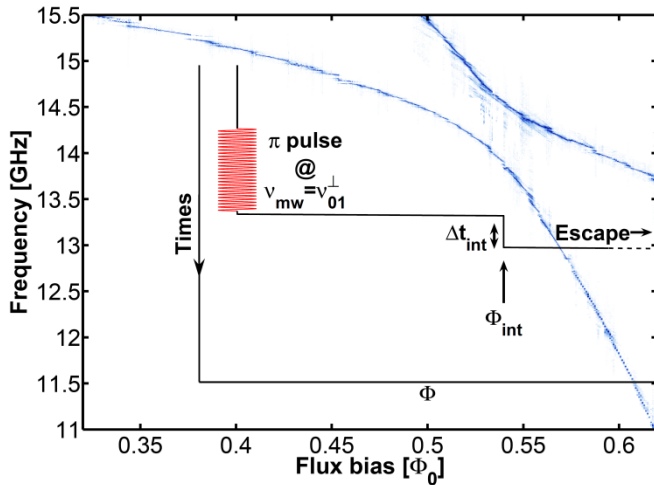

Low contrast :

Slow microwave π pulse

Readout

Non perfect adiabatic flux pulse

Parasitic TLS

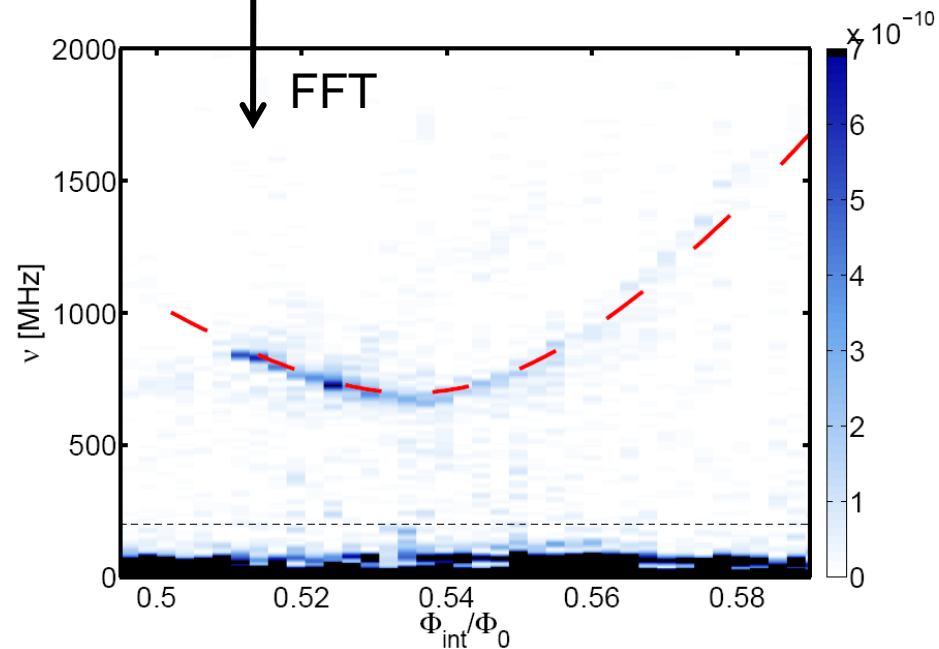

1. Quantum dynamics in a dcSQUID

2. Bridge-Free Nanofabrication Technique

3. Sequential junction cooling in dcSQUID

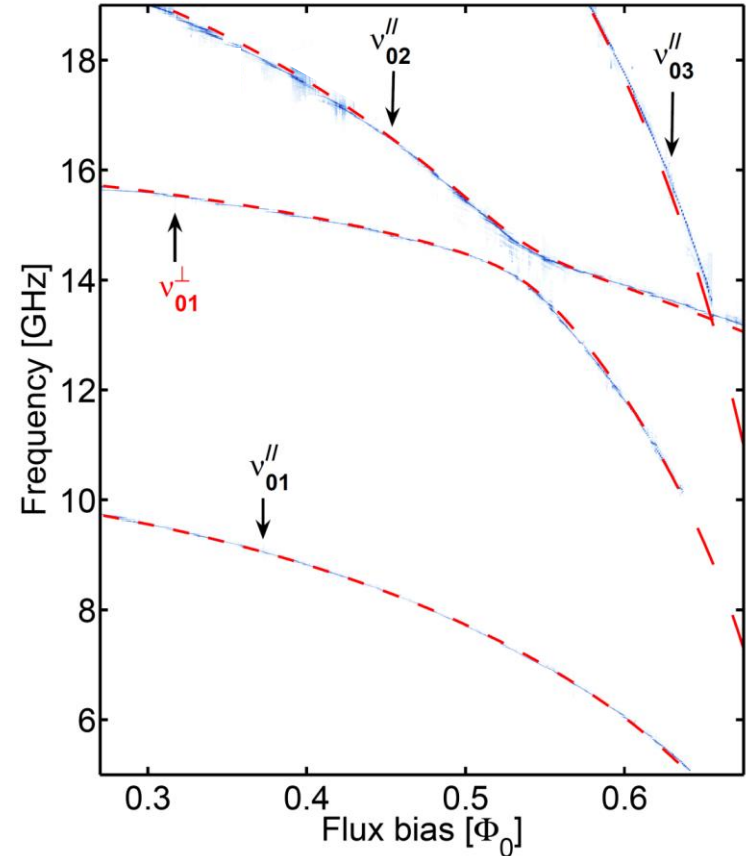
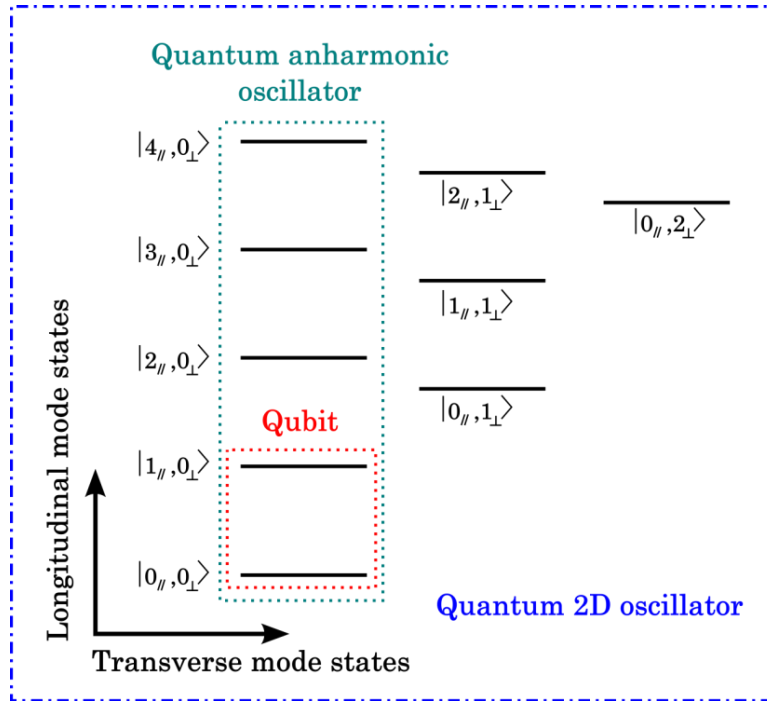

1. Quantum dynamics in a dcSQUID

2. Bridge-Free Nanofabrication Technique

3. Sequential junction cooling in dcSQUID

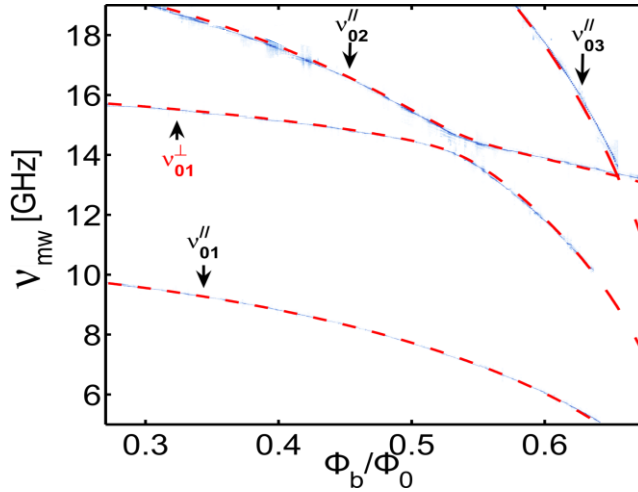

Part 2 Nano-Fabrication: Bridge-Free Technique

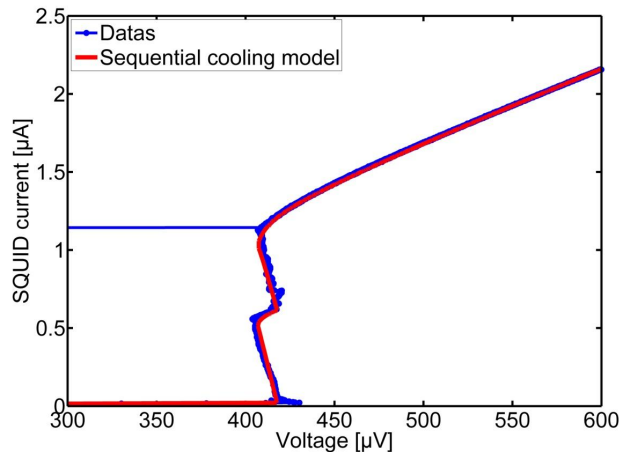

Part 1

Quantum dynamics in a dcSQUID
From a phase Qubit to a 2D oscillator

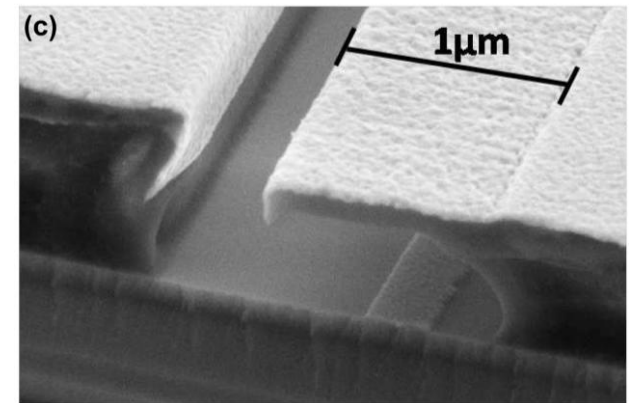

Part 3 Sequential junction cooling In a dcSQUID

Trilayer Technique

Dolata et al, *J. Appl. Phys* (2005)

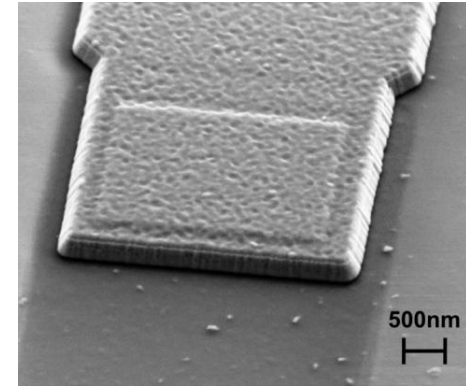
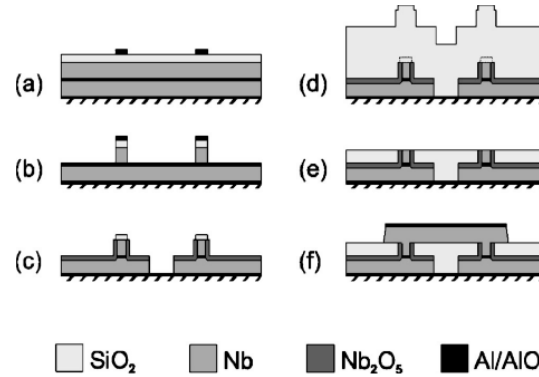

Standard shadow evaporation Dolan Bridge Technique

Dolan, *Appl. Phys. Lett.* (1977)

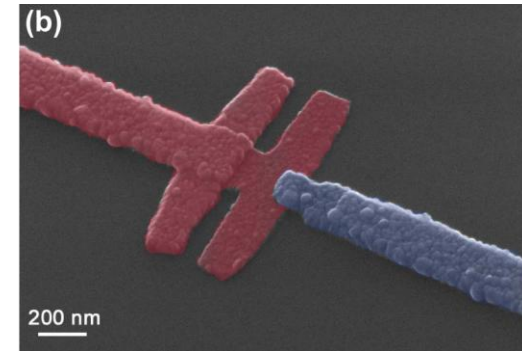
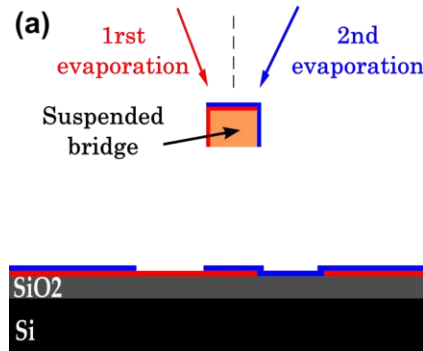

Courtesy of I.M.Pop

Bridge-Free shadow evaporation technique (BFT)

Lecocq et al, *ArXiv* (2010) submitted to *Nanotechnology*

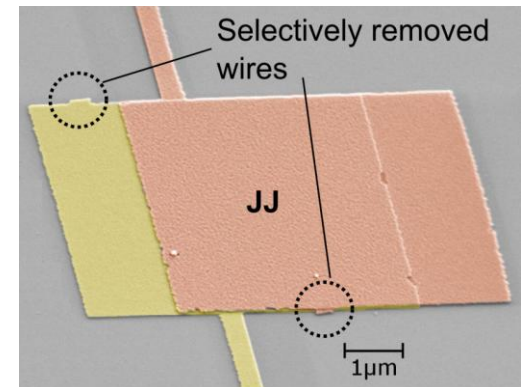

1. Design of strongly asymmetric undercut :

- e-beam lithography @ 100kV
- “double exposure” technique
Cord et al, JVST B (2006)

2. Deposition :

deposition on substrate depends on the undercut position and the angle

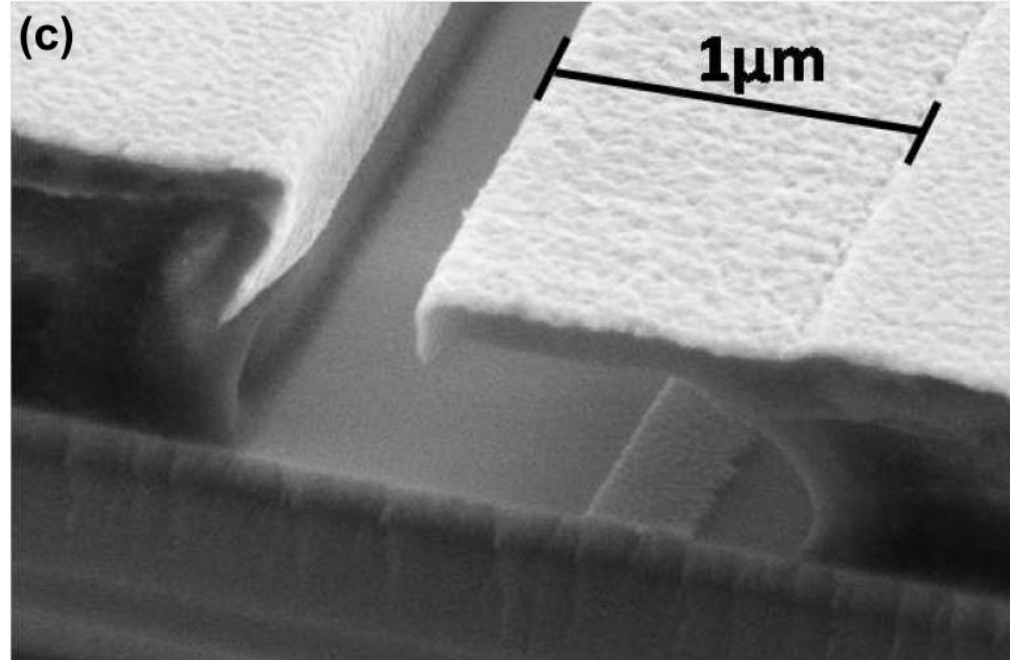
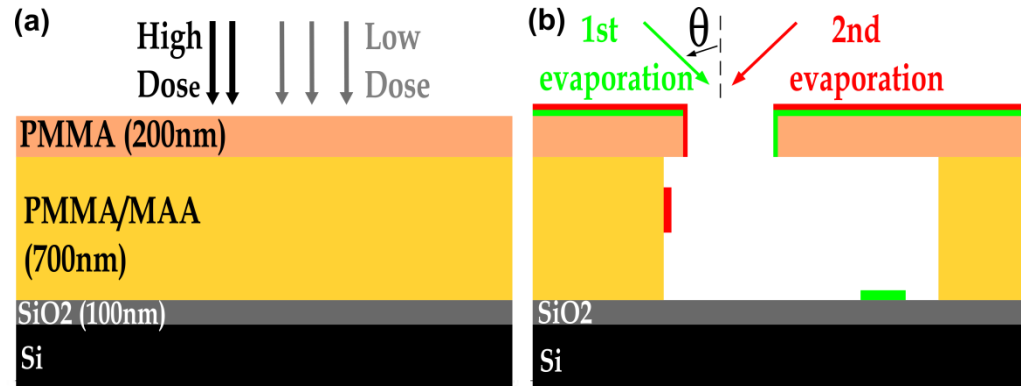

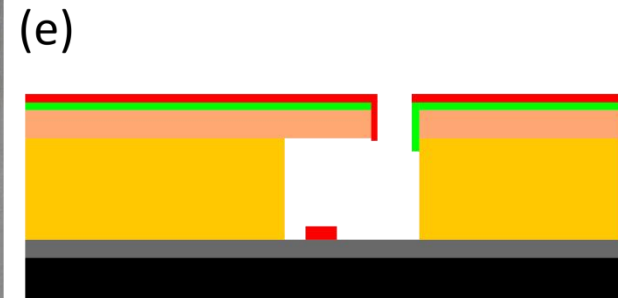
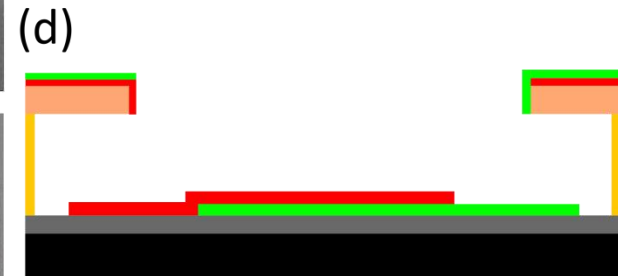
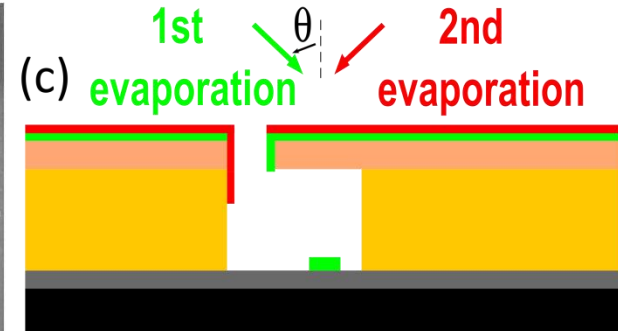
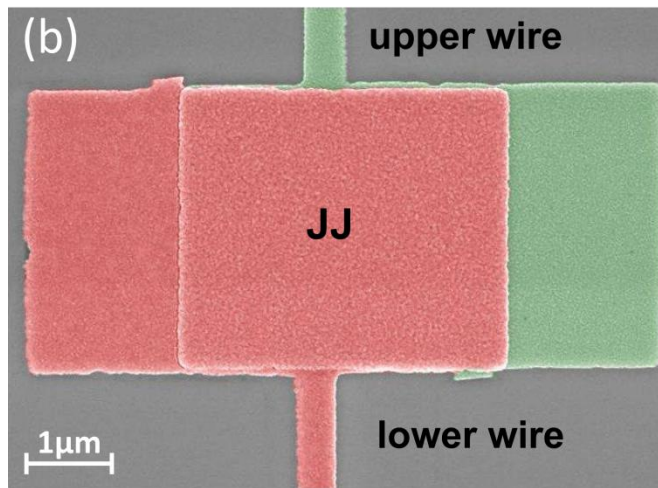
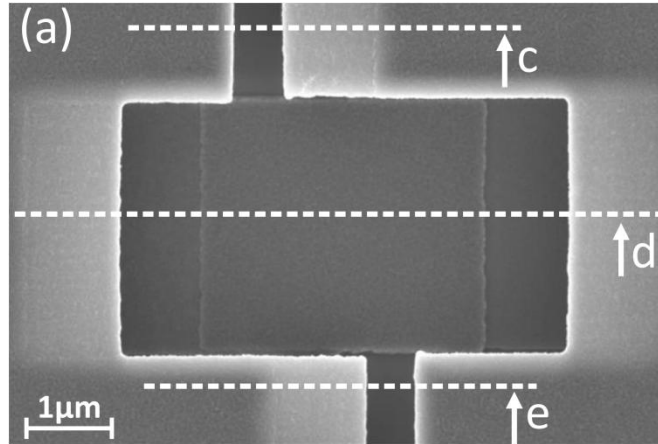

No suspended bridge

- Less mechanical issues
- Junction size from 10^{-2} to $10^4 \mu\text{m}^2$
- Easy cleaning of resist residues (RIE, IBE)

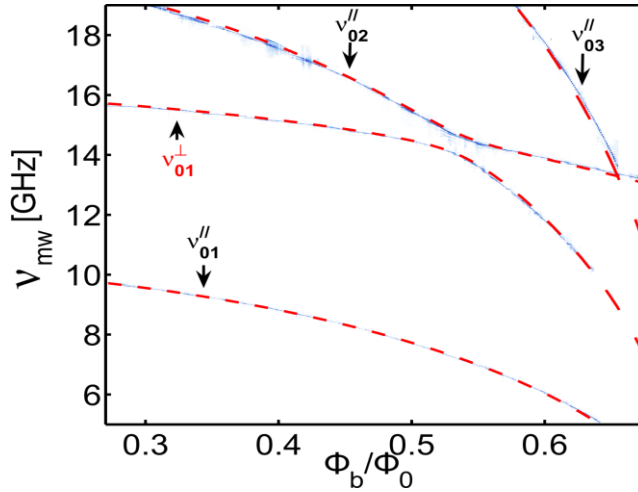

Part 2 Nano-Fabrication: Bridge-Free Technique

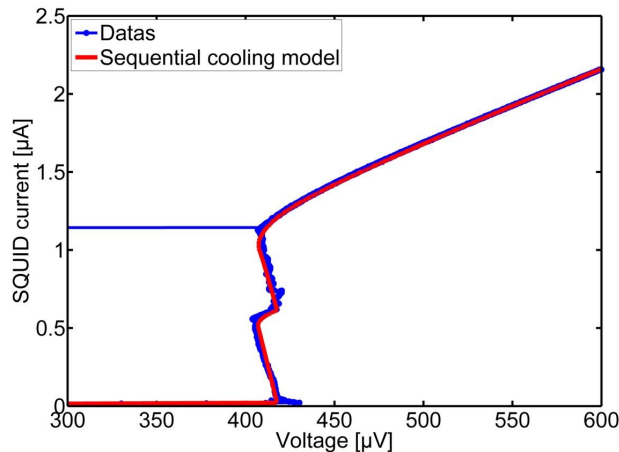

Part 1

Quantum dynamics in a dcSQUID
From a phase Qubit to a 2D oscillator

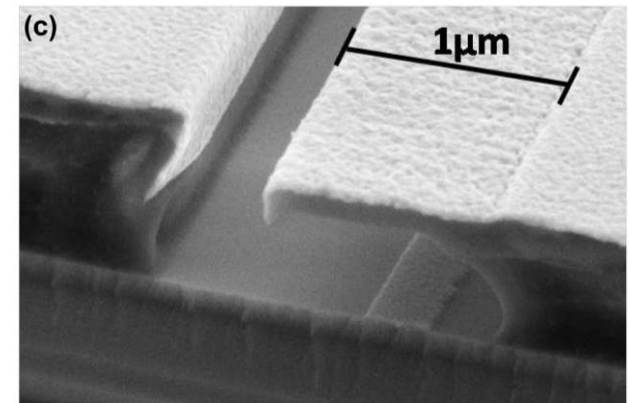

Part 3 Sequential junction cooling in a dcSQUID

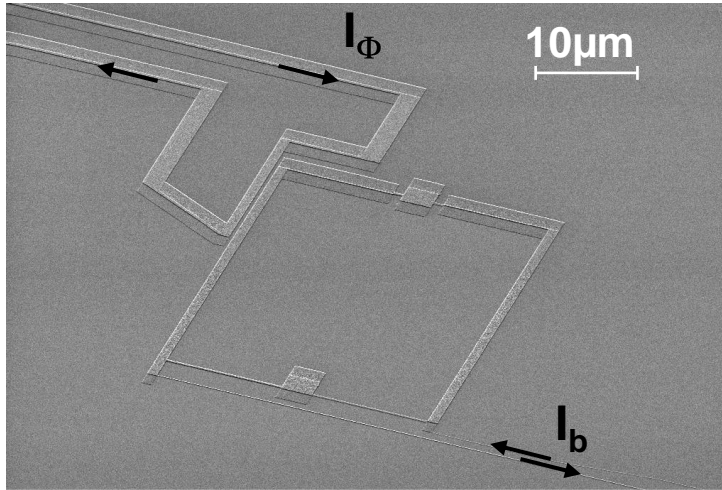

Theoretical prediction for the tunnel current fails to describe experimental results accurately

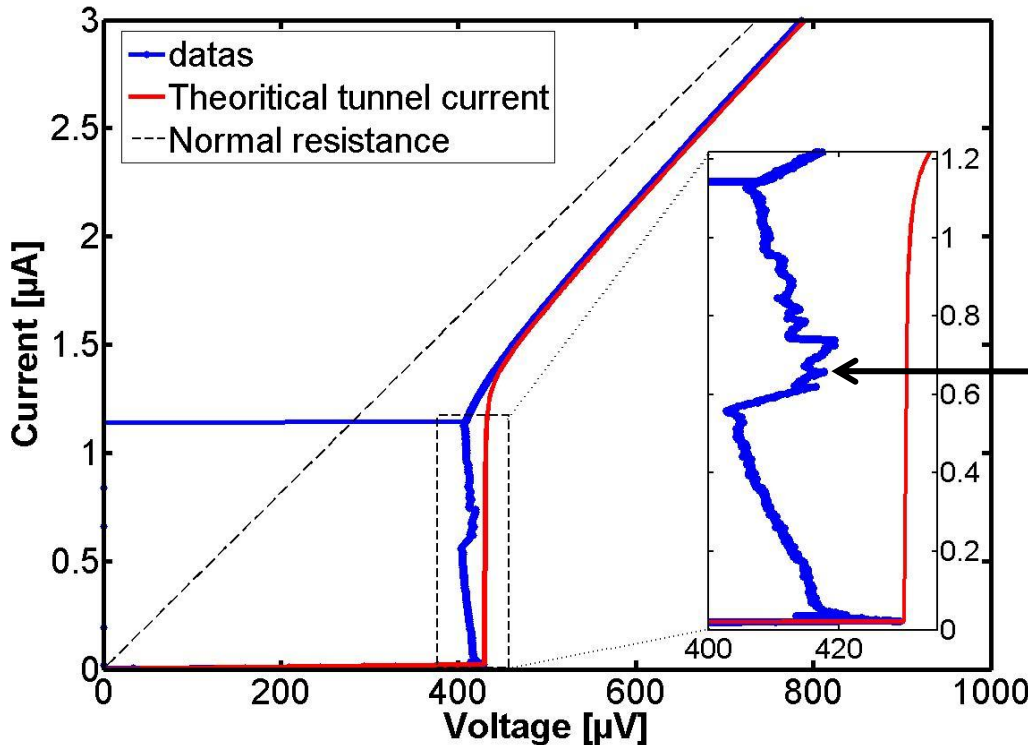

Anomaly @ $I_c/2$

1. Quantum dynamics in a dcSQUID

2. Bridge-Free Nanofabrication Technique

3. Sequential junction cooling in dcSQUID

- Anomaly

- Sequential cooling

F. Lecocq

Ph.D. Defense
May 11th 2011

Exemple of anomaly in Aluminium dcSQUID:

F. Lecocq

Ph.D. Defense
May 11th 2011

1. Quantum dynamics in a dcSQUID

2. Bridge-Free Nanofabrication Technique

3. Sequential junction cooling in dcSQUID

- Anomaly

- Sequential cooling

LeMasne, *PhD thesis* (2009)

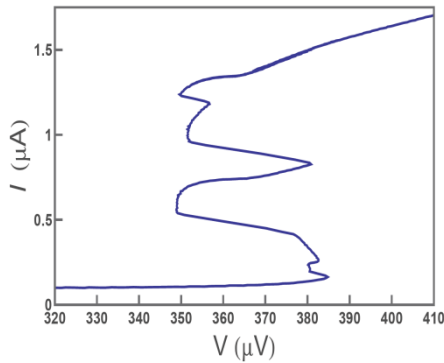

Claudon, *PhD thesis* (2005)

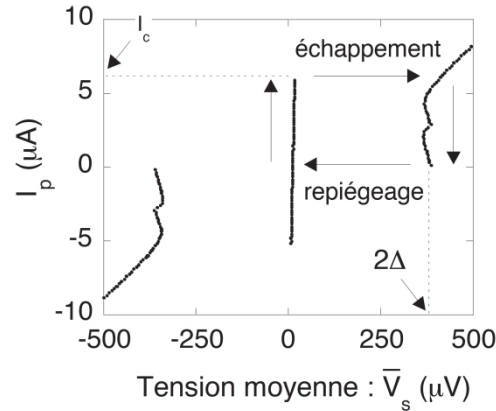

Kivioja et al, *New. J. of Phys.* (2005)

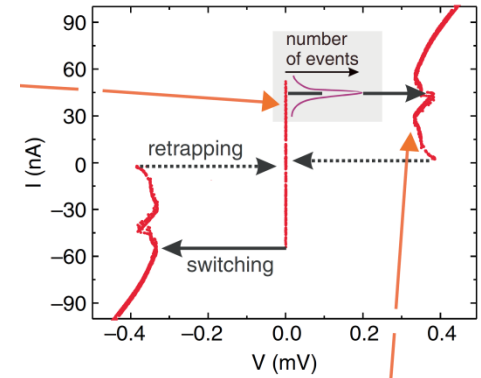

Correlated with “back-bending” in single Aluminium JJ:

LeMasne, *PhD thesis* (2009)

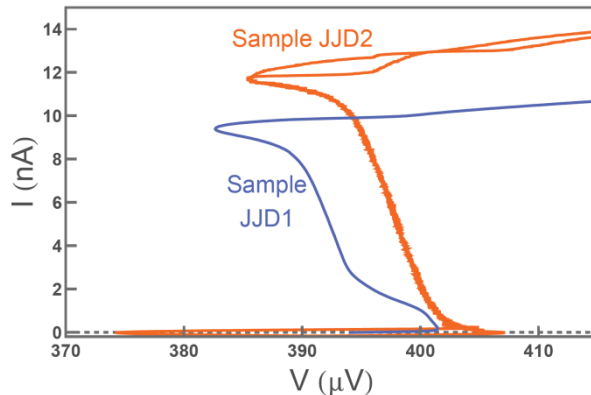

Timofeev et al, *PRL* (2007)

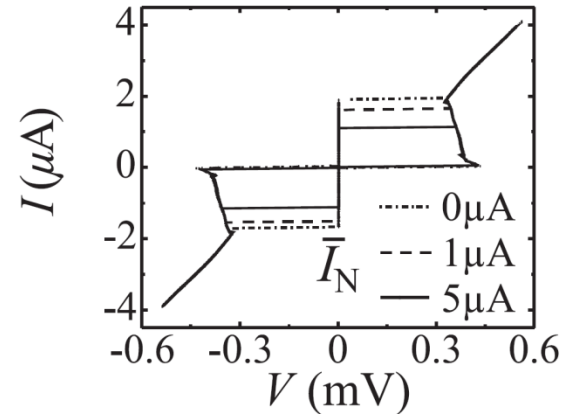

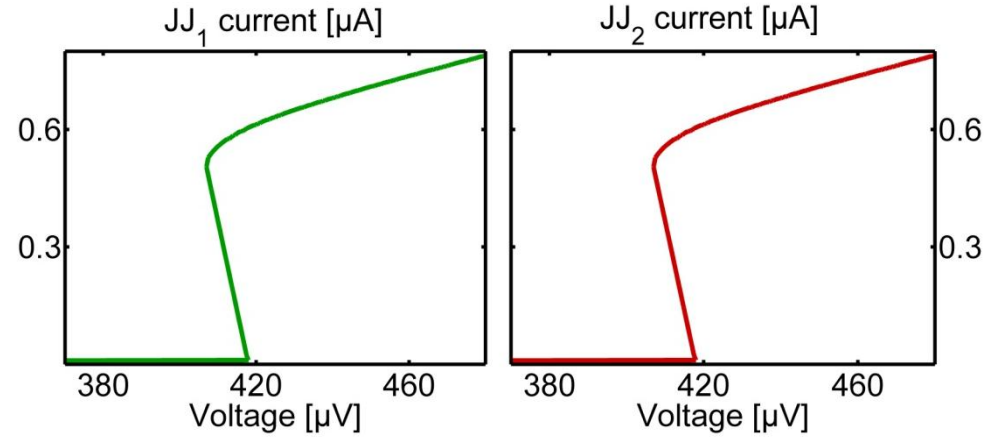
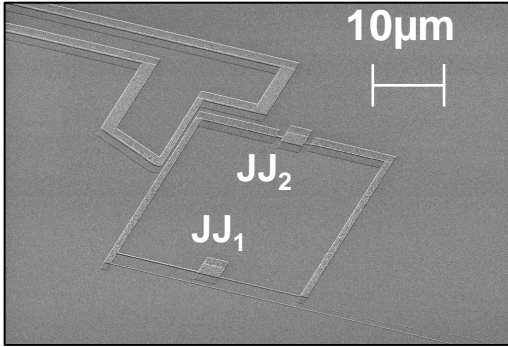

@ anomaly :

JJ 1 : almost no current
("cold junction")

JJ2 : current higher than critical current
("hot junction")

Sequential junction cooling

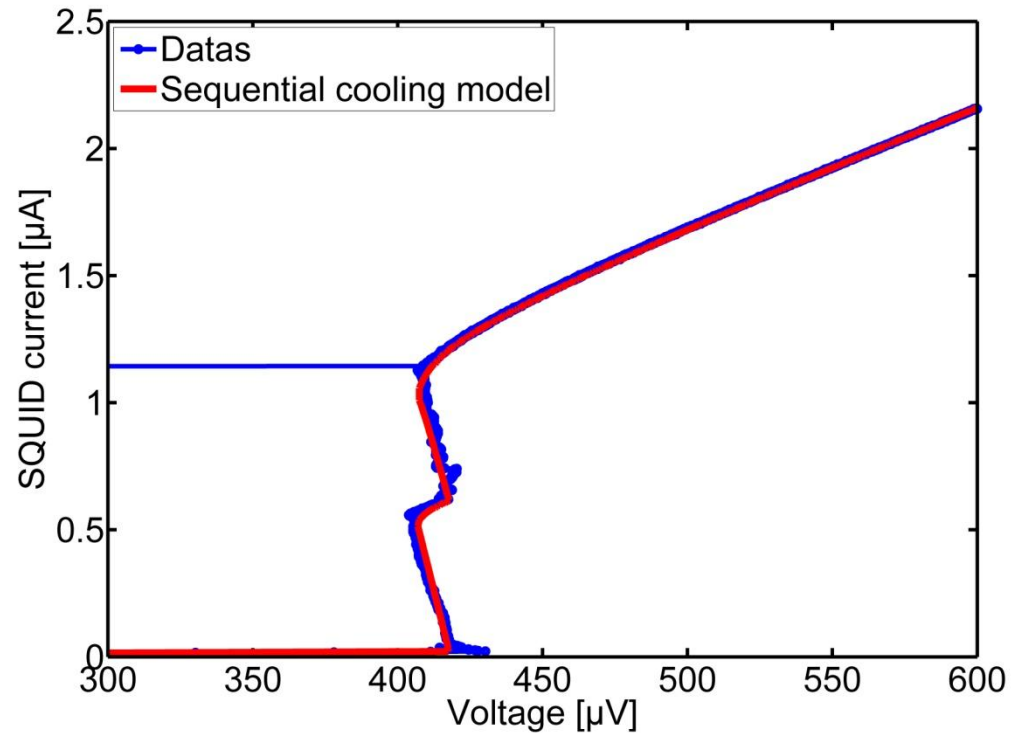

1. Quantum dynamics in a dcSQUID

2. Bridge-Free Nanofabrication Technique

3. Sequential junction cooling in dcSQUID

- Anomaly

- Sequential cooling

✓ Optimal current bias for current noise insensitive dcSQUID phase qubit

Hoskinson, Lecocq et al, PRL (2009)

✓ Measurement of a 2D superconducting artificial atom : a dcSQUID with a large inductance

✓ Bridge-free shadow evaporation technique for JJ nanofabrication

Lecocq et al, ArXiv (2010) submitted to Nanotechnology

✓ First explanation of the recurrent anomaly in IV characteristic of dcSQUID

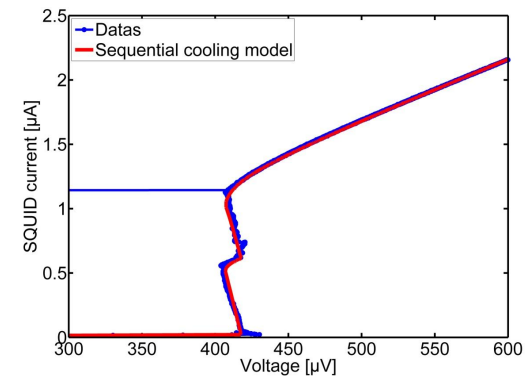
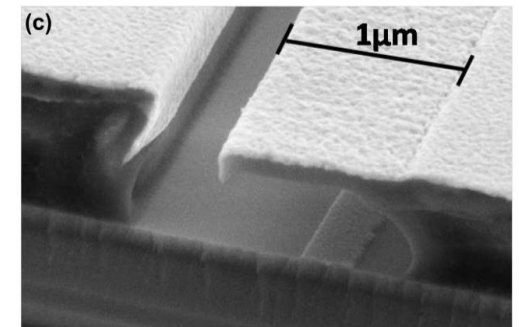
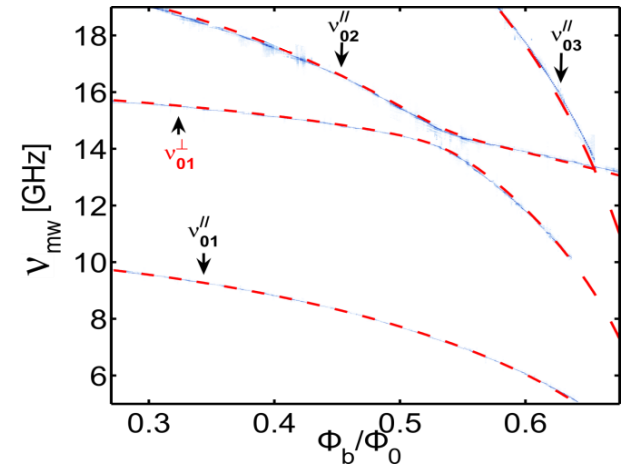

Light / matter interaction with a 2D artificial atom

Include this device in a circuit QED architecture

“Electromagnetically Induced Transparency” ?

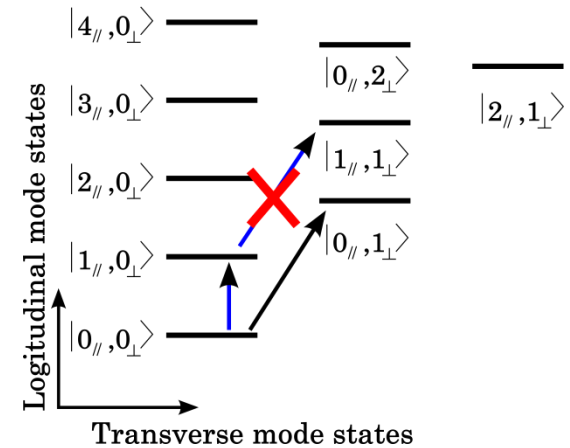

Reduce TLS density

Reduce junction size

Good dielectric (a-SiH)

Martinis et al, PRL (2005)

Steffen et al, PRL (2006)

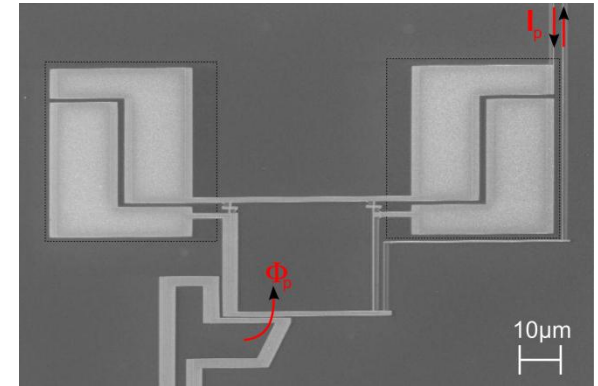

Origin of back bending ?

Thermal model
(including q.p diffusion and recombination)

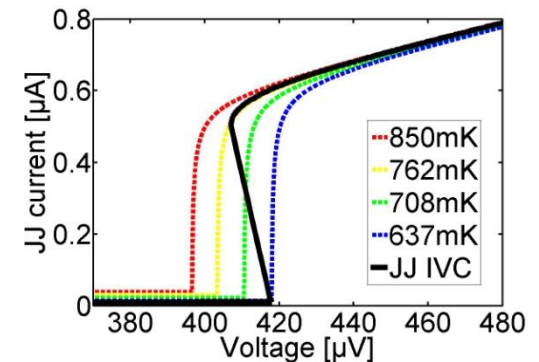



Acknowledgements



F. Lecocq

Ph.D. Defense
May 11th 2011

1. *Quantum dynamics in a dcSQUID*

2. *Bridge-Free Nanofabrication Technique*

3. *Sequential junction cooling in dcSQUID*

Thank you for your attention

And thanks to :

Services of Institut Néel

Nanofab and PTA

Electronics

Cryogénie

Liquéfacteur

Administration

Experimental team

Olivier Buisson
Wiebke Guichard
Bernard Pannetier

Ioan M. Pop
Iulian Matei
Thomas Weissl
Etienne Dumur
Alexey Feofanov

Theoretical support

Franck Hekking
Nicolas Didier
Perola Milman

PTB

Alexander Zorin
Ralf Dolata

And all the “Quantum Coherence” group !!

Best wishes for Cecile and Julie