



HAL
open science

Etude topologique de fonctions définissables par automates

Cagnard Benoit

► **To cite this version:**

Cagnard Benoit. Etude topologique de fonctions définissables par automates. Mathématiques [math]. Université Pascal Paoli, 2008. Français. NNT: . tel-00604017

HAL Id: tel-00604017

<https://theses.hal.science/tel-00604017>

Submitted on 27 Jun 2011

HAL is a multi-disciplinary open access archive for the deposit and dissemination of scientific research documents, whether they are published or not. The documents may come from teaching and research institutions in France or abroad, or from public or private research centers.

L'archive ouverte pluridisciplinaire **HAL**, est destinée au dépôt et à la diffusion de documents scientifiques de niveau recherche, publiés ou non, émanant des établissements d'enseignement et de recherche français ou étrangers, des laboratoires publics ou privés.



THÈSE

pour l'obtention du grade de

DOCTEUR DE L'UNIVERSITÉ DE CORSE

Mention Mathématiques Informatique

par

Benoît CAGNARD

ETUDE TOPOLOGIQUE DE FONCTIONS DEFINISSABLES PAR AUTOMATES

présentée et soutenue publiquement le 28 novembre 2008

Composition du jury

Rapporteurs	Professeur Olivier CARTON	Université Paris 7
	Professeur Jacques DUPARC	Université de Lausanne
Examineurs	Professeur Marie Pierre BEAL	Université Paris Est
	Professeur Paul BISGAMBIGLIA	Université de Corse
	DR CNRS Gilles GODEFROY	Université Paris 6
	MCF (HDR) Jean Martin PAOLI	Université de Corse
	Professeur Jean François SANTUCCI	Université de Corse
Directeur de thèse	MCF (HDR) Pierre SIMONNET	Université de Corse

Remerciements

Je tiens à remercier chaleureusement Olivier Carton et Jacques Duparc d'avoir eu ont eu l'extrême gentillesse d'accepter d'être rapporteur de ce travail. Je remercie également Marie Pierre Béal et Gilles Godefroy, Jean Martin Paoli, Paul Bisgambiglia et Jean François Santucci de leur bienveillante présence dans mon jury de thèse.

Merci à toi Pierre d'avoir eu suffisamment de continuité et de ténacité pour m'aider à mener à terme ce travail. Nos modes de fonctionnement respectifs bien qu'asynchrones sont peut être à délai borné...

Merci à Bernard Di Martino pour sa disponibilité sans faille et sa capacité à gérer les situations de crise de toute sorte.

Un grand et généreux merci à tous mes collègues, enseignants, chercheurs et personnels administratifs de la faculté des sciences qui m'ont accueillis au sein de cette université et me permettent de m'y épanouir depuis maintenant plus de 9 ans.

Pour les amis, vous savez bien que je mettrai bien plus de 15 jours à vous remercier.

Table des matières

Introduction	4
0.1 Langages rationnels	5
0.2 Séries rationnelles	7
0.2.1 De la série à la fraction	7
0.2.2 De la fraction à la série	8
0.3 Fonctions rationnelles	9
0.4 Fonctions ω -rationnelles	11
0.5 Représentation des réels en base θ	13
1 Automata, Borel functions and real numbers in Pisot base	17
1.1 Introduction	18
1.2 Infinite words on a finite alphabet	19
1.3 Automata on infinite words	20
1.4 Borel hierarchy	22
1.5 We can decide if a function definable in $S1S$ is Baire class 1	24
1.6 An example of non-continuous Baire class 1 function: the canonical Booth function	26
1.7 The case of the real numbers	30
1.8 Conclusion	35
2 Baire and automata	38
2.1 Introduction	39
2.2 Automata on infinite words	43
2.2.1 infinite words	43
2.2.2 Automata on infinite words	43
2.2.3 $S1S$: the monadic second order theory of one successor	46
2.2.4 ω -regular sets	46
2.3 ω -rational relations	47
2.4 Borel sets in Polish spaces	48

2.4.1	Ordinals	49
2.4.2	The Borel hierarchy	50
2.4.3	Polish spaces	51
2.4.4	Analytic sets and coanalytic sets	52
2.4.5	Complete sets	52
2.5	Baire's classes	54
2.6	An example	56
2.7	Differences hierarchy	59
2.8	Hausdorff's derivation	61
2.9	Baire's theorem	64
2.10	Application to automata theory	65
2.11	Games	66
2.11.1	Büchi, Landweber and Martin	67
2.11.2	Wadge Game	68
2.11.3	Wadge's hierarchy, Wagner's Hierarchy, Louveau's hierarchy	68
2.11.4	\mathbb{O} and \mathbb{Q}	70
2.11.5	Separation games	71
2.11.6	Steel's game and separation by Δ_2^0 sets	73
2.11.7	Mistigri Color	74
2.12	Conclusion	76
2.12.1	Π_1^1 sets and ω_1 , the boundedness theorem of Lusin	76
2.12.2	Hausdorff and automata	77
2.12.3	Game quantifier and tree automata	79
2.12.4	Baire class 1 functions	80
2.12.5	Acknowledgements	80
3	Sarkovski and automata	89
3.1	Introduction	90
3.2	automata on infinite words	90
3.3	ω -rational relations	92
3.4	The Sarkovski theorem	93
3.5	The case of ω -rational functions	95

Introduction

L'origine de ce travail de thèse est une affaire de couloir traversé dans un sens puis dans l'autre. Le bureau de Pierre Simonnet et le mien se font face au premier étage d'un bâtiment de la faculté des sciences, séparés par un simple couloir. Métaphoriquement, ce couloir peut se voir comme une frontière qui sépare ici les mathématiques de l'informatique et de la physique tant du point de vue de la recherche que de celui de l'enseignement. C'est Pierre qui le premier franchi le Rubicon, venant dans mon bureau avec des objets que je ne connaissais pas encore - langages de mots finis, de mots infinis, automates finis - et deux ou trois problèmes techniques que d'assez sommaires outils d'arithmétique sur \mathbb{Z} , de théorie des groupes ou d'algèbre linéaire permirent de résoudre.

C'est ensuite moi qui l'ai rejoint de l'autre coté du couloir en m'investissant dans l'enseignement des *mathématiques pour l'informatique* pour les filières NTIC. A cette occasion j'ai pu apprendre et enseigner différents aspects du théorème de Kleene, la détermination des automates, la minimisation des automates, l'algorithme de Berry-Sethi et aussi appréhender d'autres domaines où mathématiques et informatique restent intimement liées comme la cryptographie ou les codes détecteurs et correcteurs d'erreurs. Cette aventure d'enseignement nous a permis de jeter les bases de ce que serait ce travail, résolument transversal et ne perdant pas le lien avec l'enseignement. Actuellement à l'université de Corse un étudiant de première année n'entend pas parler de relations sur les ensembles sans graphes et en seconde année les exemples classiques des fonctions de Lebesgue-Scheffer-Sierpinski et de Péano sont vus et implémentés dans le langage de programmation de calcul formel Maple au moyen de transducteurs en utilisant la représentation des réels dans diverses bases.

Dans ce mémoire nous avons voulu étudier les notions de continuité, fonctions première classe (limites simples de suites fonctions continues), fonctions de deuxième classe (limites simples de suites de fonctions de première classe) chères au mathématicien dans le cadre des fonctions définissables par automates qui devrait intéresser l'informaticien.

0.1 Langages rationnels

Sur les langages rationnels, que dit le théorème de Kleene ?

Un langage est rationnel si et seulement si il est reconnu par un automate fini.

*Exemple 1. Soit L le langage ne pas avoir deux b consécutifs et finir par b sur l'alphabet $\{a,b\}$. Une expression rationnelle de L est $(a + ba)^*b$ et L est reconnu par l'automate (minimal) de la figure 0.1.*

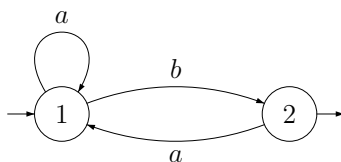

FIG. 0.1 – Automate reconnaissant le langage $(a + ba)^*b$

Nous connaissons plusieurs algorithmes permettant de passer de l'automate \mathcal{A} au langage $L \subset A^*$ et inversement. Deux parmi eux nous intéressent particulièrement.

Le premier, l'algorithme de Mac Naughton Yamada permet de passer de l'automate à l'expression rationnelle en considérant les $X_{p,q}^{(k)}$, l'ensemble des mots de A^* qui permettent de passer de l'état p à l'état q en ne transitant que par des états $\leq k$. Dans $\mathcal{P}(A^*)$ l'ensemble des parties de A^* muni d'une structure de semi-anneau avec le ou (+) et la concaténation (.) on a la relation de récurrence suivante :

$$X_{p,q}^{(k+1)} = X_{p,q}^{(k)} + X_{p,k+1}^{(k)} \cdot \left(X_{k+1,k+1}^{(k)} \right)^* \cdot X_{k+1,q}^{(k)}$$

Le langage reconnu par l'automate étant $L = \sum_{i \in I, f \in F} X_{i,f}^{(n)}$ où I est l'ensemble des états initiaux, F l'ensemble des états finaux et n le nombre d'états de l'automate. Cet algorithme fait partie de la même famille que ceux de Roy Warshall ou celui de Floyd Warshall. En fait c'est le même algorithme, il suffit de changer de semi anneau !

L'algorithme de Roy Warshall permet de calculer la clôture transitive d'une relation binaire R sur un ensemble E en se plaçant dans le semi-anneau des matrices Booléennes. On considère les matrices $S^{(k)}$ d'adjacence des relations : i est en relation avec j si il existe un chemin dans le graphe de R liant i à j en ne transitant

que par des sommets $\leq k$. On a la récurrence suivante :

$$S_{i,j}^{(k+1)} = S_{i,j}^{(k)} + S_{i,k+1}^{(k)} \cdot S_{k+1,j}^{(k)}$$

Si n est le cardinal de E , la matrice $S^{(n)}$ est alors la matrice d'adjacence de la clôture transitive de R .

L'algorithme de Floyd Warshall s'intéresse lui au problème du plus court chemin (ou de coût minimal) dans un graphe. On se place ici dans le semi-anneau des matrices à coefficients dans $\overline{\mathbb{N}} = \mathbb{N} \cup \infty$ muni des lois \min et $+$. $S^{(k)}$ est la matrice dont les coefficients $S_{i,j}^{(k)}$ représentent le coût minimal d'un chemin allant de i à j en ne transitant que par des sommets $\leq k$. On a la récurrence suivante :

$$S_{i,j}^{(k+1)} = \min \left(S_{i,j}^{(k)}, S_{i,k+1}^{(k)} + S_{k+1,j}^{(k)} \right)$$

Et la matrice $S^{(n)}$ où n est le nombre de sommet du graphe est la matrice des plus courts chemins.

Intéressons nous maintenant à une méthode qui permet de passer du langage à l'automate. Considérons un langage rationnel $L \subset A^*$, l'ensemble des quotients à gauche $\{u^{-1}L | u \in A^*\}$ est un ensemble fini avec $u^{-1}L = \{v \in A^* | uv \in L\}$. La relation $(uv)^{-1}L = v^{-1}(u^{-1}L)$ permet de déterminer aisément les $u^{-1}L$ et de construire un automate qui reconnaît L et dont les états ne sont autres que les $u^{-1}L$: cet automate est l'automate minimal qui reconnaît L . Nous verrons bientôt que cette stratégie peut être employée dans le cadre d'un alphabet à une lettre et en changeant juste de semi-anneau pour passer de la série rationnelle à la fraction rationnelle.

Remarque 1. Si cette méthode s'avère efficace et élégante sur des exemples simples, elle n'est pas du tout opérationnelle dans le cas général puisque l'on a besoin de savoir si deux expressions rationnelles définissent le même langage. Et c'est justement grâce à l'automate minimal que l'on sait répondre à cette question! Or ce passage de l'expression rationnelle à un automate qui la reconnaît est très intéressant pour le programmeur système. La commande `awk` du système UNIX permet de filtrer les lignes d'un fichier à l'aide d'une expression rationnelle. L'algorithme de Berry-Sethi constitue une bonne méthode, efficace et opérationnelle permettant de passer de l'expression rationnelle à l'automate (non déterministe) qui reconnaît le langage.

Ces digressions voulaient montrer que dans les deux sens le théorème de Kleene a un contenu algorithmique fort et utile pour l'informaticien. Mais aussi que si

l'on regarde un graphe par le biais de sa matrice d'adjacence tout ceci n'est que de l'algèbre linéaire avec des matrices à coefficients dans des semi-anneaux et cela pourrait bien intéresser l'enseignant de mathématiques.

0.2 Séries rationnelles

Le théorème de Schützenberger étend le résultat de Kleene aux séries rationnelles :

Une série est K rationnelle si et seulement si elle est K reconnaissable.

Ce théorème dit en substance que ce qui a été prouvé par Kleene dans le semi-anneau de Boole reste vrai dans n'importe quel semi-anneau K .

Afin d'illustrer notre propos dans le cas d'un alphabet à une lettre $A = \{z\}$, du semi-anneau qui sera un corps (\mathbb{R}) et dans un réflexe pavlovien, regardons le cas de la série suivante :

$$S(z) = \sum_{n=0}^{+\infty} F_n z^n$$

où F_n désigne le $n^{\text{ième}}$ terme de la suite de Fibonacci avec $F_0 = 0$ et $F_1 = 1$.

0.2.1 De la série à la fraction

Regardons les quotient à gauche de S :

$$\begin{aligned} S(z) &= \sum_{n=0}^{+\infty} F_n z^n \\ z^{-1} S(z) &= \sum_{n=0}^{+\infty} F_{n+1} z^n = \frac{S(z) - F_0}{z} \\ (z^2)^{-1} S(z) &= \sum_{n=0}^{+\infty} F_{n+2} z^n = \frac{S(z) - (F_0 + F_1 z)}{z^2} \end{aligned}$$

Comme $F_{n+2} - F_{n+1} - F_n = 0$, on en déduit :

$$(z^2)^{-1} S(z) - z^{-1} S(z) - S(z) = 0$$

Et par suite : $S(z) = \frac{z}{1 - z - z^2} = (z + z^2)^* z$.

Comme la relation de récurrence linéaire que nous avons utilisée pour décrire la rationalité de S est la plus courte, le polynôme caractéristique de la matrice associé à cette représentation linéaire est égal au polynôme minimal, ici $P_m(z) = z^2 - z - 1$. La fraction obtenue est normalisée (irréductible) et le quotient $Q(z) = 1 - z - z^2$ de celle ci est le polynôme réciproque de P_m : $Q(z) = z^2 P_m\left(\frac{1}{z}\right)$.

Remarque 2. Il est amusant de constater que si sur les langages rationnels l'étude des quotients à gauche nous avait permis de passer de l'expression rationnelle à l'automate, ici on passe de la relation de récurrence (matrice, automate à poids) à la fraction rationnelle (expression rationnelle).

Remarque 3. Ici c'est le point de départ qui pose problème. Nous ne sommes pas simplement partis d'une série reconnaissable. Nous sommes partis d'une série reconnaissable en connaissant déjà la relation de récurrence linéaire qui lie ses coefficients ou ce qui est équivalent en connaissant une représentation linéaire de cette série. Etant donné une série formelle, comment savoir si elle est reconnaissable et comment trouver une représentation linéaire de celle-ci? On sait qu'une série formelle sur K , $S \in K\langle\langle A \rangle\rangle$ est K reconnaissable si et seulement si il existe un K sous-module gauche M de $K\langle\langle A \rangle\rangle$ de type fini, stable par les opérations de quotient à gauche qui contienne S . A partir de ce sous module, on sait construire une représentation linéaire de la série. Un moyen de construire M est d'étudier les quotients à gauche $z^{-1}S$, $z \in A^$ et de considérer le sous module engendré par ces quotients. Savoir si ce sous-module est de type fini nous ramène exactement sur le problème évoqué à la remarque 1 dans le cas du semi-anneau de Boole.*

0.2.2 De la fraction à la série

Regardons toujours sur cet exemple un moyen retrouver la relation de récurrence et de retrouver ainsi la série rationnelle et un automate à poids qui la reconnaît.

On cherche donc la récurrence linéaire qui lie les coefficients de la série $S(z) = \sum_{n=0}^{+\infty} a_n z^n$ de telle sorte que :

$$S(z) = \frac{z}{1 - z - z^2}$$

De cette équation, on déduit immédiatement :

$$a_0 + (a_1 - a_0)z + \sum_{n=2}^{+\infty} (a_n - a_{n-1} - a_{n-2})z^n = 0$$

$$\text{D'où } \begin{cases} a_0 = 0 \\ a_1 = 1 \\ a_n = a_{n-1} + a_{n-2} \quad \forall n \geq 2 \end{cases}$$

Il s'en suit pour tout n que $a_n = \begin{pmatrix} 1 & 0 \\ 1 & 0 \end{pmatrix} \begin{pmatrix} 1 & 1 \\ 1 & 0 \end{pmatrix}^n \begin{pmatrix} 1 \\ 0 \end{pmatrix}$. Ce qui permet de construire

l'automate à poids de la figure 0.2. Ici, la matrice étant à coefficients dans $\{0,1\}$, tous les poids valent 1.

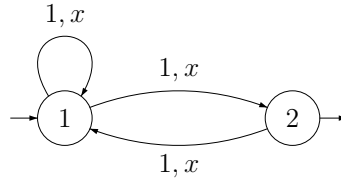

FIG. 0.2 – Suite de fibonacci

Remarque 4. Les graphes des automates des figures 0.2 et 0.1 sont identiques. Dans le premier on l'intéresse à un problème de reconnaissance et dans le second au nombre de chemins : on est passé de la série $\sum_{w \in A^*} \mathbb{1}_L(w) w$ à la série $\sum_{n \geq 0} \text{Card}(L \cap A^n) z^n$. Cet exemple est générique, pour tout langage rationnel L la série $\sum_{n \geq 0} \text{Card}(L \cap A^n) z^n$ est \mathbb{N} -rationnelle et peut donc s'écrire sous forme de fraction rationnelle. C'est pour cette raison et à la suite de Marcel Paul Schützenberger que l'école française de théorie des automates a adopté la terminologie de langages rationnels plutôt que celle utilisée par les anglo-saxons de langages réguliers.

0.3 Fonctions rationnelles

Une fonction $F : A^* \rightarrow B^*$ est dite rationnelle si son graphe est une partie rationnelle de $A^* \times B^*$. La fonctionnalité est une propriété décidable sur les relations rationnelles de $A^* \times B^*$.

Pour poursuivre l'introduction des notions qui seront développées plus tard, nous continuons à illustrer notre propos avec un exemple qui utilise la suite de Fibonacci.

Exemple 2. Considérons l'application suivante :

$$\nu_F : \{0,1\}^+ \rightarrow \mathbb{N}$$

$$u \mapsto \sum_{i=0}^n u_i F_{n-i} \quad \text{avec } n \text{ la longueur du mot } u$$

Où $(F_n)_{n \in \mathbb{N}}$ est la suite de Fibonacci avec $F_0 = 1$ et $F_1 = 2$.

Rappelons que ν_F est surjective et non injective : tout entier possède une représentation en base de Fibonacci qui peut ne pas être unique en raison de la relation

de récurrence $F_{n+2} = F_{n+1} + F_n$.

$$\nu_f(1011) = \nu_f(1100) = \nu_f(10000) = 8$$

Soit $L_n = \{u \in \{0,1\}^+ \mid u_0 = 1 \text{ et } \nu_F(u) = n\}$. Pour tout n de \mathbb{N} , L_n est un sous ensemble fini de $\{0,1\}^+$ qui possède un maximum pour l'ordre lexicographique. Le transducteur dû à Marcel Paul Schützenberger défini sur $0\{0,1\}^*$ de la figure 0.3 réalise la fonction dite de normalisation qui fournit ce maximum lexicographique. L'image de cette fonction est évidemment $(0+10)^*(1+\epsilon)$ (l'ensemble des mots qui n'ont pas deux 1 consécutifs). Sur l'entrée, l'automate est non déterministe et non ambigu.

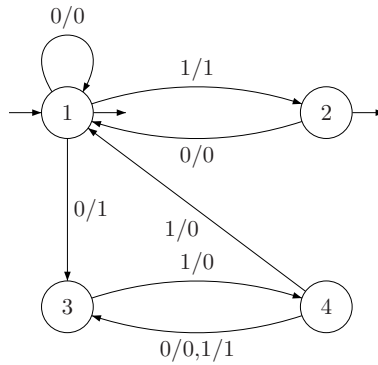

FIG. 0.3 – Normalisation en base de fibonacci

Une idée assez naturelle est de vouloir étendre de telles fonctions aux mots infinis, ici de passer de la représentation des entiers en base de Fibonacci à la représentation des réel en base du nombre d'or. Si on fait opérer le transducteur de la figure 0.3 sur les mots infinis de $0\{0,1\}^\omega$ avec une condition de Büchi, il reste non ambigu sur l'entrée mais jusqu'où doit on lire le mot α avant de pouvoir connaître les première lettres de son image? Assez loin et même plus si l'on considère les suites $((01)^n 10^\omega)_{n \in \mathbb{N}}$ ou $((01)^n 1^\omega)_{n \in \mathbb{N}}$, une retenue pouvant se propager depuis l'infini. Cette fonction a encore pour image l'ensemble des mots qui n'ont pas deux 1 consécutifs, pour autant il ne s'agit plus d'une fonction de normalisation: il suffit de considérer les mots $(01)^\omega$ et 10^ω , invariants par la fonction et qui représentent le même réel $(\frac{1}{\varphi})$ si l'on interprète ceux-ci en base du nombre d'or φ .

Toute fonction rationnelle sur les mots finis peut se décomposer en une application sous-séquentielle gauche suivie d'une sous-séquentielle droite. D'un point de vue topologique étendre aux mots infinis une application sous-séquentielle gauche fournit une application lipschitzienne alors que la même intention sur une application sous-séquentielle droite suggère la discontinuité. C'est ce qui se passe ici avec cette retenue qui peut se propager depuis l'infini. On trouvera de nombreuses informations sur les relations rationnelles et les fonctions rationnelles dans les livres de Jean Berstel et de Jacques Sakarovitch.

L'objet principal de ce travail de thèse a été d'étudier la complexité topologique de telles fonctions, d'établir des résultats de décidabilité sur celle-ci et éventuellement d'étendre ces résultats à certaines fonctions d'une variable réelles en utilisant la représentation de ceux-ci en base Pisot.

0.4 Fonctions ω -rationnelles

L'ensemble A^ω muni de la topologie produit de celle de A (topologie discrète) est un espace métrisable. La distance usuelle utilisée d est la suivante :

$$\begin{aligned} d(\alpha, \beta) &= 1/2^n \text{ avec } n = \min\{i \in \omega \mid \alpha(i) \neq \beta(i)\} \text{ si } \alpha \neq \beta \\ d(\alpha, \beta) &= 0 \text{ si } \alpha = \beta \end{aligned}$$

La famille $(uA^\omega)_{u \in A^*}$ constitue une base d'ouverts fermés pour cette topologie. L'espace (A^ω, d) est un espace polonais ce qui permet d'utiliser des résultats d'analyse classique tels le théorème de Baire.

Une relation $R \subset A^\omega \times B^\omega$ est ω -rationnelle si elle est reconnaissable par un automate de Büchi asynchrone, c'est à dire dont les transitions sont étiquetées par des couples de mots. La complexité topologique de ces relations a été étudiée par Olivier Finkel. Il montre qu'il existe des relations ω -rationnelles qui sont analytiques complètes. Il en découle des résultats d'indécidabilités tels : on ne peut décider si une relation ω -rationnelle est Borel, ouverte, Σ_2^0 ... Toutefois, comme l'a montré Françoise Gire, la fonctionnalité est décidable. Dans le cas synchrone c'est à dire quand la relation est reconnue par un automate de Büchi dont les transitions sont étiquetées par des couples de lettres, les relations restent boréliennes (combinaisons booléennes de Σ_2^0).

Si on s'intéresse à la complexité topologique des fonctions ω -rationnelles, le cadre est celui de la hiérarchie des boréliens et des classes de Baire. On remarque tout d'abord que ces fonctions sont au plus de classe 2 (lemme 2.15). Christophe Prieur a montré que le problème de la continuité est décidable : il s'agit d'une conséquence du théorème du graphe fermé et du fait que l'on peut calculer de manière effective l'adhérence topologique d'une relation ω -rationnelle. Il reste donc à savoir si être de classe 1 est décidable ou non. Nous avons pu répondre par l'affirmative (théorème 1.18) dans le cas synchrone en utilisant un résultat de Sierpinski sur les sur et sous-graphes dont nous donnons une démonstration dans notre contexte (proposition 1.17). Nous avons voulu illustrer notre propos en étendant aux mot infinis le transducteur sous-séquentiel droit implémentant l'algorithme de Booth qui minimise le nombre de 1 dans la représentation des entiers en base d'Avizienis. La technique de Booth est bien connu de la communauté de l'arithmétique des ordinateurs.

L'ensemble des points de continuité d'une fonction est toujours $\mathbf{\Pi}_2^0$. Dans le cas synchrone cet ensemble reconnaissable par un automate de Büchi déterministe (proposition 1.15). Si de plus la fonction est de classe 1 cet ensemble est un $\mathbf{\Pi}_2^0$ dense (théorème 1.10). Une fonction de classe 2 peut n'avoir aucun point de continuité (penser à la fonction caractéristique de \mathbb{Q}). Un résultat de Baire dit qu'une fonction f n'est pas de classe 1 si et seulement si il existe un fermé F non vide tel que la restriction de f à F n'ait aucun point de continuité. Nous prouvons une version automate de ce théorème (corollaire 2.33) :

Une fonction ω rationnelle n'est pas de classe 1 si et seulement si il existe un fermé F non vide reconnaissable par un automate de Büchi tel que la restriction de f à F n'ait aucun point de continuité.

La démonstration de ce dernier résultat repose sur la dérivation de Hausdorff qui s'arrête au bout d'un nombre fini d'étapes sur les langages ω -rationnels. Il serait plaisant que le vieux théorème de Baire caractérisant les fonctions de première classe puisse avoir une application concrète en arithmétique des ordinateurs.

Récemment Olivier Carton et Olivier Finkel ont montré que la nulle part continuité était indécidable pour les fonctions ω -rationnelles. Ceci suggère que le problème de savoir si une fonction ω -rationnelle est de première classe est aussi indécidable.

Enfin nous nous sommes intéressés aux orbites périodiques des fonctions définissables en base Pisot par des transducteurs synchrones au travers du théorème de Sarkovski (théorème 3.7). Contrairement aux cas précédents ce résultat sur les fonctions réelles ne s'étend pas directement aux cas des fonctions ω -rationnelles : l'existence d'un point périodique d'ordre m n'implique pas nécessairement l'existence de points périodiques d'ordre inférieurs dans l'ordre de Sarkovski comme l'illustre l'exemple 3. La raison est que le théorème de Sarkovski est un résultat de connexité alors que (A^ω, d) n'est pas connexe. Ce théorème nous permet toutefois d'obtenir un résultat de décidabilité dans le cadre de fonctions réelles que l'on peut définir à partir de fonctions ω rationnelles synchrones et qui font l'objet de la section suivante.

Exemple 3. La fonction définie sur \mathcal{Z}^ω grace au transducteur de la figure 0.4 n'a que des points périodique de période 3 et aucun d'autre période alors que 3 est le maximum dans l'ordre de Sarkovski.

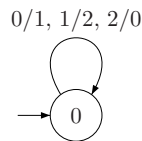

FIG. 0.4 – *Tout point est périodique de période 3*

0.5 Représentation des réels en base θ

Nous avons voulu étendre les résultat de décidabilité obtenus à certaines fonctions réelles. Pour cela on utilise la représentation des réels en base θ . Soit θ un réel >1 , un alphabet symétrique $\Delta = \{\bar{k}, \dots, 0, \dots, k\}$ et μ_θ la fonction continue surjective définie par :

$$\begin{aligned} \mu_\theta : \Delta^\omega &\rightarrow [\mu_\theta(\bar{k}^\omega), \mu_\theta(k^\omega)] \\ \alpha &\mapsto \sum_{n \geq 0} \frac{\alpha(n)}{\theta^{n+1}} \end{aligned}$$

La fonction μ_θ étant continue, pour tout mot α l'ensemble $\mu_\theta^{-1}(\mu_\theta(\{\alpha\}))$ est fermé et l'on peut construire une fonction de sélection (de normalisation) qui à tout α associe le maximum lexicographique de $\mu_\theta^{-1}(\mu_\theta(\{\alpha\}))$. Cette fonction est de première classe.

Christiane Frougny a démontré que cette fonction de normalisation est définissable dans $S1S$ dans le cas où θ est un nombre de Pisot tel le nombre d'or.

On considère alors des fonctions f ω -rationnelles synchrones telles que le diagramme suivant commute :

$$\begin{array}{ccc}
 \Delta^\omega & \xrightarrow{f} & \Delta^\omega \\
 \mu_\theta \downarrow & & \downarrow \mu_\theta \\
 [\mu_\theta(\bar{k}^\omega), \mu_\theta(k^\omega)] & \xrightarrow{F} & [\mu_\theta(\bar{k}^\omega), \mu_\theta(k^\omega)]
 \end{array}$$

Nous appuyant sur les travaux de Christiane Frougny nous avons pu obtenir quelques résultats de décidabilité sur la fonction F .

Tout d'abord en utilisant une fonction de normalisation on obtient une version décidable du théorème de Sarkovski (proposition 3.8). Puis grâce à des arguments de compacité on obtient aussi des résultats de décidabilité pour la continuité (proposition 1.24), résultat d'abord prouvé de façon combinatoire par Christian Choffrut et être de classe 1 (proposition 1.25).

Remarque 5. Ce dernier résultat n'est pas dénué d'intérêt pédagogique puisque les premiers exemples de "vraies" fonctions de classe 1 (limites simples et non uniformes de suites de fonctions continues) que l'on expose à nos étudiants sont souvent affaires de bosses glissantes et rentrent complètement dans ce cadre. Considérons pour nous en convaincre la suite $(F_n)_{n \in \mathbb{N}}$ définie sur $[0,1]$ par :

$$F_n(x) = \begin{cases} 2^n x & \forall x \leq 1/2^n \\ 1 & \forall x > 1/2^n \end{cases}$$

Pour tout n , F_n peut être réalisée en base 2 grâce à la fonction ω -rationnelle f_n et présentée dans la figure 0.5

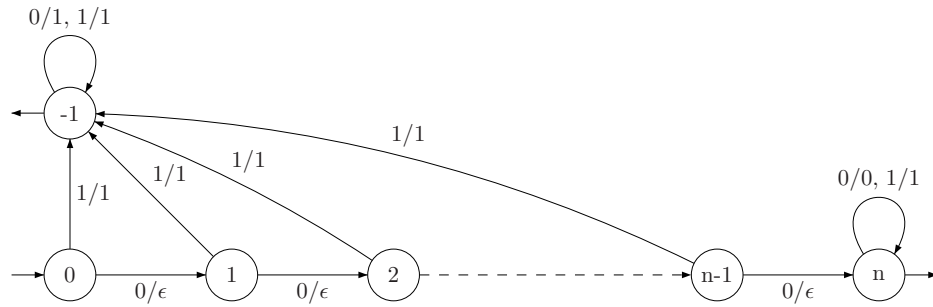

FIG. 0.5 – La fonction f_n en base 2

Pour conclure cette présentation des résultats obtenus, nous pouvons évoquer les interrogations qui subsistent dans le cas asynchrone (la décidabilité d'être de classe 1), des questions relatives à la dérivabilité dans le cas synchrone (l'ensemble des points de dérivabilité est-il reconnaissable dans le cadre des fonctions définissables par automate en base Pisot?) et enfin la construction d'un projet pédagogique avec l'espoir d'une cohérence plus grande entre l'enseignement des mathématiques et de l'informatique dans un cursus de licence scientifique.

Pour finir, puisque nous avons parlé du théorème de Kleene-Schützenberger relatif aux séries K -reconnaissables, voici une question de Pierre Simonnet :

Quelle est la complexité topologique des supports de séries \mathbb{R} -rationnelles?

Une série formelle $S \in K\langle\langle A \rangle\rangle$ est dite K -reconnaissable s'il existe un entier $n \geq 1$, un morphisme de monoïdes $\mu : A^* \rightarrow K^{n \times n}$ et deux vecteurs $\lambda \in K^{1 \times n}$ et $\nu \in K^{n \times 1}$ tels que pour tout mot w :

$$(S, w) = \lambda \mu(w) \nu$$

Le triplet (λ, μ, ν) est alors appelé une représentation linéaire de S et n sa dimension.

Le support d'une série S est l'ensemble des mots w tels que $(S, w) \neq 0$. Il est assez facile de voir que l'ensemble des parties de A^* qui sont support de séries \mathbb{R} -rationnelles est un ensemble analytique. Notons que si cet ensemble était un analytique non borélien cela fournirait une réponse positive mais non constructive au

problème suivant :

Existe-t-il un langage qui soit le support d'une série \mathbb{R} -rationnelle sans être le support d'une série \mathbb{Q} -rationnelle ? (Salomaa et Soittola, 1978)

Chapitre 1

Automata, Borel functions and real numbers in Pisot base

Benoit Cagnard, Pierre Simonnet.

Theoretical Informatics and Application 41 1 (2007) 27-44.

Abstract

This note is about functions $f : A^\omega \rightarrow B^\omega$ whose graph is recognized by a Büchi finite automaton on the product alphabet $A \times B$. These functions are Baire class 2 in the Baire hierarchy of Borel functions and it is decidable whether such function are continuous or not. In 1920 W. Sierpinski showed that a function $f : \mathbb{R} \rightarrow \mathbb{R}$ is Baire class 1 if and only if both the overgraph and the undergraph of f are F_σ . We show that such characterization is also true for functions on infinite words if we replace the real ordering by the lexicographical ordering on B^ω . From this we deduce that it is decidable whether such function are of Baire class 1 or not. We extend this result to real functions definable by automata in Pisot base.

key words: Borel set, Borel function, automata, sequential machine.

1.1 Introduction

Usually, numbers are represented in a positional number system, with a real base $\theta > 1$ and digits from the alphabet $A = \mathbb{Z} \cap [0, \theta]$. So real numbers are considered as infinite words on A with the most significant digit on the left. Then, very often in computer arithmetic a carry propagates from right to left. In [6, 17] on-line algorithms are proposed to compute arithmetic expressions from left to right. In general, on-the-fly algorithms process data in a serial manner from the most significant to the least significant digit. These algorithms however use several registers, each of them representing a correct prefix of the result, corresponding to an assumed value of the carry. In [6, 17] is presented a theoretical framework which allows to easily obtain on the fly algorithms whenever it is possible. C. Frougny [12] shows that a function is on the fly computable if and only if it is computable by a right subsequential finite state machine. The idea to read from left to right in a right subsequential finite state machine suggests non-determinism. Moreover, working on infinite words rather than finite words suggests discontinuity. A natural hierarchy exists on discontinuous Borel functions, the Baire classes of functions. A function f belongs to class 0 if it is continuous. A function f belongs to class 1 if it is the pointwiselimit of a sequence of functions of class 0. A function f belongs to class 2 if it is the pointwiselimit of a sequence of functions of class 1, and so on. The present work studies from a topological point of view functions $f : A^\omega \rightarrow B^\omega$ whose graph is recognized by a Büchi finite automaton on the product alphabet $A \times B$. Topology and automata on infinite words have been heavily studied. It is easy to see that our functions are of Baire class 2, we prove that we can decide if they are of Baire class 1. We also prove this same result when numbers are represented with a Pisot base. A Pisot number is an algebraic integer θ which is real and strictly exceeds 1, but such that its conjugate elements are all strictly less than 1 in absolute value. For example, The natural integers greater than 2 and the golden ratio are Pisot numbers. This extend the applicability of our result to the domain of real numbers. Our proof uses an old result of Sierpinski on Baire class 1 functions and decidability results of Landweber. The set of points of continuity of a function f on an infinite word is always a countable intersection of open sets which is dense whenever f is of Baire class 1. We expect that our approach will shed new light on the discussion in the field of on-the-fly algorithms. For this reason we present a detailed study of the Booth canonical recoding on infinite words. This function is an example of a discontinuous first class function.

The paper is organized as follows. First in sections 2, 3, 4 we present some necessary definitions and properties from automata theory and descriptive set theory. In section 5 we prove our decidability result on infinite words. In section 6 we study the Booth canonical recoding. In section 7 we prove our decidability result in the case where our functions define functions on real numbers represented with a Pisot base. In the conclusion we advance our impressions on the asynchronous case, that is to say the case of functions whose graph is recognized by a Büchi automaton which transitions are labeled by couples of words $(u,v) \in A^* \times B^*$ instead of couples of letters $(a,b) \in A \times B$.

1.2 Infinite words on a finite alphabet

We note ω the set of natural numbers. Let A be a finite alphabet and $<$ a linear order on A . All alphabets that we consider will have at least two letters. We denote a the smallest element (first letter) of A and z the greatest element. A finite word u on the alphabet A is a finite sequence of elements of A , $u = u(0)u(1)\cdots u(n)$ where all the $u(i)$'s are in A . The set of finite words on A will be denoted A^* . The length (number of letters) of a word u will be noted $|u|$. A particular word is the empty word ϵ , $|\epsilon| = 0$. The set A^+ is $A^* - \{\epsilon\}$. With concatenation, A^* is a monoid with unit element ϵ . There is a natural order on A^* : the lexicographical ordering, still denoted by $<$.

Lemma 1.1. *Let n be in ω , we note A^n the set of words $u \in A^*$ with $|u| = n$.*

(i) *For all $n \in \omega - \{0\}$, every word $u \in A^n$ different of a^n have an immediate predecessor in A^n noted \underline{u} , for the lexicographical ordering.*

(ii) *For all $n \in \omega - \{0\}$, every word $u \in A^n$ different of z^n have an immediate successor in A^n noted \bar{u} for the lexicographical ordering.*

Proof: By induction on n the length of u . If $u = vl$ with $v \in A^{n-1}$ and $l \in A$ then :

if $l \neq a$ or z : $\underline{u} = v(l-1)$ and $\bar{u} = v(l+1)$,

if $l = a$: $\underline{u} = \underline{v}z$ and $\bar{u} = v(a+1)$,

if $l = z$: $\underline{u} = v(z-1)$ and $\bar{u} = \bar{v}a$. □

An infinite word α on the alphabet A is an infinite sequence of elements of A , $\alpha = \alpha(0)\alpha(1)\cdots\alpha(n)\cdots$. The set of infinite words on the alphabet A will be noted A^ω . We note $\alpha[n]$ the finite word formed with the n first letters of the infinite word α , $\alpha[0] = \epsilon$, $\alpha[1] = \alpha(0)$. The set A^ω , viewed as a product of infinitely many copies of A with the discrete topology, is a metrizable space. It is equipped with the usual

distance d defined as follows. Let $\alpha, \beta \in A^\omega$,

$$\begin{aligned} d(\alpha, \beta) &= 1/2^n \text{ with } n = \min\{i \in \omega \mid \alpha(i) \neq \beta(i)\} \text{ if } \alpha \neq \beta \\ d(\alpha, \beta) &= 0 \text{ if } \alpha = \beta \end{aligned}$$

The collection $(uA^\omega)_{u \in A^*}$ is a basis of clopen sets for this topology. Recall that (A^ω, d) is a compact metric space. The set A^ω is ordered by the lexicographical ordering $<$.

1.3 Automata on infinite words

For all this section, see [20].

Definition 1.2. A Büchi (nondeterministic) automaton \mathcal{A} is a 5-tuple: $\mathcal{A} = \langle A, Q, I, T, F \rangle$, where A is a finite alphabet, Q is a finite set of states, $I \subset Q$ is the set of initial states, $T \subset Q \times A \times Q$ is the set of transitions and $F \subset Q$ the set of final states.

A path c of label α in \mathcal{A} is an infinite word $c = c(0)c(1) \cdots c(n) \cdots \in (Q \times A \times Q)^\omega$ so that $\forall n \in \omega$, $c(n)$ is of the form $(\beta(n), \alpha(n), \beta(n+1))$ with $\beta(0) \in I$ and $c(n) \in T$.

$$c = \beta_0 \xrightarrow{\alpha_0} \beta_1 \xrightarrow{\alpha_1} \beta_2 \xrightarrow{\alpha_2} \dots$$

Let us note $\text{Infinity}(c)$ the set of states which appears infinitely many times in c . An accepting path c is a path so that $\text{Infinity}(c) \cap F \neq \emptyset$. An accepted word α is a word such that exists an accepting path c of label α . We say that the word α is recognized by \mathcal{A} for the Büchi condition.

The set of words recognized by a Büchi automaton \mathcal{A} is noted $L^\omega(\mathcal{A})$.

Let us denote by $\mathcal{P}(Q)$ the power set of Q . Notice that T can be viewed as a partial function $\delta : Q \times A \rightarrow \mathcal{P}(Q)$ where $\delta(p, a) = \{q \in Q \mid (p, a, q) \in T\}$. By defining $\delta(p, ub) = \bigcup_{q \in \delta(p, u)} \delta(q, b)$ and $\delta(p, \epsilon) = \{p\}$, δ can be extended to a partial function $\delta : Q \times A^* \rightarrow \mathcal{P}(Q)$.

Example 1. Let \mathcal{A} be the Büchi automaton on alphabet $A = \{0,1\} \times \{0,1\}$, with states $Q = \{1,2,3,4,5\}$, initial states $I = \{1,3,4\}$, final states $F = \{1,3,5\}$ and transitions

$$\begin{aligned} T = \{ & (1, (0,0), 1), (1, (1,1), 2), (2, (0,0), 1), (2, (1,1), 2), \\ & (3, (1,1), 3), (4, (0,0), 4), (4, (1,1), 4), (4, (0,1), 5), (5, (1,0), 5) \} \end{aligned}$$

The graphical representation of \mathcal{A} is given in Figure 3.4, the initial (resp. final) states are represented using an ingoing (resp. outgoing) unlabeled arrow. This

automaton recognizes the graph of the function $S : \{0,1\}^\omega \rightarrow \{0,1\}^\omega$ defined by $S(\alpha) = \alpha$ if α has an infinite number of zeroes, $S(1^\omega) = 1^\omega$ and for all $u \in \{0,1\}^*$, $S(u01^\omega) = u10^\omega$. Let $\mu_2 : \{0,1\}^\omega \rightarrow [0,1]$ defined by $\mu_2(\alpha) = \sum_{i=0}^{\infty} \frac{\alpha(i)}{2^{i+1}}$. One can easily verify that for all $\alpha \in \{0,1\}^\omega$, $S(\alpha)$ is the maximum lexicographic of the binary representations of $\mu_2(\alpha)$. S is known as normalization in base 2.

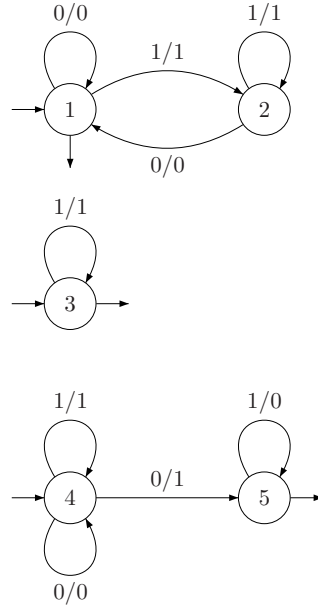

FIG. 1.1 – Normalization in base 2

Definition 1.3. A Muller automaton \mathcal{A} is a 5-tuple: $\mathcal{A} = \langle A, Q, I, T, \mathcal{F} \rangle$, where A is a finite alphabet, Q is a finite set of states, $I \subset Q$ is the set of initial states, $T \subset Q \times A \times Q$ is the set of transitions and $\mathcal{F} \subset \mathcal{P}(Q)$. The difference between Büchi automata and Muller automata is the acceptance condition.

An infinite word $\alpha \in A^\omega$ is recognized by \mathcal{A} if there is an infinite path c of label α so that $\text{Infinity}(c) \in \mathcal{F}$.

An automaton is called *deterministic* if it has a unique initial state and for each state p and each letter a there exists at most one transition $(p, a, q) \in T$. In this case the partial transition function δ can be viewed as $\delta : Q \times A \rightarrow Q$. For all infinite word α there exist, then, at most one path c of label α .

Consider the following logical language: the set \mathcal{V} of the variables, its elements noted by x, y, z, \dots , a constant symbol 0 and a unary function s (as successor). We define the set of the terms \mathcal{T} by:

- i) A variable is a term.

- ii) 0 is a term.
- iii) if $t \in \mathcal{T}$ then $s(t) \in \mathcal{T}$.

Let \mathcal{P} (as parts) another set of variables, this variables are noted $\mathcal{X}, \mathcal{Y}, \mathcal{Z}...$ and two binary predicates $=, \in$. The atomic formulae are of the form $t = t'$ with $(t, t') \in \mathcal{T}^2$ or $t \in \mathcal{X}$ with $t \in \mathcal{T}$ and $\mathcal{X} \in \mathcal{P}$.

Definition 1.4. A formula of S1S is defined as following:

- i) An atomic formula is in S1S.
- ii) If $\phi \in S1S$ then $\neg\phi, \forall x\phi, \exists x\phi, \forall \mathcal{X}\phi, \exists \mathcal{X}\phi$ are in S1S, with $x \in \mathcal{V}, \mathcal{X} \in \mathcal{P}$
- iii) If ϕ and ψ are in S1S then $\phi \wedge \psi, \phi \vee \psi, \phi \Rightarrow \psi, \phi \Leftrightarrow \psi$ are in S1S.

The interpretation of these formulae is the following: the variables of \mathcal{V} are interpreted as natural numbers, the symbol 0 as $0 \in \omega$, the symbol s as the successor function in ω , the variables of \mathcal{P} as subsets of ω and the predicates symbols as $=$ and \in in ω . If each integer is assimilated to a singleton and each subset of ω to an infinite word on the $\{0,1\}$ alphabet, then a S1S formula $\phi(\mathcal{X}_1, \mathcal{X}_2, \dots, \mathcal{X}_n)$, with $\mathcal{X}_1, \mathcal{X}_2, \dots, \mathcal{X}_n$ free variables defines the ω -language $L_\phi \subset \underbrace{2^\mathbb{N} \times \dots \times 2^\mathbb{N}}_n$ of the n -tuple of characteristic words satisfying ϕ .

An ω -language L is said *definable* in S1S if there exists a formula ϕ in S1S so that $L = L_\phi$.

Recall the following result :

Theorem 1.5. for all ω -language L , the following assertions are equivalent:

- i) $L = \bigcup_{1 \leq i \leq n} A_i B_i^\omega$ with A_i, B_i rational sets of finite words.
- ii) $L = L^\omega(\mathcal{A})$ with \mathcal{A} nondeterministic Büchi automaton.
- iii) $L = L^\omega(\mathcal{A})$ with \mathcal{A} deterministic Muller automaton.
- iv) L is definable in S1S.

We call $Rec(A^\omega)$ the family of such languages.

1.4 Borel hierarchy

For all this section, see [16, 20]. Borel sets of a topological space X are the sets obtained from open sets using complementation and countable unions. When X is metrizable we can define the hierarchy of Borel sets of finite rank, using the classical notation of Addison [16]:

Definition 1.6. Let X be a metrizable space, for $n \in \omega - \{0\}$, we define by induction the classes $\Sigma_n^0(X)$, $\Pi_n^0(X)$ and $\Delta_n^0(X)$:

$\Sigma_1^0(X) = G(X)$ the class of open sets of X

$\Pi_n^0(X) = \{A^\vee \mid A \in \Sigma_n^0(X)\}$, where A^\vee refers to the complement of A .

$\Sigma_{n+1}^0(X) = \{\cup_m A_m \mid A_m \in \Pi_n^0(X), m \in \omega\}$

$\Delta_n^0(X) = \Sigma_n^0(X) \cap \Pi_n^0(X)$

We must have a metrizable space since in a metrizable space the closed sets are Π_2^0 .

In particular, we have :

Π_1^0 is the class of closed sets.

$\Sigma_2^0 = F_\sigma$ is the class of countable unions of closed sets.

$\Pi_2^0 = G_\delta$ is the class of countable intersections of open sets.

One can prove that : $\Sigma_n^0 \cup \Pi_n^0 \subset \Delta_{n+1}^0$.

This gives us the following picture where any class is contained in every class to the right of it :

$$\begin{array}{ccccccccccc} & & \Sigma_1^0 & & \Sigma_2^0 & & \Sigma_3^0 & & & \Sigma_n^0 & & \\ \Delta_1^0 & & & \Delta_2^0 & & \Delta_3^0 & & \dots & \Delta_n & & \dots & \\ & & \Pi_1^0 & & \Pi_2^0 & & \Pi_3^0 & & & \Pi_n^0 & & \end{array}$$

The Borel hierarchy is also defined for transfinite levels [16], but we shall not need them in the present study.

For all $n \in \omega$ the classes $\Sigma_n^0(X)$, $\Pi_n^0(X)$, $\Delta_n^0(X)$ are closed by finite union and intersection, moreover $\Sigma_n^0(X)$ is closed by countable union, $\Pi_n^0(X)$ is closed by countable intersection and $\Delta_n^0(X)$ is closed by complement.

When X is an uncountable metric complete space, the Borel hierarchy is strict. In what follows X will be A^ω or $[a,b]$ with a and b real numbers.

Definition 1.7. *The definition of Baire classes for functions is recursive.*

Let X, Y be metrizable spaces and a function $f : X \rightarrow Y$.

- i) f is Baire class 0 if f is continuous.
- ii) $\forall n \in \omega$, f is Baire class $(n+1)$ if f is the pointwise limit of a sequence of Baire class n functions.

The Lebesgue, Hausdorff, Banach Theorem makes the connexion with the Borel hierarchy, see [16] :

Theorem 1.8. *Let X, Y be metrizable spaces with Y separable. Then for all $n \geq 2$, $f : X \rightarrow Y$ is Baire class n iff for all open $V \in Y$, $f^{-1}(V) \in \Sigma_{n+1}^0(X)$.*

Remark 1. Note that this result hold for $n = 1$ if in addition X is separable and either $X = A^\omega$ or else $Y = \mathbb{R}$.

Denote $\text{cont}(f)$ the set of points of continuity of f . We have the classical following Proposition, see [16]:

Proposition 1.9. *Let X, Y , be metrizable spaces and $f : X \rightarrow Y$, then $\text{cont}(f)$ is Π_2^0 .*

The following result due to Baire shows that Baire class 1 functions have many continuity points, see [16]:

Theorem 1.10. *Let X, Y , be metrizable spaces with Y separable and $f : X \rightarrow Y$ be Baire class 1. Then $\text{cont}(f)$ is a dense Π_2^0 set.*

It is well known that the graph of a continuous functions is closed. The following result is classical, see [9] for example.

Lemma 1.11. *Let X, Y , be metrizable spaces with Y compact and $f : X \rightarrow Y$. f is continuous iff its graph is closed.*

Lemma 1.12. *Let X, Y , be metrizable spaces with Y separable and $f : X \rightarrow Y$. If f is Baire class n then its graph is $\Pi_{n+1}^0(X)$.*

Proof: We give the proof in the case $X = A^\omega, Y = B^\omega$. First notice that if $f(\alpha) = \beta$ then $\forall u \in B^*, (\beta \in uB^\omega \Rightarrow f(\alpha) \in uB^\omega)$ and if $f(\alpha) \neq \beta$ then $\exists u \in B^*$ such that $\beta \in uB^\omega$ and $f(\alpha) \notin uB^\omega$. Thus :

$$(\alpha, \beta) \in \text{graph}(f) \Leftrightarrow f(\alpha) = \beta \Leftrightarrow [\forall u \in B^* (\beta \in uB^\omega \Rightarrow f(\alpha) \in uB^\omega)]$$

As f is Baire class n , $\{\alpha \in A^\omega \mid f(\alpha) \in uB^\omega\}$ is in $\Delta_{n+1}^0(A^\omega)$ and $\{\beta \in B^\omega \mid \beta \in uB^\omega\}$ is in $\Delta_1^0(B^\omega)$. Thus for all fixed $u \in B^*$, $\{(\alpha, \beta) \in A^\omega \times B^\omega \mid (\beta \in uB^\omega \Rightarrow f(\alpha) \in uB^\omega)\}$ is in $\Delta_{n+1}^0(A^\omega \times B^\omega)$ and $\{(\alpha, \beta) \in A^\omega \times B^\omega \mid \forall u \in B^* (\beta \in uB^\omega \Rightarrow f(\alpha) \in uB^\omega)\}$ is in $\Pi_{n+1}^0(A^\omega \times B^\omega)$. \square

1.5 We can decide if a function definable in S1S is Baire class 1

Definition 1.13. *Let A, B be finite alphabets, a function $f : A^\omega \rightarrow B^\omega$ is definable in S1S if its graph is defined by a formula in S1S.*

Thanks to Theorem 1.5 $f : A^\omega \rightarrow B^\omega$ is definable in S1S if its graph is recognized by a Büchi automaton on the product alphabet $A \times B$.

Recall that f is Baire class n if $f^{-1}(U) \in \Sigma_{n+1}^0$ for every open set $U \in B^\omega$. As $(uB^\omega)_{u \in B^*}$ is a basis of clopen sets, this condition is equivalent to :

$$\forall u \in B^*, \quad f^{-1}(uB^\omega) \in \Delta_{n+1}^0 \tag{1}$$

It is easy to see that sets recognizable by Muller automata are Δ_3^0 , in fact they are boolean combination of Σ_2^0 .

Proposition 1.14. *Let A, B be finite alphabets and $f : A^\omega \rightarrow B^\omega$ be a function definable in S1S. Then f is Baire class 2.*

Proof: We need only to remark that if U is recognizable by a Muller automaton then $f^{-1}(U)$ is recognizable. \square

At last, let us recall a result of Landweber [15]:

Proposition 1.15. *If $L \in \text{Rec}(A^\omega)$ and Π_2^0 then L is recognizable by a deterministic Büchi automaton.*

Moreover one can decide for $L \in \text{Rec}(A^\omega)$ if it is Σ_i^0 (resp. Π_i^0) for $i = 1, 2$.

Let f be definable in S1S, it is easy to see that $\text{cont}(f)$ is still definable in S1S. So by Proposition 1.9 and Proposition 1.15 $\text{cont}(f)$ is recognizable by a deterministic Büchi automaton. Moreover if it is Baire class 1 then by Lemma 1.12 its graph is recognizable by a deterministic Büchi automaton.

Definition 1.16. *Let $f : A^\omega \rightarrow B^\omega$ be a function where B^ω is lexicographically ordered. The overgraph and the undergraph of f are respectively:*

$$G \uparrow (f) = \{(\alpha, \beta) \in A^\omega \times B^\omega \mid f(\alpha) < \beta\} \quad (2)$$

$$G \downarrow (f) = \{(\alpha, \beta) \in A^\omega \times B^\omega \mid f(\alpha) > \beta\} \quad (3)$$

W. Sierpinski [25] has shown that a function $f : \mathbb{R} \rightarrow \mathbb{R}$ is Baire class 1 if and only if the overgraph and the undergraph of f are Σ_2^0 . We show that this characterization is also true for functions on infinite words if we replace the real ordering by the lexicographical ordering on B^ω .

Proposition 1.17. *Let A and B be two finite alphabets, then $f : A^\omega \rightarrow B^\omega$ is Baire class 1 iff the overgraph and the undergraph of f are in $\Sigma_2^0(A \times B)$.*

Proof:

(\Rightarrow)

Let $(\alpha, \beta) \in A^\omega \times B^\omega$. The word $f(\alpha)$ is lexicographically less than β iff there exists $n \in \omega$ such that $f(\alpha)[n] = \beta[n]$, i.e., they have the same prefix of length n , and $f(\alpha)(n) < \beta(n)$. Let $u = f(\alpha)[n+1] \in B^+$, then $f(\alpha) \in uB^\omega$. So:

$$G \uparrow (f) = \bigcup_{u \in B^+} (f^{-1}(uB^\omega) \times \bigcup_{v > u, |v|=|u|} vB^\omega)$$

As $\Sigma_2^0(X)$ is closed by countable unions then the overgraph of f is Σ_2^0 .

(\Leftarrow)

Let $u \in B^+$, we denote by a the minimum and z the maximum of B .

We first consider the case where u is not of the form a^n or z^n . We have :

$$\beta \in uB^\omega \Leftrightarrow \beta > \underline{u}z^\omega \text{ and } \beta < \bar{u}a^\omega$$

$$\alpha \in f^{-1}(uB^\omega) \Leftrightarrow f(\alpha) > \underline{u}z^\omega \text{ and } f(\alpha) < \bar{u}a^\omega$$

Then $f^{-1}(uB^\omega) = \{\alpha \in B^\omega \mid f(\alpha) > \underline{u}z^\omega\} \cap \{\alpha \in B^\omega \mid f(\alpha) < \bar{u}a^\omega\}$

But $\{\alpha \in B^\omega; f(\alpha) > \underline{u}z^\omega\}$ (respectively $\{\alpha \in B^\omega \mid f(\alpha) < \bar{u}a^\omega\}$) is Σ_2^0 as section of the undergraph (respectively overgraph) of f and this proves the result.

In the case where $u = a^n$, the proof is the same with $f^{-1}(uB^\omega) = \{\alpha \in B^\omega \mid f(\alpha) < \bar{u}a^\omega\}$. And for $u = z^n$, $f^{-1}(uB^\omega) = \{\alpha \in B^\omega \mid f(\alpha) > \underline{u}z^\omega\}$ \square

Remark 2. Note that the notion of Baire class 1 is purely topological so it is independent of the order on B . So to be Σ_2^0 for the overgraph and the undergraph is independent of the choice of the order on B .

Theorem 1.18. We can decide if a function $f : A^\omega \rightarrow B^\omega$ so that

$\text{Graph}(f) = \{(\alpha, \beta) \in A^\omega \times B^\omega \mid f(\alpha) = \beta\}$ is definable in $S1S$ is Baire class 1.

Proof: Fix an order on B . The lexicographical ordering on B^ω is definable in $S1S$. We have:

$$(\alpha, \beta) \in G \downarrow (f) \Leftrightarrow \exists \gamma \in B^\omega ((\alpha, \gamma) \in \text{Graph}(f) \wedge \beta < \gamma)$$

Then the overgraph and the undergraph of f are definable in $S1S$. Using Proposition 1.15, we can decide if f is Baire class 1. \square

1.6 An example of non-continuous Baire class 1 function : the canonical Booth function

In [12], C. Frougny shows that a function can be on-the-fly computed iff it is a right subsequential function. She gives as example the Booth canonical recoding, see also [19] for applications to multiplication. In this section, we extend the Booth canonical recoding on infinite words, prove that it is a non-continuous Baire class 1 function and give its set of continuity points.

We recall the definition of a right subsequential function.

Definition 1.19. A right subsequential machine with input alphabet A and output alphabet B , $\mathcal{M} = (Q, A \times B^*, T, i, s)$ is a directed graph labeled by elements of $A \times B^*$

1.6. An example of non-continuous Baire class 1 function : the canonical Booth function

where Q is the set of states, $i \in Q$ is the initial state, $T \in Q \times (A \times B^*) \times Q$ is the set of labeled transitions and $s : Q \rightarrow B^*$ is the terminal function. The machine must satisfy the following property: it is input deterministic, i.e., if $p \xrightarrow{a/u} q$ and $p \xrightarrow{a/v} r$, then $q = r$ and $u = v$. A word $u = a_0 \cdots a_n \in A^*$ has $v \in B^*$ for image by \mathcal{M} if there exists a path in \mathcal{M} starting in the initial state i

$$i \xrightarrow{a_n/v_n} q_1 \xrightarrow{a_{n-1}/v_{n-1}} \cdots q_n \xrightarrow{a_0/v_0} q_{n+1}$$

with $v_i \in B^*$ and such that $v = s(q_{n+1})v_0 \cdots v_n$.

A function $f : A^* \rightarrow B^*$ is right subsequential if there exists a right subsequential machine \mathcal{M} such that if $u \in A^*$ and $v \in B^*$, $v = f(u)$ iff v is the image of u by \mathcal{M} .

On finite words, the Booth canonical recoding is the function that maps any binary representation onto an equivalent Avizienis [1] one with the minimum number of non-zero digits: $\varphi : \{0,1\}^* \rightarrow A^*$ with $A = \{\bar{1}, 0, 1\}$ where $\bar{1}$ means -1 , see [19]. It can be obtained by a least significant digit first (LSDF) algorithm by replacing each block of the form 01^n , with $n \geq 2$, by $10^{n-1}\bar{1}$. The following right subsequential machine realizes the Booth canonical recoding [12].

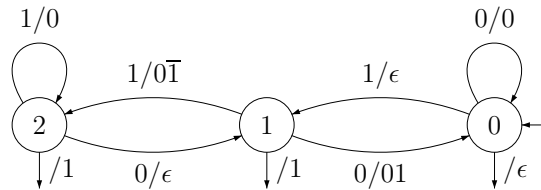

FIG. 1.2 – Right subsequential Booth canonical recoding

We will now extend the Booth canonical recoding on infinite words α which satisfy $\alpha(0) = 0$ by $\varphi : 0\{0,1\}^\omega \rightarrow A^\omega$. First note that on finite words, the pattern 00 in the input blocks a possible carry. So for $\alpha \in 0\{0,1\}^\omega$ if α contains an infinity of blocks 00 it is natural to extend Booth canonical recoding on α using the algorithm on each finite consecutive word of α starting by 00 .

Example 2. An infinite number of 00 .

$$\begin{aligned} \varphi(01100101100010100011100 \cdots) &= \varphi(011) & \varphi(001011) & \varphi(000111) \cdots \\ &= 10\bar{1} & 010\bar{1}0\bar{1} & 00100\bar{1} \cdots \\ \varphi(0101(01010011011)^\omega) &= \varphi(0101) & (\varphi(0101) & \varphi(0011011))^\omega \\ &= 0101 & (0101 & 0100\bar{1}0\bar{1})^\omega \end{aligned}$$

If the number of 00 in α is finite we must be careful because a carry can come from the infinity. This case depends of the number of 11 contained in α . If this number is finite : let n be the greatest integer such that $\alpha(n-2)\alpha(n-1) = 11$ ($n = 0$ if no block

11 appears in α) then we can extend φ on α by $\varphi(\alpha) = \varphi(\alpha[n])\alpha(n)\alpha(n+1)\dots$

Example 3. A finite number of 00 and finite number of 11.

$$\varphi((01)^\omega) = (01)^\omega$$

$$\varphi(01001011(0101001)^\omega) = 01010\bar{1}0\bar{1}(0101001)^\omega$$

At last, if in α the number of 00 is finite and the number of 11 is infinite then a carry come from the infinity and propagate up to the last 00. Let then n be the greatest integer such that $\alpha(n-1)\alpha(n) = 00$ ($n = 0$ if no 00 hold in α). Therefore we can extend φ on α by $\varphi(\alpha) = \varphi(\alpha[n])1\psi(\alpha(n+1)\alpha(n+2)\dots)$ with $\psi : \{0,1\}^\omega \rightarrow A^\omega$ the sequential function defined by $\psi(0) = \bar{1}$ and $\psi(1) = 0$.

Example 4. A finite number of 00 and infinite number of 11.

$$\varphi(01^\omega) = 10^\omega$$

$$\varphi(01100(101011)^\omega) = 10\bar{1}01(0\bar{1}0\bar{1}00)^\omega$$

With this construction, we obtain a function $\varphi : 0\{0,1\}^\omega \rightarrow A^\omega$ which still maps any binary representation onto an equivalent Avizienis one.

The graph of φ is realized by the Büchi automaton \mathcal{A} of figure 1.3.

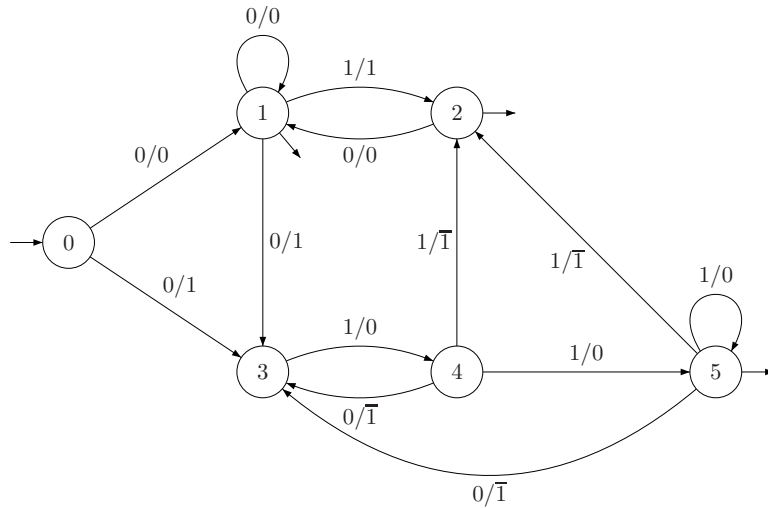

FIG. 1.3 – Booth Büchi automata

The essential difference with the finite case is that the carry can come from the infinity and this suggests discontinuity. A block of the form 11 launches or propagates the carry and a block the form 00 stops the carry. So have a finite or an infinite

number of such blocks will be important in the study of the regularity of φ .

Proposition 1.20. *The function $\varphi : 0\{0,1\}^\omega \rightarrow A^\omega$ is a non continuous Baire class 1 function.*

Proof: It is easy to see φ as the pointwise limit of a sequence of continuous function but it is more interesting to determine the topological complexity of $\varphi^{-1}(V)$ for $V \in \{vA^\omega | v \in A^*\}$ basis of clopen sets of A^ω .

1. Let $\alpha \in \varphi^{-1}(v\bar{1}A^\omega)$ with $|v| = n$. It means that $\delta(0,(\alpha[n],v)) \neq \emptyset$ and $\bigcup_{q \in \delta(0,(\alpha[n],v))} \delta(q,(\alpha(n),\bar{1})) \neq \emptyset$. So there is two possibilities for $\alpha(n)$: $\alpha(n)$ is a 0 which propagates a carry (transition from state 4 to 3 or 5 to 3) or $\alpha(n)$ is a 1 which releases a carry (transition from state 4 to 2 or 5 to 2). Let $I = \{u \in \{0,1\}^* | |u| = n, \delta(0,(u,v)) \cap \{4,5\} \neq \emptyset\}$, I is finite, and :

$$\varphi^{-1}(v\bar{1}A^\omega) = \bigcup_{u \in I} (u0(10)^*11\{0,1\}^\omega \bigcup u1(01)^*00\{0,1\}^\omega \bigcup u1(01)^\omega)$$

So $\varphi^{-1}(v\bar{1}A^\omega)$ is a non open $\Delta_2^0(\{0,1\}^\omega)$. Then φ is not continuous.

2. Let $\alpha \in \varphi^{-1}(v0A^\omega)$ with $|v| = n$. The two possibilities for $\alpha(n)$ are: $\alpha(n)$ is a 0 which does not propagate a carry (transition from state 1 to 1 or 2 to 1) or $\alpha(n)$ is a 1 which propagate a carry (transition from state 3 to 4, 4 to 5 or 5 to 5). Let $J = \{u \in \{0,1\}^* | |u| = n, \delta(0,(u,v)) \cap \{1,2\} \neq \emptyset\}$, $K = \{u \in \{0,1\}^* | |u| = n, \delta(0,(u,v)) \cap \{3,4,5\} \neq \emptyset\}$, J and K are finite, and :

$$\varphi^{-1}(v0A^\omega) = \bigcup_{u \in J} (u0(10)^*0\{0,1\}^\omega \bigcup u0(10)^\omega) \bigcup_{u \in K} u1(01)^*1\{0,1\}^\omega$$

So $\varphi^{-1}(v0A^\omega)$ is a non open $\Delta_2^0(\{0,1\}^\omega)$.

3. Let $\alpha \in \varphi^{-1}(v1A^\omega)$ with $|v| = n$. The two possibilities for $\alpha(n)$ are: $\alpha(n)$ is a 0 which stops a carry (transition from state 1 to 3) or $\alpha(n)$ is a 1 which does not propagate a carry (transition from state 1 to 2). Let $L = \{u \in \{0,1\}^* | |u| = n, \delta(0,(u,v)) = \{1\}\}$, L is finite, and :

$$\varphi^{-1}(v1A^\omega) = \bigcup_{u \in L} (u0(10)^*11\{0,1\}^\omega \bigcup u1(01)^*00\{0,1\}^\omega \bigcup u1(01)^\omega)$$

So $\varphi^{-1}(v\bar{1}A^\omega)$ is a non open $\Delta_2^0(\{0,1\}^\omega)$.

Then for all open set $V \in A^\omega$, $\varphi^{-1}(V)$ is Σ_2^0 and φ is Baire class 1. \square

Consider now the continuity points of φ . It is easy to see that φ is not continuous in $(01)^\omega$: $\varphi((01)^\omega) = (01)^\omega$, $(01)^n 1^\omega$ converges to $(01)^\omega$ and $\varphi((01)^n 1^\omega) = 1(0\bar{1})^{n-1}0^\omega$.

Proposition 1.21. *The set of points of non continuity of φ is $\{u(01)^\omega | u \in 0\{0,1\}^*\}$.*

Proof: The function φ is not continuous in α iff there exist an open set $V \in A^\omega$ so that $\alpha \in \varphi^{-1}(V) \setminus \text{Int}(\varphi^{-1}(V))$. In the proof of the previous result, we have the complete description of $\varphi^{-1}(V)$ for a basis of open sets and such α are the words of the form $u(01)^\omega$. \square

Remark 3. Note that $\text{cont}(\varphi)$ is quite a dense G_δ set.

Another example of function definable in $S1S$, Baire class 1 but not continuous, is given by the normalization (example 23) in Pisot numeration systems [13].

1.7 The case of the real numbers

In this section we consider a numeration system for real numbers with Pisot base. A real θ is a Pisot number if it is an algebraic integer strictly exceeds 1, but such that its conjugate elements are all strictly less than 1 in absolute value. For example, The natural integers greater than 2 and the golden ratio $\frac{1+\sqrt{5}}{2}$ are Pisot numbers. Real numbers are represented in Pisot base with alphabet $A \subset \mathbb{Z} \cap [0, \theta]$. Then define an *evaluation function* μ_θ :

$$\begin{aligned} \mu_\theta : A^\omega &\rightarrow [0,1] \\ \alpha &\mapsto \sum_{n \geq 0} \frac{\alpha(n)}{\theta^{n+1}} \end{aligned}$$

Let us recall that μ_θ is a continuous surjection on $[0,1]$.

C. Frougny proved that $M = \{(\alpha, \beta) \in A^\omega \times A^\omega \mid \mu_\theta(\alpha) = \mu_\theta(\beta)\}$ and $N = \{(\alpha, \beta) \in A^\omega \times A^\omega \mid \mu_\theta(\alpha) < \mu_\theta(\beta)\}$ are definable in $S1S$ [11] see also [3].

A Function $f : A^\omega \rightarrow B^\omega$ is *consistent* with μ_{θ_1} and μ_{θ_2} (where θ_1 and θ_2 are two Pisot numbers) if there exists F such that the following diagram commutes:

$$\begin{array}{ccc} A^\omega & \xrightarrow{f} & B^\omega \\ \mu_{\theta_1} \downarrow & & \downarrow \mu_{\theta_2} \\ [0,1] & \xrightarrow{F} & [0,1] \end{array}$$

From now on, we consider functions $f : A^\omega \rightarrow A^\omega$ definable in $S1S$ which are consistent with μ_θ .

In the case that the base θ is a natural integer, one can find historical examples of such continuous F in Chapter *XIII* of S.Eilenberg [5]. In 1890 Giuseppe Peano published an example of a continuous function

$$H : [0,1] \longrightarrow [0,1] \times [0,1]$$

which is surjective, the so-called square-filling curve. We have $H = (F,G)$ with $F : [0,1] \rightarrow [0,1]$, $G : [0,1] \rightarrow [0,1]$. The function F (resp G) can be defined by a consistent function $f : 9^\omega \rightarrow 3^\omega$ from base 9 to base 3. The function f is realized by a left sequential letter to letter transducer, hence f is definable in $S1S$. Other examples in the same spirit can be found in the works of Waclaw Sierpinski, Bernard Bolzano, Ludwig Scheeffer, Georg Cantor. The reader interested in history should see the book of A. Edgar [4] and the beautiful article of B. Maurey and J.P. Tacchi [18] about the Devil's staircase of Ludwig Scheeffer presented in Figures 1.4, 1.5.

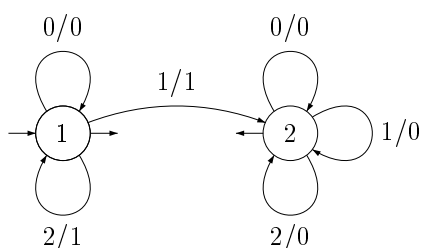

FIG. 1.4 – Automaton of the Devil staircase

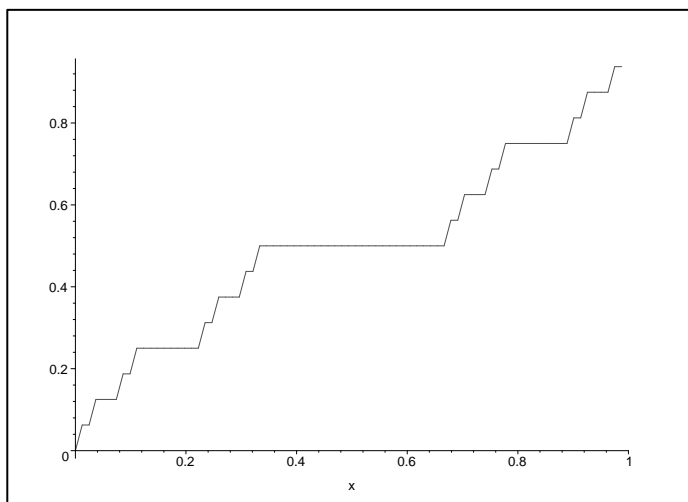

FIG. 1.5 – Graphical approximation of the Devil staircase

In the following example, we give an example of a non continuous function F definable in $S1S$ and Pisot Basis. One can see examples of some historical functions of the analysis like jumps function that we have seen in [18].

Example 5. Here we present a simple example of a jump function F definable in $S1S$. The graph of F is obtained in the following way. First we take the symmetric

of the graph of the Devil staircase about the line $y = x$. This is not the graph of a function, so we choose for each x the greatest y such that (x,y) belongs to this relation. As the Devil staircase has constant values equal to $u/2^n$ with $n \in \omega^*$, $u \in \omega$ and $0 < u < 2^n$ outside the Cantor set, our function F is discontinuous in $u/2^n$ with $n \in \omega^*$, $u \in \omega$, $0 < u < 2^n$ and jump by steps of $1/3^n$ with $n \in \omega^*$. We choose for $F(u/2^n)$ the upper bound of the interval: for example with $x = 1/2$, $F(x) \in [1/3, 2/3]$ and we choose $F(1/2) = 2/3$. So the function F is right continuous on $[0,1]$.

The function $f : \{0,1\}^\omega \rightarrow \{0,1,2\}^\omega$ given by the non deterministic automaton of Figure 1.6 is consistent with μ_2 and μ_3 . Note that discontinuity is given by non determinism. Here the set of discontinuity is $(0+1)^*01^\omega$. It is easy to see that f is Baire class 1.

Then the function $F : [0,1] \rightarrow [0,1]$ obtained in the following commutative diagram is the expected one, see Figure 1.7.

$$\begin{array}{ccc}
 \{0,1\}^\omega & \xrightarrow{f} & \{0,1,2\}^\omega \\
 \mu_2 \downarrow & & \downarrow \mu_3 \\
 [0,1] & \xrightarrow{F} & [0,1]
 \end{array}$$

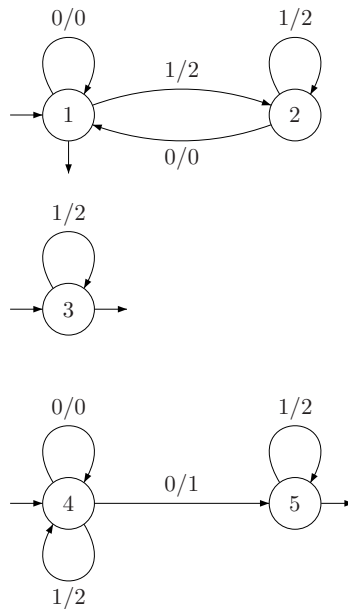
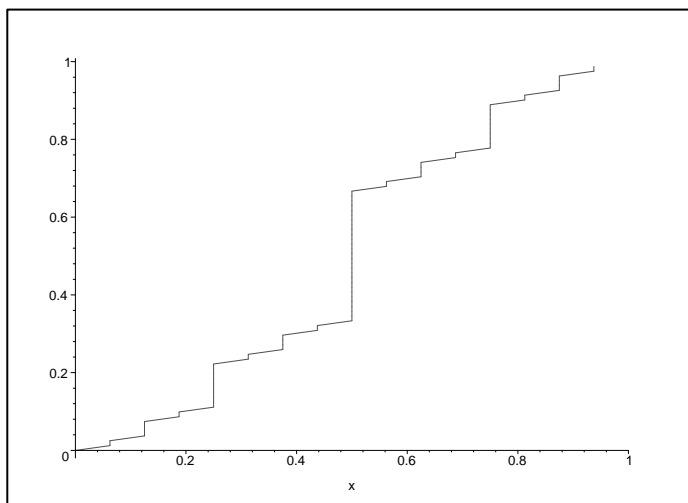

FIG. 1.6 – Automaton of a jump function

For simplify we suppose that for the input and the output, numbers are represented in the same base. Note that if f is definable in $S1S$, and if θ is a Pisot number

FIG. 1.7 – Graphical approximation of the jump function F

then one can decide if f is consistent. This can be expressed by a closed $S1S$ formula and $S1S$ is decidable [2]. For more details, we refer the reader to [3].

As f is Baire class 2, the topological complexity of such F is Baire class 2. To see this we can use the following Theorem of Saint Raymond [16, 23].

Theorem 1.22. *Let X, Y be compact metrizable spaces, Z a separable metrizable space, a continuous surjection $g : X \rightarrow Y$ and a Baire class n function $f : X \rightarrow Z$ with $n \in \omega$, then there exists a Baire class 1 function $s : Y \rightarrow X$ so that $g \circ s = Id_Y$ and $f \circ s$ is Baire class n .*

Corollary 1.23. *For f and F defined in the previous diagram, if f is Baire classe n then F is Baire class n too.*

Proof: Take $X = A^\omega$, $Y = [0,1]$ and $Z = A^\omega$. By Theorem ?? there exists a selector $s : [0,1] \rightarrow A^\omega$ so that $f \circ s$ is Baire class n . Then $F = \mu_\theta \circ f \circ s$ is Baire class n too. \square

Our aim is to extend the results of decidability to the function F .

C. Choffrut, H. Pelibossian and P. Simonnet [3] have shown that the continuity of the function F is decidable with an algorithmic proof. We give a topological proof of this result and then show that we can also decide if F is Baire class 1.

Proposition 1.24. *Let $F : [0,1] \rightarrow [0,1]$ in a base θ with θ a Pisot number so that there exist a function $f : A^\omega \rightarrow A^\omega$ which verifies :*

1. $Graph(f)$ is definable in $S1S$.
2. $\forall \alpha \in A^\omega : \mu_\theta(f(\alpha)) = F(\mu_\theta(\alpha))$.

Then we can decide if F is continuous.

Proof: The function F is continuous iff its graph is closed. So let us prove that we can decide if $\text{Graph}(F)$ is closed. Let $\boldsymbol{\mu}$ be defined by :

$$\begin{aligned} \boldsymbol{\mu} : A^\omega \times A^\omega &\rightarrow [0,1] \times [0,1] \\ (\alpha, \beta) &\mapsto (\mu_\theta(\alpha), \mu_\theta(\beta)) \end{aligned}$$

Note $H = \boldsymbol{\mu}^{-1}(\text{Graph}(F)) = \{(\alpha, \beta) \in A^\omega \times A^\omega \mid F(\mu_\theta(\alpha)) = \mu_\theta(\beta)\} = \{(\alpha, \beta) \in A^\omega \times A^\omega \mid \mu_\theta(f(\alpha)) = \mu_\theta(\beta)\}$. As θ is a Pisot number and f definable in $S1S$, H is definable in $S1S$.

If $\text{Graph}(F)$ is closed, as $\boldsymbol{\mu}$ is continuous, H is closed too. Conversely, if H is closed, as A^ω is compact and $\boldsymbol{\mu}$ is continuous and surjective, $\text{Graph}(F) = \boldsymbol{\mu}(\boldsymbol{\mu}^{-1}(\text{Graph}(F))) = \boldsymbol{\mu}(H)$ is compact. Then F is continuous iff H is closed. The set H is recognizable by automaton so by Proposition 1.15 we can decide if F is continuous. \square

Proposition 1.25. *Let $F : [0,1] \rightarrow [0,1]$ such that there exists a function $f : A^\omega \rightarrow A^\omega$ which verifies :*

1. $\text{Graph}(f)$ is definable in $S1S$.
2. $\forall \alpha \in A^\omega : \mu_\theta(f(\alpha)) = F(\mu_\theta(\alpha))$.

Then we can decide if F is Baire class one.

Proof: For the proof we use an old result of W. Sierpinski :

a function $F : \mathbb{R} \rightarrow \mathbb{R}$ is Baire class 1 iff its overgraph and its undergraph are Σ_2^0 [25].

Let $H = \boldsymbol{\mu}^{-1}(G \uparrow (F)) = \{(\alpha, \beta) \in A^\omega \times A^\omega \mid F(\mu_\theta(\alpha)) < \mu_\theta(\beta)\}$ we have $H = \{(\alpha, \beta) \in A^\omega \times A^\omega \mid \mu_\theta(f(\alpha)) < \mu_\theta(\beta)\}$. As θ is a Pisot number and f definable in $S1S$, H is definable in $S1S$.

By the same argument as in Proposition 1.24, it is easy to verify that $G \uparrow (F)$ is Σ_2^0 iff H is Σ_2^0 . To see this, note that as $\boldsymbol{\mu}$ is surjective

$$G \uparrow (F) = \boldsymbol{\mu}(\boldsymbol{\mu}^{-1}(G \uparrow (F))) = \boldsymbol{\mu}(H)$$

As $\boldsymbol{\mu}$ is continuous if $G \uparrow (F)$ is Σ_2^0 then H is Σ_2^0 . Conversely if H is Σ_2^0 , as $A^\omega \times A^\omega$ is compact, then H is K_σ (countable union of compact sets) and $G \uparrow (F) = \boldsymbol{\mu}(H)$ is K_σ as a continuous image of a K_σ set.

As H is recognizable by automaton, by Proposition 1.15 we can decide if F is Baire class 1. \square

1.8 Conclusion

Let us talk about the asynchronous case. An ω -rational relation is a relation whose graph is recognized by a Büchi automaton, and for which transitions are labeled by couples of words $(u,v) \in A^* \times B^*$ instead of couples of letters $(a,b) \in A \times B$. They were first studied by F. Gire and M. Nivat, see [10, 7, 8]. Françoise Gire has shown that the problem of functionality is decidable for an ω -rational relation. Recall that a set is analytic (Σ_1^1 in the notation of Addison see [16]) if it is the continuous image of a Borel set. It is well known that Borel sets are analytic sets but that there exist analytic sets which are not Borel [16]. It is easy to see that ω -rational relations are analytic sets. Recently O. Finkel has shown that there exist an ω -rational relation which is not Borel [7]. From this he deduces many undecidability results [8]. It is easy to see that an ω -rational function is of Baire class 2. Recently, C. Prieur [21, 22] has generalized the decidability of continuity to the ω -rational functions. Moreover the overgraph (resp. undergraph) of an ω -rational function is an ω -rational relation. Unfortunately O. Finkel has shown the following Theorem : the problem of knowing if an ω -rational relation is Σ_i^0 (resp. Π_i^0) for $i = 1$ and 2 is undecidable [8]. In addition, from O. Carton (personal communication) we have the following result : the problem of knowing if an ω -rational function is totally discontinuous is undecidable. So we think that Baire class 1 is undecidable for the ω -rational functions.

For ending we consider finite words. The following Theorem of Elgot Mezei, see [24] is well known: a rational relation which is a graph of a function f with $f(\epsilon) = \epsilon$ is the composition of a left sequential function and a right sequential function. A left sequential machine gives continuous function when we read infinite words. But a right sequential machine can give a function of Baire class 2. We think that there exists a right subsequential function such that its on-the-fly extension on infinite words is not Baire class 1. Can we interpret points of continuity, as points that need only one register in an on the fly algorithm? Finally note that the Booth canonical recoding is an ω -rational relation with bounded delay, and all ω -rational relations with bounded delay can be synchronized [10], this is what we have done.

The authors would like to thank Serge Grigorieff for very hepful comments on a preliminary version of this paper. We thank also Pierre Delfini and Alain Hertzog for historical remarks. We would like to thank also the anonymous referees for suggestions which greatly improved the manuscript.

Bibliographie

- [1] A. Avizienis. *Signed-digit number representation for fast parallel arithmetic*. IRE Transaction on Electronic Computers. 10. 1961. 389-400.
- [2] J. R. Büchi. *On a decision method in restricted second order arithmetic*. Methodology and Philosophy of Science. Stanford Univ. Press, Calif. 1962. 1-11.
- [3] C. Choffrut, H. Pelibossian and P. Simonnet. *Decision issues on functions realized by finite automata*. Journal of Automata, Languages and Combinatorics 4(3). 1999. 171–182.
- [4] A. Edgar. *Classics On Fractals*. Studies in non linearity, Westview Press. 2004.
- [5] S. Eilenberg. *Automata, Languages and Machines Vol A*. Academic Press, New York London. 1974.
- [6] M. D. Ercegovic, T. Lang. *On-the-fly conversion of redundant into conventional representations*. IEEE Trans. on Computers 36. 1987. 895–897.
- [7] O. Finkel *On the topological complexity of infinitary rational relations*. Theor. Inform. Appl. 2003. 105–113.
- [8] O. Finkel *Undecidability of topological and arithmetical properties of infinitary rational relations*. Theor. Inform. Appl. 2003. 115–126.
- [9] G. Flory *Topologie, Analyse*. Vuibert. 1976.
- [10] C. Frougny, J. Sakarovitch. *Synchronized relations of finite and infinite words*. Theoret. Comput. Sci. 1993. 45–82.
- [11] C. Frougny, B. Solomyak. *On representation of integers in linear numeration systems*. Ergodic Theory of Z^d -Actions. New Brunswick, New Jersey. 1996. 345–368.
- [12] C. Frougny. *On-the-fly algorithms and sequential machines*. IEEE Trans. on Computers 49. 2000. 859–863.
- [13] C. Frougny. *Numeration Systems*. Chapter 7 of M. Lothaire, Algebraic Combinatorics on Words. Cambridge University Press, 2002.
- [14] F. Gire. *Two decidability problems for infinite words*. Inform. Proc. Letters 22. 1986. 135–140.

-
- [15] L. H. Landweber. *Decision problem for ω -automata*. Math. Systems. Theory 3. 1969. 376–384.
- [16] A. S. Kechris. *Classical Descriptive Set Theory*. Springer-Verlag. 1995.
- [17] P. Kornerup. *Digit-set conversions: Generalizations and applications*. IEEE Trans. on Computers 43. 1994. 622–629.
- [18] B. Maurey, J.P. Tacchi. *Ludwig Scheeffler et les extensions du Théorème des Accroissements Finis*. Séminaire du Luxembourg, Travaux mathématiques, fascicule XIII. 2002. 1–60.
- [19] J. M. Muller. *Arithmétique des ordinateurs*. Masson. Paris. 1989.
- [20] D. Perrin J.-E. Pin. *Infinite words, Automata, Semigroups, Logic and Games*. volume 141 in the Pure and Applied Mathematics Series, Academic Press, Elsevier. 2004.
- [21] C. Prieur. *How to decide continuity of rational functions on infinite words*. Theoret. Comput. Sci. 250. 2001. 71–82.
- [22] C. Prieur. *How to decide continuity of rational functions on infinite words (Errata)*. Theoret. Comput. Sci. 276. 2002. 445–447.
- [23] J. Saint Raymond. *Fonctions boréliennes sur un quotient*. Bull. Soc. Math. France (2). 1976. 141–147.
- [24] J. Sakarovitch *Eléments de théorie des automates*. Vuibert informatique. 2003.
- [25] W. Sierpinski. *Sur les fonctions de première classe*. C. R. Acad. Sci. Paris 170. 1920. 919–922.

Chapitre 2

Baire and automata

Pierre Simonnet, Benoit Cagnard.

Discrete Mathematics and Theoretical Computer Science vol. 9:2 (2007) 255-296.

Abstract

In his thesis Baire defined functions of Baire class 1. A function f is of Baire class 1 if it is the pointwise limit of a sequence of continuous functions. Baire proves the following theorem. A function f is not of class 1 if and only if there exists a closed nonempty set F such that the restriction of f to F has no point of continuity. We prove the automaton version of this theorem. An ω -rational function is not of class 1 if and only if there exists a closed nonempty set F recognized by a Büchi automaton such that the restriction of f to F has no point of continuity. This gives us the opportunity for a discussion on Hausdorff's analysis of Δ_2^0 , ordinals, transfinite induction and some applications of computer science.

key words: Automata, Borel functions, ω -regular sets, coanalytic sets

2.1 Introduction

We would like to dedicate this work to the memory of Pierre Dugac, who was a great historian of Mathematics, and the French specialist of Baire's work.

In his thesis Baire introduced the hierarchy of Baire classes of functions. A function f belongs to class 0 if it is continuous. A function f belongs to class 1 if it is the pointwise limit of a sequence of functions of class 0. A function f belongs to class 2 if it is the pointwise limit of a sequence of functions of class 1, and so on. The present work concerns functions $f : A^\omega \rightarrow B^\omega$ which are ω -rational (A^ω and B^ω sets of infinite words on finite alphabets A and B). We study these objects from a topological point of view. Let us describe the work done on ω -rational relations.

Acceptance of infinite words by finite automata was first considered in the sixties by Büchi in order to study decidability of the monadic second order of one successor over the integers [14]. Since this paper the ω -regular languages have been intensively studied especially because the topological space of infinite words with the usual prefix distance has very interesting properties [69, 95, 92].

Rational relations on finite words are relations computable by finite automata with two tapes. They were first studied by Rabin and Scott [74]. A number of their properties were established by Elgot and Mezei [30]. The Decomposition Theorem characterizing functional rational transductions is one of them. A sequential function is a function whose graph is a rational relation with a condition of determinism on the input. A right (resp. left) sequential function reads words from right to left (resp. left to right). A functional rational transduction f satisfying $f(\varepsilon) = \varepsilon$ is a composition of a left sequential function and of a right sequential function [29, 12, 78]. The extension of rational relations to infinite words, called ω -rational relations, were first studied in [7, 56, 13, 40]. ω -rational relations are relations computable by a finite automaton with two tapes with a Büchi acceptance condition (and a condition to avoid $A^* \times B^*$, $A^\omega \times B^*$ and $A^* \times B^\omega$). In [41] Gire shows that functionality is decidable for a ω -rational relation. In [37] Sakarovitch and Frougny show that ω -rational relations of $A^\omega \times B^\omega$ with bounded delay are exactly the ω -regular languages on the product alphabet $A \times B$. In addition, they prove some undecidability results on ω -rational relations which can be deduced from corresponding undecidability results on rational relations over finite words. The reader should also see [55, 24] for other properties and references.

It is only in [31, 32] that the topological complexity of ω -rational relations is really investigated. Links between descriptive set theory and automata theory are

not new. They go back to Büchi and Landweber's work [54, 18, 100]. Büchi talks very early about analytic set and games [16]. In [107] Wagner and Staiger shows that a subset of A^ω (A finite) is recognize by a nondeterministic turing machine with Müller conditions if and only if it is an effective analytic set, that is to say a Σ_1^1 set (see Rogers [75] and Moschovakis [65] for a definition of the class Σ_1^1). In Staiger papers [88, 89, 90, 91, 92] one can have a good overview of the subject. We give here a short account of Finkel's recent work.

Descriptive set theory is the study of definable sets in Polish spaces. A Polish space is a topological space P which is separable (it has a countable dense subset) and have a compatible metric d such that (P, d) is complete. Compact metric spaces are Polish (2^ω the Cantor space, $[0, 1]$). Complete separable metric spaces are Polish (\mathbb{R} , \mathbb{C} , $C[0, 1]$). The most important Polish space is the Baire space ω^ω , that is the space of infinite sequence of integers. The family of Borel sets, of a polish space P , is the smallest family of subsets of P which contains open sets and is closed under complements and countable unions. A set E of a polish space P is an analytic set if it is a continuous image of the Baire space ω^ω . Another equivalent definition say that E is an analytic set if it is the projection of a Borel set $F \subset \omega^\omega \times P$ on P . It is easy to construct analytic sets. Let $L \subset A^*$, and let L^* be the monoid generated by L . Replace star operation $*$ by ω operation, then L^ω is an analytic set. If L is finite L^ω is compact. If L is not finite L is countable, so we can enumerate elements of $L = \{u_0, u_1, \dots, u_n, \dots\}$. Define an application $\phi : \omega \longrightarrow A^*$ by $\phi(n) = u_n$. Extend ϕ in monoid morphism $\phi : \omega^* \longrightarrow A^*$. Next extend ϕ in continuous application $\phi : \omega^\omega \longrightarrow A^\omega$. Since the graph of ϕ is closed, then L^ω is analytic as projection of a closed set. In 1988 Louveau showed that there exists an L such that L^ω is not Borel. Unfortunately, he only proved the existence of a such L , he didn't give effectively such a L . His work remains unpublished. An analytic complete set is an analytic set so that any other analytic set can be obtained by continuous inverse image of it. In 2000, Finkel showed that a very simple context free language L is such that L^ω is analytic complete [33]. Finally in 2001, Finkel showed that one can define an ω -rational relation R such that R is analytic complete (in particular R is not Borel) [31]. From this, and using the Post correspondance problem, Finkel discovered new undecidability results about ω -rational relations and gave another proof of the undecidability results of Sakarovitch and Frougny [32].

In this paper an ω -rational function is an (everywhere defined) application $f : A^\omega \rightarrow B^\omega$ whose graph is an ω -rational relation. The ω -rational functions are of

Baire class 2. Baire proves the following theorem.

Theorem 2.1. *A function f is not of class 1 if and only if there exists a closed nonempty set F such that the restriction of f to F has no point of continuity.*

We prove the automaton version of this theorem.

Theorem 2.2. *An ω -rational function is not of class 1 if and only if there exists a closed nonempty set F recognized by a Büchi automaton such that the restriction of f to F has no point of continuity.*

The original proof of Baire uses transfinite induction [5, 25]. The proof presented in [53, 47] is Hausdorff's proof; we will give a detailed proof of it. The characterization theorem of Baire appears as a corollary of the analysis of Δ_2^0 sets in an uncountable complete separable metric space. A Δ_2^0 set is a set which is both F_σ (countable union of closed sets) and G_δ (countable intersection of open sets). The analysis of Δ_2^0 sets uses a transfinite derivation over closed sets which is of the same kind of Cantor's derivation. Recall that Cantor discovered countable ordinals iterating in a transfinite way the operation of elimination of the isolated points of a closed set of reals (see Kechris Louveau [48]).

In fact our theorem is just a remark: when we restrict Hausdorff's derivation to ω -regular sets, it stops the derivation at an integer (a greatest fixpoint). This was remarked by the first author in 1986, who, in addition, showed a connection between an old separation theorem and work of Arnold and Nivat [4] about theory of parallelism.

Hausdorff's result is a first step in the study of Wadge's classes of Borel sets [105]. Wadge's degrees of Borel sets are essentially well ordered and the type order of the hierarchy is an old uncountable ordinal studied first by Veblen [102]. It is usual to present Wadge's degrees with games [103]. The restriction of the Wadge's hierarchy to ω -regular sets gives Wagner's hierarchy [106]. This is easily seen with Büchi Landweber's result on games such that the winning set is an ω -regular set [18, 100]. The type order of Wagner's hierarchy is the countable ordinal ω^ω . Our proof is of the same type of combinatorial proofs appearing in Wagner's paper [106].

This separation result can be extended to all Wagner classes [83, 84], this is easy using well known things from descriptive set theory and Büchi Landweber's result on game [18]. On this subject one can also study the work of Barua [6]. These results are also automata analogue of effective results of Louveau [60] which give classical results in the plane [76, 62].

For more on Wagner's hierarchy, we refer the reader to the works of Kaminski

[46], Carton and Perrin [22], Wagner [106], Selivanov [79], Staiger [92, 93]. It turns out that the topological invariants for Wagner's classes can be described with the algebra of finite monoids, see Carton and Perrin [22], Wilke [109] and Perrin and Pin [69]. For more on Wadge's hierarchy we refer the reader to the papers of Wadge [103, 105], the book of Kechris [47], and works from Louveau [60], Saint Raymond [77], Duparc [27], Finkel [35], Ressayre [26].

For recent problems in theory of parallelism one can see [11].

Now we return to Elgot Mezei's decomposition theorem. A left sequential machine which reads infinite words is a continuous function. The idea to read from left to right in a right sequential finite state machine suggests non determinism. Moreover, if we work on infinite words rather than finite words, this suggests discontinuity and the Baire hierarchy. If an ω -rational function is not of Baire class 1, one can find a rational tree (tree with a finite number of subtrees) whose set of infinite branches is a Perfect set P (closed set without isolated points [53]) and the restriction of f to P has no point of continuity. This may be interesting, even for finite words.

If the graph of $f : A^\omega \rightarrow B^\omega$ is recognized by a Büchi automaton on the product alphabet $A \times B$ we say that f is a synchronous function. Recently we have shown that one can decide if a synchronous function is Baire class 1 [20]. Our proof is topological and it is an easy corollary of Sierpinski [81] and Landweber [54]. In the present paper we would like to obtain some missing links with works by Beal, Carton, Choffrut, Frougny, Michel, Prieur, Sakarovitch. They have given more algorithmic proofs [23, 24, 9, 38, 39, 70, 71, 8, 21]. Talks with Finkel and Carton have given us the impression that for an ω -rational function, being of Baire class 1 is an undecidable property. We hope that our presentation will be useful for computer scientists. For example, it may help to understand recent results of Duparc [28] and Lecomte [57].

This paper is organized as follows. In sections 2, 3, 4, 5 we present some definitions and properties from automata theory and descriptive set theory. In section 6 we present an example which may be useful to understand the result of Baire. In section 7, we present the difference hierarchy and we give a detailed proof of Hausdorff's result in section 8. In section 9, we give the proof of Baire's result. In section 10, we prove the automaton version of Baire's result. In section 11, we present briefly the Wadge's game and separation games; we think that this sheds light about results of sections 8 and 10. Finally, we start the discussion about relations between Hausdorff's analysis of Δ_2^0 sets, ordinals, transfinite induction and applications of computer science.

2.2 Automata on infinite words

2.2.1 infinite words

For the concepts introduced in this section we refer the reader to [7, 29, 69, 92, 95]. Let ω be the set of natural numbers (the first infinite ordinal). Complement of a set E will be noted \check{E} . Let A be a finite alphabet or countable alphabet ($A = \omega$). All alphabets that we consider will have at least two letters. A finite word u over the alphabet A is a finite sequence of elements of A . The set of finite words on A will be called A^* . The length (number of letters) of a word u will be noted $|u|$. A particular word is the empty word ϵ , $|\epsilon| = 0$. As usual $A^+ = A^* - \{\epsilon\}$. With concatenation, A^* is a monoid with unit element ϵ .

An infinite word α over alphabet A is an infinite sequence of elements of A :

$\alpha = \alpha(0)\alpha(1)\dots\alpha(n)\dots$. The set of infinite words on the alphabet A will be noted A^ω . We note $\alpha[n]$ the finite word formed with the n first letters of the infinite word α , $\alpha[0] = \epsilon$, $\alpha[1] = \alpha(0)$. The set A^ω , viewed as a product of infinitely many copies of A with the discrete topology, is a metrizable space:

$$d(\alpha, \beta) = \begin{cases} 1/2^n \text{ with } n = \min\{i \in \omega \mid \alpha(i) \neq \beta(i)\} & \text{if } \alpha \neq \beta \\ 0 & \text{if } \alpha = \beta \end{cases}$$

The collection $(uA^\omega)_{u \in A^*}$ is a countable basis of clopen sets for this topology. Recall that if A is finite then (A^ω, d) is a compact metric space. If $A = \omega$, then (ω^ω, d) is a complete metric space, known as the Baire space, which is not compact. The prefix ordering is called $<$. A finite word $u \in A^*$ is a prefix of the finite word $v \in A^*$ (resp infinite word $\alpha \in A^\omega$) if there exists a finite word $w \in A^*$ (resp infinite word $\beta \in A^\omega$) so that $v = u.w$ (resp $\alpha = u.\beta$).

2.2.2 Automata on infinite words

Definition 2.3. A Büchi automaton \mathcal{A} is a 5-tuple: $\mathcal{A} = \langle A, Q, I, T, F \rangle$, where A is a finite alphabet, Q is a finite set of states, $I \subset Q$ is the set of initial states, $T \subset Q \times A \times Q$ is the set of transitions and $F \subset Q$ the set of final states.

An infinite word $\alpha \in A^\omega$ is recognized by \mathcal{A} if there is $\beta \in Q^\omega$ such that:

$\beta(0) \in I$, $\forall n \in \omega$, $(\beta(n), \alpha(n), \beta(n+1)) \in T$ and $\beta(n) \in F$ for infinitely many n .

The set of words recognized by a Büchi automaton \mathcal{A} is noted $L^\omega(\mathcal{A})$.

Remark 4. Instead of Büchi automaton one can say automaton with Büchi's acceptance.

T can be viewed as a partial function $\delta : Q \times A \rightarrow \mathcal{P}(Q)$ where $\delta(p, a) =$

$\{q \in Q \mid (p,a,q) \in T\}$. Function δ can be extended to $\delta : Q \times A^* \rightarrow \mathcal{P}(Q)$ by $\delta(p,ua) = \delta(\delta(p,u),a)$ where u is a finite word and a a letter and $\delta(p,\epsilon) = p$.

An infinite path c in \mathcal{A} is an infinite word $c = c(0)c(1)\dots c(n)\dots \in (Q \times A \times Q)^\omega$ such that $\forall n \in \omega, c(n) \in T$. For each n , $c(n)$ is of the form $c(n) = (\beta(n), \alpha(n), \beta(n+1))$. This will be denoted by the following graphical notation of path.

$$c = \beta(0) \xrightarrow{\alpha(0)} \beta(1) \xrightarrow{\alpha(1)} \beta(2) \xrightarrow{\alpha(2)} \dots$$

The infinite word $\alpha \in A^\omega$, $\alpha = \alpha(0)\alpha(1)\dots\alpha(n)\dots$, is the label of the path c . Let us note $\text{Infinity}(c)$ as the set of states which appears infinitely many times in c . A path c is said to be successful if $\beta(0) \in I$ and $\text{Infinity}(c) \cap F \neq \emptyset$. Note that an infinite word α is recognized by \mathcal{A} if there is a successful path c in \mathcal{A} of label α .

An automaton is called deterministic if it has a unique initial state and for each state p and each letter a there exists at most one transition $(p,a,q) \in T$. Consequently the transition partial function δ can be viewed as $\delta : Q \times A \rightarrow Q$. Function δ can be extended to $\delta : Q \times A^* \rightarrow Q$ by $\delta(p,ua) = \delta(\delta(p,u),a)$, where u is a finite word and a a letter and $\delta(p,\epsilon) = p$. Then for all infinite word α there exists at most one path c of label α .

Example 6. Let \mathcal{A} be the deterministic Büchi's automaton on alphabet $A = \{0,1\}$, with states $Q = \{0,1\}$, initial states $I = \{0\}$, final states $F = \{1\}$ and transitions $T = \{(0,0,0), (0,1,1), (1,0,1), (1,1,1)\}$

Figure 2.1 gives the representation of \mathcal{A} . This automaton recognizes the set

$$\mathbb{O} = \{\alpha \in 2^\omega \mid \exists m \alpha(m) = 1\}.$$

If we takes $F = \{0\}$ then this automaton recognizes the complement of \mathbb{O} :

$$\mathring{\mathbb{O}} = \{\alpha \in 2^\omega \mid \forall m \alpha(m) = 0\}.$$

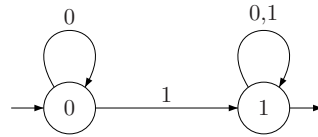

FIG. 2.1 – The open set

Example 7. Let \mathcal{B} be the deterministic Büchi automaton on alphabet $A = \{0,1\}$, with states $Q = \{0,1\}$, initial states $I = \{0\}$, final states $F = \{1\}$ and transitions $T = \{(0,0,0), (0,1,1), (1,0,0), (1,1,1)\}$

Figure 2.2 gives the representation of \mathcal{B} . Let $\mathbb{Q} = \{\alpha \in 2^\omega \mid \exists m \forall n \geq m \alpha(n) = 0\}$. This automaton recognizes the complement of \mathbb{Q} :

$$\check{Q} = \{\alpha \in 2^\omega \mid \forall m \exists n > m \alpha(n) = 1\}.$$

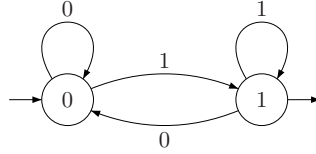

FIG. 2.2 – The set reset automaton, a deterministic Büchi automaton which recognizes the G_δ set homeomorphic to Baire space ω^ω

Example 8. Let \mathcal{C} be the non deterministic Büchi's automaton on alphabet $A = \{0,1\}$, with states $Q = \{0,1,2\}$, initial states $I = \{0,1\}$, final states $F = \{0,2\}$ and transitions $T = \{(0,0,0),(1,0,1),(1,1,1),(1,1,2),(2,0,2)\}$

Figure 2.3 gives the representation of \mathcal{C} . Let $\mathbb{Q} = \{\alpha \in 2^\omega \mid \exists m \forall n \geq m \alpha(n) = 0\}$, \mathbb{Q} is a countable dense subset of 2^ω The automaton \mathcal{C} recognizes \mathbb{Q} .

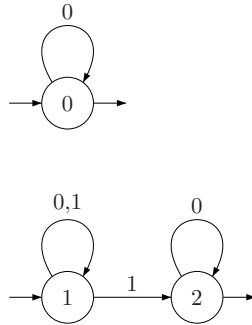

FIG. 2.3 – A non deterministic automaton which recognizes the countable dense set $\mathbb{Q} = \{\alpha \in 2^\omega \mid \exists m \forall n \geq m \alpha(n) = 0\}$

Definition 2.4. A Muller automaton \mathcal{A} is a 5-tuple: $\mathcal{A} = \langle A, Q, I, T, \mathcal{F} \rangle$, where A is a finite alphabet, Q is a finite set of states, $I \subset Q$ is the set of initial states, $T \subset Q \times A \times Q$ is the set of transitions and $\mathcal{F} \subset \mathcal{P}(Q)$.

An infinite word $\alpha \in A^\omega$ is recognized by \mathcal{A} if there is an infinite path c of label α so that $\text{Infinity}(c) \in \mathcal{F}$.

Example 9. Let again \mathcal{B} be the deterministic automaton of example 7 and take $\mathcal{F} = \{\{0\}\}$. Then this automaton recognizes \mathbb{Q} .

If we take $\mathcal{F} = \{\{1\}, \{0,1\}\}$ then this automaton recognizes \check{Q} .

2.2.3 S1S: the monadic second order theory of one successor

We now define the terms, atomic formulas, and formulas of $S1S$ the monadic theory of one successor. Let \mathcal{V} be a set of variables, its elements noted by x, y, z, \dots , the constant symbol 0 and a unary function symbol s (as successor). We define the set of the terms \mathcal{T} by:

- i) A variable is a term.
- ii) 0 is a term.
- iii) if $t \in \mathcal{T}$ then $s(t) \in \mathcal{T}$.

Let \mathcal{P} be another set of variables. Its variables are noted $\mathcal{X}, \mathcal{Y}, \mathcal{Z}, \dots$ and two predicate symbols $=, \in$. Atomic formulas are of the form $t = t'$ or $t \in \mathcal{X}$ where $(t, t') \in \mathcal{T}^2$ and $\mathcal{X} \in \mathcal{P}$.

Definition 2.5. *A formula of $S1S$ is defined as follows:*

- i) *An atomic formula is in $S1S$.*
- ii) *If $\phi \in S1S$ then $\neg\phi, \forall x\phi, \exists x\phi$ and $\forall \mathcal{X}\phi, \exists \mathcal{X}\phi$ are in $S1S$, where $x \in \mathcal{V}, \mathcal{X} \in \mathcal{P}$.*
- iii) *If ϕ and ψ are in $S1S$, then $\phi \wedge \psi, \phi \vee \psi, \phi \Rightarrow \psi$ and $\phi \Leftrightarrow \psi$ are in $S1S$.*

The interpretation of these formulas is the following: the variables of \mathcal{V} are interpreted as natural numbers, symbol 0 as $0 \in \omega$, symbol s as the successor function in ω , the variables of \mathcal{P} as subsets of ω and the predicate symbols as equality relation and membership relation in ω . If each integer is assimilated to a singleton and each subset of ω to an infinite word over alphabet $\{0,1\}$, then a $S1S$ formula $\phi(\mathcal{X}_1, \mathcal{X}_2, \dots, \mathcal{X}_n)$, with $\mathcal{X}_1, \mathcal{X}_2, \dots, \mathcal{X}_n$ free variables defines an ω -language $L_\phi \subset \underbrace{2^{\mathbb{N}} \times \dots \times 2^{\mathbb{N}}}_n$.

An ω -language L is said definable in $S1S$ if there exists a formula ϕ in $S1S$ such that $L = L_\phi$.

2.2.4 ω -regular sets

Recall the following result [14, 69, 100]:

Theorem 2.6. *for all ω -language L , the following assertions are equivalent:*

- i) $L = \bigcup_{1 \leq i \leq n} A_i B_i^\omega$ where A_i, B_i are regular sets and $n \in \omega - \{0\}$.
- ii) $L = L^\omega(\mathcal{A})$, where \mathcal{A} is a non deterministic Büchi automaton.
- iii) $L = L^\omega(\mathcal{A})$, where \mathcal{A} is a deterministic Muller automaton.
- iv) L is definable in $S1S$.

The family of languages which verify the equivalent conditions of the preceding theorem are usually call the ω -regular sets. We denote by $Rec(A^\omega)$ the class of ω -regular sets on alphabet A . Following Louveau 1987, we denote by **Auto** the family of ω -regular sets. ω -regular sets are denoted by ω -regular expression [69].

Example 10.

$$\alpha \in \mathbb{O} \Leftrightarrow \exists m \alpha(m) = 1$$

An ω -regular expression for \mathbb{O} is $0^*1(0+1)^\omega$

$$\alpha \in \check{\mathbb{O}} \Leftrightarrow \forall m \alpha(m) = 0$$

An ω -regular expression for $\check{\mathbb{O}}$ is 0^ω

$$\alpha \in \mathbb{Q} \Leftrightarrow \exists m \forall n \geq m \alpha(n) = 0$$

An ω -regular expression for \mathbb{Q} is $(0+1)^*0^\omega$

$$\alpha \in \check{\mathbb{Q}} \Leftrightarrow \forall m \exists n > m \alpha(n) = 1$$

An ω -regular expression for $\check{\mathbb{Q}}$ is $(0^*1)^\omega$

2.3 ω -rational relations

In this section, we introduce ω -rational relations which extend the notion of ω -langages (see [37, 40, 41, 56]).

Definition 2.7. A Büchi transducer \mathcal{T} is a 6-tuple: $\mathcal{T} = \langle A, B, Q, I, T, F \rangle$, where A and B are finite alphabets, Q is a finite set of states, $I \subset Q$ is the set of initial states, $T \subset Q \times A^* \times B^* \times Q$ is the finite set of transitions and $F \subset Q$ the set of final states.

An (infinite) path c in \mathcal{T} is an infinite word $c = c(0)c(1)\dots c(n)\dots \in (Q \times A^* \times B^* \times Q)^\omega$ such that $\forall n \in \omega \ c(n) \in T$.

So for each n , $c(n)$ is of the form $c(n) = (q_n, u_n, v_n, q_{n+1})$, with $u_n \in A^*$ and $v_n \in B^*$. This will be denoted by the following graphical notation of path:

$$c = q_0 \xrightarrow{u_0, v_0} q_1 \xrightarrow{u_1, v_1} q_2 \xrightarrow{u_2, v_2} \dots$$

Let $\alpha = u_0u_1\dots u_n\dots$ and $\beta = v_0v_1\dots v_n\dots$, (α, β) is the label of the path c . A path c is said to be successful if $q_0 \in I$ and $\text{Infinity}(c) \cap F \neq \emptyset$, where $\text{Infinity}(c)$ is still the set of states which appears infinitely many times in c . Let $\alpha \in A^* \cup A^\omega$ and

$\beta \in B^* \cup B^\omega$, (α, β) is recognized by \mathcal{T} if there is a successful path c in \mathcal{T} of label (α, β) .

Remark 5. A path c of label (α, β) is called *admissible* if α and β are both infinite words. In [37] it is shown that for every finite Büchi transducer \mathcal{T} , it is possible to construct another one \mathcal{T}' so that every successful path in \mathcal{T}' is admissible and the paths that are both successful and admissible are the same in \mathcal{T} and \mathcal{T}' . In the sequel of this paper all the labels (α, β) will be in $A^\omega \times B^\omega$.

An ω -rational relation is a subset of $A^\omega \times B^\omega$ which is recognizable by a Büchi's transducer. An ω -rational function $f : A^\omega \rightarrow B^\omega$ is a function whose graph is an ω -rational relation. Recall that a left sequential function $f : A^* \rightarrow B^*$ is a function that can be realized by a deterministic automaton with output (sequential transducer). A left sequential function can be extended immediately to $f : A^\omega \rightarrow B^\omega \cup B^*$. If the image of f is in B^ω then this is an example of continuous ω -rational function. This is the case when the deterministic automaton with output realizing f output one letter when he read a letter. We call 1-sequential functions these functions and these functions will be used as strategy for player 2 later.

Example 11. Let \mathcal{T} be the Büchi transducer with $A = B = \{0,1\}$, states $Q = \{1,2,3,4,5\}$, initial states $I = \{1,3,4\}$, final states $F = \{1,3,5\}$ and transitions

$$T = \{(1,(0,0),1),(1,(1,1),2),(2,(0,0),1),(2,(1,1),2), \\ (3,(1,1),3),(4,(0,0),4),(4,(1,1),4),(4,(0,1),5),(5,(1,0),5)\}$$

Figure 3.4 gives the representation of \mathcal{T} . This automaton recognizes the graph of function $S : 2^\omega \rightarrow 2^\omega$ defined by $S(\alpha) = \alpha$ if α has infinitely many 0's, $S(1^\omega) = 1^\omega$ and $S(u01^\omega) = u10^\omega$ for all $u \in 2^*$. Let $\mu_2 : 2^\omega \rightarrow [0,1]$ defined by $\mu_2(\alpha) = \sum_{i=0}^{\infty} \frac{\alpha(i)}{2^{i+1}}$. One can easily check that $S(\alpha)$ is the lexicographic maximum of the binary representations of $\mu_2(\alpha)$ for all $\alpha \in 2^\omega$. S is known as *normalization in base 2*. In fact for any Pisot number θ , normalisation in base θ is an ω -rational function (see Frougny [39]).

2.4 Borel sets in Polish spaces

For all of the topological concepts introduced in this section we refer the reader to [53, 47, 69, 87].

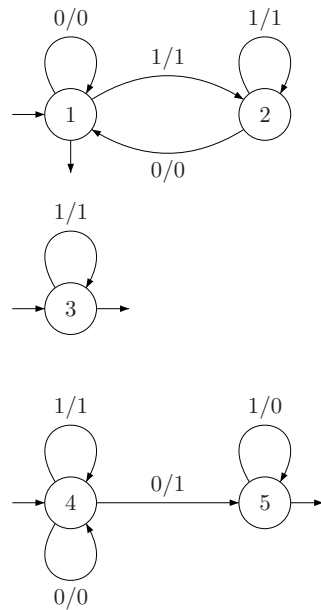

FIG. 2.4 – Normalization in base 2

2.4.1 Ordinals

For a short and comprehensive presentation of ordinals we refer the reader to Srivastava [87]. We say that two sets E and F have the same cardinal if there is a bijection from E to F . We say that two well-ordered sets E and F have the same ordinal if there is an order-preserving bijection from E to F . To each well-ordered set W we can associate a particular well-ordered set $t(W)$ called the type of W which is the ordinal associate to W . Results in the theory of ordinals use the axiom of choice and axiom of replacement.

It is common in set theory to identify an ordinal with the set of its predecessors, i.e., $\alpha = \{\beta \mid \beta < \alpha\}$ and to identify the finite ordinals with the natural numbers. Here are the first ordinals $0, 1 = \{0\}, 2 = \{0,1\}, 3 = \{0,1,2\} \dots n = \{0,1, \dots, n-1\}$. The successor of an ordinal α is the least ordinal $> \alpha$. An ordinal is **successor** if it is the successor of some ordinal, and it is **limit** if it is not 0 or successor.

The first infinite ordinal is $\omega = \{0,1,2, \dots, n, n+1, \dots\}$, it is a limit ordinal, its successor is $\omega + 1 = \{0,1,2, \dots, n, n+1, \dots, \omega\}$.

Next we have $\omega + 2, \dots, \omega + n, \dots, \omega + \omega = \omega.2, \dots, \omega.3, \dots, \omega.n, \dots, \omega.\omega = \omega^2, \dots, \omega^n, \dots, \omega^\omega$.

An ordinal is **countable** if its cardinal is countable. All ordinals we have seen are small countable ordinals. Let ω_1 be the set of countable ordinals, one can show

that ω_1 is an uncountable well-ordered set and that its cardinality is lower or equal to 2^{\aleph} . **The Continuum hypothesis** says that the cardinality of ω_1 is equal to 2^{\aleph} .

2.4.2 The Borel hierarchy

Borel subsets of a topological space X are obtained from open sets using complementation and countable unions. When X is metrizable we can define the hierarchy of Borel sets of finite rank :

Definition 2.8. *Let X be a metrizable space, for $n \in \omega - \{0\}$, we define by induction classes $\Sigma_n^0(X)$, $\Pi_n^0(X)$ and $\Delta_n^0(X)$:*

$\Sigma_1^0(X) = G(X)$ the class of open sets of X

$\Pi_n^0(X) = \{\check{A} \mid A \in \Sigma_n^0(X)\}$, where \check{A} is the complement of A .

$\Sigma_{n+1}^0(X) = \{\cup_m A_m \mid A_m \in \Pi_n^0(X), m \in \omega\}$

$\Delta_n^0(X) = \Sigma_n^0(X) \cap \Pi_n^0(X)$

In particular, we have :

Π_1^0 is the class of closed sets.

$\Sigma_2^0 = F_\sigma$ is the class of countable unions of closed sets.

$\Pi_2^0 = G_\delta$ is the class of countable intersections of open sets.

One can prove that : $\Sigma_n^0 \cup \Pi_n^0 \subset \Delta_{n+1}^0$

This gives us the following picture where any class is contained in every class to the right of it :

$$\begin{array}{cccccccc} & \Sigma_1^0 & & \Sigma_2^0 & & \Sigma_3^0 & & \Sigma_n^0 \\ \Delta_1^0 & & \Delta_2^0 & & \Delta_3^0 & \dots & \Delta_n & \dots \\ & \Pi_1^0 & & \Pi_2^0 & & \Pi_3^0 & & \Pi_n^0 \end{array}$$

The Borel hierarchy is also defined for transfinite levels $\xi < \omega_1$, but we shall not need them in the present study.

For all $n \in \omega$ the classes $\Sigma_n^0(X)$, $\Pi_n^0(X)$, $\Delta_n^0(X)$ are closed under finite unions and intersections, moreover $\Sigma_n^0(X)$ is closed under countable unions, $\Pi_n^0(X)$ closed under countable intersections and $\Delta_n^0(X)$ closed under complement. All these classes are closed by inverse image by continuous functions.

Example 12. The set \mathbb{O} is open but is not closed, i.e., $\mathbb{O} \in \Sigma_1^0$ and $\mathbb{O} \notin \Pi_1^0$.

We will see that the set \mathbb{Q} is F_σ but is not G_δ , i.e., $\mathbb{Q} \in \Sigma_2^0$ and $\mathbb{Q} \notin \Pi_2^0$.

Sets which are recognized by deterministic Büchi automaton are G_δ . One can see this easily as a deterministic automaton gives a continuous function $f : A^\omega \rightarrow Q^\omega$.

Replace $q \notin F$ by 0 and $q \in F$ by 1. The set recognized by a deterministic Büchi automaton is the inverse image of \check{Q} by a continuous function.

Sets which are recognized by deterministic Müller automaton are boolean combinations of sets which are recognized by deterministic Büchi automaton, so they are boolean combinations of Π_2^0 sets hence Δ_3^0 .

2.4.3 Polish spaces

A Polish space P is a separable topological space which admits a compatible metric d such as (P, d) is complete. A closed subset of a Polish space is Polish. An open subset of a Polish space is Polish. A G_δ subset of a Polish space is Polish. This is not true for F_σ . Recall the Baire theorem :

Theorem 2.9. *Let X be a complete space, the intersection of countably many dense open sets in X is dense.*

This is equivalent to say that in a complete space X , the union of countably many closed sets of empty interior has empty interior.

Lemma 2.10. *The set \mathbb{Q} with the relative topology induced by the one of \mathbb{R} is not Polish.*

Proof: (Saint Raymond) We have :

$$\mathbb{Q} = \bigcup_{n \in \omega} \{q_n\}$$

a countable union of closed sets. Suppose \mathbb{Q} was Polish then by the preceding theorem there must be an n such that $\{q_n\}$ has an nonempty interior, otherwise \mathbb{Q} would have an empty interior, hence will be empty. But every $\{q_n\}$ has an empty interior because \mathbb{Q} is dense in itself. Hence \mathbb{Q} can't be Polish. \square

In fact by Baire's theorem, every countable dense subset of a Polish space is not Polish. As a G_δ subset of a Polish space is Polish, every countable dense subset of a Polish space is not G_δ .

Remark 6. It is well known (for a descriptive set theorist) that every Polish space is homeomorphic to a G_δ set in a compact metric space. For example the Baire space ω^ω is homeomorphic to $\check{Q} = \{\alpha \in 2^\omega \mid \forall m, \exists n > m, \alpha(n) = 1\}$. To see this, define an application $\varphi : \omega \longrightarrow 2^*$ by $\varphi(n) = 0^n1$. Notice that $\varphi(\omega) = 0^*1$ is a regular prefix code. Extend φ in monoïd morphism $\varphi : \omega^* \longrightarrow 2^*$, $\varphi(\omega^*) = (0^*1)^*$. Next extend φ in continuous one to one application called again $\varphi : \omega^\omega \longrightarrow 2^\omega$. We have $\varphi(\omega^\omega) = (0^*1)^\omega = \check{Q}$. The set of infinite subsets of ω is homeomorphic to Baire space ω^ω .

When P is an uncountable Polish space, Borel hierarchy is strict. In the sequel P will be A^ω or $A^\omega \times B^\omega$ or $[a,b]$ with a and b reals.

2.4.4 Analytic sets and coanalytic sets

There exists another hierarchy beyond the Borel one, called the projective hierarchy, which is obtained from the Borel hierarchy by successive applications of operations of projection and complementation. We need just the first level of this hierarchy. Let $B \subseteq P \times \omega^\omega$, we will call $proj_P(B)$ the projection of B onto P , that is, $proj_P(B) = \{\alpha \in P / \exists \beta \in \omega^\omega (\alpha, \beta) \in B\}$.

A set $C \subseteq P$ is called analytic if there is a Borel set $B \subseteq P \times \omega^\omega$ such that $C = proj_P(B)$. A set $C \subseteq P$ is coanalytic if its complement is analytic. The class of analytic sets in P (resp. coanalytic) is called $\Sigma_1^1(P)$ (resp. $\Pi_1^1(P)$). Borel sets are analytic and coanalytic sets. The famous theorem of Suslin says that in Polish space P , if $B \subseteq P$ is analytic and coanalytic then B is Borel.

Existence of analytic sets which are not Borel is a kind of myth for descriptive set theorists. In 1905 Lebesgue said that the projection of Borel set in the plane was a Borel set. This was false as Suslin discovered in 1917. He called a projection of Borel set an analytic set. Here is the French evidence of Sierpinski [82]: “Par hasard j’étais présent au moment où Michel Suslin communiqua à M. Lusin sa remarque et lui donna le manuscrit de son premier travail”. Büchi commented the equivalence of theorem 2.6: “What looks like an analytic set (set recognized by a nondeterministic Büchi automaton) is in fact Borel set (a set recognized by a deterministic Müller automaton is a Δ_3^0 set)” [16]. An ω -rational relation is an analytic set of $A^\omega \times B^\omega$.

2.4.5 Complete sets

Recall the notion of completeness with regard to reduction by continuous functions. Let Γ be a class of sets in P Polish. We call $C \subseteq P$ Γ -complete if $C \in \Gamma$ and for any $B \in \Gamma$ there exists a continuous function $f : P \rightarrow P$, such that $B = f^{-1}(C)$.

Finding some simple examples of complete sets is an old tradition in descriptive set theory which goes back to Hurewicz [45] (see Louveau and Saint Raymond [62], Kechris [47]). It turns out that some simple combinatorial examples of complete sets are recognized by automata.

Example 13. We will see that $\mathbb{O} = \{\alpha \in 2^\omega \mid \exists m \alpha(m) = 1\}$ is Σ_1^0 -complete, hence $\check{\mathbb{O}} = \{\alpha \in 2^\omega \mid \forall m \alpha(m) = 0\}$ is Π_1^0 -complete.

We will see that the set $\mathbb{Q} = \{\alpha \in 2^\omega \mid \exists m \forall n \geq m \alpha(n) = 0\}$ is Σ_2^0 -complete, hence $\check{\mathbb{Q}} = \{\alpha \in 2^\omega \mid \forall m \exists n > m \alpha(n) = 1\}$ is Π_2^0 -complete. In fact a countable dense subset of $[0,1]$ is Σ_2^0 -complete Hurewicz [45], and this true in all uncountable Polish space.

Here is some well known examples of coanalytic-complete sets:

The set **WO**, as **Well Order**, that is the set of $E \subset \omega \times \omega$ such that E is the graph of Well ordered linear order, is Π_1^1 -complete, Lusin Sierpinski (1923).

The set **K(Q)** of compact sets of $[0,1]$ which are included in $\mathbb{Q} \subset \mathbb{R}$, is Π_1^1 -complete, Hurewicz [45].

The set **DIFF** of differentiable functions in $C[0,1]$ is Π_1^1 -complete, Mazurkiewicz(1933).

The set **WF** of well founded trees, that is trees on ω which have no infinite branches is Π_1^1 -complete.

The set **NDIFF** of continuous functions on $[0,1]$ which are nowhere differentiable functions in $C[0,1]$ is Π_1^1 -complete, Mauldin(1979).

Finkel showed in [31] that there exists an ω -rational relation which is Σ_1^1 -complete.

Wadge has proved^{1 2}:

For any n , $C \subseteq \omega^\omega$ is Σ_n^0 -complete (resp. Π_n^0 -complete) set iff $C \in \Sigma_n^0 \setminus \Pi_n^0$ (resp. $C \in \Pi_n^0 \setminus \Sigma_n^0$).

Definition 2.11. Let $L \subset A^*$ we define $Lim(L) = \{\alpha \in A^\omega \mid \forall n \in \omega, \exists m \geq n \text{ such that } \alpha[m] \in L\}$.

The following lemma is classical(see [54], [56], [90]).

Lemma 2.12. Let $M \subset A^\omega$ then M is Π_2^0 if and only if there exists $L \subset A^*$ so that $M = Lim(L)$.

Example 14. $\check{\mathbb{Q}} = \{\alpha \in 2^\omega \mid \forall m \exists n > m \alpha(n) = 1\}$ is Π_2^0 because $\check{\mathbb{Q}} = Lim(L)$ with L a regular set denoted by the regular expression $(0 + 1)^*1$.

\mathbb{Q} is not equal to $Lim(L)$ because \mathbb{Q} is not G_δ .

This lemma is equivalent to the following. The set $\check{\mathbb{Q}} = \{\alpha \in 2^\omega \mid \forall m, \exists n > m, \alpha(n) = 1\}$ is a Π_2^0 complete set [83], [93]. In fact we have more: this set is strategically complete [62]. We will see it in the game section.

1. Jean Saint Raymond has proved, that this valid for any uncountable Polish space.

2. See [47] page 205 for a discussion of the statement:

Let $C \subseteq \omega^\omega$, if $C \in \Pi_1^1 \setminus \Sigma_1^1$ then C is Π_1^1 -complete.

2.5 Baire's classes

Definition 2.13. *Definition of Baire's classes for functions is recursive.*

Let X, Y be metrizable spaces and $f : X \rightarrow Y$ be a function.

- i) f is of Baire class 0 if f is continuous.
- ii) f is of Baire class $(n+1)$ if f is the pointwise limit of a sequence of Baire class n functions for each integer $n \geq 0$.

The Lebesgue, Hausdorff, Banach theorem makes the connexion with the Borel hierarchy :

Theorem 2.14. *Let X, Y be metrizable spaces with Y separable. Then for all $n \geq 2$, $f : X \rightarrow Y$ is of Baire class n iff for all open V include in Y , $f^{-1}(V)$ is in $\Sigma_{n+1}^0(X)$.*

Remark 7. Note that this result holds for $n = 1$ if in addition X is separable and either $X = A^\omega$ or $Y = \mathbb{R}$.

Remark 8. If $Y = B^\omega$, as $\{uB^\omega | u \in B^*\}$ is a countable basis of clopen sets, it is equivalent to prove that $f : X \rightarrow Y$ is of Baire class n iff for all finite word u , $f^{-1}(uB^\omega)$ is in $\Delta_{n+1}^0(X)$.

Lemma 2.15. *An ω -rational function is of Baire class 2.*

Proof: We have to shows that for all finite word u , $f^{-1}(uB^\omega)$ is in Δ_3^0 . But

$$f^{-1}(uB^\omega) = \text{proj}_{A^\omega}(\text{graph}(f) \cap (A^\omega \times uB^\omega))$$

We see that $A^\omega \times uB^\omega$ is in $\text{Rec}((A \times B)^\omega)$. The family of ω -rational relation of $A^\omega \times B^\omega$ is closed by intersection with an ω -regular set of $(A \times B)^\omega$ and if $R \subset A^\omega \times B^\omega$ is an ω -rational relation then $\text{proj}_{A^\omega}(R)$ is an ω -regular set of A^ω . We have seen that an ω -regular set is a boolean combination of Π_2^0 sets, hence is a Δ_3^0 set. \square

Example 15. The characteristic function of $\mathbb{Q} \subset \mathbb{R}$, $1_{\mathbb{Q}}$ is a classical example of Baire class two function which is not of Baire class one [5, 25]. The function $1_{\mathbb{Q}}$ is the pointwise limit of the sequence $(f_m)_{m \in \mathbb{N}}$ where $f_m(x) = \lim_{n \rightarrow \infty} \cos^{2m}(n! \pi x)$. So $1_{\mathbb{Q}}$ is of Baire class two. If $1_{\mathbb{Q}}$ was a Baire class one function, then the inverse image of an open set by $1_{\mathbb{Q}}$ will be a $\Sigma_2^0(\mathbb{R})$ set, hence the inverse image of a closed set by $1_{\mathbb{Q}}$ will be a $\Pi_2^0(\mathbb{R})$ set. But as $1_{\mathbb{Q}}^{-1}(\{1\}) = \mathbb{Q}$ is not $\Pi_2^0(\mathbb{R})$, because \mathbb{Q} is a countable dense subset, so $1_{\mathbb{Q}}$ is not of Baire class one.

Let X and Y be metrizable spaces with Y compact, and $f : X \rightarrow Y$, it is well known that f is continuous if and only if its graph is closed.

Proposition 2.16. *Let $f : A^\omega \rightarrow B^\omega$ be a function of Baire class n , then its graph is $\Pi_{n+1}^0(A^\omega \times B^\omega)$.*

Proof: First notice that if $f(\alpha) = \beta$ then $\forall u \in B^*$, $(\beta \in uB^\omega \Rightarrow f(\alpha) \in uB^\omega)$ and if $f(\alpha) \neq \beta$ then $\exists u \in B^*$ such that $\beta \in uB^\omega$ and $f(\alpha) \notin uB^\omega$. Thus :

$$(\alpha, \beta) \in \text{graph}(f) \Leftrightarrow f(\alpha) = \beta \Leftrightarrow [\forall u \in Y^*(\beta \in uB^\omega \Rightarrow f(\alpha) \in uB^\omega)]$$

As f is of Baire class n , for any word u in B^* , $\{\alpha \in A^\omega | f(\alpha) \in uB^\omega\}$ is in $\Delta_{n+1}^0(A^\omega)$ and $\{\beta \in B^\omega | \beta \in uB^\omega\}$ is in $\Delta_1^0(B^\omega)$. Thus for all fixed $u \in B^*$, $\{(\alpha, \beta) \in A^\omega \times B^\omega | (\beta \in uB^\omega \Rightarrow f(\alpha) \in uB^\omega)\}$ is in $\Delta_{n+1}^0(A^\omega \times B^\omega)$ and $\{(\alpha, \beta) \in A^\omega \times B^\omega | \forall u \in B^*(\beta \in uB^\omega \Rightarrow f(\alpha) \in uB^\omega)\}$ is in $\Pi_{n+1}^0(A^\omega \times B^\omega)$. \square

When A and B are finite alphabets we have :

Proposition 2.17. *Let f be a function $f : A^\omega \rightarrow B^\omega$.*

If $\text{graph}(f) \in \Delta_2^0(A^\omega \times B^\omega)$ then f is of Baire class 1.

Proof: If $\text{graph}(f) \in \Delta_2^0(A^\omega \times B^\omega)$ then for all open $U \subset B^\omega$, $\text{graph}(f) \cap (A^\omega \times U) \in \Delta_2^0(A^\omega \times B^\omega)$. As A^ω and B^ω are compact spaces, $\text{graph}(f) \cap (A^\omega \times U)$ is K_σ (countable unions of compact sets) and then $f^{-1}(U)$ is K_σ as the continuous projection of $\text{graph}(f) \cap (A^\omega \times U)$ on A^ω . \square

Let $\text{cont}(f)$ denote the set of points of continuity of a function f .

Proposition 2.18. *Let X and Y be separable metric spaces and $f : X \rightarrow Y$. Then $\text{cont}(f)$ is $\Pi_2^0(X)$.*

Proof: We define the oscillation of f at α by :

$$\text{osc}_f(\alpha) = \inf\{\text{diam}(f(U)) | U \text{ open containing } \alpha\}$$

where $\text{diam}(E)$ is diameter of a set E .

It is easy to see that $\text{osc}_f(\alpha) = 0$ iff f is continuous at α .

Let $X_\varepsilon = \{\alpha \in X | \text{osc}_f(\alpha) < \varepsilon\}$ we show that it is an open set.

Let α be in X_ε .

$$(\text{osc}_f(\alpha) < \varepsilon) \Rightarrow (\exists U \text{ open containing } \alpha \text{ so that } \text{diam}(f(U)) < \varepsilon).$$

Then

$$\forall \beta \in U \text{ osc}_f(\beta) \leq \text{diam}(f(U)) < \varepsilon.$$

And X_ε is open.

So $\text{cont}(f) = \{\alpha \in X^\omega | \text{osc}_f(\alpha) = 0\} = \bigcap_{n>0} X_{1/n}$ is $\Pi_2^0(X)$. \square

2.6 An example

In this section we give an example of a function f such that $\text{graph}(f)$ is definable in $S1S$ hence is of Baire class 2. One can easily see that $\text{graph}(f) \in \mathbf{\Pi}_2^0$ and the set of points of continuity of f is a dense open set (hence dense $\mathbf{\Pi}_2^0$). However, f is not of Baire class 1. This example was constructed in 1996 by Tison and the first author and was unpublished. The idea of A. Louveau (1996), is the following: take the characteristic function of the Cantor set on the interval $[0,1]$. The function is continuous on the complement of the triadic Cantor set, which is a dense open set. Since the graph of f is $\mathbf{\Delta}_2^0$ set, it follows from proposition 2.17 that f is of Baire class 1. So we have to modify our function on the Cantor set to succeed. Now we will work on space $3^\omega = \{0,1,2\}^\omega$. The Cantor set is $(0+2)^\omega$

$$\alpha \in (0+2)^\omega \leftrightarrow \forall n(\alpha(n) = 0 \vee \alpha(n) = 2)$$

and its complement is the dense open set $(0+2)^*1(0+1+2)^\omega$

$$\alpha \in (0+2)^*1(0+1+2)^\omega \leftrightarrow \exists n \alpha(n) = 1$$

First define $g : \{0,1\}^\omega \longrightarrow \{0,1\}^\omega$ by :

$g(\alpha) = \alpha$, if $\alpha \in (0^*1)^\omega$ (α has infinitely many 1's).

If $\alpha \in (0+1)^*10^\omega$ (α has a non zero finite number of 1's) replace each letter of α by 0 except the last 1 which remains the same, this gives $g(0^{k_0}10^{k_1} \dots 10^{k_p}10^\omega) = 0^{k_0+k_1+\dots+k_p+p}10^\omega$.

Finally if $\alpha = 0^\omega$, $g(0^\omega) = 1^\omega$.

Figure 2.5 shows a deterministic Büchi automaton which recognizes $\text{graph}(g)$. This implies that $\text{graph}(g) \in \mathbf{\Pi}_2^0$. We will see that g has no point of continuity and is not of Baire class 1.

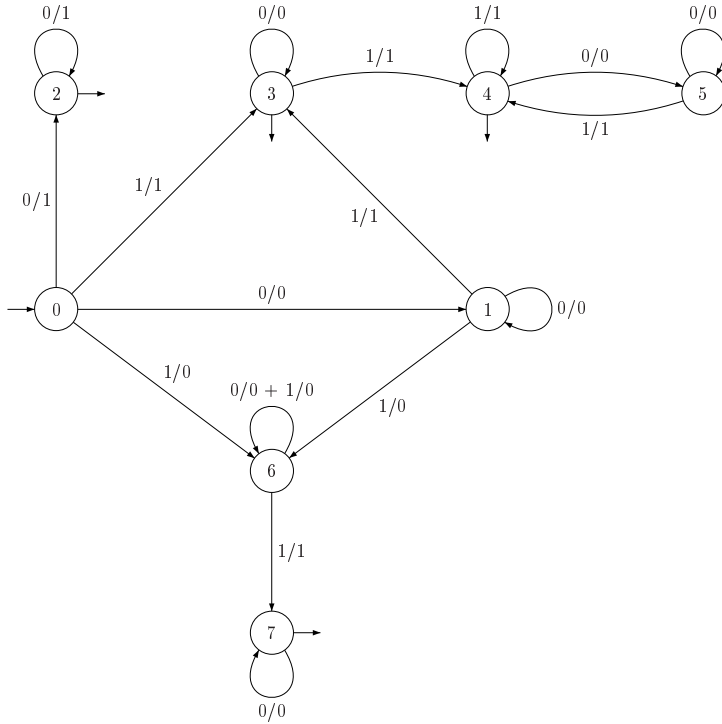

FIG. 2.5 – a totally discontinuous synchronous function

Let's see that g has no point of continuity.

If α has infinitely many 1's, $\alpha = 0^{k_0}10^{k_1}10^{k_2}1 \dots 10^{k_p} \dots$, where for each p , $k_p \geq 0$, sequence $\alpha_n = 0^{k_0}10^{k_1}10^{k_2}1 \dots 10^{k_n}10^\omega$ tends to α .

But $g(0^{k_0}10^{k_1}10^{k_2}1 \dots 10^{k_n}10^\omega) = 0^{k_0+k_1+\dots+k_n+n}10^\omega$ and sequence $g(\alpha_n)$ converges to 0^ω .

Suppose now that α has a non zero finite number of 1's, $\alpha = 0^{k_0}10^{k_1} \dots 10^{k_p}10^\omega$ with $p \geq 0$. Sequence $\alpha_n = 0^{k_0}10^{k_1} \dots 10^{k_p}10^n10^\omega$ tends to α . We have $g(\alpha) = 0^{k_0+k_1+\dots+k_p+p}10^\omega$, $g(0^{k_0}10^{k_1} \dots 10^{k_p}10^n10^\omega) = 0^{k_0+k_1+\dots+k_p+p+n+1}10^\omega$ and sequence $g(\alpha_n)$ converges to 0^ω .

If $\alpha = 0^\omega$, α is limit of the sequence $\alpha_n = 0^n10^\omega$. $g(0^\omega) = 1^\omega$, $g(0^n10^\omega) = 0^n10^\omega$ and the sequence $g(\alpha_n)$ converges to 0^ω .

One can also see that $g^{-1}(011(0+1)^\omega) = 011(0^*1)^\omega$, which is Π_2^0 but not Σ_2^0 . So g is not of Baire class one.

Now we can define our function $f : \{0,1,2\}^\omega \longrightarrow \{0,2\}^\omega$ by :

$$f(\alpha) = 0^\omega \text{ if } \alpha \in (0+2)^*1(0+1+2)^\omega \text{ (} \alpha \text{ has at least one 1)}$$

$$f(\alpha) = \alpha \text{ if } \alpha \in (0^*2)^\omega \text{ (} \alpha \text{ has no 1 and infinitely many 2's)}$$

$$f(\alpha) = 0^n20^\omega \text{ if } \alpha \in (0+2)^*20^\omega \text{ (} \alpha \text{ has no 1 and a non zero finite number of 2's)}$$

and satisfies, $\alpha \in (0+2)^n20^\omega$

$$f(\alpha) = 2^\omega \text{ if } \alpha = 0^\omega.$$

One can see in figure 2.6 that $graph(f)$ is recognized by a deterministic Büchi automaton. This implies that $graph(g) \in \mathbf{\Pi}_2^0$.

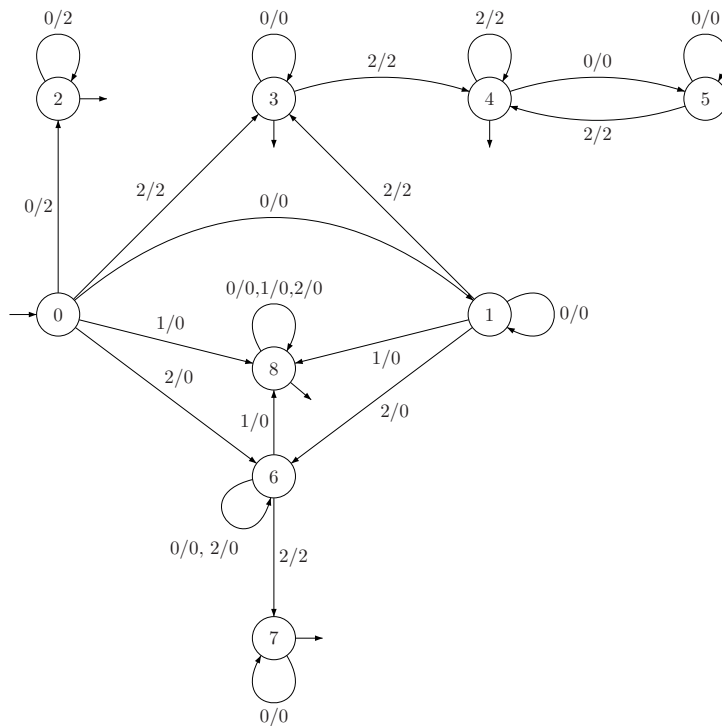

FIG. 2.6 – a dense open set of points of continuity

Notice that f is not of Baire class 1 because $f^{-1}(022(0+2)^\omega) = 022(0^*2)^\omega$ which is $\mathbf{\Pi}_2^0$ but not $\mathbf{\Sigma}_2^0$. Moreover f is continuous on a dense open set because it is constant on the dense open set $(0+2)^*1(0+1+2)^\omega$. It is easy to see that f has no point of continuity on $(0+2)^\omega$. The proof is similar to that concerning g , we just have to replace 1 by 2.

In his thesis (1899) Baire has proved that a function is of Baire class 1 if and only if for every non empty closed set F the restriction of this function to F has a point

of continuity. Our example is ω -rational function which is not of Baire class 1 and we have found an ω -regular closed set $F = (0 + 2)^\omega$ such that restriction of f to F has no point of continuity. We will see that our example is generic. If f is an ω -rational function which is not Baire class 1, then there exists a closed F , recognized by a Büchi automaton, such that restriction of f to F has no point of continuity.

The next sections will be devoted to the classical proof of Baire's result.

2.7 Differences hierarchy

In this section, we introduce the class of differences. Let ξ be an ordinal. Any ξ can be written in a unique way $\xi = \lambda + n$ with λ a limit ordinal or 0 and $n \in \omega$. Parity of ξ is by definition that of n .

Definition 2.19. *Let X be a set, ξ an ordinal and $\langle B_\eta : \eta < \xi \rangle$ an increasing sequence of subsets of X :*

$$D_\xi(\langle B_\eta : \eta < \xi \rangle) = \{x \in X \mid \exists \eta < \xi, x \in B_\eta \text{ and if } \eta_0 = \inf(\{\eta \mid x \in B_\eta\}) \\ \text{the parity of } \xi \text{ and of } \eta_0 \text{ are different}\}$$

Then :

$$\begin{aligned} D_1(\langle B_0 \rangle) &= B_0 \\ D_2(\langle B_0, B_1 \rangle) &= B_1 \setminus B_0 \\ D_3(\langle B_0, B_1, B_2 \rangle) &= (B_2 \setminus B_1) \cup B_0 \\ &\dots \\ D_\omega(\langle B_n : n \in \omega \rangle) &= \bigcup_{n \in \omega} (B_{2n+1} \setminus B_{2n}) \\ D_{\omega+1}(\langle B_n : n \leq \omega \rangle) &= (B_\omega \setminus \bigcup_{n \in \omega} B_n) \cup (\bigcup_{n \in \omega} (B_{2n+2} \setminus B_{2n+1})) \cup B_0 \end{aligned}$$

Let Γ be a family of subsets of X , $D_\xi(\Gamma)$ will be the family of all $D_\xi(\langle B_\eta : \eta < \xi \rangle)$ where $\langle B_\eta : \eta < \xi \rangle$ is an increasing sequence of length ξ of elements of Γ . In the sequel we will be particularly interested in the classes $D_\xi(\Sigma_1^0)$ and their dual classes $\check{D}_\xi(\Sigma_1^0) = \{B \mid \check{B} \in D_\xi(\Sigma_1^0)\}$, where ξ is a countable ordinal.

Example 16. Let $O_k = \{\alpha \in 2^\omega \mid \exists n_1, \exists n_2, \dots, \exists n_k, n_1 < n_2 < \dots < n_k, \alpha(n_1) = \alpha(n_2) = \dots = \alpha(n_k) = 1\}$ with $k > 0$, O_k is an ω -regular open set. We have an increasing sequence of dense open sets $O_n \subset O_{n-1} \subset O_{n-2} \dots O_2 \subset O_1$ and $D_n(\langle O_n, \dots, O_1 \rangle)$ is a $D_n(\Sigma_1^0)$ which in fact is a $D_n(\Sigma_1^0)$ -complete set. Figure 2.7 gives a deterministic Büchi automaton which recognizes $(O_1 \setminus O_2) \cup O_3$.

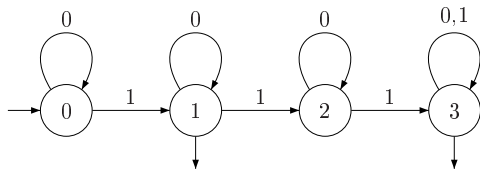

FIG. 2.7 – A deterministic Büchi automaton which recognizes a $D_3(\Sigma_1^0)$ -complete set.

Example 17. Let G_n be the following sequence of decreasing dense G_δ sets :

$$G_1 = ((0+1)^*1)^\omega = (0^*1)^\omega \quad \alpha \in G_1 \Leftrightarrow \alpha \text{ has an infinite numbers of } 1.$$

$$G_2 = ((0+1)^*11)^\omega \quad \alpha \in G_2 \Leftrightarrow \alpha \text{ has an infinite numbers of } 11.$$

$$G_3 = ((0+1)^*111)^\omega \quad \alpha \in G_3 \Leftrightarrow \alpha \text{ has an infinite numbers of } 111.$$

...

$$G_n = ((0+1)^*1^n)^\omega \quad \alpha \in G_n \Leftrightarrow \alpha \text{ has an infinite numbers of } 1^n$$

Taking the complement of these sets we obtain an increasing sequence

$$F_1 \subset F_2 \subset \dots F_{n-1} \subset F_n$$

of meager F_σ sets, $D_n(\langle F_1, \dots, F_n \rangle)$ is a $D_n(\Sigma_2^0)$ which in fact is a $D_n(\Sigma_2^0)$ -complete set. Figure 2.8 gives a deterministic Müller automaton which recognizes $(F_3 \setminus F_2) \cup F_1$, with $\mathcal{F} = \{\{0\}, \{0,1,2\}\}$.

The loops accessible from the initial state are

$L = \{\{0\}, \{0,1\}, \{0,1,2\}, \{0,1,2,3\}, \{3\}\}$, these are essential loops of the automaton [106]. Classify these essential loops in

$L_+ = \{\{0\}, \{0,1,2\}\}$ and $L_- = \{\{0,1\}, \{0,1,2,3\}, \{3\}\}$. We have the inclusion

$\{0\} \subset \{0,1\} \subset \{0,1,2\} \subset \{0,1,2,3\}$, that is to say $\{+\} \subset \{-\} \subset \{+\} \subset \{-\}$.

But we have not some $\{-\} \subset \{+\} \subset \{-\} \subset \{+\}$ inclusion. These are the $+$ chain and $-$ chain of Wagner.

It is well known that in an uncountable Polish space hierarchy of $D_\xi(\Sigma_\eta^0)$, $\xi < \omega_1$, $\eta < \omega_1$ is strict (see [47]).

Lemma 2.20. Inclusion $D_\xi(\Sigma_1^0) \subset \Delta_2^0$ holds, for all countable ordinal ξ .

Proof: First note that $\check{D}_\xi(\Sigma_1^0) \subset D_{\xi+1}(\Sigma_1^0)$. So, we have only to prove that $D_\xi(\Sigma_1^0) \subset \Sigma_2^0$. This is clear since differences $B_1 \setminus B_0$ of open sets are Σ_2^0 and Σ_2^0 is closed under countable unions. \square

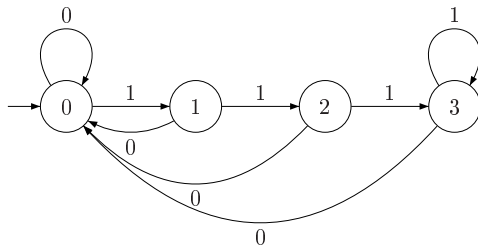

FIG. 2.8 – A deterministic Müller automaton which recognizes a $D_3(\Sigma_2^0)$ -complete set.

2.8 Hausdorff's derivation

Recall that A^ω has a countable basis for the topology. Thus we can extract countable covering from each open covering. As a consequence, if ω_1 is the first non countable ordinal, and if $(F_\xi)_{\xi < \omega_1}$ is a decreasing sequence of closed sets, it is stationary from a certain rank on, i.e., $\exists \eta < \omega_1$ such that $F_\xi = F_\eta$, $\forall \xi \geq \eta$. For more details we refer to [47].

We now define Hausdorff's derivation (see [53]).

Definition 2.21. Let M and N be two subsets of A^ω . Sequence of closed sets $(F_\xi)_{\xi < \omega_1}$ is defined by transfinite induction.

$$\begin{aligned} F_0 &= A^\omega \\ F_{\xi+1} &= \overline{F_\xi \cap M} \cap \overline{F_\xi \cap N} \\ F_\lambda &= \bigcap_{\xi < \lambda} F_\xi, \text{ if } \lambda \text{ is a limit ordinal} \end{aligned}$$

The sequence $(F_\xi)_{\xi < \omega_1}$ is a decreasing sequence of closed sets, so we know that there exists a smaller $\eta < \omega_1$ such that $F_\eta = \overline{F_\eta \cap M} \cap \overline{F_\eta \cap N}$.

Lemma 2.22. Let F be a closed set. Then $F = \overline{F \cap M} \cap \overline{F \cap N}$ if and only if $F = \overline{F \cap M} = \overline{F \cap N}$.

Proof: Indeed, if $F = \overline{F \cap M} \cap \overline{F \cap N}$ then $F \subset \overline{F \cap M}$. Moreover $F \cap M \subset F$ and $\overline{F \cap M} \subset F$ since F is closed. \square

Lemma 2.23. F_η is the largest closed set such that $F = \overline{F \cap M} \cap \overline{F \cap N}$.

Proof: Let F be a closed set such that $F = \overline{F \cap M} \cap \overline{F \cap N}$. We will show that $F \subset F_\eta$ by transfinite induction.

We have $F \subset F_0$.

If $F \subset F_\xi$ then $F \cap M \subset F_\xi \cap M$, so $F = \overline{F \cap M} \subset \overline{F_\xi \cap M}$.

Similarly $F = \overline{F \cap N} \subset \overline{F_\xi \cap N}$ thus $F \subset \overline{F_\xi \cap M} \cap \overline{F_\xi \cap N} = F_{\xi+1}$.

If λ is a limit ordinal, and if $\forall \xi < \lambda$, $F \subset F_\xi$ $\forall \xi < \lambda$ then $F \subset \bigcap_{\xi < \lambda} F_\xi = F_\lambda$. \square

We define the following sequences $(M_\xi)_{\xi < \omega_1}$ and $(N_\xi)_{\xi < \omega_1}$:

$$\begin{aligned} M_0 &= M & N_0 &= N \\ M_{\xi+1} &= M_\xi \cap \overline{N_\xi} & N_{\xi+1} &= N_\xi \cap \overline{M_\xi} \\ M_\lambda &= \bigcap_{\xi < \lambda} M_\xi & N_\lambda &= \bigcap_{\xi < \lambda} N_\xi \end{aligned} \quad \text{if } \lambda \text{ is a limit ordinal.}$$

Lemma 2.24. $\forall \xi < \omega_1$, $M_\xi = M \cap F_\xi$ and $N_\xi = N \cap F_\xi$. In particular, if η is the smallest countable ordinal such that $F_\eta = \overline{F_\eta \cap M} = \overline{F_\eta \cap N}$, then η is also the smallest countable ordinal such that $\overline{M_\eta} = \overline{N_\eta}$.

Proof: We argue again by a transfinite induction.

For $\eta = 0$ we have $M_0 = M = M \cap A^\omega = M \cap F_0$, and also $N_0 = N \cap F_0$.

If $M_\xi = M \cap F_\xi$ and $N_\xi = N \cap F_\xi$, then

$$M_{\xi+1} = M_\xi \cap \overline{N_\xi} = M \cap F_\xi \cap \overline{N \cap F_\xi} = M \cap F_\xi \cap \overline{M \cap F_\xi} \cap \overline{N \cap F_\xi}.$$

So

$$M_{\xi+1} = M \cap F_\xi \cap F_{\xi+1} = M \cap F_{\xi+1}.$$

For λ limit, if $M_\xi = M \cap F_\xi$ for $\xi < \lambda$, then :

$$M_\lambda = \bigcap_{\xi < \lambda} M_\xi = \bigcap_{\xi < \lambda} (M \cap F_\xi) = M \cap (\bigcap_{\xi < \lambda} F_\xi) = M \cap F_\lambda.$$

□

Lemma 2.25. Let M and N be two $\mathbf{\Pi}_2^0$ subsets of A^ω and F_η the largest closed set such that

$$F_\eta = \overline{F_\eta \cap M} \cap \overline{F_\eta \cap N}$$

Then $F_\eta \neq \emptyset \Rightarrow M \cap N \neq \emptyset$. In particular $F_\eta = \emptyset$ if M and N are two disjoint $\mathbf{\Pi}_2^0$.

Proof: Sets $M_\eta = M \cap F_\eta$, $N_\eta = N \cap F_\eta$ are $\mathbf{\Pi}_2^0$ sets. So, by lemma 2.12, there exists $U \subset A^*$ et $V \subset A^*$ so that : $Lim(U) = M_\eta$ and $Lim(V) = N_\eta$.

If $F_\eta \neq \emptyset$, as $F_\eta = \overline{M_\eta} = \overline{N_\eta}$, we can find $\alpha_1 \in M_\eta$ and $u_1 \in U$ such that u_1 is a prefix of α_1 . Since every open ball containing α_1 meets N_η , we can find $\beta_1 \in N_\eta$ so that u_1 is a prefix of β_1 . But $N_\eta = Lim(V)$, thus we can find $v_1 \in V$ such that v_1 is a prefix of β_1 and u_1 is a strict prefix of v_1 . Finally since every ball containing β_1 meet M_η we can find $\alpha_2 \in M_\eta$ so that v_1 is a prefix of α_2 , and since $M_\eta = Lim(U)$ we can find $u_2 \in U$ prefix of α_2 so that v_1 is a strict prefix of u_2 . Then $u_1 < v_1 < u_2$. Iterating this process, we construct two sequences (u_i) , (v_i) such that

$$u_1 < v_1 < u_2 < v_2 < \dots < u_i < v_i < u_{i+1} < v_{i+1} < \dots$$

Note $\alpha = \lim(u_i) = \lim(v_i)$, $\alpha \in \text{Lim}(U) = M_\eta \subset M$ and $\alpha \in \text{Lim}(V) = N_\eta \subset N$.
 \square

Theorem 2.26. (Hausdorff) *Let M and N be two disjoint $\mathbf{\Pi}_2^0$ subsets of A^ω . Then :*

- (i) *There exists $\zeta < \omega_1$ and a set in $D_\zeta(\mathbf{\Sigma}_1^0)$ which separates M from N .*
- (ii) *In particular, $\mathbf{\Delta}_2^0 = \cup_{\xi < \omega_1} D_\xi(\mathbf{\Sigma}_1^0)$.*

Proof: Let $P_\xi = F_\xi \setminus \overline{M \cap F_\xi}$, $R_\xi = F_\xi \setminus \overline{N \cap F_\xi}$. We have :

$$F_\xi \setminus F_{\xi+1} = F_\xi \setminus (\overline{M \cap F_\xi} \cap \overline{N \cap F_\xi}) = (F_\xi \setminus \overline{M \cap F_\xi}) \cup (F_\xi \setminus \overline{N \cap F_\xi}) = P_\xi \cup R_\xi.$$

Let η be the smallest ordinal such that $F_\eta = F_{\eta+1}$. We have :

$$A^\omega = (\cup_{\xi < \eta} (F_\xi \setminus F_{\xi+1})) \cup F_\eta.$$

By lemma 2.25, as M and N are two disjoint $\mathbf{\Pi}_2^0$, $F_\eta = \emptyset$, thus

$$A^\omega = (\cup_{\xi < \eta} P_\xi) \cup ((\cup_{\xi < \eta} R_\xi).$$

Moreover, $\forall \xi < \omega_1$, $P_\xi = F_\xi \setminus \overline{M \cap F_\xi} \subset F_\xi \setminus (M \cap F_\xi) = F_\xi \setminus M \subset A^\omega \setminus M$.

So as $\cup_{\xi < \eta} P_\xi \subset A^\omega \setminus M$ we have $M \subset A^\omega \setminus (\cup_{\xi < \eta} P_\xi)$ hence $M \subset \cup_{\xi < \eta} R_\xi$.

Also $(\cup_{\xi < \eta} R_\xi) \subset A^\omega \setminus N$, i.e., $(\cup_{\xi < \eta} R_\xi) \cap N = \emptyset$.

So $\cup_{\xi < \eta} R_\xi$ separates M from N . As it is a countable union of disjoint $D_2(\mathbf{\Pi}_1^0)$ sets it is easy to see that $\cup_{\xi < \eta} R_\xi$ is in $D_\zeta(\mathbf{\Sigma}_1^0)$ for some $\zeta < \omega_1$.

If M is in $\mathbf{\Delta}_2^0$, set $N = \check{M}$. M and N are disjoint $\mathbf{\Pi}_2^0$ sets and there exists $\zeta < \omega_1$ and a set in $D_\zeta(\mathbf{\Sigma}_1^0)$ which separates M from N . Thus M is in $D_\zeta(\mathbf{\Sigma}_1^0)$. So we have proved that $\mathbf{\Delta}_2^0 \subset \cup_{\xi < \omega_1} D_\xi(\mathbf{\Sigma}_1^0)$ and the opposite inclusion has been proved in lemma 2.20.

\square

Corollary 2.27. *Let M and N be two subsets of A^ω and let F_η be the biggest closed set so that $F_\eta = \overline{F_\eta \cap M} = \overline{F_\eta \cap N}$. Then M and N can be separated by a $\mathbf{\Delta}_2^0$ set iff $F_\eta = \emptyset$.*

Proof: In the proof of theorem 2.26 we showed that if Hausdorff's derivation stops to the empty set then M and N are separated by a $\mathbf{\Delta}_2^0$. Conversely, if M and N are separated by a $D_\zeta(\mathbf{\Sigma}_1^0)$ set C for some $\zeta < \omega_1$, we can operate the Hausdorff derivation on C and \check{C} . As C and \check{C} are disjoint $\mathbf{\Pi}_2^0$ sets this derivation goes on to the empty set, as the derivation on M and N . \square

Our proof is directly extracted from Kuratowski [53] and documents of Louveau. The result is true in uncountable Polish spaces. Our originality comes from lemma 2.25; this is in such a form that the first author discovered this problem [4]. One can

see how automata can be used to analyse problems of parallelism in [11]. Instead of lemma 2.25, a descriptive set theorist would use there Baire's theorem: a countable intersection of dense open set is dense. If M and N are two disjoint $\mathbf{\Pi}_2^0$ and if F is a non empty closed set such that $F = \overline{F \cap M} \cap \overline{F \cap N}$, then F is complete as a closed set in complete space A^ω . Sets $F \cap M$ and $F \cap N$ are G_δ in F , so they cannot be both dense since they are disjoint.

2.9 Baire's theorem

Definition 2.28. *A set E is called nowhere dense if its closure \overline{E} has an empty interior. A set E is called meager if it is included in a countable union of nowhere dense sets.*

Baire's theorem asserts that in a polish space [69] a countable intersection of dense open sets is still dense or equivalently that a countable union of nowhere dense closed sets has empty interior. We have seen that for any function f , the set of discontinuity points of f is in $\Sigma_2^0(X)$ set. In the case of a Baire class 1 function, we have more.

Proposition 2.29. *Let X and Y be two separable metric spaces and $f : X \rightarrow Y$ a Baire class 1 function. The set of discontinuity points of f is a meager set in $\Sigma_2^0(X)$.*

Proof: Let (V_n^X) (resp (V_n^Y)) be a countable basis of X (resp Y). A point $\alpha \in X$ is a discontinuity point of f if there exists n such that $f(\alpha) \in V_n^Y$ and $f(V_m^X) \not\subseteq V_n^Y$ for each m , i.e. $\alpha \in f^{-1}(V_n^Y)$ but not in its interior $\text{int}(f^{-1}(V_n^Y))$. Thus the set of discontinuity points of f is $\cup_{n \in \omega} f^{-1}(V_n^Y) \setminus \text{int}(f^{-1}(V_n^Y))$. As f is Baire class 1, all these sets are $\Sigma_2^0(X)$ and have empty interior: they are all meager and a countable union of meager sets is still meager. \square

Theorem 2.30. *Let P be a Polish space, Y a separable metric space and $f : P \rightarrow Y$. The following statements are equivalent:*

- (i) f is Baire class 1.
- (ii) For all nonempty closed set $F \subset P$, the restriction $f|_F$ of f to F has a point of continuity.

Proof: (i) \Rightarrow (ii)

Set F is a closed set of a Polish space so F is Polish too. Since f is Baire class 1, so is $f|_F$, thus, by proposition 2.29, its discontinuity points form a meager subset of F , hence by Baire category theorem, cannot be equal to F .

(ii) \Rightarrow (i)

Suppose that f is not Baire class 1. There exists an open subset U of Y such that $f^{-1}(U) \notin \Sigma_2^0(X)$. As Y is a metric space, U can be written as a countable union of closed sets $U = \cup_{n \geq 0} H_n$. Let H be the complement of U in Y . Suppose that for each n there exists $A_n \in \Delta_2^0$ which separates $f^{-1}(H_n)$ from $f^{-1}(H)$. Then :

$$f^{-1}(U) = \cup_{n \geq 0} f^{-1}(H_n) = \cup_{n \geq 0} A_n$$

and $f^{-1}(U)$ will be Σ_2^0 .

So there exists an n such that $f^{-1}(H_n)$ and $f^{-1}(H)$ can't be separated by a Δ_2^0 set. We now apply Hausdorff's derivation on $f^{-1}(H_n)$ and $f^{-1}(H)$. Let F be the biggest closed set such that $F = \overline{F \cap f^{-1}(H_n)} = \overline{F \cap f^{-1}(H)}$. By corollary 2.27, F is not empty and we will show that f has no point of continuity in F .

Let $\alpha \in \text{cont}(f|_F)$. If $f(\alpha) \notin H$, as H is closed we can find an open set B_α in F containing α such that $f(B_\alpha) \cap H = \emptyset$. This contradicts density of $f^{-1}(H)$ in F thus $f(\alpha) \in H$. By the same argument $f(\alpha) \in H_n$, but $H \cap H_n = \emptyset$. So $f|_F$ has no point of continuity. \square

Example 18. We have seen that the characteristic function of $\mathbb{Q} \subset \mathbb{R}$, $1_{\mathbb{Q}}$ is of Baire class two. Using the previous theorem we can see that $1_{\mathbb{Q}}$ is not Baire class one since it's nowhere continuous.

2.10 Application to automata theory

Lemma 2.31. *Let M and N be two languages in $\text{Rec}(A^\omega)$. Then Hausdorff's derivation on M and N stops in a finite number of steps, i.e.*

$$\exists n \in \omega \text{ such that } F_n = \overline{F_n \cap M} = \overline{F_n \cap N}.$$

Proof: Let \mathcal{A} (Resp. \mathcal{B}) be a deterministic Müller automaton which recognizes M (Resp. N). Construct the cartesian product $\mathcal{A} \times \mathcal{B}$, this is also a deterministic automaton. Compute the essential loops of the product and classify them in $L_{\mathcal{A}}$, $L_{\mathcal{B}}$, where $L_{\mathcal{A}}$ (Resp. $L_{\mathcal{B}}$) is the set of essential loops such that projection on states of \mathcal{A} (Resp. \mathcal{B}) is a positive essential loop of \mathcal{A} (Resp. \mathcal{B}), see example 17. Note that $L_{\mathcal{A}}$, $L_{\mathcal{B}}$ are disjoint if and only if M and N are disjoint. Let α in M , then there exists a essential loop F which recognizes α , and one can see that α in M is in the closure of N if and only if a loop of $L_{\mathcal{B}}$ is accessible from the loop F in $L_{\mathcal{A}}$. Process as follows: eliminate from $L_{\mathcal{A}}$ (Resp. $L_{\mathcal{B}}$) loops from which every loop in $L_{\mathcal{B}}$ (Resp. $L_{\mathcal{A}}$) is inaccessible, and iterate the work. As there is a finite number of loops, the

process will stop in a finite number of steps. At the end, if L_A and L_B are not empty, then from every loop in L_A (Resp. L_B) you can access to some loop in L_B (Resp. L_A). \square

Example 19. Let \mathbb{Q}_0 the subset of 2^ω of infinite words with finite even number of 1 and \mathbb{Q}_1 the subset of 2^ω of infinite words with finite odd number of 1. This two sets are dense, Σ_2^0 -complete sets. The Hausdorff's derivation stops after one iteration as $F_0 = 2^\omega$ and $F_1 = \overline{\mathbb{Q}_0 \cap 2^\omega} = \overline{\mathbb{Q}_1 \cap 2^\omega} = 2^\omega = F_0$.

Corollary 2.32. *One can decide if two languages in $\text{Rec}(A^\omega)$ are separated by a Δ_2^0 set. Moreover if they are separated by a Δ_2^0 set, they are separated by an ω -regular Δ_2^0 set, i.e., a finite difference of ω -regular open sets.*

Proof: Let M and N two languages in $\text{Rec}(A^\omega)$. Using corollary 2.27, M and N are separated by a Δ_2^0 set iff Hausdorff's derivation stop to the empty set, and by lemma 2.31 it comes in a finite number of steps.

By closure property of ω -regular sets, the F_n which appear in Hausdorff's derivation are ω -regular and emptiness problem is decidable for ω -regular sets. \square

Corollary 2.33. *Let $f : A^\omega \rightarrow B^\omega$ be an ω -rational function. If f is not Baire class 1 then there exists a nonempty closed set F which is recognizable by a Büchi automaton such that f restricted to F has no point of continuity.*

Proof: If f is not Baire class 1 then there exists $u \in B^*$ such that $f^{-1}(uB^\omega) \notin \Delta_2^0(X)$. So there exists $v \in B^*$ with $|u| = |v|$ such that $f^{-1}(uB^\omega)$ and $f^{-1}(vB^\omega)$ cannot be separated by a $\Delta_2^0(X)$ set. Thus, as in the proof of theorem 2.30, the Hausdorff derivation on $f^{-1}(uB^\omega)$ and $f^{-1}(vB^\omega)$ produces, in finite time, a closed set F such that $f|_F$ has no point of continuity. As $f^{-1}(uB^\omega)$ and $f^{-1}(vB^\omega)$ are recognizable by a Büchi automaton so is F by closure properties of the family $\text{Rec}(A^\omega)$. \square

2.11 Games

For this section we refer the reader to Hurewicz [45], Lusin [64], Sierpinski [82], Büchi [18], Landweber [54], Trakhtenbrot Barzdin [100], Wadge [103, 104, 105], Saint Raymond [76, 77], Lindner Staiger [56], Wagner [106], Moschovakis [65], Louveau [58, 59, 60], Kechris Louveau [48], Kechris Louveau Woodin [50], Louveau Saint Raymond [62], Staiger [90], Barua [6], Weirauch [108], Staiger Weirauch [93], Simonnet [83, 84], Hertling Weirauch [44], Kechris [47], Selivanov [79], Srivastava [87], Carton Perrin [22], Duparc [27], Duparc Finkel Ressayre [26], Perrin Pin [69].

2.11.1 Büchi, Landweber and Martin

Games are useful in descriptive set theory. They allow to give alternative proofs of some theorems like Cantor Bendixon theorem and Wadge theorem :

For any n , $C \subseteq \omega^\omega$ is Σ_n^0 -complete (resp. Π_n^0 -complete) set iff $C \in \Sigma_n^0 \setminus \Pi_n^0$ (resp. $C \in \Pi_n^0 \setminus \Sigma_n^0$).

Definition 2.34. *A game in $A^\omega \times B^\omega$ between two players I and II can be defined as follows:*

Player I plays $\alpha(0) \in A$, then player II plays $\beta(0) \in B$, I plays $\alpha(1) \in A$, and so on. The result of the game is the couple of infinite words (α, β) of $A^\omega \times B^\omega$.

Let G be a subset of $A^\omega \times B^\omega$. Player II wins the game if (α, β) is in G .

Definition 2.35. *We have :*

- *A strategy for player I is an application $\phi : B^* \rightarrow A$. Intuitively I plays following ϕ :*

$$\alpha(0) = \phi(\epsilon), \alpha(1) = \phi(\beta(0)), \alpha(2) = \phi(\beta(0)\beta(1)), \text{ etc.}$$

The application ϕ can be extended on infinite words in a continuous application (1-lipschitz) $\psi : A^\omega \rightarrow B^\omega$ by

$$\phi(\beta) = \phi(\epsilon)\phi(\beta(0))\phi(\beta(0)\beta(1)) \dots \phi(\beta(0)\beta(1) \dots \beta(n)) \dots$$

- *A strategy for player II is an application $\psi : A^+ \rightarrow B$. Intuitively II plays following ψ :*

$$\beta(0) = \psi(\alpha(0)), \beta(1) = \psi(\alpha(0)\alpha(1)), \beta(2) = \psi(\alpha(0)\alpha(1)\alpha(2)), \text{ etc.}$$

The application ψ can be extended on infinite words in a continuous application (1-lipschitz) $\psi : A^\omega \rightarrow B^\omega$ by:

$$\psi(\alpha) = \psi(\alpha(0))\psi(\alpha(0)\alpha(1)) \dots \psi(\alpha(0)\alpha(1) \dots \alpha(n)) \dots$$

A strategy ϕ for player I is a winning strategy if for any β in B^ω $(\phi(\beta), \beta)$ is not in G . A strategy ψ for player II is a winning strategy if for any α in A^ω $(\alpha, \psi(\alpha))$ is in G .

Definition 2.36. *A game is called determined if one of the two players has a winning strategy.*

It is well known that Borel's games are determined : Martin theorem [47]. Sometimes the proofs using games can be adapted to automata theory thanks to Büchi Landweber's theorem [7, 69, 84, 85]

Theorem 2.37. *(Büchi Landweber 1969) If the set G is an ω - regular subset of $A^\omega \times B^\omega$, one of the players have a winning automaton strategy: either player I has*

a winning strategy ϕ such that the tree ϕ is a rational tree, or either player II has a winning strategy ψ which is a 1-sequential function. There is an algorithm which, given an ω -regular set G , (1) determines which player has a winning strategy, and (2) constructs a winning automaton strategy. In particular if one of the players has a winning strategy, he also has a winning automaton strategy [100, 18].

2.11.2 Wadge Game

Let $X \subset A^\omega$, $Y \subset A^\omega$, in the Wadge game $G(X,Y)$ player II wins iff $(\alpha \in X \Leftrightarrow \beta \in Y)$, that is to say the winning set for II is $G = (X \times Y) \cup (\check{X} \times \check{Y})$. A winning strategy for II gives a continuous function (a Lipschitz map) φ such that $\varphi^{-1}(Y) = X$. A winning strategy for I gives a continuous function (a Lipschitz map) ψ such that $\psi^{-1}(\check{X}) = Y$. If X and Y are Borel, Wadge game is determined so we have the dichotomy: either there exists φ continuous such that $\varphi^{-1}(Y) = X$ either there exists ψ continuous such that $\psi^{-1}(\check{X}) = Y$.

2.11.3 Wadge's hierarchy, Wagner's Hierarchy, Louveau's hierarchy

Let $X \subset A^\omega$, Wadge has defined the class of Wadge of X by:

$$[X]_W = \{Y \subset A^\omega \mid \exists \varphi : A^\omega \longrightarrow A^\omega \text{ continuous } Y = \varphi^{-1}(X)\}$$

The notation W on the right gives in French: W A Droite. WADge has given a complete description of all Wadge classes of Borel set. We have $[\mathbb{O}]_W = \Sigma_1^0, [\mathbb{Q}]_W = \Sigma_2^0$. Let Γ be a class of Wadge then $\check{\Gamma} = \{\check{X} \mid X \in \Gamma\}$ is the class dual to Γ , and $\Delta(\Gamma) = \Gamma \cap \check{\Gamma}$, if $\Gamma = \check{\Gamma}$ then Γ is a selfdual class and if $\Gamma \neq \check{\Gamma}$ then Γ is a nonselfdual class. The classes Σ_ξ^0 , Π_ξ^0 , $D_\eta(\Sigma_\xi^0)$, $\xi < \omega_1$, $\eta < \omega_1$ are examples of nonselfdual Wadge classes of Borel sets.

Let $X \subset Rec(A^\omega)$, Wagner has defined the class of Wagner of X by:

$${}_W[X] = \{Y \subset A^\omega \mid \exists \varphi : A^\omega \longrightarrow A^\omega \text{ sequential } Y = \varphi^{-1}(X)\}$$

The notation W on the left gives in French: W A Gauche. WAGner has given a complete description of all Wagner classes of $Rec(A^\omega)$. One can also defined selfdual and non selfdual Wagner classes. Wagner proves (in fact maybe he didn't know Wadge at this time) that Wadge's hierarchy restricted to ω -regular set is Wagner's hierarchy: $\Gamma_W \cap \mathbf{Auto} =_W \Gamma$. The first normal form's theorems of this type for ω -regular sets are from Landweber [54]:

An ω -regular set X which is open is the inverse image of \mathbb{O} by a 1-sequential function. An ω -regular set X which is closed is the inverse image of $\check{\mathbb{O}}$ by a 1-sequential function or equivalently X is the set of infinite branches of a rational tree of A^* . From this one can deduce that synchronous continuous functions are exactly the sequential functions with bounded delay, Trakhtenbrot [99, 100]. If an ω -rational function is not of Baire class 1, one can find a rational tree (tree with a finite number of subtrees) whose set of infinite branches is a Perfect set P (closed set without isolated points [53]) and the restriction of f to P has no point of continuity.

An ω -regular set which is F_σ is the inverse image of \mathbb{Q} by a 1-sequential function. An ω -regular set X which is G_δ is the inverse image of $\check{\mathbb{Q}}$ by a 1-sequential function, or equivalently X is recognized by a deterministic Büchi automaton, $X = \text{Lim}(L)$ with L a regular set. If f is synchronous then $\text{Cont}(f)$ is definable in $S1S$ so one can't construct a deterministic Büchi automaton which recognizes $\text{Cont}(f)$.

In February 1987 Louveau used the following formalism to denote Landweber's theorems. Call

$$\Sigma_1^0(\mathbf{Auto}) = \{X \subset A^\omega \mid X = \varphi^{-1}(\mathbb{O}), \varphi : A^\omega \longrightarrow 2^\omega \text{ 1-sequential}\}$$

$$\Sigma_2^0(\mathbf{Auto}) = \{X \subset A^\omega \mid X = \varphi^{-1}(\mathbb{Q}), \varphi : A^\omega \longrightarrow 2^\omega \text{ 1-sequential}\}$$

we have

$$\Sigma_1^0 \cap \mathbf{Auto} = \Sigma_1^0(\mathbf{Auto})$$

$$\Sigma_2^0 \cap \mathbf{Auto} = \Sigma_2^0(\mathbf{Auto})$$

If an ω -rational function is not of Baire class 1, one can find a Perfect set P which is $\Pi_1^0(\mathbf{Auto})$ such that the restriction of f to P has no point of continuity. If f is synchronous then $\text{Cont}(f)$ is $\Pi_2^0(\mathbf{Auto})$.

Louveau was working in effective set theory (see Moschovakis [65]). He has defined a hierarchy of effective Borel sets of ω^ω , the Δ_1^1 sets of ω^ω . Louveau proves that Wagde's hierarchy restricted to Δ_1^1 sets is Louveau's hierarchy. His theorem gives for example [59, 60]:

$$\Sigma_1^0 \cap \Delta_1^1 = \Sigma_1^0(\Delta_1^1)$$

$$\Sigma_2^0 \cap \Delta_1^1 = \Sigma_2^0(\Delta_1^1)$$

$$\Sigma_n^0 \cap \Delta_1^1 = \Sigma_n^0(\Delta_1^1)$$

where one of the equivalent definitions of $\Sigma_1^0(\Delta_1^1)$, $\Sigma_2^0(\Delta_1^1)$ is

$$\Sigma_1^0(\Delta_1^1) = \{X \subset \omega^\omega \mid X = \varphi^{-1}(\mathbb{O}), \varphi : \omega^\omega \longrightarrow 2^\omega \text{ } \varphi \text{ strategy } \Delta_1^1\}$$

$$\Sigma_2^0(\Delta_1^1) = \{X \subset \omega^\omega \mid X = \varphi^{-1}(\mathbb{Q}), \varphi : \omega^\omega \longrightarrow 2^\omega \text{ } \varphi \text{ strategy } \Delta_1^1\}$$

And the same definition for $\Sigma_n^0(\Delta_1^1)$ with a very simple set in 2^{ω^n} recognized by a finite automaton which reads words of length ω^n (see Büchi [15], Shelah [80], Bedon [10], Choffrut Grigoriev [24] for finite automata reading transfinite words). From this effective results Louveau deduces classical results in the plane : If $X \subset \omega^\omega \times \omega^\omega$ is a Borel set with Σ_{n+1}^0 sections then X is a countable union of Borel sets in $\omega^\omega \times \omega^\omega$ with Π_n^0 sections. The first example of this kind of results is the case of Borel sets in the plane with countable sections studied by Lusin [64]. This result was extended by Novikov, Arsenin and Kunugui to the case of Borel sets in the plane with compact sections or K_σ sections (see Sierpinski [82], Saint Raymond [77], Louveau Saint Raymond [62], Kechris [47], Srivastava [87]).

2.11.4 \mathbb{O} and \mathbb{Q}

For all Wadge classes of Borel sets Γ , Wadge gives an example of a Γ -complete set in ω^ω . As remarked by Professor Jean Saint Raymond “il suffit de le faire pour les ouverts.” We will do it for open sets and F_σ sets.

Let T be a tree of A^* , we denote by $[T]$ the set of the infinite branches of T :

$$[T] = \{\alpha \in A^\omega, \forall n \in \omega \alpha[n] \in T\}.$$

Proposition 2.38. *Let F be a subset of A^ω . The set F is closed iff there exists a tree T of A^* so that $F = [T]$.*

Proof: (\Rightarrow) If F is closed, we define $T = \{u \in A^*, \exists \alpha \in F \exists n \in \omega \alpha[n] = u\}$. Then $[T] = \overline{F} = F$.

(\Leftarrow) It is clear that $[T]$ is always a closed set. □

Definition 2.39. *A set C of Σ_n^0 is called $\Sigma_n^0(A^\omega)$ -strategically complete if for any set X of $\Sigma_n^0(A^\omega)$, player II has a winning strategy in the game $G(X, C)$: II wins iff $(\alpha \in X \Leftrightarrow \beta \in C)$ ($G = (X \times C) \cup (\check{X} \times \check{C})$).*

Proposition 2.40. *The set $\mathbb{O} = \{\alpha \in 2^\omega \mid \exists m \alpha(m) = 1\}$ is $\Sigma_1^0(A^\omega)$ -strategically complete.*

Proof: Let U be in $\Sigma_1^0(A^\omega)$. The complement of U is closed, so by proposition 2.38, there exists a tree T so that $T = \check{U}$. The winning strategy $\phi : A^+ \rightarrow \{0,1\}$ for II is the following :

$$\phi(u) = \begin{cases} 0 & \text{if } u \in T \\ 1 & \text{if } u \notin T \end{cases}$$

□

In fact using Martin theorem and Wadge game every open non closed set is $\Sigma_1^0(A^\omega)$ -strategically complete. And using Büchi Landweber theorem we have $\Sigma_1^0 \cap \mathbf{Auto} = \Sigma_1^0(\mathbf{Auto})$.

Proposition 2.41. *The set $\mathbb{Q} = \{\alpha \in 2^\omega \mid \exists m \forall n > m \alpha(n) = 0\}$ is $\Sigma_2^0(A^\omega)$ -strategically complete.*

Proof: Let U be in $\Sigma_2^0(A^\omega)$. Then there exists a family $(F_n)_{n \in \omega}$ of closed sets so that $U = \bigcup_{n \in \omega} F_n$. By proposition 2.38, for any integer n , there exists a tree T_n so that $F_n = [T_n]$. The winning strategy $\phi : A^+ \rightarrow \{0,1\}$ for II is given by the following induction :

$$\begin{aligned} n &\leftarrow 0 \\ \phi(u) &= \begin{cases} 0 & \text{if } u \in T_n \\ 1 & \text{if } u \notin T_n \text{ and } n \leftarrow n + 1 \end{cases} \end{aligned}$$

Let $(\alpha, \phi(\alpha))$ be a result of the game.

- If α is in U , there exists n so that α is in $F_n = [T_n]$. Then for all m in ω , $\alpha[m]$ is in T_n . So there exists m_0 so that for all $m \geq m_0$, $\phi(\alpha[m]) = 0$ and $\phi(\alpha)$ is in \mathbb{Q} : II wins.
- If α is not in U then for all n and m in ω , there exists $\tilde{m} \geq m$ so that $\alpha[\tilde{m}]$ is not in T_n i.e. the sequence of finite words $(\alpha[m])_{m \in \omega}$ leaves any tree T_n in finite time. Then $\phi(\alpha)$ has an infinite number of 1, so $\phi(\alpha)$ is not in \mathbb{Q} and II wins.

□

In fact using Martin theorem and Wadge game every F_σ set which is not a G_δ set is $\Sigma_2^0(A^\omega)$ -strategically complete. And using Büchi Landweber theorem we have $\Sigma_2^0 \cap \mathbf{Auto} = \Sigma_2^0(\mathbf{Auto})$.

2.11.5 Separation games

In October 1984 Louveau was presenting joint work of his and Saint Raymond in the seminary of theory of effective borel sets. The title of the talk was “Jeux de Mistigri (Mistigri Games)”. This was a sort of Wadge game, a separation game. Let Y and Z be two analytic disjoint subsets of ω^ω .

In a first Game Player II wins the game iff $(\alpha \in \mathbb{O} \Rightarrow \beta \in Y \text{ and } \alpha \in \check{\mathbb{O}} \Rightarrow \beta \in Z)$. A winning strategy for II gives a continuous function (a Lipschitz map) φ such that $\varphi^{-1}(Y) = \mathbb{O}$. A winning strategy for I gives a continuous function (a Lipschitz map)

ψ such that: $\psi(Y) \subset \check{\mathbb{Q}}$, $\psi(Z) \subset \mathbb{Q}$. That is to say $\psi^{-1}(\check{\mathbb{Q}})$ separate Y from Z . It is easy to see that there is a closed set which separates Y from Z if and only if player I has a winning strategy in the first separation game. If Y and Z are ω -regular sets one can deduce from Büchi Landweber's theorem that one can decide if two ω -regular disjoint sets are separated by a closed set. Moreover if they are separated by a closed set, they are separated by a $\Pi_1^0(\mathbf{Auto})$.

In a second game, Player II wins the game iff $(\alpha \in \mathbb{Q} \Rightarrow \beta \in Y \text{ and } \alpha \in \check{\mathbb{Q}} \Rightarrow \beta \in Z)$. A winning strategy for II gives a continuous function (a Lipschitz map) φ such that $\varphi^{-1}(Y) = \mathbb{Q}$. A winning strategy for I gives a continuous function (a Lipschitz map) ψ such that: $\psi(Y) \subset \check{\mathbb{Q}}$, $\psi(Z) \subset \mathbb{Q}$. That is to say $\psi^{-1}(\check{\mathbb{Q}})$ separate Y from Z . It is easy to see that there is a Π_2^0 set which separates Y from Z if and only if player I has a winning strategy in the first separation game. If Y and Z are ω -regular sets, one can deduce from Büchi Landweber's theorem that one can decide if two ω -regular disjoint sets are separated by a Π_2^0 set. Moreover if they are separated by a Π_2^0 set, they are separated by a $\Pi_2^0(\mathbf{Auto})$, that is to say, they are separated by a set recognized by deterministic Büchi automaton.

Note that these theorems hold for all classes of Wagner's hierarchy which is of type order the ordinal of ω^ω . These results were presented to Louveau in 1987 and appear in [84, 85]. R. Barua solves the case of the $D_n(\Sigma_2^0)$ classes with a proof without games [6].

Separation games appear in Van Wesep [101]. The game where Player II wins if $(\alpha \in \mathbb{Q} \Rightarrow \beta \in Y \text{ and } \alpha \in \check{\mathbb{Q}} \Rightarrow \beta \in Z)$ is used in Kechris Louveau Woodin [50, 48, 47] to give new proof of the old Hurewicz's theorem [45]:

Any Π_1^1 set X in a compact metrizable space E which is not Π_2^0 contains a closed subset homeomorphic to \mathbb{Q} . In fact, one can also construct a homeomorphic copy F of 2^ω inside E such that $F \cap X$ is (through the homeomorphism) identified with \mathbb{Q} . The set \mathbb{Q} is a Hurewicz-witness for non Π_2^0 -ness, \mathbb{Q} is a Hurewicz-test. And we have the ω -regular case. If an ω -regular set X is not Π_2^0 then every deterministic Muller automaton which recognizes X contains a chain $\{+\} \subset \{-\}$. This was generalized to all Wagner classes by Wagner [106].

Effective results of Louveau were first proved in [59]. Let Σ_1^1 (resp. Π_1^1) be the class of effective analytic sets (resp. coanalytic sets) and $\Delta_1^1 = \Pi_1^1 \cap \Sigma_1^1$ be the class effective Borel sets (boldface=classical, lighthface=effective see Moschovakis [65]). Let Y and Z be two disjoint Σ_1^1 subsets of ω^ω . Louveau has shown that if there is a Σ_n^0

which separates Y from Z then there is a $\Sigma_n^0(\Delta_1^1)$ which separates Y from Z . From this he deduced $\Sigma_n^0 \cap \Delta_1^1 = \Sigma_n^0(\Delta_1^1)$ and by relativisation the theorem on Borel sets of the plane with Σ_n^0 sections. He used the good properties of the Gandy Harrington's topology of ω^ω , the topology generated by the Σ_1^1 subsets of ω^ω . Then in [60] Louveau has extended this separation theorem to all effective Wadge classes. In [62] Louveau and Saint Raymond use separation games to give another proof of these results [62]. They use the basic strategic theorem: if $G \subset \omega^\omega \times \omega^\omega$, the winning set for II, is a Σ_1^0 set then if player II has a strategy then he have a Δ_1^1 strategy. They also give an Hurewicz's theorems for all Wadge classes.

2.11.6 Steel's game and separation by Δ_2^0 sets

Let \mathbb{Q}_0 , the subset of 2^ω of infinite words with finite even number of 1 and \mathbb{Q}_1 the subset of 2^ω of infinite words with finite odd number of 1. We have seen that \mathbb{Q}_0 and \mathbb{Q}_1 are not separate by a Δ_2^0 set.

Let X and Y be disjoint sets. In the Steel's game, player II wins the game iff $((\alpha \in Y \Rightarrow \beta \in \mathbb{Q}_0) \text{ and } (\alpha \in Z \Rightarrow \beta \in \mathbb{Q}_1) \text{ and } (\beta \in \mathbb{Q}_0 \cup \mathbb{Q}_1))$.

Proposition 2.42. *If the sets Y and Z are borel sets, then player II has a winning strategy iff there is a Δ_2^0 set which separates Y from Z .*

Proof: A winning strategy for II gives a continuous function (a Lipschitz map) $\varphi : A^\omega \rightarrow \mathbb{Q}_0 \cup \mathbb{Q}_1$ such that $\varphi(Y) \subset \mathbb{Q}_0$ and $\varphi(Z) \subset \mathbb{Q}_1$. This implies that $\varphi^{-1}(\mathbb{Q}_0) = \varphi^{-1}(\check{\mathbb{Q}}_1)$ is a Δ_2^0 set which separates Y from Z .

A winning strategy for I gives a continuous function (a Lipschitz map) $\psi : 2^\omega \rightarrow A^\omega$ such that: $\psi(\mathbb{Q}_0) \subset Z$, $\psi(\mathbb{Q}_1) \subset Y$. If C is a Δ_2^0 set which separates Y from Z then $\psi^{-1}(C)$ is a Δ_2^0 set which separates \mathbb{Q}_0 from \mathbb{Q}_1 and this is not possible.

So if C is a Δ_2^0 set which separates Y from Z , by Borel determinacy II has a winning strategy. \square

Corollary 2.43. *One can decide if two languages in $\text{Rec}(A^\omega)$ are separated by a Δ_2^0 set. Moreover if they are separated by a Δ_2^0 set, they are separated by an ω -regular Δ_2^0 set, i.e., a finite difference of ω -regular open sets.*

Proof: If Y and Z are ω -regular sets then the Steel's game is ω -regular. So by the Büchi Landweber's theorem, we can decide if player II has a winning strategy. Moreover if player II has a winning strategy he has a sequential letter to letter strategy φ . This implies that $\varphi(\mathbb{Q}_0) = \varphi(\check{\mathbb{Q}}_1)$ is an ω -regular Δ_2^0 set which separates Y from Z . \square

2.11.7 Mistigri Color

Van Wesep and Steel Games [101, 94] were used to study structural properties of Wadge classes of Borel sets like separation property. A Wadge class Γ has the separation property if for any pair X, Y of disjoint sets in Γ there exists Z in $\Delta(\Gamma)$ which separate X from Y . In fact for each pair of nonselfdual $\Gamma, \check{\Gamma}$ Wadgeclass of Borel sets then exactly one of the classes has the separation property. And if Γ doesn't have the separation property then one can find a simple pair X, Y of disjoint sets in Γ such that X can't be separated from Y by a set in $\Delta(\Gamma)$. Another very interesting property is the norm property, in [63] Louveau and Saint Raymond study norm property of Borel Wadge classes. The classes $\Sigma_\xi^0, D_\eta(\Sigma_\xi^0), \xi < \omega_1, \eta < \omega_1$, and Π_1^1 have the norm property, and the $D_n(\Sigma_1^0(\mathbf{Auto})), D_n(\Sigma_2^0(\mathbf{Auto}))$ have the norm property [83]. If a class Γ has a norm property then Γ has the reduction property [63] that is to say for all X, Y in Γ one can find X', Y' in Γ such that $X \cup Y = X' \cup Y'$ and $X' \cap Y' = \emptyset$. Moreover if Γ has the reduction property then $\check{\Gamma}$ has the separation property. For example we have seen that the classes $\Pi_2^0, \Pi_2^0(\mathbf{Auto})$ have the separation property; in fact this is true because the classes $\Sigma_2^0, \Sigma_2^0(\mathbf{Auto})$ have the reduction property. The reduction property of classes Σ_ξ^0 is used to prove the Lebesgue, Hausdorff, Banach's theorem :

Theorem 2.44. *Let X, Y be metrizable spaces with Y separable. Then for all $\xi \geq 2$, $f : X \rightarrow Y$ is of Baire class ξ iff for all open V include in Y , $f^{-1}(V)$ is in $\Sigma_{1+\xi}^0(X)$.*

Remark 9. Note another time that this result holds for $n = 1$ if in addition X is separable and either $X = A^\omega$ or $Y = \mathbb{R}$.

The proof use finite valued Borel functions, finite Borel partition. We know four descriptions of Borel Wadge classes:

The one of Wadge(Descriptive Set Theorist) [104] is useful for a Computer Scientist (DST: Hello this set is Γ -complete and we give you a proof of that. Do you know countable choice and fundamental sequences? CS: Thank you, I will try to find some device to recognize this Γ -complete set. Is this the simplest one? What is countable choice? Do I use it? Do you think I can recognize this Γ -complete set with a Muller tree automaton? DST: what is a Muller tree automaton?).

The one of Louveau [60] is useful to study structural properties of classes, Selivanov [79] uses this description and describes the topological invariants of Wagner classes by finite trees.

The one of Saint Raymond [77] uses Borel functions of class ξ ($\xi < \omega_1$). This description has the advantage to extend immediately to the case of finite Borel coloring

of A^ω (Wadge case is Black and White, $X \subset A^\omega$, $X_0 = \check{X}$, $X_1 = X$, $A^\omega = X_0 \cup X_1$). The one of Duparc [27] follows the Cantor normal form of ordinals. This description has been used by Finkel [33, 35] to study the order type of the Wadge hierarchy restricted to ω -context-free languages.

In [77] it is quoted that games used by Van Wesep, Steel, Louveau Saint Raymond are particular case of elementary games with winning set $G = \cup_{i=0}^n X_i \times Y_i$, where the X_i, Y_i are Borel subsets of A^ω . Let (X_0, \dots, X_n) and (Y_0, \dots, Y_n) be two Borel partitions of A^ω . Define the game $G(X_0, \dots, X_n; Y_0, \dots, Y_n)$ where I plays α , II plays β and where II wins the game if $\forall i, \alpha \in X_i \Rightarrow \beta \in Y_i$. This game enable us to compare finite Borel partitions. This gives for all n the Wadge $n + 1$ colors hierarchy. If the X_i, Y_i are **Auto** this gives for all n the Wagner $n + 1$ colors hierarchy. Then you can use Büchi Landweber and this certainly has to do with the algebra of finite monoïds (see Carton Michel [21], Carton Perrin [22], Perrin Pin [69], Wilk [109]).

In [44] Hertling and Weihrauch study discontinuity of finite valued Borel functions, for understanding degeneracy in computational geometry. Here is their abstract: "We introduce levels of discontinuity and prove that they correspond to the number of tests in "continuous computation trees". We illustrate the concept of level by various simple examples from computational geometry. For a finer comparison of kinds of discontinuity we introduce a continuous reducibility relation for finite valued functions. We show that each of the resulting degrees (of finite level) can be characterized by a finite set of finite trees which describes the type of discontinuity of its functions. The ordering of the degrees is decidable in the tree sets and each level consists only of finitely many degrees". The description of Saint Raymond may have very interesting applications in computational geometry. We conclude this section with an example of Hertling Weirauch [44]. Let $f : \{0,1\}^\omega \longrightarrow \{2,3,7\}$ defined by

$$f(\alpha) = \begin{cases} 7 & \text{if } \alpha = 0^\omega \\ 3 & \text{if } \alpha \in 0^*1^\omega \\ 2 & \text{else} \end{cases}$$

This is a Baire class 1 function.

2.12 Conclusion

2.12.1 Π_1^1 sets and ω_1 , the boundedness theorem of Luzin

There is a lot of to say about the story of transfinite. For example Borel did not believe in ω_1 (“cette totalité illégitime”), Luzin seems to refuse the Third Middle excluded for projective sets. It is well known that Baire, Borel, Lebesgue, did not believe in the axiom of choice. Zermelo has proven with the axiom of choice that you can put a well order on every set. Sierpinski believed in the axiom choice, but has shown which theorems need the axiom of choice. In general, there is no need of axiom of choice when you dispose of a well order. Do you believe in ω_1 ? Do we need countable ordinals in computer science? It is an old result of Luzin and Sierpinski that **WO** (as Well Order), the code of countable ordinals, is The Example of a coanalytic set. It is a coanalytic complete set. The first examples of coanalytic-complete sets in analysis are due to Hurewicz [45, 47, 83]. These are the set $K(\mathbb{Q})$ of compact subsets of the rationals of the interval $[0,1]$ and the set K_ω of countable compact subsets of the interval $[0,1]$. Consider the stupid game in $2^\omega \times 2^\omega$ where Player I wins the game if $\alpha \in \mathbb{Q}$ and $\beta \in 2^\omega$. Player I has a simple automaton strategy: always play 0. Call, by analogy with $K(\mathbb{Q})$, $K\mathbb{Q}$ the set of winning strategies of player I, this set is Π_1^1 and extending $\varphi : \omega^* \rightarrow 2^*$ of remark 6 in $\varphi : 2^{\omega^*} \rightarrow 2^{2^*}$ one has that $\varphi^{-1}(K\mathbb{Q}) = \mathbf{WF}$, hence $K\mathbb{Q}$ is a Π_1^1 -complete set. This was first observed by Niwinski in 1986 [67]. This set is recognized by a deterministic Muller infinite tree automaton. In fact a set is recognized by deterministic Muller infinite tree automaton if and only if it is the set of winning strategies of player I in an ω -regular game, and a set is recognized by a nondeterministic Muller infinite tree automaton if it is the projection of a set recognized by a deterministic Muller infinite tree automaton. Infinite tree automaton where used by Rabin [72] to show the decidability of the monadic second order theory of the tree 2^* , $S2S$. Rabin shows that a set is recognized by a nondeterministic Muller infinite tree automaton if and only if it is definable in $S2S$. Note that it is quite clear when you read the first pages of Rabin that the set $K(\mathbb{Q})$ of compact subsets of $\mathbb{Q} = \{\alpha \in 2^\omega \mid \exists m \forall n \geq m \alpha(n) = 0\}$ is definable in $S2S$ and we know since Hurewicz that this set is Π_1^1 -complete (see [45, 48, 50, 47]). Rabin shows by transfinite induction on countable ordinals that if a set is recognized by a nondeterministic Muller infinite tree automaton then its complements is also recognized by a nondeterministic Muller infinite tree automaton. The complement of $K\mathbb{Q}$ is recognized by a nondeterministic Büchi infinite tree automaton but $K\mathbb{Q}$

is not recognized by a nondeterministic Büchi infinite tree automaton (otherwise KQ will be Borel, see also Rabin [73] for a combinatorial proof of that, the paper of Rabin [73] is a kind of Suslin Kleene Automata theorem [83]). Finkel codes the complement of KQ to obtain an ω -context free set which is analytic complete. This led to undecidability results :

The problem of knowing whether an ω -context free languages is Borel is undecidable, the problem of knowing whether an ω -context free languages is Σ_ξ^0 is undecidable. ω -context free languages are Σ_1^1 . And one can play separation games where Player II wins the game iff $(\alpha \in \mathbb{O} \Rightarrow \beta \in Y \text{ and } \alpha \in \check{\mathbb{O}} \Rightarrow \beta \in Z)$ (Resp. Player II wins the game iff $(\alpha \in \mathbb{Q} \Rightarrow \beta \in Y \text{ and } \alpha \in \check{\mathbb{Q}} \Rightarrow \beta \in Z)$) with Y and Z ω -context free languages. Probably these games are undecidable, probably one can't decide if two ω -context free languages are separated by a Σ_ξ^0 set. But Louveau's theorem is true if they are separated by a Σ_ξ^0 set ($\xi < \omega_1$), then they are separated by a $\Sigma_\xi^0(\Delta_1^1)$ set.

Later on, Finkel, with the same kind of coding, obtained an ω -rational relation which is analytic complete. This gave other undecidability results: The problem of knowing whether an ω -rational relation is Borel is undecidable, the problem of knowing whether an ω -rational relation is Σ_ξ^0 is undecidable. Finally we can remark that simple models of asynchronous parallelism on infinite words gives analytic complete sets [36]. Note that Kuratowski shows how to eliminate transfinite numbers in mathematical proofs [52]. He takes as examples the Cantor Bendixon theorem and the derivation of Hausdorff. For example, in games, ordinals are hidden in the construction of strategies. One can say : don't hide countable ordinals and you will see some true coanalytic sets. This has to do with the boundedness theorem of Lusin [64, 65, 47]. If a set X is a coanalytic set then for all $\alpha \in X$ one can associate a countable ordinal $\varphi(\alpha)$. And X is borel if and only if there exists $\xi < \omega_1$ such that for all $\alpha \in X$, $\varphi(\alpha) < \xi$. Note that Lusin don't think that such a procedure can be effective to decide if a Π_1^1 set is a true (not Borel) Π_1^1 set, and the undecidability results of Finkel shows that he was right. We think that countable ordinals are inherently hidden in models of parallelism, verification and *XML*.

2.12.2 Hausdorff and automata

We have seen Hausdorff's theorem

$$\Delta_2^0 = \cup_{\xi < \omega_1} D_\xi(\Sigma_1^0)$$

and we have seen that in the ω -regular case we have [106]

$$\Delta_2^0 \cap \mathbf{Auto} = \bigcup_{n < \omega} D_n(\Sigma_1^0(\mathbf{Auto}))$$

in the case of effective Borel sets we have [60]

$$\Delta_2^0 \cap \Delta_1^1 = \bigcup_{\xi < \omega_1^{CK}} D_\xi(\Sigma_1^0(\Delta_1^1))$$

where ω_1^{CK} is the Church Kleene ordinal, the least nonrecursive ordinal. Let us give another example of the utility of Hausdorff's derivation. In [57] Lecomte studies from a descriptive set theory point of view L^ω , the ω -power of $L \subset A^*$. Lecomte answers to questions ask by Staiger in [92]. Among the very interesting results of Lecomte, there is a surprising fact which links combinatorics on words and the Hausdorff derivation. Let $\mathcal{G}_2 := \{L \subset A^* \mid \exists u \in A^*, \exists v \in A^*, L^\omega = \{u, v\}^\omega\}$. Set \mathcal{G}_2 is the set of languages such that their ω -powers are generated by two words. The set of languages 2^{A^*} is a compact metric space, and one can ask the question of the topological complexity of \mathcal{G}_2 . Lecomte's result is the following

Theorem 2.45. \mathcal{G}_2 is a $\check{D}_\omega(\Sigma_1^0)$ which is not $D_\omega(\Sigma_1^0)$.

This is an example of a concrete $\check{D}_\omega(\Sigma_1^0)$ coming from the real world. In his proof Lecomte uses Hausdorff's derivation and the default theorem (see Bruyère [19]). In the same context, another result of Duparc [28] is relevant. The order type of the difference hierarchy of open set restricted to deterministic ω -context free languages is ω^ω . The order type of difference hierarchy of open set restricted to one counter language is at least ω^ω [33]. It seems that Finkel shows in [35] that the order type of difference hierarchy of open set restricted to ω -context free languages is at least ω_1^{CK} and that the Wadge hierarchy of Borel sets restricted to ω -context free languages has the same order type that Louveau's hierarchy. In a paper of the sixties [86], Skurczynski finds examples of sets of trees in 2^{2^*} which are Σ_n^0 complete and he remarks that they are recognized by Muller tree automata. An examination of these examples and a careful reading of the construction of $D_\xi(\Sigma_1^0)$ -strategically complete in [62] shows that you can define with tree automata a set which is $D_{\omega^n}(\Sigma_1^0)$ complete for all $n \in \omega$ [83]. The same construction gives sets recognized by non-deterministic Muller infinite tree automaton which are $D_{\omega^n}(\Sigma_n^0)$ complete and sets recognized by nondeterministic Muller tree automaton which are $D_{\omega^n}(\Pi_1^1)$ complete [83]. In particular the family of sets recognized by nondeterministic Muller infinite tree automaton is not the boolean algebra generated by the family of sets recognized by nondeterministic Büchi tree automaton. This last statement was first proved

by Hafer [43]. Finite automata read also transfinite words (see Büchi [15], Shelah [80], Bedon [10], Choffrut Grigoriev [24]), what are the degrees of the difference hierarchy of open set restricted to sets of words of length ω^n recognized by finite automata? What are the degrees of the difference hierarchy of open set restricted to sets definable in $S2S$?

2.12.3 Game quantifier and tree automata

Descriptive set theory is the study of definable sets in Polish spaces and will we be very happy to know the exact topological complexity of sets definable in $S2S$. Does the good hierarchies of sets definable in $S2S$ are the restrictions of the good old hierarchies of descriptive set theory? Let $Y \in \omega^\omega \times \omega^\omega \times \omega^\omega$, $Y_\alpha = \{(\beta, \gamma) \mid (\alpha, \beta, \gamma) \in Y\}$, and let Γ be a class of Wadge Borel sets in $\omega^\omega \times \omega^\omega \times \omega^\omega$, define the class $\partial\Gamma$ as follows: In the game Y_α player I constructs β and player II constructs γ . I wins the game if $(\alpha, \beta, \gamma) \in Y$.

A set $X \subset \omega^\omega$ is in $\partial\Gamma$ if there exists $Y \in \Gamma$ such that $\alpha \in X \leftrightarrow$ I has winning strategy in the game Y_α .

$$\partial(\Gamma) = \{(X \subset \omega^\omega \mid \exists Y \in \Gamma, Y \in \omega^\omega \times \omega^\omega \times \omega^\omega, \alpha \in X \leftrightarrow \exists \varphi : \omega^* \longrightarrow \omega, \forall \gamma (\alpha, \varphi(\gamma), \gamma) \in Y)\}$$

These classes are very interesting because if Γ has the norm property then $\partial(\Gamma)$ has the norm property (see Moschovakis [65]). Determination of the games in Γ implies that $(\partial(\check{\Gamma})) = \partial(\check{\Gamma})$. For example :

The projection of an open set is open, so if $Z \subset \omega^\omega \times \omega^\omega$ is $\mathbf{\Pi}_1^0$ (Resp. $\mathbf{\Pi}_1^0$), then $\forall \beta, Z$ is $\mathbf{\Pi}_1^0$ (Resp. $\mathbf{\Pi}_1^0$). By the Tarski Kuratowski algorithm we have $\partial(\mathbf{\Pi}_1^0) = \mathbf{\Sigma}_1^1$ so, by determination of closed games in $\omega^\omega \times \omega^\omega$, $\partial(\mathbf{\Sigma}_1^0) = \mathbf{\Pi}_1^1$. Another way to see this is to use the basis strategic theorem (see Kechris [47], Moschovakis [65]): If the winning set for I, is a Σ_1^0 set then if player I has a strategy then he have a Δ_1^1 strategy, if Y is open then if player I has a strategy in the game Y_α then he have a $\Delta_1^1(\alpha)$ strategy, that is I can choose φ in a borel way from $\alpha \in X$, φ is borel in α and the class $\mathbf{\Pi}_1^1$ is closed by substitution by Borel function. The class $\partial(\mathbf{\Sigma}_2^0)$ is a quite complicate object linked to inductive definitions (see Moschovakis [65]). It easy to see that sets definable in $S2S$ are in the classes $\partial(D_n(\mathbf{\Sigma}_2^0))$ (see Gurevitch Harrington [42]). But we are working in compacts spaces and the continuous image of a compact space is compact. The projection of a K_σ is a K_σ set so if $Z \subset 2^\omega \times 2^\omega$ is $\mathbf{\Pi}_2^0$ (Resp. $\mathbf{\Pi}_2^0$), then $\forall \beta, Z$ is $\mathbf{\Pi}_2^0$ (Resp. $\mathbf{\Pi}_2^0$). Let $\partial(\Gamma)(2^\omega) = \{(X \subset 2^\omega \times 2^\omega \mid \exists Y \in \Gamma, Y \in 2^\omega \times 2^\omega \times 2^\omega, \alpha \in X \leftrightarrow \exists \varphi : 2^* \longrightarrow 2, \forall \gamma (\alpha, \varphi(\gamma), \gamma) \in Y)\}$, by the Tarski

Kuratowski algorithm we have $\wp(\Pi_2^0)(2^\omega) = \Sigma_1^1(2^\omega)$ so, by determination of closed games in $2^\omega \times 2^\omega$, $\wp(\Sigma_2^0)(2^\omega) = \Pi_1^1(2^\omega)$. From the existence of Π_1^0 set of ω^ω which do not contain a Δ_1^1 point, one can deduce that there exists Π_1^0 game in ω^ω such that the closed Player wins the game but have no Δ_1^1 strategy (see Moschovakis [65]). And from the existence of Π_2^0 set of 2^ω which do not contain a Δ_1^1 point, one can deduce that there exists Π_2^0 game in 2^ω such that the Π_2^0 Player wins the game but have no Δ_1^1 strategy (see [97]). A direct computation of the complexity of $\wp(\Sigma_2^0)(2^\omega)$ by the Tarski Kuratowski algorithm gives a Σ_2^1 set, that is to say a projection of a coanalytic set. In a $\Sigma_2^0(2^\omega \times 2^\omega)$ game, if the Σ_2^0 player has a winning strategy does he has a Δ_1^1 strategy? If $Y \subset 2^\omega \times 2^\omega \times 2^\omega$ is Σ_2^0 and if $\alpha \in X \leftrightarrow I$ has winning strategy in the game Y_α , does I can choose φ in a borel way from $\alpha \in X$? There exists another old hierarchy in Δ_2^1 the hierarchy of C of Selivanowski starting from Σ_1^1 sets we alternate complement and Suslin scheme (see Kuratowski [52]), it turns out that the hierarchy of Selivanowski is the hierarchy of the $\wp(D_\xi(\Sigma_1^0))$ for $\xi < \omega_1$ (see Moschovakis [65], Louveau [61]).

Does there is a a difference between the classes $\wp(D_2(\Sigma_2^0))(\omega^\omega)$ and $\wp(D_2(\Sigma_2^0))(2^\omega)$? Does the hierarchies of game quantifier has to do with set definable in $S2S$. One can see presentation of Niwinski [68] to have an account of recent work and problems in $S2S$.

2.12.4 Baire class 1 functions

In conclusion, let us say that other properties of ω -rational function which are Baire class 1 can be derived from work by Kechris and Louveau [49]. One can find concrete examples of ω -rational Baire class 1 functions in [38, 39, 51, 66] and one can even define Baire class 1 functions on real numbers by using representation of real numbers in Pisot Basis [20].

Finally we remark that Baire has introduced semi continuity, oscillation and the space ω^ω .

The bibliography is big but still incomplete. We have certainly forgotten some work, especially work of Schupp on alternating automata and work on fixed point theory of Arnold, Niwinski, Kozen, Bradfield, Walukiewicz, Wilke.

2.12.5 Acknowledgements

Acknowledgements of the first author :

I began to learn automata theory in the DEA of Maurice Nivat (my adviser) in the year 1983-1984 at LITP. In particular I learned first Büchi's theory with Dominique Perrin, and ω -context free languages with Françoise Gire. In 1984 my friend Vincent Schoen brought up to me a course from Saint Raymond. In the beginning of this course was presented ordinals and Cantor's derivation and it looked like a problem on process in [4]. Then I saw on the program of Louveau's seminary a title: "Mistigri Games". Before this seminary, there was another seminary about σ -ideal of compact sets. There was the compact of a set recognized by automata, then Mistigri seminary and a game played against a set recognized by automata. Then I began to learn classical descriptive theory and effective descriptive set theory in Louveau's documents. I thank Professor Jean Saint Raymond who recognized Hausdorff's theorem in a theoretical computer science problem in 1986. I also thank Alain Louveau for his help. Alain Louveau recognized Wadge's hierarchy in Wagner's hierarchy in 1987 and he invited me in his seminary to give a talk on Wagner in 1987 and on $K\mathbb{Q}$ in 1988. He introduced old results of Hurewicz [45] and effective set theory to me. We use Louveau documents for the topological sections. I also thank Jean Pierre Ressayre who accepted to organize a workshop in 1988 about Wadge's hierarchy and Wagner's hierarchy. This is where I met Olivier Finkel and Jacques Duparc. I learned tree alternating automata with Paul Schupp and I am indebted to him for his help. Many thanks to Jean Claude Dumoncel for historical discussions on Borel. Finally I thank Professor Serge Grigorieff who accepted to advise my thesis.

The authors thank Dominique Lecomte who kindly accepted that we present his result. Gabriel Debs and Domonique Lecomte proved in 2006 that in a $\Sigma_2^0(2^\omega \times 2^\omega)$ game, the Σ_2^0 player has a Δ_1^1 winning strategy whenever he has a winning strategy. Let $f : \omega^\omega \rightarrow \omega^\omega$ be an effective borel function, that is to say its graph is a Δ_1^1 set. If f is not Baire class one, does there exists a closed nonempty set F which is Δ_1^1 (and so by Louveau F is $\Pi_1^0(\Delta_1^1)$) such that the restriction of f to F has no point of continuity?

Bibliographie

- [1] J.W. Addison. *The Theory of hierarchies*. E. Nagel, P. Suppes and Tarski, eds Logic, Methodology and Philosophy of Science, Proc. 1960 International Congress(Stanford University Press). 1962. 26-37.
- [2] J.W. Addison. *The Method of Alternating Chains*. The Theory of Models, North Holland Amsterdam. 1965. 1-16.
- [3] A. Arnold. *Topological characterization of infinite behaviours of transition systems*. Automata, Languages and programming. Lecture Notes in Comput. Sci. vol 154, Springer Verlag, Berlin, Heilenberg, New York. 1983. 28-38.
- [4] A. Arnold, M. Nivat. *Comportement de Processus* . Colloque AFCET Les mathématiques de l'informatique,France. 1982. 35-68.
- [5] R. Baire. *Oeuvres scientifiques* . Bordas, Paris 1990.
- [6] R. Barua. *Hausdroff-Kuratowski hierarchy of ω - regular languages and a hierarchy of Muller automata*. Theoretical Computer Science, Vol 16 No. 1 . 1992. 60-99.
- [7] Y M. Barzdin, B.A. Trakhtenbrot. *Finite Automata, Behaviour and Synthesis*. North Holland, Amsterdam. 1973.
- [8] M.P. Beal, O. Carton. *Determinization of transducers over finite and infinite words* Theoret. Comput. Sci., vol. 289, no. 1. 2002. 225-251.
- [9] M.P. Beal, O. Carton, C.Prieur, J.Sakarovitch. *Squaring Transducers: an efficient procedure for deciding functionality and sequentiality*. Theoretical Computer Science, Vol. 292, No. 1 . 2003. 45-63.
- [10] N. Bedon. *Finite automata and ordinals*. Theoretical Computer Science, Vol. 156, 1-2 . 1996. 199-144.
- [11] A. Bergeron, J.C. Manzoni. *An automated analysis of Ping-Pong Interactions in E-mail Services*. TACAS'99 Proceedings, LNCS 1579, Springer-Verlag, Berlin. 1999. 134-147.
- [12] J. Berstel. *Transductions and Context Free Languages* . Teubner Verlag 1979.

-
- [13] L. Boasson and M. Nivat. *Adherences of languages*. J. Comput. System Sci. 20 (3) Teubner Verlag 1980. 285-309.
- [14] J.R. Büchi. *On a decision method in restricted second order arithmetic*. Logic, Methodology and Philosophy of Science. Stanford Univ. Press, Stanford, Calif. 1962. 1-11.
- [15] J.R. Büchi, D. Siefkes. *The Monadic Theory of ω_1* . in The Monadic Second Order Theory of All Countable Ordinals, J.R. Büchi, D. Siefkes (ed) Lecture Notes in math., Vol. 328, Springer Berlin. 1973. 1-121.
- [16] J.R. Büchi. *Using determinacy of games to eliminate quantifiers*. Fundamentals of computation theory. Lecture Notes in Comput. Sci. vol. 56 Springer, Berlin 1977. 367-378.
- [17] J.R. Büchi. *State-strategies for games in $F_{\sigma\delta} \cap G_{\delta\sigma}$* . J. Symbolic Logic 48, 4. 1984. 1171-1198.
- [18] J.R. Büchi, L. H. Landweber. *Solving sequential condition by finite-state strategies*. Trans. Amer. Math. Soc. 138. 1969. 295-311.
- [19] V. Bruyère. *Codes*. Chapter 7 of M. Lothaire, Algebraic Combinatorics on Words. Cambridge University Press. 2002.
- [20] B. Cagnard, P. Simonnet. *Automata Borel functions and real numbers in Pisot basis*. 6th conference on real numbers and computers (RNC6). 2004.
- [21] O. Carton, M. Michel. *Unambiguous Büchi automata*. Theoret. Comput. Sci., vol. 297. 2003. 37-81.
- [22] O. Carton, D. Perrin. *The Wagner hierarchy*. Internat. J. Algebra Comput 9, 5. 1999. 597-620.
- [23] C. Choffrut. *Une caractérisation des Fonctions Séquentielles et des fonctions sous séquentielles en tant que Relations Rationnelles*. Theoretical Computer Science, Volume 5 (1977), 325-338. 1999. 171-182.
- [24] C. Choffrut, S. Grigorieff. *Uniformization of Rational Relations*. Jewels are Forever 1999, Springer Verlag. 59-71.
- [25] P. Dugac. *Histoire de l'analyse*. Vuibert. 2003. 253-271.
- [26] J. Duparc, O. Finkel, J.P. Ressayre. *Computer Science and the Fine Structure of Borel Sets*. Theoretical Computer Science, Volume 257 (1-2), April 2001. 85-105.
- [27] J. Duparc. *Wadge Hierarchy and Veblen Hierarchy: Part 1: Borel Sets of Finite Rank*. Journal of Symbolic Logic, 66 no. 1. 56-86. 2001.

-
- [28] J. Duparc. *A Hierarchy of Deterministic Context-Free ω -languages*. Theoretical Computer Science, Volume 290, no. 3. 1253-1300. 2003.
- [29] S. Eilenberg. *Automata, Languages and Machines Vol A*. Academic Press, New York London. 1974.
- [30] C.C. Elgot, J.E. Mezei. *on relations defined by generalised automata..* IBM J. Res. Develop. 9. 1965. 47-68.
- [31] O. Finkel. *On the topological complexity of infinitary rational relations*. Theoretic. informatics and applications. 2003. 105-113.
- [32] O. Finkel. *Undecidability of topological and arithmetical properties of infinitary rational relations*. Theoretic. informatics and applications. 2003. 115-126.
- [33] O. Finkel. *Wadge Hierarchy of Omega Context Free Languages*. Theoretical Computer Science, Volume 269 (1-2). 2001. 283-315.
- [34] O. Finkel. *Borel Hierarchy and Omega Context Free Languages*. Theoretical Computer Science, Volume 290 (3). 2003. 1385-1405.
- [35] O. Finkel. *Borel Ranks and Wadge Degrees of Context Free omega-Languages*. CIE 2005. 2005. 129-138.
- [36] O. Finkel, J.P. Ressayre, P. Simonnet *On Infinite Real Trace Rational Languages of Maximum Topological Complexity*. Zapiski Nauchnyh Seminarov POMI, Volume 316, December 2004 2004. 205-223.
- [37] C. Frougny, J. Sakarovitch. *Synchronized relations of finite and infinite words*. Theoretic. comput. sci. 1993. 45-82.
- [38] C. Frougny. *On-the-Fly algorithms and sequential machines*. IEEE Transactions on Computers 49. 2000. 859-863.
- [39] C. Frougny. *Numeration Systems*. Chapter 8 of M. Lothaire, Algebraic Combinatorics on Words. Cambridge University Press. 2002.
- [40] F. Gire, M Nivat. *Relation rationnelles infinitaires* . Calcolo XXI. 1984. 91-125.
- [41] F. Gire. *Two decidability Problems for infinite words*. Information Processing letters 22. 1986. 135-140.
- [42] Y. Gurevitch, L. Harrington. *Trees Automata and Games*. Proc. ACM Symp. on Theory of Computing. 1982. 60-65.
- [43] T. Hafer. *On the Boolean Closure of Büchi Tree Automaton Definable Set of ω -trees*. Aachener Inform. Ber., n° 87-16, R.W.T.H., Aachen. 1987.
- [44] P. Hertling, K Weihrauch. *On the Topological Classification of Degeneracies*. Informatik-Berichte, Nr. 154, FernUniversität. 1994.

-
- [45] W. Hurewicz. *Relativ perfekte Teile von Punktmengen und Mengen*. Fund. Math. 12. 1928. 78-109.
- [46] M. Kaminski. *A classification of ω -regular languages*. Theoret. Comput. Sci, 36, 2-3. 1985. 217-229.
- [47] A. S. Kechris. *Classical Descriptive Set Theory*. Springer-Verlag. 1995.
- [48] A. S. Kechris, A. Louveau. *Descriptive Set Theory and the Structure of Sets of Uniqueness*. Cambridge University Press. 1987.
- [49] A. S. Kechris, A. Louveau. *A Classification of Baire class 1 functions*. Trans. AMS. Volume 318, Number 1, March 1990. 209-236.
- [50] A. S. Kechris, A. Louveau, W. H. Woodin. *The Structure of σ -ideals of Compact Sets*. Trans. AMS. Soc. 301 (1). 263-288. 1987.
- [51] P. Kornerup. *Digit-set conversions: Generalizations and applications*. I.E.E.E. Trans. on Computers 43. 1994. 622-629.
- [52] C. Kuratowski. *Une méthode d'élimination des nombres transfinis des raisonnements mathématiques*. Fund. Math. 3. 1922. 100-.
- [53] C. Kuratowski. *Topology*. vol I, Academic Press. 1966.
- [54] L.H. Landweber. *Decision problem for ω -automata*. Math. Systems. Theory 3. 1969. 376-384.
- [55] M. Latteux, E. Timmerman. *Rational omega-Transductions*. MFCS. 1990. 407-415.
- [56] R. Lindner, L. Staiger. *Algebraische Codierungstheorie - Theorie der sequentiellen Codierungen*. Akademie-Verlag, Berlin. 1977.
- [57] D. Lecomte *ω -powers and descriptive set theory*. to appear in journal of symbolic logic december 2005.
- [58] A. Louveau. *Ensemble Analytiques et Boréliens dans les Espaces Produits*. Asterisque S.M.F. 78. 1980.
- [59] A. Louveau. *A separation theorem for Σ_1^1 sets*. Transaction A.M.S., 260. 1981. 363-378.
- [60] A. Louveau. *Some results in the Wadge Hierarchy of Borel Sets*. Cabals Sem. 79-81, A.S. Kechris, D.A. Martin and Y.N.Moschovakis, Springer, Berlin. 1983. 28-55.
- [61] A. Louveau. *Quantificateur de jeu et σ -ideal of compacts*. Séminaire de theorie effective Université Paris VI. 1987.

-
- [62] A. Louveau, J. Saint Raymond. *Borel classes and closed games Wadge-type and Hurewicz-type results*. Transaction A.M.S. 304. 1987. 431-437.
- [63] A. Louveau, J. Saint Raymond. *Les propriétés de réduction et de norme pour les classes de Boreliens*. Fundamenta Mathematica 131. 1988. 223-437.
- [64] N. Lusin. *Leçons sur les Ensembles Analytiques et leurs Applications*. Gauthiers Villard. 1930.
- [65] Y. N. Moschovakis. *Descriptive Set Theory*. North Holland, Amsterdam. 1980.
- [66] J.M. Muller. *Arithmétique des ordinateurs*. Masson. Paris. 1989.
- [67] D. Niwinski. *An Example of Non Borel Set of infinite Trees Recognizable by a Rabin Automaton, In Polish, Manuscrit*. University of Warsaw. 1985.
- [68] D. Niwinski. *On the complexity of infinite computations*. Automata, Structures and Logic, Auckland. 2004.
- [69] D. Perrin J.E. Pin. *Infinite words*. Academic Press. 2004.
- [70] C. Prieur. *How to decide continuity of rationnal functions on infinite words*. Theoretical Computer Science 250 (1-2). 2001. 71-82.
- [71] C. Prieur. *How to decide continuity of rationnal functions on infinite words*. Theoretical Computer Science 276 (1-2). 2002. 445-447.
- [72] M. O. Rabin. *Decidability of Second Order Theories and Automata on Infinite Tree*. Trans. Amer. Math. Soc. 141. 1969. 1-35.
- [73] M. O. Rabin. *Weakly Definable Relations and Special Automata*. Mathematical Logic and Foundations of Set Theory, North Holland, Amsterdam. 1970. 1-23.
- [74] M. O. Rabin, D. Scott. *Finite automata and their decision problems*. IBM J. Res. Develop. 3. 1959. 114-125.
- [75] H. Rogers. *Theory of Recursive Functions and Effective Computability*. Mc Graw Hill, New York. 1967.
- [76] J. Saint Raymond. *Boréliens à coupe K_σ* . Bull. Soc. Math. France, 104. 1976. 1-23.
- [77] J. Saint Raymond. *Classification de Wadge*. Note d'exposé, fev 1989, Séminaire Initiation à l'Analyse, G. Choquet, G. Godefroy, M. Rogalski, J. Saint raymond 28 ième année. 1989.
- [78] J. Sakarovitch. *Eléments de théorie des automates*. Vuibert informatique. 2003.
- [79] V. Selivanov. *Fine hierarchy of regular ω -languages*. Theoret. Comput, 191, 1-2. 1998. 37-59.

-
- [80] S. Shelah. *The Monadic Theory of order*. Ann. of Math. (2) 102,3. 1975. 379-419.
- [81] W. Sierpinski. *Sur les fonctions de première classe*. C. R. Acad. Sci. Paris 170. 1920. 919-922.
- [82] W. Sierpinski. *Les Ensembles Projectifs et Analytiques*. Mémorial des Sciences Mathématiques, fascicule CXII, Gauthier-Villard. 1950. 28-29.
- [83] P. Simonnet. *Automate et théorie descriptive*. Ph.D. thesis, Université Paris 7, France. 1992.
- [84] P. Simonnet. *Un théorème de séparation sur les ensembles rationnels de mots infinis*. C. R. Acad. Sci. Paris Paris, 316 Serie I . 1993. 201-203.
- [85] P. Simonnet. *Automates d'arbres infinis et choix borélien*. C. R. Acad. Sci. Paris Paris, 316 Serie I . 1993. 97-100.
- [86] J. Skurczyński. *The Borel Hierarchy is Infinite in the Class of Regular Sets of Trees*. LNCS, Vol. 380, Springer, Berlin. 1989. 416-423.
- [87] S.M. Srivastava. *A course on Borel Sets*. Springer. 1998.
- [88] L. Staiger. *Hierarchies of Recursive ω -languages*. J. Inf. Process. Cybern. EIK 22 5/6 1986. 219-241.
- [89] L. Staiger. *Research in the Theory of ω -languages*. J. Inf. Process. Cybern. EIK 23 8/9 1987. 415-439.
- [90] L. Staiger. *Sequential mappings of ω -languages*. RAIRO - Inform. Theor. Appl. , 21 2. 1987. 147-173.
- [91] L. Staiger. *Recursive Automata on Infinite Words*. STACS. 1993.
- [92] L. Staiger. *ω -languages*. Chapter of the handbook of Formal Languages, Vol 3. Springer. 1997. 201-203.
- [93] L. Staiger, K. Weihrauch *In the Cantor Space and the Baire Space, $G_\delta \setminus F_\sigma$ is a Single Wadge-Degree, an effective proof*. Informatik-Berichte Nr. 119, FernUniversität. 1992.
- [94] J. R. Steel. *Determinateness and the separation property*. J. of Symb. Logic, vol 46. 1981. 41-44.
- [95] W. Thomas. *Automata on infinite objects*. Handbook of theoretical computer science, Vol B. 1990.
- [96] W. Thomas. H. Lescow. *Logical Specifications of Infinite Computation*. 1994.
- [97] W. Thomas. *On the Synthesis of Strategies in Infinite Game*. STACS 95, Springer Berlin. 1995. 1-13.

-
- [98] W. Thomas. *Languages Automata and Logic*. Handbook of Formal Languages, Vol 3, Springer. 1997. 389-449.
- [99] B. A. Trakhtenbrot. *Finite Automata and the Monadic Predicate Calculus*. Sibirsk. Mat. Zh., 3, No 1. 1962. 103-131.
- [100] B. A. Trakhtenbrot, Y. M. Barzdin. *Finite Automata*. North-Holland, Amsterdam. 1973.
- [101] R. Van Wesep. *Separation principes and the axiom of determinateness*. J. of Symb. Logic, vol. 43. 1978. 77-81.
- [102] O. Veblen. *Continuous increasing function from finite and transfinite ordinals*. Trans. of the A.M.S. vol. 9. 1908. 280-292.
- [103] W. W. Wadge. *Degrees of complexity of subsets of the Baire space*. Notice A.M.S. 1972.
- [104] W. W. Wadge. *PH. D. Thesis*. (Handwritten notes). 1976.
- [105] W. W. Wadge. *Thesis*. Berkeley. 1984.
- [106] K. Wagner. *On ω -regular Sets*. Information and Control 43. 1979. 123-177.
- [107] K. Wagner. L. Staiger. *Recursive ω -languages*. Fundamentals of Computation Theory, LNCS, 56, Springer. 1977. 532-537.
- [108] K. Weihrauch. *The lowest Wadge degrees of subsets of the Cantor space*. Informatik-Berichte Nr.107, FernUniversität. 1991.
- [109] T. Wilke. *An algebraic theory for regular languages of finite and infinite words*. Int. J. Alg. Comput. 3. 1993. 447-489.

Chapitre 3

Sarkovski and automata

Benoit Cagnard, Christian Morelli, Pierre Simonnet.

Journées Montoises d'Informatique Théorique 2006.

Abstract

The Sarkovski theorem is about cardinality of orbits of continuous functions $f : \mathbb{R} \rightarrow \mathbb{R}$. There exists an order \triangleright , on non zero integers, the Sarkovski order so that if a continuous functions $f : \mathbb{R} \rightarrow \mathbb{R}$ has a periodic orbit of cardinality n and $n \triangleright m$ then f has a periodic orbit of cardinality m . First we note that the Sarkovski order is computable by finite automaton on finite words if we represent the integers in base 2. Then we make the connection with functions which graph is computable by synchronous finite automaton on infinite words. When the numeration system is in Pisot base, we know that for such functions one can decide if they represent continuous functions on reals. In this case, one can decide if they have periodic orbits of cardinality n for all n . In particular, one can decide if they have orbits of every cardinality $n \in \mathbb{N}^*$. Furthermore, with this functions one can construct example of functions with periodic orbit of a fixed cardinality m and none periodic orbit of cardinality m with $n \triangleright m$ in the Sarkovski order.

key words: Automata, Sarkovski theorem, periodic orbit, Pisot number.

3.1 Introduction

In the 90's, lots of physicians books about chaos were published , see for example [1], [8], [15]. A mutual particularity of this books is to introduce symbolic dynamic especially with automata as graphs. This article can be read as a complement of this books where we introduce the notions of Büchi automata, decidability, and functions definable by finite automata.

3.2 automata on infinite words

In this section, we recall few definitions and classical results on automata on infinite words. For more details, see [2], [9], [16].

We note ω the set of natural numbers, A a finite alphabet with more than tow letters. A finite word u on the alphabet A is a finite sequence of elements of A . We note A^* the set of finite words on A . The length (number of letters) of the word u is denoted $|u|$. A particular word is the empty word ϵ , $|\epsilon| = 0$. With concatenation, A^* is a monoid with unit element ϵ .

An infinite word α on alphabet A is an infinite sequence of elements of A : $\alpha = \alpha(0)\alpha(1)\dots\alpha(n)\dots$. The set of infinite words on A will be noted A^ω . We note $\alpha[n]$ the finite word formed with the n first letters of the infinite word α , $\alpha[0] = \epsilon$, $\alpha[1] = \alpha(0)$.

Definition 3.1. *A Büchi (nondeterministic) automaton \mathcal{A} is a 5-tuple: $\mathcal{A} = \langle A, Q, I, T, F \rangle$, where A is a finite alphabet, Q is a finite set of states, $I \subset Q$ is the set of initial states, $T \subset Q \times A \times Q$ is the set of transitions and $F \subset Q$ the set of final states.*

A path c of label α in \mathcal{A} is an infinite word $c = c(0)c(1)\dots c(n)\dots \in (Q \times A \times Q)^\omega$ so that $\forall n \in \omega$, $c(n)$ is of the form $(\beta(n), \alpha(n), \beta(n+1))$ with $\beta(0) \in I$ and $c(n) \in T$.

$$c = \beta_0 \xrightarrow{\alpha_0} \beta_1 \xrightarrow{\alpha_1} \beta_2 \xrightarrow{\alpha_2} \dots$$

Let us note $\text{Infinity}(c)$ the set of states which appears infinitely many times in c . An accepting path c is a path so that $\text{Infinity}(c) \cap F \neq \emptyset$. An accepted word α is a word such that exists an accepting path c of label α . We say that the word α is recognized by \mathcal{A} for the Büchi condition.

The set of words recognized by a Büchi automaton \mathcal{A} is noted $L^\omega(\mathcal{A})$.

Definition 3.2. A Muller automaton \mathcal{A} is a 5-tuple: $\mathcal{A} = \langle A, Q, I, T, \mathcal{F} \rangle$, where A is a finite alphabet, Q is a finite set of states, $I \subset Q$ is the set of initial states, $T \subset Q \times A \times Q$ is the set of transitions and $\mathcal{F} \subset \mathcal{P}(Q)$. The difference between Büchi automata and Muller automata is the acceptance condition.

An infinite word $\alpha \in A^\omega$ is recognized by \mathcal{A} if there is an infinite path c of label α so that $\text{Infinity}(c) \in \mathcal{F}$.

An automaton is called *deterministic* if it has an unique initial state and for each state p and each letter a there exists at most one transition $(p, a, q) \in T$. In this case, for all word α there exists at most one path c of label α .

Now, we define the terms, atomic formula and formula of *S1S* the first of order monadic logic of one successor. Let \mathcal{V} a set of variables, its elements noted by x, y, z, \dots , a constant symbol 0 and a unary function s (as successor). We define the set of the terms \mathcal{T} by:

- i) A variable is a term.
- ii) 0 is a term.
- iii) if $t \in \mathcal{T}$ then $s(t) \in \mathcal{T}$.

Let \mathcal{P} (as parts) another set of variables, this variables are noted $\mathcal{X}, \mathcal{Y}, \mathcal{Z}, \dots$ and two binary predicates $=, \in$. The atomic formulae are of the form $t = t'$ with $(t, t') \in \mathcal{T}^2$ or $t \in \mathcal{X}$ with $t \in \mathcal{T}$ and $\mathcal{X} \in \mathcal{P}$.

Definition 3.3. A formula of *S1S* is defined as following:

- i) An atomic formula is in *S1S*.
- ii) If $\phi \in \text{S1S}$ then $\neg\phi, \forall x\phi, \exists x\phi, \forall \mathcal{X}\phi, \exists \mathcal{X}\phi$ are in *S1S*, with $x \in \mathcal{V}, \mathcal{X} \in \mathcal{P}$
- iii) If ϕ and ψ are in *S1S* then $\phi \wedge \psi, \phi \vee \psi, \phi \Rightarrow \psi, \phi \Leftrightarrow \psi$ are in *S1S*.

The interpretation of these formulae is the following: the variables of \mathcal{V} are interpreted as natural numbers, the symbol 0 as $0 \in \omega$, the symbol s as the successor function in ω , the variables of \mathcal{P} as subsets of ω and the predicates symbols as $=$ and \in in ω . If each integer is assimilated to a singleton and each subset of ω to an infinite word on the $\{0,1\}$ alphabet, then a *S1S* formula $\phi(\mathcal{X}_1, \mathcal{X}_2, \dots, \mathcal{X}_n)$, with $\mathcal{X}_1, \mathcal{X}_2, \dots, \mathcal{X}_n$ free variables defines the ω -language $L_\phi \subset \underbrace{2^\mathbb{N} \times \dots \times 2^\mathbb{N}}_n$ of the n -tuple of characteristic words satisfying ϕ .

An ω -language L is said *definable* in *S1S* if there exists a formula ϕ in *S1S* so that $L = L_\phi$.

Recall the following result :

Theorem 3.4. *for all ω -language L , the following assertions are equivalent :*

- i) $L = \bigcup_{1 \leq i \leq n} A_i B_i^\omega$ with A_i, B_i rational sets of finite words.
- ii) $L = L^\omega(\mathcal{A})$ with \mathcal{A} a nondeterministic Büchi automaton.
- iii) $L = L^\omega(\mathcal{A})$ with \mathcal{A} a deterministic Muller automaton.
- iv) L is definable in S1S.

We call $Rec(A^\omega)$ the family of such languages.

It is easy to deduce from the precedent theorem the decidability of S1S. This result has been shown by Büchi in 1962 [4].

3.3 ω -rational relations

In this section, we briefly introduce ω -rational relations (see [11]).

Definition 3.5. *A Büchi transducer \mathcal{T} is a 6-tuple: $\mathcal{T} = \langle A, B, Q, I, T, F \rangle$, where A and B are finite alphabets, Q is a finite set of states, $I \subset Q$ is the set of initial states, $T \subset Q \times A^* \times B^* \times Q$ is the set of transitions and $F \subset Q$ is the set of final states.*

A path c of label $(\alpha, \beta) \in (A^* \cup A^\omega) \times (B^* \cup B^\omega)$ is an infinite word $c = c(0)c(1)...c(n)... \in (Q \times A^* \times B^* \times Q)^\omega$ so that $\forall n \in \omega$, $c(n)$ is of the form (q_n, u_n, v_n, q_{n+1}) with $q_0 \in I$ and $c(n) \in T$.

$$c = q_0 \xrightarrow{u_0, v_0} q_1 \xrightarrow{u_1, v_1} q_2 \xrightarrow{u_2, v_2} \dots$$

with $q_i \in Q$, $(u_i, v_i) \in A^* \times B^*$ et $\alpha = u_0 u_1 u_2 \dots$, $\beta = v_0 v_1 v_2 \dots$

$Infinity(c)$ is ever the set of states which appears infinitely many times in c . A path c of label (α, β) is an accepting path if (α, β) is recognized by \mathcal{T} , that means that $Infinity(c) \cap F \neq \emptyset$.

Remark 10. *A path c of label (α, β) is allowable if α and β are booth infinite words. In [11] it is shown that for any Büchi transducer \mathcal{T} it is possible to construct another one \mathcal{T}' so that every path in \mathcal{T}' is allowable and the accepting paths in \mathcal{T} and \mathcal{T}' are the same. I the sequel all couples (α, β) will be in $A^\omega \times B^\omega$.*

An ω -rational is a subset of $A^\omega \times B^\omega$ recognizable by a Büchi transducer. An ω -rational function $f : A^\omega \rightarrow B^\omega$ is a function which graph is an ω -rational relation.

An ω -rational function $f : A^\omega \rightarrow B^\omega$ is definable in *S1S* if there exists a synchronous Büchi transducer (letter to letter) which recognize its graph.

Remark 11. We sometimes use non-synchronous transducers. In fact this transducers are bounded delay and one can synchronize them [11].

3.4 The Sarkovski theorem

In this section, we are interest in fixed points of iterations of a function $f : E \rightarrow E$. If x is a point of E we call orbit of x the set $O_x = \bigcup_{n \in \mathbb{N}} \{f^n(x)\}$.

Definition 3.6. Let $f : E \rightarrow E$ be a function, a point $x \in E$ is periodic with period $n \in \mathbb{N}^*$ if $f^n(x) = x$ and $\forall i = 1, \dots, n - 1, f^i(x) \neq x$.

In this case $O_x = \{x, f(x), f^2(x), \dots, f^{n-1}(x)\}$ has exactly cardinality n .

A point $x \in E$ is eventually periodic with period n if there exists $p \in \mathbb{N}^*$ so that $f^p(x)$ is periodic of period n for f .

Remark 12. : A point x is eventually periodic iff its orbit is finite.

The Sarkovski order is defined as follows :

$$\begin{array}{cccccccc}
 & 3 & \triangleright & 5 & \triangleright & 7 & \triangleright \dots \triangleright & 2n+1 & \triangleright & 2n+3 & \triangleright \dots \\
 \dots \triangleright & 2.3 & \triangleright & 2.5 & \triangleright & 2.7 & \triangleright \dots \triangleright & 2(2n+1) & \triangleright & 2(2n+3) & \triangleright \dots \\
 \dots \triangleright & 2^2.3 & \triangleright & 2^2.5 & \triangleright & 2^2.7 & \triangleright \dots \triangleright & 2^2(2n+1) & \triangleright & 2^2(2n+3) & \triangleright \dots \\
 \dots \triangleright & 2^3.3 & \triangleright & 2^3.5 & \triangleright & 2^3.7 & \triangleright \dots \triangleright & 2^3(2n+1) & \triangleright & 2^3(2n+3) & \triangleright \dots \\
 & & & & & & & \vdots & & & \\
 \dots \triangleright & 2^{n+1} & \triangleright & 2^n & \triangleright & \dots & \triangleright & 2^3 & \triangleright & 2^2 & \triangleright & 2 & \triangleright & 1.
 \end{array}$$

First there are the even integers different of 1 in increasing order, then 2 times the even integers different of 1 in increasing order, then 2^2 times the even integers different of 1 in increasing order and so on. And at least there are the powers of 2 in decreasing order.

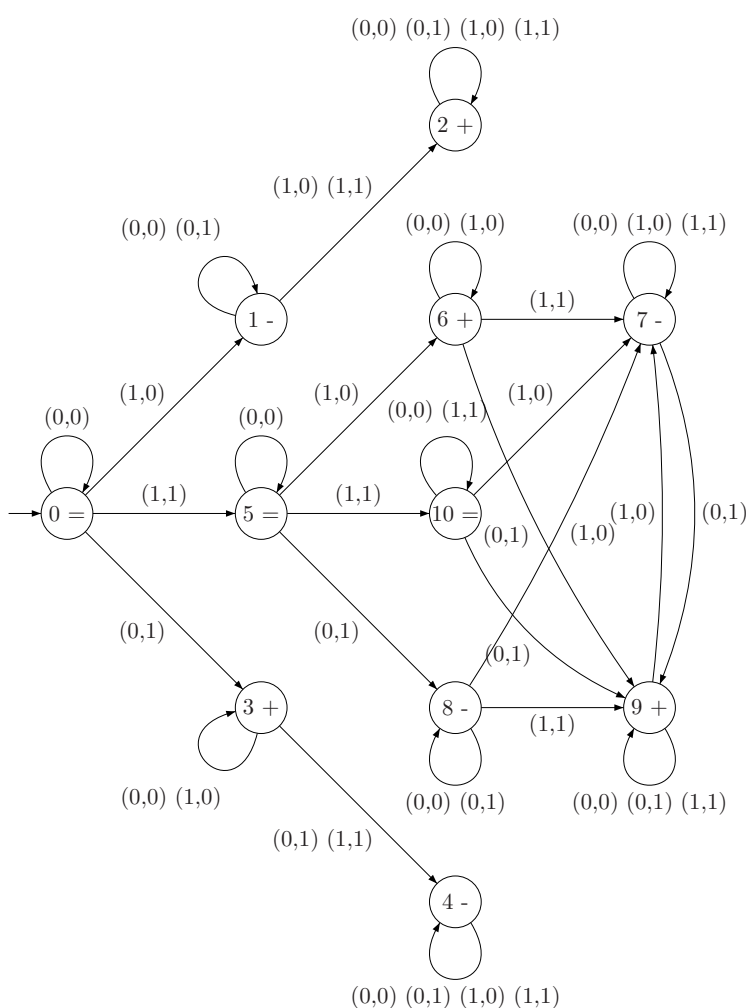

FIG. 3.1 – Sarkovski order in base 2

This order is computable by the automaton of finite words on figure 3.8 where integers are represented in base 2. This right-left automaton read couple of words with same length in $\{0,1\}^*$. If (u,v) is the couple of words which represent the couple of integers (m,n) to compare, ending a lecture in the automaton in a "+" state (2, 3, 6 et 9) means that $m \triangleright n$, in a "-" state (1, 4, 7 et 8) means that $n \triangleright m$ and in a "=" state (0, 5 et 10) means that $m = n$.

Example 20. If $(m,n) = (8,5)$, on a $8 = \langle 1000 \rangle_2$ et $5 = \langle 101 \rangle_2 = \langle 0101 \rangle_2$. As 8 is represented by a 4 letters word, we choose to represent 5 the 4 letters word 0101. Then we read the couple $(1000,0101)$ in the automaton. We begin by weak weight

bits :

$$0 \xrightarrow{0,1} 3 \xrightarrow{0,0} 3 \xrightarrow{0,1} 4 \xrightarrow{1,0} 4$$

The state 4 is a "-" state, that means $5 \triangleright 8$ in the Sarkovski order.

Theorem 3.7. Sarkovski Let be $f : \mathbb{R} \rightarrow \mathbb{R}$ a continuous function. If f has a periodic point of period n , then for all $k \in \mathbb{N}^*$ so that $n \triangleright k$, f has at least one periodic point of period k .

3.5 The case of ω -rational functions

Consider a numeration system in Pisot base, i.e θ is a Pisot number, $A \subset \mathbb{Z} \cap [-k, k]$ where k is a fixed integer and the function μ_θ defined by :

$$\begin{aligned} \mu_\theta : A^\omega &\rightarrow \left[\frac{-k}{\theta-1}, \frac{k}{\theta-1} \right] \\ \alpha &\rightarrow \sum_{n \geq 0} \frac{\alpha(n)}{\theta^{n+1}} \end{aligned}$$

Recall that μ_θ is a continuous surjection on $\left[\frac{-k}{\theta-1}, \frac{k}{\theta-1} \right]$.

In the examples, we use sometimes non-symmetric alphabets $A = \{0, \dots, k\}$.

For now on, we consider functions $f : A^\omega \rightarrow A^\omega$ which graph is definable in S1S consistent with μ_θ , i.e. functions with graph definable in S1S so that the following diagram commutes :

$$\begin{array}{ccc} A^\omega & \xrightarrow{f} & A^\omega \\ \mu_\theta \downarrow & & \downarrow \mu_\theta \\ \left[\frac{-k}{\theta-1}, \frac{k}{\theta-1} \right] & \xrightarrow{F} & \left[\frac{-k}{\theta-1}, \frac{k}{\theta-1} \right] \end{array}$$

It is evident that if α is a periodic point of f with period n , then $x = \mu_\theta(\alpha)$ is a periodic point of F with period k and k divide n . See example 21 as illustration.

On the over hand, if x is a periodic point of F , all $\alpha \in A^\omega$ so taht $x = \mu_\theta(\alpha)$ is not necessary periodic : if $\mu_\theta^{-1}(\{x\})$ is finite, such α is eventually periodic for f and if $\mu_\theta^{-1}(\{x\})$ is infinite the orbit of α can be infinite (example 22).

Example 21. Consider the function f defined on 2^ω represented by the Büchi transducer on figure 3.2. We obtain the following commutative diagram.

$$\begin{array}{ccc} 2^\omega & \xrightarrow{f} & 2^\omega \\ \mu_2 \downarrow & & \downarrow \mu_2 \\ [0,1] & \xrightarrow{F} & [0,1] \\ x & \longrightarrow & 1 - x \end{array}$$

The point 10^ω is a periodic point of f with period 2 and $\mu_2(10^\omega) = \frac{1}{2}$ is the single fixed point of F , i.e. a periodic point F with period 1.

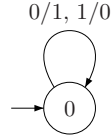

FIG. 3.2 – Inversion in base 2

Example 22. In this example, we represent reals in the Aviezinis base $A = \{\bar{1}, 0, 1\}$.

Consider the function f defined on A^ω represented by the Büchi transducer on figure 3.3. We obtain the following commutative diagram.

$$\begin{array}{ccc}
 A^\omega & \xrightarrow{f} & A^\omega \\
 \mu_2 \downarrow & & \downarrow \mu_2 \\
 [-1, 1] & \xrightarrow{Id} & [-1, 1] \\
 x & \longrightarrow & x
 \end{array}$$

We have :

$$f((10)^\omega) = 1\bar{1}(10)^\omega, f^2((10)^\omega) = (1\bar{1})^2(10)^\omega, \dots, f^n((10)^\omega) = (1\bar{1})^n(10)^\omega, \dots$$

The point $(10)^\omega$ is not periodic for f and $\mu_2((10)^\omega) = \frac{1}{2}$ is evidently a fixed point of Id .

We have the same conclusion for all words of the form $u(10)^\omega$ or $u(\bar{1}0)^\omega$ with $u \in A^*$. Then we obtain a set of non periodic point of f , dense in A^ω such that all images by μ_2 are periodic.

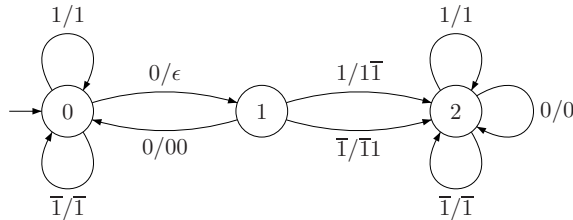

FIG. 3.3 –

This difference between periodic point of f and periodic point of F can be explain by the multiplicity of the representations of some real numbers in base θ . To twist this problem, one can normalize the function f . We compose f with a normalization

function S . Indeed, C. Frougny proved that $E = \{(\alpha, \beta) \in A^\omega \times A^\omega \mid \mu_\theta(\alpha) = \mu_\theta(\beta)\}$ is definable in $S1S$ [12], furthermore see [7]. And we know how to construct a ω -rational function, definable in $S1S$, S which realize this normalization. For all word α , $S(\alpha)$ is maximum lexicographic of $\{\beta \in A^\omega \mid \mu_\theta(\alpha) = \mu_\theta(\beta)\}$. The case of the base 2 is presented in the following example :

Example 23. In figure 3.4 we give the representation of a function $S : 2^\omega \rightarrow 2^\omega$ defined by $S(\alpha) = \alpha$ if α has infinite number of 0, $S(1^\omega) = 1^\omega$ and $S(u01^\omega) = u10^\omega$ for all $u \in 2^*$. We obtain the following commutative diagram :

$$\begin{array}{ccc} 2^\omega & \xrightarrow{S} & 2^\omega \\ \mu_2 \downarrow & & \downarrow \mu_2 \\ [0,1] & \xrightarrow{Id} & [0,1] \\ x & \longrightarrow & x \end{array}$$

It is easy to see that $S(\alpha)$ is the maximum lexicographic de la représentation binaire de $\mu_2(\alpha)$ for all $\alpha \in 2^\omega$. S est appelée la normalisation en base 2.

By composition of the function f of the example 21 with S then we have :

$$\begin{array}{ccc} 2^\omega & \xrightarrow{S \circ f} & 2^\omega \\ \mu_2 \downarrow & & \downarrow \mu_2 \\ [0,1] & \xrightarrow{F} & [0,1] \\ x & \longrightarrow & 1 - x \end{array}$$

$S \circ$:

$$f(01^\omega) = 10^\omega, f^2(01^\omega) = 01^\omega, f^2(01^\omega) = 10^\omega, \dots$$

$$S \circ f(01^\omega) = 10^\omega, (S \circ f)^2(01^\omega) = 10^\omega, (S \circ f)^3(01^\omega) = 10^\omega, \dots$$

The point 01^ω is eventually periodic for $S \circ f$ with 1. We find again the same period as the period of $\frac{1}{2} = \mu_2(01^\omega)$ for F .

There is no problem to generalize the result of this example. Then, if $x = \mu_\theta(\alpha)$ is a periodic point of F with period n , α is a periodic or eventually periodic point of $S \circ f$ with period n .

Every period of F can be find with $S \circ f$. We deduce the following result :

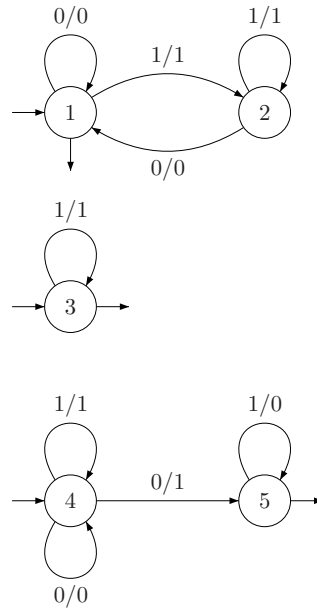

FIG. 3.4 – Normalization in base 2

Proposition 3.8. Let $F : \left[\frac{-k}{\theta-1}, \frac{k}{\theta-1}\right] \rightarrow \left[\frac{-k}{\theta-1}, \frac{k}{\theta-1}\right]$ be a function so that there exists a function $f : A^\omega \rightarrow A^\omega$ which verify:

1. The graph of f is definable in S1S.
2. $\forall \alpha \in A^\omega : \mu_\theta(f(\alpha)) = F(\mu_\theta(\alpha))$.

For all n in \mathbb{N}^* one can decide if F has periodic point with period n .

Indeed, write the existence of an orbite with cardinality n for F is a closed formula of S1S which is décidable.

Then one can decide if a such function F has a periodic point with period 3. Using the Sarkovski theorem one can decide if F has orbits with any cardinality $n \in \mathbb{N}^*$.

We also know that period 3 implies chaos [13].

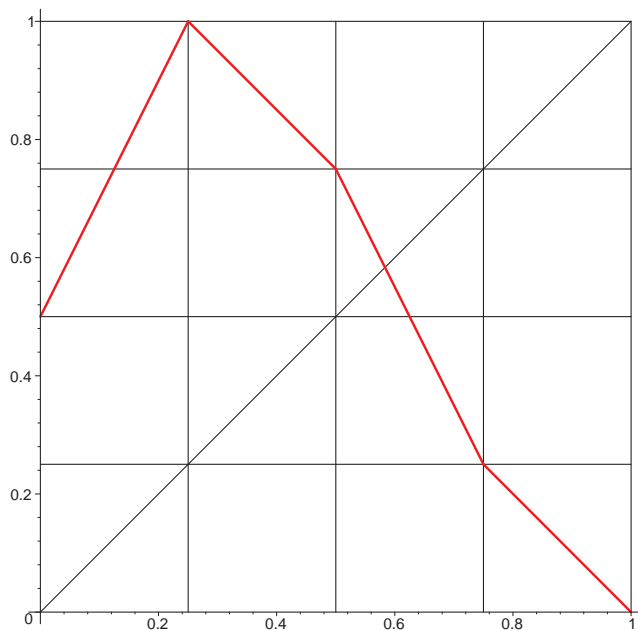

FIG. 3.5 – Example of function defined on $[0,1]$ with a 5-periodic point and none 3-periodic point

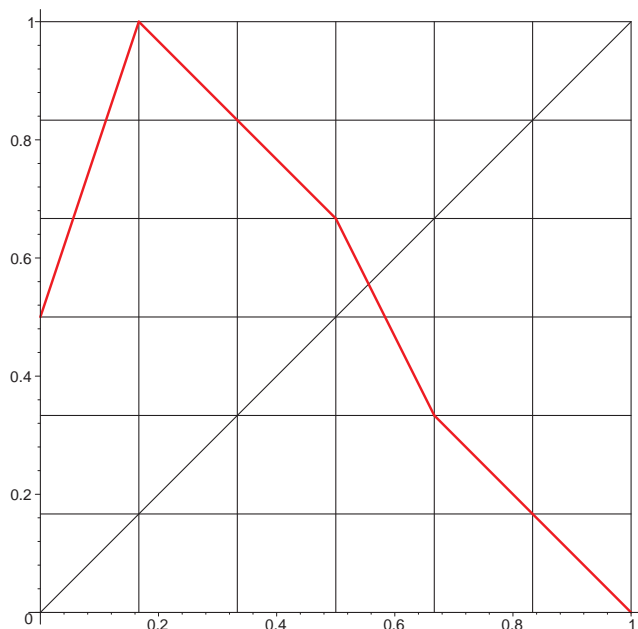

FIG. 3.6 – Example of function defined on $[0,1]$ with a 7-periodic point and none 5-periodic point

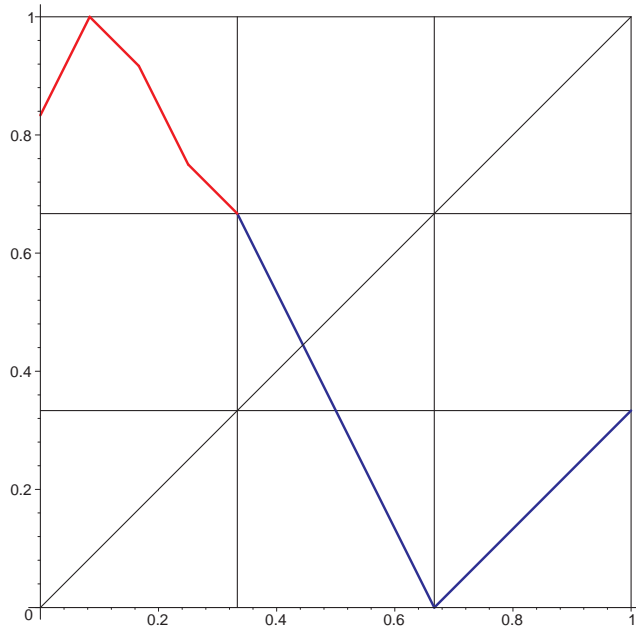

FIG. 3.7 – *Example of function defined on $[0,1]$ with a 10-periodic point and none 6-periodic point*

The Sarkovski order induce a strict hierarchy on continuous functions on \mathbb{R} , for all n there exists a continuous function $F : \mathbb{R} \rightarrow \mathbb{R}$ with a n -periodic point and none m -periodic point for all $m \triangleright n$. In [8] R. Devaney give some examples of such functions and an algorithm to construct it. This functions defined on $[0,1]$ are piecewise affine with rational slopes on intervals with rational extremities. We present some cases in figures 3.5, 3.6, 3.7.

As multiplication by integers in integer base is definable in $S1S$ (right subsequential) [12], we must note that all this functions can also be represented by functions definable in $S1S$ with a commutative diagram.

Bibliographie

- [1] K.T. Alligood, T.D. Sauer, J.A. Yorke *Chaos an introduction to dynamical systems*. Springer. 1996.
- [2] Y M. Barzdin, B.A. Trakhtenbrot. *Finite Automata, Behaviour and Synthesis*. North Holland, Amsterdam. 1973.
- [3] M.P. Beal, O. Carton, C.Prieur, J.Sakarovitch. *Squaring Transducers: an efficient procedure for deciding fonctionnality and sequentiality*. Theoretical Computer Science, Vol. 292, No. 1 . 2003. 45-63.
- [4] J.R. Büchi. *On a decision method in restricted second order arithmetic*. Methodology and Philosophy of Science. 1962. 1-11.
- [5] B. Cagnard, P Simonnet. *Automata Borel functions and real numbers in Pisot basis* . 6th CONFERENCE ON REAL NUMBERS AND COMPUTERS (RNC6). 2004.
- [6] C. Choffrut. *Une caractérisation des Fonctions Séquentielles et des fonctions sous séquentielles en tant que Relations Rationnelles*. Theoretical Computer Science, Volume 5 (1977), 325-338. 1999. 171-182.
- [7] C. Choffrut, H. Pelibossian and P. Simonnet. *Decision issues on functions realized by finite automata*. Journal of Automata, Languages and Combinatorics 4(3). 1999. 171-182.
- [8] R. Devaney. *An Introduction to Chaotic Dynamical Systems*. Perseus Books. 1989.
- [9] S. Eilenberg. *Automata, Languages and Machines Vol A*. Academic Press, New York London. 1974.
- [10] C.C. Elgot and J.E. Mezei. *on relations defined by generalised automata..* IBM J. Res. Develop. 9. 1965. 47-68.
- [11] C. Frougny, J . Sakarovitch. *Synchronized relations of finite and infinite words*. Theoretic. comput. sci. 1993. 45-82.
- [12] C. Frougny. *Numeration Systems*. Chapter 7 of M. Lothaire, Algebraic Combinatorics on Words. Cambridge University Press. 2002.

- [13] T.Y. Li, J.A. Yorke. *Period three implies chaos*. American Mathematical Monthly 82: 1975. 985-992.
- [14] J.M. Muller. *Arithmétique des ordinateurs*. Masson. Paris. 1989.
- [15] E. Ott. *Chaos in dynamical systems*. Cambridge University Press. 1994.
- [16] D. Perrin J.E. Pin. *Infinite words*. Academic Press. 2004.
- [17] J. Sakarovitch *Eléments de théorie des automates*. Vuibert informatique. 2003.

Résumé

L'objet de cette thèse est l'étude de la complexité topologique de fonctions omega-rationnelles : fonctions de mots infinis dont le graphe est reconnaissable par automate fini. Le cadre de notre étude est celui de la hiérarchie des boréliens et des classes de Baire. On remarque tout d'abord que ces fonctions sont au plus de classe 2. Christophe Prieur a montré que le problème de la continuité est décidable. Nous avons montré qu'être de classe 1 est aussi décidable dans le cas synchrone en adaptant un résultat de Sierpinski portant sur les sur et sous-graphes à notre contexte.

Notre attention s'est ensuite portée aux points de continuité de telles fonctions. Un résultat de Baire dit qu'une fonction n'est pas de classe 1 si et seulement si il existe un fermé non vide sur lequel la fonction n'admet aucun point de continuité. Nous prouvons une version automate de ce théorème : Une fonction omega-rationnelle n'est pas de classe 1 si et seulement si il existe un fermé non vide reconnaissable par un automate de Büchi tel que la restriction de la fonction à ce fermé n'ait aucun point de continuité. Ce résultat est prouvé en utilisant la dérivation de Hausdorff qui s'arrête au bout d'un nombre fini d'étapes sur les langages omega-rationnels

Ce travail s'est conclu par l'étude des orbites des fonctions réelles définissables en base Pisot par des transducteurs synchrones. L'ordre de Sarkovski permet de classifier les ordres des orbites périodiques des fonction réelles continues. Le résultat principal obtenu est la décidabilité pour tout entier n de l'existence d'orbites périodiques de cardinalité n et par suite de toute cardinalité inférieure dans l'ordre de Sarkovski.

Mots-Clefs : Automates, relations omega-rationnelles, ensembles boréliens, ensembles analytiques, fonctions boréliennes, théorème de Baire, théorème de Sarkovski, nombres de Pisot.

Abstract

This work is about the topological complexity of omega rational functions : functions of infinite words which graph is recognizable by finite automaton. The natural environment of our study is the borelian hierarchy and the Baire classes. First note that omega rational functions are Baire class 2. Christophe Prieur shows that continuity is decidable. We prove that being Baire class 1 is decidable in the synchronous case. For this we use and adapt a result of Sierpinski about over and under graph.

Then we study the set of continuity points of such functions. A result of Baire claim that a function is not Baire class one if and only if there exists a non empty closed set such that the restriction of the function on this set has no continuity point. We prove an automaton version of this result : an omega function is not Baire class one if and only if one can find a non empty closed set recognizable by Büchi automaton such that the restriction of the function on this set has no continuity point. For this we use the Hausdorff's derivation which stops in finite time on omega rational languages.

This work is closed by the study of orbits of real functions definable in Pisot base by synchronous transducers. Using the Sarkovski's order, one can classify the order of periodic orbits of continuous functions. The principal result is to be decidable for all integer n to have periodic orbits of cardinality equal to n and then any less cardinality in the Sarkovski's order.

Key words : Automata, omega-rational functions, borel set, analytic sets, borel functions, Baire's theorem, Sarkovski's theorem, Pisot numbers.