



HAL
open science

Quelques problèmes de contrôle d'équations aux dérivées partielles : inégalités spectrales, systèmes couplés et limites singulières

Matthieu Léautaud

► To cite this version:

Matthieu Léautaud. Quelques problèmes de contrôle d'équations aux dérivées partielles : inégalités spectrales, systèmes couplés et limites singulières. Mathématiques [math]. Université Pierre et Marie Curie - Paris VI, 2011. Français. NNT : . tel-00607240

HAL Id: tel-00607240

<https://theses.hal.science/tel-00607240>

Submitted on 8 Jul 2011

HAL is a multi-disciplinary open access archive for the deposit and dissemination of scientific research documents, whether they are published or not. The documents may come from teaching and research institutions in France or abroad, or from public or private research centers.

L'archive ouverte pluridisciplinaire **HAL**, est destinée au dépôt et à la diffusion de documents scientifiques de niveau recherche, publiés ou non, émanant des établissements d'enseignement et de recherche français ou étrangers, des laboratoires publics ou privés.

Quelques problèmes de contrôle d'équations aux dérivées partielles : inégalités spectrales, systèmes couplés et limites singulières

THÈSE DE DOCTORAT

présentée et soutenue publiquement le 22/06/2011

pour l'obtention du

Doctorat de l'université Pierre et Marie Curie – Paris 6

Spécialité Mathématiques Appliquées

par

Mathieu LÉAUTAUD

Composition du jury

Rapporteurs : Enrique FERNÁNDEZ-CARA
Gilles LEBEAU

Examineurs : Nicolas BURQ
Jean-Michel CORON
Olivier GLASS
Jérôme LE ROUSSEAU
Marius TUCSNAK

Directeur de thèse

Directeur de thèse



Remerciements

Mes tout premiers remerciements vont à mes deux directeurs de thèse, Olivier et Jérôme. Je leur suis infiniment reconnaissant de m'avoir fait confiance dès le début de la thèse, de m'avoir soumis des sujets passionnants, et de m'avoir encouragé tout au long de cette aventure. La qualité ainsi que la complémentarité de leur encadrement ont fait de ce travail un véritable apprentissage par la recherche. Merci pour votre disponibilité, votre patience et votre indulgence face à mes questions parfois idiotes, mes hésitations et mes doutes (parfois) existentiels.

Merci Olivier pour ton sens de humour et ta culture si vaste qu'elle réalise le grand écart entre James Joyce et le PSG ! Merci Jérôme pour ta gentillesse, ta rigueur et tes cheveux longs qui m'ont tout de suite mis en confiance (sans pour autant que ceux d'Olivier m'aient effrayé). Vous êtes pour moi deux exemples d'enseignants et de chercheurs passionnés et passionnants, et je mesure un peu plus chaque jour la chance que j'ai d'être votre élève. Merci pour tout.

Je remercie très chaleureusement Enrique Fernández-Cara et Gilles Lebeau d'avoir accepté de rapporter cette thèse. Leurs travaux respectifs m'ont beaucoup influencé, et c'est pour moi une grande joie de savoir qu'ils s'intéressent à ce que j'ai pu faire. En particulier merci à Gilles Lebeau pour m'avoir permis de corriger une subtile erreur et à Enrique Fernández-Cara pour faire pour ma soutenance une étape parisienne, à mi-parcours entre Séville et Bilbao.

C'est un honneur pour moi, et je suis très heureux que Jean-Michel Coron, Nicolas Burq et Marius Tucsnak aient accepté de faire partie de mon jury. Je tiens aussi à les remercier pour les discussions scientifiques que nous avons eues.

Durant cette thèse, j'ai eu l'occasion et le plaisir de travailler avec Fatiha Alabau-Boussouira, Belhassen Dehman et Luc Robbiano. J'ai énormément appris à leurs côtés, ce grimoire leur doit beaucoup et je leur en suis profondément reconnaissant. Merci aussi à Belhassen pour (la révolution et) l'invitation à Tunis.

Un grand merci aux laboratoires dans lesquels j'ai passé le plus clair de ces trois années : le LJLL, le laboratoire POEMS de l'ENSTA, ainsi que l'IHP. Merci aussi à tous leurs membres et employés pour l'ambiance de travail chaleureuse qui règne dans ces lieux. Les ANR CoNum et CISIFS ainsi que le GDRE CONEDP et le projet Franco-Japonais (Unified studies on control theory and inverse problems) m'ont permis de visiter les mathématiciens et des mathématiciens à différents endroits de la planète et je tiens à en remercier leurs éminents porteurs et tous leurs membres.

Je profite de l'occasion pour remercier tous les professeurs depuis le lycée, qui m'ont donné le goût des maths (ou des sciences en général), et qui ont su me transmettre leur passion. En particulier Mme Marmonier et Mr Michel en prépa, Eliane Bécache, Anne-Sophie Bonnet-Ben Dhia, Laurent Bourgeois, Christophe Hazard et Frédéric Jean à l'ENSTA, ainsi qu'à Fabrice Béthuel et à tous les enseignants du Master ANEDP. Merci en particulier à Anne-Sophie et à Christophe de m'avoir présenté Jérôme ! Je suis aussi reconnaissant à Bernard Guy pour son initiation à la recherche et à Charles Stuart qui m'a mis un pied dans cet univers lors de mon stage de M1.

Je tiens à remercier les contrôleurs pour leur coup de poignon et leur accueil dans cette joyeuse communauté. Entre autres, pour toutes les discussions mathématiques que nous avons eues, merci à Farid (Sherif?) Ammar-Khodja, Assia Benabdallah (pour les invitations à Marseille), Franck Boyer, Manolo González-Burgos, Sergio Guerrero, Luc Miller, Arnaud Münch, Luz de Teresa, Emmanuel Trélat, Lionel Rosier, Takéo Takahashi, Khai N'Guyen et Fabio Ancona. Un grand merci à Hiroshi Isozaki et Masahiro Yamamoto pour leur chaleureux accueil à Tsukuba et à Tokyo.

Merci aussi aux jeunes contrôleurs (non pas que les précédents soient vieux) pour toutes les discussions (scientifiques ou pas) et autres parties de time's up. En particulier Julie Valein, Julien Lequeur, Karine Mauffrey, Romain Joly, Yannick Privat. Merci aussi à Marianne Chapouly pour une prépa-agrég accélérée et une bonne dose de bonne humeur, à Sylvain Ervedoza pour la moussaka géante, à Camille Laurent pour Pornichet (le petit cochon) et Strichartz (non, lui n'est pas un animal).

Il va de soi que ma gratitude s'adresse également à tous les thésards et postdocs du labo pour les pauses café, les GTT (et leurs petits gâteaux), les repas dans le bon restau de Chevaleret, puis

le (je n'ai pas trouvé l'adjectif adéquat) restau de Jussieu. Tout d'abord ceux du même cru 2011 : Sepideh, Alexis, Vincent, Ange, Pierre G. et Giacomo pour tous ces intenses moments de panique administrative partagés... Merci aux vieux des Bureau 3D18 à Chevaleret, Maya(la) et Rachida, ainsi qu'à ceux du 3D24, Evelyne, Jean-Marie, Mathieu, Alex, et ceux, beaucoup plus lointains du deuxième étage, Alexandra, Thomas, Nicolas, Etienne et Benjamin B. (qui était peut-être même au premier...). Merci aussi aux tout jeunes du 16-26-333 de Jussieu : Pierre L. (et son poney), Nastasia, Fawzia, ainsi qu'à Tina, Marie, Lima (pour les canapés), Malik, Jean-Paul, Khaled, Mamadou, Charles et Nicole (qui connaît tous les restaurants où manger avec les doigts). Je remercie Khashayar pour un support informatique sans faille. Un merci tout particulier aux thésards de l'ENSTA : à Jérémi, Lauris et Benjamin G., pour l'ambiance joviale et les discussions philosophiques ainsi qu'à Juliette et Julien.

Merci depuis toutes ces inoubliables années aux amis stéphanois pour les vacances, les folles aventures, les randos, les feux de bois et tous ces conseils grâce auxquels je garde les pieds sur terre. En particulier merci à Aurél et Pépette, aux nouveaux Calédoniens, à Mabé et Clément (on n'a qu'à faire deux équipes : ceux qui vont skier et "ceux" qui rédigent leur thèse), à Edmond... et aux autres.

Merci de tout coeur à mes parents et mes trois adorables petites soeurs, toujours présents à mes côtés. Merci pour vos encouragements et votre soutien (et parfois votre émerveillement dubitatif). Merci aussi Papi, pour ta foi en la science et ton nénuphar (qui double de surface chaque jour).

Mes derniers remerciements sont pour Claire, qui réussit l'exploit de me supporter au quotidien. Ta patience, ton dynamisme et ton sourire équilibrent ma vie. Merci pour tout.

A vous, qui êtes sur le point d'entamer une lecture (exhaustive et acharnée) de ce grimoire, merci (et bon courage).

Table des matières

1	Introduction	7
1.1	Préliminaires	7
1.1.1	Contrôle de systèmes linéaires autonomes : un cadre général	8
1.1.2	Quelques problèmes classiques	11
1.1.3	Problématique de ce mémoire	16
1.2	Autour de la méthode de Lebeau-Robbiano pour le contrôle des équations paraboliques	16
1.2.1	Inégalités spectrales pour les opérateurs elliptiques non-autoadjoints et applications	19
1.2.2	Analyse et contrôle d'un modèle d'interface diffusive	27
1.3	Contrôle de systèmes d'équations hyperboliques, et applications	35
1.3.1	Stabilisation indirecte de systèmes d'équations d'ondes localement couplées	39
1.3.2	Contrôle indirect de systèmes sous des conditions géométriques	42
1.3.3	Analyse microlocale de la contrôlabilité de systèmes de deux équations d'ondes sur une variété compacte	47
1.4	Contrôle uniforme de lois de conservation scalaires dans la limite de viscosité évanescence	52

I Autour de la méthode de Lebeau-Robbiano pour le contrôle des équations paraboliques **63**

2	Inégalités spectrales pour des opérateurs elliptiques non-autoadjoints	65
2.1	Introduction	65
2.1.1	Results in an abstract setting	65
2.1.2	Some applications	67
2.2	Spectral theory of perturbed selfadjoint operators	69
2.3	Spectral inequality for perturbed selfadjoint elliptic operators	72
2.4	From the spectral inequality to a parabolic control	75
2.4.1	Elliptic controllability on $\Pi_\alpha H$ with initial datum in $P_k H$	76
2.4.2	Parabolic controllability on $\Pi_\alpha H$ with initial datum in $P_k H$	77
2.4.3	Parabolic controllability on $\Pi_\alpha H$	80

2.4.4	Decay property for the semigroup and construction of the final control	82
2.5	Application to the controllability of parabolic coupled systems	84
2.6	Application to the controllability of a fractional order parabolic equation	88
2.7	Application to level sets of sums of root functions	90
2.8	Appendix	91
2.8.1	Properties of the Gevrey function $e \in G^\sigma$, $1 < \sigma < 2$	91
2.8.2	A Paley-Wiener-type theorem	94
3	Analyse et contrôle d'un modèle d'interface diffusive	95
3.1	Introduction	96
3.1.1	Setting	97
3.1.2	Statement of the main results	98
3.1.3	Some additional results and remarks	101
3.1.4	Notation : semi-classical operators and geometrical setting	103
3.2	Well-posedness and asymptotic behavior	106
3.2.1	Well-posedness	106
3.2.2	Asymptotic behavior of the solutions as $\delta \rightarrow 0$	108
3.3	Local setting in a neighborhood of the interface	111
3.3.1	Properties of the weight functions	112
3.3.2	A system formulation	113
3.3.3	Conjugation by the weight function	113
3.3.4	Phase-space regions	114
3.3.5	Root properties	116
3.3.6	Microlocalisation operators	117
3.4	Proof of the Carleman estimate in a neighborhood of the interface	118
3.4.1	Preliminary observations	119
3.4.2	Estimate in the region \mathcal{G}	120
3.4.3	Estimate in the region \mathcal{F}	125
3.4.4	Estimate in the region \mathcal{Z}	126
3.4.5	Estimate in the region \mathcal{E}	131
3.4.6	A semi-global Carleman estimate : proof of Theorem 3.2	134
3.5	Interpolation and spectral inequalities	136
3.5.1	Interpolation inequality	136
3.5.2	Spectral inequality	140
3.6	Derivation of the model	141
3.7	Facts on semi-classical operators	145
3.8	Proofs of some technical results	150

II Stabilisation et contrôle de systèmes d'équations hyperboliques, et applications 165

4	Stabilisation indirecte de systèmes d'équations d'ondes localement couplées	167
4.1	Introduction	167
4.1.1	Motivation and general context	167
4.1.2	Results for two coupled wave equations	170
4.2	Abstract formulation and main results	174
4.2.1	Abstract setting and well-posedness	174
4.2.2	Main results	175
4.3	Proof of the main results, Theorems 4.9 and 4.12	178
4.3.1	The stability lemma	178
4.3.2	Proof of Theorem 4.9, the case B bounded	178
4.3.3	Proof of Theorem 4.12, the case B unbounded	182
4.4	Applications	185
4.4.1	Internal stabilization of locally coupled wave equations	185
4.4.2	Boundary stabilization of locally coupled wave equations	188
4.4.3	Internal stabilization of locally coupled plate equations	191
5	Contrôle indirect de systèmes sous des conditions géométriques	199
5.1	Introduction	199
5.1.1	Motivation	199
5.1.2	Main results	201
5.2	Abstract setting	205
5.2.1	Main results : admissibility, observability and controllability	206
5.2.2	Some remarks	208
5.3	Two energy levels and two key lemmata	209
5.3.1	Two energy levels	209
5.3.2	Two key lemmata	211
5.4	Proof of Theorem 5.10	214
5.4.1	The coupling Lemma	214
5.4.2	A first series of estimates	216
5.4.3	A second series of estimates	218
5.4.4	End of the proof of Theorem 5.10	221
5.5	From observability to controllability	222
5.5.1	First case : $\mathcal{B}^*(v_1, v'_1) = B^*v'_1$ with $B^* \in \mathcal{L}(H, Y)$	223
5.5.2	Second case : $\mathcal{B}^*(v_1, v'_1) = B^*v_1$ with $B^* \in \mathcal{L}(H_2, Y)$	225
5.6	Applications	226
5.6.1	Control of wave systems : Proof of Theorem 5.3	226
5.6.2	Control of diffusive systems	227
5.6.3	Control of Schrödinger systems	227

5.7	Observability for a wave equation with a right hand-side	227
6	Contrôlabilité de systèmes de deux équations d'ondes sur une variété compacte	231
6.1	Introduction and main result	231
6.2	Preliminary remarks, definitions and notation	233
6.2.1	Measures, symbols and operators	233
6.2.2	Some geometric facts	234
6.2.3	Well-posedness of System (6.4)	235
6.3	Observability for $T > T_{\omega \rightarrow \mathcal{O} \rightarrow \omega}$	236
6.3.1	Proof of a relaxed observability inequality	236
6.3.2	End of the proof of Theorem 6.5	241
6.4	Lack of observability for $T < T_{\omega \rightarrow \mathcal{O} \rightarrow \omega}$	243
6.5	Une remarque sur l'obstruction au prolongement unique pour les systèmes elliptiques	249
III	Contrôle uniforme d'un problème non-linéaire en limite singulière	253
7	Contrôlabilité uniforme de lois de conservation en limite de viscosité évanescente	255
7.1	Introduction	255
7.1.1	Motivation and main results	255
7.1.2	Some remarks	259
7.1.3	Structure of the paper, idea of the proofs	260
7.2	Three intermediate propositions	261
7.2.1	Approximate controllability using a traveling wave	261
7.2.2	Approximate controllability using a rarefaction wave	267
7.2.3	Local exact controllability	272
7.3	Proofs of the three theorems	279
7.3.1	Proof of Theorems 7.1 and 7.2, the convex case	280
7.3.2	Proof of Theorem 7.3, the non-convex case	280
7.4	Appendix : parabolic regularity estimates	283
7.4.1	Parabolic regularity estimates for classical solutions	283
7.4.2	Well-posedness of an initial-boundary value problem with low regularity	283
	Bibliographie	287
	Résumé/Abstract	295

Chapitre 1

Introduction

1.1 Préliminaires

Une des préoccupations centrales en théorie du contrôle est la question de “contrôlabilité” suivante : est-il possible d’amener un système d’évolution (par exemple d’origine physique, chimique ou biologique) depuis son état initial en un état fixé au préalable. Si c’est le cas, peut-on trouver un contrôle “meilleur” que les autres : moins cher, plus stable...

Plus précisément, on se donne un système dynamique

$$\frac{d}{dt}u = F(u, g), \quad u \in \mathcal{H}, \quad (1.1)$$

où u est la variable d’état dans l’espace d’état \mathcal{H} , et t désigne le temps. La dynamique du système (1.1) dépend d’un “paramètre” g , appelé le contrôle, grâce auquel on peut agir sur l’évolution de l’état. La question générale que l’on se pose est la suivante : est-il possible pour un temps $T > 0$ et deux états du système u_0 et u_1 de trouver un contrôle $g = g(t)$ tel que la solution u de (1.1) issue de $u(0) = u_0$ satisfasse $u(T) = u_1$?

Les propriétés de contrôlabilité du système (1.1) peuvent être très diverses, selon la nature du problème étudié. On peut ainsi distinguer le contrôle des équations différentielles ordinaires (ou contrôle en dimension finie), le contrôle des équations aux dérivées partielles (ou contrôle en dimension infinie), le contrôle des équations linéaires, non-linéaires...

Lorsque l’espace des états \mathcal{H} est de dimension finie, le problème de contrôle est complètement résolu si F est linéaire autonome (grâce au critère de Kalman) et assez bien compris dans le cas d’un système affine en le contrôle $F(u, g) = f_0(u) + \sum g_i f_i(u)$ (grâce à l’étude de l’algèbre de Lie engendrée par les f_k).

Dans le cas où l’espace d’état \mathcal{H} est de dimension infinie, et en particulier lorsque le système (1.1) correspond à une équation aux dérivées partielles (EDP), il n’y a pas de tel résultat général. Chaque équation doit être étudiée au cas par cas. Les EDP et la diversité des phénomènes qu’elles modélisent ont, depuis les années 60, apporté de nouvelles problématiques en théorie du contrôle. Après avoir été formalisés mathématiquement, nombre de ces problèmes ont été résolus dans les années 80-90, introduisant dans la théorie du contrôle de nouvelles techniques et méthodes comme l’analyse microlocale, les inégalités de Carleman, la méthode du retour...

On renvoie le lecteur aux livres de J.-L. Lions [Lio88a], de J.-M. Coron [Cor07a], et de M. Tucsnak et G. Weiss [TW09], ainsi qu’aux articles de synthèse de D.L. Russell [Rus78] et de E. Zuazua [Zua07] pour des présentations plus détaillées, des références historiques et des problèmes actuels.

Une autre question à laquelle on s’intéressera dans cette thèse concerne les problèmes de contrôlabilité uniforme. Dans ce cadre on se donne une famille de systèmes dynamiques

$$\frac{d}{dt}u^\varepsilon = F(\varepsilon, u^\varepsilon, g^\varepsilon), \quad u^\varepsilon \in \mathcal{H}^\varepsilon, \quad g^\varepsilon \in \mathcal{Y}, \quad (1.2)$$

dépendant d'un paramètre $\varepsilon > 0$. On suppose aussi que, pour un certain temps $T > 0$ et deux états du système u_0, u_1 , admissibles pour tout $\varepsilon > 0$, il est possible de trouver un contrôle g^ε tel que la solution u^ε de (1.2) issue de $u^\varepsilon(0) = u_0$ satisfasse $u^\varepsilon(T) = u_1$. Pour chaque ε fixé, on sait donc résoudre le problème de contrôlabilité défini au paragraphe précédent. *A priori*, le coût du contrôle que l'on construit, donné par une certaine norme $\|g^\varepsilon\|$, dépend du paramètre ε . Le problème de contrôlabilité uniforme dans la limite $\varepsilon \rightarrow 0^+$ est de construire un contrôle g^ε uniformément borné, c'est-à-dire satisfaisant $\|g^\varepsilon\| \leq C$ pour une constante C indépendante de ε . En particulier, on obtient alors pour le système limite un contrôle robuste vis à vis de petites perturbations $\varepsilon > 0$. Introduit par J.-L. Lions [Lio88b, Chapter 3], ce problème de contrôle uniforme se pose par exemple naturellement lorsque l'on cherche à contrôler des approximations numériques d'une EDP. Dans ce cadre, ε représente la taille de la maille et les \mathcal{H}^ε , $\varepsilon > 0$, sont des espaces d'approximations. Pour ε fixé, les propriétés du système de dimension finie obtenu sont bien comprises. Cependant, on aimerait avoir des estimées uniformes pour le contrôle, de façon à ce que le contrôle construit converge (en un certain sens) vers un contrôle pour l'EDP limite. On pourra consulter [Zua05] par exemple en ce qui concerne les approximations numériques de l'équation des ondes.

Dans certains problèmes que nous considérerons, la limite $\varepsilon \rightarrow 0^+$ correspondra à une limite singulière (de viscosité évanescence par exemple).

Dans ce mémoire, nous nous intéressons plus particulièrement à la méthode de G. Lebeau et L. Robbiano pour la contrôlabilité des équations paraboliques, à la contrôlabilité de systèmes de deux équations d'ondes ou de la chaleur couplées, ainsi qu'à la contrôlabilité uniforme des lois de conservations scalaires en limite de viscosité évanescence.

Nous rappelons pour commencer quelques définitions et résultats centraux en théorie du contrôle des équations linéaires, ainsi que certains exemples fondamentaux sur lesquels est fondée cette thèse.

1.1.1 Contrôle de systèmes linéaires autonomes : un cadre général

Nous présentons ici certains concepts et outils classiques dans l'analyse de la contrôlabilité des problèmes linéaires, qui concernent la plus grande partie de cette thèse. Cependant, l'étude des problèmes non-linéaires nécessite elle aussi une bonne compréhension de l'équation linéaire associée (voir par exemple le livre de J.-M. Coron [Cor07a]).

Le système (1.1) est ici supposé linéaire par rapport au couple (u, g) , et peut donc se réécrire sous la forme

$$\begin{cases} \frac{d}{dt}u = \mathcal{A}u + Bg \\ u(0) = u_0 \in \mathcal{H}. \end{cases} \quad (1.3)$$

On supposera ici que l'espace d'état \mathcal{H} est un espace de Hilbert, que \mathcal{A} est un opérateur, en général non borné sur \mathcal{H} , de domaine $\mathcal{D}(\mathcal{A}) \subset \mathcal{H}$. On notera \mathcal{Y} l'espace des contrôles, où g prend ses valeurs. Pour simplifier la présentation, on supposera ici que $B \in \mathcal{L}(\mathcal{Y}, \mathcal{H})$. Ceci nous évite d'introduire la notion d'opérateur de contrôle admissible, pour laquelle nous renvoyons à [TW09]¹. On remarque que notre action sur l'état du système est restreinte par l'opérateur de contrôle B . En effet, ce dernier réduit les possibilités pour le second membre d'agir sur l'état. Différents exemples sont donnés au Paragraphe 1.1.2.

De nombreux problèmes physiques entrent dans ce cadre abstrait de (1.3). Citons en particulier des systèmes oscillants (de type onde) et des systèmes dissipatifs (de type chaleur), pour lesquels nous rappelons les principaux résultats ci-dessous.

Dans la suite, on supposera que le problème $\frac{d}{dt}u = \mathcal{A}u$ est bien posé (sans quoi la signification du problème de contrôle (1.3) est moins claire). Plus précisément, on supposera ici que l'opérateur \mathcal{A} engendre sur \mathcal{H} un semi-groupe fortement continu, que l'on notera $e^{t\mathcal{A}} \in \mathcal{C}^0(\mathbb{R}_+; \mathcal{L}(\mathcal{H}))$.

1. On notera cependant que, sous cette condition supplémentaire d'admissibilité sur l'opérateur B , l'essentiel de ce que nous présentons ici reste valable pour $B \in \mathcal{L}(\mathcal{Y}, \mathcal{D}(\mathcal{A})')$, où $\mathcal{D}(\mathcal{A})'$ désigne le dual de $\mathcal{D}(\mathcal{A})$.

Là encore, l'hypothèse $B \in \mathcal{L}(\mathcal{Y}, \mathcal{H})$ permet de définir la solution de (1.3) par la formule de Duhamel²

$$u(t) = e^{t\mathcal{A}}u_0 + \int_0^t e^{(t-s)\mathcal{A}}Bg(s)ds.$$

Nous mentionnons maintenant deux problématiques centrales en théorie du contrôle linéaire, que l'on retrouvera tout au long de cette thèse : la contrôlabilité et l'observabilité.

Contrôlabilité. On définit tout d'abord précisément ce que l'on entend par contrôlabilité d'un système linéaire.

Définition 1.1. On dira que le problème (1.3) est contrôlable à zéro en temps $T > 0$ s'il existe une constante $K_{C,T} > 0$ telle que pour toute donnée initiale $u_0 \in \mathcal{H}$, il existe un contrôle $g \in L^2(0, T; \mathcal{Y})$ satisfaisant

$$\|g\|_{L^2(0, T; \mathcal{Y})} \leq K_{C,T} \|u_0\|_{\mathcal{H}}, \quad (1.4)$$

tel que la solution de (1.3) associée à g satisfasse $u(T) = 0$.

L'hypothèse (1.4) signifie de plus que l'application qui à la donnée initiale associe le contrôle doit être bornée de \mathcal{H} dans $L^2(0, T; \mathcal{Y})$. Notons cependant que l'existence d'un contrôle à zéro pour toute donnée initiale, implique en fait l'existence d'une telle application continue (voir par exemple [Cor07a, Section 2.3.2]). La donnée de (1.4) dans la définition est donc d'une certaine façon redondante, mais elle nous permet de souligner cette continuité et d'introduire la constante $K_{C,T}$. Pour cette raison, on oubliera par la suite de mentionner la continuité de cette application. La meilleure constante $K_{C,T}$ vérifiant (1.4) pour toutes données initiales (c'est-à-dire la norme de ladite application) est appelée le coût du contrôle.

À première vue, il peut paraître restrictif de ne vouloir amener l'état du système qu'à zéro. La linéarité de l'équation donne en fait beaucoup mieux : la contrôlabilité à zéro et la contrôlabilité aux trajectoires sont équivalentes. Autrement dit, si on sait amener toute solution de (1.3) à 0 en temps T , on sait aussi l'amener à l'état final de toute trajectoire libre de l'équation sans second membre, c'est-à-dire à tout $e^{T\mathcal{A}}u_1$, $u_1 \in \mathcal{H}$. Dans le cas d'une équation réversible (par exemple si $e^{t\mathcal{A}}$ est un groupe), cette dernière est elle-même équivalente à la contrôlabilité exacte, c'est-à-dire, à la possibilité d'amener u_0 à toute cible $u_1 \in \mathcal{H}$. Pour certaines équations dissipatives, au contraire, l'effet régularisant rend vaine la volonté d'amener l'état u à un état quelconque de \mathcal{H} . La notion de contrôle aux trajectoires (et donc de contrôle à zéro) est là encore la notion pertinente.

Cependant, en général, la contrôlabilité d'un système est difficile à prouver, et on doit avoir recours à des critères, dont le principal est l'observabilité.

Observabilité. On appelle $B^* \in \mathcal{L}(\mathcal{H}, \mathcal{Y})$ l'adjoint de B , et on introduit ici le système d'observation suivant sur $(0, T)$,

$$\begin{cases} \frac{d}{dt}v = -\mathcal{A}^*v, & \text{sur } (0, T), \\ v(T) = v_T \in \mathcal{H}, \\ y(t) = B^*v(t), & \text{sur } (0, T). \end{cases} \quad (1.5)$$

Ici, \mathcal{A}^* est l'opérateur adjoint de \mathcal{A} dans \mathcal{H} et le problème est bien posé de façon rétrograde en temps. En effet, le générateur du semi-groupe adjoint $[e^{t\mathcal{A}}]^*$ est \mathcal{A}^* , et la solution de (1.5) peut s'écrire $v(t) = e^{(T-t)\mathcal{A}^*}v_T$, où, par définition, $e^{(T-t)\mathcal{A}^*} = [e^{(T-t)\mathcal{A}}]^*$.

Le problème d'observabilité est le suivant : est-il possible, en n'observant que la quantité $y(t)$, de connaître l'énergie du système (1.5) à l'instant final $t = 0$, c'est-à-dire $\|v(0)\|_{\mathcal{H}}^2$ (ce qui, sous une hypothèse d'unicité rétrograde faite ci-dessous, revient à connaître l'énergie du système pour tout temps) ? Plus précisément, on a la définition suivante.

2. Si cette hypothèse n'était par satisfaite, nous aurions recours à la notion de solution de transposition pour définir la solution de (1.3) sous une condition d'admissibilité.

Définition 1.2. On dit que le système (1.5) est observable en temps $T > 0$ s'il existe une constante $K_{O,T} > 0$ telle que pour tout $v_T \in \mathcal{H}$, la solution de (1.5) satisfasse

$$\|e^{T\mathcal{A}^*} v_T\|_{\mathcal{H}}^2 = \|v(0)\|_{\mathcal{H}}^2 \leq K_{O,T}^2 \int_0^T \|B^* v(t)\|_{\mathcal{Y}}^2 dt. \quad (1.6)$$

La constante $K_{O,T}$ est appelée constante d'observabilité. Cette notion d'observabilité a un intérêt propre car elle apparaît dans de nombreuses situations concrètes lorsque l'on souhaiterait connaître l'état d'un système sur lequel on ne peut faire que des mesures partielles. C'est le cas par exemple en météorologie, en imagerie ou, plus généralement dans le domaine des problèmes inverses.

Un autre intérêt de l'observabilité réside dans son lien avec la contrôlabilité. Pour l'établir, il nous faut faire l'hypothèse suivante d'unicité rétrograde (vérifiée par tous les systèmes linéaires que nous étudierons) : toute solution v de (1.5) qui satisfait $v(0) = 0$ est identiquement nulle. On a alors le résultat suivant, montré par S. Dolecki et D.L. Russell [DR77], et J.-L. Lions [Lio88a].

Théorème 1.3. *Le système (1.5) est observable en temps T avec pour constante d'observabilité $K_{O,T}$ si et seulement si le système (1.3) est contrôlable à zéro en temps T avec pour coût du contrôle $K_{C,T} = K_{O,T}$.*

En pratique, l'observabilité d'un système (une inégalité) est souvent plus pratique à montrer que la contrôlabilité (un résultat d'existence). La partie du Théorème 1.3 qui nous sera la plus utile consiste en l'implication "observabilité \implies contrôlabilité". Nous présentons maintenant brièvement la méthode HUM (Hilbert Uniqueness Method), formalisée précisément par J.-L. Lions [Lio88a], qui montre (entre autres) cette implication. Si on prend le produit scalaire de (1.3) avec la solution v de (1.5), on obtient en intégrant par parties

$$\int_0^T (g, B^* v)_{\mathcal{Y}} dt = (u_0, v(0))_{\mathcal{H}} - (u(T), v_T)_{\mathcal{H}}. \quad (1.7)$$

On considère alors la forme bilinéaire

$$a(v_T, w_T) := \int_0^T (B^* e^{(T-t)\mathcal{A}^*} v_T, B^* e^{(T-t)\mathcal{A}^*} w_T)_{\mathcal{Y}} dt,$$

qui, grâce à l'inégalité d'observabilité, à la propriété d'unicité rétrograde et au caractère borné³ de B^* engendre un produit scalaire sur \mathcal{H} , et une norme associée (plus faible que la norme naturelle). On appelle $\overline{\mathcal{H}}$ le complété de \mathcal{H} pour cette norme. On considère alors la forme linéaire

$$L_{u_0}(v_T) := (u_0, e^{T\mathcal{A}^*} v_T)_{\mathcal{H}} = (u_0, v(0))_{\mathcal{H}},$$

qui, grâce à l'inégalité d'observabilité satisfait $|L_{u_0}(v_T)| \leq K_{O,T} \|u_0\|_{\mathcal{H}} [a(v_T, v_T)]^{\frac{1}{2}}$. Elle peut donc être étendue de façon unique en une forme linéaire continue sur $\overline{\mathcal{H}}$. Le théorème de représentation de Riesz donne alors l'existence (et l'unicité) de $v_T^* \in \overline{\mathcal{H}}$ tel que

$$a(v_T^*, v_T) = L_{u_0}(v_T) \quad \text{pour tout } v_T \in \overline{\mathcal{H}}. \quad (1.8)$$

On appelle alors Θ l'unique application continue de $\overline{\mathcal{H}}$ sur $L^2(0, T; \mathcal{Y})$ qui coïncide avec $B^* e^{(T-t)\mathcal{A}^*}$ sur \mathcal{H} . On pose $g = \Theta(v_T^*)$, qui, d'après le théorème de Riesz, satisfait

$$\|g\|_{L^2(0, T; \mathcal{Y})} = [a(v_T^*, v_T^*)]^{\frac{1}{2}} \leq K_{O,T} \|u_0\|_{\mathcal{H}}.$$

On a alors obtenu : pour tout $u_0 \in \mathcal{H}$, il existe $g \in L^2(0, T; \mathcal{Y})$ tel que pour tout $v_T \in \overline{\mathcal{H}}$, on a

$$\int_0^T (g, B^* v)_{\mathcal{Y}} dt = (u_0, v(0))_{\mathcal{H}} \quad \text{et} \quad \|g\|_{L^2(0, T; \mathcal{Y})} \leq K_{O,T} \|u_0\|_{\mathcal{H}}.$$

3. remplacé par l'inégalité d'admissibilité si ce n'est pas le cas.

Au vu de (1.7), ceci implique $(u(T), v_T)_{\mathcal{H}} = 0$ pour tout v_T , de sorte que g réalise bien un contrôle à zéro pour (1.3). Enfin, on a montré l'estimation du coût du contrôle $K_{C,T} \leq K_{O,T}$.

Le contrôle $g = \Theta(v_T^*)$ ainsi construit est celui de norme $L^2(0, T; \mathcal{Y})$ minimale, et est donc d'un intérêt particulier : c'est celui qui "coûte le moins cher" (pour le critère $L^2(0, T; \mathcal{Y})$)!

Remarquons que dans le cas où $\overline{\mathcal{H}} = \mathcal{H}$ (par exemple si (1.5) est conservatif, ou si \mathcal{H} est de dimension finie), on a $g = \Theta(v_T^*) = B^* e^{(T-t)\mathcal{A}^*} v_T^*$. Dans ce cas là, l'identité (1.8) et la définition de la forme bilinéaire $a(\cdot, \cdot)$ donnent

$$\mathcal{G}_T v_T^* = e^{T\mathcal{A}} u_0, \quad \text{avec} \quad \mathcal{G}_T = \int_0^T e^{(T-t)\mathcal{A}} B B^* e^{(T-t)\mathcal{A}^*} dt \in \mathcal{L}(\mathcal{H}).$$

L'application \mathcal{G}_T est appelée le gramien du problème de contrôle. Dans ce cas, la méthode HUM associe donc à une donnée initiale u_0 , la "bonne" donnée v_T^* du problème adjoint dont la solution de (1.5) associée $v(t)$ nous fournit un contrôle! L'inversibilité du gramien est assurée par l'inégalité d'observabilité (1.6) et nous donne l'expression de cette application HUM : $v_T^* = \mathcal{G}_T^{-1} e^{T\mathcal{A}} u_0$. Finalement, dans ce cas, le contrôle s'exprime donc "explicitement" en fonction de la donnée initiale :

$$g(t) = B^* e^{(T-t)\mathcal{A}^*} \mathcal{G}_T^{-1} e^{T\mathcal{A}} u_0.$$

Enfin, ce contrôle, donné par HUM, minimise le coût $K_{C,T}$. On appelle donc coût minimal le coût de ce meilleur contrôle, que l'on peut aussi écrire

$$K_T^{HUM} = \|B^* e^{(T-t)\mathcal{A}^*} \mathcal{G}_T^{-1} e^{T\mathcal{A}}\|_{\mathcal{L}(\mathcal{H}, L^2(0, T; \mathcal{Y}))}.$$

1.1.2 Quelques problèmes classiques

Mentionnons maintenant quelques résultats classiques en théorie du contrôle des équations linéaires. Nous commençons par le théorème de Kalman qui répond aux questions de contrôlabilité et d'observabilité pour les systèmes autonomes de dimension finie, et le contrôle d'une équation de transport linéaire en une dimension d'espace. Ensuite, nous donnons des résultats fondamentaux, plus récents sur deux équations de base de la physique : l'équation des ondes et l'équation de la chaleur. Enfin, nous présentons un résultat de contrôle uniforme pour un équation de chaleur/transport dans la limite de viscosité évanescence. On notera en particulier que les résultats de contrôle sont intimement liés au "mode de propagation de l'information" de chaque équation.

La liste n'est bien entendu pas exhaustive, mais vise uniquement à présenter les principaux résultats de référence qui nous serviront de guide et de point de départ tout au long de ce mémoire.

Systèmes de dimension finie. On s'intéresse ici au cas où tous les espaces considérés sont de dimension finie, c'est-à-dire $\mathcal{H} = \mathbb{R}^N$, et $\mathcal{Y} = \mathbb{R}^M$ pour deux entiers N et M . Dans ce cadre, $\mathcal{A} \in \mathcal{L}(\mathbb{R}^N)$ est une matrice carrée $N \times N$ et $B \in \mathcal{L}(\mathbb{R}^M, \mathbb{R}^N)$ est une matrice $N \times M$. Le problème intéressant est le cas où $M < N$: on veut contrôler N variables d'états en n'agissant sur le système qu'au moyen d'un nombre réduit M de contrôles. Pour ce type de systèmes, on a le critère algébrique suivant.

Théorème 1.4 (Critère de Kalman). *Le système de dimension finie (1.3) est contrôlable en temps $T > 0$ si et seulement si la matrice*

$$[B, AB, \mathcal{A}^2 B, \dots, \mathcal{A}^{N-1} B] \in \mathcal{L}(\mathbb{R}^{NM}, \mathbb{R}^N), \quad (1.9)$$

dont les colonnes sont constituées des colonnes de $B, \dots, \mathcal{A}^{N-1} B$, est de rang N .

Attribué à R.E. Kalman, ce critère extrêmement simple et utile en pratique apparaissait déjà dans un article de J. LaSalle. Nous renvoyons au livre de J.-M. Coron [Cor07a, Remark 1.17] pour l'historique de cette condition.

La méthode de dualité rappelée ci-dessus permet de donner un critère algébrique similaire pour l'observabilité du système adjoint (1.5). Notons que dans ce cadre, observabilité et contrôlabilité sont aussi équivalents à l'inversibilité de la matrice \mathcal{G}_T

Remarquons également que le critère algébrique du Théorème 1.4 ne dépend pas du temps. S'il est contrôlable, un système de dimension finie l'est pour tout temps $T > 0$, ce qui contraste avec certains problèmes d'EDP (voir ci-après). Cependant, il semble clair que le coût du contrôle va être une fonction décroissante du temps, qui explose lorsque $T \rightarrow 0^+$. Une question intéressante, résolue par T. Seidman en 1988 concerne la vitesse d'explosion du coût du contrôle des systèmes linéaires autonomes, lorsque le temps tend vers zéro.

Théorème 1.5 (Seidman [Sei88]). *Il existe une constante $\kappa > 0$ telle que*

$$K_T^{HUM} \sim_{T \rightarrow 0^+} \frac{\kappa}{T^{k+\frac{1}{2}}}$$

où k est le plus petit entier tel que le rang de $[B, AB, A^2B, \dots, A^k B]$ soit N .

L'explosion du coût est donc polynomiale lorsque le temps tend vers zéro. On verra que ce n'est pas le cas pour des EDP contrôlables en tout temps. L'exemple le plus simple de système différentiel linéaire, que l'on retrouvera au Paragraphe 1.3 (et, dans une moindre mesure au Paragraphe 1.2.1) est le suivant :

$$\frac{d}{dt} \begin{pmatrix} u_1 \\ u_2 \end{pmatrix} = \begin{pmatrix} a & c \\ b & d \end{pmatrix} \begin{pmatrix} u_1 \\ u_2 \end{pmatrix} + \begin{pmatrix} 1 \\ 0 \end{pmatrix} g, \quad (1.10)$$

où $u_1, u_2, [0, T] \rightarrow \mathbb{R}$ et a, b, c, d sont des constantes réelles. Dans ce cas, on se demande sous quelles conditions deux équations couplées peuvent être contrôlées au moyen d'un seul contrôle. Le Théorème 1.4 nous donne la réponse suivante : le système (1.10) est contrôlable si et seulement si le rang de la matrice

$$\begin{pmatrix} 1 & a \\ 0 & b \end{pmatrix},$$

est 2, autrement dit, si et seulement si $b \neq 0$. On comprend en effet qu'alors, g contrôle l'état u_1 , et le terme bu_1 agit comme un contrôle sur l'équation en u_2 . Enfin le Théorème 1.5 nous donne la vitesse d'explosion du coût du contrôle en temps courts : $K_T^{HUM} \sim_{T \rightarrow 0^+} \kappa T^{-\frac{3}{2}}$.

Une équation de transport. Etudions maintenant une EDP simple : l'équation de transport unidimensionnelle à vitesse constante $M > 0$, contrôlée par le bord de gauche :

$$\begin{cases} u_t + Mu_x = 0 & (t, x) \in (0, T) \times (0, L), \\ u|_{x=0} = g(t) & (t, x) \in (0, T) \times \{0\}, \\ u|_{t=0} = u_0 & \in L^2(0, L). \end{cases} \quad (1.11)$$

On remarque tout d'abord que ce problème est bien posé car la vitesse est positive et on fixe la condition sur le bord de gauche (en $x = 0$) par lequel les données "entrent". La méthode HUM telle qu'elle est décrite ci-dessus ne s'applique pas tout à fait à ce système, car l'opérateur B de contrôle par le bord n'est pas borné⁴. Mais, dans cette situation très simple, la solution est explicite, et nous n'utiliserons pas la méthode HUM. La solution de (1.11) est donnée par la méthode des caractéristiques (voir la Figure 1.1) :

$$\begin{cases} u(t, x) = u_0(x - Mt) & \text{si } x > Mt \\ u(t, x) = g(t - \frac{x}{M}) & \text{si } x < Mt \end{cases} \quad (1.12)$$

On obtient alors le résultat de contrôlabilité suivant.

Théorème 1.6. *Le système (1.11) est contrôlable à zéro dans $L^2(0, L)$ en temps T si et seulement si $T \geq \frac{L}{M}$.*

4. Cependant, cet opérateur est admissible au sens de [TW09, Section 4.2].

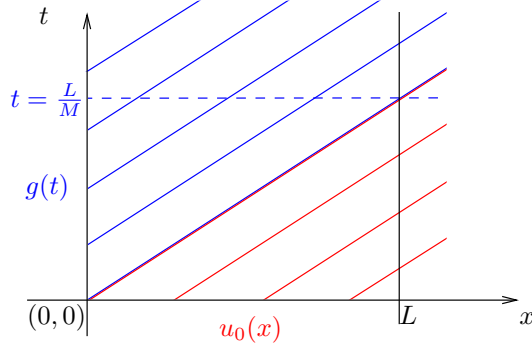

FIGURE 1.1 – Caractéristiques de l'équation de transport à vitesse M .
En rouge, la zone d'influence de la donnée initiale u_0 ; en bleu, celle du contrôle g .

On voit que la contrôlabilité du système (1.12) dépend du temps T . Ici, l'information se propage de gauche à droite à vitesse constante M . Pour $T < \frac{L}{M}$, l'information donnée par le contrôle au temps zéro n'a pas eu le temps d'atteindre la droite de l'intervalle. Pour $T \geq \frac{L}{M}$ au contraire, cette information a parcouru tout l'intervalle et le système est contrôlable.

Dans cet exemple, très particulier, on remarque que l'on fixe le contrôle en fonction de la cible uniquement, et indépendamment de la donnée initiale u_0 . Le même contrôle fonctionnera donc pour toutes les données initiales. Par exemple, le contrôle $g = 0$ amène toute condition initiale à zéro en temps $T = \frac{L}{M}$, pour un coût nul. Nous renvoyons à [Cor07a, Section 2.1] pour plus de détail sur cet exemple.

Rappelons maintenant deux résultats, démontrés dans les années 80-90, qui concernent les EDP linéaires les plus classiques : l'équation des ondes et l'équation de la chaleur. On appellera Ω un ouvert connexe borné régulier de \mathbb{R}^n (ou éventuellement une variété riemannienne connexe compacte avec ou sans bord, de dimension n) et ω un ouvert non vide inclus dans Ω . On notera $\mathbb{1}_\omega$ la fonction caractéristique de ω . Pour ces deux exemples, nous n'énoncerons qu'un résultat de contrôle interne (entrant exactement dans le cadre de la méthode HUM telle qu'elle est décrite ci-dessus). Cependant, un résultat analogue de contrôle par le bord existe (avec une subtilité liée aux points diffractifs de la zone de contrôle pour les ondes).

Equation des ondes. Conformément à l'intuition, les solutions de l'équation des ondes se propagent, à haute fréquence, le long des rayons de l'optique géométrique. Plus précisément, elles se propagent en ligne droite (ou plus généralement le long des géodésiques) à l'intérieur de Ω , et se réfléchissent sur le bord en suivant les lois de Descartes (ce point peut être délicat pour les rayons rasants, voir par exemple [MS78] ou [Hör85, Chapter 24]).

Il est donc intuitif que, dans le cas où la zone de contrôle ne "rencontre pas tous les rayons", l'équation des ondes ne pourra être contrôlée exactement (ou, de façon équivalente, observée), et réciproquement.

Définition 1.7. On dira que le couple (ω, T) satisfait la condition géométrique de contrôle (GCC) si tout rayon parcouru à vitesse 1 dans Ω et suivant les lois de l'optique géométrique entre dans ω en un temps $t < T$. On dit aussi que ω satisfait la condition géométrique de contrôle s'il existe un temps T pour lequel (ω, T) satisfait cette condition.

On a alors le résultat suivant.

Théorème 1.8 (Bardos-Lebeau-Rauch [BLR88, BLR92]). *Supposons que le couple (ω, T) satisfait GCC. Alors, pour tout $(u_0, u_1) \in H_0^1(\Omega) \times L^2(\Omega)$, il existe $g \in L^2(0, T; L^2(\Omega))$ tel que l'unique solution de*

$$\begin{cases} \partial_t^2 u - \Delta u = \mathbb{1}_\omega g & \text{dans } (0, T) \times \Omega, \\ u|_{\partial\Omega} = 0, \\ (u, \partial_t u)|_{t=0} = (u_0, u_1), \end{cases}$$

satisfasse $(u, \partial_t u)|_{t=T} = (0, 0)$.

On notera aussi que la condition géométrique de contrôle est nécessaire à la contrôlabilité des ondes [Ral69, BLR92] (voir aussi [BG97] pour le cas d'un contrôle par le bord).

Bien que très intuitif, ce résultat est très difficile. Des méthodes d'inégalités d'énergie permettent cependant de montrer ce théorème assez simplement sous des conditions plus fortes sur ω et T . Ces techniques, appelées méthodes de multiplicateurs [Lio88a, Kom94], consistent à multiplier l'équation par une fonction bien choisie de l'état u et de la variable d'espace x , et intégrer par parties de façon à obtenir une inégalité d'observabilité. On renvoie à l'introduction de [BLR92] pour un historique du contrôle de l'équation des ondes, ainsi qu'à [Mil02] pour une comparaison entre les différentes conditions géométriques. Bien que robustes, les méthodes de multiplicateurs ne permettent pas de saisir complètement la nature géométrique et propagative du problème. C'est à cette difficulté que répondent les méthodes d'analyse microlocale.

Parallèlement, J. Rauch et M. Taylor [RT74] avaient montré un résultat semblable au Théorème 1.8 (mais concernant la stabilisation) sur une variété sans bord, comme une application du théorème de propagation des singularités de Hörmander [Hör94, Theorem 26.1.1] (voir aussi [Tay81, Chapter 6, Theorem 2.1]). Le problème de la propagation du front d'onde au bord, particulièrement technique, a été résolu en 1978 par R. Melrose et J. Sjöstrand [MS78] (voir aussi [Hör85, Chapter 24]). C'est ce résultat qui a rendu possible la preuve du Théorème 1.8 (voir [BLR88]). Le problème du contrôle des ondes par le bord, encore plus difficile, a finalement été résolu dans [BLR92].

Depuis, des preuves plus simples utilisant les mesures de défaut microlocales de P. Gérard [Gér91] et L. Tartar [Tar90] ont été mises au point, sur lesquelles nous reviendrons au Paragraphe 1.3.3. Ces dernières ont permis de donner la valeur explicite du meilleur taux de décroissance de l'équation des ondes amorties (voir l'article [Leb96] de G. Lebeau), de réduire la régularité du bord et de la métrique dans le Théorème 1.8 (voir l'article [Bur97a] de N. Burq), ou de montrer que la condition géométrique pour le contrôle par le bord est nécessaire (voir l'article [BG97] de N. Burq et P. Gérard).

Equation de la chaleur. Intéressons nous à présent au problème de contrôlabilité de l'équation de la chaleur. La propagation de l'information dans l'équation de la chaleur se fait par diffusion instantanée et dans toutes les directions. On s'attend donc à obtenir un résultat de contrôle en tout temps sans aucune condition géométrique sur la zone ω . Connue en une dimension d'espace depuis les travaux de H.O. Fattorini et D.L. Russell [FR71, FR75] (ou en dimension quelconque mais avec un contrôle sur tout le bord [Rus73]), ce résultat a été prouvé dans le cas général indépendamment par G. Lebeau et L. Robbiano d'une part et par A.V. Fursikov et O.Yu. Imanuvilov d'autre part.

Théorème 1.9 (Lebeau-Robbiano [LR95], Fursikov-Imanuvilov [FI96]). *Pour tout $\omega \neq \emptyset$, pour tout temps $T > 0$ et tout $u_0 \in L^2(\Omega)$, il existe $g \in L^2(0, T; L^2(\Omega))$ tel que l'unique solution de*

$$\begin{cases} \partial_t u - \Delta u = \mathbb{1}_\omega g & \text{dans } (0, T) \times \Omega, \\ u|_{\partial\Omega} = 0, \\ u|_{t=0} = u_0, \end{cases} \quad (1.13)$$

satisfasse $u|_{t=T} = 0$.

Les deux démonstrations de ce résultat sont très différentes. La première, présentée plus en détail au Paragraphe 1.2, consiste à utiliser des propriétés spectrales du laplacien pour construire un contrôle g , tandis que la seconde consiste à montrer une inégalité d'observabilité pour le problème adjoint.

Cependant, il est remarquable qu'elles soient toutes deux fondées sur des inégalités de Carleman (sur lesquelles nous reviendrons au Paragraphe 1.2.2.1). Les propriétés du laplacien utilisées dans [LR95] se déduisent d'inégalités de Carleman pour cet opérateur (donc elliptiques). Dans [FI96], une inégalité d'observabilité est déduite d'une inégalité de Carleman pour l'opérateur de la chaleur (donc parabolique). Tandis que la première se limite *a priori* au cas d'opérateurs elliptiques autoadjoints, la seconde méthode a l'avantage de fonctionner aussi pour des perturbations non-autoadjointes (et non autonomes) du laplacien, c'est-à-dire pour l'équation parabolique $\partial_t u - \Delta u + b(t, x) \cdot \nabla u + c(t, x)u$. De plus, elle donne une estimée supérieure du coût du contrôle : $K_T^{HUM} \leq C e^{\frac{C}{T}}$ lorsque $T \rightarrow 0^+$ (taux d'explosion qui est optimal dès que $\omega \neq \Omega$, au vu du résultat de E.N. GÜICHAL [GÜI85]). Enfin, cette méthode s'adapte aux problèmes paraboliques non-linéaires (voir par exemple [FI96, Bar00, FCZ00, DFCGBZ02]). Néanmoins, comme nous le verrons au Paragraphe 1.2, la méthode de Lebeau-Robbiano a plusieurs avantages. En particulier, elle est fondée sur des propriétés spectrales fines du laplacien et de la dissipation parabolique, et permet de mesurer le coût du contrôle des basses fréquences. C'est aussi grâce à cette méthode que l'on peut montrer des résultats de contrôlabilité pour des problèmes paraboliques fractionnaires (voir [Mil06b]).

Même si les deux méthodes proposent une preuve directe de la contrôlabilité frontière, remarquons que la contrôlabilité de la chaleur par l'intérieur implique un résultat de contrôlabilité par un sous ouvert $\Gamma \subset \partial\Omega$ non vide du bord. L'idée, classique, est d'agrandir Ω au voisinage de Γ en un ouvert $\tilde{\Omega}$. On prend alors un petit ouvert $\tilde{\omega} \subset \tilde{\Omega} \setminus \Omega$ à partir duquel on peut contrôler la solution \tilde{u} du problème sur $\tilde{\Omega}$. La restriction de \tilde{u} à Ω est alors solution du problème de contrôle par le bord et la trace de \tilde{u} sur le bord Γ donne le contrôle cherché.

Enfin, pour conclure ce paragraphe, nous mentionnons un résultat de contrôle uniforme pour une équation de transport/chaleur, en limite de viscosité évanescence.

Equation de transport/chaleur en limite de viscosité évanescence. Nous présentons ici un résultat de contrôlabilité uniforme, intermédiaire entre la contrôlabilité de l'équation de transport rappelée ci-dessus et celle de l'équation de la chaleur. On s'intéresse au problème parabolique suivant

$$\begin{cases} u_t - \varepsilon u_{xx} + M u_x = 0 & (t, x) \in (0, T) \times (0, L), \\ u|_{x=0} = g(t), \quad u|_{x=L} = 0 & t \in (0, T), \\ u|_{t=0} = u_0 & x \in (0, L). \end{cases} \quad (1.14)$$

Pour $\varepsilon > 0$ fixé, le Théorème 1.9 de contrôlabilité de la chaleur, valable aussi pour l'équation (1.14) (et déjà connu en une dimension depuis [FR71]) montre que l'on peut amener la solution u de (1.14) à zéro pour tout temps $T > 0$. Un changement d'échelle permet de montrer que le contrôle g^ε construit par exemple par la méthode de Fursikov-Imanuvilov satisfait $\|g^\varepsilon\|_{L^2(0,T)} \leq C e^{\frac{C}{\varepsilon}} \|u_0\|_{L^2(0,L)}$. Ce contrôle, adapté au caractère parabolique de l'équation (1.14) diverge naturellement dans la limite $\varepsilon \rightarrow 0^+$. Cependant, pour $M > 0$ et $T \geq \frac{L}{M}$, on sait d'après le Théorème 1.6 que le système limite est lui aussi contrôlable, avec un coût nul. Une question naturelle, posée par J.-M. Coron et S. Guerrero [CG05b], est de savoir si, pour $T \geq \frac{L}{M}$, on peut construire un contrôle g^ε satisfaisant $\|g^\varepsilon\|_{L^2(0,T)} \leq C \|u_0\|_{L^2(0,L)}$, uniformément par rapport à ε . Leur premier résultat est le suivant.

Théorème 1.10 (Coron-Guerrero [CG05b]). *Pour tout $T < \frac{L}{M}$, il existe une constante $C > 0$ telle que pour tout contrôle à zéro g^ε de (1.14), on ait*

$$\|g^\varepsilon\|_{L^2(0,T)} \geq C e^{\frac{C}{\varepsilon}} \|u_0\|_{L^2(0,L)}.$$

Pour tout $T \geq 4.3 \frac{L}{M}$, il existe une constante $C > 0$ et un contrôle à zéro g^ε de (1.14), tels que l'on ait

$$\|g^\varepsilon\|_{L^2(0,T)} \leq C e^{-\frac{C}{\varepsilon}} \|u_0\|_{L^2(0,L)}.$$

Si le temps est trop court, on a donc explosion exponentielle de tout contrôle dans la limite de viscosité évanescence. Si le temps est suffisamment long, on obtient bien le résultat de contrôle uniforme escompté. Mieux, le contrôle g^ε construit ici converge fortement dans $L^2(0, L)$ vers le

contrôle nul pour l'équation de transport limite. Dans la situation intermédiaire, $\frac{L}{M} \leq T < 4.3 \frac{L}{M}$, la conjecture, toujours ouverte, est que la propriété de contrôlabilité uniforme est satisfaite.

Dans le cas d'une vitesse $M < 0$, la question du contrôle uniforme se pose aussi car la condition de Dirichlet homogène sur le bord droit de l'intervalle fait office de contrôle à zéro pour le problème limite (qui n'a qu'une condition au bord, en $x = L$). J.-M. Coron et S. Guerrero montrent dans ce cas un analogue du Théorème 1.10. Ils prouvent un résultat de contrôle uniforme pour $T \geq 57.2 \frac{L}{|M|}$, ainsi qu'un résultat assez surprenant d'explosion exponentielle pour tout $T < 2 \frac{L}{|M|}$. Les temps minimaux nécessaires pour contrôler uniformément sont améliorés par O. Glass [Gla10], et le résultat du Théorème 1.10 est généralisé aux dimensions d'espaces supérieures et à un champ de vitesse non constant par S. Guerrero et G. Lebeau [GL07]. Nous reviendrons sur un problème similaire au Paragraphe 1.4.

1.1.3 Problématique de ce mémoire

Ce mémoire comprend trois parties, correspondant chacune à l'un des Paragraphes 1.2, 1.3 et 1.4 de la présente introduction.

Dans la première partie, nous nous intéressons à la méthode développée par G. Lebeau et L. Robbiano pour le contrôle des équations paraboliques, ainsi qu'à l'inégalité spectrale qu'elle permet de démontrer. Nous montrons une telle inégalité spectrale pour certains opérateurs elliptiques non-autoadjoints et généralisons la méthode dans cette situation. Dans un second temps, utilisant cette méthode, nous montrons la contrôlabilité d'un problème parabolique contenant une interface diffuse.

La deuxième partie concerne la contrôlabilité de systèmes paraboliques ou hyperboliques linéaires couplés. Nous montrons tout d'abord des résultats de stabilisation pour des systèmes de deux équations d'ondes localement couplées. Ensuite, nous abordons le problème de contrôle de ces systèmes, ce qui nous permet de déduire un théorème de contrôlabilité de systèmes paraboliques, sous des conditions géométriques. Enfin, dans un cas simple, nous présentons une analyse microlocale d'un système d'équations d'ondes localement couplées.

Dans la troisième et dernière partie de ce mémoire, nous étudions un problème de contrôle pour une loi de conservation non-linéaire visqueuse. Nous montrons un résultat de contrôlabilité uniforme dans la limite de viscosité évanescence.

A chaque chapitre de ce mémoire correspond un paragraphe dans cette introduction. Dans chacun de ces paragraphes, nous présentons les résultats antérieurs ainsi qu'un outil essentiel à la compréhension de nos résultats. Nous donnons ensuite nos résultats principaux et concluons par des problèmes ouverts.

Le Chapitre 2, présenté dans le Paragraphe 1.2.1 reprend l'article [Léa10a]. Le Chapitre 3, présenté dans le Paragraphe 1.2.2 reprend l'article [LLR11], en collaboration avec Jérôme Le Rousseau et Luc Robbiano. Le Chapitre 4, présenté dans le Paragraphe 1.3.1 reprend l'article [ABL11c], en collaboration avec Fatiha Alabau-Boussouira. Le Chapitre 5, présenté dans le Paragraphe 1.3.2 reprend l'article [ABL11b] (dont les résultats ont été annoncés dans [ABL11a]), en collaboration avec Fatiha Alabau-Boussouira. Le Chapitre 6, résumé dans le Paragraphe 1.3.3 présente un travail en collaboration avec Belhassen Dehman et Jérôme Le Rousseau. Enfin, la partie III, présentée dans le Paragraphe 1.4 reprend l'article [Léa10b].

1.2 Autour de la méthode de Lebeau-Robbiano pour le contrôle des équations paraboliques

Dans cette partie, nous utilisons et adaptons à deux situations différentes la "méthode de Lebeau-Robbiano" [LR95] pour le contrôle des équations paraboliques. Un point central de cette méthode est l'obtention d'une inégalité spectrale portant sur les combinaisons linéaires finies de fonctions propres du laplacien. Depuis l'article original [LR95], l'inégalité spectrale et la méthode de construction du

contrôle ont connu une simplification importante [LZ98, JL99] (voir aussi [Mil06b, LL09]). Dans les paragraphes qui suivent, nous utilisons ces deux méthodes (ainsi que les deux types d'inégalités spectrales qu'elles utilisent). Nous les présentons donc maintenant dans leur cadre d'origine : la preuve du Théorème 1.9.

La méthode originelle de Lebeau-Robbiano. La démarche adoptée dans [LR95] pour montrer la contrôlabilité de l'équation de la chaleur trouve son origine dans les faits suivants :

- On sait depuis l'article [Rus73] de D.L. Russell que la contrôlabilité de l'équation des ondes $(\partial_t^2 - \Delta)u = \mathbb{1}_\omega g$ (en temps grand) entraîne la contrôlabilité de la chaleur $(\partial_t - \Delta)u = \mathbb{1}_\omega g$ pour tout temps (et de même pour le cas du contrôle frontière). Nous reviendrons au Paragraphe 1.3.2.1 sur ce type de résultats et les liens entre les propriétés de contrôlabilité des différentes équations linéaires.
- Cependant, les conditions géométriques nécessaires à la contrôlabilité des ondes ne sont pas adaptées au mode de propagation des solutions de l'équation de la chaleur, à savoir instantanément et dans toutes les directions.
- Ce mode de propagation est le même que celui de l'équation elliptique associée.

La solution proposée est donc de contrôler l'équation d'évolution elliptique

$$(\partial_t^2 + \Delta)u = \mathbb{1}_\omega g, \quad (1.15)$$

et d'adapter la méthode de Russell dans ce cas. L'avantage principal est que, pour les équations elliptiques $\Delta_{t,x}u = 0$, on dispose d'estimées de prolongement unique qui ne nécessitent aucune condition géométrique (si ce n'est $\omega \neq \emptyset$). Ces estimées quantitatives de prolongement unique (connues loin du bord [Cal58, Hör63], et montrées par G. Lebeau et L. Robbiano [LR95] jusqu'au bord) impliquent une inégalité d'observabilité pour le système adjoint de (1.15), et donnent le résultat de contrôle souhaité. Une difficulté subsiste, car le problème d'évolution (1.15) est mal posée.

Pour surmonter cette difficulté, la solution trouvée par G. Lebeau et L. Robbiano est de restreindre le problème d'évolution (1.15) à un espace spectral du laplacien, de dimension finie (sur lequel (1.15) est bien posé), et d'évaluer précisément le coût du contrôle construit par la méthode décrite précédemment en fonction de la fréquence de coupure (c'est-à-dire la plus grande valeur propre). Ce coût du contrôle est la constante d'observabilité du problème adjoint, c'est-à-dire la constante qui intervient dans la version quantifiée du prolongement unique. C'est cette inégalité d'observabilité en basse fréquence que l'on appellera "inégalité spectrale intégrée en temps".

Ensuite, le contrôle à zéro est construit par un argument itératif combinant contrôle partiel sur des sous-espaces spectraux de plus en plus grands, et dissipation parabolique à haute fréquence avec un taux de plus en plus élevé.

Plus précisément, on appelle $(\mu_j, e_j)_{j \in \mathbb{N}}$ les couples valeur propre fonction propre du laplacien muni de conditions au bord de Dirichlet $-\Delta_D$. On a $\mu_j \geq 0$, et on note $\Pi_\alpha := \sum_{\mu_j \leq \alpha} (\cdot, e_j)_{L^2(\Omega)} e_j$ le projecteur spectral sur les fonctions propres associées aux valeurs propres plus petites que α . L'inégalité spectrale prouvée dans [LR95, (6) page 340] est la suivante. Pour tout $T_0 > 0$ et tout ouvert U inclus dans $(0, T_0) \times \Omega$ (pour l'application au contrôle de (1.15), et donc de (1.13), on prend $U \subset (0, T_0) \times \omega$), il existe $C \geq 0$ tel que pour tout $\alpha > 0$, on a

$$\|w_+\|_{L^2(\Omega)}^2 + \|w_-\|_{L^2(\Omega)}^2 \leq C e^{C\sqrt{\alpha}} \left\| e^{t\sqrt{-\Delta_D}} w_+ + e^{-t\sqrt{-\Delta_D}} w_- \right\|_{L^2(U)}^2, \quad \text{pour tous } w_+, w_- \in \Pi_\alpha L^2(\Omega). \quad (1.16)$$

Dans cette inégalité, on a utilisé le calcul fonctionnel standard pour $e^{\pm t\sqrt{-\Delta_D}} \Pi_\alpha$ sur le sous-espace spectral $\Pi_\alpha L^2(\Omega) = \text{Vect}\{e_j, \mu_j \leq \alpha\}$, c'est-à-dire

$$e^{\pm t\sqrt{-\Delta_D}} \Pi_\alpha w = \sum_{\mu_j \leq \alpha} e^{\pm t\sqrt{\mu_j}} (w, e_j)_{L^2(\Omega)} e_j, \quad \text{pour } w \in L^2(\Omega).$$

Autrement dit, on a, pour toute suite $(a_j^\pm)_{j \in \mathbb{N}} \subset \mathbb{C}$, et tout $\alpha > 0$,

$$\sum_{\mu_j \leq \alpha} (|a_j^+|^2 + |a_j^-|^2) \leq C e^{C\sqrt{\alpha}} \left\| \sum_{\mu_j \leq \alpha} (a_j^+ e^{\sqrt{\mu_j}t} + a_j^- e^{-\sqrt{\mu_j}t}) e_j \right\|_{L^2(U)}^2.$$

Cette inégalité spectrale correspond à une inégalité d'observabilité pour le problème adjoint du problème de contrôle de dimension finie :

$$\begin{cases} (\partial_t^2 + \Delta_D)u = \Pi_\alpha \mathbf{1}_\omega g, \\ (u, \partial_t u)|_{t=0} = (u_0, u_1) \in (\Pi_\alpha L^2(\Omega))^2, \end{cases} \quad (1.17)$$

pour lequel on veut amener l'état à zéro en un temps T_0 . L'inégalité (1.16) donne le résultat suivant : pour tout temps $T_0 > 0$ et toutes données initiales $(u_0, u_1) \in (\Pi_\alpha L^2(\Omega))^2$, il existe un contrôle g supporté par $U \subset (0, T_0) \times \omega$ de coût borné par $C' e^{C'\sqrt{\alpha}}$ qui amène l'état à zéro en temps T_0 .

La deuxième étape correspond au passage d'un contrôle pour le système elliptique (1.17) (de dimension finie) au contrôle pour le système parabolique (de dimension finie). C'est dans cette étape qu'est utilisée l'idée de Russell. Notons que cette méthode est fondée sur des techniques de moments (projection du problème de contrôle sur chaque mode propre e_j) et est bien adaptée au caractère autoadjoint du problème. On obtient alors le résultat de contrôle parabolique basse fréquence suivant : pour toute donnée initiale $u_0 \in \Pi_\alpha L^2(\Omega)$ et tout temps $T > 0$, il existe un contrôle g supporté dans ω et de coût borné par $C e^{C\sqrt{\alpha} + \frac{1}{T^\gamma}}$ (pour un certain $\gamma > 0$) tel que la solution de

$$\begin{cases} (\partial_t - \Delta_D)u = \Pi_\alpha \mathbf{1}_\omega g, \\ u|_{t=0} = u_0 \in \Pi_\alpha L^2(\Omega), \end{cases} \quad (1.18)$$

satisfasse $u(T) = 0$. Dans ce passage du problème elliptique au problème parabolique, on obtient dans un premier temps un contrôle singulier en temps, qu'il est nécessaire de régulariser dans un second temps (par convolution avec une fonction de Gevrey). Notons ici que le point important est l'estimation fine du coût du contrôle en fonction de la fréquence de coupure $\sqrt{\alpha}$. De façon équivalente, le contrôle g ainsi construit permet d'amener la solution de (1.13) issue de n'importe quelle donnée initiale de $L^2(\Omega)$ à un état $u(T) \in (\Pi_\alpha L^2(\Omega))^\perp = (I - \Pi_\alpha)L^2(\Omega)$.

Enfin, la dernière étape consiste en une combinaison de ces contrôles partiels et de la décroissance exponentielle des solutions de la chaleur, restreintes à $(\Pi_\alpha L^2(\Omega))^\perp$. Le contrôle pour le problème parabolique complet (1.13) est construit par une suite de contrôles actifs et inactifs sur des intervalles de temps de taille de plus en plus petite au voisinage de $t = T$. Sur chacun de ces intervalles, l'idée est de contrôler à zéro tous les modes de $\Pi_\alpha L^2(\Omega)$, pour un coût de l'ordre de $e^{C\sqrt{\alpha}}$, puis de laisser la chaleur dissiper les modes restants d'un facteur $e^{-C\alpha t}$. En itérant ce processus sur des espaces spectraux de plus en plus grand, α croissant, on aboutit finalement à l'état nul au temps T .

L'inégalité spectrale et la méthode simplifiée de Lebeau-Robbiano. Dans [LZ98, JL99], G. Lebeau et E. Zuazua d'une part, et D. Jerison et G. Lebeau d'autre part, remarquent (avec différentes applications en vue) que la démonstration de l'inégalité (1.16) implique aussi le résultat suivant, plus simple car portant uniquement sur les sommes de fonctions propres du laplacien.

Théorème 1.11 (Inégalité spectrale [LR95, LZ98, JL99]). *On a, pour une constante $C > 0$ ne dépendant que de ω ,*

$$\|w\|_{L^2(\Omega)} \leq C e^{C\sqrt{\alpha}} \|w\|_{L^2(\omega)}, \quad \text{pour tout } \alpha > 0, \text{ et tout } w \in \Pi_\alpha L^2(\Omega). \quad (1.19)$$

Cette inégalité spectrale, sur laquelle nous revenons au paragraphe suivant, peut, de façon équivalente, se réécrire comme

$$\sum_{\mu_j \leq \alpha} |a_j|^2 \leq C e^{C\sqrt{\alpha}} \int_\omega \left| \sum_{\mu_j \leq \alpha} a_j e_j(x) \right|^2 dx, \quad \text{pour tous } (a_j)_{j \in \mathbb{N}} \in \mathbb{C}^{\mathbb{N}}, \alpha > 0.$$

En particulier, cette inégalité simplifie considérablement la méthode de construction du contrôle décrite au paragraphe précédent (voir [LZ98], ainsi que [Mil06b, LL09]) : il n'est plus nécessaire de passer par l'intermédiaire d'un problème de contrôle pour une équation elliptique d'évolution. La démonstration de la contrôlabilité consiste alors à montrer directement l'observabilité du problème adjoint de (1.18) à partir de (1.19), puis, de reprendre la construction itérative du contrôle de la méthode originelle.

Notons pour finir que L. Miller [Mil10] d'une part, G. Tenenbaum et M. Tucsnak [TT10] d'autre part, ont adapté cette stratégie pour montrer l'observabilité de la chaleur à partir de l'inégalité spectrale sans passer par l'intermédiaire de problèmes de contrôle (c'est-à-dire en effectuant une preuve itérative du côté de l'observabilité).

Quelques remarques sur l'inégalité spectrale. Remarquons tout d'abord que l'inégalité spectrale (1.19) fournit une mesure quantitative de la perte d'orthogonalité des fonctions propres $(e_j)_{j \in \mathbb{N}}$ lorsqu'elles sont restreintes à l'ouvert ω . D'une certaine façon, cette inégalité spectrale quantifie l'effet tunnel (sur lequel nous reviendrons au Paragraphe 1.2.2.1) en montrant que pour toute fonction $w \in \Pi_\alpha L^2(\Omega)$, $\|w\|_{L^2(\omega)}$ ne peut pas "s'écraser" plus que $Ce^{-C\sqrt{\alpha}}\|w\|_{L^2(\Omega)}$ sur n'importe quel ouvert $\omega \subset \Omega$ (voir aussi [Mil09]). On peut montrer que, tant que $\omega \neq \Omega$, la dépendance de la constante $Ce^{C\sqrt{\alpha}}$ en exponentielle de la racine de la fréquence de coupure ne peut être améliorée (voir [JL99, LL09]). Le champ d'application de ce type d'inégalité est bien plus large que la théorie du contrôle : l'inégalité (1.19) permet en particulier d'estimer la mesure de Hausdorff des ensembles de niveau de sommes de fonctions propres (voir l'article de D. Jerison et G. Lebeau [JL99]). Notons que, si ω satisfait GCC (voir la Définition 1.7), alors (comme conséquence de l'inégalité d'observabilité pour les ondes) l'inégalité spectrale est satisfaite avec une constante indépendante de la fréquence si on remplace la somme de fonctions propres par une seule fonction propre.

A ma connaissance, il existe trois façons différentes de montrer cette inégalité : la méthode originelle de [LR95], une méthode par inégalité de Carleman elliptique globale [Le 07b, BHLR10], et une méthode utilisant des propriétés doublantes (voir [AE08] en une dimension et [Phu07a] en dimension quelconque). La méthode originelle de G. Lebeau et L. Robbiano [LR95] est fondée sur des inégalités de Carleman locales, qui quantifient le prolongement unique pour les solutions de $\Delta u = f$ (voir le Paragraphe 1.2.2.1). Ces dernières impliquent des inégalités d'interpolation locales, qui, propagées, donnent une inégalité d'interpolation globale de la forme (pour un $\nu \in (0, 1)$ et $\zeta \in (0, T_0/2)$),

$$\|v\|_{H^1((\zeta, T_0 - \zeta) \times \Omega)} \leq C \|v\|_{H^1((0, T_0) \times \Omega)}^{1-\nu} \left(\|\partial_t v|_{t=0}\|_{L^2(\omega)} + \|(-\partial_t^2 - \Delta)v\|_{L^2((0, T_0) \times \Omega)} \right)^\nu, \quad (1.20)$$

pour toute fonction $v \in H^2((0, T_0) \times \Omega)$ satisfaisant $v|_{t=0} = 0$ et $v|_{\partial\Omega} = 0$. On renvoie à [LZ98] pour l'obtention de l'observation $\|\partial_t v|_{t=0}\|_{L^2(\omega)}$ dans le second membre. Enfin, un choix astucieux de fonction v donne (1.19). Remarquons que la preuve de l'inégalité (1.16) repose sur la même inégalité d'interpolation, dans laquelle l'observation $\|\partial_t v|_{t=0}\|_{L^2(\omega)}$ est remplacée par $\|v\|_{L^2(U)}$ (où $U \subset (0, T_0) \times \Omega$ est le même que celui apparaissant dans (1.16)) et est satisfaite par tout $v \in H^2((0, T_0) \times \Omega)$ tel que $v|_{\partial\Omega} = 0$.

La méthode de Lebeau-Robbiano repose donc sur deux points principaux : d'une part sur une construction du contrôle fondée sur les propriétés spectrales du laplacien, et d'autre part sur des estimées de prolongement unique : les inégalités de Carleman. Dans les Paragraphes 1.2.1 et 1.2.2, on prouve une inégalité spectrale pour différents opérateurs elliptiques, étendant dans le premier cas la partie spectrale de la preuve, et dans le second les inégalités de Carleman.

1.2.1 Inégalités spectrales pour les opérateurs elliptiques non-autoadjoints et applications

La question principale que l'on se pose dans cette partie est la suivante : la méthode de Lebeau-Robbiano, décrite ci-dessus (et tous les résultats qu'elle implique) est elle fondamentalement réservée aux opérateurs elliptiques autoadjoints du second ordre, c'est-à-dire $-\operatorname{div} c\nabla + a$ avec $a : \Omega \rightarrow \mathbb{R}$?

Ou, au contraire, peut-on l'étendre à certains opérateurs non-autoadjoints ? Pour ces derniers, le résultat de contrôle est connu depuis [FI96], et on a donc espoir de faire fonctionner aussi cette méthode pour des opérateurs du type

$$A = -\Delta + b \cdot \nabla + c \quad \text{ou} \quad A = \begin{pmatrix} -\Delta & 0 \\ 0 & -\Delta \end{pmatrix} + \begin{pmatrix} a & c \\ b & d \end{pmatrix}, \quad (1.21)$$

avec, par exemple, des conditions au bord de Dirichlet. Dans (1.21), a, b, c, d sont des fonctions régulières sur Ω . En effet, pour ces opérateurs, les inégalité de Carleman et les inégalités d'interpolation sont satisfaites. Plus précisément, comme on le verra au Paragraphe 1.2.2.1, les inégalités de Carleman sont insensibles aux termes d'ordre inférieur (qu'elles absorbent tout simplement). Notre démarche est donc la suivante : nous partons d'une inégalité d'interpolation, et nous montrons (dans un cadre englobant ces deux exemples) une inégalité spectrale et la contrôlabilité de l'équation parabolique associée.

Avant de montrer une inégalité spectrale pour ce type d'opérateurs non-autoadjoints, il faut en comprendre la théorie spectrale.

1.2.1.1 Outil principal : théorie spectrale des opérateurs autoadjoints faiblement perturbés

On va ici s'intéresser à des opérateurs du type $A = A_0 + A_1$, où A_0 est autoadjoint à résolvante compact sur l'espace de Hilbert séparable H (qui, dans les applications sera $L^2(\Omega)$ ou $(L^2(\Omega))^2$) et A_1 est une "petite perturbation" de A_0 (voir les hypothèses de la Proposition 1.12 ci-dessous pour plus de précision). L'étude des propriétés spectrales de ces opérateurs a depuis les années 60 connu un certain essor. Cependant, nous verrons que les résultats existants sont assez limités. Les problèmes principaux sont les suivants :

- l'opérateur A (à résolvante compacte) n'est pas diagonalisable. Plus précisément, pour chacune de ses valeurs propres, l'opérateur A a non seulement un vecteur propre, mais aussi toute une chaîne de Jordan de "vecteurs propres généralisés" (un bloc de Jordan). En particulier, A a une infinité de valeurs propres et le nombre de vecteurs propres généralisés associés n'est pas borné ;
- on connaît pas précisément la position des valeurs propres de A dans le plan complexe ;
- enfin et surtout, on ne sait pas toujours estimer la résolvante en fonction de la distance au spectre, comme c'est le cas pour les opérateurs autoadjoints (ou même normaux).

Le point de départ de la théorie perturbative que nous allons utiliser est le théorème de Keldysh (voir par exemple [GK69]) qui montre la complétude des vecteurs propres généralisés d'un opérateur compact autoadjoint faiblement perturbé (c'est-à-dire que l'espace qu'ils engendrent est dense dans H). Cependant, cette propriété de complétude, bien qu'un point de départ, est extrêmement faible et ne permet pas de faire du calcul.

Un résultat qui répond (partiellement) à cette attente (le Théorème 1.13 ci-dessous) a été prouvé par A.S. Markus et D.S. Katsnel'son [Kat67]. La preuve a ensuite été simplifiée par A.S. Markus et V.I. MatstaeV et est (partiellement) présentée sous cette forme dans le livre [Mar88, Chapter 1]. Nous suivons ici la présentation qui en est faite dans l'article [Agr94] de M.S. Agranovich (et qui, à ma connaissance, en présente la seule preuve complète dans la littérature anglophone). On note $R_A(z) = (z - A)^{-1}$ la résolvante de l'opérateur A . Les premières propriétés spectrales pour de tels opérateurs sont les suivantes.

Proposition 1.12 (Localisation du spectre et premières estimées de résolvante). *On suppose que*

- (a) $\operatorname{Re}(Au, u)_H \geq \lambda_0 \|u\|_H^2$, $\lambda_0 > 0$, pour tout $u \in \mathcal{D}(A)$,
- (b) $A_0 : \mathcal{D}(A_0) \subset H \rightarrow H$ est autoadjoint positif à domaine dense et à résolvante compacte,
- (c) $A_1 : \mathcal{D}(A_1) \subset H \rightarrow H$ satisfait l'hypothèse suivante de q -subordination à $A_0 : \mathcal{D}(A_0) \subset \mathcal{D}(A_1)$ et il existe $q \in [0, 1)$ tel que pour tout $u \in \mathcal{D}(A_0^{1/2})$, $|(A_1 u, u)_H| \leq C \|A_0^{1/2} u\|_H^{2q} \|u\|_H^{2-2q}$.

On a alors

- (i) $\mathcal{D}(A) = \mathcal{D}(A_0)$, et A est un opérateur à domaine dense et à résolvante compacte,
- (ii) $\operatorname{Sp}(A) \subset \mathcal{P}_{K_0}^q = \{z \in \mathbb{C}, \operatorname{Re}(z) \geq 0, |\operatorname{Im}(z)| < K_0 \operatorname{Re}(z)^q\}$, pour un certain $K_0 > 0$,

$$(iii) \|R_A(z)\|_{\mathcal{L}(H)} \leq \frac{C}{d(z, \text{Sp}(A_0))} \leq \frac{C}{d(z, \mathbb{R}_+)} \text{ pour } z \in \mathbb{C} \setminus \mathcal{P}_{K_0}^q, \text{ où } d(z_1, z_2) = |z_2 - z_1|.$$

On note tout d'abord que l'hypothèse (a) n'est pas essentielle et nous la faisons seulement par commodité; les autres hypothèses suffisent à montrer que A (et donc son spectre) est borné inférieurement. Cependant, elle n'est pas restrictive du point de vue du contrôle; on peut considérer $A + \lambda$ avec λ suffisamment grand à la place de A , sans nuire à l'inégalité spectrale ni au résultat de contrôle. L'indice q apparaissant dans l'hypothèse (b) est particulièrement important car il mesure la petitesse de la perturbation : pour les exemples de (1.21), on a

$$A_0 = -\Delta, \quad A_1 = b \cdot \nabla + c \quad \text{et } q = \frac{1}{2},$$

dans le premier cas, et

$$A_0 = \begin{pmatrix} -\Delta & 0 \\ 0 & -\Delta \end{pmatrix}, \quad A_1 = \begin{pmatrix} a & c \\ b & d \end{pmatrix}, \quad \text{et } q = 0,$$

dans le second.

Cette proposition nous donne tout d'abord une localisation du spectre dans une "parabole d'ordre q " (voir la Figure 1.2) autour de l'axe réel positif. Le point (ii) quantifie ainsi l'intuition selon laquelle le spectre est d'autant plus proche de l'axe réel que l'opérateur A est proche de l'opérateur autoadjoint A_0 . Et, en dehors de cette parabole, la résolvante décroît de la même manière que pour un opérateur autoadjoint (point (iii)). Le travail consiste donc maintenant à arriver à obtenir des estimations de la résolvante sur certaines courbes qui traversent $\mathcal{P}_{K_0}^q$.

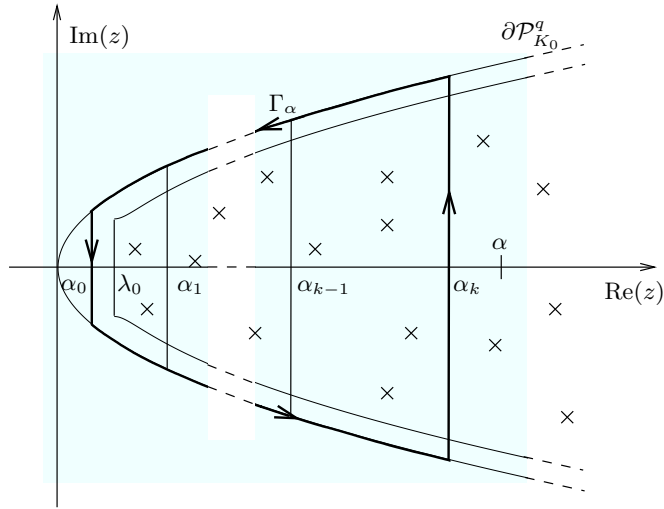

FIGURE 1.2 – Contours complexes autour du spectre de A

C'est ce que propose le théorème spectral qui suit, et que l'on peut trouver (au moins partiellement) dans les articles [Agr76, Agr94, Dzh94], et le livre [Mar88, Chapter 1], sous différentes formes.

Théorème 1.13 (Estimées de résolvante à l'intérieur de $\mathcal{P}_{K_0}^q$). *On appelle $0 \leq \mu_1 \leq \mu_2 \leq \dots \leq \mu_k \leq \dots$ le spectre de l'opérateur autoadjoint A_0 . On suppose qu'il existe $p > 0$ tel que*

$$\limsup_{j \rightarrow \infty} \mu_j j^{-p} > 0. \quad (1.22)$$

Alors, il existe une suite strictement croissante $(\alpha_k)_{k \in \mathbb{N}} \in \mathbb{R}_+^{\mathbb{N}}$, $\alpha_k \rightarrow +\infty$, telle que

$$\|R_A(z)\|_{\mathcal{L}(H)} \leq e^{C\alpha_k^\beta}, \quad \text{pour tous } k \in \mathbb{N} \text{ et } z \text{ tel que } \text{Re}(z) = \alpha_k, \quad (1.23)$$

avec $\beta = \max\{0, p^{-1} - (1 - q)\}$.

Notons que cette estimée de résolvante implique en particulier que les droites $\{\operatorname{Re}(z) = \alpha_k\}$ n'intersectent pas le spectre de A . Dans nos exemples (1.21), le comportement asymptotique des valeurs propres de A_0 est donné par la formule de Weyl. On peut alors prendre $p = \frac{2}{n}$ dans (1.22) (où n est la dimension de l'ouvert Ω). Ce théorème est un résultat perturbatif : l'idée de la preuve est de trouver, asymptotiquement, des trous dans le spectre de A_0 et de montrer l'existence des α_k à ces endroits.

Ces α_k nous permettent de construire des contours dans le plan complexe pour définir un calcul fonctionnel. Pour $\alpha \in \mathbb{R}_+$, on appelle Γ_α le contour orienté, représenté sur la Figure 1.2, qui passe par la parabole $\partial\mathcal{P}_{K_0}^q$ et par la droite $\{\operatorname{Re}(z) = \max\{\alpha_k, \alpha_k \leq \alpha\}\}$. Ceci nous permet de définir les projecteurs spectraux

$$\Pi_\alpha = \frac{1}{2i\pi} \int_{\Gamma_\alpha} R_A(z) dz,$$

qui projettent H sur les sous-espaces spectraux (propres et généralisés) de A , associés à des valeurs propres de partie réelle inférieure à $\max\{\alpha_k, \alpha_k \leq \alpha\}$. De même, on définit le calcul fonctionnel holomorphe

$$f(A)\Pi_\alpha = f(A\Pi_\alpha) = \frac{1}{2i\pi} \int_{\Gamma_\alpha} f(z)R_A(z) dz \in \mathcal{L}(\Pi_\alpha H).$$

Un intérêt majeur du Théorème 1.13 est qu'il permet de faire des estimations dans le calcul fonctionnel ainsi défini, du type

$$\|f(A)\Pi_\alpha\|_{\mathcal{L}(H)} = \frac{1}{2\pi} \left\| \int_{\Gamma_\alpha} f(z)R_A(z) dz \right\|_{\mathcal{L}(H)} \leq C\alpha e^{C\alpha^\beta} \sup_{z \in \Gamma_\alpha} |f(z)|.$$

Du fait de la symétrie des contours Γ_α par rapport à l'axe réel, les calculs fonctionnels de A et de A^* sont reliés naturellement. En particulier, les projecteurs spectraux Π_α^* de A^* sont bien les adjoints dans H des projecteurs spectraux Π_α de A .

Notons enfin que l'on contrôle la croissance de la suite $(\alpha_k)_{k \in \mathbb{N}}$. On peut en effet construire une telle suite qui croît au plus géométriquement à l'infini.

Les papiers [Agr76, Agr94, Dzh94], et le livre [Mar88, Chapter 1] montrent, à partir de ces estimations de résolvante, différentes propriétés de base (de Riesz, d'Abel...). Dans tout ce qui va suivre, nous ne ferons usage d'aucune de ces propriétés.

1.2.1.2 Principaux résultats obtenus

On souhaite montrer des inégalités spectrales du type (1.16) et (1.19) pour les deux opérateurs elliptiques définis en (1.21), en observant une "certaine quantité des fonctions propres généralisées". Introduisons tout d'abord le problème de contrôle que l'on se pose. On l'écrit sous la forme générale :

$$\begin{cases} \partial_t u + Au = Bg \\ u|_{t=0} = u_0 \in H, \end{cases} \quad (1.24)$$

où le contrôle g prend ses valeurs dans l'espace de Hilbert Y et $B \in \mathcal{L}(Y, H)$. Pour les deux applications que l'on a en vue, on aimerait contrôler par un sous domaine dans le premier exemple de (1.21), et on aimerait ne contrôler qu'une équation par un sous domain dans le second exemple de (1.21), c'est-à-dire,

$$Y = L^2(\Omega) \text{ et } B = \mathbf{1}_\omega \quad \text{ou} \quad Y = L^2(\Omega) \text{ et } B = {}^t(\mathbf{1}_\omega, 0). \quad (1.25)$$

On appelle $B^* \in \mathcal{L}(H, Y)$ l'opérateur adjoint de B .

L'inégalité spectrale adaptée au problème (1.24) doit donc être de la forme

$$\|w\|_H \leq K \|B^* w\|_H,$$

pour toute somme finie w de fonctions propres généralisées de A^* (et non de A), où K est une certaine constante à déterminer. Elle représente en effet une inégalité d'observabilité pour l'adjoint

d'une projection basses fréquences de (1.24). Si le problème de contrôle doit être projeté sur les espaces $\Pi_\alpha H$ pour donner un problème de dimension finie, le problème d'observation doit lui aussi être projeté sur $\Pi_\alpha^* H$.

On peut donc maintenant écrire dans un cadre abstrait cette inégalité spectrale, en supposant une inégalité d'interpolation du type de (1.20). Nous précisons par la suite comment une telle inégalité d'interpolation est obtenue pour les applications (1.21)-(1.25) qui nous intéressent. Il nous faut définir les analogues dans ce cadre abstrait des espaces $H^k((0, T_0) \times \Omega)$ apparaissant dans l'inégalité (1.20). Pour $k = 0, 1, 2$ et $t \in (0, T_0/2)$, on définit

$$\mathcal{K}^k(t) = \bigcap_{j \leq k} H^j(t, T_0 - t; \mathcal{D}(A_0^{\frac{k-j}{2}})).$$

Théorème 1.14. *On suppose que pour un $\zeta \in (0, T_0/2)$ et un $\nu \in (0, 1]$ on a l'inégalité suivante : pour tout $v \in \mathcal{K}^2(0)$ tel que $v(0) = 0$,*

$$\|v\|_{\mathcal{K}^1(\zeta)} \leq C' \|v\|_{\mathcal{K}^1(0)}^{1-\nu} \left(\|B^* \partial_t v(0)\|_Y + \|(-\partial_t^2 + A^*)v\|_{\mathcal{K}^0(0)} \right)^\nu. \quad (1.26)$$

Il existe alors des constantes C, D telles que pour tout $\alpha > 0$, et $w \in \Pi_\alpha^* H$, on ait

$$\|w\|_H \leq C e^{D\alpha^\theta} \|B^* w\|_Y, \quad \text{avec } \theta = \max\{1/2, p^{-1} - (1 - q)\} = \max\{1/2, \beta\}. \quad (1.27)$$

Cette inégalité spectrale est l'équivalent, pour les opérateurs non-autoadjoints que l'on considère, de l'inégalité (1.19) pour le laplacien. Cependant, on note que l'estimation du coût $C e^{D\alpha^\theta}$ en fonction de la fréquence de coupure est en général moins bonne que celle que l'on a dans le cas autoadjoint, donnée par $C e^{D\sqrt{\alpha}}$. Dans les deux exemples de (1.21), on a $\theta = \frac{n-1}{2}$ dans le cas de l'opérateur chaleur/transport, et $\theta = \frac{n}{2} - 1$ dans le cas des systèmes (ou dans le premier cas avec $b = 0$ et $c : \Omega \rightarrow \mathbb{C}$).

L'idée de la preuve du Théorème 1.14 est d'appliquer l'inégalité d'interpolation (1.26) à la fonction

$$v(t) = (A^*)^{-1/2} \sinh(t\sqrt{A^*})w = \frac{1}{2i\pi} \int_{\Gamma_\alpha} \frac{\sinh(t\sqrt{z})}{\sqrt{z}} R_{A^*}(z)w dz.$$

Les estimées de résolvante données par le Théorème 1.13 permettent alors de conclure. Dans le cadre du premier exemple de (1.21)-(1.25), l'inégalité (1.26) est satisfaite. En effet, comme pour le laplacien, on déduit des inégalités de Carleman de [LR95] des inégalités d'interpolation locales, qui, propagées donnent (1.26) de la même façon que dans [LR95, LZ98]. Le point clé ici est que les inégalités de Carleman sont insensibles aux termes d'ordre inférieur (voir le Paragraphe 1.2.2.1 ci-après). Par conséquent, on a montré l'inégalité spectrale (1.27) pour les sommes de fonctions propres généralisées des opérateurs scalaires non-autoadjoints, observées par un sous domaine (cette inégalité est rappelée en (1.31)).

Dans le deuxième exemple de (1.21)-(1.25), qui concerne les systèmes paraboliques avec une seule observation, on ne sait pas si l'inégalité d'interpolation (1.26) est satisfaite. Dans ce cas, et sous la condition $\omega \cap \{b \neq 0\} \neq \emptyset$, (sur laquelle nous reviendrons plus en détail au Paragraphe 1.3) on montre une inégalité d'interpolation plus proche de celle utilisée originellement par G. Lebeau et L. Robbiano [LR95] : pour tout $U \subset (0, T_0) \times (\omega \cap \{b \neq 0\})$, pour tout $\zeta \in (0, T_0/2)$ il existe $\nu \in (0, 1)$, tel que pour tout $v = (v_1, v_2) \in (H^2((0, T_0) \times \Omega))^2$ satisfaisant $v|_{\partial\Omega} = 0$ on ait

$$\|v\|_{(H^1((\zeta, T_0 - \zeta) \times \Omega))^2} \leq C \|v\|_{(H^1((0, T_0) \times \Omega))^2}^{1-\nu} \left(\|v_1\|_{L^2(U)} + \|(-\partial_t^2 + A^*)v\|_{(L^2((0, T_0) \times \Omega))^2} \right)^\nu. \quad (1.28)$$

On notera que l'observation $\|v_1\|_{L^2(U)}$ ne porte que sur une composante, localisée dans $(0, T_0) \times (\omega \cap \{b \neq 0\})$. L'idée est la suivante. On somme les inégalités de Carleman locales pour chacune des variables v_j , $j = 1, 2$, puis on absorbe les termes d'ordre inférieur. Ceci nous fournit une inégalité de Carleman locale pour le couple (v_1, v_2) . De cette inégalité, on déduit comme dans [LR95] des inégalités d'interpolation locales. Une fois ces inégalités propagées et recollées, on obtient une inégalité

d'interpolation globale du type de (1.28), avec deux observations à l'intérieur de U . Enfin, on élimine l'une des observations à l'aide d'une inégalité locale d'énergie dans l'ouvert U , pour finalement obtenir (1.28).

Pour déduire de cette inégalité d'interpolation une inégalité spectrale de la forme de (1.16), puis un résultat de contrôlabilité, il nous faut alors développer la méthode originelle de Lebeau-Robbiano dans le cas non-autoadjoint. On prouve donc pour commencer une "inégalité spectrale intégrée en temps". On introduit une fonction $\varphi = \varphi(t) \in \mathcal{C}_c^\infty(0, T_0)$ non identiquement nulle.

Théorème 1.15. *On suppose que pour un $\zeta \in (0, T_0/2)$ et un $\nu \in (0, 1]$ on a l'inégalité suivante : pour tout $v \in \mathcal{K}^2(0)$,*

$$\|v\|_{\mathcal{K}^1(\zeta)} \leq C' \|v\|_{\mathcal{K}^1(0)}^{1-\nu} \left(\|\varphi B^* v\|_{L^2(0, T_0; Y)} + \|(-\partial_t^2 + A^*)v\|_{\mathcal{K}^0(0)} \right)^\nu.$$

Il existe alors des constantes C, D telles que pour tout $\alpha > 0$, et $w \in \Pi_\alpha^* H$, on ait

$$\|w\|_H \leq C e^{D\alpha^\theta} \left\| \varphi B^* \left(e^{t\sqrt{A^*}} + e^{-t\sqrt{A^*}} \right) w \right\|_{L^2(0, T_0; Y)}, \quad \text{avec } \theta = \max\{1/2, p^{-1} - (1 - q)\}. \quad (1.29)$$

Cette inégalité est le pendant de l'inégalité (1.16) montrée dans [LR95] pour le laplacien. D'après (1.28), l'inégalité spectrale (1.29) est satisfaite dès que $\omega \cap \{b \neq 0\} \neq \emptyset$ dans le cas des systèmes paraboliques (1.21)-(1.25) avec une seule observation.

Comme dans le cas du laplacien, la preuve de la contrôlabilité diffère selon que l'on a pu prouver (1.27) ou (1.29). Dans le premier cas, on peut suivre la méthode simplifiée (voir [LL09] pour une exposition simple), tandis que dans le second, on doit adapter la méthode originelle de Lebeau-Robbiano.

Construction du contrôle à partir de l'inégalité spectrale (1.27). Dans le cas (favorable) où l'inégalité spectrale (1.27) est satisfaite, on obtient (grâce à la méthode HUM) assez simplement la contrôlabilité à zéro du système de dimension finie

$$\begin{cases} \partial_t u + Au = \Pi_\alpha B g_\alpha, \\ u|_{t=0} = u_0 \in \Pi_\alpha H, \end{cases} \quad (1.30)$$

par un contrôle g_α , de coût $C \frac{e^{D\alpha^\theta}}{\sqrt{T}}$. Le système (1.30) est une approximation de Galerkin du système parabolique (1.24) pour lequel on a construit un contrôle très particulier : ce contrôle explose lorsque $T \rightarrow 0^+$ comme $T^{-\frac{1}{2}}$, ce qui, d'après le Théorème 1.5, est optimal pour un système de dimension finie. Ceci traduit le fait qu'un contrôle localisé agit directement sur toutes les fréquences du problème (voir le critère du Théorème 1.5). Ce contrôle dépend aussi de façon acceptable de la fréquence de coupure, puisqu'il suffit pour construire un contrôle pour le système parabolique complet (1.24).

Notons que le contrôle fourni par la méthode HUM pour le système parabolique (1.24) à partir de l'inégalité d'observabilité (donnée par [FI96] par exemple) ne partage pas ces propriétés. Il permet en effet en particulier de contrôler (1.30) avec un coût uniformément borné par rapport à la fréquence α (puisque c'est un contrôle pour le système toutes fréquences (1.24)). Cependant, sa dépendance en T lorsque $T \rightarrow 0^+$ est de l'ordre de $e^{\frac{C}{T}}$, et il n'est donc pas adapté au contrôle des basses fréquences en temps court.

Finalement, le résultat obtenu ici de contrôle des basses fréquences par un g_α , de coût $C \frac{e^{D\alpha^\theta}}{\sqrt{T}}$ n'est *a priori* pas une conséquence de l'inégalité d'observabilité pour le système parabolique (1.24) (donnée par [FI96] par exemple). Le contrôle que l'on construit ici réalise pour la famille de systèmes (1.30) un bon compromis explosion en temps court/explosion à haute fréquence.

Pour conclure un théorème de contrôlabilité pour le problème parabolique (1.24), il s'agit, comme dans le cas autoadjoint, de combiner ce résultat de contrôle des basses fréquences et un résultat de décroissance exponentielle du semi-groupe e^{-tA} lorsque l'on le restreint au sous-espace $(I - \Pi_\alpha)H$. Des résultats généraux sur les semi-groupes (voir par exemple les livres [EN00] et [ABHN01])

donnent alors une décroissance du type $\|e^{-tA}(I - \Pi_\alpha)\|_{\mathcal{L}(H)} \leq C(\alpha)e^{-t\alpha}$. Mais on a besoin ici de la dépendance précise de la constante en fonction de la fréquence α . Les estimées de résolvante ainsi que l'expression du semi-groupe par le calcul fonctionnel

$$e^{-tA}(I - \Pi_\alpha) = \frac{1}{2i\pi} \int_{\partial\Lambda_\alpha} e^{-tz} R_A(z) dz,$$

où $\Lambda_\alpha = \{z \in \mathcal{P}_{K_0}^q, \operatorname{Re}(z) \geq \max\{\alpha_k, \alpha_k \leq \alpha\}\}$ permettent de montrer qu'elle est en fait de l'ordre de $e^{C\alpha^\theta}$. Cette constante est donc comparable à la constante de notre inégalité spectrale.

Appliquant la méthode de construction séquentielle du contrôle de [LR95], on obtient finalement le résultat suivant.

Théorème 1.16. *Si $\theta < 1$, alors pour tout $u_0 \in H$ et tout $T > 0$, il existe un contrôle $g \in \mathcal{C}_c^\infty(0, T; Y)$ tel que la solution de (1.24) satisfasse $u(T) = 0$.*

Notons que le contrôle ainsi obtenu est régulier (si $Y = H$ et si B^* préserve les domaines de A_0^k , on peut construire de plus $g \in \mathcal{C}_c^\infty(0, T; \cap_{k \in \mathbb{N}} \mathcal{D}(A_0^k))$). En contrepartie, ce contrôle n'est pas celui qui minimise la norme $L^2(0, T; Y)$, donné par la méthode HUM.

La restriction $\theta < 1$ provient du fait que la décroissance parabolique doit l'emporter sur la croissance de la solution lors de la phase de contrôle (elle même mesurée par le coût du contrôle). Dans l'application en vue ($A = -\Delta + b \cdot \nabla + c$), on a $\theta < 1$ si et seulement si $n \leq 2$. En "grande" dimension d'espace, cette méthode ne permet pas de conclure.

Une autre application de l'inégalité spectrale (1.27), inspirée de l'article de D. Jerison et G. Lebeau [JL99] concerne la mesure des ensembles nodaux des sommes de fonctions propres généralisées de l'opérateur $-\Delta + b \cdot \nabla + c$. On se place ici dans un cadre analytique (pour Ω, b, c). L'inégalité spectrale (1.27) se réécrit de la façon suivante : pour tout $\alpha > 0$, et tout $w \in \Pi_\alpha L^2(\Omega)$ (les espace duaux $\Pi_\alpha^* L^2(\Omega)$ ne jouent aucun rôle dans cette application), on a

$$\|w\|_{L^2(\Omega)} \leq C e^{D\alpha^\theta} \|w\|_{L^2(\omega)}, \quad \theta = \max \left\{ \frac{1}{2}; \frac{n-1}{2} \right\}. \quad (1.31)$$

Appelant alors \mathcal{H}_{n-1} la mesure de Hausdorff de dimension $(n-1)$ sur Ω on obtient alors l'estimée supérieure suivante, analogue de celle de [JL99] : pour tout $\alpha > 0$ et $w \in \Pi_\alpha L^2(\Omega)$,

$$\mathcal{H}_{n-1}(\{w = 0\}) \leq C_1 \alpha^\theta + C_2, \quad \theta = \max \left\{ \frac{1}{2}; \frac{n-1}{2} \right\}. \quad (1.32)$$

Ici, w est une somme de fonctions propres et de fonctions propres généralisées de $-\Delta + b \cdot \nabla + c$, associées à des valeurs propres de partie réelle inférieure à α . Encore une fois, pour le laplacien, la puissance 1/2 est optimale, car l'inégalité inverse est satisfaite par une seule fonction propre (voir [DF88, DF90] et [JL99]).

Construction du contrôle à partir de l'inégalité spectrale (1.29). Dans le cas, moins favorable, où l'on n'a que l'inégalité spectrale (1.29) à notre disposition, la construction du contrôle est plus complexe. Tout le travail est alors de montrer la contrôlabilité du problème basses fréquences (1.30), alors que ce point était quasi-immédiat dans le cas précédent. On suit pour cela la méthode originelle de Lebeau-Robbiano comme décrite au début du Paragraphe 1.2.

L'inégalité spectrale (1.29) donne tout d'abord un résultat de contrôlabilité d'un système elliptique d'évolution sur $\Pi_\alpha H$ (avec des données initiales particulières), dont le coût est bien estimé en fonction de α . Il nous faut transformer ce résultat en un résultat de contrôlabilité pour le problème (1.30), avec un coût du contrôle du même ordre.

On souhaite pour cela utiliser l'idée de Russell [Rus73]. Mais on ne peut pas comme dans le cas autoadjoint réduire cette étape à un problème de moments, en projetant le problème de contrôle elliptique et son homologue parabolique sur une base de fonctions propres de l'opérateur. On raisonne alors de la façon suivante.

Grâce à la méthode HUM décrite au Paragraphe 1.1.1, l'inégalité spectrale intégrée en temps (1.29) implique la contrôlabilité à zéro en temps T_0 du problème elliptique

$$-\partial_t^2 u + Au = \Pi_\alpha B h_\alpha,$$

avec un coût de l'ordre de $Ce^{C\alpha^\theta}$ (et pour certaines données initiales dans $\Pi_\alpha H$). Cette propriété de contrôlabilité elliptique est essentiellement équivalente à : $\forall v_\alpha \in \Pi_\alpha H, \exists h_\alpha \in \mathcal{C}_c^\infty(0, T_0; Y)$ (de norme bornée par $Ce^{C\alpha^\theta} \|v_\alpha\|_H$) tel que $\forall w \in \Pi_\alpha^* H$,

$$(v_\alpha, w)_H = \left(B h_\alpha, \left(e^{t\sqrt{A^*}} + e^{-t\sqrt{A^*}} \right) w \right)_{L^2(0, T_0; H)}.$$

Le problème de contrôle parabolique est quant à lui essentiellement équivalent à : $\forall v_\alpha \in \Pi_\alpha H, \exists g_\alpha \in L^2(0, T; Y)$ (le contrôle du problème elliptique que l'on cherche) tel que $\forall w \in \Pi_\alpha^* H$,

$$(v_\alpha, w)_H = \left(B g_\alpha, e^{-tA^*} w \right)_{L^2(0, T; H)}.$$

Et il s'avère que passer du problème elliptique au problème parabolique revient alors à montrer (via le calcul fonctionnel, voir le Paragraphe 2.4 pour plus de précision) que pour tout $h_\alpha \in \mathcal{C}_c^\infty(0, T_0; Y)$ (satisfaisant certaines estimées), il existe $g_\alpha \in L^2(0, T; Y)$ tel que

$$\int_0^{T_0} \left(e^{t\sqrt{z}} + e^{-t\sqrt{z}} \right) h_\alpha(t) dt = \int_0^T e^{-tz} g_\alpha(t) dt.$$

Si on note $\hat{f}(z) = \int_{\mathbb{R}} f(t) e^{-itz} dt$ la transformée de Fourier-Laplace de f pour $z \in \mathbb{C}$, cette dernière assertion est équivalente à montrer l'existence d'une fonction g_α supportée dans $(0, T)$ telle que

$$\hat{h}_\alpha(i\sqrt{z}) + \hat{h}_\alpha(-i\sqrt{z}) = \hat{g}_\alpha(iz).$$

La fonction $\hat{h}_\alpha(i\sqrt{z}) + \hat{h}_\alpha(-i\sqrt{z})$ étant entière, de bonnes estimées permettraient, en utilisant le théorème de Paley-Wiener, de l'identifier à la transformée de Fourier-Laplace d'une fonction g_α , à support dans $(0, T)$. Cependant, on a seulement des estimées du type $|\hat{h}_\alpha(i\sqrt{z}) + \hat{h}_\alpha(-i\sqrt{z})| \leq Ce^{C\sqrt{|z|}}$, et le théorème de Paley-Wiener pour les ultradistributions (voir [Rod93, Th 1.6.7] ou [Hör83, Th 15.1.5]) nous fournit un contrôle g_α trop singulier : une ultradistribution dans la classe $(G_0^2)'$, supportée en zéro, où G_0^2 désigne l'espace des fonctions Gevrey d'ordre 2 à support compact (voir [Rod93, Def 1.5.1]).

Il est donc nécessaire de régulariser ce contrôle en le convoluant avec une fonction $e \in G_0^\sigma$, $\sigma \in (1, 2)$, à support compact dans $(0, T)$. La transformée de Fourier-Laplace de cette fonction de Gevrey e doit aussi satisfaire de bonnes estimées inférieures sur tout l'intérieur de la parabole $\mathcal{P}_{K_0}^q$. On n'arrive à construire une telle fonction que dans le cas $q < \frac{3}{4}$.

Ceci conclut la contrôlabilité du problème basses fréquences (1.30) avec un coût du contrôle en $Ce^{C\alpha^\theta + \frac{C}{T^\gamma}}$, pour un certain $\gamma > 0$. On remarque que ce coût est du même ordre en α qu'avec la méthode simplifiée. Par contre, on a perdu ici le "bon comportement" en $T^{-\frac{1}{2}}$ lorsque $T \rightarrow 0^+$. Ceci ne nous empêche pas de conclure, de la même manière que dans le cas précédent, combinant contrôles basses fréquences et décroissance parabolique haute fréquence. On obtient alors avec cette autre inégalité spectrale le Théorème 1.16 avec comme hypothèse supplémentaire $q < \frac{3}{4}$ (hypothèse vérifiée dans toutes les applications envisagées plus haut (1.21)).

1.2.1.3 Problèmes ouverts et perspectives

Le principal problème ouvert ici concerne la théorie spectrale des opérateurs non-autoadjoints à résolvante compacte. En effet, dans tout ce que l'on a présenté, la seule limitation essentielle concerne la puissance $e^{C\alpha^\theta}$, là où l'on s'attendrait à $e^{C\sqrt{\alpha}}$. L'inégalité spectrale pour les opérateurs elliptiques non-autoadjoints du type (1.21) est-elle vraie avec $\theta = \frac{1}{2}$? On voit ici que cette mauvaise puissance θ ne provient que des estimées de résolvante dont on dispose. Tout le développement

effectué fonctionne dès que l'on sait montrer des estimées de résolvante sur certains contours (comme ceux de la Figure 1.2). Le problème essentiel est donc un problème d'estimation de résolvante.

Le théorème spectral abstrait que l'on a utilisé ici est beaucoup trop général pour obtenir des propriétés fines des opérateurs que l'on souhaite traiter. En effet, la seule caractéristique du laplacien qui est utilisée ici est son asymptotique de Weyl. Cette analyse est trop grossière pour les opérateurs différentiels que l'on a en vue.

On pourrait peut-être commencer par étudier le cas simple où Ω est une variété sans bord. Dans cette situation, les opérateurs considérés ici sont des opérateurs pseudodifférentiels. L'analyse semiclassique permet peut-être d'obtenir des estimées de résolvante en haute fréquence. On renvoie à [Sjö09, Sjö10, Roy10] pour certaines estimées de résolvante dans la limite semiclassique.

On peut aussi se demander si l'inégalité spectrale (1.27) est valable ou non pour les systèmes du deuxième exemple de (1.21). Il semblerait que ce problème soit fortement lié aux propriétés de contrôle des systèmes par le bord, problème qui est assez largement ouvert (voir le Paragraphe 1.3). La contrôlabilité des systèmes par le bord semble elle aussi très liée avec le cas $\omega \cap \{b > 0\} = \emptyset$.

On peut cependant remarquer que l'inégalité spectrale (1.27) implique, pour les basses fréquences un coût du contrôle en $T^{-\frac{1}{2}}$, lorsque $T \rightarrow 0^+$. Or concernant le système du deuxième exemple de (1.21), on se trouve dans une situation intuitivement comparable à (1.10) (même si en fait, l'opérateur Π_α redistribue le contrôle), pour laquelle le coût du contrôle se comporte comme $T^{-\frac{3}{2}}$, lorsque $T \rightarrow 0^+$. Il est donc possible que l'inégalité spectrale (1.27) soit fautive en général pour les systèmes du deuxième exemple de (1.21) avec une seule observation.

Enfin, l'inégalité spectrale et la contrôlabilité pour les systèmes dans le cas $\omega \cap \{b > 0\}$ sont des problèmes assez ouverts. Le problème de contrôlabilité dans ce cas fait l'objet du Paragraphe 1.3 ci-après. Notons que notre analyse permet de ramener ce problème à une estimée de polongement unique quantitatif pour le système elliptique associé.

1.2.2 Analyse et contrôle d'un modèle d'interface diffusive

Dans cette partie, nous allons développer la méthode de Lebeau-Robbiano pour un problème parabolique contenant une interface à travers laquelle le système dissipe. On se donne ici un ouvert $\Omega \subset \mathbb{R}^n$ borné régulier, une sous-variété de dimension $n - 1$ de Ω , appelée S , et on suppose que $\Omega \setminus S = \Omega_1 \cup \Omega_2$, où Ω_1 et Ω_2 sont deux ouverts de Ω . Cette situation est représentée sur la Figure 1.3. On munit S de la métrique induite par celle de \mathbb{R}^n , et on appelle ∂_η un champ de vecteur normal unitaire (pour cette métrique) à S sortant de Ω_1 et entrant dans Ω_2 . On appelle c un coefficient de diffusion (scalaire), régulier sur $\bar{\Omega}_1$ et $\bar{\Omega}_2$, mais discontinu à travers l'interface S , tel que $c > 0$ sur $\bar{\Omega}$. On note aussi c^s un coefficient de diffusion (scalaire), régulier sur S tel que $c^s > 0$ sur S . On définit les opérateurs elliptiques

$$-\Delta_c := -\operatorname{div} c \nabla \text{ sur } \Omega_1 \cup \Omega_2 \quad \text{et} \quad -\Delta_{c^s} := -\operatorname{div}^s c^s \nabla^s \text{ sur } S,$$

où div^s et ∇^s sont la divergence et le gradient sur S pour la métrique induite. On notera $u|_{S_j} = (u|_{\Omega_j})|_S$ pour $j = 1, 2$ la trace d'une fonction de Ω_j sur S .

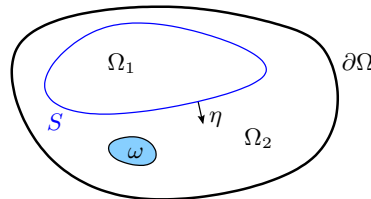

FIGURE 1.3 – Géométrie du problème d'interface.

On cherche à étudier les propriétés du problème parabolique suivant :

$$\begin{cases} \partial_t u - \Delta_c u = \mathbb{1}_\omega g & \text{dans } (0, T) \times \Omega_1 \cup \Omega_2, \\ \partial_t u^s - \Delta_{c^s} u^s = \frac{1}{\delta} ((c\partial_\eta u)|_{S_2} - (c\partial_\eta u)|_{S_1}) & \text{sur } (0, T) \times S, \\ u|_{S_1} = u^s = u|_{S_2} & \text{sur } (0, T) \times S, \\ u|_{\partial\Omega} = 0, & \end{cases} \quad (1.33)$$

avec une donnée initiale dans $L^2(\Omega_1 \cup \Omega_2) \times L^2(S)$. Notons que la première ligne de ce système contient en fait une équation de la chaleur de chaque côté de l'interface. Ici, δ est un paramètre borné, $0 < \delta \leq \delta_0$, et la zone de contrôle ω est un ouvert non vide de $\Omega_1 \cup \Omega_2$. On supposera par exemple dans ce qui suit que $\omega \subset \Omega_2$. L'état du système est le couple (u, u^s) , que l'on veut amener à zéro en temps T .

De telles conditions de couplage du second ordre ont été considérées dans les articles [KZ06] et [LZ10] pour le problème hyperbolique associé. Elles peuvent être formellement obtenues en considérant un modèle à trois couches, avec des conditions de transmission naturelles aux interfaces, lorsque l'épaisseur de la couche centrale δ est supposée petite (voir le Paragraphe 3.6).

Introduisons les espaces fonctionnels adaptés à l'étude de ce problème. Tout d'abord, on note $\mathcal{H}_\delta^0 = L^2(\Omega_1 \cup \Omega_2) \times L^2(S)$ muni du produit scalaire

$$(U, \tilde{U})_{\mathcal{H}_\delta^0} = (u, \tilde{u})_{L^2(\Omega_1 \cup \Omega_2)} + \delta (u^s, \tilde{u}^s)_{L^2(S)}, \quad U = (u, u^s), \tilde{U} = (\tilde{u}, \tilde{u}^s).$$

On introduit de même l'espace

$$\mathcal{H}_\delta^1 = \{U = (u, u^s) \in H^1(\Omega_1 \cup \Omega_2) \times H^1(S); u|_{\partial\Omega} = 0; u|_{S_1} = u^s = u|_{S_2}\},$$

muni du produit scalaire

$$(U, \tilde{U})_{\mathcal{H}_\delta^1} = (U, \tilde{U})_{\mathcal{H}_\delta^0} + (c\nabla u, \nabla \tilde{u})_{L^2(\Omega_1 \cup \Omega_2)} + \delta (c^s \nabla^s u, \nabla^s \tilde{u}^s)_{L^2(S)}.$$

On peut alors réécrire le problème (1.33) sous la forme

$$\partial_t U + A_\delta U = Bg, \quad (1.34)$$

où l'état est $U = (u, u^s) \in \mathcal{H}_\delta^0$ et l'opérateur A_δ s'écrit

$$A_\delta U = \begin{pmatrix} -\Delta_c u & -\Delta_c u \\ -\Delta_{c^s} u^s - \frac{1}{\delta} ((c\partial_\eta u)|_{S_2} - (c\partial_\eta u)|_{S_1}) & \end{pmatrix}, \quad (1.35)$$

de domaine $\mathcal{D}(A_\delta) = \{(u, u^s) \in \mathcal{H}_\delta^1; A_\delta(u, u^s) \in \mathcal{H}_\delta^0\}$. L'opérateur de contrôle B , borné de $L^2(\Omega_1 \cup \Omega_2)$ dans \mathcal{H}_δ^0 , est donné par $B : u \mapsto {}^t(\mathbb{1}_\omega u, 0)$.

Notons enfin que, lorsque $\delta \rightarrow 0^+$, le système (1.33) converge formellement vers

$$\begin{cases} \partial_t u - \Delta_c u = \mathbb{1}_\omega g & \text{dans } (0, T) \times \Omega_1 \cup \Omega_2, \\ (c\partial_\eta u)|_{S_2} = (c\partial_\eta u)|_{S_1}, \text{ et } u|_{S_1} = u|_{S_2} & \text{sur } (0, T) \times S, \\ u|_{\partial\Omega} = 0. & \end{cases} \quad (1.36)$$

Ce problème asymptotique correspond à une limite singulière pour la condition de transmission de (1.33), et on montre que la convergence n'est pas que formelle.

Proposition 1.17. *L'opérateur $(A_\delta, \mathcal{D}(A_\delta))$ est un opérateur positif autoadjoint sur \mathcal{H}_δ^0 . Pour tout $\delta > 0$, le problème (1.33) est bien posé pour des données initiales dans \mathcal{H}_δ^0 et un contrôle dans $L^2((0, T) \times \omega)$.*

Supposons de plus que le contrôle g_δ pour le problème (1.33) satisfait $g_\delta \rightarrow g$ dans $L^2((0, T) \times \omega)$ lorsque $\delta \rightarrow 0$, et que la donnée initiale est $(u^0, u^{s,0}) \in \mathcal{H}_\delta^1$. Alors, la solution u_δ de (1.33) associée à g_δ satisfait $u_\delta|_{\Omega_j} \rightarrow u|_{\Omega_j}$ dans $L^2(0, T; H^2(\Omega_j)) \cap H^1(0, T; L^2(\Omega_j))$ pour $j = 1, 2$, où u est la solution du problème (1.36) associée au contrôle g et à la donnée initiale u^0 .

D'autre part, on sait depuis les travaux de J. Le Rousseau et L. Robbiano [LR10, LR11] que le problème limite (1.36) est contrôlable.

Les deux questions que l'on se pose alors sont les suivantes. Pour δ fixé, le problème (1.33) est-il contrôlable à zéro ? Ce système est-il uniformément contrôlable dans la limite $\delta \rightarrow 0^+$? Pour répondre à ces questions nous montrons une inégalité de Carleman au voisinage de l'interface S pour l'opérateur A_δ .

1.2.2.1 Outil principal : inégalités de Carleman pour les opérateurs elliptiques

Les inégalités de Carleman sont des inégalités à poids du type

$$\|e^{\varphi/h} P v\|_{L^2(\mathbb{R}^n)} \geq C \|e^{\varphi/h} v\|_{L^2(\mathbb{R}^n)},$$

où $P = P(x, D_x)$ est un opérateur différentiel, φ est une fonction à valeur réelle, $h > 0$ est un petit paramètre et $v \in \mathcal{C}_c^\infty(\mathbb{R}^n)$. Ce type d'inégalité a été utilisé pour la première fois par T. Carleman en 1939 [Car39] pour montrer des propriétés d'unicité pour le problème de Cauchy associé à certains opérateurs non-hyperboliques. L'idée de ces inégalités à poids et à paramètre a été par la suite développée par A.-P. Calderón, utilisant une factorisation pseudodifférentielle de l'opérateur P [Cal58], puis systématisée par L. Hörmander [Hör63, Chapter VIII], en développant une version locale (voir aussi [Hör85, Chapter 17] et [Hör94, Chapter 28]). Ces inégalités correspondent à une quantification du prolongement unique et permettent de donner un analogue du théorème de Holmgren dans un cadre non-analytique.

On peut montrer de telles inégalités pour différents types d'opérateur. On renvoie par exemple à [Hör94, Chapter 28] pour des opérateurs homogènes généraux, et à [FCG06, LL09] pour des opérateurs paraboliques. Lorsque l'opérateur P est elliptique d'ordre deux, la théorie des inégalités de Carleman est plus simple, et c'est dans ce cadre plus précis que nous allons les présenter et les utiliser. On renvoie à l'article de J. Le Rousseau et G. Lebeau [LL09], qui constitue une introduction pédagogique aux inégalités de Carleman elliptiques.

Présentons maintenant plus en détail ce qu'est une inégalité de Carleman locale pour un opérateur elliptique d'ordre deux, dans le cas très simple où $P = -\Delta$.

Théorème 1.18. *Soient V un ouvert borné de \mathbb{R}^n , et φ une fonction poids satisfaisant l'hypothèse de sous-ellipticité de Hörmander sur \bar{V} et telle que $\nabla\varphi$ ne s'annule pas sur \bar{V} ; alors il existe $h_0 > 0$ et $C > 0$ tels que pour tout $v \in \mathcal{C}_c^\infty(V)$ et $0 < h < h_0$,*

$$h \|e^{\varphi/h} v\|_{L^2(\mathbb{R}^n)}^2 + h^3 \|e^{\varphi/h} \nabla v\|_{L^2(\mathbb{R}^n)}^2 \leq C h^4 \|e^{\varphi/h} P v\|_{L^2(\mathbb{R}^n)}^2. \quad (1.37)$$

L'hypothèse de sous-ellipticité de Hörmander sera précisée ci-après. On remarque que les puissances de h dans cette inégalité sont sous-elliptiques : comme une dérivée correspond à une puissance de h dans le calcul semiclassique que l'on utilise, on s'attendrait à avoir $\|e^{\varphi/h} u\|_{L^2}^2 + h^2 \|e^{\varphi/h} \nabla u\|_{L^2}^2$ dans le membre de gauche (ce qui serait une meilleure estimée car h est petit). Cependant, on peut montrer que ces puissances (ainsi que la condition de sous-ellipticité de Hörmander) sont optimales [LL09] : l'opérateur conjugué P_φ défini ci-dessous n'est pas elliptique et la perte d'une demi-dérivée se produit au voisinage de sa variété caractéristique. L'inégalité (1.37) quantifie effectivement le prolongement unique " $Pv = 0$ et v à support compact $\implies v = 0$ ". On notera aussi que les inégalités de Carleman sont insensibles à des perturbations de l'opérateur par des termes d'ordre un ou zéro (au sens où seules les constantes sont affectées). En effet, si on remplace dans (1.37) P par $P + b \cdot \nabla + c$ avec b et c bornés, on peut absorber, pour h suffisamment petit les perturbations $b \cdot \nabla + c$ dans le membre de gauche.

Esquissons l'idée générale d'une preuve de cette inégalité.

Soit $\varphi \in \mathcal{C}^\infty(\mathbb{R}^n; \mathbb{R})$ une fonction poids. On définit l'opérateur conjugué de P :

$$P_\varphi = h^2 e^{\varphi/h} P e^{-\varphi/h},$$

considéré ici comme un opérateur différentiel semiclassique, de symbole principal $p_\varphi = |\xi|^2 - |\nabla\varphi|^2 + 2i\xi \cdot \nabla\varphi$ (ici, le symbole de $\frac{h}{i}\partial$ est ξ). On décompose P_φ en sa partie autoajointe et sa partie

antiadjointe : $P_\varphi = Q_2 + iQ_1$ avec $Q_2 = \frac{P_\varphi + P_\varphi^*}{2}$ et $Q_1 = \frac{P_\varphi - P_\varphi^*}{2i}$, de symboles principaux respectifs $q_2 = |\xi|^2 - |\nabla\varphi|^2$ et $q_1 = 2\xi \cdot \nabla\varphi$. On pose $v_\varphi = e^{\varphi/h}v$ et montrer (1.37) revient à montrer

$$\|P_\varphi v_\varphi\|_{L^2(\mathbb{R}^n)}^2 \geq Ch \left(\|h\nabla v_\varphi\|_{L^2(\mathbb{R}^n)}^2 + \|v_\varphi\|_{L^2(\mathbb{R}^n)}^2 \right). \quad (1.38)$$

On calcule donc

$$\|P_\varphi v_\varphi\|_{L^2(\mathbb{R}^n)}^2 = ((Q_2^2 + Q_1^2 + i[Q_2, Q_1])v_\varphi, v_\varphi)_{L^2(\mathbb{R}^n)}, \quad (1.39)$$

et l'opérateur $Q_2^2 + Q_1^2 + i[Q_2, Q_1]$ qui apparaît a pour symbole principal (semiclassique)

$$q_2^2 + q_1^2 + h\{q_2, q_1\}.$$

L'hypothèse de sous-ellipticité de Hörmander est la suivante : sur la variété caractéristique $\{(x, \xi) \in \mathbb{R}^n \times \mathbb{R}^n; q_2(x, \xi) = q_1(x, \xi) = 0\}$, le crochet de Poisson satisfait $\{q_2, q_1\} > 0$. Cette variété étant compacte, le théorème de Gårding semiclassical nous donne alors (1.38) pour h suffisamment petit, ce qui permet de conclure la preuve. Pour des opérateurs elliptiques P , il n'est pas difficile de construire des fonctions φ satisfaisant l'hypothèse de sous-ellipticité de Hörmander. Il suffit de prendre (par exemple) $\varphi = e^{\lambda\psi}$ avec $|\nabla\psi| \neq 0$ et λ suffisamment grand.

Notons que l'on rencontre souvent ces inégalités avec un grand paramètre $\tau = \frac{1}{h}$: si l'approche est rigoureusement équivalente, elle a pour avantage de manipuler des symboles homogènes en (τ, ξ) mais pour inconvénient de nécessiter l'introduction de la métrique adaptée.

Pour conclure ce paragraphe, nous donnons quelques unes des nombreuses applications de ces inégalités de Carleman elliptiques en analyse (outre la contrôlabilité de la chaleur [LR95]).

Le prolongement unique (voir [Cal58] et [Hör94, Chapter 28]). Le théorème de prolongement unique de Calderón dans le cas simple d'opérateurs elliptiques du second ordre peut s'énoncer comme suit : soit $u \in H^2(\mathbb{R}^n)$ une solution de $\Delta u = g(u)$ avec $|g(u)| \leq C|u|$. S'il existe un ouvert ω tel que $u|_\omega = 0$, alors $u = 0$ sur tout \mathbb{R}^n . C'est l'application originelle des inégalités de Carleman.

L'effet tunnel (voir [EZ10, Mil09]). Soit ψ_h une fonction propre de l'opérateur de Schrödinger semi-classique $-h^2\Delta + V(x)$ avec conditions de Dirichlet sur $\Omega \subset \mathbb{R}^n$, associée à la valeur propre E_h . Alors, pour tout $h < h_0$, on a

$$\begin{cases} \|\psi_h\|_{L^2(\omega)} \geq e^{-C\omega/h} \|\psi_h\|_{L^2(\Omega)}, & \text{pour tout } \omega \subset \Omega \\ \|\psi_h\|_{L^2(\omega)} \leq e^{-D\omega/h} \|\psi_h\|_{L^2(\Omega)}, & \text{pour tout } \omega \subset V^{-1}(E, +\infty), \text{ si } E_h \xrightarrow{h \rightarrow 0} E. \end{cases}$$

La première inégalité se déduit d'une inégalité de Carleman et traduit l'effet tunnel (i.e., pour une particule, la probabilité de présence non-nulle dans n'importe quel $\omega \subset \Omega$); la seconde provient d'une estimée d'Agmon (assez proche d'une inégalité de Carleman) et traduit la faible probabilité d'entrer dans la zone interdite par la mécanique classique.

La stabilisation de l'équation des ondes faiblement amorties (voir [Leb96, LR97, Bur98]). Pour l'équation des ondes amorties sur un sous-domaine, aussi petit soit-il, l'énergie décroît au moins logarithmiquement lorsque le temps tend vers l'infini. Nous donnons plus de détails sur cet exemple au Paragraphe 1.3.1.1.

1.2.2.2 Résultats antérieurs

Dans le cas présent, nous voulons montrer une inégalité de Carleman pour l'opérateur elliptique A_δ qui présente à la fois un saut à travers une interface et des conditions de transmission faisant intervenir un opérateur elliptique tangentiel d'ordre deux dans l'interface. Rappelons avant tout les résultats connus en ce qui concerne les inégalités de Carleman pour les problèmes au bord et les problèmes d'interface.

Le premier résultat dans ce domaine est à ma connaissance l'article [LR95], dans lequel les auteurs montrent une inégalité de Carleman locale (l'équivalent de (1.37)) pour un opérateur elliptique du type $-\Delta$ au voisinage d'un bord de Dirichlet. Les techniques utilisées sont globalement les mêmes que celles décrites dans le paragraphe précédent. Cependant, des termes de bord apparaissent dans l'intégration par parties (1.39), faisant apparaître une forme bilinéaire dépendant de la trace et de la trace normale. Dans cet article, le théorème de Gårding est utilisé seulement dans les directions tangentielles, montrant la positivité de cette forme bilinéaire (sous une condition de signe sur la trace normale de φ). Notons que les inégalités de Carleman globales [FI96] vont elles aussi jusqu'au bord et prennent donc en compte ces conditions aux limites.

Des conditions au bord beaucoup plus complexes ont été traitées dans [LR97], incluant en particulier des conditions de Neumann. Dans cet article, les auteurs introduisent une décomposition microlocale du bord et combinent la méthode "traditionnelle" pour montrer des inégalités de Carleman avec une méthode de projecteurs de Calderón dans les zones où la forme bilinéaire de Carleman n'a pas de signe mais où l'opérateur conjugué est elliptique. Nous reprendrons cette analyse.

La question de la contrôlabilité du problème de transmission (1.36) (ou, de façon équivalente de la chaleur pour un opérateur elliptique à coefficient discontinu à travers une hypersurface) apparaît pour la première fois dans l'article de A. Doubova, A. Osses et J.-P. Puel [DOP02]. Dans ce papier, les auteurs prouvent une inégalité de Carleman parabolique globale (du type de celles de [FI96]), dans le cas où la zone de contrôle est située du côté de l'interface où le coefficient de diffusion c est le plus "petit". Cette condition de monotonie du saut de c , naturelle pour des équations hyperboliques (pour lesquelles des ondes peuvent rester piégées), ne semble pas nécessaire pour les équations paraboliques.

En effet, en une dimension d'espace, A. Benabdallah, Y. Dermenjian et J. Le Rousseau montrent dans [BDL07a] une inégalité de Carleman pour un coefficient de diffusion \mathcal{C}^1 par morceaux, sans condition sur la localisation de la zone d'observation. Ce résultat est étendu par J. Le Rousseau [Le 07a] à un coefficient à variation bornée.

Cette condition de monotonie du coefficient de diffusion a été relaxée en toute dimension dans l'article [LR10], dans lequel J. Le Rousseau et L. Robbiano montrent une inégalité de Carleman dans le cas général. L'idée de cet article est d'effectuer une analyse proche de celle de [LR97] de chaque côté de l'interface, et de choisir la fonction poids φ de façon à ce que les zones microlocales de part et d'autre de l'interface soient classées dans un ordre précis. Cette méthode a été généralisée par la suite dans [LR11] au cas d'opérateurs paraboliques généraux, nécessitant l'introduction de différentes métriques sur l'espace des phases pour pallier la non-homogénéité de l'opérateur en temps et en espace.

Dans [LL10], J. Le Rousseau et N. Lerner étendent le résultat elliptique de [LR10] au cas où c est une matrice de diffusion générale (et non plus un scalaire). Leur preuve n'utilise pas de projecteur de Calderón mais une factorisation microlocale de l'opérateur, et se rapproche en ce point de la méthode de [Cal58]. Ils donnent de plus des conditions nécessaires et suffisantes sur la fonction poids φ pour qu'une telle inégalité de Carleman soit satisfaite.

Enfin, un autre cas intéressant est celui où l'interface S touche le bord de Ω . Dans cette situation, S et $\partial\Omega$ forment un "coin", et il semble difficile de mettre en œuvre des méthodes microlocales. Les seuls résultats connus sont alors dans des domaines stratifiés [BDL07b, BDL11].

1.2.2.3 Principaux résultats obtenus

Le travail présenté dans ce paragraphe est effectué en collaboration avec Jérôme Le Rousseau et Luc Robbiano.

Notre objectif principal est de montrer la contrôlabilité du problème (1.34). La méthode de Lebeau-Robbiano ramène directement ce problème à la preuve d'inégalités de Carleman locales au voisinage de l'interface S pour l'opérateur elliptique $-\partial_t^2 + A_\delta$, où A_δ est donné dans (1.35). Si l'on veut de plus avoir un résultat de contrôle uniforme par rapport au paramètre $\delta \in (0, \delta_0]$, il faut

que toutes les constantes apparaissant dans cette inégalité de Carleman (en particulier h_0 et C) ne dépendent que de δ_0 et non de δ .

On rappelle qu'il nous suffit *a priori* de montrer une inégalité de Carleman locale au voisinage d'un point de l'interface S . En effet, ces inégalités sont vraies loin de l'interface (où notre problème est un problème elliptique standard) et sur le bord de l'ouvert (où les inégalités à prouver sont exactement celles de [LR95]).

Une inégalité de Carleman semi-globale. Dans ce paragraphe, on appelle x_0 la variable supplémentaire, appelée t au début du Paragraphe 1.2. En effet, elle ne joue dans cette partie aucun rôle particulier par rapport aux autres variables d'espace. On prend donc $x_0 \in (0, X_0) \subset \mathbb{R}$, et la variable courante est maintenant $(x_0, x) \in (0, X_0) \times \Omega \subset \mathbb{R}^{n+1}$. Pour un second membre $F = (f, f^s) = (f, \frac{\theta^s}{\delta})$, le problème elliptique $(-\partial_{x_0}^2 + A_\delta)V = F$ se réécrit, localement au voisinage de S de la façon suivante

$$\begin{cases} -\partial_{x_0}^2 v - \Delta_c v = f & \text{dans } (0, X_0) \times (\Omega_1 \cup \Omega_2), \\ -\partial_{x_0}^2 v^s - \Delta_{c^s} v^s = \frac{1}{\delta} ((c\partial_\eta v)|_{(0, X_0) \times S_2} - (c\partial_\eta v)|_{(0, X_0) \times S_1} + \theta^s) & \text{sur } (0, X_0) \times S, \\ v|_{(0, X_0) \times S_1} = v^s = v|_{(0, X_0) \times S_2} & \text{sur } (0, X_0) \times S. \end{cases} \quad (1.40)$$

Notre résultat principal est une inégalité de Carleman "semi-globale", au sens où elle est globale sur S , mais locale dans la direction x_0 et la direction normale à $(0, X_0) \times S$. On expliquera plus loin l'intérêt de ce résultat global dans la direction de l'interface (du point de vue de l'inégalité spectrale et du contrôle, une inégalité de Carleman locale suffit).

On choisit un voisinage ouvert $V \subset \Omega$ de S dans lequel on peut se placer en coordonnées géodésiques normales, et on appelle V_{x_0} un voisinage ouvert dans $(0, X_0)$ d'un point $x_0 \in (0, X_0)$. On pose $\mathcal{M} = V_{x_0} \times V$ et $\mathcal{M}_j = \mathcal{M} \cap ((0, X_0) \times \Omega_j)$, $j = 1, 2$. On considère aussi une fonction $\zeta \in \mathcal{C}_c^\infty(V)$ qui ne dépend que de la variable normale à $(0, X_0) \times S$, et telle que $\zeta = 1$ au voisinage de $(0, X_0) \times S$.

Notant $\|\cdot\|$ la norme $L^2((0, X_0) \times \Omega)$, et $|\cdot|$ la norme $L^2((0, X_0) \times S)$, on montre alors l'inégalité de Carleman semi-globale suivante.

Théorème 1.19. *Sous certaines hypothèses sur la fonction poids φ on a le résultat suivant. Pour tout $\delta_0 > 0$, il existe $C > 0$ et $h_0 > 0$ tels que*

$$\begin{aligned} h\|e^{\varphi/h}v\|^2 + h^3\|e^{\varphi/h}\nabla_{x_0,x}v\|^2 + h\|e^{\varphi/h}v^s\|^2 + \sum_{j=1,2} h^3|e^{\varphi/h}\nabla_{x_0,x}v|_{S_j}|^2 \\ \leq C\left(h^4\|e^{\varphi/h}f\|_{\mathcal{M}_1}\|^2 + h^4\|e^{\varphi/h}f\|_{\mathcal{M}_2}\|^2 + h^2\delta^2\|\zeta e^{\varphi/h}f\|_{\mathcal{M}_2}\|^2 + h^3|e^{\varphi/h}\theta^s|^2\right), \end{aligned} \quad (1.41)$$

pour tous $0 < \delta < \delta_0$, $0 < h \leq h_0$, pour (v, θ^s, f) satisfaisant (1.40), $\text{supp}(v) \subset \mathcal{M}$ et $v|_{\mathcal{M}_i} \in \mathcal{C}^\infty(\overline{\mathcal{M}_i})$.

Les conditions que φ doit satisfaire sont essentiellement les suivantes :

- φ est continue sur $\overline{\mathcal{M}}$ (donc *a fortiori* à travers l'interface) ;
- $\nabla\varphi$ ne s'annule pas sur $\overline{\mathcal{M}}$;
- φ satisfait la condition de sous-ellipticité de Hörmander sur $\overline{\mathcal{M}}$;
- φ est "croissante" (dans la direction normale) lorsque l'on passe de \mathcal{M}_1 à \mathcal{M}_2 ;
- le saut $\partial_\eta\varphi|_{S_2} - \partial_\eta\varphi|_{S_1}$ de la dérivée normale de φ à travers l'interface est suffisamment grand ;
- φ est suffisamment "plate" dans les directions tangentielles.

Notons que ces mêmes conditions permettent aussi de montrer l'inégalité de Carleman de [LR10] pour l'opérateur elliptique associé au problème de transmission limite " $\delta = 0$ ".

On remarque que le membre de droite de notre inégalité de Carleman (1.41) ne donne pas un rôle symétrique aux seconds membres $f|_{\mathcal{M}_1}$ et $f|_{\mathcal{M}_2}$, des deux côtés de la surface. Cela provient du fait que l'on veut observer la solution v du côté \mathcal{M}_2 car on a choisi $\omega \subset \Omega_2$.

A l'interface, pour des raisons techniques, les puissances de h dans le terme

$$h^2\delta^2\|\zeta e^{\varphi/h}f|_{\mathcal{M}_2}\|^2, \quad (1.42)$$

de notre inégalité ne sont pas les puissances usuelles pour des inégalités de Carleman elliptiques (qui sont celles de (1.37)). On a perdu deux puissances de h . C'est précisément ce point qui amène de nombreuses complications.

En effet, on remarque alors que pour δ fixé, on ne peut plus absorber pour h petit une perturbation d'ordre un de l'opérateur du côté Ω_2 : le terme correspondant donnerait après majoration $h^2\delta^2\|\zeta e^{\varphi/h}\nabla v|_{\mathcal{M}_2}\|^2$, que l'on ne peut pas dominer par $h^3\|e^{\varphi/h}\nabla v\|^2$. Ces puissances de h sont critiques vis à vis des perturbations d'ordre un de notre opérateur elliptique.

En particulier, si on veut montrer une inégalité de Carleman globale, la stratégie usuelle est la suivante (voir par exemple [LL09] ou [LR11]). On choisit une fonction poids φ globale sur notre domaine, que l'on appelle temporairement \mathcal{X} (et qui peut être une variété). On recouvre \mathcal{X} d'ouverts bornés dans lesquels on peut travailler en coordonnées locales. Puis, dans chaque ouvert, on montre une inégalité de Carleman en coordonnées locales. Enfin, on ramène sur \mathcal{X} ces inégalité, et, grâce à une partition de l'unité, on les recolle pour former une inégalité globale sur \mathcal{X} . Ces deux dernières étapes nécessitent de pouvoir absorber des perturbations d'ordre un qui apparaissent à la fois lors du changement de variable et lors du recollement. Ce sont précisément les puissances de h qui permettent d'effectuer ces deux opérations.

Ici, cette stratégie générale est rendue impossible au voisinage de $(0, X_0) \times S$ par le terme (1.42). De telles inégalités locales ne pourraient pas être recollées, et ce à cause de l'opérateur d'ordre deux Δ_{c^s} dans l'interface. Notons que cette obstruction disparaît naturellement dans la limite $\delta \rightarrow 0$, et l'inégalité (1.41) permet alors de retrouver l'inégalité de Carleman de [LR10].

Si on veut pouvoir montrer une inégalité globale, utile dans de nombreuses applications, on doit donc procéder autrement. On montre une inégalité de Carleman (1.41) de nature semiglobale : elle est globale dans la direction de l'interface S et locale dans la direction normale à l'interface et la direction x_0 . Grâce à l'introduction de la fonction de troncature ζ , le terme (1.42) avec les mauvaises puissances de h est supporté localement dans un voisinage de l'interface. L'inégalité (1.42) peut donc sans aucune difficulté être recollée avec des estimées loin de $(0, X_0) \times S$, pour donner une inégalité globale. De même, si on veut montrer cette inégalité pour un opérateur contenant des termes d'ordre un, il faut les inclure dans l'analyse dès le début, car on ne pourra pas les absorber *a posteriori* dans (1.41).

La première étape de la preuve, comme dans le Paragraphe 1.2.2.1, consiste à définir $v_\varphi = e^{\varphi/h}v$, $v_\varphi^s = e^{\varphi/h}v^s$ et à conjuguer les opérateurs en posant

$$P_\varphi = h^2 e^{\varphi/h} (-\partial_{x_0}^2 - \Delta_c) e^{-\varphi/h}, \quad \text{et} \quad P_\varphi^s = h^2 e^{\varphi/h} (-\partial_{x_0}^2 - \Delta_{c^s}) e^{-\varphi/h},$$

se ramenant ainsi à un problème semiclassical. Les conditions de transmission de (1.40) se réécrivent

$$\begin{cases} P_\varphi^s v_\varphi^s = \frac{h}{\delta} ((ch\partial_\eta v_\varphi)|_{(0, X_0) \times S_2} - (ch\partial_\eta v_\varphi)|_{(0, X_0) \times S_1} + he^{\varphi/h}\theta^s) & \text{sur } (0, X_0) \times S, \\ v_\varphi|_{(0, X_0) \times S_1} = v_\varphi^s = v_\varphi|_{(0, X_0) \times S_2} & \text{sur } (0, X_0) \times S. \end{cases} \quad (1.43)$$

Puis, suivant l'idée de [LR97, LR10], on introduit différentes régions microlocales tangentielles, adaptées aux zones d'ellipticité des opérateurs $P_\varphi|_{S_1}$, $P_\varphi|_{S_2}$ et P_φ^s . Ici, pour pouvoir obtenir une inégalité globale, ces régions sont définies globalement sur le fibré cotangent $T^*(\mathbb{R} \times S)$. Cette particularité nous oblige à utiliser des opérateurs pseudodifférentiels globaux sur la variété $\mathbb{R} \times S$ et amène quelques complications techniques. Cependant, nous revenons souvent à leur expression en coordonnées locales, ce qui nous permet d'utiliser certains résultats de [LR10].

Il s'agit alors de choisir une fonction poids φ qui positionne de manière favorable les zones tangentielles de non ellipticité de $P_\varphi|_{S_1}$, de $P_\varphi|_{S_2}$ et de P_φ^s . En particulier, un point central de notre démonstration repose sur le fait que l'ensemble caractéristique de P_φ^s est inclus les zones de basses fréquences, à la fois de $P_\varphi|_{S_1}$ et de $P_\varphi|_{S_2}$. Dans chacune des zones ainsi définies, on prouve une inégalité de Carleman microlocale, utilisant tantôt des techniques de projecteurs de Calderón dans les zones d'ellipticité, et tantôt la méthode usuelle de Carleman. On recolle finalement ces inégalités pour obtenir une inégalité globale dans la direction de S .

Pour que cette dernière soit uniforme lorsque $\delta \rightarrow 0^+$, il nous faut suivre la dépendance de nos inégalités par rapport à δ . En particulier, dans la zone de hautes fréquences, on introduit un calcul

adapté sur l'espace des phases (en cartes locales) nous permettant à la fois d'utiliser l'ellipticité de P_φ^s dans le régime $\delta \gtrsim h$ et l'ellipticité de l'opérateur utilisé dans [LR10] dans le régime $\delta \lesssim h$.

Notons pour finir que la perte de la puissance δ^2/h^2 dans (1.41), par rapport à une inégalité de Carleman traditionnelle, provient de la zone contenant la variété caractéristique de P_φ^s , qui est la zone de plus basses fréquences.

Dans l'inégalité (1.41) et le problème conjugué (1.43) (ainsi que dans la preuve), il apparaît que δ et h ont la même homogénéité. Le régime intermédiaire $\delta = h$ semble donc avoir un intérêt particulier. Pour ce choix de δ , l'inégalité de Carleman (1.41) mesure l'effet tunnel pour le problème d'interface semiclassique

$$\begin{cases} -h^2 \Delta_c v = f & \text{dans } \Omega_1 \cup \Omega_2, \\ -h^2 \Delta_{c^s} v^s = h(c\partial_\eta v)|_{S_2} - h(c\partial_\eta v)|_{S_1} + \theta^s & \text{sur } S, \\ v|_{S_1} = v^s \quad \text{et} \quad v|_{S_2} = v^s & \text{sur } S, \end{cases}$$

pour lequel l'épaisseur de l'interface est de l'ordre de la constante de Planck h . Néanmoins, notre inégalité (1.41) montre que l'effet tunnel a aussi lieu lorsque l'interface est d'épaisseur fixée δ (même si les puissances de h sont alors critiques).

Inégalité d'interpolation, inégalité spectrale. Avec cette inégalité de Carleman uniforme, on peut maintenant montrer une inégalité d'interpolation semi-globale au voisinage de $(\alpha_0, X_0 - \alpha_0) \times S$ (une collection d'inégalités locales au voisinage de points de $(\alpha_0, X_0 - \alpha_0) \times S$ aurait suffi). En procédant comme dans [Rob95, LR10], l'inégalité de Carleman (1.41) implique une inégalité d'interpolation locale. Cette dernière peut être recollée avec d'autres inégalités d'interpolation loin de $(0, X_0) \times S$ grâce à la méthode introduite dans [LR95] (voir aussi [LZ98]), pour obtenir une inégalité d'interpolation globale. Avant de l'énoncer, on définit, pour $\alpha \in [0, X_0/2)$ et $k = 0, 1, 2$, les espaces

$$\mathcal{K}^k(\alpha) = \bigcap_{j \leq k} H^j(\alpha, T_0 - \alpha; \mathcal{H}_\delta^{k-j}), \quad \mathcal{H}_\delta^2 = \mathcal{D}(A_\delta).$$

On a alors l'inégalité d'interpolation globale suivante.

Théorème 1.20. *Soit $\alpha_0 \in (0, X_0/2)$. Pour tout $\delta_0 > 0$, il existe $C \geq 0$ et $\nu_0 \in (0, 1)$ tels que pour tout $\delta \in (0, \delta_0)$, on a*

$$\|U\|_{\mathcal{K}_\delta^1(\alpha_0)} \leq C \|U\|_{\mathcal{K}_\delta^1(0)}^{1-\nu_0} \left(\left\| (-\partial_{x_0}^2 + A_\delta)U \right\|_{\mathcal{K}_\delta^0(0)} + \|\partial_{x_0} u(0, x)\|_{L^2(\omega)} \right)^{\nu_0}, \quad (1.44)$$

pour tout $U = (u, u^s) \in \mathcal{K}_\delta^2(0)$ satisfaisant $u|_{x_0=0} = 0$ dans $\Omega_1 \cup \Omega_2$.

Par la méthode brièvement décrite au Paragraphe 1.2.1, on déduit de cette inégalité d'interpolation une inégalité spectrale uniforme pour l'opérateur A_δ . On appelle $\mathcal{E}_{\delta,j} = (e_{\delta,j}, e_{\delta,j}^s)$, $j \in \mathbb{N}$, une base hilbertienne de \mathcal{H}_δ^0 composée de fonctions propres de A_δ associées aux valeurs propres positives $\mu_{\delta,j} \in \mathbb{R}$, $j \in \mathbb{N}$. Pour un ouvert $\omega \subset \Omega_2$, on a le résultat suivant.

Théorème 1.21. *Pour tout $\delta_0 > 0$, il existe une constante $C > 0$ telle que pour tout $0 < \delta \leq \delta_0$ et $\mu \in \mathbb{R}_+$, on a*

$$\|U\|_{\mathcal{H}_\delta^0} \leq C e^{C\sqrt{\mu}} \|u\|_{L^2(\omega)}, \quad \text{pour tout } U = (u, u^s) \in \text{Vect}\{\mathcal{E}_{\delta,j}; \mu_{\delta,j} \leq \mu\}. \quad (1.45)$$

Contrôlabilité uniforme. Suivant la méthode de Lebeau-Robbiano décrite au début du Paragraphe 1.2, l'inégalité spectrale (1.45) ci-dessus pour l'opérateur elliptique A_δ implique un résultat de contrôlabilité du problème parabolique (1.33) associé. Cette inégalité étant uniforme en δ , on obtient naturellement un résultat de contrôlabilité uniforme.

Théorème 1.22. *Soit $\delta_0 > 0$. Pour tout $T > 0$ et tout ouvert non vide $\omega \subset \Omega$ il existe $C > 0$ tel que pour toute donnée initiale $U_0 = (u_0, u_0^s) \in \mathcal{H}_\delta^0$ et tout $0 < \delta \leq \delta_0$, il existe $g_\delta \in L^2((0, T) \times \omega)$ tel que la solution (u, u^s) du problème (1.33) vérifie $(u(T), u^s(T)) = (0, 0)$ et de plus*

$$\|g_\delta\|_{L^2((0, T) \times \omega)} \leq C \|U_0\|_{\mathcal{H}_\delta^0}.$$

La borne uniforme du contrôle par rapport à δ est un point important de ce résultat. On peut alors extraire de la famille $(g_\delta)_{\delta > 0}$ une sous-suite g_{δ_k} qui converge faiblement dans $L^2((0, T) \times \omega)$. On montre que la limite faible des contrôles fournit une fonction de contrôle pour le problème limite (1.36) (déjà traité dans [LR10]), qui est robuste vis à vis des faibles perturbations visqueuses dans l'interface. De ce point de vue, le contrôle ainsi construit est meilleur que celui utilisé dans [LR10].

1.2.2.4 Problèmes ouverts et perspectives

Une question naturelle, au vu de l'inégalité de Carleman (1.41) que nous obtenons, est de savoir si les puissances de h sont optimales, ou si notre analyse manque à cet égard de précision. On a vu en effet que la "mauvaise" puissance en δ^2/h^2 provenait de la zone caractéristique de P_φ^s . Une façon de montrer l'optimalité de cette puissance serait de concentrer des quasimodes sur cette variété, comme cela est fait dans [LL09, LL10].

On peut se demander aussi si notre résultat reste valide dans le cas où les opérateurs de part et d'autre de l'interface, et sur l'interface correspondent à des métriques complètement différentes. Dans le cadre d'un problème de transmission, cette question a été résolue par l'affirmative dans [LL10]. Cependant, pour trier les différentes zones microlocales (et notamment celles adaptées à l'opérateur P_φ^s), on a ici utilisé de façon centrale le fait qu'à l'interface, toutes les métriques sont conformes les unes aux autres.

De même, on peut se demander si le résultat de contrôle reste valable pour des versions semilinéaires de (1.33). Pour montrer un tel résultat, il faudrait prouver une inégalité de Carleman parabolique globale pour l'opérateur $\partial_t - A_\delta$. Notre analyse ouvre la porte à une telle inégalité globale. Cependant, de très nombreuses complications techniques surgissent lorsque l'on veut mélanger l'analyse présentée ici et celle de [LR11]. En particulier, les différentes métriques introduites dans [LR11] sont bien adaptées à un travail en cartes locales (donc dans \mathbb{R}^n), tandis que l'on est obligé pour le recollement de travailler globalement sur S .

Un autre problème intéressant, plus général, concerne le cas où l'interface S rencontre le bord $\partial\Omega$. Le problème de transmission (1.36) n'est résolu que dans des géométries particulières [BDL07b, BDL11]. "L'angle" formé par S et $\partial\Omega$ est une forte entrave aux méthodes microlocales. Dans le cas du système d'interface diffusive (1.33), la question de contrôlabilité lorsque S rencontre $\partial\Omega$ se pose également.

Enfin, il pourrait être intéressant de montrer que le spectre de l'opérateur A_δ satisfait une asymptotique de Weyl. Si on avait $\mu_{\delta, j} \sim C_\delta j^{\frac{2}{n}}$, où n est la dimension de Ω , l'analyse effectuée au Paragraphe 1.2.1 permettrait d'étendre les résultats présentés ici aux perturbations non-autoadjointes de A_δ (d'ordre un en dimension deux, et d'ordre zéro en dimension trois). Mais dans ce cas, on ne peut pas espérer que l'inégalité spectrale et le résultat de contrôle soient uniformes dans la limite $\delta \rightarrow 0^+$, car les estimées de résolvante sont valables pour un système donné. Des résultats uniformes nécessiteraient d'obtenir des estimées de résolvante uniformes sur certains contours complexes (et avoir entre autres une convergence du spectre de A_δ vers celui de l'opérateur limite).

1.3 Contrôle de systèmes d'équations hyperboliques, et applications

Introduction au contrôle des systèmes et motivations

Dans cette partie, on s'intéresse à la contrôlabilité de systèmes linéaires couplés, de différentes natures. Cette étude a tout d'abord été motivée par les propriétés des systèmes paraboliques avec

un contrôle distribué, comme

$$\begin{cases} \partial_t u_1 - \Delta u_1 + au_1 + cu_2 = \chi g & \text{dans } (0, T) \times \Omega, \\ \partial_t u_2 - \Delta u_2 + bu_1 + du_2 = 0 & \text{dans } (0, T) \times \Omega, \\ u_1 = u_2 = 0 & \text{sur } (0, T) \times \partial\Omega, \\ (u_1, u_2)|_{t=0} = (u_1^0, u_2^0) & \text{dans } \Omega, \end{cases} \quad (1.46)$$

ou contrôlés par le bord, comme

$$\begin{cases} \partial_t u_1 - \Delta u_1 + au_1 + cu_2 = 0 & \text{dans } (0, T) \times \Omega, \\ \partial_t u_2 - \Delta u_2 + bu_1 + du_2 = 0 & \text{dans } (0, T) \times \Omega, \\ u_1 = \chi \partial g, \quad u_2 = 0 & \text{sur } (0, T) \times \partial\Omega, \\ (u_1, u_2)|_{t=0} = (u_1^0, u_2^0) & \text{dans } \Omega. \end{cases} \quad (1.47)$$

Ici, a, b, c, d et χ sont des fonctions régulières réelles sur Ω (qui ne dépendent donc pas du temps), $\chi \partial g$ est une fonction régulière réelle sur $\partial\Omega$, et g est dans les deux cas le contrôle. On se demande donc si une seule commande peut contrôler les deux variables d'état. L'exemple très simple rencontré en (1.10) montre que le coefficient de couplage important dans cette étude est le coefficient b .

De tels systèmes correspondent au linéarisé de modèles provenant de la biologie ou de la chimie. Dans ces domaines, les problèmes de réaction-diffusion sont modélisés par plusieurs équations non-linéaires couplées. Et on ne peut parfois agir que sur l'une des variables, ajoutant l'un des réactifs ou l'une des deux espèces en présence. Le modèle correspondant prend la forme du système de deux équations paraboliques couplées par des mécanismes de réaction $F_j, j = 1, 2$:

$$\begin{cases} \partial_t u_1 - \Delta u_1 + F_1(x, u_1, u_2) = \chi g & \text{dans } (0, T) \times \Omega, \\ \partial_t u_2 - \Delta u_2 + F_2(x, u_1, u_2) = 0 & \text{dans } (0, T) \times \Omega. \end{cases}$$

Avant de pouvoir étudier la contrôlabilité de tels modèles, il est utile d'avoir une bonne compréhension du linéarisé. Ce dernier s'exprime sous la forme d'un système similaire à (1.46), mais dans lequel les coefficients a, b, c, d dépendent aussi de la variable temporelle. L'objet de cette partie est d'étudier le cas où tous ces coefficients ne dépendent que de la variable d'espace $x \in \Omega$. Même dans cette situation, apparemment très simple, de nombreux problèmes sont actuellement sans réponse.

Notons aussi que certains problèmes non-linéaires ont été abordés dans les articles [AKBD06] de F. Ammar-Khodja, A. Benabdallah et C. Dupaix, [GBPG06] de M. González-Burgos et R. Pérez-García, et enfin [CGR10] de J.-M. Coron, S. Guerrero et L. Rosier.

Une autre motivation pour étudier la contrôlabilité des systèmes vient du domaine du contrôle insensibilisant. Introduit par J.-L. Lions [Lio92], ce problème consiste à trouver un contrôle pour une équation (de la chaleur par exemple), de telle sorte qu'une certaine fonctionnelle soit localement insensible aux petites perturbations de données initiales. Ce problème peut se mettre sous la forme d'un système de deux équations en cascade, l'une étant rétrograde en temps. Les résultats dans ce domaine se transposent en général au contrôle de systèmes.

Contrôle interne. Le premier résultat général concernant le système (1.46) a été prouvé par L. de Teresa [dT00] dans le contexte du contrôle insensibilisant et dans [AKBD06, GBPG06] dans le contexte du contrôle des systèmes. Il établit que si $\{b \neq 0\} \cap \{\chi \neq 0\} \neq \emptyset$, alors le système (1.46) est contrôlable à zéro en tout temps. La preuve repose sur la méthode de Fursikov-Imanuvilov [FI96] par inégalités de Carleman globales. Elle combine une inégalité de Carleman pour chaque équation, avec une observation dans un petit ouvert $U \subset \{b \neq 0\} \cap \{\chi \neq 0\}$. Puis, l'une des observations sur U est éliminée grâce au couplage par des inégalités locales d'énergie. Cette méthode est aussi utilisée par S. Guerrero [Gue07] pour un système couplé par des termes d'ordre un, dans le contexte du contrôle insensibilisant.

Au Paragraphe 1.2.1, nous avons vu que la méthode de Lebeau-Robbiano [LR95] s'adapte aussi à cette situation dans le cas où $c = b$ (cas autoadjoint) ou si la dimension de l'espace Ω est inférieure

ou égale à trois (cas non-autoadjoint). Cela permet de ramener tout le problème de contrôlabilité à une inégalité locale d'énergie pour un système elliptique, particulièrement simple à montrer. Dans le contexte des systèmes en cascade, M. González-Burgos et L. de Teresa [GBdT10] montrent la contrôlabilité de plusieurs équations en cascade avec un seul contrôle, sous une condition similaire d'intersection des zones de couplage et de la zone de contrôle. La méthode développée au Paragraphe 1.2.1 permet aussi de traiter ce cas, si les coefficients ne dépendent pas du temps.

Cependant, O. Kavian et L. de Teresa [KdT10] ont montré pour un système en cascade (avec $a = d$, $c = 0$, $b \geq 0$ sur Ω) que le système (1.46) est approximativement contrôlable même dans le cas $\{b \neq 0\} \cap \{\chi \neq 0\} = \emptyset$.

Le problème que nous allons tenter de résoudre est donc le suivant, laissé comme problème ouvert dans tous les articles précédents :

Question 1 : le système (1.46) est-il contrôlable dans le cas $\{b \neq 0\} \cap \{\chi \neq 0\} = \emptyset$?

Notons pour finir que dans le cas où tous les coefficients de couplage sont constants, le problème de contrôle est résolu pour une classe beaucoup plus large de systèmes :

$$\partial_t U - \Delta U + A_1 U = \mathbf{1}_\omega B G,$$

où l'état est $U : \Omega \rightarrow \mathbb{R}^N$, le contrôle est $G : \omega \rightarrow \mathbb{R}^M$, et $-\Delta$ désigne la matrice $N \times N$ qui ne contient que des laplaciens sur la diagonale, A_1 (resp. B) est une matrice $N \times N$ (resp. $N \times M$) à coefficients constants. Dans [AKBDGB09b], F. Ammar-Khodja, A. Benabdallah, C. Dupaix, et M. González-Burgos montrent que ce système est contrôlable si et seulement si la condition de Kalman du Théorème 1.4 est satisfaite par le couple (A_1, B) . Ce résultat a ensuite été généralisé aux systèmes non-autonomes dans [AKBDGB09a].

Contrôle frontière. Si la contrôlabilité interne de la chaleur implique la contrôlabilité par le bord, il n'en est pas de même pour les systèmes paraboliques. En effet, la méthode simple décrite au Paragraphe 1.1.2, consistant à étendre le domaine au voisinage de la zone de contrôle, et à prendre pour contrôle la trace de la solution ne fonctionne plus ici : les deux composantes u_1 et u_2 de la solution associée à un problème de contrôle interne sur un domaine "étendu" auront une trace non-nulle sur le bord. On récupérera alors un résultat avec un contrôle sur chaque équation !

La littérature traitant de la contrôlabilité frontière de (1.47) est moins fournie. On citera le cas de deux équations avec des coefficients de couplage constants en une dimension d'espace. Si on appelle $(\mu_j)_{j \in \mathbb{N}}$ les valeurs propres du laplacien et λ_1, λ_2 les valeurs propres de la matrice $A_1 = \begin{pmatrix} a & c \\ b & d \end{pmatrix}$, E. Fernandez-Cara, M. González-Burgos et L. de Teresa [FCGBdT10] montrent que, sous ces conditions, le système (1.47) est contrôlable si et seulement si la condition de Kalman est satisfaite et $\mu_j + \lambda_1 \neq \mu_k + \lambda_2$, pour tous $j, k \in \mathbb{N}$, $j \neq k$.

Obtenir une condition supplémentaire sur les valeurs propres, par rapport au résultat de contrôle interne [AKBDGB09b] est assez surprenant, bien que cette propriété soit très instable (par rapport à de petites perturbations des coefficients, de la longueur de l'intervalle...). En effet, pour les équations paraboliques, il est assez inhabituel que les problèmes de contrôle interne et de contrôle frontière aient des propriétés différentes.

Le second problème que nous allons tenter de résoudre est donc le suivant, laissé comme problème ouvert dans tous les articles cités :

Question 2 : le système (1.47) est-il contrôlable en dimension d'espace $n > 1$, et dans le cas de coefficients variables ?

Systèmes d'équations hyperboliques. Concernant les deux questions posées ci-dessus, il semblerait que la théorie des équations paraboliques et les outils utilisés se heurtent pour le moment à de sérieuses difficultés. Or on sait, depuis l'article de D.L. Russell [Rus73] que les propriétés de contrôlabilité des équations hyperboliques se transmettent aux équations paraboliques. Et, dans le

cadre des systèmes symétriques hyperboliques de contrôle interne

$$\begin{cases} \partial_t^2 u_1 - \Delta u_1 + au_1 + bu_2 = \chi g & \text{dans } (0, T) \times \Omega, \\ \partial_t^2 u_2 - \Delta u_2 + au_2 + bu_1 = 0 & \text{dans } (0, T) \times \Omega, \\ u_1 = u_2 = 0 & \text{sur } (0, T) \times \partial\Omega, \\ (u_1, u_2, \partial_t u_1, \partial_t u_2)|_{t=0} = (u_1^0, u_2^0, u_1^1, u_2^1) & \text{dans } \Omega, \end{cases} \quad (1.48)$$

ou de contrôle frontière

$$\begin{cases} \partial_t^2 u_1 - \Delta u_1 + au_1 + bu_2 = 0 & \text{dans } (0, T) \times \Omega, \\ \partial_t^2 u_2 - \Delta u_2 + au_2 + bu_1 = 0 & \text{dans } (0, T) \times \Omega, \\ u_1 = \chi \partial g, \quad u_2 = 0 & \text{sur } (0, T) \times \partial\Omega, \\ (u_1, u_2, \partial_t u_1, \partial_t u_2)|_{t=0} = (u_1^0, u_2^0, u_1^1, u_2^1) & \text{dans } \Omega, \end{cases} \quad (1.49)$$

les résultats, bien que moins nombreux, sont encourageants. En effet, F. Alabau [AB03] montre que le système (1.49) avec b constant, et $-\Delta + a$ coercif est contrôlable en temps grand dès que b est suffisamment petit et que $\{\chi_\partial > 0\}$ satisfait une condition géométrique de multiplicateurs. Ceci fournit en particulier un résultat de contrôle frontière en toute dimension d'espace!

Notre stratégie est donc la suivante : nous attaquer au problème hyperbolique pour en déduire des résultats sur le problème parabolique. Poursuivant l'étude initiée dans [AB03], nous répondons aux questions 1 et 2 posées ci-dessus pour les systèmes hyperboliques (1.48) et (1.49) sous certaines hypothèses, notamment géométriques. Nous en déduisons ensuite une réponse partielle aux questions 1 et 2 pour les systèmes (1.46) et (1.47) (avec $c = b$ et $d = a$).

Notre stratégie a aussi été suivie par L. Rosier et L. de Teresa [RdT11] qui répondent ainsi à la question 1 sur le tore unidimensionnel pour des systèmes en cascade ($c = d = a = 0$ dans (1.46) et (1.47)). Avant de nous attaquer à la contrôlabilité des systèmes hyperboliques (1.48) et (1.49) nous commencerons par montrer des propriétés de stabilisation de systèmes analogues à (1.48) et (1.49). Ce problème, plus facile, nous permettra de mieux appréhender le problème de contrôlabilité.

Le cas de deux opérateurs elliptiques différents. Dans tous les articles cités ci-dessus, le résultat de contrôlabilité est établi pour deux équations couplées contenant le même opérateur elliptique. On peut se demander si les résultats restent vrais si l'on remplace Δ dans l'une des deux équations par $\gamma\Delta$, pour $\gamma \neq 1$ (ou plus généralement $\text{div } c\nabla$ avec $c \neq \text{Id}$). Dans le cas du contrôle interne avec $\{b \neq 0\} \cap \{\chi \neq 0\} \neq \emptyset$, la méthode que nous avons développée au Paragraphe 1.2.1 (ainsi que les méthodes utilisées dans [dT00, AKBD06, GBPG06, Gue07]) permet de conclure par l'affirmative. Dans le contexte des questions 1 et 2, cependant, une discussion avec B. Dehman, J. Le Rousseau, L. Rosier et L. de Teresa nous a permis d'établir la remarque suivante (détaillée au Paragraphe 6.5). On prend $\Omega = (0, 2\pi)$ et $a = c = d = 0$, et on étudie donc les systèmes (1.46), (1.47), (1.48) et (1.49), dans lesquels

$$\begin{pmatrix} -\Delta + a & c \\ b & -\Delta + d \end{pmatrix},$$

est remplacé par

$$\begin{pmatrix} -\Delta & 0 \\ b & -\gamma\Delta \end{pmatrix}. \quad (1.50)$$

Proposition 1.23. *Pour $a = c = d = 0$ et pour tout $\gamma > 0$ tel que $\sqrt{\gamma} \in \mathbb{Q} \setminus \{1\}$, pour tout $\delta \in (0, 2\pi)$ et $r \in \mathbb{N}$, il existe $b \in \mathcal{C}^r(0, 2\pi)$, $b \geq 0$, $b \neq 0$, $\text{supp}(b) \subset (2\pi - \delta, 2\pi)$ tel qu'aucun des systèmes (1.46), (1.48) avec $\text{supp}(\chi) \subset (0, 2\pi - \delta)$, ni (1.47), (1.49) contrôlés par le bord de gauche ne soit approximativement contrôlable.*

Il suffit pour cela de construire un mode propre pour l'opérateur adjoint de (1.50) localisé loin de la zone de contrôle (qui n'est donc pas observable). Pour les fonctions b que l'on choisit, on construit même une infinité de modes invisibles. Notons que l'obstruction à la contrôlabilité est ici liée à un problème de non prolongement unique pour l'opérateur elliptique lui-même.

La non-contrôlabilité dans le cas de deux équations hyperboliques couplées, avec $\gamma \neq 1$ est encore plus claire. En effet, les variétés caractéristiques associées aux deux opérateurs différents données par $\{(t, x, \tau, \xi) \in \mathbb{R} \times \Omega \times \mathbb{R} \times \mathbb{R}^n \setminus 0, |\tau|^2 = |\xi|^2\}$ et $\{(t, x, \tau, \xi) \in \mathbb{R} \times \Omega \times \mathbb{R} \times \mathbb{R}^n \setminus 0, |\tau|^2 = \gamma|\xi|^2\}$ sont disjointes. Les singularités des deux ondes se propagent alors sans se voir, comme indiqué par le théorème de propagation des singularités de Hörmander [Hör94, 26.1.1]. Ce phénomène est similaire à ce qui se passe pour le système de Lamé, pour lequel ondes transverses et ondes longitudinales ne se propagent pas à la même vitesse (et ne sont couplées qu'au bord, voir [BL01]).

1.3.1 Stabilisation indirecte de systèmes d'équations d'ondes localement couplées

On s'intéresse dans cette partie à la décroissance des solutions du système

$$\begin{cases} \partial_t^2 u_1 - \Delta u_1 + a u_1 + b u_2 + \chi \partial_t u_1 = 0 & \text{dans } (0, T) \times \Omega, \\ \partial_t^2 u_2 - \Delta u_2 + a u_2 + b u_1 = 0 & \text{dans } (0, T) \times \Omega, \\ u_1 = u_2 = 0 & \text{sur } (0, T) \times \partial\Omega, \\ (u_1, u_2, \partial_t u_1, \partial_t u_2)|_{t=0} = (u_1^0, u_2^0, u_1^1, u_2^1) & \text{dans } \Omega, \end{cases} \quad (1.51)$$

lorsque $t \rightarrow +\infty$. Ici, et dans tout ce qui suit, on supposera que l'opérateur $-\Delta + a$ est coercif, et on appellera λ_0 la plus grande constante telle que

$$((-\Delta + a)u, u)_{L^2(\Omega)} \geq \lambda_0 \|u\|_{L^2(\Omega)}^2, \quad \text{pour tout } u \in H^2(\Omega) \cap H_0^1(\Omega). \quad (1.52)$$

Par exemple si $a = 0$, la meilleure constante λ_0 est la plus petite valeur propre du laplacien avec conditions aux bord de Dirichlet sur Ω , c'est-à-dire $\lambda_0 = 1/C_{\mathcal{P}}^2$ où $C_{\mathcal{P}}$ est la constante de Poincaré de Ω . Dans ce système, χ et b sont des fonctions positives ou nulles. Dans le Chapitre 4, on aborde aussi le problème de stabilisation par le bord.

1.3.1.1 Résultats antérieurs

Avant d'étudier la stabilisation de systèmes, rappelons les résultats classiques concernant la stabilisation d'une seule équation d'onde. Ce problème peut se formuler de la façon suivante : étant donnée une fonction $\chi \in \mathcal{C}^\infty(\bar{\Omega})$, $\chi \geq 0$ sur Ω , on cherche à connaître le comportement lorsque $t \rightarrow +\infty$ de la solution u du problème

$$\begin{cases} \partial_t^2 u - \Delta u + a u + \chi \partial_t u = 0 & \text{dans } (0, T) \times \Omega, \\ u = 0 & \text{sur } (0, T) \times \partial\Omega, \\ (u, \partial_t u)|_{t=0} = (u_0, u_1) & \text{dans } \Omega. \end{cases} \quad (1.53)$$

L'énergie de la solution est définie par

$$e_1(u(t)) = \frac{1}{2} (\|(-\Delta_D + a)^{\frac{1}{2}} u(t)\|_{L^2(\Omega)}^2 + \|\partial_t u(t)\|_{L^2(\Omega)}^2). \quad (1.54)$$

en multipliant (1.53) par $\partial_t u$ et en intégrant sur Ω , on obtient l'identité de dissipation

$$\frac{d}{dt} e_1(u(t)) = - \int_{\Omega} \chi |\partial_t u|^2 dx,$$

qui, comme χ est positif, donne une décroissance de l'énergie. Dès que χ n'est pas identiquement nul, la décroissance est stricte et le principe d'invariance de LaSalle ainsi que la propriété de prolongement unique pour le laplacien impliquent sous ces conditions que $e_1(u(t)) \rightarrow 0$ lorsque $t \rightarrow +\infty$. La question est alors de savoir à quelle vitesse l'énergie tend-elle vers zéro.

Le premier cas intéressant concerne la stabilisation uniforme : sous quelles conditions existe-t-il une fonction $\phi(t)$, $\phi(t) \rightarrow 0$, telle que

$$e_1(u(t)) \leq \phi(t) e_1(u(0)) ? \quad (1.55)$$

La réponse, fournie par J. Rauch et M. Taylor [RT74] dans le cas où Ω est une variété sans bord et C. Bardos, G. Lebeau et J. Rauch [BLR92] dans le cas d'un ouvert est la suivante : la stabilisation uniforme a lieu si et seulement si l'ensemble $\{\chi > 0\}$ satisfait la condition géométrique de contrôle (GCC, voir la Définition 1.7). Et si c'est le cas, on montre que $\phi(t) \leq Ce^{-\kappa t}$ dans (1.55), donc la décroissance de l'énergie est exponentielle. Dans [BLR92], les auteurs prouvent un résultat similaire (mais plus difficile) dans le cas où l'équation est stabilisée par le bord. Finalement, G. Lebeau donne dans [Leb96] l'expression du meilleur taux de décroissance κ en fonction de l'abscisse spectrale du générateur du semi-groupe et de la moyenne de la fonction χ sur les rayons optiques. L'auteur montre de plus l'optimalité du résultat.

Dans le cas où la zone $\{\chi > 0\}$ ne satisfait pas GCC, que peut-on dire alors sur la vitesse de décroissance de l'énergie ? G. Lebeau montre dans [Leb96] que, dès que χ n'est pas identiquement nulle, l'énergie tend au moins logarithmiquement vers zéro (voir aussi [Bur98]) :

$$e_1(u(t)) \leq \frac{C}{\log(2+t)} \left(\|u_0\|_{H^2(\Omega) \cap H_0^1(\Omega)}^2 + \|u_1\|_{H_0^1(\Omega)}^2 \right). \quad (1.56)$$

L'outil principal est ici une inégalité d'interpolation comme celles de [LR95], obtenue grâce aux inégalités de Carleman elliptiques (décrites au Paragraphe 1.2.2.1). On peut interpréter ce résultat comme une manifestation de l'effet tunnel : les solutions de l'équation des ondes ne restent jamais complètement concentrées sur les rayons de l'optique, mais débordent toujours un petit peu sur le reste du domaine, donc en particulier sur la zone $\{\chi > 0\}$. L'inégalité (1.56) donne aussi un taux de décroissance d'autant meilleur (en $\frac{C}{\log(2+t)^k}$) que les données initiales sont régulières (i.e. $(u_0, u_1) \in \mathcal{D}((-\Delta_D)^{\frac{k+1}{2}}) \times \mathcal{D}((-\Delta_D)^{\frac{k}{2}})$). L'auteur exhibe aussi des exemples pour lesquels l'énergie ne décroît pas plus vite que logarithmiquement, montrant l'optimalité de ce taux. Ces résultats de stabilisation sans condition géométrique sont généralisés au problème de stabilisation par une (petite) partie du bord dans [LR97].

On peut penser qu'il existe des situations intermédiaires entre stabilisation exponentielle, la meilleure que l'on puisse espérer, et stabilisation logarithmique, qui est toujours vérifiée. C'est en effet le cas : dans certaines situations, l'énergie décroît polynomialement avec le temps. Les propriétés de décroissance polynomiale semblent fortement liées aux propriétés dynamiques de stabilité du flot géodésique ou du billard [LR05, BH07, Phu07b], et ne sont pas à ce jour parfaitement comprises. Elles interviennent par exemple si Ω est un carré et l'ensemble $\{\chi > 0\}$ est une bande horizontale. Notons pour finir que ces situations sont étroitement liées aux situations dans lesquelles l'équation de Schrödinger est contrôlable [Jaf90, BZ04].

Concernant enfin la stabilisation de deux équations d'ondes couplées (1.51), le premier résultat formulé par F. Alabau, P. Cannarsa et V. Komornik [ACK02] est un résultat négatif. Ces auteurs montrent en effet que l'énergie du système (1.51), définie (pour b suffisamment petit) par

$$E(U(t)) = e_1(u_1(t)) + e_1(u_2(t)) + (bu_1, u_2)_{L^2(\Omega)}, \quad U = (u_1, u_2), \quad (1.57)$$

(où e_1 est défini par (1.54)) ne peut pas décroître exponentiellement. En effet, le système (1.51) est une perturbation compacte du système découplé, obtenu à partir de (1.51) en prenant $b = 0$. Ce dernier étant instable (l'énergie de la deuxième équation est conservée), la perturbation compacte ne peut pas être uniformément stable. Dans ce même article, les auteurs montrent aussi un résultat de stabilisation polynomiale si χ et b sont constants sur Ω . Ce résultat de stabilisation polynomiale est généralisé par F. Alabau [AB99, AB02] dans le cas où u_1 est amorti sur une partie de la frontière (satisfaisant une condition géométrique de multiplicateurs).

1.3.1.2 Principaux résultats obtenus

Le travail présenté dans ce paragraphe est effectué en collaboration avec Fatiha Alabau-Boussouira.

Comme on sait [ACK02] que l'énergie $E(U)$ des solutions de (1.51) ne décroît pas exponentiellement lorsque $t \rightarrow +\infty$, nous allons, sous différentes hypothèses, montrer des résultats de stabilisation logarithmique et polynomiale. On prendra ici $\chi \geq 0$ et $b \geq 0$ sur Ω . De plus on supposera que $\|b\|_{L^\infty(\Omega)} < \lambda_0$ (où λ_0 est donné par (1.52)), de sorte que l'opérateur

$$A = \begin{pmatrix} -\Delta + a & b \\ b & -\Delta + a \end{pmatrix}, \quad \mathcal{D}(A) = (H^2(\Omega) \cap H_0^1(\Omega))^2, \quad (1.58)$$

soit coercif. Sous cette condition, l'énergie définie par (1.57) est positive. On a l'identité de dissipation suivante

$$\frac{d}{dt} E(U(t)) = - \int_{\Omega} \chi |\partial_t u_1|^2 dx.$$

En particulier, dans le cas $\chi = 0$, l'énergie du système est conservée (et c'est pour cette raison que l'on a choisi un opérateur symétrique).

Stabilisation logarithmique. Notre premier résultat concerne la stabilisation logarithmique de notre système lorsque l'on ne suppose qu'une condition d'intersection entre les ensembles $\{b > 0\}$ et $\{\chi > 0\}$.

Proposition 1.24. *Supposons que $\{b > 0\} \cap \{\chi > 0\} \neq \emptyset$. Alors, la solution $U = (u_1, u_2, \partial_t u_1, \partial_t u_2)$ du problème (1.51) satisfait, pour tout $k \in \mathbb{N}$, pour toute donnée initiale $U^0 = (u_1^0, u_2^0, u_1^1, u_2^1) \in \mathcal{D}((-\Delta_D)^{\frac{k+1}{2}})^2 \times \mathcal{D}((-\Delta_D)^{\frac{k}{2}})^2$,*

$$E(U(t)) \leq \frac{C_k}{\log(2+t)^k} \sum_{i=0}^k E(\partial_t^i U(0)) \quad \forall t > 0.$$

De plus, si $U^0 \in (H_0^1(\Omega))^2 \times (L^2(\Omega))^2$, on a $E(U(t)) \rightarrow 0$ lorsque $t \rightarrow +\infty$.

La preuve de cette proposition est similaire aux preuves de [Leb96, LR97] (voir aussi [Bur98]). La seule difficulté est de montrer une inégalité d'interpolation pour le système elliptique augmenté d'une dimension avec une seule observation. Cette inégalité est exactement l'inégalité (1.28) que nous avons déjà montrée et utilisée au Paragraphe 1.2.1 pour le contrôle des systèmes paraboliques par la méthode Lebeau-Robbiano. Elle implique des inégalités de résolvante, qui fournissent la décroissance logarithmique.

Notons que ce résultat, contrairement aux suivants, peut être formulé pour une classe de systèmes plus générale. L'hypothèse $b \geq 0$ ainsi que l'égalité entre les vitesses (les métriques) des deux équations d'ondes ne sont pas nécessaires.

Stabilisation polynomiale. Dans ce paragraphe, on présente un résultat de stabilisation polynomiale sans condition sur l'intersection de $\{b > 0\}$ et $\{\chi > 0\}$. On demande cependant à chacun de ces ensembles de satisfaire la condition GCC. Notons que, sous sa forme originelle (voir le Chapitre 4), ce résultat était formulé sous des conditions de type multiplicateurs qui ont par la suite été relaxées (voir le paragraphe suivant et le chapitre 5).

Théorème 1.25. *Supposons que l'ensemble $\{\chi > 0\}$ satisfait GCC. Il existe alors une constante $b_* > 0$, telle que pour tout b tel que $\{b > 0\}$ satisfait GCC et $\|b\|_{L^\infty(\Omega)} < b_*$, la solution $U = (u_1, u_2, \partial_t u_1, \partial_t u_2)$ de (1.51) satisfait, pour $k \in \mathbb{N}$, pour toute donnée initiale $U^0 = (u_1^0, u_2^0, u_1^1, u_2^1) \in \mathcal{D}((-\Delta_D)^{\frac{k+1}{2}})^2 \times \mathcal{D}((-\Delta_D)^{\frac{k}{2}})^2$,*

$$E(U(t)) \leq \frac{C_k}{t^k} \sum_{i=0}^k E(\partial_t^i U(0)) \quad \forall t > 0. \quad (1.59)$$

De plus, si $U^0 \in (H_0^1(\Omega))^2 \times (L^2(\Omega))^2$, on a $E(U(t)) \rightarrow 0$ lorsque $t \rightarrow +\infty$.

En particulier, on a $b_* \leq \lambda_0$ pour assurer la coercivité de l'opérateur A donné par (1.58). La preuve de ce résultat repose sur une inégalité intégrale, montrée dans un cadre abstrait pour deux équations du second ordre en temps. On prouve une inégalité du type

$$\int_S^T E(U(t))dt \leq C(E(U(S)) + E(\partial_t U(S))), \quad (1.60)$$

qui implique (1.59) avec $k = 1$ (voir [AB04]). Un argument de récurrence donne alors (1.59) pour tout k , pour des données initiales assez régulières. Cette inégalité intégrale est à comparer à l'inégalité $\int_S^T E(U(t))dt \leq CE(U(S))$ équivalente (grâce à un lemme de Gronwall) à la décroissance exponentielle (voir par exemple le livre de V. Komornik [Kom94]). Pour montrer l'inégalité (1.60), les ingrédients principaux sont une estimation de couplage entre les deux équations et une inégalité d'observabilité pour une seule onde, avec un second membre. Nous détaillons ces deux derniers arguments dans le paragraphe qui suit, concernant le contrôle de systèmes.

Les conditions géométriques couvertes par ce résultat sont relativement riches, et contiennent en particulier des cas pour lesquels $\{b > 0\} \cap \{\chi > 0\} = \emptyset$ (voir la Figure 1.4).

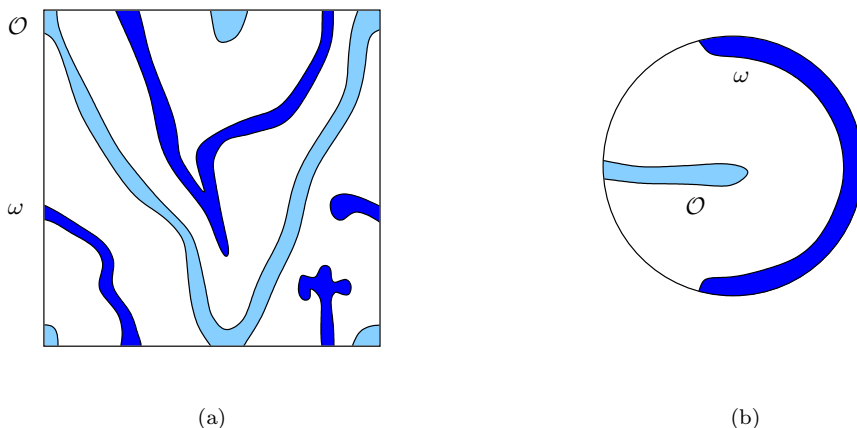

FIGURE 1.4 – Deux exemples d'ouverts $(\Omega, \omega, \mathcal{O})$ tels que ω et \mathcal{O} satisfont tous deux GCC dans Ω , mais $\omega \cap \mathcal{O} = \emptyset$: dans le cas (a), Ω est le tore plat (ou le carré), dans le cas (b), Ω est le disque.

En particulier, tous les exemples pour lesquels $\{b > 0\} \cap \{\chi > 0\} = \emptyset$, n'entrent pas dans le cadre de la Proposition 1.24. Ceci nous amène à penser que le résultat de la Proposition 1.24 doit être vrai sans la condition $\{b > 0\} \cap \{\chi > 0\} \neq \emptyset$ (au moins sous les autres conditions du Théorème 1.25), et nous fournit un premier indice en faveur de la contrôlabilité des équations paraboliques dans ce cas.

1.3.2 Contrôle indirect de systèmes sous des conditions géométriques

Après cette étude du problème de stabilisation, nous considérons maintenant le problème de contrôlabilité pour les systèmes (1.48) et (1.49). Les méthodes utilisées ici sont celles du paragraphe précédent. Comme annoncé plus haut, après avoir démontré un résultat de contrôlabilité pour les systèmes hyperboliques (1.48)-(1.49), nous en déduisons un analogue pour les problèmes paraboliques (1.46)-(1.47) (ainsi que pour deux équations de Schrödinger couplées).

1.3.2.1 Outil principal : les méthodes de transmutation

On présente ici des principes assez généraux qui relient les propriétés de contrôlabilité de différentes équations. Cela nous permettra de déduire un résultat de contrôle des systèmes paraboliques (ou d'équations de Schrödinger couplées) d'un résultat de contrôle pour les systèmes hyperboliques.

L'idée générale est que la contrôlabilité d'un système du deuxième ordre en temps est plus forte que la contrôlabilité du même système, dans lequel ∂_t^2 est remplacé par ∂_t ou $i\partial_t$. En particulier, la contrôlabilité des ondes implique la contrôlabilité de la chaleur et de Schrödinger. A ma connaissance, cette idée a tout d'abord été utilisée par D.L. Russell [Rus73], qui montre la contrôlabilité de la chaleur par tout le bord du domaine $\partial\Omega$ grâce à celle des ondes. La méthode est beaucoup plus générale car elle consiste uniquement en une manipulation sur la variable de temps, pour changer " ∂_t^2 " en " ∂_t ", passant d'un contrôle h pour l'équation

$$\partial_s^2 z + Az = Bh, \quad (1.61)$$

où s représente le temps des ondes, à un contrôle g pour l'équation

$$\partial_t u + Au = Bg, \quad (1.62)$$

où t est le temps de la chaleur. La méthode spectrale de Russell consiste à diagonaliser l'opérateur A , puis à changer une famille biorthogonale (dans $L^2(0, T)$) aux $(e^{+i\sqrt{\mu_j}s}, e^{-i\sqrt{\mu_j}s})_{j \in \mathbb{N}}$ en une famille biorthogonale aux $(e^{-\mu_j t})_{j \in \mathbb{N}}$ (ou les $(\mu_j)_{j \in \mathbb{N}}$ sont les valeurs propres de A), utilisant un théorème de Paley-Wiener. Le semi-groupe associé à l'équation du second ordre en temps (1.61) est en quelque sorte plus riche que celui associé à une équation du premier ordre (1.62). Notons que c'est avec cette même méthode de moments en temps que G. Lebeau et L. Robbiano [LR95] montrent la contrôlabilité de la chaleur à partir d'une équation elliptique, elle aussi du second ordre en temps. Nous reprenons cette analyse dans le cadre non-autoadjoint au Paragraphe 1.2.1.

Le résultat de Russell a par la suite été simplifié et généralisé par L. Miller [Mil05]. En particulier, il est aussi valable pour des opérateurs non nécessairement autoadjoints sur des espaces de Banach.

Théorème 1.26 (D.L. Russell [Rus73], L. Miller [Mil05]). *Si (1.61) est contrôlable à zéro en un certain temps $T_0 > 0$, alors (1.62) est contrôlable à zéro pour tout temps $T > 0$.*

On retrouve la propriété de contrôlabilité en tout temps pour une équation du type chaleur. L. Miller utilise cette méthode pour estimer la constante intervenant dans le coût du contrôle de la chaleur lorsque $T \rightarrow 0^+$ en fonction de certains paramètres géométriques. L'idée de la preuve (voir aussi l'article [Phu01]) est de construire le contrôle g pour (1.62) sous la forme

$$g(t) = \int k(s, t)h(s)ds$$

où h est un contrôle à zéro pour (1.61) et $k(s, t)$ est un noyau contrôlé satisfaisant en particulier

$$\partial_t k - \partial_s^2 k = 0 \quad \text{et} \quad k|_{t=T} = 0.$$

Dans cette dernière équation, les variables s et t correspondent bien aux temps des équations (1.61) et (1.62) respectivement.

D'autre part, K.-D. Phung [Phu01] et L. Miller [Mil06a] montrent aussi que le contrôle des ondes est une propriété plus forte que le contrôle de l'équation de Schrödinger

$$i\partial_t u + Au = Bg. \quad (1.63)$$

Théorème 1.27 (K.-D. Phung [Phu01], L. Miller [Mil06a]). *Si (1.61) est contrôlable à zéro en un certain temps $T_0 > 0$, alors (1.63) est contrôlable à zéro pour tout temps $T > 0$.*

En particulier, ce résultat permet de retrouver le théorème de G. Lebeau [Leb92] de contrôlabilité de Schrödinger sous GCC. Là encore, la méthode permet d'obtenir une estimation de la constante intervenant dans le coût du contrôle de l'équation de Schrödinger lorsque $T \rightarrow 0^+$.

1.3.2.2 Principaux résultats obtenus

Le travail présenté dans ce paragraphe est effectué en collaboration avec Fatiha Alabau-Boussouira.

Avant de nous intéresser au problème de contrôlabilité, nous donnons quelques propriétés de régularité des solutions des systèmes (1.48) et (1.49). Sur l'espace $(L^2(\Omega))^2$, l'opérateur A défini en (1.58) est autoadjoint. Les systèmes (1.48) et (1.49) sont donc conservatifs si le contrôle g est nul. De plus, pour un contrôle $g \in L^2((0, T) \times \Omega)$, le problème (1.48) est bien posé au sens des semi-groupes pour des données $(u_1^0, u_2^0, u_1^1, u_2^1) \in (H_0^1(\Omega))^2 \times (L^2(\Omega))^2$. De même, si on prend $g \in L^2((0, T) \times \partial\Omega)$ le problème de contrôle frontière (1.49) est bien posé pour des données $(u_1^0, u_2^0, u_1^1, u_2^1) \in (L^2(\Omega))^2 \times (H^{-1}(\Omega))^2$, au sens des solutions de transposition (voir [Lio88a]).

Si on prend maintenant pour le système (1.48) (resp. pour le système (1.49)) une donnée initiale $(u_1^0, u_2^0, u_1^1, u_2^1) \in H_0^1(\Omega) \times (H^2 \cap H_0^1(\Omega)) \times L^2(\Omega) \times H_0^1(\Omega)$ (resp. $(u_1^0, u_2^0, u_1^1, u_2^1) \in L^2(\Omega) \times H_0^1(\Omega) \times H^{-1}(\Omega) \times L^2(\Omega)$), et un contrôle $g \in L^2((0, T) \times \Omega)$ (resp. $g \in L^2((0, T) \times \partial\Omega)$), alors on voit que l'état $(u_1, u_2, \partial_t u_1, \partial_t u_2)$ reste pour tout temps dans l'espace $H_0^1(\Omega) \times (H^2 \cap H_0^1(\Omega)) \times L^2(\Omega) \times H_0^1(\Omega)$ (resp. $L^2(\Omega) \times H_0^1(\Omega) \times H^{-1}(\Omega) \times L^2(\Omega)$). En effet, dans la deuxième équation, bu_1 agit comme un second membre de régularité $L^2(0, T; H_0^1(\Omega))$ (resp. $L^2((0, T) \times \Omega)$).

Pour ces systèmes réversibles, la contrôlabilité à zéro est équivalente à la contrôlabilité exacte. Par conséquent, on voit qu'il n'est pas possible, partant d'une donnée initiale régulière (par exemple identiquement nulle), d'atteindre n'importe quel état dans $(H_0^1(\Omega))^2 \times (L^2(\Omega))^2$ (resp. $(L^2(\Omega))^2 \times (H^{-1}(\Omega))^2$). L'ensemble des états atteignables est donc inclus dans l'espace asymétrique $H_0^1(\Omega) \times (H^2 \cap H_0^1(\Omega)) \times L^2(\Omega) \times H_0^1(\Omega)$ (resp. $L^2(\Omega) \times H_0^1(\Omega) \times H^{-1}(\Omega) \times L^2(\Omega)$). La question de contrôlabilité pour les systèmes (1.48) et (1.49) devient alors : partant du repos à l'instant initial, est-il possible d'atteindre tout élément de cet espace (en temps suffisamment long) ?

On appellera GCC_∂ la condition géométrique de contrôle pour le contrôle frontière de [BLR92] : si $\Gamma \subset \partial\Omega$, on dira que (Γ, T) satisfait GCC_∂ si toute géodésique généralisée voyageant à vitesse 1 dans Ω rencontre Γ en un point non diffractif en un temps $t < T$. On dira que Γ satisfait GCC_∂ s'il existe $T > 0$ tel que (Γ, T) satisfait GCC_∂ . Les points diffractifs sont les points du bord par lesquels passe un rayon optique qui frôle le bord sans être dévié (on renvoie par exemple à [BLR92] pour une définition précise).

On supposera désormais que b, χ, χ_∂ sont des fonctions positives. Cette hypothèse, non nécessaire pour χ, χ_∂ l'est peut-être pour b (voir le Paragraphe 1.3.3 ci-après). On aura aussi besoin de supposer, comme dans le problème de stabilisation que $((-\Delta + a)u, u)_{L^2(\Omega)} \geq \lambda_0 \|u\|_{L^2(\Omega)}^2$, pour un $\lambda_0 > 0$, pour tout $u \in H^2(\Omega) \cap H_0^1(\Omega)$. On prendra aussi des fonctions b satisfaisant $\|b\|_{L^\infty(\Omega)} < \lambda_0$, pour que l'opérateur A défini en (1.58) soit coercif.

Concernant les systèmes d'équations d'ondes couplées (1.48) et (1.49), notre résultat principal de contrôlabilité en temps long peut être formulé de la façon suivante.

Théorème 1.28. *On suppose que $\{\chi > 0\}$ satisfait GCC (resp. que $\{\chi_\partial > 0\}$ satisfait GCC_∂). Alors il existe $b_* > 0$, pour tout b tel que $\{b > 0\}$ satisfait GCC et $\|b\|_{L^\infty(\Omega)} < b_*$, il existe un temps $T_* > 0$ tel que pour toutes données initiales $(u_1^0, u_2^0, u_1^1, u_2^1) \in H_0^1(\Omega) \times (H^2 \cap H_0^1(\Omega)) \times L^2(\Omega) \times H_0^1(\Omega)$ (resp. $(u_1^0, u_2^0, u_1^1, u_2^1) \in L^2(\Omega) \times H_0^1(\Omega) \times H^{-1}(\Omega) \times L^2(\Omega)$), il existe un contrôle $g \in L^2((0, T) \times \Omega)$ (resp. $g \in L^2((0, T) \times \partial\Omega)$) tel que la solution de (1.48) (resp. (1.49)) associée satisfasse $(u_1, u_2, \partial_t u_1, \partial_t u_2)|_{t=T_*} = 0$.*

Notons que b_* dépend uniquement de la géométrie de Ω et de χ (resp. χ_∂), tandis que T_* dépend de tous les paramètres du problème. Autrement dit, on montre que sous les hypothèses du Théorème 1.28, l'ensemble atteignable aux temps $T \geq T_*$ en partant de la donnée initiale nulle est exactement $H_0^1(\Omega) \times (H^2 \cap H_0^1(\Omega)) \times L^2(\Omega) \times H_0^1(\Omega)$ dans le cas d'un contrôle L^2 interne, et $L^2(\Omega) \times H_0^1(\Omega) \times H^{-1}(\Omega) \times L^2(\Omega)$ dans le cas d'un contrôle L^2 frontière.

Ce résultat généralise celui de F. Alabau-Boussouira [AB03] où le coefficient de couplage b est constant, et où la condition géométrique sur $\{\chi > 0\}$ est une condition de multiplicateurs. On obtient ici des situations géométriques plus riches, incluant de nombreux exemples pour lesquels la zone de couplage et la zone de contrôle ne s'intersectent pas (voir la Figure 1.4).

La nécessité des hypothèses faites ici est discutable. En particulier, il n'est pas naturel que le temps minimal de contrôle dépende de tous les paramètres du système : il ne devrait dépendre que de la géométrie des ensembles Ω , $\{b > 0\}$ et $\{\chi > 0\}$.

Pour montrer le Théorème 1.28, on utilise la méthode HUM. On considère ainsi le système adjoint de (1.48) et (1.49), qui s'écrit

$$\begin{cases} \partial_t^2 v_1 - \Delta v_1 + a v_1 + b v_2 = 0 & \text{dans } (0, T_*) \times \Omega, \\ \partial_t^2 v_2 - \Delta v_2 + a v_2 + b v_1 = 0 & \text{dans } (0, T_*) \times \Omega, \\ v_1 = v_2 = 0 & \text{sur } (0, T_*) \times \partial\Omega, \\ (v_1, v_2, \partial_t v_1, \partial_t v_2)|_{t=T_*} = (v_1^0, v_2^0, v_1^1, v_2^1) & \text{dans } \Omega. \end{cases} \quad (1.64)$$

On définit aussi un autre niveau d'énergie

$$e_0(u) = \frac{1}{2} (\|u(t)\|_{L^2(\Omega)}^2 + \|(-\Delta_D + a)^{-\frac{1}{2}} \partial_t u(t)\|_{L^2(\Omega)}^2),$$

qui, comme le niveau e_1 (défini en (1.54)), est préservé par les solutions d'une équation d'ondes libres (c'est-à-dire (1.53) avec $\chi = 0$).

Le résultat du théorème est alors équivalent à l'inégalité d'observabilité

$$e_1(v_1(0)) + e_0(v_2(0)) \leq C \int_0^{T_*} \text{Obs}(t) dt. \quad (1.65)$$

pour les solutions de (1.64). Dans cette inégalité d'observabilité, la quantité représentée dans le membre de droite est

$$\text{Obs}(t) = \|\chi \partial_t v_1(t)\|_{L^2(\Omega)}^2,$$

dans le cas du contrôle interne (1.48), et

$$\text{Obs}(t) = \|\chi_{\partial} \partial_{\eta} v_1(t)\|_{L^2(\partial\Omega)}^2,$$

dans le cas du contrôle frontière (1.49). Ici, η désigne la normale unitaire sortante à $\partial\Omega$. Notons que l'on observe dans l'inégalité (1.65) le niveau d'énergie e_1 de la première composante v_1 et seulement le niveau e_0 de la seconde. Cette observation dans des espaces asymétriques est le pendant du contrôle dans des espaces asymétriques. La méthode HUM, décrite au Paragraphe 1.1.1 permet alors de déduire le Théorème 1.28 de (1.65).

Pour établir cette inégalité d'observabilité, nous étendons la méthode à "deux niveaux d'énergie" de [AB03]. Nous effectuons des estimées d'énergie dans l'esprit des méthodes de multiplicateurs. Notre démonstration repose sur trois ingrédients principaux.

Le premier ingrédient est une inégalité d'observabilité pour les solutions de $\partial_t^2 v - \Delta v = f$. On montre que si $(\{b > 0\}, T_0)$ (ou, de la même manière $(\{\chi > 0\}, T_0)$, resp. $(\{\chi_{\partial} > 0\}, T_0)$) satisfait GCC (resp. GCC $_{\partial}$), alors il existe $C > 0$ telle que, pour tout $T > T_0$, on ait

$$\int_0^T e_1(v(t)) dt \leq C \left(\int_0^T \|b \partial_t v(t)\|_{L^2(\Omega)}^2 dt + \int_0^T \|f(t)\|_{L^2(\Omega)}^2 dt \right). \quad (1.66)$$

Le point clé ici est que la constante C ne dépend pas du temps T . Une telle inégalité peut être déduite de l'inégalité avec $f = 0$, et c'est ce qui nous permet d'obtenir ici des conditions géométriques optimales de contrôle. On vérifie aussi dans le cas très simple où Ω n'a pas de bord que la méthode originelle de [RT74, BLR88, BLR92] donne naturellement (1.66). Cette inégalité, obtenue ici sous des conditions géométriques optimales permet aussi d'améliorer de nombreux résultats, en particulier [AB99, AB02, AB03, ABL11c]. Dans la preuve de ces résultats, l'inégalité (1.66) était en effet obtenue par des méthodes de multiplicateurs.

Le deuxième ingrédient utilisé dans la preuve de (1.65) est l'inégalité

$$\int_0^T \|\sqrt{b}v_2\|_{L^2(\Omega)}^2 dt \leq \int_0^T \|\sqrt{b}v_1\|_{L^2(\Omega)}^2 dt + C[e_0(v_2(T)) + e_0(v_2(0))] + C[e_1(v_1(T)) + e_1(v_1(0))],$$

traduisant l'action du couplage. On l'obtient en multipliant la première ligne de (1.64) par v_2 et la seconde par v_1 , en intégrant et en prenant la différence des deux équations obtenues. Cette inégalité nous permet de dominer l'énergie localisée de la composante non observée v_2 par l'énergie de v_1 . Notons que cette inégalité de couplage fait intervenir l'énergie e_1 de la composante v_1 , mais seulement l'énergie e_0 de la composante v_2 .

Enfin, pour conclure la preuve, nous utilisons la conservation de l'énergie $E((v_1, v_2)(t))$ (définie en (1.57)) des solutions de (1.64). En particulier, ceci implique que l'intégrale sur $(0, T)$ de l'énergie $e_1(v_1(t)) + e_0(v_2(t))$ croît linéairement en fonction de T , ce qui, comme dans les approches par multiplicateurs, permet de conclure pour T grand.

Retour aux systèmes du premier ordre en temps. On déduit maintenant du Théorème 1.28 et des résultats de transmutation présentés au Paragraphe 1.3.2.1 le théorème de contrôle de systèmes paraboliques sous contraintes géométriques.

Corollaire 1.29 (Systèmes paraboliques). *On suppose que $\{\chi > 0\}$ satisfait GCC (resp. que $\{\chi_\partial > 0\}$ satisfait GCC $_\partial$). Alors il existe $b_* > 0$, pour tout b tel que $\{b > 0\}$ satisfait GCC et $\|b\|_{L^\infty(\Omega)} < b_*$, pour tout $T > 0$, toute donnée initiale $(u_1^0, u_2^0) \in L^2(\Omega) \times L^2(\Omega)$, il existe un contrôle $g \in L^2((0, T) \times \Omega)$ (resp. $g \in L^2((0, T) \times \partial\Omega)$) tel que la solution de (1.46) (resp. (1.47)) avec $d = a$ et $c = b$ satisfasse $(u_1, u_2)|_{t=T} = 0$.*

A notre connaissance, ce corollaire fournit les premiers résultats de contrôlabilité interne pour des systèmes paraboliques lorsque la zone de couplage $\{\chi > 0\}$ et la zone de contrôle $\{b > 0\}$ ne s'intersectent pas. De plus il donne un résultat de contrôle frontière en toute dimension d'espace, avec des coefficients variables. Nous répondons ainsi partiellement aux questions 1 et 2 formulées au début du Paragraphe 1.3.

Si les conditions géométriques du Corollaire 1.29 ne sont bien entendu pas naturelles, celui-ci nous conforte dans l'idée que ce résultat doit être vrai dès que les ensembles $\{\chi > 0\}$ et $\{b > 0\}$ sont non vides (toutes autres conditions étant égales par ailleurs).

Ce résultat est une conséquence des propriétés régularisantes de la chaleur (ce qui nous permet de le formuler dans des espaces symétriques) et des Théorèmes 1.26 et 1.28.

On peut de la même manière déduire du Théorème 1.28 un résultat pour des équations de Schrödinger couplées. Nous ne présentons que le cas du contrôle interne par souci de brièveté mais un résultat de contrôle frontière se déduit de la même manière.

Corollaire 1.30 (Systèmes d'équations de Schrödinger). *On suppose que $\{\chi > 0\}$ satisfait GCC. Alors il existe $b_* > 0$, pour tout b tel que $\{b > 0\}$ satisfait GCC et $\|b\|_{L^\infty(\Omega)} < b_*$, pour tout $T > 0$, toute donnée initiale $(u_1^0, u_2^0) \in L^2(\Omega) \times H_0^1(\Omega)$, il existe un contrôle $g \in L^2((0, T) \times \Omega)$ tel que la solution du système*

$$\begin{cases} i\partial_t u_1 - \Delta u_1 + au_1 + bu_2 = \chi g & \text{dans } (0, T) \times \Omega, \\ i\partial_t u_2 - \Delta u_2 + au_2 + bu_1 = 0 & \text{dans } (0, T) \times \Omega, \\ u_1 = u_2 = 0 & \text{sur } (0, T) \times \partial\Omega, \\ (u_1, u_2)|_{t=0} = (u_1^0, u_2^0) & \text{dans } \Omega, \end{cases}$$

satisfasse $(u_1, u_2)|_{t=T} = 0$.

Ce résultat est une conséquence des Théorèmes 1.27 et 1.28. Même si elles ne sont pas toujours optimales pour une seule équation de Schrödinger (voir [Jaf90, BZ04]), GCC et GCC $_\partial$ sont à ma connaissance les conditions suffisantes les plus générales connues à ce jour (voir [Leb92]).

Pour conclure, la méthode d'estimées d'énergie utilisée ici a pour principal avantage d'utiliser en "boîte noire" des inégalités d'observabilité pour une seule équation, déjà existantes. Elle permet donc de donner des résultats *a priori* de contrôlabilité, très généraux pour une large classe de systèmes du second ordre en temps. Elle permet par exemple de traiter le cas de conditions au bord de Neumann ou de Fourier [BLR92], où le cas d'un ouvert et d'une métrique peu réguliers [Bur97a] (pour des conditions au bord de Dirichlet).

Cependant, certaines de nos hypothèses semblent beaucoup trop fortes. En effet, la généralité de notre résultat et les méthodes utilisées ne permettent pas de décrire finement les propriétés de propagation des modèles étudiés. On aimerait par exemple connaître plus précisément le temps minimal de contrôle en fonction des différents paramètres. Pour les systèmes de deux ondes couplées, une approche plus fine reste donc à faire. C'est ce que nous proposons dans le paragraphe qui suit.

1.3.3 Analyse microlocale de la contrôlabilité de systèmes de deux équations d'ondes sur une variété compacte

On propose maintenant d'analyser plus précisément un modèle de deux équations d'ondes couplées du type (1.48) dans un cadre particulièrement simple. On va supposer ici que Ω est une variété riemannienne compacte pour éviter de considérer la propagation au bord, et simplifier ainsi le problème. On note Δ l'opérateur de Laplace-Beltrami sur Ω et on va s'intéresser au système en cascade suivant :

$$\begin{cases} \partial_t^2 u_1 - \Delta u_1 = \chi g & \text{dans } (0, T) \times \Omega, \\ \partial_t^2 u_2 - \Delta u_2 + bu_1 = 0 & \text{dans } (0, T) \times \Omega, \\ (u_1, u_2, \partial_t u_1, \partial_t u_2)|_{t=0} = (u_1^0, u_2^0, u_1^1, u_2^1) & \text{dans } \Omega. \end{cases} \quad (1.67)$$

Dans ce système, la fonction g contrôle l'état u_1 , qui lui même contrôle l'état u_2 . Comme dans le paragraphe précédent, on va supposer ici que le couplage b satisfait $b \geq 0$ sur Ω . On pourrait garder l'opérateur $-\Delta + a$ avec $a \geq 0$, à la place de $-\Delta$ et tous les résultats présentés ici resteraient valides. Nous avons vu au paragraphe précédent que le problème de contrôlabilité adapté au système (1.67) muni d'un contrôle $g \in L^2((0, T) \times \Omega)$ se pose dans l'espace asymétrique $(u_1^0, u_2^0, u_1^1, u_2^1) \in H^1 \times H^2 \times L^2 \times H^1$. Nos préoccupations principales sont de comprendre les propriétés de contrôlabilité de (1.67) ainsi que le temps minimal nécessaire à ce contrôle.

1.3.3.1 Outil principal : les mesures de défaut microlocales

On sait, depuis les articles [RT74, BLR92], que les outils adaptés à l'analyse des propriétés de contrôlabilité des équations de type ondes, sont des techniques d'analyse microlocale de propagation des singularités. Une approche alternative plus récente [Leb96, Bur97a, BG97] (voir aussi le cours [BG02] pour une introduction) utilise la propagation des mesures de défaut microlocales de P. Gérard [Gér91] et L. Tartar [Tar90]. Cette méthode, qui simplifie déjà le cas scalaire, permet aussi de traiter des systèmes (voir [BL01] pour des systèmes hyperboliques couplés par le bord mais découplés à l'intérieur).

Etant donnée une suite $(v^k)_{k \in \mathbb{N}}$ qui converge faiblement dans $L^2(\mathbb{R}^n)$, les mesures de défaut microlocales visent à caractériser le défaut de convergence forte de $(v^k)_{k \in \mathbb{N}}$. Plus précisément, ce sont des mesures sur le fibré cotangent en sphères $S^* \mathbb{R}^n \approx \mathbb{R}_x^n \times S_\xi^{n-1}$, où x est le point de l'espace et ξ la direction d'oscillation. P. Gérard [Gér91] et L. Tartar [Tar90] montrent qu'il existe une sous-suite de $(v^k)_{k \in \mathbb{N}}$ (notée de la même manière) et une mesure positive μ sur $S^* \mathbb{R}^n$ telles que, pour tout opérateur pseudodifférentiel polyhomogène (voir par exemple [Hör85, Definition 18.1.5]) d'ordre zéro et de noyau à support compact, on ait

$$(Av^k, v^k)_{L^2(\mathbb{R}^n)} \rightarrow \int_{S^* \mathbb{R}^n} \sigma_0(A)(x, \xi) d\mu(x, \xi),$$

où $\sigma_0(A)$ est le symbole principal de A .

Par exemple, pour $\xi_0 \in \mathbb{R}^n \setminus \{0\}$ et $\psi \in \mathcal{C}_c^\infty(\mathbb{R}^n)$, la suite oscillante de terme général $v^k = \psi(x)e^{ikx \cdot \xi_0}$ admet pour mesure $\mu = |\psi(x)|^2 dx \otimes \delta_{\xi = \xi_0 / |\xi_0|}$: ceci traduit le fait que la perte de

convergence forte est due à l'oscillation dans la direction ξ_0 . Ces mesures peuvent aussi être définies sur des variétés (voir [Tar90] ou [Bur97b]) car elles se comportent bien vis-à-vis des changements de variables. Dans la suite, on utilisera de telles mesures sur la variété $\mathbb{R} \times \Omega$.

Si de plus les termes v^k de la suite satisfont une équation, on peut en déduire des propriétés sur la mesure limite. Par exemple, pour une suite de solutions de l'équation des ondes,

$$(\partial_t^2 - \Delta)v^k = 0,$$

on montre que la mesure associée μ satisfait

$$\text{supp}(\mu) \subset \text{Char}(\partial_t^2 - \Delta), \quad \text{et} \quad H_p \mu = 0.$$

où $\text{Char}(\partial_t^2 - \Delta) = \{(t, x, \tau, \xi) \in T^*(\mathbb{R} \times \Omega), \tau^2 - |\eta|_x^2 = 0\}$ est la variété caractéristique de $\partial_t^2 - \Delta$ ($|\eta|_x$ désignant la norme de $\eta \in T_x^*(\Omega)$ pour la métrique riemannienne) et H_p est le champ de vecteurs hamiltonien du symbole $p = \tau^2 - |\eta|_x^2$. Ceci nous dit en particulier que, pour une suite de solutions de l'équation des ondes faiblement convergente, la mesure est invariante le long des bicaractéristiques. Ce sont les courbes intégrales de $\frac{d}{ds}\phi = H_p\phi$, et leur projection sur Ω sur coïncide avec les géodésiques de Ω .

Dans le cas où on considère deux suites $(v_1^k, v_2^k)_{k \in \mathbb{N}}$ qui convergent faiblement vers zéro, P. Gérard [Gér91] montre (en fait dans un cadre beaucoup plus général) que l'on peut (quitte à en extraire une sous-suite) leur associer une matrice

$$\mu = \begin{pmatrix} \mu_1 & \mu_{12} \\ \overline{\mu_{12}} & \mu_2 \end{pmatrix},$$

composée de trois mesures μ_1 , μ_2 et μ_{12} . Les mesures μ_1 et μ_2 sont les mesures positives associées aux suites $(v_1^k)_{k \in \mathbb{N}}$ et $(v_2^k)_{k \in \mathbb{N}}$. La mesure μ_{12} satisfait

$$(Av_1^k, v_2^k)_{L^2(\mathbb{R}^n)} \rightarrow \int_{S^*(\mathbb{R} \times \Omega)} \sigma_0(A)(x, \eta) d\mu_{12}(x, \eta),$$

et mesure donc le défaut d'orthogonalité des deux suites. En particulier, on montre que $\text{supp}(\mu_{12}) \subset \text{supp}(\mu_1) \cap \text{supp}(\mu_2)$. La mesure μ_{12} est a priori une mesure à valeur complexe et la matrice μ est une mesure hermitienne positive (voir [Gér91] pour plus de précision). Dans le paragraphe qui suit, nous utilisons les équations satisfaites par ces trois mesures dans le cas où (v_1^k, v_2^k) est une suite de solutions d'un système d'ondes couplées.

1.3.3.2 Principaux résultats obtenus

Le travail présenté dans ce paragraphe est effectué en collaboration avec Belhassen Dehman et Jérôme Le Rousseau.

Ici, on appelle $\omega = \{\chi \neq 0\}$ l'ouvert de contrôle et $\mathcal{O} = \{b > 0\}$ l'ouvert de couplage.

On remarque tout d'abord que si ω ne satisfait pas GCC, la première équation seule n'est pas contrôlable. De même, si \mathcal{O} ne satisfait pas GCC, la seconde équation n'est pas contrôlable. Une condition nécessaire de contrôlabilité est donc que ces deux ouverts satisfassent GCC. Pour énoncer notre résultat principal, nous devons au préalable introduire le temps de contrôle adapté.

Définition 1.31. Etant donnés deux ouverts ω et \mathcal{O} qui satisfont tous deux GCC, on appelle $T_{\omega \rightarrow \mathcal{O} \rightarrow \omega}$ la borne inférieure des temps $T > 0$ pour lesquels la condition suivante est satisfaite :

toute géodésique de Ω parcourue à vitesse 1 dans Ω entre dans ω en un temps $t_0 < T$, entre dans \mathcal{O} en un temps $t_1 \in (t_0, T)$ et entre de nouveau dans ω en un temps $t_2 \in (t_1, T)$.

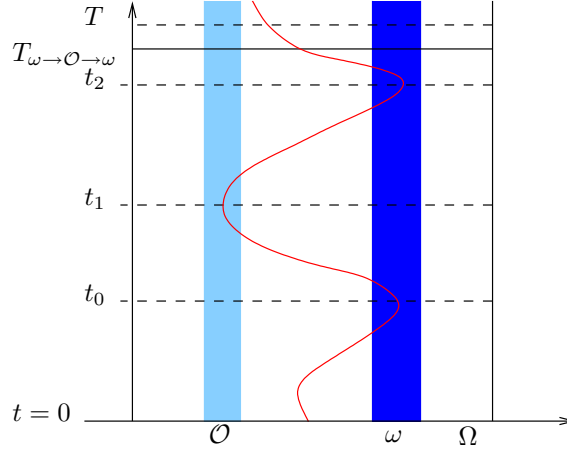
FIGURE 1.5 – Condition géométrique et temps $T_{\omega \to \mathcal{O} \to \omega}$.

Autrement dit, après le temps $T_{\omega \to \mathcal{O} \to \omega}$, tout rayon de l'optique voyageant dans Ω est passé par ω , puis \mathcal{O} , puis à nouveau ω (voir la Figure 1.5). Remarquons en particulier que si ω et \mathcal{O} satisfont GCC, alors $T_{\omega \to \mathcal{O} \to \omega} < \infty$.

Pour un ouvert $\omega \subset \Omega$ satisfaisant GCC, notons $T_\omega = \inf\{T > 0, (\omega, T) \text{ satisfait GCC}\}$. On peut alors encadrer $T_{\omega \to \mathcal{O} \to \omega}$ de la façon suivante

$$\max\{T_{\mathcal{O}}, T_\omega\} \leq T_{\omega \to \mathcal{O} \to \omega} \leq 2T_\omega + T_{\mathcal{O}}.$$

Remarquons enfin qu'en général, $T_{\omega \to \mathcal{O} \to \omega} \neq T_{\mathcal{O} \to \omega \to \mathcal{O}}$. Notons par ailleurs qu'il existe des exemples de variétés compactes Ω et d'ouverts ω et \mathcal{O} tels que ω et \mathcal{O} satisfont tous deux GCC sans s'intersecter. C'est le cas du tore Ω et des deux ouverts ω et \mathcal{O} représentés sur la Figure 1.4a. C'est aussi le cas si Ω est la sphère $S^2 = \{(x_1, x_2, x_3) \in \mathbb{R}^3, x_1^2 + x_2^2 + x_3^2 = 1\}$ (munie de la métrique induite par la métrique euclidienne de \mathbb{R}^3) et ω est un voisinage dans S^2 du demi-équateur $\{x_3 = 0, x_2 \leq 0\}$, et \mathcal{O} est un voisinage dans S^2 du demi-équateur $\{x_1 = 0, x_2 \geq 0\}$.

Notre résultat principal est le suivant.

Théorème 1.32. *On suppose que les ouverts ω et \mathcal{O} satisfont tous deux GCC. Alors, le système (1.67) est contrôlable à zéro dans l'espace $H^1 \times H^2 \times L^2 \times H^1$ si $T > T_{\omega \to \mathcal{O} \to \omega}$ et n'est pas contrôlable à zéro si $T < T_{\omega \to \mathcal{O} \to \omega}$.*

Rappelons que, dans ce cadre, la contrôlabilité à zéro et la contrôlabilité exacte sont équivalentes. La seule hypothèse faite ici concerne la positivité du coefficient de couplage. La méthode HUM permet encore une fois de ramener ce problème de contrôlabilité à un problème d'observabilité. Dans ce dernier, on applique l'opérateur $(1 - \Delta)^{\frac{1}{2}}$ (de symbole principal $|\eta|_x$) à l'une des deux équations pour pouvoir le formuler dans des espaces symétriques. La contrôlabilité de (1.67) est ainsi équivalente à l'existence d'une constante $C > 0$, telle que l'inégalité

$$e_0(v_1(0)) + e_0(v_2(0)) \leq C \int_0^T \int_\omega |\chi v_1|^2 dx dt, \quad (1.68)$$

soit satisfaite pour toutes solutions (v_1, v_2) du système

$$\begin{cases} (\partial_t^2 - \Delta)v_1 = -b(x) (1 - \Delta)^{\frac{1}{2}}v_2 & \text{dans } (0, T) \times \Omega \\ (\partial_t^2 - \Delta)v_2 = 0 & \text{dans } (0, T) \times \Omega. \end{cases} \quad (1.69)$$

On rappelle qu'ici, les énergies e_k sont définies par

$$e_k(v) = \|v\|_{H^k(\Omega)}^2 + \|\partial_t v\|_{H^{k-1}(\Omega)}^2, \quad k \in \mathbb{Z}.$$

Controlabilité pour $T > T_{\omega \rightarrow \mathcal{O} \rightarrow \omega}$. La structure de la preuve de l'inégalité d'observabilité est assez classique et utilise la méthode de compacité-unicité. On procède en deux temps. Dans un premier temps, on montre une inégalité d'observabilité plus faible que (1.68), dans laquelle on ajoute au membre de droite une énergie d'ordre inférieure (c'est-à-dire un terme compact). Dans un second temps, on montre grâce à un argument d'unicité que le terme ajouté n'est pas nécessaire. Cette méthode permet en quelque sorte de traiter les problèmes de hautes fréquences, puis de montrer que les basses fréquences ne posent aucun problème.

Nous montrons donc tout d'abord l'inégalité

$$e_0(v_1(0)) + e_0(v_2(0)) \leq C \int_0^T \int_{\omega} |\chi v_1|^2 dx dt + e_{-1}(v_1(0)) + e_{-1}(v_2(0)), \quad (1.70)$$

pour les solutions de (1.69). Pour cela, nous procédons par l'absurde, supposant l'existence d'une suite $(v_1^k, v_2^k)_{k \in \mathbb{N}}$ de solutions de (1.69), telle que $e_0(v_1^k(0)) + e_0(v_2^k(0)) = 1$ et $\int_0^T \int_{\omega} |\chi v_1^k|^2 dx dt \rightarrow 0$, et $e_{-1}(v_1^k(0)) + e_{-1}(v_2^k(0)) \rightarrow 0$. En particulier, cette suite converge faiblement vers zéro dans $L^2((0, T) \times \Omega)$ et on peut (quitte à extraire une sous-suite) lui associer une mesure de défaut micro-locale

$$\mu = \begin{pmatrix} \mu_1 & \mu_{12} \\ \bar{\mu}_{12} & \mu_2 \end{pmatrix}.$$

On montre alors que cette mesure vérifie, au sens des distributions dans $S^*(\mathbb{R} \times \Omega)$ les équations

$$\begin{cases} H_p \mu_2 = 0, \\ H_p \operatorname{Im}(\mu_{12}) = b|\eta|_x \mu_2, \\ H_p \mu_1 = 2b|\eta|_x \operatorname{Im}(\mu_{12}), \\ \operatorname{Re}(\mu_{12}) = 0. \end{cases} \quad (1.71)$$

Ce système correspond à trois équations de transport (en cascade) le long du flot bicaractéristique de $\partial_t^2 - \Delta$. De plus, comme v_1^k converge fortement sur $(0, T) \times \omega$, la mesure μ_1 (et donc aussi la mesure μ_{12}) s'annule au dessus de $(0, T) \times \omega$. On veut maintenant en déduire la nullité de ces trois mesures.

La deuxième équation du système (1.71) nous permet de conclure car c'est une équation de transport dont le second membre est une mesure positive. Le long de chaque bicaractéristique, on peut résoudre cette équation de transport. D'après notre hypothèse $T > T_{\omega \rightarrow \mathcal{O} \rightarrow \omega}$, la mesure $\operatorname{Im}(\mu_{12})$ est nulle lors du premier passage de la bicaractéristique au dessus de ω (pour $t = t_0$), et elle est toujours nulle lors de son second passage au dessus de ω (pour $t = t_2$). Ceci implique que $b|\eta|_x \mu_2$ est nulle le long de cette bicaractéristique pour tout $t \in (t_0, t_2)$, donc en particulier pour le temps t_1 . On a alors trouvé un point de chaque bicaractéristique sur lequel la mesure μ_2 s'annule. Comme elle satisfait une équation de transport libre le long du flot (la première équation de (1.71)), elle est identiquement nulle. On en déduit ensuite que $\operatorname{Im}(\mu_{12})$ et μ_1 sont elles aussi identiquement nulles, de telle sorte que la suite $(v_1^k, v_2^k)_{k \in \mathbb{N}}$ converge fortement vers zéro dans $L^2(\Omega)^2$. Ceci contredit enfin l'hypothèse, et permet d'établir l'inégalité affaiblie (1.70).

Finalement, suivant [BLR92], on montre que l'ensemble des données initiales, dont les solutions (v_1, v_2) de (1.69) associées satisfont à la fois l'inégalité (1.70) et $v_1|_{(0, T) \times \omega}$ contient un vecteur propre de l'opérateur elliptique

$$\begin{pmatrix} -\Delta & b(x) (1 - \Delta)^{\frac{1}{2}} \\ 0 & -\Delta \end{pmatrix}.$$

Or, on connaît précisément les valeurs propres et les vecteurs propres de cet opérateur elliptique : les $(\mu_j, {}^t(e_j, 0))_{j \in \mathbb{N}}$, où $(\mu_j, e_j)_{j \in \mathbb{N}}$ sont les couples valeur propre vecteur propre de $-\Delta$. Ces fonctions propres vérifient la propriété de prolongement unique $e_j|_{\omega} = 0 \Rightarrow {}^t(e_j, 0) = 0$ sur tout Ω . Ceci permet de conclure que l'inégalité d'observabilité (1.68) est satisfaite.

De même qu'au paragraphe précédent, ce résultat de contrôlabilité se transfère aux équations de la chaleur ou de Schrödinger couplées.

Non-controlabilité pour $T < T_{\omega \rightarrow \mathcal{O} \rightarrow \omega}$. L'idée consiste ici à construire une suite de solutions de (1.69) qui contredit l'inégalité d'observabilité (1.68). Dans le cas où toutes les bicaractéristiques ne passent pas par \mathcal{O} ou par ω , il suffit de nier l'observabilité pour une seule équation d'ondes, ce qui est classique.

Reste le cas où toutes les bicaractéristiques passent à la fois par \mathcal{O} et par ω , mais il en existe une qui ne passe pas par ω puis \mathcal{O} puis ω . On appelle alors Γ cette bicaractéristique. On construit une suite $(v_2^k)_{k \in \mathbb{N}}$ de solutions de l'équation des ondes libre qui converge faiblement (mais pas fortement) vers zéro, et dont la mesure de défaut μ_2 est exactement supportée par Γ . Puis, on appelle t_0 un temps pour lequel Γ rencontre $(0, T) \times \omega$. Pour construire la suite $(v_1^k)_{k \in \mathbb{N}}$, on résout alors l'équation d'ondes à partir de t_0 , avec des données initiales nulles :

$$\begin{cases} (\partial_t^2 - \Delta)v_1^k = -b(x)(1 - \Delta)^{\frac{1}{2}}v_2^k & \text{dans } (0, T) \times \Omega, \\ (v_1^k, \partial_t v_1^k)|_{t=t_0} = (0, 0) & \text{dans } \Omega. \end{cases}$$

L'hypothèse $T < T_{\omega \rightarrow \mathcal{O} \rightarrow \omega}$ nous dit qu'il existe une seule composante connexe \mathcal{C} de $\Gamma \setminus S^*((0, T) \times \mathcal{O})$ qui rencontre $(0, T) \times \omega$ (voir la Figure 1.6). On montre alors que le support de la mesure μ_1 associée à la suite $(v_1^k)_{k \in \mathbb{N}}$, est contenu dans Γ et ne rencontre pas \mathcal{C} . Cette propriété est due au fait que l'on a prescrit des données nulles pour v_1^k en t_0 . La convergence forte en ce point est propagée grâce à l'équation de transport libre que satisfait μ_1 sur \mathcal{C} (la troisième équation de (1.71)). Finalement, ceci implique la convergence forte vers zéro de v_1^k sur $(0, T) \times \omega$, ce qui contredit l'inégalité d'observabilité (1.68).

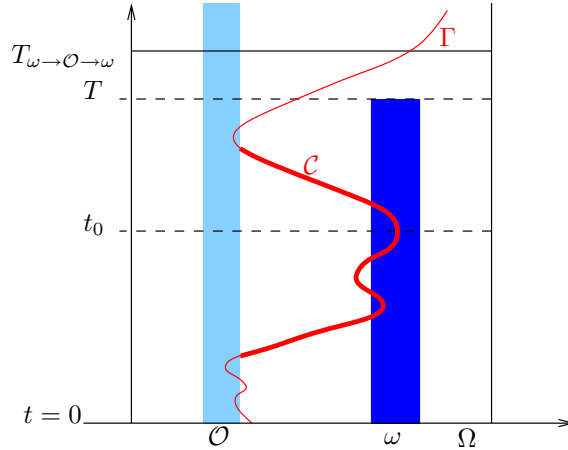

FIGURE 1.6 – Non-controlabilité en temps $T < T_{\omega \rightarrow \mathcal{O} \rightarrow \omega}$.

Problèmes ouverts et perspectives

Contrôle de systèmes d'équations d'ondes. Mentionnons tout d'abord les premières extensions de tous les résultats obtenus dans le Paragraphe 1.3 pour des systèmes de deux équations d'ondes couplées. Il serait dans un premier temps naturel d'étendre le dernier résultat pour un système d'ondes en cascade sur des variétés à bord. Cette extension, bien que très technique, ne semble pas poser de problème supplémentaire lié au couplage. En particulier, la propriété de prolongement unique pour les systèmes en cascade reste valable s'il y a un bord.

Il est vraisemblable que le résultat de contrôlabilité présenté au Paragraphe 1.3.3 soit faux en général pour un coefficient de couplage b qui change de signe. Exhiber un tel exemple serait intéressant.

Aussi, on aimerait pouvoir retrouver les résultats de contrôlabilité du Paragraphe 1.3.2 grâce aux méthodes du Paragraphe 1.3.3, ce qui nous donnerait le temps minimal de contrôle. Si les hautes

fréquences ne semblent pas poser de problèmes, ce n'est pas le cas des propriétés de prolongement unique.

Plus généralement, il nous semble particulièrement intéressant d'étudier en général la contrôlabilité des systèmes d'équations d'ondes couplées, du type

$$\partial_{tt}U - \Delta U + A_1U = BG \quad \text{sur } (0, T) \times \Omega, \quad (1.72)$$

en utilisant les méthodes d'analyse microlocale adéquates [BLR92, Bur97a, BG97, BL01]. Dans (1.72), $U : \Omega \rightarrow \mathbb{R}^N$ est le vecteur d'inconnues, Δ désigne la matrice $N \times N$ ne contenant que des laplaciens sur la diagonale, A_1 est une matrice $N \times N$ de couplage, dont les entrées sont des opérateurs différentiels d'ordre un sur Ω , B est la matrice $N \times M$ de contrôle, dont les coefficients sont des fonctions sur Ω , et $G : \Omega \rightarrow \mathbb{R}^M$ est le contrôle.

La question est alors la suivante : quelles sont les conditions nécessaires et suffisantes sur les opérateurs A_1 , B , et le temps T pour que le système (1.72) soit contrôlable ?

Concernant l'observabilité des hautes fréquences pour ce problème, on peut procéder comme au Paragraphe 1.3.3 : associer à une suite $(v_1^k, \dots, v_n^k)_{k \in \mathbb{N}}$ de solutions du système adjoint convergeant faiblement vers zéro une matrice $(\mu_{ij})_{1 \leq i, j \leq n}$ de mesures de défaut et étudier les équations satisfaites par ces mesures.

En plus des conditions géométriques, on s'attend à avoir une condition du type : chaque variable d'état doit voir le contrôle à travers une chaîne d'"états connectés" par la matrice de couplage A_1 . C'est une sorte de condition de Kalman traduisant le fait qu'il n'y a pas de variable d'état incontrôlée. Dans le contexte des EDP couplées, une telle condition nécessaire et suffisante de contrôle a déjà été montrée pour des équations paraboliques couplées par une matrice A_1 à coefficients constants [AKBDGB09b]. Traiter des coefficients dépendant de $x \in \Omega$ localisés complique considérablement la formulation même d'une telle condition.

Enfin, cette étude va nécessairement se heurter au problème de prolongement unique pour les systèmes elliptiques. Même dans le cas d'une matrice A_1 de taille 2×2 , on ne connaît pas de résultat général concernant le prolongement unique des vecteurs propres.

Le problème du prolongement unique pour les systèmes elliptiques. Au Paragraphe 1.2.1, nous avons montré que le problème de contrôlabilité de systèmes paraboliques couplés pouvait se réduire à la preuve d'estimées quantitatives de prolongement unique pour l'opérateur elliptique sous-jacent. Au Paragraphe 1.3.1, nous avons vu que ces mêmes estimées elliptiques impliquaient la stabilisation logarithmique de systèmes de deux ondes couplées. Enfin, au Paragraphe 1.3.3, nous avons vu que l'étude de la contrôlabilité de systèmes d'ondes couplées nécessitait de comprendre les propriétés de prolongement unique des vecteurs propres de l'opérateur elliptique sous-jacent.

A ce jour, nous ne savons montrer de telles estimées de prolongement unique pour des systèmes elliptiques 2×2 que dans le cas où la zone d'observation et la zone de couplage s'intersectent. Cependant, aux paragraphes 1.3.1, 1.3.2 et 1.3.3, nous avons obtenu des résultats positifs dans des cas où ces deux zones ne s'intersectent pas. Ceci nous amène à penser que, sous certaines conditions sur les coefficients, on doit pouvoir montrer des propriétés de prolongement unique quantitatif pour l'opérateur elliptique, même dans des situations où l'intersection de la zone de couplage et de la zone de contrôle est vide.

L'étude du prolongement unique pour les systèmes elliptiques joue un rôle clé dans la compréhension des propriétés de contrôlabilité et de stabilisation des systèmes paraboliques et hyperboliques associés. Une analyse précise de cette propriété de prolongement unique permettrait de résoudre de nombreux problèmes dans ces domaines, et peut-être de donner une réponse plus complète aux questions 1 et 2 formulées au début du Paragraphe 1.3.

1.4 Contrôle uniforme de lois de conservation scalaires dans la limite de viscosité évanescence

Dans cette partie, on s'intéresse à un problème non-linéaire, que l'on veut contrôler uniformément dans une limite singulière. A la limite, le problème que l'on contrôle est une équation de transport

quasilineaire, au sens où la non-linéarité apparaît dans le coefficient principal de l'équation. Notre stratégie de contrôle doit donc être adaptée à la non-linéarité du problème limite. Notons que dans le cadre non-linéaire, il existe différentes notions de contrôlabilité. En particulier, contrairement aux systèmes linéaires, les questions de contrôlabilité locale et contrôlabilité globale ne sont plus du tout équivalentes.

On dit que le système

$$\frac{d}{dt}u = F(u, g), \quad u \in \mathcal{H}, \quad (1.73)$$

est globalement exactement contrôlable en temps $T > 0$ si pour tous $u_0, u_1 \in \mathcal{H}$, il existe un contrôle g qui amène la solution de (1.73) issue de u_0 en u_1 au temps T . Etant donnée une trajectoire (\bar{u}, \bar{g}) du système (1.73), on dit que (1.73) est localement exactement contrôlable autour de cette trajectoire en temps $T > 0$, s'il existe un voisinage V_0 de \bar{u}_0 et un voisinage V_1 de \bar{u}_1 tels que pour tous $u_0 \in V_0$ et $u_1 \in V_1$, il existe un contrôle g (proche de \bar{g}) qui amène la solution de (1.73) issue de u_0 en u_1 au temps T . On renvoie au livre de J.-M. Coron [Cor07a] pour plus de précision sur ces différentes notions.

On considère ici une perturbation visqueuse d'une loi de conservation scalaire sur un intervalle borné

$$u_t + [f(u)]_x - \varepsilon u_{xx} = 0 \quad \text{dans } (0, T) \times (0, L), \quad (1.74)$$

où $L > 0$ est la longueur de l'intervalle d'étude, $\varepsilon > 0$ représente un coefficient de viscosité, et $u : (0, T) \times (0, L) \rightarrow \mathbb{R}$. On peut agir sur ce système par l'intermédiaire de deux contrôles sur le bord du domaine

$$u|_{x=0} = g_0(t) \quad \text{et} \quad u|_{x=L} = g_L(t) \quad \text{dans } (0, T). \quad (1.75)$$

Le problème de contrôlabilité exacte globale est le suivant : pour une donnée initiale

$$u|_{t=0} = u_0 \quad \text{dans } (0, L), \quad (1.76)$$

un temps $T > 0$ et une cible u_T , est-il possible de trouver des contrôles $g_0 = g_0^\varepsilon$ et $g_L = g_L^\varepsilon$ tels que la solution du système (1.74)-(1.75)-(1.76) associée, u atteigne u_T en temps T ? Ici, comme au Paragraphe 1.2.2.3, on va s'intéresser à une telle propriété de contrôlabilité uniformément par rapport à la viscosité $\varepsilon \in (0, \varepsilon_0)$. De plus, pour des raisons qui apparaîtront au Paragraphe 1.4.0.5, on ne va chercher à atteindre que des cibles constantes $u_T = M \in \mathbb{R}$.

Pour comprendre l'intérêt d'étudier ce problème en limite de viscosité évanescence ainsi que les méthodes que nous utilisons, il faut rappeler quelques propriétés du problème de Cauchy pour les lois de conservation scalaires.

1.4.0.3 Autour du problème de Cauchy pour les lois de conservation scalaires

L'étude du problème de viscosité évanescence est liée au problème de Cauchy pour la loi de conservation

$$\begin{cases} u_t + [f(u)]_x = 0 & \text{pour } (t, x) \in \mathbb{R}_+ \times \mathbb{R}, \\ u|_{t=0} = u_0 & \text{dans } \mathbb{R}. \end{cases} \quad (1.77)$$

Le problème (1.77) est une équation de transport à vitesse $f'(u)$, dépendant de l'état. Les différentes valeurs de u ne "voyagent donc pas à la même vitesse". Si le système est localement bien posé en temps (dans des espaces de fonctions régulières), on voit aussi qu'en temps grand, la solution issue d'une donnée $u_0 \in \mathcal{C}^\infty(\mathbb{R})$ développe en général des discontinuités. On ne peut donc pas espérer que le problème de Cauchy soit globalement bien posé dans des espaces de fonctions régulières. Par contre, on peut espérer l'existence globale en temps de solutions faibles contenant des discontinuités. Mais, dans ce cadre, on perd en général l'unicité. Il s'agit alors, parmi toutes les solutions faibles, d'en choisir une qui correspond aux phénomènes physiques que l'on veut modéliser. L'un des critères de sélection est de demander à la solution de satisfaire l'inégalité d'entropie suivante (voir par exemple [Kru70], [Daf00, Chapter 6]) : pour toute fonction convexe $\eta : \mathbb{R} \rightarrow \mathbb{R}$ et tout flux d'entropie associé $q(u) = \int^u \eta'(\omega) f'(\omega) d\omega$, on a

$$\eta(u)_t + q(u)_x \leq 0,$$

au sens des mesures.

Un autre critère de sélection est de demander à ce que la solution u de (1.77) soit la limite lorsque $\varepsilon \rightarrow 0^+$ d'une famille de solutions u^ε du problème

$$\begin{cases} u_t^\varepsilon + [f(u^\varepsilon)]_x - \varepsilon u_{xx}^\varepsilon = 0 & \text{pour } (t, x) \in \mathbb{R}_+ \times \mathbb{R}, \\ u^\varepsilon|_{t=0} = u_0 & \text{dans } \mathbb{R}. \end{cases} \quad (1.78)$$

Le théorème de Kružkov [Kru70] (voir aussi [Daf00, Chapter 6]) montre en particulier que ces deux définitions coïncident. D'une certaine façon, la viscosité a disparu de l'équation mais reste présente dans la sélection des discontinuités admissibles. Pour obtenir le modèle (1.77), on a en quelque sorte négligé la viscosité tout en conservant un phénomène diffusif au niveau des discontinuités. Appelant solution faible admissible (ou solution entropique) celle sélectionnée par l'un ou l'autre de ces critères, on obtient alors le résultat suivant.

Théorème 1.33 (S.N. Kružkov [Kru70]). *Pour tout $u_0 \in L^\infty(\mathbb{R})$, le système (1.77) a une unique solution faible admissible $u \in L^\infty((0, T) \times \Omega)$. De plus, $u \in \mathcal{C}^0([0, \infty); L^1_{\text{loc}}(\mathbb{R}))$ et on a $u^\varepsilon \rightarrow u$ p.p. lorsque $\varepsilon \rightarrow 0^+$.*

Une propriété fondamentale que partagent les solutions de (1.78) et la solution faible admissible de (1.77) est le principe de comparaison suivant, dont nous ferons usage.

Théorème 1.34 (S.N. Kružkov [Kru70], voir aussi [Daf00], Théorèmes 6.2.3 et 6.3.2). *Soient $u_0, \bar{u}_0 \in L^\infty(\mathbb{R})$ telles que $u_0 \leq \bar{u}_0$ p.p. $x \in \mathbb{R}$. On appelle $u^\varepsilon, \bar{u}^\varepsilon$ les solutions de (1.78) associées à u_0, \bar{u}_0 , et u, \bar{u} les solutions entropiques de (1.77) associées à u_0, \bar{u}_0 . On a alors*

$$u^\varepsilon(t, x) \leq \bar{u}^\varepsilon(t, x), \quad \text{et} \quad u(t, x) \leq \bar{u}(t, x) \quad \text{p.p. } (t, x) \in \mathbb{R}^+ \times \mathbb{R}.$$

C'est en particulier ce principe de comparaison (ainsi qu'un choix précis de couples entropie-flux d'entropie) qui permet de démontrer le Théorème 1.33, et établit un lien clair entre les solutions entropiques de (1.77) et leurs approximations visqueuses.

Pour finir ce paragraphe, introduisons des solutions particulières qui nous seront très utiles (avec lesquelles nous comparerons nos solutions). On montre que le problème visqueux (1.78) admet des solutions (voir [Daf00, Section 8.6]) de la forme

$$u^\varepsilon(t, x) = U\left(\frac{x - st}{\varepsilon}\right), \quad (t, x) \in \mathbb{R}_+ \times \mathbb{R},$$

qui convergent lorsque $\varepsilon \rightarrow 0^+$ vers un choc entre les états constants N à gauche et P à droite. Le profil U de ces solutions doit pour cela satisfaire l'équation différentielle ordinaire

$$\dot{U} = f(U) - f(N) - s(U - N), \quad (1.79)$$

$$s = \frac{f(N) - f(P)}{N - P}, \quad (1.80)$$

$$\lim_{\xi \rightarrow +\infty} U(\xi) = P, \quad \text{et} \quad \lim_{\xi \rightarrow -\infty} U(\xi) = N. \quad (1.81)$$

Ces solutions particulières sont appelées ondes progressives (ou ondes de choc visqueuses) entre N et P , de profil U et de vitesse s . Cette vitesse est exactement la vitesse associée à l'onde de choc entre P et N et est donnée par la condition de Rankine-Hugoniot (1.80). Dans le cas où f est convexe, une onde de choc visqueuse existe entre deux états donnés N et P si et seulement si $P < N$.

Dans le cas d'une fonction de flux f non convexe, il n'existe pas toujours de choc (ou d'onde progressive) entre deux états constants donnés. Nous donnons ici une condition suffisante (et presque nécessaire) pour avoir existence d'un profil de choc entre deux états. On appelle $\sigma(A, B)$ la vitesse de choc entre deux états A et B , donnée par la condition de Rankine-Hugoniot, c'est-à-dire la corde de f entre A et B :

$$\sigma(A, B) = \frac{f(B) - f(A)}{B - A} \quad \text{si } A \neq B, \quad \text{et} \quad \sigma(A, A) = f'(A).$$

On dit que f satisfait la condition d'admissibilité d'Oleinik (SOC+) entre P et N si

$$P < N \quad \text{et} \quad \sigma(P, N) < \sigma(A, N), \quad \text{pour tout } A \in (P, N). \quad (\text{SOC+})$$

Cela signifie que sur l'intervalle (P, N) , la courbe de f est dessous la corde entre P et N . On dit que f satisfait la condition d'admissibilité d'Oleinik (SOC-) entre P et N si

$$N < P \quad \text{et} \quad \sigma(P, N) > \sigma(A, N), \quad \text{pour tout } A \in (N, P). \quad (\text{SOC-})$$

Cela signifie que sur l'intervalle (N, P) , la courbe de f est dessus la corde entre P et N . Ces deux conditions assurent l'existence pour le flux f d'un choc admissible entre les deux états P et N (voir [Daf00, Section 8.6]). Elles nous seront utiles pour formuler le Théorème 1.36 de contrôlabilité uniforme dans le cas non convexe.

Si, par exemple la fonction f satisfait la condition (SOC+) sur (P, N) (notamment si f est strictement convexe entre P et N), alors le profil U de l'onde progressive a les propriétés suivantes :

- U décroît de N vers P , car la condition de Rankine-Hugoniot (1.80) et le fait que $P < U(\xi) < N$ pour tout $\xi \in \mathbb{R}$ impliquent que le membre de droite de (1.79) est négatif;
- $\lim_{\xi \rightarrow \pm\infty} U(\xi) = 0$, comme conséquence de (1.79)-(1.81);
- pour tout $\xi_0 \in \mathbb{R}$, $U_{\xi_0} = U(\cdot - \xi_0)$ est aussi solution (1.79)-(1.81) car (1.79) est autonome.

Finalement, on voit ici que la viscosité permet de décrire un système physique important pour la compréhension du problème limite. Par conséquent, après avoir rappelé les propriétés de convergence dans la limite $\varepsilon \rightarrow 0^+$, il paraît aussi naturel d'étudier le coût de la viscosité lorsque l'on s'intéresse au problème de contrôle pour la loi de conservation (1.77). Les propriétés de contrôlabilité connues pour le problème hyperbolique sont elles toujours valides pour le modèle avec une petite viscosité? Comment le coût du contrôle dépend-il de la viscosité lorsque $\varepsilon \rightarrow 0^+$? Autrement dit, est-il robuste vis à vis de petites perturbations visqueuses?

1.4.0.4 Résultats antérieurs

Comme nous nous intéressons à des propriétés de contrôlabilité uniforme dans la limite $\varepsilon \rightarrow 0^+$, il paraît naturel de rappeler les résultats connus à la fois pour des problèmes de limites singulières, pour le problème (1.74)-(1.75)-(1.76) visqueux (pour $\varepsilon > 0$, fixé) et pour le problème (1.74)-(1.75)-(1.76) non visqueux ($\varepsilon = 0$).

Contrôle uniforme en limite singulière. Les problèmes de contrôlabilité de perturbations singulières apparaissent à ma connaissance dans le livre de J.-L. Lions [Lio88b, Chapter 3], dans lequel sont étudiées des équations de plaques/ondes, dans la limite des plaques évanescences.

Dans le contexte d'équations de transport/chaleur dans la limite de viscosité évanescence, cette étude a été initiée par J.-M. Coron et S. Guerrero [CG05b]. Leurs résultats, décrits au Paragraphe 1.1.2 concernent la version linéaire de (1.74) (c'est-à-dire $f(u) = Mu$ pour un certain $M \in \mathbb{R}^*$). Les temps de contrôle obtenus dans [CG05b] ont été par la suite améliorés par O. Glass [Gla10] grâce à une méthode d'analyse complexe (complètement différente de la méthode originelle de [CG05b]). Les résultats de [CG05b] ont aussi été généralisés aux dimensions supérieures d'espace et pour un champ de vitesse non-constant par S. Guerrero et G. Lebeau dans [GL07].

De telles propriétés de contrôlabilité uniforme ont été étudiées par O. Glass et S. Guerrero dans le cas d'équations de transport en limite de dispersion évanescence [GG08] et en limite de dispersion et de viscosité évanescences dans [GG09]. Tous les résultats cités ci-dessus concernent des perturbations singulières d'équations linéaires.

Concernant les problèmes non-linéaires en limite de viscosité évanescence, le seul résultat (à ma connaissance) a été établi par O. Glass et S. Guerrero [GG07] pour l'équation de Burgers, c'est-à-dire, le cas $f(u) = \frac{u^2}{2}$. Les Théorèmes 1.35 et 1.36 ci-dessous généralisent ce résultat aux cas des fonctions de flux générales f .

Problème visqueux. Les propriétés de contrôlabilité de l'équation visqueuse (1.74) pour $\varepsilon > 0$ fixé ont été principalement étudiées dans le cas de l'équation de Burgers. Deux types de résultats ont été montrés. La contrôlabilité exacte locale aux trajectoires a été prouvée par A.V. Fursikov et O.Yu. Imanuvilov [FI96]. Dans ce même article, les auteurs démontrent aussi que le système n'est pas localement exactement contrôlable si le contrôle agit sur un sous-intervalle de $(0, L)$, ce qui est équivalent à ne contrôler qu'une des extrémités de l'intervalle. Un résultat similaire est montré par J.I. Díaz [Día96]. Concernant le contrôle exact global pour l'équation de Burgers visqueuse, E. Fernández-Cara et S. Guerrero [FCG07] donnent une estimation précise du temps minimal de contrôlabilité à zéro dans le cas d'un contrôle par une seule extrémité. D'autre part, S. Guerrero et O.Yu. Imanuvilov montrent dans [GI07] que la contrôlabilité exacte globale n'est pas satisfaite même si le contrôle agit aux deux extrémités du domaine.

Cependant, J.-M. Coron [Cor07b] donne un résultat de contrôlabilité aux états constants à partir de zéro. Plus précisément, il montre que pour $u_0 = 0$ et pour tout $T > 0$, on peut amener la solution de (1.74), (1.75), (1.76) à n'importe quel état constant M si $|M|$ est suffisamment grand par rapport à T . Ce résultat est généralisé par O. Glass et S. Guerrero [GG07] à toute donnée initiale $u_0 \in L^\infty(0, L)$. De plus les auteurs donnent un lien précis entre la cible M et le temps minimal de contrôle.

Finalement, ajoutant un troisième contrôle globalement distribué sur $(0, L)$, mais indépendant de x , M. Chapouly montre dans [Cha09a] un résultat de contrôlabilité globale pour l'équation de Burgers visqueuse en tout temps $T > 0$. La preuve de ce résultat utilise à la fois des propriétés de contrôlabilité de l'équation non-visqueuse et un résultat de contrôle local.

Problème non-visqueux. Concernant la contrôlabilité de l'équation non-visqueuse (1.77) et dans le contexte des solutions d'entropie, le problème de contrôle a été étudié par F. Ancona et A. Marson [AM98] pour des fonctions de flux strictement convexes f . Dans cet article, le problème est posé sur la demi-droite réelle avec une condition initiale nulle, et l'ensemble des états atteignables est complètement décrit.

Concernant le problème sur un intervalle borné, et pour une donnée initiale générale, la contrôlabilité de l'équation de Burgers non visqueuse ($f(u) = \frac{u^2}{2}$ dans (1.77)) a été étudiée par T. Horsin [Hor98]. Dans cet article, l'auteur donne des conditions sur l'état final pour que cet état soit atteignable. Dans le cas non visqueux, on remarque que le problème de contrôle avec un flux non convexe ne semble pas avoir déjà été étudié.

Enfin, notons qu'une motivation importante pour étudier des problèmes de contrôle en limite singulière est la recherche d'un résultat de contrôle pour le problème perturbé lui-même. Cette approche est particulièrement bien illustrée par les articles [Cor96] de J.-M. Coron, [CF96] de J. M. Coron et A.V. Fursikov et [Cha09b] de M. Chapouly, dans lesquels les auteurs s'intéressent au système de Navier-Stokes incompressible avec des conditions de Navier au bord (ou sur une variété sans bord dans [CF96]). Leur stratégie est d'utiliser un résultat de contrôlabilité global pour le système non-visqueux associé (dans ce cas, l'équation d'Euler), et d'en déduire la contrôlabilité globale approchée de Navier-Stokes.

De plus, dans [Cor96] et [Cha09b], les auteurs déduisent la contrôlabilité exacte globale du système d'un résultat de contrôlabilité exact local (conséquence d'une inégalité de Carleman pour le linéarisé).

La stratégie que nous utiliserons dans la preuve du Théorème 1.35 ci-dessous est très proche de celle-ci. En conséquence, nous obtenons aussi un résultat de contrôle pour le problème (1.74) pour une viscosité fixée (voir la Proposition 1.38).

1.4.0.5 Principaux résultats obtenus

Nos deux résultats principaux sont des théorèmes de contrôlabilité uniforme dans le cas où la fonction flux f est convexe et dans le cas où elle ne l'est pas. Notre résultat est plus précis dans le cas convexe car on obtient alors une borne sur le temps minimal de contrôle.

Le cas f convexe. Notre premier résultat concerne les fonctions de flux f convexes.

Théorème 1.35. *On suppose que la fonction de flux vérifie $f \in W_{\text{loc}}^{2,\infty}(\mathbb{R})$, $f'' \geq 0$ p.p., et $f'(u) \rightarrow +\infty$ lorsque $u \rightarrow +\infty$ (resp. $f'(u) \rightarrow -\infty$ lorsque $u \rightarrow -\infty$). Alors, il existe $\alpha_0 \geq 1$ et une constante $C > 0$ tels que pour tout $R_0 > 0$ et tout M satisfaisant $f'(M) > 0$ (resp. $f'(M) < 0$), il existe $\varepsilon_0 > 0$ tel que pour tout $u_0 \in L^\infty(0, L)$ avec $\|u_0\|_{L^\infty(0,L)} \leq R_0$, tout $T > \alpha_0 \frac{L}{|f'(M)|}$ et tout $\varepsilon \in (0, \varepsilon_0)$, il existe deux contrôles g_0^ε et g_L^ε satisfaisant*

$$\|g_0^\varepsilon\|_{L^\infty(0,T)} + \|g_L^\varepsilon\|_{L^\infty(0,T)} \leq C(R_0 + |M|),$$

tels que la solution de (1.74), (1.75) et (1.76) associée à g_0^ε et g_L^ε satisfasse $u|_{t=T} = M$ sur $(0, L)$.

Ce théorème est une généralisation de [GG07, Theorem 1.1], où l'équation de Burgers est traitée. La preuve du Théorème 1.35 montre que l'on peut choisir $\alpha_0 = 5.3$. Même dans le cas de l'équation de Burgers on améliore le temps minimal ($\alpha_0 = 6.3$) trouvé dans [GG07]. Ici comme pour une équation de transport, il est nécessaire d'avoir un temps minimal de contrôlabilité uniforme. En effet, la solution entropique du système limite (1.77) se propage à vitesse finie; en particulier, on peut montrer (voir [AM98]) qu'elle ne peut pas atteindre un état u_T (en partant par exemple de $u_0 = 0$), en un temps inférieur à $\frac{L}{\inf |f'(u_T)|}$. Par conséquent, les états constants u_T tels que $f'(u_T) = 0$ ne sont pas atteignables pour l'équation limite (à moins d'avoir $u_0 = u_T$). Ils ne semblent donc pas être uniformément atteignable lorsque $\varepsilon \rightarrow 0^+$. Avoir un temps minimal de contrôle de la forme $\alpha_0 \frac{L}{|f'(M)|}$ n'est donc pas surprenant.

Notons que, contrairement au résultat de [GG07], le coefficient ε_0 dépend ici de la donnée initiale u_0 , et pas seulement de la cible M . Cette contrainte peut être relaxée sous une hypothèse technique (mais néanmoins généralement vérifiée) sur le comportement à l'infini de f'' (voir le Théorème 7.1). Cette hypothèse est en particulier satisfaite dans le cas de l'équation de Burgers, et notre résultat en est donc bien une généralisation.

On peut se demander l'intérêt de se focaliser sur les cibles constantes $u_T = M$. Il réside dans le fait qu'il est assez difficile de décrire l'ensemble des états atteignables uniformément dans la limite $\varepsilon \rightarrow 0^+$: c'est l'intersection des trajectoires de (1.78) très régulières, et de celles de (1.77) pouvant contenir des discontinuités. Cependant, si on se restreint aux états d'équilibre (qui sont les plus intéressants du point de vue du contrôle), on montre que l'ensemble des états stationnaires uniformément atteignables dans la limite $\varepsilon \rightarrow 0^+$ est exactement l'ensemble des états constants associés à une vitesse non nulle.

L'idée principale de la preuve du Théorème 1.35 est, comme dans [GG07], de combiner des propriétés de contrôlabilité globale approchée (avec une précision dépendant de ε) reposant sur la nature hyperbolique du problème, et des propriétés de contrôlabilité exacte locale reposant sur la nature parabolique de la perturbation.

L'un des ingrédients principaux est, sous une certaine forme, la méthode du retour de J.-M. Coron, qui consiste à trouver une trajectoire particulière du système qui s'éloigne violemment de la donnée initiale, pour revenir dans un second temps vers la cible.

Cette stratégie pour montrer des résultats de contrôlabilité exacte globale est très proche de celle utilisée avec succès dans [Cor96], [CF96] et [Cha09b] pour l'équation de Navier-Stokes et dans [Cha09a] pour l'équation de Burgers. Dans la situation du Théorème 1.35, on amène tout d'abord l'état du système à un grand état constant N (tel que $f'(N)$ soit de même signe que $f'(M)$), et on retourne ensuite à la cible M . Supposons par exemple dans ce qui suit que $f'(M) > 0$.

Pour effectuer la première étape (atteindre un grand état N) on étend la donnée initiale u_0 sur $(0, L)$ en une donnée sur tout \mathbb{R} , qui vaut N à gauche. On place une onde de choc visqueuse qui tend vers N en $-\infty$ sous cette donnée initiale (voir la Figure 1.7). Par le principe de comparaison du Théorème 1.34, la solution associée à la donnée initiale u_0 ainsi prolongée sera, après un certain temps, "très proche de N ". On effectue ensuite un argument de contrôle local proche de ceux de [CG05b, GG07] : linéarisation autour de l'état cible, preuve de l'observabilité du linéarisé grâce à une inégalité de Carleman, puis théorème de point fixe pour conclure pour le cas non-linéaire. Le point clé dans cette première étape est la suivante : la proximité entre la solution que l'on construit

et l'état constant N est, pour $t > \frac{L}{s}$ de l'ordre de $e^{-\frac{Kt}{\varepsilon}}$, et contrebalance ainsi un coût du contrôle local de l'ordre de $e^{\frac{C}{\varepsilon}}$. Cette étape peut être effectuée en un temps $\frac{L}{s} + C' \frac{L}{f'(N)}$, où s est la vitesse de l'onde de choc visqueuse. Grâce à l'hypothèse $|f'(N)| \rightarrow +\infty$ lorsque $N \rightarrow \infty$, on peut donc pour tout temps $T_1 > 0$, trouver un état N (suffisamment grand) tel que $u(T_1) = N$ sur $(0, L)$.

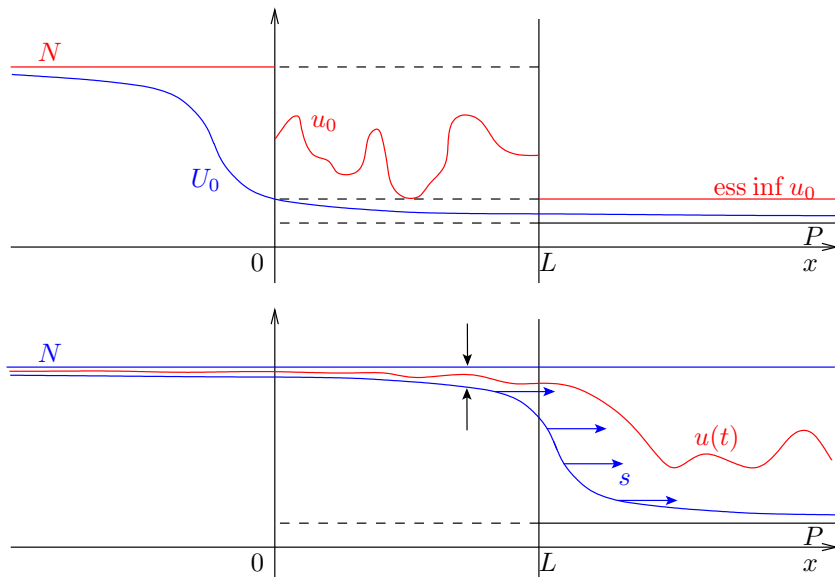

FIGURE 1.7 – Première phase : onde progressive et principe de comparaison.
Donnée initiale et solution après un temps $t > \frac{L}{s}$.

En ce qui concerne la seconde étape (revenir à M), on étend sur \mathbb{R} la nouvelle donnée N sur $(0, L)$, par N à droite, et par la cible M à gauche. La solution associée est alors une onde de détente visqueuse (voir la Figure 1.8). De même, après un temps de l'ordre de $\frac{L}{f'(M)}$, on montre que cette solution est exponentiellement proche de notre cible M . On conclut alors par le même argument local et on obtient un résultat de contrôle uniforme en temps $\alpha_0 \frac{L}{f'(M)}$.

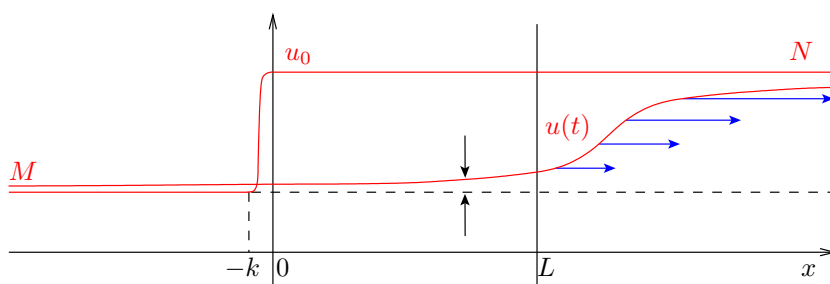

FIGURE 1.8 – Deuxième phase : onde de détente visqueuse.
Donnée initiale et solution après un temps $t > \frac{L}{f'(M)}$.

Le cas f non convexe. Nous montrons un analogue du Théorème 1.35 dans le cas d'une fonction de flux non convexe, c'est-à-dire pour une loi de conservation générale. Dans ce cadre cependant, nous n'avons pas d'estimation du temps de contrôle, et le résultat est donc moins précis.

Théorème 1.36. *On suppose que $f \in \mathcal{C}^2(\mathbb{R})$ satisfait la condition*

$$(f'')^{-1}(\{0\}) \cap K \text{ a un nombre fini de composantes connexes} \quad (1.82)$$

pour tout segment $K \subset \mathbb{R}$,

et que la donnée initiale $u_0 \in L^\infty(0, L)$ satisfait

$$[\text{ess inf } u_0, \text{ess sup } u_0] \subset I \text{ pour un intervalle ouvert } I \text{ tel que} \quad (1.83)$$

f satisfait (SOC+) ou (SOC-) sur I .

Alors, pour tout M tel que $f'(M) \neq 0$, il existe $C_0 > 0$, $T_0 > 0$ et $\varepsilon_0 > 0$ tels que pour tout $T > T_0$ et tout $\varepsilon \in (0, \varepsilon_0)$, il existe deux contrôles g_0^ε et g_L^ε satisfaisant

$$\|g_0^\varepsilon\|_{L^\infty(0,T)} + \|g_L^\varepsilon\|_{L^\infty(0,T)} \leq C_0,$$

tels que la solution de (1.74)-(1.75)-(1.76) associée à g_0^ε et g_L^ε satisfasse $u|_{t=T} = M$ sur $(0, L)$.

La condition (1.82) que nous imposons sur le flux signifie que f'' ne s'annule que sur un nombre fini de points ou d'intervalles (fermés) sur chaque borné de \mathbb{R} . Mis à part quelques cas pathologiques (par exemple $f(u) = u^5 \cos(\frac{1}{u}) + u$ pour $u \neq 0$, $f(0) = 0$) cette condition est généralement satisfaite. Plus précisément, elle est génériquement satisfaite sur $\mathcal{C}^3(\mathbb{R})$. Par contre, il est surprenant de remarquer que cette condition n'est pas générique dans l'espace $\mathcal{C}^2(\mathbb{R})$ (voir [BG77]).

La preuve de ce théorème se fait en deux temps. Tout d'abord, la condition (1.83) permet, grâce à l'existence du choc visqueux qu'elle donne, d'amener la donnée initiale à un état constant M_0 en temps fini. Cette phase repose, comme dans la première partie de la preuve du Théorème 1.35, sur le principe de comparaison avec cette onde progressive. Dans un second temps, il s'agit de contrôler l'état constant M_0 à la cible M . On procède alors à une itération de phases de contrôle semblables à celles de la démonstration du Théorème 1.35. En effet, sous la condition (1.82), le flux f est localement soit convexe, soit concave (au sens large); deux cas que nous savons maintenant traiter. On adopte alors une stratégie de contrôle de proche en proche, illustrée par la Figure 1.9. Si deux états constants sont suffisamment proches (et tous deux de vitesse non nulle), on peut amener l'état du système de l'un à l'autre grâce à une détente ou un choc convexe (symbolisé par une corde de f sur la Figure 1.9) dans le cas où f est convexe (au sens large) entre ces deux états. Une stratégie similaire fonctionne aussi si f est concave entre les deux états. Ainsi, en un nombre fini d'étapes (grâce à l'hypothèse (1.82)), on peut atteindre la cible M .

Notons que la difficulté est ici liée à la non-monotonie des vitesses, et est donc de nature hyperbolique. Le problème de viscosité évanescence est en quelque sorte traité séparément.

Remarquons enfin que la condition (1.83) est essentiellement technique et simplifie la preuve. Cependant, cette condition n'est pas essentielle et une récente discussion avec F. Ancona et K. N'Guyen a permis de la relaxer.

Quelques corollaires. On peut déduire de ce dernier théorème quelques "corollaires" concernant le système non-visqueux $\varepsilon = 0$ ainsi que le système visqueux $\varepsilon = 1$.

Dans la limite $\varepsilon \rightarrow 0^+$, la preuve du Théorème 1.36 nous donne un résultat de contrôlabilité globale pour les solutions d'entropie de (1.77) dans le cas d'un flux non convexe, qui nous semble nouveau.

Proposition 1.37. *On suppose que $f \in \mathcal{C}^2(\mathbb{R})$ satisfait la condition (1.82) et $u_0 \in L^\infty(0, L)$ satisfait (1.83). Alors, pour tout M tel que $f'(M) \neq 0$, il existe $T_0 > 0$ et une solution entropique $u \in \mathcal{C}^0(\mathbb{R}_+; L^1_{\text{loc}}(\mathbb{R}))$ de*

$$u_t + [f(u)]_x = 0 \quad \text{dans } \mathbb{R}_+ \times \mathbb{R},$$

telle que

$$u|_{t=0} = u_0 \quad \text{et} \quad u|_{t=T} = M \quad \text{sur } (0, L),$$

pour tout temps $T > T_0$.

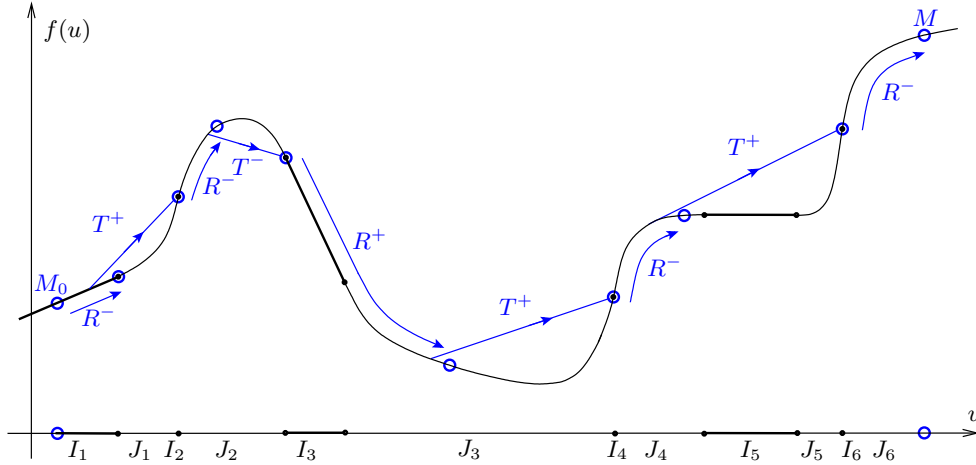

FIGURE 1.9 – Stratégie globale de contrôle pour f non convexe
 R^+ : “onde de détente convexe” ; R^- : “onde de détente concave” ;
 T^+ : “onde progressive convexe” ; T^- : “onde progressive concave”.

Cette proposition peut être vue comme un résultat de contrôle frontière sur l’intervalle $(0, L)$. Cependant, dans ce cas, il faut faire attention au sens que l’on donne aux conditions aux limites. Ces dernières ne doivent pas être comprises au sens de Dirichlet, qui n’est pas la notion adaptée aux lois de conservation, mais plutôt au sens de [BIRN79] ou [AM98].

De même, dans le cas d’une viscosité constante, l’analogie du Théorème 1.36 donne un nouveau résultat de contrôlabilité en temps grand pour certaines équations de la chaleur non-linéaires.

Proposition 1.38. *On suppose que $f \in \mathcal{C}^2(\mathbb{R})$ satisfait la condition (1.82) et $u_0 \in L^\infty(0, L)$ satisfait (1.83). Alors, pour tout M tel que $f'(M) \neq 0$, il existe $T_0 > 0$ tel que pour tout $T > T_0$, il existe deux contrôles $g_0, g_L \in L^\infty(0, T)$ tels que la solution de*

$$\begin{cases} u_t - u_{xx} + [f(u)]_x = 0 & \text{dans } (0, T) \times (0, L), \\ u|_{x=0} = g_0(t) \text{ et } u|_{x=L} = g_L(t) & \text{dans } (0, T), \\ u|_{t=0} = u_0 & \text{dans } (0, L), \end{cases}$$

satisfasse $u|_{t=T} = M$ dans $(0, L)$.

La preuve de cette proposition suit en fait celle du Théorème 1.36, en remplaçant les arguments “ ε petit” par “ T grand”. Notons que la non-linéarité ici peut être très forte. En particulier, l’hypothèse de temps grand semble naturelle pour des fortes non-linéarités car la Proposition 1.38 donne un résultat de contrôle global. Même l’équation de Burgers visqueuse n’est en général pas globalement contrôlable en tout temps (voir [GI07]). On renvoie aussi à [FCZ00] dans le contexte un peu différent des équations paraboliques semilinéaires.

1.4.0.6 Problèmes ouverts et perspectives

Dans le domaine du contrôle de lois de conservation en limite singulière, la grande majorité des problèmes est ouverte. Mentionnons tout d’abord quelques problèmes proches de nos résultats.

La conjecture de Coron-Guerrero (Théorème 1.14) sur le temps minimal nécessaire au contrôle de l’équation de transport/chaleur dans la limite de viscosité évanescence est toujours ouverte. De même, dans le cas d’un flux f convexe, et pour un temps $\frac{L}{|f'(M)|} \leq T \leq 5.3 \frac{L}{|f'(M)|}$ on ne sait pas si le système est uniformément contrôlable (on sait qu’il y a contrôlabilité pour le système limite si et seulement si $T > \frac{L}{|f'(M)|}$). Remarquons que notre méthode nécessite de toute façon d’avoir

$T > 2\frac{L}{f'(M)}$. Obtenir un résultat de non-contrôlabilité uniforme en temps $T < 2\frac{L}{f'(M)}$ serait assez surprenant au vu des propriétés de contrôlabilité du système limite.

En ce qui concerne le cas des fonctions de flux non convexes, il serait aussi très intéressant d'estimer le temps nécessaire à notre stratégie de contrôle. En particulier, ce dernier doit dépendre à la fois de la donnée initiale u_0 , de la cible M et des variations de f entre u_0 et M . D'autre part, on aimerait supprimer la condition (1.82) portant sur $(f'')^{-1}(\{0\})$ pour pouvoir considérer tout flux $f \in \mathcal{C}^2$. On peut penser à utiliser la continuité des solutions des lois de conservation scalaires (visqueuses ou non) par rapport au flux f (voir [CG05a]) ainsi que la densité dans \mathcal{C}^2 de la classe de fonctions satisfaisant (1.82). Le passage à la limite nécessitera entre autres d'avoir, pour cette classe de fonctions une borne uniforme (par rapport au flux) sur le temps de contrôle. Il semble donc crucial d'estimer le temps de contrôle donné par la stratégie décrite ici.

Plus généralement, de très nombreux problèmes sont ouverts dans le domaine du contrôle uniforme de lois de conservation.

Contrôle de systèmes hyperboliques de lois de conservation, dans la limite de viscosité évanescence. Une extension naturelle des résultats présentés ici consiste à s'intéresser aux systèmes hyperboliques en limite de viscosité évanescence, i.e. (1.74) avec $u : (0, L) \rightarrow \mathbb{R}^N$ et $f : \mathbb{R}^N \rightarrow \mathbb{R}^N$. Une motivation à (très) long terme concerne par exemple le contrôle uniforme de Navier-Stokes vers Euler (compressibles). Mais, comme pour la théorie de Cauchy, le passage des lois de conservation scalaires aux systèmes hyperboliques n'a rien de simple. Les obstructions à la méthode utilisée ici sont nombreuses qu'il faudra surpasser.

Tout d'abord, notre stratégie repose de façon essentielle sur le principe de comparaison, qui n'est pas vrai en général pour les systèmes. D'autre part, on utilise dans le cas d'un flux convexe de manière cruciale l'existence de profils de chocs visqueux entre deux états constants quelconques de \mathbb{R} . Il n'en est pas du tout de même pour les systèmes, pour lesquels l'existence d'un choc entre deux états u_g et u_d de \mathbb{R}^N est liée à l'existence d'une orbite hétérocline entre u_g et u_d pour un certain système différentiel.

Enfin, la théorie de Cauchy pour les systèmes est beaucoup plus compliquée que dans le cas scalaire. Le résultat le plus général de convergence de la solution visqueuse vers celle du système hyperbolique lorsque $\varepsilon \rightarrow 0^+$ est montré dans [BB05]. Il concerne le cas d'une viscosité diagonale et de données initiales de petite variation totale. Il semble pour l'instant inaccessible de montrer des résultats de contrôle uniforme pour des systèmes si généraux, et est donc nécessaire de s'attaquer à des systèmes particuliers. Par exemple, les systèmes 2×2 de Temple (voir par exemple [Ser96, Chapitre 13]) semblent plus abordables, car ils se rapprochent par de nombreux aspects des lois de conservation scalaires. En particulier, la théorie de Kružkov se généralise partiellement à ces systèmes et les solutions des problèmes visqueux convergent bien lorsque $\varepsilon \rightarrow 0^+$ vers la solution du problème non visqueux.

Problèmes de dispersion évanescence. La viscosité n'est pas le seul mécanisme microscopique pouvant intervenir dans la sélection des discontinuités admissibles ; la dispersion peut en effet constituer un autre phénomène de première importance, notamment pour la sélection des "chocs non classiques", en particulier lorsque f est non convexe (voir [LeF02]). Il serait très intéressant d'étudier le système

$$u_t + [f(u)]_x - \varepsilon u_{xx} + \delta u_{xxx} = 0, \quad (1.84)$$

contrôlé par le bord, dans les limites $\varepsilon \rightarrow 0^+$ et $\delta \rightarrow 0^+$, dans le cas où $u : \mathbb{R} \rightarrow \mathbb{R}$ est à valeur scalaire.

Un bon point de départ dans l'étude du contrôle uniforme de (1.84) en limite de dispersion évanescence pourrait être l'équation de Korteweg-de Vries

$$u_t + uu_x + \delta u_{xxx} = 0. \quad (1.85)$$

En particulier, dans ce contexte, la convergence des solutions de l'équation de Korteweg-de Vries vers celles de l'équation de Burgers à été étudiée par P. Lax et C. Levermore [LL83]. Ces propriétés

de convergence sont bien moins simples que dans le cas de la viscosité évanescence car on perd la monotonie (qui, dans (1.78), était due à la diffusion) : on n'a plus ici de principe de comparaison (sur lequel est fondée toute la partie de contrôle global approché de notre stratégie).

D'un autre côté, la partie locale de la preuve (linéarisation autour de l'état cible puis point fixe) est déjà partiellement traitée dans [GG08, GG09], où des inégalités de Carleman adaptées au linéarisé de (1.85) et (1.84) sont prouvées.

Enfin, à (très long) terme, il serait intéressant d'étudier (1.84) dans le cas général $\varepsilon, \delta \rightarrow 0^+$, tenant compte des différents régimes de viscosité prépondérante ou de dispersion dominante (analyse qui est effectuée dans [GG09] pour le cas linéaire).

Note : Chacun des chapitres présentés ci-après introduit ses propres notations et peut être lu indépendamment des autres. Il peut aussi arriver que la même notation ait des significations différentes dans différents chapitres.

Cherchant à donner une vision d'ensemble de ce manuscrit, nous avons, dans l'introduction qui précède (le chapitre 1), essayé d'homogénéiser les notations. Par conséquent, les notations de cette introduction ne concordent pas toujours avec celles du chapitre correspondant.

Première partie

Autour de la méthode de
Lebeau-Robbiano pour le contrôle
des équations paraboliques

Chapitre 2

Inégalités spectrales pour des opérateurs elliptiques non-autoadjoints et application à la contrôlabilité de systèmes paraboliques

Contents

2.1	Introduction	65
2.1.1	Results in an abstract setting	65
2.1.2	Some applications	67
2.2	Spectral theory of perturbed selfadjoint operators	69
2.3	Spectral inequality for perturbed selfadjoint elliptic operators	72
2.4	From the spectral inequality to a parabolic control	75
2.4.1	Elliptic controllability on $\Pi_\alpha H$ with initial datum in $P_k H$	76
2.4.2	Parabolic controllability on $\Pi_\alpha H$ with initial datum in $P_k H$	77
2.4.3	Parabolic controllability on $\Pi_\alpha H$	80
2.4.4	Decay property for the semigroup and construction of the final control	82
2.5	Application to the controllability of parabolic coupled systems .	84
2.6	Application to the controllability of a fractional order parabolic equation	88
2.7	Application to level sets of sums of root functions	90
2.8	Appendix	91
2.8.1	Properties of the Gevrey function $e \in G^\sigma$, $1 < \sigma < 2$	91
2.8.2	A Paley-Wiener-type theorem	94

Ce chapitre est la reprise de l'article [Léa10a], publié dans Journal of Functional Analysis.

2.1 Introduction

2.1.1 Results in an abstract setting

Various methods have been developed to prove the null-controllability of parabolic equations

$$\begin{cases} \partial_t u + Au = Bg \\ u|_{t=0} = u_0 \end{cases} \quad (2.1)$$

where A is of elliptic type, and B is a bounded operator (for instance a distributed control). A large number of such results are based on the seminal papers of either G. Lebeau and L. Robbiano [LR95] or A. Fursikov and O.Yu. Imanuvilov [FI96]. The first approach has been used for the treatment of self-adjoint operators A . The second approach also permits to address non-selfadjoint operators and semilinear equations. Each method has advantages. We shall focus on those of the Lebeau-Robbiano method. First, this method only relies on elliptic Carleman estimates that are simpler to produce than their parabolic counterparts as needed for the Fursikov-Imanuvilov approach. Second, it enlightens some fundamental properties of the elliptic operator A through a spectral inequality. This type of spectral inequality, further investigated in [LZ98] and [JL99], has a large field of applications, like the measurement of the level sets of sums of root functions (see [JL99] or Section 2.7). For control issues, it yields the cost of the null-controllability of the low frequencies of the elliptic operator A . Finally, based on this fine spectral knowledge of A , this approach gives an explicit iterative construction of the control function, using both the partial controllability result and the natural parabolic dissipation.

In this paper, we extend the method of [LR95] for the abstract parabolic system (2.1) to cases in which A is a non-selfadjoint elliptic operator. More precisely, we treat the case where A is a small perturbation of a selfadjoint operator, under certain spectral assumptions. We suppose $A = A_0 + A_1$ where A_1 is a relatively compact perturbation of an elliptic selfadjoint operator A_0 . We first obtain spectral inequalities of the following type. Denoting by Π_α the projector on the spectral subspaces of A associated to eigenvalues with real part less than α , we have, for some $\theta \geq 1/2$

$$\|\Pi_\alpha w\|_H \leq C e^{D\alpha^\theta} \|B^* \Pi_\alpha w\|_Y, \quad w \in H. \quad (2.2)$$

Here, $B^* \in \mathcal{L}(H; Y)$ denotes a bounded observation operator and the state space H and the observation space Y are Hilbert spaces. Typically, $B^* = \mathbb{1}_\omega$ is a distributed observation. This spectral inequality yields the cost of the measurement of some finite sums of root-vectors of A through the partial observation B^* , in terms of the largest eigenvalue of A in the considered spectral subspace. The difficulty here is not in the elliptic estimates since Carleman inequalities remains unchanged under the addition of lower order terms, but in the spectral theory of the non-selfadjoint operator A . This motivates the exposition of the spectral theory of such operators in Section 2.2, following [Agr94].

Inequalities of the type of (2.2) were first established in [LR95] for the Laplace operator under a relatively different form. In fact, the inequality proved in [LR95] reads

$$\|\Pi_\alpha w_+\|_H^2 + \|\Pi_\alpha w_-\|_H^2 \leq C e^{D\sqrt{\alpha}} \left\| \varphi B^* \left(e^{t\sqrt{A}} \Pi_\alpha w_+ + e^{-t\sqrt{A}} \Pi_\alpha w_- \right) \right\|_{L^2(0,T;Y)}^2, \quad w_+, w_- \in H, \quad (2.3)$$

where $\varphi(t)$ is a smooth cut-off function. Here, in the non-selfadjoint case, we prove a spectral inequality of the form

$$\|\Pi_\alpha w\|_H \leq C e^{D\alpha^\theta} \left\| \varphi B^* \left(e^{t\sqrt{A}} \Pi_\alpha + e^{-t\sqrt{A}} \Pi_\alpha \right) w \right\|_{L^2(0,T;Y)}, \quad w \in H. \quad (2.4)$$

We also prove that such an inequality is sufficient to deduce controllability results (in the case $\theta < 1$). Spectral inequality of the form (2.2) first appeared in [LZ98] and [JL99] for the Laplace operator with $\theta = 1/2$. Comments can be made about the two different forms of spectral inequalities, (2.2) on the one hand, and (2.3), (2.4) on the other hand, that involves an integration with respect to an additional variable. Both types can be proved with interpolation inequalities (like (2.12) or (2.14) below), themselves following from local Carleman inequalities. The interpolation inequality (2.12) used to prove (2.3) exhibits a spacially distributed observation, whereas the interpolation inequality (2.14), used to prove (2.2) is characterized by a boundary observation at time $t = 0$. This latter form is more convenient to use for control results (see Section 2.6). Yet, for systems, the derivation of such an interpolation inequality with boundary observation at time $t = 0$ is open (see Section 2.5).

In Section 2.4, we deduce from the spectral inequality (2.4) the construction of a control function for the parabolic problem (2.1). Following [LR95] and an idea that goes back to the work of D.L. Russell [Rus73], the spectral inequality yields the controllability of the parabolic system on the related finite dimensional spectral subspace $\Pi_\alpha H$ with a control cost of the form $Ce^{C\alpha^\theta}$. In the case $\theta < 1$, we can then construct a control to the full parabolic equation (2.1). We improve the method of [LR95] from a spectral point of view. The proof of the controllability in [LR95] relies on the Hilbert basis property of the eigenfunctions of the Laplace operator. Here we only use some resolvent estimate away from the spectrum. No (Hilbert or Riesz) basis property is required in the construction.

The main results of this article can be summarized as follows

- Starting from an interpolation inequality of the Lebeau-Robbiano type (2.12) (resp. (2.14)), the spectral inequality (2.4) (resp. (2.2)) holds (see Theorem 2.16, resp. 2.17).
- The spectral inequality (2.4) (resp. (2.2)) implies that the control cost needed to drive any initial datum to $(I - \Pi_\alpha)H$ is bounded by $Ce^{C\alpha^\theta}$ (see Theorem 2.27, resp. Proposition 2.36).
- In the case $\theta < 1$, the non-selfadjoint parabolic system (2.1) is null-controllable in any positive time (see Theorem 2.30).

The question of the optimality of the power θ in these spectral inequalities remains open. For an elliptic operator A , in the results we obtain, the power θ increases linearly with the space dimension n : $\theta \approx \max\{1/2; n/2 - cst\}$. In the selfadjoint case however, the spectral inequalities (2.2) and (2.4) always hold with $\theta = 1/2$, and the controllability result always follows. The power $1/2$ is known to be optimal in this case (see [JL99] or [LL09]). Moreover, thanks to global parabolic inequalities, the controllability result of Theorem 2.30 is in general known to be true, independently on θ (see [FI96]). We are thus led to consider that the spectral inequalities should be true with $\theta = 1/2$: the power θ we obtain does not seem to be natural but only technical.

Since $\theta \approx \max\{1/2; n/2 - cst\}$, our controllability results, obtained for $\theta < 1$, are limited to small dimensions n . This problem arises in all the applications we give. In fact, in each of them, the power θ is the limiting point of the theory. The origin of the dimension-depending term $n/2 - cst$ in θ cannot be found in the elliptic estimates or in the control theory described above, but only in the resolvent estimates we use (see Section 2.2). If one wants to improve our results, one has to improve the resolvent estimates of [Agr94] (maybe taking into account that A is a differential operator). On the contrary, if one wants to prove the optimality of the power θ , one needs to produce lower bounds for the resolvent of A . In any case, it does not seem to be an easy task at all.

Remark 2.1. Note that we can replace A by $A + \lambda$ in (2.1) without changing the controllability properties of the parabolic problem. More precisely, suppose that the problem

$$\begin{cases} \partial_t v + (A + \lambda)v = Bf \\ v|_{t=0} = u_0 \end{cases}$$

is null-controllable in time $T > 0$ by a control function f . Then, the control function $g = e^{\lambda t} f$ drives the solution of Problem (2.1) to zero in time T and has the same regularity as f . Hence, in the sequel, we shall consider that the operator A is sufficiently positive without any loss of generality.

Remark 2.2. In the sequel, C will denote a generic constant, whose value may change from line to line.

2.1.2 Some applications

We give several applications of such a spectral approach in Sections 2.5, 2.6 and 2.7.

This work has first been motivated by the problem of Section 2.5, i.e. the null-controllability in

any time $T > 0$ of parabolic systems of the type

$$\begin{cases} \partial_t u_1 + P_1 u_1 + a u_1 + b u_2 = 0 & \text{in } (0, T) \times \Omega, \\ \partial_t u_2 + P_2 u_2 + c u_1 + d u_2 = \mathbb{1}_\omega g & \text{in } (0, T) \times \Omega, \\ u_1|_{t=0} = u_1^0, u_2|_{t=0} = u_2^0 & \text{in } \Omega, \\ u_1 = u_2 = 0 & \text{on } (0, T) \times \partial\Omega, \end{cases} \quad (2.5)$$

where $P_i = -\operatorname{div}(c_i \nabla \cdot)$, $i = 1, 2$, are selfadjoint elliptic operators, ω is a non-empty subset of the bounded open set $\Omega \subset \mathbb{R}^n$, and a, b, c, d are bounded functions of $x \in \Omega$ and the coupling factor b does not vanish in an open subset $\mathcal{O} \subset \Omega$. Such parabolic systems have already been investigated. The first result was stated in [dT00] in the context of insensitizing control (thus, one of the equations is backward in time). In this work, a positive answer to the null-controllability problem (2.5) is given in the case $a = c = d = 0$, $b = \mathbb{1}_\mathcal{O}$ and $\mathcal{O} \cap \omega \neq \emptyset$. The control problem (2.5) was then solved in [AKBD06] and [GBPG06] in the case $\mathcal{O} \cap \omega \neq \emptyset$. In all these references, the authors used global parabolic Carleman estimates to obtain an observability estimate. They can thus treat time-dependant coefficients and semilinear reaction-diffusion problems. To the author's knowledge, the null-controllability in the case $\mathcal{O} \cap \omega = \emptyset$ remains an open problem. A recent step in this direction has been achieved in [KdT10], proving approximate controllability by a spectral method in the case $a = c = d = 0$, $b = \mathbb{1}_\mathcal{O}$ without any condition on $\mathcal{O} \cap \omega$.

The field of coupled systems of d parabolic equations, $d \geq 2$, has also been investigated in [AKBDG07] where the authors prove a Kalman-type rank condition in the case where the coefficients are constant and in [GBdT10] where the authors prove the controllability of a cascade system with nonvanishing variable coupling coefficients by one control force.

Here, we obtain a spectral inequality of the type (2.4) with $\theta = \max\{1/2; n/2 - 1\}$ for the operator

$$A = \begin{pmatrix} P_1 + a & b \\ c & P_2 + d \end{pmatrix}$$

with the measurement on only one component. As opposed to the results of [AKBD06] and [GBPG06], we can provide an estimation on the control cost of low modes for system (2.5). The null-controllability of (2.5) follows from the method described above in the case $n \leq 3$ (corresponding to $\theta < 1$ in the spectral inequality).

In Section 2.6, we address the fractional power controllability problem

$$\begin{cases} \partial_t u + A^\nu u = Bg \\ u|_{t=0} = u_0 \in H, \end{cases}$$

that has been solved in the selfadjoint case in [MZ06] and [Mil06b]. We prove the null-controllability in any time $T > 0$ when $\nu > \theta$. The case $\nu \leq \theta$ is open. In particular when $\nu = 1$, it allows us to give an estimation on the control cost of low modes for the following heat equation with a transport term

$$\begin{cases} \partial_t u - \Delta u + b \cdot \nabla u + c u = \mathbb{1}_\omega g & \text{in } (0, T) \times \Omega, \\ u|_{t=0} = u_0 & \text{in } \Omega, \\ u = 0 & \text{on } (0, T) \times \partial\Omega. \end{cases} \quad (2.6)$$

In the case $n \leq 2$ (corresponding to $\theta < 1$ in the spectral inequality), this estimate is sufficient to recover the null-controllability of (2.6).

In Section 2.7, we are not concerned with controllability issues, but with the measurement of the $(n-1)$ -dimensional Hausdorff measure of the level sets of sums of root functions of $A = -\Delta + b \cdot \nabla + c$ on the n -dimensional compact manifold Ω . Yet, the technique and the estimates used here are the same as in the other sections. We obtain the following estimate, for sums of root functions associated with eigenvalues of real part lower than α , i.e., $\varphi \in \Pi_\alpha L^2(\Omega)$, we have

$$\mathcal{H}_{n-1}(\{\varphi = K\}) \leq C_1 \alpha^\theta + C_2, \quad \theta = \max\left\{\frac{1}{2}; \frac{n-1}{2}\right\}.$$

This type of inequality has already been proved in the selfadjoint case for the Laplace operator. In [DF88] and [DF90], H. Donnelly and C. Fefferman proved, for φ an eigenfunction associated with the eigenvalue α , the estimate $\mathcal{H}_{n-1}(\{\varphi = K\}) \leq C\alpha^{1/2}$. This was generalized to sums of eigenfunctions associated with eigenvalues lower than α in [JL99]. We generalize this last result for operators that are lower order perturbations of the Laplace operator. Here, however, θ is in general strictly greater than $1/2$.

2.2 Spectral theory of perturbed selfadjoint operators

To prepare the following sections, we shall first recall a theorem about the spectral theory of some operators close to being selfadjoint. This result can be presented with numerous variations and refinements. This subject has been a well-developed research field since the 60's. The first step of the theory is the Keldysh theorem on the completeness of the root vectors of a weakly perturbed compact selfadjoint operator (see [GK69] for more precisions). The main result here, Theorem 2.7, was first proved by A.S. Markus and by D.S. Katsnel'son [Kat67]. A simplified proof was given later by A.S. Markus and V.I. Matstaev with Matsaev's method of "artificial lacuna". This proof is presented in the book [Mar88, Chapter 1] by A.S. Markus in the more general case of weak perturbations of certain normal operators. For later use in the following sections, we sharpen some of the results as given by M.S. Agranovich [Agr94], following the steps of his proof.

Let H be a separable Hilbert space, $(\cdot, \cdot)_H$ be the scalar product on H and $\|\cdot\|_H$ be the associated norm. The set of bounded linear operators on H is denoted by $\mathcal{L}(H)$ and is equipped with the subordinated norm $\|\cdot\|_{\mathcal{L}(H)}$. As usual, for a given operator A on H , we denote by $\mathcal{D}(A)$ its domain, by $\rho(A)$ its resolvent set, i.e., the subset of \mathbb{C} where the resolvent $R_A(z) = (z - A)^{-1}$ is defined and bounded, and by $\text{Sp}(A) = \mathbb{C} \setminus \rho(A)$ its spectrum.

Proposition 2.3. *Let $A = A_0 + A_1$ be an operator on H . Assume that*

- (a) $\text{Re}(Au, u)_H \geq 0$ for all $u \in \mathcal{D}(A)$,
- (b) $A_0 : \mathcal{D}(A_0) \subset H \rightarrow H$ is selfadjoint, positive, with a dense domain and compact resolvent,
- (c) $A_1 : \mathcal{D}(A_1) \subset H \rightarrow H$ is q -subordinate to A_0 , i.e., there exist $k_0 > 0$ and $q \in [0, 1)$ such that for every $u \in \mathcal{D}(A_0^{1/2})$, $|(A_1 u, u)_H| \leq \frac{k_0}{2} \|A_0^{1/2} u\|_H^{2q} \|u\|_H^{2-2q}$.

We then have,

- (i) $\mathcal{D}(A) = \mathcal{D}(A_0) \subset \mathcal{D}(A_1) \subset H$ and A has a dense domain and a compact resolvent,
- (ii) $\text{Sp}(A) \subset O_{k_0}^q = \{z \in \mathbb{C}, \text{Re}(z) \geq 0, |\text{Im}(z)| < k_0 |z|^q\}$
- (iii) $\|R_A(z)\|_{\mathcal{L}(H)} \leq \frac{2}{d(z, \text{Sp}(A_0))} \leq \frac{2}{d(z, \mathbb{R}_+)} \text{ for } z \in \mathbb{C} \setminus O_{2k_0}^q$, where $d(z, S)$ denotes the euclidian distance from z to the subset S of \mathbb{C} .

Remark 2.4. Note that the subordination assumption (b) can be found under the different forms :

- $\mathcal{D}(A_0^q) \subset \mathcal{D}(A_1)$, and $\|A_1 u\|_H \leq C \|A_0^q u\|_H$ for $u \in \mathcal{D}(A_0^q)$ in [Agr76];
- $\mathcal{D}(A_0) \subset \mathcal{D}(A_1)$, and $\|A_1 u\|_H \leq C \|A_0 u\|_H^q \|u\|_H^{1-q}$ for $u \in \mathcal{D}(A_0)$ in [Mar88, Chapter 1];
- $\|A_1 A_0^{-q}\|_{\mathcal{L}(H)} = C < +\infty$ in [Dzh94].

Replacing assumption (b) by one of these assertions does not change the conclusions of Proposition 2.3 and Theorem 2.7.

Remark 2.5. Point (i) implies that $\text{Sp}(A)$ contains only isolated eigenvalues, with finite multiplicity and without any accumulation point. Furthermore, for every $\lambda \in \text{Sp}(A)$, the sequence of iterated null-spaces $N_k = N((A - \lambda)^k)$ is stationary.

For what follows, we shall need the spectrum of A to be located in a "parabolic neighborhood" of the real positive axis. We note that there exist $\lambda_0 > 0$, $K_0 > 0$ such that

$$\text{Sp}(A + \lambda_0) \subset O_{k_0}^q + \lambda_0 \subset O_{2k_0}^q + \lambda_0 \subset \mathcal{P}_{K_0}^q = \{z \in \mathbb{C}, \text{Re}(z) \geq 0, |\text{Im}(z)| < K_0 \text{Re}(z)^q\}, \quad (2.7)$$

see Fig. 2.1. We now fix λ_0 and K_0 satisfying this assumption. Referring to Remark 2.1, we shall work with the operator $A + \lambda_0$, yet writing A for simplicity.

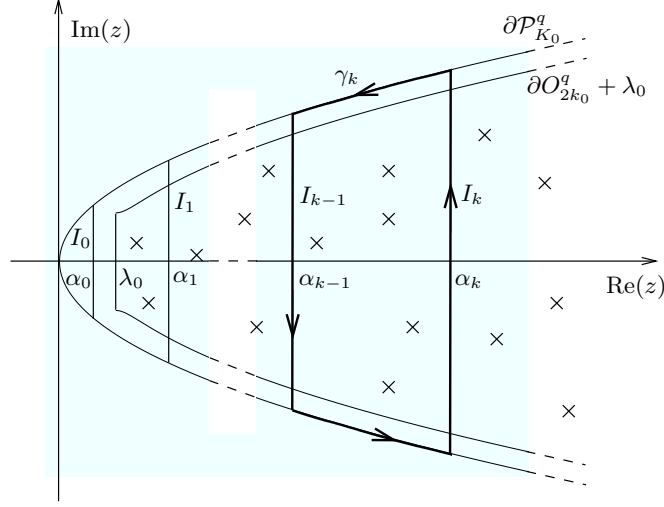
FIGURE 2.1 – Complex contours around the spectrum of A

Definition 2.6. Let $(\alpha_k)_{k \in \mathbb{N}} \subset \mathbb{R}_+$ be an increasing sequence, $0 < \alpha_0 < \alpha_1 < \dots < \alpha_k < \dots$ tending to $+\infty$, and such that $\alpha_k \notin \text{Re}(\text{Sp}(A))$, for every $k \in \mathbb{N}$. Then, we set $I_k = \{z \in \mathbb{C}, \text{Re}(z) = \alpha_k, |\text{Im}(z)| \leq K_0 \alpha_k^q\}$ and by γ_k , we denote the positively oriented contour delimited by the vertical line segments I_k on the right and I_{k-1} on the left and by the parabola $\partial \mathcal{P}_{K_0}^q$ on the upper and the lower side (see Fig. 2.1). We also define the associated spectral projectors

$$P_k = \frac{1}{2i\pi} \int_{\gamma_k} R_A(z) dz.$$

Note that the spectral projector P_k is a projector on the characteristic subspaces of A associated with the eigenvalues that are inside γ_k . The projectors satisfy the identity $P_k P_j = \delta_{jk} P_k$. Moreover, thanks to Remark 2.5, the projectors P_k , $k \in \mathbb{N}$, have finite rank.

We can now state the main spectral result, that can (at least partially) be found under different forms in [Agr76], [Mar88, Chapter 1], [Agr94], [Dzh94].

Theorem 2.7. Let $0 < \lambda_1 \leq \lambda_2 \leq \dots \leq \lambda_k \leq \dots$ be the spectrum of the selfadjoint operator A_0 . We assume the additional condition that there exists $p > 0$ such that $\limsup_{j \rightarrow \infty} \lambda_j j^{-p} > 0$. Then, setting $\beta = \max\{0, p^{-1} - (1 - q)\}$, there exists a sequence $(\alpha_k)_{k \in \mathbb{N}} \subset \mathbb{R}_+$ as in Definition 2.6 such that for some $C > 0$

$$\|R_A(z)\|_{\mathcal{L}(H)} \leq e^{C\alpha_k^\beta}, \quad k \in \mathbb{N}, z \in I_k. \quad (2.8)$$

Remark 2.8. Note that Proposition 2.3 point (iii) implies that $\|R_A(z)\|_{\mathcal{L}(H)} \leq \frac{2}{K_0 \alpha_k^q} \leq \frac{2}{K_0 \alpha_0^q}$ for $z \in \gamma_k \cap \partial \mathcal{P}_{K_0}^q$. Thus the resolvent estimate (2.8), $\|R_A(z)\|_{\mathcal{L}(H)} \leq e^{C\alpha_k^\beta}$ holds for all $z \in \gamma_k$.

Remark 2.9. Comments can be made about this theorem and its proof :

- The idea of the proof of Theorem 2.7 is to find uniform gaps around vertical lines $\text{Re}(z) = \alpha_k$ in the spectrum of A , to be sure that the resolvent R_A is well-defined in these regions. To find such gaps, one proves the existence of sufficiently large gaps in the spectrum of A_0 and places α_k in these zones. The results presented in [Agr76], [Mar88, Chapter 1], [Agr94], [Dzh94] are in fact a bit stronger than Theorem 2.7 since they contain not only the resolvent estimate (2.8) but also some basis properties.
- In the case $p(1 - q) \geq 1$ one can prove a Riesz basis property for the subspaces $P_k H$, i.e. one can write $H = \bigoplus_{k \in \mathbb{N}} P_k H$ and there exists $c > 0$ such that for all $u \in H$, $c^{-1} \|u\|_H^2 \leq \sum_{k \in \mathbb{N}} \|P_k u\|_H^2 \leq c \|u\|_H^2$.

- In the case $p(1 - q) < 1$ one can prove a weaker basis property (so-called Abel basis) for the subspaces $P_k H$.

For $\alpha \in \mathbb{R}_+$ we define the spectral projector on the characteristic subspace of H associated with the eigenvalues of real part less than $\max\{\alpha_k; \alpha_k \leq \alpha\}$:

$$\Pi_\alpha = \sum_{\alpha_k \leq \alpha} P_k = \frac{1}{2i\pi} \int_{\Gamma_\alpha} R_A(z) dz = \frac{1}{2i\pi} \int_{\bigcup_{\alpha_k \leq \alpha} \gamma_k} R_A(z) dz,$$

where Γ_α is the positively oriented contour delimited by the vertical line segments $\text{Re}(z) = \max\{\alpha_k; \alpha_k \leq \alpha\}$ on the right and $\text{Re}(z) = \alpha_0 > 0$ on the left and by the parabola $\mathcal{P}_{K_0}^q$ on the upper and the lower side.

On each finite dimensional subspace $P_k H$ (or equivalently $\Pi_\alpha H$) we have a holomorphic calculus for A (e.g. see [Kat80]); given a holomorphic function f , we have

$$f(A)P_k = f(AP_k) = \frac{1}{2i\pi} \int_{\gamma_k} f(z)R_A(z) dz \in \mathcal{L}(P_k H).$$

In the subsequent sections, we shall consider the adjoint problem of the abstract parabolic system (2.1), involving $A^* = A_0 + A_1^*$. The spectral theory of A and A^* and their respective functional calculus are connected by the following proposition (see [Kat80]).

Proposition 2.10. *Let f be a holomorphic function, γ a positively oriented contour in $\mathbb{C} \setminus \text{Sp}(A)$. We denote $\check{f} : z \mapsto \overline{f(\bar{z})}$, $f^\gamma(A) = \frac{1}{2i\pi} \int_\gamma f(z)R_A(z) dz$ and $\bar{\gamma}$ the positively oriented complex conjugate contour of γ . Then, $\bar{\gamma}$ is a contour in $\mathbb{C} \setminus \text{Sp}(A^*)$ and $(f^\gamma(A))^* = \check{f}^{\bar{\gamma}}(A^*)$.*

With this new notation, $f^{\gamma_k}(A) = f(A)P_k = f(AP_k)$. Noting that with the choices made above, $\overline{\gamma_k} = \gamma_k$, $\bar{\Gamma}_\alpha = \Gamma_\alpha$, we obtain

$$P_k(A^*) = 1^{\gamma_k}(A^*) = (1^{\gamma_k}(A))^* = P_k(A)^* = P_k^*$$

and $\Pi_\alpha(A^*) = (\Pi_\alpha(A))^* = \Pi_\alpha^*$. More generally, if $\check{f} = f$, we have $f^{\gamma_k}(A^*) = (f^{\gamma_k}(A))^*$ and $f^{\Gamma_\alpha}(A^*) = (f^{\Gamma_\alpha}(A))^*$.

Example 2.11. For $t \in \mathbb{R}$, the functions $f(z) = e^{tz}$ or $f(z) = e^{t\sqrt{z}}$ (taking for \sqrt{z} the principal value of the square root of $z \in \mathbb{C}$) or $f(z) = \int_{\mathbb{R}} \psi(t)e^{-itz} dt$ (ψ being a real function) fulfill the property $\check{f} = f$. For all these functions, we have $f^{\gamma_k}(A^*) = (f^{\gamma_k}(A))^*$, $f^{\Gamma_\alpha}(A^*) = (f^{\Gamma_\alpha}(A))^*$. This will be used in the following sections.

Remark 2.12. Note that $\|R_{A^*}(z)\|_{\mathcal{L}(H)} = \|R_A(\bar{z})\|_{\mathcal{L}(H)}$. As a consequence, any sequence satisfying (2.8) for A also satisfies (2.8) for A^* .

In the course of the construction of a control function that we present below, we shall need a precise asymptotics of the increasing sequence $(\alpha_k)_{k \in \mathbb{N}}$, that is not given in [Agr94]. We first remark that if $(\alpha_k)_{k \in \mathbb{N}}$ is a sequence satisfying properties (i) – (iii) of Theorem 2.7, then every subsequence of $(\alpha_k)_{k \in \mathbb{N}}$ also satisfies these properties. We shall thus seek a minimal growth for the asymptotics of $(\alpha_k)_{k \in \mathbb{N}}$.

For $\mu \in \mathbb{R}$, we set $\mathcal{N}(\mu) = \#\{k \in \mathbb{N}, \lambda_k \in \text{Sp}(A_0), \lambda_k \leq \mu\}$. Here, we prove the following proposition.

Proposition 2.13. *If the eigenvalues of A_0 satisfy the following asymptotics : $\mathcal{N}(\mu) = m_0 \mu^{\frac{1}{p}} + o(\mu^{\frac{1}{p}})$, as $\mu \rightarrow +\infty$, then, for all $\delta > 1$ we can choose the sequence $(\alpha_n)_{n \in \mathbb{N}}$ such that there exists $N \in \mathbb{N}$ and for every $n \geq N$, we have $\delta^{n-1} \leq \alpha_n \leq \delta^n$.*

First note that the assumption we make here for the asymptotics of the eigenvalues is stronger than that made in Theorem 2.7 for it implies $\lambda_k \sim_{k \rightarrow \infty} Ck^p$.

To prove Proposition 2.13, we briefly recall how the sequence $(\alpha_k)_{k \in \mathbb{N}}$ is built in [Agr94]. Every α_n is in the interval $[\mu_n - h\mu_n^q, \mu_n + h\mu_n^q]$, where $(\mu_n)_{n \in \mathbb{N}}$ is a sequence increasing to infinity such that $\#\{k \in \mathbb{N}, \lambda_k \in \text{Sp}(A_0), \lambda_k \in [\mu_n - h\mu_n^q, \mu_n + h\mu_n^q]\} \leq C\mu_n^\beta$. We thus need to show the existence of such a sequence $(\mu_n)_{n \in \mathbb{N}}$, having a precise asymptotics as n goes to infinity. This is the aim of Lemma 2.14 below, replacing [Agr94, Lemma 7]. With such a result, for all fixed $\delta > 1$ we can build $(\alpha_n)_{n \in \mathbb{N}}$ such that there exists $N \in \mathbb{N}$ and for every $n \geq N$, α_n satisfies $\delta^{n-1} \leq \alpha_n \leq \delta^n$. We can then follow the proof of [Agr94] to finish that of Proposition 2.13, estimating the resolvent on vertical lines $\text{Re}(z) = C \in [\mu_n - h\mu_n^q, \mu_n + h\mu_n^q]$.

Lemma 2.14. *We set $r = p^{-1}$ and recall that $\beta = \max\{0, r - 1 + q\}$. Assume that*

$$\mathcal{N}(\mu) = m_0\mu^r + o(\mu^r) \text{ as } \mu \rightarrow +\infty. \quad (2.9)$$

Then, for every $h > 0$, $\delta > 1$, there exist $C > 0$ and $N \in \mathbb{N}$ such that for every $n \geq N$, there exists μ_n such that $[\mu_n - h\mu_n^q, \mu_n + h\mu_n^q] \subset [\delta^{n-1}, \delta^n]$ and $\mathcal{N}(\mu_n + h\mu_n^q) - \mathcal{N}(\mu_n - h\mu_n^q) \leq C\mu_n^\beta$.

Proof. We proceed by contradiction. Let $h > 0$, $\delta > 0$, and suppose that

$$\forall C > 0, \forall N \in \mathbb{N}, \exists n_0 \geq N + 1, \forall \mu \text{ satisfying } [\mu - h\mu^q, \mu + h\mu^q] \subset [\delta^{n_0-1}, \delta^{n_0}], \quad (2.10)$$

we have $\mathcal{N}(\mu + h\mu^q) - \mathcal{N}(\mu - h\mu^q) > C\mu^\beta$.

We choose $0 < \varepsilon < m_0$. From the asymptotics (2.9) of \mathcal{N} , there exists $N_0 \in \mathbb{N}$ such that for every $n \geq N_0$,

$$(m_0 - \varepsilon)\delta^{nr} \leq \mathcal{N}(\delta^n) \leq (m_0 + \varepsilon)\delta^{nr}. \quad (2.11)$$

Let us fix $C \geq \frac{2h\delta^{\beta+1}}{\delta-1}(m_0 + \varepsilon + 1)$ and $N \in \mathbb{N}$ such that $N \geq N_0$, and for all $n \geq N + 1$, $(m_0 - \varepsilon)\delta^{nr} - \frac{2h\delta^{\beta+1}}{\delta-1}(m_0 + \varepsilon + 1)\delta^{n\beta} \geq 0$. Such a N exists since $\beta \leq r + q - 1 < r$. Then for these C and N , assumption (2.10) gives the existence of $n_0 \geq N + 1 \geq N_0 + 1$ such that for every μ satisfying $[\mu - h\mu^q, \mu + h\mu^q] \subset [\delta^{n_0-1}, \delta^{n_0}]$, we have $\mathcal{N}(\mu + h\mu^q) - \mathcal{N}(\mu - h\mu^q) > C\mu^\beta$.

We denote by $[x]$ the floor function. In the interval $[\delta^{n_0-1}, \delta^{n_0}]$, there are at least $\left\lfloor \frac{\delta^{n_0} - \delta^{n_0-1}}{2h\delta^{n_0q}} \right\rfloor$ disjoint intervals of the type $[\mu - h\mu^q, \mu + h\mu^q]$, each containing more than $C\delta^{(n_0-1)\beta}$ eigenvalues of A_0 . Hence,

$$\mathcal{N}(\delta^{n_0}) - \mathcal{N}(\delta^{n_0-1}) \geq C\delta^{(n_0-1)\beta} \left\lfloor \frac{\delta^{n_0} - \delta^{n_0-1}}{2h\delta^{n_0q}} \right\rfloor \geq C\delta^{(n_0-1)\beta} \left(\frac{\delta-1}{2h\delta} \delta^{n_0(1-q)} - 1 \right).$$

Then, taking into account the lower bound on C and the asymptotics (2.11) for $n = n_0 - 1 \geq N \geq N_0$, we obtain

$$\begin{aligned} \mathcal{N}(\delta^{n_0}) &\geq (m_0 + \varepsilon + 1)\delta^{n_0\beta+n_0(1-q)} - \frac{2h\delta^{\beta+1}}{\delta-1}(m_0 + \varepsilon + 1)\delta^{(n_0-1)\beta} + (m_0 - \varepsilon)\delta^{r(n_0-1)} \\ &\geq (m_0 + \varepsilon + 1)\delta^{n_0(\beta+1-q)}, \end{aligned}$$

since $n_0 \geq N + 1$. The asymptotics (2.11) for n_0 gives $\mathcal{N}(\delta^{n_0}) \leq (m_0 + \varepsilon)\delta^{n_0r} \leq (m_0 + \varepsilon)\delta^{n_0(\beta+1-q)}$ since $\beta \geq r - 1 + q$. This yields a contradiction and concludes the proof of the lemma. \square

2.3 Spectral inequality for perturbed selfadjoint elliptic operators

In this section, we prove in an abstract setting some spectral inequalities where the norm of a finite sum of root vectors of A is bounded by a partial measurement of these root vectors. For the proof, we assume that some interpolation inequality holds. This inequality will be proved in the case of different elliptic operators in Section 2.5.

Such interpolation inequalities were used in [LR95] and [LZ98] to achieve a spectral inequality of the type we prove here. Note that this type of spectral inequality can however be obtained by other means (e.g. doubling properties [Phu07a, AE08], or directly from global Carleman estimates [Le 07b, BHLR10]).

Here, we suppose that $A = A_0 + A_1 : \mathcal{D}(A) \subset H \longrightarrow H$ satisfies some of the spectral properties of Section 2.2, i.e. (a) – (c) of Proposition 2.3 and the resolvent estimate (2.8) of Theorem 2.7. We define the following Sobolev spaces based on the selfadjoint operator A_0 .

Definition 2.15. For $s \in \mathbb{N}$ and $\tau_1 < \tau_2$, we set

$$\mathcal{H}^s(\tau_1, \tau_2) = \bigcap_{n=0}^s H^{s-n}(\tau_1, \tau_2; \mathcal{D}(A_0^{n/2})),$$

which is a Hilbert space with the natural norm

$$\|v\|_{\mathcal{H}^s(\tau_1, \tau_2)} = \left(\sum_{n+m \leq s} \|\partial_t^m A_0^{n/2} v\|_{L^2(\tau_1, \tau_2; H)}^2 \right)^{1/2} \approx \left(\sum_{n=0}^s \|v\|_{H^{s-n}(\tau_1, \tau_2; \mathcal{D}(A_0^{n/2}))}^2 \right)^{1/2}.$$

Note that $\mathcal{H}^0(\tau_1, \tau_2) = L^2(\tau_1, \tau_2; H)$.

Let Y be another Hilbert space, $B^* \in \mathcal{L}(H, Y)$ be a bounded operator. Let T_0 be a positive number, $\varphi \in \mathcal{C}_c^\infty(0, T_0; \mathbb{C})$, $\varphi \neq 0$ and $\theta = \max\{1/2, p^{-1} - (1 - q)\} = \max\{1/2, \beta\}$.

Theorem 2.16. *Suppose that there exist $C' > 0$, $\zeta \in (0, T_0/2)$ and $\nu \in (0, 1]$ such that for every $v \in \mathcal{H}^2(0, T_0)$*

$$\|v\|_{\mathcal{H}^1(\zeta, T_0 - \zeta)} \leq C' \|v\|_{\mathcal{H}^1(0, T_0)}^{1-\nu} \left(\|\varphi B^* v\|_{L^2(0, T_0; Y)} + \|(-\partial_t^2 + A^*)v\|_{\mathcal{H}^0(0, T_0)} \right)^\nu. \quad (2.12)$$

Then, there exist positive constants C, D such that for every positive α , for all $w \in \Pi_\alpha^ H$,*

$$\|w\|_H \leq C e^{D\alpha^\theta} \left\| \varphi B^* \left(e^{t\sqrt{A^*}} + e^{-t\sqrt{A^*}} \right) w \right\|_{L^2(0, T_0; Y)}. \quad (2.13)$$

In other situations, we can prove another interpolation inequality with an observation at the boundary $t = 0$. In this case, we obtain a simpler spectral inequality, involving no time integration in the observation term.

Theorem 2.17. *Suppose that there exist $C' > 0$, $\zeta \in (0, T_0/2)$ and $\nu \in (0, 1]$ such that for every $v \in \mathcal{H}^2(0, T_0)$ satisfying $v(0) = 0$, we have*

$$\|v\|_{\mathcal{H}^1(\zeta, T_0 - \zeta)} \leq C' \|v\|_{\mathcal{H}^1(0, T_0)}^{1-\nu} \left(\|B^* \partial_t v(0)\|_Y + \|(-\partial_t^2 + A^*)v\|_{\mathcal{H}^0(0, T_0)} \right)^\nu. \quad (2.14)$$

Then, there exist positive constants C, D such that for every positive α , for all $w \in \Pi_\alpha^ H$,*

$$\|w\|_H \leq C e^{D\alpha^\theta} \|B^* w\|_Y. \quad (2.15)$$

The estimation of the constant in the inequality in terms of the maximal eigenvalue in the finite sum is the key point in the control applications below.

Proof of Theorem 2.16 For $w \in \Pi_\alpha^* H$, we set

$$v(t) = \left(e^{t\sqrt{A^*}} + e^{-t\sqrt{A^*}} \right) w = \frac{1}{2i\pi} \int_{\Gamma_\alpha} \left(e^{t\sqrt{z}} + e^{-t\sqrt{z}} \right) R_{A^*}(z) w dz.$$

We have $v \in H^2(0, T_0; H) \cap H^1(0, T_0; \mathcal{D}(A)) \subset \mathcal{H}^2(0, T_0)$ as $\mathcal{D}(A) = \mathcal{D}(A_0)$. We first notice that $(-\partial_t^2 + A^*)v = 0$. Second, we have to estimate every single term of

$$\|v\|_{\mathcal{H}^1(0, T_0)}^2 = \|v\|_{L^2(0, T_0; H)}^2 + \|\partial_t v\|_{L^2(0, T_0; H)}^2 + \|A_0^{1/2} v\|_{L^2(0, T_0; H)}^2 :$$

$$\begin{aligned}
\|v\|_H &\leq \left\| \left(e^{t\sqrt{A^*}} + e^{-t\sqrt{A^*}} \right) \Pi_\alpha^* \right\|_{\mathcal{L}(H)} \|w\|_H \\
&\leq \left\| \frac{1}{2i\pi} \int_{\Gamma_\alpha} \left(e^{t\sqrt{z}} + e^{-t\sqrt{z}} \right) R_{A^*}(z) dz \right\|_{\mathcal{L}(H)} \|w\|_H \\
&\leq C \operatorname{meas}(\Gamma_\alpha) \sup_{z \in \Gamma_\alpha} \|R_{A^*}(z)\|_{\mathcal{L}(H)} \sup_{z \in \Gamma_\alpha} \left| e^{t\sqrt{z}} + e^{-t\sqrt{z}} \right| \|w\|_H \\
&\leq C\alpha e^{C(\alpha^\beta + t\sqrt{\alpha})} \|w\|_H
\end{aligned}$$

since $\operatorname{meas}(\Gamma_\alpha) \leq C\alpha$, $\|R_{A^*}(z)\|_{\mathcal{L}(H)} \leq e^{C\alpha^\beta}$ from estimate (2.8) of Theorem 2.7, Remark 2.12 and,

$$\left| e^{t\sqrt{z}} + e^{-t\sqrt{z}} \right| \leq 2e^{t \operatorname{Re}(\sqrt{z})},$$

with $\operatorname{Re}(\sqrt{z}) \leq \sqrt{|z|} \leq C\sqrt{\alpha}$ for $z \in \Gamma_\alpha$.

Thus, for some $C > 0$, $\|v\|_{L^2(0, T_0; H)} \leq Ce^{C\alpha^\theta} \|w\|_H$. Concerning the second term in $\|v\|_{\mathcal{H}^1(0, T_0)}$, we have

$$\|\partial_t v\|_{L^2(0, T_0; H)} = \left\| \sqrt{A^*} \left(e^{t\sqrt{A^*}} - e^{-t\sqrt{A^*}} \right) w \right\|_{L^2(0, T_0; H)},$$

and similar computations show that $\|\partial_t v\|_{L^2(0, T_0; H)} \leq Ce^{C\alpha^\theta} \|w\|_H$. In order to estimate the third term in $\|v\|_{\mathcal{H}^1(0, T_0)}$, we use assumption (a) of Proposition 2.3, observing that for all $u \in H$,

$$\begin{aligned}
\|A_0^{1/2} u\|_H^2 &= (A_0 u, u)_H = (A^* u, u)_H - (A_1^* u, u)_H \\
&\leq (A^* u, u)_H + \frac{k_0}{2} \|A_0^{1/2} u\|_H^{2q} \|u\|_H^{2-2q} \\
&\leq (A^* u, u)_H + \frac{k_0}{2} \left(q\varepsilon^{\frac{1}{q}} \|A_0^{1/2} u\|_H^2 + (1-q)\varepsilon^{-\frac{1}{1-q}} \|u\|_H^2 \right)
\end{aligned}$$

for every positive ε and every $q \in (0, 1)$, thanks to Young's inequality. We then choose ε such that $\frac{7}{2} q\varepsilon^{\frac{1}{q}} \leq \frac{1}{2}$ and we obtain for every $u \in H$,

$$\|A_0^{1/2} u\|_H^2 \leq C \left((A^* u, u)_H + \|u\|_H^2 \right) \leq C \left(\|A^* u\|_H \|u\|_H + \|u\|_H^2 \right).$$

The same estimate is obvious in the case $q = 0$. Similar computations as those performed above yield $\|A_0^{1/2} v\|_{L^2(0, T_0; H)} \leq Ce^{C\alpha^\theta} \|w\|_H$, and we have finally

$$\|v\|_{\mathcal{H}^1(0, T_0)} \leq Ce^{C\alpha^\theta} \|w\|_H, \quad w \in \Pi_\alpha^* H.$$

We now produce a lower bound for the left-hand side of (2.12). We first notice that the operator $\left(e^{t\sqrt{A^*}} + e^{-t\sqrt{A^*}} \right) \Pi_\alpha^*$ is an isomorphism on $\Pi_\alpha^* H$ and we compute an upper bound for its inverse :

$$\begin{aligned}
\left\| \left[\left(e^{t\sqrt{A^*}} + e^{-t\sqrt{A^*}} \right) \Pi_\alpha^* \right]^{-1} \right\|_{\mathcal{L}(H)} &= \left\| \frac{1}{2i\pi} \int_{\Gamma_\alpha} \left(e^{t\sqrt{z}} + e^{-t\sqrt{z}} \right)^{-1} R_{A^*}(z) dz \right\|_{\mathcal{L}(H)} \\
&\leq C \operatorname{meas}(\Gamma_\alpha) e^{C\alpha^\beta} \sup_{z \in \Gamma_\alpha} \left| e^{t\sqrt{z}} + e^{-t\sqrt{z}} \right|^{-1} \\
&\leq C\alpha e^{C(\alpha^\beta + t\sqrt{\alpha})} \sup_{z \in \Gamma_\alpha} \frac{1}{|e^{2t\sqrt{z}} + 1|}.
\end{aligned}$$

Then, we have

$$|e^{2t\sqrt{z}} + 1| \geq e^{2t \operatorname{Re}(\sqrt{z})} - 1 \geq 2t \operatorname{Re}(\sqrt{z}) \geq 2t\sqrt{\alpha_0}, \quad (2.16)$$

since $\operatorname{Re}(\sqrt{z}) \geq \sqrt{\alpha_0} > 0$ on Γ_α . Hence, for some constant $C > 0$,

$$\left\| \left[\left(e^{t\sqrt{A^*}} + e^{-t\sqrt{A^*}} \right) \Pi_\alpha^* \right]^{-1} \right\|_{\mathcal{L}(H)} \leq \frac{C}{t} e^{C(\alpha^\beta + t\sqrt{\alpha})}.$$

Concerning the left-hand-side of (2.12), we thus have the following lower bound :

$$\begin{aligned}
\|v\|_{\mathcal{H}^1(\zeta, T_0-\zeta)}^2 &\geq \|v\|_{L^2(\zeta, T_0-\zeta; H)}^2 \geq \int_{\zeta}^{T_0-\zeta} \left\| \left[\left(e^{t\sqrt{A^*}} + e^{-t\sqrt{A^*}} \right) \Pi_{\alpha}^* \right]^{-1} \right\|_{\mathcal{L}(H)}^{-2} dt \|w\|_H^2 \\
&\geq C e^{-2C\alpha^\beta} \int_{\zeta}^{T_0-\zeta} t^2 e^{-2tC\sqrt{\alpha}} dt \|w\|_H^2 \\
&\geq C e^{-2C\alpha^\beta} \zeta^2 \int_{\zeta}^{T_0-\zeta} e^{-2tC\sqrt{\alpha}} dt \|w\|_H^2 \\
&\geq C e^{-2C\alpha^\beta} \zeta^2 \frac{e^{-T_0 C\sqrt{\alpha}}}{\sqrt{\alpha}} \sinh(C\sqrt{\alpha}(T_0 - 2\zeta)) \|w\|_H^2 \\
&\geq C \zeta^2 (T_0 - 2\zeta) e^{-C(\alpha^\beta + \sqrt{\alpha})} \|w\|_H^2 \geq C e^{-C\alpha^\theta} \|w\|_H^2.
\end{aligned}$$

The interpolation inequality (2.12) then gives

$$C e^{-C\alpha^\theta} \|w\|_H \leq \left(C e^{C\alpha^\theta} \|w\|_H \right)^{1-\nu} \left\| \varphi B^* \left(e^{t\sqrt{A^*}} + e^{-t\sqrt{A^*}} \right) w \right\|_{L^2(0, T_0; Y)}^\nu.$$

Dividing both side by $\|w\|_H^{1-\nu}$, we finally obtain the existence of positive constants C, D such that for every positive α , for all $w \in \Pi_{\alpha}^* H$,

$$\|w\|_H \leq C e^{D\alpha^\theta} \left\| \varphi B^* \left(e^{t\sqrt{A^*}} + e^{-t\sqrt{A^*}} \right) w \right\|_{L^2(0, T_0; Y)}.$$

□

Proof of Theorem 2.17 This proof follows the same; for $w \in \Pi_{\alpha}^* H$, we take

$$v(t) = (A^*)^{-1/2} \sinh(t\sqrt{A^*}) w = \frac{1}{2i\pi} \int_{\Gamma_{\alpha}} \frac{\sinh(t\sqrt{z})}{\sqrt{z}} R_{A^*}(z) w dz,$$

instead of $v(t) = \left(e^{t\sqrt{A^*}} + e^{-t\sqrt{A^*}} \right) w$, see [LZ98], [JL99]. It satisfies $(-\partial_t^2 + A^*)v = 0$, $v(0) = 0$ and $\partial_t v(0) = w$. We also have $v \in \mathcal{H}^2(0, T_0)$ and $\|v\|_{\mathcal{H}^1(0, T_0)} \leq C e^{C\alpha^\theta} \|w\|_H$ as above. Only the lower bound for $\|v\|_{\mathcal{H}^1(\zeta, T_0-\zeta)}$ has to be proved. To begin with, the operator $(A^*)^{-1/2} \sinh(t\sqrt{A^*}) \Pi_{\alpha}^*$ is an isomorphism on $\Pi_{\alpha}^* H$ and we compute an upper bound for its inverse :

$$\begin{aligned}
\left\| \left[(A^*)^{-1/2} \sinh(t\sqrt{A^*}) \Pi_{\alpha}^* \right]^{-1} \right\|_{\mathcal{L}(H)} &= \left\| \frac{1}{2i\pi} \int_{\Gamma_{\alpha}} \left(\frac{\sinh(t\sqrt{z})}{\sqrt{z}} \right)^{-1} R_{A^*}(z) dz \right\|_{\mathcal{L}(H)} \\
&\leq C \alpha e^{C\alpha^\beta} \sup_{z \in \Gamma_{\alpha}} \left| \frac{\sqrt{z}}{\sinh(t\sqrt{z})} \right| \\
&\leq C \alpha^{3/2} e^{C\alpha^\beta} \sup_{z \in \Gamma_{\alpha}} \frac{1}{|e^{t\sqrt{z}} - e^{-t\sqrt{z}}|} \\
&\leq C \alpha^{3/2} e^{C(\alpha^\beta + t\sqrt{\alpha})} \sup_{z \in \Gamma_{\alpha}} \frac{1}{|e^{2t\sqrt{z}} - 1|}.
\end{aligned}$$

Then, $|e^{2t\sqrt{z}} - 1| \geq e^{2t \operatorname{Re}(\sqrt{z})} - 1$, and (2.16) gives a lower bound for $\|v\|_{\mathcal{H}^1(\zeta, T_0-\zeta)} \geq \|v\|_{L^2(\zeta, T_0-\zeta; H)}$ as in the preceding proof. The conclusion follows as in the proof of Theorem 2.16. □

2.4 From the spectral inequality to a parabolic control

In this section we construct a control for the parabolic abstract problem (2.1). We follow the method introduced by G. Lebeau and L. Robbiano in [LR95]. The non-selfadjoint nature of the problem requires however modifications in their approach.

Let H and Y be two Hilbert spaces, H standing for the state space and Y the control space. We suppose that $B \in \mathcal{L}(Y, H)$ is a bounded control operator and A is an unbounded operator $A : \mathcal{D}(A) \subset H \rightarrow H$ that satisfies all the spectral properties of Section 2.2, i.e. (a) – (c) (and thus also (i) – (iii)) of Proposition 2.3, the resolvent estimate (2.8) of Theorem 2.7, and the asymptotics given by Proposition 2.13. In particular, the properties (a) – (c) of Proposition 2.3 imply that $-A$ generates a \mathcal{C}^0 -semigroup of contraction on H . If we take u_0 in H , problem (2.1) is then well-posed in H .

Let T_0 be a positive number, $\varphi \in \mathcal{C}_c^\infty(0, T_0; \mathbb{C})$, $\varphi \neq 0$, and $B^* \in \mathcal{L}(H, Y)$ the adjoint operator of B , i.e., such that $(By, h)_H = (B^*h, y)_Y$ for every $y \in Y$, $h \in H$. We assume that the result of Theorem 2.16, (i.e. the spectral inequality (2.13)) holds. An example will be given in Section 2.5. We shall first interpret this spectral inequality (2.13) of Theorem 2.16 as an observability estimate for an elliptic evolution problem.

Remark 2.18. Note that if we suppose the spectral inequality (2.15) of Theorem 2.17 instead of (2.13), the construction of the control function follows that of [Mil06b] or [LL09] and is much simpler. In fact, the spectral inequality (2.15) directly yields an observability inequality for the partial problem (2.27) and implies an analogous of Theorem 2.26. This proof can be found in Section 2.6, taking $\nu = 1$. Section 2.4.4 then ends the proof of the null-controllability. Note that in this case, there is no restriction on the subordination number q (in Proposition 2.22, we require $q < 3/4$) since there is no need of the regularisation with a Gevrey function.

2.4.1 Elliptic controllability on $\Pi_\alpha H$ with initial datum in $P_k H$

From the spectral inequality (2.13), we deduce a controllability result for a family of (finite dimensional) elliptic evolution problems. Let first \mathcal{G}_α be the following gramian operator

$$\mathcal{G}_\alpha = \int_0^{T_0} \left(e^{t\sqrt{A}} + e^{-t\sqrt{A}} \right) \Pi_\alpha B |\varphi(t)|^2 B^* \left(e^{t\sqrt{A^*}} + e^{-t\sqrt{A^*}} \right) \Pi_\alpha^* dt.$$

Lemma 2.19. *The operator \mathcal{G}_α is an isomorphism from $\Pi_\alpha^* H$ onto $\Pi_\alpha H$. We denote by \mathcal{G}_α^{-1} the inverse of \mathcal{G}_α on $\Pi_\alpha H$.*

Then, there exists $D_0 > 0$ and for every $s \in \mathbb{N}$ there exists C_s such that for every $T_0 > 0$, $\alpha > 0$, $k \in \mathbb{N}^$ satisfying $\alpha_k \leq \alpha$, for every $v_k \in P_k H$, the function*

$$h_k(t) = |\varphi(t)|^2 B^* \left(e^{t\sqrt{A^*}} + e^{-t\sqrt{A^*}} \right) \mathcal{G}_\alpha^{-1} v_k \quad (2.17)$$

satisfies

- (i) $h_k \in \mathcal{C}_c^\infty(0, T_0; Y)$;
- (ii) $\|\partial_t^s h_k\|_{L^\infty(0, T_0; Y)} \leq C_s \alpha^{\frac{s}{2}} e^{D_0 \alpha^0} \|v_k\|_H$;
- (iii) for all $w \in \Pi_\alpha^* H$, $(v_k, w)_H = \left(B h_k, \left(e^{t\sqrt{A^*}} + e^{-t\sqrt{A^*}} \right) w \right)_{L^2(0, T_0; H)}$.

Remark 2.20. Here, we could actually take the “initial datum” v in $\Pi_\alpha H$ and the result and its proof remain the same. We have chosen to take v in $P_k H$ since it is the precise result we use in Proposition 2.22, in particular to prove the estimate (iii) of Proposition 2.22, which in turn is a key point in the proof of Theorem 2.27 below.

Proof. We first observe that the spectral inequality (2.13) implies that \mathcal{G}_α is an isomorphism from $\Pi_\alpha^* H$ onto $\Pi_\alpha H$.

Then, we note that point (ii) implies (i), and is itself a direct consequence of expression (2.17) where B^* is bounded and $\|\mathcal{G}_\alpha^{-1}\|_{\mathcal{L}(H)} \leq C e^{D_0 \alpha^0}$ from the spectral inequality (2.13).

Finally, we check that (iii) holds. For $w \in \Pi_\alpha^* H$, we compute

$$\begin{aligned}
& \left(Bh_k, \left(e^{t\sqrt{A^*}} + e^{-t\sqrt{A^*}} \right) w \right)_{L^2(0, T_0; H)} \\
&= \left(B|\varphi(t)|^2 B^* \left(e^{t\sqrt{A^*}} + e^{-t\sqrt{A^*}} \right) \mathcal{G}_\alpha^{-1} v_k, \left(e^{t\sqrt{A^*}} + e^{-t\sqrt{A^*}} \right) w \right)_{L^2(0, T_0; H)} \\
&= \underbrace{\left(\left(\int_0^{T_0} \left(e^{t\sqrt{A}} + e^{-t\sqrt{A}} \right) \Pi_\alpha B|\varphi(t)|^2 B^* \left(e^{t\sqrt{A^*}} + e^{-t\sqrt{A^*}} \right) \Pi_\alpha^* dt \right) \mathcal{G}_\alpha^{-1} v_k, w \right)}_{\mathcal{G}_\alpha} \Big|_H \\
&= (v_k, w)_H.
\end{aligned}$$

□

Remark 2.21. Lemma 2.19 corresponds to a null-controllability property on $[0, T_0]$ in $\Pi_\alpha H$ for the elliptic control problem with initial condition in $P_k H$

$$\begin{cases} -\partial_t^2 u + Au = \Pi_\alpha Bh_k, \\ u|_{t=0} = 0, \\ \partial_t u|_{t=0} = v \in P_k H, \\ u|_{t=T_0} = \partial_t u|_{t=T_0} = 0, \end{cases}$$

whose dynamics remains in $\Pi_\alpha H$ for every $t \in [0, T_0]$. The adjoint problem is the following, well-posed in $\Pi_\alpha^* H$:

$$\begin{cases} -\partial_t^2 z + A^* z = 0, \\ z|_{t=T_0} = w \in \Pi_\alpha^* H, \\ \partial_t z|_{t=T_0} = 0. \end{cases}$$

The estimation of the “cost” of the control h_k is the key point for the following parabolic partial controllability properties.

2.4.2 Parabolic controllability on $\Pi_\alpha H$ with initial datum in $P_k H$

From the elliptic controllability result of Lemma 2.19, we now deduce a corresponding parabolic controllability result. The main tools here are the transformation introduced in [Rus73] and a Paley-Wiener-type theorem.

Proposition 2.22. *We suppose that the subordination number satisfies $q < \frac{3}{4}$ and we fix $\gamma > \max\{\frac{2(1-q)}{3-4q}, 1\}$. Then, for all $\mathcal{T} > 0$ there exists $D_1 > 0$ and for every $s \in \mathbb{N}$ there exists C_s such that for every $0 < T < \mathcal{T}$, $\alpha > 0$, $k \in \mathbb{N}^*$ satisfying $\alpha_k \leq \alpha$, for every $u_{k,0} \in P_k H$, there exists a control function G_k such that :*

- (i) $G_k \in \mathcal{C}_c^\infty(0, T; Y)$;
- (ii) $\|\partial_t^s G_k\|_{L^\infty(0, T; Y)} \leq C_s T^{-2\gamma s} \exp\left(D_1\left(\alpha^\theta + \frac{1}{T^\gamma} + (T\alpha_k)^{\frac{\gamma}{2\gamma-1}}\right) - T\alpha_{k-1}\right) \|u_{k,0}\|_H$;
- (iii) for all $w \in \Pi_\alpha^* H$, $-(u_{k,0}, e^{-TA^*} w)_H = (BG_k, e^{-(T-t)A^*} w)_{L^2(0, T; H)}$.

Remark 2.23. For technical requirements, that can be found in the proof of Lemma 2.40 in Appendix 2.8.1, we have assumed that the subordination q of A_1 to A_0 is less than $\frac{3}{4}$ here. This will be the case in all the applications we present in Section 2.5.

Remark 2.24. The new variable \mathcal{T} here is the time in which we want to control the full equation (2.29), appearing in Section 2.4.4.

Proof. From Lemma 2.19, we have for any positive T_0 (that will be fixed equal to 1 below) : for all $v_k \in P_k H$, there exists h_k (that we know with precision) such that for all $w \in \Pi_\alpha^* H$,

$$\begin{aligned} (v_k, w)_H &= (v_k, P_k^* w)_H = \left(B h_k, \left(e^{t\sqrt{A^*}} + e^{-t\sqrt{A^*}} \right) P_k^* w \right)_{L^2(0, T_0; H)} \\ &= \left(\int_0^{T_0} \left(e^{t\sqrt{A}} + e^{-t\sqrt{A}} \right) P_k B h_k(t) dt, w \right)_H \\ &= \left(\int_0^{T_0} \left(\frac{1}{2i\pi} \int_{\gamma_k} \left(e^{t\sqrt{z}} + e^{-t\sqrt{z}} \right) R_A(z) dz \right) B h_k(t) dt, w \right)_H \\ &= \left(\frac{1}{2i\pi} \int_{\gamma_k} R_A(z) B \int_0^{T_0} \left(e^{t\sqrt{z}} + e^{-t\sqrt{z}} \right) h_k(t) dt dz, w \right)_H. \end{aligned}$$

We introduce the Fourier-Laplace transform of a function :

$$\hat{f}(z) = \int_{\mathbb{R}} f(t) e^{-itz} dt, \quad z \in \mathbb{C}.$$

If $f \in \mathcal{C}_c^\infty(0, T_0; Y)$, then \hat{f} is an entire function with values in Y . We write $\hat{f} \in \mathcal{H}(\mathbb{C}; Y)$. Recalling that $h_k \in \mathcal{C}_c^\infty(0, T_0; Y)$, we have $\hat{h}_k \in \mathcal{H}(\mathbb{C}; Y)$ and

$$(v_k, w)_H = \left(\frac{1}{2i\pi} \int_{\gamma_k} R_A(z) B \left(\hat{h}_k(i\sqrt{z}) + \hat{h}_k(-i\sqrt{z}) \right) dz, w \right)_H. \quad (2.18)$$

From Lemma 2.19 (ii), taken with $s = 0$, we obtain $\|\hat{h}_k(z)\|_Y \leq C_0 e^{D_0 \alpha^\theta} e^{T_0 |\operatorname{Im}(z)|} \|v_k\|_H$. Following [Rus73] and [LR95], we set

$$Q_k(-iz^2) = \hat{h}_k(iz) + \hat{h}_k(-iz),$$

and note that $Q_k(z)$ is an entire function with respect to z . We now have for every $v_k \in P_k H$, the existence of $Q_k \in \mathcal{H}(\mathbb{C}; Y)$ such that for all $w \in \Pi_\alpha^* H$,

$$(v_k, w)_H = \left(\frac{1}{2i\pi} \int_{\gamma_k} R_A(z) B Q_k(-iz) dz, w \right)_H, \quad (2.19)$$

with Q_k satisfying

$$\|Q_k(z)\|_Y \leq C_0 e^{D_0 \alpha^\theta} e^{T_0 \sqrt{|z|}} \|v_k\|_H. \quad (2.20)$$

The goal is now to see Q_k as the Fourier-Laplace transform of a regular function with compact support in $(0, T)$. However, (a Hilbert-valued version of) the Paley-Wiener theorem [Hör83, Theorem 15.1.5] indicates that the inverse Fourier transform of Q_k is only in the dual space $(G^2(\mathbb{R}; Y))'$ of the space of Gevrey functions of order 2. With the convolution by a function $e \in G^\sigma$, $\sigma \in (1, 2)$, i.e. by multiplying Q_k by \hat{e} , we can now regularize the inverse Fourier transform of Q_k .

We fix $T_0 = 1$ and set $\sigma = 2 - \frac{1}{\gamma} \in (1, 2)$. Since we have required that $q < \frac{3}{4}$ and $\gamma > \max\{\frac{2(1-q)}{3-4q}, 1\}$, the Gevrey index $\sigma = 2 - \frac{1}{\gamma}$ satisfies $\sigma > \frac{1}{2(1-q)}$ what is equivalent to $q < 1 - \frac{1}{2\sigma}$. Under these conditions, Lemma 2.40 of Appendix 2.8.1 gives the existence of a Gevrey function $e \in G^\sigma$ satisfying (the constants c_i are positive)

$$\begin{cases} \operatorname{supp}(e) = [0, 1] \text{ and } 0 < e(t) \leq 1 \text{ for all } t \in (0, 1), \\ |\hat{e}(z)| \leq c_1 e^{-c_2 |z|^{\frac{1}{\sigma}}} \text{ if } \operatorname{Im}(z) \leq 0, \\ |\hat{e}(z)| \geq c_3 e^{-c_4 |z|^{\frac{1}{\sigma}}} \text{ in } -i\mathcal{P}_{K_0 T^{1-q}}^q = -i\{z \in \mathbb{C}, \operatorname{Re}(z) \geq 0, |\operatorname{Im}(z)| < K_0 T^{1-q} \operatorname{Re}(z)^q\}. \end{cases} \quad (2.21)$$

The parabola $\mathcal{P}_{K_0 T^{1-q}}^q$ is chosen here so that for every $k \in \mathbb{N}$, for every $z \in \gamma_k \subset \overline{\mathcal{P}_{K_0}^q}$ (defined in (2.7)), we have $Tz \in \mathcal{P}_{K_0 T^{1-q}}^q$ and the lower bound of (2.21) holds.

We set, for $T < \mathcal{T}$,

$$\hat{g}_k(z) = \hat{e}(Tz)Q_k(z) \in \mathcal{H}(\mathbb{C}; Y),$$

and because of (2.20) and the first two points of (2.21), $\hat{g}_k(z)$ satisfies the following estimates

$$\|\hat{g}_k(z)\|_Y \leq C_0 e^{T \operatorname{Im}(z)} e^{D_0 \alpha^\theta} e^{\sqrt{|z|}} \|v_k\|_H \text{ for every } z \in \mathbb{C}, \quad (2.22)$$

$$\|\hat{g}_k(z)\|_Y \leq C_0 c_1 e^{-c_2 |Tz|^{\frac{1}{\sigma}}} e^{D_0 \alpha^\theta} e^{\sqrt{|z|}} \|v_k\|_H \text{ if } \operatorname{Im}(z) \leq 0. \quad (2.23)$$

From (2.22), (2.23) and the Paley-Wiener-type theorem given in Proposition 2.42 in Appendix 2.8.2, there exists $g_k \in \mathcal{C}_c^\infty(0, T; Y)$ such that $\hat{g}_k(z) = \int_{\mathbb{R}} g_k(t) e^{-izt} dt$ for every $z \in \mathbb{C}$. The function g_k is then given by $g_k(t) = \frac{1}{2\pi} \int_{\mathbb{R}} \hat{g}_k(\tau) e^{i\tau t} d\tau$. From (2.23), g_k satisfies the estimates

$$\|\partial_t^s g_k\|_{L^\infty(0, T; Y)} \leq \frac{C_0 c_1}{2\pi} e^{D_0 \alpha^\theta} \int_{\mathbb{R}} |\tau|^s e^{-c_2 |T\tau|^{\frac{1}{\sigma}}} e^{\sqrt{|\tau|}} d\tau \|v_k\|_H, \quad s \in \mathbb{N}.$$

The Laplace method [Erd56] applied to this integral (only dependent on s and γ) finally implies that there exists $C > 0$ and for every $s \in \mathbb{N}$ there exists $C_s > 0$ such that for every $T > 0$, $\alpha > 0$, $k \in \mathbb{N}^*$ such that $\alpha_k \leq \alpha$, for every $v_k \in P_k H$,

$$\|\partial_t^s g_k\|_{L^\infty(0, T; Y)} \leq C_s e^{D_0 \alpha^\theta} T^{-2\gamma s} e^{\frac{C}{T^\gamma}} \|v_k\|_H. \quad (2.24)$$

Let us now properly construct the control function that satisfies the three assertions of the proposition. We first note that for $T < \mathcal{T}$, the operators $\hat{e}(-iTA)$ and e^{-TA} are two isomorphisms of $P_k H$ since the holomorphic functions $\hat{e}(-iTz)$ and e^{-Tz} do not vanish in $\mathcal{P}_{K_0}^q$.

Given $u_{k,0} \in P_k H$, we set $v_k = -[\hat{e}(-iTA)]^{-1} e^{-TA} u_{k,0} \in P_k H$ and g_k the associated control function given as preceding. We set $G_k(t) = g_k(T-t)$, which satisfies point (i) of the proposition. From (2.24), we obtain

$$\|\partial_t^s G_k\|_{L^\infty(0, T; Y)} \leq C_s e^{D_0 \alpha^\theta} T^{-2\gamma s} e^{\frac{C}{T^\gamma}} \|[\hat{e}(-iTA)]^{-1} P_k\|_{\mathcal{L}(H)} \|e^{-TA} P_k\|_{\mathcal{L}(H)} \|u_{k,0}\|_H. \quad (2.25)$$

We can estimate

$$\begin{aligned} \|[\hat{e}(-iTA)]^{-1} P_k\|_{\mathcal{L}(H)} &= \left\| \frac{1}{2i\pi} \int_{\gamma_k} \frac{1}{\hat{e}(-iTz)} R_A(z) dz \right\|_{\mathcal{L}(H)} \\ &\leq \frac{1}{2\pi} \operatorname{meas}(\gamma_k) \sup_{z \in \gamma_k} \frac{1}{|\hat{e}(-iTz)|} \sup_{z \in \gamma_k} \|R_A(z)\|_{\mathcal{L}(H)} \\ &\leq C \alpha_k \sup_{z \in \gamma_k} \frac{1}{|\hat{e}(-iTz)|} \sup_{z \in \gamma_k} \|R_A(z)\|_{\mathcal{L}(H)} \\ &\leq C' \alpha_k \sup_{z \in \gamma_k} c_3^{-1} e^{c_4 |Tz|^{\frac{1}{\sigma}}} e^{C \alpha_k^\beta} \\ &\leq C'' e^{\tilde{c}_4 (|T \alpha_k|^{\frac{1}{\sigma}} + \alpha^\theta)}, \end{aligned}$$

where we have used the third property of the Gevrey function e given in (2.21) and the resolvent estimate (2.8) of Theorem 2.7 on γ_k . A similar estimate for $\|e^{-TA} P_k\|_{\mathcal{L}(H)}$ gives

$$\|e^{-TA} P_k\|_{\mathcal{L}(H)} \leq C \alpha_k e^{-T \alpha_{k-1} + C \alpha^\theta}.$$

We finally obtain from (2.25) that for all $T > 0$ there exists $D_1 > 0$ and for every $s \in \mathbb{N}$ there exists $C_s > 0$ such that for every $0 < T < \mathcal{T}$, $\alpha > 0$, $k \in \mathbb{N}^*$ such that $\alpha_k \leq \alpha$, for every $u_{k,0} \in P_k H$,

$$\|\partial_t^s G_k\|_{L^\infty(0, T; Y)} \leq C_s e^{D_1 \alpha^\theta} T^{-2\gamma s} e^{\frac{D_1}{T^\gamma}} e^{D_1 |T \alpha_k|^{\frac{1}{\sigma}}} e^{-T \alpha_{k-1}} \|u_{k,0}\|_H. \quad (2.26)$$

Point (ii) of the proposition is thus proved recalling that $\frac{1}{\sigma} = \frac{\gamma}{2\gamma-1}$. To prove (iii), we compute

$(BG_k, e^{-(T-t)A^*} w)_{L^2(0,T;H)}$, with $w \in \Pi_\alpha^* H$. We have

$$\begin{aligned} (BG_k, e^{-(T-t)A^*} w)_{L^2(0,T;H)} &= (Bg_k, e^{-tA^*} w)_{L^2(0,T;H)} = (e^{-tA} Bg_k, w)_{L^2(0,T;H)} \\ &= \left(\int_0^T \left(\frac{1}{2i\pi} \int_{\gamma_k} e^{-tz} R_A(z) dz \right) Bg_k(t) dt, w \right)_H \\ &= \left(\frac{1}{2i\pi} \int_{\gamma_k} R_A(z) B \int_0^T e^{-tz} g_k(t) dt dz, w \right)_H \end{aligned}$$

As $\text{supp}(g_k) \subset (0, T)$, we obtain

$$\begin{aligned} (BG_k, e^{-(T-t)A^*} w)_{L^2(0,T;H)} &= \left(\frac{1}{2i\pi} \int_{\gamma_k} R_A(z) B \hat{g}_k(-iz) dz, w \right)_H \\ &= \left(\frac{1}{2i\pi} \int_{\gamma_k} R_A(z) B \hat{e}(-iTz) Q_k(-iz) dz, w \right)_H \\ &= \left(\hat{e}(-iTA) \frac{1}{2i\pi} \int_{\gamma_k} R_A(z) B Q_k(-iz) dz, w \right)_H \end{aligned}$$

because the holomorphic calculus gives for $\phi \in \mathcal{H}(\mathbb{C}; \mathbb{C})$ and $\psi \in \mathcal{H}(\mathbb{C}; H)$

$$\left(\frac{1}{2i\pi} \int_{\gamma_k} \phi(z) R_A(z) dz \right) \left(\frac{1}{2i\pi} \int_{\gamma_k} R_A(z) \psi(z) dz \right) = \frac{1}{2i\pi} \int_{\gamma_k} \phi(z) R_A(z) \psi(z) dz.$$

From (2.19), we then have

$$\begin{aligned} (BG_k, e^{-(T-t)A^*} w)_{L^2(0,T;H)} &= \left(\frac{1}{2i\pi} \int_{\gamma_k} R_A(z) B Q_k(-iz) dz, \hat{e}(-iTA^*) w \right)_H \\ &= (v_k, \hat{e}(-iTA^*) w)_H \end{aligned}$$

as $\hat{e}(-iTA^*) w \in \Pi_\alpha^* H$. Recalling that $v_k = -[\hat{e}(-iTA)]^{-1} e^{-TA} u_{k,0}$, we have obtained that the function G_k constructed here satisfies for all $w \in \Pi_\alpha^* H$

$$\begin{aligned} (BG_k, e^{-(T-t)A^*} w)_{L^2(0,T;H)} &= (-[\hat{e}(-iTA)]^{-1} e^{-TA} u_{k,0}, \hat{e}(-iTA^*) w)_H \\ &= -(e^{-TA} u_{k,0}, w)_H, \end{aligned}$$

for every $u_{k,0} \in P_k H$. Point (iii) is thus proved. This concludes the proof of Proposition 2.22. \square

Remark 2.25. Proposition 2.22 is a null-controllability property on $[0, T]$ in the finite dimensional space $\Pi_\alpha H$ for the parabolic control problem :

$$\begin{cases} \partial_t u + Au = \Pi_\alpha B G_k, \\ u|_{t=0} = u_{k,0} \in P_k H, \\ u|_{t=T} = 0. \end{cases}$$

This also means that for every initial datum $u_{0,k} \in P_k H$ and $T > 0$, there exists $G_k \in \mathcal{C}_c^\infty(0, T; Y)$ such that the solution of

$$\begin{cases} \partial_t u + Au = B G_k, \\ u|_{t=0} = u_{k,0} \in P_k H, \end{cases}$$

satisfies $\Pi_\alpha u(T) = 0$.

2.4.3 Parabolic controllability on $\Pi_\alpha H$

We shall now combine the controllability results for initial datum in $P_k H$, $\alpha_k \leq \alpha$ to obtain a null-controllability result for an initial datum in $\Pi_\alpha H$, i.e., for the problem

$$\begin{cases} \partial_t u + Au = \Pi_\alpha B G_\alpha \\ u|_{t=0} = u_0 \in \Pi_\alpha H \\ u|_{t=T} = 0. \end{cases} \quad (2.27)$$

The norm of the control function G_α will be estimated to prepare for the next section, where a control for an arbitrary initial condition in H is constructed.

Theorem 2.26. *For the control problem (2.27), for every positive T , for every γ sufficiently large, there exists a control function $G_\alpha \in \mathcal{C}_c^\infty(0, T; Y)$ driving u_0 to 0 in time T with a cost given by $\|G_\alpha\|_{L^\infty(0, T; Y)} \leq C \exp(D(\alpha^\theta + \frac{1}{T^\gamma})) \|u_0\|_H$.*

Actually, we prove the following more precise result.

Theorem 2.27. *Let $q < \frac{3}{4}$ and $\gamma > \max\{\frac{2(1-q)}{3-4q}, 1\}$. For all $T > 0$, there exists $D > 0$ and for every $s \in \mathbb{N}$ there exists C_s such that for every $0 < T < \mathcal{T}$, $\alpha > 0$, for every $u_0 \in \Pi_\alpha H$, there exists a control function G_α such that :*

- (i) $G_\alpha \in \mathcal{C}_c^\infty(0, T; Y)$;
- (ii) $\|\partial_t^s G_\alpha\|_{L^\infty(0, T; Y)} \leq C_s T^{-2\gamma s} \exp(D(\alpha^\theta + \frac{1}{T^\gamma})) \|u_0\|_H$;
- (iii) for all $w \in \Pi_\alpha^* H$, $-(u_0, e^{-TA^*} w)_H = (BG_\alpha, e^{-(T-t)A^*} w)_{L^2(0, T; H)}$.

Proof. We write $u_0 = \sum_{\alpha_k \leq \alpha} P_k u_0 \in \Pi_\alpha H$, with $P_k u_0 \in P_k H$ and Proposition 2.22 gives for every k the existence of a control function G_k satisfying :

$$\left\{ \begin{array}{l} \text{for all } w \in \Pi_\alpha^* H, \quad -(P_k u_0, e^{-TA^*} w)_H = (BG_k, e^{-(T-t)A^*} w)_{L^2(0, T; H)}; \\ \|\partial_t^s G_k\|_{L^\infty(0, T; Y)} \leq C_s T^{-2\gamma s} \exp\left(D_1(\alpha^\theta + \frac{1}{T^\gamma} + (T\alpha_k)^{\frac{\gamma}{2\gamma-1}}) - T\alpha_{k-1}\right) \|P_k u_0\|_H \end{array} \right. \quad (2.28)$$

We set

$$G_\alpha = \sum_{\alpha_k \leq \alpha} G_k \in \mathcal{C}_c^\infty(0, T; Y).$$

and (i) is clear as the sum is finite. To prove (iii), given $w \in \Pi_\alpha^* H$, we simply compute

$$\begin{aligned} -(u_0, e^{-TA^*} w)_H &= \sum_{\alpha_k \leq \alpha} -(P_k u_0, e^{-TA^*} w)_H = \sum_{\alpha_k \leq \alpha} (BG_k, e^{-(T-t)A^*} w)_{L^2(0, T; H)} \\ &= (BG_\alpha, e^{-(T-t)A^*} w)_{L^2(0, T; H)}. \end{aligned}$$

We now prove point (ii). Here, we use the asymptotic estimation for the sequence $(\alpha_k)_{k \in \mathbb{N}}$ given in Proposition 2.13. Let $\delta > 1$, there exists $N \in \mathbb{N}$ such that $\delta^{k-1} \leq \alpha_k \leq \delta^k$ if $k \geq N$. We then have

$$\begin{aligned} \|\partial_t^s G_\alpha\|_{L^\infty(0, T; Y)} &\leq \sum_{\alpha_k \leq \alpha} \|\partial_t^s G_k\|_{L^\infty(0, T; Y)} \\ &\leq C_s T^{-2\gamma s} e^{D_1(\alpha^\theta + \frac{1}{T^\gamma})} \sum_{\alpha_k \leq \alpha} e^{D_1(T\alpha_k)^{\frac{\gamma}{2\gamma-1}} - T\alpha_{k-1}} \|P_k u_0\|_H \\ &\leq C_s T^{-2\gamma s} e^{D_1(\alpha^\theta + \frac{1}{T^\gamma})} \|u_0\|_H \sum_{\alpha_k \leq \alpha} e^{D_1(T\delta^k)^{\frac{\gamma}{2\gamma-1}} - T\delta^{k-2}}. \end{aligned}$$

It remains to estimate the sum. Recalling that $\frac{\gamma}{2\gamma-1} < 1$, the function $x \mapsto e^{D_1 x^{\frac{\gamma}{2\gamma-1}} - \delta^{-2} x}$ is bounded on \mathbb{R}_+ by a constant $\kappa = \kappa(\gamma, \delta)$. We thus have

$$\sum_{\alpha_k \leq \alpha} e^{D_1(T\delta^k)^{\frac{\gamma}{2\gamma-1}} - T\delta^{k-2}} \leq N\kappa + \sum_{\substack{k \geq N \\ \alpha_k \leq \alpha}} \kappa \leq \kappa \left(N + \frac{\ln(\alpha)}{\ln(\delta)} \right).$$

Finally, changing the constants C_s , we conclude that

$$\|\partial_t^s G_\alpha\|_{L^\infty(0, T; Y)} \leq C_s T^{-2\gamma s} \exp\left(D(\alpha^\theta + \frac{1}{T^\gamma})\right) \|u_0\|_H.$$

□

Remark 2.28. Here, we have constructed a control in $\mathcal{C}_c^\infty(0, T; Y)$. In the case $Y = H$ and for every $p \in \mathbb{N}$, $B^* \in \mathcal{L}(\mathcal{D}(A^p))$, we are able to construct with the same techniques a control function in $\mathcal{C}_c^\infty(0, T; \bigcap_{p \in \mathbb{N}} \mathcal{D}(A^p))$, following [LR95].

2.4.4 Decay property for the semigroup and construction of the final control

We shall now conclude the proof of the main controllability theorem. We consider the full controllability problem : given $\mathcal{T} > 0$, we construct a control function g such that the solution of the problem

$$\begin{cases} \partial_t u + Au = Bg, \\ u|_{t=0} = u_0 \in H, \end{cases} \quad (2.29)$$

satisfies $u(\mathcal{T}) = 0$ in H . The proof uses both the partial control result of Theorem 2.26 and the decay rate of the semigroup generated by $-A$, once restricted to $(I - \Pi_\alpha)H$. We first prove an estimate of this decay rate. We denote by $(S_A(t))_{t \in \mathbb{R}_{+*}}$ the \mathcal{C}^0 -semigroup of contraction generated by $-A$.

Proposition 2.29. *There exist $C > 0$ and $\tilde{N} \in \mathbb{N}$ such that for every $k \geq \tilde{N}$, $t \geq \frac{1}{\alpha_k}$,*

$$\|S_A(t)(I - \Pi_{\alpha_k})\|_{\mathcal{L}(H)} \leq C e^{C\alpha_k^\theta - t\alpha_k}.$$

Proof. From [Paz83, Theorem 1.7.7] we first write the semigroup generated by $-A(I - \Pi_{\alpha_k})$ as an integral over the infinite positively oriented contour $\partial\mathcal{P}_{K_0}^q$

$$S_A(t)(I - \Pi_{\alpha_k}) = S_{A(I - \Pi_{\alpha_k})}(t) = \frac{1}{2i\pi} \int_{\partial\mathcal{P}_{K_0}^q} e^{-tz} R_{A(I - \Pi_{\alpha_k})}(z) dz.$$

We set $\Lambda_k = \{z \in \mathcal{P}_{K_0}^q, \operatorname{Re}(z) \geq \alpha_k\}$, $\partial\Lambda_k^+ = \{z \in \partial\Lambda_k, \operatorname{Re}(z) > \alpha_k, \operatorname{Im}(z) \geq 0\}$ and $\partial\Lambda_k^- = \{z \in \partial\Lambda_k, \operatorname{Re}(z) > \alpha_k, \operatorname{Im}(z) \leq 0\}$ so that $\partial\Lambda_k = \partial\Lambda_k^+ \cup I_k \cup \partial\Lambda_k^-$ and is a positively oriented contour.

Since $R_{A(I - \Pi_{\alpha_k})}$ is holomorphic in $\mathbb{C} \setminus \Lambda_k$, we may shift the path of integration from $\partial\mathcal{P}_{K_0}^q$ to $\partial\Lambda_k$ without changing the value of the integral. Hence,

$$\begin{aligned} S_A(t)(I - \Pi_{\alpha_k}) &= \frac{1}{2i\pi} \int_{\partial\Lambda_k} e^{-tz} R_A(z) dz \\ &= \frac{1}{2i\pi} \int_{\partial\Lambda_k^+} e^{-tz} R_A(z) dz + \frac{1}{2i\pi} \int_{I_k} e^{-tz} R_A(z) dz + \frac{1}{2i\pi} \int_{\partial\Lambda_k^-} e^{-tz} R_A(z) dz, \end{aligned}$$

where

$$\left\| \int_{\partial\Lambda_k^+} e^{-tz} R_A(z) dz \right\|_{\mathcal{L}(H)} \leq \int_{\alpha_k}^{\infty} C e^{-tx} dx \leq C \frac{e^{-t\alpha_k}}{t},$$

since $R_A(z)$ is uniformly bounded on $\partial\Lambda_0$ from Proposition 2.3 point (iii). The same estimate holds for the integral over $\partial\Lambda_k^-$. Finally estimate (2.8) of Theorem 2.7 gives

$$\left\| \int_{I_k} e^{-tz} R_A(z) dz \right\|_{\mathcal{L}(H)} \leq C \alpha_k^q e^{C\alpha_k^\theta - t\alpha_k}.$$

Then, for some $C > 0$, we obtain the following estimation of the semigroup

$$\|S_A(t)(I - \Pi_{\alpha_k})\|_{\mathcal{L}(H)} \leq C \left(e^{C\alpha_k^\theta - t\alpha_k} + \frac{e^{-t\alpha_k}}{t} \right), \quad t > 0.$$

Thus, taking $\tilde{N} \in \mathbb{N}$ such that for $k \geq \tilde{N}$, $\frac{1}{\alpha_k} \geq e^{-C\alpha_k^\theta}$, we finally obtain

$$\|S_A(t)(I - \Pi_{\alpha_k})\|_{\mathcal{L}(H)} \leq C e^{C\alpha_k^\theta - t\alpha_k}, \quad k \geq \tilde{N}, t \geq \frac{1}{\alpha_k},$$

and the proposition is proved. \square

For the sake of completeness, we now construct the control function for the parabolic problem (2.29), following [LR95]. The decay rate proved in Proposition 2.29 shows that we have now to restrict ourselves to the case $\theta < 1$, i.e. $p^{-1} + q < 2$. We recall that N is an integer such that for all $n \geq N$, $\delta^{n-1} \leq \alpha_n \leq \delta^n$ (see Proposition 2.13).

Theorem 2.30. *Suppose that $q < \frac{3}{4}$ and $\theta < 1$. Then, for every $\mathcal{T} > 0$, $u_0 \in H$, there exists a control function $g \in \mathcal{C}_c^\infty(0, \mathcal{T}; Y)$ such that the solution u of the problem (2.29) satisfies $u(\mathcal{T}) = 0$.*

Proof. We first fix ρ and $\gamma > \max\{\frac{2(1-q)}{3-4q}, 1\}$ such that $0 < \rho < \min\{\frac{1}{\gamma}, \frac{1-\theta}{\theta}\}$. We set $T_j = K\delta^{-j\rho\theta}$, K being such that $\sum_{j \in \mathbb{N}} 2T_j = \mathcal{T}$. We divide the time interval $[0, \mathcal{T}] = \bigcup_{j \in \mathbb{N}} [a_j, a_{j+1}]$, with $(a_j)_{j \in \mathbb{N}}$ such that $a_0 = 0$ and $a_{j+1} = a_j + 2T_j$. Hence, $\lim_{j \rightarrow \infty} a_j = \mathcal{T}$.

For $u_j \in \Pi_{\alpha_j} H$, we define by $G_{\alpha_j}(u_j, T_j)$ the control function given by Theorem 2.27 that drives u_j to zero in time T_j , which in particular satisfies the estimate (ii) of this theorem.

We set J_0 an integer such that $J_0 \geq \max\{N, \tilde{N}\}$ (so that $\delta^{j-1} \leq \alpha_j \leq \delta^j$ for $j \geq J_0$ and the decay rate of Proposition 2.29 holds) and $T_j \geq \delta^{-(j-1)} \geq \alpha_j^{-1}$ for every $j \geq J_0$. We now define the control function g :

- if $t \leq a_{J_0}$, we set $g = 0$, and $u(t) = S_A(t)u_0$;
- if $j \geq J_0$, $t \in (a_j, a_j + T_j]$, we set $g = G_{\alpha_j}(\Pi_{\alpha_j} u(a_j), T_j)$, and

$$u(t) = S_A(t - a_j)u(a_j) + \int_{a_j}^t S_A(t - s)Bg(s)ds;$$

- if $j \geq J_0$, $t \in (a_j + T_j, a_{j+1}]$, we set $g = 0$, and

$$u(t) = S_A(t - a_j - T_j)u(a_j + T_j).$$

We recall that $\|S_A(t)\|_{\mathcal{L}(H)} \leq 1$ because we have required A to be positive. During the first phase $0 \leq t \leq a_{J_0}$, we simply have $\|u(a_{J_0})\|_H \leq \|u_0\|_H$. The choice of the control function during the second phase implies for $j \geq J_0$, $\Pi_{\alpha_j} u(a_j + T_j) = 0$ and

$$\|u(a_j + T_j)\|_H \leq C \exp(C\delta^{j\theta} + C\delta^{j\gamma\rho\theta}) \|u(a_j)\|_H \leq \exp(C'\delta^{j\theta}) \|u(a_j)\|_H,$$

as $\gamma\rho < 1$.

Finally, during the third phase, the decay rate of the semigroup is given for $j \geq J_0$ by Proposition 2.29 and we then have

$$\|u(a_{j+1})\|_H \leq C \exp(C\delta^{j\theta} - T_j\delta^{j-1}) \|u(a_j + T_j)\|_H \leq \exp\left(C''\delta^{j\theta} - K\delta^{j(1-\rho\theta)}\right) \|u(a_j + T_j)\|_H$$

Combining the estimations given on the three phases, we obtain for $j \geq J_0$

$$\|u(a_{j+1})\|_H \leq \exp\left(\sum_{k=J_0}^j C''\delta^{k\theta} - K\delta^{k(1-\rho\theta)}\right) \|u_0\|_H.$$

Because of our choice $\rho < \frac{1-\theta}{\theta}$, we have $1 - \rho\theta > \theta$, and for some $c > 0$,

$$\left(\sum_{k=J_0}^j C''\delta^{k\theta} - K\delta^{k(1-\rho\theta)}\right) \leq c \exp\left(-c\delta^{j(1-\rho\theta)}\right),$$

and thus for every $j \geq J_0$,

$$\|u(a_{j+1})\|_H \leq c \exp\left(-c\delta^{j(1-\rho\theta)}\right) \|u_0\|_H. \quad (2.30)$$

From Theorem 2.27 point (ii) and Estimate (2.30), we have

$$\begin{aligned} \|\partial_t^s g\|_{L^\infty(0, \mathcal{T}; Y)} &\leq \sup_{j \geq J_0} \left\{ C_s T_j^{-2\gamma s} \exp\left(D\left(\alpha_j^\theta + \frac{1}{T_j^\gamma}\right)\right) \|u(a_j)\|_H \right\} \\ &\leq \sup_{j \geq J_0} \left\{ C_s \delta^{2j\rho\theta\gamma s} \exp\left(D\left(\delta^{j\theta} + K\delta^{j\rho\gamma\theta}\right) - c\delta^{(j-1)(1-\rho\theta)}\right) \|u_0\|_H \right\} < +\infty, \end{aligned}$$

following the same estimations as above. Thus, $g \in \mathcal{C}_c^\infty(0, T; Y)$. This implies in particular that the solution u of (2.29) is continuous with values in H . Hence, from (2.30) we directly obtain

$$\|u(T)\|_H = \lim_{j \rightarrow \infty} \|u(a_{j+1})\|_H = 0,$$

and $u(T) = 0$ in H . \square

2.5 Application to the controllability of parabolic coupled systems

In this section, we apply the abstract results proved in the previous sections to second order elliptic operators and to the controllability of parabolic systems. In the following, we first check that the assumptions of Proposition 2.3 and Theorem 2.7 for these elliptic operators are fulfilled and we prove the interpolation inequality (2.12). Sections 2.3 and 2.4 then directly yield the spectral inequality and the controllability results.

We are concerned with the system

$$\begin{cases} \partial_t u_1 + P_1 u_1 + a u_1 + b u_2 = 0 & \text{in } (0, T) \times \Omega, \\ \partial_t u_2 + P_2 u_2 + c u_1 + d u_2 = \mathbf{1}_\omega g & \text{in } (0, T) \times \Omega, \\ u_1|_{t=0} = u_1^0, u_2|_{t=0} = u_2^0 & \text{in } \Omega, \\ u_1 = u_2 = 0 & \text{on } (0, T) \times \partial\Omega, \end{cases} \quad (2.31)$$

where Ω is an open connected subset of \mathbb{R}^n with $n \leq 3$ (a compact connected Riemannian manifold with or without boundary of dimension $n \leq 3$). We suppose that $\partial\Omega$ is at least of class \mathcal{C}^2 . The function $\mathbf{1}_\omega(x)$ stands for the characteristic function of the open subset $\omega \subset \Omega$ and $a, b, c, d \in L^\infty(\Omega)$. Here, P_i , $i = 1, 2$, denotes a positive elliptic selfadjoint operator on Ω : $P_i u = -\operatorname{div}_x(c_i(x)\nabla_x u)$ where $c_i(x)$ is a symmetric uniformly elliptic matrix, i.e. $c_i \in W^{1,\infty}(\Omega)$ and there exists $C > 0$ such that for every $x \in \Omega$, $\xi \in \mathbb{R}^n$, $\xi \cdot c_i(x)\xi \geq C|\xi|^2$. We set $H = (L^2(\Omega))^2$, $\mathcal{D}(A_0) = (H^2(\Omega) \cap H_0^1(\Omega))^2$, and

$$A_0 = \begin{pmatrix} P_1 & 0 \\ 0 & P_2 \end{pmatrix} \quad \text{and} \quad A_1 = \begin{pmatrix} a & b \\ c & d \end{pmatrix}.$$

Referring to Remark 2.1, we shift $A = A_0 + A_1$ by a $\lambda_0 > 0$ sufficiently large so that Eq. (2.7) is satisfied. We carry on the analysis with the operator $A + \lambda_0$, which we write A by abuse of notation. Then, the operator A satisfies the assumptions (a) – (c) of Proposition 2.3 with $q = 0$ since A_1 is bounded in H . Moreover, for $\mu \in \mathbb{R}_+$ the number of eigenvalues of the operator P_i lower than μ is given by the Weyl asymptotics $\mathcal{N}_i(\mu) = m_i \mu^{n/2} + o(\mu^{n/2})$ as $\mu \rightarrow +\infty$. Thus, for A , \mathcal{N} is given by $\mathcal{N}(\mu) = \mathcal{N}_1(\mu) + \mathcal{N}_2(\mu) = (m_1 + m_2)\mu^{n/2} + o(\mu^{n/2})$ and A satisfies the assumption of Proposition 2.13 and that of Theorem 2.7 with $p = 2/n$. The assumption $\theta < 1$ of Theorem 2.30 is satisfied if and only if $n/2 - 1 < 1$, i.e., $n \leq 3$.

We set $Y = L^2(\Omega)$ as the control space and the operator B is given by $B : g \rightarrow (0, \mathbf{1}_\omega g)^T$, and is bounded from $L^2(\Omega)$ to $(L^2(\Omega))^2$ and its adjoint is $B^* : (u_1, u_2)^T \rightarrow \mathbf{1}_\omega u_2 \in \mathcal{L}((L^2(\Omega))^2; L^2(\Omega))$.

Now, it remains to prove the interpolation inequality (2.12) to apply Theorem 2.16.

Proposition 2.31. *Let $T_0 > 0$, $\zeta \in (0, T_0/2)$. Suppose that there exists an open subset $\mathcal{O} \subset \Omega$, $\mathcal{O} \cap \omega \neq \emptyset$ such that the coupling coefficient $b \in L^\infty(\Omega)$ satisfies $|b(x)| \geq b_0 > 0$ for almost every $x \in \mathcal{O}$. Then, there exist $C > 0$, $\varphi \in \mathcal{C}_c^\infty(0, T_0)$ and $\nu \in (0, 1)$ such that for every $v \in (H^2((0, T_0) \times \Omega))^2$, $v|_{(0, T_0) \times \partial\Omega} = 0$, we have*

$$\|v\|_{(H^1((\zeta, T_0 - \zeta) \times \Omega))^2} \leq C \|v\|_{(H^1((0, T_0) \times \Omega))^2}^{1-\nu} \left(\|\varphi B^* v\|_{L^2((0, T_0) \times \Omega)} + \|(-\partial_t^2 + A^*)v\|_{(L^2((0, T_0) \times \Omega))^2} \right)^\nu. \quad (2.32)$$

Proof. We first prove (2.32) with $\|\varphi B^* v\|_{L^2((0, T_0) \times \Omega)}$ replaced by $\|v\|_{L^2(V)}$ with $\bar{V} \subset (0, T_0) \times \mathcal{O} \cap \omega$. In a second step, thanks to local elliptic energy estimates, we eliminate the first component and obtain (2.32).

Here, the time variable does not play a particular role. Thus, for the sake of clarity, we simplify the notation, denoting by ∇ the time-space gradient $(\partial_t, \nabla_x)^T$, by div the time-space divergence $\partial_t + \operatorname{div}_x$, by C_i the time-space diffusion matrices $C_i = \begin{pmatrix} 1 & 0 \\ 0 & c_i \end{pmatrix}$, and by $-\Delta_i$ the time-space elliptic operators

$$-\Delta_i = -\partial_t^2 + P_i = -\partial_t^2 - \operatorname{div}_x(c_i \nabla_x \cdot) = -\operatorname{div}(C_i \nabla \cdot).$$

We also set

$$\widetilde{A}^* = -\partial_t^2 + A^* = \begin{pmatrix} -\Delta_1 + a & c \\ b & -\Delta_2 + d \end{pmatrix}.$$

We also denote by (\cdot, \cdot) the L^2 scalar product on $L^2((0, T_0) \times \Omega)$ or $(L^2((0, T_0) \times \Omega))^{n+1}$, $\|\cdot\|$ the associated norms, and by $(\cdot, \cdot)_i$, $i = 1, 2$, the L^2 scalar product defined by

$$(\xi, \xi')_i = (C_i \xi, \xi'), \quad \xi, \xi' \in (L^2((0, T_0) \times \Omega))^{n+1}, \quad i = 1, 2,$$

and $\|\cdot\|_i$ the associated norm. With the assumptions made on c_i , the norms $\|\cdot\|_i$ and $\|\cdot\|$ are equivalent on $(L^2((0, T_0) \times \Omega))^{n+1}$.

We first state local Carleman estimates for \widetilde{A}^* . These are direct consequences of the classical local Carleman estimates for the elliptic operators Δ_i . We first choose a local weight function ϕ satisfying a subellipticity condition with respect to both Δ_1 and Δ_2 (which can be done taking $\phi = e^{\lambda\psi}$ for λ sufficiently large and ψ satisfying $|\nabla\psi| \geq C > 0$, see [Hör63, Chapter 8], [LR95] or [LL09]). Then there exists $h_1 > 0$ and $C > 0$ such that for every $w \in (\mathcal{C}_c^\infty((0, T_0) \times \Omega))^2$, $w = (w_1, w_2)^T$, and $0 < h < h_1$,

$$h\|e^{\phi/h} w_i\|^2 + h^3\|e^{\phi/h} \nabla w_i\|^2 \leq Ch^4\|e^{\phi/h} \Delta_i w_i\|^2, \quad i = 1, 2$$

(see [LR95], or [FI96] in the case $c_i \in W^{1, \infty}$). Adding these two estimates and absorbing the zero-order terms for h sufficiently small, we directly obtain the same estimate for \widetilde{A}^* :

$$h\|e^{\phi/h} w\|^2 + h^3\|e^{\phi/h} \nabla w\|^2 \leq Ch^4\|e^{\phi/h} \widetilde{A}^* w\|^2, \quad \nabla w = \begin{pmatrix} \nabla w_1 \\ \nabla w_2 \end{pmatrix}.$$

By optimizing in h (see [LR95]), these local Carleman estimates yield local interpolation estimates of the form

$$\|v\|_{(H^1(B(3r)))^2} \leq C\|v\|_{(H^1((0, T_0) \times \Omega))^2}^{1-\nu} \left(\|v\|_{(H^1(B(r)))^2} + \|\widetilde{A}^* v\|_{(L^2((0, T_0) \times \Omega))^2} \right)^\nu,$$

where $B(r)$ denote concentric balls of radius r .

Similar estimates at the boundary $(0, T_0) \times \partial\Omega$ are also direct consequences of the Carleman estimates at the boundary for a scalar elliptic operator.

Then, following [LR95], these local interpolation inequalities can be “propagated”, so that we obtain the following global interpolation inequality, with two observations in H^1 norm, localized in any nonempty open subset W of $(\zeta, T_0 - \zeta) \times \Omega$:

$$\|v\|_{(H^1((\zeta, T_0 - \zeta) \times \Omega))^2} \leq C\|v\|_{(H^1((0, T_0) \times \Omega))^2}^{1-\nu} \left(\|v\|_{(H^1(W))^2} + \|\widetilde{A}^* v\|_{(L^2((0, T_0) \times \Omega))^2} \right)^\nu. \quad (2.33)$$

Let us take the open subsets W , V , and U such that $\bar{W} \subset V$, $\bar{V} \subset U$, and $\bar{U} \subset (0, T_0) \times \mathcal{O} \cap \omega$. Elliptic regularity for the operators Δ_i , $i = 1, 2$, shows that there exists $C > 0$ such that

$$\|v\|_{H^1(W)} \leq C(\|\widetilde{A}^* v\| + \|v\|_{L^2(V)}).$$

It finally remains to eliminate one of the two observations with energy estimates. In fact, we prove that

$$\|v_1\|_{L^2(V)} \leq C(\|\widetilde{A}^*v\| + \|v_2\|_{L^2(U)}).$$

We write $f = (f_1, f_2)^T = \widetilde{A}^*v$, i.e.

$$\begin{cases} f_1 = -\Delta_1 v_1 + av_1 + cv_2, \\ f_2 = -\Delta_2 v_2 + bv_1 + dv_2. \end{cases} \quad (2.34)$$

Let χ be a cut-off function such that $\chi \in \mathcal{C}_c^\infty(U)$, $0 \leq \chi \leq 1$, and $\chi = 1$ on $V \subset U$. We set

$$\eta = \chi^\tau, \quad \eta_1 = \chi^{\tau+1}, \quad \eta_2 = \chi^{\tau-1},$$

for a real number $\tau > 2$, so that η, η_1, η_2 and $\chi^{\tau-2}$ are also cut-off functions of the same type. We notice that $\nabla \eta_1 = \eta(\tau+1)\nabla \chi$ and $\nabla \eta = \eta_2 \tau \nabla \chi$, where $\nabla \chi$ is a bounded function.

We form the scalar product of the second equation of (2.34) by $\eta^2 v_1$

$$(\eta^2 v_1, bv_1) = (\eta^2 v_1, f_2) - (\eta^2 v_1, dv_2) + (\eta^2 v_1, \Delta_2 v_2).$$

The third term can be estimated as follows, using the equivalence of the norms $\|\cdot\|_2$ and $\|\cdot\|$:

$$\begin{aligned} (\eta^2 v_1, \Delta_2 v_2) &= -(\eta \nabla v_1, \eta \nabla v_2)_2 - (v_1(2\eta \nabla \eta), \nabla v_2)_2 \\ &\leq C \left(\varepsilon_1 \|\eta_1 \nabla v_1\|^2 + \frac{1}{\varepsilon_1} \|\eta_2 \nabla v_2\|^2 + \varepsilon_2 \|\eta v_1\|^2 + \frac{1}{\varepsilon_2} \|\eta_2 \nabla v_2\|^2 \right), \end{aligned}$$

for every positive ε_1 and ε_2 , thanks to Young's inequality. Hence,

$$\begin{aligned} (\eta^2 v_1, bv_1) &\leq C \left(\varepsilon_1 \|\eta_1 \nabla v_1\|^2 + \frac{1}{\varepsilon_1} \|\eta_2 \nabla v_2\|^2 + \varepsilon_2 \|\eta v_1\|^2 + \frac{1}{\varepsilon_2} \|\eta_2 \nabla v_2\|^2 \right) \\ &\quad + |(\eta^2 v_1, f_2)| + |(\eta^2 v_1, dv_2)|. \end{aligned} \quad (2.35)$$

Moreover, forming the scalar product of the first equation of (2.34) by $\delta_1 \eta_1^2 v_1$ and the second one by $\delta_2 \eta_2^2 v_2$ for $\delta_1, \delta_2 > 0$, we obtain

$$\begin{cases} 0 = \delta_1(\eta_1^2 v_1, \Delta_1 v_1) + \delta_1(\eta_1^2 v_1, f_1) - \delta_1(\eta_1^2 v_1, av_1) - \delta_1(\eta_1^2 v_1, cv_2), \\ 0 = \delta_2(\eta_2^2 v_2, \Delta_2 v_2) + \delta_2(\eta_2^2 v_2, f_2) - \delta_2(\eta_2^2 v_2, dv_2) - \delta_2(\eta_2^2 v_2, bv_1), \end{cases} \quad (2.36)$$

with

$$\begin{aligned} \delta_1(\eta_1^2 v_1, \Delta_1 v_1) &= -\delta_1 \|\eta_1^2 \nabla v_1\|_1^2 - \delta_1 (v_1(2\eta_1 \nabla \eta_1), \nabla v_1)_1 \\ &\leq -\delta_1 \|\eta_1 \nabla v_1\|_1^2 + C \left(\delta_1 \varepsilon_3 \|\eta_1 \nabla v_1\|_1^2 + \frac{\delta_1}{\varepsilon_3} \|\eta v_1\|_1^2 \right), \end{aligned} \quad (2.37)$$

and similarly

$$\delta_2(\eta_2^2 v_2, \Delta_2 v_2) \leq -\delta_2 \|\eta_2 \nabla v_2\|_2^2 + C \left(\delta_2 \varepsilon_3 \|\eta_2 \nabla v_2\|_2^2 + \frac{\delta_2}{\varepsilon_3} \|v_2 \nabla \eta_2\|_2^2 \right) \quad (2.38)$$

for all positive ε_3 .

Replacing (2.37) and (2.38) in (2.36), and adding (2.35) and (2.36), we obtain, for positive constants C_0, K_0

$$\begin{aligned} (\eta^2 v_1, bv_1) &\leq C_0 \left\{ |(\eta^2 v_1, f_2)| + |(\eta^2 v_1, dv_2)| + \varepsilon_1 \|\eta_1 \nabla v_1\|^2 + \frac{1}{\varepsilon_1} \|\eta_2 \nabla v_2\|^2 + \varepsilon_2 \|\eta v_1\|^2 \right. \\ &\quad + \frac{1}{\varepsilon_2} \|\eta_2 \nabla v_2\|^2 + \delta_1 |(\eta_1^2 v_1, f_1)| + \delta_1 |(\eta_1^2 v_1, av_1)| + \delta_1 |(\eta_1^2 v_1, cv_2)| \\ &\quad + \delta_2 |(\eta_2^2 v_2, f_2)| + \delta_2 |(\eta_2^2 v_2, dv_2)| + \delta_2 |(\eta_2^2 v_2, bv_1)| + \delta_1 \varepsilon_3 \|\eta_1 \nabla v_1\|^2 + \frac{\delta_1}{\varepsilon_3} \|\eta v_1\|^2 \\ &\quad \left. + \delta_2 \varepsilon_3 \|\eta_2 \nabla v_2\|^2 + \frac{\delta_2}{\varepsilon_3} \|v_2 \nabla \eta_2\|^2 \right\} - K_0 \left\{ \delta_1 \|\eta_1 \nabla v_1\|^2 + \delta_2 \|\eta_2 \nabla v_2\|^2 \right\}, \end{aligned}$$

where we used the equivalence between the norms $\|\cdot\|_1$, $\|\cdot\|_2$ and $\|\cdot\|$ to write everything in terms of $\|\cdot\|$. Note that all the positive parameters δ_i, ε_j have not been fixed yet. Now we suppose that $b \geq b_0 > 0$ on U . The case $b \leq -b_0 < 0$ follows the same. We thus have,

$$b_0 \|\eta v_1\|^2 \leq (\eta^2 v_1, bv_1) \leq C_0 \{J_1 + J_2\} + K_0 J_3 \quad (2.39)$$

where J_1 contains only the terms without gradient, and

$$\begin{cases} J_3 &= -\delta_1 \|\eta_1 \nabla v_1\|^2 - \delta_2 \|\eta_2 \nabla v_2\|^2, \\ J_2 &= \varepsilon_1 \|\eta_1 \nabla v_1\|^2 + \frac{1}{\varepsilon_1} \|\eta_2 \nabla v_2\|^2 + \frac{1}{\varepsilon_2} \|\eta_2 \nabla v_2\|^2 + \delta_1 \varepsilon_3 \|\eta_1 \nabla v_1\|^2 \\ &\quad + \delta_2 \varepsilon_3 \|\eta_2 \nabla v_2\|^2 + \frac{\delta_2}{\varepsilon_3} \|v_2 \nabla \eta_2\|^2. \end{cases}$$

The term $C_0 J_2 + K_0 J_3$ in (2.39) is thus non-positive as soon as the conditions

$$\begin{cases} C_0(\varepsilon_1 + \delta_1 \varepsilon_3) - K_0 \delta_1 &\leq 0, \\ C_0(\frac{1}{\varepsilon_1} + \frac{1}{\varepsilon_2} + \delta_2 \varepsilon_3) - K_0 \delta_2 &\leq 0 \end{cases}$$

are satisfied. In this case, we obtain from (2.39) $b_0 \|\eta v_1\|^2 \leq C_0 J_1$. Let us now estimate $C_0 J_1$, using that $a, b, c, d \in L^\infty$ and Young's inequality with the parameters 1, ε_2 or $\varepsilon_4 > 0$:

$$\begin{aligned} C_0 J_1 &\leq C_1 \left\{ \varepsilon_2 \|\eta v_1\|^2 + \frac{1}{\varepsilon_2} \|f_2\|^2 + \frac{1}{\varepsilon_2} \|\eta v_2\|^2 + \delta_1 \|\eta v_1\|^2 + \delta_1 \|f_1\|^2 + \delta_1 \|\eta v_2\|^2 \right. \\ &\quad \left. + \delta_2 \|\eta_2 v_2\|^2 + \delta_2 \|f_2\|^2 + \varepsilon_4 \delta_2 \|\eta v_1\|^2 + \frac{\delta_2}{\varepsilon_4} \|\chi^{\tau-2} v_2\|^2 + \frac{\delta_1}{\varepsilon_3} \|\eta v_1\|^2 \right\} \\ &\leq C_1 \left(\varepsilon_2 + \delta_1 + \varepsilon_4 \delta_2 + \frac{\delta_1}{\varepsilon_3} \right) \|\eta v_1\|^2 + C(\delta_i, \varepsilon_j) (\|\chi^{\tau-2} v_2\|^2 + \|f_1\|^2 + \|f_2\|^2). \end{aligned}$$

If we choose the parameters such that $C_1 \left(\varepsilon_2 + \delta_1 + \varepsilon_4 \delta_2 + \frac{\delta_1}{\varepsilon_3} \right) \leq \frac{b_0}{2}$, since we now have $b_0 \|\eta v_1\|^2 \leq C_0 J_1$, we then obtain

$$\begin{aligned} \|\eta v_1\|_{L^2(V)}^2 &\leq C(\delta_i, \varepsilon_j) \left(\|v_2\|_{L^2(U)}^2 + \|f_1\|^2 + \|f_2\|^2 \right), \\ \|v_1\|_{L^2(V)} &\leq C \left(\|v_2\|_{L^2(U)} + \|\widetilde{A^* v}\| \right). \end{aligned}$$

Recalling that the open subset U is chosen such that $\bar{U} \subset (0, T_0) \times \mathcal{O} \cap \omega$, we take $\varphi \in \mathcal{C}_c^\infty(0, T_0; \mathbb{C})$, with $\varphi = 1$ on the time support of U and we have

$$\|v_2\|_{L^2(U)} \leq \|\varphi B^* v\|_{L^2((0, T_0) \times \Omega)}.$$

The proof of the proposition is complete.

It only remains to note that it is possible to choose the parameters δ_i, ε_j satisfying

$$\begin{cases} \delta_1(C_0 \varepsilon_3 - K_0) + C_0 \varepsilon_1 &\leq 0, \\ \delta_2(C_0 \varepsilon_3 - K_0) + C_0 \left(\frac{1}{\varepsilon_1} + \frac{1}{\varepsilon_2} \right) &\leq 0, \\ \varepsilon_2 + \delta_1 + \varepsilon_4 \delta_2 + \frac{\delta_1}{\varepsilon_3} &\leq \frac{b_0}{2C_1}. \end{cases}$$

This can be done, fixing first $\varepsilon_2 + \delta_1 \leq \frac{b_0}{6C_1}$ and $\varepsilon_3 < \min\{1, \frac{K_0}{C_0}\}$. Second, choosing $\varepsilon_1 \leq \delta_1(\frac{K_0}{C_0} - \varepsilon_3)$, the first condition is satisfied. Third, we can fix δ_2 sufficiently large so that the second condition is satisfied and finally ε_4 such that $\varepsilon_4 \delta_2 \leq \frac{b_0}{6C_1}$ and the last condition is fulfilled. \square

As a consequence of Proposition 2.31, the spectral inequality (2.13) of Theorem 2.16, the partial controllability result of Theorem 2.27 and the null-controllability result of Theorem 2.30 hold in this case. Under the assumptions made above, in particular those of Proposition 2.31, the coupled parabolic system (2.31) is null-controllable in any positive time by a control function $g \in \mathcal{C}_c^\infty(0, T; L^2(\Omega))$. Note that in this context, the spectral inequality (2.13) corresponds to the estimation of a finite sum of root vectors of A by a localized measurement of only one component of this finite sum of root vectors.

Remark 2.32. In the local energy estimates made in the proof, we see that the assumption $\mathcal{O} \cap \omega \neq \emptyset$ is crucial. In the case $\mathcal{O} \cap \omega = \emptyset$, the spectral inequality and the null-controllability remain open problems to the author's knowledge.

Remark 2.33. In the case where the operator A is selfadjoint (i.e. $b = c$ in (2.31)), the spectral inequality (2.13) is much easier to prove, once the interpolation inequality (2.32) holds. This spectral inequality can take the following form. We denote by $(\mu_j)_{j \in \mathbb{N}}$ the eigenvalues of $A = A^*$ and $\{(\phi_j, \psi_j)^T\}_{j \in \mathbb{N}}$ the associated eigenfunctions, that form a Hilbert basis of $(L^2(\Omega))^2$. Then, for every open subset $U \subset (0, T) \times \mathcal{O}$, there exist $C > 0$ such that for every sequence $(a_j, b_j)_{j \in \mathbb{N}} \subset \mathbb{C}$ and $\alpha > 0$, we have

$$\sum_{\mu_j \leq \alpha} (|a_j|^2 + |b_j|^2) \leq C e^{C\sqrt{\alpha}} \left\| \sum_{\mu_j \leq \alpha} (a_j e^{\sqrt{\mu_j} t} + b_j e^{-\sqrt{\mu_j} t}) \psi_j \right\|_{L^2(U)}^2.$$

Following the proof of [LR95] or Section 2.4, it yields the controllability of the coupled problem (2.31), without restriction on the dimension of Ω .

Remark 2.34. The same proof also yields a spectral inequality, a partial controllability and a null-controllability result for the following cascade system of d equations with one control force

$$\begin{cases} \partial_t u_1 + P_1 u_1 + \mathbb{1}_{\omega_1} u_2 = 0, \\ \partial_t u_2 + P_2 u_2 + \mathbb{1}_{\omega_2} u_3 = 0, \\ \dots \\ \partial_t u_{d-1} + P_{d-1} u_{d-1} + \mathbb{1}_{\omega_{d-1}} u_d = 0, \\ \partial_t u_d + P_d u_d = \mathbb{1}_{\omega_d} g, \\ u_j|_{t=0} = u_j^0, \quad j \in \{1 \dots d\}, \\ u_j = 0 \text{ on } (0, T) \times \partial\Omega, \quad j \in \{1 \dots d\}, \end{cases}$$

where $P_j = -\operatorname{div}(c_j(x)\nabla \cdot)$ for some symmetric uniformly elliptic matrices c_j . Note that the null-controllability result is a particular case of the article [GBdT10]. We have to suppose that $\bigcap_{j=1}^d \omega_j \neq \emptyset$.

The spaces here are the same as above, the operator A_0 is $\operatorname{diag}(P_1 \dots P_d)$ and A_1 is

$$\begin{pmatrix} 0 & \mathbb{1}_{\omega_1} & & & \\ & \ddots & \ddots & & \\ & & \ddots & \mathbb{1}_{\omega_{d-1}} & \\ & & & & 0 \end{pmatrix}.$$

The above analysis directly yields the spectral inequality (2.13) of Theorem 2.16 and the partial control result of Theorem 2.27. The null-controllability result of Theorem 2.30 in any positive time, by only one control function $g \in \mathcal{C}_c^\infty(0, T; L^2(\Omega))$ holds, supposing that $\Omega \subset \mathbb{R}^n$, $n \leq 3$.

2.6 Application to the controllability of a fractional order parabolic equation

Following [MZ06] and [Mil06b], we give here an application of the spectral inequality (2.15) of Theorem 2.17 to the null-controllability of the following parabolic-type problem in which the dynamics is given by a fractional power of the non-selfadjoint operator A . We only treat the “good” case, i.e., when the power $\nu > 0$ is sufficiently large. In this case, the selfadjoint problem is null-controllable. We consider

$$\begin{cases} \partial_t u + A^\nu u = Bg \\ u|_{t=0} = u_0 \in H. \end{cases} \quad (2.40)$$

Here, we define $(\mathcal{D}(A^\nu), -A^\nu)$ as the infinitesimal generator of the strongly continuous semigroup

$$\frac{1}{2i\pi} \int_{\partial \mathcal{P}_{K_0}^q} e^{-tz^\nu} R_A(z) dz = S_{A^\nu}(t),$$

or equivalently one of the following expressions (see [Haa06]),

$$\begin{aligned} A^\nu &= \frac{1}{2i\pi} \lim_{t \rightarrow 0^+} \int_{\partial \mathcal{P}_{K_0}^q} z^\nu e^{-tz^\nu} R_A(z) dz = (A + I)^m \frac{1}{2i\pi} \int_{\partial \mathcal{P}_{K_0}^q} z^\nu (z + 1)^{-m} R_A(z) dz \\ &= \left[\frac{1}{2i\pi} \int_{\partial \Sigma} z^{-\nu} R_A(z) dz \right]^{-1}, \end{aligned}$$

where $m \in \mathbb{N}$, $m \geq \nu + 1$, and $\Sigma = \{z \in \mathbb{C}, \arg(z) \leq \arctan(K_0 \alpha_0^{q-1}), \operatorname{Re}(z) \geq \alpha_0\}$ denotes a sector containing the spectrum of A . Here, we have to suppose that the operator A is positive, since Remark 2.1 does not hold in the case $\nu \neq 1$. In the case $\nu \notin \mathbb{N}$, we choose the principal value of the fractional root. Hence, on each finite-dimensional subspace $P_k H$, we can write A^ν in terms of the functional calculus $A^\nu P_k = \frac{1}{2i\pi} \int_{\gamma_k} z^\nu R_A(z) dz$. Moreover, from Proposition 2.10 we have $(A^\nu P_k)^* = (A^*)^\nu P_k^*$. The same holds with Π_α instead of P_k .

We now assume that the spectral inequality (2.15) of Theorem 2.17 holds for A and we obtain the following partial controllability result for $\partial_t + A^\nu$. It is the analogous of Theorem 2.26, supposing the spectral inequality (2.15) instead of (2.13). Note that in this case we have no additional restriction on the subordination number q (as opposed to the statement of Theorem 2.30). The proof follows that of [Mil06b] or [LL09]. However, when A is not selfadjoint, the operator A^ν is not necessarily positive. As a consequence, we also have to treat the possibly non-positive low frequencies of A^ν . This problem does not arise when A is positive selfadjoint since A^ν is always positive.

For $\nu > 0$, we define $N_\nu = \min\{k \in \mathbb{N}, \operatorname{Re}(z^\nu) > 0, \forall z \in I_k\}$, such that $A^\nu(I - \Pi_{\alpha_k})$ (and also $A^{*\nu}(I - \Pi_{\alpha_k}^*)$) is a positive operator if $k \geq N_\nu$.

Proposition 2.35. *Let $\alpha \geq \alpha_{N_\nu}$. The partial control problem*

$$\begin{cases} \partial_t u + A^\nu u = \Pi_\alpha B g \\ u|_{t=0} = u_0 \in \Pi_\alpha H, \end{cases} \quad (2.41)$$

is null-controllable in any positive time T by a control function satisfying

$$\|g\|_{L^2(0,T;H)} \leq CT^{-1/2} e^{CT\alpha_{N_\nu}^\nu + C\alpha^\theta} \|u_0\|_H.$$

Note that the additional cost $e^{CT\alpha_{N_\nu}^\nu}$ of the control function is needed to handle the exponentially increasing low frequencies.

Proof. The adjoint system of (2.41) is

$$\begin{cases} -\partial_t w + A^{*\nu} w = 0 \\ w|_{t=T} = w_T \in \Pi_\alpha^* H. \end{cases}$$

Thus $w(0) \in \Pi_\alpha^* H$ and $w(t) = e^{tA^{*\nu}} w(0)$. We first estimate

$$\begin{aligned} \|e^{-tA^{*\nu}} \Pi_\alpha^* w_T\|_{\mathcal{L}(H)} &= \left\| \frac{1}{2i\pi} \int_{\Gamma_k} e^{-tz^\nu} R_{A^*}(z) dz \right\|_{\mathcal{L}(H)} \\ &\leq \frac{1}{2\pi} \left(\int_{\Gamma_{\alpha_{N_\nu}}} \|e^{-tz^\nu} R_{A^*}(z)\|_{\mathcal{L}(H)} dz + \int_{\bigcup_{\alpha_{N_\nu} < \alpha_k \leq \alpha} \gamma_k} \|e^{-tz^\nu} R_{A^*}(z)\|_{\mathcal{L}(H)} dz \right). \end{aligned}$$

The second term is bounded by $Ce^{C\alpha^\theta} \sup e^{-t\operatorname{Re}(z^\nu)} \leq Ce^{C\alpha^\theta}$ since $\operatorname{Re}(z^\nu) \geq 0$ on each γ_k , $\alpha_{N_\nu} < \alpha_k \leq \alpha$. Concerning the first term, we have $\operatorname{Re}(z^\nu) \geq -C\alpha_{N_\nu}^\nu$ for $z \in \Gamma_{\alpha_{N_\nu}}$ and thus

$$\int_{\Gamma_{\alpha_{N_\nu}}} \|e^{-tz^\nu} R_{A^*}(z)\|_{\mathcal{L}(H)} dz \leq Ce^{CT\alpha_{N_\nu}^\nu + C\alpha^\theta}.$$

We thus obtain the estimate $\|e^{-tA^{*\nu}} \Pi_{\alpha_k}^* \|_{\mathcal{L}(H)} \leq C e^{CT\alpha_{N_\nu}^\nu + C\alpha^\theta}$. We then have the observability inequality

$$T\|w(0)\|_H^2 \leq \int_0^T \left(C e^{CT\alpha_{N_\nu}^\nu + C\alpha^\theta} \right)^2 \|w(t)\|_H^2 dt \leq C e^{CT\alpha_{N_\nu}^\nu + C\alpha^\theta} \|B^* w\|_{L^2(0,T;Y)}^2$$

from (2.15) applied to $w(t) \in \Pi_{\alpha_k}^* H$. By duality, the proposition is proved. \square

The same type of estimates as those performed in the proof of Proposition 2.29 gives the following decay property, for k sufficiently large ($k \geq N_\nu$), for some constant $0 < c < 1$,

$$\|S_{A_\nu}(t)(I - \Pi_{\alpha_k})\|_{\mathcal{L}(H)} \leq C e^{C\alpha_k^\theta - ct\alpha_k^\nu}, \quad t \geq \frac{1}{\alpha_k}.$$

We finally have the analogous of Theorem 2.30, which proof follows the same (choosing $J_0 \geq N_\nu$).

Proposition 2.36. *Suppose that $\nu > \theta$. For every $\mathcal{T} > 0$, for every $u_0 \in H$, there exists a control function $g \in L^2(0, \mathcal{T}; Y)$ such that the solution u of the problem (2.40) satisfies $u(\mathcal{T}) = 0$.*

In the case where A is a second order selfadjoint elliptic operator, the spectral inequality (2.15) always holds for $\theta = 1/2$, and $\nu > 1/2$ is sufficient for the null-controllability (see [MZ06] and [Mil06b]). Here, with the estimations we have proved, the case $1/2 < \nu \leq \theta$ is open.

Remark 2.37. Using arguments of measure theory given in [Wan08], Proposition 2.36 still holds if we replace the control operator B in (2.40) by $\mathbf{1}_E B$, for any subset of positive measure $E \subset (0, \mathcal{T})$. This means that the control function g given by Proposition 2.36 can be chosen so that $g(t) = 0$ for $t \notin E$.

Example 2.38. For $\Omega \subset \mathbb{R}^n$ and ω a non-empty subset of Ω , we take $H = Y = L^2(\Omega)$, $\mathcal{D}(A_0) = H^2 \cap H_0^1(\Omega)$, $A_0 = -\Delta$ and $A_1 = b \cdot \nabla + c$ with $b \in W^{1,\infty}(\Omega; \mathbb{C}^n)$, $c \in L^\infty(\Omega; \mathbb{C})$ chosen so that A is positive. Here, B^* is a localized observation, i.e. $B^* = B = \mathbf{1}_\omega \in \mathcal{L}(L^2(\Omega))$. Under the conditions above, Proposition 2.3 is valid with $q = 1/2$ and the assumption of Theorem 2.7 is satisfied for $p = 2/n$. Moreover, the interpolation inequality (2.14) is well known in this case. In fact, it originates from Carleman inequalities [LR95], which form is invariant under changes in the operator by lower order terms. Hence, the spectral inequality (2.15) of Theorem 2.17 holds for $\theta = \max\{1/2, \frac{n-1}{2}\}$. For any time $\mathcal{T} > 0$ and $E \subset (0, \mathcal{T})$ satisfying $\text{meas}(E) > 0$, Proposition 2.36 and Remark 2.37 give the null-controllability of the problem

$$\begin{cases} \partial_t u + (-\Delta + b \cdot \nabla + c)^\nu u = \mathbf{1}_{E \times \omega} g & \text{in } (0, \mathcal{T}) \times \Omega, \\ u|_{t=0} = u_0 & \text{in } \Omega, \\ u = 0 & \text{on } (0, \mathcal{T}) \times \partial\Omega, \end{cases}$$

for any $n \in \mathbb{N}$, $\nu > \max\{1/2, \frac{n-1}{2}\}$.

2.7 Application to level sets of sums of root functions

Following Jerison and Lebeau [JL99], we give here an application of the spectral inequality (2.15) of Theorem 2.17 to the measurement of the level sets of finite sums of root functions in term of the largest eigenvalue. The operator involved here is a non-selfadjoint perturbation of the Laplace operator.

Let Ω be a bounded open set in \mathbb{R}^n (or a n -dimensional Riemannian compact manifold with or without boundary). We set $H = Y = L^2(\Omega)$. Let $-\Delta$ be the Laplace operator on Ω and $P(x, D)$ a differential operator of order $d \in \{0, 1\}$, such that $A_1 = P(x, D)$ is a relatively compact perturbation of $A_0 = -\Delta$, with dirichlet boundary conditions. We set $A = A_0 + A_1 = -\Delta + P(x, D)$ and take for B^* a localized observation, i.e. $B^* = B = \mathbf{1}_\omega \in \mathcal{L}(L^2(\Omega))$ for some nonempty open subset $\omega \subset \Omega$.

First note that under the conditions above, Proposition 2.3 is valid with $q = d/2 < 1$ and assumption (a) of Theorem 2.7 is satisfied for $p = 2/n$. Moreover, the interpolation inequality (2.14) holds in this case (see Example 2.38 above). Note that a function φ is a sum of root functions of the operator A associated with eigenvalues of real part lower than $\max\{\alpha_k; \alpha_k \leq \alpha\}$ if $\varphi \in \Pi_\alpha L^2(\Omega)$. From Theorem 2.17, we have the following spectral inequality : there exist positive constants C, D such that for every positive α , for all $\varphi \in \Pi_\alpha L^2(\Omega)$ (the dual space $\Pi_\alpha^* L^2(\Omega)$ does not play any role here),

$$\|\varphi\|_{L^2(\Omega)} \leq C e^{D\alpha^\theta} \|\varphi\|_{L^2(\omega)}, \quad \theta = \max \left\{ \frac{1}{2}; \frac{n+d}{2} - 1 \right\}. \quad (2.42)$$

Assume now that Ω is real-analytic, and, moreover the differential operator $P(x, D)$ has real-analytic coefficients. Under these conditions, the operator $-\partial_t^2 + A$ is real-analytic hypoelliptic on $\mathbb{R} \times \Omega$ [Tre80, Theorem 5.4], and $\varphi \in \Pi_\alpha L^2(\Omega)$ implies that φ is real-analytic. We denote by \mathcal{H}_{n-1} the $(n-1)$ -dimensional Hausdorff measure on Ω . We can now state the analogous of the result of Jerison and Lebeau [JL99] for the class of non-selfadjoint elliptic operators we consider.

Theorem 2.39. *For every level set $K \in \mathbb{R}$, there exist positive constants C_1, C_2 such that for all $\alpha > 0$ and $\varphi \in \Pi_\alpha L^2(\Omega)$,*

$$\mathcal{H}_{n-1}(\{\varphi = K\}) \leq C_1 \alpha^\theta + C_2, \quad \theta = \max \left\{ \frac{1}{2}; \frac{n+d}{2} - 1 \right\}. \quad (2.43)$$

The proof follows exactly the same of [JL99] and uses arguments from [DF88] and [DF90].

This estimations (2.42) and (2.43) are known to be optimal for the Laplace operator, with $\theta = 1/2$, see [JL99]. As a consequence, one cannot hope to have better estimates in the cases where $\frac{n+d}{2} - 1 \leq \frac{1}{2}$, i.e. $n \leq 3$ if $A = -\Delta + c(x)$ and $n \leq 2$ if $A = -\Delta + b(x) \cdot \nabla + c(x)$.

However in the case $\frac{n+d}{2} - 1 > \frac{1}{2}$, the results (2.42), (2.43) do not seem to be optimal.

2.8 Appendix

2.8.1 Properties of the Gevrey function $e \in G^\sigma$, $1 < \sigma < 2$

Here, we prove the existence of the Gevrey function e that is needed in the proof of Proposition 2.22.

Lemma 2.40. *For every $\sigma > 1$, $B_0 > 0$ and $\kappa \leq 1 - \frac{1}{2\sigma}$, there exists a Gevrey function $e \in G^\sigma$ such that*

(i) $\text{supp}(e) = [0, 1]$ and $0 < e(t) \leq 1$ for all $t \in (0, 1)$;

(ii) $|\hat{e}(z)| \leq c_1 e^{-c_2 |z|^{\frac{1}{\sigma}}}$ if $\text{Im}(z) \leq 0$

(iii) $|\hat{e}(z)| \geq c_3 e^{-c_4 |z|^{\frac{1}{\sigma}}}$ in $-i\mathcal{P}_{B_0}^\kappa$

where the constants c_i are positive and $-i\mathcal{P}_{B_0}^\kappa = -i\{z \in \mathbb{C}, \text{Re}(z) \geq 0, |\text{Im}(z)| < B_0 \text{Re}(z)^\kappa\}$.

Proof. The function

$$e_0(t) = \exp \left(-t^{\frac{-1}{\sigma-1}} - (1-t)^{\frac{-1}{\sigma-1}} \right)$$

is in G^σ and satisfies the properties (i) and (ii).

We aim to prove a lower bound for $|\hat{e}_0(z)|$ as $|z| \rightarrow \infty$ in the parabola $-i\mathcal{P}_{B_0}^\kappa$. To have a precise estimation, we develop in detail the Laplace method, following [Erd56]. Let κ and B_0 two positive

integers. For $\beta < B_0$, we estimate

$$\begin{aligned}\hat{e}_0(-i(s + i\beta s^\kappa)) &= \int_0^1 \exp\left(-t^{\frac{-1}{\sigma-1}} - (1-t)^{\frac{-1}{\sigma-1}}\right) \exp(-(s + i\beta s^\kappa)t) dt \\ &= \int_0^s \frac{\sigma-1}{\sigma} \exp\left(s^{\frac{1}{\sigma}}(-u^{\frac{-1}{\sigma-1}} - u)\right) \exp\left(-(1 - s^{-\frac{\sigma-1}{\sigma}}u)^{-\frac{1}{\sigma-1}} - i\beta u s^{\kappa + \frac{1}{\sigma} - 1}\right) s^{-\frac{\sigma-1}{\sigma}} du\end{aligned}$$

after the rescaling change of variable $t = s^{-\frac{\sigma-1}{\sigma}}u$. We then set $\omega = s^{\frac{1}{\sigma}}$ the increasing parameter, $h(u) = -u^{\frac{-1}{\sigma-1}} - u$ and

$$g_\beta(\omega, u) = \exp\left(-\left(1 - \omega^{-(\sigma-1)}u\right)^{-\frac{1}{\sigma-1}} - i\beta\omega u^{1+\sigma(\kappa-1)}\right),$$

such that we write

$$\hat{e}_0(-i(s + i\beta s^\kappa)) = I(\omega, \beta) = \int_0^{\omega^{\sigma-1}} \omega^{-(\sigma-1)} e^{\omega h(u)} g_\beta(\omega, u) du.$$

The function $h(u)$ is negative on \mathbb{R}_{+*} , concave and $h(u) < h(a) < 0$ for $u \neq a$ with $a = (\sigma-1)^{-\frac{\sigma-1}{\sigma}} > 0$.

Following the Laplace method, we then split the integral $I(\omega, \beta)$ in three parts. The most important contribution comes from the region where h reaches its maximum. We write

$$I(\omega, \beta) = \omega^{-(\sigma-1)}(I_1(\omega, \beta) + I_2(\omega, \beta) + I_3(\omega, \beta)), \quad (2.44)$$

with

$$\begin{aligned}I_1(\omega, \beta) &= \int_0^{a-\eta} e^{\omega h(u)} g_\beta(\omega, u) du, \quad I_2(\omega, \beta) = \int_{a-\eta}^{a+\eta} e^{\omega h(u)} g_\beta(\omega, u) du \\ I_3(\omega, \beta) &= \int_{a+\eta}^{\omega^{\sigma-1}} e^{\omega h(u)} g_\beta(\omega, u) du\end{aligned} \quad (2.45)$$

for $\eta > 0$, sufficiently small, that will be fixed below.

We first treat the main contribution I_2 : Morse Lemma [GS94] implies that for η sufficiently small, there exists two positive constants ν_1 and ν_2 and a diffeomorphism $\mathcal{H}: (a - \eta, a + \eta) \rightarrow (-\nu_1, \nu_2)$ such that $h \circ \mathcal{H}^{-1}(x) = h(a) - \frac{x^2}{2}$ for $x \in (-\nu_1, \nu_2)$. Moreover, the jacobian $J(x) = |\det(d\mathcal{H}^{-1})|(x)$ satisfies $J(0)^2 = |h''(a)|^{-1}$.

With this change of variable, we obtain

$$I_2(\omega, \beta) = \int_{-\nu_1}^{\nu_2} g_\beta(\omega, \mathcal{H}^{-1}(x)) e^{\omega h(a) - \frac{\omega x^2}{2}} J(x) dx.$$

Setting $y = \sqrt{\frac{\omega}{2}}x$, we obtain

$$I_2(\omega, \beta) = \sqrt{\frac{2}{\omega}} e^{\omega h(a)} \int_{\mathbb{R}} \mathbf{1}_{(-\nu_1, \nu_2)}\left(\sqrt{\frac{2}{\omega}}y\right) J\left(\sqrt{\frac{2}{\omega}}y\right) g_\beta\left(\omega, \mathcal{H}^{-1}\left(\sqrt{\frac{2}{\omega}}y\right)\right) e^{-y^2} dy.$$

The modulus of the integrand is clearly bounded on \mathbb{R} by Ce^{-y^2} , independent of ω and integrable. Let us study the asymptotics of the integrand as $\omega \rightarrow +\infty$.

$$\begin{aligned}g_\beta\left(\omega, \mathcal{H}^{-1}\left(\sqrt{\frac{2}{\omega}}y\right)\right) &= \exp\left(-\left(1 - \omega^{-(\sigma-1)}\mathcal{H}^{-1}\left(\sqrt{\frac{2}{\omega}}y\right)\right)^{-\frac{1}{\sigma-1}}\right) \\ &\quad \times \exp\left(-i\beta\mathcal{H}^{-1}\left(\sqrt{\frac{2}{\omega}}y\right)\omega^{1+\sigma(\kappa-1)}\right).\end{aligned}$$

The first exponential converges when $\omega \rightarrow +\infty$. In fact, setting

$$\psi(\omega, y) = \mathbb{1}_{(-\nu_1, \nu_2)} \left(\sqrt{\frac{2}{\omega}} y \right) J \left(\sqrt{\frac{2}{\omega}} y \right) \exp \left(- \left(1 - \omega^{-(\sigma-1)} \mathcal{H}^{-1} \left(\sqrt{\frac{2}{\omega}} y \right) \right)^{-\frac{1}{\sigma-1}} \right),$$

we have

$$\psi(\omega, y) \longrightarrow e^{-1} J(0) = e^{-1} |h''(a)|^{-\frac{1}{2}}, \quad \text{as } \omega \rightarrow +\infty.$$

For the second exponential in g_β (the oscillating part), as $\mathcal{H}^{-1}(0) = a$, we write $\mathcal{H}^{-1}(x) = a + xK(x)$ where $K \in \mathcal{C}^\infty(\mathbb{R})$ and we have

$$\begin{aligned} \exp \left(-i\beta \mathcal{H}^{-1} \left(\sqrt{\frac{2}{\omega}} y \right) \omega^{1+\sigma(\kappa-1)} \right) &= \exp \left(-i\beta \omega^{1+\sigma(\kappa-1)} \left(a + \sqrt{\frac{2}{\omega}} y K \left(\sqrt{\frac{2}{\omega}} y \right) \right) \right) \\ &= \exp \left(-i\beta \omega^{1+\sigma(\kappa-1)} a \right) \exp \left(-i\sqrt{2}\beta \omega^{\frac{1}{2}+\sigma(\kappa-1)} y K \left(\sqrt{\frac{2}{\omega}} y \right) \right). \end{aligned}$$

We may thus write

$$I_2(\omega, \beta) = \sqrt{\frac{2}{\omega}} e^{\omega h(a)} \exp \left(-i\beta \omega^{1+\sigma(\kappa-1)} a \right) \tilde{I}_2(\omega, \beta),$$

where

$$\tilde{I}_2(\omega, \beta) = \int_{\mathbb{R}} \psi(\omega, y) \exp \left(-i\sqrt{2}\beta \omega^{\frac{1}{2}+\sigma(\kappa-1)} y K \left(\sqrt{\frac{2}{\omega}} y \right) \right) e^{-y^2} dy.$$

The integrand in $\tilde{I}_2(\omega, \beta)$ converges as $\omega \rightarrow +\infty$ under the condition $\frac{1}{2} + \sigma(\kappa-1) \leq 0$. By summated convergence, we have

$$\tilde{I}_2(\omega, \beta) \longrightarrow L(\beta) = \frac{\sqrt{\pi}}{e} |h''(a)|^{-\frac{1}{2}}, \quad \text{if } \frac{1}{2} + \sigma(\kappa-1) < 0,$$

and

$$\tilde{I}_2(\omega, \beta) \longrightarrow L(\beta) = \frac{\sqrt{\pi}}{e} |h''(a)|^{-\frac{1}{2}} \exp \left(-\frac{\beta^2 K(0)^2}{2} \right), \quad \text{if } \frac{1}{2} + \sigma(\kappa-1) = 0.$$

Moreover, similar arguments show that $\tilde{I}_2(\omega, \beta) - L(\beta)$ is $\mathcal{C}^1([-B_0, B_0])$ with respect to the variable β . Then there exists k_0 such that for every ω sufficiently large

$$\left| \frac{\partial(\tilde{I}_2 - L)}{\partial \beta}(\omega, \beta) \right| \leq k_0, \quad \beta \in [-B_0, B_0].$$

Thus, $\tilde{I}_2 - L$ is uniformly Lipschitz with respect to the variable β and tends to zero for every fixed β as $\omega \rightarrow +\infty$. Lemma 2.41 below implies that for all $\varepsilon > 0$, there exists $\omega_0 > 0$ such that $|\tilde{I}_2(\omega, \beta) - L(\beta)| < \varepsilon$ for $\omega > \omega_0$ and $\beta \in [-B_0, B_0]$.

We now address the terms I_1 and I_3 in (2.45). As $h(u) < h(a) < 0$ for $u \neq a$, we can write $h(a - \eta) = h(a) - C_-$ and $h(a + \eta) = h(a) - C_+$ with $C_+, C_- > 0$, depending only on η . Because h increases on $(0, a]$, decreases on $[a, +\infty)$, and $|g_\beta| \leq 1$, we have

$$|I_1(\omega, \beta)| \leq a e^{\omega h(a)} e^{-\omega C_-}, \quad |I_3(\omega, \beta)| \leq \omega^{\sigma-1} e^{\omega h(a)} e^{-\omega C_+}.$$

Finally, for every fixed $\kappa \leq 1 - \frac{1}{2\sigma}$, we can write

$$I(\omega, \beta) = \sqrt{2}\omega^{\frac{1}{2}-\sigma} e^{\omega h(a)} \left(\exp \left(-i\beta \omega^{1+\sigma(\kappa-1)} a \right) \tilde{I}_2(\omega, \beta) + D(\omega, \beta) \right)$$

with $|D(\omega, \beta)| \leq C\omega^{\sigma-\frac{1}{2}}e^{-C\pm\omega}$ and \tilde{I}_2 converging to a non-zero limit uniformly in β .

As a consequence, there exist $C_1, C_2 > 0$ and $\omega_0 > 0$ such that

$$|I(\omega, \beta)| \geq C_1 e^{-C_2\omega}, \quad \omega > \omega_0, \quad \beta \in [-B_0, B_0].$$

Switching back to the variable $s = \omega^\sigma$, we then have for some $s_0 > 0$

$$|\hat{e}_0(-i(s + i\beta s^\kappa))| \geq C_1 e^{-C_2 s^{\frac{1}{\sigma}}}, \quad s > s_0, \quad \beta \in [-B_0, B_0].$$

To conclude the lemma, we now set $e(t) = e^{-s_0 t} e_0(t)$ that is also in G^σ and satisfies property (i). For $z \in \mathbb{C}$, we have $\hat{e}(z) = \hat{e}_0(z - is_0)$ and (ii) holds. Property (iii) follows from what precedes. \square

Lemma 2.41. *Let K be a compact set and $I(\omega, x)$ a function defined on $\mathbb{R}_+ \times K$, that is uniformly Lipschitz on $\mathbb{R}_+ \times K$ with respect to the variable $x \in K$, i.e.,*

$$\exists k_0 > 0, \quad |I(\omega, x_2) - I(\omega, x_1)| \leq k_0 |x_2 - x_1|, \quad \omega \in \mathbb{R}_+, \quad x_1, x_2 \in K.$$

If for every $x \in K$, $\lim_{\omega \rightarrow +\infty} I(\omega, x) = 0$, then $\lim_{\omega \rightarrow +\infty} \max_{x \in K} I(\omega, x) = 0$.

2.8.2 A Paley-Wiener-type theorem

Here we prove a Paley-Wiener-type theorem adapted to the situation of Proposition 2.22

Proposition 2.42. *Let Y be a separable Hilbert space and $f \in \mathcal{H}(\mathbb{C}; Y)$ satisfying for positive constants C_N, C_ε :*

$$\|f(z)\|_Y \leq C_\varepsilon e^{\varepsilon|z|} e^{T \operatorname{Im}(z)}, \quad \forall \varepsilon > 0, z \in \mathbb{C}; \quad (2.46)$$

$$\|f(\tau)\|_Y \leq C_N (1 + |\tau|)^{-N}, \quad \forall N \in \mathbb{N}, \tau \in \mathbb{R}. \quad (2.47)$$

Then, there exists $u \in \mathcal{C}_c^\infty(0, T; Y)$ such that $\hat{u}(z) = f(z)$, $z \in \mathbb{C}$.

Proof. Let $(e_j)_{j \in \mathbb{N}}$ be a Hilbert basis of Y . For every j , $z \mapsto (f(z), e_j)_Y \in \mathcal{H}(\mathbb{C}; \mathbb{C})$. Equation (2.46) gives $|(f(z), e_j)_Y| \leq C_\varepsilon e^{\varepsilon|z|} e^{T \operatorname{Im}(z)}$, $\forall \varepsilon > 0, z \in \mathbb{C}$, and the Paley-Wiener theorem [Hör83, Theorem 15.1.5] then implies that there exists an analytic functional u_j carried by $(0, T)$ (see [Hör90, Chapter 9] for a precise definition) such that $\hat{u}_j(z) = (f(z), e_j)_Y$, $z \in \mathbb{C}$. Moreover, (2.47) yields $|\hat{u}_j(\tau)| \leq C_N (1 + |\tau|)^{-N}$, $\forall N \in \mathbb{N}, \tau \in \mathbb{R}$ and thus, $u_j \in \mathcal{C}_c^\infty(0, T; \mathbb{C})$.

We now set $u = \sum_{j \in \mathbb{N}} u_j e_j$ and observe that $u \in L^2(\mathbb{R}; Y)$

$$\|u\|_{L^2(\mathbb{R}; Y)}^2 = \sum_{j \in \mathbb{N}} \|u_j\|_{L^2(\mathbb{R})}^2 = \frac{1}{2\pi} \sum_{j \in \mathbb{N}} \|\hat{u}_j\|_{L^2(\mathbb{R})}^2 = \frac{1}{2\pi} \sum_{j \in \mathbb{N}} \|(f(\cdot), e_j)_Y\|_{L^2(\mathbb{R})}^2 = \frac{1}{2\pi} \|f\|_{L^2(\mathbb{R}; Y)}^2.$$

We note that $\operatorname{supp}(u) \subset (0, T)$ since $\operatorname{supp}(u_j) \subset (0, T)$ for all $j \in \mathbb{N}$. Hence the Fourier-Laplace transform of u is an entire function, satisfying, for $z \in \mathbb{C}$

$$(\hat{u}(z), e_k)_Y = \left(\int_0^T \sum_{j \in \mathbb{N}} u_j(t) e^{-itz} e_j dt, e_k \right)_Y = \int_0^T \sum_{j \in \mathbb{N}} u_j(t) e^{-itz} (e_j, e_k)_Y dt = \hat{u}_k(z).$$

Thus,

$$\hat{u}(z) = \sum_{j \in \mathbb{N}} \hat{u}_j(z) e_j = \sum_{j \in \mathbb{N}} (f(z), e_j)_Y e_j = f(z)$$

and f is the Fourier-Laplace of u . Finally, (2.47) yields $\|\hat{u}(\tau)\|_Y \leq C_N (1 + |\tau|)^{-N}$, $\forall N \in \mathbb{N}, \tau \in \mathbb{R}$ and thus $u \in \mathcal{C}^\infty$. \square

Chapitre 3

Analyse et contrôle d'un modèle d'interface diffusive

Contents

3.1	Introduction	96
3.1.1	Setting	97
3.1.2	Statement of the main results	98
3.1.3	Some additional results and remarks	101
3.1.4	Notation : semi-classical operators and geometrical setting	103
3.2	Well-posedness and asymptotic behavior	106
3.2.1	Well-posedness	106
3.2.2	Asymptotic behavior of the solutions as $\delta \rightarrow 0$	108
3.3	Local setting in a neighborhood of the interface	111
3.3.1	Properties of the weight functions	112
3.3.2	A system formulation	113
3.3.3	Conjugation by the weight function	113
3.3.4	Phase-space regions	114
3.3.5	Root properties	116
3.3.6	Microlocalisation operators	117
3.4	Proof of the Carleman estimate in a neighborhood of the interface	118
3.4.1	Preliminary observations	119
3.4.2	Estimate in the region \mathcal{G}	120
3.4.3	Estimate in the region \mathcal{F}	125
3.4.4	Estimate in the region \mathcal{L}	126
3.4.5	Estimate in the region \mathcal{E}	131
3.4.6	A semi-global Carleman estimate : proof of Theorem 3.2	134
3.5	Interpolation and spectral inequalities	136
3.5.1	Interpolation inequality	136
3.5.2	Spectral inequality	140
3.6	Derivation of the model	141
3.6.1	A first-order model	143
3.6.2	A zero-order model	145
3.7	Facts on semi-classical operators	145
3.7.1	Results for tangential semi-classical operators on \mathbb{R}^d , $d \geq 2$	145
3.7.2	Semi-classical (tangential) operators on a manifold	147
3.7.3	A particular class of semi-classical operators on \mathcal{M}_+	149
3.8	Proofs of some technical results	150

3.8.1	Proof of Lemma 3.8	150
3.8.2	Proof of Proposition 3.11	151
3.8.3	Proof of Proposition 3.12	153
3.8.4	Proof of Lemma 3.24	154
3.8.5	Proof of Lemma 3.26	155
3.8.6	Proof of Lemma 3.29	155
3.8.7	Proof of Lemma 3.32	156
3.8.8	Proof of Lemma 3.34	157
3.8.9	Proof of Theorem 3.39 : change of variables for semi-classical operators	157
3.8.10	Proof of Proposition 3.45	162
3.8.11	Proof of Proposition 3.46	162
3.8.12	Proof of Proposition 3.48	163
3.8.13	Proof of Proposition 3.50	164

Ce chapitre est la reprise de l'article [LLR11] en collaboration avec Jérôme Le Rousseau et Luc Robbiano, soumis pour publication.

3.1 Introduction

When considering elliptic and parabolic operators in \mathbb{R}^n with a diffusion coefficient that jumps across an interface of codimension one, say $\{x_n = 0\}$, we can interpret the associated equations as two equations with solutions that are coupled at the interface via transmission conditions at $x_n = 0$, viz. in the parabolic case,

$$\partial_t y_1 + \nabla_x c_1 \nabla_x y_1 = f_1 \text{ in } \{x_n < 0\}, \quad \partial_t y_2 + \nabla_x c_2 \nabla_x y_2 = f_2 \text{ in } \{x_n > 0\}, \quad (3.1)$$

and

$$y_1|_{x_n=0^-} = y_2|_{x_n=0^+}, \quad c_1 \partial_{x_n} y_1|_{x_n=0^-} = c_2 \partial_{x_n} y_2|_{x_n=0^+}. \quad (3.2)$$

Here, we are interested in parabolic/elliptic models in which part of the diffusion occurs along the interface. Then the transmission conditions are of higher order, involving differentiations in the direction of the interface. Such a model can be viewed as an idealization of two diffusive media separated by a thin membrane. We derive this model starting from three media and formally letting the thickness of the intermediate layer become very small. We introduce a small parameter $\delta > 0$ that measures the thickness of this layer. Questions such as unique continuation, observation and controllability are natural for such a model. This is the main goal of the present article.

Most of the analysis that we shall carry concerns a related elliptic operator, including an additional variable. Our key result is the derivation of a Carleman estimate for this operator (see Theorem 3.2 below). The general form of Carleman estimates for a second-order elliptic operator P is (local form)

$$h \|e^{\varphi/h} w\|_{L^2}^2 + h^3 \|e^{\varphi/h} \nabla w\|_{L^2}^2 \leq Ch^4 \|e^{\varphi/h} Pw\|_{L^2}^2, \quad (3.3)$$

for h sufficiently small, an appropriately chosen weight function φ , and for smooth compactly supported functions w . We then deduce an interpolation inequality and a spectral inequality for the original operator in the spirit of the work [LR95]. This spectral inequality then yields the null controllability of the considered parabolic system. A important feature of the results we obtain here is their uniformity in the thickness parameter δ . In particular this allows us to recover the earlier results obtained on (3.1)–(3.2) in [LR10]; this corresponds to the limit $\delta \rightarrow 0$ in the model we consider here.

3.1.1 Setting

Let (Ω, g) be a smooth compact n -dimensional ($n \geq 2$) connected Riemannian manifold (with or without boundary), with g denoting the metric, and S a $n - 1$ -dimensional smooth submanifold of Ω (without boundary). We assume⁵ that $\Omega \setminus S = \Omega_1 \cup \Omega_2$ with $\Omega_1 \cap \Omega_2 = \emptyset$, so that Ω_1 and Ω_2 are two smooth open subsets of Ω . Endowed with the metric $g|_{T(S)}$, S has a Riemannian structure. We denote by ∂_η a non vanishing vector field defined in a neighborhood of S and normal to S (for the Riemannian metric). We choose the vector field ∂_η outgoing from Ω_1 , incoming in Ω_2 . In local coordinates, we have

$$\partial_\eta = \sum_j \eta^j \partial_{x_j}, \quad \text{with } \eta^j = \lambda \sum_k n_k g^{jk}, \quad |\eta|_g = 1,$$

where $g^{ij} g_{jk} = \delta_k^i$, $\lambda^2 = (g^{ij} n_i n_j)^{-1}$, and n is the normal to S for the Euclidean metric in the local coordinates, outgoing from Ω_1 , incoming in Ω_2 . In fact $\lambda^2_S = \det(g) / \det(g|_{T(S)})$ at S .

The covariant gradient and the divergence operators are given in local coordinates by

$$\nabla_g = \sum_i g^{ij} \partial_{x_i}, \quad \operatorname{div}_g v = \frac{1}{\sqrt{\det(g)}} \sum_i \partial_{x_i} (\sqrt{\det(g)} v_i),$$

with similar definition for the gradient $\nabla^s = \nabla_{g|_{T(S)}}$ and divergence $\operatorname{div}^s = \operatorname{div}_{g|_{T(S)}}$ on the interface S with the metric $g|_{T(S)}$.

We consider a (scalar) diffusion coefficient $c(x)$ with $c|_{\Omega_i} \in \mathcal{C}^\infty(\overline{\Omega_i})$, $i = 1, 2$, yet discontinuous across S and satisfies $c(x) \geq c_{\min} > 0$ uniformly for $x \in \Omega_1 \cup \Omega_2$. We set

$$\Delta_c = \operatorname{div}_g c(x) \nabla_g = \frac{1}{\sqrt{\det(g)}} \sum_{i,j} \partial_{x_i} (c g^{ij} \sqrt{\det(g)} \partial_{x_j}), \quad \text{in } \Omega_1 \cup \Omega_2,$$

in local coordinates. Let us denote c^s a smooth (scalar) diffusion coefficient on S satisfying $c^s(x) \geq c_{\min}^s > 0$. Similarly we define $\Delta_{c^s} = \operatorname{div}^s c^s \nabla^s$ as a second-order elliptic differential operator on S .

In what follows, we shall use the notation $z|_{S_j} = (z|_{\Omega_j})|_S$, $j = 1, 2$, for the traces of functions on S .

Given a time $T > 0$, we consider the following parabolic control problem

$$\begin{cases} \partial_t z - \Delta_c z = \mathbf{1}_\omega u & \text{in } (0, T) \times \Omega_1 \cup \Omega_2, \\ \partial_t z^s - \Delta_{c^s} z^s = \frac{1}{\delta} ((c \partial_\eta z)|_{S_2} - (c \partial_\eta z)|_{S_1}) & \text{in } (0, T) \times S, \\ z|_{S_1} = z^s = z|_{S_2} & \text{in } (0, T) \times S, \\ z|_{\partial\Omega} = 0; \end{cases} \quad (3.4)$$

with some initial data in $L^2(\Omega_1 \cup \Omega_2) \times L^2(S)$. Here, δ denotes a *bounded* parameter, $0 < \delta \leq \delta_0$, and ω is an open nonempty subset of $\Omega_1 \cup \Omega_2$. Let us suppose for instance that $\omega \subset \Omega_2$. The function u is a control function and the null-controllability problem concerns the ability to drive the solution (z, z^s) to zero at the final time T .

Such a coupling condition at the interface was considered in [KZ06] and [LZ10] for the associated hyperbolic system. In Appendix 3.6, we briefly explain how this model can be formally derived. This model corresponds to two diffusive media separated by a thin layer in which diffusion also occurs. The parameter δ is then a measure of the thickness of this intermediate layer. In the derivation of the model δ is assumed small.

We present here some function spaces and operators and their basic properties to formulate Problem (3.4) in a more abstract way. The reader is referred to Section 3.2 for the details. We introduce the Hilbert space $\mathcal{H}_\delta^0 = L^2(\Omega_1 \cup \Omega_2) \times L^2(S)$ with the inner product

$$(Z, \tilde{Z})_{\mathcal{H}_\delta^0} = (z, \tilde{z})_{L^2(\Omega_1 \cup \Omega_2)} + \delta (z^s, \tilde{z}^s)_{L^2(S)}, \quad Z = (z, z^s), \quad \tilde{Z} = (\tilde{z}, \tilde{z}^s),$$

⁵. other geometrical situations can be dealt with because of the local nature of the estimates we prove here. See Section 3.1.3.2 below.

where

$$(z, \tilde{z})_{L^2(\Omega_1 \cup \Omega_2)} = \int_{\Omega_1 \cup \Omega_2} z \bar{\tilde{z}} \, d\nu, \quad (z^s, \tilde{z}^s)_{L^2(S)} = \int_S z^s \bar{\tilde{z}^s} \, d\nu^s, \quad (3.5)$$

with $d\nu = \sqrt{\det(g)} \, dx$ and $d\nu^s = \sqrt{\det(g|_{T(S)})} \, dy$. We also introduce the following Hilbert space

$$\mathcal{H}_\delta^1 = \{Z = (z, z^s) \in H^1(\Omega_1 \cup \Omega_2) \times H^1(S); z|_{\partial\Omega} = 0; z|_{S_1} = z^s = z|_{S_2}\}, \quad (3.6)$$

with the inner product

$$(Z, \tilde{Z})_{\mathcal{H}_\delta^1} = (Z, \tilde{Z})_{\mathcal{H}_\delta^0} + (c\nabla_g z, \nabla_g \tilde{z})_{L^2(\Omega_1 \cup \Omega_2)} + \delta (c^s \nabla^s z, \nabla^s \tilde{z}^s)_{L^2(S)}, \quad Z = (z, z^s), \tilde{Z} = (\tilde{z}, \tilde{z}^s).$$

Problem (3.4) can be written as

$$\partial_t Z + A_\delta Z = Bu, \quad (3.7)$$

where the state is $Z = (z, z^s) \in \mathcal{H}_\delta^0$ and the operator A_δ reads

$$A_\delta Z = \begin{pmatrix} -\Delta_c z & -\Delta_c z \\ -\Delta_{c^s} z^s - \frac{1}{\delta} ((c\partial_\eta z)|_{S_2} - (c\partial_\eta z)|_{S_1}) & \end{pmatrix}, \quad (3.8)$$

with domain

$$D(A_\delta) = \{(z, z^s) \in \mathcal{H}_\delta^1; A_\delta(z, z^s) \in \mathcal{H}_\delta^0\}. \quad (3.9)$$

The operator $(A_\delta, D(A_\delta))$ is nonnegative self-adjoint on \mathcal{H}_δ^0 . The control operator B is the bounded operator from $L^2(\Omega_1 \cup \Omega_2)$ into $L^2(\Omega_1 \cup \Omega_2) \times L^2(S)$ given by $B : u \mapsto {}^t(\mathbb{1}_\omega u, 0)$. We shall prove that System (3.7), i.e. System (3.4), is well-posed for an initial condition in \mathcal{H}_δ^0 .

Remark 3.1. In the limit $\delta \rightarrow 0$, from System (3.4), we obtain the following system (see Section 3.2.2 for a proof of convergence)

$$\begin{cases} \partial_t z - \Delta_c z = \mathbb{1}_\omega u & \text{in } (0, T) \times \Omega_1 \cup \Omega_2, \\ (c\partial_\eta z)|_{S_2} = (c\partial_\eta z)|_{S_1} \text{ and } z|_{S_1} = z|_{S_2} & \text{in } (0, T) \times S, \\ z|_{\partial\Omega} = 0; \end{cases} \quad (3.10)$$

which corresponds to the case studied in [LR10]. We also refer to the recent works [DOP02, BDL07a, Le 07a, BDL07b, BGLR07, LR11, LL10, BDL11] for the derivation of Carleman estimates for elliptic and parabolic operators with such coefficients with applications to controllability and inverse problems.

3.1.2 Statement of the main results

3.1.2.1 Carleman estimate

The Carleman estimate we prove concerns an augmented elliptic operator : we introduce an additional coordinate, $x_0 \in (0, X_0) \subset \mathbb{R}$, so that $(x_0, x) \in (0, X_0) \times \Omega$. This variable x_0 was introduced in [LR95]; there it allowed to obtain the null-controllability of the heat equation. This approach was followed in several works [LZ98, JL99, LR10]. It was also used to prove stabilization properties of the wave equation [Leb96, LR97].

We consider the $n + 1$ -dimensional partially determined elliptic problem

$$\begin{cases} -\partial_{x_0}^2 w - \Delta_c w + \nabla_a w + bw = f & \text{in } (0, X_0) \times (\Omega_1 \cup \Omega_2), \\ -\partial_{x_0}^2 w^s - \Delta_{c^s} w^s + \nabla_a^s w^s + b^s w^s \\ \quad = \frac{1}{\delta} ((c\partial_\eta w)|_{(0, X_0) \times S_2} - (c\partial_\eta w)|_{(0, X_0) \times S_1} + \theta^s) & \text{in } (0, X_0) \times S, \\ w|_{(0, X_0) \times S_1} = w^s + \theta^1 \text{ and } w|_{(0, X_0) \times S_2} = w^s + \theta^2 & \text{in } (0, X_0) \times S. \end{cases} \quad (3.11)$$

Note that we add lower-order terms to the elliptic operators here : ∇_a (resp. ∇_a^s) denotes any smooth vector field on $\Omega_1 \cup \Omega_2$ (resp. S) and b (resp. b^s) are some bounded functions on $\Omega_1 \cup \Omega_2$

(resp. S). Moreover, we include source terms θ^j , $j = 1, 2$, θ^s at the interface through the transmission conditions. This system is not fully determined as we do not prescribe any boundary condition on $\{0\} \times \Omega$ and $\{X_0\} \times \Omega$.

In Section 3.3, we introduce a small neighborhood V_ε of S in Ω , where we can use coordinates of the form (y, x_n) with $y \in S$ and $x_n \in [-2\varepsilon, 2\varepsilon]$. We then set $\mathcal{M} = (0, X_0) \times V_\varepsilon$ and $\mathcal{M}_j = \mathcal{M} \cap ((0, X_0) \times \Omega_j)$, $j = 1, 2$.

For a properly chosen weight function φ (see Section 3.3.1), for some $0 < \alpha_0 < X_0/2$, and a cut-off function $\zeta = \zeta(x_n) \in \mathcal{C}_c^\infty([0, 2\varepsilon])$, with $\zeta = 1$ on $[0, \varepsilon]$, we shall prove the following theorem.

Theorem 3.2. *For all $\delta_0 > 0$, there exist $C > 0$, and $h_0 > 0$ such that*

$$\begin{aligned} & h \|e^{\varphi/h} w\|_0^2 + h^3 \|e^{\varphi/h} \nabla_{x_0, x} w\|_0^2 + h \sum_{j=1,2} |e^{\varphi/h} w|_{S_j}|_0^2 + h^3 \sum_{j=1,2} |e^{\varphi/h} \nabla_{x_0, x} w|_{S_j}|_0^2 \\ & \leq C \left(h^4 \|e^{\varphi/h} f_{|\mathcal{M}_1}\|_0^2 + h^4 \|e^{\varphi/h} f_{|\mathcal{M}_2}\|_0^2 + h^2 \delta^2 \|\zeta e^{\varphi/h} f_{|\mathcal{M}_2}\|_0^2 \right. \\ & \left. + h |e^{\varphi/h} \theta^1|_0^2 + \left(h + \frac{\delta^2}{h} \right) |e^{\varphi/h} \theta^2|_0^2 + h^3 |e^{\varphi/h} \nabla_{x_0, S} \theta^1|_0^2 + h^3 |e^{\varphi/h} \nabla_{x_0, S} \theta^2|_0^2 + h^3 |e^{\varphi/h} \theta^s|_0^2 \right), \end{aligned} \quad (3.12)$$

for all $0 < \delta < \delta_0$, $0 < h \leq h_0$, for $(w, \theta^1, \theta^2, \theta^s, f)$ satisfying (3.11), $w|_{\mathcal{M}_j} \in \mathcal{C}^\infty(\overline{\mathcal{M}_j})$, and $w^s \in \mathcal{C}^\infty((0, X_0) \times S)$ with

$$\text{supp}(w) \subset (\alpha_0, X_0 - \alpha_0) \times S \times (-2\varepsilon, 2\varepsilon), \quad \text{supp}(w^s) \subset (\alpha_0, X_0 - \alpha_0) \times S.$$

Here $\nabla_{x_0, x} = (\partial_{x_0}, \nabla_g)^t$, $\nabla_{x_0, S} = (\partial_{x_0}, \nabla^s)^t$ and $\|\cdot\|_0, |\cdot|_0$ are L^2 -norms on \mathcal{M} and $(0, X_0) \times S$ respectively. The weight function φ will be chosen increasing when crossing S from \mathcal{M}_1 to \mathcal{M}_2 , which corresponds to an observation on the side $(0, X_0) \times \Omega_2$. Observe the non symmetric form of the r.h.s. of the estimate above. This originates from our choice of observing the solution w in $(0, X_0) \times \Omega_2$.

This type of Carleman estimate is well known away from the interface S (see [Hör63], and [LR95] for an estimate at the Dirichlet boundary $\partial\Omega$).

Remark 3.3. The additional variable x_0 is used here to obtain the spectral inequality of Theorem 3.5 below. The same Carleman inequality holds for the operator A_δ . The proof can be adapted from that of Theorem 3.12. In fact, without the additional variable, the proof becomes less involved.

The Carleman estimate of Theorem 3.2 exhibits the loss of a half derivative apart from one term in the r.h.s. (see below). Usually, one proves such Carleman estimates locally in a neighborhood of a point, for instance using local coordinates, treating only the principal part of the operator. Next, one includes lower order terms in the operator, exploiting that the associated contributions can be absorbed thanks to the coefficients h^α of the terms in the l.h.s. of the Carleman estimate⁶. Finally, one patches these estimates together if a global estimate is needed. This can be achieved again thanks to the precise powers of h in all the terms. For a review of these derivations see for example [LL09].

At the interface, for technical reasons, the powers of h obtained in the following terms in the r.h.s. of (3.12) are

$$h^2 \delta^2 \|\zeta e^{\varphi/h} f_{|\mathcal{M}_2}\|_0^2 + \frac{\delta^2}{h} |e^{\varphi/h} \theta^2|_0^2.$$

For the first term this corresponds in fact to a loss of one and a half derivative. We do not know if they are optimal or not. If we simply prove the Carleman estimate in the neighborhood of a point, because of the powers of h in these terms such local estimates cannot be patched together. The obstruction originates from the diffusion that occurs in the $(n-1)$ -dimensional submanifold S through the operator Δ_{e^s} . Note that this obstruction naturally disappears in the limit $\delta \rightarrow 0$.

Our strategy will thus differ from what is done classically. The estimate of Theorem 3.2 is of semi-global nature. It is global in the direction of the submanifold S and local in the other directions

6. Note that the powers of h in estimate (3.3) are in fact optimal.

(x_0 and a normal direction to S in Ω) : we work in a neighborhood of the whole interface S . Thanks to the cut-off function ζ that confines the term

$$h^2 \delta^2 \|\zeta e^{\varphi/h} f_{|\mathcal{M}_2}\|_0^2$$

in a neighborhood of S , estimate (3.12) can in turn be patched with Carleman estimates away from the interface to form a global estimate. Moreover for the same reasons we do not restrict our analysis to the principal part : in proof we consider also the first-order terms of the operator ⁷.

Following [LR10] we shall introduce microlocal regions. Here, the regions are defined on the whole (cotangent bundle of) S . For each region we shall derive a partial Carleman estimate. The different estimates can then be patched together to yield (3.12). Our strategy requires us to work on S globally ; we shall thus consider (pseudo-)differential operators on S . Yet, we shall often use their expression in local coordinates ; this will allow us to use some of the results proven in [LR10].

For the purpose of proving the null controllability of the parabolic problem (3.4), a local Carleman estimate of the form of Theorem 3.2 in the neighborhood of any point at the interface would be sufficient. Yet, an important property of Carleman estimates resides in the possibility of patching them together to obtain a global estimate. Our result thus preserves this important feature.

3.1.2.2 Interpolation inequality

With the Carleman estimate of Theorem 3.2 we then prove an interpolation inequality of the form of that introduced in [LR95]. This type of interpolation inequality for elliptic operators has also been used in [Leb96, LR97] to address stabilization problems for the wave equation.

Let $\alpha_1 \in [0, X_0/2)$, we set $\mathcal{K}_\delta^0(\alpha_1) = L^2((\alpha_1, X_0 - \alpha_1); \mathcal{H}_\delta^0)$ with also $\mathcal{K}_\delta^0 = \mathcal{K}_\delta^0(0)$, and the following Sobolev spaces

$$\mathcal{K}_\delta^1(\alpha_1) = L^2((\alpha_1, X_0 - \alpha_1); \mathcal{H}_\delta^1) \cap H^1((\alpha_1, X_0 - \alpha_1); \mathcal{H}_\delta^0), \quad \mathcal{K}_\delta^1 = \mathcal{K}_\delta^1(0),$$

and

$$\mathcal{K}_\delta^2 = L^2((0, X_0); D(A_\delta)) \cap H^1((0, X_0); \mathcal{H}_\delta^1) \cap H^2((0, X_0); \mathcal{H}_\delta^0).$$

Theorem 3.4. *For all $\delta_0 > 0$, there exist $C \geq 0$ and $\nu_0 \in (0, 1)$ such that for all $\delta \in (0, \delta_0)$ we have*

$$\|U\|_{\mathcal{K}_\delta^1(\alpha_1)} \leq C \|U\|_{\mathcal{K}_\delta^1}^{1-\nu_0} \left(\left\| (-\partial_{x_0}^2 + A_\delta)U \right\|_{\mathcal{K}_\delta^0} + \|\partial_{x_0} u(0, x)\|_{L^2(\omega)} \right)^{\nu_0}, \quad (3.13)$$

for all $U = (u, u^s) \in \mathcal{K}_\delta^2$ with $u|_{x_0=0} = 0$ in $\Omega_1 \cup \Omega_2$.

An important consequence of this interpolation inequality is the spectral inequality that we present in the next section.

3.1.2.3 Spectral inequality and null-controllability result

From the above interpolation inequality we deduce a spectral inequality for the elliptic operator A_δ defined in (3.8). We consider $\mathcal{E}_{\delta,j} = (e_{\delta,j}, e_{\delta,j}^s)$, $j \in \mathbb{N}$, a Hilbert basis of \mathcal{H}_δ^0 composed of eigenfunctions of the operator A_δ associated with the nonnegative eigenvalues $\mu_{\delta,j} \in \mathbb{R}$, $j \in \mathbb{N}$, sorted in an increasing sequence (see Proposition 3.14).

Theorem 3.5. *For $\delta_0 > 0$, there exists $C > 0$ such that for all $0 < \delta \leq \delta_0$ and $\mu \in \mathbb{R}$, we have*

$$\|Z\|_{\mathcal{H}_\delta^0} \leq C e^{C\sqrt{\mu}} \|z\|_{L^2(\omega)}, \quad Z = (z, z^s) \in \text{Span}\{\mathcal{E}_{\delta,j}; \mu_{\delta,j} \leq \mu\}. \quad (3.14)$$

⁷. This technical point explains the regularity requirements we made above for ∇_a and ∇_a^s . Yet, we can treat bounded coefficients for the zero-order terms.

Following [LR95], this estimation then yields a construction of the control function $u_\delta(t, x)$ in (3.4), by sequentially acting on a finite yet increasing number of eigenspaces, and we hence obtain the following δ -uniform controllability theorem. The proof can be adapted to those in [LR95] or [LZ98, Section 5, Proposition 2] and the uniformity w.r.t. the parameter $\delta > 0$ comes naturally. We refer also to [LL09] for an exposition of the method and to [Mil06b, Léa10a, Mil10, TT10] for further developments.

Theorem 3.6. *Let $\delta_0 > 0$. For an arbitrary time $T > 0$ and an arbitrary nonempty open subset $\omega \subset \Omega$ there exists $C > 0$ such that : for all initial conditions $Z_0 = (z_0, z_0^s) \in \mathcal{H}_\delta^0$ and all $0 < \delta \leq \delta_0$, there exists $u_\delta \in L^2((0, T) \times \omega)$ such that the solution (z, z^s) of (3.4) satisfies $(z(T), z^s(T)) = (0, 0)$ and moreover*

$$\|u_\delta\|_{L^2((0, T) \times \omega)} \leq C \|Z_0\|_{\mathcal{H}_\delta^0}.$$

An important feature of this result is that the control is uniformly bounded as $\delta \rightarrow 0$, so that we can extract a subsequence u_δ weakly convergent in $L^2((0, T) \times \omega)$. In Corollary 3.18 we prove that the associated solution of Problem (3.4) converges towards a controlled solution of Problem (3.10). For this last control problem (previously treated in [LR10]), we hence construct a control function which is robust with respect to small viscous perturbations in the interface.

It is classical to deduce a boundary null controllability result from the previous distributed control result.

N.B. Here, for the sake of fixing the notation for the statement of the Carleman estimate above we chose the observation in Ω_2 . This corresponds to $\omega \subset \Omega_2$ in the proofs of Theorems 3.4, 3.5 and 3.6. Yet, ω can be chosen as any arbitrary open subset of Ω .

3.1.3 Some additional results and remarks

3.1.3.1 A stabilization result.

A second important consequence of the interpolation inequality of Theorem 3.4 concerns the stabilization properties of the hyperbolic system (studied in [KZ06, LZ10])

$$\begin{cases} \partial_{tt}z - \Delta_c z + a(x)\partial_t z = 0 & \text{in } (0, T) \times \Omega_1 \cup \Omega_2, \\ \partial_{tt}z^s - \Delta_{c^s} z^s = \frac{1}{\delta} ((c\partial_\eta z)|_{S_2} - (c\partial_\eta z)|_{S_1}) & \text{in } (0, T) \times S, \\ z|_{S_1} = z^s = z|_{S_2} & \text{in } (0, T) \times S, \\ z|_{\partial\Omega} = 0; \end{cases} \quad (3.15)$$

where a is a nonvanishing nonnegative smooth function on $\Omega_1 \cup \Omega_2$. According to [Leb96, LR97], a local version of (3.13) (see Lemma 3.35 below) allows one to produce resolvent estimates which in turn give a result of the following type : for all $\delta_0 > 0$ and all $k \in \mathbb{N}$ there exists $C > 0$ such that for any $0 < \delta < \delta_0$, we have the energy decay estimate

$$\|(\partial_t z, \partial_t z^s)\|_{\mathcal{H}_\delta^0} + \|(z, z^s)\|_{\mathcal{H}_\delta^1} \leq \frac{C}{[\log(2+t)]^k} \left(\|(\partial_t z, \partial_t z^s)|_{t=0}\|_{D(A_\delta^{\frac{k}{2}})} + \|(z, z^s)|_{t=0}\|_{D(A_\delta^{\frac{k+1}{2}})} \right),$$

for all solutions of (3.15). In particular, this decay rate is uniform w.r.t. δ . See [Bur98, Theorem 3] to obtain the power k exactly. The same properties can be obtained for this hyperbolic system with a boundary damping (see [LR97]).

3.1.3.2 Other geometrical situations

Above we assumed that Ω could be partitioned according to $\Omega = \Omega_1 \cup \Omega_2 \cup S$. More general situations can be treated (interpolation and spectral inequalities, and null controllability result) because of the local nature of the Carleman estimate of Theorem 3.2. If V is a neighborhood of S ,

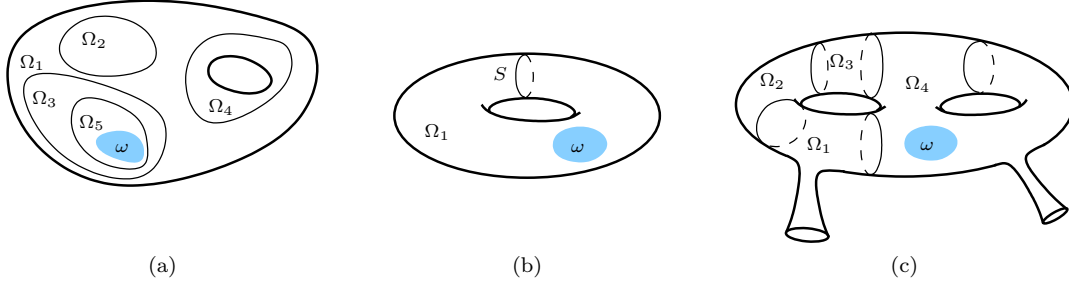

FIGURE 3.1 – Other geometrical situations : (a) Ω is an bounded open subset of \mathbb{R}^n ; (b) and (c) Ω is a compact manifold with boundary.

we require V to be of the form $V_1 \cup V_2 \cup S$ with V_1 and V_2 on both sides of S . Several non intersecting interfaces can be considered as well. For example, the geometrical situations in Figure 3.1 can be addressed as well. If needed the derivation of a global Carleman estimate can done by combining Theorem 3.2 and the arguments of Section 5 in [LR11].

3.1.3.3 Lack of controllability from the interface

It is important to note that the parabolic controllability result of Theorem 3.6 does not hold in general if the control function acts on the interface S . Let ω^s be an open subset of S then in general there is no $u \in L^2((0, T) \times S)$ that brings the solution of

$$\begin{cases} \partial_t z - \Delta_c z = 0 & \text{in } (0, T) \times \Omega_1 \cup \Omega_2, \\ \partial_t z^s - \Delta_{c^s} z^s = \frac{1}{\delta} ((c \partial_\eta z)|_{S_2} - (c \partial_\eta z)|_{S_1}) + \mathbb{1}_{\omega^s} u & \text{in } (0, T) \times S, \\ z|_{S_1} = z^s = z|_{S_2} & \text{in } (0, T) \times S, \\ z|_{\partial\Omega} = 0 & \end{cases} \quad (3.16)$$

to zero at time T .

Let us consider the following two-dimensional example : $\Omega = \mathbb{R}/(2\pi\mathbb{Z}) \times (-\pi, \pi)$ is the cylinder endowed with a flat metric. For consistency with the notation of Section 3.3 we use (y, x_n) as the coordinates in Ω , with periodic conditions in y . We define the interface as $S = \{x_n = 0\} = \mathbb{R}/(2\pi\mathbb{Z}) \times \{0\}$, so that $\Omega_1 = \{x_n < 0\}$ and $\Omega_2 = \{x_n > 0\}$.

We take the diffusion coefficient c to be piecewise constant (i.e. $c = c_j$ in Ω_j for $j = 1, 2$) and define the operator A_δ as in (3.8) (with Dirichlet boundary conditions in the x_n -variable). In this geometrical context, we have the following result.

Proposition 3.7. *If $\gamma := \sqrt{\frac{c_2}{c_1}} \in \mathbb{N}^*$, then for all $c^s > 0$, $\delta > 0$, and $j \in \mathbb{Z}$, the function*

$$\mathcal{E}_{\delta, j} := \begin{pmatrix} e_{\delta, j} \\ 0 \end{pmatrix}, \quad \text{with} \quad e_{\delta, j}(y, x_n) = \begin{cases} e^{ij\gamma y} \sin(\gamma^2 j x_n) & \text{for } x_n < 0, \\ e^{ij\gamma y} \sin(j x_n) & \text{for } x_n > 0, \end{cases}$$

is an eigenfunction of the operator A_δ associated with the eigenvalue $c_2 j^2 (1 + \gamma^2)$.

As a consequence, the adjoint problem of (3.16) (which is of the same form as (3.16) without any control function) does not satisfy the unique continuation property when observed from any subset of S . More precisely, we notice that the set of “invisible” modes is of infinite dimension. As a consequence, System (3.16) is not approximately controllable in this case and moreover the set of non-controllable modes is of infinite dimension.

The phenomenon exhibited in this example is due to the high level of symmetry. However, in a general setting, if the Laplace operator has an eigenfunction which has a \mathcal{C}^∞ closed nodal curve, then the associated problem (3.16) with $c_1 = c_2 = 1$ and S given by this nodal curve is not controllable from S . We hence see that this question is connected to properties of the eigenfunctions of the Laplace operator and of their nodal sets.

3.1.4 Notation : semi-classical operators and geometrical setting

3.1.4.1 Semi-classical operators on \mathbb{R}^d

We shall use of the notation $\langle \eta \rangle := (1 + |\eta|^2)^{\frac{1}{2}}$. For a parameter $h \in (0, h_0]$ for some $h_0 > 0$, we denote by $S^m(\mathbb{R}^d \times \mathbb{R}^d)$, S^m for short, the space of smooth functions $a(z, \zeta, h)$ that satisfy the following property : for all α, β multi-indices, there exists $C_{\alpha, \beta} \geq 0$, such that

$$\left| \partial_z^\alpha \partial_\zeta^\beta a(z, \zeta, h) \right| \leq C_{\alpha, \beta} \langle \zeta \rangle^{m - |\beta|}, \quad z \in \mathbb{R}^d, \zeta \in \mathbb{R}^d, h \in (0, h_0].$$

Then, for all sequences $a_{m-j} \in S^{m-j}$, $j \in \mathbb{N}$, there exists a symbol $a \in S^m$ such that $a \sim \sum_j h^j a_{m-j}$, in the sense that

$$a - \sum_{j < N} h^j a_{m-j} \in h^N S^{m-N} \quad (3.17)$$

(see for instance [Mar02, Proposition 2.3.2] or [Hör85, Proposition 18.1.3]), with a_m as principal symbol. We define Ψ^m as the space of semi-classical operators $A = \text{Op}(a)$, for $a \in S^m$, formally defined by

$$A u(z) = (2\pi h)^{-d} \iint e^{i\langle z-t, \zeta \rangle / h} a(z, \zeta, h) u(t) dt d\zeta, \quad u \in \mathcal{S}'(\mathbb{R}^d).$$

We shall denote the principal symbol a_m by $\sigma(A)$. We shall use techniques of pseudo-differential calculus in this article, such as construction of parametrices, composition formula, formula for the symbol of the adjoint operator, etc. We refer the reader to [Tay81, Hör85, Mar02]. We provide composition and change of variables formula.e. in the case of tangential operators in Appendix 3.7. Those formula.e. can be adapted to the case of operators acting in the whole space \mathbb{R}^d . In the main text the variable z will be $(x_0, x) \in \mathbb{R}^{n+1}$ and $\zeta = (\xi_0, \xi) \in \mathbb{R}^{n+1}$.

We set

$$\begin{aligned} S^{-\infty} &= \bigcap_{m > 0} S^{-m}, & h^\infty S^{-\infty} &= \bigcap_{m > 0} h^m S^{-m}, \\ \Psi^{-\infty} &= \bigcap_{m > 0} \Psi^{-m}, & h^\infty \Psi^{-\infty} &= \bigcap_{m > 0} h^m \Psi^{-m}. \end{aligned}$$

Note that if there exists a closed set F such that in the asymptotic expansion (3.17) we have $\text{supp}(a_{m-j}) \subset F$, $j \in \mathbb{N}$, then a representative of a modulo $h^\infty S^{-\infty}$ can be chosen supported in F .

We shall also denote by \mathcal{D}^m the space of semi-classical *differential* operators, i.e., the case where $a(z, \zeta, h)$ is a polynomial function of order m in ζ . In particular we set

$$D = \frac{h}{i} \partial, \quad \text{and we have } \sigma(D) = \xi.$$

We now introduce Sobolev spaces on \mathbb{R}^d and Sobolev norms which are adapted to the scaling parameter h . The natural norm on $L^2(\mathbb{R}^d)$ is written as $\|u\|_{L^2(\mathbb{R}^d)} = \|u\|_0 := (\int |u(x)|^2 dx)^{\frac{1}{2}}$. Let $r \in \mathbb{R}$; we then set

$$\|u\|_r = \|u\|_{\mathcal{H}^r(\mathbb{R}^d)} = \|\Lambda^r u\|_0, \quad \text{with } \Lambda^r := \text{Op}(\langle \xi \rangle^r) \quad \text{and } \mathcal{H}^r(\mathbb{R}^d) := \{u \in \mathcal{S}'(\mathbb{R}^d); \|u\|_r < \infty\}.$$

The space $\mathcal{H}^r(\mathbb{R}^d)$ is algebraically equal to the classical Sobolev space $H^r(\mathbb{R}^d)$. For a fixed value of h , the norm $\|\cdot\|_r$ is equivalent to the classical Sobolev norm that we write $\|\cdot\|_{H^r(\mathbb{R}^d)}$. However, these norms are not uniformly equivalent as h goes to 0.

3.1.4.2 Tangential semi-classical operators on \mathbb{R}^d , $d \geq 2$

We set $z = (z', z_d)$, $z' = (z_1, \dots, z_{d-1})$ and $\zeta' = (\zeta_1, \dots, \zeta_{d-1})$ accordingly. We denote by $S_T^m(\mathbb{R}^d \times \mathbb{R}^{d-1})$, S_T^m for short, the space of smooth functions $b(z, \zeta', h)$, defined for $h \in (0, h_0]$ for

some $h_0 > 0$, that satisfy the following property : for all α, β multi-indices, there exists $C_{\alpha,\beta} \geq 0$, such that

$$\left| \partial_z^\alpha \partial_{\zeta'}^\beta b(z, \zeta', h) \right| \leq C_{\alpha,\beta} \langle \zeta' \rangle^{m-|\beta|}, \quad z \in \mathbb{R}^d, \quad \zeta' \in \mathbb{R}^{d-1}, \quad h \in (0, h_0].$$

As above, for any sequence $b_{m-j} \in S_T^{m-j}$, $j \in \mathbb{N}$, there exists a symbol $b \in S_T^m$ such that $b \sim \sum_j h^j b_{m-j}$, in the sense that $b - \sum_{j < N} h^j b_{m-j} \in h^N S_T^{m-N}$, with b_m as principal symbol. We define Ψ_T^m as the space of tangential semi-classical operators $B = \text{Op}_T(b)$ (observe the notation we adopt is different from above to avoid confusion), for $b \in S_T^m$, formally defined by

$$B u(z) = (2\pi h)^{-(d-1)} \iint e^{i\langle z' - t', \zeta' \rangle / h} b(z, \zeta', h) u(t', z_d) dt' d\zeta', \quad u \in \mathcal{S}'(\mathbb{R}^d).$$

In the main text the variable z will be $(x_0, x', x_n) \in \mathbb{R}^{n+1}$ and $\zeta' = (\xi_0, \xi') \in \mathbb{R}^n$.

We shall also denote the principal symbol b_m by $\sigma(B)$. In the case where the symbol is polynomial in ζ' and h , we shall denote the space of associated tangential *differential* operators by \mathcal{D}_T^m . We shall denote by Λ_T^s the tangential pseudo-differential operator whose symbol is $\langle \zeta' \rangle^s$. We set

$$\begin{aligned} S_T^{-\infty} &= \bigcap_{m>0} S_T^{-m}, & h^\infty S_T^{-\infty} &= \bigcap_{m>0} h^m S_T^{-m}, \\ \Psi_T^{-\infty} &= \bigcap_{m>0} \Psi_T^{-m}, & h^\infty \Psi_T^{-\infty} &= \bigcap_{m>0} h^m \Psi_T^{-m}. \end{aligned}$$

For function defined on $z_d = 0$ or restricted to $z_d = 0$, following [LR95, LR97], we shall denote by $(\cdot, \cdot)_0$ the inner product, i.e., $(f, g)_0 := \iint f(z') \bar{g}(z') dz'$. The induced norm is denoted by $|\cdot|_0$, i.e., $|f|_0^2 = (f, f)_0$. For $r \in \mathbb{R}$ we introduce

$$|f|_{\mathcal{H}^r(\mathbb{R}^{d-1})} = |f|_r := |\Lambda_T^r f|_0. \quad (3.18)$$

The composition Formula and the action of change of variables are given in Appendix 3.7.1.

Note that we shall keep the notation Ψ_T^m for operators with symbols independent of z_d , acting on $\{z_d = 0\}$. These operators are in fact in $\Psi^m(\mathbb{R}^{d-1})$. A similar notation will be used in the case of operators on a manifold.

3.1.4.3 Local charts, pullbacks, and Sobolev norms

The submanifold S is of dimension $n-1$ and is furnished with a *finite* atlas (U_j, ϕ_j) , $j \in J$. The maps $\phi_j : U_j \rightarrow \tilde{U}_j \subset \mathbb{R}^{n-1}$ is a smooth diffeomorphism. If $U_j \cap U_k \neq \emptyset$ we also set

$$\begin{aligned} \phi_{jk} : \phi_j(U_j \cap U_k) &\subset \tilde{U}_j \rightarrow \phi_k(U_j \cap U_k) \subset \tilde{U}_k, \\ y &\mapsto \phi_k \circ \phi_j^{-1}(y). \end{aligned}$$

The local charts and the diffeomorphisms we introduce are illustrated in Figure 3.2.

For a diffeomorphism ϕ between two open sets, $\phi : U_1 \rightarrow U_2$, the associated pullback (here stated for continuous functions) is

$$\begin{aligned} \phi^* : \mathcal{C}(U_2) &\rightarrow \mathcal{C}(U_1), \\ u &\mapsto u \circ \phi. \end{aligned}$$

For a function defined on phase-space, e.g. a symbol, the pullback is given by

$$\phi^* u(y, \eta) = u(\phi(y), {}^t(\phi'(y))^{-1} \eta), \quad y \in U_1, \eta \in T_y^*(U_1), \quad u \in \mathcal{C}(T^*U_2). \quad (3.19)$$

We shall use semi-classical Sobolev norms over the manifold S together with a finite atlas $(U_j, \phi_j)_j$, $\phi_j : U_j \rightarrow \mathbb{R}^{n-1}$, and a partition of unity $(\psi_j)_j$ subordinated to this covering of S :

$$\psi_j \in \mathcal{C}^\infty(S), \quad \text{supp}(\psi_j) \subset U_j, \quad 0 \leq \psi_j \leq 1, \quad \sum_j \psi_j = 1.$$

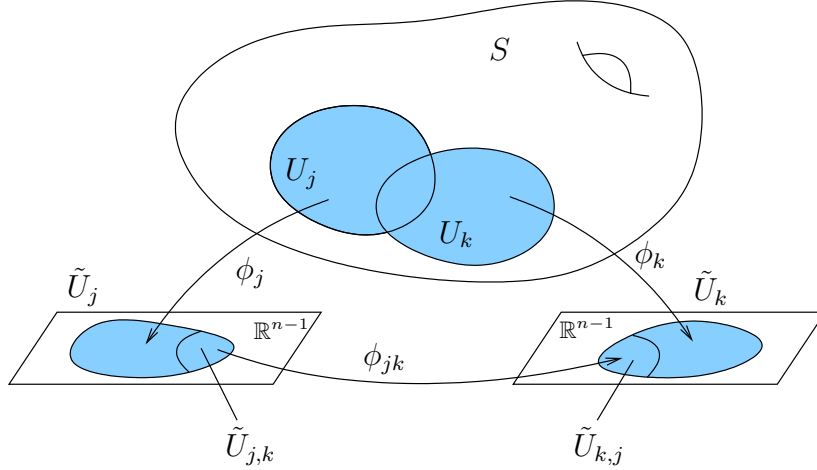

FIGURE 3.2 – Local charts and diffeomorphisms for the submanifold S .

We then set :

$$|u|_{\mathcal{H}^r(S)} = \sum_j |(\phi_j^{-1})^* \psi_j u|_{\mathcal{H}^r(\mathbb{R}^{n-1})}. \quad (3.20)$$

Note that the l.h.s. denotes a norm on the manifold and the r.h.s. is defined in (3.18). We shall need the following elementary result.

Lemma 3.8. *Let $(f_j)_j$ be a family of smooth functions on S with $\text{supp}(f_j) \subset U_j$ and $\sum_j f_j = f \geq C > 0$ in S . We set $N_r(u) = \sum_j |(\phi_j^{-1})^* f_j u|_{\mathcal{H}^r(\mathbb{R}^{n-1})}$. Then N_r is an equivalent norm to $|\cdot|_{\mathcal{H}^r(\mathbb{R}^{n-1})}$, uniformly in h .*

For a proof see Appendix 3.8.1. Note that the L^2 -norm ($r = 0$) defined in (3.20) is equivalent to the natural L^2 -norm on the Riemannian manifold S given through the inner product in (3.5).

Norms in codimension 1. For a function u defined on $(0, X_0) \times \mathbb{R}^{n-1}$ we set

$$|u|_0 = |u|_{L^2((0, X_0) \times \mathbb{R}^{n-1})}, \quad |u|_1^2 = |D_{x_0} u|_0^2 + \int_0^{X_0} |u|_{\mathcal{H}^1(\mathbb{R}^{n-1})}^2 dx_0.$$

Note that the latter norm is equivalent to $|u|_{\mathcal{H}^1(\mathbb{R} \times \mathbb{R}^{n-1})}$ if moreover the function u is compactly supported in the x_0 variable. For a function u defined on $(0, X_0) \times S$, we set

$$|u|_\ell = \sum_j |(\phi_j^{-1})^* \psi_j u|_\ell, \quad \ell = 0, 1, \quad (3.21)$$

where ϕ_j stands for $\text{Id} \otimes \phi_j$.

Norms in all dimensions. For a function u defined on $(0, X_0) \times \mathbb{R}^{n-1} \times \mathbb{R}$ we set

$$\|u\|_0 = \|u\|_{L^2((0, X_0) \times \mathbb{R}^{n-1} \times \mathbb{R})}, \quad \|u\|_1^2 = \|D_{x_0} u\|_0^2 + \int_0^{X_0} \int_{\mathbb{R}} \|u\|_{\mathcal{H}^1(\mathbb{R}^{n-1})}^2 dx_0 dx_n + \|D_{x_n} u\|_0^2.$$

Note that the latter norm is equivalent to $\|u\|_{\mathcal{H}^1(\mathbb{R} \times \mathbb{R}^{n-1} \times \mathbb{R})}$ if moreover the function u is compactly support in the x_0 variable. For a function u defined on $(0, X_0) \times S \times \mathbb{R}$, we set

$$\|u\|_\ell = \sum_j \|(\phi_j^{-1})^* \psi_j u\|_\ell, \quad \ell = 0, 1, \quad (3.22)$$

where $\hat{\phi}_j$ stands for $\text{Id} \otimes \hat{\phi}_j \otimes \text{Id}$.

The following lemma is a counterpart of Lemma 3.8 when working on a local chart of $(0, X_0) \times S$ or $(0, X_0) \times S \times \mathbb{R}$.

Lemma 3.9. *Let u be such that $\text{supp}(u) \subset K \subset (0, X_0) \times U_j$ (resp. $(0, X_0) \times U_j \times \mathbb{R}$) with K compact. Then for some constant C_K we have*

$$C_K^{-1}|u|_\ell \leq |(\hat{\phi}_j^{-1})^* u|_\ell \leq C_K|u|_\ell \quad (\text{resp. } C_K^{-1}\|u\|_\ell \leq \|(\hat{\phi}_j^{-1})^* u\|_\ell \leq C_K\|u\|_\ell), \quad \ell = 0, 1.$$

Proof. We treat the case of a function defined in $(0, X_0) \times U_j$. Consider a partition of unity of S , $\sum_k \hat{\psi}_k = 1$, $\hat{\psi}_k \in \mathcal{C}_c^\infty((0, X_0) \times U_k)$, such that $1 \otimes \hat{\psi}_j = 1$ in a neighborhood of K . Then the induced norms are equivalent to that given above by Lemma 3.8 and for the particular function u they are equal to $|(\hat{\phi}_j^{-1})^* u|_\ell$, $\ell = 0, 1$. \square

Tangential semi-classical operators on a manifold. We can define tangential semi-classical operators on a manifold by means of local representations. This relies on the change of variables formula for semi-classical operators in \mathbb{R}^d presented in Appendix 3.7.1. We provide details of this construction in Appendix 3.7.2. In particular we define the local symbol of the operator in each chart and its principal symbol on the manifold. We also provide composition and Sobolev regularity results for such operators. In Section 3.3.6 below we introduce a particular class of tangential operators that will be important in the proof of the Carleman estimate as they will allow us to separate the analysis into microlocal regions.

A trace formula. In the sections below, we shall also use of the following trace formula [LR97, page 486] connecting the tangential and volume norms introduced above :

$$|\psi|_{x_n=0^+}|_0 \leq Ch^{-\frac{1}{2}}\|\psi\|_1, \quad (3.23)$$

for ψ defined on \mathbb{R}^{n+1} , as well as for ψ defined on $(0, X_0) \times S \times [0, 2\varepsilon]$.

3.2 Well-posedness and asymptotic behavior

We introduce a more general operator

$$\mathcal{A}_\delta Z = \begin{pmatrix} -\Delta_c z + \nabla_a z + bz \\ -\Delta_{c^s} z^s + \nabla_a^s z^s + b^s z^s - \frac{1}{\delta}((c\partial_\eta z)|_{S_2} - (c\partial_\eta z)|_{S_1}) \end{pmatrix},$$

with domain $D(\mathcal{A}_\delta) = D(A_\delta)$ (see (3.9)), where ∇_a (resp. ∇_a^s) denotes a smooth vector field $a(x)\nabla_g$ (resp. $a^s(x)\nabla^s$), and b (resp. b^s) is a bounded function.

We start by considering the well-posedness of the evolution problem (3.4), $\partial_t Z + \mathcal{A}_\delta Z = F$. Note that the lower-order perturbations we add to A_δ to form \mathcal{A}_δ do not affect the well-posedness properties (compare with (3.8)).

3.2.1 Well-posedness

In this section we simply assume that a, a^s are bounded coefficients. For $Z, \tilde{Z} \in D(\mathcal{A}_\delta)$, an integration by parts gives

$$\begin{aligned} ((\mathcal{A}_\delta + \lambda \text{Id})Z, \tilde{Z})_{\mathcal{H}_\delta^0} &= (c\nabla_g z, \nabla_g \tilde{z})_{L^2(\Omega_1 \cup \Omega_2)} + (\nabla_a z + (b + \lambda)z, \tilde{z})_{L^2(\Omega_1 \cup \Omega_2)} \\ &\quad + \delta(c^s \nabla^s z^s, \nabla^s \tilde{z}^s)_{L^2(S)} + \delta(\nabla_a^s z^s + (b^s + \lambda)z^s, \tilde{z}^s)_{L^2(S)} \\ &=: a_\lambda(Z, \tilde{Z}). \end{aligned} \quad (3.24)$$

The bilinear form a_λ is in fact continuous on $(\mathcal{H}_\delta^1)^2$.

Lemma 3.10. *There exists $\lambda_0 \geq 0$ sufficiently large such that the bilinear form a_λ is coercive, uniformly in δ , if $\lambda \geq \lambda_0$.*

Proof. The result follows since we have

$$\begin{aligned} a_\lambda(Z, Z) &\geq \frac{c_{\min}}{2} \|\nabla_g z\|_{L^2(\Omega_1 \cup \Omega_2)}^2 + \left(\lambda - \frac{\|a\|_{L^\infty(\Omega_1 \cup \Omega_2)}^2}{2c_{\min}} - \|b\|_{L^\infty(\Omega_1 \cup \Omega_2)} \right) \|z\|_{L^2(\Omega_1 \cup \Omega_2)}^2 \\ &\quad + \delta \frac{c_{\min}^s}{2} |\nabla^s z^s|_{L^2(S)}^2 + \delta \left(\lambda - \frac{|a^s|_{L^\infty(S)}^2}{2c_{\min}^s} - |b^s|_{L^\infty(S)} \right) |z^s|_{L^2(S)}^2. \end{aligned}$$

□

The coercivity of a_λ shows that the problem $(\mathcal{A}_\delta + \lambda \text{Id})Z = F$ for $F \in \mathcal{H}_\delta^0$ is well-posed in a weak sense; for any continuous linear form L on \mathcal{H}_δ^1 , the Lax-Milgram theorem ensures the existence and uniqueness of $Z \in \mathcal{H}_\delta^1$ satisfying

$$a_\lambda(Z, \tilde{Z}) = L(\tilde{Z}) \quad \text{for any } \tilde{Z} \in \mathcal{H}_\delta^1. \quad (3.25)$$

and $\|Z\|_{\mathcal{H}_\delta^1} \leq C \|L\|_{(\mathcal{H}_\delta^1)'} with the constant C uniform in δ . If we take $L(\tilde{Z}) = (F, \tilde{Z})_{\mathcal{H}_\delta^0}$ for some $F \in \mathcal{H}_\delta^0$, this linear form is continuous on \mathcal{H}_δ^1 . Then, for some constant $C > 0$ uniform in δ the solution satisfies$

$$\|Z\|_{\mathcal{H}_\delta^1} \leq C \|F\|_{\mathcal{H}_\delta^0}. \quad (3.26)$$

Higher regularity can be obtained.

Proposition 3.11. *Let $\lambda \geq \lambda_0$ and $F \in \mathcal{H}_\delta^0$. The unique weak solution $Z = (z, z^s) \in \mathcal{H}_\delta^1$ to (3.25) with $L(\tilde{Z}) = (F, \tilde{Z})_{\mathcal{H}_\delta^0}$ belongs to $D(\mathcal{A}_\delta)$. Hence, for all $F \in \mathcal{H}_\delta^0$ there exists a unique $Z \in D(\mathcal{A}_\delta)$ such that $\mathcal{A}_\delta Z + \lambda Z = F$ and moreover for some positive constant C uniform in δ we have*

$$\sum_{i=1,2} \|z|_{\Omega_i}\|_{H^2(\Omega_i)} + \delta^{\frac{1}{2}} |z^s|_{H^2(S)} \leq C \|F\|_{\mathcal{H}_\delta^0}. \quad (3.27)$$

Proposition 3.12. *Let $\lambda \geq \lambda_0$ and $F = (f, f^s) \in H^m(\Omega_1 \cup \Omega_2) \times H^m(S)$. The unique weak solution $Z = (z, z^s) \in \mathcal{H}_\delta^1$ to (3.25) with $L(\tilde{Z}) = (F, \tilde{Z})_{\mathcal{H}_\delta^0}$ belongs to $H^{m+2}(\Omega_1 \cup \Omega_2) \times H^{m+2}(S)$ with*

$$\sum_{i=1,2} \|z|_{\Omega_i}\|_{H^{m+2}(\Omega_i)} + \delta^{\frac{1}{2}} |z^s|_{H^{m+2}(S)} \leq C \left(\sum_{i=1,2} \|f|_{\Omega_i}\|_{H^m(\Omega_i)} + \delta^{\frac{1}{2}} |f^s|_{H^m(S)} \right) \quad (3.28)$$

We refer to Appendices 3.8.2 and 3.8.3 for proofs.

A consequence of the properties we have gathered on \mathcal{A}_δ is the following well-posedness for the evolution problem.

Proposition 3.13. *Let a, b, a^s, b^s be bounded coefficients. Then, the operator $(-\mathcal{A}_\delta, D(\mathcal{A}_\delta))$ generates a \mathcal{C}^0 -semigroup on \mathcal{H}_δ^0 . If moreover $a = 0$, $a^s = 0$ and $b, b^s \in \mathbb{R}$, then \mathcal{A}_δ is self-adjoint on \mathcal{H}_δ^0 .*

Proof. Lemma 3.10 shows that $\mathcal{A}_\delta + \lambda_0 \text{Id}$ is monotone and Proposition 3.11 shows that this operator maps its domain $D(\mathcal{A}_\delta)$ onto \mathcal{H}_δ^0 . Hence $\mathcal{A}_\delta + \lambda_0 \text{Id}$ is maximal monotone. The Lumer-Phillips theorem (see e.g. [Paz83]) then allows one to conclude that \mathcal{A}_δ generates a strongly continuous semigroup on \mathcal{H}_δ^0 .

Note that if $a = 0$, $a^s = 0$ and $b, b^s \in \mathbb{R}$, with (3.24) we see that the operator \mathcal{A}_δ is symmetric. It is self-adjoint as the surjectivity of $\mathcal{A}_\delta + \lambda_0 I$ implies $D(\mathcal{A}_\delta^*) = D(\mathcal{A}_\delta) = D(\mathcal{A}_\delta)$ (see e.g. [Bre83, Proposition VII-6]). □

With the Rellich theorem we see that \mathcal{H}_δ^1 can be compactly injected in \mathcal{H}_δ^0 . It follows that the inverse $(\mathcal{A}_\delta + \lambda_0 \text{Id})^{-1}$ that we constructed is a compact map from \mathcal{H}_δ^0 into itself. One then deduces the following spectral result.

Proposition 3.14. *There exists a Hilbert basis of \mathcal{H}_δ^0 formed of eigenfunctions $\mathcal{E}_j = (e_{\delta,j}, e_{\delta,j}^s)$, $j \in \mathbb{N}$, of the self-adjoint operator A_δ associated with the eigenvalues $0 \leq \mu_{\delta,0} \leq \mu_{\delta,1} \leq \dots \leq \mu_{\delta,j} \leq \dots$.*

Note that if Ω is a manifold with no boundary then 0 is an eigenfunction for A_δ . If Ω has a boundary, the Dirichlet boundary condition that we prescribe yield the first eigenvalue to be positive.

Corollary 3.15. *The following space of functions*

$$\mathcal{T} = \{(z, z^s) \in \mathcal{H}_\delta^1; z|_{\Omega_i} \in \mathcal{C}^\infty(\overline{\Omega_i}), i = 1, 2\}$$

is dense in $D(A_\delta)$.

Proof. From Proposition 3.12 the eigenfunctions of A_δ are in \mathcal{T} . The results follows as they generate a dense subset in $D(A_\delta)$. \square

3.2.2 Asymptotic behavior of the solutions as $\delta \rightarrow 0$

3.2.2.1 Asymptotic behavior in the elliptic problem

Consider $F_\delta = (f_\delta, f_\delta^s) \in \mathcal{H}_\delta^0$. Let $Z_\delta = (z_\delta, z_\delta^s)$ be the strong solution defined in the previous section for the elliptic equation $(A_\delta + \lambda)Z_\delta = F_\delta$.

We also consider the weak solution $\mathbf{z} \in H_0^1$ of the elliptic problem

$$-\operatorname{div}_g(c\nabla_g \mathbf{z}) + \lambda \mathbf{z} = \mathbf{f} \quad \text{in } \Omega. \quad (3.29)$$

Arguing as in the previous section such a solution exists and is unique for $\lambda \geq \lambda_0$ (the same value of λ_0 as in Lemma 3.10 can be used). In particular we have $\mathbf{z}|_{S_1} = \mathbf{z}|_{S_2}$, i.e. the solution is continuous across the interface, and as $c\nabla_g \mathbf{z}$ has its divergence in $L^2(\Omega)$ we have $c\partial_\eta \mathbf{z}|_{S_1} = c\partial_\eta \mathbf{z}|_{S_2}$. Moreover $\mathbf{z}|_{\Omega_i} \in H^2(\Omega_i)$ and

$$\sum_{i=1,2} \|\mathbf{z}|_{\Omega_i}\|_{H^2(\Omega_i)} \leq C \|\mathbf{f}\|_{L^2(\Omega_1 \cup \Omega_2)}. \quad (3.30)$$

Proposition 3.16. *Suppose that $\|F_\delta\|_{\mathcal{H}_\delta^0} \leq C$ uniformly in δ and that $f_\delta \rightarrow \mathbf{f}$ in $L^2(\Omega_1 \cup \Omega_2)$ as $\delta \rightarrow 0$. Then, $z_\delta|_{\Omega_j} \rightarrow \mathbf{z}|_{\Omega_j}$ in $H^2(\Omega_j)$ for $j = 1, 2$.*

Note that the assumption $\|F_\delta\|_{\mathcal{H}_\delta^0} \leq C$ implies that there always exists a sequence $\delta_n \rightarrow 0$ such that $f_{\delta_n} \rightarrow \mathbf{f}$.

Proof. We set $\zeta_\delta := z_\delta - \mathbf{z}$. According to (3.27), the boundedness assumption on F_δ , and (3.30), we have

$$\sum_{i=1,2} \|\zeta_\delta|_{\Omega_i}\|_{H^2(\Omega_i)} \leq C,$$

uniformly in δ . Moreover, ζ_δ satisfies

$$\begin{cases} -\operatorname{div}_g(c\nabla_g \zeta_\delta) + \lambda \zeta_\delta = f_\delta - \mathbf{f} & \text{in } \Omega_1 \cup \Omega_2, \\ (c\partial_\eta \zeta_\delta)|_{S_2} - (c\partial_\eta \zeta_\delta)|_{S_1} = \delta(-\Delta_{c^s} z_\delta^s + \lambda z_\delta^s - f_\delta^s) & \text{in } S, \\ \zeta_\delta|_{S_1} = \zeta_\delta|_{S_2} & \text{in } S, \\ \zeta_\delta|_{\partial\Omega} = 0. \end{cases}$$

Taking the inner product of the first line of this system with ζ_δ and integrating by parts, we obtain

$$(c\nabla_g \zeta_\delta, \nabla_g \zeta_\delta)_{L^2(\Omega_1 \cup \Omega_2)} + ((c\partial_\eta \zeta_\delta)|_{S_2} - (c\partial_\eta \zeta_\delta)|_{S_1}, \zeta_\delta)_{L^2(S)} + \lambda (\zeta_\delta, \zeta_\delta)_{L^2(\Omega_1 \cup \Omega_2)} = (f_\delta - \mathbf{f}, \zeta_\delta)_{L^2(\Omega_1 \cup \Omega_2)}.$$

In this expression, we have

$$\begin{aligned} |((c\partial_\eta \zeta_\delta)|_{S_2} - (c\partial_\eta \zeta_\delta)|_{S_1}, \zeta_\delta)_{L^2(S)}| &= \delta^{\frac{1}{2}} \left| \left(\delta^{\frac{1}{2}} \Delta_{c^s} z_\delta^s - \delta^{\frac{1}{2}} \lambda z_\delta^s + \delta^{\frac{1}{2}} f_\delta^s, \zeta_\delta \right)_{L^2(S)} \right| \\ &\leq C \delta^{\frac{1}{2}} \left(\delta^{\frac{1}{2}} |z_\delta^s|_{H^2(S)} + \|F_\delta\|_{\mathcal{H}_\delta^0} \right) \|\zeta_\delta\|_{H^1(\Omega_1 \cup \Omega_2)} \\ &\leq C \delta^{\frac{1}{2}} \|\zeta_\delta\|_{H^2(\Omega_1 \cup \Omega_2)} \rightarrow 0, \end{aligned} \quad (3.31)$$

according to (3.27), the trace estimate and the boundedness assumption on F_δ . Moreover, since ζ_δ is bounded in $H^2(\Omega_1 \cup \Omega_2)$, for all sequence $\delta_n \rightarrow 0$, we can extract a subsequence, also called δ_n , such that ζ_{δ_n} converges strongly in $L^2(\Omega_1 \cup \Omega_2)$, and we have

$$(f_{\delta_n} - \mathbf{f}, \zeta_{\delta_n})_{L^2(\Omega_1 \cup \Omega_2)} \rightarrow 0.$$

As a consequence, we obtain

$$(c\nabla_g \zeta_{\delta_n}, \nabla_g \zeta_{\delta_n})_{L^2(\Omega_1 \cup \Omega_2)} + \lambda (\zeta_{\delta_n}, \zeta_{\delta_n})_{L^2(\Omega_1 \cup \Omega_2)} \rightarrow 0,$$

i.e. $\zeta_{\delta_n} \rightarrow 0$ in $H^1(\Omega_j)$, for $j = 1, 2$. Because the limit is the same for any subsequence of ζ_{δ_n} , this implies that the whole ζ_δ converges to zero in $H^1(\Omega_j)$. Since $\zeta_{\delta|_{\Omega_j}}$ is uniformly bounded in $H^2(\Omega_j)$, the result follows. \square

3.2.2.2 Asymptotic behavior in the parabolic problem

Here, we discuss, for some $\lambda > 0$ (one can take $\lambda = 0$ if $\partial\Omega \neq \emptyset$) the convergence properties of the solution $Z_\delta = (z_\delta, z_\delta^s)$ of

$$\begin{cases} \partial_t z_\delta - \Delta_c z_\delta + \lambda z_\delta = f_\delta & \text{in } (0, T) \times \Omega_1 \cup \Omega_2, \\ \partial_t z_\delta^s - \Delta_{c^s} z_\delta^s + \lambda z_\delta^s = \frac{1}{\delta} ((c\partial_\eta z_\delta)|_{S_2} - (c\partial_\eta z_\delta)|_{S_1}) + f_\delta^s & \text{in } (0, T) \times S, \\ z_\delta|_{S_1} = z_\delta^s|_{S_2} = z_\delta|_{S_2} & \text{in } (0, T) \times S, \\ z_\delta|_{\partial\Omega} = 0 & \text{in } (0, T), \\ z_\delta|_{t=0} = z_0 \text{ and } z_\delta^s|_{t=0} = z_0^s, & \end{cases} \quad (3.32)$$

towards the solution \mathbf{z} of

$$\begin{cases} \partial_t \mathbf{z} - \Delta_c \mathbf{z} + \lambda \mathbf{z} = \mathbf{f} & \text{in } (0, T) \times \Omega_1 \cup \Omega_2, \\ \mathbf{z}|_{S_1} = \mathbf{z}|_{S_2} \text{ and } (c\partial_\eta \mathbf{z})|_{S_2} = (c\partial_\eta \mathbf{z})|_{S_1} & \text{in } (0, T) \times S, \\ \mathbf{z}|_{\partial\Omega} = 0 & \text{in } (0, T), \\ \mathbf{z}|_{t=0} = z_0 & \text{in } \Omega. \end{cases} \quad (3.33)$$

Proposition 3.17. *Suppose that $\|F_\delta\|_{L^2(0, T; \mathcal{H}_\delta^0)} \leq C$ uniformly in δ , that $f_\delta \rightharpoonup \mathbf{f}$ in $L^2((0, T) \times \Omega_1 \cup \Omega_2)$ as $\delta \rightarrow 0$ and that $z_0 \in H_0^1(\Omega)$ and $z_0^s \in H^1(S)$. Then, we have, $z_{\delta|_{\Omega_j}} \rightharpoonup \mathbf{z}|_{\Omega_j}$ in $L^2(0, T; H^2(\Omega_j)) \cap H^1(0, T; L^2(\Omega_j))$ and $*$ -weak in $L^\infty(0, T; H^1(\Omega_j))$, and there exists $C' > 0$ such that for all $t \in [0, T]$, $\|z_{\delta|_{\Omega_j}}(t)\|_{H^1(\Omega_j)} \leq C'$ for $j = 1, 2$.*

Proof. First, Problem (3.32) can be equivalently rewritten as $\partial_t Z_\delta + (A_\delta + \lambda)Z_\delta = F_\delta$ with $Z_\delta(0) = (z_0, z_0^s)$. For $Z_\delta(0) \in D(A_\delta)$ and $F_\delta \in \mathcal{C}^0([0, T]; \mathcal{H}_\delta^0)$ the semigroup solution of this equation is in $\mathcal{C}^0([0, T]; D(A_\delta)) \cap \mathcal{C}^1([0, T]; \mathcal{H}_\delta^0)$ (see [Paz83, Corollary 2.6 Chap 4] or [Bre83, Théorème VII.10]). As a consequence, we can form the square of the \mathcal{H}_δ^0 -norm of this equation and integrate on $(0, T)$. This yields

$$\int_0^T \frac{d}{dt} \|(A_\delta + \lambda)^{\frac{1}{2}} Z_\delta\|_{\mathcal{H}_\delta^0}^2 + \int_0^T \|(A_\delta + \lambda)Z_\delta(t)\|_{\mathcal{H}_\delta^0}^2 dt + \int_0^T \|\partial_t Z_\delta(t)\|_{\mathcal{H}_\delta^0}^2 dt = \int_0^T \|F_\delta(t)\|_{\mathcal{H}_\delta^0}^2 dt,$$

which, in turns gives the stability estimate for the solution of (3.32) :

$$\|Z_\delta(T)\|_{\mathcal{H}_\delta^1}^2 + \int_0^T \|(A_\delta + \lambda)Z_\delta(t)\|_{\mathcal{H}_\delta^0}^2 dt + \int_0^T \|\partial_t Z_\delta(t)\|_{\mathcal{H}_\delta^0}^2 dt \leq C \left(\int_0^T \|F_\delta(t)\|_{\mathcal{H}_\delta^0}^2 dt + \|Z_\delta(0)\|_{\mathcal{H}_\delta^1}^2 \right),$$

uniformly in δ . With a density argument, this energy estimate remains valid if $Z_\delta(0) \in \mathcal{H}_\delta^1$ and $F_\delta(t) \in L^2(0, T; \mathcal{H}_\delta^0)$.

According to (3.27), this yields

$$\begin{aligned} \|z_\delta(T)\|_{H^1}^2 + \delta |z_\delta^s(T)|_{H^1(S)}^2 + \int_0^T \|z_\delta(t)\|_{H^2}^2 dt + \delta \int_0^T |z_\delta^s(t)|_{H^2(S)}^2 dt \\ + \int_0^T \|\partial_t z_\delta(t)\|_{L^2}^2 dt + \delta \int_0^T |\partial_t z_\delta^s(t)|_{L^2(S)}^2 dt \leq C \left(\int_0^T \|F_\delta(t)\|_{\mathcal{H}_\delta^0}^2 dt + \|Z_\delta(0)\|_{\mathcal{H}_\delta^1}^2 \right) \leq C, \end{aligned} \quad (3.34)$$

uniformly in δ (the volume norms are taken over $\Omega_1 \cup \Omega_2$).

In addition, the solution of (3.33) also satisfies

$$\|\mathbf{z}(T)\|_{H^1}^2 + \int_0^T \|(-\Delta_c + \lambda)\mathbf{z}(t)\|_{L^2}^2 dt + \int_0^T \|\partial_t \mathbf{z}(t)\|_{L^2}^2 dt \leq C \left(\int_0^T \|\mathbf{f}(t)\|_{L^2}^2 dt + \|\mathbf{z}(0)\|_{H^1}^2 \right),$$

where all the norms are taken over $\Omega_1 \cup \Omega_2$. Using the additional regularity (3.30), this gives

$$\|\mathbf{z}(T)\|_{H^1}^2 + \int_0^T \|\mathbf{z}(t)\|_{H^2}^2 dt + \int_0^T \|\partial_t \mathbf{z}(t)\|_{L^2}^2 dt \leq C \left(\int_0^T \|\mathbf{f}(t)\|_{L^2}^2 dt + \|\mathbf{z}(0)\|_{H^1}^2 \right). \quad (3.35)$$

Now, we set $\zeta_\delta = z_\delta - \mathbf{z}$. According to (3.34)-(3.35), we have,

$$\sum_{j=1,2} \left(\|\zeta_\delta|_{\Omega_j}\|_{L^\infty(0,T;H^1(\Omega_j))} + \|\zeta_\delta|_{\Omega_j}\|_{L^2(0,T;H^2(\Omega_j))} + \|\zeta_\delta|_{\Omega_j}\|_{H^1(0,T;L^2(\Omega_j))} \right) \leq C, \quad (3.36)$$

uniformly in δ . Moreover, ζ_δ satisfies

$$\begin{cases} \partial_t \zeta_\delta - \Delta_c \zeta_\delta + \lambda \zeta_\delta = f_\delta - \mathbf{f} & \text{in } (0, T) \times (\Omega_1 \cup \Omega_2), \\ (c\partial_\eta \zeta_\delta)|_{S_2} - (c\partial_\eta \zeta_\delta)|_{S_1} = \delta (\partial_t z_\delta^s - \Delta_{c^s} z_\delta^s + \lambda z_\delta^s - f_\delta^s) & \text{in } (0, T) \times S, \\ \zeta_\delta|_{S_1} = \zeta_\delta|_{S_2} & \text{in } (0, T) \times S, \\ \zeta_\delta|_{\partial\Omega} = 0 & \text{in } (0, T), \\ \zeta_\delta|_{t=0} = 0 & \text{in } \Omega. \end{cases} \quad (3.37)$$

Forming the inner product of the first line of this system with ζ_δ and integrating on $(0, T)$, we obtain

$$\begin{aligned} \frac{1}{2} \|\zeta_\delta(T)\|_{L^2(\Omega)}^2 + \|\sqrt{c}\nabla_g \zeta_\delta\|_{L^2((0,T)\times\Omega)}^2 + \lambda \|\zeta_\delta\|_{L^2((0,T)\times\Omega)}^2 \\ + ((c\partial_\eta \zeta_\delta)|_{S_2} - (c\partial_\eta \zeta_\delta)|_{S_1}, \zeta_\delta)_{L^2((0,T)\times S)} = (f_\delta - \mathbf{f}, \zeta_\delta)_{L^2((0,T)\times\Omega)}. \end{aligned}$$

In this expression, we have

$$\begin{aligned} \left| ((c\partial_\eta \zeta_\delta)|_{S_2} - (c\partial_\eta \zeta_\delta)|_{S_1}, \zeta_\delta)_{L^2((0,T)\times S)} \right| &= \delta^{\frac{1}{2}} \left| \left(\delta^{\frac{1}{2}} \partial_t z_\delta^s - \delta^{\frac{1}{2}} \Delta_{c^s} z_\delta^s + \delta^{\frac{1}{2}} \lambda z_\delta^s - \delta^{\frac{1}{2}} f_\delta^s, \zeta_\delta \right)_{L^2((0,T)\times S)} \right| \\ &\leq C \delta^{\frac{1}{2}} \|\zeta_\delta\|_{L^2(0,T;H^2(\Omega_1 \cup \Omega_2))} \rightarrow 0, \end{aligned}$$

according to (3.34) (proceeding as in (3.31)). Proceeding as in the proof of Proposition 3.16, we have

$$(f_\delta - \mathbf{f}, \zeta_\delta)_{L^2((0,T)\times(\Omega_1 \cup \Omega_2))} \rightarrow 0,$$

for a subsequence, and we obtain

$$\frac{1}{2} \|\zeta_\delta(T)\|_{L^2(\Omega)}^2 + \|\sqrt{c}\nabla_g \zeta_\delta\|_{L^2((0,T)\times\Omega)}^2 + \lambda \|\zeta_\delta\|_{L^2((0,T)\times\Omega)}^2 \rightarrow 0.$$

This, together with (3.36) concludes the proof of the proposition. \square

As a consequence, we can obtain a convergence result for the control problem under view. We denote by u_δ the control function given by Theorem 3.6, that satisfies

$$\begin{cases} \partial_t Z_\delta + A_\delta Z_\delta = B u_\delta \\ Z_\delta|_{t=0} = Z_0 \\ Z_\delta|_{t=T} = 0. \end{cases}$$

According to Theorem 3.6, u_δ is uniformly bounded in $L^2((0, T) \times \omega)$, so that we can extract a subsequence (also denoted by u_δ) weakly converging in this space towards u . We also consider the solution $\tilde{Z}_\delta = (\tilde{z}_\delta, \tilde{z}_\delta^s)$ of

$$\begin{cases} \partial_t \tilde{Z}_\delta + A_\delta \tilde{Z}_\delta = B u \\ \tilde{Z}_\delta|_{t=0} = Z_0. \end{cases} \quad (3.38)$$

The following result is a consequence of Proposition 3.17.

Corollary 3.18. *The limit u is a null-control function for the limit system (3.10). Moreover, $(\tilde{z}_\delta - z_\delta)|_{\Omega_j} \rightharpoonup 0$ in $L^2(0, T; H^2(\Omega_j)) \cap H^1(0, T; L^2(\Omega_j))$ and $*$ -weak in $L^\infty(0, T; H^1(\Omega_j))$, and there exists $C > 0$ such that for all $t \in [0, T]$, $\|z_\delta|_{\Omega_j}(t) - \tilde{z}_\delta|_{\Omega_j}(t)\|_{H^1(\Omega_j)} \leq C$ for $j = 1, 2$.*

In particular, we have $\tilde{z}_\delta(T) \rightharpoonup 0$ in $H^1(\Omega)$. This shows that the limit u is a control function for the limit system (3.10) which is robust with respect to small viscous perturbations. Indeed, it realizes an approximate control for System (3.38).

3.3 Local setting in a neighborhood of the interface

In a sufficiently small neighborhood of S , say V_ε , we place ourselves in normal geodesic coordinates (w.r.t. to the spatial variables x). More precisely (see [Hör85, Appendix C.5]) for ε sufficiently small, there exists a diffeomorphism

$$\begin{aligned} F : S \times [-2\varepsilon, 2\varepsilon] &\rightarrow V_\varepsilon \\ (y, x_n) &\mapsto F(y, x_n), \end{aligned}$$

so that the differential operator $-\partial_{x_0}^2 - \Delta_c + \nabla_a$ takes the form on both sides of the interface :

$$-\partial_{x_0}^2 - c(y, x_n) (\partial_{x_n}^2 - R_2(y, x_n)) + R_1(y, x_n),$$

and the differential operator $-\partial_{x_0}^2 - \Delta_c^s + \nabla_a^s$ takes the form on the interface

$$-\partial_{x_0}^2 + c^s(y) R_2(y, x_n = 0) + R_1^s(y),$$

where $R_2(y, x_n)$ is a x_n -family of second-order elliptic differential operators on S , i.e., a tangential operator, with principal symbol $r(y, x_n, \eta)$, $\eta \in T_y^*(S)$, that satisfies

$$r(y, x_n, \eta) \in \mathbb{R}, \quad \text{and} \quad C_1 |\eta|_g^2 \leq r(y, x_n, \eta) \leq C_2 |\eta|_g^2, \quad (3.39)$$

for some $0 < C_1 \leq C_2 < \infty$, and $R_1(y, x_n)$ is a x_n -family of first-order operators on $S \times [-2\varepsilon, 2\varepsilon]$, $R_1^s(y)$ is a first-order operator on S .

By abuse of notation we shall write V_ε in place of $S \times [-2\varepsilon, 2\varepsilon]$. In this setting, we have

$$V_\varepsilon^- = F(S \times [-2\varepsilon, 0]) = V_\varepsilon \cap \Omega_1, \quad V_\varepsilon^+ = F(S \times (0, 2\varepsilon]) = V_\varepsilon \cap \Omega_2,$$

and we recall that the observation region ω is in Ω_2 .

In the sequel, we shall often write

$$x := (y, x_n), \quad \text{and} \quad \mathbf{x} := (x_0, x) = (x_0, y, x_n) \in [0, X_0] \times S \times [-2\varepsilon, 2\varepsilon].$$

We set

$$P = -\frac{1}{c}\partial_{x_0}^2 - (\partial_{x_n}^2 - R_2(x)) + \frac{1}{c}R_1(x), \quad P^s = -\frac{1}{c^s}\partial_{x_0}^2 + R_2(y, x_n = 0) + \frac{1}{c^s}R_1^s(y).$$

They both have smooth coefficients.

In this framework, in the neighborhood V_ε of S , System (3.11) becomes

$$\begin{cases} Pw = F, & \text{in } (0, X_0) \times S \times ([-2\varepsilon, 0) \cup (0, 2\varepsilon]), \\ P^s w^s = \frac{1}{c^s \delta} ((c \partial_{x_n} w)|_{x_n=0^+} - (c \partial_{x_n} w)|_{x_n=0^-} + \Theta^s) & \text{in } (0, X_0) \times S, \\ w|_{x_n=0^-} = w^s + \theta^1 \quad \text{and} \quad w|_{x_n=0^+} = w^s + \theta^2, & \text{in } (0, X_0) \times S, \end{cases} \quad (3.40)$$

with

$$F = \frac{1}{c}f + R_0 w, \quad \Theta^s = \theta^s + \delta R_0^s w^s, \quad (3.41)$$

where R_0 and R_0^s are zero-order operators with *bounded* coefficients on $S \times ([-2\varepsilon, 0) \cup (0, 2\varepsilon])$ and S respectively.

3.3.1 Properties of the weight functions

We denote by $\tilde{r}(x, \eta, \eta')$ the symmetric bilinear form associated with the quadratic principal symbol $r(x, \eta)$. We introduce the following symmetric bilinear form

$$\tilde{\beta}(x; \xi_0, \eta; \xi'_0, \eta') = \frac{1}{c(x)} \xi_0 \xi'_0 + \tilde{r}(x, \eta, \eta'). \quad (3.42)$$

and the associated positive definite quadratic form $\beta(x; \xi_0, \eta)$. We choose a positive bounded continuous function $\gamma(x)$ in $\overline{V_\varepsilon^+}$ such that

$$\beta(y, -x_n; \xi_0, \eta) - \gamma(y, x_n) \beta(y, x_n; \xi_0, \eta) \geq C |(\xi_0, \eta)|^2 > 0, \quad (\xi_0, \eta) \in \mathbb{R} \times T_y^*(S), \quad (3.43)$$

for $x = (y, x_n) \in \overline{V_\varepsilon^+}$.

We then choose a function $\varphi = \varphi(\mathbf{x})$ on $[0, X_0] \times V_\varepsilon$ that that is smooth on both sides of the interface and simply continuous across the interface, that moreover satisfies the following properties.

1. For a function γ' such that $0 < \gamma'(x) \leq \gamma(x) - \epsilon$ in $\overline{V_\varepsilon^+}$, for some $\epsilon > 0$, we have

$$\gamma'(y, x_n) (\partial_{x_n} \varphi)^2(x_0, y, x_n) - (\partial_{x_n} \varphi)^2(x_0, y, -x_n) \geq C > 0, \quad (3.44)$$

for $x_0 \in [0, X_0]$, and $x = (y, x_n) \in V_\varepsilon^+$.

2. For a given value of $\nu > 0$ sufficiently small we have

$$|\partial_{x_0} \varphi(\mathbf{x})| + |\nabla^s \varphi(\mathbf{x})|_g \leq \nu \inf_{\overline{V_\varepsilon}} |\partial_{x_n} \varphi|, \quad \mathbf{x} = (x_0, x) \in [0, X_0] \times V_\varepsilon. \quad (3.45)$$

3. We have $|\partial_{x_0} \varphi| + |\nabla^s \varphi|_g + |\partial_{x_n} \varphi| > 0$ in $[0, X_0] \times V_\varepsilon$ and Hörmander's sub-ellipticity condition is satisfied on both sides of the interface. This condition will be precisely stated below after the introduction of the conjugated operator (see (3.56)).

Note that we have $\inf_{V_\varepsilon^+} |\partial_{x_n} \varphi| \geq C > 0$.

The first condition states the increase in the normal slope of the weight function when crossing the interface. The value of ν in the second condition will be determined below (see (3.57)-(3.58) and the proof of Proposition 3.23). We thus ask the weight function to be relatively flat in the tangent directions to the interface as compared to its variations in the normal direction. We explain below how a weight function satisfying the sub-ellipticity condition can be built through a convexification procedure (see Remark 3.21).

Remark 3.19. Property (3.44) and $|\partial_{x_0}\varphi| + |\nabla^s\varphi|_g + |\partial_{x_n}\varphi| > 0$ can be obtained by choosing φ such that $(\partial_{x_n}\varphi)|_{[0, X_0] \times S} \geq C > 0$ and assuming that (3.44) only holds on $[0, X_0] \times S$ and then shrinking the neighborhood V_ε by choosing ε sufficiently small.

An example of such a function will be given in the application of the Carleman estimate in Section 3.5.

Remark 3.20. Note that the conditions we impose on the weight function are much simpler than the conditions given in [LR10]. Such condition are proven sharp in [LL10] in the limiting case $\delta \rightarrow 0$. If (3.43) is not satisfied, i.e., the increase in the normal slope of the weight function is chosen too small, one can then build a quasi-mode that concentrates at the interface and shows that the Carleman estimate cannot hold.

3.3.2 A system formulation

Following [Bel03, LR10], we shall consider (3.40) as a system of two equations coupled at the boundary $x_n = 0^+$. Here, the coupling involves a tangential second-order elliptic operator. In $[0, X_0] \times S \times [-2\varepsilon, 0)$, we make the change of variables x_n to $-x_n$. For a function ψ defined in V_ε , we set

$$\psi^r(y, x_n) = \psi(y, x_n) \quad \text{and} \quad \psi^l(y, x_n) := \psi(y, -x_n), \quad \text{for } x_n \geq 0,$$

and similarly for symbols and operators, e.g.,

$$r^r(y, x_n, \eta) = r(y, x_n, \eta) \quad \text{and} \quad r^l(y, x_n, \eta) = r(y, -x_n, \eta), \quad \text{for } x_n \geq 0.$$

We set $V_\varepsilon^+ = S \times (0, 2\varepsilon]$. System (3.40) then takes the form

$$\begin{cases} P^{r/l} w^{r/l} = F^{r/l}, & \text{in } (0, X_0) \times V_\varepsilon^+, \\ P^s w^s = \frac{1}{c^s \delta} ((c^r \partial_{x_n} w^r)|_{x_n=0^+} + (c^l \partial_{x_n} w^l)|_{x_n=0^+} + \Theta^s) & \text{in } (0, X_0) \times S, \\ w^{r/l}|_{x_n=0^+} = w^s + \theta^{r/l} & \text{in } (0, X_0) \times S, \end{cases} \quad (3.46)$$

3.3.3 Conjugation by the weight function

We now consider the weight functions $\varphi^{r/l}$ built up as above from the *continuous* function φ defined on V_ε . We introduce the following conjugated differential operators

$$P_\varphi^{r/l} = h^2 e^{\varphi^{r/l}/h} P^{r/l} e^{-\varphi^{r/l}/h}, \quad P_\varphi^s = h^2 e^{\varphi|_S/h} P^s e^{-\varphi|_S/h},$$

With the functions

$$\begin{aligned} v^{r/l} &= e^{\varphi^{r/l}/h} w^{r/l}, & v^s &= e^{\varphi|_S/h} w^s, \\ F_\varphi^{r/l} &= h^2 e^{\varphi^{r/l}/h} F^{r/l}, & \Theta_\varphi^s &= -ih e^{\varphi|_S/h} \Theta^s, & \theta_\varphi^{r/l} &= e^{\varphi|_S/h} \theta^{r/l}, \end{aligned}$$

with $0 < h < h_0$, System (3.46) can be rewritten as

$$\begin{cases} P_\varphi^{r/l} v^{r/l} = F_\varphi^{r/l} & \text{in } (0, X_0) \times V_\varepsilon^+, \\ P_\varphi^s v^s = \frac{hi}{c^s \delta} (c^r (D_{x_n} + i\partial_{x_n}\varphi^r)v^r|_{x_n=0^+} \\ \quad + c^l (D_{x_n} + i\partial_{x_n}\varphi^l)v^l|_{x_n=0^+} + \Theta_\varphi^s) & \text{in } (0, X_0) \times S, \\ v^{r/l}|_{x_n=0^+} = v^s + \theta_\varphi^{r/l} & \text{in } (0, X_0) \times S, \end{cases} \quad (3.47)$$

Recall that $D = h\partial/i$ here. We shall consider the operators $P_\varphi^{r/l}$ and P_φ^s as semi-classical differential operators.

We separate the self- and anti-adjoint parts of the operators $P_\varphi^{r/l}$, viz.,

$$\tilde{Q}_2^{r/l} = \frac{1}{2}(P_\varphi^{r/l} + (P_\varphi^{r/l})^*), \quad \tilde{Q}_1^{r/l} = \frac{1}{2i}(P_\varphi^{r/l} - (P_\varphi^{r/l})^*),$$

The (semi-classical) principal symbols \tilde{q}_j of \tilde{Q}_j , $j = 1, 2$ are then

$$\begin{aligned}\tilde{q}_2^{7/h}(\mathbf{x}, \xi_0, \eta, \xi_n) &= \xi_n^2 + q_2^{7/h}(\mathbf{x}, \xi_0, \eta), \\ \tilde{q}_1^{7/h}(\mathbf{x}, \xi_0, \eta, \xi_n) &= 2\xi_n \partial_{x_n} \varphi^{7/h} + 2q_1^{7/h}(\mathbf{x}, \xi_0, \eta),\end{aligned}$$

for $(y, \eta) \in T^*(S)$, with

$$\begin{aligned}q_2^{7/h}(\mathbf{x}, \xi_0, \eta) &= \frac{\xi_0^2}{c^{7/h}} + r^{7/h}(x, \eta) - \left(\frac{(\partial_{x_0} \varphi^{7/h})^2}{c^{7/h}} + r^{7/h}(x, d_y \varphi^{7/h}) + (\partial_{x_n} \varphi^{7/h})^2 \right) \\ q_1^{7/h}(\mathbf{x}, \xi_0, \eta) &= \frac{\xi_0 \partial_{x_0} \varphi^{7/h}}{c^{7/h}} + \tilde{r}^{7/h}(x; \eta, d_y \varphi^{7/h}).\end{aligned}$$

Recall that $\tilde{r}^{7/h}(x, \eta, \eta')$ stands for the symmetric bilinear form associated with the quadratic principal symbol $r^{7/h}(x, \eta)$. The principal symbol of $P_\varphi^{7/h}$ is naturally

$$p_\varphi^{7/h} = \tilde{q}_2^{7/h} + i\tilde{q}_1^{7/h} = \xi_n^2 + 2i\xi_n \partial_{x_n} \varphi^{7/h} + q_2^{7/h} + 2iq_1^{7/h}. \quad (3.48)$$

For the sake of concision we have at places omitted some of the variable dependencies, e.g. writing $\varphi^{7/h}$ in place of $\varphi^{7/h}(\mathbf{x})$.

Note also that the symbol of P_φ^s is given by

$$\begin{aligned}p_\varphi^s &= \frac{\xi_0^2}{c^s} + r(x, \eta) - \left(\frac{(\partial_{x_0} \varphi)^2}{c^s} + r(x, d_y \varphi|_{x_n=0}) \right) \Big|_{x_n=0} \\ &\quad + 2i \left(\frac{\xi_0 \partial_{x_0} \varphi}{c^s} + \tilde{r}(x; \eta, d_y \varphi|_{x_n=0}) \right) \Big|_{x_n=0}.\end{aligned} \quad (3.49)$$

(Recall that r^l and r^r (resp. φ^l and φ^r) coincide at $x_n = 0^+$.)

3.3.4 Phase-space regions

Following [LR97, LR10] we introduce the following quantity

$$\mu^{7/h}(\mathbf{x}, \xi_0, \eta) = q_2^{7/h}(\mathbf{x}, \xi_0, \eta) + \frac{(q_1^{7/h}(\mathbf{x}, \xi_0, \eta))^2}{(\partial_{x_n} \varphi^{7/h})^2}, \quad (3.50)$$

and the following sets in the (tangential) phase space :

$$E^{7/h, \pm} = \{(x_0, y, x_n; \xi_0, \eta) \in [0, X_0] \times S \times [0, 2\varepsilon] \times \mathbb{R} \times T_y^*(S); \mu^{7/h}(x_0, y, x_n; \xi_0, \eta) \geq 0\}, \quad (3.51)$$

$$Z^{7/h} = \{(x_0, y, x_n; \xi_0, \eta) \in [0, X_0] \times S \times [0, 2\varepsilon] \times \mathbb{R} \times T_y^*(S); \mu^{7/h}(x_0, y, x_n; \xi_0, \eta) = 0\}. \quad (3.52)$$

The analysis we carry on will make precise the behavior of the roots of $p_\varphi^{7/h}$ (viewing $p_\varphi^{7/h}$ as a second-order polynomial in the variable ξ_n , see (3.48)) as $(\mathbf{x}, \xi_0, \eta)$ varies. In particular, we prove that $(\mathbf{x}, \xi_0, \eta) \in Z^{7/h}$, i.e. $\mu^{7/h}(\mathbf{x}, \xi_0, \eta) = 0$, if and only if there exists $\xi_n \in \mathbb{R}$ such that $(\mathbf{x}, \xi_0, \eta, \xi_n) \in \text{Char}(P_\varphi^{7/h})$.

With the following symmetric bilinear forms,

$$\begin{aligned}\tilde{\beta}^{7/h}(x; \xi_0, \eta; \xi'_0, \eta') &= \frac{1}{c^{7/h}} \xi_0 \xi'_0 + \tilde{r}^{7/h}(x, \eta, \eta'), \\ \tilde{\alpha}^{7/h}(x; \xi_0, \eta, \xi_n; \xi'_0, \eta', \xi'_n) &= \tilde{\beta}^{7/h}(x; \xi_0, \eta; \xi'_0, \eta') + \xi_n \xi'_n,\end{aligned}$$

and the associated quadratic forms, $\beta^{7/h}(x; \xi_0, \eta)$ and $\alpha^{7/h}(x; \xi_0, \eta, \xi_n)$, we have

$$\mu^{7/h}(\mathbf{x}, \xi_0, \eta) = \beta^{7/h}(x, \xi_0, \eta) + \frac{(\tilde{\beta}^{7/h}(x; \xi_0, \eta; \partial_{x_0} \varphi^{7/h}, d_y \varphi^{7/h}))^2}{(\partial_{x_n} \varphi^{7/h})^2} - \alpha^{7/h}(x; \partial_{x_0} \varphi^{7/h}, d_y \varphi^{7/h}, \partial_{x_n} \varphi^{7/h}),$$

We also set the following quadratic form

$$\beta_\varphi^{7/l}(\mathbf{x}; \xi_0, \eta) = (\tilde{\beta}^{7/l}(x; \xi_0, \eta; \partial_{x_0}\varphi^{7/l}, d_y\varphi^{7/l}))^2.$$

The quadratic forms $\beta^{7/l}$ are positive definite. With the function $\gamma(x)$ on $\overline{V_\varepsilon^+}$ we chose in Section 3.3.1 we have

$$\beta^l(x; \xi_0, \eta) - \gamma(x)\beta^r(x; \xi_0, \eta) \geq C|(\xi_0, \eta)|^2 > 0. \quad (3.53)$$

From the properties of the weight function listed in Section 3.3.1 we have

$$\gamma'(\partial_{x_n}\varphi^r)^2 - (\partial_{x_n}\varphi^l)^2 \geq C > 0, \quad 0 < \gamma'(x) \leq \gamma(x) - \epsilon, \quad \epsilon > 0, \quad (3.54)$$

and

$$|\partial_{x_0}\varphi^{7/l}| + |d_y\varphi^{7/l}|_g \leq \nu \inf(|\partial_{x_n}\varphi^l|), \quad (3.55)$$

with $\nu > 0$ sufficiently small. Furthermore $|\partial_{x_0}\varphi^{7/l}| + |\nabla_g\varphi^{7/l}| + |\partial_{x_n}\varphi^{7/l}| > 0$ in $[0, X_0] \times \overline{V_\varepsilon^+}$ and the following sub-ellipticity property is satisfied

$$\forall \mathbf{x} \in [0, X_0] \times \overline{V_\varepsilon^+}, (\xi_0, \eta, \xi_n) \in \mathbb{R} \times T_y^*(S) \times \mathbb{R}, \\ p_\varphi^{7/l}(\mathbf{x}, \xi_0, \eta, \xi_n) = 0 \Rightarrow \{\tilde{q}_2^{7/l}, \tilde{q}_1^{7/l}\}(\mathbf{x}, \xi_0, \eta, \xi_n) > 0. \quad (3.56)$$

The sub-ellipticity property (3.56) is necessary for the derivation of the Carleman estimate and is geometrically invariant (see e.g. [Hör63, Section 8.1, page 186], see also [LL09]).

Remark 3.21. A weight function φ that satisfies the properties of Section 3.3.1, or (3.54)–(3.56) equivalently, can be obtained in the following classical way. Choose a continuous function ψ , smooth on both sides of S , such that $\psi^{7/l}$ satisfies conditions (3.54), (3.55) and $|\partial_{x_0}\psi^{7/l}| + |\nabla^g\psi^{7/l}|_g + |\partial_{x_n}\psi^{7/l}| > 0$ on $[0, X_0] \times \overline{V_\varepsilon^+}$. These conditions are then also satisfied by $\varphi = e^{\lambda\psi}$, $\lambda \geq 1$. For the parameter λ sufficiently large φ will also fulfill the sub-ellipticity condition (see e.g. Lemma 3 in [LR95, Section 3.B], Theorem 8.6.3 in [Hör63, Chapter 8], or Proposition 28.3.3 in [Hör94, Chapter 28]).

Using (3.53), (3.54) and (3.55) for ν sufficiently small, we obtain

$$\beta^l - \gamma(x)(\beta^r + \beta_\varphi^r/(\partial_{x_n}\varphi^r)^2) \geq C|(\xi_0, \eta)|^2 > 0, \quad (3.57)$$

and

$$\gamma(x)\alpha^r(x; \partial_{x_0}\varphi^r, d_y\varphi^r, \partial_{x_n}\varphi^r) - \alpha^l(x; \partial_{x_0}\varphi^l, d_y\varphi^l, \partial_{x_n}\varphi^l) \geq C > 0, \quad (3.58)$$

where we have used that $\gamma \geq \gamma' + \epsilon$.

The assumption we have formulated yields the following *key* property.

Proposition 3.22. *There exists $C_0 > 0$ such that in the neighborhood V_ε we have*

$$(\mu^l - \gamma(x)\mu^r)(\mathbf{x}, \xi_0, \eta) \geq C_0\langle(\xi_0, \eta)\rangle^2 > 0, \quad \mathbf{x} = (x_0, x) = (x_0, y, x_n), \quad (\xi_0, \eta) \in \mathbb{R} \times T_y^*(S).$$

In particular, $E^{r,+} \cup Z^r \subset E^{l,+}$.

Proof. With the properties of the weight function of Section 3.3.1, and more precisely (3.57)–(3.58) that follow from them, we have

$$\begin{aligned} \mu^l &= \beta^l(x; \xi_0, \eta) - \gamma(x)(\beta^r(x; \xi_0, \eta) + \beta_\varphi^r(\mathbf{x}; \xi_0, \eta)/(\partial_{x_n}\varphi^r)^2) + \beta_\varphi^l(\mathbf{x}; \xi_0, \eta)/(\partial_{x_n}\varphi^l)^2 \\ &\quad + \gamma(x)\alpha^r(x; \varphi^r) - \alpha^l(x; \varphi^l) + \gamma(x)\mu^r \\ &\geq C\langle(\xi_0, \eta)\rangle^2 + \gamma(x)\mu^r. \end{aligned}$$

□

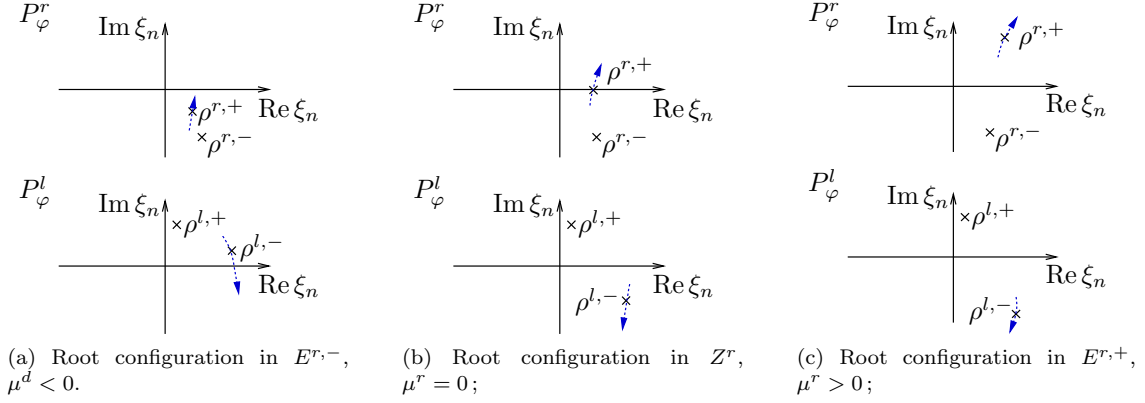

FIGURE 3.3 – The root $\rho^{r,+}$ crosses the real axis before the root $\rho^{l,-}$ does, as μ^r decreases.

Proposition 3.23. *With the properties of the weight function of Section 3.3.1 we have*

$$\text{Char}(p_\varphi^s) \subset \text{Char}(\text{Re } p_\varphi^s) \subset (E^{l,-} \cap \{x_n = 0\}).$$

Proof. From the form of (3.49) we see that $\text{Re } p_\varphi^s = 0$ implies

$$|\eta|_g + |\xi_0| \leq C(|\partial_{x_0} \varphi^{7l}| + |d_y \varphi^{7l}|_g)_{x_n=0}, \quad (3.59)$$

and we find

$$\mu^l|_{x_n=0^+} = \left[(\xi_0^2 - (\partial_{x_0} \varphi)^2) \left(\frac{1}{c^l} - \frac{1}{c^s} \right) - (\partial_{x_n} \varphi^l)^2 + \frac{1}{(\partial_{x_n} \varphi^2)} \left(\frac{\xi_0 \partial_{x_0} \varphi}{c^l} + \tilde{r}(x; \eta, d_y \varphi|_{x_n=0}) \right)^2 \right] \Big|_{x_n=0}.$$

Using (3.59) together with (3.55) in this expression gives

$$\mu^l|_{x_n=0^+} \leq \left[-(\partial_{x_n} \varphi^l)^2 + C\nu \inf((\partial_{x_n} \varphi^l)^2) \right] \Big|_{x_n=0}.$$

The result thus follows when taking ν sufficiently small. \square

3.3.5 Root properties

The following lemma describes the position of the roots of p_φ^{7l} of (3.48) viewed as a second-order polynomial in ξ_n . The proof is given in Appendix 3.8.4.

Lemma 3.24. *We have the following root properties.*

1. *In the region $E^{7l,+}$, the polynomial p_φ^{7l} defined in (3.48) has two distinct roots that satisfy $\text{Im } \rho^{7l,+} > 0$ and $\text{Im } \rho^{7l,-} < 0$. Moreover we have*

$$\mu^{7l} \geq C > 0 \quad \Leftrightarrow \quad \text{Im } \rho^{7l,+} \geq C' > 0 \quad \text{and} \quad \text{Im } \rho^{7l,-} \leq -C' < 0,$$

2. *In the region $E^{7l,-}$, the imaginary parts of the two roots have the same sign as that of $-\partial_{x_n} \varphi^{7l}$.*
3. *In the region Z^{7l} , one of the roots is real.*

Moreover, there exist $C > 0$ and $H > 0$ such that $|\rho^{7l,+} - \rho^{7l,-}| \geq |\text{Im } \rho^{7l,+} - \text{Im } \rho^{7l,-}| \geq C > 0$ in the region $\{\mu^{7l} \geq -H\}$.

Remark 3.25. Note that $(\mathbf{x}, \xi_0, \eta) \in E^{7l,+}$ for $|\xi_0| + |\eta|_g$ sufficiently large, say $|\xi_0| + |\eta|_g \geq R$, uniformly in $\mathbf{x} \in [0, X_0] \times \overline{V_\varepsilon^+}$ and for h bounded. Note also that in the region $\{\mu^{7l} \geq -H\}$, the roots $\rho^{7l,\pm}$ are smooth since they do not cross.

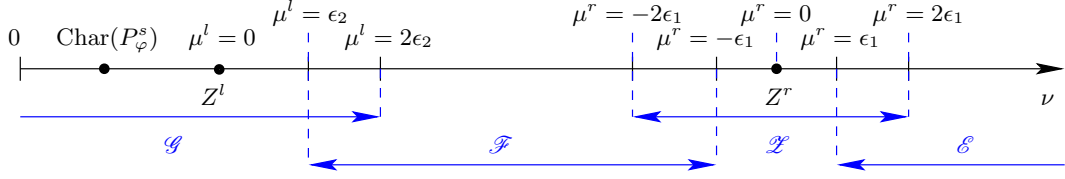

FIGURE 3.4 – Sketch of the relative localization of the different phase-space regions. Here, $(\mathbf{x}, \xi_0, \eta)$ is fixed and we plot the different zones for $(\mathbf{x}, \nu\xi_0, \nu\eta)$ as ν increases from 0 to ∞ . Here, ν represents the norm of the tangential frequencies. This situation can be represented under this form since for \mathbf{x} fixed, the sets $E^{j_l, -}$ and $\{p_\varphi^s \leq 0\}$ are star-shaped with respect to 0 in the variables $(\xi_0, \eta) \in T_{(x_0, y)}^*((0, X_0) \times S)$.

For the polynomial p_φ^r , for $|\xi_0| + |\eta|_g$ small, i.e. in the region $E^{r, -}$, the two roots $\rho^{r, +}$ and $\rho^{r, -}$ both have *negative* imaginary parts. As the value of μ^r increases, the root $\rho^{r, +}$ moves towards the real axis, and crosses it in the region Z^r . In the region $E^{r, +}$ we have $\text{Im } \rho^{r, +} > 0$ and $\text{Im } \rho^{r, -} < 0$.

For the polynomial p_φ^l , for $|\xi_0| + |\eta|_g$ small, i.e. in the region $E^{l, -}$, the two roots $\rho^{l, +}$ and $\rho^{l, -}$ both have *positive* imaginary parts. As the value of μ^l increases, the root $\rho^{l, -}$ moves towards the real axis, and crosses it in the region Z^l . In the region $E^{l, +}$ we have $\text{Im } \rho^{l, +} > 0$ and $\text{Im } \rho^{l, -} < 0$. The “motion” of the roots of p_φ^l and p_φ^r is illustrated in Figure 3.3.

We now call

$$\mathcal{M}_+ = (0, X_0) \times S \times [0, 2\varepsilon].$$

We also set

$$\mathcal{M}_+^* := \{(x_0, y, x_n, \xi_0, \eta) \in (0, X_0) \times S \times [0, 2\varepsilon] \times \mathbb{R} \times T_y^*(S)\} \simeq T^*((0, X_0) \times S) \times [0, 2\varepsilon].$$

With the symbols defined in Section 3.7.2 (see Definition 3.42) we obtain the following result.

Lemma 3.26. *Let H be as given in Lemma 3.24. Let $\chi^{7l} \in S_T^0(\mathcal{M}_+^*)$ with support in $\{\mu^{7l} \geq -H\}$. Then $\chi^{7l} \rho^{7l, \pm} \in S_T^1(\mathcal{M}_+^*)$. Let $C_0 > 0$, there exists $C > 0$ such that $|\text{Im } \rho^{7l, \pm}| \geq C(1 + |\xi_0| + |\eta|_g)$ in $\{\mu^{7l} \geq C_0\}$. It follows that for some $C' > 0$ we have*

$$|\rho^{7l, +} - \rho^{7l, -}| \geq |\text{Im}(\rho^{7l, +} - \rho^{7l, -})| \geq C'(1 + |\xi_0| + |\eta|_g), \quad \text{in } \{\mu^{7l} \geq C_0\}.$$

We refer to Appendix 3.8.5 for a proof.

3.3.6 Microlocalisation operators

We define the following open sets in (tangential) phase-space :

$$\begin{aligned} \mathcal{E} &= \{(\mathbf{x}, \xi_0, \eta) \in \mathcal{M}_+^*; \epsilon_1 < \mu^r(\mathbf{x}, \xi_0, \eta)\}, \\ \mathcal{L} &= \{(\mathbf{x}, \xi_0, \eta) \in \mathcal{M}_+^*; -2\epsilon_1 < \mu^r(\mathbf{x}, \xi_0, \eta) < 2\epsilon_1\}, \\ \mathcal{F} &= \{(\mathbf{x}, \xi_0, \eta) \in \mathcal{M}_+^*; \epsilon_2 < \mu^l(\mathbf{x}, \xi_0, \eta), \text{ and } \mu^r(\mathbf{x}, \xi_0, \eta) < -\epsilon_1\}, \\ \mathcal{G} &= \{(\mathbf{x}, \xi_0, \eta) \in \mathcal{M}_+^*; \mu^l(\mathbf{x}, \xi_0, \eta) < 2\epsilon_2\}. \end{aligned} \quad (3.60)$$

The constants ϵ_1 and ϵ_2 are taken such that $\sup(\gamma)\epsilon_1 + \epsilon_2 < C_0/2$, with C_0 as in Proposition 3.22. Our analysis in the region \mathcal{L} will require ϵ_1 to be small (see Section 3.4.4 below). Recall that γ is defined in Section 3.3.1. This yields $\mathcal{G} \cap \mathcal{L} = \emptyset$. As a consequence of Propositions 3.22 and 3.23, the localization of the different microlocal zones can be represented as in Figure 3.4. In particular, we have $\text{Char}(p_\varphi^s) \subset (\mathcal{G} \setminus \mathcal{F}) \cap \{x_n = 0\}$.

With the open covering of \mathcal{M}_+^* by \mathcal{E} , \mathcal{L} , \mathcal{F} and \mathcal{G} we introduce a \mathcal{C}^∞ partition of unity,

$$\chi_{\mathcal{E}} + \chi_{\mathcal{L}} + \chi_{\mathcal{F}} + \chi_{\mathcal{G}} = 1, \quad 0 \leq \chi_{\bullet} \leq 1, \quad \text{supp}(\chi_{\bullet}) \subset \bullet, \quad \bullet = \mathcal{E}, \mathcal{L}, \mathcal{F}, \mathcal{G}.$$

The sets \mathcal{L} , \mathcal{F} and \mathcal{G} are relatively compact which gives $\chi_{\mathcal{L}}, \chi_{\mathcal{F}}, \chi_{\mathcal{G}} \in S_{\mathcal{T}}^{-\infty}(\mathcal{M}_+^*)$ and consequently $\chi_{\mathcal{E}} \in S_{\mathcal{T}}^0(\mathcal{M}_+^*)$. Associated with these symbols we now define tangential pseudo-differential operators on \mathcal{M}_+ .

Given $0 < \alpha_0 < X_0/2$, we choose a function $\zeta^1 \in \mathcal{C}_c^\infty(0, X_0)$ that satisfies $\zeta^1 = 1$ on a neighborhood of $(\alpha_0, X_0 - \alpha_0)$ and $0 \leq \zeta^1 \leq 1$. Setting

$$\zeta_j(x_0, y, x_n) = \zeta^1(x_0)\psi_j(y) \quad (3.61)$$

gives a partition of unity on $(\alpha_0, X_0 - \alpha_0) \times S \times [0, 2\varepsilon]$. Recall that $(\psi_j)_{j \in J}$ is a partition of unity on S (see Section 3.1.4.3).

We define the following operators on \mathcal{M}_+ :

$$\Xi_{\bullet} = \sum_{j \in J} \Xi_{\bullet, j}, \quad \text{with} \quad \Xi_{\bullet, j} = \phi_j^* \text{Op}_{\mathcal{T}}(\chi_{\bullet, j})(\phi_j^{-1})^* \zeta_j, \quad j \in J, \quad \bullet = \mathcal{E}, \mathcal{L}, \mathcal{F}, \mathcal{G}, \quad (3.62)$$

where ϕ_j^* denotes the pullback by the function ϕ_j and

$$\chi_{\bullet, j} = \tilde{\zeta}_j(\phi_j^{-1})^* \chi_{\bullet}, \quad (3.63)$$

and $\tilde{\zeta}_j$ denotes a function in $\mathcal{C}_c^\infty((0, X_0) \times \tilde{U}_j)$ with $\tilde{\zeta}_j = 1$ in a neighborhood of $\text{supp}((\phi_j^{-1})^* \zeta_j)$.

Proposition 3.52 in Appendix 3.7.3 shows that the operators Ξ_{\bullet} are zero-order tangential semi-classical operators on \mathcal{M}_+ , with principal symbol $\zeta^1(x_0)\chi_{\bullet}(\mathbf{x}, \xi_0, \eta)$.

Remark 3.27. The role of the parameter α_0 introduced here is to avoid considering boundary problems on $(\{0\} \cup \{X_0\}) \times S \times [0, 2\varepsilon]$.

3.4 Proof of the Carleman estimate in a neighborhood of the interface

In this section, we prove Carleman estimates in the four microlocal regions described above, that is, for functions $\Xi_{\bullet} v^{7l}$, with $v^{7l} \in \mathcal{C}_c^\infty((0, X_0) \times S \times [0, 2\varepsilon])$ and $\bullet = \mathcal{E}, \mathcal{L}, \mathcal{F}, \mathcal{G}$. It will be more convenient to do this in local coordinates⁸, since we then can use the techniques and some of the results of [LR10].

Our strategy in each microlocal region \bullet (with $\bullet = \mathcal{E}, \mathcal{L}, \mathcal{F}, \mathcal{G}$) is hence the following : we first produce Carleman estimates in each local chart $(0, X_0) \times \tilde{U}_j \times [0, 2\varepsilon]$ for the functions

$$u_{\bullet, j}^{7l} := \text{Op}_{\mathcal{T}}(\chi_{\bullet, j})v_j^{7l} \quad \text{and} \quad u_{\bullet, j}^s := \text{Op}_{\mathcal{T}}(\chi_{\bullet, j}|_{x_n=0^+})v_j^s, \quad (3.64)$$

where

$$v_j^{7l} := (\phi_j^{-1})^* \zeta_j v^{7l} \quad \text{and} \quad v_j^s := (\phi_j^{-1})^* \zeta_j v^s,$$

with ζ_j defined in (3.61). Then, we pull the local estimates back to the manifold and patch them together to finally obtain a Carleman estimate for $\Xi_{\bullet} v^{7l}$, as

$$\Xi_{\bullet} v^{7l} = \sum_j \phi_j^* u_{\bullet, j}^{7l}. \quad (3.65)$$

Note that the functions v_j^{7l} (resp. v_j^s) are defined in $(0, X_0) \times \tilde{U}_j \times [0, 2\varepsilon]$ (resp. $(0, X_0) \times \tilde{U}_j$). Yet, because of their compact support, we naturally extend them by zero to $\mathbb{R} \times \mathbb{R}^{n-1} \times \mathbb{R}^+$ (resp. $\mathbb{R} \times \mathbb{R}^{n-1}$). In the sequel, functions with such a compact support will be extended similarly.

In what follows, we shall use the notation \lesssim for $\leq C$, with a constant C independent of δ and h (but depending on δ_0 and h_0).

8. However, note that it would be interesting to obtain the results of [LR10] directly in a global setting.

3.4.1 Preliminary observations

In the local chart \tilde{U}_j , the differential operators P_φ^α , $\alpha = r, l$ or s , are given by

$$P_{\varphi,j}^\alpha = (\phi_j^{-1})^* P_\varphi^\alpha \phi_j^*,$$

with principal symbol $p_{\varphi,j}^\alpha = (\phi_j^{-1})^* p_\varphi^\alpha$.

Observe that the definition of $\mu^{7/l}$ in (3.50), and of the associated microlocal regions $Z^{7/l}, E^{7/l,\pm}$ in (3.51)–(3.52), and $\mathcal{E}, \mathcal{Z}, \mathcal{F}$ and \mathcal{G} in (3.60), are geometrically invariant.

In local coordinates, System (3.47) becomes

$$\begin{cases} P_{\varphi,j}^{7/l} v_j^{7/l} = \tilde{F}_{\varphi,j}^{7/l} & \text{in } (0, X_0) \times \tilde{U}_j \times [0, 2\varepsilon), \\ P_{\varphi,j}^s v_j^s = \frac{hi}{c_j^s \delta} (c_j^r (D_{x_n} + i\partial_{x_n} \varphi_j^r) v_j^r|_{x_n=0^+} \\ \quad + c_j^l (D_{x_n} + i\partial_{x_n} \varphi_j^l) v_j^l|_{x_n=0^+} + \tilde{\Theta}_{\varphi,j}^s) & \text{in } (0, X_0) \times \tilde{U}_j, \\ v_j^{7/l}|_{x_n=0^+} = v_j^s + \theta_{\varphi,j}^{7/l} & \text{in } (0, X_0) \times \tilde{U}_j, \end{cases} \quad (3.66)$$

where we have set

$$\begin{cases} \tilde{F}_{\varphi,j}^{7/l} = (\phi_j^{-1})^* \zeta_j F_\varphi^{7/l} + (\phi_j^{-1})^* [P_\varphi^{7/l}, \zeta_j] v^{7/l}, \\ \theta_{\varphi,j}^{7/l} = (\phi_j^{-1})^* \zeta_j \theta_\varphi^{7/l}, \\ \Theta_{\varphi,j}^s = (\phi_j^{-1})^* \zeta_j \Theta_\varphi^s, \quad \tilde{\Theta}_{\varphi,j}^s = \Theta_{\varphi,j}^s + \frac{c_j^s \delta}{hi} (\phi_j^{-1})^* [P_\varphi^s, \zeta_j] v^s, \\ \varphi_j^{7/l} = (\phi_j^{-1})^* \varphi^{7/l}, \quad c_j^{7/l} = (\phi_j^{-1})^* c^{7/l}, \quad c_j^s = (\phi_j^{-1})^* c^s, \end{cases} \quad (3.67)$$

with $[P_\varphi^{7/l}, \zeta_j] \in h\mathcal{D}^1(\mathcal{M}_+)$ and $[P_\varphi^s, \zeta_j] \in h\mathcal{D}_T^1(\mathcal{M}_+)$.

We now formulate System (3.66) in terms of $u_{\bullet,j}$ in preparation for the estimations in the four different microlocal zones. First, we have

$$P_{\varphi,j}^{7/l} u_{\bullet,j}^{7/l} = \text{Op}_T(\chi_{\bullet,j}) P_{\varphi,j}^{7/l} v_j^{7/l} + \underbrace{[P_{\varphi,j}^{7/l}, \text{Op}_T(\chi_{\bullet,j})] v_j^{7/l}}_{\in h(\Psi_T^0 D_{x_n} + \Psi_T^1)}.$$

In particular, this gives

$$\|P_{\varphi,j}^{7/l} u_{\bullet,j}^{7/l}\|_0 \lesssim \|P_{\varphi,j}^{7/l} v_j^{7/l}\|_0 + h \|v_j^{7/l}\|_1. \quad (3.68)$$

Second, as a consequence of (3.66), the transmission conditions satisfied by $u_{\bullet,j}^{7/l}$ and $u_{\bullet,j}^s$ read

$$\begin{cases} \frac{\delta c_j^s}{hi} P_{\varphi,j}^s u_{\bullet,j}^s = (c_j^l (D_{x_n} + i\partial_{x_n} \varphi_j^l) u_{\bullet,j}^l|_{x_n=0^+} + (c_j^r (D_{x_n} + i\partial_{x_n} \varphi_j^r) u_{\bullet,j}^r|_{x_n=0^+} + G_1, \\ u_{\bullet,j}^{7/l}|_{x_n=0^+} = u_{\bullet,j}^s + \theta_{\bullet,j}^{7/l}, \end{cases} \quad (3.69)$$

with $\theta_{\bullet,j}^{7/l} = \text{Op}_T(\chi_{\bullet,j}|_{x_n=0^+}) \theta_{\varphi,j}^{7/l}$ and

$$\begin{aligned} G_1 &= \frac{\delta c_j^s}{hi} \underbrace{[P_{\varphi,j}^s, \text{Op}_T(\chi_{\bullet,j}|_{x_n=0^+})] v_j^s}_{\in h\Psi_T^1} + \underbrace{[\text{Op}_T(\chi_{\bullet,j}|_{x_n=0^+}), c_j^l (D_{x_n} + i\partial_{x_n} \varphi_j^l)] v_j^l|_{x_n=0^+}}_{\in h\Psi_T^0} \\ &\quad + \underbrace{[\text{Op}_T(\chi_{\bullet,j}|_{x_n=0^+}), c_j^r (D_{x_n} + i\partial_{x_n} \varphi_j^r)] v_j^r|_{x_n=0^+}}_{\in h\Psi_T^0} + \text{Op}_T(\chi_{\bullet,j}|_{x_n=0^+}) \tilde{\Theta}_{\varphi,j}^s. \end{aligned}$$

We have the following estimate

$$\begin{aligned} |G_1|_0 &\lesssim \delta |v_j^s|_1 + h |v_j^l|_{x_n=0^+}|_0 + h |v_j^r|_{x_n=0^+}|_0 + |\tilde{\Theta}_{\varphi,j}^s|_0 \\ &\lesssim (\delta + h) |v_j^s|_1 + h |\theta_{\varphi,j}^l|_0 + h |\theta_{\varphi,j}^r|_0 + |\Theta_{\varphi,j}^s|_0, \end{aligned} \quad (3.70)$$

by (3.66) and (3.67). We set

$$\gamma_0(u_{\bullet,j}^{7l}) = u_{\bullet,j}^{7l}|_{x_n=0^+}, \quad \gamma_1(u_{\bullet,j}^{7l}) = (D_{x_n} u_{\bullet,j}^{7l})|_{x_n=0^+}. \quad (3.71)$$

In this local setting we also introduce

$$\beta = (c_j^r/c_j^l)|_{x_n=0^+}, \quad \tilde{G}_1 = i\partial_{x_n}\varphi_j^l(\theta_{\bullet,j}^l - \theta_{\bullet,j}^r) + \frac{1}{c_j^l|_{x_n=0^+}} G_1, \quad (3.72)$$

$$k = -i(\partial_{x_n}\varphi_j^l|_{x_n=0^+} + \beta\partial_{x_n}\varphi_j^r|_{x_n=0^+}). \quad (3.73)$$

Transmission conditions (3.69) can be written as

$$\begin{cases} \frac{\delta c_j^s}{h i c_j^l} P_{\varphi,j}^s u_{\bullet,j}^s = \gamma_1(u_{\bullet,j}^l) + \beta\gamma_1(u_{\bullet,j}^r) - k\gamma_0(u_{\bullet,j}^r) + \tilde{G}_1, \\ \gamma_0(u_{\bullet,j}^{7l}) = u_{\bullet,j}^s + \theta_{\bullet,j}^{7l}. \end{cases} \quad (\text{TC}_{\bullet,j})$$

where the remainder \tilde{G}_1 can be estimated thanks to (3.70) by

$$|\tilde{G}_1|_0 \lesssim (\delta + h)|v_j^s|_1 + |\Theta_{\varphi,j}^s|_0 + |\theta_{\varphi,j}^l|_0 + |\theta_{\varphi,j}^r|_0. \quad (3.74)$$

We are now prepared to prove the different Carleman estimates in the four microlocal regions.

3.4.2 Estimate in the region \mathcal{G}

Here, we place ourselves in the region \mathcal{G} , and prove a Carleman estimate for $u_{\mathcal{G},j}$, and consequently for $\Xi_{\mathcal{G}}v$.

We introduce a microlocal cut-off function $\chi_{\mathcal{G}\mathcal{F}} \in \mathcal{C}_c^\infty(\mathcal{M}_+^*)$, $0 \leq \chi_{\mathcal{G}\mathcal{F}} \leq 1$, satisfying

$$\begin{aligned} \chi_{\mathcal{G}\mathcal{F}} &= 1 \text{ on a neighborhood of } \text{supp}(\chi_{\mathcal{G}}), \\ \chi_{\mathcal{G}} + \chi_{\mathcal{F}} &= 1 \text{ on a neighborhood of } \text{supp}(\chi_{\mathcal{G}\mathcal{F}}). \end{aligned} \quad (3.75)$$

We choose $\zeta^2 \in \mathcal{C}_c^\infty(0, X_0)$ such that $0 \leq \zeta^2 \leq 1$, $\zeta^2 = 1$ on a neighborhood of $\text{supp}(\zeta^1)$ (with ζ^1 defined in (3.61)), and such that $\tilde{\zeta}_j = 1$ on $\text{supp}((\phi_j^{-1})^* \zeta_j^2)$ where $\zeta_j^2(x_0, y) = \zeta^2(x_0)\psi_j(y)$. As in (3.63) we set

$$\chi_{\mathcal{G}\mathcal{F},j} = \tilde{\zeta}_j (\phi_j^{-1})^* \chi_{\mathcal{G}\mathcal{F}},$$

and we define the associated tangential pseudo-differential operator $\Xi_{\mathcal{G}\mathcal{F}}$ by

$$\Xi_{\mathcal{G}\mathcal{F}} = \sum_{j \in J} \Xi_{\mathcal{G}\mathcal{F},j}, \quad \text{with } \Xi_{\mathcal{G}\mathcal{F},j} = \phi_j^* \text{Op}_{\mathcal{T}}(\chi_{\mathcal{G}\mathcal{F},j})(\phi_j^{-1})^* \zeta_j^2, \quad j \in J,$$

Note that the local symbol (see Proposition 3.45) of $\Xi_{\mathcal{G}\mathcal{F}}$ in each chart is equal to one in the support of that of $\Xi_{\mathcal{G}}$.

We recall that the function $\zeta = \zeta(x_n) \in \mathcal{C}_c^\infty([0, 2\varepsilon])$ satisfies $\zeta(0) = 1$ on $[0, \varepsilon]$.

Making use of the Calderón projector technique for $P_{\varphi,j}^r$ and of the standard Carleman techniques for $P_{\varphi,j}^l$, we obtain the following partial estimate.

Proposition 3.28. *Suppose that the weight function φ satisfies the properties listed in Section 3.3.1. Then, for all $\delta_0 > 0$, there exist $C > 0$ and $h_0 > 0$ such that, for all $0 < \delta \leq \delta_0$ and $0 < h \leq h_0$, $v^{7l} \in \mathcal{C}_c^\infty((0, X_0) \times S \times [0, 2\varepsilon])$ and $v^s \in \mathcal{C}_c^\infty((0, X_0) \times S)$ satisfying (3.47), we have*

$$\|\Xi_{\mathcal{G}}v^r\|_1^2 + h|\Xi_{\mathcal{G}}v^r|_{x_n=0^+}|_1^2 + h|D_{x_n}\Xi_{\mathcal{G}}v^r|_{x_n=0^+}|_0^2 \leq C \left(\|P_{\varphi}^r v^r\|_0^2 + h^2 \|v^r\|_1^2 + h^4 |D_{x_n} v^r|_{x_n=0^+}|_0^2 \right), \quad (3.76)$$

and

$$\begin{aligned}
& h\|\Xi_{\mathcal{G}}v^l\|_1^2 + h|\Xi_{\mathcal{G}}v^l|_{x_n=0^+}|_1^2 + h|D_{x_n}\Xi_{\mathcal{G}}v^l|_{x_n=0^+}|_0^2 \\
& \leq C\left(1 + \frac{\delta^2}{h^2}\right)\left(\|\zeta P_{\varphi}^r v^r\|_0^2 + h^2\|\Xi_{\mathcal{G}\mathcal{F}}v^r\|_1^2 + h^4|D_{x_n}v^r|_{x_n=0^+}|_0^2 + h^4\|v^r\|_1^2 + h^3|v^s|_1^2\right) \\
& \quad + C\left(\|P_{\varphi}^l v^l\|_0^2 + h^2\|v^l\|_1^2 + h|\theta_{\varphi}^l|_1^2 + \frac{\delta^2}{h}|\theta_{\varphi}^r|_0^2 + h|\theta_{\varphi}^r|_1^2 + h|\Theta_{\varphi}^s|_0^2\right). \tag{3.77}
\end{aligned}$$

Proof. The function $u_{\mathcal{G},j}$, defined in (3.64), satisfies $(\text{TC}_{\bullet,j})$, with $\bullet = \mathcal{G}$. On the “ r ” side, the root configuration described in Lemma 3.24 (and represented in Figure 3.3) allows us to apply the Calderón projector technique used in [LR97, LR10]. According to [LR10, Remark 2.5] and using Eqs. (2.59), (2.60), and (2.61) therein, applied with v^d replaced here by v_j^r , we have

$$\|u_{\mathcal{G},j}^r\|_1 + h^{\frac{1}{2}}|\gamma_0(u_{\mathcal{G},j}^r)|_1 + h^{\frac{1}{2}}|\gamma_1(u_{\mathcal{G},j}^r)|_0 \lesssim \|P_{\varphi,j}^r v_j^r\|_0 + h\|v_j^r\|_1 + h^2|D_{x_n}v_j^r|_{x_n=0^+}|_0, \tag{3.78}$$

which is a local version of (3.76).

Let us now explain how such local estimates can be patched together to yield (3.76). Concerning the first term on the left hand-side of (3.78), and using the definition of Sobolev norms given in (3.20)–(3.22), we have

$$\|\Xi_{\mathcal{G}}v^r\|_1 \lesssim \sum_{j \in J} \|u_{\mathcal{G},j}^r\|_1, \quad |\Xi_{\mathcal{G}}v^r|_{x_n=0^+}|_1 \lesssim \sum_{j \in J} |\gamma_0(u_{\mathcal{G},j}^r)|_1 \tag{3.79}$$

by (3.65) and Lemma 3.53. Similarly we have $D_{x_n}\Xi_{\mathcal{G}}v^r|_{x_n=0^+}|_0 = \sum_j \phi_j^* \gamma_1(u_{\mathcal{G},j}^r)$ since ϕ_j^* does not depend on the x_n -variable. As a consequence, we obtain

$$|(D_{x_n}\Xi_{\mathcal{G}}v^r)|_{x_n=0^+}|_0 \leq \sum_{j \in J} |\phi_j^* \gamma_1(u_{\mathcal{G},j}^r)|_0 \lesssim \sum_{j \in J} |\gamma_1(u_{\mathcal{G},j}^r)|_0, \tag{3.80}$$

by Lemma 3.9.

Now concerning the right hand-side of (3.78), we directly have

$$\|v_j^r\|_1 = \|(\phi_j^{-1})^* \zeta_j v^r\|_1 = \|\zeta^1(\phi_j^{-1})^* \psi_j v^r\|_1 \lesssim \|(\phi_j^{-1})^* \psi_j v^r\|_1 \lesssim \|v^r\|_1, \tag{3.81}$$

by the definition of $\|\cdot\|_1$ on \mathcal{M}_+ , as well as

$$|D_{x_n}v_j^r|_{x_n=0^+}|_0 \lesssim |D_{x_n}v^r|_{x_n=0^+}|_0. \tag{3.82}$$

Finally, we compute $P_{\varphi,j}^r v_j^r = (\phi_j^{-1})^* P_{\varphi}^r \phi_j^* (\phi_j^{-1})^* \zeta_j v^r = (\phi_j^{-1})^* \zeta_j P_{\varphi}^r v^r + (\phi_j^{-1})^* [P_{\varphi}^r, \zeta_j] v^r$. We have

$$\|(\phi_j^{-1})^* \zeta_j P_{\varphi}^r v^r\|_0 = \|\zeta^1(\phi_j^{-1})^* \psi_j P_{\varphi}^r v^r\|_0 \leq \|P_{\varphi}^r v^r\|_0, \tag{3.83}$$

and, using Lemma 3.9,

$$\|(\phi_j^{-1})^* [P_{\varphi}^r, \zeta_j] v^r\|_0 \lesssim \|[P_{\varphi}^r, \zeta_j] v^r\|_0 \lesssim h\|v^r\|_1, \tag{3.84}$$

since $[P_{\varphi}^r, \zeta_j] \in h\mathcal{D}^1(\mathcal{M}_+)$. Finally combining all the estimates (3.79)–(3.84), together with the local inequalities (3.78) summed over $j \in J$, we obtain the sought global estimate (3.76) on \mathcal{M}_+ .

To obtain Estimate (3.77) on the “ l ” side we first need a more precise estimate for the “ r ” side. For this, we introduce another microlocal cut-off function $\tilde{\chi}_{\mathcal{G}\mathcal{F}}$ satisfying the same requirements (3.75) as $\chi_{\mathcal{G}\mathcal{F}}$, and such that $\chi_{\mathcal{G}\mathcal{F}} = 1$ on a neighborhood of $\text{supp}(\tilde{\chi}_{\mathcal{G}\mathcal{F}})$. We choose $\zeta^3 \in \mathcal{C}_c^\infty(0, X_0)$ such that $0 \leq \zeta^3 \leq 1$, $\zeta^3 = 1$ on a neighborhood of $\text{supp}(\zeta^1)$, and such that $\zeta^2 = 1$ on a neighborhood of $\text{supp}(\zeta^3)$. As in (3.63) we set

$$\tilde{\chi}_{\mathcal{G}\mathcal{F},j} = \tilde{\zeta}_j (\phi_j^{-1})^* \tilde{\chi}_{\mathcal{G}\mathcal{F}},$$

and we define the associated tangential pseudo-differential operator $\tilde{\Xi}_{\mathcal{G}\mathcal{F}}$ by

$$\tilde{\Xi}_{\mathcal{G}\mathcal{F}} = \sum_{j \in J} \tilde{\Xi}_{\mathcal{G}\mathcal{F},j}, \quad \text{with} \quad \tilde{\Xi}_{\mathcal{G}\mathcal{F},j} = \phi_j^* \text{Op}_{\mathcal{T}}(\tilde{\chi}_{\mathcal{G}\mathcal{F},j})(\phi_j^{-1})^* \zeta_j^3, \quad \zeta_j^3 = \zeta^3 \psi_j, \quad j \in J,$$

According to [LR10, Remark 2.5] and using (2.60) and (2.61) therein, applied with v^d replaced by $\zeta(x_n)(\phi_j^{-1})^* \zeta_j \tilde{\Xi}_{\mathcal{G}\mathcal{F}} v^r$, we have

$$\begin{aligned} & h^{\frac{1}{2}} |\gamma_0(\text{Op}_{\mathcal{T}}(\chi_{\mathcal{G},j})(\phi_j^{-1})^* \zeta_j \tilde{\Xi}_{\mathcal{G}\mathcal{F}} v^r)|_1 + h^{\frac{1}{2}} |\gamma_1(\text{Op}_{\mathcal{T}}(\chi_{\mathcal{G},j})(\phi_j^{-1})^* \zeta_j \tilde{\Xi}_{\mathcal{G}\mathcal{F}} v^r)|_0 \\ & \lesssim \|P_{\varphi,j}^r \zeta(\phi_j^{-1})^* \zeta_j \tilde{\Xi}_{\mathcal{G}\mathcal{F}} v^r\|_0 + h \|\zeta(\phi_j^{-1})^* \zeta_j \tilde{\Xi}_{\mathcal{G}\mathcal{F}} v^r\|_1 + h^2 |\gamma_1((\phi_j^{-1})^* \zeta_j \tilde{\Xi}_{\mathcal{G}\mathcal{F}} v^r)|_0. \end{aligned} \quad (3.85)$$

We notice that the right hand-side of this inequality can directly be bounded by global quantities. First, we have

$$\|\zeta(\phi_j^{-1})^* \zeta_j \tilde{\Xi}_{\mathcal{G}\mathcal{F}} v^r\|_1 \lesssim \|\tilde{\Xi}_{\mathcal{G}\mathcal{F}} v^r\|_1 \quad (3.86)$$

Second, we estimate

$$|\gamma_1((\phi_j^{-1})^* \zeta_j \tilde{\Xi}_{\mathcal{G}\mathcal{F}} v^r)|_0 \leq |(D_{x_n} \tilde{\Xi}_{\mathcal{G}\mathcal{F}} v^r)|_{x_n=0^+}|_0,$$

where

$$(D_{x_n} \tilde{\Xi}_{\mathcal{G}\mathcal{F}} v^r)|_{x_n=0^+} = (\tilde{\Xi}_{\mathcal{G}\mathcal{F}} D_{x_n} v^r)|_{x_n=0^+} + \underbrace{([D_{x_n}, \tilde{\Xi}_{\mathcal{G}\mathcal{F}}] v^r)}_{\in h\Psi_{\mathcal{T}}^0(\mathcal{M}_+)}|_{x_n=0^+}.$$

Using Proposition 3.50 and the trace formula (3.23), we have the estimate

$$h^2 |\gamma_1((\phi_j^{-1})^* \zeta_j \tilde{\Xi}_{\mathcal{G}\mathcal{F}} v^r)|_0 \lesssim h^2 |D_{x_n} v^r|_{x_n=0^+}|_0 + h^{\frac{5}{2}} \|v^r\|_1. \quad (3.87)$$

Concerning the term with $P_{\varphi,j}^r$ in the right hand-side of (3.85), we can proceed as in (3.83)-(3.84) to obtain

$$\|P_{\varphi,j}^r \zeta(\phi_j^{-1})^* \zeta_j \tilde{\Xi}_{\mathcal{G}\mathcal{F}} v^r\|_0 = \|(\phi_j^{-1})^* P_{\varphi}^r \zeta \zeta_j \tilde{\Xi}_{\mathcal{G}\mathcal{F}} v^r\|_0 \lesssim \|P_{\varphi}^r \zeta \tilde{\Xi}_{\mathcal{G}\mathcal{F}} v^r\|_0 + h \|\tilde{\Xi}_{\mathcal{G}\mathcal{F}} v^r\|_1 \quad (3.88)$$

Moreover, using Proposition 3.48, we have $\tilde{\Xi}_{\mathcal{G}\mathcal{F}}(1 - \Xi_{\mathcal{G}\mathcal{F}}) \in h^\infty \Psi_{\mathcal{T}}^{-\infty}(\mathcal{M}_+)$, as their local symbols in every chart have disjoint supports by Proposition 3.52, because of the supports of ζ^3 and $\tilde{\chi}_{\mathcal{G}\mathcal{F}}$. We then obtain with Proposition 3.50

$$h \|\tilde{\Xi}_{\mathcal{G}\mathcal{F}} v^r\|_1 \lesssim h \|\tilde{\Xi}_{\mathcal{G}\mathcal{F}} \Xi_{\mathcal{G}\mathcal{F}} v^r\|_1 + h \|\tilde{\Xi}_{\mathcal{G}\mathcal{F}}(1 - \Xi_{\mathcal{G}\mathcal{F}}) v^r\|_1 \lesssim h \|\Xi_{\mathcal{G}\mathcal{F}} v^r\|_1 + h^2 \|v^r\|_1. \quad (3.89)$$

We also have

$$\|P_{\varphi}^r \zeta \tilde{\Xi}_{\mathcal{G}\mathcal{F}} v^r\|_0 \lesssim \|\tilde{\Xi}_{\mathcal{G}\mathcal{F}} \zeta P_{\varphi}^r v^r\|_0 + \|[P_{\varphi}^r, \tilde{\Xi}_{\mathcal{G}\mathcal{F}} \zeta] v^r\|_0. \quad (3.90)$$

Arguing as above with Propositions 3.48 and 3.52, and also Corollary 3.49, we have

$$[P_{\varphi}^r, \tilde{\Xi}_{\mathcal{G}\mathcal{F}} \zeta] = \underbrace{[P_{\varphi}^r, \tilde{\Xi}_{\mathcal{G}\mathcal{F}} \zeta] \Xi_{\mathcal{G}\mathcal{F}}}_{\in h\Psi^1(\mathcal{M}_+)} + \underbrace{[P_{\varphi}^r, \tilde{\Xi}_{\mathcal{G}\mathcal{F}} \zeta] (1 - \Xi_{\mathcal{G}\mathcal{F}})}_{\in h^\infty \Psi^{-\infty}(\mathcal{M}_+)}$$

so that (3.90) now reads with Proposition 3.50

$$\|P_{\varphi}^r \zeta \tilde{\Xi}_{\mathcal{G}\mathcal{F}} v^r\|_0 \lesssim \|\zeta P_{\varphi}^r v^r\|_0 + h \|\Xi_{\mathcal{G}\mathcal{F}} v^r\|_1 + h^2 \|v^r\|_1. \quad (3.91)$$

The three estimates (3.88), (3.89) and (3.91) give

$$\|P_{\varphi,j}^r \zeta(\phi_j^{-1})^* \zeta_j \tilde{\Xi}_{\mathcal{G}\mathcal{F}} v^r\|_0 \lesssim \|\zeta P_{\varphi}^r v^r\|_0 + h \|\Xi_{\mathcal{G}\mathcal{F}} v^r\|_1 + h^2 \|v^r\|_1. \quad (3.92)$$

Combining (3.85) together with (3.86)–(3.87), (3.89) and (3.92), we finally have

$$\begin{aligned} & h^{\frac{1}{2}} |\gamma_0(\text{Op}_{\mathcal{T}}(\chi_{\mathcal{G},j})(\phi_j^{-1})^* \zeta_j \tilde{\Xi}_{\mathcal{G}\mathcal{F}} v^r)|_1 + h^{\frac{1}{2}} |\gamma_1(\text{Op}_{\mathcal{T}}(\chi_{\mathcal{G},j})(\phi_j^{-1})^* \zeta_j \tilde{\Xi}_{\mathcal{G}\mathcal{F}} v^r)|_0 \\ & \lesssim \|\zeta P_{\varphi}^r v^r\|_0 + h \|\Xi_{\mathcal{G}\mathcal{F}} v^r\|_1 + h^2 |D_{x_n} v^r|_{x_n=0^+}|_0 + h^2 \|v^r\|_1. \end{aligned} \quad (3.93)$$

Then, we need the following lemma to come back to the variable $u_{\mathcal{G},j}^r = \text{Op}_{\mathcal{T}}(\chi_{\mathcal{G},j})(\phi_j^{-1})^* \zeta_j v^r$ on the left hand-side of (3.93).

Lemma 3.29. *There exists $R \in h^\infty \Psi_{\mathcal{T}}^{-\infty}(\mathcal{M}_+)$, such that*

$$\text{Op}_{\mathcal{T}}(\chi_{\mathcal{G},j})(\phi_j^{-1})^* \zeta_j \tilde{\Xi}_{\mathcal{G},\mathcal{F}} v^r = u_{\mathcal{G},j}^r + (\phi_j^{-1})^* R v^r.$$

This lemma is proven in Appendix 3.8.6. As a consequence we have

$$\begin{aligned} h^{\frac{1}{2}} |\gamma_0(u_{\mathcal{G},j}^r)|_1 &\lesssim h^{\frac{1}{2}} |\gamma_0(\text{Op}_{\mathcal{T}}(\chi_{\mathcal{G},j})(\phi_j^{-1})^* \zeta_j \tilde{\Xi}_{\mathcal{G},\mathcal{F}} v^r)|_1 + h^{\frac{1}{2}} |\gamma_0((\phi_j^{-1})^* R v^r)|_0 \\ &\lesssim h^{\frac{1}{2}} |\gamma_0(\text{Op}_{\mathcal{T}}(\chi_{\mathcal{G},j})(\phi_j^{-1})^* \zeta_j \tilde{\Xi}_{\mathcal{G},\mathcal{F}} v^r)|_1 + h^2 \|v^r\|_1 \end{aligned}$$

with the trace formula (3.23). This, together with Estimate (3.93) give

$$h^{\frac{1}{2}} |\gamma_0(u_{\mathcal{G},j}^r)|_1 \lesssim \|\zeta P_{\varphi}^r v^r\|_0 + h \|\Xi_{\mathcal{G},\mathcal{F}} v^r\|_1 + h^2 \|v^r\|_1 + h^2 |D_{x_n} v^r|_{x_n=0^+}|_0. \quad (3.94)$$

Lemma 3.29 also yields

$$\begin{aligned} h^{\frac{1}{2}} |\gamma_1(u_{\mathcal{G},j}^r)|_0 &\lesssim h^{\frac{1}{2}} |\gamma_1(\text{Op}_{\mathcal{T}}(\chi_{\mathcal{G},j})(\phi_j^{-1})^* \psi_j \tilde{\Xi}_{\mathcal{G},\mathcal{F}} v^r)|_0 + h^{\frac{1}{2}} |\gamma_1((\phi_j^{-1})^* R v^r)|_0, \\ &\lesssim h^{\frac{1}{2}} |\gamma_1(\text{Op}_{\mathcal{T}}(\chi_{\mathcal{G},j})(\phi_j^{-1})^* \psi_j \tilde{\Xi}_{\mathcal{G},\mathcal{F}} v^r)|_0 + h^2 \|v^r\|_1 + h^2 |D_{x_n} v^r|_{x_n=0^+}|_0, \end{aligned} \quad (3.95)$$

Combining (3.93) together with (3.95), we finally obtain

$$h^{\frac{1}{2}} |\gamma_1(u_{\mathcal{G},j}^r)|_0 \lesssim \|\zeta P_{\varphi}^r v^r\|_0 + h \|\Xi_{\mathcal{G},\mathcal{F}} v^r\|_1 + h^2 \|v^r\|_1 + h^2 |D_{x_n} v^r|_{x_n=0^+}|_0. \quad (3.96)$$

On the “ l ” side, we apply the Carleman method. With the properties of the weight function of Section 3.3.1 and in particular by (3.56), and by Lemma 2 in [LR95], we then have

$$h \|u_{\mathcal{G},j}^l\|_1^2 + \text{Re} \left(h \mathcal{B}^l(u_{\mathcal{G},j}^l) + h^2 ((D_n u_{\mathcal{G},j}^l + L_1^l u_{\mathcal{G},j}^l)|_{x_n=0^+}, L_0^l u_{\mathcal{G},j}^l|_{x_n=0^+})_0 \right) \lesssim \|P_{\varphi,j} u_{\mathcal{G},j}^l\|_0^2, \quad (3.97)$$

for $0 < h \leq h_0$, h_0 sufficiently small, where $L_1^l \in \mathcal{D}_{\mathcal{T}}^1$, $L_0^l \in \Psi_{\mathcal{T}}^0$. The quadratic form \mathcal{B}^l is given by

$$\mathcal{B}^l(\psi) = \left(\begin{pmatrix} 2\partial_{x_n} \varphi_j^l|_{x_n=0^+} & B_1^l \\ B_1^{l'} & B_2^l \end{pmatrix} \begin{pmatrix} \gamma_1(\psi) \\ \gamma_0(\psi) \end{pmatrix}, \begin{pmatrix} \gamma_1(\psi) \\ \gamma_0(\psi) \end{pmatrix} \right), \quad \text{supp}(\psi) \subset (0, X_0) \times \tilde{U}_j \times [0, 2\varepsilon), \quad (3.98)$$

where $B_1^l, B_1^{l'} \in \mathcal{D}_{\mathcal{T}}^1$, with principal symbols $\sigma(B_1^l) = \sigma(B_1^{l'}) = 2(\phi_j^{-1})^* q_1^l|_{x_n=0^+}$ and $B_2^l \in \mathcal{D}_{\mathcal{T}}^2$, with $\sigma(B_2^l) = -2\partial_{x_n} \varphi_j^l (\phi_j^{-1})^* q_2^l|_{x_n=0^+}$.

Observe that we have

$$\left| ((D_n u_{\mathcal{G},j}^l + L_1^l u_{\mathcal{G},j}^l)|_{x_n=0^+}, L_0^l u_{\mathcal{G},j}^l|_{x_n=0^+})_0 \right| \lesssim |\gamma_1(u_{\mathcal{G},j}^l)|_0^2 + |\gamma_0(u_{\mathcal{G},j}^l)|_1^2. \quad (3.99)$$

and

$$|\mathcal{B}^l(u_{\mathcal{G},j}^l)| \lesssim |\gamma_0(u_{\mathcal{G},j}^l)|_1^2 + |\gamma_1(u_{\mathcal{G},j}^l)|_0^2. \quad (3.100)$$

Now, using (3.97), together with the estimates (3.99) and (3.100), we have,

$$h \|u_{\mathcal{G},j}^l\|_1^2 \lesssim \|P_{\varphi,j}^l u_{\mathcal{G},j}^l\|_0^2 + h |\gamma_0(u_{\mathcal{G},j}^l)|_1^2 + h |\gamma_1(u_{\mathcal{G},j}^l)|_0^2. \quad (3.101)$$

It remains to estimate the traces on the “ l ” side by the traces on the “ r ” side, through the transmission conditions $(\text{TC}_{\bullet,j})$:

$$\begin{cases} \gamma_0(u_{\mathcal{G},j}^l) = \gamma_0(u_{\mathcal{G},j}^r) + \theta_{\mathcal{G},j}^l - \theta_{\mathcal{G},j}^r \\ \gamma_1(u_{\mathcal{G},j}^l) = \frac{\delta c_j^s}{h i c_j^l} P_{\varphi,j}^s (\gamma_0(u_{\mathcal{G},j}^r) - \theta_{\mathcal{G},j}^r) - \beta \gamma_1(u_{\mathcal{G},j}^r) + k \gamma_0(u_{\mathcal{G},j}^r) - \tilde{G}_1, \\ u_{\mathcal{G},j}^s = \gamma_0(u_{\mathcal{G},j}^r) - \theta_{\mathcal{G},j}^r. \end{cases}$$

As a consequence, $\gamma_0(u_{\mathcal{G},j}^l)$ and $\gamma_1(u_{\mathcal{G},j}^l)$ can be estimated as follows

$$\begin{cases} |\gamma_0(u_{\mathcal{G},j}^l)|_1 \leq |\gamma_0(u_{\mathcal{G},j}^r)|_1 + |\theta_{\mathcal{G},j}^l|_1 + |\theta_{\mathcal{G},j}^r|_1, \\ |\gamma_1(u_{\mathcal{G},j}^l)|_0 \lesssim |\gamma_1(u_{\mathcal{G},j}^r)|_0 + \frac{\delta}{h} |P_{\varphi,j}^s \gamma_0(u_{\mathcal{G},j}^r)|_0 + \frac{\delta}{h} |P_{\varphi,j}^s \theta_{\mathcal{G},j}^r|_0 + |\gamma_0(u_{\mathcal{G},j}^r)|_0 + |\tilde{G}_1|_0. \end{cases} \quad (3.102)$$

We now prove that, on the support of $\chi_{\mathcal{G},j}$, the operator $P_{\varphi,j}^s$ is of order 0. For this, let $\tilde{\chi} \in \mathcal{C}_c^\infty(T^*(\mathbb{R}^n))$, be equal to one on a neighborhood of the $\text{supp}(\chi_{\mathcal{G},j}|_{x_n=0+})$. We then have

$$\gamma_0(u_{\mathcal{G},j}^r) = \text{Op}_{\mathcal{T}}(\chi_{\mathcal{G},j})v_j^r|_{x_n=0+} = \text{Op}_{\mathcal{T}}(\tilde{\chi}) \text{Op}_{\mathcal{T}}(\chi_{\mathcal{G},j})v_j^r|_{x_n=0+} + \underbrace{\text{Op}_{\mathcal{T}}(1 - \tilde{\chi}) \text{Op}_{\mathcal{T}}(\chi_{\mathcal{G},j})v_j^r|_{x_n=0+}}_{\in h^\infty \Psi_{\mathcal{T}}^{-\infty}},$$

which yields

$$P_{\varphi,j}^s \gamma_0(u_{\mathcal{G},j}^r) = \underbrace{(P_{\varphi,j}^s \text{Op}_{\mathcal{T}}(\tilde{\chi}))}_{\in \Psi_{\mathcal{T}}^0} \gamma_0(u_{\mathcal{G},j}^r) + \underbrace{P_{\varphi,j}^s \text{Op}_{\mathcal{T}}(1 - \tilde{\chi}) \text{Op}_{\mathcal{T}}(\chi_{\mathcal{G},j})v_j^r|_{x_n=0+}}_{\in h^\infty \Psi_{\mathcal{T}}^{-\infty}}.$$

This, together with the trace formula (3.23) gives the estimate,

$$\frac{\delta}{h} |P_{\varphi,j}^s \gamma_0(u_{\mathcal{G},j}^r)|_0 \leq C \frac{\delta}{h} |\gamma_0(u_{\mathcal{G},j}^r)|_0 + C_N \delta h^N \|v_j^r\|_1, \quad N \in \mathbb{N}.$$

Similarly, we have the estimate

$$\frac{\delta}{h} |P_{\varphi,j}^s \theta_{\mathcal{G},j}^r|_0 \leq C \frac{\delta}{h} |\theta_{\mathcal{G},j}^r|_0 + C_N \delta h^N |\theta_{\varphi,j}^r|_0 \lesssim \frac{\delta}{h} |\theta_{\varphi,j}^r|_0.$$

The last two estimates and the second equation of (3.102) yield,

$$|\gamma_1(u_{\mathcal{G},j}^l)|_0 \lesssim |\gamma_1(u_{\mathcal{G},j}^r)|_0 + \left(1 + \frac{\delta}{h}\right) |\gamma_0(u_{\mathcal{G},j}^r)|_0 + \frac{\delta}{h} |\theta_{\varphi,j}^r|_0 + |\tilde{G}_1|_0 + C_N \delta h^N \|v_j^r\|_1, \quad N \in \mathbb{N}.$$

Using estimates (3.94) and (3.96) to bound the traces on the “r” side, we obtain

$$\begin{aligned} h^{\frac{1}{2}} |\gamma_1(u_{\mathcal{G},j}^l)|_0 &\lesssim \left(1 + \frac{\delta}{h}\right) (\|\zeta P_{\varphi}^r v^r\|_0 + h \|\Xi_{\mathcal{G},\mathcal{F}} v^r\|_1 + h^2 \|v^r\|_1 + h^2 |D_{x_n} v^r|_{x_n=0+}|_0) \\ &\quad + \frac{\delta}{h^{\frac{1}{2}}} |\theta_{\varphi,j}^r|_0 + h^{\frac{1}{2}} |\tilde{G}_1|_0, \end{aligned}$$

for $0 < h \leq h_0$, and, using (3.74) to estimate the remainder, we have

$$\begin{aligned} h^{\frac{1}{2}} |\gamma_1(u_{\mathcal{G},j}^l)|_0 &\lesssim \left(1 + \frac{\delta}{h}\right) \left(\|\zeta P_{\varphi}^r v^r\|_0 + h \|\Xi_{\mathcal{G},\mathcal{F}} v^r\|_1 + h^2 \|v^r\|_1 + h^2 |D_{x_n} v^r|_{x_n=0+}|_0\right. \\ &\quad \left.+ h^{\frac{3}{2}} |v_j^s|_1 + h^{\frac{1}{2}} |\theta_{\varphi,j}^r|_0\right) + h^{\frac{1}{2}} |\Theta_{\varphi,j}^s|_0 + h^{\frac{1}{2}} |\theta_{\varphi,j}^l|_0, \end{aligned} \quad (3.103)$$

We observe now that the first line of (3.102) together with (3.94) yields

$$\begin{aligned} h^{\frac{1}{2}} |\gamma_0(u_{\mathcal{G},j}^l)|_1 &\lesssim \|\zeta P_{\varphi}^r v^r\|_0 + h \|\Xi_{\mathcal{G},\mathcal{F}} v^r\|_1 + h^2 \|v^r\|_1 + h^2 |D_{x_n} v^r|_{x_n=0+}|_0 \\ &\quad + h^{\frac{1}{2}} |\theta_{\varphi,j}^l|_1 + h^{\frac{1}{2}} |\theta_{\varphi,j}^r|_1. \end{aligned} \quad (3.104)$$

Combining (3.68), with (3.101), (3.103) and (3.104) we obtain

$$\begin{aligned} &h \|u_{\mathcal{G},j}^l\|_1^2 + h |\gamma_0(u_{\mathcal{G},j}^l)|_1^2 + h |\gamma_1(u_{\mathcal{G},j}^l)|_0^2 \\ &\lesssim \left(1 + \frac{\delta^2}{h^2}\right) \left(\|\zeta P_{\varphi}^r v^r\|_0^2 + h^2 \|\Xi_{\mathcal{G},\mathcal{F}} v^r\|_1^2 + h^4 \|v^r\|_1^2 + h^4 |D_{x_n} v^r|_{x_n=0+}|_0^2 + h^3 |v_j^s|_1^2\right) \\ &\quad + h |\theta_{\varphi,j}^l|_1^2 + \frac{\delta^2}{h} |\theta_{\varphi,j}^r|_0^2 + h |\theta_{\varphi,j}^r|_1^2 + h |\Theta_{\varphi,j}^s|_0^2 + \|P_{\varphi,j}^l v_j^l\|_0^2 + h^2 \|v_j^l\|_1^2. \end{aligned} \quad (3.105)$$

This is a local version of (3.77). Patching together on \mathcal{M}_+ the local Carleman estimates (3.105) as we did in (3.79)-(3.84) yields (3.77). This concludes the proof of Proposition 3.28. \square

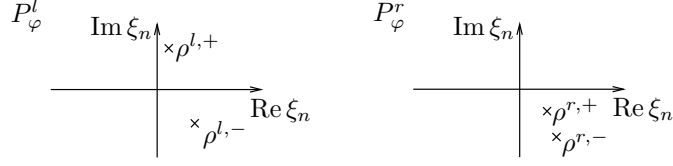
FIGURE 3.5 – Root configuration in the region \mathcal{F} .

3.4.3 Estimate in the region \mathcal{F}

Here, we place ourselves in the region \mathcal{F} , and prove a Carleman estimate for $u_{\mathcal{F},j}$, and consequently for $\Xi_{\mathcal{F}}v$. Making use of the Calderón projector technique for both $P_{\varphi,j}^r$ and $P_{\varphi,j}^l$, we obtain the following partial estimate.

Proposition 3.30. *Suppose that the weight function φ satisfies the properties listed in Section 3.3.1. Then, for all $\delta_0 > 0$, there exist $C > 0$ and $h_0 > 0$ such that, for all $0 < \delta \leq \delta_0$ and $0 < h \leq h_0$, $v^{7l} \in \mathcal{C}^\infty((0, X_0) \times S \times [0, 2\varepsilon))$ and $v^s \in \mathcal{C}^\infty((0, X_0) \times S)$ satisfying (3.47), we have*

$$\|\Xi_{\mathcal{F}}v^r\|_1^2 + h|\Xi_{\mathcal{F}}v^r|_{x_n=0^+}|_1^2 + h|D_{x_n}\Xi_{\mathcal{F}}v^r|_{x_n=0^+}|_0^2 \leq C\left(\|P_{\varphi}^r v^r\|_0^2 + h^2\|v^r\|_1^2 + h^4|D_{x_n}v^r|_{x_n=0^+}|_0^2\right), \quad (3.106)$$

and

$$\begin{aligned} & \|\Xi_{\mathcal{F}}v^l\|_1^2 + h|\Xi_{\mathcal{F}}v^l|_{x_n=0^+}|_1^2 + h|D_{x_n}\Xi_{\mathcal{F}}v^l|_{x_n=0^+}|_0^2 \\ & \leq C\left(\|P_{\varphi}^l v^l\|_0^2 + h^2\|v^l\|_1^2 + h^4|D_{x_n}v^l|_{x_n=0^+}|_0^2 + \|P_{\varphi}^r v^r\|_0^2 \right. \\ & \quad \left. + h^2\|v^r\|_1^2 + h^4|D_{x_n}v^r|_{x_n=0^+}|_0^2 + h|\theta_{\varphi}^l|_1^2 + h|\theta_{\varphi}^r|_1^2\right). \end{aligned} \quad (3.107)$$

Proof. Here, the functions $u_{\mathcal{F},j}^{7l}$, $j \in J$ satisfy $(\text{TC}_{\bullet,j})$, with $\bullet = \mathcal{F}$. On both the “r” and “l” sides, the roots configuration described in Lemma 3.24 (and represented in Figure 3.5) allows us to use the Calderón projector technique used in [LR97, LR10]. According to [LR10, Remark 2.5] and using Eqs. (2.59), (2.60), and (2.61) therein, applied with v^d replaced here by v_j^r , we have

$$\|u_{\mathcal{F},j}^r\|_1 + h^{\frac{1}{2}}|\gamma_0(u_{\mathcal{F},j}^r)|_1 + h^{\frac{1}{2}}|\gamma_1(u_{\mathcal{F},j}^r)|_0 \lesssim \|P_{\varphi,j}^r v_j^r\|_0 + h\|v_j^r\|_1 + h^2|D_{x_n}v_j^r|_{x_n=0^+}|_0. \quad (3.108)$$

This is a local version of (3.106). Patching together on \mathcal{M}_+ the local Carleman estimates (3.108) as we did in (3.79)-(3.84) yields (3.106).

On the “l” side, since both roots are separated by the real axis (see Figure 3.5) we only obtain one relation between the two traces at the interface : according to [LR10, Eq. (2.67)], we have

$$\|u_{\mathcal{F},j}^l\|_1 \lesssim \|P_{\varphi,j}^l v_j^l\|_0 + h\|v_j^l\|_1 + h^{\frac{1}{2}}|\gamma_0(u_{\mathcal{F},j}^l)|_1 + h^{\frac{1}{2}}|\gamma_1(u_{\mathcal{F},j}^l)|_0 + h^2|D_{x_n}v_j^l|_{x_n=0^+}|_0, \quad (3.109)$$

together with the following relation between the two traces [LR10, Eq. (2.68)] :

$$(1 - \text{Op}_{\mathcal{T}}(a^l)) \gamma_0(u_{\mathcal{F},j}^l) = \text{Op}_{\mathcal{T}}(b^l) \gamma_1(u_{\mathcal{F},j}^l) + G_2^l, \quad (3.110)$$

where $a^l \in S_{\mathcal{T}}^0$ and $b^l \in S_{\mathcal{T}}^{-1}$ have for principal part respectively

$$a_0^l = - \left(\tilde{\chi} \frac{\rho_j^{l,-}}{\rho_j^{l,+} - \rho_j^{l,-}} \right) \Big|_{x_n=0^+}, \quad \text{and} \quad b_{-1}^l = \left(\tilde{\chi} \frac{1}{\rho_j^{l,+} - \rho_j^{l,-}} \right) \Big|_{x_n=0^+},$$

where $\rho_j^{l,\pm}$ are the roots of $p_{\varphi,j}^l$ (i.e. $\rho_j^{l,\pm} = (\phi_j^{-1})^* \rho^{l,\pm}$ with $\rho^{l,\pm}$ described in Lemma 3.24) and $\tilde{\chi} \in \mathcal{C}_c^\infty(T^*(\mathbb{R}^n))$ is compactly supported and equal to one on a neighborhood of the support of $\chi_{\mathcal{F},j}|_{x_n=0^+}$. The remainder G_2^l (coming from the Calderón projector method) satisfies [LR10, Eq. (2.69)] :

$$|G_2^l|_1 \lesssim h^{-\frac{1}{2}} (\|P_{\varphi,j}^l v_j^l\|_0 + h\|v_j^l\|_1 + h^2|D_{x_n} v_j^l|_{x_n=0^+}|_0). \quad (3.111)$$

Let $\hat{\chi} \in \mathcal{C}^\infty(T^*(\mathbb{R}^n))$ satisfy the same requirements as $\tilde{\chi}$ with $\tilde{\chi}$ equal to one a neighborhood the support of $\hat{\chi}$. Since b_{-1}^l does not vanish in a neighborhood of $\text{supp}(\hat{\chi})$, one can introduce a parametrix for $\text{Op}_{\mathcal{T}}(b^l)$, say $\text{Op}_{\mathcal{T}}(e)$, with $e \in S_{\mathcal{T}}^l$, satisfying

$$\text{Op}_{\mathcal{T}}(e) \text{Op}_{\mathcal{T}}(b^l) = \text{Op}_{\mathcal{T}}(\hat{\chi}) + R, \quad R \in h^\infty \Psi_{\mathcal{T}}^{-\infty}.$$

Applying this parametrix to (3.110) gives the estimate

$$|\gamma_1(u_{\mathcal{F},j}^l)|_0 \lesssim |\gamma_0(u_{\mathcal{F},j}^l)|_1 + |G_2^l|_1 + C_N h^N (\|v_j^l\|_1 + |D_{x_n} v_j^l|_{x_n=0^+}|_0), \quad N \in \mathbb{N}. \quad (3.112)$$

Here, we have used the trace formula (3.23) together with

$$\begin{aligned} \gamma_1(u_{\mathcal{F},j}^l) &= \text{Op}_{\mathcal{T}}(\hat{\chi})\gamma_1(u_{\mathcal{F},j}^l) + \underbrace{\left((1 - \text{Op}_{\mathcal{T}}(\hat{\chi})) \text{Op}_{\mathcal{T}}(\chi_{\mathcal{F},j})|_{x_n=0^+} \right)}_{\in h^\infty \Psi_{\mathcal{T}}^{-\infty}} D_{x_n} v_j^l|_{x_n=0^+} \\ &\quad + \underbrace{\left((1 - \text{Op}_{\mathcal{T}}(\hat{\chi})) [D_{x_n}, \text{Op}_{\mathcal{T}}(\chi_{\mathcal{F},j})]|_{x_n=0^+} \right)}_{\in h^\infty \Psi_{\mathcal{T}}^{-\infty}} v_j^l|_{x_n=0^+}. \end{aligned} \quad (3.113)$$

We now use the second equation in the transmission conditions $(\text{TC}_{\bullet,j})$, which with (3.108) yields

$$\begin{aligned} h^{\frac{1}{2}} |\gamma_0(u_{\mathcal{F},j}^l)|_1 &\leq h^{\frac{1}{2}} |\gamma_0(u_{\mathcal{F},j}^r)|_1 + h^{\frac{1}{2}} |\theta_{\mathcal{F},j}^l|_1 + h^{\frac{1}{2}} |\theta_{\mathcal{F},j}^r|_1 \\ &\lesssim \|P_{\varphi,j}^r v_j^r\|_0 + h\|v_j^r\|_1 + h^2 |D_{x_n} v_j^r|_{x_n=0^+}|_0 + h^{\frac{1}{2}} |\theta_{\mathcal{F},j}^l|_1 + h^{\frac{1}{2}} |\theta_{\mathcal{F},j}^r|_1. \end{aligned}$$

This estimate together with (3.111) and (3.112) provides an estimate for $|\gamma_1(u_{\mathcal{F},j}^l)|_0$, which, summed with (3.109) yields

$$\begin{aligned} \|u_{\mathcal{F},j}^l\|_1 + h^{\frac{1}{2}} |\gamma_0(u_{\mathcal{F},j}^l)|_1 + h^{\frac{1}{2}} |\gamma_1(u_{\mathcal{F},j}^l)|_0 &\lesssim \|P_{\varphi,j}^l v_j^l\|_0 + h\|v_j^l\|_1 + h^2 |D_{x_n} v_j^l|_{x_n=0^+}|_0 \\ &\quad + \|P_{\varphi,j}^r v_j^r\|_0 + h\|v_j^r\|_1 + h^2 |D_{x_n} v_j^r|_{x_n=0^+}|_0 + h^{\frac{1}{2}} |\theta_{\mathcal{F},j}^l|_1 + h^{\frac{1}{2}} |\theta_{\mathcal{F},j}^r|_1. \end{aligned}$$

This is a local version of (3.107). Patching together on \mathcal{M}_+ such local estimates as we did in (3.79)-(3.84) yields (3.107). This concludes the proof of Proposition 3.30. \square

3.4.4 Estimate in the region \mathcal{Z}

Here, we place ourselves in the region \mathcal{Z} , and prove a Carleman estimate for $u_{\mathcal{Z},j}$, and consequently for $\Xi_{\mathcal{Z}} v$.

As a consequence of property (3.44) of the weight function (see also (3.54)) and the compactness of $[0, X_0] \times S \times [0, 2\varepsilon]$, we remark that in the region \mathcal{Z} , there exists $K_1 > 0$ such that

$$(\partial_{x_n} \varphi^r)^2 - \mu^r \geq \min (\partial_{x_n} \varphi^r)^2 - 2\varepsilon_1 \geq K_1 > 0 \quad (3.114)$$

for ε_1 sufficiently small (the constant ε_1 is used in the definition of the microlocal regions in (3.60)).

Making use of the Calderón projector technique for $P_{\varphi,j}^l$, and standard techniques to prove Carleman estimates for $P_{\varphi,j}^r$, we obtain the following partial estimate.

Proposition 3.31. *Suppose that the weight function φ satisfies the properties listed in Section 3.3.1. Then, for all $\delta_0 > 0$, there exist $C > 0$ and $h_0 > 0$ such that, for all $0 < \delta \leq \delta_0$ and $0 < h \leq h_0$, $v^l \in \mathcal{C}_c^\infty((0, X_0) \times S \times [0, 2\varepsilon))$ and $v^s \in \mathcal{C}_c^\infty((0, X_0) \times S)$ satisfying (3.47), we have*

$$\begin{aligned} & h \|\Xi_{\mathcal{Z}} v^r\|_1^2 + h \left(1 + \frac{\delta^2}{h^2}\right) |\Xi_{\mathcal{Z}} v^r|_{x_n=0^+}|_1^2 + h |D_{x_n} \Xi_{\mathcal{Z}} v^r|_{x_n=0^+}|_0^2 \\ & \leq C \left(\|P_\varphi^r v^r\|_0^2 + h^2 \|v^r\|_1^2 + h(\delta^2 + h^2) |v^s|_1^2 + \|P_\varphi^l v^l\|_0^2 + h^2 \|v^l\|_1^2 + h^4 |D_{x_n} v^l|_{x_n=0^+}|_0^2 \right. \\ & \quad \left. + \frac{\delta^2}{h} |\theta_\varphi^r|_0^2 + h |\theta_\varphi^l|_1^2 + h |\theta_\varphi^r|_1^2 + h |\Theta_\varphi^s|_0^2 \right), \end{aligned} \quad (3.115)$$

and

$$\begin{aligned} & \|\Xi_{\mathcal{Z}} v^l\|_1^2 + h |\Xi_{\mathcal{Z}} v^l|_{x_n=0^+}|_1^2 + h |D_{x_n} \Xi_{\mathcal{Z}} v^l|_{x_n=0^+}|_0^2 \\ & \leq C \left(\|P_\varphi^l v^l\|_0^2 + h^2 \|v^l\|_1^2 + h^4 |D_{x_n} v^l|_{x_n=0^+}|_0^2 + h^3 |v^s|_1^2 + \frac{h^2}{\delta^2 + h^2} (\|P_\varphi^r v^r\|_0^2 + h^2 \|v^r\|_1^2) \right. \\ & \quad \left. + h |\theta_\varphi^l|_1^2 + h |\theta_\varphi^r|_1^2 + \frac{h^3}{\delta^2 + h^2} |\Theta_\varphi^s|_0^2 \right). \end{aligned} \quad (3.116)$$

Proof. The function $u_{\mathcal{Z},j}$ satisfies (TC $_{\bullet,j}$), with $\bullet = \mathcal{Z}$. On the “ l ” side, the roots configuration described in Lemma 3.24 (and represented in Figure 3.3b) allows us to apply the Calderón projector technique as in [LR97, LR10]. Since both roots are separated by the real axis we only obtain one relation between the two traces at the interface : according to [LR10, Eq. (2.67)], we have

$$\|u_{\mathcal{Z},j}^l\|_1 \lesssim \|P_{\varphi,j}^l v_j^l\|_0 + h \|v_j^l\|_1 + h^{\frac{1}{2}} |\gamma_0(u_{\mathcal{Z},j}^l)|_1 + h^{\frac{1}{2}} |\gamma_1(u_{\mathcal{Z},j}^l)|_0 + h^2 |D_{x_n} v_j^l|_{x_n=0^+}|_0, \quad (3.117)$$

together with the following relation between the two traces [LR10, Eq. (2.68)] :

$$(1 - \text{Op}_{\mathcal{T}}(a^l)) \gamma_0(u_{\mathcal{Z},j}^l) = \text{Op}_{\mathcal{T}}(b^l) \gamma_1(u_{\mathcal{Z},j}^l) + G_2^l, \quad (3.118)$$

where $a^l \in S_{\mathcal{T}}^0$ and $b^l \in S_{\mathcal{T}}^{-1}$ have for principal part respectively

$$a_0^l = - \left(\tilde{\chi} \frac{\rho_j^{l,-}}{\rho_j^{l,+} - \rho_j^{l,-}} \right) \Big|_{x_n=0^+}, \quad \text{and} \quad b_{-1}^l = \left(\tilde{\chi} \frac{1}{\rho_j^{l,+} - \rho_j^{l,-}} \right) \Big|_{x_n=0^+}, \quad (3.119)$$

where $\rho_j^{l,\pm}$ are the roots of $p_{\varphi,j}^l$ (i.e. $\rho_j^{l,\pm} = (\phi_j^{-1})^* \rho^{l,\pm}$ with $\rho^{l,\pm}$ described in Lemma 3.24) and $\tilde{\chi} \in \mathcal{C}_c^\infty(T^*(\mathbb{R}^n))$ is equal to one on a neighborhood of the support of $\chi_{\mathcal{Z},j}|_{x_n=0^+}$ and equal to zero in a neighborhood of

$$\left((\phi_j^{-1})^* \mathcal{G} \right) \cap \{x_n = 0\} = \{(x_0, \phi_j(y); \xi_0, {}^t d\phi_j^{-1}(\phi_j(y))\eta); (x_0, y, 0; \xi_0, \eta) \in \mathcal{G}\}.$$

The remainder G_2^l (coming from the Calderón projector method) satisfies [LR10, Eq. (2.69)] :

$$|G_2^l|_1 \lesssim h^{-\frac{1}{2}} (\|P_{\varphi,j}^l v_j^l\|_0 + h \|v_j^l\|_1 + h^2 |D_{x_n} v_j^l|_{x_n=0^+}|_0). \quad (3.120)$$

On the “ r ” side, we apply the Carleman method to the operators $P_{\varphi,j}^r$. With the properties of the weight function of Section 3.3.1, and in particular by (3.56), and by Lemma 2 in [LR95], we then have

$$h \|u_{\mathcal{Z},j}^r\|_1^2 + \text{Re} \left(h \mathcal{B}^r(u_{\mathcal{Z},j}^r) + h^2 \left((D_n u_{\mathcal{Z},j}^r + L_1^r u_{\mathcal{Z},j}^r)|_{x_n=0^+}, L_0^r u_{\mathcal{Z},j}^r|_{x_n=0^+} \right)_0 \right) \lesssim \|P_{\varphi,j}^r u_{\mathcal{Z},j}^r\|_0^2, \quad (3.121)$$

for h sufficiently small, where $L_1^r \in \mathcal{D}_{\mathcal{T}}^1$, $L_0^r \in \Psi_{\mathcal{T}}^0$. The quadratic form \mathcal{B}^r is given by

$$\mathcal{B}^r(\psi) = \left(\left(\begin{array}{cc} 2\partial_{x_n} \varphi_j^r|_{x_n=0^+} & B_1^r \\ B_1^{r'} & B_2^r \end{array} \right) \begin{pmatrix} \gamma_1(\psi) \\ \gamma_0(\psi) \end{pmatrix}, \begin{pmatrix} \gamma_1(\psi) \\ \gamma_0(\psi) \end{pmatrix} \right)_0, \quad \text{supp}(\psi) \subset (0, X_0) \times \tilde{U}_j \times [0, 2\varepsilon), \quad (3.122)$$

where $B_1^r, B_1^{r'} \in \mathcal{D}_T^1$, $B_2^r \in \mathcal{D}_T^2$, with principal symbols $\sigma(B_1^r) = \sigma(B_1^{r'}) = 2q_{1,j}^r|_{x_n=0^+}$ and $\sigma(B_2^r) = -2\partial_{x_n}\varphi_j^r q_{2,j}^r|_{x_n=0^+}$ with $q_{k,j}^r = (\phi_j^{-1})^* q_k^r$, $k = 1, 2$.

Observe that we have

$$\left| \left((D_n u_{\mathcal{Z},j}^r + L_1^r u_{\mathcal{Z},j}^r)|_{x_n=0^+}, L_0^r u_{\mathcal{Z},j}^r|_{x_n=0^+} \right)_0 \right| \lesssim |\gamma_1(u_{\mathcal{Z},j}^r)|_0^2 + |\gamma_0(u_{\mathcal{Z},j}^r)|_1^2. \quad (3.123)$$

Thanks to the transmission conditions $(\text{TC}_{\bullet,j})$ at the interface and the trace relation (3.118) on the “ l ” side, we shall be able to express $\gamma_1(u_{\mathcal{Z},j}^r)$ from $\gamma_0(u_{\mathcal{Z},j}^r)$ on the “ r ” side. This will allow us to turn \mathcal{B}^r into a quadratic form operating on $\gamma_0(u_{\mathcal{Z},j}^r)$ only. We first formulate $(\text{TC}_{\bullet,j})$ in the following manner :

$$\begin{cases} \gamma_0(u_{\mathcal{Z},j}^l) = \gamma_0(u_{\mathcal{Z},j}^r) + \theta_{\mathcal{Z},j}^l - \theta_{\mathcal{Z},j}^r \\ \gamma_1(u_{\mathcal{Z},j}^l) = \frac{\delta c_j^s}{h i c_j^l} P_{\varphi,j}^s (\gamma_0(u_{\mathcal{Z},j}^r) - \theta_{\mathcal{Z},j}^r) - \beta \gamma_1(u_{\mathcal{Z},j}^r) + k \gamma_0(u_{\mathcal{Z},j}^r) - \tilde{G}_1, \\ u_{\mathcal{Z},j}^s = \gamma_0(u_{\mathcal{Z},j}^r) - \theta_{\mathcal{Z},j}^r. \end{cases} \quad (3.124)$$

Let $\hat{\chi} \in \mathcal{C}^\infty(T^*(\mathbb{R}^n))$ satisfy the same requirements as $\tilde{\chi}$ with $\tilde{\chi}$ equal to one a neighborhood the support of $\hat{\chi}$. Since the principal part b_{-1}^l does not vanish in a neighborhood of $\text{supp}(\hat{\chi})$ (see (3.119)) one can introduce a parametrix for $\text{Op}_T(b^l)$, say $\text{Op}_T(e)$, with $e \in S_T^1$, satisfying

$$\text{Op}_T(e) \text{Op}_T(b^l) = \text{Op}_T(\hat{\chi}) + R, \quad R \in h^\infty \Psi_T^{-\infty}.$$

Note that the principal part of the parametrix e is given by $\sigma(e) = \hat{\chi} (\rho_j^{l,+} - \rho_j^{l,-})|_{x_n=0^+}$. Applying this parametrix to (3.118) gives

$$\begin{aligned} \text{Op}_T(e) (1 - \text{Op}_T(a^l)) \gamma_0(u_{\mathcal{Z},j}^l) &= \text{Op}_T(\hat{\chi}) \gamma_1(u_{\mathcal{Z},j}^l) + R \gamma_1(u_{\mathcal{Z},j}^l) + \text{Op}_T(e) G_2^l \\ &= \gamma_1(u_{\mathcal{Z},j}^l) + R_1 D_{x_n} v_j^l|_{x_n=0^+} + R_0 v_j^l|_{x_n=0^+} + \text{Op}_T(e) G_2^l, \end{aligned} \quad (3.125)$$

with $R_1 \in h^\infty \Psi_T^{-\infty}$ and $R_0 \in h^\infty \Psi_T^{-\infty}$, since

$$\begin{aligned} \gamma_1(u_{\mathcal{Z},j}^l) &= \text{Op}_T(\hat{\chi}) \gamma_1(u_{\mathcal{Z},j}^l) + \underbrace{(1 - \text{Op}_T(\hat{\chi})) \text{Op}_T(\chi_{\mathcal{Z},j})}_{\in h^\infty \Psi_T^{-\infty}} D_{x_n} v_j^l|_{x_n=0^+} \\ &\quad + \underbrace{(1 - \text{Op}_T(\hat{\chi})) [D_{x_n}, \text{Op}_T(\chi_{\mathcal{Z},j})]}_{\in h^\infty \Psi_T^{-\infty}} v_j^l|_{x_n=0^+}, \end{aligned}$$

and

$$R \gamma_1(u_{\mathcal{Z},j}^l) = \underbrace{R \text{Op}_T(\chi_{\mathcal{Z},j})}_{\in h^\infty \Psi_T^{-\infty}} D_{x_n} v_j^l|_{x_n=0^+} + \underbrace{R [D_{x_n}, \text{Op}_T(\chi_{\mathcal{Z},j})]}_{\in h^\infty \Psi_T^{-\infty}} v_j^l|_{x_n=0^+}.$$

Using the first relation of (3.124) to replace $\gamma_0(u_{\mathcal{Z},j}^l)$ by $\gamma_0(u_{\mathcal{Z},j}^r)$ in (3.125), we obtain

$$\begin{aligned} \text{Op}_T(e) (1 - \text{Op}_T(a^l)) (\gamma_0(u_{\mathcal{Z},j}^r) + \theta_{\mathcal{Z},j}^l - \theta_{\mathcal{Z},j}^r) \\ = \gamma_1(u_{\mathcal{Z},j}^l) + R_1 D_{x_n} v_j^l|_{x_n=0^+} + R_0 v_j^l|_{x_n=0^+} + \text{Op}_T(e) G_2^l. \end{aligned} \quad (3.126)$$

Now, replacing (3.126) in the second equation of (3.124) yields the following relation between the two traces of $u_{\mathcal{Z},j}^r$:

$$\begin{aligned} \beta \gamma_1(u_{\mathcal{Z},j}^r) &= \left(\frac{\delta c_j^s}{h i c_j^l} P_{\varphi,j}^s - \text{Op}_T(e) (1 - \text{Op}_T(a^l)) + k \right) \gamma_0(u_{\mathcal{Z},j}^r) - \frac{\delta c_j^s}{h i c_j^l} P_{\varphi,j}^s \theta_{\mathcal{Z},j}^r \\ &\quad - \text{Op}_T(e) (1 - \text{Op}_T(a^l)) (\theta_{\mathcal{Z},j}^l - \theta_{\mathcal{Z},j}^r) - \tilde{G}_1 + \text{Op}_T(e) G_2^l \\ &\quad + R_1 D_{x_n} v_j^l|_{x_n=0^+} + R_0 v_j^l|_{x_n=0^+}. \end{aligned}$$

This equation can be written under the form

$$\gamma_1(u_{\mathcal{Z},j}^r) = \Sigma_\delta \gamma_0(u_{\mathcal{Z},j}^r) + G_3 \quad (3.127)$$

where

$$\Sigma_\delta = \frac{1}{\beta} \left(\frac{\delta c_j^s}{h i c_j^l} P_{\varphi,j}^s - \text{Op}_{\mathcal{T}}(e) (1 - \text{Op}_{\mathcal{T}}(a^l)) + k \right), \quad (3.128)$$

and with (3.74) and (3.120) the term G_3 can be estimated as

$$\begin{aligned} |G_3|_0 &\lesssim \frac{\delta}{h} |\theta_{\varphi,j}^r|_0 + |\theta_{\varphi,j}^l|_1 + |\theta_{\varphi,j}^r|_1 + (\delta + h) |v_j^s|_1 + |\Theta_{\varphi,j}^s|_0 \\ &\quad + h^{-\frac{1}{2}} (\|P_{\varphi,j}^l v_j^l\|_0 + h \|v_j^l\|_1 + h^2 |D_{x_n} v_j^l|_{x_n=0^+}|_0), \end{aligned} \quad (3.129)$$

where we have used the trace formula (3.23) and

$$P_{\varphi,j}^s \theta_{\mathcal{Z},j}^r = P_{\varphi,j}^s \underbrace{\text{Op}_{\mathcal{T}}(\chi_{\mathcal{Z},j})}_{\in \Psi_{\mathcal{T}}^0} \theta_{\varphi,j}^r.$$

In $\text{supp}(\hat{\chi})$, from (3.119) the symbol σ_δ of Σ_δ reads

$$\sigma_\delta = \beta^{-1} \left(-i \frac{\delta c_j^s}{h c_j^l} p_{\varphi,j}^s - \rho_j^{l,+} + k \right) + r, \quad \text{with } r \in \delta S_{\mathcal{T}}^1 + h S_{\mathcal{T}}^0. \quad (3.130)$$

where functions are evaluated at the interface, i.e. $x_n = 0^+$.

Using (3.127) in (3.122), we can now write $\mathcal{B}^r(u_{\mathcal{Z},j}^r)$ as

$$\begin{aligned} \mathcal{B}^r(u_{\mathcal{Z},j}^r) &= \left(\begin{pmatrix} 2\partial_{x_n} \varphi_j^r|_{x_n=0^+} & B_1^r \\ B_1^{r'} & B_2^r \end{pmatrix} \begin{pmatrix} \Sigma_\delta \gamma_0(u_{\mathcal{Z},j}^r) + G_3 \\ \gamma_0(u_{\mathcal{Z},j}^r) \end{pmatrix}, \begin{pmatrix} \Sigma_\delta \gamma_0(u_{\mathcal{Z},j}^r) + G_3 \\ \gamma_0(u_{\mathcal{Z},j}^r) \end{pmatrix} \right)_0 \\ &= \left(\tilde{\Sigma}_\delta \gamma_0(u_{\mathcal{Z},j}^r), \gamma_0(u_{\mathcal{Z},j}^r) \right)_0 + 4 \text{Re} \left(\partial_{x_n} \varphi_j^r|_{x_n=0^+} \Sigma_\delta \gamma_0(u_{\mathcal{Z},j}^r), G_3 \right)_0 \\ &\quad + \left(B_1^r \gamma_0(u_{\mathcal{Z},j}^r), G_3 \right)_0 + \left(B_1^{r'} G_3, \gamma_0(u_{\mathcal{Z},j}^r) \right)_0 + 2 \left(\partial_{x_n} \varphi_j^r|_{x_n=0^+} G_3, G_3 \right)_0, \end{aligned} \quad (3.131)$$

with

$$\tilde{\Sigma}_\delta = 2\Sigma_\delta^* \partial_{x_n} \varphi_j^r|_{x_n=0^+} \Sigma_\delta + \Sigma_\delta^* B_1^r + B_1^{r'} \Sigma_\delta + B_2^r. \quad (3.132)$$

The following lemma makes use of condition (3.114) that describes the smallness of the region \mathcal{Z} .

Lemma 3.32. *Let $\tilde{\sigma}_\delta$ be the symbol of $\tilde{\Sigma}_\delta$. We have $\hat{\chi} \frac{h^2}{h^2 + \delta^2} \tilde{\sigma}_\delta \in S_{\mathcal{T}}^0$. Moreover, in $\text{supp}(\hat{\chi})$, for $h_0 > 0$ sufficiently small, we have*

$$\frac{h^2}{h^2 + \delta^2} \tilde{\sigma}_\delta \geq C_0 > 0, \quad 0 < h \leq h_0.$$

We refer to Appendix 3.8.7 for a proof.

Let $\tilde{\chi} \in \mathcal{C}_c^\infty(T^*(\mathbb{R}^n))$, be equal to one on a neighborhood of $\text{supp}(\chi_{\mathcal{Z},j}|_{x_n=0^+})$ and such that $\hat{\chi}$ is equal to one on a neighborhood of $\text{supp}(\tilde{\chi})$. We then write

$$\frac{h^2}{h^2 + \delta^2} \tilde{\sigma}_\delta = s_\delta + r_\delta, \quad s_\delta = \frac{h^2}{h^2 + \delta^2} \tilde{\sigma}_\delta \tilde{\chi} + C_0 \langle (\xi_0, \xi') \rangle^2 (1 - \tilde{\chi}), \quad r_\delta = \left(\frac{h^2}{h^2 + \delta^2} \tilde{\sigma}_\delta - C_0 \langle (\xi_0, \xi') \rangle^2 \right) (1 - \tilde{\chi}).$$

With Lemma 3.32, we have $s_\delta \geq C_0 \langle (\xi_0, \xi') \rangle^2$ and observe that $s_\delta \in S_{\mathcal{T}}^2$. The Gårding inequality yields, for h_0 sufficiently small and $0 < h \leq h_0$,

$$\left(\tilde{\Sigma}_\delta \gamma_0(u_{\mathcal{Z},j}^r), \gamma_0(u_{\mathcal{Z},j}^r) \right)_0 \geq C \left(1 + \frac{\delta^2}{h^2} \right) |\gamma_0(u_{\mathcal{Z},j}^r)|_1^2 - C_N h^N |v_j^r|_{x_n=0^+}|_0^2, \quad (3.133)$$

as $\text{supp}(r_\delta) \cap \text{supp}(\chi_{\mathcal{Z},j}) = \emptyset$.

We now estimate the other terms in the expression (3.131). Using the Young inequality, we have, for all $\varepsilon > 0$,

$$\begin{aligned} & |(B_1^r \gamma_0(u_{\mathcal{Z},j}^r), G_3)_0| + |(B_1^{r'} G_3, \gamma_0(u_{\mathcal{Z},j}^r))_0| + 2|(\partial_{x_n} \varphi_j^r|_{x_n=0^+}, G_3)_0| \\ & \lesssim \varepsilon \left(1 + \frac{\delta^2}{h^2}\right) |\gamma_0(u_{\mathcal{Z},j}^r)|_1^2 + \left(1 + \frac{h^2}{\varepsilon(h^2 + \delta^2)}\right) |G_3|_0^2. \end{aligned} \quad (3.134)$$

For the remaining term in (3.131), we have

$$4 \left| \text{Re} \left(\partial_{x_n} \varphi_j^r|_{x_n=0^+}, \Sigma_\delta \gamma_0(u_{\mathcal{Z},j}^r), G_3 \right)_0 \right| \lesssim \left(\frac{\delta}{h} |P_{\varphi,j}^s \gamma_0(u_{\mathcal{Z},j}^r)|_0 + |\gamma_0(u_{\mathcal{Z},j}^r)|_1 \right) |G_3|_0,$$

according to (3.128) and (3.130). Taking $\tilde{\chi}$ as above, we can write

$$P_{\varphi,j}^s \gamma_0(u_{\mathcal{Z},j}^r) = \underbrace{P_{\varphi,j}^s \text{Op}_T(\tilde{\chi})}_{\in \Psi_T^0} \gamma_0(u_{\mathcal{Z},j}^r) + \underbrace{P_{\varphi,j}^s (1 - \text{Op}_T(\tilde{\chi})) \text{Op}_T(\chi_{\mathcal{Z},j})}_{\in h^\infty \Psi_T^{-\infty}} v_j^r|_{x_n=0^+}. \quad (3.135)$$

Using the Young inequality, for all $\varepsilon > 0$, $N \in \mathbb{N}$ we obtain

$$\begin{aligned} & 4 \left| \text{Re} \left(\partial_{x_n} \varphi_j^r|_{x_n=0^+}, \Sigma_\delta \gamma_0(u_{\mathcal{Z},j}^r), G_3 \right)_0 \right| \\ & \lesssim \varepsilon \left(1 + \frac{\delta^2}{h^2}\right) |\gamma_0(u_{\mathcal{Z},j}^r)|_1^2 + \frac{1}{\varepsilon} |G_3|_0^2 + \varepsilon C_N \delta^2 h^N |v_j^r|_{x_n=0^+}|_0^2. \end{aligned} \quad (3.136)$$

Combining (3.133) and (3.131) together with (3.134) and (3.136) gives, for ε sufficiently small and $\delta \leq \delta_0$,

$$\left(1 + \frac{\delta^2}{h^2}\right) |\gamma_0(u_{\mathcal{Z},j}^r)|_1^2 \lesssim \mathcal{B}^r(u_{\mathcal{Z},j}^r) + |G_3|_0^2 + C_N h^N |v_j^r|_{x_n=0^+}|_0^2.$$

Finally, turning back to the Carleman form at the boundary (3.121), and using (3.123), we obtain, for all $N \in \mathbb{N}$, for h_0 sufficiently small and $0 < h \leq h_0$,

$$h \|u_{\mathcal{Z},j}^r\|_1^2 + h \left(1 + \frac{\delta^2}{h^2}\right) |\gamma_0(u_{\mathcal{Z},j}^r)|_1^2 \lesssim \|P_{\varphi,j}^r v_j^r\|_0^2 + h |G_3|_0^2 + C_N h^N |v_j^r|_{x_n=0^+}|_0^2 + h^2 |\gamma_1(u_{\mathcal{Z},j}^r)|_0^2.$$

Using (3.127), (3.128), (3.130) and (3.135) to estimate $|\gamma_1(u_{\mathcal{Z},j}^r)|_0$ in terms of $|\gamma_0(u_{\mathcal{Z},j}^r)|_1$, we obtain

$$|\gamma_1(u_{\mathcal{Z},j}^r)|_0 \lesssim \left(1 + \frac{\delta}{h}\right) |\gamma_0(u_{\mathcal{Z},j}^r)|_1 + |G_3|_0 + C_N h^N |v_j^r|_{x_n=0^+}|_0.$$

Then, replacing $|G_3|_0$ by its estimate (3.129) gives, for h_0 sufficiently small and $0 < h \leq h_0$,

$$\begin{aligned} & h \|u_{\mathcal{Z},j}^r\|_1^2 + h |\gamma_1(u_{\mathcal{Z},j}^r)|_0^2 + h \left(1 + \frac{\delta^2}{h^2}\right) |\gamma_0(u_{\mathcal{Z},j}^r)|_1^2 \\ & \lesssim \|P_{\varphi,j}^r v_j^r\|_0^2 + h^2 \|v_j^r\|_1^2 + h(\delta^2 + h^2) |v_j^r|_1^2 + \|P_{\varphi,j}^l v_j^l\|_0^2 + h^2 \|v_j^l\|_1^2 + h^4 |D_{x_n} v_j^l|_{x_n=0^+}|_0^2 \\ & \quad + \frac{\delta^2}{h} |\theta_{\varphi,j}^r|_0^2 + h |\theta_{\varphi,j}^l|_1^2 + h |\theta_{\varphi,j}^r|_1^2 + h |\Theta_{\varphi,j}^s|_0^2, \end{aligned} \quad (3.137)$$

using the trace formula (3.23). This is a local version of (3.115). Patching together on \mathcal{M}_+ such local estimates as we did in (3.79)-(3.84) yields (3.115).

Let us now conclude the proof on the “l” side. The trace equation (3.125) yields

$$\begin{aligned} |\gamma_1(u_{\mathcal{Z},j}^l)|_0 & \leq |\gamma_0(u_{\mathcal{Z},j}^l)|_1 + |G_2^l|_1 + C_N h^N (|D_{x_n} v_j^l|_{x_n=0^+}|_0 + |v_j^l|_{x_n=0^+}|_0), \quad N \in \mathbb{N}, \\ & \leq |\gamma_0(u_{\mathcal{Z},j}^r)|_1 + |\theta_{\varphi,j}^r|_1 + |\theta_{\varphi,j}^l|_1 + |G_2^l|_1 \\ & \quad + C_N h^N (|D_{x_n} v_j^l|_{x_n=0^+}|_0 + |v_j^l|_{x_n=0^+}|_0), \quad N \in \mathbb{N}, \end{aligned}$$

after using the first relation of (3.124).

Using this last inequality, together with Estimates (3.137) on $|\gamma_0(u_{\mathcal{E},j}^r)|_1$, Estimate (3.120) on $|G_2^l|_1$, (3.117), and the first transmission condition in (3.124), we finally obtain, for h_0 sufficiently small, and $0 < h \leq h_0$,

$$\begin{aligned} & \|u_{\mathcal{E},j}^l\|_1^2 + h|\gamma_0(u_{\mathcal{E},j}^l)|_1^2 + h|\gamma_1(u_{\mathcal{E},j}^l)|_0^2 \\ & \lesssim \|P_{\varphi,j}^l v_j^l\|_0^2 + h^2 \|v_j^l\|_1^2 + h^4 |D_{x_n} v_j^l|_{x_n=0^+}|_0^2 + \frac{h^2}{\delta^2 + h^2} (\|P_{\varphi,j}^r v_j^r\|_0^2 + h^2 \|v_j^r\|_1^2) + h^3 |v_j^s|_1^2 \\ & \quad + \frac{h\delta^2}{\delta^2 + h^2} |\theta_{\varphi,j}^r|_0^2 + h|\theta_{\varphi,j}^r|_1^2 + h|\theta_{\varphi,j}^l|_1^2 + \frac{h^3}{\delta^2 + h^2} |\Theta_{\varphi,j}^s|_0^2. \end{aligned}$$

This is a local version of (3.116). Patching together on \mathcal{M}_+ such local estimates as we did in (3.79)-(3.84) yields (3.116). \square

3.4.5 Estimate in the region \mathcal{E}

Here, we place ourselves in the region \mathcal{E} (high frequencies), and prove a Carleman estimate for $u_{\mathcal{E},j}$, and consequently for $\Xi_{\mathcal{E}} v$. Using in this region the ellipticity of $P_{\varphi,j}^s$ and the Calderón projector technique for both $P_{\varphi,j}^r$ and $P_{\varphi,j}^l$, we obtain the following partial estimate.

Proposition 3.33. *Suppose that the weight function φ satisfies the properties listed in Section 3.3.1. Then, for all $\delta_0 > 0$, there exist $C > 0$ and $h_0 > 0$ such that, for all $0 < \delta \leq \delta_0$ and $0 < h \leq h_0$, $v^{7l} \in \mathcal{C}_c^\infty((0, X_0) \times S \times [0, 2\varepsilon))$ and $v^s \in \mathcal{C}_c^\infty((0, X_0) \times S)$ satisfying (3.47), we have*

$$\begin{aligned} & \|\Xi_{\mathcal{E}} v^{7l}\|_1^2 + h|\Xi_{\mathcal{E}} v^{7l}|_{x_n=0^+}|_1^2 + h|D_{x_n} \Xi_{\mathcal{E}} v^{7l}|_{x_n=0^+}|_0^2 \\ & \leq C \left(\|P_{\varphi}^r v^r\|_0^2 + h^2 \|v^r\|_1^2 + h^4 |D_{x_n} v^r|_{x_n=0^+}|_0^2 + \|P_{\varphi}^l v^l\|_0^2 + h^2 \|v^l\|_1^2 + h^4 |D_{x_n} v^l|_{x_n=0^+}|_0^2 \right. \\ & \quad \left. + h^3 |v^s|_1^2 + h|\Theta_{\varphi}^s|_0^2 + h|\theta_{\varphi}^r|_1^2 + h|\theta_{\varphi}^l|_1^2 \right). \end{aligned} \quad (3.138)$$

Proof. The function $u_{\mathcal{E},j}$ satisfies (TC $_{\bullet,j}$), with $\bullet = \mathcal{E}$. On each side, the roots configuration described in Lemma 3.24 (and represented in Figure 3.3c) allows us to apply the Calderón projector technique as in [LR97, LR10]. Since both roots are separated by the real axis we only obtain one relation between the two traces at the interface : according to [LR10, Eq. (2.37)], we have

$$\|u_{\mathcal{E},j}^{7l}\|_1 \lesssim \|P_{\varphi,j}^{7l} v_j^{7l}\|_0 + h \|v_j^{7l}\|_1 + h^{\frac{1}{2}} |\gamma_0(u_{\mathcal{E},j}^{7l})|_1 + h^{\frac{1}{2}} |\gamma_1(u_{\mathcal{E},j}^{7l})|_0 + h^2 |D_{x_n} v_j^{7l}|_{x_n=0^+}|_0, \quad (3.139)$$

together with one relation between the two traces [LR10, Eq. (2.38)] :

$$\left(1 - \text{Op}_{\mathcal{T}}(a^{7l})\right) \gamma_0(u_{\mathcal{E},j}^{7l}) = \text{Op}_{\mathcal{T}}(b^{7l}) \gamma_1(u_{\mathcal{E},j}^{7l}) + G_2^{7l}. \quad (3.140)$$

In this last expression, $a^{7l} \in S_{\mathcal{T}}^0$ and $b^{7l} \in S_{\mathcal{T}}^{-1}$ have for principal part respectively

$$a_0^{7l} = - \left(\tilde{\chi} \frac{\rho_j^{7l,-}}{\rho_j^{7l,+} - \rho_j^{7l,-}} \right) \Big|_{x_n=0^+}, \quad \text{and} \quad b_{-1}^{7l} = \left(\tilde{\chi} \frac{1}{\rho_j^{7l,+} - \rho_j^{7l,-}} \right) \Big|_{x_n=0^+}, \quad (3.141)$$

where $\rho_j^{l,\pm}$ are the roots of $p_{\varphi,j}^l$ (i.e. $\rho_j^{l,\pm} = (\phi_j^{-1})^* \rho^{l,\pm}$ with $\rho^{l,\pm}$ described in Lemma 3.24) and $\tilde{\chi} \in \mathcal{C}^\infty(T^*(\mathbb{R}^n))$ is equal to one in the neighborhood of the support of $\chi_{\mathcal{E},j}|_{x_n=0^+}$, with support in

$$\left((\phi_j^{-1})^* \mathcal{E} \right) \cap \{x_n = 0\} = \{ (x_0, \phi_j(y); \xi_0, {}^t d\phi_j^{-1}(\phi_j(y))\eta); (x_0, y, 0; \xi_0, \eta) \in \mathcal{E} \}.$$

The remainder G_2^{7l} satisfies

$$|G_2^{7l}|_1 \lesssim h^{-\frac{1}{2}} \left(\|P_{\varphi,j}^{7l} v_j^{7l}\|_0 + h \|v_j^{7l}\|_1 + h^2 |D_{x_n} v_j^{7l}|_{x_n=0^+}|_0 \right). \quad (3.142)$$

The principal part of b^{7l} satisfies

$$b_{-1}^{7l} \geq C \langle (\xi_0, \xi') \rangle^{-1} \quad \text{in } \text{supp}(\tilde{\chi}),$$

as $\rho_j^{7l,+}$ and $\rho_j^{7l,-}$ are tangential symbol of order one such that $\rho_j^{7l,+} - \rho_j^{7l,-}$ does not vanish in a neighborhood of $\text{supp}(\tilde{\chi})$. Let $\hat{\chi} \in \mathcal{C}^\infty(T^*(\mathbb{R}^n))$ satisfy the same requirements as $\tilde{\chi}$ with $\tilde{\chi}$ equal to one a neighborhood the support of $\hat{\chi}$. We can introduce parametrices for $\text{Op}_{\mathcal{T}}(b^{7l})$, say $\text{Op}_{\mathcal{T}}(e^{7l})$, with $e^{7l} \in S_{\mathcal{T}}^1$, satisfying

$$\text{Op}_{\mathcal{T}}(e^{7l}) \text{Op}_{\mathcal{T}}(b^{7l}) = \text{Op}_{\mathcal{T}}(\hat{\chi}) + R^{7l}, \quad R^{7l} \in h^\infty \Psi_{\mathcal{T}}^{-\infty}.$$

Note that the principal parts of the parametrices e^{7l} are given by $\sigma(e^{7l}) = \hat{\chi} \left(\rho_j^{7l,+} - \rho_j^{7l,-} \right) |_{x_n=0^+}$.

Applying these parametrices to (3.140) and arguing as in (3.113) give

$$\text{Op}_{\mathcal{T}}(e^{7l}) \left(1 - \text{Op}_{\mathcal{T}}(a^{7l}) \right) \gamma_0(u_{\mathcal{E},j}^{7l}) = \gamma_1(u_{\mathcal{E},j}^{7l}) + R_1^{7l} D_{x_n} v_j^{7l} |_{x_n=0^+} + R_0^{7l} v_j^{7l} |_{x_n=0^+} + \text{Op}_{\mathcal{T}}(e^{7l}) G_2^{7l}, \quad (3.143)$$

with $R_0^{7l}, R_1^{7l} \in h^\infty \Psi_{\mathcal{T}}^{-\infty}$. This yields the following estimate of $\gamma_1(u_{\mathcal{E},j}^{7l})$, in terms of $\gamma_0(u_{\mathcal{E},j}^{7l})$:

$$|\gamma_1(u_{\mathcal{E},j}^{7l})|_0 \lesssim |\gamma_0(u_{\mathcal{E},j}^{7l})|_1 + |G_2^{7l}|_1 + C_N h^N \left(|D_{x_n} v_j^{7l} |_{x_n=0^+}|_0 + |v_j^{7l} |_{x_n=0^+}|_0 \right), \quad N \in \mathbb{N}. \quad (3.144)$$

On the other hand, replacing $u_{\mathcal{E},j}^s$ in the first equation of $(\text{TC}_{\bullet,j})$ by its expression in the second equation of $(\text{TC}_{\bullet,j})$ gives

$$\delta \frac{c_j^s}{i c_j^l} P_{\varphi,j}^s (\gamma_0(u_{\mathcal{E},j}^r) - \theta_{\mathcal{E},j}^r) = h \left(\gamma_1(u_{\mathcal{E},j}^l) + \beta \gamma_1(u_{\mathcal{E},j}^r) - k \gamma_0(u_{\mathcal{E},j}^r) + \tilde{G}_1 \right).$$

Using (3.143) and the first equation of $(\text{TC}_{\bullet,j})$, this yields

$$\Omega_\delta \gamma_0(u_{\mathcal{E},j}^r) = G_3, \quad (3.145)$$

with

$$\Omega_\delta = \delta \frac{c_j^s}{i c_j^l} P_{\varphi,j}^s + h \left(k - \beta \text{Op}_{\mathcal{T}}(e^r) (1 - \text{Op}_{\mathcal{T}}(a^r)) - \text{Op}_{\mathcal{T}}(e^l) (1 - \text{Op}_{\mathcal{T}}(a^l)) \right), \quad (3.146)$$

and

$$\begin{aligned} G_3 = & \delta \frac{c_j^s}{i c_j^l} P_{\varphi,j}^s \theta_{\mathcal{E},j}^r + h \tilde{G}_1 - h \beta \left(R_1^r D_{x_n} v_j^r |_{x_n=0^+} + R_0^r v_j^r |_{x_n=0^+} + \text{Op}_{\mathcal{T}}(e^r) G_2^r \right) \\ & - h \left(R_1^l D_{x_n} v_j^l |_{x_n=0^+} + R_0^l v_j^l |_{x_n=0^+} + \text{Op}_{\mathcal{T}}(e^l) G_2^l + \text{Op}_{\mathcal{T}}(e^l) (1 - \text{Op}_{\mathcal{T}}(a^l)) (\theta_{\mathcal{E},j}^r - \theta_{\mathcal{E},j}^l) \right). \end{aligned} \quad (3.147)$$

Here, we introduce a class of pseudo-differential operators adapted to the operator Ω_δ in order to perform uniform estimates in the singular limit $\delta \rightarrow 0^+$. On the tangential phase-space $W = T^*(\mathbb{R}^n)$, we define the order function

$$\Lambda^2 := \frac{\delta}{\delta + h} \langle (\xi_0, \xi') \rangle^2 + \frac{h}{\delta + h} \langle (\xi_0, \xi') \rangle,$$

associated with the metric,

$$g_W = |d(x_0, x')|^2 + \frac{|d(\xi_0, \xi')|^2}{\langle (\xi_0, \xi') \rangle^2}.$$

Lemma 3.34. *The order function Λ is admissible, i.e., slowly varying and temperate.*

We refer to Appendix 3.8.8 for a proof. For a review of these notions see [Hör79] or [Hör85, Sec. 18.4–5] or the recent monograph [Ler10, def. 2.2.4 and 2.2.15]. Thanks to the previous lemma, we can define a proper Hörmander-class calculus. We now prove that Ω_δ is elliptic in this class.

We set

$$\omega_\delta = \delta \frac{c_j^s}{i c_j^l} p_{\varphi,j}^s + h \left(k - \beta \hat{\chi} \rho_j^{r,+} - \hat{\chi} \rho_j^{l,+} \right).$$

We have $(\delta + h)^{-1} \omega_\delta \in S_{\mathcal{T}}(\Lambda^2, g_W)$. With (3.141) we see that

$$\Omega_\delta - \text{Op}_{\mathcal{T}}(\omega_\delta) \in h \delta \Psi_{\mathcal{T}}^1 + h^2 \Psi_{\mathcal{T}}^0 \subset (h + \delta) \Psi_{\mathcal{T}}(h \Lambda^2 / \langle (\xi_0, \xi') \rangle, g_W). \quad (3.148)$$

From the definition of k in (3.73) this gives

$$\text{Im}(\omega_\delta) = -\delta \frac{c_j^s}{c_j^l} \text{Re}(p_{\varphi,j}^s) - h (\partial_{x_n} \varphi_j^l|_{x_n=0^+} + \beta \partial_{x_n} \varphi_j^r|_{x_n=0^+} + \hat{\chi} \text{Im}(\rho_j^{l,+} + \beta \rho_j^{r,+})).$$

In this expression, we have

$$\text{Re}(p_{\varphi,j}^s) \geq C \langle (\xi_0, \xi') \rangle^2 \text{ on } \text{supp } \hat{\chi}, \quad (3.149)$$

by Proposition 3.23 (see also the localization of $\text{Char}(P_{\varphi,j}^s)$ on Figure 3.4). Next, in the region where $\hat{\chi} = 1$ we have

$$\begin{aligned} \partial_{x_n} \varphi_j^l|_{x_n=0^+} + \beta \partial_{x_n} \varphi_j^r|_{x_n=0^+} + \text{Im}(\rho_j^{l,+} + \beta \rho_j^{r,+}) &= \frac{1}{2} \text{Im}(\rho_j^{l,+} - \rho_j^{l,-}) + \frac{\beta}{2} \text{Im}(\rho_j^{r,+} - \rho_j^{r,-}) \\ &\geq C \langle (\xi_0, \xi') \rangle, \end{aligned} \quad (3.150)$$

as $\partial_{x_n} \varphi_j^{r,l} = -\frac{1}{2} \text{Im}(\rho_j^{l,+} + \rho_j^{l,-})$ and with Lemma 3.26. Estimates (3.149) and (3.150) yield

$$|\omega_\delta| \geq C(\delta + h)\Lambda^2,$$

in the region where $\hat{\chi} = 1$. There, the symbol $(\delta + h)^{-1} \omega_\delta$ is elliptic in the class $S_{\mathcal{T}}(\Lambda^2, g_W)$. Hence, there exists $l \in S_{\mathcal{T}}(\Lambda^{-2}, g_W)$ (with principal part $\tilde{\chi} \omega_\delta^{-1}$) such that

$$\text{Op}_{\mathcal{T}}(l)(\delta + h)^{-1} \text{Op}_{\mathcal{T}}(\Omega_\delta) = \text{Op}_{\mathcal{T}}(\tilde{\chi}) + R, \quad R \in h^\infty \Psi_{\mathcal{T}}^{-\infty},$$

by (3.148), for some $\tilde{\chi} \in \mathcal{C}^\infty(T^*(\mathbb{R}^n))$ equal to one on a neighborhood of $\text{supp}(\chi_{\mathcal{E},j}|_{x_n=0^+})$ and such that $\tilde{\chi}$ is equal to one on a neighborhood of $\text{supp}(\hat{\chi})$.

Applying this parametrix to Equation (3.145) gives

$$\gamma_0(u_{\mathcal{E},j}^r) + R\gamma_0(u_{\mathcal{E},j}^r) + \tilde{R}v_j^r|_{x_n=0^+} = \text{Op}_{\mathcal{T}}(l)(\delta + h)^{-1} G_3, \quad (3.151)$$

with $R \in h^\infty \Psi_{\mathcal{T}}^{-\infty}$ and $\tilde{R} = \text{Op}_{\mathcal{T}}(\tilde{\chi} - 1) \text{Op}_{\mathcal{T}}(\chi_{\mathcal{E},j}|_{x_n=0^+}) \in h^\infty \Psi_{\mathcal{T}}^{-\infty}$.

We estimate

$$|\text{Op}_{\mathcal{T}}(l)(\delta + h)^{-1} G_3|_1 = |\text{Op}_{\mathcal{T}}(\langle (\xi_0, \xi') \rangle) \text{Op}_{\mathcal{T}}(l)(\delta + h)^{-1} G_3|_0,$$

with

$$\text{Op}_{\mathcal{T}}(\langle (\xi_0, \xi') \rangle) \text{Op}_{\mathcal{T}}(l)(\delta + h)^{-1} \in \Psi_{\mathcal{T}}\left(\frac{\langle (\xi_0, \xi') \rangle}{(\delta + h)\Lambda^2}, g_W\right) = \Psi_{\mathcal{T}}\left(\frac{1}{\delta \langle (\xi_0, \xi') \rangle + h}, g_W\right).$$

We thus obtain, as $\text{Op}_{\mathcal{T}}\left(\frac{1}{\delta \langle (\xi_0, \xi') \rangle + h}\right)$ is a Fourier multiplier,

$$|\text{Op}_{\mathcal{T}}(l)(\delta + h)^{-1} G_3|_1 \lesssim \left| \text{Op}_{\mathcal{T}}\left(\frac{1}{\delta \langle (\xi_0, \xi') \rangle + h}\right) G_3 \right|_0.$$

With (3.147), this yields

$$\begin{aligned} & |\text{Op}_{\mathcal{T}}(l)(\delta + h)^{-1}G_3|_1 \\ & \lesssim |P_{\varphi,j}^s \theta_{\mathcal{E},j}^r|_{-1} + \left| \text{Op}_{\mathcal{T}} \left(\frac{h}{\delta \langle (\xi_0, \xi') \rangle + h} \right) \tilde{G}_1 \right|_0 + |R_1^r D_{x_n} v_j^r|_{x_n=0^+}|_0 + |R_0^r v_j^r|_{x_n=0^+}|_0 \\ & \quad + |R_1^l D_{x_n} v_j^l|_{x_n=0^+}|_0 + |R_0^l v_j^l|_{x_n=0^+}|_0 + |G_2^r|_1 + |G_2^l|_1 + |\theta_{\mathcal{E},j}^r|_1 + |\theta_{\mathcal{E},j}^l|_1. \end{aligned}$$

As we have

$$\left| \text{Op}_{\mathcal{T}} \left(\frac{h}{\delta \langle (\xi_0, \xi') \rangle + h} \right) \tilde{G}_1 \right|_0 \leq \frac{h}{\delta + h} |\tilde{G}_1|_0,$$

and with (3.74), (3.142), and the trace formula (3.23), using also $P_{\varphi,j}^s \in \Psi_{\mathcal{T}}^2$, gives

$$\begin{aligned} |\text{Op}_{\mathcal{T}}(l)(\delta + h)^{-1}G_3|_1 & \lesssim h|v_j^s|_1 + h^{-\frac{1}{2}} (\|P_{\varphi,j}^r v_j^r\|_0 + h\|v_j^r\|_1 + h^2|D_{x_n} v_j^r|_{x_n=0^+}|_0) \\ & \quad + h^{-\frac{1}{2}} (\|P_{\varphi,j}^l v_j^l\|_0 + h\|v_j^l\|_1 + h^2|D_{x_n} v_j^l|_{x_n=0^+}|_0) \\ & \quad + |\theta_{\varphi,j}^r|_1 + |\theta_{\varphi,j}^l|_1 + |\Theta_{\varphi,j}^s|_0. \end{aligned}$$

With (3.151), the transmission conditions (TC $_{\bullet,j}$), and (3.143) that gives $\gamma_1(u_{\mathcal{E},j}^{7l})$ as a function of $\gamma_0(u_{\mathcal{E},j}^{7l})$ (thanks to the Calderón projectors), we obtain

$$\begin{aligned} h^{\frac{1}{2}}|\gamma_0(u_{\mathcal{E},j}^{7l})|_1 + h^{\frac{1}{2}}|\gamma_1(u_{\mathcal{E},j}^{7l})|_0 & \lesssim h^{\frac{3}{2}}|v_j^s|_1 + \|P_{\varphi,j}^r v_j^r\|_0 + h\|v_j^r\|_1 + h^2|D_{x_n} v_j^r|_{x_n=0^+}|_0 \\ & \quad + \|P_{\varphi,j}^l v_j^l\|_0 + h\|v_j^l\|_1 + h^2|D_{x_n} v_j^l|_{x_n=0^+}|_0 \\ & \quad + h^{\frac{1}{2}}|\theta_{\varphi,j}^r|_1 + h^{\frac{1}{2}}|\theta_{\varphi,j}^l|_1 + h^{\frac{1}{2}}|\Theta_{\varphi,j}^s|_0. \end{aligned}$$

Injecting these estimates in (3.139) we obtain a local version of (3.138). Patching together on \mathcal{M}_+ such local estimates as we did in (3.79)-(3.84) yields the result. \square

3.4.6 A semi-global Carleman estimate : proof of Theorem 3.2

In this section, we explain how we can patch together the four microlocal estimate of Propositions 3.28, 3.30, 3.31 and 3.33, to obtain a global Carleman estimate in a neighborhood of S , and prove Theorem 3.2.

First, let us introduce some notation. We set

$$\begin{aligned} \text{BT}(w) & := h|w|_{x_n=0^+}|_1^2 + h|D_{x_n} w|_{x_n=0^+}|_0^2, \\ \text{RHS}^{7l}(w) & := \|P_{\varphi}^{7l} w\|_0^2 + h^2\|w\|_1^2 + h^4|D_{x_n} w|_{x_n=0^+}|_0^2, \\ R_{\theta} & := h|\Theta_{\varphi}^s|_0^2 + h|\theta_{\varphi}^r|_1^2 + h|\theta_{\varphi}^l|_1^2. \end{aligned}$$

This allows us to formulate concisely the four microlocal estimates of Propositions 3.28, 3.30, 3.31 and 3.33.

$$\|\Xi_{\mathcal{G}} v^r\|_1^2 + \text{BT}(\Xi_{\mathcal{G}} v^r) \lesssim \text{RHS}^r(v^r), \quad (3.152)$$

$$\begin{aligned} \varepsilon h \|\Xi_{\mathcal{G}} v^l\|_1^2 + \varepsilon \text{BT}(\Xi_{\mathcal{G}} v^l) & \lesssim \left(1 + \frac{\delta^2}{h^2}\right) \left(\varepsilon \|\zeta P_{\varphi}^r v^r\|_0^2 + \varepsilon h^4 |D_{x_n} v^r|_{x_n=0^+}|_0^2 + \varepsilon h^4 \|v^r\|_1^2\right) \\ & \quad + \varepsilon \text{RHS}^l(v^l) + \boxed{\varepsilon(h^2 + \delta^2) \|\Xi_{\mathcal{G}} v^r\|_1^2} + \boxed{\varepsilon h(h^2 + \delta^2) |v^s|_1^2} + \varepsilon R_{\theta} + \varepsilon \frac{\delta^2}{h} |\theta_{\varphi}^r|_0^2. \end{aligned} \quad (3.153)$$

$$\|\Xi_{\mathcal{F}} v^r\|_1^2 + \text{BT}(\Xi_{\mathcal{F}} v^r) \lesssim \text{RHS}^r(v^r), \quad (3.154)$$

$$\|\Xi_{\mathcal{F}} v^l\|_1^2 + \text{BT}(\Xi_{\mathcal{F}} v^l) \lesssim \text{RHS}^l(v^l) + \text{RHS}^r(v^r) + R_{\theta}. \quad (3.155)$$

$$\varepsilon h \|\Xi_{\mathcal{F}} v^r\|_1^2 + \varepsilon \text{BT}(\Xi_{\mathcal{F}} v^r) \lesssim \varepsilon \text{RHS}^r(v^r) + \varepsilon \text{RHS}^l(v^l) + \boxed{\varepsilon h(h^2 + \delta^2) |v^s|_1^2} + \varepsilon \frac{\delta^2}{h} |\theta_{\varphi}^r|_0^2 + \varepsilon R_{\theta}, \quad (3.156)$$

$$\|\Xi_{\mathcal{F}}v^l\|_1^2 + \text{BT}(\Xi_{\mathcal{F}}v^l) \lesssim \text{RHS}^l(v^l) + h^3|v^s|_1^2 + \frac{h^2}{\delta^2 + h^2} \text{RHS}^r(v^r) + R_\theta. \quad (3.157)$$

$$\|\Xi_{\mathcal{E}}v^{7l}\|_1^2 + \text{BT}(\Xi_{\mathcal{E}}v^{7l}) \lesssim \text{RHS}^l(v^l) + \text{RHS}^r(v^r) + h^3|v^s|_1^2 + R_\theta. \quad (3.158)$$

To derive the final Carleman estimate we need to sum together these microlocal estimate and many terms in the r.h.s. need to be “absorbed” by those in the l.h.s.. This is a standard procedure usually making use of the powers of the parameter h in front of these terms and by choosing h sufficiently small. Note, however, that some powers of h are critical here so that the related terms (in frames) in the right hand-sides cannot be “absorbed” directly. To overcome this problem, we have multiplied the two concerned equations by a small parameter $\varepsilon > 0$ whose value is independent of h and δ .

Note that these three atypical terms are the reason for the introduction of the microlocal region \mathcal{F} (compare with the microlocal regions used in [LR10]). In fact, the microlocal region \mathcal{F} acts as a buffer : as \mathcal{F} is an elliptic region for both the operators P_φ^{7l} , it provides terms in the l.h.s. of the associated microlocal estimates of better quality than those obtained in the regions \mathcal{G} and \mathcal{L} (compare the powers of h in the l.h.s. terms of these estimates).

Observe that the property $\chi_{\mathcal{E}} + \chi_{\mathcal{L}} + \chi_{\mathcal{F}} + \chi_{\mathcal{G}} = 1$ implies, see Section 3.3.6,

$$\Xi_{\mathcal{G},j} + \Xi_{\mathcal{F},j} + \Xi_{\mathcal{L},j} + \Xi_{\mathcal{E},j} = \zeta_j(x_0, y).$$

As a consequence of the definition of the operators Ξ_\bullet , $\bullet = \mathcal{E}, \mathcal{L}, \mathcal{F}, \mathcal{G}$, given in (3.62)-(3.63), this yields

$$\Xi_{\mathcal{E}} + \Xi_{\mathcal{L}} + \Xi_{\mathcal{F}} + \Xi_{\mathcal{G}} = \zeta^1(x_0). \quad (3.159)$$

We now treat the three atypical terms and use the small parameter ε .

As $\text{supp}(v^s) \subset (\alpha_0, X_0 - \alpha_0) \times S$ (see the statement of Theorem 3.2 and Section 3.3.3), with (3.159), and using the transmission conditions (3.47), we have

$$\begin{aligned} v^s &= \zeta^1 v^s = \Xi_{\mathcal{E}}v^s + \Xi_{\mathcal{L}}v^s + \Xi_{\mathcal{F}}v^s + \Xi_{\mathcal{G}}v^s \\ &= \Xi_{\mathcal{E}}v^l - \Xi_{\mathcal{E}}\theta_\varphi^l + \Xi_{\mathcal{L}}v^l - \Xi_{\mathcal{L}}\theta_\varphi^l + \Xi_{\mathcal{F}}v^l - \Xi_{\mathcal{F}}\theta_\varphi^l + \Xi_{\mathcal{G}}v^r - \Xi_{\mathcal{G}}\theta_\varphi^r, \quad \text{at } x_n = 0^+. \end{aligned}$$

Hence, for $\delta \leq \delta_0$ and $h \leq h_0$ we can estimate the two atypical terms concerning v^s in (3.153) and (3.156) as

$$\varepsilon h \delta^2 |v^s|_1^2 \lesssim \varepsilon h |\Xi_{\mathcal{E}}v^l|_1^2 + \varepsilon h |\Xi_{\mathcal{L}}v^l|_1^2 + \varepsilon h |\Xi_{\mathcal{F}}v^l|_1^2 + \varepsilon h |\Xi_{\mathcal{G}}v^r|_1^2 + \varepsilon R_\theta.$$

When summing all the estimates (3.152)-(3.158) together and taking ε sufficiently small, the four terms $\varepsilon h |\Xi_{\mathcal{E}}v^l|_1^2$, $\varepsilon h |\Xi_{\mathcal{L}}v^l|_1^2$, $\varepsilon h |\Xi_{\mathcal{F}}v^l|_1^2$, $\varepsilon h |\Xi_{\mathcal{G}}v^r|_1^2$ can be “absorbed” by the l.h.s. of (3.158), (3.157), (3.155), and (3.152) respectively.

The remaining atypical term is in (3.153) :

$$\varepsilon (h^2 + \delta^2) \|\Xi_{\mathcal{G}\mathcal{F}}v^r\|_1^2 \lesssim \varepsilon \|\Xi_{\mathcal{G}\mathcal{F}}v^r\|_1^2.$$

We choose a function $\zeta^4 \in \mathcal{C}_c^\infty(0, X_0)$ such that $\zeta^4 = 1$ on a neighborhood of $(\alpha_0, X_0 - \alpha_0)$, $\zeta^4 = 1$ on a neighborhood of $\text{supp}(\zeta^4)$ and $0 \leq \zeta^4 \leq 1$. Since $\text{supp}(v^r) \subset (\alpha_0, X_0 - \alpha_0) \times S \times [0, 2\varepsilon)$, we have

$$\Xi_{\mathcal{G}\mathcal{F}}v^r = \Xi_{\mathcal{G}\mathcal{F}}(\Xi_{\mathcal{G}} + \Xi_{\mathcal{F}})v^r + \Xi_{\mathcal{G}\mathcal{F}}(1 - \Xi_{\mathcal{G}} - \Xi_{\mathcal{F}})\zeta^4 v^r. \quad (3.160)$$

From Proposition 3.52 and Proposition 3.48, the principal symbol of the operator $\Xi_{\mathcal{G}\mathcal{F}}(1 - \Xi_{\mathcal{G}} - \Xi_{\mathcal{F}})\zeta^4$ is

$$\zeta^2 \chi_{\mathcal{G}\mathcal{F}}(1 - \zeta^1(\chi_{\mathcal{G}} + \chi_{\mathcal{F}}))\zeta^4 = \zeta^2 \chi_{\mathcal{G}\mathcal{F}}(1 - (\chi_{\mathcal{G}} + \chi_{\mathcal{F}}))\zeta^4 = 0$$

since $\chi_{\mathcal{G}} + \chi_{\mathcal{F}} = 1$ on $\text{supp}(\chi_{\mathcal{G}\mathcal{F}})$ by (3.75). We thus have $\Xi_{\mathcal{G}\mathcal{F}}(1 - \Xi_{\mathcal{G}} - \Xi_{\mathcal{F}})\zeta^4 \in h\Psi_{\mathcal{T}}^{-1}(\mathcal{M}_+)$, so that (3.160) gives

$$\varepsilon (h^2 + \delta^2) \|\Xi_{\mathcal{G}\mathcal{F}}v^r\|_1^2 \lesssim \varepsilon \|\Xi_{\mathcal{G}}v^r\|_1^2 + \varepsilon \|\Xi_{\mathcal{F}}v^r\|_1^2 + \varepsilon h^2 \|v^r\|_1^2.$$

When summing all the estimates (3.152)-(3.158) together and taking ε sufficiently small, the two terms $\varepsilon\|\Xi_{\mathcal{G}}v^r\|_1^2$, $\varepsilon\|\Xi_{\mathcal{F}}v^r\|_1^2$ in this expression can be absorbed by the l.h.s. of (3.152) and (3.154), respectively. This is possible since in these two estimates are obtained in elliptic regions yielding better powers in h .

Now, if we sum all the partial estimates (3.152)-(3.158), and handle the atypical terms as explained above, we obtain

$$\begin{aligned} & \|\Xi_{\mathcal{G}}v^r\|_1^2 + \text{BT}(\Xi_{\mathcal{G}}v^r) + h\|\Xi_{\mathcal{G}}v^l\|_1^2 + \text{BT}(\Xi_{\mathcal{G}}v^l) + \|\Xi_{\mathcal{F}}v^r\|_1^2 + \text{BT}(\Xi_{\mathcal{F}}v^r) + \|\Xi_{\mathcal{F}}v^l\|_1^2 \\ & \quad + \text{BT}(\Xi_{\mathcal{F}}v^l) + h\|\Xi_{\mathcal{Z}}v^r\|_1^2 + \text{BT}(\Xi_{\mathcal{Z}}v^r) + \|\Xi_{\mathcal{Z}}v^l\|_1^2 + \text{BT}(\Xi_{\mathcal{Z}}v^l) + \|\Xi_{\mathcal{E}}v^{7l}\|_1^2 + \text{BT}(\Xi_{\mathcal{E}}v^{7l}) \\ & \lesssim \text{RHS}^r(v^r) + \text{RHS}^l(v^l) + \left(1 + \frac{\delta^2}{h^2}\right)\|\zeta P_{\varphi}^r v^r\|_0^2 + h^3|v^s|_1^2 + h^2|D_{x_n}v^r|_{x_n=0^+}|_0^2 + R_{\theta} + \frac{\delta^2}{h}|\theta_{\varphi}^r|_0^2, \end{aligned} \quad (3.161)$$

Using $\text{supp}(v^{7l}) \subset (\alpha_0, X_0 - \alpha_0) \times S \times [0, 2\varepsilon)$ and (3.159), we can write

$$\|v^{7l}\|_1 \leq \|\Xi_{\mathcal{G}}v^{7l}\|_1 + \|\Xi_{\mathcal{F}}v^{7l}\|_1 + \|\Xi_{\mathcal{Z}}v^{7l}\|_1 + \|\Xi_{\mathcal{E}}v^{7l}\|_1,$$

together with

$$|v^{7l}|_{x_n=0^+}|_1 \leq |\Xi_{\mathcal{G}}v^{7l}|_{x_n=0^+}|_1 + |\Xi_{\mathcal{F}}v^{7l}|_{x_n=0^+}|_1 + |\Xi_{\mathcal{Z}}v^{7l}|_{x_n=0^+}|_1 + |\Xi_{\mathcal{E}}v^{7l}|_{x_n=0^+}|_1,$$

and

$$|D_{x_n}v^{7l}|_{x_n=0^+}|_0 \leq |D_{x_n}\Xi_{\mathcal{G}}v^{7l}|_{x_n=0^+}|_0 + |D_{x_n}\Xi_{\mathcal{F}}v^{7l}|_{x_n=0^+}|_0 + |D_{x_n}\Xi_{\mathcal{Z}}v^{7l}|_{x_n=0^+}|_0 + |D_{x_n}\Xi_{\mathcal{E}}v^{7l}|_{x_n=0^+}|_0.$$

These three inequalities together with (3.161) give

$$\begin{aligned} & h\|v^{7l}\|_1^2 + h|v^{7l}|_{x_n=0^+}|_1^2 + h|D_{x_n}v^{7l}|_{x_n=0^+}|_0^2 \\ & \lesssim \|P_{\varphi}^l v^l\|_0^2 + h^2\|v^l\|_1^2 + h^4|D_{x_n}v^l|_{x_n=0^+}|_0^2 + \left(1 + \frac{\delta^2}{h^2}\right)\|\zeta P_{\varphi}^r v^r\|_0^2 + \|P_{\varphi}^r v^r\|_0^2 \\ & \quad + h^2\|v^r\|_1^2 + h^2|D_{x_n}v^r|_{x_n=0^+}|_0^2 + h^3|v^s|_1^2 + R_{\theta} + \frac{\delta^2}{h}|\theta_{\varphi}^r|_0^2, \end{aligned}$$

Taking $0 < h \leq h_0$ with h_0 sufficiently small in this expression gives

$$\begin{aligned} & h\|v^{7l}\|_1^2 + h|v^{7l}|_{x_n=0^+}|_1^2 + h|D_{x_n}v^{7l}|_{x_n=0^+}|_0^2 \\ & \lesssim \|P_{\varphi}^l v^l\|_0^2 + \|P_{\varphi}^r v^r\|_0^2 + \left(1 + \frac{\delta^2}{h^2}\right)\|\zeta P_{\varphi}^r v^r\|_0^2 + R_{\theta} + \frac{\delta^2}{h}|\theta_{\varphi}^r|_0^2. \end{aligned}$$

Recalling the definitions of $v^{7l} = e^{\varphi^{7l}/h}w^{7l}$, F_{φ}^{7l} , θ_{φ}^{7l} , Θ_{φ}^s (see Section 3.3.3 and Equation (3.41)), and observing that we have

$$\|e^{\varphi^{7l}/h}D_{x_k}w^{7l}\|_0 \leq \|D_{x_k}(e^{\varphi^{7l}/h}w^{7l})\|_0 + \|(\partial_{x_k}\varphi^{7l})e^{\varphi^{7l}/h}w^{7l}\|_0,$$

and similar inequalities for the norms at the interface $\{x_n = 0^+\}$, we can “absorb” the zero-order terms in (3.41), which concludes the proof of Theorem 3.2. \square

3.5 Interpolation and spectral inequalities

3.5.1 Interpolation inequality

Here, we prove the result of Theorem 3.4. We shall start by proving a local version of the interpolation inequality at the interface. In fact, the inequality we prove is local in (x_0, x_n) but global on S . Here, we closely follow the geometrical setting of [LR10]. As in Section 3.3 we use local coordinates where the interface is given by $\{x_n = 0\}$, in a small neighborhood $[0, X_0] \times V_{\varepsilon}$.

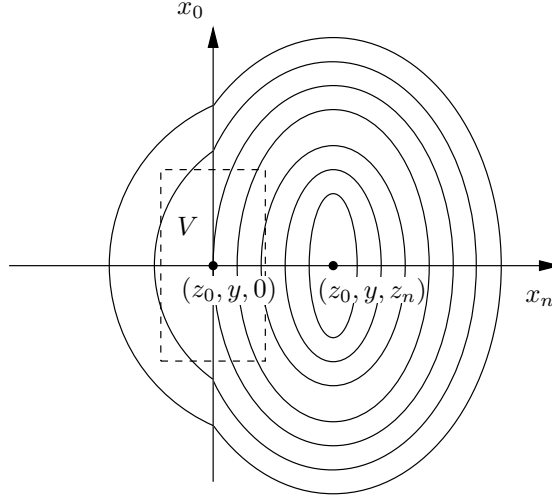

FIGURE 3.6 – Level sets for the weight functions ψ and $\varphi = e^{\lambda\psi}$ in (x_0, x_n) coordinates. The manifold $S \ni y$ can be represented normal to the drawing. The Carleman estimate of Theorem 3.2 can be applied in a region V close to $\{z_0\} \times S \times \{0\}$ (represented with a dashed line).

We choose a point $z_0 \in (\alpha_1, X_0 - \alpha_1)$. We also pick α_0 such that $0 < \alpha_0 < \alpha_1$ to be used for the application of the Carleman estimate of Theorem 3.2.

We define the following anisotropic distance in \mathbb{R}^2 :

$$\text{dist}_\alpha((a_0, a_n), (b_0, b_n)) = (\alpha|a_0 - b_0|^2 + |a_n - b_n|^2)^{\frac{1}{2}}, \quad \alpha > 0.$$

We fix $z_n \in \mathbb{R}_+^*$. Then, for $(x_0, x_n) \in [0, X_0] \times \mathbb{R}$ and $\kappa > 0$, we set

$$\psi(x_0, x_n) = \begin{cases} -\text{dist}_\alpha((x_0, x_n), (z_0, z_n)) & \text{if } x_n \geq 0, \\ -\text{dist}_\alpha((x_0, \kappa x_n), (z_0, z_n)) & \text{if } x_n < 0. \end{cases}$$

We shall also consider ψ as a function on $V_{z_0} \times S \times \mathbb{R}$. We note that ψ is continuous across the interface $\{x_n = 0\}$ and that

$$\begin{aligned} \partial_{x_n} \psi(x_0, x_n) &= (x_n - z_n)(\psi(x_0, x_n))^{-1} \quad \text{if } x_n \geq 0, \\ \partial_{x_n} \psi(x_0, x_n) &= \kappa(\kappa x_n - z_n)(\psi(x_0, x_n))^{-1} \quad \text{if } x_n \leq 0, \end{aligned}$$

which yields $\partial_{x_n} \psi|_{x_n=0^-} = \kappa \partial_{x_n} \psi|_{x_n=0^+}$. We also have

$$\partial_{x_0} \psi(x_0, x_n) = \alpha(x_0 - z_0)(\psi(x_0, x_n))^{-1}. \quad (3.162)$$

Let us check that the associated weight function $\varphi = e^{\lambda\psi}$ satisfies the properties listed in Section 3.3.1.

According to Remark 3.21, it suffices to check that ψ satisfies properties (3.44) and (3.45) possibly with different constants. In fact, we work in a sufficiently small neighborhood $V = V_{z_0} \times V_{\varepsilon'}$ of $\{z_0\} \times S \times \{0\}$ which does not contain (z_0, y, z_n) for all $y \in S$, where V_{z_0} is a neighborhood of z_0 in $(\alpha_0, X_0 - \alpha_0)$ and $0 < \varepsilon' < \varepsilon$, so that $\nabla \psi$ does not vanish in V . First fixing κ sufficiently small, we see that Property (3.44) is satisfied. Second, note that $|x_0 - z_0|$ is bounded. Hence, from (3.162), we can choose the parameter α sufficiently small to have $|\partial_{x_0} \psi|$ small as compared to $\inf |\partial_{x_n} \psi|$, so that (3.45) is satisfied. Level sets for the function ψ are represented in Figure 3.6.

The Carleman estimate of Theorem 3.2 then follows, with the weight function φ .

We choose $0 < s_1 < s'_1$ and $0 < \sigma < \sigma'$ such that

$$\mathcal{U}' = \{(x_0, y, x_n); |x_0 - z_0| < s'_1, y \in S, |x_n| < \sigma'\} \subset V.$$

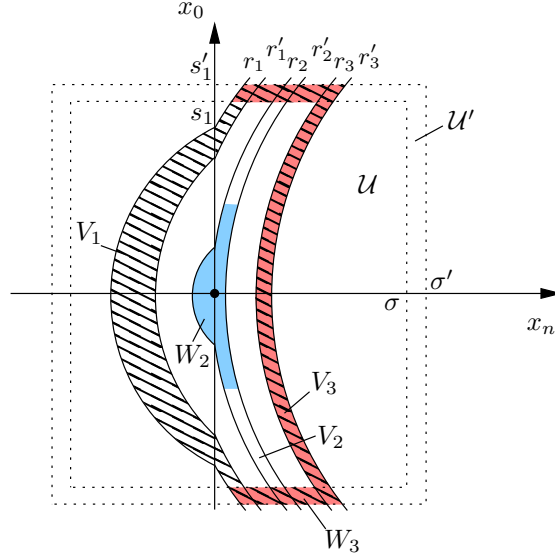

FIGURE 3.7 – Neighborhoods around the point of interest for the proof of the interpolation inequality.

We also set

$$\mathcal{U} = \{(x_0, y, x_n); |x_0 - z_0| < s_1, y \in S, |x_n| < \sigma\} \subset \mathcal{U}'.$$

We now choose $r_1 < r'_1 < r_2 < \psi(z_0, 0) < r'_2 < r_3 < r'_3$, such that

$$\begin{aligned} \mathcal{C}_1 &= \{(x_0, y, x_n) \in \mathbb{R} \times S \times \mathbb{R}; \psi(x_0, x_n) = r_1\} \\ \text{and } \mathcal{C}'_3 &= \{(x_0, y, x_n) \in \mathbb{R} \times S \times \mathbb{R}; \psi(x_0, x_n) = r'_3\} \end{aligned}$$

satisfy $\mathcal{C}_1 \cap \{x_n < 0\} \subset \mathcal{U}$, $\mathcal{C}_1 \cap \{x_n > 0\} \cap \mathcal{U} \neq \emptyset$, which is equivalent to having

$$\psi(z_0 \pm s_1, 0) = -(\alpha s_1^2 + z_0^2)^{\frac{1}{2}} < r_1,$$

and finally $\mathcal{C}'_3 \cap \mathcal{U}' \subset \{x_n \leq \sigma\}$. We illustrate these choices in Figure 3.7. We set $R_j = e^{\lambda r_j}$, $R'_j = e^{\lambda r'_j}$, $j = 1, 2, 3$.

Following [LR95], we introduce

$$V_j := \{(x_0, y, x_n) \in \mathcal{U}'; r_j < \psi(x_0, x_n) < r'_j\}, \quad j = 1, 2, 3.$$

and we further set

$$V'_{1 \rightarrow 3} := \{(x_0, y, x_n) \in \mathcal{U}; r'_1 < \psi(x_0, x_n) < r_3\}, \quad V'_{1 \rightarrow 3'} := \{(x_0, y, x_n) \in \mathcal{U}'; r_1 < \psi(x_0, x_n) < r'_3\}$$

$$W_3 = V_3 \cup (V'_{1 \rightarrow 3'} \setminus \mathcal{U}).$$

The region W_3 is represented shaded and stripped in Figure 3.7. With the choices we have made above, the region W_3 is contained in $\{x_n > 0\}$ and is finitely away from the interface $\mathbb{R}_{x_0} \times S = \{x_n = 0\}$. For $s_0 \in (0, s_1)$ we also choose $W_2 = V_2 \cap \{(x_0, y, x_n); |x_0 - z_0| < s_0, y \in S\} \Subset \mathcal{U}$. The region W_2 contains $\{z_0\} \times S \times \{0\}$ and is represented shaded in Figure 3.7.

Now that the geometrical context is set, we can state a local interpolation inequality in the neighborhood of $\{z_0\} \times S \times \{0\}$.

Lemma 3.35. *For all $\delta_0 > 0$, there exist $C \geq 0$ and $\nu_0 \in (0, 1)$ such that for all $\delta \in (0, \delta_0)$ we have*

$$\|u\|_{H^1(W_2)} + \delta^{\frac{1}{2}} |u^s|_{H^1(W_2 \cap \{x_n=0\})} \leq C \|U\|_{\mathcal{K}_\delta^1}^{1-\nu} \left(\|u\|_{H^1(W_3)} + \left\| (-\partial_{x_0}^2 + A_\delta)U \right\|_{\mathcal{K}_\delta^0} \right)^\nu \quad (3.163)$$

for all $0 < \nu \leq \nu_0$ and $U = (u, u^s) \in \mathcal{K}_\delta^2$.

This inequality can be read as the “observation” of the local \mathcal{K}_δ^1 norm of U in the neighborhood W_2 of any strip $\{z_0\} \times S \times \{0\}$ by the H^1 norm of u in a neighborhood away from the interface and the \mathcal{K}_δ^0 norm of $(-\partial_{x_0}^2 + A_\delta)U$.

Proof. We choose $\chi \in \mathcal{C}_c^\infty(\mathcal{U}')$ independent of $y \in S$ such that χ is equal to one on $V_{1' \rightarrow 3}$ and vanishes outside $V'_{1 \rightarrow 3'}$. Then $\nabla_{x_0, x_n} \chi$ vanishes outside $V'_{1 \rightarrow 3'} \setminus V_{1' \rightarrow 3}$ which is the stripped region in Figure 3.7.

For $U = (u, u^s) \in \mathcal{K}_\delta^2$, we set

$$\begin{cases} Bu := -(\partial_{x_0}^2 + \Delta_c)u \in L^2((0, X_0) \times \Omega_1 \cup \Omega_2) \\ B^s U := -(\partial_{x_0}^2 + \Delta_{c^s})u^s - \frac{1}{\delta}((c\partial_{x_n} u)|_{x_n=0^+} - (c\partial_{x_n} u)|_{x_n=0^-}) \in L^2((0, X_0) \times S), \end{cases}$$

and recall that $u|_{x_n=0^-} = u^s = u|_{x_n=0^+}$. Setting $W = (w, w^s)$ with $w = \chi u$ and $w^s = \chi|_{x_n=0} u^s$, we have

$$\begin{cases} Bw = \chi Bu + F, & \text{in } \mathcal{U} \\ B^s W = \frac{1}{\delta}(\delta \chi B^s U + \Theta) & \text{in } \mathcal{U} \cap S, \\ w|_{x_n=0^-} = w^s = w|_{x_n=0^+} & \text{in } \mathcal{U} \cap S, \end{cases}$$

where

$$\begin{cases} F = [-(\partial_{x_0}^2 + \Delta_c), \chi]u \\ \Theta = \delta [-(\partial_{x_0}^2 + \Delta_{c^s}), \chi]u^s - (c|_{x_n=0^+} - c|_{x_n=0^-})\partial_{x_n} \chi|_{x_n=0} u^s. \end{cases}$$

Using the density result of Corollary 3.15, the Carleman estimate of Theorem 3.2 can be applied to $W = (w, w^s)$:

$$\begin{aligned} & h \|e^{\varphi/h} w\|_0^2 + h^3 \|e^{\varphi/h} \nabla_{x_0, x} w\|_0^2 + h \|e^{\varphi/h} w^s\|_0^2 + h^3 \|e^{\varphi/h} \nabla_{x_0, S} w^s\|_0^2 \\ & \lesssim h^2 (h^2 + \delta^2) \|e^{\varphi/h} \chi Bu\|_0^2 + h^2 (h^2 + \delta^2) \|e^{\varphi/h} F\|_0^2 + h^3 \delta^2 \|e^{\varphi/h} \chi B^s U\|_0^2 + h^3 \|e^{\varphi/h} \Theta\|_0^2. \end{aligned} \quad (3.164)$$

Note that Θ is supported in $V_1 \cap \{x_n = 0\}$ and in this set $e^{\varphi/h} \leq e^{R'_1/h}$. Similarly, F is supported in $V'_{1 \rightarrow 3'} \setminus V_{1' \rightarrow 3}$ and in this set $e^{\varphi/h} \leq e^{R'_3/h}$. Moreover, the operators $[-(\partial_{x_0}^2 + \Delta_c), \chi]$ and $[-(\partial_{x_0}^2 + \Delta_{c^s}), \chi]$ are of order one. We thus have

$$\|e^{\varphi/h} F\|_0 \lesssim e^{R'_3/h} \|u\|_{H^1(W_3)} + e^{R'_1/h} \|u\|_{H^1(V_1)} \lesssim e^{R'_3/h} \|u\|_{H^1(W_3)} + e^{R'_1/h} \|U\|_{\mathcal{K}_\delta^1}, \quad (3.165)$$

$$|e^{\varphi/h} \Theta|_0 \lesssim e^{R'_1/h} (\delta |u^s|_{H^1(V_1 \cap \{x_n=0\})} + |u^s|_{L^2(V_1 \cap \{x_n=0\})}).$$

Using the trace formula together with $\delta \leq \delta^{\frac{1}{2}} \delta_0^{\frac{1}{2}}$ in this last inequality, we obtain

$$|e^{\varphi/h} \Theta|_0 \lesssim e^{R'_1/h} \left(\delta^{\frac{1}{2}} |u^s|_{H^1((0, X_0) \times S)} + \|u\|_{H^1(\mathcal{U}')} \right) \lesssim e^{R'_1/h} \|U\|_{\mathcal{K}_\delta^1}. \quad (3.166)$$

We also have

$$\|e^{\varphi/h} \chi Bu\|_0 \lesssim e^{R'_3/h} \|Bu\|_{L^2(\mathcal{U}')} \lesssim e^{R'_3/h} \|(-\partial_{x_0}^2 + A_\delta)U\|_{\mathcal{K}_\delta^0}, \quad (3.167)$$

and

$$\delta^{\frac{1}{2}} |e^{\varphi/h} \chi B^s U|_0 \lesssim \delta^{\frac{1}{2}} e^{R'_3/h} |B^s U|_{L^2(\mathcal{U}' \cap \{x_n=0\})} \lesssim e^{R'_3/h} \|(-\partial_{x_0}^2 + A_\delta)U\|_{\mathcal{K}_\delta^0}. \quad (3.168)$$

Concerning the l.h.s. of (3.164), we have $e^{\varphi/h} \geq e^{R_2/h}$ and $\chi = 1$ on W_2 , so that, using $\delta \leq \delta_0$,

$$\begin{aligned} & h \|e^{\varphi/h} w\|_0^2 + h^3 \|e^{\varphi/h} \nabla_{x_0, y, x_n} w\|_0^2 + h \|e^{\varphi/h} w^s\|_0^2 + h^3 \|e^{\varphi/h} \nabla_{x_0, y} w^s\|_0^2 \\ & \gtrsim h^3 e^{2R_2/h} \|u\|_{H^1(W_2)}^2 + h^3 \delta e^{2R_2/h} |u^s|_{H^1(W_2 \cap \{x_n=0\})}^2. \end{aligned} \quad (3.169)$$

Using (3.165)-(3.169) in (3.164), we thus obtain,

$$\begin{aligned} h^{\frac{3}{2}} e^{R_2/h} \left(\|u\|_{H^1(W_2)} + \delta^{\frac{1}{2}} |u^s|_{H^1(W_2 \cap \{x_n=0\})} \right) \\ \lesssim h \left(e^{R'_1/h} \|U\|_{\mathcal{K}_\delta^1} + e^{R'_3/h} \left(\|(-\partial_{x_0}^2 + A_\delta)U\|_{\mathcal{K}_\delta^0} + \|u\|_{H^1(W_3)} \right) \right). \end{aligned} \quad (3.170)$$

Fixing some $\tilde{R}_2 \in (R'_1, R_2)$, we have $h^{\frac{1}{2}} e^{R_2/h} \gtrsim e^{\tilde{R}_2/h}$ for all $0 < h < h_0$. Thus, (3.170) becomes

$$\begin{aligned} e^{\tilde{R}_2/h} \left(\|u\|_{H^1(W_2)} + \delta^{\frac{1}{2}} |u^s|_{H^1(W_2 \cap \{x_n=0\})} \right) \\ \lesssim e^{R'_1/h} \|U\|_{\mathcal{K}_\delta^1} + e^{R'_3/h} \left(\|(-\partial_{x_0}^2 + A_\delta)U\|_{\mathcal{K}_\delta^0} + \|u\|_{H^1(W_3)} \right). \end{aligned}$$

Finally, optimizing w.r.t. to h as in [Rob95] we obtain the sought local interpolation inequality. \square

Away from the interface, the \mathcal{K}_δ^s norms, $s = 0, 1$ coincide with the usual H^s norm, and similar local interpolation inequalities as (3.163) are proven in [LR95, Lemme 3 page 352]. Now that we have obtained the interpolation inequality (3.163) at the interface, we can apply the procedure described in [LR95, pages 353-356] (propagation of smallness) and prove the sought global interpolation inequality (3.13). See [LZ98, Proof of Theorem 3] to obtain the term $\|\partial_{x_0} u(0, x)\|_{L^2(\omega)}$ in the r.h.s. of (3.13). This concludes the proof of Theorem 3.4. \square

3.5.2 Spectral inequality

From the interpolation inequality proven in Theorem 3.4, we now deduce the uniform spectral inequality of Theorem 3.5. Recall that $\mathcal{E}_{\delta,j} = (e_{\delta,j}, e_{\delta,j}^s)$, $j \in \mathbb{N}$, denotes a Hilbert basis of \mathcal{H}_δ^0 composed of eigenfunctions of the operator A_δ associated with the positive eigenvalues $\mu_{\delta,j} \in \mathbb{R}$, $j \in \mathbb{N}$, sorted in an increasing sequence. We denote by $\Pi_{\delta,\mu}$ the spectral projector over the eigenfunctions associated with eigenvalues lower than μ , i.e.,

$$\Pi_{\delta,\mu} Y = \sum_{\mu_{\delta,j} \leq \mu} (Y, \mathcal{E}_{\delta,j})_{\mathcal{H}_\delta^0} \mathcal{E}_{\delta,j}, \quad Y \in \mathcal{H}_\delta^0.$$

The proof of Theorem 3.5 is classical. Yet, we have to make sure that all the constants involved do not depend upon the parameter δ .

First we take some $Y_\delta = (y_\delta, y_\delta^s) \in \Pi_{\delta,\mu} \mathcal{H}_\delta^0$, and apply the interpolation inequality (3.13) of Theorem 3.4 to

$$U_\delta = (u_\delta, u_\delta^s) = A_\delta^{-\frac{1}{2}} \sinh(x_0 A_\delta^{\frac{1}{2}}) Y_\delta,$$

defined with the classical functional calculus for self-adjoint operators⁹.

We notice that we have $(-\partial_{x_0}^2 + A_\delta)U_\delta = 0$, $U_\delta(0, x) = 0$ and $\|\partial_{x_0} u_\delta(0, x)\|_{L^2(\omega)} = \|y_\delta\|_{L^2(\omega)}$. Concerning the l.h.s. of the interpolation inequality (3.13), we have

$$\begin{aligned} \|U_\delta\|_{\mathcal{K}_\delta^1(\alpha_1)}^2 &\geq \|U_\delta\|_{\mathcal{K}_\delta^0(\alpha_1)}^2 = \|U_\delta\|_{L^2(\alpha_1, X_0 - \alpha_1; \mathcal{H}_\delta^0)}^2 = \int_{\alpha_1}^{X_0 - \alpha_1} \|A_\delta^{-\frac{1}{2}} \sinh(x_0 A_\delta^{\frac{1}{2}}) Y_\delta\|_{\mathcal{H}_\delta^0}^2 dx_0 \\ &\geq \int_{\alpha_1}^{X_0 - \alpha_1} \left\| \left[A_\delta^{-\frac{1}{2}} \sinh(x_0 A_\delta^{\frac{1}{2}}) \Pi_{\delta,\mu} \right]^{-1} \right\|_{\mathcal{L}(\mathcal{H}_\delta^0)}^{-2} \|Y_\delta\|_{\mathcal{H}_\delta^0}^2 dx_0 \\ &\geq \int_{\alpha_1}^{X_0 - \alpha_1} x_0^2 dx_0 \|Y_\delta\|_{\mathcal{H}_\delta^0}^2 \geq C(X_0, \alpha_1) \|Y_\delta\|_{\mathcal{H}_\delta^0}^2, \end{aligned} \quad (3.171)$$

9. Note that if A_δ is not invertible, i.e. $0 \in \text{Sp}(A_\delta)$ (this occurs if Ω has no boundary), the following analysis can be done with $A_\delta + \text{Id}$ in place of A_δ . Theorem 3.2 and Theorem 3.4 remains valid for this operator. The spectral inequality proven for $A_\delta + \text{Id}$ implies the same inequality for A_δ .

since $t^{-\frac{1}{2}} \sinh(x_0 t^{\frac{1}{2}}) \geq x_0$ for $t > 0$. Now, concerning the r.h.s. of the interpolation inequality (3.13) we have

$$\|U_\delta\|_{\mathcal{K}_\delta^1}^2 = \|U_\delta\|_{\mathcal{K}_\delta^0}^2 + \|A_\delta^{\frac{1}{2}} U_\delta\|_{\mathcal{K}_\delta^0}^2 + \|\partial_{x_0} U_\delta\|_{\mathcal{K}_\delta^0}^2 = \int_0^{X_0} \left(\|U_\delta\|_{\mathcal{H}_\delta^0}^2 + \|A_\delta^{\frac{1}{2}} U_\delta\|_{\mathcal{H}_\delta^0}^2 + \|\partial_{x_0} U_\delta\|_{\mathcal{H}_\delta^0}^2 \right) dx_0. \quad (3.172)$$

Let us estimate the three terms in this expression. First, we have,

$$\begin{aligned} \int_0^{X_0} \|U_\delta\|_{\mathcal{H}_\delta^0}^2 dx_0 &\leq \int_0^{X_0} \|A_\delta^{-\frac{1}{2}} \sinh(x_0 A_\delta^{\frac{1}{2}}) \Pi_{\delta, \mu}\|_{\mathcal{L}(\mathcal{H}_\delta^0)}^2 \|Y_\delta\|_{\mathcal{H}_\delta^0}^2 dx_0 \\ &\leq \int_0^{X_0} (x_0 e^{x_0 \sqrt{\mu}})^2 dx_0 \|Y_\delta\|_{\mathcal{H}_\delta^0}^2 \\ &\leq X_0^3 e^{2X_0 \sqrt{\mu}} \|Y_\delta\|_{\mathcal{H}_\delta^0}^2, \end{aligned}$$

since $t^{-\frac{1}{2}} \sinh(x_0 t^{\frac{1}{2}}) \leq x_0 e^{x_0 \sqrt{\mu}}$ for $0 \leq t \leq \mu$. Second, We have

$$\begin{aligned} \int_0^{X_0} \|A_\delta^{\frac{1}{2}} U_\delta\|_{\mathcal{H}_\delta^0}^2 dx_0 &\leq \int_0^{X_0} \|\sinh(x_0 A_\delta^{\frac{1}{2}}) \Pi_{\delta, \mu}\|_{\mathcal{L}(\mathcal{H}_\delta^0)}^2 \|Y_\delta\|_{\mathcal{H}_\delta^0}^2 dx_0 \\ &\leq \int_0^{X_0} e^{2x_0 \sqrt{\mu}} dx_0 \|Y_\delta\|_{\mathcal{H}_\delta^0}^2 \\ &\leq X_0 e^{2X_0 \sqrt{\mu}} \|Y_\delta\|_{\mathcal{H}_\delta^0}^2, \end{aligned}$$

together with

$$\int_0^{X_0} \|\partial_{x_0} U_\delta\|_{\mathcal{H}_\delta^0}^2 dx_0 = \int_0^{X_0} \|\cosh(x_0 A_\delta^{\frac{1}{2}}) Y_\delta\|_{\mathcal{H}_\delta^0}^2 dx_0 \leq \int_0^{X_0} e^{2x_0 \sqrt{\mu}} dx_0 \|Y_\delta\|_{\mathcal{H}_\delta^0}^2 \leq X_0 e^{2X_0 \sqrt{\mu}} \|Y_\delta\|_{\mathcal{H}_\delta^0}^2.$$

Using the last three estimates in (3.172), together with (3.171), the interpolation inequality (3.13) yields

$$\|Y_\delta\|_{\mathcal{H}_\delta^0} \leq C(X_0, \alpha_1) \left(e^{X_0 \sqrt{\mu}} \|Y_\delta\|_{\mathcal{H}_\delta^0} \right)^{1-\nu_0} \|y_\delta\|_{L^2(\omega)}^{\nu_0}.$$

Finally, for $\delta_0 > 0$, there exists $C > 0$ such that for all $0 < \delta \leq \delta_0$ and $\mu \in \mathbb{R}$, we have

$$\|Y_\delta\|_{\mathcal{H}_\delta^0} \leq C e^{X_0 \frac{1-\nu_0}{\nu_0} \sqrt{\mu}} \|y_\delta\|_{L^2(\omega)}, \quad Y_\delta = (y_\delta, y_\delta^s) \in \Pi_{\delta, \mu} \mathcal{H}_\delta^0.$$

This concludes the proof of Theorem 3.5. □

3.6 Derivation of the model

Here, we (formally) derive the model (3.4) studied in the main part of this article. We use the notation of the beginning of Section 3.3. In a small neighborhood of the interface S we use normal geodesic coordinates

$$\begin{aligned} \mathbf{F} : S \times [-2\varepsilon, 2\varepsilon] &\rightarrow V_\varepsilon \\ (y, x_n) &\mapsto \mathbf{F}(y, x_n). \end{aligned}$$

In such coordinates the metric reads

$$g = \begin{pmatrix} g|_{T(S)} & 0 \\ 0 & 1 \end{pmatrix},$$

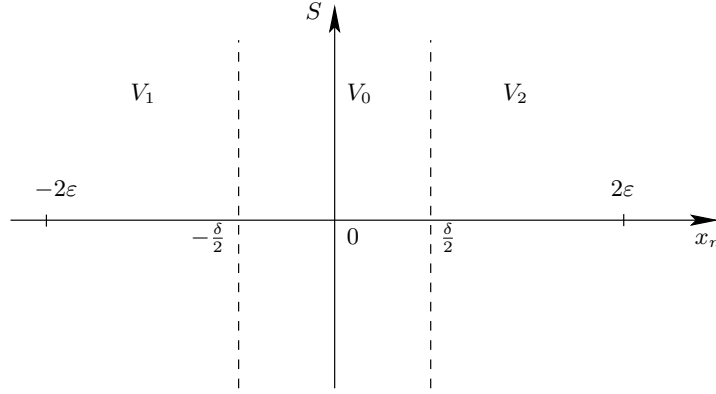

FIGURE 3.8 – Local geometry of a three-layer model near the interface $S = \{x_n = 0\}$. The inner layer, V_0 , shrinks to zero as δ goes to zero.

and the type of elliptic operators we consider, $-\operatorname{div}_g c \nabla_g$, take the form $-\partial_{x_n} c \partial_{x_n} - \operatorname{div}^s c \nabla^s$. The interface S is given by $\{x_n = 0\}$.

Let $\delta \in (0, 4\varepsilon)$. We consider three regions in V_ε as represented in Figure 3.8.

$$V_1 = \{-2\varepsilon \leq x_n \leq -\delta/2\}, \quad V_0 = \{-\delta/2 \leq x_n \leq \delta/2\}, \quad V_2 = \{\delta/2 \leq x_n \leq 2\varepsilon\}.$$

With three coefficients c^0, c^1, c^2 we have in mind the following parabolic problem :

$$\partial_t z^j - \operatorname{div}_g(c^j \nabla_g z^j) = f^j \quad \text{in } (0, T) \times V_j, \quad j = 1, 0, 2, \quad (3.173)$$

along with the natural transmission conditions at $x_n = \frac{\delta}{2}$ and $x_n = -\frac{\delta}{2}$, given by the continuity of the solution and the continuity of the flux :

$$z^1|_{x_n=-\frac{\delta}{2}} = z^0|_{x_n=-\frac{\delta}{2}}, \quad z^0|_{x_n=\frac{\delta}{2}} = z^2|_{x_n=\frac{\delta}{2}}, \quad (3.174)$$

and

$$(c^1 \partial_{x_n} z^1)|_{x_n=-\frac{\delta}{2}} = (c^0 \partial_{x_n} z^0)|_{x_n=-\frac{\delta}{2}}, \quad (c^0 \partial_{x_n} z^0)|_{x_n=\frac{\delta}{2}} = (c^2 \partial_{x_n} z^2)|_{x_n=\frac{\delta}{2}}. \quad (3.175)$$

We now wish to describe the present three-region model as the thickness δ of the inner region, V_0 , becomes asymptotically small. This implies some approximation. Resulting approximate models can be very useful in practice as one is in need of effective models.

We introduce the mean values of z^0 and f^0 in the normal direction x_n

$$z^s(y) := \frac{1}{\delta} \int_{-\delta/2}^{\delta/2} z^0(y, x_n) dx_n \quad \text{and} \quad f^s(y) := \frac{1}{\delta} \int_{-\delta/2}^{\delta/2} f^0(y, x_n) dx_n, \quad y \in S.$$

Keeping in mind that δ is meant to be asymptotically small, we first make the following approximation.

Assumption 3.36. *The diffusion coefficient c^0 does not depend on the normal variable x_n . We set $c^s(y) = c^0(y, x_n)$.*

Under this assumption, using the transmission conditions (3.175), we have

$$\begin{aligned} f^s(y) &= \frac{1}{\delta} \int_{-\delta/2}^{\delta/2} \left(\partial_t z^0 - \operatorname{div}_g(c^0 \nabla_g z^0) \right) dx_n = \partial_t z^s - \operatorname{div}^s(c^s \nabla^s z^s) - \frac{1}{\delta} \int_{-\delta/2}^{\delta/2} \partial_{x_n} c^0 \partial_{x_n} z^0 dx_n \\ &= \partial_t z^s - \operatorname{div}^s(c^s \nabla^s z^s) - \frac{1}{\delta} \left((c^0 \partial_{x_n} z^0)|_{x_n=\frac{\delta}{2}} - (c^0 \partial_{x_n} z^0)|_{x_n=-\frac{\delta}{2}} \right) \\ &= \partial_t z^s - \operatorname{div}^s(c^s \nabla^s z^s) - \frac{1}{\delta} \left((c^2 \partial_{x_n} z^2)|_{x_n=\frac{\delta}{2}} - (c^1 \partial_{x_n} z^1)|_{x_n=-\frac{\delta}{2}} \right). \end{aligned} \quad (3.176)$$

This provides a first transmission condition between z^1 and z^2 that involves the function z^s . For the problem to be closed, we need two additional transmission conditions.

We begin with a first-order approximation of the system. Yet we show that it cannot be used for the purpose of modeling controllability properties of the original system. We then lower the degree of our approximations and obtain the model studied in the main part of this article.

3.6.1 A first-order model

Using the transmission conditions (3.174)–(3.175) we write

$$\begin{aligned} z^2(y, \delta/2) - z^1(y, -\delta/2) &= z^0(y, \delta/2) - z^0(y, -\delta/2) = \int_{-\delta/2}^{\delta/2} \partial_{x_n} z^0(y, x_n) dx_n \\ &= \left[x_n \partial_{x_n} z^0(y, x_n) \right]_{-\delta/2}^{\delta/2} + R_1 \\ &= \frac{\delta}{2} (\partial_{x_n} z^0(y, \delta/2) + \partial_{x_n} z^0(y, -\delta/2)) + R_1 \\ &= \frac{\delta}{2c^s(y)} (c^2(y, \delta/2) \partial_{x_n} z^2(y, \delta/2) + c^1(y, -\delta/2) \partial_{x_n} z^1(y, -\delta/2)) + R_1, \end{aligned}$$

with $R_1 = - \int_{-\delta/2}^{\delta/2} x_n \partial_{x_n}^2 z^0(y, x_n) dx_n$.

A second set of transmission conditions is needed. With two integrations by parts we write

$$\begin{aligned} z^s(y) &= \frac{1}{\delta} \int_{-\delta/2}^{\delta/2} z^0(y, x_n) dx_n \\ &= \frac{1}{\delta} \left[x_n z^0(y, x_n) \right]_{-\delta/2}^{\delta/2} - \frac{1}{\delta} \left[\frac{x_n^2}{2} \partial_{x_n} z^0(y, x_n) \right]_{-\delta/2}^{\delta/2} + \frac{1}{\delta} \int_{-\delta/2}^{\delta/2} \frac{x_n^2}{2} \partial_{x_n}^2 z^0(y, x_n) dx_n \\ &= \frac{1}{2} (z^0(y, \delta/2) + z^0(y, -\delta/2)) - \frac{\delta}{8} (\partial_{x_n} z^0(y, \delta/2) - \partial_{x_n} z^0(y, -\delta/2)) + \frac{1}{\delta} \int_{-\delta/2}^{\delta/2} \frac{x_n^2}{2} \partial_{x_n}^2 z^0(y, x_n) dx_n \\ &= \frac{1}{2} (z^2(y, \delta/2) + z^1(y, -\delta/2)) + R_2, \end{aligned}$$

with

$$R_2 = -\frac{\delta}{8} (\partial_{x_n} z^0(y, \delta/2) - \partial_{x_n} z^0(y, -\delta/2)) + \frac{1}{\delta} \int_{-\delta/2}^{\delta/2} \frac{x_n^2}{2} \partial_{x_n}^2 z^0(y, x_n) dx_n$$

We now make the following assumption on the variations of z^0 with respect to x_n .

Assumption 3.37. *We have $|\partial_{x_n}^2 z^0(y, x_n)| \leq C$ uniformly in δ , (and x_n , and $y \in S$).*

We then find that $R_1 = O(\delta^2)$. Observe that we have

$$\partial_{x_n} z^0(y, \delta/2) - \partial_{x_n} z^0(y, -\delta/2) = \int_{-\delta/2}^{\delta/2} \partial_{x_n}^2 z^0(y, x_n) dx_n = O(\delta).$$

We then find that $R_2 = O(\delta^2)$.

At first order in δ we thus obtain

$$\begin{cases} z^2(y, \delta/2) - z^1(y, -\delta/2) = \frac{\delta}{2c^s(y)} (c^2(y, \delta/2) \partial_{x_n} z^2(y, \delta/2) + c^1(y, -\delta/2) \partial_{x_n} z^1(y, -\delta/2)) \\ z^s(y) = \frac{1}{2} (z^2(y, \delta/2) + z^1(y, -\delta/2)). \end{cases} \quad (3.177)$$

As δ is small we consider that z^1 and z^2 are defined on $\{x_n < 0\}$ and $\{x_n > 0\}$ respectively. We thus write $z^2|_{x_n=0+}$ and $c^2 \partial_{x_n} z^2|_{x_n=0+}$ in place of $z^2(y, \delta/2)$ and $(c^2 \partial_{x_n} z^2)(y, \delta/2)$ and similarly

$z^1|_{x_n=0^-}$ and $c^1 \partial_{x_n} z^1|_{x_n=0^-}$ in place of $z^1(y, -\delta/2)$ and $(c^2 \partial_{x_n} z^2)(y, -\delta/2)$. We obtain the following model :

$$\partial_t z^j - \operatorname{div}_g c^j \nabla_g z^j = f^j \quad \text{in } (0, T) \times \Omega_j, \quad j = 1, 2, \quad (3.178)$$

and

$$\begin{cases} \partial_t z^s - \operatorname{div}^s(c^s \nabla^s z^s) = f^s + \frac{1}{\delta} ((c^2 \partial_{x_n} z^2)|_{x_n=0^+} - (c^1 \partial_{x_n} z^1)|_{x_n=0^-}) \\ z^s = \frac{1}{2} (z^2|_{x_n=0^+} + z^1|_{x_n=0^-}) \\ z^2|_{x_n=0^+} - z^1|_{x_n=0^-} = \frac{\delta}{2c^s} ((c^2 \partial_{x_n} z^2)|_{x_n=0^+} + (c^1 \partial_{x_n} z^1)|_{x_n=0^-}) \end{cases} \quad (3.179)$$

in $(0, T) \times S$.

For the study of the controllability of such a parabolic model we wish to investigate the unique continuation properties of the associated elliptic problem :

$$-\operatorname{div}_g c^j \nabla_g z^j = f^j \quad \text{in } (0, T) \times \Omega_j, \quad j = 1, 2, \quad (3.180)$$

and

$$\begin{cases} -\operatorname{div}^s(c^s \nabla^s z^s) = f^s + \frac{1}{\delta} ((c^2 \partial_{x_n} z^2)|_{x_n=0^+} - (c^1 \partial_{x_n} z^1)|_{x_n=0^-}) \\ z^s = \frac{1}{2} (z^2|_{x_n=0^+} + z^1|_{x_n=0^-}) \\ z^2|_{x_n=0^+} - z^1|_{x_n=0^-} = \frac{\delta}{2c^s} ((c^2 \partial_{x_n} z^2)|_{x_n=0^+} + (c^1 \partial_{x_n} z^1)|_{x_n=0^-}) \end{cases} \quad (3.181)$$

in $(0, T) \times S$.

Note that unique continuation holds for the original problem. This is an important property that we wish to see preserved in this approximation process. Here, we show that there are instances for which eigenfunctions of the elliptic operator in the approximate model (3.180)–(3.181) vanish on one side of the interface. These eigenmodes are then *invisible* for the observability of the parabolic system (3.178)–(3.179) ruining any hope of controllability. This is similar to the situation described in Section 3.1.3.3.

Let us consider the following two-dimensional example : $\Omega = \mathbb{R}/(2\pi\mathbb{Z}) \times (-\pi, \pi)$ is the cylinder endowed with a flat metric. For consistency with the notation of Section 3.3 we use (y, x_n) as the coordinates in Ω , with periodic conditions in y . We define the interface as $S = \{x_n = 0\} = \mathbb{R}/(2\pi\mathbb{Z}) \times \{0\}$, so that $\Omega_1 = \{x_n < 0\}$ and $\Omega_2 = \{x_n > 0\}$.

Proposition 3.38. *Let c^s and c^1 be constant functions such that $c^s = rc^1$ with $r > 1$. For any $\delta_0 > 0$, there exist $0 < \delta \leq \delta_0$, $e^1 \in \mathcal{C}^\infty(\Omega_1)$, $e^s \in \mathcal{C}^\infty(S)$, $\lambda > 0$ such that*

$$-\operatorname{div}_g c^1 \nabla_g e^1 = \lambda e^1 \quad \text{in } \Omega_1, \quad -\operatorname{div}^s(c^s \nabla^s e^s) + \frac{1}{\delta} (c^1 \partial_{x_n} e^1)|_{x_n=0^-} = \lambda e^s \quad \text{in } S, \quad (3.182)$$

and

$$e^s = \frac{1}{2} e^1|_{x_n=0^-}, \quad -e^1|_{x_n=0^-} = \frac{\delta}{2c^s} (c^1 \partial_{x_n} e^1)|_{x_n=0^-}, \quad \text{in } S, \quad (3.183)$$

and $e^1|_{x_n=-\pi} = 0$. Hence $(e^1, e^s, 0)$ is an eigenfunction of the elliptic operator in (3.180)–(3.181) associated with the eigenvalue λ , for Dirichlet boundary conditions (in x_n).

Proof. We choose $k \in \mathbb{N}$ such that $(r-1)k > 1$. For $\mu \in (0, 1)$ we set

$$g(\mu) = \left(\frac{1}{r((r-1)k^2 - \mu^2)} \right)^{\frac{1}{2}} \frac{\mu \cos(\mu\pi)}{\sin(\mu\pi)}.$$

As g vanishes for $\mu = 1/2$ and $\lim_{\mu \rightarrow 1^-} g(\mu) = -\infty$, there exists $\mu_0 \in (1/2, 1)$ such that $g(\mu_0) = -1$. We then set

$$\delta = 2 \left(\frac{r}{((r-1)k^2 - \mu_0^2)} \right)^{\frac{1}{2}}, \quad \alpha = \frac{2}{\sin(\mu_0\pi)}.$$

For any given δ_0 we can have $0 < \delta \leq \delta_0$ by choosing k sufficiently large. We have

$$\frac{\delta \mu_0 \cos(\mu_0\pi)}{2r \sin(\mu_0\pi)} = -1. \quad (3.184)$$

We now set

$$e^s(y) = e^{iky}, \quad e^1(y, x_n) = \alpha \sin(\mu_0(x_n + \pi))e^s(y), \quad -\pi \leq x_n \leq 0.$$

We have $e^1|_{x_n=-\pi} = 0$. Hence the Dirichlet boundary condition is satisfied at $x_n = -\pi$.

We have $-c^1(\partial_y^2 + \partial_{x_n}^2)e^1 = \lambda e^1$ with $\lambda = c^1(k^2 + \mu_0^2)$. Observing that $\partial_{x_n} e^1|_{x_n=0^-} = \alpha \mu_0 \cos(\mu_0 \pi) e^s$ we find

$$\begin{aligned} -c^s \partial_y^2 e^s + \frac{1}{\delta} c \partial_{x_n} e^1|_{x_n=0^-} &= c^1 \left(rk^2 + \frac{\alpha \mu_0}{\delta} \cos(\mu_0 \pi) \right) e^s = c^1 \left(rk^2 + \frac{2\mu_0}{\delta \sin(\mu_0 \pi)} \cos(\mu_0 \pi) \right) e^s \\ &= c^1 \left(rk^2 - \frac{4r}{\delta^2} \right) e^s = c^1 \left(rk^2 - ((r-1)k^2 - \mu_0) \right) e^s = \lambda e^s, \end{aligned}$$

by (3.184) and the value we have assigned to δ . We have thus obtained (3.182).

We now compute, using (3.184) and the value we have assigned to α ,

$$\frac{1}{2} e^1|_{x_n=0^-} = \frac{\alpha}{2} \sin(\mu_0 \pi) e^s = e^s.$$

Using (3.184) we also compute

$$e^1|_{x_n=0^-} + \frac{\delta}{2c^s} (c^1 \partial_{x_n} e^1)|_{x_n=0^-} = \alpha \sin(\mu_0 \pi) \left(1 + \frac{\delta}{2r} \mu_0 \frac{\cos(\mu_0 \pi)}{\sin(\mu_0 \pi)} \right) e^s = 0.$$

We have thus obtained (3.183). □

3.6.2 A zero-order model

The lack of unique continuation of the previous (elliptic) model makes us consider a simpler model. We make a lower-order approximation and we show how to formally obtain the model studied in the main text of this article.

Neglecting the first-order terms in δ in (3.177) we find

$$z^2(y, \delta/2) = z^1(y, -\delta/2) = z^s(y).$$

As $\delta^{-1}(\partial_{x_n} z^0(y, \delta/2) - \partial_{x_n} z^0(y, -\delta/2)) = O(1)$ we cannot neglect this term in (3.176). Proceeding as above we thus obtain the following model

$$\partial_t z^j - \operatorname{div}_g c^j \nabla_g z^j = f^j \quad \text{in } (0, T) \times \Omega_j, \quad j = 1, 2,$$

and

$$\begin{cases} \partial_t z^s - \operatorname{div}^s(c^s \nabla^s z^s) = f^s + \frac{1}{\delta} ((c^2 \partial_{x_n} z^2)|_{x_n=0^+} - (c^1 \partial_{x_n} z^1)|_{x_n=0^-}) \\ z^2|_{x_n=0^+} = z^s = z^1|_{x_n=0^-}, \end{cases}$$

in $(0, T) \times S$.

3.7 Facts on semi-classical operators

3.7.1 Results for tangential semi-classical operators on \mathbb{R}^d , $d \geq 2$

Semi-classical operators are defined in Section 3.1.4. Here, we provide the properties that we need in the main text.

The composition formula for tangential symbols, $b \in S_T^m$, $b' \in S_T^{m'}$, is given by

$$\begin{aligned} (b \# b')(z, \zeta') &= (2\pi h)^{-(d-1)} \iint e^{-i\langle t', \tau' \rangle / h} b(z, \zeta' + \tau', h) b'(z' + t', z_d, \zeta', h) dt' d\tau' \\ &= \sum_{|\alpha| < N} \frac{(-ih)^{|\alpha|}}{\alpha!} \partial_{\zeta'}^\alpha b(z, \zeta', h) \partial_{z'}^\alpha b'(z, \zeta', h) + r_N, \quad r_N \in h^N S_T^{m+m'-N}, \end{aligned} \quad (3.185)$$

where

$$r_N = \frac{(-ih)^N}{(2\pi h)^{(d-1)}} \sum_{|\alpha|=N} \int_0^1 \frac{(N)(1-s)^{N-1}}{\alpha!} \iint e^{-i\langle t', \tau' \rangle / h} \partial_{\zeta'}^\alpha b(z, \zeta' + \tau', h) \\ \times \partial_{z'}^\alpha b'(z' + st', z_d, \zeta', h) dt' d\tau' ds,$$

and yields a tangential symbol in $S_{\mathcal{T}}^{m+m'}$.

If $s, m \in \mathbb{R}$ and $b \in S_{\mathcal{T}}^m$ we then have the following regularity result :

$$\|\Lambda_{\mathcal{T}}^s \text{Op}_{\mathcal{T}}(b)u\|_{L^2(\mathbb{R}^d)} \leq \|\Lambda_{\mathcal{T}}^{s+m}u\|_{L^2(\mathbb{R}^d)}, \quad u \in \mathcal{S}'(\mathbb{R}^d).$$

We now consider the effect of change of variables.

Theorem 3.39. *Let Z' and Z'_κ be open subsets of \mathbb{R}^{d-1} and let $\kappa : Z' \rightarrow Z'_\kappa$ be a diffeomorphism. If $b(z, \zeta', h) \in S_{\mathcal{T}}^m$, and the kernel of $\text{Op}_{\mathcal{T}}(b)$ has its support contained in $K \times \mathbb{R} \times K \times \mathbb{R}$, with K compact of Z' then the function*

$$b_\kappa(\hat{z}', z_d, \zeta', h) = \begin{cases} e^{-i\langle \kappa(z'), \zeta' \rangle / h} \text{Op}_{\mathcal{T}}(b) e^{i\langle \kappa(z'), \zeta' \rangle / h} & \text{if } \hat{z}' = \kappa(z') \in Z'_\kappa, \\ 0 & \text{if } \hat{z}' \notin Z'_\kappa, \end{cases} \quad (3.186)$$

is in $S_{\mathcal{T}}^m$, and the kernel of $\text{Op}_{\mathcal{T}}(b_\kappa)$ has its support contained in $\kappa(K) \times \mathbb{R} \times \kappa(K) \times \mathbb{R}$, and

$$(\kappa \otimes \text{Id})^* \text{Op}_{\mathcal{T}}(b_\kappa)u = \text{Op}_{\mathcal{T}}(b)((\kappa \otimes \text{Id})^*u), \quad u \in \mathcal{S}'(\mathbb{R}^d). \quad (3.187)$$

For b_κ we have the following asymptotic expansion

$$b_\kappa(\kappa(z'), z_d, \zeta', h) - T_{\kappa, N}(b)(\kappa(z'), z_d, \zeta', h) \in h^{N/2} S_{\mathcal{T}}^{m-N/2}, \quad (3.188)$$

with

$$T_{\kappa, N}(b)(\kappa(z'), z_d, \zeta', h) = \sum_{\alpha < N} \frac{(-ih)^{|\alpha|}}{\alpha!} \partial_{\zeta'}^\alpha b(z', z_d, {}^t\kappa(z')'\zeta', h) \partial_{t'}^\alpha e^{i\langle \rho_{z'}(t'), \zeta' \rangle / h} \Big|_{t'=z'} \quad (3.189)$$

where $\rho_{z'}(t') = \kappa(z') - \kappa(t') - \kappa'(z')(t' - z')$.

A proof is provided in Appendix 3.8.9. In particular we find that

$$b_\kappa(\kappa(z'), z_d, \zeta, h) = b(z', z_d, {}^t\kappa(z')'\zeta', h) + hr(z', z_d, \zeta', h), \quad \text{with } r \in hS_{\mathcal{T}}^{m-1}, \quad (3.190)$$

The principal symbol thus transforms as the regular pullback of a function defined in phase-space (see Section 3.1.4.3).

Lemma 3.40. *Let $a \in S_{\mathcal{T}}^m$ be such that the kernel $K_h(z, t) = \mathcal{K}_{h, z_d}(z', t') \otimes \delta(z_d - td)$ of $\text{Op}_{\mathcal{T}}(a)$ is such that $\mathcal{K}_{h, z_d}(z', t')$ vanishes if $|z' - t'| \leq \eta$ for some $\eta > 0$. Then $a \in h^\infty S_{\mathcal{T}}^{-\infty}$.*

Proof. We write, as an oscillatory integral,

$$\mathcal{K}_{h, z_d}(z', t') = \frac{1}{(2\pi h)^{d-1}} \int e^{i\langle z' - t', \zeta' \rangle / h} a(z, \zeta', h) d\zeta'.$$

Let $\chi \in \mathcal{C}^\infty(\mathbb{R}^{d-1})$ be such that $\chi(z') = 0$ if $|z'| \leq \frac{\eta}{2}$ and $\chi(z') = 1$ if $|z'| \geq \eta$. Then $\mathcal{K}_{h, z_d}(z', t') = \chi(z' - t') \mathcal{K}_{h, z_d}(z', t')$. Hence, $\chi(z' - t')a(z, \zeta', h)$ is an amplitude for $\text{Op}_{\mathcal{T}}(a)$. The asymptotic series providing the associated symbol, which is in fact $a(z, \zeta', h)$, is [GS94]

$$a(z, \zeta', h) \sim \sum_{\alpha} \frac{(-i)^{|\alpha|} h^{|\alpha|}}{\alpha!} \partial_{t'}^\alpha \partial_{\zeta'}^\alpha (\chi(z' - t')a(z, \zeta', h)) \Big|_{t'=z'}.$$

Because of the support of χ the result follows. \square

3.7.2 Semi-classical (tangential) operators on a manifold

In the present article, we consider semi-classical operators that act on both the x_0 and y variables, $x_0 \in (0, X_0)$ and $y \in S$.

Let \mathcal{X} be a manifold of the form $(0, X_0) \times S \times \mathbb{R}$. We denote by (x_0, y, x_n) a typical element. We also set $\mathcal{X}' = (0, X_0) \times S$. By abuse of notation we shall also call ϕ_j the map $\text{Id} \otimes \phi_j \otimes \text{Id}$ (resp. $\text{Id} \otimes \phi_j$) on $\mathbb{R} \times U_j \times \mathbb{R}$ (resp. $\mathbb{R} \times U_j$); see Section 3.1.4.3 where the diffeomorphisms ϕ_j , $j \in J$, are defined.

We recall the definition of a tangential semi-classical symbol in an open set $O \subset \mathbb{R}^d$.

Definition 3.41. We say that $a(z, \zeta', h) \in S_{\mathcal{T}}^m(O \times \mathbb{R}^{d-1})$ if, for any $\chi \in \mathcal{C}_c^\infty(O)$, $\chi a \in S_{\mathcal{T}}^m(\mathbb{R}^d \times \mathbb{R}^{d-1})$.

We also recall the definition of tangential semi-classical symbols and operators on a manifold.

Definition 3.42. 1. Let $m \in \mathbb{R}$, $j \in J$, and $a \in \mathcal{C}^\infty(T^*((0, X_0) \times U_j) \times \mathbb{R})$. We say that $a \in S_{\mathcal{T}}^m(T^*((0, X_0) \times U_j) \times \mathbb{R})$ if, $(\phi_j^{-1})^* a \in S_{\mathcal{T}}^m((0, X_0) \times \tilde{U}_j \times \mathbb{R} \times \mathbb{R}^n)$.

2. Let $a \in \mathcal{C}^\infty(T^*(\mathcal{X}') \times \mathbb{R})$. We say that $a \in S_{\mathcal{T}}^m(T^*(\mathcal{X}') \times \mathbb{R})$ if, for all $j \in J$, $a|_{T^*((0, X_0) \times U_j) \times \mathbb{R}} \in S_{\mathcal{T}}^m(T^*((0, X_0) \times U_j) \times \mathbb{R})$.

Definition 3.43. An operator $A : \mathcal{C}_c^\infty(\mathcal{X}) \rightarrow \mathcal{C}^\infty(\mathcal{X})$ is said to be tangential semi-classical on \mathcal{X} of order $m \in \mathbb{R}$ if :

1. Its kernel is of the form

$$K_h(x_0, y, x_n; \hat{x}_0, \hat{y}, \hat{x}_n) = \mathcal{K}_{h, x_n}(x_0, y; \hat{x}_0, \hat{y}) \otimes \delta(x_n - \hat{x}_n).$$

2. Its kernel is regularizing outside $\text{diag}(\mathcal{X} \times \mathcal{X})$ in the semi-classical sense : for all $\chi, \hat{\chi} \in \mathcal{C}_c^\infty(\mathcal{X}')$ such that $\text{supp}(\chi) \cap \text{supp}(\hat{\chi}) = \emptyset$ we have

$$\chi(x_0, y) \hat{\chi}(\hat{x}_0, \hat{y}) \mathcal{K}_{h, x_n}(x_0, y; \hat{x}_0, \hat{y}) \in \mathcal{C}^\infty(\mathcal{X}' \times \mathcal{X}'),$$

and for all $N, \alpha \in \mathbb{N}$, and for any semi-norm q on $\mathcal{C}^\infty(\mathcal{X}' \times \mathcal{X}')$ there exists $C = C_{\chi, \hat{\chi}, N, \alpha, q} > 0$ such that

$$\sup_{x_n \in \mathbb{R}} q(\chi(x_0, y) \hat{\chi}(\hat{x}_0, \hat{y}) \partial_{x_n}^\alpha \mathcal{K}_{h, x_n}(x_0, y; \hat{x}_0, \hat{y})) \leq Ch^N. \quad (3.191)$$

3. For all $j \in J$ and all $\lambda \in \mathcal{C}_c^\infty((0, X_0) \times U_j)$, $\tilde{\lambda} \in \mathcal{C}_c^\infty((0, X_0) \times \tilde{U}_j)$, we have

$$\mathcal{S}'(\mathbb{R}^{n+1}) \ni u \mapsto (\phi_j^{-1})^*(\lambda \otimes \text{Id}) A \phi_j^*(\tilde{\lambda} \otimes \text{Id}) u$$

in $\Psi_{\mathcal{T}}^m(\mathbb{R}^{n+1})$.

In this case, we write $A \in \Psi_{\mathcal{T}}^m(\mathcal{X})$.

Note that we shall often write λ and $\tilde{\lambda}$ in place of $\lambda \otimes \text{Id}$ and $\tilde{\lambda} \otimes \text{Id}$ respectively.

We set

$$h^\infty S_{\mathcal{T}}^{-\infty}((0, X_0) \times \tilde{U}_j \times \mathbb{R} \times \mathbb{R}^n) = \bigcap_{N \in \mathbb{N}} h^N S_{\mathcal{T}}^{-N}((0, X_0) \times \tilde{U}_j \times \mathbb{R} \times \mathbb{R}^n),$$

$$h^\infty \Psi_{\mathcal{T}}^{-\infty}((0, X_0) \times \tilde{U}_j \times \mathbb{R}) = \bigcap_{N \in \mathbb{N}} h^N \Psi_{\mathcal{T}}^{-N}((0, X_0) \times \tilde{U}_j \times \mathbb{R}),$$

Remark 3.44. The first two points of Definition 3.43 in fact state that the semi-classical wave front of the kernel of the operator is confined in the conormal bundle of the diagonal of \mathcal{X} . As a consequence, A maps $\mathcal{E}'(\mathcal{X})$ into $\mathcal{D}'(\mathcal{X})$ [Hör90, Theorem 8.2.13]. We also note that the same properties hold for the transpose (resp. adjoint) operator. If moreover A is properly supported then

$$A : \mathcal{C}_c^\infty(\mathcal{X}) \rightarrow \mathcal{C}_c^\infty(\mathcal{X}), \quad \mathcal{C}^\infty(\mathcal{X}) \rightarrow \mathcal{C}^\infty(\mathcal{X}), \quad \mathcal{E}'(\mathcal{X}) \rightarrow \mathcal{E}'(\mathcal{X}), \quad \mathcal{D}'(\mathcal{X}) \rightarrow \mathcal{D}'(\mathcal{X}), \quad (3.192)$$

continuously, and the same holds for ${}^t A$.

Observe that tangential semi-classical *differential* operators naturally satisfy all the properties listed above.

Proposition 3.45. *If $A \in \Psi_T^m(\mathcal{X})$, for all $j \in J$, there exists $a_j(x_0, x', x_n; \xi_0, \xi') \in S_T^m((0, X_0) \times \tilde{U}_j \times \mathbb{R} \times \mathbb{R}^n)$ such that for all $\lambda \in \mathcal{C}_c^\infty((0, X_0) \times U_j)$, $\tilde{\lambda} \in \mathcal{C}_c^\infty((0, X_0) \times \tilde{U}_j)$ we have*

$$(\phi_j^{-1})^* \lambda A \phi_j^* \tilde{\lambda} - \text{Op}_T \left(((\phi_j^{-1})^* \lambda) a_j \right) \tilde{\lambda} \in h^\infty \Psi_T^{-\infty}(\mathbb{R}^n \times \mathbb{R}).$$

Moreover, a_j is uniquely defined up to $h^\infty S_T^{-\infty}((0, X_0) \times \tilde{U}_j \times \mathbb{R} \times \mathbb{R}^n)$.

We refer to Appendix 3.8.10 for a proof. We say that a_j is the (representative of the) local symbol of A (modulo $h^\infty S_T^{-\infty}$) in the chart $(0, X_0) \times \tilde{U}_j \times \mathbb{R}$. We find that the symbol of $(\phi_j^{-1})^* \lambda A \phi_j^* \tilde{\lambda}$ is given by $\left((\phi_j^{-1})^* \lambda \right) a_j \# \tilde{\lambda}$ modulo $h^\infty S_T^{-\infty}(\mathbb{R}^n \times \mathbb{R} \times \mathbb{R}^n)$, from the previous proposition. The symbols $(a_j)_{j \in J}$ follow the natural transformations when going from one chart to another.

Proposition 3.46. *If $U_j \cap U_k \neq \emptyset$, we introduce*

$$\tilde{U}_{j,k} = \phi_j(U_j \cap U_k) \subset \tilde{U}_j \quad \text{and} \quad \tilde{U}_{k,j} = \phi_k(U_j \cap U_k) \subset \tilde{U}_k.$$

Let $A \in \Psi_T^m(\mathcal{X})$ with a_j as given in Proposition 3.45, we have

$$a_{k|(0, X_0) \times \tilde{U}_{k,j} \times \mathbb{R}} - T_{\phi_{j,k}, N}(a_{j|(0, X_0) \times \tilde{U}_{j,k} \times \mathbb{R}}) \in h^N S_T^{m-N/2}((0, X_0) \times \tilde{U}_{k,j} \times \mathbb{R} \times \mathbb{R}^n).$$

We refer to Appendix 3.8.11 for a proof. The notation $T_{\phi_{j,k}, N}$ is defined in (3.189). The open sets $\tilde{U}_{j,k}$ and $\tilde{U}_{k,j}$ are represented in Figure 3.2.

As a consequence, only considering the first term in the sum defining $T_{\phi_{j,k}, N}(a_j)$, we observe that the principle part of a_j defined on $(0, X_0) \times \tilde{U}_j \times \mathbb{R} \times \mathbb{R}^n$ transforms as a function on $T^*(\mathcal{X}') \times \mathbb{R}$ through a change of variables.

Let $A \in \Psi_T^m(\mathcal{X})$ and let a_j , $j \in J$, be representatives of the local symbol (class) given in the local chart by Proposition 3.45. We set $a = \sum_{j \in J} \psi_j \phi_j^* a_j$ and find

$$a - \phi_j^* a_j \in h \Psi_T^{m-1}(T^*((0, X_0) \times U_j) \times \mathbb{R}).$$

This defines a modulo $h S_T^{m-1}(T^*(\mathcal{X}') \times \mathbb{R})$.

Definition 3.47. We define the principal symbol of A as the class of a in $S_T^m(T^*(\mathcal{X}') \times \mathbb{R}) / h S_T^{m-1}(T^*(\mathcal{X}') \times \mathbb{R})$ and we denote it by $\sigma(A)$.

Proposition 3.48. *Let $A \in \Psi_T^m(\mathcal{X})$, $B \in \Psi_T^{m'}(\mathcal{X})$ be both properly supported. Then $AB \in \Psi_T^{m+m'}(\mathcal{X})$ and (a representative of) its local symbol in any chart (U_j, ϕ_j) is given by $a_j \# b_j$ with the notation of Proposition 3.45. In particular, we have $\sigma(AB) = \sigma(A)\sigma(B)$.*

We refer to Appendix 3.8.12 for a proof.

The following natural result is a consequence of what precedes.

Corollary 3.49. *If $A \in \Psi_T^m(\mathcal{X})$ and $B \in \Psi_T^{m'}(\mathcal{X})$ are both properly supported then the commutator $[A, B] \in h \Psi_T^{m+m'-1}(\mathcal{X})$ and $\frac{h}{i} \{\sigma(A), \sigma(B)\}$ is (a representative of) its principal symbol.*

With the Sobolev norms defined in Section 3.1.4.3 we have the following result.

Proposition 3.50. *Let $A \in \Psi_T^\ell(\mathcal{X})$ be properly supported, $\ell = 0, 1$. Let K be a compact set of \mathcal{X}' . Then there exist L , a compact of \mathcal{X}' , and $C > 0$ such that for all $u \in \mathcal{C}_c^\infty(\mathcal{X}')$ with $\text{supp}(u) \subset K$ we have*

$$\text{supp}((Au)|_{x_n=0}) \subset L \quad \text{and} \quad |(Au)|_{x_n=0}|_k \leq C|u|_{\ell+k} \quad \text{with } k = \begin{cases} 0 \text{ or } 1 & \text{if } \ell = 0, \\ 0 & \text{if } \ell = 1. \end{cases}$$

We refer to Appendix 3.8.13 for a proof. The norms in the proposition are those defined in (3.21).

3.7.3 A particular class of semi-classical operators on \mathcal{M}_+

In this section, we prove that the operators Ξ_\bullet defined in (3.62), $\bullet = \mathcal{E}, \mathcal{F}, \mathcal{G}, \mathcal{Z}$, are tangential semi-classical pseudo-differential operators on \mathcal{M}_+ . We also establish some properties of their symbols.

Let $\zeta^0 \in \mathcal{C}_c^\infty(0, X_0)$ that satisfies $\zeta^0 = 1$ on a neighborhood of $(\alpha_0, X_0 - \alpha_0)$ and $0 \leq \zeta^0 \leq 1$. We set

$$\zeta_j^0(x_0, y, x_n) = \zeta^0(x_0)\psi_j(y).$$

For all $j \in J$, we choose $\tilde{\zeta}_j^0 \in \mathcal{C}_c^\infty((0, X_0) \times \tilde{U}_j)$ with $\tilde{\zeta}_j^0 = 1$ in a neighborhood of $\text{supp}((\phi_j^{-1})^* \zeta_j^0)$.

Let $p \in S_T^m(\mathcal{M}_+^*)$. We define, for some $j \in J$, $p_j = \tilde{\zeta}_j^0(\phi_j^{-1})^* p$ and $Q = \phi_j^* \text{Op}_T(p_j)(\phi_j^{-1})^* \zeta_j^0$.

Lemma 3.51. *We have $Q \in \Psi_T^m(\mathcal{M}_+)$. Moreover, denoting by q_k (a representative of) the local symbol of Q in the chart \tilde{U}_k , we have*

1. $q_j = p_j \# \left((\phi_j^{-1})^* \zeta_j^0 \right) \bmod h^\infty S_T^{-\infty}(\mathbb{R}^n \times [0, 2\varepsilon] \times \mathbb{R}^n)$ and q_j can be chosen such that $\text{supp}(q_j) \subset \text{supp}(\tilde{\zeta}_j^0) \times \mathbb{R}^n \times [0, 2\varepsilon] \subset \tilde{U}_j \times \mathbb{R}^n \times [0, 2\varepsilon]$;
2. $q_k = 0$ if $U_j \cap U_k = \emptyset$;
3. $q_k = T_{\phi_{jk}, N}(q_j) \bmod h^{N/2} S_T^{m-N/2}(\mathbb{R}^n \times [0, 2\varepsilon] \times \mathbb{R}^n)$ for all $N \in \mathbb{N}$ and $\text{supp}(q_k) \subset \phi_k(U_j \cap U_k) \times \mathbb{R}^n \times \mathbb{R}$ if $k \neq j$ and $U_j \cap U_k \neq \emptyset$.

Proof. Let us first check that $Q \in \Psi_T^m(\mathcal{M}_+)$. The definition of Q first yields $\text{supp}(K_{Q,h}) \subset ((0, X_0) \times U_j \times [0, 2\varepsilon])^2$. Then, for $\lambda \in \mathcal{C}_c^\infty((0, X_0) \times U_j)$, $\tilde{\lambda} \in \mathcal{C}_c^\infty((0, X_0) \times \tilde{U}_j)$, we have

$$(\phi_j^{-1})^* \lambda Q \phi_j^* \tilde{\lambda} = \left((\phi_j^{-1})^* \lambda \right) \text{Op}_T(p_j) \left((\phi_j^{-1})^* \zeta_j^0 \right) \tilde{\lambda} \in \Psi_T^m(\mathbb{R}^n \times [0, 2\varepsilon]),$$

and the symbol of this operator is $\left((\phi_j^{-1})^* \lambda \right) \# p_j \# \left((\phi_j^{-1})^* \zeta_j^0 \right) \tilde{\lambda}$. According to Proposition 3.45, this yields $q_j = p_j \# (\phi_j^{-1})^* \zeta_j^0 \bmod h^\infty S_T^{-\infty}(\mathbb{R}^n \times [0, 2\varepsilon] \times \mathbb{R}^n)$. The local representation q_j can be chosen with compact support in \tilde{U}_j since $p_j = \tilde{\zeta}_j^0(\phi_j^{-1})^* p$ and $\text{supp}(\tilde{\zeta}_j^0) \subset \tilde{U}_j$. As a consequence, the first point is fulfilled.

Taking now λ and $\tilde{\lambda}$ such that $\text{supp}(\lambda) \cap \text{supp}(\phi_j^* \tilde{\lambda}) = \emptyset$, we find $(\phi_j^{-1})^* \lambda Q \phi_j^* \tilde{\lambda} \in h^\infty \Psi_T^{-\infty}(\mathbb{R}^n \times [0, 2\varepsilon])$, so that the kernel of Q satisfies (3.191). Next, we take $k \in J$, $k \neq j$ and $\lambda \in \mathcal{C}_c^\infty((0, X_0) \times U_k)$, $\tilde{\lambda} \in \mathcal{C}_c^\infty((0, X_0) \times \tilde{U}_k)$ and compute $(\phi_k^{-1})^* \lambda Q \phi_k^* \tilde{\lambda}$.

If $U_j \cap U_k = \emptyset$, this is the null operator and the second point is satisfied. If $U_j \cap U_k \neq \emptyset$, we take

- $\hat{\lambda}_j \in \mathcal{C}_c^\infty((0, X_0) \times (U_j \cap U_k))$ such that $\hat{\lambda}_j = 1$ on $\text{supp}(\phi_j^* \tilde{\zeta}_j^0) \cap \text{supp}(\lambda)$
- $\lambda_j^{(1)}, \lambda_j^{(2)} \in \mathcal{C}_c^\infty((0, X_0) \times (U_j \cap U_k))$ such that $\lambda_j^{(1)} = \lambda_j^{(2)} = 1$ on $\text{supp}(\zeta_j^0) \cap \text{supp}(\phi_k^* \tilde{\lambda})$.

We have

$$(\phi_k^{-1})^* \lambda Q \phi_k^* \tilde{\lambda} = \left((\phi_k^{-1})^* \lambda \right) (\phi_{jk}^{-1})^* \tilde{Q} (\phi_{jk})^* \left((\phi_k^{-1})^* \lambda_j^{(1)} \right) \tilde{\lambda}$$

where

$$\tilde{Q} = \left((\phi_j^{-1})^* \hat{\lambda}_j \right) \text{Op}_T(p_j) \left((\phi_j^{-1})^* \zeta_j^0 \lambda_j^{(2)} \right)$$

The kernel of the operator \tilde{Q} has a compact support and we can hence apply the change of variables Theorem 3.39. According to Formula (3.188) the symbol of the operator $(\phi_k^{-1})^* \lambda Q \phi_k^* \tilde{\lambda}$ is given by

$$\begin{aligned} & (\phi_k^{-1})^* \lambda \# T_{\phi_{jk}, N} \left(\left((\phi_j^{-1})^* \hat{\lambda}_j \right) \# p_j \# \left((\phi_j^{-1})^* \zeta_j^0 \lambda_j^{(2)} \right) \right) \# \left((\phi_k^{-1})^* \lambda_j^{(1)} \right) \tilde{\lambda} \\ & \bmod h^{N/2} S_T^{m-N/2}(\mathbb{R}^n \times [0, 2\varepsilon] \times \mathbb{R}^n) \end{aligned}$$

Combining the definition of $T_{\phi_{jk},N}$, the composition formula, and the definition of q_j we find this symbol to be

$$\begin{aligned} & (\phi_k^{-1})^* \lambda \# T_{\phi_{jk},N} \left(p_j \# (\phi_j^{-1})^* \zeta_j^0 \right) \# \tilde{\lambda} \quad \text{mod } h^{N/2} S_{\mathcal{T}}^{m-N/2}(\mathbb{R}^n \times [0, 2\varepsilon] \times \mathbb{R}^n) \\ & = (\phi_k^{-1})^* \lambda \# T_{\phi_{jk},N}(q_j) \# \tilde{\lambda} \quad \text{mod } h^{N/2} S_{\mathcal{T}}^{m-N/2}(\mathbb{R}^n \times [0, 2\varepsilon] \times \mathbb{R}^n), \end{aligned}$$

because of the supports of $\hat{\lambda}_j$, $\lambda_j^{(1)}$ and $\lambda_j^{(2)}$. This proves the third point. Finally, we obtain $Q \in \Psi_{\mathcal{T}}^m(\mathcal{M}_+)$, which concludes the proof of the lemma. \square

Proposition 3.52. *Let $P = \sum_{j \in J} \phi_j^* \text{Op}_{\mathcal{T}}(p_j) (\phi_j^{-1})^* \zeta_j^0$ with $p_j = \tilde{\zeta}_j^0 (\phi_j^{-1})^* p$. Then, we have $P \in \Psi_{\mathcal{T}}^m(\mathcal{M}_+)$ and its principal symbol is $\sigma(P)(\mathbf{x}, \xi_0, \eta) = \zeta^0(x_0) p(\mathbf{x}, \xi_0, \eta)$. Moreover, in each chart \tilde{U}_k , there exists a (representative of the) local symbol of P supported in $\text{supp}(\zeta^0 \phi_k^* p)$.*

Proof. According to Lemma 3.51, in the chart \tilde{U}_k , the local symbol of P is

$$p_k \# (\phi_k^{-1})^* \zeta_k^0 + \sum_{j \neq k} T_{\phi_{jk},N} \left(p_j \# (\phi_j^{-1})^* \zeta_j^0 \right) \quad \text{mod } h^{N/2} S_{\mathcal{T}}^{m-N/2}(\mathbb{R}^n \times [0, 2\varepsilon] \times \mathbb{R}^n) \quad (3.193)$$

for all $N \in \mathbb{N}$. According to the composition formula (3.185) and the definition of $T_{\phi_{jk},N}$ (3.189), the principal part of this local representation is

$$\begin{aligned} & p_k (\phi_k^{-1})^* \zeta_k^0 + \sum_{j \neq k} (\phi_{jk}^{-1})^* \left(p_j (\phi_j^{-1})^* \zeta_j^0 \right) \\ & = \tilde{\zeta}_k^0 (\phi_k^{-1})^* p \zeta_k^0 + \sum_{j \neq k} (\phi_{jk}^{-1})^* \tilde{\zeta}_j^0 (\phi_j^{-1})^* p \zeta_j^0 \\ & = \left((\phi_k^{-1})^* p \right) \sum_{j \in J} (\phi_{jk}^{-1})^* \zeta_j^0 = \zeta^0 (\phi_k^{-1})^* p. \end{aligned}$$

since $\sum_{j \in J} \zeta_j^0 = \zeta^0$, defined in Section 3.3.6. Moreover, for every $N \in \mathbb{N}$, the expression (3.193) is supported in the support of $(\phi_k^{-1})^* p$. This property can be preserved by a representative of the asymptotic series $N \rightarrow +\infty$. This concludes the proof of the proposition. \square

With the Sobolev norms introduced in Section 3.1.4.3 we have the following natural result.

Lemma 3.53. *Let P be as in Proposition 3.52 and let $v \in \mathcal{C}^\infty(\mathcal{M}_+)$ and set $u_j = \text{Op}_{\mathcal{T}}(p_j) (\phi_j^{-1})^* \zeta_j^0 v$. Then we have*

$$\|Pv\|_\ell \lesssim \sum_{j \in J} \|u_j\|_\ell, \quad |(Pv)|_{x_n=0^+}|_\ell \lesssim \sum_{j \in J} |u_j|_{x_n=0^+}|_\ell, \quad \ell = 0, 1.$$

Proof. We treat the case of norms in all dimensions. We have $Pv = \sum_{j \in J} \phi_j^* u_j$. Then

$$\|Pv\|_\ell \leq \sum_{j \in J} \|\phi_j^* u_j\|_\ell.$$

We then conclude with Lemma 3.9. \square

3.8 Proofs of some technical results

3.8.1 Proof of Lemma 3.8

Let $(g_j)_j$ be a family of smooth functions on S with $\text{supp}(g_j) \subset U_j$ and $\sum_j g_j = g \geq C > 0$ in S . We set $M_r(u) = \sum_j |(\phi_j^{-1})^* g_j u|_{\mathcal{H}^r(\mathbb{R}^{n-1})}$. It is sufficient to prove that $|(\phi_j^{-1})^* f_j u|_{\mathcal{H}^r(\mathbb{R}^{n-1})} \leq CM_r(u)$ for some constant $C > 0$.

We set $\tilde{g}_j = g_j/g$ which forms a partition of unity. We have

$$|(\phi_j^{-1})^* f_j u|_{\mathcal{H}^r(\mathbb{R}^{n-1})} \leq \sum_k |(\phi_j^{-1})^* f_j \tilde{g}_k u|_{\mathcal{H}^r(\mathbb{R}^{n-1})}$$

Next we write

$$|(\phi_j^{-1})^* f_j \tilde{g}_k u|_{\mathcal{H}^r(\mathbb{R}^{n-1})} \leq C |(\phi_k^{-1})^* f_j \tilde{g}_k u|_{\mathcal{H}^r(\mathbb{R}^{n-1})}$$

as ϕ_{jk} is a \mathcal{C}^∞ -diffeomorphism between $\phi_j(U_j \cap U_k)$ and $\phi_k(U_j \cap U_k)$. Introducing $\hat{g}_k \in \mathcal{C}_c^\infty(U_k)$ such that $\hat{g}_k = 1$ on $\text{supp}(g_k)$ we find

$$\begin{aligned} |(\phi_j^{-1})^* f_j \tilde{g}_k u|_{\mathcal{H}^r(\mathbb{R}^{n-1})} &\leq C |(\phi_k^{-1})^* f_j \hat{g}_k g_k/g u|_{\mathcal{H}^r(\mathbb{R}^{n-1})} \\ &= C |(\phi_k^{-1})^* (f_j \hat{g}_k/g) (\phi_k^{-1})^* (g_k u)|_{\mathcal{H}^r(\mathbb{R}^{n-1})} \\ &\leq C' |(\phi_k^{-1})^* (g_k u)|_{\mathcal{H}^r(\mathbb{R}^{n-1})} \leq C'' M_r(u), \end{aligned}$$

as $v \mapsto v(\phi_k^{-1})^* (f_j \hat{g}_k/g)$ is continuous in $\mathcal{H}^r(\mathbb{R}^{n-1})$. The proof is complete. \square

3.8.2 Proof of Proposition 3.11

First we note that in the proof it suffices to consider the operator $A_\delta + \lambda \text{Id}$ for λ sufficiently large, in place of $\mathcal{A}_\delta + \lambda \text{Id}$. An inspection of the proof that follows also shows that a piecewise \mathcal{C}^1 regularity of the coefficients c and a \mathcal{C}^1 regularity of c^s is sufficient to prove the result.

We consider a finite open covering $(O_j)_j$ of $\bar{\Omega}$ together with a subordinated partition of unity $\sum_j \theta_j = 1$ that satisfies moreover, if $O_j \cap S \neq \emptyset$,

1. we can choose local coordinates in O_j such that S is given by $\{x_n = 0\}$.
2. $\partial_\eta \theta_j|_S = 0$, i.e. θ_j is flat at S in the normal direction to S .

The result of Proposition 3.11 is clear away from S by standard elliptic regularity theory. We thus place ourselves in $O = O_j$ such that $O_j \cap S \neq \emptyset$. With $\theta = \theta_j$ we set $v = \theta z$ and $v^s = \theta z^s$ and $V = (v, v^s)$. From (3.26) we have

$$\|V\|_{\mathcal{H}_\delta^1} \lesssim \|F\|_{\mathcal{H}_\delta^0}. \quad (3.194)$$

The result will be achieved if we prove

$$\sum_{i=1,2} |v|_{\Omega_i} |_{H^2(O \cap \Omega_i)} + \delta^{\frac{1}{2}} |v^s|_{H^2(O \cap S)} \lesssim \|F\|_{\mathcal{H}_\delta^0}, \quad (3.195)$$

uniformly in δ .

We write $c \nabla_g v = c(\nabla_g \theta)z + c\theta(\nabla_g z)$. If $\psi \in H_0^1(O)$ we then have

$$\begin{aligned} (c \nabla_g v, \nabla_g \psi)_{L^2(O)} &= (c(\nabla_g \theta)z, \nabla_g \psi)_{L^2(O)} + (c(\nabla_g z)\theta, \nabla_g \psi)_{L^2(O)} \\ &= - \sum_{i=1,2} (\nabla_g(c(\nabla_g \theta)z), \psi)_{L^2(O \cap \Omega_i)} + (c \nabla_g z, \nabla_g(\theta \psi))_{L^2(O)} \\ &\quad - (c(\nabla_g z \nabla_g \theta), \psi)_{L^2(O)}, \end{aligned}$$

with an integration by parts using that $\partial_\eta \theta|_S = 0$.

Similarly for $\psi^s \in H_0^1(O \cap S)$ we have

$$\begin{aligned} (c^s \nabla^s v^s, \nabla^s \psi^s)_{L^2(O \cap S)} &= - (\nabla^s(c^s(\nabla^s \theta)z^s), \psi^s)_{L^2(O \cap S)} + (c^s \nabla^s z^s, \nabla^s(\theta \psi^s))_{L^2(O \cap S)} \\ &\quad - (c^s(\nabla^s z^s \nabla^s \theta), \psi^s)_{L^2(O \cap S)}. \end{aligned}$$

Considering the weak problem (3.25) satisfied by Z we thus obtain

$$\begin{aligned} (c \nabla_g v, \nabla_g \psi)_{L^2(O)} + \delta (c^s \nabla^s v^s, \nabla^s \psi^s)_{L^2(O \cap S)} + \lambda (v, \psi)_{L^2(O)} + \delta \lambda (v^s, \psi^s)_{L^2(O \cap S)} \\ = (\phi, \psi)_{L^2(O)} + \delta (\phi^s, \psi^s)_{L^2(O \cap S)}, \end{aligned} \quad (3.196)$$

for $\Psi = (\psi, \psi^s) \in \mathcal{H}_\delta^1$, where $\Phi = (\phi, \phi^s) \in L^2 \times L^2$ with

$$\begin{aligned} \phi|_{\Omega_i} &= (-\nabla_g(c(\nabla_g\theta)z) - c(\nabla_g z \nabla_g \theta) + \theta f)|_{\Omega_i}, \quad i = 1, 2 \\ \phi^s &= -\nabla^s(c^s(\nabla^s\theta)z^s) - c^s(\nabla^s z^s \nabla^s \theta) + \theta f^s, \end{aligned}$$

and by (3.26) we have

$$\|\Phi\|_{\mathcal{H}_\delta^0} \lesssim \|F\|_{\mathcal{H}_\delta^0}.$$

We now make a local change of variable in O such that S becomes $\{x_n = 0\}$. The weak problem that (v, v^s) satisfies takes the form

$$\begin{aligned} \sum_{k,l} \int_O \underline{c}_{k,l} \partial_{x_k} v \partial_{x_l} \bar{\psi} \, dx + \delta \sum'_{k,l} \int_{O \cap S} \underline{c}_{k,l}^s \partial_{x_k} v^s \partial_{x_l} \bar{\psi}^s \, dx + \lambda \int_O \alpha v \bar{\psi} \, dx + \lambda \delta \int_{O \cap S} \beta v^s \bar{\psi}^s \, dx \\ = \int_O \alpha \phi \bar{\psi} \, dx + \delta \int_{O \cap S} \beta \phi^s \bar{\psi}^s \, dx, \quad \Psi = (\psi, \psi^s) \in \mathcal{H}_\delta^1, \end{aligned} \quad (3.197)$$

where $\sum_{k,l}$ is a sum with k, l running over $\{1, \dots, n\}$ and $\sum'_{k,l}$ is a sum with k, l running over $\{1, \dots, n-1\}$. The functions α and β originate from the Jacobians. The functions $\underline{c}_{k,l}$ are piecewise \mathcal{C}^1 with a discontinuity across the interface S and the functions $\underline{c}_{k,l}^s$ are \mathcal{C}^1 . Note that $v \in H^1(O)$ and $v^s \in H^1(O \cap S)$ with their supports finitely away from ∂O .

We now use the Nirenberg translation method. Let h be parallel to S . Define D_h by $D_h(\rho) = (\rho(x+h) - \rho(x))/|h|$. Observe that $D_{-h}(D_h v) \in H_0^1(O)$ and $D_{-h}(D_h v^s) \in H_0^1(O \cap S)$ for $|h|$ sufficiently small and set $\psi = D_{-h}(D_h v)$ and $\psi^s = D_{-h}(D_h v^s)$. As $(D_h f_1 f_2) = f_1(x+h) D_h f_2 + (D_h f_1) f_2$ this yields

$$\begin{aligned} \sum_{k,l} \int_O \underline{c}_{k,l}(x+h) \partial_{x_k} D_h v \partial_{x_l} D_h \bar{v} \, dx + \delta \sum'_{k,l} \int_{O \cap S} \underline{c}_{k,l}^s(x+h) \partial_{x_k} D_h v^s \partial_{x_l} D_h \bar{v}^s \, dx \\ + \lambda \int_O \alpha(x+h) |D_h v|^2 \, dx + \lambda \delta \int_{O \cap S} \beta(x+h) |D_h v^s|^2 \, dx \\ + \sum_{k,l} \int_O (D_h \underline{c}_{k,l}) \partial_{x_k} v \partial_{x_l} D_h \bar{v} \, dx + \delta \sum'_{k,l} \int_{O \cap S} (D_h \underline{c}_{k,l}^s) \partial_{x_k} v^s \partial_{x_l} D_h \bar{v}^s \, dx \\ + \lambda \int_O (D_h \alpha) v D_h \bar{v} \, dx + \delta \lambda \int_{O \cap S} (D_h \beta) v^s D_h \bar{v}^s \, dx \\ = \int_O \alpha \phi D_{-h}(D_h \bar{v}) \, dx + \delta \int_{O \cap S} \beta \phi^s D_{-h}(D_h \bar{v}^s) \, dx. \end{aligned}$$

We note that

$$\begin{aligned} \left| \sum_{k,l} \int_O (D_h \underline{c}_{k,l}) \partial_{x_k} v \partial_{x_l} D_h \bar{v} \, dx + \delta \sum'_{k,l} \int_{O \cap S} (D_h \underline{c}_{k,l}^s) \partial_{x_k} v^s \partial_{x_l} D_h \bar{v}^s \, dx \right. \\ \left. + \lambda \int_O (D_h \alpha) v D_h \bar{v} \, dx + \delta \lambda \int_{O \cap S} (D_h \beta) v^s D_h \bar{v}^s \, dx \right| \\ \lesssim \|V\|_{\mathcal{H}_\delta^1} \|D_h V\|_{\mathcal{H}_\delta^1}. \end{aligned}$$

If $\rho \in H_0^1(O)$ with its support finitely away from the boundary ∂O then $|D_h(\rho)|_{L^2(O)} \leq |\nabla \rho|_{L^2(O)}$ for $|h|$ sufficiently small [Bre83, Proposition IX.3]. We thus have

$$\left| \int_O \alpha \phi D_{-h}(D_h \bar{v}) \, dx + \delta \int_{O \cap S} \beta \phi^s D_{-h}(D_h \bar{v}^s) \, dx \right| \lesssim \|\Phi\|_{\mathcal{H}_\delta^0} \|D_h V\|_{\mathcal{H}_\delta^1}.$$

We thus find

$$|a_\lambda(D_h v, D_h v)| \lesssim (\|V\|_{\mathcal{H}_\delta^1} + \|\Phi\|_{\mathcal{H}_\delta^0}) \|D_h V\|_{\mathcal{H}_\delta^1} \lesssim \|\Phi\|_{\mathcal{H}_\delta^0} \|D_h V\|_{\mathcal{H}_\delta^1}.$$

uniformly in δ , using (3.194). The coercivity of a_λ gives

$$\|D_h V\|_{\mathcal{H}_\delta^1} \lesssim \|F\|_{\mathcal{H}_\delta^0}.$$

For $k \in \{1, \dots, n\}$ and $\psi \in \mathcal{C}_c^\infty(O)$, we choose h in the direction of the x_l coordinate, $l \in \{1, \dots, n-1\}$. we then have

$$\left| (\partial_{x_k} v, D_{-h} \psi)_{L^2(O)} \right| = \left| (D_h \partial_{x_k} v, \psi)_{L^2(O)} \right| \leq \|D_h V\|_{\mathcal{H}_\delta^1} \|\psi\|_{L^2} \lesssim \|F\|_{\mathcal{H}_\delta^0} \|\psi\|_{L^2}.$$

As the l.h.s. converges to $\left| (\partial_{x_k} v, \partial_{x_l} \psi)_{L^2(O)} \right|$ we obtain that $\partial_{x_k x_l}^2 v \in L^2$ and

$$\|\partial_{x_k x_l}^2 v\|_{L^2} \lesssim \|F\|_{\mathcal{H}_\delta^0}, \quad (k, l) \neq (n, n)$$

Similarly for $k \in \{1, \dots, n-1\}$ and $\psi^s \in \mathcal{C}_c^\infty(O \cap S)$, we choose h in the direction of the x_l coordinate, $l \in \{1, \dots, n-1\}$. We have

$$\delta^{\frac{1}{2}} \left| (\partial_{x_k} v^s, D_{-h} \psi^s)_{L^2(O \cap S)} \right| = \delta^{\frac{1}{2}} \left| (D_h \partial_{x_k} v^s, \psi^s)_{L^2(O \cap S)} \right| \leq \|D_h V\|_{\mathcal{H}_\delta^1} \|\psi^s\|_{L^2} \lesssim \|F\|_{\mathcal{H}_\delta^0} \|\psi^s\|_{L^2}.$$

and we obtain $\partial_{x_k x_l}^2 v^s \in L^2(O)$ and moreover

$$\delta^{\frac{1}{2}} \|\partial_{x_k x_l}^2 v^s\|_{L^2(O)} \lesssim \|F\|_{\mathcal{H}_\delta^0}, \quad k, l \in \{1, \dots, n-1\}$$

From (3.197) observe now that (in a weak sense) we have in $\Omega_i \cap O$, $i = 1, 2$,

$$\partial_{x_n}^2 v = -\frac{1}{c_{nn}} \left(\sum_{(k,l) \neq (n,n)} \partial_{x_k} c_{kl} \partial_{x_l} v + \alpha \phi + (\partial_{x_n} c_{nn}) \partial_{x_n} v - \lambda \alpha v \right).$$

It follows that $\partial_{x_n}^2 v|_{\Omega_i} \in L^2(\Omega_i)$ and

$$\|\partial_{x_n}^2 v|_{\Omega_i}\|_{L^2(\Omega_i)} \lesssim \|F\|_{\mathcal{H}_\delta^0}, \quad i = 1, 2,$$

which concludes the proof. \square

3.8.3 Proof of Proposition 3.12

An inspection of the proof shows that is sufficient to assume that c is piecewise \mathcal{C}^{m+1} , c^s is \mathcal{C}^{m+1} and that S is of class \mathcal{C}^{m+2} . We proceed by induction. The case $m = 0$ is treated in Proposition 3.11. Let $m_0 > 0$. Assume the result is true for $0 \leq m \leq m_0 - 1$ and $f|_{\Omega_i} \in H^{m_0}(\Omega_i)$, $i = 0, 1$, and $f^s \in H^{m_0}(S)$. We thus have $Z = (z, z^s) \in H^{m_0+1}(\Omega_1 \cup \Omega_2) \times H^{m_0+1}(S)$ with

$$\sum_{i=1,2} \|z|_{\Omega_i}\|_{H^{m_0+1}(\Omega_i)} + \delta^{\frac{1}{2}} \|z^s\|_{H^{m_0+1}(S)} \lesssim \sum_{i=1,2} \|f|_{\Omega_i}\|_{H^{m_0}(\Omega_i)} + \delta^{\frac{1}{2}} \|f^s\|_{H^{m_0}(S)} = N_{m_0}(F).$$

We use the same partition of unity θ_j , $j = 1, \dots, N$, as in the proof of Proposition 3.11. Since the result is known away from S by standard elliptic regularity theory. We thus place ourselves in $O = O_j$ such that $O_j \cap S \neq \emptyset$. With $\theta = \theta_j$ we set $v = \theta z$ and $v^s = \theta z^s$ and $V = (v, v^s)$. With the notation of the proof of Proposition 3.11 we obtain after a local change of variables

$$\begin{aligned} & \sum_{k,l} \int_O c_{k,l} \partial_{x_k} v \partial_{x_l} \bar{\psi} dx + \delta \sum'_{k,l} \int_{O \cap S} c_{k,l}^s \partial_{x_k} v^s \partial_{x_l} \bar{\psi}^s dx + \lambda \int_O \alpha v \bar{\psi} dx + \delta \lambda \int_{O \cap S} \beta v^s \bar{\psi}^s dx \\ &= \int_O \alpha \phi \bar{\psi} dx + \delta \int_{O \cap S} \beta \phi^s \bar{\psi}^s dx, \end{aligned} \quad (3.198)$$

for $\Psi = (\psi, \psi^s) \in \mathcal{H}_\delta^1$, where $\sum_{k,l}$ is a sum with k, l running over $\{1, \dots, n\}$ and $\sum'_{k,l}$ is a sum with k, l running over $\{1, \dots, n-1\}$. We have $v \in H^{m_0+1}(O)$ and $v^s \in H^{m_0+1}(O \cap S)$ with their supports finitely away from ∂O and $\Phi = (\phi, \phi^s)$ is such that

$$\sum_{i=1,2} \|\phi|_{\Omega_i}\|_{H^{m_0}(\Omega_i)} + \delta^{\frac{1}{2}} \|\phi^s\|_{H^{m_0}(S)} \lesssim N_{m_0}(F).$$

The functions $\underline{c}_{k,l}$ are piecewise \mathcal{C}^{m+1} with a discontinuity across the interface S and the functions $\underline{c}_{k,l}^s$ are \mathcal{C}^{m+1} .

For $j = 1, \dots, n-1$, if Ψ is chosen such that

$$\psi = \partial_{x_j} \tilde{\psi}, \quad \psi^s = \partial_{x_j} \tilde{\psi}^s, \quad \text{with } (\tilde{\psi}, \tilde{\psi}^s) \in (\mathcal{C}_c^\infty(O) \times \mathcal{C}_c^\infty(S \cap O)) \cap \mathcal{H}_\delta^1,$$

as we have $\partial_{x_j} v|_{\Omega_i} \in H^1(\Omega_i)$ and $\partial_{x_j} v^s \in H^1(S)$, we find

$$\begin{aligned} \sum_{k,l} \int_O \underline{c}_{k,l} \partial_{x_k x_j}^2 v \partial_{x_l} \bar{\psi} dx + \delta \sum'_{k,l} \int_{O \cap S} \underline{c}_{k,l}^s \partial_{x_k x_j}^2 v^s \partial_{x_l} \bar{\psi}^s dx + \lambda \int_O \alpha \partial_{x_j} v \bar{\psi} dx + \delta \lambda \int_{O \cap S} \beta \partial_{x_j} v^s \bar{\psi}^s dx \\ = \int_O \tilde{\phi} \bar{\psi} dx + \delta \int_{O \cap S} \tilde{\phi}^s \bar{\psi}^s dx, \end{aligned}$$

with

$$\sum_{i=1,2} \|\tilde{\phi}|_{\Omega_i}\|_{H^{m_0-1}(\Omega_i)} + \delta^{\frac{1}{2}} |\tilde{\phi}^s|_{H^{m_0-1}(S)} \lesssim N_{m_0}(F).$$

The induction assumption then yields¹⁰

$$\sum_{i=1,2} \|\partial_{x_j} v|_{\Omega_i}\|_{H^{m_0+1}(\Omega_i \cap O)} + \delta^{\frac{1}{2}} |\partial_{x_j} v^s|_{H^{m_0+1}(S \cap O)} \lesssim N_{m_0}(F). \quad (3.199)$$

From (3.198) we have in $\Omega_i \cap O$, in a weak sense, $i = 1, 2$,

$$\partial_{x_n}^2 v = -\frac{1}{\underline{c}_{nn}} \left(\sum_{(k,l) \neq (n,n)} \partial_{x_k} \underline{c}_{kl} \partial_{x_l} v + \alpha \phi + (\partial_{x_n} \underline{c}_{nn}) \partial_{x_n} v - \lambda \alpha v \right).$$

Yet, as $v|_{\Omega_i} \in H^2(\Omega_i)$, this also holds in $L^2(\Omega_i)$. We thus conclude that $\partial_{x_n}^2 v|_{\Omega_i} \in H^{m_0}(\Omega_i \cap O)$ and

$$\|\partial_{x_n}^2 v|_{\Omega_i}\|_{H^{m_0}(\Omega_i)} \lesssim N_{m_0}(F),$$

by (3.199). This concludes the proof. \square

3.8.4 Proof of Lemma 3.24

The proof we give extends that of Lemma 3 page 480 in [LR97]. We drop the “ γ_l ” notation here since the same argument holds for both cases. We have $p_\varphi = \xi_n^2 + 2i(\partial_{x_n} \varphi) \xi_n + q_2 + 2iq_1$. We set $\alpha \in \mathbb{C}$ such that $\alpha^2 = (\partial_{x_n} \varphi)^2 + q_2 + 2iq_1$. Then the imaginary parts of the two roots of p_φ are $-\partial_{x_n} \varphi \pm \text{Re}(\alpha)$ and have opposite signs if and only if $|\text{Re}(\alpha)| > |\partial_{x_n} \varphi|$. We note that

$$|\text{Re}(z)| > A \Leftrightarrow \text{Re}(z^2) > A^2 - \frac{(\text{Im}(z^2))^2}{4A^2}, \quad z \in \mathbb{C}, \quad (3.200)$$

with a similar equivalence in the case of equalities on both sides. Substituting α for z , and $|\partial_{x_n} \varphi|$ for A , we thus obtain that the imaginary part of the roots have opposite signs if and only if $\mu > 0$, as $\mu = q_2 + q_1^2 / (\partial_{x_n} \varphi)^2$. In the case $\mu = 0$ only one of the roots is real and the imaginary part of the second one is of the opposite sign of $\partial_{x_n} \varphi$. In the case $\mu < 0$ both imaginary parts of the roots have the same sign equal to the opposite sign of $\partial_{x_n} \varphi$.

If we have $\text{Im}(\rho^+) \geq C_0 > 0$ and $\text{Im}(\rho^-) \leq -C_0$ then $|\text{Re}(\alpha)| \geq |\partial_{x_n} \varphi| + C_0$ and by (3.200) we obtain

$$(\partial_{x_n} \varphi)^2 + q_2 = \text{Re}(\alpha^2) \geq (|\partial_{x_n} \varphi| + C_0)^2 - \frac{q_1^2}{(|\partial_{x_n} \varphi| + C_0)^2}.$$

10. The induction assumption is applied to the local form of the elliptic problem here, i.e., (3.198).

which gives

$$\mu \geq C_0^2 + 2C_0|\partial_{x_n}\varphi| + q_1^2 \left(\frac{1}{(\partial_{x_n}\varphi)^2} - \frac{1}{(|\partial_{x_n}\varphi| + C_0)^2} \right) \geq C > 0.$$

Conversely, let us assume that $\mu \geq C_1 > 0$. Note that for all $M > 0$, there exists $R > 0$ such that $|\xi_0| + |\eta|_g \geq R \Rightarrow |\operatorname{Re}(\alpha)| \geq M$. Actually, we have

$$\operatorname{Re}(\alpha^2) - M^2 + \frac{\operatorname{Im}(\alpha^2)^2}{4M^2} > 0$$

for $|\xi_0| + |\eta|_g \geq R \Rightarrow |\operatorname{Re}(\alpha)|$ sufficiently large, which yields $|\operatorname{Re}(\alpha)| \geq M$. Taking now $M = |\partial_{x_n}\varphi| + C$, we obtain $|\operatorname{Im}(\rho^\pm)| \geq C$.

It suffices to take $|\xi_0| + |\eta|_g \leq R$, $x_0 \in [0, X_0]$, $x_n \in [-2\varepsilon, 2\varepsilon]$. The variables $(x_0, y, x_n, \xi_0, \eta)$ such that $\mu \geq C_1$ are in a compact set K . Then, $\min_K |\operatorname{Im}(\rho^\pm)|$ is reached. Finally, $\mu \geq C_1$ implies $|\operatorname{Im}(\rho^\pm)| \geq C > 0$ as $\operatorname{Im}(\rho^\pm)$ does not vanish if $\mu > 0$. This concludes the proof of the first part of the lemma.

We now address the last point of the lemma. Let $0 < l < L < \inf_{V_\varepsilon^+} |\partial_{x_n}\varphi|$ and let $H = L^2 - l^2$. We consider the region $\{\mu \geq -H\}$. In this region we have

$$\mu \geq l^2 - (\partial_{x_n}\varphi)^2 \geq (l^2 - (\partial_{x_n}\varphi)^2) \left(1 + \frac{q_1^2}{l^2(\partial_{x_n}\varphi)^2} \right) = l^2 - (\partial_{x_n}\varphi)^2 + q_1^2 \left(\frac{1}{(\partial_{x_n}\varphi)^2} - \frac{1}{l^2} \right).$$

Since $\mu = q_2 + q_1^2/(\partial_{x_n}\varphi)^2$ we then have $q_2 + (\partial_{x_n}\varphi)^2 \geq l^2 - \frac{q_1^2}{l^2}$ which by (3.200) yields $|\operatorname{Re}(\alpha)| \geq l$. We conclude by observing that $|\rho^+ - \rho^-| \geq |\operatorname{Im}\rho^+ - \operatorname{Im}\rho^-| = 2|\operatorname{Re}(\alpha)|$. \square

3.8.5 Proof of Lemma 3.26

We follow the notation of the proof of Lemma 3.24 above and we drop the “ γ_i ” notation here since the same argument holds for both cases. We choose $\alpha \in \mathbb{C}$ such that $\alpha^2 = (\partial_{x_n}\varphi)^2 + q_2 + 2iq_1 = r(x, \xi_0, \eta) - r(x, \partial_{x_0}\varphi, d_y\varphi) + 2i\tilde{r}(x, \xi_0, \eta, \partial_{x_0}\varphi, d_y\varphi)$ which yields the roots to be $-i\partial_{x_n}\varphi \pm i\alpha$. We set $\lambda_{\mathcal{T}} = (1 + \xi_0^2 + |\eta|_g^2)^{\frac{1}{2}} \in S_{\mathcal{T}}^1(\mathcal{M}_+^*)$ and write $(\alpha/\lambda_{\mathcal{T}})^2 = \nu_1 + \nu_2$ with

$$\nu_1 = \frac{r(x, \xi_0, \eta)}{\lambda_{\mathcal{T}}^2} \quad \text{and} \quad \nu_2 = \frac{1}{\lambda_{\mathcal{T}}^2} \left(-r(x, \partial_{x_0}\varphi, d_y\varphi) + 2i\tilde{r}(x, \xi_0, \eta, \partial_{x_0}\varphi, d_y\varphi) \right).$$

To prove the first result, i.e., $\chi\rho^\pm \in S_{\mathcal{T}}^1(\mathcal{M}_+^*)$, it suffices to consider $\lambda_{\mathcal{T}}$ large, as we already know that the two roots are smooth in $\operatorname{supp}(\chi)$. Note that there exists $L > 0$ such that $|\nu_1| \geq 2L$, and $|\nu_2| \leq L$ for $\lambda_{\mathcal{T}}$ large, say $\lambda_{\mathcal{T}} \geq R_1$. In this region we have $\operatorname{Re}(\alpha^2/\lambda_{\mathcal{T}}^2) \geq \nu_1 - |\operatorname{Re}(\nu_2)| \geq L$. In particular,

$$\operatorname{Re}(\alpha/\lambda_{\mathcal{T}}) \geq C > 0. \tag{3.201}$$

If $\lambda_{\mathcal{T}} \geq R_1$, we have thus obtained that $(\alpha/\lambda_{\mathcal{T}})^2$ remains away from a neighborhood of the branch \mathbb{R}_- for the complex square root and we may thus choose $\alpha/\lambda_{\mathcal{T}} = F((\alpha/\lambda_{\mathcal{T}})^2)$ with $F = \mathcal{C}^\infty(\mathbb{C})$. Since $(\alpha/\lambda_{\mathcal{T}})^2 \in S_{\mathcal{T}}^0(\mathcal{M}_+^*)$, it follows from Theorem 18.1.10 in [Hör85] that $\alpha/\lambda_{\mathcal{T}} \in S_{\mathcal{T}}^0(\mathcal{M}_+^*)$, for $\lambda_{\mathcal{T}} \geq R_1$, and it yields the first conclusion.

Let $C_0 > 0$ and let us place ourselves in a region $\{\mu \geq C_0\}$. By Lemma 3.24 we have $\operatorname{Im}(\rho^+) \geq C > 0$ and $\operatorname{Im}(\rho^-) \leq -C$. By (3.201), we obtain $|\operatorname{Im}(\rho^\pm)| \geq C\lambda_{\mathcal{T}}$. Since $\operatorname{Im}(\rho^+) - \operatorname{Im}(\rho^-) = 2\operatorname{Re}(\alpha)$, and since $|\operatorname{Im}(\rho^+) - \operatorname{Im}(\rho^-)| \geq C$, we obtain the final result with (3.201). \square

3.8.6 Proof of Lemma 3.29

Using (3.62) We have

$$\operatorname{Op}_{\mathcal{T}}(\chi_{\mathcal{G},j})(\phi_j^{-1})^* \zeta_j \tilde{\Xi}_{\mathcal{G},\mathcal{F}} v^r = (\phi_j^{-1})^* \Xi_{\mathcal{G},j} \tilde{\Xi}_{\mathcal{G},\mathcal{F}} v^r.$$

We then write

$$\text{Op}_T(\chi_{\mathcal{G},j})(\phi_j^{-1})^* \zeta_j \tilde{\Xi}_{\mathcal{G},\mathcal{F}} v^r = (\phi_j^{-1})^* \Xi_{\mathcal{G},j} v^r - (\phi_j^{-1})^* \Xi_{\mathcal{G},j} (1 - \tilde{\Xi}_{\mathcal{G},\mathcal{F}}) v^r.$$

Note that $u_{\mathcal{G},j} = (\phi_j^{-1})^* \Xi_{\mathcal{G},j} v^r$ by (3.64). We have $\Xi_{\mathcal{G},j} (1 - \tilde{\Xi}_{\mathcal{G},\mathcal{F}}) \in h^\infty \Psi_T^{-\infty}(\mathcal{M}_+)$ as their local symbols in every chart have disjoint supports by Proposition 3.52, because of the supports of ζ^3 and $\tilde{\chi}_{\mathcal{G},\mathcal{F}}$. This concludes the proof. \square

3.8.7 Proof of Lemma 3.32

Here, all functions are evaluated at the interface, i.e. $x_n = 0^+$. From (3.130) we have

$$\tilde{\sigma}_\delta = \tilde{\sigma}_\delta^{(0)} + \tilde{r}$$

with

$$\tilde{\sigma}_\delta^{(0)} = 2\partial_{x_n} \varphi_j^r |\sigma_\delta|^2 + 4q_{1,j}^r \text{Re}(\sigma_\delta) - 2(\partial_{x_n} \varphi_j^r) q_{2,j}^r$$

and $\tilde{r} \in \frac{\delta^2}{h} S_T^3 + \delta S_T^2 + h S_T^1$, according to the definitions of $\tilde{\Sigma}_\delta$ in (3.132), of σ_δ in (3.130), and B_1^r , $B_1^{r'}$, B_2^r in (3.122). Observe that $\hat{\chi} \frac{h^2}{\delta^2 + h^2} \tilde{\sigma}_\delta^{(0)} \in S_T^0$ and that the remainder satisfies

$$\hat{\chi} \frac{h^2}{\delta^2 + h^2} \tilde{r} \in h S_T^0, \quad (3.202)$$

since $\langle (\xi_0, \xi') \rangle \leq C$ in $\text{supp}(\hat{\chi})$.

Now, let us produce a lower bound for the symbol $\tilde{\sigma}_\delta^{(0)}$. Recalling the definition of μ^r in (3.50), denoting $\mu_j^r = (\phi_j^{-1})^* \mu^r$ and $\vartheta = -i \frac{\delta c_j^s}{h c_j^l} p_{\varphi,j}^s$, we find

$$\begin{aligned} \tilde{\sigma}_\delta^{(0)} &= \frac{2}{\beta^2} (\partial_{x_n} \varphi_j^r) |\vartheta - \rho_j^{l,+} + k|^2 + \frac{4}{\beta} \text{Re}(\vartheta - \rho_j^{l,+} + k) q_{1,j}^r - 2(\partial_{x_n} \varphi_j^r) q_{2,j}^r \\ &= 2\partial_{x_n} \varphi_j^r \left(|\vartheta - \rho_j^{l,+} + k|/\beta + q_{1,j}^r / |\partial_{x_n} \varphi_j^r|^2 - \mu_j^r \right) \\ &\geq 2\partial_{x_n} \varphi_j^r \left(\left(\text{Im}(-\vartheta + \rho_j^{l,+} - k)/\beta \right)^2 - \mu_j^r \right), \end{aligned}$$

since $\partial_{x_n} \varphi_j^r \geq C > 0$ and $q_{1,j}^r$ is real. We hence have

$$\text{Im}(-\vartheta + \rho_j^{l,+} - k) = \frac{\delta c_j^s}{h c_j^l} \text{Re} p_\varphi^s + (\text{Im} \rho_j^{l,+} - \text{Im} \rho_j^{l,-})/2 + \beta \partial_{x_n} \varphi_j^r,$$

as (3.73) gives $-\text{Im} k = \partial_{x_n} \varphi_j^l + \beta \partial_{x_n} \varphi_j^r$ and the properties of the roots of the polynomial p_φ^{7l} given in (3.48) yield $\partial_{x_n} \varphi_j^l = -(\text{Im} \rho_j^{l,+} + \text{Im} \rho_j^{l,-})/2$. The first point of Lemma 3.24 gives $\text{Im} \rho_j^{l,+} - \text{Im} \rho_j^{l,-} \geq 0$, and we thus obtain

$$\text{Im}(-\vartheta + \rho_j^{l,+} - k) \geq K_2 \delta/h + \beta \partial_{x_n} \varphi_j^r,$$

since in the present region, $\text{Re}(p_{\varphi,j}^s)$ is positive elliptic by Proposition 3.23 and the form of (3.49). Using condition (3.114), i.e., $(\partial_{x_n} \varphi_j^r)^2 - \mu_j^r \geq K_1 > 0$ we find

$$\tilde{\sigma}_\delta^{(0)} \geq 2\partial_{x_n} \varphi_j^r \left(\frac{\delta^2 K_2^2}{h^2 \beta^2} + K_1 \right).$$

This, together with (3.202) concludes the proof. \square

3.8.8 Proof of Lemma 3.34

Let $X = (x_0, x', \xi_0, \xi') \in W$ and $\tilde{X} = (\tilde{x}_0, \tilde{x}', \tilde{\xi}_0, \tilde{\xi}') \in W$. If

$$g_{W,X}(X - \tilde{X}) = |(x_0, x') - (\tilde{x}_0, \tilde{x}')|^2 + \frac{|(\xi_0, \xi') - (\tilde{\xi}_0, \tilde{\xi}')|^2}{\langle (\xi_0, \xi') \rangle^2} < r^2,$$

then, for r sufficiently small, we have $C^{-1} \leq \frac{\langle (\tilde{\xi}_0, \tilde{\xi}') \rangle}{\langle (\xi_0, \xi') \rangle} \leq C$ for some $C > 0$. As a consequence, we obtain $C^{-1} \leq \frac{\Lambda(\tilde{X})}{\Lambda(X)} \leq C$ with $h, \delta > 0$ arbitrary. Hence Λ is slowly varying.

Next, we have

$$\langle (\tilde{\xi}_0, \tilde{\xi}') \rangle^2 \lesssim \langle (\xi_0, \xi') \rangle^2 (1 + |(\xi_0, \xi') - (\tilde{\xi}_0, \tilde{\xi}')|^2)$$

so that

$$\frac{\Lambda(\tilde{X})^2}{\Lambda(X)^2} \lesssim (1 + |(\xi_0, \xi') - (\tilde{\xi}_0, \tilde{\xi}')|^2) \lesssim (1 + g_{W,X}^\sigma(X - \tilde{X})),$$

for $h, \delta > 0$ arbitrary. Here g_W^σ denotes the dual metric on W , $g_W^\sigma = \langle (\xi_0, \xi') \rangle^2 |d(x_0, x')|^2 + |d(\xi_0, \xi')|^2$. Hence, the order function Λ is temperate, which concludes the proof. \square

3.8.9 Proof of Theorem 3.39 : change of variables for semi-classical operators

Here we consider operators on the whole space \mathbb{R}^n of the form

$$a(x, D_x, \tau) = u(x) = \iint e^{i\langle x-y, \xi \rangle} a(x, \xi, \tau) u(y) dy d\xi, \quad d\xi = (2\pi)^{-n} d\xi, \quad (3.203)$$

where $a(x, \xi, \tau)$ is smooth in x and ξ and satisfies for some $m \in \mathbb{R}$,

$$|\partial_x^\alpha \partial_\xi^\beta a(x, \xi, \tau)| \leq C_{\alpha, \beta} \mu^{m-|\beta|}, \quad \mu^2 = \tau^2 + |\xi|^2, \quad \tau \geq 1. \quad (3.204)$$

We say that $a \in S(\mu^m)$. We shall prove a change of variables formula for this kind of operators. We choose this form of operator to make use of parts of existing proofs. Operators of the form (3.203) are also called semi-classical.

We recall that the semi-classical operators we consider in the main part of the article, i.e., with a small parameter h , can be put in the form (3.203). In fact, with $a(x, \xi, h) \in S^m$, we write

$$\text{op}(a)u(x) = (2\pi h)^{-n} \iint e^{i\langle x-y, \xi \rangle/h} a(x, \xi, h) u(y) dy d\xi = \iint e^{i\langle x-y, \xi \rangle} a(x, h\xi, h) u(y) dy d\xi,$$

and we have $|\partial_x^\alpha \partial_\xi^\beta a(x, h\xi, h)| \lesssim h^{|\beta|} \langle h\xi \rangle^{m-|\beta|}$. With $\tau = 1/h$ we find

$$|\partial_x^\alpha \partial_\xi^\beta \tau^m a(x, h\xi, h)| \lesssim \tau^{m-|\beta|} (1 + |\xi|/\tau)^{m-|\beta|} \lesssim \mu^{m-|\beta|}.$$

Hence, the symbol $h^{-m} a(x, h\xi, h)$ satisfies (3.204).

Theorem 3.39 is the translation for semi-classical tangential operators with a small parameter h of the following theorem.

Theorem 3.54. *Let X and X_κ be open subsets of \mathbb{R}^n and let $\kappa : X \rightarrow X_\kappa$ be a diffeomorphism. If $a \in S(\mu^m)$ and the kernel of $a(x, D_x, \tau)$ has compact support in $X \times X$ then the function*

$$a_\kappa(y, \eta, \tau) = \begin{cases} e^{-i\langle \kappa(x), \eta \rangle} a(x, D_x, \tau) e^{i\langle \kappa(x), \eta \rangle} & \text{if } y = \kappa(x) \in X_\kappa, \\ 0 & \text{if } y \notin X_\kappa, \end{cases} \quad (3.205)$$

is in $S(\mu^m)$, the kernel of $a_\kappa(x, D_x, \tau)$ has compact support in $X_\kappa \times X_\kappa$, and

$$(a_\kappa(x, D_x, \tau)u) \circ \kappa = a(x, D_x, \tau)(u \circ \kappa), \quad u \in \mathcal{S}'(\mathbb{R}^n). \quad (3.206)$$

For a_κ we have the following asymptotic expansion

$$a_\kappa(\kappa(x), \eta, \tau) - \sum_{\alpha < N} \frac{(-i)^{|\alpha|}}{\alpha!} \partial_\xi^\alpha a(x, {}^t\kappa(x)' \eta, \tau) \partial_y^\alpha e^{i\langle \rho_x(y), \eta \rangle} \Big|_{y=x} \in S(\mu^{m-N/2}), \quad (3.207)$$

where $\rho_x(y) = \kappa(y) - \kappa(x) - \kappa'(x)(y - x)$.

Note that $\rho_x(y)$ vanishes at second order at x and that the terms in the series are in $S(\mu^{m-|\alpha|/2})$. In fact the order of each term in the asymptotic series (3.207) is explained by the following result that we shall use below.

Lemma 3.55. *We can write $\partial_y^\alpha e^{i\langle \rho_x(y), \eta \rangle}$ as a linear combination of terms*

$$\prod_{j \in \mathcal{I}} \langle x - y, \rho_{x,j}(y) \eta \rangle \prod_{j \in \mathcal{J}} \langle \partial_y^{\alpha_j} \rho_x(y), \eta \rangle e^{i\langle \rho_x(y), \eta \rangle},$$

for some matrix-valued function $\rho_{x,j}$, $j \in \mathcal{I} \cup \mathcal{J}$, with $|\alpha_j| \geq 2$ if $j \in \mathcal{J}$, $k = |\mathcal{I}|$ and $\ell = |\mathcal{I}| + |\mathcal{J}|$ such that $k \leq \ell \leq |\alpha|$ and $\ell \leq \frac{|\alpha| + k}{2}$. In particular, $|\partial_y^\alpha e^{i\langle \rho_x(y), \eta \rangle} \Big|_{x=y}| \leq C_\alpha \langle \eta \rangle^{\frac{\alpha}{2}}$.

Proof. We note that $\partial_y^\alpha (e^{i\langle \rho_x(y), \eta \rangle})$ can be written linear combination of terms of the form

$$e^{i\langle \rho_x(y), \eta \rangle} \prod_{1 \leq j \leq p} \langle \partial_y^{\alpha_j} \rho_x(y), \eta \rangle, \quad \text{with} \quad \sum_{1 \leq j \leq p} |\alpha_j| = |\alpha|, \quad p \leq |\alpha|, \quad |\alpha_j| \geq 1.$$

We set $\mathcal{I} = \{1 \leq j \leq p; |\alpha_j| = 1\}$ and $\mathcal{J} = \{1 \leq j \leq p; |\alpha_j| \geq 2\}$. We have $|\mathcal{I}| + |\mathcal{J}| = p \leq |\alpha|$ and moreover $|\alpha| \geq |\mathcal{I}| + 2|\mathcal{J}|$, which gives $|\mathcal{I}| + |\mathcal{J}| \leq (|\alpha| + |\mathcal{I}|)/2$. As $\rho_x(y)$ vanishes at second order at $y = x$ we obtain $\langle \partial_y^{\alpha_j} \rho_x(y), \eta \rangle = \langle x - y, \rho_{x,j}(y) \eta \rangle$ for some function $\rho_{x,j}$ if $j \in \mathcal{I}$. \square

Proof of Theorem 3.54 Let the kernel of $a(x, D_x, \tau)$ be supported in $K \times K$, $K \subset X$, compact. In particular $a(x, \xi, \tau) = 0$ if $x \notin K$. Let $\phi \in \mathcal{C}_c^\infty(X)$ be such that $\phi = 1$ in a neighborhood of K , and $\tilde{\phi} \in \mathcal{C}_c^\infty(X)$ be such that $\tilde{\phi} = 1$ in a neighborhood of $\text{supp}(\phi)$. Here, we follow the proof of Theorem 18.1.17 in [Hör85], and we first obtain that for τ fixed formula (3.206) holds for a_κ given by (3.205). Moreover a_κ is smooth w.r.t. x and ξ and we have

$$a_\kappa(\kappa(x), \xi) = \phi(x) \iint e^{i\langle x-y, \xi \rangle + i\langle \kappa(y) - \kappa(x), \eta \rangle} a(x, \xi, \tau) \tilde{\phi}(y) dy d\xi, \quad x \in X. \quad (3.208)$$

It thus remains to prove that $a_\kappa \in S(\mu^m)$ and that the asymptotic representation (3.207) holds.

For the proof we shall distinguish two regimes : $\tau \lesssim |\eta|$ and $\tau \gtrsim |\eta|$. We thus introduce $w \in \mathcal{C}_c^\infty(\mathbb{R})$ such that $w = 1$ in a neighborhood of 0 and set

$$\gamma_1(x, \eta, \tau) = w(\tau/\langle \eta \rangle) a_\kappa(\kappa(x), \eta, \tau), \quad \gamma_2(x, \eta, \tau) = (1 - w)(\tau/\langle \eta \rangle) a_\kappa(\kappa(x), \eta, \tau).$$

We shall prove the following two propositions below.

Proposition 3.56. *We have $\gamma_1(x, \eta, \tau) \in S(\mu^m)$ and*

$$\gamma_1(x, \eta, \tau) - w(\tau/\langle \eta \rangle) \sum_{\alpha < N} \frac{(-i)^{|\alpha|}}{\alpha!} \partial_\xi^\alpha a(x, {}^t\kappa(x)' \eta) \partial_y^\alpha e^{i\langle \rho_x(y), \eta \rangle} \Big|_{y=x} \in S(\mu^{m-N/2}). \quad (3.209)$$

Proposition 3.57. *We have $\gamma_2(x, \eta, \tau) \in S(\mu^m)$ and*

$$\gamma_2(x, \eta, \tau) - (1 - w)(\tau/\langle \eta \rangle) \sum_{\alpha < N} \frac{(-i)^{|\alpha|}}{\alpha!} \partial_\xi^\alpha a(x, {}^t\kappa(x)' \eta) \partial_y^\alpha e^{i\langle \rho_x(y), \eta \rangle} \Big|_{y=x} \in S(\mu^{m-N/2}). \quad (3.210)$$

With these two results the proof of Theorem 3.54 clearly follows as κ is a diffeomorphism. \square

We shall need the following result in the course of the proofs, which is the counterpart of Proposition 18.1.4 in [Hör85] for semi-classical symbols.

Lemma 3.58. Let $a_j(x, \xi, \tau) \in S(\mu^{m_j})$, $j \in N$, with $m_j \rightarrow -\infty$ as $j \rightarrow \infty$. Let $a(x, \xi, \tau)$ be smooth with respect to x and ξ such that for all α, β for some $C > 0$ and ν depending on α and β

$$|\partial_x^\alpha \partial_\xi^\beta a(x, \xi, \tau)| \leq C\mu^\nu, \quad x, \xi \in \mathbb{R}^n, \quad \tau \geq 1. \quad (3.211)$$

Assume there is a sequence $\nu_k \rightarrow -\infty$ such that

$$|a(x, \xi, \tau) - \sum_{j < k} a_j(x, \xi, \tau)| \leq C_k \mu^{\nu_k}, \quad x, \xi \in \mathbb{R}^n, \quad \tau \geq 1, \quad (3.212)$$

then $a \in S(\mu^m)$, $m = \sup m_j$, and $a(x, \xi, \tau) - \sum_{j < k} a_j(x, \xi, \tau) \in S(\mu^{m'_k})$, with $m'_k = \max_{j \geq k} m_j$.

The proof of lemma 3.58 is similar to that of Proposition 18.1.4 in [Hör85]. It is left to the reader.

Proof of Proposition 3.56. We have

$$\begin{aligned} \gamma_1(x, \eta, \tau) &= w(\tau/\langle \eta \rangle) a_\kappa(\kappa(x), \xi) \\ &= w(\tau/\langle \eta \rangle) \phi(x) \iint e^{i\langle x-y, \xi \rangle + i\langle \kappa(y) - \kappa(x), \eta \rangle} a(x, \xi, \tau) \tilde{\phi}(y) dy d\xi, \quad x \in X. \end{aligned} \quad (3.213)$$

Let C_0 be such that $\max(|\kappa'(y)|, |\kappa'(y)^{-1}|) \leq C_0$. Setting $\Phi(\xi, \eta) = \int e^{i\langle \kappa(y), \eta \rangle - i\langle y, \xi \rangle} \tilde{\phi}(y) dy$, one obtains through a non-stationary phase argument [Hör85, page 82]

$$|\Phi(\xi, \eta)| \leq C_N (1 + |\xi| + |\eta|)^{-N}, \quad \text{if } |\xi| \leq \frac{|\eta|}{2C_0} \text{ or } |\xi| \geq 2C_0|\eta|. \quad (3.214)$$

Let then $\chi(\xi) \in \mathcal{C}_c^\infty(\mathbb{R}^n)$ be equal to 1 if $(2C_0)^{-1} < |\xi| < 2C_0$ and equal to 0 if $|\xi| < (4C_0)^{-1}$ and let us write $\gamma_1 = I_1 + I_2$ with

$$\begin{aligned} I_1(x, \eta, \tau) &= w(\tau/\langle \eta \rangle) \phi(x) \iint e^{i\langle x-y, \xi \rangle + i\langle \kappa(y) - \kappa(x), \eta \rangle} a(x, \xi, \tau) \tilde{\phi}(y) (1 - \chi)(\xi/|\eta|) dy d\xi \\ &= w(\tau/\langle \eta \rangle) \phi(x) e^{-i\langle \kappa(x), \eta \rangle} \int e^{i\langle x, \xi \rangle} a(x, \xi, \tau) \Phi(\xi, \eta) (1 - \chi)(\xi/|\eta|) d\xi, \end{aligned}$$

and

$$\begin{aligned} I_2 &= w(\tau/\langle \eta \rangle) \phi(x) \iint e^{i\langle x-y, \xi \rangle + i\langle \kappa(y) - \kappa(x), \eta \rangle} a(x, \xi, \tau) \tilde{\phi}(y) \chi(\xi/|\eta|) dy d\xi \\ &= w(\tau/\langle \eta \rangle) \phi(x) \omega^n e^{-i\langle \kappa(x), \eta \rangle} \iint e^{i\omega \langle x-y, \xi \rangle + i\omega \langle \kappa(y), \eta/\omega \rangle} a(x, \omega\xi, \tau) \tilde{\phi}(y) \chi(\xi) dy d\xi, \quad \omega = |\eta|. \end{aligned}$$

With (3.214) and as $\tau \lesssim |\eta|$ here we find

$$|I_1(x, \eta, \tau)| \leq C_N |w(\tau/\langle \eta \rangle)| \int (\tau + |\xi|)^m (1 + |\xi| + |\eta|)^{-(N+n+1+m)} d\xi, \quad N \in \mathbb{N}.$$

which gives

$$|I_1(x, \eta, \tau)| \leq \begin{cases} C_N |w(\tau/\langle \eta \rangle)| \int (|\eta| + |\xi|)^m (1 + |\xi| + |\eta|)^{-(N+n+1+m)} d\xi & \text{if } m \geq 0, \\ C_N |w(\tau/\langle \eta \rangle)| \int (1 + |\xi|)^m (1 + |\xi| + |\eta|)^{-(N+n+1+m)} d\xi, & \text{if } m < 0. \end{cases}$$

In any case we find

$$|I_1(x, \eta, \tau)| \leq C'_N \frac{|w(\tau/\langle \eta \rangle)|}{(1 + |\eta|)^N} \leq C'_N \frac{1}{(\tau + |\eta|)^N}, \quad N \in \mathbb{N}. \quad (3.215)$$

For the term I_2 we first write

$$I_2 = w(\tau/\langle \eta \rangle) \phi(x) \omega^n e^{-i\langle \kappa(x), \eta \rangle} \iint e^{i\omega \langle \kappa(x+y), \eta/\omega \rangle - \langle y, \xi \rangle} a(x, \omega\xi, \tau) \tilde{\phi}(x+y) \chi(\xi) dy d\xi, \quad \omega = |\eta|.$$

to apply the stationary-phase result of Theorem 7.7.7 in [Hör90], which yields for $k \geq n$:

$$\begin{aligned} & \left| I_2(x, \eta, \tau) - w(\tau/\langle \eta \rangle) \phi(x) \right. \\ & \quad \times \sum_{\nu=0}^{k-n} \frac{(-i)^\nu}{\nu!} \langle \partial_y, \partial_\xi / \omega \rangle^\nu \left(e^{i\omega \langle \rho_x(x+y), \eta / \omega \rangle} a(x, \omega \xi, \tau) \tilde{\phi}(x+y) \chi(\xi) \Big|_{y=0, \xi=t\kappa'(x)\eta/\omega} \right) \Big| \\ & \leq C \omega^{(n-k)/2} w(\tau/\langle \eta \rangle) \sum_{|\alpha| \leq 2k} \sup_{y, \xi} |D_{y, \xi}^\alpha (\tilde{\phi}(x+y) \chi(\xi) a(x, \omega \xi, \tau))| \end{aligned}$$

As $\tau \lesssim \omega$, and ξ is bounded, we observe that

$$|\omega^\alpha (D_\xi^\alpha a)(x, \omega \xi)| \lesssim \omega^{|\alpha|} (\tau + \omega |\xi|)^{m-|\alpha|} \lesssim (\tau + \omega)^m.$$

We also have $\chi(\xi) = 1$ in a neighborhood of ${}^t\kappa'(x)\eta/\omega$. As $\phi = 1$ and $\tilde{\phi} = 1$ in a neighborhood of K we thus obtain

$$\begin{aligned} & \left| I_2(x, \eta, \tau) - w(\tau/\langle \eta \rangle) \sum_{\nu=0}^{k-n} \frac{(-i)^\nu}{\nu!} \langle \partial_y, \partial_\xi \rangle^\nu \left(e^{i\langle \rho_x(y), \eta \rangle} a(x, \xi, \tau) \Big|_{y=x, \xi=t\kappa'(x)\eta/\omega} \right) \right| \\ & \leq C \omega^{(n-k)/2} (\tau + \omega)^m w(\tau/\langle \eta \rangle) \lesssim (\tau + |\eta|)^{m+\frac{n}{2}-\frac{k}{2}}, \quad x \in K. \end{aligned}$$

We have thus obtained an asymptotic development in the form of (3.212). As each term in the series is also a semi-classical symbol, by (3.215) we find that an estimate of the form (3.211) is achieved when no derivation is applied to γ_1 . Applying partial derivatives w.r.t. x and η to $\gamma_1(x, \eta, \tau)$ results in a sum of terms with the same form as (3.213) with additional expressions with at most polynomial growth in η . The analysis carried out above also yields an estimate of the form (3.211). With Lemma 3.58 this completes the proof. \square

Proof of Proposition 3.57. We have

$$\begin{aligned} \gamma_2(x, \eta, \tau) &= (1-w)(\tau/\langle \eta \rangle) a_\kappa(\kappa(x), \xi) \\ &= (1-w)(\tau/\langle \eta \rangle) \phi(x) \iint e^{i\langle x-y, \xi \rangle + i\langle \kappa(y) - \kappa(x), \eta \rangle} a(x, \xi, \tau) \tilde{\phi}(y) dy d\xi, \quad x \in X. \end{aligned} \quad (3.216)$$

This representation is to be understood in the sense of oscillatory integrals, which justifies the manipulations we perform below.

In the support of $(1-w)(\tau/\langle \eta \rangle)$ we have $\tau \gtrsim |\eta|$. As $\rho_x(y) = \kappa(y) - \kappa(x) - \kappa'(x)(y-x)$ we write

$$\begin{aligned} \gamma_2(x, \eta, \tau) &= (1-w)(\tau/\langle \eta \rangle) \phi(x) \iint e^{i\langle x-y, \xi \rangle - t\kappa'(x)\eta + i\langle \rho_x(y), \eta \rangle} a(x, \xi, \tau) \tilde{\phi}(y) dy d\xi \\ &= (1-w)(\tau/\langle \eta \rangle) \phi(x) \iint e^{i\langle x-y, \xi \rangle + i\langle \rho_x(y), \eta \rangle} a(x, \xi + {}^t\kappa'(x)\eta, \tau) \tilde{\phi}(y) dy d\xi, \end{aligned}$$

which by the Taylor formula gives $\gamma_2 = \gamma_{2,N} + r_N$ with

$$\gamma_{2,N}(x, \eta, \tau) = \sum_{|\alpha| < N} \frac{1}{\alpha!} (1-w)(\tau/\langle \eta \rangle) \phi(x) \iint e^{i\langle x-y, \xi \rangle + i\langle \rho_x(y), \eta \rangle} \xi^\alpha \partial_\xi^\alpha a(x, {}^t\kappa'(x)\eta, \tau) \tilde{\phi}(y) dy d\xi,$$

and

$$r_N = N \sum_{|\alpha|=N} \int_0^1 \frac{(1-\sigma)^{N-1}}{\alpha!} \iint e^{i\langle x-y, \xi \rangle + i\langle \rho_x(y), \eta \rangle} \xi^\alpha \partial_\xi^\alpha a(x, \sigma \xi + {}^t\kappa'(x)\eta, \tau) \tilde{\phi}(y) dy d\xi d\sigma.$$

Observing that $\xi^\alpha e^{i\langle x-y, \xi \rangle} = i^{|\alpha|} \partial_y^\alpha e^{i\langle x-y, \xi \rangle}$ we find

$$\begin{aligned} \gamma_2(x, \eta, \tau) &= (1-w)(\tau/\langle \eta \rangle) \phi(x) \sum_{|\alpha| < N} \frac{(-i)^{|\alpha|}}{\alpha!} \iint e^{i\langle x-y, \xi \rangle} \partial_y^\alpha (\tilde{\phi}(y) e^{i\langle \rho_x(y), \eta \rangle}) \partial_\xi^\alpha a(x, {}^t\kappa'(x)\eta, \tau) dy d\xi \\ &= (1-w)(\tau/\langle \eta \rangle) \phi(x) \sum_{|\alpha| < N} \frac{(-i)^{|\alpha|}}{\alpha!} \partial_y^\alpha (\tilde{\phi}(y) e^{i\langle \rho_x(y), \eta \rangle}) \Big|_{y=x} \partial_\xi^\alpha a(x, {}^t\kappa'(x)\eta, \tau) \\ &= (1-w)(\tau/\langle \eta \rangle) \sum_{|\alpha| < N} \frac{(-i)^{|\alpha|}}{\alpha!} \partial_y^\alpha (e^{i\langle \rho_x(y), \eta \rangle}) \Big|_{y=x} \partial_\xi^\alpha a(x, {}^t\kappa'(x)\eta, \tau), \end{aligned}$$

for $x \in K$, because of the supports of ϕ and $\tilde{\phi}$. From the properties of $\rho_y(x)$ given in Lemma 3.55 each term in the sum is in $S(\mu^{m-|\alpha|/2})$. Similarly we have

$$\begin{aligned} r_N(x, \eta, \tau) &= (1-w)(\tau/\langle \eta \rangle)\phi(x)N(-i)^N \sum_{|\alpha|=N} \sum_{\beta \leq \alpha} \binom{\alpha}{\beta} \int_0^1 \frac{(1-\sigma)^{N-1}}{\alpha!} \\ &\quad \times \iint e^{i\langle x-y, \xi \rangle} (\partial_y^{\beta-\alpha} \tilde{\phi}(y)) (\partial_y^\beta e^{i\langle \rho_x(y), \eta \rangle}) \partial_\xi^\alpha a(x, \sigma\xi + {}^t\kappa'(x)\eta, \tau) dy d\xi d\sigma. \end{aligned} \quad (3.217)$$

If we prove that $r_N \lesssim (\tau + |\eta|)^{m+n+1-N/2}$ if $N \geq m$, we then obtain an estimate of the form (3.212). In particular this yield $|\gamma_2| \lesssim \mu^\nu$ for some $\nu \in \mathbb{R}$.

Applying partial derivatives w.r.t. x and η to $\gamma_2(x, \eta, \tau)$ results in a sum of terms with the same form as (3.216) with additional expressions with at most polynomial growth in η . Computing $\partial_x^\alpha \partial_\eta^\beta \gamma_2$ we may apply a similar analysis and find $|\partial_x^\alpha \partial_\eta^\beta \gamma_2| \lesssim \mu^\nu$ for some $\nu \in \mathbb{R}$. We thus have an estimate of the form (3.211). With Lemma 3.58 this will complete the proof.

With Lemma 3.55 the remainder term r_N in (3.217) is a linear combination of terms of the form

$$\begin{aligned} r'_N(x, \eta, \tau) &= (1-w)(\tau/\langle \eta \rangle)\phi(x) \int_0^1 (1-\sigma)^{N-1} \iint e^{i\langle x-y, \xi \rangle} \hat{\phi}(y) \prod_{j \in \mathcal{J}} \langle \partial_y^{\alpha_j} \rho_x(y), \eta \rangle e^{i\langle \rho_x(y), \eta \rangle} \\ &\quad \times \prod_{j \in \mathcal{I}} \langle x-y, \rho_{x,j}(y)\eta \rangle \partial_\xi^\alpha a(x, \sigma\xi + {}^t\kappa'(x)\eta, \tau) dy d\xi d\sigma, \end{aligned}$$

with $|\alpha_j| \geq 2$ if $j \in \mathcal{J}$ and $k = |\mathcal{I}|$ and $\ell = |\mathcal{I}| + |\mathcal{J}|$ such that

$$k \leq \ell \leq |\beta| \leq |\alpha| = N, \quad \ell \leq \frac{|\beta| + k}{2}. \quad (3.218)$$

Here the function $\hat{\phi}$ has support in K and is constant on $\text{supp}(\phi)$.

As $\langle x-y, \rho_{x,j}(y)\eta \rangle e^{i\langle x-y, \xi \rangle} = -i\langle \partial_\xi, \rho_{x,j}(y)\eta \rangle e^{i\langle x-y, \xi \rangle}$ we obtain

$$\begin{aligned} r'_N(x, \eta, \tau) &= i^k (1-w)(\tau/\langle \eta \rangle)\phi(x) \int_0^1 (1-\sigma)^{N-1} \iint e^{i\langle x-y, \xi \rangle} \hat{\phi}(y) \prod_{j \in \mathcal{J}} \langle \partial_y^{\alpha_j} \rho_x(y), \eta \rangle e^{i\langle \rho_x(y), \eta \rangle} \\ &\quad \times \prod_{j \in \mathcal{I}} \langle \partial_\xi, \rho_{x,j}(y)\eta \rangle \partial_\xi^\alpha a(x, \sigma\xi + {}^t\kappa'(x)\eta, \tau) dy d\xi d\sigma, \end{aligned}$$

and we may thus write r_N as a linear combination of terms of the following form

$$\begin{aligned} r''_N(x, \eta, \tau) &= (1-w)(\tau/\langle \eta \rangle)\phi(x) \int_0^1 \sigma^{|\gamma|} (1-\sigma)^{N-1} \iint e^{i\langle x-y, \xi \rangle} \hat{\phi}(y) p(x, y, \eta) e^{i\langle \rho_x(y), \eta \rangle} \\ &\quad \times \partial_\xi^{\alpha+\gamma} a(x, \sigma\xi + {}^t\kappa'(x)\eta, \tau) dy d\xi d\sigma, \end{aligned}$$

where $|\gamma| = k$ and $p(x, y, \eta)$ is a polynomial in η of order ℓ with smooth coefficients.

We note that $\langle \xi \rangle^{-2} (1 + i\langle \xi, \partial_y \rangle) e^{i\langle x-y, \xi \rangle} = e^{i\langle x-y, \xi \rangle}$. This yields, for $q \in \mathbb{N}$,

$$\begin{aligned} r''_N(x, \eta, \tau) &= (1-w)(\tau/\langle \eta \rangle)\phi(x) \int_0^1 \sigma^{|\gamma|} (1-\sigma)^{N-1} \iint e^{i\langle x-y, \xi \rangle} (1 - i\langle \xi, \partial_y \rangle)^q \left(\hat{\phi}(y) p(x, y, \eta) e^{i\langle \rho_x(y), \eta \rangle} \right) \\ &\quad \times \langle \xi \rangle^{-2q} \partial_\xi^{\alpha+\gamma} a(x, \sigma\xi + {}^t\kappa'(x)\eta, \tau) dy d\xi d\sigma, \end{aligned}$$

We choose $|\alpha| = N \geq m$ and $q = n + 1$. We then have

$$|\partial_\xi^{\alpha+\gamma} a(x, \sigma\xi + {}^t\kappa'(x)\eta, \tau)| \leq (\tau + |\sigma\xi + {}^t\kappa'(x)\eta|)^{m-N-|\gamma|} \lesssim \tau^{m-N-|\gamma|}.$$

We thus obtain

$$|r''_N(x, \eta, \tau)| \leq |(1-w)(\tau/\langle \eta \rangle)| |\eta|^{\ell+n+1} \tau^{m-N-|\gamma|} \lesssim \tau^{m+\ell+n+1-N-|\gamma|},$$

as $m - N - |\gamma| \leq 0$ and $|\eta| \lesssim \tau$. Since $\ell \leq (N + k)/2 = (N + |\gamma|)/2$ this yields

$$|r''_N(x, \eta, \tau)| \lesssim \tau^{m+n+1-(N+|\gamma|)/2} \lesssim (\tau + |\eta|)^{m+n+1-N/2},$$

as claimed above. This concludes the proof. \square

3.8.10 Proof of Proposition 3.45

The proof follows some of the lines of that of Proposition 18.1.19 in [Hör85]. We fix $j \in J$. We take $\tilde{\lambda}_l$, $l \in L$, a locally finite partition of unity of $(0, X_0) \times \tilde{U}_j$. For all $k, l \in L$, we set $\sigma_{kl} \in S_{\mathcal{T}}^m(\mathbb{R}^n \times \mathbb{R} \times \mathbb{R}^n)$ as

$$\text{Op}_{\mathcal{T}}(\sigma_{kl}) = (\phi_j^{-1})^* \lambda_k A \phi_j^* \tilde{\lambda}_l, \quad \text{where } \lambda_k = \phi_j^* \tilde{\lambda}_k.$$

Note that $\text{supp}(\sigma_{kl}) \subset (0, X_0) \times \tilde{U}_j \times \mathbb{R} \times \mathbb{R}^n$. We define $a_j := \sum'_{k,l} \sigma_{kl}$ where \sum' denotes the sum over the pairs k, l such that $\text{supp}(\lambda_l) \cap \text{supp}(\lambda_k) \neq \emptyset$. This sum is locally finite, which gives $a_j \in S_{\mathcal{T}}^m((0, X_0) \times \tilde{U}_j \times \mathbb{R} \times \mathbb{R}^n)$.

For $\lambda \in \mathcal{C}_c^\infty((0, X_0) \times U_j)$, $\tilde{\lambda} \in \mathcal{C}_c^\infty((0, X_0) \times \tilde{U}_j)$ we consider

$$\begin{aligned} R &= (\phi_j^{-1})^* \lambda A \phi_j^* \tilde{\lambda} - \left((\phi_j^{-1})^* \lambda \right) \text{Op}_{\mathcal{T}}(a_j) \tilde{\lambda} \\ &= \sum_{k,l} (\phi_j^{-1})^* \lambda \lambda_k A \phi_j^* \tilde{\lambda}_l \tilde{\lambda} - \left((\phi_j^{-1})^* \lambda \right) \text{Op}_{\mathcal{T}}(a_j) \tilde{\lambda}. \end{aligned}$$

Note that the sum only involves k, l such that $\text{supp}(\lambda_k) \cap \text{supp}(\lambda) \neq \emptyset$, $\text{supp}(\tilde{\lambda}_l) \cap \text{supp}(\tilde{\lambda}) \neq \emptyset$. Hence, the sum is finite. We find

$$R = \sum'_{k,l} (\phi_j^{-1})^* \lambda \lambda_k A \phi_j^* \tilde{\lambda}_l \tilde{\lambda} - \left((\phi_j^{-1})^* \lambda \right) \text{Op}_{\mathcal{T}}(a_j) \tilde{\lambda} + R_1$$

where R_1 is a finite sum of operators in $\Psi_{\mathcal{T}}^m(\mathbb{R}^n \times \mathbb{R})$ (and also in $\Psi_{\mathcal{T}}^m((0, X_0) \times \tilde{U}_j \times \mathbb{R})$) with kernels vanishing in a neighborhood of the diagonal. By Lemma 3.40, we have $R_1 \in h^\infty \Psi_{\mathcal{T}}^{-\infty}(\mathbb{R}^n \times \mathbb{R})$. Moreover, observe that

$$(\phi_j^{-1})^* \lambda \lambda_k A \phi_j^* \tilde{\lambda}_l \tilde{\lambda} = \left((\phi_j^{-1})^* \lambda \right) \text{Op}_{\mathcal{T}}(\sigma_{kl}) \tilde{\lambda}.$$

We thus have $R = R_1$ from the definition of a_j .

We now prove uniqueness. Let \tilde{a}_j satisfy the same properties as a_j . Introducing $b = a_j - \tilde{a}_j$, for all $\lambda \in \mathcal{C}_c^\infty((0, X_0) \times U_j)$, $\tilde{\lambda} \in \mathcal{C}_c^\infty((0, X_0) \times \tilde{U}_j)$ we have

$$\left((\phi_j^{-1})^* \lambda \right) \text{Op}_{\mathcal{T}}(b) \tilde{\lambda} \in h^\infty \Psi_{\mathcal{T}}^{-\infty}(\mathbb{R}^n \times \mathbb{R}).$$

Let K be a compact set in $(0, X_0) \times \tilde{U}_j$ and we choose $\lambda, \tilde{\lambda}$ such that $(\phi_j^{-1})^* \lambda = 1$ on K and $\tilde{\lambda} = 1$ on $\text{supp}((\phi_j^{-1})^* \lambda)$. The symbol of $\left((\phi_j^{-1})^* \lambda \right) \text{Op}_{\mathcal{T}}(b) \tilde{\lambda}$ is in $h^\infty S_{\mathcal{T}}^{-\infty}(\mathbb{R}^n \times \mathbb{R} \times \mathbb{R}^n)$ and is given by

$$\left((\phi_j^{-1})^* \lambda \right) b \# \tilde{\lambda} \in (\phi_j^{-1})^* \lambda b + h^\infty S_{\mathcal{T}}^{-\infty}(\mathbb{R}^n \times \mathbb{R} \times \mathbb{R}^n)$$

by the composition formula (3.185). As a consequence, according to Definition 3.41, we have

$$b \in h^\infty S_{\mathcal{T}}^{-\infty}((0, X_0) \times \tilde{U}_j \times \mathbb{R} \times \mathbb{R}^n).$$

□

3.8.11 Proof of Proposition 3.46

Let K be a compact set in $(0, X_0) \times (U_j \cap U_k)$. Let $\lambda, \hat{\lambda} \in \mathcal{C}_c^\infty((0, X_0) \times (U_j \cap U_k))$ be equal to one on K . We set $\tilde{\lambda}_\ell = (\phi_\ell^{-1})^* \hat{\lambda}$, $\ell = j, k$. We also introduce $A_{\lambda, \hat{\lambda}, \ell} = (\phi_\ell^{-1})^* \lambda A \phi_\ell^* \tilde{\lambda}_\ell$ and find

$$A_{\lambda, \hat{\lambda}, \ell} = \text{Op}_{\mathcal{T}}(\tilde{a}_\ell) \quad \text{mod } h^\infty \Psi_{\mathcal{T}}^{-\infty}(\mathbb{R}^n \times \mathbb{R}), \quad \text{with } \tilde{a}_\ell = \left((\phi_\ell^{-1})^* \lambda \right) a_\ell \# \tilde{\lambda}_\ell, \quad \ell = j, k.$$

The kernel of $A_{\lambda, \hat{\lambda}, j}$ (resp. $A_{\lambda, \hat{\lambda}, k}$) has a compact support in $((0, X_0) \times \tilde{U}_{j,k})^2$ (resp. $((0, X_0) \times \tilde{U}_{k,j})^2$). Observe that we have

$$A_{\lambda, \hat{\lambda}, k} = (\phi_{jk}^{-1})^* A_{\lambda, \hat{\lambda}, j} \phi_{jk}^*.$$

From Theorem 3.39, we have for all $N \in \mathbb{N}$,

$$\tilde{a}_k - T_{\phi_{jk}, N}(\tilde{a}_j) \in h^N S_{\mathcal{T}}^{m-N/2}(\mathbb{R}^n \times \mathbb{R} \times \mathbb{R}^n).$$

Set $K_k = \phi_k(K)$ and $\chi \in \mathcal{C}_c^\infty(K_k)$. Since $\lambda = \hat{\lambda} = 1$ on K , we have

$$\chi a_k = \chi \tilde{a}_k \quad \text{mod } h^\infty S_{\mathcal{T}}^{-\infty}(\mathbb{R}^n \times \mathbb{R} \times \mathbb{R}^n).$$

We also have

$$\begin{aligned} \chi \tilde{a}_k &= \chi T_{\phi_{jk}, N}(\tilde{a}_j) \quad \text{mod } h^N S_{\mathcal{T}}^{m-N/2}(\mathbb{R}^n \times \mathbb{R} \times \mathbb{R}^n) \\ &= \chi T_{\phi_{jk}, N}(a_j) \quad \text{mod } h^N S_{\mathcal{T}}^{m-N/2}(\mathbb{R}^n \times \mathbb{R} \times \mathbb{R}^n), \end{aligned}$$

because of the form of $T_{\phi_{jk}, N}$ in (3.189). We thus obtain

$$\chi(a_k - T_{\phi_{jk}, N}(a_j)) \in h^N S_{\mathcal{T}}^{m-N/2}(\mathbb{R}^n \times \mathbb{R} \times \mathbb{R}^n). \quad (3.219)$$

As K is arbitrary, (3.219) holds for any $\chi \in \mathcal{C}_c^\infty(\tilde{U}_{k,j})$. This gives the conclusion according to Definition 3.41. \square

3.8.12 Proof of Proposition 3.48

Let $K_{A,h}$ and $K_{B,h}$ be the kernels of A and B . We shall use the notation of Definition 3.43.

As the two operators are properly supported the composition makes sense and $AB : \mathcal{C}_c^\infty(\mathcal{X}) \rightarrow \mathcal{C}_c^\infty(\mathcal{X})$. We denote its distribution kernel by $K_{AB,h}$. (Note that we use the Riemannian structure here to identify function, densities, and half-densities on \mathcal{X}). We have

$$\mathcal{K}_{AB,h}(x_0, y; \hat{x}_0, \hat{y}) = \iint_{\mathcal{X}'} \mathcal{K}_{A,h}(x_0, y; \check{x}_0, \check{y}) \mathcal{K}_{B,h}(\check{x}_0, \check{y}; \hat{x}_0, \hat{y}) d\check{x}_0 d\check{y}$$

in the sense given at the end of Section 8.2 in [Hör90]. We choose $\chi, \hat{\chi} \in \mathcal{C}_c^\infty(\mathcal{X}')$ such that $\text{supp}(\chi) \cap \text{supp}(\hat{\chi}) = \emptyset$. In addition we introduce $\tilde{\chi}$ such that $\text{supp}(\chi) \cap \text{supp}(\tilde{\chi}) = \emptyset$ and $\tilde{\chi} = 1$ on $\text{supp}(\hat{\chi})$. We then write

$$\begin{aligned} &\chi(x_0, y) \hat{\chi}(\hat{x}_0, \hat{y}) \mathcal{K}_{AB,h}(x_0, y; \hat{x}_0, \hat{y}) \\ &= \hat{\chi}(\hat{x}_0, \hat{y}) \iint_{\mathcal{X}'} \chi(x_0, y) \tilde{\chi}(\check{x}_0, \check{y}) \mathcal{K}_{A,h}(x_0, y; \check{x}_0, \check{y}) \mathcal{K}_{B,h}(\check{x}_0, \check{y}; \hat{x}_0, \hat{y}) d\check{x}_0 d\check{y} \\ &\quad + \chi(x_0, y) \iint_{\mathcal{X}'} \hat{\chi}(\hat{x}_0, \hat{y}) (1 - \tilde{\chi}(\check{x}_0, \check{y})) \mathcal{K}_{A,h}(x_0, y; \check{x}_0, \check{y}) \mathcal{K}_{B,h}(\check{x}_0, \check{y}; \hat{x}_0, \hat{y}) d\check{x}_0 d\check{y}. \end{aligned}$$

We note that in the first sum $\chi(x_0, y) \tilde{\chi}(\check{x}_0, \check{y}) \mathcal{K}_{A,h}(x_0, y; \check{x}_0, \check{y})$ is smooth and compactly supported because of the disjoint supports of the cut-off functions and the regularity of the kernel $\mathcal{K}_{A,h}$ off the diagonal. In the second sum $\hat{\chi}(\hat{x}_0, \hat{y}) (1 - \tilde{\chi}(\check{x}_0, \check{y})) \mathcal{K}_{B,h}(\check{x}_0, \check{y}; \hat{x}_0, \hat{y})$ is also smooth as $\text{supp}(\hat{\chi}) \cap \text{supp}(1 - \tilde{\chi}) = \emptyset$ and compactly supported as $\mathcal{K}_{B,h}$ is properly supported. Because of (3.192) both terms then yield a smooth function in the variables $x_0, y, \hat{x}_0, \hat{y}$ and estimating derivatives then yields a proper estimate of the form of (3.191).

We now consider $j \in J$ and $\lambda \in \mathcal{C}_c^\infty((0, X_0) \times U_j)$, $\tilde{\lambda} \in \mathcal{C}_c^\infty((0, X_0) \times \tilde{U}_j)$. We set

$$\alpha = (\phi_j^{-1})^* \lambda AB \phi_j^*(\tilde{\lambda}).$$

We then introduce $\chi, \hat{\chi} \in \mathcal{C}_c^\infty((0, X_0) \times U_j)$ such that both $\chi = 1$ and $\hat{\chi} = 1$ on $\text{supp}(\phi_j^* \tilde{\lambda})$. We write $\alpha = \beta + R$ with

$$\beta = (\phi_j^{-1})^* \lambda A \chi \hat{\chi} B \phi_j^*(\tilde{\lambda}), \quad R = (\phi_j^{-1})^* \lambda A (1 - \chi \hat{\chi}) B \phi_j^*(\tilde{\lambda}).$$

Arguing as above we find that the kernel K_R of R is a smooth function and it satisfies an estimate of the form $\sup_{x_n} q(K_R) \leq Ch^N$, for any $N \in \mathbb{N}$ and q semi-norm on $\mathcal{C}^\infty((\mathbb{R}^n \times \mathbb{R})^2)$. Moreover its support is compact. Hence $R \in h^\infty \Psi_{\mathcal{T}}^{-\infty}(\mathbb{R}^n \times \mathbb{R})$.

Next, with $\tilde{\chi} = (\phi_j^{-1})^* \chi$ we write

$$\beta = (\phi_j^{-1})^* \lambda A \phi_j^* \tilde{\chi} (\phi_j^{-1})^* \hat{\chi} B \phi_j^*(\tilde{\lambda}).$$

By Proposition 3.45 we obtain a semi-classical tangential operator on $\mathbb{R}^n \times \mathbb{R}$ with symbol

$$\beta_j = \left(((\phi_j^{-1})^* \lambda) a_j \right) \# \left(\tilde{\chi} ((\phi_j^{-1})^* \hat{\chi}) b_j \right) \# \tilde{\lambda} \quad \text{mod } h^\infty S_{\mathcal{T}}^{-\infty}(\mathbb{R}^n \times \mathbb{R}).$$

which belongs to $S_{\mathcal{T}}^{m+m'}(\mathbb{R}^n \times \mathbb{R})$. The operator AB is thus in $\Psi_{\mathcal{T}}^{m+m'}(\mathbb{R}^n \times \mathbb{R})$.

From the composition formula 3.185, because of the supports of $\tilde{\chi}$ and $(\phi_j^{-1})^* \hat{\chi}$ we further obtain

$$\beta_j = \left((\phi_j^{-1})^* \lambda (a_j \# b_j) \right) \# \tilde{\lambda} \quad \text{mod } h^\infty S_{\mathcal{T}}^{-\infty}(\mathbb{R}^n \times \mathbb{R}).$$

Hence by Proposition 3.45 $a_j \# b_j$ is a representative of the local symbol of AB in this chart. \square

3.8.13 Proof of Proposition 3.50

The existence of L is only related to the proper support of the kernel of A . We have

$$|(Au)|_{x_n=0}|_k = \sum_j |(\phi_j^{-1})^* \psi_j (Au)|_{x_n=0}|_k.$$

Let $j \in J$. It suffices to prove that

$$|(\phi_j^{-1})^* \psi_j (Au)|_{x_n=0}|_k \leq C_K |u|_{k+\ell}.$$

We choose a partition of unity $\sum_k \hat{\psi}_k = 1$, subordinated to the open covering $(U_k)_{k \in J}$ such that $\hat{\psi}_j = 1$ in a neighborhood of $\text{supp}(\psi_j)$. Then $\text{supp}(\hat{\psi}_k) \cap \text{supp}(\psi_j) = \emptyset$ for $k \neq j$. We then have

$$\psi_j Au = \sum_{k \neq j} \psi_j A \hat{\psi}_k u + \psi_j A \hat{\psi}_j u$$

The terms in the sum are then associated with properly supported operators with smooth kernels for which the operator continuity (after restriction to $x_n = 0$) is clear. To treat the last term we choose $\lambda \in \mathcal{C}_c^\infty((0, X_0) \times U_j)$ such that $\lambda = 1$ on $L \cap ((0, X_0) \times \text{supp}(\psi_j))$, and $\hat{\lambda} \in \mathcal{C}_c^\infty((0, X_0) \times \tilde{U}_j)$ such that $\hat{\lambda} = 1$ on $K \cap ((0, X_0) \times \text{supp}((\phi_j^{-1})^* \psi_j))$. We then have

$$(\phi_j^{-1})^* \psi_j A \hat{\psi}_j u = (\phi_j^{-1})^* \lambda \psi_j A \phi_j^* \hat{\lambda} (\phi_j^{-1})^* \hat{\psi}_j u = B (\phi_j^{-1})^* \hat{\psi}_j u \quad \text{at } x_n = 0,$$

with $B \in \Psi_{\mathcal{T}}^\ell(\mathbb{R}^{n+1})$ by Definition 3.43. Hence

$$|(\phi_j^{-1})^* \psi_j (A \hat{\psi}_j u)|_{x_n=0}|_k \lesssim |(\phi_j^{-1})^* \hat{\psi}_j u|_{k+\ell} \lesssim |u|_{k+\ell}$$

by (3.22). \square

Deuxième partie

Stabilisation et contrôle de systèmes d'équations hyperboliques, et applications

Chapitre 4

Stabilisation indirecte de systèmes d'équations d'ondes localement couplées

Contents

4.1	Introduction	167
4.1.1	Motivation and general context	167
4.1.2	Results for two coupled wave equations	170
4.2	Abstract formulation and main results	174
4.2.1	Abstract setting and well-posedness	174
4.2.2	Main results	175
4.3	Proof of the main results, Theorems 4.9 and 4.12	178
4.3.1	The stability lemma	178
4.3.2	Proof of Theorem 4.9, the case B bounded	178
4.3.3	Proof of Theorem 4.12, the case B unbounded	182
4.4	Applications	185
4.4.1	Internal stabilization of locally coupled wave equations	185
4.4.2	Boundary stabilization of locally coupled wave equations	188
4.4.3	Internal stabilization of locally coupled plate equations	191

Ce chapitre est la reprise de l'article [ABL11c] en collaboration avec Fatiha Alabau-Boussouira, accepté pour publication dans le journal ESAIM, Control, Optimization and Calculus of Variations.

4.1 Introduction

4.1.1 Motivation and general context

The decay properties for the energy of a solution of the damped wave equation are well known since the works [Lio88a], [Kom94] and definitively [BLR92] and [Leb96]. More precisely, given a bounded open domain $\Omega \subset \mathbb{R}^N$ with boundary $\Gamma = \partial\Omega$, we consider either the internally damped wave equation

$$\begin{cases} u'' - \Delta u + bu' = 0 & \text{in } (0, +\infty) \times \Omega, \\ u = 0 & \text{on } (0, +\infty) \times \Gamma, \\ (u, u')(0, \cdot) = (u^0(\cdot), u^1(\cdot)) & \text{in } \Omega, \end{cases} \quad (4.1)$$

or the boundary damped wave equation

$$\begin{cases} u'' - \Delta u = 0 & \text{in } (0, +\infty) \times \Omega, \\ \frac{\partial u}{\partial \nu} + lu + bu' = 0 & \text{on } (0, +\infty) \times \Gamma_b, \Gamma_b \subset \Gamma, \\ u = 0 & \text{on } (0, +\infty) \times (\Gamma \setminus \Gamma_b), \\ (u, u')(0, \cdot) = (u^0(\cdot), u^1(\cdot)) & \text{in } \Omega. \end{cases} \quad (4.2)$$

Here, $u = u(t, x)$, u' denotes the time derivative of u and ν stands for the outward unit normal to Γ . In these two cases, the dissipation is due to the damping term bu' , where $b = b(x)$ is a non-negative function on Ω in (4.1), on Γ in (4.2). The dissipation of the energy

$$E(u(t)) = \frac{1}{2} \int_{\Omega} (|u'|^2 + |\nabla u|^2) dx \quad \text{or} \quad E(u(t)) = \frac{1}{2} \int_{\Omega} (|u'|^2 + |\nabla u|^2) dx + \frac{1}{2} \int_{\Gamma_b} l(x) u^2 d\gamma$$

is given by

$$E'(u(t)) = - \int_{\Omega} b(x) |u'|^2 dx \quad \text{or} \quad E'(u(t)) = - \int_{\Gamma_b} b(x) |u'|^2 d\gamma$$

respectively in the internal and the boundary damping case. In both cases, the localization of the damping, $\text{supp}(b)$ must satisfy some geometric conditions (see [BLR92], [Lio88a], [Kom94]) in order for the energy of the solutions to decay exponentially, i.e., so that there exist two constants $M, \kappa > 0$ satisfying

$$E(u(t)) \leq M e^{-\kappa t} E(u(0)), \quad t > 0,$$

for all initial data (u^0, u^1) of finite energy. In the case of internal damping (4.1), the explicit value of the best decay rate κ is moreover given in [Leb96].

Besides, when no feedback is applied to the wave equation, i.e., $b = 0$ in Ω in (4.1) or on Γ in (4.2), then the energy is conserved, $E(u(t)) = E(u(0))$ for every $t > 0$.

The question we are interested in is what are the stability properties of the following systems, obtained by coupling an exponentially stable wave equation with a conservative one, that is

$$\begin{cases} u_1'' - \Delta u_1 + \delta p u_2 + b u_1' = 0 & \text{in } (0, +\infty) \times \Omega, \\ u_2'' - \Delta u_2 + p u_1 = 0 & \text{in } (0, +\infty) \times \Omega, \\ u_1 = u_2 = 0 & \text{on } (0, +\infty) \times \Gamma, \\ u_j(0, \cdot) = u_j^0(\cdot), u_j'(0, \cdot) = u_j^1(\cdot), j = 1, 2 & \text{in } \Omega, \end{cases} \quad (4.3)$$

in the case of internal damping, and

$$\begin{cases} u_1'' - \Delta u_1 + \delta p u_2 = 0 & \text{in } (0, +\infty) \times \Omega, \\ u_2'' - \Delta u_2 + p u_1 = 0 & \text{in } (0, +\infty) \times \Omega, \\ \frac{\partial u_1}{\partial \nu} + l u_1 + b u_1' = 0 & \text{on } (0, +\infty) \times \Gamma_b, \Gamma_b \subset \Gamma, \\ u_1 = 0 & \text{on } (0, +\infty) \times (\Gamma \setminus \Gamma_b), \\ u_2 = 0 & \text{on } (0, +\infty) \times \Gamma, \\ u_j(0, \cdot) = u_j^0(\cdot), u_j'(0, \cdot) = u_j^1(\cdot), j = 1, 2 & \text{in } \Omega, \end{cases} \quad (4.4)$$

in the case of boundary damping. Here, $\delta > 0$ is a constant and $p \geq 0$ denotes the coupling coefficient. The case of a constant coupling p has already been treated in [ACK02] for (4.3) (internal damping) and in [AB99, AB02] for (4.4) (boundary damping). One key assumption in these three works is that the coupling coefficient satisfies $p(x) \geq C > 0$ for all $x \in \Omega$. The main goal of this paper is to generalize these results to cases for which the coupling $p = p(x)$ can vanish in some part of Ω . It seems natural that we shall have to suppose some geometric conditions on the localization of the coupling, that is, on the support of the function $p(x)$.

The study of systems like (4.3)-(4.4) (and more generally (4.5) below) is motivated by several physical considerations. Indirect damping of reversible systems occurs in many applications in engineering and mechanics. Indeed, it arises whenever it is impossible or too expensive to damp all the components of the state, and it is hence important to study stabilization properties of coupled

systems with a reduced number of feedbacks. For finite dimensional systems, this problem is fully understood thanks to the Kalman rank condition. In the case of coupled PDE's, the situation is much more involved. Effectiveness of indirect damping mechanisms depends in a complex way on the assumptions on all the operators involved (i.e. on the operators A_1 , A_2 , P and B in System (4.5) below). In [Lio88a], J.-L. Lions considers the case of several different coupled wave-wave or wave-Petrowsky systems and studies partial observability or controllability properties. In [ACK02], the authors give the following example of two elastic membranes subjected to an elastic force that attracts one membrane to the other with coefficient $\kappa > 0$,

$$\begin{cases} u_1'' - \Delta u_1 + \kappa u_1 - \kappa u_2 + \beta u_1' = 0 & \text{in } (0, +\infty) \times \Omega, \\ u_2'' - \Delta u_2 + \kappa u_2 - \kappa u_1 = 0 & \text{in } (0, +\infty) \times \Omega, \\ u_1 = u_2 = 0 & \text{on } (0, +\infty) \times \Gamma, \\ u_j(0, \cdot) = u_j^0(\cdot), u_j'(0, \cdot) = u_j^1(\cdot), j = 1, 2 & \text{in } \Omega. \end{cases}$$

Another example raised by mechanical applications is the so-called Timoshenko beams. This system consists in two one-dimensional wave equations coupled by first order terms. One can show that polynomial stability holds through indirect mechanisms (see [AB07], [AKBMnRR03] and the references therein) such as the ones considered in the present paper. Similar questions arise in the analysis of indirect control of locally coupled parabolic PDE's (see System (4.8) below). We here also point out the works [LZ99] and [BL01, Section 6] where the exponential and the polynomial stabilization of a coupled hyperbolic-parabolic system of thermoelasticity are addressed with microlocal techniques.

In a more general setting, we are interested in the stability properties of systems of second order evolution equations coupling a conservative equation and an exponentially stable one. The abstract model that we shall refer to is the following

$$\begin{cases} u_1'' + A_1 u_1 + \delta P u_2 + B u_1' = 0, \\ u_2'' + A_2 u_2 + P^* u_1 = 0, \\ (u_j, u_j')(0) = (u_j^0, u_j^1), \quad j = 1, 2, \end{cases} \quad (4.5)$$

where A_1 and A_2 are positive selfadjoint operators with compact resolvent on an infinite dimensional Hilbert space H . The coupling operator P is assumed to be bounded on H and P^* is its adjoint. The stabilization operator B will be supposed to be either bounded on H (which corresponds to the case of internal stabilization) or unbounded (which corresponds to the case of boundary stabilization). The total energy of a solution $U = (u_1, u_2)$ of (4.5) is defined by

$$E(U(t)) = \frac{1}{2} \left(\|u_1'\|_H^2 + \|A_1^{1/2} u_1\|_H^2 + \delta \|u_2'\|_H^2 + \delta \|A_2^{1/2} u_2\|_H^2 \right) + \delta (u_1, P u_2)_H, \quad (4.6)$$

where $(\cdot, \cdot)_H$ denotes the inner product on H and $\|\cdot\|_H$ the associated norm. Note that we have to consider different operators A_j , $j = 1, 2$, in order to treat the boundary damping case. In the applications to coupled wave equations, A_1 and A_2 will be the same Laplace operator, i.e., with the same speed of propagation, but with different boundary conditions. We have moreover to suppose the natural assumption that δ and $p^+ = \|P\|_{\mathcal{L}(H)} = \sup\{\|Pv\|_H, \|v\|_H = 1\}$ are sufficiently small so that the energy is positive.

The question is now : is the full system (4.5) stable, and if so, at which rate ?

A first answer to this question is that System (4.5) cannot be exponentially stable (see [ACK02]). Indeed, this system is a compact perturbation of the decoupled system (obtained by taking $P = 0$ in (4.5)), which is unstable.

Despite this negative result, one can prove polynomial stability properties for certain classes of operators A_1, A_2, P, B . More precisely, under the assumption that the operator P is coercive on H , the authors prove in [ACK02], [AB02] and [Bey04] that the energy decays at least polynomially at infinity. In these papers, the coercivity assumption on P is essential. In the applications we want to address (see (4.3), (4.4) with $p(x)$ locally supported), this assumption clearly fails. For these

examples, as well as in the abstract setting (4.5), one has to develop new ideas and hypotheses to understand how the damping effect is transmitted from the first equation to the second one. We shall instead suppose that P is only partially coercive (see Assumption (A1) below). For the PDE systems under view (see Sections 4.1.2 and 4.4), this assumption holds under geometric conditions of multiplier type on the support of the coupling coefficient p . Similar conditions are required on the support of the damping coefficient b , so that we prove polynomial stabilization in several situations in which the damping region and the coupling region have a very small intersection (see Figure 4.2 below). In particular in one space dimension, we prove such a result with an empty intersection. This is an important feature since it shows that the information is transferred from the damping region to the coupling region in a sufficient way to stabilize indirectly the second equation, even though these two regions do not meet. In particular, one can notice that in the damping region, the second equation is decoupled from the first one and is conservative in this area (see also Figure 4.2 below). More generally, such locally coupled systems of PDE's can be viewed as transmission problems between areas of active/inactive dampings and couplings to areas with inactive/active dampings and couplings.

In this paper, the main result concerning the abstract system (4.5) is a polynomial stability Theorem under certain assumptions on the operators P and B (see Theorem 4.9 in the case B bounded and Theorem 4.12 in the case B unbounded). This abstract result can then be applied to a large class of second order evolution equations. In Section 4.4, we treat the case of two locally coupled wave or plate equations, with an internal or a boundary damping. The problem that first motivated this work is the case (4.3) of partially internally damped wave equations. We now detail the results obtained for this problem, that sum up our study.

4.1.2 Results for two coupled wave equations

In this section, we consider problem (4.3) in a domain $\Omega \subset \mathbb{R}^N$ with \mathcal{C}^2 boundary. The damping function b and the coupling function p are two bounded real valued functions on Ω , satisfying

$$\begin{cases} 0 \leq b \leq b^+ \text{ and } 0 \leq p \leq p^+ \text{ on } \Omega, \\ b \geq b^- > 0 \text{ on } \omega_b, \\ p \geq p^- > 0 \text{ on } \omega_p, \end{cases} \quad (4.7)$$

for ω_b and ω_p two non-empty open subsets of Ω . As usual for damped wave equations, we have to make some geometric assumptions on the sets ω_b and ω_p so that the energy of a single wave decays sufficiently rapidly at infinity. Here, we shall use the Piecewise Multipliers Geometric Condition (PMGC).

Definition 4.1 (PMGC). We say that $\omega \subset \Omega$ satisfies the PMGC if there exist $\Omega_j \subset \Omega$ having Lipschitz boundary and $x_j \in \mathbb{R}^N$, $j = 1 \dots J$ such that $\Omega_j \cap \Omega_i = \emptyset$ for $j \neq i$ and ω contains a neighborhood in Ω of the set $\bigcup_{j=1}^J \gamma_j(x_j) \cup \left(\Omega \setminus \bigcup_{j=1}^J \Omega_j \right)$, where $\gamma_j(x_j) = \{x \in \partial\Omega_j, (x - x_j) \cdot \nu_j(x) > 0\}$ and ν_j is the outward unit normal to $\partial\Omega_j$.

This geometric assumption was introduced in [Liu97] and further used in [AB04, AB05]. It is a generalization of the usual multiplier geometric condition (or Γ -condition) of [Lio88a, Zua90], saying that ω contains a neighborhood in Ω of the set $\{x \in \partial\Omega, (x - x_0) \cdot \nu(x) > 0\}$, for some $x_0 \in \mathbb{R}^N$. However, the PMGC is of course much more restrictive than the sharp Geometric Control Condition (GCC) introduced in [BLR92], saying that every generalized geodesic (i.e. ray of geometrical optics) enters the region ω in finite time. Let us briefly compare these three different geometric conditions on the following simple 2-D example. We consider the case where Ω is a disk and draw on Figure 4.1 three different subsets of Ω . The Γ -condition is only satisfied by ω_0 , for some x_0 sufficiently far on the left of the figure. The PMGC is satisfied by ω_0 , and by ω_1 (which contains a neighborhood of a diameter) for some x_1 on the left and x_2 on the right, sufficiently far. However, ω_2 , containing only a neighborhood of a radius, does not satisfy the PMGC, since $\Omega \setminus \bar{\omega}_2$ is connected, so that the

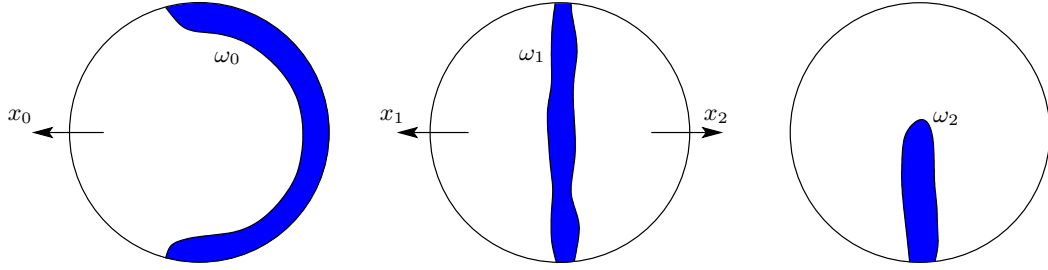

FIGURE 4.1 – Comparison between the different geometric conditions in the disk

PMGC is reduced in this case to the Γ -condition (which is here not satisfied). Finally, the GCC is satisfied by these three different subsets of Ω .

In other geometric situations, the Γ -condition and the GCC are further compared in [BLR92, pp 1030-1032]. In particular (in the context of boundary stabilization), the authors provide several 2-D examples in which the GCC is satisfied but not the Γ -condition. In [Mil02, Remark 6.], the author proves directly from a geometrical point of view that the GCC implies the PMGC (and more generally, that the GCC implies any multiplier condition). Then, in [Mil02, Section 5.], he describes in dimension two different situations for which GCC holds but neither the Γ -condition nor the PMGC do. To conclude this comparison, let us note that in one space dimension, the PMGC is equivalent to the GCC, and is satisfied by every nonempty subset of the interval Ω .

We denote by λ the smallest eigenvalue of the Laplace operator on Ω , with Dirichlet boundary conditions. We also have the identity $\lambda = 1/C_{\mathcal{P}}^2$, where $C_{\mathcal{P}}$ is the Poincaré's constant of Ω . Note that according to (4.6), the energy of a solution U of (4.3) is defined by

$$E(U(t)) = \frac{1}{2} \left(\|u'_1\|_{L^2(\Omega)}^2 + \|\nabla u_1\|_{L^2(\Omega)}^2 + \delta \|u'_2\|_{L^2(\Omega)}^2 + \delta \|\nabla u_2\|_{L^2(\Omega)}^2 \right) + \delta (pu_1, u_2)_{L^2(\Omega)},$$

and is positive as soon as $p^+ < \lambda$ and $0 < \delta < \frac{\lambda}{p^+}$. Finally, for $n \in \mathbb{N}$, we denote by $\mathcal{D}((-\Delta_D)^{\frac{n}{2}})$ the domain of the Laplace operator with Dirichlet boundary conditions to the power $\frac{n}{2}$. We recall that we have for instance

$$\begin{aligned} \mathcal{D}((-\Delta_D)^{\frac{n}{2}}) &= \{v \in H^n(\Omega), v = 0 \text{ on } \partial\Omega\} && \text{for } n = 1, 2, \\ \mathcal{D}((-\Delta_D)^{\frac{n}{2}}) &= \{v \in H^n(\Omega), v = 0 \text{ and } \Delta v = 0 \text{ on } \partial\Omega\} && \text{for } n = 3, 4, \text{ etc...} \end{aligned}$$

With this notation, we can state the stability theorem for System (4.3).

Theorem 4.2. (i) Suppose that ω_b and ω_p satisfy the PMGC. Then there exists $p_* \in (0, \lambda]$ such that for all $0 < p^+ < p_*$ there exists $\delta_* = \delta_*(p^+, p^-) \in (0, \frac{\lambda}{p^+}]$, such that for all $\delta \in (0, \delta_*)$ and all $b, p \in W^{q, \infty}(\Omega)$ satisfying (4.7), the solution $U = (u_1, u_2, u'_1, u'_2)$ of (4.3) satisfies for $n \in \mathbb{N}, n \leq q$, for some $C_n > 0$,

$$E(U(t)) \leq \frac{C_n}{t^n} \sum_{i=0}^n E(U^{(i)}(0)) \quad \forall t > 0, U^0 = (u_1^0, u_2^0, u_1^1, u_2^1) \in \mathcal{D}((-\Delta_D)^{\frac{n+1}{2}})^2 \times \mathcal{D}((-\Delta_D)^{\frac{n}{2}})^2.$$

Besides, if $U^0 \in (H_0^1)^2 \times (L^2)^2$, then $E(U(t))$ converges to zero as t goes to infinity.

(ii) If moreover either $\omega_b \subset \omega_p$ or $\omega_p \subset \omega_b$, then the result holds for $\delta_* = \frac{\lambda}{p^+}$.

This theorem is a consequence of Theorem 4.9 below. The fact that Problem (4.3) satisfies the assumptions of Theorem 4.9 is postponed in Section 4.4.1. Note that the constants p_* and δ_* are explicit functions of the parameters of the problem and of the constants coming from the multiplier method. Moreover, the constants C_n depend on δ, p^+, p^-, b^+ and b^- . The smoothness assumption on the coefficients p and b comes from Lemma 4.11. If these parameters are not smooth, Theorem 4.2

is still valid for initial data in $\mathcal{D}(\mathcal{A}_{P,\delta}^n)$ where the operator $\mathcal{A}_{P,\delta}$ is defined in (4.13) below. However, in this case, we cannot explicit the space $\mathcal{D}(\mathcal{A}_{P,\delta}^n)$ in terms of classical Sobolev spaces.

Let us draw on Figure 4.2 some geometric situations covered by Theorem 4.2 (i).

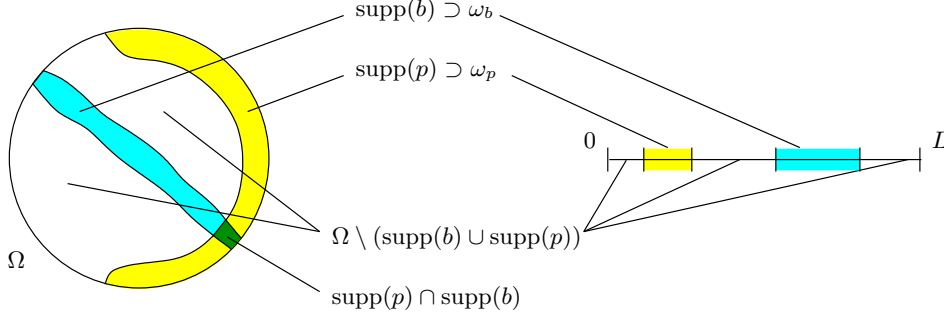

FIGURE 4.2 – Some one and two dimensional geometric situations covered by Theorem 4.2 (i)
Locally, the equations satisfied by u_1 and u_2 are

$$\begin{cases} u_1'' - \Delta u_1 = 0 & \text{and } u_2'' - \Delta u_2 = 0 & \text{in } \mathcal{D}'((0, +\infty) \times \Omega \setminus (\text{supp}(b) \cup \text{supp}(p))), \\ u_1'' - \Delta u_1 + bu_1' = 0 & \text{and } u_2'' - \Delta u_2 = 0 & \text{in } \mathcal{D}'((0, +\infty) \times \overset{\circ}{\text{supp}}(b) \setminus \overset{\circ}{\text{supp}}(p)), \\ u_1'' - \Delta u_1 + \delta pu_2 = 0 & \text{and } u_2'' - \Delta u_2 + pu_1 = 0 & \text{in } \mathcal{D}'((0, +\infty) \times \overset{\circ}{\text{supp}}(p) \setminus \overset{\circ}{\text{supp}}(b)), \\ u_1'' - \Delta u_1 + \delta pu_2 + bu_1' = 0 & \text{and } u_2'' - \Delta u_2 + pu_1 = 0 & \text{in } \mathcal{D}'((0, +\infty) \times \overset{\circ}{\text{supp}}(p) \cap \overset{\circ}{\text{supp}}(b)). \end{cases}$$

In particular, in $\Omega \setminus (\text{supp}(b) \cup \text{supp}(p))$, the states u_1 and u_2 are decoupled and both satisfy a conservative equation. Besides, the subset of Ω where u_1 and u_2 are coupled and u_1 is damped, i.e. $\text{supp}(p) \cap \text{supp}(b)$, might be reduced to the empty set, as it is the case in the one dimensional example.

Some comments can be made about Theorem 4.2. One particularly interesting question for this type of coupled problem is the case $\omega_b \cap \omega_p = \emptyset$. This question first arised in the field of control theory for coupled evolution equations, and, to the authors' knowledge, is still unsolved. More precisely, consider the parabolic system

$$\begin{cases} u_1' - \Delta u_1 + \delta pu_2 = \mathbf{1}_{\omega_b} f & \text{in } (0, T) \times \Omega, \\ u_2' - \Delta u_2 + pu_1 = 0 & \text{in } (0, T) \times \Omega, \\ u_1 = u_2 = 0 & \text{on } (0, T) \times \partial\Omega, \\ u_1(0, \cdot) = u_1^0, u_2(0, \cdot) = u_2^0 & \text{in } \Omega, \end{cases} \quad (4.8)$$

or its hyperbolic counterpart

$$\begin{cases} u_1'' - \Delta u_1 + \delta pu_2 = \mathbf{1}_{\omega_b} f & \text{in } (0, T) \times \Omega, \\ u_2'' - \Delta u_2 + pu_1 = 0 & \text{in } (0, T) \times \Omega, \\ u_1 = u_2 = 0 & \text{on } (0, T) \times \partial\Omega, \\ u_1(0, \cdot) = u_1^0, u_2(0, \cdot) = u_2^0 & \text{in } \Omega, \\ u_1'(0, \cdot) = u_1^1, u_2'(0, \cdot) = u_2^1 & \text{in } \Omega, \end{cases} \quad (4.9)$$

where the function p and the subset ω_b are the same as in the stabilization problem. In these two cases, the null-controllability problem under interest is the following : given a positive time T and initial data, is it possible to find a control function f so that the state has been driven to zero in time T ? The parabolic null-controllability problem (4.8) is fully solved in the case $\omega_b \cap \omega_p \neq \emptyset$ (see [dT00, AKBD06, GBPG06, Léa10a]). However, this problem is still open in the case $\omega_b \cap \omega_p = \emptyset$. Only the approximate controllability has been proved in [KdT10] in this case for $\delta = 0$. Concerning

the hyperbolic null-controllability problem (4.9), only the case of constant coupling p have been considered, to our knowledge [You09] (and [AB03] for a boundary control).

The second reason for which the case $\omega_b \cap \omega_p = \emptyset$ is of particular interest in the stabilization problem (4.3) is that, in this case, we don't even know if the strong stability property holds, i.e., if the energy goes to zero as t goes to infinity. To our knowledge, the only strong (and logarithmic) stability result for system (4.3) is the following one (we suppose here that p and b are smooth).

Proposition 4.3. *Suppose that $\omega_b \cap \omega_p \neq \emptyset$. Then, the solution $U = (u_1, u_2, u'_1, u'_2)$ of (4.3) satisfies for $n \in \mathbb{N}$, for some $C_n > 0$,*

$$E(U(t)) \leq \frac{C_n}{\log(2+t)^n} \sum_{i=0}^n E(U^{(i)}(0)) \quad \forall t > 0,$$

for all initial data $U^0 = (u_1^0, u_2^0, u_1^1, u_2^1) \in \mathcal{D}((-\Delta_D)^{\frac{n+1}{2}})^2 \times \mathcal{D}((-\Delta_D)^{\frac{n}{2}})^2$.

This is a direct consequence of the interpolation inequality for the associated elliptic system, proved in [Léa10a, Proposition 5.1], together with the resolvent estimates of [Leb96, LR97] (see also [Bur98] to obtain the exact power n). Note that it is natural that logarithmic stability holds without geometric control conditions on the sets ω_b and ω_p . However the interpolation inequality for the associated elliptic problem is not known in the case $\omega_b \cap \omega_p = \emptyset$ and even the strong stability is open.

Now, concerning the stability Theorem 4.2, it first has to be noted that, in dimension $N \geq 2$ the assumption that both ω_b and ω_p satisfy the PMGC implies that $\omega_b \cap \omega_p \neq \emptyset$ (whereas this is not the case if ω_b and ω_p satisfy the optimal condition of [BLR92]). This Theorem is hence of particular interest in dimension $N = 1$ (see Figure 4.2). In this case, $\Omega = (0, L)$ for some $L > 0$, and any non-empty open subinterval ω satisfies the PMGC. As a consequence, we obtain the following corollary of Theorem 4.2 point (i).

Corollary 4.4. *Suppose that $\Omega = (0, L)$. Then, for any non-empty subsets $\omega_b \subset \Omega$ and $\omega_p \subset \Omega$ (i.e., for any non-vanishing non-negative functions p and b), there exists $p_* \in (0, \lambda]$ such that for all $0 < p^+ < p_*$ there exists $\delta_* = \delta_*(p^+, p^-) \in (0, \frac{\lambda}{p^+}]$, such that for all $\delta \in (0, \delta_*)$ and all b, p sufficiently smooth, satisfying (4.7), the polynomial stability result of Theorem 4.2 holds.*

In particular, this yields in this case a strong (and logarithmic) stability result with $\omega_b \cap \omega_p = \emptyset$, improving Proposition 4.3. Moreover, this can be a first step to address first the hyperbolic control problem (4.9) and then its parabolic counterpart (4.8) in the case $\omega_b \cap \omega_p = \emptyset$. Similarly, Theorem 4.21 on boundary stabilization can be a first step to solve the hyperbolic coupled problem controlled from the boundary (to our knowledge only addressed in [AB03] in the case of constant coupling p). Then, it could allow one to solve its parabolic counterpart, also controlled from the boundary, which seems to be widely open in several space dimensions.

To conclude this section, let us come back to the geometric assumptions we make. The PMGC does not seem to be necessary or optimal in these problems, but only technical. All the results we state in these paper should hold true (and would be also very interesting in several space dimensions) under the GCC. Replacing PGMC by GCC in all our results would be possible provided that we are able to prove Assumptions (A2) and (A3) below with microlocal techniques, what we did not yet manage to do.

Remark 4.5. In the sequel, C will denote a generic constant, whose value may change from line to line. Writing $C = C(p, \beta, \dots)$ or $C = C_{p, \beta, \dots}$ means that this constant depends on the parameters p, β, \dots

4.2 Abstract formulation and main results

4.2.1 Abstract setting and well-posedness

Let H and V_j , $j = 1, 2$, be infinite dimensional Hilbert spaces such that the injections $V_j \subset H$ are dense and compact. We identify H with its dual space and denote by V_j' the dual space of V_j , so that the injections $V_j \subset H \subset V_j'$ are dense and compact. We denote by $(\cdot, \cdot)_H$ (resp. $(\cdot, \cdot)_{V_j}$) the inner product on H (resp. V_j), $\|\cdot\|_H$ (resp. $\|\cdot\|_{V_j}$) the associated norm and $\|\cdot\|_{V_j'}$ the norm on V_j' . Moreover, we write $\langle \cdot, \cdot \rangle_{V_j', V_j}$ the duality product and A_j the duality mapping from V_j to V_j' defined by

$$\langle A_j v, w \rangle_{V_j', V_j} = (v, w)_{V_j} \quad \forall v, w \in V_j.$$

By abuse of notation, we also write A_j the unbounded operator on H with domain

$$\mathcal{D}(A_j) = \{v \in V_j, A_j v \in H\} \subset V_j \subset H,$$

defined by

$$A_j : v \in \mathcal{D}(A_j) \subset H \longrightarrow A_j v \in H.$$

In this setting, each operator A_j is positive selfadjoint in H and has a compact resolvent.

We shall moreover assume that the subspace V_2 is continuously imbedded in V_1 , so that we have the following scheme :

$$V_2 \hookrightarrow V_1 \hookrightarrow H \hookrightarrow V_1' \hookrightarrow V_2', \quad (4.10)$$

where the first and the last inclusions are continuous and the two central ones are dense and compact. We denote $i : V_2 \hookrightarrow V_1$ the natural injection and $\Pi_V : V_1 \mapsto V_2$ the natural projection from V_1 to V_2 . We recall that for $u_1 \in V_1$, $\Pi_V u_1$ is characterized by

$$\begin{cases} \langle A_1 i(\Pi_V u_1), i(\phi) \rangle_{V_1', V_1} = \langle A_1 u_1, i(\phi) \rangle_{V_1', V_1} & \forall \phi \in V_2, u_1 \in V_1, \\ \text{and } \Pi_V u_1 \in V_2. \end{cases}$$

Moreover the operators i , A_1 and A_2 are linked by

$$\langle A_2 \phi, \psi \rangle_{V_2', V_2} = (\phi, \psi)_{V_2} = (i(\phi), i(\psi))_{V_1} = \langle A_1 i(\phi), i(\psi) \rangle_{V_1', V_1} \quad \forall \phi, \psi \in V_2,$$

thanks to the definitions of A_1 , A_2 , i and to Assumption (4.10). Note also that under these assumptions, the unbounded operators A_1 and A_2 coincide on $\mathcal{D}(A_1) \cap \mathcal{D}(A_2)$.

The coupling operator P is a bounded operator on H and P^* is its adjoint, $\|P\|_{\mathcal{L}(H)} = p^+$. The damping operator B will be supposed to be at least bounded from V_1 to V_1' and symmetric non-negative :

$$\langle Bv, w \rangle_{V_1', V_1} = \langle Bw, v \rangle_{V_1', V_1}, \quad \langle Bv, v \rangle_{V_1', V_1} \geq 0 \quad \forall v, w \in V_1. \quad (4.11)$$

We denote by λ_j , $j = 1, 2$, the largest constant satisfying

$$\|v\|_{V_j}^2 \geq \lambda_j \|v\|_H^2 \quad \forall v \in V_j,$$

that is, the smallest eigenvalue of the selfadjoint positive operator A_j .

Let us study now the abstract system (4.5). This linear evolution equation can be rewritten under the form

$$\begin{cases} U' + \mathcal{A}_{P,\delta} U = 0 \\ U(0) = U^0 \in \mathcal{H}, \end{cases} \quad (4.12)$$

where $\mathcal{H} = V_1 \times V_2 \times H^2$,

$$U = \begin{pmatrix} u_1 \\ u_2 \\ v_1 \\ v_2 \end{pmatrix}, U^0 = \begin{pmatrix} u_1^0 \\ u_2^0 \\ v_1^1 \\ v_2^1 \end{pmatrix}, \mathcal{A}_{P,\delta} = \begin{pmatrix} 0 & 0 & -\text{Id} & 0 \\ 0 & 0 & 0 & -\text{Id} \\ A_1 & \delta P & B & 0 \\ P^* & A_2 & 0 & 0 \end{pmatrix}, \mathcal{D}(\mathcal{A}_{P,\delta}) = \{U \in \mathcal{H}, \mathcal{A}_{P,\delta} U \in \mathcal{H}\}. \quad (4.13)$$

We recall that the energy of this system is given by

$$\begin{aligned} E(U(t)) &= \frac{1}{2} (\|v_1\|_H^2 + \|u_1\|_{V_1}^2 + \delta\|v_2\|_H^2 + \delta\|u_2\|_{V_2}^2) + \delta(u_1, Pu_2)_H \\ &= \frac{1}{2} (\|u_1'\|_H^2 + \|u_1\|_{V_1}^2 + \delta\|u_2'\|_H^2 + \delta\|u_2\|_{V_2}^2) + \delta(u_1, Pu_2)_H \end{aligned} \quad (4.14)$$

and we will require this energy to be positive for any solution $U(t)$. We have the lower bound for the energy

$$\begin{aligned} E(U) &\geq \frac{1}{2} (\|u_1'\|_H^2 + \lambda_1\|u_1\|_H^2 + \delta\|u_2'\|_H^2 + \delta\lambda_2\|u_2\|_H^2) - \frac{\delta p^+}{2} (\|u_1\|_H^2 + \|u_2\|_H^2) \\ &\geq \frac{1}{2} (\|u_1'\|_H^2 + \delta\|u_2'\|_H^2) + \frac{1}{2} (\lambda_1 - \delta p^+) \|u_1\|_H^2 + \frac{\delta}{2} (\lambda_2 - p^+) \|u_2\|_H^2. \end{aligned} \quad (4.15)$$

Therefore, in the sequel, we shall suppose

$$0 < p^+ < \lambda_2, \text{ and } 0 < \delta < \frac{\lambda_1}{p^+} \quad (4.16)$$

so that (4.15) holds with positive constants, i.e., E is a positive energy that measures the whole state U .

Remark 4.6. Note that for any $\delta > 0$, the operator $\begin{pmatrix} A_1 & \delta P \\ P^* & A_2 \end{pmatrix}$ is selfadjoint on the space $H \times H$ endowed with the weighted inner product $(u, v)_\delta = (u_1, v_1)_H + \delta(u_2, v_2)_H$ (which is the energy space). This operator is moreover positive under the condition (4.16). In the case $B = 0$, the operator $\mathcal{A}_{P,\delta}$ is skewadjoint and thus generates a group.

Under the assumptions made above, the system (4.12) (and thus, (4.5)) is well-posed in the sense of semigroup theory.

Proposition 4.7. For all $0 \leq p^+ < \lambda_2$ and $0 \leq \delta < \frac{\lambda_1}{p^+}$, the operator $\mathcal{A}_{P,\delta}$ is maximal monotone on \mathcal{H} . As a consequence, for every $U^0 \in \mathcal{H}$, Problem (4.12) has a unique solution $U \in \mathcal{C}^0([0, +\infty); \mathcal{H})$. If in addition, $U^0 \in \mathcal{D}(\mathcal{A}_{P,\delta}^k)$, for some $k \in \mathbb{N}$, then, the solution U is in $\bigcap_{j=0}^k \mathcal{C}^{k-j}([0, +\infty); \mathcal{D}(\mathcal{A}_{P,\delta}^j))$. Moreover, the energy $E(U)$ of the solution defined by (4.14) is locally absolutely continuous, and for strong solutions, i.e., when $U^0 \in \mathcal{D}(\mathcal{A}_{P,\delta})$, we have

$$E'(U(t)) = - \langle Bu_1', u_1' \rangle_{V_1', V_1}. \quad (4.17)$$

4.2.2 Main results

In all the following, we have to suppose some additional assumptions on the operators P and B , in order to prove the stability results. Let us first precise Assumptions (A1) and (A2), related with the operator P . We assume that P is partially coercive, i.e.,

$$(A1) \left\{ \begin{array}{l} \text{there exists an operator } \Pi_P \in \mathcal{L}(H), \|\Pi_P\|_{\mathcal{L}(H)} = 1, \text{ and a number } p^- > 0 \\ \text{such that } (Pv, v)_H \geq p^- \|\Pi_P v\|_H^2 \quad \forall v \in H. \end{array} \right.$$

Note that $p^- \leq p^+ = \|P\|_{\mathcal{L}(H)}$ and that (A1) implies that the operators P and P^* are non-negative. We shall moreover make the following Assumption (A2) on one decoupled equation, without damping, but with a right hand-side :

$$(A2) \left\{ \begin{array}{l} \exists \alpha_2, \beta_2, \gamma_2 > 0 \text{ such that for all } f_2 \in \mathcal{C}^1([0, +\infty); H) \text{ and all } 0 \leq S \leq T, \\ \text{the solution } u_2 \text{ of} \\ \quad u_2'' + A_2 u_2 = f_2 \text{ in } V_2', \\ \quad (u_2, u_2')(0) = (u_2^0, u_2^1) \in V_2 \times H, \\ \text{satisfies, with } e_2(t) = 1/2 (\|u_2'\|_H^2 + \|u_2\|_{V_2}^2), \text{ the inequality} \\ \int_S^T e_2(t) dt \leq \alpha_2 (e_2(S) + e_2(T)) + \beta_2 \int_S^T \|f_2(t)\|_H^2 dt + \gamma_2 \int_S^T \|\Pi_P u_2'(t)\|_H^2 dt. \end{array} \right.$$

This corresponds to the second equation in which the coupling term is viewed as a forcing term. This type of estimate will be proved in the applications below by means of multiplier estimates (for a single equation with a right hand-side). Note that the operator Π_P involved in the estimate of Assumption (A2) is the operator given by Assumption (A1).

Concerning the operator B , we shall make the following “stability” assumption for a single damped equation :

$$(A3) \left\{ \begin{array}{l} \exists \alpha_1, \beta_1, \gamma_1 > 0 \text{ such that for all } f_1 \in \mathcal{C}^1([0, +\infty); H) \text{ and all } 0 \leq S \leq T, \\ \text{the solution } u_1 \text{ of} \\ \quad u_1'' + A_1 u_1 + B u_1' = f_1 \text{ in } V_1', \\ \quad (u_1, u_1')(0) = (u_1^0, u_1^1) \in V_1 \times H, \\ \text{satisfies, with } e_1(t) = 1/2 (\|u_1'\|_H^2 + \|u_1\|_{V_1}^2), \text{ the inequality} \\ \int_S^T e_1(t) dt \leq \alpha_1 (e_1(S) + e_1(T)) + \beta_1 \int_S^T \|f_1(t)\|_H^2 dt + \gamma_1 \int_S^T \langle B u_1', u_1' \rangle_{V_1', V} dt. \end{array} \right.$$

Remark 4.8. Assumption (A3) implies in particular that the single damped equation is exponentially stable, since for $f_1 = 0$, we deduce that $e_1(t)$, which is locally absolutely continuous and nonincreasing, satisfies the classical integral inequality (see [Har78], [Kom94]).

$$\int_S^T e_1(t) dt \leq (2\alpha_1 + \gamma_1) e_1(S) \quad \forall 0 \leq S \leq T.$$

The next assumption we make on the damping operator B depends on its boundedness.

4.2.2.1 The case B bounded

In the bounded case, we shall moreover suppose

$$(A4b) \quad \|B\|_{\mathcal{L}(H)} = b^+ \quad \text{and} \quad V_2 = V_1 = V.$$

As a consequence, we have

$$A_1 = A_2 = A, \quad \lambda_1 = \lambda_2 = \lambda, \quad \text{and} \quad i = \Pi_V = \text{Id}_{V_1}.$$

The positivity condition (4.16) for the energy becomes

$$0 < p^+ < \lambda, \quad \text{and} \quad 0 < \delta < \frac{\lambda}{p^+}. \quad (4.18)$$

The main result here is

Theorem 4.9. (i) Suppose (A1), (A2), (A3), (A4b). Then there exists $p_* \in (0, \lambda]$ such that for all $0 < p^+ < p_*$ there exists $\delta_* = \delta_*(p^+, p^-) \in (0, \frac{\lambda}{p^+}]$, such that for all $\delta \in (0, \delta_*)$, the solution $U(t) = \exp(-\mathcal{A}_{P,\delta} t) U^0$ of (4.5) satisfies for some $C_n > 0$,

$$E(U(t)) \leq \frac{C_n}{t^n} \sum_{i=0}^n E(U^{(i)}(0)) \quad \forall t > 0, U^0 \in \mathcal{D}(\mathcal{A}_{P,\delta}^n).$$

Besides, if $U^0 \in \mathcal{H}$, then $E(U(t))$ converges to zero as t goes to infinity.

(ii) Suppose moreover either

$$\|Pv\|_H^2 \leq p^+ (Pv, v)_H \quad \text{and} \quad (Bv, v)_H \leq \frac{b^+}{p^-} (Pv, v)_H, \quad \forall v \in H, \quad (4.19)$$

or

$$\text{there exists } b^- > 0 \text{ such that } (Pv, v)_H \leq \frac{p^+}{b^-} (Bv, v)_H, \quad \forall v \in H. \quad (4.20)$$

Then the result holds for $\delta_* = \frac{\lambda}{p^+}$.

Remark 4.10. In Case (ii) of Theorem 4.9, the conclusion is much stronger than in Case (i). As one sees in the proof below, δ_* is very small in Case (i), whereas in Case (ii), the result holds for a large panel of δ , including the interval $(0, 1]$. More precisely, the constants p_* and δ_* are explicit, that is,

$$\begin{aligned} - p_* &= \min \left\{ \frac{1}{2\gamma_2}, \lambda \right\} \text{ and } \delta_* = \delta_*(p^+, p^-) = \min \left\{ \frac{\lambda}{2\beta_2(p^+)^2 p^-}, \frac{\lambda p^-}{2\beta_1(p^+)^2}, \frac{\lambda}{p^+} \right\} \text{ in (i);} \\ - p_* &= \min \left\{ \frac{1}{2\beta_1}, \lambda \right\} \text{ and } \delta_* = \frac{\lambda}{p^+} \text{ in the first case of (ii);} \\ - p_* &= \min \left\{ \frac{1}{2\beta_1}, \frac{1}{2\beta_2}, \lambda \right\} \text{ and } \delta_* = \frac{\lambda}{p^+} \text{ in the second case of (ii).} \end{aligned}$$

Note that the question whether our stability result can be extended to $\delta = 1$ (i.e. for the symmetric coupled system) in Case (i) remains open.

In this case, we are moreover able to give a simple characterization of the space $\mathcal{D}(\mathcal{A}_{P,\delta}^n)$, in terms of the spaces $\mathcal{D}(A^n)$, which is useful in the applications. More precisely, setting $\mathcal{H}_n = (\mathcal{D}(A^{\frac{n+1}{2}}))^2 \times (\mathcal{D}(A^{\frac{n}{2}}))^2 \subset \mathcal{H}$, we prove the following lemma, inspired by [ACK02, Lemma 3.1].

Lemma 4.11. *Suppose that for every $0 < k \leq n - 1$ (no assumption if $n = 1$), we have*

$$P\mathcal{D}(A^{\frac{k+1}{2}}) \subset \mathcal{D}(A^{\frac{k}{2}}) \quad , \quad P^*\mathcal{D}(A^{\frac{k+1}{2}}) \subset \mathcal{D}(A^{\frac{k}{2}}) \quad \text{and} \quad B\mathcal{D}(A^{\frac{k+1}{2}}) \subset \mathcal{D}(A^{\frac{k}{2}}). \quad (4.21)$$

Then $\mathcal{H}_k = \mathcal{D}(\mathcal{A}_{P,\delta}^k)$ for every $0 \leq k \leq n$.

Proof. We proceed by induction on $n \in \mathbb{N}$. In the case $n = 1$, there is no need of an additional assumption since the operators B and P are bounded on H . Now, we assume that $\mathcal{H}_{n-1} = \mathcal{D}(\mathcal{A}_{P,\delta}^{n-1})$ and prove $\mathcal{H}_n = \mathcal{D}(\mathcal{A}_{P,\delta}^n)$. We have

$$\begin{aligned} \mathcal{D}(\mathcal{A}_{P,\delta}^n) &= \left\{ U \in \mathcal{D}(\mathcal{A}_{P,\delta}^{n-1}), \mathcal{A}_{P,\delta} U \in \mathcal{D}(\mathcal{A}_{P,\delta}^n) \right\} \\ &= \left\{ (u_1, u_2, v_1, v_2) \in (\mathcal{D}(A^{\frac{n}{2}}))^2 \times (\mathcal{D}(A^{\frac{n-1}{2}}))^2, \right. \\ &\quad \left. (-v_1, -v_2, Au_1 + \delta Pu_2 + Bv_1, Au_2 + P^*u_1) \in (\mathcal{D}(A^{\frac{n}{2}}))^2 \times (\mathcal{D}(A^{\frac{n-1}{2}}))^2 \right\}, \end{aligned}$$

when using the induction Assumption $\mathcal{D}(\mathcal{A}_{P,\delta}^{n-1}) = \mathcal{H}_{n-1}$. Now using assumption (4.21) for $k = n - 1$, we see that having

$$\begin{cases} v_1 \in \mathcal{D}(A^{\frac{n}{2}}) & ; & v_2 \in \mathcal{D}(A^{\frac{n}{2}}), \\ Au_1 + \delta Pu_2 + Bv_1 \in \mathcal{D}(A^{\frac{n-1}{2}}), \\ Au_2 + P^*u_1 \in \mathcal{D}(A^{\frac{n-1}{2}}), \end{cases}$$

is equivalent to having

$$v_1 \in \mathcal{D}(A^{\frac{n}{2}}) \quad ; \quad v_2 \in \mathcal{D}(A^{\frac{n}{2}}) \quad ; \quad Au_1 \in \mathcal{D}(A^{\frac{n-1}{2}}) \quad ; \quad Au_2 \in \mathcal{D}(A^{\frac{n-1}{2}}),$$

that is exactly $(u_1, u_2, v_1, v_2) \in (\mathcal{D}(A^{\frac{n+1}{2}}))^2 \times (\mathcal{D}(A^{\frac{n}{2}}))^2 = \mathcal{H}_n$. This gives $\mathcal{D}(\mathcal{A}_{P,\delta}^n) = \mathcal{H}_n$ and concludes the proof of the lemma. \square

4.2.2.2 The case B unbounded

Here, we replace Assumption (A4b) by the following

$$(A4u) \begin{cases} \langle Bu_1, i(\phi) \rangle_{V'_1, V_1} = 0 \quad \forall \phi \in V_2, u_1 \in V_1, \text{ and} \\ \exists \beta > 0, \|u_1 - \Pi_V u_1\|_H^2 \leq \beta \langle Bu_1, u_1 \rangle_{V'_1, V_1} \quad \forall u_1 \in V_1. \end{cases}$$

Assumption (A4u) implies that B satisfies a “weak” coercivity property (since the norm on the left hand side of the second inequality in (A4u) is the weaker H -norm in the subspace orthogonal to the closed subspace V_2 . As will be seen in Section 4.4, this property is satisfied for all the systems under view (e.g. wave, plate...). We have the analogous of Theorem 4.9.

Theorem 4.12. *Suppose (A1), (A2), (A3), (A4u). Then there exists $p_* \in (0, \lambda_2]$ such that for all $0 < p^+ < p_*$ there exists $\delta_* = \delta_*(p^+, p^-) \in (0, \frac{\lambda_1}{p^+}]$, such that for all $\delta \in (0, \delta_*)$, the solution $U(t) = \exp(-\mathcal{A}_{P,\delta}t)U^0$ of (4.5) satisfies for some $C_n > 0$,*

$$E(U(t)) \leq \frac{C_n}{t^n} \sum_{i=0}^{2n} E(U^{(i)}(0)) \quad \forall t > 0, U^0 \in \mathcal{D}(\mathcal{A}_{P,\delta}^{2n}).$$

Besides, if $U^0 \in \mathcal{H}$, then $E(U(t))$ converges to zero as t goes to infinity.

Remark 4.13. – As in Theorem 4.9, the constants p_* and δ_* here are explicit, that is $p_* = \min \left\{ \frac{1}{2\gamma_2}, \lambda_2 \right\}$ and $\delta_* = \delta_*(p^+, p^-) = \min \left\{ \frac{\lambda_1}{2\beta_2(p^+)^2 p^-}, \frac{\lambda_2 p^-}{2\beta_1(p^+)^2}, \frac{\lambda_1}{p^+} \right\}$.
– Note the difference between the conclusions of Theorem 4.9 and 4.12. For $U^0 \in D(\mathcal{A}_{P,\delta}^{2n})$, Theorem 4.9 gives a decay rate of the form C/t^{2n} , whereas Theorem 4.12 only gives a decay rate of the form C/t^n . This comes from the unbounded nature of the operator B (in the applications below, the boundary stabilization).
– Note also that item (ii) of Theorem 4.9 has no counterpart here since P and B are not of the same nature.

4.3 Proof of the main results, Theorems 4.9 and 4.12

4.3.1 The stability lemma

In the sequel, to prove polynomial stability, we shall use the following lemma, which proof can be found in [AB99], [AB02], [ACK02].

Lemma 4.14. *Let $U(t) = \exp(-t\mathcal{A})U(0)$ a strongly continuous semigroup generated by $(\mathcal{A}, \mathcal{D}(\mathcal{A}))$. Suppose that $t \mapsto E(U(t))$ is a nonincreasing, locally absolutely continuous function from $[0, +\infty)$ to $[0, +\infty)$. Assume moreover that there exists $k \in \mathbb{N}^*$ and $c_i > 0$, $i = 0, \dots, k$ such that*

$$\int_S^T E(U(t))dt \leq \sum_{i=0}^k c_i E(U^{(i)}(t)) \quad \forall 0 \leq S \leq T, \quad \forall U(0) \in \mathcal{D}(\mathcal{A}^k). \quad (4.22)$$

Then, for every $n \in \mathbb{N}$, there exists $C_n > 0$ such that

$$E(U(t))dt \leq \frac{C_n}{t^n} \sum_{i=0}^{kn} E(U^{(i)}(t)) \quad \forall t > 0, \quad \forall U(0) \in \mathcal{D}(\mathcal{A}^{kn}).$$

Besides, if $U(0) \in \mathcal{H}$, then $E(U(t))$ converges to zero as t goes to infinity.

To prove the stability results Theorem 4.9 and 4.12, we only have to perform energy estimates of the type (4.22). For this we shall use the dissipation relation (4.17), that yields, for all $0 \leq S \leq T$,

$$\int_S^T \langle Bu'_1, u'_1 \rangle_{V',V} dt \leq E(U(S)) - E(U(T)) \leq E(U(S)). \quad (4.23)$$

4.3.2 Proof of Theorem 4.9, the case B bounded

The link between u_1 and u_2 in the following estimates is given by the following coupling relation.

Lemma 4.15. *Assume (A4b) and (4.18). Then, for all $U^0 = (u_1^0, u_2^0, u_1^1, u_2^1) \in \mathcal{H}$, the solution $U(t) = \exp(-t\mathcal{A}_{P,\delta})U^0 = (u_1, u_2, v_1, v_2)$ of (4.5) satisfies for some $C = C(\delta, p^+) > 0$*

$$\delta \int_S^T (Pu_2, u_2)_H dt \leq \int_S^T (Pu_1, u_1)_H dt + \varepsilon \int_S^T (Bu_2, u_2)_H dt + C \left(1 + \frac{1}{\varepsilon}\right) E(U(S)) \quad (4.24)$$

for all $\varepsilon > 0$ and $0 \leq S \leq T$.

Proof. Assume first that $U^0 \in \mathcal{D}(\mathcal{A}_{P,\delta})$. In this case, the solution $U(t) = \exp(-t\mathcal{A}_{P,\delta})U^0 = (u_1, u_2, v_1, v_2)$ of (4.5) is in $\mathcal{C}^0([0, +\infty); \mathcal{D}(\mathcal{A}_{P,\delta}) \cap \mathcal{C}^1([0, +\infty); \mathcal{H}))$. Hence $U = (u_1, u_2, v_1, v_2)$ satisfies

$$\begin{cases} v_1 = u'_1, & v_2 = u'_2, \\ u''_1 + Au_1 + Bu'_1 + \delta Pu_2 = 0 & \text{in } H, \\ u''_2 + Au_2 + P^*u_1 = 0 & \text{in } H, \end{cases}$$

As a consequence, we have $\forall 0 \leq S \leq T$,

$$\int_S^T (u''_1 + Au_1 + Bu'_1 + \delta Pu_2, u_2)_H - (u''_2 + Au_2 + P^*u_1, u_1)_H dt = 0. \quad (4.25)$$

We first notice that $(Au_1, u_2)_H - (Au_2, u_1)_H = 0$ since A is selfadjoint, and

$$\begin{aligned} \left| \int_S^T (u''_1, u_2)_H - (u''_2, u_1)_H dt \right| &= \left| [(u'_1, u_2)_H - (u'_2, u_1)_H]_S^T \right| \\ &\leq \frac{1}{2} \sum_{j=1,2} (\|u'_j(S)\|_H^2 + \|u'_j(T)\|_H^2 + \|u_j(S)\|_H^2 + \|u_j(T)\|_H^2). \end{aligned}$$

From (4.15) and (4.18), each of the terms here is bounded by the energy, i.e., for $j = 1, 2$,

$$\|u'_j(S)\|_H^2 + \|u_j(S)\|_H^2 \leq CE(U(S)) \quad \text{and} \quad \|u'_j(T)\|_H^2 + \|u_j(T)\|_H^2 \leq CE(U(T)),$$

where $C = C(\delta, p^+)$. Since the energy is decaying and $T \geq S$, we have $E(U(T)) \leq E(U(S))$, so that

$$\left| \int_S^T (u''_1, u_2)_H - (u''_2, u_1)_H dt \right| \leq CE(U(S)).$$

Now, (4.25) becomes

$$\begin{aligned} \delta \int_S^T (Pu_2, u_2)_H dt &\leq \int_S^T (Pu_1, u_1)_H dt + \left| \int_S^T (Bu'_1, u_2)_H dt \right| + CE(U(S)) \\ &\leq \int_S^T (Pu_1, u_1)_H dt + \frac{C}{\varepsilon} \int_S^T (Bu'_1, u'_1)_H dt + \varepsilon \int_S^T (Bu_2, u_2)_H dt + CE(U(S)), \end{aligned} \quad (4.26)$$

for all $\varepsilon > 0$, since B is selfadjoint on H . From (4.23), we have $\int_S^T (Bu'_1, u'_1)_H dt \leq CE(U(S))$, and (4.26) yields

$$\delta \int_S^T (Pu_2, u_2)_H dt \leq \int_S^T (Pu_1, u_1)_H dt + \varepsilon \int_S^T (Bu_2, u_2)_H dt + C \left(1 + \frac{1}{\varepsilon}\right) E(U(S)) \quad (4.27)$$

for all $\varepsilon > 0$ and $0 \leq S \leq T$. By a density argument, we deduce that (4.27) holds for every $U^0 \in \mathcal{H}$. \square

We can now prove Theorem 4.9.

Proof of Theorem 4.9 We first prove assertion (i). Assume that $U^0 \in \mathcal{D}(\mathcal{A}_{P,\delta})$, then, the solution U of (4.5) is in $\mathcal{C}^0([0, +\infty); \mathcal{D}(\mathcal{A}_{P,\delta}) \cap \mathcal{C}^1([0, +\infty); \mathcal{H}))$ (see Proposition 4.7). We denote by $e_j(t) = 1/2 (\|u'_j\|_H^2 + \|u_j\|_V^2)$, $j = 1, 2$, the partial energies. The regularity of $U(t)$ gives in particular $Pu_2 \in \mathcal{C}^1([0, +\infty); H)$ and $P^*u_1 \in \mathcal{C}^1([0, +\infty); H)$, so that Assumptions (A2) and (A3) yield

$$\int_S^T e_1(t) dt \leq CE(U(S)) + \beta_1 \int_S^T \|\delta Pu_2(t)\|_H^2 dt + \gamma_1 \int_S^T \langle Bu'_1, u'_1 \rangle_{V',V} dt, \quad (4.28)$$

$$\int_S^T e_2(t) dt \leq CE(U(S)) + \beta_2 \int_S^T \|P^* u_1(t)\|_H^2 dt + \gamma_2 \int_S^T \|\Pi_P u'_2(t)\|_H^2 dt, \quad (4.29)$$

since $e_j(t) \leq CE(U(t)) \leq CE(U(S))$ for $t \geq S$. From (4.23), we have $\int_S^T \langle B u'_1, u'_1 \rangle_{V',V} dt \leq E(U(S))$, so that (4.28) yields

$$\int_S^T e_1(t) dt \leq CE(U(S)) + \beta_1 \delta^2 (p^+)^2 \int_S^T \|u_2(t)\|_H^2 dt. \quad (4.30)$$

On the other side, Assumption (A1) and the coupling relation (4.24) of Lemma 4.15, applied to $U' \in \mathcal{C}^0([0, +\infty); \mathcal{H})$ give, for all $\varepsilon > 0$,

$$\delta p^- \int_S^T \|\Pi_P u'_2\|_H^2 dt \leq \delta \int_S^T (P u'_2, u'_2)_H dt \leq p^+ \int_S^T \|u'_1\|_H^2 dt + \varepsilon b^+ \int_S^T \|u'_2\|_H^2 dt + C_\varepsilon E(U'(S)). \quad (4.31)$$

Replacing (4.31) in (4.29), we obtain

$$\begin{aligned} \delta p^- \int_S^T e_2(t) dt &\leq CE(U(S)) + \beta_2 \delta p^- (p^+)^2 \int_S^T \|u_1\|_H^2 dt \\ &\quad + \gamma_2 p^+ \int_S^T \|u'_1\|_H^2 dt + \varepsilon \gamma_2 b^+ \int_S^T \|u'_2\|_H^2 dt + C_\varepsilon E(U'(S)). \end{aligned} \quad (4.32)$$

Then, recalling that for all $v \in V$, $\|v\|_H^2 \leq 1/\lambda \|v\|_V^2$, and adding (4.30) and (4.32), we obtain, for all $\varepsilon > 0$,

$$\begin{aligned} \left(\frac{1}{2} - \gamma_2 p^+\right) \int_S^T \|u'_1\|_H^2 dt + \left(\frac{1}{2} - \frac{\beta_2 \delta (p^+)^2 p^-}{\lambda}\right) \int_S^T \|u_1\|_V^2 dt + \left(\frac{\delta p^-}{2} - \varepsilon \gamma_2 b^+\right) \int_S^T \|u'_2\|_H^2 dt \\ + \left(\frac{\delta p^-}{2} - \frac{\beta_1 \delta^2 (p^+)^2}{\lambda}\right) \int_S^T \|u_2\|_V^2 dt \leq CE(U(S)) + C_\varepsilon E(U'(S)). \end{aligned} \quad (4.33)$$

We now set $p_* = \min\left\{\frac{1}{2\gamma_2}, \lambda\right\} > 0$ and $\delta_* = \delta_*(p^+, p^-) = \min\left\{\frac{\lambda}{2\beta_2 (p^+)^2 p^-}, \frac{\lambda p^-}{2\beta_1 (p^+)^2}, \frac{\lambda}{p^+}\right\} > 0$. Then for all $p^+ \in (0, p_*)$ and $\delta \in (0, \delta_*)$, one can choose $0 < \varepsilon < \frac{\delta p^-}{2b^+}$, so that the following bound on the energy holds

$$\begin{aligned} \int_S^T E(U(t)) dt &\leq C(\delta, p^+) \int_S^T (\|u'_1(t)\|_H^2 + \|u_1(t)\|_V^2 + \|u'_2(t)\|_H^2 + \|u_2(t)\|_V^2) dt \\ &\leq C(\delta, p^+, p^-) (E(U(S)) + E(U'(S))), \quad \forall 0 \leq S \leq T, \quad \forall U^0 \in \mathcal{D}(\mathcal{A}_{P,\delta}), \end{aligned}$$

from (4.33) and the choice of p_* and δ_* . Using now Lemma 4.14, we obtain

$$E(U(t)) \leq \frac{C_n}{t^n} \sum_{i=0}^n E(U^{(i)}(0)) \quad \forall t > 0, \quad \forall U^0 \in \mathcal{D}(\mathcal{A}_{P,\delta}^n),$$

and (i) is proved.

We now prove the first case of (ii) and suppose (4.19). Thanks to this assumption, the coupling relation (4.24) of Lemma 4.15, applied to $U \in \mathcal{C}^1([0, +\infty); \mathcal{H})$ gives for all $\varepsilon > 0$

$$\delta \int_S^T (P u_2, u_2)_H dt \leq \int_S^T (P u_1, u_1)_H dt + \frac{\varepsilon b^+}{p^-} \int_S^T (P u_2, u_2)_H dt + C_\varepsilon E(U(S)).$$

This and assumption (4.19) yield for all $0 < \varepsilon < \frac{p^- \delta}{b^+}$

$$\int_S^T \|P u_2\|_H^2 dt \leq p^+ \int_S^T (P u_2, u_2)_H dt \leq \frac{(p^+)^2}{\delta - \varepsilon b^+ / p^-} \int_S^T \|u_1\|_H^2 dt + C_\varepsilon E(U(S)),$$

so that (4.28) gives, for all $0 < \varepsilon < \frac{p^- \delta}{b^+}$,

$$\int_S^T e_1(t) dt \leq \frac{\beta_1 \delta^2 (p^+)^2}{\delta - \varepsilon b^+ / p^-} \int_S^T \|u_1\|_H^2 dt + C_\varepsilon E(U(S)).$$

Now we set $\varepsilon = (1 - \eta) \frac{p^- \delta}{b^+}$ and we obtain, for all $\eta \in (0, 1)$,

$$\frac{1}{2} \int_S^T \|u_1'\|_H^2 dt + \left(\frac{1}{2} - \frac{\beta_1 \delta (p^+)^2}{\eta \lambda} \right) \int_S^T \|u_1\|_V^2 dt \leq C_\eta E(U(S)). \quad (4.34)$$

Choosing $p_* = \min \left\{ \frac{1}{2\beta_1}, \lambda \right\}$, we have for every $p^+ < p_*$,

$$(p^+)^2 < \frac{\lambda}{2\beta_1 \delta}, \quad (4.35)$$

since δ is chosen such that $0 < p^+ < \lambda/\delta$. From (4.35), for all $p^+ \in (0, p_*)$ and $\delta \in (0, \lambda/p^+)$, there exists $0 < \eta < 1$, such that $\frac{2\beta_1 \delta (p^+)^2}{\lambda} < \eta$ and (4.34) implies the existence of $C = C(\delta, p^+)$, such that

$$\int_S^T e_1(t) dt \leq CE(U(S)). \quad (4.36)$$

Besides, the coupling relation (4.24) of Lemma 4.15, applied to $U' \in \mathcal{C}^0([0, +\infty); \mathcal{H})$ implies in this case, for all $\varepsilon > 0$,

$$\delta \int_S^T (Pu_2', u_2')_H dt \leq \int_S^T (Pu_1', u_1')_H dt + \frac{\varepsilon b^+}{p^-} \int_S^T (Pu_2', u_2')_H dt + C_\varepsilon E(U'(S)).$$

Proceeding as above, we obtain for all $0 < \varepsilon < p^- \delta / b^+$,

$$p^- \left(\delta - \frac{\varepsilon b^+}{p^-} \right) \int_S^T \|\Pi_P u_2'\|_H^2 dt \leq p^+ \int_S^T \|u_1'\|_H^2 dt + C_\varepsilon E(U'(S)). \quad (4.37)$$

Fixing $\varepsilon \in (0, p^- \delta / b^+)$ and replacing (4.37) in (4.29), we obtain for some $C = C(\delta, b^+, p^-, p^+)$,

$$\begin{aligned} \int_S^T e_2(t) dt &\leq CE(U(S)) + \beta_2 (p^+)^2 \int_S^T \|u_1\|_H^2 dt + C \int_S^T \|u_1'\|_H^2 dt + CE(U'(S)) \\ &\leq C \int_S^T e_1(t) dt + CE(U(S)) + CE(U'(S)). \end{aligned}$$

Estimate (4.36) on e_1 gives

$$\int_S^T e_2(t) dt \leq CE(U(S)) + CE(U'(S)),$$

so that the following bound on the energy holds

$$\begin{aligned} \int_S^T E(U(t)) dt &\leq C(\delta, p^+) \int_S^T (\|u_1'(t)\|_H^2 + \|u_1(t)\|_V^2 dt + \|u_2'(t)\|_H^2 + \|u_2(t)\|_V^2) dt \\ &\leq C(\delta, p^+, p^-) (E(U(S)) + E(U'(S))), \quad \forall 0 \leq S \leq T, \quad \forall U^0 \in \mathcal{D}(\mathcal{A}_{P, \delta}). \end{aligned}$$

We conclude the proof of the first part of (ii) as in Case (i) with Lemma 4.14.

To conclude the proof of (ii), suppose now assumption (4.20), i.e., there exists $b^- > 0$ such that $(Pv, v)_H \leq p^+ / b^- (Bv, v)_H$, for all $v \in H$. In this case, the coupling relation (4.24) of Lemma 4.15, applied to $U' \in \mathcal{C}^0([0, +\infty); \mathcal{H})$ gives

$$\delta p^- \int_S^T \|\Pi_P u_2'\|_H^2 dt \leq \delta \int_S^T (Pu_2', u_2')_H dt \leq \frac{p^+}{b^-} \int_S^T (Bu_1', u_1')_H dt + \varepsilon b^+ \int_S^T \|u_2'\|_H^2 dt + C_\varepsilon E(U'(S)). \quad (4.38)$$

We recall that $\int_S^T (Bu'_1, u'_1)_H dt \leq E(U(S))$. Replacing (4.38) in (4.29), we obtain

$$\delta \int_S^T e_2(t) dt \leq CE(U(S)) + \beta_2 \delta (p^+)^2 \int_S^T \|u_1\|_H^2 dt + \frac{\varepsilon b^+ \gamma_2}{p^-} \int_S^T \|u'_2\|_H^2 dt + C_\varepsilon E(U'(S)), \quad (4.39)$$

which, summed with (4.30), yields

$$\begin{aligned} \frac{1}{2} \int_S^T \|u'_1\|_H^2 dt + \left(\frac{1}{2} - \frac{\beta_2 \delta (p^+)^2}{\lambda} \right) \int_S^T \|u_1\|_V^2 dt + \left(\frac{\delta}{2} - \frac{\varepsilon b^+ \gamma_2}{p^-} \right) \int_S^T \|u'_2\|_H^2 dt \\ + \left(\frac{\delta}{2} - \frac{\beta_1 \delta^2 (p^+)^2}{\lambda} \right) \int_S^T \|u_2\|_V^2 dt \leq CE(U(S)) + C_\varepsilon E(U'(S)). \end{aligned} \quad (4.40)$$

Now, setting $p_* = \min \left\{ \frac{1}{2\beta_1}, \frac{1}{2\beta_2}, \lambda \right\}$, we have for every $p^+ < p_*$

$$(p^+)^2 < \min \left\{ \frac{\lambda}{2\delta\beta_1}; \frac{\lambda}{2\delta\beta_2} \right\}, \quad (4.41)$$

since δ is chosen such that $0 < p^+ < \lambda/\delta$. From (4.41), for all $p^+ \in (0, p_*)$ and $\delta \in (0, \lambda/p^+)$, one can choose $0 < \varepsilon < \frac{\delta p^-}{2b^+ \gamma_2}$, so that the following bound on the energy holds

$$\begin{aligned} \int_S^T E(U(t)) dt &\leq C(\delta, p^+) \int_S^T (\|u'_1(t)\|_H^2 + \|u_1(t)\|_V^2 dt + \|u'_2(t)\|_H^2 + \|u_2(t)\|_V^2) dt \\ &\leq C(\delta, p^+, p^-) (E(U(S)) + E(U'(S))), \quad \forall 0 \leq S \leq T, \quad \forall U^0 \in \mathcal{D}(\mathcal{A}_{P,\delta}). \end{aligned}$$

We conclude the proof of the last part of (ii) as before with Lemma 4.14. This ends the proof of Theorem 4.9 \square

4.3.3 Proof of Theorem 4.12, the case B unbounded

We first state the analogous of Lemma 4.15, that provides a coupling relation between u_1 and u_2 .

Lemma 4.16. *Assume (A4u) and (4.16). Then, for all $U^0 = (u_1^0, u_2^0, u_1^1, u_2^1) \in \mathcal{D}(\mathcal{A}_{P,\delta})$, the solution $U(t) = \exp(-t\mathcal{A}_{P,\delta})U^0 = (u_1, u_2, v_1, v_2)$ of (4.5) satisfies for some $C = C(\delta, p^+) > 0$*

$$\delta \int_S^T (Pu_2, u_2)_H dt \leq \int_S^T (P^*u_1, \Pi_V u_1)_H dt + \varepsilon \int_S^T \|u_2\|_H^2 dt + \frac{C}{\varepsilon} E(U'(S)) + CE(U(S)) \quad (4.42)$$

for all $\varepsilon > 0$ and $0 \leq S \leq T$.

Remark 4.17. The main difference with the bounded case (Lemma 4.15) is that here, the energy of the derivative of U is needed in the coupling relation.

Proof. Assume first that $U^0 \in \mathcal{D}(\mathcal{A}_{P,\delta}^2)$. In this case, the solution $U(t) = \exp(-t\mathcal{A}_{P,\delta})U^0 = (u_1, u_2, v_1, v_2)$ of (4.5) is in $\mathcal{C}^0([0, +\infty); \mathcal{D}(\mathcal{A}_{P,\delta}^2)) \cap \mathcal{C}^1([0, +\infty); \mathcal{D}(\mathcal{A}_{P,\delta})) \cap \mathcal{C}^2([0, +\infty); \mathcal{H})$. Hence $U = (u_1, u_2, v_1, v_2)$ satisfies

$$\begin{cases} v_1 = u'_1, & v_2 = u'_2, \\ u''_1 + A_1 u_1 + B u'_1 + \delta P u_2 = 0 & \text{in } H, \\ u''_2 + A_2 u_2 + P^* u_1 = 0 & \text{in } H, \end{cases}$$

As a consequence, we have $\forall 0 \leq S \leq T$,

$$\int_S^T (u''_1 + A_1 u_1 + B u'_1 + \delta P u_2, u_2)_H - (u''_2 + A_2 u_2 + P^* u_1, \Pi_V u_1)_H dt = 0,$$

i.e., $K_1 + K_2 + K_3 = 0$, with

$$\begin{aligned} K_1 &= \int_S^T (u_1'', u_2)_H - (u_2'', \Pi_V u_1)_H dt, \\ K_2 &= \int_S^T (A_1 u_1 + B u_1', u_2)_H - (A_2 u_2, \Pi_V u_1)_H dt, \\ K_3 &= \int_S^T \delta(P u_2, u_2)_H - (P^* u_1, \Pi_V u_1)_H dt. \end{aligned}$$

We first consider K_1 . Since U^0 is taken in $\mathcal{D}(\mathcal{A}_{P,\delta}^2)$, $u_i \in \mathcal{C}^2([0, +\infty); V_i)$ for $i = 1, 2$. Hence, $(\Pi_V u_1)'' = \Pi_V(u_1'')$ and

$$K_1 = \int_S^T (u_1'' - \Pi_V u_1'', u_2)_H dt + [(\Pi_V u_1', u_2)_H - (\Pi_V u_1, u_2')_H]_S^T.$$

As a consequence, for all $\varepsilon > 0$,

$$\begin{aligned} |K_1| \leq \frac{C}{\varepsilon} \int_S^T \|u_1'' - \Pi_V u_1''\|_H^2 + \varepsilon \int_S^T \|u_2\|_H^2 dt \\ + \sum_{j=1,2} (\|u_j'(S)\|_H^2 + \|u_j'(T)\|_H^2 + \|u_j(S)\|_H^2 + \|u_j(T)\|_H^2). \end{aligned} \quad (4.43)$$

From (4.15) and (4.16), each of the terms of the sum is bounded by the energy, i.e., for $j = 1, 2$,

$$\|u_j'(S)\|_H^2 + \|u_j(S)\|_H^2 \leq CE(U(S)) \quad \text{and} \quad \|u_j'(T)\|_H^2 + \|u_j(T)\|_H^2 \leq CE(U(T)) \leq CE(U(S)),$$

since the energy is decaying and $T \geq S$. Replacing this in (4.43), and using Assumption (A4u), we obtain, for all $\varepsilon > 0$,

$$|K_1| \leq \frac{C}{\varepsilon} \int_S^T \beta \langle B u_1'', u_1'' \rangle_{V_1', V_1} dt + \varepsilon \int_S^T \|u_2\|_H^2 dt + CE(U(S)).$$

On the other side, Proposition 4.7 gives $E'(U(t)) = -\langle B u_1', u_1' \rangle_{V_1', V_1}$ for $U^0 \in \mathcal{D}(\mathcal{A}_{P,\delta})$, so that we have $E'(U'(t)) = -\langle B u_1'', u_1'' \rangle_{V_1', V_1}$ for $U^0 \in \mathcal{D}(\mathcal{A}_{P,\delta}^2)$. Recalling that $E(U(\cdot))$ and $E(U'(\cdot))$ are nonincreasing, we obtain, for all $\varepsilon > 0$,

$$|K_1| \leq \varepsilon \int_S^T \|u_2\|_H^2 dt + \frac{C}{\varepsilon} E(U'(S)) + CE(U(S)).$$

We now consider K_2 . From Assumption (A4u), we have,

$$(A_1 u_1 + B u_1', u_2)_H = \langle A_1 u_1 + B u_1', i(u_2) \rangle_{V_1', V_1} = \langle A_1 u_1, i(u_2) \rangle_{V_1', V_1},$$

since $U^0 \in \mathcal{D}(\mathcal{A}_{P,\delta}^2)$ yields $u_2 \in \mathcal{D}(A_2) \subset V_2$. The definition of Π_V also gives

$$\langle A_1 u_1, i(u_2) \rangle_{V_1', V_1} = \langle A_1 i(\Pi_V u_1), i(u_2) \rangle_{V_1', V_1} = \langle A_2 \Pi_V u_1, u_2 \rangle_{V_2', V_2} = \langle A_2 u_2, \Pi_V u_1 \rangle_{V_2', V_2}.$$

Moreover, since $u_2 \in \mathcal{D}(A_2)$, we have $\langle A_2 u_2, \Pi_V u_1 \rangle_{V_2', V_2} = (A_2 u_2, \Pi_V u_1)_H$, so that

$$(A_1 u_1 + B u_1', u_2)_H = (A_2 u_2, \Pi_V u_1)_H,$$

and $K_2 = 0$.

Finally, replacing in

$$\int_S^T \delta(P u_2, u_2)_H dt = \int_S^T (P^* u_1, \Pi_V u_1)_H dt - K_1 - K_2$$

the estimates on $|K_1|$ and K_2 , we have for all $\varepsilon > 0$,

$$\int_S^T \delta(Pu_2, u_2)_H dt \leq \int_S^T (P^*u_1, \Pi_V u_1)_H dt + \varepsilon \int_S^T \|u_2\|_H^2 dt + \frac{C}{\varepsilon} E(U'(S)) + CE(U(S)). \quad (4.44)$$

This concludes the proof of the proposition for an initial datum $U^0 \in \mathcal{D}(\mathcal{A}_{P,\delta}^2)$. By a density argument, we deduce that (4.44) holds for every $U^0 \in \mathcal{D}(\mathcal{A}_{P,\delta})$. \square

We can now prove Theorem 4.12. This proof follows the same steps as in the proof of Theorem 4.9 point (i). We give it for the sake of completeness.

Proof of Theorem 4.12 Assume that $U^0 \in \mathcal{D}(\mathcal{A}_{P,\delta}^2)$, then, the solution U of (4.5) is in

$$\mathcal{C}^0([0, +\infty); \mathcal{D}(\mathcal{A}_{P,\delta}^2)) \cap \mathcal{C}^1([0, +\infty); \mathcal{D}(\mathcal{A}_{P,\delta})) \cap \mathcal{C}^2([0, +\infty); \mathcal{H})$$

(see Proposition 4.7). We recall the notation $e_j(t) = 1/2 (\|u'_j\|_H^2 + \|u_j\|_{V_j}^2)$, $j = 1, 2$. The regularity of $U(t)$ gives in particular $Pu_2 \in \mathcal{C}^1([0, +\infty); H)$ and $P^*u_1 \in \mathcal{C}^1([0, +\infty); H)$, so that Assumptions (A2) and (A3) yield

$$\int_S^T e_1(t) dt \leq CE(U(S)) + \beta_1 \int_S^T \|\delta Pu_2(t)\|_H^2 dt + \gamma_1 \int_S^T \langle Bu'_1, u'_1 \rangle_{V'_1, V_1} dt, \quad (4.45)$$

$$\int_S^T e_2(t) dt \leq CE(U(S)) + \beta_2 \int_S^T \|P^*u_1(t)\|_H^2 dt + \gamma_2 \int_S^T \|\Pi_P u'_2(t)\|_H^2 dt. \quad (4.46)$$

From (4.23), we have $\int_S^T \langle Bu'_1, u'_1 \rangle_{V'_1, V_1} dt \leq E(U(S))$, so that (4.45) yields

$$\int_S^T e_1(t) dt \leq CE(U(S)) + \beta_1 \delta^2 (p^+)^2 \int_S^T \|u_2(t)\|_H^2 dt. \quad (4.47)$$

On the other side, Assumption (A1) and the coupling relation (4.42) of Lemma 4.16, applied to $U' \in \mathcal{C}^0([0, +\infty); \mathcal{D}(\mathcal{A}_{P,\delta}))$ give, for all $\varepsilon > 0$,

$$\begin{aligned} \delta p^- \int_S^T \|\Pi_P u'_2\|_H^2 dt &\leq \delta \int_S^T (Pu'_2, u'_2)_H dt \\ &\leq p^+ \int_S^T \|u'_1\|_H^2 dt + \varepsilon \int_S^T \|u'_2\|_H^2 dt + C_\varepsilon E(U''(S)) + CE(U'(S)). \end{aligned} \quad (4.48)$$

Replacing (4.48) in (4.46), we obtain

$$\begin{aligned} \delta p^- \int_S^T e_2(t) dt &\leq CE(U(S)) + CE(U'(S)) + \beta_2 \delta p^- (p^+)^2 \int_S^T \|u_1(t)\|_H^2 dt \\ &\quad + \gamma_2 p^+ \int_S^T \|u'_1\|_H^2 dt + \varepsilon \gamma_2 \int_S^T \|u'_2\|_H^2 dt + C_\varepsilon E(U''(S)). \end{aligned} \quad (4.49)$$

Then, recalling that for all $v \in V_j$, $\|v\|_H^2 \leq 1/\lambda_j \|v\|_{V_j}^2$, $j = 1, 2$, and adding (4.47) and (4.49), we obtain, for all $\varepsilon > 0$,

$$\begin{aligned} \left(\frac{1}{2} - \gamma_2 p^+\right) \int_S^T \|u'_1\|_H^2 dt &+ \left(\frac{1}{2} - \frac{\beta_2 \delta (p^+)^2 p^-}{\lambda_1}\right) \int_S^T \|u_1\|_{V_1}^2 dt + \left(\frac{\delta p^-}{2} - \varepsilon \gamma_2\right) \int_S^T \|u'_2\|_H^2 dt \\ &+ \left(\frac{\delta p^-}{2} - \frac{\beta_1 \delta^2 (p^+)^2}{\lambda_2}\right) \int_S^T \|u_2\|_{V_2}^2 dt \leq CE(U(S)) + CE(U'(S)) + C_\varepsilon E(U''(S)). \end{aligned} \quad (4.50)$$

We now set $p_* = \min\left\{\frac{1}{2\gamma_2}, \lambda_2\right\} > 0$ and $\delta_* = \delta_*(p^+, p^-) = \min\left\{\frac{\lambda_1}{2\beta_2(p^+)^2 p^-}, \frac{\lambda_2 p^-}{2\beta_1(p^+)^2}, \frac{\lambda_1}{p^+}\right\} > 0$. Then for all $p^+ \in (0, p_*)$ and $\delta \in (0, \delta_*)$, one can choose $0 < \varepsilon < \frac{\delta p^-}{2\gamma_2}$, so that the following bound on the energy holds for all $0 \leq S \leq T$ and $U^0 \in \mathcal{D}(\mathcal{A}_{P,\delta}^2)$,

$$\begin{aligned} \int_S^T E(U(t))dt &\leq C(\delta, p^+) \int_S^T (\|u'_1(t)\|_H^2 + \|u_1(t)\|_V^2 + \|u'_2(t)\|_H^2 + \|u_2(t)\|_V^2) dt \\ &\leq C(\delta, p^+, p^-)(E(U(S)) + E(U'(S)) + E(U''(S))), \end{aligned}$$

from (4.50) and the choice of p_* and δ_* . Using now Lemma 4.14, we obtain

$$E(U(t)) \leq \frac{C_n}{t^n} \sum_{i=0}^{2n} E(U^{(i)}(0)) \quad \forall t > 0, \quad \forall U^0 \in \mathcal{D}(\mathcal{A}_{P,\delta}^{2n}),$$

and Theorem 4.12 is proved. □

4.4 Applications

We now apply the results of Theorem 4.9 and Theorem 4.12 to different second order coupled systems. In each of the following sections, we first explain how the problem can be formulated in the abstract setting of Section 4.2.1. All these systems are well-posed in the spaces we choose, according to Proposition 4.7. Hence, we only have to check that Assumptions (A1) – (A4) hold in order to apply Theorem 4.9 or Theorem 4.12 and obtain the expected stability results. This strategy shall be followed in Section 4.4.1 to address internal stabilization of coupled wave equations, in Section 4.4.2 to address boundary stabilization of coupled wave equations, and in Section 4.4.3 to address internal stabilization of coupled plate equations. For the sake of brevity, we do not treat the case of boundary stabilization of coupled plate equations. However, one can prove as well that Theorem 4.12 can be applied in this case.

4.4.1 Internal stabilization of locally coupled wave equations

Here, we prove Theorem 4.2 in the context presented in the introduction. We recall that $\Omega \subset \mathbb{R}^N$, $\Gamma = \partial\Omega$ is of class \mathcal{C}^2 , and consider the evolution problem (4.3). We take $H = L^2(\Omega)$, $V = H_0^1(\Omega)$ with the usual inner products and norms. We moreover take for B and P respectively the multiplication in L^2 by the functions $b, p \in L^\infty(\Omega)$, satisfying

$$\begin{cases} 0 \leq b \leq b^+ \text{ and } 0 \leq p \leq p^+ \text{ on } \Omega, \\ b \geq b^- > 0 \text{ on } \omega_b, \\ p \geq p^- > 0 \text{ on } \omega_p, \end{cases}$$

for ω_b and ω_p two open subsets of Ω , satisfying the PMGC. As a consequence, Assumption (A4b) is satisfied and Assumption (A1) is fulfilled taking for Π_P the multiplication by $\mathbb{1}_{\omega_p}$. It only remains to check Assumptions (A2) and (A3), that are consequences of the following lemma.

Lemma 4.18. *Let ω be a subset of Ω satisfying the PMGC. Then, there exist $\alpha, \beta, \gamma > 0$ such that for all $f \in \mathcal{C}^1(\mathbb{R}^+; L^2(\Omega))$ and all $0 \leq S \leq T$, the solution u of*

$$\begin{cases} u'' - \Delta u = f & \text{in } (0, +\infty) \times \Omega, \\ u = 0 & \text{on } (0, +\infty) \times \Gamma, \\ (u, u')(0, \cdot) = (u^0(\cdot), u^1(\cdot)) & \in H_0^1(\Omega) \times L^2(\Omega), \end{cases} \quad (4.51)$$

satisfies, with $e(t) = 1/2 \left(\|u'\|_{L^2(\Omega)}^2 + \|\nabla u\|_{L^2(\Omega)}^2 \right)$, the inequality

$$\int_S^T e(t) dt \leq \alpha(e(S) + e(T)) + \beta \int_S^T \|f(t)\|_{L^2(\Omega)}^2 dt + \gamma \int_S^T \|\mathbb{1}_\omega u'(t)\|_{L^2(\Omega)}^2 dt. \quad (4.52)$$

This Lemma directly yields (A2), since ω_p is supposed to satisfy the PMGC. To prove (A3), we note that the solution u of (4.51) is $\mathcal{C}^1(\mathbb{R}^+; L^2(\Omega))$ and apply the lemma to $u = u_1$, $\omega = \omega_b$ and $f = f_1 - bu'_1 \in \mathcal{C}^1(\mathbb{R}^+; L^2(\Omega))$. This yields

$$\begin{aligned} \int_S^T e_1(t) dt &\leq \alpha(e_1(S) + e_1(T)) + \beta \int_S^T \|f_1(t) - bu'_1(t)\|_{L^2(\Omega)}^2 dt + \gamma \int_S^T \|\mathbb{1}_{\omega_b} u'_1(t)\|_{L^2(\Omega)}^2 dt \\ &\leq \alpha(e_1(S) + e_1(T)) + 2\beta \int_S^T \|f_1(t)\|_{L^2(\Omega)}^2 dt + \left(2\beta + \frac{\gamma}{(b^-)^2}\right) \int_S^T \|bu'_1(t)\|_{L^2(\Omega)}^2 dt, \end{aligned}$$

which is (A3) with $\beta_1 = 2\beta$ and $\gamma_1 = \left(2\beta + \frac{\gamma}{(b^-)^2}\right)$.

Now applying Theorem 4.9, we have proved the following theorem.

Theorem 4.19. (i) Suppose that ω_b and ω_p satisfy the PMGC. Then there exists $p_* \in (0, \lambda]$ such that for all $0 < p^+ < p_*$ there exists $\delta_* = \delta_*(p^+, p^-) \in (0, \frac{\lambda}{p^+}]$, such that for all $\delta \in (0, \delta_*)$, the solution $U = (u_1, u_2, u'_1, u'_2)$ of (4.3) satisfies for $n \in \mathbb{N}$, for some $C_n > 0$,

$$E(U(t)) \leq \frac{C_n}{t^n} \sum_{i=0}^n E(U^{(i)}(0)) \quad \forall t > 0, \quad U^0 = (u_1^0, u_2^0, u_1^1, u_2^1) \in \mathcal{D}(\mathcal{A}_{P, \delta}^n),$$

where $\mathcal{D}(\mathcal{A}_{P, \delta}^n)$ is defined in (4.13). Besides, if $U^0 \in \mathcal{H} = (H_0^1)^2 \times (L^2)^2$, then $E(U(t))$ converges to zero as t goes to infinity.

(ii) If moreover either $\omega_b \subset \omega_p$ or $\omega_p \subset \omega_b$, then the result holds for $\delta_* = \frac{\lambda}{p^+}$.

Theorem 4.2 is now a corollary of Theorem 4.19 in the case of smooth coefficients since Lemma 4.11 allows us to explicit the spaces $\mathcal{D}(\mathcal{A}_{P, \delta}^n)$.

Proof of Lemma 4.18 We here prove the energy estimate (4.52) for the solutions of (4.51), using the piecewise multiplier method. We proceed as in [Mar99] and [AB05]. The subset ω satisfies the PMGC. Hence, denoting by Ω_j and x_j , $j = 1 \dots J$ the sets and the points given by the PMGC, we have $\omega \supset \mathcal{N}_\varepsilon \left(\bigcup_j \gamma_j(x_j) \cup (\Omega \setminus \bigcup_j \Omega_j) \right) \cap \Omega$. In this expression, $\mathcal{N}_\varepsilon(\mathcal{O}) = \{x \in \mathbb{R}^N, d(x, \mathcal{O}) \leq \varepsilon\}$ with $d(\cdot, \mathcal{O})$ the usual euclidian distance to the subset \mathcal{O} of \mathbb{R}^N , and $\gamma_j(x_j) = \{x \in \Gamma_j, (x - x_j) \cdot \nu_j(x) > 0\}$, where ν_j denotes the outward unit normal to $\Gamma_j = \partial\Omega_j$. Let $\varepsilon_0 < \varepsilon_1 < \varepsilon_2 < \varepsilon$ and define

$$Q_i = \mathcal{N}_{\varepsilon_i} \left(\bigcup_j \gamma_j(x_j) \cup (\Omega \setminus \bigcup_j \Omega_j) \right), \quad i = 0, 1, 2.$$

Since $(\overline{\Omega_j} \setminus Q_1) \cap \overline{Q_0} = \emptyset$, we can construct a function $\psi_j \in \mathcal{C}_c^\infty(\mathbb{R}^N)$ which satisfies

$$0 \leq \psi_j \leq 1, \quad \psi_j = 1 \text{ on } \overline{\Omega_j} \setminus Q_1, \quad \psi_j = 0 \text{ on } Q_0.$$

For $m_j(x) = x - x_j$, we define the \mathcal{C}^1 vector field on Ω :

$$h(x) = \begin{cases} \psi_j(x)m_j(x) & \text{if } x \in \Omega_j, \\ 0 & \text{if } x \in \Omega \setminus \bigcup_j \Omega_j. \end{cases}$$

Multiplying (4.51) by the multiplier $h \cdot \nabla u$ and integrating on $(S, T) \times \Omega_j$, we obtain

$$\int_S^T \int_{\Omega_j} h(x) \cdot \nabla u (u'' - \Delta u - f) dx dt = 0.$$

For the sake of concision, we will omit the $dx dt$ in the following integrals. This gives, after integration by parts

$$\begin{aligned} \int_S^T \int_{\Gamma_j} \left(\partial_{\nu_j} u h \cdot \nabla u + \frac{1}{2} (h \cdot \nu) (u'^2 - |\nabla u|^2) \right) &= \left[\int_{\Omega_j} u' h \cdot \nabla u \right]_S^T \\ &+ \int_S^T \int_{\Omega_j} \left(\frac{1}{2} \operatorname{div} h (u'^2 - |\nabla u|^2) + \sum_{i,k} \frac{\partial h_k}{\partial x_i} \frac{\partial u}{\partial x_i} \frac{\partial u}{\partial x_k} - f h \cdot \nabla u \right). \end{aligned} \quad (4.53)$$

Thanks to the choice of ψ_j , only the boundary term on $(\Gamma_j \setminus \gamma_j(x_j)) \cap \Gamma$ is nonvanishing in the left hand side of (4.53). But on this part of the boundary $u = 0$, so that $u' = 0$ and $\nabla u = \partial_\nu u \nu = \partial_{\nu_j} u \nu_j$. Hence, the left hand side of (4.53) reduces to

$$\frac{1}{2} \int_S^T \int_{(\Gamma_j \setminus \gamma_j(x_j)) \cap \Gamma} (\partial_{\nu_j} u)^2 \psi_j (m_j \cdot \nu_j) \leq 0.$$

Therefore, since $\psi_j = 0$ on Q_0 and thanks to the above inequality used in (4.53), we deduce that

$$\left[\int_{\Omega_j} u' h \cdot \nabla u \right]_S^T + \int_S^T \int_{\Omega_j \setminus Q_0} \left(\frac{1}{2} \operatorname{div} h (u'^2 - |\nabla u|^2) + \sum_{i,k} \frac{\partial h_k}{\partial x_i} \frac{\partial u}{\partial x_i} \frac{\partial u}{\partial x_k} - f h \cdot \nabla u \right) \leq 0.$$

Using $\psi_j = 1$ on $\overline{\Omega_j} - Q_1$ and summing the resulting inequalities on j , we obtain

$$\begin{aligned} \left[\int_{\Omega} u' h \cdot \nabla u \right]_S^T + \int_S^T \int_{\Omega \setminus Q_1} \frac{1}{2} (N u'^2 + (2 - N) |\nabla u|^2) - \int_S^T \int_{\Omega} f h \cdot \nabla u \\ \leq - \sum_j \int_S^T \left[\int_{\Omega_j \cap Q_1} \frac{1}{2} \operatorname{div}(\psi_j m_j) (u'^2 - |\nabla u|^2) + \sum_{i,k} \frac{\partial h_k}{\partial x_i} \frac{\partial u}{\partial x_i} \frac{\partial u}{\partial x_k} \right] \\ \leq C \int_S^T \int_{\Omega \cap Q_1} (u'^2 + |\nabla u|^2), \end{aligned} \quad (4.54)$$

where C is a positive constant which depends only on ψ_j and m_j . We now use the second multiplier $u(N-1)/2$ and therefore evaluate the term

$$\frac{N-1}{2} \int_S^T \int_{\Omega} u (u'' - \Delta u - f) = 0.$$

Hence, one has

$$\frac{N-1}{2} \left[\int_{\Omega} u u' \right]_S^T + \frac{N-1}{2} \int_S^T \int_{\Omega} |\nabla u|^2 - u'^2 - u f = 0. \quad (4.55)$$

We set $M(u) = h \cdot \nabla u + \frac{N-1}{2} u$. Adding (4.55) to (4.54), we obtain

$$\int_S^T e(t) dt \leq C \int_S^T \int_{\Omega \cap Q_1} |\nabla u|^2 + C \int_S^T \int_{\Omega \cap Q_1} u'^2 - \left[\int_{\Omega} M(u) u' \right]_S^T + \int_S^T \int_{\Omega} M(u) f. \quad (4.56)$$

We now estimate the terms on the right hand side of (4.56) as follows. First, we have

$$\left| \left[\int_{\Omega} M(u) u' \right]_S^T \right| \leq C(e(S) + e(T)). \quad (4.57)$$

Second, we estimate the last term of (4.56) as follows

$$\left| \int_S^T \int_{\Omega} M(u) f \right| \leq \frac{C}{\mu} \int_S^T \int_{\Omega} |f|^2 + \mu \int_S^T e(t) dt \quad \forall \mu > 0. \quad (4.58)$$

The difficulty is now to estimate the first term on the right hand side of (4.56). We just follow techniques developed in [Mar99]. We give the steps for the sake of completeness. First, we dominate the integral of $|\nabla u|^2$ in (4.56) by the integral of u^2 and u'^2 , localized inside the region of observation. Second, in (4.60) below, we bound the integral of u^2 in terms of the integral of u'^2 in the same region. Since $\mathbb{R}^N \setminus Q_2 \cap \overline{Q_1} = \emptyset$, there exists a function $\xi \in \mathcal{C}_c^\infty(\mathbb{R}^N)$ such that

$$0 \leq \xi \leq 1, \quad \xi = 1 \text{ on } Q_1, \quad \xi = 0 \text{ on } \mathbb{R}^N \setminus Q_2.$$

Multiplying (4.51) by ξu and integrating on $[S, T] \times \Omega$, we obtain after integrations by parts

$$\int_S^T \int_\Omega \xi |\nabla u|^2 = \int_S^T \int_\Omega \left(\xi |u'|^2 + \frac{1}{2} \Delta \xi u^2 \right) - \left[\int_\Omega \xi u u' \right]_S^T + \int_S^T \int_\Omega \xi u f.$$

We thus have

$$\int_S^T \int_{\Omega \cap Q_1} |\nabla u|^2 \leq C \int_S^T \int_{\Omega \cap Q_2} (|u'|^2 + u^2 + |f|^2) + C(e(S) + e(T)).$$

Since $\overline{\mathbb{R}^N \setminus \omega} \cap \overline{Q_2} = \emptyset$, there exists a function $\beta \in \mathcal{C}_c^\infty(\mathbb{R}^N)$ such that

$$0 \leq \beta \leq 1, \quad \beta = 1 \text{ on } Q_2, \quad \beta = 0 \text{ on } \mathbb{R}^N \setminus \omega.$$

Proceeding as in [CR93], we fix t and consider the solution z of the following elliptic problem

$$\begin{cases} \Delta z = \beta(x)u & \text{in } \Omega, \\ z = 0 & \text{on } \Gamma. \end{cases}$$

Hence, z and z' satisfy the following estimates

$$\|z\|_{L^2(\Omega)} \leq C \|u\|_{L^2(\Omega)}, \quad \text{and} \quad \|z'\|_{L^2(\Omega)}^2 \leq C \int_\Omega \beta |u'|^2. \quad (4.59)$$

Multiplying (4.51) by z and integrating on $[S, T] \times \Omega$, we obtain after integrations by parts

$$\int_S^T \int_\Omega \beta u^2 = \left[\int_\Omega z u' \right]_S^T + \int_S^T \int_\Omega -z' u' - z f.$$

Hence, using the estimates (4.59) in the above relation, we obtain for all $\eta > 0$

$$\int_S^T \int_{\Omega \cap Q_2} |u|^2 \leq \frac{C}{\eta} \int_S^T \int_\omega |u'|^2 + \frac{C}{\eta} \int_S^T \int_\Omega |f|^2 + \eta \int_S^T e + C(e(S) + e(T)). \quad (4.60)$$

Combined with the estimates (4.57), (4.58) and (4.60) in (4.56), this gives for all $\mu > 0$

$$\int_S^T e \leq C(e(S) + e(T)) + C\mu \int_S^T e + \frac{C}{\mu} \int_S^T \left[\int_\omega |u'|^2 + \int_\Omega |f|^2 \right].$$

Choosing μ sufficiently small, we finally have

$$\int_S^T e \leq C(e(S) + e(T)) + C \int_S^T \left[\int_\omega |u'|^2 + \int_\Omega |f|^2 \right],$$

and the lemma is proved. \square

4.4.2 Boundary stabilization of locally coupled wave equations

Here, we are interested in boundary stabilization. The results given generalize the ones of [AB99] and [AB02] where the case of constant coupling has been considered. Given $\Omega \subset \mathbb{R}^N$ and $\Gamma = \partial\Omega$ of class \mathcal{C}^2 we shall use the following Boundary Multiplier Geometric Condition (BMGC).

Definition 4.20 (BMGC). Let $\{\Sigma_1, \Sigma_0\}$ be a partition of Γ such that $\overline{\Sigma_1} \cap \overline{\Sigma_0} = \emptyset$. We say that $\{\Sigma_1, \Sigma_0\}$ satisfies the BMGC if there exists $x_0 \in \mathbb{R}^N$ such that $m \cdot \nu \leq 0$ on Σ_0 and $m \cdot \nu \geq m^- > 0$ on Σ_1 , where $m(x) = x - x_0$.

The most simple situation covered by this condition is the case where Ω is star-shaped with respect to x_0 . In this case $\Sigma_0 = \emptyset$ and $\Sigma_1 = \Gamma$. Another interesting and somehow more general situation is the case where $\Omega = \Omega_1 \setminus \overline{\Omega_2}$, with Ω_2 and Ω_1 two open subset of \mathbb{R}^N , both star-shaped with respect to x_0 , and such that $\overline{\Omega_2} \subset \Omega_1$. In this case, $\partial\Omega = \partial\Omega_1 \cup \partial\Omega_2$ with a disjoint union, $\Sigma_0 = \partial\Omega_2$ and $\Sigma_1 = \partial\Omega_1$ satisfy the BMGC.

For $\Gamma_b \subset \Gamma$, and $\Gamma_0 = \Gamma \setminus \Gamma_b$, we consider the following coupled stabilization problem

$$\begin{cases} u_1'' - \Delta u_1 + \delta p u_2 = 0 & \text{in } (0, +\infty) \times \Omega, \\ u_2'' - \Delta u_2 + p u_1 = 0 & \text{in } (0, +\infty) \times \Omega, \\ \frac{\partial u_1}{\partial \nu} + m \cdot \nu (l u_1 + b u_1') = 0 & \text{on } (0, +\infty) \times \Gamma_b, \\ u_1 = 0 & \text{on } (0, +\infty) \times \Gamma_0, \\ u_2 = 0 & \text{on } (0, +\infty) \times \Gamma, \\ u_j(0, \cdot) = u_j^0(\cdot), u_j'(0, \cdot) = u_j^1(\cdot), j = 1, 2 & \text{in } \Omega, \end{cases} \quad (4.61)$$

where l is a non-negative function on Γ_b . Note that we added $m \cdot \nu$, where $m(x) = x - x_0$ in the stabilization term to avoid some technical estimates. This term can be removed, provided that we do some more assumptions on the functions b and l . Here we make the following assumptions on the coefficients b and p

$$\begin{cases} 0 \leq b \leq b^+ \text{ on } \Gamma, \text{ and } b \geq b^- > 0 \text{ on } \Gamma_b \\ 0 \leq p \leq p^+ \text{ on } \Omega, \text{ and } p \geq p^- > 0 \text{ on } \omega_p, \end{cases}$$

Moreover we set $H_{\Gamma_0}^1(\Omega) = \{u \in H^1(\Omega), u = 0 \text{ on } \Gamma_0\}$, and we shall assume for the sake of clarity that $l \neq 0$ or $\text{meas}(\Gamma_0) \neq 0$. We take $H = L^2(\Omega)$ and $V_1 = H_{\Gamma_0}^1(\Omega)$ equipped respectively with the L^2 inner product and the inner product $(u, z)_{V_1} = \int_{\Omega} \nabla u \cdot \nabla z + \int_{\Gamma_b} (m \cdot \nu l u z)$ and the corresponding norms. Moreover we take $V_2 = H_0^1(\Omega)$ equipped with the inner product $(u, z)_{V_2} = \int_{\Omega} \nabla u \cdot \nabla z$ and the associated norm. We define the duality mappings A_1 and A_2 as in Section 4.2.1. We also define the continuous linear operator B from V_1 to V_1' by

$$\langle Bu, z \rangle_{V_1', V_1} = \int_{\Gamma_b} m \cdot \nu b u z d\gamma,$$

that satisfies (4.11). As in Section 4.4.2, we take for P the multiplication in L^2 by the function $p \in L^\infty$. With these notations, system (4.61) can be rewritten under the form (4.5).

Theorem 4.21. *Suppose that ω_p satisfies the PMGC and $\{\Gamma_b, \Gamma_0\}$ satisfies the BMGC. Then there exists $p_* \in (0, \lambda]$ such that for all $0 < p^+ < p_*$ there exists $\delta_* = \delta_*(p^+, p^-) \in (0, \frac{\lambda}{p^+}]$, such that for all $\delta \in (0, \delta_*)$, the solution $U = (u_1, u_2, u_1', u_2')$ of (4.61) satisfies, for $n \geq 1$, for some $C_n > 0$,*

$$E(U(t)) \leq \frac{C_n}{t^n} \sum_{i=0}^{2n} E(U^{(i)}(0)) \quad \forall t > 0, \quad \forall U^0 = (u_1^0, u_2^0, u_1^1, u_2^1) \in \mathcal{D}(\mathcal{A}_{P,\delta}^{2n}).$$

Besides, if $U^0 \in \mathcal{H} = H_{\Gamma_0}^1 \times H_0^1 \times (L^2)^2$, then $E(U(t))$ converges to zero as t goes to infinity.

We recall that the operator $\mathcal{A}_{P,\delta}$ is defined in (4.13). As opposed to the results for internal damping, we do not have here a simple expression of $\mathcal{D}(\mathcal{A}_{P,\delta}^{2n})$ in terms of Sobolev spaces.

To prove this Theorem, we just need to check that the Assumptions (A1) – (A4u) are satisfied and then apply Theorem 4.12 in a convenient setting. First, Assumption (A1) is satisfied with Π_P the multiplication by $\mathbf{1}_{\omega_p}$, and Assumption (A2) is a consequence of Lemma 4.22 as in Section 4.4.1, since the internal coupling is here the same.

We now check Assumption (A4u) and follow the lines of [AB02]. For the sake of clarity, we identify $i(\phi)$ with ϕ for $\phi \in V_2$ (where i is the canonical injection from V_2 in V_1). We first remark that the first equality in Assumption (A4u) is satisfied thanks to the definition of B and V_2 . We define Π_V and A_2 as in Section 4.2.1. Then, $\Pi_V u_1$ is the weak solution of

$$\begin{cases} -\Delta \Pi_V u_1 = -\Delta u_1 & \text{in } \Omega, \\ \Pi_V u_1 \in V_2, \end{cases}$$

and A_2 is defined by

$$\langle A_2\phi, \psi \rangle_{V_2', V_2} = \int_{\Omega} \nabla\phi \cdot \nabla\psi \, dx, \quad \forall \psi, \phi \in V_2.$$

We now check the second relation in (A4u). For this, we set $z = u_1 - \Pi_V u_1$, so that z is the weak solution of

$$\begin{cases} -\Delta z = 0 & \text{in } \Omega, \\ z = u_1, & \text{on } \Gamma. \end{cases}$$

By elliptic regularity, we deduce that there exists a constant $c > 0$ such that $\|z\|_H \leq c\|u_1|_{\Gamma_b}\|_{L^2(\Gamma_b)}$. Since we assume the BMGC, $m \cdot \nu b \geq m^- b^- > 0$ on Γ_b , there exists then $\beta > 0$ such that

$$\|z\|_H^2 \leq \beta \langle Bu_1, u_1 \rangle_{V_1', V_1} \quad \forall u_1 \in V_1,$$

and (A4u) is satisfied.

The last assumption (A3) is a direct consequence of the following lemma. Theorem 4.21 follows then from Theorem 4.12.

Lemma 4.22. *Suppose that $\{\Gamma_b, \Gamma_0\}$ satisfies the BMGC. Then, there exist $\alpha, \beta, \gamma > 0$ such that for all $f \in \mathcal{C}^1(\mathbb{R}^+; L^2(\Omega))$ and all $0 \leq S \leq T$, the solution u of*

$$\begin{cases} u'' - \Delta u = f & \text{in } (0, +\infty) \times \Omega, \\ \frac{\partial u}{\partial \nu} + m \cdot \nu (lu + bu') = 0 & \text{on } (0, +\infty) \times \Gamma_b, \\ u = 0 & \text{on } (0, +\infty) \times \Gamma_0, \\ (u, u')(0, \cdot) = (u^0(\cdot), u^1(\cdot)) \in H_0^1(\Omega) \times L^2(\Omega), \end{cases} \quad (4.62)$$

satisfies, with $e(t) = 1/2 \left(\|u'\|_{L^2(\Omega)}^2 + \|\nabla u\|_{L^2(\Omega)}^2 + \int_{\Gamma_b} m \cdot \nu lu^2 d\gamma \right)$, the inequality

$$\int_S^T e(t) \, dt \leq \alpha(e(S) + e(T)) + \beta \int_S^T \|f(t)\|_{L^2(\Omega)}^2 \, dt + \gamma \int_S^T \int_{\Gamma_b} m \cdot \nu bu'^2 \, dx dt. \quad (4.63)$$

Proof. Proceeding as in [Kom94, Theorem 8.6], we first use the multiplier $Mu = m(x) \cdot \nabla u + \frac{(N-1)}{2}u$ and set $R = \sup\{|m(x)|, x \in \Omega\}$. Multiplying (4.62) by Mu , we obtain after integrations by parts

$$\begin{aligned} \int_S^T e(t) dt &= \int_S^T \int_{\Omega} f Mu - \left[\int_{\Omega} u' Mu \right]_S^T + \frac{1}{2} \int_S^T \int_{\Gamma_0} m \cdot \nu \left| \frac{\partial u}{\partial \nu} \right|^2 d\gamma dt \\ &\quad + \int_S^T \int_{\Gamma_b} m \cdot \nu \left(\frac{1}{2} u'^2 - \frac{1}{2} |\nabla u|^2 - (lu + bu')(m \cdot \nabla u + \frac{N-1}{2}u) + l \frac{u^2}{2} \right). \end{aligned}$$

Setting $h = \frac{u'^2 - |\nabla u|^2}{2} + R|lu + bu'| |\nabla u| + |2 - N|l \frac{u^2}{2} - buu' \frac{(N-1)}{2}$, this yields, for all $\eta > 0$,

$$\int_S^T e(t) dt \leq C(e(S) + e(T)) + \frac{C}{\eta} \int_S^T \int_{\Omega} f^2 + \eta \int_S^T e(t) dt + \int_S^T \int_{\Gamma_b} m \cdot \nu h. \quad (4.64)$$

We now estimate the term h . Since $b \geq b^- > 0$ on Γ_b , we have for all $\varepsilon > 0$,

$$h \leq C \left(1 + \frac{1}{\varepsilon} \right) bu'^2 + Clu^2 + \varepsilon u^2. \quad (4.65)$$

Concerning the last term, in this equation, we have the trace inequality

$$\varepsilon \int_S^T \int_{\Gamma_b} m \cdot \nu u^2 \leq C\varepsilon \int_S^T \left(\int_{\Omega} \frac{|\nabla u|^2}{2} + \int_{\Gamma_b} m \cdot \nu lu^2 \right). \quad (4.66)$$

Hence, for ε and η sufficiently small, using (4.66) and (4.65) in (4.64), we obtain

$$\int_S^T e(t)dt \leq C(e(T) + e(S)) + C \int_S^T \int_{\Omega} f^2 + C \int_S^T \int_{\Gamma_b} m \cdot \nu b u'^2 + C \int_S^T \int_{\Gamma_b} m \cdot \nu l u^2 \quad (4.67)$$

It only remains to treat the last term in this inequality. For this, we use the method introduced in [CR93]. Let z be the solution of the following elliptic problem :

$$\begin{cases} \Delta z = 0 & \text{in } \Omega, \\ z = u & \text{on } \Gamma_b, \\ z = 0 & \text{on } \Gamma_0. \end{cases}$$

Note that this definition yields

$$\int_{\Omega} |\nabla z|^2 + z^2 \leq C \int_{\Gamma_b} u^2 \quad \text{and} \quad \int_{\Omega} \nabla z \cdot \nabla u = \int_{\Omega} |\nabla z|^2. \quad (4.68)$$

We multiply (4.62) by z and integrate on $(S, T) \times \Omega$. Integrating by parts and using (4.68) and the boundary conditions for u , we obtain

$$\begin{aligned} \int_S^T \int_{\Gamma_b} m \cdot \nu l u^2 &= \int_S^T \int_{\Omega} (u' z' - |\nabla z|^2 + f z) - \left[\int_{\Omega} u' z \right]_S^T - \int_S^T m \cdot b u' u \\ &\leq \varepsilon \int_S^T \int_{\Omega} u'^2 + \frac{C}{\varepsilon} \int_S^T \int_{\Omega} z'^2 + \frac{C}{\varepsilon} \int_S^T \int_{\Omega} f^2 + C\varepsilon \int_S^T \int_{\Omega} z^2 \\ &\quad + C(e(T) + e(S)) + \frac{C}{\varepsilon} \int_S^T \int_{\Gamma_b} m \cdot \nu b u'^2 + \varepsilon \int_S^T \int_{\Gamma_b} u^2, \end{aligned} \quad (4.69)$$

for all $\varepsilon > 0$. Now noting that

$$\int_S^T \int_{\Omega} z'^2 \leq \int_S^T \int_{\Gamma_b} m^{-b} z'^2 \leq \int_S^T \int_{\Gamma_b} m \cdot \nu b z'^2,$$

and

$$\int_S^T \int_{\Omega} u'^2 + \int_S^T \int_{\Omega} z^2 + \int_S^T \int_{\Gamma_b} u^2 \leq C \int_S^T e(t)dt,$$

the estimate (4.69) yields, for all $\varepsilon > 0$,

$$\int_S^T \int_{\Gamma_b} m \cdot \nu l u^2 \leq C\varepsilon \int_S^T e(t)dt + \frac{C}{\varepsilon} \int_S^T \int_{\Omega} f^2 + C(e(T) + e(S)) + \frac{C}{\varepsilon} \int_S^T \int_{\Gamma_b} m \cdot \nu b u'^2.$$

Finally, replacing this in (4.67) and taking ε sufficiently small, we obtain

$$\int_S^T e(t)dt \leq C(e(T) + e(S)) + C \int_S^T \int_{\Omega} f^2 + C \int_S^T \int_{\Gamma_b} m \cdot \nu b u'^2,$$

and the lemma is proved. \square

4.4.3 Internal stabilization of locally coupled plate equations

In this last application, we are concerned with a system of two weakly coupled plate equations. This generalizes the case of constant coupling investigated in [ACK02]. Here, we assume that the boundary $\Gamma = \partial\Omega$ is at least of class \mathcal{C}^4 and we consider the following system :

$$\begin{cases} u_1'' + \Delta^2 u_1 + \delta p u_2 + b u_1' = 0 & \text{in } (0, +\infty) \times \Omega, \\ u_2'' + \Delta^2 u_2 + p u_1 = 0 & \text{in } (0, +\infty) \times \Omega, \\ u_1 = 0 \text{ and } u_2 = 0 & \text{on } (0, +\infty) \times \Gamma, \\ \frac{\partial u_1}{\partial \nu} = 0 \text{ and } \frac{\partial u_2}{\partial \nu} = 0 & \text{on } (0, +\infty) \times \Gamma, \\ u_j(0, \cdot) = u_j^0(\cdot), u_j'(0, \cdot) = u_j^1(\cdot), j = 1, 2 & \text{in } \Omega \end{cases} \quad (4.70)$$

We take $H = L^2(\Omega)$, and $V_1 = V_2 = H_0^2(\Omega)$ endowed with the inner product $(y, z)_{H_0^2(\Omega)} = \int_{\Omega} \Delta y \Delta z dx$. Hence, $A = \Delta^2$ with Neumann and Dirichlet boundary conditions, $\mathcal{D}(A^{\frac{n}{2}}) \subset H^{2n}(\Omega)$ is the domain of $A^{\frac{n}{2}}$ and λ denotes its lowest eigenvalue. We moreover take for B and P respectively the multiplication in L^2 by the functions $b, p \in L^\infty(\Omega)$ satisfying, as in Section 4.4.1,

$$\begin{cases} 0 \leq b \leq b^+ \text{ and } 0 \leq p \leq p^+ \text{ on } \Omega, \\ b \geq b^- > 0 \text{ on } \omega_b, \\ p \geq p^- > 0 \text{ on } \omega_p, \end{cases} \quad (4.71)$$

for ω_b and ω_p two open subsets of Ω . As for coupled waves, we have the following stability result.

Theorem 4.23. (i) *Suppose that ω_b and ω_p satisfy the PMGC. Then there exists $p_* \in (0, \lambda]$ such that for all $0 < p^+ < p_*$ there exists $\delta_* = \delta_*(p^+, p^-) \in (0, \frac{\lambda}{p^+}]$, such that for all $\delta \in (0, \delta_*)$, the solution $U = (u_1, u_2, u'_1, u'_2)$ of (4.70) satisfies for $n \in \mathbb{N}$, for some $C_n > 0$,*

$$E(U(t)) \leq \frac{C_n}{t^n} \sum_{i=0}^n E(U^{(i)}(0)) \quad \forall t > 0, U^0 = (u_1^0, u_2^0, u_1^1, u_2^1) \in \mathcal{D}(\mathcal{A}_{P,\delta}^n).$$

Besides, if $U^0 \in (H_0^2)^2 \times (L^2)^2$, then $E(U(t))$ converges to zero as t goes to infinity.

(ii) *If moreover either $\omega_b \subset \omega_p$ or $\omega_p \subset \omega_b$, then the result holds for $\delta_* = \frac{\lambda}{p^+}$.*

We recall that the operator $\mathcal{A}_{P,\delta}$ is defined in (4.13). Under some smoothness assumptions on the coefficients p and b , we can explicit the space $\mathcal{D}(\mathcal{A}_{P,\delta}^n)$ in terms of iterated domains of the bilaplacian with Dirichlet and Neumann boundary conditions, thanks to Lemma 4.11. This gives the following corollary.

Corollary 4.24. (i) *Suppose that ω_b and ω_p satisfy the PMGC. Then there exists $p_* \in (0, \lambda]$ such that for all $0 < p^+ < p_*$ there exists $\delta_* = \delta_*(p^+, p^-) \in (0, \frac{\lambda}{p^+}]$, such that for all $\delta \in (0, \delta_*)$, for all $b, p \in W^{2q,\infty}(\Omega)$ satisfying (4.71), the solution $U = (u_1, u_2, u'_1, u'_2)$ of (4.70) satisfies, for $n \in \mathbb{N}, n \leq q$, for some $C_n > 0$,*

$$E(U(t)) \leq \frac{C_n}{t^n} \sum_{i=0}^n E(U^{(i)}(0)) \quad \forall t > 0, U^0 = (u_1^0, u_2^0, u_1^1, u_2^1) \in \mathcal{D}(A^{\frac{n+1}{2}})^2 \times \mathcal{D}(A^{\frac{n}{2}})^2.$$

Besides, if $U^0 \in (H_0^2)^2 \times (L^2)^2$, then $E(U(t))$ converges to zero as t goes to infinity.

(ii) *If moreover either $\omega_b \subset \omega_p$ or $\omega_p \subset \omega_b$, then the result holds for $\delta_* = \frac{\lambda}{p^+}$.*

To prove Theorem 4.23, we only have to check that Assumptions (A1) – (A4b) hold and use Theorem 4.9. From (4.71), Assumption (A4b) is satisfied and Assumption (A1) is fulfilled, taking for Π_P the multiplication in L^2 by $\mathbb{1}_{\omega_p}$. It only remains to check Assumptions (A2) and (A3), that are consequences of the following lemma.

Lemma 4.25. *Let ω be a subset of Ω satisfying the PMGC. Then, there exist $\alpha, \beta, \gamma > 0$ such that for all $f \in \mathcal{C}^1(\mathbb{R}^+; L^2(\Omega))$ and all $0 \leq S \leq T$, the solution u of*

$$\begin{cases} u'' + \Delta^2 u = f & \text{in } (0, +\infty) \times \Omega, \\ u = 0 \text{ and } \frac{\partial u}{\partial \nu} = 0 & \text{on } (0, +\infty) \times \Gamma, \\ (u, u')(0, \cdot) = (u^0(\cdot), u^1(\cdot)) \in H_0^2(\Omega) \times L^2(\Omega), \end{cases} \quad (4.72)$$

satisfies, with $e(t) = 1/2 \left(\|u'\|_{L^2(\Omega)}^2 + \|\Delta u\|_{L^2(\Omega)}^2 \right)$, the inequality

$$\int_S^T e(t) dt \leq \alpha(e(S) + e(T)) + \beta \int_S^T \|f(t)\|_{L^2(\Omega)}^2 dt + \gamma \int_S^T \|\mathbb{1}_\omega u'(t)\|_{L^2(\Omega)}^2 dt. \quad (4.73)$$

This Lemma directly yields (A2), since ω_p is supposed to satisfy the PMGC. Proving (A3) is done exactly as in Section 4.4.1, taking $u = u_1$, $\omega = \omega_b$ and $f = f_1 - bu'_1$ in Lemma 4.25. Theorem 4.23 is then a consequence of Theorem 4.9.

Proof. We give here the details of the piecewise multiplier method for a plate equation, following [AB06], so that the proof is selfcontained. We denote by $\mathcal{N}_\varepsilon(\cup_j \gamma_j(x_j) \cup (\Omega \setminus \cup_j \Omega_j))$ the neighborhood given by the PMGC (see Definition 4.1 in the introduction). Let $0 < \varepsilon_0 < \varepsilon_1 < \varepsilon_2 < \varepsilon$ and define for $i = 0, 1, 2$

$$Q_i = \mathcal{N}_{\varepsilon_i}(\cup_j \gamma_j(x_j) \cup (\Omega \setminus \cup_j \Omega_j)),$$

where Ω_j , x_j and $\gamma_j(x_j)$ are given by the PMGC. Recall that $\Gamma_j = \partial\Omega_j$ and $m_j(x) = x - x_j$. Since $(\overline{\Omega_j} \setminus Q_1) \cap \overline{Q_0} = \emptyset$, we can construct a function $\psi_j \in \mathcal{C}_c^\infty(\mathbb{R}^N)$ which satisfies

$$0 \leq \psi_j \leq 1, \quad \psi_j = 1 \text{ on } \overline{\Omega_j} \setminus Q_1, \quad \psi_j = 0 \text{ on } Q_0.$$

We define the \mathcal{C}^1 vector field on Ω :

$$h(x) = \begin{cases} \psi_j(x)m_j(x) & \text{if } x \in \Omega_j, \\ 0 & \text{if } x \in \Omega \setminus \cup_j \Omega_j. \end{cases}$$

Proceeding as in [AB06], we multiply (4.72) by $h \cdot \nabla u$ and integrate on each $(S, T) \times \Omega_j$

$$\int_S^T \int_{\Omega_j} h(x) \cdot \nabla u (u'' + \Delta^2 u - f) dx dt = 0.$$

For the sake of concision, we will omit the $dx dt$ in the following integrals. This gives, after integrations by parts

$$\begin{aligned} & \int_S^T \int_{\Gamma_j} \left[\frac{1}{2} h \cdot \nu_j (|u'|^2 - |\Delta u|^2) + \Delta u \frac{\partial(h \cdot \nabla u)}{\partial \nu} - h \cdot \nabla u \frac{\partial \Delta u}{\partial \nu} \right] \\ &= \left[\int_{\Omega_j} u' h \cdot \nabla u \right]_S^T + \int_S^T \int_{\Omega_j} \left(\frac{1}{2} \operatorname{div} h (u'^2 - |\Delta u|^2) + \Delta h_k \frac{\partial u}{\partial x_k} \Delta u + 2 \nabla h_k \cdot \nabla \left(\frac{\partial u}{\partial x_k} \right) \Delta u - f h \cdot \nabla u \right). \end{aligned} \quad (4.74)$$

Thanks to the choice of ψ_j , only the boundary term on $(\Gamma_j \setminus \gamma_j(x_j)) \cap \Gamma$ is nonvanishing in the left hand side of (4.74). But on this part of the boundary, we claim that $\partial_\nu(h \cdot \nabla u) = h \cdot \nu \Delta u$ (see also [Lag89] and [Kom94]). For this, we first remark that $u = 0 = \partial_\nu u$ there. Hence, $\partial_i u = 0$ for $1 \leq i \leq N$ on $(\Gamma_j \setminus \gamma_j(x_j)) \cap \Gamma$, and we have

$$\partial_\nu(h \cdot \nabla u) = \sum_{j=1}^N \partial_j \left(\sum_i^N h_i \partial_i u \right) \nu_j = \sum_{i,j} \partial_j (h_i \partial_i u) \nu_j = \sum_{i,j} h_i \partial_{ij} u \nu_j. \quad (4.75)$$

Setting $v = \partial_j u$, and recalling that $\nabla u = 0$ on $(\Gamma_j \setminus \gamma_j(x_j)) \cap \Gamma$, we have $\nabla v = \partial_\nu v \nu$. Hence, $\partial_i v = \sum_{k=1}^N \partial_k v \nu_k \nu_i$ for all $1 \leq i \leq N$. Coming back to $\partial_j u$, we obtain

$$\partial_{ij} u = \sum_k \partial_{kj} u \nu_k \nu_i, \quad (4.76)$$

and in particular

$$\partial_{jj} u = \sum_k \partial_{kj} u \nu_k \nu_j. \quad (4.77)$$

Using (4.76) in (4.75), we deduce that

$$\partial_\nu(h \cdot \nabla u) = \sum_{i,j,k} h_i \partial_{kj} u \nu_k \nu_i \nu_j = \sum_i h_i \nu_i \sum_j \left[\sum_k (\partial_{kj} u \nu_k) \nu_j \right].$$

Using (4.77) in this last identity, we obtain

$$\partial_\nu(h \cdot \nabla u) = \sum_i h_i \nu_i \sum_j \partial_{jj} u = h \cdot \nu \Delta u,$$

which proves our claim. Since in addition, $u' = 0$ on $(\Gamma_j \setminus \gamma_j(x_j)) \cap \Gamma$, we deduce that the left hand side of (4.74) reduces to

$$\frac{1}{2} \int_S \int_{(\Gamma_j \setminus \gamma_j(x_j)) \cap \Gamma} h \cdot \nu |\Delta u|^2 \leq 0. \quad (4.78)$$

Therefore, since $\psi_j = 0$ on Q_0 and thanks to the above inequality used in (4.74), we deduce that

$$\begin{aligned} \left[\int_{\Omega_j} u' h \cdot \nabla u \right]_S^T + \int_S \int_{\Omega_j \setminus Q_0} \left(\frac{1}{2} \operatorname{div} h (u'^2 - |\Delta u|^2) \right. \\ \left. + \Delta h_k \frac{\partial u}{\partial x_k} \Delta u + 2 \nabla h_k \cdot \nabla \left(\frac{\partial u}{\partial x_k} \right) \Delta u - f h \cdot \nabla u \right) \leq 0. \end{aligned} \quad (4.79)$$

Using $\psi_j = 1$ on $\overline{\Omega_j} - Q_1$ and summing the resulting inequalities on j , we obtain

$$\begin{aligned} \left[\int_{\Omega} u' h \cdot \nabla u \right]_S^T + \int_S \int_{\Omega \setminus Q_1} \frac{1}{2} (N u'^2 + (2 - N) |\nabla u|^2) - \int_S \int_{\Omega} f h \cdot \nabla u \\ \leq - \sum_j \int_S \int_{\Omega_j \cap Q_1} \left[\frac{1}{2} \operatorname{div} h (u'^2 - |\Delta u|^2) + \Delta h_k \frac{\partial u}{\partial x_k} \Delta u + 2 \nabla h_k \cdot \nabla \left(\frac{\partial u}{\partial x_k} \right) \Delta u \right] \\ \leq C \int_S \int_{\Omega \cap Q_1} (u'^2 + |\Delta u|^2 + |\nabla u|^2 + \frac{\partial^2 u}{\partial x_i \partial x_k} \frac{\partial^2 u}{\partial x_i \partial x_k}), \end{aligned} \quad (4.80)$$

where C is a positive constant which depends only on ψ_j and m_j . We now use the second multiplier $u(N-2)/2$ and evaluate the term

$$\frac{N-2}{2} \int_S \int_{\Omega} u (u'' + \Delta u^2 - f) = 0.$$

Hence, one has

$$\frac{N-2}{2} \left[\int_{\Omega} u u' \right]_S^T + \frac{N-2}{2} \int_S \int_{\Omega} |\Delta u|^2 - u'^2 - u f = 0. \quad (4.81)$$

We set $M(u) = h \cdot \nabla u + \frac{N-2}{2} u$. Adding (4.81) to (4.80), we obtain

$$2 \int_S \int_{\Omega} e dt \leq C \int_S \int_{\Omega \cap Q_1} \left[u'^2 + |\Delta u|^2 + |\nabla u|^2 + \frac{\partial^2 u}{\partial x_i \partial x_k} \frac{\partial^2 u}{\partial x_i \partial x_k} \right] - \left[\int_{\Omega} M(u) u' \right]_S^T + \int_S \int_{\Omega} M(u) f. \quad (4.82)$$

We estimate the terms on the right hand side of (4.82) as follows. First, we have

$$\left| \left[\int_{\Omega} M(u) u' \right]_S^T \right| \leq C(e(S) + e(T)). \quad (4.83)$$

Second, we estimate the last term of (4.82) as follows

$$\left| \int_S \int_{\Omega} M(u) f \right| \leq \frac{C}{\mu} \int_S \int_{\Omega} |f|^2 + \mu \int_S \int_{\Omega} e dt \quad \forall \mu > 0. \quad (4.84)$$

Using (4.83) and (4.84) in (4.82), we obtain for all $\mu > 0$:

$$(2 - \mu) \int_S^T e \, dt \leq C \int_S^T \int_{\Omega \cap Q_1} \left[u'^2 + |\nabla u|^2 + |\Delta u|^2 + \frac{\partial^2 u}{\partial x_i \partial x_k} \frac{\partial^2 u}{\partial x_i \partial x_k} \right] + C(e(S) + e(T)) + \frac{C}{\mu} \int_S^T \int_{\Omega} |f|^2. \quad (4.85)$$

We now have to estimate the first term on the right hand side of (4.85), that we will denote by X :

$$X = \int_S^T \int_{\Omega \cap Q_1} \left[u'^2 + |\nabla u|^2 + |\Delta u|^2 + \frac{\partial^2 u}{\partial x_i \partial x_k} \frac{\partial^2 u}{\partial x_i \partial x_k} \right].$$

This is where the piecewise multiplier method takes its place.

Step 1 : Estimate of the terms corresponding to second derivatives in space in X :

Since $\overline{\mathbb{R}^N \setminus Q_2} \cap \overline{Q_1} = \emptyset$, there exists a function $\xi \in \mathcal{C}_c^\infty(\mathbb{R}^N)$ such that

$$0 \leq \xi \leq 1, \quad \xi = 1 \text{ on } Q_1, \quad \xi = 0 \text{ on } \mathbb{R}^N \setminus Q_2.$$

We need the following result, that is proved in [AB06, Proposition 4.1].

Lemma 4.26. *Let ξ be defined as above. Then for all $v \in H_0^2(\Omega)$, we have*

$$\int_{\Omega} \nabla \xi \cdot \nabla v \Delta v = - \int_{\Omega} \frac{\partial^2 \xi}{\partial x_i \partial x_k} \frac{\partial v}{\partial x_i} \frac{\partial v}{\partial x_k} + \frac{1}{2} \int_{\Omega} \Delta \xi |\nabla v|^2. \quad (4.86)$$

and

$$\int_{\Omega} \xi \frac{\partial^2 v}{\partial x_i \partial x_k} \frac{\partial^2 v}{\partial x_i \partial x_k} = \int_{\Omega} \left[- \frac{\partial^2 \xi}{\partial x_i \partial x_k} \frac{\partial v}{\partial x_i} \frac{\partial v}{\partial x_k} + \Delta \xi |\nabla v|^2 + \xi |\Delta v|^2 \right]. \quad (4.87)$$

From (4.87), we deduce that

$$\int_{\Omega \cap Q_1} \frac{\partial^2 u}{\partial x_i \partial x_k} \frac{\partial^2 u}{\partial x_i \partial x_k} \leq \int_{\Omega} \xi |\Delta u|^2 + C \int_{\Omega \cap Q_2} |\nabla u|^2. \quad (4.88)$$

We use now the multiplier ξu in the first equation of (4.72), and consider the expression :

$$\int_S^T \int_{\Omega} (u'' + \Delta^2 u - f) \xi u \, dx \, dt = 0.$$

After integrations by parts, this gives

$$\int_S^T \int_{\Omega} \xi |\Delta u|^2 = \int_S^T \int_{\Omega} \xi |u'|^2 - 2 \nabla \xi \cdot \nabla u \Delta u - u \Delta u \Delta \xi - \left[\int_{\Omega} \xi u u' \right]_S^T + \int_S^T \int_{\Omega} \xi u f.$$

Using (4.86) in this last identity, we obtain

$$\begin{aligned} \int_S^T \int_{\Omega} \xi |\Delta u|^2 = \int_S^T \int_{\Omega} \left[\xi |u'|^2 + 2 \frac{\partial^2 \xi}{\partial x_i \partial x_k} \frac{\partial u}{\partial x_i} \frac{\partial u}{\partial x_k} \right. \\ \left. + \Delta \xi |\nabla u|^2 + u \Delta u \Delta \xi \right] - \left[\int_{\Omega} \xi u u' \right]_S^T + \int_S^T \int_{\Omega} \xi u f. \end{aligned} \quad (4.89)$$

On the other hand, one has $\int_{\Omega} u \Delta u \Delta \xi = \int_{\Omega} \left(\frac{u^2}{2} \Delta^2 \xi - |\nabla u|^2 \Delta \xi \right)$. Using this identity in (4.89), we obtain

$$\int_S^T \int_{\Omega} \xi |\Delta u|^2 = \int_S^T \int_{\Omega} \left[\xi |u'|^2 + 2 \frac{\partial^2 \xi}{\partial x_i \partial x_k} \frac{\partial u}{\partial x_i} \frac{\partial u}{\partial x_k} - \frac{u^2}{2} \Delta^2 \xi \right] - \left[\int_{\Omega} \xi u u' \right]_S^T + \int_S^T \int_{\Omega} \xi u f.$$

We estimate the second term on the right hand side of the above inequality as previously (see (4.83)). Moreover, since $\xi = 1$ on Q_1 , whereas $\xi = 0$ on $\mathbb{R}^N \setminus Q_2$, we deduce that

$$\int_S^T \int_{\Omega} \xi |\Delta u|^2 \leq C(e(S) + e(T)) + C \int_S^T \int_{\Omega \cap Q_2} |u'|^2 + |\nabla u|^2 + u^2 + |f|^2. \quad (4.90)$$

Using (4.90) in (4.88), we obtain that

$$\int_{\Omega \cap Q_1} \frac{\partial^2 u}{\partial x_i \partial x_k} \frac{\partial^2 u}{\partial x_i \partial x_k} \leq C(e(S) + e(T)) + C \int_S^T \int_{\Omega \cap Q_2} |u'|^2 + |\nabla u|^2 + u^2 + |f|^2, \quad (4.91)$$

and

$$\int_S^T \int_{\Omega \cap Q_1} |\Delta u|^2 \leq C(e(S) + e(T)) + C \int_S^T \int_{\Omega \cap Q_2} |u'|^2 + |\nabla u|^2 + u^2 + |f|^2. \quad (4.92)$$

Using both (4.91) and (4.92) in (4.85), we obtain for all $\mu > 0$

$$(2 - \mu) \int_S^T e \, dt \leq C \int_S^T \int_{\Omega \cap Q_2} [u'^2 + |\nabla u|^2 + |u|^2] + C(e(S) + e(T)) + C \left(1 + \frac{1}{\mu}\right) \int_S^T \int_{\Omega} |f|^2.$$

Step 2 : Estimate of the terms corresponding to first derivatives in space in X :

Since $\overline{\mathbb{R}^N \setminus Q_3} \cap \overline{Q_2} = \emptyset$, there exists a function $\beta \in \mathcal{C}_c^\infty(\mathbb{R}^N)$ such that

$$0 \leq \beta \leq 1, \quad \beta = 1 \text{ on } Q_2, \quad \beta = 0 \text{ on } \mathbb{R}^N \setminus Q_3.$$

We fix t and consider the solution θ of the following elliptic problem :

$$\begin{cases} \Delta^2 \theta = \beta \Delta u & \text{in } \Omega, \\ \theta = 0 = \frac{\partial \theta}{\partial \nu} & \text{on } \Gamma. \end{cases}$$

Then, we have

$$\int_{\Omega} |\Delta \theta|^2 = \int_{\Omega} \theta \Delta^2 \theta = \int_{\Omega} u \Delta(\beta \theta) = \int_{\Omega \cap Q_3} u (\beta \Delta \theta + 2 \nabla \beta \cdot \nabla \theta + \theta \Delta \beta) \leq C \int_{\Omega \cap Q_3} |u|^2, \quad (4.93)$$

and similarly,

$$\int_{\Omega} |\Delta \theta'|^2 \leq C \int_{\Omega \cap Q_3} |u'|^2. \quad (4.94)$$

We now consider the multiplier θ for (4.72) and evaluate the expression

$$\int_S^T \int_{\Omega} \theta (u'' + \Delta u^2 - f) = 0.$$

This yields, after integrations by parts,

$$\int_S^T \int_{\Omega} \beta u \Delta u - \int_S^T \int_{\Omega} \theta' u' + \left[\int_{\Omega} \theta u' \right]_S^T - \int_S^T \int_{\Omega} \theta f = 0.$$

Integrating by parts the first term of this expression, we obtain

$$\int_S^T \int_{\Omega} \beta |\nabla u|^2 = - \int_S^T \int_{\Omega} \theta' u' + \int_S^T \int_{\Omega} \frac{\Delta \beta}{2} |u|^2 + \left[\int_{\Omega} \theta u' \right]_S^T + \int_S^T \int_{\Omega} \theta f.$$

Since $\beta = 1$ on $\Omega \cap Q_2$, whereas $\beta = 0$ on $\Omega \setminus Q_3$, and thanks to (4.93), we obtain for all $\mu > 0$:

$$\begin{aligned} \int_S^T \int_{\Omega \cap Q_2} \beta |\nabla u|^2 &\leq \frac{\mu}{2} \int_S^T \int_{\Omega} |u'|^2 + \frac{1}{2\mu} \int_S^T \int_{\Omega} |\theta'|^2 \\ &\quad + C \int_S^T \int_{\Omega \cap Q_3} |u|^2 + C \int_S^T \int_{\Omega} |f|^2 + C(e(S) + e(T)). \end{aligned}$$

Using, (4.94) in this last inequality, we deduce that, for all $\mu > 0$

$$\begin{aligned} \int_S^T \int_{\Omega \cap Q_2} |\nabla u|^2 &\leq \mu \int_S^T e + \frac{C}{\mu} \int_S^T \int_{\Omega \cap Q_3} |u'|^2 \\ &\quad + C \int_S^T \int_{\Omega \cap Q_3} |u|^2 + C \int_S^T \int_{\Omega} |f|^2 + C(e(S) + e(T)). \end{aligned}$$

Finally, putting this into (4.93), we obtain for all $\mu > 0$

$$\begin{aligned} (2 - C\mu) \int_S^T e \, dt &\leq C \int_S^T \int_{\Omega \cap Q_3} |u|^2 + C \left(1 + \frac{1}{\mu}\right) \int_S^T \int_{\Omega \cap Q_3} u'^2 \\ &\quad + C \left(1 + \frac{1}{\mu}\right) \int_S^T \int_{\Omega} |f|^2 + C(e(S) + e(T)). \end{aligned} \quad (4.95)$$

Step 3 : Estimate of the zero order terms in X :

Since $\overline{\mathbb{R}^N \setminus \omega} \cap \overline{Q_3} = \emptyset$, there exists a function $\psi \in \mathcal{C}_c^\infty(\mathbb{R}^N)$ such that

$$0 \leq \psi \leq 1, \quad \psi = 1 \text{ on } Q_3, \quad \psi = 0 \text{ on } \mathbb{R}^N \setminus \omega.$$

We fix t and consider the solution z of the following elliptic problem

$$\begin{cases} \Delta^2 z = \psi u & \text{in } \Omega, \\ z = 0 = \frac{\partial z}{\partial \nu} & \text{on } \Gamma. \end{cases}$$

Then, we have

$$\int_{\Omega} |\Delta z|^2 \leq C \int_{\omega} \psi |u|^2, \quad \text{and} \quad \int_{\Omega} |\Delta z'|^2 \leq C \int_{\omega} |u'|^2. \quad (4.96)$$

We now consider the multiplier z for (4.72) and evaluate the expression

$$\int_S^T \int_{\Omega} z (u'' + \Delta u^2 - f) = 0.$$

This yields

$$\int_S^T \int_{\Omega} \psi |u|^2 - \int_S^T \int_{\Omega} z' u' + \left[\int_{\Omega} z u' \right]_S^T - \int_S^T \int_{\Omega} z f = 0.$$

Integrating by parts the first term of this expression, we obtain

$$\int_S^T \int_{\Omega} \psi |u|^2 = \int_S^T \int_{\Omega} z' u' - \left[\int_{\Omega} z u' \right]_S^T + \int_S^T \int_{\Omega} z f.$$

Hence, using (4.96) to estimate the third and fourth terms on the right hand side of the above equality, we obtain for all $\eta > 0$, $\mu > 0$:

$$\int_S^T \int_{\Omega} \psi |u|^2 \leq \frac{\mu}{2} \int_S^T \int_{\Omega} |u'|^2 + \eta \int_S^T \int_{\Omega} |z|^2 + \frac{c}{\mu} \int_S^T \int_{\Omega} |z'|^2 + \frac{c}{\eta} \int_S^T \int_{\Omega} |f|^2 + C(e(S) + e(T)).$$

Using now the definition of the energy, together with (4.96), we deduce that

$$(1 - c\eta) \int_S^T \int_\Omega \psi |u|^2 \leq \mu \int_S^T e + \frac{c}{\mu} \int_S^T \int_\omega |u'|^2 + \frac{c}{\eta} \int_S^T \int_\Omega |f|^2 + C(e(S) + e(T)).$$

As a consequence, since $\psi = 1$ on Q_3 and choosing η sufficiently small, we have for all $\mu > 0$:

$$\int_S^T \int_{\Omega \cap Q_3} |u|^2 \leq c\mu \int_S^T e + \frac{c}{\mu} \int_S^T \int_\omega |u'|^2 + c \int_S^T \int_\Omega |f|^2 + C(e(S) + e(T)).$$

Using this last estimate in (4.95), we obtain for all $\mu > 0$

$$(2 - c\mu) \int_S^T e \, dt \leq C \left(1 + \frac{1}{\mu}\right) \int_S^T \int_\omega |u'|^2 + C \left(1 + \frac{1}{\mu}\right) \int_S^T \int_\Omega |f|^2 + C(e(S) + e(T)).$$

Finally, choosing now μ sufficiently small, we have

$$\int_S^T e \, dt \leq C(e(S) + e(T)) + C \int_S^T \int_\Omega |f|^2 + C \int_S^T \int_\omega |u'|^2,$$

and the lemma is proved. □

Chapitre 5

Contrôle indirect de systèmes sous des conditions géométriques

Contents

5.1	Introduction	199
5.1.1	Motivation	199
5.1.2	Main results	201
5.2	Abstract setting	205
5.2.1	Main results : admissibility, observability and controllability	206
5.2.2	Some remarks	208
5.3	Two energy levels and two key lemmata	209
5.3.1	Two energy levels	209
5.3.2	Two key lemmata	211
5.4	Proof of Theorem 5.10	214
5.4.1	The coupling Lemma	214
5.4.2	A first series of estimates	216
5.4.3	A second series of estimates	218
5.4.4	End of the proof of Theorem 5.10	221
5.5	From observability to controllability	222
5.5.1	First case : $\mathcal{B}^*(v_1, v'_1) = B^*v'_1$ with $B^* \in \mathcal{L}(H, Y)$.	223
5.5.2	Second case : $\mathcal{B}^*(v_1, v'_1) = B^*v_1$ with $B^* \in \mathcal{L}(H_2, Y)$.	225
5.6	Applications	226
5.6.1	Control of wave systems : Proof of Theorem 5.3	226
5.6.2	Control of diffusive systems	227
5.6.3	Control of Schrödinger systems	227
5.7	Observability for a wave equation with a right hand-side	227

Ce chapitre est la reprise de l'article [ABL11b] en collaboration avec Fatiha Alabau-Boussouira.

5.1 Introduction

5.1.1 Motivation

During the last decade, the controllability properties of coupled parabolic equations like

$$\begin{cases} \partial_t u_1 - \Delta_c u_1 + a u_1 + p u_2 = b f & \text{in } (0, T) \times \Omega, \\ \partial_t u_2 - \Delta_c u_2 + a u_2 + p u_1 = 0 & \text{in } (0, T) \times \Omega, \\ u_1 = u_2 = 0 & \text{on } (0, T) \times \partial\Omega, \\ (u_1, u_2)|_{t=0} = (u_1^0, u_2^0) & \text{in } \Omega, \end{cases} \quad (5.1)$$

have been intensively studied. Here, the coefficients p and b are smooth non-negative functions on the bounded domain Ω and $-\Delta_c$ is a second order selfadjoint elliptic operator. The null-controllability problem under view is the following : given a time $T > 0$ and initial data, is it possible to find a control function f so that the state (u_1, u_2) has been driven to zero in time T ? It has been proved in [dT00, AKBD06, GBPG06, Léa10a] with different methods that System (5.1) is null-controllable as soon as $\{p > 0\} \cap \{b > 0\} \neq \emptyset$. In these works, the case $\{p > 0\} \cap \{b > 0\} = \emptyset$ has been left as an open problem. However, Kavian and de Teresa [KdT10] have proved for a cascade system (i.e. without the term pu_2 in the first equation of (5.1)) that approximate controllability holds. The natural question is then whether or not null-controllability (which is a stronger property) still holds in the case $\{p > 0\} \cap \{b > 0\} = \emptyset$:

Question 1 : is System (5.1) null-controllable in the case $\{p > 0\} \cap \{b > 0\} = \emptyset$?

The second Problem under interest here is the boundary controllability of systems like

$$\begin{cases} \partial_t u_1 - \Delta_c u_1 + au_1 + pu_2 = 0 & \text{in } (0, T) \times \Omega, \\ \partial_t u_2 - \Delta_c u_2 + au_2 + pu_1 = 0 & \text{in } (0, T) \times \Omega, \\ u_1 = b_\partial f, u_2 = 0 & \text{on } (0, T) \times \partial\Omega, \\ (u_1, u_2)|_{t=0} = (u_1^0, u_2^0) & \text{in } \Omega, \end{cases} \quad (5.2)$$

where b_∂ is a smooth function on $\partial\Omega$. The recent work [FCGBdT10] studies such systems in one space dimension and with constant coupling coefficients. The cases of higher space dimensions and varying coupling coefficients (and in particular when the coefficients vanish in a neighborhood of the boundary) are to our knowledge completely open. The second question under interest is then :

Question 2 : is System (5.2) null-controllable for non-constant coupling coefficients p ? Is System (5.2) null-controllable if the dimension of Ω is larger than one ?

Concerning these two open problems, it seems that the parabolic theory and associated tools encounter for the moment some essential difficulties.

On the other hand, it is known from [Rus73] that controllability properties can be transferred from hyperbolic equations to parabolic ones. And it seems, at least for boundary control problems, that the theory for coupled hyperbolic equations of the type

$$\begin{cases} \partial_t^2 u_1 - \Delta_c u_1 + au_1 + pu_2 = bf & \text{in } (0, T) \times \Omega, \\ \partial_t^2 u_2 - \Delta_c u_2 + au_2 + pu_1 = 0 & \text{in } (0, T) \times \Omega, \\ u_1 = u_2 = 0 & \text{on } (0, T) \times \partial\Omega, \\ (u_1, u_2, \partial_t u_1, \partial_t u_2)|_{t=0} = (u_1^0, u_2^0, u_1^1, u_2^1) & \text{in } \Omega, \end{cases} \quad (5.3)$$

and

$$\begin{cases} \partial_t^2 u_1 - \Delta_c u_1 + au_1 + pu_2 = 0 & \text{in } (0, T) \times \Omega, \\ \partial_t^2 u_2 - \Delta_c u_2 + au_2 + pu_1 = 0 & \text{in } (0, T) \times \Omega, \\ u_1 = b_\partial f, u_2 = 0 & \text{on } (0, T) \times \partial\Omega, \\ (u_1, u_2, \partial_t u_1, \partial_t u_2)|_{t=0} = (u_1^0, u_2^0, u_1^1, u_2^1) & \text{in } \Omega, \end{cases} \quad (5.4)$$

is better understood (see [AB03]), even less studied. In the case of varying coefficients and several space-dimensions, the associated stabilization problem is addressed in [AB02, ABL11c]. In particular in [ABL11c], a polynomial stability result is proved for solutions of the system

$$\begin{cases} \partial_t^2 u_1 - \Delta_c u_1 + au_1 + pu_2 + b^2 \partial_t u_1 = 0 & \text{in } \mathbb{R}^+ \times \Omega, \\ \partial_t^2 u_2 - \Delta_c u_2 + au_2 + pu_1 = 0 & \text{in } \mathbb{R}^+ \times \Omega, \\ u_1 = u_2 = 0 & \text{on } \mathbb{R}^+ \times \partial\Omega, \end{cases} \quad (5.5)$$

in some cases where $\{p > 0\} \cap \{b > 0\} = \emptyset$. This gives hope to prove some null-controllability results for (5.3) in the same situations.

In the present work, we answer Questions 1 and 2 for hyperbolic problems (like (5.3) and (5.4)), improving the results of [AB03, ABL11c]. Then, we deduce a (partial) solution to the two open

questions raised above for parabolic systems. Indeed, we prove that Systems (5.1)-(5.3) are null-controllable (in appropriate spaces) as soon as $\{p > 0\}$ and $\{b > 0\}$ both satisfy the Geometric Control Condition (recalled below) and $\|p\|_{L^\infty(\Omega)}$ satisfies a smallness assumption. This contains several examples with $\{p > 0\} \cap \{b > 0\} = \emptyset$, and partially answer to the first question. We prove as well that similar controllability results hold for the boundary control problems (5.2) and (5.4), which partially answers to the second question. Of course, the geometric conditions needed here are essential (and even sharp) for coupled waves, but inappropriate for parabolic equation. However, this is a first step towards a better understanding of these types of systems. In one space dimension in particular, the geometric conditions are reduced to a non-emptiness condition and are hence optimal for parabolic systems as well.

In the end of the present introduction, we state our main results for wave/heat/Shrödinger-type Systems. In Section 5.2, we introduce an abstract setting adapted to second order (in time) control problems. Then, in Section 5.3, we present the tools used in the proof of the main theorem, together with a key lemma : an observability inequality for an equation with a right hand-side (for which we give another proof in Appendix 5.7). Section 5.4 is devoted to the proof the observability of hyperbolic systems in the abstract setting, and controllability is deduced in Section 5.5. Finally, in Section 5.6, we come back to the applications to wave/heat/Shrödinger-type Systems. The results of this paper were announced in [ABL11a].

5.1.2 Main results

Let Ω be a bounded domain in \mathbb{R}^n with smooth (say \mathcal{C}^∞) boundary (or a smooth connected compact Riemannian manifold with or without boundary) and $\Delta_c = \text{div}(c\nabla)$ a (negative) elliptic operator (or the Laplace Beltrami operator with respect to the Riemannian metric) on Ω . Here, c denotes a smooth (say \mathcal{C}^∞) positive symmetric matrix i.e. in particular $C_0^{-1}|\xi|^2 \leq c(x)\xi \cdot \xi \leq C_0|\xi|^2$ for some $C_0 > 0$, for all $x \in \bar{\Omega}$, $\xi \in \mathbb{R}^n$. We consider the more general first order (in time) control problem

$$\begin{cases} e^{i\theta} \partial_t u_1 - \Delta_c u_1 + a u_1 + p u_2 = b f & \text{in } (0, T) \times \Omega, \\ e^{i\theta} \partial_t u_2 - \Delta_c u_2 + a u_2 + p u_1 = 0 & \text{in } (0, T) \times \Omega, \\ u_1 = u_2 = 0 & \text{on } (0, T) \times \partial\Omega, \\ (u_1, u_2)|_{t=0} = (u_1^0, u_2^0) & \text{in } \Omega, \end{cases} \quad (5.6)$$

with $\theta \in [-\pi/2, \pi/2]$, including Schrödinger-type systems for $\theta = \pm\pi/2$ and diffusion-type systems for $\theta \in (-\pi/2, \pi/2)$. In particular we recover System (5.1) when taking (5.6) for $\theta = 0$. We also consider System (5.3), consisting in a wave-type system, with only one control force. In these systems, $a = a(x)$, $p = p(x)$ and $b = b(x)$ are smooth real-valued functions on Ω and f is the control function, that can act on the system.

We shall also consider the same systems controlled from the boundary through the (smooth) real-valued function b_∂ :

$$\begin{cases} e^{i\theta} \partial_t u_1 - \Delta_c u_1 + a u_1 + p u_2 = 0 & \text{in } (0, T) \times \Omega, \\ e^{i\theta} \partial_t u_2 - \Delta_c u_2 + a u_2 + p u_1 = 0 & \text{in } (0, T) \times \Omega, \\ u_1 = b_\partial f, u_2 = 0 & \text{on } (0, T) \times \partial\Omega, \\ (u_1, u_2)|_{t=0} = (u_1^0, u_2^0) & \text{in } \Omega, \end{cases} \quad (5.7)$$

which includes System (5.2) when $\theta = 0$.

We first notice that, on the space $(L^2(\Omega))^2$ endowed with the natural inner product

$$(U, V)_{L^2(\Omega) \times L^2(\Omega)} = (u_1, v_1)_{L^2(\Omega)} + (u_2, v_2)_{L^2(\Omega)}, \quad U = (u_1, u_2), V = (v_1, v_2),$$

the operator

$$A_p = \begin{pmatrix} -\Delta_c + a & p \\ p & -\Delta_c + a \end{pmatrix},$$

with domain $\mathcal{D}(A_p) = (H^2(\Omega) \cap H_0^1(\Omega))^2$, is selfadjoint. As a consequence, for $f \in L^2((0, T) \times \Omega)$, the Cauchy problem (5.6), resp. (5.3), is well-posed in $(L^2(\Omega))^2$, resp. $(H_0^1(\Omega))^2 \times (L^2(\Omega))^2$, in the sense

of semigroup theory. Then, taking $f \in L^2((0, T) \times \partial\Omega)$ the initial-boundary value problem (5.7), resp. (5.4), is well-posed in $(H^{-1}(\Omega))^2$, resp. $(L^2(\Omega))^2 \times (H^{-1}(\Omega))^2$, in the sense of transposition solution (see [Lio88a, TW09]).

The strategy we adopt here is to prove some controllability results for the hyperbolic systems (5.3) and (5.4), extending the two-levels energy method introduced in [AB03]. Then, using transmutation techniques, we deduce controllability properties of (5.6) and (5.7).

An important remark to make before addressing the controllability problem for the hyperbolic systems (5.3)-(5.4) is concerned with the regularity of solutions. If one takes for system (5.3) (resp. (5.4)) initial data $(u_1^0, u_2^0, u_1^1, u_2^1) \in H_0^1(\Omega) \times (H^2 \cap H_0^1(\Omega)) \times L^2(\Omega) \times H_0^1(\Omega)$ (resp. $(u_1^0, u_2^0, u_1^1, u_2^1) \in L^2(\Omega) \times H_0^1(\Omega) \times H^{-1}(\Omega) \times L^2(\Omega)$), and a control function $f \in L^2((0, T) \times \Omega)$ (resp. $f \in \tilde{L}^2((0, T) \times \partial\Omega)$), then the state $(u_1, u_2, \partial_t u_1, \partial_t u_2)$ remains in the space $H_0^1(\Omega) \times (H^2 \cap H_0^1(\Omega)) \times L^2(\Omega) \times H_0^1(\Omega)$ (resp. $L^2(\Omega) \times H_0^1(\Omega) \times H^{-1}(\Omega) \times L^2(\Omega)$) for all time. We recall that for Systems (5.3) and (5.4), the null-controllability is equivalent to the exact controllability. As a consequence, it is not possible, taking for instance zero as initial data to reach any target state in $(H_0^1(\Omega))^2 \times (L^2(\Omega))^2$ (resp. $(L^2(\Omega))^2 \times (H^{-1}(\Omega))^2$). The controllability question for (5.3)-(5.4) hence becomes : starting from rest at time $t = 0$, is it possible to reach all $H_0^1(\Omega) \times (H^2 \cap H_0^1(\Omega)) \times L^2(\Omega) \times H_0^1(\Omega)$ (resp. $L^2(\Omega) \times H_0^1(\Omega) \times H^{-1}(\Omega) \times L^2(\Omega)$) in time $t = T$ sufficiently large ?

To state our results, we recall the classical Geometric Control Conditions GCC (resp. GCC_∂). We recall that GCC was introduced in [RT74] for manifolds without boundaries, in [BLR88] for domains with boundaries and that GCC_∂ was introduced in [BLR92]. From these works, it is known that, making the generic assumption that $\partial\Omega$ has no contact of infinite order with its tangents, GCC (resp. GCC_∂) is a necessary and sufficient condition for the internal (resp. boundary) observability and controllability of one wave equation (see also [BG97]).

Definition 5.1 (GCC (resp. GCC_∂)). Let $\omega \subset \Omega$ (resp. $\Gamma \subset \partial\Omega$) and $T > 0$. We say that the couple (ω, T) satisfies GCC (resp. (Γ, T) satisfies GCC_∂) if every generalized geodesic (i.e. ray of geometric optics) traveling at speed one in Ω meets ω (resp. meets Γ on a non-diffractive point) in a time $t < T$. We say that ω satisfies GCC (resp. Γ satisfies GCC_∂) if there exists $T > 0$ such that (ω, T) satisfies GCC (resp. (Γ, T) satisfies GCC_∂).

We shall make the following key assumptions.

Assumption 5.2. (i) We have $((-\Delta_c + a)u, u)_{L^2(\Omega)} \geq \lambda_0 \|u\|_{L^2(\Omega)}^2$, for some $\lambda_0 > 0$, for all $u \in (H^2(\Omega) \cap H_0^1(\Omega))$.
(ii) We have $p \geq 0$ on Ω , $\{p > 0\} \supset \bar{\omega}_p$ for some open subset $\omega_p \subset \Omega$ and we set $p^+ := \|p\|_{L^\infty(\Omega)}$.
(iii) We have $b \geq 0$ on Ω , $\{b > 0\} \supset \bar{\omega}_b$ (resp. $b_\partial \geq 0$ on $\partial\Omega$ and $\{b_\partial > 0\} \supset \bar{\Gamma}_b$) for some open subset $\omega_b \subset \Omega$ (resp. $\Gamma_b \subset \partial\Omega$).

Note that in the case where $c = \text{Id}$ and $a = 0$, the best constant λ_0 is the smallest eigenvalue of the Laplace operator on Ω with Dirichlet boundary conditions. We also have the identity $\lambda_0 = 1/C_{\mathcal{P}}^2$, where $C_{\mathcal{P}}$ is the Poincaré's constant of Ω .

We shall also require that the operator A_p satisfies, for some constant $C > 0$,

$$(A_p(v_1, v_2), (v_1, v_2))_{L^2(\Omega) \times L^2(\Omega)} \geq C(\|v_1\|_{H_0^1(\Omega)}^2 + \|v_2\|_{H_0^1(\Omega)}^2)$$

for all $(v_1, v_2) \in \mathcal{D}(A_p)$. This is the case when assuming $p^+ < \lambda_0$.

In the case of coupled wave equations, our main result can be formulated as follows.

Theorem 5.3 (Wave-type systems). *Suppose that (i) holds, that ω_p satisfies GCC and that ω_b (resp. Γ_b) satisfies GCC (resp. GCC_∂). Then, for all b (resp. b_∂) satisfying (iii), there exists a constant $p_* > 0$ (depending only on the geometry of Ω and on b , resp. b_∂) such that for all $p^+ < p_*$, there exists*

a time $T_* > 0$ such that for all $T > T_*$, all p satisfying (ii), and all initial data $(u_1^0, u_2^0, u_1^1, u_2^1) \in H_0^1(\Omega) \times (H^2 \cap H_0^1(\Omega)) \times L^2(\Omega) \times H_0^1(\Omega)$ (resp. $(u_1^0, u_2^0, u_1^1, u_2^1) \in L^2(\Omega) \times H_0^1(\Omega) \times H^{-1}(\Omega) \times L^2(\Omega)$), there exists a control function $f \in L^2((0, T) \times \Omega)$ (resp. $f \in L^2((0, T) \times \partial\Omega)$) such that the solution of (5.3) (resp. (5.4)) satisfies $(u_1, u_2, \partial_t u_1, \partial_t u_2)|_{t=T} = 0$.

Another way to formulate this result is to say that, under the assumptions of Theorem 5.3, the reachable set at time $T > T_*$ with zero initial data is exactly $H_0^1(\Omega) \times (H^2 \cap H_0^1(\Omega)) \times L^2(\Omega) \times H_0^1(\Omega)$ in the case of L^2 internal control and $L^2(\Omega) \times H_0^1(\Omega) \times H^{-1}(\Omega) \times L^2(\Omega)$ in the case of L^2 boundary control.

Some comments should be made about this result. First this is a generalization of the work [AB03] where the coupling coefficients considered have to satisfy $p(x) \geq C > 0$ for all $x \in \Omega$. The geometric situations covered by Theorem 5.3 are richer, and include in particular several examples of coupling and control regions that do not intersect (see Figure 5.1). Second, we do not know if the coercivity assumption (i) for $-\Delta_c + a$ and the smallness assumption on p^+ are only technical and inherent to the method we use here. Moreover, the control time T_* we obtain depends on all the parameters of the system, and not only the sets ω_p , ω_b and Γ_b (as it is the case for a single wave equation). This feature does not seem to be very natural. Finally, the fact that we consider twice the same elliptic operator Δ_c is a key point in our proof and it is likely that this result does not hold for waves with different speeds (see [AB03] for results with different speeds and different operators). Similarly, the fact that $p \geq 0$ (see Assumption(ii)) is very important here. It is possible that Theorem 5.3 does not work if the sign of p varies.

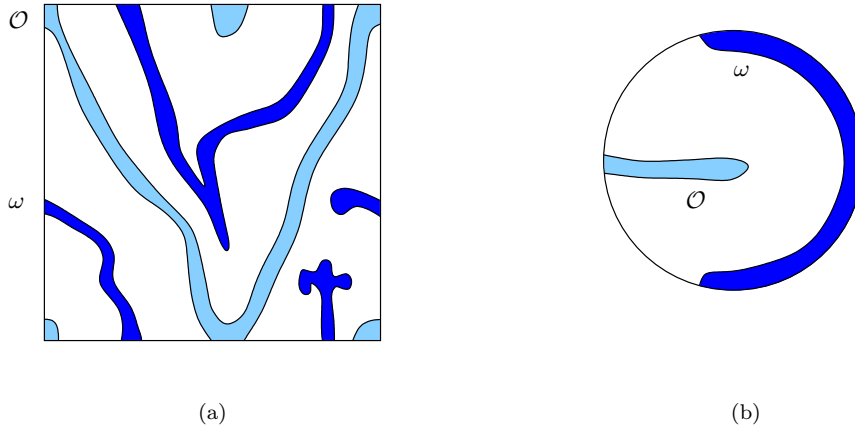

FIGURE 5.1 – Examples of open sets $(\Omega, \omega, \mathcal{O})$ such that ω and \mathcal{O} both satisfy GCC in Ω , with $\omega \cap \mathcal{O} = \emptyset$: in the case (a), Ω is the flat torus (or the square), in the case (b), Ω is the disk.

As a consequence of Theorem 5.3 and using transmutation techniques (due to [Rus73, Mil05] for heat-type equations and to [Phu01, Mil06a] for Schrödinger-type equations), we can now state the associated results for Systems (5.6) and (5.7).

Corollary 5.4 (Heat-type systems). *Suppose that (i) holds, that ω_p satisfies GCC and that ω_b (resp. Γ_b) satisfies GCC (resp. GCC_∂). Then, for all b (resp. b_∂) satisfying (iii), there exists a constant $p_* > 0$ (depending only on the geometry of Ω and on b , resp. b_∂) such that for all $p^+ < p_*$, for all $T > 0$, $\theta \in (-\pi/2, \pi/2)$, for all p satisfying (ii) and all initial data $(u_1^0, u_2^0) \in (L^2(\Omega))^2$ (resp. $(u_1^0, u_2^0) \in (H^{-1}(\Omega))^2$), there exists a control function $f \in L^2((0, T) \times \Omega)$ (resp. $f \in L^2((0, T) \times \partial\Omega)$) such that the solution of (5.6) (resp. (5.7)) satisfies $(u_1, u_2)|_{t=T} = 0$.*

To our knowledge, this corollary gives the first controllability result for coupled parabolic equations when the coupling region ω_p and the control region ω_b do not intersect. Moreover, this seems to

be also the first positive result for boundary control of parabolic systems in several space dimensions or with variable coupling coefficients.

Note that the spaces for which the controllability result of Corollary 5.4 holds are symmetric. This is due to the smoothing effect of parabolic equations. The proof of this result is given in Section 5.6.2.

The geometric conditions in this theorem are not sharp for parabolic equations. This leads us to think that the same result still holds under the only conditions $\omega_p \neq \emptyset$ (i.e. p is not the null function) and $\omega_b \neq \emptyset$ (i.e. b is not the null function). This remains an open problem. Note that our control result holds for any $T > 0$, which is natural for parabolic equations.

Concerning coupled Schrödinger equations, we have the following result.

Corollary 5.5 (Schrödinger-type systems). *Suppose that (i) holds, that ω_p satisfies GCC and that ω_b (resp. Γ_b) satisfies GCC (resp. GCC_∂). Then, for all b (resp. b_∂) satisfying (iii), there exists a constant $p_* > 0$ (depending only on the geometry of Ω and on b , resp. b_∂) such that for all $p^+ < p_*$, for all $T > 0$, all p satisfying (iii) and all initial data $(u_1^0, u_2^0) \in L^2(\Omega) \times H_0^1(\Omega)$ (resp. $(u_1^0, u_2^0) \in H^{-1}(\Omega) \times L^2(\Omega)$), there exists a control function $f \in L^2((0, T) \times \Omega)$ (resp. $f \in L^2((0, T) \times \partial\Omega)$) such that the solution of (5.6) (resp. (5.7)) with $\theta = \pm\pi/2$ satisfies $(u_1, u_2)|_{t=T} = 0$.*

The proof of this result is given in Section 5.6.3. Since there is no smoothing effect in this case, we still obtain a controllability result in asymmetric spaces here : the uncontrolled variable u_2 has to be more regular than the other one. This shows that the attainable set from zero for a L^2 internal control (resp. L^2 boundary control) contains $L^2(\Omega) \times H_0^1(\Omega)$ (resp. $H^{-1}(\Omega) \times L^2(\Omega)$). Whether or not a general target in $(L^2(\Omega))^2$ (resp. $(H^{-1}(\Omega))^2$) is reachable for (5.6) (resp. (5.7)) with $\theta = \pm\pi/2$ remains open.

Note finally that the geometric conditions GCC and GCC_∂ are not necessary in the case of Schrödinger equations but are not far from being optimal. The most general control result for a single Schrödinger equation [Leb92] is that GCC (resp. GCC_∂) implies null-controllability in any positive time. However, in some cases (see [Jaf90, BZ04]), these conditions are not necessary. Here, we do not recover these properties (since our result is deduced from a controllability result for waves). It would be interesting to prove such a result with weaker geometric conditions in particular situations (see [RdT11] in the case of a square). Note also that our control result holds for any $T > 0$, which is natural for Schrödinger equations [Leb92] (and which is not the case in the results of [RdT11]).

Remark 5.6. Different boundary conditions (like Neumann or Fourier boundary conditions) can also be addressed with the same techniques since we use the observability inequality for a single wave equation as a black box. In the work [BLR92], the authors prove this observability inequality with all these boundary conditions (all compatible with the Melrose-Sjöstrand theorem of propagation of singularities).

Remark 5.7. Similarly, our results also hold (in the case of Dirichlet boundary conditions) for a boundary $\partial\Omega$ and a metric c having a limited smoothness (i.e. \mathcal{C}^3 for $\partial\Omega$ and \mathcal{C}^2 for c) according to the article [Bur97a]. Note as well that we supposed that the coefficients a , p and b are smooth. It is sufficient that a and p preserve the regularity of u_1 and u_2 and b (resp. b_∂) that of the control function f . For instance, one can take $b \in L^\infty(\Omega)$ (resp. $b_\partial \in L^\infty(\partial\Omega)$) and $a, p \in W^{2,\infty}(\Omega)$.

Remark 5.8. We could also replace the operator A_p in all the systems studied here, by the operator

$$A_\delta = \begin{pmatrix} -\Delta_c + a & \delta p \\ p & -\Delta_c + a \end{pmatrix},$$

for $\delta > 0$. This is what we did in [ABL11a]. This operator is selfadjoint on $(L^2(\Omega))^2$ endowed with the inner product $(U, V)_\delta = (u_1, v_1)_{L^2(\Omega)} + \delta(u_2, v_2)_{L^2(\Omega)}$. The controllability results obtained in this case (for all equations, as well as in the abstract setting) hold for all (δ, p^+) such that $\sqrt{\delta}p^+ < p_*$. Such results in this setting seem more general since they allow to consider large p^+ or large δ (provided that the other is small enough). For these choices of δ , the systems obtained are “less symmetric” than the ones for $\delta = 1$.

However, we can pass from the system with δ to the system without δ with a change of variables. Suppose that (z_1, z_2) is the solution of the system

$$\begin{cases} \partial_t^2 z_1 - \Delta_c z_1 + a z_1 + \delta p z_2 = b f & \text{in } (0, T) \times \Omega, \\ \partial_t^2 z_2 - \Delta_c z_2 + a z_2 + p z_1 = 0 & \text{in } (0, T) \times \Omega, \\ z_1 = z_2 = 0 & \text{on } (0, T) \times \partial\Omega, \\ (z_1, z_2, \partial_t z_1, \partial_t z_2)|_{t=0} = (z_1^0, z_2^0, z_1^1, z_2^1) & \text{in } \Omega, \end{cases}$$

then, setting $u_1 = z_1$ and $u_2 = \sqrt{\delta} z_2$, the new variable (u_1, u_2) satisfies the fully symmetric system

$$\begin{cases} \partial_t^2 u_1 - \Delta_c u_1 + a u_1 + \sqrt{\delta} p u_2 = b f & \text{in } (0, T) \times \Omega, \\ \partial_t^2 u_2 - \Delta_c u_2 + a u_2 + \sqrt{\delta} p u_1 = 0 & \text{in } (0, T) \times \Omega, \\ u_1 = u_2 = 0 & \text{on } (0, T) \times \partial\Omega, \\ (u_1, u_2, \partial_t u_1, \partial_t u_2)|_{t=0} = (z_1^0, \sqrt{\delta} z_2^0, z_1^1, \sqrt{\delta} z_2^1) & \text{in } \Omega, \end{cases}$$

to which Theorem 5.3 applies (for $\sqrt{\delta} p^+ < p_*$).

5.2 Abstract setting

In this section, we describe the abstract setting in which we prove Theorem 5.3 for Systems (5.3) and (5.4), and define the appropriate spaces and operators. Let H be a Hilbert space and $(A, \mathcal{D}(A))$ a selfadjoint positive operator on H with compact resolvent. We denote by $(\cdot, \cdot)_H$ the inner product on H and $\|\cdot\|_H$ the associated norm. For $k \in \mathbb{N}$, we set $H_k = \mathcal{D}(A^{\frac{k}{2}})$ endowed with the inner product $(\cdot, \cdot)_{H_k} = (A^{\frac{k}{2}} \cdot, A^{\frac{k}{2}} \cdot)_H$ and associated norm $\|\cdot\|_{H_k} = \|A^{\frac{k}{2}} \cdot\|_H$. We define H_{-k} as the dual space of H_k with respect to the pivot space $H = H_0$. We write $(\cdot, \cdot)_{H_k, H_{-k}} = (A^{\frac{k}{2}} \cdot, A^{-\frac{k}{2}} \cdot)_H$ the duality product between H_k and H_{-k} , and $\|\cdot\|_{H_{-k}} = \|A^{-\frac{k}{2}} \cdot\|_H$ is the norm on H_{-k} . The operator A can be extended to an isomorphism from H_k to H_{k-2} for any $k \leq 1$, still denoted by A . According to the properties of the operator A , the injection $H_k \hookrightarrow H_{k-1}$ is dense and compact for any $k \in \mathbb{Z}$.

We denote by $\lambda_0 > 0$ the largest constant satisfying

$$\|v\|_{H_1}^2 \geq \lambda_0 \|v\|_H^2 \quad \text{for all } v \in H_1, \quad (5.8)$$

that is, the smallest eigenvalue of the selfadjoint positive operator A . Note that we also have, for all $\alpha \geq 0$,

$$\|A^{-\alpha}\|_{\mathcal{L}(H)} = \lambda_0^{-\alpha}.$$

In this abstract setting, we shall denote φ' the derivative with respect to time of a function $\varphi : \mathbb{R} \rightarrow H_k$, for some $k \in \mathbb{Z}$. In the following, as in [AB03], we shall make use of the different energy levels

$$e_k(\varphi(t)) = \frac{1}{2} (\|\varphi(t)\|_{H_k}^2 + \|\varphi'(t)\|_{H_{k-1}}^2), \quad k \in \mathbb{Z}$$

which are all preserved through time if φ is a solution of $\varphi'' + A\varphi = 0$. Moreover, the coercivity assumption (5.8) yields, for all $k \in \mathbb{Z}$, $v \in H_k$,

$$\|v\|_{H_k}^2 \geq \lambda_0 \|v\|_{H_{k-1}}^2 \quad \text{and} \quad e_k(v) \geq \lambda_0 e_{k-1}(v). \quad (5.9)$$

We consider that the coupling operator P is bounded on H and denote by P^* is its adjoint, $p^+ := \|P\|_{\mathcal{L}(H)} = \|P^*\|_{\mathcal{L}(H)}$.

Before addressing the control problem, let us introduce the adjoint system

$$\begin{cases} v_1'' + A v_1 + P v_2 = 0, \\ v_2'' + A v_2 + P^* v_1 = 0, \\ (v_1, v_2, v_1', v_2')|_{t=0} = (v_1^0, v_2^0, v_1^1, v_2^1), \end{cases} \quad (5.10)$$

which shall stand for our observation system. This system can be recast as a first order differential equation

$$\mathcal{V}' = \mathcal{A}_P \mathcal{V}, \quad \mathcal{V}(0) = \mathcal{V}^0, \quad (5.11)$$

where

$$\mathcal{A}_P = \begin{pmatrix} 0 & \text{Id} \\ -A_P & 0 \end{pmatrix}, \quad A_P = \begin{pmatrix} A & P \\ P^* & A \end{pmatrix}, \quad V = (v_1, v_2), \quad \mathcal{V} = (V, V') = (v_1, v_2, v_1', v_2').$$

Note that the operator A_P is selfadjoint on the space $H \times H$ endowed with the inner product $(V, \tilde{V})_{H \times H} = (v_1, \tilde{v}_1)_H + (v_2, \tilde{v}_2)_H$. Using (5.9) with $k = 1$, we obtain

$$(A_P V, V)_{H \times H} = (Av_1, v_1)_H + (Av_2, v_2)_H + 2(Pv_2, v_1)_H \geq \left(1 - \frac{p^+}{\lambda_0}\right) (\|v_1\|_{H_1}^2 + \|v_2\|_{H_1}^2). \quad (5.12)$$

As a consequence, we shall suppose that $p^+ < \lambda_0$, so that A_P is coercive. Under this assumption, $(A_P^{\frac{1}{2}} V, A_P^{\frac{1}{2}} \tilde{V})_{H \times H}$ defines an inner product on $(H_1)^2$, equivalent to the natural one. Assuming that $P, P^* \in \mathcal{L}(H_k)$ and writing

$$\mathcal{H}_k = (H_k)^2 \times H_{k-1}^2, \quad k \in \mathbb{Z},$$

the operator \mathcal{A}_P is an isomorphism from \mathcal{H}_k to \mathcal{H}_{k-1} and is skewadjoint on \mathcal{H}_k , equipped with the inner product

$$((U, V), (\tilde{U}, \tilde{V}))_{\mathcal{H}_k} = (A_P^{\frac{k}{2}} U, A_P^{\frac{k}{2}} \tilde{U})_{H \times H} + (A_P^{\frac{k-1}{2}} V, A_P^{\frac{k-1}{2}} \tilde{V})_{H \times H}.$$

Note that this is an inner product according to the coercivity assumption for A_P , which is equivalent to the natural inner product of \mathcal{H}_k . Hence, \mathcal{A}_P generates a group $e^{t\mathcal{A}_P}$ on \mathcal{H}_k , and the homogeneous problem (5.10) is well-posed in these spaces. An important feature of solutions $\mathcal{V}(t)$ of System (5.10) is that all energies

$$E_k(\mathcal{V}(t)) = 1/2 \|\mathcal{V}(t)\|_{\mathcal{H}_k}^2, \quad k \in \mathbb{Z},$$

are positive and preserved through time.

5.2.1 Main results : admissibility, observability and controllability

For System (5.10), now studied in \mathcal{H}_1 , we shall observe only the state of the first component, i.e. (u_1, u_1') , and hence define an observation operator $\mathcal{B}^* \in \mathcal{L}(H_2 \times H, Y)$, where Y is a Hilbert space, standing for our observation space. This definition is sufficiently general to take into account both the boundary observation problem (taking $\mathcal{B}^* \in \mathcal{L}(H_2, Y)$) and the internal observation problem (taking $\mathcal{B}^* \in \mathcal{L}(H, Y)$). We assume that \mathcal{B}^* is an admissible observation for one equation :

$$\left\{ \begin{array}{l} \text{For all } T > 0 \text{ there exists a constant } C > 0, \\ \text{such that all solutions } \varphi \text{ of } \varphi'' + A\varphi = f \in L^2(0, T; H) \text{ satisfy} \\ \int_0^T \|\mathcal{B}^*(\varphi, \varphi')\|_Y^2 dt \leq C \left(e_1(\varphi(0)) + e_1(\varphi(T)) + \int_0^T e_1(\varphi(t)) dt + \int_0^T \|f\|_H^2 dt \right). \end{array} \right. \quad (\text{A1})$$

Under this assumption, we have the following lemma.

Lemma 5.9 (Admissibility). *The operator \mathcal{B}^* is an admissible observation for (5.10). More precisely, for all $p^+ < \frac{\lambda_0}{\sqrt{2}}$ and all $T > 0$, there exists a constant $C > 0$, such that all the solutions of (5.10) satisfy*

$$\int_0^T \|\mathcal{B}^*(v_1, v_1')(t)\|_Y^2 dt \leq C \{e_1(v_1(0)) + e_0(v_2(0))\}. \quad (5.13)$$

Note that only the e_0 energy level of the second component v_2 is necessary in this admissibility estimate. Hence, we cannot hope to observe the whole \mathcal{H}_1 energy of \mathcal{V} and the best observability we can expect only involves $e_0(v_2)$. Our aim is now to prove this inverse inequality of (5.13). For this,

we have to suppose some additional assumptions on the operators P and \mathcal{B}^* . Let us first precise Assumption (A2), related with the operator P :

$$\left\{ \begin{array}{l} \text{We have } \|Pv\|_H^2 \leq p^+(Pv, v)_H \text{ and there exists an operator } \Pi_P \in \mathcal{L}(H), \|\Pi_P\|_{\mathcal{L}(H)} = 1, \\ \text{and a number } p^- > 0 \text{ such that } (Pv, v)_H \geq p^- \|\Pi_P v\|_H^2 \quad \forall v \in H. \end{array} \right. \quad (\text{A2})$$

Note that $p^- \leq p^+ = \|P\|_{\mathcal{L}(H)}$ and that (A2) implies that the operators P and P^* are non-negative.

Next, we shall suppose that a single equation is observable both by \mathcal{B}^* and by Π_P in sufficiently large time :

$$\left\{ \begin{array}{l} \text{There exist } T_B, T_P > 0 \text{ such that all solutions } \varphi \text{ of } \varphi'' + A\varphi = 0 \text{ satisfy} \\ e_1(\varphi(0)) \leq C_B(T) \int_0^T \|\mathcal{B}^*(\varphi, \varphi')\|_Y^2 \quad \text{for all } T > T_B, \\ e_1(\varphi(0)) \leq C_P(T) \int_0^T \|\Pi_P \varphi'\|_H^2 dt \quad \text{for all } T > T_P. \end{array} \right. \quad (\text{A3})$$

In the context of Theorem 5.3, these observability assumptions are satisfied as soon as ω_p and ω_b satisfy GCC (resp. Γ_b satisfies GCC_∂). We can now state our main result, i.e. an observability inequality.

Theorem 5.10 (Observability). *Suppose that Assumptions (A1)-(A3) hold. Then there exists a constant p_* such that for all $p^+ < p_*$, there exists a time T_* such that for all $T > T_*$ there exists $C > 0$, such that for all $\mathcal{V}^0 \in \mathcal{H}_1$, the solution $\mathcal{V}(t) = e^{tA_P} \mathcal{V}^0$ of (5.10) satisfies*

$$e_1(v_1(0)) + e_0(v_2(0)) \leq C \int_0^T \|\mathcal{B}^*(v_1, v_1')(t)\|_Y^2 dt. \quad (5.14)$$

Note that the constants p_* and T_* can be given explicitly in terms of the different parameters of the system. In particular, $T_* \geq \max\{T_B, T_P\}$, and p_* depends only on λ_0 , on the time T_B and on the observability constant $C_B(T_B^*)$ (given in Assumption (A3)) for some $T_B^* > T_B$. See Proposition 5.23 and Lemma 5.16 below for more precision.

Applying the Hilbert Uniqueness Method (HUM) of [Lio88a], we deduce now controllability results for the adjoint system. In this context, we have to define more precisely the observation operator. We shall treat two cases : First, $\mathcal{B}^*(v_1, v_1') = B^*v_1'$ with $B^* \in \mathcal{L}(H, Y)$, corresponding to internal observability (with $Y = L^2(\Omega)$), and second $\mathcal{B}^*(v_1, v_1') = B^*v_1$ with $B^* \in \mathcal{L}(H_2, Y)$, corresponding to boundary observability (with $Y = L^2(\partial\Omega)$). In both cases, we define the control operator B as the adjoint of B^* , and the control problem reads, for a control function f taking its values in Y ,

$$\left\{ \begin{array}{l} u_1'' + Au_1 + Pu_2 = Bf, \\ u_2'' + Au_2 + P^*u_1 = 0, \\ (u_1, u_2, u_1', u_2')|_{t=0} = (u_1^0, u_2^0, u_1^1, u_2^1). \end{array} \right. \quad (5.15)$$

This is an abstract version of (5.3)-(5.4). Note that under this form, System (5.15) not only contains (5.3)-(5.4), but also locally coupled systems of plate equations, with a distributed or a boundary control.

First case : $\mathcal{B}^*(v_1, v_1') = B^*v_1'$ with $B^* \in \mathcal{L}(H, Y)$. In this case, $B \in \mathcal{L}(Y, H)$ and the control problem (5.15) is well-posed in \mathcal{H}_1 for $f \in L^2(0, T; Y)$. Note that, as in the concrete setting, it also preserves the space $H_1 \times H_2 \times H \times H_1$ through time as soon as $P \in \mathcal{L}(H_1)$. There is thus no hope to control in whole \mathcal{H}_1 . In this setting, we first deduce from (5.14) the following other observability estimate for solutions \mathcal{W} of (5.10) in \mathcal{H}_0 : $e_0(w_1(0)) + e_{-1}(w_2(0)) \leq C \int_0^T \|B^*w_1(t)\|_Y^2 dt$. The internal control result of Theorem 5.3 is then a direct consequence of the HUM since Assumptions (A1)-(A3) are satisfied in this application.

Theorem 5.11 (Controllability). *Suppose that Assumptions (A1)-(A3) hold. Then, there exists a constant p_* such that for all $p^+ < p_*$, there exists a time T_* such that for all $T > T_*$ and $\mathcal{U}^0 \in H_1 \times H_2 \times H \times H_1$, there exists a control function $f \in L^2(0, T; Y)$ such that the solution $\mathcal{U}(t)$ of (5.15) satisfies $\mathcal{U}(T) = 0$.*

To prove this theorem, we first have to deduce from the observability estimate (5.14) the following other observability estimate for all $\mathcal{W} = e^{tA_P}\mathcal{W}^0$ (solution of (5.10) in \mathcal{H}_0): $e_0(w_1(0)) + e_{-1}(w_2(0)) \leq C \int_0^T \|B^*w_1(t)\|_Y^2 dt$. Then, Theorem 5.11 is a direct consequence of the HUM.

Second case : $\mathcal{B}^*(v_1, v_1') = B^*v_1$ **with** $B^* \in \mathcal{L}(H_2, Y)$. As a consequence of the admissibility inequality (5.13), System (5.15) is well-posed in \mathcal{H}_0 in the sense of transposition solutions. Moreover, System (5.15) also preserves the space $H \times H_1 \times H_{-1} \times H$, and there is no hope to control in whole \mathcal{H}_0 . In this setting, the boundary control result of Theorem 5.3 is a direct consequence of the HUM and Theorem 5.10 since Assumptions (A1)-(A3) are satisfied in this application.

Theorem 5.12 (Controllability). *Suppose that Assumptions (A1)-(A3) hold. Then, there exists a constant p_* such that for all $p^+ < p_*$, there exists a time T_* such that for all $T > T_*$ and $\mathcal{U}^0 \in H \times H_1 \times H_{-1} \times H$, there exists a control function $f \in L^2(0, T; Y)$ such that the solution $\mathcal{U}(t)$ of (5.15) satisfies $\mathcal{U}(T) = 0$.*

Theorem 5.3 is a consequence of Theorem 5.11 in the case of an internal control and of Theorem 5.12 in the case of a boundary control since Assumptions (A1)-(A3) are satisfied in this application. Theorem 5.11 and 5.12 are proved in Section 5.5.

5.2.2 Some remarks

Let us make some remarks about these results and their proofs.

First notice that System (5.15) is reversible in time, so that the concepts of null-controllability and controllability from zero are equivalent.

A consequence of Lemma 5.9 and Theorem 5.10 is that we here describe exactly the attainable set of The control system (5.15) (which was not done in [AB03]). More precisely, starting for zero initial data, we prove that for $T > T_*$ the attainable set is $H_1 \times H_2 \times H \times H_1$ in the first case and $H \times H_1 \times H_{-1} \times H$ in the second case.

Let us briefly describe the method of the proof of Theorem 5.10 which is inspired by the “two energy levels” method of [AB03]. Everything here is based on energy estimates, considering the H_1 energy of v_1 and the H_0 energy of v_2 , and comes from multiplier methods. There are three main ingredients in our proof.

Our first ingredient is an observability inequality for a single wave-type equation with a right hand-side (see Lemma 5.16). Such observability inequality used to be proved with multiplier techniques [AB03, ABL11c], and thus, under too strong (and not optimal) geometric conditions. Here, we prove such inequalities as a consequence of usual observability inequalities. We also prove for wave equations that such an observability inequality with optimal geometric conditions for an equation with a right hand-side is very natural (see Appendix 5.7). This improvement can in fact be used in several works using multiplier conditions, replacing them with optimal geometric conditions; in particular, the stabilization results of [ABL11c] now hold with GCC.

Our second main ingredient is the energy estimate obtained by multiplying the first line of (5.10) by v_2 and the second one by v_1 and taking the difference of the two equalities. This coupling inequality allows us to estimate the “localized” energy of the unobserved component v_2 by the energy of the observed one v_1 (see Lemma 5.17 below).

Finally to conclude the proof, we use in a crucial way the conservation of the \mathcal{H}_k -energy of the solution \mathcal{V} . This implies roughly that the integral on $(0, T)$ of the energy is increasing linearly with respect to T , for T sufficiently large.

If the operator B is bounded, we proved in [ABL11c] (under similar assumptions) a polynomial decay result for the $E_1(\mathcal{U}(t))$ energy of the system

$$\begin{cases} u_1'' + Au_1 + Pu_2 + BB^*u_1' = 0, \\ u_2'' + Au_2 + P^*u_1 = 0, \\ (u_1, u_2, u_1', u_2')|_{t=0} = \mathcal{U}^0 \in H_1 \times H_1 \times H \times H. \end{cases}$$

The observability estimates for a single equation with a right hand-side we prove here (Lemma 5.16) also improve the results of [ABL11c] in the case B bounded. Now, these results also hold under optimal geometric conditions for waves. We have the following proposition, where $-\Delta_D$ denotes the Laplace operator with Dirichlet boundary conditions.

Proposition 5.13. *Suppose that Assumption 5.2 holds, and that ω_b and ω_p satisfy GCC. Then there exists $p_* > 0$ such that for all $0 < p^+ < p_*$, the solution $\mathcal{U} = (u_1, u_2, \partial_t u_1, \partial_t u_2)$ of (5.5) satisfies for $n \in \mathbb{N}$, for any initial data $\mathcal{U}^0 = (u_1, u_2, \partial_t u_1, \partial_t u_2)|_{t=0} \in \mathcal{D}((-\Delta_D)^{\frac{n+1}{2}})^2 \times \mathcal{D}((-\Delta_D)^{\frac{n}{2}})^2$,*

$$E_1(\mathcal{U}(t)) \leq \frac{C_n}{t^n} \sum_{i=0}^n E_1(\mathcal{U}^{(i)}(0)) \quad \forall t > 0.$$

Besides, if $\mathcal{U}^0 \in (H_0^1)^2 \times (L^2)^2$, then $E_1(\mathcal{U}(t))$ converges to zero as t goes to infinity.

The method of energy estimates we use here has several advantages and drawbacks. The main advantage is that it furnishes a systematic method for both internal and boundary controllability problems for a large class of second order in time equations. We only have to check if an observability inequality is known for a single equation, and the results can directly be transferred to systems.

However, we have here to make several assumptions : symmetry of the system, coercivity of the elliptic operator, smallness of the coupling coefficients, large control time... We do not know precisely which assumptions are really needed and which ones are superfluous. We here provide a general *a priori* analysis of such coupled models. A more precise analysis (for instance for wave systems) remains to be done.

Finally, note that these exact controllability results for abstract second order hyperbolic equations yield null-controllability results for heat or Schrödinger type systems in the abstract setting as well. However, for the sake of clarity, we do not state these results in an abstract setting but only for heat or Schrödinger systems (see Sections 5.6.2 and 5.6.3).

5.3 Two energy levels and two key lemmata

5.3.1 Two energy levels

In the following sections, when proving Lemma 5.9 and Theorem 5.10, we shall use two different energy levels. Let us consider \mathcal{V} a \mathcal{H}_1 solution of (5.11). We regularize the state \mathcal{V} once by setting

$$\mathcal{W} = \mathcal{A}_P^{-1} \mathcal{V}, \quad \text{i.e.} \quad \begin{cases} w_1' = v_1, \\ w_2' = v_2, \\ Aw_1 + Pw_2 = -v_1', \\ Aw_2 + P^*w_1 = -v_2'. \end{cases} \quad (5.16)$$

Note that this system has a unique solution (w_1, w_2) , since the operator \mathcal{A}_P is coercive, that also satisfies

$$\begin{cases} w_1'' + Aw_1 + Pw_2 = 0, \\ w_2'' + Aw_2 + P^*w_1 = 0. \end{cases} \quad (5.17)$$

Now, the idea, is that, for p^+/λ_0 sufficiently small, the e_0 energy of v_2 is almost equivalent to the e_1 energy of w_2 . And we shall see that the e_1 energy level is more practical to handle. This is summarized in the first three identities of the following proposition. The last two identities are technical estimates, used at some points of the proof of the observability inequality.

Proposition 5.14. *We have the following energy estimates for all $\mathcal{V} = (v_1, v_2, v'_1, v'_2)$ in \mathcal{H}_1 and $\mathcal{W} = (w_1, w_2, w'_1, w'_2)$ defined by (5.16) :*

$$\left(1 - \frac{p^+}{\lambda_0}\right) [e_1(v_1) + e_1(v_2)] \leq E_1(\mathcal{V}) \leq \left(1 + \frac{p^+}{\lambda_0}\right) [e_1(v_1) + e_1(v_2)], \quad (5.18)$$

$$\left(1 - \frac{p^+}{\lambda_0}\right) [e_1(w_1) + e_1(w_2)] \leq E_1(\mathcal{W}) \leq \left(1 + \frac{p^+}{\lambda_0}\right) [e_1(w_1) + e_1(w_2)], \quad (5.19)$$

$$\left(\frac{1}{2} - \left(\frac{p^+}{\lambda_0}\right)^2\right) (e_1(w_1) + e_1(w_2)) \leq e_0(v_1) + e_0(v_2) \leq \left(2 + 2\left(\frac{p^+}{\lambda_0}\right)^2\right) (e_1(w_1) + e_1(w_2)), \quad (5.20)$$

$$e_0(v_2) \leq 2\left(1 + \frac{(p^+)^2}{\lambda_0^2}\right) e_1(w_2) + 2\frac{(p^+)^2}{\lambda_0^2} e_0(v_1), \quad (5.21)$$

$$e_1(v_1) \geq \frac{\lambda_0}{2} e_1(w_1) - \frac{(p^+)^2}{\lambda_0} e_1(w_2). \quad (5.22)$$

As a consequence of this lemma, assuming that $\frac{p^+}{\lambda_0} < \frac{1}{\sqrt{2}}$, we see that the energies $e_1(v_1) + e_1(v_2)$, $e_1(w_1) + e_1(w_2)$ and $e_0(v_1) + e_0(v_2)$ are almost preserved through time for (v_1, v_2) solutions of (5.10).

Proof. First recall that E_1 is defined by

$$2E_1(\mathcal{V}) = \|v'_1\|_H^2 + \|v'_2\|_H^2 + (Av_1, v_1)_H + (Av_2, v_2)_H + 2(Pv_2, v_1)_H.$$

Then, using the fact that $2|(Pv_2, v_1)_H| \leq \frac{p^+}{\lambda_0} (\|A^{\frac{1}{2}}v_1\|_H^2 + \|A^{\frac{1}{2}}v_2\|_H^2)$, we have

$$\begin{aligned} 2E_1(\mathcal{V}) &\geq \|v'_1\|_H^2 + \|v'_2\|_H^2 + \left(1 - \frac{p^+}{\lambda_0}\right) (\|A^{\frac{1}{2}}v_1\|_H^2 + \|A^{\frac{1}{2}}v_2\|_H^2) \\ &\geq 2\left(1 - \frac{p^+}{\lambda_0}\right) (e_1(v_1) + e_1(v_2)), \end{aligned}$$

together with

$$\begin{aligned} 2E_1(\mathcal{V}) &\leq \|v'_1\|_H^2 + \|v'_2\|_H^2 + \left(1 + \frac{p^+}{\lambda_0}\right) (\|A^{\frac{1}{2}}v_1\|_H^2 + \|A^{\frac{1}{2}}v_2\|_H^2) \\ &\leq 2\left(1 + \frac{p^+}{\lambda_0}\right) (e_1(v_1) + e_1(v_2)), \end{aligned}$$

and (5.18) is proved. Since (5.18) holds for all $\mathcal{V} \in \mathcal{H}_1$, it also holds for \mathcal{W} , which gives (5.19).

Now, applying $A^{-\frac{1}{2}}$ to the last two lines of System (5.16) gives

$$\begin{cases} w'_1 = v_1, \\ w'_2 = v_2, \\ A^{\frac{1}{2}}w_1 + A^{-\frac{1}{2}}Pw_2 = -A^{-\frac{1}{2}}v'_1, \\ A^{\frac{1}{2}}w_2 + A^{-\frac{1}{2}}P^*w_1 = -A^{-\frac{1}{2}}v'_2. \end{cases} \quad (5.23)$$

Since we have $\|A^{-\frac{1}{2}}Pw_2\|_H \leq \frac{p^+}{\lambda_0} \|A^{\frac{1}{2}}w_2\|_H$ and $\|A^{-\frac{1}{2}}P^*w_1\|_H \leq \frac{p^+}{\lambda_0} \|A^{\frac{1}{2}}w_1\|_H$, System (5.23) yields

$$\begin{aligned} 2(e_0(v_1) + e_0(v_2)) &= \|v_1\|_H^2 + \|v_2\|_H^2 + \|A^{-\frac{1}{2}}v'_1\|_H^2 + \|A^{-\frac{1}{2}}v'_2\|_H^2 \\ &\leq \|w'_1\|_H^2 + \|w'_2\|_H^2 + 2\|A^{\frac{1}{2}}w_1\|_H^2 + 2\left(\frac{p^+}{\lambda_0}\right)^2 \|A^{\frac{1}{2}}w_2\|_H^2 \\ &\quad + 2\|A^{\frac{1}{2}}w_2\|_H^2 + 2\left(\frac{p^+}{\lambda_0}\right)^2 \|A^{\frac{1}{2}}w_1\|_H^2 \\ &\leq \left(2 + 2\left(\frac{p^+}{\lambda_0}\right)^2\right) 2(e_1(w_1) + e_1(w_2)), \end{aligned}$$

together with

$$\begin{aligned} 2(e_0(v_1) + e_0(v_2)) &\geq \|w'_1\|_H^2 + \|w'_2\|_H^2 + \frac{1}{2}\|A^{\frac{1}{2}}w_1\|_H^2 - \left(\frac{p^+}{\lambda_0}\right)^2 \|A^{\frac{1}{2}}w_2\|_H^2 \\ &\quad + \frac{1}{2}\|A^{\frac{1}{2}}w_2\|_H^2 - \left(\frac{p^+}{\lambda_0}\right)^2 \|A^{\frac{1}{2}}w_1\|_H^2 \\ &\geq \left(\frac{1}{2} - \left(\frac{p^+}{\lambda_0}\right)^2\right) 2(e_1(w_1) + e_1(w_2)), \end{aligned}$$

and (5.20) is proved. To prove (5.21), we also use the last equation of (5.23), which gives

$$\|A^{-\frac{1}{2}}v'_2\|_H \leq \frac{p^+}{\lambda_0}\|A^{\frac{1}{2}}w_1\|_H + \|A^{\frac{1}{2}}w_2\|_H.$$

Using the third equation of (5.23) to eliminate $A^{\frac{1}{2}}w_1$ in this estimate, we obtain

$$\begin{aligned} \|A^{-\frac{1}{2}}v'_2\|_H &\leq \frac{p^+}{\lambda_0}\|A^{-\frac{1}{2}}Pw_2\|_H + \frac{p^+}{\lambda_0}\|A^{-\frac{1}{2}}v'_1\|_H + \|A^{\frac{1}{2}}w_2\|_H \\ &\leq \left(1 + \frac{(p^+)^2}{\lambda_0^2}\right)\|A^{\frac{1}{2}}w_2\|_H + \frac{p^+}{\lambda_0}\|A^{-\frac{1}{2}}v'_1\|_H. \end{aligned}$$

Hence, with the second equation of (5.23), we have

$$\|A^{-\frac{1}{2}}v'_2\|_H^2 + \|v_2\|_H^2 \leq 2\left(1 + \frac{(p^+)^2}{\lambda_0^2}\right)^2 \|A^{\frac{1}{2}}w_2\|_H^2 + 2\frac{(p^+)^2}{\lambda_0^2}\|A^{-\frac{1}{2}}v'_1\|_H^2 + \|w'_2\|_H^2,$$

which concludes the proof of (5.21). To prove (5.22), we first notice that the third line of (5.23) gives

$$\|A^{\frac{1}{2}}w_1\|_H^2 \leq 2\|A^{-\frac{1}{2}}Pw_2\|_H^2 + 2\|A^{-\frac{1}{2}}v'_1\|_H^2 \leq 2\lambda_0^{-2}(p^+)^2\|A^{\frac{1}{2}}w_2\|_H^2 + 2\lambda_0^{-1}\|v'_1\|_H^2.$$

Hence, using the first line of (5.23), we obtain

$$\begin{aligned} 2e_1(v_1) &= \|A^{\frac{1}{2}}w'_1\|_H^2 + \|v'_1\|_H^2 \geq \lambda_0\|w'_1\|_H^2 + \frac{\lambda_0}{2}\|A^{\frac{1}{2}}w_1\|_H^2 - \frac{(p^+)^2}{\lambda_0}\|A^{\frac{1}{2}}w_2\|_H^2 \\ &\geq \lambda_0e_1(w_1) - \frac{2(p^+)^2}{\lambda_0}e_1(w_2), \end{aligned}$$

which yields (5.22), and concludes the proof of the lemma. \square

5.3.2 Two key lemmata

In this section, we prove Lemma 5.9 together with a key observability inequality for a classical “wave-type” equation with a right hand-side. For both proofs, we shall use the classical well-posedness properties of the equation $\varphi'' + A\varphi = f$ that we recall in the following lemma.

Lemma 5.15. *For any $k \in \mathbb{Z}$, there exists $C > 0$ such that for all $(\varphi^0, \varphi^1) \in H_k \times H_{k-1}$ and $f \in L^1(\mathbb{R}^+; H_{k-1})$ the equation $\varphi'' + A\varphi = f$ has a unique solution, satisfying for all $T > 0$,*

$$e_k(\varphi(T)) \leq C \left(e_k(\varphi(0)) + \|f\|_{L^1(0,T;H_{k-1})}^2 \right). \quad (5.24)$$

Note that in this energy inequality, the constant C does not depend on the time T .

5.3.2.1 Proof of Lemma 5.9 : admissibility

Here, we prove that Assumption (A1) implies the amissibility inequality (5.13) for the whole system.

Proof of Lemma 5.9 We suppose that (v_1, v_2) satisfies System (5.10). In particular, we have,

$$v_1'' + Av_1 = -Pv_2.$$

As a consequence of Assumption (A1), we have for all $T > 0$,

$$\int_0^T \|\mathcal{B}^*(v_1, v_1')\|_Y^2 dt \leq C(T) \left(e_1(v_1(0)) + e_1(v_1(T)) + \int_0^T e_1(v_1(t)) dt + \int_0^T \|Pv_2(t)\|_H^2 dt \right). \quad (5.25)$$

Then, the energy estimate (5.24) for $k = 1$, the Cauchy-Schwarz inequality and the boundedness of P on H yield

$$e_1(v_1(T)) \leq C \left(e_1(v_1(0)) + \|Pv_2\|_{L^1(0,T;H)}^2 \right) \leq C \left(e_1(v_1(0)) + T(p^+)^2 \|v_2\|_{L^2(0,T;H)}^2 \right), \quad (5.26)$$

together with

$$\int_0^T e_1(v_1(t)) dt \leq C \left(T e_1(v_1(0)) + T^2 (p^+)^2 \|v_2\|_{L^2(0,T;H)}^2 \right). \quad (5.27)$$

Now, we note that, according to (5.16), $\|v_2\|_{L^2(0,T;H)}^2 = \|w_2'\|_{L^2(0,T;H)}^2 \leq \int_0^T E_1(\mathcal{W}(t)) dt$. Since \mathcal{W} is a solution of (5.17), its energy is preserved through time, so that $\int_0^T E_1(\mathcal{W}(t)) dt = T E_1(\mathcal{W}(0))$. Using inequalities (5.19) and (5.20) (i.e. the equivalence of the different energies), we obtain, for all $p^+ < \frac{\lambda_0}{\sqrt{2}}$,

$$\begin{aligned} \|v_2\|_{L^2(0,T;H)}^2 &\leq T \left(1 + \frac{p^+}{\lambda_0} \right) [e_1(w_1(0)) + e_1(w_2(0))] \\ &\leq T \left(1 + \frac{p^+}{\lambda_0} \right) \left(\frac{1}{2} - \left(\frac{p^+}{\lambda_0} \right)^2 \right)^{-1} [e_0(v_1(0)) + e_0(v_2(0))]. \end{aligned} \quad (5.28)$$

We recall that (5.9) yields $e_0(v_1(0)) \leq \lambda_0^{-1} e_1(v_1(0))$. Finally, combining (5.25)-(5.28), we obtain

$$\int_0^T \|\mathcal{B}^*(v_1, v_1')\|_Y^2 dt \leq C(T, \lambda_0, p^+) (e_1(v_1(0)) + e_0(v_2(0))),$$

with $C(T, \lambda_0, p^+) = C(T) \left\{ 1 + C(1+T) + C(p^+)^2 T \lambda_0^{-1} (1+T+T^2) \left(1 + \frac{p^+}{\lambda_0} \right) \left(\frac{1}{2} - \left(\frac{p^+}{\lambda_0} \right)^2 \right)^{-1} \right\}$, and the admissibility of \mathcal{B}^* is proved. \square

5.3.2.2 Proof of an observability inequality with a right hand-side

Here, we prove the following lemma.

Lemma 5.16. *Suppose that Assumptions (A1) and (A3) hold. Then, for all $T_B^* > T_B$ and $T_P^* > T_P$, there exist constants $K_B, K_P > 0$ such that for any solution φ of $\varphi'' + A\varphi = f \in L^2(0, T; H)$, we have*

$$\int_0^T e_1(\varphi(t)) dt \leq K_B \left(\int_0^T \|\mathcal{B}^*(\varphi, \varphi')\|_Y^2 dt + \int_0^T \|f(t)\|_H^2 dt \right) \quad \text{for all } T \geq T_B^*, \quad (5.29)$$

and

$$\int_0^T e_1(\varphi(t)) dt \leq K_P \left(\int_0^T \|\Pi_P \varphi'\|_H^2 dt + \int_0^T \|f(t)\|_H^2 dt \right) \quad \text{for all } T \geq T_P^*. \quad (5.30)$$

Note that the important feature is that the observability constants K_B, K_P here do not depend on the time T as $T \rightarrow +\infty$. More precisely, K_B only depends on T_B^* and on $C_B(T_B^*)$ for some $T_B^* > T_B$, where T_B and C_B are defined in Assumption (A3). Such observability inequalities are proved with multiplier techniques for the wave equation or the plate equation in [AB02, AB03, ABL11a]. It is then often used to perform energy estimates. Here, proving (5.29) and (5.30) as a consequence of the associated observability inequality for the free equation (Assumption (A3)) and an admissibility assumption (A1) has several advantages. In particular, we can use as a black-box the different observability inequalities obtained for the different equations (i.e. for instance [BLR88, BLR92] for waves) and we hence obtain results with the optimal geometric conditions.

However, for the sake of completeness, we also prove Lemma 5.16 in a simple case for the wave equation in a direct way in Appendix 5.7, with optimal geometric conditions. This shows that the norms used here are the natural ones.

Proof of Lemma 5.16 We here only prove (5.29). The proof of (5.30) is simpler since the observation operator Π_P is bounded (and we thus do not need an admissibility assumption).

To prove the first inequality of (5.29), we first split a solution of $\varphi'' + A\varphi = f$ into $\varphi = \phi + \psi$, where ϕ and ψ satisfy

$$\begin{cases} \phi'' + A\phi = f, \\ (\phi(0), \phi'(0)) = (0, 0), \end{cases}$$

and

$$\begin{cases} \psi'' + A\psi = 0, \\ (\psi(0), \psi'(0)) = (\varphi(0), \varphi'(0)). \end{cases}$$

We have

$$\int_0^T e_1(\varphi(t))dt \leq \int_0^T e_1(\phi(t))dt + \int_0^T e_1(\psi(t))dt, \quad (5.31)$$

and we provide upper bounds for both integrals on the right hand-side. The energy estimate (5.24) applied to ϕ gives, for all $t > 0$,

$$e_1(\phi(t)) \leq C\|f\|_{L^1(0,t;H)}^2 \leq Ct\|f\|_{L^2(0,t;H)}^2. \quad (5.32)$$

Then, the observability Assumption (A3) can be applied to ψ , which gives, for all $t > 0$ and $T > T_B$,

$$e_1(\psi(t)) = e_1(\psi(0)) \leq C \int_0^T \|\mathcal{B}^*(\psi, \psi')\|_Y^2 dt. \quad (5.33)$$

Integrating (5.32) and (5.33) for $t \in (0, T)$, and using (5.31), we now have, for all $T > T_B$,

$$\int_0^T e_1(\varphi(t))dt \leq CT^2 \int_0^T \|f\|_H^2 dt + CT \int_0^T \|\mathcal{B}^*(\psi, \psi')\|_Y^2 dt. \quad (5.34)$$

To obtain the observation on φ instead of ψ in the right hand-side, we write

$$\int_0^T \|\mathcal{B}^*(\psi, \psi')\|_Y^2 dt \leq \int_0^T \|\mathcal{B}^*(\varphi, \varphi')\|_Y^2 dt + \int_0^T \|\mathcal{B}^*(\phi, \phi')\|_Y^2 dt. \quad (5.35)$$

Then, using the admissibility Assumption (A1) for ϕ , we obtain

$$\int_0^T \|\mathcal{B}^*(\phi, \phi')\|_Y^2 dt \leq C \left(e_1(\phi(T)) + \int_0^T e_1(\phi(t))dt + \int_0^T \|f\|_H^2 dt \right) \leq C(T + T^2 + 1) \int_0^T \|f\|_H^2 dt, \quad (5.36)$$

after having used (5.32). Combining (5.34), (5.35) and (5.36), we finally obtain for all $T > T_B$ the existence of a constant $D(T)$ such that

$$\int_0^T e_1(\varphi(t))dt \leq D(T) \left(\int_0^T \|f\|_H^2 dt + \int_0^T \|\mathcal{B}^*(\varphi, \varphi')\|_Y^2 dt \right).$$

Now, we explain how this constant can be uniformly bounded for large times. For all $T_B^* > T_B$, we set $D^*(T) = \sup_{T_B^* \leq t \leq T} D(t)$, so that the application $T \rightarrow D^*(T)$ is nondecreasing on $[T_B^*, +\infty)$. Since the equation $\varphi'' + A\varphi = f$ is invariant under time translations, the last inequality yields, for all $T_2 \geq T_1 + T_B^*$,

$$\int_{T_1}^{T_2} e_1(\varphi(t))dt \leq D^*(T_2 - T_1) \left(\int_{T_1}^{T_2} \|f\|_H^2 dt + \int_{T_1}^{T_2} \|\mathcal{B}^*(\varphi, \varphi')\|_Y^2 dt \right). \quad (5.37)$$

For $T \geq T_B^*$, there exists an integer k_0 such that $T \in [k_0 T_B^*, (k_0 + 1)T_B^*)$. We have,

$$\int_0^T e_1(\varphi(t))dt = \sum_{k=0}^{k_0-2} \int_{kT_B^*}^{(k+1)T_B^*} e_1(\varphi(t))dt + \int_{(k_0-1)T_B^*}^T e_1(\varphi(t))dt$$

In each of these integrals the time interval is larger than T_B^* so that we can apply (5.37). This yields, for all $T \geq 2T_B^*$

$$\begin{aligned} \int_0^T e_1(\varphi(t))dt &\leq D^*(T_B^*) \sum_{k=0}^{k_0-2} \int_{kT_B^*}^{(k+1)T_B^*} (\|f\|_H^2 + \|\mathcal{B}^*(\varphi, \varphi')\|_Y^2) dt \\ &\quad + D^*(T - (k_0 - 1)T_B^*) \int_{(k_0-1)T_B^*}^T (\|f\|_H^2 + \|\mathcal{B}^*(\varphi, \varphi')\|_Y^2) dt \\ &\leq D^*(2T_B^*) \int_0^T (\|f\|_H^2 + \|\mathcal{B}^*(\varphi, \varphi')\|_Y^2) dt, \end{aligned}$$

since $T \in [k_0 T_B^*, (k_0 + 1)T_B^*)$ and D^* is nondecreasing. This inequality is also true for $T_B^* \leq T \leq 2T_B^*$, and this concludes the proof of (5.29), taking $K_B = D^*(2T_B^*)$. The proof of (5.30) follows exactly the same. \square

5.4 Proof of Theorem 5.10

In this section, we shall often use the notation $A \lesssim B$, meaning that there exists a universal numerical constant $C > 0$ (depending on none of the parameters of the system) such that $A \leq CB$.

5.4.1 The coupling Lemma

In this section, we give the link between v_1 and v_2 that we shall use in the following.

Lemma 5.17. *Let $\mathcal{V} = (v_1, v_2, v'_1, v'_2) \in \mathcal{H}_1$ be solution of (5.10) and $\mathcal{W} = (w_1, w_2, w'_1, w'_2)$ be defined by (5.16). Then, for all $T \geq 0$, we have*

$$\begin{aligned} \int_0^T (Pv_2, v_2)_H dt &\leq \int_0^T (Pv_1, v_1)_H dt + 2\lambda_0^{\frac{1}{2}} \left(1 + \frac{(p^+)^2}{\lambda_0^2}\right)^2 [e_1(w_2(T)) + e_1(w_2(0))] \\ &\quad + \frac{1}{\lambda_0^{\frac{1}{2}}} \left(1 + 2\frac{(p^+)^2}{\lambda_0^2}\right) [e_1(v_1(T)) + e_1(v_1(0))], \end{aligned} \quad (5.38)$$

and

$$\begin{aligned} \int_0^T (Pw_2, w_2)_H dt &\leq \int_0^T (Pw_1, w_1)_H dt + \frac{1}{\lambda_0^{\frac{1}{2}}} \left(1 + \frac{2(p^+)^2}{\lambda_0^2}\right) [e_1(w_2(T)) + e_1(w_2(0))] \\ &\quad + \frac{2}{\lambda_0^{\frac{3}{2}}} [e_1(v_1(T)) + e_1(v_1(0))]. \end{aligned} \quad (5.39)$$

Proof. Since \mathcal{V} is a solution of (5.10), we have

$$\int_0^T (v_1'' + Av_1 + Pv_2, v_2)_H - (v_2'' + Av_2 + P^*v_1, v_1)_H dt = 0. \quad (5.40)$$

We first notice that $(Av_1, v_2)_H - (Av_2, v_1)_H = 0$ since A is selfadjoint, and

$$\begin{aligned} \left| \int_0^T (v_1'', v_2)_H - (v_2'', v_1)_H dt \right| &= \left| [(v_1', v_2)_H - (v_2', v_1)_H]_0^T \right| \\ &\leq \frac{1}{2} \left[\frac{1}{\varepsilon} \|v_2\|_H^2 + \varepsilon \|v_1'\|_H^2 + \frac{1}{\varepsilon} \|v_2'\|_{H_{-1}}^2 + \varepsilon \|v_1\|_{H_1}^2 \right] (t=0) \\ &\quad + \frac{1}{2} \left[\frac{1}{\varepsilon} \|v_2\|_H^2 + \varepsilon \|v_1'\|_H^2 + \frac{1}{\varepsilon} \|v_2'\|_{H_{-1}}^2 + \varepsilon \|v_1\|_{H_1}^2 \right] (t=T) \\ &\leq \frac{1}{\varepsilon} [e_0(v_2(T)) + e_0(v_2(0))] + \varepsilon [e_1(v_1(T)) + e_1(v_1(0))], \end{aligned}$$

for all $\varepsilon > 0$ and $T \geq 0$. Once having isolated the term $\int_0^T (Pv_2, v_2)_H dt$ in (5.40), this yields

$$\int_0^T (Pv_2, v_2)_H dt \leq \int_0^T (Pv_1, v_1)_H dt + \frac{1}{\varepsilon} [e_0(v_2(T)) + e_0(v_2(0))] + \varepsilon [e_1(v_1(T)) + e_1(v_1(0))].$$

Using (5.21) in this expression, we now have for all $\varepsilon > 0$ and $T \geq 0$,

$$\begin{aligned} \int_0^T (Pv_2, v_2)_H dt &\leq \int_0^T (Pv_1, v_1)_H dt + \frac{1}{\varepsilon} \left[2 \left(1 + \frac{(p^+)^2}{\lambda_0^2} \right)^2 e_1(w_2(T)) + 2 \frac{(p^+)^2}{\lambda_0^2} e_0(v_1(T)) \right. \\ &\quad \left. + 2 \left(1 + \frac{(p^+)^2}{\lambda_0^2} \right)^2 e_1(w_2(0)) + 2 \frac{(p^+)^2}{\lambda_0^2} e_0(v_1(0)) \right] + \varepsilon [e_1(v_1(T)) + e_1(v_1(0))] \\ &\leq \int_0^T (Pv_1, v_1)_H dt + \frac{2}{\varepsilon} \left(1 + \frac{(p^+)^2}{\lambda_0^2} \right)^2 [e_1(w_2(T)) + e_1(w_2(0))] \\ &\quad + \left(\varepsilon + 2 \frac{(p^+)^2}{\varepsilon \lambda_0^3} \right) [e_1(v_1(T)) + e_1(v_1(0))], \end{aligned}$$

since $e_0(v_1) \leq \lambda_0^{-1} e_1(v_1)$. We then set $\varepsilon = \lambda_0^{-\frac{1}{2}}$ and Estimate (5.38) is proved.

Since \mathcal{W} is a solution of (5.17), we also have

$$\int_0^T (w_1'' + Aw_1 + Pw_2, w_2)_H - (w_2'' + Aw_2 + P^*w_1, w_1)_H dt = 0.$$

Following the same procedure, and recalling that $w_1' = v_1$, we obtain,

$$\begin{aligned} \int_0^T (Pw_2, w_2)_H dt &\leq \int_0^T (Pw_1, w_1)_H dt + \left| \int_0^T (w_1'', w_2)_H - (w_2'', w_1)_H dt \right| \\ &\leq \int_0^T (Pw_1, w_1)_H dt + \left| [(v_1, w_2)_H - (w_2', w_1)_H]_0^T \right|. \end{aligned} \quad (5.41)$$

Next, we estimate

$$|(v_1, w_2)_H| + |(w_2', w_1)_H| \leq \frac{1}{2} \left[\frac{1}{\varepsilon} \|w_2\|_H^2 + \varepsilon \|v_1\|_H^2 + \varepsilon \|w_2'\|_H^2 + \frac{1}{\varepsilon} \|w_1\|_H^2 \right], \quad (5.42)$$

and notice that System (5.16) yields $w_1 = -A^{-1}v'_1 - A^{-1}Pw_2$, and hence

$$\|w_1\|_H \leq \lambda_0^{-1} \|v'_1\|_H + p^+ \lambda_0^{-\frac{3}{2}} \|A^{\frac{1}{2}} w_2\|_H.$$

This, together with (5.42) gives

$$\begin{aligned} |(v_1, w_2)_H| + |(w'_2, w_1)_H| &\leq \frac{1}{2} \left[\frac{1}{\varepsilon \lambda_0} \|A^{\frac{1}{2}} w_2\|_H^2 + \frac{\varepsilon}{\lambda_0} \|A^{\frac{1}{2}} v_1\|_H^2 + \varepsilon \|w'_2\|_H^2 \right. \\ &\quad \left. + \frac{2}{\varepsilon \lambda_0^2} \|v'_1\|_H^2 + \frac{2(p^+)^2}{\varepsilon \lambda_0^3} \|A^{\frac{1}{2}} w_2\|_H^2 \right]. \end{aligned}$$

Taking $\varepsilon = \lambda_0^{-\frac{1}{2}}$, we obtain

$$|(v_1, w_2)_H| + |(w'_2, w_1)_H| \leq \frac{1}{\lambda_0^{\frac{1}{2}}} \left[1 + \frac{2(p^+)^2}{\lambda_0^2} \right] e_1(w_2) + \frac{2}{\lambda_0^{\frac{3}{2}}} e_1(v_1),$$

which, together with (5.41) yields Estimate (5.39), and concludes the proof of the lemma. \square

5.4.2 A first series of estimates

Note that until now, we did not assume that p^+/λ_0 is small, except for the coercivity assumption on A_P and the equivalence of the different energies in (5.19)-(5.20) (used in the proof of the Admissibility Lemma 5.9). Using the coupling relation (5.38), we now prove a first series of estimates, that will be made more precise later.

Lemma 5.18. *For all $T \geq 0$, all $\frac{(p^+)^2}{\lambda_0^2} \leq \frac{1}{2}$, all $\mathcal{V} = (v_1, v_2, v'_1, v'_2) \in \mathcal{H}_1$ solution of (5.10) and $\mathcal{W} = (w_1, w_2, w'_1, w'_2)$ defined by (5.16), we have the following estimates*

$$e_1(w_2(T)) + e_1(w_2(0)) \lesssim \lambda_0^{-1} e_1(v_1(0)) + \frac{p^+}{\lambda_0^{\frac{3}{2}}} \int_0^T e_1(v_1(t)) dt + e_1(w_2(0)) + p^+ \lambda_0^{\frac{1}{2}} \int_0^T \|w_1\|_H^2 dt, \quad (5.43)$$

$$e_1(v_1(T)) + e_1(v_1(0)) \lesssim e_1(v_1(0)) + \frac{p^+}{\lambda_0^{\frac{1}{2}}} \int_0^T e_1(v_1(t)) dt + \lambda_0 e_1(w_2(0)) + p^+ \lambda_0^{\frac{3}{2}} \int_0^T \|w_1\|_H^2 dt, \quad (5.44)$$

$$\int_0^T (Pv_2, v_2)_H dt \lesssim \frac{1}{\lambda_0^{\frac{1}{2}}} e_1(v_1(0)) + \frac{p^+}{\lambda_0} \int_0^T e_1(v_1(t)) dt + \lambda_0^{\frac{1}{2}} e_1(w_2(0)) + p^+ \lambda_0 \int_0^T \|w_1\|_H^2 dt. \quad (5.45)$$

Proof. Taking the inner product of the first equation of (5.10) by v'_1 , we obtain the following H_1 -dissipation relation for v_1 :

$$\frac{d}{dt} e_1(v_1) = -(Pv_2, v'_1)_H$$

Integrated on the time interval $(0, T)$, this yields,

$$\begin{aligned} e_1(v_1(T)) + e_1(v_1(0)) &= 2e_1(v_1(0)) - \int_0^T (Pv_2, v'_1)_H dt \\ &\leq 2e_1(v_1(0)) + \frac{p^+}{2\varepsilon \lambda_0^{\frac{1}{2}}} \int_0^T \|v'_1\|_H^2 dt + \frac{\varepsilon \lambda_0^{\frac{1}{2}}}{2} \int_0^T (Pv_2, v_2)_H dt, \end{aligned}$$

after having used Assumption (A2) on P and the Young inequality. Using the coupling relation (5.38) of Lemma 5.17 in this estimate gives

$$\begin{aligned} e_1(v_1(T)) + e_1(v_1(0)) &\leq 2e_1(v_1(0)) + \frac{p^+}{2\varepsilon\lambda_0^{\frac{1}{2}}} \int_0^T \|v_1'\|_H^2 dt + \frac{\varepsilon\lambda_0^{\frac{1}{2}}p^+}{2} \int_0^T \|v_1\|_H^2 dt \\ &\quad + \varepsilon\lambda_0 \left(1 + \frac{(p^+)^2}{\lambda_0^2}\right) [e_1(w_2(T)) + e_1(w_2(0))] \\ &\quad + \frac{\varepsilon}{2} \left(1 + 2\frac{(p^+)^2}{\lambda_0^2}\right) [e_1(v_1(T)) + e_1(v_1(0))]. \end{aligned}$$

We obtain for all $\frac{(p^+)^2}{\lambda_0^2} \leq \frac{1}{2}$ and ε sufficiently small,

$$\begin{aligned} e_1(v_1(T)) + e_1(v_1(0)) &\lesssim e_1(v_1(0)) + \frac{p^+}{\lambda_0^{\frac{1}{2}}} \int_0^T \|v_1'\|_H^2 dt + \lambda_0^{\frac{1}{2}}p^+ \int_0^T \|v_1\|_H^2 dt \\ &\quad + \lambda_0 [e_1(w_2(T)) + e_1(w_2(0))]. \end{aligned} \quad (5.46)$$

Putting this back into (5.38), we also have for all $\frac{(p^+)^2}{\lambda_0^2} \leq \frac{1}{2}$,

$$\begin{aligned} \int_0^T (Pv_2, v_2)_H dt &\lesssim \int_0^T (Pv_1, v_1)_H dt + \lambda_0^{\frac{1}{2}} [e_1(w_2(T)) + e_1(w_2(0))] + \frac{1}{\lambda_0^{\frac{1}{2}}} e_1(v_1(0)) \\ &\quad + \frac{p^+}{\lambda_0} \int_0^T \|v_1'\|_H^2 dt + p^+ \int_0^T \|v_1\|_H^2 dt \\ &\lesssim \frac{1}{\lambda_0^{\frac{1}{2}}} e_1(v_1(0)) + \frac{p^+}{\lambda_0} \int_0^T e_1(v_1(t)) dt + \lambda_0^{\frac{1}{2}} [e_1(w_2(T)) + e_1(w_2(0))]. \end{aligned} \quad (5.47)$$

Now, we take the inner product of the second equation of System (5.17) on \mathcal{W} by $w_2' = v_2$. We obtain the following H_1 -dissipation relation for w_2 :

$$\frac{d}{dt} e_1(w_2) = -(P^*w_1, w_2')_H = -(w_1, Pv_2)_H$$

Integrated on the time interval $(0, T)$, this yields,

$$\begin{aligned} e_1(w_2(T)) + e_1(w_2(0)) &= 2e_1(w_2(0)) - \int_0^T (w_1, Pv_2)_H dt \\ &\leq 2e_1(w_2(0)) + \frac{p^+\lambda_0^{\frac{1}{2}}}{2\varepsilon} \int_0^T \|w_1\|_H^2 dt + \frac{\varepsilon}{2\lambda_0^{\frac{1}{2}}} \int_0^T (Pv_2, v_2)_H dt, \end{aligned}$$

for all $\varepsilon > 0$, after having used Assumption (A2) on P and the Young inequality. Using (5.47) in this last inequality, we obtain, for all $\varepsilon > 0$,

$$\begin{aligned} e_1(w_2(T)) + e_1(w_2(0)) &\lesssim e_1(w_2(0)) + \frac{p^+\lambda_0^{\frac{1}{2}}}{\varepsilon} \int_0^T \|w_1\|_H^2 dt + \frac{\varepsilon}{\lambda_0} e_1(v_1(0)) \\ &\quad + \frac{p^+\varepsilon}{\lambda_0^{\frac{3}{2}}} \int_0^T e_1(v_1(t)) dt + \varepsilon [e_1(w_2(T)) + e_1(w_2(0))]. \end{aligned}$$

Taking ε sufficiently small, this yields

$$[e_1(w_2(T)) + e_1(w_2(0))] \lesssim e_1(w_2(0)) + p^+\lambda_0^{\frac{1}{2}} \int_0^T \|w_1\|_H^2 dt + \frac{1}{\lambda_0} e_1(v_1(0)) + \frac{p^+}{\lambda_0^{\frac{3}{2}}} \int_0^T e_1(v_1(t)) dt.$$

When using this estimate in (5.46) and (5.47), we obtain

$$e_1(v_1(T)) + e_1(v_1(0)) \lesssim e_1(v_1(0)) + \frac{p^+}{\lambda_0^{\frac{1}{2}}} \int_0^T e_1(v_1(t)) dt + \lambda_0 e_1(w_2(0)) + p^+ \lambda_0^{\frac{3}{2}} \int_0^T \|w_1\|_H^2 dt,$$

and

$$\int_0^T (Pv_2, v_2)_H dt \lesssim \frac{1}{\lambda_0^{\frac{1}{2}}} e_1(v_1(0)) + \frac{p^+}{\lambda_0} \int_0^T e_1(v_1(t)) dt + \lambda_0^{\frac{1}{2}} e_1(w_2(0)) + p^+ \lambda_0 \int_0^T \|w_1\|_H^2 dt.$$

These three inequalities yield the result of the lemma. \square

5.4.3 A second series of estimates

Using the weak coupling relation (5.39), we now eliminate the terms with $\int_0^T \|w_1\|_H^2 dt$ in Estimates (5.43)-(5.45) of the previous section.

Lemma 5.19. *There exists $\eta > 0$ such that for all $T \geq 0$, all $\frac{p^+}{\lambda_0} \leq \eta$, all $\mathcal{V} = (v_1, v_2, v'_1, v'_2) \in \mathcal{H}_1$ solution of (5.10) and $\mathcal{W} = (w_1, w_2, w'_1, w'_2)$ defined by (5.16), we have the estimates*

$$\int_0^T \|w_1\|_H^2 dt \lesssim \frac{1}{\lambda_0^2} \int_0^T e_1(v_1(t)) dt + \frac{p^+}{\lambda_0^{\frac{7}{2}}} e_1(v_1(0)) + \frac{p^+}{\lambda_0^{\frac{5}{2}}} e_1(w_2(0)), \quad (5.48)$$

and

$$\int_0^T (Pv_2, v_2)_H dt \lesssim \frac{1}{\lambda_0^{\frac{1}{2}}} e_1(v_1(0)) + \frac{p^+}{\lambda_0} \int_0^T e_1(v_1(t)) dt + \lambda_0^{\frac{1}{2}} e_1(w_2(0)). \quad (5.49)$$

Proof. Using Estimates (5.43) and (5.44) in relation (5.39), together with $\frac{p^+}{\lambda_0} \leq \frac{1}{2}$, we have

$$\begin{aligned} \int_0^T (Pw_2, w_2)_H dt &\lesssim p^+ \int_0^T \|w_1\|_H^2 dt + \frac{1}{\lambda_0^{\frac{1}{2}}} \left(1 + \frac{2(p^+)^2}{\lambda_0^2} \right) \left[\frac{1}{\lambda_0} e_1(v_1(0)) + \frac{p^+}{\lambda_0^{\frac{3}{2}}} \int_0^T e_1(v_1(t)) dt \right. \\ &\quad \left. + e_1(w_2(0)) + p^+ \lambda_0^{\frac{1}{2}} \int_0^T \|w_1\|_H^2 dt \right] + \frac{1}{\lambda_0^{\frac{3}{2}}} \left[e_1(v_1(0)) \right. \\ &\quad \left. + \frac{p^+}{\lambda_0^{\frac{1}{2}}} \int_0^T e_1(v_1(t)) dt + \lambda_0 e_1(w_2(0)) + p^+ \lambda_0^{\frac{3}{2}} \int_0^T \|w_1\|_H^2 dt \right] \\ &\lesssim p^+ \int_0^T \|w_1\|_H^2 dt + \frac{1}{\lambda_0^{\frac{3}{2}}} e_1(v_1(0)) + \frac{p^+}{\lambda_0^2} \int_0^T e_1(v_1(t)) dt + \frac{1}{\lambda_0^{\frac{1}{2}}} e_1(w_2(0)). \end{aligned} \quad (5.50)$$

Now, we want to eliminate the term with $\int_0^T \|w_1\|_H^2 dt$ in these estimates. According to the third line of (5.16), we have $w_1 = -A^{-1}v'_1 - A^{-1}Pw_2$, so that

$$\|w_1\|_H^2 \leq 2\|A^{-1}v'_1\|_H^2 + 2\|A^{-1}Pw_2\|_H^2 \leq 2\lambda_0^{-2}\|v'_1\|_H^2 + 2\lambda_0^{-2}p^+(Pw_2, w_2)_H$$

after having used Assumption (A2) on the operator P . Integrating this estimate on $(0, T)$ and using (5.50) yields

$$\begin{aligned} \int_0^T \|w_1\|_H^2 dt &\lesssim \frac{1}{\lambda_0^2} \int_0^T \|v'_1\|_H^2 dt + \frac{(p^+)^2}{\lambda_0^2} \int_0^T \|w_1\|_H^2 dt + \frac{p^+}{\lambda_0^{\frac{7}{2}}} e_1(v_1(0)) \\ &\quad + \frac{(p^+)^2}{\lambda_0^4} \int_0^T e_1(v_1(t)) dt + \frac{p^+}{\lambda_0^{\frac{5}{2}}} e_1(w_2(0)). \end{aligned}$$

Now, we suppose that $\frac{p^+}{\lambda_0} \leq \eta$, with η sufficiently small. This yields

$$\begin{aligned} \int_0^T \|w_1\|_H^2 dt &\lesssim \frac{1}{\lambda_0^2} \int_0^T \|v_1'\|_H^2 dt + \frac{p^+}{\lambda_0^{\frac{7}{2}}} e_1(v_1(0)) + \frac{(p^+)^2}{\lambda_0^4} \int_0^T e_1(v_1(t)) dt + \frac{p^+}{\lambda_0^{\frac{5}{2}}} e_1(w_2(0)) \\ &\lesssim \frac{1}{\lambda_0^2} \int_0^T e_1(v_1(t)) dt + \frac{p^+}{\lambda_0^{\frac{7}{2}}} e_1(v_1(0)) + \frac{p^+}{\lambda_0^{\frac{5}{2}}} e_1(w_2(0)), \end{aligned}$$

which is exactly (5.48). Finally, using this inequality in (5.45), we obtain for all $\frac{p^+}{\lambda_0} \leq \eta$,

$$\begin{aligned} \int_0^T (Pv_2, v_2)_H dt &\lesssim \frac{1}{\lambda_0^{\frac{1}{2}}} e_1(v_1(0)) + \frac{p^+}{\lambda_0} \int_0^T e_1(v_1(t)) dt + \lambda_0^{\frac{1}{2}} e_1(w_2(0)) \\ &\quad + p^+ \lambda_0 \left[\frac{1}{\lambda_0^2} \int_0^T e_1(v_1(t)) dt + \frac{p^+}{\lambda_0^{\frac{7}{2}}} e_1(v_1(0)) + \frac{p^+}{\lambda_0^{\frac{5}{2}}} e_1(w_2(0)) \right] \\ &\lesssim \frac{1}{\lambda_0^{\frac{1}{2}}} e_1(v_1(0)) + \frac{p^+}{\lambda_0} \int_0^T e_1(v_1(t)) dt + \lambda_0^{\frac{1}{2}} e_1(w_2(0)). \end{aligned}$$

This yields (5.49), and concludes the proof of the lemma. \square

Using the two estimates of this lemma, together with the observability inequality with a right hand-side for the operator Π_P , given in Lemma 5.16, we are now able to prove the following lemma.

Lemma 5.20. *There exists $\eta > 0$ such that for all $T_P^* > T_P$, there exists a constant K_P such that for all $T > T_P^*$ and $p^+/\lambda_0 \leq \eta$, for all $\mathcal{V} = (v_1, v_2, v_1', v_2') \in \mathcal{H}_1$ solution of (5.10) and $\mathcal{W} = (w_1, w_2, w_1', w_2')$ defined by (5.16), we have*

$$\int_0^T e_1(w_2(t)) dt \lesssim K_P \left(\frac{1}{p^-} + 1 \right) \left(\frac{1}{\lambda_0^{\frac{1}{2}}} e_1(v_1(0)) + \frac{p^+}{\lambda_0} \int_0^T e_1(v_1(t)) dt + \lambda_0^{\frac{1}{2}} e_1(w_2(0)) \right). \quad (5.51)$$

Proof. First, we Apply (5.30) to w_2 for some $T_P^* > T_P$, which, according to (5.17), satisfies $w_2'' + Aw_2 = -P^*w_1$. We have, for all $T > T_P^*$,

$$\int_0^T e_1(w_2(t)) dt \leq K_P \left(\int_0^T \|\Pi_P w_2'\|_H^2 dt + \int_0^T \|P^*w_1\|_H^2 dt \right).$$

Using Assumption (A2) on P together with the fact that $w_2' = v_2$, this yields

$$\int_0^T e_1(w_2(t)) dt \leq K_P \left(\frac{1}{p^-} \int_0^T (Pv_2, v_2)_H dt + (p^+)^2 \int_0^T \|w_1\|_H^2 dt \right).$$

Combining this inequality with Estimates (5.48)-(5.49) of Lemma 5.19, we obtain, for all $T > T_P^*$ and $p^+/\lambda_0 \leq \eta$,

$$\begin{aligned} \int_0^T e_1(w_2(t)) dt &\lesssim K_P \frac{1}{p^-} \left(\frac{1}{\lambda_0^{\frac{1}{2}}} e_1(v_1(0)) + \frac{p^+}{\lambda_0} \int_0^T e_1(v_1(t)) dt + \lambda_0^{\frac{1}{2}} e_1(w_2(0)) \right) \\ &\quad + K_P (p^+)^2 \left(\frac{1}{\lambda_0^2} \int_0^T e_1(v_1(t)) dt + \frac{p^+}{\lambda_0^{\frac{7}{2}}} e_1(v_1(0)) + \frac{p^+}{\lambda_0^{\frac{5}{2}}} e_1(w_2(0)) \right) \\ &\lesssim \frac{K_P}{\lambda_0^{\frac{1}{2}}} \left(\frac{1}{p^-} + 1 \right) e_1(v_1(0)) + \frac{K_P p^+}{\lambda_0} \left(\frac{1}{p^-} + 1 \right) \int_0^T e_1(v_1(t)) dt \\ &\quad + K_P \lambda_0^{\frac{1}{2}} \left(\frac{1}{p^-} + 1 \right) e_1(w_2(0)), \end{aligned}$$

which concludes the proof of the lemma. \square

Lemma 5.21 (Almost conservation of the energy). *For all $T \geq 0$, all $\frac{p^+}{\lambda_0} \leq \frac{1}{\sqrt{2}}$, all $\mathcal{V} = (v_1, v_2, v'_1, v'_2) \in \mathcal{H}_1$ solution of (5.10) and $\mathcal{W} = (w_1, w_2, w'_1, w'_2)$ defined by (5.16), we have*

$$\int_0^T [\lambda_0^{-1} e_1(v_1(t)) + e_1(w_2(t))] dt \geq \frac{T}{2} \left(1 + \frac{p^+}{\lambda_0}\right)^{-1} \left(1 - \frac{p^+}{\lambda_0}\right) [e_1(w_1(0)) + e_1(w_2(0))]. \quad (5.52)$$

Proof. First, as a consequence of (5.22) of Proposition 5.14, we have

$$\lambda_0^{-1} e_1(v_1) + e_1(w_2) \geq \frac{1}{2} e_1(w_1) + \left(1 - \frac{(p^+)^2}{\lambda_0^2}\right) e_1(w_2) \geq \frac{1}{2} [e_1(w_1) + e_1(w_2)],$$

as soon as $\frac{(p^+)^2}{\lambda_0^2} \leq \frac{1}{2}$. Integrating this inequality on the interval $(0, T)$, and using Identity (5.19) together with the the conservation of the energy $E_1(\mathcal{W})$, we obtain

$$\begin{aligned} \int_0^T [\lambda_0^{-1} e_1(v_1(t)) + e_1(w_2(t))] dt &\geq \frac{1}{2} \int_0^T [e_1(w_1(t)) + e_1(w_2(t))] dt \geq \left(1 + \frac{p^+}{\lambda_0}\right)^{-1} \frac{1}{2} \int_0^T E_1(\mathcal{W}(t)) dt \\ &\geq \left(1 + \frac{p^+}{\lambda_0}\right)^{-1} \frac{T}{2} E_1(\mathcal{W}(0)) \\ &\geq \frac{T}{2} \left(1 + \frac{p^+}{\lambda_0}\right)^{-1} \left(1 - \frac{p^+}{\lambda_0}\right) [e_1(w_1(0)) + e_1(w_2(0))], \end{aligned}$$

which yields (5.52), and concludes the proof of the lemma. \square

Lemma 5.22 (Lower bound for $\int_0^T e_1(v_1(t)) dt$). *There exists $C > 0$ and $\eta > 0$ such that for all $T \geq 0$, all $\frac{p^+}{\lambda_0} \leq \eta$, all $\mathcal{V} = (v_1, v_2, v'_1, v'_2) \in \mathcal{H}_1$ solution of (5.10) and $\mathcal{W} = (w_1, w_2, w'_1, w'_2)$ defined by (5.16), we have*

$$\left(1 + \frac{Tp^+}{\lambda_0^{\frac{1}{2}}}\right) \int_0^T e_1(v_1(t)) dt \gtrsim T e_1(v_1(0)) - T \lambda_0 e_1(w_2(0)). \quad (5.53)$$

Proof. Taking the inner product of the first equation of (5.10) with v'_1 gives

$$\frac{d}{dt} e_1(v_1) = -(Pv_2, v'_1)_H.$$

For $0 < t < T$, we integrate this identity on the interval $(0, t)$ and obtain, for all $\varepsilon > 0$,

$$e_1(v_1(t)) \geq e_1(v_1(0)) - \int_0^t \|Pv_2\|_H \|v'_1\|_H ds \geq e_1(v_1(0)) - \frac{\varepsilon}{2} \int_0^t \|Pv_2\|_H^2 dt - \frac{1}{2\varepsilon} \int_0^t \|v'_1\|_H^2 dt.$$

Using now Assumption (A2) and integrating the last inequality on the interval $(0, T)$, this gives, for all $\varepsilon > 0$,

$$\int_0^T e_1(v_1(t)) dt \geq T e_1(v_1(0)) - \frac{T\varepsilon p^+}{2} \int_0^T (Pv_2, v_2)_H dt - \frac{T}{\varepsilon} \int_0^T e_1(v_1(t)) dt.$$

This, together with (5.49) yields, for some constant $C > 0$ and for all $\varepsilon > 0$,

$$\begin{aligned} \int_0^T e_1(v_1(t)) dt &\geq T e_1(v_1(0)) - \frac{CT\varepsilon p^+}{\lambda_0^{\frac{1}{2}}} e_1(v_1(0)) \\ &\quad - \left(\frac{CT\varepsilon(p^+)^2}{\lambda_0} + \frac{T}{\varepsilon}\right) \int_0^T e_1(v_1(t)) dt - CT\varepsilon p^+ \lambda_0^{\frac{1}{2}} e_1(w_2(0)). \end{aligned}$$

Now we choose $\varepsilon = \frac{\lambda_0^{\frac{1}{2}}}{2Cp^+}$, so that we have

$$\int_0^T e_1(v_1(t)) dt \geq \frac{T}{2} e_1(v_1(0)) - \frac{Tp^+}{\lambda_0^{\frac{1}{2}}} \left(2C + \frac{1}{2}\right) \int_0^T e_1(v_1(t)) dt - \frac{T\lambda_0}{2} e_1(w_2(0)),$$

and the lemma is proved. \square

5.4.4 End of the proof of Theorem 5.10

In this section, we conclude the proof of Theorem 5.10. Using the key estimates of the preceding sections, we prove in fact the following more precise proposition.

Proposition 5.23. *Suppose that Assumptions (A1)-(A3) hold. Then, there exists $\eta, \gamma > 0$ such that for all $p^+ < p_* := \min\{\eta\lambda_0, \gamma\sqrt{\frac{\lambda_0}{K_B}}\}$, there exists a time $T_* \geq \max\{T_B^*, T_P^*\}$ (depending on $p^+, p^-, \lambda_0, K_B, K_P$) such that for all $T > T_*$ there exists $C > 0$, such that for all $\mathcal{V}^0 \in \mathcal{H}_1$, the solution $\mathcal{V}(t) = e^{tA_P}\mathcal{V}^0$ of (5.10) satisfies*

$$e_1(v_1(0)) + e_0(v_2(0)) \leq C \int_0^T \|\mathcal{B}^*(v_1, v_1')(t)\|_Y^2 dt.$$

A numerical inspection of the proof shows that one can take for instance $\eta = \frac{1}{5}$ and $\gamma = \frac{1}{50}$.

Proof. First, we use the observability inequality for a single equation with a right hand-side, given by Lemma 5.16. Since v_1 is a solution of $v_1'' + Av_1 + Pv_2 = 0$ from (5.10), Assumptions (A1) and (A3) and Estimate (5.29) yield, for all $T \geq T_B^*$,

$$\int_0^T e_1(v_1(t))dt \leq K_B \left(\int_0^T \|\mathcal{B}^*(v_1, v_1')\|_Y^2 dt + \int_0^T \|Pv_2\|_H^2 dt \right).$$

According to Assumption (A2), this gives

$$\begin{aligned} K_B \int_0^T \|\mathcal{B}^*(v_1, v_1')\|_Y^2 &\geq \int_0^T e_1(v_1(t))dt - K_B p^+ \int_0^T (Pv_2, v_2)_H dt \\ &\geq \varepsilon \int_0^T (e_1(v_1(t)) + \lambda_0 e_1(w_2(t)))dt + (1 - \varepsilon) \int_0^T e_1(v_1(t))dt \\ &\quad - \varepsilon \lambda_0 \int_0^T e_1(w_2(t))dt - K_B p^+ \int_0^T (Pv_2, v_2)_H dt, \end{aligned}$$

for some $\varepsilon \in (0, 1)$, to be chosen later on. In this expression, we replace $\int_0^T (Pv_2, v_2)_H dt$ by Estimate (5.49) given in Lemma 5.19 and $\int_0^T e_1(w_2(t))dt$ by Estimate (5.51) given in Lemma 5.20. We obtain, for some constant $C_0 > 0$ all $T \geq \max\{T_B^*, T_P^*\}$,

$$\begin{aligned} K_B \int_0^T \|\mathcal{B}^*(v_1, v_1')\|_Y^2 &\geq \varepsilon \int_0^T (e_1(v_1(t)) + \lambda_0 e_1(w_2(t)))dt + (1 - \varepsilon) \int_0^T e_1(v_1(t))dt \\ &\quad - \varepsilon \lambda_0 C_0 K_P \left(\frac{1}{p^-} + 1 \right) \left\{ \frac{1}{\lambda_0^{\frac{1}{2}}} e_1(v_1(0)) + \frac{p^+}{\lambda_0} \int_0^T e_1(v_1(t))dt \right. \\ &\quad \left. + \lambda_0^{\frac{1}{2}} e_1(w_2(0)) \right\} - C_0 \left\{ \frac{K_B p^+}{\lambda_0^{\frac{1}{2}}} e_1(v_1(0)) \right. \\ &\quad \left. + \frac{K_B (p^+)^2}{\lambda_0} \int_0^T e_1(v_1(t))dt + K_B p^+ \lambda_0^{\frac{1}{2}} e_1(w_2(0)) \right\}. \end{aligned}$$

This can be rewritten under the form

$$\begin{aligned} K_B \int_0^T \|\mathcal{B}^*(v_1, v_1')\|_Y^2 &\geq \varepsilon \int_0^T (e_1(v_1(t)) + \lambda_0 e_1(w_2(t)))dt + L_1(\varepsilon) \int_0^T e_1(v_1(t))dt \\ &\quad - L_2(\varepsilon) e_1(v_1(0)) - L_3(\varepsilon) e_1(w_2(0)), \end{aligned} \tag{5.54}$$

with

$$\begin{cases} L_1(\varepsilon) = 1 - \varepsilon - \varepsilon C_0 K_P p^+ \left(\frac{1}{p^-} + 1 \right) - C_0 \frac{K_B (p^+)^2}{\lambda_0}, \\ L_2(\varepsilon) = \varepsilon C_0 K_P \lambda_0^{\frac{1}{2}} \left(\frac{1}{p^-} + 1 \right) + C_0 \frac{K_B p^+}{\lambda_0^{\frac{1}{2}}}, \\ L_3(\varepsilon) = \varepsilon C_0 K_P \lambda_0^{\frac{3}{2}} \left(\frac{1}{p^-} + 1 \right) + C_0 K_B p^+ \lambda_0^{\frac{1}{2}}. \end{cases}$$

Taking p^+ such that $C_0 \frac{K_B(p^+)^2}{\lambda_0} < 1$ and ε sufficiently small, we obtain $L_1(\varepsilon) > 0$.

In Inequality (5.54), we replace the two terms integrated on $(0, T)$ by their estimates (5.52) given in Lemma 5.21 (almost conservation of the energy) and (5.53) of Lemma 5.22. We obtain, for some $C_1 > 0$, for $\frac{p^+}{\lambda_0} \leq \eta$, $(p^+)^2 < \frac{\lambda_0}{C_0 K_B}$,

$$K_B \int_0^T \|\mathcal{B}^*(v_1, v'_1)\|_Y^2 \geq \varepsilon \lambda_0 \frac{T}{3} [e_1(w_1(0)) + e_1(w_2(0))] - L_2(\varepsilon)e_1(v_1(0)) - L_3(\varepsilon)e_1(w_2(0)) \\ + C_1 L_1(\varepsilon) \left(1 + \frac{T p^+}{\lambda_0^{\frac{1}{2}}}\right)^{-1} [T e_1(v_1(0)) - T \lambda_0 e_1(w_2(0))].$$

This yields

$$K_B \int_0^T \|\mathcal{B}^*(v_1, v'_1)\|_Y^2 \geq M_1(\varepsilon)e_1(v_1(0)) + M_2(\varepsilon)e_1(w_2(0)) + \varepsilon \lambda_0 \frac{T}{3} e_1(w_1(0)), \quad (5.55)$$

with

$$\begin{cases} M_1(\varepsilon) = C_1 L_1(\varepsilon) \left(1 + \frac{T p^+}{\lambda_0^{\frac{1}{2}}}\right)^{-1} T - L_2(\varepsilon), \\ M_2(\varepsilon) = \varepsilon \lambda_0 \frac{T}{3} - C_1 L_1(\varepsilon) T \lambda_0 \left(1 + \frac{35 T p^+}{\lambda_0^{\frac{1}{2}}}\right)^{-1} - L_3(\varepsilon). \end{cases}$$

Now, it remains to check that these coefficients are positive for a suitable choice of ε (small) and T (large). The coefficients $M_1(\varepsilon)$ and $M_2(\varepsilon)$ are positive if and only if we have

$$\begin{cases} T \left\{ C_1 L_1(\varepsilon) - \frac{L_2(\varepsilon) p^+}{\lambda_0^{\frac{1}{2}}} \right\} - L_2(\varepsilon) > 0, \\ T^2 \left(\frac{\varepsilon}{3} \lambda_0^{\frac{1}{2}} p^+ \right) + T \left\{ \frac{\varepsilon \lambda_0}{3} - C_1 L_1(\varepsilon) \lambda_0 - \frac{L_3(\varepsilon) p^+}{\lambda_0^{\frac{1}{2}}} \right\} - L_3(\varepsilon) > 0. \end{cases} \quad (5.56)$$

The first condition of (5.56) is satisfied for large T if

$$1 - \varepsilon - \varepsilon C_0 \left(1 + \frac{1}{C_1}\right) K_P p^+ \left(\frac{1}{p^-} + 1\right) - C_0 \left(1 + \frac{1}{C_1}\right) \frac{K_B(p^+)^2}{\lambda_0} > 0,$$

i.e. as soon as

$$\begin{cases} C_0 \left(1 + \frac{1}{C_1}\right) \frac{K_B(p^+)^2}{\lambda_0} < 1, \text{ and} \\ \varepsilon \left(1 + C_0 \left(1 + \frac{1}{C_1}\right) K_P p^+ \left(\frac{1}{p^-} + 1\right)\right) < 1 - C_0 \left(1 + \frac{1}{C_1}\right) \frac{K_B(p^+)^2}{\lambda_0}. \end{cases}$$

This is the case when taking $p^+ \leq \min\{\eta \lambda_0, \gamma \sqrt{\frac{\lambda_0}{K_B}}\}$ for some constant $\gamma > 0$, and ε sufficiently small. Then, the second condition of (5.56) is always satisfied for large T since $\varepsilon > 0$. Hence, for this choice of p^+ , ε sufficiently small, and T sufficiently large, we obtain from (5.55) the existence of a constant $C > 0$ such that

$$C \int_0^T \|\mathcal{B}^*(v_1, v'_1)\|_Y^2 \geq e_1(v_1(0)) + e_1(w_2(0)).$$

This concludes the proof of Proposition 5.23 (and hence, that of Theorem 5.10) since $e_0(v_2(0))$ can be estimated by $e_1(w_2(0))$ and $e_1(v_1(0))$ according to (5.21). \square

5.5 From observability to controllability

In this Section, we prove that the observability inequality of Theorem 5.10 (or equivalently Proposition 5.23) implies the controllability results of Theorems 5.11 and 5.12. This is done classically with the use of the Hilbert Uniqueness Method (see [Lio88a]), that we shall follow here.

5.5.1 First case : $\mathcal{B}^*(v_1, v'_1) = B^*v'_1$ with $B^* \in \mathcal{L}(H, Y)$.

In this case, $B \in \mathcal{L}(Y, H)$ and the control problem (5.15) is well-posed in \mathcal{H}_1 for $f \in L^2(0, T; Y)$. Note that, as in the concrete setting, it also preserves the space $H_1 \times H_2 \times H \times H_1$ through time as soon as $P \in \mathcal{L}(H_1)$. There is thus no hope to control in whole \mathcal{H}_1 .

Note that a direct application of the HUM, at the $H_1 \times H \times H \times H_{-1}$ energy level for the adjoint variable \mathcal{V} would yield a controllability result in $H \times H_{-1} \times H_1 \times H$ with a control $Bf \in L^2(0, T; H_{-1})$ (and we would have to suppose that $B \in \mathcal{L}(Y, H_{-1})$). Since we want the control result to hold at a more regular level, we study an adjoint problem in a less regular space.

Lemma 5.24. *For any $\mathcal{Z}^T = (z_1^T, z_2^T, \tilde{z}_1^T, \tilde{z}_2^T) \in H \times H_{-1} \times H_{-1} \times H_{-2}$ the system*

$$\begin{cases} z_1'' + Az_1 + Pz_2 = 0, \\ z_2'' + Az_2 + P^*z_1 = 0, \\ (z_1, z_2, z'_1, z'_2)|_{t=T} = (z_1^T, z_2^T, \tilde{z}_1^T, \tilde{z}_2^T). \end{cases} \quad (5.57)$$

is well-posed backward in time and the unique solution satisfies $\mathcal{Z} \in \mathcal{C}^0([0, T]; H \times H_{-1} \times H_{-1} \times H_{-2})$. Moreover suppose that Assumptions (A1)-(A3) hold and that $p^+ < p_* = \min\{\eta\lambda_0, \gamma\sqrt{\frac{\lambda_0}{KB}}\}$ (where η and γ are given by Proposition 5.23). Then, for all $T > T_*$ (given by Proposition 5.23), the solution \mathcal{Z} satisfies for some constant $C > 1$ the estimates

$$C^{-1} \int_0^T \|B^*z_1(t)\|_Y^2 dt \leq e_0(z_1(0)) + e_{-1}(z_2(0)) \leq C \int_0^T \|B^*z_1(t)\|_Y^2 dt. \quad (5.58)$$

Of course, we prove this lemma as a consequence of (5.13) and (5.14) for more regular functions. We thus regularize \mathcal{Z} , setting $\mathcal{V} := \mathcal{A}_P^{-1}\mathcal{Z}$, end then apply to \mathcal{V} the results of the previous sections.

Proof. First, we know that \mathcal{A}_P generates a group on \mathcal{H}_{-1} . Hence, for $\mathcal{Z}^T \in H \times H_{-1} \times H_{-1} \times H_{-2} \subset \mathcal{H}_{-1}$, System (5.58) has a unique solution in $\mathcal{C}^0([0, T]; \mathcal{H}_{-1})$, and, in particular, $z_2 \in \mathcal{C}^0([0, T]; H_{-1})$. Then, z_1 is solution of the first line of (5.57) with final data in $H \times H_{-1}$ and a right hand side $-Pz_2 \in \mathcal{C}^0([0, T]; H_{-1})$. Hence, the solution (z_1, z'_1) (which is unique in $H_{-1} \times H_{-2}$) is in $\mathcal{C}^0([0, T]; H \times H_{-1})$, and this concludes the first part of the lemma.

Second, we set $(v_1^T, v_2^T, \tilde{v}_1^T, \tilde{v}_2^T) = \mathcal{V}^T := \mathcal{A}_P^{-1}\mathcal{Z}^T$. We call $\mathcal{V} = e^{(T-t)\mathcal{A}_P}\mathcal{V}^T = (v_1, v_2, v'_1, v'_2)$, which satisfies

$$\begin{cases} v_1'' + Av_1 + Pv_2 = 0, \\ v_2'' + Av_2 + P^*v_1 = 0, \end{cases}$$

and we have, for all $t \in (0, T)$,

$$\begin{cases} v'_1 = z_1, \\ v'_2 = z_2, \\ Av_1 + Pv_2 = -z'_1, \\ Av_2 + P^*v_1 = -z'_2. \end{cases} \quad (5.59)$$

Now, let us only consider the smooth solutions, i.e. $\mathcal{Z} \in \mathcal{C}^0([0, T]; \mathcal{H}_0)$, which yields $\mathcal{V} \in \mathcal{C}^0([0, T]; \mathcal{H}_1)$. For these solutions, Theorem 5.10 and Lemma 5.9 yield

$$C^{-1} \int_0^T \|B^*v'_1(t)\|_Y^2 dt \leq e_1(v_1(0)) + e_0(v_2(0)) \leq C \int_0^T \|B^*v'_1(t)\|_Y^2 dt. \quad (5.60)$$

We notice that $B^*v'_1 = B^*z_1$, so that in order to prove (5.58), it only remains to show the existence of a constant $C > 1$ such that

$$C^{-1}\{e_1(v_1(0)) + \lambda_0 e_0(v_2(0))\} \leq e_0(z_1(0)) + \lambda_0 e_{-1}(z_2(0)) \leq C\{e_1(v_1(0)) + \lambda_0 e_0(v_2(0))\}. \quad (5.61)$$

According to (5.59), we have (skipping the time dependance)

$$\begin{aligned}
2\{e_0(z_1) + \lambda_0 e_{-1}(z_2)\} &= \|A^{-\frac{1}{2}} z'_1\|_H^2 + \|z_1\|_H^2 + \lambda_0 \|A^{-1} z'_2\|_H^2 + \lambda_0 \|A^{-\frac{1}{2}} z_2\|_H^2 \\
&= \|A^{\frac{1}{2}} v_1 + A^{-\frac{1}{2}} P v_2\|_H^2 + \|v'_1\|_H^2 + \lambda_0 \|v_2\|_H^2 + \|A^{-1} P^* v_1\|_H^2 + \lambda_0 \|A^{-\frac{1}{2}} v'_2\|_H^2 \\
&\leq 2\|A^{\frac{1}{2}} v_1\|_H^2 + 2\|A^{-\frac{1}{2}} P v_2\|_H^2 + \|v'_1\|_H^2 + 2\lambda_0 \|v_2\|_H^2 \\
&\quad + 2\lambda_0 \|A^{-1} P^* v_1\|_H^2 + \lambda_0 \|A^{-\frac{1}{2}} v'_2\|_H^2 \\
&\leq 2(1 + (p^+)^2 \lambda_0^{-2}) \|A^{\frac{1}{2}} v_1\|_H^2 + \|v'_1\|_H^2 + 2(\lambda_0 + (p^+)^2 \lambda_0^{-1}) \|v_2\|_H^2 \\
&\quad + \lambda_0 \|A^{-\frac{1}{2}} v'_2\|_H^2 \leq C\{e_1(v_1) + \lambda_0 e_0(v_2)\},
\end{aligned}$$

which proves the right inequality of (5.61). We also have

$$\begin{aligned}
2\{e_1(v_1) + \lambda_0 e_0(v_2)\} &= \|v'_1\|_H^2 + \|A^{\frac{1}{2}} v_1\|_H^2 + \lambda_0 \|A^{-\frac{1}{2}} v'_2\|_H^2 + \lambda_0 \|v_2\|_H^2 \\
&= \|z_1\|_H^2 + \|A^{-\frac{1}{2}} z'_1 + A^{-\frac{1}{2}} P v_2\|_H^2 + \lambda_0 \|A^{-\frac{1}{2}} z_2\|_H^2 + \lambda_0 \|A^{-1} P^* v_1 + A^{-1} z'_2\|_H^2 \\
&\leq \|z_1\|_H^2 + 2\|A^{-\frac{1}{2}} z'_1\|_H^2 + 2\|A^{-\frac{1}{2}} P v_2\|_H^2 + \lambda_0 \|A^{-\frac{1}{2}} z_2\|_H^2 \\
&\quad + 2\lambda_0 \|A^{-1} P^* v_1\|_H^2 + 2\lambda_0 \|A^{-1} z'_2\|_H^2 \\
&\leq 4\{e_0(z_1) + \lambda_0 e_{-1}(z_2)\} + 2(p^+)^2 \lambda_0^{-1} \|v_2\|_H^2 + 2(p^+)^2 \lambda_0^{-2} \|v_1\|_H^2.
\end{aligned}$$

For $(p^+)^2 \lambda_0^{-2} < 1/2$, the last two terms in this inequality can be absorbed in the left hand side, yielding

$$e_1(v_1) + \lambda_0 e_0(v_2) \leq C\{e_0(z_1) + \lambda_0 e_{-1}(z_2)\}$$

This proves (5.61) and concludes the proof of the lemma. \square

To prove Theorem 5.11 with the HUM, we shall also make use of the following lemma.

Lemma 5.25. *Let (u_1, u_2, u'_1, u'_2) be the solution of (5.15) associated with $(u_1^0, u_2^0, u_1^1, u_2^1) \in H_1 \times H_2 \times H \times H_1$ and $f \in L^2(0, T; Y)$ and (z_1, z_2, z'_1, z'_2) the solution of (5.57) associated with*

$$(z_1^T, z_2^T, \tilde{z}_1^T, \tilde{z}_2^T) \in H \times H_{-1} \times H_{-1} \times H_{-2}.$$

Then, we have

$$\left[(u'_1, z_1)_H - (u_1, z'_1)_{H_1, H_{-1}} + (u'_2, z_2)_{H_1, H_{-1}} - (u_2, z'_2)_{H_2, H_{-2}} \right]_0^T = (f, B^* z_1)_{L^2(0, T; Y)} \quad (5.62)$$

Proof. It suffices to prove (5.62) for regular data. The general case can be deduced with a density argument. We take the inner product of the first line of (5.15) with z_1 and the second line of (5.15) with z_2 and integrate on $(0, T)$. Summing the two identities, we obtain

$$\int_0^T (Bf, z_1)_H dt = \int_0^T ((u''_1 + Au_1 + Pu_2), z_1)_H dt + \int_0^T ((u''_2 + Au_2 + P^* u_1), z_2)_H dt$$

After two integrations by parts, using the selfadjointness of A together with (5.57), we have

$$\int_0^T (f, B^* z_1)_Y dt = [(u'_1, z_1)_H - (u_1, z'_1)_H + (u'_2, z_2)_H - (u_2, z'_2)_H]_0^T,$$

which directly yields (5.62) for smooth solutions. We conclude the proof of the lemma with a density argument. \square

With Lemmata 5.24 and 5.25, we can now prove Theorem 5.11, following [Lio88a].

Proof of Theorem 5.11 Let us fix initial data $(u_1^0, u_2^0, u_1^1, u_2^1) \in H_1 \times H_2 \times H \times H_1$. On the Hilbert space $\mathcal{X} := H \times H_{-1} \times H_{-1} \times H_{-2}$, we consider the bilinear form

$$a(\mathcal{Z}^T, \underline{\mathcal{Z}}^T) = \int_0^T (B^* z_1(t), B^* \underline{z}_1(t))_Y dt,$$

and the linear form

$$L(\mathcal{Z}^T) = (u_1^1, z_1(0))_H - \langle u_1^0, z_1'(0) \rangle_{H_1, H_{-1}} + \langle u_2^1, z_2(0) \rangle_{H_1, H_{-1}} - \langle u_2^0, z_2'(0) \rangle_{H_2, H_{-2}},$$

where $\mathcal{Z} = (z_1, z_2, z_1', z_2')$ (resp. $\underline{\mathcal{Z}} = (z_1, \underline{z}_2, z_1', \underline{z}_2')$) is the the solution of (5.57) associated with the final data $\mathcal{Z}^T = (z_1^T, z_2^T, \tilde{z}_1^T, \tilde{z}_2^T)$, (resp. $\underline{\mathcal{Z}}^T = (z_1^T, \underline{z}_2^T, \tilde{z}_1^T, \tilde{z}_2^T)$). The linear form L is continuous on \mathcal{X} by definition and, according to (5.58), the bilinear form a is both continuous and coercive on $\mathcal{X} \times \mathcal{X}$ as soon as $T > T_*$. The Lax-Milgram theorem then yields for $T > T_*$ the existence (and uniqueness) of $\underline{\mathcal{Z}}^T$ such that

$$a(\mathcal{Z}^T, \underline{\mathcal{Z}}^T) = L(\mathcal{Z}^T), \quad \text{for all } \mathcal{Z}^T \in \mathcal{X}.$$

Now, choosing $f = B^* \underline{z}_1 \in L^2(0, T; Y)$ as a control function for the initial data $(u_1^0, u_2^0, u_1^1, u_2^1)$, we obtain for all test function $\mathcal{Z}^T \in \mathcal{X}$,

$$(u_1^1, z_1(0))_H - \langle u_1^0, z_1'(0) \rangle_{H_1, H_{-1}} + \langle u_2^1, z_2(0) \rangle_{H_1, H_{-1}} - \langle u_2^0, z_2'(0) \rangle_{H_2, H_{-2}} = (f, B^* z_1)_{L^2(0, T; Y)}.$$

According to (5.62), this yields $(u_1(T), u_2(T), u_1'(T), u_2'(T)) = (0, 0, 0, 0)$, where (u_1, u_2, u_1', u_2') is the solution of (5.15) associated with $(u_1^0, u_2^0, u_1^1, u_2^1)$ and f . This concludes the proof of Theorem 5.11. \square

5.5.2 Second case : $\mathcal{B}^*(v_1, v_1') = B^* v_1$ with $B^* \in \mathcal{L}(H_2, Y)$.

In this setting, we directly apply the HUM in the space $H \times H_1 \times H_{-1} \times H$ for the control problem, and thus in $H_1 \times H \times H \times H_{-1}$ for the observation problem. There is no need of regularizing our observation system and observability inequality.

This means that the adjoint problem of the control problem (5.15) is directly System (5.10), for which we proved the admissibility inequality (5.13) and the observability inequality (5.14). Recall that in this case, the control operator B is in $\mathcal{L}(Y, H_{-2})$, which is not sufficient for (5.15) to be well-posed in the classical sense in \mathcal{H}_0 for a control function $f \in L^2(0, T; Y)$. Nevertheless, as a consequence of the admissibility inequality (5.13), System (5.15) is well-posed in \mathcal{H}_0 in the sense of transposition solutions (see [Lio88a]). Moreover, these solutions remain in $H \times H_1 \times H_{-1} \times H$ for all time if the initial data are in this space, and there is no hope to control in whole \mathcal{H}_0 .

In this setting, the boundary control result of Theorem 5.3 is a direct consequence of the HUM and Theorem 5.10 since Assumptions (A1)-(A3) are satisfied in this application.

Lemma 5.26. *Let (u_1, u_2, u_1', u_2') be the transposition solution of (5.15) associated with $(u_1^0, u_2^0, u_1^1, u_2^1) \in H \times H_1 \times H_{-1} \times H$ and $f \in L^2(0, T; Y)$ and (v_1, v_2, v_1', v_2') the backward solution of (5.10) associated with $(v_1^T, v_2^T, \tilde{v}_1^T, \tilde{v}_2^T) \in H_1 \times H \times H \times H_{-1}$. Then, we have*

$$\left[\langle u_1', v_1 \rangle_{H_{-1}, H_1} - (u_1, v_1)_H + (u_2', v_2)_H - \langle u_2, v_2' \rangle_{H_1, H_{-1}} \right]_0^T = (f, B^* v_1)_{L^2(0, T; Y)} \quad (5.63)$$

The proof of this lemma is exactly the same as the one of Lemma 5.25. We can now sketch the proof of Theorem 5.12, which follows that of Theorem 5.11.

Proof of Theorem 5.12 We fix initial data $(u_1^0, u_2^0, u_1^1, u_2^1) \in H \times H_1 \times H_{-1} \times H$. On the Hilbert space $\mathcal{X} := H_1 \times H \times H \times H_{-1}$, we consider the bilinear form

$$a(\mathcal{V}^T, \underline{\mathcal{V}}^T) = \int_0^T (B^* v_1(t), B^* \underline{v}_1(t))_Y dt,$$

and the linear form

$$L(\mathcal{V}^T) = \langle u_1^1, v_1(0) \rangle_{H_{-1}, H_1} - (u_1^0, v_1'(0))_H + (u_2^1, v_2(0))_H - \langle u_2^0, v_2'(0) \rangle_{H_1, H_{-1}},$$

where $\mathcal{V} = (v_1, v_2, v_1', v_2')$ (resp. $\underline{\mathcal{V}} = (\underline{v}_1, \underline{v}_2, \underline{v}_1', \underline{v}_2')$) is the the solution of (5.10) associated with the final data $\mathcal{V}^T = (v_1^T, v_2^T, \tilde{v}_1^T, \tilde{v}_2^T)$, (resp. $\underline{\mathcal{V}}^T = (\underline{v}_1^T, \underline{v}_2^T, \underline{\tilde{v}}_1^T, \underline{\tilde{v}}_2^T)$). The linear form L is continuous on \mathcal{X} and, according to the admissibility inequality (5.13) and the observability inequality (5.14), the bilinear form a is both continuous and coercive on $\mathcal{X} \times \mathcal{X}$ as soon as $T > T_*$. We conclude the proof as the one of Theorem 5.11, using the Lax-Milgram Theorem. \square

5.6 Applications

In this section, we explain how Theorem 5.3 and Corollaries 5.4 and 5.5 can be deduced from the abstract results.

5.6.1 Control of wave systems : Proof of Theorem 5.3

Here, we prove Theorem 5.3. We only have to explain how the situation of this theorem can be put in the abstract setting. Here, $H = L^2(\Omega)$ with usual inner product. For A , we take the operator $-\Delta_c + a$ with domain $H^2(\Omega) \cap H_0^1(\Omega)$, which, according to Assumption 5.2-(i) is coercive. Hence $H_1 = H_0^1(\Omega)$ is endowed with the inner product $(u, v)_{H_1} = (c\nabla u, \nabla v)_{L^2(\Omega)} + (au, v)_{L^2(\Omega)}$, $H_{-1} = H^{-1}(\Omega)$ and $H_2 = H^2(\Omega) \cap H_0^1(\Omega)$.

For the operator P we take the multiplication in $L^2(\Omega)$ by the bounded function p , and the operator Π_P needed in Assumption (A2) is the multiplication in $L^2(\Omega)$ by the characteristic function $\mathbf{1}_{\omega_p}$. According to Assumption 5.2-(ii), ω_p satisfies GCC, so that the observability inequality of [BLR88, BLR92] directly implies the second part of Assumption (A3).

First case : internal control. The observation space here is $Y = L^2(\Omega)$ and the observation operator B^* is the multiplication in $L^2(\Omega)$ by the bounded (real) function b . In this case, the operator B^* is bounded and we have $B = B^*$. Since B^* is bounded, the admissibility assumption (A1) is directly satisfied. Finally, according to Assumption 5.2-(iii), ω_b satisfies GCC, so that the observability inequality of [BLR88, BLR92] directly implies the first part of Assumption (A3).

All the assumptions of Theorem 5.11 are then satisfied, so that it implies Theorem 5.3 in the internal control case.

Second case : boundary control. The observation space here is $Y = L^2(\partial\Omega)$ and the observation operator B^* is defined on $H^2(\Omega) \cap H_0^1(\Omega)$ by

$$B^*v = b_\partial \frac{\partial v}{\partial n},$$

where n denotes the outward normal to $\partial\Omega$. Hence, in this case $B^* \in \mathcal{L}(H^2(\Omega) \cap H_0^1(\Omega); L^2(\partial\Omega))$. The fact that this observation is admissible is a well-known hidden regularity result, see [Lio88a] or [TW09, Section 7.1]. As a consequence, the admissibility assumption (A1) is satisfied. The control operator B is defined in this case as the Dirichlet map for which we refer to [TW09, Section 10.6]. The duality identity (5.63) shows in fact that it corresponds to a boundary control, i.e. to Problem (5.4). Finally, according to Assumption 5.2-(iii), Γ_b satisfies GCC_∂ , so that the observability inequality of [BLR92] directly implies the first part of Assumption (A3).

All the assumptions of Theorem 5.12 are then satisfied, so that it implies Theorem 5.3 in the boundary control case.

5.6.2 Control of diffusive systems

Here, we prove Corollary 5.4. Our control strategy consists in first regularizing the initial data (thanks to the natural smoothing effect of the heat equation), and then apply a transmutation argument.

First case : internal control. Let $T > 0$. On the time interval $(0, \frac{T}{2})$, we set $f = 0$. Hence, the initial data $(u_1^0, u_2^0) \in (L^2(\Omega))^2$ are driven to some $(u_1, u_2)|_{t=\frac{T}{2}} \in \mathcal{D}(A_p) = (H^2(\Omega) \cap H_0^1(\Omega))^2 \subset H_0^1(\Omega) \times L^2(\Omega)$. As a consequence of Theorem 5.3, combined with [Mil06a, Theorem 3.4] there exists a control function $f \in L^2((\frac{T}{2}, T) \times \Omega)$ such that $(u_1, u_2)|_{t=T} = 0$.

Second case : boundary control. Let $T > 0$. On the time interval $(0, \frac{T}{2})$, we set $f = 0$. Hence, the initial data $(u_1^0, u_2^0) \in (H^{-1}(\Omega))^2$ are driven to some $(u_1, u_2)|_{t=\frac{T}{2}} \in (H_0^1(\Omega))^2 \subset L^2(\Omega) \times H^{-1}(\Omega)$. As a consequence of Theorem 5.3, combined with [Mil06a, Theorem 3.4] there exists a control function $f \in L^2((\frac{T}{2}, T) \times \partial\Omega)$ such that $(u_1, u_2)|_{t=T} = 0$.

Note that we could have taken the initial data in less regular spaces, provided that the coefficients a, p are smooth enough.

5.6.3 Control of Schrödinger systems

The proof of Corollary 5.5 is the same as that of Corollary 5.4, except that the Schrödinger equation does not enjoy smoothing properties. Hence, Corollary 5.5 is a direct consequence of Theorem 5.3, combined with [Mil05, Theorem 3.1].

5.7 Appendix : a direct proof of Lemma 5.16 : Observability for a wave equation with a right hand-side

In this section, we provide a direct proof of Lemma 5.16 for a wave equation in a very simple setting. For this, we suppose that (Ω, g) is a compact connected Riemannian manifold without boundary, and we closely follow the proofs of [RT74, BLR88, BLR92]. This shows in particular that the observability inequality for equations with a right hand-side (5.29)-(5.30) are indeed the natural energy estimates in the spaces we consider. In the following, Δ denotes the (negative) Laplace-Beltrami operator on Ω for the metric g , and $P = P(t, x, \partial_t, \partial_x) = \partial_t^2 - \Delta + 1$ denotes the d'Alembert operator on $\mathbb{R} \times \Omega$. Its principal symbol is given by $p(t, x, \tau, \eta) = -\tau^2 + |\eta|_x^2$ for $(t, x, \tau, \eta) \in \mathbb{R} \times \Omega \times \mathbb{R} \times T_x^*\Omega \subset T^*(\mathbb{R} \times \Omega)$, where $|\eta|_x^2 = g_x(\eta, \eta)$ denotes the Riemannian norm in the cotangent space of Ω at x .

Lemma 5.27. *Suppose that the couple (ω_b, T_b) satisfies GCC. Then, there exists a constant $C_b > 0$ such that for all $T \geq T_b$ and $v \in H^1((0, T) \times \Omega)$ solution of $Pv = f \in L^2((0, T) \times \Omega)$, we have*

$$\int_0^T \|v\|_{H^1(\Omega)}^2 + \|\partial_t v\|_{L^2(\Omega)}^2 dt \leq C_b \left(\int_0^T \int_{\omega} |\partial_t v|^2 dx dt + \int_0^T \|f\|_{L^2(\Omega)}^2 dt \right). \quad (5.64)$$

Proof. We first remark that it is sufficient to prove (5.64) with a time depending constant $C_b = C(T)$. The time invariance property of the equation $Pv = f$ then yields the desired result.

The proof relies on a compactness-uniqueness method. In a first step, we prove the following weaker energy estimate

$$\int_0^T \|v\|_{H^1(\Omega)}^2 + \|\partial_t v\|_{L^2(\Omega)}^2 dt \leq C(T) \left(\int_0^T \int_{\omega} |\partial_t v|^2 dx dt + \int_0^T \|f\|_{L^2(\Omega)}^2 dt + \int_0^T \|v\|_{L^2(\Omega)}^2 dt \right), \quad (5.65)$$

in which a compact term has been added in the right hand-side. In a second step we use a uniqueness argument to get rid of this additional term.

We define the two following vector spaces :

$$E = F = \{v \in H^1((0, T) \times \Omega); Pv \in L^2((0, T) \times \Omega)\},$$

endowed with the norms

$$\begin{aligned} \|v\|_E^2 &= \|v\|_{H^1((0, T) \times \Omega)}^2 + \|Pv\|_{L^2((0, T) \times \Omega)}^2, \\ \|v\|_F^2 &= \|v\|_{L^2((0, T) \times \Omega)}^2 + \|\partial_t v\|_{L^2((0, T) \times \omega)}^2 + \|Pv\|_{L^2((0, T) \times \Omega)}^2. \end{aligned}$$

We first remark that E is a Hilbert space for the norm $\|\cdot\|_E$ and that we have $E \subset F$ with $\|\cdot\|_F \leq \|\cdot\|_E$. If we prove that the space F is complete, the Banach isomorphism theorem then yields the inverse inequality : $\|\cdot\|_E \leq C\|\cdot\|_F$, which implies (5.65). Let us consider a Cauchy sequence $(v^k)_{k \in \mathbb{N}}$ of F . Since $L^2((0, T) \times \Omega)$ and $L^2((0, T) \times \omega)$ are complete, there exist $\underline{v} \in L^2((0, T) \times \Omega)$, $\underline{w} \in L^2((0, T) \times \omega)$ and $\underline{f} \in L^2((0, T) \times \Omega)$ such that

$$\begin{aligned} v^k &\rightarrow \underline{v} \text{ in } L^2((0, T) \times \Omega), \\ \partial_t v^k|_\omega &\rightarrow \underline{w} \text{ in } L^2((0, T) \times \omega), \\ Pv^k &\rightarrow \underline{f} \text{ in } L^2((0, T) \times \Omega). \end{aligned}$$

Since $\partial_t v^k \rightarrow \partial_t \underline{v}$ and $Pv^k \rightarrow P\underline{v}$ in $\mathcal{D}'((0, T) \times \Omega)$, we also have $\partial_t \underline{v}|_\omega = \underline{w} \in L^2((0, T) \times \omega)$ and $P\underline{v} = \underline{f} \in L^2((0, T) \times \Omega)$. The first order differential operator ∂_t is microlocally elliptic on $\text{Char}(P) = \{\rho \in T^*(\mathbb{R} \times \Omega), p(\rho) = 0\}$, so that $\underline{v} \in H^1((0, T) \times \Omega)$. As a consequence, \underline{v} satisfies

$$\begin{cases} P\underline{v} = \underline{f} \in L^2((0, T) \times \Omega), \\ \underline{v} \in H^1((0, T) \times \Omega). \end{cases} \quad (5.66)$$

Now, pick any point $\rho = (t, x, \tau, \eta) \in T^*(\mathbb{R} \times \Omega) \setminus 0$ such that $t \in (0, T)$. If $\rho \notin \text{Char}(P)$, then P is elliptic of order two at ρ and the first equation of (5.66) yields that $\underline{v} \in H^2$ microlocally at ρ . If $\rho \in \text{Char}(P)$, we denote by $\Gamma = \{\gamma(s), s \in (-S_-, S_+)\}$ the maximal bicharacteristic curve of P satisfying $\gamma(0) = \rho$. Since the couple (ω, T) satisfies the geometric control condition, there exists $s^* \in (-S_-, S_+)$ such that $\pi(\gamma(s^*)) \in (0, T) \times \omega$, where $\pi : T^*(\mathbb{R} \times \Omega) \rightarrow \mathbb{R} \times \Omega$ denotes the natural projection. The second line of (5.66) implies that $\underline{v} \in H^1$, microlocally at $\gamma(s^*)$. Hörmander's theorem on propagation of singularities [Tay81, Chapter 6, Theorem 2.1] (see also [Hör94, Theorem 26.1.1]) yields that $\underline{v} \in H^1$ microlocally at ρ since \underline{v} satisfies $P\underline{v} \in L^2$. Note that the L^2 regularity for f is the natural one, required by the propagation theorem.

Finally we obtain $\underline{v} \in H^1((0, T) \times \Omega)$. Hence, the Cauchy sequence $(v^k)_{k \in \mathbb{N}}$ of F converges towards $\underline{v} \in F$, and F is complete. The Banach isomorphism theorem gives the existence of a constant $C > 0$ (depending on T) such that $\|\cdot\|_E \leq C\|\cdot\|_F$, which implies (5.65).

Now, we must get rid of the additional term $\|v\|_{L^2((0, T) \times \Omega)}^2$ in (5.65). For this, we prove that there exists a constant $C > 0$ such that for all $v \in E$ satisfying $Pv = f \in L^2((0, T) \times \omega)$, we have

$$\|v\|_{L^2((0, T) \times \Omega)}^2 \leq C(\|\partial_t v\|_{L^2((0, T) \times \omega)}^2 + \|f\|_{L^2((0, T) \times \omega)}^2). \quad (5.67)$$

We suppose that this inequality is false. Then, there exists a sequence $(v^k)_{k \in \mathbb{N}}$, such that

$$\begin{aligned} \|v^k\|_{L^2((0, T) \times \Omega)} &= 1, \\ \partial_t v^k|_\omega &\rightarrow 0 \text{ in } L^2((0, T) \times \omega), \\ Pv^k &\rightarrow 0 \text{ in } L^2((0, T) \times \Omega). \end{aligned}$$

Hence, the energy estimate (5.65) gives $\|v^k\|_{H^1((0,T)\times\Omega)} \leq C$ uniformly, so that we can extract a subsequence (also denoted v^k) that converges in $L^2((0,T)\times\Omega)$. Calling $\underline{v} \in L^2((0,T)\times\Omega)$ its limit, we have

$$\begin{cases} \|\underline{v}\|_{L^2((0,T)\times\Omega)} = 1 \\ \partial_t \underline{v}|_\omega = 0 \text{ on } (0,T) \times \omega \\ P\underline{v} = 0 \text{ in } (0,T) \times \Omega \end{cases} \quad (5.68)$$

Once again, the propagation of regularity [Tay81, Chapter 6, Theorem 2.1] together with GCC gives (for instance) $\underline{z} \in H^2((0,T)\times\Omega)$. According to a uniqueness result [Rob91], the last two lines of (5.68) yield $\underline{z} = 0$ on $(0,T)\times\Omega$, which contradicts the first line of (5.68). This gives (5.67), and concludes the proof of the lemma. □

Chapitre 6

Analyse microlocale de la contrôlabilité de systèmes de deux équations d'ondes sur une variété compacte

Contents

6.1	Introduction and main result	231
6.2	Preliminary remarks, definitions and notation	233
6.2.1	Measures, symbols and operators	233
6.2.2	Some geometric facts	234
6.2.3	Well-posedness of System (6.4)	235
6.3	Observability for $T > T_{\omega \rightarrow \mathcal{O} \rightarrow \omega}$	236
6.3.1	Proof of a relaxed observability inequality	236
6.3.2	End of the proof of Theorem 6.5	241
6.4	Lack of observability for $T < T_{\omega \rightarrow \mathcal{O} \rightarrow \omega}$	243
6.5	Une remarque sur l'obstruction au prolongement unique pour les systèmes elliptiques	249

Ce chapitre est la reprise d'un travail en collaboration avec Belhassen Dehman et Jérôme Le Rousseau.

6.1 Introduction and main result

Let (Ω, g) be a \mathcal{C}^∞ compact connected Riemannian manifold without boundary. We denote by Δ the (negative) Laplace-Beltrami operator on Ω for the metric g , and $P = P(t, x, \partial_t, \partial_x) = \partial_t^2 - \Delta$ denotes the d'Alembert operator (or wave operator) on the manifold $\mathbb{R} \times \Omega$. We take two smooth functions b^ω and b on Ω . We consider the controllability problem for the system of coupled wave equations

$$\begin{cases} Pu_1 + b(x) u_2 = 0 & \text{in } (0, T) \times \Omega \\ Pu_2 = b^\omega(x) f & \text{in } (0, T) \times \Omega \end{cases} \quad (6.1)$$

Here, the state of the system is $(u_1, u_2, \partial_t u_1, \partial_t u_2)$ and f is our control function, localized on $\{b^\omega \neq 0\}$. Taking zero initial data, together with a forcing term $f \in L^2((0, T) \times \Omega)$, the associated solution of (6.1) lies for any time in the space $H^2(\Omega) \times H^1(\Omega) \times H^1(\Omega) \times L^2(\Omega)$ as $u_2 \in L^2(0, T; H^1(\Omega))$.

There is thus a gain of regularity for the uncontrolled variable u_1 (see also [AB03, ABL11a, ABL11b]). The adapted control problem is then the following : can one drive the solution of (6.1) from zero to any target $(u_1, u_2, \partial_t u_1, \partial_t u_2)|_{t=T} \in H^2(\Omega) \times H^1(\Omega) \times H^1(\Omega) \times L^2(\Omega)$?

We shall assume that the function b is non-negative on Ω , and denote by $\omega = \{b^\omega \neq 0\}$ the control set and by $\mathcal{O} = \{b > 0\}$ the coupling set (which is the indirect control set for the second equation). A natural necessary and sufficient condition to have controllability for wave equations is to suppose that the control set satisfies the Geometric Control Condition (GCC) defined in [RT74, BLR92]. For $\omega \subset \Omega$ and $T > 0$, we shall say that (ω, T) satisfies the GCC if every geodesic traveling at speed one in Ω meets ω in a time $t < T$. We say that ω satisfies GCC if there exists $T > 0$ such that (ω, T) satisfies GCC. We also set $T_\omega = \inf\{T > 0, (\omega, T) \text{ satisfies GCC}\}$.

Note that in the situation of System (6.1), a necessary condition is that both sets ω and \mathcal{O} satisfy GCC (otherwise one of the two equations is not controllable). If ω does not satisfy GCC, even the second equation of (6.1) is not controllable (see [BLR92, Bur97a] for a single wave equation). If \mathcal{O} does not satisfy GCC, the first equation of (6.1) is not controllable for the same reason.

Systems like (6.1) have already been addressed in [ABL11a, ABL11b, RdT11]. In the first two papers, and in the context of *symmetric* systems, it is proved that controllability holds in large time under optimal geometric conditions on the sets ω and \mathcal{O} . However, the minimal time given in these articles depends upon all parameters of the problem (i.e. b and b^ω). In the situation of System (6.1), it seems natural that the control time should depend only on the geometry of the sets Ω , ω and \mathcal{O} , as it is the case for a single wave equation. In [RdT11], the authors study System (6.1) in the one dimensional torus. They have a sharper estimate on the control time than in [ABL11a, ABL11b] (in particular, it depends only on the sets Ω , ω and \mathcal{O}). Yet, it is in general not optimal.

The purpose of this paper is to prove controllability for System (6.1) and to find an explicit expression of the minimal control time in the simple situation where Ω is a compact manifold without boundary.

To state our main result, let us to introduce the adapted control time.

Definition 6.1. Given two sets ω and \mathcal{O} both satisfying GCC, we set $T_{\omega \rightarrow \mathcal{O} \rightarrow \omega}$ the infimum of times $T > 0$ for which the following assertion is satisfied :

every geodesic traveling at speed one in Ω meets ω in a time $t_0 < T$, meets \mathcal{O} in a time $t_1 \in (t_0, T)$ and meets ω again in a time $t_2 \in (t_1, T)$.

Note that in general $T_{\omega \rightarrow \mathcal{O} \rightarrow \omega} \neq T_{\mathcal{O} \rightarrow \omega \rightarrow \mathcal{O}}$, and that we have the estimate

$$\max\{T_{\mathcal{O}}, T_\omega\} \leq T_{\omega \rightarrow \mathcal{O} \rightarrow \omega} \leq 2T_\omega + T_{\mathcal{O}}.$$

We can now state our main theorem.

Theorem 6.2. *Suppose that the sets ω and \mathcal{O} both satisfy GCC. Then, System (6.1) is controllable if $T > T_{\omega \rightarrow \mathcal{O} \rightarrow \omega}$ and is not controllable if $T < T_{\omega \rightarrow \mathcal{O} \rightarrow \omega}$.*

In particular this result holds without restriction on the smallness of the coefficient b as in [ABL11a, ABL11b]. According to the Hilbert Uniqueness Method (HUM) of J.-L. Lions [Lio88a], the controllability property of Theorem 6.2 is equivalent to an observability inequality for the adjoint system. More precisely, System (6.1) is exactly controllable in time T if and only if

$$E_{-1}(v_1(0)) + E_0(v_2(0)) \leq C \int_0^T \int_\omega |b^\omega v_2|^2 dx dt \tag{6.2}$$

holds for every (v_1, v_2) solutions of

$$\begin{cases} P v_1 = 0 & \text{in } (0, T) \times \Omega, \\ P v_2 = -b(x) v_1 & \text{in } (0, T) \times \Omega. \end{cases} \tag{6.3}$$

In the observability inequality (6.2), we have used the notation

$$E_k(v) = \|v\|_{H^k(\Omega)}^2 + \|\partial_t v\|_{H^{k-1}(\Omega)}^2, \quad k \in \mathbb{Z},$$

where the space $H^k(\Omega)$ is endowed with the norm

$$\|v\|_{H^k(\Omega)} = \|(1 - \Delta)^{\frac{k}{2}}v\|_{L^2(\Omega)}, \quad k \in \mathbb{Z},$$

and associated inner product.

Work in asymmetric spaces can be awkward. We thus set $w_1 = (1 - \Delta)^{-\frac{1}{2}}v_1$, $w_2 = v_2$. Having (v_1, v_2) solution to (6.3) is then equivalent to having (w_1, w_2) solution of

$$\begin{cases} Pw_1 = 0 & \text{in } (0, T) \times \Omega \\ Pw_2 = -b(x)(1 - \Delta)^{\frac{1}{2}}w_1 & \text{in } (0, T) \times \Omega, \end{cases} \quad (6.4)$$

as P and $(1 - \Delta)^{-\frac{1}{2}}$ commute. Hence, System (6.1) is exactly controllable in time T if and only if

$$E_0(w_1(0)) + E_0(w_2(0)) \leq C \int_0^T \int_{\omega} |b^\omega w_2|^2 dx dt \quad (6.5)$$

is satisfied for all solutions of (6.4).

The outline of this article is the following. In Section 6.2, we give some notation, define the tools used in the main part of this chapter and recall some basic well-posedness results for System (6.4). Then, in Section 6.3, we prove that the observability inequality (6.5) holds if $T > T_{\omega \rightarrow \mathcal{O} \rightarrow \omega}$. Conversely, we prove in Section 6.4 that the observability inequality (6.5) does not hold in the case $T < T_{\omega \rightarrow \mathcal{O} \rightarrow \omega}$.

6.2 Preliminary remarks, definitions and notation

We define the manifold $M = \mathbb{R} \times \Omega$ and its restriction to $(0, T) : M_T = (0, T) \times \Omega = \{(t, x) \in M \text{ such that } t \in (0, T)\}$. We also write T^*M_T the restriction of the cotangent bundle of M to $(0, T)$, i.e. $T^*M_T = \{(t, x, \tau, \eta) \in T^*M, t \in (0, T)\}$. We define

$$S^*M = \{(t, x, \tau, \eta) \in T^*M, |\tau|^2 + g_x(\eta, \eta) = 1\},$$

the cosphere bundle of M , and similarly S^*M_T its restriction to $(0, T)$. We denote by $\pi : S^*M \rightarrow M$ the natural projection, which also maps S^*M_T onto M_T .

6.2.1 Measures, symbols and operators

Here, we follow [Bur97b, Section 1.1] for the notation. We write $H^k(X; \mathbb{C}^j)$ or $H_{\text{loc}}^k(X; \mathbb{C}^j)$, with $j = 1$ or 2 and $X = \Omega, M$, or M_T the usual Sobolev space for functions valued in \mathbb{C}^j , endowed with the natural inner product and norm. In particular, the $L^2(X; \mathbb{C}^j)$ inner product is denoted by $(\cdot, \cdot)_{L^2(X; \mathbb{C}^j)}$.

We define $S_{\text{phg}}^m(T^*M_T; \mathbb{C}^{j \times j})$, with $j = 1$ or 2 as the set of matrix valued polyhomogeneous symbols of order m on M_T with compact support in M_T . We recall that symbols in the class $S_{\text{phg}}^m(T^*\mathbb{R}^n; \mathbb{C}^{j \times j})$ behave well with respect to changes of variables, up to symbols in $S_{\text{phg}}^{m-1}(T^*\mathbb{R}^n; \mathbb{C}^{j \times j})$ (see [Hör85, Theorem 18.1.17]).

For any m , the restriction to the sphere

$$S_{\text{phg}}^m(T^*M_T; \mathbb{C}^{j \times j}) \rightarrow \mathcal{C}_c^\infty(S^*M_T; \mathbb{C}^{j \times j}), \quad a \rightarrow a|_{S^*M_T}, \quad (6.6)$$

is onto. This will allow us to identify an homogeneous symbol with a smooth function on the sphere.

We denote by $\Psi_{\text{phg}}^m(M_T; \mathbb{C}^{j \times j})$, with $j = 1$ or 2 the space of polyhomogeneous pseudodifferential operators of order m on M_T , with a compactly supported kernel in $M_T \times M_T$.

For $A \in \Psi_{\text{phg}}^m(M_T; \mathbb{C}^{j \times j})$, we denote by $\sigma_m(A) \in S_{\text{phg}}^m(T^*M_T; \mathbb{C}^{j \times j})$ the principal symbol of A (see [Hör85, Chapter 18.1]). The application σ_m enjoys the following properties

- $\sigma_m : \Psi_{\text{phg}}^m(M_T; \mathbb{C}^{j \times j}) \rightarrow S_{\text{phg}}^m(T^*M_T; \mathbb{C}^{j \times j})$ is onto.

- For all $A \in \Psi_{\text{phg}}^m(M_T; \mathbb{C}^{j \times j})$, $\sigma_m(A) = 0$ if and only if $A \in \Psi_{\text{phg}}^{m-1}(M_T; \mathbb{C}^{j \times j})$.
- For all $A \in \Psi_{\text{phg}}^m(M_T; \mathbb{C}^{j \times j})$, $\sigma_m(A^*) = \overline{t \sigma_m(A)}$.
- For all $A_1 \in \Psi_{\text{phg}}^{m_1}(M_T; \mathbb{C}^{j \times j})$ and $A_2 \in \Psi_{\text{phg}}^{m_2}(M_T; \mathbb{C}^{j \times j})$, we have $A_1 A_2 \in \Psi_{\text{phg}}^{m_1+m_2}(M_T; \mathbb{C}^{j \times j})$ with

$$\sigma_{m_1+m_2}(A_1 A_2) = \sigma_{m_1}(A_1) \sigma_{m_2}(A_2).$$

- For all $A_1 \in \Psi_{\text{phg}}^{m_1}(M_T; \mathbb{C})$ and $A_2 \in \Psi_{\text{phg}}^{m_2}(M_T; \mathbb{C})$, we have $[A_1, A_2] = A_1 A_2 - A_2 A_1 \in \Psi_{\text{phg}}^{m_1+m_2-1}(M_T; \mathbb{C})$ with

$$\sigma_{m_1+m_2-1}([A_1, A_2]) = \frac{1}{i} \{ \sigma_{m_1}(A_1), \sigma_{m_2}(A_2) \}.$$

Here, $\{a_1, a_2\}$ denotes the Poisson bracket, given in local charts by

$$\{a_1, a_2\} = \partial_\tau a_1 \partial_t a_2 - \partial_t a_1 \partial_\tau a_2 + \sum_l (\partial_{\xi_l} a_1 \partial_{x_l} a_2 - \partial_{x_l} a_1 \partial_{\xi_l} a_2).$$

- If $A \in \Psi_{\text{phg}}^m(M_T; \mathbb{C}^{j \times j})$, then A maps continuously $H^k(M_T; \mathbb{C}^j)$ into $H^{k-m}(M_T; \mathbb{C}^j)$ (resp. $H_{\text{loc}}^k(M_T; \mathbb{C}^j)$ into $H_{\text{loc}}^{k-m}(M_T; \mathbb{C}^j)$). In particular, for $m < 0$, A is compact on $L^2(M_T; \mathbb{C}^j)$. Given an operator $A \in \Psi_{\text{phg}}^m(M_T; \mathbb{C})$, we define $\text{Char}(A) = \{\rho \in T^*M, \sigma_m(A)(\rho) = 0\}$.

It will also be useful to define a function $\lambda \in \mathcal{C}^\infty(T^*M)$ such that

$$\begin{aligned} \lambda(t, x, \tau, \eta) &= (|\tau|^2 + g_x(\eta, \eta))^{\frac{1}{2}} \quad \text{for } (t, x, \tau, \eta) \in T^*M, \text{ with } (|\tau|^2 + g_x(\eta, \eta))^{\frac{1}{2}} \geq \frac{1}{2} \\ \lambda(t, x, \tau, \eta) &\geq C > 0 \quad \text{for } (t, x, \tau, \eta) \in T^*M, \text{ with } (|\tau|^2 + g_x(\eta, \eta))^{\frac{1}{2}} \leq \frac{1}{2}. \end{aligned} \quad (6.7)$$

This gives $\chi \lambda^m \in S_{\text{phg}}^m(T^*M; \mathbb{C})$ for all $m \in \mathbb{Z}$ and all $\chi \in \mathcal{C}_c^\infty(M)$.

Finally, we define $\mathcal{M}(S^*M_T; \mathbb{R})$ to be the set of real valued measures on S^*M_T , $\mathcal{M}_+(S^*M_T)$ the set of positive measures on S^*M_T , and $\mathcal{M}_+(S^*M_T; \mathbb{C}^{2 \times 2})$ the set of measures valued in non-negative hermitian 2×2 matrices. For $\mu \in \mathcal{M}(S^*M_T; \mathbb{R})$ (resp. $\mu \in \mathcal{M}_+(S^*M_T; \mathbb{C}^{2 \times 2})$) and $a \in \mathcal{C}_c^0(S^*M_T; \mathbb{R})$ (resp. $a \in \mathcal{C}_c^0(S^*M_T; \mathbb{C}^{2 \times 2})$), we shall write

$$\langle \mu, a \rangle_{S^*M_T} = \int_{S^*M_T} a(\rho) \mu(d\rho), \quad \left(\text{resp. } \int_{S^*M_T} \text{tr}\{a(\rho) \mu(d\rho)\} \right),$$

for the duality bracket. The same notation will also be used for $a \in S_{\text{phg}}^0(T^*M_T; \mathbb{R})$ (resp. $a \in S_{\text{phg}}^0(T^*M_T; \mathbb{C}^{2 \times 2})$) according to the identification (6.6).

6.2.2 Some geometric facts

In local coordinates, we write g_{ij} for the metric g on the tangent bundle TM . As a metric on the cotangent bundle T^*M , g reads g^{ij} in local coordinates.

The principal symbol of the operator $P(t, x, \partial_t, \partial_x)$ is given by

$$\sigma_2(P)(t, x, \tau, \eta) = p(t, x, \tau, \eta) = -\tau^2 + |\eta|_x^2, \quad \text{for } (t, x, \tau, \eta) \in \mathbb{R} \times \Omega \times \mathbb{R} \times T_x^*\Omega \subset T^*M, \quad (6.8)$$

where $|\eta|_x^2 = g_x(\eta, \eta)$ denotes the Riemannian norm in the cotangent space of Ω at x . We denote by H_p the associated hamiltonian vector field. In local charts, we have

$$p = -|\tau|^2 + \sum_{i,j} g^{ij} \eta_i \eta_j \quad \text{and} \quad H_p = (\nabla_{\tau, \eta} p, -\nabla_{t, x} p). \quad (6.9)$$

Note that for $a \in S_{\text{phg}}^m(M; \mathbb{C})$, we have $H_p a = \{p, a\}$. We shall make use of the Hamiltonian flow map ϕ_s , i.e. the maximal solutions of

$$\frac{d}{ds} \phi_s(\rho) = H_p \phi_s(\rho), \quad \phi_0(\rho) = \rho \in T^*M \setminus 0. \quad (6.10)$$

Let Γ be an integral curve (6.10). First notice that p is constant along Γ since $H_p p = 0$. In particular, the flow ϕ_s preserves $\text{Char}(P)$. Moreover, as g is independent of time t , (6.10) also gives $\partial_t p = 0$. Hence, τ is constant along Γ . As is done classically, we call bicharacteristics the integral curves for which $p = 0$. Then $|\eta|_x^2 = |\tau|^2$ is also constant along bicharacteristics. Observe then that (6.10) defines a flow on the manifold

$$\text{Char}(P) \cap S^*M = \{(t, x, \tau, \xi), |\tau|^2 = 1/2 \text{ and } |\eta|_x^2 = 1/2\}.$$

In particular, this implies $H_p a \in \mathcal{C}_c^\infty(S^*M_T; \mathbb{C})$ for any $a \in \mathcal{C}_c^\infty(S^*M_T; \mathbb{C})$

Now, we can rewrite the geometric condition given in Definition 6.1 in terms of bicharacteristics of the operator P .

With this notation, Definition 6.1 can be reformulated more precisely as follows.

Definition 6.3. The time $T_{\omega \rightarrow \mathcal{O} \rightarrow \omega}$ is the infimum of times $T > 0$ for which the following assertion is satisfied :

for any $\rho_* = (0, x_*, \tau_*, \eta_*) \in \text{Char}(P) \cap S^*M$, there exists $0 < t_0 < t_1 < t_2 < T$ such that we have $\pi(\phi_{t_0}(\rho_*)) \in (0, T) \times \omega$, $\pi(\phi_{t_1}(\rho_*)) \in (0, T) \times \mathcal{O}$, $\pi(\phi_{t_2}(\rho_*)) \in (0, T) \times \omega$.

6.2.3 Well-posedness of System (6.4)

We introduce

$$\mathcal{H} = L^2(\Omega)^2 \times H^{-1}(\Omega)^2,$$

endowed with the natural inner product.

Proposition 6.4. For any $(w_1^0, w_2^0, w_1^1, w_2^1) \in \mathcal{H}$ and any $T > 0$, System (6.4) with

$$(w_1, w_2, \partial_t w_1, \partial_t w_2)|_{t=0} = (w_1^0, w_2^0, w_1^1, w_2^1),$$

has a unique solution $(w_1, w_2) \in \mathcal{C}^0(-T, T; L^2(\Omega)^2) \cap \mathcal{C}^1(-T, T; H^{-1}(\Omega)^2)$, depending continuously on $(w_1^0, w_2^0, w_1^1, w_2^1)$, i.e.

$$\sup_{t \in (-T, T)} \{E_0(w_1(t)) + E_0(w_2(t))\} \leq C(T) (\|w_1^0\|_{L^2(\Omega)}^2 + \|w_1^1\|_{H^{-1}(\Omega)}^2 + \|w_2^0\|_{L^2(\Omega)}^2 + \|w_2^1\|_{H^{-1}(\Omega)}^2). \tag{6.11}$$

System (6.4) can be written as the first-order system

$$\partial_t \mathcal{W} + \mathcal{A} \mathcal{W} = 0, \tag{6.12}$$

where $\mathcal{W} = {}^t(w_1, w_2, \partial_t w_1, \partial_t w_2)$ and the operator \mathcal{A} is given by

$$\mathcal{A} = \begin{pmatrix} 0 & 0 & -\text{Id} & 0 \\ 0 & 0 & 0 & -\text{Id} \\ -\Delta & 0 & 0 & 0 \\ b(1 - \Delta)^{\frac{1}{2}} & -\Delta & 0 & 0 \end{pmatrix}, \quad D(\mathcal{A}) = H^1(\Omega)^2 \times L^2(\Omega)^2. \tag{6.13}$$

The Lumer-Phillips Theorem [Paz83] can be applied to (6.12) for positive and negative times t since the operators $\lambda_0 \text{Id} \pm \mathcal{A}$ are maximal monotone for λ_0 sufficiently large (due to the cascade structure of the system). Hence $-\mathcal{A}$ generates a strongly continuous group that we shall denote by $(e^{-t\mathcal{A}})_{t \in \mathbb{R}}$.

At place, we shall also write System (6.4) as

$$\mathcal{P}W = 0, \quad W = (w_1, w_2)^T,$$

with

$$\mathcal{P} = \begin{pmatrix} P & 0 \\ B & P \end{pmatrix} \in \Psi_{\text{phg}}^2(M; \mathbb{C}^{2 \times 2}), \quad \text{and } B = b(x)(1 - \Delta)^{\frac{1}{2}}.$$

According to [See67] or [Shu01, Theorem 11.2], we have $B \in \Psi_{\text{phg}}^1(M; \mathbb{C})$, with principal symbol $\sigma_1(B) = b|\eta|_x$ (which is a homogeneous symbol up to a modification on $\{|\eta|_x \leq \frac{1}{2}\}$).

6.3 Observability for $T > T_{\omega \rightarrow \mathcal{O} \rightarrow \omega}$

In this section, we prove the following theorem.

Theorem 6.5. *Suppose that $T > T_{\omega \rightarrow \mathcal{O} \rightarrow \omega}$. Then, the observability inequality (6.5) holds for any $\mathcal{C}^0(0, T; L^2(\Omega)^2) \cap \mathcal{C}^1(0, T; H^{-1}(\Omega)^2)$ -solution of (6.4).*

The positive controllability result of Theorem 6.2 is then a direct consequence of Theorem 6.5 and HUM.

To prove Theorem 6.5, we follow the compactness-uniqueness method of [RT74, BLR92, Bur97a], which consists in two steps. First we prove the observability inequality (6.5) in a weaker form, adding compact terms on the right hand-side. This allows one to handle high frequencies. Second, we use a uniqueness argument to handle low frequencies and conclude the proof of the observability inequality (6.5).

6.3.1 Proof of a relaxed observability inequality

Proposition 6.6. *Suppose that $T > T_{\omega \rightarrow \mathcal{O} \rightarrow \omega}$. Then, the observability inequality*

$$E_0(w_1(0)) + E_0(w_2(0)) \leq C \left(\int_0^T \int_{\omega} |b^\omega w_2|^2 dx dt + E_{-1}(w_1(0)) + E_{-1}(w_2(0)) \right) \quad (6.14)$$

holds for any $\mathcal{C}^0(0, T; L^2(\Omega)^2) \cap \mathcal{C}^1(0, T; H^{-1}(\Omega)^2)$ -solution of (6.4).

Proof. We proceed by contradiction and suppose that the observability inequality (6.14) is not satisfied. Thus, there exists a sequence $(w_1^k, w_2^k)_{k \in \mathbb{N}}$ of $\mathcal{C}^0(0, T; L^2(\Omega)) \cap \mathcal{C}^1(0, T; H^{-1}(\Omega))$ -solutions of

$$\begin{cases} Pw_1^k = 0 & \text{in } (0, T) \times \Omega, \\ Pw_2^k + Bw_1^k = 0 & \text{in } (0, T) \times \Omega, \end{cases} \quad (6.15)$$

such that

$$E_0(w_1^k(0)) + E_0(w_2^k(0)) = 1, \quad (6.16)$$

$$\int_0^T \int_{\omega} |b^\omega w_2^k|^2 dx dt \rightarrow 0, \quad k \rightarrow \infty, \quad (6.17)$$

$$E_{-1}(w_1^k(0)) + E_{-1}(w_2^k(0)) \rightarrow 0, \quad k \rightarrow \infty. \quad (6.18)$$

According to (6.16) and the continuity of the solution with respect to the initial data, the sequence (w_1^k, w_2^k) is bounded in $L^2(M_T; \mathbb{C}^2)$. According to (6.18) and the continuity of the solution with respect to the initial data, the sequence (w_1^k, w_2^k) converges to zero in $H^{-1}(M_T; \mathbb{C}^2)$. It follows that

$$(w_1^k, w_2^k) \rightharpoonup (0, 0) \quad \text{in } L^2(M_T; \mathbb{C}^2).$$

As a consequence of [Gér91, Theorem 1] (See also [Tar90]), there exists a subsequence of $(W^k)_{k \in \mathbb{N}} = (w_1^k, w_2^k)_{k \in \mathbb{N}}$ (still denoted $(W^k)_{k \in \mathbb{N}} = (w_1^k, w_2^k)_{k \in \mathbb{N}}$) and a microlocal defect measure

$$\mu = \begin{pmatrix} \mu_1 & \mu_{12} \\ \bar{\mu}_{12} & \mu_2 \end{pmatrix} \in \mathcal{M}_+(S^*M_T; \mathbb{C}^{2 \times 2}),$$

such that for any $\mathcal{A} \in \Psi_{\text{phg}}^0(M_T; \mathbb{C}^{2 \times 2})$ (recall that symbols are compactly supported in time t here),

$$\lim_{k \rightarrow \infty} (\mathcal{A}W^k, W^k)_{L^2(M_T; \mathbb{C}^2)} = \int_{S^*M_T} \text{tr}\{\sigma_0(\mathcal{A})(\rho)\mu(d\rho)\}. \quad (6.19)$$

Testing the measure on different operators \mathcal{A} , the limit equation (6.19) can be equivalently written as

$$\begin{cases} \lim_{k \rightarrow \infty} (Aw_1^k, w_1^k)_{L^2(M_T; \mathbb{C})} = \langle \mu_1, \sigma_0(A) \rangle_{S^*M_T}, \\ \lim_{k \rightarrow \infty} (Aw_2^k, w_2^k)_{L^2(M_T; \mathbb{C})} = \langle \mu_2, \sigma_0(A) \rangle_{S^*M_T}, \\ \lim_{k \rightarrow \infty} (Aw_1^k, w_2^k)_{L^2(M_T; \mathbb{C})} = \langle \mu_{12}, \sigma_0(A) \rangle_{S^*M_T}, \end{cases} \quad (6.20)$$

for any $A \in \Psi_{\text{phg}}^0(M_T; \mathbb{C})$.

The following lemma gives the properties of the three measures μ_1 , μ_2 and μ_{12} , and is a key point in the proof of Proposition 6.6.

Lemma 6.7 (Properties of the measure μ). *1. From (6.15) and (6.18), we have $\mu_1, \mu_2 \in \mathcal{M}_+(S^*M_T)$, $\text{supp}(\mu_1) \subset \text{Char}(P)$, $\text{supp}(\mu_2) \subset \text{Char}(P)$. Moreover, we have $\text{supp}(\mu_{12}) \subset \text{supp}(\mu_1) \cap \text{supp}(\mu_2) \subset \text{Char}(P)$. Finally these three measures satisfy the equations*

$$\begin{cases} \langle \mu_1, H_p a \rangle_{S^*M_T} = 0, \\ \langle \mu_2, H_p a \rangle_{S^*M_T} = - \langle \text{Im}(\mu_{12}), 2b|\eta|_x a \rangle_{S^*M_T}, \\ \langle \text{Im}(\mu_{12}), H_p a \rangle_{S^*M_T} = - \langle \mu_1, b|\eta|_x a \rangle_{S^*M_T}, \\ \langle \text{Re}(\mu_{12}), H_p a \rangle_{S^*M_T} = 0, \end{cases} \quad (6.21)$$

for any $a \in S_{\text{phg}}^{-1}(T^*M_T; \mathbb{C})$.

2. From (6.17), we also have $\text{supp}(\mu_2) \cap \pi^{-1}((0, T) \times \omega) = \emptyset$ and $\text{supp}(\mu_{12}) \cap \pi^{-1}((0, T) \times \omega) = \emptyset$.

The proof of this lemma is postponed to the end of this section.

We see that the measure $\text{Re}(\mu_{12})$ is not coupled to the other ones. We shall prove below that the first and the last equations in (6.21) yield a ‘‘free’’ propagation result for the measures μ_1 and $\text{Re}(\mu_{12})$. In particular, since $\mu_{12} = 0$ on $\pi^{-1}((0, T) \times \omega)$, and $T > T_{\omega \rightarrow \mathcal{O} \rightarrow \omega} \geq T_\omega$, this will give $\text{Re}(\mu_{12}) = 0$.

The most important equation in (6.21) is the third one, which gives a transport equation on the measure $\text{Im}(\mu_{12})$.

We already know that the supports of the three measures are included in $\text{Char}(P) \cap S^*M_T$. Let us pick $\rho_* = (t_*, x_*, \tau_*, \eta_*) \in \text{Char}(P) \cap S^*M_T$. According to Definition 6.3, there exist $0 < t_0 < t_1 < t_2 < T$ such that

$$\phi_{t_0-t_*}(\rho_*) \in \pi^{-1}((0, T) \times \omega), \quad \phi_{t_1-t_*}(\rho_*) \in \pi^{-1}((0, T) \times \mathcal{O}), \quad \phi_{t_2-t_*}(\rho_*) \in \pi^{-1}((0, T) \times \omega).$$

We take three open subsets $\theta_0, \theta_1, \theta_2 \subset S^*M_T$, satisfying

$$\phi_{t_j-t_*}(\rho_*) \in \theta_j \text{ for } j = 0, 1, 2, \quad \pi(\theta_0) \subset (0, T) \times \omega, \quad \pi(\theta_1) \subset (0, T) \times \mathcal{O}, \quad \pi(\theta_2) \subset (0, T) \times \omega. \quad (6.22)$$

This geometrical situation is sketched on Figure 6.1.

We now choose a function $e \in \mathcal{C}_c^\infty(S^*M_T)$ such that

$$\text{supp}(e) \subset \phi_{t_1-t_0}(\theta_0) \cap \theta_1 \cap \phi_{t_1-t_2}(\theta_2), \quad e \geq 0, \quad \text{and} \quad e(\phi_{t_1-t_*}(\rho_*)) = 1. \quad (6.23)$$

Note that the set $\phi_{t_1-t_0}(\theta_0) \cap \theta_1 \cap \phi_{t_1-t_2}(\theta_2)$ is open since $\phi_t : S^*M_T \rightarrow S^*M_T$ is bicontinuous and is nonempty since it contains $\phi_{t_1-t_*}(\rho_*)$, according to (6.22).

Now, we apply the third identity of (6.21) to $a = e \circ \phi_s \in \mathcal{C}_c^\infty(S^*M_T)$ (which can be extended as a symbol $\lambda^{-1}a(t, x, \tau/\lambda, \eta/\lambda) \in S_{\text{phg}}^{-1}(T^*M_T; \mathbb{R})$, where λ is defined in (6.7)) for $s \in (t_1 - t_2, t_1 - t_0)$, as a consequence of (6.22)-(6.23). We obtain

$$\begin{aligned} - \langle \mu_1, b|\eta|_x e \circ \phi_s \rangle_{S^*M_T} &= \langle \text{Im}(\mu_{12}), H_p(e \circ \phi_s) \rangle_{S^*M_T}, \\ &= \left\langle \text{Im}(\mu_{12}), \frac{d}{ds} e \circ \phi_s \right\rangle_{S^*M_T}, \\ &= \frac{d}{ds} \langle \text{Im}(\mu_{12}), e \circ \phi_s \rangle_{S^*M_T}. \end{aligned}$$

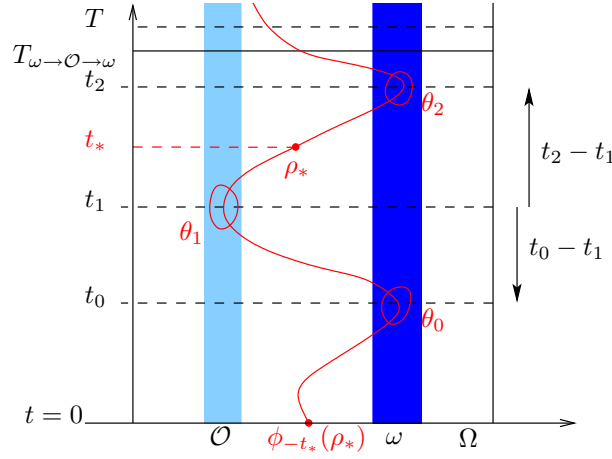
 FIGURE 6.1 – Geometrical situation in the case $T > T_{\omega \rightarrow \mathcal{O} \rightarrow \omega}$.

Integrating this equation on the interval $(t_1 - t_2, t_1 - t_0)$ gives

$$-\int_{t_1-t_2}^{t_1-t_0} \langle \mu_1, b|\eta|_x e \circ \phi_s \rangle_{S^*M_T} ds = \langle \text{Im}(\mu_{12}), e \circ \phi_{t_1-t_0} \rangle_{S^*M_T} - \langle \text{Im}(\mu_{12}), e \circ \phi_{t_1-t_2} \rangle_{S^*M_T}. \quad (6.24)$$

Moreover, from (6.23), we have $\text{supp}(e \circ \phi_{t_1-t_2}) \subset \theta_2$ and $\text{supp}(e \circ \phi_{t_1-t_0}) \subset \theta_0$. Since $\pi(\theta_0), \pi(\theta_2) \subset (0, T) \times \omega$ and $\pi(\text{supp}(\mu_{12})) \cap (0, T) \times \omega = \emptyset$ from Lemma 6.7, the right hand-side of (6.24) vanishes, and we obtain

$$\int_{t_1-t_2}^{t_1-t_0} \langle \mu_1, b|\eta|_x e \circ \phi_s \rangle_{S^*M_T} ds = 0.$$

In this expression, the measure μ_1 and the functions $|\eta|_x, b$ and $e \circ \phi_s$ are non-negative on the interval $(t_1 - t_2, t_1 - t_0)$. We thus obtain, for any $s \in (t_1 - t_2, t_1 - t_0)$,

$$\langle \mu_1, b|\eta|_x e \circ \phi_s \rangle_{S^*M_T} = 0,$$

and in particular

$$\langle \mu_1, b|\eta|_x e \rangle_{S^*M_T} = 0.$$

Our construction of the symbol e in (6.23) yields $e(\phi_{t_1-t_*}(\rho_*)) = 1$ and $b(\pi(\phi_{t_1-t_*}(\rho_*))) > 0$ since $\pi(\phi_{t_1-t_*}(\rho_*)) \in (0, T) \times \mathcal{O}$. We hence have

$$\phi_{t_1-t_*}(\rho_*) \notin \text{supp}(\mu_1). \quad (6.25)$$

Once we have proved that the measure μ_1 vanishes in a neighborhood of one point of the bicharacteristic $\{\phi_s(\rho_*), s \in \mathbb{R}\}$, we can now prove that this measure is identically zero on this bicharacteristic. This is a direct consequence of the first equation of (6.21) : applied to $a \circ \phi_s$ in place of a as long as $\text{supp}(a \circ \phi_s) \subset S^*M_T$, it yields

$$0 = \langle \mu_1, H_p a \circ \phi_s \rangle_{S^*M_T} = \left\langle \mu_1, \frac{d}{ds} a \circ \phi_s \right\rangle_{S^*M_T} = \frac{d}{ds} \langle \mu_1, a \circ \phi_s \rangle_{S^*M_T}.$$

This directly gives

$$\langle \mu_1, a \circ \phi_s \rangle_{S^*M_T} = \langle \mu_1, a \rangle_{S^*M_T}, \quad \text{for all } a \in S_{\text{phg}}^{-1}(T^*M_T; \mathbb{C}), s \text{ such that } \text{supp}(a \circ \phi_s) \subset S^*M_T. \quad (6.26)$$

From the argument above, there exists $a \in S_{\text{phg}}^{-1}(T^*M_T; \mathbb{C})$ with a small support in a neighborhood of $\phi_{t_1-t_*}(\rho_*)$ and $a(\phi_{t_1-t_*}(\rho_*)) = 1$, such that $\langle \mu_1, a \rangle_{S^*M_T} = 0$. Taking $s = t_1 - t_*$ in (6.26) then yields

$$\langle \mu_1, a \circ \phi_{t_1-t_*} \rangle_{S^*M_T},$$

with $a \circ \phi_{t_1-t_*}(\rho_*) = 1$. This implies

$$\rho_* \notin \text{supp}(\mu_1).$$

This holds for any $\rho_* \in S^*M_T$, and we finally obtain $\mu_1 = 0$ on S^*M_T . The third equation of (6.21) then becomes $\langle \text{Im}(\mu_{12}), H_p a \rangle_{S^*M_T} = 0$ for all $a \in S_{\text{phg}}^{-1}(T^*M_T; \mathbb{C})$. The same analysis directly yields the propagation of the measure $\text{Im}(\mu_{12})$. This, together with $\text{supp}(\text{Im}(\mu_{12})) \cap \pi^{-1}((0, T) \times \omega) = \emptyset$ gives $\text{Im}(\mu_{12}) = 0$ on S^*M_T , as $T > T_{\omega \rightarrow \mathcal{O} \rightarrow \omega} \geq T_\omega$. Similarly, we obtain $\text{Re}(\mu_{12}) = 0$ on S^*M_T with the last equation of (6.21). Finally, the second equation of (6.21) now reads $\langle \mu_2, H_p a \rangle_{S^*M_T} = 0$ for all $a \in S_{\text{phg}}^{-1}(T^*M_T; \mathbb{C})$. This implies $\mu_2 = 0$ on S^*M_T as we already know that $\text{supp}(\mu_2) \cap \pi^{-1}((0, T) \times \omega) = \emptyset$ from Lemma 6.7.

Since $\mu = 0$, we have

$$(w_1^k, w_2^k) \rightarrow (0, 0) \quad \text{strongly in } L_{\text{loc}}^2(M_T; \mathbb{C}^2).$$

Let us take $\chi \in \mathcal{C}_c^\infty(0, T; \mathbb{C})$, multiply the first equation of (6.15) by $\chi(1 - \Delta)^{-1}w_2^k$ and integrate on $(0, T) \times \Omega$. After an integration by parts in time, this gives

$$\begin{aligned} - \int_0^T \int_\Omega \chi |(1 - \Delta)^{-\frac{1}{2}} \partial_t w_2^k|^2 - \int_0^T \int_\Omega \partial_t \chi \partial_t w_2^k (1 - \Delta)^{-1} w_2^k - \int_0^T \int_\Omega \chi \Delta w_2^k (1 - \Delta)^{-1} w_2^k \\ = \int_0^T \int_\Omega \chi B w_1^k (1 - \Delta)^{-1} w_2^k. \end{aligned}$$

In this expression, we have

$$\int_0^T \int_\Omega \partial_t \chi \partial_t w_2^k (1 - \Delta)^{-1} w_2^k \rightarrow 0 \quad \text{since } \partial_t \chi \partial_t (1 - \Delta)^{-1} \in \Psi_{\text{phg}}^{-1}(M_T; \mathbb{C}),$$

$$\int_0^T \int_\Omega \chi B w_1^k (1 - \Delta)^{-1} w_2^k \rightarrow 0 \quad \text{since } \chi(1 - \Delta)^{-1} B \in \Psi_{\text{phg}}^{-1}(M_T; \mathbb{C}),$$

and

$$\int_0^T \int_\Omega \chi \Delta w_2^k (1 - \Delta)^{-1} w_2^k \rightarrow \langle \mu_2, \chi \rangle_{S^*M_T} = 0.$$

As a consequence, we obtain, for all $\chi \in \mathcal{C}_c^\infty(0, T; \mathbb{C})$

$$\int_0^T \int_\Omega \chi |(1 - \Delta)^{-\frac{1}{2}} \partial_t w_2^k|^2 \rightarrow 0.$$

This yields, for all $0 < \varepsilon_1 < \varepsilon_2 < T$,

$$\int_{\varepsilon_1}^{\varepsilon_2} E_0(w_2^k(t)) dt \rightarrow 0.$$

The same method with the first equation of (6.15) also gives $\int_{\varepsilon_1}^{\varepsilon_2} E_0(w_1^k(t)) dt \rightarrow 0$. Hence, $E_0(w_2^k(t)) + E_0(w_1^k(t)) \rightarrow 0$ for almost every $t \in (\varepsilon_1, \varepsilon_2)$. Picking such a time, say t_3 , the (backward) well-posedness result of Proposition 6.4 for the Cauchy problem (6.15) with data given at t_3 gives

$$E_0(w_1^k(0)) + E_0(w_2^k(0)) \leq C(E_0(w_1^k(t_3)) + E_0(w_2^k(t_3))).$$

This yields $E_0(w_1^k(0)) + E_0(w_2^k(0)) \rightarrow 0$, gives a contradiction with (6.16), and concludes the proof of the proposition. \square

For the proof of Proposition 6.6 to be complete, it remains to prove Lemma 6.7.

Proof of Lemma 6.7 The fact that the measures μ_1 and μ_2 are real and non-negative is a direct consequence of the first two equations of (6.20), tested on selfadjoint non-negative operators. Note also that the measures μ_1 and μ_2 are microlocal defect measures associated with the scalar sequences $(w_1^k)_{k \in \mathbb{N}}$ and $(w_2^k)_{k \in \mathbb{N}}$ respectively.

Let us prove that $\text{supp}(\mu_2) \subset \text{Char}(P)$. Proving that $\text{supp}(\mu_1) \subset \text{Char}(P)$ follows the same steps. Recalling that the symbol $\lambda \in S_{\text{phg}}^1(T^*M; \mathbb{C})$ is defined in (6.7), there exists $\Lambda_{-2} \in \Psi_{\text{phg}}^{-2}(M; \mathbb{C})$ that satisfies $\sigma_{-2}(\Lambda_{-2}) = \lambda^{-2}$. For $\chi \in \mathcal{C}_c^\infty(M_T)$, the second equation of (6.15) gives

$$(\chi \Lambda_{-2} P w_2^k, w_2^k)_{L^2(M_T; \mathbb{C})} = -(\chi \Lambda_{-2} B w_1^k, w_2^k)_{L^2(M_T; \mathbb{C})}.$$

Since $\chi \Lambda_{-2} B \in \Psi_{\text{phg}}^{-1}(M_T; \mathbb{C})$, we have $\chi \Lambda_{-2} B w_1^k \rightarrow 0$ in $L^2(M_T; \mathbb{C})$ so that we obtain

$$(\chi \Lambda^{-2} P w_2^k, w_2^k)_{L^2(M_T; \mathbb{C})} \rightarrow 0.$$

The second equation of (6.20) then gives

$$0 = \langle \mu_2, \chi \lambda^{-2} p \rangle_{S^*M_T} = \langle \mu_2, \chi p \rangle_{S^*M_T},$$

which is satisfied for all $\chi \in \mathcal{C}_c^\infty(M_T)$ if and only if $\text{supp}(\mu_2) \subset \text{Char}(P)$.

Now, let $\rho \notin \text{supp}(\mu_1)$. Let $a \in S_{\text{phg}}^0(T^*M_T; \mathbb{C})$ be such that $\text{supp}(a) \cap \text{supp}(\mu_1) = \emptyset$ and $\rho \in \text{supp}(a)$. We take $A \in \Psi_{\text{phg}}^0(M_T; \mathbb{C})$ such that $\sigma_0(A) = a$. Then, we have

$$\|A w_1^k\|_{L^2(M_T; \mathbb{C})}^2 = (A^* A w_1^k, w_1^k)_{L^2(M_T; \mathbb{C})} \rightarrow \langle \mu_1, |a|^2 \rangle_{S^*M_T} = 0.$$

Hence,

$$\langle \mu_{12}, a \rangle_{S^*M_T} = \lim_{k \rightarrow \infty} (A w_1^k, w_2^k)_{L^2(M_T; \mathbb{C})} = 0,$$

since $(w_2^k)_{k \in \mathbb{N}}$ is bounded in $L^2(M_T; \mathbb{C})$. As a consequence, $\rho \notin \text{supp}(\mu_{12})$. This finally yields $\text{supp}(\mu_{12}) \subset \text{supp}(\mu_1)$. Similarly, we have $\text{supp}(\mu_{12}) \subset \text{supp}(\mu_2)$.

Next, we define the operator

$$\mathcal{Q} = \begin{pmatrix} P & B^* \\ 0 & P \end{pmatrix} \in \Psi_{\text{phg}}^2(M, \mathbb{C}^{2 \times 2}),$$

where, B^* denotes the adjoint of the operator B . For all

$$\mathcal{A} = \begin{pmatrix} A_{11} & A_{12} \\ A_{21} & A_{22} \end{pmatrix} \in \Psi_{\text{phg}}^{-1}(M_T, \mathbb{C}^{2 \times 2}),$$

we have

$$\mathcal{A} P W^k = 0,$$

together with

$$(\mathcal{Q} A W^k, W^k)_{L^2(M_T; \mathbb{C}^2)} = (A W^k, P W^k)_{L^2(M_T; \mathbb{C}^2)} = 0,$$

since the operator \mathcal{A} has a kernel with compact support. Hence, we have

$$0 = ((\mathcal{A} P - \mathcal{Q} A) W^k, W^k)_{L^2(M_T; \mathbb{C}^2)}. \quad (6.27)$$

Note that we also have

$$(\mathcal{A} P - \mathcal{Q} A) = \begin{pmatrix} [A_{11}, P] + A_{12} B - B^* A_{21} & [A_{12}, P] - B^* A_{22} \\ [A_{21}, P] + A_{22} B & [A_{22}, P] \end{pmatrix} \in \Psi_{\text{phg}}^0(M_T, \mathbb{C}^{2 \times 2}). \quad (6.28)$$

As a consequence of (6.19), (6.27) and (6.28), we obtain

$$0 = \int_{S^*M_T} \text{tr} \left\{ \left(\begin{array}{cc} \frac{1}{i}\{a_{11}, p\} + b|\eta|_x(a_{12} - a_{21}) & \frac{1}{i}\{a_{12}, p\} - b|\eta|_x a_{22} \\ \frac{1}{i}\{a_{21}, p\} + b|\eta|_x a_{22} & \frac{1}{i}\{a_{22}, p\} \end{array} \right) \left(\begin{array}{cc} \mu_1 & \mu_{12} \\ \bar{\mu}_{12} & \mu_2 \end{array} \right) (d\rho) \right\},$$

with $a_{jl} = \sigma_{-1}(A_{jl})$, $j, l = 1, 2$. Since the application $A \rightarrow \sigma_{-1}(A)$ is from $\Psi_{\text{phg}}^{-1}(M_T)$ onto $S_{\text{phg}}^{-1}(T^*M_T; \mathbb{C})$, this is equivalent to

$$\begin{cases} \langle \mu_1, \frac{1}{i}\{a_{11}, p\} \rangle_{S^*M_T} = 0, \\ \langle \mu_2, \frac{1}{i}\{a_{22}, p\} \rangle_{S^*M_T} + \langle 2i \text{Im}(\mu_{12}), b|\eta|_x a_{22} \rangle_{S^*M_T} = 0, \\ \langle \mu_1, b|\eta|_x(a_{12} - a_{21}) \rangle_{S^*M_T} + \langle \mu_{12}, \frac{1}{i}\{a_{21}, p\} \rangle_{S^*M_T} + \langle \bar{\mu}_{12}, \frac{1}{i}\{a_{12}, p\} \rangle_{S^*M_T} = 0, \end{cases} \quad (6.29)$$

for any $a_{11}, a_{22}, a_{12}, a_{21} \in S_{\text{phg}}^{-1}(T^*M_T; \mathbb{C})$. Taking successively $a_{21} = a_{12}$ and $a_{21} = -a_{12}$ in the last identity of (6.29) yields

$$\left\langle \text{Re}(\mu_{12}), \frac{1}{i}\{a_{12}, p\} \right\rangle_{S^*M_T} = 0 \quad \text{and} \quad \langle \mu_1, b|\eta|_x a_{12} \rangle_{S^*M_T} - \langle \text{Im}(\mu_{12}), \{a_{12}, p\} \rangle_{S^*M_T} = 0.$$

These equations together with the first two identities of (6.29) give (6.21), which concludes the proof of the first part of the lemma.

Moreover, (6.17) yields

$$0 = \lim_{k \rightarrow \infty} (|b^\omega|^2 w_2^k, w_2^k)_{L^2(M_T; \mathbb{C})} = \langle \mu_2, |b^\omega|^2 \rangle_{S^*M_T},$$

which directly gives $\pi(\text{supp}(\mu_2)) \cap ((0, T) \times \omega) = \emptyset$ as $\mu_2 \geq 0$ and $\{b^\omega > 0\} = \omega$. This concludes the proof of the second part of the lemma as $\text{supp}(\mu_{12}) \subset \text{supp}(\mu_2)$. \square

6.3.2 End of the proof of Theorem 6.5

With the relaxed observability inequality of Proposition 6.6, we are now able to handle the low-frequencies and conclude the proof Theorem 6.5. The main point here is a unique continuation result for solutions of the elliptic problem associated with System (6.4). Here we follow the expository lectures [BG02].

We first define for any $T > 0$ the set of invisible solutions (see [BLR92]) from $(0, T) \times \omega$:

$$\mathcal{N}(T) = \{ \mathscr{W} = (w_1^0, w_2^0, w_1^1, w_2^1) \in \mathcal{H} \text{ such that the associated solution of (6.4) satisfies } w_2(t, x) = 0 \text{ for all } (t, x) \in (0, T) \times \omega \},$$

and prove the following lemma.

Lemma 6.8. *For $T > T_{\omega \rightarrow \mathcal{O} \rightarrow \omega}$, we have $\mathcal{N}(T) = \{0\}$.*

The proof of this lemma is provided below. We can now conclude the proof of Theorem 6.5.

End of the proof of Theorem 6.5 We suppose that the result of Theorem 6.5 is false. Thus, there exists a sequence $(w_1^k, w_2^k)_{k \in \mathbb{N}}$ of $\mathcal{C}^0(0, T; L^2(\Omega)) \cap \mathcal{C}^1(0, T; H^{-1}(\Omega))$ -solutions of (6.4) such that

$$E_0(w_1^k(0)) + E_0(w_2^k(0)) = 1, \quad (6.30)$$

$$\int_0^T \int_\omega |b^\omega w_2^k|^2 dx dt \rightarrow 0. \quad (6.31)$$

Equation (6.30) and Proposition 6.4 imply that the sequence $(w_1^k, w_2^k)_{k \in \mathbb{N}}$ is bounded in $L^2(M_T; \mathbb{C}^2)$. Hence, there exists a subsequence (also denoted $(w_1^k, w_2^k)_{k \in \mathbb{N}}$) weakly converging in $L^2(M_T; \mathbb{C}^2)$, towards $(w_1, w_2) \in L^2(M_T; \mathbb{C}^2)$. From (6.31), this limit satisfies, for all $t \in (0, T)$, $w_2|_\omega = 0$ and is moreover a solution of (6.4). Hence, we have $(w_1(0), w_2(0), \partial_t w_1(0), \partial_t w_2(0)) \in \mathcal{N}(T)$. According to

Lemma 6.8, this yields $(w_1, w_2) = (0, 0)$. Besides, the imbedding $\mathcal{H} \subset H^{-1}(\Omega)^2 \times H^{-2}(\Omega)^2$ being compact, we have

$$E_{-1}(w_1^k(0)) + E_{-1}(w_2^k(0)) \rightarrow E_{-1}(w_1(0)) + E_{-1}(w_2(0)).$$

The relaxed observability inequality (6.14) hence yields

$$1 \leq C(E_{-1}(w_1(0)) + E_{-1}(w_2(0))).$$

This contradicts the fact that $(w_1, w_2) = (0, 0)$, and concludes the proof of the theorem. \square

It remains to prove Lemma 6.8.

Proof of Lemma 6.8 First, Proposition 6.4 implies that $\mathcal{N}(T)$ is a closed subspace of \mathcal{H} . Second, applying the relaxed observability inequality (6.14) to an element of $\mathcal{N}(T)$ gives

$$\|\mathcal{W}\|_{\mathcal{H}} = E_0(w_1(0)) + E_0(w_2(0)) \leq C(E_{-1}(w_1(0)) + E_{-1}(w_2(0))). \quad (6.32)$$

Using the compact imbedding $\mathcal{H} \subset H^{-1}(\Omega)^2 \times H^{-2}(\Omega)^2$, this implies that $\mathcal{N}(T)$ has a finite dimension, and is thus complete for any norm. Moreover, setting $\delta = \frac{1}{2}(T - T_{\omega \rightarrow \mathcal{O} \rightarrow \omega}) > 0$, we remark that (6.32) is also satisfied by all $\mathcal{W} \in \mathcal{N}(T - \delta)$. Taking $\mathcal{W} \in \mathcal{N}(T)$ implies that, for all $\varepsilon \in (0, \delta)$, we have $e^{-\varepsilon \mathcal{A}} \mathcal{W} \in \mathcal{N}(T - \delta)$. We also have

$$(\lambda_0 + \mathcal{A})^{-1} \frac{1}{\varepsilon} (\text{Id} - e^{-\varepsilon \mathcal{A}}) \mathcal{W} = \frac{1}{\varepsilon} (\text{Id} - e^{-\varepsilon \mathcal{A}}) (\lambda_0 + \mathcal{A})^{-1} \mathcal{W} \xrightarrow{\varepsilon \rightarrow 0^+} \mathcal{A} (\lambda_0 + \mathcal{A})^{-1} \mathcal{W} \quad \text{in } \mathcal{H},$$

as $(\lambda_0 + \mathcal{A})^{-1} \mathcal{W} \in D(\mathcal{A})$. As a consequence, the sequence $(\frac{1}{\varepsilon} (\text{Id} - e^{-\varepsilon \mathcal{A}}) \mathcal{W})_{\varepsilon > 0}$ is a Cauchy sequence in $\mathcal{N}(T)$, endowed with the norm $\|(\lambda_0 + \mathcal{A})^{-1} \cdot\|_{\mathcal{H}}$. According to (6.32), we have

$$\|\mathcal{W}\|_{\mathcal{H}} \leq C(E_{-1}(w_1(0)) + E_{-1}(w_2(0))) \leq C\|(\lambda_0 + \mathcal{A})^{-1} \mathcal{W}\|_{\mathcal{H}}, \quad \text{for all } \mathcal{W} \in \mathcal{N}(T).$$

The sequence $(\frac{1}{\varepsilon} (\text{Id} - e^{-\varepsilon \mathcal{A}}) \mathcal{W})_{\varepsilon > 0}$ is thus also a Cauchy sequence in $\mathcal{N}(T)$, endowed with the norm $\|\cdot\|_{\mathcal{H}}$, which yields $\mathcal{A} \mathcal{W} \in \mathcal{H}$. Hence, we have $\mathcal{N}(T) \subset D(\mathcal{A})$. Writing $\tilde{\mathcal{W}}(t)$ the solution of

$$\partial_t \tilde{\mathcal{W}} + \mathcal{A} \tilde{\mathcal{W}} = 0, \quad \tilde{\mathcal{W}}|_{t=0} = \mathcal{W}, \quad \text{with } \tilde{\mathcal{W}} \in \mathcal{C}^1([0, T]; \mathcal{H}) \cap \mathcal{C}^0([0, T]; D(\mathcal{A})),$$

from semigroup theory, we remark that we have

$$\mathcal{A} \mathcal{W} = \partial_t \tilde{\mathcal{W}}|_{t=0} \in \mathcal{N}(T) \quad \text{if } \mathcal{W} \in \mathcal{N}(T).$$

Next, as $w_2(t, x) = 0$ for all $(t, x) \in (0, T) \times \omega$, the same holds for $\partial_t w_2$, and consequently $\mathcal{A} \mathcal{N}(T) \subset \mathcal{N}(T)$.

Since $\mathcal{N}(T)$ is a finite dimensional subspace of $D(\mathcal{A})$, stable by the action of the operator \mathcal{A} , it hence contains an eigenfunction of \mathcal{A} . There exist $\mu \in \mathbb{C}$ and $\mathcal{W}_\mu \in \mathcal{N}(T)$ such that $\mathcal{A} \mathcal{W}_\mu = \mu \mathcal{W}_\mu$. Writing $\mathcal{W}_\mu = {}^t(w_1^0, w_2^0, w_1^1, w_2^1)$, this is equivalent to having

$$\begin{cases} -w_1^1 = \mu w_1^0, \\ -w_2^1 = \mu w_2^0, \\ -\Delta w_1^0 = \mu w_1^1, \\ -\Delta w_2^0 + b(x)(1 - \Delta)^{\frac{1}{2}} w_1^0 = \mu w_2^1. \end{cases}$$

This system implies

$$\begin{cases} -\Delta w_1^0 = -\mu^2 w_1^0, \\ -\Delta w_2^0 + b(x)(1 - \Delta)^{\frac{1}{2}} w_1^0 = -\mu^2 w_2^0. \end{cases} \quad (6.33)$$

The first equation gives $\mu = i\sqrt{\kappa}$ with $\kappa \in \text{Sp}(-\Delta) \subset \mathbb{R}_+$ and w_1^0 is an eigenfunction of $-\Delta$ associated to κ . Hence, taking the $L^2(\Omega)$ -inner product of the first line of (6.33) with $(1 - \Delta)^{\frac{1}{2}} w_2^0$, and that of the second line of (6.33) with $(1 - \Delta)^{\frac{1}{2}} w_1^0$, we obtain

$$\int_{\Omega} b(x) |(1 - \Delta)^{\frac{1}{2}} w_1^0|^2 dx = 0.$$

Since $b \geq 0$ and b does not vanish identically, this proves that $(1 - \Delta)^{\frac{1}{2}} w_1^0 = 0$ on \mathcal{O} . As $(1 - \Delta)^{\frac{1}{2}} w_1^0$ is an eigenfunction of the Laplace operator vanishing on \mathcal{O} , a unique continuation result (see for instance the classical reference [Aro57, AKS62], the book [Zui83] or the exposition article [LL09]) yields $(1 - \Delta)^{\frac{1}{2}} w_1^0 = 0$ on Ω . Hence $w_1^0 = 0$ on Ω .

Moreover, $\mathscr{W} \in \mathcal{N}(T)$ yields $w_2^0 = 0$ on ω . This proves that $w_2^0 = 0$ on Ω , as w_2^0 is an eigenfunction of the Laplace operator as a consequence of (6.33). This concludes the proof of the lemma. \square

Remark 6.9. Note that elliptic unique continuation properties as those used here are not known in general for 2×2 elliptic systems. For these types of general systems, such a result holds if $\omega \cap \mathcal{O} \neq \emptyset$ [Léa10a, Proposition 5.1]. However the case $\omega \cap \mathcal{O} = \emptyset$ remains open in general.

Here, the cascade structure of System (6.4) allows us to bypass a more involved unique continuation theorem. We use that the eigenvalues and eigenfunctions of the operator

$$\begin{pmatrix} -\Delta & 0 \\ b(1 - \Delta)^{\frac{1}{2}} & -\Delta \end{pmatrix},$$

are $(\kappa_j, {}^t(0, \varphi_j))_{j \in \mathbb{N}}$, where $(\kappa_j, \varphi_j)_{j \in \mathbb{N}}$ are the eigenvalues and eigenfunctions of $-\Delta$. This is a very particular feature of cascade systems with twice the same elliptic operator on the diagonal.

6.4 Lack of observability for $T < T_{\omega \rightarrow \mathcal{O} \rightarrow \omega}$

In this section, we prove the following theorem.

Theorem 6.10. *Suppose that $T < T_{\omega \rightarrow \mathcal{O} \rightarrow \omega}$. Then, there exists a bounded sequence $(w_1^k, w_2^k)_{k \in \mathbb{N}}$ of $\mathcal{C}^0(0, T; L^2(\Omega)^2) \cap \mathcal{C}^1(0, T; H^{-1}(\Omega)^2)$ -solutions of (6.4) satisfying*

$$\begin{cases} \liminf_{k \rightarrow \infty} (E_0(w_1^k(0)) + E_0(w_2^k(0))) \geq 1, \\ (w_1^k, w_2^k) \rightharpoonup 0 \text{ in } L^2(M_T; \mathbb{C}^2), \end{cases} \quad (6.34)$$

such that the sequence $(w_2^k)_{k \in \mathbb{N}}$ is pure and its microlocal defect measure μ_2 satisfies

$$\langle \mu_2, \chi^2 |b^\omega|^2 \rangle_{S^*M_T} = 0, \quad (6.35)$$

for any $\chi \in \mathcal{C}_c^\infty(0, T)$.

We refer to [Gér91, Definition 1.3] for the definition of a pure sequence. As a direct consequence of this theorem, we have the following non-observability result.

Corollary 6.11. *If $T < T_{\omega \rightarrow \mathcal{O} \rightarrow \omega}$, the observability inequality (6.5) does not hold.*

The negative controllability result of Theorem 6.2 is then a direct consequence of Corollary 6.11 and HUM.

Proof of Corollary 6.11 Suppose that the observability inequality (6.5) holds for some constant $C > 0$, for all solutions of (6.4). Then, for the sequence $(w_1^k, w_2^k)_{k \in \mathbb{N}}$ given by Theorem 6.10, we have, for k sufficiently large,

$$\frac{1}{2} \leq E_0(w_1^k(0)) + E_0(w_2^k(0)) \leq K \int_0^T \int_\omega |b^\omega w_2^k|^2 dx dt, \quad K > 0. \quad (6.36)$$

The sequence $(w_1^k, w_2^k)_{k \in \mathbb{N}}$ being bounded in the energy space, we have in particular

$$\int_\omega |b^\omega w_2^k(t, x)|^2 dx \leq C_0, \quad \text{for some } C_0 > 0, \text{ and all } k \in \mathbb{N}, t \in [0, T].$$

This yields, for any $\varepsilon \in (0, \frac{T}{2})$,

$$\begin{aligned} \int_0^T \int_{\omega} |b^{\omega} w_2^k|^2 dx dt &= \int_0^{\varepsilon} \int_{\omega} |b^{\omega} w_2^k|^2 dx dt + \int_{\varepsilon}^{T-\varepsilon} \int_{\omega} |b^{\omega} w_2^k|^2 dx dt + \int_{T-\varepsilon}^T \int_{\omega} |b^{\omega} w_2^k|^2 dx dt \\ &\leq 2\varepsilon C_0 + \int_{\varepsilon}^{T-\varepsilon} \int_{\omega} |b^{\omega} w_2^k|^2 dx dt \leq 2\varepsilon C_0 + \int_0^T \int_{\omega} |\chi b^{\omega} w_2^k|^2 dx dt, \end{aligned}$$

with $\chi \in \mathcal{C}_c^{\infty}(0, T)$ such that $\chi = 1$ on $(\varepsilon, T - \varepsilon)$. We fix ε such that $2\varepsilon C_0 = \frac{1}{8K}$ and obtain

$$\int_0^T \int_{\omega} |b^{\omega} w_2^k|^2 dx dt \leq \frac{1}{8K} + \int_0^T \int_{\omega} |\chi b^{\omega} w_2^k|^2 dx dt.$$

According to (6.35), this gives

$$\int_0^T \int_{\omega} |b^{\omega} w_2^k|^2 dx dt \leq \frac{1}{4K},$$

for k sufficiently large. This yields a contradiction with (6.36), and concludes the proof of the corollary. \square

We shall use the following lemma in the proof of Theorem 6.10.

Lemma 6.12. *For any bicharacteristic curve Γ of the d'Alembert operator P , there exists a pure sequence $(w^k)_{k \in \mathbb{N}}$ of $\mathcal{C}^0(0, T; L^2(\Omega)) \cap \mathcal{C}^1(0, T; H^{-1}(\Omega))$ -solutions of $Pw^k = 0$ such that*

$$\begin{cases} \liminf_{k \rightarrow \infty} E_0(w^k(0)) \geq 1, \\ w^k \rightharpoonup 0 \text{ in } L^2(M_T; \mathbb{C}), \end{cases} \quad (6.37)$$

and the microlocal defect measure of $(w^k)_{k \in \mathbb{N}}$ is supported in Γ .

We now prove Theorem 6.10. The proof of Lemma 6.12 is postponed to the end of this section.

Proof of Theorem 6.10 Since $T < T_{\omega \rightarrow \mathcal{O} \rightarrow \omega}$, Definition 6.3 gives the existence of $\rho_* = (0, x_*, \tau_*, \eta_*) \in \text{Char}(P) \cap S^*M$ such that the following condition holds :

$$\text{For any } 0 < t_0 < t_1 < t_2 < T, \text{ we have} \quad (6.38)$$

$$\pi(\phi_{t_0}(\rho_*)) \notin (0, T) \times \omega, \quad \text{or} \quad \pi(\phi_{t_1}(\rho_*)) \notin (0, T) \times \mathcal{O}, \quad \text{or} \quad \pi(\phi_{t_2}(\rho_*)) \notin (0, T) \times \omega.$$

We set

$$\Gamma = \{\phi_s(\rho_*), s \in [0, T]\}.$$

We now construct the sequence $(w_1^k, w_2^k)_{k \in \mathbb{N}}$.

First, if $\pi(\Gamma) \cap ((0, T) \times \omega) = \emptyset$ (which only occurs if $T < T_{\omega}$), we take $w_1^k = 0$ for all $k \in \mathbb{N}$ and $(w_2^k)_{k \in \mathbb{N}}$ as given by Lemma 6.12. In this case, (6.35) is clear as $\text{supp}(\mu_2) \subset \Gamma$ and $\pi(\Gamma) \cap ((0, T) \times \omega) = \emptyset$ (this is a classical non-observability result for a single wave equation [BLR92, Bur97a, BG97]).

Second, if $\pi(\Gamma) \cap ((0, T) \times \omega) \neq \emptyset$, we choose $(w_1^k)_{k \in \mathbb{N}}$ as given by Lemma 6.12. In particular, according to Lemma 6.12, this gives $\liminf_{k \rightarrow \infty} (E_0(w_1^k(0)) + E_0(w_2^k(0))) \geq 1$ for all $\mathcal{C}^0(0, T; L^2(\Omega)) \cap \mathcal{C}^1(0, T; H^{-1}(\Omega))$ -sequence $(w_2^k)_{k \in \mathbb{N}}$. We also pick some $t_0 \in (0, T)$ such that $\pi(\phi_{t_0}(\rho_*)) \in (0, T) \times \omega$. The geometrical situation is sketched on Figure 6.2.

We choose w_2^k to be the unique (forward and backward) solution of

$$\begin{cases} Pw_2^k = -Bw_1^k & \text{in } (0, T) \times \Omega, \\ (w_2^k, \partial_t w_2^k)|_{t=t_0} = (0, 0) & \text{on } \Omega. \end{cases} \quad (6.39)$$

In particular, the well-posedness of the wave equation yields $w_2^k \in \mathcal{C}^0(0, T; L^2(\Omega)) \cap \mathcal{C}^1(0, T; H^{-1}(\Omega))$ and

$$\|w_2^k\|_{L^2(M_T)} \leq C \|Bw_1^k\|_{L^2(0, T; H^{-1}(\Omega))} \leq C \|w_1^k\|_{L^2(M_T)},$$

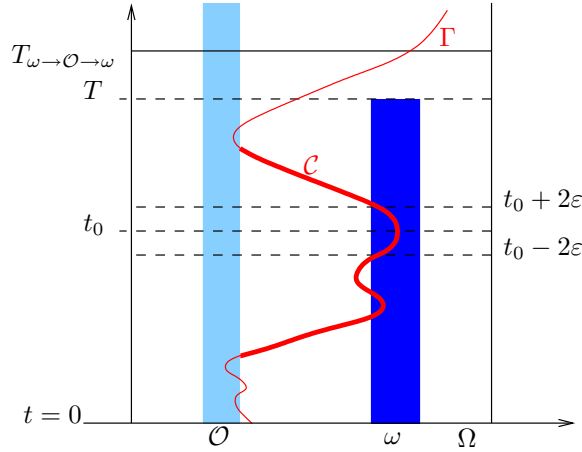

FIGURE 6.2 – Geometrical situation in the case $T < T_{\omega \rightarrow \mathcal{O} \rightarrow \omega}$ with $\pi(\Gamma) \cap ((0, T) \times \omega) = \emptyset$.

as $B = b(1 - \Delta)^{\frac{1}{2}}$. Since $(w_1^k)_{k \in \mathbb{N}}$ is bounded in $L^2(M_T; \mathbb{C})$ from Lemma 6.12, the sequence $(w_1^k, w_2^k)_{k \in \mathbb{N}}$ is bounded in $L^2(M_T; \mathbb{C}^2)$. Moreover, the well-posedness of the wave equation in $\mathcal{C}^0(0, T; H^{-1}(\Omega)) \cap \mathcal{C}^1(0, T; H^{-2}(\Omega))$ also gives

$$\|w_2^k\|_{H^{-1}(M_T)} \leq C \|Bw_1^k\|_{L^2(0, T; H^{-2}(\Omega))} \leq C \|w_1^k\|_{H^{-1}(M_T)} \rightarrow 0,$$

since $w_1^k \rightarrow 0$ in $L^2(M_T; \mathbb{C})$. Finally, the sequence $(w_1^k, w_2^k)_{k \in \mathbb{N}}$ satisfies all the conditions (6.34).

Since $(w_1^k, w_2^k) \rightarrow 0$ in $L^2(M_T; \mathbb{C}^2)$, and according to [Gér91, Theorem 1], there exists a subsequence (still denoted $(W^k)_{k \in \mathbb{N}} = (w_1^k, w_2^k)_{k \in \mathbb{N}}$) and a microlocal defect measure

$$\mu = \begin{pmatrix} \mu_1 & \mu_{12} \\ \bar{\mu}_{12} & \mu_2 \end{pmatrix} \in \mathcal{M}_+(S^*M_T; \mathbb{C}^{2 \times 2}),$$

such that for any $\mathcal{A} \in \Psi_{\text{phg}}^0(M_T; \mathbb{C}^{2 \times 2})$,

$$\lim_{k \rightarrow \infty} (\mathcal{A}W^k, W^k)_{L^2(M_T; \mathbb{C}^2)} = \langle \mu, \sigma_0(\mathcal{A}) \rangle_{S^*M_T}.$$

Moreover, μ_1 is the microlocal defect measure associated with the sequence $(w_1^k)_{k \in \mathbb{N}}$. As this sequence is (a subsequence of a sequence) chosen by means of Lemma 6.12, we have $\text{supp}(\mu_1) \subset \Gamma$. Observe now that the sequence $(W^k)_{k \in \mathbb{N}}$ satisfies all the assumptions of the first part of Lemma 6.7, which gives $\mu_2 \in \mathcal{M}_+(S^*M_T)$, $\text{supp}(\mu_2) \subset \text{Char}(P)$, and $\text{supp}(\mu_{12}) \subset \text{supp}(\mu_1) \subset \Gamma$. Finally these three measures satisfy the equations

$$\begin{cases} \langle \mu_1, H_p a \rangle_{S^*M_T} = 0, \\ \langle \mu_2, H_p a \rangle_{S^*M_T} = - \langle \text{Im}(\mu_{12}), 2b|\eta|_x a \rangle_{S^*M_T}, \\ \langle \text{Im}(\mu_{12}), H_p a \rangle_{S^*M_T} = - \langle \mu_1, b|\eta|_x a \rangle_{S^*M_T}, \end{cases} \quad (6.40)$$

for any $a \in S_{\text{phg}}^{-1}(T^*M_T; \mathbb{C})$.

We denote by \mathcal{C} the connected component of $\Gamma \setminus \pi^{-1}((0, T) \times \bar{\mathcal{O}})$ that contains $\Gamma \cap \pi^{-1}((0, T) \times \omega)$ (indicated by a thick line in Figure 6.2). We have $\phi_{t_0}(\rho_*) \in \mathcal{C}$. In the present case, Condition (6.38) gives

$$\pi(\Gamma) \cap ((0, T) \times \omega) \cap ((0, T) \times \mathcal{O}) = \emptyset. \quad (6.41)$$

Moreover, Condition (6.38) yields the uniqueness of such a connected component.

The end of the proof consists in showing that $\text{supp}(\mu_2) \subset \Gamma$ and that $\mathcal{C} \cap \text{supp}(\mu_2) = \emptyset$. For this, we first prove that μ_2 vanishes identically on $\pi^{-1}((t_0 - 2\varepsilon, t_0 + 2\varepsilon) \times \Omega)$ for $\varepsilon > 0$ sufficiently small. Then, a propagation argument with (6.40) gives $\text{supp}(\mu_2) \subset \Gamma$ and that μ_2 vanishes on \mathcal{C} .

Let us take $\varepsilon > 0$ with $2\varepsilon < \min(t_0, T - t_0)$, to be chosen below. The well-posedness for the wave equation (6.39) gives

$$\begin{aligned} \|w_2^k\|_{L^2((t_0-\varepsilon, t_0+\varepsilon) \times \Omega)} &\leq C \|Bw_1^k\|_{L^2(t_0-\varepsilon, t_0+\varepsilon; H^{-1}(\Omega))} \\ &\leq C \|(1-\Delta)^{-\frac{1}{2}} b(1-\Delta)^{\frac{1}{2}} w_1^k\|_{L^2((t_0-\varepsilon, t_0+\varepsilon) \times \Omega)} \\ &\leq C \|\chi(1-\Delta)^{-\frac{1}{2}} b(1-\Delta)^{\frac{1}{2}} w_1^k\|_{L^2((t_0-2\varepsilon, t_0+2\varepsilon) \times \Omega)} \end{aligned} \quad (6.42)$$

for some $\chi \in \mathcal{C}_c^\infty(t_0 - 2\varepsilon, t_0 + 2\varepsilon)$ satisfying $0 \leq \chi \leq 1$ and $\chi = 1$ on $(t_0 - \varepsilon, t_0 + \varepsilon)$. In this last expression, we have $\chi(1-\Delta)^{-\frac{1}{2}} b(1-\Delta)^{\frac{1}{2}} \in \Psi_{\text{phg}}^0(M_T; \mathbb{C})$, with principal symbol $\sigma_0(\chi(1-\Delta)^{-\frac{1}{2}} b(1-\Delta)^{\frac{1}{2}}) = \chi b$. As a consequence, we have

$$\|\chi(1-\Delta)^{-\frac{1}{2}} b(1-\Delta)^{\frac{1}{2}} w_1^k\|_{L^2((t_0-2\varepsilon, t_0+2\varepsilon) \times \Omega)}^2 \rightarrow \langle \mu_1, \chi^2 b^2 \rangle_{S^*M_T} \quad (6.43)$$

Since $\pi^{-1}((0, T) \times \omega)$ is an open set in S^*M_T , containing $\phi_{t_0}(\rho_*)$, there exists $\varepsilon > 0$ such that

$$\phi_s(\rho_*) \in \pi^{-1}((0, T) \times \omega), \quad \text{for all } s \in (t_0 - 2\varepsilon, t_0 + 2\varepsilon). \quad (6.44)$$

For this choice of ε , we have

$$\text{supp}(\mu_1) \cap \pi^{-1}((t_0 - 2\varepsilon, t_0 + 2\varepsilon) \times \Omega) \subset \Gamma \cap \pi^{-1}((t_0 - 2\varepsilon, t_0 + 2\varepsilon) \times \Omega) = \{\phi_s(\rho_*), s \in (t_0 - 2\varepsilon, t_0 + 2\varepsilon)\}.$$

According to (6.44), this last set is contained in $\Gamma \cap \pi^{-1}((0, T) \times \omega)$, i.e.

$$\text{supp}(\mu_1) \cap \pi^{-1}((t_0 - 2\varepsilon, t_0 + 2\varepsilon) \times \Omega) \subset \Gamma \cap \pi^{-1}((0, T) \times \omega).$$

From (6.41), we then obtain $\text{supp}(\mu_1) \cap \pi^{-1}((t_0 - 2\varepsilon, t_0 + 2\varepsilon) \times \Omega) \cap \pi^{-1}((0, T) \times \mathcal{O}) = \emptyset$, which gives

$$\text{supp}(\mu_1) \cap \pi^{-1}(\text{supp}(\chi)) \cap \pi^{-1}(\text{supp}(b)) = \emptyset.$$

This, together with (6.43) gives

$$\|\chi(1-\Delta)^{-\frac{1}{2}} b(1-\Delta)^{\frac{1}{2}} w_1^k\|_{L^2((t_0-2\varepsilon, t_0+2\varepsilon) \times \Omega)} \rightarrow 0.$$

Using (6.42), we now obtain $\|w_2^k\|_{L^2((t_0-\varepsilon, t_0+\varepsilon) \times \Omega)} \rightarrow 0$, and thus

$$\text{supp}(\mu_2) \cap \pi^{-1}((t_0 - \varepsilon, t_0 + \varepsilon) \times \Omega) = \emptyset. \quad (6.45)$$

As $\text{supp}(\mu_{12}) \subset \Gamma$, the second equation of (6.40) yields

$$\langle \mu_2, H_p a \rangle_{S^*M_T} = 0 \quad (6.46)$$

for any $a \in S_{\text{phg}}^{-1}(T^*M_T; \mathbb{C})$ such that $a = 0$ in a neighborhood of Γ . As in the proof of Proposition 6.6, this gives the invariance of the measure μ_2 along the flow ϕ_s away from Γ . Together with (6.45), this also yields

$$\text{supp}(\mu_2) \subset \Gamma. \quad (6.47)$$

The second equation of (6.40) also gives (6.46) for any $a \in S_{\text{phg}}^{-1}(T^*M_T; \mathbb{C})$ such that $a = 0$ in a neighborhood of $\pi^{-1}((0, T) \times \mathcal{O})$, as b is supported in $\overline{\mathcal{O}}$. Once again, this gives the invariance of the measure μ_2 along the flow ϕ_s on $S^*M_T \setminus \pi^{-1}((0, T) \times \overline{\mathcal{O}})$. Together with Equation (6.45), this gives, with a propagation argument,

$$\text{supp}(\mu_2) \cap \mathcal{C} = \emptyset. \quad (6.48)$$

Finally, Equations (6.47) and (6.48) together with the definition of \mathcal{C} give

$$\text{supp}(\mu_2) \cap \pi^{-1}((0, T) \times \omega) = \emptyset.$$

This implies (6.35) as b^ω is supported in $\overline{\omega}$, and concludes the proof of Theorem 6.10. \square

To conclude this section, we give a proof of Lemma 6.12. For this, we construct the sequence $(w^k)_{k \in \mathbb{N}}$.

Proof of Lemma 6.12 A proof of this lemma can be found in the semiclassical setting in [Bur97a, Section 4.2] (see also [BG97]). We can parametrize the bicharacteristic Γ as

$$\Gamma \cap \pi^{-1}(M_T) = \{\phi_s(\rho_0), s \in (0, T)\},$$

with

$$\rho_0 = (0, x_0, \tau_0, \eta_0) \in \Gamma \cap \{t = 0\}.$$

We have $\tau_0^2 = |\eta_0|_x^2$. Let us assume that $\tau_0 > 0$. The case $\tau_0 < 0$ can be treated similarly. We set

$$\nu_0 = (x_0, \frac{\eta_0}{|\eta_0|_x}) \in S^*\Omega.$$

There exists a local chart (U_κ, κ) of Ω such that $x_0 \in U_\kappa$. We denote by (y_0, ξ_0) the coordinates of ν_0 in this chart. We choose $\psi \in \mathcal{C}_c^\infty(\mathbb{R}^n)$ such that $\text{supp}(\psi) \subset \kappa(U_\kappa)$, and $\psi = 1$ in a neighborhood of y_0 . Next we define

$$v^k = C_0 k^{\frac{n}{4}} e^{ik\varphi(y)} \psi(y), \quad \text{with } \varphi(y) = y \cdot \xi_0 + i(y - y_0)^2 \text{ and } C_0 > 0.$$

Now, we set

$$w_0^k = \kappa^* v^k \in \mathcal{C}_c^\infty(\Omega).$$

We have $w_0^k \rightharpoonup 0$ in $L^2(\Omega)$, $\lim_{k \rightarrow \infty} \|w_0^k\|_{L^2(\Omega)} = 1$ for an appropriate choice of C_0 . Moreover, a classical computation on $(v^k)_{k \in \mathbb{N}}$ shows that $(w_0^k)_{k \in \mathbb{N}}$ is pure and admits the microlocal defect measure $m = \delta_{(x, \eta) = \nu_0}$.

We set $w_1^k = i\sqrt{-\Delta} w_0^k \in$ and let w^k be the solution of

$$\begin{cases} Pw^k = 0 & \text{in } (0, T) \times \Omega, \\ (w^k, \partial_t w^k)|_{t=0} = (w_0^k, w_1^k) & \text{on } \Omega. \end{cases}$$

For the sequence $(w^k)_{k \in \mathbb{N}}$, (6.37) is satisfied. We denote by $L_+ = \frac{1}{i}\partial_t + \sqrt{-\Delta}$ and $L_- = \frac{1}{i}\partial_t - \sqrt{-\Delta}$, so that $P = -L_+ L_-$. Note that $\sqrt{-\Delta} \in \Psi_{\text{phg}}^1(M_T; \mathbb{C})$ by [See67] or [Shu01, Theorem 11.2]. Setting $z^k = L_- w^k$, we have $L_+ z^k = 0$ and

$$z^k|_{t=0} = (\frac{1}{i}\partial_t w^k - \sqrt{-\Delta} w^k)|_{t=0} = \frac{1}{i} w_1^k - \sqrt{-\Delta} w_0^k = 0.$$

Therefore, $z^k = 0$ in $\mathbb{R}^+ \times \Omega$, i.e. w^k solves the first-order equation

$$\begin{cases} L_- w^k = 0 & \text{in } (0, T) \times \Omega, \\ w^k|_{t=0} = w_0^k & \text{on } \Omega. \end{cases} \quad (6.49)$$

System (6.49) is well-posed, and the sequence $(w^k)_{k \in \mathbb{N}}$ is bounded in $L^2(M_T)$ (see [Hör85, Section 23.1]), weakly converging to zero and hence admits a microlocal defect measure μ (up to a subsequence).

We prove that $\text{supp}(\mu) \subset \Gamma$. Since w^k solves (6.49), the measure μ is preserved along the bicharacteristic flow of $\ell_- = \sigma_1(L_-) = \tau - |\eta|_x$, the principal symbol of L_- . Note that the bicharacteristic of L_- originating from ρ_0 coincides with Γ . Hence, it suffices to prove that any point $(0, x_1, \tau_1, \eta_1) \in \text{Char}(L_-) \cap S^*M$ different from $(0, x_0, \tau_0, \eta_0)$ is not in $\text{supp}(\mu)$. Note that $\text{Char}(L_-) = \{\tau = |\eta|_x > 0\}$.

Let $a \in S_{\text{phg}}^0(T^*\Omega; \mathbb{C})$ be a zero-order homogeneous symbol, with compact support near x_1 , such that $a = 1$ in a conic neighborhood of (x_1, η_1) and $a = 0$ in a conic neighborhood of (x_0, η_0) . Taking $A \in \Psi_{\text{phg}}^0(\Omega; \mathbb{C})$ such that $\sigma_0(A) = a$, we have

$$Aw_0^k \rightarrow 0 \quad \text{in } L^2(\Omega),$$

because of the support of the measure m . We denote by ϕ_s^- the bicaracteristic flow associated with the symbol ℓ_- , i.e. the maximal solutions of

$$\frac{d}{ds}\phi_s^-(\rho) = H_{\ell_-}\phi_s^-(\rho), \quad \phi_0^-(\rho) = \rho \in T^*M \setminus 0.$$

As we have $\partial_t \ell_- = 0$ and $\partial_\tau \ell_- = 1$, the flow ϕ_s^- can be written under the form

$$\phi_s^-(t, \tau, x, \eta) = (t + s, \tau, \varphi_s^-(x, \eta)),$$

where $\frac{d}{ds}\varphi_s^-(x, \eta) = H_{-|\eta|_x}\varphi_s^-(x, \eta)$, for $(x, \eta) \in T^*\Omega \setminus 0$.

Now, we define the tangential polyhomogeneous symbol¹¹

$$q(t, x, \eta) = a(\varphi_{-t}^-(x, \eta)) \in S_T^0((-T, T) \times T^*\Omega; \mathbb{C}),$$

which satisfies

$$\begin{cases} H_{\ell_-}q = 0, \\ q(0, x, \eta) = a(x, \eta). \end{cases}$$

We denote by $\Psi_T^m((-T, T) \times \Omega; \mathbb{C})$ the set of tangential operators of order m . We take $Q \in \Psi_T^0((-T, T) \times \Omega; \mathbb{C})$ such a tangential operator satisfying $\sigma_0(Q) = q$. The commutator $[L_-, Q]$ satisfies $[L_-, Q] \in \Psi_T^0((-T, T) \times \Omega; \mathbb{C})$ with principal symbol $\frac{1}{i}\{\ell_-, q\} = \frac{1}{i}H_{\ell_-}q = 0$. Hence, we have $[L_-, Q] \in \Psi_T^{-1}((-T, T) \times \Omega; \mathbb{C})$. Now, we compute

$$\begin{cases} L_-Qw^k = [L_-, Q]w^k \rightarrow 0 & \text{in } L^2(M_T), \\ Qw^k|_{t=0} = Aw_0^k \rightarrow 0 & \text{in } L^2(\Omega). \end{cases}$$

Applying then the hyperbolic energy inequality, to this first-order system, we obtain

$$\|Qw^k\|_{L^\infty(0, T; L^2(\Omega))} \leq C(\|Aw_0^k\|_{L^2(\Omega)} + \|[L_-, Q]w^k\|_{L^1(0, T; L^2(M_T))}) \rightarrow 0.$$

Finally, let $r \in S_{\text{phg}}^0(T^*M; \mathbb{C})$ be such that $r = 1$ in a neighborhood of $(0, x_1, \tau_1, \eta_1)$, $r = 0$ for $|\eta|_x < \frac{|\tau|}{2}$, and r has a compact support in the time variable t , included in $(-\frac{T}{2}, \frac{T}{2})$. Taking $R \in \Psi_{\text{phg}}^0(M; \mathbb{C})$ such that $\sigma_0(R) = r$ the operator RQ is in the class $\Psi_{\text{phg}}^0(M; \mathbb{C})$, according to [Hör85, Theorem 18.1.35]. Moreover, RQ is elliptic at $(0, x_1, \tau_1, \eta_1)$ since $r(0, x_1, \tau_1, \eta_1)q(0, x_1, \eta_1) = 1$ and we have

$$\|RQw^k\|_{L^2(M_T)} \leq C\|Qw^k\|_{L^2(M_T)} \rightarrow 0.$$

As a consequence, $(0, x_1, \tau_1, \eta_1) \notin \text{supp}(\mu)$. The invariance of μ along the bicaracteristic flow finally gives $\text{supp}(\mu) \subset \Gamma$, which concludes the proof of Lemma 6.12. \square

11. For tangential symbols $S_T^m((-T, T) \times T^*\Omega; \mathbb{C})$ and associated operators $\Psi_T^m((-T, T) \times \Omega; \mathbb{C})$, we refer to [Hör85, page 94 (bottom)]. Here, t stands for the parameter upon which the symbols depend.

6.5 Une remarque sur l'obstruction au prolongement unique pour les systèmes elliptiques

Ce paragraphe est le fruit d'une discussion avec Belhassen Dehman, Jérôme Le Rousseau, Lionel Rosier et Luz de Teresa.

Let \mathbb{T} be the one-dimensional torus, i.e. $\mathbb{T} = (0, 2\pi)$, with periodic boundary conditions. Given $a \in L^\infty(\mathbb{T})$, we consider on the Hilbert space $(L^2(\mathbb{T}))^2$ the following cascade elliptic operator

$$A^* = \begin{pmatrix} -\gamma\Delta & 0 \\ a(x) & -\Delta \end{pmatrix}, \quad \mathcal{D}(A^*) = (H^2(\mathbb{T}))^2.$$

The associated eigenvalue problem consists in finding $\lambda \in \mathbb{C}$ and $(w_1, w_2) \in \mathcal{D}(A^*) \setminus \{(0, 0)\}$ satisfying

$$\begin{cases} -\gamma\Delta w_1 = \lambda w_1 \\ -\Delta w_2 + a(x)w_1 = \lambda w_2. \end{cases} \quad (6.50)$$

For this problem, we prove that the unique continuation fails to hold for some $\gamma > 0$ and some coupling function a .

Theorem 6.13. *For all $\gamma \neq 1$ such that $\sqrt{\gamma} \in \mathbb{Q}$, for all $\delta \in (0, 2\pi)$ and $r \in \mathbb{N}$, there exists $a \in \mathcal{C}^r(\mathbb{T})$, $a \geq 0$, $a \neq 0$, $\text{supp}(a) \subset (2\pi - \delta, 2\pi)$ and an eigenvalue $\lambda \in \mathbb{R}^+$ and associated eigenfunction $(w_1, w_2) \neq (0, 0)$ satisfying (6.50), together with $w_2|_{(0, 2\pi - \delta)} = 0$.*

For these parameters of the problem, we have the (non-unique continuation) property

$$B_\omega^* W = 0 \text{ and } A^* W = \lambda W \text{ do not imply } W \equiv 0,$$

where $W = (w_1, w_2)$ and $B_\omega^* W = \mathbb{1}_\omega w_2$, as soon as $\omega \subset (0, 2\pi - \delta)$.

Proof. Dividing the first equation of (6.50) by γ , we see that λ/γ is an eigenvalue of $-\Delta$ on \mathbb{T} . Hence, we have $\lambda/\gamma = n^2$ for some $n \in \mathbb{N}$, associated (for instance) to the eigenfunction $w_1(x) = e^{inx}$. System (6.50) becomes

$$\begin{cases} -\partial_{xx} w_1 = n^2 w_1 \\ -\partial_{xx} w_2 + a(x)w_1 = \gamma n^2 w_2 \end{cases} \quad (6.51)$$

We now solve the second equation of (6.51) and find w_2 . Choosing zero Cauchy data on some point $x_0 \in (0, 2\pi - \delta)$ we see that $w_2 \equiv 0$ on $(0, 2\pi - \delta)$. Moreover, we have

$$w_2(x) = \frac{e^{i\sqrt{\gamma}nx}}{2i\sqrt{\gamma}n} \int_{2\pi - \delta}^x a(s)e^{in(1 - \sqrt{\gamma})s} ds - \frac{e^{-i\sqrt{\gamma}nx}}{2i\sqrt{\gamma}n} \int_{2\pi - \delta}^x a(s)e^{in(1 + \sqrt{\gamma})s} ds, \quad x \in [2\pi - \delta, 2\pi].$$

It remains now to choose a so that $w_2 \in \mathcal{D}(A^*)$, i.e. $w_2(2\pi) = 0$ and $\partial_x w_2(2\pi) = 0$ (under this condition, for $a \in \mathcal{C}^r(\mathbb{T})$, a bootstrap argument in the second equation of (6.51) shows that $w_2 \in \mathcal{C}^{r+2}(\mathbb{T})$). This is equivalent to having

$$\int_{2\pi - \delta}^{2\pi} a(s)e^{in(1 - \sqrt{\gamma})s} ds = 0, \quad \text{and} \quad \int_{2\pi - \delta}^{2\pi} a(s)e^{in(1 + \sqrt{\gamma})s} ds = 0. \quad (6.52)$$

We choose $k \in \mathbb{N}^*$ such that $\frac{2\pi}{k} < \delta$ and set

$$a(x) = \mathbb{1}_{(2\pi(\frac{k-1}{k}), 2\pi)} \left(\sin \left(\frac{kx}{2} - \pi(k-1) \right) \right)^m, \quad \text{with } m = 2 \left\lfloor \frac{r}{2} \right\rfloor + 2, \quad (6.53)$$

which satisfies all the assumptions of the theorem since $u(x) = \frac{kx}{2} - \pi(k-1)$ maps linearly $[2\pi(\frac{k-1}{k}), 2\pi]$ into $[0, \pi]$. Let us check condition (6.52) :

$$\begin{aligned} \int_{2\pi-\delta}^{2\pi} a(s)e^{in(1\pm\sqrt{\gamma})s} ds &= \int_{2\pi(\frac{k-1}{k})}^{2\pi} \left(\sin\left(\frac{ks}{2} - \pi(k-1)\right) \right)^m e^{in(1\pm\sqrt{\gamma})s} ds \\ &= \frac{2}{k} \int_0^\pi (\sin u)^m e^{in(1\pm\sqrt{\gamma})(\frac{2u}{k} + 2\pi\frac{k-1}{k})} du \\ &= \frac{2e^{in(1\pm\sqrt{\gamma})(2\pi\frac{k-1}{k})}}{k(2i)^m} \int_0^\pi (e^{iu} - e^{-iu})^m e^{in(1\pm\sqrt{\gamma})\frac{2u}{k}} du \\ &= \frac{2e^{in(1\pm\sqrt{\gamma})(2\pi\frac{k-1}{k})}}{k(2i)^m} \sum_{j=0}^m (-1)^j C_j^m \int_0^\pi e^{i(m-2j)u} e^{in(1\pm\sqrt{\gamma})\frac{2u}{k}} du. \end{aligned}$$

We now choose the integer n so that each integral in this expression is zero, i.e.,

$$m - 2j + \frac{2n}{k}(1 \pm \frac{p}{q}) \in 2\mathbb{Z}, \quad (6.54)$$

where we have put $\sqrt{\gamma} = \frac{p}{q}$, $p \in \mathbb{Z}$, $q \in \mathbb{N}^*$. Taking $n = kq \in \mathbb{N}$, condition (6.54) is satisfied since m is even according to (6.53). This concludes the proof of the theorem. \square

Note that we see that the conclusion of the theorem is still valid when taking any $n \in kq\mathbb{N}$ in (6.54). As a consequence, given γ and a as in Theorem 6.13, there are infinitely many eigenvalues (and associated eigenfunctions) that do not satisfy the unique continuation property...

Remark 6.14. This results also works with Dirichlet or Neumann boundary conditions since the function a is real. Taking $w_2(x) = \sin(nx)$ for Dirichlet boundary conditions or $w_2(x) = \cos(nx)$ for Neumann boundary conditions, the proof remains unchanged.

Corollary 6.15 (No parabolic unique continuation). *For γ and a as in Theorem 6.13 and $\omega \cap \text{supp}(a) = \emptyset$, there exists $U \in \mathcal{C}^\infty(\mathbb{R}_*^+; \mathcal{C}^{r+2}(\mathbb{T}))$ such that*

$$\begin{cases} \partial_t U + A^*U = 0 & \forall t > 0 \\ B_\omega^*U(t) = 0 & \forall t > 0 \\ U(t) \neq 0 & \forall t > 0. \end{cases} \quad (6.55)$$

Proof. Taking (λ, W) the eigenvalue and associated eigenfunction given by Theorem 6.13, we see that $U(t) = e^{-\lambda t}W$ satisfies (6.55), and the corollary is proved. \square

Corollary 6.16 (No parabolic approximate controllability). *For γ and a as in Theorem 6.13 and $\omega \cap \text{supp}(a) = \emptyset$, the system $\partial_t V + AV = B_\omega g$, i.e.*

$$\begin{cases} \partial_t v_1 - \gamma \Delta v_1 + a(x)v_2 & = 0 \\ \partial_t v_2 - \Delta v_2 & = \mathbb{1}_\omega g, \end{cases} \quad (6.56)$$

is not approximately controllable.

The same negative properties also hold for the associated hyperbolic system.

Corollary 6.17 (No hyperbolic unique continuation). *For γ and a as in Theorem 6.13 and $\omega \cap \text{supp}(a) = \emptyset$, there exists $U \in \mathcal{C}^\infty(\mathbb{R}_*^+; \mathcal{C}^{r+2}(\mathbb{T}))$ such that*

$$\begin{cases} \partial_{tt}U + A^*U = 0 & \forall t > 0 \\ B_\omega^*U(t) = 0 & \forall t > 0 \\ U(t) \neq 0 & \forall t > 0. \end{cases} \quad (6.57)$$

Proof. Taking (λ, W) the eigenvalue and associated eigenfunction given by Theorem 6.13, we see that $U(t) = e^{i\lambda t}W$ satisfies (6.57), and the corollary is proved. \square

Corollary 6.18 (No hyperbolic approximate controllability). *For γ and a as in Theorem 6.13 and $\omega \cap \text{supp}(a) = \emptyset$, the system $\partial_{tt}V + AV = B_\omega g$, i.e.*

$$\begin{cases} \partial_{tt}v_1 - \gamma\Delta v_1 + a(x)v_2 & = 0 \\ \partial_{tt}v_2 - \Delta v_2 & = \mathbb{1}_\omega g, \end{cases} \quad (6.58)$$

is not approximately controllable.

Troisième partie

Contrôle uniforme d'un problème non-linéaire en limite singulière

Chapitre 7

Contrôlabilité uniforme de lois de conservation scalaires dans la limite de viscosité évanescente

Contents

7.1	Introduction	255
7.1.1	Motivation and main results	255
7.1.2	Some remarks	259
7.1.3	Structure of the paper, idea of the proofs	260
7.2	Three intermediate propositions	261
7.2.1	Approximate controllability using a traveling wave	261
7.2.2	Approximate controllability using a rarefaction wave	267
7.2.3	Local exact controllability	272
7.3	Proofs of the three theorems	279
7.3.1	Proof of Theorems 7.1 and 7.2, the convex case	280
7.3.2	Proof of Theorem 7.3, the non-convex case	280
7.4	Appendix : parabolic regularity estimates	283
7.4.1	Parabolic regularity estimates for classical solutions	283
7.4.2	Well-posedness of an initial-boundary value problem with low regularity	283

Cette partie est la reprise de l'article [Léa10b], soumis pour publication.

7.1 Introduction

7.1.1 Motivation and main results

We are concerned with the controllability of the following nonlinear parabolic equation

$$u_t + [f(u)]_x - \varepsilon u_{xx} = 0 \quad \text{in } (0, T) \times (0, L), \quad (7.1)$$

where T is a positive time, L a positive length, and ε a positive viscosity coefficient. On both endpoints of the interval, we act on the system through the boundary conditions

$$u|_{x=0} = g_0(t) \quad \text{in } (0, T), \quad u|_{x=L} = g_L(t) \quad \text{in } (0, T). \quad (7.2)$$

The problem of exact controllability is the following : given an initial datum

$$u|_{t=0} = u_0 \quad \text{in } (0, L), \quad (7.3)$$

a time $T > 0$ and a prescribed state u_T , is it possible to find control functions $g_0 = g_0^\varepsilon$ and $g_L = g_L^\varepsilon$ so that the associated solution u of the system (7.1), (7.2), (7.3) is steered to u_T in time T ? The aim of this paper is to prove such a controllability result uniformly with respect to the viscosity coefficient ε in a sufficiently small range. That is to say, is it possible to find such control functions $g_0 = g_0^\varepsilon$, $g_L = g_L^\varepsilon$ which norms in a suitable Banach space remain bounded as $\varepsilon \rightarrow 0^+$? More precisely, we shall only consider the uniform controllability to constant targets $u_T = M \in \mathbb{R}$. The relevance of this assumption is discussed in Remark 7.5.

Uniform controllability problems for singular perturbations of partial differential equations have already been considered in several works, beginning with [Lio88b, Chapter 3]. In the context of transport/heat equation (i.e. $f(u) = Vu$ for some constant $V \in \mathbb{R}$) in vanishing viscosity limit, this study was initiated by Coron and Guerrero in [CG05b], where the authors make a conjecture on the minimal time needed to achieve uniform controllability. Then, the estimates on this minimal time are improved in [Gla10] with a complex analytic method. The result of [CG05b] was also generalized in several space dimensions and for non-constant transport speed in [GL07]. Such uniform control properties in singular limits are also addressed for vanishing dispersion in [GG08] and for vanishing dispersion and viscosity in [GG09]. All these articles deal with singular perturbations of linear transport equations.

Concerning nonlinear control problems in vanishing viscosity, the only result up to our knowledge has been stated by Glass and Guerrero [GG07] for the Burgers equation, i.e., in the case $f(u) = \frac{u^2}{2}$. Theorems 7.1, 7.2 and 7.3 generalize this for general flux functions.

Our first result is concerned with convex flux functions f .

Theorem 7.1. *Assume that the flux function satisfies $f \in W_{\text{loc}}^{2,\infty}(\mathbb{R})$, $f'' \geq 0$ a.e., and*

$$\liminf_{A \rightarrow +\infty} A^{-\gamma} f''(A) > 0 \quad ; \quad \limsup_{A \rightarrow +\infty} e^{-A^{2\gamma+1-\delta}} f''(A) < +\infty \text{ for some } \gamma > -\frac{1}{2}, \delta > 0 \quad (\text{A+})$$

$$\text{(resp. } \liminf_{A \rightarrow -\infty} |A|^{-\gamma} f''(A) > 0 \quad ; \quad \limsup_{A \rightarrow -\infty} e^{-|A|^{2\gamma+1-\delta}} f''(A) < +\infty \text{ for some } \gamma > -\frac{1}{2}, \delta > 0\text{).}$$

(A-)

Then, there exist $\alpha_0 \geq 1$ and a constant $C = C(\alpha_0) > 0$ such that for all M satisfying $f'(M) > 0$ (resp. $f'(M) < 0$), there exists $\varepsilon_0 > 0$ such that for any $u_0 \in L^\infty(0, L)$, any time $T > \alpha_0 \frac{L}{|f'(M)|}$ and any $\varepsilon \in (0, \varepsilon_0)$, there exist two control functions g_0^ε and g_L^ε satisfying

$$\|g_0^\varepsilon\|_{L^\infty(0,T)} + \|g_L^\varepsilon\|_{L^\infty(0,T)} \leq C (\|u_0\|_{L^\infty(0,L)} + |M|),$$

such that the solution of (7.1), (7.2) and (7.3) associated to g_0^ε and g_L^ε satisfies $u|_{t=T} = M$ on $(0, L)$.

This theorem is the direct generalization of [GG07, Theorem 1.1]. Note that we shall see that one can take $\alpha_0 = 6$, or, as found numerically $\alpha_0 = 5.3$. Even in the case of a Burgers equation, this improves the minimal control time found in [GG07] (which is $\alpha_0 = 9$, or, as found numerically $\alpha_0 = 6.3$). Having a minimal controllability time is natural here since the inviscid system (for $\varepsilon = 0$) has a finite propagation speed (see also Remark 7.4 below).

In this theorem, the second part of Assumptions (A+) and (A-) is due to a technical argument, and does not seem to be necessary (see also Remarks 7.11 and 7.20 below). Under more natural (and weaker) assumptions, we prove the following (weaker) result for convex flux functions.

Theorem 7.2. *Assume that the flux function satisfies $f \in W_{\text{loc}}^{2,\infty}(\mathbb{R})$, $f'' \geq 0$ a.e. and $f'(u) \rightarrow +\infty$ as $u \rightarrow +\infty$ (resp. $f'(u) \rightarrow -\infty$ as $u \rightarrow -\infty$). Then, there exists $\alpha_0 \geq 1$ and a constant $C = C(\alpha_0) > 0$ such that for all $R_0 > 0$ and all M satisfying $f'(M) > 0$ (resp. $f'(M) < 0$), there exists $\varepsilon_0 > 0$ such that for any $u_0 \in L^\infty(0, L)$ with $\|u_0\|_{L^\infty(0,L)} \leq R_0$, any time $T > \alpha_0 \frac{L}{|f'(M)|}$ and any $\varepsilon \in (0, \varepsilon_0)$, there exist two control functions g_0^ε and g_L^ε satisfying*

$$\|g_0^\varepsilon\|_{L^\infty(0,T)} + \|g_L^\varepsilon\|_{L^\infty(0,T)} \leq C (R_0 + |M|),$$

such that the solution of (7.1), (7.2) and (7.3) associated to g_0^ε and g_L^ε satisfies $u|_{t=T} = M$ on $(0, L)$.

The only difference with the result of Theorem 7.1 is that here, ε_0 also depends on the norm of the initial datum u_0 . The question whether the result of Theorem 7.1 still holds only with the assumptions of Theorem 7.2 remains open. In particular, Theorem 7.1 does not apply for flux functions satisfying $f(u) \sim_{u \rightarrow +\infty} u^\rho$ with $1 < \rho \leq \frac{3}{2}$, whereas Theorem 7.2 does.

We also prove a result for non-convex flux functions, that is, for general non linear transport equations. In this setting however, we do not estimate the time needed to control, and our result is less precise. Before stating it, let us define $\sigma(A, B)$ the shock speed between two constant states A and B , given by the Rankine-Hugoniot condition, i.e., the slope of the chord of f between A and B ,

$$\sigma(A, B) = \frac{f(B) - f(A)}{B - A} \text{ if } A \neq B, \quad \text{and} \quad \sigma(A, A) = f'(A). \tag{7.4}$$

On the interval $(P, N) \subset \mathbb{R}$, the strict Oleinik admissibility conditions for the flux function f read

$$\sigma(P, N) < \sigma(A, N), \quad \text{for all } A \in (P, N), \tag{SOC+}$$

meaning that, on the interval (P, N) , the graph of f is below the chord between P and N , or

$$\sigma(P, N) > \sigma(A, N), \quad \text{for all } A \in (P, N), \tag{SOC-}$$

meaning that, on the interval (P, N) , the graph of f is above the chord between P and N . Note that (SOC+) (resp. (SOC-)) is equivalent to having $\sigma(A, P) < \sigma(P, N)$ (resp. $\sigma(A, P) > \sigma(P, N)$) for all $A \in (P, N)$. Conditions (SOC+) or (SOC-) ensure the existence of an admissible shock wave between P and N (see [Daf00, Section 8.6]).

We can now state the result concerning non-convex flux functions.

Theorem 7.3. *Suppose that $f \in \mathcal{C}^2(\mathbb{R})$ and $u_0 \in L^\infty(0, L)$ satisfy the two following conditions :*

- (i) $(f'')^{-1}(\{0\}) \cap K$ has a finite number of connected components for any compact interval $K \subset \mathbb{R}$,
- (ii) There exists an open interval $I \subset \mathbb{R}$ such that $[\text{ess inf } u_0, \text{ess sup } u_0] \subset I$ and f satisfies (SOC+) or (SOC-) on I .

Then, for all M satisfying $f'(M) \neq 0$, there exist $C_0 > 0$, $T_0 > 0$ and $\varepsilon_0 > 0$ (only depending on I and M) such that for any time $T > T_0$ and any $\varepsilon \in (0, \varepsilon_0)$, there exist two control functions g_0^ε and g_L^ε satisfying

$$\|g_0^\varepsilon\|_{L^\infty(0, T)} + \|g_L^\varepsilon\|_{L^\infty(0, T)} \leq C_0,$$

such that the solution of (7.1), (7.2) and (7.3) associated to g_0^ε and g_L^ε satisfies $u|_{t=T} = M$ on $(0, L)$.

Note that Condition (i) actually means that f'' vanishes on a finite union of points and (closed) intervals on each bounded subset of \mathbb{R} . This is generally satisfied except for some pathological examples (for instance $f(u) = u^5 \cos(\frac{1}{u}) + u$ if $u \neq 0$, $f(0) = 0$ and the target is 0). More precisely, this condition is generically satisfied in $\mathcal{C}^3(\mathbb{R})$, since for any compact $K \subset \mathbb{R}$, the set

$$A = \{f \in \mathcal{C}^3(K; \mathbb{R}), (f''(x), f'''(x)) \neq (0, 0) \text{ for all } x \in K\}$$

is open and dense in $\mathcal{C}^3(K; \mathbb{R})$. However, note that this genericity property does not hold in the space $\mathcal{C}^2(\mathbb{R})$ (see [BG77]).

Condition (ii) concerning the initial datum means that there exists an admissible shock wave allowing to get rid of the initial condition, and is more restrictive. For instance, it is not satisfied if $f(u) = \cos(u)$ and $[\text{ess inf } u_0, \text{ess sup } u_0]$ contains $k\pi$ for some $k \in \mathbb{Z}$. Yet, it is satisfied in a large range of situations, including, for any $u_0 \in L^\infty(0, L)$, the case where f satisfies $\lim_{u \rightarrow +\infty} f'(u) = \pm\infty$.

Since we are interested in the properties of uniform controllability as $\varepsilon \rightarrow 0^+$, it seems natural to refer to the results that are known both for the viscous problem (for $\varepsilon > 0$, fixed) and for the inviscid problem ($\varepsilon = 0$).

First, the controllability of the viscous equation (7.1) for fixed $\varepsilon > 0$ has mainly been considered for the Burgers equation. Two different types of control results have been proved. The local exact controllability to trajectories for this equation has been established in [FI96]. In this work, the authors also prove that the local exact controllability does not hold as long as one controls in a sub-interval of $(0, L)$, which is equivalent to controlling at one endpoint. Concerning the global exact controllability for the viscous Burgers equation, it is proved in [GI07], that it does not hold even if the control is acting on both sides of the domain. However, in [Cor07b] the author proves a global controllability result from 0 to constant states. More precisely, he states that for $u_0 = 0$ and for any $T > 0$, one can drive the solution of (7.1), (7.2), (7.3) to any constant M provided that $|M|$ is sufficiently large with respect to T . This result is improved (as a Corollary of the uniform controllability result) in [GG07], allowing any $u_0 \in L^\infty(0, L)$ and giving a precise condition on the target M and the minimal control time. Finally, adding a third control globally distributed on $(0, L)$, and independent on x , the author of [Cha09a] establishes the global controllability of the viscous Burgers equation for any $T > 0$. Note that this last result is proved by using both controllability properties of the nonviscous equation and a local result.

Second, concerning the inviscid problem

$$u_t + [f(u)]_x = 0, \tag{7.5}$$

and in the context of entropy solutions, controllability questions have been addressed by Ancona and Marson for general strictly convex flux functions f in [AM98]. In this work the controllability problem is posed in the half real line with null initial condition and the set of attainable states is completely described. For the problem on a bounded interval and with a general initial datum, the controllability of the non-viscous Burgers equation ($f(u) = \frac{u^2}{2}$) was studied in [Hor98], where some conditions are given on the final state in order to ensure this property.

We recall that for conservation laws such as (7.5), classical solutions starting out from smooth initial data generally develop discontinuities in finite time. As a consequence, only weak solutions may exist for large times. In the context of weak solutions however, uniqueness is lost. To overcome the obstacle of nonuniqueness, restrictions need to be imposed to select the physically relevant weak solution. One criterium for such a selection is to require that the admissible solution satisfies an entropy condition, which reads as follows (see [Daf00, Chapter 6] for instance) : for any smooth convex function $\eta : \mathbb{R} \rightarrow \mathbb{R}$ and associated entropy flux $q(u) = \int^u \eta'(\omega) f'(\omega) d\omega$, the following holds in the sense of measures :

$$\eta(u)_t + q(u)_x \leq 0.$$

Another selection principle is to require that the admissible solution is the limit of a family of solutions of equations containing a diffusive term, such as the one considered here. One can prove (see [Kru70] or [Daf00, Chapter 6]) that both definitions coincide, so that entropy solutions are the ones which can be obtained by vanishing viscosity. One can summarize the situation by saying that the viscosity has disappeared from the equation, and is only effective for the selection of admissible discontinuities. The Cauchy problem, together with the convergence of vanishing viscosity approximations to the entropy solutions of a general scalar conservation law were studied in the seminal work of Kruzkov [Kru70].

It is therefore very natural, when considering control problems for conservation laws, to study the cost of the viscosity, that is, to determine if known controllability properties for the hyperbolic equation are still valid for the model with small viscosity, and how the size of the control evolves as the viscosity approaches 0.

Another important motivation for studying singular limit in control problems is the seek of controllability properties for the perturbed system itself. This is well-illustrated by the papers [Cor96], [CF96] and [Cha09b], where the authors investigate the Navier-Stokes system with Navier slip boundary conditions. They use a global controllability result for the inviscid equation (in this case, the Euler equation) to deduce global approximate controllability of the the Navier-Stokes system. Note that in [Cor96] and [Cha09b], global exact controllability is then deduced by a local controllability result obtained by a Carleman inequality. The strategy we use to prove Theorem 7.1

is very close to the one of these works. We here also provide a controllability result for Equation (7.1) for a fixed viscosity (see Proposition 7.7 below).

7.1.2 Some remarks

Here, we make some remarks concerning the set of uniformly attainable states, and state two propositions concerning the inviscid system ($\varepsilon = 0$) and the viscous system with $\varepsilon = 1$.

Remark 7.4. In general, entropy solutions of (7.5) cannot reach a state u_T (starting for instance from $u_0 = 0$), in a time less than $\frac{L}{\inf |f'(u_T)|}$. In particular, the states u_T satisfying $f'(u_T) = 0$ cannot be reached unless one has $u_0 = u_T$. This can be proved by considering generalized backward characteristics (see [AM98]). Hence the minimal control time $\alpha_0 \frac{L}{|f'(M)|}$ in Theorem 7.1 is not surprising. Note that even in the cases of linear transport equation at speed $M \in \mathbb{R}$ or Burgers equation, the uniform controllability results [CG05b], [Gla10], [GG09], [GL07] and [GG07] consider a time of control of the form $C \frac{L}{|M|}$, $C > 1$.

Remark 7.5. Here, we are looking for the set \mathcal{E}_T of states that are controllable uniformly in the asymptotics $\varepsilon \rightarrow 0^+$ at time $t = T$. This implies in particular that \mathcal{E}_T is contained in the reachable set \mathcal{E}_T^0 for the nonviscous equation (7.5) and in the reachable set $\mathcal{E}_T^\varepsilon$ for the viscous equation (7.1), for any $\varepsilon \in (0, \varepsilon_0) : \mathcal{E}_T \subset \bigcap_{0 < \varepsilon < \varepsilon_0} \mathcal{E}_T^\varepsilon \cap \mathcal{E}_T^0$. In general, this intersection seems difficult to describe since the solutions of (7.1) are very regular whereas the solutions of (7.5) can have discontinuities. We thus restrict ourselves to equilibrium points of the system, that are the most interesting states to control. Let $u_T(x)$ be a uniformly controllable stationary state as $\varepsilon \rightarrow 0^+$. It satisfies both

$$f(u_T)_x = 0, \quad \text{and} \quad f(u_T)_x - \varepsilon u_{T,xx} = 0, \quad \text{on } (0, L),$$

so that we have, for some constants c and d ,

$$u_T(x) = cx + d, \quad \text{and} \quad f'(cx + d)c = 0, \quad \text{on } (0, L).$$

As a consequence, either $c = 0$ and u_T is constant, or $c \neq 0$, $u_T(x) = cx + d$ and $f'(u_T) = 0$ on $(0, L)$. Referring to Remark 7.4, we see that states satisfying $f'(u_T) = 0$ are not attainable for the inviscid system (7.5), and necessarily $u_T = d$ is a constant. Finally, the set of uniformly attainable stationary states for (7.1) is exactly the set of constant states with non-zero speed.

In the vanishing viscosity limit $\varepsilon \rightarrow 0^+$, (the proof of) Theorem 7.3 gives a controllability result to constant states for entropy solutions of (7.5), which is new as well.

Proposition 7.6. *Suppose that $f \in \mathcal{C}^2(\mathbb{R})$ and $u_0 \in L^\infty(0, L)$ satisfy conditions (i) and (ii) of Theorem 7.3. Then, for all M satisfying $f'(M) \neq 0$, there exists $T_0 > 0$ and an entropy solution $u \in \mathcal{C}^0(\mathbb{R}_+; L^1_{\text{loc}}(\mathbb{R}))$ of*

$$u_t + [f(u)]_x = 0 \quad \text{in } \mathbb{R}_+ \times \mathbb{R},$$

such that

$$u|_{t=0} = u_0 \quad \text{and} \quad u|_{t=T} = M \quad \text{on } (0, L),$$

for any time $T > T_0$.

Even if this proposition can be viewed as a consequence of Theorem 7.3, it can also be proved directly constructing entropy solutions. Such a proof follows the construction of Section 7.3.2, using shock waves in place of traveling waves and rarefaction waves in place of viscous ones. This type of direct proof of Proposition 7.6 would already contain all the ideas and the difficulties of Theorem 7.3 since the vanishing viscosity problem is addressed separately in Section 7.2.

Note that this proposition can be seen as a boundary control result for conservation laws on the interval $(0, L)$. However, in this case, one has to take care of the sense we give to boundary conditions. Indeed, they must not be understood in the sense of Dirichlet, which is not the adapted notion for conservation laws, but rather in the sense of [BIRN79] or [AM98].

Note also that even in the case of a constant viscosity, the analogous of Theorem 7.3 provides a new global controllability result to constant states in large time for semilinear heat equations.

Proposition 7.7. *Suppose that $f \in \mathcal{C}^2(\mathbb{R})$ and $u_0 \in L^\infty(0, L)$ satisfy conditions (i) and (ii) of Theorem 7.3. Then, for all M satisfying $f'(M) \neq 0$, there exists $T_0 > 0$ such that for any time $T > T_0$, there exist two control functions $g_0, g_L \in L^\infty(0, T)$ such that the solution of*

$$\begin{cases} u_t - u_{xx} + [f(u)]_x = 0 & \text{in } (0, T) \times (0, L), \\ u|_{x=0} = g_0(t) \text{ and } u|_{x=L} = g_L(t) & \text{in } (0, T), \\ u|_{t=0} = u_0 & \text{in } (0, L), \end{cases}$$

satisfies $u|_{t=T} = M$ in $(0, L)$.

To prove this proposition, it suffices to follow the proof of Theorem 7.3 line by line and replace the argument “ ε small” by “ T large”. It works since all the constants we obtain in the approximate controllability arguments are of the form $e^{-K\frac{T}{\varepsilon}}$ (see also Remark 7.15 below).

7.1.3 Structure of the paper, idea of the proofs

The main idea for proving Theorems 7.1, 7.2 and 7.3 is to combine global approximate controllability results relying on the hyperbolic nature of the problem and local exact controllability relying on the parabolic perturbation term.

The proof of Theorems 7.1 and 7.2 follows the strategy of the article [GG07]. One of its main ingredients is the use of the return method of J.-M. Coron, which consists in finding a particular trajectory of the system which moves far away from the initial state to get back to the final state afterwards. This strategy to prove global controllability results is for instance very close to the one used in [Cor96], [CF96] and [Cha09b] for the Navier Stokes equations and [Cha09a] for the Burgers equation. In the situation of Theorems 7.1 and 7.2, we steer the system to a large constant state N (such that $f'(N)$ has the same sign as $f'(M)$), and then we get back to the constant target M . The first step (reaching N) can be done as fast as needed, taking N sufficiently large.

The main difference between our proof of Theorems 7.1, 7.2 and the one in [GG07] is concerned with the global approximate controllability results (see Sections 7.2.1 and 7.2.2). The proofs given in [GG07] for the Burgers equation rely on the Hopf formula, which gives an explicit expression of the solution of the viscous Burgers equation on the real line. Up to our knowledge, this formula does not exist for general flux functions, so we have to develop different arguments. We hence have to study the convergence rate of viscous shock waves (resp. viscous rarefaction waves) to non viscous ones as $\varepsilon \rightarrow 0^+$.

Then, the proof of Theorem 7.3 relies on an iterative version of proof of Theorem 7.2. In a first step, we use Assumption (ii) to get rid of the initial condition thanks to a viscous shock wave (see a definition in the next paragraph). After that, under Assumption (i), there is between the initial datum and the target a finite number of zones on which $f'' \geq 0$ or $f'' \leq 0$. In each of these intervals we can develop the same type of arguments as in the proof of Theorem 7.2. We also have to study how to pass from one zone to another. Note that in this proof, the difficulty does not come from the uniformity with respect to ε . The problem here is to handle the non monotonicity of the speeds (i.e. the non-convex flux function), and is hence of hyperbolic nature. The inviscid framework (for $\varepsilon = 0$) already contains the difficulties encountered here, and the proof still holds in this case (see Proposition 7.6 above)

The outline of the paper is the following : In Section 7.2, we prove three intermediate propositions needed for the proof of Theorems 7.1, 7.2 and 7.3. Sections 7.2.1 and 7.2.2 are concerned with two different global approximate controllability results. Then, Section 7.2.3 deals with the local exact controllability argument, that will be used systematically after the approximate controllability results of both Sections 7.2.1 and 7.2.2. In Section 7.3, we finally combine these arguments and conclude

the proofs of Theorems 7.1, 7.2 and 7.3. Note that the local exact controllability result is proved using a fixed point argument for which we need to have a small parameter (ε in the three theorems) or a large parameter (T in Proposition 7.7 or N in the first step of the proof of Theorem 7.1).

To conclude this section, let us introduce the traveling wave (or viscous shock wave) solutions of (7.1), and recall some of their basic properties (see [Daf00, Section 8.6]). In the following, we shall make an intensive use of these solutions. Searching a solution \check{u} of (7.1) on whole \mathbb{R} , under the form

$$\check{u}(t, x) = U\left(\frac{x - st}{\varepsilon}\right), \quad (t, x) \in \mathbb{R}_+ \times \mathbb{R},$$

that approximates as $\varepsilon \rightarrow 0^+$ a shock wave between N and P , leads to considering the ordinary differential equation

$$\dot{U} = f(U) - f(N) - s(U - N), \tag{7.6}$$

$$s = \sigma(P, N), \tag{7.7}$$

$$\lim_{\xi \rightarrow +\infty} U(\xi) = P, \quad \text{and} \quad \lim_{\xi \rightarrow -\infty} U(\xi) = N, \tag{7.8}$$

once having replaced \check{u} by U in (7.1) and integrated. Here \dot{U} denotes the derivative with respect to ξ , $U = U(\xi)$, $\xi \in \mathbb{R}$ is the wave profile and s the speed of the wave. This speed is exactly the speed of the associated shock wave and is prescribed by the Rankine-Hugoniot condition (7.7). Under the assumptions (SOC+) and $P < N$ (resp. (SOC-) and $P > N$), System (7.6)-(7.8) admits a solution (see [Daf00, Section 8.6]), that moreover has the following properties :

- U is decreasing (resp. increasing) from N to P , since the Rankine-Hugoniot condition (7.7) together with the fact that $P < U(\xi) < N$ (resp. $N < U(\xi) < P$) for all $\xi \in \mathbb{R}$ implies that the vector field in the right hand-side of (7.6) is always negative (resp. positive);
- $\lim_{\xi \rightarrow \pm\infty} \dot{U}(\xi) = 0$, as a consequence of (7.6)-(7.8);
- for any $\xi_0 \in \mathbb{R}$, $U_{\xi_0} = U(\cdot - \xi_0)$ is still a solution of (7.6)-(7.8) since (7.6) is autonomous;
- $U \in W^{3,\infty}(\mathbb{R})$ for $f \in W_{\text{loc}}^{2,\infty}(\mathbb{R})$ by a bootstrap argument in (7.6).

In the following, we shall say that a solution U of (7.6)-(7.8) is a traveling wave “from P to N ” if the vector field in the right hand side of (7.6) is oriented from P to N . If (SOC+) is satisfied between P and N , U is a traveling wave “from P to N ” if $P < N$ and $s > 0$ or if $P > N$ and $s < 0$. If (SOC-) is satisfied between P and N , U is a traveling wave “from P to N ” if $P < N$ and $s < 0$ or if $P > N$ and $s > 0$.

Remark 7.8. In the sequel, during proofs, C will denote a generic positive constant, whose value may change from line to line. Writing $C = C(p, \beta, \dots)$ means that this constant depends on the parameters p, β, \dots

7.2 Three intermediate propositions

7.2.1 Approximate controllability using a traveling wave

Here, we prove the approximate controllability to a large state N , using a traveling wave. Given $A, B \in \mathbb{R}$, let us recall that $\sigma(A, B)$ is defined in (7.4) and denotes the slope of the chord of f between A and B . It represents the speed of the potential shock wave between A and B , if it is admissible. Since $f \in W_{\text{loc}}^{2,\infty}(\mathbb{R})$, we have $\sigma \in W_{\text{loc}}^{1,\infty}(\mathbb{R}^2)$. On the interval $(P, N] \subset \mathbb{R}$, we shall use the following particular version of the Oleinik condition for the flux function f , which is a sufficient admissibility condition for a shock wave between P and N :

$$\sigma(P, N) < \sigma(A, N), \quad \text{for all } A \in (P, N]. \tag{POC}$$

This is the strict Oleinik condition (SOC+) with the additional assumption $\sigma(P, N) < f'(N)$. Note that (POC) implies in particular the existence of a traveling wave (with speed $\sigma(P, N)$) between P and N (which is equivalent to the usual non-strict Oleinik condition, see [Daf00, Section 8.6]). Under the additional assumption $f(N) > f(P)$, the speed of this traveling wave is positive. According to the convention described at the end of Section 7.1.3, it is a traveling wave from P to N .

Proposition 7.9. *Suppose that there exist constant states P and N , with $P < \text{ess inf } u_0 \leq \text{ess sup } u_0 < N$, such that (POC) holds on $(P, N]$, and $f(N) > f(P)$. Then, for all $\varepsilon > 0$, there exist control functions g_0 and g_L with*

$$\|g_0\|_{L^\infty(0,+\infty)} \leq \max(|N|, |P|) \quad \text{and} \quad \|g_L\|_{L^\infty(0,+\infty)} \leq \max(|N|, |P|), \quad (7.9)$$

such that the solution u of (7.1), (7.2), (7.3) satisfies, for any $\kappa > 0$, $\nu \in (0, 1)$ and $t^* > \frac{L+\kappa}{(1-\nu)s}$,

$$\|u(t^*, \cdot) - N\|_{H^1(0,L)} \leq C_\kappa \frac{t^{*2}}{\varepsilon^{\frac{5}{2}}}(N - P) \|f'\|_{L^\infty(P,N)}^{\frac{5}{2}} \\ (\|f'\|_{L^\infty(P,N)} + \|f''\|_{L^\infty(P,N)} \|f\|_{L^\infty(P,N)}) e^{-\frac{\nu}{\varepsilon} s(\sigma_m - s)t^*}, \quad (7.10)$$

where $s = \sigma(P, N)$, $\sigma_m = \min\{\sigma(A, N), A \in [\text{ess inf } u_0, N]\}$ and C_κ is independent from t^* , P , N , ε .

Note that $s > 0$ and $\sigma_m > s$ under Assumptions (POC) and $f(N) > f(P)$, so that u converges exponentially to N on the interval considered as $\varepsilon \rightarrow 0^+$ or $t^* \rightarrow +\infty$. In the case where f is convex, we have $\sigma_m = \sigma(\text{ess inf } u_0, N)$ since $\sigma(\cdot, N)$ is nondecreasing. If we replace (POC) by (SOC+) in the assumptions of Proposition 7.9, then $\sigma_m = \inf\{\sigma(A, N), A \in [\text{ess inf } u_0, N]\}$, and $\sigma_m = s$ can occur. Under the weaker assumption (SOC+), we thus no longer have systematically exponential decay.

Proof of Proposition 7.9 The solution u in Proposition 7.9 is obtained by taking the restriction to $(0, t^*) \times (0, L)$ of the solution defined on whole $\mathbb{R}_+ \times \mathbb{R}$ (still denoted u) of the following problem (see Figure 7.1)

$$\begin{cases} u_t + [f(u)]_x - \varepsilon u_{xx} = 0 & \text{in } \mathbb{R}_+ \times \mathbb{R}, \\ u|_{t=0} = \tilde{u}_0 & \text{in } \mathbb{R}, \end{cases} \quad (7.11)$$

with

$$\tilde{u}_0(x) = \begin{cases} N & \text{if } x \leq 0, \\ u_0 & \text{if } x \in (0, L), \\ \text{ess inf } u_0 & \text{if } x \geq L. \end{cases} \quad (7.12)$$

Then, the control functions g_0 and g_L are obtained by taking the trace of u along the lines $(0, t^*) \times \{0\}$ and $(0, t^*) \times \{L\}$. The estimates on the control cost (7.9) follow directly from the comparison principle [Daf00, Theorem 6.3.2], and hence, we only have to prove (7.10). We first prove the following lemma, that gives a L^∞ estimate of the convergence rate of traveling waves (viscous shock waves) to the associated non-viscous shock wave as $\varepsilon \rightarrow 0^+$. Then a comparison principle gives a L^∞ estimate of the convergence rate of u to N . This strategy is illustrated in Figure 7.1.

Lemma 7.10. *Suppose that there exist constant states P and N , with $P < \text{ess inf } u_0 \leq \text{ess sup } u_0 < N$, such that (POC) holds on $(P, N]$, and $f(N) > f(P)$. Then, for every $\varepsilon > 0$ and $\beta \in \mathbb{R}$, the solution u of (7.11), (7.12) satisfies*

$$\|N - u(t, \cdot)\|_{L^\infty(-\infty, \beta)} \leq (N - \text{ess inf } u_0) e^{-\frac{\beta}{\varepsilon}(\sigma_m - s)(t - \frac{\beta}{s})}, \quad \text{for } t > \frac{\beta}{s}, \quad (7.13)$$

where $s = \sigma(P, N)$ and $\sigma_m = \min\{\sigma(A, N), A \in [\text{ess inf } u_0, N]\}$.

Proof. We introduce the family of traveling waves from P to N , given by

$$\tilde{u}(t, x) = U\left(\frac{x - st}{\varepsilon}\right), \quad (t, x) \in \mathbb{R}_+ \times \mathbb{R}$$

whose existence is ensured by Assumption (POC) (see [Daf00, Section 8.6]). Here, $U = U(\xi)$, $\xi \in \mathbb{R}$ is the wave profile and $s = \sigma(P, N) > 0$ the speed of the wave. The ordinary differential equation (7.6) satisfied by U can be reformulated as

$$\frac{d}{d\xi}(U - N) = (-s + \sigma(U, N))(U - N),$$

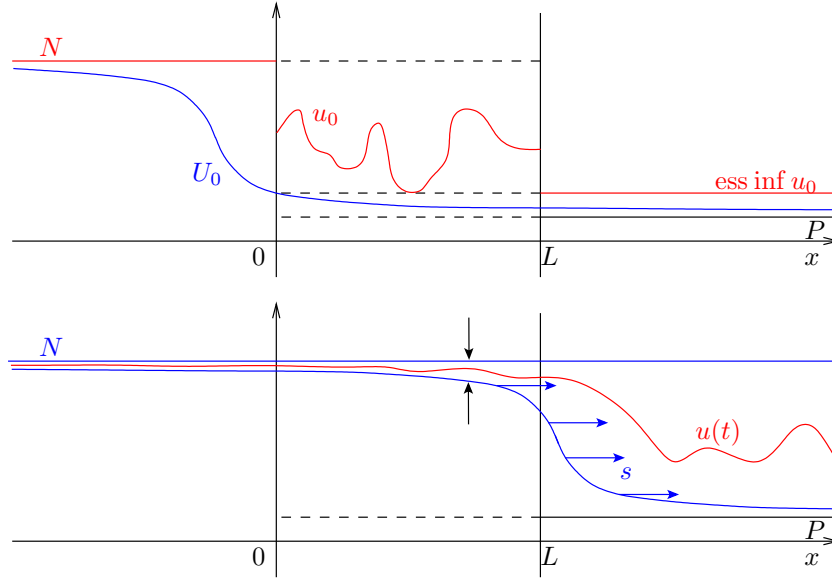

FIGURE 7.1 – Comparison principle during the traveling wave. Initial data, and solution after a time $t > \frac{L}{s}$ has gone by.

which yields, for any $\xi, \xi_0 \in \mathbb{R}$

$$(U(\xi) - N) = (U(\xi_0) - N) \exp \left(\int_{\xi_0}^{\xi} (-s + \sigma(U(\tau), N)) d\tau \right).$$

From now on, we select the traveling wave that satisfies

$$U_0(0) = \text{ess inf } u_0 > P,$$

(which is unique since it now solves a Cauchy problem) so that

$$0 < N - U_0(\xi) = (N - \text{ess inf } u_0) \exp \left(\int_0^{\xi} (-s + \sigma(U_0(\tau), N)) d\tau \right). \quad (7.14)$$

Note also that $U(\xi) \rightarrow P$ when $\xi \rightarrow +\infty$, and the solution U_0 can also be characterized by

$$\int_0^{+\infty} (-s + \sigma(U_0(\tau), N)) d\tau = \log \left(\frac{N - P}{N - \text{ess inf } u_0} \right).$$

For $\xi < 0$ and $\tau \in [\xi, 0]$, we have $U_0(\tau) \in [U_0(0), U_0(\xi)] \subset [U_0(0), N]$. On the compact interval $[U_0(0), N]$, the function $A \mapsto \sigma(A, N)$ is continuous and satisfies $\sigma(A, N) > s$, so that

$$-s + \sigma(U_0(\tau), N) \geq \sigma_m - s > 0, \quad \text{for all } \xi < 0, \tau \in [\xi, 0].$$

As a consequence,

$$\int_0^{\xi} -s + \sigma(U_0(\tau), N) d\tau \leq \xi(\sigma_m - s), \quad \text{for all } \xi < 0,$$

so that (7.14) now yields

$$0 < N - U_0(\xi) \leq (N - \text{ess inf } u_0) e^{\xi(\sigma_m - s)}, \quad \text{for all } \xi < 0.$$

Coming back to the variables t, x , we obtain for $x \in (-\infty, \beta)$

$$0 < N - U_0\left(\frac{x - st}{\varepsilon}\right) \leq (N - \text{ess inf } u_0)e^{\frac{1}{\varepsilon}(\sigma_m - s)(\beta - st)}, \quad \text{for } t > \frac{\beta}{s}, \quad (7.15)$$

since U_0 is decreasing. We conclude the proof by comparing the traveling wave U_0 and the solution u of (7.11), (7.12). From the choice of $U_0(0)$, we have at time $t = 0$,

$$U_0\left(\frac{x}{\varepsilon}\right) \leq \tilde{u}_0(x) \leq N, \quad \text{for all } x \in \mathbb{R}, \varepsilon > 0.$$

The comparison principle [Daf00, Theorem 6.3.2] then implies that for every $(t, x) \in \mathbb{R}_+ \times \mathbb{R}$,

$$U_0\left(\frac{x - st}{\varepsilon}\right) \leq u(t, x) \leq N,$$

so that estimate (7.15) now yields

$$\|N - u(t, \cdot)\|_{L^\infty(-\infty, \beta)} \leq (N - \text{ess inf } u_0)e^{-\frac{s}{\varepsilon}(\sigma_m - s)(t - \frac{\beta}{s})}, \quad \text{for } t > \frac{\beta}{s},$$

and the lemma is proved. □

Remark 7.11. If f is convex on (P, N) , the decay rate obtained does not seem to be optimal. In this case, under the assumptions of Lemma 7.10, one can prove that for any $\theta < 1$, there exists $\xi_0 = \xi_0(N) > 0$ and $C > 0$ such that

$$\|N - u(t, \cdot)\|_{L^\infty(-\infty, \beta)} \leq Ce^{-\frac{\theta}{\varepsilon}s(f'(N) - s)(t - \frac{\beta}{s})}, \quad \text{for } t > \frac{\beta + \xi_0\varepsilon}{s}.$$

The convergence rate that we can expect is thus in the convex case of the form $\theta s(f'(N) - s)$. This plays an important role when taking N large, as in the first part of the proof of Theorem 7.1 since $\theta s(f'(N) - s)$ is much larger than $s(\sigma_m - s)$. For the Burgers equation [GG07] for instance, $\theta s(f'(N) - s) \sim \theta N^2/4$ whereas $s(\sigma_m - s) \sim (\text{ess inf } u_0 - P)N$ as $N \rightarrow +\infty$. The problem for general convex functions f is to give the asymptotic behaviour of $\xi_0(N)$. If $\xi_0(N)/s \rightarrow 0$, then Assumption (A+) can be replaced by the more general (and somehow more natural) assumption :

$$\liminf_{A \rightarrow +\infty} A^{-\gamma} f''(A) > 0 \quad ; \quad \limsup_{A \rightarrow +\infty} e^{-A^{2\gamma+2-\delta}} f''(A) < +\infty \text{ for some } \gamma > -1, \delta > 0.$$

Such a condition would include in particular flux functions satisfying $f(u) \sim_{u \rightarrow +\infty} u^\rho$ with $1 < \rho \leq \frac{3}{2}$, for which Assumption (A+) does not hold.

We can now conclude the proof of Proposition 7.9 by a bootstrap argument.

Back to proof of Proposition 7.9. We study the evolution of (7.11), (7.12) for $t \in (0, t^*)$, where t^* is the time at which we want to obtain Estimate (7.10). First, we set

$$v(t, x) = (u - N)(t, x + f'(N)t),$$

so that, for any $\beta \in \mathbb{R}$,

$$\|v(t, \cdot)\|_{L^\infty(-\infty, \beta)} = \|u(t, \cdot) - N\|_{L^\infty(-\infty, \beta + f'(N)t)}.$$

Estimate (7.13) of Lemma 7.10 gives,

$$\|v(t, \cdot)\|_{L^\infty(-\infty, \beta)} \leq (N - \text{ess inf } u_0) \exp\left(-\frac{s}{\varepsilon}(\sigma_m - s)\left(t - \frac{\beta + f'(N)t}{s}\right)\right), \quad (7.16)$$

for $t > \frac{\beta + f'(N)t}{s}$, i.e. $t < \frac{-\beta}{f'(N) - s}$. For some $\mu > 1$ that will be chosen later on, we fix $\beta^* = -(f'(N) - s)\mu t^* < 0$, so that estimate (7.16) holds for every $t \in (0, \mu t^*)$. Estimate (7.16) now becomes

$$\|v(t, \cdot)\|_{L^\infty(-\infty, \beta^*)} \leq (N - \text{ess inf } u_0) \exp\left(-\frac{1}{\varepsilon}(\sigma_m - s)(f'(N) - s)(\mu t^* - t)\right), \quad \text{for } t < \mu t^*. \quad (7.17)$$

We denote by $\Omega_1 = (a_1, b_1)$ a bounded open interval of $(-\infty, \beta^*)$ and $\chi_1 \in \mathcal{C}_c^\infty(\Omega_1)$ a cut-off function satisfying $\chi_1 = 1$ on some $\tilde{\Omega}_2$, with $\tilde{\Omega}_2 \subset \Omega_1$. The function $w_1(t, x) = \chi_1(x)v(t, x)$ satisfies

$$\begin{cases} w_{1,t} - \varepsilon w_{1,xx} = [f'(N) - f'(u)](w_{1,x} - \chi_1'v) - \varepsilon(\chi_1''v + 2\chi_1'v_x) & \text{in } (0, t^*) \times \Omega_1 \\ w_1 = 0 & \text{on } \partial\Omega_1 \\ w_1(0, x) = 0 & \text{in } \Omega_1 \end{cases}$$

The parabolic regularizing effect (see Lemma 7.25 for $m = 0$) gives for this system

$$\varepsilon \int_0^{t^*} \|w_1\|_{H_0^1(\Omega_1)}^2 dt \leq \frac{1}{\varepsilon} \int_0^{t^*} \|[f'(N) - f'(u)](w_{1,x} - \chi_1'v) - \varepsilon(\chi_1''v + 2\chi_1'v_x)\|_{H^{-1}(\Omega_1)}^2 dt. \quad (7.18)$$

Let us now estimate each of the terms on the right hand-side. Denoting by $C_{\Omega_1} = \frac{|\Omega_1|}{\pi}$ (the Poincaré's constant of Ω_1), and defining the H^{-1} norm on Ω_1 as in Section 7.4.1, we have for the first term

$$\begin{aligned} \int_0^{t^*} \|[f'(N) - f'(u)]w_{1,x}(t, \cdot)\|_{H^{-1}(\Omega_1)}^2 dt &\leq \int_0^{t^*} \|[f'(N) - f'(u)]\|_{H^1(\Omega_1)}^2 \|w_{1,x}(t, \cdot)\|_{H^{-1}(\Omega_1)}^2 dt \\ &\leq \int_0^{t^*} \left(C|\Omega_1\| \|f'\|_{L^\infty(P,N)}^2 + \|u_x f''(u)\|_{L^2(\Omega_1)}^2\right) \|w_1(t, \cdot)\|_{L^2(\Omega_1)}^2 dt \\ &\leq \int_0^{t^*} \left(C|\Omega_1\| \|f'\|_{L^\infty(P,N)}^2 + \|f''\|_{L^\infty(P,N)} \|u_x(t, \cdot + f'(N)t)\|_{L^2(\Omega_1)}^2\right) |\Omega_1| \|v\|_{L^\infty(\Omega_1)}^2 dt. \end{aligned} \quad (7.19)$$

It only remains to estimate $\|u_x(t, \cdot + f'(N)t)\|_{L^2(\Omega_1)}^2$. For this, we consider another bounded open set $\tilde{\Omega}_1$ such that $\Omega_1 = (a_1, b_1) \subset [a_1, b_1 + f'(N)t^*] \subset \tilde{\Omega}_1$. We take $\tilde{\chi}_1 \in \mathcal{C}_c^\infty(\tilde{\Omega}_1)$ such that $\tilde{\chi}_1 = 1$ on $[a_1, b_1 + f'(N)t^*]$ and set $y_1(t, x) = \tilde{\chi}_1(x)u(t, x)$. Since y_1 satisfies

$$y_{1,t} - \varepsilon y_{1,xx} = -\tilde{\chi}_1[f(u)]_x - \varepsilon(\tilde{\chi}_1''u + 2\tilde{\chi}_1'u_x),$$

the parabolic regularizing effect (see Lemma 7.25 for $m = 0$) gives

$$\varepsilon^2 \int_0^{t^*} \|y_1\|_{H_0^1(\tilde{\Omega}_1)}^2 dt \leq \varepsilon \|u_0\|_{L^2(\tilde{\Omega}_1)}^2 + C \int_0^{t^*} \|f(u)\|_{L^2(\tilde{\Omega}_1)}^2 dt + C|\tilde{\Omega}_1|^2 \varepsilon^2 \int_0^{t^*} \|u\|_{L^2(\tilde{\Omega}_1)}^2 dt,$$

and hence,

$$\int_0^{t^*} \|u_x(t, \cdot + f'(N)t)\|_{L^2(\Omega_1)}^2 dt \leq \frac{|\tilde{\Omega}_1|t^*}{\varepsilon^2} \left(\|f\|_{L^\infty(P,N)}^2 + \varepsilon \max(|P|^2, |N|^2)\right).$$

Coming back to (7.19) and using estimate (7.17) on v , this yields

$$\begin{aligned} \int_0^{t^*} \|[f'(N) - f'(u)]w_{1,x}(t, \cdot)\|_{H^{-1}(\Omega_1)}^2 dt &\leq C \left(|\Omega_1\| \|f'\|_{L^\infty(P,N)}^2 + \frac{|\tilde{\Omega}_1|}{\varepsilon^2} \|f''\|_{L^\infty(P,N)}^2 \|f\|_{L^\infty(P,N)}^2 \right) \\ &\quad \times |\Omega_1| t^* (N - P)^2 e^{-\frac{2}{\varepsilon}(\sigma_m - s)(f'(N) - s)(\mu - 1)t^*}, \end{aligned} \quad (7.20)$$

Concerning the other terms in (7.18), we simply have

$$\begin{aligned} & \int_0^{t^*} \|[f'(N) - f'(u)]\chi_1'v - \varepsilon(\chi_1''v + 2\chi_1'v_x)\|_{H^{-1}(\Omega_1)}^2 dt \\ & \leq C \int_0^{t^*} (\|f'\|_{L^\infty(P,N)}^2 |\Omega_1|^2 + |\Omega_1|^2 \varepsilon^2 + \varepsilon^2) \|v\|_{L^2(\Omega_1)}^2 dt \\ & \leq C \|f'\|_{L^\infty(P,N)}^2 |\Omega_1|^3 t^* (N - P)^2 e^{-\frac{2}{\varepsilon}(\sigma_m - s)(f'(N) - s)(\mu - 1)t^*}, \end{aligned} \quad (7.21)$$

after using estimate (7.17) on v .

Now, replacing (7.20) and (7.21) in (7.18), we obtain

$$\begin{aligned} \int_0^{t^*} \|w_1\|_{H_0^1(\Omega_1)}^2 dt & \leq C \frac{|\tilde{\Omega}_1|^3}{\varepsilon^4} \left(\|f'\|_{L^\infty(P,N)}^2 + \|f''\|_{L^\infty(P,N)}^2 \|f\|_{L^\infty(P,N)}^2 \right) \\ & \quad \times t^* (N - P)^2 e^{-\frac{2}{\varepsilon}(\sigma_m - s)(f'(N) - s)(\mu - 1)t^*}. \end{aligned} \quad (7.22)$$

We now take $\chi_2 \in \mathcal{C}_c^\infty(\Omega_2)$ and set $w_2(t, x) = \chi_2(x)w_1(t, x) = \chi_2(x)v(t, x)$, that satisfies

$$\begin{cases} w_{2,t} - \varepsilon w_{2,xx} = [f'(N) - f'(u)]\chi_2 w_{1,x} - \varepsilon(\chi_2''w_1 + 2\chi_2'w_{1,x}) & \text{in } (0, t^*) \times \Omega_1 \\ w_2 = 0 & \text{on } \partial\Omega_1 \\ w_2(0, x) = 0 & \text{in } \Omega_1 \end{cases}$$

The parabolic regularizing effect (see Lemma 7.25 for $m = 1$) gives for this system

$$\|w_2(t^*, \cdot)\|_{H_0^1(\Omega_1)}^2 \leq \frac{1}{\varepsilon} \int_0^{t^*} \|[f'(N) - f'(u)]\chi_2 w_{1,x} - \varepsilon(\chi_2''w_1 + 2\chi_2'w_{1,x})\|_{L^2(\Omega_1)}^2 dt,$$

which directly yields

$$\|w_2(t^*, \cdot)\|_{H_0^1(\Omega_1)}^2 \leq \frac{C}{\varepsilon} \|f'\|_{L^\infty(P,N)}^2 \int_0^{t^*} \|w_1\|_{H_0^1(\Omega_1)}^2 dt.$$

As a consequence of (7.22), we thus have, for $t^* > 0$,

$$\begin{aligned} \|w_2(t^*, \cdot)\|_{H^1(\Omega_2)} & \leq C \frac{|\tilde{\Omega}_1|^{\frac{3}{2}}}{\varepsilon^{\frac{5}{2}}} \sqrt{t^*} (N - P) \|f'\|_{L^\infty(P,N)} \\ & \quad \times (\|f'\|_{L^\infty(P,N)} + \|f''\|_{L^\infty(P,N)} \|f\|_{L^\infty(P,N)}) e^{-\frac{1}{\varepsilon}(\sigma_m - s)(f'(N) - s)(\mu - 1)t^*}. \end{aligned} \quad (7.23)$$

Note that we could have proved the same type of estimate for the H^2 norm, but not more since we only supposed $f \in W_{\text{loc}}^{2,\infty}$. However, if f is more regular, we can prove the estimate in higher regularity spaces.

Now, to come back to u , we choose the sets Ω_1, Ω_2 and the function χ_2 such that $\chi_2 = 1$ on $(-f'(N)t^*, \beta^* - \kappa) \subset \Omega_2 \subset \Omega_1 = (-f'(N)t^* - \kappa, \beta^*)$ for some constant $\kappa > 0$, and for $t^* > 0$ satisfying $\beta^* - \kappa > -f'(N)t^*$ (i.e., $[\mu s + (1 - \mu)f'(N)]t^* > \kappa$). Note that $|\Omega_1| = \beta^* + \kappa + f'(N)t^* = \kappa + [\mu s + (1 - \mu)f'(N)]t^*$ depends on t^* and on N . Estimate (7.23) now yields for all $\kappa > 0$ and $t^* > \frac{\kappa}{\mu s + (1 - \mu)f'(N)}$,

$$\|v(t^*, \cdot)\|_{H^1(-f'(N)t^*, \beta^* - \kappa)} \leq D e^{-\frac{1}{\varepsilon}(\sigma_m - s)(f'(N) - s)(\mu - 1)t^*},$$

with

$$D = C_\kappa \frac{t^{*2}}{\varepsilon^{\frac{5}{2}}} (N - P) \|f'\|_{L^\infty(P,N)}^{\frac{5}{2}} \left(\|f'\|_{L^\infty(P,N)} + \|f''\|_{L^\infty(P,N)} \|f\|_{L^\infty(P,N)} \right).$$

Recalling the expression of β^* and v , we obtain

$$\begin{aligned} \|u(t^*, \cdot) - N\|_{H^1(0, -\mu(f'(N)-s)t^* + f'(N)t^* - \kappa)} &\leq D e^{-\frac{1}{\varepsilon}(\sigma_m - s)(f'(N) - s)(\mu - 1)t^*} \\ \|u(t^*, \cdot) - N\|_{H^1(0, [(1-\mu)f'(N) + \mu s]t^* - \kappa)} &\leq D e^{-\frac{1}{\varepsilon}(\sigma_m - s)(f'(N) - s)(\mu - 1)t^*}. \end{aligned} \quad (7.24)$$

We now choose $\mu = 1 + \nu \frac{s}{f'(N) - s}$ with $\nu \in (0, 1)$, so that

$$\begin{cases} (\mu - 1) = \nu \frac{s}{f'(N) - s} > 0 \\ (1 - \mu)f'(N) + \mu s = (1 - \nu)s > 0. \end{cases}$$

Replacing this in (7.24) gives for any $\kappa > 0$, $\nu \in (0, 1)$ and $t^* > \frac{\kappa}{(1-\nu)s}$,

$$\|u(t^*, \cdot) - N\|_{H^1(0, (1-\nu)st^* - \kappa)} \leq D e^{-\frac{\nu}{\varepsilon}s(\sigma_m - s)t^*}.$$

Finally, on $(0, L)$, we obtain, for any $\kappa > 0$, $\nu \in (0, 1)$ and $t^* > \frac{L + \kappa}{(1-\nu)s}$,

$$\|u(t^*, \cdot) - N\|_{H^1(0, L)} \leq D e^{-\frac{\nu}{\varepsilon}s(\sigma_m - s)t^*},$$

and the proposition is proved. \square

7.2.2 Approximate controllability using a rarefaction wave

We here prove the approximate controllability from a large state N to the state M , thanks to a rarefaction wave.

Proposition 7.12. *Suppose that $f'' \geq 0$ on the interval (M, N) and $f'(M) > 0$. Then, for all $\varepsilon_0 > 0$, $\kappa > 0$, and $t^* > \frac{L + \kappa}{f'(M)}$, there exists a constant $\delta(t^*) = \delta(t^*, \kappa, \varepsilon_0, M, N) > 0$ such that for all $\varepsilon \in (0, \varepsilon_0)$, there exist control functions g_0 and g_L with*

$$\|g_0\|_{L^\infty(0, t^*)} \leq \max(|M|, |N|) \quad \text{and} \quad \|g_L\|_{L^\infty(0, t^*)} \leq \max(|M|, |N|), \quad (7.25)$$

such that the solution u of (7.1), (7.2) with initial condition $u|_{t=0} = N$ satisfies,

$$\|u(t^*, \cdot) - M\|_{H^1(0, L)} \leq \frac{\delta(t^*)}{\varepsilon^{\frac{3}{2}}} \exp\left(-\frac{1}{4\varepsilon t^*}(f'(M)t^* - L - \kappa)^2\right). \quad (7.26)$$

As for the proof of Proposition 7.12, the solution u is obtained by taking the restriction to $(0, t^*) \times (0, L)$ of the solution defined on whole $\mathbb{R}_+ \times \mathbb{R}$ (still denoted u) of the following problem (see Figure 7.2)

$$\begin{cases} u_t + [f(u)]_x - \varepsilon u_{xx} = 0 & \text{in } \mathbb{R}_+ \times \mathbb{R}, \\ u|_{t=0} = u_0 & \text{in } \mathbb{R}, \end{cases} \quad (7.27)$$

with

$$u_0(x) \begin{cases} = M & \text{if } x \leq -k, \\ = N & \text{if } x \geq 0, \\ \in \mathcal{C}^\infty([-k, 0]), & \text{increasing,} \end{cases} \quad (7.28)$$

for some (small) $k > 0$.

Then, the control functions g_0 and g_L are obtained by taking the traces of u along the lines $(0, t^*) \times \{0\}$ and $(0, t^*) \times \{L\}$. As in Section 7.2.1, (7.25) follows directly from the comparison principle [Daf00, Theorem 6.3.2], and we hence only have to prove (7.26).

To that purpose, we first prove the following lemma, that gives a L^2 estimate of the convergence rate of a viscous rarefaction wave to the associated non-viscous one. Its proof is inspired by [Dan97, Theorem 1.1.], where the author proves dissipation results for the Navier-Stokes equations and associated vortex patches in the vanishing viscosity limit.

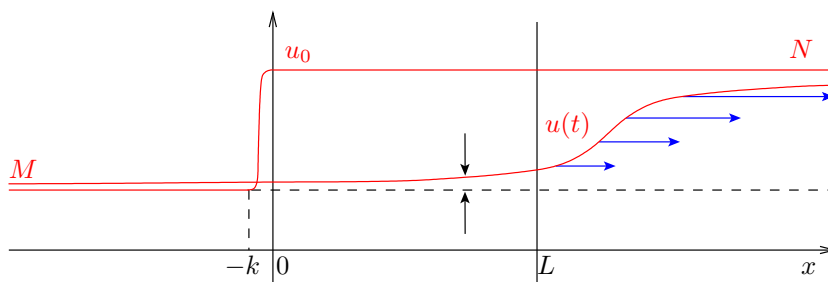

FIGURE 7.2 – Rarefaction wave.

Initial data, and solution after a time $t > \frac{L}{f'(M)}$ has gone by.

Lemma 7.13. *Let u be the solution of the problem (7.27), (7.28). Then for all $\varepsilon_0 > 0$, $k > 0$, and $t^* \geq 0$, there exists $\gamma(t^*) = \gamma(t^*, k, \varepsilon_0, M, N) > 0$ (nondecreasing with respect to t^*) such that for any $\varepsilon \in (0, \varepsilon_0)$ and $\eta > 0$,*

$$\|u(t^*, \cdot) - M\|_{L^2(-\infty, -\eta - k + f'(M)t^*)} + \|u(t^*, \cdot) - N\|_{L^2(\eta + f'(N)t^*, +\infty)} \leq \gamma(t^*) e^{-\frac{\eta^2}{4\varepsilon t^*}}. \quad (7.29)$$

Note that the function $\gamma(t^*)$ is relatively explicit, i.e.,

$$\gamma(t^*) = \|X\|_{L^2(0, t^*; L^2(\mathbb{R}))} e^{\frac{t^*}{2} (\|f''\|_{L^\infty(M, N)} \|u_{0,x}\|_{L^\infty(\mathbb{R})} + 1)},$$

where the function X can be estimated uniformly with respect to ε , as in (7.31).

Proof. We first consider a function $w \in \mathcal{C}^\infty(\mathbb{R}_+ \times \mathbb{R})$ satisfying

$$\begin{cases} w(t, x) = M & \text{if } x \leq -k + f'(M)t, \quad t \geq 0 \\ w(t, x) = N & \text{if } x \geq f'(N)t, \quad t \geq 0 \\ w(t, \cdot) & \text{is increasing on } [-k + f'(M)t, f'(N)t], \quad t \geq 0, \\ w|_{t=0} = u_0 & \text{in } \mathbb{R}. \end{cases}$$

We shall make estimates on $v := u - w$, that satisfies the problem

$$\begin{cases} v_t + f'(u)v_x - \varepsilon v_{xx} = -w_t - f'(u)w_x + \varepsilon w_{xx} & \text{in } \mathbb{R}_+ \times \mathbb{R}, \\ v|_{t=0} = 0 & \text{in } \mathbb{R}, \end{cases} \quad (7.30)$$

We set

$$X(t, x) := -w_t - f'(u)w_x + \varepsilon w_{xx},$$

and notice that for all $t \geq 0$, X has a compact support with respect to x , included in $[-k + f'(M)t, f'(N)t]$. Hence, for $t \geq 0$, $X(t, \cdot) \in L^2(\mathbb{R})$ and we have the estimate

$$\|X(t, \cdot)\|_{L^2} \leq \|w_t(t, \cdot)\|_{L^2} + f'(N)\|w_x(t, \cdot)\|_{L^2} + \varepsilon_0\|w_{xx}(t, \cdot)\|_{L^2}. \quad (7.31)$$

Moreover, the right hand-side of (7.31) is continuous with respect to t , so that $X \in L^2_{\text{loc}}(\mathbb{R}_+; L^2(\mathbb{R}))$, uniformly with ε .

We define ψ the flow associated with the vector field $f'(u)$, i.e., the solution of

$$\psi(t, x) = x + \int_0^t f'(u)(s, \psi(s, x)) ds, \quad (7.32)$$

and ψ^{-1} the associated backward flow. Following [Dan97], we set, for $\alpha \in \mathbb{R}$,

$$\Phi(t, x) = \exp(\alpha g(\psi^{-1}(t, x))), \quad (7.33)$$

so that the function Φ is constant along flow lines, that is $\frac{d}{dt}(\Phi(t, \psi(t, x))) = 0$. Here, the function $g \in W_{\text{loc}}^{1,\infty}(\mathbb{R})$ and the constant $\alpha = \alpha(t^*)$ will be chosen later on. We suppose moreover that g is equal to a constant R outside a compact set (see the definition in (7.36)). In particular, this yields $\Phi \in \mathcal{C}^0(\mathbb{R}_+; W^{1,\infty}(\mathbb{R}))$ and $\Phi v \in \mathcal{C}^0(\mathbb{R}_+; H^1(\mathbb{R}))$ since $v \in \mathcal{C}^0(\mathbb{R}_+; H^1(\mathbb{R}))$ from (7.30). As a consequence of (7.30), Φv satisfies the following equation

$$(\Phi v)_t + f'(u)(\Phi v)_x - \varepsilon(\Phi v)_{xx} = v(\Phi_t + f'(u)\Phi_x) - \varepsilon v\Phi_{xx} - 2\varepsilon v_x\Phi_x + X.$$

Since Φ is constant along flow lines, the first term on the right hand-side vanishes. Next, taking the inner product of this equation with Φv yields

$$\frac{1}{2} \frac{d}{dt} \|\Phi v\|_{L^2}^2 + \int_{\mathbb{R}} f'(u)(\Phi v)_x \Phi v + \varepsilon \|(\Phi v)_x\|_{L^2}^2 = -\varepsilon \int_{\mathbb{R}} v^2 \Phi_{xx} \Phi - 2\varepsilon \int_{\mathbb{R}} v_x \Phi_x \Phi v + \int_{\mathbb{R}} X \Phi v. \quad (7.34)$$

In this expression, we have, after integrations by parts,

$$\int_{\mathbb{R}} f'(u)(\Phi v)_x \Phi v = -\frac{1}{2} \int_{\mathbb{R}} (f'(u))_x (\Phi v)^2,$$

and

$$-\varepsilon \int_{\mathbb{R}} v^2 \Phi_{xx} \Phi - 2\varepsilon \int_{\mathbb{R}} v_x \Phi_x \Phi v = 2\varepsilon \int_{\mathbb{R}} v_x \Phi_x \Phi v + \varepsilon \int_{\mathbb{R}} (v\Phi_x)^2 - 2\varepsilon \int_{\mathbb{R}} v_x \Phi_x \Phi v = \varepsilon \int_{\mathbb{R}} (v\Phi_x)^2.$$

Now, Equation (7.34) yields

$$\frac{1}{2} \frac{d}{dt} \|\Phi v\|_{L^2}^2 \leq \frac{1}{2} \int_{\mathbb{R}} (f'(u))_x (\Phi v)^2 + \varepsilon \|v\Phi_x\|_{L^2}^2 + \int_{\mathbb{R}} X \Phi v. \quad (7.35)$$

We choose the function g in (7.33) as

$$g(x) = \min\{R, d(x, [-k, 0])\} \in W^{1,\infty}(\mathbb{R}) \quad (7.36)$$

for some constant $R > 0$. Notice that we have $\|g'\|_{L^\infty(\mathbb{R})} = 1$. Then, $\Phi_x = \alpha(\psi^{-1})_x g' \circ \psi^{-1} \Phi$ can be estimated thanks to the following lemma.

Lemma 7.14. *Let u be the solution of (7.27), (7.28) and ψ^{-1} the backward flow associated with the vector field $f'(u)$. Then we have, for any $t \geq 0$ and $\varepsilon > 0$,*

$$0 \leq u_x(t, x) \leq \|u_{0,x}\|_{L^\infty(\mathbb{R})} \quad (7.37)$$

and

$$\|(\psi^{-1})_x(t, \cdot)\|_{L^\infty(\mathbb{R})} \leq 1. \quad (7.38)$$

Note that the estimates (7.37) and (7.38) are consequences of the fact that the solution of (7.27), (7.28) is a rarefaction wave. The proof of this lemma is postponed to the end of this proof.

As a consequence of Lemma 7.14, we now have

$$\|(f'(u))_x\|_{L^\infty(\mathbb{R})} \leq \|f''\|_{L^\infty(M,N)} \|u_{0,x}\|_{L^\infty(\mathbb{R})}, \quad (7.39)$$

from (7.37) and

$$\|\alpha(\psi^{-1})_x g' \circ \psi^{-1}\|_{L^\infty(\mathbb{R}_+ \times \mathbb{R})} \leq \alpha \|(\psi^{-1})_x\|_{L^\infty} \|g'\|_{L^\infty} \leq \alpha, \quad (7.40)$$

from (7.38). Coming back to (7.35), estimates (7.39) and (7.40) yield

$$\frac{1}{2} \frac{d}{dt} \|\Phi v\|_{L_x^2}^2 \leq \frac{\|f''\|_{L^\infty(M,N)} \|u_{0,x}\|_{L^\infty(\mathbb{R})}}{2} \|\Phi v\|_{L_x^2}^2 + \varepsilon \alpha^2 \|\Phi v\|_{L_x^2}^2 + \frac{1}{2} \|X\|_{L_x^2}^2 + \frac{1}{2} \|\Phi v\|_{L_x^2}^2. \quad (7.41)$$

Now, using Gronwall's lemma in

$$\frac{d}{dt} \|\Phi v\|_{L_x^2}^2 \leq (2\varepsilon \alpha^2 + \|f''\|_{L^\infty(M,N)} \|u_{0,x}\|_{L^\infty(\mathbb{R})} + 1) \|\Phi v\|_{L_x^2}^2 + \|X\|_{L_x^2}^2$$

yields, for any $t^* > 0$,

$$\|\Phi v(t^*, \cdot)\|_{L^2}^2 \leq \|X\|_{L^2(0, t^*; L^2(\mathbb{R}))}^2 \exp \left[(2\varepsilon\alpha^2 + \|f''\|_{L^\infty(M, N)} \|u_{0, x}\|_{L^\infty(\mathbb{R})} + 1) t^* \right], \quad (7.42)$$

since $(\Phi v)|_{t=0} = 0$. We set $\gamma(t^*)^2 = \|X\|_{L^2(0, t^*; L^2(\mathbb{R}))}^2 e^{(\|f''\|_{L^\infty(M, N)} \|u_{0, x}\|_{L^\infty(\mathbb{R})} + 1)t^*}$ which does not depend on ε, α . It depends only on ε_0 and k through the initial condition u_0 and X .

Let us now take $\eta \in (0, R)$. If $x \in \psi(t^*, (-\infty, -k - \eta) \cup (\eta, +\infty))$, then $\psi^{-1}(t^*, x) \in (-\infty, -k - \eta) \cup (\eta, +\infty)$ and $g \circ \psi^{-1}(t^*, x) \geq \eta$. Thus, $\Phi(t^*, x) = e^{\alpha g \circ \psi^{-1}(t^*, x)} \geq e^{\alpha\eta}$ so that

$$\|\Phi v(t^*, \cdot)\|_{L^2(\mathbb{R})} \geq e^{\alpha\eta} \|v(t^*, \cdot)\|_{L^2(\psi(t^*, (-\infty, -k - \eta) \cup (\eta, +\infty)))}.$$

This, together with (7.42) gives

$$\begin{aligned} \|v(t^*, \cdot)\|_{L^2(\psi(t^*, (-\infty, -k - \eta) \cup (\eta, +\infty)))} &\leq \gamma(t^*) e^{\varepsilon\alpha^2 t^* - \alpha\eta}, \\ \|v(t^*, \cdot)\|_{L^2((-\infty, \psi(t^*, -k - \eta)) \cup (\psi(t^*, \eta), +\infty))} &\leq \gamma(t^*) e^{-\frac{\eta^2}{4\varepsilon t^*}}, \end{aligned} \quad (7.43)$$

after having chosen $\alpha = \frac{\eta}{2\varepsilon t^*}$. This inequality does not depend on R , so making $R \rightarrow +\infty$, we see that (7.43) holds for any $\eta > 0$.

It only remains to prove that $(-\infty, -k - \eta + f'(M)t^*) \cup (\eta + f'(N)t^*, +\infty) \subset (-\infty, \psi(t^*, -k - \eta)) \cup (\psi(t^*, \eta), +\infty)$. Actually, this is a direct consequence of

$$\begin{aligned} \psi(t^*, \eta) &= \eta + \int_0^{t^*} f'(u)(t, \psi(t, \eta)) dt \leq \eta + f'(N)t^*, \\ \psi(t^*, -k - \eta) &= -k - \eta + \int_0^{t^*} f'(u)(t, \psi(t, -k - \eta)) dt \geq -k - \eta + f'(M)t^*, \end{aligned}$$

where we have used the convexity of f and the comparison principle [Daf00, Theorem 6.3.2] for the solutions of viscous conservation laws. This concludes the proof of Lemma 7.13. \square

We now have to prove Lemma 7.14.

Proof of Lemma 7.14 Firstly, we check that for any $\varepsilon > 0$ and $t \geq 0$, the speed $f'(u)$ is nondecreasing, i.e., $(f'(u))_x \geq 0$. Since $f'' \geq 0$, we only have to prove that u_x is nonnegative. The function $y = u_x$ is solution of

$$\begin{cases} y_t - \varepsilon y_{xx} + f'(u)y_x + f''(u)y^2 = 0 & \text{in } \mathbb{R}_+ \times \mathbb{R}, \\ y|_{t=0} = u_x|_{t=0} \geq 0 & \text{in } \mathbb{R}, \end{cases} \quad (7.44)$$

As a consequence of the weak maximum principle for parabolic equations (see for instance [Eva98, p. 368]), we have $u_x(t, x) = y(t, x) \geq 0$ in $\mathbb{R}_+ \times \mathbb{R}$, and

$$(f'(u))_x(t, x) \geq 0, \quad (t, x) \in \mathbb{R}_+ \times \mathbb{R}. \quad (7.45)$$

Secondly, since $f'' \geq 0$, Equation (7.44) yields

$$\begin{cases} y_t - \varepsilon y_{xx} + f'(u)y_x \leq 0 & \text{in } \mathbb{R}_+ \times \mathbb{R}, \\ y|_{t=0} = u_x|_{t=0} \in L^\infty(\mathbb{R}). \end{cases}$$

For this system, the same maximum principle gives $u_x(t, x) = y(t, x) \leq \|y|_{t=0}\|_{L^\infty(\mathbb{R})} = \|u_x|_{t=0}\|_{L^\infty(\mathbb{R})}$. Hence, we have

$$0 \leq u_x(t, x) \leq \|u_x|_{t=0}\|_{L^\infty(\mathbb{R})}, \quad (t, x) \in \mathbb{R}_+ \times \mathbb{R},$$

and (7.37) is proved.

Finally, to prove (7.38), we recall that the backward flow ψ^{-1} is given by

$$\psi^{-1}(t, x) = x - \int_0^t f'(u)(s, \psi^{-1}(s, x)) ds, \quad (t, x) \in \mathbb{R}_+ \times \mathbb{R},$$

which yields, derivating with respect to x and t ,

$$\begin{cases} \frac{d}{dt}(\psi^{-1})_x(t, x) = -(\psi^{-1})_x(t, x) \cdot (f'(u))_x(t, \psi^{-1}(t, x)), & (t, x) \in \mathbb{R}_+ \times \mathbb{R}, \\ (\psi^{-1})_x(0, x) = 1. \end{cases}$$

This can be rewritten under the form $(\psi^{-1})_x(t, x) = \exp\left(-\int_0^t (f'(u))_x(s, \psi^{-1}(s, x)) ds\right)$, which, thanks to (7.45), yields

$$0 \leq (\psi^{-1})_x(t, x) \leq 1, \quad (t, x) \in \mathbb{R}_+ \times \mathbb{R},$$

and Lemma 7.14 is proved. \square

As a consequence of Lemma 7.13 and using a bootstrap argument, we are now able to prove the central result of this section.

Proof of Proposition 7.12 We study the evolution of (7.27), (7.28) for $t \in (0, t^*)$. First, we set

$$v(t, x) = (u - M)(t, x + f'(M)t),$$

for which estimate (7.29) of Lemma 7.13 yields, for any $\eta > 0$,

$$\|v(t, \cdot)\|_{L^2(-\infty, -k-\eta)} \leq \gamma(t)e^{-\frac{\eta^2}{4\varepsilon t}}, \quad t \geq 0. \quad (7.46)$$

As in the proof of Proposition 7.9, we denote by Ω_1 a bounded open interval of $(-\infty, -k - \eta)$ and $\chi_1 \in \mathcal{C}_c^\infty(\Omega_1)$ a cut-off function satisfying $\chi_1 = 1$ on $\overline{\Omega_2}$ with $\overline{\Omega_2} \subset \Omega_1$. The function $w_1(t, x) = \chi_1(x)v(t, x)$ satisfies

$$\begin{cases} w_{1,t} - \varepsilon w_{1,xx} = [f'(M) - f'(u)]\chi_1 v_x - \varepsilon(\chi_1'' v + 2\chi_1' v_x) & \text{in } (0, t^*) \times \Omega_1 \\ w_1 = 0 & \text{on } \partial\Omega_1 \\ w_1(0, x) = 0 & \text{in } \Omega_1 \end{cases}$$

The parabolic regularizing effect (see Lemma 7.25 for $m = 0$) gives for this system

$$\varepsilon \int_0^{t^*} \|w_1\|_{H_0^1(\Omega_1)}^2 dt \leq \frac{1}{\varepsilon} \int_0^{t^*} \|[f'(M) - f'(u)]\chi_1 v_x - \varepsilon(\chi_1'' v + 2\chi_1' v_x)\|_{H^{-1}(\Omega_1)}^2 dt. \quad (7.47)$$

Let us now estimate each of the terms on the right hand-side as in the proof of Proposition 7.9. Here however, we see that thanks to Lemma 7.14, it is not necessary to perform a preliminary H^1 estimate on u , as opposed to the proof of Proposition 7.9. The first term is

$$\|[f'(M) - f'(u)]\chi_1 v_x\|_{H^{-1}(\Omega_1)} \leq C (\|f'\|_{L^\infty(M, N)} + \|(f'(u))_x\|_{L^\infty(\Omega_1)}) \|v\|_{L^2(\Omega_1)}.$$

As a consequence of Lemma 7.14, we have $\|(f'(u))_x\|_{L^\infty(\mathbb{R})} \leq \|f''\|_{L^\infty(M, N)} \|u_{0,x}\|_{L^\infty(\mathbb{R})}$, so that

$$\|[f'(M) - f'(u)]\chi_1 v_x\|_{H^{-1}(\Omega_1)} \leq C \|v\|_{L^2(\Omega_1)}.$$

Concerning the other terms, we have

$$\varepsilon \|(\chi_1'' v + 2\chi_1' v_x)\|_{H^{-1}(\Omega_1)} \leq \varepsilon C (C_{\Omega_1} + 1) \|v\|_{L^2(\Omega_1)},$$

where the constants denoted by C do not depend on Ω_1 and $C_{\Omega_1} = \frac{|\Omega_1|}{\pi}$ as before. Coming back to (7.47) and using (7.46), we now have

$$\int_0^{t^*} \|w_1\|_{H_0^1(\Omega_1)}^2 dt \leq C \left(\frac{1}{\varepsilon^2} + |\Omega_1|^2\right) \int_0^{t^*} \|v\|_{L^2(\Omega_1)}^2 dt \leq C \left(\frac{1}{\varepsilon^2} + |\Omega_1|^2\right) t^* \gamma(t^*)^2 e^{-\frac{\eta^2}{2\varepsilon t^*}}, \quad (7.48)$$

from (7.46), since $\Omega_1 \subset (-\infty, -k - \eta)$ the functions $\gamma(t)$ and $e^{-\frac{\eta^2}{2\varepsilon t}}$ are non-decreasing with respect to t .

We now take $\chi_2 \in \mathcal{C}_c^\infty(\Omega_2)$ and set $w_2(t, x) = \chi_2(x)w_1(t, x) = \chi_2(x)v(t, x)$, that satisfies

$$\begin{cases} w_{2,t} - \varepsilon w_{2,xx} = [f'(M) - f'(u)]\chi_2 w_{1,x} - \varepsilon(\chi_2'' w_1 + 2\chi_2' w_{1,x}) & \text{in } (0, t^*) \times \Omega_1 \\ w_2 = 0 & \text{on } \partial\Omega_1 \\ w_2(0, x) = 0 & \text{in } \Omega_1 \end{cases}$$

The parabolic regularizing effect (see Lemma 7.25 for $m = 1$) directly yields

$$\|w_2(t^*, \cdot)\|_{H_0^1(\Omega_1)}^2 \leq \frac{C}{\varepsilon} \int_0^{t^*} \|w_{1,x}\|_{L^2(\Omega_1)}^2 + \varepsilon^2 \|w_1\|_{L^2(\Omega_1)}^2 dt \leq \frac{C}{\varepsilon} \int_0^{t^*} \|w_1\|_{H_0^1(\Omega_1)}^2 dt.$$

As a consequence of (7.48), we thus have

$$\|w_2(t^*, \cdot)\|_{H_0^1(\Omega_1)}^2 \leq \frac{C}{\varepsilon} \left(\frac{1}{\varepsilon^2} + |\Omega_1|^2 \right) t^* \gamma(t^*)^2 e^{-\frac{\eta^2}{2\varepsilon t^*}}. \tag{7.49}$$

Now, to come back to u , we choose the sets Ω_1, Ω_2 , and the function χ_2 such that $\chi_2 = 1$ on $(-f'(M)t^*, -\eta - 2k) \subset \Omega_2 \subset \Omega_1 = (-f'(M)t^* - k, -\eta - k) \subset (-\infty, -\eta - k)$. With this choice, we have $|\Omega_1| = f'(M)t^* - \eta$ and estimate (7.49) yields, for any $t^* > 0$ and $0 < \eta < f'(M)t^*$,

$$\|u(t^*, \cdot) - M\|_{H^1(0, -\eta - 2k + f'(M)t^*)} \leq \frac{C}{\sqrt{\varepsilon}} \left(\frac{1}{\varepsilon} + |f'(M)t^* - \eta| \right) \sqrt{t^*} \gamma(t^*) e^{-\frac{\eta^2}{4\varepsilon t^*}}.$$

It remains to choose η so that $-\eta - 2k + f'(M)t^* = L$, that is, $\eta = f'(M)t^* - L - 2k$, which is positive as soon as $t^* > \frac{L+2k}{f'(M)}$. Finally, we have for any $t^* > \frac{L+2k}{f'(M)}$,

$$\|u(t^*, \cdot) - M\|_{H^1(0, L)} \leq \frac{C}{\sqrt{\varepsilon}} \left(\frac{1}{\varepsilon} + (L + 2k) \right) \sqrt{t^*} \gamma(t^*) \exp\left(-\frac{1}{4\varepsilon t^*} (f'(M)t^* - L - 2k)^2\right),$$

and Proposition 7.12 is proved, setting $\kappa = 2k$ and $\delta(t^*) = C\sqrt{t^*} \gamma(t^*)$. □

Remark 7.15. This proposition and its proof need slight modifications when proving Proposition 7.7, since the right hand-side of (7.26) needs to be exponentially decreasing as $t^* \rightarrow +\infty$. For this, we first replace $\frac{1}{2}\|X\|_{L_x^2}^2 + \frac{1}{2}\|\Phi v\|_{L_x^2}^2$ in Estimate (7.41) by $\frac{1}{2\mu}\|X\|_{L_x^2}^2 + \frac{\mu}{2}\|\Phi v\|_{L_x^2}^2$ for all $\mu > 0$. Choosing u_0 such that $\|u_{0,x}\|_{L^\infty(\mathbb{R})} = \frac{C}{k}$, Estimate (7.26) for $\varepsilon = 1$ now reads, for all $k, \mu > 0$,

$$\|u(t^*, \cdot) - M\|_{H^1(0, L)} \leq C(L + 2k) \sqrt{\frac{t^*}{\mu}} \|X\|_{L^2(0, t^*; L^2(\mathbb{R}))} e^{\left(\frac{C}{2k}\|f''\|_{L^\infty(M, N)} + \frac{\mu}{2}\right)t^* - \frac{1}{4t^*}(f'(M)t^* - L - 2k)^2}.$$

Noting that $\|X\|_{L^2(0, t^*; L^2(\mathbb{R}))}$ increases at most linearly in t^* and fixing k large enough and μ small enough so that $\left(\frac{C}{2k}\|f''\|_{L^\infty(M, N)} + \frac{\mu}{2}\right) < \frac{f'(M)^2}{4}$, we obtain the sought exponential decay as $t^* \rightarrow +\infty$.

7.2.3 Local exact controllability

In this section, we perform the local controllability argument. We suppose that the initial condition u_0 is H^1 -exponentially close (in terms of ε) to the constant target, say N , and we want to reach it exactly. This will be done both after the “shock phase” and the rarefaction phase, i.e., for an initial datum that satisfies the estimate (7.10) or (7.26). More precisely, we prove the following proposition, where we assume that $f'(N) > 0$ for simplicity (the case $f'(N) < 0$ follows the same procedure).

Proposition 7.16. *Assume that $f'(N) > 0$, and that $u_0 \in H^1(0, L)$ satisfies*

$$\|u_0 - N\|_{H^1(0, L)} \leq e^{-\frac{\kappa_0}{\varepsilon}}$$

for some $K_0 > 0$. Then, there exist $\alpha_1 > 0$ and $\varepsilon_0 > 0$ such that for all $T \geq \alpha_1 \frac{L}{F'(N)}$ and $0 < \varepsilon < \varepsilon_0$, there exist two control functions g_0 and g_L , with

$$\|g_0\|_{L^\infty(0,T)} \leq 2|N| \quad \text{and} \quad \|g_L\|_{L^\infty(0,T)} \leq 2|N|,$$

such that the solution u of (7.1), (7.2) and (7.3) satisfies

$$u|_{t=T} = N \quad \text{in } (0, L).$$

The proof of Proposition 7.16 follows the steps of [GG07]. When doing this, we shall see that one can take $\alpha_1 = 5$ (or, as found numerically $\alpha_1 = 4.3$).

We first set $y(t, x) = u(t, x) - N$, so that y satisfies

$$\begin{cases} y_t + [f(N + y)]_x - \varepsilon y_{xx} = 0 & \text{in } (0, T) \times (0, L), \\ y|_{t=0} = y_0 = u_0 - N & \text{in } (0, L), \\ \|y_0\|_{H^1(0,L)} \leq e^{-\frac{K_0}{\varepsilon}}. \end{cases} \quad (7.50)$$

Now, our objective is to find boundary controls $y|_{x=0} = g_0(t) - N$ and $y|_{x=L} = g_L(t) - N$ such that $y|_{t=T} = 0$ and

$$\|g_0 - N\|_{L^\infty(0,T)} \leq |N| \quad \text{and} \quad \|g_L - N\|_{L^\infty(0,T)} \leq |N|.$$

More precisely, we prove the existence of a controlled solution y , satisfying (7.50) and $y|_{t=T} = 0$, and then take the traces of y on $(0, T) \times \{0\}$ and $(0, T) \times \{L\}$ to obtain the controls. The existence of such a controlled solution is proved by means of a fixed point argument. For this, let us first consider the following linearization of System (7.50), for some $z \in L^1(0, T; W^{1,\infty}(0, L)) \cap L^\infty((0, T) \times (0, L))$:

$$\begin{cases} y_t - \varepsilon y_{xx} + [\sigma(N + z(t, x), N)y]_x = 0 & \text{in } (0, T) \times (0, L), \\ y|_{x=0} = \tilde{g}_0, \quad y|_{x=L} = \tilde{g}_L & \text{in } (0, T), \\ y|_{t=0} = y_0 & \text{in } (0, L), \end{cases} \quad (7.51)$$

where we have denoted $\sigma(N + z, N) = \frac{f(N+z) - f(N)}{z}$, with $\sigma(N + \cdot, N) \in W_{\text{loc}}^{1,\infty}(\mathbb{R})$. Note that formally, a fixed point of a map $z \mapsto y$, where y is a solution of (7.51) associated to some controls \tilde{g}_0, \tilde{g}_L , is a solution of the problem (7.50). It will be convenient to extend this control problem to (a, b) for some $a < 0$ and $b > L$, and introduce \tilde{y}_0 and \tilde{z} smooth extensions of y_0 and z , satisfying

$$\begin{aligned} \tilde{y}_0 &= y_0 \text{ on } (0, L), \quad \tilde{y}_0(a) = \tilde{y}_0(b) = 0, \quad \text{and} \quad \|\tilde{y}_0\|_{H_0^1(a,b)} \leq C_E \|y_0\|_{H^1(0,L)}, \\ \tilde{z} &= z \text{ on } (0, T) \times (0, L), \quad \text{and} \quad \|\tilde{z}\|_{L^1 W^{1,\infty} \cap L^\infty L^\infty} \leq C_E \|z\|_{L^1 W^{1,\infty} \cap L^\infty L^\infty}. \end{aligned} \quad (7.52)$$

(see for instance [Eva98, Section 5.4]). We now consider the following extended linear system

$$\begin{cases} \tilde{y}_t - \varepsilon \tilde{y}_{xx} + [\sigma(N + \tilde{z}(t, x), N)\tilde{y}]_x = 0 & \text{in } (0, T) \times (a, b), \\ \tilde{y}|_{x=a} = \tilde{g}(t), \quad \tilde{y}|_{x=b} = 0 & \text{in } (0, T), \\ \tilde{y}|_{t=0} = \tilde{y}_0 & \text{in } (a, b). \end{cases} \quad (7.53)$$

To prove the null-controllability of this system, we shall prove an observability estimate for its adjoint. We set

$$\zeta(t, x) = \sigma(N + \tilde{z}(t, x), N) - f'(N)$$

and

$$\lambda = b - a > L. \quad (7.54)$$

We have the following controllability lemma.

Lemma 7.17. *There exist $\alpha_1 > 0$ and $\varepsilon_0 > 0$ such that for all $\zeta \in L^1(0, T; W^{1,\infty}(0, L)) \cap L^\infty((0, T) \times (0, L))$ satisfying*

$$\|\zeta_x\|_{L^1 L^\infty} + \|\zeta\|_{L^\infty L^\infty} \leq C_E e^{-\frac{K_0}{2\varepsilon}}, \quad (7.55)$$

(where K_0 is introduced in Proposition 7.16 and C_E is the norm of the extension operator introduced in (7.52)), for all $T \geq \alpha_1 \frac{\lambda}{f'(N)}$, all $\varepsilon \in (0, \varepsilon_0)$ and $\tilde{y}_0 \in H_0^1(a, b)$ satisfying $\|\tilde{y}_0\|_{H_0^1(a, b)} \leq C_E e^{-\frac{K_0}{\varepsilon}}$, there exists a control function $\tilde{g} \in L^2(0, T)$ with $\|\tilde{g}\|_{L^2(0, T)} \leq e^{-\frac{K_0}{\varepsilon}}$ such that the associated solution to (7.53) satisfies

$$\tilde{y}|_{t=T} = 0 \quad \text{on } (a, b).$$

Note that the constant α_1 here is the same as the one in Proposition 7.16. In the course of the proof, we shall see that one can take α_1 as claimed before.

Proof. For this linear control problem (7.53), we use the classical approach, consisting in obtaining a suitable observability inequality for the adjoint system of (7.53), which reads

$$\begin{cases} -\varphi_t - \varepsilon \varphi_{xx} - (f'(N) + \zeta(t, x))\varphi_x = 0 & \text{in } (0, T) \times (a, b) \\ \varphi|_{x=a} = 0, \quad \varphi|_{x=b} = 0 & \text{in } (0, T) \\ \varphi|_{t=T} = \varphi_T & \text{in } (a, b) \end{cases} \quad (7.56)$$

where $\varphi_T \in L^2(a, b)$ is the final condition of this backward problem. We aim to prove the following observability inequality for the solutions of (7.56) :

$$\|\varphi|_{t=0}\|_{L^2(a, b)} \leq K(T, \varepsilon) \|\varphi_x|_{x=a}\|_{L^2(0, T)}. \quad (7.57)$$

Then, classical duality arguments give the null-controllability of System (7.53) with a control function \tilde{g} whose L^2 norm is bounded by

$$\frac{K(T, \varepsilon)}{\varepsilon} \|\tilde{y}_0\|_{H_0^1(a, b)} \leq C_E \frac{K(T, \varepsilon)}{\varepsilon} e^{-\frac{K_0}{\varepsilon}}.$$

To prove (7.57), we mostly follow [GG07] and use two of their technical estimates. More precisely, once rescaled with respect to the parameters, the dissipation estimate and the Carleman estimate read as follows (λ is defined in (7.54)).

Dissipation result : for every $t \in \left(\frac{\lambda}{f'(N) - \|\zeta\|_{L^\infty L^\infty}}, T\right)$, we have

$$\|\varphi(0, \cdot)\|_{L^2(a, b)}^2 \leq \exp \left\{ \frac{\lambda^2 \|\zeta_x\|_{L^1 L^\infty}}{4} - \frac{((f'(N) - \|\zeta\|_{L^\infty L^\infty})t - \lambda)^2}{2\varepsilon t} e^{-4\lambda^2 \|\zeta_x\|_{L^1 L^\infty}} \right\} \|\varphi(t, \cdot)\|_{L^2(a, b)}^2. \quad (7.58)$$

Note that $f'(N) - \|\zeta\|_{L^\infty L^\infty} > 0$ for ε sufficiently small (or $f'(N)$ sufficiently large in the proof of Proposition 7.19 below).

Carleman inequality : Assume that ζ satisfies (7.55) and $T > \frac{3}{2} \frac{\lambda}{f'(N) - \|\zeta\|_{L^\infty L^\infty}}$. Then, we have

$$\int_a^b \int_{2T/3}^{5T/6} |\varphi|^2 dt dx \leq C e^{\frac{\kappa \lambda^2}{\varepsilon T}} \left(\int_0^T |\varphi_x(t, a)|^2 dt + \int_a^b |\varphi(0, x)|^2 dx \right). \quad (7.59)$$

These two estimates are proved in [GG07, Section 4], with $\kappa = 4$ or $\kappa = 2.61$ as found numerically.

To obtain the observability inequality (7.57), we suppose that $T > \frac{3}{2} \frac{\lambda}{f'(N) - \|\zeta\|_{L^\infty L^\infty}}$. As a consequence (7.58) holds on $(\frac{2T}{3}, \frac{5T}{6}) \subset \left(\frac{\lambda}{f'(N) - \|\zeta\|_{L^\infty L^\infty}}, T\right)$. Integrating (7.58) on $(\frac{2T}{3}, \frac{5T}{6})$, we hence obtain

$$\begin{aligned} \frac{T}{6} \|\varphi(0, \cdot)\|_{L^2(a, b)}^2 &\leq \exp \left\{ \frac{\lambda^2 \|\zeta_x\|_{L^1 L^\infty}}{4} \right\} \\ &\times \int_{2T/3}^{5T/6} \exp \left\{ -\frac{((f'(N) - \|\zeta\|_{L^\infty L^\infty})t - \lambda)^2}{2\varepsilon t} e^{-4\lambda^2 \|\zeta_x\|_{L^1 L^\infty}} \right\} \|\varphi(t, \cdot)\|_{L^2(a, b)}^2 dt. \end{aligned}$$

Using the fact that

$$t \mapsto \frac{((f'(N) - \|\zeta\|_{L^\infty L^\infty})t - \lambda)^2}{2\varepsilon t}$$

is an increasing function as soon as $t > \frac{\lambda}{f'(N) - \|\zeta\|_{L^\infty L^\infty}}$, together with (7.59), we have

$$\|\varphi(0, \cdot)\|_{L^2(a,b)}^2 \leq C e^{-\frac{D(\varepsilon, T, \lambda, \zeta)}{\varepsilon T}} \left(\int_0^T |\varphi_x(t, a)|^2 dt + \int_a^b |\varphi(0, x)|^2 dx \right), \tag{7.60}$$

with

$$D(\varepsilon, T, \lambda, \zeta) = \frac{3e^{-4\lambda^2 \|\zeta_x\|_{L^1 L^\infty}}}{4} \left((f'(N) - \|\zeta\|_{L^\infty L^\infty}) \frac{2T}{3} - \lambda \right)^2 - \kappa \lambda^2.$$

Now we see that for T sufficiently large, i.e. $T \geq \alpha_1 \frac{\lambda}{f'(N)}$, we have $D(\varepsilon, T, \lambda, \zeta) > 0$ and we can absorb the last term in (7.60) by the left hand-side, taking $\varepsilon_0 = \varepsilon_0(\alpha_1)$ sufficiently small so that it works with $T = \alpha_1 \frac{\lambda}{f'(N)}$. We also notice that we can take $\alpha_1 = 5$ if $\kappa = 4$ or $\alpha_1 = 4.30$ if $\kappa = 2.61$.

Finally, we obtain the observability inequality (7.57) with $K(T, \varepsilon) = C e^{-\frac{D(\varepsilon, T, \lambda, \zeta)}{\varepsilon T}}$. This concludes the proof of Lemma 7.17. \square

Now given this result for the linearized system, we are able to implement a fixed point strategy to conclude the proof of Proposition 7.16.

Proof of Proposition 7.16 We first recall Kakutani's fixed point Theorem as presented in [Sma74, Theorem 9.2.2].

Theorem 7.18. *Let \mathcal{Z} be a Banach space, E a subset of \mathcal{Z} and $\Lambda : E \rightarrow 2^{\mathcal{Z}}$ a multivalued mapping. Suppose that*

- (i) E is compact convex nonempty and for every $z \in E$, $\Lambda(z) \subset E$.
- (ii) For every $z \in E$, $\Lambda(z)$ is a compact convex nonempty subset of \mathcal{Z} .
- (iii) Λ is "upper semicontinuous", i.e. if $z_n \rightarrow z$ in E and $y_n \in \Lambda(z_n)$ satisfies $y_n \rightarrow y$ in \mathcal{Z} , then $y \in \Lambda(z)$.

Then Λ has a fixed point in E , i.e. there exists $z \in E$ such that $z \in \Lambda(z)$.

Let us now define the appropriate space \mathcal{Z} , subset E and mapping Λ . We choose

$$\mathcal{Z} = H^{\frac{3}{4}}(0, T; L^2(0, L)) \cap L^2(0, T; H^1(0, L)), \tag{7.61}$$

for the Banach space and

$$E^\varepsilon = \left\{ z \in H^1(0, T; L^2(0, L)) \cap L^2(0, T; H^2(0, L)), \|z\|_{H^1 L^2 \cap L^2 H^2} \leq e^{-\frac{\kappa_0}{2\varepsilon}} \right\} \subset \mathcal{Z}.$$

Given a fixed $y_0 \in H^1(0, L)$ such that $\|y_0\|_{H^1(0, L)} \leq e^{-\frac{\kappa_0}{\varepsilon}}$, we set

$$\Lambda(z) = \{y \in H^1(0, T; L^2(0, L)) \cap L^2(0, T; H^2(0, L)) \text{ satisfying conditions (7.62)-(7.65)}\}$$

with

$$y_t - \varepsilon y_{xx} = -[\sigma(N + z, N)y]_x \quad \text{in } (0, T) \times (0, L), \tag{7.62}$$

$$y|_{t=0} = y_0 \quad \text{in } (0, L), \tag{7.63}$$

$$y|_{t=T} = 0 \quad \text{in } (0, L), \tag{7.64}$$

$$\|y\|_{H^1 L^2 \cap L^2 H^2} \leq e^{-\frac{\kappa_0}{2\varepsilon}}, \tag{7.65}$$

and check that Kakutani's Theorem applies with \mathcal{Z} , E^ε and Λ for ε sufficiently small.

To prove (i), note that the compact injection of $H^1 L^2 \cap L^2 H^2$ in \mathcal{Z} gives the compactness of E^ε in \mathcal{Z} and the fact that it is a ball yields its convexity. Moreover E^ε is nonempty since it contains the null function, and $\Lambda(z) \subset E^\varepsilon$ if $z \in E^\varepsilon$, as a consequence of their definition.

To prove (ii), notice first that $\Lambda(z)$ is convex since the conditions (7.62)-(7.64) are linear and (7.65) is convex. To prove that it is closed (and hence compact), let us consider a sequence $(y_n)_{n \in \mathbb{N}} \subset \Lambda(z)$ converging to y in \mathcal{Z} . Since $\mathcal{Z} \subset \mathcal{C}^0([0, T]; L^2(0, L))$, conditions (7.63) and (7.64) are still valid for the limit y . Since the right hand-side of (7.65) does not depend on n , this estimate also holds for y . Moreover, y_n converges to y in $\mathcal{D}'((0, T) \times (0, L))$ and hence, the linear equation (7.62) is satisfied by y in $\mathcal{D}'((0, T) \times (0, L))$. As a consequence of (7.65), $y \in H^1 L^2 \cap L^2 H^2$, so that y satisfies (7.62) in $L^2 L^2$, and $\Lambda(z)$ is closed.

Let us now prove that $\Lambda(z)$ is non-empty if $z \in E^\varepsilon$. We denote by \tilde{z} and \tilde{y}_0 extensions of z and y_0 on (a, b) satisfying (7.52). Denoting \tilde{y} the associated solution of (7.53) (for any control \tilde{g}), we see that $\tilde{y}|_{(0, L)}$ solves (7.62)-(7.63). Moreover, we have $\|\tilde{y}_0\|_{H_0^1(a, b)} \leq C e^{-\frac{\kappa_0}{\varepsilon}}$ and

$$\|\tilde{z}\|_{L^1 W^{1, \infty}(a, b) \cap L^\infty L^\infty(a, b)} \leq C \|\tilde{z}\|_{L^1 W^{1, \infty}(0, L) \cap L^\infty L^\infty(0, L)} \leq C \|z\|_{H^1 L^2(0, L) \cap L^2 H^2(0, L)} \leq C e^{-\frac{\kappa_0}{2\varepsilon}}.$$

Hence, denoting by $\zeta(t, x) = \sigma(N + \tilde{z}, N) - f'(N)$, we have

$$\|\zeta\|_{L^\infty L^\infty} \leq \frac{\|f''\|_{L^\infty(K)}}{2} \|\tilde{z}\|_{L^\infty L^\infty} \leq C e^{-\frac{\kappa_0}{2\varepsilon}}, \quad (7.66)$$

for some compact $K \subset \mathbb{R}$ containing N , and

$$\|\zeta_x\|_{L^1 L^\infty} = \|[\sigma(N + \tilde{z}, N)]_x\|_{L^1 L^\infty} \leq \|f''\|_{L^\infty(K)} \|\tilde{z}_x\|_{L^1 L^\infty} \leq C e^{-\frac{\kappa_0}{2\varepsilon}}. \quad (7.67)$$

As a consequence of (7.66) and (7.67), Estimate (7.55) holds and Lemma 7.17 applies as soon as $T \geq \alpha_1 \frac{\lambda}{f'(N)}$ (that we shall suppose in the following). In particular, for $\varepsilon < \varepsilon_0$, there exists a control function \tilde{g} such that $\|\tilde{g}\|_{L^2(0, T)} \leq C e^{-\frac{\kappa_0}{\varepsilon}}$ and the associated solution of (7.53) satisfies $\tilde{y}|_{t=T} = 0$, and thus $\tilde{y}|_{(0, L)}$ fulfills (7.64). Moreover, \tilde{y} is defined as a transposition solution of (7.53) so that the regularity estimate (7.84) of Lemma 7.26 gives, for some $C > 0$ independent from ε ,

$$\|\tilde{y}\|_{L^2 L^2(a, b)} \leq \frac{C}{\sqrt{\varepsilon}} (\|\tilde{g}\|_{L^2(0, T)} + \|\tilde{y}_0\|_{L^2(a, b)}). \quad (7.68)$$

We now take open intervals Ω_1 and Ω_2 such that $[0, L] \subset \Omega_2 \subset \bar{\Omega}_2 \subset \Omega_1 \subset \bar{\Omega}_1 \subset (a, b)$ and a cut-off function $\chi_1 \in \mathcal{C}_c^\infty(\Omega_1)$ defined as before. The function $w_1 = \chi_1 \tilde{y}$ satisfies

$$\begin{cases} w_{1,t} - \varepsilon w_{1,xx} = -\chi_1 [\sigma(N + \tilde{z}, N) \tilde{y}]_x - 2\varepsilon \chi_1' \tilde{y}_x - \varepsilon \chi_1'' \tilde{y} & \text{in } (0, T) \times \Omega_1, \\ w_1 = 0, & \text{in } (0, T) \times \partial\Omega_1, \\ w_1|_{t=0} = \chi_1 \tilde{y}_0 & \in H_0^1(\Omega_1), \end{cases}$$

so that the parabolic regularity result of Lemma 7.25, taken for $m = 0$, gives

$$\|w_1\|_{L^2 H_0^1(\Omega_1)} \leq \frac{C}{\varepsilon} (\|\chi_1 \tilde{y}_0\|_{L^2(\Omega_1)} + \|\chi_1 [\sigma(N + \tilde{z}, N) \tilde{y}]_x + 2\varepsilon \chi_1' \tilde{y}_x + \varepsilon \chi_1'' \tilde{y}\|_{L^2 H^{-1}(\Omega_1)}).$$

The last two terms in the right hand-side can be estimated by $C \|\tilde{y}\|_{L^2 L^2(\Omega_1)}$, and we have

$$\|\chi_1 [\sigma(N + \tilde{z}, N) \tilde{y}]_x\|_{L^2 H^{-1}(\Omega_1)} \leq C \|\sigma(N + \tilde{z}, N) \tilde{y}\|_{L^2 L^2(\Omega_1)} \leq C \|\tilde{y}\|_{L^2 L^2(a, b)}$$

since $\sigma(N + \cdot, N) \in L^\infty$ and $\tilde{z} \in L^\infty L^\infty$. As a consequence of (7.68), we now obtain

$$\|w_1\|_{H^1 H^{-1}(\Omega_1) \cap L^2 H_0^1(\Omega_1) \cap L^\infty L^2(\Omega_1)} \leq \frac{C}{\varepsilon^{\frac{3}{2}}} (\|\tilde{g}\|_{L^2(0, T)} + \|\tilde{y}_0\|_{L^2(a, b)}). \quad (7.69)$$

Taking another cut-off function $\chi_2 \in \mathcal{C}_c^\infty(\Omega_2)$ as before, the function $w_2 = \chi_2 w_1 = \chi_2 \tilde{y}$ satisfies

$$\begin{cases} w_{2,t} - \varepsilon w_{2,xx} = -\chi_2 [\sigma(N + \tilde{z}, N) w_1]_x - 2\varepsilon \chi_2' w_{1,x} - \varepsilon \chi_2'' w_1 & \text{in } (0, T) \times \Omega_2, \\ w_2 = 0, & \text{in } (0, T) \times \partial\Omega_2, \\ w_2|_{t=0} = \chi_2 w_1 & \in H_0^1(\Omega_2), \end{cases}$$

so that the parabolic regularity result of Lemma 7.25, taken for $m = 1$, gives

$$\begin{aligned} \|w_2\|_{L^2(H^2 \cap H_0^1(\Omega_2)) \cap H^1 L^2(\Omega_2)} &\leq \frac{C}{\varepsilon} (\|\chi_2 w_1\|_{H_0^1(\Omega_2)} \\ &\quad + \|\chi_2 [\sigma(N + \tilde{z}, N) w_1]_x + 2\varepsilon \chi_2' w_{0,x} + \varepsilon \chi_2'' w_1\|_{L^2 L^2(\Omega_2)}). \end{aligned} \quad (7.70)$$

In this expression, we can estimate

$$\begin{aligned} \|\chi_2 [\sigma(N + \tilde{z}, N) w_1]_x\|_{L^2 L^2(\Omega_2)} &\leq \|\sigma(N + \tilde{z}, N) w_{0,x}\|_{L^2 L^2(\Omega_1)} + \|[\sigma(N + \tilde{z}, N)]_x w_1\|_{L^2 L^2(\Omega_1)} \\ &\leq \|\sigma(N + \tilde{z}, N)\|_{L^\infty L^\infty} \|w_1\|_{L^2 H_0^1(\Omega_1)} + \|\sigma(N + \tilde{z}, N)\|_{L^2 W^{1,\infty}} \|w_1\|_{L^\infty L^2(\Omega_1)} \end{aligned}$$

where all the terms in the right hand-side are finite, since $\sigma(N + \cdot, N) \in L^\infty$, $\tilde{z} \in L^\infty L^\infty \cap L^2 W^{1,\infty}$, and w_1 satisfies (7.69). Replacing this in (7.70) and using (7.69) yields

$$\|w_2\|_{L^2(H^2 \cap H_0^1(\Omega_2)) \cap H^1 L^2(\Omega_2)} \leq \frac{C}{\varepsilon^{\frac{5}{2}}} (\|\tilde{g}\|_{L^2(0,T)} + \|\tilde{y}_0\|_{L^2(a,b)}),$$

and thus

$$\|\tilde{y}|_{(0,L)}\|_{L^2 H^2(0,L) \cap H^1 L^2(0,L)} \leq \|w_2\|_{L^2(H^2 \cap H_0^1(\Omega_2)) \cap H^1 L^2(\Omega_2)} \leq \frac{C}{\varepsilon^{\frac{5}{2}}} \left(2e^{-\frac{\kappa_0}{\varepsilon}} + e^{-\frac{\kappa_0}{\varepsilon}}\right) \leq e^{-\frac{\kappa_0}{2\varepsilon}},$$

for $0 < \varepsilon < \varepsilon_0$. This implies that $\tilde{y}|_{(0,L)}$ satisfies (7.65) for $0 < \varepsilon < \varepsilon_0$ and hence all conditions (7.62)-(7.65), and $\Lambda(z)$ is nonempty.

To prove (iii), let us consider two sequences, $z_n \rightarrow z$ in E^ε for the topology of $H^1 L^2 \cap L^2 H^2$, and $y_n \in \Lambda(z_n)$ satisfying $y_n \rightarrow y$ in \mathcal{Z} , and check that $y \in \Lambda(z)$. The three assertions (7.63)-(7.65) still hold for y since (7.63)-(7.65) do not depend on z_n , and in particular $y \in H^1 L^2 \cap L^2 H^2$. Let us denote R_n the right hand-side of (7.62) for z_n and y_n , and R its counterpart for z and y . We have

$$R_n - R = [\sigma(N + z, N)]_x y + \sigma(N + z, N) y_x - [\sigma(N + z_n, N)]_x y_n - \sigma(N + z_n, N) y_{n,x}$$

and hence $\|R_n - R\|_{L^2 L^2} \leq A_n + B_n$, with

$$\begin{aligned} A_n &= \|[\sigma(N + z, N)]_x y - [\sigma(N + z, N)]_x y_n\|_{L^2 L^2} + \|[\sigma(N + z, N)]_x y_n - [\sigma(N + z_n, N)]_x y_n\|_{L^2 L^2} \\ &\leq \|[\sigma(N + z, N)]_x\|_{L^2 L^\infty} \|y - y_n\|_{L^\infty L^2} + \|[\sigma(N + z, N)]_x - [\sigma(N + z_n, N)]_x\|_{L^2 L^\infty} \|y_n\|_{L^\infty L^2}, \end{aligned}$$

and

$$\begin{aligned} B_n &= \|\sigma(N + z, N) y_x - \sigma(N + z, N) y_{n,x}\|_{L^2 L^2} + \|\sigma(N + z, N) y_{n,x} - \sigma(N + z_n, N) y_{n,x}\|_{L^2 L^2} \\ &\leq \|\sigma(N + z, N)\|_{L^\infty L^\infty} \|y_x - y_{n,x}\|_{L^2 L^2} + \|\sigma(N + z, N) - \sigma(N + z_n, N)\|_{L^\infty L^\infty} \|y_{n,x}\|_{L^2 L^2} \end{aligned}$$

Recalling that $z_n \rightarrow z$ in E^ε and $y_n \rightarrow y$ in \mathcal{Z} , we deduce $\lim_{n \rightarrow +\infty} A_n = 0$ since $y_n \rightarrow y$ in $H^{\frac{3}{4}} L^2 \subset L^\infty L^2$ and $\sigma(N + z_n, N) \rightarrow \sigma(N + z, N)$ in $L^2 W^{1,\infty}$. Moreover, $\lim_{n \rightarrow +\infty} B_n = 0$ since $y_n \rightarrow y$ in $L^2 H^1$ and $\sigma(N + z_n, N) \rightarrow \sigma(N + z, N)$ in $L^\infty L^\infty$. We can now write (7.62) for z_n and y_n as

$$y_{n,t} - \varepsilon y_{n,xx} = R_n \quad (7.71)$$

where the right hand-side R_n satisfies $R_n \rightarrow R$ in $L^2 L^2$. This, together with (7.65) implies that when $n \rightarrow +\infty$ we have,

$$y_t - \varepsilon y_{xx} = R \quad \text{in } L^2 L^2, \quad (7.72)$$

so that (7.62) holds for the limit y . Finally, $y \in \Lambda(z)$, and condition (iii) is fulfilled.

Consequently, Kakutani's Theorem applies and there exists $y \in \Lambda(y)$, that is to say, for y_0 satisfying $\|y_0\|_{H^1(0,L)} \leq e^{-\frac{\kappa_0}{\varepsilon}}$, we have found a function y satisfying

$$\begin{cases} y_t - \varepsilon y_{xx} + [\sigma(N + y, N)]_x y = 0 & \text{in } (0, T) \times (0, L), \\ y|_{t=0} = y_0 & \text{in } (0, L), \\ y|_{t=T} = 0 & \text{in } (0, L), \\ \|y\|_{H^1 L^2 \cap L^2 H^2} \leq e^{-\frac{\kappa_0}{2\varepsilon}}. \end{cases}$$

It suffices now to take the control functions

$$g_0(t) := y|_{x=0}(t) + N \quad \text{and} \quad g_L(t) := y|_{x=L}(t) + N.$$

With this choice, we have $g_0, g_L \in L^\infty(0, T)$ since $H^1 L^2 \cap L^2 H^2 \subset H^{\frac{3}{5}} H^{\frac{4}{5}}$ and

$$\max(\|g_0\|_{L^\infty(0, T)}, \|g_L\|_{L^\infty(0, T)}) \leq |N| + C e^{-\frac{K_0}{2\varepsilon}} \leq 2|N|$$

for $0 < \varepsilon < \varepsilon_0$. In addition, this proof works for any time of control $T \geq \alpha_1 \frac{\lambda}{F'(N)}$, for any $\lambda > L$ (but all the constants depend on λ). This yields the result for any $T \geq \alpha_1 \frac{L}{F'(N)}$, and concludes the proof of Proposition 7.16. \square

To conclude this section, we give a slight modification of Proposition 7.16, adapted to the first phase of the proof of Theorem 7.1, which consists in reaching exactly a large state N , without assuming ε small. To this aim, the strategy adopted here is the same as the one of Proposition 7.16 except that we take “ N large” instead of “ ε small” in the fixed point argument. To do so, we carefully keep track of the dependence with respect to the parameter N , as $N \rightarrow +\infty$.

Proposition 7.19. *Suppose that Assumption (A+) holds. Then, there exist $\alpha_1 > 0$ such that for all $\varepsilon_0 > 0$, there exist $N_0 > 0$ such that for all $\varepsilon \in (0, \varepsilon_0)$, $N > N_0$, $T \geq \alpha_1 \frac{L}{F'(N)}$, and $u_0 \in H^1(0, L)$ satisfying for some $P < N_0$*

$$\|u_0 - N\|_{H^1(0, L)} \leq C(N - P) \|f'\|_{L^\infty(P, N)}^{\frac{5}{2}} (\|f'\|_{L^\infty(P, N)} + \|f''\|_{L^\infty(P, N)} \|f\|_{L^\infty(P, N)}) e^{-K_0 s(\sigma_m - s)}, \quad (7.73)$$

with $s = \sigma(P, N)$, $\sigma_m = \sigma(E, N)$ and $P < E$, there exist two control functions g_0 and g_L such that the result of Proposition 7.16 holds.

To use this after Proposition 7.9, we take $E = \text{ess inf } u_0 > P$. We now sketch the proof of this proposition.

Proof. Here, we only replace the argument “ ε small” in the previous proof by “ N large”. This is possible since Assumption (A+) implies the existence of $Q \in \mathbb{R}$, $l_0, C > 0$, $\gamma > -\frac{1}{2}$ and $\delta > 0$ such that

$$f''(A) \geq l_0 A^\gamma \quad \text{and} \quad f''(A) \leq C e^{A^{2\gamma+1-\delta}}$$

for all $A > Q$. Since we have

$$f(N) = f(Q) + (N - Q)f'(Q) + \int_Q^N f''(\tau)(N - \tau)d\tau \geq \frac{l_0}{(\gamma + 1)(\gamma + 2)} N^{\gamma+2} + O(N),$$

we can estimate

$$\sigma_m - s \geq (E - P) \frac{f(N)}{N^2} + O\left(\frac{1}{N}\right) \geq (E - P) \frac{l_0}{(\gamma + 1)(\gamma + 2)} N^\gamma + O\left(\frac{1}{N}\right),$$

and

$$s \geq (E - P) \frac{f(N)}{2N} + O\left(\frac{1}{N}\right) \geq \frac{l_0}{2(\gamma + 1)(\gamma + 2)} N^{\gamma+1} + O(1),$$

so that

$$e^{-K_0 s(\sigma_m - s)} \leq C e^{-\frac{K_0 l_0^2 (E - P)}{2(\gamma + 1)^2 (\gamma + 2)^2} N^{2\gamma+1}}. \quad (7.74)$$

Since we supposed $\gamma > -\frac{1}{2}$, this expression is exponentially decaying as $N \rightarrow +\infty$. It suffices now to follow the proof of Proposition 7.16, replacing the exponential decay $\|u_0 - N\|_{H^1(0, L)} \leq e^{-\frac{K_0}{\varepsilon}}$ as $\varepsilon \rightarrow 0^+$, by the exponential decay

$$\begin{aligned} \|u_0 - N\|_{H^1(0, L)} &\leq C(N - P) \|f'\|_{L^\infty(P, N)}^{\frac{5}{2}} (\|f'\|_{L^\infty(P, N)} + \|f''\|_{L^\infty(P, N)} \|f\|_{L^\infty(P, N)}) e^{-K_0 s(\sigma_m - s)} \\ &\leq C e^{N^{2\gamma+1-\delta}} e^{-\frac{K_0 l_0^2 (E - P)}{2(\gamma + 1)^2 (\gamma + 2)^2} N^{2\gamma+1}} \leq e^{-K_1 N^{2\gamma+1}}, \end{aligned}$$

as $N \rightarrow +\infty$, for some $K_1 > 0$, as a consequence of Assumption (A+) and (7.74). We also have to use systematically $e^{-\frac{K_1}{2}N^{2\gamma+1}}$ in place of $e^{-\frac{K_0}{2\varepsilon}}$ and $N > N_0$ in place of $\varepsilon < \varepsilon_0$ in the proof Proposition 7.16. The analogous of Estimates (7.66) and (7.67) are performed using the fact that in these expressions, K is the ball centered on N of radius smaller than $e^{-K_1N^{2\gamma+1}}$. □

Remark 7.20. This is the only place where we use the unnatural assumption (A+). Any other condition on f allowing to perform the fixed point argument is sufficient for proving Theorem 7.1. Note that if we had proved a decay rate of the form $\theta s(f'(N) - s)$, Estimate (7.74) would be replaced by $e^{-K_0s(f'(N)-s)} \leq Ce^{-CN^{2\gamma+2}}$, which explains the more general condition written in Remark 7.11.

7.3 Proofs of the three theorems

With the use of Propositions 7.9, 7.12 and 7.16 (resp. 7.19), we are now able to prove Theorems 7.2, 7.3 (resp. 7.1). Before that, we combine the global approximate controllability results and the local one to provide two different global exact controllability results using a traveling wave (see Proposition 7.21 below) or a rarefaction wave (see Proposition 7.22 below). After that, we can conclude the proofs of the theorems.

Proposition 7.21. *Suppose that there exist constant states P and N , such that one of these conditions is satisfied :*

- (a) $P < \text{ess inf } u_0 \leq \text{ess sup } u_0 < N$, $f(N) > f(P)$, and (SOC+) holds on (P, N) ;
- (b) $N < \text{ess inf } u_0 \leq \text{ess sup } u_0 < P$, $f(N) > f(P)$, and (SOC+) holds on (N, P) ;
- (c) $P < \text{ess inf } u_0 \leq \text{ess sup } u_0 < N$, $f(N) < f(P)$, and (SOC-) holds on (P, N) ;
- (d) $N < \text{ess inf } u_0 \leq \text{ess sup } u_0 < P$, $f(N) < f(P)$, and (SOC-) holds on (N, P) .

Then, setting $s = \sigma(P, N)$, there exist $C > 0$ only depending on f and $\varepsilon_0 > 0$ such that for all $T > \alpha_1 \frac{L}{|f'(N)|} + \frac{L}{|s|}$ and $0 < \varepsilon < \varepsilon_0$, there exist two control functions g_0 and g_L , with

$$\|g_0\|_{L^\infty(0,T)} \leq C(|N| + |P|) \quad \text{and} \quad \|g_L\|_{L^\infty(0,T)} \leq C(|N| + |P|),$$

such that the solution u of (7.1), (7.2) and (7.3) satisfies

$$u|_{t=T} = N \quad \text{in } (0, L).$$

Proof. Here, we only prove the proposition in the case (a). The proof of cases (b)-(d) follows the one of (a) for a modified Proposition 7.9, since the conditions that we write are the conditions of existence of a traveling wave from P to N or from N to P .

Since P and N satisfy the strict condition (SOC+) and $f(N) > f(P)$, one can find P' close to P , and N' close to N , such that the stronger condition (POC) is satisfied on (P', N') , together with $P' < \text{ess inf } u_0 \leq \text{ess sup } u_0 < N'$ and $f(N') > f(P')$. As a consequence, Proposition 7.9 applies and hence one can find control functions that drive u_0 to a state u_1 which is H^1 -exponentially close to N in any time $T_1 > \frac{L}{|s|}$. After that, the assumptions of Proposition 7.16 are satisfied, and thus u_1 can be steered exactly to N in any time $T_2 \geq \alpha_1 \frac{L}{|f'(N)|}$. Finally the result of Proposition 7.21 holds for any time $T \geq T_1 + T_2$. □

Proposition 7.22. *Suppose that one of these conditions is satisfied :*

- (a) $M < N$, $f'' \geq 0$ on the interval (M, N) and $f'(M) > 0$;
- (b) $N < M$, $f'' \geq 0$ on the interval (N, M) and $f'(M) < 0$;
- (c) $M < N$, $f'' \leq 0$ on the interval (M, N) and $f'(M) < 0$;
- (d) $N < M$, $f'' \leq 0$ on the interval (N, M) and $f'(M) > 0$.

Then, there exist $C > 0$ only depending on f and $\varepsilon_0 > 0$ such that for all $T > (\alpha_1 + 1) \frac{L}{|f'(M)|}$ and $0 < \varepsilon < \varepsilon_0$, there exist two control functions g_0 and g_L , with

$$\|g_0\|_{L^\infty(0,T)} \leq C(|M| + |N|) \quad \text{and} \quad \|g_L\|_{L^\infty(0,T)} \leq C(|M| + |N|), \tag{7.75}$$

such that the solution u of (7.1), (7.2) with initial condition $u|_{t=0} = N$ satisfies,

$$u|_{t=T} = M \quad \text{in } (0, L).$$

Proof. Here, we only prove the proposition in the case (a). The proof of cases (b)-(d) follows the one of (a) for a modified Proposition 7.12, since the conditions we write are the conditions of existence of a rarefaction wave steering N to M , having a speed of non-vanishing fixed sign.

In the case (a), the assumptions of Proposition 7.12 are satisfied and hence one can find control functions that drive u_0 to a state u_1 which is H^1 -exponentially close to M in any time $T_1 > \frac{L}{|f'(M)|}$. After that, the assumptions of Proposition 7.16 are satisfied, and thus u_1 can be steered exactly to N in a time $T_2 \geq \alpha_1 \frac{L}{|f'(M)|}$. Finally, the result of Proposition 7.21 holds for any time $T \geq T_1 + T_2$. \square

7.3.1 Proof of Theorems 7.1 and 7.2, the convex case

In this section, we suppose $f'' \geq 0$. Let us first prove Theorem 7.2, using Propositions 7.21 and 7.22.

Proof of Theorem 7.2 We first suppose that $f'(M) > 0$ and choose some $P < \text{ess inf } u_0$. Since $\lim_{u \rightarrow +\infty} f'(u) = +\infty$, and setting $s = \sigma(N, P)$, we have $\lim_{N \rightarrow +\infty} s = +\infty$. As a consequence, for any time $T_1 > 0$ there exists $N > \text{ess sup } u_0$ sufficiently large so that $f(N) > f(P)$ and $0 < \alpha_1 \frac{L}{f'(N)} + \frac{L}{s} < T_1$. As a consequence of Proposition 7.21, one can reach N exactly, uniformly with ε in time T_1 . Then Proposition 7.22 holds between N and M , and for any $T_2 > \alpha_0 \frac{L}{f'(M)}$ (with $\alpha_0 = \alpha_1 + 1$), there exist two control functions bounded uniformly with respect to ε such that $u|_{t=T_1+T_2} = M$. Finally, the result of Theorem 7.1 holds for any time $T \geq T_1 + T_2$.

In the case $f'(M) < 0$, exactly the same proof still holds using $\lim_{u \rightarrow -\infty} f'(u) = -\infty$, together with Proposition 7.21 (b) and Proposition 7.22 (b). \square

In Theorem 7.1, however, we do not want ε_0 to depend on the initial datum u_0 . For this, we use the following proposition instead of Proposition 7.21.

Proposition 7.23. *Suppose that condition (A+) holds. Then, for all $\varepsilon_0 > 0$ and $T > 0$, there exists a state $N_0 > 0$, such that for all $\varepsilon \in (0, \varepsilon_0)$ and $N > N_0$, there exist control functions g_0 and g_L with*

$$\|g_0\|_{L^\infty(0,T)} \leq \|u_0\|_{L^\infty(0,L)} + 2|N| \quad \text{and} \quad \|g_L\|_{L^\infty(0,T)} \leq \|u_0\|_{L^\infty(0,L)} + 2|N|,$$

such that the solution u of (7.1), (7.2) and (7.3) satisfies

$$u|_{t=T} = N \quad \text{in } (0, L).$$

The proof of this proposition combines the approximate controllability result to the large state N of Proposition 7.9 and the local exact controllability result of Proposition 7.19. Both results hold for any $\varepsilon > 0$, for N sufficiently large, for control times $T > \frac{L}{s}$ and $T \geq \alpha_1 \frac{L}{f'(N)}$, both vanishing as $N \rightarrow +\infty$.

The proof of Theorem 7.1 then exactly follows that of Theorem 7.2, using both Proposition 7.23 to reach the large constant N and Proposition 7.22 to come back to the state M with a rarefaction wave.

7.3.2 Proof of Theorem 7.3, the non-convex case

For the sake of brevity in the following proof, we do not mention that every control step is done uniformly with respect to ε , as a consequence of Propositions 7.21 and 7.22.

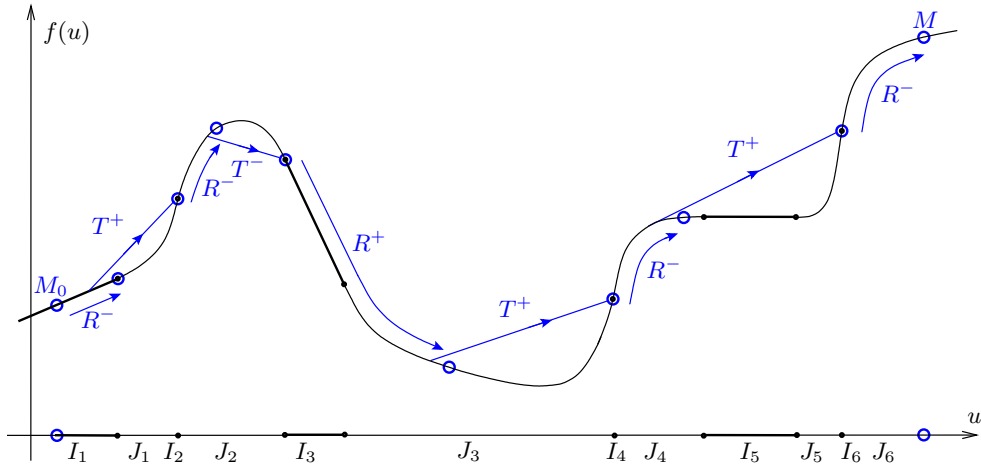

FIGURE 7.3 – Global control strategy for non-convex f
 R^+ : “convex rarefaction wave” ; R^- : “concave rarefaction wave” ;
 T^+ : “convex traveling wave” ; T^- : “concave traveling wave”.

Proof of Theorem 7.3 The first step is to “get rid of” the initial condition u_0 , and that is the only role of Assumption (ii). This assumption, together with Proposition 7.21 gives the controllability from u_0 to some constant state M_0 with $f'(M_0) \neq 0$. All the proof is reduced now to a controllability problem between two constant states (M_0 and M) and is illustrated in Figure 7.3.

Let us suppose that $M_0 < M$ (the case $M_0 > M$ follows from the same arguments). From Assumption (i), $(f'')^{-1}(\{0\}) \cap [M_0, M]$ can be written as $\bigcup_{j=1}^m I_j$ where the union is disjoint and ordered. Note that each I_j is a segment (possibly reduced to a point) since f'' is supposed to be continuous here. Let us denote $(J_k)_{1 \leq k \leq p}$ the connected components of $(M_0, M) \setminus \bigcup_{j=1}^m I_j$, so that $(M_0, M) \setminus \bigcup_{j=1}^m I_j = \bigcup_{k=1}^p J_k$, where this last union is disjoint and ordered. As a consequence, J_k is an open interval on which either $f'' > 0$ or $f'' < 0$.

1. *Driving A to B with $A, B \in \bar{J}_k$.*

We first prove that, for any $A \in \bar{J}_k$ and $B \in \bar{J}_k$ satisfying $f'(A) \neq 0$ and $f'(B) \neq 0$, one can steer A to B in a finite time. We suppose that $f'' > 0$ on J_k (the case $f'' < 0$ follows from the same arguments) and denote by L_k (resp. R_k) the left (resp. right) endpoint of \bar{J}_k .

- If $f'(L_k) > 0$, then, as a consequence of Lemma 7.24 below, and using the fact that f is strictly convex on (L_k, R_k) , there exists $L'_k < L_k$ such that f satisfies (SOC+) on (L'_k, R_k) . Thus, there exists a traveling wave from L'_k to R_k and, according to Proposition 7.21 (a), A can be driven to R_k in finite time (see the situation in J_1 in Figure 7.3). Then, we are in the situation of Proposition 7.22 (a) and a rarefaction wave drives R_k to B in finite time. Note that if $f'(L_k) = 0$, we have $L_k < A$ and the same strategy holds.

- If $f'(R_k) \leq 0$, f has no local minimum on J_k and this case follows the same.

- If $f'(L_k) < 0$ and $f'(R_k) > 0$, there exists $C_k \in J_k$ satisfying $f'(C_k) = 0$. The situation $f'(A)f'(B) > 0$ has already been treated, so we only have to consider the case $f'(A) < 0$ and $f'(B) > 0$ (the case $f'(A) > 0$ and $f'(B) < 0$ follows exactly the same arguments). According to Proposition 7.22 (b), A can be brought to A' as close to C_k as needed, by means of a rarefaction wave (see the situation in J_3 in Figure 7.3). It suffices to take A' so that $f(A') < f(B)$, and as a consequence of Proposition 7.21 (a), we can steer A' to B thanks to a traveling wave (f is convex on J_k and hence satisfies (SOC+) on this interval).

2. *Driving A to B with $A, B \in I_j$.*

Next, we prove that, if $f' \neq 0$ on I_j for some j , then for any $A, B \in I_j$, one can steer A to B in finite

time. Recall that $f'' = 0$ on I_j . If $f' > 0$ on I_j and $B < A$, we are in the context of Proposition 7.22 (a) and a “convex rarefaction wave” drives A to B (see the situation in I_3 in Figure 7.3). If $f' > 0$ on I_j and $A < B$, Proposition 7.22 (d) applies and a “concave rarefaction wave” drives A to B (see the situation in I_1 in Figure 7.3). We can do the same if $f' < 0$ on I_j using Proposition 7.22 (b) and (c). Note that in this case, Equation (7.1) is only a linear transport equation with constant speed, which we control on both endpoints of the interval, and the result is also a consequence of [CG05b].

3. Driving A to B with $A \in J_k$ and $B \in J_{k+1}$, when f' vanishes between J_k and J_{k+1}

The last case to consider is the case where $J_k = (L_k, L_j)$, $I_j = [L_j, R_j]$, $J_{k+1} = (R_j, R_{k+1})$, $f' = 0$ on I_j , $A \in J_k$, $B \in J_{k+1}$, and we want to steer A to B . Suppose that $f'(A) > 0$ (the case $f'(A) < 0$ follows the same). Then, according to Proposition 7.22 (d), a “concave rarefaction wave” can bring A to some A' as close as we want from L_j (see the situation in J_4 in Figure 7.3).

- If $f'(B) < 0$, we can choose $A' < L_j$ such that $f(A') > f(B)$, so that Proposition 7.21 (c) holds and we can steer A' to B by means of a concave traveling wave.
- If $f'(B) > 0$, the continuity of f' yields that we can choose $A' < L_j$ such that $0 < f'(A') < \sigma(A', B)$ so that (SOC+) holds on (A', B) and, according to Proposition 7.21 (a), we can steer A' to B by means of a “convex traveling wave” (see the situation in I_5 in Figure 7.3).

Therefore, using iteratively the three arguments above, one can pass from each zone I_j to the neighboring zone J_k (case 2.) and to each J_k to the neighboring I_j (case 1.) since $I_j \cap \bar{J}_k \neq \emptyset$, provided that $f' \neq 0$ on I_j . If $f' = 0$ on I_j , one can jump from J_k before I_j to J_{k+1} after I_j (case 3.). Finally, from Assumption (i), there is a finite number of I_j and J_k between M_0 and M , so that we can steer M_0 to M with a finite number of such iterations, i.e., in finite time. This global strategy is illustrated in Figure 7.3. □

Note that this proof does not provide an estimate on the minimal time T_0 needed to control. Moreover, the strategy developed here is clearly not optimal in time since it is mainly a local strategy. For instance, in Figure 7.3, we see that one can steer the point $I_3 \cap \bar{J}_3$ directly to a point in J_6 with a single traveling wave, a strategy which is much faster than the one described in the proof. Optimizing this strategy in time seems to be an interesting open problem.

We end this section by proving a Lemma used in the Proof of Theorem 7.3.

Lemma 7.24. *Suppose that $f \in \mathcal{C}^1(\mathbb{R})$ satisfies (SOC+) on the interval (L, R) and that $f'(L) < \sigma(L, R)$. Then, there exists $\rho_0 > 0$ such that for all $\rho \in (0, \rho_0)$, the function f satisfies (SOC+) on $(L - \rho, R)$.*

Proof. First, we have

$$\frac{\partial}{\partial u} \sigma(u, R)|_{u=L} = \frac{1}{R - L} (\sigma(L, R) - f'(L)) > 0.$$

Hence, there exists $\rho_1 > 0$ such that for all $\rho \in (0, \rho_1)$, $\sigma(L - \rho, R) < \sigma(L, R)$. Since (SOC+) reads $\sigma(L, R) < \sigma(u, R)$ for all $u \in (L, R)$, we now have

$$\sigma(L - \rho, R) < \sigma(u, R), \quad \text{for all } \rho \in (0, \rho_1), u \in (L, R). \tag{7.76}$$

Second, the assumption $f'(L) < \sigma(L, R)$ together with the continuity of f' and $\sigma(\cdot, R)$ gives the existence of $\rho_2 > 0$ such that for all $\rho \in (0, \rho_2)$ and all $v \in (L - \rho, L)$, we have $f'(v) < \sigma(L - \rho, R)$. Integrating this inequality with respect to v on $(L - \rho, u)$, for $u \in (L - \rho, L)$ and dividing by $(u - (L - \rho))$ yields $\sigma(L - \rho, u) < \sigma(L - \rho, R)$. This is equivalent to having

$$\sigma(L - \rho, R) < \sigma(u, R), \quad \text{for all } \rho \in (0, \rho_2), u \in (L - \rho, L). \tag{7.77}$$

Finally, setting $\rho_0 = \min\{\rho_1, \rho_2\}$ and combining (7.76) and (7.77) concludes the proof of the lemma. □

7.4 Appendix : parabolic regularity estimates

7.4.1 Parabolic regularity estimates for classical solutions

For the sake of completeness, we recall here a classical regularity result for the heat equation, that is used in the previous sections. However, we give a precise dependence with respect to ε , and a simple proof. Let Ω be a bounded domain of \mathbb{R}^n with smooth boundary. For $m \geq 0$, we denote by $\mathcal{H}^m = \mathcal{D}((-\Delta)^{\frac{m}{2}})$ the domain of the fractional Laplace-Dirichlet operator on $L^2(\Omega)$, and $\mathcal{H}^{-m} = (\mathcal{H}^m)'$. Here the duality is taken with respect to $\mathcal{H}^0 = L^2(\Omega)$. For instance we have $\mathcal{H}^1 = H_0^1(\Omega)$, $\mathcal{H}^2 = H^2(\Omega) \cap H_0^1(\Omega)$ and $\mathcal{H}^{-1} = H^{-1}(\Omega) = (H_0^1(\Omega))'$. We have the following regularity result.

Lemma 7.25. *Let $u(t, x)$ be a classical solution of*

$$\begin{cases} \partial_t u - \varepsilon \Delta u = f & \text{in } (0, t^*) \times \Omega, \\ u = 0 & \text{on } (0, t^*) \times \partial\Omega, \\ u|_{t=0} = u_0 & \text{in } \Omega. \end{cases} \quad (7.78)$$

and let $m \in \mathbb{R}$. Suppose that $u_0 \in \mathcal{H}^m$ and $f \in L^2(0, t^*; \mathcal{H}^{m-1})$, then

$$u \in \mathcal{C}^0(0, t^*; \mathcal{H}^m) \cap L^2(0, t^*; \mathcal{H}^{m+1}) \cap H^1(0, t^*; \mathcal{H}^{m-1})$$

and we have, for all $t^* > 0$,

$$\varepsilon \|u(t^*)\|_{\mathcal{H}^m}^2 + \varepsilon^2 \int_0^{t^*} \|u(t)\|_{\mathcal{H}^{m+1}}^2 dt + \int_0^{t^*} \|u_t(t)\|_{\mathcal{H}^{m-1}}^2 dt = \varepsilon \|u_0\|_{\mathcal{H}^m}^2 + \int_0^{t^*} \|f(t)\|_{\mathcal{H}^{m-1}}^2 dt. \quad (7.79)$$

Proof. We denote by $(\omega_j^2, \phi_j)_{j \in \mathbb{N}^*}$ the (positive) eigenvalues and associated eigenfunctions of the Laplace-Dirichlet operator on Ω , forming a Hilbert basis of $L^2(\Omega)$. We have $-\Delta \phi_j = \omega_j^2 \phi_j$ and $\phi_j|_{\partial\Omega} = 0$. We here suppose that $m \geq 1$. In the case $m \leq 1$, we do the following computations with smooth functions f and u , and conclude with a density argument. Taking the inner product of (7.78) with ϕ_j , we obtain

$$\begin{cases} u_{j,t} + \varepsilon \omega_j^2 u_j = f_j & \text{in } (0, t^*), \\ u_j|_{t=0} = u_{j,0}, \end{cases}$$

where $u_j = (u, \phi_j)_{L^2}$, $u_{j,0} = (u_0, \phi_j)_{L^2}$, and $f_j = (f, \phi_j)_{L^2}$. Multiplying the first equation by ω_j^{m-1} and squaring it, we have

$$\omega_j^{2m-2} |u_{j,t}|^2 + \varepsilon^2 \omega_j^{2m+2} |u_j|^2 + 2\varepsilon \omega_j^{2m} u_j u_{j,t} = \omega_j^{2m-2} |f_j|^2.$$

Integrating this equation on $(0, t^*)$, we now obtain

$$\omega_j^{2m-2} \int_0^{t^*} |u_{j,t}|^2 dt + \varepsilon^2 \omega_j^{2m+2} \int_0^{t^*} |u_j|^2 dt + \varepsilon \omega_j^{2m} |u_j|^2(t^*) = \varepsilon \omega_j^{2m} |u_{j,0}|^2 + \omega_j^{2m-2} \int_0^{t^*} |f_j|^2 dt. \quad (7.80)$$

The right hand-side is summable over $j \in \mathbb{N}^*$ since we supposed $\sum_{j \in \mathbb{N}^*} \omega_j^{2m} |u_{j,0}|^2 = \|u_0\|_{\mathcal{H}^m}^2 < +\infty$ and $\sum_{j \in \mathbb{N}^*} \omega_j^{2m-2} \int_0^{t^*} |f_j|^2 dt = \|f\|_{L^2(0, t^*; \mathcal{H}^{m-1})}^2 < +\infty$. Hence, the left hand-side is summable. Since its three terms are non-negative, they are all summable. Finally, summing (7.80) over $j \in \mathbb{N}^*$ yields (7.79) and the lemma is proved. \square

7.4.2 Well-posedness of an initial-boundary value problem with low regularity

We here prove the well-posedness of Problem (7.53) in some energy space and give the associated regularity estimates used in (7.68). More precisely, we consider the problem

$$\begin{cases} u_t - \varepsilon u_{xx} + [W(t, x)u]_x = 0 & \text{in } (0, T) \times (a, b), \\ u|_{x=a} = g(t), \quad u|_{x=b} = 0 & \text{in } (0, T), \\ u|_{t=0} = u_0 & \text{in } (a, b), \end{cases} \quad (7.81)$$

with W and g having low regularity and show that (7.81) is well-posed in a weak sense, viz. in the sense of transposition solutions. We have the following result.

Lemma 7.26. *Suppose that $W \in L^\infty(0, T; L^\infty(a, b)) \cap L^1(0, T; W^{1, \infty}(a, b))$. Then for any $g \in L^2(0, T)$ and $u_0 \in L^2(a, b)$, there exists a unique $u \in L^2(0, T; L^2(a, b))$ such that*

$$\int_0^T \int_a^b u(t, x) F(t, x) dx dt = \int_a^b u_0(x) \varphi(0, x) dx + \varepsilon \int_0^T g(t) \varphi_x(t, a) dt \quad (7.82)$$

for every test function $F \in L^2(0, T; L^2(a, b))$ and associated φ satisfying

$$\begin{cases} -\varphi_t - \varepsilon \varphi_{xx} - W(t, x) \varphi_x = F(t, x) & \text{in } (0, T) \times (a, b), \\ \varphi|_{x=a} = 0, \quad \varphi|_{x=b} = 0 & \text{in } (0, T), \\ \varphi|_{t=T} = 0 & \text{in } (a, b), \end{cases} \quad (7.83)$$

in the classical sense. Moreover, there exists $C = C(T, \|W\|_{L^\infty L^\infty}, \|W_x\|_{L^1 L^\infty}) > 0$ independent from ε such that

$$\|u\|_{L^2(0, T; L^2(a, b))} \leq \frac{C}{\sqrt{\varepsilon}} (\|g\|_{L^2(0, T)} + \|u_0\|_{L^2(a, b)}). \quad (7.84)$$

The solution u is called the transposition solution of (7.81). Note that u is in particular a solution of the first equation of (7.81) in the sense of distributions.

Proof. First notice that for any $W \in L^\infty(0, T; L^\infty(a, b)) \cap L^1(0, T; W^{1, \infty}(a, b))$ and $F \in L^2(0, T; L^2(a, b))$, the backward problem (7.83) is well-posed in the classical sense and a regularity estimate for its solution $\varphi \in H^1(0, T; L^2(a, b)) \cap L^2(0, T; H^2 \cap H_0^1(a, b))$ is given in Lemma 7.27 below. We now remark that, given $u_0 \in L^2(a, b)$ and $g \in L^2(0, T)$, the mapping

$$l : F \mapsto \int_a^b u_0(x) \varphi(0, x) dx + \varepsilon \int_0^T g(t) \varphi_x(t, a) dt,$$

is linear. Furthermore, we have, using (7.85) below,

$$\begin{aligned} |l(F)| &\leq \|u_0\|_{L^2(a, b)} \|\varphi(0, \cdot)\|_{L^2(a, b)} + \varepsilon \|g\|_{L^2(0, T)} \|\varphi_x(\cdot, a)\|_{L^2(0, T)} \\ &\leq \|u_0\|_{L^2(a, b)} \|\varphi\|_{H^1(0, T; L^2(a, b))} + \varepsilon \|g\|_{L^2(0, T)} \|\varphi\|_{L^2(0, T; H^2(a, b))} \\ &\leq \frac{C}{\sqrt{\varepsilon}} (\|u_0\|_{L^2(a, b)} + \|g\|_{L^2(0, T)}) \|F\|_{L^2 L^2}. \end{aligned}$$

As a consequence l is a continuous linear form on $L^2 L^2$, and Riesz representation Theorem gives the existence of a unique $u \in L^2 L^2$ satisfying (7.82) for every $F \in L^2 L^2$. In addition, we have

$$\|u\|_{L^2 L^2} \leq \frac{C}{\sqrt{\varepsilon}} (\|u_0\|_{L^2(a, b)} + \|g\|_{L^2(0, T)})$$

and the lemma is proved. \square

Note that refining our estimates, we could have proved that $u \in L^2(0, T; H^{\frac{1}{2}-\delta}(a, b))$ for any $\delta > 0$ (which we do not need here).

Lemma 7.27. *Suppose that $W \in L^\infty(0, T; L^\infty(a, b)) \cap L^1(0, T; W^{1, \infty}(a, b))$, $F \in L^2(0, T; L^2(a, b))$ and that φ is a solution of the backward problem (7.83). Then $\varphi \in L^\infty(0, T; H_0^1) \cap L^2(0, T; H^2 \cap H_0^1) \cap H^1(0, T; L^2)$ and we have for some $C = C(T, \|W\|_{L^\infty L^\infty}, \|W_x\|_{L^1 L^\infty})$, independent from ε ,*

$$\varepsilon^2 \|\varphi\|_{L^\infty(0, T; H_0^1)}^2 + \varepsilon^3 \|\varphi\|_{L^2(0, T; H^2 \cap H_0^1)}^2 + \varepsilon \|\varphi_t\|_{L^2(0, T; L^2)}^2 \leq C \|F\|_{L^2(0, T; L^2)}^2. \quad (7.85)$$

Proof. Multiplying the first line of (7.83) by φ and integrating on (a, b) yields

$$-\frac{1}{2} \frac{d}{dt} \|\varphi(t, \cdot)\|_{L^2}^2 + \varepsilon \|\varphi_x(t, \cdot)\|_{L^2}^2 - \int_a^b W(t, x) \left(\frac{\varphi(t, x)^2}{2} \right)_x dx = \int_a^b F(t, x) \varphi(t, x) dx,$$

which, after an integration by parts, gives the estimate

$$-\frac{1}{2} \frac{d}{dt} \|\varphi(t, \cdot)\|_{L^2}^2 + \varepsilon \|\varphi_x(t, \cdot)\|_{L^2}^2 \leq \frac{1}{2} \|F(t, \cdot)\|_{L^2}^2 + \frac{1}{2} \|\varphi(t, \cdot)\|_{L^2}^2 + \|W_x(t, \cdot)\|_{L^\infty} \|\varphi(t, \cdot)\|_{L^2}^2. \quad (7.86)$$

Forgetting the term $\varepsilon \|\varphi_x(t, \cdot)\|_{L^2}^2$ and applying Gronwall's lemma backward in time yields

$$\|\varphi\|_{L^\infty(0, T; L^2)}^2 \leq \frac{1}{2} \exp\left(\|W_x\|_{L^1(0, T; L^\infty)} + \frac{T}{2}\right) \|F(t, \cdot)\|_{L^2(0, T; L^2)}^2, \quad (7.87)$$

since $\varphi|_{t=T} = 0$. Now integrating (7.86) on $(0, T)$ and using (7.87), we obtain

$$\varepsilon \|\varphi_x\|_{L^2(0, T; L^2)}^2 \leq \left[\frac{1}{2} + \left(\frac{T}{4} + \frac{\|W_x\|_{L^1(0, T; L^\infty)}}{2}\right) \exp\left(\|W_x\|_{L^1(0, T; L^\infty)} + \frac{T}{2}\right)\right] \|F\|_{L^2(0, T; L^2)}^2. \quad (7.88)$$

Next, we write the first equation of (7.83) as

$$-\varphi_t - \varepsilon \varphi_{xx} = W \varphi_x + F,$$

where the right handside is in $L^2(0, T; L^2(a, b))$ since $W \in L^\infty(0, T; L^\infty(a, b))$ and $\varphi_x \in L^2(0, T; L^2(a, b))$. The regularity estimate (7.79) of Lemma 7.25 for the heat equation (taken backward in time) for $m = 1$ directly yields Estimate (7.85) and concludes the proof of the lemma. \square

Bibliographie

- [AB99] F. Alabau-Boussouira. Stabilisation frontière indirecte de systèmes faiblement couplés. *C. R. Acad. Sci. Paris Sér I Math*, 328 :1015–1020, 1999.
- [AB02] F. Alabau-Boussouira. Indirect boundary stabilization of weakly coupled systems. *SIAM J. Control Optim.*, 41 :511–541, 2002.
- [AB03] F. Alabau-Boussouira. A two-level energy method for indirect boundary observability and controllability of weakly coupled hyperbolic systems. *SIAM J. Control Optim.*, 42 :871–906, 2003.
- [AB04] F. Alabau-Boussouira. Une formule générale pour le taux de décroissance des systèmes dissipatifs non linéaires. *C. R. Acad. Sci. Paris Sér I Math*, 338 :35–40, 2004.
- [AB05] F. Alabau-Boussouira. Convexity and weighted integral inequalities for energy decay rates of nonlinear dissipative hyperbolic systems. *Appl. Math. and Optimization*, 51 :61–105, 2005.
- [AB06] F. Alabau-Boussouira. Piecewise multiplier method and nonlinear integral inequalities for petrowsky equation with nonlinear dissipation. *J. Evolution Equations*, 6 :95–112, 2006.
- [AB07] F. Alabau-Boussouira. Asymptotic behavior for timoshenko beams subject to a single nonlinear feedback control. *NoDEA*, 14 :643–669, 2007.
- [ABHN01] W. Arendt, C.J.K. Batty, M. Hieber, and F. Neubrander. *Vector-valued Laplace transforms and Cauchy problems*, volume 96 of *Monographs in Mathematics*. Birkhäuser Verlag, Basel, 2001.
- [ABL11a] F. Alabau-Boussouira and M. Léautaud. Indirect controllability of locally coupled systems under geometric conditions. *C. R. Acad. Sci. Paris, Ser. I*, 349 :395–400, 2011.
- [ABL11b] F. Alabau-Boussouira and M. Léautaud. Indirect controllability of symmetric systems of two locally coupled wave-type equations and applications. *preprint*, 2011.
- [ABL11c] F. Alabau-Boussouira and M. Léautaud. Indirect stabilization of locally coupled wave-type systems. *ESAIM Control Optim. Calc. Var.*, 10.1051/cocv/2011106, 2011.
- [ACK02] F. Alabau, P. Cannarsa, and V. Komornik. Indirect internal damping of coupled systems. *J. Evolution Equations*, 2 :127–150, 2002.
- [AE08] G. Alessandrini and L. Escauriaza. Null-controllability of one-dimensional parabolic equations. *ESAIM Control Optim. Calc. Var.*, 14 :284–293, 2008.
- [Agr76] M.S. Agranovich. Summability of series in root vectors of non-selfadjoint elliptic operators. *Functional analysis and its applications*, 10 :165–174, 1976.
- [Agr94] M.S. Agranovich. On series with respect to root vectors of operators associated with forms having symmetric principal part. *Functional analysis and its applications*, 28 :151–167, 1994.
- [AKBD06] F. Ammar-Khodja, A. Benabdallah, and C. Dupaix. Null controllability of some reaction-diffusion systems with one control force. *J. Math. Anal. Appl.*, 320 :928–943, 2006.
- [AKBDG07] F. Ammar-Khodja, A. Benabdallah, C. Dupaix, and M. González-Burgos. Controllability for a class of reaction-diffusion systems : the generalized kalman’s condition. *C. R. Acad. Sci. Paris, Ser I.*, 345 :543–548, 2007.
- [AKBDGB09a] F. Ammar Khodja, A. Benabdallah, C. Dupaix, and M. González-Burgos. A generalization of the Kalman rank condition for time-dependent coupled linear parabolic systems. *Differ. Equ. Appl.*, 1(3) :427–457, 2009.

- [AKBDGB09b] F. Ammar-Khodja, A. Benabdallah, C. Dupaix, and M. González-Burgos. A Kalman rank condition for the localized distributed controllability of a class of linear parabolic systems. *J. Evol. Equ.*, 9(2) :267–291, 2009.
- [AKBMnRR03] F. Ammar-Khodja, A. Benabdallah, J. E. Muñoz Rivera, and R. Racke. Energy decay for Timoshenko systems of memory type. *J. Differential Equations*, 194 :82–115, 2003.
- [AKS62] N. Aronszajn, A. Krzywicki, and J. Szarski. A unique continuation theorem for exterior differential forms on Riemannian manifolds. *Ark. Mat.*, 4 :417–453, 1962.
- [AM98] F. Ancona and A. Marson. On the attainable set for scalar nonlinear conservation laws with boundary control. *SIAM J. Control Optim.*, 36 :290–312, 1998.
- [Aro57] N. Aronszajn. A unique continuation theorem for solutions of elliptic partial differential equations or inequalities of second order. *J. Math. Pures Appl. (9)*, 36 :235–249, 1957.
- [Bar00] V. Barbu. Exact controllability of the superlinear heat equation. *Appl. Math. Optim.*, 42 :73–89, 2000.
- [BB05] S. Bianchini and A. Bressan. Vanishing viscosity solutions of nonlinear hyperbolic systems. *Ann. of Math. (2)*, 161(1) :223–342, 2005.
- [BDL07a] A. Benabdallah, Y. Dermenjian, and J. Le Rousseau. Carleman estimates for the one-dimensional heat equation with a discontinuous coefficient and applications to controllability and an inverse problem. *J. Math. Anal. Appl.*, 336 :865–887, 2007.
- [BDL07b] A. Benabdallah, Y. Dermenjian, and J. Le Rousseau. On the controllability of linear parabolic equations with an arbitrary control location for stratified media. *C. R. Acad. Sci. Paris, Ser. I.*, 344 :357–362, 2007.
- [BDL11] A. Benabdallah, Y. Dermenjian, and J. Le Rousseau. Carleman estimates for stratified media. *J. Funct. Anal.*, to appear, 2011.
- [Bel03] M. Bellassoued. Carleman estimates and distribution of resonances for the transparent obstacle and application to the stabilization. *Asymptotic Anal.*, 35 :257–279, 2003.
- [Bey04] A. Beyrath. Indirect linear locally distributed damping of coupled systems. *Bol. Soc. Parana. Mat.*, 22 :17–34, 2004.
- [BG77] A.M. Bruckner and K.M. Garg. The level structure of a residual set of continuous functions. *Trans. Amer. Math. Soc.*, 232 :307–321, 1977.
- [BG97] N. Burq and P. Gérard. Condition nécessaire et suffisante pour la contrôlabilité exacte des ondes. *C. R. Acad. Sci. Paris Sér. I Math.*, 325(7) :749–752, 1997.
- [BG02] N. Burq and P. Gérard. Contrôle optimal des équations aux dérivées partielles. *Cours de l'École Polytechnique*, 2002. <http://www.math.u-psud.fr/%7Eburq/articles/coursX.pdf>.
- [BGLR07] A. Benabdallah, P. Gaitan, and J. Le Rousseau. Stability of discontinuous diffusion coefficients and initial conditions in an inverse problem for the heat equation. *SIAM J. Control Optim.*, 46(5) :1849–1881, 2007.
- [BH07] N. Burq and M. Hitrik. Energy decay for damped wave equations on partially rectangular domains. *Math. Res. Lett.*, 14(1) :35–47, 2007.
- [BHLR10] F. Boyer, F. Hubert, and J. Le Rousseau. Discrete Carleman estimates for elliptic operators and uniform controllability of semi-discretized parabolic equations. *J. Math. Pures Appl. (9)*, 93(3) :240–276, 2010.
- [BL01] N. Burq and G. Lebeau. Mesures de défaut de compacité, application au système de Lamé. *Ann. Sci. École Norm. Sup. (4)*, 34(6) :817–870, 2001.
- [BLR88] C. Bardos, G. Lebeau, and J. Rauch. Un exemple d'utilisation des notions de propagation pour le contrôle et la stabilisation de problèmes hyperboliques. *Rend. Sem. Mat. Univ. Politec. Torino*, (Special Issue) :11–31 (1989), 1988. Nonlinear hyperbolic equations in applied sciences.
- [BLR92] C. Bardos, G. Lebeau, and J. Rauch. Sharp sufficient conditions for the observation, control, and stabilization of waves from the boundary. *SIAM J. Control Optim.*, 30 :1024–1065, 1992.
- [BIRN79] C. Bardos, A.Y. le Roux, and J.-C. Nédélec. First order quasilinear equations with boundary conditions. *Comm. Partial Differential Equations*, 4 :1017–1034, 1979.
- [Bre83] H. Brezis. *Analyse Fonctionnelle*. Masson, Paris, 1983.

- [Bur97a] N. Burq. Contrôlabilité exacte des ondes dans des ouverts peu réguliers. *Asymptot. Anal.*, 14(2) :157–191, 1997.
- [Bur97b] N. Burq. Mesures semi-classiques et mesures de défaut. *Astérisque*, (245) :Exp. No. 826, 4, 167–195, 1997. Séminaire Bourbaki, Vol. 1996/97.
- [Bur98] N. Burq. Décroissance de l'énergie locale de l'équation des ondes pour le problème extérieur et absence de résonance au voisinage du réel. *Acta Math.*, 180(1) :1–29, 1998.
- [BZ04] N. Burq and M. Zworski. Geometric control in the presence of a black box. *J. Amer. Math. Soc.*, 17(2) :443–471, 2004.
- [Cal58] A.-P. Calderón. Uniqueness in the Cauchy problem for partial differential equations. *Amer. J. Math.*, 80 :16–36, 1958.
- [Car39] T. Carleman. Sur une problème d'unicité pour les systèmes d'équations aux dérivées partielles à deux variables indépendantes. *Ark. Mat. Astr. Fys.*, 26B(17) :1–9, 1939.
- [CF96] J.-M. Coron and A.V. Fursikov. Global exact controllability of the 2-D Navier-Stokes equations on a manifold without boundary. *Russian J. Math. Phys.*, 4 :429–448, 1996.
- [CG05a] R.M. Colombo and P. Gwiazda. L^1 stability of semigroups with respect to their generators. *Quart. Appl. Math.*, 63(3) :509–526, 2005.
- [CG05b] J.-M. Coron and S. Guerrero. Singular optimal control : A linear 1-D parabolic-hyperbolic example. *Asympt. Anal.*, 44 :237–257, 2005.
- [CGR10] J.-M. Coron, S. Guerrero, and L. Rosier. Null controllability of a parabolic system with a cubic coupling term. *SIAM J. Control Optim.*, 48(8) :5629–5653, 2010.
- [Cha09a] M. Chapouly. Global controllability of nonviscous and viscous Burgers-type equations. *SIAM J. Control Optim.*, 48 :1567–1599, 2009.
- [Cha09b] M. Chapouly. On the global null controllability of a Navier-Stokes system with Navier slip boundary conditions. *J. Differential Equations*, 247 :2094–2123, 2009.
- [Cor96] J.-M. Coron. On the controllability of the 2-D incompressible Navier-Stokes equations with the Navier slip boundary conditions. *ESAIM Control Optim. Calc. Var.*, 1 :35–75, 1996.
- [Cor07a] J.-M. Coron. *Control and nonlinearity*, volume 136 of *Mathematical Surveys and Monographs*. American Mathematical Society, Providence, RI, 2007.
- [Cor07b] J.-M. Coron. Some open problems on the control of nonlinear partial differential equations. In *Perspectives in nonlinear partial differential equations*, volume 446 of *Contemp. Math.*, pages 215–243. Amer. Math. Soc., Providence, RI, 2007.
- [CR93] F. Conrad and B. Rao. Decay of solutions of the wave equation in a star-shaped domain with nonlinear boundary feedback. *Asymptotic Anal.*, 7 :159–177, 1993.
- [Daf00] C.M. Dafermos. *Hyperbolic conservation laws in continuum physics*. Springer-Verlag, Berlin, 2000.
- [Dan97] R. Danchin. Poches de tourbillon visqueuses. *J. Math. Pures Appl.*, 76 :609–647, 1997.
- [DF88] H. Donnelly and C. Fefferman. Nodal sets of eigenfunctions on riemannian manifolds. *Invent. Math.*, 93 :161–183, 1988.
- [DF90] H. Donnelly and C. Fefferman. Nodal sets of eigenfunctions : Riemannian manifolds with boundary. In *Analysis, et cetera (Moser volume)*, volume 93, pages 251–262. Academic Press, Boston, MA, 1990.
- [DFCGBZ02] A. Doubova, E. Fernández-Cara, M. Gonzales-Burgos, and E. Zuazua. On the controllability of parabolic systems with a nonlinear term involving the state and the gradient. *SIAM J. Control Optim.*, 41 :798–819, 2002.
- [Día96] J.I. Díaz. Obstruction and some approximate controllability results for the Burgers equation and related problems. In *Control of partial differential equations and applications (Laredo, 1994)*, volume 174 of *Lecture Notes in Pure and Appl. Math.*, pages 63–76. Dekker, New York, 1996.
- [DOP02] A. Doubova, A. Osses, and J.-P. Puel. Exact controllability to trajectories for semilinear heat equations with discontinuous diffusion coefficients. *ESAIM Control Optim. Calc. Var.*, 8 :621–661, 2002.
- [DR77] S. Dolecki and D.L. Russell. A general theory of observation and control. *SIAM J. Control Optim.*, 15(2) :185–220, 1977.

- [dT00] L. de Teresa. Insensitizing controls for a semilinear heat equation. *Comm. Partial Differential Equations*, 25(1-2) :39–72, 2000.
- [Dzh94] L.S. Dzhanelatyan. Basis properties of the system of root vectors for weak perturbations of a normal operator. *Functional analysis and its applications*, 28 :204–207, 1994.
- [EN00] K.-J. Engel and R. Nagel. *One-parameter semigroups for linear evolution equations*, volume 194 of *Graduate Texts in Mathematics*. Springer-Verlag, New York, 2000.
- [Erd56] A. Erdélyi. *Asymptotic expansions*. Dover publications, Inc, New York, 1956.
- [Eva98] L.C. Evans. *Partial differential equations*. Graduate Studies in Mathematics. American Mathematical Society, Providence, RI, 1998.
- [EZ10] L.C. Evans and M. Zworski. *Lectures on semiclassical analysis*. <http://math.berkeley.edu/~zworski/semiclassical.pdf>, 2010.
- [FCG06] E. Fernández-Cara and S. Guerrero. Global Carleman inequalities for parabolic systems and application to controllability. *SIAM J. Control Optim.*, 45(4) :1395–1446, 2006.
- [FCG07] E. Fernández-Cara and S. Guerrero. Null controllability of the Burgers system with distributed controls. *Systems Control Lett.*, 56(5) :366–372, 2007.
- [FCGBdT10] E. Fernández-Cara, M. González-Burgos, and L. de Teresa. Boundary controllability of parabolic coupled equations. *J. Funct. Anal.*, 259(7) :1720–1758, 2010.
- [FCZ00] E. Fernández-Cara and E. Zuazua. Null and approximate controllability for weakly blowing up semilinear heat equations. *Ann. Inst. H. Poincaré, Analyse non lin.*, 17 :583–616, 2000.
- [FI96] A. V. Fursikov and O. Yu. Imanuvilov. *Controllability of evolution equations*, volume 34 of *Lecture Notes Series*. Seoul National University Research Institute of Mathematics Global Analysis Research Center, Seoul, 1996.
- [FR71] H.O. Fattorini and D.L. Russell. Exact controllability theorems for linear parabolic equations in one space dimension. *Arch. Rational Mech. Anal.*, 43 :272–292, 1971.
- [FR75] H.O. Fattorini and D.L. Russell. Uniform bounds on biorthogonal functions for real exponentials with an application to the control theory of parabolic equations. *Quart. Appl. Math.*, 32 :45–69, 1974/75.
- [GBdT10] M. González-Burgos and L. de Teresa. Controllability results for cascade systems of m coupled parabolic PDEs by one control force. *Port. Math.*, 67(1) :91–113, 2010.
- [GBPG06] M. González-Burgos and R. Pérez-García. Controllability results for some nonlinear coupled parabolic systems by one control force. *Asymptotic Analysis*, 46 :123–162, 2006.
- [Gér91] P. Gérard. Microlocal defect measures. *Comm. Partial Differential Equations*, 16(11) :1761–1794, 1991.
- [GG07] O. Glass and S. Guerrero. On the uniform controllability of the Burgers equation. *SIAM J. Control Optim.*, 46 :1211–1238, 2007.
- [GG08] O. Glass and S. Guerrero. Some exact controllability results for the linear KdV equation and uniform controllability in the zero-dispersion limit. *Asymptot. Anal.*, 60 :61–100, 2008.
- [GG09] O. Glass and S. Guerrero. Uniform controllability of a transport equation in zero diffusion-dispersion limit. *Math. Models Methods Appl. Sci.*, 19 :1567–1601, 2009.
- [GI07] S. Guerrero and O.Yu. Imanuvilov. Remarks on global controllability for the Burgers equation with two control forces. *Ann. Inst. H. Poincaré Anal. Non Linéaire*, 24 :897–906, 2007.
- [GK69] I.C. Gohberg and M.G. Krein. *Introduction to the theory of linear non-selfadjoint operators*, volume 18 of *Transl. Math. Monogr.* Amer. Math. Soc., Providence, R.I., 1969.
- [GL07] S. Guerrero and G. Lebeau. Singular optimal control for a transport-diffusion equation. *Comm. Partial Differential Equations*, 32 :1813–1836, 2007.
- [Gla10] O. Glass. A complex-analytic approach to the problem of uniform controllability of a transport equation in the vanishing viscosity limit. *J. Funct. Anal.*, 258 :852–868, 2010.
- [GS94] A. Grigis and J. Sjöstrand. *Microlocal Analysis for Differential Operators*. Cambridge University Press, Cambridge, 1994.
- [Gue07] S. Guerrero. Null controllability of some systems of two parabolic equations with one control force. *SIAM J. Control Optim.*, 46(2) :379–394, 2007.

- [Güi85] E.N. Güichal. A lower bound of the norm of the control operator for the heat equation. *J. Math. Anal. Appl.*, 110(2) :519–527, 1985.
- [Haa06] M. Haase. *The Functional Calculus for Sectorial Operators*. Birkhäuser Verlag, Basel, 2006.
- [Har78] A. Haraux. Semi-groupes linéaires et équations d'évolution linéaires périodiques. *Publication du Laboratoire d'Analyse Numérique, Université Pierre et Marie Curie*, 78011 :123–162, 1978.
- [Hör63] L. Hörmander. *Linear Partial Differential Operators*. Springer-Verlag, Berlin, 1963.
- [Hör79] L. Hörmander. The Weyl calculus of pseudo-differential operators. *Comm. Pure Appl. Math.*, 32 :359–443, 1979.
- [Hör83] L. Hörmander. *The Analysis of Linear Partial Differential Operators*, volume II. Springer-Verlag, Berlin, 1983.
- [Hör85] L. Hörmander. *The Analysis of Linear Partial Differential Operators*, volume III. Springer-Verlag, 1985. Second printing 1994.
- [Hör90] L. Hörmander. *The Analysis of Linear Partial Differential Operators*, volume I. Springer-Verlag, Berlin, second edition, 1990.
- [Hör94] L. Hörmander. *The analysis of linear partial differential operators. IV*, volume 275 of *Grundlehren der Mathematischen Wissenschaften*. Springer-Verlag, Berlin, 1994. Fourier integral operators, Corrected reprint of the 1985 original.
- [Hor98] T. Horsin. On the controllability of the Burgers equation. *ESAIM Control Optim. Calc. Var.*, 3 :83–95, 1998.
- [Jaf90] S. Jaffard. Contrôle interne exact des vibrations d'une plaque rectangulaire. *Portugal. Math.*, 47(4) :423–429, 1990.
- [JL99] D. Jerison and G. Lebeau. Nodal sets of sums of eigenfunctions. In *Harmonic analysis and partial differential equations (Chicago, IL, 1996)*, Chicago Lectures in Math., pages 223–239. Univ. Chicago Press, Chicago, IL, 1999.
- [Kat67] V.E. Katsnel'son. Conditions under which systems of eigenvectors of some classes of operators form a basis. *Functional analysis and its applications*, 1 :122–132, 1967.
- [Kat80] T. Kato. *Perturbation Theory for Linear Operators*. Springer-Verlag, Berlin, 1980.
- [KdT10] O. Kavian and L. de Teresa. Unique continuation principle for systems of parabolic equations. *ESAIM Control Optim. Calc. Var.*, 16(2) :247–274, 2010.
- [Kom94] V. Komornik. *Exact controllability and stabilization*. RAM : Research in Applied Mathematics. Masson, Paris, 1994. The multiplier method.
- [Kru70] S.N. Kružkov. First order quasilinear equations with several independent variables. (russian). *Mat. Sb. (N.S.)*, 81 :228–255, 1970.
- [KZ06] H. Koch and E. Zuazua. A hybrid system of pde's arising in multi-structure interaction : coupling of wave equations in n and $n - 1$ space dimensions. *Recent trends in partial differential equations, Contemp. Math.*, 409 :55–77, 2006.
- [Lag89] J. E. Lagnese. Boundary stabilization of thin plates. *SIAM Studies in Applied Mathematics*, 10, 1989.
- [Le 07a] J. Le Rousseau. Carleman estimates and controllability results for the one-dimensional heat equation with BV coefficients. *J. Differential Equations*, 233 :417–447, 2007.
- [Le 07b] J. Le Rousseau. *Représentation Microlocale de Solutions de Systèmes Hyperboliques, Application à l'Imagerie, et Contributions au Contrôle et aux Problèmes Inverses pour des Équations Paraboliques*. Mémoire d'habilitation à diriger des recherches. Universités d'Aix-Marseille, Université de Provence, 2007. <http://tel.archives-ouvertes.fr/tel-00201887/fr/>.
- [Léa10a] M. Léautaud. Spectral inequalities for non-selfadjoint elliptic operators and application to the null-controllability of parabolic systems. *J. Funct. Anal.*, 258 :2739–2778, 2010.
- [Léa10b] M. Léautaud. Uniform controllability of scalar conservation laws in the vanishing viscosity limit. *submitted*, 2010.
- [Leb92] G. Lebeau. Contrôle de l'équation de Schrödinger. *J. Math. Pures Appl. (9)*, 71(3) :267–291, 1992.

- [Leb96] G. Lebeau. Équation des ondes amorties. In *Algebraic and geometric methods in mathematical physics (Kaciveli, 1993)*, volume 19 of *Math. Phys. Stud.*, pages 73–109. Kluwer Acad. Publ., Dordrecht, 1996.
- [LeF02] P.G. LeFloch. *Hyperbolic systems of conservation laws*. Lectures in Mathematics ETH Zürich. Birkhäuser Verlag, Basel, 2002. The theory of classical and nonclassical shock waves.
- [Ler10] N. Lerner. *Metrics on the phase space and non-selfadjoint pseudo-differential operators*. Birkhäuser Verlag, Basel, 2010.
- [Lio88a] J.-L. Lions. *Contrôlabilité exacte, perturbations et stabilisation de systèmes distribués. Tome 1*, volume 8 of *Recherches en Mathématiques Appliquées*. Masson, Paris, 1988.
- [Lio88b] J.-L. Lions. *Contrôlabilité exacte, perturbations et stabilisation de systèmes distribués. Tome 2*, volume 9 of *Recherches en Mathématiques Appliquées*. Masson, Paris, 1988. Perturbations.
- [Lio92] J.-L. Lions. *Sentinelles pour les systèmes distribués à données incomplètes*, volume 21 of *Recherches en Mathématiques Appliquées*. Masson, Paris, 1992.
- [Liu97] K. Liu. Locally distributed control and damping for the conservative systems. *SIAM, J. Control Optimization*, 35 :1574–1590, 1997.
- [LL83] P.D. Lax and C.D. Levermore. The small dispersion limit of the Korteweg-de Vries equation. I-III. *Comm. Pure Appl. Math.*, 36 :253–290, 571–593, 809–829, 1983.
- [LL09] J. Le Rousseau and G. Lebeau. On Carleman estimates for elliptic and parabolic operators. applications to unique continuation and control of parabolic equations. *Preprint*, <http://hal.archives-ouvertes.fr/hal-00351736/fr/>, 2009.
- [LL10] J. Le Rousseau and N. Lerner. Carleman estimates for elliptic operators with jumps at an interface : Anisotropic case and sharp geometric conditions. *Preprint*, 2010.
- [LLR11] J. Le Rousseau, M. Léautaud, and L. Robbiano. Controllability of a diffusive interface problem. *submitted*, 2011.
- [LR95] G. Lebeau and L. Robbiano. Contrôle exact de l'équation de la chaleur. *Comm. Partial Differential Equations*, 20 :335–356, 1995.
- [LR97] G. Lebeau and L. Robbiano. Stabilisation de l'équation des ondes par le bord. *Duke Math. J.*, 86 :465–491, 1997.
- [LR05] Z. Liu and B. Rao. Characterization of polynomial decay rate for the solution of linear evolution equation. *Z. Angew. Math. Phys.*, 56(4) :630–644, 2005.
- [LR10] J. Le Rousseau and L. Robbiano. Carleman estimate for elliptic operators with coefficients with jumps at an interface in arbitrary dimension and application to the null controllability of linear parabolic equations. *Arch. Rational Mech. Anal.*, 105 :953–990, 2010.
- [LR11] J. Le Rousseau and L. Robbiano. Local and global Carleman estimates for parabolic operators with coefficients with jumps at interfaces. *Invent. Math.*, 183 :245–336, 2011.
- [LZ98] G. Lebeau and E. Zuazua. Null-controllability of a system of linear thermoelasticity. *Arch. Rational Mech. Anal.*, 141 :297–329, 1998.
- [LZ99] G. Lebeau and E. Zuazua. Decay rates for the three-dimensional linear system of thermoelasticity. *Arch. Rational Mech. Anal.*, 148 :179–231, 1999.
- [LZ10] V. Lescarret and E. Zuazua. Numerical scheme for waves in multi-dimensional media : convergence in asymmetric spaces. *Preprint*, 2010.
- [Mar88] A.S. Markus. *Introduction to the Spectral Theory of Polynomial Operator Pencils*, volume 71 of *Transl. Math. Monogr.* Amer. Math. Soc., Providence, R.I., 1988.
- [Mar99] P. Martinez. A new method to obtain decay rate estimates for dissipative systems with localized damping. *Rev. Mat. Complut.*, 12 :251–283, 1999.
- [Mar02] A. Martinez. *An Introduction to Semiclassical and Microlocal Analysis*. Springer-Verlag, 2002.
- [Mil02] L. Miller. Escape function conditions for the observation, control, and stabilization of the wave equation. *SIAM J. Control Optim.*, 41 :1554–1566, 2002.
- [Mil05] L. Miller. Controllability cost of conservative systems : resolvent condition and transmutation. *J. Funct. Anal.*, 218(2) :425–444, 2005.

- [Mil06a] L. Miller. The control transmutation method and the cost of fast controls. *SIAM J. Control Optim.*, 45(2) :762–772, 2006.
- [Mil06b] L. Miller. On the controllability of anomalous diffusions generated by the fractional laplacian. *Mathematics of Control, Signals, and Systems*, 3 :260–271, 2006.
- [Mil09] L. Miller. Unique continuation estimates for sums of semiclassical eigenfunctions and null-controllability from cones. *preprint*, <http://hal.archives-ouvertes.fr/hal-00411840/fr/>, 2009.
- [Mil10] L. Miller. A direct Lebeau-Robbiano strategy for the observability of heat-like semigroups. *Discrete Contin. Dyn. Syst. Ser. B*, 14(4) :1465–1485, 2010.
- [MS78] R.B. Melrose and J. Sjöstrand. Singularities of boundary value problems. I. *Comm. Pure Appl. Math.*, 31(5) :593–617, 1978.
- [MZ06] S. Micu and E. Zuazua. On the controllability of a fractional order parabolic equation. *SIAM J. Cont. Optim.*, 44 :1950–1979, 2006.
- [Paz83] A. Pazy. *Semigroups of Linear Operators and Applications to Partial Differential Equations*. Springer-Verlag, New York, 1983.
- [Phu01] K.-D. Phung. Observability and control of Schrödinger equations. *SIAM J. Control Optim.*, 40(1) :211–230, 2001.
- [Phu07a] K.-D. Phung. Mémoire d’Habilitation à diriger des Recherches. 2007.
- [Phu07b] K.-D. Phung. Polynomial decay rate for the dissipative wave equation. *J. Differential Equations*, 240(1) :92–124, 2007.
- [Ral69] J.V. Ralston. Solutions of the wave equation with localized energy. *Comm. Pure Appl. Math.*, 22 :807–823, 1969.
- [RdT11] L. Rosier and L. de Teresa. Exact controllability of a cascade system of conservative equations. *C. R. Acad. Sci. Paris, Ser. I*, doi :10.1016/j.crma.2011.01.014, 2011.
- [Rob91] L. Robbiano. Théorème d’unicité adapté au contrôle des solutions des problèmes hyperboliques. *Comm. Partial Differential Equations*, 16(4-5) :789–800, 1991.
- [Rob95] L. Robbiano. Fonction de coût et contrôle des solutions des équations hyperboliques. *Asymptotic Anal.*, 10 :95–115, 1995.
- [Rod93] L. Rodino. *Linear partial differential operators in Gevrey spaces*. World Scientific Publishing Co. Inc., River Edge, NJ, 1993.
- [Roy10] J. Royer. *Analyse haute fréquence de l’équation de Helmholtz dissipative*. Thèse de Doctorat. Université de Nantes, 2010. <http://www.math.sciences.univ-nantes.fr/~jroyer/these.pdf>.
- [RT74] J. Rauch and M. Taylor. Exponential decay of solutions to hyperbolic equations in bounded domains. *Indiana Univ. Math. J.*, 24 :79–86, 1974.
- [Rus73] D.L. Russell. A unified boundary controllability theory for hyperbolic and parabolic partial differential equations. *Studies in Appl. Math.*, 52 :189–221, 1973.
- [Rus78] D.L. Russell. Controllability and stabilizability theory for linear partial differential equations : recent progress and open questions. *SIAM Rev.*, 20(4) :639–739, 1978.
- [See67] R. T. Seeley. Complex powers of an elliptic operator. In *Singular Integrals (Proc. Sympos. Pure Math., Chicago, Ill., 1966)*, pages 288–307. Amer. Math. Soc., Providence, R.I., 1967.
- [Sei88] T.I. Seidman. How violent are fast controls? *Math. Control Signals Systems*, 1(1) :89–95, 1988.
- [Ser96] D. Serre. *Systèmes de lois de conservation. II*. Fondations. Diderot Editeur, Paris, 1996. Structures géométriques, oscillation et problèmes mixtes.
- [Shu01] M. A. Shubin. *Pseudodifferential Operators and Spectral Theory*. Springer-Verlag, Berlin Heidelberg, second edition, 2001.
- [Sjö09] J. Sjöstrand. Some results on nonselfadjoint operators : a survey. In *Further progress in analysis*, pages 45–74. World Sci. Publ., Hackensack, NJ, 2009.
- [Sjö10] J. Sjöstrand. Resolvent estimates for non-selfadjoint operators via semigroups. In *Around the research of Vladimir Maz’ya. III*, volume 13 of *Int. Math. Ser. (N. Y.)*, pages 359–384. Springer, New York, 2010.

- [Sma74] D.R. Smart. *Fixed point theorems*. Cambridge University Press, London-New York, 1974.
- [Tar90] L. Tartar. H -measures, a new approach for studying homogenisation, oscillations and concentration effects in partial differential equations. *Proc. Roy. Soc. Edinburgh Sect. A*, 115(3-4) :193–230, 1990.
- [Tay81] M. E. Taylor. *Pseudodifferential Operators*. Princeton University Press, Princeton, New Jersey, 1981.
- [Tre80] F. Trèves. *Introduction to Pseudodifferential Operators and Fourier Integral Operators*, volume I. Plenum Press, New York, 1980.
- [TT10] G. Tenenbaum and M. Tucsnak. On the null-controllability of diffusion equations. *Preprint*, http://www.iecn.u-nancy.fr/~tucsnak/cosfrac_fin.pdf, 2010.
- [TW09] M. Tucsnak and G. Weiss. *Observation and control for operator semigroups*. Birkhäuser Advanced Texts : Basel Textbooks. Birkhäuser Verlag, Basel, 2009.
- [Wan08] G. Wang. L^∞ -null controllability for the heat equation and its consequences for the time optimal control problem. *SIAM J. Cont. Optim.*, 47 :1701–1720, 2008.
- [You09] W. Youssef. Contrôle et stabilisation de systèmes élastiques couplés. *Thèse de doctorat de l'université de Metz*, 2009.
- [Zua90] E. Zuazua. Exponential decay for the semilinear wave equation with locally distributed damping. *Comm. Partial Differential Equations*, 15 :205–235, 1990.
- [Zua05] E. Zuazua. Propagation, observation, and control of waves approximated by finite difference methods. *SIAM Rev.*, 47(2) :197–243, 2005.
- [Zua07] E. Zuazua. Controllability and observability of partial differential equations : some results and open problems. In *Handbook of differential equations : evolutionary equations. Vol. III*, Handb. Differ. Equ., pages 527–621. Elsevier/North-Holland, Amsterdam, 2007.
- [Zui83] C. Zuily. *Uniqueness and nonuniqueness in the Cauchy problem*, volume 33 of *Progress in Mathematics*. Birkhäuser Boston Inc., Boston, MA, 1983.

Résumé

Dans cette thèse, on s'intéresse à la contrôlabilité de différentes équations aux dérivées partielles.

La première partie est consacrée à la méthode de Lebeau-Robbiano pour le contrôle des équations paraboliques linéaires. On étend tout d'abord cette méthode à des opérateurs elliptiques non-autoadjoints, montrant une inégalité spectrale ainsi que la contrôlabilité de l'équation parabolique associée. On prouve ensuite ces deux propriétés pour un modèle de transmission à travers une interface, pour lequel la condition de transmission implique une diffusion tangentielle. La preuve repose sur une inégalité de Carleman, uniforme par rapport au petit paramètre représentant l'épaisseur de l'interface.

Dans la deuxième partie, on analyse les propriétés de certains systèmes d'équations aux dérivées partielles linéaires couplées par des termes d'ordre zéro. Après avoir étudié la stabilisation de deux équations d'ondes, dont une seulement est amortie, on montre la contrôlabilité en temps grand d'un système similaire au moyen d'un seul contrôle, sous des conditions géométriques optimales sur les zones de contrôle et de couplage. Par des méthodes d'analyse microlocale, on obtient de plus la contrôlabilité de systèmes d'ondes en cascade, ainsi que l'expression exacte du temps minimal de contrôle. On déduit de ces résultats la contrôlabilité des systèmes paraboliques associés, dans des situations où les zones de contrôle et de couplage sont disjointes.

Enfin, dans la troisième partie, on étudie la contrôlabilité uniforme de perturbations visqueuses de lois de conservation scalaires, dans la limite de viscosité évanescence. On montre la contrôlabilité exacte globale aux états constants au moyen de contrôles uniformément bornés lorsque la viscosité tend vers zéro.

Mots-clés: contrôlabilité, stabilisation, inégalités spectrales, équations paraboliques, équation des ondes, systèmes couplés, problème de transmission, lois de conservation scalaires, viscosité évanescence, opérateurs non-autoadjoints, opérateurs elliptiques, inégalités de Carleman, théorie spectrale, analyse microlocale et semiclassique.

Abstract

In this work, we are concerned with the controllability of different partial differential equations.

The first part is devoted to the Lebeau-Robbiano method for the control of linear parabolic equations. We first extend this method to some non-selfadjoint elliptic operators, proving a spectral inequality together with the controllability of the associated parabolic equation. Then, we prove these two properties for a transmission model across an interface, where the transmission conditions involve a tangential diffusion. The proof relies on a Carleman estimate which is uniform with respect to the small parameter representing the thickness of the interface.

In the second part, we analyse some linear systems of partial differential equations, coupled by zero order terms. After having studied the stabilization of two wave equations, only one of them being damped, we prove the controllability in large time of a similar system with one control force only, under optimal geometric conditions on the control and the coupling regions. Using microlocal analysis methods, we moreover obtain the controllability of cascade systems of wave equations, together with the exact minimal time needed to control. These results imply in particular the controllability of the associated parabolic systems, in some situations where the control and the coupling regions are disjoint.

Finally, in a third part, we study the uniform controllability of viscous perturbations of scalar conservation laws in the vanishing viscosity limit. We prove the exact global controllability to constant states by means of controls that are uniformly bounded when the viscosity goes to zero.

Keywords: controllability, stabilization, spectral inequalities, parabolic equations, wave equation, coupled systems, transmission problem, scalar conservation laws, vanishing viscosity, non-selfadjoint operators, elliptic operators, Carleman estimates, spectral theory, microlocal and semiclassical analysis.

