



**HAL**  
open science

# Research of Nonlinear System High Order Sliding Mode Control and its Applications for PMSM

Yi-Geng Huangfu

► **To cite this version:**

Yi-Geng Huangfu. Research of Nonlinear System High Order Sliding Mode Control and its Applications for PMSM. Chemical and Process Engineering. Northwestern Polytechnical University (Chine), 2010. English. NNT: 2010BELF0130 . tel-00608229

**HAL Id: tel-00608229**

**<https://theses.hal.science/tel-00608229>**

Submitted on 12 Jul 2011

**HAL** is a multi-disciplinary open access archive for the deposit and dissemination of scientific research documents, whether they are published or not. The documents may come from teaching and research institutions in France or abroad, or from public or private research centers.

L'archive ouverte pluridisciplinaire **HAL**, est destinée au dépôt et à la diffusion de documents scientifiques de niveau recherche, publiés ou non, émanant des établissements d'enseignement et de recherche français ou étrangers, des laboratoires publics ou privés.

A Dissertation for the Degree of Philosophy Doctor

**Research of Nonlinear System High Order  
Sliding Mode Control and its Applications  
for PMSM**

by

**Huangfu Yi-geng**

Supervised by

**Prof. Abdellatif MIRAOUI**

and

**Prof. LIU Wei-guo**

University of Technology of Belfort-Montbéliard

And

Northwestern Polytechnical University

January, 2010

---

## **ACKNOWLEDGMENTS**

My great gratitude goes primarily to my adviser, Professor Abdellatif MIRAOUI and Professor Weiguo LIU, for intellectual support, encouragement, and enthusiasm which made this dissertation possible.

I also wish to thank my committee members, Professor Taha BOUKHOBZA and Professor Ruiqing MA, for their valuable advices on this dissertation.

Further, I am grateful to my parents for their prayers, guidance and support throughout my education. Their inspiration and encouragement has been invaluable. Finally, thanks to my wife, Di WU, for her love, support and patience especially during the write-up and viva preparation when she has to handle all the housework alone.

I thank Chinese Scholarship Council (CSC) for their financial support when I studied in France.

□

---

---

## ABSTRACT

Nonlinear system control has been widely concern of the research. At present, the nonlinear system decoupling control and static feedback linearization that based on the theory of differential geometry brought the research getting rid of limitation for local linearization and small scale motion. However, differential geometry control must depend on precise mathematical model. As a matter of fact, the control system usually is with parameters uncertainties and output disturbance. In this thesis, nonlinear system of control theory has been studied deeply. Considering sliding mode variable structure control with good robust, which was not sensitive for parameters perturbation and external disturbance, the combination idea of nonlinear system and sliding mode controls was obtained by reference to the large number of documents. Thus, it not only can improve system robustness but solve the difficulties problem of nonlinear sliding mode surface structure. As known to all, traditional sliding mode had a defect that is famous chattering phenomenon. A plenty of research papers focus on elimination/avoidance chattering by using different methods. By comparing, the document is concerned with novel design method for high order sliding mode control, which can eliminate chattering fundamentally. Especially, the approach and realization of nonlinear system high order sliding mode control is presented in this paper.

High order sliding mode technique is the latest study. This thesis from the theory analysis to the simulation and experiment deeply study high order sliding mode control principle and its applications. By comparison, the second order sliding mode control law (also known as dynamic sliding mode control, DSM) may be effective to eliminate the chattering phenomenon. But it is still unable to shake off the requirement of system relative degree. Therefore, arbitrary order sliding mode controller is employed, whose relative degree can equal any values instead of one. The robot car model adopted high order sliding mode is taken as an example. The simulation results show that the tracking control is effective.

In the control systems design, it is very often to differentiate the variables. Through the derivation of sliding mode, the expression of sliding mode differential value is obtained. The simulation results certificate sliding mode differentiator with robustness and precision. At the same time, the differentiator for arbitrary sliding mode is given to avoiding conventional complex numerical calculation. It not only remains the precision of variables differential value, but also

---

obtains the robustness. A direct application is simplification for high order sliding mode controller.

Due to its inherent advantages, the permanent magnet synchronous motor (PMSM) deserves attention and is the most used drive in machine tool servos and modern speed control applications. For improving performance, this paper will applied nonlinear high order sliding mode research achievement to MIMO permanent magnet synchronous motor. It changes the coupling nonlinear PMSM to single input single output (SISO) linear subsystem control problem instead of near equilibrium point linearization. Thereby, the problem of nonlinear and coupling for PMSM has been solved. In addition, Uncertainty nonlinear robust control system has been well-received study of attention. Because the robust control theory is essentially at the expense of certain performance. This kind of robust control strategy often limits bandwidth of closed loop, so that system tracking performance and robustness will be decreased. So, sliding mode control is an effective approach for improving system robust. This thesis first proposed a robust high order sliding mode controller for PMSM. The system has good position servo tracking precision in spite of parameters uncertainties and external torque disturbance.

On this basis, According to the principle of high order sliding mode, as well as differentiator, the state variables of PMSM are identified online firstly and successfully. The results of simulation indicate observe value has high precision when sliding mode variable and its differentials are convergent into zero. The same theory is used in external unknown torque disturbance estimation online for PMSM. As if, load torque will no longer be unknown disturbance. System performance can be improved greatly. It establishes theoretical foundation for the future applications.

At the end of paper, using advanced half-physical platform controller dSPACE to drive a PMSM, hardware experiment implement is structured completely. The experiment results illustrate that PMSM adopting precious feedback linearization decoupling and high order sliding mode controller can realize system servo tracking control with good dynamic and steady character.

**Keywords: Nonlinear system, Differential geometry theory, Precious feedback linearization, High order sliding mode, Differentiator, Permanent magnet synchronous motor, dSPACE**

---

---

# CATALOGUE

<b>ACKNOWLEDGMENTS</b> .....	II
<b>ABSTRACT</b> .....	III
<b>CATALOGUE</b> .....	5
<b>Chapter 1 Introduction</b> .....	7
1.1 Introduction .....	7
1.2 The developing history and present state of nonlinear control theories .....	11
1.2.1 The developing history of nonlinear control theories .....	11
1.2.2 The present state of nonlinear control theories .....	12
1.3 The basic principle of sliding mode control theory .....	13
1.3.1 Basic concepts .....	14
1.3.2 The principle, merits and drawbacks of sliding mode control .....	18
1.3.3 Chattering problem and solving .....	21
1.4 The application and research of nonlinear sliding mode control systems .....	27
1.5 The main research contents of the paper .....	28
<b>Chapter 2 Nonlinear system high order sliding mode control</b> .....	31
2.1 Second order sliding mode control .....	32
2.2 Simulation example (levant,2003) .....	36
2.3 Arbitrary order sliding mode control .....	41
2.4 Simulation example .....	43
2.5 Quasi-continuous high order sliding mode control .....	47
2.6 Summary .....	51
<b>Chapter 3 Robust exact high order sliding mode differentiator</b> .....	52
3.1 Robust sliding mode differentiator .....	52
3.2 Numerical simulation .....	54
3.3 Arbitrary order sliding mode differentiator .....	56
3.4 Simulation example .....	58
3.5 Summary .....	60
<b>Chapter 4 Application — Nonlinear permanent magnetic synchronous motor high order sliding mode control</b> .....	62
4.1 Mathematical model of PMSM .....	63
4.2 Robust high order sliding mode control for PMSM .....	65

---

4.3	State variable estimation for PMSM .....	74
4.4	Disturbance torque estimation for PMSM .....	81
4.5	Summary of this chapter .....	83
<b>Chapter 5 Experimental system based on dSPACE.....</b>		<b>84</b>
5.1	Introduction of dSPACE control platform.....	84
5.2	PMSM control system based dSPACE.....	85
5.3	Development steps of control system.....	87
5.4	Experiment results and analysis .....	89
5.5	Summary of this chapter .....	95
<b>Chapter 6 Summary.....</b>		<b>96</b>
6.1	The chief work and research results of the paper .....	96
6.2	Several issues to be resolved.....	98
<b>Reference.....</b>		<b>100</b>
<b>Publications .....</b>		<b>112</b>

---

## Chapter 1 Introduction

In recent years, the robustness control of nonlinear system has already become one of the main research areas for numerous researchers. At present, the ideas applied to solve the problem mainly include nonlinear  $H_\infty$ , adapting control, stepping control, sliding mode control and so on. The document makes an intensive study into nonlinear system control theories, and meanwhile combines with a technology named high order sliding mode, which ensures the accuracy of decoupling control and improves the robustness of systems.

The contents of chapter 1 are shown as follows. Section 1 simply summarizes the application of nonlinear system and its technology background. Section 2 introduces the development and current situation of nonlinear system control theories. Section 3 presents the fundamental principles of sliding mode control technology. Section 4 analyzes the application of sliding mode control in nonlinear system. Section 5 shows chief research contents, structural arrangement and creative points of the paper.

### 1.1 Introduction

The historical process in which human beings know and change the world is always a gradual developing process from low class to top grade, from simplicity to complexity, from surface to inner. And the same to the aspect of control area, the early research on control system is all linear. For example, Watt steam-engine regulator, adjusting the liquid level and so on. It was limited by the current knowledge of human being on the natural phenomena and the ability to deal with the practical problems, for the linear system's physical description and its mathematical solving is much easier to achieve. In addition, it has already formed a perfect series of linear theories and research methods. By contrast, for nonlinear systems, except for minority situations, so far there hasn't been a feasible series of general methods. Even if there are several methods that will only solve problems belonging to one category, they can't be applied generally. Accordingly, that is to say, how we study and dispose the nonlinear system control is still staying at the elementary stage on the whole. Besides, from the viewpoint of the accuracy we need to control the system, it will get a satisfactory result within limits to utilize the linear system theories to deal with the most technology problems in engineering at present. Therefore, the nonlinear factors of one



---

real system are often neglected on purpose or substituted for various linear relations. To sum up, that is the principal cause which prompts the linear system theories to develop quickly and become correspondingly perfect day by day and restricts the nonlinear system theories from getting much attention and developing over a long term.

The present system has become more and more complicated, integrative and intelligent, while the request on its performance has become more and more strict. The research on the motion laws and analytical methods of the nonlinear system has already become a significant branch in the automatic control theories. Strictly speaking, the real systems mostly belong to nonlinear system. By contrast, linear systems are ideal models in order to simplify the mathematic problems. The contrast between linearity and non linearity is that the last one is a "non propriety". Yet, this main characteristic is a negation of propriety and cannot be used to have any unification in the methods or techniques used to analyze and control such systems. As a result, it determines the complexity on research. For nonlinear systems, in the past the researchers adopted the method of approximate linearization to linearize them, such as Taylor unfolding method, Jacobian matrix method and so on. These methods should be applied to nonlinear systems under the better initial value and the higher accuracy, which are effective to dispose the systems with the working point moving on a small scale. At the same time, the working point in practical systems is always moving. If the point moves beyond the scale or some component works in the nonlinear area, the output will bring strange phenomenon which can not be explained by linear theories. In addition, there are still some running behaviors such as asynchronous suppression, bifurcation, chaos, strange attractors from complicated systems which belong to nonlinear phenomenon in substance. Obviously, they can't be analyzed by means of linear models. Therefore, the nonlinear problems in mathematics should be solved with the theories and methods in the nonlinear science.

During the last two decades of the 20th century, differential geometry theory and its applications have developed fast, so that the research on nonlinear system control theories and their applications got a breakthrough improvement. With the help of differential geometry theory, necessary and sufficient conditions ([Hermann,1977](#); [Isidori,96](#)) of controllability and observability and were set up systematically via the research on the dependency relationships among the state, input and output of nonlinear system, which were studied by the basic tools such as Lie bracket. The

---

research models of differential geometry control theory get rid of partial linearization and movement on a small scale and realize the global analysis and synthesization on the dynamic systems. Nonlinear system control theory based on differential geometry theory realizes the linearization of nonlinear systems by means of state feedback and coordinate transformation under some conditions on the control. The point that doesn't neglect any high order nonlinear item in the linearization progress is different from traditional approximate linearization methods. So the linearization is not only accurate but also global, that is to say, it can be applied to the whole scale with definitions (Howze,1973). Among others, the linearization based on differential geometry theory in the algorithm still need the accurate nonlinear system models. However, it's impractical to use an accurate mathematic model to describe the dynamic character for a system. So it's inevitable to exist the factors such as parameter uncertainty, time-varying parameters, time delay, external disturbance which will have an influence on controller design. Accordingly, it's also considerably crucial to research on the robustness of nonlinear systems.

In the recent years, nonlinear  $H_\infty$  robust control, the fuzzy control, expert system, neural nets, adapting control, stepping control, sliding mode control and etc. have become the main research aspects. In addition, there are still several research results from some literatures which combine the control technologies together to improve them. Meanwhile, they are all accomplished under the more restrictive conditions on mathematic models. Among the researches on various nonlinear control techniques, each one has its own property. For it's not sensitive for the changing structure of sliding mode to react on the perturbation of system parameters and external elements, while for it's of strong robustness and its control structure design is simple to come true, sliding mode control has been an indispensable branch in the system robustness control theories. How to utilize the nonlinear coordinate change of diffeomorphism to devise sliding controllers is a point for the sliding mode control of nonlinear systems. In the process, it's supposed to ensure sliding mode to be strong robustness, to realize the linearization easily and to be immune to uncertain system parameters.

As we known, permanent magnet synchronous motor has so many advantages such as compact structure, high power density, high air-gap flux, no conversion spark and high torque inertia ratio, which is widely used in servo systems (Caravani,1998; Glumineau,1993; Ziribi,2001). Considering permanent magnet synchronous motor is

---

a nonlinear system with MIMO and coupling, which includes the product term of angular velocity and d-q axis current, it must achieve decoupling and linearization of the system to get the accurate control performance. Adopting permanent magnet synchronous motor as a typical application example in nonlinear kinetic control servo systems has universal significance. Permanent magnet synchronous motor is a MIMO and nonlinear time-varying system. In the past, adopting the traditional linearization can only realize partial approximation to get a mathematic model which can not describe the dynamic and static process of system accurately. The practice demonstrates that control method based on approximate linearization is so limited that it can not adjust to the converting system parameters and satisfy the request of wide speed regulation. And feedback linearization based on differential geometry overcomes the shortcoming of traditional linearization that the balance point can only keep steady on a small scale. So it's desire to need a control algorithm with good robustness to adapt the uncertain parameters. Recently, sliding mode control method which basically overcomes the shortcomings of system in theory is widely used in control systems of permanent magnet synchronous motor(), for it is not sensitive to the inner parameters and external interferences when motor runs dynamically and can avoid the conversion of load and parameters from affecting the dynamic performance of motor. But chattering problem exists in traditional sliding mode control when sliding mode surfaces switch, which would affect the stability of system if severe. Accordingly, experts in each country advance several new type sliding mode control methods with little or no chatter.

To sum up, the thesis shows that there are still some issues to study and solve in the applications of nonlinear high order sliding mode control in the kinetic servo system of permanent magnet synchronous motor as follows.

1. The feedback linearization of nonlinear system state needs the accurate mathematic model of the system, that is to say, it's a robustness problem of nonlinear servo control.

2. If we can't ensure that chattering exists in sliding mode control system, while we must assure the global constringency, how to reduce or eliminate the chattering effect as possible.

3. Permanent magnet synchronous motor is a typical nonlinear system with MIMO and coupling. To realize the accurate control of motor servo system, decoupling and linearization should be the main problems in the study of controller

---

---

design.

4. Because of some factors such as surroundings, the parameters of permanent magnet synchronous motor will not steady. How to devise a strong robustness controller is so critical under the external load disturbance.

5. Make good use of the advantages of sliding mode control to launch the research on some key technologies of permanent magnet synchronous motor, such as parameter identification, state estimation, load disturbance estimation and so on.

6. Adopt the advanced dSPACE semi-physical real-time experimental platform to accomplish the construction of permanent magnet synchronous motor system based on high order sliding mode control and demonstrate the validity of high order sliding mode control and the ability to eliminate chattering.

The paper will make a deep study on the above problems.

## **1.2 The developing history and present state of nonlinear control theories**

### **1.2.1 The developing history of nonlinear control theories**

In the 1930s to the 1940s, so many scholars such as Nyquist, Bode, Weiner, Nichols, Routh, Hurwitz strived to construct classic control theory based on frequency domain method and root locus technique. They adopted Laplace conversion as the mathematic tool and mainly studied the linear time-invariant system of SISO. They also converted the differential equation and difference equation which describe the system into complex number field in order to get transfer functions of the system. Generally speaking, they used feedback control to form the so-called closed loop control system. But there were still several obvious limitations in classic control theory. Especially, the theory is very difficult to apply in time-varying systems and nonlinear systems available and to show the much deeper characteristics. Consequently, the above promote modern control theory to develop.

In modern control theory, the multi input multi output system was studied thoroughly. And then it is pretty significant to construct basic theory which depicts the essences of control systems such as controllability, observability, realization theory, decomposition theory and so on. Meanwhile, it prompts control to develop from a class of engineering design methods to a new science. Based on state-space method, modern control theory adopts linear algebra and differential equations as the main mathematical tools to analyze and design control systems. The state-space method is

---

essentially a time domain approach, which not only describes the external characteristics of the system, but also describes and reveals the internal states and performances of the system. The goals of analysis and synthesis are to reveal the inherent laws of the system and then to realize the optimization of the system in a certain sense. In principle, it can be a single variable, linear, time-invariant and continuous, and it can also be multi-variable, nonlinear, time-varying and discrete. At the same time, its existence is to solve many practical control problems at a high level from theory to application and to promote nonlinear control, adaptive control, robustness control, etc. to be an independent science branch with fruitful achievements.

Before the development of nonlinear control theory, nonlinear controller has been applied in industry, such as a variety of relay control because of its reliable structure and good performance. Early, the study of nonlinear system control has made some significant progress. Main methods are describing function method, phase-plane method and Lyapunov method. These methods have been widely used to solve the practical problems of nonlinear systems. However, these methods still can not become a general method to analyze nonlinear systems.

To summarize the study results in the historical stage, the researching problems principally center on the absolute stability of the system, which limit the nonlinear term to a fan-shaped domains and allow a linear function to replace the nonlinear function.

### **1.2.2 The present state of nonlinear control theories**

Since the 1970s, nonlinear control system theory and its application research have achieved a breakthrough development. The successful application of modern mathematical tools such as modern differential geometry and differential algebraic theory played a key role in the area. For the input and output response of a nonlinear system, Slotine, Khalil, Isidori and others adopted state feedback approach and used Lie algebra to linearize it accurately.

**Feedback linearization:** its basic idea is to use algebraic transformation to convert the motion characteristics of a nonlinear system all or partially into linear dynamic characteristics. As a result, it can be analyzed by well-known linear control theory. This approach is completely different from approximate linear method. The difference is that, feedback linearization is achieved by means of the rigorous state

---

conversion and feedback rather than the linear approximation of dynamic characteristics. Feedback linearization can be considered as a method that transforms the original system model into the form of a relatively simple equivalent model.

The design method of feedback linearization also has some limitations. For example, it does not apply to all nonlinear systems, when it only applies to the system which is a smooth nonlinear system with precise mathematical model. When parameters are uncertain or model dynamic characteristics are not created, the system robustness will not be guaranteed. In order to overcome the above shortcomings, people are launching the ongoing active research to process nonlinear essence and then use feedback linearization to control, but also extend the feedback linearization into the non-minimum phase system or the weak non-minimum phase system. At the same time, we are also introducing robustness control, adaptive control and sliding mode control to feedback linearization system in order to increase the robustness of the system with uncertain parameters.

### **1.3 The basic principle of sliding mode control theory**

The concept of sliding mode control first appeared in Russian literature in the fifties of the twentieth century. The former Soviet Union experts Emelyanov first proposed the concept of sliding mode variable structure. In fact, before that, 1932, V. Kulebakin used in variable structure control and DC generator for an aircraft in 1934; Nikolski used the relay to operate the ship trajectory, these can be considered as earlier "Sliding Mode Control" (Utkin, 1999). Later, Utkin has written an English summary of papers on the sliding mode control (Utkin, 1977). Then, the sliding mode control theory was widely disseminated to the different areas. Seventies, sliding mode variable structure system with its unique advantages and characteristics attracted western scholars' attention, which was subsequently a number of scholars from different theoretical point of view, using a variety of mathematical tools for their in-depth research. They make the sliding mode control theory gradually developed into an independent research branch.

In the linear system control theory, after the single-input single-output (SISO) and multiple-input multiple-output (MIMO) system establishing standard type, the sliding mode control strategy had been further in-depth study (Edwards,1998; Utkin,1992; Utkin,1999). In which, R. A. DeCarlo designed the sliding mode controller for multi-variable nonlinear system (DeCarlo,1988); Later, the theory of

---

nonlinear systems differential geometry had been developed (Isidori,1995). This theory will soon be applied to sliding mode control and related fields. The sliding mode control itself is a nonlinear controller, so its application is not limited to linear systems, also applies to nonlinear systems. If a nonlinear system using approximate linearization into a linear system, then designing sliding mode controller, the effect is clearly not as good as designing a controller for nonlinear system directly. However, for the nonlinear systems, it should be converted to standard affine form usually, which is not all nonlinear systems can be accomplished. Proceeding from the practical problems, Slotine, who has designed a sliding mode based on input-output decoupling controller (Slotine,1983; Slotine,1993), whose sliding mode surface is composed by the Hurwitz polynomial on output error and error derivatives.

Differential algebraic theory first appeared in Fliess research results in (Fliess, 1990a; Fliess, 1990b). He has opened up a new direction for nonlinear systems sliding mode control, who proposed a general algorithm about nonlinear system converting into a controllable standard form. The algorithm used the dynamic system state and input output decoupling. Sira-Ramirez presented a controllable standards design approach based on sliding mode control, using this method designed a special sliding surface (Sira-Ramirez, 1992; Sira-Ramirez, 1993; Sira -Ramirez, 2002). X.Y. Lu and S.K. Spurgeon also raised the standard model based on general sliding mode control strategy of nonlinear control system (Lu, 1998).

### 1.3.1 Basic concepts

The sliding mode control is the essence of high-frequency switching feedback control. The switching value of its control law switches over according to the system state. The design the sliding mode controller is composed mainly by two parts, the sliding surface and control law. So that the dynamic system have been bound at the sliding mode surface. This kind of state also is known as sliding mode state, which is only relative with the choice of sliding surface. The dynamic system of the sliding state is without outside influence.

#### 1. Linear sliding mode and nonlinear sliding mode

The sliding mode control is to make the system slide into the sliding surface, and thus into the sliding state. In other words, when the system goes into the sliding state, the sliding mode variable also is able to converge to zero. In engineering applications, people commonly use the error between control objectives and the reference input and

---

its derivative to form the sliding surface. If the sliding surface is the linear combination of the error and its corresponding differentiation, it becomes a linear sliding surface. In a similar way, if the sliding surface is the nonlinear combination of the error and its corresponding differentiation, it becomes a nonlinear sliding surface (Man, 1997). The linear sliding surface of the system state is an asymptotic convergence into the reference, while the system requires input relative degree equal to 1. But the nonlinear sliding surface  $S(x,t)$  is a finite time convergence into zero (Bhatt, 2000; Tang, 1998), it is not restricted by the relative degree.

For demonstration purposes, take an affine nonlinear system as an example.

$$\begin{aligned}
 \dot{x}_1 &= x_2 \\
 \dot{x}_2 &= x_3 \\
 &\vdots \\
 \dot{x}_n &= f(x,t) + g(x,t)u(t) \\
 y &= x_1
 \end{aligned} \tag{1.1}$$

Where,  $x = (x_1, x_2, \dots, x_n) \in R^n$  is the system state vector,  $u(t)$  is the system input,  $y$  is the system output. Both of  $f(x,t)$  and  $g(x,t)$  are smooth bounded functions. The control object is to let the system output track the reference trajectory  $y_{ref}$ .

Set the sliding mode surface

$$s = S(x,t) \tag{1.2}$$

Here,  $S(x,t)$  is differential equation defined on state variable  $x$ . And  $t$  is the system running time. Through the sliding mode control law, the system will enter in sliding mode state on the sliding mode surface. In this way, the system can converge into origin progressively or within limited time. When the system enters in sliding mode state, it satisfies

$$S(x,t) = 0 \tag{1.3}$$

Take linear sliding mode as an example, the design usually is

$$s = e^{(n-1)} + \dots + c_2 \ddot{e} + c_1 \dot{e} + c_0 e \tag{1.4}$$

Where,  $e = y - y_{ref}$ . It is the error between system output and reference value. The coefficients of differential equation  $c_i (i = 0, 1, \dots, n-1)$  satisfy Hurwitz



polynomial. From this expression, when the sliding mode variable  $s = 0$ , the error will converge into origin progressively. It means  $e = 0 \rightarrow y = y_{ref}$ . Thus, object track is achieved. However, the linear sliding mode surface requires the relative degree of input must equal to 1. The reason is

$$\dot{s} = f(x,t) - y_{ref}^{(n)} + \sum_{i=0}^{n-2} c_i e^{(i+1)} + g(x,t)u(t) \quad (1.5)$$

The next step of controller design should make the system (1.5) stable. At this time, the tracking trajectory of  $n$  order affine nonlinear system (1.1) is transformed into the solution of 1 order dynamic system stabilization. Because the linear sliding mode surface strictly requires the relative degree of system input to equal to 1. The nonlinear sliding mode surface design will be explained by following chapter.

## 2. Linear control law and nonlinear control law

The aim of the control law is to drive the system into sliding mode surface (also called sliding mode manifold). And it retains sliding mode surface without influence of parameters uncertainty and external disturbance. In other words, the controller achieves sliding mode state as quickly by adjusting its control parameters. The method of Lyapunov provides a dynamic system stable analysis approach. If we can construct a positive definite function  $V$  so that its derivative  $\dot{V} < 0$ , the system is stable. This kind of method is usually used to design sliding mode controller.

Suppose the positive definite Lyapunov function selected as

$$V = \frac{1}{2}s^2 \quad (1.6)$$

Thus,

$$\dot{V} = s \dot{s} \quad (1.7)$$

So, the convergent condition of sliding mode variable is

$$s \dot{s} < 0 \quad (1.8)$$

The equation (1.8) expresses the convergence condition of sliding mode surface. The general definition about convergence condition is found in (Lu,1997b; 高为炳,1996). In order to let the sliding mode variable  $s$  satisfy convergence condition, the control law can be designed by following equations, where both of  $k_1$  and  $k_2$  are positive constants.

---

$$\dot{s} = -k_1 \operatorname{sgn}(s) \quad (1.10)$$

$$\dot{s} = -k_1 s - k_2 \operatorname{sgn}(s) \quad (1.11)$$

If the control law satisfy above conditions, it guarantees  $s \dot{s} < 0$ . The convergence speed is decided by positive constant  $k_1$ . Equation (1.10) and (1.11) are nonlinear sliding mode control law, which let the sliding mode variable converges into origin within finite time. And the convergence time is relevant to constant  $k_1$ ,  $k_2$  and system initial state.

### 3. Equivalent control

The equivalent control is average control in fact. This is not the actual control applied but represents the average sense of the applied control. Its main idea is to suppose the system existing ideal sliding mode state  $\dot{s} = 0$ . In this case, the solution of control vector is called equivalent control, written as  $u_{eq}$ .

The expression of equivalent control can be solved from equation (1.5)

$$u_{eq} = g(x, t)^{-1} (-f(x, t) + y_{ref}^{(n)} - \sum_{i=0}^{n-2} c_i e^{(i+1)}) \quad (1.12)$$

The equivalent control is not control input in actual system, but a mean value of actual control. The system goes along sliding mode state  $s = 0$  to the equilibrium under the equivalent control. The actual control should be composed by the equivalent control and sliding mode control.

$$u = u_{eq} + g(x, t)^{-1} \dot{s} \quad (1.13)$$

For example, if the system adopts nonlinear control law (1.10), the actual control should be

$$u = u_{eq} - g(x, t)^{-1} k_1 \operatorname{sgn}(s) \quad k_1 > 0 \quad (1.14)$$

Now, we can design the parameter  $k_1$  to converge into origin within limited time.

---

### 1.3.2 The principle, merits and drawbacks of sliding mode control

In order to clearly illustrate the work principle and advantage of sliding mode control, a simple 2 order dynamic system is taken as an example to declare.

$$\ddot{x} + a_2\dot{x} + a_1x = u + f(t) \quad (1.15)$$

Where,  $a_1$  and  $a_2$  are system parameters;  $u$  is control input;  $x$  is system variables;  $f(t)$  is external bounded disturbance, which has  $\|f(t)\| < \varepsilon$ . Suppose  $x_1 = x$ ,  $x_2 = \dot{x}$ , the original 2 order dynamic system can be transformed to following state equations.

$$\begin{bmatrix} \dot{x}_1 \\ \dot{x}_2 \end{bmatrix} = \begin{bmatrix} 0 & 1 \\ -a_1 & -a_2 \end{bmatrix} \begin{bmatrix} x_1 \\ x_2 \end{bmatrix} + \begin{bmatrix} 0 \\ 1 \end{bmatrix} u + \begin{bmatrix} 0 \\ 1 \end{bmatrix} f(t) \quad (1.16)$$

If the sliding mode surface is selected as

$$s = x_2 + cx_1 \quad (1.17)$$

Then,

$$\dot{s} = \dot{x}_2 + c\dot{x}_1 = (c - a_2)x_2 - a_1x_1 + f(t) + u \quad (1.18)$$

Set the sliding mode control law as

$$u = -k_1 \operatorname{sgn}(s) \quad (1.19)$$

According to the Lyapunov Second Law, the function  $V = s^2/2$  is constructed, thus

$$\begin{aligned} \dot{V} &= s \dot{s} = (x_2 + cx_1)[(c - a_2)x_2 - a_1x_1 + f(t) - k_1 \operatorname{sgn}(s)] \\ &= (c - a_2)x_2^2 - a_1cx_1^2 + (c^2 - ca_2 - a_1)x_1x_2 + (x_2 + cx_1)f(t) - k_1 \operatorname{sgn}(s)s \end{aligned} \quad (1.20)$$

Suppose system variables  $x_1$  and  $x_2$  are bounded, with  $\|x_1\| < X_{1\max}$ ,  $\|x_2\| < X_{2\max}$ . Where,  $X_{1\max}$  and  $X_{2\max}$  are constants, expressing the maximum of system variables. Then,

$$\dot{V} < (c - a_2)X_{2\max}^2 - a_1cX_{1\max}^2 + (c^2 - ca_2 - a_1)X_{1\max}X_{2\max} + (X_{2\max} + cX_{1\max})\varepsilon - k_1|s| \quad (1.21)$$

From the equation (1.21), it can be seen that  $\dot{V} < 0$  if choosing parameter  $k_1$ . In other word, the new system is stable. The sliding mode control is arriving at sliding mode surface  $s = 0$  from the initial value after a period time  $t_r$ . The sliding mode trajectory is shown in figure 1-1.

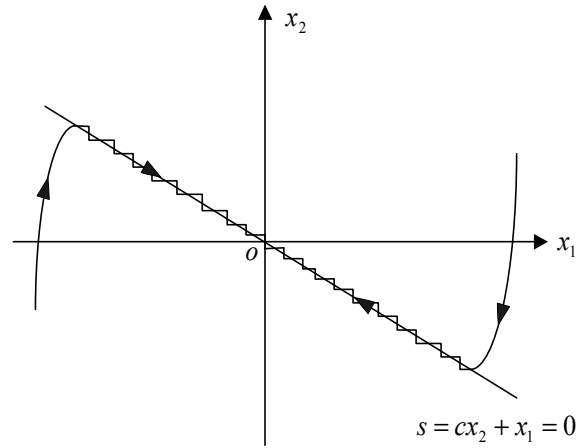

Fig. 1-1 Phase plane trajectory of system sliding mode control

When the system goes into sliding mode motion, with  $s = x_2 + cx_1 = 0$ , we can get the solution

$$x_1 = x_1(t_r)e^{-c(t-t_r)} \quad (1.22)$$

From the equation (1.22), it is can be seen that the solution has nothing to do with parameter  $a_1$ ,  $a_2$  and disturbance  $f(t)$ . It also illustrates the controller is insensitive to system parameter and disturbance with robustness. At the same time, original 2 order dynamic system is transformed to 1 order system by sliding mode control, achieving system deflation. The sliding mode controller design is very easy only with a sign function, which is easy to realize. Because of these advantages, the sliding mode control is widely spread in control field.

However, from the figure 1-1, the drawback is chattering problem due to the discontinuous control law acting on the sliding mode when system goes into sliding mode state. This is harmful in engineering control. For example, it can increase the loss and reduce the life of component. So it is should be overcome as possible as we can.

According to the above design step of sliding mode control, we do the simulation for the 2 order dynamic system. Selecting sliding mode surface as  $s = x_2 + x_1$ , we use the control law  $u = -5\text{sgn}(s)$ . The initialization of system variables are  $x_1(0) = 1$

and  $x_2(0) = 0$ . Then, the phase plane of system is shown in figure 1-2. If we amplify the partial sliding mode surface  $s = 0$ , the figure 1-3 displays the chattering.

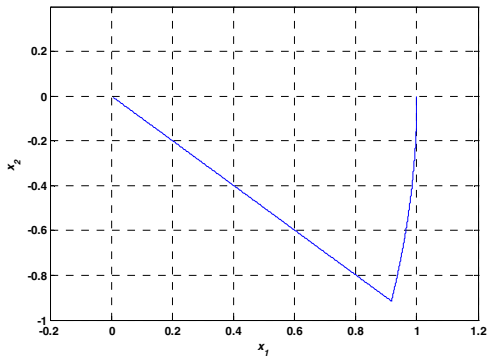

Fig. 1-2 Phase plane of second order system

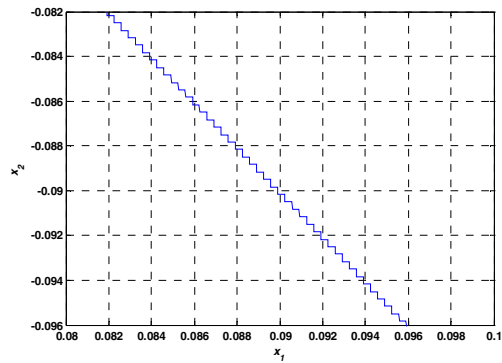

Fig. 1-3 Partial enlarged drawing SM surface

The figure 1-4 shows that the system variables will converge into origin after a short time. When the control law converges, the system is stable as well. The figure 1-5 is the sliding mode control law, which is a nonlinear discrete control like a relay. That's the reason why the sliding mode control has chattering phenomenon.

In order to illustrate the high robustness of sliding mode control, the system is injected uncertain disturbance  $f(t) = 5e^{-0.2t} \sin(2t)$  that is shown in figure 1-6. The figure 1-7 declares that sliding mode trajectory just is different in spite of the disturbance. When it reaches sliding mode state, the situation is the same. It illustrates the system with high robustness.

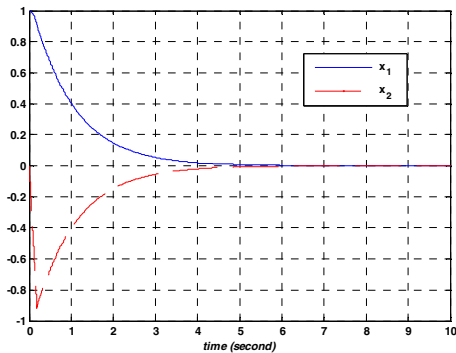

Fig. 1-4 State variables trajectory

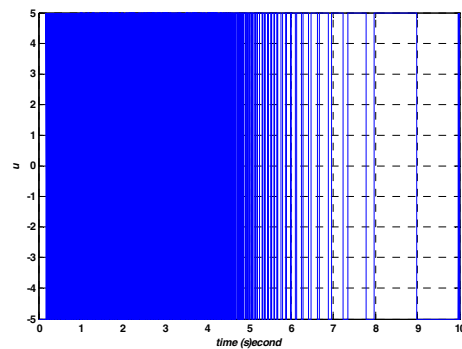

Fig. 1-5 Sliding mode control law

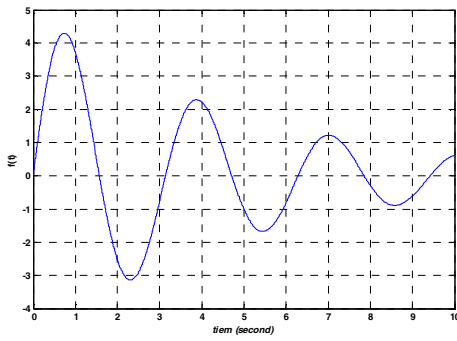

Fig. 1-6 Uncertainty bounded disturbance

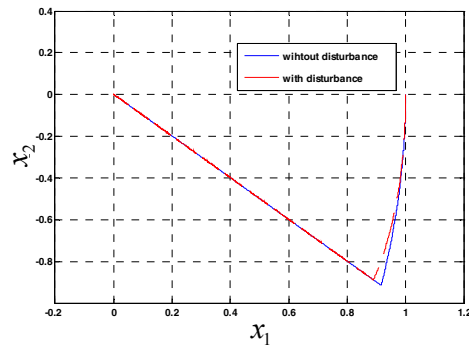

Fig. 1-7 System phase plane with disturbance

### 1.3.3 Chattering problem and solving

The sliding mode control actually is the structure of feedback controller occur changes according to certain rules when the system state passes across the different regions in state space. It makes the control systems has a certain adaptive ability to the internal parameter variations and external disturbance so that the system performance achieves the desired targets. However, due to the sliding mode control law with a discrete switch control, it has chattering. Moreover, the ideal switching frequency of sliding mode control is infinity, which can not be realized in the actual system. In addition, in practical applications, the switch with time-delay, discontinuous sampling, system inertia, and even the error of state measurement will cause the chattering phenomenon in sliding mode control. In this way, the sliding mode control system is equivalent to high gain system accompanied by high frequency jitter, which could bring a very harmful consequence for control systems.

Therefore, the chattering phenomenon has become the biggest developing obstacle of sliding mode control technology. The academics have continued to weaken or prevent the chattering without interruption. In order to reduce or eliminate chattering, a large number of researchers have put a lot of hard work in their respective areas of research. To sum up, it is mainly in the following several ways.

**Pseudo-sliding mode:** to reduce the chattering, the first thought is to improve the control law to weaken the impact of chattering. Literature (Slotine,1983) introduced a concept of "pseudo-sliding mode" and the "boundary layer". It adopted saturation function  $sat(s, \delta)$  instead of sign function  $sgn(s)$  to realize the sliding mode control.

$$sat(s, \delta) = \begin{cases} \text{sgn}(s) & \text{if } |s| > \delta \\ s/\delta & \text{if } |s| \leq \delta \end{cases} \quad \delta > 0$$

Outside the boundary layer, it uses switch sliding mode control. Otherwise, inside the boundary layer, it uses continuous state feedback control. In this way, it reduces the chattering, but loses the finite time convergence. The figure 1-8 is the saturation function and sign function.

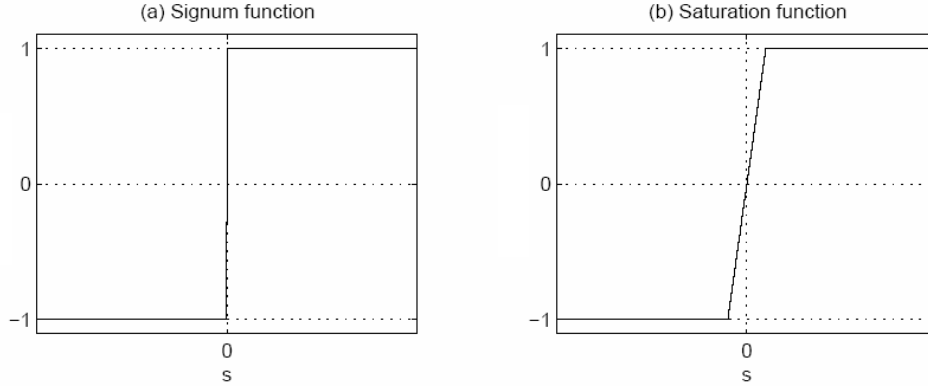

Fig. 1-8 sign function  $\text{sgn}(s)$  and saturation function  $sat(s, \delta)$

After that, many scholars start to study the switch function and boundary layer. Some of them propose serialization of unit vector.

$$u(s, \delta) = k \frac{s}{|s| + \delta} \quad (1.23)$$

Some literature calls it signum-like function. Where, the choose of  $\delta$  can guarantee precision. Besides, there is power law interpolation.

$$u(s, \delta) = \begin{cases} k \text{sgn}(s) & \text{if } |s| > \delta \\ k(\delta/|s|)^{q-1} \text{sgn}(s) & 0 < |s| \leq \delta \quad q \in [0,1] \\ 0 & s = 0 \end{cases} \quad (1.24)$$

In addition, there are arc tangent function  $u(s, \delta) = k \cdot \tan^{-1}(s/\delta)$ , hyperbolic curve  $u(s, \delta) = \tanh(s/\delta)$  and etc. instead of original switch function  $\text{sgn}(s)$ . Their aim is to reduce or remove the chattering. The various approximate functions are shown in figure 1-9.

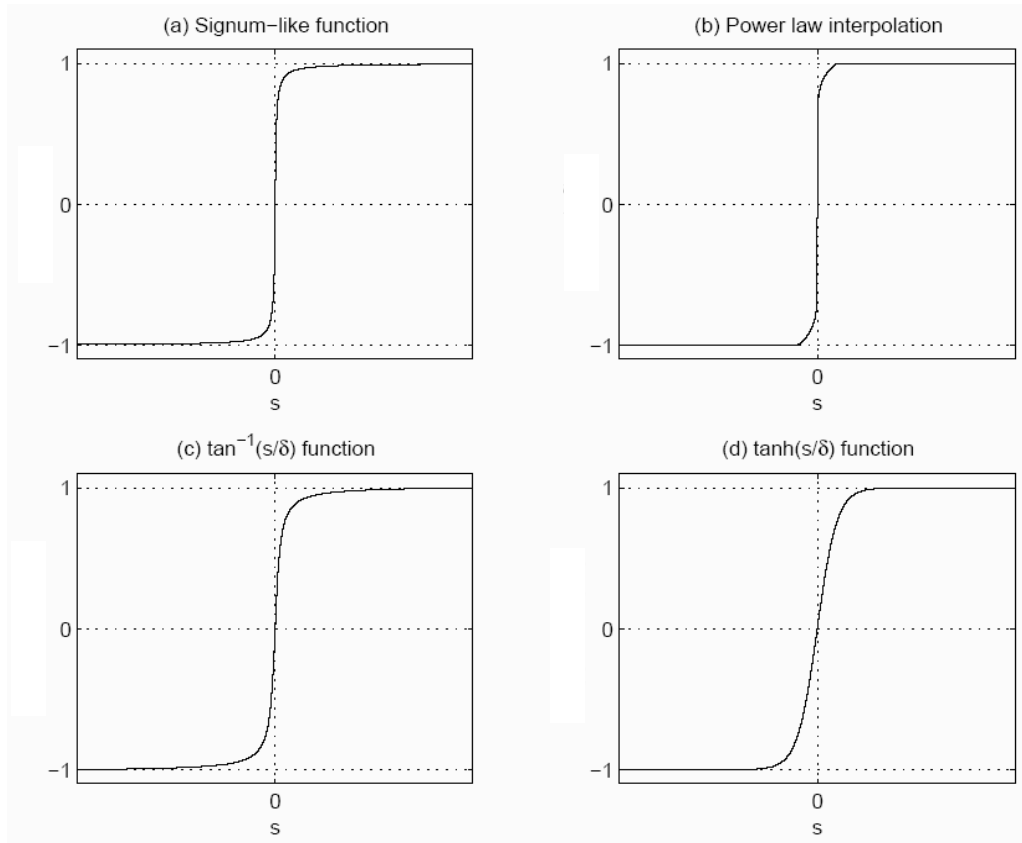

Fig. 1-9 Approximated function effect schematic plan

The smaller the boundary layer, the control effect will be better. But, at the same time, this will enlarge the control gain and chattering enhancement; On the contrary, the greater the boundary layer, the chattering will be smaller. But they will decrease the control gain, and the effect of control become worse. In fact, this approximate sliding mode control is the balance between the system performance and robustness.

**Approach law:** Prof. Gao Weibing proposed approach law (高为炳,1996) in 1989. Take the exponential approach law  $\dot{s} = -\varepsilon \operatorname{sgn}(s) - ks$  as an example, through the adjustment of parameter  $k$  and  $\varepsilon$ , it can not only guarantee the dynamic quality of sliding mode arrival procession, but also weaken high frequent chattering of control signal. But if the  $\varepsilon$  is too great, it will result in chattering. The approach law is used to study dynamic quality of arrival procession, when the system converges from the any initialization within limited time. According to the different system, we can design the various approach law, such as

Uniform approach law	$\dot{s} = -\varepsilon \operatorname{sgn}(s)$
Power approach law	$\dot{s} = -k  s ^\alpha \operatorname{sgn}(s)$
Exponential approach law	$\dot{s} = -\varepsilon \operatorname{sgn}(s) - ks$



---



---

$$\text{General approach law} \quad \dot{s} = -\varepsilon \operatorname{sgn}(s) - f(s)$$

Where, the parameter of these approach law require  $\varepsilon > 0$ ,  $k > 0$ ,  $1 > \alpha > 0$  and  $s \cdot f(s) > 0$ . The literature (翟长连,2000) analyzes the chattering reason caused by approach coefficient, when the exponential approach law is used to the discrete system. It also made quantitative analysis for the relationship between approach coefficient and chattering. He proposed self-adaptive adjustment algorithm of approach coefficient  $\varepsilon$ . And the literature (于双和,2001) proposed the combinative control strategy of discrete approach law and equivalent control. The discrete control law just acts at the approach procession. When the system arrives at sliding mode state, the discrete control law is used to guarantee good quality of approach sliding mode state. The literature (Jiang,2002) brought the fuzzy control into exponential approach control law. Through the analysis of the fuzzy relation between switch function and coefficient in approach law, he adopted fuzzy rule to adjust coefficient of exponential approach law, in which the absolute value of switching function is taken as the fuzzy rules input. The coefficient of exponential approach law  $k$  and  $\varepsilon$  are taken as fuzzy rule output. In this way, it ameliorates the quality of sliding mode so that remove the high frequent chattering. Most of the domestic literature on sliding mode control techniques are used is this approach.

**Filters:** through the use of filters, smoothing the control signal is an effective way to eliminate chattering. Literature (Kachroo,1996; Kang,1997; Yanada,1999) adopt a low-pass filter to smooth the switch function. It effectively eliminates the chattering and suppresses high-frequency noise, and to ensures system stability as well. The literature (Krupp,1999), in order to overcome the chattering caused by unmodeled dynamics character, designed a new type of sliding mode controller, whose output achieve a smooth output signal through a second-order filter. Where, the auxiliary coefficient of sliding mode surface is obtained by sliding mode observer. Literature (Xu,2000) proposed a new control law, which is consists of three parts: namely the equivalent control, switching control and continuous control. In the control law the two low-pass filters are used. A low-pass filter gets the switched gain, another low-pass filter get the equivalent control. It also analyses the convergence and stability to effectively restrain chattering and achieve high-performance control of multi-joint robot. As the filter design parameters more complicated, as well as the delay and other factors of the filter itself, its application is limited.

**Observer:** Using the observer to eliminate external disturbance and uncertain

---

items has become a study to solve the chattering problem. The literature (Kawamura, 1994) designed a new type observer of disturbance. Through feedforward compensation for the external perturbation injected, it greatly reduced switching gain of sliding mode controller, and effectively eliminated the chattering. Y. S. Kim designed a disturbance observer based on binary control theory. In this paper, the disturbance observed was used for feedforward compensation to reduce the chattering. (Kin,1996). In addition, the literature (Edwards,2004) designed a sliding mode observer to achieve a fault detection and fault-tolerant control.

**Neural Sliding:** neural network is a nonlinear continuous time dynamic system. It has a very strong self-learning function and a powerful mapping ability for nonlinear systems. The neural networks used for the sliding mode control, can reduce the chattering. The literature (Morioka,1995) used neural network to estimate the uncertainty and unknown external disturbance, and achieve the equivalent control based on neural network. It effectively eliminated the chattering as well. The literature (Ertugrul,2000) proposed a new type neural network method of sliding mode control, using two neural networks to approach equivalent control and switch control of sliding mode control respectively without the object model. It effectively eliminates the chattering, which has been successfully applied to robot trajectory tracking. The literature (Huang,2003) used the approximation capability of neural networks, designed a sliding mode controller based RBF neural network. It will take the switch function as network input. And the controller is realized entirely by continuous RBF function, which eliminates the switching chattering. In the literature (Da,2000), the sliding mode controller is divided into two parts. One part is for the neural network sliding mode controller, the other part is a linear feedback controller. Using fuzzy neural network sliding mode control to replace the output of the switching function, it ensures the continuity of the control law, essentially eliminates the chattering.

**Fuzzy sliding mode:** According to experience, the fuzzy rules design can effectively reduce the chattering in sliding mode control. Fuzzy sliding mode control often the control signals, change the discontinuous control signals to continuous one. It can reduce or avoid the chattering of sliding mode control. The fuzzy logic sliding mode control can achieve parameters self-adjusting. The input of fuzzy control is not  $(e, \dot{e})$  but  $(s, \dot{s})$ . Through the design of fuzzy rule, it drives sliding mode surface to zero, so that remove the switching part of the sliding mode control. Literature (Ha, 2001) used the equivalent control, switching control and fuzzy control constituting the

---

fuzzy sliding mode controller. In the fuzzy controller, the design of fuzzy rules reduces the impact of the switching control, effectively eliminates the chattering. Literature (Zhuang,2000) took the use of fuzzy control system to estimate the uncertainty items online, achieving fuzzy switching gain self-adjust. It guarantees the sliding mode to reach the condition satisfied as far as reducing the switching gain. Literature (Ryu,2001) established the chattering indicators of sliding mode control in order to reduce chattering to design fuzzy rules. The fuzzy rules, input indicators for the current chattering size of the output of fuzzy rules for the boundary layer thickness, through the fuzzy reasoning, realize the adaptive adjustment of boundary layer thickness. Literature (张天平,1995) proposed a fuzzy logic based on continuous sliding mode control method, using continuous fuzzy logic switch instead of non-continuous sliding mode control to avoid chattering.

**Higher-order sliding-mode:** the high order sliding mode control is a new method proposed in last decade (Levant,1993). The switch function in traditional sliding mode control is generally dependent on the system state, has nothing to do with the control input. Discontinuous items will be directly transferred to the controller. But, the high order sliding mode control constitutes a new sliding mode surface using the sliding mode control variable and its differentiations, transfers the discrete items to the first order or higher order derivative of sliding mode variable. That is expressed by  $S = \{s = \dot{s} = \dots = s^{(r-1)} = 0\}$ . It should be clear is that when the differential order of sliding mode variables equals to 2, it is called the second order sliding mode control in some reference (Koshkouei,2005;晁红敏,2001;吴玉香,2006). Sometimes, it also is known as dynamic sliding mode control (dynamic sliding mode , DSM). Literature (Bartolini,1998; Bartolini,2001) through the design of the second order derivative of sliding mode variable, it achieves to sliding mode control without chattering in the un-modeled dynamics and uncertain systems. And the method is extended to multiple-input multiple-output system. The high order sliding mode controller has the advantage of simple design, easy to implement, without precise mathematical models. It can effectively eliminate the chattering and improve the convergence precision as well.

Using high order sliding mode control, it not only eliminates the chattering problems that exist in the traditional sliding mode, but also avoids the requirements of relative degree that must be equal to 1 in the control law design. In this paper, after the analysis and comparison of several sliding mode control techniques, high order

---

sliding mode control is mainly used to eliminate chattering, implement model uncertain robust control for nonlinear systems. The thesis also focuses on multi-input multi-output nonlinear systems robust decoupling control.

#### **1.4 The application and research of nonlinear sliding mode control systems**

The sliding mode control system has strong robustness to the uncertainties in the system. Therefore, there is a great deal of applied research on sliding mode control theory in aviation, aerospace, electrical motor and power systems, robotics and industrial control (Shtessel,1996; Galzi,2007; Laghrouche,2003).

Actually, the sliding mode control of nonlinear systems in the industry control field has received considerable attention. In the initial stage of variable structure, it's mainly applied to the field of industry control. With the development of industrial technologies, the requirements of control precision and robustness to multi-variable, nonlinear practical equipments has gradually increased day by day and the application of sliding mode control in the industry control field has prompted step by step (Corradini,2000; Kim,2004; Rios-Gastelum, 2003). For the first time in 1983, the sliding mode control was applied into robot control by Slotine, who designed the sliding mode controller of time-varying referring trajectory. Subsequently, he combined the sliding mode control and the feedback linearization technique to extend research results to the sliding mode controller design of more general rigid-body robot and to achieve the referring trajectory tracking control. Yeh studied the sliding mode tracking control of satellites (Yeh,2000). Calise learned the robust sliding mode control of helicopter movement system with uncertain nonlinear system. Lu X.Y. designed trajectory tracking robust controller for the control problem of large aircraft from aerospace controller (Lu,1997). Y.B. Shtessel used robust sliding mode control to achieve the missile guidance control and wing flight control of F18 (Shtessel,2007). Toumes achieved a high altitude rocket navigation control. McDuffie designed decoupled sliding mode observer for satellite attitude control (McDuffie,1997). These controllers must be strong robustness to the system parameter variations and external disturbances. In recent years, the sliding mode control for nonlinear systems has been widespread paid much attention and become a research hot spot.

There are so many characteristics for permanent magnet synchronous motor such as compact structure, high power density, high air-gap flux and high-torque inertia ratio, which in the servo system has been widely used. But the permanent magnet

---

synchronous motor is a nonlinear system, which includes the product term of angular velocity and  $d$ - $q$  axis electric current, it must achieve decoupling and linearization of the system to get the accurate control performance. So, the feedback linearization in nonlinear control theory can transform nonlinear systems into linear systems (Bodson,1993). However, the parameters in motor dynamic model will be affected by the complex environment and the effect is still changing. Accordingly, the robust control has become an effective way to improve performances. M. Kadjoudj designed a high performance permanent magnet synchronous motor with an adaptive fuzzy controller (Kadjoudj,2001). J. Xu designed a robust adaptive stepping controller to improve motor performance (J. Xu,1998). S. Laghrouche adopted second order sliding mode control to design a nonlinear robustness controller for permanent magnet synchronous motor (Laghrouche,2004). These high performance robust controllers in synchronous motors have been very successful in the application. But because permanent magnet motor is affected by external influences and its own changing parameters and many other factors, there are still many issues worth studying, such as motor parameter identification, state estimation, perturbation estimation and so on.

The requirements in the applications to the control performance point out the direction for further study of sliding mode control theory and should be of great significance to the development of sliding mode control. As there are a large number of nonlinear problems in engineering, approximate linear model can not describe the dynamic characteristics of the system. In the real production, because of the environment in which a number of nonlinear controlled objects work is very complex, many internal uncertainties and external disturbance affect the control systems. Therefore, the robust control of uncertain system is an important research area in nonlinear sliding mode control.

### **1.5 The main research contents of the paper**

Based on the research of the current sliding mode control theory applied to nonlinear systems, it chiefly launches an in-depth study and exploration in allusion to several facing issues of nonlinear sliding mode control theory and gives the corresponding research findings and results.

1. The thesis shows the research background and systematically introduces the history and the current development situation of nonlinear control and sliding mode control theory. At the same time, it describes the control superior advantages of their

---

---

combination. Meanwhile, it analyzes the problems in the current sliding mode control and sum up various research directions to overcome the chattering. On this basis, it illustrates the study significance of the topic.

2. It introduces the basic theory of differential geometry as well as the latest research results of exact feedback linearization field in detail. The decoupling control of nonlinear MIMO system has always been a critical study of nonlinear problems. In sequence, decoupling controllers are designed for each nonlinear system. Through simulation study, it has established a basic theoretical research for further application of multi-variable complex systems.

3. As the chattering phenomenon which exists in the traditional sliding mode controller is extremely negative to industrial control, adopting high order sliding mode control algorithm can not only guarantee the control precision but also eliminate the chatters. Besides, it uses simulation experiments to demonstrate the validity of research results.

4. In the controller design, we frequently encounter the problem of solving variables' different order differentiations. But the traditional numerical method needs a large quantity of calculation and its accuracy level is not high. We study the sliding mode differentiator which uses high order sliding mode algorithm to achieve the variable derivative of arbitrary order. In engineering, the differentiator with strong robustness and high accuracy can not only greatly simplify the calculation of the workload but also ensure the calculation accuracy. At last, the paper designs a precise sliding mode differentiator and carries out application simulation research for MIMO nonlinear systems.

5. It takes research results of the sliding mode control for nonlinear systems studied to apply to servo system of the MIMO permanent magnet synchronous motor system, and combines the multi-variable nonlinear decoupling control and recent studied high order sliding mode control with strong robustness. In addition, it designs the robust sliding mode controller for the system under the parameters uncertain and external torque disturbance, in order to improve the performances of the motor. Meanwhile, for several current research focused on synchronous motor, it uses high order sliding mode control and its differential algorithm to achieve the items of state estimation, parameter identification and disturbance torque estimation for permanent magnet synchronous motor.

6. Finally, through real-time physical control platform dSPACE, it makes the

---

physical verification to robust sliding mode servo driving control MIMO system of the permanent magnet synchronous motor, in order to validate the consistency of experimental and theoretical research.

---

## Chapter 2 Nonlinear system high order sliding mode control

In the introduction of first chapter, we have known the sliding mode control with the strong robustness for the internal parameters and external disturbances. In addition, the appropriate sliding surface can be selected to reduce order for control system. However, due to the chattering phenomena of sliding mode control, the high frequency oscillation of control system brings challenge for the application of sliding mode control. On the other hand, the choice of sliding surface strictly requires system relative degree to equal to 1, which limits the choice of sliding surface.

In order to solve the above problems, the introduction of first chapter also illustrates the current developments and research methods in this field. This chapter focuses on a new type of sliding mode control, that is, higher order sliding mode control. The technology not only retains advantage of strong robustness in the traditional sliding mode control, but also enables discontinuous item variables transmit into the first order or higher order sliding mode derivative to eliminate the chattering. Besides, the design of the controller no longer must require relative degree to be 1. Therefore, it is greatly simplified to design parameters of sliding mode surface.

Emelyanov and others first time propose the concept of high order differentiation of sliding mode variable, but also provide a second order sliding mode twisting algorithm, and prove its convergence (Emelyanov,1996). Another algorithm is super twisting, which can completely eliminate chattering (Emelyanov,1990), although the relative degree of sliding mode variable is required to equal to 1. In the second order sliding mode control, Levant proved sliding mode accuracy is proportional to  $o(\tau^2)$  the square of the switching delay time. It has also become one of the merits of high order sliding mode control (Levant,1993). Since then, the high order sliding mode controller has been developed and applied rapidly. For example, Bartolini and others propose a second order sliding mode control applied the sub-optimal algorithm (Bartolini,1997; Bartolini,1999). After the concept of high order sliding mode control was applied to bound operator in (Bartolini,2000). Levant used high order sliding mode control in aircraft pitch control (Levant,2000) as well as the exact robust differentiator (Levant,1998). About the summary of high order sliding mode control is also described in the literature (Fridman,2002).

This chapter is structured as follows: 2.1, introduce a second order sliding mode



---

control that eliminate the chattering essentially; 2.2, Give simulation examples of the actual system against the algorithm of 2.1; 2.3, Introduce the algorithm arbitrary order sliding model control in detail; 2.4, Take simulation research to the algorithm of 2.3; 2.5, Give a quasi-continuous high order sliding mode control algorithm so that state variable can be more smooth; 2.6, Summary of this chapter.

## 2.1 Second order sliding mode control

Strictly speaking, second order sliding mode control is a special kind of high order sliding mode control actually. But, in the design of the controller, the highest order of sliding mode variable is 2, so called second order sliding mode control (SOSM). Some literatures also call it as the dynamic sliding mode control (DSM).

Without losing generality, considering a state equation of single input nonlinear system as

$$\begin{aligned}\dot{x} &= f(x) + g(x)u \\ y &= s(x, t)\end{aligned}\tag{2.1}$$

Where,  $x \in R^n$  is system state variable,  $t$  is time,  $y$  is output,  $u$  is control input. Here,  $f(x)$ ,  $g(x)$  and  $s(x)$  are smooth function. The control objective is making output function  $s \equiv 0$ .

Differentiate the output variables continuously, we can get every order derivative of  $s$ . According to the conception of system relative degree, there are two conditions.

- I. Relative degree  $r = 1$ , if and only if  $\frac{\partial}{\partial u} \dot{s} \neq 0$
- II. Relative degree  $r \geq 2$ , if  $\frac{\partial}{\partial u} s^{(i)} = 0$  ( $i = 1, 2, \dots, r-1$ ), and  $\frac{\partial}{\partial u} s^{(r)} \neq 0$

If the relative degree  $r = 1$ , traditional sliding mode control can be used to design controller. Else, it needs to design a second order sliding mode controller. Second order sliding mode control is able to eliminate chattering.

Suppose system relative degree equals 1, differentiate sliding mode variable twice continuously, then

$$\dot{s} = \frac{\partial}{\partial t} s(x, t) + \frac{\partial}{\partial x} s(x, t) [f(x) + g(x)u]\tag{2.2}$$

$$\begin{aligned}\ddot{s} &= \underbrace{\frac{\partial}{\partial t} \dot{s}(x,t) + \frac{\partial}{\partial x} \dot{s}(x,t)[f(x) + g(x)u]}_{\varphi(x)} + \underbrace{\frac{\partial}{\partial u} \dot{s}(x,t)}_{\gamma(x)} \dot{u} \\ &= \varphi(x) + \gamma(x)\dot{u}\end{aligned}\quad (2.3)$$

In order to achieve this aim of eliminating chattering, the  $\dot{u}$  derivative of control input  $u$  is made as actual control variable. The discontinuous control law  $\dot{u}$  will drive sliding mode variable  $s = 0$  in the second order sliding mode surface  $S^2$ . In this way, chattering is eliminated. Figure 2-2 shows trajectory of second order sliding mode control. It will convergent into origin point along the intersection of sliding mode surface  $s = 0$  and  $\dot{s} = 0$  in the limited time. Comparing with traditional sliding mode (Fig. 2-1), second order sliding mode control removes the chattering.

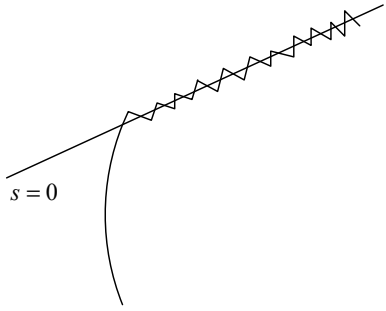

Fig. 2-1 Traditional sliding mode trajectory

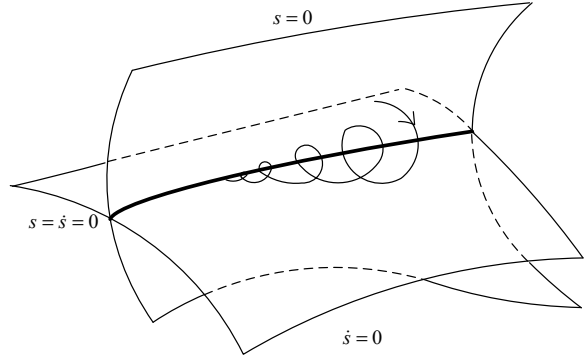

Fig. 2-2 Second order sliding mode trajectory

**Definition 2.1.1** Suppose given sliding mode variable is  $s(x,t)$ , second order sliding mode surface (or called sliding mode manifold) is defined as

$$S^2 = \{x \in X \mid s(x,t) = \dot{s}(x,t) = 0\} \quad x \in R^n \quad (2.4)$$

To illustrate the tightness of control algorithm, the following conditions must be met

- a)  $u$  is continuous and bounded norm function;;
- b)  $\|f(x)\|_2$  and  $\|g(x)\|_2$  are bounded, and  $\gamma(x) > 0$ ;

In meeting the above bounded conditions, there must be positive constants  $\Gamma_m$ ,  $\Gamma_M$ , and  $\Phi$  so that

$$\begin{aligned}0 < \Gamma_m &\leq \gamma(x) \leq \Gamma_M \\ |\varphi(x)| &\leq \Phi\end{aligned}$$

Here are some of the control algorithms to make the dynamic system (2.3) stability. And they ensure that the second order sliding mode convergence in finite time.

**Twisting algorithm:**

Owing to the phase trajectories of this algorithm twisting converges to the origin, as shown in Figure 2-3, it was called Twisting algorithm (Levant,1993) vividly. When the phase trajectory approaches the origin point, the different amplitude controlled by the switch decides convergence speed within finite time.

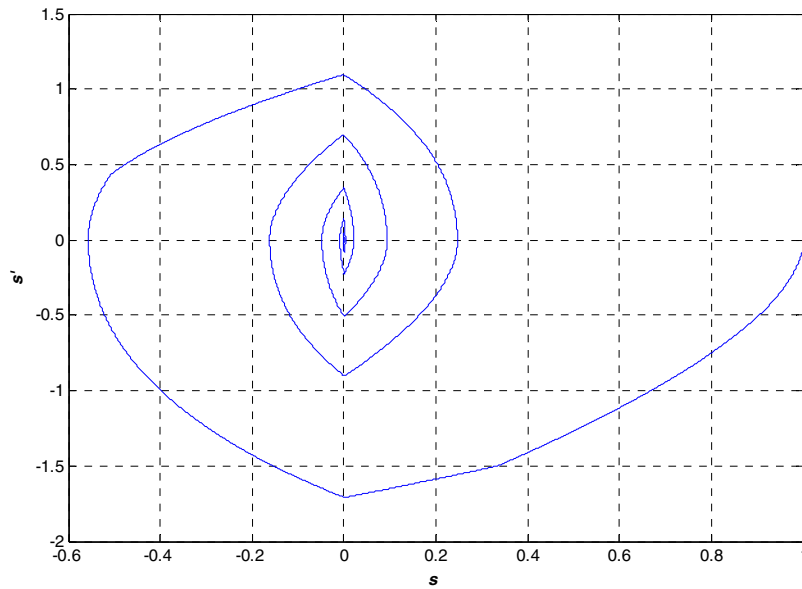

Fig. 2-3 Twisting algorithm phase trajectory

According to the knowledge of nonlinear system coordinate transformation, new local coordinate  $z_1 = s$  and  $z_2 = \dot{s}$  is supposed. Then, original system (2.3) can be rewritten by

$$\begin{aligned} \dot{z}_1 &= z_2 \\ \dot{z}_2 &= \varphi(x,t) + \gamma(x,t)\dot{u} \end{aligned} \tag{2.5}$$

At this time, second order sliding mode control is equivalent to solve a second order system stability. Although function  $\varphi(\cdot)$  and  $\gamma(\cdot)$  in equation (2.5) are uncertain, but they are bounded, and satisfy condition in (2.4).

The expression of twisting algorithm (Levant,1993; Emelyanov,1996) is

$$\dot{u} = \begin{cases} -u & |u| > u_0 \\ -V_m \operatorname{sgn}(s) & s\dot{s} > 0, |u| < u_0 \\ -V_M \operatorname{sgn}(s) & s\dot{s} \leq 0, |u| < u_0 \end{cases} \quad (2.6)$$

Where,  $u_0$ ,  $V_m$  and  $V_M$  are positive constant. The sufficient condition of sliding mode surface convergence within limited time is

$$\begin{aligned} V_m &> \max(4\Gamma_M/s_0, \Phi/\Gamma_m) \\ V_M &> V_m \\ \Gamma_m V_M - \Phi &> \Gamma_M V_m + \Phi \end{aligned} \quad (2.7)$$

Similarly, if the system relative degree is 2, the control algorithm is

$$u = \begin{cases} -V_m \operatorname{sgn}(s) & s\dot{s} \leq 0 \\ -V_M \operatorname{sgn}(s) & s\dot{s} > 0 \end{cases} \quad (2.8)$$

### Super twisting algorithm:

The phase trajectory of super twisting algorithm is shown in figure 2-4. It is also twisting convergent to origin, which is similar with twisting algorithm. But only its control algorithm is continuous. Control input  $u$  is composed by two parts (Levant,1993). One is differentiation of discontinuous item. The other is continuous functions of sliding mode variable. The expression is

$$\begin{aligned} u(t) &= u_1(t) + u_2(t) \\ \dot{u}_1(t) &= \begin{cases} -u & |u| > 1 \\ -W \operatorname{sgn}(s) & |u| \leq 1 \end{cases} \\ u_2(t) &= \begin{cases} -\lambda |s_0|^\rho \operatorname{sgn}(s) & |s| > s_0 \\ -\lambda |s|^\rho \operatorname{sgn}(s) & |s| \leq s_0 \end{cases} \end{aligned} \quad (2.9)$$

Where,  $W$ ,  $\lambda$ ,  $s_0$  and  $\rho$  are positive constant. The sufficient condition of second order sliding mode surface convergence within limited time is

$$\begin{aligned} W &> \Phi/\Gamma_m \\ \lambda^2 &\geq \frac{4\Phi \Gamma_M (W + \Phi)}{\Gamma_m^2 \Gamma_m (W - \Phi)} \\ 0 &< \rho \leq 0.5 \end{aligned} \quad (2.10)$$

From the equation (2.9), we can see that this algorithm need not differentiate

sliding mode variable. In addition, if  $\rho = 1$ , super twisting algorithm is convergent to origin exponentially. At the moment, control input  $u$  hasn't requirement of bound. When  $s_0 = \infty$ , Algorithm can be simplified as

$$\begin{aligned} u &= -\lambda |s|^\rho \operatorname{sgn}(s) + u_1 \\ \dot{u}_1 &= -W \operatorname{sgn}(s) \end{aligned} \quad (2.11)$$

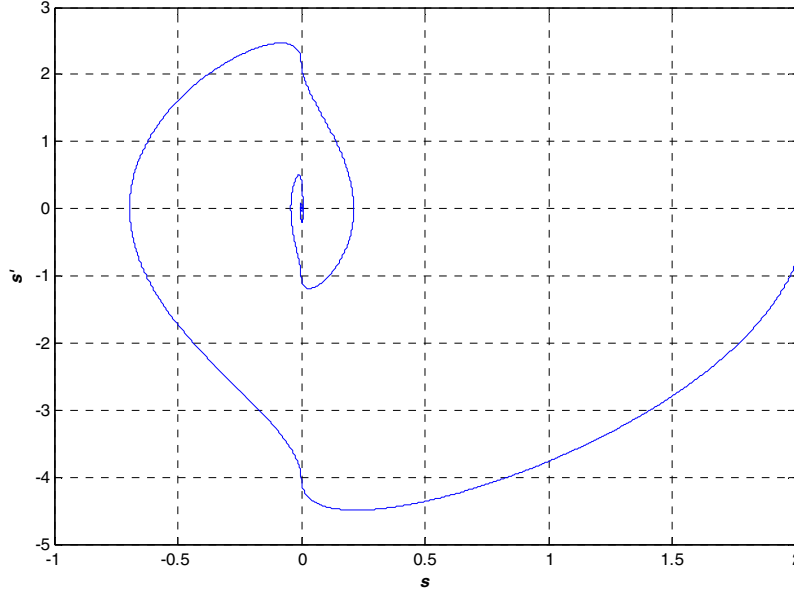

Fig. 2-4 Super Twisting algorithm phase trajectory

From the results of second order sliding mode control algorithm, the design object of controller  $u$  is to make  $S^2 = \{x \in X \mid s(x,t) = \dot{s}(x,t) = 0\}$  in second order sliding mode surface.

## 2.2 Simulation example (levant,2003)

Considering a single input single output nonlinear dynamic system of double-wheel drive motion robot (figure 2-5), the mathematic model is

$$\begin{aligned} \dot{x} &= v \cos \varphi \\ \dot{y} &= v \sin \varphi \\ \dot{\varphi} &= \frac{v}{l} \tan \theta \\ \dot{\theta} &= u \end{aligned} \quad (2.12)$$

Where,  $x$  and  $y$  are Cartesian coordinate,  $\varphi$  is orientation angle,  $v$  is forward velocity,  $l$  is the length of two axle,  $\theta$  is drive angle.

It is known that  $v=10m/s$  and  $l=5m$ . The trajectory tracked is  $d(x)=10\sin(0.05x)+5$ . The initial value of state is  $x(0)=y(0)=\varphi(0)=\theta(0)=0$ .

The control aim is to drive robot tracking given trajectory  $y=d(x)$  from the initial position. So choosing the sliding mode variable  $s=y-d(x)$ , according to the principle of sliding mode control, it achieve the control aim when the sliding mode variable converge into origin ( $s=0$ ) finally. However, in the second order sliding mode, the control law requires the relative degree of sliding mode variable to equal 1. Obviously, the relative degree of  $s=y-d(x)$  doesn't equal 1. So, under the requirement of relative degree, the Hurwitz polynomial should be structured. That is  $P(z)=z^{(n)}+\lambda_{n-1}z^{(n-1)}+\dots+\lambda_1z+\lambda_0z$ , the parameters  $\lambda_i(0\leq i\leq n-1)$  are positive constant.

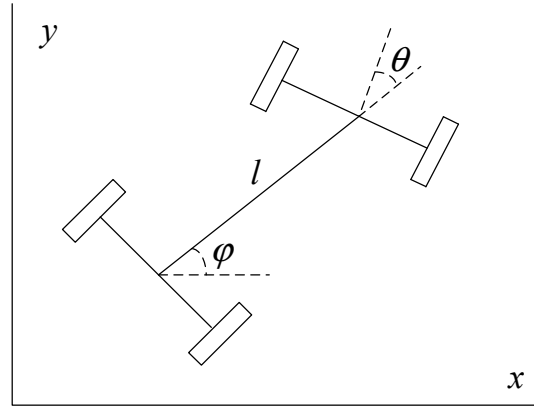

Fig. 2-5 Double drive motive robot model

Thus, the sliding surface satisfying relative degree can be redesigned as

$$s = \ddot{y} - \ddot{d}(x) + \lambda_1(\dot{y} - \dot{d}(x)) + \lambda_0(y - d(x)) \quad (2.13)$$

Differentiate sliding mode variable  $s$ , then

$$\dot{s} = \ddot{y} - \ddot{d}(x) + \lambda_1(\dot{y} - \dot{d}(x)) + \lambda_0(y - d(x)) \quad (2.14)$$

Take the numerical calculation into (2.14), then

$$\begin{aligned} \dot{s} = & -40\sin\varphi \cdot \tan^2\theta + 20\cos\varphi \cdot \sec^2\theta \cdot u + 1.25\cos(0.05x) \cdot \cos^3\varphi \\ & - 10\sin(0.05x) \cdot \sin\varphi \cdot \tan\theta - 5\sin(0.05x) \cdot \cos\varphi \cdot \sin\varphi \cdot \tan\theta \\ & + 20\cos(0.05x) \cdot \cos\varphi \cdot \tan^2\theta + 10\cos(0.05x) \cdot \sin\varphi \cdot \sec^2\theta \cdot u \\ & + \lambda_1(20\cos\varphi \cdot \tan\theta + 2.5\sin(0.05x) \cdot \cos^2\varphi \\ & + 10\cos(0.05x) \cdot \sin\varphi \cdot \tan\theta) + \lambda_0(10\sin\varphi - 5\cos(0.05x) \cdot \cos\varphi) \end{aligned} \quad (2.15)$$

From the equation (2.15) we can see that the control input  $u$  first time appears in the first order derivative of sliding mode variable  $s$ . That means the relative degree of sliding mode variable to control input is 1. At the moment, according to the twisting algorithm, controller  $u$  can be designed. Here,  $u$  is obtained by integral of  $\dot{u}$ . The value of the parameters  $V_m$  and  $V_M$  are smaller, the convergence time is longer. But the value of the parameters  $V_m$  and  $V_M$  are greater, the chattering is more obvious. Thus, the parameters in this controller are  $V_m = 10$  and  $V_M = 30$ . In addition, the coefficient of Hurwitz polynomial are  $\lambda_1 = 2$  and  $\lambda_0 = 1$ . The track trajectory curve of system is shown in figure 2-6.

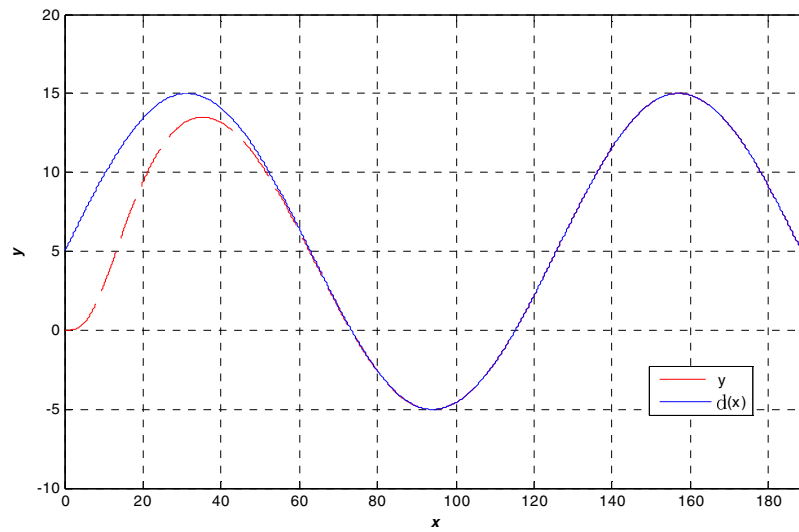

Fig. 2-6 Track trajectory curve

From the figure 2-6 we can see that system dynamic effectiveness is good. After a limited time, second order sliding mode control law converges into origin to guarantee system track effectiveness. The figure 2-7 is convergence trajectory of sliding mode variable within limited time. The system converges into origin at the 0.5s, at that time, for the control system  $s = y - d(x) = 0$ . It achieve dynamic track of given trajectory.

Figure 2-7 also shows that second order sliding mode control transfer chattering to a higher order sliding mode surface. It is the biggest difference with the traditional sliding mode control. Therefore, first order (or lower order) sliding surface become smooth. So, the second order sliding mode control eliminates the impact of the chattering essentially. But also precisely because of this reason, a strong impetus to the second order sliding mode control and high order sliding mode control are greatly

promoted in application and development.

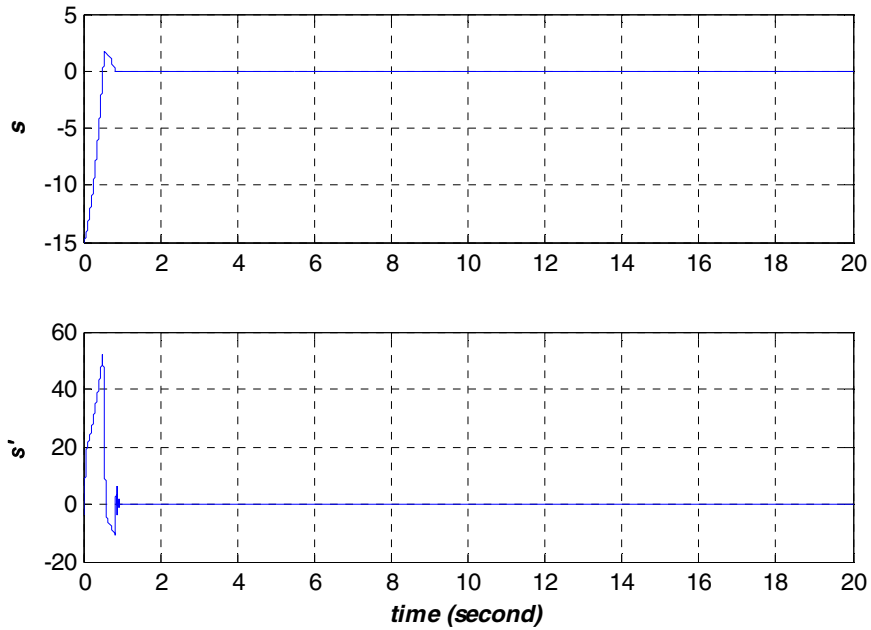

Fig. 2-7 Sliding mode variables  $s$  and  $\dot{s}$

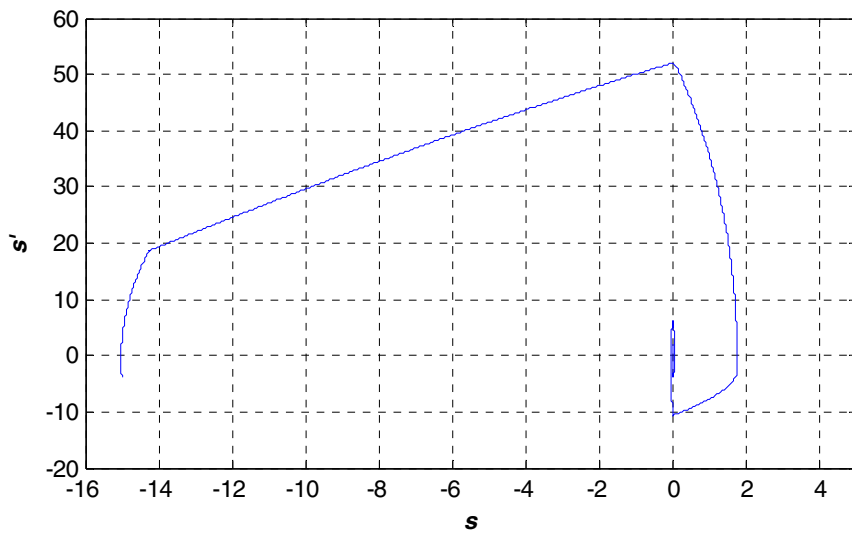

Fig. 2-8 Twisting algorithm phase trajectory

Figure 2-8 shows the twisting algorithm phase trajectory. From this figure, we can see that the sliding mode variables converge into zero after finite time, it is  $s = \dot{s} = 0$ .

Figure 2-9 is the curve of second order sliding mode control law. Comparing with the figure 2-10 which displays the derivative of sliding mode control law, this curve also illustrates second order sliding mode control law is smoother.



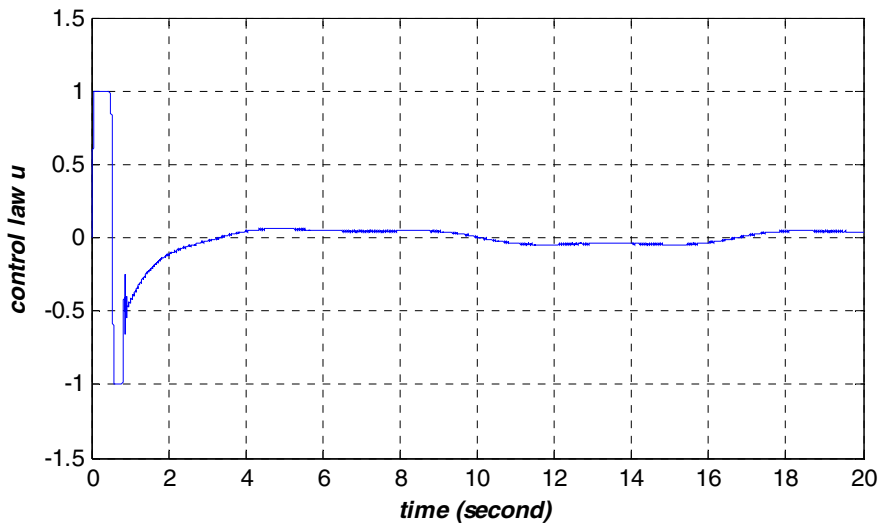

Fig. 2-9 Control law curve

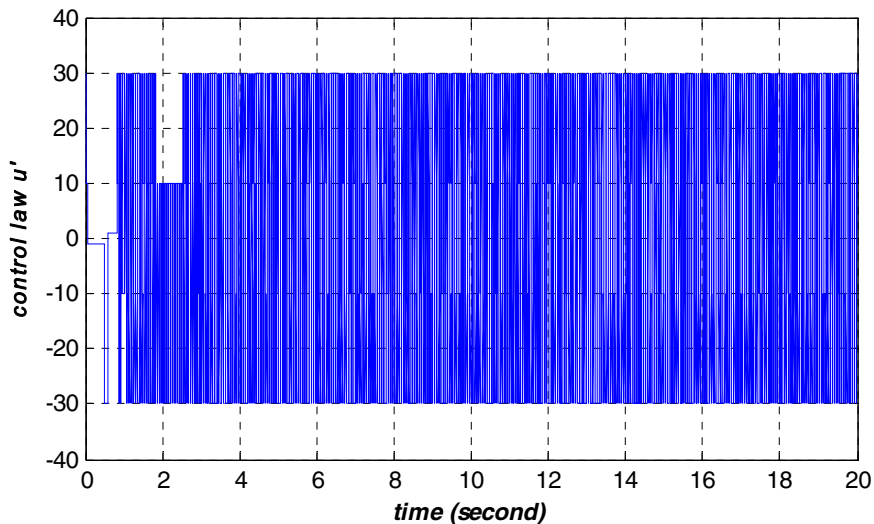

Fig. 2-10 Control law derivative curve

It should be noted that, the regulation of the system controller parameters (also including a Hurwitz polynomial parameters) is actually not very easy. It need repeat several times in order to meet the requirements of control. But in the actual system applications, because of too many parameters to adjust and match, the problem becomes more difficult. The following section will introduce an arbitrary order sliding mode control to avoid the strict condition requirements of the relative degree equal to 1. In this case, the relative degree can be arbitrary values. So the corresponding controller can be designed so as no longer afraid of suitable Hurwitz polynomial

---

parameters. And it greatly simplifies the design process and the application.

Here, we should give a summary. Besides the super-twisting and twisting algorithm, second order sliding mode control law has many else control law algorithm. In this field, many scholars have invested in a substantial amount of research. For example, in some literatures (Bartolini,1998; Bartolini,1998b; Bartolini,1998c) also introduced the Sub-optimal algorithm, the literature (Emelyanov,1986;Levant,1993) introduced the Drift algorithm, and so on.

### 2.3 Arbitrary order sliding mode control

Second order sliding mode control takes the use of the differential role of control law in the second order sliding surface, within the limited time to convergence, and to eliminate the chattering in the first order sliding mode surface. However, the second order sliding mode control algorithm requires the relative degree of system to equal to 1. If the relative degree of system is 2 or more, is there a general algorithm for it? Fortunately, the answer to this question is yes.

In recent years, because arbitrary order sliding mode control technique not only retains the traditional sliding mode control simple structure with strong robustness, but also eliminates the chattering phenomenon in the traditional sliding mode, at the same time, gets rid of the constraints of system relative degree. Therefore theoretical research and engineering applications has caused widespread concern and has been constant development. In arbitrary order sliding mode control, its core idea is the discrete function acts on a higher order sliding mode surface, making

$$s(x,t) = \dot{s}(x,t) = \ddot{s}(x,t) = \cdots s^{(r-1)}(x,t) = 0 \quad (2.16)$$

Suppose the relative degree of system (2.1) equals to  $r$ , generally speaking, when the control input  $u$  first time appears in  $r$ -order derivative of  $s$ , that is  $ds^{(r)}/du \neq 0$ , then we take  $r$ -order derivative of  $s$  for the output of system (2.1),  $s, \dot{s}, \ddot{s}, \cdots s^{(r-1)}$  can be obtained. They are continuous function for all the  $x$  and  $t$ . However, corresponding discrete control law  $u$  acts on  $s^{(r)}$ . Selecting a new local coordinate, then

$$y = (y_1, y_2, \cdots y_r) = (s, \dot{s}, \cdots s^{(r-1)}) \quad (2.17)$$

So,

$$s^{(r)} = a(y,t) + b(y,t)u, \quad b(y,t) \neq 0 \quad (2.18)$$

Therefore, high order sliding mode control is transformed to stability of  $r$  order dynamic system (2.12), (2.18). Through calculation, it is very easy to verify that

$$\begin{aligned} b &= L_g L_f^{r-1} s = \frac{d}{du} s^{(r)} \\ a &= L_f^r s \end{aligned} \quad (2.19)$$

Suppose  $\eta = (y_{r+1}, y_{r+2}, \dots, y_n)$ , then

$$\eta = \xi(t, s, \dot{s}, \dots, s^{(r-1)}, \eta) + \chi(t, s, \dot{s}, \dots, s^{(r-1)}, \eta)u \quad (2.20)$$

Now, equation (2.17), (2.18) and (2.20) are transformed to Isidori-Brunowsky canonical form. The sliding mode equivalent control is  $u_{eq} = -a(y,t)/b(y,t)$  (Utkin,1992). At present, the aim of control is to design a discrete feedback control  $u = U(x,t)$ , so that new system converge into origin on the  $r$  order sliding mode surface within limited time. Therefore, in equation (2.18), both  $a(y,t)$  and  $b(y,t)$  are bounded function. There are positive constants  $K_m$ ,  $K_M$  and  $C$  so that

$$\begin{aligned} 0 < K_m \leq b(y,t) \leq K_M \\ |a(y,t)| \leq C \end{aligned} \quad (2.21)$$

**Theorem 2.1.1** (levant,1998;levant,2003) Suppose the relative degree of nonlinear system (2.1) to output function  $s(x,t)$  is  $r$ , and satisfying the condition (2.21), the arbitrary order sliding mode controller has following expression

$$u = -\alpha \operatorname{sgn}(\psi_{r-1,r}(s, \dot{s}, \dots, s^{(r-1)})) \quad (2.22)$$

Where,

$$\begin{aligned} \psi_{0,r} &= s \\ \psi_{1,r} &= \dot{s} + \beta_1 N_{1,r} \operatorname{sgn}(s) \\ \psi_{i,r} &= s^{(r)} + \beta_i N_{i,r} \operatorname{sgn}(\psi_{i-1,r}), \quad i = 1, \dots, r-1 \\ N_{1,r} &= |s|^{(r-1)/r} \\ N_{i,r} &= (|s|^{p/r} + |\dot{s}|^{p/(r-1)} \dots + |s^{(i-1)}|^{p/(r-i+1)})^{(r-i)/p} \quad i = 1, \dots, r-1 \\ N_{r-1,r} &= (|s|^{p/r} + |\dot{s}|^{p/(r-1)} \dots + |s^{(r-2)}|^{p/2})^{1/p} \end{aligned} \quad (2.23)$$

Properly choose positive parameters  $\beta_1, \beta_2, \dots, \beta_{r-1}$ , the system converge into

origin on the  $r$  order sliding mode surface within limited time. Finally, when  $s \equiv 0$ , it achieves control object.

The choice of positive parameters  $\beta_1, \beta_2, \dots, \beta_{r-1}$  is not unique. Here,  $r \leq 4$  order sliding mode controller is given, which is also tested.

$$\begin{aligned}
1. & u = -\alpha \operatorname{sgn}(s) \\
2. & u = -\alpha \operatorname{sgn}(\dot{s} + |s|^{1/2} \operatorname{sgn}(s)) \\
3. & u = -\alpha \operatorname{sgn}(\ddot{s} + 2(|\dot{s}|^3 + |s|^2)^{1/6} \operatorname{sgn}(\dot{s} + |s|^{2/3} \operatorname{sgn}(s))) \\
4. & u = -\alpha \operatorname{sgn}\{\ddot{s} + 3[(\ddot{s})^6 + (\dot{s})^4 + |s|^3]^{1/12} \operatorname{sgn}[\ddot{s} + ((\dot{s})^4 \\
& + |s|^3)^{1/6} \operatorname{sgn}(\dot{s} + 0.5|s|^{3/4} \operatorname{sgn}(s))]\} \\
& \vdots
\end{aligned} \tag{2.24}$$

From the above equation (2.24) we can also see that, when  $r = 1$ , the controller is traditional relay sliding mode control; when  $r = 2$ , in fact, the controller is super twisting algorithm of second order sliding mode.

## 2.4 Simulation example

In order to explain the problem, arbitrary order sliding mode control law is still used for the driven robot model. The aim of control is to let the system track the given trajectory accurately. So, sliding mode variable can be selected for

$$s = y - d(x) \tag{2.25}$$

Differentiate sliding mode variable  $s$  continuously, then

$$\begin{aligned}
\dot{s} &= v \sin \varphi - \dot{d}(x) \\
\ddot{s} &= \frac{v^2}{l} \cos \varphi \tan \theta - \ddot{d}(x) \\
\dddot{s} &= -\frac{v^3}{l^2} \sin \varphi \tan^2 \theta - \dddot{d}(x) + \left(\frac{v^2}{l} \cos \varphi \sec^2 \theta\right) u
\end{aligned} \tag{2.26}$$

The control input  $u$  appears in the 3 order derivative of  $s$ . So the system relative degree is 3. Here, if we adopt Lie derivative, we can get the same results.

$$\begin{aligned}
L_f^0 h(x) &= h(x) = s = y - d(x) \\
L_f h(x) &= \frac{\partial h(x)}{\partial x} f(x) = v \cdot \sin \varphi - \dot{d}(x) \\
L_f^2 h(x) &= \frac{\partial L_f h(x)}{\partial x} f(x) = \frac{v^2}{l} \cos \varphi \tan \theta - \ddot{d}(x) \\
L_f^3 h(x) &= \frac{\partial L_f^2 h(x)}{\partial x} f(x) = -\frac{v^3}{l^2} \sin \varphi \cdot \tan^2 \theta - \dddot{d}(x)
\end{aligned} \tag{2.27}$$

Lie derivative is

$$\begin{aligned}
L_g L_f^0 h(x) &= \frac{\partial h(x)}{\partial x} g(x) = 0 \\
L_g L_f h(x) &= \frac{\partial L_f h(x)}{\partial x} g(x) = 0 \\
L_g L_f^2 h(x) &= \frac{\partial L_f^2 h(x)}{\partial x} g(x) = \frac{v^2}{l} \cos \varphi \cdot \sec^2 \theta \neq 0
\end{aligned} \tag{2.28}$$

From the equation (2.28), because  $r-1=2$ , the system relative degree  $r=3$ . Then,

$$\begin{aligned}
\ddot{s} &= L_f^2 h(x) + L_g L_f^2 h(x)u \\
&= -\frac{v^3}{l^2} \sin \varphi \tan^2 \theta - \ddot{d}(x) + \left(\frac{v^2}{l} \cos \varphi \sec^2 \theta\right) u
\end{aligned} \tag{2.29}$$

According to the theorem 2.1.1, when the relative degree  $r=3$ , system (2.26) should adopt 3 order sliding mode control. The expression is shown in following.

$$u = -\alpha \operatorname{sgn}(\ddot{s} + 2(|\dot{s}|^3 + |s|^2)^{1/6} \operatorname{sgn}(\dot{s} + |s|^{2/3} \operatorname{sgn}(s))) \tag{2.30}$$

In equation (2.30), set parameter  $\alpha=20>0$ , it is can be seen from the expression of controller that the value of  $s$ ,  $\dot{s}$  and  $\ddot{s}$  should be calculated. The sample frequency is 8000Hz in simulation system. The run time is  $t=20s$ . And the given trajectory  $g(x)$  is displayed in figure 2-6.

From the figure 2-11 we can see that  $s = y - d(x) \equiv 0$  after a period time by using high order sliding mode controller. The motion trajectory of robot can track given trajectory completely. It has good performance.

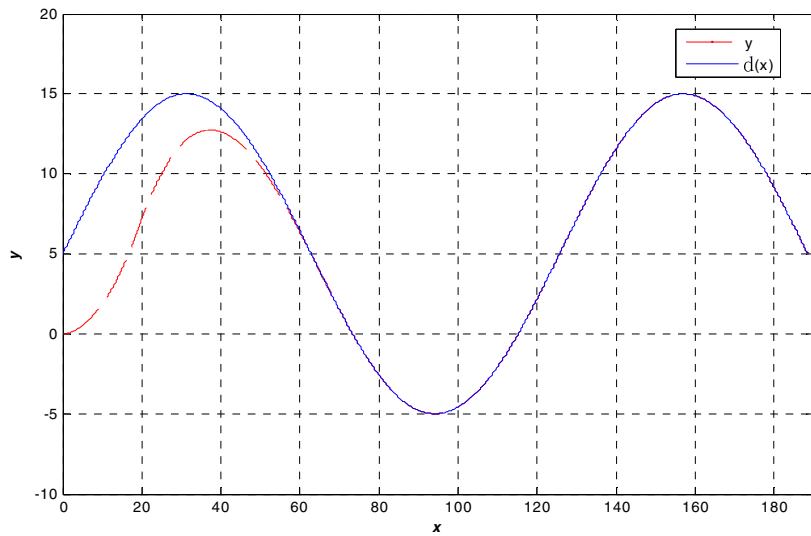

Fig. 2-11 Robot tracking trajectory

The figure 2-12 illustrates 3 order sliding mode control converges into origin within limited time ( $t < 8s$ ), that is  $s(x,t) = \dot{s}(x,t) = \ddot{s}(x,t) = 0$ . In this case, it achieves the control object. From the figure 2-10 we can also see that discrete control law  $u$  acts on 3 order sliding mode surface  $\ddot{s}$ . So, the chattering is removed in 1 order sliding mode  $s$  surface, which becomes smooth.

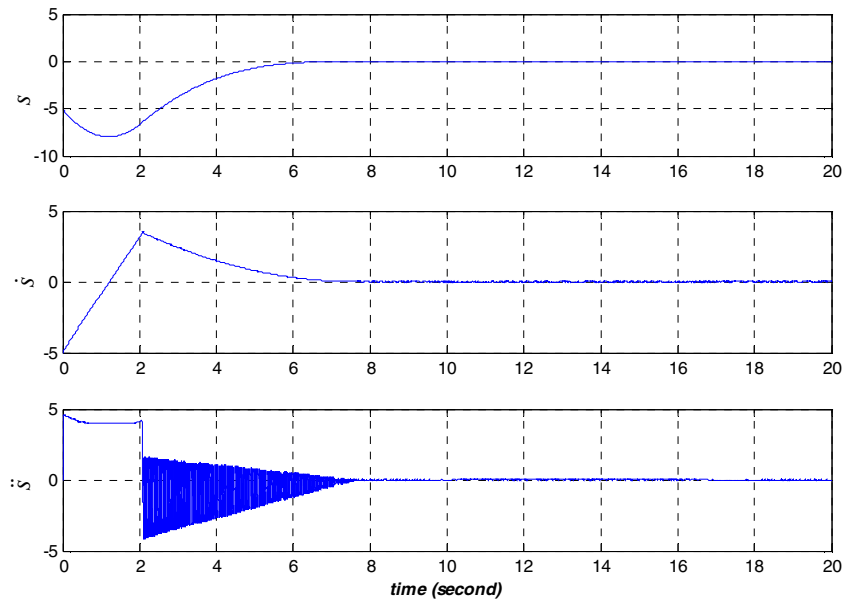

Fig. 2-12 System sliding mode variables  $s$ ,  $\dot{s}$  and  $\ddot{s}$

Figure 2-13 and 2-14 are the curve of system state variable  $\theta$  and control law

$u$  respectively. The control law still is high frequent discrete signal. But the aim of high order sliding mode makes it act on high order sliding mode surface, so that eliminate chattering in lower order sliding mode surface.

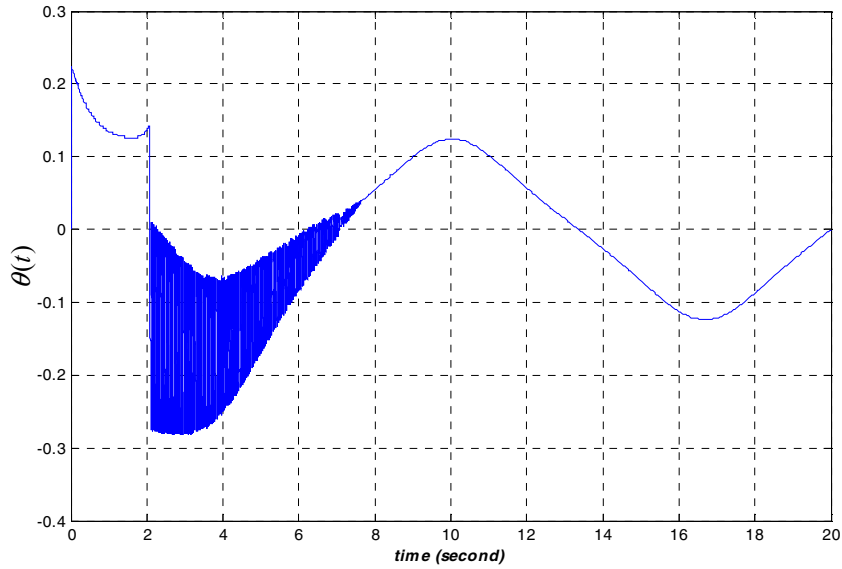

Fig. 2-13 State variable  $\theta(t)$  curve

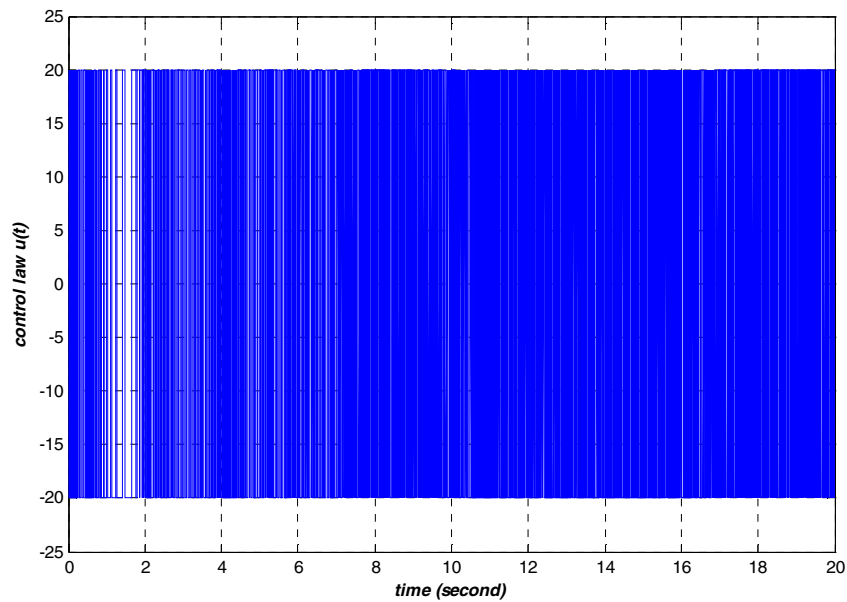

Fig. 2-14 System control law  $u$

High order sliding mode controller eliminates chattering existed in traditional sliding mode essentially. Moreover, the design of controller is no longer restrained by

relative degree. It greatly enhances the applicability of the sliding mode control. In the design of high order sliding mode controller, we only need to know sliding mode variable and its corresponding derivatives. This controller has simple structure and is easy to implement.

## 2.5 Quasi-continuous high order sliding mode control

In the design of high order sliding mode, the controller adopts high frequent sign function. Because the relative degree ( $r=1$ ) of state variable  $\theta$  to the control input  $u$  is lowest, in the figure 2-8, the chattering phenomenon is the most serious as well. In order to weaken or remove the effectiveness of chattering, according to the homogeneous principle of high order sliding mode (Levant,2005), the control law is

$$U(s, \dot{s}, \dots, s^{(r-1)}) = U(\kappa^r s, \kappa^{r-1} \dot{s}, \dots, \kappa s^{(r-1)}) \quad (2.31)$$

Where,  $\kappa > 0$ , it is arbitrary positive constant. When the system (2.18) satisfies condition (2.21), then

$$s^{(r)} \in [-C, C] + [K_m, K_M]u \quad (2.32)$$

Closed set differential equation (2.32) satisfies Filippov criterion (Filippov,1988). That is the vector field in right half plane is extended to a special way to meet the identified convex function and semi-continuous condition. Therefore, within the limited time, the system (2.32) is stable at the origin. It is equivalent that the original system (2.18) satisfies the conditions in (2.21) to converge into the origin.  $s(x, t) = \dot{s}(x, t) = \dots = s^{(r-1)}(x, t) = 0$

Sufficiently large choice of parameters  $\beta_1, \beta_2, \dots, \beta_{r-1}$ ,  $\alpha > 0$ , according to the homogeneous principle of high order sliding mode, a quasi-continuous sliding mode controller can be designed, which is continuous except the points of  $s = \dot{s} = \dots = s^{(r-1)} = 0$ . The detail expression is following.

$$u = -\alpha \Psi_{r-1,r}(s, \dot{s}, \dots, s^{(r-1)}) \quad (2.33)$$

Visually observe quasi-continuous sliding mode control (2.33), comparing with high order sliding mode controller (2.22), the sign function is cancelled. The discrete control law is transformed to continuous control law. Where,



$$\begin{aligned}
\varphi_{0,r} &= s \\
N_{0,r} &= |s| \\
\Psi_{0,r} &= \varphi_{0,r}/N_{0,r} = \text{sgn}(s) \\
\varphi_{i,r} &= s^{(r)} + \beta_i N_{i-1,r}^{(r-i)/(r-i+1)} \Psi_{i-1,r} \\
N_{i,r} &= |s^{(r)}| + \beta_i N_{i-1,r}^{(r-i)/(r-i+1)} \\
\Psi_{i,r} &= \varphi_{i,r}/N_{i,r} \quad i = 0,1,\dots,r-1
\end{aligned} \tag{2.34}$$

The controller (2.33) doesn't erase sign function as well, so it is called quasi-continuous high order sliding mode controller. In order to facilitate the use, let  $\beta_1=1$ ,  $\beta_2=2$ ,  $\beta_3=3$ ,  $\dots$ , the expressions of  $r \leq 4$  order is shown following (Levant,2005).

1.  $u = -\alpha \text{sgn}(s)$
2.  $u = -\alpha \frac{\dot{s} + |s|^{1/2} \text{sgn}(s)}{|\dot{s}| + |s|^{1/2}}$
3.  $u = -\alpha \frac{\ddot{s} + 2(|\dot{s}| + |s|^{2/3})^{-1/2} [\dot{s} + |s|^{2/3} \text{sgn}(s)]}{|\ddot{s}| + 2(|\dot{s}| + |s|^{2/3})^{1/2}}$
4.  $u = -\alpha \frac{\ddot{\ddot{s}} + 3[\ddot{s} + (|\dot{s}| + 0.5|s|^{3/4})^{-1/3} (\dot{s} + 0.5|s|^{3/4} \text{sgn}(s))][|\ddot{s}| + (|\dot{s}| + 0.5|s|^{3/4})^{2/3}]^{-1/2}}{|\ddot{\ddot{s}}| + 3[|\ddot{s}| + (|\dot{s}| + 0.5|s|^{3/4})^{2/3}]^{1/2}}$
- $\vdots$

If re-design the dynamic robot track trajectory system (2.12) adopting quasi-continuous sliding mode controller, suppose other conditions unchanged, the new controller can be written as

$$u = -\alpha \frac{\ddot{s} + 2(|\dot{s}| + |s|^{2/3})^{-1/2} [\dot{s} + |s|^{2/3} \text{sgn}(s)]}{|\ddot{s}| + 2(|\dot{s}| + |s|^{2/3})^{1/2}} \tag{2.35}$$

The figure 2-15 is tracking curve of robot motion trajectory. From this figure, adopting quasi-continuous sliding mode control, the system output converges into origin within limited time as well. In this case, it achieves higher precision tracking control. In addition, the comparison of Figure 2-12 and 2-16, it is not difficult to find the use of quasi-continuous high order sliding mode makes the first, second order derivative of sliding mode variable more smooth than the previous high order sliding mode control.

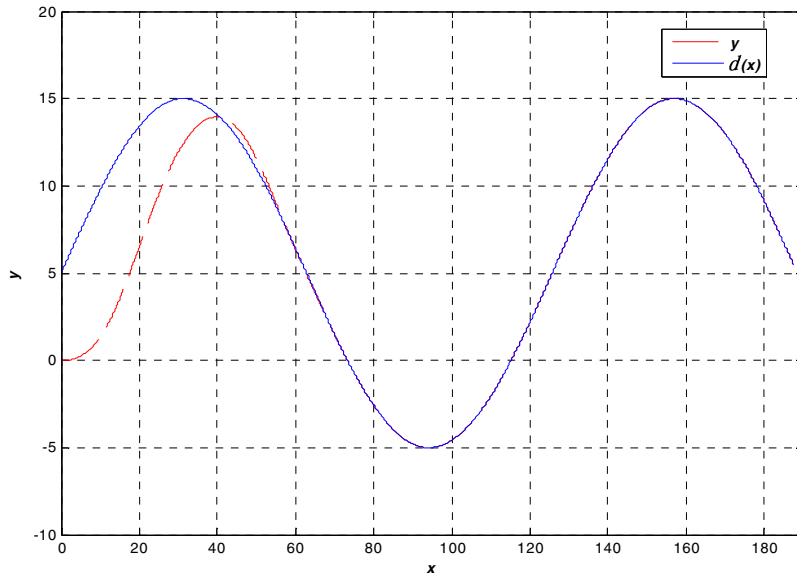

Fig. 2-15 Robot tracking trajectory

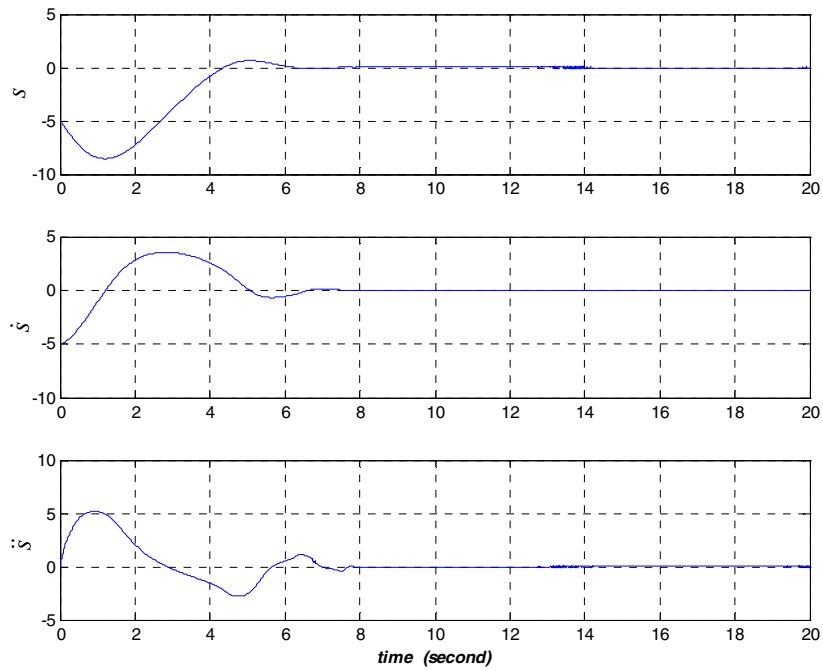

Fig. 2-16 Sliding mode variables  $s$ ,  $\dot{s}$  and  $\ddot{s}$

In high order sliding mode, because relative degree of state variable  $\theta$  to control input  $u$  equals to 1,  $\theta$  is effected by discrete control law  $u$  greatly. From the figure 2-13 we can see that the chattering is eliminated obviously. Through the improvement of control law, without affecting the accuracy of the premise, as far as

possible to improve smooth, the quasi-continuous high order sliding mode control are designed. Figure 2-17 is the state variables of the dynamic curve after using a new type of high order sliding mode controller, it has been improved obviously by quasi-continuous sliding mode control for the state variables of the system than figure 2-13. The controller plays a role in smoothing, which is very important in practical engineering applications.

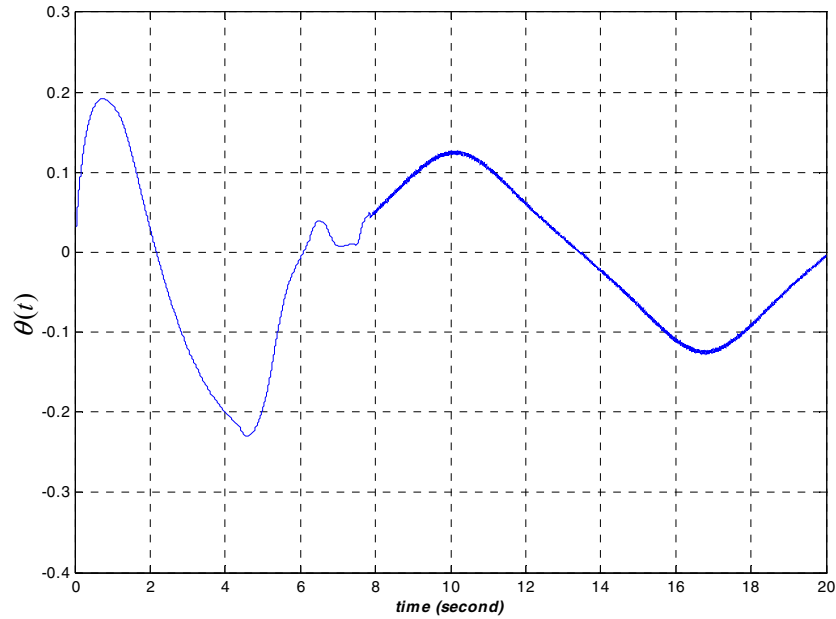

Fig. 2-17 System state variable  $\theta(t)$

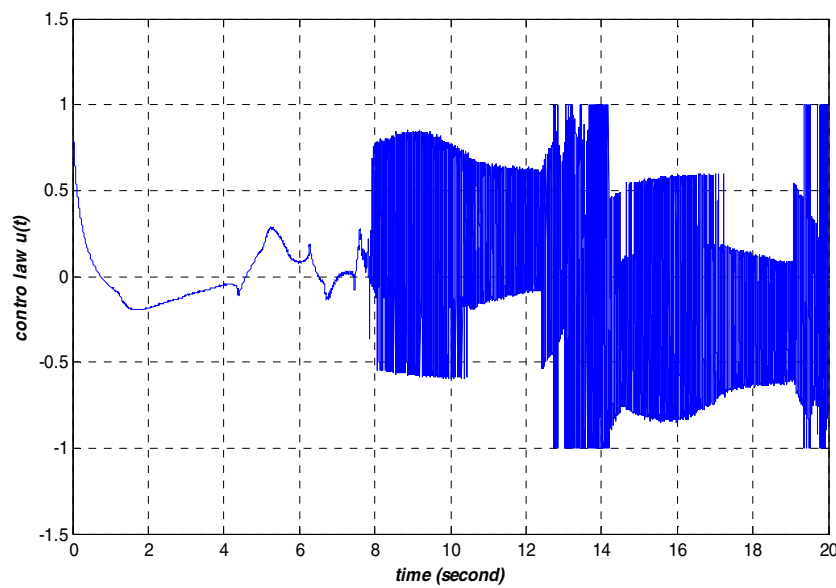

Fig. 2-18 Quais-continuous high order sliding mode control law

---

Figure 2-18 is a quasi-continuous high-order sliding mode control law curve. Comparing with the higher order sliding mode controller, especially before entering the sliding mode, the switching frequency is reduced.

## **2.6 Summary**

This chapter from a simple beginning of the second-order sliding mode control, the step by step analyses the causes how the second order sliding mode control eliminates chattering essentially. The second order sliding mode control algorithm is still strict requirements of the system relative degree, so design of arbitrary order controller is necessary. In view of this consideration, this chapter gives a high order (arbitrary order) sliding mode control algorithm, combined with a simulation example for the simulation studies. The simulation results show that the high order sliding mode control achieves higher precious trajectory tracked. At the same time, the quasi-continuous high-order sliding mode control algorithm is given to smooth the system state variable.

---

## Chapter 3 Robust exact high order sliding mode differentiator

To get the differentiation of a given signal is always to be studied. In automatic control systems, we often need derivative a variable or function. So there are a lot of numerical algorithms for this issue. The same situation also appears in the design of high order sliding mode controller (2.24) that needs to calculate the derivative values of sliding mode variable. In order to be able to accurately calculate, at the same time simplifying the algorithm, this chapter directly uses own advantages of high order sliding mode control due to high accuracy and robustness. We can design a high order sliding mode differentiator used to calculate the numerical derivative of the variables (Levant,2003).

Presentation in the previous chapter has been explained in detail the principles of high order sliding mode control and sliding mode controller design method. This chapter focuses on how to take use of high order sliding mode technique to solve the differentiation of a given signal or variable function. And their simulation results are verified.

This chapter is structured as follows: 3.1, derive a robust sliding mode differentiator; 3.2, verify its feasibility with the numerical simulation; 3.3, give the high order sliding mode differentiator used to solve arbitrary order derivative; 3.4 take a simulation example of arbitrary order sliding mode differentiator applications; 3.5, summary of this chapter.

### 3.1 Robust sliding mode differentiator

Suppose given signal is  $f(t)$ , now set a dynamic system as

$$\dot{x} = u \quad (3.1)$$

The control object is to make the variable  $x$  follow given signal  $f(t)$ , that is

$$x = f(t) \quad (3.2)$$

Therefore, sliding mode surface is selected as

$$s = x - f(t) \quad (3.3)$$

At this moment, according to the principle of sliding mode control, a proper

controller is designed. When the system enter into sliding mode,  $s = x - f(t) = 0$ . Derivative of sliding mode surface (3.3),

$$\dot{s} = \dot{x} - \dot{f}(t) = u - \dot{f}(t) \quad (3.4)$$

Because control input  $u$  first time appears in the derivative of sliding mode surface  $s$ , the relative degree of system is  $r=1$ . It satisfies the requirement about relative degree of second order sliding mode. So the super twisting algorithm (2.8) is adopted. Let  $\rho = 1/2$ , then

$$\begin{aligned} u &= -\lambda |x - f(t)|^{1/2} \operatorname{sgn}(x - f(t)) + u_1 \\ \dot{u}_1 &= -\alpha \operatorname{sgn}(x - f(t)) \end{aligned} \quad (3.5)$$

Where,  $\lambda > 0$ ,  $\alpha > 0$  are positive constant. Definite a function as  $\Theta(\alpha, \lambda, C) = |\Psi(t)|$ ,  $C$  is Lipschitz constant about derivative of  $f(x)$ .  $(\Sigma(t), \Psi(t))$  is the solution of equation of (3.6), the initial value are  $\Sigma(0) = 0$ ,  $\Psi(0) = 1$

$$\begin{aligned} \dot{\Sigma} &= -|\Sigma|^{1/2} + \Psi \\ \dot{\Psi} &= \begin{cases} -\frac{1}{\lambda^2}(\alpha - C), & -|\Sigma|^{1/2} + \Psi > 0 \\ -\frac{1}{\lambda^2}(\alpha + C), & -|\Sigma|^{1/2} + \Psi \leq 0 \end{cases} \end{aligned} \quad (3.6)$$

**Theorem 3.1.1** (Convergence) (Levant,1998) Let  $\alpha > C > 0$ ,  $\lambda > 0$ , function  $\Theta(\alpha, \lambda, C) < 1$ . Then, provided  $f(t)$  has a derivative with Lipschitz's constant  $C$ , the equality  $u = \dot{f}(t)$  is fulfilled identically after finite time transient process. And the smaller value of  $\Theta$ , faster convergence; If  $\Theta(\alpha, \lambda, C) > 1$ , control input  $u$  will not converge into  $\dot{f}(t)$ .

Observer parameters should meet the following sufficient condition for convergence of the second-order sliding mode control,

$$\begin{aligned} \alpha &> C \\ \lambda^2 &\geq 4C \frac{\alpha + C}{\alpha - C} \end{aligned} \quad (3.7)$$

According to the principle of second order sliding mode, after a finite time, the system will converge into the origin, that is,

$$s(x, t) = \dot{s}(x, t) = 0 \quad (3.8)$$

Then,

$$u = \dot{f}(t) \quad (3.9)$$

Now, observer input  $u$  is the estimation of derivative of given signal  $f(t)$ . Using a sliding mode controller achieve differentiation of variable function.

**Theorem 3.1.2 (Robustness) (Levant,1998)** Let input signal be presented in the form  $f(t) = f_0(t) + n(t)$ , where  $f_0(t)$  is a differentiable base signal,  $f_0(t)$  has a derivative with Lipschitz's constant  $C > 0$ , and  $n(t)$  is a noise,  $|n(t)| < \varepsilon$ . Then, there exists such a constant  $b > 0$  depend on  $(\alpha - C)/\lambda^2$  and  $(\alpha + C)/\lambda^2$  that after a finite time, the inequality  $|u(t) - \dot{f}_0(t)| < \lambda b \varepsilon^{1/2}$  holds.

### 3.2 Numerical simulation

In order to verify the calculation results of sliding mode differentiator, suppose given signal is  $f(t) = \sin t + 5t$ , the parameter of controller is selected as  $\alpha = 8$ ,  $\lambda = 6$ .

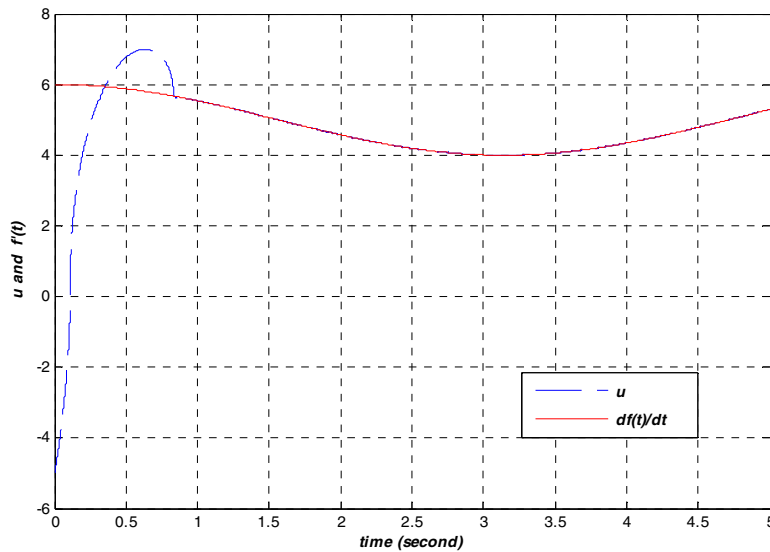

Fig. 3-1 Derivative of  $f(t)$  and its estimation

The figure 3-1 is the curve of differentiation  $\dot{f}(t)$  and control input  $u$ . From this figure we can see that the system enters in sliding mode after 0.8s, after that  $u = \dot{f}(t)$ . In other words, we can use the  $u$  to estimate  $\dot{f}(t)$  online. This kind of sliding mode differentiator not only reserves strong robustness, but also achieves differentiation of given signal.

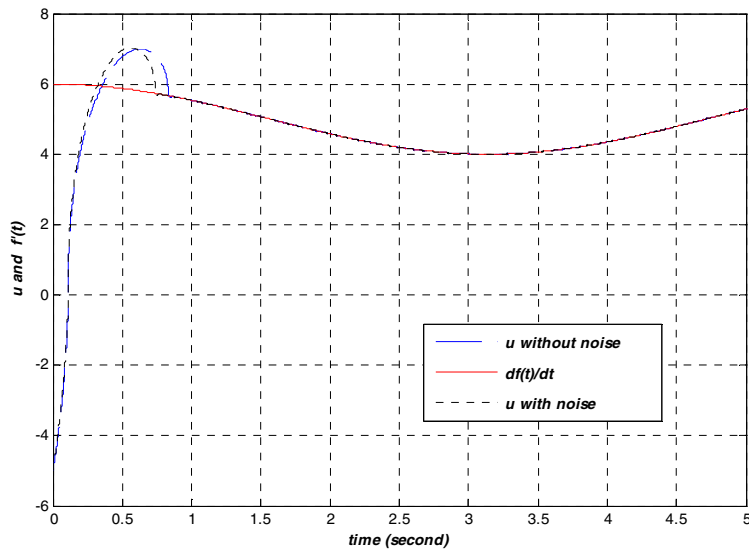

Fig. 3-2 Signal  $u$  is estimation of  $\dot{f}(t)$  under disturbance

The figure 3-2 illustrates sliding mode differentiator has strong robustness for the estimation of  $\dot{f}(t)$  in spite of external disturbance. After a short time adjusting, the system still can converge into origin.

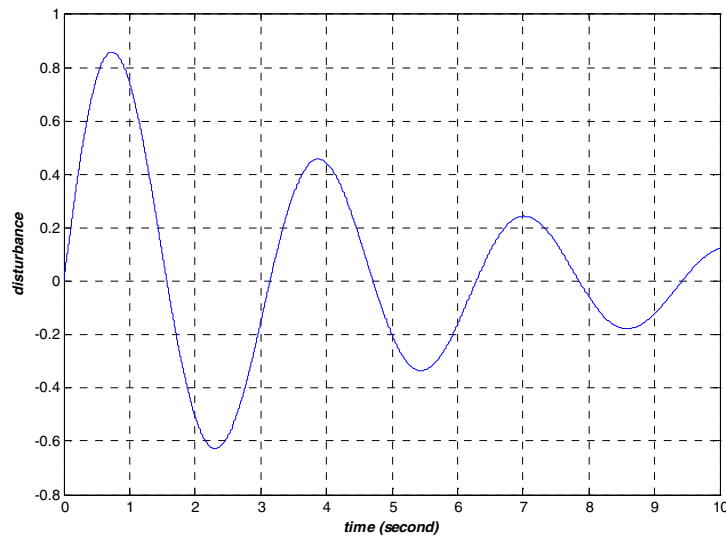

Fig. 3-3 Disturbance signal  $n = e^{-0.2t} \sin(2t)$

The disturbance signal injected is  $n(t) = e^{-0.2t} \sin(2t)$ , which is shown in figure 3-3. The figure 3-4 is the error between differentiator estimation and actual derivative of function  $f(t)$ . The error is less than  $10^{-3}$ , that is  $|u - \dot{f}(t)| < 10^{-3}$ .



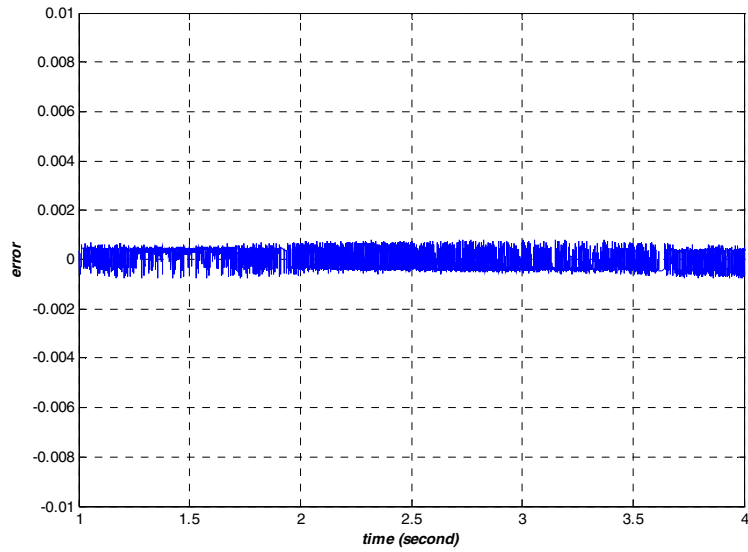

Fig. 3-4 The error between  $u$  and  $\hat{f}(t)$  despite disturbance

To sum up, sliding mode differentiator not only can achieve precious estimation for derivative of given signal, but also has robust characteristics of its own. Therefore, the differentiator has a broad application and practical value.

### 3.3 Arbitrary order sliding mode differentiator

Through the first order sliding mode differentiator description of the working principle, it will naturally think, whether can design a sliding mode differentiator to obtain the arbitrary order derivative of given signal. Well, the design of high order sliding mode controller (2.24) needs to know all sliding mode variables and their corresponding differentiation. If we can design an arbitrary order sliding mode differentiator, which can be used to estimate the derivative value of sliding mode variables, so as to achieve a simplified numerical differential purposes.

The same with first order sliding mode differentiator, suppose given signal is  $f(t)$ ,  $t \in [0, \infty)$ . It has been known that the  $n$  order derivative of  $f(t)$  has Lipschitz constant, recorded as  $L > 0$ . Now, the object of sliding mode differentiator is estimating the value of  $\dot{f}(t), \ddot{f}(t), \dots, f^{(n)}(t)$  in real time.

Arbitrary order sliding mode differentiator has the following recursive form,

$$\begin{aligned}
\dot{z}_0 &= v_0 \\
v_0 &= -\lambda_0 |z_0 - f(t)|^{n/(n+1)} \operatorname{sgn}(z_0 - f(t)) + z_1, \\
\dot{z}_1 &= v_1 \\
v_1 &= -\lambda_1 |z_1 - v_0|^{(n-1)/n} \operatorname{sgn}(z_1 - v_0) + z_2, \\
&\vdots \\
\dot{z}_{n-1} &= v_{n-1} \\
v_{n-1} &= -\lambda_{n-1} |z_{n-1} - v_{n-2}|^{1/2} \operatorname{sgn}(z_{n-1} - v_{n-2}) + z_n, \\
\dot{z}_n &= -\lambda_n \operatorname{sgn}(z_n - v_{n-1})
\end{aligned} \tag{3.10}$$

It can be verified, When  $n=1$ , it is first order differentiator. Suppose  $f_0(t)$  is basic value of given signal  $f(t)$ ,  $\delta(t)$  is uncertain part, but bounded, satisfying  $|\delta(t)| < \varepsilon$ , then  $f(t) = f_0(t) + \delta(t)$ .

**Theorem 3.3.1** (Levant,2003) If properly choose parameter  $\lambda_i (0 \leq i \leq n)$ , the following equalities are true in the absence of input noise after a finite time of a transient process.

$$\begin{aligned}
z_0 &= f_0(t) \\
z_i = v_i &= f_0^{(i)}(t), \quad i=1, \dots, n
\end{aligned} \tag{3.11}$$

The theorem 3.3.1 illustrates that arbitrary order sliding mode differentiator can use differentiation  $z_i (0 \leq i \leq n)$  to estimate any order derivative of input function  $f(t)$  online within limited time.

**Theorem 3.3.2** (Levant,2003) Let the input noise satisfy the inequality  $\delta(t) = |f(t) - f_0(t)| \leq \varepsilon$ . Then the following inequality are established in finite time for some positive constants  $\mu_i, \tau_i$  depending exclusively on the parameters of the differentiator

$$\begin{aligned}
|z_i - f_0^{(i)}(t)| &\leq \mu_i \varepsilon^{(n-i+1)/(n+1)} \quad i=0, \dots, n \\
|v_i - f_0^{(i+1)}(t)| &\leq \tau_i \varepsilon^{(n-i)/(n+1)} \quad i=0, \dots, n-1
\end{aligned} \tag{3.12}$$

By Theorem 3.3.2, we can see that the arbitrary order sliding mode differentiator has robustness.

The arbitrary order sliding mode differentiator can accurately estimate any order derivative of a given input. If this differentiator can be used in high order sliding mode controller (2.24), any order derivative of sliding mode variable  $s$  can be accurately estimated avoiding the complicated calculation, which greatly simplifies

the controller design. Adopting the differentiator, consider  $s(t)$  in high order sliding mode controller as given input for differentiator. Then the output of differentiator  $z_i(0 \leq i \leq n)$  can substitute any order derivative of  $s(t)$ , that is

$$\begin{aligned} z_0 &= s \\ z_i &= s^{(i)} \quad i = 1, \dots, n \end{aligned} \quad (3.13)$$

The sliding mode controller (2.22) can be rewritten by

$$u = -\alpha \operatorname{sgn}(\psi_{r-1,r}(z_0, z_1, \dots, z_{(r-1)})) \quad (3.14)$$

The expression from this controller can also be clearly seen, with high order sliding mode differentiator, the differentiation of arbitrary order sliding mode variable will not be difficult to solve, which makes the high order sliding mode controller design has been simplified greatly.

### 3.4 Simulation example

In order to facilitate description and comparison, the system still uses the robot model (2.21). Owing to system relative degree with  $r = 3$ , the controller adopted should be

$$u = -\alpha \operatorname{sgn}(\ddot{s} + 2(|\dot{s}|^3 + |s|^2)^{1/6} \operatorname{sgn}(\dot{s} + |s|^{2/3} \operatorname{sgn}(s))) \quad (3.15)$$

If without sliding mode differentiator, the controller should calculate the value of  $s$ ,  $\dot{s}$  and  $\ddot{s}$ . Taking use of differentiator, variable  $s$  is considered as given input of the differentiator. Then, the output of differentiator  $z$  can be used to estimate corresponding order derivative of  $s$ . The following design of differentiator is given

$$\begin{aligned} \dot{z}_0 &= v_0, \quad v_0 = -14.7 |z_0 - s|^{2/3} \operatorname{sgn}(z_0 - s) + z_1 \\ \dot{z}_1 &= v_1, \quad v_1 = -30 |z_1 - v_0|^{1/2} \operatorname{sgn}(z_1 - v_0) + z_2 \\ \dot{z}_2 &= -440 |z_2 - v_1| \end{aligned} \quad (3.16)$$

Now, according theorem 3.3.1, controller (3.15) can be rewritten by

$$u = -\alpha \operatorname{sgn}(z_2 + 2(|z_1|^3 + |z_0|^2)^{1/6} \operatorname{sgn}(z_1 + |z_0|^{2/3} \operatorname{sgn}(z_0))) \quad (3.17)$$

Where, control parameter  $\alpha = 1 > 0$ ; sliding mode differentiator parameters  $\lambda_0 = 14.7$ ,  $\lambda_1 = 30$  and  $\lambda_2 = 440$ .

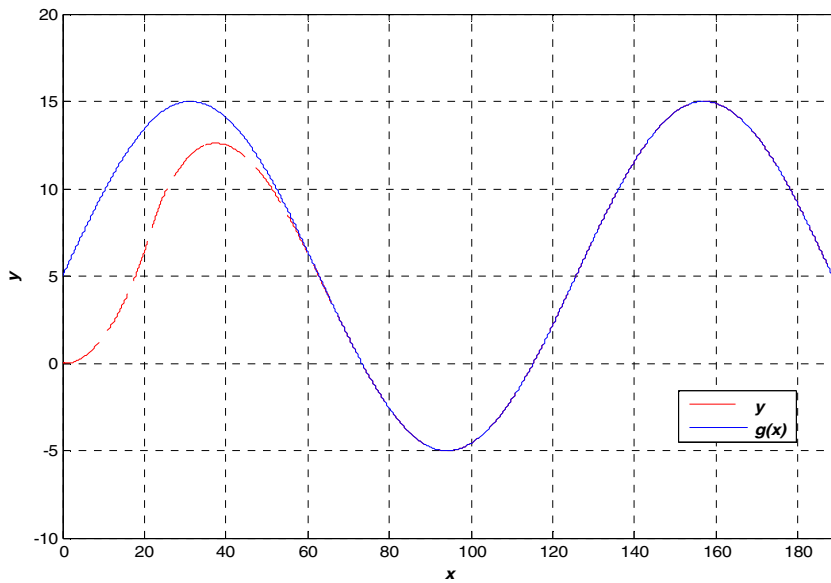

Fig. 3-5 Robot tracking trajectory curve

The figure 3-5 is the robot tracking trajectory curve using arbitrary order sliding mode differentiator. Compared with figure 2-6, the system has the same tracking effectiveness, which illustrates sliding mode differentiator with a good performance. Its main advantage is any order differentiations only based on sliding mode variable can be obtained. Thus, it eliminates the need of the arbitrary order derivative calculations in high order sliding mode controller.

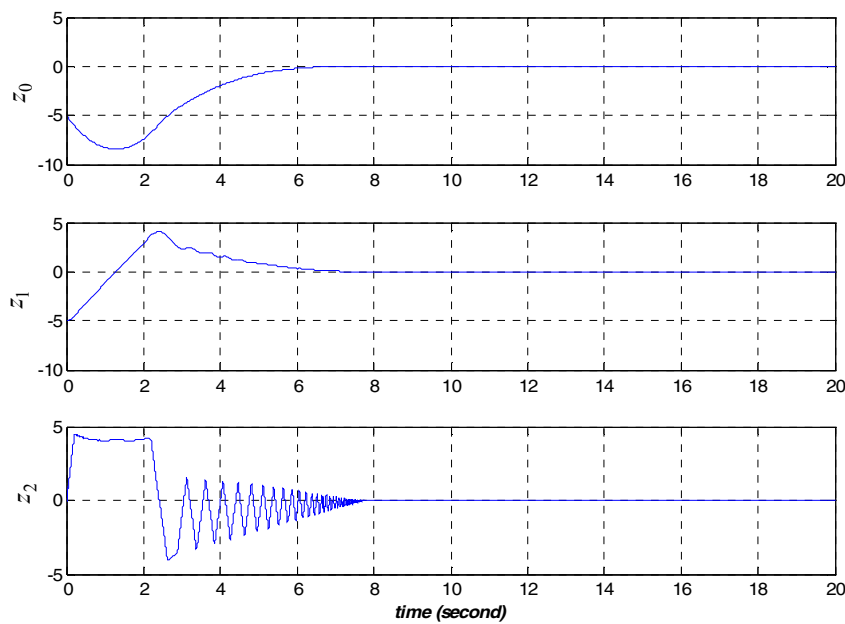

Fig. 3-6 differentiator output  $z_0$ ,  $z_1$  and  $z_2$

The figure 3-6 is the output  $z_0$ ,  $z_1$  and  $z_2$  of sliding mode differentiator. Comparing with figure 2-7, we get the similar result. It also illustrates that sliding mode differentiator can precisely estimate the any order derivative of input variable, that is  $z_0 = s$ ,  $z_1 = \dot{s}$  and  $z_2 = \ddot{s}$ .

The figure 3-7 is the discrete control law which acts on 3 order sliding mode surface. Because the discrete control law is transferred to higher order sliding mode surface, the lower sliding mode surface becomes smooth when it converges.

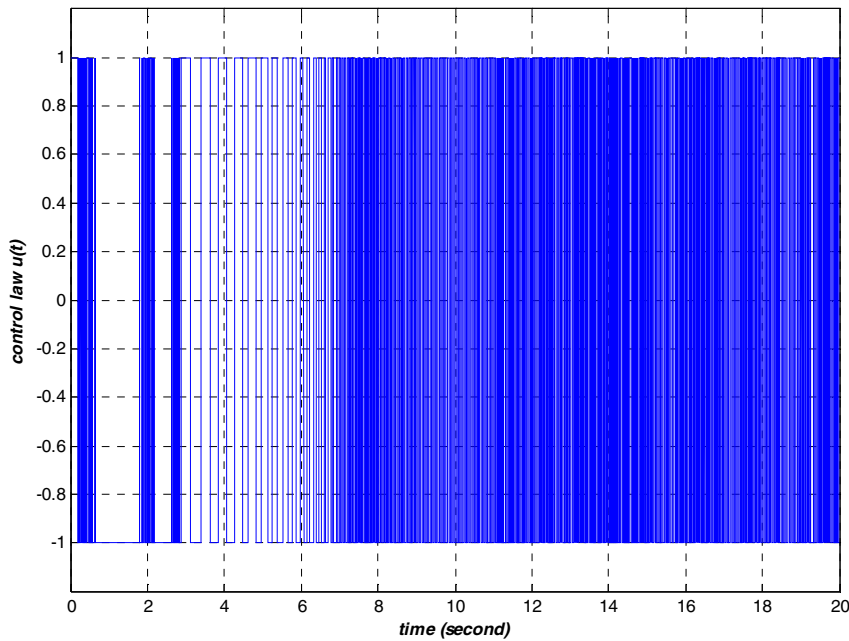

Fig. 3-7 Control law  $u(t)$

Through this example, the work characteristic of arbitrary order sliding mode differentiator is authenticated. It also provides a new way for the derivative of sliding mode variable in high order sliding mode controller. At the same time, it makes the calculation of controller very simple, and increases system robustness. The future research also provides a theoretical basis.

### 3.5 Summary

The chapter 3 draws into the high order sliding mode differentiator, which enable the calculation of the any order differentiation of a variable or function easier. And its accuracy and robustness have been guaranteed. The most direct application is to use a

---

high order sliding mode differentiator to solve a sliding variable and its any order derivative value. In this way, the calculation becomes simply, and the high order sliding mode controller design is facilitating. At the same time, taking advantage of this differentiator can be implemented with observation online.

---

## Chapter 4 Application — Nonlinear permanent magnetic synchronous motor high order sliding mode control

Permanent magnet synchronous motors (PMSM) are receiving increased attention for electric drive applications due to their high power density, large torque to inertia ratio and high efficiency over other kinds of motors ([Glumineau,1993](#); [Ziribi,2001](#); [Caravani,1998](#)).

But the dynamic model of a PMSM is highly nonlinear because of the coupling between the motor speed and the electrical quantities, such as the d, q axis currents. In last years, many different control algorithms have been used to improve the performance of the magnet motor. For example, as the dynamic model of the machine is nonlinear, a natural approach is the exact feedback linearization control method, by which the original nonlinear model can be transformed into a linear model through proper coordinate transformation. However, in general, the dynamics of the synchronous motors may not be fully known, since some of parameters appearing in the equations will vary. For instance, the resistance and inductance will be changed when the temperature alters. As a consequence, nonlinearities can only be partially cancelled by the feedback linearization technique, and parameters uncertainties act on the equations of the motion. Then an important aim of the control design is to develop a robust controller which ensures good dynamic performances in spite of parameters uncertainties and perturbation.

The sliding mode control is known to be a robust approach to solve the control problems of nonlinear systems. Robustness properties against various kinds of uncertainties such as parameter perturbations and external disturbances can be guaranteed. However, this control strategy has a main drawback: the well known chattering phenomenon. In order to reduce the chattering, the sign function can be replaced by a smooth approximation. However, this technique induces deterioration in accuracy and robustness. In last decade, another approach called higher order sliding mode (HOSM) has been proposed and developed. It is the generalization of classical sliding mode control and can be applied to control systems with arbitrary relative degree  $r$  respecting to the considered output. In HOSM control, the main objective is to obtain a finite time convergence in the non empty manifold  $S = \{x \in X \mid s = \dot{s} = \ddot{s} = \dots = s^{(r-1)} = 0\}$  by acting discontinuously on  $r$  order

derivatives of the sliding variable  $s$ . Advantageous properties of HOSM are: the chattering effect is eliminated, higher order precision is provided whereas all the qualities of standard sliding mode are kept, and control law is not limited by relative degree of the output.

This chapter is structured as follows: 4.1, derive mathematical model of PMSM; 4.2, propose the robust control for permanent magnet synchronous motor using high order sliding mode control and nonlinear decoupling technique; 4.3, propose an estimation method by using higher order sliding mode controller with differentiator to achieve a synchronous motor state variable estimation online; 4.4, according to the principle of high order sliding mode control and differentiator, the external disturbance torque of the motor is estimated online successfully; 4.5, Summary of this chapter.

#### 4.1 Mathematical model of PMSM

The common analysis of permanent magnet synchronous motor is  $d$ - $q$  axis mathematical model. It can be used to analyze not only the permanent magnet synchronous motor steady state operating characteristics, but also can be used to analyze the transient performance motor (Tang Ren-Yuan, 2002). In order to establish sinusoidal PMSM  $d$ - $q$  axis mathematical model, firstly assume:

- I. motor core saturation neglected;
- II. Excluding the eddy current and magnetic hysteresis loss of motor;
- III. The motor current is symmetrical three phase sine wave current.

Thereby, the following voltage, flux linkage, electromagnetic torque and mechanical motion equations can be obtained, where all the values in equations are transient.

The voltage equation:

$$\begin{aligned} u_d &= \frac{d\psi_d}{dt} - \omega\psi_q + Ri_d \\ u_q &= \frac{d\psi_q}{dt} + \omega\psi_d + Ri_q \end{aligned} \quad (4.1)$$

The flux linkage equation:

$$\begin{aligned} \psi_d &= L_d i_d + \psi_f \\ \psi_q &= L_q i_q \end{aligned} \quad (4.2)$$



---

The electromagnetic torque equation:

$$\begin{aligned} T_{em} &= P(\psi_d i_q - \psi_q i_d) \\ &= P[(L_d - L_q)i_d i_q + \psi_f i_q] \end{aligned} \quad (4.3)$$

The motor motion equation:

$$J \frac{d\Omega}{dt} = T_{em} - T_l - B\Omega \quad (4.4)$$

Where:  $u_d$ 、 $u_q$  —  $d$ - $q$  axis stator voltage;

$i_d$ 、 $i_q$  —  $d$ - $q$  axis stator current;

$L_d$ 、 $L_q$  —  $d$ - $q$  axis stator inductance, when  $L_d = L_q$ , motor is non-salient pole; when  $L_d < L_q$ , motor is salient pole;

$\psi_d$ 、 $\psi_q$  —  $d$ - $q$  axis stator flux linkage;

$\psi_f$  — magnetic potential generated by permanent magnet rotor;

$\omega$  — motor's electrical angular velocity;

$R$  — stator phase resistance;

$P$  — number of motor pole pairs;

$T_{em}$  — electromagnetic torque;

$T_l$  — load torque;

$\Omega$  — motor's mechanical angular velocity, with  $\Omega = P\omega$ ;

$J$  — total inertia of rotor and load;

$B$  — viscous friction coefficient.

Set of equations (4.1), (4.2), (4.3) and (4.4), we can get the state equation expression of PMSM as following.

$$\begin{bmatrix} \frac{d\Omega}{dt} \\ \frac{di_d}{dt} \\ \frac{di_q}{dt} \end{bmatrix} = \begin{bmatrix} \frac{P}{J}[(L_d - L_q)i_d + \psi_f]i_q - \frac{B}{J}\Omega - \frac{T_l}{J} \\ -\frac{R}{L_d}i_d + P\frac{L_q}{L_d}\Omega i_q + \frac{1}{L_d}u_d \\ -P\frac{\psi_f}{L_q}\Omega - P\frac{L_d}{L_q}\Omega i_d - \frac{R}{L_q}i_q + \frac{1}{L_q}u_q \end{bmatrix} \quad (4.5)$$

Suppose  $\theta_e$  is the electrical angle between rotor axis and stator  $A$  phase axis,  $\theta$  is mechanical angular position of motor, with  $\theta = P\theta_e$ , and following equality is set up.

$$\theta = \int \Omega dt + \theta_0 \quad (4.6)$$

Where,  $\theta_0$  is rotor initial angular position. Considering position control, equation (4.5) can be rewritten by

$$\begin{bmatrix} \frac{d\theta}{dt} \\ \frac{d\Omega}{dt} \\ \frac{di_d}{dt} \\ \frac{di_q}{dt} \end{bmatrix} = \begin{bmatrix} \Omega \\ \frac{P}{J}[(L_d - L_q)i_d + \psi_f]i_q - \frac{B}{J}\Omega - \frac{T_l}{J} \\ -\frac{R}{L_d}i_d + P\frac{L_q}{L_d}\Omega i_q + \frac{1}{L_d}u_d \\ -P\frac{\psi_f}{L_q}\Omega - P\frac{L_d}{L_q}\Omega i_d - \frac{R}{L_q}i_q + \frac{1}{L_q}u_q \end{bmatrix} \quad (4.7)$$

From the equation (4.7) we can see that PMSM is a multi-variable, coupling, nonlinear time varying systems. In addition, the variables in  $d$ - $q$  axis can be changed to three phase  $abc$  axis by coordinate transformation.

## 4.2 Robust high order sliding mode control for PMSM

Because of their own advantages of permanent magnet synchronous motor, it is very suitable for modern industrial control and applications. But the synchronous motor is a typical nonlinear, multivariable system with coupling. So, in recent years, there are a lot of algorithms to improve the performance of motor control, For instance, exact feedback linearization control. But in a dynamic system, it is impossible to accurately inform of all the parameters of the synchronous motor. The system parameters in the equation will change due to the environment, such as resistors and inductors will be changed as different external temperature. Therefore, the design of robust controller is very important to ensure good dynamic performance

with the parameter uncertainties and external disturbances. It is based on this consideration, such as adaptive control,  $H_\infty$  control, and observer control and etc. proposed and applied.

Another theory with robustness in the control method is the sliding mode control. In recent years, a new type of high order sliding mode control is proposed, and has been widely used. The characteristic of the control is high order derivative of sliding mode variables in place of the original discrete control, so that the chattering disappears in the high order differentiation. At present, the majority of the use of high order sliding mode control for single input single output system in the majority of technical literature. The literature for multi-input multi-output system is rare. This section will use the high order sliding mode control algorithm with differentiator, in spite of system parameter uncertainties, external disturbances and other factors, to design a robust controller for nonlinear multi-input multi-output permanent magnet synchronous motor. The advantage of this controller is the elimination of the chattering in standard sliding mode. At the same time, it is still with precision and robustness of the standard sliding mode control. And its control law no longer subjects to relative degree constraints.

Firstly, let  $x$  denotes the motor state variable  $x = [x_1, x_2, x_3, x_4]^T = [\theta, \Omega, i_d, i_q]^T$ , and control input  $u = [u_1, u_2]^T = [u_d, u_q]^T$ . The parameters  $R$ ,  $L_d$ ,  $L_q$  and  $B$  are considered as uncertain parameters, such as  $R$  will change with the temperature rise of the synchronous motor. Therefore, use  $R_0$ ,  $L_{d0}$ ,  $L_{q0}$  and  $B_0$  to express their nominal value part of  $R$ ,  $L_d$ ,  $L_q$  and  $B$  respectively. In order to facilitate the calculation, the coefficient  $k_i (1 \leq i \leq 10)$  is used to plan these variable expressions:

$$\begin{aligned}
k_1 &= k_{01} + \delta k_1 = P(L_d - L_q) / J \\
k_2 &= k_{02} + \delta k_2 = P\psi_f / J \\
k_3 &= k_{03} + \delta k_3 = -B / J \\
k_4 &= k_{04} + \delta k_4 = -R / L_d \\
k_5 &= k_{05} + \delta k_5 = PL_q / L_d \\
k_6 &= k_{06} + \delta k_6 = 1 / L_d \\
k_7 &= k_{07} + \delta k_7 = -P\psi_f / L_q \\
k_8 &= k_{08} + \delta k_8 = -PL_d / L_q \\
k_9 &= k_{09} + \delta k_9 = -R / L_q \\
k_{10} &= k_{010} + \delta k_{10} = 1 / L_q
\end{aligned} \tag{4.10}$$

Where,  $k_{0i} (1 \leq i \leq 10)$  is the nominal value of the concerned parameter,  $\delta k_i$  is the uncertainty on the concerned parameter such that  $|\delta k_i| \leq \delta k_{0i} \leq k_{0i}$ , with  $\delta k_{0i}$  a known positive bound. The state variable  $x \in R^4$ , such that  $|x_i| \leq x_{iMAX} (2 \leq i \leq 4)$ ,  $x_{2MAX}$  is the maximum values of the angular velocity,  $x_{3MAX}$  and  $x_{4MAX}$  are the maximum values of the current  $i_d$  and  $i_q$  respectively. And control input  $u \in R^2$  such that  $|u_i| \leq u_{iMAX}, (1 \leq i \leq 2)$ . Where,  $u_{1MAX}$  and  $u_{2MAX}$  are the maximum values of the voltage input  $v_d$  and  $v_q$  respectively.

Then the state space model of the synchronous motor can be changed as following nonlinear system.

$$\begin{bmatrix} \dot{x}_1 \\ \dot{x}_2 \\ \dot{x}_3 \\ \dot{x}_4 \end{bmatrix} = \underbrace{\begin{bmatrix} x_2 \\ (k_1 x_3 + k_2)x_4 + k_3 x_2 - T_l / J \\ k_4 x_3 + k_5 x_2 x_4 \\ k_7 x_2 + k_8 x_2 x_3 + k_9 x_4 \end{bmatrix}}_{f(x,t)} + \underbrace{\begin{bmatrix} 0 & 0 \\ 0 & 0 \\ k_6 & 0 \\ 0 & k_{10} \end{bmatrix}}_{g(x,t)} \begin{bmatrix} u_1 \\ u_2 \end{bmatrix} \quad (4.11)$$

The aim is to design an appropriate control which guarantees robust performance in presence of parameters and load variations. The control objective is double aspect. First, the rotor angular position  $x_1 = \theta$  must track a reference trajectory angular position  $x_{1ref}$ . Second, the nonlinear electromagnetic torque must be linearized to avoid reluctance effects and torque ripple. This objective is equivalent to constrain  $x_3 = i_d$  to track a constant direct current reference  $x_{3ref} = 0$ .

As we known that PMSM is a multi-input multi-output nonlinear dynamic system. It is assumed that the position and current are available for measurement. A first sliding variable  $s$  for the tracking of direct current  $x_3$  towards its equilibrium point  $x_{3ref}$  is defined from the direct current error. So, the first sliding mode variable is

$$s_1 = h_1(x) = x_3 - x_{3ref} \quad (4.12)$$

Derivative of  $s_1$ , we can see that the relative degree of sliding mode variable  $s_1$  equals 1, that is

$$\begin{aligned} \dot{s}_1 &= \dot{x}_3 - \dot{x}_{3ref} \\ &= k_4 x_3 + k_5 x_2 x_4 + k_6 u_1 - \dot{x}_{3ref} \end{aligned} \quad (4.13)$$

To track the angular position  $x_1 = \theta$ , another sliding manifold is proposed so that the error dynamics follows a desired third order dynamic. Denoting  $x_{1ref}$  the desired trajectory, following form can be obtained.

$$s_2 = h_2(x) = x_1 - x_{1ref} \quad (4.14)$$

Considering load torque as external disturbance, derivative of  $s_2$  continuously until control input appears.

$$\begin{aligned} \dot{s}_2 &= \dot{x}_1 - \dot{x}_{1ref} = x_2 - \dot{x}_{1ref} \\ \ddot{s}_2 &= \dot{x}_2 - \ddot{x}_{1ref} = (k_1x_3 + k_2)x_4 + k_3x_2 - \ddot{x}_{1ref} \\ \dddot{s}_2 &= k_1x_4(k_3x_3 + k_5x_2x_4) + k_1k_6x_4u_1 + k_3[(k_1x_3 + k_2)x_4 + k_3x_2] \\ &\quad + (k_1x_3 + k_2)(k_7x_2 + k_8x_2x_3 + k_9x_4) + (k_1x_3 + k_2)k_{10}u_2 - \ddot{\ddot{x}}_{1ref} \end{aligned} \quad (4.15)$$

The control input  $u$  appears in the 3 order derivative of  $s_2$ , so the relative degree of  $s_2$  equals 3. Considering sliding mode variable  $s = [\dot{s}_1, \ddot{s}_2]^T$  as a new dynamical system, the space state express can be written by

$$\begin{bmatrix} \dot{s}_1 \\ \ddot{s}_2 \end{bmatrix} = \begin{bmatrix} A_1 \\ A_2 \end{bmatrix} + \begin{bmatrix} B_{11} & 0 \\ B_{21} & B_{22} \end{bmatrix} \begin{bmatrix} u_1 \\ u_2 \end{bmatrix} \quad (4.16)$$

Where,

$$\begin{aligned} A_1 &= k_4x_3 + k_5x_2x_4 =: A_{10} + \delta A_1 \\ A_2 &= (k_1x_3 + k_2)(k_7x_2 + k_8x_2x_3 + k_9x_4) + k_3[(k_1x_3 + k_2)x_4 + k_3x_2] \\ &\quad + k_1x_4(k_3x_3 + k_5x_2x_4) - \ddot{\ddot{x}}_{1ref} \\ &=: A_{20} + \delta A_2 \\ B_{11} &= k_6 =: B_{110} + \delta B_{11} \\ B_{21} &= k_1k_6x_4 =: B_{210} + \delta B_{21} \\ B_{22} &= (k_1x_3 + k_2)k_{10} =: B_{220} + \delta B_{22} \end{aligned}$$

$A_{10}$ ,  $A_{20}$ ,  $B_{110}$ ,  $B_{210}$  and  $B_{220}$  are the known nominal expressions whereas the expressions of  $\delta A_1$ ,  $\delta A_2$ ,  $\delta B_{11}$ ,  $\delta B_{21}$  and  $\delta B_{22}$  contain all the uncertainties due to parameters and load torque variations.

Next, controller should be designed so that sliding mode variable  $s_1$  achieve to zero in finite time. Another sliding mode variable  $s_2$  and its first and second derivative likewise achieve to zero in finite time. When the sliding mode happens, then

$$\begin{aligned} S_1 &= \{x \in X \mid s_1(x, t) = 0\} \\ S_2 &= \{x \in X \mid s_2(x, t) = \dot{s}_2(x, t) = \ddot{s}_2(x, t) = 0\} \end{aligned} \quad (4.17)$$

The control problem equivalent to the finite time stabilization of the following MIMO system.

$$\begin{bmatrix} \dot{s}_1 \\ \vdots \\ \ddot{s}_2 \end{bmatrix} = A + B \begin{bmatrix} u_1 \\ u_2 \end{bmatrix} \quad (4.18)$$

Where,

$$A = \begin{bmatrix} A_{10} \\ A_{20} \end{bmatrix} + \begin{bmatrix} \delta A_1 \\ \delta A_2 \end{bmatrix} =: A_0 + \delta A \quad (4.19)$$

$$B = \begin{bmatrix} B_{110} & 0 \\ B_{210} & B_{220} \end{bmatrix} + \begin{bmatrix} \delta B_{11} & 0 \\ \delta B_{21} & \delta B_{22} \end{bmatrix} =: B_0 + \delta B \quad (4.20)$$

From the equation (4.15), the outputs of this MIMO system are coupled since  $\ddot{s}_2$  is affected by  $u_1$  and  $u_2$ . So a input-output feedback linearization technique can be used

$$u = B_0^{-1} \cdot [-A_0 + w] \quad (4.21)$$

Now, if considering influence of external disturbance and parameter uncertainties, equation (4.18) can be rewritten by

$$\begin{aligned} s &= A + Bu \\ &= A_0 + \delta A + (B_0 + \delta B)u \\ &= A_0 + \delta A + (B_0 + \delta B)[B_0^{-1}(-A_0 + w)] \end{aligned} \quad (4.22)$$

Evolute and ordinate, then

$$\Rightarrow \begin{bmatrix} \dot{s}_1 \\ \vdots \\ \ddot{s}_2 \end{bmatrix} = \begin{bmatrix} \hat{A}_1 \\ \hat{A}_2 \end{bmatrix} + \begin{bmatrix} \hat{B}_{11} & 0 \\ \hat{B}_{21} & \hat{B}_{22} \end{bmatrix} \begin{bmatrix} w_1 \\ w_2 \end{bmatrix} \quad (4.23)$$

Where,

$$\begin{aligned} \hat{A}_1 &= \delta A_1 - \frac{\delta B_{11}}{B_{110}} A_{10} \\ \hat{A}_2 &= \delta A_2 - \left[ \frac{\delta B_{21}}{B_{110}} - \frac{\delta B_{22} B_{210}}{B_{110} B_{220}} \right] A_{10} - \frac{\delta B_{22}}{B_{220}} A_{20} \\ \hat{B}_{11} &= 1 + \frac{\delta B_{11}}{B_{110}} \\ \hat{B}_{21} &= \frac{\delta B_{21}}{B_{110}} - \frac{\delta B_{22} B_{210}}{B_{110} B_{220}} \\ \hat{B}_{22} &= 1 + \frac{\delta B_{22}}{B_{220}} \end{aligned}$$

In the new dynamic system with  $w = [w_1, w_2]^T$ , it leads to  $s_1$  equals integrator of  $w_1$  and  $s_2$  equals three time integrators of  $w_2$ , if the part of uncertainties  $\delta A = 0$  and  $\delta B = 0$ . Then  $w_1$  and  $w_2$  are designed to stabilize in this new system.

In fact, the term  $-B_0^{-1}A_0$  of (4.21) is the so-called equivalent control in the sliding mode context. In this new system, due to state variable  $x_i (2 \leq x \leq 4)$ , there exist three positive constants  $C_1, C_2, K_{11m}, K_{22m}, K_{11M}, K_{22M}$  and  $K_{21}$ , so that

$$\begin{aligned} |\hat{A}_1| &\leq C_1, \quad 0 < K_{11m} \leq \hat{B}_{11} \leq K_{11M} \\ |\hat{A}_2| &\leq C_2, \quad 0 < K_{22m} \leq \hat{B}_{22} \leq K_{22M} \\ |\hat{B}_{21}| &\leq K_{21} \end{aligned}$$

Then, owing to the relative degree of  $s_1$  equals 1, the first order sliding mode algorithm previously presented with control law

$$w_1 = -\alpha_1 \operatorname{sgn}(s_1) \quad (4.24)$$

Where  $\alpha_1$  is positive constant.. In the actual system, due to all the state variables have the bound, selecting parameter  $\alpha_1$  properly to satisfy convergence. For the motor angular position control, a 3 order sliding mode control law is used. In this case, only a single scalar parameter  $\alpha_2$  is to be adjusted. Actually, the control input  $w_2$  can be chosen as following.

$$w_2 = -\alpha_2 \operatorname{sgn}(\ddot{s}_2 + 2(|\dot{s}_2|^3 + |s_2|^2)^{1/6} \operatorname{sgn}(\dot{s}_2 + |s_2|^{2/3} \operatorname{sgn}(s_2))) \quad (4.25)$$

According to the principle of sliding mode differentiator, the arbitrary order derivative of  $s_2$  can be estimated by the output of differentiator  $z_0, z_1$  and  $z_2$ .

$$\begin{aligned} \dot{z}_0 &= v_0, \quad v_0 = -150 |z_0 - s|^{2/3} \operatorname{sgn}(z_0 - s) + z_1 \\ \dot{z}_1 &= v_1, \quad v_1 = -160 |z_1 - v_0|^{1/2} \operatorname{sgn}(z_1 - v_0) + z_2 \\ \dot{z}_2 &= -400 |z_2 - v_1| \end{aligned} \quad (4.26)$$

Then, substituting  $z_0, z_1$  and  $z_2$  for  $s_2, \dot{s}_2$  and  $\ddot{s}_2$  respectively in equation (4.25), that is

$$w_2 = -\alpha_2 \operatorname{sgn}(z_2 + 2(|z_1|^3 + |z_0|^2)^{1/6} \operatorname{sgn}(z_1 + |z_0|^{2/3} \operatorname{sgn}(z_0))) \quad (4.27)$$

The figure 4-1 is the block graph of control system, the first sliding mode variable  $s_1$  is given by the error between direct axis current reference and feedback. And the second variable  $s_2$  is defined by the error between the motor reference position and actual feedback. According to the Theorem 3.3.1 after finite time,  $z_0, z_1$  and  $z_2$  can be used to estimate  $s_2, \dot{s}_2$  and  $\ddot{s}_2$ . In system, the state variable

speed of motor  $w_2$  is obtained by differentiator of angle position signal  $\theta$ . Finally, the nonlinear dynamic system must be linearized by input-output feedback linearization, then the control input  $u_1$  and  $u_2$  are used to drive the synchronous motor.

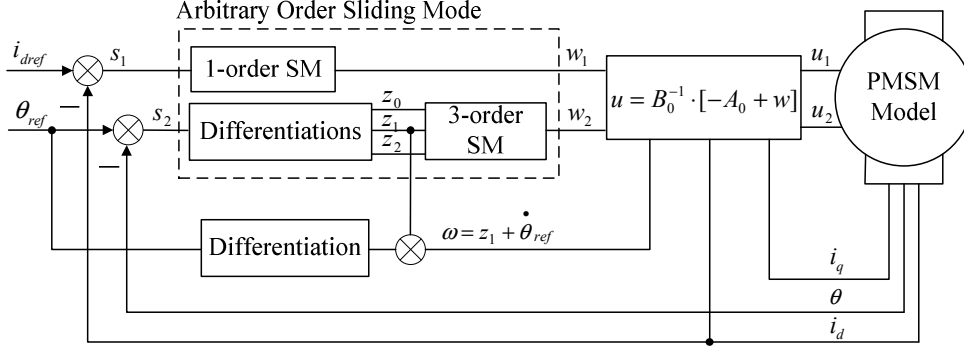

Fig. 4-1 The block graph of dynamic system structure

In the simulation, The PMSM is a DutymAx 95DSC060300 (Leroy Somer Co.) drive. Two sensors give measurements of phase currents, a optical encoder is used to measure the position of the motor. The parameters of synchronous motor are  $P = 3$ ,  $B = 0.0034 N \cdot m \cdot s$ ,  $R = 3.3 \Omega$ ,  $L_d = 0.027 H$ ,  $L_q = 0.0034 H$ ,  $\psi_f = 0.341 Wb$ ,  $J = 0.00037 kg \cdot m^2$ . A phase current of the maximum accepted value is  $6.0 A$ , the load torque maximum value is  $6 N \cdot m$ , and angular velocity is  $3000 rpm$ .

To achieve the efficiency of controller, the parameter in (4.24) and (4.27) are chosen by  $\alpha_1 = 5$ ,  $\alpha_2 = 3300$ . In the differentiator, the coefficient of (4.26) are selected by  $\lambda_0 = 150$ ,  $\lambda_1 = 160$ ,  $\lambda_2 = 400$  in order to allow the convergence of the differentiator. The system sampling frequency is  $8000 Hz$ .

To show the system robustness of the controller, consider permanent magnet synchronous motor parameters uncertainties (with  $\delta R = \pm 50\% R$ , with  $\delta L_{d0} = \pm 25\% L_d$  and  $\delta L_{q0} = \pm 25\% L_q$  and with  $\pm 20\% B$ ).

The trajectory of motor angular position reference and feedback are shown in figure 4-2(a) in spite of PMSM parameters uncertainties. From this figure, we can see that the servo system track trajectory has good performance. The precision can achieve  $10^{-3}$ . In addition, using high order sliding mode control, the chattering is eliminated in lower sliding mode surface so that the track trajectory become more smooth.



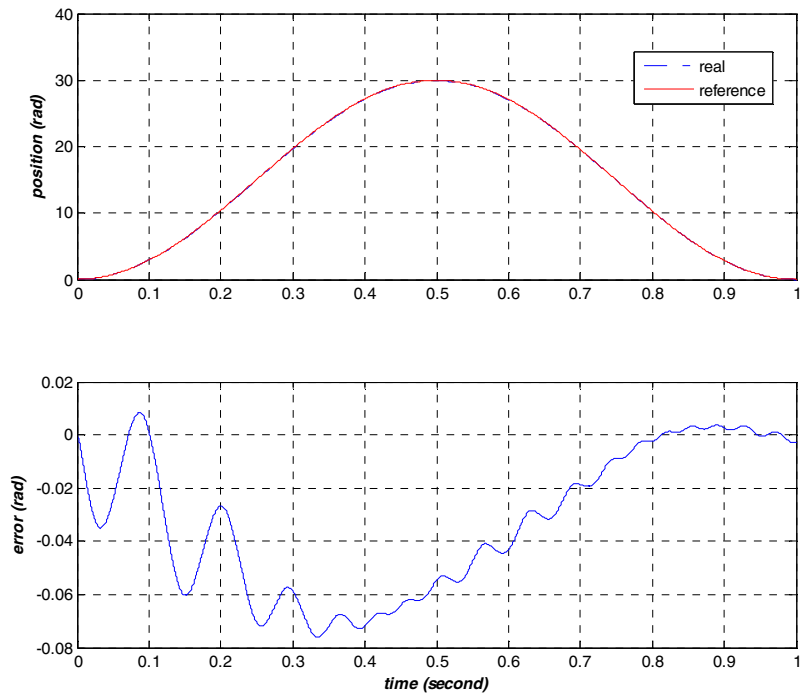

Fig. 4-2 Reference angle position and actual angle position

Fig. 4-2(b) shows position tracking error, which does not exceed 0.09 rad. It means that the controller has high robust capability versus the parameters variations.

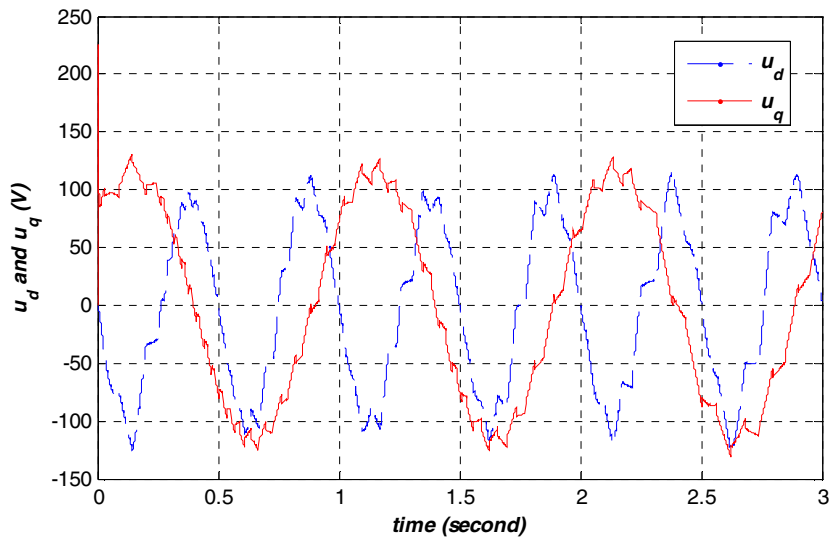

Fig. 4-3 The curve of input  $u_d$  and  $u_q$

The figure 4-3 shows the curve of input  $u_d$  and  $u_q$  for PMSM using the high order sliding mode observer.

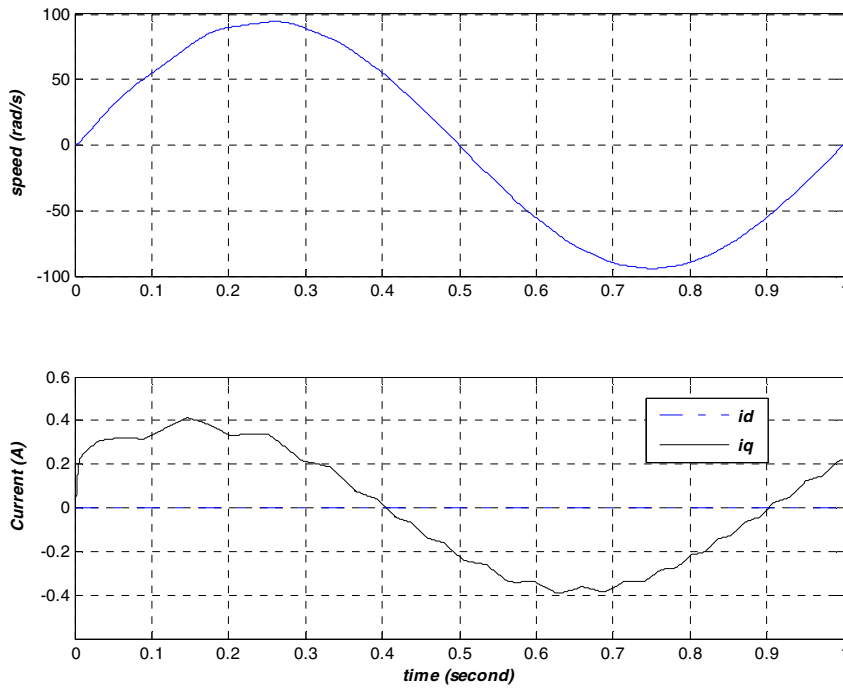

Fig. 4-4 Four quadrant run and quadrature/direct axis currents

The figure 4-4 is the speed and  $d$ - $q$  axis current of synchronous motor. The motor in the four-quadrant operation, with acceleration, deceleration, has good dynamic performance. In this figure, direct axis current  $i_d$  is very near reference  $i_{dref} = 0$ .

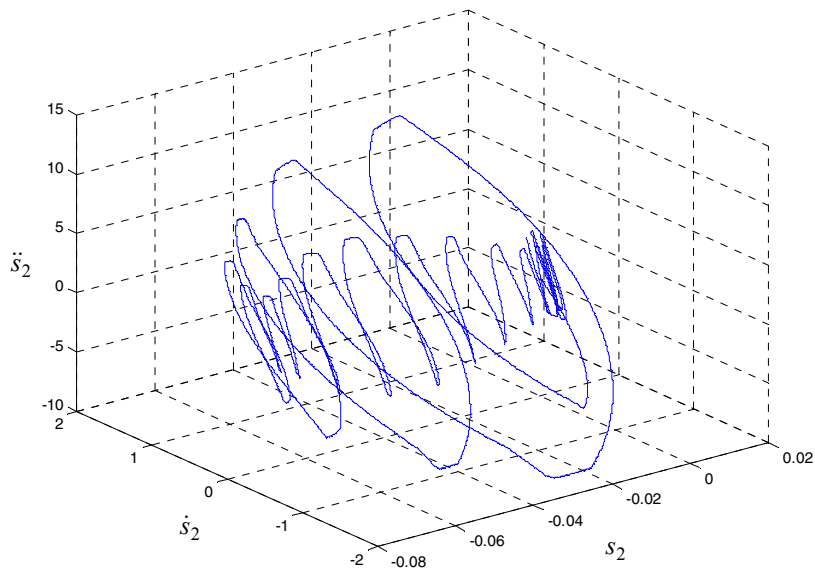

Fig. 4-5 Sliding mode variables  $s_2$ ,  $\dot{s}_2$  and  $\ddot{s}_2$

The figure 4-5 shows that sliding mode variable  $s_2$  converge into origin in three dimensional surface within limited time.

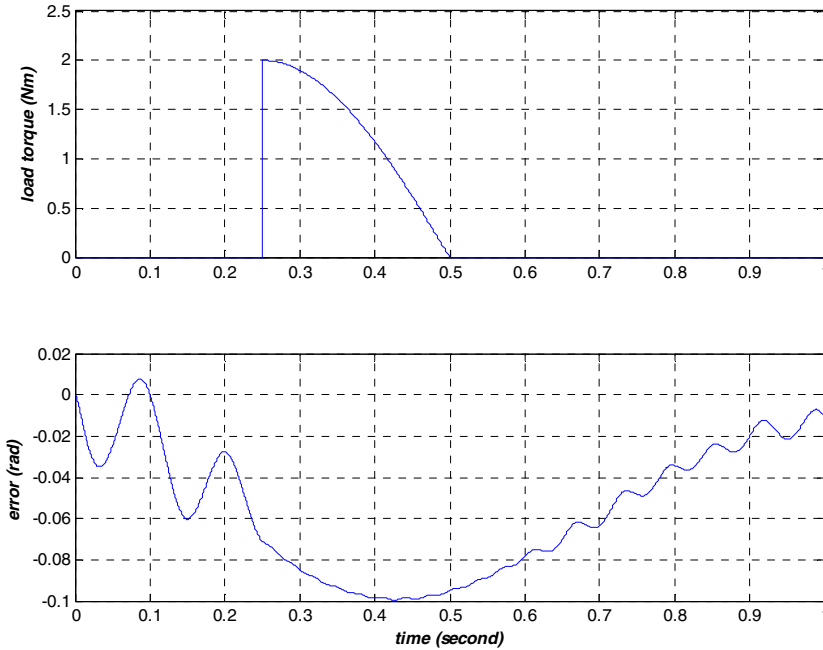

Fig. 4-6 Tracking error of motor with the load torque disturbance

The Figure 4-6 shows the controller is strong robustness versus the load torque variations. The error of angular position does not exceed 0.1 rad even though the load perturbation.

To sum up, this section takes the multiple-input multiple-output nonlinear permanent magnet synchronous motor as control object, and designs a robust high order sliding mode controller with differentiator, through the state feedback linearization to decouple the system. The simulation results show that, despite the existence of parameter uncertainties and external disturbances, the system still has a better dynamic performance and robustness, which is due to higher order sliding mode control converge within limited time. Comparing with the traditional sliding mode control, high order sliding mode control eliminates the chattering phenomenon. And the better test results proves the feasibility of the theory.

### 4.3 State variable estimation for PMSM

The parameters and state estimation of permanent magnet synchronous motor has been more concerned in motor control. As the motor itself is a typical nonlinear,

---

multivariable system with strong coupling, there are a lot algorithms to improve the motor control performance in recent years. Earlier off-line estimation of the static dynamic system can not satisfy the control requirements; the use of extended Kalman filter (EKF) usually have a group of high order nonlinear equations, which is not conducive to the calculation (Yan,2006), and its stability is also a local stable; In least squares procedure, the matrix forgotten factor (Poznyak,1999; Poznyak,1999b) is used to solve non-static parameter identification; as a result of sliding mode control with strong robustness and global convergence, In recent years, sliding mode observer (Floret-Pontet,2001; Koshkouei,2002) has been used for dynamic system state and parameter estimation, but the observer feedback gain is usually not easy to choose.

With the development of nonlinear theory, in order to enhance the performance of permanent magnet synchronous motor, many advanced control strategies have been proposed and used in motor control, which requires the state of motor can be measured, such as mechanical angular position, rotational speed, the electrical current and so on. Hence mechanical, electromagnetic or photoelectric sensor are needed, as well known to all, the sensors have many other shortcomings such as drift, friction, high costs, as well as electromagnetic interference caused by additional conductors. Therefore, the control system should be as possible as release the use of sensors to ensure the reliability and stability, which requires the system observer to precisely estimate the value of the state.

The high order sliding mode control is widely used in last decade, which take high order derivatives of sliding mode variables to substitute original discrete control, so that the chattering disappears in the high order differentiation. This section uses a high order sliding mode observer with differentiator algorithm to estimates the value of state variables. In this case, it removes the speed and current sensors of motor, and a better control precision and accurate state estimation are obtained.

In this section, the mathematical model of PMSM is the same with above section (4.11). In order to make control effectiveness more smooth, the relative order is raised artificially. Considering control input  $\dot{u}$  as a new input, original sliding mode variable (4.13) and (4.15) are transformed into

$$\begin{aligned} \ddot{s}_1 &= A_1' + B_{11}' \dot{u}_1 \\ s_2^{(4)} &= A_2' + B_{21}' \dot{u}_1 + B_{22}' \dot{u}_2 \end{aligned} \quad (4.28)$$

Then, the coefficient matrix of original system  $A_1$ ,  $A_2$ ,  $B_{11}$ ,  $B_{21}$  and  $B_{22}$  become new matrixes  $A_1'$ ,  $A_2'$ ,  $B_{11}'$ ,  $B_{21}'$  and  $B_{22}'$ . Where,

$$A_1' = k_4(k_4x_3 + k_5x_2x_4 + k_6u_1) + k_5[(k_1x_3 + k_2)x_4 + k_3x_2]x_4 \\ + k_5x_2(k_7x_2 + k_8x_2x_3 + k_9x_4 + k_{10}u_2) - \ddot{x}_{3ref}$$

$$A_2' = (k_1k_5x_4^2 + k_1k_7x_3 + k_1k_8x_3^2 + k_2k_7 + k_2k_8x_3 + k_3^2)[(k_1x_3 + k_2)x_4 + k_3x_2] \\ + (k_1k_4x_4 + k_1k_7x_2 + 2k_1k_8x_2x_3 + k_1k_9x_4 + k_2k_8x_2 + k_1k_{10}u_2 + k_1k_3x_4)(k_4x_3 \\ + k_5x_2x_4 + k_6u_1) + 2k_1k_5x_2x_4 + k_1k_6u_1 + k_1k_9x_3 + k_2k_9 + k_1k_3x_3 + (k_1k_4x_3 \\ + k_2k_3)(k_7x_2 + k_8x_2x_3 + k_9x_4 + k_{10}u_2) - x_{3ref}^{(4)}$$

$$B_{11}' = k_6; \quad B_{21}' = k_1k_6x_4; \quad B_{22}' = (k_1x_3 + k_2)k_{10};$$

Next, it still is high order sliding mode controller design that make the sliding mode variables converge into origin within limited time in the sliding mode surface. In another word, it should satisfy following conditions.

$$S_1 = \{x \in X \mid s_1(x, t) = \dot{s}_1(x, t) = 0\} \\ S_2 = \{x \in X \mid s_2(x, t) = \dot{s}_2(x, t) = \ddot{s}_2(x, t) = \ddot{\ddot{s}}_2(x, t) = 0\} \quad (4.29)$$

Let  $s = [\dot{s}_1, s_2^{(4)}]^T$ ,  $u = [\dot{u}_1, \dot{u}_2]$ , this control object is equivalent to stable of following multi-input multi-output system in limited time.

$$s = A's + B'u \quad (4.30)$$

Due to  $s_2^{(4)}$  effected by  $\dot{u}_1$  and  $\dot{u}_2$ , the output of this system are coupled. Here, input-output feedback linearization technology is used to decouple system.

$$u = \frac{1}{L_g L_f^{r-1} h(x)} (w - L_f^r h(x)) = B'^{-1} \cdot [-A' + w]$$

After decoupling, the relative degree of  $s_1$  equals 2, so 2 order sliding mode control law is adopted

$$w_1 = -\alpha_1 \operatorname{sgn}(\dot{s}_1 + |s_1|^{1/2} \operatorname{sgn}(s_1)) \quad (4.31)$$

Where,  $\alpha_1$  is a positive constant. Now, we use the output of sliding mode differentiator  $z_{01}$  and  $z_{11}$  to estimate the value of  $s_1$  and  $\dot{s}_1$ .

$$\dot{z}_{01} = v_{01}, \quad v_{01} = -\lambda_{01} |z_{01} - s_1|^{1/2} \operatorname{sgn}(z_{01} - s_1) + z_{11} \\ \dot{z}_{11} = -\lambda_{11} \operatorname{sgn}(z_{11} - v_{01}) \quad (4.32)$$

For the motor's angular position control, 4 order sliding mode control law is used. In this case, we only adjust a single parameter  $\alpha_2$  to make the system converge within limited time..

$$w_2 = -\alpha_2 \operatorname{sgn}\{\ddot{s}_2 + 3[(\dot{s}_2)^6 + (\dot{s}_2)^4 + |s_2|^3]^{1/12} \operatorname{sgn}[\ddot{s}_2 + (|\dot{s}_2|^4 + |s_2|^3)^{1/6} \operatorname{sgn}(\dot{s}_2 + 0.5 |s_2|^{3/4} \operatorname{sgn}(s_2))]\} \quad (4.33)$$

Similarly, the output  $z_{02}, z_{12}, z_{22}$  of 3 order differentiator is used to estimated sliding mode variables  $s_2, \dot{s}_2, \ddot{s}_2$ .

$$\begin{aligned} \dot{z}_{02} &= v_{02}, & v_{02} &= -\lambda_{02} |z_{02} - s_2|^{3/4} \operatorname{sgn}(z_{02} - s_2) + z_{12}; \\ \dot{z}_{12} &= v_{12}, & v_{12} &= -\lambda_{12} |z_{12} - v_{02}|^{2/3} \operatorname{sgn}(z_{12} - v_{02}) + z_{22}; \\ \dot{z}_{22} &= v_{22}, & v_{22} &= -\lambda_{22} |z_{22} - v_{12}|^{1/2} \operatorname{sgn}(z_{22} - v_{12}) + z_{32} \\ \dot{z}_{32} &= -\lambda_{32} \operatorname{sgn}(z_{32} - v_{22}) \end{aligned} \quad (4.34)$$

Generally speaking, in the actual system not all the state variables is measurable. Sometimes, due to the limitation of condition, some state variables can not be measured. Therefore, it requires the controller can estimate state variables of system as possible as accurate.

PMSM only uses the position sensors, taking the use of high order sliding mode control techniques, so that its speed and the current state variable is estimated online. In this way, it avoids the use of other sensors, at the same time ensures the motor position tracking progress.

In the design of controller, we have obtained that

$$\dot{s}_1 = k_4 x_3 + k_5 x_2 x_4 + k_6 u_2 - x_{3ref} \quad (4.35)$$

$$\dot{s}_2 = x_2 - \dot{x}_{1ref} \quad (4.36)$$

$$\ddot{s}_2 = \ddot{x}_1 - \ddot{x}_{1ref} = (k_1 x_3 + k_2) x_4 + k_3 x_2 - \ddot{x}_{1ref} \quad (4.37)$$

From the above equations, we can calculate the speed estimation of synchronous motor  $\tilde{x}_2 = \dot{s}_2 + \dot{x}_{1ref}$ , so the current estimation expressed by

$$\begin{aligned} \tilde{x}_3 &= \frac{1}{k_4} [\dot{s}_1 - k_5 \tilde{x}_4 (\dot{s}_2 + \dot{x}_{1ref}) - k_6 u_2] \\ \tilde{x}_4 &= \frac{\ddot{s}_2 - k_3 (\dot{s}_2 + \dot{x}_{1ref}) + \ddot{x}_{1ref}}{k_1 \tilde{x}_3 + k_2} \end{aligned} \quad (4.38)$$

For calculating  $\tilde{x}_3$  and  $\tilde{x}_4$ , considering sliding mode variables  $\dot{s}_1, \dot{s}_2, \ddot{s}_2$  and  $u_2$  as known value, adopt recursive algorithm to get

$$\begin{aligned} \tilde{x}_{3(n+1)} &= \frac{1}{k_4} [\dot{s}_{1(n)} - k_5 \tilde{x}_{4(n)} (\dot{s}_{2(n)} + \dot{x}_{1ref}) - k_6 u_{2(n)}] \\ \tilde{x}_{4(n+1)} &= \frac{\ddot{s}_{2(n)} - k_3 (\dot{s}_{2(n)} + \dot{x}_{1ref}) + \ddot{x}_{1ref}}{k_1 \tilde{x}_{3(n)} + k_2} \quad n = 1, 2, \dots \end{aligned} \quad (4.39)$$

Where,  $n$  is the  $n$ th sample point of system,  $n+1$  is the next sample point. Through the above recursive equation, current estimation  $\tilde{x}_3$  and  $\tilde{x}_4$  are obtained. Take these estimation into the control system so that save the sensors. Thereby, system become more simple and reliability.

In the simulation, we use the DutyMAX95-BSC060300 permanent magnetic synchronous motor. The parameters of motor are  $P=3$ ,  $B=0.0034N \cdot m \cdot s$ ,  $R=3.3\Omega$ ,  $L_d=0.027H$ ,  $L_q=0.0034H$ ,  $\psi_f=0.341Wb$ ,  $J=0.0037kg \cdot m^2$ . A phase current of the maximum accepted value is  $6.0A$ , the load torque maximum value is  $6N \cdot m$ , and angular velocity is  $3000rpm$ .

The parameter of controller are  $\alpha_1=5$  and  $\alpha_2=50$ ; the parameter of sliding mode differentiator are  $\lambda_{01}=2$ ,  $\lambda_{11}=1.5$ ,  $\lambda_{02}=25$ ,  $\lambda_{12}=25$ ,  $\lambda_{22}=33$  and  $\lambda_{32}=500$ .

From the figure 4-7(a) we can see that the permanent magnet synchronous motor control system has good performance. This figure shows the permanent magnet synchronous motor can precisely track the given position. And the error between reference and the actual position feedback is shown in Figure 4-7(b) below. The maximal error does not exceed to 0.08 rad.

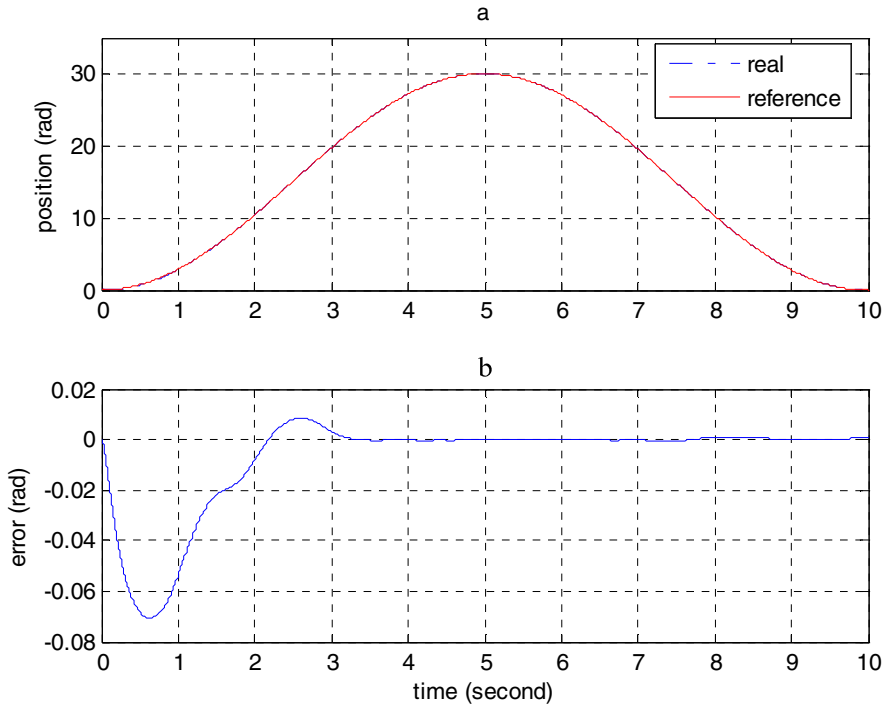

Fig. 4-7 Position tracking and error curve of PMSM

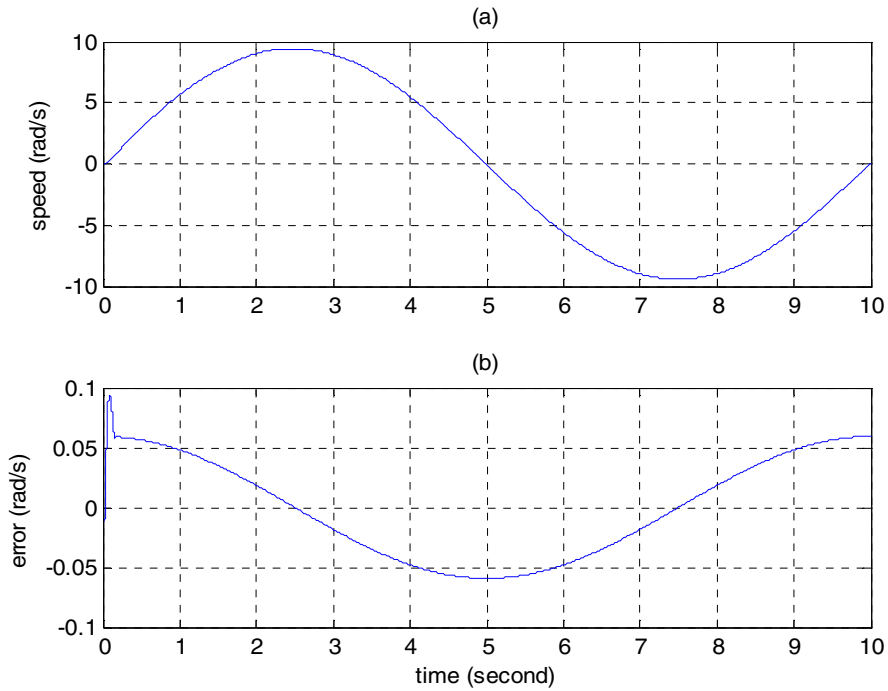

Fig. 4-8 Speed estimation and error curve of PMSM

The figure 4-8(a) shows the motor angular speed by derivative of the motor's angular position. The figure 4-8(b) shows the error between the estimation of the electrical angular speed and the value calculated by the formula (4.36).

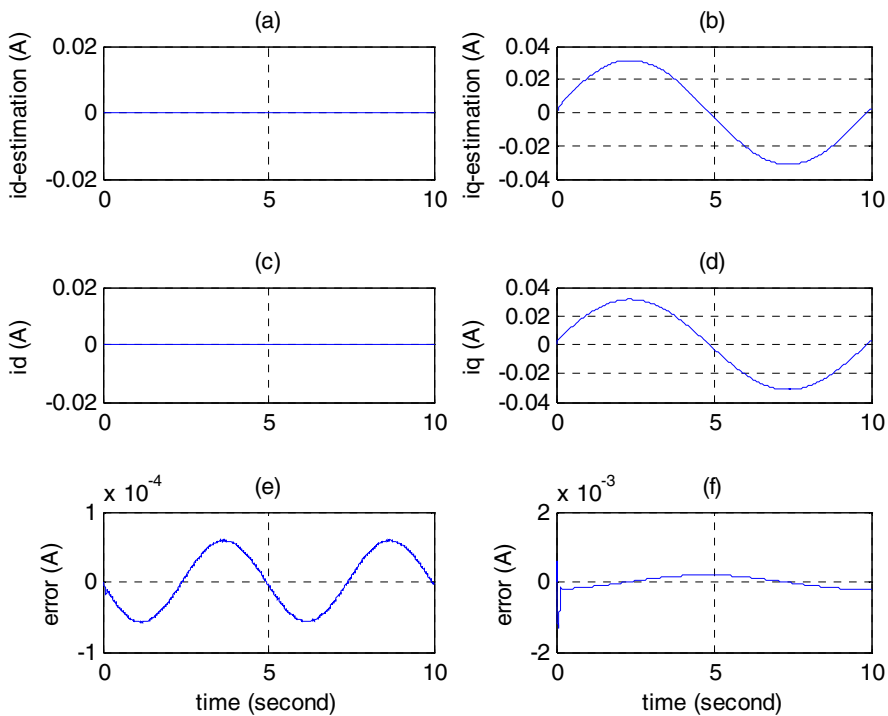

Fig. 4-9 The quadrature/direct axis currents and their estimations



For permanent magnet synchronous motor, its angular position, speed and current are system state values. The figure 4-9(a), (b), (c), (d) shows that the estimated value and actual current value of direct axis and quadrature axis respectively. The figure 4-9(e), (f) are the error between actual current value and the estimated value. In this figure, the error of direct axis current is between  $\pm 1.0 \times 10^{-4}(A)$ , and the error of quadrature axis is between  $\pm 1.0 \times 10^{-3}(A)$ .

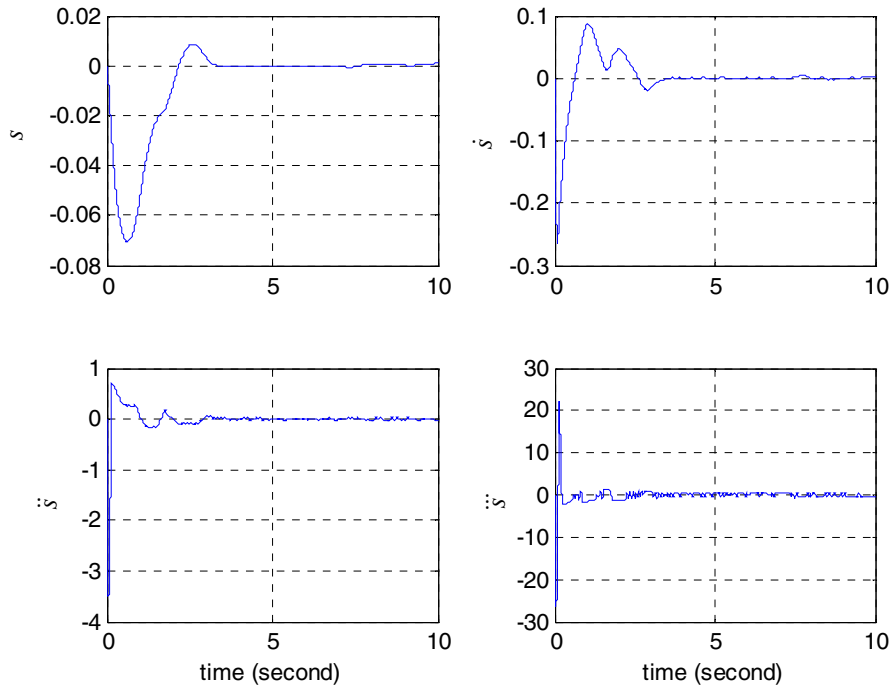

Fig. 4-10 System sliding mode variables curve

The figure 4-10 is the convergence curve of sliding mode variable and its high order derivatives. From the figure we can clearly see that the discrete control law acts on the high order sliding mode surface, which makes the lower sliding mode surface smooth. That is the reason why high order sliding mode control can eliminate the chattering.

This subsection focuses on a state estimation of PMSM online. In the practical systems, not all the state variables are measurable, or because of objective reasons they are often not easy to measure. In this section, we just use the motor position sensor, through the high order sliding mode control with differentiator, to achieve the state variables of motor estimation online. The simulation results show that the PMSM control system has good dynamic performance, while the electrical angular

speed,  $d$ - $q$  axis current are estimated precisely.

#### 4.4 Disturbance torque estimation for PMSM

In high precious servo control, the disturbance load will impact servo control. Therefore, the estimation of the disturbance load is very necessary to reduce its influence. Usually in the actual system, the disturbance load torque is often random and uncertain. So, this requires the controller can estimate the value of state variables as accurately as possible. This section will use the arbitrary order sliding mode differentiator, to calculate the high order derivative of sliding mode variables online, so as to avoid the complexity of differential calculation. Then, through the expression of the unknown disturbance load torque, it is estimated. Take the estimation as system input, thereby enhancing the system performance. In the simulation, the position and current sensors of PMSM are used. Adopt high order sliding mode control, its disturbance torque is estimated online. Then, the unknown uncertain external disturbance torque can be entered as a known value so that improve the motor position tracking accuracy.

In order to facilitate the description, the mathematical model of motor still use system state equation (4.7) in  $d$ - $q$  axis coordinate. The meaning of the parameters remains unchanged. Then, from the mathematical model of PMSM, the following solution can easily get

$$\tilde{T}_l = p[(L_d - L_q)x_3 + \psi_f]x_4 - B\tilde{x}_2 - J\dot{\tilde{x}}_2 \quad (4.40)$$

In equation (4.40),  $\tilde{T}_l$  is the estimation of external torque.  $\tilde{x}_2$  and  $\dot{\tilde{x}}_2$  are the estimation of angular speed and angular acceleration respectively.

From the controller of previous section, the following expression can be obtained

$$\begin{aligned} \dot{s}_2 &= x_2 - \dot{x}_{1ref} \\ \ddot{s}_2 &= \ddot{x}_1 - \ddot{x}_{1ref} = \dot{x}_2 - \dot{x}_{1ref} \end{aligned} \quad (4.41)$$

Therefore, the above equation (4.41) can solve the estimation of angular speed and angular acceleration.

$$\begin{aligned} \tilde{x}_2 &= \dot{s}_2 + \dot{x}_{1ref} \\ \dot{\tilde{x}}_2 &= \ddot{s}_2 + \ddot{x}_{1ref} \end{aligned} \quad (4.42)$$

Until now, if we can get the 1 and 2 order derivative of sliding mode variable  $s_2$ ,

the estimation of state variable  $\tilde{x}_2$  and its differentiation  $\tilde{\dot{x}}_2$  can be solved. According to the principle of high order sliding mode differentiator,  $\dot{s}_2$  and  $\ddot{s}_2$  in equation (4.42) can be estimated by the output of differentiator  $z_{12}$  and  $z_{22}$ .

$$\begin{aligned}\dot{z}_{02} &= v_0, \quad v_0 = -130 |z_{02} - s_2|^{2/3} \text{sgn}(z_{02} - s_2) + z_{12} \\ \dot{z}_{12} &= v_1, \quad v_1 = -150 |z_{12} - v_0|^{1/2} \text{sgn}(z_{12} - v_0) + z_{22} \\ \dot{z}_{22} &= -500 |z_{22} - v_1|\end{aligned}\quad (4.43)$$

Available into the equation (4.40)

$$\tilde{T}_l = p[(L_d - L_q)x_3 + \psi_f]x_4 - B(z_{12} + \dot{x}_{1ref}) - J(z_{22} + \ddot{x}_{1ref}) \quad (4.44)$$

Through calculation online, the estimation of disturbance load is obtained. Take the estimated value into the control system so that the uncertain disturbance load become the determine input. In this case, the system performance is improved effectively.

From the figure 4-11 we can see that, taking use of high order sliding mode with differentiator, disturbance load torque get a better estimation. Disturbance torque is estimated online successfully so that it is no longer unknown uncertainties factor. It also improves the performance of the system. The maximum torque value is  $2N \cdot m$  in the figure. The sliding mode variable converges into origin at the 0.25s.

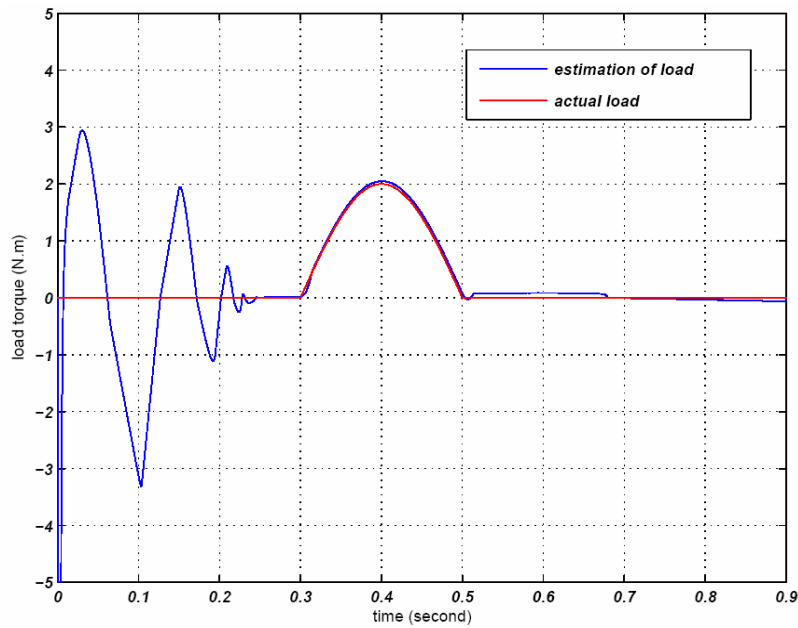

Fig. 4-11 External disturbance load torque and its estimation of motor

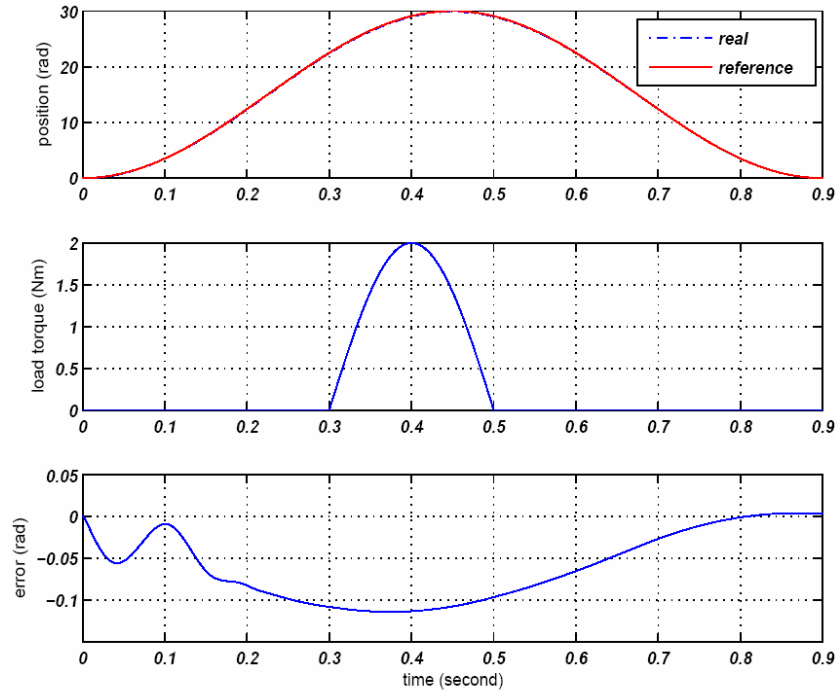

Fig. 4-12 Position tracking curve with load torque disturbance

The figure 4-12 shows that the actual angular position track reference of PMSM with the disturbance load. From the figure we can see that the maximum error of the angular position is not more than 0.12 rad. The system gets a better control performance.

#### 4.5 Summary of this chapter

This chapter first time applies the research of nonlinear control and high order sliding mode control theory in PMSM control, and achieves robust control for a PMSM in spite of the internal parameter uncertainties and unknown external disturbance load torque. The simulation results show good performance; in addition, the estimation online of system state variables is also one of the hot issues in the control field. In this chapter, the a new design based on high order sliding mode with differentiator for PMSM, access to the state variable estimation of PMSM; Besides, unknown uncertain load impacts the performance of motor control. In order to improve system performance, this chapter also achieves external disturbance load estimation online. It makes sure the load can be accurately estimated.

---

## Chapter 5 Experimental system based on dSPACE

dSPACE is a equipment of control exploitation and test system based on MATLAB/Simulink that is from Germany. It implements seamless link with the MATLAB/Simulink completely. It can complete the control algorithm design, test and implementation, overcoming the shortage of the traditional control system, for example, the difficult to achieve the complex algorithm and the long development cycle. It has advantages of high speed, ease to use and user-friendly.

This chapter is structured as follows: 5.1, introduce the basic functions of the dSPACE real time control platform; 5.2, design a permanent magnet synchronous motor control system based the dSPACE; 5.3, describe development process of the control system in detail; 5.4 experiment results confirm the feasibility of high order sliding mode control for the nonlinear permanent magnet synchronous motor, and compared with the traditional sliding mode control; 5.5, Summary of this chapter.

### 5.1 Introduction of dSPACE control platform

In the design and development process of permanent magnet synchronous motor control system, the traditional digital/analog circuit exist the following questions:

(1) In the situation of the control law or control features not yet fully grasped, if the hardware circuit has been manufactured, but do not know whether the program can satisfy the requirements, it will result in a waste of hardware costs;

(2) As a result of manual programming, so the code would have the unreliable problem. If in the course of test, it is difficult to determine the fault reason due to unsatisfactory control program or software code with an error;

(3) Even if the software does not exist, if control program is not satisfactory, needed for modification, both of hardware and software must be revised. It is based on the above considerations, a high-tech company in Germany dSPACE provides hardware and software platform for development and test of control projects.

Due to the dSPACE with the powerful real time systems, it can be connected to the actual control object (known as rapid control prototyping), when it played the role of the main controller; and can be connected to the actual controller (known as hardware-in-the-loop simulation), when it played the role of the object. Thus the development cycle is shorted and the development cost is reduced, which based on the

dSPACE. The dSPACE has a high integration and modularity that allows users to set up user's system in accordance with the requirements. Whether software or hardware, the dSPACE provides a number of options. The dSPACE based graphical development interface, which eliminates the designers to debug complex manual programming errors, uses in high speed processor, and with a wealth of I/O support. Furthermore, its software environment is powerful and easy to use, including real time code automatic generation/download and test/debug tool packages (马培蓓, 2004; 潘峰, 2004).

## 5.2 PMSM control system based dSPACE

Permanent magnet synchronous motor control system based dSPACE, besides the core of dSPACE for the control, still needs to design and expand the circuits, including current and voltage signal sample and process circuit, inverter of signal output, isolation circuit of analog and digital, feedback circuit of position and speed, power drive and protection circuit.

### (1) Current/Voltage sampling circuit

Current detection and voltage detection use LEM modules of Hall-effect sensor. The current sensor through the magnetic field generated by primary current  $I_p$  equalizes with magnetic field generated by secondary coil current. The Hall devices and auxiliary circuits generate magnetic compensation current in secondary one, this current can be accurately reflected in the primary current, the principle is shown in figure 5-1(a).

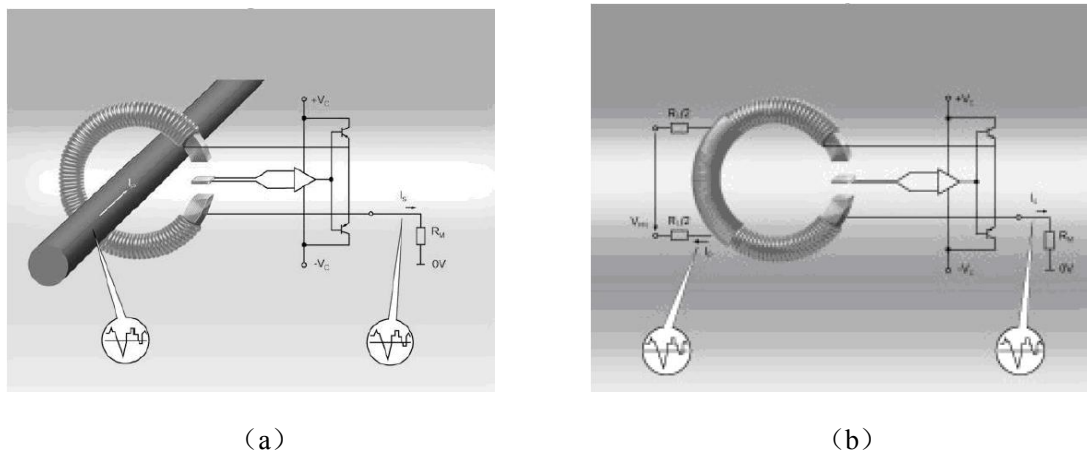

Fig. 5-1 Principle structure graph of sensors

The voltage sensor through the series resistance arising from the primary micro-current will be detected and enlarged. At this point the voltage sensor converts

as a current sensor to detect current. The current can accurately reflect the primary voltage. Primary resistance is not the built-in product. It needs to match by the users. And the principle is shown in figure 5-1(b) below.

At present, voltage and current detection of motor usually use Hall voltage/current sensors. Its biggest advantage is high accuracy measurement, linearity, and non-contact detection. The normal sensor can not be attained. The signal adopted by the Hall sensor through conditioning circuit as shown in figure 5-2 convert to  $\pm 10V$  voltage signal. After that, isolation circuit sends this signal to DS2001AD interface of dSPACE to deal with the.

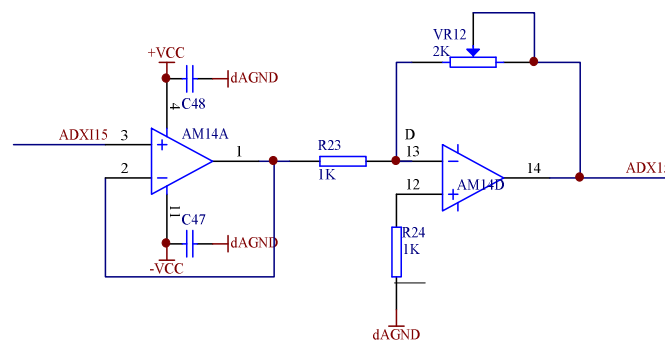

Fig. 5-2 Active filter circuit

## (2) Position/Speed feedback unit

Through acquisition of the position, speed signal, selection of appropriate control strategies, adjustment of the corresponding controller parameters, the closed-loop control of position/speed can be achieved. In the experiment, position/speed feedback signal from the optical encoder and the four frequency counters. The optical encoder has been installed in the servo motor coaxially. When the motor rotates, there will be 6 channels pulse signal. They are PA, PB, and PZ and the corresponding reverse signal /PA, /PB and /PZ respectively. The pulses number generated by the optical encoder reflects the position of servo motor, and the pulse frequency reflects the speed of servo motor. The pulse phase difference between the PA and PB reflects the rotation direction of motor. When PA phase advance PB phase up to  $90^\circ$ , the motor runs in anti-clockwise; when the PB phase advance PA phase up to  $90^\circ$ , the motor runs in clockwise. In the experiment, the resolution of optical encoder is 2048, that is, motor generates pulse count of 2048 turning every lap. And then by a four frequency multiplier, motor has the resolution of 8192 pulses. PZ signal is primarily used for check. The encoder output signal of a PZ when the motor rotates one cycle. Finally, the output from the optical encoder is sent to dSPACE's DS3002 interface for

---

processing.

### (3) Isolation and protection circuit

The current detection of main power uses LT208—S7 produced by LEM company. This kind of current sensor has rated 200A current. Its peak value can reach the 300A, and working voltage is  $\pm 12V \sim \pm 15V$ , whose interior with feedback closed-loop control. The output is the current-mode output, corresponding to the rated output current of 100mA. So, we should pay attention to choose a suitable design of the precision resistors, making the current-mode output convert into voltage-mode output. Through the resistor, current-mode output signal can be converted to voltage-mode output signal. And then after the active filter, we can generate PWM control circuit enable by setting the threshold.

The voltage detection of main power uses LV25—P produced by LEM company. The measurement range of this kind of voltage sensor is 10V~500V. Its primary rated input current is  $I_{PN} = 10mA$ , secondary output current is  $I_{OUT} = 25mA$ , and peak value is  $I_p = 14mA$ , and working voltage is  $\pm 12V \sim \pm 15V$ . Due to this sensor without series resistance in primary coil, the resistance needs to calculate and adapt. After then, this voltage signal is sent to active filter and amplifier. Comparing with setting value, we can know whether this voltage is over-current or over-voltage. In this way, the whole system can be get the protection.

In order to avoid mutual interference between strong and weak power, especially in high current circuit interference for analog circuits and digital circuits, the system mainly uses high speed optical coupling components to isolate interferes. In fact, most of the signal interface depends on the merits of optical coupling. Assisted pull-up resistor determines the steep or flat of rising edge and trailing edge, which should be adjusted in the experiment. Through the experiment, HCPL4504 optical coupling produced by Hewlett-Packard holds absolute advantage.

## 5.3 Development steps of control system

The dSPACE is divided into two types from the hardware structure. One is complete real time control single board system with integrated I/O such as DS1103. The other is processor departed from user I/O such as DS1005PPC control board. The latter one aims to expand the ability of processor and I/O. In addition, the communication between processor and I/O adopts PHS (Peripheral High-speed Bus).

Taking DS1005PPC control board as the core, with DS2001AD acquisition



board, DS2002/2003 multi-channel AD acquisition board, CP4002 Multi-I/O board, DS2102DA output board, DS3002 incremental encoder interface board, we constitute a standard component hardware parts of dSPACE DS1005 system, which is used in this experiment.

After the completion of the experimental platform, the development steps of control system for PMSM based on the dSPACE include the following points:

(1) MATLAB/Simulink modeling and off-line simulation. Take use of MATLAB/Simulink to establish a mathematical model for the simulation object, and design control programs. At the same time, complete the system off-line simulation.

(2) Input/output interface (I/O) experimental model. In the MATLAB/Simulink environment, we need to retain module that is downloaded to the dSPACE. Select the real-time control required for I/O modules from the RTI library. Replace the original connection relationship with the hardware interface, and configure I/O parameters. In some special cases, we also need to set up hardware and software interrupt priority levels.

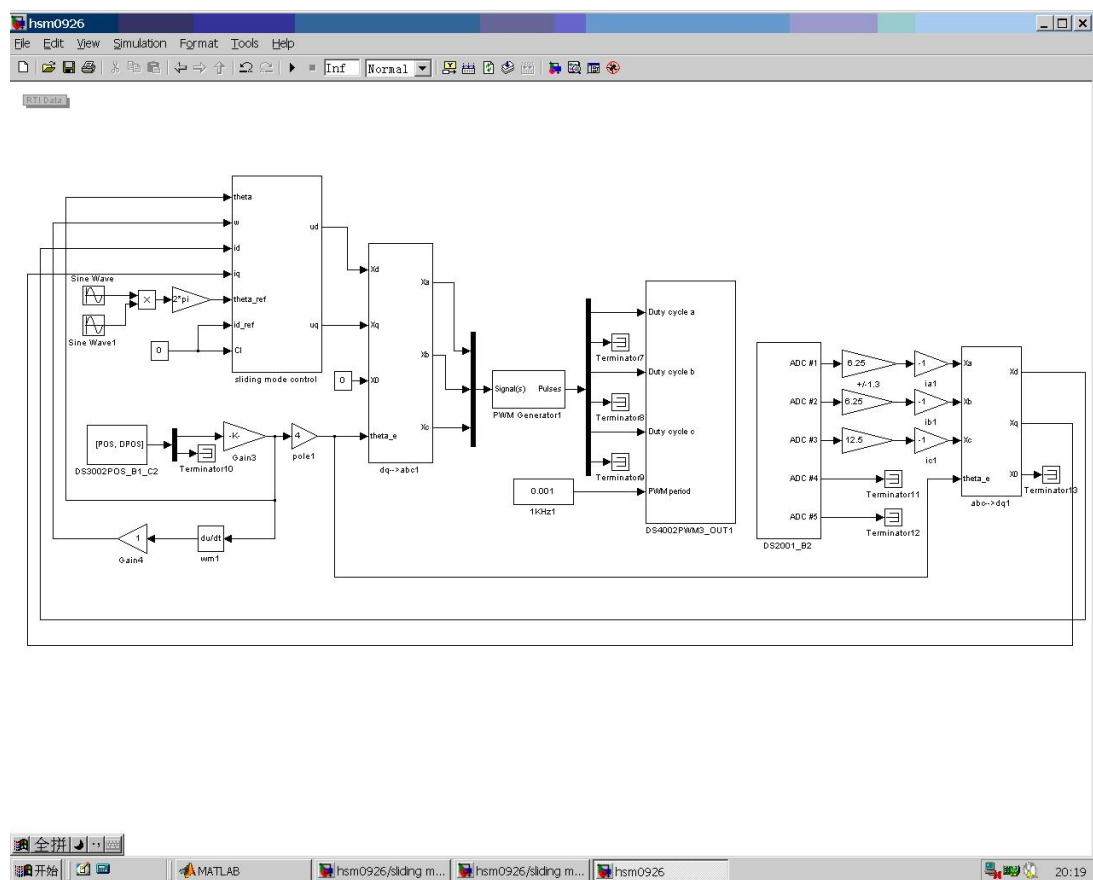

Fig. 5-6 MATLAB/Simulink environment based on dSPACE/RTI control system

The figure 5-6 is a control system in MATLAB/Simulink environment with the

dSPACE/RTI module. In detail, PWM interface RTI modules produce a variety of optional items depending on the PWM methods. The PWM output has 8-channel at most. But for the three phase motor, we only need to select the 3-channel PWM interface RTI module from DS4002PWM3\_OUT. Usually, motor speed can be obtained by coaxial encoder. The RTI module DS3002POS\_B1\_C1 can get the position and delta position signals. The module of DS3002HW\_INDEX\_B1\_C1 can get a zero-position signal. Due to the requirement of current and voltage sample, we use the AD interface DS2001\_B1/ DS2002\_B1 /DS2003\_B1. Among them, DS2001\_B1 can sample 5-channel analog signal ( $\pm 5V$  or  $\pm 10V$ ) at the same time. In addition, for the output analog signals, we can use the DA interface DS2102\_B1 that creates analog signals ( $\pm 5V$ ,  $\pm 10V$  or  $0\sim 10V$ ) easily. It's worth noting that the output value  $\pm 1$  of MATLAB/Simulink corresponds analog output  $\pm 5V$  or  $\pm 10V$ , and the output value  $0\sim 1$  corresponds analog output  $0\sim 10V$ .

(3) The dSPACE/RTW provides tools to automatically generate code and download. Since MATLAB and dSPACE with seamless connectivity features, a simple operation can complete real-time C code generation, compile, link and download for the target system. In other word, model is downloaded into target board DS1005PPC as running program.

(4) The dSPACE integrated experiment and debugging. The dSPACE provides real-time ControlDesk software as well, which changes the parameters and real-time control.

## 5.4 Experiment results and analysis

### I. Content and intention:

1. Validate feasibility of high order sliding mode control in PMSM;
2. Test system using high sliding mode control whether it can release chattering phenomenon;
3. Test system using high sliding mode control whether it has robustness.

### II. Equipments:

Name	Type	Unit	Amount
dSPACE controller	DS1005	Dais	1
DC regulated power	WYK-303B <sub>2</sub>	Dais	1

Slide-wire rheostat	BX8D-3/7	Dais	3
Switch regulated power	S-100-24	Dais	1
Universal meter	LINI-T/UT58A	Dais	1
Ondoscope	Tektronix/TDS2024	Dais	1
Industrial computer	ADLINK	Dais	1

### III. Experimental procession:

Step 1: Off-line simulation. According to the principle of high order sliding mode control and differentiator, combining with chapter 5 of the application for permanent magnet synchronous motor, the theoretical simulation is researched in the MATLAB/Simulink firstly. In detail, set the sampling frequency and differential equation solution, and save the .mdl model file;

Step 2: After the control algorithm verification, remove the inverter model and motor model replaced by the physical prototypes of actual system. And then complete all of the system interface, including the A/D, D/A, I/O, PWM and other interfaces of the dSPACE. Afterwards, compile on-line to generate. cof configuration file;

Step 3: Check all connections are correct. After that, start the dSPACE. Compile and download files real-time (RTI) in the environment of MATLAB/Simulink. At this moment, algorithm program code is downloaded to the DSP core program area of dSPACE controller;

Step 4: Start the dSPACE/ControlDesk. Create an experimental file .prj in the interface, and design the required .lay layer file. Observe compiler-generated variable file .sdf in order to facilitate observe the real-time dynamic performance of the system;

Step 5: After the completion of the above, check the status of external devices is good or not. Finally, start bus power, while start system operation in dSPACE/ControlDesk interface.

### IV. Controlled device:

The controlled object in experiments uses non-salient pole permanent magnet synchronous motor of Delta's ASMT series, whose main parameters are as follows Table 5-1:

Tab. 5-1 Parameters of PMSM in experiment

<i>Name</i>	<i>Resistance</i>	<i>Inductance</i>	<i>Rating Power</i>	<i>Torque</i>
Value	$R = 2.052$	$L = 8.4$	$P = 1.0$	$T = 3.3$
Unit	$\Omega$	$mH$	$kW$	$N \cdot m$

<i>Name</i>	<i>Pole-pairs</i>	<i>Voltage</i>	<i>Speed</i>	<i>Rotary inertia</i>
Value	$N_p = 4$	$U = 300$	$n_N = 3000$	$J = 0.00026$
Unit	—	$V$	$r / \text{min}$	$kg \cdot m^2$

Host-computer control surface adopts visual man-machine surface the dSPACE/ControDesk to realize data acquisition and display. Fig. 5-8 is pictorial diagram based on the dSPACE control system. The system consists of inverter, isolation circuit, detection circuit, power circuit and etc.

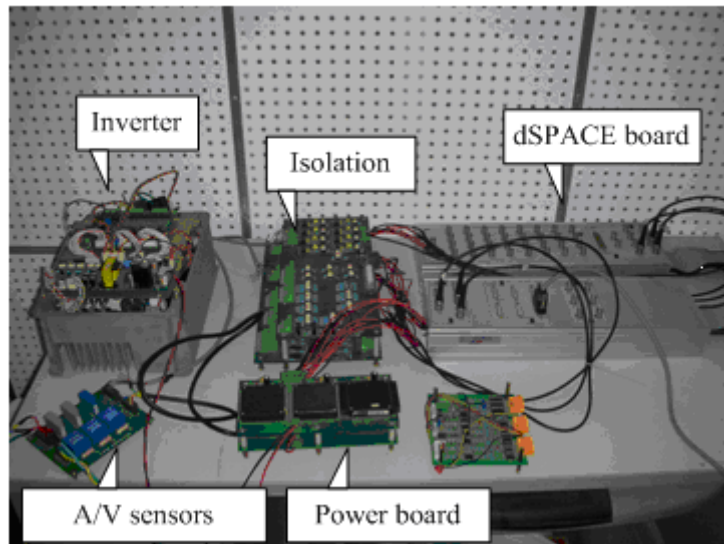

Fig. 5-8 Control system hardware circuit with dSPACE interface

## V. Waveform:

Because the research of nonlinear system high order sliding mode control theory still is in primary stage, it is face with much challenge. For example, it strictly requires all of the system functions are smooth, and norm-bounded. Otherwise, there is the higher derivative of reference value in control law. In our experiment, 60V DC regulated power is supplied. Experiment is tested under the conditions above. The main test results are following.

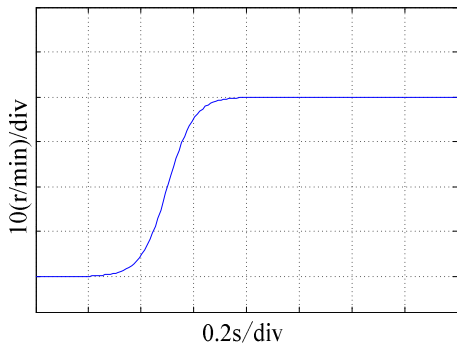

Fig. 5-13 Speed reference curve of PMSM

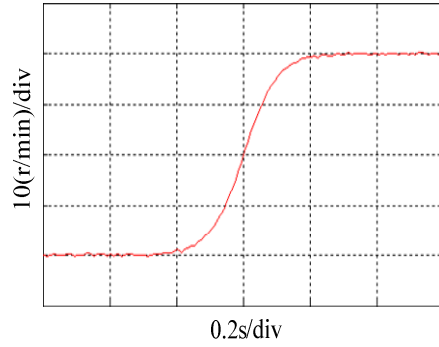

Fig. 5-14 Dynamic speed feedback curve

High order sliding mode control law has high derivative of reference signal, so the reference signal must be smooth and continues enough function. For testing speed dynamic response of PMSM in the experiment, the reference signal is set as Fig. 5-13. Actual measurement of speed dynamic response is shown in Fig. 5-14.

By comparing Fig. 5-13 and Fig 5-14, nonlinear PMSM holds good dynamic tracking character with high order sliding mode control.

Fig. 5-15 is steady speed clockwise/anti-clockwise curve of PMSM. It is can be seen that the PMSM also takes on good steady performance.

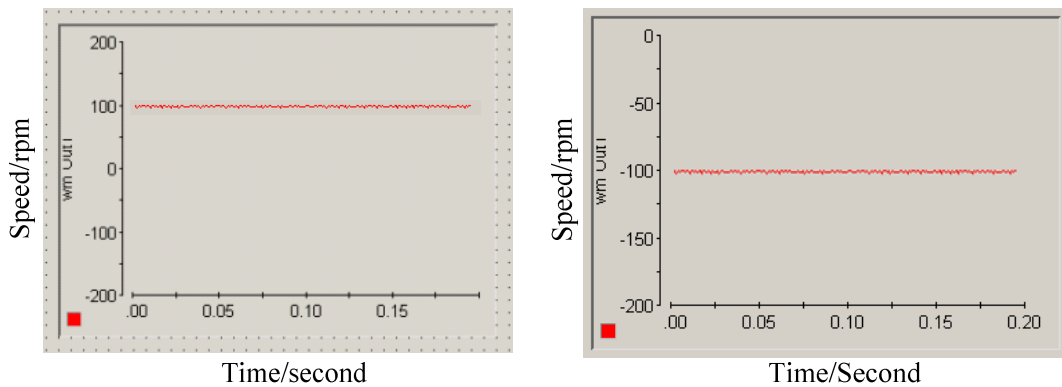

Fig. 5-15 Steady speed of clockwise/ Anti-clockwise displayed in dSPACE/ControlDesk

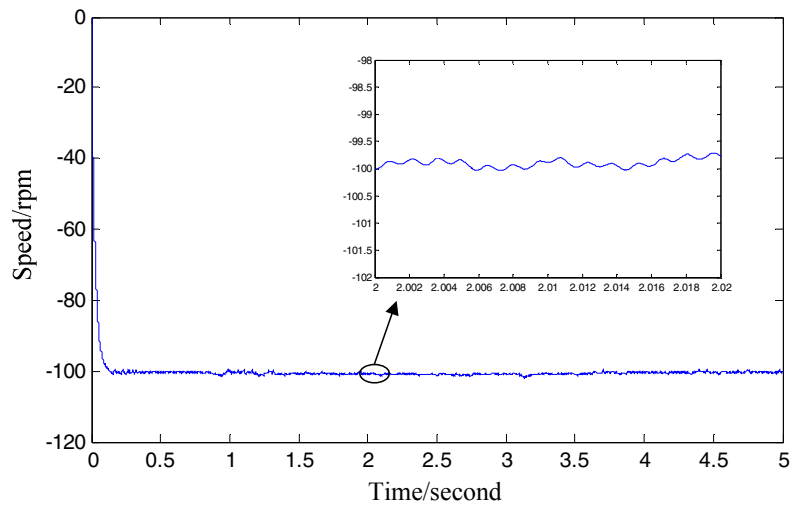

Fig. 5-16 Speed curve of PMSM in MATLAB/Simulink using traditional sliding mode control

The Fig. 5-16 is outline simulation speed waveform of PMSM using traditional sliding mode control. It displays anti-clockwise speed waveform of PMSM. And the Fig. 5-17 is outline simulation speed curve of PMSM using high order sliding mode. After partial amplification, comparing with Fig. 5-16, high order sliding mode control is provided with the ability of avoidance chattering. But, its algorithm is more complicated than tradition. The adjusting time is longer, too.

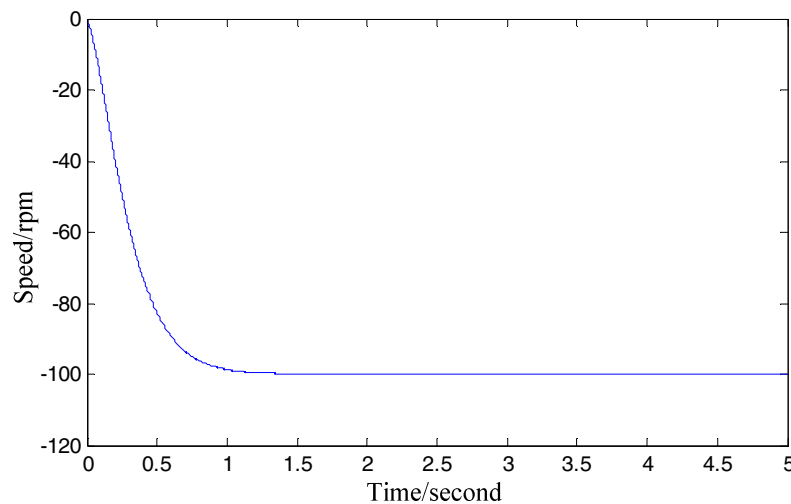

Fig. 5-17 Speed curve of PMSM in MATLAB/Simulink using high order sliding mode control

To validate experiment intention 2 and 3, show high order sliding mode control with free chattering and robustness, the experiment designs traditional sliding mode controller, too. Simulation and actual measurement are recorded in order to compare with high order sliding mode.

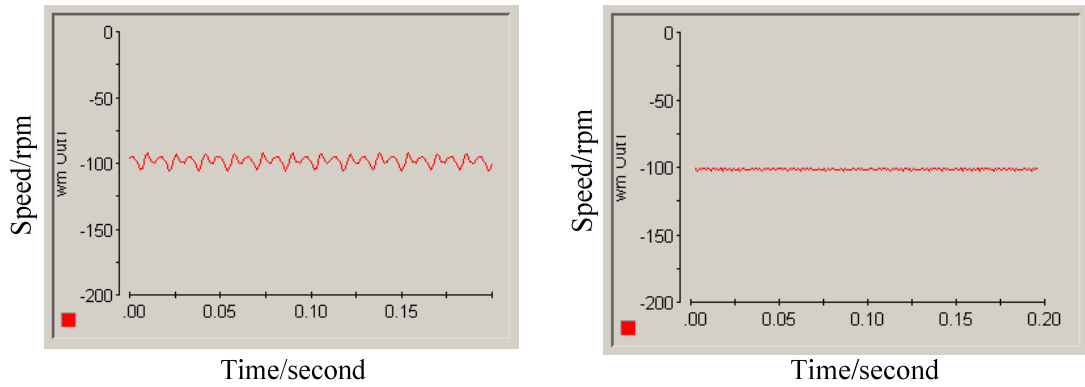

Fig. 5-18 Speed curve in dSPACE/ControlDesk using traditional (high order) sliding mode control

Due to the traditional sliding mode control uses discontinues control law acting on sliding mode manifold surface, chattering problem is caused. The great of the coefficient in sliding mode control law, the faster of convergence, when the system enter into sliding mode, chattering phenomenon is more obvious. Fig. 5-18(a) is actual measurement speed curve of PMSM, which adopts conventional sliding mode control. The control law is  $u = -K_i \text{sgn } s$ , in current loop  $K_1 = 5$ , in speed loop  $K_2 = 8.2$ . From the Fig. 5-18, we can obtain a conclusion that chattering is released in high order sliding mode.

Hereto, both of simulation and experiment results prove that high order sliding mode control can reduce the chattering phenomenon which exists in conventional. Following experiment will test the robustness of high order sliding mode control.

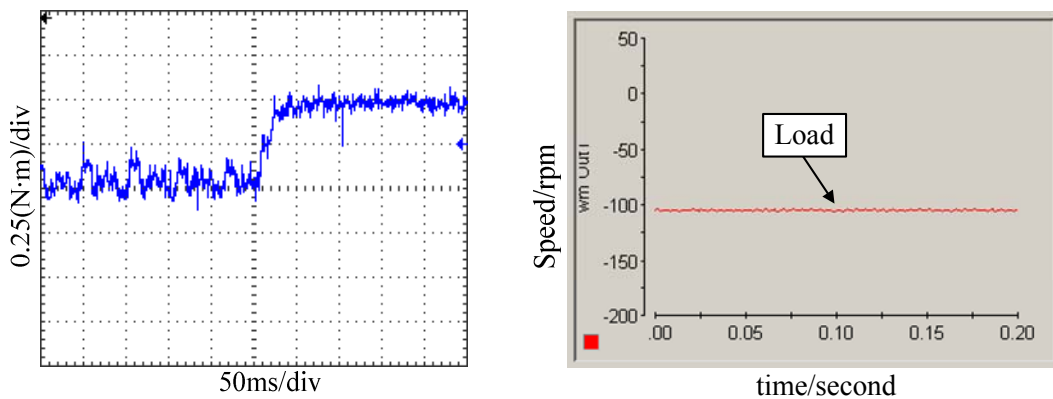

Fig. 5-19 Speed curve of  $0.5 \text{ N}\cdot\text{m}$  disturbance load in dSPACE/ControlDesk

The PMSM is a typical complex system because of elevated temperature, saturation, time delay and a good many elements. These reasons lead to the synchronous motor is nonlinear, variation parameter, close coupled system. For the sake of testing high order sliding control, which is insensitive to the parameter

---

uncertainty and disturbance, experiment is injected about  $0.5 N \cdot m$  external load disturbance at the 0.01 second. The speed actual measurement waveform is shown in Fig. 5-19. From this figure, speed curve is smooth without flutter. The experiment result illuminates high order sliding mode control reserves robustness of conventional sliding mode.

Experimentally verified, high order sliding mode control provides an effective method to improve accuracy and robustness further for nonlinear systems.

## **5.5 Summary of this chapter**

This chapter first described dSPACE physics experiment control platform the build and development process in detail. Through the dSPACE real-time control platform, the nonlinear high order sliding mode control theory research is applied to the control of permanent magnet synchronous motor. The experimental results and simulation results are consistently indicate that synchronous motor has better dynamic performance and steady accuracy, proves the feasibility of this technology in practical application systems; It is also verified by high order sliding mode control technique that preserves the robustness of traditional sliding mode control. The high order sliding mode essentially eliminates the chattering caused by discrete control law. From another point of view, the simulation and physical experiment provide a certain reference value for the nonlinear systems high order sliding mode control further application.



---

## Chapter 6 Summary

This paper focuses on the nonlinear system control theory and high order sliding mode control theory. The exact feedback linearization technology of nonlinear systems needs to be applied under the accurate model of the technical requirements, which is not easy to achieve in the actual system. High order sliding mode control technology preserves the strong robustness of the traditional sliding mode control, which is not sensitive to the uncertain parameters of systemic model and the unknown external disturbances. But in comparison with the traditional sliding mode control, high order sliding mode control technique uses high order differential of sliding mode variable to transfer the chattering phenomenon generated in discontinuous discrete control into higher order sliding surface, making the low order sliding surface eliminate the chattering and improving the control precision. Considered all above together, this paper will organically integrate nonlinear control and high order sliding mode control with their full strengths to improve the overall performances of system. For permanent magnet synchronous motor is a typical MIMO nonlinear system, we conduct a high order sliding mode control experiment, mainly including the research areas of servo control, robustness, state estimation and disturbance estimation so that it can get a better good application effect.

### 6.1 The chief work and research results of the paper

1. As the differential geometry theory is based on precise mathematical models, but in the actual system the uncertain system parameters and the unknown external disturbances can not be avoided, so the application of exact feedback linearization theory has been somewhat restricted. In this paper, use the robustness of sliding mode control on parameter uncertainty and external disturbance to design a high order sliding mode controller with the combination of exact linearization theory. It can not only eliminate the chattering in traditional sliding mode control and improve the control precision, but also circumvent the application condition that the relevant degree requirement is stringently equal to 1.

2. In the design of high order sliding mode controller, we often need to know the arbitrary order derivative of sliding variable values, so how to get each variable differential becomes considerable complex and cumbersome. This paper presents an

---

arbitrary order differentiator designed by high order sliding mode observer, which can avoid the large number of numerical method calculation. From the application example, it can be seen that the differentiator is not only high accurate but also strong robust. This paper will also use the differentiator to apply to the on-line observation of MIMO nonlinear system state and input variables, and consequently get more ideal control effect. This lays the foundation for the next application of the actual system.

3. For permanent magnet synchronous motor commonly used in industrial control, taking into account its nonlinear characteristics and the strong coupling relationship between multiple variables of the system as well as the impact of the working environment, this paper designs a robust high order sliding mode controller applied to permanent magnet synchronous motor at the first time. First, it conducts the exact feedback linearization to the mathematical model of nonlinear MIMO motor and achieves a decoupling control. In this way, the design of complex nonlinear systems is converted to control a number of SISO linear subsystems so that control objectives are easy to implement. Then, based on high order sliding mode control theory, it designs the double closed-loop robustness controller in position and current for permanent magnet motor. Through the simulation, it can be seen the position tracking of the system tracks with high precision and the maximum error is only 0.09rad. Although there are some factors such as the parameter uncertainty and external unknown torque disturbance in the system, it still has a strong robustness. In addition, chattering phenomenon has been significantly ameliorated after the application of higher order sliding mode controller.

4. Taking into account that the arbitrary order sliding mode differentiator has the role of observer, this paper uses sliding mode differentiator to construct on-line accurate observation on the motor state variables for the permanent magnet synchronous motor at the first time. The sliding mode observer is designed to achieve the observation on motor speed,  $d$ - $q$  axis current state variables. From another viewpoint, the value of state variable feedback for motor controller can not be obtained only through sensors but be directly obtained from the output of the observations. Thus it eliminates the effect of mechanical or electronic sensors, reducing the cost and improving the reliability of the system. Simulation results show that the high order sliding mode controller with differentiator, its speed and current values are observed with high accuracy.

5. In the motor control technologies, we often encounter the external unknown

---

and uncertain disturbances. The most primary is the external load torque which poses a severe challenge to the system control performances. The application of robustness control techniques has become the studying hot point. This thesis uses high order sliding mode observer to present on-line estimate expression of external torque. Through the real-time calculation of the expression, we can estimate the more accurate value of disturbance torque by using high order sliding mode differentiations and related system variable values. As a result, the external disturbance signal of system is no longer unknown but can be accurately estimated. Therefore, the system's capacity to resist external disturbances has further improved.

6. In order to verify the simulation results, this paper adopts dSPACE semi-physical simulation experimental platform to complete the physical experiment at last. Through the results from the MATLAB/Simulink simulation, the system downloads software programs of nonlinear high order sliding mode control algorithm into the memorizer of dSPACE's subordinate computer in order to control the motor drivers to work, and ultimately it achieves on-line and real-time experiment of synchronous motor. Experimental results show the high order sliding mode control theory of nonlinear systems can be successfully applied to permanent magnet synchronous motor control system. The method not only retains the robustness of traditional sliding mode control, but also effectively eliminates the chattering problems in the traditional sliding mode control. This lays the foundation for the widespread application in the future.

## **6.2 Several issues to be resolved**

The study of nonlinear system control theory is one difficult and challenging topic in present control theories. And the sliding mode control of nonlinear system develops at the initial stage. In terms of high order sliding mode control of nonlinear system studied in this paper, there are still some important issues need to be explored and further studied.

1. Nonlinear control is a subject with relatively broad range and rather deep content. This paper focuses on the affine and matching high order sliding mode control of nonlinear system. For non-affine or non-matching non-linear systems, it doesn't carry out study, which is to be in-depth study area for nonlinear sliding mode control.

2. The application of quasi-continuous high order sliding mode control

---

technique with smooth control law has not yet been generalized, because the theory itself has certain limitations. Its core idea is to minimize discrete sign function items in the control law. But for some specific practical systems, it is possible to appear uncertain items when the denominator of control law approaches zero. Nevertheless, this idea is still very useful, which is the problem to be solved in the future.

3. It is well known that using sliding mode control with differentiator can achieve state estimation and external disturbance estimation for nonlinear permanent magnet synchronous motor. With the thought, it should also be able to achieve the on-line parameter identification of system. In the simulation experiments, it's showed that the stator resistances as well as the value of motor flux can be better identified. For motors, the inductance is undoubtedly a more important parameter. However, the inductance identification results found in many simulation experiments were unsatisfactory. It is due to under normal circumstances the unit of the electrical inductance is millihenry, when we use sliding mode variable and relevant state variables to estimate it, occurring a zero-zero phenomenon. Specifically, when the sliding variable is converging to zero in finite time, the molecular and denominator of the inductance are also converging to zero. Thus, the identification reliability of the method remains to be further studied.

4. High order sliding mode control technology with higher control accuracy essentially eliminates the chattering phenomenon and keeps the robustness of the traditional sliding mode control. However, a fly in the ointment is that the technology needs to seek high order derivatives under a given reference value. So a given function is required to be continuously differentiable everywhere in the time domain. In fact, that is much harsher in a real system. Therefore, how to relax the using conditions is also an important research area for high order sliding mode control technology.

---

## Reference

- [Baik,1998] I. C. Baik, K. H. Kim and M. Y. Youn. Robust nonlinear speed control of PM synchronous motor using adaptive and sliding mode control techniques[J]. *IEEE Proceedings of Electrical Power Application*, vol. 145(4), pp. 369–375, 1998
- [Bartolini,1997] G. Bartolini, A. Ferrara and E. Usai. Application of a sub-optimal discontinuous control algorithm for uncertain second order systems[J]. *International Journal of Robust and Nonlinear Control*, Vol. 7, 299-319, 1997
- [Bartolini,1998] G. Bartolini, A. Ferrara and E. Usai. Chattering avoidance by second order sliding mode control[J]. *IEEE Transactions on Automatic Control*, Vol. 43(2), 241-246, 1998
- [Bartolini,1998b] G. Bartolini, M. Coccoli and A. Ferrara. Vibration damping and second order sliding modes in the control of a single finger of the AMADEUS gripper[J]. *International Journal of Systems Science*, Vol. 29(5), 497-512, 1998
- [Bartolini,1998c] G. Bartolini, A. Ferrara, A. Levant and Usai E. On second order sliding mode controllers[J]. *Processing of 5<sup>th</sup> International Workshop on VSS*, Longboat Key, Florida. 1998
- [Bartolini,1999] G. Bartolini, A. Ferrara and Giacomini. A robust control design for a class of uncertain nonlinear systems featuring a second order sliding mode[J]. *International Journal of Control*, Vol. 72(4), 321-331, 1999
- [Bartolini,1999b] G. Bartolini, A. Levant, E. Usai and A. Pisano. 2-Sliding Mode with Adaptation[J]. *Proceedings of the 7th Mediterranean Conference on Control and Automation*, pp. 2421–2429, 1999
- [Bartolini,2000] G. Bartolini, A. Ferrara and E. Punta. Multi-input second order sliding mode hybrid control of constrained manipulators[J]. *Dynamics and Control*, Vol. 10, 277-296, 2000
- [Bartolini,2000b] G. Bartolini, A. Ferrara and E. Usai and V.I. Utkin. On multi-input chattering free second order sliding mode control[J]. *IEEE Transaction on Automatic Control*, Vol. 45(9), 1711-1718, 2000

- 
- [Bartolini,2001] G. Bartolini, A. Ferrara, A. Pisano and E. Usai. On the convergence of 2-order sliding algorithm for nonlinear uncertain systems[J]. *International Journal of Control*, Vol. 74(7), 718-731, 2001
- [Bartolini,2003] G. Bartolini, A. Pisano, E. Punta and E. Usai. A survey of applications of second-order sliding mode control to mechanical systems[J]. *Int. Journal of Control*, Vol. 76, pp. 875–892, 2003
- [Baumann,1988] W.T. Baumann. Feedback control of multi-input nonlinear systems by extended linearization[J]. *IEEE Transactions on Automatic Control* , 33(2):193-197, 1988
- [Bhatt,2000] S.P. Bhatt. and D.S. Bernstein. Finite-time stability of continuous autonomous systems[J]. *SIAM Journal of Control and Optimization*, Vol. 38(3), 751-766, 2000
- [Bodson,1993] M. Bodson, J. Chiasson, R. Novotnak, and R. Rekowski. High performance nonlinear feedback control of a permanent magnet stepper motor[J]. *Control System Technology*, Vol. 1, pp. 5-14, 1993.
- [Byrnes,1989] C.I. Byrnes and A. Isidori. New results and examples in nonlinear feedback[J]. *Systems and Control Letters*. Vol. 12:437-442, 1989
- [Caravani,1998] P. Caravani and S. D. Gennaro. Robust control of synchronous motor with non-linear and parameter uncertainties[J]. *Automatica*, vol. 34, pp. 445–450, 1998.
- [Corradini,2000] M. L. Corradini, T. Leo and G. Orlando. Robust stabilization of a class of nonlinear systems via multiple model sliding mode control[J]. *Proceedings of the American Control Conference*. Vol. 1, 631-635, 2000
- [dSPACE,2003] dSPACE Release New Features and Migration (release 3.5) [Z]. Paderborn: Dspace GmbH, 2003
- [Da,2000] F.P. Da. Decentralized sliding mode adaptive controller design based on fuzzy neural networks for interconnected uncertain nonlinear systems[J]. *IEEE Trans on Neural Networks*, Vol. 11(6), 1471 –1480, 2000
- [Davila,2005] J. Davila, L. Fridman and A. Levant. Second-Order Sliding-Mode Observer for Mechanical Systems[J]. *IEEE transactions on automatic control*, Vol.

---

50(11), 1785-1789, 2005

[DeCarlo,1988] R.A. DeCarlo, S.H. Zak and G.P. Matthews. Variable structure control of nonlinear multivariable systems: A tutorial[J]. *Proceeding of IEEE*, Vol. 76(3):212-232, 1988

[Edwards,1998] C. Edwards and S.K. Spurgeon. Sliding mode control: Theory and applications[M]. Taylor & Francis, 1998

[Edwards,2003] C. Edwards. A practical method for the design of sliding mode controller using linear matrix inequalities[J]. *42<sup>nd</sup> IEEE Conference on Decision and Control*, Vol. 3, 9-12, 2003

[Edwards,2004] C. Edwards and P.T. Chee. Fault tolerant control using sliding mode observer[J]. *43<sup>rd</sup> IEEE Conference on Decision and Control*. Vol. 5, 5254-5259, 2004

[Emelyanov,1986] S.V. Emelyanov, S.K. Korovin and A. Levantovskiy. Drift algorithm in control of uncertain processes[J]. *Problems of Control and Information Theory*, Vol. 15(6), 425-438, 1986

[Emelyanov,1990] S.V. Emelyanov, S.K. Korovin and A. Levantovskiy. New class of second order sliding algorithm[J]. *Mathematical modeling*, Vol. 2(3), 85-100, 1990

[Emelyanov,1996] S.V. Emelyanov, S.K. Korovin and A. Levant. High-order sliding modes in control systems[J]. *Computational mathematics and modeling*, Vol. 7(3), 294-318, 1996

[Ertugrul,2000] M. Ertugrul, and O. Kaynak. Neuro Sliding Mode Control of Robotic Manipulators[J]. *Mechatronics*, Vol. 10(1-2), 239 – 263, 2000

[Filippov,1988] A. F. Filippov. Differential Equations with Discontinuous Right Hand Side[J]. *Dordrecht*, The Netherland: Kluwer, 1988

[Fliess,1990a] M. Fliess. Generalized controller canonical form for linear and nonlinear dynamics[J]. *IEEE Transaction on Automatic Control*, Vol. 35(9), 994-1001, 1990

[Fliess,1990b] M. Fliess. What the Kalman state variable representation is food for[J]. *Proceeding of 29<sup>th</sup> Conference on Decision and Control*, Honolulu, Hawaii, 1282-1287, 1990

[Floret-Pontet,2001] F. Floret-Pontet and F. Lamnabhi-Lagarigue. Parameter

---

identification methodology using sliding mode observers[J]. *International Journal of Control*, vol. 74, pp. 1743–1753, 2001.

[Fridman,2002] L. Fridman and A. Levant. High order sliding modes. In W. Perruquetti and J.P. Barbot, editors, *Sliding Mode Control in Engineering[M], Control Engineering*, Pages 53-102. Marcel Dekker, New York, 2002

[Fridman,2007] L. Fridman, Y. Shtessel, C. Edwards and Xing-Guang Yan. State Estimation and Input Reconstruction in Nonlinear Systems via Higher Order Sliding Mode Observer[J]. *Proceedings of the 2007 American Control Conference*, pp. 3807–3812, 2007

[Galzi,2007] D. Galzi and Y. Shtessel. Closed-Coupled Formation Flight Control Using Quasi-Continuous High-Order Sliding-Mode. *Proceedings of the 2007 American Control Conference*, pp. 1799-1804, 2007

[Glumineau,1993] A. Glumineau, M. Hamy, C. Lanier and C. Moog. Robust control of a brushless servo motor via sliding mode[J]. *International Journal of Control*, vol. 58, pp. 979–990, 1993.

[Ha,2001] Q.P. Ha, Q.H. Nguyen, D.C. Rye and H.F. Durrant-Whyte. Fuzzy sliding-mode controllers with applications[J]. *IEEE Trans on Industrial Electronics*, Vol. 48(1), 38 – 41, 2001

[Hermann,1977] Hermann, R. and Krener, A.J., Nonlinear controllability and Observability, *IEEE Transactions on Automation and Control*, 22, No 9, pp. 728–740,1977

[Howze,1973] J.W. Howze. Necessary and sufficient condition for decoupling using output feedback[J]. *IEEE Transactions on Automatic Control*, 1973, 18:44-46

[Huang,2003] S.J. Huang, K.S. Huang and K.C. Chiou. Development and application of a novel radial basis function sliding mode controller[J]. *Mechatronics*, Vol. 13(4), 313 – 329, 2003

[Isidori,1995] A. Isidori. *Nonlinear Control Systems[M]. Springer-Verlag, London, third edition*, 1995

[Jiang,2002] K. Jiang, J.G. Zhang and Z.M. Chen. A new approach for the sliding mode control based on fuzzy reaching law[J]. *Processing of the 4<sup>th</sup> World Congress on*



- 
- Intelligent Control and Automation*. Shanghai, China. Vol. 6, 656-660, 2002
- [Kachroo,1996] P. Kachroo and M. Tomizuka. Chattering reduction and error convergence in the sliding mode control of a class of nonlinear systems[J]. *IEEE Transactions on Automatic Control*, Vol. 41(7), 1063-1068, 1996
- [Kadjoudj,2001] M. Kadjoudj, R. Abdessemed, N. Golea and M. E. Benbouzid. Adaptive fuzzy logic control for high performance pm synchronous drives[J]. *Electric Power Components and Systems*, Vol. 29(19), 789-807, 2001
- [Kang,1997] B.P. Kang and J.L. Ju. Sliding mode controller with filtered signal for robot manipulators using virtual plant/controller[J]. *Mechatronics*, Vol. 7(3), 277-286, 1997
- [Kawamura,1994] A. Kawamura, H. Itoh and K. Sakamoto. Chattering reduction of disturbance observer based sliding mode control[J]. *IEEE Transactions on Industry Applications*, Vol. 30(2), 456-461, 1994
- [Kim,1996] Y. S. Kim, Y. S. Han and W. S. You. Disturbance observer with binary control theory. Power Electronics Specialists Conference, 2:1229~1234, 1996
- [Kim,2002] K. H. Kim and M. J. Youn. A Nonlinear Speed Control for a PM Synchronous Motor Using a Simple Disturbance Estimation Technique[J]. *IEEE Transaction on Industrial Electronics*, vol. 49(3), pp. 524–535, 2002
- [Kim,2004] Y.K. Kim and G.J. Jeon. Error reduction of sliding mode control using sigmoid-type nonlinear interpolation in the boundary layer[J]. *International Journal of Control, Automation and Systems*. Vol. 2(4), 523-529, 2004
- [Kim,2005] K. H. Kim. Nonlinear speed control for a PM synchronous motor with a sequential parameter auto-tuning algorithm[J]. *IEEE Proceedings of Electrical and Power Application*, Vol. 152(5), pp. 1253–1262, 2005
- [Koshkouei,2002] A. Koshkouei and A. Zinober. Sliding mode observers for a class of nonlinear systems[J]. *Proceedings of American Control Conference*, vol. 8, pp. 2106 – 2111, 2002.
- [Koshkouei,2002] A. Koshkouei and A. Zinober. Sliding mode observers for a class of nonlinear systems[J]. *Proceedings of American Control Conference*, vol. 8, pp. 2106 – 2111, 2002.

- 
- [Koshkouei,2005] A.J. Koshkouei, K.J. Burnham and A.S. Zinober. Dynamic sliding mode control design[J]. *IEEE Proceeding of Control Theory Application*. Vol. 152(4), 392-396, 2005
- [Krupp,1999] D. Krupp and Y.B. Shtessel. Chattering-free sliding mode control with unmodeled dynamics[J]. *Processing of American Control Conference*. San Diego: IEEE Press, vol.6, pp.530-534, 1999
- [Laghrouche,2004] S. Laghrouche, F. Plestan and A. Glumineau. A higher order sliding mode controller for a class of mimo nonlinear systems: application to pm synchronous motor control[J]. *Proceeding of the 2004, American Control Conference*, Vol. 3 2592-2597, 2004
- [Laghrouche,2005] S. Laghrouche, F. Plestan and A. Glumineau. Multivariable practical higher order sliding mode control[J]. *Proceedings of the 44<sup>th</sup> IEEE Conference on Decision and Control*, pp. 1252–1257, 2005
- [Laghrouche,2005b] S. Laghrouche, M. Smaoui, X. Brun and F. Plestan. Robust second order sliding mode controller for electropneumatic acurator[J]. *American Control Conference*, pp. 5090–5095, 2005
- [Laghrouche,2007] S. Laghrouche, F. Plestan and A. Glumineau. Higher order sliding mode control based on integral sliding mode[J]. *Automatica*, Vol. 43, pp. 531–537, 2007
- [Levant,1993] A. Levant. Sliding order and sliding accuracy in sliding mode control[J]. *International Journal of Control*, Vol. 58(6), 1247-1263, 1993
- [Levant,1998] A. Levant. Robust exact differentiation via sliding mode technique[J]. *Automatica*, Vol. 34(3), 379-384, 1998
- [Levant,2000] A. Levant, A. Pridor, J.Z. Ben-Asher, R. Gitizadeh and I. Yaesh. 2-sliding mode implementation in aircraft pitch control[J]. *Journal of Guidance Control and Dynamics*, Vol. 23(4), 586-594, 2000
- [Levant,2003] A. Levant. Higher-order sliding modes, differentiation and output feedback control[J]. *International Journal of Control*, Vol. 76, 924-941, 2003
- [Levant,2005] A. Levant. Homogeneity approach to high-order sliding mode design[J]. *Automatica*, Vol. 41(5), 823-830, 2005

- 
- [Levant,2005b] A. Levant. Quasi-Continuous High-Order Sliding-Mode Controllers[J]. *IEEE Transactions on Automatic and Control*, Vol. 50(11), 1812-1815, 2005
- [Levant,2007] A. Levant. Principle of 2-sliding mode design[J]. *Automatica*, Vol. 43, 576-586, 2007
- [Lu,1997] X.Y. Lu, S.K. Spurgeon and I. Postlethwaite. Robust variable structure control of a PVTOL aircraft[J]. *International Journal of Systems Science*. Vol. 28(6), 547-558, 1997
- [Lu,1997b] X.Y. Lu, S.K. Spurgeon. Robust sliding mode control of uncertain nonlinear systems[J]. *Systems and Control Letters*, Vol. 32, 75-90, 1997
- [Lu,1998] X.Y. Lu and S.K. Spurgeon. Asymptotic stabilization of multiple input nonlinear systems via sliding modes[J]. *Dynamics and Control*, Vol. 8, 231-254, 1998
- [Man,1997] Z. Man and X.H. Yu. Terminal sliding mode control of MIMO linear systems[J]. *IEEE Trans. on Circuit and Systems-I*, Vol. 44(11), 1065-1070, 1997
- [Morioka,1995] H. Morioka, K. Wada, A. Sabanovic and K. Jezernik. Neural network based chattering free sliding mode control[J]. *Processing of the 34<sup>th</sup> SICE Annual Conf.* Tokyo, Japan. Vol. 7, 1303 –1308, 1995
- [Plestan,2006] F. Plestan, S. Laghrouche and A. Glumineau. Robust control of uncertain nonlinear system: a new higher order sliding mode based solution[J]. *Proceedings of the 2006 American Control Conference*, pp. 5401-5406, 2006
- [Poznyak,1999] A. S. Poznyak and J. Medel. Matrix forgetting with adaptation[J]. *International Journal of Systems Science*, vol. 30, pp. 865–878, 1999.
- [Poznyak,1999b] A. S. Poznyak, Matrix forgetting factor[J]. *International Journal of Systems Science*, vol. 2, pp. 165–174, 1999.
- [Riso-Gastelum,2003] O.G. Riso-Gastelum, B. Castillo-Toledo and A.G. Loukianov. *Proceeding of the IEEE Conference on Decision and Control*. Vol. 3, 3124-3129, 2003
- [Ryu,2001] S.H. Ryu and J.H. Park. Auto-tuning of sliding mode control parameters using fuzzy logic[J]. *Processing of American Control Conf. Arlington, USA*. Vol. 6, 618 – 623, 2001

- 
- [Shtessel,2007] Yuri B. Shtessel, Ilya A. Shkolnikov and A. Levant, Smooth second-order sliding modes: Missile guidance application[J]. *Automatica*, Vol. 43, 1470-1476, 2007
- [Sira-Ramirez,1992] H. Sira-Ramirez. On the sliding mode control of nonlinear systems[J]. *Systems and Control Letters*, Vol. 19, 303-312, 1992
- [Sira-Ramirez,1993] H. Sira-Ramirez. On the dynamic sliding mode control of nonlinear systems[J]. *International Journal of Control*, Vol. 57(5), 1039-1061, 1993
- [Sira-Ramirez,2002] H. Sira-Ramirez and V.M. Hernandez. Sliding modes, differential flatness and integral reconstructors. In Xinghuo Yu and Jian-Xin Xu, editors[J], *Variable structure systems: towards the 21<sup>st</sup> century, volume 274 of Lecture Notes in Control and Optimization*, 315-340. Springer, London, 2002
- [Shtessel,1996] Yuri Shtessel and Christian Tournes. Nonminimum Phase Output Tracking in Dynamic Sliding Manifolds with Application to Aircraft Control. *Proceedings of the 35th Conference on Decision and Control*, pp.2071-2076, 1996
- [Slotine,1983] J.J. Slotine and S.S. Sastry. Tracking control of non-linear system using sliding surfaces with application to robot manipulators[J]. *International Journal of Control*, Vol. 38(2), 465-492, 1983
- [Slotine,1993] J.J Slotine and J.K. Hedrick. Robust input output feedback linearization[J]. *International Journal of Control*, Vol. 57(5), 1133-1139, 1993
- [Smaoui,2007] M. Smaoui, X. Brun and D. Thomasset. High-order sliding mode for an electropneumatic system: A robust differentiator-controller design[J]. *International Journal of Robust and Nonlinear Control* (in press), 2007
- [Solsona,2000] J. Solsona, M. I. Valla and C. Muravchik. Nonlinear Control of a Permanent Magnet Synchronous Motor with Disturbance Torque Estimation[J]. *IEEE Transactions on Energy Conversion*, Vol. 15(2), pp. 163–168, 2000
- [Tang,1998] Y. Tang. Terminal sliding mode control for rigid robots[J]. *Automatica*, Vol. 34, 51-56, 1998
- [Utkin,1977] V.I. Utkin. Variable structure systems with sliding mode[J]. *IEEE Trans. on Automatic Control*, AC-22:212-222, 1977
- [Utkin,1992] V.I. Utkin. Sliding modes in control and optimization[M]. *Springer-*

---

Verlag, 1992

[Utkin,1999] V.I. Utkin, J. Guldner and J. Shi. Sliding mode control in electro-mechanical systems[M]. *Taylor & Francis*, 1999

[Xu,1998] J. Xu, T. Heng Lee, Q. Jia and M. Wang. On adaptive robust backstepping control schemes suitable for pm synchronous motors[J]. *International Journal of Control*, Vol. 70, 893-920, 1998

[Xu,2000] J.X. Xu, Y.J. Pan and T.H. Lee. Again scheduled sliding mode control scheme using filtering techniques with applications to multi-link robotic manipulators[J]. *International Journal of Dynamic Systems, Measurement and Control*, vol.122(4), 641-649, 2000

[Yan,2005] X. G. Yan and C. Edwards. Robust sliding mode observer-based actuator fault detection and isolation for a class of nonlinear systems[J]. *44<sup>th</sup> IEEE Conference on Decision and Control, and the European Control Conference 2005*, pp: 987-992, 2005

[Yan,2006] Y. Yan, J. Zhu, Y. Guo, and H. Lu. Modeling and simulation of direct torque controlled pmsm drive system incorporating structural and saturation saliencies[J]. *Industry Applications Conference, 2006. 41<sup>st</sup> IAS Annual Meeting. Conference Record of the 2006 IEEE*, vol. 1, Oct. 2006, pp. 76–83.

[Yanada,1999] H. Yanada and H. Frequency-shaped sliding mode control of an electro-hydraulic servomotor[J]. *Journal of Systems and Control and Dynamics*, Vol. 213(1), 441-448, 1999

[Yeh,2000] Yeh H. H., Nelson E. and Sparks A. Nonlinear tracking control for satellite formations. *Proceedings of the IEEE Conference on Decision and Control*. pp. 328-333, 2000

[Zhuang,2000] K.Y. Zhuang, H.Y. Su, J. Chu and K.Q. Zhuang. Globally stable robust tracking of uncertain systems via fuzzy integral sliding mode control[J]. *World Congress Intelligent Control and Automation*. Hefei, China. Vol. 6, 1827 – 1831, 2000

[Ziribi,2001] M. Ziribi, Sira H. Ramirez and A. Ngai. Static and dynamic sliding mode control schemes for a permanent magnet stepper motor[J]. *International Journal of Control*, vol. 74, pp. 103–117, 2001

- 
- [晁红敏,2001] 晁红敏, 胡跃明. 动态滑模控制及其在移动机器人输出跟踪中的应用[J]. 控制与决策. 第 16 卷 5 期, 565-568, 2001
- [陈伯时,1998] 陈伯时. 交流调速系统[M]. 北京: 机械工业出版社, 1998
- [陈硕,2003] 陈硕, 辻峰男, 山田英二. 感应电机无速度传感器矢量控制系统的定子电阻在线辨识[J].中国电机工程学报. 第 23 卷 2 期, 88-92, 2003
- [董景新,2007] 董景新, 吴秋平. 现代控制理论与方法概论[M]. 清华大学出版社, 2007
- [段学超,2007] 段学超, 仇原鹰, 段宝岩. 平面倒立摆自适应滑模模糊控制[J].控制与决策. 第 22 卷 7 期, 774-777, 2007
- [富立新,2003] 富立新, 苟智德, 丘昌涛. 同步电机参数辨识[J]. 大电机技术, 2003, (2): 8-10.
- [葛宝明,2007] 葛宝明, 林飞, 李国国. 先进控制理论及其应用[M]. 机械工业出版社, 2007
- [高为炳,1996] 高为炳. 变结构控制理论和设计方法[M]. 科学出版社, 1996
- [辜承林,2005] 辜承林, 陈乔夫, 熊永前. 电机学[M]. 武汉: 华中科技大学出版社 (第 2 版), 2007
- [胡军,1997] 胡军, 朱东起, 高景德. 滑模观测器及其在无机械传感器永磁同步电机驱动系统的应用[J]. 清华大学学报. 第 37 卷 1 期, 13-17, 1997
- [李崇坚,2007] 李崇坚. 交流同步电机调速系统[M]. 北京: 科学出版社, 2007
- [李会艳,2001] 李会艳, 王江, 胡龙根. 基于滑模观测器的故障诊断及在主动悬架系统中的应用[J]. 上海海运学院学报, 2001, 22(3):30-34
- [李发海,2007] 李发海, 朱东起. 电机学[M]. 北京: 科学出版社(第 4 版), 2007
- [李永东,2002] 李永东. 交流电机数字控制系统[M]. 北京: 机械工业出版社, 2002
- [李志明,1996] 李志明, 张遇杰. 同步电动机调速系统[M]. 北京: 机械工业出版社, 1996
- [李钟明,1996] 李钟明, 刘卫国. 稀土永磁电机[M]. 北京: 国防工业出版社, 2001
- [刘栋良,2005] 刘栋良, 严伟灿, 赵光宙. 基于转矩扰动估计的电机反馈线性

- 
- 化控制[J]. 电力系统及其自动化学报. 第 17 卷 5 期, 60-63, 2005
- [刘金琨,2005] 刘金琨. 滑模变结构控制 MATLAB 仿真[M]. 北京: 清华大学出版社, 2005
- [刘金琨,2007] 刘金琨, 孙富春. 滑模变结构控制理论及其算法研究与发展[J]. 控制理论与应用. 第 24 卷 3 期, 407-418, 2007
- [刘智平,2007] 刘智平, 周凤岐, 周军. 具有参数不确定性的飞行器的变结构姿态控制[J]. 宇航学报. 第 28 卷 1 期, 43-48, 2007
- [马培蓓,2004] 马培蓓, 吴进华, 纪军等. dSPACE 实时仿真平台软件环境及应用[J]. 系统仿真学报, 2004, 16(4): 667-670
- [潘峰,2004] 潘峰, 薛定宇, 徐心和. 基于 dSPACE 半物理仿真技术的伺服控制研究与应用[J]. 系统仿真学报, 2004, 16(5): 936-939
- [米增强,1998] 米增强, 陈志忠, 南志远. 同步发电机动态参数辨识[J]. 中国电机工程学报. 1998, 18(2): 101-105.
- [孙宜标,2004] 孙宜标, 郭庆鼎. 基于滑模观测器的直线伺服系统反馈线性化速度跟踪控制[J]. 控制理论与应用. 第 21 卷 3 期, 391-397, 2004
- [唐任远,2002] 唐任远. 现代永磁电机理论与设计[M]. 北京: 机械工业出版社, 2002
- [王广雄,2007] 王广雄, 何联. 控制系统设计[M]. 北京: 清华大学出版社, 2007
- [吴强,2006] 吴强, 李槐树, 向东, 让余奇. 同步电机参数在线小扰动辨识技术研究[J]. 海军工程大学学报. 第 18 卷 4 期, 70-74, 2006
- [吴守箴,2003] 吴守箴, 臧英杰. 电气传动的脉宽调制控制技术[M]. 北京: 机械工业出版社 (第二版), 2003
- [吴玉香,2006] 吴玉香, 胡跃明. 二阶动态滑模控制在移动机械臂输出跟踪中的应用[J]. 控制理论与应用. 第 23 卷 3 期, 411-415, 2006
- [夏长亮,2006] 夏长亮, 刘均华, 俞卫, 李志强. 基于扩张状态观测的永磁无刷直流电机滑模变结构控制[J]. 中国电机工程学报. 第 26 卷 20 期, 139-143, 2006
- [于双和,2001] 于双和, 强文义, 傅佩琛. 无抖振离散准滑模控制[J]. 控制与决策. 第 16 卷 3 期, 380-382, 2001
- [翟长连,2000] 翟长连, 吴智铭. 一种离散时间系统的变结构控制方法[J]. 上海

---

交通大学学报. 第 34 卷 5 期, 719-722, 2000

[张涛,2001] 张涛, 蒋静坪, 张国宏. 交流永磁同步电机伺服系统的线性化控制[J]. 中国电机工程学报. 第 21 卷 6 期, 40-43, 2001

[张天平,1995] 张天平, 冯纯伯. 基于模糊逻辑的连续滑模控制[J]. 控制与决策, 第 10 卷 6 期, 503 – 507, 1995

[张燕宾,2005] 张燕宾. SPWM 变频调速应用技术[M]. 北京: 机械工业出版社 (第 3 版), 2005

[Cathey,2005] J. J. Cathey 著, 戴文进译. 电机原理与设计的 MATLAB 分析[M]. 北京: 电子工业出版社, 2005

[Dorf,2007] Richard C. Dorf, Robert H. Bishop 著, 谢卫红, 邹逢兴, 张明, 李鹏波, 李琦译. 现代控制系统[M]. 北京: 高等教育出版社 (第 8 版), 2007



---

## Publications

1. HUANGFU Yigeng, LIU Weiguo, MA Ruiqing. Permanent Magnet Synchronous Motor Fault Detection and Isolation Using Second Order Sliding Mode Observer. *3<sup>rd</sup> IEEE Conference on Industrial Electronics and Application*, pp:639-644, Singapore, 2008.6 (EI: 083911591076, ISTP: 000258323800125)
2. HUANGFU Yi-geng, LIU Wei-guo, MA Rui-qing. Robust High Order Sliding Mode for PMSM with Differentiator Controller Design. *20<sup>th</sup> Chinese Control and Decision Conference*, pp:4957-4961, Yantai, China, 2008. (EI: 084011610642, ISTP: 000260562703119)
3. Yigeng Huangfu, Weiguo Liu, S. Laghrouche, A. Miraoui. Quasi-continuous High order sliding mode controller design for PMSM. *11<sup>th</sup> International Conference on Electrical Machines and Systems*, pp:3785-3788, Wuhan, China, 2008. (EI: 20092812172753, ISTP: 000265395402083)
4. HUANGFU Yigeng, LIU Weiguo, S. Laghrouche, A. Miraoui. A Chattering Avoidance Sliding Mode Controller for Nonlinear PMSM. *21<sup>th</sup> Chinese Control and Decision Conference*, Guilin, Guangxi, 2009.6 (EI: 20094712470243)
5. Weiguo Liu, Yigeng Huangfu, Luo Guangzhao. Key Technology Research of BLDCM for High Performance Driving System. *11<sup>th</sup> International Conference on Electrical Machines and Systems*, pp:2797-2801, Wuhan, China, 2008. (EI: 20092712171015, ISTP: 000265395401223)
6. Ruiqing Ma, Yigeng Huangfu, Ping Fan. Speed Regulation of Wider Range for Rare Earth Permanent Magnet Brushless DC Motor. *11<sup>th</sup> International Conference on Electrical Machines and Systems*, pp:3254-3256, Wuhan, China, 2008. (EI: 20092712171104, ISTP: 000265395401313)
7. Huangfu Yigeng, Liu Weiguo, Ma Ruiqing. High Order Sliding Mode Control for a PMSM with Disturbance Torque Estimation. *Journal of Northwestern Polytechnical University*. Vol.27(5), pp:630-634, 2009; 皇甫宜耿, 刘卫国, 马瑞卿. 永磁同步电机高阶滑模控制与扰动转矩估计[J]. 西北工业大学学报. 第27卷第5期, 630-634

---

页, 2009 年

8. HUANGFU Yi-geng, LIU Wei-guo, MA Rui-qing. State Estimation Online for PMSM via High Order Sliding Mode Control. *Proceedings of the CSU-EPSA*. Vol.21(5), pp:18-23, 2009; 皇甫宜耿, 刘卫国, 马瑞卿. 基于高阶滑模控制的永磁同步电机在线状态估计[J]. 电力系统及其自动化学报. 第 21 卷第 5 期, 18-23 页, 2009
9. 皇甫宜耿, 刘卫国, 马瑞卿, 杨永亮. 基于鲁棒高阶滑模的电动舵机伺服控制[J]. 火力与指挥控制. (已录用)
10. 皇甫宜耿, 刘卫国, 马瑞卿. 二阶滑模控制在速度伺服系统中的应用[J]. 微特电机. 第 36 卷第 2 期, 32-34 页, 2008 年。
11. 皇甫宜耿, 刘卫国, 马瑞卿. 非线性永磁同步电机建模方法与仿真[J]. 电气传动自动化. 第 30 卷第 6 期, 30-33 页, 2008 年。
12. 皇甫宜耿, 刘卫国, 马瑞卿. 基于二阶滑模观测器永磁同步电动机伺服控制[J]. 微特电机. 第 36 卷第 11 期, 32-34 页, 2008 年。
13. 皇甫宜耿, 马瑞卿, 杨永亮. 基于 RS232 串口通信的双冗余无刷直流电动机控制系统[J]. 微特电机. 第 35 卷第 5 期, 43-45 页, 2007 年。
14. 皇甫宜耿, 马瑞卿, 杨永亮. 窗口过滤测速法在无刷直流电机测控系统中的应用[J]. 测控技术. 第 25 卷第 9 期, 64-66 页, 2006 年。