

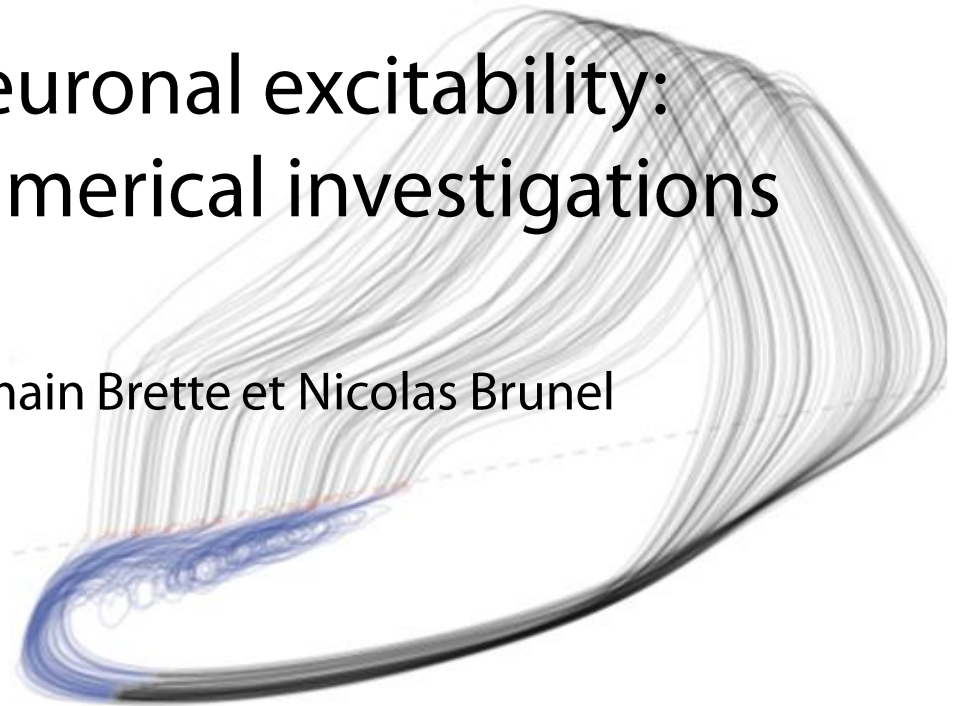

Dynamics of neuronal excitability: theoretical and numerical investigations

Thèse dirigée par Romain Brette et Nicolas Brunel



A. What is the system studied?

Neurons

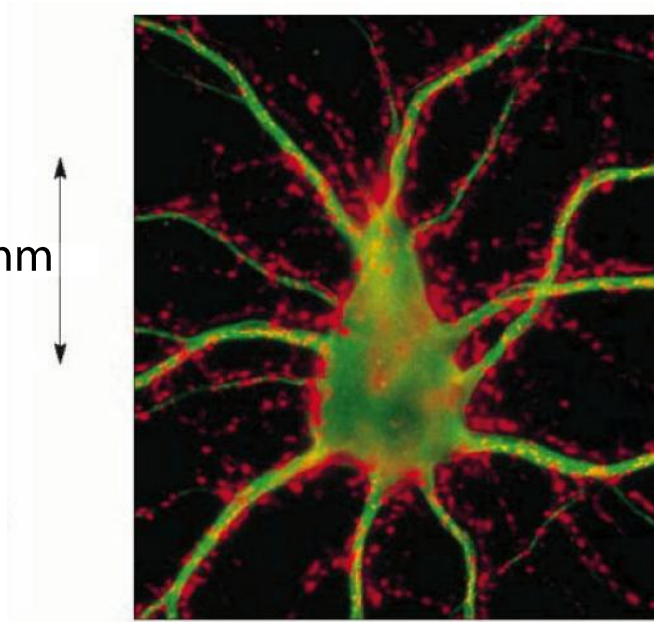

A. What is the system studied?

In vivo activity in mammals

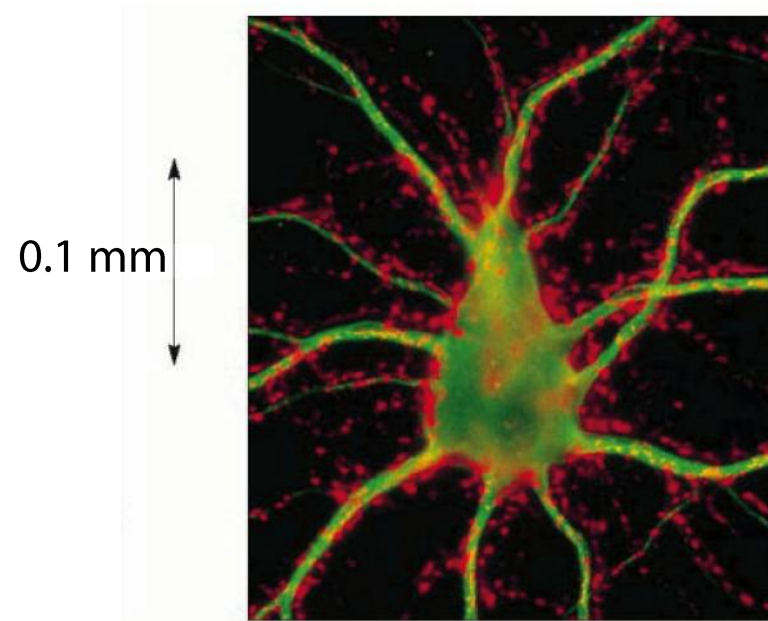

A. What is the system studied?

Intracellular recordings

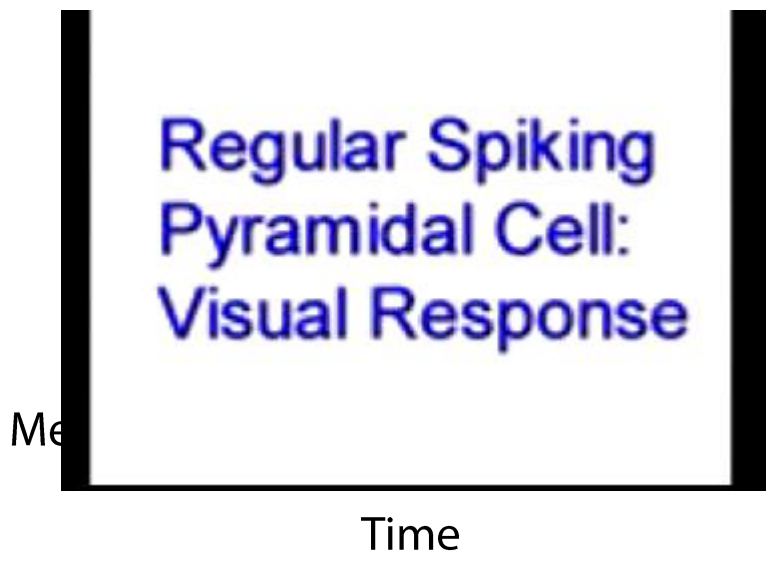

B. Biological question

Signal transmission

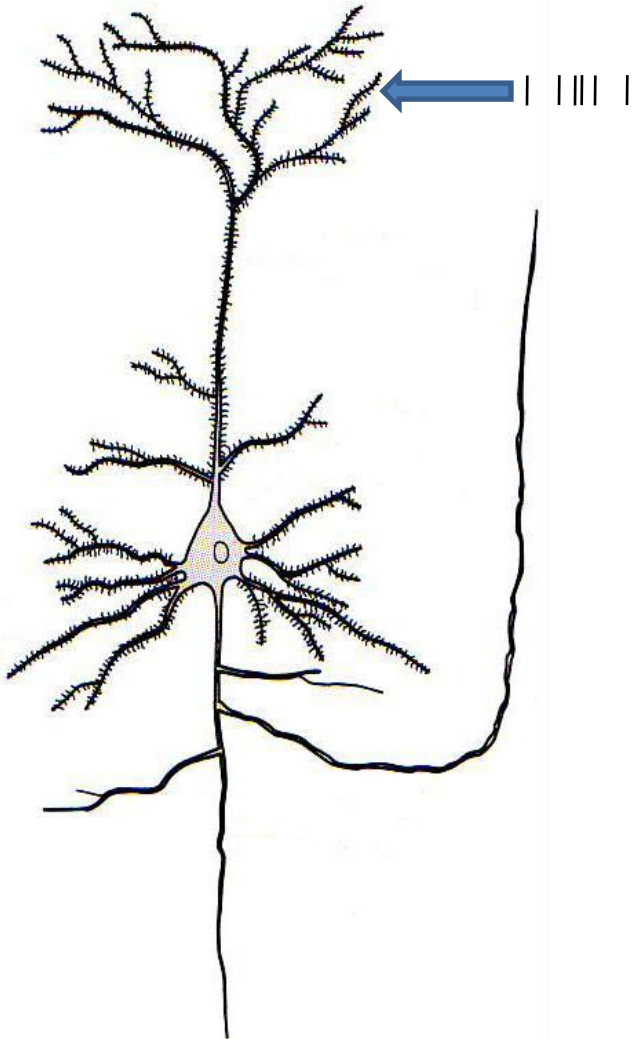

Input = 1 spike train

B. Biological question

Signal transmission

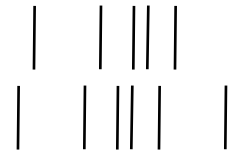
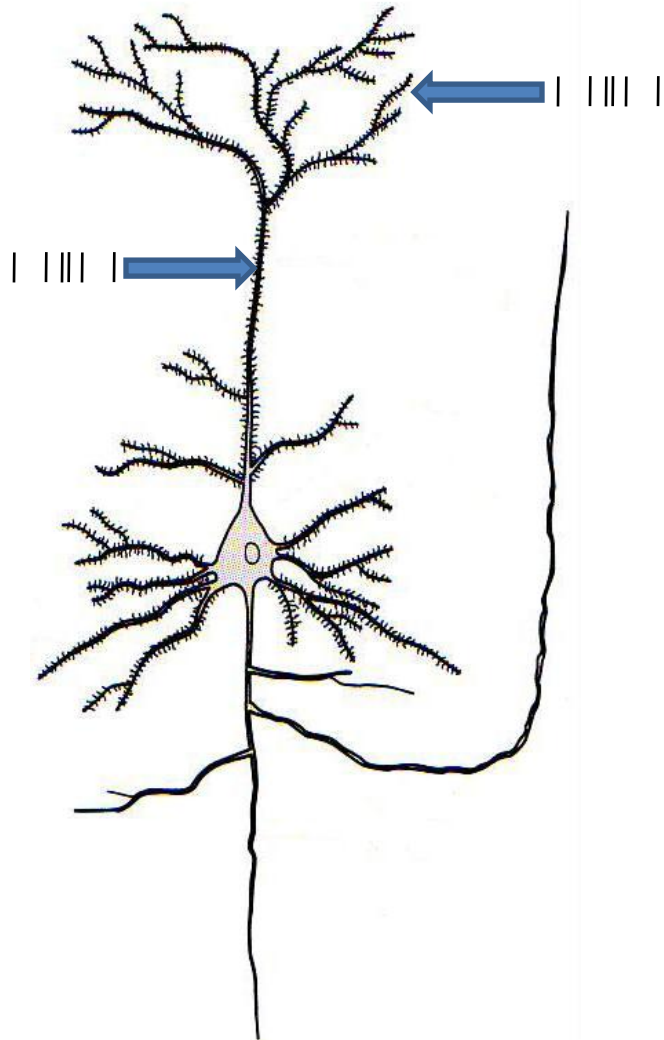

Input = 2 spike trains

B. Biological question

Signal transmission

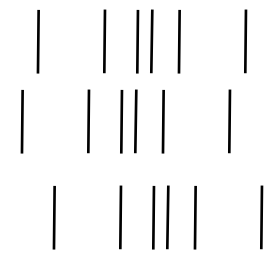
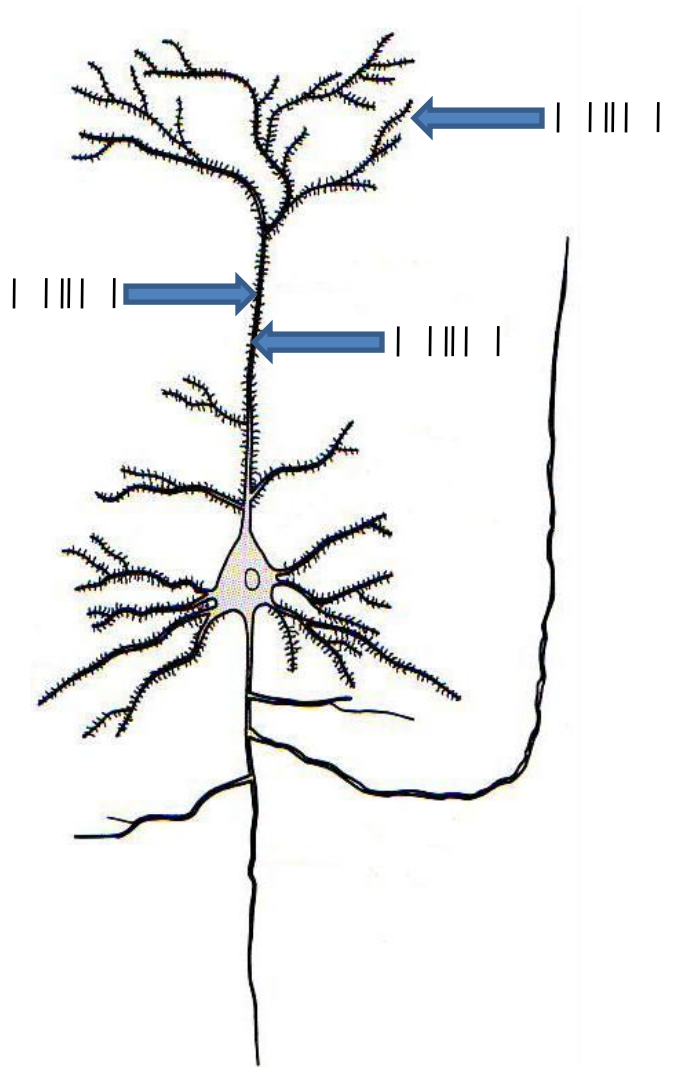

Input = 3 spike trains

B. Biological question

Signal transmission

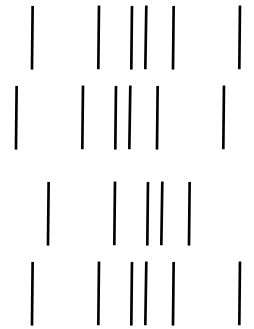
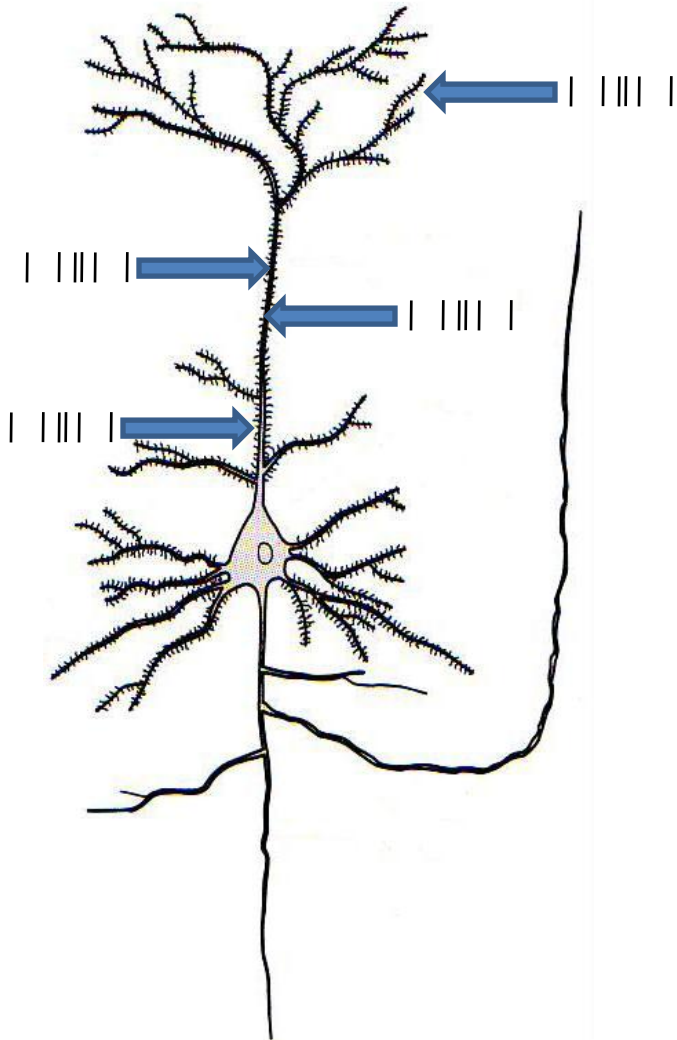

Input = N spike trains

B. Biological question

Signal transmission

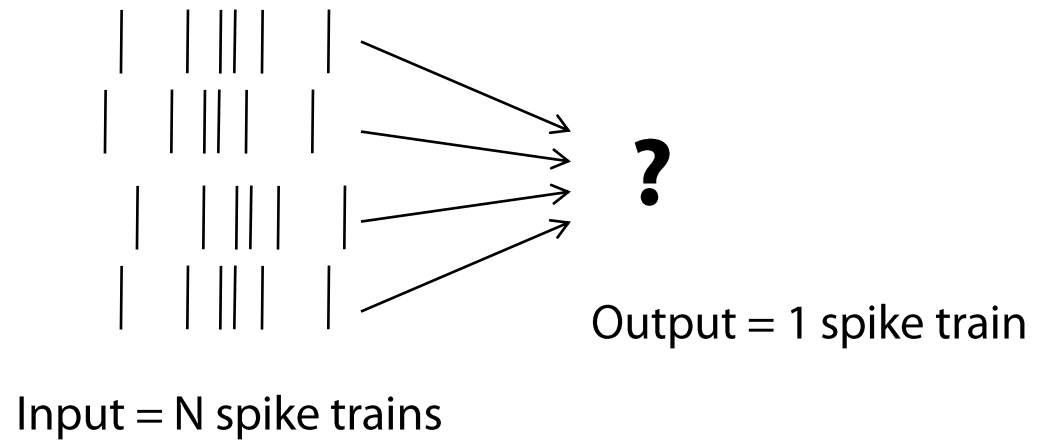
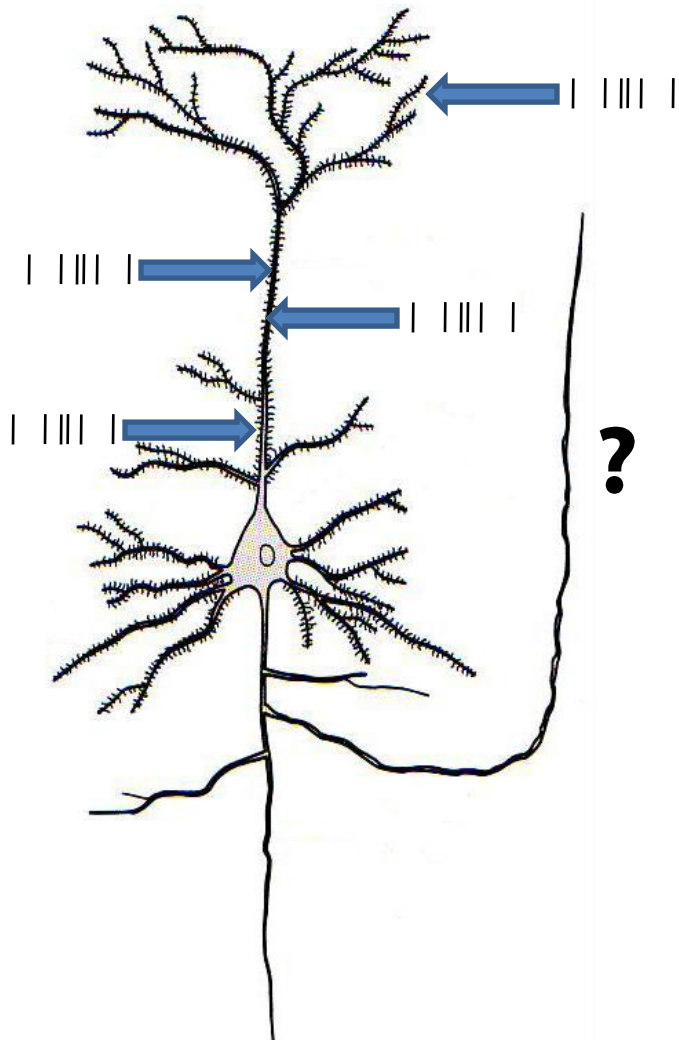

B. Biological question

Signal transmission

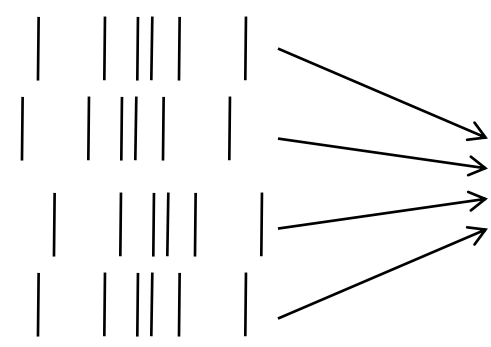
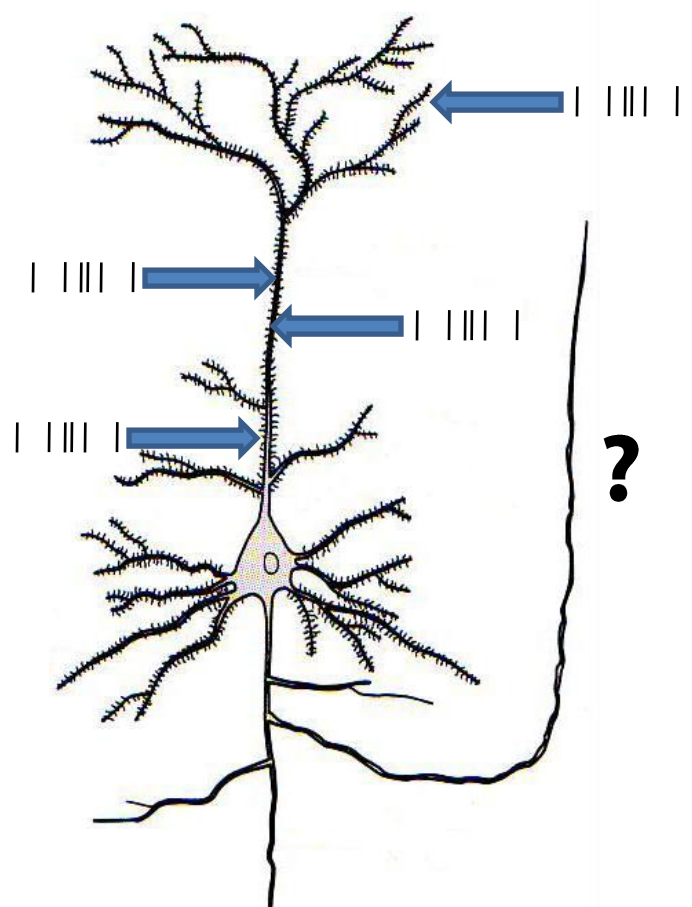

Input = N spike trains

Output = 1 spike train

What does biophysics tell us about signal transmission by neurons?

B. Biological question

Implications

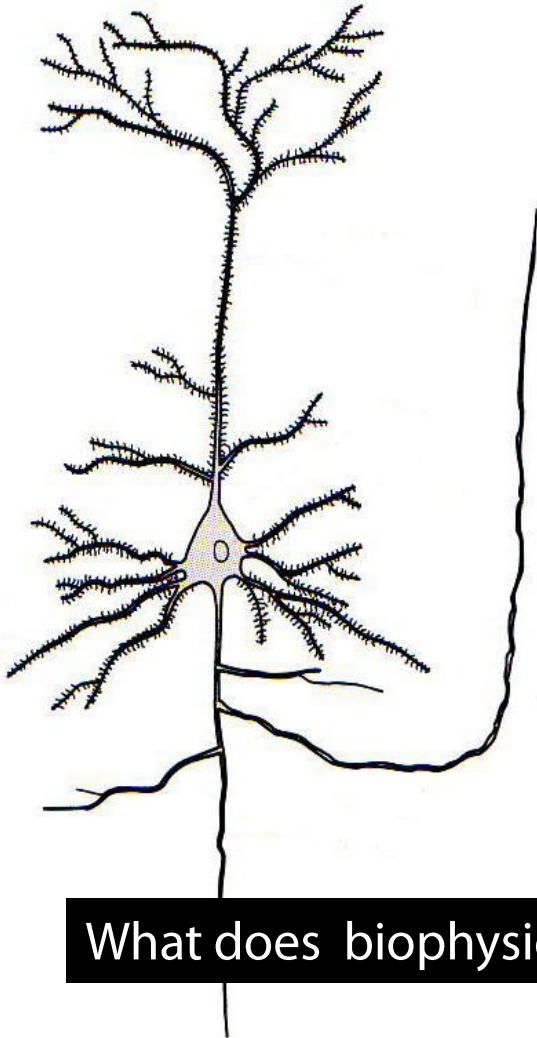

Predicting a neuron function
from the measure of its biophysical characteristics

What does biophysics tell us about signal transmission by neurons?

B. Biological question

Implications

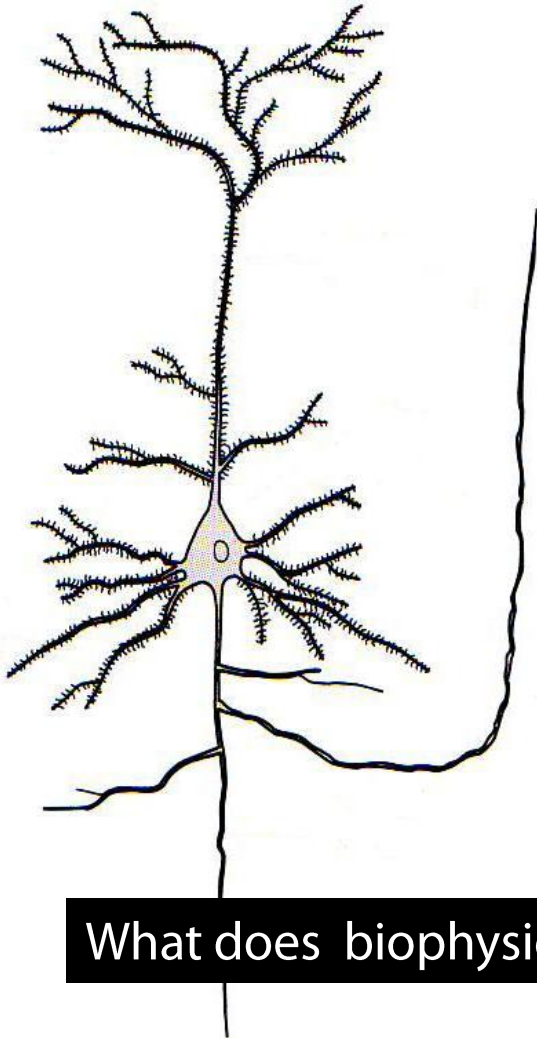

- ▶ Predicting a neuron function from the measure of its biophysical characteristics
- ▶ Understanding better how biophysical characteristics are constrained by the neuronal functions

What does biophysics tell us about signal transmission by neurons?

1. Experimental framework
2. Threshold basics
3. Threshold equation
4. Impact of Na channel inactivation

1. Experimental framework

2. Threshold basics

3. Threshold equation

4. Impact of Na channel inactivation

A. The fixed threshold picture

Sensory selectivity

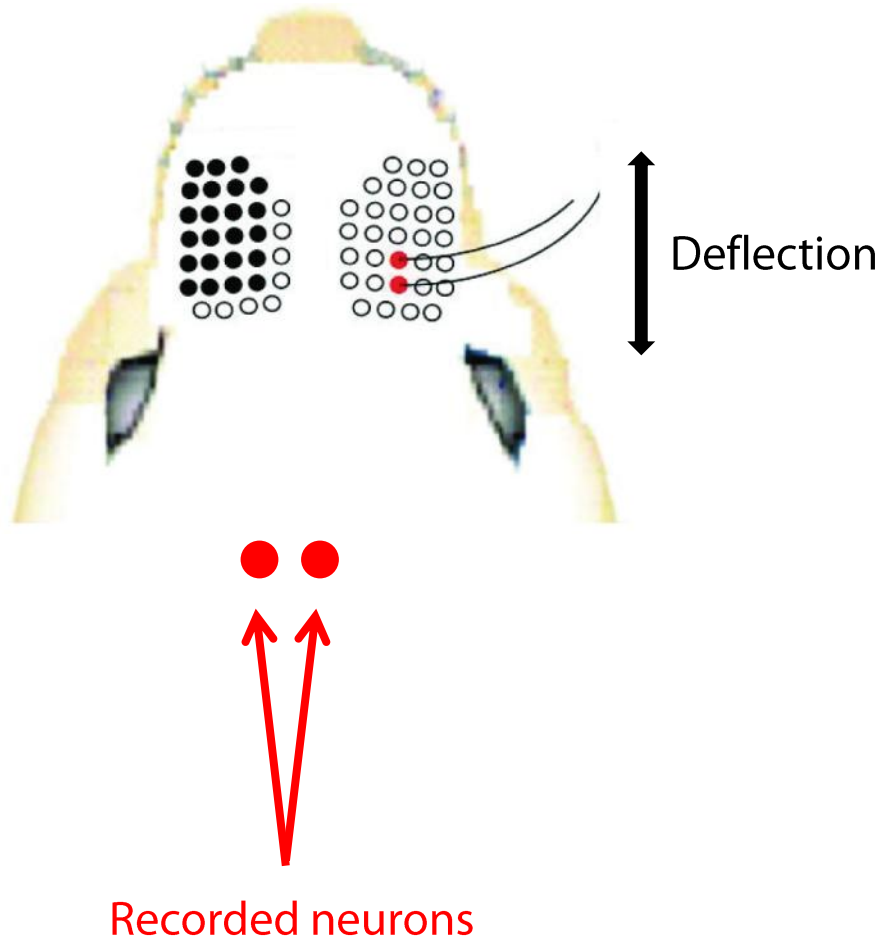

A. The fixed threshold picture

Sensory selectivity

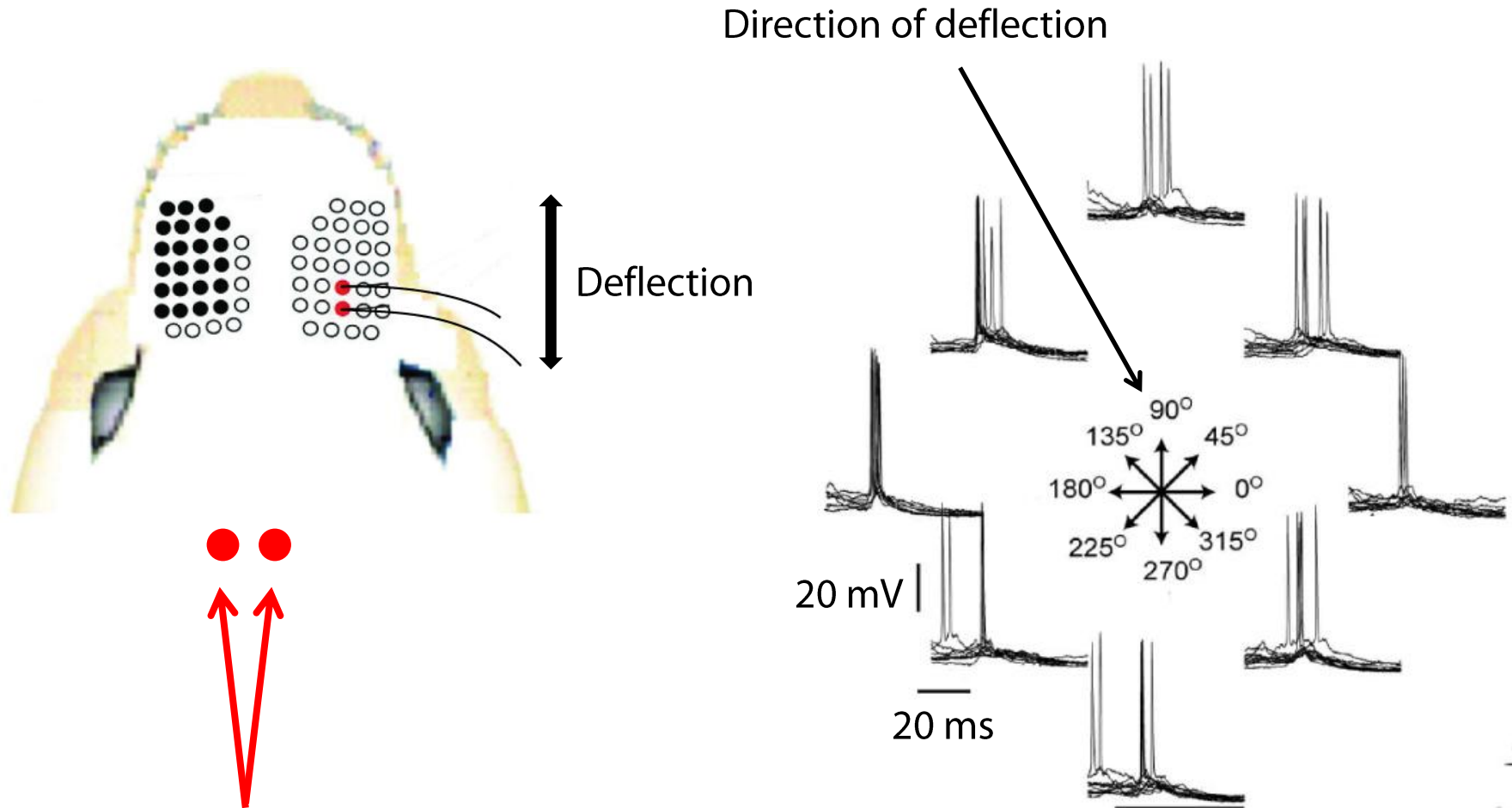

A. The fixed threshold picture

Sensory selectivity

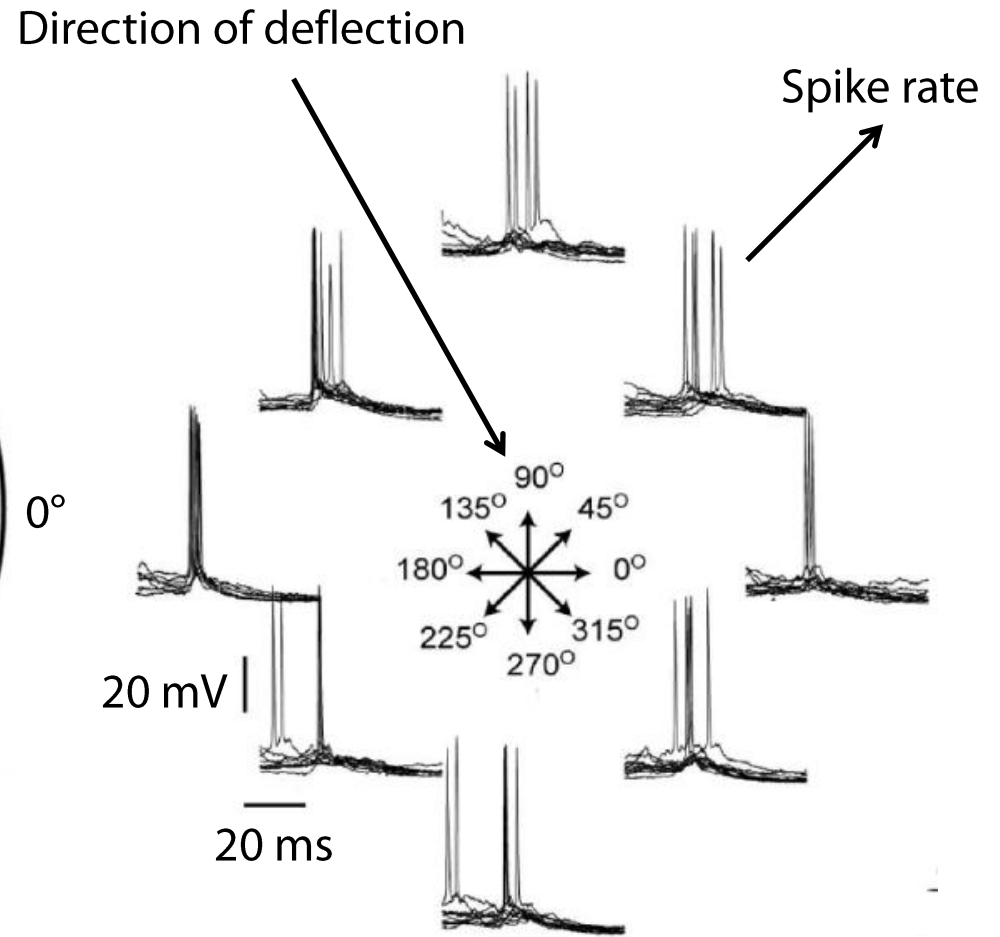
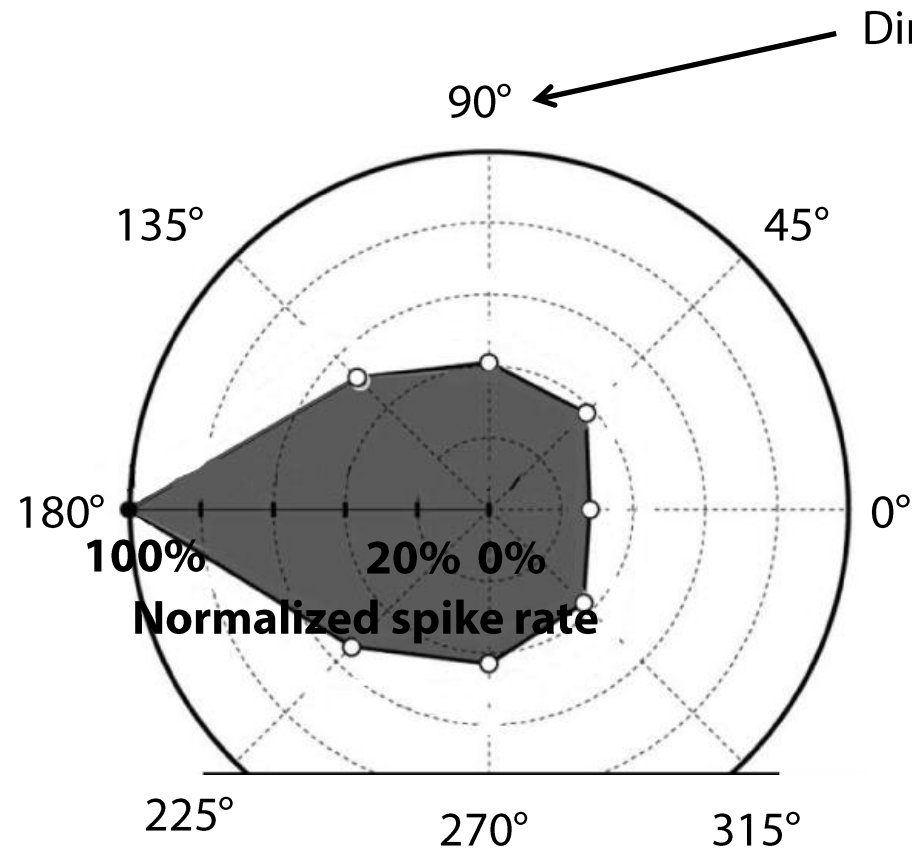

A. The fixed threshold picture

Synaptic integration

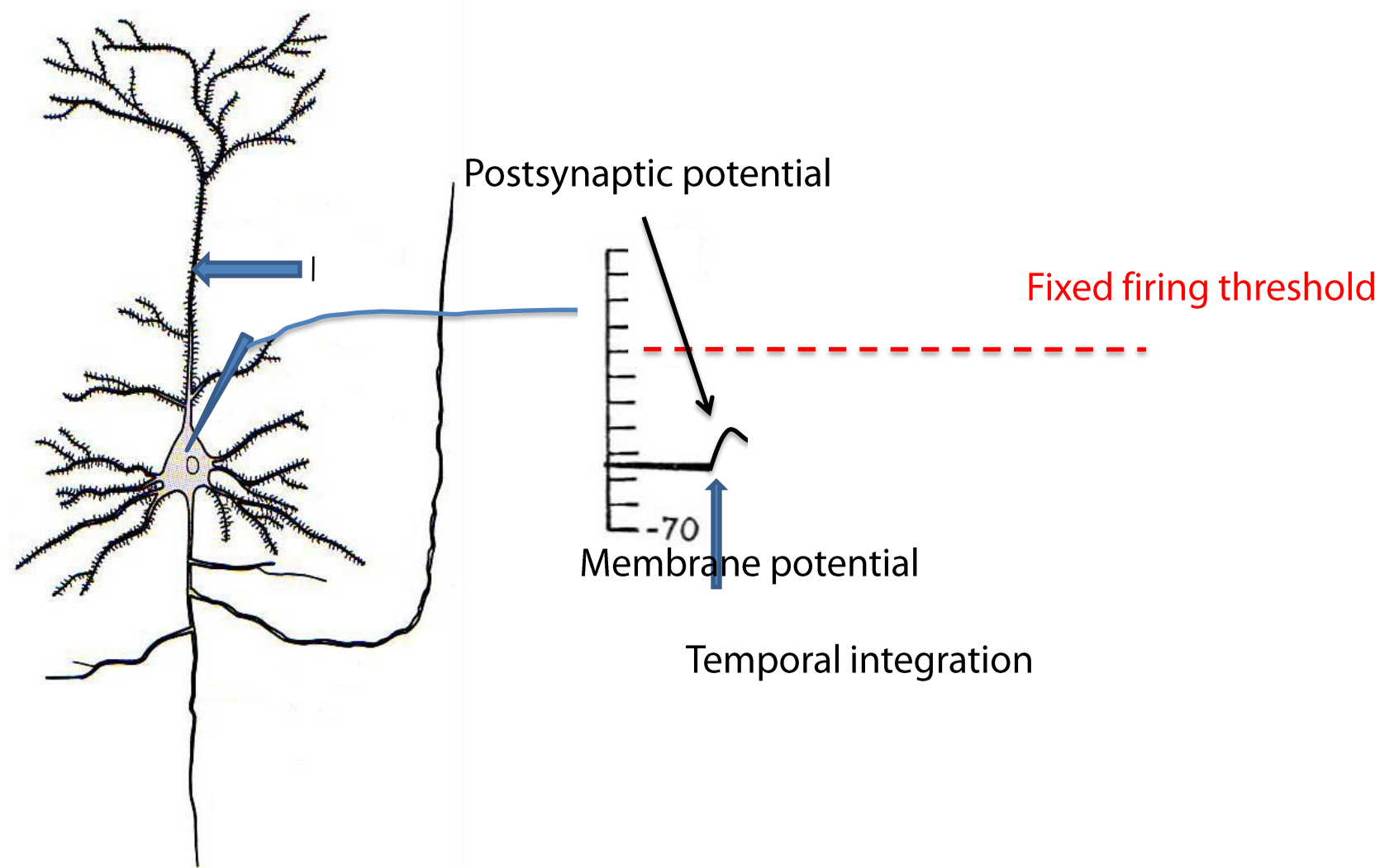

A. The fixed threshold picture

Synaptic integration

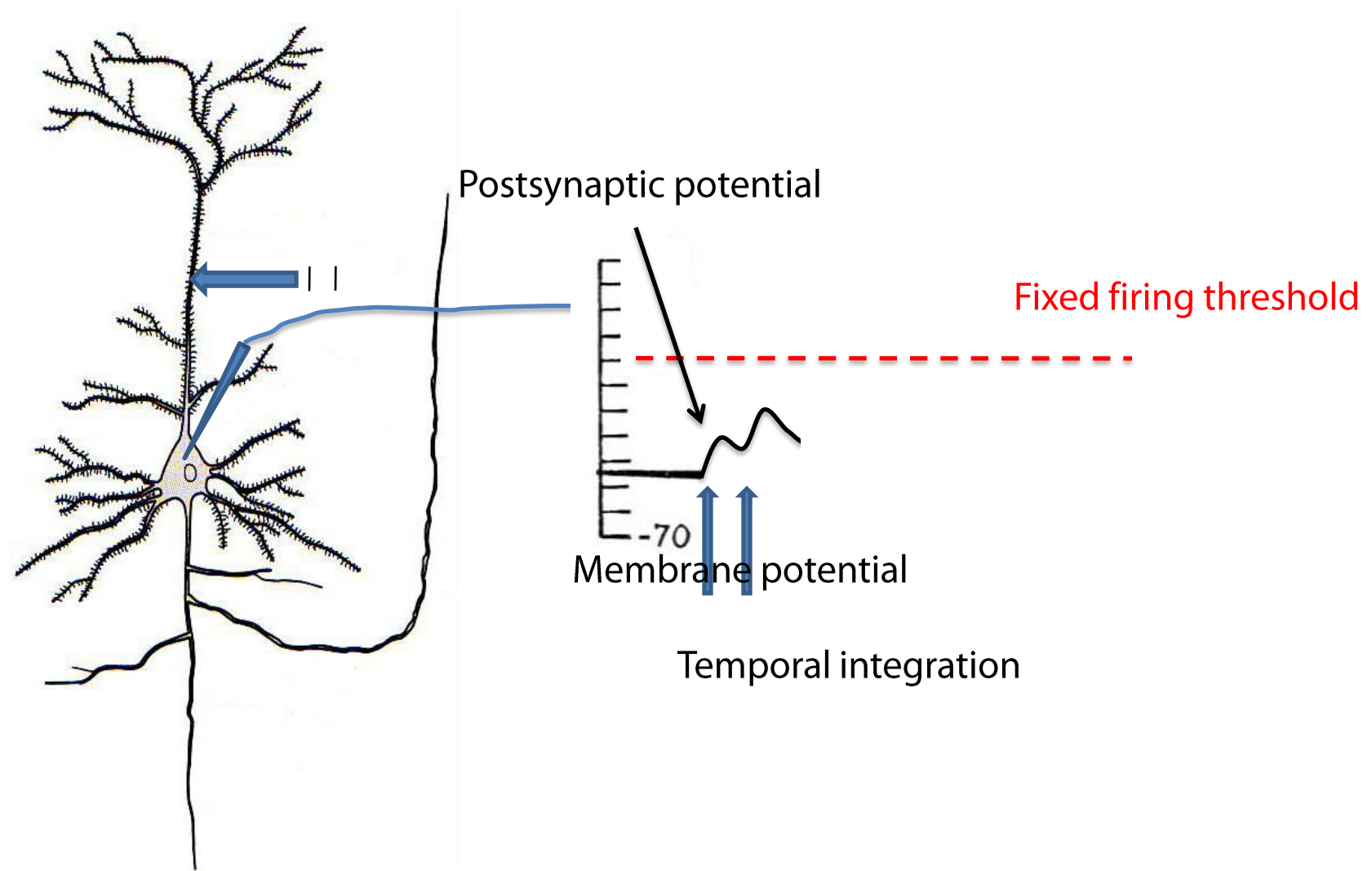

A. The fixed threshold picture

Synaptic integration

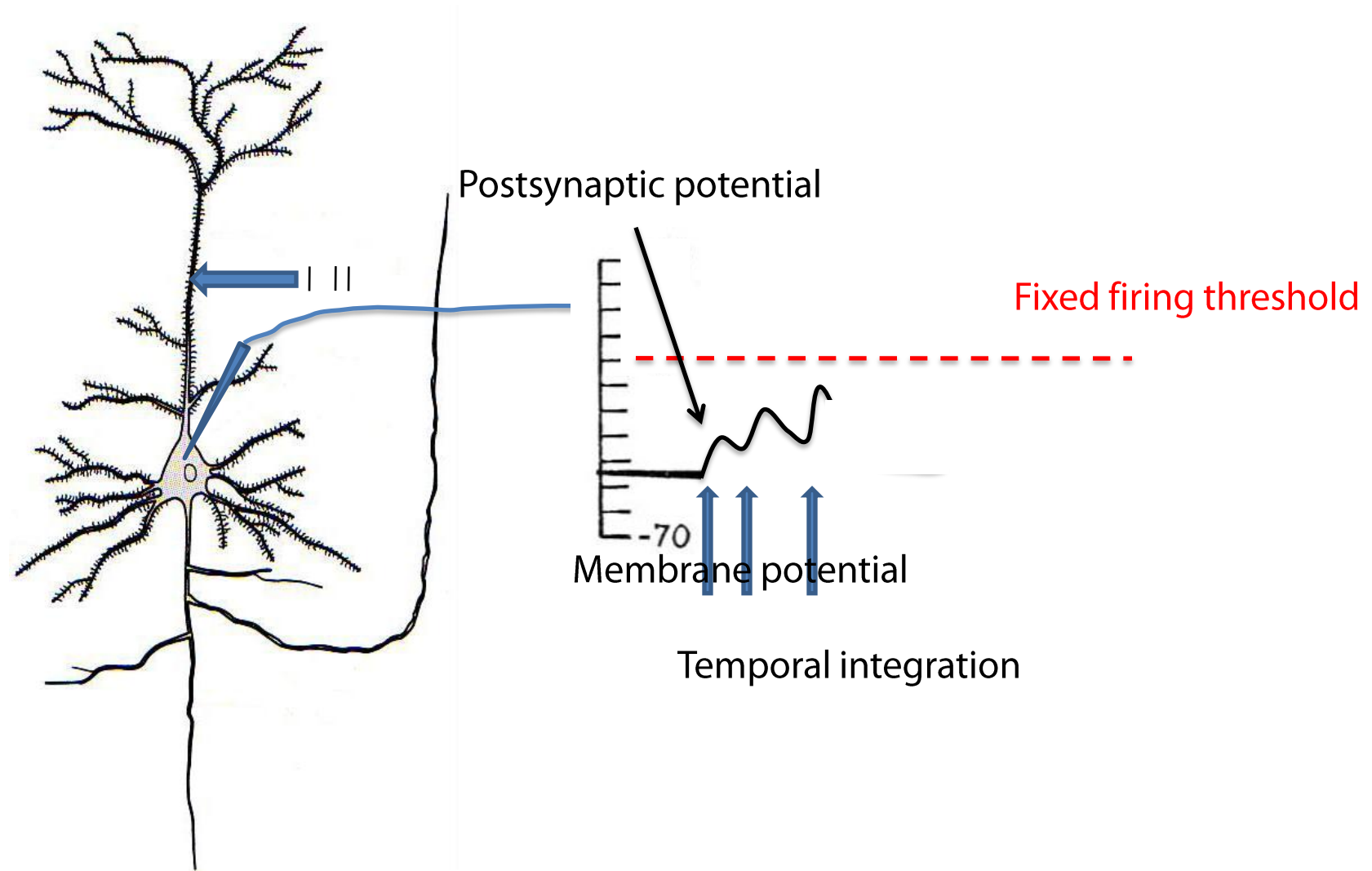

A. The fixed threshold picture

Synaptic integration

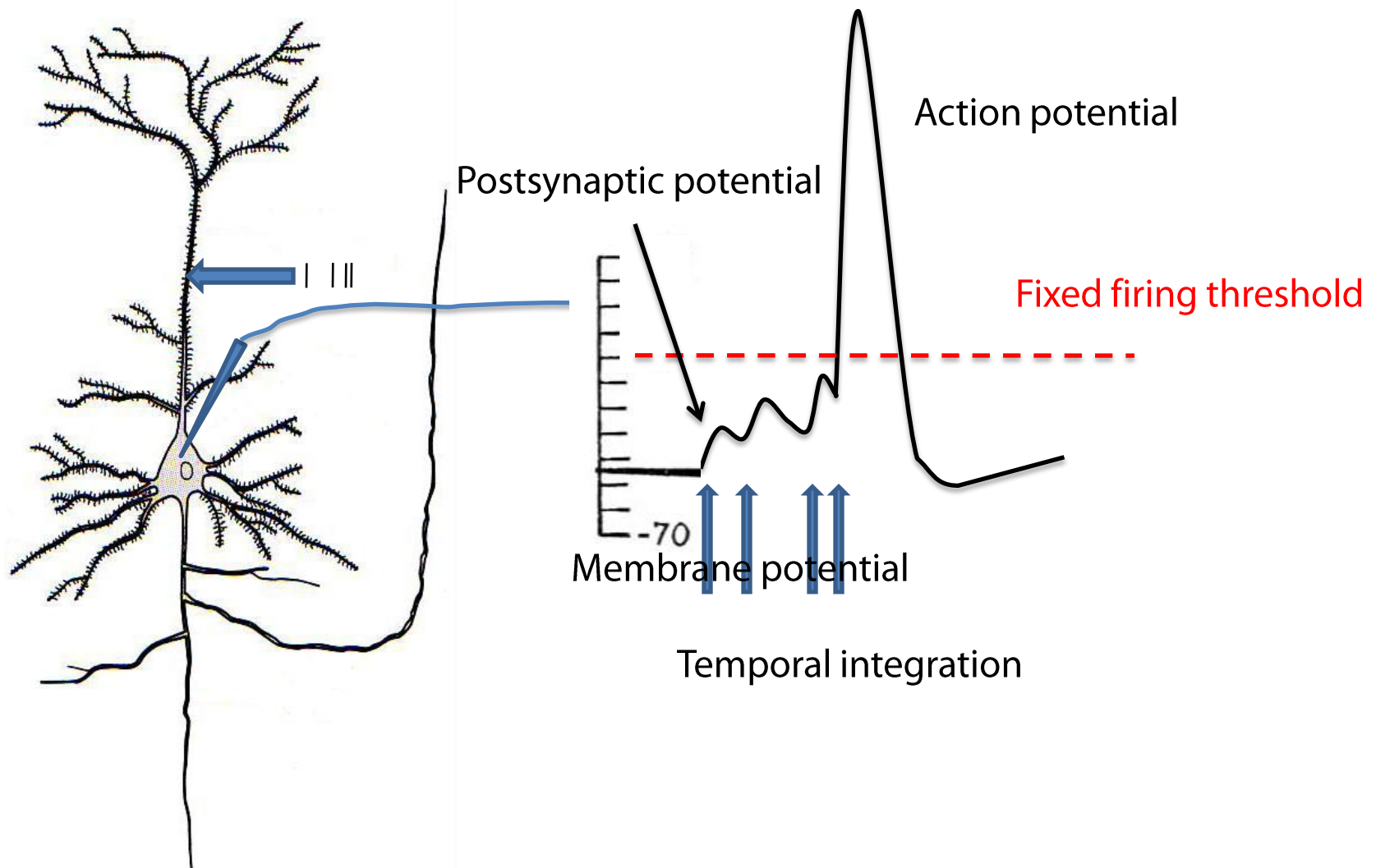

A. The fixed threshold picture

Sensory selectivity

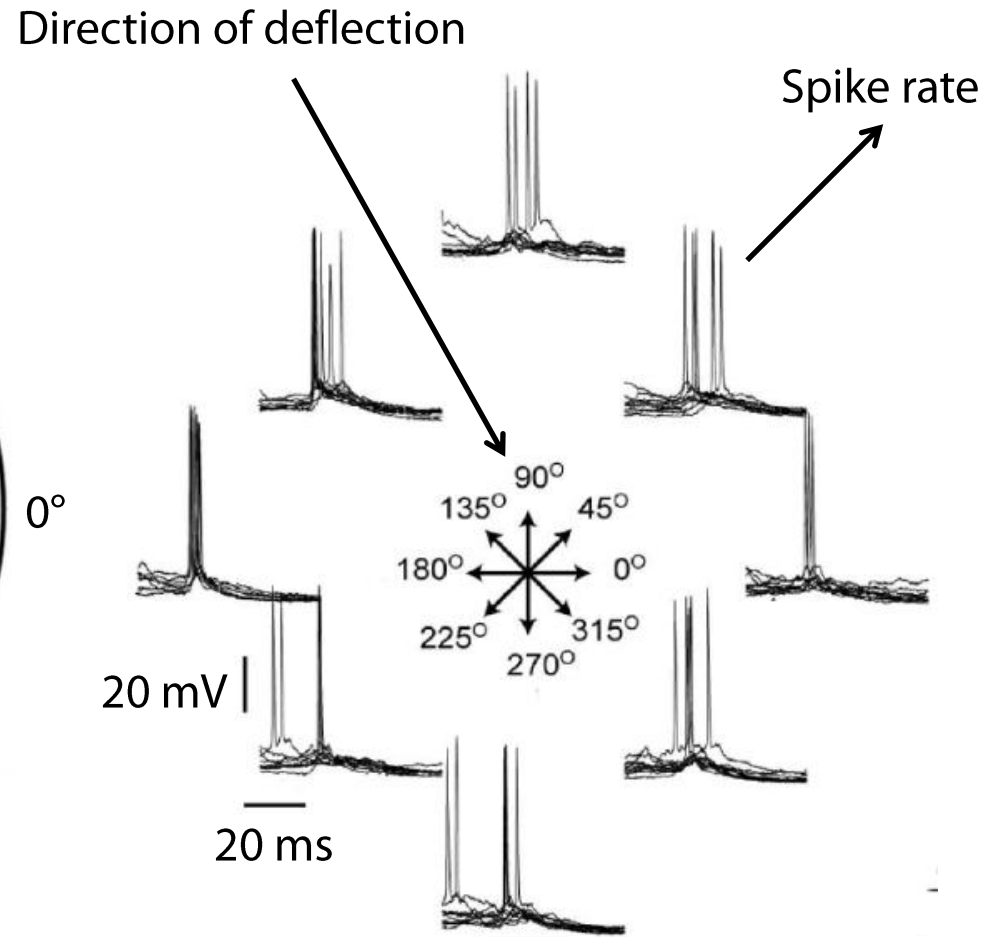
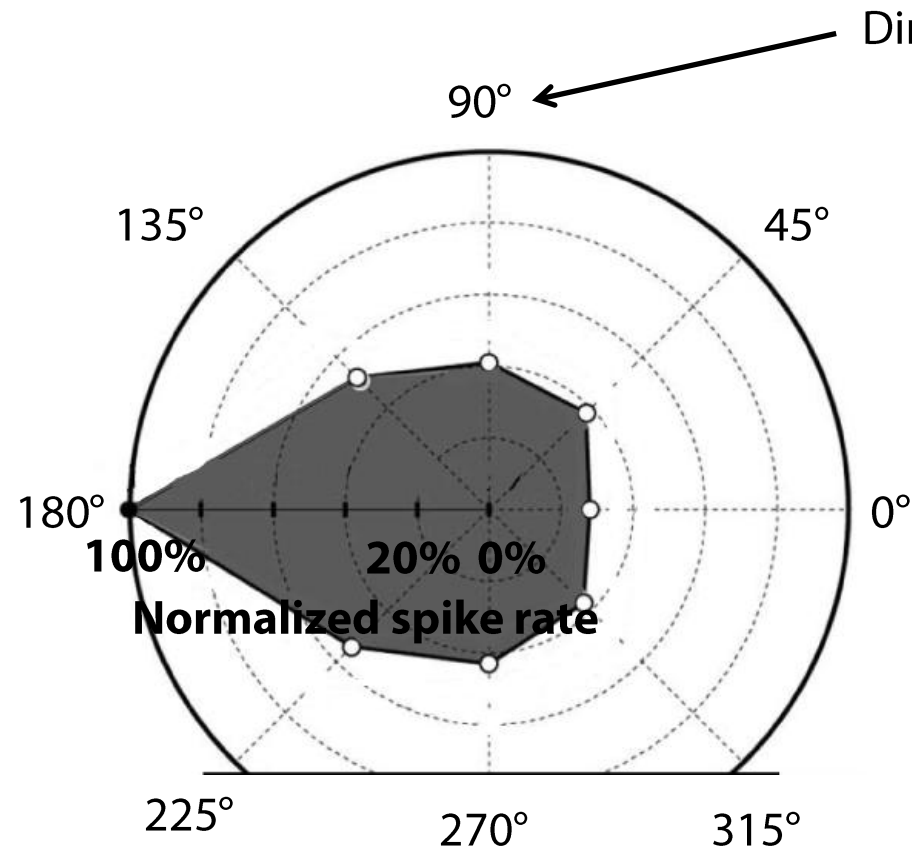

A. The fixed threshold picture

Sensory selectivity

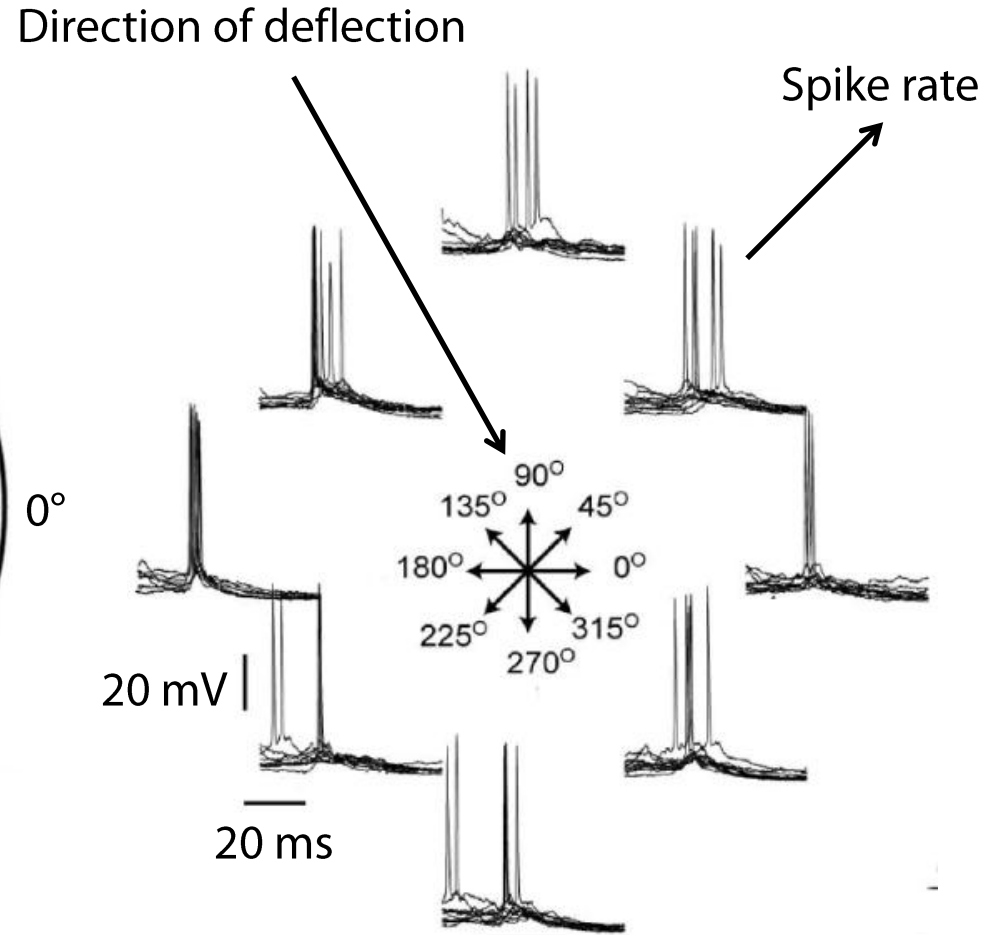
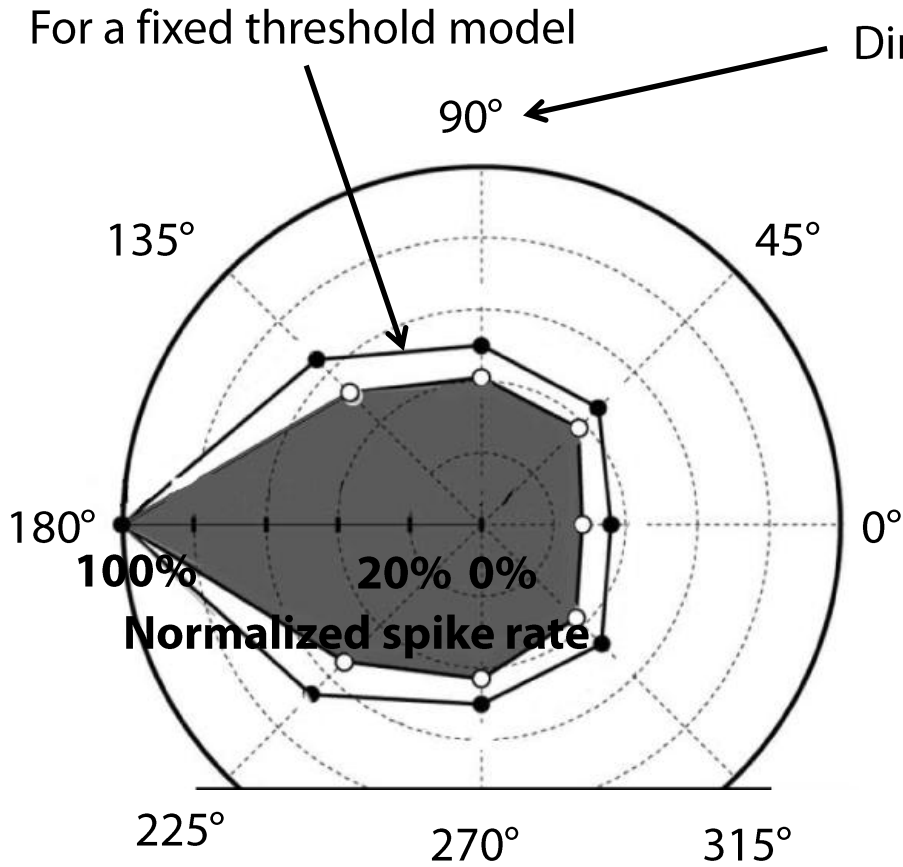

B. The threshold is not fixed

Observations

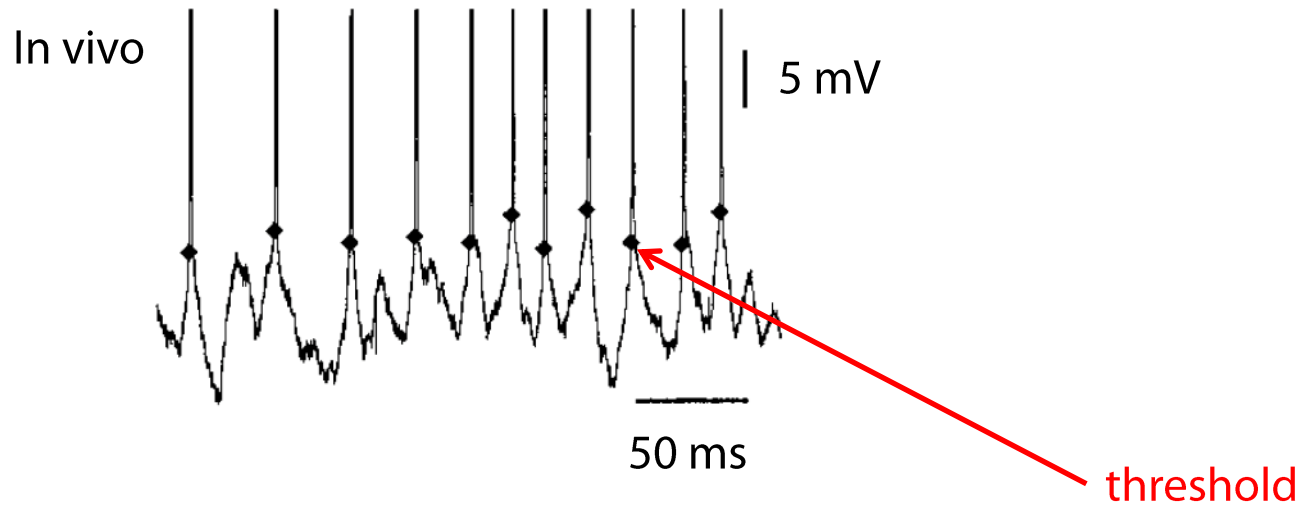

B. The threshold is not fixed

Observations

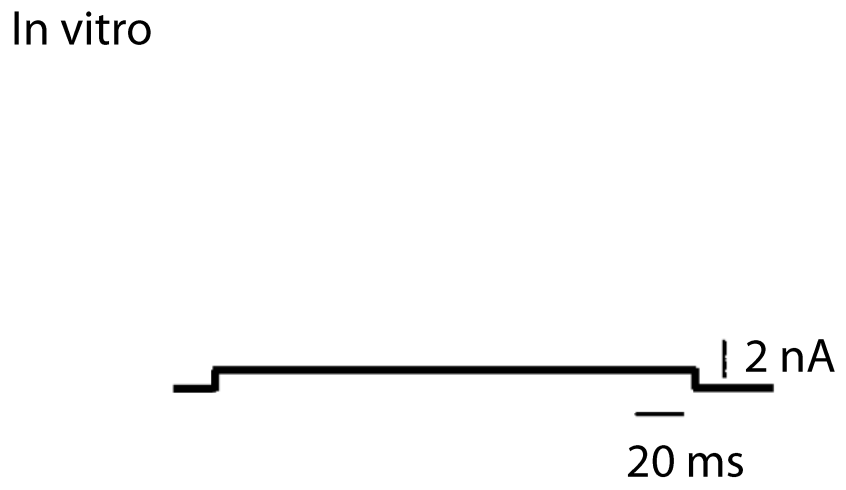
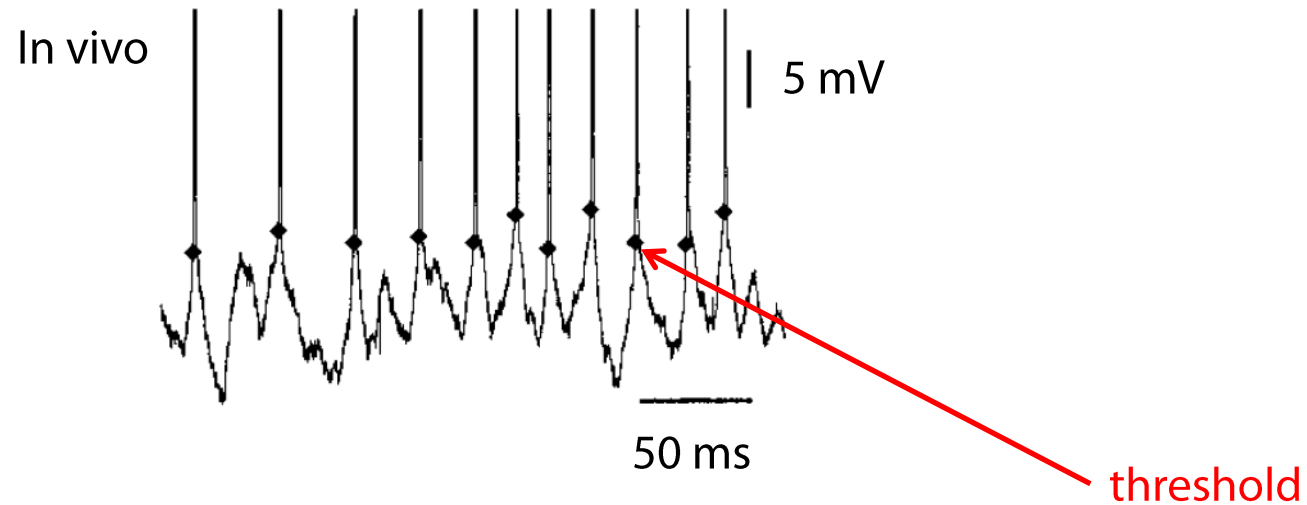

B. The threshold is not fixed

Observations

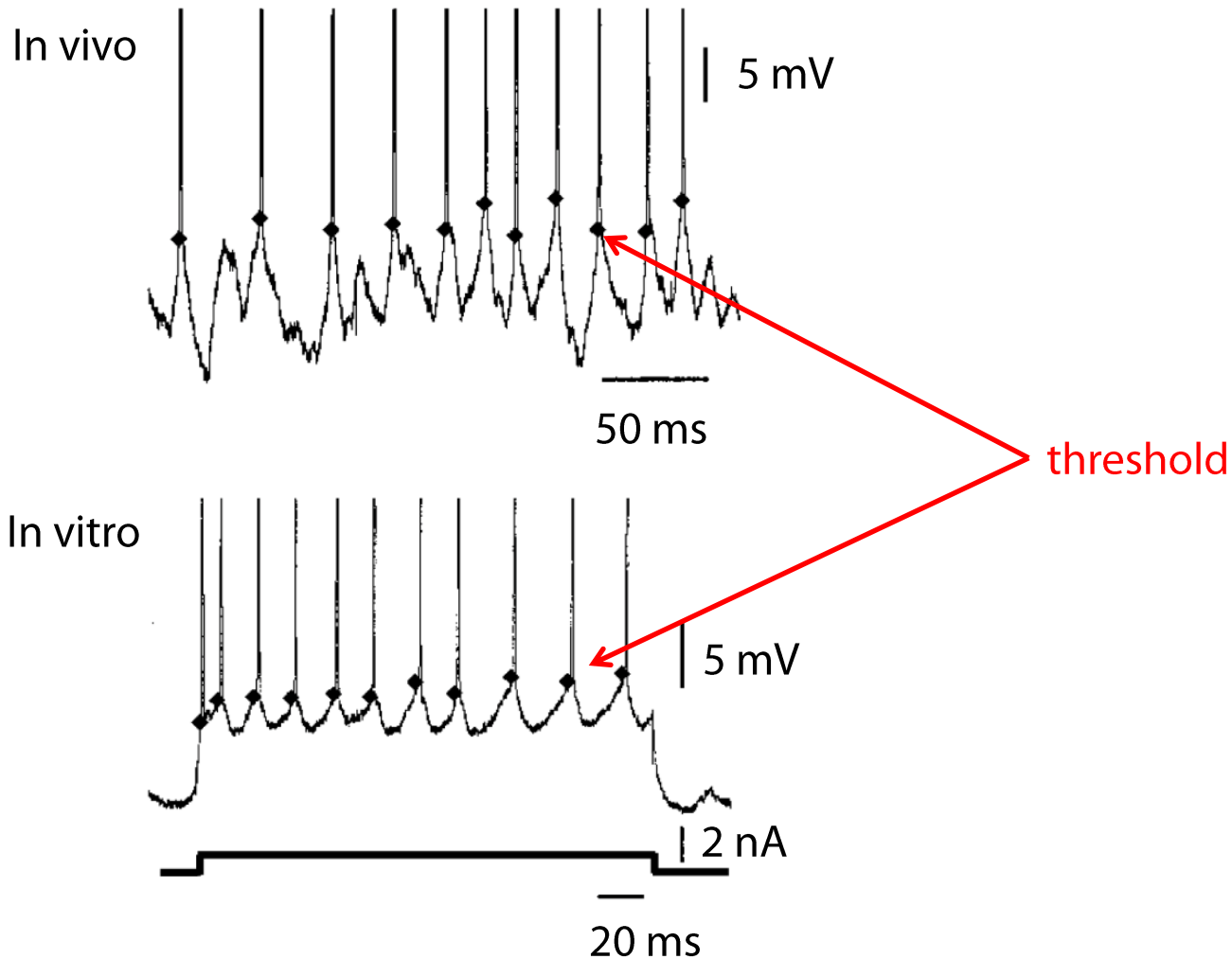

B. The threshold is not fixed

Observations

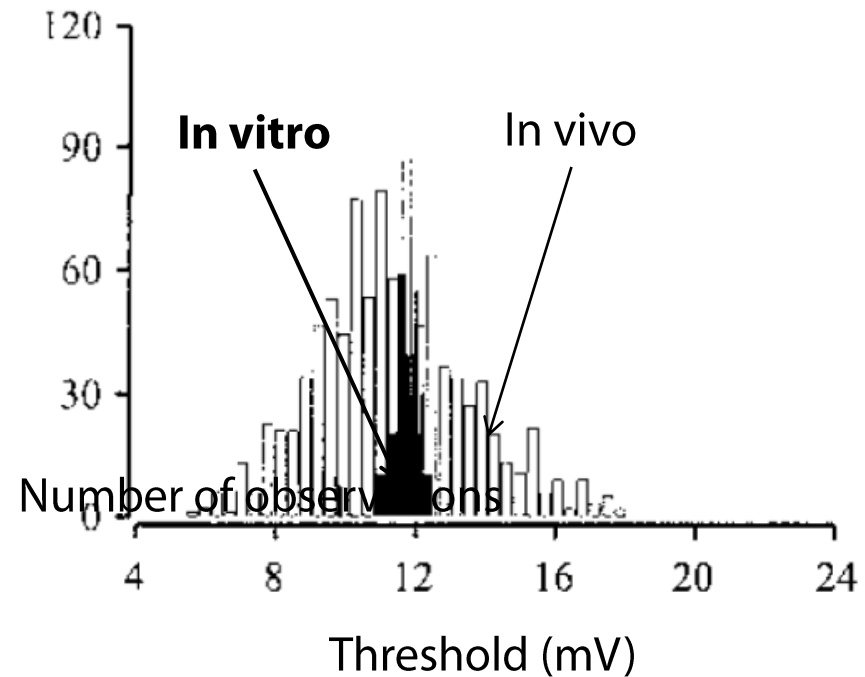
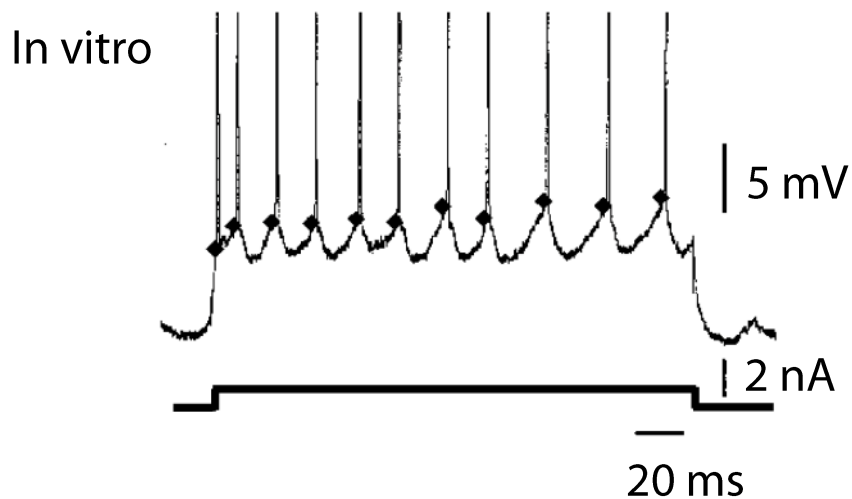
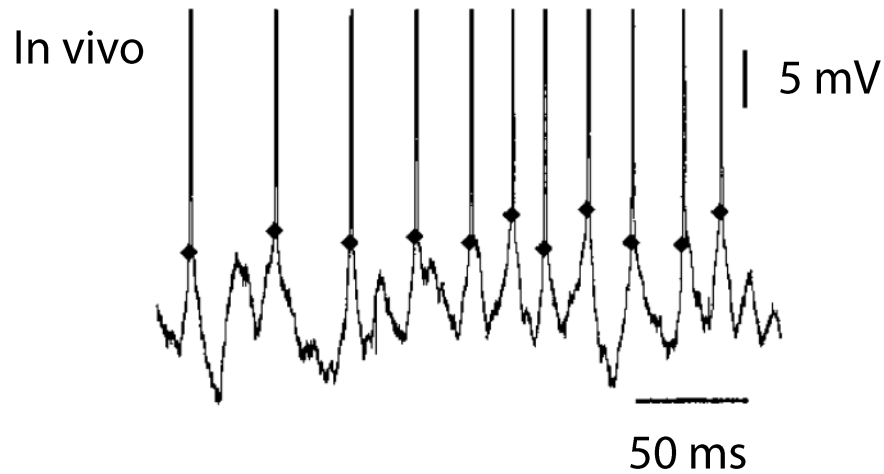

B. The threshold is not fixed

Observations

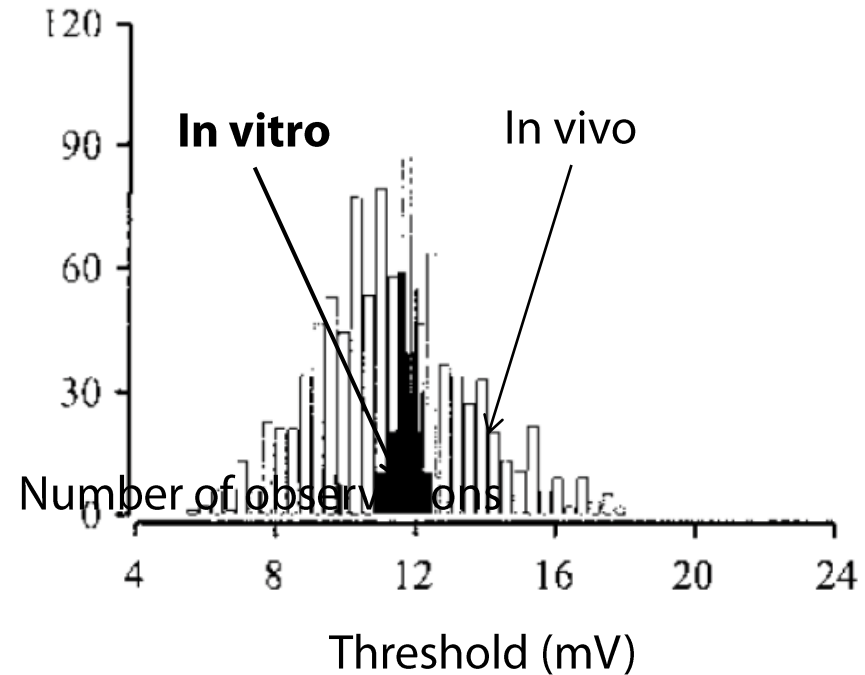
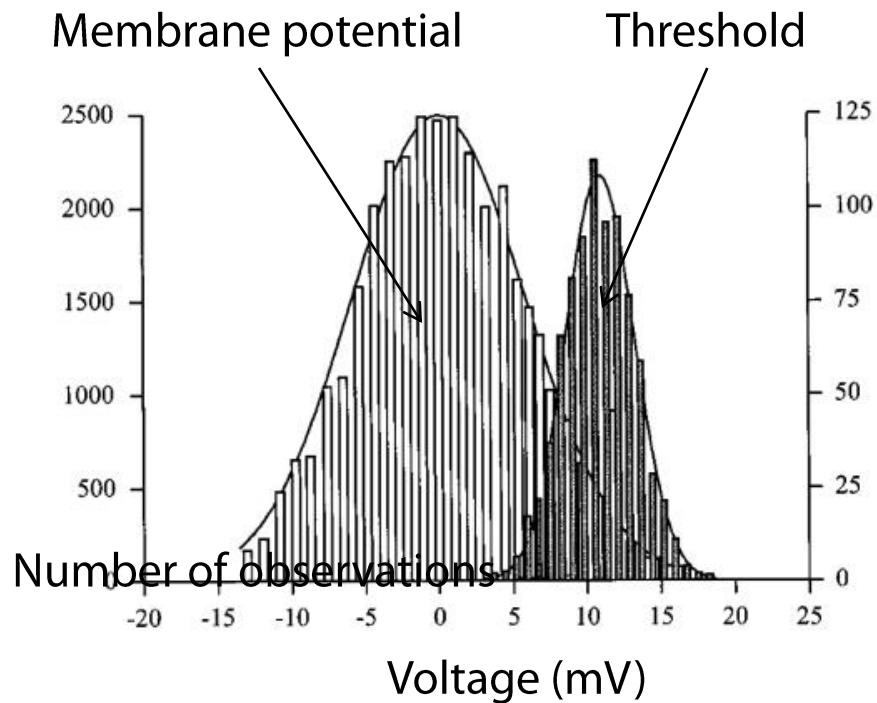

B. The threshold is not fixed

1st issue

How do the different biophysical mechanisms contribute to threshold variability?

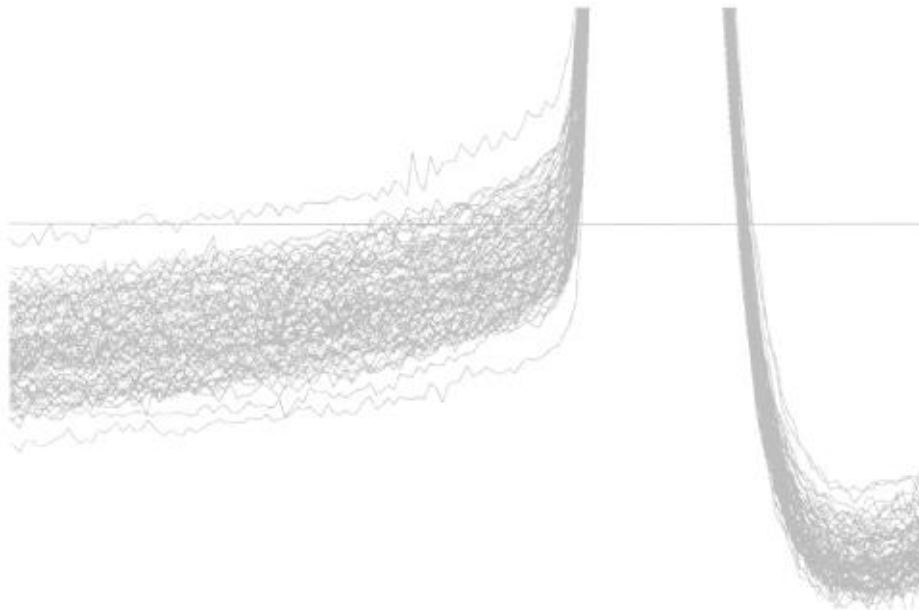

C. Action potential initiation

Controversy

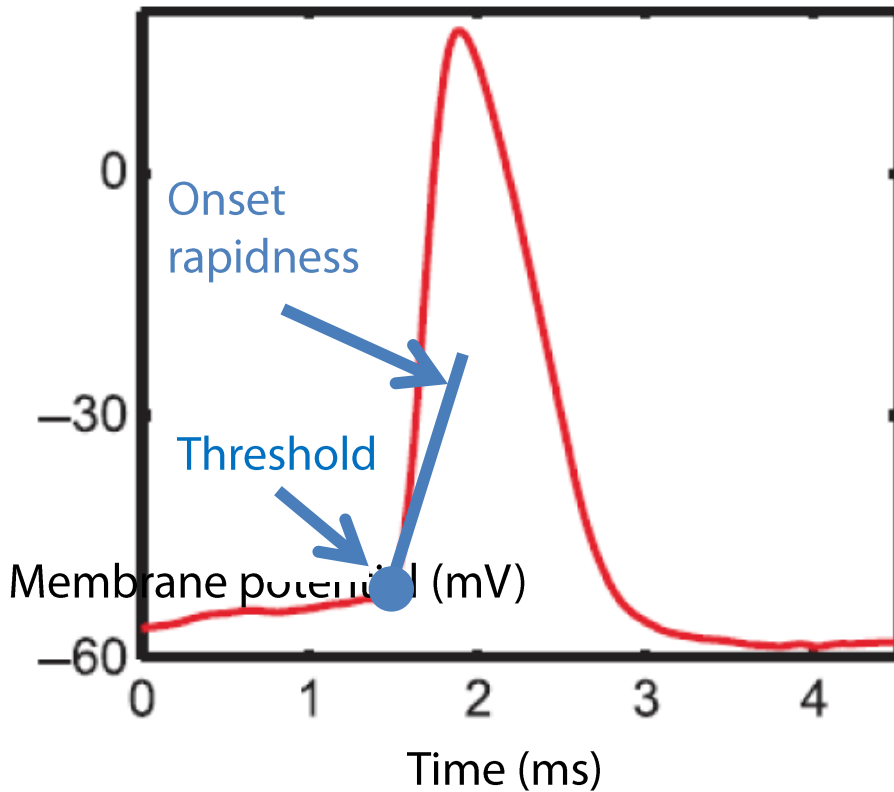

$$\text{onset rapidness} = \frac{\Delta dV / dt}{\Delta V} (V = \text{Threshold})$$

C. Action potential initiation

Controversy

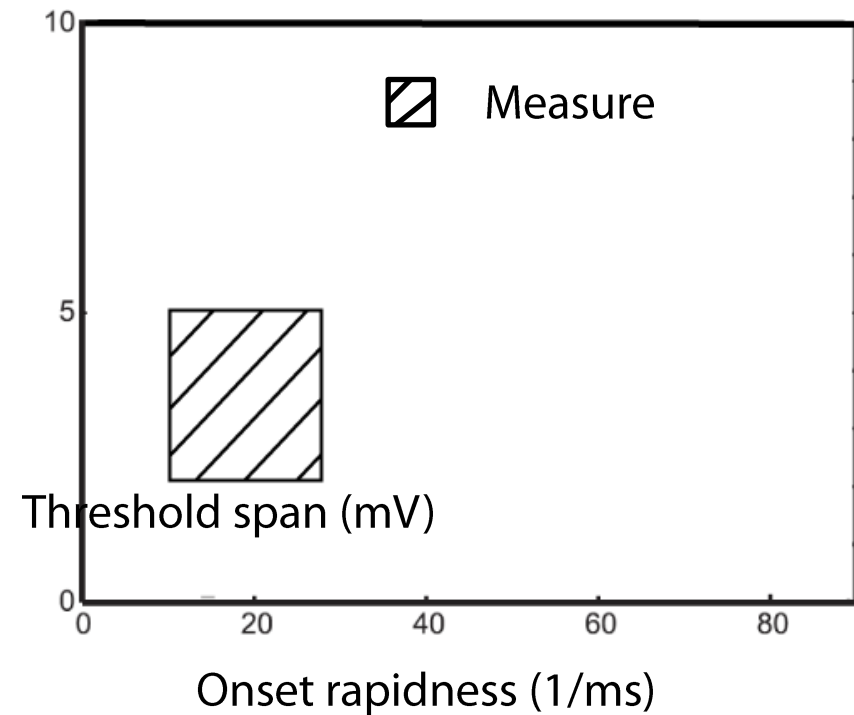
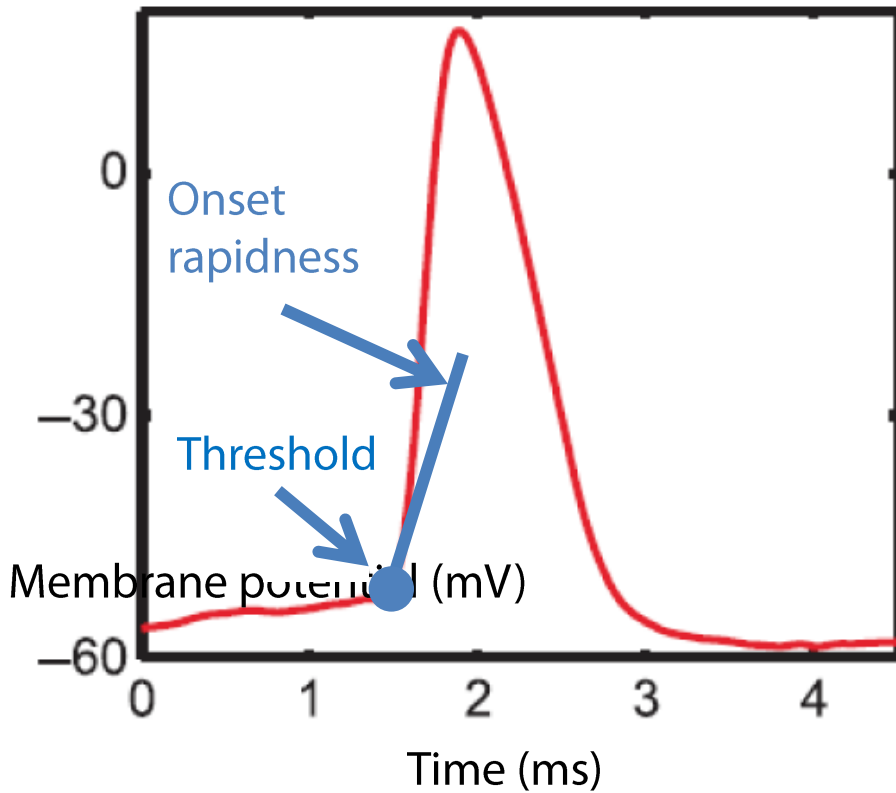

C. Action potential initiation

Controversy

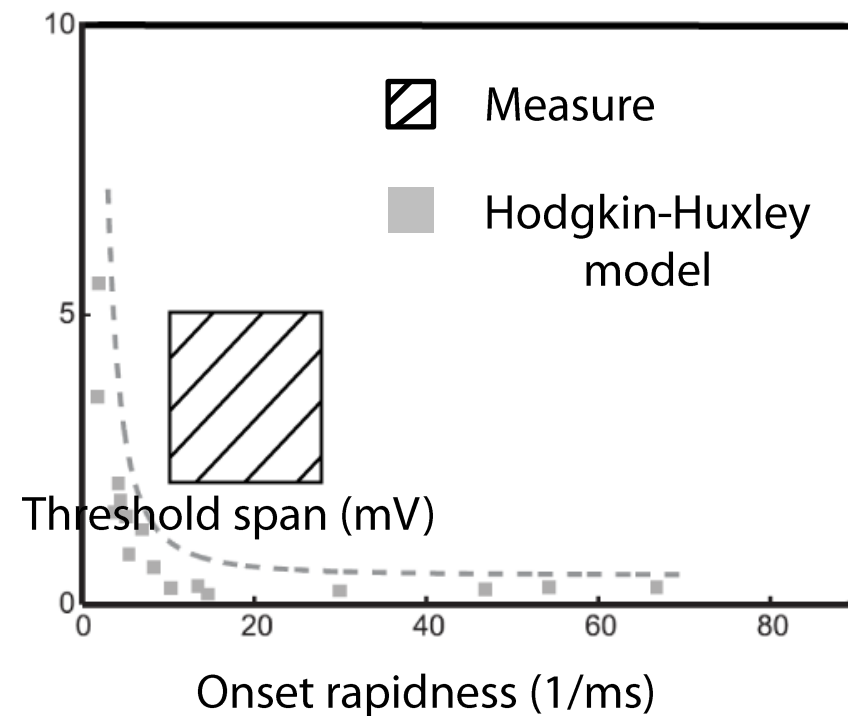
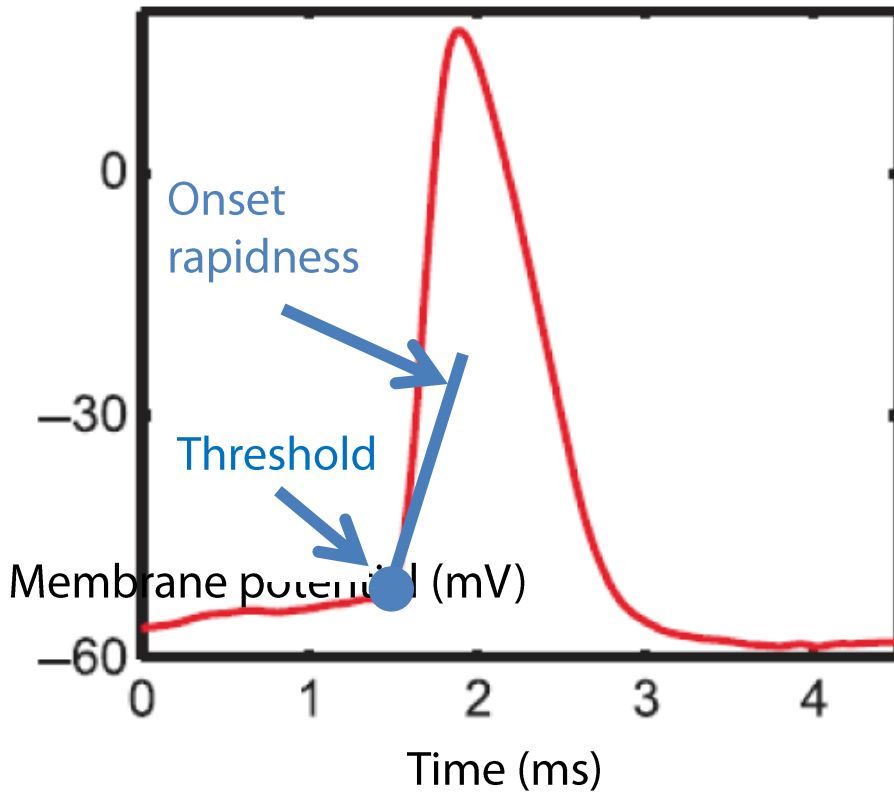

C. Action potential initiation

Controversy

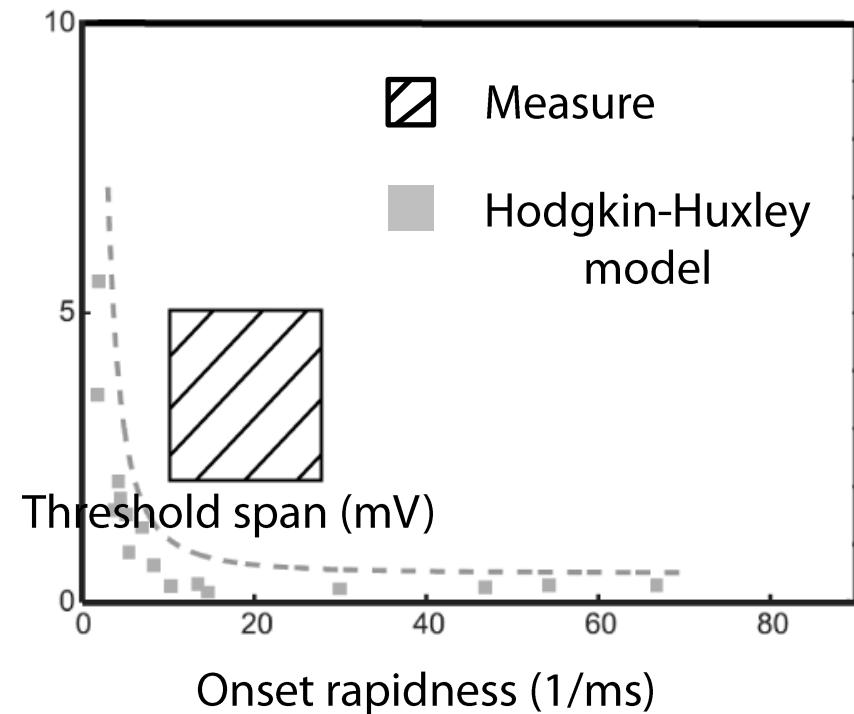
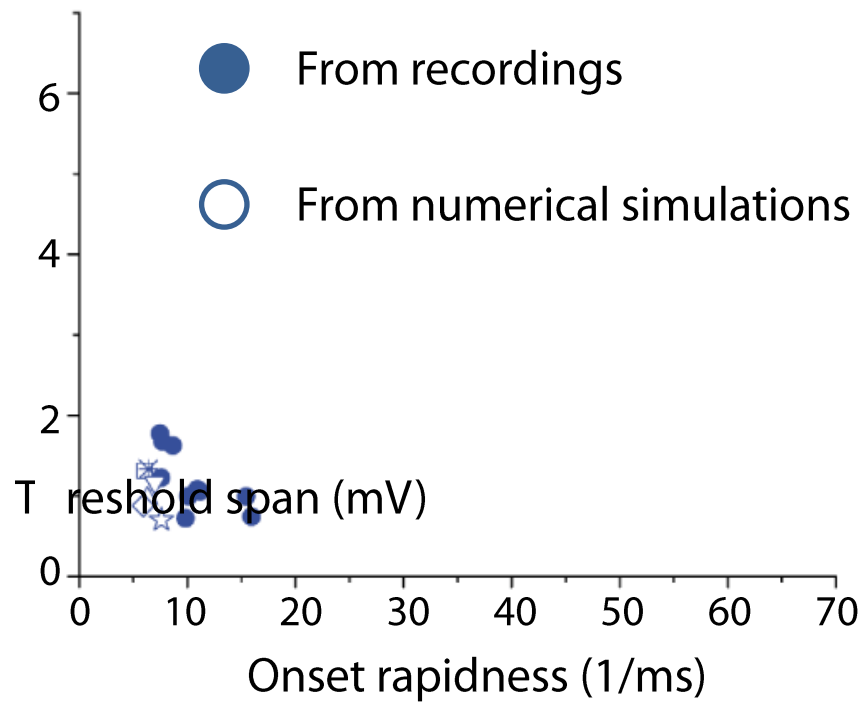

C. Action potential initiation

2nd issue

Can the original Hodgkin-Huxley model account for a substantial threshold variability?

D. The threshold is moving

Observations

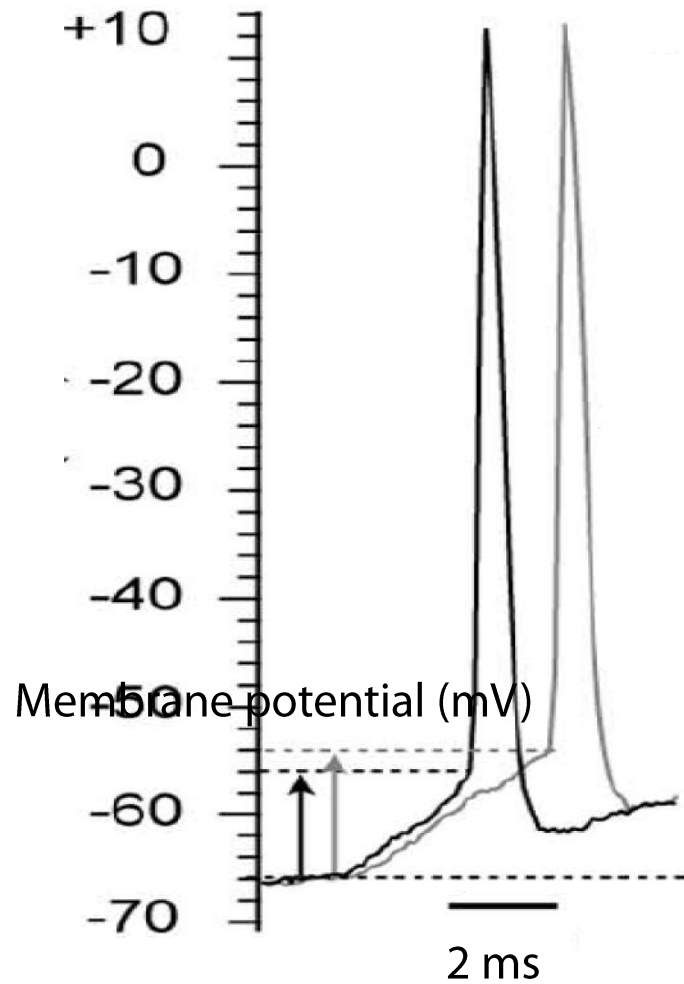

D. The threshold is moving

Observations

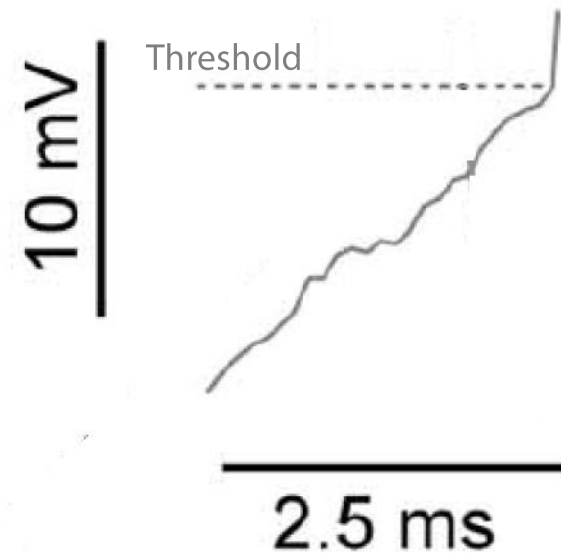
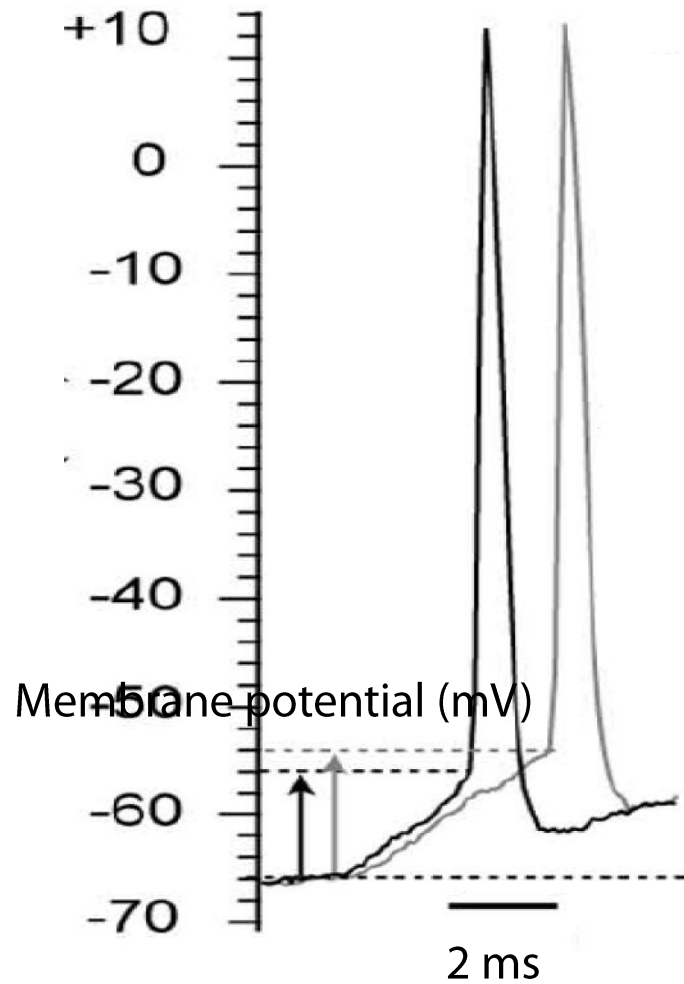

D. The threshold is moving

Observations

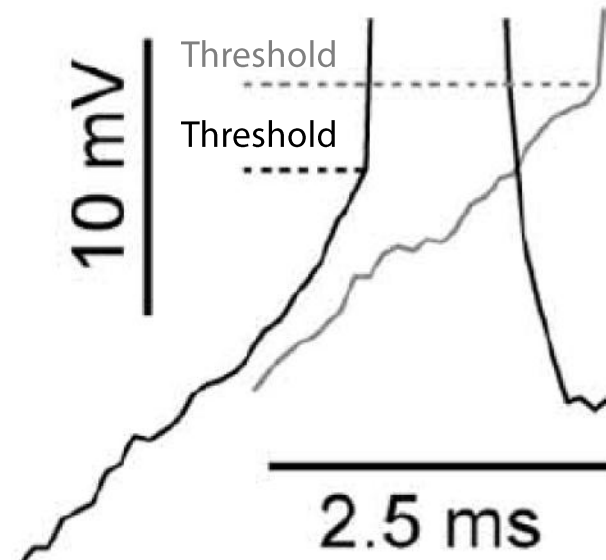
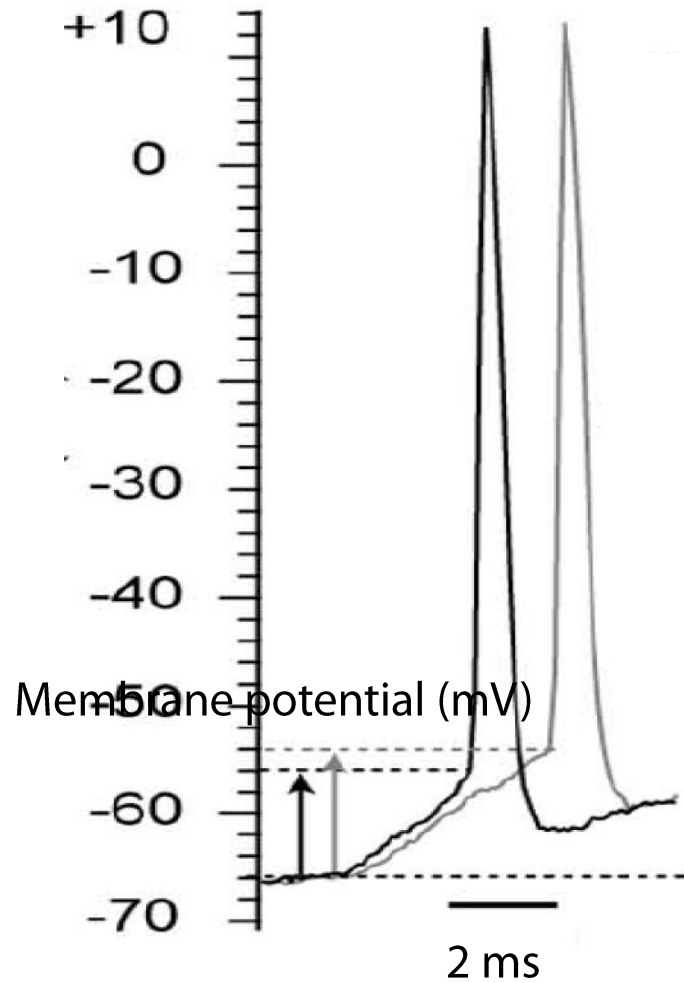

D. The threshold is moving

Observations

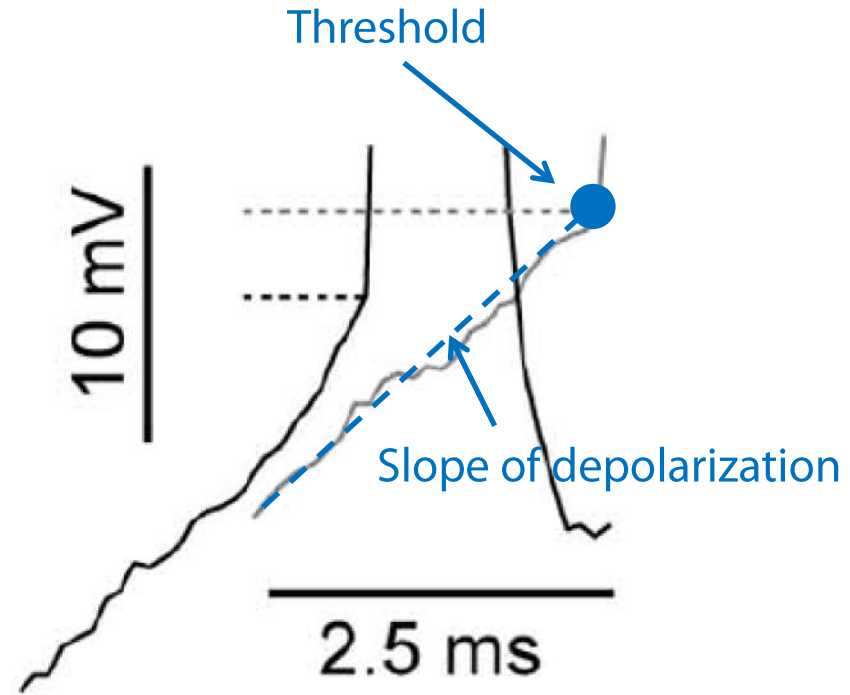
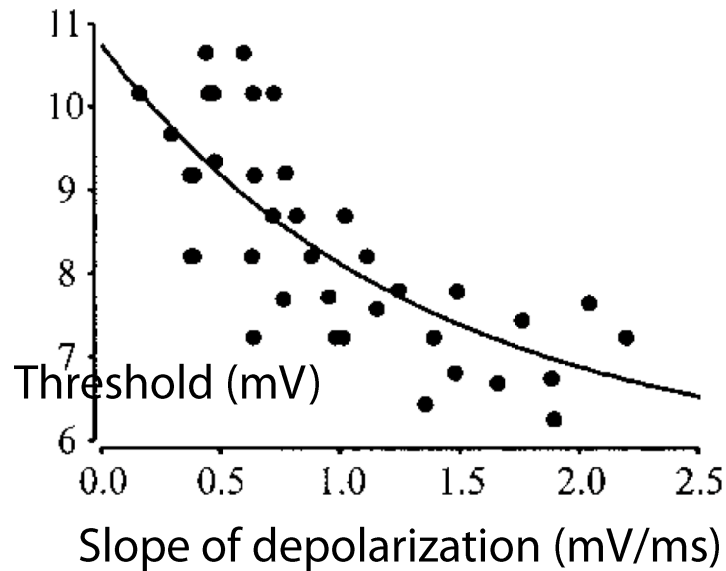

D. The threshold is moving

Observations

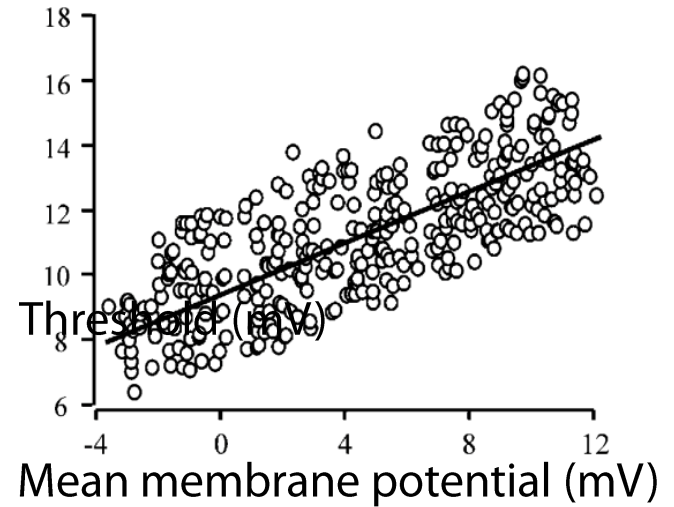
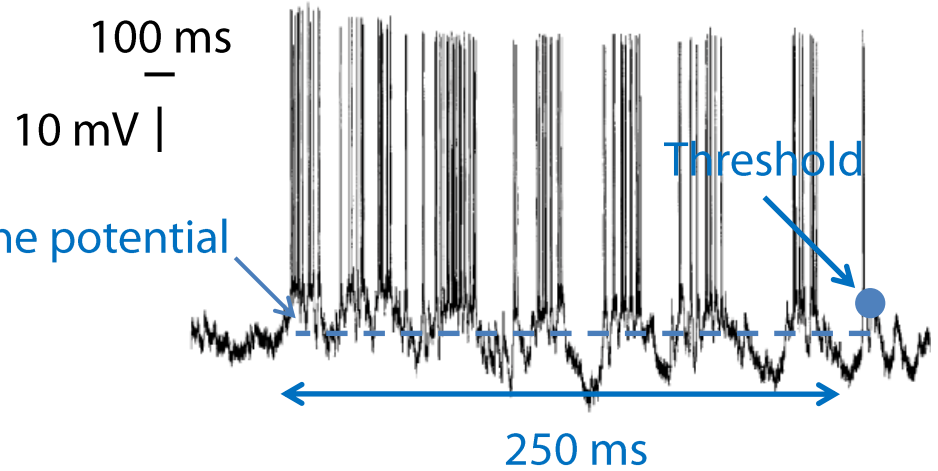
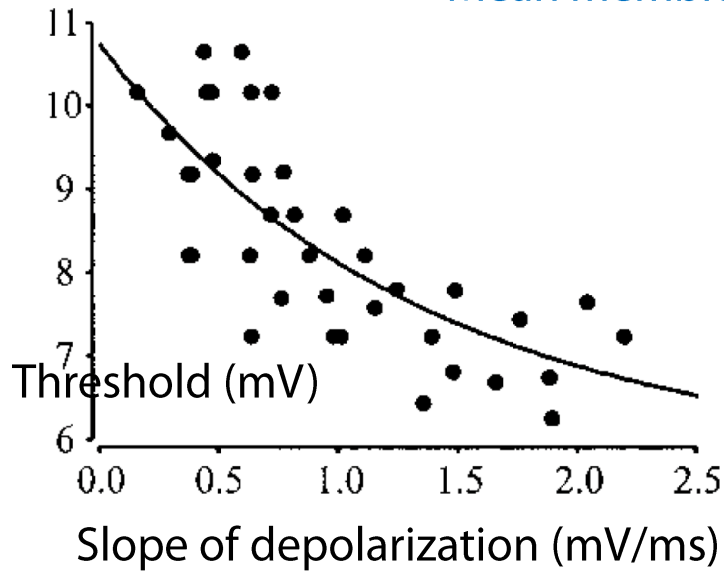

D. The threshold is moving

Synaptic integration

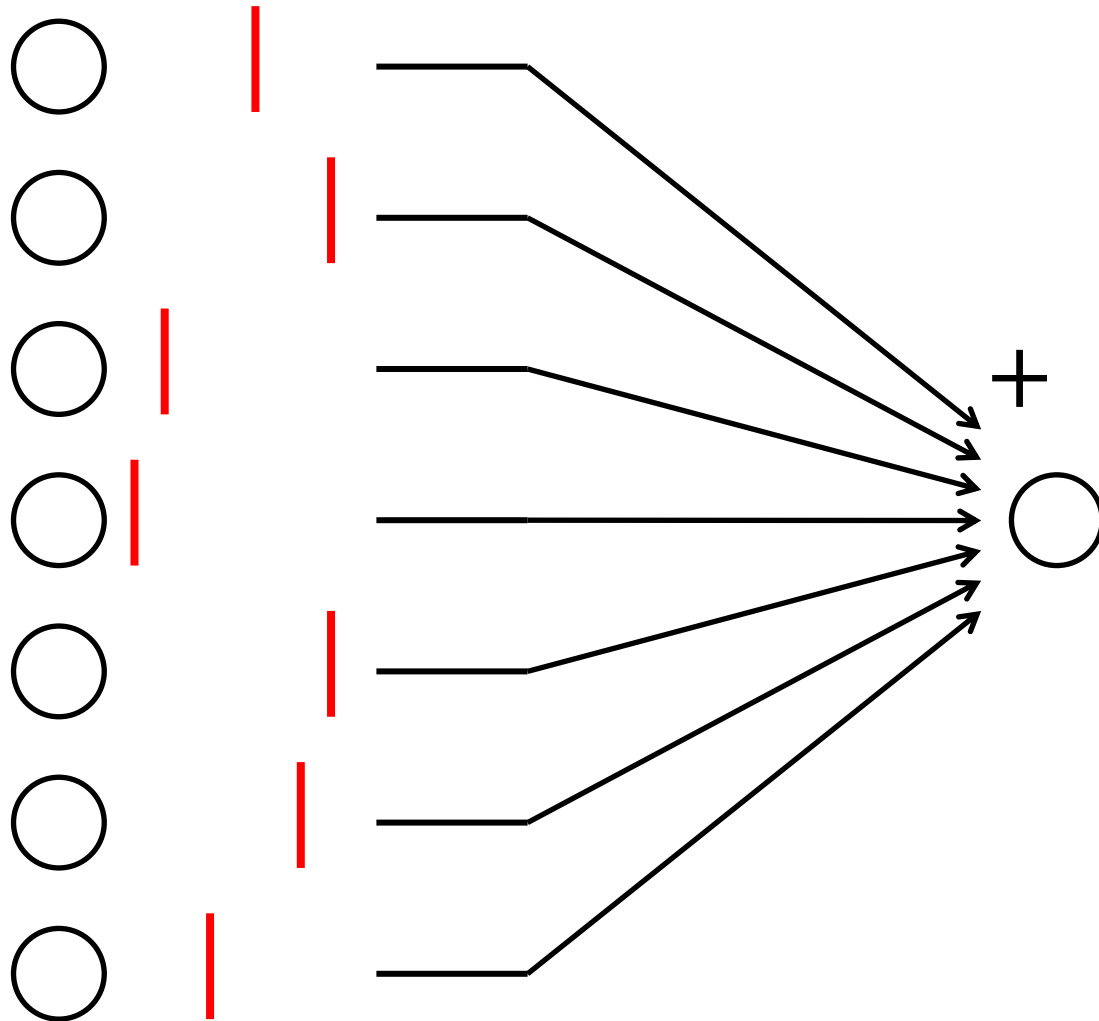

D. The threshold is moving

Synaptic integration

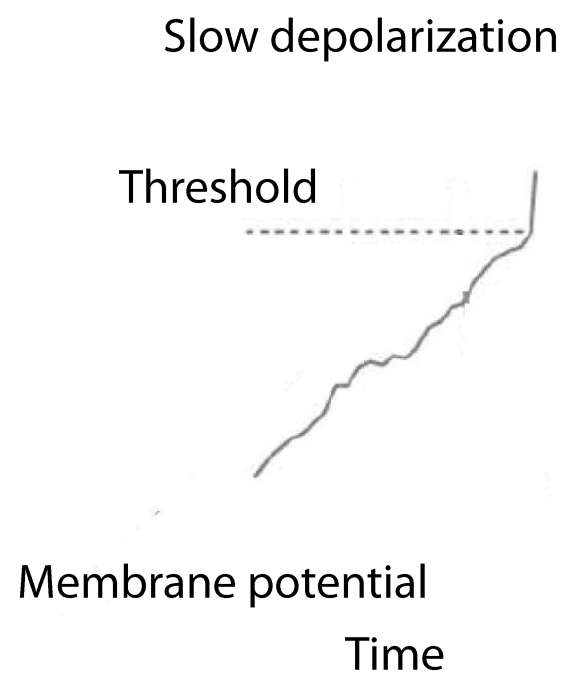
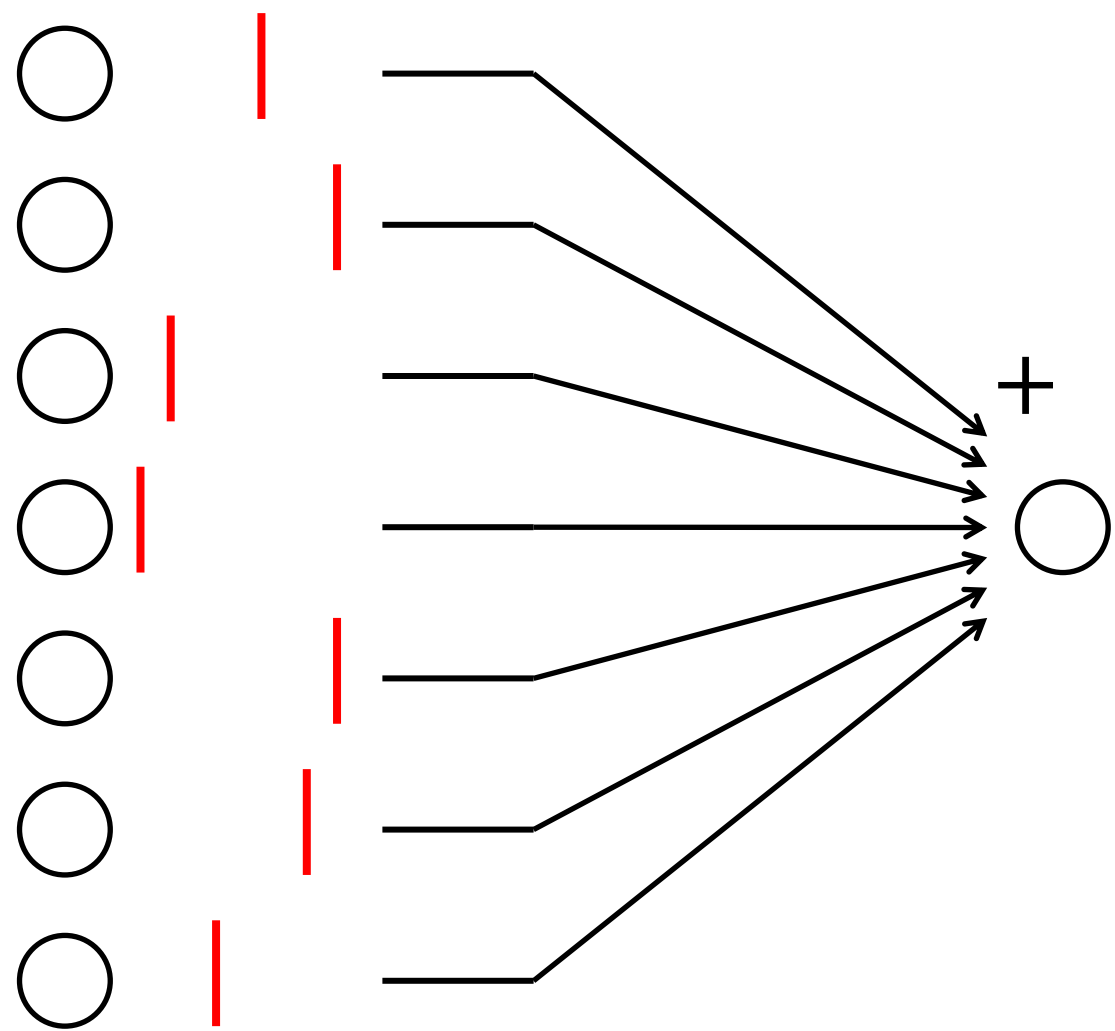

D. The threshold is moving

Synaptic integration

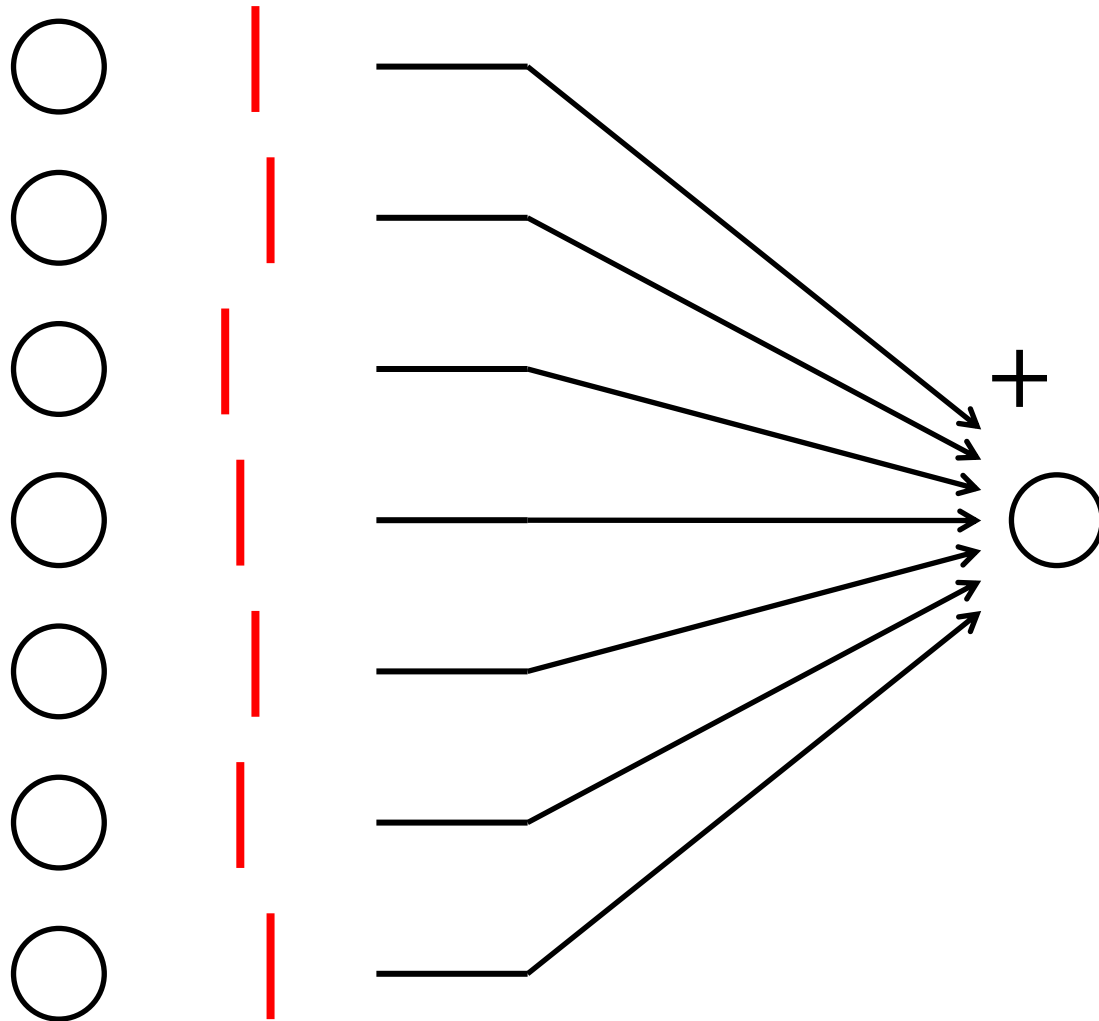

D. The threshold is moving

Synaptic integration

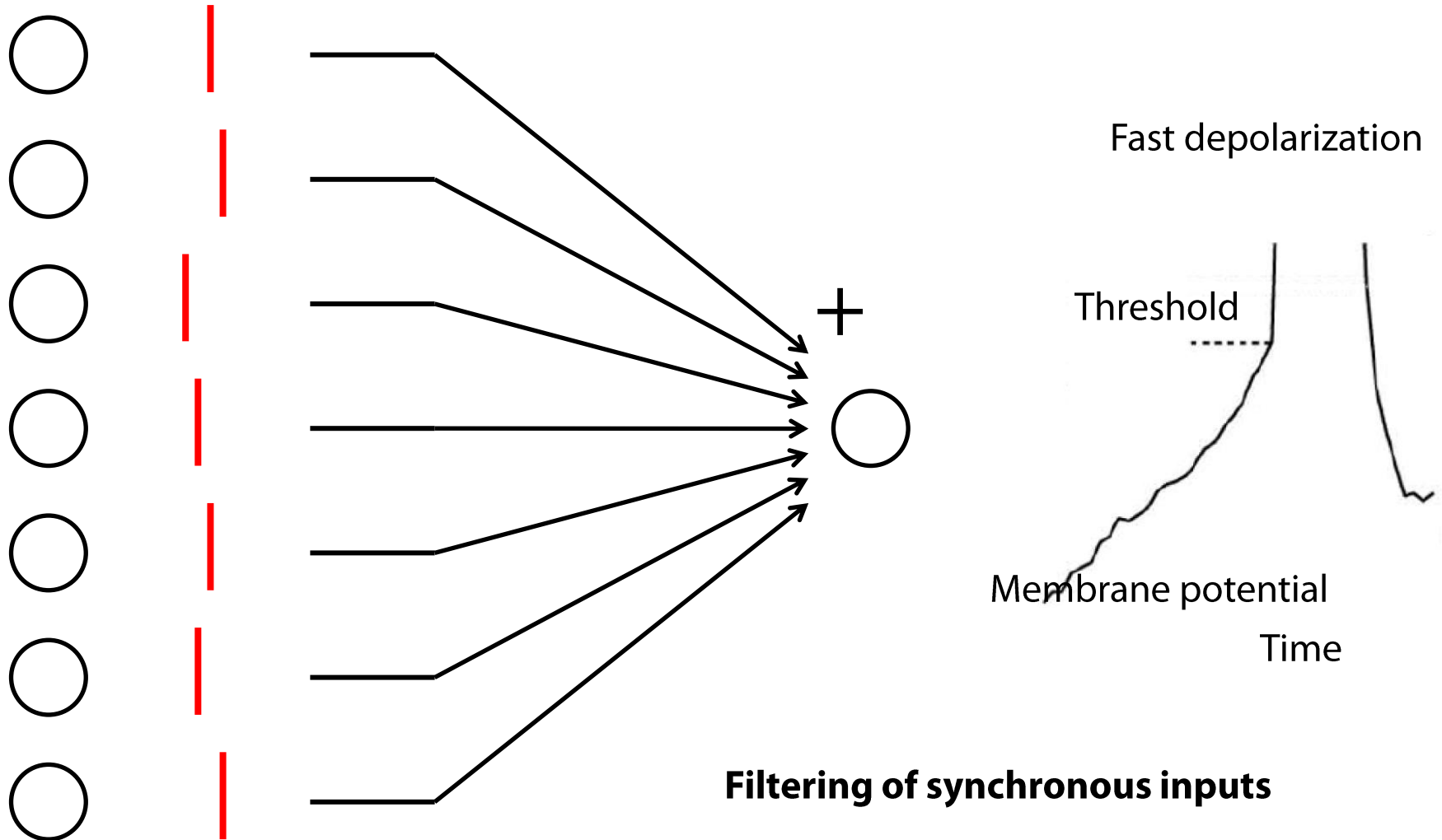

How does Na channel inactivation shape synaptic activity?

1. Experimental framework

2. Threshold basics

3. Threshold variability prediction

4. Impact of Na channel inactivation

A. Threshold definition

A. Threshold definition

In vitro

Input current

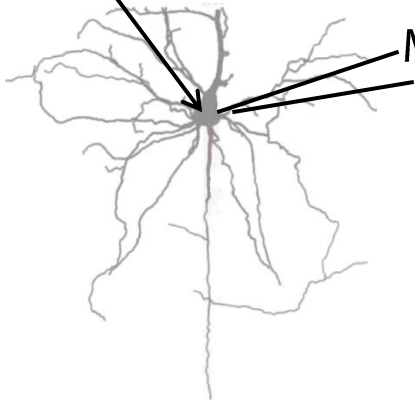

Membrane potential

Membrane potential



Input current

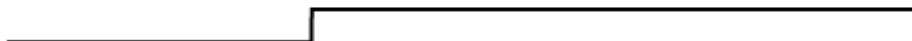

Time

A. Threshold definition

In vitro

Input current

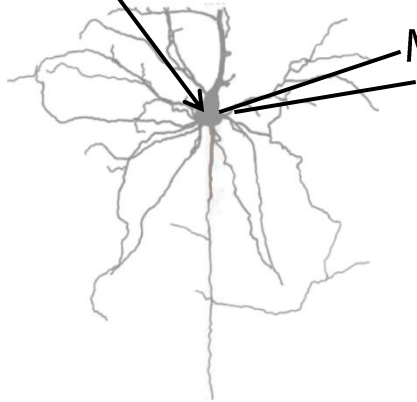

Membrane potential

Membrane potential

Input current

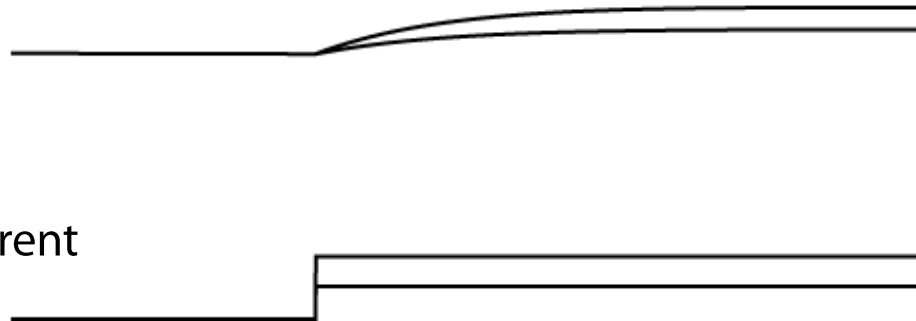

Time

A. Threshold definition

In vitro

Input current

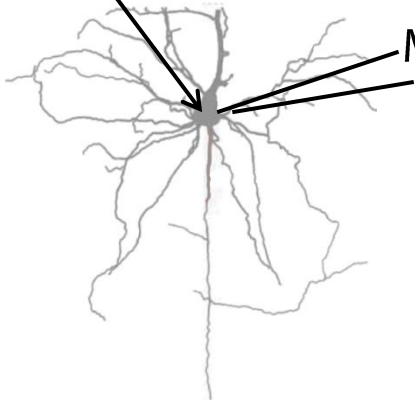

Membrane potential

Membrane potential



Input current

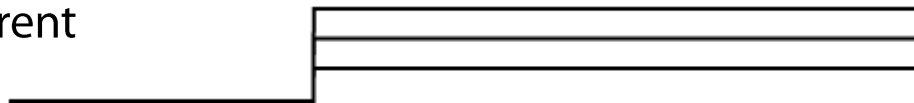

Time

A. Threshold definition

In vitro

Input current

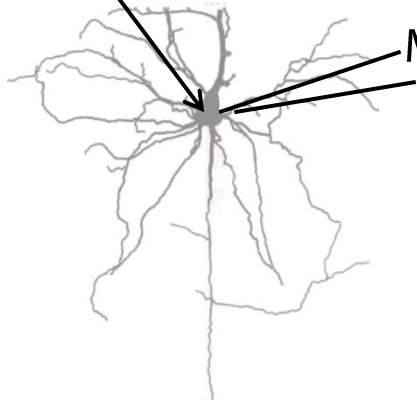

Membrane potential

Membrane potential



Input current

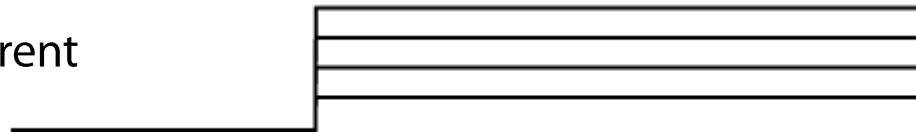

Time

A. Threshold definition

In vitro

Input current

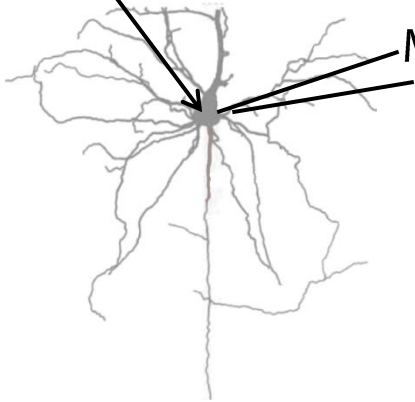

Membrane potential

Voltage at current threshold

Membrane potential

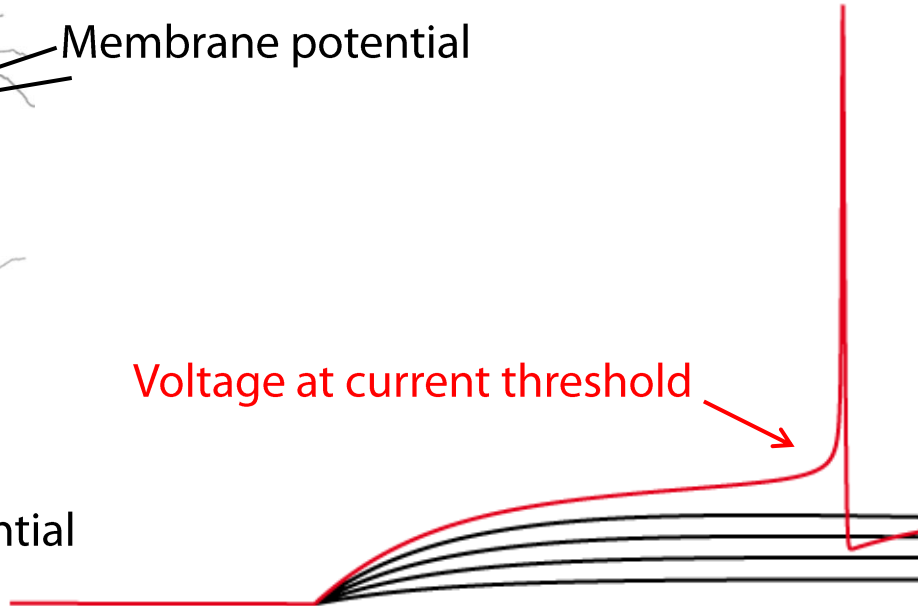

Input current

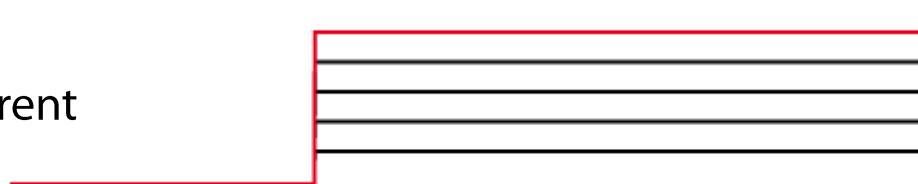

Current threshold

Time

A. Threshold definition

Dynamical system

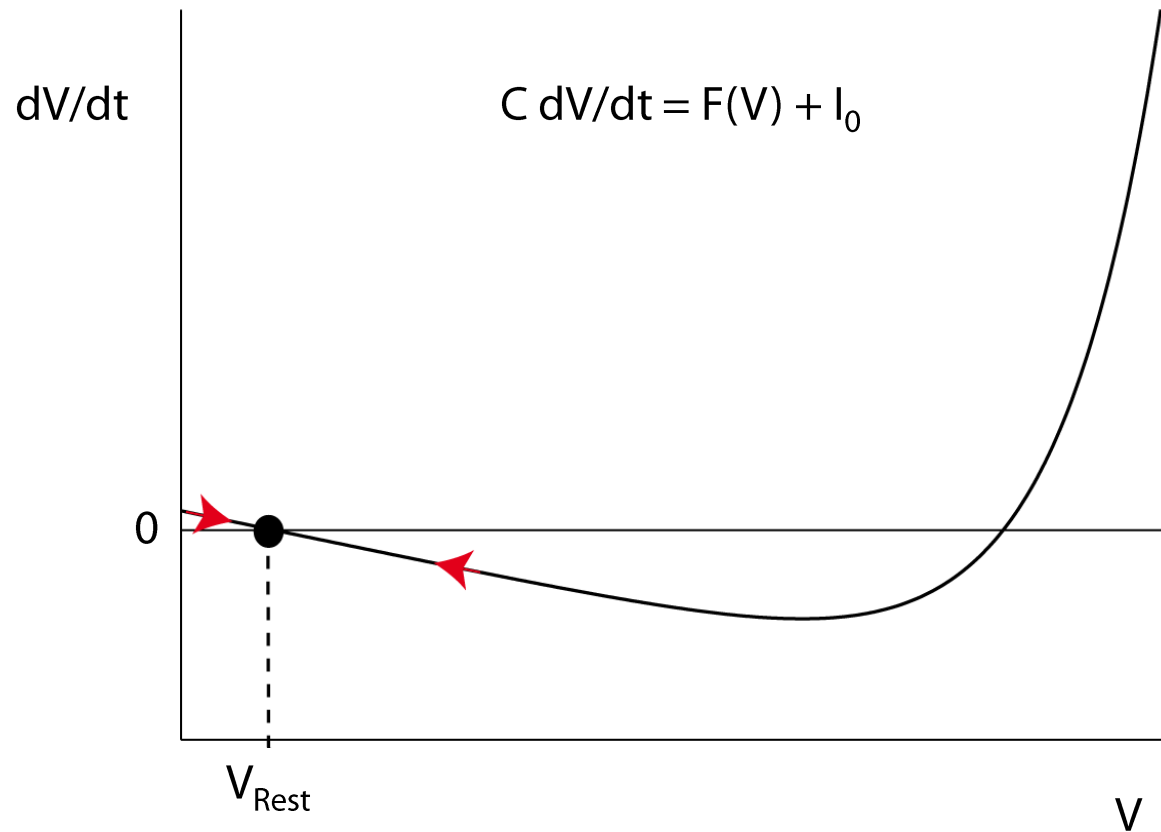

A. Threshold definition

Dynamical system

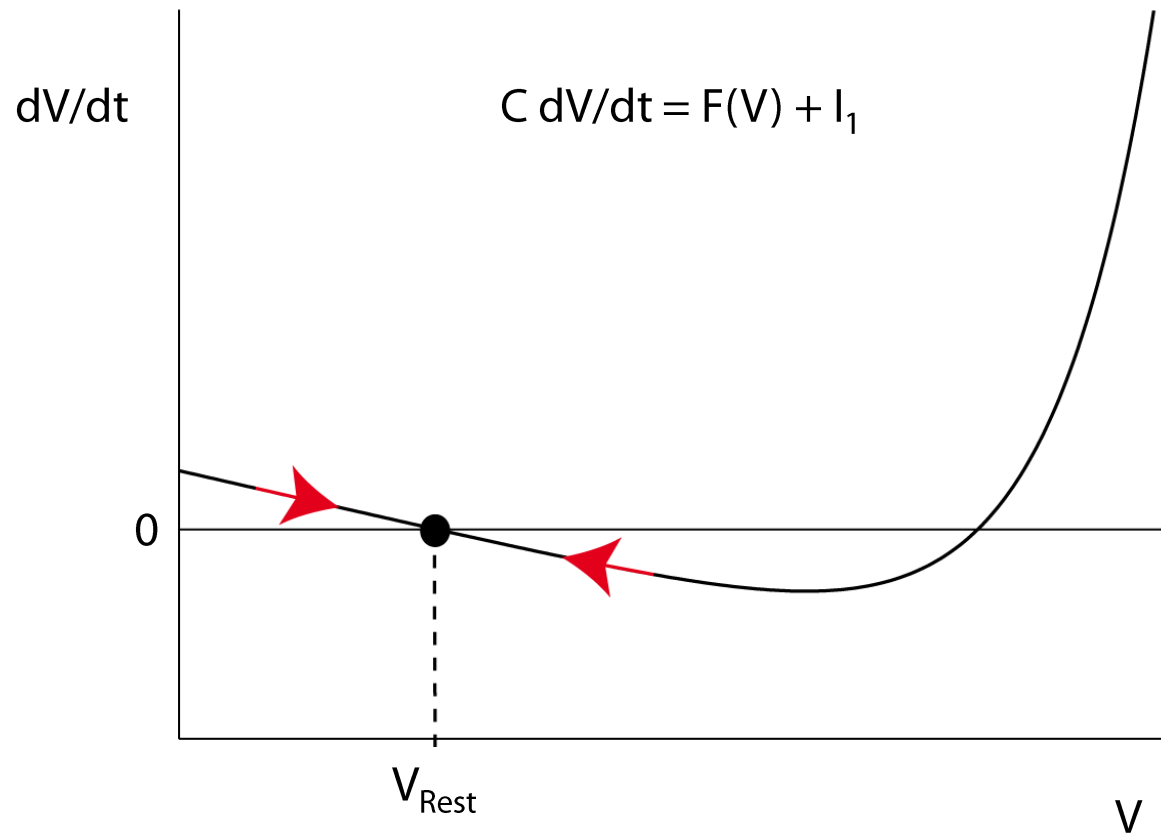

A. Threshold definition

Dynamical system

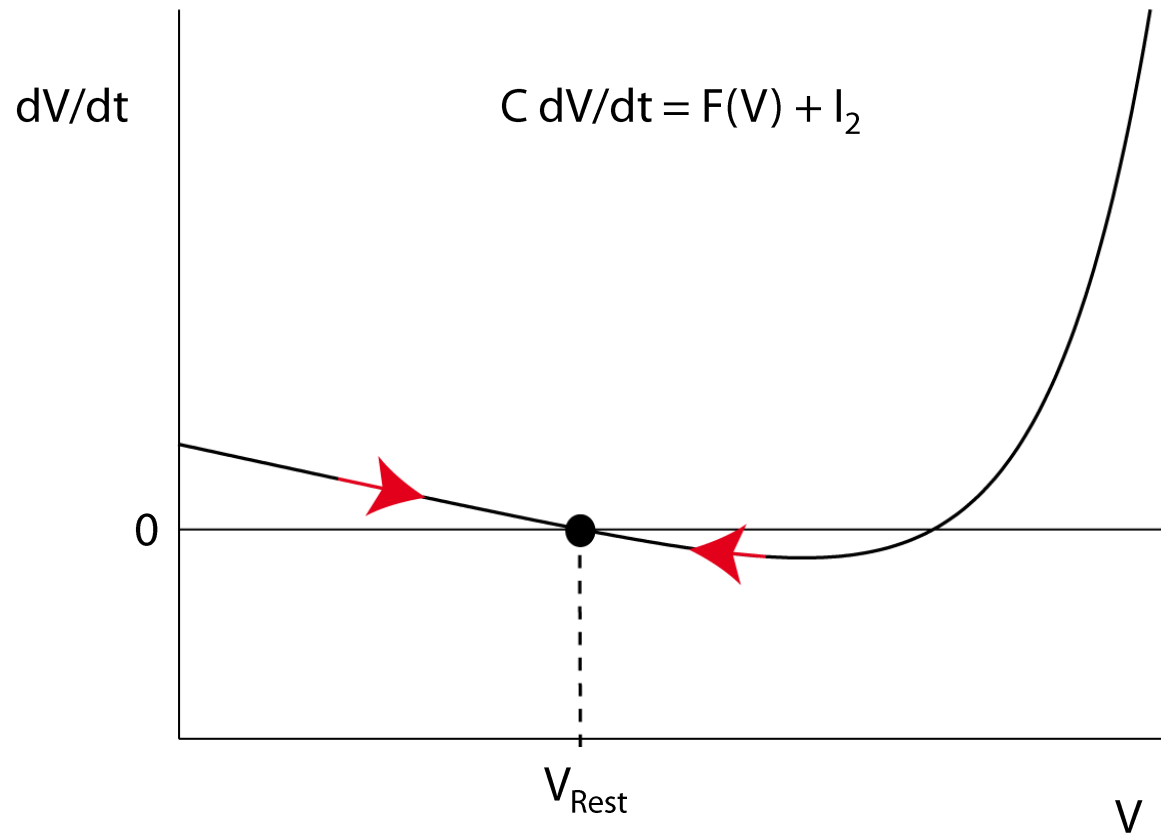

A. Threshold definition

Dynamical system

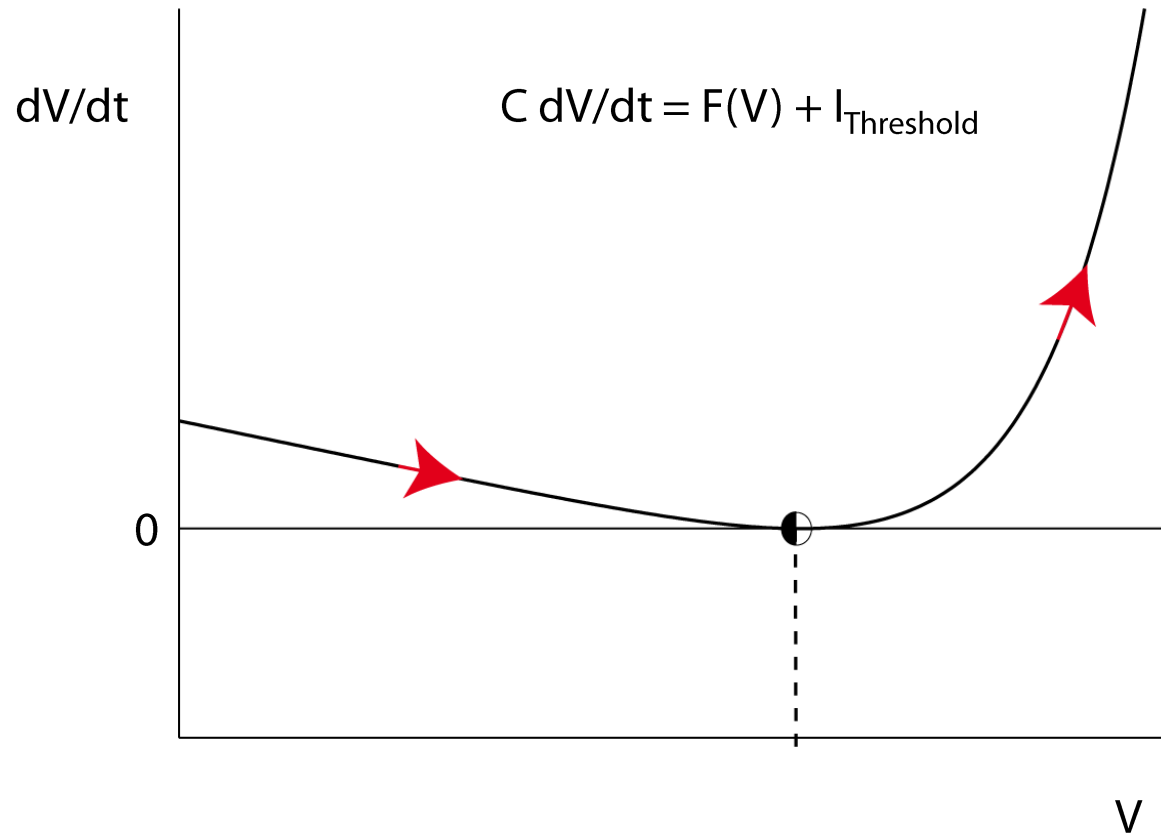

A. Threshold definition

Dynamical system

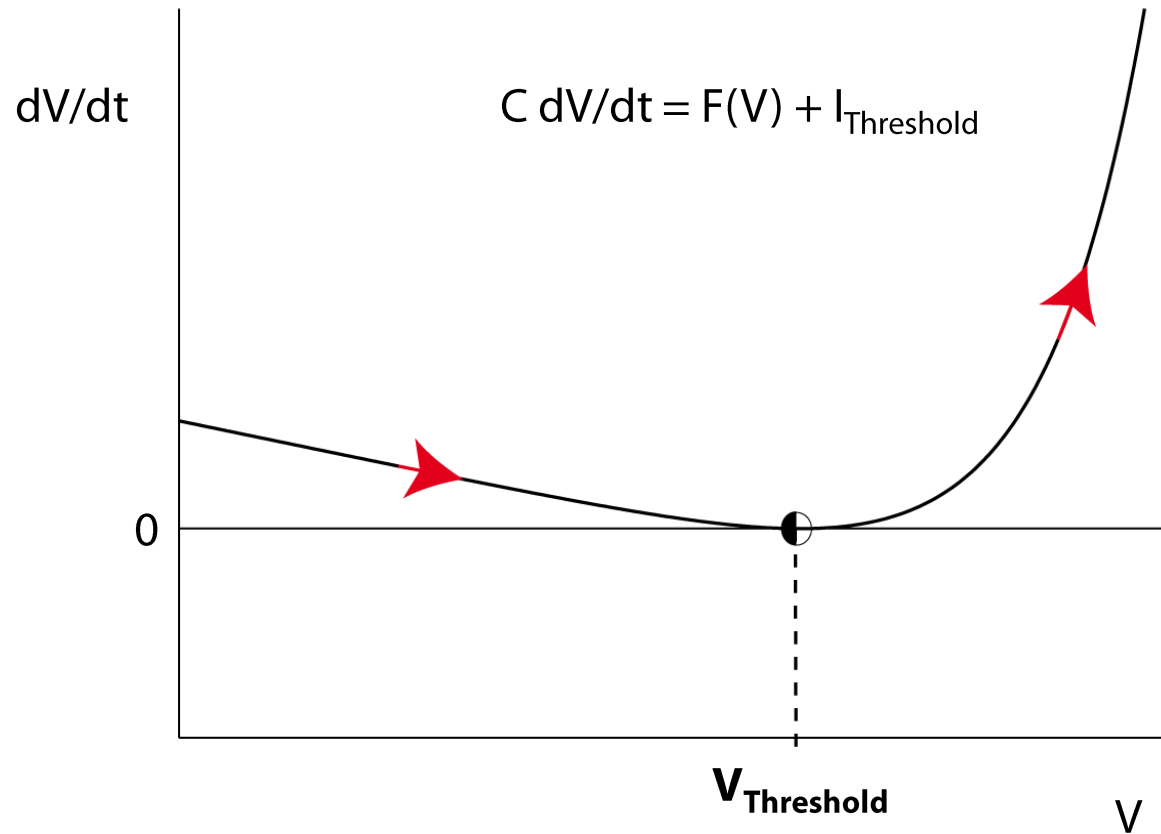

A. Threshold definition

In vivo

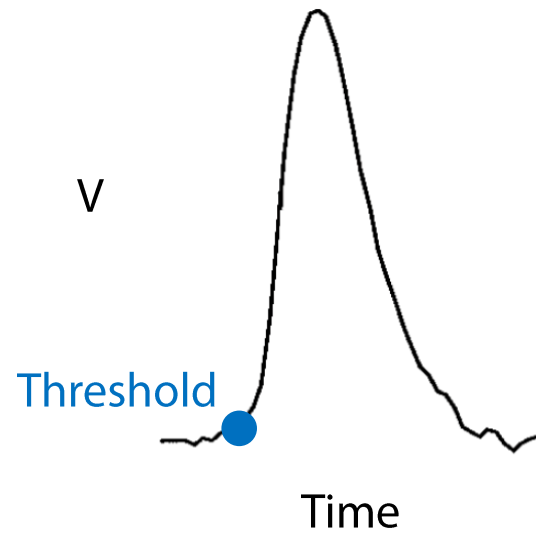

A. Threshold definition

In vivo

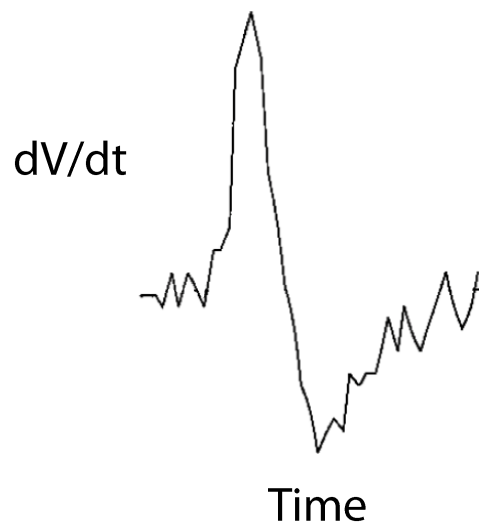
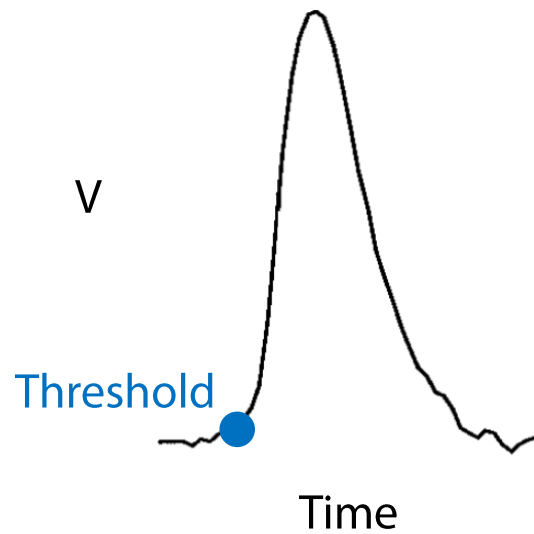

A. Threshold definition

In vivo

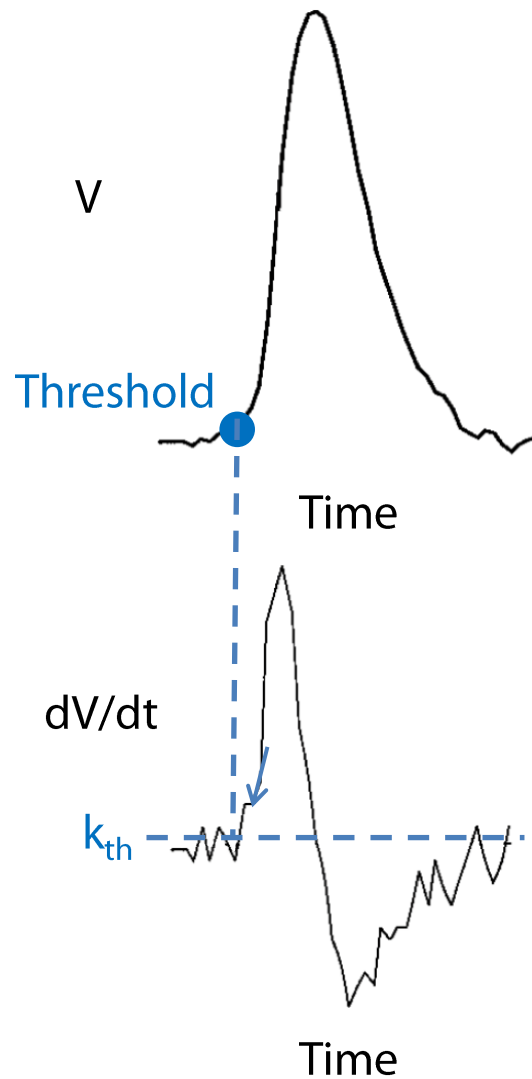

A. Threshold definition

In vivo

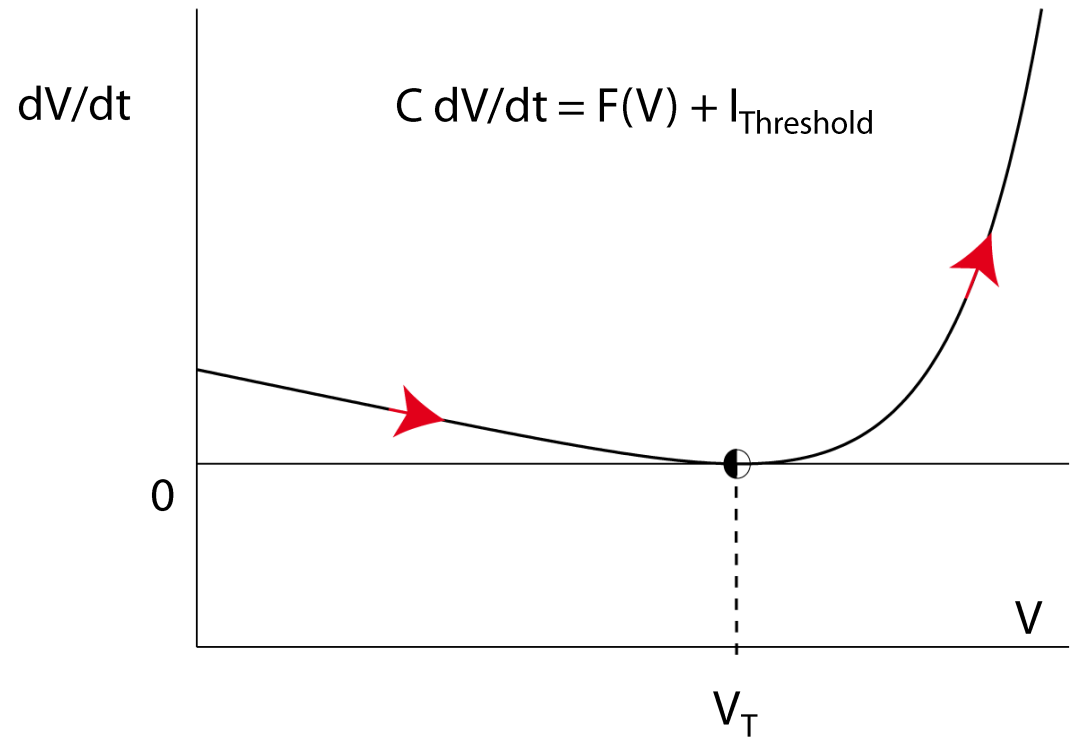
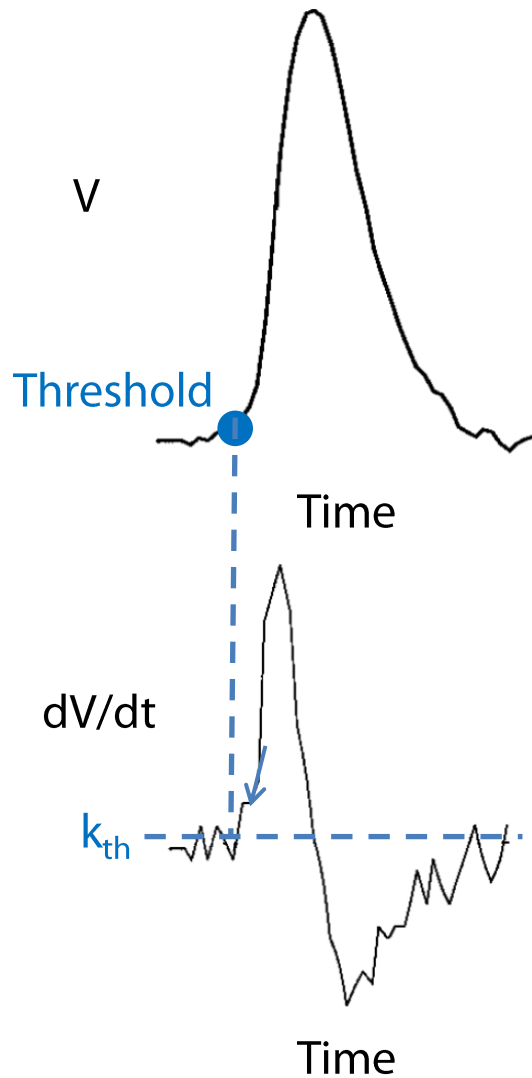

A. Threshold definition

In vivo

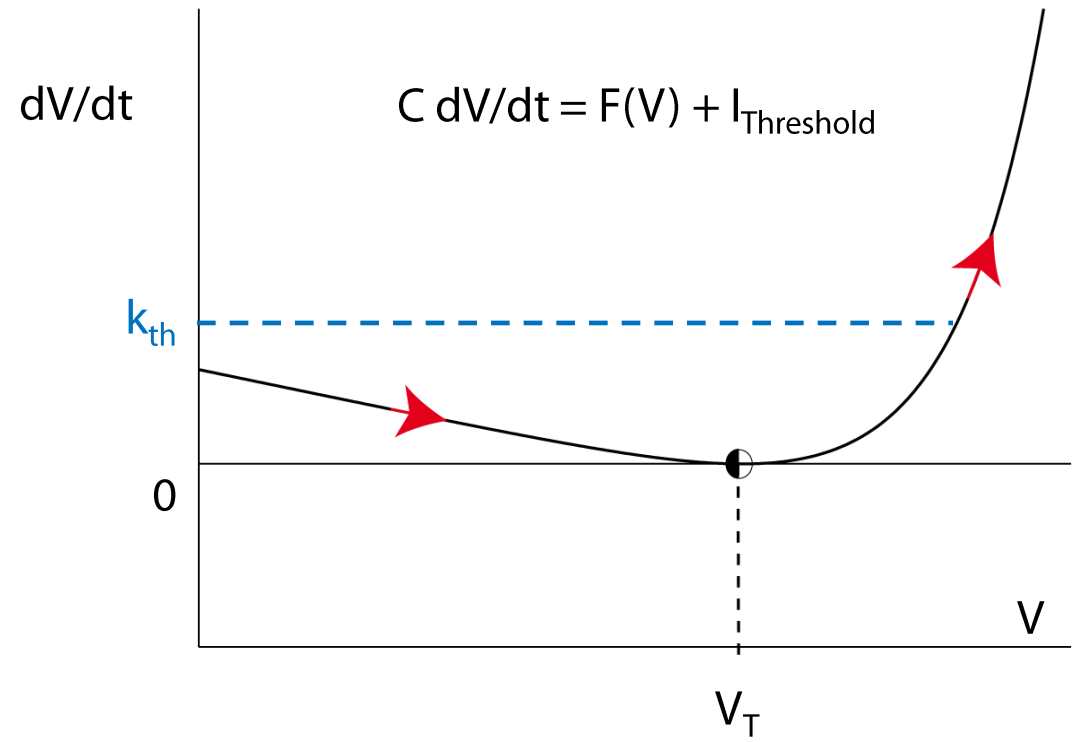
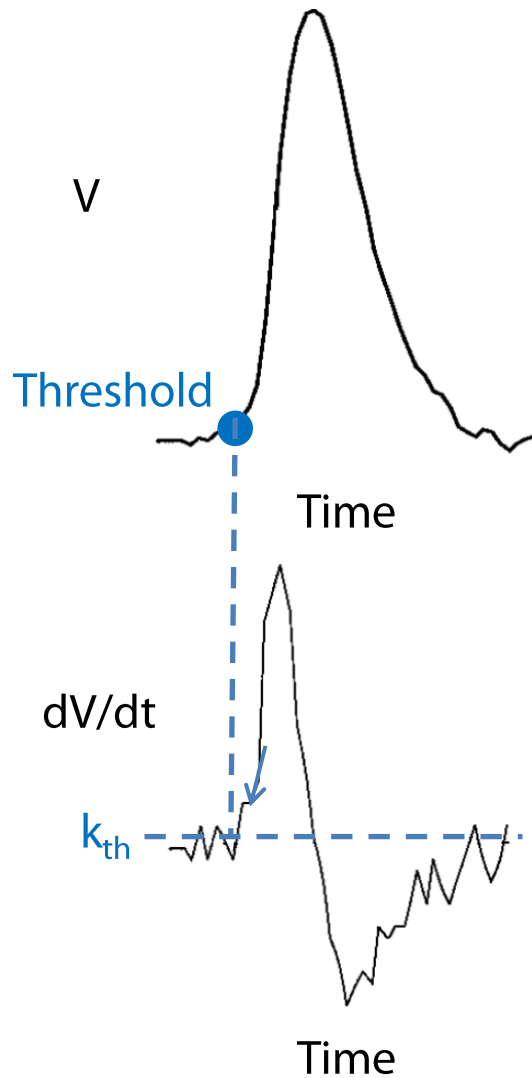

A. Threshold definition

In vivo

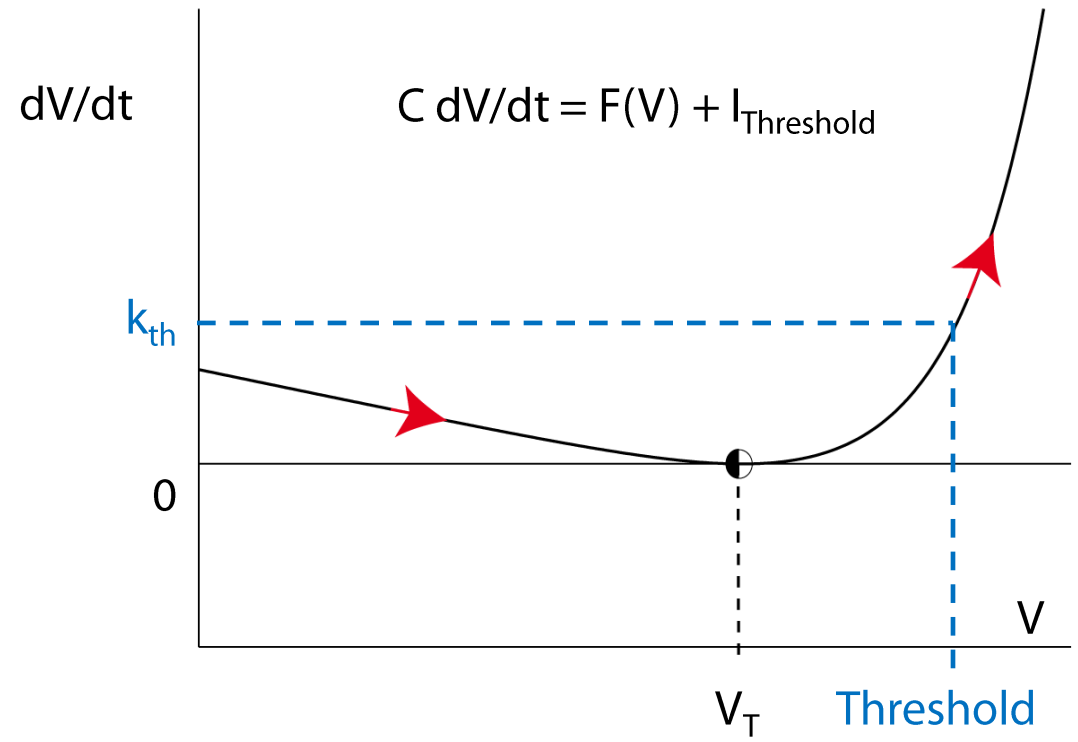
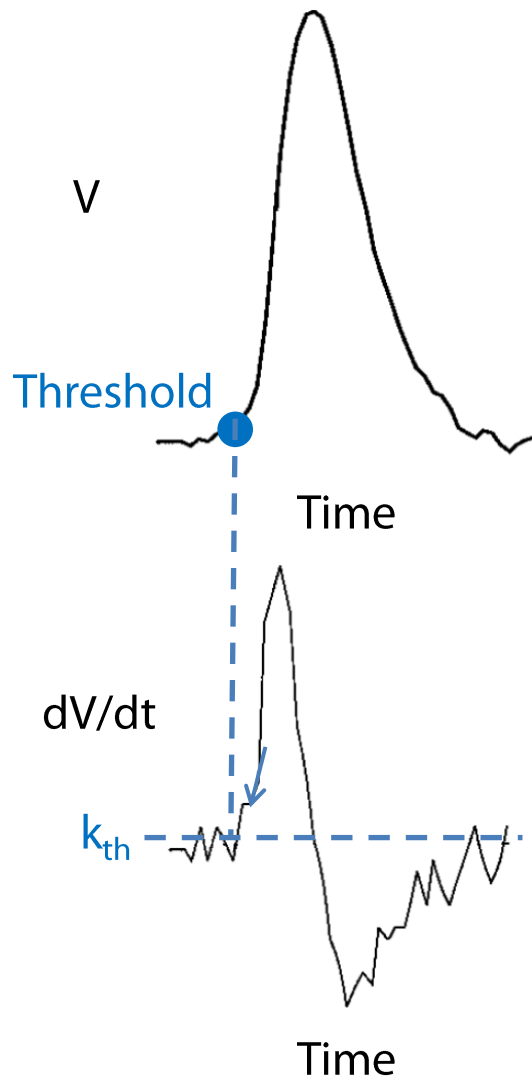

B. Sources of variability

B. Sources of variability

Mechanisms

Biophysics of action potential

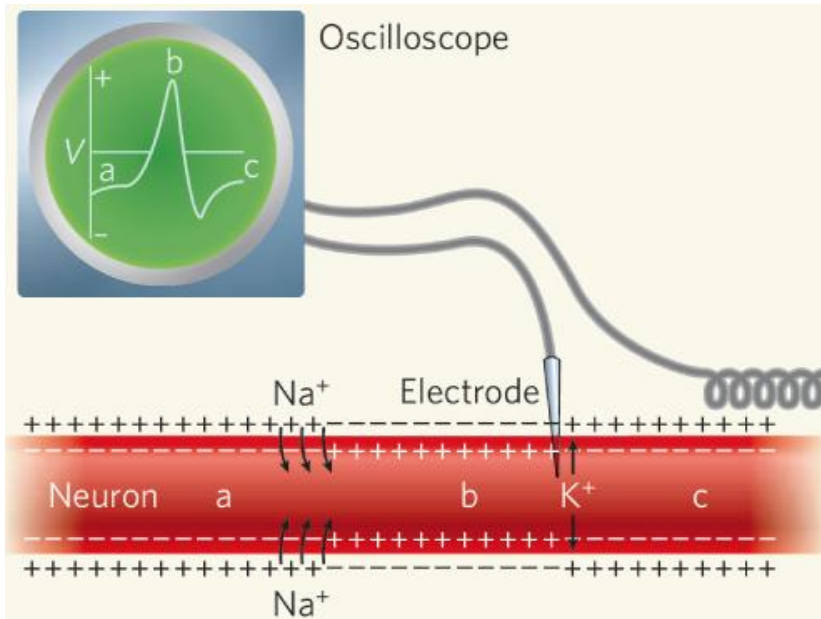

B. Sources of variability

Mechanisms

Biophysics of action potential

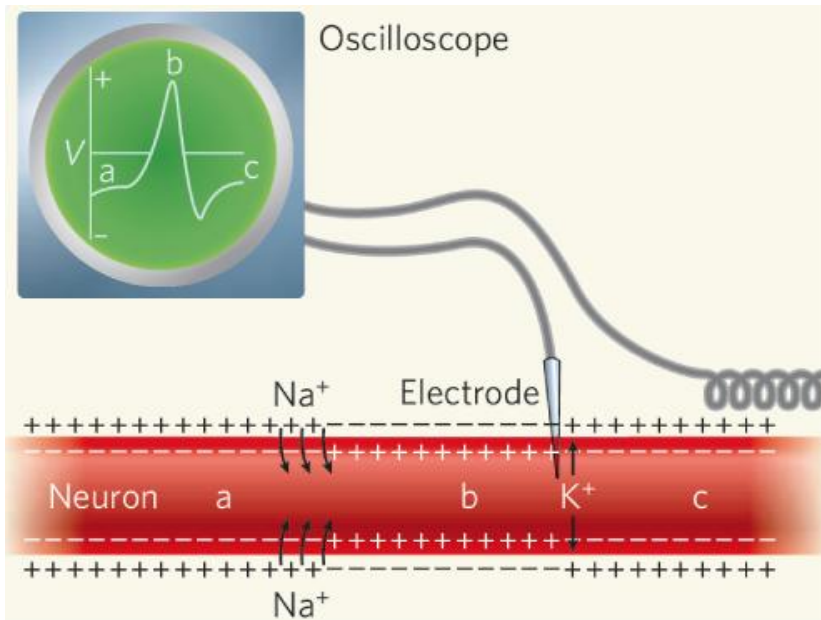

Inactivation of Na channel

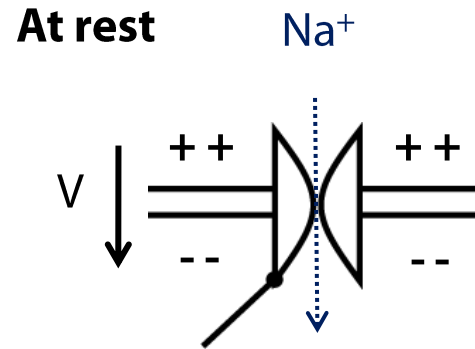

B. Sources of variability

Mechanisms

Biophysics of action potential

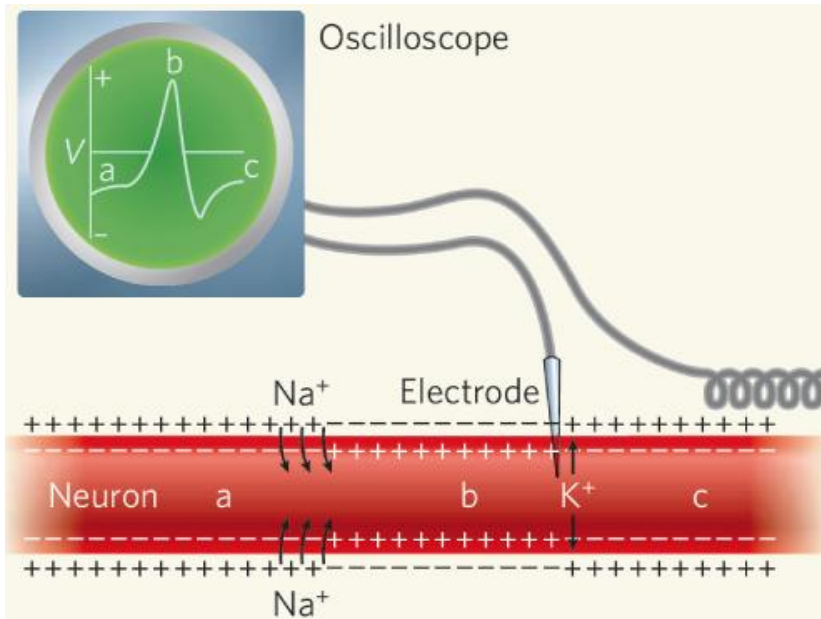

Inactivation of Na channel

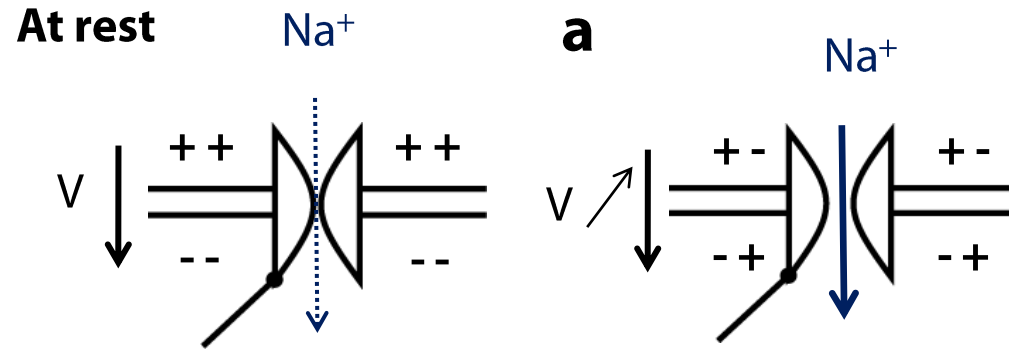

B. Sources of variability

Mechanisms

Biophysics of action potential

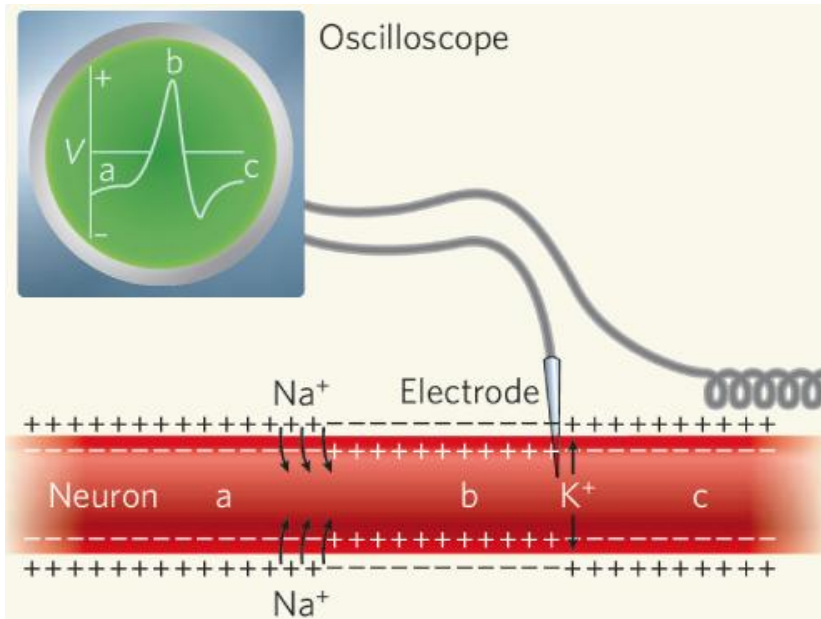

Inactivation of Na channel

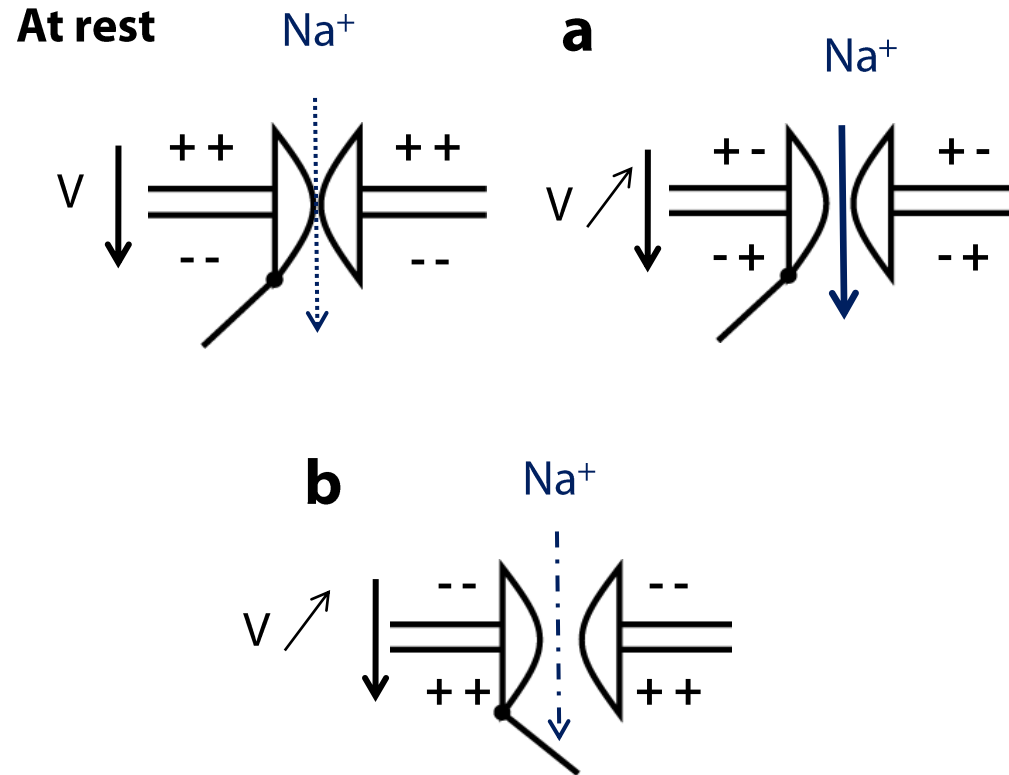

B. Sources of variability

Mechanisms

Activation of K channel

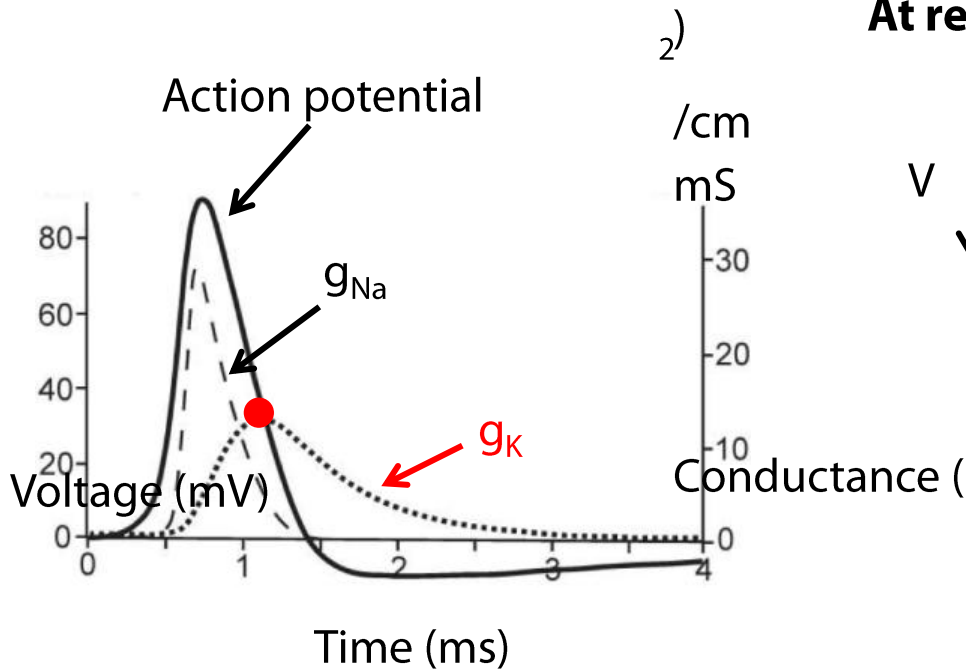

Inactivation of Na channel

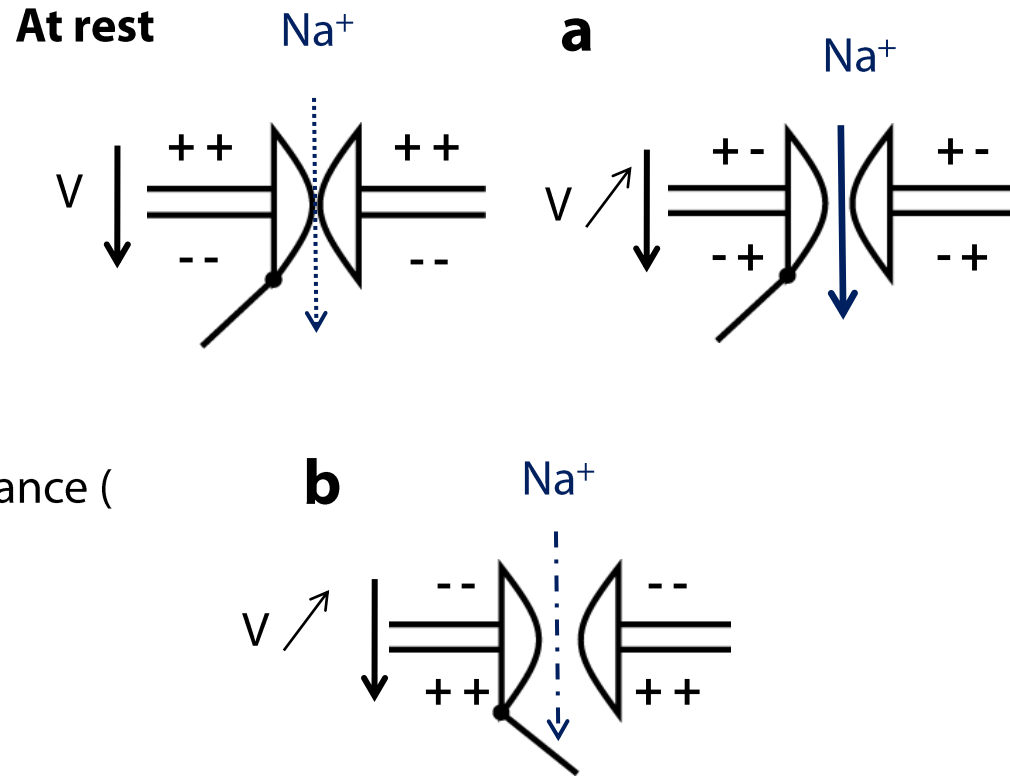

B. Sources of variability

Mechanisms

Channel noise

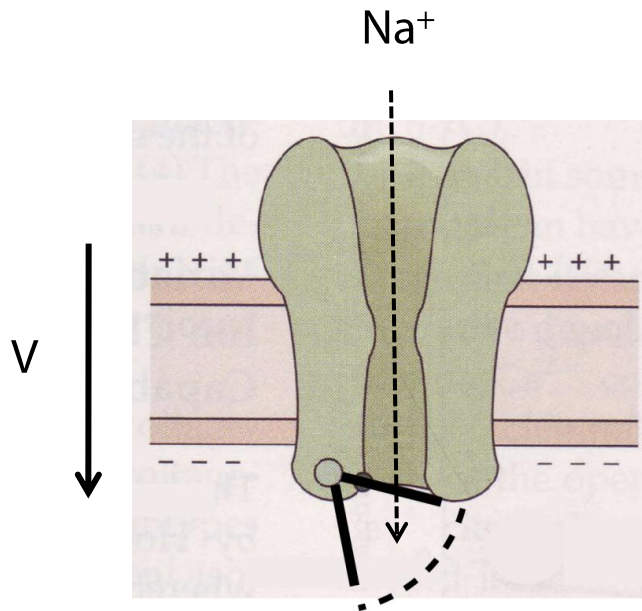

B. Sources of variability

Mechanisms

Channel noise

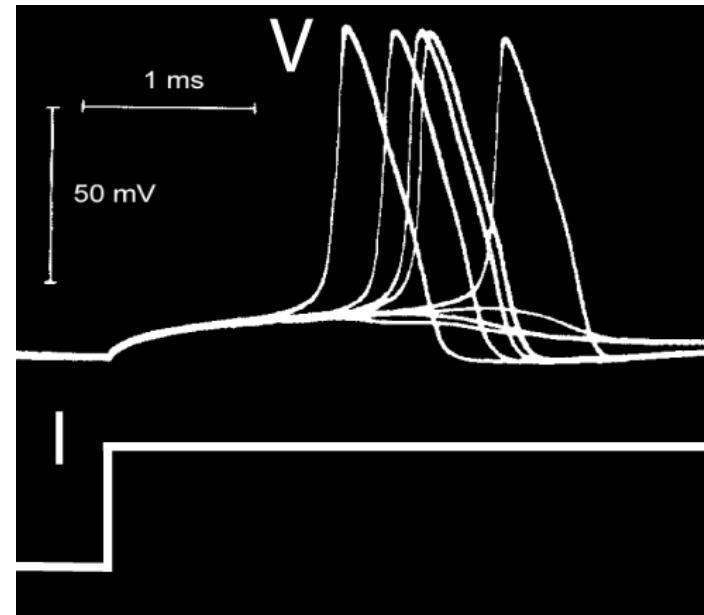
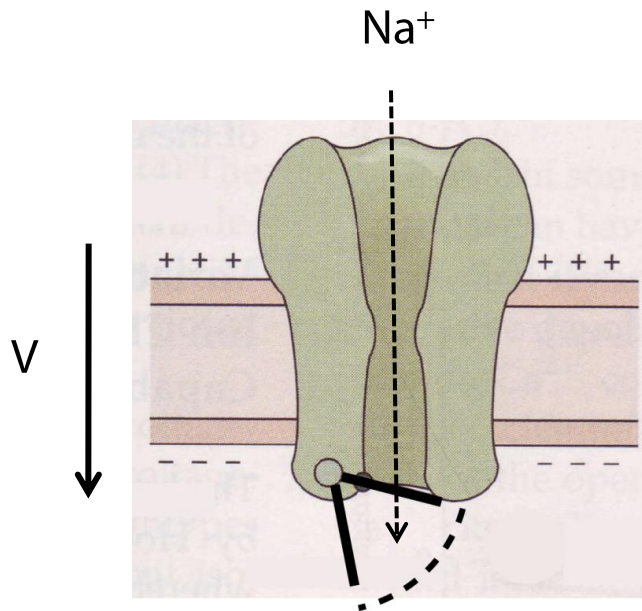

B. Sources of variability

Mechanisms

Synaptic conductances

Presynaptic spike trains

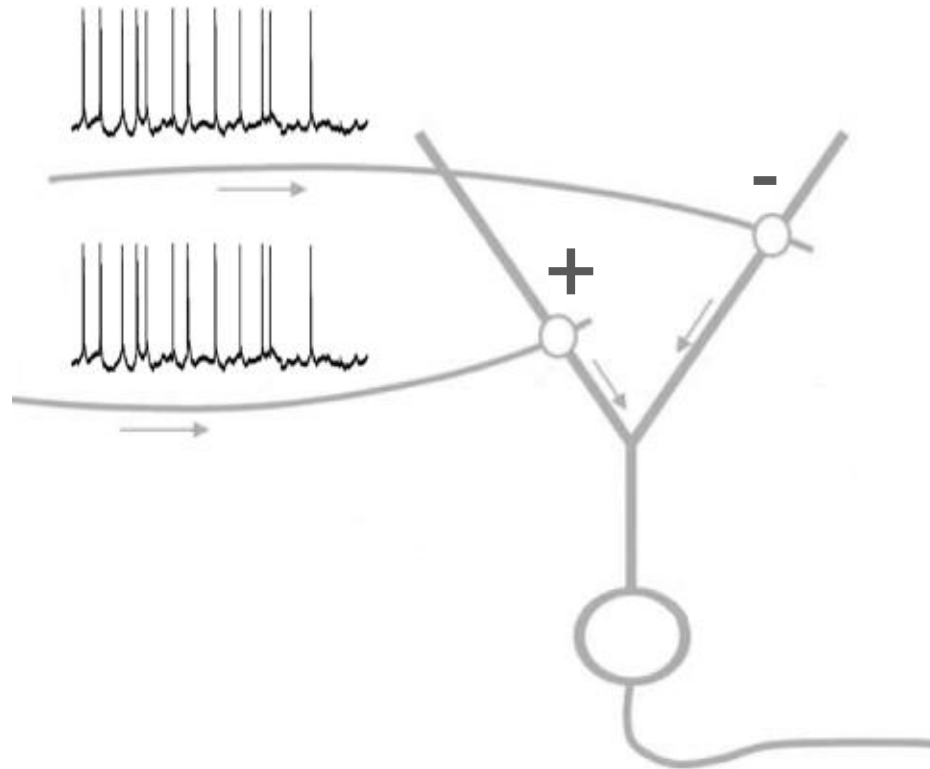

B. Sources of variability

Mechanisms

Synaptic conductances

Presynaptic spike trains

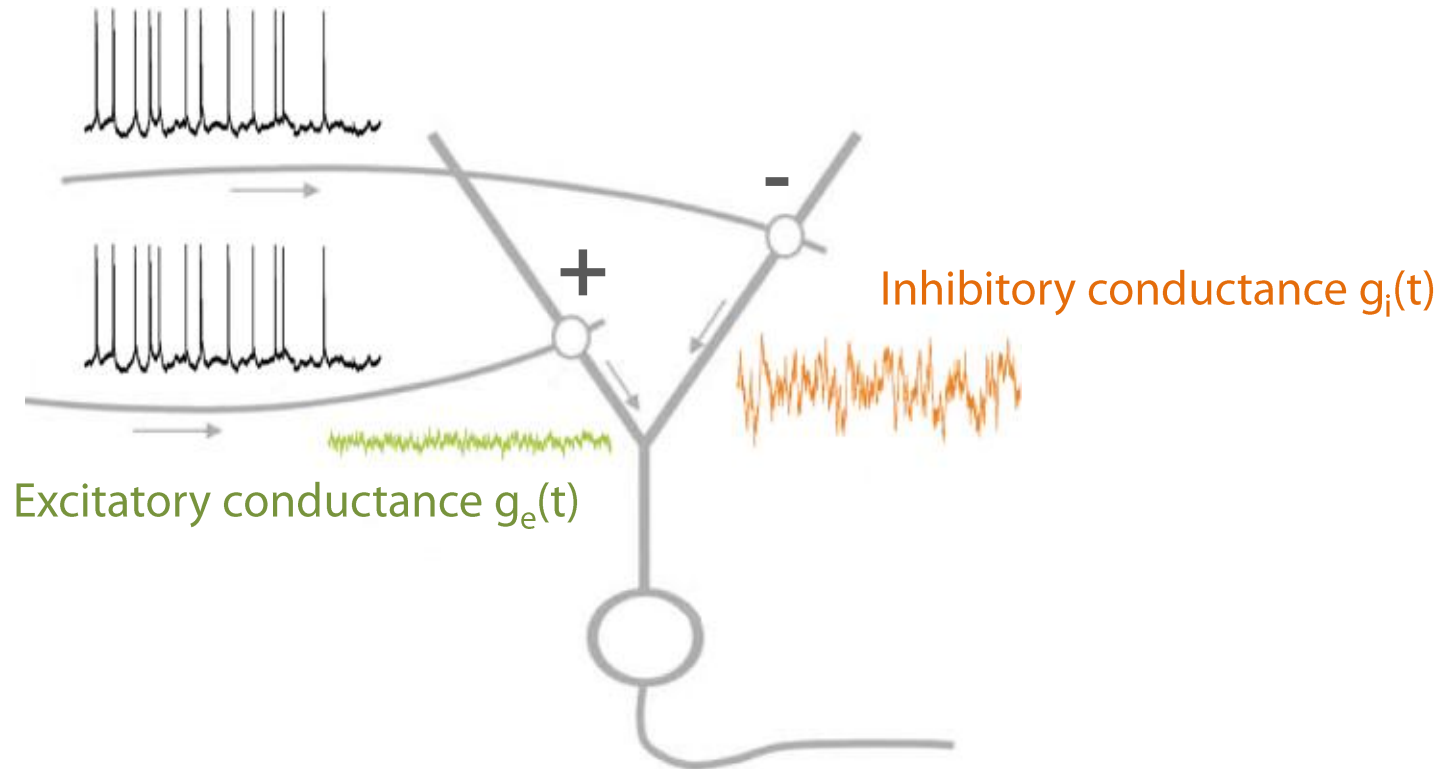

B. Sources of variability

Mechanisms

Synaptic conductances

Presynaptic spike trains

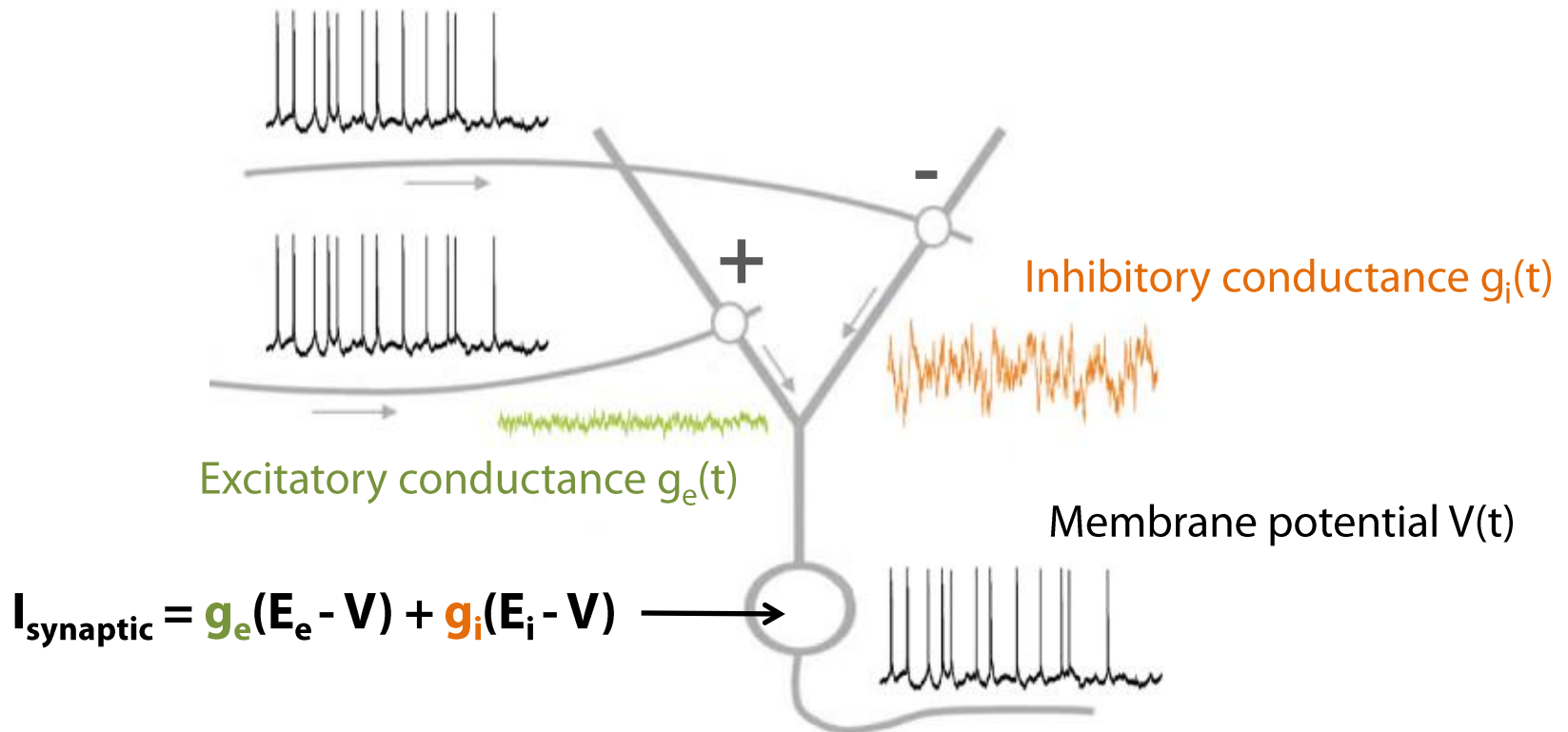

B. Sources of variability

Artefacts

Site of action potential initiation

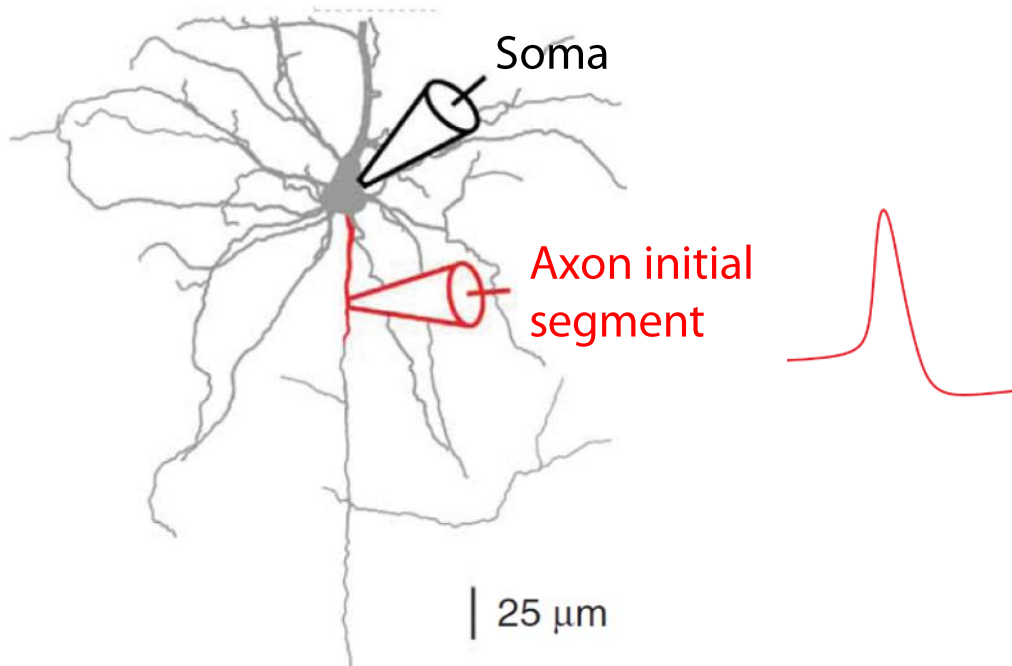

B. Sources of variability

Artefacts

Site of action potential initiation

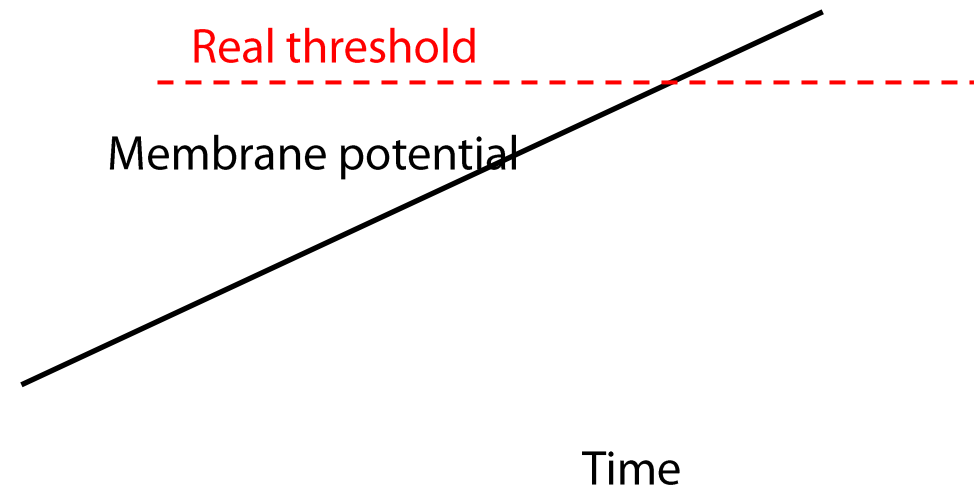
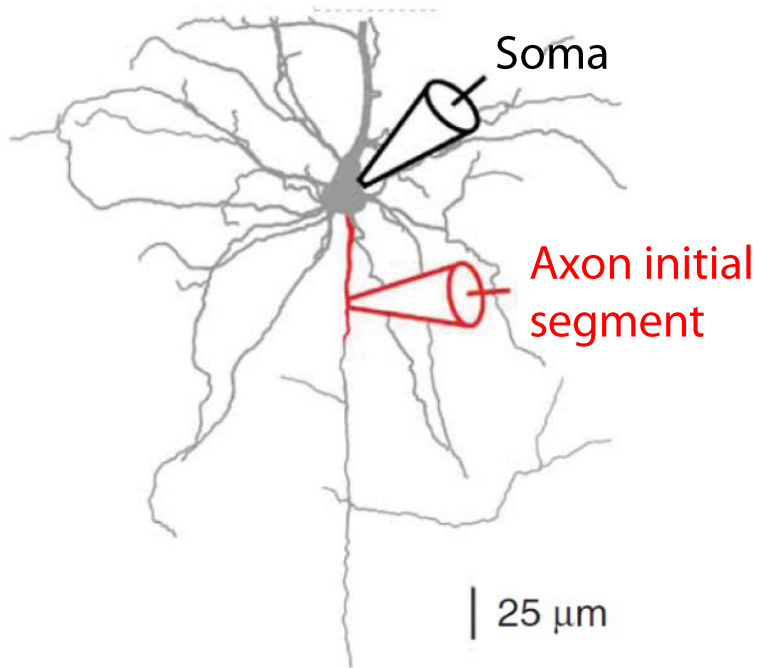

B. Sources of variability

Artefacts

Site of action potential initiation

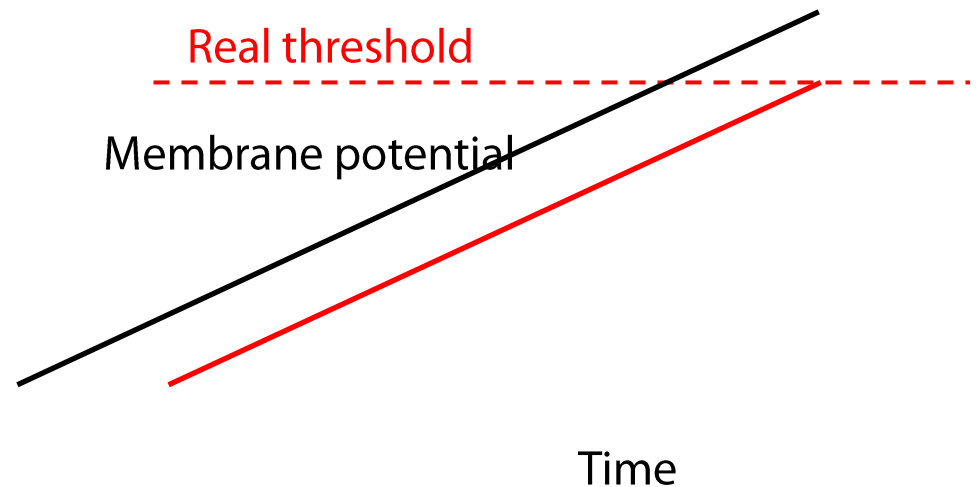
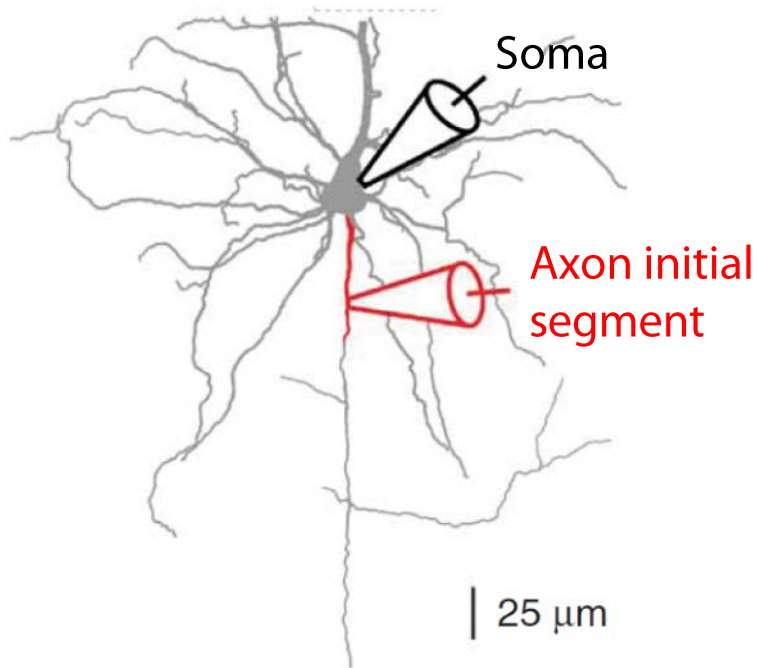

B. Sources of variability

Artefacts

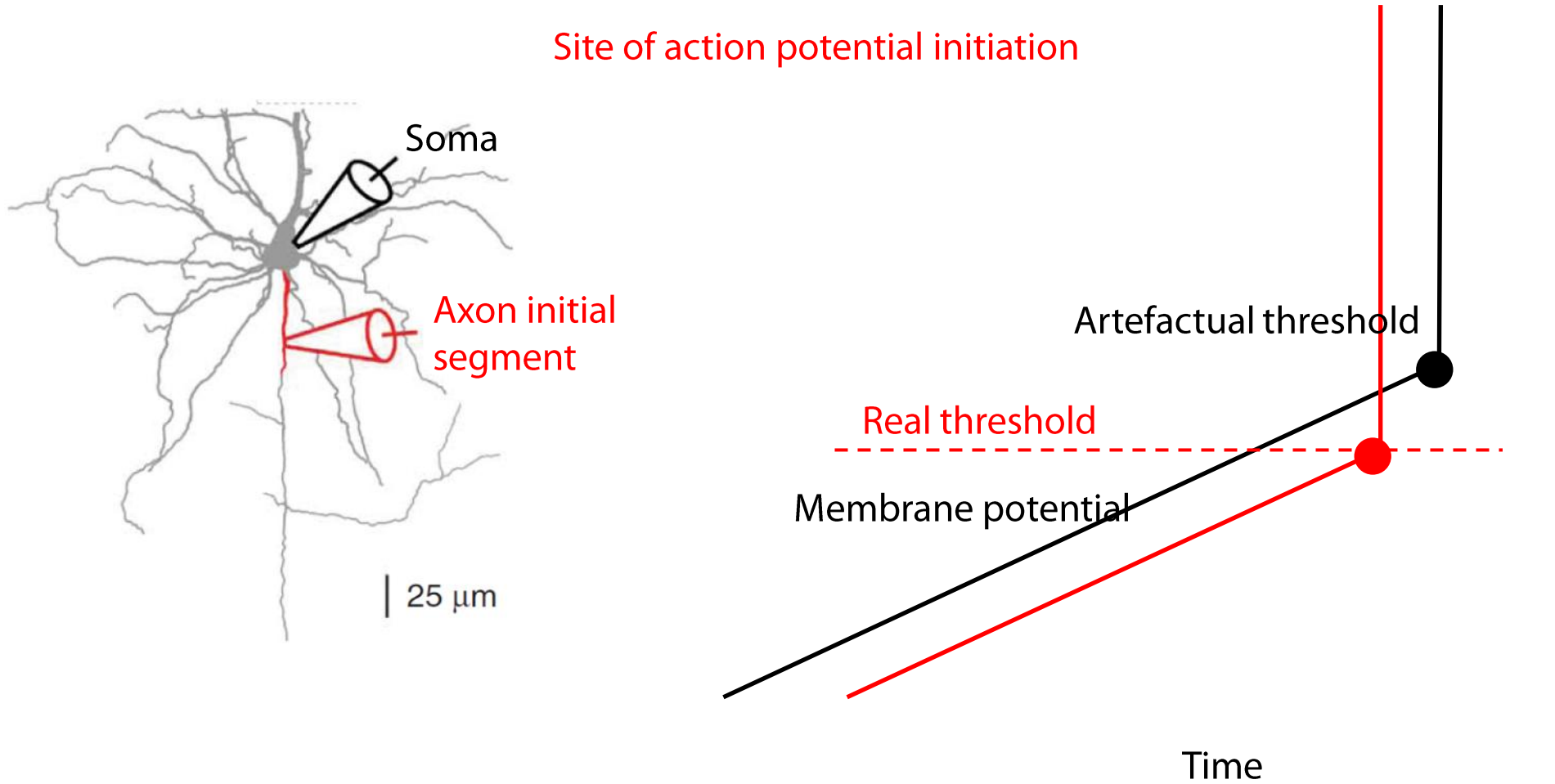

B. Sources of variability

Artefacts

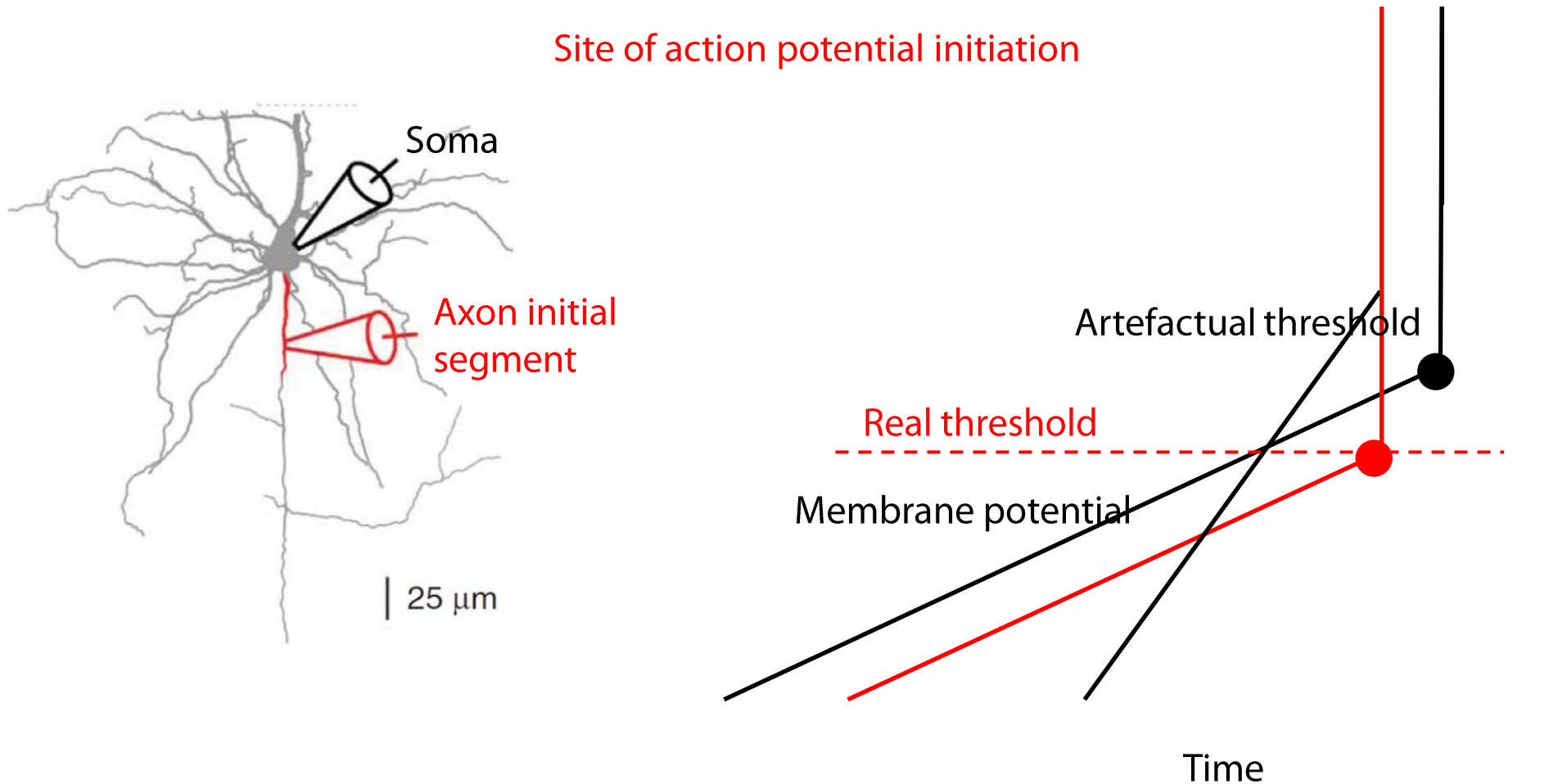

B. Sources of variability

Artefacts

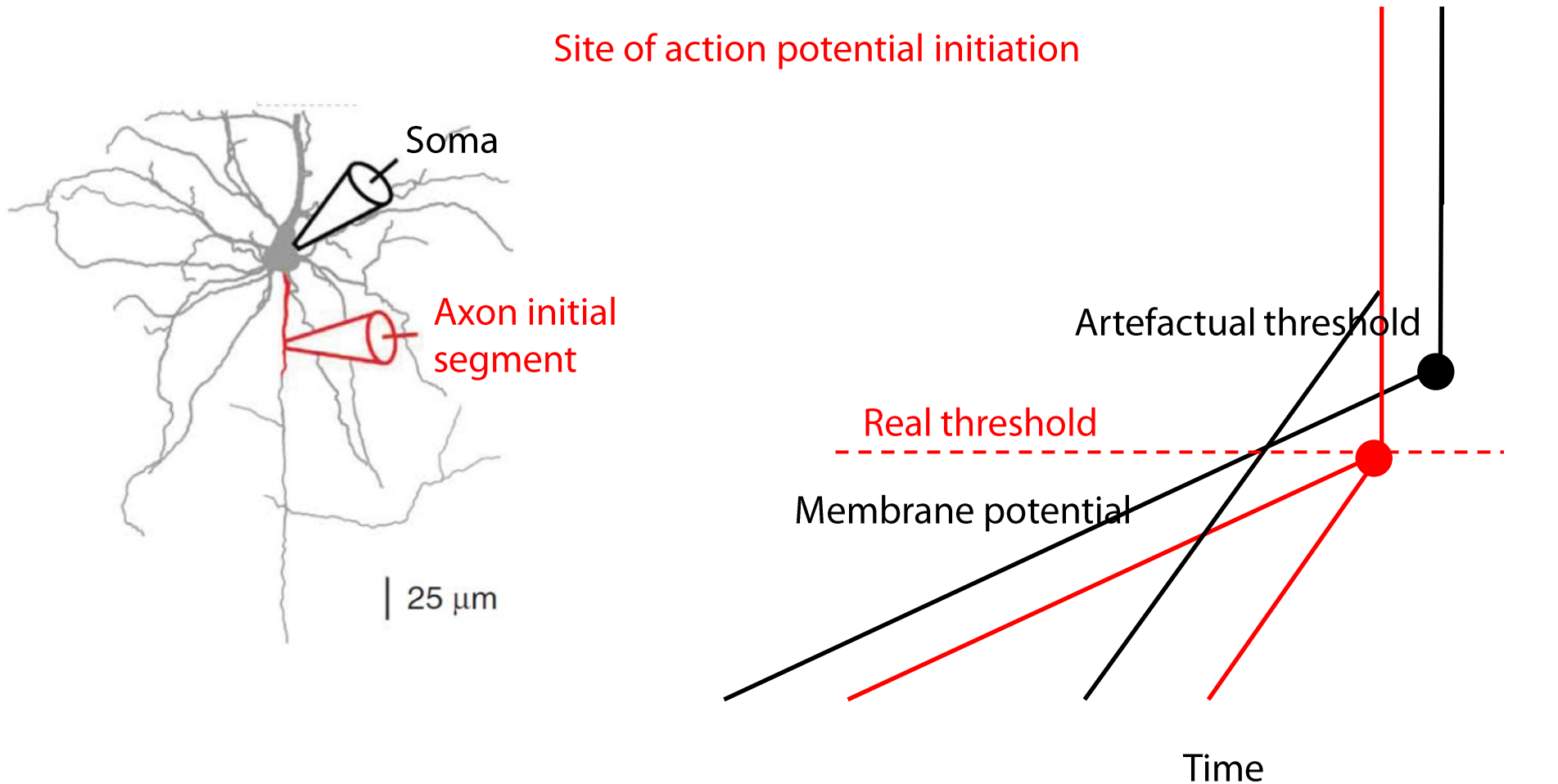

B. Sources of variability

Artefacts

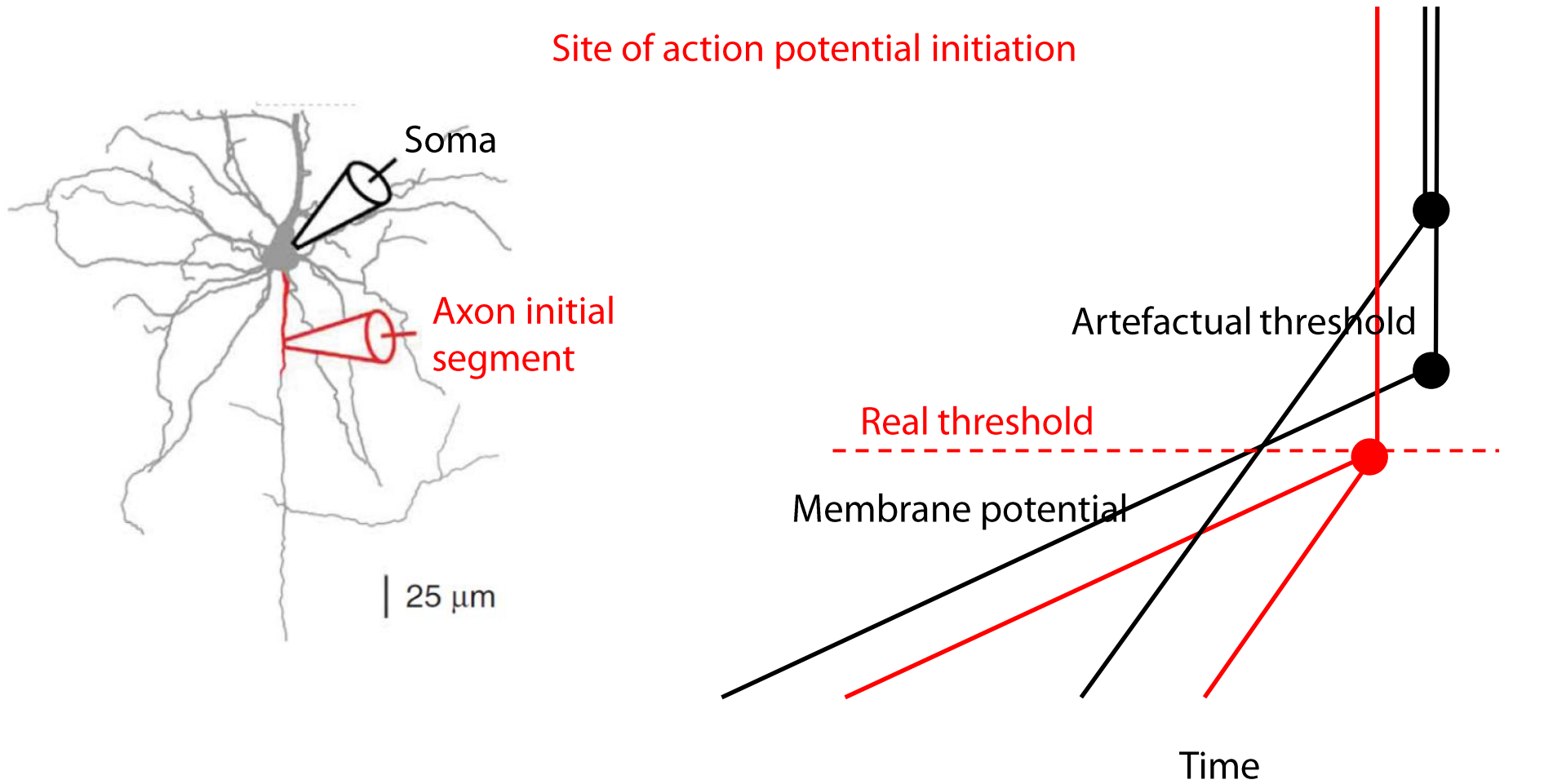

B. Sources of variability

Artefacts

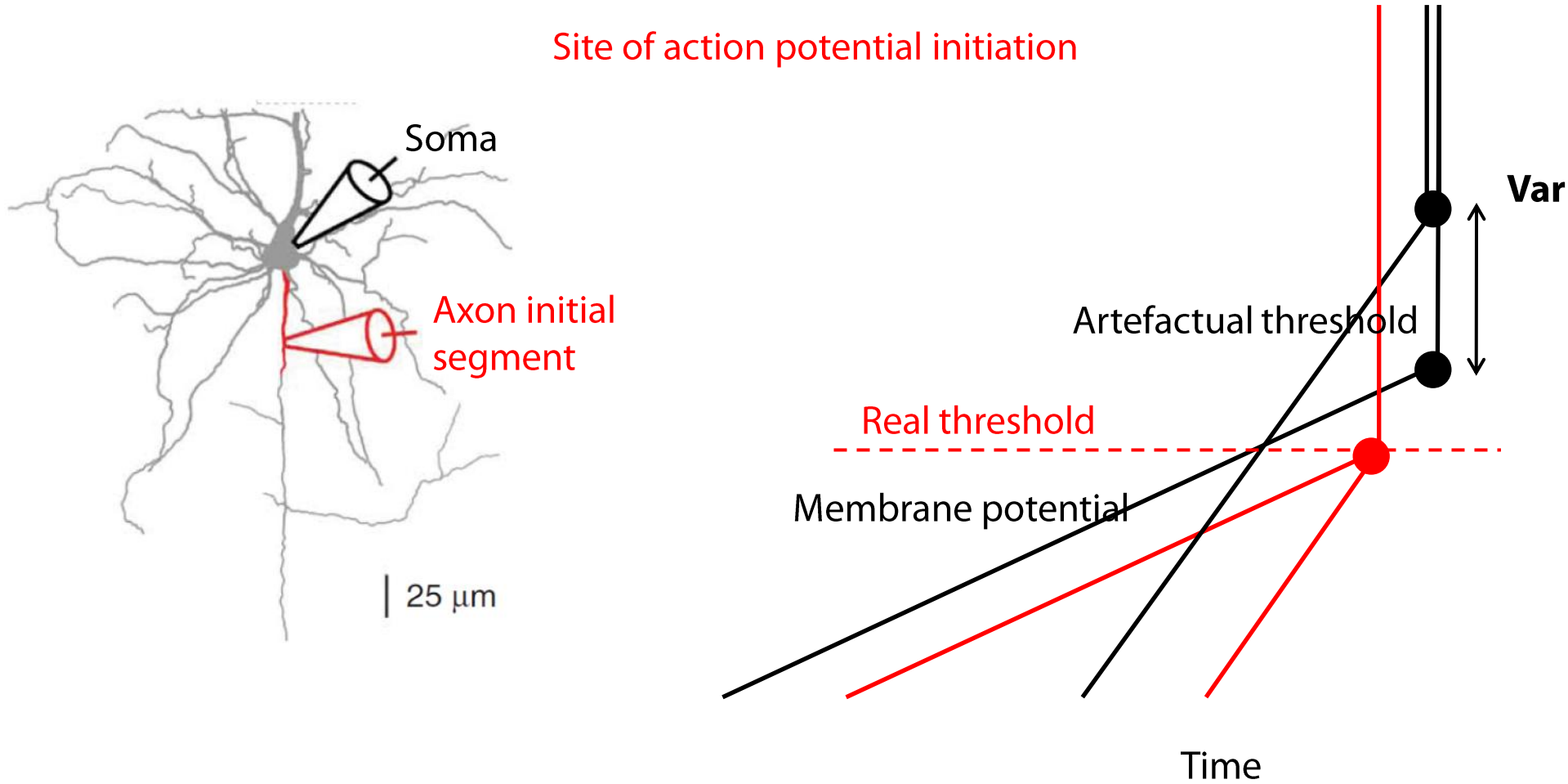

B. Sources of variability

Artefacts

Threshold empirical measure

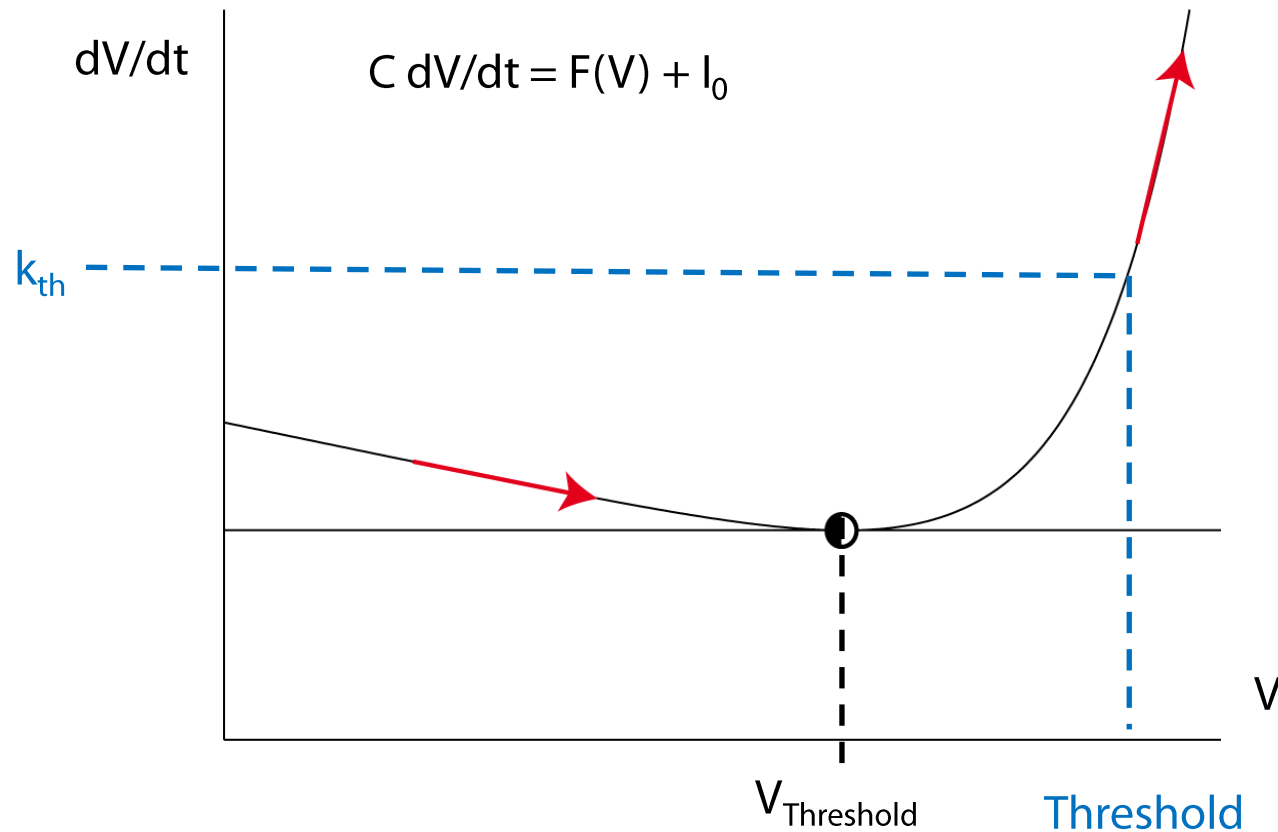

B. Sources of variability

Artefacts

Threshold empirical measure

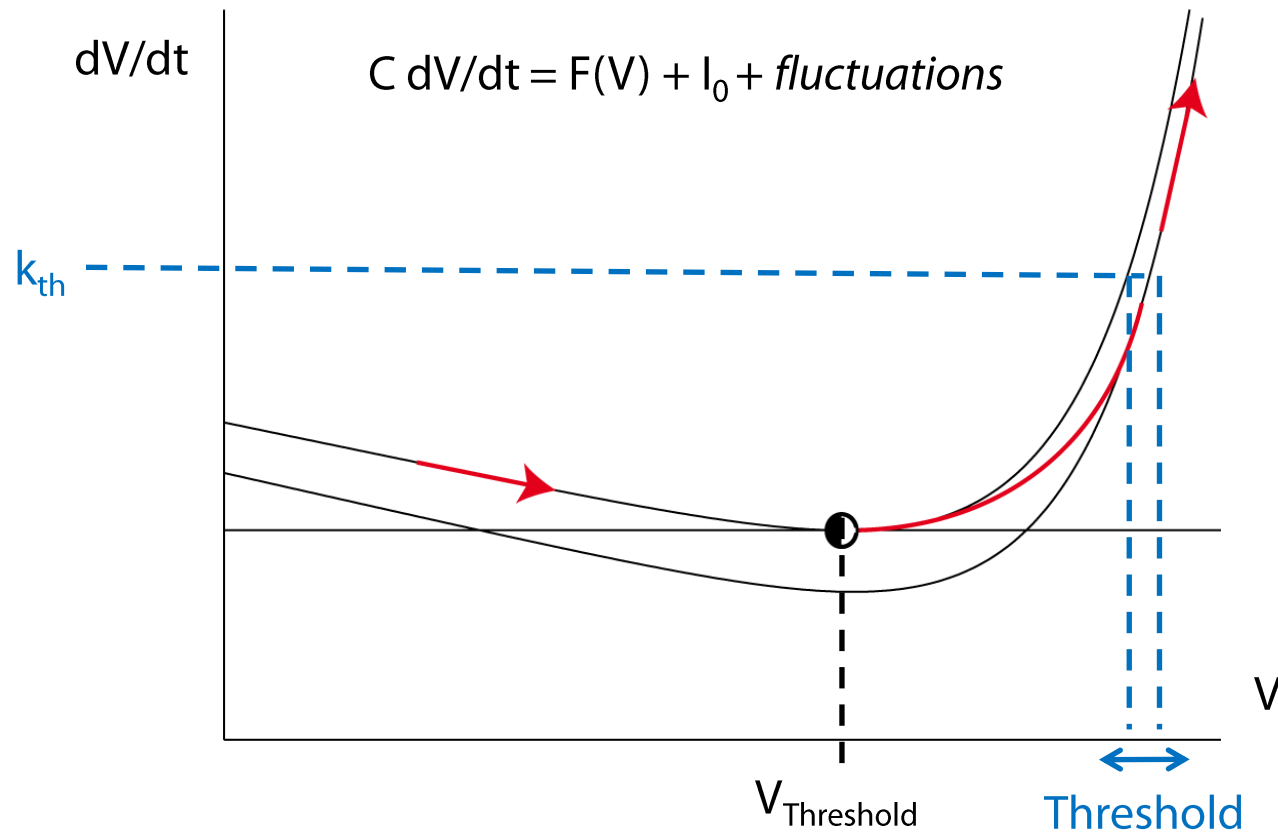

1. Experimental framework
2. Threshold basics
3. Threshold equation
4. Impact of Na channel inactivation

Problem

Multi-compartmental model

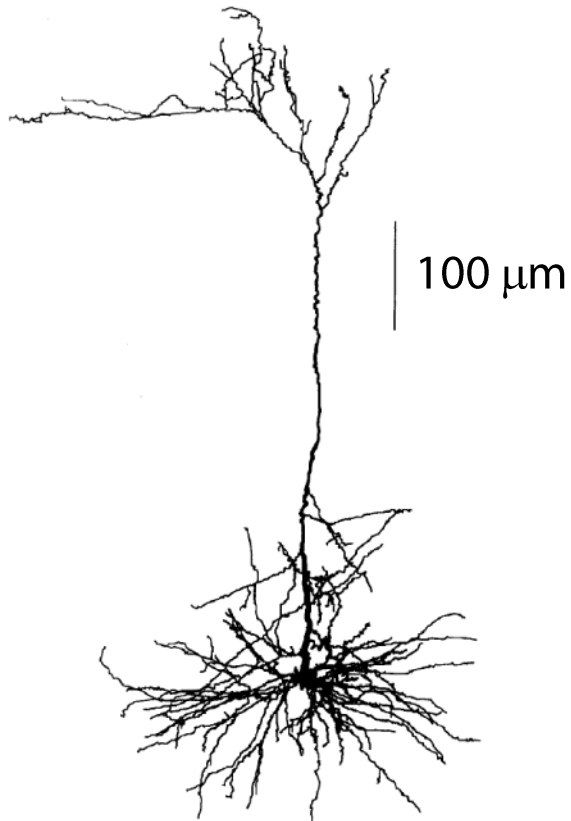

Problem

Multi-compartmental model

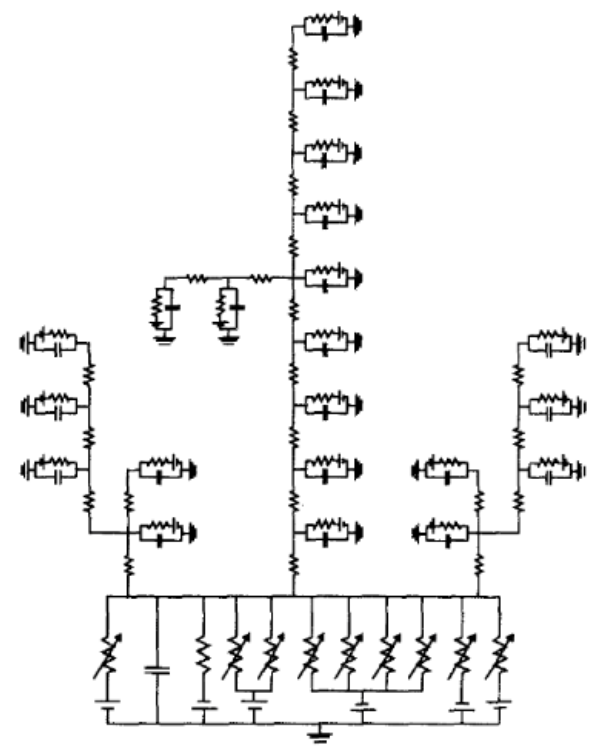
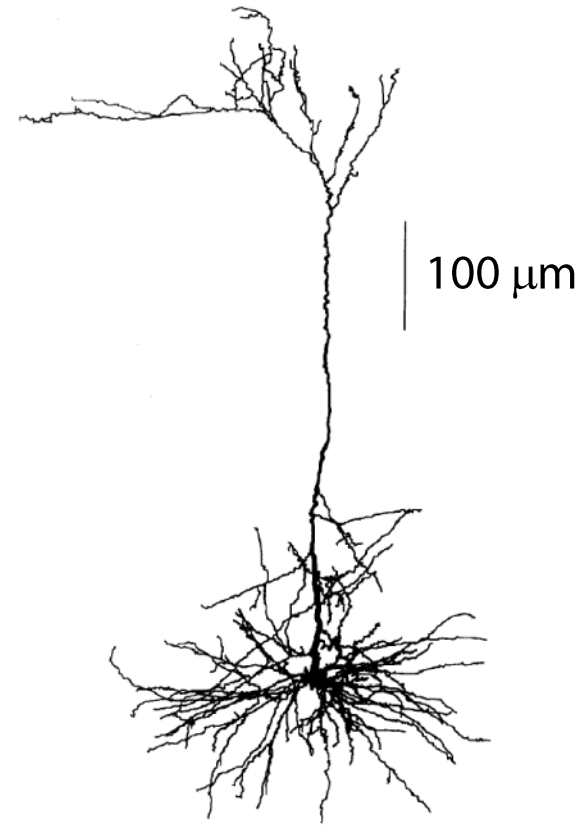

Problem

Multi-compartmental model

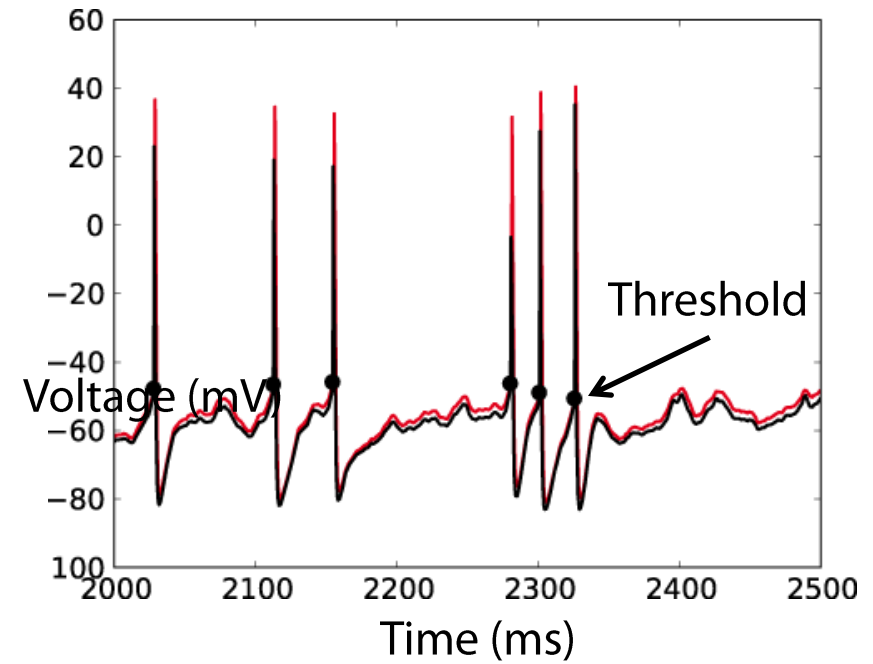
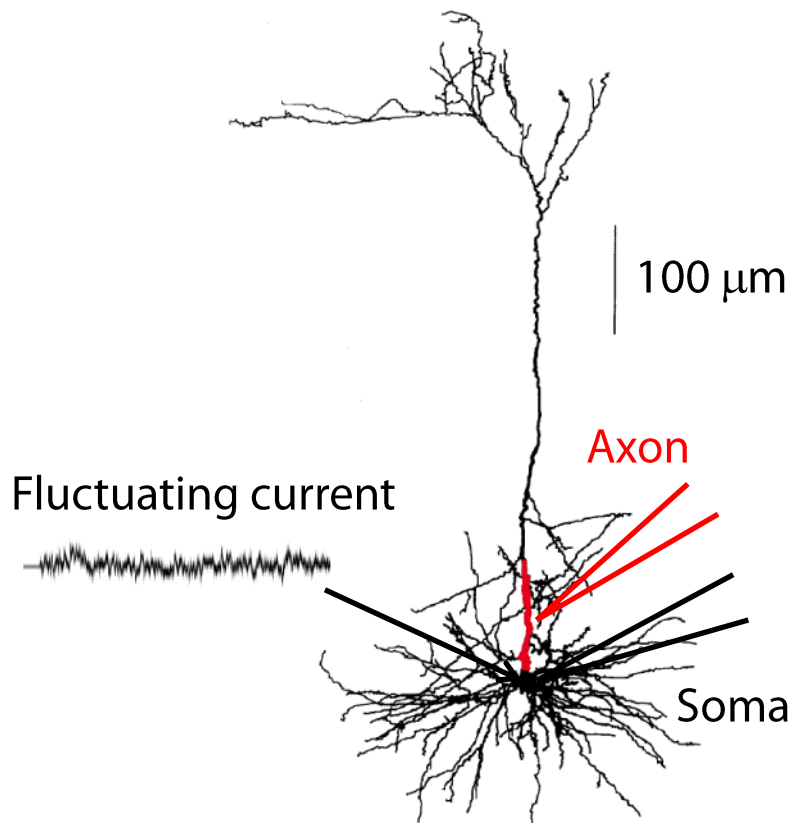

Problem

Is it possible to predict this threshold variability from the model variables?

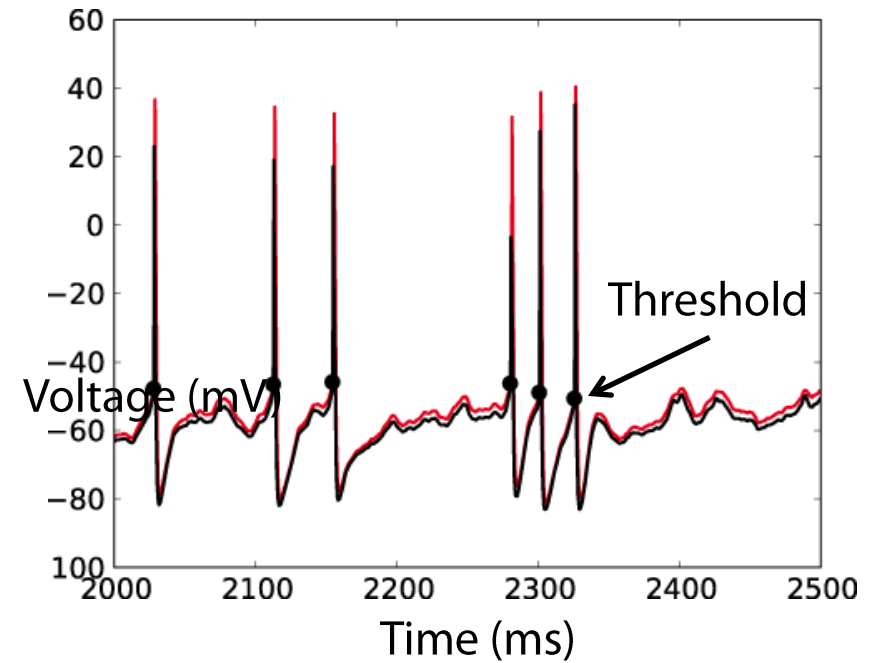
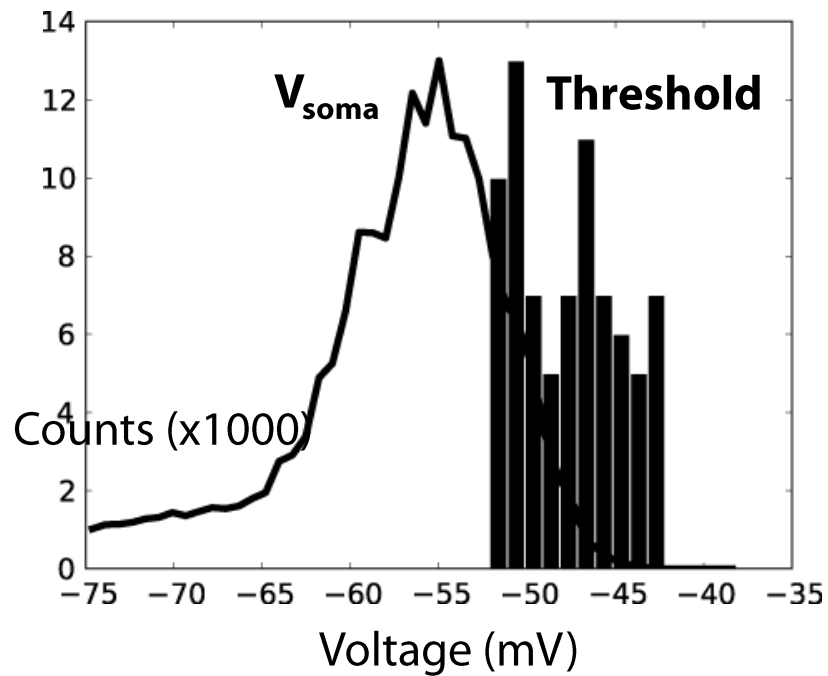

A. Exponential approximation

Exponential model

$$C \frac{dV}{dt} = g_L \Delta_T e^{\frac{V-V_T}{\Delta_T}} + g_L (E_L - V) + I$$

A. Exponential approximation

Exponential model

$$C \frac{dV}{dt} = g_L \Delta_T e^{\frac{V-V_T}{\Delta_T}} + g_L (E_L - V) + I$$

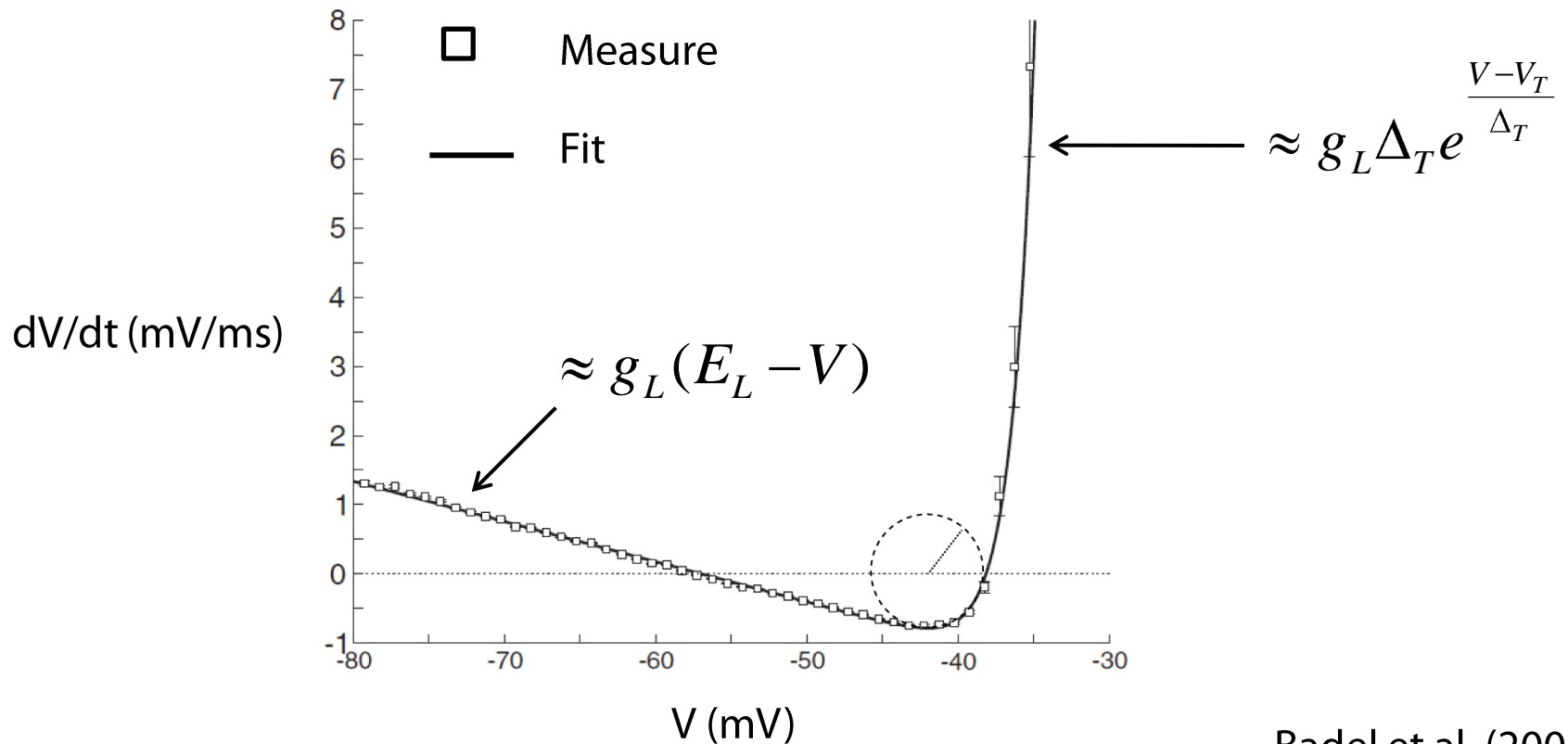

A. Exponential approximation

Exponential model

$$C \frac{dV}{dt} = g_L \Delta_T e^{\frac{V-V_T}{\Delta_T}} + g_L (E_L - V) + I$$

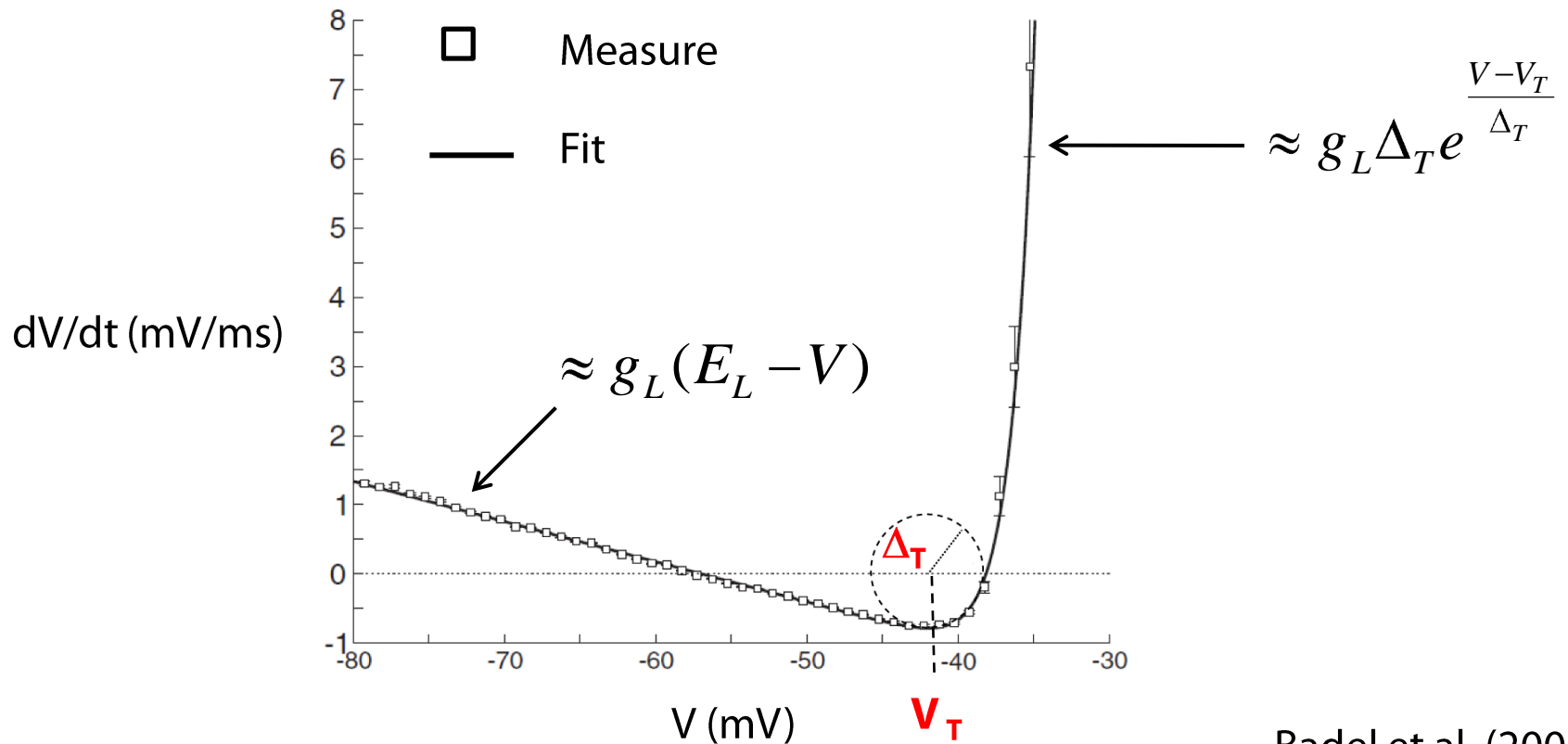

A. Exponential approximation

Instantaneous activation

$$I_{Na} = \bar{g}_{Na, Axon} m^3 h (E_{Na} - V)$$

?

Hodgkin-Huxley model

$$\approx g_L \Delta_T e^{\frac{V - V_T}{\Delta_T}}$$

Exponential model

A. Exponential approximation

Instantaneous activation

$$I_{Na} = \bar{g}_{Na, Axon} m^3 h (E_{Na} - V)$$

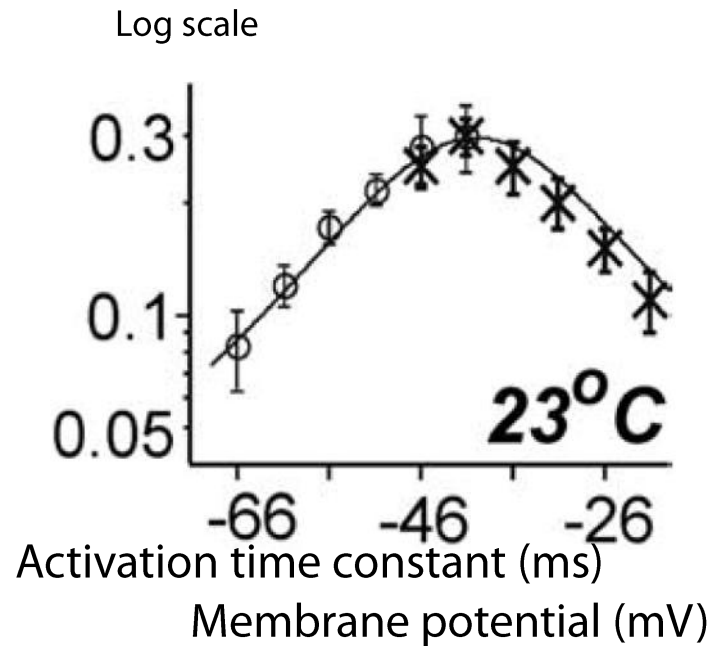

A. Exponential approximation

Instantaneous activation

$$I_{Na} = \bar{g}_{Na, Axon} m^3 h (E_{Na} - V)$$

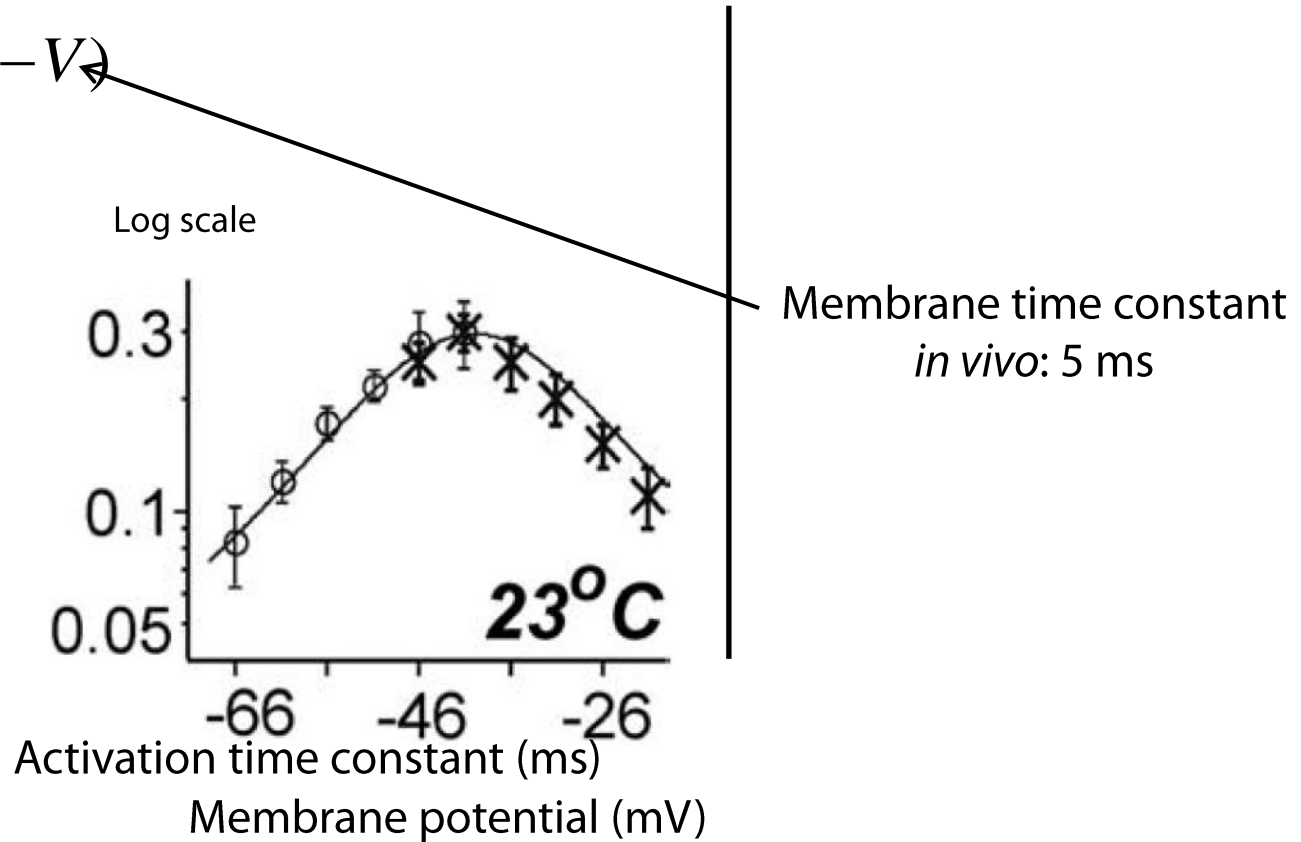

A. Exponential approximation

Instantaneous activation

$$I_{Na} \approx \bar{g}_{Na, Axon} m_{\infty}^3 h (E_{Na} - V)$$

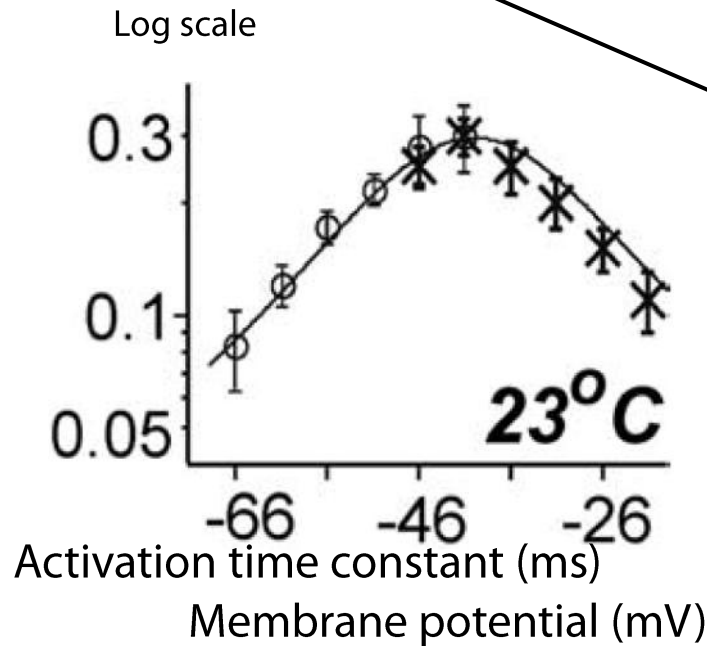

Membrane time constant
in vivo: 5 ms

A. Exponential approximation

Action potential initiation

$$I_{Na} \approx \bar{g}_{Na,Axon} m_{\infty}(V)^3 h(E_{Na} - V)$$

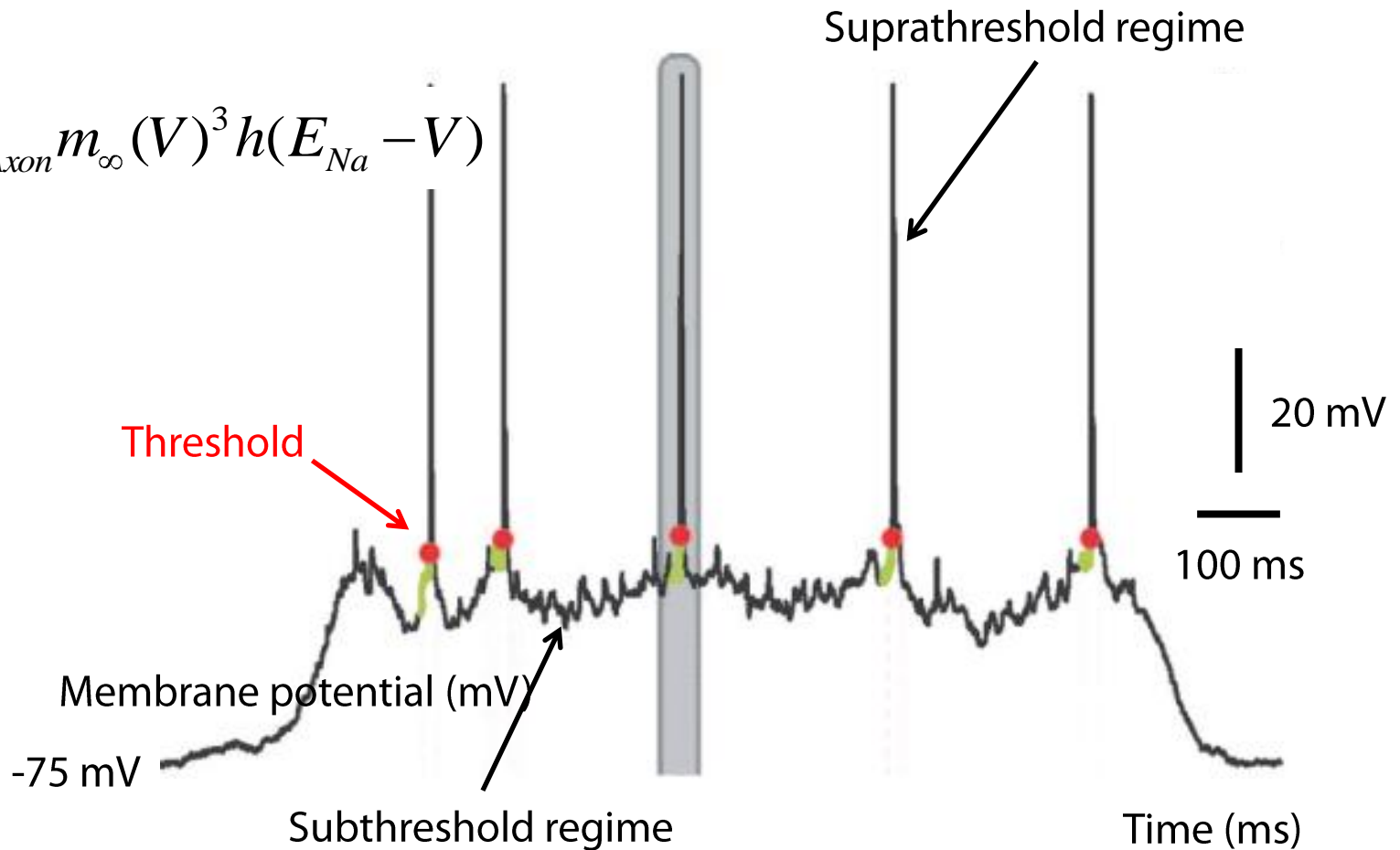

A. Exponential approximation

Action potential initiation

$$I_{Na} \approx \bar{g}_{Na, Axon} m_{\infty}(V)^3 h(E_{Na} - V)$$

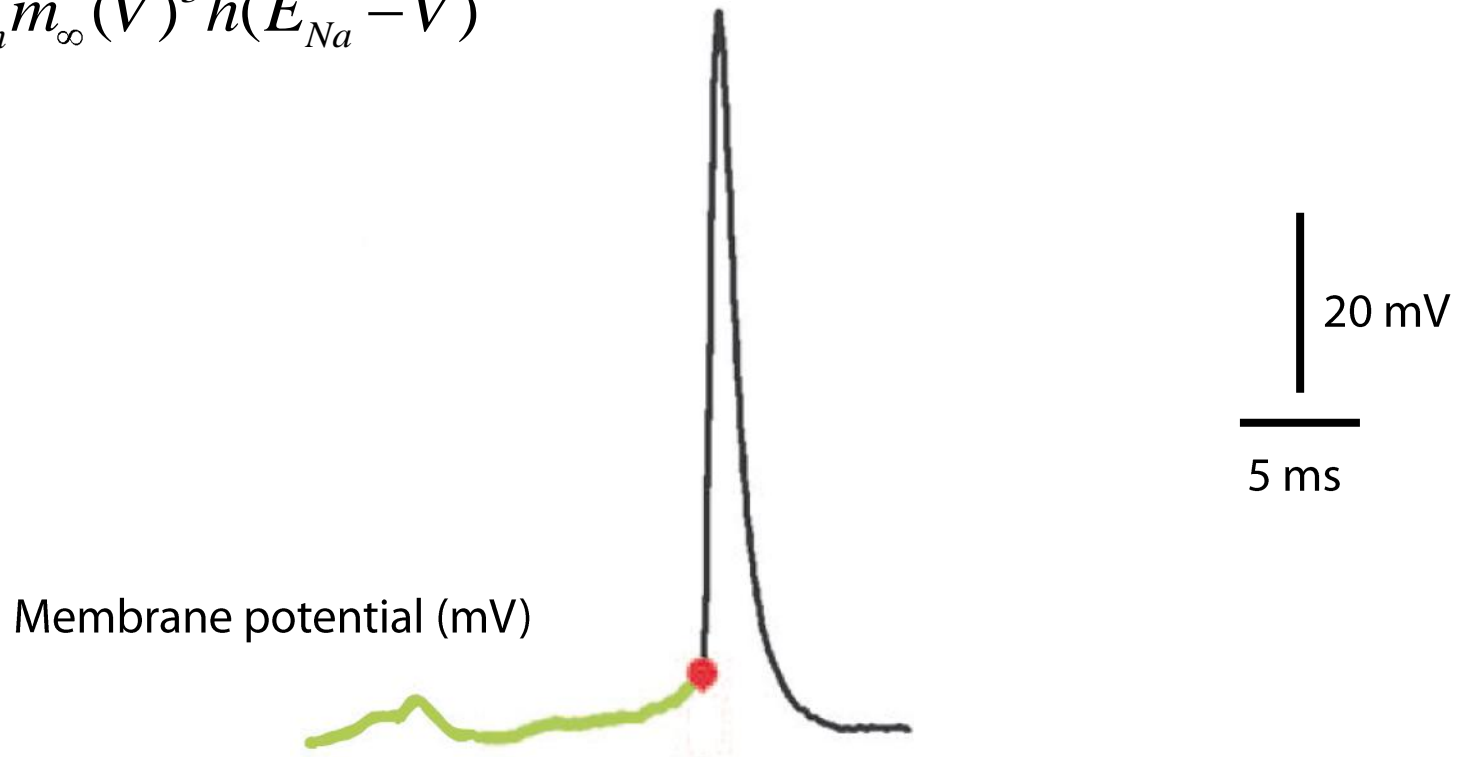

Time (ms)

Léger et al. (2005)

A. Exponential approximation

Action potential initiation

$$I_{Na} \approx \bar{g}_{Na,Axon} m_{\infty}(V)^3 h(E_{Na} - V)$$

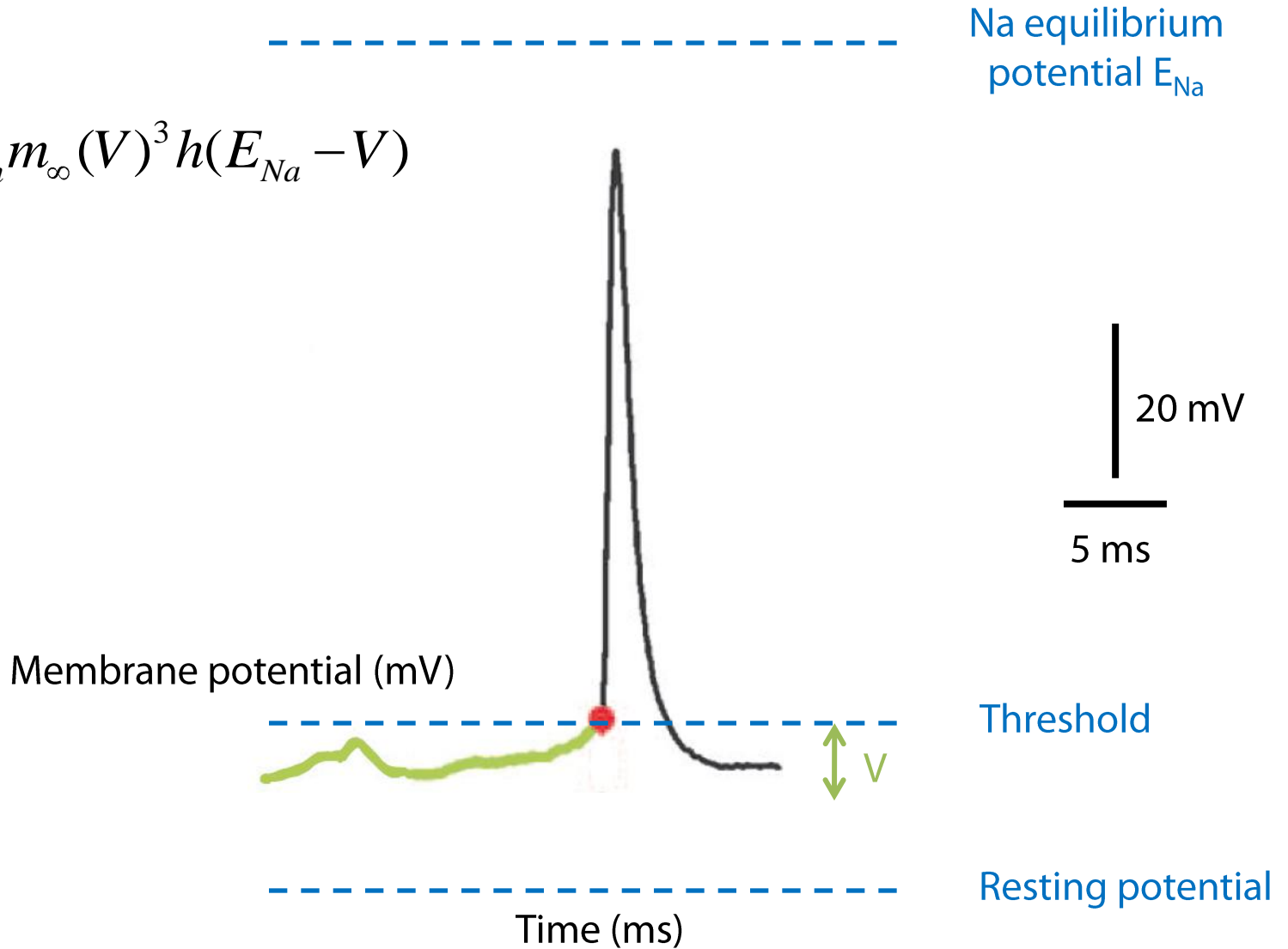

A. Exponential approximation

Action potential initiation

$$I_{Na} \approx \bar{g}_{Na, Axon} m_{\infty}(V)^3 h(E_{Na} - V)$$

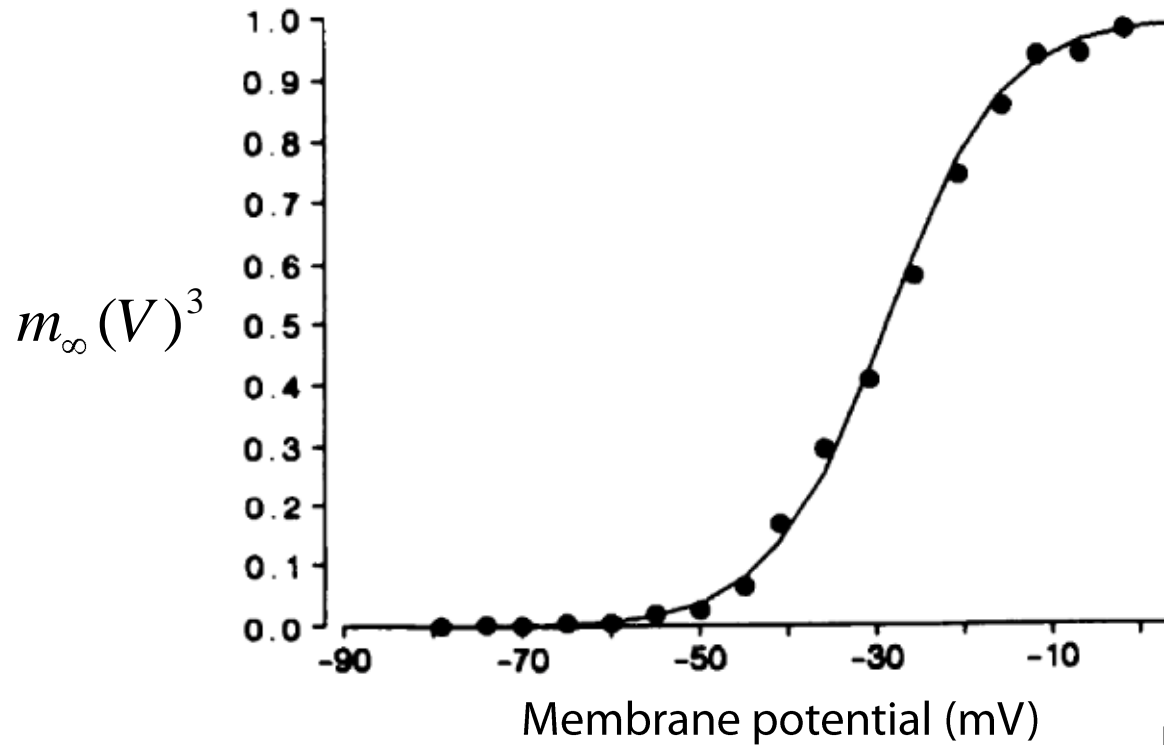

A. Exponential approximation

Action potential initiation

$$I_{Na} \approx \bar{g}_{Na, Axon} m_{\infty}(V)^3 h(E_{Na} - V)$$

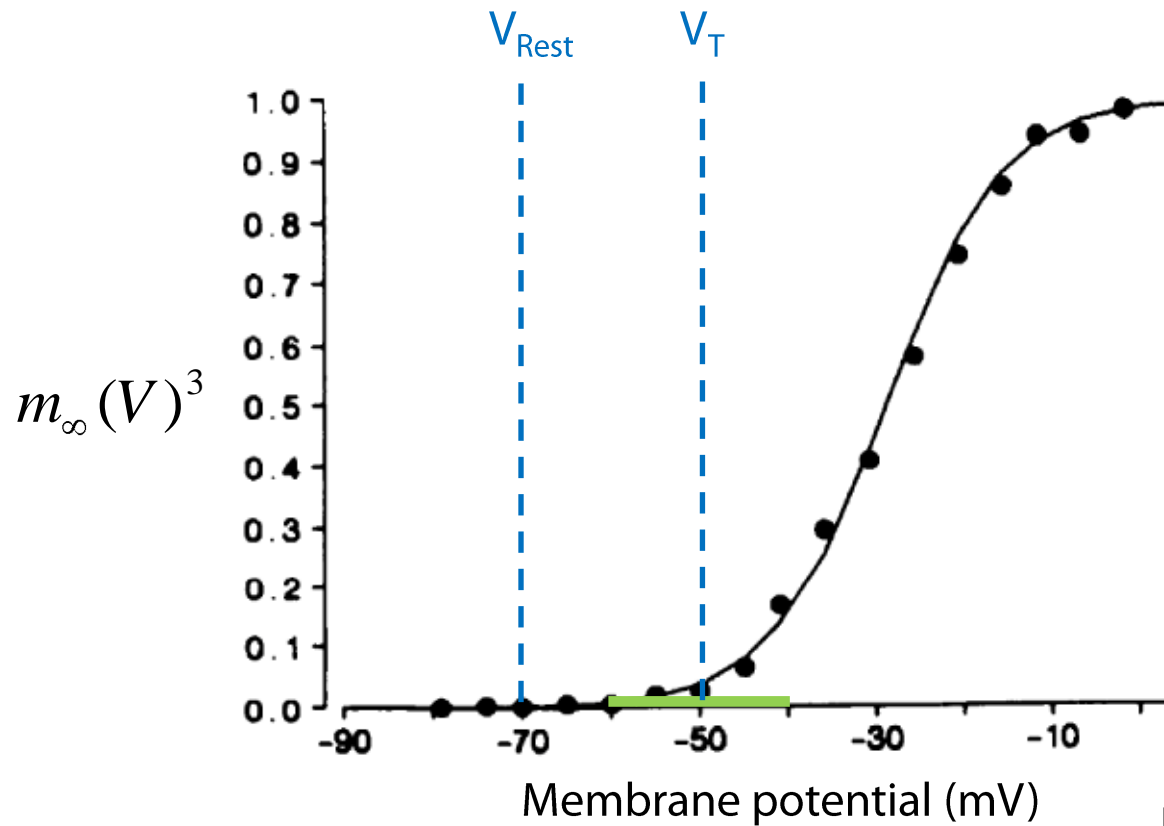

A. Exponential approximation

Minimal voltage threshold

$$I_{Na} \approx g_{L,Soma-Dendrites} k_a h e^{\frac{V-V_T}{k_a}}$$

$$m_{\infty}(V)^3$$

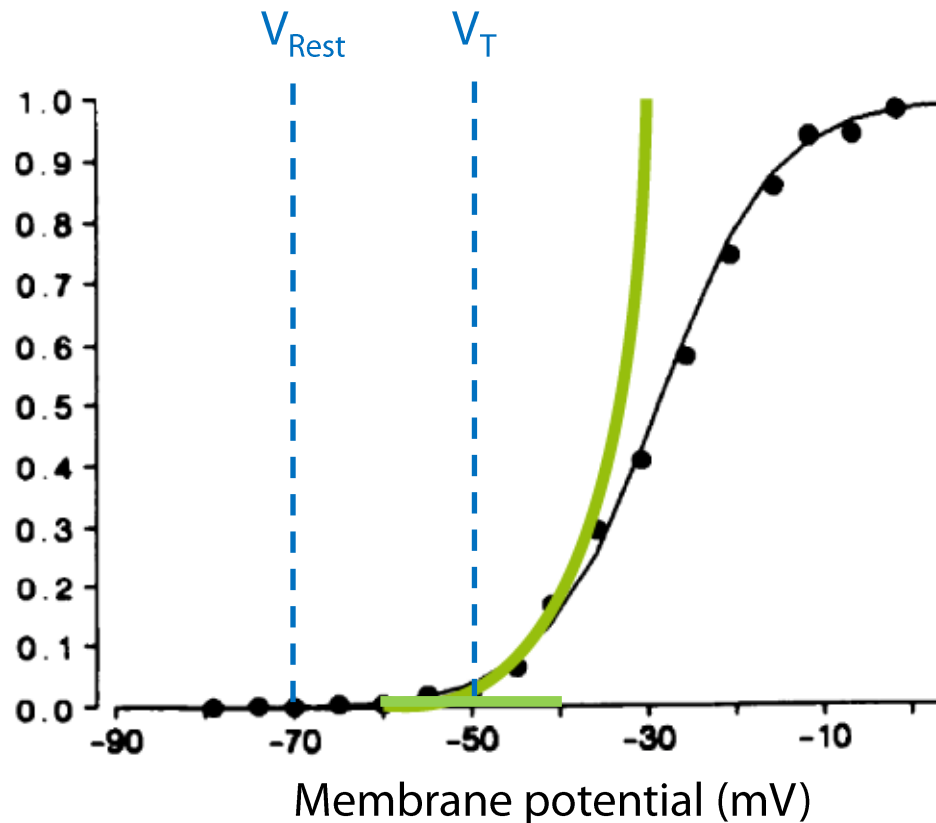

A. Exponential approximation

Minimal voltage threshold

$$I_{Na} \approx g_{L,Soma-Dendrites} k_a h e^{\frac{V-V_T}{k_a}}$$

$$V_T = V_a - k_a \log \frac{g_{Na,Axon}}{g_{L,Soma-Dendrites}} \frac{E_{Na} - V_a}{k_a}$$

$m_\infty(V)^3$

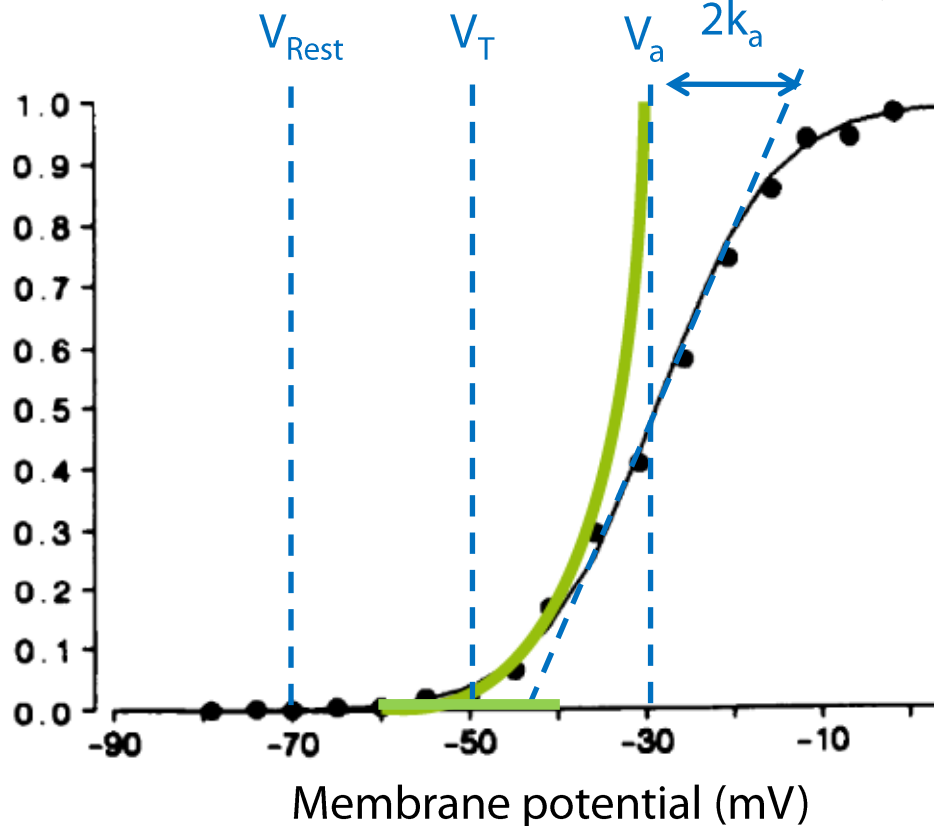

A. Exponential approximation

Instantaneous threshold

$$I_{Na} \approx g_{L,Soma-Dendrites} k_a e^{\frac{V-V_T}{k_a}}$$

$$V_T = V_a - k_a \log \frac{\bar{g}_{Na,Axon}}{g_{L,Soma-Dendrites}} \frac{E_{Na} - V_a}{k_a}$$

A. Exponential approximation

Instantaneous threshold

$$I_{Na} \approx g_{L,Soma-Dendrites} k_a e^{\frac{V-V_T + \log h}{k_a}}$$

A. Exponential approximation

Instantaneous threshold

$$I_{Na} \approx g_{L,Soma-Dendrites} k_a e^{\frac{V-(V_T-k_a \log h)}{k_a}}$$

A. Exponential approximation

Instantaneous threshold

$$I_{Na} \approx g_{L,Soma-Dendrites} k_a e^{\frac{V - (V_T - k_a \log h)}{k_a}}$$

$$\theta = V_T - k_a \log h$$

A. Exponential approximation

Instantaneous threshold

$$I_{Na} \approx g_{L,Soma-Dendrites} k_a e^{\frac{V-\theta}{k_a}}$$

$$\theta = V_T - k_a \log h$$

Instantaneous threshold

$$I_{Na} \approx g_{L,Soma-Dendrites} k_a e^{\frac{V-\theta}{k_a}}$$

$$\theta(t) = V_T - k_a \log h(t)$$

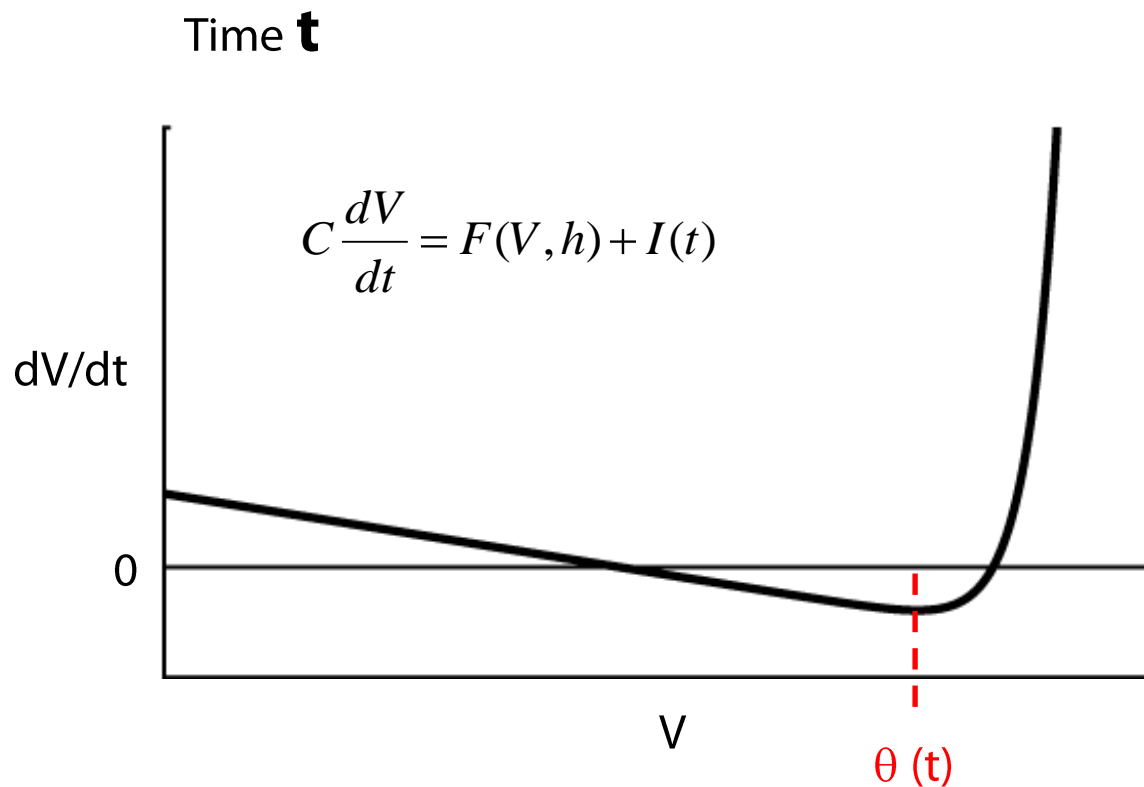

Instantaneous threshold

$$\theta(t) = V_T - k_a \log h(t)$$

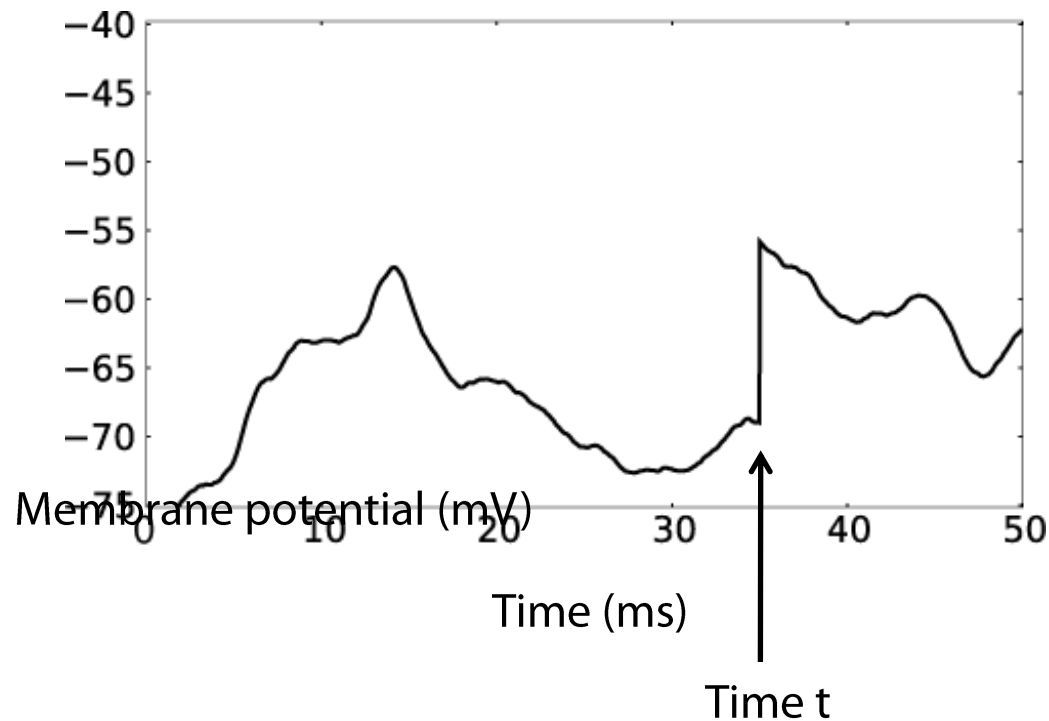

Instantaneous threshold

$$\theta(t) = V_T - k_a \log h(t)$$

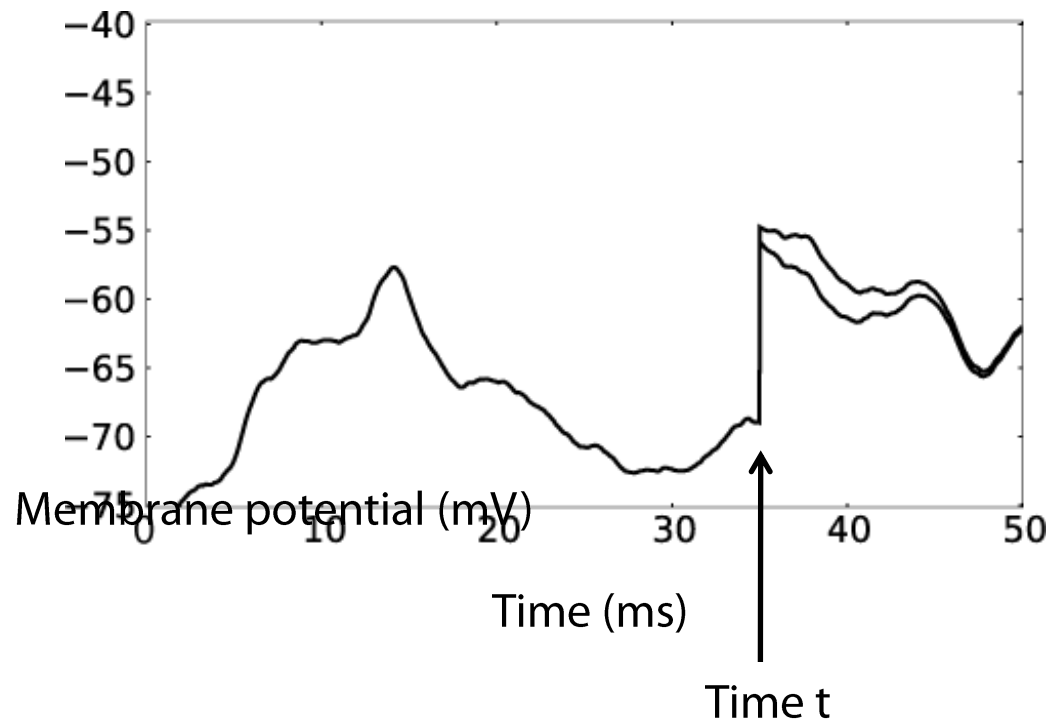

Instantaneous threshold

$$\theta(t) = V_T - k_a \log h(t)$$

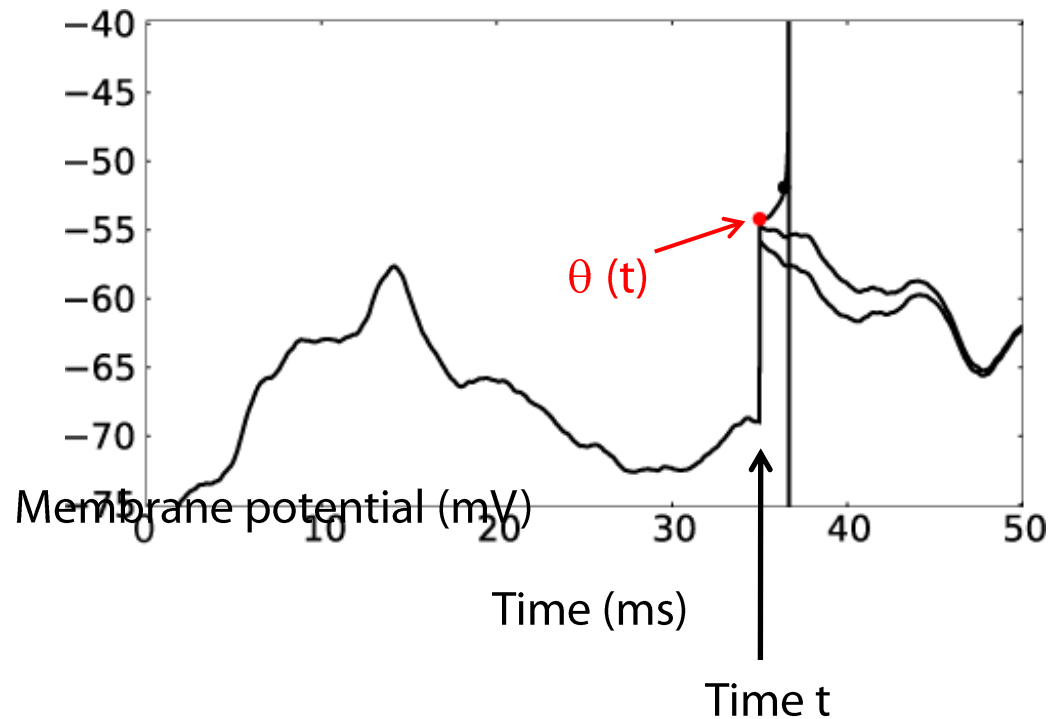

Instantaneous threshold

$$\theta(t) = V_T - k_a \log h(t)$$

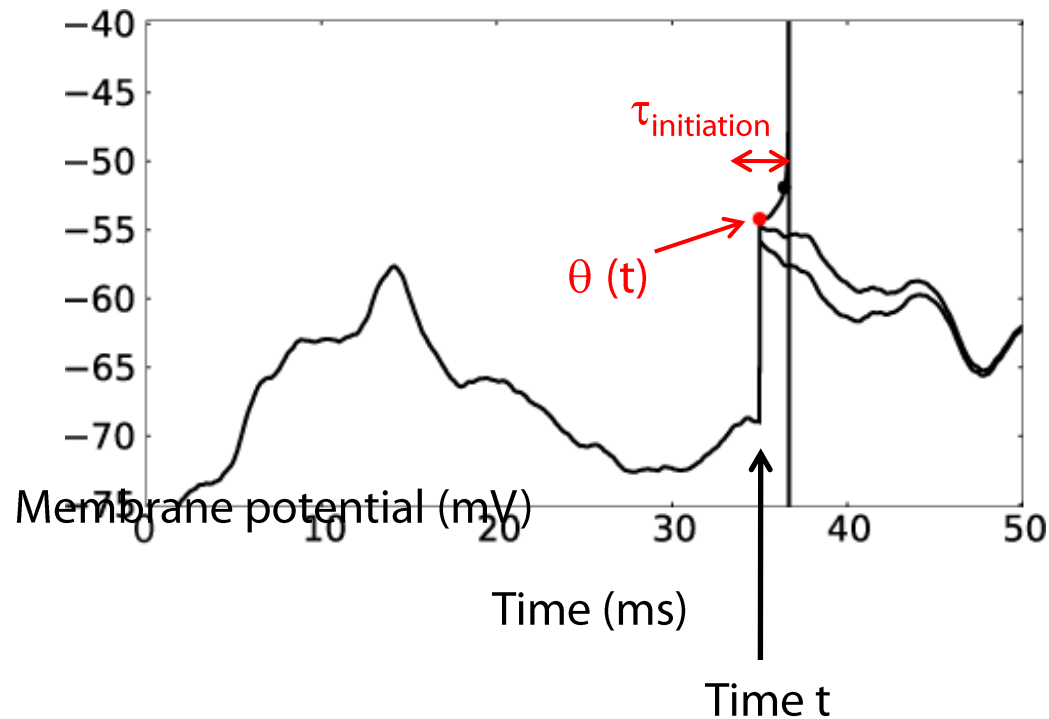

Instantaneous threshold

$$\theta(t + \tau_{\text{initiation}}) \sim \theta(t) \quad \leftarrow \dots \tau_h \gg \tau_{\text{initiation}}$$

$$\theta(t) = V_T - k_a \log h(t)$$

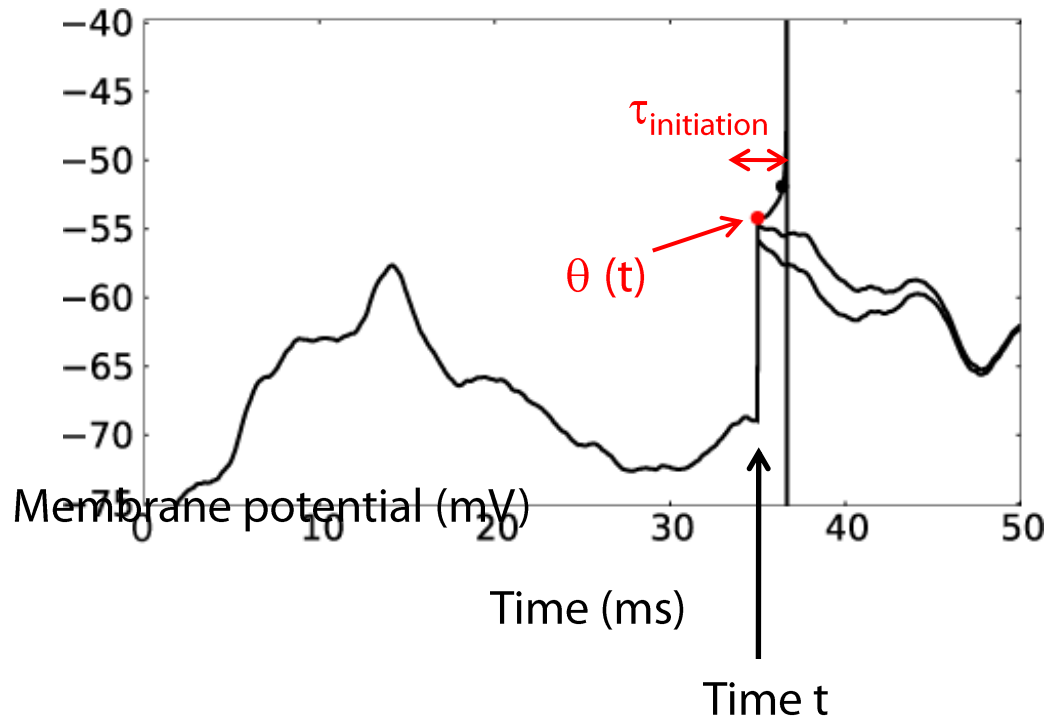

Instantaneous threshold

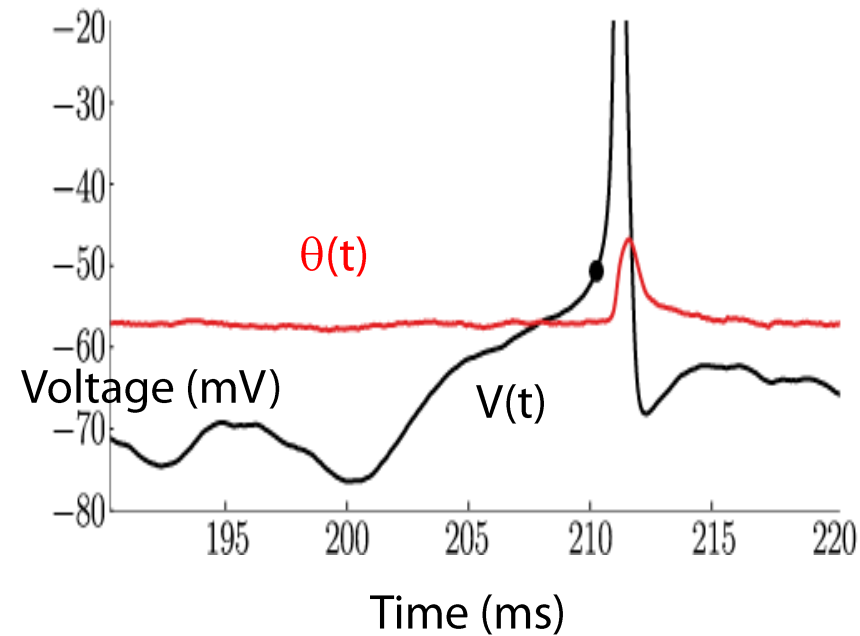

Validation

$$\theta = V_T - k_a \log h$$

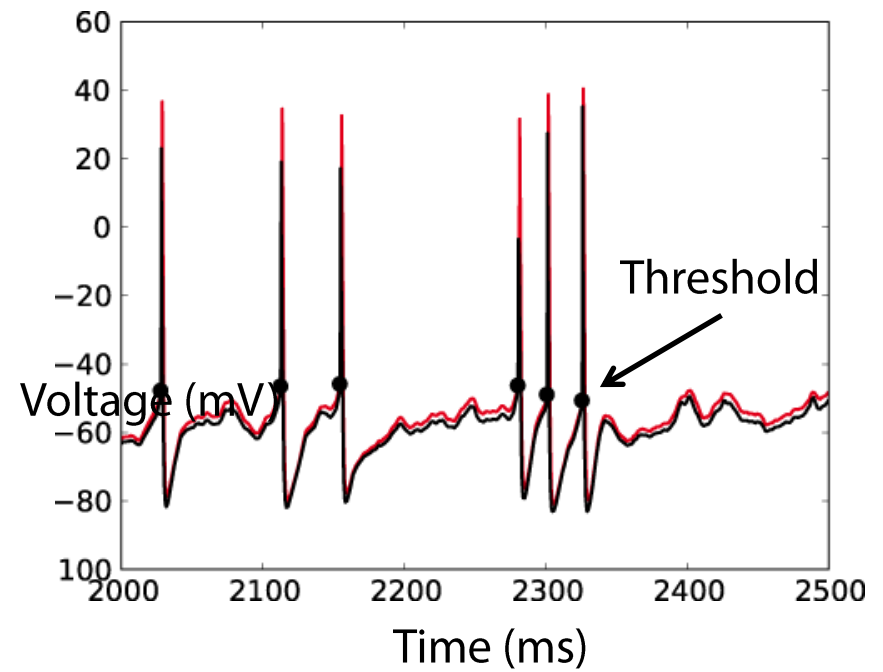
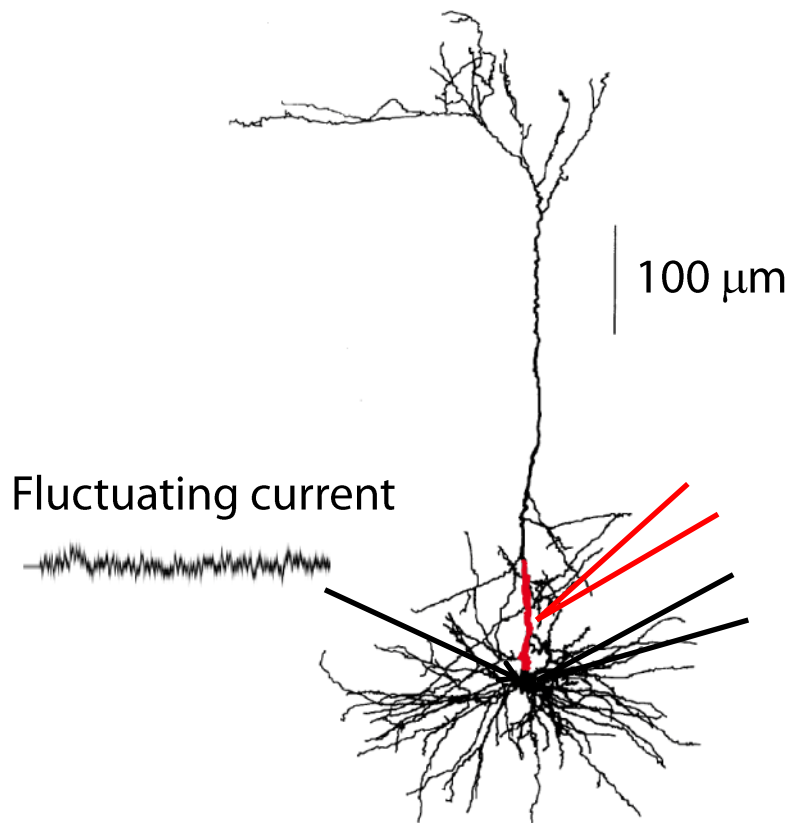

Validation

$$\theta = V_T - k_a \log h_{Axon}$$

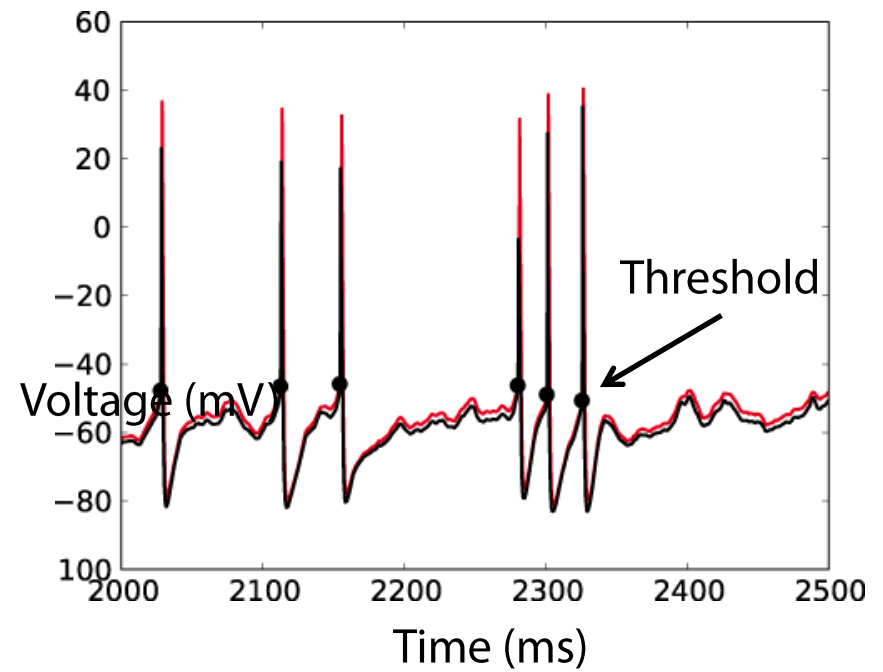
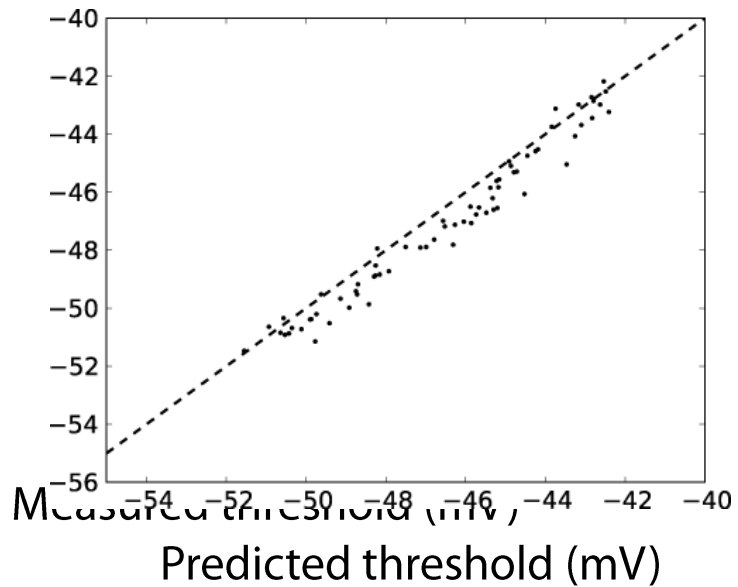

Validation

$$\theta = V_T - k_a \log h_{Axon}$$

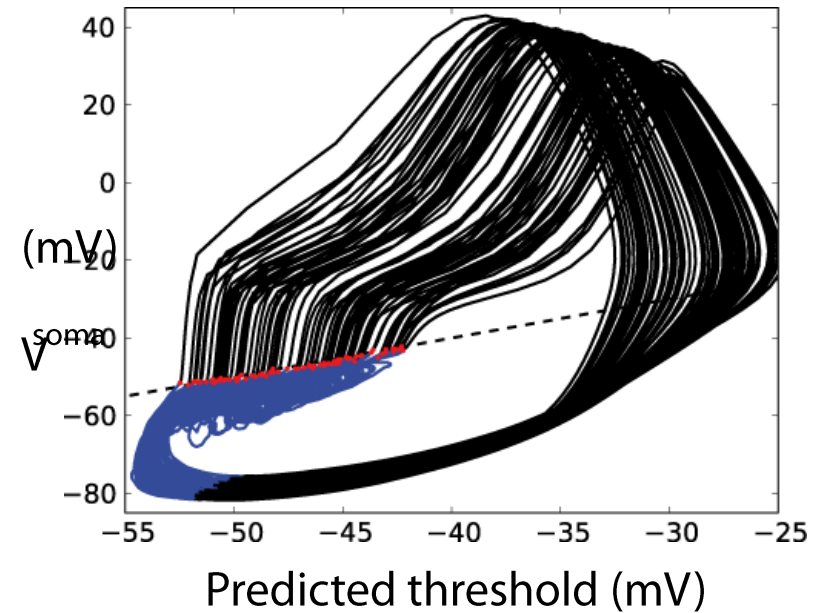
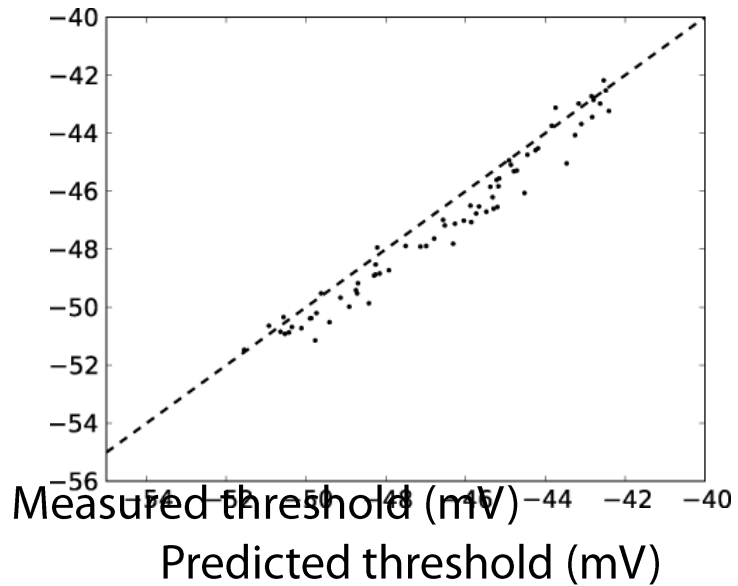

1. Experimental framework
2. Threshold basics
3. Threshold variability prediction
4. Impact of Na channel inactivation

Platkiewicz and Brette (2010). *Impact of sodium channel inactivation on spike threshold dynamic and synaptic integration*

A. Variability conditions

Steady-state threshold

$$\theta = V_T - k_a \log h$$

A. Variability conditions

Steady-state threshold

$$\theta = V_T - k_a \log h$$

$$\theta_{\infty}(V) = V_T - k_a \log h_{\infty}(V)$$

A. Variability conditions

Inactivation curve

$$\theta = V_T - k_a \log h$$

$$\theta_{\infty}(V) = V_T - k_a \log h_{\infty}(V)$$

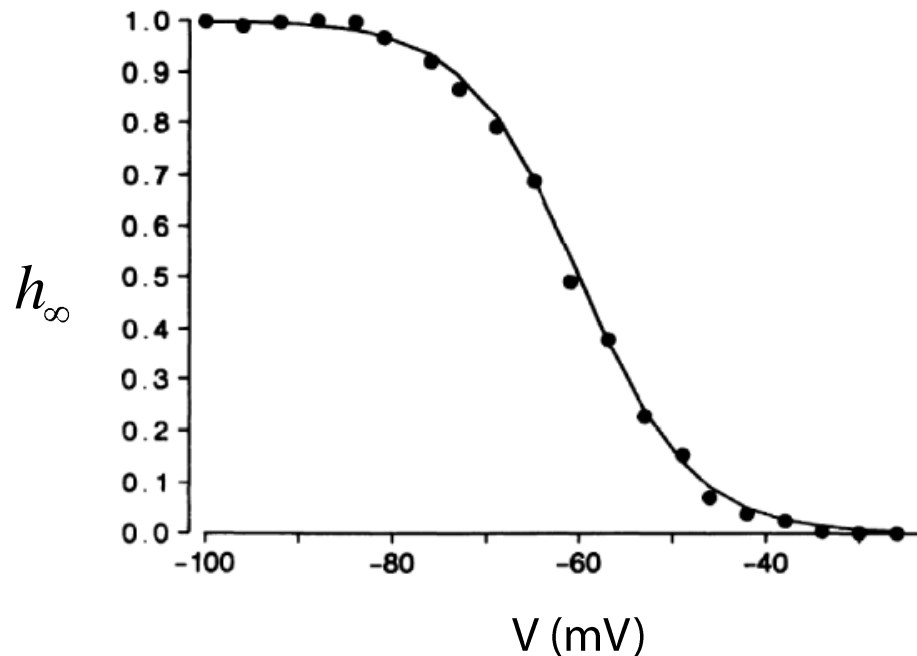

A. Variability conditions

Inactivation curve

$$\theta = V_T - k_a \log h$$

$$\theta_\infty(V) = V_T - k_a \log h_\infty(V)$$

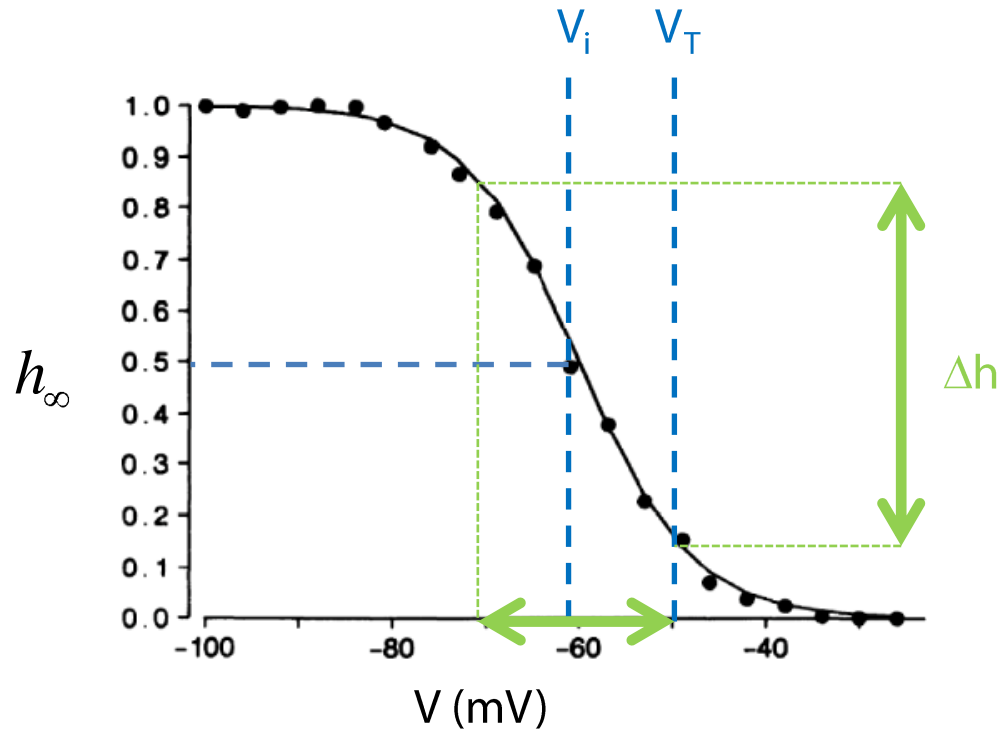

A. Variability conditions

Condition on V_i

$$\theta = V_T - k_a \log h$$

$$\theta_\infty(V) = V_T - k_a \log h_\infty(V)$$

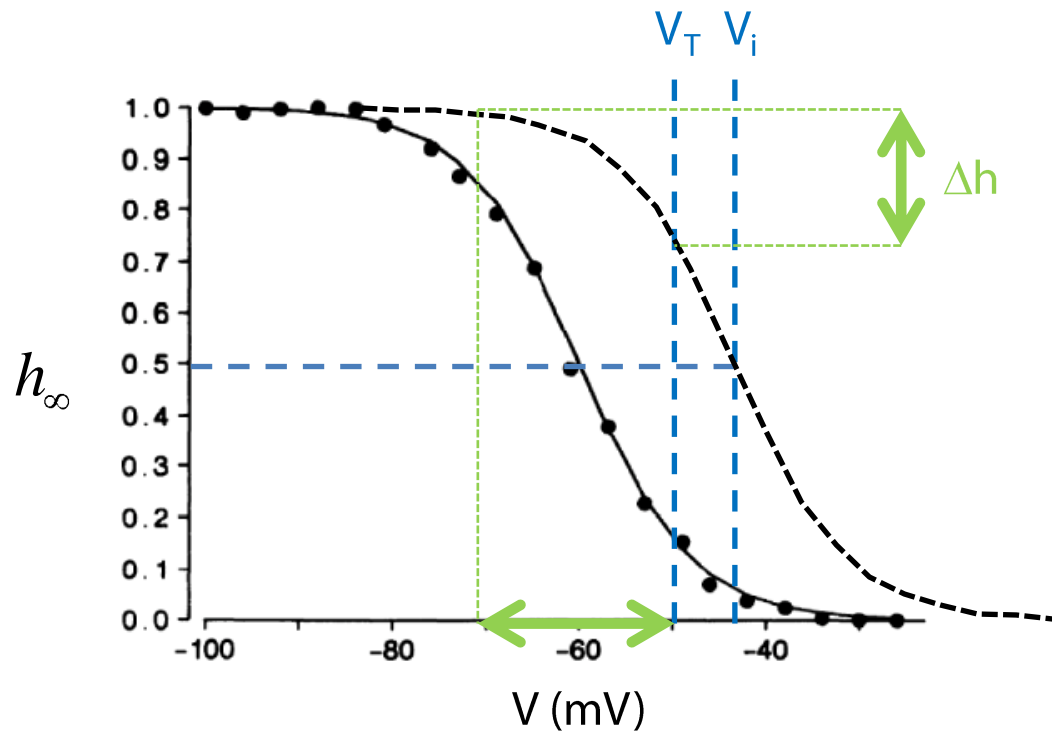

A. Variability conditions

Condition on V_i

$$\theta = V_T - k_a \log h$$

$$\theta_\infty(V) = V_T - k_a \log h_\infty(V)$$

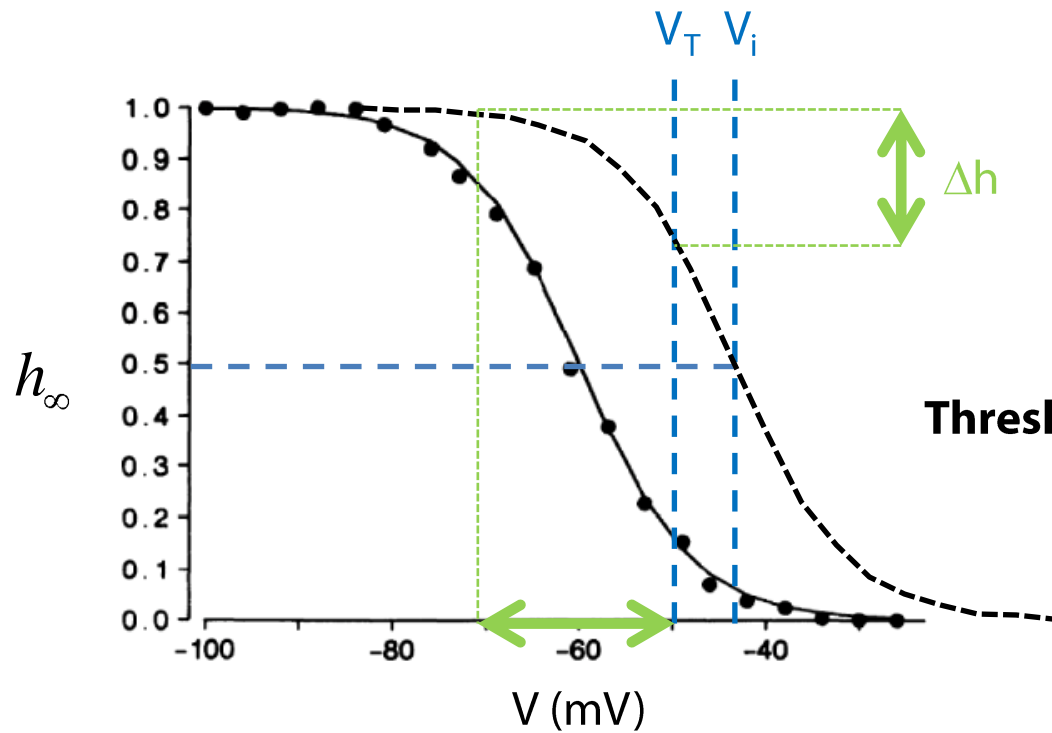

Threshold variability condition 1:

$$V_i < V_T$$

A. Variability conditions

Condition on V_i

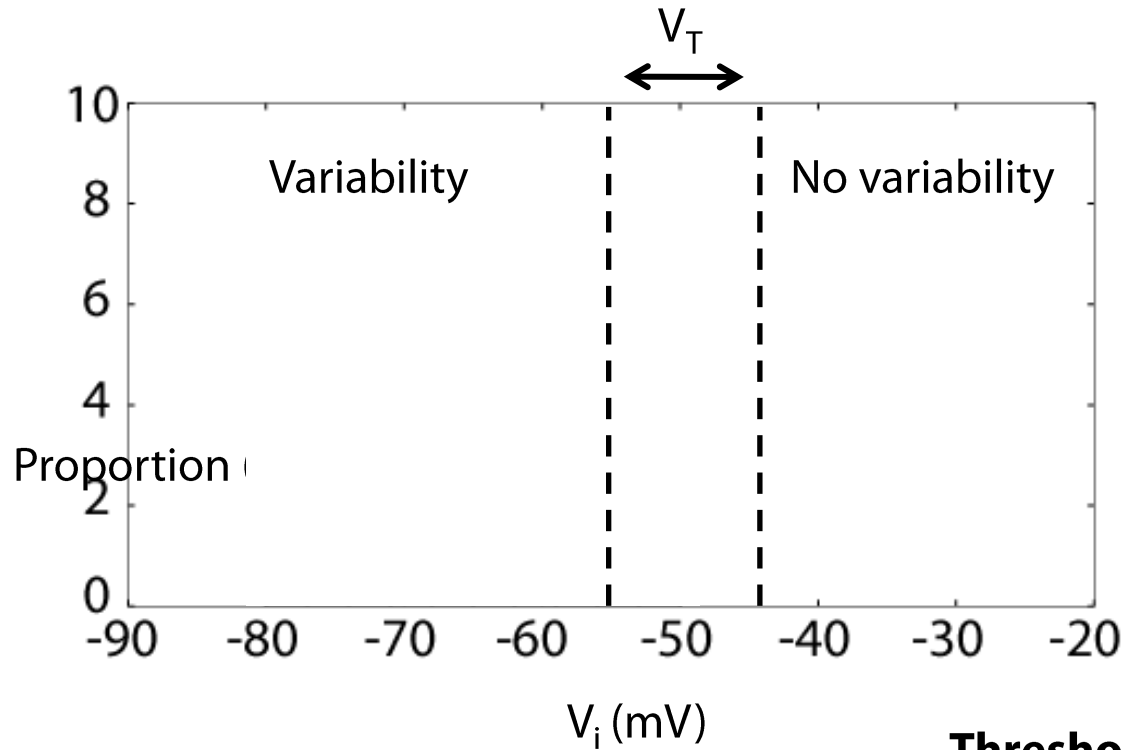

Threshold variability condition 1:

$$\mathbf{V_i < V_T}$$

A. Variability conditions

Condition on V_i

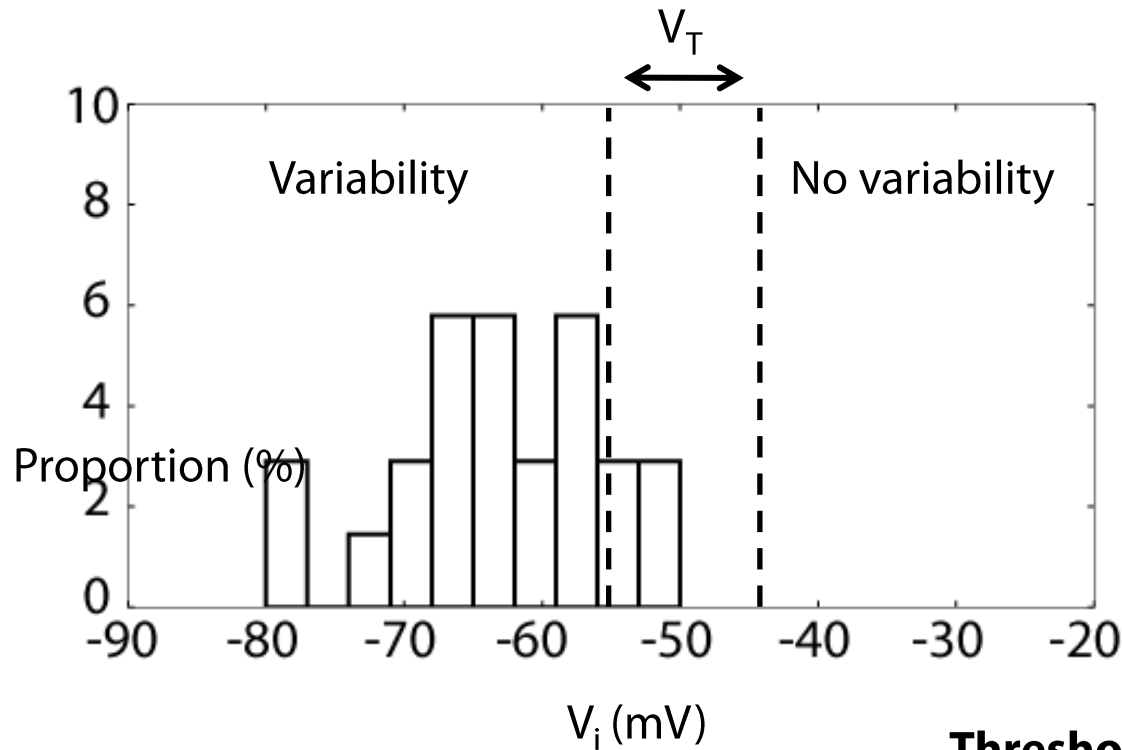

Threshold variability condition 1:

$$V_i < V_T$$

Patch-clamp data from central neurons

A. Variability conditions

Condition on k_i

$$\theta = V_T - k_a \log h$$

$$\theta_\infty(V) = V_T - k_a \log h_\infty(V)$$

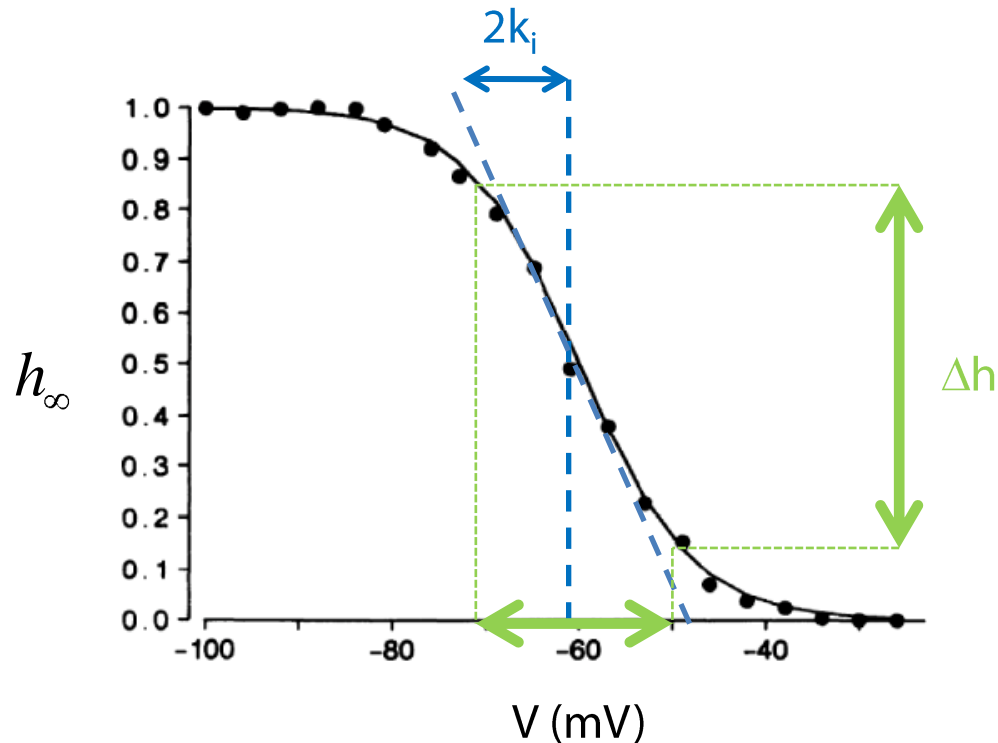

A. Variability conditions

Condition on k_i

$$\theta = V_T - k_a \log h$$

$$\theta_\infty(V) = V_T - k_a \log h_\infty(V)$$

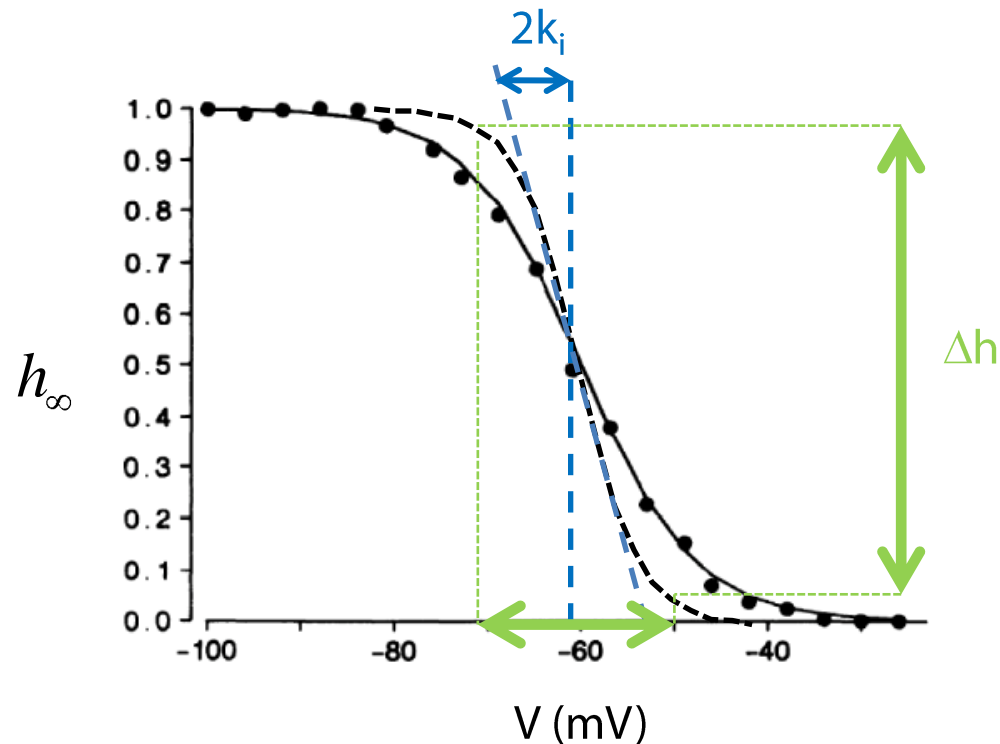

A. Variability conditions

Condition on k_i

$$\theta = V_T - k_a \log h$$

$$\theta_\infty(V) = V_T - k_a \log h_\infty(V)$$

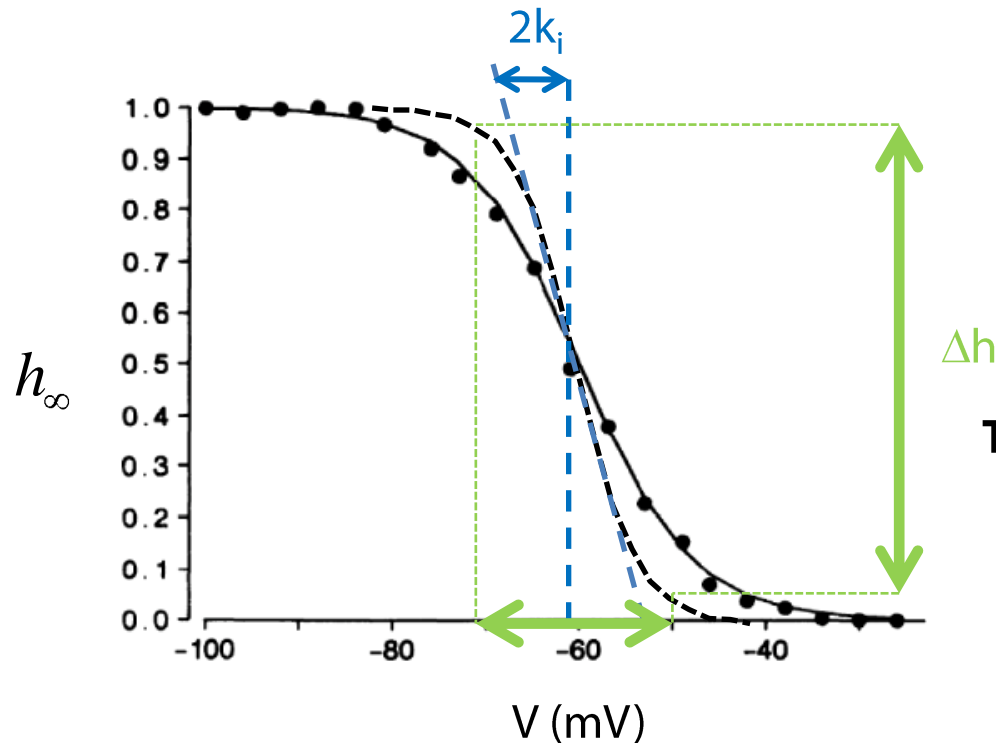

Threshold variability condition 2:

$$k_i < k_a$$

A. Variability conditions

Condition on k_i

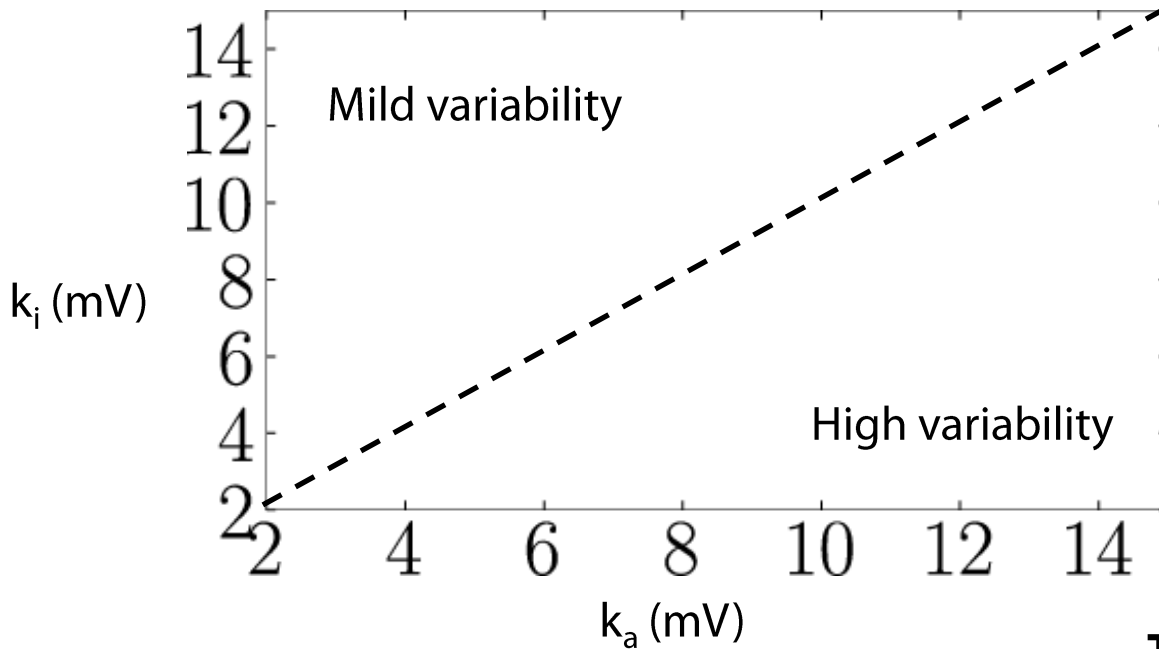

Threshold variability condition 2:

$$\mathbf{k_i < k_a}$$

A. Variability conditions

Condition on k_i

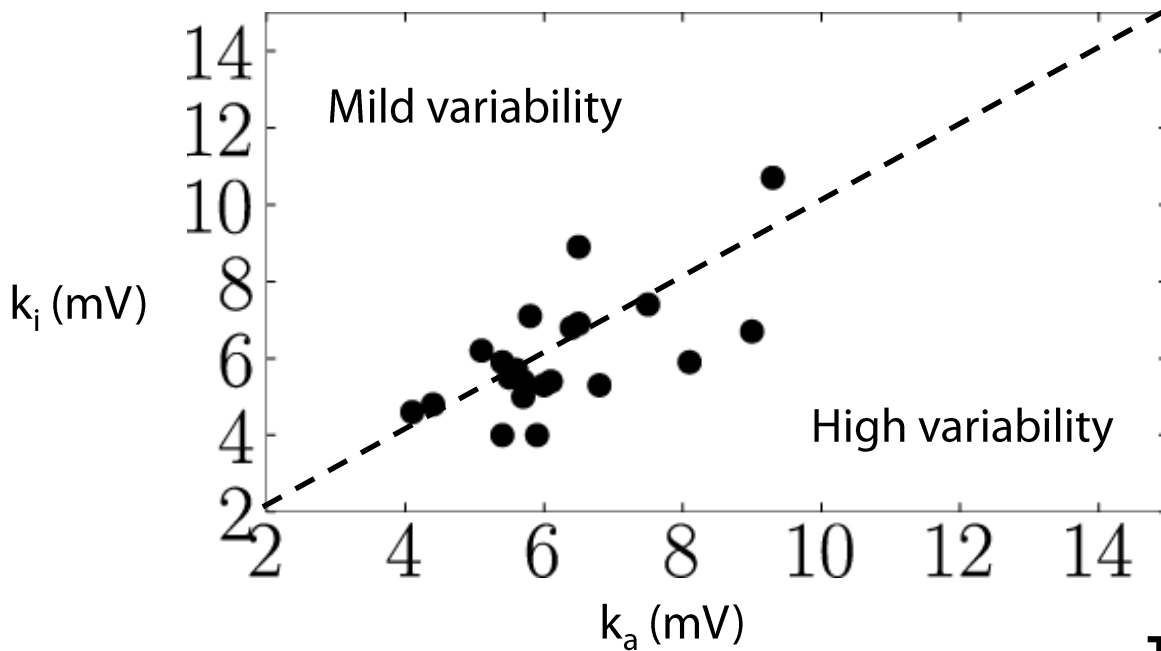

Threshold variability condition 2:

$$k_i < k_a$$

Patch-clamp data from central neurons

Threshold differential equation

$$\theta = V_T - k_a \log h$$

$$\tau_h(V) \frac{dh}{dt} = h_\infty(V) - h$$

Threshold differential equation

$$\theta = V_T - k_a \log h$$

$$\tau_h(V) \frac{dh}{dt} = h_\infty(V) - h$$

$$\frac{d\theta}{dt} = V_T - k_a \frac{dh/dt}{h}$$

Threshold differential equation

$$\theta = V_T - k_a \log h$$

$$\tau_h(V) \frac{dh}{dt} = h_\infty(V) - h$$

$$\frac{d\theta}{dt} = V_T - k_a \frac{dh/dt}{h}$$

$$\tau_h(V) \frac{d\theta}{dt} = \theta_\infty(V) - \theta$$

Threshold dynamics characteristics

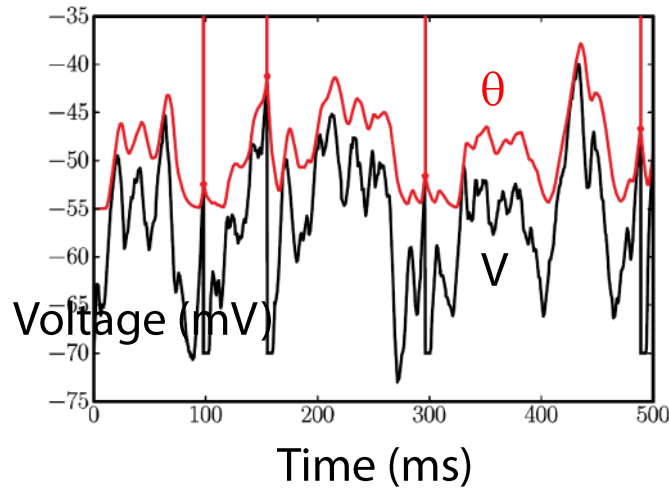

Spike if: $V > \theta$

$$\tau_h(V) \frac{d\theta}{dt} = \theta_\infty(V) - \theta$$

Threshold dynamics characteristics

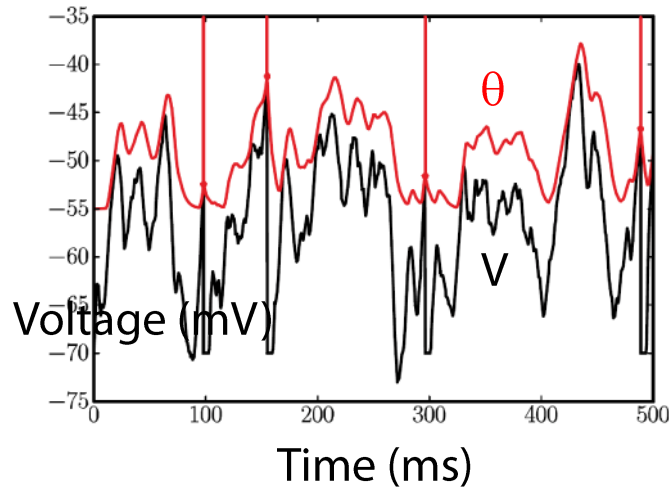

Spike if: $V > \theta$

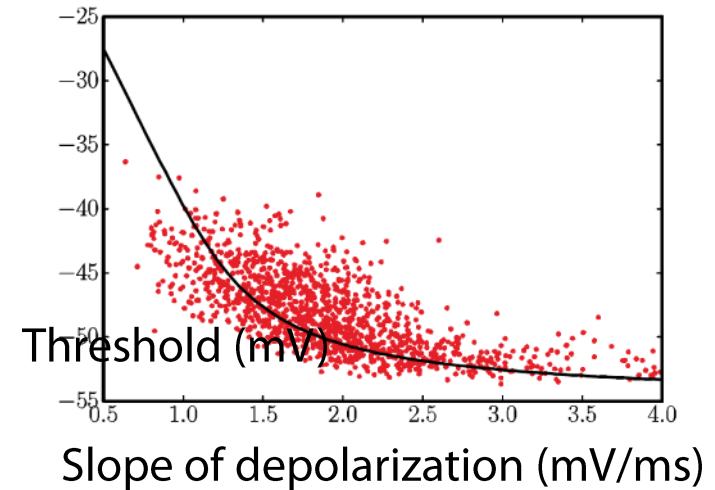

$$\tau_h(V) \frac{d\theta}{dt} = \theta_\infty(V) - \theta$$

Threshold dynamics characteristics

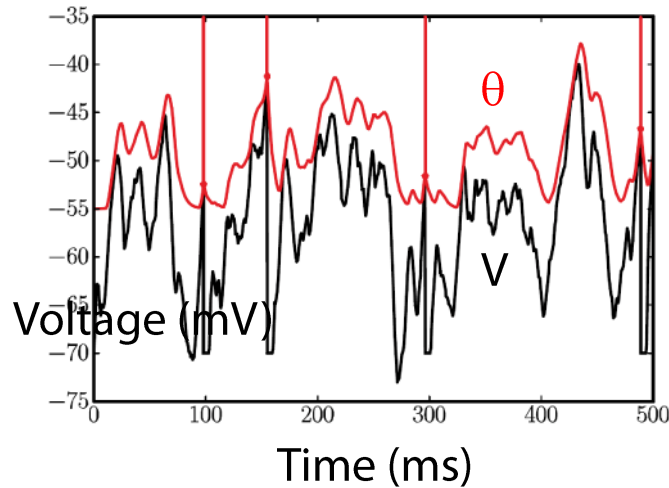

Spike if: $V > \theta$

$$\tau_h(V) \frac{d\theta}{dt} = \theta_\infty(V) - \theta$$

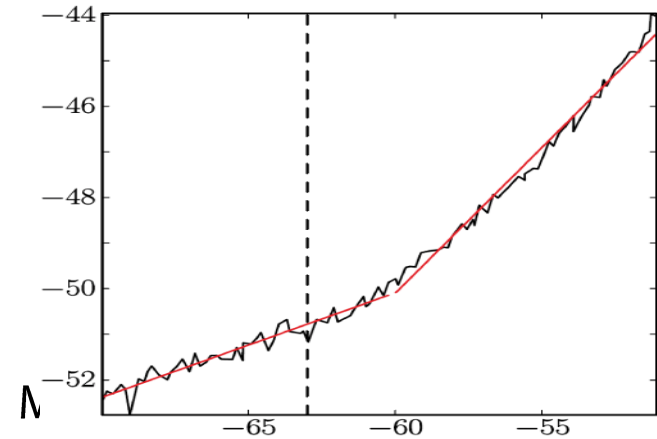
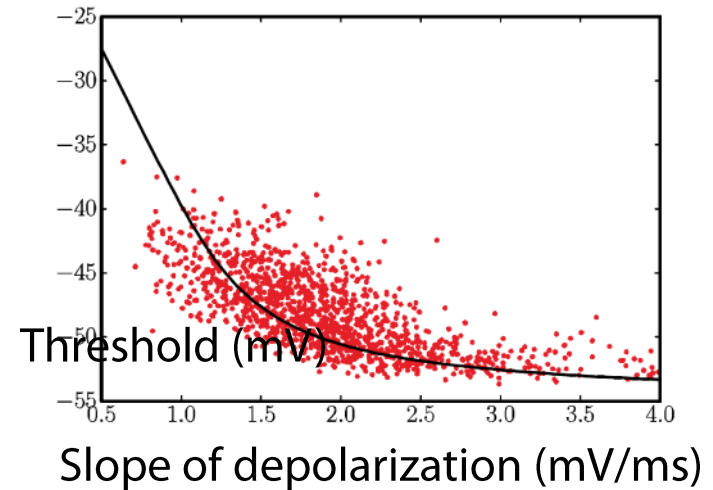

B. Synaptic integration

Effective postsynaptic potential

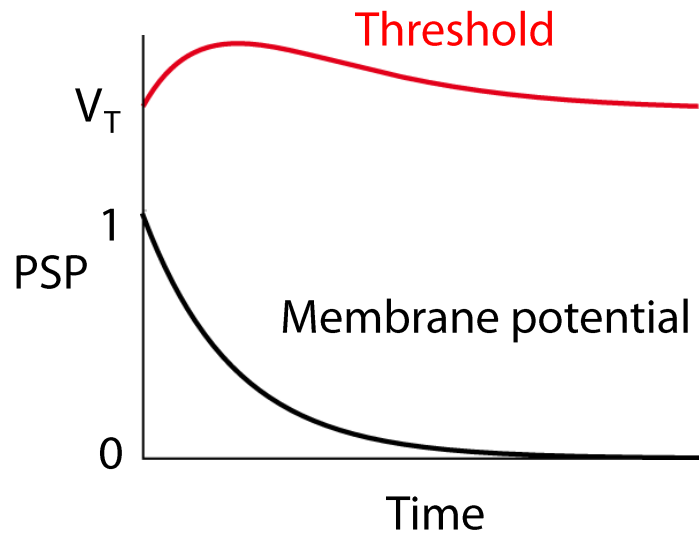

B. Synaptic integration

Effective postsynaptic potential

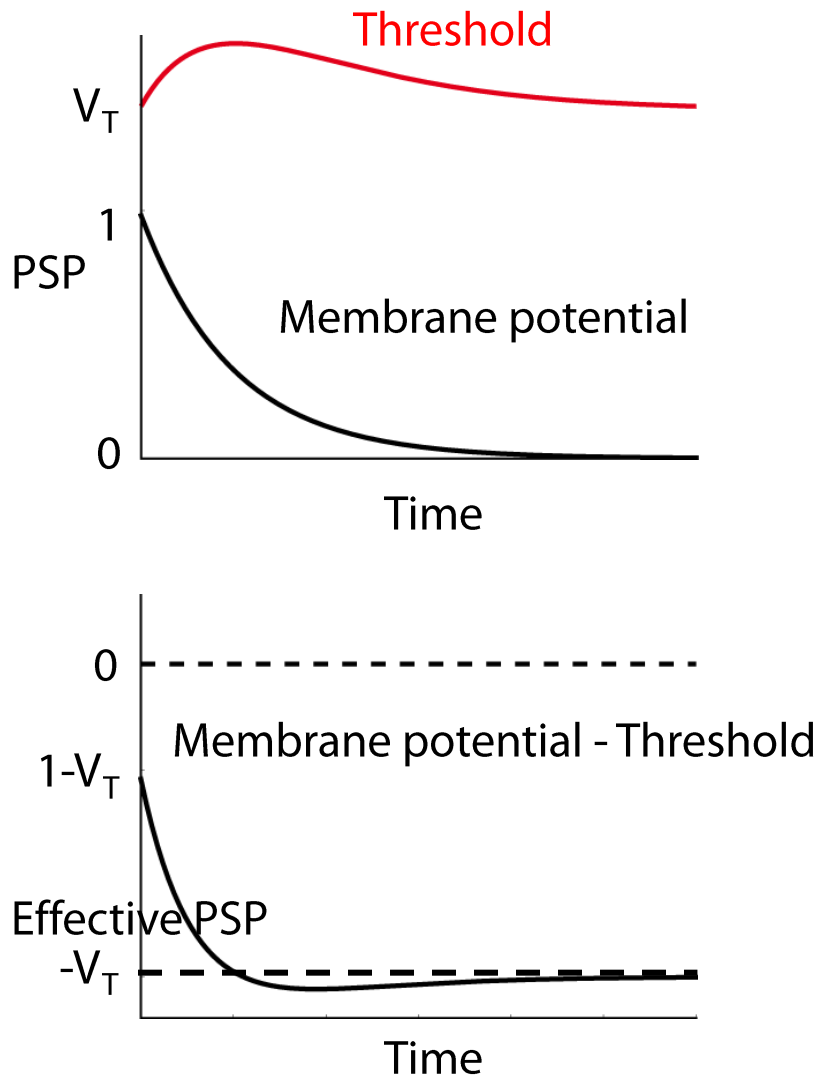

B. Synaptic integration

Effective postsynaptic potential

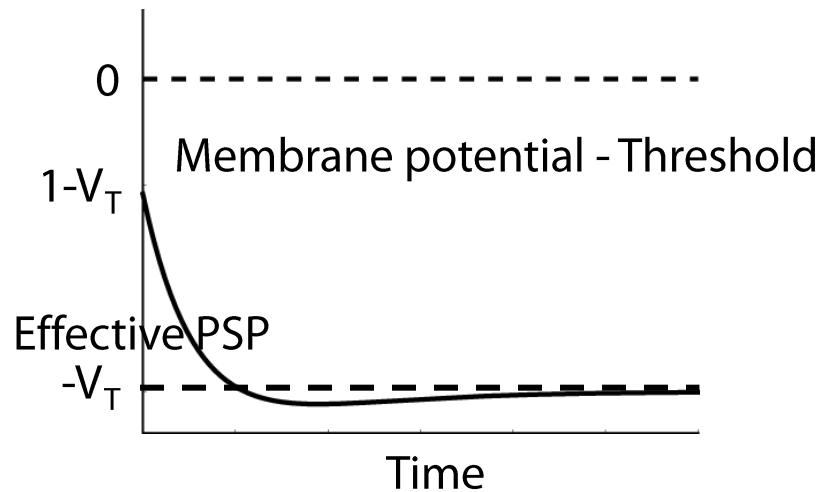
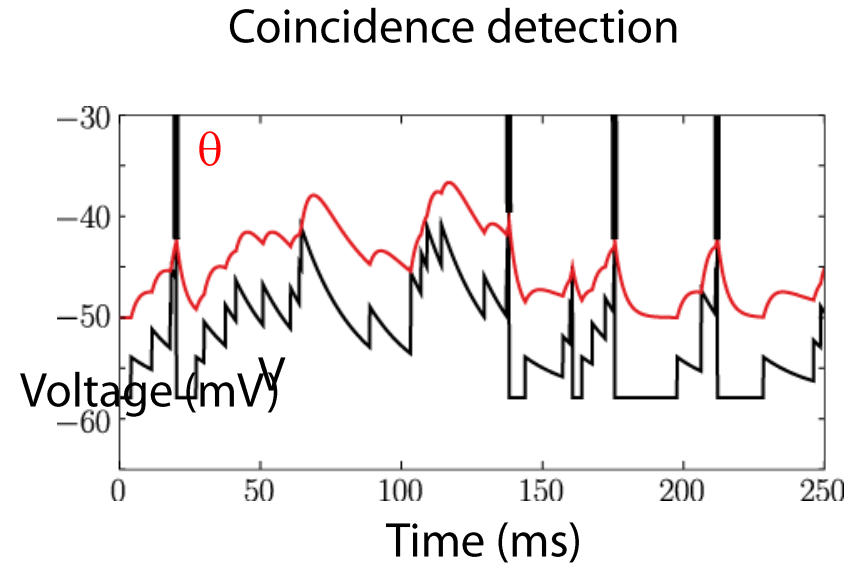
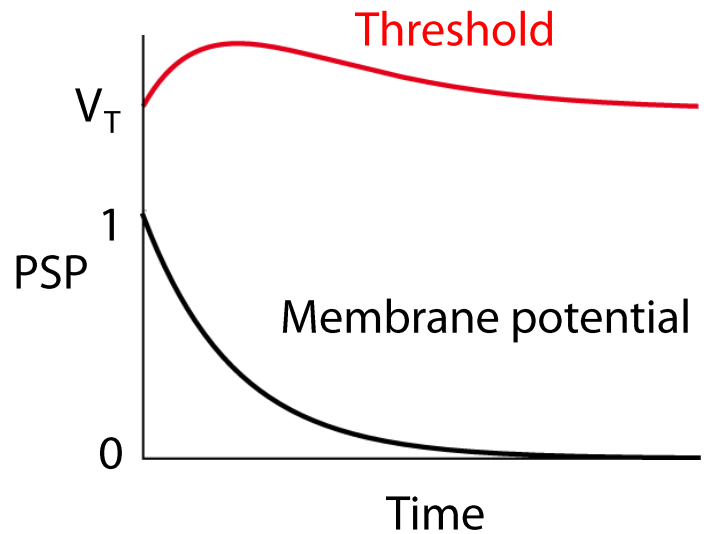

B. Synaptic integration

Effective postsynaptic potential

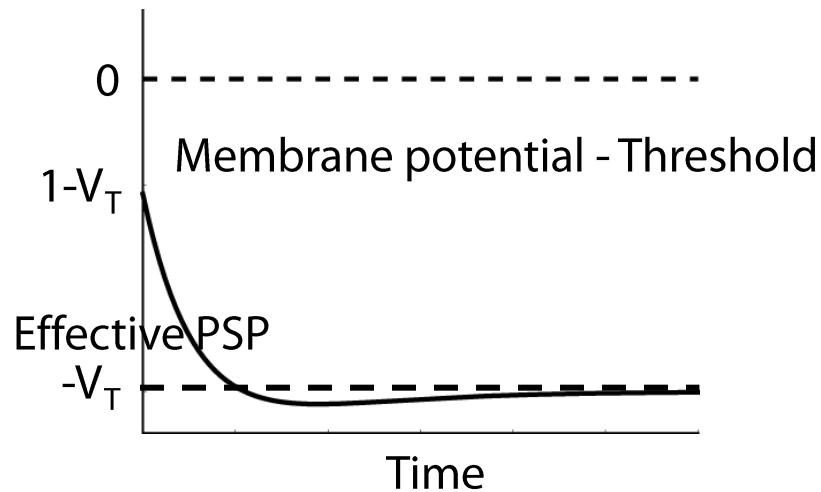
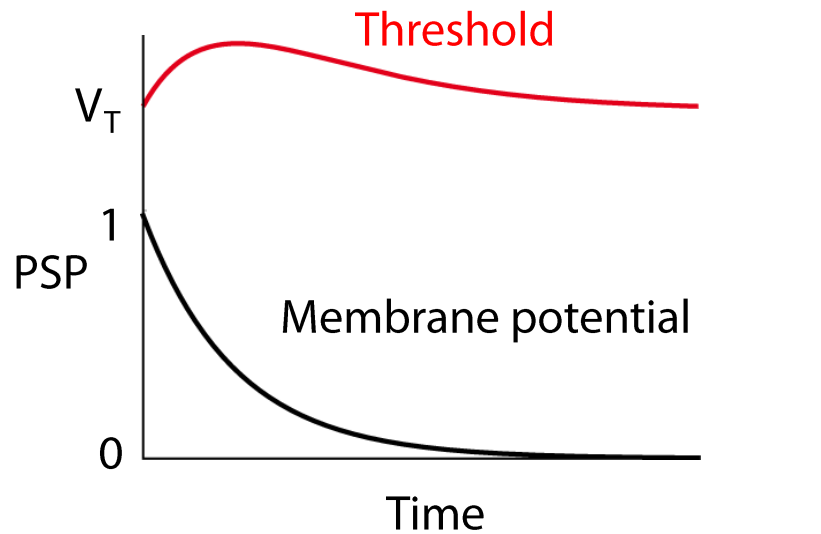

Coincidence detection

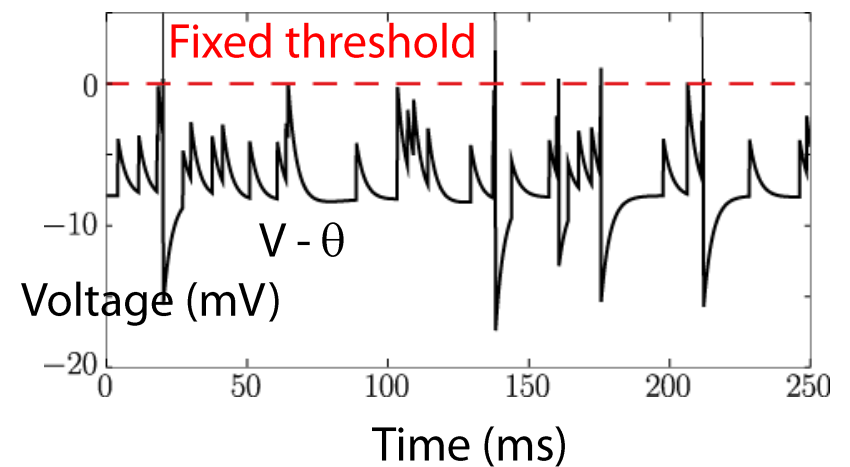
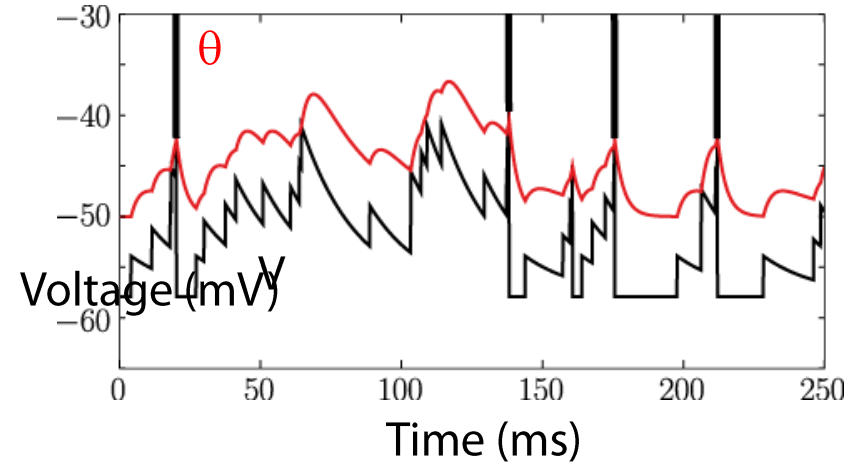

Conclusion

- ▶ The threshold can be **highly variable** in detailed **biophysical model** of cortical neuron.

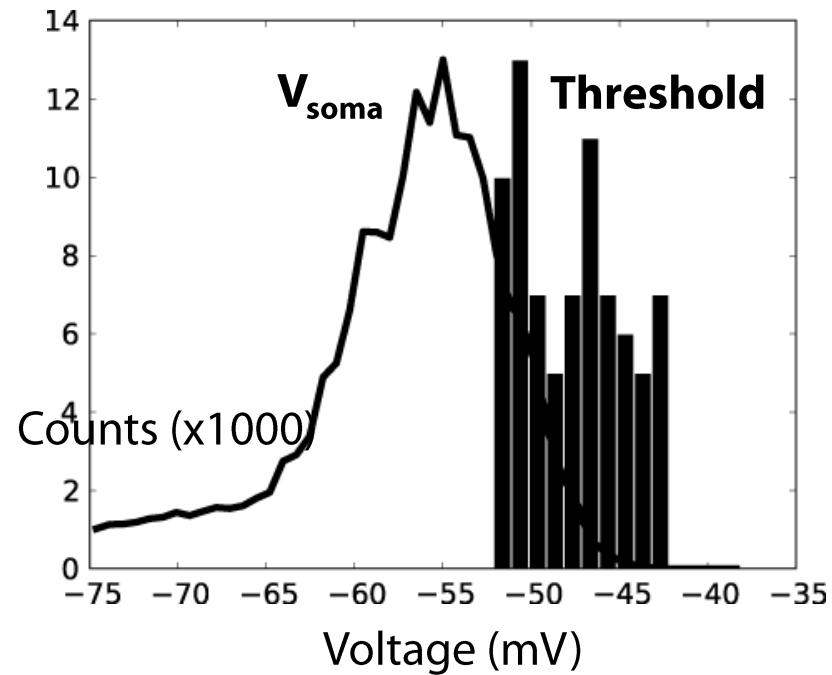

- ▶ The threshold can be **highly variable** in detailed **biophysical model** of cortical neuron.
- ▶ This variability comes only from **biophysical mechanisms** and can be **predicted** from the dynamics of the model variables.

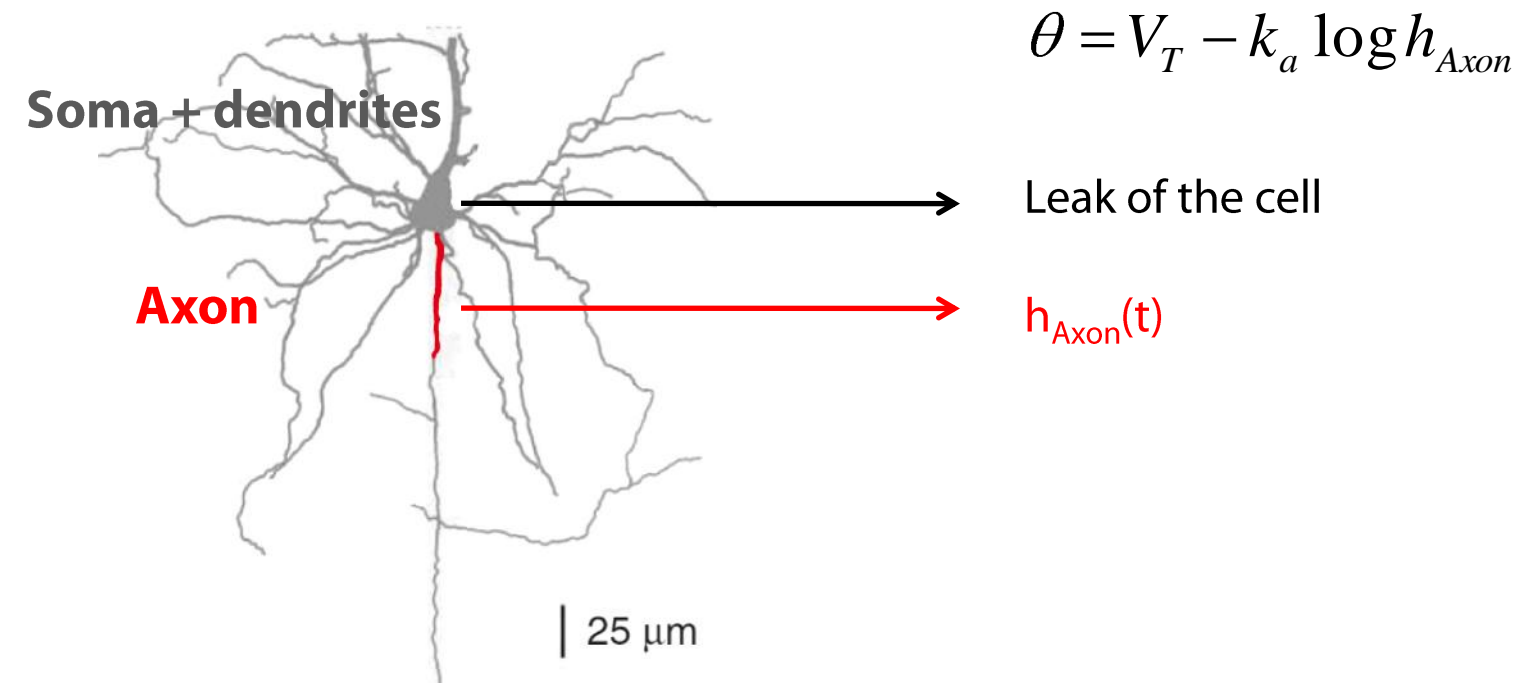

- ▶ The threshold can be **highly variable** in detailed **biophysical model** of cortical neuron.
- ▶ This variability comes only from **biophysical mechanisms** and can be **predicted** from the dynamics of the model variables.
- ▶ It is possible to give **explicit constraints** on Na channel **kinetics parameters** for having a variable threshold .

$$V_i < V_T \text{ and } k_i < k_a$$

- ▶ The threshold can be **highly variable** in detailed **biophysical model** of cortical neuron.
- ▶ This variability comes only from **biophysical mechanisms** and can be **predicted** from the dynamics of the model variables.
- ▶ It is possible to give **explicit constraints** on Na channel **kinetics parameters** for having a variable threshold .
- ▶ Interestingly, these constraints are satisfied by **patch-clamp** data on central neurons Na channels.

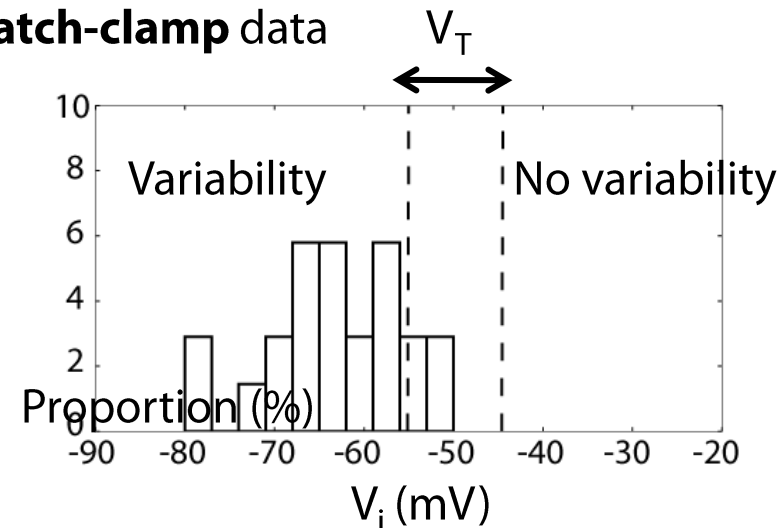

- ▶ The threshold can be **highly variable** in detailed **biophysical model** of cortical neuron.
- ▶ This variability comes only from **biophysical mechanisms** and can be **predicted** from the dynamics of the model variables.
- ▶ It is possible to give **explicit constraints** on Na channel **kinetics parameters** for having a variable threshold .
- ▶ Interestingly, these constraints are satisfied by **patch-clamp** data on central neurons Na channels.
- ▶ Na channel inactivation can be seen as a **virtual synapse**, **balancing** simultaneously real synapses.

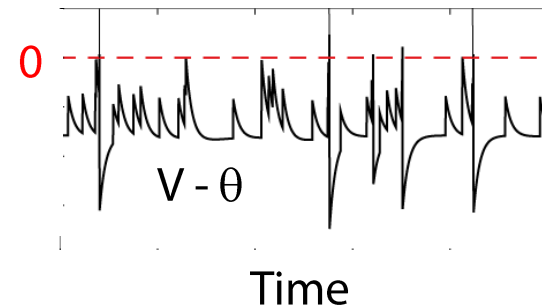

Diversity of Na channels

We have made a large dataset on Na channel kinetics parameters from patch-clamp recordings.

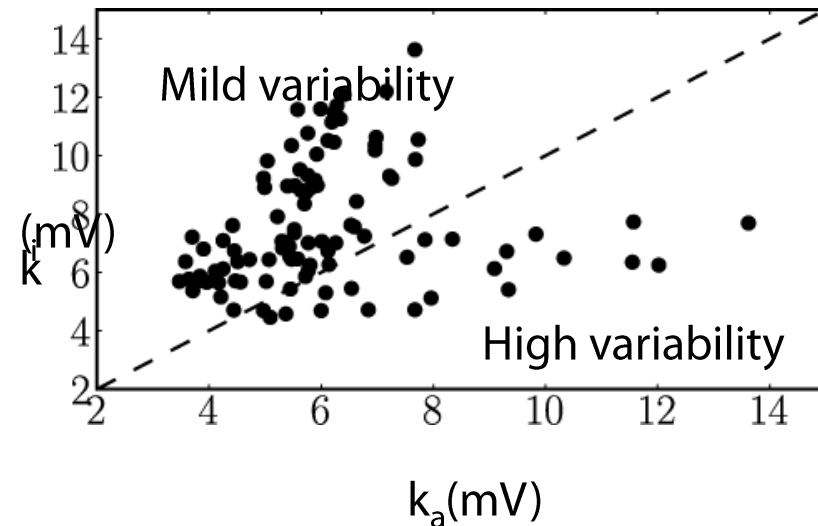
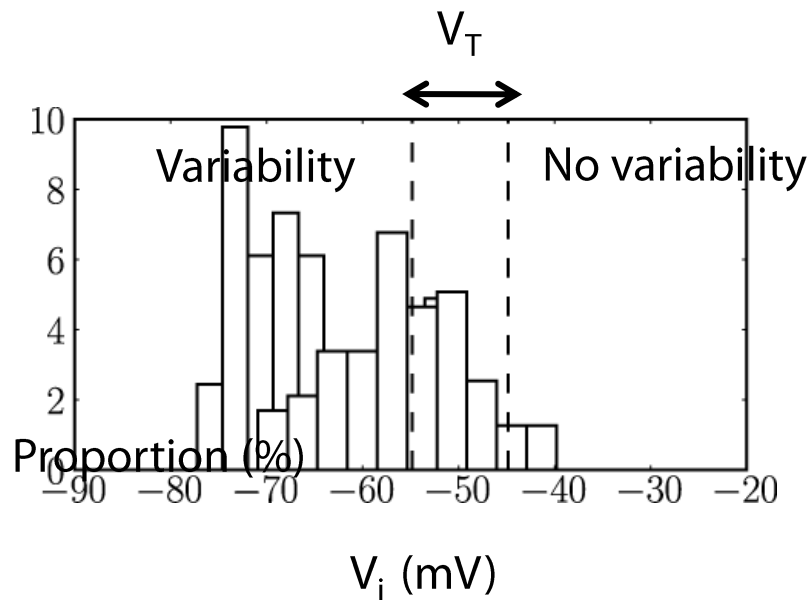

Diversity of Na channels

Nav1.6 is supposed to be responsible for **action potential initiation** in central neurons.

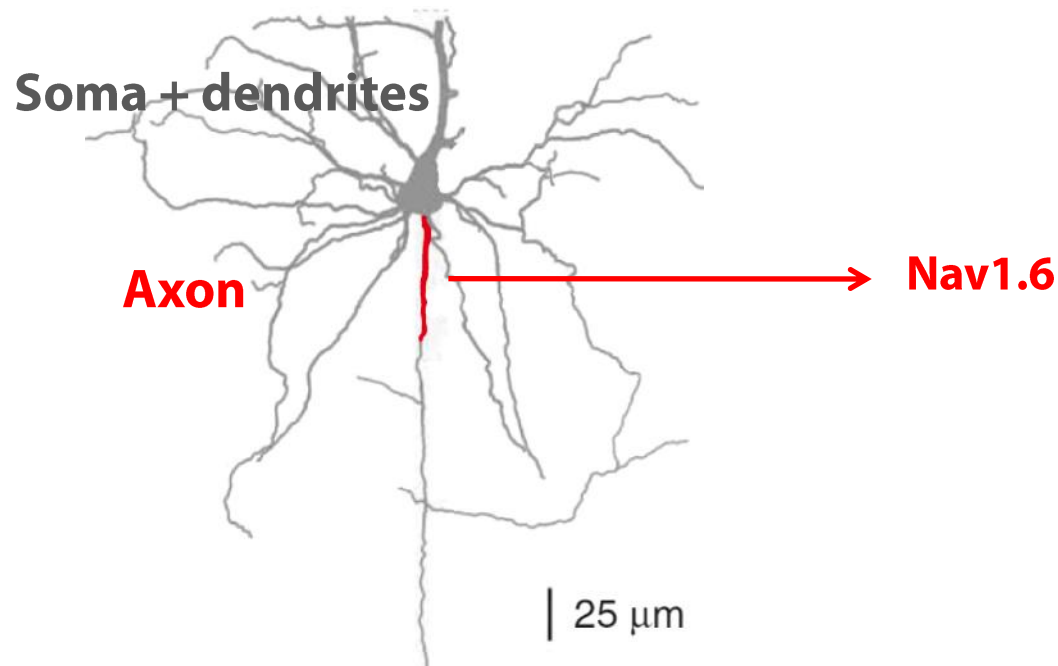

Diversity of Na channels

Its kinetics parameters satisfy well the threshold variability constraints.

Nav1.6 analyzed

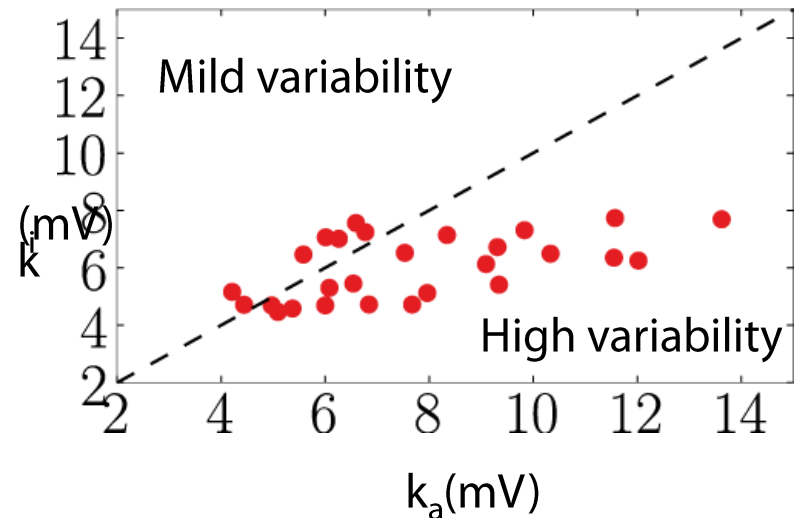
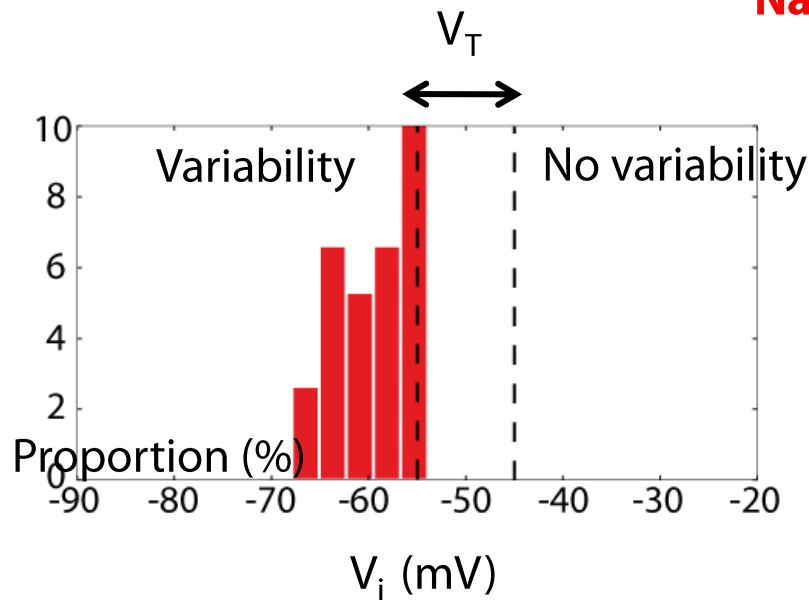

Experimental validations

Experimental condition: *in vitro*, intracellular recordings

Experimental validations

Experimental condition: *in vitro*, intracellular recordings

▶ Experimental validations of the threshold equation

$$\theta = V_T - k_a \log h$$

Experimental validations

Experimental condition: *in vitro*, intracellular recordings

▶ Experimental validations of the threshold equation

$$\theta = V_T - k_a \log h$$

▶ Empirical determination of the threshold dynamics

$$\tau_h(V) \frac{d\theta}{dt} = \theta_\infty(V) - \theta$$

Experimental validations

Experimental condition: *in vitro*, intracellular recordings

▶ Experimental validations of the threshold equation

$$\theta = V_T - k_a \log h$$

▶ Empirical determination of the threshold dynamics

$$\tau_h(V) \frac{d\theta}{dt} = \theta_\infty(V) - \theta$$

▶ Specific modification of Na channel kinetics or density in parallel with threshold measure

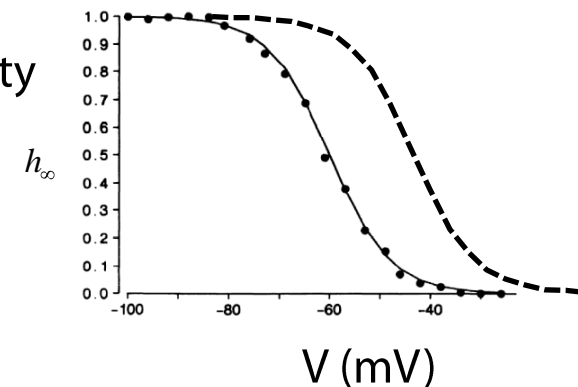

Thank you for your attention!