



**HAL**  
open science

# Conception and synthesis of iminoglycolipids as inhibitors of lysosomal enzymes acting as pharmacological chaperones

Farah Oulaïdi

► **To cite this version:**

Farah Oulaïdi. Conception and synthesis of iminoglycolipids as inhibitors of lysosomal enzymes acting as pharmacological chaperones. Other. Université d'Orléans, 2011. English. NNT : 2011ORLE2001 . tel-00623109

**HAL Id: tel-00623109**

**<https://theses.hal.science/tel-00623109>**

Submitted on 13 Sep 2011

**HAL** is a multi-disciplinary open access archive for the deposit and dissemination of scientific research documents, whether they are published or not. The documents may come from teaching and research institutions in France or abroad, or from public or private research centers.

L'archive ouverte pluridisciplinaire **HAL**, est destinée au dépôt et à la diffusion de documents scientifiques de niveau recherche, publiés ou non, émanant des établissements d'enseignement et de recherche français ou étrangers, des laboratoires publics ou privés.

**THÈSE PRÉSENTÉE A L'UNIVERSITÉ D'ORLÉANS  
POUR OBTENIR LE GRADE DE**

**DOCTEUR DE L'UNIVERSITÉ D'ORLÉANS**

par

**Farah OULAÏDI**

**ÉCOLE DOCTORALE SCIENCES ET TECHNOLOGIES**

**Discipline: Chimie Organique**

**CONCEPTION ET SYNTHÈSE D'IMINOGLYCOLIPIDES  
COMME INHIBITEURS D'ENZYMES LYSOSOMALES  
À EFFET CHAPERON PHARMACOLOGIQUE**

*Soutenue le 28 janvier 2011*

Thèse dirigée par :

**M. Olivier R. MARTIN** Professeur, Université d'Orléans - Directeur de thèse

**M. Philippe COMPAIN** Professeur, ECPM, Strasbourg 1 - Co-Directeur de thèse

Rapporteurs :

**M. Mikael BOLS** Professeur, Université de Copenhague, Danemark

**Mme Marielle LEMAIRE** Professeur, UBP, Clermont-Ferrand

Jury :

**M. Olivier R. MARTIN** Professeur, Université d'Orléans

**M. Philippe COMPAIN** Professeur, ECPM, Strasbourg 1

**M. Mikael BOLS** Professeur, Université de Copenhague, Danemark

**Mme Marielle LEMAIRE** Professeur, UBP, Clermont-Ferrand

**M. Yves LE MERRER** Professeur, Université Paris V

**M. Jean-Claude JACQUINET** Directeur de recherche, INSERM, Université d'Orléans

**A THESIS SUBMITTED FOR THE DEGREE OF  
DOCTOR OF ORGANIC CHEMISTRY**

**UNIVERSITY OF ORLÉANS, FRANCE**

**BY**

**Farah OULAÏDI**

**DOCTORAL SCHOOL OF SCIENCES AND TECHNICS**

**CONCEPTION AND SYNTHESIS OF IMINOGLYCOLIPIDS  
AS INHIBITORS OF LYSOSOMAL ENZYMES  
ACTING AS PHARMACOLOGICAL CHAPERONES**

*Defended on Friday, January 28<sup>th</sup> 2011*

Directed by :

**Mr Olivier R. MARTIN** Professor, University of Orléans

**Mr Philippe COMPAIN** Professor, ECPM, Strasbourg 1

Referees :

**Mr Mikael BOLS** Professor, University of Copenhagen, Denmark

**Mrs Marielle LEMAIRE** Professor, UBP, Clermont-Ferrand

Thesis comitee :

**Mr Olivier R. MARTIN** Professor, University of Orléans

**Mr Philippe COMPAIN** Professor, ECPM, Strasbourg 1

**Mr Mikael BOLS** Professor, University of Copenhagen, Denmark

**Mrs Marielle LEMAIRE** Professor, UBP, Clermont-Ferrand

**Mr Yves LE MERRER** Professor, University of Paris V

**Mr Jean-Claude JACQUINET** Research director, INSERM, University of Orléans

## *Acknowledgements*

I would like to thank my supervisors, Prof. Olivier R. Martin and Prof. Philippe Compain, for their advice and guidance during the course of this work. Both supervisors took a personal involvement in the outcome of this thesis and their efforts have been greatly appreciated. I am particularly thankful to Prof. Olivier R. Martin for allowing me some extra time to finish my experimental work and for his cheerful enthusiasm and ever-friendly nature that I was able to finish my research work in excellent conditions.

I would like to express gratitude to CNRS and Region Centre for a fellowship.

Besides my supervisors, I would like to thank the members of my thesis committee: Prof. Marielle Lemaire, Prof. Mikael Bols, Prof. Yves Le Merrer, and Dr Jean-Claude Jacquinet for the precious time they spent reading the manuscript and for providing me their valuable suggestions.

My sincere thanks also go to Prof. Aldo Orlacchio (University of Perugia, Italy) for offering me an internship opportunity in his group and leading me to work on biological experimentation.

I thank my fellow labmates: Gary, Ana, Cyril, and especially Estelle and Sophie for the stimulating discussions and for all the fun we have had in the last three years. Also, I thank my friends: Serour, Sheima, Aurelien, Karim, Samir, Henriette and Saida. I would also thank my love Olivier who always managed to understand how things were going and find the time to help me along.

My deepest gratitude goes to my family, for their unflagging love and support throughout my life; this dissertation was simply impossible without them. I am indebted to my father, Ben Achir Oulaidi, for his care and love. Although he is no longer with us, he is forever remembered. I am sure he shares our joy and happiness in the heaven.



# Contents

## Acknowledgement

Contents.....	1
Biological and medicinal glossary.....	5
Abbreviations.....	8
Avant propos.....	9
Chapter 1 .....	14
From health to disease: the vital role of Glycosphingolipids .....	14
Introduction .....	14
I. Lysosomal storage disorders .....	15
I.1. Lysosome .....	15
I.1.a. Synthesis and trafficking of lysosomal enzymes.....	15
I.1.b. Structure and function .....	17
I.2. Lysosomal storage disorders .....	17
II. Glycosphingolipids .....	21
II.1. Structure and function.....	21
II.2. Sphingolipid Biosynthesis .....	22
II.3. Glycosphingolipid Biosynthesis .....	25
II.4. Glycosphingolipid catabolism .....	27
III. Therapies for GSLs Storage .....	32
III.1. Therapy by substitution .....	32
III.1.a. Enzyme Replacement Therapy (ERT).....	32
III.1.b. Haematopoietic Cell Transplantation (HCT) .....	34
III.1.c. ERT in combination with HCT.....	35
III.2. Substrate Reduction Therapy (SRT) .....	35
III.3. Chaperone Mediated Therapy (CMT or ASSC).....	37
III.4. Conclusion.....	44
IV. Gaucher disease.....	46
IV.1. Causes of the disease.....	46
IV.2. Clinical aspect .....	48
IV.3. Physiopathology .....	49
IV.4. Related allelic disorder: Parkinson disease .....	50
IV.5. Therapy for Gaucher disease.....	51
IV.6. Conclusion.....	52
V. Krabbe disease (Globoid cell leukodystrophy, GLD) .....	53
V.1. Causes of the disease .....	53
V.1.a. pathogenic mechanism.....	53

V.1.b. GALC mutations .....	54
V.2. Clinical aspect .....	56
V.3. Therapy for Krabbe disease .....	57
Objectives .....	58
Chapter 2 .....	60
Improvement of the synthesis of $\alpha$ -1-C-alkyl-iminoxylitols as inhibitors and pharmacological chaperones of GCCase .....	60
I. Synthetic target .....	60
II. Previous synthetic pathway .....	61
III. Addition to imines: improved strategies.....	63
III.1. Protection of the anomeric center.....	64
III.1.a. Direct tritylation of the primary alcohol function.....	64
III.1.b. Benzyl glycoside .....	65
III.1.c. Methyl glycoside .....	66
III.2. Preparation of partially protected derivative 16 .....	67
III.3. Preparation of the imine .....	67
III.3.a. <i>N</i> -Benzylimine.....	67
III.3.b. <i>N</i> -Alkylsulfinylimine.....	68
III.4. Addition of Grignard reagents.....	69
III.4.a. Addition to the <i>N</i> -Benzylimine.....	69
III.4.b. Addition to the <i>N</i> -Sulfinylimine.....	70
III.5. Preparation of $\alpha$ -1-C-hexyl DIX.....	70
III.5.a. From the benzylamino derivative 20 .....	70
III.5.b. From the <i>N</i> -Alkylsulfinylamine derivative 21.....	71
III.5.c. Interpretation of the stereochemical outcome of the alkylation reaction.....	72
III.6. Conclusion.....	73
IV. Addition to protected xylosylamines.....	74
IV.1. Synthetic strategy .....	74
IV.2. Preparation of hemiacetal 27.....	75
IV.3. Preparation of amines.....	75
IV.4. Preparation of the imino sugar .....	76
IV.5. Preparation of the $\alpha$ -1- $C_n$ DIX .....	77
IV.6. Conclusion.....	78
V. Inhibitory activity .....	78
VI. Conclusion.....	79
Résumé Chapitre 2 : .....	80
Chapter3 .....	81
Synthesis of <i>O</i> -alkyl-iminoxylitols as potential inhibitors and pharmacological chaperones of GCCase .....	81
I. Synthetic target .....	81

II. Synthesis of racemic 2/4- <i>O</i> -alkyl analogs of DIX .....	82
II.1. Synthetic strategy.....	82
II.2. Preparation of the aldehyde 40 .....	82
II.3. Preparation of the diol intermediate 42.....	83
II.4. Preparation of mono- and di- <i>O</i> -alkyl analogs of DIX .....	84
II.5. Hydrogenolysis .....	84
II.6. Conclusion .....	85
III. Synthesis of 3- <i>O</i> -hexyl DIX.....	85
III.1. Synthetic strategy .....	85
III.2. Preparation of the aldehyde 48.....	86
III.3. Preparation of 3- <i>O</i> -hexyl DIX.....	86
III.4. Conclusion.....	87
IV. Inhibitory activity.....	87
V. Enantiopure <i>O</i> -alkyl derivatives of DIX .....	90
V.1. Synthetic strategy .....	90
V.1.a. Retrosynthesis of 2- <i>O</i> -hexyl DIX .....	90
V.1.b. Retrosynthesis of 4- <i>O</i> -hexyl DIX.....	90
V.2. Synthesis of 2- <i>O</i> -hexyl DIX .....	91
V.2.a. Preparation of the alcohol 16 .....	91
V.2.b. Preparation of the iminoxylitol 51 .....	91
V.2.c. Preparation of 2- <i>O</i> -hexyl DIX 53 .....	92
V.2.d. Conclusion.....	94
V.3. Synthesis of 4- <i>O</i> -hexyl DIX.....	94
V.3.a. Preparation of the iminoxylitol 56.....	94
V.3.b. Preparation of 4- <i>O</i> -hexyl DIX 58.....	95
V.3.c. Conclusion .....	96
V.4. Inhibitory activity .....	96
VI. Conclusion .....	98
Résumé Chapitre 3 : .....	99
Chapter 4 .....	100
Synthesis of imino-L-arabinitols as potential inhibitors and pharmacological chaperones of GALC .....	100
I. Synthetic target .....	100
II. Synthesis of $\alpha$ -1- <i>C</i> -alkyl DIA.....	101
II.1. Synthetic strategy.....	101
II.2. Synthesis of the <i>N</i> -alkylsulfinylimine.....	102
II.2.a. Preparation of the protected intermediate 62 .....	102
II.2.b. Synthesis of the aldehyde 64 .....	103
II.2.c. Synthesis of the sulfinylimine 65.....	104
II.3. Synthesis of the $\alpha$ - and $\beta$ -1- <i>C</i> -alkyl DIA.....	104

II.3.a. Addition of Grignard reagents to the imine 65 .....	104
II.3.b. Desulfinylation, hydrogenolysis and intramolecular reductive amination .....	106
II.3.c. Removal of the isopropilidene protecting group.....	108
II.3.c. Interpretation of the stereochemical outcome of the alkylation reaction .....	109
II.4. Conclusion .....	110
III. Synthesis of <i>O</i> -alkyl iminoarabinitol analogs .....	111
III.1. Synthetic strategy .....	111
III.1.a. Retrosynthesis of the 2- <i>O</i> -alkyl DIA derivatives .....	111
III.1.b. Retrosynthesis of the 4- <i>O</i> -alkyl DIA derivatives .....	111
III.2. Synthesis of the 2- <i>O</i> -hexyl DIA analogs.....	112
III.2.a. Preparation of the iminoarabinitols carrying free hydroxyl group on C-2 .....	112
III.2.b. Protection of the nitrogen and <i>O</i> -alkylation .....	112
III.2.c. Removal of protecting groups .....	113
III.2.d. Conclusion.....	113
III.3. Synthesis of the 4- <i>O</i> -alkyl DIA derivatives .....	114
III.3.a. Epimerization at C-4.....	114
III.3.b. <i>O</i> -alkylation and hydrogenolysis.....	115
III.3.c. Conclusion .....	115
Résumé Chapitre 4 : .....	116
Chapter 5 .....	117
Inhibitory and chaperone activity of new iminoglycolipids .....	117
I. Iminoxylylitol series.....	117
I.1. Inhibitory activity.....	117
I.1.a. Effect of the alkyl chain length .....	117
I.1.b. Effect of the conformation and configuration .....	118
I.1.c. Effect of the position of the alkyl chain .....	119
I.2. Chaperone activity .....	120
II. Inhibitory activity of iminoarabinitol derivatives .....	121
Résumé Chapitre 5 : .....	125
Conclusion.....	126
Experimental section .....	129



# **Biological & Medical Glossary**

## **Allele**

One of several alternative forms of a gene. In a diploid cell (containing a double genome) each gene will typically have two alleles, occupying the corresponding position (locus) on homologous chromosomes.

## **Apoptosis**

A programmed cell death, in which a “suicide” program is activated within a cell, thus leading to rapid cell death mediated by intracellular proteolytic enzymes called caspases.

## **Apraxia**

Apraxia is a neurological disorder affecting the ability to control fine and gross motor movement and gestures. This disorder can also affect communication skills.

## **Arthrogyrosis**

A rare congenital disorder that is characterized by multiple joint contractures and can include muscle weakness and fibrosis. It is a non-progressive disease. This disease derives its name from Greek, literally meaning 'curved or hooked joints'.

## **Autophagy**

Digestion of worn-out organelles by the cell's own lysosomes.

## **Autosome**

Any chromosome other than a sex chromosome.

## **Axon**

Long nerve cell projection that can rapidly conduct nerve impulses over long distances so as to deliver signals to other cells.

## **Bulbar muscles**

The bulbar muscles are those supplied by the motor nerves from the brain stem which controls swallowing, breathing and speech.

## **Chemokine**

Chemotactic cytokine. Small secreted protein that attracts cells, such as white blood cells, to move towards its source. Important in the functioning of the immune system.

## **Cytokine**

Extracellular signal protein or peptide that acts as a local mediator in cell-cell communication.

## **Connective tissue**

Any supporting tissue that lies between other tissues and consists of cells embedded in a relatively large amount of extracellular matrix. Includes bone, cartilage, and loose connective tissue.

## **Cytosol**

Content of the main compartment of the cytoplasm, excluding membrane-bound organelles such as endoplasmic reticulum and mitochondria.

**Endoplasmic reticulum (ER)**

Labyrinthine membrane bounded compartment in the cytoplasm of eukaryotic cells, where lipids are synthesized and membrane-bound proteins and secretory proteins are made.

**ER lumen**

Space enclosed by the membrane of the endoplasmic reticulum.

**Endosome**

Membrane-bounded organelle in animal cells that carries material newly ingested by endocytosis and passes much of it onto lysosomes for degradation.

**Fibroblast**

Common cell type found in connective tissue. Secretes an extracellular matrix rich in collagen and other extracellular matrix macromolecules. Migrates and proliferates readily in wounded tissue and tissue culture.

**Hematopoietic cells**

Term for all bone marrow-derived cell types in the blood. Hematopoietic cells are subgrouped broadly into myeloid cells and the lymphoid cells. Cells that do not produce hemoglobin are leukocytes. Cells that produce hemoglobin are erythrocytes.

**Heterophagy**

Process of lysosomal digestion of material ingested from the process of endocytosis. Examples of heterophagocytosis include the uptake and digestion of bacteria by neutrophils and the removal of apoptotic cells by macrophages.

**Heterozygous**

Having the two alleles for one gene at the corresponding loci

**Homozygous**

Having identical alleles for one gene at the corresponding loci

**Hyperesthesia**

Condition that involves an abnormal increase in sensitivity to stimuli of the senses. Stimuli of the senses can include sound that one hears, foods that one tastes, textures that one feels, and so forth. Increased touch sensitivity is referred to as "tactile hyperesthesia", and increased sound sensitivity is called "auditory hyperesthesia.

**Ichthyosis**

All types of ichthyosis have dry, thickened, scaly or flaky skin. The skin is said to resemble the scales on a fish.

**Lymphoid organ**

Organ involved in the production or function of lymphocytes. The lymphoid tissue includes the lymph nodes, spleen, tonsils and adenoids, and the thymus.

**Macrophage**

Phagociting cell derived from blood monocytes, which reside in most tissues and that is able to roam.

**Pancytopenia**

Medical condition in which there is a reduction in the number of red and white blood cells, as well as platelets.

**Phenotype**

The observable character (including both physical appearance and behavior) of a cell or organism.

**RNA Splicing**

In most eukaryotic genes, coding regions (exons) are interrupted by noncoding regions (introns). During transcription, the entire gene is copied into a pre-mRNA, which includes exons and introns. During the process of RNA splicing, introns are removed and exons joined to form a contiguous coding sequence. This "mature" mRNA is ready for translation.

**Stratum corneum**

The horny outer layer of the epidermis, consisting mainly of dead or peeling cells.

**Thrombocytopenia**

Medical condition in which there is the presence of relatively few platelets in blood.

## Abbreviations

Ac	acetyl
AcOH	acetic acid
Bn	benzyl
BnBr	benzyl bromide
Bu	butyl
CMT	Chaperon mediated therapy
DMF	<i>N,N</i> -dimethylformamide
ERT	Enzyme Replacement Therapy
Et <sub>3</sub> N	triethylamine
eq	equivalent
FDA	Food and Drug Administration
IC <sub>50</sub>	the half maximum inhibitory concentration
<i>K<sub>i</sub></i>	dissociation constant for inhibitor binding
mM	millimolar
nM	nanomolar
Pd/C	palladium on carbon
PTSA	<i>p</i> -toluenesulfonic acid
Pyr	pyridine
NI	no inhibition
NMR	nuclear magnetic resonance
r.t	room temperature
SRT	Substrate reduction Therapy
TFA	trifluoroacetic acid
THF	tetrahydrofurane
TMSOTf	trimethylsilyl trifluoromethanesulfonate
TrCl	Trityl chloride
μM	micromolar

## Avant propos

Les maladies lysosomales sont dues à un fonctionnement anormal de l'une des enzymes contenues dans le lysosome. Une erreur génétique sur le code d'une enzyme lysosomale aboutit à la déficience de celle-ci qui ne peut alors plus accomplir l'hydrolyse de son substrat ; ce dernier s'accumule et entraîne le dysfonctionnement des organes concernés.

La thérapie chaperon apparaît comme une thérapie innovante et prometteuse pour le traitement de ce type de maladie. De petites molécules, mimes du substrat, tels que des iminosucres, vont agir en se positionnant au cœur de l'enzyme déficiente mais toujours catalytiquement active, stabiliser et rigidifier sa structure. Transporté ensuite dans le lysosome, et en présence du substrat l'iminosucre se « détache » du site actif et l'enzyme peut accomplir son rôle en hydrolysant le substrat accumulé.

En 2006, notre groupe a réalisé la synthèse d' $\alpha$ -1-C-alkyl iminoxylitols qui se sont révélés être de puissants inhibiteurs, sélectifs de la  $\beta$ -glucocérébrosidase (GCCase), l'enzyme impliquée dans la maladie de Gaucher. Cette famille d'iminosucres a montré en outre qu'elle agissait comme chaperon pharmacologique; l'augmentation de l'activité résiduelle de la GCCase à faible concentration font que ces molécules sont porteuses d'espoir pour le traitement de cette pathologie. Qu'il s'agisse du traitement par administration d'enzymes recombinantes ou par réduction de substrat, ce sont tous deux des traitements lourds pour le patient et extrêmement coûteux (90000 à 150000 €/patient/an). L'administration de composés appartenant à la famille des  $\alpha$ -1-C-alkyl iminoxylitols serait une réelle alternative aux traitements existants. Ainsi, nous nous devons de nous rapprocher de conditions favorables pour une application thérapeutique de nos composés, un des objectifs du programme ANR MRAR de notre équipe.

Dans cette optique, l'objectif de ce travail de thèse consistait, dans un premier temps, à l'amélioration de la voie de synthèse conduisant à cette famille d'iminosucres. Pour ce faire, plusieurs stratégies ont été étudiées et les nombreuses difficultés rencontrées nous ont conduits à l'élaboration de trois voies de synthèse dont une particulièrement efficace passant par une xylopyranosylamine.

Dans un deuxième temps, pour se rapprocher de notre objectif, il est apparu nécessaire de réaliser la synthèse d' $\alpha$ -1-C-alkyl iminoxylitols portant une chaîne alkyle raccourcie. En effet, une longue chaîne alkyle étant potentiellement cytotoxique, des composés avec de courtes

chaînes ont été préparés. L'activité inhibitrice de ces composés a été déterminée par l'équipe du Dr Naoki Asano, au Japon, afin de vérifier que ces nouveaux dérivés ne perdent pas de leur efficacité ainsi que leur sélectivité.

Suite à cela, nous avons entrepris d'explorer l'influence de la position de la chaîne alkyle en synthétisant de nouveaux composés portant une chaîne alkyle en O-2, O-3 ou O-4, et nous avons constaté que les composés substitués en O-2 avaient une activité comparable à celles des iminoxylitols 1-C-alkylés.

Forts des résultats obtenus pour nos composés sur la  $\beta$ -glucocérébrosidase, nous avons souhaité utiliser notre savoir-faire à l'élaboration de nouveaux iminosucres pour le traitement d'autres maladies lysosomales. Nous nous sommes particulièrement intéressés à la  $\beta$ -galactocérébrosidase (GALC), l'enzyme défailante dans la maladie de Krabbe. Notre implication n'a été que renforcée par la complexité de cette pathologie et l'absence de traitement qui entraîne dans la plupart des cas le décès dans les premiers mois ou années de la vie de ces patients.

Une nouvelle série de composés mimes de galactolipides ont ainsi été préparés et les tests d'inhibition sur la GALC et de l'éventuel effet chaperon sont actuellement en cours de réalisation.

# Chapter 1

## From health to disease: the vital role of Glycosphingolipids

---

### Introduction

In the late 1950s, Christian de Duve and colleagues identified and characterized the lysosome<sup>1,2</sup> as a cellular organelle responsible for intracellular digestion and recycling of macromolecules. This was the scientific breakthrough that would lead to the understanding of the physiological basis of the lysosomal storage disorders (LSDs).

Although Tay-Sachs disease was described in 1881, Pompe disease was the first disease to be identified as a LSD in 1963 by Hers and co-workers.<sup>3</sup> The authors reported a link between an enzyme deficiency and a storage disorder. Since these discoveries, there are to date over fifty diseases that are due to LSDs, which result in significant therapeutic implications.

This introduction will give an overview of LSDs and of the different types of treatments for these rare genetic diseases: from the oldest therapy, reported by Christian de Duve in 1964, who first initiated the concept of enzyme replacement therapy (ERT), or, by Norman Radin in 1970, who initiated the concept of substrate reduction therapy, to more recent and innovative therapeutic strategies, like chaperon therapy which makes use of small molecules being able to rescue proteins (ASSC: active site specific chaperones).

All these ingenious ideas have been widely studied and, owing to key discoveries in cellular biology, an application of ERT to type 1 Gaucher disease was implemented in the early 1990s. The inhibition of the glucosylceramide synthase, the enzyme which produces glucosylceramide, the substrate accumulated in Gaucher disease, was possible only recently.

Major advances in molecular biology and genetics contributed among other factors to develop animal models, to produce recombinant proteins for ERT on a large scale and to design new therapeutic strategies like ASSCs applicable to certain types of mutations.

---

<sup>1</sup> de Duve, C.; Pressman, B. C.; Gianetto, R.; Wattiaux, R.; Appelmans, F. *Biochem. J.* **1955**, *60*, 604-617.

<sup>2</sup> de Duve, C. *Science* **1975**, *189*, 186-194.

<sup>3</sup> Hers, H. G. *Biochem. J.* **1963**, *86*, 11-16.

# I. Lysosomal storage disorders

All lysosomal storage disorders are related to a common pathogenesis: a genetic defect in a specific lysosomal enzyme which acts as a receptor target, activator protein, membrane protein, or even transporter, leading to an accumulation of substrates in cell lysosomes. The clinical manifestations, however, are widely varying across the LSD category and sometimes even within a particular disease, depending on the genetic defect and the particular substrate stored.

## I.1. Lysosome

Lysosomes<sup>4,5</sup> form the digestive system of the cell. They are always described as sac-like organelles containing largely hydrolytic enzymes. Their activities are very diverse and involve degradation of extracellular materials of exogenous origin (heterophagy) or intracellular material of endogenous origin (autophagy). They are also responsible for the turnover of cellular constituents to simple products for building new molecule.

### I.1.a. Synthesis and trafficking of lysosomal enzymes

The lysosomal enzymes (Figure 1) which are glycoproteins, are synthesized in the rough endoplasmic reticulum (RER). They are then transported through the Golgi apparatus, where they undergo a series of changes leading to the acquisition of a mannose 6-phosphate (M6-P) ligand.<sup>6</sup> Phosphorylation of mannose is performed by two enzymes that react sequentially: a phosphotransferase<sup>7</sup> and a phosphodiesterase.<sup>8</sup> The first one specifically binds lysosomal hydrolase and adds GlcNAc-phosphate to the mannose residue on oligosaccharide chain and the second enzyme cleaves off the GlcNAc residue, leaving behind a newly created M6-P marker. This marker M6-P allows, via a high affinity with receptors concentrated in the *trans* Golgi area, the enzymes to bud off from the Golgi apparatus as vesicles.

---

<sup>4</sup> de Duve, C.; Wattiaux, R. *Annu. Rev. Physiol.* **1966**, 28, 435-492.

<sup>5</sup> Sabatini, D. D.; Adesnik, M. B. The biogenesis of membranes and organelles. *In: The Metabolic and Molecular Basis of Inherited Disease* Scriver C. R.; Sly, W.S.; Childs, B.; Beaudet, A.L.; Valle, D.; Kinzler K.W.; Vogelstein, B. eds., Vol II., McGraw-Hill, Columbus, USA **2001**, 433-51.

<sup>6</sup> Ghosh, P.; Dahms, N. M.; Kornfeld, S. *Nat. Rev. Mol. Cell. Biol.* **2003**, 4, 202-212.

<sup>7</sup> Reitman, M. L.; Kornfeld, S. *J. Biol. Chem.* **1981**, 256, 4275-4281.

<sup>8</sup> Varki, A.; Kornfeld, S. *J. Biol. Chem.* **1981**, 256, 9937-9943.



However, the M6-P marker is not required for all lysosomal enzymes. In that case they are called lysosomal membrane proteins. For instance,  $\beta$ -Glucosidase interacts with the lysosomal membrane integral proteins from the ER. Besides, patients affected by Mucopolysaccharidosis II,<sup>9</sup> which presents a lysosomal enzyme deficiency because of a failure in the M6-P acquisition process, are still carriers of other lysosomal proteins.

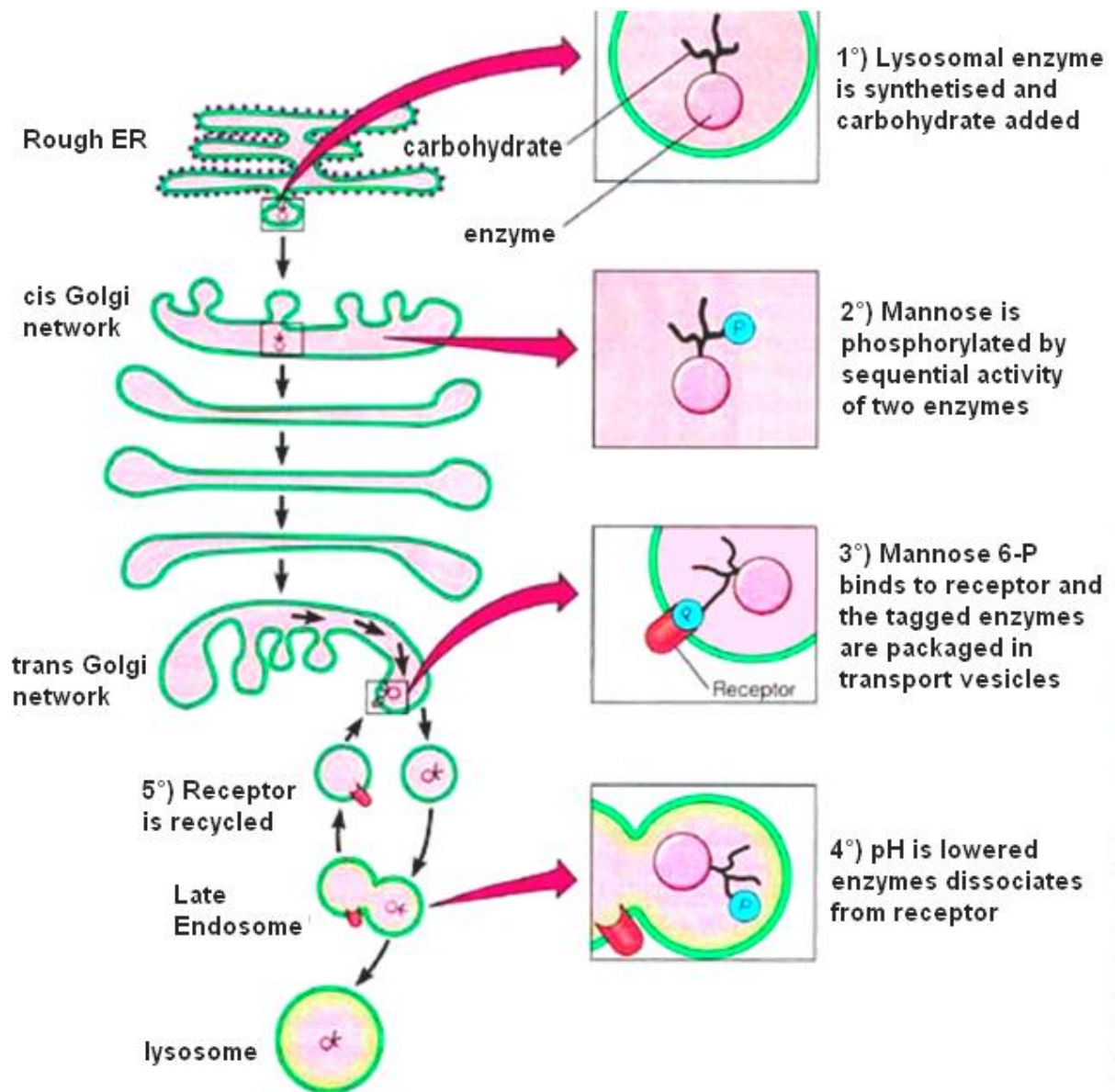

**Figure 1:** Synthesis of soluble lysosomal enzymes to endosomes and lysosomes and Phosphorylation of mannose residues on lysosomal enzymes catalyzed by two enzymes.

(Extracted from: <http://ocw.core.org.cn/CORE/biology/cell-biology/online-course-1/chapter-7/>)

<sup>9</sup> Kollmann, K.; Pohl, S.; Marschner, K.; Encarnação, M.; Sakwa, I.; Tiede, S.; Poorthuis, B. J.; Lübke, T.; Müller-Loennies, S.; Storch, S.; Braulke, T. *Eur. J. Cell. Biol.* **2010**, *89*, 117-123.

### **I.1.b. Structure and function**

The lysosomes are not like other cell organelles. Indeed, both their size and shape are very variable. The "acid hydrolases" contained in the lysosomes function at an acidic pH (5.0). This acidity is maintained by pumping protons from the cytosol that has a pH of 7.2. The protons are pumped across the membrane via proton pumps<sup>10</sup> (hydrogen ion ATPases) and chloride ion channels. Thereby the membrane acts as a protective barrier for the cytosol and the rest of the cell against the hydrolytic enzymes within the lysosome.

Thanks to its many hydrolytic enzymes and its acidic pH, the lysosome will be able to degrade most of complex macromolecules. Furthermore, it is within the lysosome that these enzymes break down their substrates.

### **I.2. Lysosomal storage disorders**

Lysosomal storage disorders (LSD's) mostly involve the dysfunction of lysosomal hydrolases,<sup>11</sup> which result in impaired substrate degradation. Any disruption of lysosomal function can lead to the accumulation of undegraded substrates in lysosomes. The accumulation of the primary storage material can cause a chain of secondary disruptions to other biochemical and cellular functions, which ultimately leads to the severe pathology of lysosomal storage disorders.<sup>12</sup> Like many genetic diseases, LSDs present heterogeneous clinical signs, but they are all characterized by an autosomal recessive transmission mode except Fabry disease which is an X-linked recessive inherited disease. They can occur at any age with different degrees of severity. One can explain that by the difference in rate of substrate accumulation into different tissues. It depends on many parameters such as:

- Nature and function of the abnormal enzyme
- Nature of the substrate
- Residual activity of the enzyme (considering that a patient without any enzymatic function presents the most severe form of the disease)

---

<sup>10</sup> Arai, K.; Shimaya, A.; Hiratani, N.; Ohkuma, S. *J. Biol. Chem.* **1993**, 268, 5649-5660.

<sup>11</sup> Verity, M. A.; Andimann, R.; Munsat, T. L.; Smith, R. E.; Szego, C. M. *An. Intern. Med.* **1973**, 78, 725-738.

<sup>12</sup> Hers, H. G.; VanHoof, F. Genetic Abnormalities of Lysosomes. In: Dingle, J. T.; Fell, H. B. eds., *Lysosomes in Biology and Pathology*, New York: American Elsevier Publishing Co., Inc., **1969**, 2, 19-40.

Most of LSD's are due to a deficiency of a single lysosomal enzyme. However, these genetic diseases appear to be complex and multifactorial.<sup>13</sup> Because of the lack of hydrolysis-specific enzymes, accumulation of substrate occurs in lysosomes and induces severe diseases, which are characterized by a variety of symptoms. Within the framework of this thesis, we focused our attention on this kind of disease. A description of the rare genetic diseases and the associated enzymes is given in table 1.

---

<sup>13</sup> Maire, I. J. *Inherit. Metab. Dis.* **2001**, 24 Suppl 2, 57-61; discussion 45-46.

Sphingolipidoses		
Disorder	Defective enzyme	Accumulated substrates
Fabry disease <sup>14,15,16</sup>	$\alpha$ -Galactosidase A	globotriaosylceramide
Farber disease <sup>17,18</sup>	Acid ceramidase	ceramide
Gaucher disease <sup>19*</sup>	Glucocerebrosidase	Glucosylceramide
GM1 gangliosidosis <sup>20</sup>	Acid $\beta$ -galactosidase	Ganglioside GM1, KS, $\beta$ -galactosyl-OS
Tay Sach disease <sup>21</sup>	$\beta$ -Hexosaminidase A	Ganglioside GM2
Sandhoff disease <sup>21</sup>	$\beta$ -Hexosaminidase A/B	Ganglioside GM2, OS, Glycolipids
Krabbe disease <sup>22*</sup>	Galactocerebrosidase	Galactosylceramide, Psychosine
Metachromatic leucodystrophy <sup>23</sup>	Aryl sulfatase A	Sulfatides
Niemann-Pick disease,(types A/B) <sup>24</sup>	Acid sphingomyelinase	Sphingomyeline

<sup>14</sup> Hoffmann, B. *Orphanet J. Rare Dis.* **2009**, *4*, 21.

<sup>15</sup> Schiffmann, R. *Pharmacol. Ther.* **2009**, *122*, 65-77.

<sup>16</sup> Desnick, R. J.; Ioannou, Y. A.; Eng, C. M.  $\alpha$ -Galactosidase A deficiency: Fabry disease. In: Scriver, C. R.; Beaudet, A. L.; Sly, W. S.; Valle, D. eds. *The metabolic and molecular bases of inherited disease*, 7th ed. McGraw-Hill, New York, **1995**, 2741-2184.

<sup>17</sup> Yeager, A. M.; Uhas, K. A.; Coles, C. D.; Davis, P. C.; Krause, W. L.; Moser, H. W. *Bone Marrow Transplant* **2000**, *26*, 357-363

<sup>18</sup> Park, J.; Schuchman, E. H. *Biochim. Biophys. Acta* **2006**, *1758*, 2133-2138.

<sup>19</sup> Beutler, E.; Grabowski, G. A. Gaucher disease. In: Scriver, C. R.; Beaudet, A. L.; Sly, W. S.; Valle, D. eds. *The metabolic and molecular bases of inherited disease*, 7th ed. McGraw-Hill, New York, **1995**, 2641-2670.

<sup>20</sup> Brunetti-Pierri, N.; Scaglia, F. *Mol. Genet. Metab.* **2008**, *94*, 391-396.

<sup>21</sup> Gravel, R. A.; Kabback, M. M.; Proia, R. L.; Sandhoff, K.; Suzuki, K.; Suzuki, K. The GM2 gangliosidoses. In: Scriver, C. R.; Beaudet, A. L.; Valle, D.; Sly, W.S. eds. *The metabolic and molecular bases of inherited disease*, 7th ed. McGraw-Hill, New York, **2001**, 3827-3876.

<sup>22</sup> Suzuki, K.; Suzuki, Y.; Suzuki, K. Galactosylceramide lipidosis: globoid-cell leukodystrophy (Krabbe disease) In: Scriver, C. R.; Beaudet, A. L.; Sly, W. S.; Valle, D. eds. *The metabolic and molecular bases of inherited disease*, 7th ed. McGraw-Hill, New York, **1995**, 2671-2692.

<sup>23</sup> Kolodny, E. H.; Fluharty, A. L. Metachromatic leukodystrophy and multiple sulfatase deficiency: sulfatide lipidosis In: Scriver, C. R.; Beaudet, A. L.; Sly, W. S.; Valle, D. eds. *The metabolic and molecular bases of inherited disease*, 7th ed. McGraw-Hill, New York, **1995**, 2693-2739.

<sup>24</sup> Schuchman, E. H.; Desnick, R. J. Niemann-Pick disease types A and B: acid sphingomyelinase deficiency In: Scriver, C. R.; Beaudet, A. L.; Sly, W. S.; Valle, D. eds. *The metabolic and molecular bases of inherited disease*, 7th ed. McGraw-Hill, New York, **1995**, 2601-2624.

<b>Glycogen storage disease</b>		
<b>Disorder</b>	<b>Defective enzyme</b>	<b>Accumulated substrates</b>
Pompe disease <sup>25</sup>	Acid $\alpha$ -glucosidase	Glycogen
<b>Mucopolysaccharidoses (MPS)<sup>26</sup></b>		
<b>Disorder</b>	<b>Defective enzyme</b>	<b>Accumulated substrates</b>
Hurler-Scheie disease (MPS I)	$\alpha$ -L-Idurinidase	DS,KS
Hunter disease (MPS II)	Iduronate-2-sulfatase	DS, KS
Sanfilippo disease (MPS III A)	Heparan <i>N</i> -sulfatase	HS
Sanfilippo disease (MPS III B)	$\alpha$ - <i>N</i> -Acetylglucosaminidase	HS
Sanfilippo disease (MPS III C)	Acetyl-CoA, $\alpha$ -glucosaminide <i>N</i> -acetyltransferase	HS
Sanfilippo disease (MPS III D)	<i>N</i> -Acetylglucosamine-6-sulfate sulfatase	HS
Morquio disease (MPS IV A)	<i>N</i> -Acetylgalactosamine-6-sulfate sulfatase	KS
Morquio disease (MPS IV B)	Acid $\beta$ -galactosidase	KS, $\beta$ -Galactosyl-OS
Maroteaux Lamy disease (MPS VI)	<i>N</i> -Acetylgalactosamine-6-sulfate sulfatase or Arylsulfatase B	DS
Sly disease (MPS VII)	$\beta$ -Glucuronidase	DS, HS, CS

**Table 1:** Overview of lysosomal storage disorders.

(Extracted from « Les maladie lysosomales » by Irene Maire, with changes)

\*lysosomal disorders described later.

Abbreviations: KS, keratin sulfate; OS, oligosaccharides; DS, dermatane sulfate; HS, heparan sulfate; CS, chondroitine sulfate.

As mentioned earlier, to every disorder is associated an enzymatic deficiency. Still, considering that the breakdown of certain glycosphingolipids requires not only their respective hydrolases but also the presence of activator proteins, one must also consider the influence of these proteins in the sphingolipidoses disorder.

This is discussed further in section II.4.

<sup>25</sup> Hirschhorn, R.; Reuser, A. J. J. Glycogen storage disease type II: acid alpha-glucosidase (acid maltase) deficiency. In: Scriver, C. R.; Beaudet, A.; Sly, W. S.; Valle, D. assoc. eds; Childs B, Kinzler KW, Vogelstein B, eds *The Metabolic and Molecular Bases of Inherited Disease*, 8th ed. McGraw-Hill, New York, **2000**, 3389-3420.

<sup>26</sup> Neufield, E. F.; Muenzer, J. The Mucopolysaccharidoses In: Scriver CR, Beaudet AL, Sly WS, Valle D, eds. *The metabolic and molecular bases of inherited disease*, 8th ed. McGraw-Hill, New York, **2001**, 3421-3452.

## II. Glycosphingolipids

In 1884, the physician J.L.W. Thudichum isolated an organic base (in addition to other sugars and fatty acids) from ethanolic brain extracts which he named *sphingosine*. It was obtained by fractional crystallization of alcoholic brain extracts.<sup>27,28</sup> He isolated and named also several brain lipids such as ceramide, sphingomyeline, and cerebroside. But, elucidation of the structure of these compounds was achieved only several years later. In 1947 the structure of sphingosine was described by Carter,<sup>29</sup> and in 1962 the structure of sialic acid was described by Kuhn.<sup>30,31</sup>

### II.1. Structure and function

Sphingolipids (SLs) and Glycosphingolipids (GSLs) are a class of lipids which are essential in the composition of eukaryotic cell membranes. GSLs are composed of a hydrophobic ceramide moiety that acts as a membrane anchor of lipid-bound carbohydrate. Ceramide itself consists of a long amino alcohol chain, *N*-acylated sphingosine. Coupling of individual carbohydrate building blocks gives rise to the simplest GSLs: glucosylceramide and galactosylceramide. Further additions of oligosaccharides and sulfate groups to GSLs offer a wide range of complex GSLs like globosides, gangliosides and cerebrosides. Those with a capping *N*-acetylneuraminic acid (sialic acid) are called Gangliosides (Figure 2).

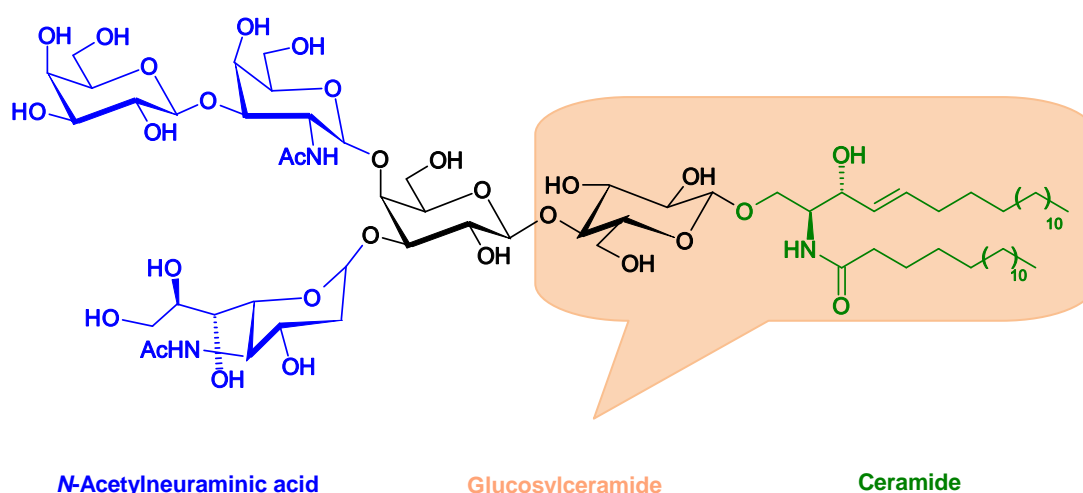

**Figure 2:** Structure of the glycosphingolipid ganglioside GM1.

<sup>27</sup> Thudichum, J. L. W. *A Treatise on the Chemical Constitution of the Brain*. London, Bailliere, Tindall, and Cox, **1884**.

<sup>28</sup> Yamakawa, T. *Glycoconjugate J* **1996**, *13*, 123-126.

<sup>29</sup> Carter, H. E.; Johnson, P.; Weber, E. J. *Annu. Rev. Biochem.* **1965**, *34*, 109-142.

<sup>30</sup> Kuhn, R.; Baschang, G. *Chem. Ber.* **1962**, *95*, 2384-2385.

<sup>31</sup> Kuhn, R.; Wiegandt, H. *Chem. Ber.* **1963**, *96*, 866-880.

GSLs on the cell surface play an important role in cellular recognition.<sup>32</sup> In fact, they act as the major structural markers at the surface of eukaryotic cells, and they are recognized by other cells, bacteria and toxins. This is made possible because of the existence of specific carbohydrate recognition sites on the interacting cell surface. Indeed, the carbohydrate moiety of the membrane GSLs binds to lectins<sup>33</sup> on the surface of neighboring cells like pathogens. Formation of myelin layers around axons of neuronal cells is another example that is based on this principle.<sup>34</sup>

Overall, GSLs play many important functions. After having described their different roles we will now discuss biosynthesis and catabolism of SLs and GSLs.

## II.2. Sphingolipid Biosynthesis

Sequential reactions from a common precursor, the ceramide,<sup>35</sup> lead to various Sphingolipids and Glycosphingolipids.<sup>36</sup> This key precursor is generated on the cytosolic wall of the membrane of the ER by the sequence of steps described in Figure 3.

The initial rate-limiting reaction is the condensation of palmitoyl CoA and serine, a reaction catalyzed by PLP-dependant serine palmitoyltransferase (SPT),<sup>37</sup> to produce 3-ketosphinganine. The enzyme SPT has a lower activity than the subsequent enzymes of ceramide biosynthesis and catalyzes the rate-determining step of this metabolic pathway.

The newly formed 3-ketosphinganine is subsequently reduced stereoselectively by NADPH-dependent ketosphinganine reductase to sphinganine.<sup>38</sup> Then linking the fatty acyl group as amide to dihydrosphingosine forms dihydroceramide. This reaction is catalyzed by dihydroceramide synthase, an enzyme which promotes the acylation of various long-chain bases and utilizes a wide spectrum of fatty acyl-CoAs.<sup>39</sup>

---

<sup>32</sup> Varki, A. *Glycobiology* **1993**, *3*, 97-130.

<sup>33</sup> Lectins are sugar-binding proteins that are highly specific for their sugar moieties. They play a role in biological recognition phenomena involving cells and proteins.

<sup>34</sup> Yang, L. J.; Zeller, C. B.; Shaper, N. L.; Kiso, M.; Hasegawa, A.; Shapiro, R. E.; Schnaar, R. L. *Proc. Natl. Acad. Sci. U.S.A* **1996**, *93*, 814-818.

<sup>35</sup> Hanada, K.; Kumagai, K.; Yasuda, S.; Miura, Y.; Kawano, M.; Fukasawa, M.; Nishijima, M. *Nature* **2003**, *426*, 803-809.

<sup>36</sup> Wennekes, T.; van den Berg, R. J. B. H. N.; Boot, R. G.; van der Marel, G. A.; Overkleeft, H. S.; Aerts, J. M. F. G. *Angew. Chem. Int. Ed. Engl.* **2009**, *48*, 8848-8869.

<sup>37</sup> Braun, P. E.; Snell, E. E. *J. Biol. Chem.* **1968**, *243*, 3775-3783.

<sup>38</sup> Stoffel, W.; LeKim, D.; Sticht, G. *Hoppe-Seyler's Z. Physiol. Chem.* **1968**, *349*, 664-670.

<sup>39</sup> Merrill, A. H.; Wang, E. *J. Biol. Chem.* **1986**, *261*, 3764-3769.

From there, the major part of dihydroceramide is dehydrogenated to ceramides by dihydroceramide desaturase.<sup>40</sup> However, the dihydroceramide is also transformed into phytosphingosine by the action of two enzymes: DES2 (sphingolipid C-4 hydroxylase) and Ceramidase.<sup>41</sup> The phytosphingosine is a characteristic sphingoid base, which is present at high level in Stratum Corneum, the outermost layer of the epidermis.

Biosynthesis of ceramide occurs in the ER, ceramide is then transported to the Golgi apparatus to undergo further transformation. A phosphocholine head group is transferred from phosphatidylcholine onto Ceramide by the Phosphatidylcholine transferase (SM synthase) to give the sphingomyelin, which is found especially in the membranous myelin sheath that surrounds some nerve cell axons.<sup>42</sup> The reaction takes place in the plasma membrane and Golgi, with distinct integral enzymes in each organelle.

In an alternative pathway, ceramide is phosphorylated at the cell membrane by ceramide kinase (CERK). It is now known that ceramide-1-phosphate possesses a number of biological functions, some of which are confined to specific types of cells and are very different from those of other sphingolipid metabolites. For example, it is an important mediator in inflammation and a potent inhibitor of cell survival.

The enzyme ceramidase acts upon ceramide to release sphingosine, and this is phosphorylated by sphingosine kinase, an ubiquitous enzyme in the cytosol and endoplasmic reticulum. As a result, sphingosine-1-phosphate, which is essential to life since its loss is embryonically fatal, is formed.

---

<sup>40</sup> Michel, C.; van Echten-Deckert, G.; Rother, J.; Sandhoff, K.; Wang, E.; Merrill, A. H. *J. Biol. Chem.* **1997**, *272*, 22432-22437.

<sup>41</sup> Mao, C.; Xu, R.; Szulc, Z. M.; Bielawska, A.; Galadari, S. H.; Obeid, L. M. *J. Biol. Chem.* **2001**, *276*, 26577-26588.

<sup>42</sup> Kearns, B. G.; McGee, T. P.; Mayinger, P.; Gedvilaite, A.; Phillips, S. E.; Kagiwada, S.; Bankaitis, V. A. *Nature* **1997**, *387*, 101-105.



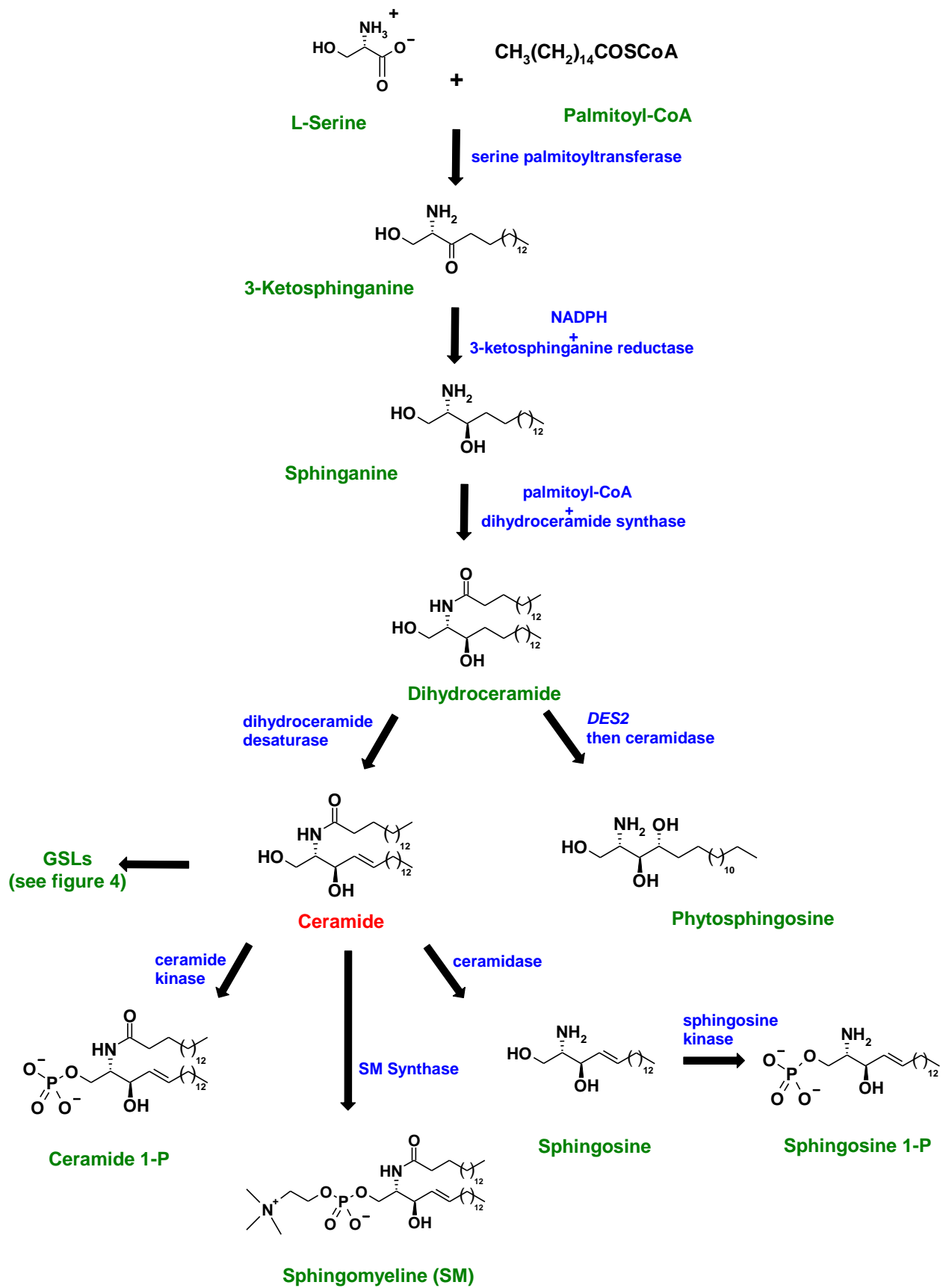

Figure 3: Ceramide biosynthesis.<sup>43</sup>

<sup>43</sup> van Echten, G.; Sandhoff, K. *J. Biol. Chem.* **1993**, 268, 5341-5344.

### II.3. Glycosphinglipid Biosynthesis

After its synthesis in the ER, ceramide undergoes a series of transformation that will lead to GSLs. Successive additions of monosaccharidic residues are catalyzed by different families of glycosyltransferases. Each reaction involves the transfer of a monosaccharidic residue from a nucleotide-sugar (XDP-monosaccharide) donor to an acceptor one.

In mammalian GSLs biosynthesis, a glucose or galactose residue is linked  $\beta$ -glycosidically to the ceramide. Galactosylation of the ceramide is performed by a ceramide galactosyltransferase in the lumen of the ER. Successive glycosylations and sulfatations of the Galactosylceramide will lead to the formation of glycolipids of the galacto series. For example, galactosylceramide (GalCer) and sulfatide<sup>44</sup> (GalCer-3-sulfate) are present at high concentrations in the multilamellar layers of the myelin that surrounds the axons of the neuronal cells.

Contrary to Galactosylation, Glucosylation<sup>45</sup> of the ceramide does not occur in the ER and requires ceramide transport molecules (CERT) to transport ceramide from the ER to the Golgi apparatus where the transformation takes place. Even if the transport pathway is not well understood yet it is known that Glucosylceramide is produced by the action of GlcCer synthase; the glucosyltransferase that is the target of Substrate Reduction Therapy for the treatment of certain lysosomal disease.

Glucosylceramide will be at the origin of the biosynthesis of a number of GSLs. Galactosylation of GlcCer leads to the formation of lactosylceramide<sup>46,47</sup> (LacCer), which represents the starting material for the formation of most of the gangliosides. Lactosylceramide is formed by the action of galactosyltransferase I, which transfers a galactose residue from UDP-Galactose to glucosylceramide. This reaction occurs on the luminal site of the Golgi apparatus and implies a membrane translocation of glucosylceramide, which is mediated by an ATP-independent Golgi localized “flippase” protein.<sup>48,49</sup>

---

<sup>44</sup> Gupta, G.; Surolia, A. *FEBS Lett.* **2010**, *584*, 1634-1641.

<sup>45</sup> Coste, H.; Martel, M. B.; Got, R. *Biochim. Biophys. Acta* **1986**, *858*, 6-12.

<sup>46</sup> Lannert, H.; Bünning, C.; Jeckel, D.; Wieland, F. T. *FEBS Lett.* **1994**, *342*, 91-96.

<sup>47</sup> Paul, P.; Kamisaka, Y.; Marks, D. L.; Pagano, R. E. *J. Biol. Chem.* **1996**, *271*, 2287-2293.

<sup>48</sup> Buton, X.; Hervé, P.; Kubelt, J.; Tannert, A.; Burger, K. N. J.; Fellmann, P.; Müller, P.; Herrmann, A.; Seigneuret, M.; Devaux, P. F. *Biochem.* **2002**, *41*, 13106-13115.

Gangliosides biosynthesis is described briefly here using Svennerholm's nomenclature.<sup>50</sup> In this nomenclature G stands for ganglioside, A for asialo-, M for monosialo-, D for disialo- and T for trisialoganglioside.<sup>51</sup> Lactosylceramide and its sialylated derivatives GM3, GD3, and GT3 serve as precursors for complex gangliosides of the 0, a, b, and c series (Figure 4). Gangliosides from the 0 and c series are found only in trace amounts in adult human tissues. The stepwise glycosylation of these precursors is performed by only a few nonspecific glycosyltransferase, which transfer the respective sugar to the glycosyl acceptors that differ only in a number of sialic acids bound to the inner galactose.<sup>52,53</sup> Although the synthesis of LacCer, GM3, GD3 and GT3 seems to occur both in proximal and distal Golgi, synthesis of more complex gangliosides appears to be limited for distal Golgi.

Once synthesized, glycosphingolipids still have to reach their main destination: plasma membrane. To this end, they employ transport vesicles to be carried through the different parts of the Golgi apparatus.<sup>54</sup>

---

<sup>49</sup> Menon, A. K. *Trends Cell. Biol.* **1995**, 5, 355-360.

<sup>50</sup> Svennerholm, L. *J. Lipid Res.* **1964**, 5, 145-155.

<sup>51</sup> Kolter, T.; Proia, R. L.; Sandhoff, K. *J. Biol. Chem.* **2002**, 277, 25859-25862.

<sup>52</sup> Iber, H.; Zacharias, C.; Sandhoff, K. *Glycobiology* **1992**, 2, 137-142.

<sup>53</sup> Maccioni, H. J.; Daniotti, J. L.; Martina, J. A. *Biochim. Biophys. Acta* **1999**, 1437, 101-118.

<sup>54</sup> Schwarzmann, G.; Sandhoff, K. *Biochem.* **1990**, 29, 10865-10871.

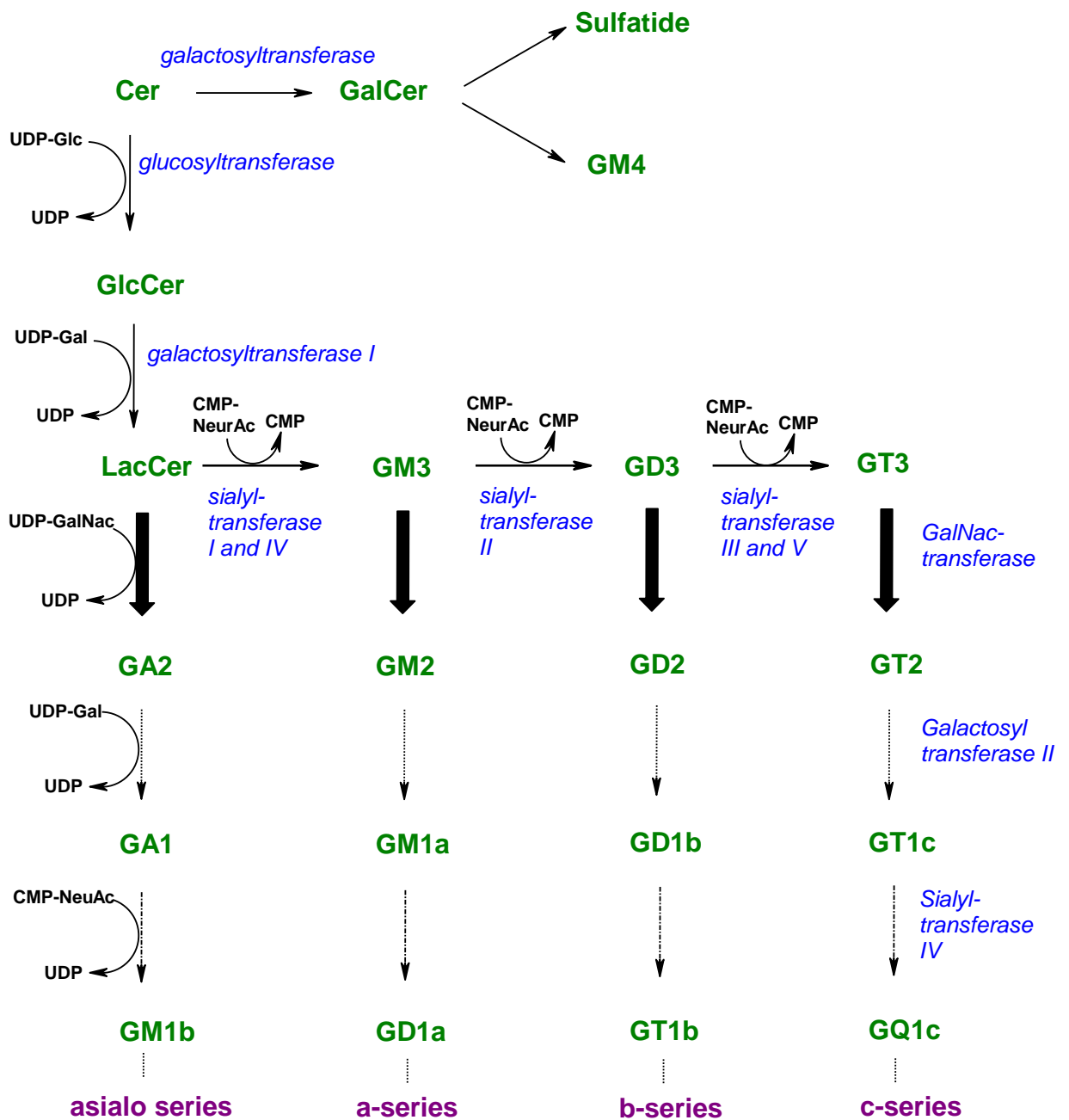

Figure 4: Biosynthesis of glycosphingolipids.

## II.4. Glycosphingolipid catabolism

The catabolism of complex GSLs proceeds by stepwise sequential removal of sugars by lysosomal exohydrolases to the final common products: sphingosine and fatty acid.

Degradation of GSLs commences in the acidified compartments of the endosomal route, for terminal degradation in lysosomes.<sup>55,56</sup>

However, the length of the sugar head group inevitably shrinks in size, thus becoming less accessible to water-soluble glycosidases. To overcome this physico-chemical obstacle and to bring sphingolipids and their respective enzymes in close proximity, mammals possess five saposins encoded by two genes.<sup>57,58</sup> The first gene encodes PSAP (prosaposin), the common precursor to the four saposins<sup>59</sup> (A, B, C and D). The second gene encodes the GM2AP (GM2 activator protein). To summarize, in the case of glycolipids, with short oligosaccharide head groups, two proteins are required for the physiological degradation of each glycolipid substrate, a water-soluble lysosomal exohydrolase and a sphingolipid activator protein or saposins. Each of these saposins possesses specificity for a particular GSL hydrolase. They facilitate the interaction between vesicle-bound substrate and water-soluble enzyme.

Deficiency of a saposin results in a clinical phenotype that may resemble a lysosomal disease. For example, for the lysosomal degradation of glucosylceramide, the enzyme glucocerebrosidase and the protein cofactor SAP-C (also called saposin C) are required. SAP-C deficiency causes a variant form of Gaucher disease with glucosylceramide storage.<sup>60,61</sup>

Deficiency of prosaposin results in a combined saposin deficiency with a severe phenotype, as might be expected.<sup>62</sup> And, because each saposin activates more than one enzyme, saposin deficiency often results in features of more than one disorder.

---

<sup>55</sup> Sandhoff, K. *Angew. Chem. Int. Ed. Engl.* **1977**, *16*, 273-285.

<sup>56</sup> Luzio, J. P.; Pryor, P. R.; Bright, N. A. *Nat. Rev. Mol. Cell Biol.* **2007**, *8*, 622-632.

<sup>57</sup> Rorman, E. G.; Scheinker, V.; Grabowski, G. A. *Genomics* **1992**, *13*, 312-318.

<sup>58</sup> Kolter, T.; Sandhoff, K. *Annu. Rev. Cell Dev. Biol.* **2005**, *21*, 81-103.

<sup>59</sup> Darmoise, A.; Maschmeyer, P.; Winau, F. *Adv. Immunol.* **2010**, *105*, 25-62.

<sup>60</sup> Christomanou, H.; Chabás, A.; Pámpols, T.; Guardiola, A. *Klin. Wochenschr.* **1989**, *67*, 999-1003.

<sup>61</sup> Wilkening, G.; Linke, T.; Sandhoff, K. *J. Biol. Chem.* **1998**, *273*, 30271-8.

<sup>62</sup> Bradová, V.; Smíd, F.; Ulrich-Bott, B.; Roggendorf, W.; Paton, B. C.; Harzer, K. *Hum. Genet.* **1993**, *92*, 143-152.

**Figure 5:** Lysosomal sphingolipid degradation. Inherited diseases (red) caused by genetic defects of proteins in the GSLs and gangliosides degradation pathway.

Abbreviations: **AC** (acid ceramidase), **ASA** (arylsulfatase A), **aSMase** (acid sphingomyelinase), **GALC** (galactosylceramide  $\beta$ -galactocerebrosidase), **GCase** (glucocerebrosidase), **GLA** ( $\alpha$ -galactosidase), **GM1-GLB** (GM1- $\beta$ -galactosidase),  **$\beta$ -Hex A, B** ( $\beta$ -hexosaminidase A, B), **SAP** (sphingolipid activator protein)

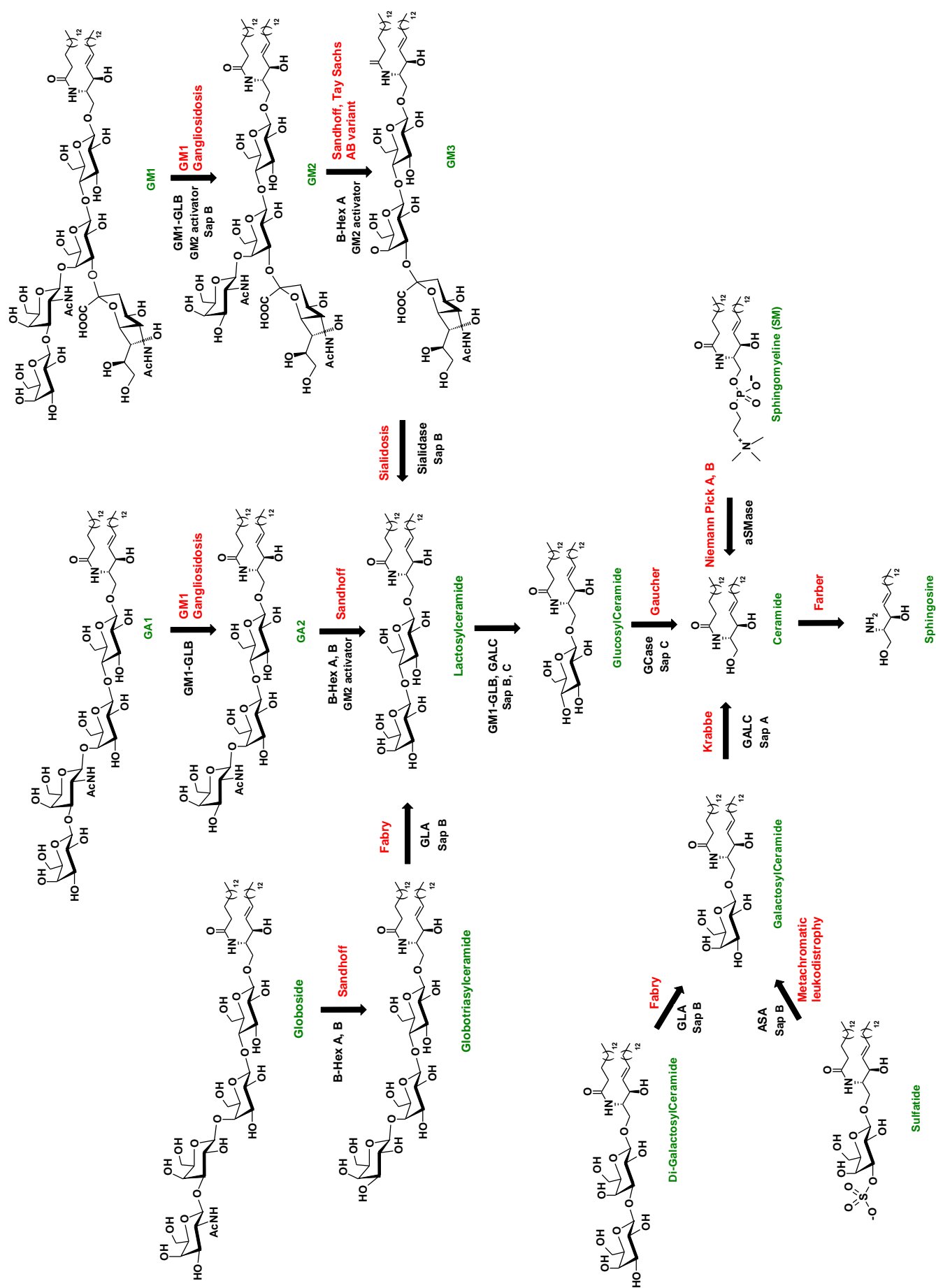

The importance of endosomal catabolism of GSLs is unfortunately well illustrated by the existence of a number of inherited diseases caused by genetic defects of individual hydrolases.<sup>63</sup> Figure 5 gives an overview of glycosidases, activator proteins and diseases associated with GSLs. One exception is lactosylceramide degradation,<sup>64</sup> which can be carried out by two enzymes in combination with two activator proteins.

About forty hydrolases are involved in lysosomal degradation of biomolecules including proteases, glycosidases, lipases, phospholipases, nucleases, phosphatases and sulfatases. The material undergoing degradation can reach the lysosomes by way of endocytosis or autophagy. The building blocks thus released, such as for example monosaccharides, fatty acids, and sphingoid bases, are able to leave the lysosome. They can serve either as energy sources or cellular components for further synthesis in other subcellular compartments. Their passage through the lysosomal membrane takes place by diffusion or with the help of transporter proteins. The synthesis/degradation pathway of GSLs metabolism forms a network, where the product of one enzyme can be used as a substrate for other enzymes.

The inherited dysfunction of one or more degradation steps leads to the accumulation of non degradable material and to lysosomal storage diseases, which are related to the nature of the stored substances. Moreover, the manifestation of degradation dysfunction is remarkably heterogeneous and depends on the cell type that is predominantly affected by the storage. Neuronal diseases are a consequence of ganglioside storage whereas the accumulation of ceramide and glucosylceramide affects mainly the skin and lymphoid tissues which constitute visceral organs.<sup>65</sup> But not only, as it appeared recently, the abnormal functioning of glucosylceramidase may predispose people for Parkinson disease.<sup>66,67</sup>

Nevertheless, for a same pathology, various manifestations can exist; for instance it is the case of Gaucher disease.<sup>68</sup> These can be manifested at the time of birth and be dramatic, up to an almost asymptomatic pathology at adult age.

---

<sup>63</sup> Kolter, T.; Sandhoff, K. *Biochim. Biophys. Acta* **2006**, *1758*, 2057-2079.

<sup>64</sup> Zschoche, A.; Furst, W.; Schwarzmann, G.; Sandhoff, K. *Eur. J. Biochem.* **1994**, *222*, 83-90.

<sup>65</sup> Beutler, E.; Gabowsky, G. A. Gaucher disease. In: Scriver, C. R.; Beaudet, A. L.; Sly, W. S.; Valle, D. *The metabolic and molecular bases of inherited disease*. 8th ed. New York: McGraw-Hill; **2001**, 3635-3668.

<sup>66</sup> Parkinson, J. J. *Neuropsychiatry Clin. Neurosci.* **2002**, *14*, 223-236.

<sup>67</sup> Goker-Alpan, O.; Lopez, G.; Vithayathil, J.; Davis, J.; Hallett, M.; Sidransky, E. *Arch. Neurol.* **2008**, *65*, 1353-1357.

<sup>68</sup> Beutler, E. *Acta Paediatr. Suppl.* **2006**, *95*, 103-109.



### III. Therapies for GSLs Storage

Recent progresses in the development of therapies for inherited lysosomal storage disorders are substantial. All therapies that were developed for this kind of disease tend to restore and regulate GSLs degradation pathway.

#### III.1. Therapy by substitution

Lysosomal storage disorders are caused by defects in enzymes responsible for the degradation of particular compounds in lysosomes. All therapies based on substitution<sup>69</sup> consist in the introduction of the missing enzymes into the lysosome (via intravenous administration of recombinant enzyme, gene therapy, etc). This leads to the restoration of GSLs catabolism and to a considerable decrease of the symptoms of the disease.

##### III.1.a. Enzyme Replacement Therapy (ERT)

First used to treat type I Gaucher disease, the most prevalent lysosomal disorder known in the group of LSDs, ERT was a breakthrough in the treatment of some of the LSD diseases.

Recombinant human enzymes are produced in an organism like an animal cell (Chinese Hamster Ovary) or bacteria cell (*Escherichia coli*). In the case of Gaucher disease, which was the first application of the ERT therapy,<sup>70,71</sup> it was postulated that contrary to most of the lysosomal glycoproteins,<sup>72</sup>  $\beta$ -glucosidase is not targeted towards the lysosome through the mannose-6-phosphate receptor-mediated system.<sup>73,74,75</sup>

To tackle this problem, the *N*-linked oligosaccharide chains of this enzyme were modified by sequentially removing its sialic acid,  $\beta$ -galactose and  $\beta$ -*N*-acetylglucosamine residues (Figure 6). These modifications exposed the terminal mannose residues on the enzyme, giving rise to a “mannose-terminated” glycoform that was efficiently recognized by the abundant mannose

---

<sup>69</sup> Desnick, R. J.; Schuchman, E. H. *Nat. Rev. Genet.* **2002**, *3*, 954-966.

<sup>70</sup> de Duve, C. *Fed. Proc.* **1964**, *23*, 1045-1049.

<sup>71</sup> Brady, R. O.; Pentchev, P. G.; Gal, A. E.; Hibbert, S. R.; Dekaban, A. S. *N. Engl. J. Med.* **1974**, *291*, 989-993.

<sup>72</sup> Kornfeld, S.; Mellman, I. *Annu. Rev. Cell Biol.* **1989**, *5*, 483-525.

<sup>73</sup> Kornfeld, S. *Biochem. Soc. Trans.* **1990**, *18*, 367-374.

<sup>74</sup> Kornfeld, S. *Annu. Rev. Biochem.* **1992**, *61*, 307-330.

<sup>75</sup> Edmonds, T. *Directory of therapeutic enzymes Ceredase* **2006**, Chapter 6, 117-133.

receptors on the plasma membranes of macrophage and was delivered to macrophage lysosomes for substrate catabolism.<sup>76</sup>

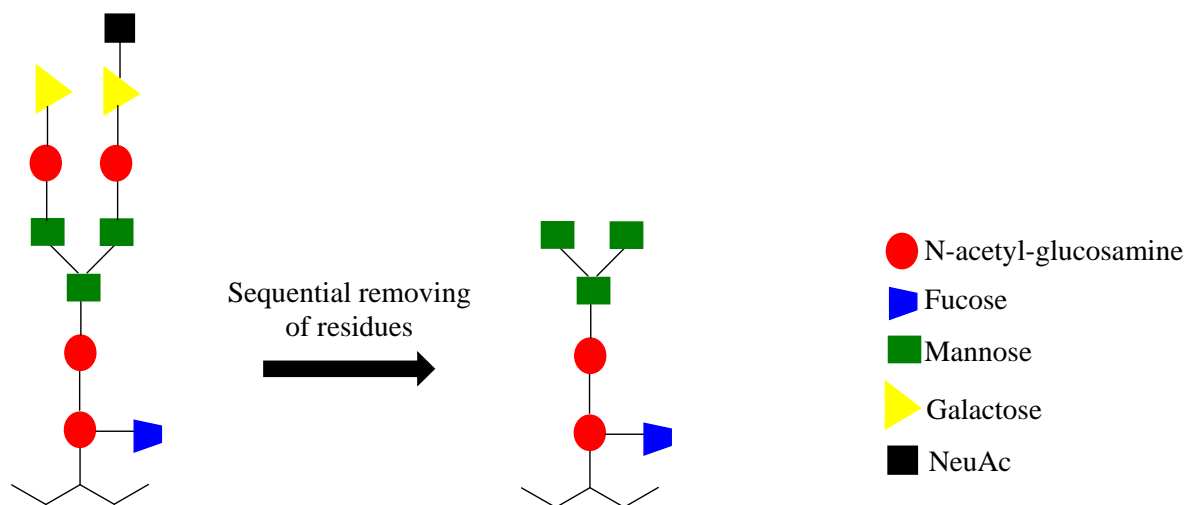

**Figure 6:** Modification of the *N*-linked oligosaccharide chain of the acid  $\beta$ -glucosidase.

(Extracted from « protéines recombinants thérapeutiques- Genzyme »with changes)

Introduction by intravenous infusion of this mannose-terminated enzyme reduced significantly the symptom of the type I Gaucher disease. This success allowed the development of this type of therapy for some other LSDs including Fabry disease.<sup>77,78</sup>

Although, this therapeutic strategy opens the way to an undeniable progress in the treatment of LSDs, ERTs have many limitations. Indeed, this treatment requires life-long intravenous infusions at least once every 2 weeks. Another limitation is the delivery of the recombinant enzyme, which cannot cross the blood brain barrier and therefore cannot be used for neuronopathic Gaucher disease. There are also poor effects on bones and lungs in patients with severe pre-existing lesions.<sup>79</sup>

<sup>76</sup> Doebber, T. W.; Wu, M. S.; Bugianesi, R. L.; Ponpipom, M. M.; Furbish, F. S.; Barranger, J. A.; Brady, R. O.; Shen, T. Y. *J. Biol. Chem.* **1982**, *257*, 2193-2199.

<sup>77</sup> Ioannou, Y. A.; Zeidner, K. M.; Gordon, R. E.; Desnick, R. J. *Am. J. Hum. Genet.* **2001**, *68*, 14-25.

<sup>78</sup> Mehta, A.; Beck, M.; Eyskens, F.; Feliciani, C.; Kantola, I.; Ramaswami, U.; Rolfs, A.; Rivera, A.; Waldek, S.; Germain, D. P. *QJM: Monthly Journal of the Association of Physicians* **2010**, *103*, 641-659.

<sup>79</sup> Futerman, A. H.; Sussman, J. L.; Horowitz, M.; Silman, I.; Zimran, A. *Trends Pharmacol. Sci.* **2004**, *25*, 147-51.

To finish, this treatment is one of the most costly in the world (in the order of 150 000 € per year per patient)<sup>80</sup> and therefore cannot be administered to patients living in deprived populations.

### III.1.b. Haematopoietic Cell Transplantation (HCT)

The main rationale for HCT<sup>81</sup> is based on the continuous provision of correcting enzymes by donor cells within and outside the blood compartment. As a matter of fact, the major aim of HCT is to offer a normal or near-normal life and normal neurodevelopment to patients who suffer from LSDs.

For the last 25 years, hematopoietic cell transplantation has been used as an effective therapy for selected inborn errors of metabolism, mainly lysosomal storage diseases and proximal disorders. This concept evolved from the pioneering work of Fratantoni and Neufeld in 1969.<sup>82</sup> They laid the foundation for the modern understanding of transferable lysosomal enzymes by demonstrating cross-correction of metabolic defects in co-cultures of fibroblasts from Hurler and Hunter syndrome patients. A few years later, this observation and the demonstration of correction of the deficient enzyme with lymphocyte extracts or serum<sup>83,84</sup> led to trial HCT as a permanent source of enzyme in a Hurler patient in the early 1980s.<sup>85</sup>

However, the exact mechanisms for therapeutic benefit of HCT<sup>86</sup> are not completely understood and may differ between the various diseases. Last but not least, unfortunately this therapeutic strategy cannot alleviate all patients affected by LSDs. Transplants appear to be effective only for Hurler syndrome (MPS I), Maroteau-Lamy disease (MPS VI), Hunter disease and globoid cell leukodystrophy including Krabbe disease.

---

<sup>80</sup> Beutler, E. *Mol. Gen. Metab.* **2006**, 88, 208-15.

<sup>81</sup> Boelens, J. J. *J. Inherit. Metab. Dis.* **2006**, 29, 413-420.

<sup>82</sup> Fratantoni, J. C.; Hall, C. W.; Neufeld, E. F. *Proc. Natl. Acad. Sci. U.S.A* **1969**, 64, 360-366.

<sup>83</sup> Ferrante, N. D.; Nichols, B. L.; Donnelly, P. V.; Neri, G.; Hrgovcic, R.; Berglund, R. K. *Proc. Natl. Acad. Sci. U.S.A* **1971**, 68, 303-307.

<sup>84</sup> Knudson, A. G.; Di Ferrante, N.; Curtis, J. E. *Proc. Natl. Acad. Sci. U.S.A* **1971**, 68, 1738-1741.

<sup>85</sup> Hobbs, J. R.; Hugh-Jones, K.; Barrett, A. J.; Byrom, N.; Chambers, D.; Henry, K.; James, D. C.; Lucas, C. F.; Rogers, T. R.; Benson, P. F.; Tansley, L. R.; Patrick, A. D.; Mossman, J.; Young, E. P. *Lancet* **1981**, 2, 709-712.

<sup>86</sup> Peters, C.; Steward, C. G. *Bone Marrow Transplant* **2003**, 31, 229-239.

Nevertheless, continuous evolutions which include stem cell<sup>87,88</sup> sources from unrelated cord blood as emerging stem cell sources are very encouraging for diseases like Krabbe syndrome.<sup>89</sup>

### **III.1.c. ERT in combination with HCT**

ERT and HCT present a real solution to treat many disorders but they have their limitations which prevent them from becoming generalized. Nonetheless, these two therapies can act complementarily and offer a new hope of cure for LSDs patients.

The major drawback of ERT is the “blood brain barrier” which cannot be crossed by the recombinant enzymes. In order to avoid this obstacle, HCT will be needed. Despite this weakness, it was postulated that ERT could influence the mortality rates by bringing the patient into a better clinical condition before HCT, and positively influence the engraftment rates.<sup>90</sup> Unfortunately, giving ERT prior or during HCT is only considered for patients with poor clinical conditions.

Improvement in HCT techniques, the development of novel stem cell and alternative therapies will significantly impact the safety and efficacy of these therapies as well as extend the list of candidate diseases. The most significant example is the use of unrelated cord blood (UCB) which makes HCT feasible in patients with rapidly progressive neurological diseases.

### **III.2. Substrate Reduction Therapy (SRT)**

The goal of all treatments is to reduce glycolipids storage, thus diminishing the deleterious effects caused by its accumulation. ERT and HCT achieve this by supplementing defective enzymes with recombinant active ones or transplantation, whereas, SRT<sup>91,92,93,94</sup> works by lowering the rate of synthesis of the substrate, thus reducing glycolipids accumulation.

---

<sup>87</sup> Chao, N. J.; Emerson, S. G.; Weinberg, K. I. *Hematology* **2004**, *2004*, 354-371.

<sup>88</sup> Staba, S. L.; Escolar, M. L.; Poe, M.; Kim, Y.; Martin, P. L.; Szabolcs, P.; Allison-Thacker, J.; Wood, S.; Wenger, D. A.; Rubinstein, P.; Hopwood, J. J.; Krivit, W.; Kurtzberg, J.; *N. Engl. J. Med.* **2004**, *350*, 1960-1969.

<sup>89</sup> Escolar, M. L.; Poe, M. D.; Provenzal, J. M.; Richards, K. C.; Allison, J.; Wood, S.; Wenger, D. A.; Pietryga, D.; Wall, D.; Champagne, M.; Morse, R.; Krivit, W.; Kurtzberg, J. *N. Engl. J. Med.* **2005**, *352*, 2069-2081.

<sup>90</sup> Boelens, J. J.; Wynn, R.; Wraith, E.; O'Mearra, A.; Veys, P.; Wulffraat, N. *ASH Annual Meeting Abstracts* **2005**, *106*, 5307.

<sup>91</sup> Jeyakumar, M.; Butters, T. D.; Dwek, R. A.; Platt, F. M. *Neuropathol. Appl. Neurobiol.* **2002**, *28*, 343-357.

<sup>92</sup> Beck, M. *Hum. Genet.* **2007**, *121*, 1-22.

<sup>93</sup> Jakóbkiewicz-Banecka, J.; Wegrzyn, A.; Wegrzyn, G. *J. Appl. Genet.* **2007**, *48*, 383-388.

SRT is based on the use of small chemical molecules acting as inhibitors of synthesis of the glycolipids that cannot be degraded in lysosomes because of an enzymatic defect. In this approach, the inhibitory molecule which is small and non-ionic can cross the blood brain barrier and correct the storage in the central nervous system as well as in somatic tissues.

Administered orally, this treatment is more convenient than ERT and less costly (in order of 90 000 € per year per person),<sup>95</sup> with among other advantages, no complications due to intravenous delivery.

Radin initiated this concept during the late 1970s. A few years later, he discovered the first inhibitor<sup>96</sup> of the glucosylceramide synthase, and showed that a suitable inhibitor of this enzyme can slow down the synthesis of glucosylceramide,<sup>97</sup> the glycolipid that accumulates in Gaucher disease. With an inhibitory constant ( $K_i$ ) of 0.7  $\mu\text{M}$ , PDMP<sup>98</sup> (D,L-*threo*-1-phenyl-2-decanoylamino-3-morpholino-1-propanol, **1**) was the first example of a glucosylceramide synthase (GCS) inhibitor, this initiated the development of a series of analogues. This first class of inhibitors contains phenyl *N*-acyl groups and diverse heterocycles that mimic ceramide with good binding affinities. However, it rapidly appeared that many of these compounds are not selective of the GCS and inhibit the lysosomal phospholipase A2, which can cause phospholipidosis.<sup>99</sup>

Nevertheless, these compounds serve as a tool for biochemists and permit progress in the understanding of the GSLs.

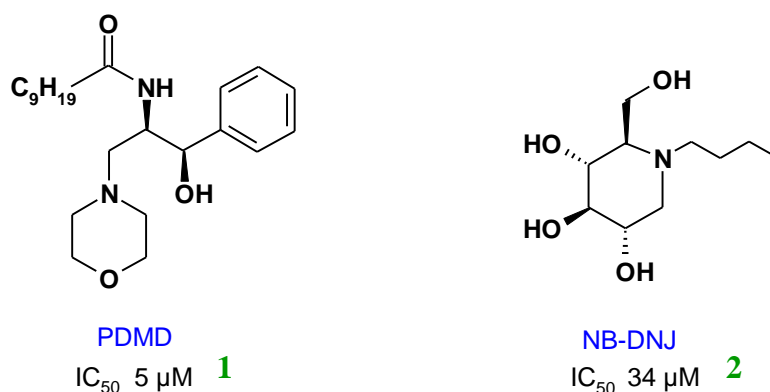

**Figure 7:** Structure and inhibitory profile for GCS's inhibitors.

<sup>94</sup> Butters, T. D. *Expert Opin. Pharmacother.* **2007**, *8*, 427-435.

<sup>95</sup> Heitner, R.; Elstein, D.; Aerts, J.; Weely, S. V.; Zimran, A. *Blood Cells Mol. Dis.* **2002**, *28*, 127-133.

<sup>96</sup> Radin, N. S.; Vunnam, R. R. *Methods Enzymol.* **1981**, *72*, 673-684.

<sup>97</sup> Radin, N. S. *Scient. Com.* **1996**.

<sup>98</sup> Inokuchi, J.; Radin, N. *J. Lipid Res.* **1987**, *28*, 565-571.

<sup>99</sup> Abe, A.; Hiraoka, M.; Shayman, J. A. *J. Lipid Res.* **2007**, *48*, 2255-2263.

The discovery of Miglustat<sup>100</sup> which is an effective GCS inhibitor, now sold under the name of Zavesca<sup>101,102</sup> (*N*-butyl-deoxynojirimycin; NB-DNJ; Figure 7), promoted a rush for iminosugars<sup>103</sup> development as GCS inhibitors. More specifically, this development focused on those which are *N*-substituted with groups containing a minimum of three carbon atoms.<sup>104</sup>

Miglustat, first reported as an inhibitor of HIV virus replication,<sup>105</sup> can be used to treat mainly Gaucher disease but also LSDs with neurological effects. Decreasing the biosynthesis of GlcCer may indeed be beneficial for most LSD's. For Niemann Pick<sup>106,107</sup> and Sandhoff<sup>108,109,110</sup> diseases, the drug is currently under clinical trial (2010). However Zavesca<sup>®</sup> has limitations. This treatment causes series side effects such as diarrhea, abdominal pains, tremor, including peripheral neuropathy. Further, long term reduction in glycolipid levels could affect a variety of cell functions since these lipids play essential roles in normal cell physiology.<sup>111</sup>

For all these reasons, Zavesca<sup>®</sup> is limited to patients for whom ERT is unsuitable, and remains therefore an option of last resort.

### III.3. Chaperone Mediated Therapy (CMT or ASSC)

Residual enzyme activity in the lysosome and the theory according to which minimal changes on it cause major changes in substrate turnover were the foundations of this therapy.<sup>112, 113</sup>

---

<sup>100</sup> Platt, F. M.; Neises, G. R.; Dwek, R. A.; Butters, T. D. *J. Biol. Chem.* **1994**, *269*, 8362-8365.

<sup>101</sup> Cox, T.; Lachmann, R.; Hollak, C.; Aerts, J.; van Weely, S.; Hrebíček, M.; Platt, F.; Butters, T.; Dwek, R.; Moyses, C.; Gow, I.; Elstein, D.; Zimran, A. *Lancet* **2000**, *355*, 1481-1485.

<sup>102</sup> Lachmann, R. H. *Curr. Opin. Investig. Drugs* **2003**, *4*, 472-479.

<sup>103</sup> Compain, P.; Martin, O. R. *Iminosugars: From Synthesis to Therapeutic Applications*, Wiley-VCH, Weinheim, **2007**.

<sup>104</sup> Platt, F. M.; Neises, G. R.; Karlsson, G. B.; Dwek, R. A.; Butters, T. D. *J. Biol. Chem.* **1994**, *269*, 27108 - 27114.

<sup>105</sup> Fleet, G. W.; Karpas, A.; Dwek, R. A.; Fellows, L. E.; Tyms, A. S.; Petursson, S.; Namgoong, S. K.; Ramsden, N. G.; Smith, P. W.; Son, J. C. *FEBS Lett.* **1988**, *237*, 128-132.

<sup>106</sup> Patterson, M. C.; Vecchio, D.; Prady, H.; Abel, L.; Wraith, J. E. *Lancet Neurol.* **2007**, *6*, 765-772.

<sup>107</sup> Pineda, M.; Perez-Poyato, M. S.; O'Callaghan, M.; Vilaseca, M. A.; Pocovi, M.; Domingo, R.; Portal, L. R.; Pérez, A. V.; Temudo, T.; Gaspar, A.; Peñas, J. J. G.; Roldán, S.; Fumero, L. M.; de la Barca, O. B.; Silva, M. T. G.; Macías-Vidal, J.; Coll, M. J. *Mol. Genet. Metab.* **2010**, *99*, 358-366.

<sup>108</sup> Jeyakumar, M.; Thomas, R.; Elliot-Smith, E.; Smith, D. A.; van der Spoel, A. C.; d'Azzo, A.; Perry, V. H.; Butters, T. D.; Dwek, R. A.; Platt, F. M. *Brain* **2003**, *126*, 974-987.

<sup>109</sup> Aerts, J. M. F. G.; Hollak, C. E. M.; Boot, R. G.; Groener, J. E. M.; Maas, M. *J. Inherit. Metab. Dis.* **2006**, *29*, 449-456.

<sup>110</sup> Wortmann, S. B.; Lefeber, D. J.; Dekomien, G.; Willemsen, M. A. A. P.; Wevers, R. A.; Morava, E. *J. Inherit. Metab. Dis.* **2009**.

<sup>111</sup> Buccoliero, R.; Bodennec, J.; Futerman, A. H. *Neurochem. Res.* **2002**, *27*, 565-574.

<sup>112</sup> Fan, J. *Trends Pharmacol. Sci.* **2003**, *24*, 355-360.

<sup>113</sup> Fan, J. *Biol. Chem.* **2008**, *389*, 1-11.

Some DNA mutations such as missense or deletion lead to improperly folded or unstable proteins. The most common DNA mutation in LSD is the missense mutation, which results in a protein bearing an amino acid substituted by another one at only one position.

The mutant enzymes which are unable to adopt the correct three-dimensional structure are recognized and retained until they are properly folded. Eventually, misfolded and unstable proteins will be eliminated by the endoplasmic reticulum-associated degradation pathway (ERAD). They will be exported from the ER to be degraded by the proteasomes via the cell's own internal degradation process. In this pathway, the endoplasmic reticulum acts as the quality control system of the cell.

However, many DNA mutations still give rise to biologically active proteins, which means that if these misfolded and unstable enzymes could be rescued from a premature degradation, it would then be possible to enhance the residual activity of the enzyme. That would lead to a decrease of the accumulated substrates in the lysosome and a reduction of the effects of the disease.

In this strategy, a small molecule, named a pharmacological chaperone, selectively binds and stabilizes the three-dimensional conformation of the mutant enzyme (Figure 8), thus allowing it to pass through the quality control process and to be transported to the lysosome via the Golgi apparatus.

Once in the lysosome, the pharmacological chaperone is displaced and the mutant enzyme can break down its own substrate. This is possible because these small molecules are designed to mimic part of the natural substrate of the target enzyme and are reversible competitive inhibitors. It means that they have a good affinity for lysosomal enzyme in the ER. Then, they can be separated easily from it in the lysosome because of the large amount of undegraded substrates that may compete for the lysosomal enzyme active site.

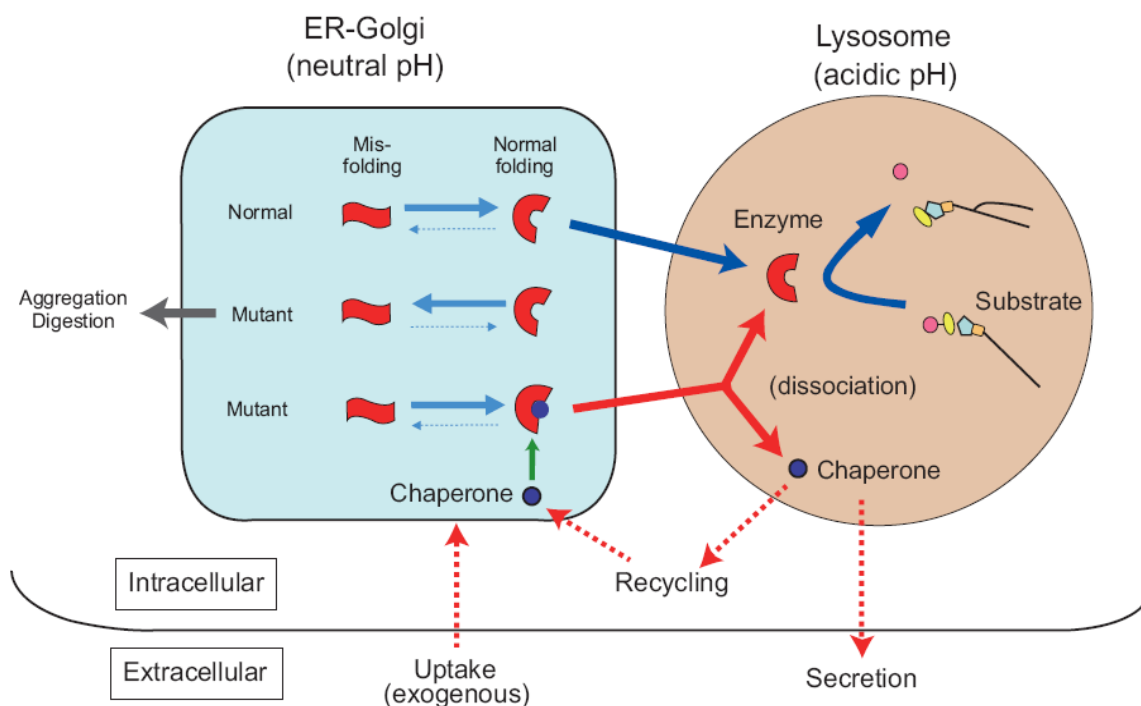

**Figure 8:** Proposed mechanism of action for pharmacological chaperones in LSDs.<sup>114</sup>

Pharmacological chaperones offer many advantages, the most important one being the ability to increase enzyme activity levels in a diversity of tissues such as brain, muscle, liver, and bones.

Physically small compared to proteins, pharmacological chaperones are orally administered. And, with a relatively short half-life time which facilitates their elimination from the body, this approach for the treatment of a human genetic diseases appears to be a novel and an innovative therapy.

Many imino sugars are reported to be effective pharmacological chaperones. The first example was 1-deoxygalactonojirimycin (DGJ) **3** (Figure 9) discovered by Fan and co-workers,<sup>115</sup> which enhanced the residual activity of the R301Q  $\alpha$ -galactosidase A from patients with Fabry disease by a factor of forty (1.5 to 28-fold for 49 different missense mutant forms of  $\alpha$ -Gal A).<sup>116</sup> From there the company Amicus Therapeutics developed the compound under the name Amigal<sup>®</sup>. According to the company, this drug is currently in phase III clinical trials for Fabry disease.

<sup>114</sup> Suzuki, Y.; Ogawa, S.; Sakakibara, Y. *Perspectives Med. Chem.* **2009**, *3*, 7-19.

<sup>115</sup> Fan, J. Q.; Ishii, S.; Asano, N.; Suzuki, Y. *Nat. Med.* **1999**, *5*, 112-115.

<sup>116</sup> Benjamin, E. R.; Flanagan, J. J.; Schilling, A.; Chang, H. H.; Agarwal, L.; Katz, E.; Wu, X.; Pine, C.; Wustman, B.; Desnick, R. J.; Lockhart, D. J.; Valenzano, K. J. *J. Inherit. Metab. Dis.* **2009**, *32*, 424-440.



In the same time,  $\alpha$ -Homogalactonojirimycin<sup>117,118</sup> ( $\alpha$ -HGJ) **4** bearing a hydroxymethyl group at the C-1 $\alpha$  position of DG which has been synthesized in our group acts also as pharmacological chaperone for R301Q  $\alpha$ -Gal A by enhance 5.2-fold the residual activity of the enzyme.<sup>119</sup>

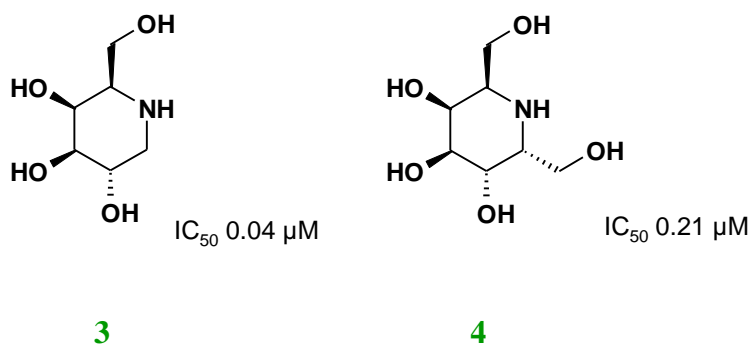

**Figure 9:** Structure and  $IC_{50}$  of Amigal<sup>®</sup> and  $\alpha$ -HGJ.

A wide range of pharmacological chaperones based on an iminosugar skeleton have also been demonstrated to be effective for several mutations of GCase (Figure 10).

Based on lead compound **2** many research groups have developed new compounds with the hope to identify more potent and selective glucocerebrosidase inhibitors exhibiting the chaperone effect. It should be noted that the major side effect by using iminosugars as drugs is the inhibition of intestinal  $\alpha$ -glycosidases.

Long alkyl chain improves inhibition of GCase. Unfortunately, it also increases the cytotoxicity of these compounds, arising mainly from membrane insertion and pore formation.<sup>120</sup> On one hand, a minimum length is necessary for the inhibition of the GCase, on the other hand lengthening the alkyl chain enhances the inhibitory effect. The nature of the toxicity is related to membrane anchorage but is still misunderstood.

<sup>117</sup> Martin, O. R.; Xie, F.; Liu, L. *Tetrahedron Lett.* **1995**, *36*, 4027-4030.

<sup>118</sup> Martin, O. R.; Saavedra, O. M.; Xie, F.; Liu, L.; Picasso, S.; Vogel, P.; Kizu, H.; Asano, N. *Bioorg. Med. Chem.* **2001**, *9*, 1269-1278.

<sup>119</sup> Asano, N.; Ishii, S.; Kizu, H.; Ikeda, K.; Yasuda, K.; Kato, A.; Martin, O. R.; Fan, J. *Eur. J. Biochem.* **2001**, *267*, 4179-4186.

<sup>120</sup> Mellor, H. R.; Platt, F. M.; Dwek, R. A.; Butters, T. D. *Biochem. J.* **2003**, *374*, 307-314:

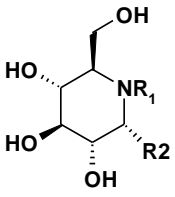
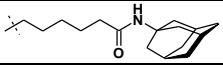
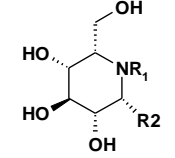
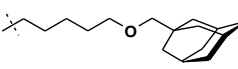
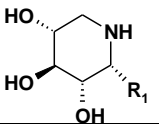
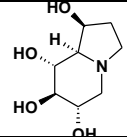
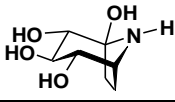
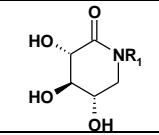
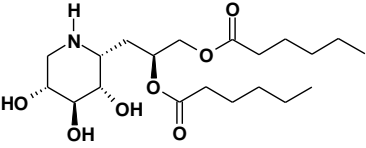
Structure		R <sub>1</sub>	R <sub>2</sub>	Fold increase of N370S-GCase	IC <sub>50</sub> (μM)
	<b>2</b>	butyl	H	2.3	270 <sup>121</sup>
	<b>5</b>	nonyl	H	2 to 2.5	0.66 <sup>122,123</sup>
	<b>6</b>		H	2	1.2 <sup>124</sup>
	<b>7</b>	H	butyl	-	100 <sup>123</sup>
	<b>8</b>	H	nonyl	1.7	0.27 <sup>125</sup>
	<b>9</b>	H	hexyl	-	4.2 <sup>126</sup>
	<b>10</b>		H	-	2 <sup>127</sup>
	<b>11</b>	H	-	-	2.3 <sup>125</sup>
	<b>12</b>	nonyl	-	1.6	0.007 <sup>125</sup>
	<b>13</b>	-	-	-	19 <sup>128</sup>
	<b>14</b>	-	-	1.3 to 2.1	1 <sup>128</sup>
	<b>15b</b>	octyl	-	6 (?)	175 <sup>129</sup>
	<b>16</b>	-	-	-	0.005 <sup>130</sup>

**Table 2:** Structures and IC<sub>50</sub> values of glucocerebrosidase inhibitors.

<sup>121</sup> Alfonso, P.; Pampín, S.; Estrada, J.; Rodríguez-Rey, J. C.; Giraldo, P.; Sancho, J.; Pocoví, M. *Blood Cells Mol. Dis.* **2005**, *35*, 268-276.

<sup>122</sup> Sawkar, A. R.; Schmitz, M.; Zimmer, K.; Reczek, D.; Edmunds, T.; Balch, W. E.; Kelly, J. W. *ACS Chem. Biol.* **2006**, *1*, 235-251.

<sup>123</sup> Yu, L.; Ikeda, K.; Kato, A.; Adachi, I.; Godin, G.; Compain, P.; Martin, O.; Asano, N. *Bioorg. Med. Chem.* **2006**, *14*, 7736-7744.

<sup>124</sup> Sawkar, A. R.; Adamski-Werner, S. L.; Cheng, W.; Wong, C.; Beutler, E.; Zimmer, K.; Kelly, J. W. *Chem. Biol.* **2005**, *12*, 1235-1244.

<sup>125</sup> Compain, P.; Martin, O. R.; Boucheron, C.; Godin, G.; Yu, L.; Ikeda, K.; Asano, N. *Chembiochem* **2006**, *7*, 1356-1359.

<sup>126</sup> Schönemann, W.; Gallienne, E.; Compain, P.; Ikeda, K.; Asano, N.; Martin, O. R. *Bioorg. Med. Chem.* **2010**, *18*, 2645-2650.

<sup>127</sup> Wennekes, T.; van den Berg, R. J.; Bongers, K. M.; Donker-Koopman, W. E.; Ghisaidoobe, A.; van der Marel, G. A.; Strijland, A.; Aerts, J. M.; Overkleeft, H. S. *Tetrahedron. Asym.* **2009**, *20*, 836-846.

<sup>128</sup> Chang, H.; Asano, N.; Ishii, S.; Ichikawa, Y.; Fan, J. *FEBS J.* **2006**, *273*, 4082-4092.

<sup>129</sup> Wang, G. N.; Reinkensmeier, G.; Zhang, S. W.; Zhou, J.; Zhang, L. R.; Zhang, L. H.; Butters, T. D.; Ye, X. *S. J. Med. chem.* **2009**, *52*, 3146-9.

<sup>130</sup> Schönemann, W.; Gallienne, E.; Compain, P.; Ikeda, K.; Asano, N.; Martin, O. R. *Unpublished results.*

Later, D-gluco (**2**, **5-8**) and  $\alpha$ -1-C-alkyl-1-deoxyimino-D-xylitol (**12**) proved to be potent inhibitors acting as a pharmacological chaperone able to increase twofold the residual activity of the GCase.

Surprisingly, it appeared recently that certain weak Gcase inhibitors (**15b**) turned out to be excellent pharmacological chaperones able to increase sixfold the residual activity of the N370S Gcase. As shown on Table 3 this result is stunning because it depends strongly of the length of the chain.<sup>125</sup>

We question this result as it is the only reported instance of a chaperone effect on N370S Gcase greater than 2.0.

Entry	R <sub>1</sub>	IC <sub>50</sub> (μM)	Fold increase of N370S-Gcase
<b>15a</b>	butyl	> 0.5 mM	ND
<b>15b</b>	octyl	175	6.2
<b>15c</b>	nonyl	102	2.0
<b>15d</b>	dodecyl	46	2.1

**Table 3**

Bicyclic structures related to calystegines (**14**) a class of iminosugars discovered in the 1990s, and castanospermine (**13**), were also found to be μM inhibitors of the Gcase.<sup>124</sup>

All of these examples, even those with a weak GCase inhibitory effect (**9**) allowed research groups, including ours, to draw important conclusions on structure-activity relationship in GCase inhibition by iminosugars. For example, it was found that the length of the alkyl chain was critical and that the “CH<sub>2</sub>OH” carrying by the carbon five appeared detrimental. In fact, compounds carrying “CH<sub>2</sub>OH” on C-5 showed an inhibition for others glycosidases. Its absence induced a great selectivity for Gcase. At this stage, our compounds  $\alpha$ -1-C DIX appeared to be the most powerful at low concentration and selective for GCase.

Amicus Therapeutics is currently investigating (2010) the use of isofagomine (**17**, Figure 10), known under the trade name Plicera<sup>®</sup> as the first pharmacological chaperone for the treatment of Gaucher disease. Indeed, this compound proved to be one of the very good inhibitors as

well as a selective pharmacological chaperon of the GCCase.<sup>131</sup> Completion of the phase clinical 2 trials is under way.

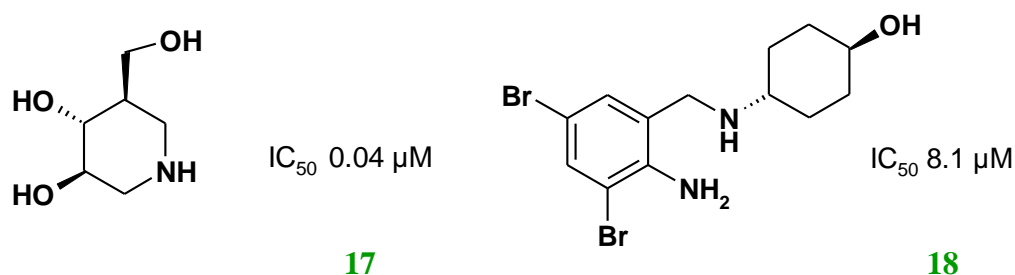

**Figure 10:** Structure and  $IC_{50}$  of Plicera<sup>®</sup> and EXR-202.

One molecule (**18**) found during the screening of the chemical libraries from “the Food and Drug Administration (FDA)-approved compounds” is under investigation by ExSAR, another US-based company developing therapies for protein misfolding diseases. This compound has been approved by European and other foreign regulatory agencies for other indications. It can be administered orally and has shown an outstanding efficacy in cell lines derived from GD patient fibroblasts. Phase I clinical trials are planned for this drug named EXR-202<sup>132</sup> or Ambroxol.

CMT is paradoxical therapeutic strategy: small molecule inhibitors are indeed used to enhance the residual activity of the mutant enzyme. This can be explained by the mode of treatment. Indeed, the inhibitor is applied at subinhibitory concentrations, allowing it to bind to such proteins, have a stabilizing effect and ensure their correct trafficking to the lysosome. Then, the pharmacological chaperone is displaced from the enzyme active site, in the lysosome where substrate concentration becomes dominant.

An apparent disadvantage of CMT is the relationship between types and locations of mutations in the enzyme involved in the disease and the response to the pharmacological chaperone. It is undeniably true that this therapy cannot be applied to rescue enzymes in which the mutation does inactivate the catalytic site. However, in general, LSD associated mutations are localized in regions of the enzymes away from catalytic site. Thus CMT can be

<sup>131</sup> Khanna, R.; Benjamin, E. R.; Pellegrino, L.; Schilling, A.; Rigat, B. A.; Soska, R.; Nafar, H.; Ranes, B. E.; Feng, J.; Lun, Y.; Powe, A. C.; Palling, D. J.; Wustman, B. A.; Schiffmann, R.; Mahuran, D. J.; Lockhart, D. J.; Valenzano, K. J. *FEBS J.* **2010**, *277*, 1618-1638.

<sup>132</sup> Maegawa, G. H. B.; Tropak, M. B.; Buttner, J. D.; Rigat, B. A.; Fuller, M.; Pandit, D.; Tang, L.; Kornhaber, G. J.; Hamuro, Y.; Clarke, J. T. R.; Mahuran, D. J. *J. Biol. Chem.* **2009**, *284*, 23502-23516.

used for many different mutations such as in Fabry disease,<sup>133</sup> at the condition that the mutated enzyme retains some residual activity.

The case of Gaucher disease illustrates very well this problem. Until recently, for the two most prevalent missense mutations (N370S and L444P), only the activity of the N370S GCase was increased by pharmacological chaperones. Indeed, at present, only a few reports shows small increase in L444P GCase activity including our  $\alpha$ -1-C-octyl DNJ<sup>119</sup> which showed a weak enhancement effect; remarkably, isofagomine was shown to double the residual activity of L444P GCase.<sup>131</sup>

Beyond lysosomal storage disorders, pharmacological chaperones have potential clinical applications in a broad range of genetic diseases, especially neurodegenerative disorders.<sup>134</sup> For example, the CMT approach to restore cell surface expression and function of mutant melanocortin-4-receptor (MC4R) which is involved in early onset obesity in humans could offer a promising therapeutic strategy.<sup>135</sup> It is also possible that the favorable effects of miglustat (*N*-butyl DNJ) in activation the CFTR mutant protein, which causes cystic fibrosis, is due to a chaperoning effect.

### III.4. Conclusion

Therapies of lysosomal storage disorders have made significant progress in the last two decades. All these studies allow us to better understand how lysosome work and how we can improve treatments for these dramatic disorders.

Despite the success of ERT, this treatment reveals significant limitations. For instance, the production of Cerezyme<sup>®</sup> used to treat patients with a confirmed diagnosis of non-neuronopathic (Type 1) or chronic neuronopathic (Type 3) Gaucher disease suffers currently from an interruption in production. The recombinant protein synthetic pathway has been

---

<sup>133</sup> Shin, S. H.; Kluepfel-Stahl, S.; Cooney, A. M.; Kaneski, C. R.; Quirk, J. M.; Schiffmann, R.; Brady, R. O.; Murray, G. J. *Pharmacogenet. Genomics* **2008**, *18*, 773-780.

<sup>134</sup> Gazit, E. *Angew. Chem. Int. Ed.* **2002**, *41*, 257-259.

<sup>135</sup> Rene, P.; Le Gouill, C.; Pogozeva, I. D.; Lee, G.; Mosberg, H. I.; Farooqi, I. S.; Valenzano, K. J.; Bouvier, M. J. *Pharmacol. Exp. Ther.* **2010**.

contaminated by a virus. In order to protect the most vulnerable patients, guidance was established by the international Cerezyme Stakeholders Working Group.<sup>136</sup>

One lesson learnt from that is the necessity to expand therapies in order to not be dependent on a single type of treatment and avoid risks for patients.

The CMT approach has shown promising results in many enzymes deficiencies such as  $\beta$ -glucosidase and clinical proof of concept was provided. Clearly, this approach deserves further investigation especially in the treatment of diseases of lower incidence in which there is no treatment like Krabbe disease.

---

<sup>136</sup> Hollak, C. E. M.; vom Dahl, S.; Aerts, J. M. F. G.; Belmatoug, N.; Bembi, B.; Cohen, Y.; Collin-Histed, T.; Deegan, P.; van Dussen, L.; Giraldo, P.; Mengel, E.; Michelakakis, H.; Manuel, J.; Hrebicek, M.; Parini, R.; Reinke, J.; di Rocco, M.; Pocovi, M.; Sa Miranda, M. C.; Tytki-Szymanska, A.; Zimran, A.; Cox, T. M. *Blood Cells Mol. Dis.* **2010**, *44*, 41-47.

## IV. Gaucher disease

This disease was first described by Phillippe Gaucher in 1882.<sup>137</sup> The identification of the storage material<sup>138</sup> and the defective enzyme<sup>139,140</sup> was elucidated many years later. Since these discoveries, impressive investigations were conducted by research groups allowing this pathology to be the best studied LSD.

Gaucher disease is one of the most common lysosomal disorders known, with an estimated incidence of 1 in 60,000 in general population<sup>141</sup> and 1 in 800 in the Ashkenazi Jewish population.<sup>142</sup> This recessive inherited disorder is characterized by the deficiency of  $\beta$ -glucocerebrosidase (GCCase) which causes the accumulation of  $\beta$ -glucopyranosyl-ceramide.<sup>67</sup> Mutations in the saposin C activator protein, the protein required for an optimal GCCase activity, can also lead to various forms of Gaucher disease.<sup>63,143</sup> However, it occurs very rarely.

### IV.1. Causes of the disease

The role of GCCase is to cleave by hydrolysis the  $\beta$ -glycosidic linkage of the glucosylceramide into glucose and ceramide.

Deficiency of the GCCase is caused by point mutations widely distributed throughout the protein which varies in their frequency and in the severity of the resulting disease (Figure 11). Most of these result in misfolding and decreased stability of the GCCase. The mutant proteins are retained in the ER and then degraded by the quality-control process of the cell (ERAD).

This leads to the accumulation of substrate and although the defect in glucocerebrosidase is systemic, glucocerebroside storage is restricted mainly to cells of the macrophage lineage, one of its important role being the removal of dead cell material. Clinically, this results in variant forms of the disorder.

---

<sup>137</sup> Gaucher, P. C. E. *De l'epithelioma primitif de la rate, hypertrophie idiopathique de la rate sans leucemie [academic thesis]*, **1882**, Paris, France.

<sup>138</sup> Aghion, A. *La maladie de Gaucher dans l'enfance [academic thesis]*, **1934**, Paris, France.

<sup>139</sup> Brady, R. O.; Kanfer, J. N.; Shapiro, D. *Biochem. Biophys. Res. Commun.* **1965**, *18*, 221-225.

<sup>140</sup> Patrick, A. D. *Clin. Sci.* **1965**, *28*, 427-443.

<sup>141</sup> Grabowski, G. A. *Adv. Hum. Genet.* **1993**, *21*, 377-441.

<sup>142</sup> Beutler, E.; Nguyen, N. J.; Henneberger, M. W.; Smolec, J. M.; McPherson, R. A.; West, C.; Gelbart, T. *Am. J. Hum. Genet.* **1993**, *52*, 85-88.

<sup>143</sup> Horowitz, M.; Zimran, A. *Hum. Mutat.* **1994**, *3*, 1-11.

Many mutations have been reported but only four mutations are common in Gaucher disease for both general and Ashkenazi Jewish population (table 4).

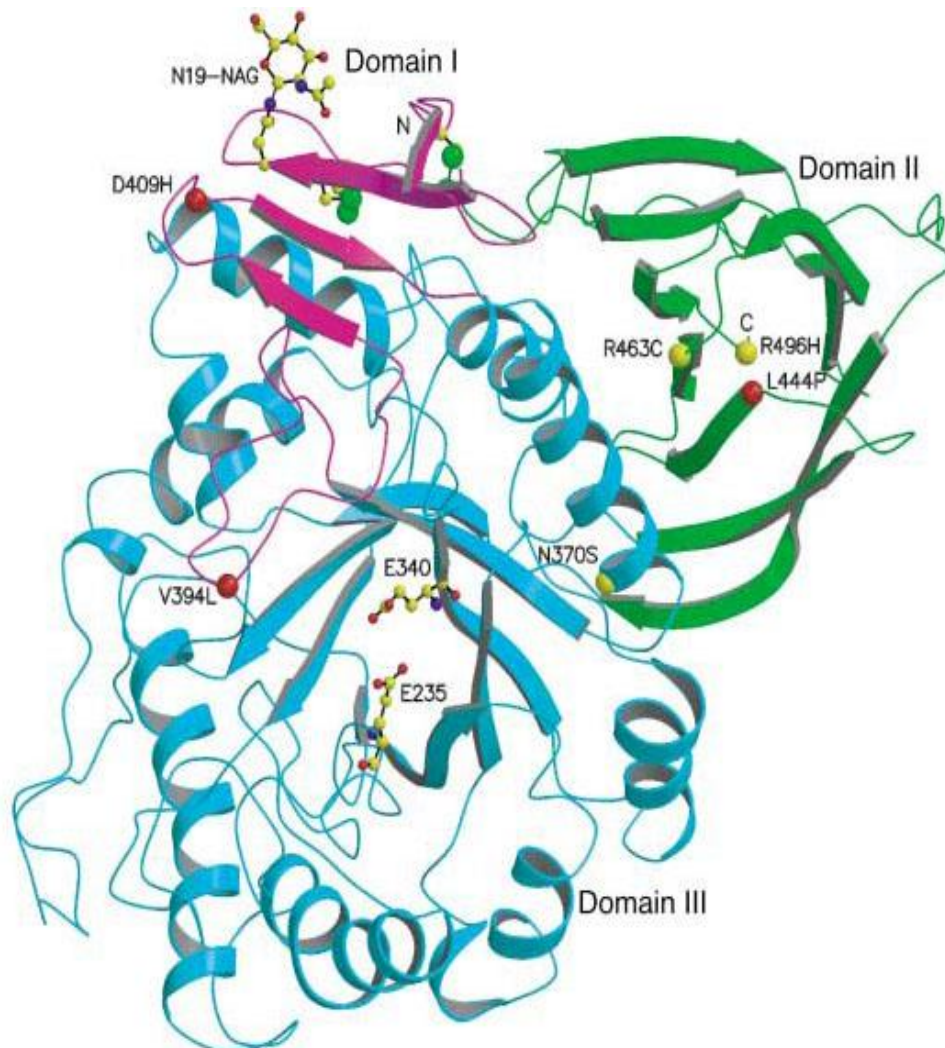

**Figure 11:** GCCase with identified point mutations. Residues are color coded as follows: red spots residues whose mutation causes severe forms of the disease; yellow spots, residues whose mutations causes mild forms of the disease. E235 and E340 which represent active-site residues are shown and are not mutated in the disease.<sup>144</sup>

The most prevalent one, N370S and L444P alleles, are missense mutations which means that a single nucleotide change in DNA has for consequence the substitution of one amino acid by another in the protein. The mutation c84-85insG denotes that a Guanine is inserted between nucleotides 84 and 85 of the coding DNA reference sequence. Finally, the mutation IVS2+1G>A represents a splice mutation<sup>145</sup> which destroys the splice donor consensus site via insertion of a nucleotide during the processing of precursor messenger RNA into mature messenger RNA.

<sup>144</sup> Atrian, S.; López-Viñas, E.; Gómez-Puertas, P.; Chabás, A.; Vilageliu, L.; Grinberg, D. *Proteins* **2008**, *70*, 882-891.

<sup>145</sup> He, G. S.; Grabowski, G. A. *Am. J. Hum. Genet.* **1992**, *51*, 810-820.



Genotype	% of Ashkenazi Jewish individual	% of non-Jewish individual	mutations	% of affected individual
N370S/N370S	41%	9%	N370S/N370S	29%
			N370S/?	20%
N370S/L444P	3%	19%	N370S/L444P	16%
			N370S/c84-85insG	12%
N370S/c84-85insG	23%	0%	L444P/L444P	6%
			L444P/?	3%
N370S/IVS2+1G>A	6%	2%	N370S/IVS2+1G>A	3%

**Table 4:** Frequencies of the most common genotype associated with N370S and proportion of individuals with GCase mutations using the four common ones. Based on data from GeneReview-Gaucher disease.

## IV.2. Clinical aspect

This pathology is known for encompassing a continuum of clinical findings from a perinatal-lethal form to an asymptomatic form.<sup>146</sup> However, it can be classified in a tree clinical subtype,<sup>147</sup> which is useful to describe the wide spectrum of clinical findings and broad variability in presentation. Three major clinical types are defined by the absence (type 1) or presence (types 2 and 3) of the involvement of the primary central nervous system.<sup>148,149</sup>

*Type 1* (95% of the cases):

The most frequent nonneuropathic form by far; it is clinically heterogeneous and characterized by the prevalence of the N370S mutation. This is often called the adult form (medical diagnosis in general at 20 year old), although the cause is present since the time of conception. The major sign is hepatosplenomegaly with pancytopenia and in the course of the disease, disabilities due to bone deformities develop. These patients present also coagulation abnormalities which induce among other symptoms spontaneous hematoma and nosebleed. Pulmonary, cardiac and renal complications are rarer.

*Type 2* (1 / 500 000 ):

It is the most severe and rarest form of Gaucher disease. The onset of symptoms is before age two. Unfortunately, neurological symptoms with hepatosplenomegaly develop rapidly and

<sup>146</sup> Germain, D. P. *Pathol. biol.* **2004**, *52*, 343-50.

<sup>147</sup> Cox, T. M.; Schofield, J. P. *Baillieres Clin. Haematol.* **1997**, *10*, 657-689.

<sup>148</sup> Gieselmann, V. *Biochim. Biophys. Acta* **1995**, *1270*, 103-136.

<sup>149</sup> Stirnemann, J. *Rev. Med. Interne* **2008**, *29*, 176-178.

cause the death by age two to four. First signs are an oculomotor apraxia, a saccadic initiation failure associated with bulbar signs and swallowing difficulty. Convulsions arrive later expressed by myoclonic epilepsy resisting antiepileptic treatments.

*Type 3 (5% of the cases):*

This type of Gaucher disease is characterized by a slower progression of neuronopathic disease contrary to type 2 Gaucher disease. In general, patients who present homozygous L444P mutation tend to have severe disease, with neurologic complications. It explains why homozygosity for the L444P mutation is the most common genotype among individuals with type 3 Gaucher disease.<sup>150</sup> The signs and symptoms of type 3 Gaucher disease usually appear in childhood and vary widely among affected individuals. Characteristic features include hepatosplenomegaly, anemia, thrombocytopenia and bone pain. And, because the central nervous system is affected, it causes loss of muscle coordination, paralysis of the eye muscles and dementia.

*Foetal form (less than 1% of the cases):*

It is a rare and severe variant of Gaucher disease which is in general lethal.<sup>151</sup> Hepatosplenomegaly is a major sign, associated with ichthyosis, arthrogyposis, and facial dysmorphism. Moreover, genotypic heterogeneity is significant in this rare form of the disease. However, it is presumed that homozygosity for mutations 84GG (c84-85insG) and IVS2+1 are lethal and there is no example of live birth for either mutations.

### **IV.3. Physiopathology**

There are several potential ways in which accumulated substrate might cause a disease. The most obvious is enlargement of the affected cell, resulting in enlargement of the respective organ.

In Gaucher disease glucocerebroside which is derived from the membranes of apoptotic red and white blood cells, is normally phagocytosed by macrophages for recycling. Gaucher

---

<sup>150</sup> Koprivica, V.; Stone, D. L.; Park, J. K.; Callahan, M.; Frisch, A.; Cohen, I. J.; Tayebi, N.; Sidransky, E. *Am. J. Hum. Genet.* **2000**, *66*, 1777-1786.

<sup>151</sup> Mignot, C.; Gelot, A.; Bessières, B.; Daffos, F.; Voyer, M.; Menez, F.; Fallet Bianco, C.; Odent, S.; Le Duff, D.; Loget, P.; Fargier, P.; Costil, J.; Josset, P.; Roume, J.; Vanier, M.; Maire, I.; Billette de Villemeur, T. *Am. J. Med. Genet.* **2003**, *120A*, 338-344.

macrophages appear as enlarged cells with a characteristic wrinkled tissue paper appearance due to the accumulation of glucocerebroside membrane structures. The influx of Gaucher macrophages to the liver and spleen of Gaucher patients, and the resulting inflammation, presumably contribute to the hepatosplenomegaly. The infiltration of macrophages into the bone marrow is believed to displace hematopoietic stem cells, leading to pancytopenia which is expressed by a reduction of the numbers of red and white blood cells in peripheral blood.<sup>152</sup> Macrophages activation following storage is reported for all storage disorder. They are related to a chronic low-grade inflammation in patients with Gaucher disease, consistent with increased levels of pro-inflammatory and anti-inflammatory cytokines and chemokines.

The process of how a storage disorder contributes to neurodegenerative disease is still misunderstood. Neurons in storage disorders display storage of primary substrate. However, they also display a variety of other changes: disruption of spatial and temporal controls for cellular signaling which are in part controlled by lipids' components. The dysfunction in synaptic activity and the loss of synaptic connections play also pivotal roles in neurodegeneration.<sup>153</sup>

#### **IV.4. Related allelic disorder: Parkinson disease**

Recently, several publications have reported an association between Gaucher disease and the development of Parkinsonism.<sup>154</sup> Parkinsonism (also known as Parkinson's syndrome or secondary Parkinson's) is a neurodegenerative syndrome in which the loss of neurons in locus niger (black substance) is the most common cause of the syndrome.

The individuals with glucocerebrosidase mutations had documented abnormal aggregates of protein that develop inside nerve cells in Parkinson disease that were not confined to the locus niger. These findings suggested that mutations in glucocerebrosidase, even in heterozygotes, might be a significant risk factor for the development of Parkinsonism.

Mutation L444P found in patients from all over the world which is the second most commonly identified mutation in Gaucher disease correlates with Parkinson disease.

---

<sup>152</sup> Parkinson-Lawrence, E. J.; Shandala, T.; Prodoehl, M.; Plew, R.; Borlace, G. N.; Brooks, D. A. *Physiology (Bethesda)* **2010**, *25*, 102-115.

<sup>153</sup> Haughey, N. J. *Neuromol. Med.* **2010**.

<sup>154</sup> Sidransky, E. *Mol. Genet. Metab.* **2005**, *84*, 302-304.

Parkinsonian features have also been reported in a few individuals with type 1 Gaucher disease carrying N370S mutation.<sup>155,156,157</sup>

However, the study is ongoing and future assessments will better establish relationships between Parkinsonism and Gaucher disease.

#### **IV.5. Therapy for Gaucher disease**

Two specific treatments are available for Gaucher disease and widely used. Enzyme Replacement Therapy which provides recombinant human enzyme (Cerezyme<sup>®</sup>) to overcome the blocking in the catabolic pathway via a reduction of the stored substrate and, Substrate Reduction Therapy (Zavesca<sup>®</sup>) which reduce the flux of glucosylceramide that cannot be degraded due to the GCase defect.

Regular intravenous infusions (~ two hours every two weeks) of Cerezyme<sup>®</sup> are efficient for patients with type 1 Gaucher disease. It really improves health-related quality of life after one or two years of treatment and reverses those features resulting from hematologic and visceral involvement.<sup>158,159</sup> It reduces also the rate of bone loss and bone crisis but it takes years of treatment. This treatment can be applied to patients with type 3 Gaucher disease allowing them to stay alive longer.<sup>160,161</sup> Even if Cerezyme<sup>®</sup> is well tolerated in general, attention should be given at the beginning of the treatment because some people can develop antibodies to the infused enzyme.

Zavesca<sup>®</sup> was the first treatment orally administrated for patients with mild to moderate Gaucher disease for whom ERT is not a therapeutic option. Because of several side effects such as diarrhea, abdominal pains, tremor and peripheral neuropathy, this treatment is administrated under strict conditions. However, Zavesca<sup>®</sup> can cross the blood brain barrier and correct the storage in the central nervous system and also in somatic tissues. Treatment results in a significant decrease in liver and spleen volume after six to eighteen months, with

---

<sup>155</sup> Tayebi, N.; Callahan, M.; Madike, V.; Stubblefield, B. K.; Orvisky, E.; Krasnewich, D.; Fillano, J. J.; Sidransky, E. *Mol. Genet. Metab.* **2001**, *73*, 313-321.

<sup>156</sup> Tayebi, N.; Walker, J.; Stubblefield, B.; Orvisky, E.; LaMarca, M. E.; Wong, K.; Rosenbaum, H.; Schiffmann, R.; Bembi, B.; Sidransky, E. *Mol. Genet. Metab.* **2003**, *79*, 104-109.

<sup>157</sup> Goker-Alpan, O.; Lopez, G.; Vithayathil, J.; Davis, J.; Hallett, M.; Sidransky, E. *Arch. Neurol.* **2008**, *65*, 1353-1357.

<sup>158</sup> Weinreb, N. *J. Expert Opin. Pharmacother.* **2008**, *9*, 1987-2000.

<sup>159</sup> Charrow, J. *Expert Opin. Biol. Ther.* **2009**, *9*, 121-131.

<sup>160</sup> Erikson, A.; Forsberg, H.; Nilsson, M.; Aström, M.; Månsson, J. *Acta Paediatr.* **2006**, *95*, 312-317.

<sup>161</sup> Davies, E. H.; Erikson, A.; Collin-Histed, T.; Mengel, E.; Tytki-Szymanska, A.; Vellodi, A. *J. Inherit. Metab. Dis.* **2007**, *30*, 935-942.

clinical improvement noted over 24 months for patients with type 2 and 3 Gaucher disease. Bone involvement and platelet and hemoglobin values remained stable which lead rapidly to an increase in bone density.<sup>162</sup>

Chaperone Mediated Therapy using Plicera<sup>®</sup> as the first pharmacological chaperone for the treatment of Gaucher disease was in preclinical trials when we started our work in 2007. Plicera<sup>®</sup> is currently in clinical trials in order to establish its safety and efficacy. With hope that this therapy will afford an efficient alternative for all patients with Gaucher disease.

Until Plicera<sup>®</sup> become available, people who were not receiving Cerezyme<sup>®</sup> or Zavesca<sup>®</sup> had to receive hard symptomatic treatment including partial or total splenectomy for massive splenomegaly and thrombocytopenia. All patients also had to undergo:

- Transfusion of blood products for severe anemia and bleeding
- Analgesics for bone pain
- Joint replacement surgery for relief from chronic pain and restoration of function
- Oral bisphosphonates and calcium for osteopenia.

## **IV.6. Conclusion**

Gaucher disease is one of the first genetic diseases to be treated using small organic molecule as therapeutic agent. However, it is a multisystemic disorder with broad variability in clinical presentations which requires taking into account each symptom in order to offer the most efficient treatment for each patient.

All progress realized in the treatment of this GSL disorder enable a better understanding of the pathology. Some points such as the physiopathology of bone pain and the relationship between Parkinsonism and Gaucher disease are still largely misunderstood.

It is also important to consider the quality of life of patients. Indeed, we can imagine how restrictive it can be for a patient to have to go every week or two to a hospital in order to receive a treatment such as the one used for ERT. Improvements are needed in this area in particular for patients from the Ashkenazy Jewish community, for whom Gaucher disease is not a rare genetic disease.

---

<sup>162</sup> Wenstrup, R. J.; Bailey, L.; Grabowski, G. A.; Moskovitz, J.; Oestreich, A. E.; Wu, W.; Sun, S. *Blood* **2004**, *104*, 1253-1257.

## V. Krabbe disease (Globoid cell leukodystrophy, GLD)

The Krabbe disease<sup>163</sup> was initially based on clinical and pathological findings from the Danish physician Knud Krabbe in 1916. He reported cases of infants, who suffered from episodes of violent crying and irritability, progressive muscular rigidity, tonic spasms evoked by such stimuli as noise, light or touching. These infants were reported to die before reaching the age of two of an “acute infantile familial diffuse brain sclerosis”.<sup>164</sup>

It took half a century to attribute this pathology to the deficiency of galactosylceramidase (GALC) as the underlying genetic cause.<sup>165</sup> However, the defect of this lysosomal hydrolase is not necessarily accompanied by the lysosomal concentration of its substrate. Indeed, it was subsequently reported that the concentration of the toxic substance of a related metabolite, galactosylsphingosine so-called psychosine, was a critical factor in the biological pathogenesis.<sup>166</sup>

In general the incidence of this globoid cell leukodystrophy (GLD) which is an autosomal recessive disorder is very low (one in 100,000). But extremely high frequencies are found in some populations: the Druze community in northern Israel and two Muslim Arab villages located near Jerusalem show an incidence of 1 to 6 in 1000 births.<sup>167</sup>

### V.1. Causes of the disease

#### V.1.a. pathogenic mechanism

Some aspects of the metabolism of galactosylceramide should be reminded when the pathogenetic mechanism of globoid cell leukodystrophy is considered. In the synthetic direction, the same enzyme (ceramide galactosyltransferase) can galactosylate directly ceramide and sphingosine to give respectively galactosylceramide and psychosine. In the catabolic direction, galactosylceramide and psychosine are degraded by galactosylceramidase,

---

<sup>163</sup> Wenger, D. A.; Suzuki, K.; Suzuki, Y. Galactosylceramide lipidoses: globoid cell leukodystrophy (Krabbe disease). In: Scriver, C. R.; Beaudet, A. L.; Sly, W. S.; Valle, D. eds. *The metabolic and molecular bases of inherited disease*, 8th ed. McGraw-Hill, New York, **2001**, 3669-3694.

<sup>164</sup> Krabbe, K. *Brain* **1916**, *39*, 74 -114.

<sup>165</sup> Suzuki, K.; Suzuki, Y. *Proc. Natl. Acad. Sci. U.S.A.* **1970**, *66*, 302 -309.

<sup>166</sup> Miyatake, T.; Suzuki, K. *Biochem. Biophys. Res. Com.* **1972**, *48*, 538-543.

<sup>167</sup> Wenger, D. A. In: Pagon, R. A.; Bird, T. C.; Dolan, C. R.; Stephens, K. editors. GeneReviews [Internet]. Seattle (WA): University of Washington, Seattle; **1993-2000** [updated 2008].

which is genetically deficient in Krabbe disease. In addition, the presence of saposin A, the sphingolipid activator is required for the degradation of the galactosylceramide.

Unlike other LSDs, in Krabbe disease, the primary source of the disorder is not the accumulation of galactosylceramide, but the toxic effects of psychosine.<sup>168,169</sup> Psychosine is normally broken down by GALC, and in its absence psychosine accumulates to a toxic level, causing death of myelin. It is noted that GALC is nearly exclusively localized in the myelin-forming cells. Synthesis of psychosine occurs only in the oligodendrocytes and Schwann cells and its accumulation (Figure 12). The mechanism of action of psychosine has not been fully elucidated. It seems to induce apoptosis in oligodendrocytes through a mitochondrial pathway and to up-regulate inflammatory cytokines production resulting in oligodendrocyte loss.<sup>170</sup>

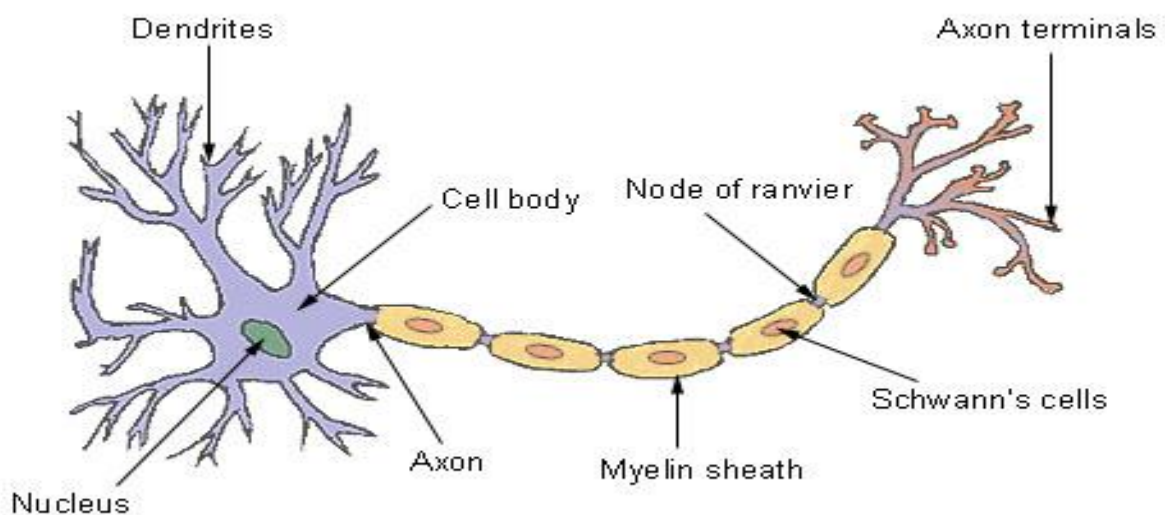

**Figure 12:** Structure of a typical neuron.

(Extract from: [www.StemCellsPuhua.com](http://www.StemCellsPuhua.com))

### V.1.b. GALC mutations

To date over seventy disease-causing mutations in the GALC human gene have been identified, many of which occur in heterozygote patterns in patients.<sup>142</sup> The Human gene

<sup>168</sup> Svennerholm, L.; Vanier, M. T.; Månsson, J. E. *J. Lipid Res.* **1980**, *21*, 53-64.

<sup>169</sup> Matsuda, J.; Suzuki, K. in Barranger, J. A.; Cabrera-Salazar, M. A. *Lysosomal Storage Disorders*; Springer US: Boston, MA, 2007.

<sup>170</sup> Formichi, P.; Radi, E.; Battisti, C.; Pasqui, A.; Pompella, G.; Lazzerini, P. E.; Laghi-Pasini, F.; Leonini, A.; Di Stefano, A.; Federico, A. *J. Cell. Physiol.* **2007**, *212*, 737-743.

GALC was cloned in 1993–1994,<sup>171,172</sup> and the available sequence information provides the framework for the study of disease-causing mutations (table 5).

Mutations	% of mutant allele	Patients from :	Comments
30-kb deletion	50%	Northern Europe and the the United States, <i>including those with Mexican ancestry</i>	The major mutation on GALC gene which always occurs with the “502T/del” polymorphism. <sup>142,173</sup>
	75%	Sweden	
C1538T	10-15%	Europe or with Europe ancestry	C1538T denotes that at nucleotide 1538 a C is changed to a T. <sup>174</sup>
A1652C	10-15%	Europe or with Europe ancestry	A1652C denotes that at nucleotide 1652 an A is changed to a C. <sup>175</sup>
I583S	-	Druze population in Northern Israel and two Moslem village near Jerusalem	Major mutation (T→G transversion at nucleotide 1748) identified in a homozygous state.
D528N	-	Druze population in Northern Israel and Two Moslem village near Jerusalem	Major mutation (G→A transition at nucleotide 1582) identified in a homozygous state and always occurs with the “I546T” polymorphism. <sup>176</sup>
I234T	-	Greece	Cause GLD in a homozygous state
L629R	-	Germany	Cause GLD in a homozygous state. <sup>177</sup>
3 kb deletion in the saposin A domain	One case reported. <sup>178</sup>	Moslem village	-

**Table 5:** Most Common Disease-Causing Mutations in *GALC* in Individuals from different origin.

<sup>171</sup> Chen, Y. Q.; Wenger, D. A. *Biochim. Biophys. Acta* **1993**, *1170*, 53-61.

<sup>172</sup> Sakai, N.; Inui, K.; Fujii, N.; Fukushima, H.; Nishimoto, J.; Yanagihara, I.; Isegawa, Y.; Iwamatsu, A.; Okada, S. *Biochem. Biophys. Res. Com.* **1994**, *198*, 485-491.

<sup>173</sup> The genetic polymorphism is the existence together of many forms of DNA sequences at a locus within the population.

<sup>174</sup> Kleijer, W. J.; Keulemans, J. L.; van der Kraan, M.; Geilen, G. G.; van der Helm, R. M.; Rafi, M. A.; Luzi, P.; Wenger, D. A.; Halley, D. J.; van Diggelen, O. P. *J. Inherit. Metab. Dis.* **1997**, *20*, 587-594.

<sup>175</sup> Wenger, D. A.; Rafi, M. A.; Luzi, P. *Hum. Mutat.* **1997**, *10*, 268-279.

<sup>176</sup> Rafi, M. A.; Luzi, P.; Zlotogora, J.; Wenger, D. A. *Hum. Genet.* **1996**, *97*, 304-308.

<sup>177</sup> Jardim, L. B.; Giugliani, R.; Pires, R. F.; Haussen, S.; Burin, M. G.; Rafi, M. A.; Wenger, D. A. *Arch. Neurol.* **1999**, *56*, 1014-1017.

<sup>178</sup> Spiegel, R.; Bach, G.; Sury, V.; Mengistu, G.; Meidan, B.; Shalev, S.; Shneor, Y.; Mandel, H.; Zeigler, M. *Mol. Genet. Metab.* **2005**, *84*, 160-166.



## V.2. Clinical aspect

In the infantile form (90% of the cases), clinical course can be divided into three stages:<sup>179</sup>

### *Stage 1:*

This stage is characterized by hyperirritability, hyperesthesia, stiffness of limbs and episodic fever without infection. The child, apparently normal for the first few months after birth, becomes hypersensitive to auditory, tactile, or visual stimuli and begins to cry frequently without apparent cause. Slight intellectual disability or regression of psychomotor development as well as vomiting with feeding difficulties leading to progressive loss of weight is reported as first clinical symptoms.

### *Stage 2:*

Rapid and severe motor and intellectual deterioration develops. Child present a hypertonicity with extend and crossed legs, flexed arms, and a backward-bent head. Tendon reflexes are hyperactive. Minor tonic or clonic seizures occur. Optic atrophy and sluggish pupillary reactions to light are common.

### *Stage 3:*

The infant is decerebrate and blind with no contact with surroundings. It's the "burnt out" stage; patients rarely survive for more than few years.

For a very long time, cases of patients with late-onset Krabbe disease were considered exceptional. But new diagnosis process revealed that late-onset GLD is reported in increasing frequency. Individuals with late-onset forms can be clinically normal until almost any age when symptoms of weakness, vision loss, and intellectual regression become evident. However, late-onset Krabbe disease can be divided into two types:

*Late infantile form (or early childhood which onset at age six months to three years):*

Patients with the late-infantile form develop psychomotor difficulties, stiffness, irritability, ataxia and vision loss. The course is progressive, resulting in death in two to seven years after diagnosis.

---

<sup>179</sup> Hagberg, B.; Sourander, P.; Svennerholm, L. *J. Neurol. Neurosurg. Psychiatr.* **1963**, 26, 195-198.

*Juvenil form (or Late childhood which onset at three to eight years):*

Patients commonly develop loss of vision, together with hemiparesis, ataxia, and psychomotor regression. In general, patients with the juvenile form present showed a rapid deterioration followed by a more gradual progression lasting for years. On the contrary, adult patients may develop slowly progressive symptoms. Progressive and generalized neurological deterioration may not be apparent until 40 years of age.

### **V.3. Therapy for Krabbe disease**

Unfortunately, there is no treatment for Krabbe disease.<sup>180</sup> Treatment is limited to supportive care to control the irritability and spasticity of patients.

This disease is unique in having three well-characterized animal models available for study including mice, dogs and monkeys. Studies using these animal models to investigate other treatment options including gene therapy, enzyme replacement therapy, substrate reduction therapy, and chemical chaperone therapy<sup>181</sup> are being conducted.

However, at this time hematopoietic stem cell transplantation<sup>182,183</sup> and bone marrow transplantation<sup>184</sup> are the most effective method of therapy in the animal models of Krabbe disease.

None of these other methods are ready for human trials. But, it is hoped that these studies may lead as soon as possible to the development of therapeutics to help patients with Krabbe disease.

---

<sup>180</sup> Wenger, D. A.; Rafi, M. A.; Luzi, P.; Datto, J.; Costantino-Ceccarini, E. *Mol. Genet. Metab.* **2000**, *70*, 1-9.

<sup>181</sup> Lee, W. C.; Kang, D.; Causevic, E.; Herdt, A. R.; Eckman, E. A.; Eckman, C. B. *J Neurosci.* **2010**, *30*, 5489-5497.

<sup>182</sup> Krivit, W.; Shapiro, E. G.; Peters, C.; Wagner, J. E.; Cornu, G.; Kurtzberg, J.; Wenger, D. A.; Kolodny, E. H.; Vanier, M. T.; Loes, D. J.; Dusenbery, K.; Lockman, L. A. *N. Engl. J. Med.* **1998**, *338*, 1119-1126.

<sup>183</sup> Tunici, P.; Pellegatta, S.; Finocchiaro, G. *Cytotechnology* **2003**, *41*, 93-101.

<sup>184</sup> Miyake, N.; Miyake, K.; Karlsson, S.; Shimada, T. *Mol. Ther.* **2010**, *18*, 1373-1378.

## Objectives

The aim of this PhD project was the synthesis of new iminosugars which could act as pharmacological chaperone for a Chaperone Mediated Therapy application.

A new family of iminosugar derivatives that are potent and highly selective inhibitors of human  $\beta$ -glucocerebrosidase (GCCase), the enzyme involved in Gaucher disease, was identified by our group in 2006. These compounds were shown to be excellent candidate for treating Gaucher disease using the Chaperone Mediated Therapy.

The lead compound of this family is  $\alpha$ -1-*C*-nonyl-iminoxylitol also named  $\alpha$ -1-*C*<sub>9</sub>-DIX (Table 2, compound **12**). It appeared that this compound is:

- One of the most powerful inhibitors of the GCCase (*K<sub>i</sub>* 2.2 nM).<sup>125</sup>
- Selective towards GCCase which means that it has no effect on  $\alpha$ -glucosidases including the intestinal  $\alpha$ -glucosidases.
- Able to increase 1.8-fold the residual activity of the mutant GCCase at extremely low concentration (10 nM).

Based on this promising lead compound, our aim was to get closer to a pharmacological application. In order to reach this objective it was necessary to solve some problems associated with this compound. Indeed, the first generation synthesis for the preparation of our compound was not satisfactory. In order to synthesize this and new iminosugars efficiently, the synthetic strategy had to be improved and optimized.

Moreover, our investigations focused on structural variations of the lead compound  $\alpha$ -1-*C*<sub>9</sub>-DIX. Firstly, the nonyl chain is potentially a source of cytotoxicity.<sup>120</sup> A shorter alkyl chain such as hexyl or butyl should address this obstacle. Secondly, the strong influence of the position of the alkyl chain was demonstrated by synthesizing compounds with short alkyl chain at various positions (O-2, O-3 or O-4). Finally, for a better understanding of how the conformation of the piperidine-ring acts upon GCCase inhibition compounds with different conformation were studied (Figure 13).

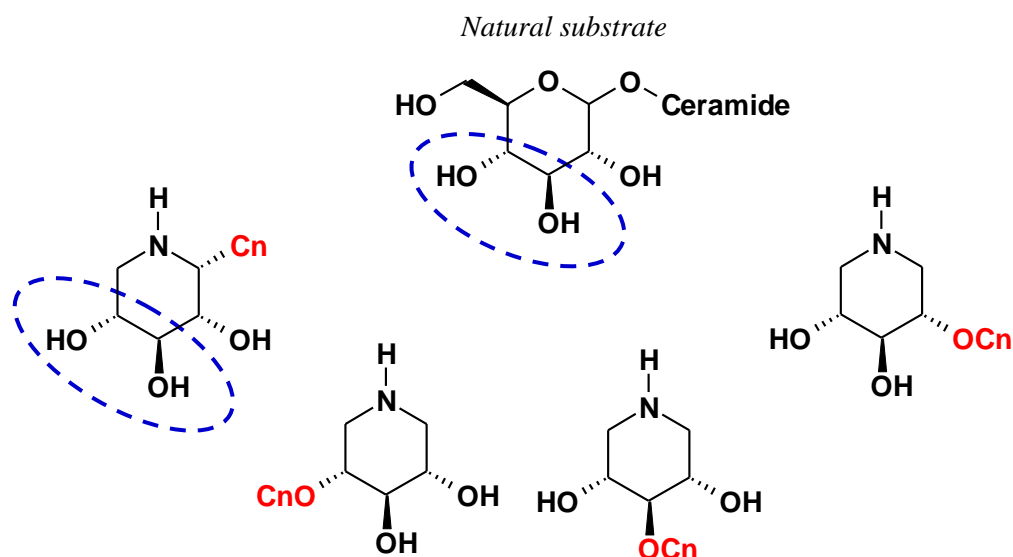

**Figure 13:** Iminosugars with the “gluco-like” configuration

The second objective of this project was to extend our expertise on iminosugars as pharmacological chaperones to other lysosomal glycosidases. Our next target was galactocerebrosidase which is responsible for Krabbe disease (Figure 14). To reach this, iminosugars which mimic the “galacto” configuration of the substrate could be powerful inhibitors of the GALC and act as pharmacological chaperones at subinhibitory concentration.

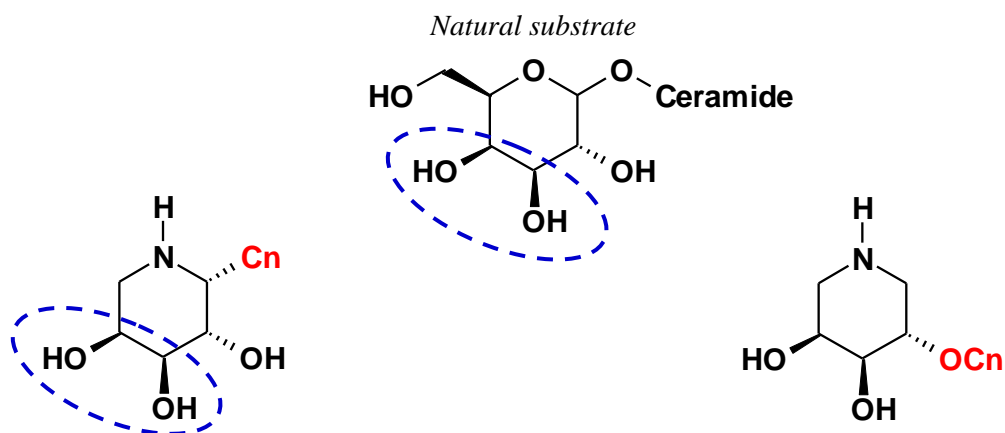

**Figure 14:** Iminosugars with the “galacto” configuration.

Our third objective was to realize biological assays of our compounds. Our group has a privileged collaboration with Dr Asano in Japan; this team performs testing of our compounds on several glycosidases as well as chaperone effect. Then, in the next phase, new lead compounds would be assessed for *in vitro* cytotoxicity and *in vivo* tolerability in mice, and pharmacokinetics and pharmacodynamics parameters will be determined. These last tests are being performed on our compounds by Dr Ryffel’s team in the laboratory of Molecular Immunology and Embryology (IEM) in Orléans.

## Chapter 2

# Improvement of the synthesis of $\alpha$ -1-C-alkyl-iminoxylitols as inhibitors and pharmacological chaperones of GCase

---

This chapter is devoted to the optimization of the synthesis of  $\alpha$ -1-C-alkyl-iminoxylitols. Indeed, we wanted to solve problems associated with the first synthetic strategy and prepare efficiently DIX derivatives bearing an “ $\alpha$ -1-C alkyl” chain.

### I. Synthetic target

Based on our lead compound  $\alpha$ -1-C-nonyl-iminoxylitol, we targeted  $\alpha$ -1-C-alkyl DIX derivatives (Figure 15). In fact, we wanted to address several problems linked to this compound such as low-yielding steps in the synthesis and the cytotoxicity associated with the long alkyl chain.

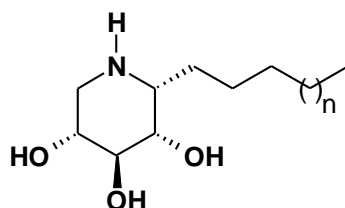

Figure 15

Our aim here was to develop an efficient synthetic strategy to obtain this family of iminosugars and to apply it to the analogs with shorter alkyl chains.

As illustrated with  $\alpha$ -1-C-nonyl DIX, we know that this family of compounds are potent GCase inhibitors and act as pharmacological chaperones. And, we wanted to verify if compounds with a shorter alkyl chain would still have an inhibition activity in nanomolar range.

## II. Previous synthetic pathway

Starting from L-xylose, the first synthesis of  $\alpha$ -1-C-alkyl DIX was performed in 10 steps (Figure 16).<sup>185</sup>

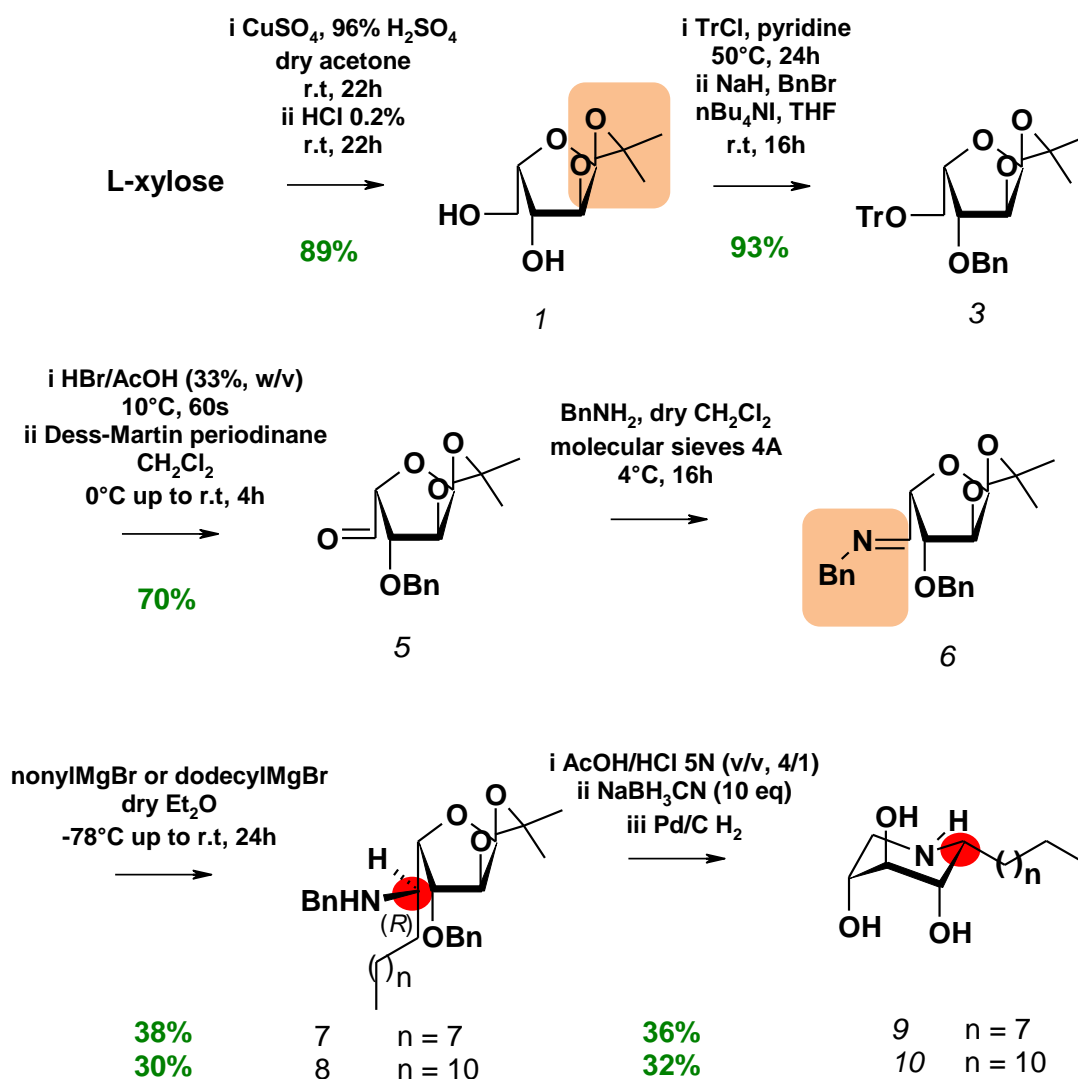

Figure 16

Double acetalization of L-xylose under conventional conditions<sup>186</sup> followed by selective deprotection of the 3,5-*O*-isopropylidene group led to the building block **1** with two unprotected hydroxyl groups. The primary alcohol was isolated by a three-step procedure: tritylation at *O*-5 followed by benzylation of the 3-*OH* group and finally removal of the trityl

<sup>185</sup> PhD thesis of Boucheron, C., *Conception et synthèse d'iminoglycolipides d'intérêt thérapeutique contre la maladie de Gaucher* 2006-University of Orléans.<sup>125</sup>

<sup>186</sup> a)Renaut, P.; Millet, J.; Sepulchre, C.; Theveniaux, J.; Barberousse, V.; Jeanneret, V.; Vogel, P. *Helv. Chim. Acta.* **1998**, *81*, 2043-2052. b) Levene, P. A.; Raymond, A. *J. Biol. Chem.* **1933**, *102*, 317-330.

protecting group.<sup>187</sup> This resulting primary alcohol was then oxidized using Dess-Martin periodinane to give in good yield aldehyde **5**.<sup>188</sup>

Addition of benzylamine to compound **5** in the presence of molecular sieves provided the imine **6** which was directly used in the next step.<sup>189</sup>

The addition of the Grignard reagents derived from 1-bromononane and 1-bromododecane to this imine was highly diastereoselective (d.e. > 98%) and gave rise to amines **7** and **8** respectively, in low yield. This diastereoselectivity was explained by the chelation model shown in Figure 17.<sup>190</sup> Indeed, eclipsing of the C=N and C-4/O bonds might afford a conformation which facilitates the coordination of the metal (Mg) with the imine nitrogen and the endocyclic oxygen.<sup>191</sup> In these conditions, the *Re* face was favored for the nucleophilic attack, thus producing the *R*-stereoisomer of the resulting amine.

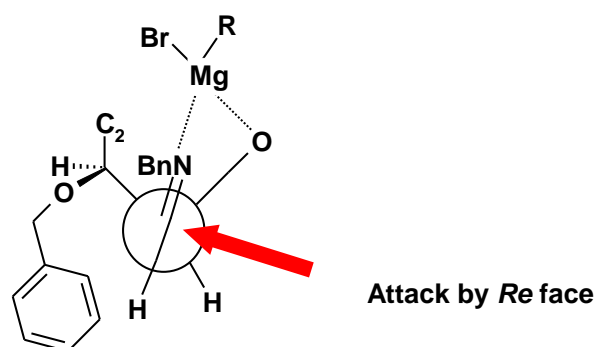

Figure 17

Finally, the isopropylidene protecting group was cleaved<sup>192</sup> and the intramolecular reductive amination was performed by 2 consecutive additions of sodium cyanoborohydride.<sup>193</sup> Hydrogenolysis of the benzyl ether groups afforded the iminoxylitols **9** and **10** carrying an alkyl chain at C-1 in low yield.

This synthetic strategy showed weaknesses and strength. To begin, the use of the isopropylidene protecting group was detrimental because of the difficulties to remove it in late stage of the synthesis. Moreover, the preparation of the imine was not effective and the low

<sup>187</sup> Streicher, H.; Meisch, J.; Bohner, C. *Tetrahedron* **2001**, *57*, 8851-8859.

<sup>188</sup> Dess, D. B.; Martin, J. C. *J. Org. Chem.* **1983**, *48*, 4155-4156.

<sup>189</sup> Feldman, K. S.; Mingo, P.A.; Hawkins, P. C. D. *Heterocycles* **1999**, *51*, 1283-1294.

<sup>190</sup> Reetz, M. T. *Angew. Chem. Int. Ed. Engl.* **1984**, *23*, 556-569.

<sup>191</sup> van Delft, F. L.; de Kort, M.; van der Marel, G. A.; van Boom, J. H. *J. Org. Chem.* **1996**, *61*, 1883-1885.

<sup>192</sup> Nortey, S. O.; Wu, W.; Maryanoff, B. E. *Carbohydr. Res.* **1997**, *304*, 29-38.

<sup>193</sup> Hutchins, R. O.; Su, W. Y.; Sivakumar, R.; Cistone, F.; Stercho, Y. P. *J. Org. Chem.* **1983**, *48*, 3412-3422.

yield of Grignard additions showed its low reactivity. However, the major strength of this synthetic strategy was the high diastereoselectivity of the Grignard addition which led to the desired *R*-configuration required to form “ $\alpha$ -1-*C*-alkyl” isomers.

The weaknesses prompted us to imagine an improved strategy with the following changes:

- Use of an anomeric protecting group that can be more readily cleaved at the end of the synthesis
- Use of a more reactive imine which could provide the alkylation with the same excellent diastereoselectivity but better yields.

### III. Addition to imines: improved strategies

The stereochemical analogy between our iminosugars and aldoses shows that this family of compounds can be reached from *L*-xylose by way of *C*-5 chain extension reaction (Figure 18):

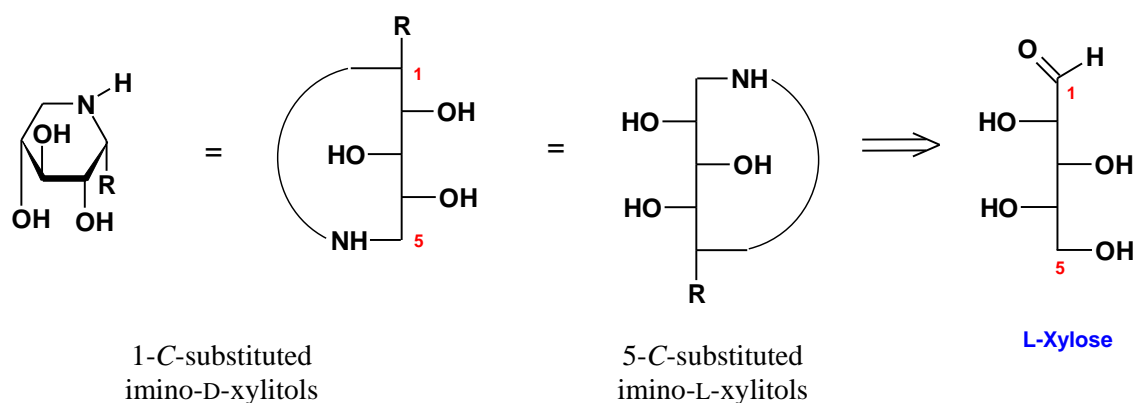

**Figure 18:**

After extensive investigations, described in the following sections, an improved synthesis of the  $\alpha$ -1-*C*-alkyl DIX was developed according to the following retro-synthetic scheme (Figure 19).



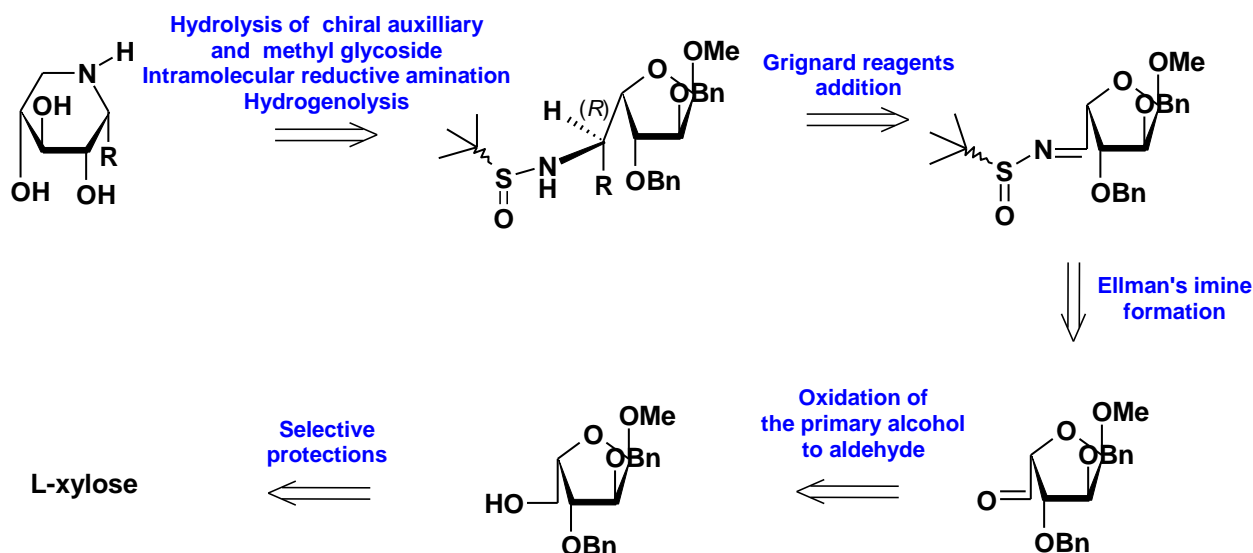

Figure 19: Retrosynthesis of the  $\alpha$ -1-C-alkyl DIX

The major changes from Boucheron's synthesis are the use of methyl glycosides as substrates and of *tert*-butanesulfinylimines (Ellman's imine) as more reactive imines.

### III.1. Protection of the anomeric center

The choice of the anomeric protecting group in this multi-step synthesis was difficult. Our investigations reported below show the types of problems we encountered and why in the end we chose to use methyl furanosides.

#### III.1.a. Direct tritylation of the primary alcohol function

Regioselective tritylation of the primary sugar hydroxyl group can be used to lock reducing pentoses into the furanose form. In our case, we wanted to convert L-xylose, in which the pyranose form predominates, to 5-*O*-tritylated L-xylofuranose with trityl chloride in pyridine.<sup>194,195</sup> Indeed, our aim was to prepare 1,2,3-tri-*O*-benzyl-L-xylofuranose by way of this intermediate.

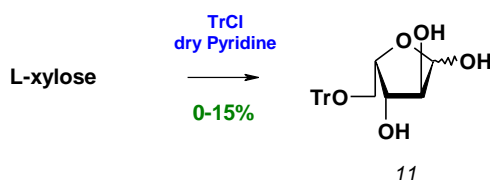

Figure 20

<sup>194</sup> Kam, B. L.; Oppenheimer, N. J. *Carbohydr. Res.* **1979**, *69*, 308-310.

<sup>195</sup> Smellie, I. A.; Bhakta, S.; Sim, E.; Fairbanks, A. J. *Org. Biomol. Chem.* **2007**, *5*, 2257.

Although the synthesis has previously been reported in the arabino series, in our hands it proved much more difficult to obtain **II** in good yield than could be inferred from published procedures. We tried to perform the reaction (Table 6) under careful by controlled conditions such as checking that the reaction temperature did not exceed 30°C.

Entry	Solvent	Conditions			Result	Yield (%)
		TrCl	T°C	Time		
1	Pyridine	1.2 eq	r.t	48h	Mixture of mono- and di-trityl derivatives	30
2	Pyridine	0.9 eq	r.t	18h	Compound <b>II</b>	15
3	Pyridine	1.0 eq	r.t	48h	Compound <b>II</b>	17

**Table 6**

A related selective silylation procedure<sup>196</sup> was also investigated but this eventually turned out to give worse results than the trityl approach. For our planned synthetic route the anomerically protected starting material has to be prepared on a large scale and this low-yielding approach was clearly not the suitable one.

### III.1.b. Benzyl glycoside

The use of a benzyl furanosides would considerably simplify the synthetic sequence: anomeric deprotection, intramolecular reductive amination and final deprotection could be performed in a single step. This requires the preparation of 1,2,3-tri-*O*-benzyl-L-xylofuranose by way of benzyl glycoside **12a**.

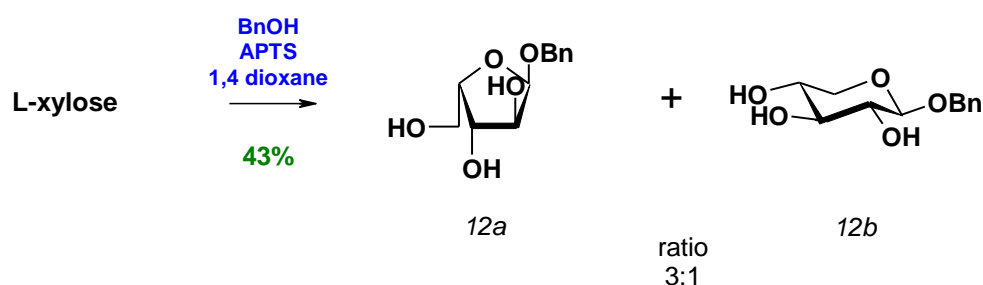

**Figure 21**

<sup>196</sup> Pigro, M. C.; Angiuoni, G.; Piancatelli, G. *Tetrahedron* **2002**, 58, 5459-5466.

Even if considerable optimization of the procedure<sup>197,198</sup> was reported, it was not sufficient. In fact, our conditions favored benzyl xylofuranoside, but we could not avoid the presence of benzyl xylopyranoside. Moreover, the mixture of furanose and pyranose forms was obtained in poor yield (Table 7).

Entry	Solvent	Conditions			Ratio		Yield (%)
		PTSA	T°C	Time	12a	12b	
1	BnOH	0.15 eq	90	12h	1	1	58
2	BnOH/1,4-dioxane (v:v, 1:2.5)	0.15 eq	90	12h	3	1	43
3	BnOH/1,4-dioxane (v:v, 1:2.5)	0.15 eq	90	3h	1	1	41
4	BnOH/1,4-dioxane (v:v, 1:2.5)	0.15 eq	60	12h	1	1	34

**Table 7**

In pentoses, the formation of furanosides is normally kinetically favored, and this provides a synthetically useful approach to methyl furanosides in all four series. It is remarkable that this process cannot be successfully extended to benzyl glycosides. We could not find conditions leading to a very large excess of benzyl furanosides.

### III.1.c. Methyl glycosides

Methyl glycosides are quite stable glycosides and even if it is well known that their hydrolysis requires strong acid-catalyzed conditions, a new cleavage procedure using trityl tetrafluoroborate encouraged us to pursue in this area.<sup>199</sup>

Methyl L-xylofuranosides were prepared quantitatively following optimized Fisher's conditions.<sup>200,201</sup> As indicated above, the methyl furanosides are kinetic products and can be isolated in high yields if the reaction is performed under controlled conditions (short reaction time, low temperature). In fact, when the reaction was stirred for more than 1 hour at 60°C we started to get a mixture of methyl xylofuranosides and xylopyranosides.

<sup>197</sup> Francisco, C. G.; León, E. I.; Martín, A.; Moreno, P.; Rodríguez, M. S.; Suárez, E. *J. Org. Chem.* **2001**, *66*, 6967-6976.

<sup>198</sup> Schwögler, A.; Gramlich, V.; Carell, T. *Helv. Chim. Acta.* **2000**, *83*, 2452-2463.

<sup>199</sup> Kumar, A.; Doddi, V. R.; Vankar, Y. D. *J. Org. Chem.* **2008**, *73*, 5993-5995.

<sup>200</sup> Augestad, I.; Berner, E. *Acta Chem. Scand.* **1954**, 251-256.

<sup>201</sup> Behr, J.; Erard, A.; Guillermin, G. *Eur. J. Org. Chem.* **2002**, *2002*, 1256-1262.

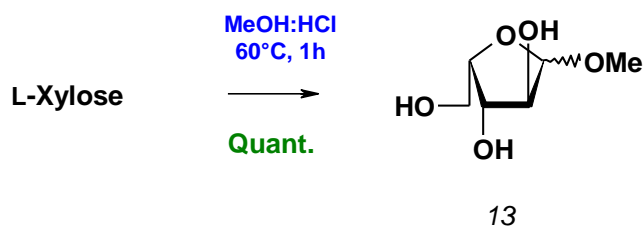

Figure 22

### III.2. Preparation of partially protected derivative **16**

Selective protection of the primary alcohol **13** in pyridine using trityl chloride as the reagent, followed by benzylation of the free hydroxyl groups afforded compound **15** in satisfactory yield.<sup>202,203</sup> Cleavage of the trityl group was achieved under mild acidic conditions using aqueous acetic acid and gave compound **16** in high yield.<sup>204</sup> At this stage, the  $\alpha$  and  $\beta$ -anomers of **16** were separated and all subsequent reactions were performed on a single anomer.

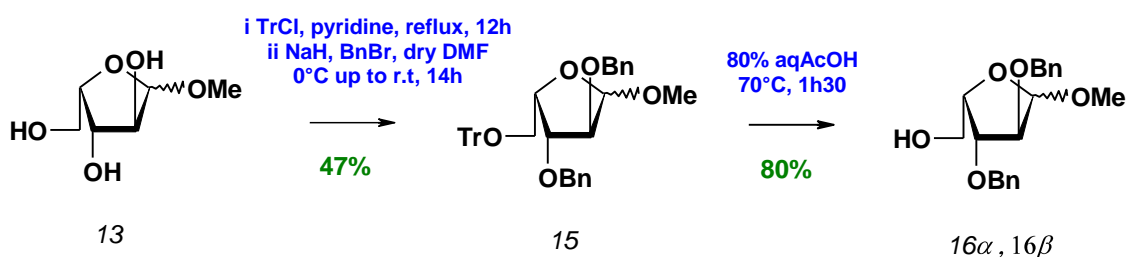

Figure 23

### III.3. Preparation of the imine

#### III.3.a. *N*-Benzylimine

The primary alcohol function of **16** was oxidized quantitatively to an aldehyde using Dess-Martin periodinane reagent.<sup>184</sup> Condensation of **17** with benzylamine in dichloromethane in

<sup>202</sup> Le Camus, C.; Chassagne, A.; Badet-Denisot, M.; Badet, B. *Tetrahedron Lett.* **1998**, *39*, 287-288.

<sup>203</sup> Wender, P. A.; Bi, F. C.; Buschmann, N.; Gosselin, F.; Kan, C.; Kee, J.; Ohmura, H. *Org. Lett.* **2006**, *8*, 5373-5376.

<sup>204</sup> Cuzzupe, A. N.; Di Florio, R.; Rizzacasa, M. A. *J. Org. Chem.* **2002**, *67*, 4392-4398.

the presence of 4Å molecular sieves provided the compound **18** as controlled by TLC.<sup>205</sup> These reactions were also performed on the  $\alpha$ -anomers.

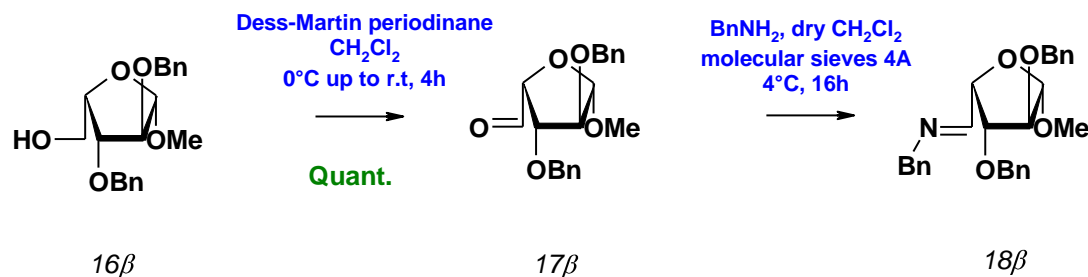

Figure 24

The main advantage of using *N*-benzylimine is the high diastereoselectivity of Grignard additions. However, this imine was used without any purification which could induce difficulties for the addition of organometallic nucleophiles; in addition, such *N*-alkylimines have an inherent low reactivity towards organometallic reagents such as Grignard reagents or organolithium compounds,<sup>206</sup> which probably explain the low yields previously obtained. Thus we decided to prepare another imine derivative known as being more reactive: a *N*-alkylsulfinylimine.

### III.3.b. *N*-Alkylsulfinylimine

Condensation of aldehyde **17** with (*S*)-*tert*-butanesulfinamide (Ellman's reagent)<sup>207,208</sup> in dry dichloromethane in the presence of anhydrous CuSO<sub>4</sub> afforded the (*S*)-*tert*-butanesulfinylimine **19** which can be purified by silica gel chromatography.

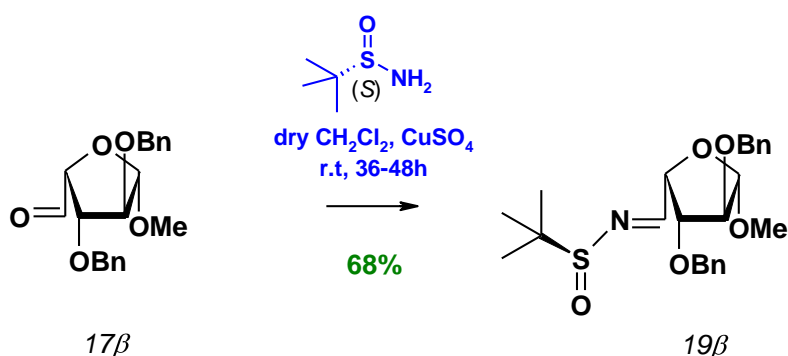

Figure 25

<sup>205</sup> Godin, G.; Compain, P.; Masson, G.; Martin, O. R. *J. Org. Chem.* **2002**, *67*, 6960-6970.

<sup>206</sup> Bloch, R. *Chem. Rev.* **1998**, *98*, 1407-1438.

<sup>207</sup> Ellman, J. A.; Owens, T. D.; Tang, T. P. *Acc. Chem. Res.* **2002**, *35*, 984-995.

<sup>208</sup> Liu, G.; Cogan, D. A.; Owens, T. D.; Tang, T. P.; Ellman, J. A. *J. Org. Chem.* **1999**, *64*, 1278-1284.

The diastereomeric imine carrying an (*R*)-tert-butanesulfinyl group was also prepared in order to study the stereochemistry of the addition of organometallic reagents onto these “chiral” imines (see III.5.c).

### III.4. Addition of Grignard reagents

#### III.4.a. Addition to the *N*-Benzylimine

In a typical experimental procedure, a solution of 3 equiv of hexylmagnesium bromide in ether was added dropwise to a cooled solution (-78°C) of *N*-benzylimine **18β** in ether. The reaction mixture was slowly warmed up to room temperature and stirred several hours. <sup>1</sup>H NMR analysis of the crude product after workup revealed the presence of a single diastereoisomer (*R* at C-5, as shown later). The high stereoselectivity of the addition of the organometallic species to the *Re* face of imine **18β** was explained by the same chelation model as for the previous synthetic pathway (Figure 26).

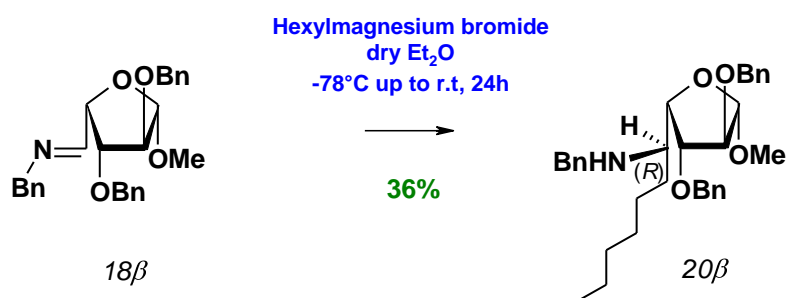

Figure 26

The reaction was also performed on **18α**; the stereochemistry of the addition was not affected! However, this reaction was not reproducible and required optimization. We also tried using the organocerium reagent in the presence of cerium chloride in order to form a more nucleophilic organometallic species.<sup>206,209,210</sup> In spite of extensive investigations, the yield could not be improved beyond 35%; and these understanding results prompted us to change the benzylimine group by a more reactive and easy to handle one.

<sup>209</sup> Matsumoto, T.; Kobayashi, Y.; Takemoto, Y.; Ito, Y.; Kamijo, T.; Harada, H.; Terashima, S. *Tetrahedron Lett.* **1990**, *31*, 4175-4176.

<sup>210</sup> van Delft, F. L.; de Kort, M.; van der Marel, G. A.; van Boom, J. H. *Tetrahedron Asym.* **1994**, *5*, 2261-2264.

### III.4.b. Addition to the *N*-Sulfinylimine

Introduction of the alkyl chain was performed via addition of hexylmagnesium bromide on the sulfinylimine derived from **17** in very good yield.<sup>211</sup> The absolute configuration of the newly created stereocenter was unambiguously established to be *R* at the stage of the cyclic product. The use of *N*-alkylsulfinylimine was a good alternative to the *N*-benzylimine; it allowed us to enhance the yield of the addition and constitutes a more practical technique.

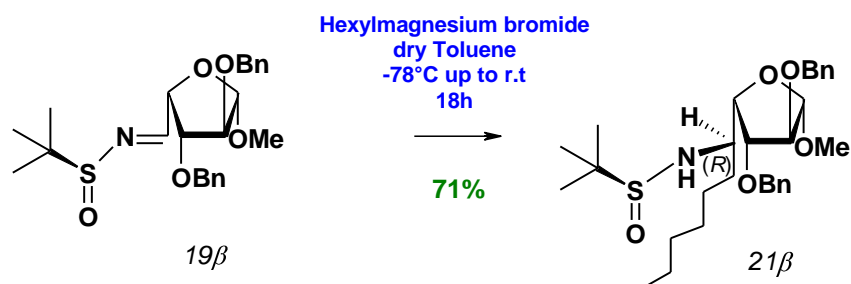

Figure 27

The influence of the chiral group at nitrogen is discussed in section III.5.c

## III.5. Preparation of $\alpha$ -1-*C*-hexyl DIX

### III.5.a. From the benzylamino derivative **20**

One of the critical steps in this synthetic sequence was the cleavage of the methyl glycoside. Unfortunately, it turned out that the use of trityl tetrafluoroborate didn't work in our case.<sup>196</sup> Therefore, we decided to perform the removal of this anomeric protecting group under acidic conditions but several assays which are shown below proved unsuccessful (table 8); the methyl glycoside could not be cleaved!

<sup>211</sup> Raunkjaer, M.; El Oualid, F.; van der Marel, G. A.; Overkleeft, H. S.; Overhand, M. *Org. Lett* **2004**, *6*, 3167-3170.

Entry	Solvent	Conditions		Result
		T°C	Time	
1	Ph <sub>3</sub> CBF <sub>4</sub> , CH <sub>2</sub> Cl <sub>2</sub>	r.t	10min to 10h	Starting material
2	AcOH /4N H <sub>2</sub> SO <sub>4</sub> (v:v, 85:15)	85	15min to 1h	degradation
3	TFA/water (v:v, 1:1)	0°C up to r.t	15min to 5h	degradation
4	AcOH/water/1N HCl (v:v:v, 48:1.2:2)	80	1h	degradation
5	DOWEX50WX8-H <sup>+</sup> 1,4-dioxane/water (v:v, 1/1)	r.t	Several hours	Starting material

Table 8

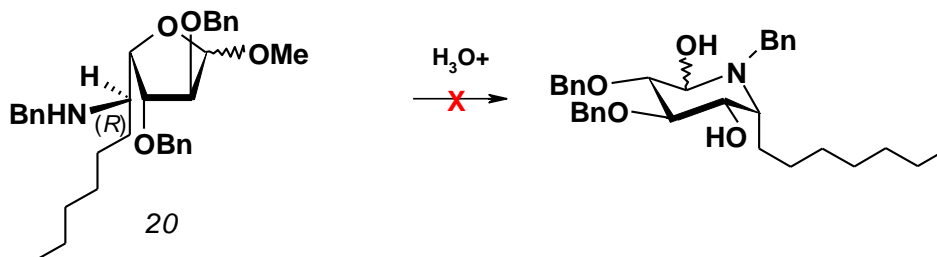

Figure 28

Compound **20** was completely consumed by these different assays and this step was not further investigated.

### III.5.b. From the *N*-Alkylsulfinylamine derivative **21**

Compound **21** was desulfinylated under the influence of HCl in methanol to give the corresponding ammonium salt which was directly used in the next step. Cleavage of the methyl glycoside using Paulsen's conditions,<sup>212,213,214</sup> followed by hydrogenolysis and intramolecular reductive amination were performed in one pot and afforded the  $\alpha$ -1-*C*-hexyl-imino-D-xylitol **22** in 30% yield (3 steps).

<sup>212</sup> Paulsen, H.; Leupold, F. *Chem. Ber.* **1969**, *102*, 2804-2821.

<sup>213</sup> Paulsen, H.; Leupold, F. *Chem. Ber.* **1969**, *102*, 2822-2834.

<sup>214</sup> Paulsen, H.; Hayauchi, Y.; Sinnwell, V. *Chem. Ber.* **1980**, *113*, 2601-2608.



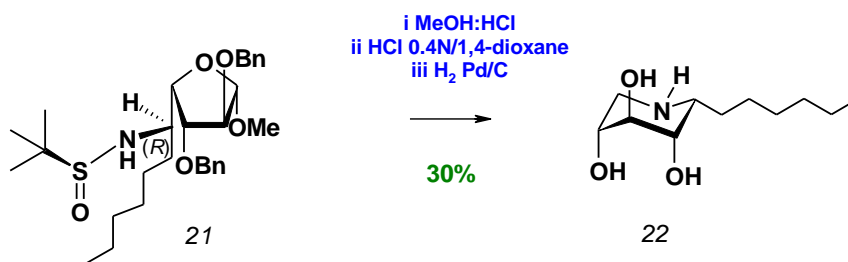

Figure 29

NMR data (small  $J_{2,3}$  and  $J_{3,4}$ ) of **22** are consistent with the “pseudo- $\alpha$ -anomer” adopting a  ${}^1C_4$  conformation. In fact, the alternative “ $\beta$ -anomer” would have an all equatorial conformation and could be easily distinguished.

### III.5.c. Interpretation of the stereochemical outcome of the alkylation reaction

We also investigated the nucleophilic addition of hexylmagnesium bromide to **23**, the  $S_R$  imine coming from the addition of (*R*)-*tert*-butanesulfinamide to **17**. The addition was again found to proceed in good yield and high diastereoselectivity, to give compound **24** (Figure 30). Desulfinylation of **24** followed by the same sequence of reaction as **21** afforded the same pseudo- $\alpha$ -epimer. The stereoselectivity of the addition to *N*-alkylsulfinylamines **19** and **23** is exclusively controlled by the pentoside moiety! The chiral auxiliary carried by the nitrogen atom plays here no role in the stereocontrol!

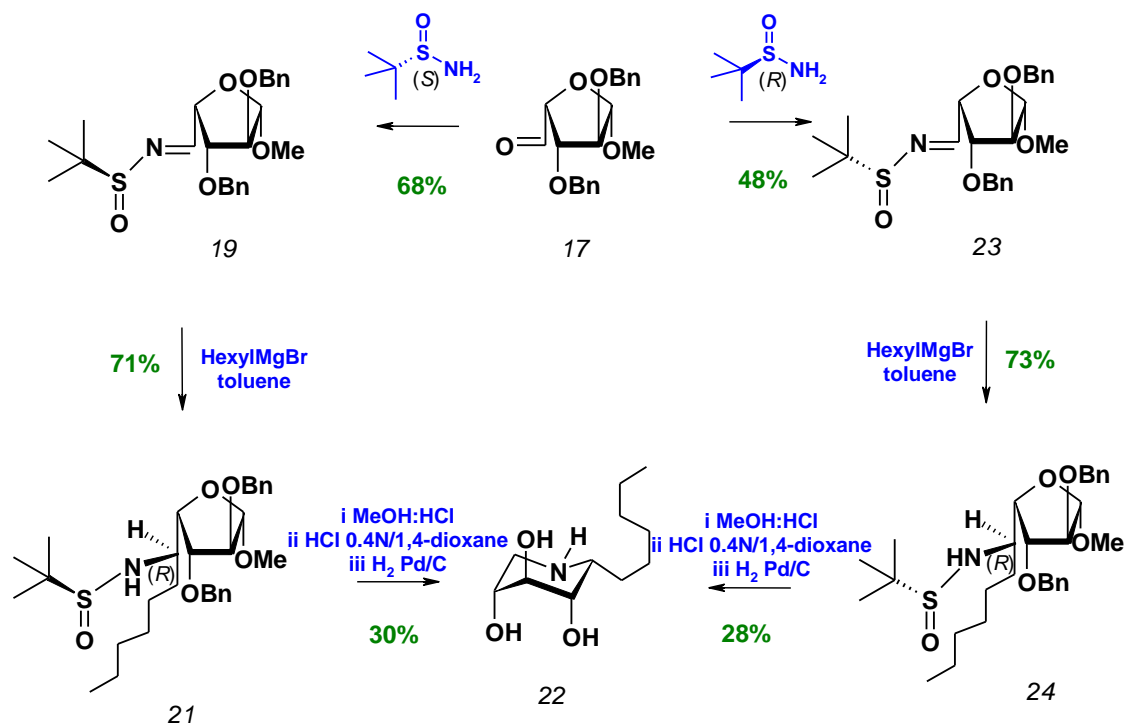

Figure 30

The high stereoselectivity of the addition of the organometallic species to the *Re* face of the imine **19** and **23** can be rationalized by the same chelated model as for the previous synthetic pathway shown on figure 17. In fact, this model involves as ligands the nitrogen atom of the *N*-sulfinylimine and the endocyclic oxygen atom of the xylofuranose moiety. In that case, the endocyclic oxygen of the furanoid system acts as a strongly coordinating Lewis base,<sup>215</sup> as it has been observed in the additions of organometallic reagents to pentodialdo-furanose derivatives.

Similar results in pyranoid systems were reported by Overkleeft *et al* and reinforce our explanation.<sup>216</sup>

This chelation effect seems to counterbalance the possible chair-transition state intermediate proposed by Ellman<sup>203</sup> (Figure 31). In this model the magnesium atom of Grignard reagent is chelated to the oxygen atom of the sulfinylimine.

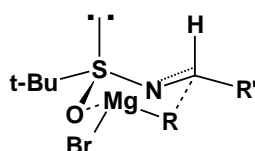

Figure 31

### III.6. Conclusion

In conclusion, we developed a modified pathway to  $\alpha$ -1- $C_n$  DIX. However, despite our efforts, this synthetic strategy was not as efficient as we expected, in particular because of low yields in the deprotection of the anomeric position. Therefore, we considered yet another synthesis, which will not require such a step.

<sup>215</sup> a) Inch, T.D. *Adv Carbohydr. Chem. Biochem.* **1972**, 27, 191. b) Danisfesky, S. J.; DeNinno, M. P.; Phillips, G.B.; Zelle, R. E.; Lartey, P. A. *Tetrahedron* **1986**, 42, 2809.

<sup>216</sup> Risseeuw, M. D. P.; Mazurek, J.; Langenvelde, A. V.; Marel, G. A. V. D.; Overkleeft, H. S.; Overhand, M. *Org. Biomol. Chem.* **2007**, 5, 2311-2314.

# IV. Addition to protected xylosylamines

## IV.1. Synthetic strategy

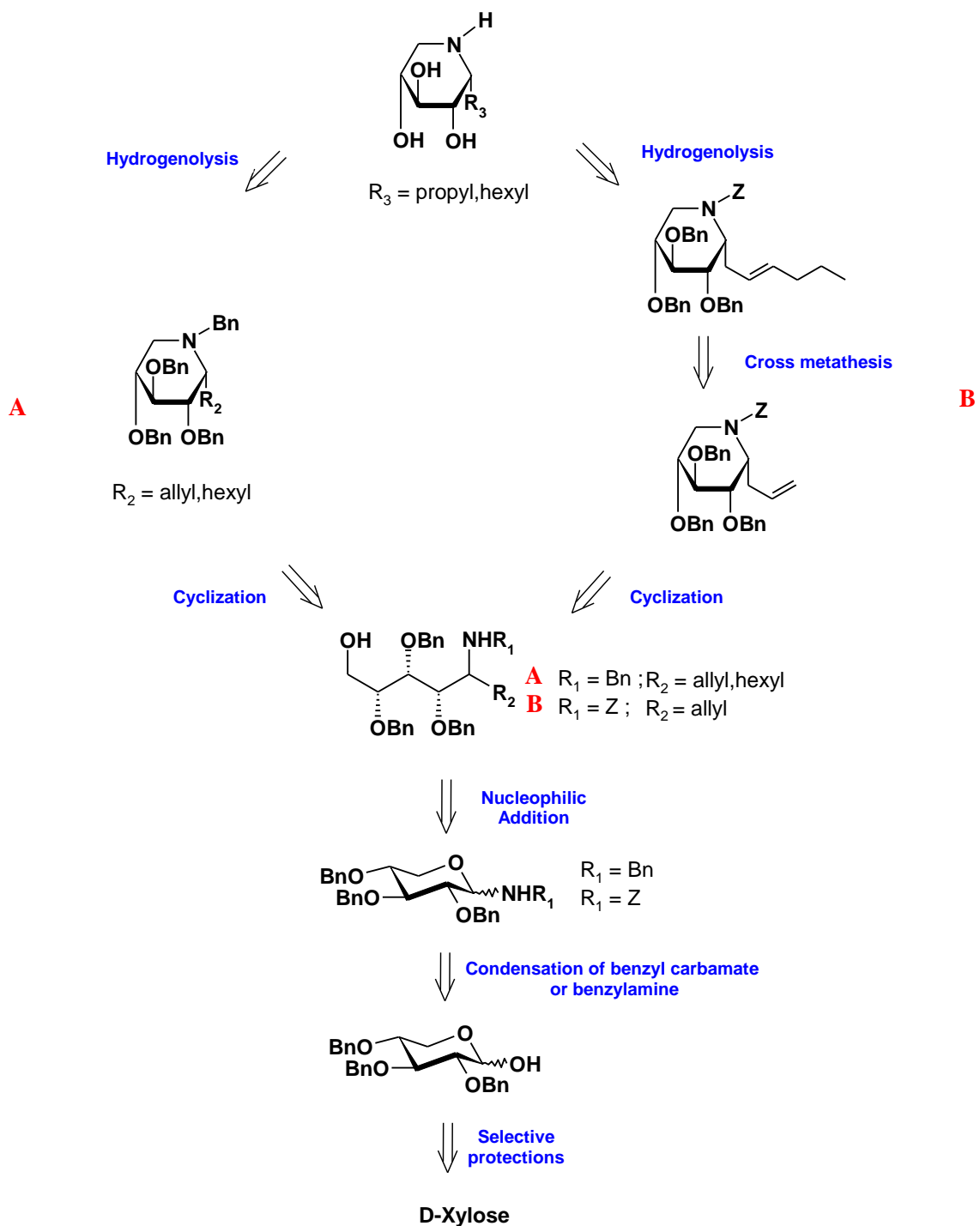

Figure 32: Retrosynthesis of the  $\alpha$ -1- $C_6$  DIX

This strategy, inspired by Nicotra's work<sup>217</sup> on the synthesis of various 1-*C*-alkyliminosugars, is based on a C-1-extension of the pentose chain and starts from D-xylose. It involves the addition of an organometallic species to a preformed glycosylamine, followed by a cyclisation by an intramolecular SN<sub>2</sub> reaction. The synthesis was performed (Figure 32) by way of two different glycosamines in parallel, in order to find the most efficient synthetic pathway.

The addition of benzyl amine (route **A**) or benzyl carbamate (route **B**) onto a protected xylofuranose hemiacetal provided the required fully protected xylopyranosyl amines.

Then, nucleophilic addition followed by cyclization using mesyl chloride produced the iminosugar carrying an allyl or alkyl chain on C-1. The desired  $\alpha$ -1-*C*-alkyl DIX was obtained either by simple hydrogenolysis or by cross metathesis followed by hydrogenolysis.

## IV.2. Preparation of hemiacetal 27

Synthesis of methyl xylopyranoside from D-xylose followed by benzylation of the free hydroxyl groups to give **26**, and hydrolysis of the methyl glycoside under strongly acidic conditions afforded the reducing sugar **27** in satisfactory yield.<sup>218</sup>

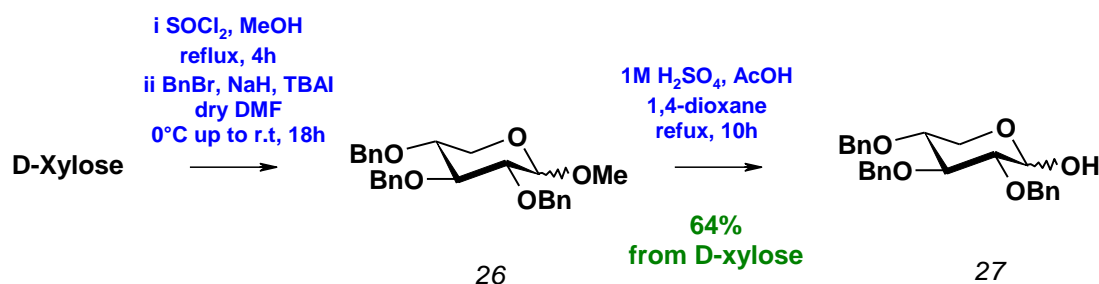

Figure 33

## IV.3. Preparation of amines

Compound **27** was acylated using acetic anhydride in the presence of pyridine to give **28**,<sup>219</sup> then the introduction at the anomeric position of the benzylcarbamate (compound **29**) was realized under the condition described in our group by V. Liautard.<sup>220</sup>

For *N*-benzyl glycosylamine **30**, benzylamine<sup>221</sup> was directly added to compound **27**.

<sup>217</sup> Cipolla, L.; Lay, L.; Nicotra, F.; Pangrazio, C.; Panza, L. *Tetrahedron* **1995**, *51*, 4679-4690.

<sup>218</sup> Nadein, O. N.; Kornienko, A. *Org. Lett.* **2004**, *6*, 831-834.

<sup>219</sup> Lucero, C. G.; Woerpel, K. A. *J. Org. Chem.* **2006**, *71*, 2641-2647.

<sup>220</sup> Liautard, V.; Pillard, C.; Desvergnès, V.; Martin, O. R. *Carbohydr. Res.* **2008**, *343*, 2111-2117.

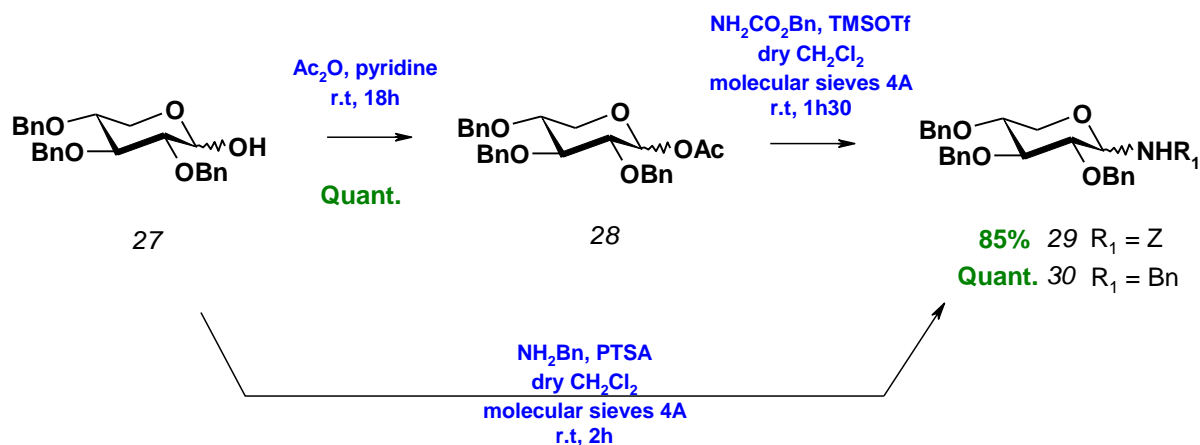

**Figure 34**

Only compound **29** was purified by chromatography on silica gel since crude compound **30** was a white crystalline solid which contain only traces of benzylamine.

#### IV.4. Preparation of the imino sugar

The two synthetic pathways (Figure 32) could be distinguished at this stage. In fact, route **A** should give the desired  $\alpha$ -1-C-alkyl DIX more easily than the route **B**, because route **B** is compatible only with the addition of an allyl group.

However, the addition of hexylmagnesium bromide directly onto compound **30** gave the expected product in very low yield (Figure 35). The strategy was nevertheless carried out until the end. This addition of allylmagnesium bromide to glycosylamine **30** gave the expected open chain product **32** in good yield but with lower diastereoselectivity than the previous additions to the imine.

The cyclization of both **32** and **33** here was performed upon mesylation and afforded iminosugars **35** and **36**.<sup>222</sup>

<sup>221</sup> Cipolla, L.; Lay, L.; Nicotra, F.; Pangrazio, C.; Panza, L. *Tetrahedron* **1995**, *51*, 4679-4690.

<sup>222</sup> Liautard, V.; Desvergnès, V.; Itoh, K.; Liu, H.; Martin, O. R. *J. Org. Chem.* **2008**, *73*, 3103-3115.

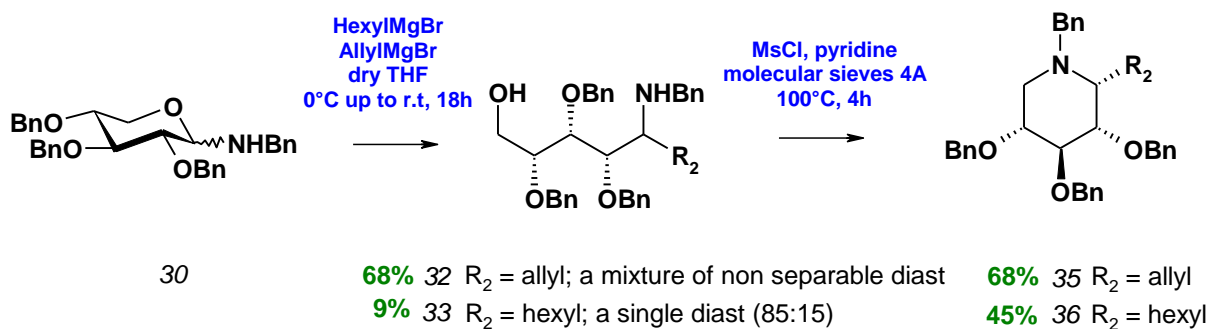

Figure 35

Route **B** turned out to be more efficient, not only because of better yields and more reliable reactions but also because a better diastereoselectivity (98:2; R>S) was observed for the addition of the allyl chain to the *N*-glycosyl benzylcarbamate than to the *N*-glycosyl benzylamine (85:15; R>S). Finally, the cyclization was performed by way of the mesylate using a strong base (tBuOK) in order to overcome the lower reactivity of the *N*-benzylcarbamate (Figure 36).

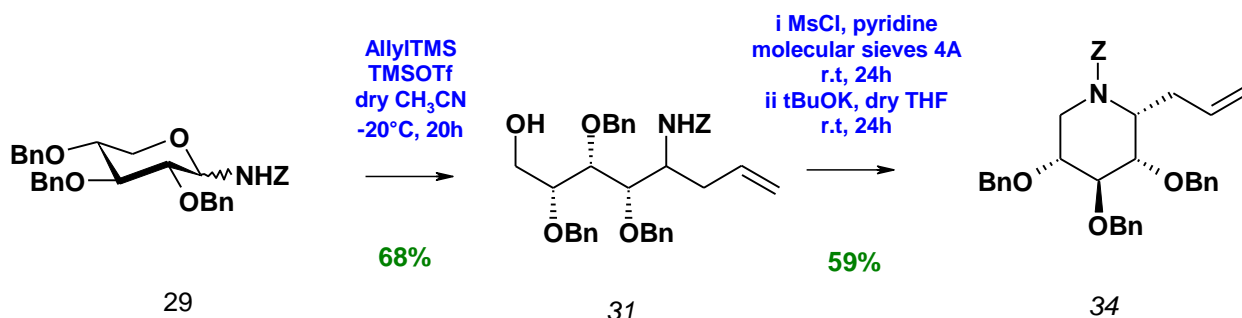

Figure 36

#### IV.5. Preparation of the $\alpha$ -1- $C_n$ DIX

On one hand,  $\alpha$ -1- $C_3$  DIX and  $\alpha$ -1- $C_6$  DIX were obtained by simple hydrogenolysis of **35** and **36** respectively. On the other hand, a cross metathesis on compound **34** with pentene using second generation Hoveyda-Grubbs catalyst followed by hydrogenolysis provided  $\alpha$ -1-hexyl DIX in satisfactory yield.

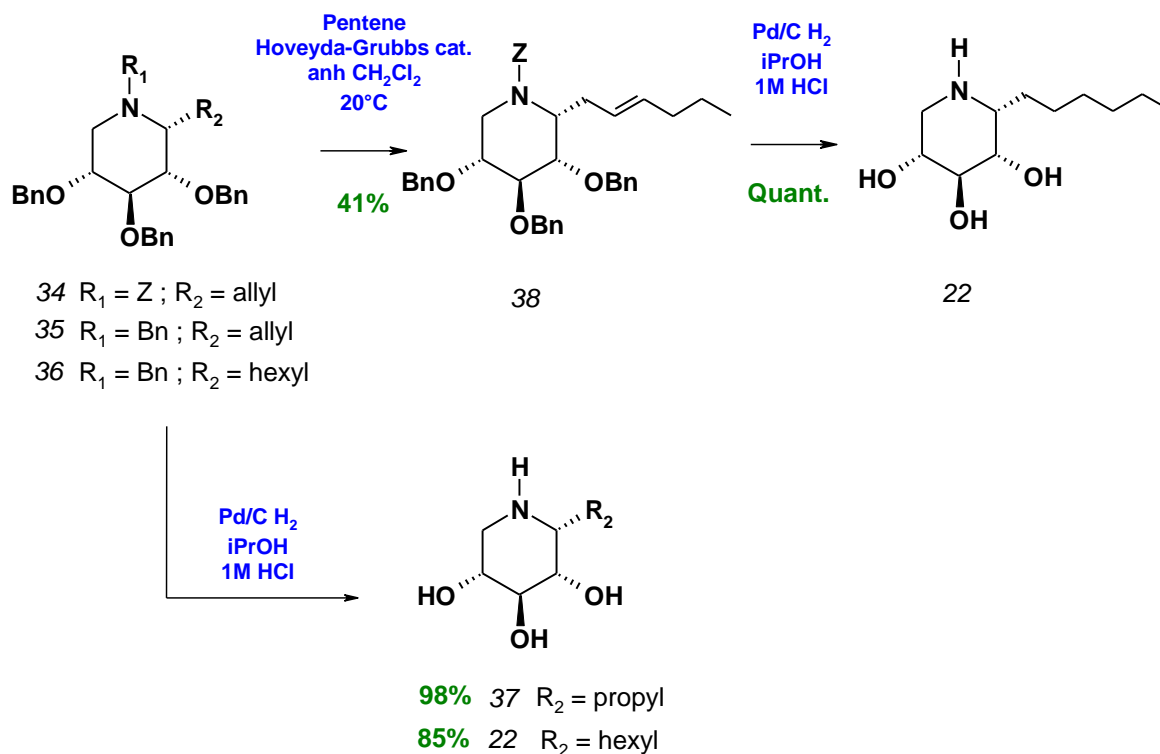

Figure 37

## IV.6. Conclusion

In conclusion, after considerable investigation and assays, we developed an efficient synthetic pathway to  $\alpha$ -1- $C_n$  DIX which was also used with adaptation for the synthesis of iminosugars having a pseudo “ $\beta$ -L-ido” configuration. In fact, addition to protected xylosamines following the described route **B** is so far the most efficient strategy pathway to  $\alpha$ -1- $C_n$  DIX. It allowed us to produce on a large scale the  $\alpha$ -1- $C$ -hexyl DIX (300 mg) in order to test it on animal model carrying Gaucher disease by Ryffel group in IEM (Orléans).

## V. Inhibitory activity

Biological evaluation of compounds **22** and **37** was performed with recombinant human  $\beta$ -glucocerebrosidase (Ceredase) from Genzyme as the enzyme source and  $p$ -nitrophenyl- $\beta$ -D-glucopyranoside as the substrate by Asano’s group in Japan.

According to the previous results obtained with the  $\alpha$ -1- $C_9$  DIX ( $K_i$  2.2 nM)<sup>125</sup>, compound **22** might also be a competitive inhibitor of GCCase.

Compound	Structure	GCCase (Ceredase) IC <sub>50</sub> (nM)	Acid $\alpha$ -glucosidase (Myozyme) IC <sub>50</sub> (nM)
Chapter1: 12 <sup>125</sup>		7	NI
22		19	NI
37		560	NI

Table 9

(NI: less than 50% inhibition at 1000 $\mu$ M.)

Remarkably, the  $\alpha$ -1- $C_6$  DIX **22** was found to be a potent inhibitor of human GCCase with a level of inhibition comparable to that of  $\alpha$ -1- $C_9$  DIX. Reduction of the alkyl chain length by three  $CH_2$  groups only slightly lowered the inhibition effect. However, a larger reduction of the alkyl chain length is clearly detrimental: the inhibitory activity was indeed reduced 80-fold from the  $C_9$  to  $C_3$  compounds.

Therefore, the alkyl chain length needed to be optimized since a long alkyl chain is potentially cytotoxic and a short alkyl chain reduced the inhibitory activity. Compound **22** seems to be a very good compromise between these two conditions.

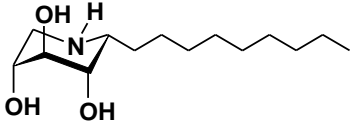
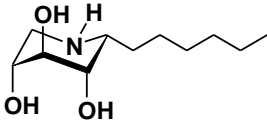
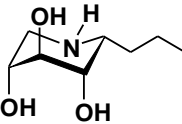
## VI. Conclusion

In conclusion, the aim of this work was to get closer to a pharmacological application for the treatment of Gaucher disease. To reach that, a more efficient synthetic route to obtain “ $\alpha$ -1- $C_n$ ” iminoxylitol derivatives was developed and used for the synthesis on a large scale of  $\alpha$ -1- $C_6$  DIX. Compound **22** with a shorter alkyl chain which might avoid cytotoxicity was found to retain an inhibition in the nM range.



## Résumé Chapitre 2 :

Optimisation de la synthèse des  $\alpha$ -1-C-alkyl-iminoxylitols, inhibiteurs et chaperon pharmacologiques de la  $\beta$ -glucocérébrosidase.

Ce chapitre a été dédié, d'une part, à l'optimisation de la synthèse des  $\alpha$ -1-C-alkyl-iminoxylitols. Pour ce faire, différentes stratégies de synthèses (voir ci-dessous) avec des avantages distincts ont été réalisées. Une voie de synthèse particulièrement efficace à finalement été trouvée (**D**), elle a permis d'obtenir des composés issus de cette famille d'iminosucres et d'autre dérivés.

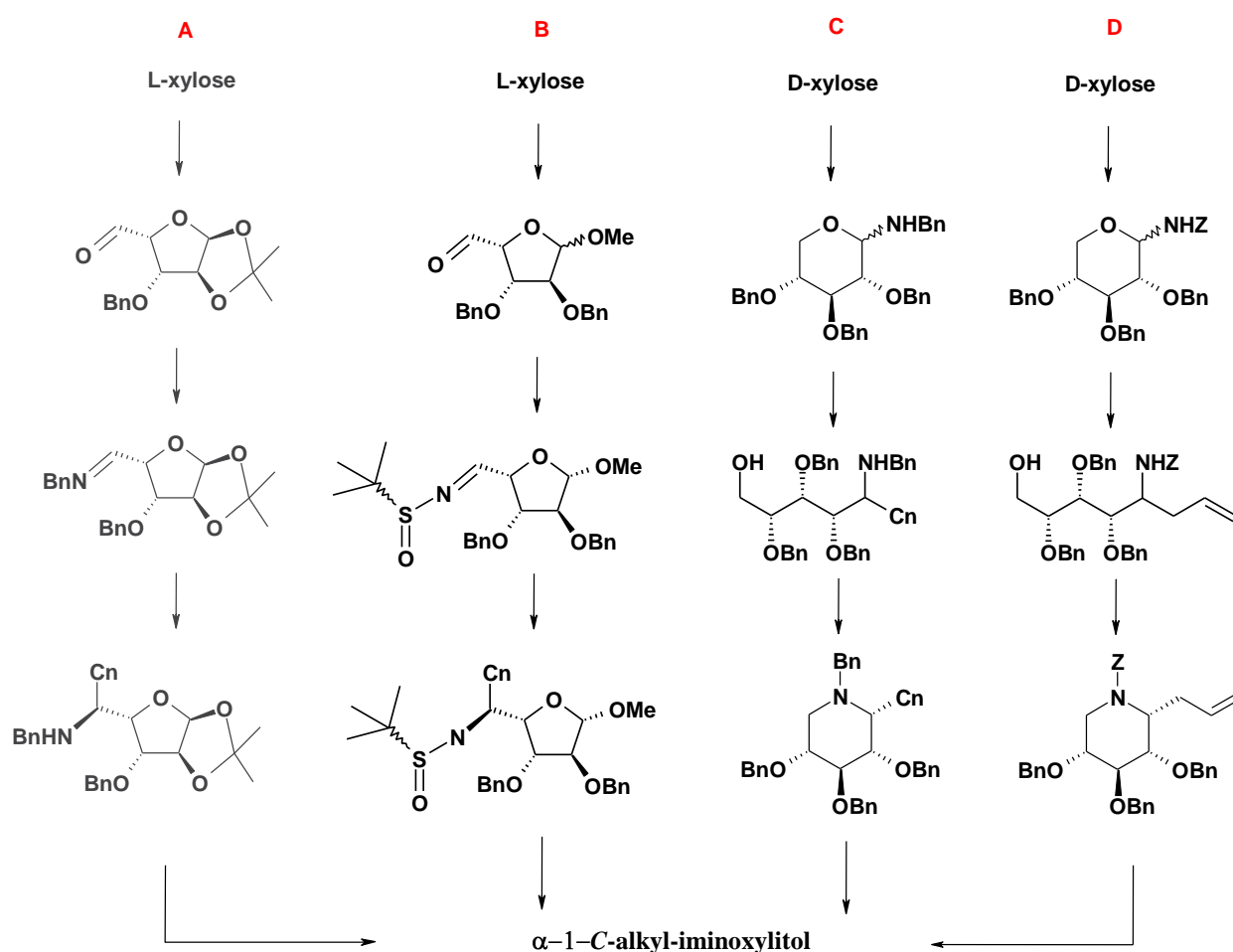

Figure a : en gris : 1<sup>ère</sup> stratégie qui nous a permis d'obtenir le  $\alpha$ -1-C<sub>9</sub> DIX-thèse de Charlotte Boucheron.

D'autre part, dans le but de se rapprocher un peu plus d'une application thérapeutique, des composés portant une chaîne alkyl plus courte (une longue chaîne alkyle étant potentiellement cytotoxique) ont été synthétisés. Il a ainsi pu être vérifié que ces composés conservaient une inhibition de l'ordre du nano molaire pour la GCCase.

## Chapter 3

# Synthesis of *O*-alkyl-iminoxylitols as potential inhibitors and pharmacological chaperones of GCase

This chapter is devoted to the search for new structurally simplified GCase inhibitors which can also act as pharmacological chaperones.

### I. Synthetic target

Our investigation focused on the position of the short alkyl chain. This study was based on the work of our group: as shown in figure 38, we had demonstrated that the addition of an alkyl chain was beneficial to the activity of iminoxylitols as GCase inhibitors, and that the effect is strongest when the chain was linked to C-1, in 1,2-*cis* relationship to O-2. We then asked the question of iminoxylitol derivatives carrying an *O*-alkyl chain.

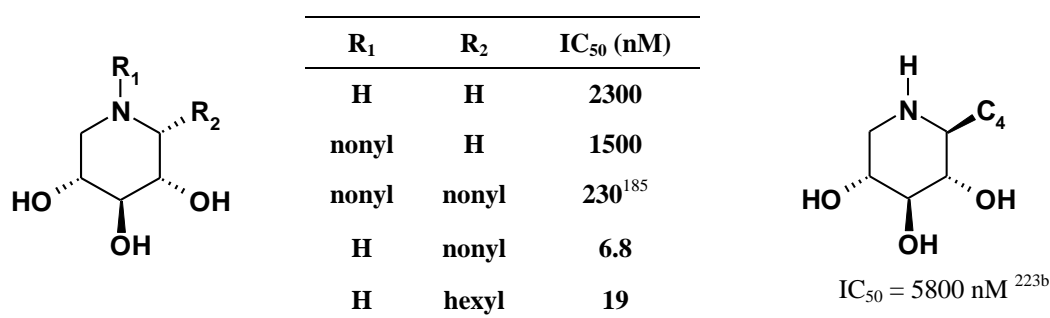

Figure 38<sup>125,223</sup>: Alkylated iminoxylitols

As shown above, compounds with an *O*-alkyl chain have never been synthesized in this series. Therefore our next aim was the synthesis of *O*-alkyl-iminoxylitols derivatives. To explore rapidly the influence of the position of the alkyl chain on the different hydroxyl groups, we first developed a synthesis of racemic 2/4-*O*-alkyl derivatives of DIX. Following the same synthetic strategy the 3-*O*-hexyliminoxylitol was also synthesized.

<sup>223</sup> a) Oulaïdi, F.; Front-Deschamps, S.; Gallienne, E.; Compain, P.; Martin, O. R. *publication in preparation*. b) Schmidt, S.; Gallienne, E.; Compain, P.; Martin, O. R. *et al, unpublished results*.

## II. Synthesis of racemic 2/4-*O*-alkyl analogs of DIX

### II.1. Synthetic strategy

Starting from inexpensive diacetone-D-glucose, the synthesis of racemic 2/4-*O*-alkyl iminoxylitols was performed in six steps.

As shown in the retrosynthetic scheme (Figure 39), racemic 2/4-*O*-alkyl iminoxylitol derivatives, as well as 2,4-di-*O*-alkyl iminoxylitol derivatives, are readily accessible from diacetone glucose by way of achiral *xylo*-dialdose **41**.

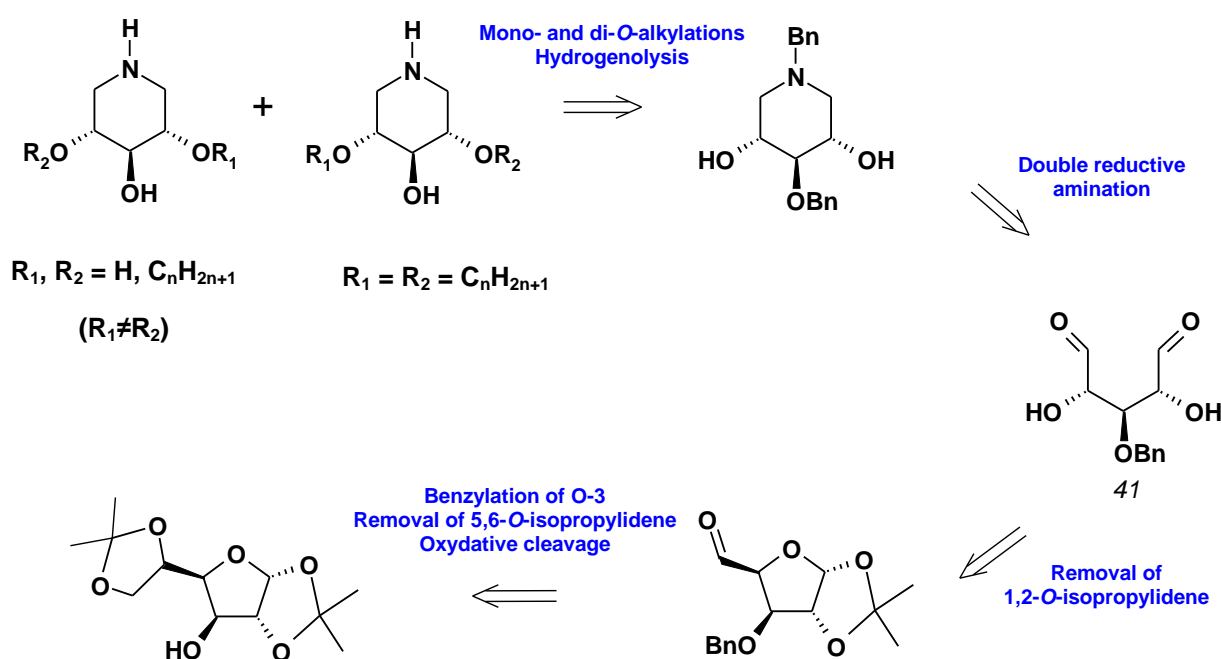

**Figure 39:** Retrosynthesis of the 2/4-*O*-alkyl-iminoxylitols and 2,4-di-*O*-alkyl-iminoxylitols.

### II.2. Preparation of the aldehyde **40**

Diacetone-D-glucose was benzylated at O-3 under slightly modified Williamson conditions,<sup>224</sup> employing sodium hydride and tetrabutylammonium iodide as a catalyst in *N,N*-dimethylformamide. Removal of the 5,6-*O*-isopropylidene group under mild acidic condition,

<sup>224</sup> Brimacombe, J. S.; Jones, B. D.; Stacey, M.; Willard, J. J. *Carbohydr. Res.* **1966**, 2, 167-169.

followed by oxidative cleavage were performed following a one pot procedure.<sup>225,226</sup> The aldehyde **40** was directly used in the next reaction.

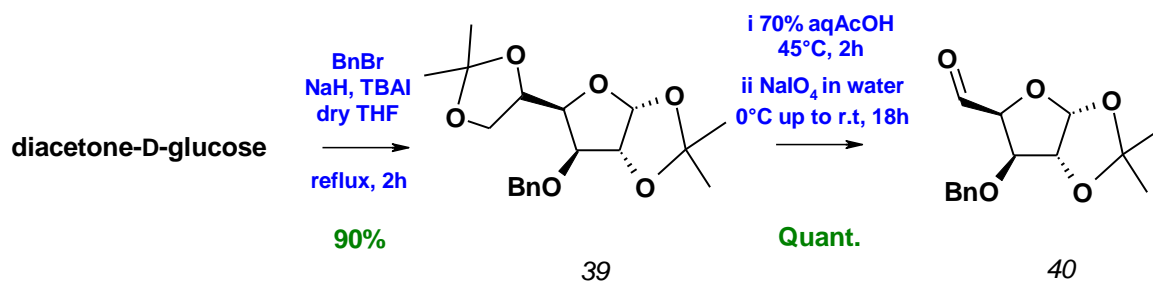

Figure 40

### II.3. Preparation of the diol intermediate **42**

Removal of the 1,2-*O*-isopropylidene group in **40** under acidic conditions afforded the *meso* dialdehyde **41**.<sup>227,228</sup> Double reductive amination of the pentanedial to form piperidine involved the addition of sodium borohydride and benzylamine in dry methanol at -78°C in the presence of acetic acid. After warming up to room temperature the mixture was stirred for 18 hours to give the *N*-benzyl-3-*O*-benzyl-1,5-dideoxy-1,5-iminoxylitol **42** in very high yield,<sup>229</sup> (Figure 41).

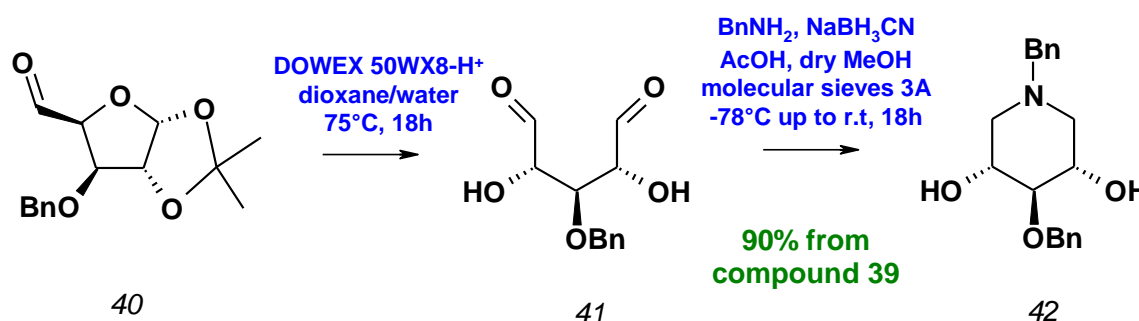

Figure 41

<sup>225</sup> Wolfrom, M. L.; Hanessian, S. J. *J. Org. Chem.* **1962**, *27*, 1800-1804.

<sup>226</sup> Horton, D.; Swanson, F. O. *Carbohydr. Res.* **1970**, *14*, 159-171.

<sup>227</sup> Shankar, B. B.; Kirkup, M. P.; McCombie, S. W.; Ganguly, A. K. *Tetrahedron Lett.* **1993**, *34*, 7171-7174.

<sup>228</sup> Tite, T.; Lallemand, M.; Poupon, E.; Kunesch, N.; Tillequin, F.; Gravier-Pelletier, C.; Le Merrer, Y.; Husson, H. *Bioorg. Med. Chem.* **2004**, *12*, 5091-5097.

<sup>229</sup> Painter, G. F.; Falshaw, A. *J. Chem. Soc., Perkin Trans. 1* **2000**, 1157-1159.

## II.4. Preparation of mono- and di-*O*-alkyl analogs of DIX

The key diol intermediate **42** gave a direct access to the racemic mono- and symmetrical di-*O*-alkyl iminoxylitol derivatives. In fact, the procedure shown below provided both the mono and di-*O*-alkyl compounds which were separable on silica gel.<sup>230</sup>

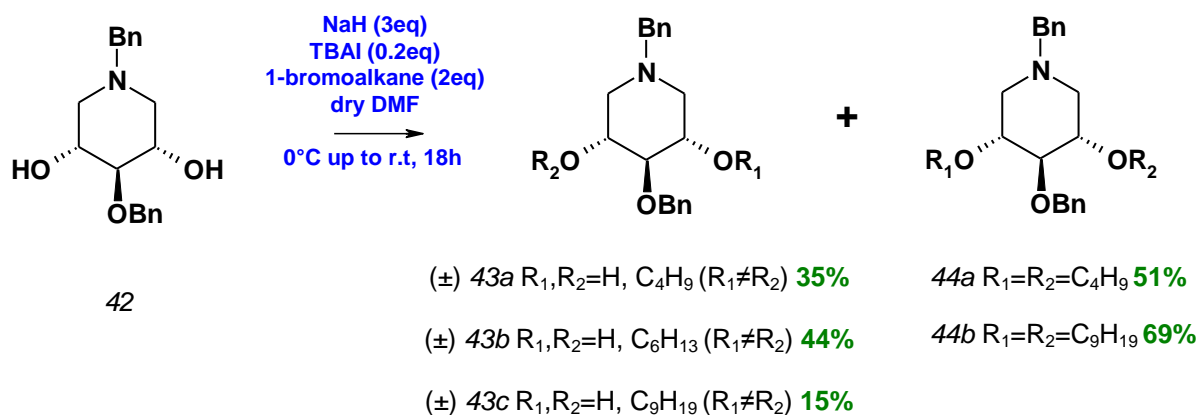

Figure 42

## II.5. Hydrogenolysis

Removal of the benzyl protecting groups required an excess of 10% Pd/C in a mixture of isopropanol/dichloromethane (2/1, v/v) under a H<sub>2</sub> atmosphere. Indeed, we observed that the *N*-benzyl group was the first protecting group totally cleaved by hydrogen in the presence of palladium on activated carbon catalyst, whereas in general *O*-debenzylation takes place more easily. This observation suggested that the presence of the amine function was inhibiting the *O*-debenzylation.<sup>231</sup> For this reason, in order to have a complete *O*-debenzylation the reaction was conducted under the same conditions but in the presence of (5%, v/v) of acetic acid.

<sup>230</sup> For a related procedure, see: Boucheron, C.; Desvergnès, V.; Compain, P.; Martin, O. R.; Lavi, A.; Mackeen, M.; Wormald, M.; Dwek, R.; Butters, T. D. *Tetrahedron Asym.* **2005**, *16*, 1747-1756.

<sup>231</sup> Czech, B. P.; Bartsch, R. A. *J. Org. Chem.* **1984**, *49*, 4076-4078.

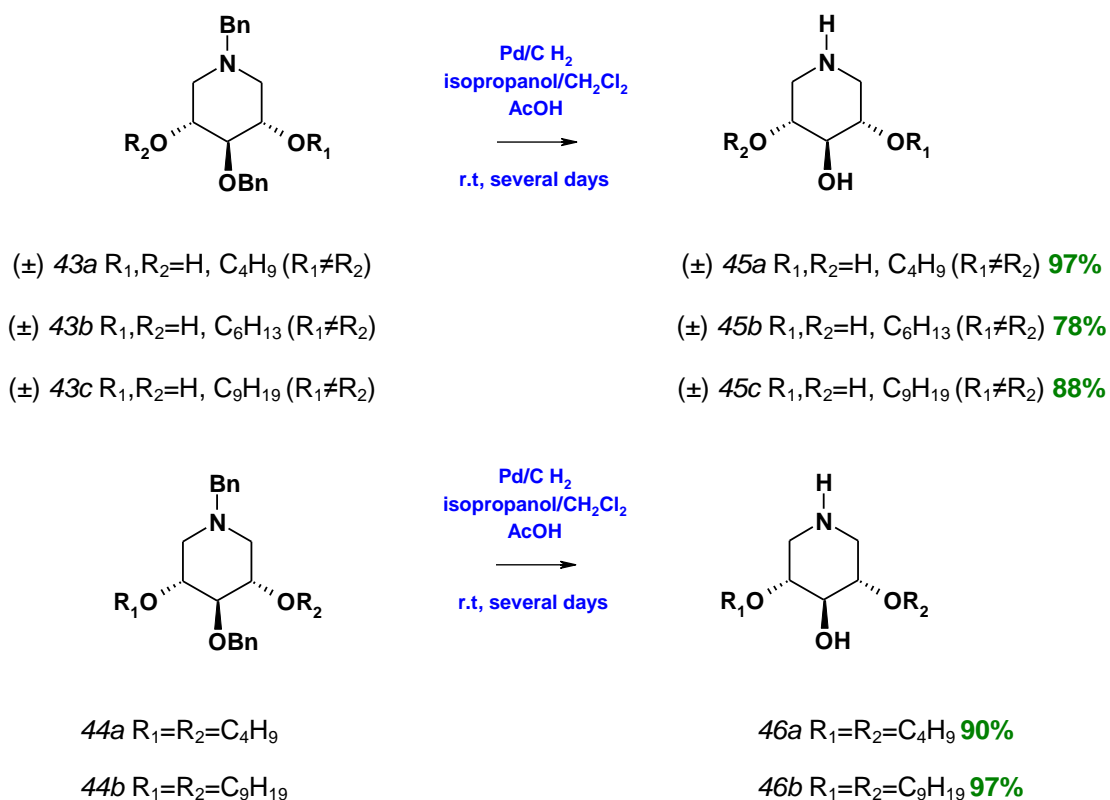

Figure 43

## II.6. Conclusion

To conclude we developed a rapid access to 2,4-di-*O*-alkyl and racemic 2/4-*O*-alkyl derivatives of DIX. The formation of the bis-aldehyde **41** immediately followed by the double reductive amination was pivotal and gave rise to the key intermediate: *N*-benzyl-3-*O*-benzyl-1,5-dideoxy-1,5-iminoxylitol **42**.

Evaluation of these iminosugars as GCCase inhibitors and pharmacological chaperones was realized and these results are discussed later.

## III. Synthesis of 3-*O*-hexyl DIX

### III.1. Synthetic strategy

The synthesis of the 3-*O*-alkyl-iminoxylitol derivatives were performed following the same simple synthetic strategy as the one previously described.

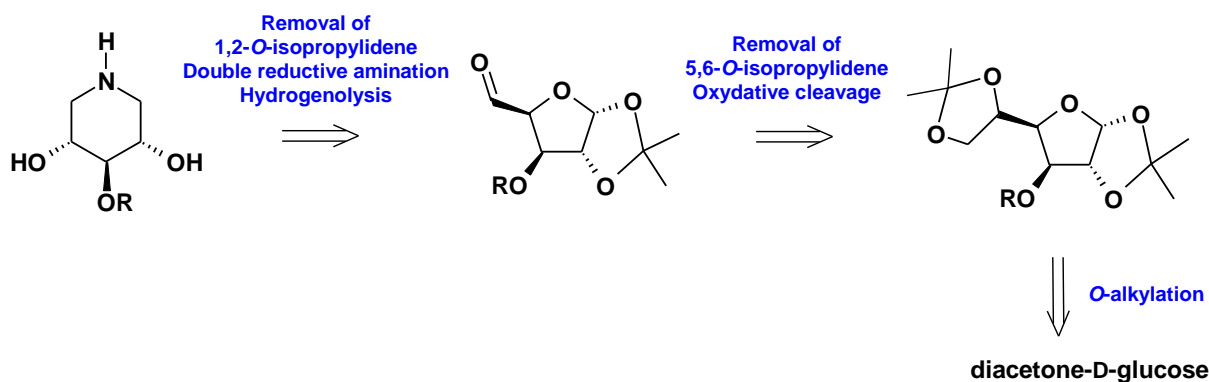
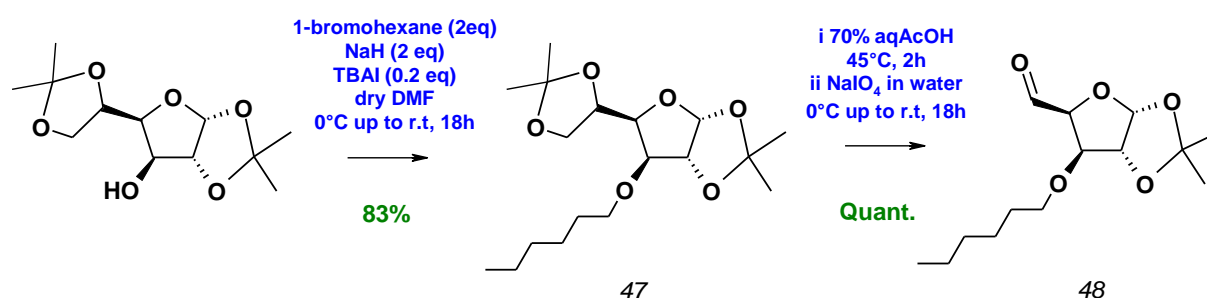

**Figure 44**

The 3-*O*-alkyl group is introduced at the stage of diacetone-D-glucose, which is then submitted to the same sequence of reactions as before.

### III.2. Preparation of the aldehyde **48**

Following the same *O*-alkylation procedure, a hexyl chain was introduced on diacetone-D-glucose.<sup>232</sup> Regioselective hydrolysis of the less stable isopropylidene acetal and oxidative cleavage of the diol<sup>233</sup> afforded the 3-*O*-hexyl-1,2-*O*-isopropylidene- $\alpha$ -D-xylo-pentodialdo-1,4-furanose, **48**.



**Figure 45**

### III.3. Preparation of 3-*O*-hexyl **DIX**

Reductive amination of the 3-*O*-hexyl xylo-dialdose obtained after acidic treatment of aldehyde **48** afforded the compound **49** in very poor yield due to difficulties in the purification process. This reaction deserved more investigations but our aim was to rapidly synthesize the new compound **50** in order to evaluate its GCCase inhibitory activity. For this reason, we didn't optimize this step.

<sup>232</sup> Ikekawa, T.; Irinoda, K.; Saze, K.; Katori, T.; Matsuda, H.; Ohkawa, M.; Kosik, M. *Chem. Pharm. Bull.* **1987**, *35*, 2894-2899.

<sup>233</sup> Krueger, E. B.; Hopkins, T. P.; Keaney, M. T.; Walters, M. A.; Boldi, A. M. *J. Comb. Chem.* **2002**, *4*, 229-238.

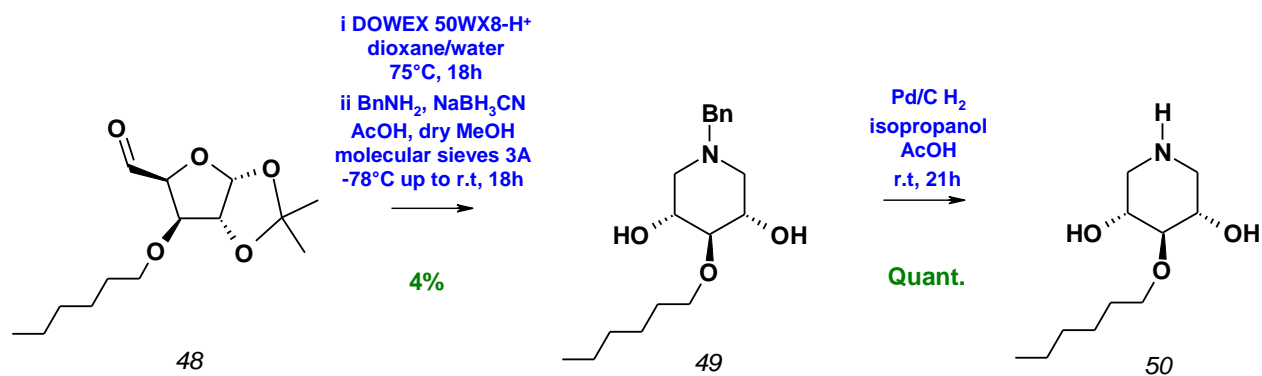

Figure 46

### III.4. Conclusion

In conclusion, we performed a rapid synthesis of 3-*O*-hexyl DIX. Optimization and generalization of this synthetic route will depend on the inhibitory results of compound **50**.

### IV. Inhibitory activity

The objective of this work was clearly to obtain a new family, structurally simplified, of GCase inhibitors, as an alternative of the imino-*C*-glycoside series. Inhibitory activity was again been performed by Asano's group in Japan and the results are listed below (Table 10).

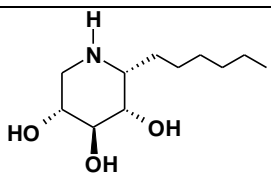
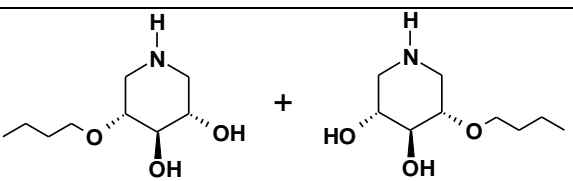
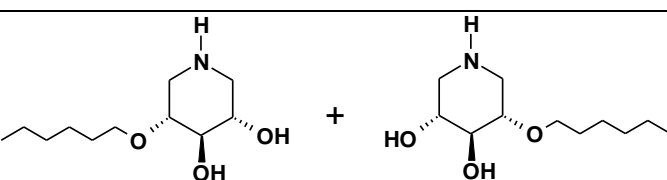
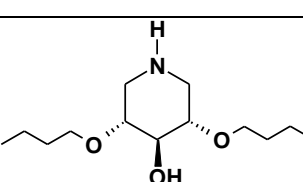
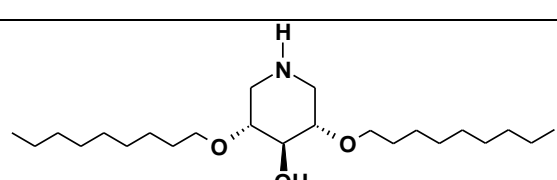
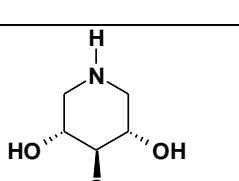

Compound	Structure	GCase (Ceredase) IC <sub>50</sub> (nM)	Acid α-glucosidase (Myozyme) IC <sub>50</sub> (nM)
22		19	NI
(±)45a		41	NI
(±)45b		13	NI
46a		950	NI
46b		270	NI
50		404000	NI

**Table 10**

(NI: less than 50% inhibition at 1000μM.)

When we saw these results, a compound rapidly attracted our attention: the (±)-2-*O*-hexyl-iminoxylitol **45b** which is structurally close to **22**, our lead compound in the imino-*C*-glycoside series. Remarkably, the (±)-2-*O*-alkyl derivatives of DIX were found to be very potent inhibitors of human GCase with a level of inhibition comparable to that of **22** (IC<sub>50</sub> = 19 nM).

Also, we observed that the reduction of the alkyl chain length (from hexyl in **45b** to butyl in **45a**) slightly lowered the inhibition effect.

Addition of a second alkyl chain at O-4 appeared to be unfavorable since the inhibitory activity is decreased by more than 20-fold compare to that of mono-2-*O*-alkyl analogs (**46a** and **45a** respectively).

Furthermore, the simple shift of the alkyl chain from O-2 to O-3 (compound **50**) was found to abolish almost completely the inhibitory activity. Indeed, we move from a compound with a nM inhibition to a compound with a mM inhibition.

Lastly, this new family of iminosugar derivatives was found to be potent as well as highly selective inhibitors of human  $\beta$ -glucocerebrosidase (GCCase). In other words, all tested iminoxylitols displayed no inhibition towards acid  $\alpha$ -glucosidase, and most likely do not have any effect on intestinal  $\alpha$ -glucosidases as the enzymes are not inhibited by DIX.

We were pleasantly surprised by these results and we wanted to go further with the separation of both enantiomers of racemic ( $\pm$ )-2-*O*-hexyl iminoxylitol **45b**. In fact, it was important to rapidly determine the inhibitory activity of each member of this racemic mixture.

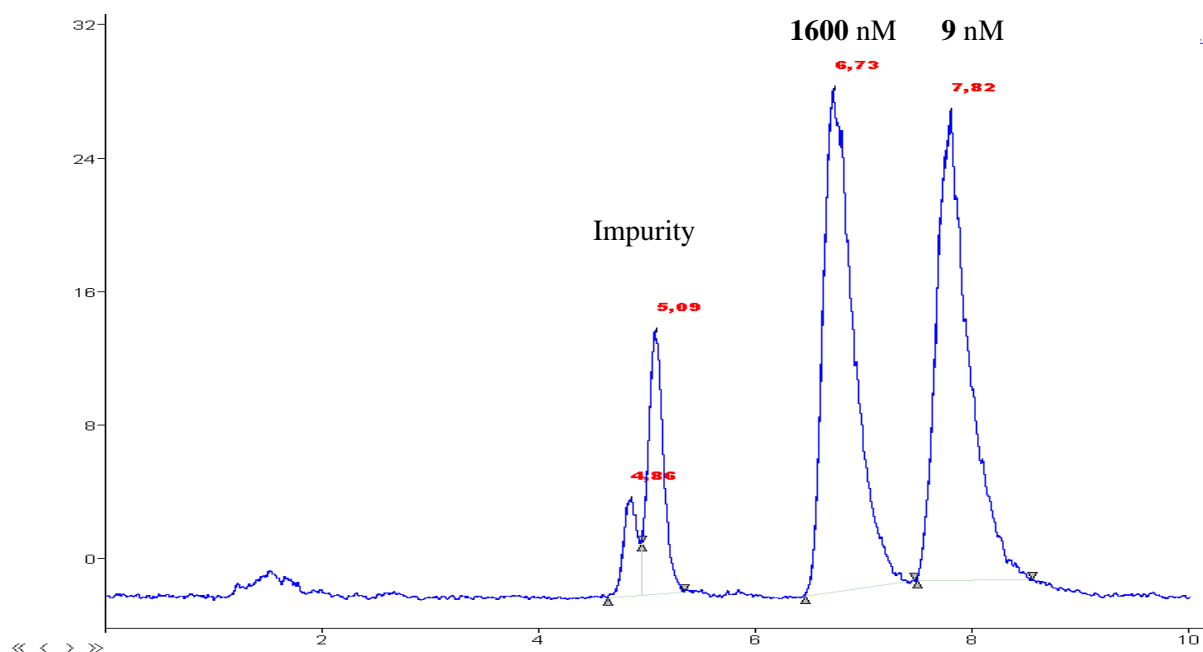

Figure 47

In collaboration with E. Lesselier, at ICOA, a separation by semi-preparative Supercritical Fluid Chromatography on a LUX2 chiral phase (cellulose tris(3-chloro-4-methylphenylcarbamate)) using CO<sub>2</sub>/EtOH (85:15, v/v) as the mobile phase was conducted.

This allowed the mg-scale separation of each enantiomer (Figure 47). The inhibitory effect of each one was then evaluated on GCCase. As shown above, the enantiomer which has a retention time of 6'73" appeared to be the less powerful GCCase inhibitor ( $IC_{50} = 1600$  nM). In contrast, the enantiomer which has a retention time of 7'82" was found to be the most active and exhibit an  $IC_{50}$  of 9 nM. It is indeed more active than the  $\alpha$ -1-C-hexyl DIX derivative!

Then, the objective was to determine the configuration of the most potent enantiomer. In order to reach this aim a straightforward synthesis of enantiopure 2-*O*-hexyl-imino-D-xylitol and 4-*O*-hexyl-imino-D-xylitol from L-xylose and D-xylose respectively was developed.

## V. Enantiopure *O*-alkyl derivatives of DIX

### V.1. Synthetic strategy

#### V.1.a. Retrosynthesis of 2-*O*-hexyl DIX

Synthesis of an iminoxylitol from aldehyde **17** arising from L-xylose provides a derivative having a free 2-OH group, thus giving access to 2-*O*-alkyl DIX (Figure 48).

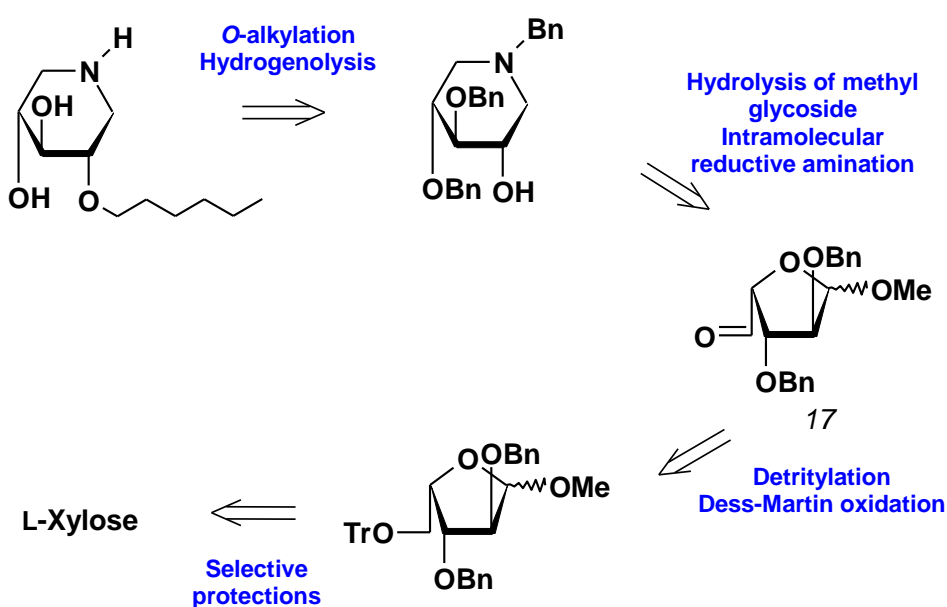

Figure 48

#### V.1.b. Retrosynthesis of 4-*O*-hexyl DIX

The same strategy applied to D-xylose gives access to 4-*O*-alkyl imino-D-xylitol derivatives.

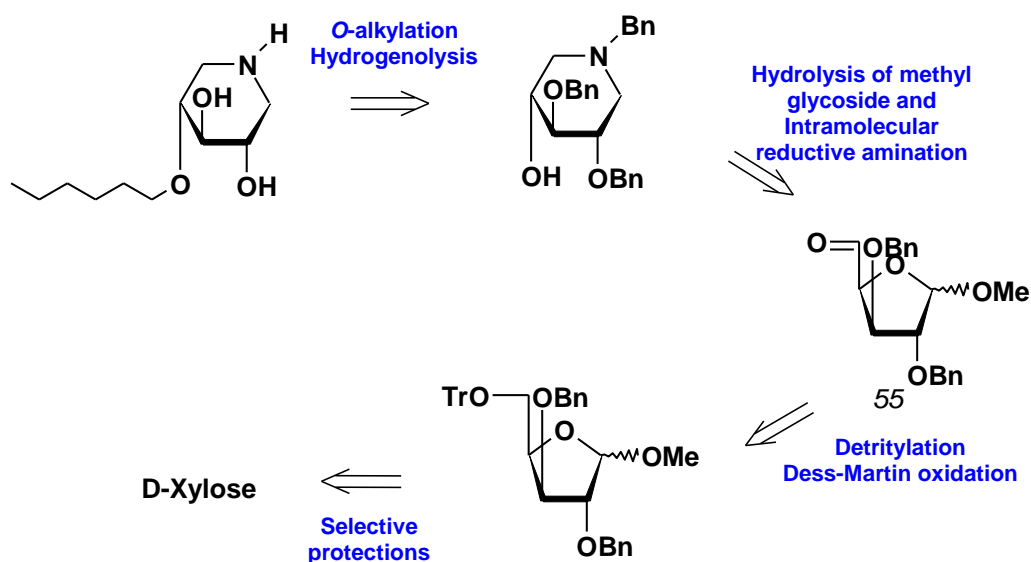

Figure 49

## V.2. Synthesis of 2-*O*-hexyl DIX

### V.2.a. Preparation of the alcohol **16**

As presented in chapter 2, treatment of L-xylose with methanolic HCl, tritylation of the crude product and benzylation of the free hydroxyl groups afforded the compound **15** with good yields. Removal of the trityl protecting group using aqueous acetic acid produced the alcohol **16**. All these steps were performed with the anomeric mixture since it was unimportant for the desired sequence. But as anomeric separation was possible for **16**, the next reactions were realized on  $\alpha$  or  $\beta$  anomer, which simplifies greatly NMR interpretations.

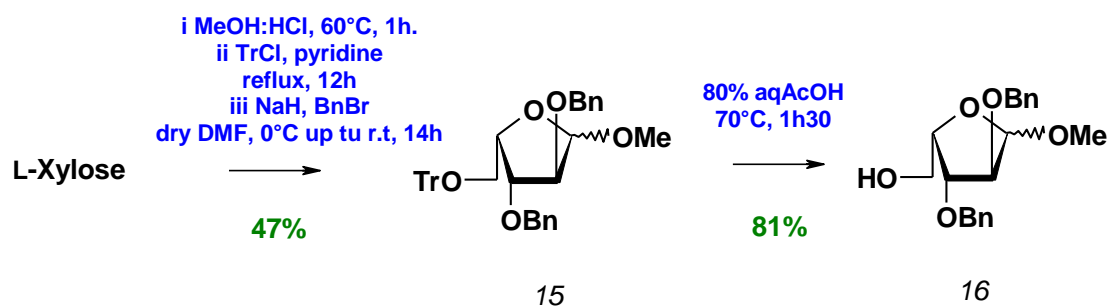

Figure 50

### V.2.b. Preparation of the iminoxylitol **51**

Alcohol **16** was oxidized using Dess-Martin periodinane to aldehyde **17**. Then, hydrolysis of the glycosidic bond followed by double reductive amination was performed one pot by

heating the aldehyde **17** in a mixture of 1,4-dioxane and aqueous HCl followed by neutralization and by the addition of sodium cyanoborohydride and benzylamine.

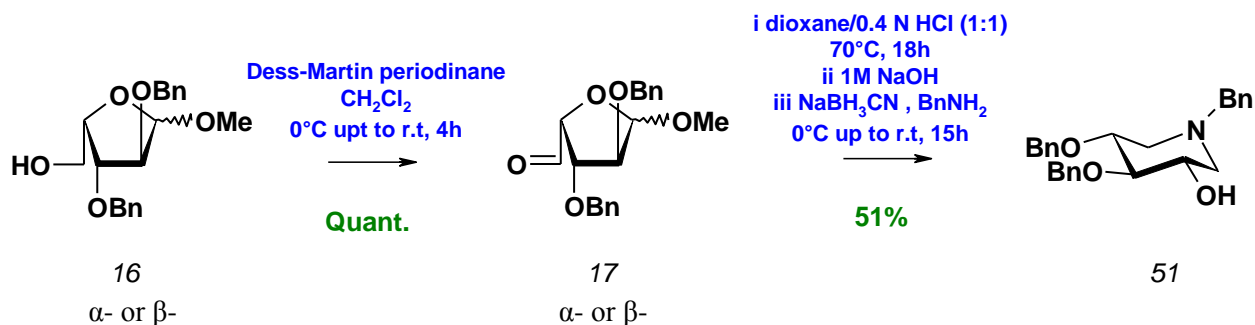

Figure 51

Surprisingly the last reactions could be realized in one pot and worked with a satisfactory yield without taking any specific precaution. The mechanism showed below explains how the iminosugar is formed and justified the position of the free hydroxyl group (Figure 52).

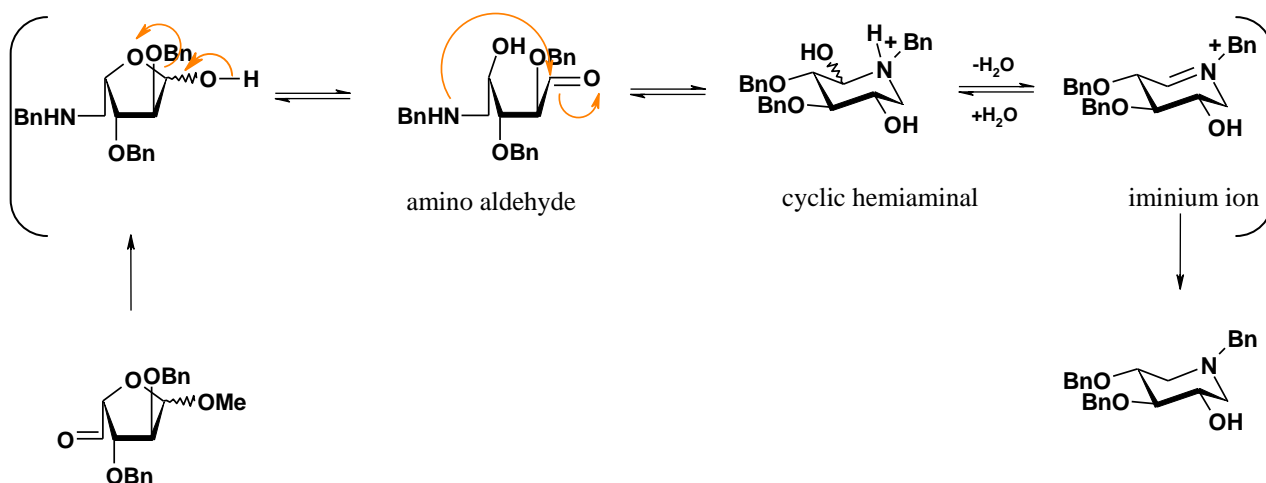

Figure 52

### V.2.c. Preparation of 2-*O*-hexyl DIX **53**

Alkylation of the iminoxylitol **51** bearing a free hydroxyl group on C-2 and subsequent removal of the benzyl groups afforded (+)-2-*O*-hexylimino-D-xylitol **53**.

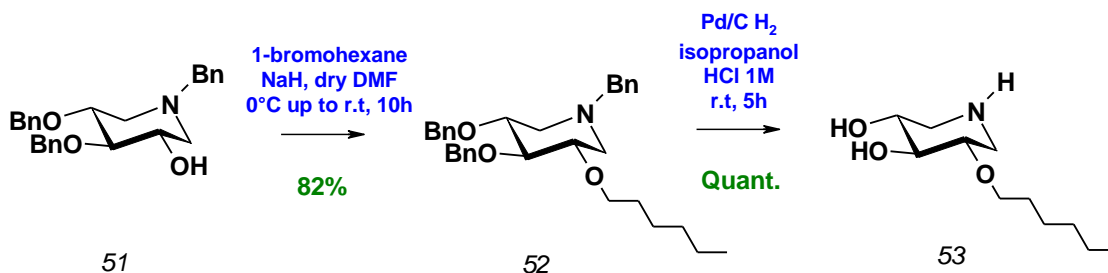

Figure 53

However, the removal of the benzyl ethers groups was difficult and required optimization (Table 11). Indeed, at the beginning we performed a hydrogenolysis using Pd/C in the presence of acetic acid in methanol; this led to the *N*-methyl derivatives. We realized some changes to address this problem:

Entry	Solvent	Conditions				Result
		Cat.	T°C	Time	Acid (10mol%)	
1	MeOH	Pd/C 10%	r.t	6h	AcOH	 54
2	iPrOH	Pd/C 10%	r.t	8h	AcOH	 (5:95, unseparable mixture)
3	iPrOH	Pd/C 10%	r.t	5h	1M HCl	 53

Table 11

These results could be explained by the fact that hydrochloric acid is a strong acid which might completely protonates the amine, thus preventing from *N*-alkylation. On the contrary, acetic acid might protonate partially the amine which led to the *N*-alkyl compounds.

## V.2.d. Conclusion

In conclusion, the desired enantiomer (+)-2-*O*-hexylimino-D-xylitol was obtained in eight steps and 16% overall yield from L-xylose. Moreover, we have developed a short, efficient and straightforward access to enantiopure 2-*O*-alkyl DIX.

## V.3. Synthesis of 4-*O*-hexyl DIX

The same strategy was applied to the synthesis of (-)-4-*O*-hexyl-imino-D-xylitol with the same success.

### V.3.a. Preparation of the iminoxylitol 56

The aldehyde 55 was obtained using the synthetic route described above. Hydrolysis of the methyl glycoside followed by double reductive amination in the presence of benzylamine afforded the iminoxylitol 56 carrying a free hydroxyl group on C-4.

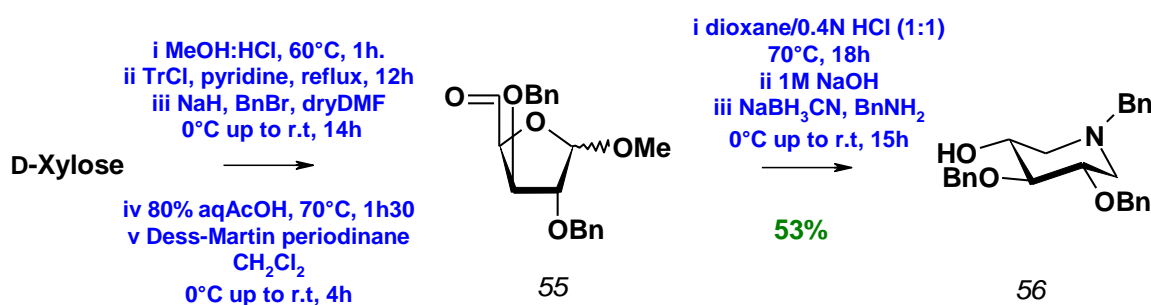

Figure 54

The mechanism showed below explain how we get the unprotected alcohol on C-4. Indeed, it was obvious that the amino aldehyde intermediate led to the hemiaminal ring and consequently to the (+)-*N*-benzyl-2,3-di-*O*-benzyl-1,5-dideoxy-1,5-imino-D-xylitol. We prove here that starting from D-xylose gives the second enantiomer.

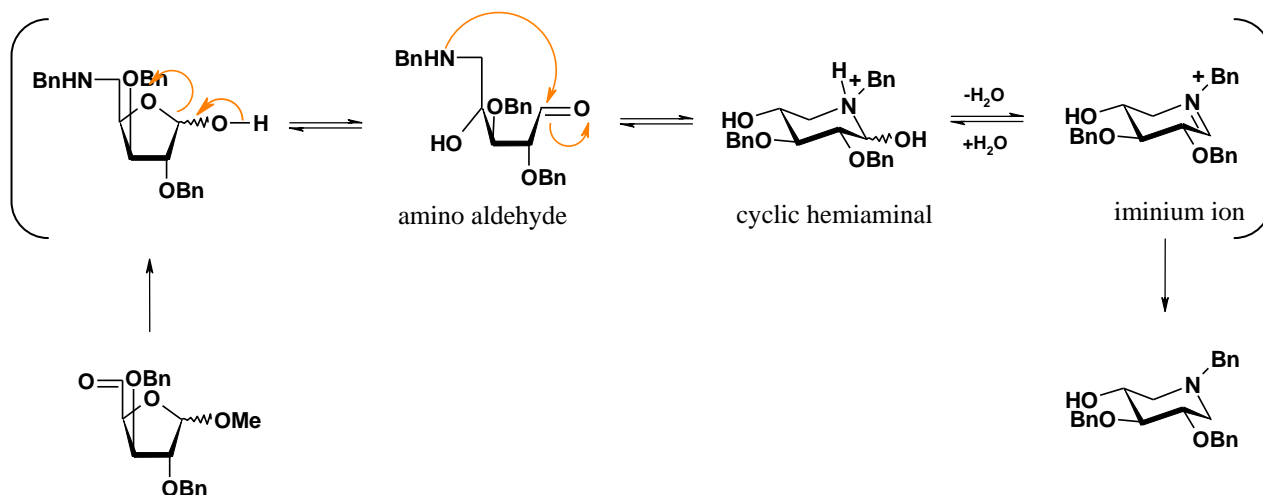

Figure 55

### V.3.b. Preparation of 4-*O*-hexyl DIX 58

Alkylation of the alcohol **56** followed by Pd/C hydrogenolysis of the benzyl ethers groups in the presence of 1M HCl afforded the (-)-4-*O*-hexyl-imino-D-xylitol in good yield.

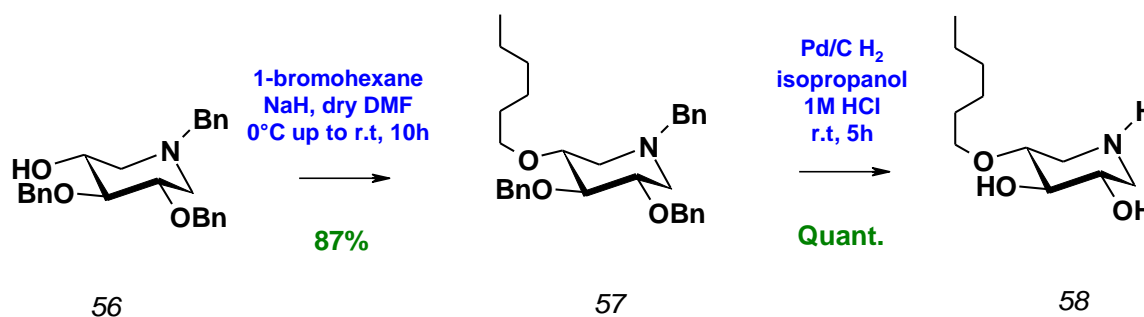
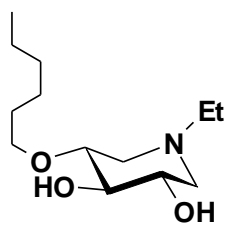

Figure 56

Before realizing the hydrogenolysis under the conditions described above we performed it using acetic acid in ethanol. We obtained exclusively the compound **59**. This result confirmed the importance of using HCl as the acid source for hydrogenolysis.





59

Figure 57

### V.3.c. Conclusion

In conclusion, the desired enantiomer (-)-4-*O*-hexylimino-D-xylitol was obtained successfully from D-xylose.

### V.4. Inhibitory activity

The objective of this work was to determine the configuration of the most active enantiomer.

In order to know that, each synthesized enantiomer was analyzed by SFC using the same conditions as for the separation. Therefore we were able to assign each enantiomer to each signal and activity (Figure 58): the more active compound is imino-(D)-xylitol carrying an alkyl chain at O-2.

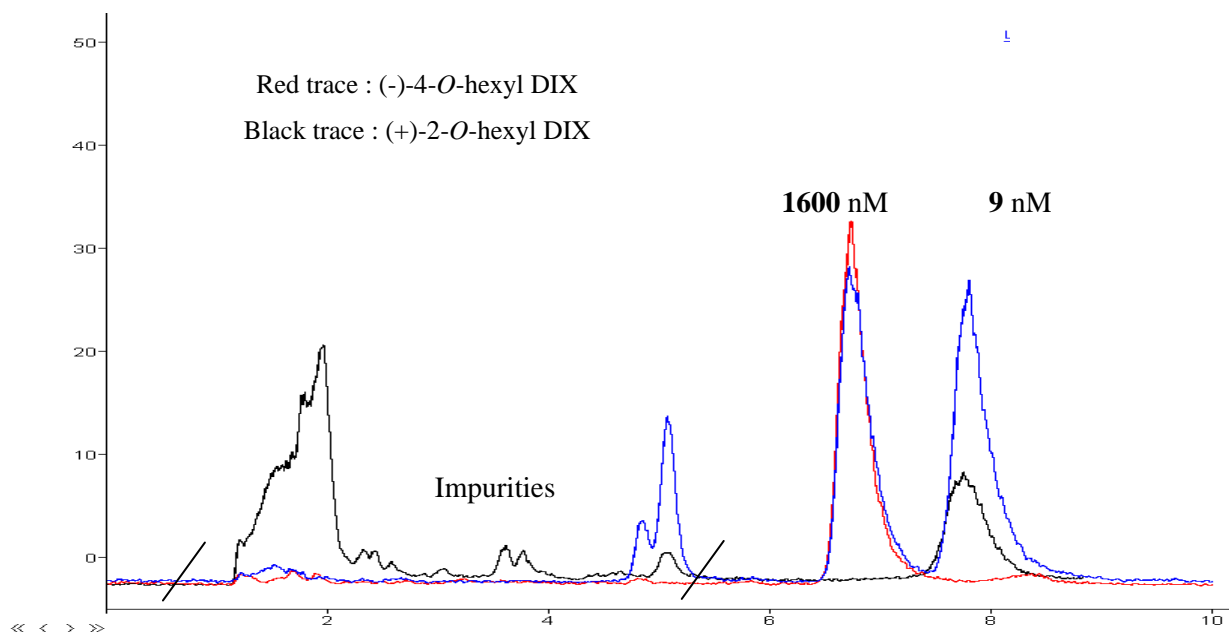
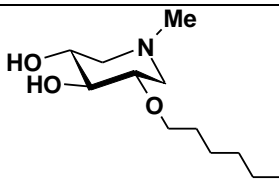
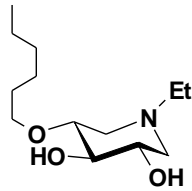

Figure 58

We went further by testing each enantiomer and *N*-alkylated compounds **54** and **59**. These tests performed by Dr Asano's team confirmed the results obtained by SFC which means that (+)-2-*O*-hexyl DIX is the most potent GCCase inhibitor of the two enantiomers. It also appeared that short *N*-alkyl chains were detrimental to GCCase inhibitory activity (Table 12).

Compound	Structure	GCCase (Ceredase) IC <sub>50</sub> (nM)	Acid $\alpha$ -glucoside (Myozyme) IC <sub>50</sub> (nM)
54		33	NI
59		58000	NI

**Table 12**

(NI: less than 50% inhibition at 1000 $\mu$ M.)

Finally, when we gather our results together as in table 13 we clearly see the dramatic influence of the position of the alkyl chain in DIX ( $\alpha$ -C-1, O-2, O-3 or O-4) on GCCase inhibition.<sup>234</sup>

R <sub>1</sub>	R <sub>2</sub>	R <sub>3</sub>	R <sub>4</sub>	R <sub>5</sub>	IC <sub>50</sub>
hexyl	H	H	H	H	19 nM
H	hexyl	H	H	H	9 nM
H	H	hexyl	H	H	404000 nM
H	H	H	hexyl	H	1600 nM
H	H	H	H	hexyl	>1500 nM <sup>235</sup>

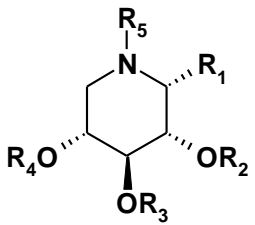

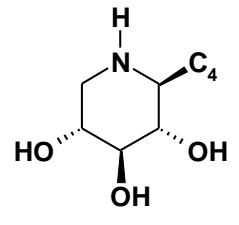

IC<sub>50</sub> = 5800 nM<sup>223b</sup>

**Table 13**

It also appeared that  $\beta$ -1-*C<sub>n</sub>* DIX are less active than its anomer  $\alpha$ .

<sup>234</sup> Oulaïdi, F.; Front-Deschamps, S.; Compain, P.; Ikeda, K.; Asano, N.; Gallienne, E.; Martin, O. R. *et al ChemMedChem*, in press.

<sup>235</sup> IC<sub>50</sub> for *N*-nonyl DIX = 1500 nM<sup>125</sup>. Estimated IC<sub>50</sub> value for *N*-hexyl DIX is therefore > 1500 nM.

## VI. Conclusion

In conclusion a series of simplified *O*-alkylated analogs of DIX was successfully prepared. This new generation of iminosugars was evaluated as GCCase inhibitors and has demonstrated the dramatic influence of the position of the alkyl chain in DIX on GCCase inhibition.

Moreover, this new class of compounds was prepared in a shorter synthetic sequence with removal of the stereogenic center at C-1. This allowed us to avoid a difficult C-C bond forming step.

We were pleasantly surprised to discover that a simple 1,2-shift of the alkyl chain from C-1 to the hydroxyl group on C-2 maintained high inhibition towards GCCase.

In addition, decreasing of the chain length in *O*-alkyl derivatives only slightly lowered the inhibition towards GCCase.

(+)-2-*O*-hexyl DIX is therefore a promising lead for the treatment of Gaucher disease by means of pharmacological chaperone therapy. Likewise, the influence of this compound on human GCCase activities in N370S fibroblasts, in other words the chaperone activity, will be demonstrated in chapter 5.

## Résumé Chapitre 3 :

Synthèse de *O*-alkyl-iminoxylitols, inhibiteurs et chaperon pharmacologiques de la  $\beta$ -glucocérébrosidase de seconde génération.

Ce chapitre a été dédié à la recherche de nouveaux inhibiteurs agissant comme chaperon pharmacologique de la GCCase, structurellement plus simplifié.

Pour ce faire différentes stratégies de synthèse ont été réalisées. Nous avons ainsi obtenu des composés mono alkylé en O-2, O-3 et O-4 ainsi que des composés di-alkylé en O-2 et O-4.

Les résultats des tests d'inhibitions sur la N370S GCCase, ci-contre, montrent l'importante influence de la chaîne alkyle sur les DIX.

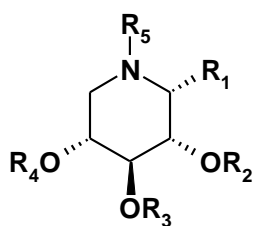

R <sub>1</sub>	R <sub>2</sub>	R <sub>3</sub>	R <sub>4</sub>	R <sub>5</sub>	IC <sub>50</sub>
hexyl	H	H	H	H	19 nM
H	hexyl	H	H	H	9 nM
H	H	hexyl	H	H	404000 nM
H	H	H	hexyl	H	1600 nM
H	H	H	H	hexyl	>1500 Nm <sup>235</sup>

Figure b : résultats des tests d'inhibitions sur la GCCase

Il apparaît clairement que le 2-*O*-hexyl-DIX est un très bon inhibiteur de la GCCase. C'est donc sur ce composé que les effets chaperons ont été évalués par l'équipe d'Asano au Japon. Ces résultats sont présentés chapitre 5.

Issue d'une stratégie de synthèse courte et efficace, ce composé apparaît donc comme une réelle alternative au  $\alpha$ -1-*C*-alkyl-DIX. En effet, on évite ici la création d'une liaison carbone-carbone qui nous aura posé de nombreux problèmes auparavant.

Nous avons trouvé ici une nouvelle famille d'iminosucres qui se sont révélés être d'excellents inhibiteurs de la GCCase.

## Chapter 4

# Synthesis of imino-L-arabinitols as potential inhibitors and pharmacological chaperones of GALC

This chapter is devoted to the search of new inhibitors of (Globoid Cell Leukodystrophy, GLD)  $\beta$ -galactocerebrosidase (GALC), the enzyme involved in Krabbe disease, which can act as pharmacological chaperones.

### I. Synthetic target

In chapter 2 and 3 we found that alkylated iminoxylitol compounds such as  $\alpha$ -1-C-hexyl-iminoxylitol and 2-O-hexyl-iminoxylitol are powerful and selective GCCase inhibitors ( $IC_{50}$  = 19 and 8 nM respectively) but devoid of activity towards  $\alpha$ -glucosidases.

In view of these results, we considered that it would be interesting to investigate the activity and selectivity of related *L-arabino* iminopentitol derivatives carrying a 1-C- or an O-alkyl substituent. Such compounds are mimics of galactosides and, therefore potential inhibitor of lysosomal galactosidases, most importantly of GALC:

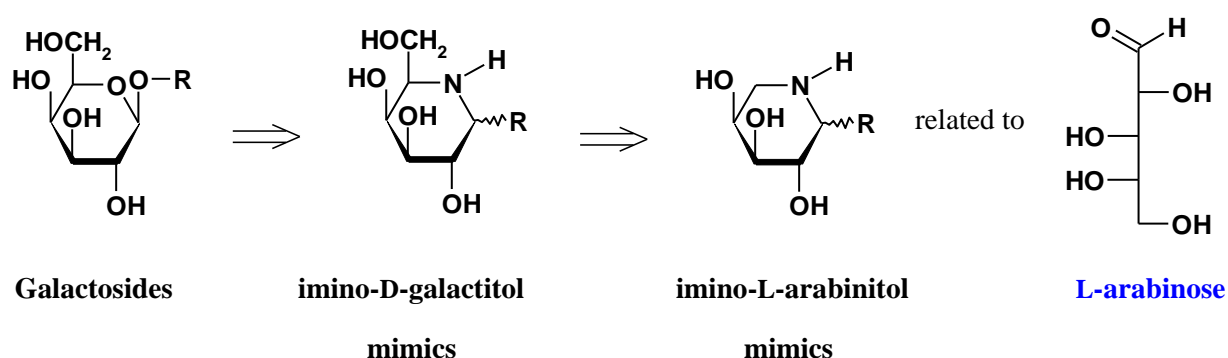
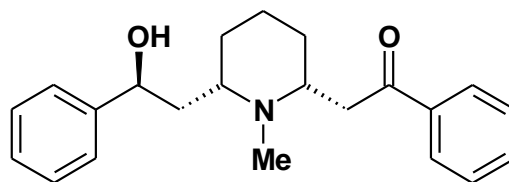

Figure 59

As there is no treatment of Krabbe disease, which is due to the dysfunction of GALC, the finding of potent inhibitors of this enzyme having pharmacological chaperone activity, would be particularly significant as a possible first therapeutic approach to this disease.

Very recently Eckman and coworkers<sup>181</sup> examined the effect of  $\alpha$ -lobeline (Figure 60), a weak inhibitor of GALC. After treatment, activity of GALC carrying the D528N mutation

was significantly increased. This study suggests that mutations in GALC can cause GLD by impaired protein processing and/or folding and show for the first time that pharmacological chaperones may be potential therapeutic agents for patients carrying certain mutations.

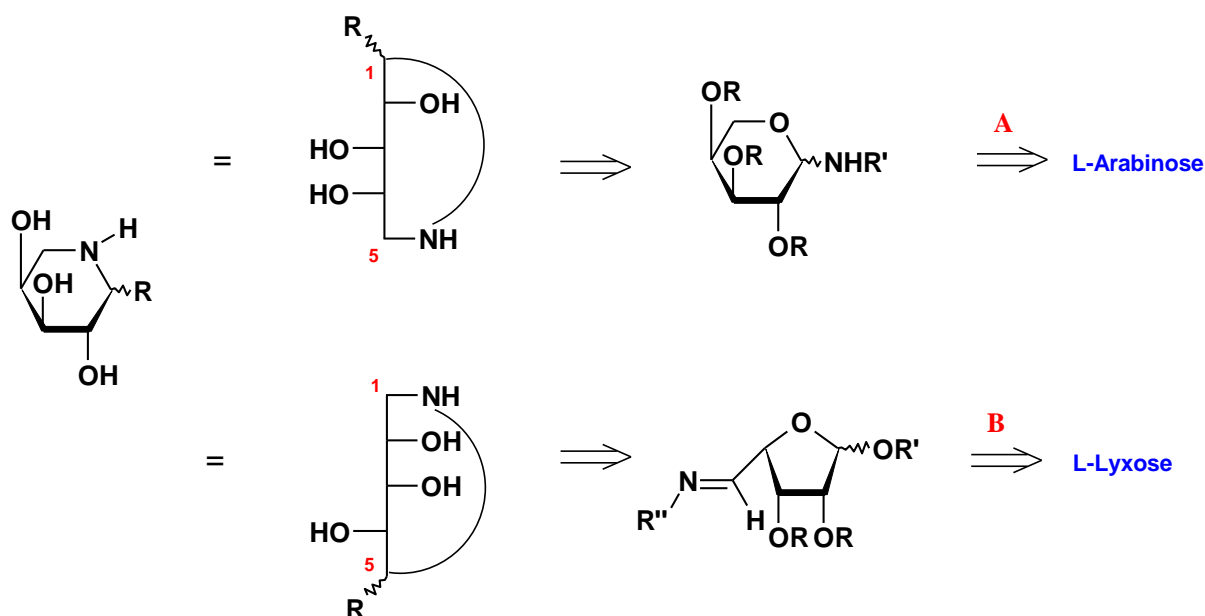

**Figure 60:**  $\alpha$ -lobeline usually used for smoking cessation<sup>236,237</sup> and approved by Food and Drug Administration was screened for GALC inhibition.

## II. Synthesis of $\alpha$ -1-C-alkyl DIA

### II.1. Synthetic strategy

The synthesis of the C-alkylated imino-L-arabinitols can be envisaged either by the C-1-chain extension of L-arabinose derivatives, by way of an L-arabinopyranosylamine (route **A**) or by the C-5-chain extension of L-lyxose derivatives, by way of an L-lyxofuranoside (route **B**) (Figure 61).



**Figure 61**

<sup>236</sup> Stead, L. F.; Hughes, J. R. *Cochrane Database Syst. Rev.* **2000**, CD000124.

<sup>237</sup> Marlow, S. P.; Stoller, J. K. *Respir. Care* **2003**, *48*, 1238-1254; discussion 1254-1256.

We chose the second strategy for two reasons: reliable stereochemical control in the addition of organometallic reagents to carbohydrate-derived imines and, access to imino-L-arabinitol derivatives in which the OH groups are differentiated.

The lack of availability of L-lyxose as starting material can be favorably bypassed by starting from commercial L-gulono-lactone. This compound can be readily converted into 5-aldehydro-L-lyxofuranoside **64**, and the retrosynthetic scheme is therefore as follows:

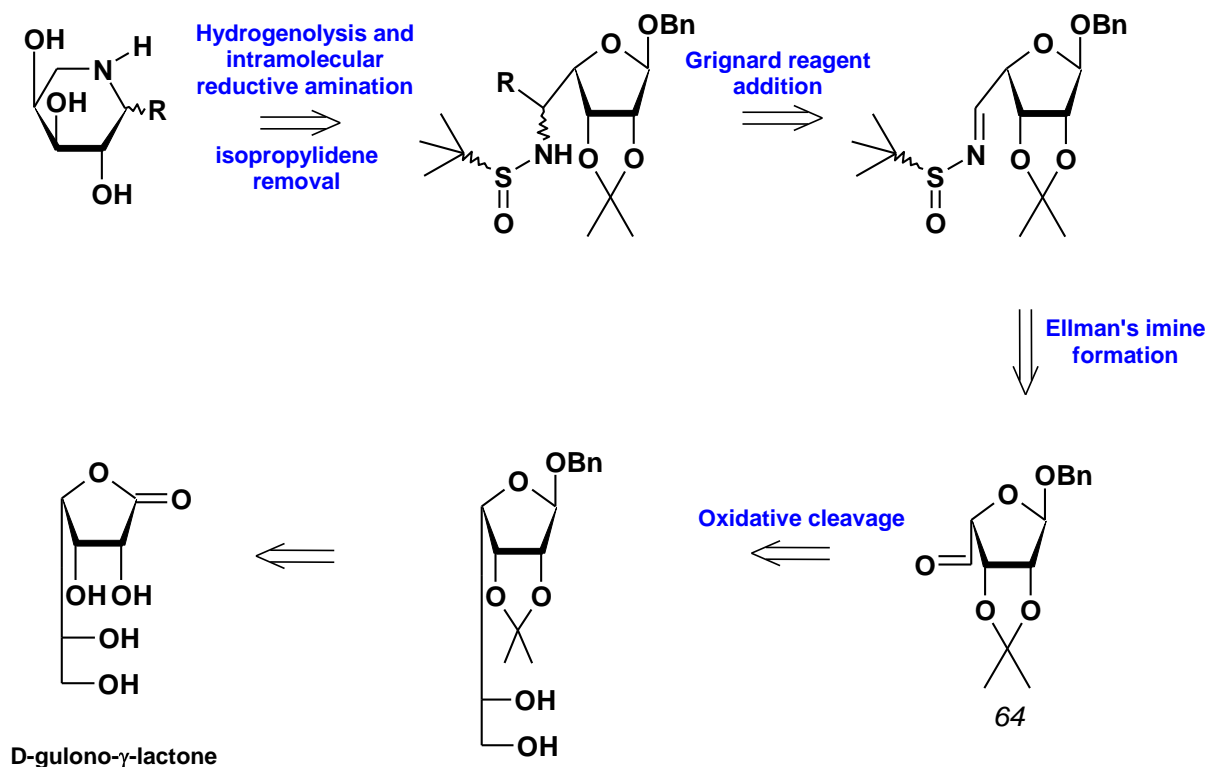

Figure 62: Retrosynthesis of the 1-C-alkyl-imino-L-arabinitols.

## II.2. Synthesis of the *N*-alkylsulfinylimine

### II.2.a. Preparation of the protected intermediate **62**

Commercially available D-gulonolactone was transformed into **62** via optimization of known reactions.

Isopropylidene acetals were introduced using distilled acetone and sulfuric acid as a catalyst which led to the 2,3:5,6-di-*O*-isopropylidene-D-gulono-1,4-lactone **60**.<sup>238</sup> Reduction of the  $\gamma$ -lactone with diisobutylaluminium hydride furnished crystalline hemi-acetals **61** in very high

<sup>238</sup> Buchanan, J. G.; Moorhouse, S. J.; Wightman, R. H. *J. Chem. Soc., Perkin Trans. 1* **1981**, 2258. Seo, M. J.; An, J.; Shim, J. H.; Kim, G. *Tetrahedron Lett.* **2003**, *44*, 3051-3052

yield.<sup>239</sup> Hemi-acetals **61** were then converted into a separable mixture of the two anomer benzyl furanosides (**62b**:**62a** = 1/8.2)<sup>240</sup> which were prepared under classical Williamson conditions. To avoid difficult interpretation of NMR spectra, the rest of the synthetic sequence was performed with the major  $\beta$ -anomer **62a**.

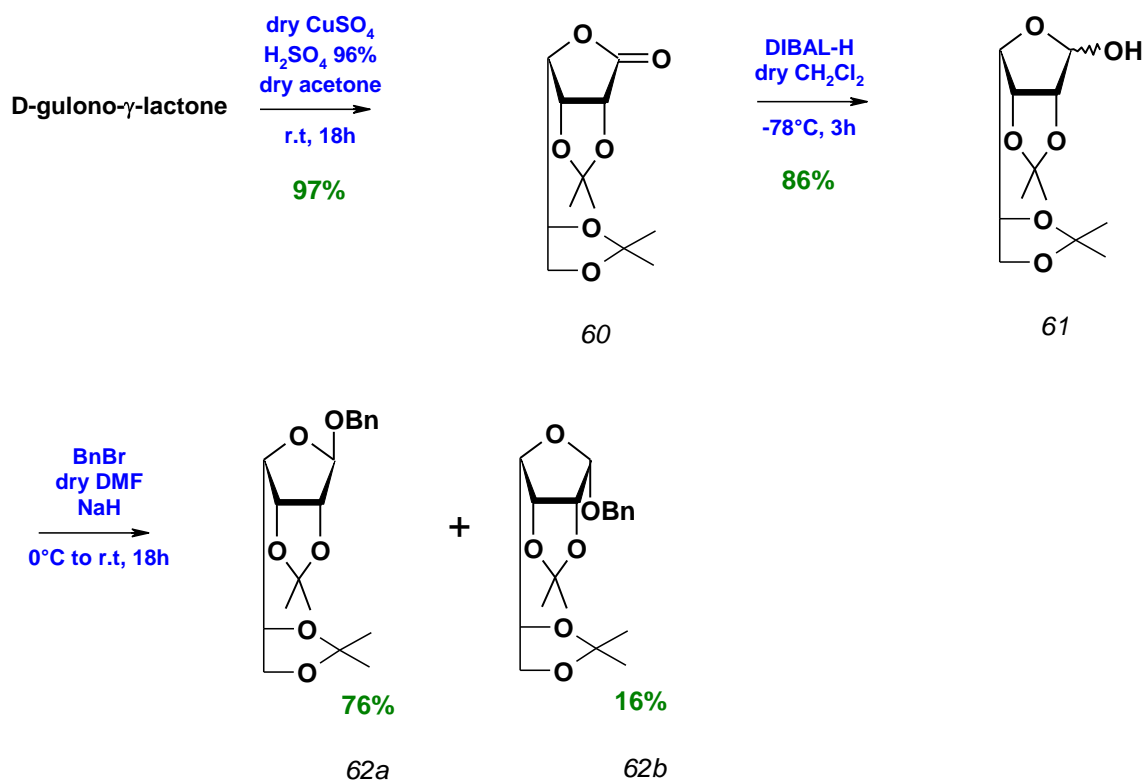

Figure 63

## II.2.b. Synthesis of the aldehyde **64**

The less stable 5,6-*O*-isopropylidene group was selectively cleaved to produce compound **63** with a free diol.<sup>241,242</sup> Oxidative cleavage of **63** was efficient and easy. In fact, thanks to the use of silica gel-supported sodium periodate in dichloromethane the corresponding aldehyde **64** was obtained quantitatively.<sup>243</sup>

<sup>239</sup> Rosen, T.; Taschner, M. J.; Heathcock, C. H. *J. Org. Chem.* **1984**, *49*, 3994-4003.

<sup>240</sup> Seo, M. J.; An, J.; Shim, J. H.; Kim, G. *Tetrahedron Lett.* **2003**, *44*, 3051-3052.

<sup>241</sup> Ješelnik, M.; Leban, I.; Polančič, M.; Zupan, M. *Org. Lett.* **2003**, *5*, 2651-2653.

<sup>242</sup> Chen, F.; Zhao, J.; Xiong, F.; Xie, B.; Zhang, P. *Carbohydr. Res.* **2007**, *342*, 2461-2464.

<sup>243</sup> Zhong, Y.; Shing, T. K. M. *J. Org. Chem.* **1997**, *62*, 2622-2624.



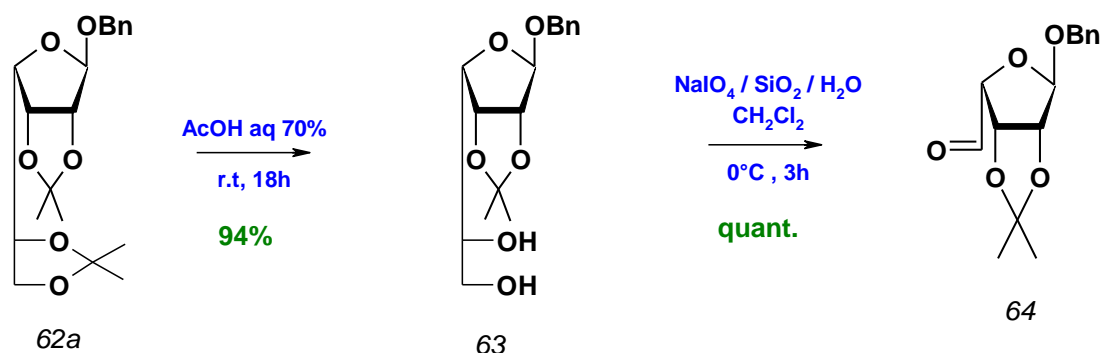

Figure 64

### II.2.c. Synthesis of the sulfinylimine **65**

Based on our previous work (Chapter 2) we decided to form again the reactive imine derived from a sulfinamide. However, Ellman's reagent was used here in its racemic form, as it was shown previously that the addition of Grignard reagent to the *N*-alkylsulfinylimine was not controlled by the chiral sulfinyl group. Condensation of the aldehyde **64** with commercially available ( $\pm$ )-*tert*-butanesulfinamide in the presence of anhydrous  $\text{CuSO}_4$  in dry dichloromethane provided carbohydrate-derived *N*-*tert*-butanesulfinylimine **65** in high yield.

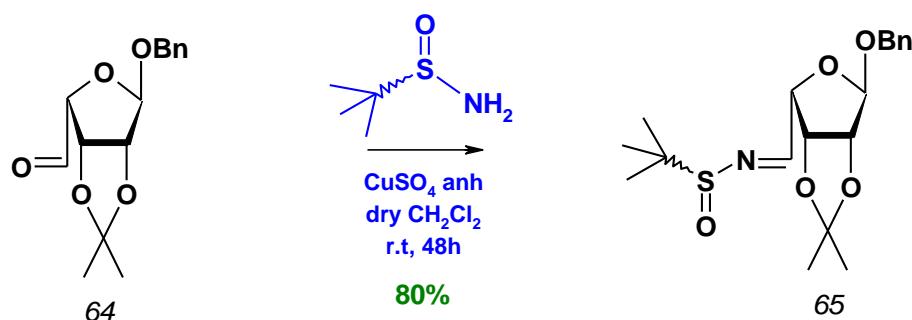
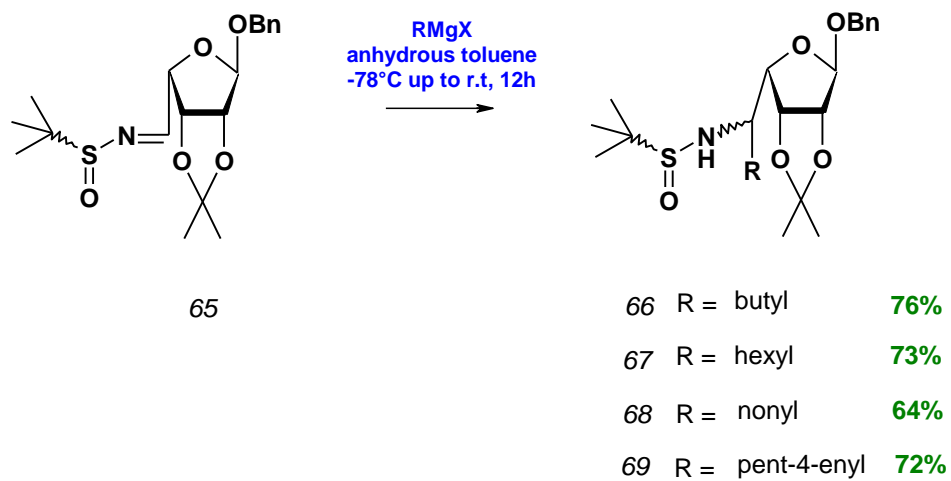

Figure 65

## II.3. Synthesis of the $\alpha$ - and $\beta$ -1-*C*-alkyl DIA

### II.3.a. Addition of Grignard reagents to the imine **65**

Addition of alkyl magnesium bromide reagents to the imine **65** afforded compounds **66** to **69** in good yields. All these reactions were performed in anhydrous toluene at  $-78^\circ\text{C}$  up to room temperature.



**Figure 66**

### II.3.b. Desulfinylation, hydrogenolysis and intramolecular reductive amination

Alkylated compounds were then desulfinylated under the influence of HCl in MeOH to give corresponding HCl salts. Hydrogenolysis of the anomeric benzyl ethers in the presence of acetic acid provided the quite stable desulfinylated and debenzylated compounds carrying a free amino group and a free hemiacetal function; an example is shown below (Figure 67).

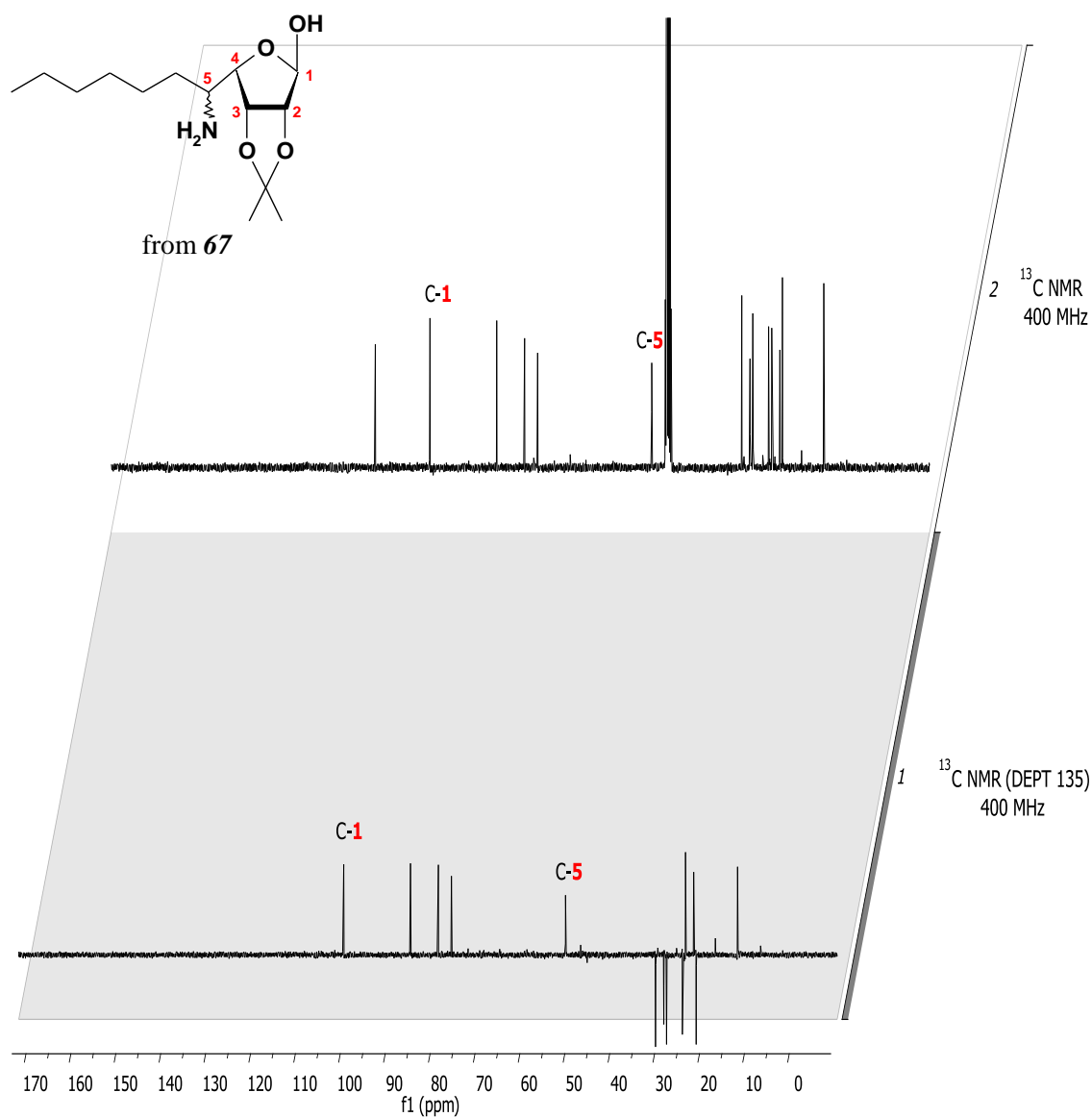

**Figure 67:** <sup>13</sup>C NMR spectra (CD<sub>3</sub>OD) of a desulfinylated and debenzylated compound isolated after 24h of stirring.

Desulfinylation and debenzylation were followed by a slow intramolecular reductive amination which afforded imino sugars **70** to **75** in a one pot process. Indeed, this step required the mixture to be stirred for a long time since the ratio between the furanose and the iminosugar form of the amine intermediate appeared to favor the hemiacetal form (Figure 68).

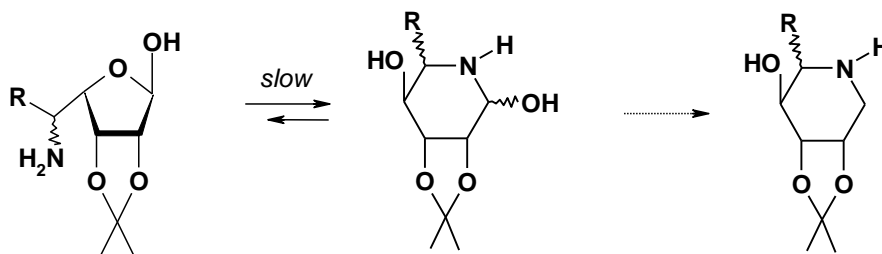

Figure 68

This phenomenon might be caused by the fused dioxolane ring which reduces the compound flexibility, and makes the formation of the six-membered ring less favorable.

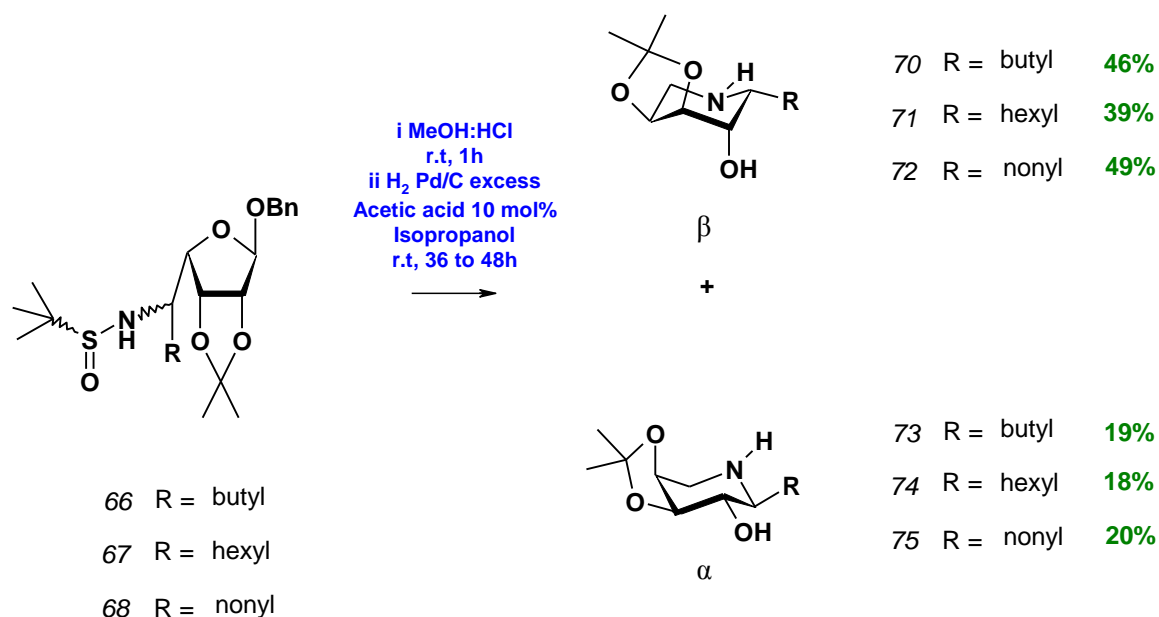

Figure 69

Surprisingly, removal of the two protecting groups followed by intramolecular reductive amination provided two distinct compounds: a  $\beta$ -1-C-alkyl-3,4-O-isopropylidene-imino-L-arabinitol and an  $\alpha$ -1-C-alkyl-3,4-O-isopropylidene-imino-L-arabinitol. NMR data appear to indicate that the two families of iminoarabinitols adopt two different conformations,  ${}^1C_4$  and  ${}^4C_1$  respectively. The poor yields obtained for  $\alpha$ -derivatives were caused by difficulties in chromatography separation of the two anomers.

### II.3.c. Removal of the isopropylidene protecting group

The 3,4-*O*-isopropylidene group was more resistant to acidic hydrolysis than the same group at positions 5,6. Use of acidic ion exchange resin (Dowex 50WX8-H<sup>+</sup>) in dioxane and water (v/v, 1/1) allowed the removal of the acetal easily.<sup>244</sup> In fact, a simple filtration followed by several washings with 0.15N ammonium hydroxide afforded quantitatively iminosugars **76** to **81**.

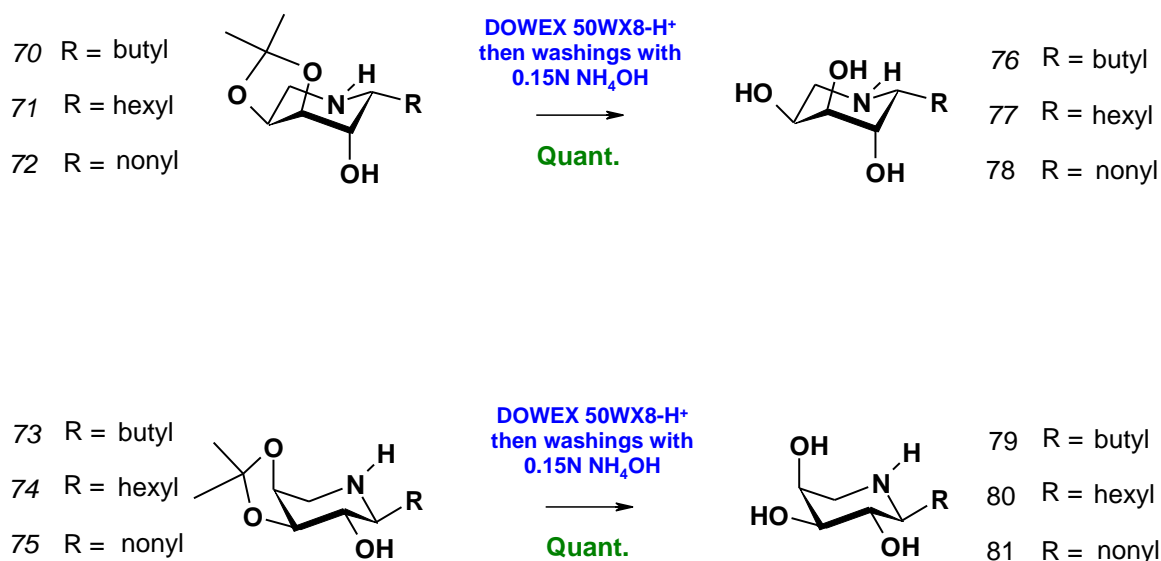

Figure 70

It was more obvious and easier for us to establish the configuration and conformational shape of our iminosugars without the fused dioxolane ring (Figure 71). Thus, the coupling constants shown below proved that on one hand we obtained the  $\beta$ -1-*C*-alkyl DIA in <sup>1</sup>C<sub>4</sub> conformation and on the other hand the  $\alpha$ -1-*C*-alkyl DIA in <sup>4</sup>C<sub>1</sub> conformation.

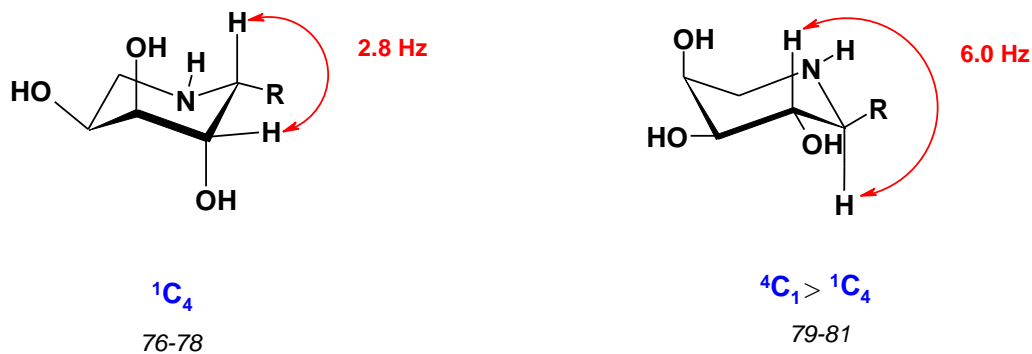

Figure 71

<sup>244</sup> Sato, K.; Akai, S.; Hiroshima, T.; Aoki, H.; Sakuma, M.; Suzuki, K. *Tetrahedron Lett.* **2003**, *44*, 3513-3516.

### II.3.c. Interpretation of the stereochemical outcome of the alkylation reaction

For the synthesis of these 1-*C*-alkyl-iminoarabinitol derivatives, we used racemic *tert*-butanesulfinamide. In the case of 1-*C*-alkyl-iminoxylitol, we proved that chiral imines did not induce diastereocontrol. However, we obtained here two compounds from **65** carrying  $S_R$ ,  $S_S$ -sulfinyl group. Why do we observe such a diastereocontrol in this family of compounds and what is responsible for it?

In order to find answers to these questions, we realized the same study as we did for 1-*C*-alkyl-iminoxylitol derivatives: we prepared both *S*-epimeric *N*-*tert*-butanesulfinyl imines derived from **65**, compounds **82** and **84**, and investigated the stereochemistry of the addition using butylmagnesium bromide.

The reaction of **82** and **84** gave a diastereoisomeric sulfinylamine **83** and **85**, treatment of which as before provided the *C*-1 epimeric 1-*C*-alkyl-iminoarabinitols **76** and **79**.

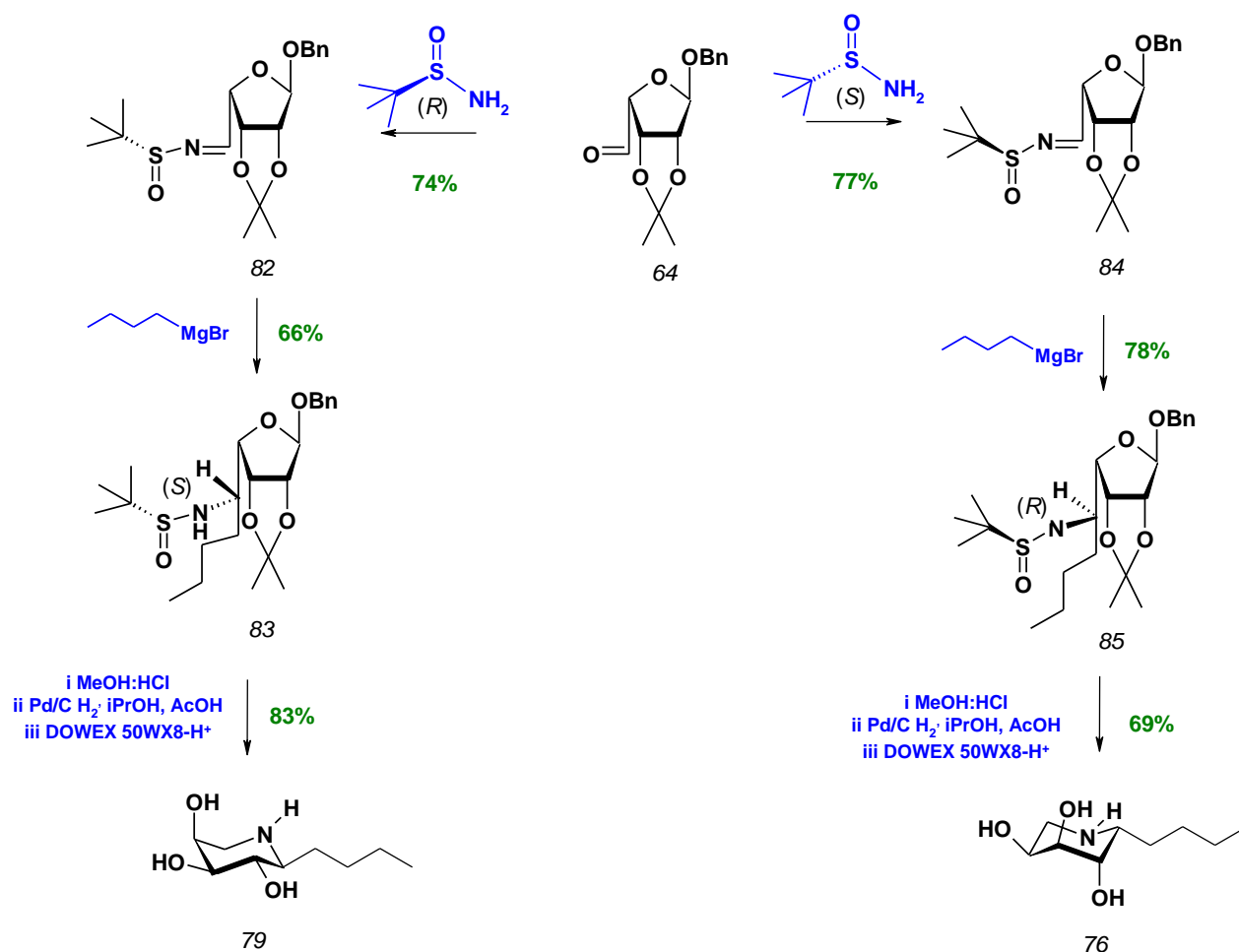

Figure 72

Thus, in this case, the *tert*-butanesulfinyl group not only activated the imine for nucleophilic addition but also served as a powerful chiral directing group. A six-membered cyclic transition state with Mg coordinated to the sulfinyl oxygen is consistent with the observed sense of asymmetric induction (Figure 73 Scheme **A**).

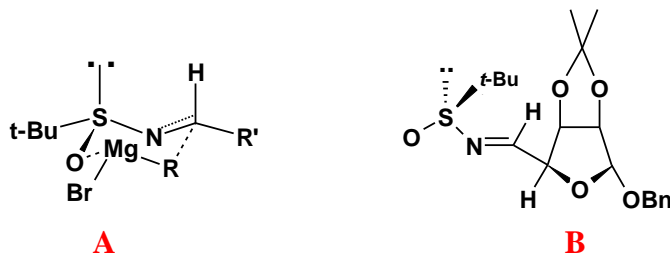

Figure 73

As shown above on scheme **B** the 2,3-*O*-isopropylidene acetal induces strong conformational constraints and steric effects. The conformation of the imine around the  $sp^2$ - $sp^3$  bond required for chelation becomes less favorable, and the system probably adopts an “open” conformation which favors sulfinylimine-induced stereocontrol by the transition state **A**.

## II.4. Conclusion

In conclusion, we developed an efficient and stereocontrolled access to  $\alpha$ - or  $\beta$ -1-*C*-alkyl-1,5-dideoxyimino-*L*-arabinotols. The key step involves nucleophilic addition to pentose-derived imines generated from enantiopure *tert*-butanesulfinamide. Comparison with results obtained in the *D*-*xylo* series indicated that, depending on the pentose structure, the stereoselectivity of the addition step was only controlled here by the configuration at the stereogenic sulfur center. Evaluation of these iminosugars as chaperones for the treatment of glycosphingolipidoses is currently in progress.

### III. Synthesis of *O*-alkyl iminoarabinitol analogs

#### III.1. Synthetic strategy

##### III.1.a. Retrosynthesis of the 2-*O*-alkyl DIA derivatives

Starting from compound **64** the synthetic strategy to get 2-*O*-alkyl-iminoarabinitols was based on the use of the following retrosynthetic analysis:

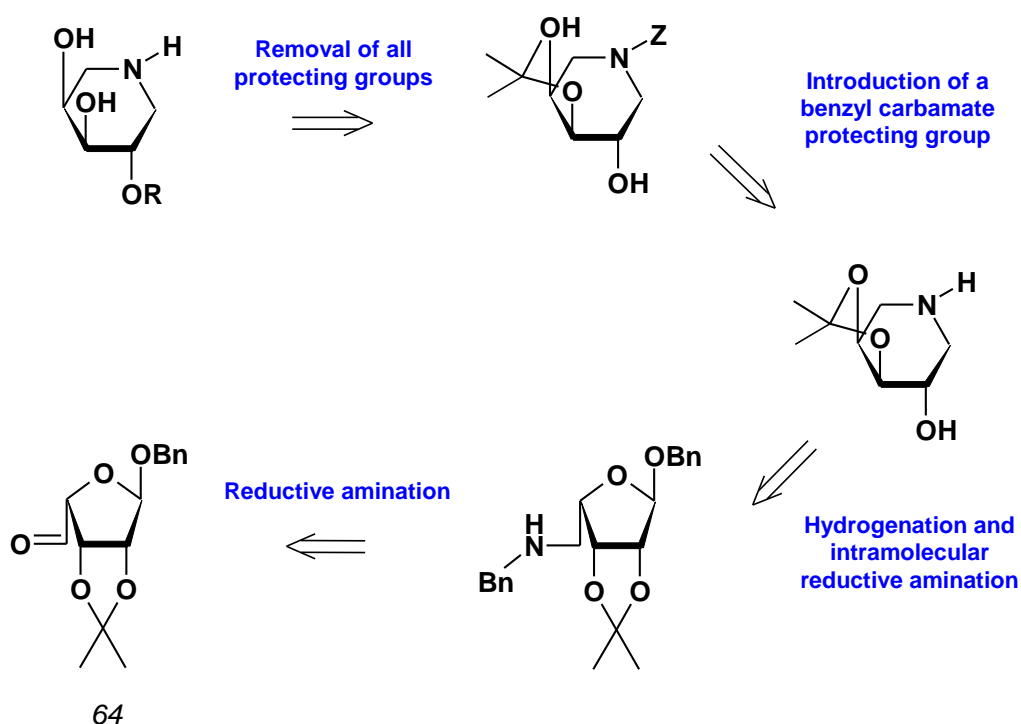

Figure 74

Starting from L-lyxo aldehyde **64**, the strategy has the advantage of leading to an iminoarabinitol derivative having a free 2-OH group.

##### III.1.b. Retrosynthesis of the 4-*O*-alkyl DIA derivatives

Having compound **56** from the synthesis of 4-*O*-alkylated iminoxylitols, the synthetic strategy to get 4-*O*-alkyl-iminoarabinitols was simply by way of the epimerization of the equatorial hydroxyl group at C-4. This approach was to be achieved by an oxidation-reduction sequence.



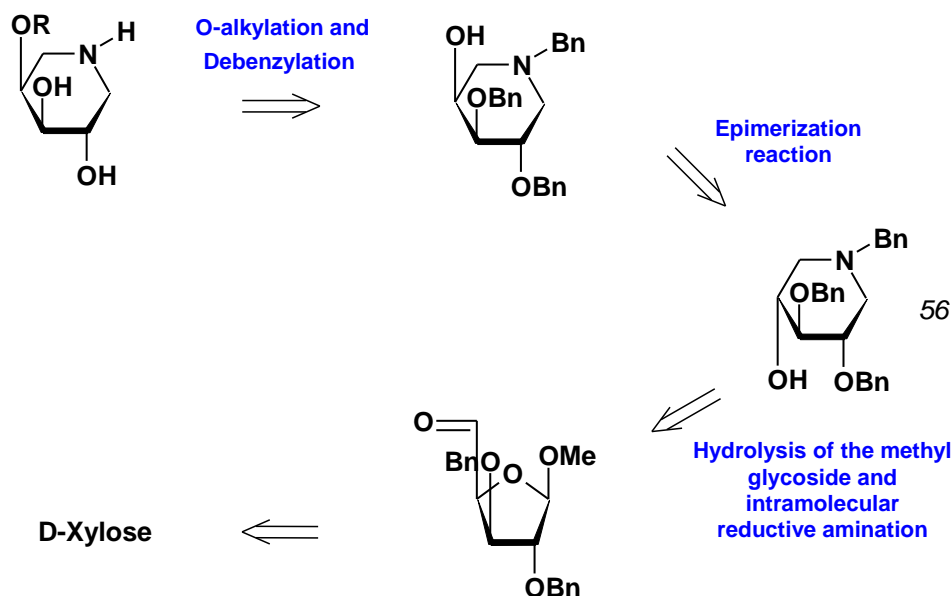

Figure 75

## III.2. Synthesis of the 2-*O*-hexyl DIA analogs

### III.2.a. Preparation of the iminoarabinitols carrying free hydroxyl group on C-2

The reductive amination<sup>183</sup> of **64** using benzylamine was carried out with sodium cyanoborohydride as reductant in MeOH. This reaction gave compound **86** in satisfactory yield. Hydrogenolysis of the *O*- and *N*-benzyl groups in the presence of acetic acid was followed by an intramolecular reductive amination to afford compound **87** quantitatively. Again because of the fused dioxolane ring the formation of the iminoarabinitol required an extended length of time.

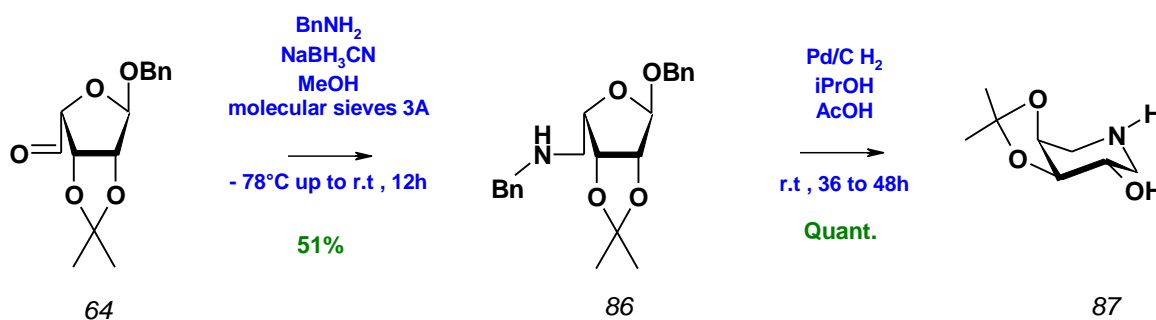

Figure 76

### III.2.b. Protection of the nitrogen and *O*-alkylation

*N*-protection of compound **87** was performed using an excess of benzylchloroformate in methanol in the presence of the Hünig's base to give **88**. In fact, the excess of benzyl

chloroformate reacts with methanol which avoids reaction with the free hydroxyl group. However, the spectrum of **88** was unclear because of the benzyl carbamate function which exists as two slowly exchanging rotamers. Then, under classical Williamson conditions, the *O*-alkylation of **88** at *O*-2 was carried out to give **89** in high yield.

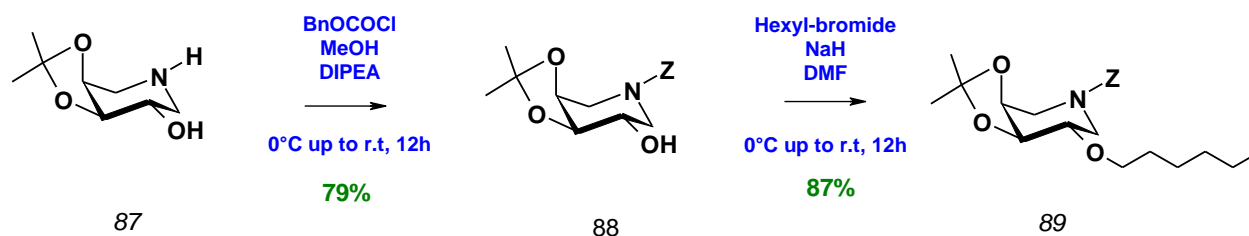

Figure 77

### III.2.c. Removal of protecting groups

At this stage we wanted to take precautions by protecting nitrogen. Therefore we first realized the hydrogenolysis of the benzyl carbamate in isopropanol and then we performed the hydrolysis of the isopropylidene. This was made in order to avoid *N*-alkylation by the solvent.

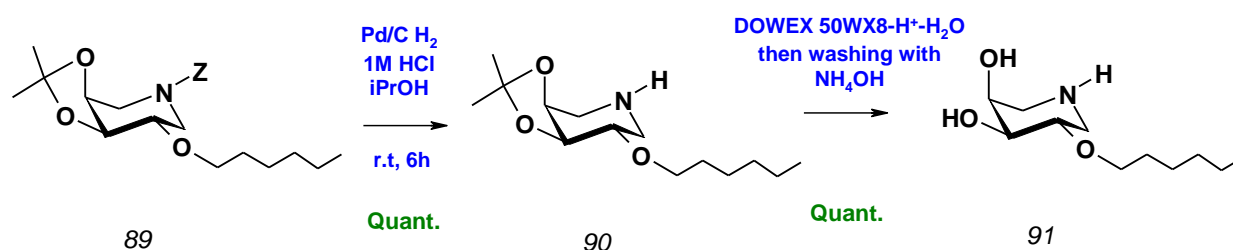

Figure 78

### III.2.d. Conclusion

In conclusion, we developed an efficient access to 2-*O*-alkyl-imino-L-arabinitols by taking advantage of the 1-*C*-alkyl-imino-L-arabinitols pathway. The key compound **64** was useful and easy to handle and allowed us to perform efficient reaction sequences. Evaluation of this iminosugar as chaperone for the treatment of glycosphingolipidoses is currently in progress.

### III.3. Synthesis of the 4-*O*-alkyl DIA derivatives

#### III.3.a. Epimerization at C-4

Compound **56** was in our hands. Epimerization of **56** at C-4 would lead to D-*galacto* like derivatives. According to similar work reported in our group,<sup>245</sup> the epimerization should be feasible by a one pot oxidation-reduction step. Indeed, the oxidation-reduction sequence applied to a 1-deoxynojirimycin derivative (*gluco*) having a free 4-OH group gave stereoselectively the C-4 inverted, *galacto* epimer in good yield.

Consequently, the Swern oxidation<sup>246,247</sup> of **56** was followed by the addition of a sodium borohydride solution in methanol.

The addition of the reducing reagent should be done as fast as possible after the oxidation.<sup>248,249,250,251</sup> Unfortunately, after work up, we recovered our starting material. Since the oxidation worked well, as indicated by TLC analysis, the difficult step is the reduction which appeared to have the undesired stereoselectivity, reducing the keto group in the wrong direction. Therefore, K-Selectride was used as the reducing agent. Indeed, K-selectride can reduce cyclic ketones with a stereoselectivity quite different from that of NaBH<sub>4</sub>, owing to its great steric hindrance. Surprisingly, the reaction produced again the starting material.

The flexibility of our compound, compared to hexose-related iminosugars, can explain this result in part. However, this reaction deserves more investigation. For example, the use of Luche conditions usually used for selective 1,2-reduction of enones could provide the *galacto* derivative.<sup>252</sup>

---

<sup>245</sup> Boucheron, C.; Compain, P.; Martin, O. R. *Tetrahedron Lett.* **2006**, *47*, 3081-3084.

<sup>246</sup> Mancuso, A. J.; Swern, D. *Synthesis* **1981**, 165.

<sup>247</sup> Pourashraf, M.; Delair, P.; Rasmussen, M. O.; Greene, A. E. *J. Org. Chem.* **2000**, *65*, 6966-6972.

<sup>248</sup> Pandey, G.; Kapur, M. *Org. Lett.* **2002**, *4*, 3883-3886.

<sup>249</sup> Jourdan, A.; Zhu, J. *Tetrahedron Lett.* **2000**, *41*, 7033-7036.

<sup>250</sup> Badorrey, R.; Cativiela, C.; Díaz-de-Villegas, M. D.; Gálvez, J. A. *Tetrahedron* **2002**, *58*, 341-354.

<sup>251</sup> Shirude, P. S.; Kumar, V. A.; Ganesh, K. N. *Tetrahedron* **2004**, *60*, 9485-9491.

<sup>252</sup> Bae, J. W.; Lee, S. H.; Jung, Y. J.; Maing Yoon, C.; Yoon, C. M. *Tetrahedron Lett.* **2001**, *42*, 2137-2139.

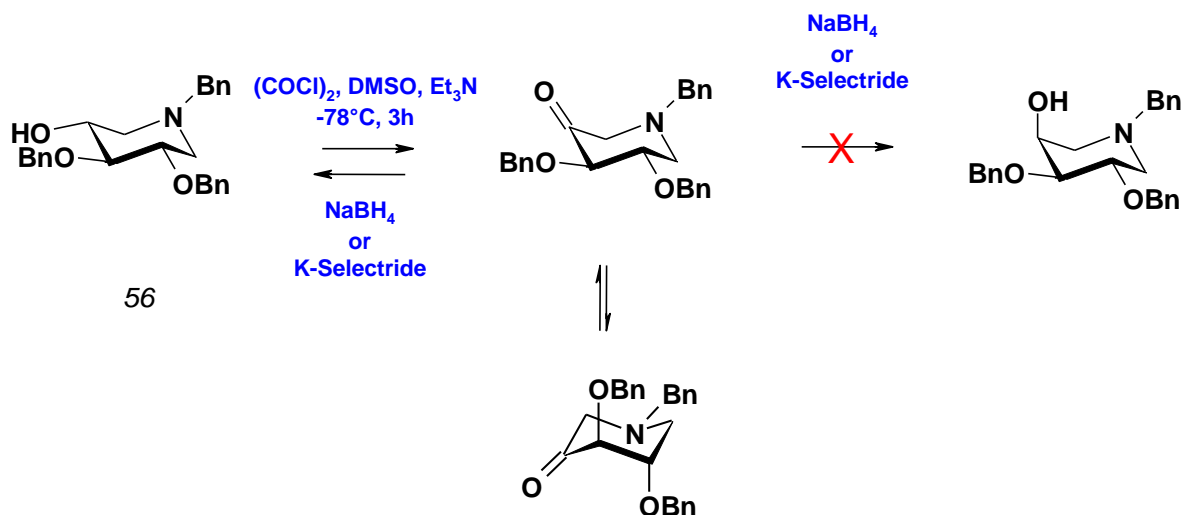

Figure 79

### III.3.b. *O*-alkylation and hydrogenolysis

The end of this reaction sequence would have probably been realized without any difficulty. In fact, the *O*-alkylation under Williamson conditions followed by the hydrogenolysis of benzyl ethers would afford the 4-*O*-alkyl-iminoarabinitol derivatives.

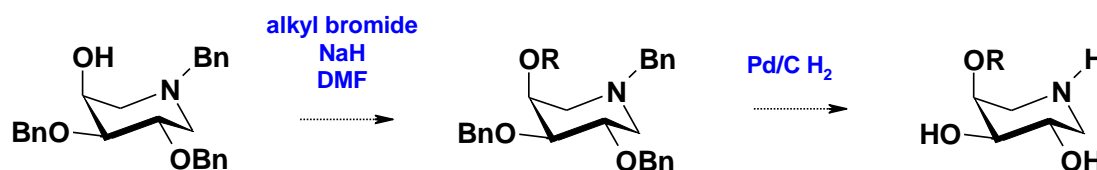

Figure 80

### III.3.c. Conclusion

In conclusion, the synthetic pathway did not provide access to 4-*O*-alkyl-iminoarabinitols derivatives. Epimerization at C-4 of **56** deserved more investigations since only a few assays were realized.

## Résumé Chapitre 4 :

Synthèse d'iminoarabinitols, inhibiteurs et chaperons pharmacologiques potentiels de la  $\beta$ -galactocérébroside, l'enzyme impliquée dans la maladie de Krabbé.

Ce chapitre a été dédié à la recherche d'inhibiteurs agissant comme chaperon pharmacologique potentiel de la GALC.

Nous avons réalisé dans les chapitres précédents la synthèse d'iminosucres portant une chaîne alkyle en C-1 ou O-2. Ceux-ci se sont révélés être de très bons inhibiteurs de la GCase et ont montré qu'à faible concentration ils agissaient comme chaperons pharmacologiques. Par analogie, nous avons réalisé la synthèse d'iminoarabinitols portant une chaîne alkyle en C-1 ainsi qu'en O-2. Les points forts des stratégies précédentes ont été exploitées afin d'obtenir les iminosucres souhaités (Figure c).

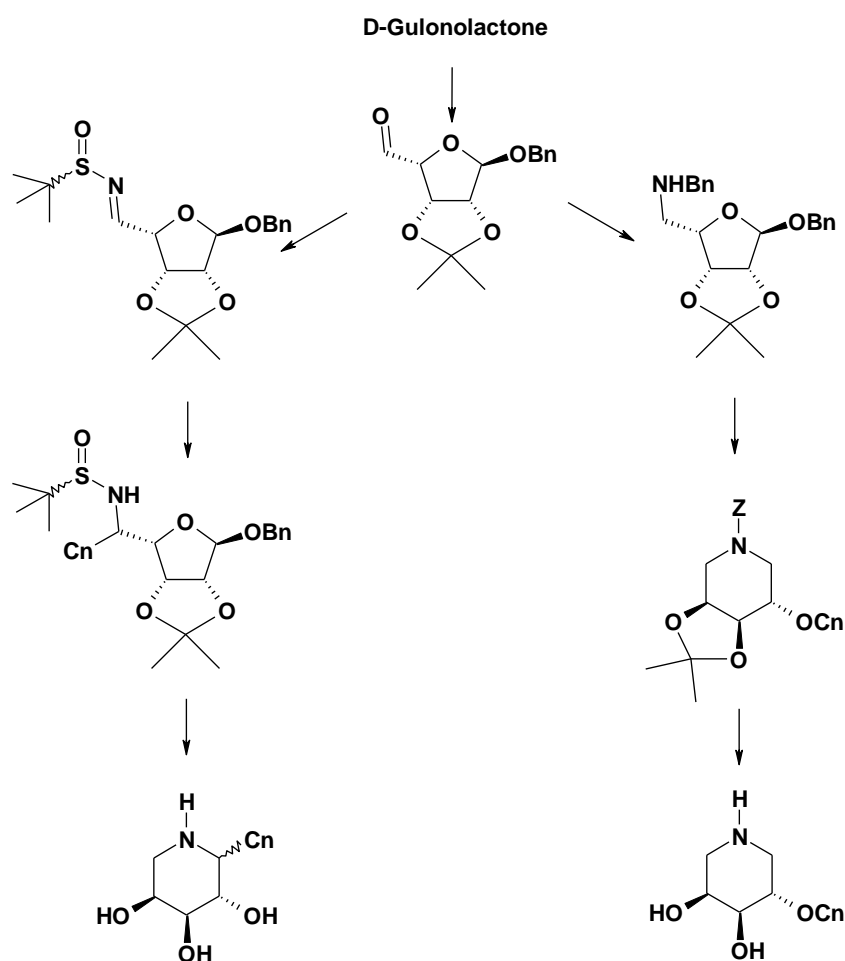

Figure c

## Chapter 5

### Inhibitory and chaperone activity of new iminoglycolipids

---

This chapter describes the results of the biological assays realized on our compounds by Dr Naoki Asano and his team in Kanazawa (Hokuriku University, Japan). It gives a summary of inhibitory activity which allowed us to draw important conclusions on structure-activity relationship.

#### I. Iminoxytilitol series

##### I.1. Inhibitory activity

###### I.1.a. Effect of the alkyl chain length

As described in Chapter 2, we have prepared in this work  $\alpha$ -1-C-propyl and  $\alpha$ -1-C-hexyl-iminoxytilitols **37** and **22**. The activity of these compounds and of the C<sub>9</sub> and C<sub>12</sub> derivatives previously as GCCase inhibitors is reported graphically in figure 81, as a function of alkyl length GCCase inhibitor.

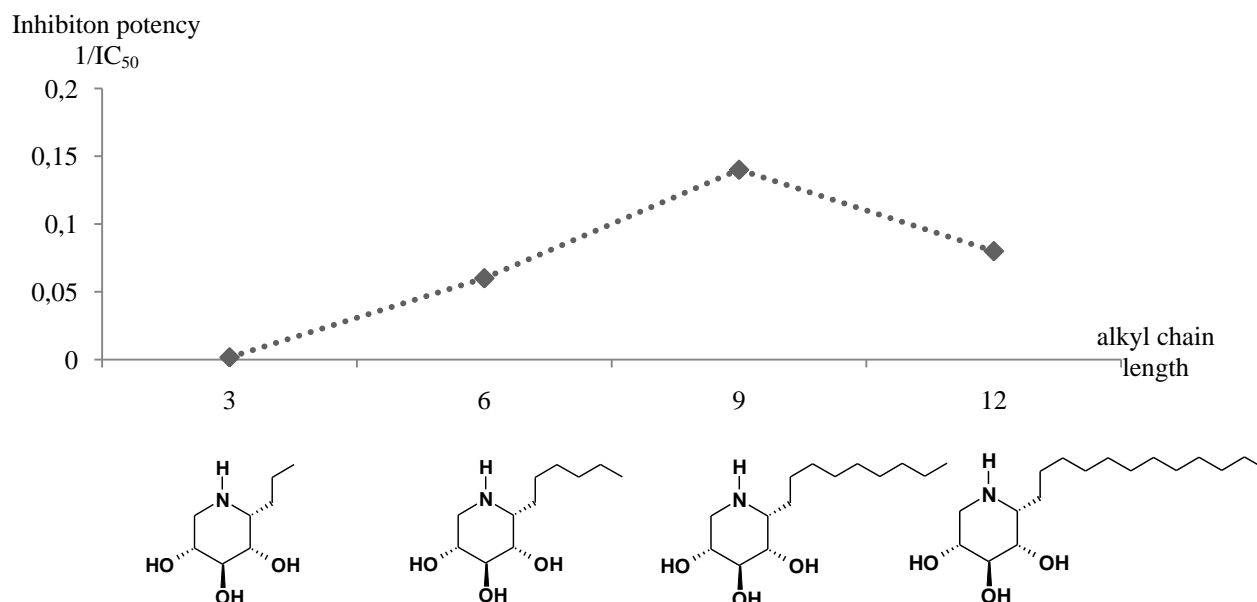

Figure 81

This study shows clearly that there is an optimal chain length, which is near 9C, although we do not have data on C<sub>10</sub> and C<sub>11</sub> compounds. From previous studies in other series, we had already established that a C<sub>9</sub> chain is more effective than a C<sub>8</sub> chain. However, as we indicated previously, the  $\alpha$ -1-C-hexyl DIX derivative seems to be the best compromise between inhibitory activity and toxicity since long alkyl chains induce cytotoxicity.

### I.1.b. Effect of the conformation and configuration

To begin, comparison between  $\alpha$ -1-C-alkyl and  $\beta$ -1-C-alkyl DIX derivatives shows clearly those “ $\alpha$ -anomers” are significantly more active than  $\beta$ -anomers: data for  $\beta$ -1-C-butyl DIX<sup>222b</sup> shows an IC<sub>50</sub> equal to 5.8  $\mu$ M while data for  $\alpha$ -1-C-butyl DIX have an IC<sub>50</sub> in nM range.<sup>253</sup>

The potent inhibitory effect of  $\alpha$ -1-C-alkyl DIX derivatives was first thought to be related to their <sup>1</sup>C<sub>4</sub> conformation. In order to verify this hypothesis, the synthesis of compounds carrying a hexyl chain at C-1 in “ $\beta$ -L-ido” and “ $\alpha$ -D-gluco” series was performed in our group,<sup>126</sup> in order to compare structures which adopt more rigid (although not locked) <sup>1</sup>C<sub>4</sub> and <sup>4</sup>C<sub>1</sub> conformation.

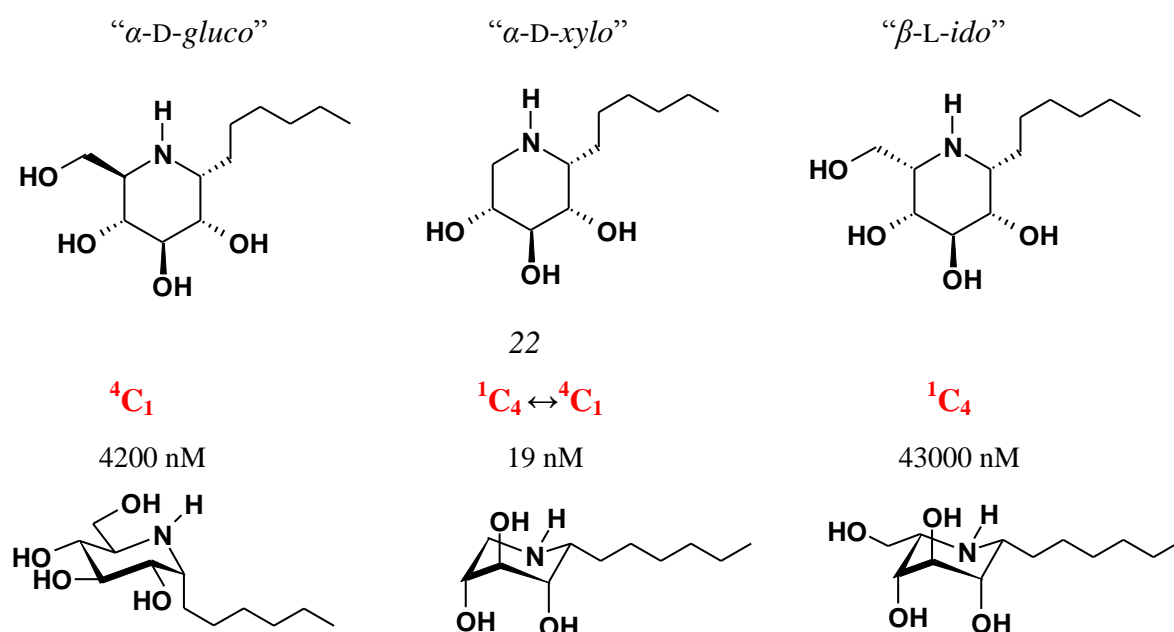

Figure 82

Surprisingly, the *L-ido* epimer, which was expected to have significant activity towards GCase because of its close relation to **22**, was found to be by far not as good an inhibitor as

<sup>253</sup> IC<sub>50</sub>  $\alpha$ -1-C-propyl DIX = 560 nM ; IC<sub>50</sub>  $\alpha$ -1-C-hexyl DIX = 19 nM. Estimated IC<sub>50</sub> value for  $\alpha$ -1-C-butyl DIX is therefore in nM range (560 nM > IC<sub>50</sub> of  $\alpha$ -1-C-butyl DIX > 19 nM).

the iminoxylitol. Moreover, it appeared to be an even weaker inhibitor than the parent *D-gluco* isomer.

This clearly indicated that, the hydroxymethyl group is detrimental to the affinity of these iminosugar derivatives for GCCase. This is in a sense quite remarkable since the natural substrate carries a hydroxymethyl group at C-5. We believe that the selectivity of the 1-*C*-alkyl DIX derivatives for GCCase is mainly due to the lack of this hydroxymethyl group. Indeed, this group is essential to observe strong inhibition of  $\alpha$ -glucosidases by piperidine-iminosugar derivatives (1-deoxynojirimycin and related compounds), as shown by many examples such as miglitol (N-hydroxyethyl DNJ).

The flexibility of  $\alpha$ -1-*C*-alkyl DIX compounds which allow them to adopt more easily the  ${}^1C_4$  conformation is probably an important point for their affinity and selectivity for the GCCase. Notably, as reported by Bols' group,<sup>254</sup> axial hydroxyl groups in the  ${}^1C_4$  conformation might increase the basicity of the amine function of our compound.

### I.1.c. Effect of the position of the alkyl chain

As describes in chapter 3, the position of the alkyl chain is also an important factor which has directed our work. In fact, as shown below, the 2-*O*-hexyl-imino-D-xylitol **53** appears to be the most promising candidate for a pharmacological application: potent and selective GCCase inhibition, and simplified, efficient and reproducible synthetic pathway.

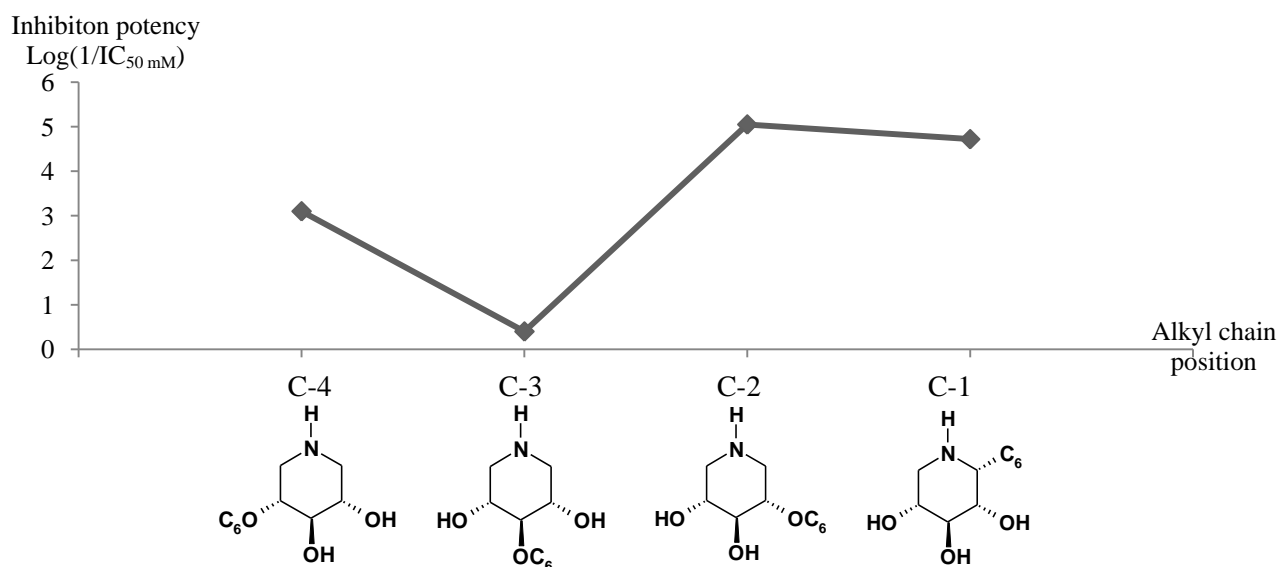

Figure 83

<sup>254</sup> Jensen, H. H.; Lyngbye, L.; Bols, M. *Angew. Chem. Int. Ed. Engl.* **2001**, *40*, 3447-3449.



For these reasons, we selected to have the chaperone activity determined in human N370S fibroblasts of the 2-*O*-hexyl iminoxylitol **53**, by Dr Asano and his team.

## I.2. Chaperone activity

The second part of the biological assays was to investigate the influence of the 2-*O*-hexyl DIX **53** on GCCase activities in human N370S fibroblasts. This constitutes a good *in vitro* model for type 1 of Gaucher disease. Compound **53** was found to increase significantly the GCCase activity in a dose-dependent manner.

Treatment of cells with compound **53** led to an increase of the N370S GCCase activity up to a maximum of 160% (enhancement  $\times 1.6$ ), at the very low concentration of 10 nM: at higher concentration, its chaperoning activity decreased (Figure 82), and inhibition becomes predominant.

For comparison, our first lead compound  $\alpha$ -1-*C*-nonyl DIX increased N370S GCCase activity by a factor of 1.8 at the same concentration.

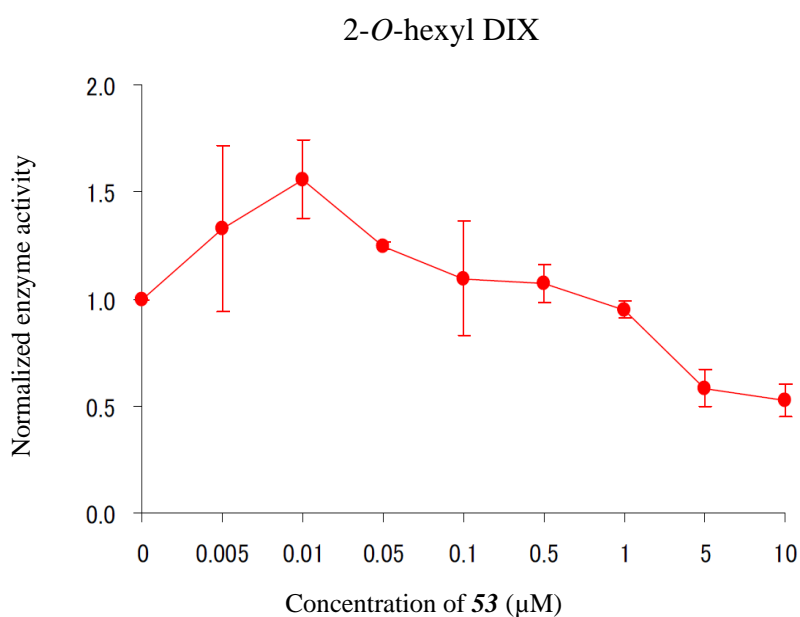

**Figure 84**

In conclusion, we found that 2-*O*-alkyl-imino-D-xylitol derivatives form a new class of promising leads for the treatment of Gaucher disease by means of pharmacological chaperone therapy.

These compounds have desirable properties for future pharmacological development: very high selectivity for lysosomal  $\beta$ -glucosidase, chaperone effect at very low concentration, simplified chemical synthesis.

It should be noted that, as indicated in the introduction, enhancement of N370S GCase has never exceeded  $\sim 2$ , with one questionable exception (see chapter 1; section III.3 table.2 and 3). In spite of this apparently minimal activation effect, bringing the activity of mutant GCase above a certain threshold may be sufficient to consider the chaperones as potential therapeutic agents.

One such compound (IFG = Plicera,<sup>®</sup> see chapter 1; section III.3, figure 10, compound **17**) is under development at Amicus Therapeutics. Plicera<sup>®</sup> enhances the activity of N370S GCase by a factor of  $\sim 2.2$ - to 2.4-fold at 30 or 100  $\mu\text{M}$ <sup>255</sup> respectively.

However, preliminary result with Plicera<sup>®</sup> indicated that this drug is not expected to advance into clinical phase III at this time. In fact, phase II clinical trials indicated that treatment of Gaucher patients with Plicera<sup>®</sup> was well tolerated but only one patient presented real clinical improvements.<sup>256</sup> Why? Are these results due to the weak enhancement of residual activity of GCase by contrast to Amigal<sup>®</sup> for the treatment of Fabry disease which enhance the residual activity of the enzyme by at least 5-fold?

The weak efficacy of Plicera<sup>®</sup> may be attributed to several reasons including low selectivity for GCase and the requirement for relatively high concentration. Therefore, our lead compounds **22** and **53** deserve more extensive investigations. These new compounds are being assessed for *in vitro* and *in vivo* toxicity and tolerability in mice and on a mouse model of Gaucher disease. These tests are being performed by Dr. Ryffel's team in Molecular Immunology and Embryology laboratory in Orléans (IEM, UMR 6218).

## II. Inhibitory activity of iminoarabinitol derivatives

Alkylated iminoarabinitols designed as potential inhibitors of GALC were prepared. With the exception of  $\alpha$ -lobelline (chapter 4; section I, figure 60) which shows a slight chaperone effect

---

<sup>255</sup> Steet, R. A.; Chung, S.; Wustman, B.; Powe, A.; Do, H.; Kornfeld, S. A. *Proc. Natl. Acad. Sci. U.S.A* **2006**, *103*, 13813-13818.

<sup>256</sup> Horne, G.; Wilson, F. X.; Tinsley, J.; Williams, D. H.; Storer, R. *Drug Discov. Today* **2010**.

on D528N GALC, there is no example of compounds which enhance residual activity of GALC.

Before, testing our compounds on GALC mutant variants, it was important to determine their activity on other lysosomal galactosidases, as they may be inhibitors of these enzymes.  $\alpha$ -Galactosidase A and  $\beta$ -galactosidase, which are involved in Fabry and G<sub>M1</sub> Gangliosidosis respectively, belongs to these lysosomal galactosidases. Therefore, inhibitory activity of arabinitol derivatives was tested towards these  $\alpha$ - and  $\beta$ -galactosidase (Table 14) by Dr. N. Asano.

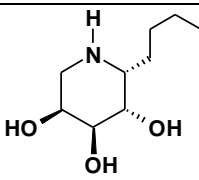
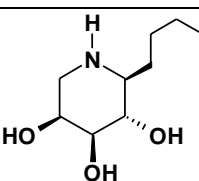
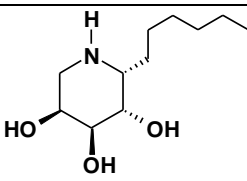
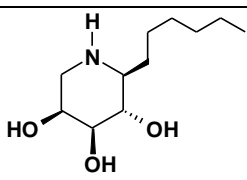
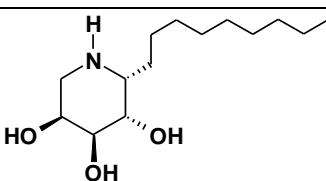
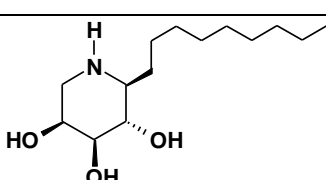
Compound	Structure	$\alpha$ -Gal A	$\beta$ -Gal
76		NI	NI
79		NI	NI
77		NI	NI
80		NI	NI
78		NI	NI
81		NI	NI

**Table 14:** (NI: less than 50% inhibition at 1000 $\mu$ M.)

Surprisingly, it was found that these compounds have no inhibition effect on these enzymes. The iminoarabinitol derivatives synthesized may be highly selective for GALC like the parent iminoxylitol, but this remains to be established.

At this stage, we wanted to go further by testing our compounds on GALC and determine their inhibitory activity.

Orlacchio's group (University of Perugia, Italy) reported an isolation and purification procedure<sup>257</sup> for GALC. We contacted them for testing our compounds. I spent three weeks in the Department of biology in Perugia University in June 2010. This offered me the opportunity to work with them and start to establish a procedure for testing iminoarabinitol derivatives. Indeed, Orlacchio's group is specialized in separating lysosomal enzymes and to determine their activities, in particular in cell cultures from Krabbe's patients. It was a great opportunity for us to work with them.

During this internship, we performed the separation of GALC extracted from human and animal cells (Figure 85).

#### Figure 85

---

<sup>257</sup> Martino, S.; Tiribuzi, R.; Tortori, A.; Conti, D.; Visigalli, I.; Lattanzi, A.; Biffi, A.; Gritti, A.; Orlacchio, A. *Clin. Chem.* **2009**, *55*, 541-8.

As shown above, we clearly isolated the GALC by gel filtration according to the new Orlacchio's procedure. The second part of this work would consist in the measure of the inhibitory activity of our compounds, but because of time constraints, we were not yet able to determine if our compound are, or not inhibitors of GALC. This work is still in progress.

## Résumé Chapitre 5 :

### Résultats des tests d'inhibition et effets chaperon.

---

Ce chapitre répertorie les résultats des tests d'inhibitions réalisés sur les composés synthétisés ainsi que les résultats des évaluations des effets chaperons.

Ces résultats nous ont conduits à déduire des conclusions importantes sur les relations reliant les structures des iminoxylitols et leur activités.

Une étude sur l'effet de la longueur de la chaîne alkyle ainsi que sur l'effet de la conformation des composés sur l'inhibition a été réalisé.

L'effet chaperon ayant d'ores et déjà été démontré sur les  $\alpha$ -1- $C_n$  DIX, nous voulions découvrir si le 2-*O*-hexyl iminoxylitol **53** pouvait lui aussi agir comme chaperon pharmacologique sur la GCCase.

Les résultats ci-contre correspondent à nos attentes puisque **53** multiplie l'activité résiduel de la N370S GCCase par un facteur de 1.6.

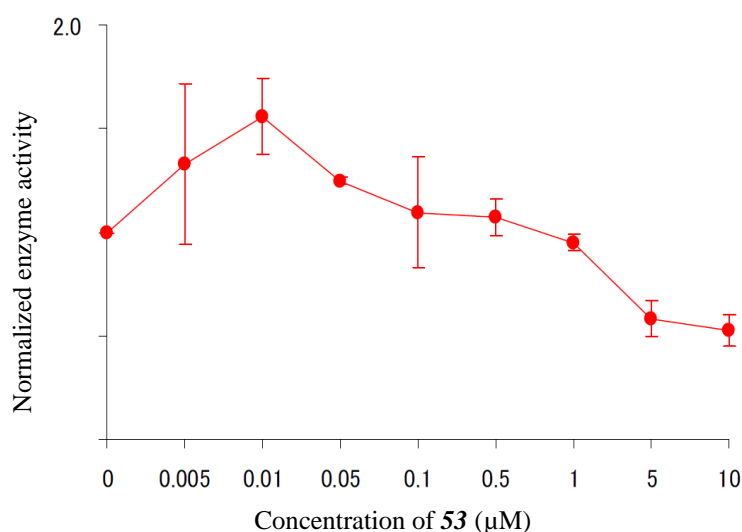

Figure d

Les iminoarabinitols synthétisés ne sont pas des inhibiteurs de  $\alpha$ -Galactosidase A and  $\beta$ -galactosidase; les tests sur la GALC sont en cours.

## Conclusion

---

The aim of this PhD project was the synthesis of new iminosugars which could act as pharmacological chaperones for a Chaperone Mediated Therapy application.

In 2006, our team identified a new family of iminosugar derivatives,  $\alpha$ -1-*C*-alkyl-iminoxylitols that are potent and highly selective inhibitors of human GCCase, the enzyme involved in Gaucher disease. These compounds appeared to be excellent candidates for treating Gaucher disease, at extremely low concentration (10 nM) using Chaperone Mediated Therapy with a 2-fold increase in the residual activity of GCCase carrying N370S mutation, the most prevalent one in Gaucher disease.

Based on this promising lead our aim was to get closer to a pharmaceutical application. To reach this objective we solved problems associated with these compounds. After strong investigations and assays we passed through difficulties and found an efficient, reproducible and easy to handle synthetic pathway.

Following this improved synthetic route,  $\alpha$ -1-*C*-alkyl-iminoxylitol derivatives carrying shorter alkyl chain were prepared. In fact, long alkyl chains are potentially a source of cytotoxicity and a shorter alkyl chain such as hexyl addresses this obstacle. In addition,  $\alpha$ -1-*C*-hexyl-iminoxylitol was found to be a strong inhibitor of GCCase with a 19 nM IC<sub>50</sub>.

Moreover, new prepared iminosugar derivatives are all highly selective and strong inhibitors of GCCase. According to these results we can add that these compounds carrying shorter alkyl chains are competitive inhibitors and act as pharmacological chaperones at extremely low concentration.

Then, we explored the influence of the alkyl chain position by synthesizing compounds carrying short alkyl chain at various positions (O-2, O-3 or O-4). During these investigations it was found that 2-*O*-alkyl iminoxylitol derivatives are potent, selective and synthetically simplified inhibitors of GCCase. With these analogs we found a second generation of iminoxylitols as strong as  $\alpha$ -1-*C*-alkyl-iminoxylitols and with the ability to act as pharmacological chaperones at extremely low concentration (10 nM).

To finish, we extended our expertise in iminosugars as pharmacological chaperones for others glycosidases and we targeted galactocerebrosidase which is responsible for Krabbe disease. To reach this objective we prepared iminosugar derivatives which mimic the “*galacto*” configuration and with the same characteristics which make iminoxylitols so efficient:

- The absence of a hydroxymethyl group at C-5 which might enhance its selectivity
- A shorter alkyl chain on C-1 and O-2

Biological assays performed on prepared iminoarabinitol derivatives appeared to have no inhibitory activity towards  $\alpha$ -galactosidase A and  $\beta$ -galactosidase, enzymes involved in Fabry disease and G<sub>MI</sub>-Gangliosidosis respectively.

Nevertheless, these results are encouraging since our aim is to prepare highly selective inhibitors of GALC. Our collaboration with Prof Aldo Orlacchio (University of Perugia, Italy) will lead to the evaluation of inhibitory activities and chaperone effects of these compounds.

In fact, during my stay at Orlacchio’s laboratory, I had not the time to determine the inhibitory activities of our iminoarabinitols, as GALC which is a very unstable enzyme, requires special precautions and must be assayed directly after its isolation.

When these results are available, the action of the best inhibitors will be determined on cultured cells from Krabbe patients, in order to identify a possible enhancement of the GALC activity level. It will be also important to examine the activity of our compounds on mutant forms of GALC expressed as described by Eckman.<sup>181</sup> This would provide a strong biochemical basis of the effectiveness of our compounds as GALC chaperones.

In longer term objectives, the principle of “dehydroxymethylating” the substrate in order to achieve selectivity might be applied to other families of lysosomal glycosidases, notably hexosaminidases A and B. Indeed, finding selective lysosomal hexosaminidase inhibitors is a real challenge: such inhibition should not have an action on so-called intracellular O-GlcNAc-ase, an enzyme involved in mediating signaling events.

Thus D-xylo or L-*arabino*-iminopentitols carrying a NHAc group may be the next targets of these studies:



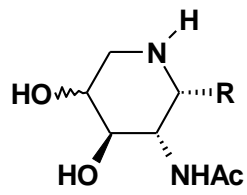

This could provide an approach to pharmacological chaperones for mutant hexosaminidases A and B (Sandhoff and Tay-Sachs diseases).

## **Experimental section**

### 5-*O*-Trityl-L-xylofuranose

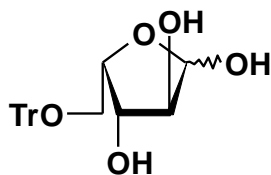

392.46

C<sub>24</sub>H<sub>24</sub>O<sub>5</sub>**11**

To L-xylose (1 g, 6.7 mmol) dissolved in pyridine (135 mL) was added triphenylmethyl chloride (1.80 g, 6.7 mmol, 1 eq). The mixture was stirred for 18h at room temperature. The resulting solution was evaporated to dryness and pyridine removed from the residue by co evaporation with toluene. After purification by column chromatography (eluent: CH<sub>2</sub>Cl<sub>2</sub>-MeOH, 95:5, v/v) compound **11** was obtained. Analytical data are in accordance with the literature data.<sup>191</sup>

### Benzyl L-xylofuranosides

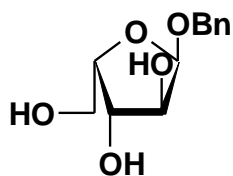

240.26

C<sub>12</sub>H<sub>16</sub>O<sub>5</sub>**12**

*p*-Toluenesulfonic acid (51.5 mg, 0.29 mmol) was added to a stirred solution of L-xylose (303.8 mg, 2.02 mmol) in benzyl alcohol (1 mL, 29 mmol) and 1,4-dioxane (2.5 mL) the reaction mixture was heated to 90 °C for 12 h. The solution was neutralized with Amberlit IRA-400-OH<sup>-</sup> ion exchange resin, filtered and concentrated under high vacuum. The residue was purified by column chromatography (eluent: CH<sub>2</sub>Cl<sub>2</sub>-MeOH, 95:5, v/v) to yield the benzyl derivative (209 mg, 43%) as a mixture of isomers: white crystalline solid (3:1, benzyl xylofuranoside: benzyl xylopyranoside).

$\delta_{\text{H}}$  (400 MHz; CDCl<sub>3</sub>) 3.10 (1H, dd, *J* 8.0 and 12.0, H-5a), 3.16 (1H, dd, *J* 8.0 and 12.0, H-2), 3.20-3.22 (1H, m, H-3), 3.29 (1H, dd, *J* 4.0 and 12.0, H-2), 3.35-3.48 (4H, m, 2H-4 and H-5ab), 3.50-3.55 (1H, t, *J* 12.0, H-3), 3.79 (1H, dd, *J* 4.0 and 12.0, H-5b), 4.20 (1H, d, *J* 8.0, H-1), 4.42 (1H, d<sub>AB</sub>, *J* 12.0, OCH<sub>2</sub>Ph), 4.52 (1H, d<sub>AB</sub>, *J* 12.0, OCH<sub>2</sub>Ph), 4.63 (1H, d<sub>AB</sub>, *J* 12.0, OCH<sub>2</sub>Ph), 4.73 (1H, d, *J* 4.0, H-1), 4.75 (1H, d<sub>AB</sub>, *J* 12.0, OCH<sub>2</sub>Ph), 7.17-7.32 (10H, m, Haro).

$\delta_{\text{C}}$  (101 MHz; CDCl<sub>3</sub>) 61.78 (C-5), 65.56 (C-5), 68.85 (OCH<sub>2</sub>Ph), 70.14 (C-4), 70.17 (C-4), 70.42 (OCH<sub>2</sub>Ph), 72.21 (C-2), 73.53 (C-2), 73.76 (C-3), 76.42 (C-3), 98.10 (C-1), 102.72 (C-1), 127.30-127.92 (CH<sub>Ar</sub>), 137.59 (Cq<sub>Ar</sub>).

**(+) MS (ESI):**  $m/z = 263.0$   $[M+Na]^+$

**HRMS (ESI)**  $C_{12}H_{16}NO_5Na$ : calcd:  $m/z=263.0895$ , found:  $m/z = 263.0882$ .

**IR (cm<sup>-1</sup>):** 3476, 2916, 1453, 1137, 1032.

**TLC:** (CH<sub>2</sub>Cl<sub>2</sub>/MeOH ; 95/5) R<sub>f</sub> = 0.10.

**MP:** 96 °C

### Methyl 5-*O*-trityl-L-xylofuranosides

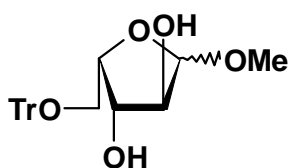

406.48

 $C_{25}H_{26}O_5$ **14**

L-xylose (1.60 g, 10.68 mmol) was stirred refluxing MeOH/HCl (33 mmol/L; 80 mL) solution for 1 hour to afford quantitatively, as described,<sup>197</sup> the corresponding methyl xylofuranoside **13** as colorless oil. Tritylation of the crude material with TrCl (3.44 g, 12.33 mmol, 1.3 eq) in anhydrous pyridine (40 mL) for 12 hours at reflux yielded the protected sugar **14** (2.97 g, 77%) as a white foam after purification by flash chromatography on silica gel (eluent: EtOAc/petroleum ether, 1:1, v/v).

#### Data for $\alpha$ -anomer:

$\delta_H$  (400 MHz;  $CDCl_3$ ) 2.64-2.66 (1H, d,  $J$  6.5, OH-2), 2.88-2.91 (1H, d,  $J$  10.2, OH-3), 3.37 (3H, s,  $OCH_3$ ), 3.34-3.37 (1H, dd,  $J$  6.3 and 10.1, H-5), 3.42-3.45 (1H, dd,  $J$  4.4 and 10.1, H-5), 4.02-4.05 (1H, dd,  $J$  4.5 and 10.1, H-2), 4.21-4.25 (1H, m, H-3), 4.48-4.52 (1H, m, H-4), 5.07-5.08 (1H, d,  $J$  4.1, H-1), 7.21-7.49 (15H, m, Haro).

$\delta_C$  (101 MHz;  $CDCl_3$ ) 55.90 ( $OCH_3$ ), 63.57 (C-5), 76.77 (C-2), 77.81 (C-3), 82.04 (C-4), 86.93 (Cq, OTr), 101.97 (C-1), 128.70-127.03 ( $CH_{Ar}$ ), 143.78 (Cq $_{Ar}$ ).

#### Data for $\beta$ -anomer:

$\delta_H$  (400 MHz;  $CDCl_3$ ) 1.93-1.95 (1H, d,  $J$  4.4, OH-2), 2.08-2.79 (1H, d,  $J$  6.4, OH-3), 3.51 (3H, s,  $OCH_3$ ), 3.24-3.28 (1H, dd,  $J$  3.4 and 10.2, H-5), 3.47-3.51 (1H, dd,  $J$  5.0 and 10.3, H-5), 4.18-4.19 (1H, d,  $J$  3.4, H-2), 4.21-4.25 (1H, m, H-3), 4.28-4.31 (1H, m, H-4), 4.89 (1H, s, H-1), 7.21-7.49 (15H, m, Haro).

$\delta_C$  (101 MHz;  $CDCl_3$ ) 55.35 ( $OCH_3$ ), 62.62 (C-5), 77.09 (C-2), 78.48 (C-3), 79.92 (C-4), 87.44 (Cq, OTr), 108.71 (C-1), 127.03- 128.70 ( $CH_{Ar's}$ ), 143.33 (Cq $_{Ar's}$ ).

Data for the mixture:

(+) **MS (ESI):**  $m/z = 429.0 [M+Na]^+$

**IR ( $cm^{-1}$ ):** 3416, 2932, 1447, 1032.

**TLC:** (PE/EtOAc ; 1/1)  $R_f = 0.40$ .

Methyl 2,3-di-*O*-benzyl-5-*O*-trityl-L-xylofuranosides

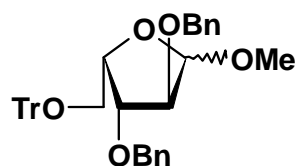

586.73

C<sub>39</sub>H<sub>38</sub>O<sub>5</sub>

**15**

Benylation of this mixture of anomers was achieved with BnBr (3.47 mL, 29.2 mmol) and NaH 60% (1.17g, 29.2 mmol) in DMF (45 mL) for 14 hours at room temperature. The mixture was then cooled at 0°C and MeOH was cautiously added. The solution was diluted with EtOAc. The organic phase was washed 3 times with brine, and then dried over MgSO<sub>4</sub>. The solid was filtered and the filtrate was concentrated under vacuum. The residue was purified by flash chromatography on silica gel (eluent: EtOAc/petroleum ether, 7:3, v/v) to give compound **15** (2.98 g, 69%) as a yellow oil after purification.

Data for α-anomer:

δ<sub>H</sub> (400 MHz; CDCl<sub>3</sub>) 3.24-3.38 (2H, m, H-5), 3.44 (3H, s, OCH<sub>3</sub>), 4.02 (1H, dd, *J* 4.5 and 5.1, H-2), 4.21 (1H, dd, *J* 5.4 and 6.6, H-3), 4.35-4.42 (1H, m, H-4), 4.45 (2H, q, *J* 11.9, OCH<sub>2</sub>Ph), 4.54 (1H, d<sub>AB</sub>, *J* 12.0, OCH<sub>2</sub>Ph), 4.68 (1H, d<sub>AB</sub>, *J* 12.0, OCH<sub>2</sub>Ph), 4.85 (1H, d, *J* 4.2, H-1), 7.46-7.02 (25H, m, Haro).

δ<sub>C</sub> (101 MHz; CDCl<sub>3</sub>) 55.40 (OCH<sub>3</sub>), 63.07 (C-5), 72.48 (OCH<sub>2</sub>Ph), 72.71 (OCH<sub>2</sub>Ph), 76.48 (C-4), 81.77 (C-3), 83.85 (C-2), 86.91 (C<sub>q</sub>, OTr), 100.90 (C-1), 128.84-126.91 (CH<sub>Ar</sub>), 137.87-138.06 (C<sub>qAr</sub>), 144.11 (C<sub>qAr</sub>).

Data for β-anomer:

δ<sub>H</sub> (400 MHz; CDCl<sub>3</sub>): 3.30 (1H, dd, *J* 4.6 and 9.9, H-5), 3.38 (3H, s, OCH<sub>3</sub>), 3.48 (1H, dd, *J* 6.9 and 9.9, H-5), 3.94 (1H, d, *J* 2.1, H-2), 3.96 (1H, td, *J* 2.2 and 5.4, H-3), 4.29-4.32 (1H, d, *J* 12.0, OCH<sub>2</sub>Ph), 4.44 (1H, s, H-4), 4.43 (1H, d<sub>AB</sub>, *J* 9.9, OCH<sub>2</sub>Ph), 4.50-4.53 (1H, d, *J* 12.0, OCH<sub>2</sub>Ph), 4.56 (1H, d<sub>AB</sub>, *J* 10.0, OCH<sub>2</sub>Ph), 4.94 (1H, d, *J* 1.0, H-1), 7.06-7.49 (25H, m, Haro).

δ<sub>C</sub> (101 MHz; CDCl<sub>3</sub>) 55.81 (OCH<sub>3</sub>), 63.52 (C-5), 71.96 (OCH<sub>2</sub>Ph), 71.97 (OCH<sub>2</sub>Ph), 80.84 (C-4), 80.92 (C-3), 86.54 (C-2), 86.79 (C<sub>q</sub>, OTr), 108.30 (C-1), 126.93-128.86 (CH<sub>Ar</sub>'s), 137.66-137.78 (C<sub>qAr</sub>), 144.15 (C<sub>qAr</sub>).

Data for the mixture:

**(+) MS (ESI):**  $m/z = 609.5 [M+Na]^+$

**IR (cm<sup>-1</sup>):** 3450, 2929, 1448, 1053.

**TLC:** (PE/EtOAc ; 1/1)  $R_f = 0.30$ .

### Methyl 2,3-di-*O*-benzyl-L-xylofuranosides

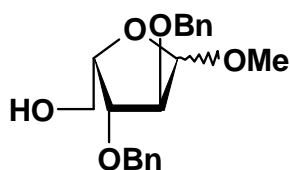

344.41

C<sub>20</sub>H<sub>24</sub>O<sub>5</sub>**16**

To the compound **15** (2.02 g, 3.45 mmol) was added 80% aqueous acetic acid (100 mL) and the mixture was heated at 70°C for 1.5h. Water was added, and the aqueous phase was extracted with Et<sub>2</sub>O. The combined extracts were washed with water, saturated aqueous NaHCO<sub>3</sub>, brine and dried (MgSO<sub>4</sub>). The solvent was removed under high vacuum and then flash chromatography on silica gel (eluent: EtOAc/petroleum ether, 9/1→7:3, v/v) gave compound **16** (959 mg, 81%) as a separable anomeric mixture (α:β, 2:1).

Data for α-anomer: white crystalline solid

δ<sub>H</sub> (400 MHz; CDCl<sub>3</sub>) 3.38 (3H, s, OCH<sub>3</sub>), 3.71 (2H, dd, *J* 3.6 and 12.4, H-5), 4.04 (1H, dd, *J* 4.2 and 6.4, H-2), 4.22 (1H, ddd, *J* 3.9 and 7.7, H-4), 4.44 (1H, dd, *J* 6.6 and 7.6, H-3), 4.55 (1H, d<sub>AB</sub>, *J* 12.0, OCH<sub>2</sub>Ph), 4.56 (1H, d<sub>AB</sub>, *J* 12.0, OCH<sub>2</sub>Ph), 4.68 (1H, d<sub>AB</sub>, *J* 12.0, OCH<sub>2</sub>Ph), 4.76 (1H, d<sub>AB</sub>, *J* 12.0, OCH<sub>2</sub>Ph), 4.80 (1H, d, *J* 4.2, H-1), 7.25-7.35 (10H, m, Haro).

δ<sub>C</sub> (101 MHz; CDCl<sub>3</sub>) 55.01 (OCH<sub>3</sub>), 62.18 (C-5), 72.55 (OCH<sub>2</sub>Ph), 72.67 (OCH<sub>2</sub>Ph), 76.15 (C-4), 82.15 (C-3), 84.46 (C-2), 101.07 (C-1), 127.65-128.46 (CH<sub>Ar</sub>), 137.40-137.48 (Cq<sub>Ar</sub>).

[α]<sub>D</sub><sup>25</sup> = -68 (c=1.9, CHCl<sub>3</sub>)

(+) MS (ESI): *m/z* = 367.0 [M+Na]<sup>+</sup>

IR (cm<sup>-1</sup>): 3412, 2936, 1717, 1268, 1028.

TLC: (PE/EtOAc ; 7/3) R<sub>f</sub> = 0.58.

MP: 52°C

Data for β-anomer: yellow oil

δ<sub>H</sub> (400 MHz; CDCl<sub>3</sub>): 3.41 (3H, s, OCH<sub>3</sub>), 3.78 (2H, m, H-5), 4.09-4.11 (1H, dd, *J* 1.8 and 3.7, H-2), 4.17 (1H, dd, *J* 3.8 and 6.7, H-3), 4.28-4.32 (1H, m, H-4), 4.49 (1H, d<sub>AB</sub>, *J* 12.0, OCH<sub>2</sub>Ph), 4.51 (1H, d<sub>AB</sub>, *J* 11.9, OCH<sub>2</sub>Ph), 4.59 (1H, d<sub>AB</sub>, *J* 11.6, OCH<sub>2</sub>Ph), 4.63 (1H, d, *J* 12.0, OCH<sub>2</sub>Ph), 4.89 (1H, d, *J* 1.8, H-1), 7.25-7.36 (10H, m, Haro).



$\delta_C$  (101 MHz;  $CDCl_3$ ) 55.61 ( $O\text{C}\underline{H}_3$ ), 62.25 (C-5), 72.19 ( $O\text{C}\underline{H}_2\text{Ph}$ ), 72.3 ( $O\text{C}\underline{H}_2\text{Ph}$ ), 80.48 (C-4), 82.84 (C-3), 87.15 (C-2), 107.93 (C-1), 127.75-128.48 ( $CH_{Ar}$ ), 137.47 ( $Cq_{Ar}$ ), 137.48 ( $Cq_{Ar}$ ).

$[\alpha]_D^{25} = +44$  (c=1.1,  $CHCl_3$ )

(+) **MS (ESI)** : m/z = 367.0  $[M+Na]^+$

**IR** ( $cm^{-1}$ ) 3434, 2931, 1720, 1453, 1027.

**TLC** (PE/EtOAc ; 7/3)  $R_f = 0.46$ .

Methyl 2,3-di-*O*-benzyl-L-xylo-pentadialdo-1,4-furanosides

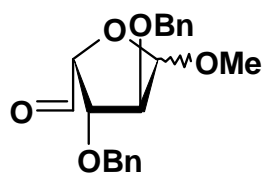

342.39

C<sub>20</sub>H<sub>22</sub>O<sub>5</sub>

**17**

To a solution of methyl 2,3-di-*O*-benzyl- $\alpha/\beta$ -L-xylofuranoside **16** (1.51 g, 4.39 mmol) in anhydrous dichloromethane (60 mL) was added Dess-martin periodinane (2.25 g, 5.27 mmol, 1.2 eq). The mixture was stirred during 1 hour at 0°C and 4 hours at room temperature. Then, the mixture was filtered through a millipore filter and washed 3 times (25 mL) with diethyl ether to give the expected compound **17** (1.49 g, quant.) as a colorless oil.

Data for  $\alpha$ -anomer:

$\delta_{\text{H}}$  (400 MHz; CDCl<sub>3</sub>) 3.41 (3H, s, OCH<sub>3</sub>), 4.06 (1H, dd, *J* 4.29 and 5.16, H-2), 4.59 (1H, d<sub>AB</sub>, *J* 12.2, OCH<sub>2</sub>Ph), 4.65 (1H, d<sub>AB</sub>, *J* 12.2, OCH<sub>2</sub>Ph), 4.53-4.57 (4H, m, H-3, H-4, OCH<sub>2</sub>Ph), 4.94 (1H, d, *J* 4.16, H-1), 7.26-7.34 (10H, m, Haro), 9.58 (1H, d, *J* 2.8, H-5).

$\delta_{\text{C}}$  (101 MHz; CDCl<sub>3</sub>) 55.78 (OCH<sub>3</sub>), 71.76 (OCH<sub>2</sub>Ph), 72.98 (OCH<sub>2</sub>Ph), 80.79 (C-3), 83.12 (C-2), 83.46 (C-4), 101.94 (C-1), 127.93-128.63 (CH<sub>Ar</sub>), 137.27 (C<sub>qAr</sub>), 137.36 (C<sub>qAr</sub>), 199.01 (C-5).

$[\alpha]_{\text{D}}^{25} = -49$  (c=1.2, CHCl<sub>3</sub>)

(+) **MS (ESI):** *m/z* = 365.0 [M+Na]<sup>+</sup>

**IR (cm<sup>-1</sup>)** 3031, 2933, 1702, 1027.

**TLC** (PE/EtOAc ; 7/3) *R<sub>f</sub>* = 0.60.

Data for  $\beta$ -anomer:

$\delta_{\text{H}}$  (400 MHz; CDCl<sub>3</sub>) 3.50 (3H, s, OCH<sub>3</sub>), 4.03 (1H, s, H-2), 4.32 (1H, dd, *J* 1.3 and 6.3, H-3), 4.43 (1H, d<sub>AB</sub>, *J* 12.0, OCH<sub>2</sub>Ph), 4.46 (1H, d<sub>AB</sub>, *J* 7.8, OCH<sub>2</sub>Ph), 4.49 (1H, d<sub>AB</sub>, *J* 7.1, OCH<sub>2</sub>Ph), 4.50 (1H, d<sub>AB</sub>, *J* 12.2, OCH<sub>2</sub>Ph), 4.58 (1H, dd, *J* 2.7 and 6.8, H-4), 5.09 (1H, s, H-1), 7.27-7.35 (10H, m, Haro), 9.58-9.59 (1H, d, *J* 2.0, H-5).

$\delta_{\text{C}}$  (101 MHz; CDCl<sub>3</sub>) 55.36 (OCH<sub>3</sub>), 71.66 (OCH<sub>2</sub>Ph), 72.18 (OCH<sub>2</sub>Ph), 82.88 (C-3), 85.24 (C-2), 85.48 (C-4), 108.70 (C-1), 127.41-128.19 (CH<sub>Ar</sub>), 137.09 (C<sub>qAr</sub>), 137.10 (C<sub>qAr</sub>), 200.44 (C-5).

**$[\alpha]_D^{25} = +38$**  (c=1.2, CHCl<sub>3</sub>)

**(+) MS (ESI):** m/z = 365.0 [M+Na]<sup>+</sup>

**IR (cm<sup>-1</sup>)** 3059, 2953, 1716, 1453, 1044.

**TLC** (PE/EtOAc ; 7/3) = 0.53.

**Methyl 2,3-di-*O*-benzyl-5-*N*-benzylimino-L-xylofuranosides**

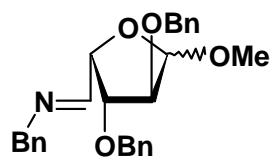

431.54

C<sub>27</sub>H<sub>29</sub>NO<sub>4</sub>

**18**

---

To a solution of **12** in anhydrous CH<sub>2</sub>Cl<sub>2</sub> (5 mL/mmol) were added powdered 4Å molecular sieves (50 mg/mmol) and benzylamine (1 eq) at room temperature. After 4 hours at 4 °C without stirring, the solids were removed by filtration and washed with anhydrous CH<sub>2</sub>Cl<sub>2</sub> (5 mL/mmol). The filtrate was concentrated in vacuo to afford **18** as an orange oil: the crude product was directly engaged for the next step.

## Methyl 2,3-di-*O*-benzyl-5-(*Ss*)-*N*-*tert*-butanesulfinylimino-L-xylofuranosides

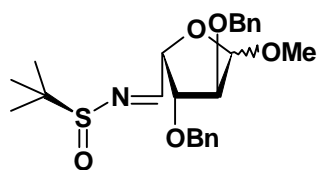

445.58  
C<sub>24</sub>H<sub>31</sub>NO<sub>5</sub>S

**19**

The aldehyde **17** (1.33 g, 3.9 mmol), (*S*)-*tert*-butanesulfinamide (544 mg, 4.5 mmol, 1.1 eq) and anhydrous CuSO<sub>4</sub> (3.1 g, 19.5 mmol, 5 eq) were dissolved in dry CH<sub>2</sub>Cl<sub>2</sub> (45 mL) and stirred at room temperature for 36 hours. The suspension was filtered and the filtrate was evaporated. Flash chromatography on silica gel (eluent: EtOAc/petroleum ether, 3/7, v/v) gave compound **19** as a colorless oil (1.18 g, 68%).

### Data for α-anomer:

δ<sub>H</sub> (400 MHz; CDCl<sub>3</sub>) 1.17 (9H, s, C(CH<sub>3</sub>)<sub>3</sub>), 3.41 (3H, s, OCH<sub>3</sub>), 4.05 (1H, dd, *J* 4.0 and 6.4, H-2), 4.52-4.60 (3H, m, H-3 and OCH<sub>2</sub>Ph), 4.62 (1H, d<sub>AB</sub>, *J* 12.0, OCH<sub>2</sub>Ph), 4.67 (1H, d<sub>AB</sub>, *J* 12.0, OCH<sub>2</sub>Ph), 4.88 (1H, d, *J* 4.4, H-1), 4.97 (1H, dd, *J* 4.8 and 7.2, H-4), 7.24-7.35 (10H, m, Haro), 8.01 (1H, d, *J* 4.8, H-5).

δ<sub>C</sub> (101 MHz; CDCl<sub>3</sub>) 22.49 (C(CH<sub>3</sub>)<sub>3</sub>), 55.62 (OCH<sub>3</sub>), 57.26 (C(CH<sub>3</sub>)<sub>3</sub>), 72.71 (OCH<sub>2</sub>Ph), 72.76 (OCH<sub>2</sub>Ph), 77.81 (C-4), 82.62 (C-3), 82.85 (C-2), 101.22 (C-1), 127.83-128.47 (CH<sub>Ar</sub>), 137.27 (C<sub>qAr</sub>), 137.35 (C<sub>qAr</sub>), 165.98 (C-5).

[α]<sub>D</sub><sup>25</sup> = +42 (c=1.6, CHCl<sub>3</sub>)

(+) **MS (ESI):** m/z = 446.5 [M+H]<sup>+</sup>, 468.5 [M+Na]<sup>+</sup>

**IR (cm<sup>-1</sup>):** 3336, 3243, 2984, 2935, 1728, 1455, 1299, 1112, 1050.

**TLC** (PE/EtOAc ; 7/3) = 0.35.

### Data for β-anomer:

δ<sub>H</sub> (400 MHz; CDCl<sub>3</sub>) 1.19 (9H, s, C(CH<sub>3</sub>)<sub>3</sub>), 3.42 (3H, s, OCH<sub>3</sub>), 3.88-3.91 (1H, m, H-5), 4.04 (1H, s, H-2), 4.11 (1H, t, *J* 5.8, H-4), 4.20-4.23 (1H, m, H-3), 4.51 (4H, m, OCH<sub>2</sub>Ph), 4.84 (1H, d, *J* 1.9, H-1), 7.21-7.32 (10H, m, Haro), 8.01 (1H, d, *J* 4.8, H-5).

δ<sub>C</sub> (101 MHz; CDCl<sub>3</sub>) 22.37 (C(CH<sub>3</sub>)<sub>3</sub>), 55.59 (OCH<sub>3</sub>), 57.25 (C(CH<sub>3</sub>)<sub>3</sub>), 72.69 (OCH<sub>2</sub>Ph), 72.66 (OCH<sub>2</sub>Ph), 77.79 (C-4), 85.55 (C-3), 85.85 (C-2), 108.22 (C-1), 127.80-128.50 (CH<sub>Ar</sub>), 137.19 (C<sub>qAr</sub>), 137.33 (C<sub>qAr</sub>), 166.00 (C-5).

[α]<sub>D</sub><sup>25</sup> = -38 (c=1.1, CHCl<sub>3</sub>)

**(+) MS (ESI):**  $m/z = 468.5 [M+Na]^+$

**IR (cm<sup>-1</sup>):** 3336, 3239, 2971, 2929, 1725, 1454, 1299, 1111, 1049.

**TLC (PE/EtOAc ; 7/3) = 0.35.**

Methyl 2,3-di-*O*-benzyl-5(*R*)-5-hexyl-5-*N*-benzylamino-*L*-xylofuranosides

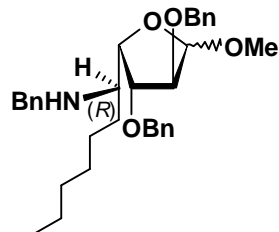

517.71  
C<sub>33</sub>H<sub>43</sub>NO<sub>4</sub>  
**20**

The imine **18** (89 mg, 0.21 mmol) was dissolved in dry Et<sub>2</sub>O (20 mL) and the solution was cooled to -78°C under Ar. Hexylmagnesium bromide (1M in THF, 840 μL, 0.84 mmol, 4 eq) was added dropwise. The reaction was then allowed to warm to room temperature, causing a color change from colorless to orange. The reaction was then quenched with saturated aqueous NH<sub>4</sub>Cl solution at 0°C and then extracted with diethyl ether (3×50 mL), and the combined layers were dried (MgSO<sub>4</sub>) and evaporated to an orange oil. Flash chromatography on silica gel of the residue (eluent: EtOAc/petroleum ether, 3/7, v/v) gave compound **20** as a yellow oil (39 mg, 36%).

Data for α-anomer:

δ<sub>H</sub> (400 MHz; CDCl<sub>3</sub>) 0.87 (3H, t, *J* 6.9, CH<sub>3</sub>), 1.14-1.44 (8H, m, CH<sub>2</sub>), 1.55-1.63 (2H, m, CH<sub>2</sub>), 1.81-1.84 (1H, br s, NH), 2.89-2.95 (1H, m, H-5), 3.41 (3H, s, OCH<sub>3</sub>), 3.70 (1H, d<sub>AB</sub>, *J* 12.6, NCH<sub>2</sub>Ph), 3.81 (1H, d<sub>AB</sub>, *J* 12.6, NCH<sub>2</sub>Ph), 4.12-4.18 (3H, m, H-2, H-3 and H-4), 4.43 (1H, d<sub>AB</sub>, *J* 11.7, OCH<sub>2</sub>Ph), 4.53 (1H, d<sub>AB</sub>, *J* 11.9, OCH<sub>2</sub>Ph), 4.60 (1H, d<sub>AB</sub>, *J* 11.7, OCH<sub>2</sub>Ph), 4.68 (1H, d<sub>AB</sub>, *J* 11.9, OCH<sub>2</sub>Ph), 4.88 (1H, d, *J* 3.8, H-1), 7.24-7.37 (15H, m, Haro).

δ<sub>C</sub> (101 MHz; CDCl<sub>3</sub>) 14.08 (CH<sub>3</sub>), 22.58-25.93-29.27-31.77-33.71 (CH<sub>2</sub>), 50.98 (NCH<sub>2</sub>Ph), 55.25 (OCH<sub>3</sub>), 55.77 (C-5), 71.94-72.57 (OCH<sub>2</sub>Ph), 78.40 (C-3), 82.32 (C-4), 84.26 (C-2), 100.65 (C-1), 126.64-128.40 (CH<sub>Ar</sub>), 137.68-137.80 (Cq<sub>Ar</sub>).

[α]<sub>D</sub><sup>25</sup> = -39 (c=0.9, CHCl<sub>3</sub>)

Data for β-anomer:

δ<sub>H</sub> (400 MHz; CDCl<sub>3</sub>) 0.87 (3H, t, *J* 6.9, CH<sub>3</sub>), 1.17-1.36 (8H, m, CH<sub>2</sub>), 1.49-1.59 (2H, m, CH<sub>2</sub>), 2.16-2.18 (1H, br s, NH), 3.05 (3H, s, OCH<sub>3</sub>), 3.70-3.76 (1H, m, H-5), 3.70-3.3.73 (1H, m, H-4), 3.85 (1H, dd, *J* 2.6 and 6.5, H-3), 4.40 (1H, d<sub>AB</sub>, *J* 13.1, NCH<sub>2</sub>Ph), 4.53 (1H, d<sub>AB</sub>, *J* 13.1, NCH<sub>2</sub>Ph), 4.56 (1H, d<sub>AB</sub>, *J* 11.9, OCH<sub>2</sub>Ph), 4.68 (1H, d<sub>AB</sub>, *J* 11.7, OCH<sub>2</sub>Ph), 4.78 (1H, d<sub>AB</sub>, *J* 11.9, OCH<sub>2</sub>Ph), 4.82 (1H, d, *J* 1.0, H-1), 7.23-7.33 (15H, m, Haro).

$\delta_C$  (101 MHz;  $CDCl_3$ ) 14.04 ( $CH_3$ ), 22.57-25.70-28.94-30.51-31.56 ( $CH_2$ ), 48.14 ( $NCH_2Ph$ ), 55.53 ( $OCH_3$ ), 56.16 (C-5), 71.93-72.17 ( $OCH_2Ph$ ), 82.94 (C-3), 83.23 (C-4), 86.94 (C-2), 108.62 (C-1), 126.64-128.40 ( $CH_{Ar}$ ), 137.68-137.80 ( $C_{qAr}$ ).

$[\alpha]_D^{25} = +45$  (c=0.8,  $CHCl_3$ )

Data for both anomers:

(+) **MS (ESI):** m/z = 518.5  $[M+H]^+$

**IR ( $cm^{-1}$ ):** 3299, 3020, 2958, 1454, 1209, 1066.

**TLC** (PE/EtOAc ; 7/3) = 0.23.



## Methyl 2,3-di-*O*-benzyl-5(*R*)-5-hexyl-(*S<sub>s</sub>*)-*N*-*tert*-butanesulfinylimino-*L*-xylofuranosides

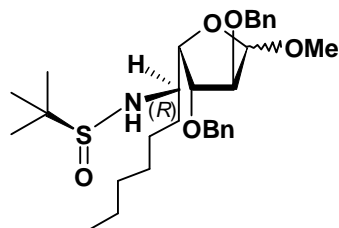

531.30  
C<sub>30</sub>H<sub>45</sub>NO<sub>5</sub>S

21

The imine **19** (111.4 mg, 0.25 mmol) was dissolved in dry toluene (20 mL) and the solution was cooled to -78°C under Ar. Hexylmagnesium bromide (1M in THF, 1 mL, 1 mmol, 4 eq) was added drop by drop. The reaction was then allowed to warm to room temperature, causing a color change from colorless to orange. The reaction was then quenched with saturated aqueous NH<sub>4</sub>Cl solution at 0°C and then extracted with diethyl ether (3×15 mL), and the combined layers were dried (MgSO<sub>4</sub>) and evaporated to an orange oil. Flash chromatography on silica gel of the residue (eluent: EtOAc/PE, 3/7, v/v) gave the compound **24** as a yellow oil (70.4 mg, 53%).

### Data for $\alpha$ -anomer:

$\delta_{\text{H}}$  (400 MHz; CDCl<sub>3</sub>) 0.89 (3H, t, *J* 6.8, CH<sub>3</sub>), 1.10 (9H, s, C(CH<sub>3</sub>)<sub>3</sub>), 1.20-1.24 (8H, m, CH<sub>2</sub>), 1.61-1.66 (2H, m, CH<sub>2</sub>), 3.40 (3H, s, OCH<sub>3</sub>), 3.96 (1H, d, *J* 10.0, H-5), 4.22 (1H, dd, *J* 3.2 and 7.5, H-3), 4.35 (1H, dd, *J* 4.1 and 5.9, H-2), 4.41 (1H, dd, *J* 6.0 and 7.4, H-4), 4.51 (1H, d<sub>AB</sub>, *J* 11.3, OCH<sub>2</sub>Ph), 4.55 (1H, d<sub>AB</sub>, *J* 11.7, OCH<sub>2</sub>Ph), 4.64 (1H, d<sub>AB</sub>, *J* 11.8, OCH<sub>2</sub>Ph), 4.68 (1H, d<sub>AB</sub>, *J* 11.3, OCH<sub>2</sub>Ph), 5.04 (1H, d, *J* 4.1, H-1), 7.26-7.36 (10H, m, Haro).

$\delta_{\text{C}}$  (101 MHz; CDCl<sub>3</sub>) 13.89 (CH<sub>3</sub>), 22.48 (C(CH<sub>3</sub>)<sub>3</sub>), 22.56-26.28-28.77-30.04-31.53 (CH<sub>2</sub>), 55.01 (OCH<sub>3</sub>), 55.63 (C-5), 59.86 (C(CH<sub>3</sub>)<sub>3</sub>), 72.27 (OCH<sub>2</sub>Ph), 72.36 (OCH<sub>2</sub>Ph), 78.27 (C-4), 82.09 (C-3), 84.77 (C-2), 100.49 (C-1), 127.46-128.36 (CH<sub>Ar</sub>), 137.66-137.69 (Cq<sub>Ar</sub>).

$[\alpha]_{\text{D}}^{25} = +91$  (c=0.5, CHCl<sub>3</sub>).

(+) **MS (ESI):**  $m/z = 532.5$  [M+H]<sup>+</sup>

**HRMS (ESI)** C<sub>30</sub>H<sub>45</sub>NO<sub>5</sub>SNa: calcd:  $m/z = 554.2916$ , found:  $m/z = 554.2910$ .

**IR (cm<sup>-1</sup>):** 3296, 2958, 2926, 1454, 1045.

**TLC** (PE/EtOAc ; 7/3) = 0.19.

Following the same procedure:

Data for  $\beta$ -anomer:

$\delta_{\text{H}}$  (400 MHz;  $\text{CDCl}_3$ ) 0.90 (3H, t,  $J$  6.8,  $\text{CH}_3$ ), 1.21-1.30 (17H, m, ,  $\text{C}(\underline{\text{CH}}_3)_3$  and  $\text{CH}_2$ ), 1.49-1.68 (2H, m,  $\text{CH}_2$ ), 3.46 (3H, s,  $\text{OCH}_3$ ), 3.57-3.66 (1H, m, H-5), 4.07 (1H, dd,  $J$  1.0 and 5.0, H-3), 4.18-4.21 (1H, d,  $J$  4.8, H-2), ), 4.30 (1H, t,  $J$  5.0, H-4), 4.44 (1H,  $d_{\text{AB}}$ ,  $J$  12.1,  $\text{OCH}_2\text{Ph}$  ), 4.57 (1H,  $d_{\text{AB}}$ ,  $J$  12.0,  $\text{OCH}_2\text{Ph}$ ), 4.61 (1H,  $d_{\text{AB}}$ ,  $J$  12.0,  $\text{OCH}_2\text{Ph}$ ), 4.68 (1H,  $d_{\text{AB}}$ ,  $J$  12.1,  $\text{OCH}_2\text{Ph}$  ), 4.96 (1H, d,  $J$  0.8, H-1), 7.29-7.37 (10H, m, Haro).

$\delta_{\text{C}}$  (101 MHz;  $\text{CDCl}_3$ ) 14.06 ( $\text{CH}_3$ ), 22.59 ( $\text{C}(\underline{\text{CH}}_3)_3$ ), 22.70-25.34-29.35-31.72-31.97 ( $\text{CH}_2$ ), 54.82 (C-5), 55.60 ( $\underline{\text{C}}(\text{CH}_3)_3$ ), 55.77 ( $\text{OCH}_3$ ), 71.96 ( $\text{OCH}_2\text{Ph}$ ), 72.01 ( $\text{OCH}_2\text{Ph}$ ), 81.46 (C-3), 82.02 (C-4), 85.57 (C-2), 107.85 (C-1), 127.77-128.48 ( $\text{CH}_{\text{Ar}}$ ), 137.35-137.50 ( $\text{C}_{\text{qAr}}$ ).

$[\alpha]_{\text{D}}^{25} = -88$  ( $c=0.6$ ,  $\text{CHCl}_3$ ).

**TLC** (PE/EtOAc ; 7/3) = 0.20.

**$\alpha$ -1-C-hexyl-1,5-dideoxy-1,5-imino-D-xylitol**

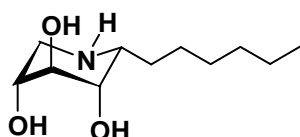

217.31  
C<sub>11</sub>H<sub>23</sub>NO<sub>3</sub>  
**22**

---

From compound **21** (or **24**):

Compound **21** (34 g, 0.06 mmol) was dissolved in 1,4-dioxane and 0.4N HCl (10 mL, 1:1, v:v) and heated at 70°C for 25 hours. Then, the mixture was cooled to room temperature and the 10% Pd/C was added and the mixture was stirred for 15 hours. The mixture was filtered through a Millipore membrane. The catalyst was washed several times with isopropanol (20 mL) to give compound **22** (4.2 mg, 30%) as a white solid.

From compound **36**:

Compound **36** (54 mg, 0.09 mmol) was dissolved in isopropanol (6 mL) and CH<sub>2</sub>Cl<sub>2</sub> (3 mL), containing 1 M HCl (0.8 mL). An excess of palladium on charcoal (10% Pd/C) was added and the reaction was stirred at room temperature under H<sub>2</sub> for 24h. The mixture was filtered through a Millipore membrane. The catalyst was washed with isopropanol (15 mL). The residual solvents were evaporated and coevaporated with toluene (15 mL) to give compound **22** (17 mg, 85 %) as a white solid.

From compound **38**:

Compound **38** (731.4 mg, 1.18 mmol) was dissolved in isopropanol (10 mL) containing 1M HCl (1.2 mL, 1 eq). An excess of 10% palladium on charcoal (350 mg) was added and the reaction was stirred at room temperature under H<sub>2</sub> for 24h. The mixture was filtered through a Millipore membrane. The catalyst was washed with isopropanol (15 mL). The residual solvent was evaporated to give compound **22** quantitatively (256.4 mg) as a white solid. The compound **22** was then purified on resin Amberlite-H<sup>+</sup> and eluted with 0.5N aqueous ammonia.

$\delta_H$  (400 MHz; CDCl<sub>3</sub>) 0.92 (3H, t, *J* 6.8, CH<sub>3</sub>), 1.26-1.52 (8H, m, CH<sub>2</sub>), 1.60-1.70 (1H, m, CH<sub>2</sub>), 1.79-1.96 (1H, m, CH<sub>2</sub>), 3.19 (1H, d, *J* 12.9, H-5a), 3.34-3.43 (m, 2H, H-5b, H-1), 3.81-3.86 (1H, br s, H-2), 3.92 (1H, m, H-4), 3.96 (1H, m, H-3).

$\delta_C$  (101 MHz; CDCl<sub>3</sub>) 14.37 (CH<sub>3</sub>), 23.58-25.81-26.92-29.63-32.70 (CH<sub>2</sub>), 47.30 (C-5), 56.33 (C-1), 67.89 (C-3), 68.20 (C-4), 69.45 (C-2).

(+) **MS (ESI):**  $m/z = 218.0 [M+H]^+$ ,  $240.0 [M+Na]^+$

**HRMS (ESI)**  $C_{11}H_{24}NO_3$ : calcd:  $m/z = 218.1756$ , found:  $m/z = 218.1753$ .

**TLC** ( $CH_2Cl_2/MeOH$  ; 6/1) = 0.06.

Methyl 2,3-di-*O*-benzyl-5-*(S<sub>R</sub>)*-*N*-*tert*-butanesulfinylimino-*L*-xylofuranosides

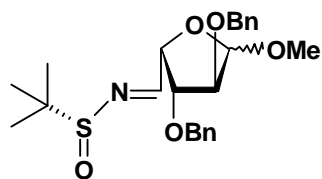

445.58  
C<sub>24</sub>H<sub>31</sub>NO<sub>5</sub>S

**23**

The aldehyde **17** (693 mg, 2.0 mmol), (*R*)-*tert*-butanesulfinamide (270 mg, 2.2 mmol, 1.1 eq) and anhydrous CuSO<sub>4</sub> (1.58 g, 10 mmol, 5 eq) was dissolved in dry CH<sub>2</sub>Cl<sub>2</sub> (20 mL) and stirred at room temperature for 48 hours. The suspension was filtered and the filtrate was evaporated. Flash chromatography on silica gel (eluent: EtOAc/petroleum ether, 3/7, v/v) gave compound **23** as a colorless oil (1.18 g, 68%).

Data for α-anomer:

δ<sub>H</sub> (400 MHz; CDCl<sub>3</sub>) 1.17 (9H, s, C(CH<sub>3</sub>)<sub>3</sub>), 3.42 (3H, s, OCH<sub>3</sub>), 4.04 (1H, dd, *J* 4.2 and 6.5, H-2), 4.53 (1H, dd, *J* 6.9 and 7.1, H-3), 4.55-4.56 (1H, br s, OCH<sub>2</sub>Ph), 4.60 (1H, d<sub>AB</sub>, *J* 12.0, OCH<sub>2</sub>Ph), 4.64 (1H, d<sub>AB</sub>, *J* 12.0, OCH<sub>2</sub>Ph), 4.88 (1H, d, *J* 4.2, H-1), 4.96 (1H, dd, *J* 4.8 and 7.4, H-4), 7.24-7.35 (10H, m, Haro), 8.01 (1H, d, *J* 4.9, H-5).

δ<sub>C</sub> (101 MHz; CDCl<sub>3</sub>) 22.49 (C(CH<sub>3</sub>)<sub>3</sub>), 55.61 (OCH<sub>3</sub>), 57.25 (C(CH<sub>3</sub>)<sub>3</sub>), 72.70 (OCH<sub>2</sub>Ph), 72.76 (OCH<sub>2</sub>Ph), 77.81 (C-4), 82.84 (C-3), 82.98 (C-2), 101.80 (C-1), 127.85-128.46 (CH<sub>Ar</sub>), 137.27-137.34 (C<sub>qAr</sub>), 165.98 (C-5).

[α]<sub>D</sub><sup>25</sup> = -36 (c=1.9, CHCl<sub>3</sub>)

(+) **MS (ESI):** m/z = 446.5 [M+H]<sup>+</sup>, 468.5 [M+Na]<sup>+</sup>

**IR (cm<sup>-1</sup>):** 3336, 3243, 2984, 2933, 1455, 1299, 1112, 1050.

**TLC** (PE/EtOAc ; 7/3) = 0.35.

Data for β-anomer:

δ<sub>H</sub> (400 MHz; CDCl<sub>3</sub>) 1.16 (9H, s, C(CH<sub>3</sub>)<sub>3</sub>), 3.42 (3H, s, OCH<sub>3</sub>), 3.84-3.88 (1H, br s, H-5), 4.11-4.12 (1H, br s, H-2), 4.33 (1H, dd, *J* 3.2 and 7.0, H-3), 4.53-4.57 (4H, m, OCH<sub>2</sub>Ph), 5.01-5.07 (2H, m, H-1 and H-4), 7.29-7.38 (10H, m, Haro), 8.12 (1H, d, *J* 5.8, H-5).

δ<sub>C</sub> (101 MHz; CDCl<sub>3</sub>) 22.16 (C(CH<sub>3</sub>)<sub>3</sub>), 55.19 (OCH<sub>3</sub>), 56.82 (C(CH<sub>3</sub>)<sub>3</sub>), 71.84 (OCH<sub>2</sub>Ph), 72.24 (OCH<sub>2</sub>Ph), 82.24 (C-4), 82.24 (C-3), 86.10 (C-2), 108.29 (C-1), 127.52-128.29 (CH<sub>Ar</sub>), 137.02-137.88 (C<sub>qAr</sub>), 166.56 (C-5).

[α]<sub>D</sub><sup>25</sup> = +42 (c=1.1, CHCl<sub>3</sub>)

**Methyl-2,3-di-*O*-benzyl-5(*R*)-5-hexyl-5-(*S<sub>R</sub>*)-*N*-*tert*-butanesulfinylimino- $\alpha$ -L-xylofuranosides**

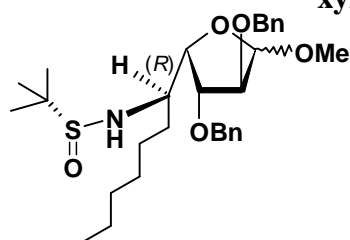

531.30  
C<sub>30</sub>H<sub>45</sub>NO<sub>5</sub>S  
**24**

The imine **23** (102 mg, 0.25 mmol) was dissolved in dry toluene (15 mL) and the solution was cooled to  $-78^{\circ}\text{C}$  under Ar. Hexylmagnesium bromide (1M in THF, 920  $\mu\text{L}$ , 0.92 mmol, 4 eq) was added dropwise. The reaction was then allowed to warm to room temperature, causing a color change from colorless to orange. The reaction was then quenched with saturated aqueous  $\text{NH}_4\text{Cl}$  solution at  $0^{\circ}\text{C}$  and then extracted with diethyl ether ( $3 \times 15$  mL), and the combined layers were dried ( $\text{MgSO}_4$ ) and evaporated to a orange oil. Flash chromatography on silica gel of the residue (eluent: EtOAc/PE, 3/7, v/v) gave the compound **24** as a yellow oil (89.2 mg, 73%).

Data for  $\alpha$ -anomer:

$\delta_{\text{H}}$  (400 MHz;  $\text{CDCl}_3$ ) 0.87 (3H, t,  $J$  6.8,  $\text{CH}_3$ ), 1.09 (9H, s,  $\text{C}(\text{CH}_3)_3$ ), 1.18-1.20 (8H, m,  $\text{CH}_2$ ), 1.55-1.63 (2H, m,  $\text{CH}_2$ ), 3.38 (3H, s,  $\text{OCH}_3$ ), 3.45-3.50 (1H, m, H-5), 4.04-4.06 (1H, m, H-2 and  $\text{NH}$ ), 4.32-4.38 (2H, m, H-4 and H-3), 4.50 (1H,  $d_{\text{AB}}$ ,  $J$  11.8,  $\text{OCH}_2\text{Ph}$ ), 4.55 (1H,  $d_{\text{AB}}$ ,  $J$  11.8,  $\text{OCH}_2\text{Ph}$ ), 4.66-4.72 (1H,  $d_{\text{AB}}$ ,  $J$  11.9,  $\text{OCH}_2\text{Ph}$ ), 4.72 (1H,  $d_{\text{AB}}$ ,  $J$  11.9,  $\text{OCH}_2\text{Ph}$ ), 4.82-4.83 (1H, d,  $J$  4.2, H-1), 7.26-7.36 (10H, m, Haro).

$\delta_{\text{C}}$  (101 MHz;  $\text{CDCl}_3$ ) 14.05 ( $\text{CH}_3$ ), 22.55 ( $\text{C}(\text{CH}_3)_3$ ), 22.66-25.83-29.22-30.90-31.70 ( $\text{CH}_2$ ), 55.20 ( $\text{OCH}_3$ ), 55.68 ( $\text{C}(\text{CH}_3)_3$ ), 56.16 (C-5), 72.44 ( $\text{OCH}_2\text{Ph}$ ), 72.61 ( $\text{OCH}_2\text{Ph}$ ), 76.98 (C-4), 82.25 (C-3), 84.09 (C-2), 100.38 (C-1), 127.75-128.43 ( $\text{CH}_{\text{Ar}}$ ), 137.54-137.67 ( $\text{C}_{\text{qAr}}$ ).

$[\alpha]_{\text{D}}^{25} = -108$  ( $c=0.9$ ,  $\text{CHCl}_3$ ).

(+) **MS (ESI):**  $m/z = 532.5$   $[\text{M}+\text{H}]^+$

**HRMS (ESI)**  $\text{C}_{30}\text{H}_{45}\text{NO}_5\text{SNa}$ : calcd:  $m/z = 554.2916$ , found:  $m/z = 554.2924$ .

**IR ( $\text{cm}^{-1}$ ):** 3296, 2958, 2926, 1454, 1045.

**TLC** (PE/EtOAc ; 7/3) = 0.19.

Following the same procedure:

Data for  $\beta$ -anomer:

$\delta_{\text{H}}$  (400 MHz;  $\text{CDCl}_3$ ) 0.85-0.89 (3H, t,  $J$  6.8,  $\text{CH}_3$ ), 1.17 (9H, s,  $\text{C}(\underline{\text{CH}}_3)_3$ ), 1.21-1.25 (8H, m,  $\text{CH}_2$ ), 1.44-1.51 (2H, m,  $\text{CH}_2$ ), 3.40 (3H, s,  $\text{OCH}_3$ ), 3.55-3.61 (1H, m, H-5), 4.03-4.05 (1H, q,  $J$  2.4 and 6.0, H-3), 4.14 (1H, s,  $\text{NH}$ ), 4.16-4.17 (1H, d,  $J$  4.8, H-2), ), 4.25-4.28 (1H, t,  $J$  5.6, H-4), 4.41 (1H,  $d_{\text{AB}}$ ,  $J$  12.0,  $\text{OCH}_2\text{Ph}$ ), 4.52 (1H,  $d_{\text{AB}}$ ,  $J$  11.8,  $\text{OCH}_2\text{Ph}$ ), 4.58 (1H,  $d_{\text{AB}}$ ,  $J$  11.8,  $\text{OCH}_2\text{Ph}$ ), 4.64 (1H,  $d_{\text{AB}}$ ,  $J$  12.0,  $\text{OCH}_2\text{Ph}$ ), 4.92 (1H, s, H-1), 7.27-7.37 (10H, m, Haro).

$\delta_{\text{C}}$  (101 MHz;  $\text{CDCl}_3$ ) 14.06 ( $\text{CH}_3$ ), 22.58 ( $\text{C}(\underline{\text{CH}}_3)_3$ ), 22.70-25.33-29.35-31.72-31.96 ( $\text{CH}_2$ ), 54.82 (C-5), 55.60 ( $\underline{\text{C}}(\text{CH}_3)_3$ ), 55.77 ( $\text{OCH}_3$ ), 71.96 ( $\text{OCH}_2\text{Ph}$ ), 72.01 ( $\text{OCH}_2\text{Ph}$ ), 81.46 (C-3), 82.02 (C-4), 85.57 (C-2), 107.84 (C-1), 127.77-128.47 ( $\text{CH}_{\text{Ar}}$ ), 137.54-137.67 ( $\text{Cq}_{\text{Ar}}$ ).

$[\alpha]_{\text{D}}^{25} = +90$  ( $c=1.1$ ,  $\text{CHCl}_3$ ).

(+) **MS (ESI):**  $m/z = 532.5$   $[\text{M}+\text{H}]^+$

**TLC** (PE/EtOAc ; 7/3) = 0.19.

### Methyl 2,3,4-tri-*O*-benzyl- $\alpha/\beta$ -D-xylopyranoside

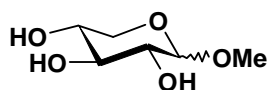

161.27

 $C_9H_{21}O_2$ **25**

---

Thionyl chloride (2 mL, 0.027 mmol, 0.41 eq) was added dropwise in a cooled solution of methanol (100 mL) at 0°C. D-xylose (10 g, 0.067 mmol) was added and the mixture was stirred for 4h under reflux. The reaction was warmed to room temperature and sodium hydrogenocarbonate (7 g, 0.083 mmol, 1.25 eq) was added. The solvent was evaporated under reduced pressure, the residue was dissolved in ethanol (80 mL), concentrated for half part and diluted with toluene (40 mL). All solvents were evaporated and the crude residue **25** was used for the next step.

Analytical data are in accordance with the literature data.<sup>218</sup>

### Methyl 2,3,4-tri-*O*-benzyl- $\alpha/\beta$ -D-xylopyranoside

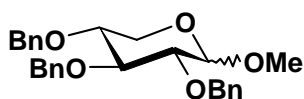

434.54

 $C_{27}H_{30}O_5$ **26**

---

To a solution of methyl D-xylopyranoside (10,93 g, 0.067 mmol) in dry DMF (200 mL) at 0°C was added NaH (60% in mineral oil, 13.3 g, 0.33 mmol, 5 eq) cautiously. The mixture was stirred for 30 min at 0°C, tetrabutyl ammonium iodide (4.5 g, 0.012 mmol, 0.18 eq) and benzyl bromide (32 ml, 0.268 mmol, 4 eq) were added slowly. After stirring for 18 h at room temperature, the reaction was quenched using NH<sub>4</sub>Cl aqueous solution 10% (50 mL). The mixture was diluted with water (160 mL) and the aqueous phase was extracted twice with diethyl ether (80 mL). The organic phase was washed twice with water (120 mL), dried over MgSO<sub>4</sub>, filtered and concentrated under vacuum to give **26** which was used directly in next step.

Analytical data are in accordance with the literature data.<sup>218</sup>



### 2,3,4-tri-*O*-benzyl-D-xylopyranose

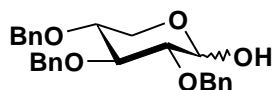

420.51

 $C_{26}H_{28}O_6$ **27**

---

Methyl 2,3,4-tri-*O*-benzyl- $\alpha/\beta$ -D-xylofuranoside (28.9 g, 67 mmol) **26** was dissolved in 1,4-dioxane (80 mL). Acetic acid (96 mL) and 1M H<sub>2</sub>SO<sub>4</sub> (84 mL) were added cautiously and the mixture was stirred for 10 hours under reflux. The solution was cooled to room temperature and hexane (40 mL) and water (320 mL) were added. The mixture was vigorously stirred until the formation of a precipitate. The precipitate was filtered, washed with hexane (400 mL) dried and recrystallized in MeOH (170 mL) to give pure **27** (18.03 mg, 64%) as white solid.

Analytical data are in accordance with the literature data.<sup>218</sup>

### 1-*O*-Acetyl 2,3,4-tri-*O*-benzyl-D-xylopyranose

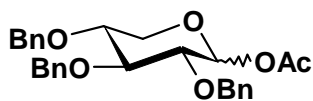

461.4

 $C_{28}H_{30}O_6$ **28**

---

2,3,4-tri-*O*-benzyl- $\alpha/\beta$ -D-xylofuranose (6.0 g, 14.3 mmol) **27** was dissolved in dry pyridine (30 mL) under argon. Acetic anhydride (6.5 mL, 69.2 mmol, 4.8 eq) was added and the mixture was stirred for 18 hours at room temperature. The mixture was concentrated and co-evaporated twice with toluene. The organic layer was diluted with EtOAc, washed with water (400 mL), dried over MgSO<sub>4</sub>. The solid was filtered and the filtrate was concentrated under vacuum to afford quantitatively **28** which was engaged for the next step.

Analytical data are in accordance with the literature data.<sup>219</sup>

***N*-Benzyloxycarbonyl-2,3,4-tri-*O*-benzyl-*D*-xylopyranosylamine**

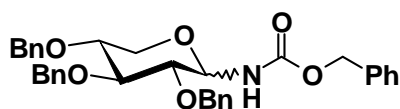

553.66

C<sub>34</sub>H<sub>35</sub>NO<sub>6</sub>

**29**

1-*O*-Acetyl 2,3,4-tri-*O*-benzyl- $\alpha/\beta$ -*D*-xylofuranose (6.6 g, 14.3 mmol) **28** was dissolved in dry CH<sub>2</sub>Cl<sub>2</sub> (30 mL) and stirred for 10 min in the presence of 4Å molecular sieve under argon. Benzyl carbamate (4.3 g, 28.4 mmol, 2 eq) was added. Trimethylsilyl trifluoromethanesulfonate (2.6 mL, 14.4 mmol, 1 eq) was added and the mixture was stirred for 2 hours at room temperature. Et<sub>3</sub>N (4 mL) was added cautiously. The solid was removed by filtration over celite, the filtrate was washed using CH<sub>2</sub>Cl<sub>2</sub> and concentrated under vacuum. Purification by flash chromatography on silica gel (eluent: Tol/EtOAc, 9:1, v/v) afforded compound **29** (6.76 g, 85%) as a white solid.

$\delta_{\text{H}}$  (400 MHz; CDCl<sub>3</sub>) 3.22-3.32 (1.4H, m, H-2 $_{\beta}$  and H-5 $_{\beta}$ ), 3.43 (0.3H, dd, *J* 6.0 and 10.3, H-4 $_{\alpha}$ ), 3.53-3.59 (1H, m, H-2 $_{\alpha}$  and H-4 $_{\beta}$ ), 3.61-3.72 (1.4H, m, H-3 $_{\beta}$ , H-3 $_{\alpha}$  and H-5 $_{\alpha}$ ), 3.78 (0.3H, dd, *J* 3.9 and 12.2, H-5 $_{\alpha}$ ), 3.90 (0.7H, dd, *J* 5.1 and 11.6, H-5 $_{\beta}$ ), 4.48-4.91 (6.7H, m, OCH<sub>2</sub>Ph and H-1 $_{\beta}$ ), 5.03-5.06 (0.6H, m, COOCH<sub>2</sub>Ph $_{\alpha}$ ), 5.11-5.13 (1.4H, m, COOCH<sub>2</sub>Ph $_{\beta}$ ), 5.20 (0.6H, br s, NH $_{\beta}$ ), 5.34 (0.3H, dd, *J* 3.6 and 8.0, H-1 $_{\alpha}$ ), 5.80 (0.3H, d, *J* 8.0, NH $_{\alpha}$ ), 7.24-7.32 (20H, m, Haro).

$\delta_{\text{C}}$  (101 MHz; CDCl<sub>3</sub>) 62.51 (C-5 $_{\alpha}$ ), 65.30 (C-5 $_{\beta}$ ), 67.13-67.23 (COOCH<sub>2</sub>Ph), 72.41-72.72-73.22-74.11-74.84-75.61 (OCH<sub>2</sub>Ph), 74.90 (C-4 $_{\alpha}$ ), 76.10 (C-2 $_{\alpha}$ ), 76.81 (C-3 $_{\alpha}$ ), 77.47 (C-1 $_{\alpha}$ ), 77.81 (C-4 $_{\beta}$ ), 79.73 (C-2 $_{\beta}$ ), 82.21 (C-1 $_{\beta}$ ), 84.60 (C-3 $_{\beta}$ ), 127.81-128.63 (CH<sub>Ar</sub>), 136.15-138.55 (C<sub>qAr</sub>), 155.61-155.90 (C=O).

(+) **MS (ESI):** *m/z* = 554.5 [M+H]<sup>+</sup>; *m/z* = 576.5 [M+Na]<sup>+</sup>

**HRMS (ESI)** C<sub>34</sub>H<sub>35</sub>NO<sub>6</sub>Na: calcd: *m/z* = 576.2362, found: *m/z* = 576.2357.

**IR (cm<sup>-1</sup>):** 3355, 3063, 3032, 2868, 1700, 1531, 1453, 1281, 1232, 1090, 1073, 1042.

**TLC:** (Tol/EtOAc ; 9/1) R<sub>f</sub> = 0.29 ( $\alpha$ ), 0.19 ( $\beta$ ).

**MP:** 125-129°C

***N*-Benzyl-2,3,4-tri-*O*-benzyl-D-xylopyranosylamine**

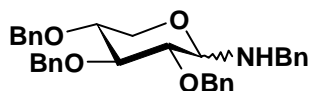

509.64

C<sub>18</sub>H<sub>29</sub>NO<sub>3</sub>

**30**

---

To a solution compound **27** (1g, 2.38 mmol) in CH<sub>2</sub>Cl<sub>2</sub> (2 mL) under argon, were added *p*-toluenesulfonic acid-H<sub>2</sub>O (410 mg, 2.38 mmol, 1 eq) and benzylamine (2.6 mL, 23.8 mmol, 10 eq). After stirring for 48 h at room temperature, the mixture was diluted with CH<sub>2</sub>Cl<sub>2</sub> (50 mL) and the organic phase was washed with saturated NaHCO<sub>3</sub> (20 mL), dried over MgSO<sub>4</sub>, filtered. The solvent was evaporated and the residue was coevaporated two times with toluene and dried for 18 h under high vacuum to give crude compound **30** (anomer ratio: 1:1) as a crystalline white solid but containing a trace of benzylamine.

$\delta_{\text{H}}$  (400 MHz; CDCl<sub>3</sub>) 3.98 (1H, d, *J* 8.5, H-1 <sub>$\beta$</sub> ), 4.48 (1H, s, H-1 <sub>$\alpha$</sub> ).

$\delta_{\text{C}}$  (101 MHz; CDCl<sub>3</sub>) 46.53-49.93 (NHCH<sub>2</sub>), 60.14-65.06 (C-5), 73.00-73.14-73.32-75.04-75.21-75.75 (OCH<sub>2</sub>Ph), 77.60-78.46-79.22-80.02-82.18 (C-H), 84.20 (C-1 <sub>$\alpha$</sub> ), 85.10 (C-H), 90.71 (C-1 <sub>$\beta$</sub> ).

(+) **MS (ESI):**  $m/z = 510.5$  [M+H]<sup>+</sup>;  $m/z = 532.5$  [M+Na]<sup>+</sup>

**(1R)-1-C-allyl-2,3,4-tri-O-benzyl-1-benzylaminocarbonyl-1-deoxy-D-xylitol**

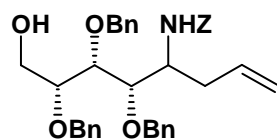

595.74

C<sub>37</sub>H<sub>41</sub>NO<sub>6</sub>

**31**

To a solution compound **29** (6.67 g, 12.00 mmol) in CH<sub>3</sub>CN (120 mL) under argon at -20°C, were added AllTMS (410 mg, 2.38 mmol, 1 eq). After stirring for 15 h at room temperature, TMSOTf (2.2 mL, 12.1 mL, 1 eq) was added and the mixture was stirred for 20 hours at -20°C. NaHCO<sub>3</sub> was added at 0°C. The crude product was diluted with ethyl acetate. The organic phase was washed with brine and dried over MgSO<sub>4</sub>. The solid material was filtered and the filtrate was concentrated under vacuum. Purification was performed by column chromatography (eluent: EP/EtOAc, 8:1, v/v) affording the desired diastereoisomer **31** (4.86 mg, 68%) as a colorless oil.

$\delta_{\text{H}}$  (400 MHz; CDCl<sub>3</sub>) 2.07-2.27. (3H, m, OH and H-6ab), 3.65-3.82 (6H, m, H-1, H-2, H-3, H-4 and H-5ab), 4.52 (1H, d<sub>AB</sub>, *J* 11.7, OCH<sub>2</sub>Ph), 4.52 (1H, d<sub>AB</sub>, *J* 11.1, OCH<sub>2</sub>Ph), 4.58 (1H, d<sub>AB</sub>, *J* 11.2, OCH<sub>2</sub>Ph), 4.68 (1H, d<sub>AB</sub>, *J* 11.7, OCH<sub>2</sub>Ph), 4.77 (1H, d<sub>AB</sub>, *J* 11.2, OCH<sub>2</sub>Ph), 4.88 (1H, d<sub>AB</sub>, *J* 11.1, OCH<sub>2</sub>Ph), 4.93-4.99 (2H, m, C=CH<sub>2</sub>), 5.06 (2H, s, COOCH<sub>2</sub>Ph), 5.14 (1H, d, *J* 10.0, NH), 5.52-5.63 (1H, m, CH=CH<sub>2</sub>), 7.28-7.34 (20H, m, Haro).

$\delta_{\text{C}}$  (101 MHz; CDCl<sub>3</sub>) 38.00 (C-6), 51.62 (C-1), 61.44 (C-5), 66.9 (COOCH<sub>2</sub>Ph), 72.33-75.25 (OCH<sub>2</sub>Ph), 77.73 (C-2), 79.84 (C-3), 80.33 (C-4), 117.9 (C=C<sub>2</sub>H<sub>2</sub>), 127.80-128.64 (CH<sub>Ar</sub>), 134.62 (CH=CH<sub>2</sub>), 136.11-138.02-138.35 (C<sub>qAr</sub>), 156.33 (C=O).

$[\alpha]_{\text{D}}^{25} = +11$  (c=1.5, CHCl<sub>3</sub>)

(+) MS (ESI): *m/z* = 596.5 [M+H]<sup>+</sup>; *m/z* = 618.5 [M+Na]<sup>+</sup>

HRMS (ESI) C<sub>37</sub>H<sub>41</sub>NO<sub>6</sub>Na: calcd: *m/z*=618.2832, found: *m/z* = 618.2831.

IR (cm<sup>-1</sup>): 3434, 3064, 3031, 2931, 2874, 1713, 1498, 1454, 1210, 1049, 1026.

TLC: (EP/EtOAc ; 8/2) R<sub>f</sub> = 0.11.

(1*R*)-1-*C*-allyl-2,3,4-tri-*O*-benzyl-1-benzylamino-1-deoxy-*D*-xylitol

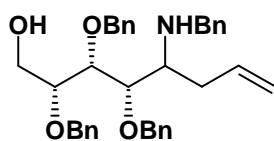

595.74

C<sub>37</sub>H<sub>41</sub>NO<sub>6</sub>

**32**

Under argon, compound **30** (2.17 g, 4.25 mmol) was dissolved in dry THF (200 mL). Then allylmagnesium bromide in diethyl ether (20 mL, 21 mmol, 5 eq.) was slowly added at 0°C and the solution was stirred at room temperature 18 hours. The reaction mixture was quenched with NH<sub>4</sub>Cl (10 mL) and the organic layer was washed 3 times with water (100 mL). After drying over MgSO<sub>4</sub> the solvent was evaporated and the crude product was purified by flash chromatography on silica gel (EtOAc:EP:NH<sub>3</sub>, 20:80:1, dried over MgSO<sub>4</sub>). The product **32** was obtained as a colorless oil (1.58 g, 2.87 mmol, 68%). The reaction gives a 15:85 (*S*:*R*) mixture of diastereoisomers.

$\delta_{\text{H}}$  (400 MHz; CDCl<sub>3</sub>), 2.16-2.49 (2H, m, H-6 <sub>$\alpha$</sub>  and H-6 <sub>$\beta$</sub> ), 2.52-2.68 (1H, m, H-1 <sub>$\alpha$</sub> ), 2.78-2.99 (0.15H, m, H-1 <sub>$\beta$</sub> ), 3.30-3.43 (0.85H, m, H-4 <sub>$\alpha$</sub> ), 3.54-3.81 (4.15H, m, H-2, H-5, PhCH<sub>2</sub>N, H-4 <sub>$\beta$</sub> ), 3.86 (0.85H, d, *J* 11.5, PhCH<sub>2</sub>N), 3.99-4.21 (1H, m, H-3), 4.38-4.88 (6H, m, OCH<sub>2</sub>Ph), 4.89-5.23 (2H, m, C=CH<sub>2</sub>), 5.49-5.69 (0.85H, m, CH=CH<sub>2</sub>), 5.70-5.91 (0.15H, m, CH=CH<sub>2</sub>), 7.12-7.41 (20H, m, CH<sub>Ar</sub>).

(1*R*)-2,3,4-tri-*O*-benzyl-1-benzylamino-1-*C*-hexyl-1-deoxy-*D*-xylitol

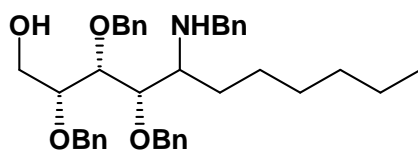

509.64

C<sub>39</sub>H<sub>49</sub>NO<sub>3</sub>

**33**

To a solution of crude compound **30** (1.21 g, 2.37 mmol theoretical) in dry THF (100 mL) at -78°C under argon, 1.4 M hexylmagnesium bromide in diethylether (8.5 mL, 11.9 mmol, 5 eq) was added dropwise. The mixture was stirred for 8 days at room temperature and then cooled to 0°C. The mixture was diluted with ethyl acetate (150 mL) and the organic phase was washed with saturated aqueous NaHCO<sub>3</sub> (80 mL), dried over MgSO<sub>4</sub>, filtered and evaporated. The residue was submitted to a first silica gel column chromatography (petroleum ether/ethyl acetate 4/1) and to a second silica gel column chromatography (CH<sub>2</sub>Cl<sub>2</sub>/Acetone 25/1) in order to isolate a small amount of one major isomer of compound **33** (133 mg, 9%) as a yellow syrup.

$\delta_{\text{H}}$  (400 MHz; CDCl<sub>3</sub>) 0.88 (3H, t, *J* 7, CH<sub>3</sub>), 1.11-1.31 (8H, m, CH<sub>2</sub>), 1.32-1.42 (1H, m, CH<sub>2</sub>), 1.43-1.60 (1H, m, CH<sub>2</sub>), 2.44-2.49 (1H, m, H-5), 3.34 (1H, dd, *J* 4.3 and 9.1, H-2), 3.58 (1H, d<sub>AB</sub>, *J* 13.0, NCH<sub>2</sub>Ph), 3.63 (1H, dd, *J* 4.0 and 11.7, H-1), 3.73 (1H, dd, *J* 5.2 and 9.1, H-1), 3.76 (1H, dd, *J* 2.4 and 7.0, H-4), 3.86 (1H, d<sub>AB</sub>, *J* 13.0, NCH<sub>2</sub>Ph), 4.07 (1H, dd, *J* 4.2 and 7.0, H-3), 4.37 (1H, d<sub>AB</sub>, *J* 11.6, OCH<sub>2</sub>Ph), 4.53 (1H, d<sub>AB</sub>, *J* 10.0, OCH<sub>2</sub>Ph), 4.56 (1H, d<sub>AB</sub>, *J* 10.0, OCH<sub>2</sub>Ph), 4.69 (1H, d<sub>AB</sub>, *J* 11.4, OCH<sub>2</sub>Ph), 4.79 (1H, d<sub>AB</sub>, *J* 11.4, OCH<sub>2</sub>Ph), 4.82 (1H, d<sub>AB</sub>, *J* 11.5, OCH<sub>2</sub>Ph), 7.22-7.35 (20H, m, Haro).

$\delta_{\text{C}}$  (101 MHz; CDCl<sub>3</sub>) 14.24 (CH<sub>3</sub>), 22.76-26.68-29.79-30.69 (CH<sub>2</sub>), 31.96-51.27 (NHCH<sub>2</sub>Ph), 56.75 (C-5), 61.88 (C-1), 72.05-74.60-74.85 (OCH<sub>2</sub>Ph), 78.44 (C-2), 80.25 (C-4), 80.52 (C-3), 117.9 (C=CH<sub>2</sub>), 126.89-128.75 (CH<sub>Ar</sub>), 138.35-138.45-138.88-141.05 (C<sub>qAr</sub>).

(+) **MS (ESI)**: *m/z* = 596.5 [M+H]<sup>+</sup>; *m/z* = 618.5 [M+Na]<sup>+</sup>

**$\alpha$ -1-C-Allyl-N-benzyloxycarbonyl-2,3,4-tri-O-benzyl-1,5-dideoxy-1,5-imino-D-xylitol**

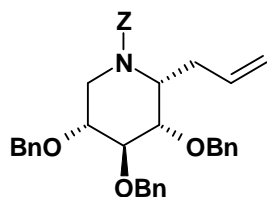

577.73

C<sub>37</sub>H<sub>39</sub>NO<sub>5</sub>

**34**

Under anhydrous conditions compound **31** (569 mg, 0.95 mmol) was dissolved in dry CH<sub>2</sub>Cl<sub>2</sub> (10 mL) and Et<sub>3</sub>N (300  $\mu$ L, 2.15 mmol, 2.25 eq). 4Å Molecular sieves were added and the mixture was stirred for 10 min. Mesyl chloride (155  $\mu$ L, 2.00 mmol, 2.1 eq) was added and the reaction mixture was stirred for 24 hours at room temperature. It was filtered over celite, diluted with ethyl acetate and washed with water. After drying over MgSO<sub>4</sub> the solvent was evaporated and the crude product was evaporated 4 times with toluene. tBuOK (267 mg, 2.38 mmol, 2.5 eq) was added to a solution of the crude mesylated in dry THF and the reaction mixture was stirred for 24 hours at room temperature. Concentration on rotavapor and the purification performed by flash chromatography on silica gel (Toluene/EtOAc: 97:3; v/v) afforded **34** (325 mg, 59%) as colorless oil. We observed 2 rotamers (ratio: A:B, 1:1).

$\delta_{\text{H}}$  (400 MHz; CDCl<sub>3</sub>) 2.25-2.35. (1H, m, H-6Aa and H-6Ba), 2.51-2.62 (1H, m, H-6Ab and H-6Ba), 2.74 (0.5H, dd, *J* 11.1 and 13.5, H-5a A or B), 2.76 (0.5H, dd, *J* 11.1 and 13.5, H-5a A or B), 3.41 (0.5H, ddd, *J* 5.7 and 9.3 and 11.1, H-4 A or B), 3.46 (0.5H, m, H-4 A or B), 3.50 (0.5H, dd, *J* 5.9 and 9.3, H-2A), 3.56 (0.5H, dd, *J* 5.9 and 9.3, H-2B), 3.68 (1H, t, *J* 9.3, H-3A and H-3B), 4.17 (0.5H, dd, *J* 5.7 and 13.5, H-5 A or B), 4.41 (0.5H, dd, *J* 5.7 and 13.5, H-5 A or B), 4.41 (0.5H, m, H-1A), 4.61-4.72 (4.5H, m, H-1B and 2OCH<sub>2</sub>Ph), 4.81-4.89 (2H, m, OCH<sub>2</sub>Ph), 4.92-5.14 (4H, m, COOCH<sub>2</sub>Ph and C=CH<sub>2</sub>), 5.50-5.61 (0.5H, m, CH=CH<sub>2</sub> A), 5.66-5.76 (0.5H, m, CH=CH<sub>2</sub> B), 7.25-7.37 (20H, m, Haro).

$\delta_{\text{C}}$  (101 MHz; CDCl<sub>3</sub>) 29.70-29.88 (C-6), 40.82-41.11 (C-5), 52.33-53.00 (C-1), 67.53-67.61 (COOCH<sub>2</sub>Ph), 72.90-73.24-73.45-75.91 (OCH<sub>2</sub>Ph), 78.33-78.46 (C-4), 79.84 (C-2), 82.17-82.22 (C-3), 117.46-117.77 (C=CH<sub>2</sub>), 127.70-128.64 (CH<sub>Ar</sub>), 134.44-134.53 (CH=CH<sub>2</sub>), 136.66-138.93 (C<sub>qAr</sub>), 155.66-155.70 (C=O).

$[\alpha]_{\text{D}}^{25} = -15$  (c=1.1, CHCl<sub>3</sub>)

(+) **MS (ESI)**: *m/z* = 600.5 [M+Na]<sup>+</sup>

**HRMS (ESI)** C<sub>37</sub>H<sub>39</sub>NO<sub>5</sub>Na: calcd: *m/z* = 600.2726, found: *m/z* = 600.2707.

**IR (cm<sup>-1</sup>)**: 3064, 3031, 2901, 2871, 1699, 1454, 1423, 1314, 1209, 1094.

**TLC**: (Tol/EtOAc ; 98/2) R<sub>f</sub> = 0.21.

**$\alpha$ -1-C-Allyl-N-benzyl-2,3,4-tri-O-benzyl-1,5-dideoxy-1,5-imino-D-xylitol**

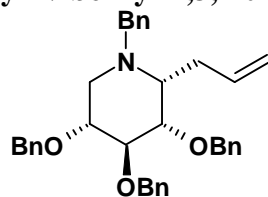

533.70

C<sub>36</sub>H<sub>39</sub>NO<sub>3</sub>

**35**

Under anhydrous conditions, compound **32** (1.58 g, 2.87 mmol) was dissolved in dry pyridine (30 mL). 4Å Molecular sieves were added and the mixture was stirred for 10 min. Mesyl chloride (0.55 mL, 5.7 mmol, 2.5 eq) was added and the reaction mixture was stirred for 4h at 100°C. It was filtered over celite, diluted with ethyl acetate and washed with water. After drying over MgSO<sub>4</sub> the solvent was evaporated and the crude product was evaporated 4 times with toluene. The separation of the diastereoisomers and the purification were done by flash chromatography on silica gel (eluent: EtOAc:EP, 1:20, v/v). A first column gave a fraction of pure diastereomer **35** (1.03g, 68%) and a mixed fraction. A second column allowed separation of two diastereomers and afforded the other diastereoisomer (0.12 g, 8%).

$\delta_{\text{H}}$  (400 MHz; CDCl<sub>3</sub>) 2.45 (2H, m, H-6), 2.53-2.67 (1H, m, H-5a), 2.71-2.78 (1H, m, H-5b), 3.10-3.15 (1H, m, H-1), 3.52-3.76 (5H, m, H-2, H-3, H-4, NCH<sub>2</sub>Ph), 4.45-4.95 (6H, m, OCH<sub>2</sub>Ph), 4.95-5.18 (2H, m, C=CH<sub>2</sub>), 5.73-5.85 (1H, m, CH=CH<sub>2</sub>), 7.00-7.59 (20H, m, Haro).

$\delta_{\text{C}}$  (101 MHz; CDCl<sub>3</sub>) 28.16 (C-6), 48.15 (C-5), 59.13 (NCH<sub>2</sub>Ph), 60.22 (C-1), 75.71-73.14-72.70 (OCH<sub>2</sub>Ph), 82.82-80.76-78.65 (C-2, C-3, C-4), 115.82 (C=CH<sub>2</sub>), 126.70-128.66 (CH<sub>Ar</sub>), 135.54-137.92 (C<sub>qAr</sub>), 138.58 (CH=CH<sub>2</sub>).

$[\alpha]_{\text{D}}^{25} = +25$  (c=1.1, CHCl<sub>3</sub>)

(+) **MS (ESI):** m/z = 534.5 [M+H]<sup>+</sup>

**IR (cm<sup>-1</sup>):** 3062, 3029, 2903, 2868, 1638, 1494, 1453, 1089, 1069.

**TLC:** (EP/EtOAc ; 20/1) R<sub>f</sub> = 0.19.

Data for the minor  $\beta$ -anomer:

$\delta_{\text{H}}$  (400 MHz; CDCl<sub>3</sub>) 1.73-1.92 (1H, m, H-5a), 2.30-2.45 (1H, m, H-1), 2.60 (2H, s, H-6ab), 2.90 (1H, d, *J* 11.4, H-5b), 3.08 (1H, d<sub>AB</sub>, *J* 13.3, NCH<sub>2</sub>Ph), 3.32-3.52 (m, 3H, H-2,H-3,H-4), 4.01 (1H, d<sub>AB</sub>, *J* 13.3, NCH<sub>2</sub>Ph), 4.43 (2H, q, *J* 11.7, OCH<sub>2</sub>Ph), 4.57 (1H, d<sub>AB</sub>, *J* 10.9, OCH<sub>2</sub>Ph), 4.68-4.77 (1H, m, OCH<sub>2</sub>Ph), 4.81-4.95 (2H, m, OCH<sub>2</sub>Ph), 4.96-5.12 (2H, m, C=CH<sub>2</sub>), 5.78-6.00 (1H, m, CH=CH<sub>2</sub>), 7.06-7.31 (20H, m, Haro).



$\delta_C$  (101 MHz;  $CDCl_3$ ) 31.90 (C-6), 53.77 (C-5), 55.85 (NCH<sub>2</sub>Ph), 64.2 (C-1), 75.08-75.30-72.41 (OCH<sub>2</sub>Ph), 87.42-79.93-78.14 (C-2, C-3, C-4), 117.46 (C=CH<sub>2</sub>), 134.17 (CH=CH<sub>2</sub>).

***N*-Benzyl-2,3,4-tri-*O*-benzyl- $\alpha$ -1-*C*-hexyl-1,5-dideoxy-1,5-imino-*D*-xylitol**

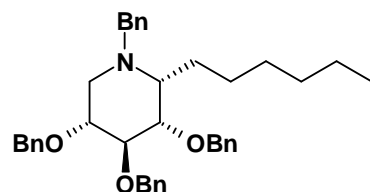

577.81

C<sub>39</sub>H<sub>47</sub>NO<sub>3</sub>

**36**

Compound **33** (133 mg, 0.223 mmol) was dissolved in anhydrous pyridine (5 mL) and stirred 30 min with molecular sieves under argon. Mesyl chloride (43  $\mu$ L, 0.558 mmol, 2.5 eq) was added and the mixture was stirred for 7h at 100°C. After removal of solids by filtration over celite, the filtrate was diluted with ethyl acetate (30 mL) and the organic phase was washed with water (15 mL), dried with MgSO<sub>4</sub>, filtered, evaporated and coevaporated twice with toluene. The residue was purified by silica gel column chromatography (eluent: PE/ethyl acetate; 8:1; v/v) to give pure compound **36** (58 mg, 45%).

$\delta_{\text{H}}$  (400 MHz; CDCl<sub>3</sub>) 0.88 (3H, t,  $J$  6.8, H-6), 1.19-1.31 (6H, m, CH<sub>2</sub>), 1.32-1.49 (1H, m, CH<sub>2</sub>), 1.50-1.61 (1H, m, CH<sub>2</sub>), 1.77-1.81 (1H, m, CH<sub>2</sub>), 2.61 (1H, dd,  $J$  10.7 and 12.7, H-5a), 2.77 (1H, dd,  $J$  5.7 and 12.7, H-5b), 2.91 (1H, m, H-1), 3.49 (1H, d<sub>AB</sub>,  $J$  13.6, NCH<sub>2</sub>Ph), 3.62 (1H, d<sub>AB</sub>,  $J$  13.6, NCH<sub>2</sub>Ph), 3.64-3.71 (1H, m, H-4), 3.75-3.82 (2H, m, H-2 and H-3), 4.42 (1H, d<sub>AB</sub>,  $J$  11.9, OCH<sub>2</sub>Ph), 4.49 (1H, d<sub>AB</sub>,  $J$  11.8, OCH<sub>2</sub>Ph), 4.53 (1H, d<sub>AB</sub>,  $J$  12.0, OCH<sub>2</sub>Ph), 4.57 (1H, d<sub>AB</sub>,  $J$  12.0, OCH<sub>2</sub>Ph), 4.96 (1H, d<sub>AB</sub>,  $J$  11.4, OCH<sub>2</sub>Ph), 5.00 (1H, d<sub>AB</sub>,  $J$  11.4, OCH<sub>2</sub>Ph), 7.01-7.44 (20H, m, Haro).

*note* : from <sup>1</sup>H NMR in CDCl<sub>3</sub>, after irradiation of CH<sub>2</sub>a, we found that  $J_{1-2} = 5.2$  Hz. We can conclude that the alkyl chain is in  $\alpha$  position. (according to coupling constant  $J_{5-4} = 5.7, 10.7$  Hz, we knew that **36** adopt the chair conformation <sup>4</sup>C<sub>1</sub>).

$\delta_{\text{C}}$  (101 MHz; CDCl<sub>3</sub>) 14.29 (CH<sub>3</sub>), 22.83-23.80-28.42-29.69-31.99(CH<sub>2</sub>), 47.86 (C-5), 58.94 (NCH<sub>2</sub>Ph), 59.56 (C-1), 72.83-73.12-75.74 (OCH<sub>2</sub>Ph), 78.21 (C-3 or C-4), 80.27 (C-2), 83.32 (C-3 or C-4), 127.12-128.49 (CH<sub>Ar</sub>), 138.72-138.87-139.35-139.77 (C<sub>qAr</sub>).

(+) **MS (ESI)**:  $m/z = 578.5$  [M+H]<sup>+</sup>

**HRMS (ESI)** C<sub>37</sub>H<sub>40</sub>NO<sub>5</sub>: calcd:  $m/z = 578.3634$ , found:  $m/z = 578.3632$ .

**TLC**: (EP/EtOAc ; 8/1) R<sub>f</sub> = 0.44.

**$\alpha$ -1-C-Propyl-1,5-dideoxy-1,5-imino-D-xylitol**

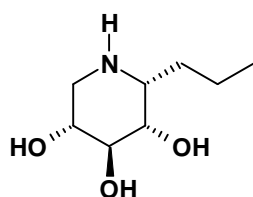

175.23

C<sub>8</sub>H<sub>17</sub>NO<sub>3</sub>

**37**

Compound **35** (119 mg, 0.224 mmol) was dissolved in a mixture of dichloromethane (1 mL), isopropanol (5 mL) and 1 N hydrochloric acid (1 mL). 10% Pd/C (50 mg) and Pd black (50 mg) were added to the mixture. The mixture was stirred for 18 hours under hydrogen atmosphere. The reaction mixture was filtered over Millipore and the catalyst washed with isopropanol. The filtrate was passed over an ion-exchange resin (Dowex 50WX8-H<sup>+</sup>). The product was recovered using 0.5 N aqueous ammonia. The solvent was evaporated and compound **37** was obtained as colorless oil (39 mg, 98%).

$\delta_{\text{H}}$  (400 MHz; CDCl<sub>3</sub>) 0.98 (2H, t, *J* 7.0, CH<sub>3</sub>), 1.30-1.52 (3H, m, CH<sub>2</sub>), 1.67-1.53 (1H, m, CH<sub>2</sub>), 2.81 (1H, d, *J* 12.8, H-5b), 3.00 (1H, m, H-1), 3.07 (1H, d, *J* 12.8, H-5a), 3.58 (2H, s, H-2,H-4), 3.80 (1H, s, H-3).

$\delta_{\text{C}}$  (101 MHz; CDCl<sub>3</sub>) 15.11-20.80 (CH<sub>2</sub>), 33.6 (C-6), 48.1 (C-5), 55.9 (C-1), 72.33-71.85-71.11 (C-2, C-3, C-4).

$[\alpha]_{\text{D}}^{25} = -0.2$  (c=1.0, CHCl<sub>3</sub>)

(+) **MS (ESI):** *m/z* = 176.5 [M+H]<sup>+</sup>

**$\alpha$ -1-C-(Hex-2-enyl)-N-benzyloxycarbonyl-2,3,4-tri-O-benzyl-1,5-dideoxy-1,5-imino-D-xylitol**

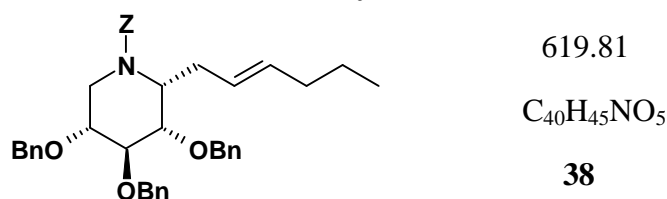

Under anhydrous conditions, compound **34** (294 mg, 0.51 mmol) was dissolved in dry CH<sub>2</sub>Cl<sub>2</sub> (2 mL). Second generation Hoveyda-Grubbs catalyst (16 mg, 0.03 mmol, 0.05 eq) was added and the mixture was stirred for 10 min at room temperature. Pentene (380  $\mu$ L, 3.47 mmol, 6.8 eq) was added at 0°C and the reaction mixture was stirred for 36 hours at 20°C. The solvent was evaporated and the crude was purified by flash chromatography on silica gel (Toluene/EtOAc: 98:2; v/v) to afford **38** (129 mg, 41%) as colorless oil. We observed 2 rotameres (ratio: A:B, 1:1).

$\delta_{\text{H}}$  (400 MHz; CDCl<sub>3</sub>) 0.87 (3H, t, *J* 6.9, CH<sub>3</sub>), 1.23-1.36 (2H, m, CH<sub>2</sub>), 1.82-1.99 (2H, m, CH<sub>2</sub>), 2.19-2.22 (1H, m, H-6Aa and H-6Ba), 2.45-2.54 (1H, m, H-6Ab and H-6Ba), 2.74 (1H, m, H-5a A or B), 3.37-3.39 (1H, m, H-4A and H-4B), 3.45-3.50 (0.5H, m, H-4 A or B), 3.46 (0.5H, m, H-2A), 3.54-3.58 (0.5H, m, H-2B), 3.65-3.71 (1H, m, H-3A and H-3B), 4.16 (1H, dd, *J* 6.0 and 13.6, H-5B), 4.36-4.42 (1H, m, H-1A or H-5A), 4.60-4.71 (4.5H, m, H-1B and OCH<sub>2</sub>Ph), 4.80-4.89 (2H, m, OCH<sub>2</sub>Ph), 5.01-5.13 (2H, m, COOCH<sub>2</sub>Ph), 5.19-5.21 (1H, m, C=CH<sub>2</sub>), 5.25-5.33 (1H, m, CH=CH<sub>2</sub> A), 5.38-5.47 (0.5H, m, CH=CH<sub>2</sub> B), 7.22-7.36 (20H, m, Haro).

$\delta_{\text{C}}$  (101 MHz; CDCl<sub>3</sub>) 13.66-13.75 (CH<sub>3</sub>), 22.60-22.89 (CH<sub>2</sub>), 28.54-29.64 (CH<sub>2</sub>), 34.75-34.65 (C-6), 40.76-41.03 (C-5), 52.38-53.29 (C-1), 67.41-67.48 (COOCH<sub>2</sub>Ph), 72.72-73.11-73.20-73.36-75.82-75.83 (OCH<sub>2</sub>Ph), 78.36-78.41 (C-4), 79.89 (br s, C-2), 82.07-82.21 (C-3), 125.53-125.72 (C=CH<sub>2</sub>), 127.64-128.62 (CH<sub>Ar</sub>), 133.37-133.62 (CH=CH<sub>2</sub>), 136.66-138.97 (Cq<sub>Ar</sub>), 155.54-155.69 (C=O).

**TLC:** (Tol/EtOAc ; 98/2) R<sub>f</sub> = 0.33.

**3-O-benzyl-1,2:5,6-di-O-isopropylidene- $\alpha$ -D-glucofuranose**

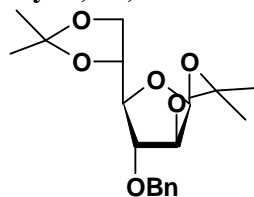

350.42

C<sub>19</sub>H<sub>26</sub>O<sub>6</sub>

**39**

Commercially available 1,2:5,6-isopropylidene-D-glucofuranose (13.5 g, 0.052 mmol) in anhydrous THF (65 mL) was added under argon atmosphere at 0°C to a cooled suspension of sodium hydride (2.5 g, 0.062 mol, 1.2 eq, 60% dispersion in mineral oil) in THF anhydrous (40 mL) containing tetrabutylammonium iodide (149 mg, 0.40 mmol). After warming to room temperature, benzyl bromide (9 mL, 76 mmol, 1.3 eq) was added dropwise. After stirring 2 hours under reflux, methanol (20 mL) was added cautiously. The mixture was diluted with CH<sub>2</sub>Cl<sub>2</sub> (100 mL) and water (40 mL). The organic phase was separated and the aqueous phase was extracted 3 times with CH<sub>2</sub>Cl<sub>2</sub> (50 mL). Organic phases were combined and dried over MgSO<sub>4</sub>, filtered and evaporated under vacuum. The residue was purified by silica gel column chromatography (eluent: cyclohexane/diethyl ether 4/1, Et<sub>3</sub>N 0.4%) to give compound **39** (16.42 g, 90%) as a yellow oil.

$\delta_{\text{H}}$  (400 MHz; CDCl<sub>3</sub>) 1.31 (3H, s, CH<sub>3</sub>), 1.37 (3H, s, CH<sub>3</sub>), 1.43 (3H, s, CH<sub>3</sub>), 1.49 (3H, s, CH<sub>3</sub>), 4.00 (1H, d, *J* 5.6 and 8.4, H-6a), 4.02 (1H, d, *J* 3.0, H-3), 4.11 (1H, d, *J* 6.0, H-6b), 4.15 (1H, d, *J* 3.0 and 7.6, H-4), 4.34-4.40 (1H, m, H-5), 4.58 (1H, d, *J* 3.6, H-2), 4.66 (2H, q<sub>AB</sub>, OCH<sub>2</sub>Ph), 5.90 (1H, d, *J* 3.6, H-1), 7.27.35 (5H, m, Haro).

$\delta_{\text{C}}$  (101 MHz; CDCl<sub>3</sub>) 25.57 (CH<sub>3</sub>), 26.37 (CH<sub>3</sub>), 26.92 (CH<sub>3</sub>), 26.97 (CH<sub>3</sub>), 67.53 (C-6), 72.50 (OCH<sub>2</sub>Ph), 72.65 (C-5), 81.45 (C-4), 81.83 (C-3), 82.79 (C-2), 105.42 (C-1), 109.10 (C<sub>q</sub>), 111.90 (C<sub>q</sub>), 127.77-127.96-128.52 (C<sub>Ar</sub>), 137.77 (C<sub>qAr</sub>).

**TLC:** (Cyclohexane/diethyl ether ; 98/2) R<sub>f</sub> = 0.33.

**3-O-Benzyl-1,2-O-isopropylidene- $\alpha$ -D-xylo-pentodialdo-1,4-furanose**

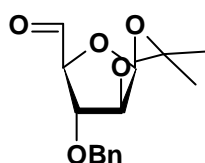

278.31

C<sub>15</sub>H<sub>18</sub>O<sub>5</sub>

**40**

A solution of **39** (1.03 g, 2.94 mmol) in a mixture of acetic acid (21 mL) and water (9 mL) was heated to 45°C for 2 hours. After cooling to 0°C, a solution of NaIO<sub>4</sub> (692 mg, 3.23 mmol, 1.1 eq) in water (7 mL) was added and the mixture was stirred for 18h at room temperature. CH<sub>2</sub>Cl<sub>2</sub> (60 mL) was added, the aqueous phase was extracted 3 times with CH<sub>2</sub>Cl<sub>2</sub> and the organic phases were combined and washed with water twice (35 mL), dried over MgSO<sub>4</sub>, filtered and evaporated then coevaporated twice using toluene under high vacuum. The aldehyde **40** was used without any purification.

$\delta_{\text{H}}$  (250 MHz, CDCl<sub>3</sub>): 1.33 (3H, s, CH<sub>3</sub>), 1.47 (3H, s, CH<sub>3</sub>), 4.33 (1H, d, *J* 3.7, H-3), 4.49 (1H, d<sub>AB</sub>, *J* 12.0, OCH<sub>2</sub>Ph), 4.54 (1H, d<sub>AB</sub>, *J* 12.0, OCH<sub>2</sub>Ph), 4.61 (1H, dd, *J* 1.5 and 3.7, H-4), 4.64 (1H, d, *J* 3.7, H-2), 6.12 (1H, d, *J* 3.6, H-1), 7.1-7.4 (5H, m, Haro), 9.67 (1H, d, *J* 0.8, CHO).

**3-O-benzyl-xylo-pentodialdose**

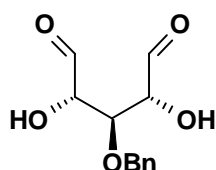

238.34

C<sub>12</sub>H<sub>14</sub>O<sub>5</sub>

**41**

Dowex 50WX8 (H<sup>+</sup>) ion exchange resin (3.4 g) was added to a solution of compound **40** in dioxane (10 mL)/water (4 mL) and the mixture was slowly stirred at 75°C for 18h. The resin was removed by filtration and the solvents were evaporated under vacuum. The residue was coevaporated twice with toluene to give dialdose **41** (700 mg, 100%) as a red foam and used directly in the next step.

***N*-Benzyl-3-*O*-benzyl-1,5-dideoxy-1,5-imino-xylitol**

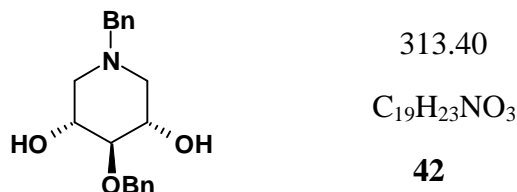

Crude **41** was dried over P<sub>2</sub>O<sub>5</sub> for 24 hours, then stirred in the presence of 3Å molecular sieves for 15 min and finally dissolved in dry MeOH (50 mL). NaBH<sub>3</sub>CN (554 mg, 8.82 mmol, 3 eq) was added. The mixture was cooled to -78°C and AcOH (332 mL, 5.80 mmol, 2 eq) and BnNH<sub>2</sub> (292 mL, 2.67 mmol, 0.9 eq) were added. The mixture was allowed to warm to room temperature and was stirred for a total of 18 hours. The solid was removed by filtration over Celite and washed twice with EtOAc. The filtrate was concentrated under vacuum. The residue was dissolved in EtOAc (60 mL), and the solution was washed with saturated Na<sub>2</sub>CO<sub>3</sub> followed by H<sub>2</sub>O. The organic phase was dried over MgSO<sub>4</sub>, and then concentrated under vacuum. Compound **42** was obtained as a white solid (824 mg, 90% from 3-*O*-benzyl-1,2:5,6-di-*O*-isopropylidene-D-glucofuranose), which was used in the next step without further purification.

δ<sub>H</sub> (250 MHz, CDCl<sub>3</sub>): 2.24 (2H, dd, *J* 8 and 11, H-1a and H-5a), 2.42-2.45 (1H, s, OH), 2.85 (2H, dd, *J* 3.8 and 11.2, H-1b, H5b), 2.25 (1H, t, *J* 7.5, H-3), 3.55 (2H, s, NCH<sub>2</sub>Ph), 3.77 (2H, dt, *J* 3.8 and 7.5, H-2 and H-4), 4.76 (2H, s, OCH<sub>2</sub>Ph), 7.20-7.40 (10H, m, Haro).

δ<sub>C</sub> (101 MHz, CDCl<sub>3</sub>): 57.12 (C-1, C-5), 62.20 (NCH<sub>2</sub>Ph), 69.91 (C-2, C-4), 73.98 (OCH<sub>2</sub>Ph), 84.30 (C-3), 127.39-129.14 (CH<sub>Ar</sub>), 137.86-138.68 (C<sub>qAr</sub>).

(+) **MS (ESI)**: *m/z* = 314.0 [M+H]<sup>+</sup>; *m/z* = 336.0 [M+Na]<sup>+</sup>

**HRMS (ESI)** : C<sub>19</sub>H<sub>24</sub>NO<sub>3</sub>: calcd: *m/z* = 314.1756, found : *m/z* = 314.1743.

**TLC**: (CH<sub>2</sub>Cl<sub>2</sub>/MeOH; 8:1) R<sub>f</sub> = 0.50.

**General procedure for alkylation:** NaH (60% dispersion in mineral oil, 3 eq) was added to a solution of **42** in dry DMF (0.05M) at 0°C. The mixture was stirred at 0°C for 30 min and then Bu<sub>4</sub>NI (0.2 eq) and 1-bromoalkane (2 eq) were added. After stirring for 18 h at room temperature, the mixture was cooled to 0°C and MeOH was cautiously added. The solution was diluted with EtOAc (40 mL/mmol). The organic phase was washed three times with brine, dried over MgSO<sub>4</sub> and concentrated under vacuum. The residue was purified by flash chromatography on silica gel.

(±)-*N*-Benzyl-3-*O*-benzyl-2-*O*-butyl-1,5-dideoxy-1,5-imino-D,L-xylitol

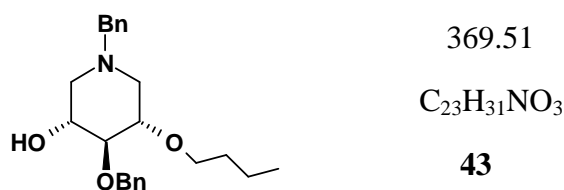

Compound **43a** (83 mg, 35%) was obtained from **42** (200.5 mg, 0.64 mmol) as an oil, after purification (petroleum ether/EtOAc, 3:1, v:v).

$\delta_{\text{H}}$  (400 MHz, CDCl<sub>3</sub>): 0.90 (3H, t, *J* 6.8, CH<sub>3</sub>), 1.35 (2H, m, CH<sub>2</sub>), 1.53 (2H, m, CH<sub>2</sub>), 2.26 (2H, m, H-1 and H-5), 2.83 (2H, dd, *J* 3.0 and 11.6, H-1b and H-5b), 3.32 (1H, t, *J* 6.8, H-3), 3.3-3.51 (3H, m, OCH<sub>2</sub> and H-2), 3.50 (1H, d<sub>AB</sub>, *J* 13.2, NCH<sub>2</sub>Ph), 3.60 (1H, d<sub>AB</sub>, *J* 13.2, NCH<sub>2</sub>Ph), 3.69 (1H, dt, *J* 6.9, H-4), 4.63 (1H, d<sub>AB</sub>, *J* 11.7, OCH<sub>2</sub>Ph), 4.75 (1H, d<sub>AB</sub>, *J* 11.7, OCH<sub>2</sub>Ph), 7.21-7.36 (10H, m, Haro).

$\delta_{\text{C}}$  (101 MHz, CDCl<sub>3</sub>): 14.03 (CH<sub>3</sub>), 19.46 (CH<sub>2</sub>), 32.33 (CH<sub>2</sub>), 54.45 (C-1), 56.60 (C-5), 62.32 (NCH<sub>2</sub>Ph), 69.33 (C-4), 69.84 (OCH<sub>2</sub>), 73.90 (OCH<sub>2</sub>Ph), 78.20 (C-2), 82.31 (C-3), 127.25-129.03 (CH<sub>Ar</sub>), 138.11-138.84 (C<sub>Ar</sub>).

(+) **MS (ESI):** *m/z* = 370.5 [M+H]<sup>+</sup>, *m/z* = 393.0 [M+Na]<sup>+</sup>.

**HRMS (ESI) :** C<sub>23</sub>H<sub>33</sub>NO<sub>3</sub>: calcd: *m/z* = 370.2382, found : *m/z* = 370.2390.

**TLC:** (petroleum ether/EtOAc; 3:2) R<sub>f</sub> = 0.37.



(±)-*N*-Benzyl-3-*O*-benzyl-2-*O*-hexyl-1,5-dideoxy-1,5-imino-D,L-xylitol

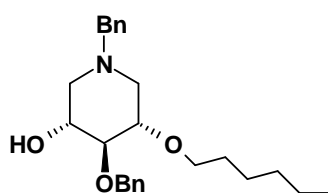

397.56

C<sub>25</sub>H<sub>35</sub>NO<sub>3</sub>

**43b**

Compound **43b** (56 mg, 44%) was obtained from **42** (100 mg, 0.32 mmol) as an oil, after purification (petroleum ether/EtOAc, 3:1, v:v).

$\delta_{\text{H}}$  (400 MHz, CDCl<sub>3</sub>): 0.87 (3H, t, *J* 6.8 Hz, CH<sub>3</sub>), 1.22–1.36 (6H, m, CH<sub>2</sub>), 1.50–1.57 (2H, m, CH<sub>2</sub>), 2.23–2.27 (2H, m, H-1<sub>ax</sub>, H-5<sub>ax</sub>), 2.83 (2H, dd, *J* 3.4, *J* 11.0, H-1<sub>eq</sub>, H-5<sub>eq</sub>), 3.32 (1H, t, *J* 7.0, H-3), 3.37–3.51 (3H, m, H-2 and H-6), 3.50 (1H, d<sub>AB</sub>, *J* 13.2, NCH<sub>2</sub>Ph), 3.60 (1H, d<sub>AB</sub>, *J* 13.2, NCH<sub>2</sub>Ph), 3.69 (1H, dt, *J* 3.4 and 7.0, H-4), 4.65 (1H, d<sub>AB</sub>, *J* 11.7, OCH<sub>2</sub>Ph), 4.85 (1H, d<sub>AB</sub>, *J* 11.7, OCH<sub>2</sub>Ph), 7.21–7.36 (10 H, m, Haro).

$\delta_{\text{C}}$  (101 MHz, CDCl<sub>3</sub>): 14.2 (CH<sub>3</sub>), 22.7–26.0–31.8 (CH<sub>2</sub>), 30.2 (CH<sub>2</sub>), 54.5, 56.6 (C-1, C-5), 62.3 (NCH<sub>2</sub>Ph), 69.3 (C-4), 70.2 (OCH<sub>2</sub>), 73.9 (OCH<sub>2</sub>Ph), 78.2 (C-2), 82.4 (C-3), 127.2–129.0 (CH<sub>Ar</sub>), 138.1–138.8 (C<sub>Ar</sub>).

(+) **MS (ESI)**: *m/z* = 398.5 [M+H]<sup>+</sup>, *m/z* = 414.5 [M+NH<sub>4</sub>]<sup>+</sup>.

**TLC**: (petroleum ether/EtOAc; 3:2) R<sub>f</sub> = 0.57

(±)-*N*-Benzyl-3-*O*-benzyl-2-*O*-nonyl-1,5-dideoxy-1,5-imino-*D,L*-xylitol

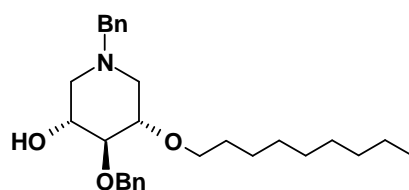

439.64

C<sub>28</sub>H<sub>41</sub>NO<sub>3</sub>

**43c**

Compound **43c** (41 mg, 15%) was obtained from **42** (194 mg, 0.62 mmol) as an oil, after purification (petroleum ether/EtOAc, 3:1, v:v).

$\delta_{\text{H}}$  (250 MHz, CDCl<sub>3</sub>): 0.88 (3H, t, *J* 6.9, CH<sub>3</sub>), 1.26 (12H, m, CH<sub>2</sub>), 1.53 (2H, m, CH<sub>2</sub>), 2.26 (2H, m, H-1a, H-5a), 2.84 (2H, dd, *J* 3.3 and 11.2, H-1b, H-5b), 3.32 (1H, t, *J* 6.8, H-3), 3.34-3.53 (3H, m, OCH<sub>2</sub> and H-2), 3.50 (1H, d<sub>AB</sub>, *J* 13.1, NCH<sub>2</sub>Ph), 3.60 (1H, d<sub>AB</sub>, *J* 13.1, NCH<sub>2</sub>Ph), 3.69 (1H, dt, *J* 3.4 and 7.0, H-4), 4.65 (1H, d<sub>AB</sub>, *J* 11.9, OCH<sub>2</sub>Ph), 4.84 (1H, d<sub>AB</sub>, *J* 11.9, OCH<sub>2</sub>Ph), 7.21-7.36 (10H, m, Haro).

$\delta_{\text{C}}$  (101 MHz, CDCl<sub>3</sub>): 14.25 (CH<sub>3</sub>), 22.80-26.30-29.40-29.61-29.69-30.27 (CH<sub>2</sub>), 32.01, 54.45 (C-1), 56.58 (C-5), 62.31 (NCH<sub>2</sub>Ph), 69.32 (C-4), 70.09 (OCH<sub>2</sub>), 73.91 (OCH<sub>2</sub>Ph), 78.20 (C-2), 82.37 (C3), 127.27- 129.05 (CH<sub>Ar</sub>), 138.05-138.84 (C<sub>Ar</sub>).

(+) **MS (ESI)**: *m/z* = 440.0 [M+H]<sup>+</sup>.

**HRMS (ESI)** : C<sub>28</sub>H<sub>42</sub>NO<sub>3</sub> : calcd: *m/z* = 440.3165 , found : *m/z* = 440.3156.

**TLC**: (petroleum ether/EtOAc; 3:2) R<sub>f</sub> = 0.41

***N*-Benzyl-3-*O*-benzyl-2,4-di-*O*-butyl-1,5-dideoxy-1,5-imino-D,L-xylitol**

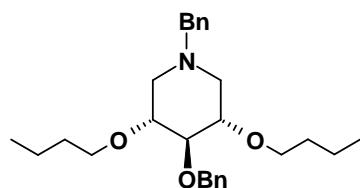

425.62

C<sub>27</sub>H<sub>39</sub>NO<sub>3</sub>

**44a**

Compound **44a** (140 mg, 51%) was obtained from **42** (201 mg, 0.64 mmol) as an oil, after purification (petroleum ether/EtOAc, 3:2, v:v).

$\delta_{\text{H}}$  (250 MHz, CDCl<sub>3</sub>): 0.87 (6H, t, *J* 6.8, CH<sub>3</sub>), 1.35 (4H, m, CH<sub>2</sub>), 1.51 (4H, m, CH<sub>2</sub>), 1.88 (2H, t, *J* 10.5, H-1a and H-5a), 3.03 (dd, 2H, *J* 4.8, H-1b and H-5b), 3.23 (1H, t, *J* 8.9, H-3), 3.37-3.41 (2H, m, H2 and H4), 3.49-3.60 (6H, m, NCH<sub>2</sub>Ph and OCH<sub>2</sub>), 4.83 (2H, s, OCH<sub>2</sub>Ph), 7.20-7.41 (10H, m, Haro).

$\delta_{\text{C}}$  (62 MHz, CDCl<sub>3</sub>): 14.05 (2 CH<sub>3</sub>), 19.42 (2 CH<sub>2</sub>), 32.52 (2 CH<sub>2</sub>), 56.29 (C-1, C-5), 62.25 (NCH<sub>2</sub>Ph), 70.95 (2 OCH<sub>2</sub>), 75.39 (OCH<sub>2</sub>Ph), 79.17 (C-2, C-4), 86.38 (C-3), 127.26- 128.93 (CH<sub>Ar</sub>), 138.06-139.46 (C<sub>Ar</sub>).

(+) **MS (ESI)**: *m/z* = 426.5 [M+H]<sup>+</sup>.

**HRMS (ESI)**: C<sub>27</sub>H<sub>40</sub>NO<sub>3</sub> : calcd: *m/z* = 426.3008 , found : *m/z* = 426.3018.

**TLC**: (petroleum ether/EtOAc; 3:2) R<sub>f</sub> = 0.93.

***N*-Benzyl-3-*O*-benzyl-2,4-di-*O*-nonyl-1,5-dideoxy-1,5-imino-D,L-xylitol**

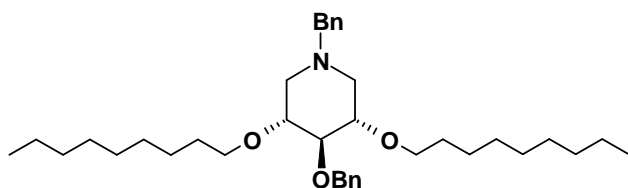

565.89

C<sub>37</sub>H<sub>59</sub>NO<sub>3</sub>

**44b**

Compound **44b** (250 mg, 69%) was obtained from **42** (201 mg, 0.64 mmol) as an oil, after purification (petroleum ether/EtOAc, 3:1→1.5:1, v:v).

$\delta_{\text{H}}$  (400 MHz, CDCl<sub>3</sub>): 0.87 (6H, t, 2CH<sub>3</sub>), 1.23 (24H, m, CH<sub>2</sub>), 1.52 (4H, m, CH<sub>2</sub>), 1.88 (2H, t, *J* 10.8, H-1a and H-5a), 3.03 (2H, dd, *J* 4.1, H-1b and H-5b), 3.23 (1H, t, H-3, *J* 8.9), 3.39 (2H, m, H-2, H-4), 3.49-3.57 (6H, m, NCH<sub>2</sub>Ph and OCH<sub>2</sub>), 4.83 (2H, s, OCH<sub>2</sub>Ph), 7.20-7.41 (10H, m, Haro).

$\delta_{\text{C}}$  (101 MHz, CDCl<sub>3</sub>): 14.25 (2 CH<sub>3</sub>), 22.81-26.29-29.42-29.66-29.67-30.47-32.02 (CH<sub>2</sub>), 56.30 (C-1, C-5), 62.26 (NCH<sub>2</sub>Ph), 71.32 (2 OCH<sub>2</sub>), 75.37 (OCH<sub>2</sub>Ph), 79.17 (C-2, C-4), 86.38 (C-3), 127.27-128.95 (CH<sub>Ar</sub>), 138.04-139.49 (C<sub>Ar</sub>).

(+) **MS (ESI)**: *m/z* = 566.5 [M+H]<sup>+</sup>.

**HRMS (ESI)**: C<sub>37</sub>H<sub>60</sub>NO<sub>3</sub> : calcd: *m/z* = 566.4573 , found : *m/z* = 566.4564.

**TLC**: (petroleum ether/EtOAc; 3:2) R<sub>f</sub> = 0.92.

**General procedure for hydrogenolysis:** Compounds **43a–c**, **44a** and **44b** were dissolved in a mixture of *i*PrOH/CH<sub>2</sub>Cl<sub>2</sub> (2:1) or EtOH (0.01M) containing AcOH (5% v/v); 10% Pd/C was added and the reaction was stirred at room temperature under a H<sub>2</sub> atmosphere until completion. More catalyst was added if needed. The reaction mixture was filtered through a membrane and the catalyst was washed three times with *i*PrOH/CH<sub>2</sub>Cl<sub>2</sub> or EtOH. The filtrate was concentrated under vacuum and co-evaporated three times with toluene to give **45 a–c**, **46a** and **46c** as white solids.

(±)-2-*O*-Butyl-1,5-dideoxy-1,5-imino-D,L-xylitol

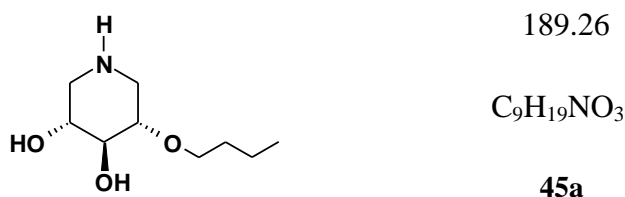

Compound (±)**45a** (30 mg, 97%) was obtained from **43a** (60 mg, 0.162 mmol), using EtOH as solvent and after 3 supplementary additions of Pd/C (3x100 mg) and 3 days of stirring.

$\delta_{\text{H}}$  (400 MHz, CD<sub>3</sub>OD) 0.94 (3H, t, *J* 7.4, CH<sub>3</sub>), 1.35-1.44 (2H, m, CH<sub>2</sub>), 1.54-1.63 (2H, m, CH<sub>2</sub>), 2.95 (2H, dd, *J* 7.1, 12.6, H-5<sub>ax</sub>), 2.97 (1H, dd, *J* 7.1 and 12.6, H-1<sub>ax</sub>), 3.33 (1H, dd, *J* 3.7 and 12.6, H-5<sub>eq</sub>), 3.41 (1H, dd, *J* 3.7 and 12.6, H-1<sub>eq</sub>), 3.52 (1H, dt, *J* 3.7 and 7.1, H-2), 3.59-3.67 (3H, m, OCH<sub>2</sub> and H-3), 3.75 (1H, dt, *J* 3.7 and 7.1, H-4).

$\delta_{\text{C}}$  (101 MHz, CD<sub>3</sub>OD) 14.21 (CH<sub>3</sub>), 20.23 - 33.10 (CH<sub>2</sub>), 45.55 (C-1), 47.80 (C-5), 68.81 (C-4), 71.80 (OCH<sub>2</sub>), 72.77 (C-3), 76.76 (C-2).

**HRMS (ESI):** C<sub>9</sub>H<sub>20</sub>NO<sub>3</sub> : calcd: *m/z* = 190.1443; found *m/z* = 190.1429.

(±)-2-*O*-Hexyl-1,5-dideoxy-1,5-imino-D,L-xylitol

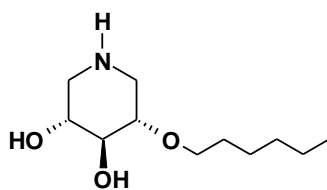

217.31

C<sub>11</sub>H<sub>23</sub>NO<sub>3</sub>

**45b**

---

Compound **45b** was obtained from **43b** using EtOH as solvent and after purification by flash chromatography on silica gel (CHCl<sub>3</sub>/MeOH/H<sub>2</sub>O, 70/40/1, v:v:v). It was obtained in racemic form as white solid (24 mg, 75%).

$\delta_{\text{H}}$  (250 MHz, CD<sub>3</sub>OD): 0.90 (3H, t, *J* 6.8, CH<sub>3</sub>), 1.32 (6H, m, CH<sub>2</sub>), 1.55 (2H, m, CH<sub>2</sub>), 2.39 (2H, m, H-1a and H-5b), 3.05 (1H, dd, *J* 12.6, H-1b), 3.11-3.23 (2H, m, H-2 and H-5b), 3.28 (1H, t, *J* 8.2, H-3), 3.43 (1H, m, H-4), 3.59 (2H, t, *J* 6.6, OCH<sub>2</sub>).

$\delta_{\text{C}}$  (62 MHz, CD<sub>3</sub>OD): 14.39 (CH<sub>3</sub>), 23.69-26.83-31.16-32.87 (CH<sub>2</sub>), 49.28-50.88 (C-1, C-5), 71.90 (OCH<sub>2</sub>), 72.10-78.01-80.20 (C-2, C-3, C-4).

(+) **MS (ESI)** :  $m/z = 217.17$  [M+H]<sup>+</sup>;  $m/z = 241.0$  [M+Na]<sup>+</sup>

**HRMS (ESI)**: C<sub>11</sub>H<sub>24</sub>NO<sub>3</sub>: calcd:  $m/z = 218.1756$ , found :  $m/z = 218.1754$ .

**TLC**: (CHCl<sub>3</sub>/MeOH/H<sub>2</sub>O; 70:40:1) R<sub>f</sub> = 0.43.

(±)-2-*O*-Nonyl-1,5-dideoxy-1,5-imino-D,L-xylitol

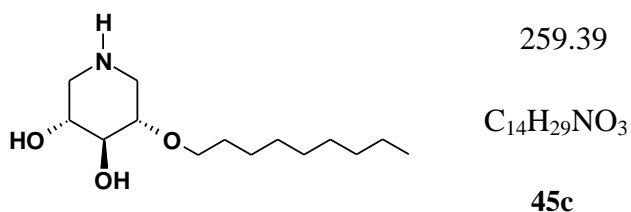

Compound (±)**45c** (15 mg, 88%) was obtained from **43c** (29 mg, 0.066 mmol), using EtOH as solvent.

$\delta_{\text{H}}$  (400 MHz, CD<sub>3</sub>OD) 0.90 (3H, t, *J* 6.9, CH<sub>3</sub>), 1.25-1.38 (12H, m, CH<sub>2</sub>), 1.53-1.62 (m, 2H, CH<sub>2</sub>), 2.42-2.54 (2H, m, H-5<sub>ax</sub> and H-1<sub>ax</sub>), 3.10 (1H, dd, *J* 4.4 and 12.5, H-5<sub>eq</sub>), 3.18-3.26 (2H, m, H-2 and H-1<sub>eq</sub>), 3.34 (1H, t, *J* 7.7, H-3), 3.45-3.51 (1H, m, H-4), 3.57-3.62 (2H, m, H-6).

$\delta_{\text{C}}$  (101 MHz, CD<sub>3</sub>OD) 14.40 (CH<sub>3</sub>), 23.71-27.11-30.45-30.63-30.72-31.26-33.10 (CH<sub>2</sub>), 48.2 (C-1), 50.55 (C-5), 71.70 (C-4), 71.91 (C-6), 77.33 (C-3), 79.82 (C-2).

**MS (ESI+)** *m/z* = 260.5 [M+H]<sup>+</sup>; 282.5 [M+Na]<sup>+</sup>.

**2,4-Di-*O*-butyl-1,5-dideoxy-1,5-imino-D-xylitol**

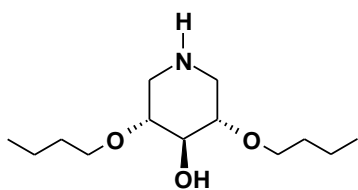

245.37

C<sub>13</sub>H<sub>27</sub>NO<sub>3</sub>

**46a**

---

Compound **46a** (35 mg, 90%) was obtained from **44a** (67 mg, 0.157 mmol), after 1 supplementary addition of Pd/C and 2 days of stirring.

$\delta_{\text{H}}$  (250 MHz, CD<sub>3</sub>OD) 0.93 (6H, t, *J* 7.3, CH<sub>3</sub>), 1.33-1.48 (4H, m, CH<sub>2</sub>), 1.49-1.64 (4H, m, CH<sub>2</sub>), 2.75 (2H, dd, *J* 7.5 and 12.5, H1<sub>ax</sub> and H5<sub>ax</sub>), 3.27-3.33 (2H, m, H-1<sub>eq</sub> and H-5<sub>eq</sub>), 3.35-3.43 (2H, m, H-2 and H-4), 3.54-3.67 (5H, m, OCH<sub>2</sub>, H-3).

$\delta_{\text{C}}$  (63 MHz, CD<sub>3</sub>OD) 14.3 (CH<sub>3</sub>), 20.2-33.2 (CH<sub>2</sub>), 46.8 (C-1, C-5), 71.5 (OCH<sub>2</sub>), 72.4 (C-3), 77.9 (C-2, C-4).

**HRMS (ESI):** C<sub>13</sub>H<sub>28</sub>NO<sub>3</sub>: calcd for C<sub>13</sub>H<sub>28</sub>NO<sub>3</sub> *m/z* = 246.2069; found *m/z* = 246.2057.



**2,4-Di-*O*-nonyl-1,5-dideoxy-1,5-imino-D-xylitol**

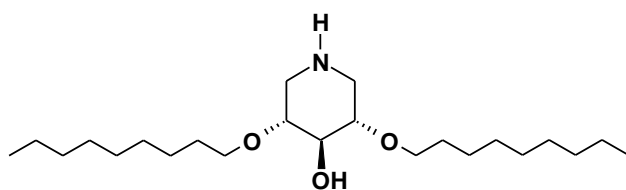

385.64

C<sub>23</sub>H<sub>47</sub>NO<sub>3</sub>

**46b**

Compound **46b** (39 mg, 97%) was obtained from **44b** (58 mg, 0.103 mmol), after 1 supplementary addition of Pd/C and 2 days of stirring.

$\delta_{\text{H}}$  (250 MHz, CD<sub>3</sub>OD) 0.90 (6H, t, *J* 6.5, CH<sub>3</sub>), 1.25-1.40 (24H, m, CH<sub>2</sub>), 1.53-1.67 (4H, m, CH<sub>2</sub>), 3.08 (2H, dd, *J* 5.5 and 12.8, H-1<sub>ax</sub> and H-5<sub>ax</sub>), 3.38 (2H, dd, *J* 2.9 and 12.8, H-1<sub>eq</sub> and H-5<sub>eq</sub>), 3.51-3.67 (6H, m, OCH<sub>2</sub>, H-2 and H-4), 3.88 (1H, t, *J* 5.2, H-3).

$\delta_{\text{C}}$  (63 MHz, CD<sub>3</sub>OD) 14.52 (CH<sub>3</sub>), 23.72-27.25-30.54-30.77-30.80-31.10-33.11 (CH<sub>2</sub>), 45.23 (C-1, C-5), 68.1 (C-3), 71.8 (OCH<sub>2</sub>), 76.0 (C-2, C-4).

**HRMS (ESI):** calcd for C<sub>23</sub>H<sub>48</sub>NO<sub>3</sub> *m/z* = 386.3634; found *m/z* = 386.3626.

### 3-*O*-Hexyl-1,2:5,6-di-*O*-isopropylidene- $\alpha$ -D-glucofuranose

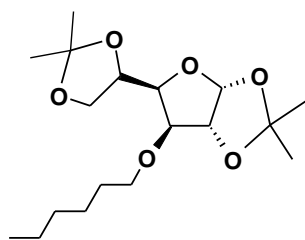

344.45

C<sub>18</sub>H<sub>32</sub>O<sub>6</sub>

47

To a solution of commercial 1,2:5,6-di-*O*-isopropylidene- $\alpha$ -D-glucofuranose **5** (2 g, 7.68 mmol) in dry DMF (150 mL) was added NaH (60% dispersion in mineral oil) (553 mg, 13.8 mmol, 1.8 eq) at 0°C. The mixture was stirred at 0°C for 30 min and then Bu<sub>4</sub>NI (567 mg, 1.54 mmol, 0.2 eq) and 1-bromohexane (2 mL, 14.2 mmol, 1.8 eq) were added. After stirring for 18 h at room temperature, MeOH (10 mL) was cautiously added. The mixture was diluted with EtOAc (200 mL) and the organic phase was washed 3 times with brine (60 mL), dried over MgSO<sub>4</sub> and then concentrated under vacuum. The residue was purified by flash chromatography on silica gel (PE/EtOAc, 4:1) to give **13** (2.12 g, 83%) as a colorless liquid.

$\delta_{\text{H}}$  (250 MHz, CDCl<sub>3</sub>) 0.89 (3H, t, *J* 6.7, CH<sub>3</sub>), 1.23-1.39 (6H, m, CH<sub>2</sub>), 1.32 (3H, s, CH<sub>3</sub>), 1.35 (3H, s, CH<sub>3</sub>), 1.43 (3H, s, CH<sub>3</sub>), 1.50 (3H, s, CH<sub>3</sub>), 1.49-1.62 (2H, m, CH<sub>2</sub>), 3.51 (1H, dt, *J* 6.4 and 9.3, OCH<sub>2</sub>), 3.61 (1H, dt, *J* 6.4 and 9.3, OCH<sub>2</sub>), 3.85 (1H, d, *J* 3.0, H-3), 3.98 (1H, dd, *J* 6.0 and 8.5, H-6a), 4.08 (1H, dd, *J* 6.0 and 8.5, H-6b), 4.13 (1H, dd, *J* 3.0 and 7.5, H-4), 4.31 (dt, 1H, *J* 6.0 and 7.5, H-5), 4.53 (1H, d, *J* 3.7, H-2), 5.87 (d, 1H, *J* 3.7, H-1).

$\delta_{\text{C}}$  (63 MHz, CDCl<sub>3</sub>) 14.10 (CH<sub>3</sub>), 22.70-25.81-31.64 (CH<sub>2</sub>), 25.44-26.32-26.81-26.90 (CH<sub>3</sub>), 29.70 (CH<sub>2</sub>), 67.30 (C-6), 70.71 (OCH<sub>2</sub>), 72.63 (C-5), 81.33 (C-4), 82.20 (C-3), 82.63 (C-2), 105.31 (C-1), 108.92, 111.71 (C<sub>q</sub>).

**3-*O*-Hexyl-1,2-*O*-isopropylidene- $\alpha$ -D-xylo-pentodialdo-1,4-furanose**

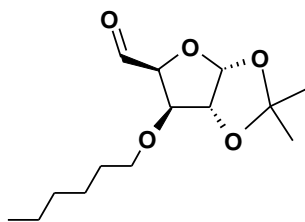

272.34

C<sub>14</sub>H<sub>24</sub>O<sub>5</sub>

**48**

A solution of **47** (2.0 g, 5.81 mmol) in 70% aq. AcOH (60 mL) was heated at 45°C for 2 h. The reaction was cooled down to 0°C and a solution of NaIO<sub>4</sub> (1.37 g, 6.41 mmol, 1.1 eq) in H<sub>2</sub>O (14 mL) was added. The mixture was stirred at room temperature for 18 h. CH<sub>2</sub>Cl<sub>2</sub> (100 mL) was added, the aqueous phase was separated and extracted 3 times with CH<sub>2</sub>Cl<sub>2</sub> (25 mL). The combined organic phases were washed with H<sub>2</sub>O (2x25 mL), dried over MgSO<sub>4</sub> and concentrated under vacuum. The residue was coevaporated twice with toluene, thus affording quantitatively crude aldehyde **48** (1.58 g), which was used in the next step without further purification.

$\delta_{\text{H}}$  (250 MHz, CDCl<sub>3</sub>) 0.88 (3H, t, *J* 6.7, CH<sub>3</sub>), 1.20-1.29 (6H, m, CH<sub>2</sub>), 1.34 (3H, s, CH<sub>3</sub>), 1.48 (3H, s, CH<sub>3</sub>), 1.43-1.51 (2H, m, CH<sub>2</sub>), 3.38 (1H, dt, *J* 6.5 and 9.2, H-6a), 3.54 (1H, dt, *J* 6.5 and 9.2, H-6b), 4.20 (1H, d, *J* 3.8, H-3), 4.54 (1H, dd, *J* 1.6 and 3.8, H-4), 4.59 (1H, d, *J* 3.5, H-2), 6.10 (1H, d, *J* 3.5, H-1), 9.65 (1H, d, *J* 1.6, H-5).

***N*-Benzyl-3-*O*-hexyl-1,5-dideoxy-1,5-imino-xylitol**

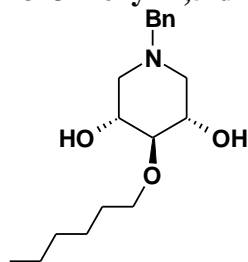

307.44

C<sub>18</sub>H<sub>29</sub>NO<sub>3</sub>

**49**

Dowex 50WX8 (H<sup>+</sup>) ion exchange resin (6.8 g) was added to a solution of **48** (1.58 g, 5.81 mmol) in a 5:2 mixture of dioxane/H<sub>2</sub>O (28 mL). The mixture was slowly stirred at 75°C for 18 h. The resin was removed by filtration and the solvents were evaporated under vacuum. The residue was coevaporated twice with toluene to give **3-*O*-hexyl-xylo-pentodialdose** as a foam. This compound was dried over P<sub>2</sub>O<sub>5</sub> for 24 h, then stirred in the presence of 3 Å molecular sieves for 15 min and finally dissolved in dry MeOH (50 mL). NaBH<sub>3</sub>CN (1.09 g, 17.4 mmol, 3 eq) was added. The mixture was cooled down to -78°C and AcOH (650 μL, 11.4 mmol, 2 eq) and BnNH<sub>2</sub> (577 μL, 5.28 mmol, 0.9 eq) were added. The mixture was allowed to warm up to room temperature and stirred for a total of 18 h. The solid was removed by filtration over Celite and washed twice with EtOAc. The filtrate was concentrated under vacuum. The residue was dissolved in EtOAc (60 mL) and the solution was washed with saturated Na<sub>2</sub>CO<sub>3</sub> followed by H<sub>2</sub>O. The organic phase was dried over MgSO<sub>4</sub>, then concentrated under vacuum. The residue was purified with difficulty by flash chromatography on silica gel (CH<sub>2</sub>Cl<sub>2</sub>/MeOH, 20:1) to give **49** (76 mg, 4% from **48**) as a white solid.

δ<sub>H</sub> (400 MHz, CDCl<sub>3</sub>) 0.88 (3H, t, *J* 6.8, CH<sub>3</sub>), 1.24-1.35 (6H, m, CH<sub>2</sub>), 1.53-1.61 (2H, m, CH<sub>2</sub>), 2.27 (2H, dd, *J* 7.1 and 11.2, H-1<sub>ax</sub> and H-5<sub>ax</sub>), 2.43 (2H, br s, 2OH), 2.82 (2H, dd, *J* 3.6 and 11.2, H-1<sub>eq</sub> and H-5<sub>eq</sub>), 3.11 (1H, t, *J* 7.1, H-3), 3.56 (2H, s, NCH<sub>2</sub>Ph), 3.67 (2H, t, *J* 6.7, H-6), 3.72 (2H, dt, *J* 3.6 and 7.1, H-2 and H-4), 7.21-7.36 (5H, m, Haro).

δ<sub>C</sub> (101 MHz, CDCl<sub>3</sub>) 14.20 (CH<sub>3</sub>), 22.71-25.93-31.86 (CH<sub>2</sub>), 30.4 (CH<sub>2</sub>), 57.1 (C-1, C-5), 62.23 (NCH<sub>2</sub>Ph), 69.81 (C-2, C-4), 72.22 (OCH<sub>2</sub>), 84.11 (C-3), 127.43-128.52-129.10 (CH<sub>Ar</sub>), 137.9 (C<sub>Ar</sub>).

**MS (ESI+)** *m/z* = 308.5 [M+H]<sup>+</sup>; 330.5 [M+Na]<sup>+</sup>.

**HRMS (ESI):** calcd for C<sub>18</sub>H<sub>30</sub>NO<sub>3</sub> *m/z* = 308.2226; found *m/z* = 308.2215.

**3-O-Hexyl-1,5-dideoxy-1,5-imino-xylitol**

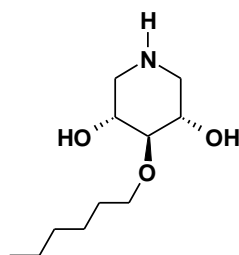

217.31

C<sub>11</sub>H<sub>23</sub>NO<sub>3</sub>

**50**

Compound **49** (72 mg, 0.234 mmol) was dissolved in iPrOH (6 mL) containing AcOH (0.5 mL). 10% Pd/C (100 mg) was added and the reaction was stirred at room temperature under a H<sub>2</sub> atmosphere for 2.5 hours. More Pd/C (50 mg) was added and the reaction was stirred for 18 h. The reaction mixture was filtered through a membrane and the catalyst was washed 3 times with iPrOH (5 mL). The filtrate was concentrated under vacuum and the residue was coevaporated 3 times with toluene to give **50** (51 mg, 100 %) as a white solid.

$\delta_{\text{H}}$  (400 MHz, CD<sub>3</sub>OD)  $\delta$  0.91 (3H, t, *J* 6.8, CH<sub>3</sub>), 1.29-1.35 (6H, m, CH<sub>2</sub>), 1.54-1.64 (2H, m, CH<sub>2</sub>), 2.86 (2H, dd, *J* 6.6 and 12.8, H-1<sub>ax</sub> and H-5<sub>ax</sub>), 3.20 (1H, dd, *J* 3.6 and 12.8, H-1<sub>eq</sub>, H-5<sub>eq</sub>), 3.27 (1H, t, *J* 6.6, H-3), 3.70 (2H, t, *J* 6.7, H-6), 3.78 (2H, dt, *J* 3.6 and 6.6, H-2 and H-4).

$\delta_{\text{C}}$  (101 MHz, CD<sub>3</sub>OD)  $\delta$  14.44 (CH<sub>3</sub>), 23.70-26.81-32.90 (CH<sub>2</sub>), 31.20 (CH<sub>2</sub>), 48.6 (C-1, C5), 68.5 (C-2, C-4), 73.2 (OCH<sub>2</sub>), 81.7 (C-3).

**HRMS (ESI)** calcd for C<sub>11</sub>H<sub>24</sub>NO<sub>3</sub> *m/z* = 218.1756; found *m/z* = 218.1747.

(-)-*N*-Benzyl-3,4-di-*O*-benzyl-1,5-dideoxy-1,5-imino-D-xylitol

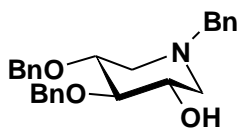

403.21

C<sub>26</sub>H<sub>29</sub>NO<sub>3</sub>

51

A solution of **17** (1.50 g, 4.38 mmol) in a 1:1 mixture of dioxane/0.4N HCl (30 mL) was heated at 70°C for 18 h. The reaction was cooled down to 0°C and the pH was adjusted to ~5 by addition of 1M NaOH. BnNH<sub>2</sub> (1.2 mL, 11.0 mmol, 2.5 eq) and NaBH<sub>3</sub>CN (1.38 g, 22.0 mmol, 5 eq) were added and the mixture was stirred at room temperature for 15 h. The reaction mixture was extracted twice with EtOAc (60 mL). The combined organic phases were washed with saturated NaHCO<sub>3</sub>, brine, dried over MgSO<sub>4</sub> and concentrated under vacuum. The residue was purified by flash chromatography on silica gel (PE/EtOAc, 7:3, v:v) to give (-)-(**51**) (905 mg, 51%) as a colorless oil.

$\delta_{\text{H}}$  (400 MHz, CDCl<sub>3</sub>) 2.25-2.36 (2H, m, H-1<sub>ax</sub>, H-5<sub>ax</sub>), 2.85 (2H, dd, *J* 3.4 and 11.3, H-1<sub>eq</sub>, H-5<sub>eq</sub>), 3.40 (1H, t, *J* 6.7, H-3), 3.51 (1H, d<sub>AB</sub>, *J* 13.2 Hz, NCH<sub>2</sub>Ph), 3.61 (1H, d<sub>AB</sub>, *J* 13.2 Hz, NCH<sub>2</sub>Ph), 3.60-3.64 (1H, m, H-4), 3.68-3.73 (1H, m, H-2), 4.54 (2H, AB, *J* 11.6 Hz, OCH<sub>2</sub>Ph), 4.65 (1H, d<sub>AB</sub>, *J* 11.6 Hz, OCH<sub>2</sub>Ph), 4.85 (1H, d<sub>AB</sub>, *J* 11.6 Hz, OCH<sub>2</sub>Ph), 7.26-7.34 (15H, m, H<sub>Ar</sub>).

$\delta_{\text{C}}$  (101 MHz, CDCl<sub>3</sub>) 54.30, 56.62 (C-1, C-5), 62.30 (NCH<sub>2</sub>Ph), 69.44 (C-2), 71.90, 74.00 (OCH<sub>2</sub>Ph), 77.51 (C-4), 82.45 (C-3), 127.25-128.93 (CH<sub>Ar</sub>), 137.99, 138.11, 138.72 (C<sub>Ar</sub>).

$[\alpha]_{\text{D}}^{25} = -5.0$  (c = 1.2, CHCl<sub>3</sub>).

**IR** (cm<sup>-1</sup>): 3474, 3062, 2918, 1495, 1453, 1093, 1066.

**MS** (ESI+) *m/z* = 426.5 [M+Na]<sup>+</sup>.

**HRMS** (ESI) [M+H]<sup>+</sup> calcd for C<sub>26</sub>H<sub>30</sub>NO<sub>3</sub> *m/z* = 404.2226; found *m/z* = 404.2225.

**(-)-*N*-benzyl-3,4-di-*O*-benzyl-2-*O*-hexyl-1,5-dideoxy-1,5-imino-D-xylitol**

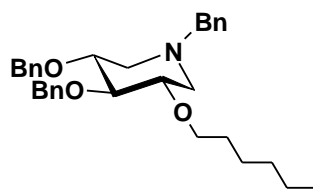

487.69

C<sub>32</sub>H<sub>41</sub>NO<sub>3</sub>

**52**

To a solution of (-)-**(51)** (635 mg, 1.57 mmol) in dry DMF (20 mL) was added NaH (60% dispersion in mineral oil) (126 mg, 3.15 mmol, 2 eq) at 0°C. The mixture was stirred at 0°C for 30 min and then 1-bromohexane (661 μL, 4.71 mmol, 3 eq) was added. After 10 h of stirring at room temperature, the reaction was quenched by slow addition of H<sub>2</sub>O, and the reaction mixture was extracted twice with EtOAc (40 mL). The combined organic phases were washed with saturated NaHCO<sub>3</sub>, brine, dried over MgSO<sub>4</sub>, and concentrated under vacuum. The residue was purified by flash chromatography on silica gel (PE/EtOAc, 4:1) to give (-)-**(52)** (627 mg, 82%) as a colorless oil.

$\delta_{\text{H}}$  (400 MHz, CDCl<sub>3</sub>) 0.86 (3H, t, *J* 6.6, CH<sub>3</sub>), 1.25-1.33 (6H, m, CH<sub>2</sub>), 1.46-1.58 (m, 2H, CH<sub>2</sub>), 1.93 (2H, dt, *J* 7.2 and 10.7, H-1<sub>ax</sub> and H-5<sub>ax</sub>), 3.01-3.05 (2H, m, H-1<sub>eq</sub> and H-5<sub>eq</sub>), 3.33 (1H, t, *J* 8.8, H-3), 3.39-3.45 (1H, m, H-2), 3.52-3.59 (5H, m, H-4, H-6 and NCH<sub>2</sub>Ph), 4.59 (1H, d<sub>AB</sub>, *J* 11.6, OCH<sub>2</sub>Ph), 4.68 (1H, d<sub>AB</sub>, *J* 11.6, OCH<sub>2</sub>Ph), 4.86 (2H, AB, *J* 11.1, OCH<sub>2</sub>Ph), 7.24-7.37 (15H, m, Haro).

$\delta_{\text{C}}$  (101 MHz, CDCl<sub>3</sub>) 14.1 (CH<sub>3</sub>), 22.6, 25.8, 31.7 (CH<sub>2</sub>), 30.3 (CH<sub>2</sub>), 56.09, 56.12 (C-1, C-5), 62.1 (NCH<sub>2</sub>Ph), 71.1 (OCH<sub>2</sub>), 73.0 (OCH<sub>2</sub>Ph), 75.3 (OCH<sub>2</sub>Ph), 78.7 (C-4), 79.2 (C-2), 86.3 (C-3), 127.1-128.8 (CH<sub>Ar</sub>), 137.9, 138.7, 139.2 (C<sub>Ar</sub>).

$[\alpha]_{\text{D}}^{25} = -3.4$  (c=1.01, CHCl<sub>3</sub>).

**IR** (cm<sup>-1</sup>): 2921, 1253, 1095, 1069.

**MS** (ESI+) *m/z* = 488.5 [M+H]<sup>+</sup>.

**HRMS** (ESI) C<sub>32</sub>H<sub>42</sub>NO<sub>3</sub> calcd *m/z* = 488.3165; found *m/z* = 488.3186.

**(+)-2-*O*-Hexyl-1,5-dideoxy-1,5-imino-D-xylitol**

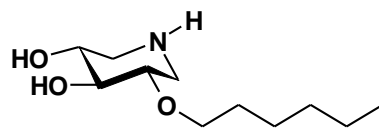

217.17

C<sub>11</sub>H<sub>23</sub>NO<sub>3</sub>

53

Compound (-)-**(52)** (538 mg, 1.10 mmol) was dissolved in iPrOH (26 mL). 10% Pd/C (80 mg) and 1M HCl (100  $\mu$ L) were added and the reaction was stirred 5 h at room temperature under a H<sub>2</sub> atmosphere. The reaction mixture was filtered through a membrane and the catalyst was washed several times with iPrOH to give quantitatively (+)-**(53)** (240 mg) as a colorless oil.

$\delta_{\text{H}}$  (400 MHz, CD<sub>3</sub>OD) 0.91 (3H, t, *J* 7.2, CH<sub>3</sub>), 1.28-1.36 (6H, m, CH<sub>2</sub>), 1.56-1.62 (2H, m, CH<sub>2</sub>), 2.99 (1H, dd, *J* 6.8 and 12.4, H-5<sub>ax</sub>), 3.04 (1H, dd, *J* 7.2 and 12.6, H-1<sub>ax</sub>), 3.37 (1H, dd, *J* 3.2 and 12.4, H-5<sub>eq</sub>), 3.44 (1H, dd, *J* 3.2 and 12.6, H-1<sub>eq</sub>), 3.53-3.57 (1H, m, H-2), 3.62-3.67 (3H, m, H-3 and H-6), 3.77-3.81 (1H, m, H-4).

$\delta_{\text{C}}$  (101 MHz, CD<sub>3</sub>OD) 14.4 (CH<sub>3</sub>), 23.6, 26.7, 32.8 (CH<sub>2</sub>), 30.9 (CH<sub>2</sub>), 45.2, 47.4 (C-1, C-5), 68.3 (C-4), 72.1 (C-3), 72.2 (C-6), 76.2 (C-2).

$[\alpha]_{\text{D}}^{25} = +16$  (*c* 1.1, MeOH).

**HRMS (ESI)** C<sub>11</sub>H<sub>24</sub>NO<sub>3</sub> calcd *m/z* = 218.1756; found *m/z* = 218.1749.

**IR (cm<sup>-1</sup>):** 3310, 2927, 2858, 1591, 1456, 1090, 1061.

**TLC** (MeOH/CH<sub>2</sub>Cl<sub>2</sub> ; 15/1) R<sub>f</sub> = 0.08.



***N*-Methyl-2-*O*-hexyl-1,5-dideoxy-1,5-imino-D-xylitol**

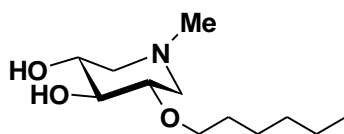

231.34

C<sub>12</sub>H<sub>25</sub>NO<sub>3</sub>

**54**

---

Compound **52** (63.1 mg, 0.13 mmol) was dissolved in methanol (10 mL). 10% Palladium on activated charcoal (15 mg), acetic acid (50  $\mu$ L) were added to the residue. The reaction was stirred 12 hours under hydrogen and then filtrated through Millipore and washed several times with methanol to give **54** quantitatively.

$\delta_{\text{H}}$  (400 MHz; CDCl<sub>3</sub>) 0.79-0.82 (3H, t, *J* 6.6, CH<sub>3</sub>), 1.18-1.28 (6H, m, CH<sub>2</sub>), 1.43-1.50 (2H, m, CH<sub>2</sub>), 1.75-1.82 (2H, dd, H-1<sub>ax</sub> and H-5<sub>ax</sub>), 2.76-2.81 (1H, dd, *J* 1.9 and 4.6, H-1<sub>eq</sub>), 2.90-2.94 (1H, dd, *J* 1.9 and 4.8, H-5<sub>eq</sub>), 3.03-3.09 (1H, t, *J* 9.0, H-3), 3.11-3.18 (1H, m, H-2), 3.38-3.40 (1H, m, H-4), 3.47-3.51 (1H, t, *J* 6.8, OCH<sub>2</sub>).

$\delta_{\text{C}}$  (101 MHz; CDCl<sub>3</sub>) 14.38 (CH<sub>3</sub>), 23.68 (CH<sub>2</sub>), 26.82 (CH<sub>2</sub>), 31.15 (CH<sub>2</sub>), 32.86 (CH<sub>2</sub>), 45.78 (NCH<sub>3</sub>), 58.88 (C-5), 61.32 (C-1), 71.24 (C-4), 71.92 (OCH<sub>2</sub>), 78.73 (C-3), 79.52 (C-2).

(+) **MS (ESI)**: *m/z* = 232.5 [M+H]<sup>+</sup>; *m/z* = 254.5 [M+Na]<sup>+</sup>

**HRMS (ESI)** C<sub>12</sub>H<sub>23</sub>NO<sub>3</sub>: calcd: *m/z*=232.1912 [M+H]<sup>+</sup>, found: *m/z* = 232.1913 [M+H]<sup>+</sup>

**IR (cm<sup>-1</sup>)**: 3340, 2954, 2927, 2858, 1582, 1458, 1062.

**TLC** (MeOH/CH<sub>2</sub>Cl<sub>2</sub> ; 15/1) R<sub>f</sub> = 0.08.

(+)-*N*-Benzyl-2,3-di-*O*-benzyl-1,5-dideoxy-1,5-imino-D-xylitol

231.34

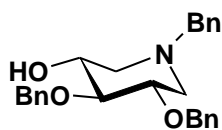

C<sub>12</sub>H<sub>25</sub>NO<sub>3</sub>

56

The methyl 2,3-di-*O*-benzyl- $\alpha/\beta$ -D-xyllo-pentodialdo-1,4-furanoside **55** (987 mg, 2.88 mmol) was reacted as for **17** to yield (+)-(**56**) (619 mg, 53%) as a colorless oil.

$\delta_{\text{H}}$  (400 MHz; CDCl<sub>3</sub>) 2.26-2.36 (2H, m, H-1<sub>eq</sub> and H-5<sub>eq</sub>), 2.84-2.87 (2H, dd, *J* 3.4 and 11.3, H-1<sub>ax</sub> and H-5<sub>ax</sub>), 3.38-3.41 (1H, t, *J* 6.7, H-3), 3.50-3.63 (2H, q, *J* 13.2, NCH<sub>2</sub>Ph), 3.60-3.64 (1H, m, H-4), 3.69-3.73 (1H, m, H-2), 4.51-4.58 (2H, AB, *J* 12.0, OCH<sub>2</sub>Ph), 4.63-4.86 (2H, AB, *J* 11.7, OCH<sub>2</sub>Ph), 7.25-7.34 (10H, m, Haro).

$\delta_{\text{C}}$  (101 MHz; CDCl<sub>3</sub>) 54.30 (C-1 or C-5), 56.62 (C-1 or C-5), 62.27 (NCH<sub>2</sub>Ph), 69.37 (C-2), 71.90 (OCH<sub>2</sub>Ph), 73.96 (OCH<sub>2</sub>Ph), 77.47 (C-4), 129.42-127.17 (CH<sub>Ar</sub>), 138.05 (C<sub>qAr</sub>), 138.71 (2×C<sub>qAr</sub>).

$[\alpha]_{\text{D}}^{25} = +13$  (c=0.9, CHCl<sub>3</sub>).

(+) MS (ESI) : *m/z* = 426.5 [M+Na]<sup>+</sup>

HRMS (ESI) C<sub>26</sub>H<sub>29</sub>NO<sub>3</sub>: calcd: *m/z*=404.2221 [M+H]<sup>+</sup>, found: *m/z* = 404.2226 [M+H]<sup>+</sup>

IR (cm<sup>-1</sup>) 3470, 3059, 2920, 1495, 1035.

TLC (PE/EtOAc ; 7/3) R<sub>f</sub> = 0.15.

**(+)-*N*-Benzyl-2,3-di-*O*-benzyl-4-*O*-hexyl-1,5-dideoxy-1,5-imino-D-xylitol**

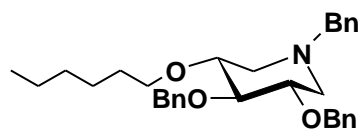

487.69

C<sub>32</sub>H<sub>31</sub>NO<sub>3</sub>

**57**

---

(+)-(56) (110 mg, 0.27 mmol) was reacted as for (-)-(51) to give (+)-(57) (115 mg, 87%) as a colorless oil.

**MS (ESI+)**  $m/z = 488.5 [M+H]^+$

**(-)-4-*O*-Hexyl-1,5-dideoxy-1,5-imino-D-xylitol**

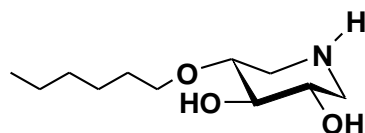

217.17

C<sub>11</sub>H<sub>23</sub>NO<sub>3</sub>

**58**

---

(+)-(57) (15 mg, 0.03 mmol) was reacted as for (-)-(53) to give quantitatively (-)-(58) (6.6 mg).

$[\alpha]_D^{25} = -13$  (*c* 0.16, MeOH). **MS (ESI+)**

**MS (ESI+)**  $m/z = 218.5 [M+H]^+$ ; 240.0  $[M+Na]^+$ .

**HRMS (ESI)** C<sub>11</sub>H<sub>24</sub>NO<sub>3</sub> calcd  $m/z = 218.1756$ ; found  $m/z = 218.1760$ .

***N*-Ethyl-4-*O*-hexyl-1,5-dideoxy-1,5-imino-D-xylitol**

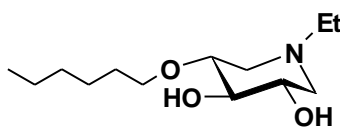

245.37

C<sub>13</sub>H<sub>27</sub>NO<sub>3</sub>

**59**

Compound **57** (48 mg, 0.10 mmol) was dissolved in ethanol (10 mL). 10% Palladium on activated charcoal (15 mg), acetic acid (50  $\mu$ L) were added to the residue. The reaction was stirred for 12 hours under hydrogen and then filtrated through Millipore and washed several times with isopropanol to give **59** quantitatively.

$\delta_{\text{H}}$  (400 MHz; CDCl<sub>3</sub>) 0.79-0.82 (3H, t, *J* 6.7, CH<sub>3</sub><sub>hexyl</sub>), 0.98-1.02 (3H, t, *J* 7.2, NCH<sub>2</sub>CH<sub>3</sub>), 1.15-1.22 (6H, m, 3 $\times$ CH<sub>2</sub><sub>hexyl</sub>), 1.44-1.49 (2H, m, CH<sub>2</sub><sub>hexyl</sub>), 1.74-1.83 (2H, m, H-1<sub>ax</sub> and H-5<sub>ax</sub>), 2.38-2.44 (1H, qd, *J* 3.2 and 7.2, NCH<sub>2</sub>CH<sub>3</sub>), 2.87-2.91 (2H, dd, *J* 2.1 and 11.0, H-1<sub>eq</sub> or H-5<sub>eq</sub>), 2.99-3.03 (1H, dd, *J* 2.2 and 11.0, H-1<sub>eq</sub> or H-5<sub>eq</sub>), 3.04-3.10 (1H, m, H-3), 3.11-3.17 (1H, m, H-2), 3.37-3.43 (4H, m, H-4), 3.48-3.51 (2H, t, *J* 6.6, OCH<sub>2</sub><sub>hexyl</sub>).

$\delta_{\text{C}}$  (101 MHz; CDCl<sub>3</sub>) 11.93 (NCH<sub>2</sub>CH<sub>3</sub>), 14.38 (CH<sub>3</sub>), 23.69 (CH<sub>2</sub>), 26.83 (CH<sub>2</sub>), 31.18 (CH<sub>2</sub>), 32.88 (CH<sub>2</sub>), 52.75 (NCH<sub>2</sub>CH<sub>3</sub>), 56.40 (C-5), 58.64 (C-1), 71.34 (C-4), 71.96 (OCH<sub>2</sub>), 79.64 (C-2).

(+) **MS (ESI)**:  $m/z = 218.5$  [M+H]<sup>+</sup>;  $m/z = 240.0$  [M+Na]<sup>+</sup>

**HRMS (ESI)** C<sub>13</sub>H<sub>28</sub>NO<sub>3</sub>: calcd:  $m/z = 246.2072$ , found:  $m/z = 246.2069$ .

**IR (cm<sup>-1</sup>)**: 3345, 2955, 2927, 2857, 1568, 1454, 1062.

**TLC** (MeOH/CH<sub>2</sub>Cl<sub>2</sub>; 15/1) R<sub>f</sub> = 0.08.

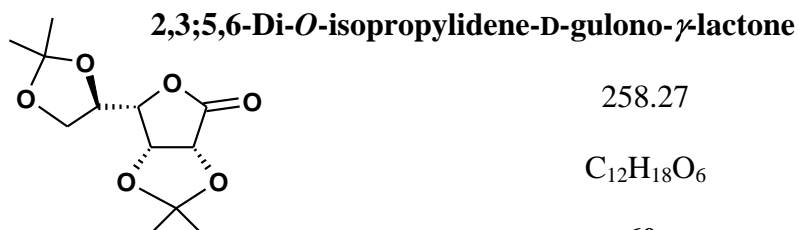

258.27

C<sub>12</sub>H<sub>18</sub>O<sub>6</sub>

**60**

To a solution of D-gulono- $\gamma$ -lactone (10 g, 56 mmol) in acetone was added anhydrous copper sulfate (45 g, 281 mmol, 5 eq) and concentrated sulfuric acid (1 mL). The mixture was stirred at room temperature for 24 hours. The solution was neutralized with solid sodium hydrogenocarbonate, filtered and the solvent was evaporated. After recrystallization from ethanol the 2,3;5,6-di-*O*-isopropylidene-D-gulono- $\gamma$ -lactone **60** (14.02 g, 97%) was obtained as a white crystalline solid.

$\delta_{\text{H}}$  (400 MHz; CDCl<sub>3</sub>) 1.38 (3H, s, CH<sub>3</sub>), 1.40 (3H, s, CH<sub>3</sub>), 1.47 (3H, s, CH<sub>3</sub>), 1.48 (3H, s, CH<sub>3</sub>), 3.82 (1H, dd, *J* 5.4 and 8.7, H-6a), 4.22 (1H, dd, *J* 6.3 and 8.8, H-6b), 4.43 (2H, m, H-4 and H-5), 4.74 (1H, dd, *J* 3.5 and 5.6, H-3), 4.83 (2H, d, *J* 5.6, H-2).

$\delta_{\text{C}}$  (101 MHz; CDCl<sub>3</sub>) 25.19 (CH<sub>3</sub>), 25.86 (CH<sub>3</sub>), 26.65 (CH<sub>3</sub>), 26.73 (CH<sub>3</sub>), 65.19 (C-6), 75.23 (C-5), 75.70 (C-3), 76.02 (C-2), 80.88 (C-4), 110.49 (Cq acetal), 114.72 (Cq acetal), 172.84 (C=O).

$[\alpha]_{\text{D}}^{25} = -49$  (c=1.0, CHCl<sub>3</sub>)

(+) **MS (ESI):** *m/z* = 281.5 [M+Na]<sup>+</sup>

**IR (cm<sup>-1</sup>):** 3397, 2993, 2940, 1738, 1373, 1071.

**TLC:** (CH<sub>2</sub>Cl<sub>2</sub>/MeOH ; 95/5) R<sub>f</sub> = 0.6.

**MP:** 142-144°C.

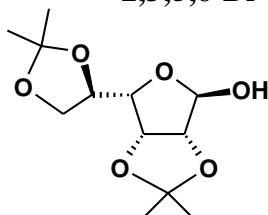
**2,3;5,6-Di-*O*-isopropylidene- $\beta$ -D-gulofuranose**

260.29

C<sub>12</sub>H<sub>20</sub>O<sub>6</sub>**61**

Lactone **60** (6.5 g, 25 mmol) was dissolved in anhydrous CH<sub>2</sub>Cl<sub>2</sub> (50 mL) and cooled to -78°C. Diisobutylaluminium hydride (1M in hexane, 37.5 mL, 37.5 mmol, 1.5 eq) was added and the mixture was stirred at -78°C for 3 hours. The mixture was then poured into a vigorously stirring mixture of ice (140 g), acetic acid (44 mL), and CH<sub>2</sub>Cl<sub>2</sub> (200 mL). The mixture was stirred vigorously for 1 hour, the layers were separated, and the organic phase was washed with saturated aqueous NaHCO<sub>3</sub> (200 mL), and brine (200 mL). The organic layer was dried (MgSO<sub>4</sub>), and the solvent was removed. The residue was recrystallized from hexane to afford the 2,3;5,6-di-*O*-isopropylidene- $\beta$ -D-gulofuranose (5.6 g, 86%) as a white crystalline solid.

$\delta_{\text{H}}$  (400 MHz; CDCl<sub>3</sub>) 1.32 (3H, s, CH<sub>3</sub>), 1.42 (3H, s, CH<sub>3</sub>), 1.48 (6H, s, 2×CH<sub>3</sub>), 3.72-3.78 (1H, t, *J* 7.8, H-6a), 4.14-4.19 (1H, dd, *J* 3.6 and 8.5, H-4), 4.22-4.28 (1H, dd, *J* 6.5 and 8.2, H-6b), 4.36-4.44 (1H, m, H-5), 4.65-4.67 (1H, d, *J* 6.0, H-2), 4.71-4.75 (1H, dd, H-3), 5.48-5.49 (1H, d, *J* 1.7, H-1).

$\delta_{\text{C}}$  (101 MHz; CDCl<sub>3</sub>) 24.71 (CH<sub>3</sub>), 25.40 (CH<sub>3</sub>), 25.95 (CH<sub>3</sub>), 26.71 (CH<sub>3</sub>), 66.00 (C-6), 75.51 (C-5), 79.85 (C-2), 82.44 (C-4), 85.59 (C-3), 101.45 (C-1), 109.78 (Cq acetal), 112.94 (Cq acetal).

$[\alpha]_{\text{D}}^{25} = -22$  (*c*=0.9, CHCl<sub>3</sub>)

(+) **MS (ESI)**: *m/z* = 283.0 [M+Na]<sup>+</sup>; *m/z* = 278.0 [M+NH<sub>4</sub>]<sup>+</sup>

**IR (cm<sup>-1</sup>)**: 3427, 2987, 2893, 1377, 1209, 1062.

**TLC**: (T/EtOAc ; 9/1) *R<sub>f</sub>* = 0.38.

**MP**: 113-115°C.

**Benzyl 2,3;5,6-di-*O*-isopropylidene-D-gulofuranoside**

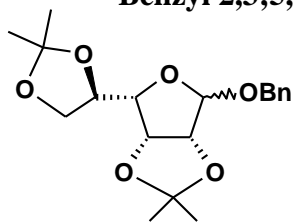

350.42

C<sub>19</sub>H<sub>26</sub>O<sub>6</sub>

**62**

Compound **61** (4.10 g, 15.7 mmol) was benzylated of with BnBr (7.5 mL, 63 mmol) and NaH 60% (5.0 g, 126 mmol) in DMF (79 mL) and stirred for 12h at room temperature. The reaction was quenched by slow addition of MeOH at 0°C. The solution was then diluted with EtOAc (300 mL). The organic phase was washed 3 times with brine, dried over MgSO<sub>4</sub> and concentrate under vacuum. Purification by flash chromatography on silica gel afforded the Benzyl 2,3;5,6-di-*O*-isopropylidene-β-D-gulonofuranoside **62a** (4.2 g, 76%) as a yellow oil (eluent: EtOAc/petroleum ether, 95:5, v/v) and the benzyl 2,3;5,6-di-*O*-isopropylidene-α-D-gulofuranoside **62b** (896 mg, 16%).

Data for benzyl 2,3;5,6-di-*O*-isopropylidene-β-D-gulofuranoside: major stereoisomer.

δ<sub>H</sub> (400 MHz; CDCl<sub>3</sub>) 1.31 (3H, s, CH<sub>3</sub>), 1.44 (3H, s, CH<sub>3</sub>), 1.48 (3H, s, CH<sub>3</sub>), 1.50 (3H, s, CH<sub>3</sub>), 3.76(1H, dd, *J* 7.1 and 8.3, H-6a), 4.03(1H, d, *J* 8.4, H-4), 4.26 (1H, dd, *J* 6.7 and 8.3, H-6b), 4.40-4.49 (1H, m, H-5), 4.54-4.78 (2H, d<sub>AB</sub>, *J* 11.8, OCH<sub>2</sub>Ph), 4.69 (2H, s, H-2 and H-3), 5.22 (1H, s, H-1), 7.36-7.39 (5H, m, Haro).

δ<sub>C</sub> (101 MHz; CDCl<sub>3</sub>) 24.73 (CH<sub>3</sub>), 25.36 (CH<sub>3</sub>), 25.91 (CH<sub>3</sub>), 26.811 (CH<sub>3</sub>), 66.02 (C-6), 69.02 (OCH<sub>2</sub>Ph), 75.54 (C-5), 77.31 (C-3), 82.17 (C-4), 85.13 (C-2), 105.65 (C-1), 109.69 (Cq acetal), 112.79 (Cq acetal), 127.62-128.38 (CH<sub>Ar</sub>), 137.36 (Cq<sub>Ar</sub>).

[α]<sub>D</sub><sup>25</sup> = -35 (c=1.0, CHCl<sub>3</sub>)

(+) **MS (ESI):** m/z = 368.5 [M+NH<sub>4</sub>]<sup>+</sup>

**IR (cm<sup>-1</sup>):** 2933, 2919, 1373, 1205, 1094.

**TLC:** (PE/EtOAc ; 95/5) R<sub>f</sub> = 0.70.

**MP:** 134-136°C.

Data for benzyl 2,3;5,6-di-*O*-isopropylidene-α-D-gulofuranoside:

δ<sub>H</sub> (400 MHz; CDCl<sub>3</sub>) 1.32 (3H, s, CH<sub>3</sub>), 1.39 (3H, s, CH<sub>3</sub>), 1.47 (3H, s, CH<sub>3</sub>), 1.51 (3H, s, CH<sub>3</sub>), 3.65 (1H, dd, *J* 7.4 and 8.5, H-6a), 3.74(1H, dd, *J* 4.3 and 8.4, H-4), 4.18 (1H, dd, *J* 6.7 and 8.5, H-6b), 4.47(1H, m, H-5), 4.63 (2H, m, H-2 and H-3), 4.71-5.04 (2H, d<sub>AB</sub>, *J* 11.8, OCH<sub>2</sub>Ph), 4.87 (1H, d, *J* 3.3, H-1), 7.37-7.39 (5H, m, Haro).

$\delta_C$  (101 MHz; CDCl<sub>3</sub>) 25.32 (CH<sub>3</sub>), 25.46 (CH<sub>3</sub>), 25.70 (CH<sub>3</sub>), 26.79 (CH<sub>3</sub>), 66.16 (C-6), 70.95 (OCH<sub>2</sub>Ph), 76.30 (C-5), 79.34 (C-2), 80.11 (C-3), 80.29 (C-4), 101.20 (C-1), 109.58 (Cq acetal), 114.59 (Cq acetal), 126.97-128.55 (CH<sub>Ar</sub>), 137.49 (Cq<sub>Ar</sub>).

$[\alpha]_D^{25} = +28$  (c=1.1, CHCl<sub>3</sub>)

(+) **MS (ESI):** m/z = 368.5 [M+NH<sub>4</sub>]<sup>+</sup>

**IR (cm<sup>-1</sup>):** 2929, 1372, 1210, 1080.

**TLC:** (PE/EtOAc ; 7/3) R<sub>f</sub> = 0.38.

**MP:** 134-136°C.



### Benzyl 2,3-*O*-isopropylidene- $\beta$ -D-gulofuranoside

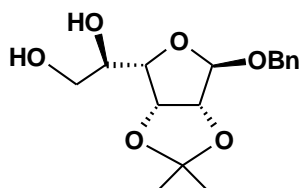

310.35

C<sub>16</sub>H<sub>22</sub>O<sub>6</sub>

**63**

A solution of **62** (1.2 g, 3.4 mmol) and AcOH 70 % (21 mL) was stirred for 18 h at room temperature, and concentrated under diminished pressure. The residue was dissolved in EtOAc (100 mL), washed with saturated aqueous NaHCO<sub>3</sub> (70 mL), water (70 mL) and brine (70 mL). The organic layer was dried (MgSO<sub>4</sub>), and the solvent removed. The residue was recrystallized from pentane to afforded the benzyl 2,3-*O*-isopropylidene- $\beta$ -D-gulofuranose (991 mg, 94%) as a white crystalline solid.

$\delta_{\text{H}}$  (400 MHz; CDCl<sub>3</sub>) 1.30 (3H, s, CH<sub>3</sub>), 1.47 (3H, s, CH<sub>3</sub>), 3.72-3.74 (2H, m, H-6ab), 3.92 (1H, dd, *J* 3.6 and 5.4, H-4), 4.02-4.10 (1H, m, H-5), 4.32-4.58 (2H, d<sub>AB</sub>, *J* 10.8, OCH<sub>2</sub>Ph), 4.65 (1H, d, *J* 5.8, H-2), 4.79 (1H, dd, *J* 3.6 and 5.9, H-3), 5.09 (1H, s, H-1), 7.26-7.35 (5H, m, Haro).

$\delta_{\text{C}}$  (101 MHz; CDCl<sub>3</sub>) 24.39 (CH<sub>3</sub>), 25.87 (CH<sub>3</sub>), 63.56 (C-6), 69.30 (OCH<sub>2</sub>Ph), 70.68 (C-5), 79.27 (C-4), 80.32 (C-3), 85.39 (C-2), 105.28 (C-1), 112.77 (Cq acetal), 127.89 (CH<sub>Ar</sub>), 128.04 (CH<sub>Ar</sub>), 128.47 (CH<sub>Ar</sub>), 137.33 (Cq<sub>Ar</sub>).

$[\alpha]_{\text{D}}^{25} = -29$  (c=1.0, CHCl<sub>3</sub>)

(+) **MS (ESI):** *m/z* = 333.5 [M+Na]<sup>+</sup>

**IR (cm<sup>-1</sup>):** 3086, 2933, 2919, 1373, 1205, 1094.

**TLC:** (PE/EtOAc ; 7/3) R<sub>f</sub> = 0.26.

**MP:** 136-138°C.

**Benzyl 2,3-*O*-isopropylidene- $\alpha$ -L-lyxo-pentodialdo-1,4-furanoside**

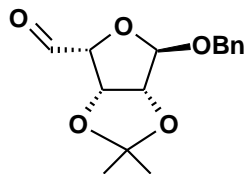

278.31

C<sub>15</sub>H<sub>18</sub>O<sub>5</sub>

**64**

To a solution of the vicinal diol **63** (860 mg, 2.8 mmol) in CH<sub>2</sub>Cl<sub>2</sub> (34 mL), was added at 0°C, the silica gel-supported NaIO<sub>4</sub> reagent (5.54 g, 2g/mmol). The mixture was stirred for 2 hours and then filtered. The silica gel was thoroughly washed with CH<sub>2</sub>Cl<sub>2</sub>. Removal of solvent from the filtrate afforded quantitatively the aldehyde **64**.

$\delta_{\text{H}}$  (400 MHz; CDCl<sub>3</sub>) 1.30 (3H, s, CH<sub>3</sub>), 1.47 (3H, s, CH<sub>3</sub>), 3.93 (1H, dd, *J* 3.6 and 5.4, H-4), 4.08 (1H, dd, *J* 5.1 and 10, H-5), 4.45 (2H, d<sub>AB</sub>, *J* 11.8, OCH<sub>2</sub>Ph), 4.65 (2H, d, *J* 5.8, H-2), 4.79 (1H, dd, *J* 3.6 and 5.9, H-3), 5.16 (1H, s, H-1), 7.26-7.35 (5H, m, Haro).

$\delta_{\text{C}}$  (101 MHz; CDCl<sub>3</sub>) 24.39 (CH<sub>3</sub>), 25.87 (CH<sub>3</sub>), 69.30 (OCH<sub>2</sub>Ph), 70.68 (C-5), 79.27 (C-4), 80.32 (C-4), 105.28 (C-1), 112.77 (C<sub>q</sub> acetal), 127.89 (CH<sub>Ar</sub>), 128.04 (CH<sub>Ar</sub>), 128.47 (CH<sub>Ar</sub>), 137.33 (C<sub>qAr</sub>).

$[\alpha]_{\text{D}}^{25} = -24$  (c=1.0, CHCl<sub>3</sub>)

**IR** (cm<sup>-1</sup>): 3068, 2925, 1728, 1442, 1380, 1208, 1070.

**TLC:** (PE/EtOAc ; 7/3) R<sub>f</sub> = 0.52.

**Benzyl 2,3-*O*-isopropylidene-5-(*S<sub>R,S</sub>*)-*N*-*tert*-butanesulfinylimineo- $\alpha$ -L-lyxofuranoside**

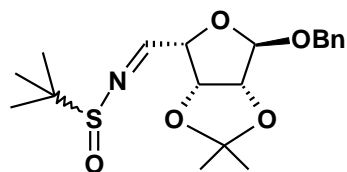

381.49

C<sub>19</sub>H<sub>27</sub>NO<sub>5</sub>S

**65**

Aldehyde **64** (1.08 g, 3.90 mmol), (*R/S*)-*tert*-butanesulfinamide (527 mg, 4.29 mmol, 1.1 eq) and anhydrous CuSO<sub>4</sub> (3.10 g, 19.5 mmol, 5 eq) were dissolved in dry CH<sub>2</sub>Cl<sub>2</sub> (39 mL) and stirred at room temperature for 36h. The suspension was then filtered and the filtrate was evaporated. Flash chromatography on silica gel (eluent: EtOAc/petroleum ether, 3:7, v/v) gave the compound **65** as a colorless oil (1.19 g, 80%).

$\delta_{\text{H}}$  (400 MHz; CDCl<sub>3</sub>) 1.23 (9H, s, C(CH<sub>3</sub>)<sub>3</sub>), 1.26 (3H, s, CH<sub>3</sub>), 1.42 (3H, s, CH<sub>3</sub>), 4.56 (2H, d<sub>AB</sub>, *J* 11.8, OCH<sub>2</sub>Ph), 4.71 (2H, d, *J* 5.6, H-2), 4.80 (1H, t, *J* 3.6, H-4), 4.97 (1H, dd, *J* 3.8 and 5.7, H-3), 5.25 (1H, s, H-1), 7.27-7.36 (5H, m, Haro), 8.08 (1H, d, *J* 3.9, CHN).

$\delta_{\text{C}}$  (101 MHz; CDCl<sub>3</sub>) 22.13 (C(CH<sub>3</sub>)<sub>3</sub>), 24.71 (CH<sub>3</sub>), 25.98 (CH<sub>3</sub>), 57.31 (C(CH<sub>3</sub>)<sub>3</sub>), 69.32 (OCH<sub>2</sub>Ph), 80.95 (C-4), 81.29 (C-3), 84.90 (C-2), 105.89 (C-1), 113.19 (Cq acetal), 128.02 (CH<sub>Ar</sub>), 128.50 (CH<sub>Ar</sub>), 128.54 (CH<sub>Ar</sub>), 136.89 (Cq<sub>Ar</sub>), 164.95 (CHN).

(+) **MS (ESI):** *m/z* = 382.0 [M+Na]<sup>+</sup>

**HRMS (ESI)** C<sub>19</sub>H<sub>28</sub>NO<sub>5</sub>S: calcd: *m/z*=382.1682, found: *m/z* = 382.1688.

**IR (cm<sup>-1</sup>):** 2946, 1706, 1670, 1450, 1240, 1010.

**TLC:** (PE/EtOAc ; 7/3) R<sub>f</sub> = 0.46.

**Benzyl 5-(*R,S*)-5-butyl-2,3-*O*-isopropylidene-5-(*S,R,S*)-*N*-*tert*-butanesulfinylimino- $\alpha$ -L-**

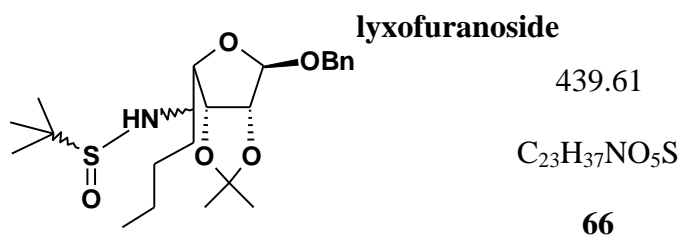

Imine **65** (120.6 mg, 0.33 mmol) was dissolved in dry toluene (15 mL) and the solution was cooled to  $-78^{\circ}C$  under Ar. Butylmagnesium bromide (1M in THF, 1.65 mL, 1.65 mmol, 5 eq) was added dropwise. The reaction was allowed to warm to room temperature and stirred for 12 hours. The reaction was then quenched with saturated aqueous  $NH_4Cl$  solution at  $0^{\circ}C$  and then extracted with diethyl ether ( $3 \times 15$  mL), and the combined layers were dried ( $MgSO_4$ ) and evaporated to afford an orange oil. Flash chromatography on silica gel (eluent: EtOAc/petroleum ether, 3:7, v/v) gave the compound **66** as a yellow oil (110.3 mg, 76%).

$\delta_H$  (400 MHz;  $CDCl_3$ ) 0.94 (6H, t,  $J$  6.8,  $CH_3$ ), 1.23-1.26 (18H, br s,  $C(CH_3)_3$ ), 1.31 (3H, s,  $CH_3$ ), 1.32 (3H, s,  $CH_3$ ), 1.46 (3H, s,  $CH_3$ ), 1.50 (3H, s,  $CH_3$ ), 1.31-1.79 (12H, m,  $CH_2$ ), 3.34-3.52 (1H, m, H-5), 3.61-3.70 (1H, m, H-5), 3.74-3.75 (1H, br s,  $NH$ ), 3.88 (1H, d,  $J$  7.3,  $NH$ ), 3.93 (1H, dd,  $J$  3.3 and 7.1, H-4), 4.05 (1H, dd,  $J$  3.5 and 9.0, H-4), 4.50 (1H,  $d_{AB}$ ,  $J$  11.9,  $OCH_2Ph$ ), 4.52 (1H,  $d_{AB}$ ,  $J$  11.8,  $OCH_2Ph$ ), 4.63 (1H,  $d_{AB}$ ,  $J$  11.0,  $OCH_2Ph$ ), 4.64 (2H, d,  $J$  5.1, H-2), 4.70 (1H,  $d_{AB}$ ,  $J$  11.6,  $OCH_2Ph$ ), 4.83 (1H, dd,  $J$  3.4 and 5.9, H-3), 4.92 (1H, dd,  $J$  3.6 and 5.9, H-3), 5.01 (1H, s, H-1), 5.14 (1H, s, H-1), 7.33-7.36 (10H, m, Haro).

(+) **MS (ESI)**:  $m/z = 440.5 [M+H]^+$ ;  $m/z = 462.5 [M+Na]^+$

**HRMS (ESI)**  $C_{23}H_{38}NO_5S$ : calcd:  $m/z = 440.2478$ , found:  $m/z = 440.2471$ .

**IR** ( $cm^{-1}$ ): 2924, 2854, 1456, 1208, 1071, 1018.

**TLC**: (PE/EtOAc; 7/3)  $R_f = 0.32$ .

**Benzyl 5-(*R,S*)-hexyl-2,3-*O*-isopropylidene-5-(*S,R,S*)-*N*-*tert*-butanesulfinylimine- $\alpha$ -L-**

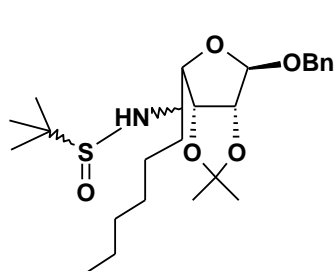

**lyxofuranoside**

467.27

C<sub>25</sub>H<sub>41</sub>NO<sub>5</sub>S

**67**

Imine **65** (494.6 mg, 1.12 mmol) was dissolved in dry toluene (45 mL) and the solution was cooled to -78°C under Ar. Hexylmagnesium bromide (1M in THF, 5.60 mL, 5.60 mmol, 5 eq) was added dropwise. The reaction was allowed to warm to room temperature and stirred for 12 hours. The reaction was then quenched with saturated aqueous NH<sub>4</sub>Cl solution at 0°C and then extracted with diethyl ether (3×45 mL), and the combined layers were dried (MgSO<sub>4</sub>) and evaporated to afford a yellow oil. Flash chromatography on silica gel (eluent: EtOAc/petroleum ether, 3:7, v/v) gave the compound **67** as a yellow oil (359.4 mg, 73%).

$\delta_{\text{H}}$  (400 MHz; CDCl<sub>3</sub>) 0.82 (6H, t, *J* 6.8, CH<sub>3</sub>), 1.15-1.22 (18H, br s, C(CH<sub>3</sub>)<sub>3</sub>), 1.20-1.22 (22H, br s, CH<sub>2</sub> and CH<sub>3</sub>), 1.41 (3H, s, CH<sub>3</sub>), 1.42 (3H, s, CH<sub>3</sub>), 1.44-1.56 (4H, m, CH<sub>2</sub>), 3.54-3.62 (1H, m, H-5), 3.64-3.67 (1H, m, H-5), 3.75-3.76 (1H, br s, NH), 3.78 (1H, d, *J* 8.0 NH), 3.86 (1H, dd, *J* 3.3 and 7.1, H-4), 4.04 (1H, dd, *J* 3.2 and 9.1, H-4), 4.42 (1H, d<sub>AB</sub>, *J* 11.8, OCH<sub>2</sub>Ph), 4.49 (1H, d<sub>AB</sub>, *J* 11.0, OCH<sub>2</sub>Ph), 4.55 (2H, d, *J* 4.0, H-2), 4.60 (1H, d<sub>AB</sub>, *J* 11.0, OCH<sub>2</sub>Ph), 4.70 (1H, d<sub>AB</sub>, *J* 11.8, OCH<sub>2</sub>Ph), 4.77 (1H, dd, *J* 4.0 and 8.0, H-3), 4.83 (1H, dd, *J* 3.9 and 7.9, H-3), 5.05 (1H, br s, H-1), 5.14 (1H, br s, H-1), 7.24-7.35 (10H, m, Haro).

$\delta_{\text{C}}$  (101 MHz; CDCl<sub>3</sub>) 14.06 (2CH<sub>3</sub>), 22.59-22.60 (CH<sub>2</sub>), 22.77 (br s, C(CH<sub>3</sub>)<sub>3</sub>), 24.58-24.70 (CH<sub>3</sub>), 25.60 (2CH<sub>2</sub>), 26.04-26.11 (CH<sub>3</sub>), 29.19-29.30 (CH<sub>2</sub>), 31.72-31.80 (CH<sub>2</sub>), 32.79 (2CH<sub>2</sub>), 55.55 (2C-5), 56.07 (C(CH<sub>3</sub>)<sub>3</sub>), 69.11-69.09 (OCH<sub>2</sub>Ph), 79.85-78.99 (C-3), 80.95-80.96 (C-4), 85.07 (C-2), 105.42-105.47 (C-1), 112.55 (Cq acetal), 127.74-128.41 (CH<sub>Ar</sub>), 137.48-137.78 (Cq<sub>Ar</sub>).

(+) **MS (ESI)**:  $m/z = 468.5$  [M+H]<sup>+</sup>

**HRMS (ESI)** C<sub>25</sub>H<sub>42</sub>NO<sub>5</sub>S: calcd:  $m/z = 468.2784$ , found:  $m/z = 468.2765$ .

**IR (cm<sup>-1</sup>)**: 2927, 2858, 1455, 1208, 1071, 1017.

**TLC**: (PE/EtOAc ; 7/3) R<sub>f</sub> = 0.37.

**Benzyl 5-(*R,S*)-nonyl-2,3-*O*-isopropylidene-5-(*S<sub>R,S</sub>*)-*N*-*tert*-butanesulfinylimine- $\beta$ -D-lyxofuranoside**

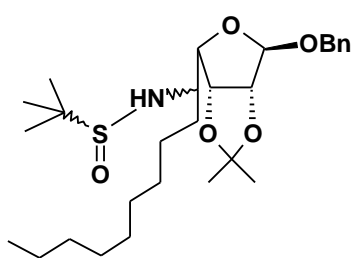

509.75

C<sub>28</sub>H<sub>47</sub>NO<sub>5</sub>S

**68**

Imine **65** (253.5 mg, 0.67 mmol) was dissolved in dry toluene (20 mL) and the solution was cooled to -78°C under Ar. Nonylmagnesium bromide (1M in hexane, 3.35 mL, 3.35 mmol, 5 eq) was added dropwise. The reaction was allowed to warm to room temperature and was stirred for 12 hours. The reaction was then quenched with saturated aqueous NH<sub>4</sub>Cl solution at 0°C and then extracted with diethyl ether (3×25 mL), and the combined layers were dried (MgSO<sub>4</sub>) and evaporated to afford a yellow oil. Flash chromatography on silica gel (eluent: EtOAc/petroleum ether, 3:7, v/v) gave the compound **68** as a yellow oil (216.8 mg, 64%).

$\delta_{\text{H}}$  (400 MHz; CDCl<sub>3</sub>) 0.90 (6H, t, *J* 6.2, CH<sub>3</sub>), 1.24 (18H, br s, C(CH<sub>3</sub>)<sub>3</sub>), 1.26-1.29 (28H, m, CH<sub>2</sub>), 1.31 (3H, s, CH<sub>3</sub>), 1.33 (3H, s, CH<sub>3</sub>), 1.48 (3H, s, CH<sub>3</sub>), 1.50 (3H, s, CH<sub>3</sub>), 1.54-1.77 (4H, m, CH<sub>2</sub>), 3.62-3.73 (1H, m, H-5), 3.74-3.79 (1H, m, H-5), 3.83-3.84 (1H, br s, NH), 3.87 (1H, d, *J* 7.4, NH), 3.96 (1H, dd, *J* 3.2 and 7.1, H-4), 4.10 (1H, dd, *J* 3.5 and 9.1, H-4), 4.51 (1H, d<sub>AB</sub>, *J* 11.8, OCH<sub>2</sub>Ph), 4.62 (1H, d<sub>AB</sub>, *J* 11.0, OCH<sub>2</sub>Ph), 4.64 (2H, d, *J* 5.9, H-2), 4.70 (1H, d<sub>AB</sub>, *J* 11.8, OCH<sub>2</sub>Ph), 4.86 (1H, dd, *J* 3.3 and 5.8, H-3), 4.91 (1H, dd, *J* 3.4 and 5.7, H-3), 5.06 (1H, br s, H-1), 5.15 (1H, br s, H-1), 7.29-7.39 (10H, m, Haro).

$\delta_{\text{C}}$  (101 MHz; CDCl<sub>3</sub>) 14.10 (2CH<sub>3</sub>), 22.66-22.67 (CH<sub>2</sub>), 22.77 (br s, C(CH<sub>3</sub>)<sub>3</sub>), 24.56-26.57 (CH<sub>3</sub>), 26.04 (2CH<sub>2</sub>), 26.10 (2CH<sub>3</sub>), 29.29 (br s, 3CH<sub>2</sub>), 31.88-31.91 (CH<sub>2</sub>), 32.80-32.88 (CH<sub>2</sub>), 55.55 (2C-5), 56.07 (br s, C(CH<sub>3</sub>)<sub>3</sub>), 69.12-69.20 (OCH<sub>2</sub>Ph), 79.85-79.86 (C-3), 80.94-81.03 (C-4), 85.07-85.10 (C-2), 105.42-105.45 (C-1), 112.56-112.60 (Cq acetal), 127.75-128.41 (CH<sub>Ar</sub>), 137.47-137.49 (Cq<sub>Ar</sub>).

(+) **MS (ESI)**: *m/z* = 510.5 [M+H]<sup>+</sup>; *m/z* = 532.5 [M+Na]<sup>+</sup>

**HRMS (ESI)** C<sub>28</sub>H<sub>48</sub>NO<sub>5</sub>S: calcd: *m/z* = 510.3253, found: *m/z* = 510.3228.

**IR (cm<sup>-1</sup>)**: 2923, 2854, 1455, 1208, 1071, 1018.

**TLC**: (PE/EtOAc; 7/3) R<sub>f</sub> = 0.49.

**Benzyl 5-(*R,S*)-5-pentenyl-2,3-*O*-isopropylidene-5-(*S<sub>R,S</sub>*)-*N*-*tert*-butanesulfinylimine- $\alpha$ -L-**

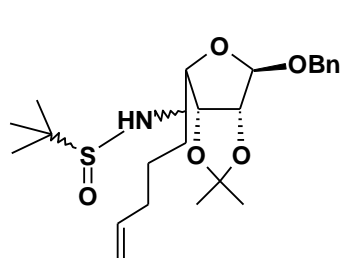

**lyxofuranoside**

467.67

C<sub>25</sub>H<sub>41</sub>NO<sub>5</sub>S

**69**

Imine **65** (99.5 mg, 0.27 mmol) was dissolved in dry toluene (10 mL) and the solution was cooled to  $-78^{\circ}\text{C}$  under Ar. Pent-4-enylmagnesium bromide (1M in THF, 4.8 mL, 4.8 mmol, 5 eq) was added dropwise. The reaction was stirred for 8 hours and allowed to warm to room temperature. The reaction was then quenched with saturated aqueous NH<sub>4</sub>Cl solution at  $0^{\circ}\text{C}$  and then extracted with diethyl ether (3 $\times$ 10 mL), and the combined layers dried (MgSO<sub>4</sub>) and evaporated to give an orange oil. Flash chromatography on silica gel (eluent: EtOAc/petroleum ether, 3:7, v/v) gave compound **69** as a yellow oil (91 mg, 72%).

$\delta_{\text{H}}$  (400 MHz; CDCl<sub>3</sub>) 1.23 (9H, s, C(CH<sub>3</sub>)<sub>3</sub>), 1.25 (3H, s, CH<sub>3</sub>), 1.43 (3H, s, CH<sub>3</sub>), 1.49-1.79 (4H, m, CH<sub>2</sub>), 2.01-2.18 (2H, m, CH<sub>2</sub>), 3.53-3.59 (2H, m, H-5 and NH), 4.03 (1H, dd, *J* 4.1 and 7.1, H-4), 4.47 (1H, d<sub>AB</sub>, *J* 12.0, OCH<sub>2</sub>Ph), 4.62-4.66 (1H, m, H-2 and H-3), 4.72 (1H, d<sub>AB</sub>, *J* 12.0, OCH<sub>2</sub>Ph), 5.01 (1H, s, H-1), 4.94-5.07 (2H, m, =CH<sub>2</sub>), 5.84 (1H, ddt, *J* 6.4, 10 and 16, CH=), 7.26-7.34 (5H, m, Haro).

$\delta_{\text{C}}$  (101 MHz; CDCl<sub>3</sub>; Me<sub>4</sub>Si) 22.76 (br s, C(CH<sub>3</sub>)<sub>3</sub>), 24.75 (CH<sub>2</sub> and CH<sub>3</sub>), 26.01 (CH<sub>3</sub>), 29.36 (CH<sub>2</sub>), 33.27 (CH<sub>2</sub>), 56.04 (C(CH<sub>3</sub>)<sub>3</sub>), 56.35 (C-5), 68.45 (OCH<sub>2</sub>Ph), 79.41 (C-2 or C-3), 83.10 (C-4), 85.37 (C-2 or C-3), 104.07 (C-1), 112.36 (Cq acetal), 114.74 (=CH<sub>2</sub>), 127.79-128.41 (CH<sub>Ar</sub>), 137.26 (Cq<sub>Ar</sub>), 138.46 (CH=).

(+) **MS (ESI):**  $m/z = m/z = 468.5$  [M+Na]<sup>+</sup>

**HRMS (ESI)** C<sub>25</sub>H<sub>42</sub>NO<sub>5</sub>S: calcd:  $m/z = 468.2784$ , found:  $m/z = 468.2788$ .

**IR (cm<sup>-1</sup>):** 3068, 2981, 2937, 1641, 1454, 1208, 1076, 1019, 975.

**TLC:** (PE/EtOAc ; 7/3) R<sub>f</sub> = 0.27.

1,5-Dideoxy-1,5-imino-3,4-*O*-isopropylidene-1-*C*-butyl-L-arabinitols

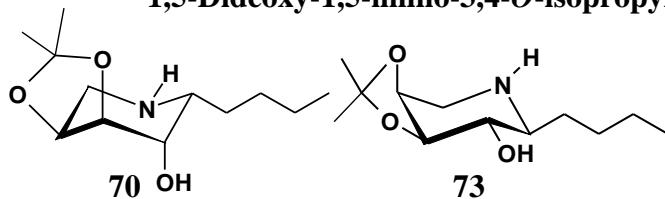

229.32

C<sub>12</sub>H<sub>23</sub>NO<sub>3</sub>

Compound **66** (101 mg, 0.23 mmol) was dissolved in MeOH:HCl (5 mL, *c* = 0.003 M). The mixture was then stirred for 2 hours and concentrated. Palladium on activated charcoal (10%) (35 mg) and acetic acid (100  $\mu$ L) were added to a solution of the residue in isopropanol (10 mL). The reaction was stirred for 36 hours under hydrogen and then filtered through millipore and washed several times with isopropanol. Flash chromatography on silica gel (eluent: CH<sub>2</sub>Cl<sub>2</sub>/MeOH, 6:1  $\rightarrow$  1:1, v/v) gave compound **70** (46%, 24 mg) and compound **73** (19%, 10 mg) as yellow oils.

Data for  $\beta$  anomer **70**:

$\delta_{\text{H}}$  (400 MHz; MeOD) 0.92 (3H, t, *J* 7.0, CH<sub>3</sub>), 1.24-1.45 (4H, m, CH<sub>2</sub> and CH<sub>3</sub>), 1.56 (3H, s, CH<sub>3</sub>), 1.77-1.95 (2H, m, CH<sub>2</sub>), 3.29 (1H, q, *J* 3.5 and 8.9, H-5a), 3.47-3.51 (1H, m, H-1 and H-5b), 3.97 (1H, t, *J* 5.0, H-2), 4.24 (1H, t, *J* 5.1, H-3), 4.24 (1H, m, H-4).

$\delta_{\text{C}}$  (101 MHz; MeOD) 13.71 (CH<sub>3</sub>), 22.41 (CH<sub>2</sub>), 25.17 (CH<sub>3</sub>), 27.21 (CH<sub>3</sub>), 27.22 (CH<sub>2</sub>), 29.67 (CH<sub>2</sub>), 42.35 (C-5), 55.60 (C-1), 69.13 (C-4), 70.05 (C-2), 76.60 (C-3), 110.15 (Cq acetal).

$[\alpha]_{\text{D}}^{25} = +22$  (*c* = 1.1, MeOD)

(+) **MS (ESI)**: *m/z* = 252.5 [M+Na]<sup>+</sup>

**HRMS (ESI)** C<sub>12</sub>H<sub>24</sub>NO<sub>3</sub>: calcd: *m/z* = 230.1756, found: *m/z* = 230.1732

**IR (cm<sup>-1</sup>)**: 3378, 2930, 2855, 1148, 1045.

**TLC**: (CH<sub>2</sub>Cl<sub>2</sub>/MeOH; 6:1  $\rightarrow$  1:1,) R<sub>f</sub> = 0.11.

Data for  $\alpha$  anomer **73**:

$\delta_{\text{H}}$  (400 MHz; MeOD) 0.91 (3H, t, *J* 7.0, CH<sub>3</sub>), 1.30-1.41 (4H, m, CH<sub>2</sub>), 1.36 (3H, s, CH<sub>3</sub>), 1.53 (3H, s, CH<sub>3</sub>), 1.87-1.95 (2H, m, CH<sub>2</sub>), 2.81 (1H, q, *J* 6.6 and 12.0, H-1), 3.29 (2H, qd, *J* 3.5 and 8.9, H-5ab), 3.67 (1H, t, *J* 6.6, H-2), 4.07 (1H, t, *J* 5.7, H-3), 4.33-4.36 (1H, m, H-4).



$\delta_C$  (101 MHz; MeOD) 13.88 (CH<sub>3</sub>), 22.66 (CH<sub>2</sub>), 25.26 (CH<sub>3</sub>), 25.85 (CH<sub>3</sub>), 27.87 (CH<sub>2</sub>), 30.12 (CH<sub>2</sub>), 43.81 (C-5), 58.37 (C-1), 71.5 (C-4), 71.97 (C-2), 78.41 (C-3), 110.10 (Cq acetal).

$[\alpha]_D^{25} = -27$  (c=0.9, MeOD)

(+) **MS (ESI):** m/z = 252.5 [M+Na]<sup>+</sup>

**IR (cm<sup>-1</sup>):** 3378, 2931, 2859, 1150, 1045.

**TLC:** (CH<sub>2</sub>Cl<sub>2</sub>/MeOH; 6:1→1:1) R<sub>f</sub> = 0.08.

**1,5-Dideoxy-1,5-imino-3,4-O-isopropylidene-1-C-hexyl-L-arabinitols**

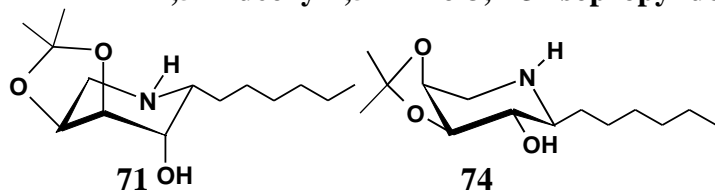

257.19

C<sub>14</sub>H<sub>27</sub>NO<sub>3</sub>

Compound **67** (101 mg, 0.23 mmol) was dissolved in MeOH:HCl (5 mL, *c*= 0.003 M). The mixture was then stirred for 2 hours and concentrated. Palladium on activated charcoal 10% (35 mg) and acetic acid (100  $\mu$ L) were added to a solution of the residue in isopropanol (10 mL). The reaction was stirred for 36 hours under hydrogen and then filtered through millipore and washed several times with isopropanol. Flash chromatography on silica gel (eluent: CH<sub>2</sub>Cl<sub>2</sub>/MeOH, 6:1 $\rightarrow$ 1:1, v/v) gave compound **71** (46%, 24 mg) and compound **74** (19%, 10 mg) as yellow oils.

Data for  $\beta$  anomer **71**:

$\delta_{\text{H}}$  (400 MHz; MeOD) 0.87 (3H, t, *J* 6.8, CH<sub>3</sub>), 1.20-1.45 (4H, m, CH<sub>2</sub> and CH<sub>3</sub>), 1.54 (3H, s, CH<sub>3</sub>), 1.84-1.89 (2H, m, CH<sub>2</sub>), 3.07 (1H, dd, *J* 6.1 and 13.0, H-5a), 3.28 (1H, m, H-1), 3.51 (1H, dd, *J* 4.5 and 13.2, H-5b), 4.09 (1H, t, *J* 5.7, H-2), 4.35 (1H, m, H-3), 4.58 (1H, m, H-4).

$\delta_{\text{C}}$  (101 MHz; MeOD) 14.01 (CH<sub>3</sub>), 22.70 (CH<sub>2</sub>), 25.58 (CH<sub>3</sub>), 26.62 (CH<sub>3</sub>), 28.92-29.79-30.42-31.01 (CH<sub>2</sub>), 46.61 (C-5), 54.91 (C-1), 74.90 (C-4), 75.58 (C-2), 80.68 (C-3), 109.83 (Cq acetal).

$[\alpha]_{\text{D}}^{25} = +26$  (*c*=0.9, MeOD)

(+) **MS (ESI):** *m/z* = 281.5 [M+Na]<sup>+</sup>

**TLC:** (CH<sub>2</sub>Cl<sub>2</sub>/MeOH; 6:1 $\rightarrow$ 1:1,) R<sub>f</sub> = 0.13.

Data for  $\alpha$  anomer **74**:

$\delta_{\text{H}}$  (400 MHz; MeOD) 0.87-0.90 (3H, t, *J* 6.8, CH<sub>3</sub>), 1.28-1.31 (8H, m, CH<sub>2</sub>), 1.40 (3H, s, CH<sub>3</sub>), 1.55 (3H, s, CH<sub>3</sub>), 1.87-1.99 (2H, m, CH<sub>2</sub>), 2.81 (1H, m, H-1), 2.99 (2H, qd, *J* 3.0 and 14.9, H-5a), 3.35 (1H, dd, *J* 7.3 and 9.8, H-2), 3.44 (1H, d, *J* 15.0, H-5), 3.91 (1H, dd, *J* 5.5 and 7.1, H-3), 4.17-4.19 (1H, m, H-4).

$\delta_{\text{C}}$  (101 MHz; MeOD) 14.41 (CH<sub>3</sub>), 23.70 (CH<sub>2</sub>), 26.58 (CH<sub>3</sub>), 26.60 (CH<sub>3</sub>), 28.90-29.70-30.52-31.94 (CH<sub>2</sub>), 46.62 (C-5), 60.14 (C-1), 75.12 (C-4), 75.58 (C-2), 81.64 (C-3), 110.13 (Cq acetal).

$[\alpha]_D^{25} = -21$  (c=0.6, MeOD)

(+) **MS (ESI):**  $m/z = 252.5$   $[M+Na]^+$

**HRMS (ESI)**  $C_{14}H_{28}NO_3$ : calcd:  $m/z=258.2069$ , found:  $m/z = 258.2060$ .

**TLC:** ( $CH_2Cl_2/MeOH$ ; 6:1→1:1)  $R_f = 0.08$ .

**1,5-Dideoxy-1,5-imino-3,4-*O*-isopropylidene-1-*C*-nonyl-L-arabinitols**

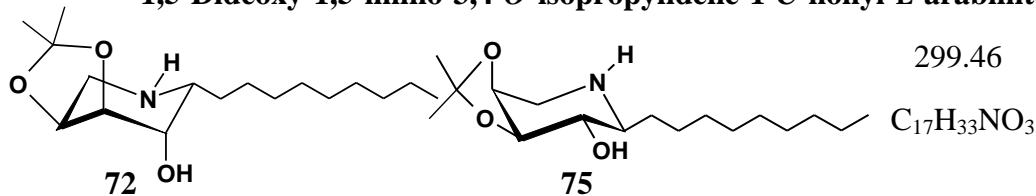

Compound **68** (121 mg, 0.24 mmol) was dissolved in MeOH:HCl (10 mL,  $c = 0.003$  M). The mixture was then stirred for 2 hours and concentrated. Palladium on activated charcoal 10% (35 mg) and acetic acid (100  $\mu$ L) were added to a solution of the residue in isopropanol (20 mL). The reaction was stirred for 48 hours under hydrogen and then filtered through millipore and washed several times with isopropanol. Flash chromatography on silica gel (eluent: CH<sub>2</sub>Cl<sub>2</sub>/MeOH, 6:1  $\rightarrow$  1:1, v/v) gave compound **72** (49%, 33 mg) and compound **75** (20%, 14 mg) as yellow oils.

Data for  $\beta$ -anomer **72**:

$\delta_{\text{H}}$  (400 MHz; MeOD) 0.87 (3H, t,  $J$  6.8, CH<sub>3</sub>), 1.26-1.35 (17H, m, CH<sub>2</sub> and CH<sub>3</sub>), 1.42 (3H, s, CH<sub>3</sub>), 1.48-1.54 (2H, m, CH<sub>2</sub>), 3.00 (1H, dd,  $J$  6.1 and 13.0, H-5a), 3.28 (1H, m, H-1), 3.51 (1H, dd,  $J$  4.5 and 13.2, H-5b), 3.80 (1H, t,  $J$  5.7, H-2), 4.15 (1H, m, H-3), 4.28 (1H, m, H-4).

(+) **MS (ESI)**:  $m/z = 322.5$  [M+Na]<sup>+</sup>

**TLC**: (CH<sub>2</sub>Cl<sub>2</sub>/MeOH; 6:1  $\rightarrow$  1:1,) R<sub>f</sub> = 0.15.

Data for  $\alpha$ -anomer **75**:

$\delta_{\text{H}}$  (400 MHz; MeOD) 0.88 (3H, t,  $J$  6.8, CH<sub>3</sub>), 1.28-1.43 (10H, m, CH<sub>2</sub> and CH<sub>3</sub>), 1.52 (3H, s, CH<sub>3</sub>), 1.87-1.99 (2H, m, CH<sub>2</sub>), 2.79 (1H, m, H-1), 3.04 (2H, m, H-5ab), 3.36 (1H, dd,  $J$  7.3 and 9.8, H-2), 3.43 (1H, d,  $J$  14.8, H-5), 3.89 (1H, dd,  $J$  5.5 and 7.2, H-3), 4.09-4.22 (1H, m, H-4).

(+) **MS (ESI)**:  $m/z = 322.5$  [M+Na]<sup>+</sup>

**TLC**: (CH<sub>2</sub>Cl<sub>2</sub>/MeOH; 6:1  $\rightarrow$  1:1) R<sub>f</sub> = 0.10.

**General procedure for hydrolysis:** Dowex 50WX8 (H<sup>+</sup>) ion exchange resin (1.17 g per mmol) was added to a solution of **70** (to **75**) in a 1:1 mixture of dioxane/H<sub>2</sub>O (10 mL per mmol). The mixture was slowly stirred at room temperature for 6 hours. Filtration followed by several washing with aqueous ammonia 0.15N and concentration afforded the imino sugars quantitatively.

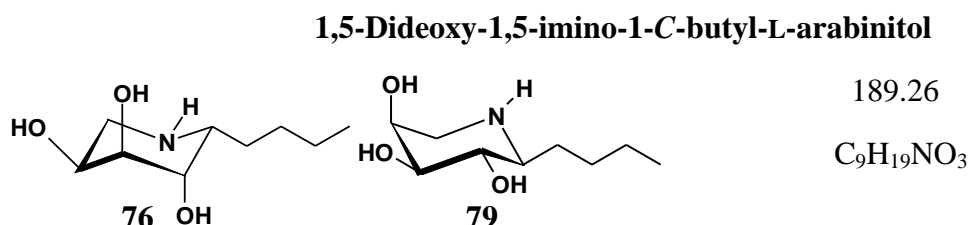

Compound **76** (10.9 mg) and **79** (5.4 mg) were obtained from **70** (15 mg, 0.06 mmol) and **73** (8 mg, 0.03 mmol) respectively.

Data for  $\alpha$ -anomer **79**:

$\delta_{\text{H}}$  (400 MHz; MeOD) 0.85 (3H, t, *J* 6.8, CH<sub>3</sub>), 1.24-1.41 (5H, m, CH<sub>2</sub>), 1.79-1.85 (1H, m, CH<sub>2</sub>), 2.37 (1H, t, *J* 6.0, H-1), 2.72 (1H, d, *J* 12.8, H-5a), 2.95 (1H, d, *J* 13.6, H-5b), 3.30-3.36 (2H, m, H-2 and H-3), 3.83 (1H, br s, H-4).

$\delta_{\text{C}}$  (101 MHz; MeOD) 14.00 (CH<sub>3</sub>), 23.63 (CH<sub>2</sub>), 28.46 (CH<sub>2</sub>), 31.67 (CH<sub>2</sub>), 50.03 (C-5), 61.30 (C-1), 69.44 (C-4), 72.56 (C-3), 75.7 (C-2).

$[\alpha]_{\text{D}}^{25} = +3$  (c=0.3, MeOD)

(+) **MS (ESI):** *m/z* = 212.5 [M+Na]<sup>+</sup>

**HRMS (ESI)** C<sub>9</sub>H<sub>20</sub>NO<sub>3</sub>: calcd: *m/z*=190.1443, found: *m/z* = 190.1451.

Data for  $\beta$ -anomer **76**:

$\delta_{\text{H}}$  (400 MHz; MeOD) 0.89 (3H, t, *J* 7.0, CH<sub>3</sub>), 1.28-1.39 (5H, m, CH<sub>2</sub>), 1.88-1.95 (1H, m, CH<sub>2</sub>), 2.72 (1H, dd, *J* 2.8 and 13.5, H-5a), 2.88 (1H, ddd, *J* 2.8 and 7.3, H-1), 3.07 (1H, d, *J* 13.5, H-5b), 3.42-3.51 (2H, m, H-2 and H-4), 4.33-4.36 (1H, m, H-3).

$\delta_{\text{C}}$  (101 MHz; MeOD) 14.01 (CH<sub>3</sub>), 23.61 (CH<sub>2</sub>), 28.47 (CH<sub>2</sub>), 31.67 (CH<sub>2</sub>), 47.5 (C-5), 55.67 (C-1), 71.9 (C-4), 72.07 (C-3), 72.10 (C-2).

$[\alpha]_{\text{D}}^{25} = -5$  (c=0.6, MeOD)

(+) **MS (ESI):** *m/z* = 212.5 [M+Na]<sup>+</sup>

### 1,5-Dideoxy-1,5-imino-1-C-hexyl-L-arabinitols

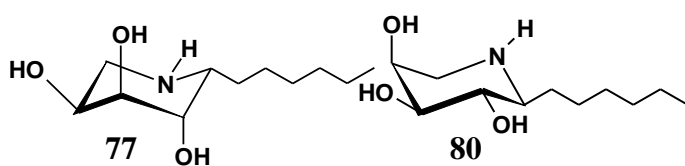

217.31

C<sub>11</sub>H<sub>23</sub>NO<sub>3</sub>

Compound **77** (10.7 mg) and **80** (5.8 mg) were obtained from **71** (14 mg, 0.05 mmol) and **74** (7 mg, 0.02 mmol) respectively.

#### Data for anomer $\alpha$ **80**:

$\delta_{\text{H}}$  (400 MHz; MeOD) 0.89 (3H, t,  $J$  6.8, CH<sub>3</sub>), 1.26-1.41 (5H, m, CH<sub>2</sub>), 1.77-1.84 (1H, m, CH<sub>2</sub>), 2.32 (1H, t,  $J$  5.9, H-1), 2.72 (2H, d,  $J$  13.5, H-5a), 2.95 (1H, d,  $J$  13.5, H-5b), 3.27-3.32 (2H, m, H-2 and H-3), 3.88 (1H, br s, H-4).

$\delta_{\text{C}}$  (101 MHz; MeOD) 14.01 (CH<sub>3</sub>), 23.71 (CH<sub>2</sub>), 28.46 (CH<sub>2</sub>), 30.5 (CH<sub>2</sub>), 30.7 (CH<sub>2</sub>), 31.67 (CH<sub>2</sub>), 50.05 (C-5), 61.20 (C-1), 70.02 (C-4), 72.56 (C-2), 75.73 (C-3).

**HRMS (ESI)** C<sub>11</sub>H<sub>24</sub>NO<sub>3</sub>: calcd:  $m/z$ =218.1756, found:  $m/z$  = 218.1748.

#### Data for anomer $\beta$ **77**:

$\delta_{\text{H}}$  (400 MHz; MeOD) 0.89 (3H, t,  $J$  7.0, CH<sub>3</sub>), 1.27-1.39 (5H, m, CH<sub>2</sub>), 1.89-1.95 (1H, m, CH<sub>2</sub>), 2.73 (1H, dd,  $J$  2.8 and 13.5, H-5a), 2.88 (1H, ddd,  $J$  2.7 and 7.2, H-1), 3.10 (1H, dd,  $J$  3.0 and 13.5, H-5b), 3.44 (1H, m, H-2 and H-3), 4.29-4.35 (1H, m, H-4).

$\delta_{\text{C}}$  (101 MHz; MeOD) 14.01 (CH<sub>3</sub>), 23.61 (CH<sub>2</sub>), 28.47 (CH<sub>2</sub>), 30.4 (CH<sub>2</sub>), 30.8 (CH<sub>2</sub>), 31.66 (CH<sub>2</sub>), 47.4 (C-5), 56.07 (C-1), 71.6 (C-4), 72.03 (C-2), 78.39 (C-3).

**HRMS (ESI)** C<sub>11</sub>H<sub>24</sub>NO<sub>3</sub>: calcd:  $m/z$ =218.1756, found:  $m/z$  = 2178.1766.

### 1,5-Dideoxy-1,5-imino-1-C-nonyl-L-arabinitols

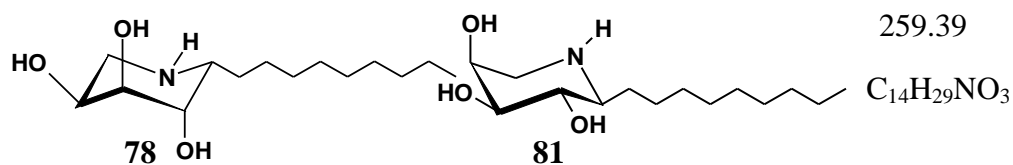

Compound **78** (7.6 mg) and **85** (3.9 mg) were obtained from **72** (9.8 mg, 0.03 mmol) and **75** (5 mg, 0.02 mmol) respectively.

#### Data for $\alpha$ -anomer **81**:

$\delta_H$  (400 MHz; MeOD) 0.90 (3H, t,  $J$  6.9,  $CH_3$ ), 1.24-1.39 (5H, m,  $CH_2$ ), 1.76-1.83 (1H, m,  $CH_2$ ), 2.33 (1H, t,  $J$  6.0, H-1), 2.69 (2H, d,  $J$  12.9, H-5a), 2.93 (1H, d,  $J$  13.5, H-5b), 3.25-3.33 (2H, m, H-2 and H-3), 3.89 (1H, br s, H-4).

(+) **MS (ESI)**:  $m/z = 282.5 [M+Na]^+$

#### Data for $\beta$ -anomer **78**:

$\delta_H$  (400 MHz; MeOD) 0.89 (3H, t,  $J$  7.0,  $CH_3$ ), 1.25-1.38 (5H, m,  $CH_2$ ), 1.90-1.95 (1H, m,  $CH_2$ ), 2.73 (1H, dd,  $J$  2.8 and 13.5, H-5a), 2.89 (1H, ddd,  $J$  2.6 and 7.2, H-1), 3.13 (1H, dd,  $J$  3.0 and 13.5, H-5b), 3.41 (1H, m, H-2 and H-3), 4.30-4.37 (1H, m, H-4).

(+) **MS (ESI)**:  $m/z = 282.5 [M+Na]^+$

**Benzyl 2,3-*O*-isopropylidene-5-(*S<sub>R</sub>*)-*N*-*tert*-butanesulfinylimino- $\alpha$ -L-lyxofuranoside**

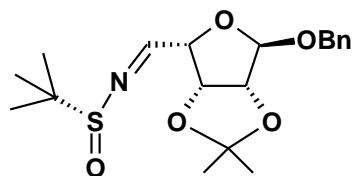

381.49

C<sub>19</sub>H<sub>27</sub>NO<sub>5</sub>S

**82**

Aldehyde **64** (380 mg, 1.36 mmol), (*R*)-*tert*-butanesulfinamide (194 mg, 1.6 mmol, 1.15eq) and anhydrous CuSO<sub>4</sub> (1.11 g, 7 mmol, 5 eq) were dissolved in dry CH<sub>2</sub>Cl<sub>2</sub> (14 mL) and stirred at room temperature for 36h. The suspension was filtered and the filtrate was evaporated. Flash chromatography on silica gel (eluent: EtOAc/petroleum ether, 3:7, v/v) gave the compound **82** as a colorless oil (384 mg, 74%).

$\delta_{\text{H}}$  (400 MHz; CDCl<sub>3</sub>) 1.24 (9H, s, C(CH<sub>3</sub>)<sub>3</sub>), 1.26 (3H, s, CH<sub>3</sub>), 1.42 (3H, s, CH<sub>3</sub>), 4.53 (2H, d<sub>AB</sub>, *J* 11.8, OCH<sub>2</sub>Ph), 4.70 (2H, d, *J* 5.6, H-2), 4.84 (1H, t, *J* 3.6, H-4), 4.99 (1H, dd, *J* 3.8 and 5.7, H-3), 5.25 (1H, s, H-1), 7.27-7.36 (5H, m, Haro), 8.08 (1H, d, *J* 3.9, CHN).

$\delta_{\text{C}}$  (101 MHz; CDCl<sub>3</sub>) 22.09 (C(CH<sub>3</sub>)<sub>3</sub>), 24.61 (CH<sub>3</sub>), 26.02 (CH<sub>3</sub>), 57.30 (C(CH<sub>3</sub>)<sub>3</sub>), 69.42 (OCH<sub>2</sub>Ph), 80.99 (C-4), 81.35 (C-3), 84.94 (C-2), 106.03 (C-1), 113.28 (Cq acetal), 127.92 (CH<sub>Ar</sub>), 127.93 (CH<sub>Ar</sub>), 128.48 (CH<sub>Ar</sub>), 137.11 (Cq<sub>Ar</sub>), 163.94 (CHN).

$[\alpha]_{\text{D}}^{25} = +104$  (c=1.0, CHCl<sub>3</sub>)

(+) **MS (ESI)**: *m/z* = 382.0 [M+Na]<sup>+</sup>

**HRMS (ESI)** C<sub>20</sub>H<sub>27</sub>NO<sub>5</sub>S: calcd: *m/z*=382.1682, found: *m/z* = 382.1688.

**IR (cm<sup>-1</sup>)**: 2956, 1702, 1670, 1447, 1240, 1024.

**TLC**: (PE/EtOAc ; 7/3) R<sub>f</sub> = 0.46.



**Benzyl 2,3-O-isopropylidene-5-(*S*<sub>S</sub>)-*N*-*tert*-butanesulfinylimino- $\alpha$ -L-lyxofuranoside**

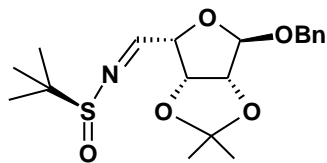

381.49

C<sub>19</sub>H<sub>27</sub>NO<sub>5</sub>S

**83**

Aldehyde **64** (402 mg, 1.44 mmol), (*S*)-*tert*-butanesulfinamide (200 mg, 1.65 mmol, 1.15eq) and anhydrous CuSO<sub>4</sub> (1.14 g, 7.2 mmol, 5 eq) was dissolved in dry CH<sub>2</sub>Cl<sub>2</sub> (15 mL) and stirred at room temperature for 36h. The suspension was filtered and the filtrate was evaporated. Flash chromatography on silica gel of the residue (eluent: EtOAc/petroleum ether, 3:7, v/v) gave the compound **83** as a colorless oil (423 mg, 77%).

$\delta_{\text{H}}$  (400 MHz; CDCl<sub>3</sub>) 1.23 (9H, s, C(CH<sub>3</sub>)<sub>3</sub>), 1.26 (3H, s, CH<sub>3</sub>), 1.41 (3H, s, CH<sub>3</sub>), 4.58 (2H, d<sub>AB</sub>, *J* 11.8, CH<sub>2</sub>OBn), 4.00-4.71 (2H, d, *J* 5.8, H-2), 4.80 (1H, t, *J* 4.0, H-4), 4.96 (1H, dd, *J* 4.1 and 5.7, H-3), 5.25 (1H, s, H-1), 7.29-7.37 (5H, m, Haro), 8.08 (1H, d, *J* 3.9, CHN).

$\delta_{\text{C}}$  (101 MHz; CDCl<sub>3</sub>) 22.47 (C(CH<sub>3</sub>)<sub>3</sub>), 24.84 (CH<sub>3</sub>), 25.96 (CH<sub>3</sub>), 57.34 (C(CH<sub>3</sub>)<sub>3</sub>), 69.24 (OCH<sub>2</sub>Ph), 80.88 (C-4), 80.89 (C-3), 84.86 (C-2), 105.75 (C-1), 113.20 (Cq acetal), 128.23(CH<sub>Ar</sub>), 128.50 (CH<sub>Ar</sub>), 128.55 (CH<sub>Ar</sub>), 136.98 (Cq<sub>Ar</sub>), 165.59 (CHN).

$[\alpha]_{\text{D}}^{25} = -100$  (c=1.2, CHCl<sub>3</sub>)

(+) **MS (ESI):**  $m/z = 382.0$  [M+H]<sup>+</sup>

**HRMS (ESI)** C<sub>20</sub>H<sub>27</sub>NO<sub>5</sub>S: calcd:  $m/z = 382.1682$ , found:  $m/z = 382.1686$ .

**IR (cm<sup>-1</sup>):** 2946, 1702, 1669, 1450, 1238, 1014.

**TLC:** (PE/EtOAc ; 7/3) R<sub>f</sub> = 0.46.

**Benzyl 5-(S)-5-butyl-2,3-O-isopropylidene-5-(S<sub>R</sub>)-N-tert-butanesulfinylamino- $\alpha$ -L-lyxofuranoside**

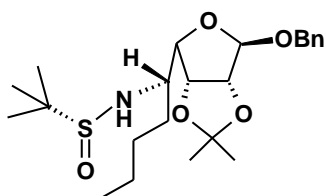

439.61

C<sub>23</sub>H<sub>37</sub>NO<sub>5</sub>S

**84**

Imine **82** (148.1 mg, 0.4 mmol) was dissolved in dry toluene (15 mL) and the solution was cooled to -78°C under Ar. Butylmagnesium bromide (1M in THF, 2.22 mL, 2.2 mmol, 5 eq) was added dropwise. The reaction was stirred for 8 hours and allowed to warm to room temperature. The reaction was then quenched with saturated aqueous NH<sub>4</sub>Cl at 0°C and then extracted with diethyl ether (3×20 mL), and the combined layers were dried (MgSO<sub>4</sub>) and evaporated to an orange oil. Flash chromatography on silica gel (eluent: EtOAc/petroleum ether, 3:7, v/v) gave the compound **84** as a yellow oil (116 mg, 66%) which provided **79**.

$\delta_{\text{H}}$  (400 MHz; CDCl<sub>3</sub>) 0.92 (3H, t, *J* 6.8, CH<sub>3</sub>), 1.20 (9H, s, C(CH<sub>3</sub>)<sub>3</sub>), 1.31 (3H, s, CH<sub>3</sub>), 1.31-1.49 (6H, m, CH<sub>2</sub>), 1.48 (3H, s, CH<sub>3</sub>), 3.62-3.68 (1H, m, H-5), 3.83 (1H, d, *J* 7.4, NH), 3.93 (1H, dd, *J* 3.3 and 7.2, H-4), 4.48 (1H, d<sub>AB</sub>, *J* 11.8, OCH<sub>2</sub>Ph), 4.62 (1H, d, *J* 5.8, H-2), 4.65 (1H, d<sub>AB</sub>, *J* 11.8, OCH<sub>2</sub>Ph), 4.84 (1H, dd, *J* 3.3 and 5.8, H-3), 5.12 (1H, s, H-1), 7.27-7.34 (5H, m, Haro).

$\delta_{\text{C}}$  (101 MHz; CDCl<sub>3</sub>) 14.00 (CH<sub>3</sub>), 21.01 (CH<sub>2</sub>), 22.39 (C(CH<sub>3</sub>)<sub>3</sub>), 24.55 (CH<sub>3</sub>), 25.91 (CH<sub>3</sub>), 27.82 (CH<sub>2</sub>), 32.46 (CH<sub>2</sub>), 55.51 (C-5), 56.05 (C(CH<sub>3</sub>)<sub>3</sub>), 69.12 (OCH<sub>2</sub>Ph), 79.84 (C-3), 80.97 (C-4), 85.06 (C-2), 105.42 (C-1), 112.55 (Cq acetal), 127.87-128.14-129.77 (CH<sub>Ar</sub>), 137.47 (Cq<sub>Ar</sub>).

$[\alpha]_{\text{D}}^{25} = +26$  (c=0.9, CHCl<sub>3</sub>)

(+) **MS (ESI)**: *m/z* = 440.5 [M+H]<sup>+</sup>; *m/z* = 462.5 [M+Na]<sup>+</sup>

**HRMS (ESI)** C<sub>23</sub>H<sub>38</sub>NO<sub>5</sub>S: calcd: *m/z* = 440.2478, found: *m/z* = 440.2471.

**IR (cm<sup>-1</sup>)**: 3223, 2923, 2854, 1455, 1208, 1071.

**TLC**: (PE/EtOAc; 7/3) R<sub>f</sub> = 0.42.

**Benzyl 5-(*R*)-5-butyl-2,3-*O*-isopropylidene-5-(*S*<sub>S</sub>)-*N*-*tert*-butanesulfinylamino- $\alpha$ -L-lyxofuranoside**

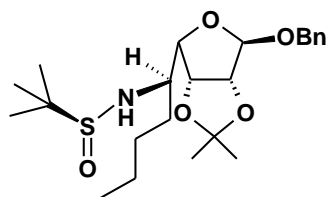

439.61

C<sub>23</sub>H<sub>37</sub>NO<sub>5</sub>S

**85**

Imine **83** (268.7 mg, 0.7 mmol) was dissolved in dry toluene (26 mL) and the solution was cooled to -78°C under Argon. Butylmagnesium bromide (1M in THF, 3.6 mL, 3.6 mmol, 5 eq) was added dropwise. The reaction was stirred for 8 hours and allowed to warm to room temperature. The reaction was then quenched with saturated aqueous NH<sub>4</sub>Cl solution at 0°C and then extracted with diethyl ether (3×30 mL), and the combined layers were dried (MgSO<sub>4</sub>) and evaporated to an orange oil. Flash chromatography on silica gel (eluent: EtOAc/petroleum ether, 3:7, v/v) gave the compound **85** as a yellow oil (251 mg, 78%) which provided **76**.

$\delta_{\text{H}}$  (400 MHz; CDCl<sub>3</sub>) 0.91-0.93 (3H, t, *J* 7.0, CH<sub>3</sub>), 1.21 (9H, s, C(CH<sub>3</sub>)<sub>3</sub>), 1.31 (3H, s, CH<sub>3</sub>), 1.31-1.77 (6H, m, CH<sub>2</sub>), 1.48 (3H, s, CH<sub>3</sub>), 3.62-3.68 (1H, m, H-5), 3.82 (1H, d, *J* 7.4, NH), 3.93 (1H, dd, *J* 3.3 and 7.2, H-4), 4.48 (1H, d<sub>AB</sub>, *J* 11.8, OCH<sub>2</sub>Ph), 4.62 (1H, d<sub>AB</sub>, *J* 11.8, OCH<sub>2</sub>Ph), 4.64 (1H, d, *J* 5.9, H-2), 4.82-4.85 (1H, dd, *J* 3.6 and 5.8, H-3), 5.15 (1H, s, H-1), 7.28-7.37 (5H, m, Haro),

$\delta_{\text{C}}$  (101 MHz; CDCl<sub>3</sub>) 14.01 (CH<sub>3</sub>), 22.60 (CH<sub>2</sub>), 22.76 (C(CH<sub>3</sub>)<sub>3</sub>), 24.57 (CH<sub>3</sub>), 26.04 (CH<sub>3</sub>), 27.83 (CH<sub>2</sub>), 32.47 (CH<sub>2</sub>), 55.50 (C-5), 56.05 (C(CH<sub>3</sub>)<sub>3</sub>), 69.14 (OCH<sub>2</sub>Ph), 79.84 (C-3), 81.00 (C-4), 85.07 (C-2), 105.43 (C-1), 112.57 (C<sub>q</sub> acetal), 127.76-127.97-128.43 (CH<sub>Ar</sub>), 137.47 (C<sub>q</sub>Ar).

$[\alpha]_{\text{D}}^{25} = -21$  (c=1.5, CHCl<sub>3</sub>)

(+) **MS (ESI)**: *m/z* = 462.5 [M+Na]<sup>+</sup>

**HRMS (ESI)** C<sub>23</sub>H<sub>38</sub>NO<sub>5</sub>S: calcd: *m/z* = 440.2478, found: *m/z* = 440.2471.

**IR (cm<sup>-1</sup>)**: 3229, 2930, 2855, 1441, 1212, 1060.

**TLC**: (PE/EtOAc ; 7/3) R<sub>f</sub> = 0.42.

**Benzyl 5-*N*-benzylamino-2,3-*O*-isopropylidene- $\alpha$ -L-lyxofuranoside**

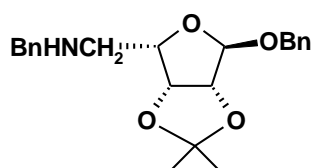

369.19

C<sub>22</sub>H<sub>27</sub>NO<sub>4</sub>

**86**

Aldehyde **64** (946 mg, 3.4 mmol) was dissolved in dry MeOH (30 mL) in the presence of 3Å molecular sieves and stirred at room temperature for 10 minutes. NaBH<sub>3</sub>CN (1.07 g, 17 mmol, 5 eq) was added. The mixture was cooled down to -78°C and AcOH (389 μL, 6.8 mmol, 2 eq) and BnNH<sub>2</sub> (446 μL, 4.1 mmol, 1.2 eq) were added. The mixture was allowed to warm up to room temperature and stirred for a total of 12h. The solid was removed by filtration over Celite and washed twice with EtOAc. The filtrate was concentrated under vacuum. The residue was dissolved in EtOAc (30 mL) and the solution was washed with saturated NaHCO<sub>3</sub> (40 mL) followed by H<sub>2</sub>O (40 mL). The organic phase was dried over MgSO<sub>4</sub>, and then concentrated under vacuum. Compound **86** (640 mg, 51%) was obtained as colorless oil after flash chromatography on silica gel (eluent: EtOAc/petroleum ether, 3:5, v/v).

$\delta_{\text{H}}$  (400 MHz; CDCl<sub>3</sub>) 1.28 (3H, s, CH<sub>3</sub>), 1.42 (3H, s, CH<sub>3</sub>), 2.25 (1H, s, NH), 2.95-2.97 (2H, m, H-5ab), 3.78-3.83 (2H, m, NHCH<sub>2</sub>Ph), 4.18 (1H, dt, *J* 3.7, 3.8 and 5.9, H-4), 4.46 (1H, d<sub>AB</sub>, *J* 11.9, OCH<sub>2</sub>Ph), 4.63 (1H, dd, *J* 3.9, H-2), 4.65 (1H, d<sub>AB</sub>, *J* 12.0, OCH<sub>2</sub>Ph), 4.69 (1H, dd, *J* 3.6 and 5.8, H-3), 5.08 (1H, s, H-1), 7.30-7.33 (10H, m, Haro).

$\delta_{\text{C}}$  (101 MHz; CDCl<sub>3</sub>) 24.868 (CH<sub>2</sub>), 25.89 (CH<sub>3</sub>), 47.83 (C-5), 53.98 (NCH<sub>2</sub>Ph), 68.84 (OCH<sub>2</sub>Ph), 79.12 (C-4), 79.99 (C-3), 85.07 (C-2), 105.11 (C-1), 112.31 (C<sub>q</sub> acetal), 126.90-127.21 (CH<sub>Ar</sub>), 137.30 (C<sub>qAr</sub>), 139.82 (C<sub>qAr</sub>).

(+) **MS (ESI)**:  $m/z = 392.5$  [M+Na]<sup>+</sup>

**HRMS (ESI)** C<sub>22</sub>H<sub>28</sub>NO<sub>4</sub>: calcd:  $m/z = 370.2118$ , found:  $m/z = 370.2016$ .

**IR (cm<sup>-1</sup>)**: 3329, 2921, 2850, 1431, 1213, 1050.

**TLC**: (PE/EtOAc ; 5/3) R<sub>f</sub> = 0.19.

**3,4-*O*-isopropylidene-1,5-dideoxy-1,5-imino-L-arabinitol**

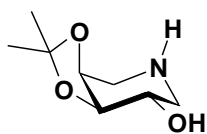

173.21

C<sub>8</sub>H<sub>15</sub>NO<sub>3</sub>

**87**

---

Compound **86** (563 mg, 1.52 mmol) was dissolved in isopropanol (20 mL) containing AcOH (5%, v:v). 10% Pd/C was added and the reaction was stirred at room temperature under H<sub>2</sub> atmosphere during 12 hours. The reaction mixture was filtered through a membrane and the catalyst was washed 3 times with isopropanol. The filtrate was concentrated under vacuum to give **87** (260 mg).

$\delta_{\text{H}}$  (400 MHz; MeOD) 1.35 (3H, s, CH<sub>3</sub>), 1.50 (3H, s, CH<sub>3</sub>), 2.39 (1H, dd, *J* 9.1 and 13.1, H-1a), 2.92-2.97 (2H, m, H-1b and H-5a), 3.12 (1H, dd, *J* 2.4 and 14.6, H-5b), 3.69 (1H, ddd, *J* 4.4, 6.3 and 9.1, H-2), 3.99 (1H, dd, *J* 5.8 and 6.0, H-3), 4.19 (1H, m, H-4).

$\delta_{\text{C}}$  (101 MHz; MeOD) 26.54 (CH<sub>3</sub>), 28.43 (CH<sub>3</sub>), 46.66 (C-5), 49.1 (C-1), 70.37 (C-2), 74.08 (C-4), 79.94 (C-3), 110.07 (Cq acetal).

(+) **MS (ESI):**  $m/z = 174.5$  [M+H]<sup>+</sup>

**TLC:** (CH<sub>2</sub>Cl<sub>2</sub>/MeOH; 7:1) R<sub>f</sub> = 0.10.

**HRMS (ESI):** in progress

***N*-benzyloxycarbonyl-3,4-*O*-isopropylidene-1,5-dideoxy-1,5-imino-L-arabinitol**

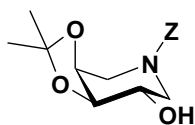

307.35

C<sub>16</sub>H<sub>21</sub>NO<sub>5</sub>

**88**

Compound **87** (214 mg, 1.24 mmol) was dissolved in methanol (10 mL). DIPEA (324  $\mu$ L, 1.86 mmol, 1.5 eq) and benzylchloroformate (265  $\mu$ L, 1.86 mmol, 1.5 eq) were added at 0°C and the reaction was stirred for 12 hours. The reaction mixture was concentrated under vacuum. Compound **88** (300 mg, 79%) was obtained as a colorless oil after flash chromatography on silica gel (eluent: EtOAc/petroleum ether, 1:1, v/v).

$\delta_{\text{H}}$  (400 MHz; MeOD) 1.34 (3H, s, CH<sub>3</sub>), 1.45 (3H, s, CH<sub>3</sub>), 2.34 (0.4H, s, OH), 2.59 (0.6H, s, OH), 3.34-3.44 (1H, m, H-1a), 3.53 (1H, dd, *J* 2.5 and 14.2, H-5a), 3.67 (1H, d, *J* 13.2, H-1b), 3.89-4.01 (2H, m, H-2, H-5), 4.06-4.13 (1H, br s, H-3), 4.30-4.41 (1H, br s, H-4), 5.14 (2H, s, OCH<sub>2</sub>Ph), 7.27-7.37 (5H, m, Haro).

$\delta_{\text{C}}$  (101 MHz; MeOD) 24.98 (CH<sub>3</sub>), 27.28 (CH<sub>3</sub>), 42.72 (C-1), 44.65 (C-5), 67.24 (OCH<sub>2</sub>Ph), 67.60 (C-2), 71.75 (C-4), 75.46 (C-3), 109.20 (Cq acetal), 127.71-127.97-128.44 (CH<sub>Ar</sub>), 136.56 (Cq<sub>Ar</sub>), 159.37 (C=O).

(+) **MS (ESI):**  $m/z = 308.5$  [M+H]<sup>+</sup>

**TLC:** (EtOAc/PE; 1:1)  $R_f = 0.28$ .

**HRMS (ESI):** in progress

***N*-benzyloxycarbonyl-2-*O*-hexyl-3,4-*O*-isopropylidene-1,5-dideoxy-1,5-imino-L-arabinitol**

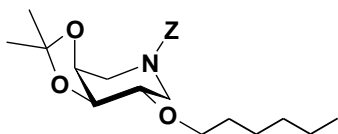

391.51

C<sub>22</sub>H<sub>33</sub>NO<sub>5</sub>

**89**

To a solution of **88** (101 mg, 0.33 mmol) in dry DMF was added NaH (60% dispersion in mineral oil) (26.4 mg, 0.66 mmol, 2q) at 0°C. The mixture was stirred at 0°C for 30 min and then 1-bromohexane (93 µL, 0.66 mmol, 2 eq) was added. After 12 hours of stirring at room temperature, the mixture was cooled to 0°C and MeOH was cautiously added. The solution was diluted with EtOAc (20 mL). The organic phase was washed 3 times with brine (15 mL) and then dried over MgSO<sub>4</sub>. The solid was filtered and the filtrate concentrated under vacuum. The residue was purified by flash chromatography on silica gel (eluent: EtOAc/petroleum ether, 1:4, v/v) to give **89** (112 mg, 87 %).

$\delta_{\text{H}}$  (400 MHz; MeOD) 0.88 (3H, t,  $J$  7.0, CH<sub>3</sub>), 1.24-1.27 (9H, s, CH<sub>3</sub>), 1.36 (3H, s, CH<sub>3</sub>), 1.45-1.55 (2H, m, CH<sub>2</sub>), 3.41-3.57 (5H, m, H-1, H-2, H-5a and OCH<sub>2</sub>), 3.98-4.01 (1H, m, H-5b), 4.15-4.19 (1H, m, H-3), 4.37-4.40 (1H, m, H-4), 5.16 (2H, s, OCH<sub>2</sub>Ph), 7.29-7.36 (5H, m, Haro).

$\delta_{\text{C}}$  (101 MHz; MeOD) 14.02 (CH<sub>3</sub>), 22.57 (CH<sub>2</sub>), 24.63 (CH<sub>3</sub>), 25.72 (CH<sub>2</sub>), 27.28 (CH<sub>3</sub>), 29.68 (CH<sub>2</sub>), 31.57 (CH<sub>2</sub>), 41.06 (C-1), 42.26 (C-5), 66.99 (OCH<sub>2</sub>Ph), 69.45 (OCH<sub>2</sub>), 72.09 (C-4), 73.22 (C-3), 74.35 (C-2), 109.20 (Cq acetal), 127.66-127.83-128.39 (CH<sub>Ar</sub>), 136.84 (Cq<sub>Ar</sub>), 156.21 (C=O).

(+) **MS (ESI)**:  $m/z = 392.0$  [M+H]<sup>+</sup>;  $m/z = 414.0$  [M+Na]<sup>+</sup>

**IR (cm<sup>-1</sup>)**: 2927, 2857, 1702, 1419, 1379, 1209, 1109, 1061.

**TLC**: (EtOAc/PE; 1:4) R<sub>f</sub> = 0.58.

**HRMS (ESI)**: in progress

**2-*O*-Hexyl-3,4-*O*-isopropylidene-1,5-dideoxy-1,5-imino-L-arabinitol**

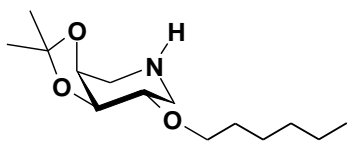

257.38

C<sub>14</sub>H<sub>27</sub>NO<sub>3</sub>

**90**

Compound **89** (72 mg, 0.18 mmol) was dissolved in isopropanol (10 mL) containing 1M HCl (5%, v:v). 10% Pd/C was added and the reaction was stirred at room temperature under H<sub>2</sub> atmosphere during 6 hours. The reaction mixture was filtered through a membrane and the catalyst was washed 3 times with isopropanol. The filtrate was concentrated under vacuum to give **90** (46.3 mg).

$\delta_{\text{H}}$  (400 MHz; MeOD) 0.92 (3H, t, *J* 7.0, CH<sub>3</sub>), 1.29-1.34 (6H, s, CH<sub>2</sub>), 1.39 (3H, s, CH<sub>3</sub>), 1.53 (3H, s, CH<sub>3</sub>), 1.57-1.62 (2H, m, CH<sub>2</sub>), 3.21 (1H, dd, *J* 4.2 and 13.0, H-1a), 3.29-3.32 (1H, m, H-1b), 3.38-3.47 (2H, m, H-5ab), 3.61-3.68 (2H, m, OCH<sub>2</sub>), 3.68-3.70 (1H, m, H-2), 4.32 (1H, dd, *J* 3.2 and 6.8, H-3), 4.57 (1H, dt, *J* 2.6, 2.6 and 6.5, H-4).

$\delta_{\text{C}}$  (101 MHz; MeOD) 14.37 (CH<sub>3</sub>), 23.65 (CH<sub>2</sub>), 24.61 (CH<sub>3</sub>), 26.79 (CH<sub>2</sub>), 26.93 (CH<sub>3</sub>), 30.85 (CH<sub>2</sub>), 32.80 (CH<sub>2</sub>), 40.47 (C-1), 41.25 (C-5), 70.41 (C-4), 71.43 (OCH<sub>2</sub>), 72.49 (C-3), 73.34 (C-2).

(+) **MS (ESI):** *m/z* = 258.0 [M+H]<sup>+</sup>

**TLC:** (EtOAc/PE; 1:4) *R<sub>f</sub>* = 0.09.

**HRMS (ESI):** in progress



**2-O-Hexyl-1,5-dideoxy-1,5-imino-L-arabinitol**

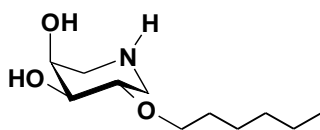

217.31

C<sub>11</sub>H<sub>23</sub>NO<sub>3</sub>

**91**

---

Dowex 50WX8 (H<sup>+</sup>) ion exchange resin (1.17 g per mmol) was added to a solution of **90** (33 mg, 0.13 mmol) in a 1:1 mixture of dioxane/H<sub>2</sub>O (5 mL). The mixture was slowly stirred at room temperature for 12 hours. Filtration followed by several washing with aqueous ammonia 0.15N and concentration afforded the iminosugar **91** quantitatively.

$\delta_{\text{H}}$  (400 MHz; MeOD) 0.92 (3H, t,  $J$  6.9, CH<sub>3</sub>), 1.30-1.39 (6H, s, CH<sub>2</sub>), 1.51-1.56 (2H, m, CH<sub>2</sub>), 2.46 (1H, dd,  $J$  6.8 and 13.2, H-1a), 2.67 (1H, dd,  $J$  2.8 and 13.2, H-5a), 2.84 (1H,  $J$  6.4 and 13.2, H-5b), 3.05 (1H,  $J$  3.2 and 13.2, H-1b), 3.42 (1H, m, H-2), 3.53-3.57 (1H, m, OCH<sub>2</sub>), 3.64 (1H, dd,  $J$  2.8 and 7.2, H-3), 3.84 (1H, q,  $J$  2.6, 2.6 and 6.5, H-4).

$\delta_{\text{C}}$  (101 MHz; MeOD) 14.38 (CH<sub>3</sub>), 23.69 (CH<sub>2</sub>), 26.90 (CH<sub>2</sub>), 31.18 (CH<sub>2</sub>), 32.87 (CH<sub>2</sub>), 46.91 (C-1), 47.80 (C-5), 69.29 (C-4), 71.27 (OCH<sub>2</sub>), 73.03 (C-3), 78.52 (C-2).

(+) **MS (ESI)**:  $m/z = 218.0$  [M+H]<sup>+</sup>

**HRMS (ESI)**: in progress

## CONCEPTION ET SYNTHÈSE D'IMINOGLYCOLIPIDES COMME INHIBITEURS D'ENZYMES LYSOSOMALES À EFFET CHAPERON PHARMACOLOGIQUE

### Résumé :

La thérapie chaperon représente une approche thérapeutique stratégique et innovante, en particulier dans le traitement des maladies lysosomales. Ces maladies génétiques rares ont une gravité variable, qui peut aller de la létalité avant la naissance jusqu'à la nécessité d'une prise en charge permanente ; elles apparaissent à tous les stades de la vie.

Des mimes du substrat appelé iminosucres, vont agir en allant au cœur du site actif de l'enzyme, stabiliser l'enzyme mutée qui est instable mais non inactive. Paradoxalement, la plupart des chaperons pharmacologiques sont des inhibiteurs de l'enzyme visée mais leur administration à faible concentration leur permet de réaliser leur mission de sauvetage de l'enzyme mutée. Dans cette optique, des recherches effectuées au sein de notre laboratoire ont fait état de la synthèse d'iminosucres, tels que les  $\alpha$ -1-C-alkyl iminoxylitols qui sont de très bons inhibiteurs de la  $\beta$ -glucocérébrosidase, l'enzyme défaillante dans la maladie de Gaucher, mais aussi qui doublent l'activité enzymatique résiduelle. Une nouvelle voie de synthèse plus efficace a été réalisée afin d'obtenir plus efficacement ce type d'iminosucres et d'autres dérivés. Ces travaux ont également été l'occasion de développer des iminoxylitols structurellement simplifiés qui agissent comme chaperons pharmacologiques toujours pour le traitement de la maladie de Gaucher.

Une partie de ces travaux a aussi été consacrée à la recherche d'inhibiteurs de la  $\beta$ -galactocérébrosidase, l'enzyme impliquée dans la maladie de Krabbe, et qui pourront agir comme chaperons pharmacologiques. Différentes évaluations pharmacologiques ont été réalisées, notamment des tests d'inhibition et la détermination des effets chaperons.

**Mot clés :** Maladie lysosomale ; inhibiteurs ;  $\beta$ -glucocérébrosidase ;  $\beta$ -galactocérébrosidase ; chaperon pharmacologique ; iminoglycolipides

## CONCEPTION AND SYNTHESIS OF IMINOGLYCOLIPIDS AS INHIBITORS OF LYSOSOMAL ENZYMES ACTING AS PHARMACOLOGICAL CHAPERONES

### Abstract:

Chaperone Mediated Therapy represents an innovative and strategic approach to treat lysosomal storage disorders which a class of rare genetic diseases. Competitive inhibitors for some of these lysosomal enzymes can, at sub inhibitory concentrations, act as chaperones and rescue the mutant proteins. In fact, enzymes carrying some mutations are still catalytically active.

$\alpha$ -1-C-alkyl iminoxylitols represent a class of iminosugars which mimic the "gluco" configuration of the substrate and give powerful inhibitors of  $\beta$ -glucocerebrosidase, the enzyme involved in Gaucher disease. Moreover, this class of iminosugars, synthesized by our group, act as pharmacological chaperones and are able to double the residual activity of the N370S mutant.

In order to synthesize more efficiently these iminosugars, the synthetic strategy was improved and optimized. Moreover, we focused our investigations on structural variations on our lead compound ( $\alpha$ -1-C<sub>9</sub> iminoxylitol) and draw important conclusions on structure-activity relationship. Then, we extended our expertise on iminosugars as pharmacological chaperones to another lysosomal glycosidase. In particular, we targeted  $\beta$ -galactocerebrosidase, the enzyme responsible for Krabbe disease, and synthesized a series of iminosugars which mimic the "galacto" configuration. Biological assays were performed on our compounds to determine their activity as inhibitors and for some of them, their chaperone effects.

**Key words:** Lysosomal Storage Disorder ;  $\beta$ -glucocerebrosidase ;  $\beta$ -galactocerebrosidase; inhibitors ; pharmacological chaperone ; iminoglycolipids.



LABORATOIRE ICOA  
BP 6759  
rue de Chartres  
45067 Orléans cedex 2

