



**HAL**  
open science

## Eco-design of power transmissions systems

Wenlu Wang

► **To cite this version:**

Wenlu Wang. Eco-design of power transmissions systems. Other. Ecole Centrale de Lyon, 2011. English. NNT : 2011ECDL0022 . tel-00627890

**HAL Id: tel-00627890**

**<https://theses.hal.science/tel-00627890>**

Submitted on 29 Sep 2011

**HAL** is a multi-disciplinary open access archive for the deposit and dissemination of scientific research documents, whether they are published or not. The documents may come from teaching and research institutions in France or abroad, or from public or private research centers.

L'archive ouverte pluridisciplinaire **HAL**, est destinée au dépôt et à la diffusion de documents scientifiques de niveau recherche, publiés ou non, émanant des établissements d'enseignement et de recherche français ou étrangers, des laboratoires publics ou privés.

# THÈSE

Présentée devant

## L'ÉCOLE CENTRALE DE LYON

Pour obtenir le grade de

**DOCTEUR**

(Arrêté du 30/03/1992)

**Spécialité : Génie Électrique**

Préparée au sein de

**L'ÉCOLE DOCTORALE  
ÉLECTRONIQUE, ÉLECTROTECHNIQUE, AUTOMATIQUE  
DE LYON**

par

**Wenlu WANG**

---

## ECO-DESIGN OF POWER TRANSMISSIONS SYSTEMS

-----

## ECO-CONCEPTION DES SYSTEMES DE TRANSMISSION DE L'ENERGIE ELECTRIQUE

---

*Soutenue le 12 juillet 2011 devant la commission d'examen :*

**JURY : MM.**

<b>P.BROCHET</b>	Professeur – Ecole Centrale de Lille	<b>Rapporteur</b>
<b>M. INVERNIZZI</b>	Professeur – Université de Gênes - Italie	<b>Rapporteur</b>
<b>A. BEROUAL</b>	Professeur – AMPERE – Ecole Centrale de Lyon	<b>Examineur</b>
<b>H. RAZIK</b>	Professeur – Université Claude Bernard – Lyon 1	<b>Président</b>
<b>J-L. BESSEDE</b>	Docteur Ingénieur – Schneider-Electric, Grenoble	<b>Examineur</b>
<b>G. TREMOUILLE</b>	Ingénieur – ALSTOM GRID System	<b>Invité</b>



**Liste des personnes Habilitées à Diriger des Recherches  
en poste à l'Ecole Centrale de Lyon**

<i>Nom-Prénom</i>	<i>Corps grade</i>	<b>Laboratoire ou à défaut département ECL</b>	<b>Etablissement</b>
<i>AURIOL Philippe</i>	<i>professeur</i>	AMPERE	ECL
<i>BEROUAL Abderrahmane</i>	<i>professeur</i>	AMPERE	ECL
<i>BURET François</i>	<i>professeur</i>	AMPERE	ECL
<i>JAFFREZIC-RENAULT Nicole</i>	<i>directeur de recherche</i>	AMPERE	CNRS/ECL
<i>KRÄHENBÜHL Laurent</i>	<i>directeur de recherche</i>	AMPERE	CNRS/ECL
<i>MARTELET Claude</i>	<i>professeur</i>	AMPERE	ECL
<i>NICOLAS Alain</i>	<i>professeur</i>	AMPERE	ECL
<i>NICOLAS Laurent</i>	<i>directeur de recherche</i>	AMPERE	CNRS/ECL
<i>SCORLETTI Gérard</i>	<i>professeur</i>	AMPERE	ECL
<i>SIMONET Pascal</i>	<i>chargé de recherche</i>	AMPERE	CNRS/ECL
<i>THOMAS Gérard</i>	<i>professeur</i>	AMPERE	ECL
<i>VOLLAIRE Christian</i>	<i>professeur</i>	AMPERE	ECL

***Nbre Ampère 12***

<i>HELLOUIN Yves</i>	<i>maître de conférences</i>	DER EEA	ECL
<i>LE HELLEY Michel</i>	<i>professeur</i>	DER EEA	ECL

***Nbre DER EEA 2***

<i>GUIRALDENQ Pierre</i>	<i>professeur émérite</i>	DER STMS	ECL
<i>VINCENT Léo</i>	<i>professeur</i>	DER STMS	ECL

***Nbre DER STMS 2***

<i>LOHEAC Jean-Pierre</i>	<i>maître de conférences</i>	ICJ	ECL
<i>MAITRE Jean-François</i>	<i>professeur émérite</i>	ICJ	ECL
<i>MARION Martine</i>	<i>professeur</i>	ICJ	ECL
<i>MIRONESCU Elisabeth</i>	<i>professeur</i>	ICJ	ECL
<i>MOUSSAOUI Mohand</i>	<i>professeur</i>	ICJ	ECL
<i>MUSY François</i>	<i>maître de conférences</i>	ICJ	ECL
<i>ZINE Abdel-Malek</i>	<i>maître de conférences</i>	ICJ	ECL

***Nbre ICJ 7***

<i>DAVID Bertrand</i>	<i>professeur</i>	ICTT	ECL
-----------------------	-------------------	------	-----

**Nbre ICTT 1**

<i>CALLARD Anne-Ségolène</i>	<i>maître de conférences</i>	INL	ECL
<i>CLOAREC Jean-Pierre</i>	<i>maître de conférences</i>	INL	ECL
<i>GAFFIOT Frédéric</i>	<i>professeur</i>	INL	ECL
<i>GAGNAIRE Alain</i>	<i>maître de conférences</i>	INL	ECL
<i>GARRIGUES Michel</i>	<i>directeur de recherche</i>	INL	CNRS/ECL
<i>GENDRY Michel</i>	<i>directeur de recherche</i>	INL	CNRS/ECL
<i>GRENET Geneviève</i>	<i>directeur de recherche</i>	INL	CNRS/ECL
<i>HOLLINGER Guy</i>	<i>directeur de recherche</i>	INL	CNRS/ECL
<i>JOSEPH Jacques</i>	<i>professeur</i>	INL	ECL
<i>KRAWCZYK Stanislas</i>	<i>directeur de recherche</i>	INL	CNRS/ECL
<i>LETARTRE Xavier</i>	<i>chargé de recherche</i>	INL	CNRS/ECL
<i>MARTIN Jean-René</i>	<i>professeur émérite</i>	INL	ECL
<i>O'CONNOR Ian</i>	<i>professeur</i>	INL	ECL
<i>PHANER-GOUTORBE Magali</i>	<i>professeur</i>	INL	ECL
<i>ROBACH Yves</i>	<i>professeur</i>	INL	ECL
<i>SAINT-GIRONS Guillaume</i>	<i>chargé de recherche</i>	INL	CNRS/ECL
<i>SEASSAL Christian</i>	<i>chargé de recherche</i>	INL	CNRS/ECL
<i>SOUTEYRAND Eliane</i>	<i>directeur de recherche</i>	INL	CNRS/ECL
<i>TARDY Jacques</i>	<i>directeur de recherche</i>	INL	CNRS/ECL
<i>VIKTOROVITCH Pierre</i>	<i>directeur de recherche</i>	INL	CNRS/ECL

**Nbre INL 20**

<i>CHEN Liming</i>	<i>professeur</i>	LIRIS	ECL
--------------------	-------------------	-------	-----

**Nbre LIRIS 1**

<i>BAILLY Christophe</i>	<i>professeur</i>	LMFA	ECL
<i>BERTOGLIO Jean-Pierre</i>	<i>directeur de recherche</i>	LMFA	CNRS/ECL
<i>BLANC-BENON Philippe</i>	<i>directeur de recherche</i>	LMFA	CNRS/ECL
<i>BOGEY Christophe</i>	<i>chargé de recherche</i>	LMFA	CNRS/ECL
<i>CAMBON Claude</i>	<i>directeur de recherche</i>	LMFA	CNRS/ECL
<i>CARRIERE Philippe</i>	<i>chargé de recherche</i>	LMFA	CNRS/ECL
<i>CHAMPOUSSIN J-Claude</i>	<i>professeur émérite</i>	LMFA	ECL
<i>COMTE-BELLOT geneviève</i>	<i>professeur émérite</i>	LMFA	ECL
<i>FERRAND Pascal</i>	<i>directeur de recherche</i>	LMFA	CNRS/ECL
<i>GALLAND Marie-Annick</i>	<i>professeur</i>	LMFA	ECL
<i>GODEFERD Fabien</i>	<i>chargé de recherche</i>	LMFA	CNRS/ECL
<i>GOROKHOVSKI Mikhail</i>	<i>professeur</i>	LMFA	ECL
<i>HENRY Daniel</i>	<i>directeur de recherche</i>	LMFA	CNRS/ECL
<i>JEANDEL Denis</i>	<i>professeur</i>	LMFA	ECL

<i>JUVE Daniel</i>	<i>professeur</i>	LMFA	ECL
<i>LE RIBAUT Catherine</i>	<i>chargée de recherche</i>	LMFA	CNRS/ECL
<i>LEBOEUF Francis</i>	<i>professeur</i>	LMFA	ECL
<i>PERKINS Richard</i>	<i>professeur</i>	LMFA	ECL
<i>ROGER Michel</i>	<i>professeur</i>	LMFA	ECL
<i>SCOTT Julian</i>	<i>professeur</i>	LMFA	ECL
<i>SHAO Liang</i>	<i>chargé de recherche</i>	LMFA	CNRS/ECL
<i>SIMOENS Serge</i>	<i>chargé de recherche</i>	LMFA	CNRS/ECL
<i>TREBINJAC Isabelle</i>	<i>maître de conférences</i>	LMFA	ECL

**Nbre LMFA 23**

<i>BENAYOUN Stéphane</i>	<i>professeur</i>	LTDS	ECL
<i>CAMBOU Bernard</i>	<i>professeur</i>	LTDS	ECL
<i>COQUILLET Bernard</i>	<i>maître de conférences</i>	LTDS	ECL
<i>DANESCU Alexandre</i>	<i>maître de conférences</i>	LTDS	ECL
<i>FOUVRY Siegfried</i>	<i>chargé de recherche</i>	LTDS	CNRS/ECL
<i>GEORGES Jean-Marie</i>	<i>professeur émérite</i>	LTDS	ECL
<i>GUERRET Chrystelle</i>	<i>chargé de recherche</i>	LTDS	CNRS/ECL
<i>HERTZ Dominique</i>	<i>past</i>	LTDS	ECL
<i>ICHCHOU Mohamed</i>	<i>professeur</i>	LTDS	ECL
<i>JEZEQUEL Louis</i>	<i>professeur</i>	LTDS	ECL
<i>JUVE Denyse</i>	<i>ingénieur de recherche</i>	LTDS	ECL
<i>KAPSA Philippe</i>	<i>directeur de recherche</i>	LTDS	CNRS/ECL
<i>LE BOT Alain</i>	<i>chargé de recherche</i>	LTDS	CNRS/ECL
<i>LOUBET Jean-Luc</i>	<i>directeur de recherche</i>	LTDS	CNRS/ECL
<i>MARTIN Jean-Michel</i>	<i>professeur</i>	LTDS	ECL
<i>MATHIA Thomas</i>	<i>directeur de recherche</i>	LTDS	CNRS/ECL
<i>MAZUYER Denis</i>	<i>professeur</i>	LTDS	ECL
<i>PERRET-LIAUDET Joël</i>	<i>maître de conférences</i>	LTDS	ECL
<i>SALVIA Michelle</i>	<i>maître de conférences</i>	LTDS	ECL
<i>SIDOROFF François</i>	<i>professeur</i>	LTDS	ECL
<i>SINOUE Jean-Jacques</i>	<i>maître de conférences</i>	LTDS	ECL
<i>STREMSDOERFER Guy</i>	<i>professeur</i>	LTDS	ECL
<i>THOUVEREZ Fabrice</i>	<i>professeur</i>	LTDS	ECL
<i>TREHEUX Daniel</i>	<i>professeur</i>	LTDS	ECL
<i>VANNES André-Bernard</i>	<i>professeur émérite</i>	LTDS	ECL
<i>VINCENS Eric</i>	<i>maître de conférences</i>	LTDS	ECL

**Nbre LTDS 26**

Total HdR ECL

91



## **Abstract**

The demand to preserve the environment and form a sustainable development is greatly increasing in the recent decades all over the world, and this environmental concern is also merged in electrical power industry, resulting in many eco-design approaches in Transmission & Distribution (T & D) industries.

As a method of eco-design, Life Cycle Assessment (LCA) is a systematic tool that enables the assessment of the environmental impacts of a product or service throughout its entire life cycle, i.e. raw material production, manufacture, distribution, use and disposal including all intervening transportation steps necessary or caused by the product's existence.

In T & D industries, LCA has been done for a lot of products individually, in order to see one product's environmental impacts and to seek for ways of improving its environmental performance. This eco-design for product approach is a rather well-developed trend, however, as only a single electrical product cannot provide the electrical power to users, electrical system consists of a huge number of components, in order to investigate system's environmental profile, the entire environmental profiles of different composing products has to be integrated systematically, that is to say, a system approach is needed.

Under this philosophy, the study "Eco-design of Power Transmission Systems" is conducted in this thesis, with the purpose of analyzing the transmission systems' environmental impacts, locating the major environmental burden sources of transmission systems, selecting and/or developing methodologies of reducing its environmental impacts.

## **Keywords**

Eco-design; Transmission System; Life Cycle Assessment (LCA); 765 kV AC; 1000 kV AC; Ultra High Voltage; Extra High Voltage





## **Acknowledgements**

This thesis is under collaboration between Ecole Centrale de Lyon and Alstom Grid (former AREVA T&D).

I owe my deepest gratitude to my academic tutor - Prof. Abderrahmane BEROUAL, and industrial tutors - Mr. Jean-Luc BESSEDE and Mr. Gilles TREMOUILLE, for the continuous support of my PhD study and research, for their encouragement, patience, and profound knowledge. Without their advices, this thesis would not have been possible.

Besides, I'm heartily thankful to Mr. François GALLON, Mr. Tarek MIHIRI and Mr. Roger Critchley, who always kindly help me with many kinds of technical problems; as well as for the great administrative support from Mr. Peter KIRCHESCH.

My sincere thanks also go to my colleagues, Ms. Snezana DRAGIN, Mr. Joris COUSTILLAS, Ms. Elodie LARUELLE, Mr. Stéphane SARKIS, Mr. Philipp ERLINGHAGEN, Mr. Mehrdad HASSENZADEH, Mr. Ian JAMES, Mr. Wassim DAOUD, Mr. François CLUZEL, Mr. Olivier HAPETIAN, Mr. Sylvain MESTRE and Mr. Michael JOAN.

Last but not least, I am extremely grateful to my family, I appreciate the understanding and help from my parents through all these years along, and the endless support from my wife.



## List of Abbreviations

AA	Air Acidification
AAC	All Aluminium Conductor
AC	Alternating Current
ACAR	Aluminium Conductor Alloy Reinforced
AIS	Air-Insulated Switchgear
AT	Air Toxicity
CFC11	Trichlorofluoromethane
CT	Current Transformer
CVT	Capacitor Voltage Transformer
DC	Direct Current
ED	Energy Depletion
EHV	Extra High Voltage
EIME	Environmental Information & Management Explorer
EPDM	Ethylene Propylene Diene Monomer
FACTS	Flexible Alternating Current Transmission System
GIS	Gas-Insulated Switchgear
GW	Global Warming
GWP	Global Warming Potential
HV	High Voltage
HWP	Hazardous Waste Production
IEC	International Electrotechnical Commission
ISO	International Organization for Standardization
LCA	Life Cycle Assessment
LCI	Life Cycle Inventory
LCIA	Life Cycle Impact Assessment
LEETS	Life cycle Economic and Environmental assessment of Transmission Systems

MCM	thousand circular mils
MOV	Metal Oxide Varistor
MV	Medium Voltage
ODP	Ozone Depletion
OHL	Overhead Line
PA 6	Polyamide 6
PC	Polycarbonate
PCB	Polychlorinated biphenyl
PE	Polyethylene
PETP	Polyethylene terephthalate
PLC	Power Line Carrier
PP	Polypropylene
Pt	Personal Equivalent
PTFE	Polytetrafluoroethylene
RMD	Raw Material Depletion
SDR	Switch Disconnecter Railway
SF <sub>6</sub>	Sulphur hexafluoride
SIL	Surge Impedance Loading
T & D	Transmission & Distribution
UHV	Ultra High Voltage
UHVAC	Ultra High Voltage Alternating Current
UHVDC	Ultra High Voltage Direct Current
VT	Voltage Transformer
WACS	Wide Area Control System
WAMS	Wide Area Measurement System
WBCSD	World Business Council for Sustainable Development
WD	Water Depletion
WE	Water Eutrophication
WT	Water Toxicity

# Table of Contents

<b>Abstract</b>	<b>I</b>
<b>Acknowledgements</b>	<b>III</b>
<b>List of Abbreviations</b>	<b>V</b>
<b>Table of Contents</b>	<b>VII</b>
<b>INTRODUCTION</b>	<b>1</b>
<b>1 Background on Eco-design in T&amp;D Industries</b>	<b>7</b>
1.1 Standards Related to Eco-design .....	8
1.1.1 ISO Standards .....	8
1.1.2 IEC Standards .....	9
1.2 Introduction to Life Cycle Assessment .....	9
1.3 Different Eco-design Approaches .....	11
1.3.1 Product Approach .....	12
1.3.2 System Approach .....	23
1.3.3 Decision-Making Approach .....	27
1.4 Conclusion .....	30
<b>2 Energy Losses of Different Transmission Lines &amp; Relevant CO<sub>2</sub>-Equivalent Emissions</b>	<b>31</b>
2.1 Power Losses of Different Overhead Lines (OHL) .....	32
2.1.1 Power Losses of AC Overhead Line .....	32
2.1.2 Power Losses of DC Overhead Lines .....	36
2.2 CO <sub>2</sub> -Equivalent Emissions by Different Ways of Transmission .....	37

2.2.1 Scenarios Setting .....	37
2.2.2 CO <sub>2</sub> -Equivalent Emissions .....	40
2.3 Conclusion .....	44
.	
<b>3 Environmental Impact of a Venezuelan 765 kV AC Transmission System</b> .....	<b>47</b>
.	
3.1 Life Cycle Assessment of Transmission Lines .....	48
3.1.1 Life Cycle Assessment of Conductors .....	49
3.1.2 Life Cycle Assessment of Ground Wires .....	54
3.1.3 Life Cycle Assessment of Towers .....	55
3.1.4 Life Cycle Assessment of Insulators .....	59
3.1.5 Life Cycle Impact Assessment Results of Transmission Lines .....	62
.	
3.2 Life Cycle Assessment of Equipments in Substations .....	67
3.2.1 Life Cycle Assessment of Power Transformer .....	67
3.2.2 Life Cycle Assessment of Circuit Breakers .....	70
3.2.3 Life Cycle Assessment of Surge Arresters .....	76
3.2.4 Life Cycle Assessment of Current Transformers .....	79
3.2.5 Life Cycle Assessment of Voltage Transformers .....	84
3.2.6 Life Cycle Assessment of Shunt Reactor .....	91
3.2.7 Life Cycle Assessment of Disconnecter .....	93
3.2.8 Life Cycle Assessment of Post Insulator .....	94
3.2.9 Life Cycle Assessment of Line Trap and Coupling Capacitor .....	95
3.3 Life Cycle Assessment of Substations .....	99
3.3.1 Materials Inventories of Guri Substation .....	99
3.3.2 Materials Inventories of Malena Substation .....	104
3.3.3 Materials Inventories of San Geronimo Substation .....	106
3.3.4 Materials Inventories of Yaracuy Substation .....	108
3.3.5 Materials Inventories of La Arenosa Substation .....	111
3.3.6 Materials Inventories of La Horqueta Substation .....	114
3.3.7 Materials Inventories of Sur Substation .....	116

3.3.8 Materials Inventories of Total Substation .....	119
3.4 Life Cycle Assessment of Total Transmission System .....	129
3.4.1 Life Cycle Impact Assessment of Total Transmission System .....	129
3.4.2 Environmental Comparisons of Different Generation Methods .....	133
3.5 Conclusion .....	134
<b>4 Environmental Impacts Comparison between Ultra High Voltage and Extra High Voltage Transmission Lines</b> .....	<b>137</b>
4.1 1000 kV AC Transmission Line .....	139
4.1.1 Materials Inventories .....	139
4.1.2 Use Phase of Transmission Line .....	143
4.1.3 End-of-Life Phase of Transmission Line .....	144
4.2 765 kV AC Transmission Line .....	144
4.2.1 Materials Inventories .....	145
4.2.2 Use Phase of Transmission Line .....	147
4.2.3 End-of-Life Phase of Transmission Line .....	147
4.3 Life Cycle Assessment of 1000 kV AC & 765 kV AC Transmission Lines .....	148
4.4 Conclusion .....	153
<b>CONCLUSIONS</b> .....	<b>155</b>
<b>RERERENCES</b> .....	<b>163</b>
<b>Annex A</b>	
<b>Annex B</b>	
<b>Annex C</b>	
<b>Résumé Français</b>	





## INTRODUCTION

Eco-design is an international concept, developed by the World Business Council for Sustainable Development (WBCSD) at the Rio summit. Eco-design means the integration of environmental aspects into product design and development with the aim of improving the environmental performance throughout its whole life cycle. The term “life cycle” refers to raw material production, manufacture, distribution, use and disposal including all intervening transportation steps necessary or caused by the product's existence, see Fig. 1. As a preventive approach, eco-design optimizes the environmental performance of products, while maintaining their functional quality [1]. However, eco-design cannot exist alone; it's just one part of design and development process of a product or service.

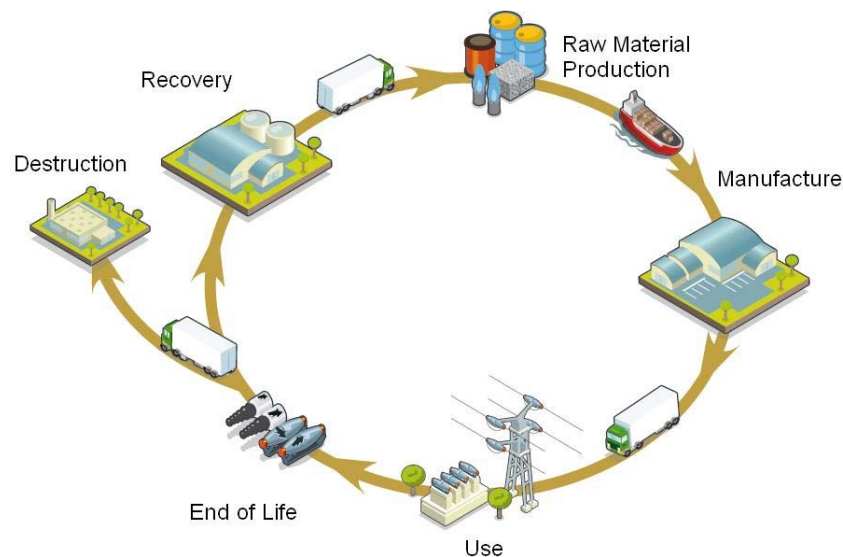

Fig. 1 : Life Cycle Notion [2]

Besides “eco-design”, there are many other terms existing in the same time around the world, such as “design for environment”, “ecological design”, “environmentally friendly design”, “environmentally conscious design”, “environmentally responsible design”, “sustainable product design”, etc. However, in the nature, they are all the same as they refer to the same approach of product design and development related to

and aiming at improving environmental performance.

In order to perform eco-design on a product, its environmental aspects have to be assessed, and this can be done from two different perspectives: the life cycle perspective and the stakeholder perspective. The former is to assess the environmental impacts caused by this product regarding to its life cycle. The latter is to assess the environmental aspects based on the stakeholders' point of view, such as legal requirements, market demands, and competitors' products [3].

Life Cycle Assessment (LCA) is commonly used tool for environmental aspects assessment of a product for eco-design, which is a systematic tool that enables the quantitative analysis of the potential environmental impacts of a product or service throughout its entire life cycle [3]. LCA assesses a series of environmental impact categories, such as Global Warming (GWP), Air Acidification (AA), Ozone Depletion (ODP), Photochemical Ozone Creation (POC), Water Eutrophication (WE), Air Toxicity (AT), Water Toxicity (WT), Raw Material Depletion (RMD), Energy Depletion (ED), Hazardous Waste Production (HWP), Water Depletion (WD), etc.

But full LCA has some drawbacks in respect to time and cost, as it requires a huge amount of data collection for all life stages of a product. Instead, simplification can be made either by reducing the effort for data collection or focusing only on particular types of environmental impacts or parameters. Through the use of similar data or databases, by omitting certain life cycle stages, and by the exclusion of particular inventory parameters simplification can be achieved [3].

Environmental assessment yields to a set of significant parameters of a product' impact on environment, and based on this eco-design task can be realized by development in improving its environmental impacts.

Currently eco-design has been applied vastly to industrial products, and in particular applied to the electrical equipments. A great number of electrical products have been subjected to be eco-designed all over the world, for instance, eco-design products or green products (no matter what they are called) are put into market by a lot of T & D (Transmission and Distribution) companies. And these newly green products are supposed to have less environmental impacts compared with their traditional counter-parts. However, now it appears that only this separate "product approach" is no longer sufficient in addressing the environmental improvement issues on a system scale, and currently arises the question of determination of environmental impacts of integration of all kinds of composing products in complete systems: transmission & distribution systems, even to the integration of the complete electrical networks. The eco-design of electrical systems is therefore a logical continuation of the "product approach", which is able to make it possible of decreasing the electrical products' environmental impacts in a systematic view, not just looking at the environmental profile of individual product alone.

Thus, under this philosophy, the purpose of this study is to analyze the transmission systems' environmental impacts, locate the major environmental burden sources of transmission systems, select and/or develop methodologies of reducing its environmental impacts.

Fig. 2 illustrates one typical AC transmission system, it connects the generated power plants by high voltage lines (e.g. 220 kV, 500 kV), and simultaneously sends the power to load centers. As the power needed to be sent and distance between lines are different, in one transmission system different voltage levels might be used. In load center, after distributed through medium voltage by distribution system, electrical power is then sent to users.

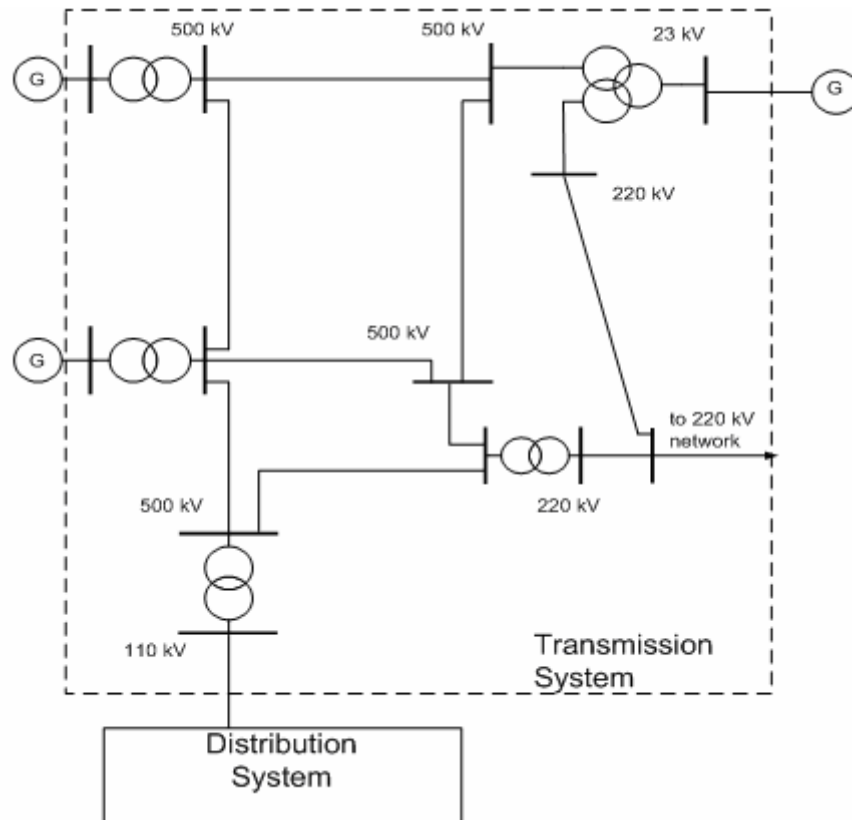

Fig. 2 : Illustration of a simple AC transmission system

In the thesis the contents are as follows:

Chapter 1 summarizes eco-design methods and different approaches relating to consideration of environmental impacts of Transmission & Distribution industries, which are categorized as “product approach”, “system approach” and “decision-making approach”.

In Chapter 2, in the aim of investigating the environmental impacts of Ultra High Voltage (UHV) and Extra High Voltage (EHV) transmission lines, energy efficiency of a series of transmission lines (500kV AC, 765kV AC, 1200kV AC,  $\pm 500$ kV DC and  $\pm 800$ kV DC) and CO<sub>2</sub>-equivalent emissions due to the energy loss (Joule loss) through the transmission lines are studied, also considering the impact of the different types of electricity generation methods.

Chapter 3 investigates environmental impacts of a real case of 765 kV AC transmission system in Venezuela, by using LCA. The major environmental burden sources of transmission system is located, and environmental impacts comparison between lines and substations, comparison of different life stages of this transmission system are explained. Besides, environmental impacts of most of equipments in substations are analyzed, such as power transformers, circuit breakers, instrument transformers, etc.

Chapter 4 investigates environmental impacts of a UHV transmission line newly built in China, which is Chinese first 1000 kV AC transmission line. And it is also compared with impacts of an EHV line, regarding to the environmental burdens. This investigation compensates for the lack of materials' based environmental impacts, happening in Chapter 2 for environment impact analysis in comparison between UHV and EHV transmission lines.



# **Chapter 1**

## **Background on Eco-design in T&D Industries**

Currently in Transmission & Distribution (T&D) industries, eco-design approach is widely considered and integrated by major companies in their products and services. All the major T&D companies adopt this approach, maybe not directly called “eco-design”, in order to reduce their products and services’ environmental impacts, help protect the environment and help realize the sustainable development.

This eco-design trend is not only influenced by the legal requirement, but by the increased interest of various stakeholders in the environmental aspects and impacts of products. This interest is reflected in discussions among business, consumers, governments and non-governmental organizations concerning sustainable development, design for the environment, trade measures, and government or sector-based voluntary initiatives. This interest is also reflected in the economics of various market segments that are recognizing and taking advantage of these new approaches to product design. These new approaches may result in improved resource and process efficiencies, potential product differentiation, reduction in regulatory burden and potential liability, and costs savings. More organizations are coming to realize that there are substantial benefits in integrating environmental aspects into product design and development. Some of these benefits may include: lower costs, stimulation of innovation, new business opportunities, and improved product quality.



## **1.1 Standards Related to Eco-design**

### **1.1.1 ISO Standards**

ISO (International Organization for Standardization) technical committee ISO/TC 207 is responsible for developing and maintaining the ISO 14000 family of standards.

ISO/TR 14062, Environmental Management - Integrating Environmental Aspects into Product Design and Development [4], addresses key factors to consider in eco-design, and a generic eco-design approach applicable to all types of products and even services.

ISO/TR 14062 describes concepts and current practices relating to the integration of environmental aspects into product design and development. The technical report is intended for use by all those involved in the design and development of products, regardless of organization type, size, location and complexity, and for all types of products whether new or modified. It is written for those directly involved in the process of product design and development and for those responsible for the policy/decision-making process. This technical report is not intended for use as a specification for certification and registration purposes; however, it can be used in developing sector-specific documents.

One of the most prominent features of ISO/TR 14062 is the holistic approach in integrating environmental aspects of products to the existing product design and development processes. Considering not only product issues, but also strategic as well as management issues when integrating environmental aspects is the key to the success of the integration process. This technical report adopts a holistic approach by specifically addressing issues relating to strategic, management and product considerations.

The ISO 14040 series [5-9] standards, Life Cycle Assessment, address quantitative assessment methods for the assessment of the environmental aspects of a product or service in its entire life cycle stages. ISO 14040 is an overarching standard encompassing all four phases of LCA. The series are as below:

### **1.1.2 IEC Standards**

IEC 62430:2009, Environmentally Conscious Design for Electrical and Electronic Products [10], specifies requirements and procedures to integrate environmental aspects into design and development processes of electrical and electronic products, including combination of products, and the materials and components of which they are composed. It has the status of a horizontal standard in accordance with IEC Guide 108.

IEC Guide 114, Environmentally Conscious Design Integrating Environmental Aspects into Design and Development of Electrotechnical Products [11], describes concepts relating to the integration of environmental aspects into electrotechnical product design and development. It is intended for use by all those involved in the design and development of products, regardless of organization type, size, location and complexity, and for all types of electrical and electronic equipment, whether new or modified. It is written for those directly involved in the process of product development and for those responsible for the policy and decision-making process within the organization.

## **1.2 Introduction to Life Cycle Assessment**

A Life Cycle Assessment comprises four distinct phases (see Fig. 1-1), i.e. the goal and scope definition, inventory analysis, impact assessment, and interpretation.

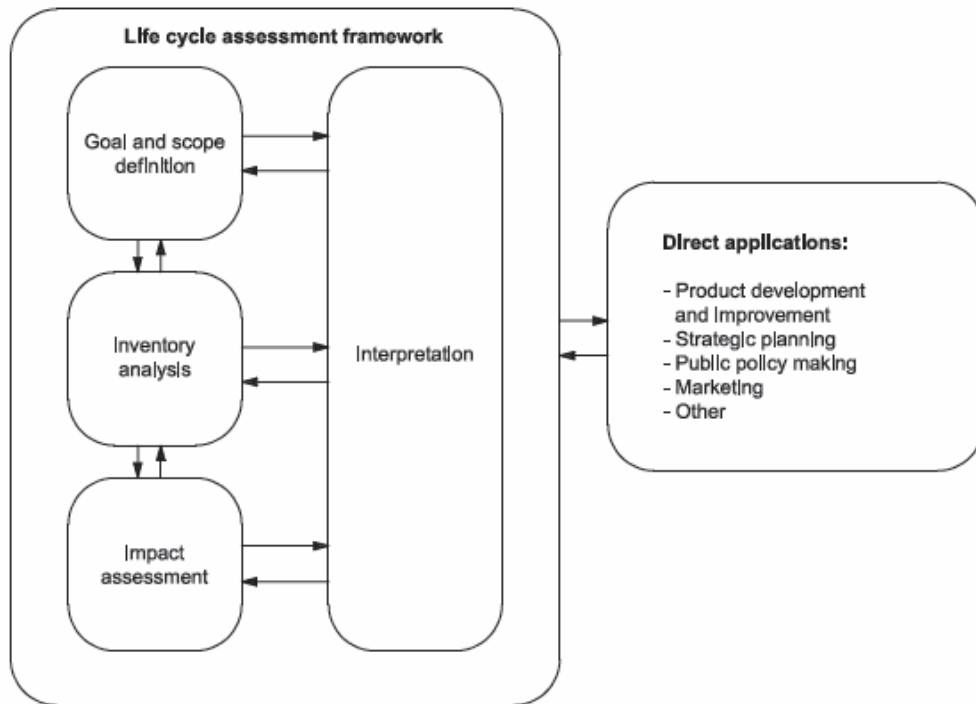

Fig. 1-1 : Four phases of LCA [5]

In “goal and scope definition” phase, the LCA practitioner specifies the goal and scope of study in relation to the intended application. The object of study is described in terms of a “functional unit”.

The “Life Cycle Inventory (LCI)” phase involves data collection and calculation to quantify inputs and outputs of materials and energy associated with a product system under study. Examples of inputs and outputs quantities include inputs of materials, energy, chemicals, etc, and outputs of air emissions, water emissions or solid waste, etc. Usually, LCI is carried out by using a dedicated software package, such as SimaPro [12] or GaBi [13].

The “Life Cycle Impact Assessment (LCIA)” phase is aimed at evaluating the contribution to impact categories such as Global Warming, Acidification, etc. The classification step is assignment of LCI results in to category indicators, and the characterization step is the calculation of category indicator results of potential environmental impacts. The next steps are normalization and weighting, but these are

both voluntary according the ISO standard. The normalization and weighting steps are optional in LCIA.

In the “Interpretation” phase the findings from the inventory analysis and the impact assessment are considered together or, in the case of LCI studies, the findings of the inventory analysis only. It is an analysis of the major contributions, sensitivity analysis and uncertainty analysis. The interpretation phase should deliver results that are consistent with the defined goal and scope and which reach conclusions, explain limitations and provide recommendations.

### 1.3 Different Eco-design Approaches

In T&D industries many companies have integrated eco-design into their products and services, for instance, within Alstom Grid, since 1995 eco-design philosophy was initiated, and then an innovative methodology has been developed in order to integrate environmental issues in the design of T&D products. Wang et al [2] explains the integration of this methodology into Alstom Grid eco-design policy, which focuses on 4 aspects: Management, Hazardous Substances Management, End-of-Life Management and Environmental Advantages (see Fig. 1-2).

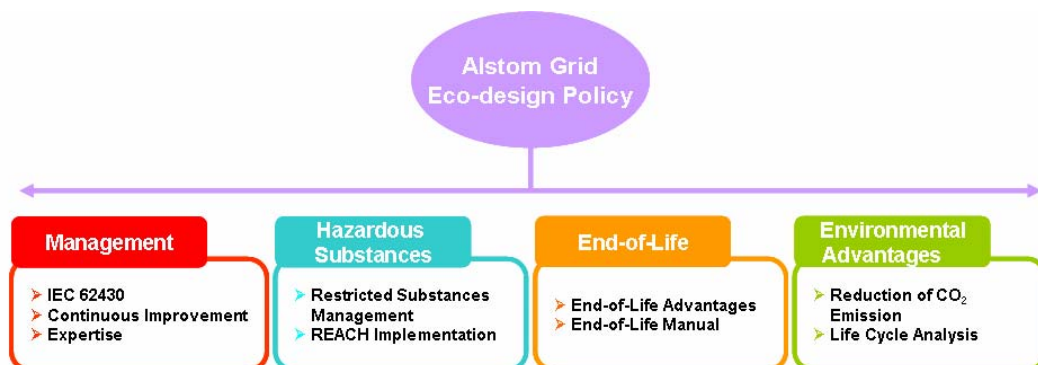

Fig. 1-2 : Alstom Grid Eco-design Policy

Besides Alstom Grid, the other major T&D companies, such as Siemens, ABB, Schneider Electric, etc, and other organizations have their own eco-design

managements and approaches.

In general, these eco-design approaches can be categorized into “product approach”, which focus on reduction of individual product’s environmental impacts; “system approach”, which considers a system’ s environmental burdens, which are composed of many individual products to perform a certain function; and “decision-making approach”, which deals with the environmental impacts in a higher scale.

### 1.3.1 Product Approach

Hereinafter describes some examples of “product approach”.

Huet et al [14-16] performs the eco-design in designing one new type of 3-phase encapsulated 72.5 kV Gas Insulated Station (GIS) in Alstom Grid, which is named F35 used for indoor and outdoor with characteristics of 2500 A continuous current and 31.5 kA short circuit rating (see Fig. 1-3). For the purpose of determining the design improvement, this new 3-phase GIS is compared with 3 single-phase encapsulated GIS, i.e. type B65 (see Fig. 1-4), designed for voltage level from 72.5 kV to 145 kV.



Fig. 1-3 : Alstom Grid 72.5 kV GIS F35



Fig. 1-4 : Alstom Grid 72.5 kV GIS  
B65

Regarding different stages of its life cycle, different procedures to decrease the environmental impacts are taken.

In the manufacture phase, reduction of size and weight by 30% is realized by the 3-phase architecture compared with its single-phase counterpart, which is positive for both civil engineering requirement and reduction of raw material. Removal of heavy metals (lead, hexavalent chromium and cadmium) is fulfilled. The hexavalent chromium used in anti-corrosion paint is avoided by developing a tank without anti-corrosion paint. Cadmium, used in the treatment of anti-corrosion of some standard parts such as screws, nuts and metallic gaskets, is eliminated by replacement with standard parts of stainless steel. Thermosetting Epoxy insulating parts are replaced by thermoplastic Polyethylene terephthalate (PETP), with the aim of increasing the recyclability. An effort has been made to reduce the leakage of SF<sub>6</sub> gas to maximum, by optimized seals, guaranteeing leakage rate of less than 0.5 % per volume per year according to IEC 62271-203 [17]. Also the new design allows the use of recycled gas according to IEC 60480-Ed.2 [18].

The environmental impact of the transportation and use phases depends strongly on the new shape. A decrease in volume and weight influenced the shipping requirements and were optimized in order that the environmental impact is less than before.

As for the end-of-life phase, the replacement for thermosetting insulators with thermoplastic PETP has a great impact on the recyclability of GIS. The recycling of SF<sub>6</sub> is set up with subcontractor.

The environmental profile of this new type of GIS is evaluated by the use of LCA software EIME (Environmental Information & Management Explorer), and a comparison is made with the single-phase GIS, results (Table 1-1) shows that the new design reduces the environmental impacts compared with its single-phase counterpart.

Table 1-1: Environmental profiles of GIS B65 and F35

Weight & Environmental Indicators	Single-phase design (%)	3-phase design (%)
Weight	100	68
Raw Material Depletion (RMD)	100	64
Water Depletion (WD)	100	86
Ozone Depletion (OD)	100	61
Air Toxicity (AT)	100	96
Photochemical Ozone Creation (POC)	100	92
Air Acidification Potential (AA)	100	92
Water Toxicity (WT)	100	83
Water Eutrophication (WE)	100	71
Hazardous Waste Production (HWP)	100	93

As the continuation and evolution of design the new 3-phase encapsulated GIS F35 range, Pohlink et al [19] integrate the eco-design in the development of GIS F35 – 145 kV, which is extension of this F35 range. Then the environmental comparisons are made by the use of software EIME on the 3 types of GIS, results (Fig. 1-5) show that globally both the 72.5 kV and 145 kV ratings of F35 GIS are reducing the environmental impacts compared with B65 GIS.

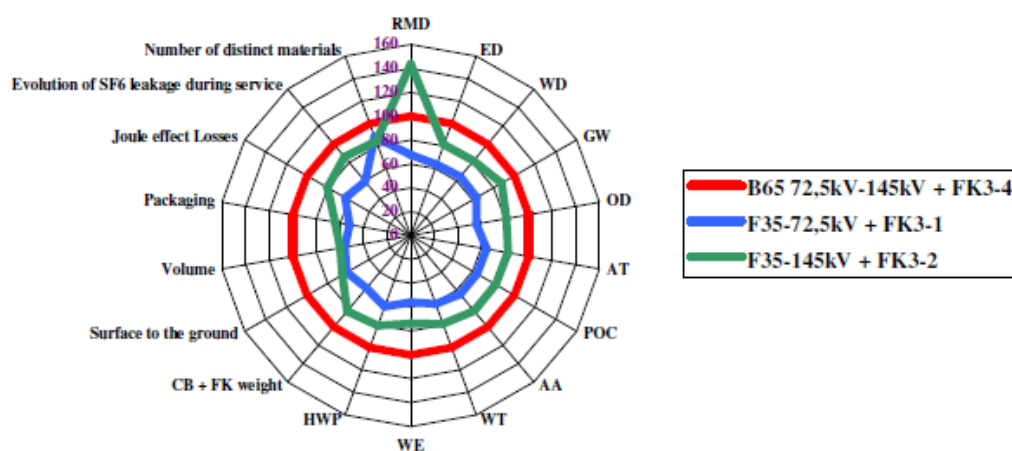

Fig. 1-5 : Environmental comparisons between B65 and F35

Up till now, GIS up to 170 kV level is made of either 3-phase or single-phase design, while GIS above this voltage level are mainly made of single-phase design and occasionally made of mixed 3-phase and single-phase design. When designing a new 245 kV GIS, the essential question arises as which type of enclosures (3-phase or single-phase) offers the best advantages to the market and to the environment. Generally, the choice between 3-phase and single-phase design is determined by electrical and thermal concerns, in addition, Ponchon et al [20] make a preliminary study with regards to environmental concerns to answer this question.

From different eco-design studies carried out on developed GIS, it's determined that environmental impact is in direct relation with the weight of materials. As in a typical double-busbar 245 kV GIS, aluminium, epoxy and SF<sub>6</sub> compose most of the weight (over 70% of the total weight), then in this preliminary design phase these materials are focused on to consider the possible environmental impacts of the 2 different enclosure designs.

The results indicate that single-phase GIS uses fewer materials (see Fig. 1-6), equivalently this means single-phase design is making less impact on environment. Calculations on Joules losses show that there is not significant differences between the two designs, and estimation based on weight of materials gives a quite substantial indication that single-phase design offers more economical advantage than three-phase design.

This study is an example of integration of eco-design approach into very beginning stage of preliminary design of new products.



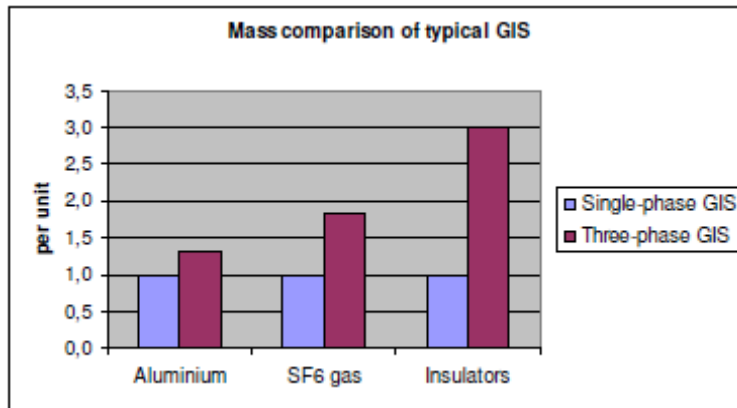

Fig. 1-6 : Mass comparison of single-phase and 3-phase GIS

Hassenzadeh et al [21, 22] make some improvements in manufacturing processes of ZnO varistors used for distribution polymer housed surge arresters in Schneider Electric, by integrating treatment, recycling and recovery of wastes into former manufacturing processes, which result in reduction of environmental impacts of manufacture of MOV (Metal Oxide Varistor) compared to former processes. By use of EIME software the environmental impacts are examined and results (see Fig. 1-7) illustrate that concerning all the investigated impact indicators (GW, OD, AT...) the new processes significantly decreased the environmental impact.

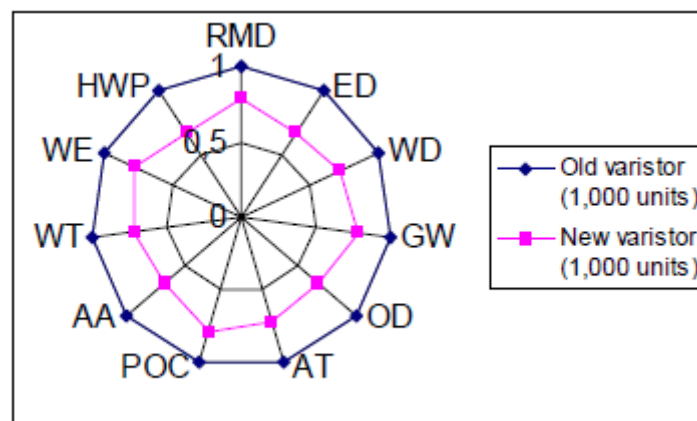

Fig. 1-7 : Comparison of environmental impacts between the new and former manufacture processes of MOV

Furthermore, they re-design the arrangement of the composite wrapping and introduce soft interfaces between layers of materials in order to make available the dismantling of major parts of the whole surge arrester at its end-of-life phase.

An LCA is conducted on 24 kV surge arrester VARISIL HE 24 (Fig. 1-8) manufactured in Schneider Electric, with the aim to identify and then optimize its environmental impacts, by Hassenzadeh et al [23].



Fig. 1-8 : Schneider Electric's 24 kV surge arrester VARISIL HE 24

With the use of EIME software, results (see Fig. 1-9) show that distribution phase does not have significant impacts on environment compared to manufacture and use phases. As to the end-of-life phase, 2 “extreme” alternatives are investigated, one corresponds to a situation whereby total dismantling of the device is carried out and the other corresponds to total crushing of the product. The former case achieves a recycling rate of 98.1 %, and 89.4 % for the latter case. However, total dismantling is the best end-of-life alternative when there is low cost manpower and short distance transportation to the treatment plant. On the contrary, the total crushing solution is the best end-of-life alternative when manpower is expensive and the treatment plant is located abroad with a harder waste legislation or too far from the working place of the surge arrester. In fact, the best solution is a compromise between the two “extreme” alternatives.

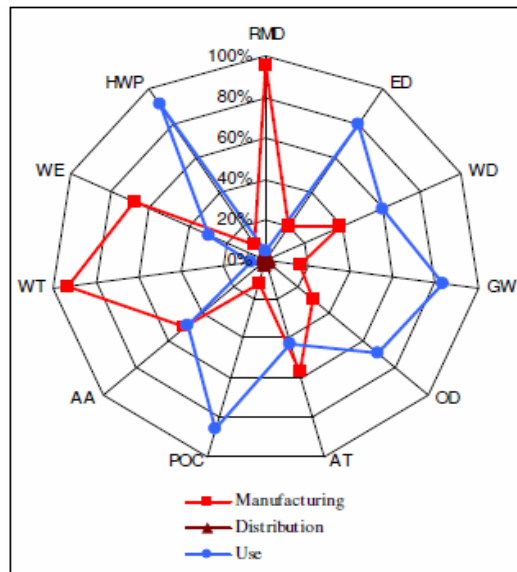

Fig. 1-9 : Environmental impacts contribution of different phases of life cycle of surge arrester VARISIL HE 24

Hassenzadeh and Li et al [24-32], in collaboration between Schneider Electric and Chinese State Key Lab of Electrical Insulation & Power Equipment, develop a method for the selection of environmentally friendly alternative insulating materials into medium voltage switchgear, and then introduce these alternative materials to replace former ones. Concerning the selected demonstrator - 25 kV pole-mounted SDR (Switch Disconnecter Railway) switch used on the railway network (see Fig. 1-10) - the epoxy tie rod and EPDM (Ethylene Propylene Diene Monomer) bushing are subject to be replaced by environmentally friendly insulating materials in this study, which have less environmental impacts.

As for the selection method, they set up several environmental indicators to be investigated, such as GW (Global warming), AT (Air Toxicity), POC (Photochemical Ozone Creation), etc, as well as functional indicators, such as electrical, mechanical, thermal properties. As it's difficult to solve all types of environmental impacts in the same time, weighting of different indicators is performed based on the company's strategy, which is in line with regulatory, economic and societal constraints.

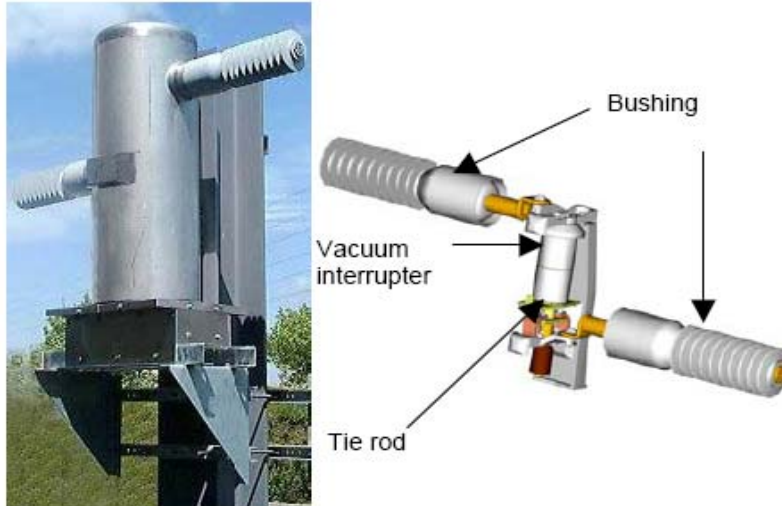

Fig. 1-10 : 25 kV pole-mounted SDR

For the tie rod, the environmental impacts of many thermoplastics, wood, glass ceramic materials and epoxy as well are simulated by EIME software (see Fig. 1-11), and results reviewed are displayed in Table 1-2, the values displayed have been normalized so a direct comparison can be made with the existing epoxy tie rod. In order to evaluate the environmental performance of materials 2 mathematical methods are used, in method 1, the environmental impacts of epoxy is set to 1, a value less than 1 means that this material has less impacts than epoxy; in method 2, the environmental impacts of epoxy is set to 0, a negative value means that this material has less impacts than epoxy. As for the functional performance, the value more than 1 means that this material has better performances with regard to the electrical, mechanical and thermal properties. The selection of materials with a functional performance  $>1$  and an environmental value  $< 1$  for Method 1 and a negative value for Method 2 are preferred. Then the selected materials are used to fabricate into prototype (Fig. 1-12) tie rods, with suitable design for relevant material, to be subject to a series of mechanical, electrical and thermal tests as qualification procedures, in order to choose the final environmentally friendly alternative.

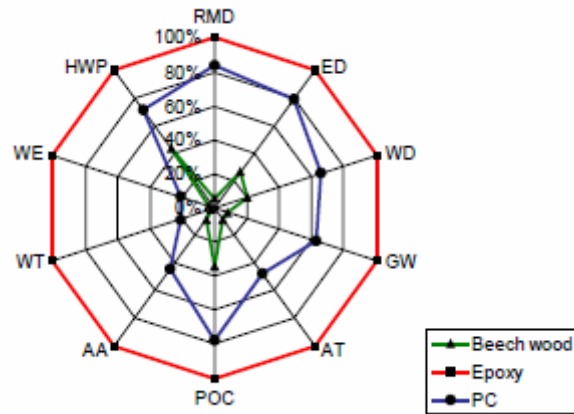

Fig. 1-11 : Comparisons of environmental impacts between wood, thermoplastic (PC) and epoxy

Table 1-2 : Materials’ environmental & functional performances for tie rod

Generic type	Normalised Functional performance (Weighted average)	Environmental Performance #	
		Normalised Method 1	Method 2
PC-GF 20%	1.39	0.54	-29
PC	1.30	0.54	-5
PET-GF30%	1.22	0.62	-33
PBT -GF30%	1.25	0.58	-28
PPS- GF40%	1.25	0.78	-24
PES -GF30%	1.35	1.50	-7
PPO -GF30%	1.29	1.02	-17
PEI -GF 30%	1.09	1.46	-9
PEI	0.94	1.5	-5
PBT	0.92	0.58	-27
PA66	1.22	1.24	11
PI	0.70	1.50	4
Glass ceramic	1.19	0.54	-52
Wood*	0.81	0.54	-45
SMC	1.33	1.30	-12
Epoxy tie rod	1.00	1.00	0



Fig. 1-12 : Different tie rod materials

As for selection of environmentally friendly material for bushing, the same method applies. Then the silicone rubber is selected to replace the former EPDM bushing (Fig. 1-13).

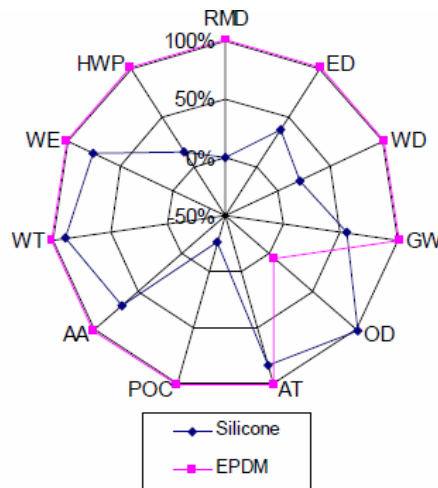

Fig. 1-13 : Comparisons of environmental impacts between Silicone and EPDM

In the other companies in T& D industries, the eco-design approach is more or less similar to that of Alstom Grid. For example, Leclerc [33] presents a case study, in VA TECH Transmission & Distribution Company, of taking environmental aspects into account in the new design for 245 kV GIS, including LCA and environmental declarations.

With the new compact design of 245 kV GIS (see Fig. 1-14 and Fig. 1-15), the environmental impacts are reduced by decrease of weight, operation energy, SF<sub>6</sub> leakage. This reduction is shown in the LCA results (Fig. 1-16), conducted by EIME software.



Fig. 1-14 : new type of 245 kV GIS of VA Tech

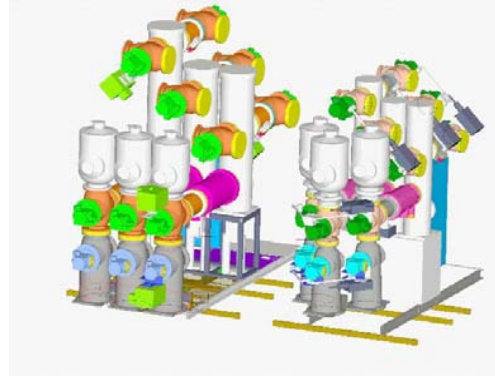

Fig. 1-15 : compact dimensions of the new GIS (right) compared with the former GIS (left)

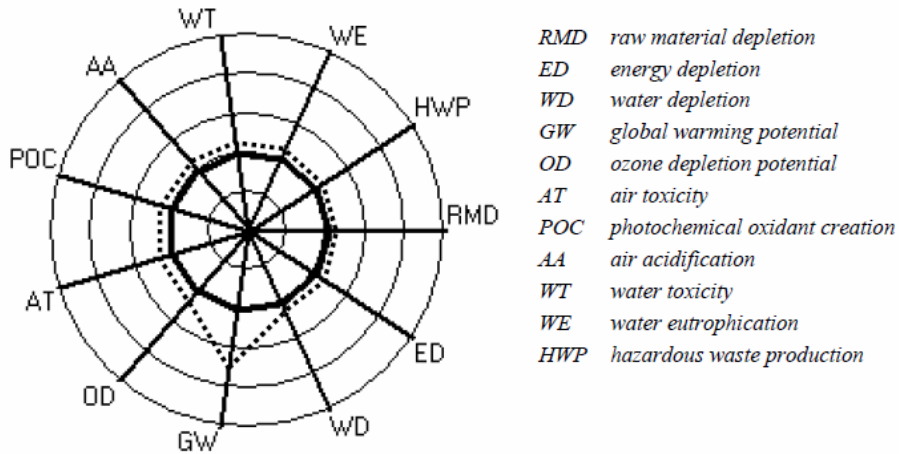

Fig. 1-16 : comparison of environmental performance between former GIS (dotted line) and the new GIS (full line)

Lauraire et al [34] describe the products' environmental development and integration of eco-design of medium voltage products in Alstom and Schneider Electric, through case studies of Alstom's PIX cubicle (Fig. 1-17) and Schneider Electric's protection relay SEPAM unit, the optimization methods are explained as : reduction of total weight, improvement of dismantability, increase of recycling and recovery rates at end-of-life phase.



Fig. 1-17 : PIX cubicle

Alonso et al [35] describes Design-for-Environment within the Electrical and Electronic of Lear Corporation.

The eco-design for product approach is quite a well-developed trend in T&D industries, reflected from all the mentioned documents. However, as only a single electrical product cannot provide the electrical power to uses, electrical system consists of a huge number of components, in order to investigate system's environmental profile, the entire environmental profiles of different composing products has to be integrated systematically, that is to say, a system approach is needed.

### **1.3.2 System Approach**

As for example of a system approach, Mersiowsky [36] summarizes an LCA comparison between 2 medium voltage power distribution systems using Gas Insulated Switchgear (GIS) technology and Air Insulated Switchgear (AIS) technology, respectively, in order to investigate their environmental profiles and to determine the role of SF<sub>6</sub> in environmental impact in a grid level.

For comparison, the functional unit is set as distribution of a certain amount of



electricity on the medium-voltage level during one year, and the comparison is **not** made switchgear by switchgear, but encompasses representative product mixes (including transformer substations, ring-main units, and consumer substations) and grid designs.

Results show that, in grid level, if ohmic losses from cables, lines, and transformers are taken into consideration, the differences between MV switchgear technologies AIS and GIS become all but negligible. This life cycle assessment (LCA) indicates that electrical power losses due to ohmic resistance of cables, lines, and HV/MV transformers constitute the predominant contribution to the Global Warming Potential (GWP) of distribution grids.

Because of their compact construction and their sealed, gas-tight compartments, the investigated GIS are advantageous from an environmental point of view, even concerning the Global Warming Potential. Nevertheless, the environmental benefits by giving preference to AIS or GIS technology in medium-voltage applications are insignificant AIS and GIS switchgear are competitive from an environmental point of view.

Recently, UHV transmission technologies are developing in many countries, such as China and India. Macharey et al [37] give an example of a system approach of UHV transmission line.

In [37] Life Cycle Assessment comparisons between UHV systems (both AC and DC) and 420 kV EHV AC transmission networks are summarized, in the purpose for investigating the environmental profiles of the newly developed UHV systems.

UHV systems data are extracted from Russian 1150 kV AC, Japanese 1000 kV AC and Chinese 1000 kV AC. For comparison, 6000 MW electrical power is set to transmitted by 1000 kV UHV AC and 800 kV UHV DC and 420 kV EHV AC

transmission line with a length of 1000 km. In LCA only layout of transmission lines are taken into account, i.e., conductors (Aluminium and steel), ground wires (optical glass fibers), towers (steel and concrete in foundations), not including substations. In the results analysis, the categories of global warming potential (GWP), acidification potential (AP) and eutrophication potential (EP) of different transmission line layout materials are obtained, in addition to global warming potential of power losses in different transmission lines.

Results (Fig. 1-18) show that power system losses dominating GWP, compared to that of power system components. Both investigated UHV AC and DC transmission lines bring up ecological benefits in an overall system's point of view; considering the environmental impact category of greenhouse gas emissions, 800 kV DC brings a reduction of CO<sub>2</sub>-equivalent emissions by 3/4 compared to 420 kV AC transmission line.

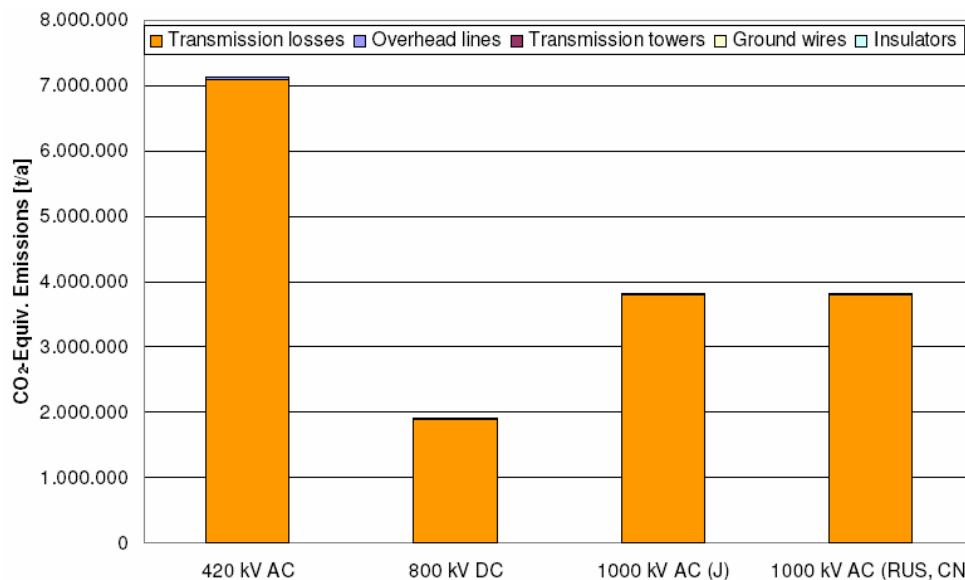

Fig. 1-18 : Comparison Global Warming Potential generated by transmission losses and materials production of different system layouts

In a more detailed system level, Invernizzi et al [38] propose a methodology to assess the benefits of Transmission & Distribution (T&D) state-of-the-art technologies,

collaborated by T&D Europe (European Association of the Electricity Transmission and Distribution Equipment and Services Industry) and N.I.C.E.S. Lab (Laboratory for Network Infrastructures and Complex Energy Systems), located in the Electrical Engineering Department at the University of Genoa, Italy.

As worldwide political agreements emphasized attention to environmental impact of human activities, posing targets to reach with a deadline in year 2020, with particular concern to efficiency, CO<sub>2</sub> reduction and renewable energies rate of penetration, this study will investigate T&D state-of-art technologies' influences on 7 aspects, which are energy efficiency, CO<sub>2</sub> reduction, renewables rate of penetration, steady-state quality in transmission and distribution grids, distribution harmonic power quality, transmission dynamic quality and distribution dynamic quality on a sample T&D systems (see Fig. 1-19). The investigated state-of-art technologies include replacement/refurbishment of power components, WAMS/WACS (Wide Area Measurement System & Wide Area Control System) & upgrading protection and control devices for communication, increase of voltage level of the power grid, installation of power quality devices (distribution networks), HVDC (line and forced commutated) and FACTS (Flexible AC Transmission System).

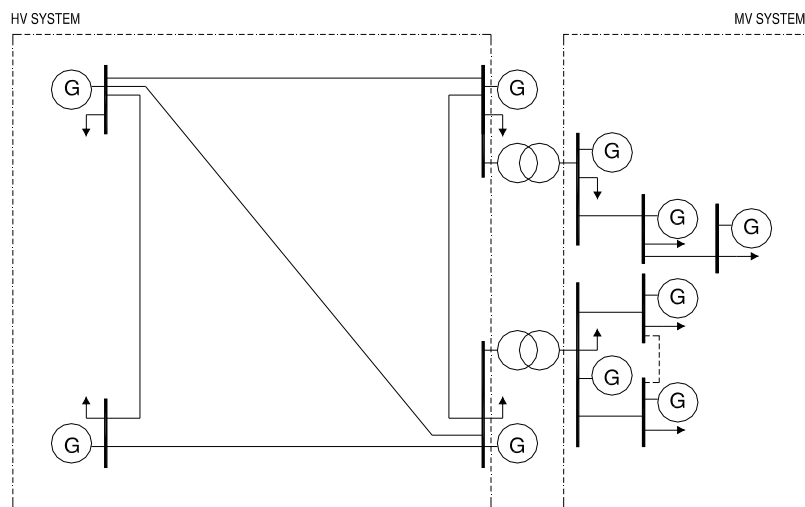

Fig. 1-19 : HV-MV sample network for the study of performance indices

### **1.3.3 Decision-Making Approach**

In a higher level, CIGRE Working Group C3.06 [39] summarize the main aspects of Strategic Environmental Assessment (SEA) studies for power systems (both generation and transmission systems), which include collection and analysis of legislation and technical standards about SEA in different countries; and presents the main characteristics of SEA studies for each country participating in the Working Group, including the local legislation and practical experiences, including Australia, Belgium, Brazil, Canada, China, France, Italy, Portugal, South Africa, Spain, UK and US.

Strategic Environmental Assessment, also called Environmental Evaluation of Plans and Programmes, is becoming a normal practice in many countries (EU, Brazil, South Africa, US, etc.), as part of the planning process of the power sector, as well as for large infrastructure and/or service projects. The reason of conducting SEA for power sector is that power plants (both transmission lines and sub-stations) have difficulties relating to authorization and social acceptance, essentially due to increased environmental sensitivity.

As principles of environmental assessment applied to projects can also apply to policy, plan and programme proposals, then consideration of environmental factors at this higher level of decision making can result in more environmentally sustainable policy-making.

The generic processes of SEA study are as below:

- Screening: identification of the need for SEA;
- Scoping: targets setting the boundaries for the study;
- Report: environmental analysis and report preparation and review;
- Decision: consultation and decision making;

- Monitoring: monitoring and follow-up.

The overview of SEA objectives and corresponding indicators are shown in Table 1-3.

In addition, in [40-46] experiences on Strategic Environmental Assessment for power systems in many countries are seen.

Table 1-3: Overview of SEA objectives and corresponding indicators

Aspects	Objectives	Indicators	Parameters
Land use	Optimize land use and limit fragmentation	Direct land use	Surface x factor (fragmentation)
Biodiversity	Prevent impact on protected and other green (non-protected) areas	Presence of protected and other green (not-protected) areas	Distance from/ length in/ surface in x factor (protection level)
Noise	Minimize noise impact	Noise level of installations	Noise level x factor (norm)
Soil	Minimize perturbation of soil and groundwater	Situation in vulnerable soil Vicinity of water-collection area	Length/ surface x factor (soil type) Distance from
Climate	Reduce emissions of CO <sub>2</sub> Prevent SF <sub>6</sub> losses	Electricity transmission losses SF <sub>6</sub> volume in installation	Electricity loss x factor (CO <sub>2</sub> emission) Volume
Landscape	Preserve landscape integrity Preserve protected buildings	Visual impact installation Presence/ crossing of protected buildings/ landscapes	Frontal surface x factor (surrounding) Distance from /length in
Material welfare	Maintain reliability of provisioning the residential tissue	Average Interruption Time (AIT) to the distribution network	AIT

<b>Aspects</b>	<b>Objectives</b>	<b>Indicators</b>	<b>Parameters</b>
Employment	Supporting employment	Investments in new infrastructure	Investment budget
Integration of infrastructure	Taking into account the apprehension for new electric installations	Localisation of infrastructure in living areas	Length/ surface in living area x factor (installation)
Health	Minimize the electric risks	Number of people living under or nearby a HV line	Number of people
Economic efficiency and competitiveness	Assure transmission to meet the needs of the economy and society.	Contribution in the increase of BNP	% increase in power distribution to the industry
Liberalization of the market	Develop international interconnections Increase independency of production	Increase of the import capacity Reduction of risk on re-dispatch	Power Reduction stress factor installations
Tariff		Find the economic optimum for customers	Optimal for the HV/MV/LV* network
Diversification in sources of provisioning	Receive new unities of RES**.	New connected RES** unites	Connected power

Havenga [40] describes South Africa experience in SEA, [41] – [43] for Brazil; [44] for Belgium, [45] for Italy, [46] for UK. And Stevens et al [46] introduce a currently developed methodology in UK, i.e., Life cycle Economic and Environmental assessment of Transmission Systems (LEETS), designed for joint economic and environmental impact assessment.

LEETS is an integrated economic and environmental systems tool for decision support which is currently being applied within the electricity transmission industry. LEETS calculates economic and local environmental impacts over the life cycle in three stages - construction, operation and decommissioning. Since LEETS considers

both economic and environmental impacts, it has potential to reduce overall project cost and also aid the search for more environmentally acceptable solutions.

#### **1.4 Conclusion**

In this chapter we could see that as the industrial products are major sources of environmental impacts, T&D companies and different organizations integrate eco-design in their products and services, the scale of eco-design approaches are very wide, from the individual product to strategic decision. However, the method of assessing the environmental profile is focused on LCA. In the T&D industries in order to conduct eco-design, LCA or on most common occasions simplified LCA is applied, as the full LCA sometimes is not available or necessary, concerning time, cost and even data availability.

The present study is based on “system approach” of eco-design, which will focus on transmission systems’ environmental impacts, and the contents will be shown in the coming chapters.

## **Chapter 2**

# **Energy Losses of Different Transmission Lines & Relevant CO<sub>2</sub>-Equivalent Emissions**

In order to transmit a certain amount of power to a load center that is far from the power generation, there now exists transmission lines of different voltage levels around the world. The transmission lines can be classified, according to the type of current, into Alternating Current (AC) and Direct Current (DC) transmission lines. Currently there is the trend towards developing transmission line of higher and higher voltage level, such as Ultra High Voltage (UHV) range, generally meaning: AC - Voltage  $\geq 1000$  kV; DC - Voltage  $\geq 800$  kV. These UHV transmission lines are more and more needed in very fast developing countries and/or when long distances must be covered, such as China, India, Brazil, etc...

UHV transmission line shows its merits on higher capacity and higher energy efficiency, compared with EHV (Extra High Voltage) transmission lines, in addition to these technical benefits, UHV also shows its environmental advantages.

With the aim of investigating the environmental impacts of UHV and EHV transmission lines, Life Cycle Assessments (LCA) could be done, but as indicated in [37] that transmission lines' energy losses are the key issue, therefore it's meaningful first to investigate energy efficiency of these transmission lines. As for the environmental impact indicators, it's obvious that Global Warming Potential (GWP) is the first choice to be investigated.



Thus, in this chapter a series of EHV and UHV transmission lines, say, 500kV AC, 765kV AC, 1200kV AC,  $\pm 500$ kV DC and  $\pm 800$ kV DC are set as target to investigate their energy efficiency and CO<sub>2</sub>-equivalent emissions due to the energy loss (Joule loss) through the transmission line. The impact of the different types of electricity generation methods, which of course is a major parameter, is also investigated.

## 2.1 Power Losses of Different Overhead Lines (OHL)

### 2.1.1 Power Losses of AC Overhead Line

The  $\Pi$  model (Fig. 2-1) is used to quantitatively represent the overhead line, and used to calculate the different parameters of AC transmission overhead line, such as Joule losses, inductive losses and capacitive losses, etc.

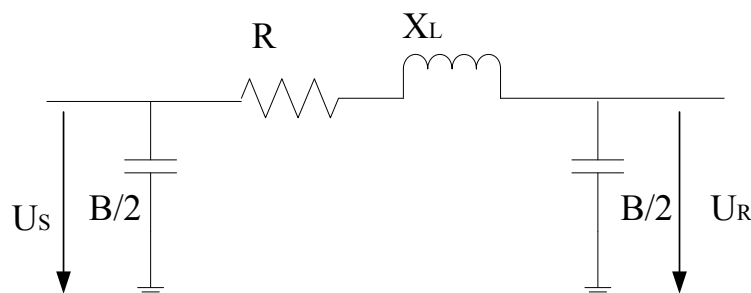

Fig. 2-1 :  $\Pi$  model of AC transmission line

R - line resistance;  $X_L$  - line reactance; B - line susceptance;  
 $U_S$  - sending end voltage;  $U_R$  - receiving end voltage

As transmission line loss is varying with increase of transmission length, thus a length of 1200 km is chosen as the transmission distance, since this value is able to reflect the realistic transmission distance of UHV transmission lines around the world.

The Surge Impedance Loading (SIL) reflects the transmission capacity of an AC

transmission line. Eq. 2-1 and Eq. 2-2 demonstrate the calculations of SIL, which is the intrinsic property of AC overhead line. Once the types and layout of overhead line are set, their SIL remains constant. Table 2-2 shows the calculated results of SIL of different AC transmission lines, using the parameters indicated in Table 2-1.

$$Z_C = \sqrt{\frac{X_L}{B}} \quad (\text{Eq. 2-1})$$

in which :

$Z_C$  – surge impedance of transmission line

$X_L$  – reactance of each phase of transmission line

$B$  – susceptance of each phase of transmission line

$$P_C = \frac{U_s^2}{Z_C} \quad (\text{Eq. 2-2})$$

where :

$P_C$  – Surge Impedance Loading

$U_s$  – sending end line-to-line voltage

Table 2-1 : Parameters of overhead lines for 500 kV AC, 765 kV AC, 1200 kV AC,  $\pm 500$  kV DC and  $\pm 800$  kV DC

	500 kV AC	765 kV AC	1200 kV AC	$\pm 500$ kV DC	$\pm 800$ kV DC
Sub-conductors per phase / pole	4×ACSR* -300 mm <sup>2</sup> [47]	4×ACAR** - 659 mm <sup>2</sup> [48]	8×ACSR -597 mm <sup>2</sup> [49]	4×ACSR -720 mm <sup>2</sup> [50]	6×ACSR - 630/45 mm <sup>2</sup> [51]
Resistance of each phase / pole R ( $\Omega$ /km)	0.02625	0.01415	0.008519	0.00996	0.00772
Reactance of each phase $X_L$ ( $\Omega$ /km)	0.284	0.2853	0.2435	-	-
Susceptance of each phase B (S/km)	$3.9 \times 10^{-6}$	$3.98 \times 10^{-6}$	$4.65 \times 10^{-6}$	-	-

\* ACSR: Aluminium Conductor Steel Reinforced

\*\* ACAR: Aluminium Conductor Alloy Reinforced

Table 2-2 : Calculated Joules losses of different AC lines

	500 kV AC	765 kV AC	1200 kV AC
Nominal voltage (kV)	500	765	1150
Power factor	0.98	0.98	0.98
SIL (MW)	926	2186	5347
Apparent power S (MVA)	945	2231	5456
Line current (kA)	1.09	1.68	2.74
Joules losses (MW)	113	144	230
Joules losses rate	12.16%	6.61%	4.30%

For a certain kind of transmission line, the power losses and loss rate are varying when it sends different amount of power. Taking 500 kV AC as an example, the joules losses are different when it sends 50 MW and when it sends 100 MW power. However, in most of cases, the SIL is set as the amount of power to be sent by a certain kind of transmission line. In this case the reactive power generated by susceptance of the line and that absorbed by reactance of the line are balanced by each other, that is to say, there is no reactive power in the transmission line. For instance, 926 MW is the reasonable amount of power to be sent by a 500 kV AC transmission line, although the sending capacity could be larger than 926 MW, it cannot surpass this amount too much. Otherwise, compensation of the reactive power is needed, such as introduction of series capacitor.

So, it's reasonable to compare the AC overhead lines' power losses when they are sending the amount of SIL power. In order to calculate the ohmic loss of an AC line, the apparent power, line current have to be first determined and they are calculated by Eq. 2-3 and Eq. 2-4. As an assumption the power factor is set to 0.98.

$$S = SIL / pf \quad (\text{Eq. 2-3})$$

where :

$S$  – apparent power transmitted by 3 phases of AC line

$pf$  – power factor of transmission line

$$S = \sqrt{3}UI \quad (\text{Eq. 2-4})$$

in which :

$S$  – apparent power transmitted by 3 phases of AC line

$U$  – line-to-line voltage

$I$  – line current

$$Loss_{Joules} = 3I^2 R \cdot L \quad (\text{Eq. 2-5})$$

where :

$Loss_{Joules}$  – ohmic loss of 3 phases of AC line

$I$  – line current

$R$  – resistance of each phase per km

$L$  – length of AC line

Then the ohmic losses of different AC lines are calculated by Eq. 2-5, and results are displayed in Table 2-2.

Fig. 2-2 illustrates the fact that increase of transmission line's voltage reduces the line's power loss.

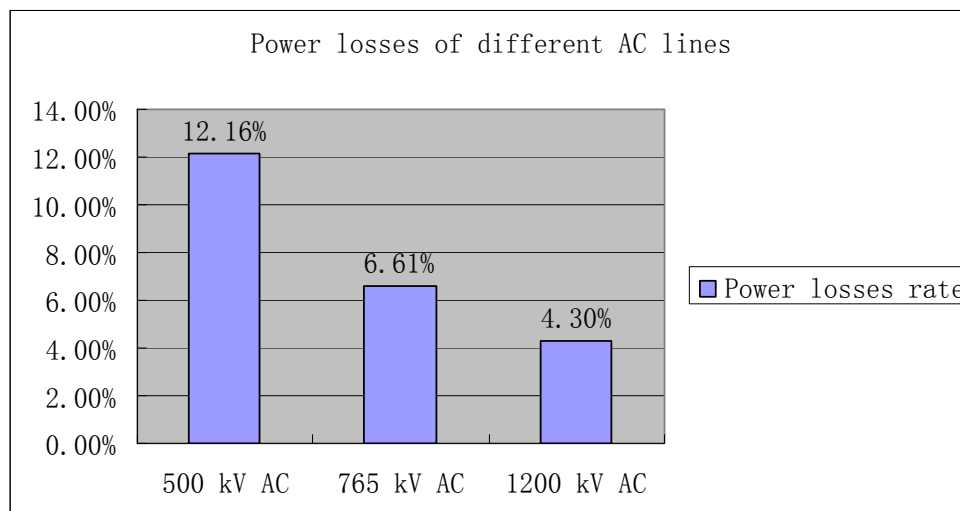

Fig. 2-2 : Power losses of different AC lines

### 2.1.2 Power Losses of DC Overhead Lines

For the DC transmission line, bipolar overhead lines are constructed, taking  $\pm 800$  kV DC as an example (see Fig. 2-3), one pole is at +800 kV, the other is at -800 kV.

$\pm 500$  kV DC transmission line is able to send 3000 MW power and  $\pm 800$  kV DC transmission line is able to send 6400 MW power. The ohmic loss of DC line is calculated by Eq. 2-6, and results are shown in Table 2-3.

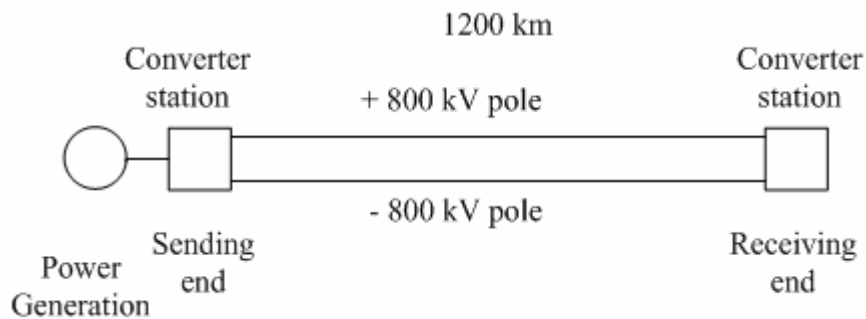

Fig. 2-3 : Illustration of  $\pm 800$  kV DC line

$$Loss_{Joules} = I^2 R \cdot L \quad (\text{Eq. 2-6})$$

in which :

$Loss_{Joules}$  – ohmic loss of DC transmission line

$I$  – pole current

$R$  – resistance of each pole per km

$L$  – length of DC line

Table 2-3 : Ohmic losses of  $\pm 500$  kV DC and  $\pm 800$  kV DC transmission line  
(transmission line length : 1200 km)

	$\pm 500$ kV DC	$\pm 800$ kV DC
Power to send (MW)	3000	6400
Pole current (kA)	3.00	4.00
Joules losses (MW)	215	296
Joules losses rate	7.17%	4.63%

Table 2-4 and Fig. 2-4 summarizes power losses rates of different AC and DC lines, it shows the fact that increase of transmission line's voltage reduces the line's power loss, which applies for both AC and DC lines.

Table 2-4 : Power losses of different AC lines and DC lines  
(transmission line length : 1200 km)

	500 kV AC	765 kV AC	1200 kV AC	±500 kV DC	±800 kV DC
Power losses rate	12.16%	6.61%	4.30%	7.17%	4.63%

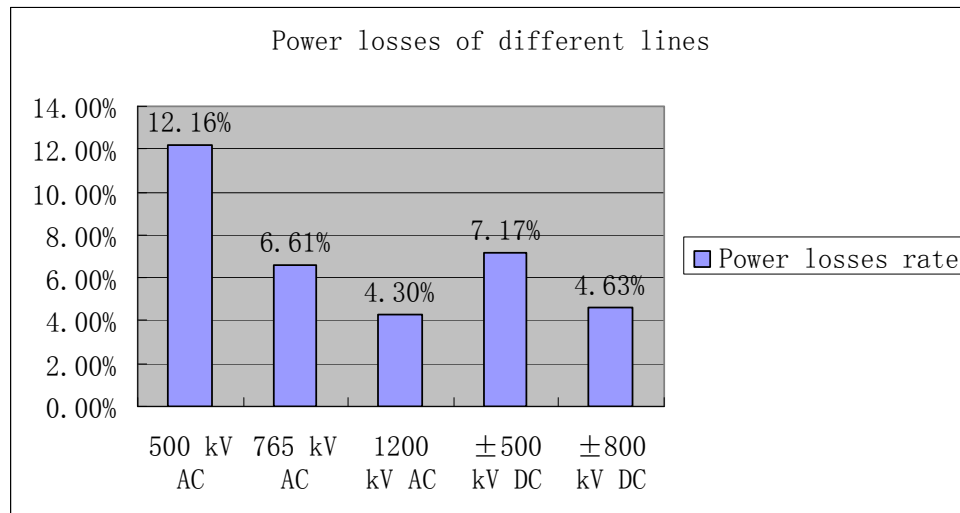

Fig. 2-4 : Power losses of different AC lines and DC lines  
(transmission line length : 1200 km)

## 2.2 CO<sub>2</sub>-Equivalent Emissions by Different Ways of Transmission

### 2.2.1 Scenarios Setting

Due to the different power losses rates caused by different transmission lines, in order to receive a certain amount of power through a certain distance, different transmission lines need different amount of power at the sending end.

Nowadays, bulk power transmitted over long distance (over 1000 km) is seen a trend for transmission lines, especially in China and India, as in these countries power centers are far from load centers. Due to this fact, a more realistic scenario is built to investigate the different CO<sub>2</sub>-equivalent emissions, that 6000 MW to be received through 1200 km transmitted by different transmission lines investigated hereinbefore, say, 500 kV AC line, 765 kV AC line, 1200 kV AC line, ±500 kV DC and ±800 kV DC line.

In order to transmit 6000 MW power, the required circuits of different transmission lines and their right-of-way are listed in Table 2-5 and shown in Fig. 2-5. For example, in order to send 6000 MW power, 3 circuits of 765 kV AC line is required, whereas only one circuit of ±800 kV DC transmission line is needed (see Fig. 2-6), ±800 kV DC transmission line reduces the required right-of-way, which is obviously beneficial to environment. The increase of transmission line's voltage reduces the number of required circuits of transmission line, as the transmission line of higher voltage level has higher transmission capacity, therefore decreases the total right-of-way. This reduces the occupation of land along the transmission line, and also helps lessen the visual impacts on landscape.

Table 2-5 : Required numbers of circuits & right-of-way of different transmission lines for sending 6000 MW power

Capacity 6000 MW	500 kV AC	765 kV AC	1200 kV AC	±500 kV DC	±800 kV DC
Number of circuits*	7	3	2	2	1
Right of way (m)	7×61 [52]	3×75 [53]	2×91 [49]	2×50 [53]	1×50 [37]

\* One circuit for AC line is defined as composed of 3 phases;  
one circuit of DC line consists of bi-poles.

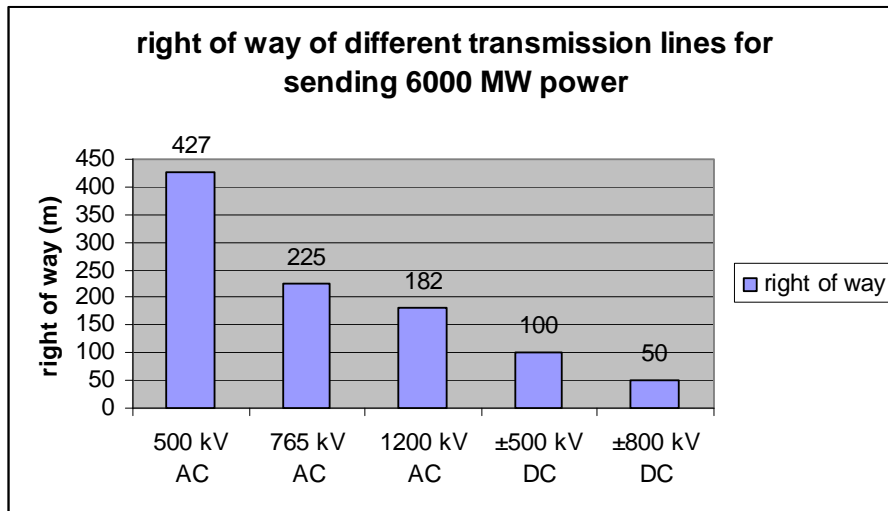

Fig. 2-5 : Right-of-way of different transmission lines for sending 6000 MW power

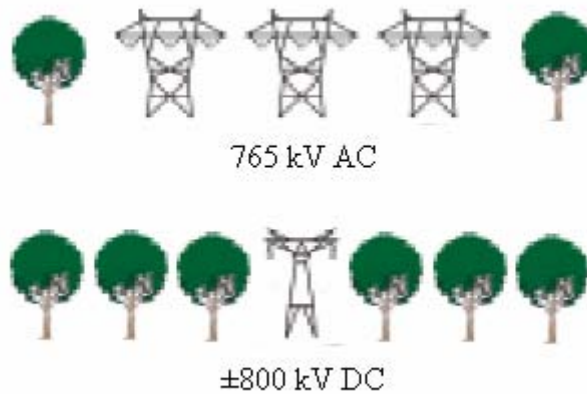

Fig. 2-6 : Illustration of right-of-way of 765 kV AC and ±800 kV DC transmission lines for sending 6000 MW power

According to the different power losses rates of different transmission lines (Table 2-4), the power needed at sending end of the different transmission lines are listed in Table 2-6, and the related power losses of different transmission lines are also shown in Fig. 2-7.

Table 2-6 : Power losses through different transmission lines

Type of transmission line	Power needed at sending end (MW)	Power received at receiving end (MW)	Power loss in transmission (MW)
500 kV AC	6831	6000	831



765 kV AC	6425	6000	425
1200 kV AC	6270	6000	270
±500 kV DC	6463	6000	463
±800 kV DC	6291	6000	291

The UHV transmission lines both AC and DC have less power losses, which is only 1/3 of 500 kV AC transmission line's power loss, they save 9% of sending power (6000 MW) which is supposed to lose by heat through the 500 kV AC transmission line.

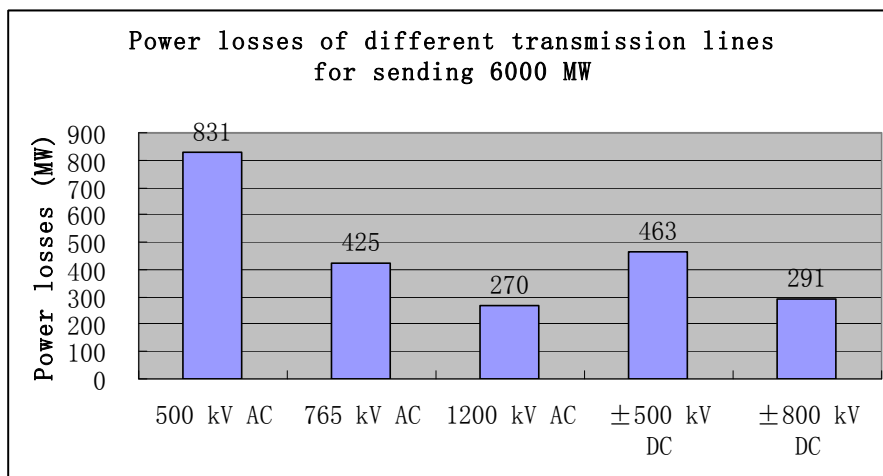

Fig. 2-7 : Power losses of different transmission lines for sending 6000 MW to 1200 km

### 2.2.2 CO<sub>2</sub>-Equivalent Emissions

In the sending end of transmission line, the electric energy can be generated by different ways, the traditional methods of electric generation are investigated for CO<sub>2</sub>-equivalent emissions herein below, such as generation by hydro, natural gas and coal.

CO<sub>2</sub>-equivalent is a quantity that describes, for a given mixture and amount of greenhouse gas, the amount of CO<sub>2</sub> that would have the same global warming potential (GWP), when measured over a specified timescale (generally 100 years)

[54]. For example, the GWP for methane over 100 years is 25 and for nitrous oxide 298. This means that emissions of 1 kg of methane and nitrous oxide respectively are equivalent to emissions of 25 and 298 kg of carbon dioxide.

CO<sub>2</sub>-equivalent emissions of different methods of electric generation are shown in Table 2-7 and Fig. 2-8; this figure means in order to generate 1 kWh electric energy a certain amount of CO<sub>2</sub>-equivalent greenhouse gases are emitted. In the Life Cycle Inventory process, fuel extraction, power plant construction, land use and operation are taken into account, as well as generation.

These CO<sub>2</sub>-equivalent emissions data are for UCPTE countries, quoted from ETH-ESU 96 database updated in 2004. The reason for using data of European countries is that, although UHVAC and UHVDC projects are constructed in China, India, etc. the technology is as advanced as European projects', so the CO<sub>2</sub>-equivalent emissions are comparatively the same as European's.

In the real case, the power flow in transmission line is varying in line with loads, sometimes the transmission line can be light-loaded while sometimes it can be over-loaded as well. Here simplification is made that the transmission lines are running in fixed capacity in the whole year, regardless of availability caused by power failure and maintenance, that is to say, in the whole year the transmission lines are 100% available.

Table 2-7 : CO<sub>2</sub>-equivalent emissions of different electric generation  
(Data taken from ETH-ESU 96 database [12] for UCPTE\* countries)

	Hydro	Natural Gas	Coal
CO <sub>2</sub> -equivalent emitted (kg/kWh)	0.004	0.922	1.09

\* UCPTE : Union for the Coordination of Production and Transmission of Electricity, including 24 western European countries.

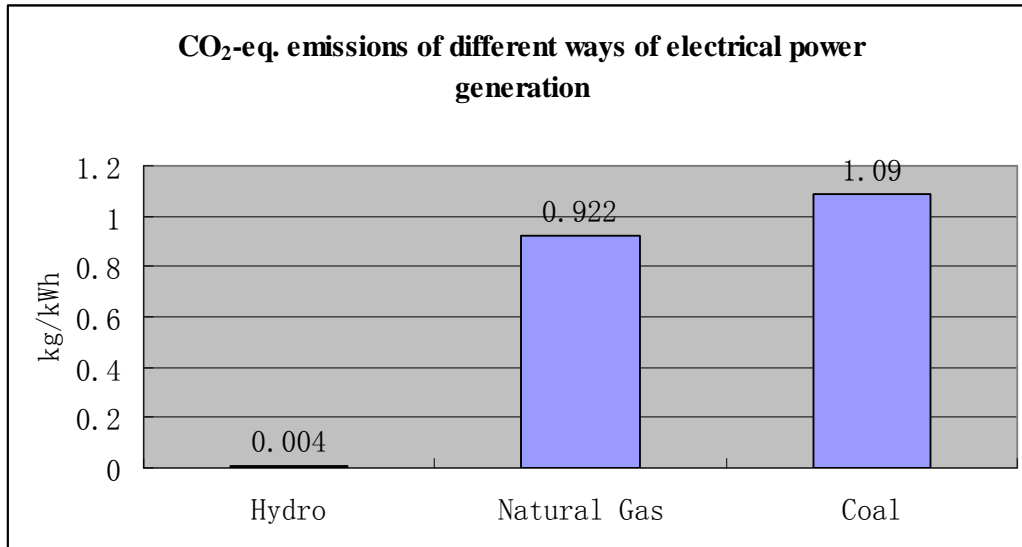

Fig. 2-8 : CO<sub>2</sub>-equivalent emissions of different ways of power generation

For example, for 500 kV transmission line, in the whole year it sends 6831 MW power at the sending end incessantly, so it needs 59.8 TWh electric energy to be generated at the sending end in one year, and 7.3 TWh of electricity is lost in the transmission line (illustrated in Table 2-8), then after 1200 km 6000 MW electrical power is received at the receiving end.

According to the data listed in Table 2-7 and Table 2-8, the different CO<sub>2</sub>-equivalent emissions caused by different transmission lines' energy losses are calculated and shown in Table 2-9, meanwhile the different electric generation methods are also taken into account.

Table 2-8 : Per annum energy losses of different transmission lines  
for sending 6000 MW to 1200 km

Type of transmission line	Power to be generated (MW)	Total electric energy to be generated per year (TWh)	Transmission line energy loss per year (TWh)
500 kV AC	6831	59.8	7.3
765 kV AC	6425	56.3	3.7
1200 kV AC	6270	54.9	2.4
±500 kV DC	6463	56.6	4.1
±800 kV DC	6291	55.1	2.5

Table 2-9 : Per annum CO<sub>2</sub>-equivalent emissions of different transmission lines energy losses for sending 6000 MW to 1200 km

Type of power production	Type of line	Total electric energy losses in transmission per year (TWh)	Total CO <sub>2</sub> -equivalent emitted by line loss (t/year)	Reduced CO <sub>2</sub> -equivalent emissions compared with 500 kV AC line (t/year)
Hydro	500 kV AC	7.3	$2.91 \times 10^4$	-
	765 kV AC	3.7	$1.48 \times 10^4$	$1.43 \times 10^4$
	1200 kV AC	2.4	$0.95 \times 10^4$	$1.96 \times 10^4$
	±500 kV DC	4.1	$1.62 \times 10^4$	$1.29 \times 10^4$
	±800 kV DC	2.5	$1.02 \times 10^4$	$1.89 \times 10^4$
Natural Gas	500 kV AC	7.3	$6.71 \times 10^6$	-
	765 kV AC	3.7	$3.41 \times 10^6$	$3.30 \times 10^6$
	1200 kV AC	2.4	$2.18 \times 10^6$	$4.53 \times 10^6$
	±500 kV DC	4.1	$3.74 \times 10^6$	$2.97 \times 10^6$
	±800 kV DC	2.5	$2.35 \times 10^6$	$4.36 \times 10^6$
Coal	500 kV AC	7.3	$7.93 \times 10^6$	-
	765 kV AC	3.7	$4.03 \times 10^6$	$3.90 \times 10^6$
	1200 kV AC	2.4	$2.58 \times 10^6$	$5.35 \times 10^6$
	±500 kV DC	4.1	$4.42 \times 10^6$	$3.51 \times 10^6$
	±800 kV DC	2.5	$2.78 \times 10^6$	$5.15 \times 10^6$

Table 2-9 also illustrates the fact that the voltage increase of transmission lines reduces the CO<sub>2</sub>-equivalent emissions, compared with 500 kV, 765 kV AC lines and ±500 kV DC, 1200 kV AC line and ±800 kV DC line can avoid CO<sub>2</sub>-equivalent emissions.

In China and India both UHVAC and UHVDC transmission lines are constructed and commissioned, in order to deliver the bulk power from long distance (over 1000 km) to their load centers, respectively. Taking the hydro-electric generation for example, the 1200 kV AC and ±800 kV DC transmission lines can, respectively, avoid  $1.96 \times 10^4$  tons and  $1.89 \times 10^4$  tons of CO<sub>2</sub>-equivalent emissions per year, compared with 500 kV AC transmission line in order to send 6000 MW power to 1200 km away (Fig. 2-9).

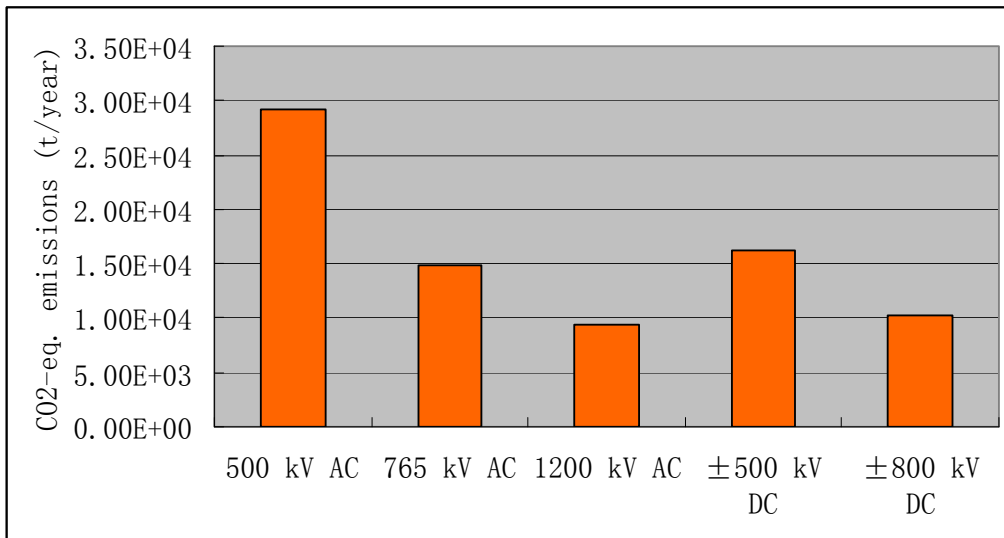

Fig. 2-9 : Per annum CO<sub>2</sub>-equivalent emissions caused by different energy losses in transmission lines for sending 6000 MW (hydroelectric generation) to 1200 km

This result indicates that the UHV transmission line reduces the environmental impacts compared with EHV transmission line, as far as energy loss is concerned. However, to answer the question whether UHV transmission system is more beneficial to environment than EHV transmission system, the materials-based aspects as to overhead lines and different equipments have to be considered, and only when the LCA is available can this question be analyzed thoroughly and systematically.

### 2.3 Conclusion

For the purpose of investigation of energy efficiency and Global Warming Potential due to overhead line losses, a basic design of a 1200 km transmission line at 500 kV AC, 765kV AC, 1200 kV AC, ±500 kV DC and ±800 kV DC is defined.

Results indicate that UHV transmission line is more energy-efficient, as 1200 kV AC line loses 4.30% of power through the line and ±800 kV DC line loses 4.63%, while 12.16% for 500 kV AC, 6.61% for 765 kV AC, and 7.17% for ±500 kV DC.

In order to transmit the same amount of power, UHV transmission line reduces the required right-of-way, especially  $\pm 800$  kV DC line, which is obviously beneficial to environment, and helps lessen the visual impacts on landscape. Besides, for  $\pm 800$  kV DC, it needs fewer conductors, and there is no need to build substations in a very long distance, therefore, it also shows its economic benefits.

Then CO<sub>2</sub>-equivalent emissions due to transmission line losses are calculated, and results show that UHV transmission lines are able to avoid CO<sub>2</sub>-equivalent emissions, compared to EHV transmission lines.

Nevertheless, as in this chapter the CO<sub>2</sub>-equivalent emissions are investigated only relating to overhead lines' energy losses, the construction of overhead lines, construction of substations and energy use in substations are not taken into account, which also has to be considered in the investigation of environmental impacts. Therefore, in next chapter, the environmental impacts aspects regarding materials of overhead lines and substations will be displayed in one LCA conducted on a Venezuelan 765 kV AC transmission system.



## Chapter 3

# Environmental Impact of a Venezuelan 765 kV AC Transmission System

A real case of 765 kV AC transmission system (Fig. 3-1) is selected to investigate environmental impacts of the whole system.

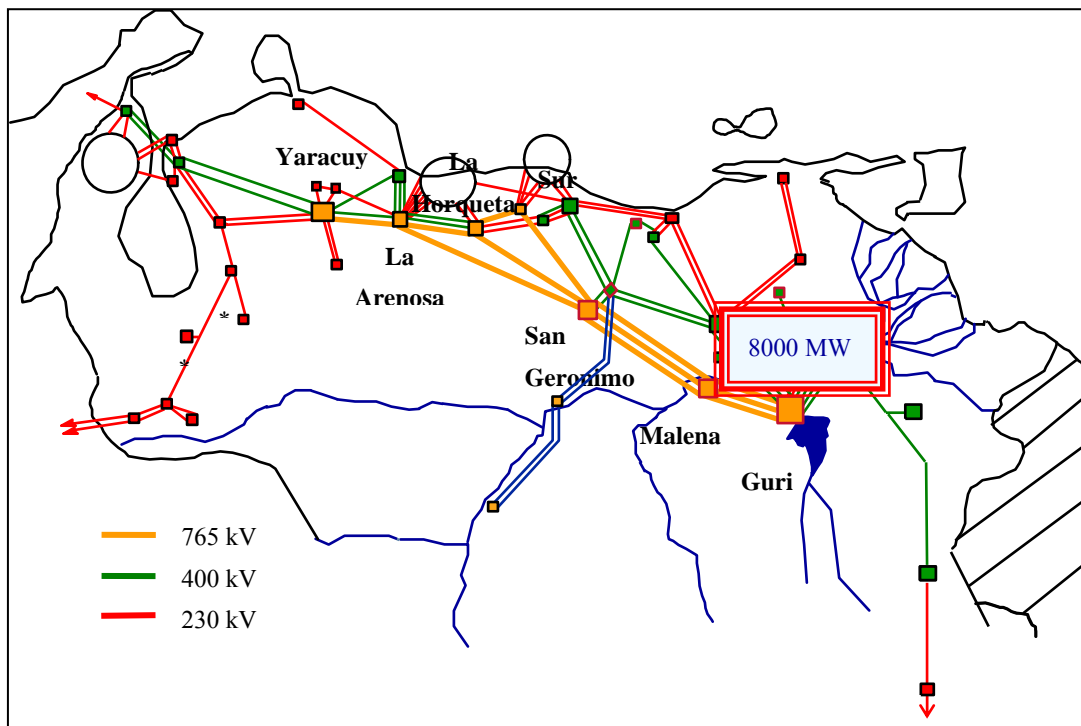

Fig. 3-1 : Illustration of Venezuelan 765 kV AC transmission system

The reason for choosing this transmission system is that nowadays in many countries, the Extra High Voltage AC transmission systems exist to transmit bulk power to long distance, and thus it's valuable to investigate the environmental impacts of these transmission systems. The most difficult part of conducting a Life Cycle Assessment is the collection of needed data for different equipments in substations; otherwise it's



impossible to analyze a transmission system's environmental impacts. Almost all major equipments in this Venezuelan 765 kV AC transmission system are supplied from Alstom Grid, so the data is accessible, which makes this project a typical model of Extra High Voltage AC transmission system to be assessed its environmental impacts.

This Venezuelan 765 kV AC transmission system transmits 8000 MW hydro-electrical power from Guri to this country's load centers, located in the north of the country (see Fig. 3-1). There are 4 receiving end substations (Yaracuy, La Arenosa, La Horqueta and Sur), and the distance from Guri to the receiving end is around 760 km, during the course 2 intermediate substations (Malena and San Geronimo) are built to make reactive compensation. All the substations are equipped with Air-Insulated Switchgears.

Thus, the functional unit of this LCA investigation of this 765 kV AC transmission system is to transmit 8000 MW hydro-electrical power to 760 km, during its service life of 60 years. The scope of this LCA only focuses on the transmission system, neither the generation plant nor the set-up transformers (18/765 kV) are included.

As this transmission system is a huge system, for the clarity in logic and convenience of conducting the LCA, the investigation is split up into 2 steps, i.e. Life Cycle Assessment of transmission lines and Life Cycle Assessment of substations.

### **3.1 Life Cycle Assessment of Transmission Lines**

Fig. 3-1 illustrates the transmission lines connection in this Venezuelan 765 kV AC transmission system, each line represents one circuit, consisting of 3 phases. For example, from Guri substation to Malena substation, there are 3 lines, so this means there exist 3 circuits, as shown in Fig. 3-2.



Fig. 3-2 : Illustration of 3 circuits of 765 kV AC transmission line

In the LCA investigation, transmission lines are composed of conductors, ground wires, towers and insulators.

### 3.1.1 Life Cycle Assessment of Conductors

The transmission line conductors used in this transmission system are ACAR (Aluminium Conductor Alloy Reinforced) type, which is made of a combination of aluminium and aluminium alloy wires. The out layers of 18 aluminium strands are reinforced with a core of 19 strands of aluminium alloy. 4-conductor bundles are used per phase, see illustration in Table 3-1.

Table 3-1 : ACAR 1300 MCM conductor

ACAR	
Weight (kg/km)	1817 [48]
Conductor section illustration	 18/19

In calculation, all the weight of conductor is regarded as Aluminium weight, with regards to weight of ACAR conductor (see Table 3-1), then Aluminium used as conductor for this project is:

$$1817 \text{ kg/km} \times 4 \times 3 \text{ phase} \times 2280 \text{ km} = 49714 \text{ ton}$$

All the conductors were manufactured from Venezuelan suppliers, so the transportation phase is simulated as transported by lorry for an average distance of 500 km.

The use phase of conductors is defined as energy losses due to Joule effects in conductors during the service life of 60 years of this transmission system. The energy losses are determined by the current and resistance of conductors. The resistance of the conductor is listed in Table 3-2, and the average current in each conductors are calculated in Annex A, then the energy losses are listed in Table 3-3.

Table 3-2 : Parameters of conductor

Categories	
Sub-conductors per phase	ACAR 1300 MCM 4×659 mm <sup>2</sup>
Diameter of conductor	3.332 cm
Spacing of bundle conductor	45 cm
Illustration of the bundle conductor	
Phase-to-phase clearance	15.0 m
AC Resistance (Ω/km) @75°C [55]	0.01415

Table 3-3 : Energy losses in different sections of transmission lines

	Distance (km)	Current (A)	Power loss (MW)	Transmission line loss during 60 years (MWh)
Guri – Malena	220	1214	41.3	$2.17 \times 10^7$
Malena – San Geronimo	280	1214	52.6	$2.76 \times 10^7$
San Geronimo – La Arenosa	180	1214	11.3	$5.92 \times 10^6$

San Geronimo – La Horqueta	180	1214	11.3	$5.92 \times 10^6$
San Geronimo – Sur	120	1214	7.5	$3.95 \times 10^6$
La Horqueta – Sur	100	290	0.4	$1.88 \times 10^5$
La Horqueta – La Arenosa	100	371	0.6	$3.07 \times 10^5$
La Arenosa – Yaracuy	100	680	2.0	$1.03 \times 10^6$
Total			126.8	$6.66 \times 10^7$

During the service life of 60 years of this transmission system, considering that the load profile of is 60% [56], the total Joule losses of all the conductors is  $6.66 \times 10^7$  MWh, i.e. power loss of 126.8 MW.

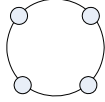
The end-of-life phase is defined as the recycling of the Aluminium.

Since materials inventories, use phase, transportation phase and the end-of-life phase of conductors are defined, the Life Cycle Inventory of total substations are carried out by using software package SimaPro 7.1, through the analysis by the impacts assessment method EDIP/UMIP 97 (Environmental Design of Industrial Products, in Danish UMIP) version 2.03 [57], the characterization result of Life Cycle Impact Assessment is shown in Fig. 3-3 and detailed value is listed in Annex B. The characterization is the calculation of category indicator results of potential environmental impacts.

The environmental impacts are ascribed as potential environmental impacts to all relevant emissions no matter where and when they take place. Positive potential impacts are burdens to environment, while negative potential impacts are savings to the environment. In the characterization of EDIP/UMIP 97 method, environmental impacts are assessed by different impact categories, such as Global Warming, Ozone Depletion, Acidification, etc. The meanings of the impact categories are explained in

Table 3-4.

Table 3-4 : Explanations of impact categories of EDIP/UMIP 97 method

Impact Categories	Meanings
Global Warming	aggregates all greenhouse gas emissions into CO <sub>2</sub> -equivalent (g CO <sub>2</sub> )
Ozone Depletion	aggregates all emissions leading to stratospheric ozone depletion into CFC11-equivalent (g CFC11)
Acidification	aggregates all emissions leading to acidification into SO <sub>2</sub> -equivalent (g SO <sub>2</sub> )
Eutrophication	aggregates all nutrient enriching emissions into NO <sub>3</sub> -equivalent (g NO <sub>3</sub> )
Photochemical Smog	aggregates all emissions leading to photochemical ozone formation into C <sub>2</sub> H <sub>4</sub> -equivalent (g C <sub>2</sub> H <sub>4</sub> )
Ecotoxicity in Soil and Water	aggregates all toxic emissions potentially impacting the environment into soil (m <sup>3</sup> ) or water (m <sup>3</sup> )
Human Toxicity via Soil, Air and Water	aggregates all toxic emissions potentially impacting the human health into soil (m <sup>3</sup> ), air or water (m <sup>3</sup> )
Waste	Waste streams are divided in 4 categories, bulk waste (not hazardous), hazardous waste, radioactive waste and slags and ashes.
Resources	consumption of resources such as fossil fuels, metals and renewable resources; calculated as the mass of pure resources used, not the mass of ore materials.

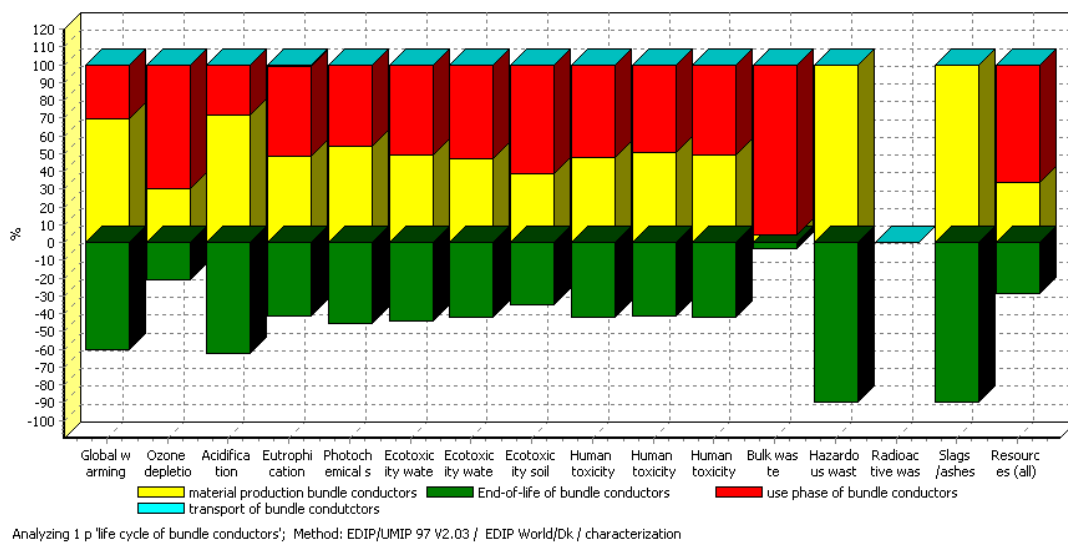

Fig. 3-3 : Characterization result of bundle conductors

It's seen in Fig. 3-3 that end-of-life phase gives the negative value on most of all

impacts indicators, which means the end-of-life can avoid a certain amount of environmental impact, as it avoids exploiting more raw materials, and consequently beneficial to the environment. As in this LCA the end-of-life phase is defined as recycling of materials, then it can be integrated along with material production phase into one combination “materials”, in order to investigate the potential environmental impacts caused by materials, although these impacts may happen in different places at different time. Thus, Fig. 3-4 gives the characterization result of bundle conductors when integrating the materials production phase and end-of-life phase.

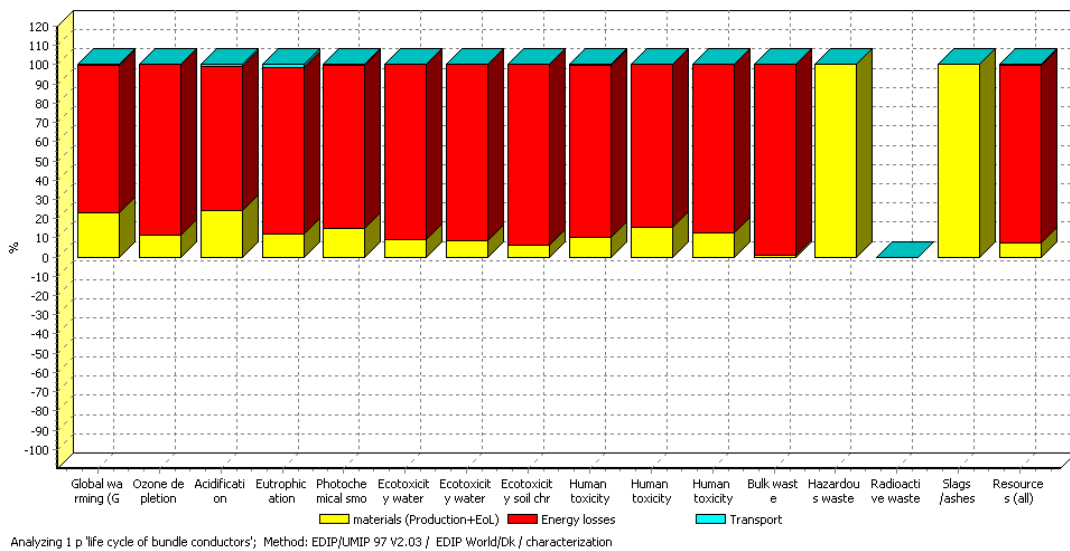

Fig. 3-4 : Characterization result of bundle conductors (integrating the materials production phase and end-of-life phase into the impacts of materials)

Herein the indicator - Global Warming - is used as explanatory analysis, as CO<sub>2</sub>-equivalent emissions are most concerned environment impact around the world nowadays. It's indicated that energy losses of bundle conductors account for 76.4% of CO<sub>2</sub>-equivalent emissions, materials (production plus end-of-life) for 23.1% of CO<sub>2</sub>-equivalent emissions and transportation for 0.5% CO<sub>2</sub>-equivalent emissions.

### 3.1.2 Life Cycle Assessment of Ground Wires

The ground wire is Alumoweld 7#7 type wire (Fig. 3-5), which is an aluminum-clad steel wire, in the finished size, Alumoweld has an aluminum coating equaling to 25 percent of the cross-sectional area of the composite wire, and a coating thickness guaranteed to be a minimum of ten percent of the wire radius. Alumoweld 7 #7 is conductor with 7 aluminum-clad steel wires stranded together; specifications are listed in Table 3-5.



Fig. 3-5 : Alumoweld 7 #7 wire [58]

Table 3-5 : Parameters of ground wires in Venezuelan 765 kV transmission lines

Categories	
Material of ground wire	Alumoweld (7 #7)
Diameter of ground wire	1.1 cm
Cross-section area	75 mm <sup>2</sup>
Weight per km	492 kg/km [59]
Weight of Al per km	49.9 kg/km
Weight of steel per km	442.1 kg/km

As total length of single circuit (composed of 3 phases) is 2280 km, and 2 ground wires are equipped per circuit, then total weight of Aluminium in ground wires used in the transmission lines is :

$$49.9 \text{ kg/km} \times 2280 \text{ km} \times 2 = 227.6 \text{ ton}$$

Total weight of steel in ground wires used in the transmission lines is :

$$442.1 \text{ kg/km} \times 2280 \text{ km} \times 2 = 2016 \text{ ton}$$

The ground wires were manufactured in Venezuela, the transportation phase is modeled as an average of 500 km by truck. The end-of-life phase is simulated as the recycling of the Aluminium and steel. No use phase is defined.

Characterization result of ground wires in the transmission lines is shown in Fig. 3-6, detailed value is listed in Annex B.

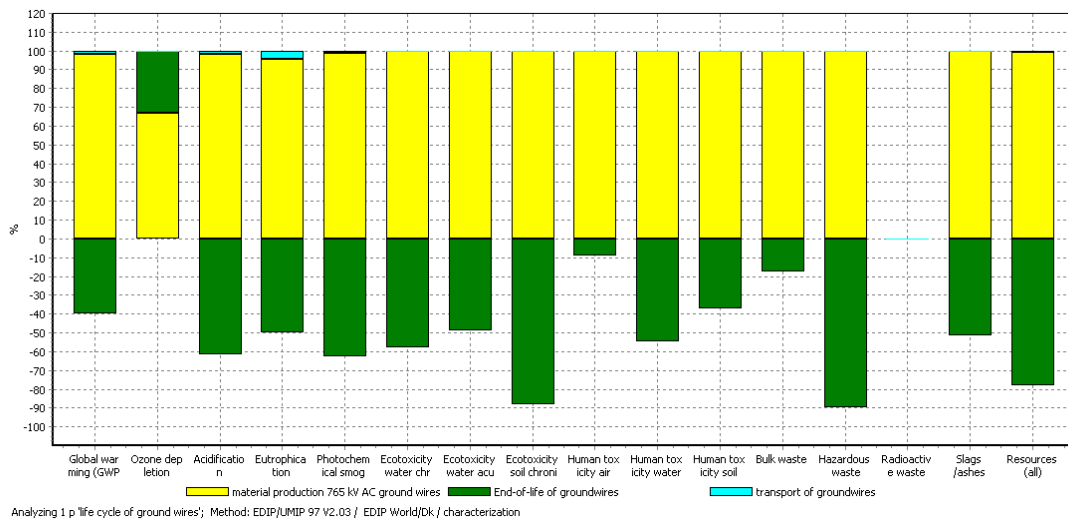

Fig. 3-6 : Characterization result of ground wires

### 3.1.3 Life Cycle Assessment of Towers

5 kinds of self-supporting towers are constructed in these 765 kV transmission lines (see Fig 3-7). S/480 suspension tower is used in straight line, while S5/480 suspension tower, A/60 angle tension tower and A/30 angle tension tower are used at line angles at 5°, 60°, and 30°, respectively.

The 765 kV transmission lines are transposed at 1/6, 1/3, 1/3 and 1/6 of line length, then ST/480 transposition tower is used for transposition. As there are 12 sections (between 2 adjacent substations) of single circuits in the project, and 4 pieces of ST/480 towers are needed in one section of single circuits, so 48 pieces of ST/480 towers are used in this project.



The average distance between 2 adjacent towers is 450 m, and total length of single-circuit line is 2280 km, then 5067 towers are constructed in the transmission lines.

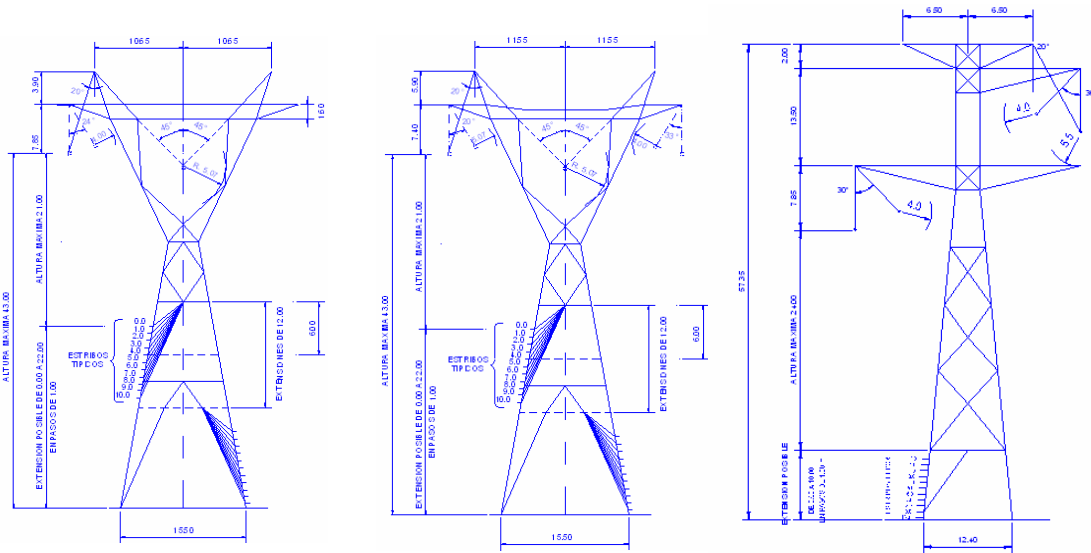

a) S/480  
suspension tower  
13 ton

b) S5/480  
suspension tower  
17 ton

c) ST/480  
transposition tower  
13 ton

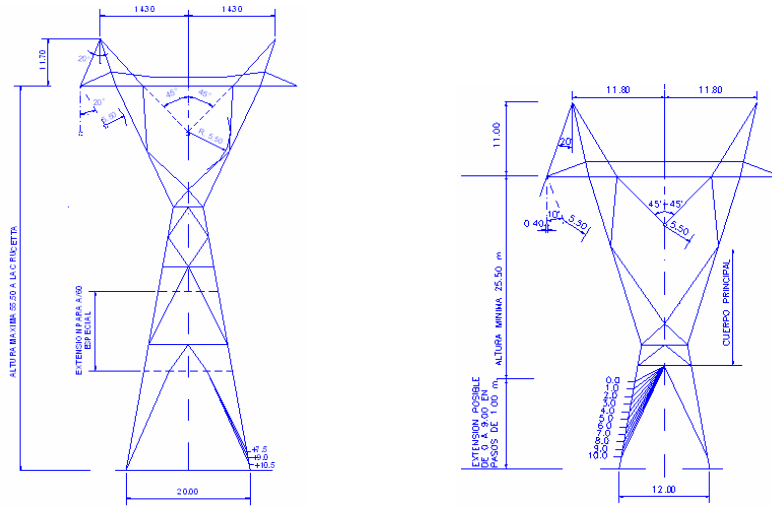

d) A/60 angle tension tower  
27 ton

e) A/30 angle tension tower  
27 ton

Fig. 3-7 : Illustration of tower types in transmission lines

In order to calculate total weights of towers, an assumption is made that the amount of

S5/480 towers consists of 70% of total amount of towers, A30 for 10%, A60 for 10%, and S/480 and ST480 together for 10%. As the amount for ST/480 is 48 pieces, then ST/480 consist of 0.95% of total amount, and S/480 for 9.05%, see Table 3-6.

Table 3-6 : Weight and percentage of different tower types

	S/480	S5/480	ST/480	A30	A60
Weight (ton)	13	17	13	27	27
Percentage in total amount of towers	9.05%	70%	0.95%	10%	10%
Quantity (pieces)	460	3547	48	506	506

According to tower weight and percentage in transmission lines, the average weight of one tower is :

$$13 \times 9.05\% + 17 \times 70\% + 13 \times 0.95\% + 27 \times 10\% + 21 \times 10\% = 18 \text{ ton}$$

Thus the weight of total 5067 towers is :

$$5067 \times 18 = 91026 \text{ ton}$$

All 5 types of towers are hot-dip galvanized, according to practical experience that Zn coatings are roughly 5% in weight of a tower, then Zn used in all towers is 4551 ton, see Table 3-7.

Table 3-7 : Weight of steel and Zn coatings for towers

	765 kV AC
Tower numbers	5067
Average tower weight	18 ton
Total towers weight	91026 ton
Steel for towers (95% tower weight)	86475 ton
Zn coatings (5% tower weight)	4551 ton

In the inventories of materials, the reinforced concrete for towers has to be taken into consideration, which weighs averagely 36.8 ton per tower, then total weight of reinforced concrete for 5067 towers is :

$$5067 \times 36.8 = 186466 \text{ ton}$$

All the towers were manufactured in Venezuela, so the transportation phase is modeled as transport of towers structures by truck in an average distance of 500 km. However, transportation of concrete is not modeled.

The end-of-life phase is simulated as the recycling of steel tower structures, and waste treatment of reinforced concrete. No use phase is defined.

Characterization result of the towers is shown in Fig. 3-8, detailed value is listed in Annex B, it's noticed that materials production of tower structures gives the most environmental impacts, and end-of-life phase has sometimes “positive” values on some impacts indicators. This is because in the recycling processes of steel, although recycled steel is beneficial to environment, in some impact categories, the steel recycling processes itself make more impacts than it potentially reduces by useful recycled steel. The environmental impacts of concrete are not very large compared with the tower structures’.

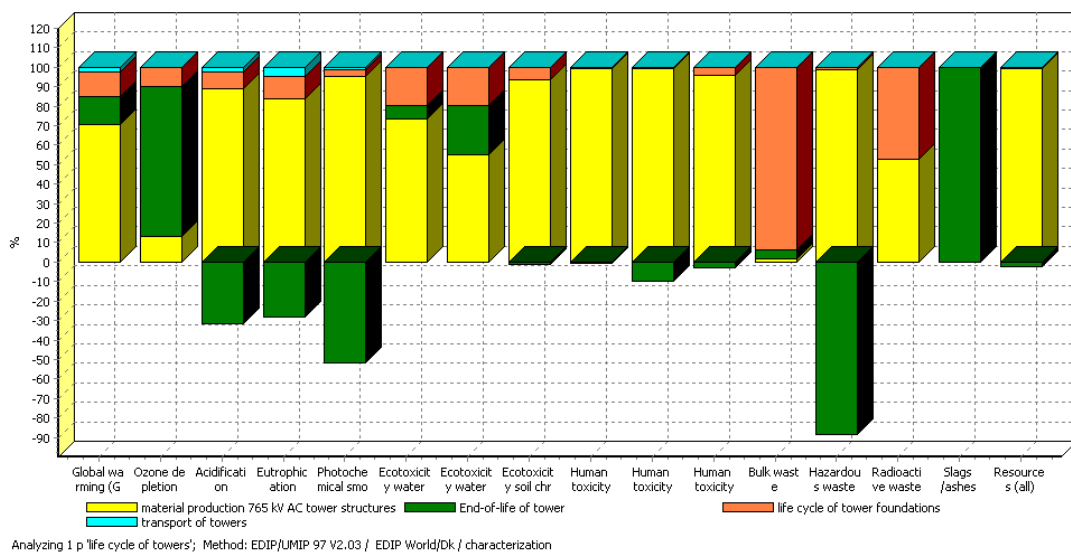

Fig. 3-8 : Characterization result of towers

### 3.1.4 Life Cycle Assessment of Insulators

Both ceramic and glass insulators are used in this project, but for the simplicity of calculation, the assumption is applied that all insulators are ceramic.

Table 3-8 specifies the amount of different types of insulators used in the transmission lines.

Table 3-8 : Insulators used in 765 kV transmission lines

	S/480 tower	S5/480 tower	ST/480 tower	A/30 tower	A/60 tower
Tower number	460	3547	48	506	506
Insulator string type	IVI (Fig. 3-9)	IVI	III (Fig. 3-10)	Double strings	Double strings
Insulators number per tower in low contamination area (70% in this project)	4×37 A1	4×37 A1	3 ×37 A1	6×35 C	6×35 C
Insulators number per tower in high contamination area (30% in this project)	4×37 A2	4×37 A2	3×37 A2	6×45 C	6×45 C
Total insulators amount	47656 A1 + 20424 A2	367484 A1 + 157472 A2	3774 A1 + 1554 A2	115368 C	115368 C

70% areas crossed by the 765 kV transmission lines are low contamination area, and in these areas, 37 type A1 insulators (160 kN/210 kN, 170×280mm, leakage distance 370 mm) per string are for suspension tower, 35 insulators type C (300 kN, 195×320mm, leakage distance 370 mm) per string are for tension tower. Type A1 insulators contain both 160 kN and 210 kN insulators, here the assumption is made that 50% of A1 insulators is 160 kN, and the rest of 50% is 210 kN.



Fig. 3-9 : IVI insulator strings



Fig. 3-10 : III insulator strings

Note: These Figures illustrate configurations of IVI & III insulator strings, are not from the 765 kV Venezuelan transmission lines

In the rest 30% of high contamination areas, 37 type A2 (160 kN/210 kN, 170×320mm, leakage distance 540 mm) insulators per string are for suspension towers, 45 insulators type C are for tension towers. Type A2 insulators contain both 160 kN and 210 kN insulators, here the assumption is made that 50% of A2 insulators is 160 kN, and the rest of 50% is 210 kN.

One ceramic insulator consists of a dielectric ceramic shell cemented between a cap and pin metal fitting. The end fittings are normally a malleable or ductile cast iron cap and a forged steel pin, both hot-dip galvanized [60]. For calculation of materials used for insulators, all cap and pin are regarded as cast iron, and no Zn coatings are taken into account. Calculation results are shown in Table 3-9, based on the assumption that 60% of total weight of one insulator is cast iron for cap and pin, and 40% is for ceramic.

Since the ceramic insulators' lifespan is assumed as 30 years, during the service life of 60 years the needed number of insulators is twice of that in service (Table 3-10).

Table 3-9 : Insulators specifications and materials in insulators

Type	A1	A2	C	Total
Specification	160 kN/210 kN, 170×280mm, leakage distance 370 mm	160 kN/210 kN, 170×320mm, leakage distance 540 mm	300 kN, 195×320mm, leakage distance 370 mm	
Approx. net weight per insulator [61]	6.5 kg (160 kN) 7.2 kg (210 kN)	8.9 kg (160 kN) 10.2 kg (210 kN)	10.6 kg	
Amount of pieces used in project	418914 (50% 160 kN + 50% 210 kN)	179450 (50% 160kN + 50% 210kN)	230736	
Cast iron (cap + pin) weight 60% weight per insulator	1721.7 ton	1028.2 ton	1467.5 ton	4217.4 ton
Ceramic weight 40% weight per insulator	1147.8 ton	685.5 ton	978.3 ton	2811.6 ton

Table 3-10 : Materials used in insulators during 60 years

	Material	Weight	
Insulators	ceramic	5624 ton	13984 ton
	cast iron (cap + pin)	8360 ton	

The insulators were manufactured in France, the transportation is modeled as 1000 km by truck and 7000 km by ship. In the end-of-life phase, the ceramic is landfilled, and the caps plus pins are recycled as steel. No use phase is defined.

Characterization result of the insulators is shown in Fig. 3-11, detailed value is listed in Annex B. It's noticed that transportation determines a large amount of environmental impacts, e.g. as to Global Warming Potential, transportation accounts for 75.2% of CO<sub>2</sub>-equivalent emissions, materials production for 18.5%, and

end-of-life for 6.3%. This is because the transport of insulators covers a long distance. As to the Ozone Depletion, the end-of-life has the most impacts (91.8%), which is also due to the recycling steel processes.

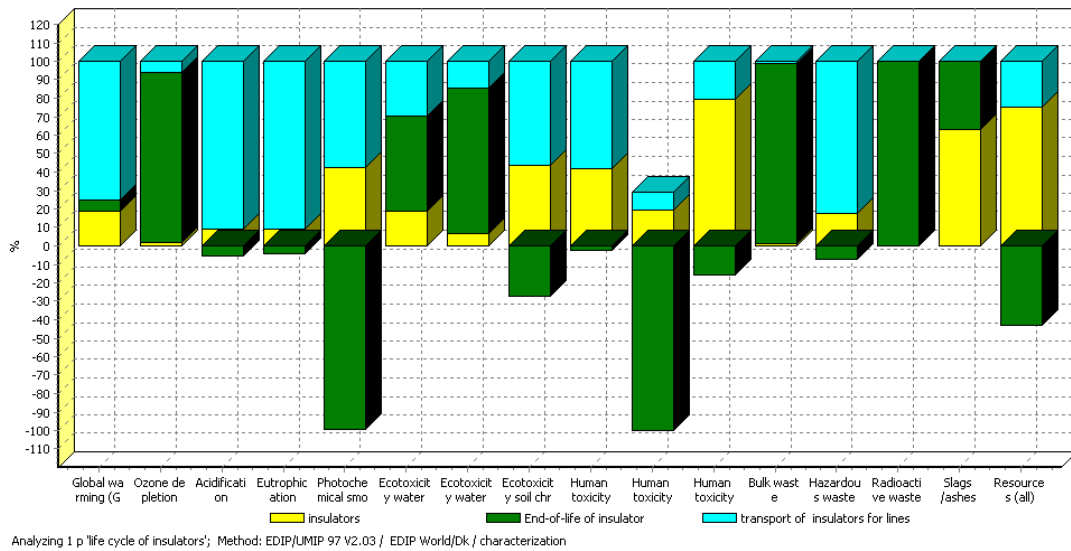

Fig. 3-11 : Characterization result of insulators in transmission lines

### 3.1.5 Life Cycle Impact Assessment Results of Transmission Lines

All the transmission lines' components have been investigated separately, with regards to their environmental impacts, thus it's possible to analyze the whole transmission lines' environmental profile.

Table 3-11 lists all the considered materials in transmission lines. The use phase of transmission lines is defined as energy losses due to Joule effects in conductors during the service life of 60 years of this transmission system, which is  $6.66 \times 10^7$  MWh, i.e. power loss of 126.8 MW.

Transportation phase of total transmission lines is the sum of individual transportation phase of different components of transmission lines, and so is the end-of-life phase of transmission lines.

Table 3-11 : Materials used in 765 kV AC transmission line during 60 years

Components	Material	Weight	
		Conductors	Al
Ground wires	Al	227.6 ton	2243.6 ton
	steel	2016 ton	
Towers	steel	86475 ton	109159 ton
	reinforced concrete	186466 ton	
	Zn coatings	4218 ton	
Insulators	ceramic	5624 ton	13984 ton
	cast iron (cap + pin)	8360 ton	

It should be emphasized that the considered materials of transmission lines include the major parts of the transmission lines, while the rest materials are not included, say, hardware to fix insulators and conductors, spacers for conductors, etc. Besides, as a matter of fact, manufacturing all the components have environment impacts too, for example, in order to fabricate a tower, except for manufacturing the needed steel, the processes to solder and fix steel fractures together into a tower is giving impacts on environment. However, as these processes' environmental impacts has to be studied by consulting the manufacturers, and sometimes it's hard to get and not so accurate. Thus in this LCA the manufacturing processes for all the components are omitted. Moreover, as for the transportation phase, only the transport of tower structures, bundle conductors, ground wires and insulators are simulated, the transport of concrete is not considered. This is to say, in this study, relevant omissions, substitutions, simplifications are applied, otherwise implementing the full LCA could be too time-consuming and costly. Also it should be noticed that the LCA results depend on how well the simulation is conducted, and how accurate the data are used.

The Life Cycle Inventory of total lines are carried out by using software package SimaPro 7.1, through the analysis by the impacts assessment method EIDP/UMIP 97, the characterization result of Life Cycle Impact Assessment is shown in Fig. 3-12 and detailed value is listed in Annex B.



The material production phase is dominating the CO<sub>2</sub>-equivalent emissions, however, since some materials in transmission lines are recycled in the end-of-life phase, integrating the materials production phase and end-of-life phase into the impacts of materials, it can be seen in Fig. 3-13 that energy losses of bundle conductors account for 52.6% of CO<sub>2</sub>-equivalent emissions, materials (production plus end-of-life) for 44.1% of CO<sub>2</sub>-equivalent emissions and transportation for 3.3% CO<sub>2</sub>-equivalent emissions.

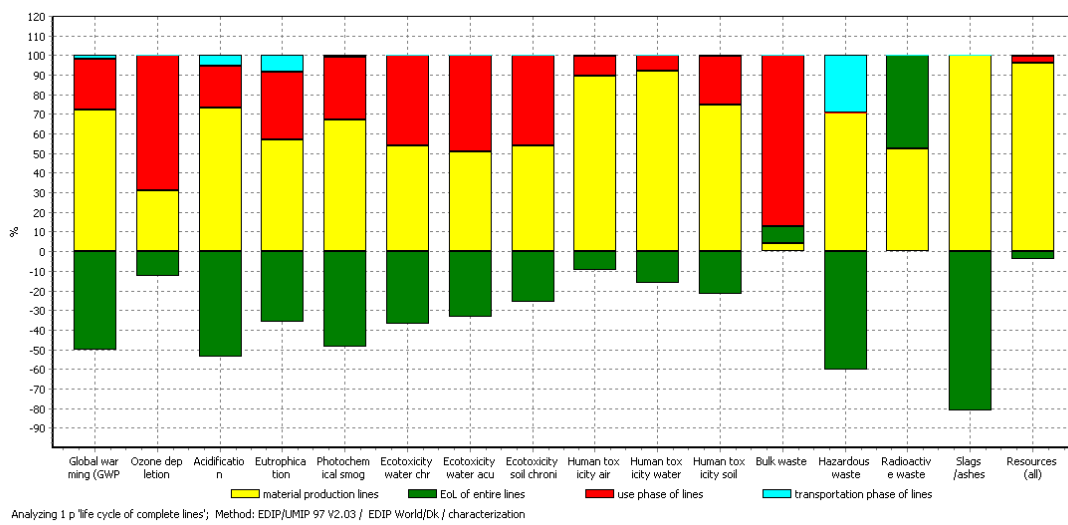

Fig. 3-12 : Characterization result of Venezuelan 765 kV AC transmission lines

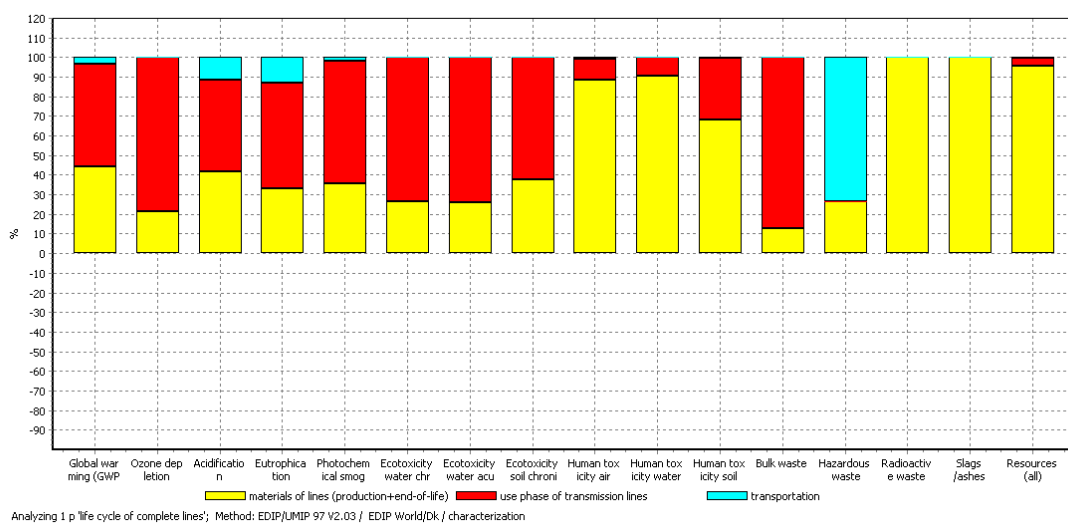

Fig. 3-13 : Characterization result of Venezuelan 765 kV AC transmission lines (Integrating the materials production phase and end-of-life phase into the impacts of materials)

Fig. 3-14 shows single score result of Life Cycle Impact Assessment of 765 kV AC transmission lines, and detailed value is shown in Annex B.

In Life Cycle Impact Assessment, the categories of environmental impact or resource consumption can be normalized to show the relative magnitude of each category. Normalization gives an impression of which impact categories are large or small by comparing them to a common reference for all categories. The normalization references in the EDIP/UMIP 97 method are the annual environmental impact or resource consumption of one person in each of the categories. The potential impact or resource consumption of a given category is divided by the corresponding normalization reference, and the unit of the normalized results is Person Equivalent (Pt). All categories of environmental impact and resource consumption are assigned the same unit and thereby made comparable. Furthermore, people can choose to assign a weight to each category if they are of unequal importance. The weighting method in EDIP/UMIP 97 method is that environmental impacts are weighted by political reduction targets, and resources are weighted based on reserves. Thus, the single score of environment impacts is the sum of the weighted results (unit in Person Equivalent) of different categories.

However, the normalization and weighting are optional in Life Cycle Impact Assessment, and the single score is not recommended by the authors of EDIP/UMIP 97 method [57], as resources may never be included in a single score, due to a different weighting method for resources (based on reserves rather than political targets).

Herein the single score result is utilized to show the impact magnitude of different phases of transmission lines, thus it could be interpreted that use phase is the major environment impact, as use phase accounts for 60.7% of single score of environmental impacts of the transmission lines, materials (production plus end-of-life) takes up for 39.0%, and the transportation phase for only 0.3%.

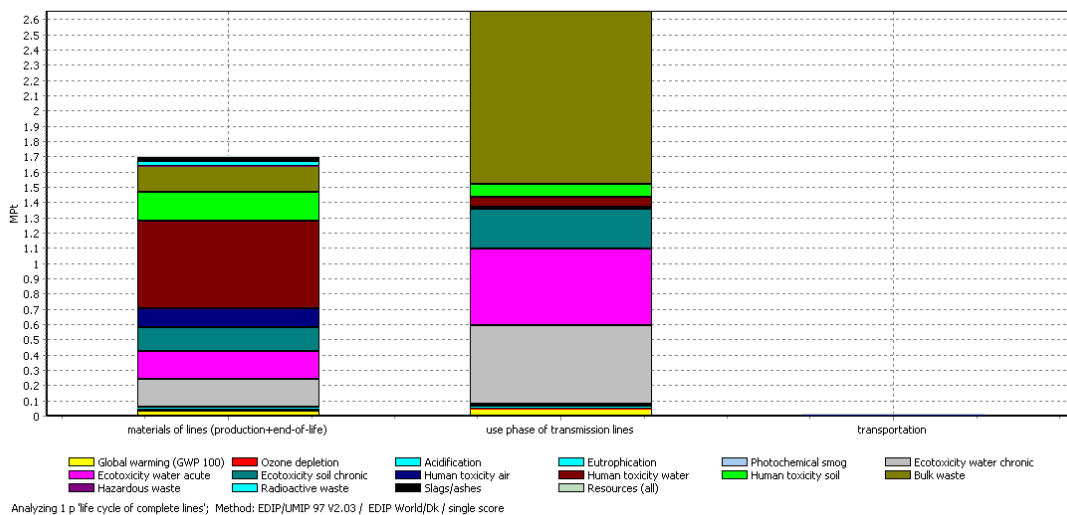

Fig. 3-14 : Single score result of Venezuelan 765 kV AC transmission lines (Integrating the materials production phase and end-of-life phase into the impacts of materials)

Through the LCA, it's known that energy losses due to Joule effects of conductors are the largest part of environmental impacts of the transmission lines, and the materials can not be ignored either. If we are going to think of ways to decrease transmission lines' environmental impacts, focus should first be put on the methods of reducing energy losses of conductors and materials used in the lines. Sometimes it's hard to decrease the amount of materials used to construct transmission lines, then reducing the energy losses is the best way to improve the transmission lines' environment burdens.

Fig. 3-15 shows the comparisons of individual component's environmental impacts (detailed value is shown in Annex B), it's indicated that bundle conductors have the most environmental impacts amongst all the investigated components, which is due to the energy losses during 60 years; towers shows comparable impacts as they consume a large amount of raw materials, especially steels, besides the process of recycling steel itself makes more impacts than it potentially reduces by useful recycled steel. The insulators and transportation phase are not the major sources of environmental impacts.

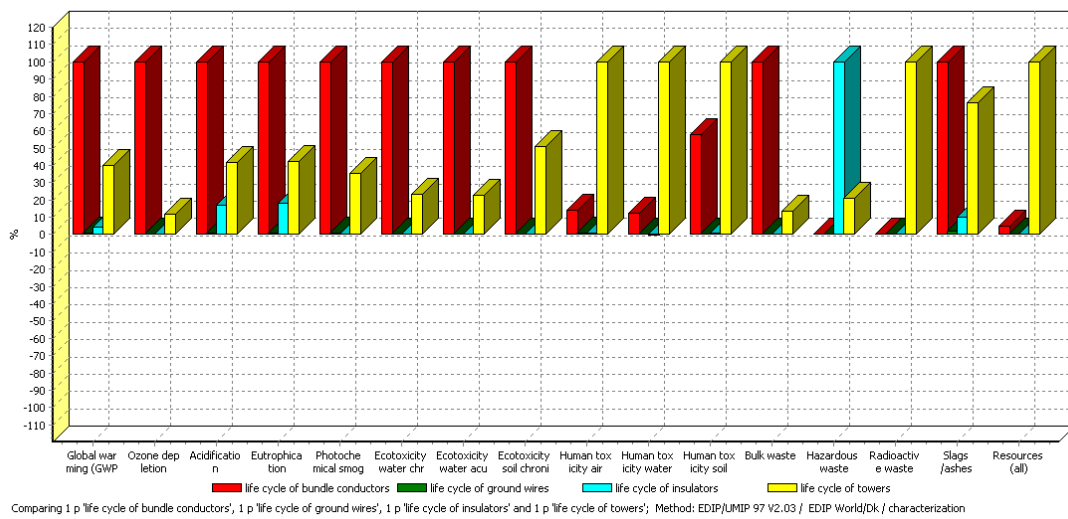

Fig. 3-15 : Environmental impacts comparisons of different components in transmission lines

### 3.2 Life Cycle Assessment of Equipments in Substations

#### 3.2.1 Life Cycle Assessment of Power Transformer

The main power transformer in the substations is shown in Fig. 3-16, which is 500 MVA autotransformer (765/400/20 kV) manufactured in Alstom Grid.



Fig. 3-16 : Illustration of autotransformer 765/400/20 kV, 500 MVA

The main materials used in one power transformer of this type are the listed in Table 3-12, the weight includes all parts of power transformer, such as screws, washers, etc, but package is **not** included in the system. In the LCA **no** processes are simulated for manufacturing of transformer, that is to say, environmental impacts during manufacturing phase are not included in this study.

Table 3-12 : Materials in 765/400/20 kV power transformer

Materials	Weight (ton)	Percentage (%)
Steel	131.3	58.88
Oil (no PCB)	50	22.42
Copper	26.6	11.93
Pressboard+paper	11.7	5.25
Wood	1	0.45
Porcelain	1	0.45
Others	1.4	0.63
Total	223	100

This type of transformer was manufactured in France, so the transportation phase is modeled as 1000 km by truck and 7000 km by ship.

The use phase of power transformer is defined as electrical energy losses during its designed expected lifespan of **60** years. The electrical energy losses vary with load current, and it's determined by Eq. 3-1.

$$P_T = \left[ (P_{LL}) \times (\%L)^2 + P_{NL} \right] \times 24 \times 365 \times lifespan \quad (\text{Eq. 3-1})$$

in which :

$P_T$  – total energy losses

$P_{LL}$  – copper loss = 650 kW

$P_{NL}$  – no-load loss = 165 kW

$\%L$  – load factor

The average load factor is **60%** in the transmission system, according to the Eq. 3-1, total energy loss in use phase is  $2.1 \times 10^6$  kWh. Total primary energy consumption depends on the means used for the production of electricity, in this case, generation method is hydro-electric.

In the end-of-life phase, different waste treatment measures are simulated. As to transformer oil, usually oil is extracted on site for heavy power transformers or on disassembly site for light ones and other products. Then, if oil quality is sufficient (80% of the time), it is regenerated with a regeneration rate of 97%. Otherwise, it is used as fuel in cement plants. Ratios of incineration and recycling are given by SRRHU (oil recycler). In this case, as the oil quality is sufficient (with 50 t mineral oil per transformer), then the end-of-life of mineral oil is modeled as: before dismantling, the mineral oil contained in the transformer is drained on site and then is regenerated. 97% of original amount of mineral oil is regenerated. Oil sludge of pressboard and paper is modeled to be sent to special waste incinerator. Distribution of oil is not taken into account. After regeneration, oil may be sent in different industries like metallurgy, building and cement factories [62].

The impregnated papers and pressboards are difficult to be recycled, these materials are strongly impregnated with the transformer oil, and consequently they are destroyed by incineration. For phenolic plastic laminated wood the recycling solution is difficult, consequently they are destroyed by incineration. Copper and steel are recycled.

The characterization result is shown in Fig. 3-17, and detailed value is shown in Annex B. In Fig. 3-18 the environmental impacts of materials (production and end-of-life are integrated), transport, energy losses and foundations are compared, it's noticed that the energy losses is dominating environmental impacts on many indicators, and foundations only yields to a few impacts.



Fig. 3-17 : Characterization result of 765/400/20 kV, 500 MVA power transformer

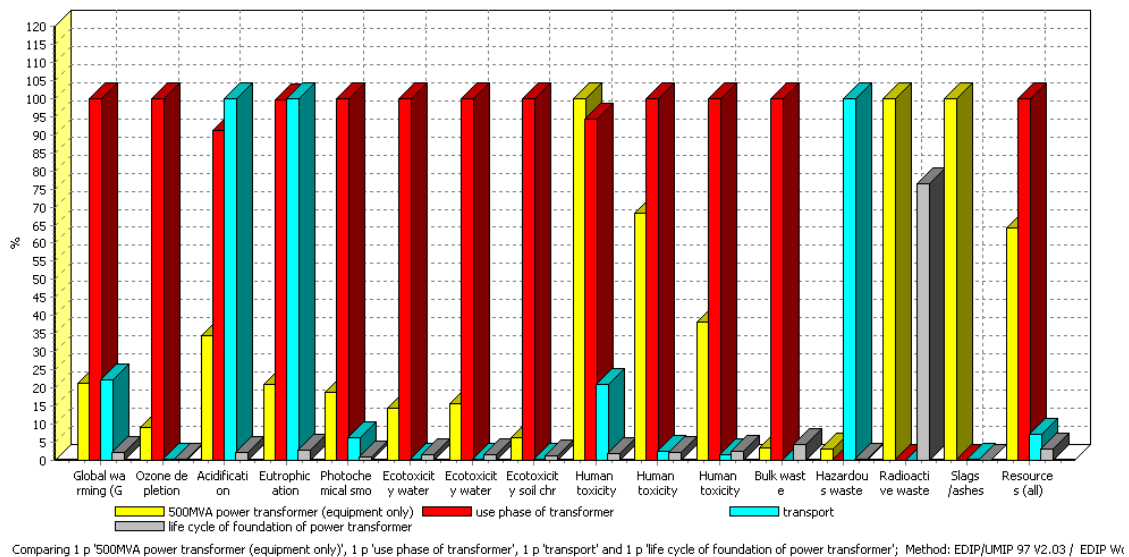

Fig. 3-18 : Environmental impacts comparisons of different life stages of power transformer (including life cycle of foundations)

### 3.2.2 Life Cycle Assessment of Circuit Breakers

FX42 (without closing resistor), FX42D (with closing resistor = 360 ohms), FX42D (with closing resistor = 5040 ohms), these 3 types of 800 kV AC circuit breakers are utilized in substations, which were all manufactured in Alstom Grid. Actually, the difference between FX42 and FX42D is that as for FX42D, it has one more extra

component – closing resistor, which is to permit system damping of over-voltage due to closing on unloaded long lines. Except for closing resistor (which is only about 0.5% of the total weight of FX42), the rest of these 3 types circuit breakers are the same.

Fig. 3-19 shows FX42D circuit breakers. The FX42 range is air-insulated circuit breaker, and there are 4 interrupting chambers per phase, which contains the contacts system and SF<sub>6</sub> inside as interrupting media.



Fig. 3-19 : FX42D circuit breakers

The main characteristics of FX42 range circuit breakers are:

Type: FX42, FX42D

Rated voltage: 800 kV

Rated Current: 4000 A

Breaking capacity: 50 kA

Operating mechanism: hydraulic

The main materials in these circuit breakers are listed in Table 3-13 to Table 3-15, the weight does **not** include operating mechanism, packages or supporting frame. The total weight is for a combination of circuit breakers for all 3 phases.



Table 3-13 : Materials in FX42

Materials	Total weight (kg)	
Aluminium	1609.9	
Steel	409.5	
Stainless steel	110.9	
Cast iron	1232.6	
Copper-Tungsten alloy (20/80)	10.2	
Copper-Tungsten alloy (40/60)	20.8	
Copper	135.4	
Brass	5.9	
Bronze	2.1	
Porcelain	9031.2	
Epoxy	32.4	
PE (Polyethylene)	7.3	
EPDM (Ethylene Propylene Diene Monomer)	3.2	
Cardboard	0.4	
PTFE (Polytetrafluoroethylene)	10.5	
SF <sub>6</sub> (Sulphur hexafluoride)	circuit breaker volume	120
	emission in manufacture	1.2
	emission in maintenance	1.2
	refill in 40 years	24
Total	12769	

The percentages of the different categories of materials in FX42 circuit breaker are:

- metals : nearly 27.7% of the total mass of the product;
- porcelain: nearly 70.7% of the total mass of the product;
- polymers : nearly 0.4% of the total mass of the product;
- SF<sub>6</sub> : nearly 1.1% of the total mass of the product.

Table 3-14: Materials in FX42D (closing resistor = 360 ohms)

Materials	Total weight (kg)
Aluminium	1633.9
Steel	409.5
Stainless steel	114.5
Cast iron	1232.6
Copper-Tungsten alloy (20/80)	10.2
Copper-Tungsten alloy (40/60)	20.8
Copper	135.4

Brass	5.9	
Bronze	2.1	
Porcelain	9031.2	
Epoxy	34.8	
PE (Polyethylene)	7.3	
EPDM (Ethylene Propylene Diene Monomer)	3.2	
cardboard	0.4	
PTFE (Polytetrafluoroethylene)	10.5	
Carbon ceramic	17.1	
SF <sub>6</sub> (Sulphur hexafluoride)	circuit breaker volume	120
	emission in manufacture	1.2
	emission in maintenance	1.2
	refill in 40 years	24
Total	12816	

Table 3-15 : Materials in FX42D (closing resistor = 5040 ohms)

Materials	Total weight (kg)	
Aluminium	1633.9	
Steel	409.5	
Stainless steel	114.5	
Cast iron	1232.6	
Copper-Tungsten alloy (20/80)	10.2	
Copper-Tungsten alloy (40/60)	20.8	
Copper	135.4	
Brass	5.9	
Bronze	2.1	
Porcelain	9031.2	
Epoxy	34.8	
PE (Polyethylene)	7.3	
EPDM (Ethylene Propylene Diene Monomer)	3.2	
cardboard	0.4	
PTFE (Polytetrafluoroethylene)	10.5	
Carbon ceramic	34.2	
SF <sub>6</sub> (Sulphur hexafluoride)	circuit breaker volume	120
	emission in manufacture	1.2
	emission in maintenance	1.2
	refill in 40 years	24
Total	12833	

On site circuit breakers are erected on steel supporting frames, which are connected to the reinforced concrete base, the supporting frame and reinforced concrete have to be considered in the LCA.

Table 3-16 shows the materials for supporting frames; the Zn Coating weight is calculated by taking into account 0.61 kg/m<sup>2</sup> of Zn to supporting frame's surface area [63]. The weight of foundation for circuit breaker (3 phases) is 86.2 ton.

Table 3-16 : Supporting frames (3 phases) for 765 kV circuit breaker

Materials	Weight (ton)
Steel	3.54
Zinc coating	0.051

In the LCA **no** processes are simulated for manufacturing of circuit breakers, however, a rate of 1% of SF<sub>6</sub> leakage during manufacturing is taken into account, which is 1.2 kg.

All these 3 types of circuit breakers were manufactured in France, the transportation phase is modeled as 1000 km by truck and 7000 km by ship.

During the service life of 40 years of circuit breaker, the use phase of circuit breaker is defined as SF<sub>6</sub> leakage and energy loss of circuit breaker.

SF<sub>6</sub> leakage (Table 3-17) is one important factor of environmental impact, during the life of 40 years of circuit breaker, the leakage rate is 0.5% per annum, then the in-service SF<sub>6</sub> loss is 24 kg; and maintenance occurs once during its working life, with a leakage of SF<sub>6</sub> at rate of 1%.

As to the energy loss, a realistic hypothesis is made for evaluation, that circuit breaker operates at 80% of the time in 25% of I<sub>N</sub> and at 20% of the time in 60% of I<sub>N</sub>, that is

to say, it operates in 1 kA at 80% of time and at the rest time it's in 2.4 kV [64].

Table 3-17 : Total SF<sub>6</sub> leakage in life cycle of circuit breakers (3 phases)

Leakage types	Rate	Amount
Leakage during manufacture & commissioning	1%	1.2 kg
in-service leakage	0.5% per annum	24 kg
Maintenance leakage	1%	1.2 kg
Dismantling leakage	1%	1.2 kg

In the service life of 40 years, taking in account parameters shown in Table 3-18, electrical energy losses of 3 phases 800 kV circuit breakers are shown in Table 3-19.

Table 3-18 : Electrical parameters of FX42 range circuit breakers

Nominal voltage	800 kV
Nominal current	4000 A
Resistance of current path per phase	168 μΩ

Table 3-19 : Electrical energy losses of 3 phases circuit breakers in use phase

	Time (hour)	Power losses (W)	Energy losses (kWh)
80% of service life	350400	504	176602
20% of service life	87600	2903	254306
total energy loss (kWh)			430908

In the end-of-life phase, different waste treatment measures are simulated. SF<sub>6</sub> is extracted from the circuit breaker, and sent to special treatment company, to be regenerated (90% of the time). Otherwise, it is burned in special waste incinerator. Ratios of incineration and recycling are given by AVANTEC ( SF<sub>6</sub> recycler company). In this case, distribution is not taken into account.

Copper, steel and aluminium are recycled. PTFE is sent to dangerous waste landfill, PE, EPDM and Epoxy are incinerated. Porcelains are landfilled, and remains are incinerated.

The characterization result is shown in Fig. 3-20, and detailed value is shown in Annex B. It's noticed that the SF<sub>6</sub> has the most CO<sub>2</sub>-equivalent impact, energy loss of circuit breaker gives a few impacts.

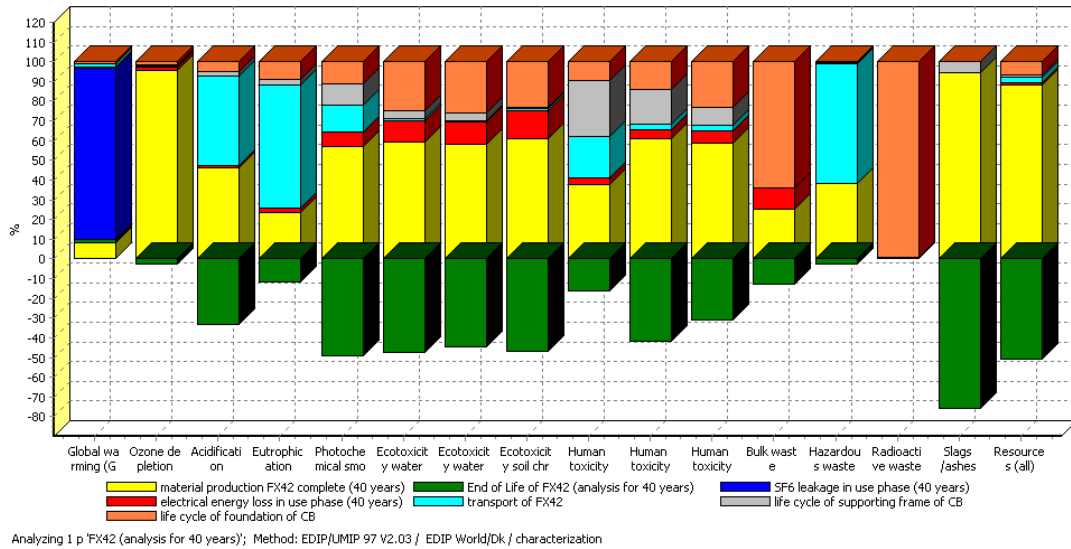

Fig. 3-20 : Characterization result of circuit breakers FX42 (3 phases)

### 3.2.3 Life Cycle Assessment of Surge Arresters

In the substations, 3 kinds of surge arresters are used, namely PS2B 612 Z for (765 kV), PSB 396 Z (for 400 kV), PSB 228 Z (for 230 kV), they are gapless and porcelain housed surge arresters.

The main materials used in surge arresters are listed in Table 3-20 to Table 3-22, the weight includes all parts of surge arrester, such as screws, washers, etc, but package is **not** included. The materials of supporting frames of the surge arresters are shown in Table 3-23.

Table 3-20 : Materials for 765 kV surge arrester PS2B 612 Z

Materials	Weight (kg)	Percentage (%)
Porcelain	680	62.9
ZnO (MOV blocks)	212	19.6
Aluminium	129	11.9

Steel	44	4.1
Epoxy	14.4	1.3
EPDM	1.0	0.1
Total	1080.4	100

Table 3-21 : Materials for 400 kV surge arrester PSB 396 Z

Materials	Weight (kg)
Steel	29.0
Aluminium	44.7
Porcelain	260
ZnO (MOV blocks)	25.2
Epoxy	4.56
EPDM	0.488
Total	364

Table 3-22 : Materials for 230 kV surge arrester PSB 228 Z

Materials	Weight (kg)
Steel	28.3
Aluminium	38.5
Porcelain	260
ZnO (MOV blocks)	14
Epoxy	3.04
EPDM	0.488
Total	345

Table 3-23 : Supporting frame for these 3 voltage level surge arresters

Materials	Weight (ton)
Steel	0.73
Zinc coating	0.013

These 3 types surge arresters were manufactured in France, so the transportation phase is modeled as 1000 km by truck and 7000 km by ship.

The use phase of 765 kV surge arrester is set as the energy loss due to its resistive leakage current. The resistive leakage current is approximately assumed as 0.3 mA [65], and it operates at  $765/\sqrt{3}$  kV line-to-ground voltage, so the power loss is 132

W, and during its service life of 30 years the energy loss is  $3.48 \times 10^4$  kWh.

As to 400 kV the resistive leakage current is also approximately assumed as 0.3 mA, and it operates at  $400/\sqrt{3}$  kV line-to-ground voltage, so the power loss is 69 W, and during its service life of 30 years the energy loss is  $1.82 \times 10^4$  kWh.

The same resistive leakage current is approximately assumed to 230 kV surge arrester, which is 0.3 mA, and it operates at  $230/\sqrt{3}$  kV line-to-ground voltage, so the power loss is 40 W, and during its service life of 30 years the energy loss is  $1.05 \times 10^4$  kWh.

In the end-of-life phase, Porcelain (including ZnO MOV) is landfilled; aluminum and steel are recycled; EPDM and Epoxy are incinerated, and remains are incinerated.

The characterization result is shown in Fig. 3-21 to Fig. 3-23, and detailed values are shown in Annex B. It's noticed that the foundations have the most environmental impacts.

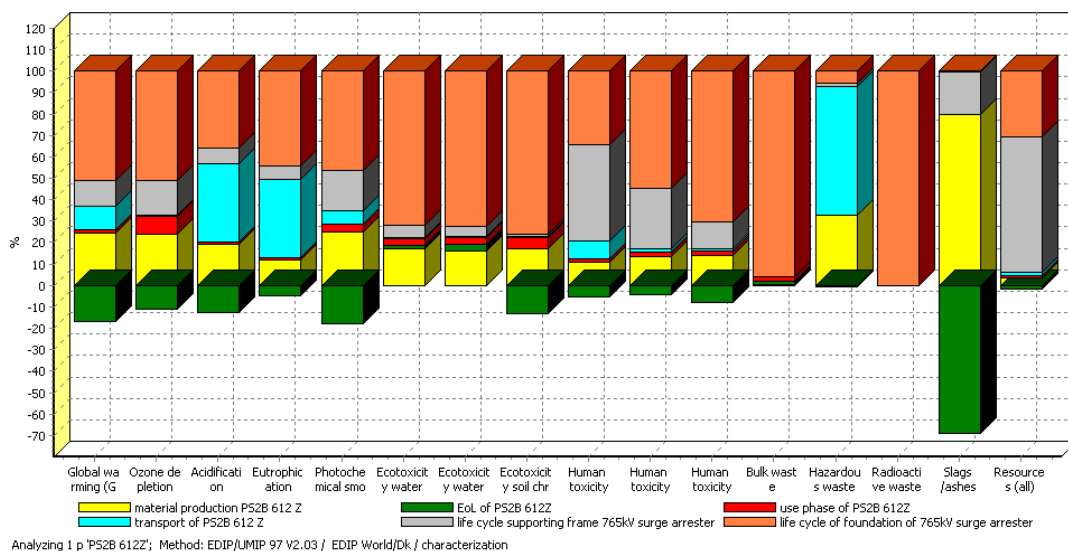

Fig. 3-21 : LCA result of 765 kV surge arrester

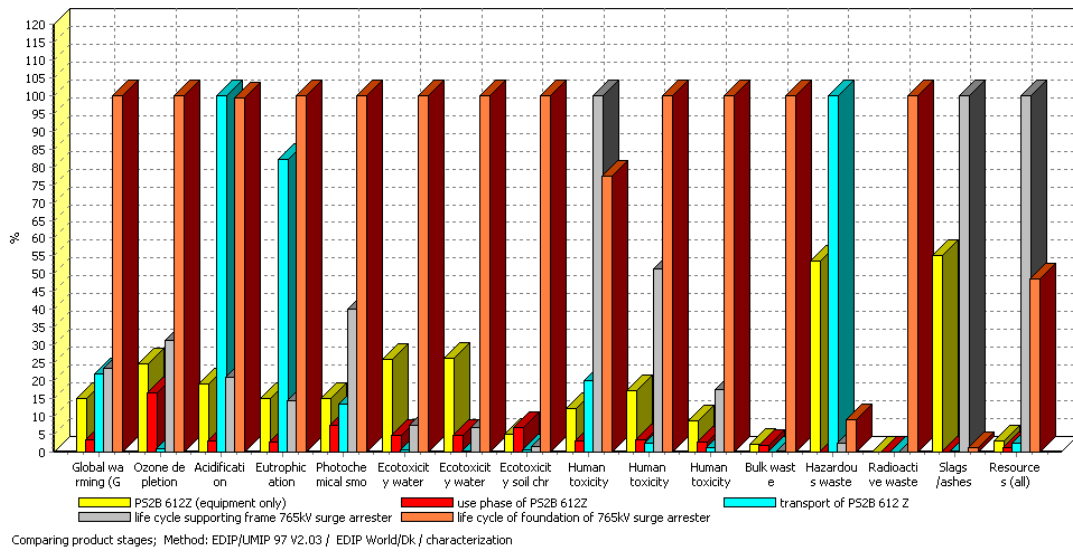

Fig. 3-22 : Characterization result of 765 kV surge arrester (comparison)

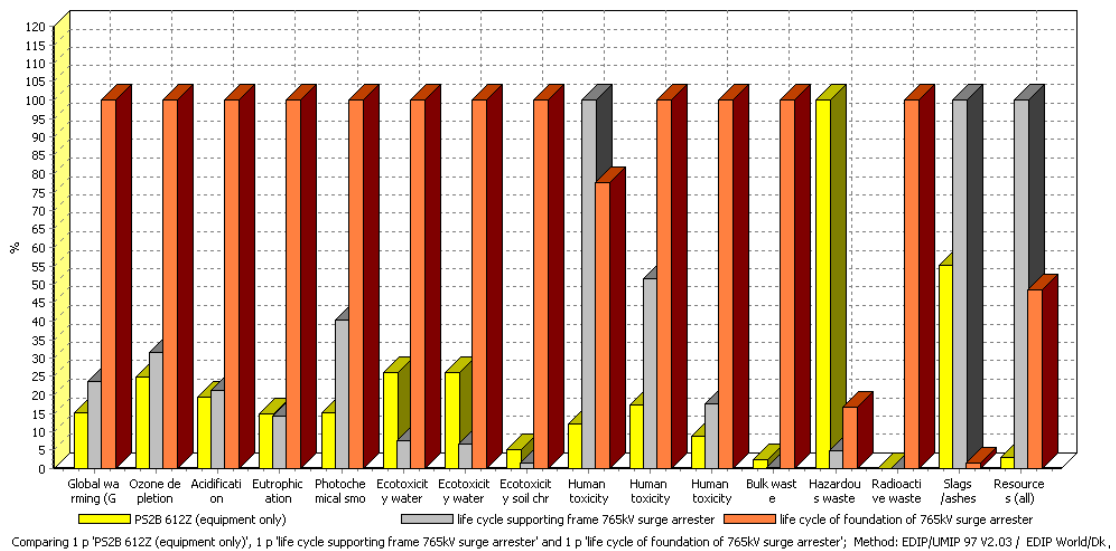

Fig. 3-23 : Environmental impacts comparisons of 765 kV surge arrester, supporting frame and foundations

### 3.2.4 Life Cycle Assessment of Current Transformers

The current transformers in substations are 765 kV Alstom IH800-13, 400 kV Alstom IH420-12 and 230 kV Alstom IH245-12 current transformers, as it's hard to get their data, current transformer OSKF 765 (see Fig. 3-24), OSKF 420 and OSKF 245 made in Alstom Grid are used as substitution, respectively.





Fig. 3-24 : Alstom OSKF 765 current transformer

Table 3-24 lists the materials of one OSKF 765 current transformer, and the weight of foundation for one Alstom IH800-13 is 39.56 ton. Table 3-25 shows the supporting frame for one 765 kV current transformer.

Table 3-24 : Materials of OSKF 765 current transformer

Materials	Weight (kg)	Percentage (%)
Porcelain	1144	32.7
Mineral Oil	784	22.4
Steel	695	19.8
Pressboard+paper	312	8.9
Aluminium	306	8.8
Copper	215	6.1
Epoxy resin	25	0.7
Wood	4	0.1
Polyamide 6 (PA6)	2.1	0.1
Zinc	1	0.03
Others	11.3	0.32
Total	3500	100

Table 3-25 : Supporting frame for one Alstom IH800-13 current transformer

Materials	Weight (ton)
Steel	1.28
Zinc coating	0.017

Table 3-26 lists the materials of one OSKF 420 current transformer, Table 3-27 lists the supporting frame for one 400 kV current transformer, and the weight of foundation for one Alsthom IH420-12 is 21 ton.

Table 3-26 : materials in OSKF 420 current transformer

Materials	Weight (kg)	Percentage (%)
Porcelain	550	32.7
Mineral Oil	377	22.4
Steel	334	19.8
Pressboard+paper	150	8.9
Aluminium	147.3	8.8
Copper	103.4	6.1
Epoxy resin	12	0.7
Wood	2	0.1
Polyamide 6 (PA 6)	1	0.1
Zinc	0.5	0.03
Others	5.5	0.3
Total	1682.7	100

Table 3-27 : Supporting frame for current transformer Alsthom IH420-12

Materials	Weight (ton)
Steel	0.92
Zinc coating	0.009

Table 3-28 shows materials for one 230 kV current transformer, Table 3-29 lists the supporting frame for one 230 kV current transformer, and the weight of foundation for one Alsthom IH245-12 is 9.9 ton.

Table 3-28 : Materials of one OSKF 245 current transformer

Materials	Weight (kg)	Percentage (%)
Porcelain	253.3	32.7
Mineral Oil	173.6	22.4
Steel	153.9	19.9
Pressboard+paper	69.1	8.9
Aluminium	67.8	8.7
Copper	47.6	6.1

Epoxy resin	5.5	0.7
Wood	0.9	0.1
Polyamide 6 (PA6)	0.5	0.1
Zinc	0.2	0.03
Others	2.5	0.3
Total	774.9	100

Table 3-29 : Supporting frame for one Alsthom IH420-12 current transformer

Materials	Weight (ton)
Steel	0.42
Zinc coating	0.005

All current transformers were manufactured in France, so the transportation phase is modeled as 1000 km by truck and 7000 km by ship.

The use phase of one 765 kV current transformer is assumed to be the load of secondary winding, which is 8 VA continuously. The load is largely resistive, so during its service life of 30 years, the energy loss is 2104 kWh.

The use phase of one 400 kV current transformer is assumed to be the load of secondary winding, which is 7 VA continuously. The load is largely resistive, so during its service life of 30 years, the energy loss is 1840 kWh.

The use phase of one 230 kV current transformer is assumed to be the load of secondary winding, which is 6 VA continuously. The load is largely resistive, so during its service life of 30 years, the energy loss is 1577 kWh.

In the end-of-life phase, porcelain is landfilled; mineral oil is treated in the same way as transformer oil stated in power transformer; steel, copper and aluminium are recycled; reinforced bar in concrete is recycled, the rest is landfilled; the pressboard, paper, epoxy and PA6 are incinerated; the rest is incinerated.

The characterization result is shown in Fig. 3-25, and detailed value is shown in Annex B.

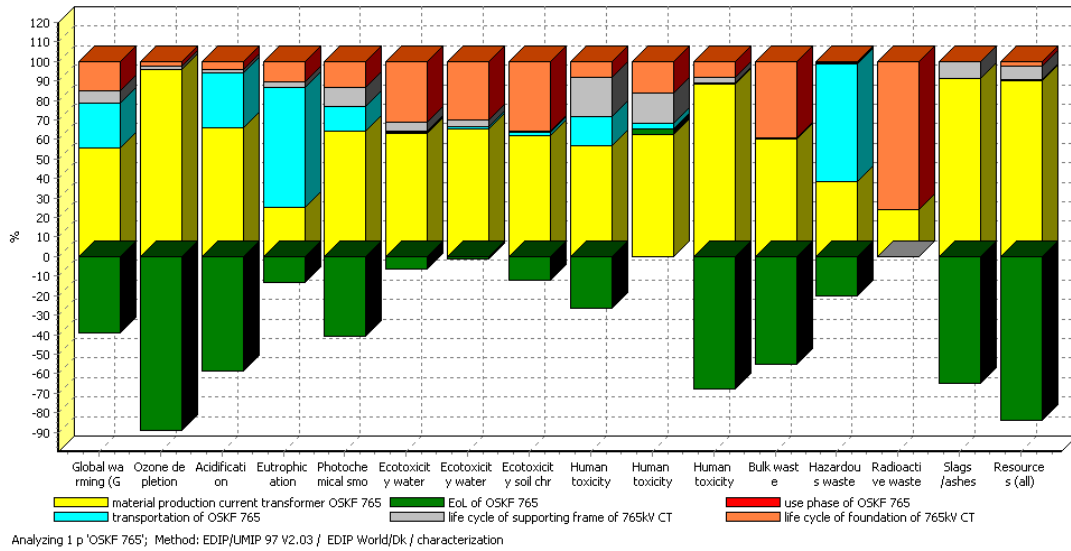

Fig. 3-25 : LCA result of OSKF 765 current transformer

In Fig. 3-26 the environmental impacts comparisons are shown, materials of OSKF 765 (materials production and end-of-life are integrated), transport, energy loss, supporting frame and foundations are compared with view to their environmental impacts, it's seen that materials of current transformer and transportations impact more, while the energy loss is rather negligible.

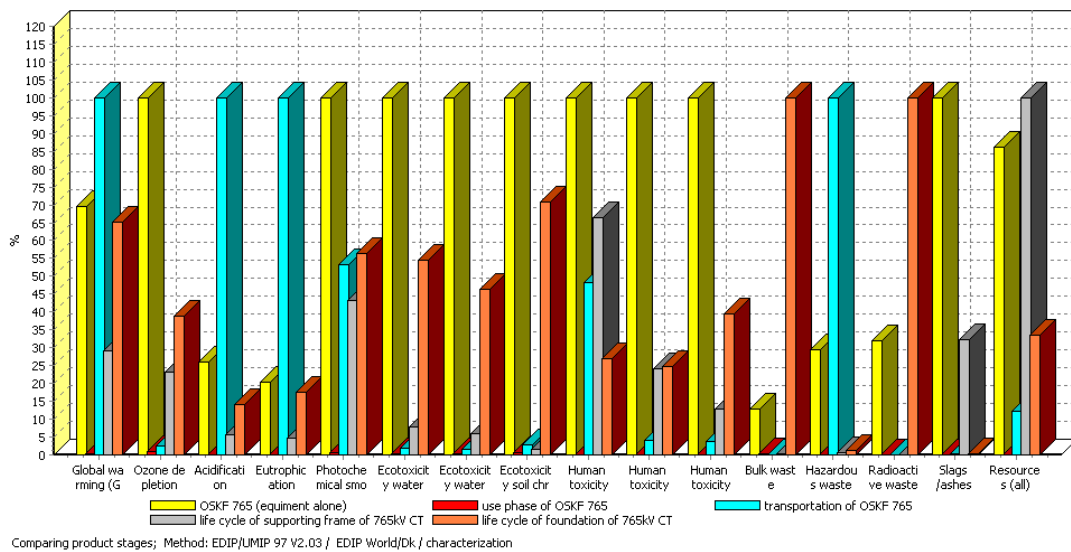

Fig. 3-26 : Environmental impacts comparisons of different life stages of OSKF 765 current transformer (including life cycle of supporting frame & foundations)

In Fig. 3-27 the life cycle of current transformer, supporting frame and foundations are compared, and the results indicate that the current transformer itself has more environmental impacts than supporting frame and foundations.

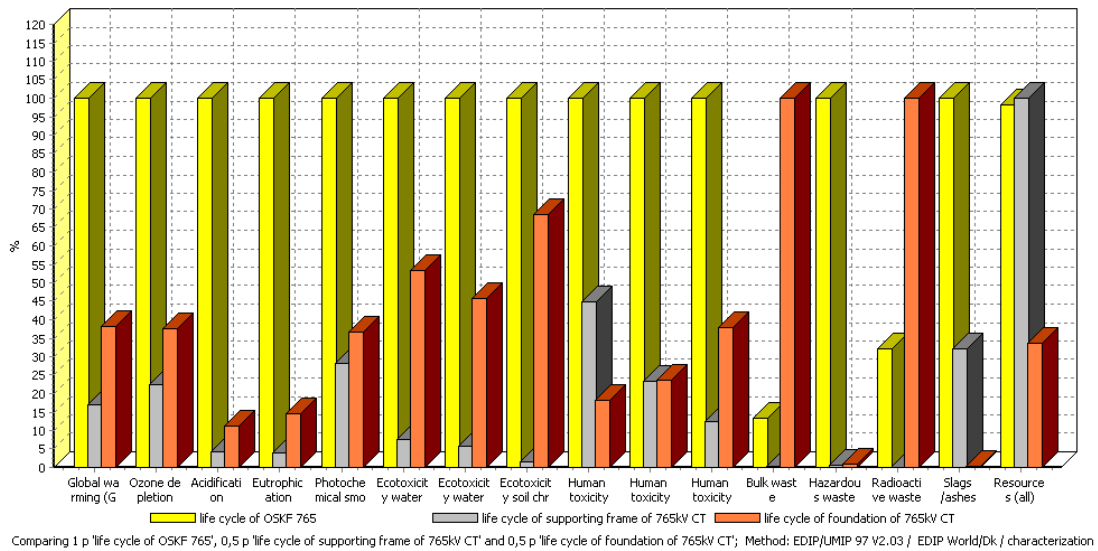

Fig. 3-27 : Environmental impacts comparisons of OSKF 765 current transformer, life cycle of supporting frame and foundations

### 3.2.5 Life Cycle Assessment of Voltage Transformers

#### 3.2.5.1 Life Cycle Assessment of Capacitor Voltage Transformer

The type of 765 kV capacitor voltage transformer in substations is Alstom UHC800, as it's hard to get its data, capacitor voltage transformer OTCF 765 (Fig. 3-28) made in Alstom is used as substitution.

Table 3-30 lists the materials of one OTCF 765 current transformer and Table 3-31 shows the supporting frame, and foundation for one original capacitor transformer Alstom UHC800 is 15.68 ton.

This voltage transformer is manufactured in France; the transportation phase is modeled as 1000 km by truck and 7000 km by ship.



Fig. 3-28 : Alstom OTCF current transformer

Table 3-30 : Materials in one OTCF 765 capacitor voltage transformer

Materials	Weight (kg)	Percentage (%)
Porcelain	518.5	52.2
Aluminium	146.3	14.7
Synthetic oil	111.8	11.3
Steel	99.3	10
Polypropylene (PP)	42.8	4.3
Glass fiber	34.2	3.4
Pressboard+paper	24.2	2.4
Epoxy resin	2.7	0.27
PET	1.5	0.15
Brass	0.7	0.07
Copper	0.6	0.06
Polyamide 6 (PA6)	0.4	0.04
Others	9.5	1.11
Total	992.5	100

Table 3-31 : Supporting frame for one Alstom UHC800 capacitor transformer

Materials	Weight (ton)
Steel	1.27
Zinc coating	0.017

The use phase of capacitor voltage transformer is assumed to be the load of secondary winding, which is 5 VA continuously. The load is largely resistive, so during its service life of 30 years, the energy loss is 1314 kWh.

In the end-of-life phase, porcelain is landfilled; synthetic oil is simulated according to the same treatment as transformer oil stated in power transformer; aluminum, steel, copper and brass are recycled; reinforced bar in concrete is recycled, the rest is landfilled; the pressboard, paper, epoxy, PET, PP and PA6 are incinerated; the rest is incinerated.

The characterization result is shown in Fig. 3-29. In Fig. 3-30 the life cycle of capacitor voltage transformer, supporting frame and foundations are compared.

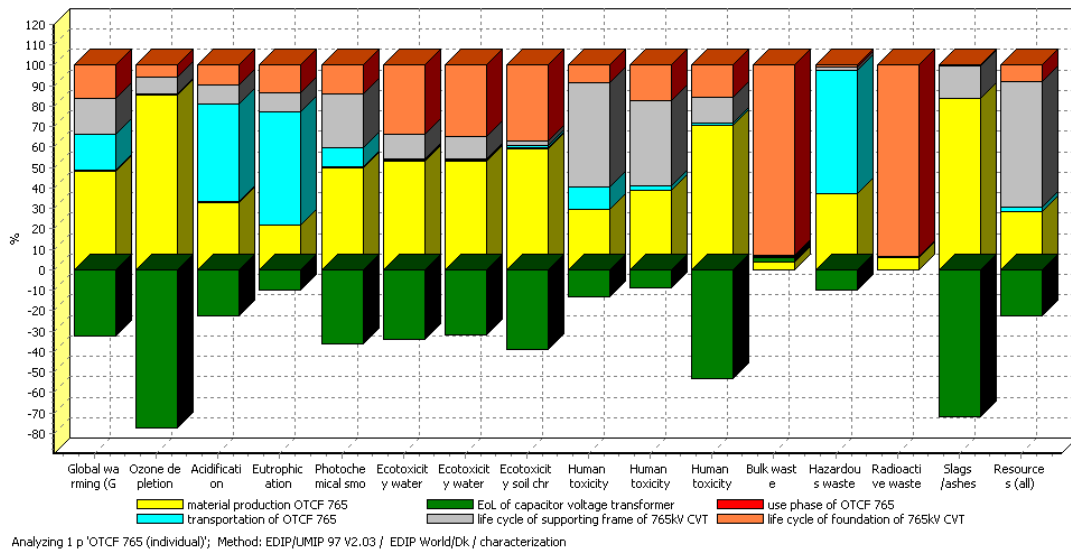

Fig. 3-29 : LCA result of OTCF 765 capacitor voltage transformer

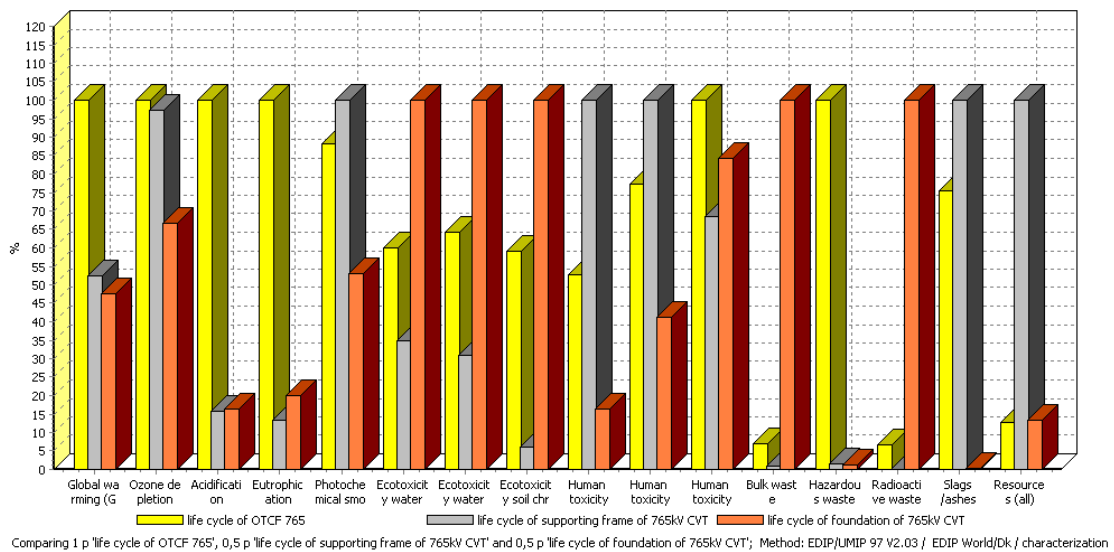

Fig. 3-30 : Environmental impacts comparisons of OTCF 765 capacitor voltage transformer, life cycle of supporting frame and foundations

Fig. 3-31 shows the environmental impacts comparisons of different life stages of OTCF 765.

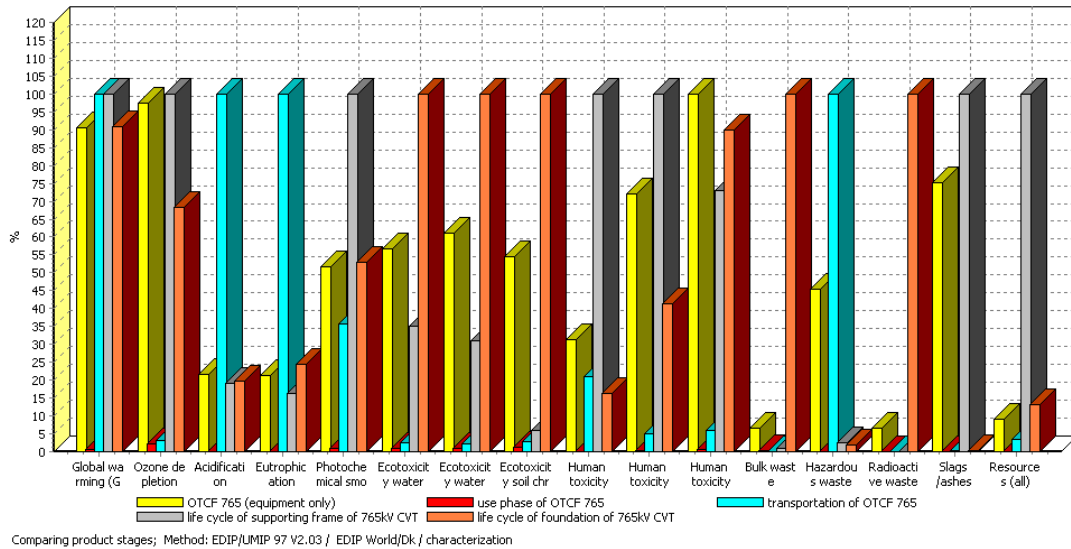

Fig. 3-31 : Environmental impacts comparisons of different life stages of OTCF 765 capacitor voltage transformer (including life cycle of supporting frame & foundations)

### 3.2.5.2 Life Cycle Assessment of Inductive Voltage Transformers

Besides the capacitor voltage transformers, the inductive type voltage transformers are also used.

The inductive voltage transformers in substations are 765 kV Alstom UH800, 400 kV Alstom UH420 and 230 kV Alstom UH245 inductive voltage transformers, as it's hard to get their data, inductive voltage transformer OTEF 765 (see Fig. 3-32), OTEF 420 and OTEF 245 made in Alstom Grid are used as substitution for calculation, respectively.

Table 3-32, Table 3-34, Table 3-36 list the materials of one inductive voltage transformer OTEF 765, OTEF 420 and OTEF 245, respectively. Table 3-33, Table 3-35, Table 3-37 show the supporting frame for one 765 kV inductive voltage



transformer, one 420 kV inductive voltage transformer and one 245 kV inductive voltage transformer, respectively. The weight of foundation for one Alstom UH800 voltage transformer is 33.08 ton, 19 ton for one 420 kV inductive voltage transformer, and 8.9 ton for one 245 kV inductive voltage transformer.



Fig. 3-32 : Illustration of Alstom OTEF inductive voltage transformer

Table 3-32 : Materials of one OTEF 765 inductive voltage transformer

Materials	Weight (kg)	Percentage (%)
Porcelain	929	32.5
Mineral Oil	714	25
Steel	682	23.9
Aluminium	200	7
Pressboard+paper	179	6.3
Copper	116	4.1
Brass	17.9	0.6
Epoxy resin	8.9	0.3
Others	10	0.4
Total	2856.8	100

Table 3-33 : Supporting frame for one 765 kV inductive voltage transformer

Materials	Weight (ton)
Steel	1.33
Zinc coating	0.019

Table 3-34 : Materials of one OTEF 420 inductive voltage transformer

Materials	Weight (kg)	Percentage (%)
Porcelain	520	32.4
Mineral Oil	400	24.9
Steel	382	23.8
Aluminium	112	7
Pressboard+paper	100	6.2
Copper	65	4.1
Brass	10	0.6
Epoxy resin	5	0.3
Others	10	0.6
Total	1604	100

Table 3-35 : Supporting frame for one 420 kV inductive voltage transformer

Materials	Weight (ton)
Steel	0.84
Zinc coating	0.012

Table 3-36 : Materials of one OTEF 245 inductive voltage transformer

Materials	Weight (kg)	Percentage (%)
Porcelain	240	32.4
Mineral Oil	184	24.9
Steel	176	23.8
Aluminium	52	7
Pressboard+paper	46	6.2
Copper	30.2	4.1
Brass	4.4	0.6
Epoxy resin	2.2	0.3
Others	5	0.7
Total	740	100

Table 3-37 : supporting frame for one 245 kV inductive voltage transformer

Materials	Weight (ton)
Steel	0.38
Zinc coating	0.005

All inductive voltage transformers were manufactured in France, so the transportation phase is modeled as 1000 km by truck and 7000 km by ship.

The use phase of inductive voltage transformer is assumed to be the load of secondary winding, which is 4 VA continuously for these 3 voltage levels, say, 765 kV, 400 kV and 230 kV. The load is largely resistive, so during its service life of 30 years, the energy losses are 1051 kWh.

In the end-of-life phase, porcelain is landfilled; mineral oil is simulated according to the same treatment as transformer oil stated in power transformer; aluminum, steel, copper and brass are recycled; reinforced bar in concrete is recycled, the rest is landfilled; the pressboard, paper and epoxy, are incinerated; the rest is incinerated.

The characterization result of OTEF 765 voltage level inductive voltage transformers is shown in Fig. 3-33 and Fig. 3-34, and detailed value is shown in Annex B.

Environmental impacts comparisons of OTEF 765, OTEF 420 OTEF 245 (supporting frames and foundations are included) are shown in Fig. 3-35, it indicates that the OTEF 420's environmental impacts are 57.4% of OTEF 765's, and OTEF 245's is 26.6% of OTEF 765's.

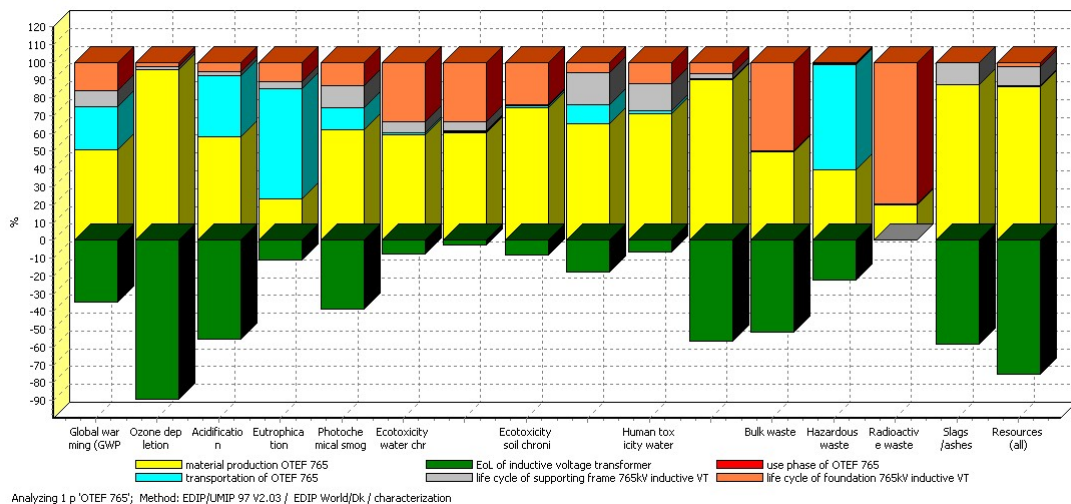

Fig. 3-33 : Characterization result of OTEF 765 inductive voltage transformer

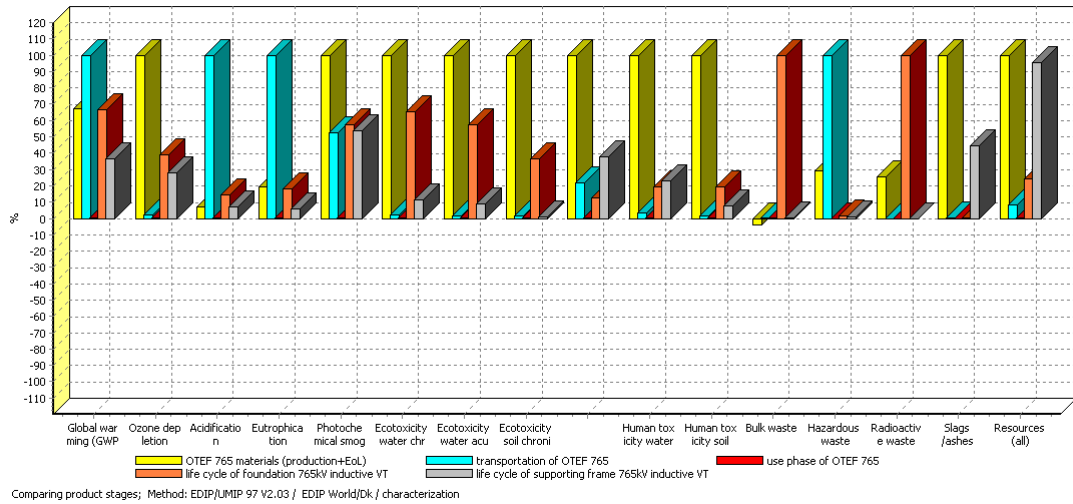

Fig. 3-34 : Environmental impacts comparisons of different life stages of OTEF 765 (including life cycle of supporting frame & foundations)

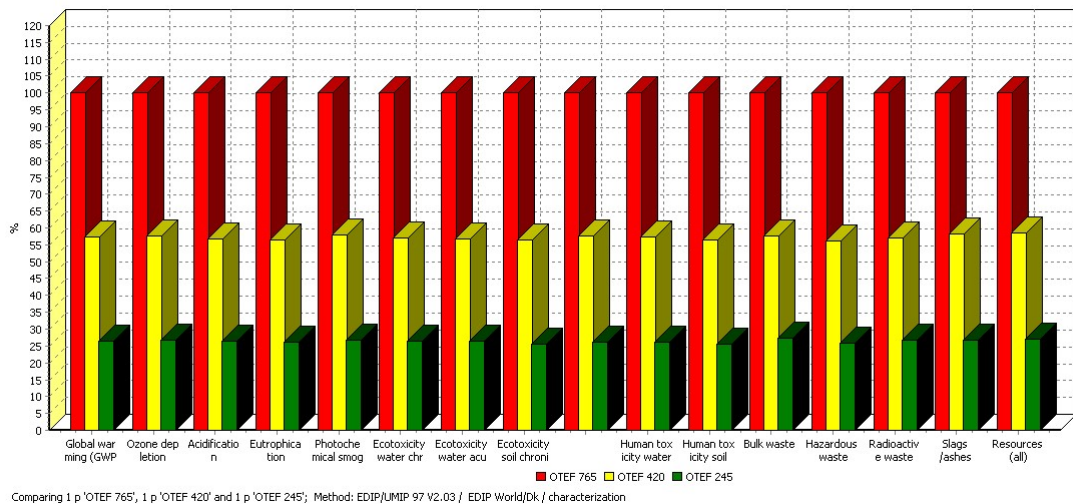

Fig. 3-35 : Comparisons of OTEF 765, OTEF 420 OTEF 245 (supporting frames and foundations are included)

### 3.2.6 Life Cycle Assessment of Shunt Reactor

765/ $\sqrt{3}$  kV, 100 MVar shunt reactors are used in order to compensate the reactive power in the transmission system. Table 3-38 lists the materials of one shunt reactor of this type.

Table 3-38 : Materials in one  $765/\sqrt{3}$  kV, 100 MVA shunt reactor

Materials	Weight (ton)	Percentage (%)
Steel	51.3	52.3
Mineral oil	30	30.6
Copper	7.6	7.8
Pressboard+paper	5	5.1
Wood	1	1.0
Porcelain	0.5	0.5
Others	2.6	2.7
Total	98	100

All shunt reactors were manufactured in Alstom in France, thus the transportation phase is modeled as 1000 km by truck and 7000 km by ship. The use phase is defined as the energy loss of shunt reactor, the total power loss of this type shunt reactor is 230 kW. As the energy loss shunt reactor is irrelevant to load profile of transmission system, and supposing that the shunt reactor is full-time energized, thus its energy loss during service life of 30 years is  $6.04 \times 10^4$  MWh. In the end-of-life phase, porcelain is landfilled; mineral oil is treated in the same way as transformer oil stated in power transformer; steel, copper are recycled; the pressboard, paper, and wood are incinerated; the rest is incinerated.

The characterization result of one shunt reactor is shown in Fig. 3-36

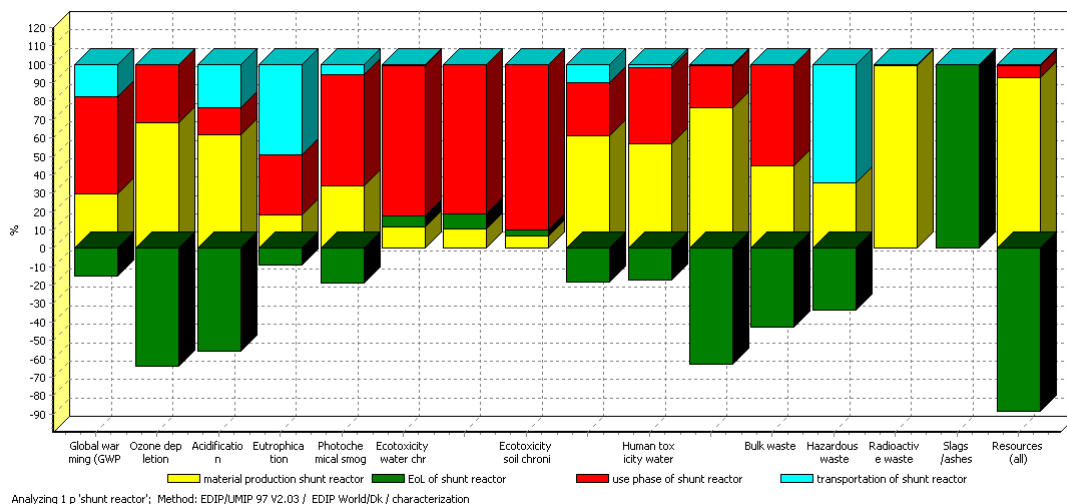

Fig. 3-36 : Characterization result of one shunt reactor

### 3.2.7 Life Cycle Assessment of Disconnecter

The 765 kV disconnectors equipped in substations were manufactured in Alstom in France, the transportation phase is modeled as 1000 km by truck and 7000 km by ship.

Table 3-39 lists the main materials used in one 765 kV disconnector. The weight of foundation for one 765 kV disconnector is 26.47 ton.

Table 3-39 : Materials in 765 kV disconnector

Materials	Weight (kg)	Percentage (%)
Porcelain	1796	69.8
Steel	588	22.8
Aluminium	147	5.7
Copper	17	0.7
Polyamide 6 (PA6)	1.1	0.04
Zinc	12	0.5
Others	12	0.5
Total	2573.1	100

Use phase is simulated as the Joule loss in one disconnector, which is evaluated to be 87 W, significantly lower than that of power transformer's. During its service life of 30 years the energy loss in disconnector is  $2.29 \times 10^4$  kWh.

As to the end-of-life phase, porcelain is landfilled; aluminum, steel and copper are recycled; reinforced bar in concrete is recycled, the rest is landfilled; PA6 are incinerated and remains are incinerated.

The characterization result of one 765 kV disconnector is shown in Fig.3-37.

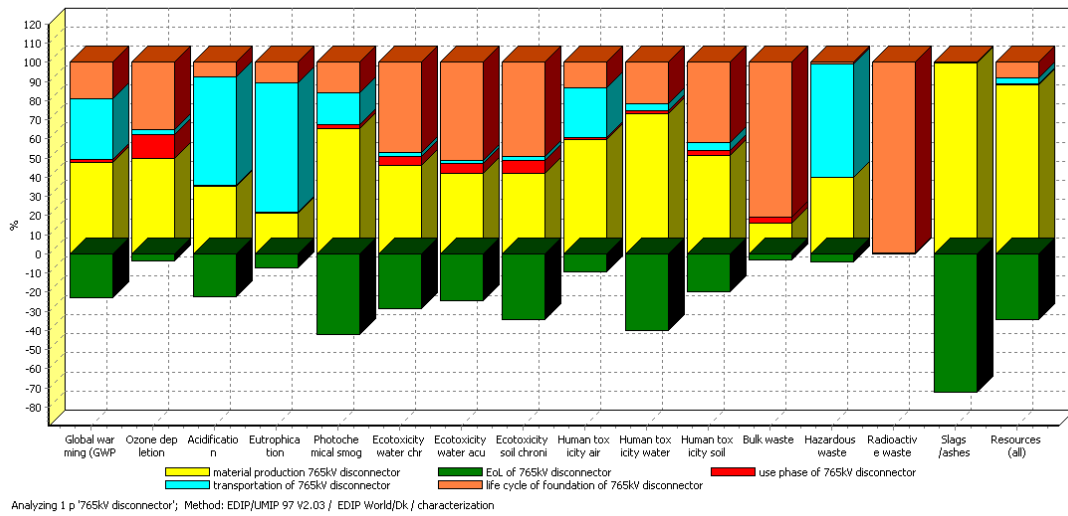

Fig. 3-37 : Characterization result of one 765 kV disconnecter

### 3.2.8 Life Cycle Assessment of Post Insulator

Table 3-40 lists the materials of one 765 kV post insulators and Table 3-41 shows the supporting frame for one 765 kV post insulator, and the weight of foundation for one 765 kV post insulator is 11.99 ton.

Table 3-40 : Materials in one 765 kV post insulator

Materials	Weight (kg)	Percentage (%)
Porcelain	303.95	85.3
Steel	46.2	13
Aluminium	6	1.7
Total	356.15	100

Table 3-41 : Supporting frame for one 765 kV post insulator

Materials	Weight (ton)
Steel	0.7
Zinc coating	0.015

The post insulators were manufactured in France, the transportation phase is modeled as 1000 km by truck and 7000 km by ship.

As there is not energy loss of post insulator during its service life, no use phase is simulated.

In the end-of-life phase, porcelain is landfilled; aluminum and steel are recycled; reinforced bar in concrete is recycled, the rest is landfilled; remains are incinerated.

The characterization result of 765 kV post insulator is shown in Fig.3-38.

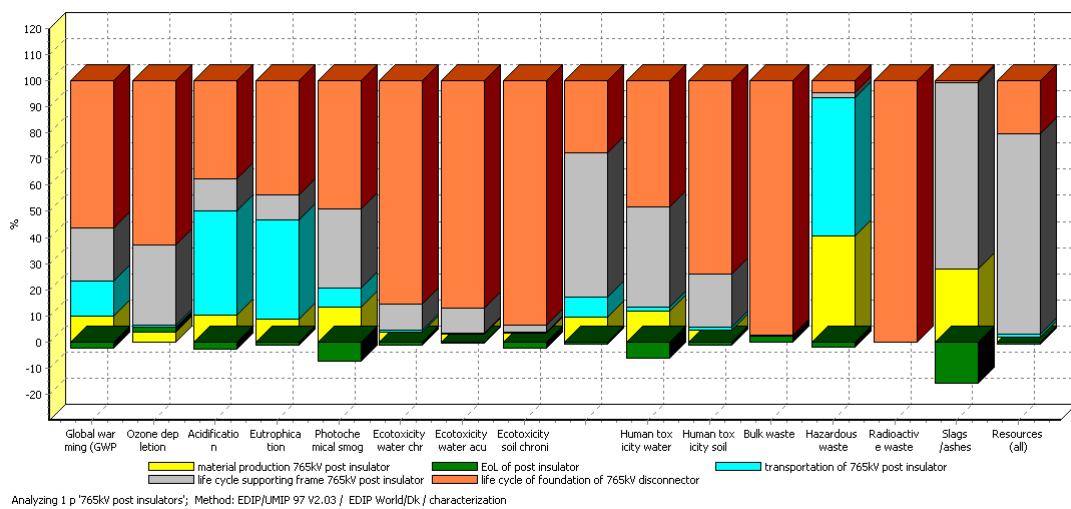

Fig. 3-38 : Characterization result of 765 kV post insulator

### 3.2.9 Life Cycle Assessment of Line Trap and Coupling Capacitor

Line trap (also named wave trap) is connected in series with high voltage transmission lines, and is a key component in Power Line Carrier (PLC) systems used for remote control signal, voice communication, remote metering and control between substations in the electrical T&D network. PLC integrates the transmission of communication signal and 50/60 Hz power signal through the same electric power line, with major benefit of union of two important applications in a single system. The main function of line trap is to present high impedance at the carrier frequency band while introducing negligible impedance at the power frequency, with the result of



preventing transmission of these high frequency signals to unwanted directions without loss of energy at power frequency [66].

Coupling capacitors are used to transmit communication signals to transmission lines. In signal transmission the coupling capacitor is part of a power line carrier circuit, and a coupling capacitor is used in circuit in conjunction with a line trap, see Fig. 3-39.

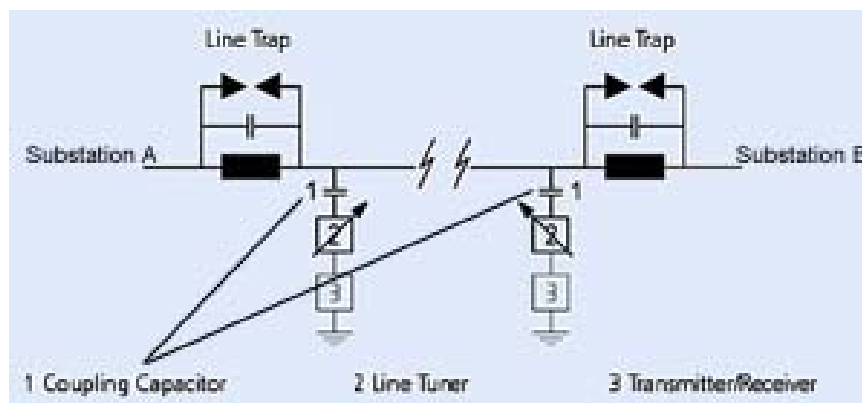

Fig. 3-39 : Illustration of lines traps and coupling capacitor

Line traps installed in Venezuelan substations were manufactured from the former Heafely Technology, now Trench Group. Since there is no available data for this type of line trap and its technology hasn't varied much, relevant line trap of 0.2mH/3150A from Alstom Grid are taken as substitute (see Fig. 3-40).



Fig. 3-40 : Alstom Grid line traps

Table 3-42 lists the materials of one line trap, and Table 3-43 shows materials of a coupling capacitor, in substation a line trap is mounted on one coupling capacitor, and then coupling capacitor is erected on a steel supporting frame, which is connected to the reinforced concrete base. The weight of foundation for one coupling capacitor is 15.68 ton, and Table 3-44 lists the materials for one supporting frame.

Table 3-42 : Materials for Alstom Line Trap 0.2mH/3150A

Materials	Weight (kg)	Percentage (%)
Aluminium	280.5	81.3
Glassfiber	45.2	13.1
Others	19.3	5.6
Total	345	100

Table 3-43 : Materials in one 765 kV coupling capacitor

Materials	Weight (kg)	Percentage (%)
Steel	49.3	5.6
Copper	0.6	0.07
Aluminium	101.3	11.4
Synthetic Oil	111.8	12.6
Pressboard+paper	24.2	2.7
Porcelain	517.8	58.3
Epoxy resin	2	0.2
Polyamide 6 (PA 6)	0.4	0.05
Glass fiber	33	3.7
Polypropylene (PP)	42.8	4.8
Others	4.4	0.5
Total	887.5	100

Table 3-44 : Supporting frame for coupling capacitor

Materials	Weight (ton)
Steel	1.27
Zinc coating	0.018

The line traps and coupling capacitors were manufactured in France, so the transportation phase is modeled as 1000 km by truck and 7000 km by ship.

Use phase of coupling capacitor is simulated as dielectric losses, equaling to 919 W based on dissipation factor of 0.5% ( $\tan\delta$ ) of capacitance. During its service lifespan of 30 years, the energy loss is  $2.42 \times 10^5$  kWh. While the use phase of line trap is defined as the Joule loss, which is 2 W, and during its service lifespan of 30 years, the energy loss is 526 kWh.

In the end-of-life phase, porcelain is landfilled; synthetic oil is treated in the same way as transformer oil stated in power transformer; steel, copper and aluminium are recycled; reinforced bar in concrete is recycled, the rest is landfilled; the pressboard, paper, epoxy, PP and PA6 are incinerated; the rest is incinerated.

The characterization result of Alstom Line Trap 0.2mH/3150A and 765 kV coupling capacitor are shown in Fig.3-41 and Fig.3-42, respectively.

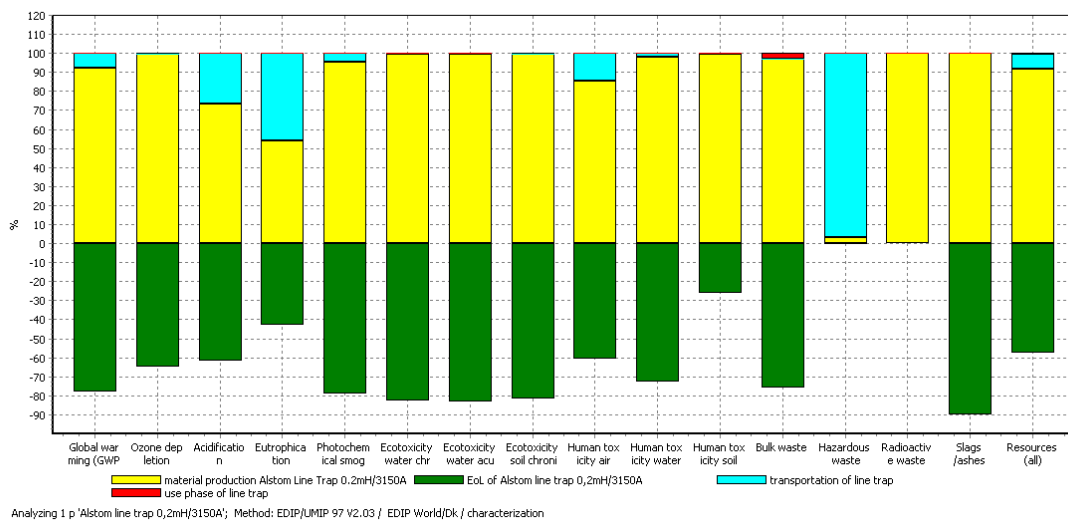

Fig. 3-41 : Characterization result of Alstom Line Trap 0.2mH/3150A

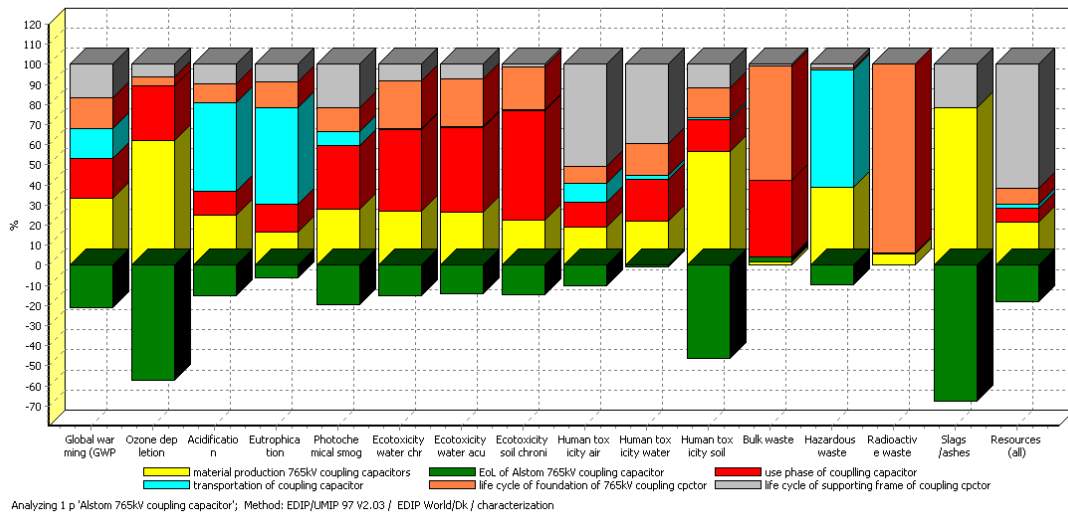

Fig. 3-42 : Characterization result of 765 kV coupling capacitor

### 3.3 Life Cycle Assessment of Substations

In this section, LCA of total 7 substations in this 765 kV AC transmission system is investigated.

In this investigation, only the primary system is included, the so-called “secondary systems” - such as low voltage (lower than 1 kV) cables, lighting system, controlling systems (computers, electronic devices, IT, etc) - are not integrated.

#### 3.3.1 Materials Inventories of Guri Substation

The investigated materials of substation include the composing equipments (including their supporting frames and foundations), all kinds of conductors, constructions such as gantries, gravels, access roads, etc. These investigated materials are depicted hereinafter. Fig. 3-43 shows the single-line diagram of Guri substation.

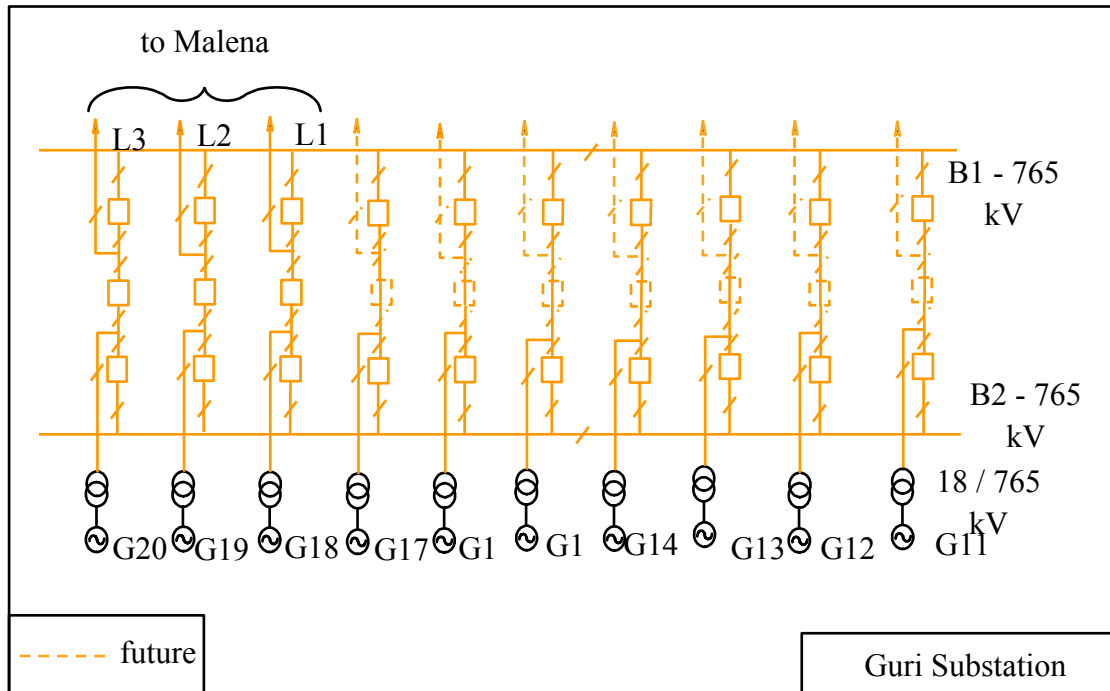

Fig. 3-43 : Single-line diagram of Guri substation

Table 3-45 lists all the equipments in Guri 765 kV substation needed to be considered in LCA. Since the service life time of substation is set as 60 years, considering the different service life time of different equipments, the total quantities of needed equipments are listed. Taking current transformer as an example, its service life time is 30 years, if there are 3 current transformers in substation, then during 60 years there needs 6 current transformers. The supporting frame and reinforced concrete foundation of each equipment do not need changing during 60 years, as they are able to have a service life of 60 years. As to the detailed materials for each equipment, section 3.2 “Life Cycle of equipments in substations” in this Chapter is able to be referred to.

Table 3-45 : Equipments in Guri 765 kV substation

Equipment	Model	Quantity	Quantity during 60 years of service life
Circuit breaker	FX42 range (detailed type not specified)	69	138
Disconnecter	Alstom 765 kV disconnecter	186	372

Current transformer	Alstom OSKF 765 CT	69	138
Voltage transformer	Alstom OTCF 765 CVT	34	68
	Alstom OTEF 765 inductive VT	9	18
Surge Arrester	Alstom PSB 612 Z	9	18
Post insulator	Alstom 800 kV	180	360
Wave trap	Alstom 0.2mH/3150A	6	12
Coupling capacitor	Alstom 800 kV CC	6	12
Ceramic insulator	170×300 mm	23100	46200

In the LCA of substations conductors, busbars and ground wires have to be considered. Table 3-46 lists the parameters of conductors in all substations and Table 3-47 gives the weight of conductors in Guri substation.

Table 3-46 : Parameters of conductors in all substations

	AAC 4000 MCM	ACAR 1300 MCM
Sub-conductors per phase	2×2027 mm <sup>2</sup>	4×659 mm <sup>2</sup>
Diameter of conductor	5.87 cm	3.332 cm
Spacing of bundle conductor	45 cm	45 cm
AC Resistance per phase @75°C (Ω/km)	0.01085 [67]	0.01415
Weight per phase (kg/km)	2×5589=11178	4×1817=7268

Table 3-47 : Weight of conductors in Guri substation

	AAC 4000 MCM	ACAR 1300 MCM
Total length of bundle conductors (m)	6651	4902
Total weight (ton)	74.3	35.6

Busbars in this project are ACAR wires, the details are calculated and shown in Table 3-48.

Table 3-48 : Busbars in Guri substation

Wire type	ACAR 1300 MCM
Numbers of wires per phase	4

Total length of bundle	2820 m
Total weight	20.5 ton

The ground wire is the same Alumoweld 7#7 wire as used in transmission lines, detailed specifications has been mentioned hereinbefore, and weight of ground wires in Guri substation is listed in Table 3-49.

Table 3-49 : Ground wires in Guri substation

Wire type	Alumoweld 7#7
Total length (m)	5050
Total weight (kg)	2484.6
Al weight (kg)	124
Steel weight (kg)	2360.6

Besides the equipments and all kinds of conductors, the gantries (see Fig. 3-44), gravels and access roads in substations have to taken into account too. In all these 7 substations 3 types of gantries are constructed, Type 1 is supporting 765 kV conductors, Type 2 is supporting 765 kV busbars and Type 3 is supporting 230 kV or 400 kV conductors. Gantries are made of stainless steel with Zinc coatings, Table 3-50 shows the detailed weight of steel and Zinc of gantries and their relevant foundations.



Fig. 3-44 : Gantries in substation

Table 3-50 : Materials of different gantry types

Gantry	Steel (ton)	Zinc (kg)	Reinforced concrete foundation (ton)
Type 1	21.14	364	201
Type 2	15.1	261	201
Type 3	7.36	170	81

An average thickness of 10 cm gravels are on the surface of substation except for roads in substation. Taking into account the size of Guri substation, then  $320 \text{ m} \times 470 \text{ m} \times 0.1 \text{ m} = 15040 \text{ m}^3$  gravels are in Guri substation, considering the gravel's density of  $1.5 \text{ ton/m}^3$ , then the graveled surface consists of approximately 22560 ton.

Access road width is 4 m, and its length is 2860 m in Guri substation, thus there is  $11440 \text{ m}^2$  of access road. The road in substation is simulated as consisting of 20 cm of concrete, 5 cm of gravels and 25 cm of stones [68]. As in SimaPro there is not specific category of "stone", then "stone" is substituted by "gravel" in calculation. Table 3-51 shows the materials of access road in Guri substation.

Table 3-51 : Materials of access road in Guri substation

Road	Concrete	Gravel +Stone
Volume ( $\text{m}^3$ )	2288	3432
Density ( $\text{ton/m}^3$ )	2.2	1.5
Weight (ton)	5033.6	5148

The access roads, gravels and gantries constructed, to be considered in LCA, in Guri substation are listed in Table 3-52.

Table 3-52 : Construction structures in Guri 765 kV substation

Structure	Notes	Quantity during 60 years of service life
Gantries	Type 1 (supporting 765 kV conductors)	43 pieces
	Type 2 (supporting 765 kV busbar)	12 pieces
Gravel		22560 ton



Access road	consisting of 20 cm of concrete, 25 cm of stones and 5 cm of gravels	11440 m <sup>2</sup>
-------------	--	----------------------

### 3.3.2 Material Inventories of Malena Substation

Figure 3-45 depicts the single-line diagram of Malena substation and Table 3-53 lists the equipments in Malena substation to be considered in LCA.

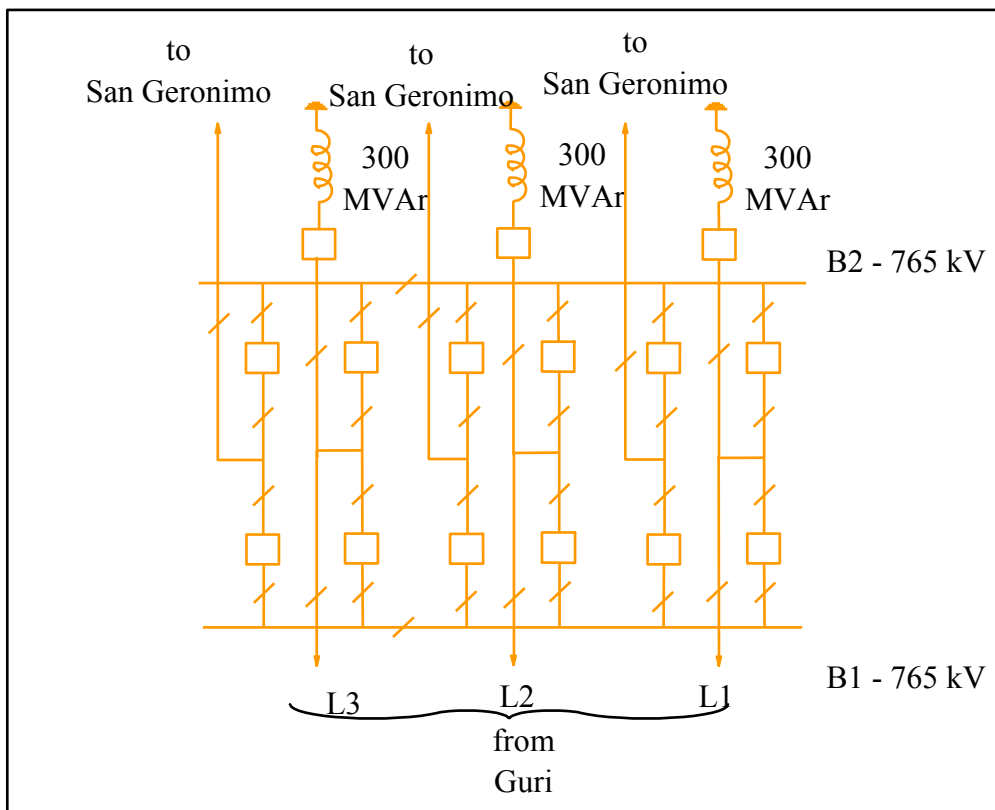

Fig. 3-45 : Single-line diagram of Malena substation

Table 3-53 : Equipments in Malena 765 kV substation

Equipment	Model	Quantity	Quantity during 60 years of service life
Circuit breaker	FX42 range (detailed type not specified)	45	90
Disconnecter	Alstom 765 kV disconnector	105	210
Current transformer	Alstom OSKF 765 CT	45	90

Voltage transformer	Alstom OTCF 765 CVT	4	8
	Alstom OTEF 765 inductive VT	18	36
Surge Arrester	Alstom PSB 612 Z	18	36
Post insulator	Alstom 800 kV	108	216
Wave trap	Alstom 0.2mH/3150A	12	24
Coupling capacitor	Alstom 800 kV CC	12	24
Shunt reactor	100 MVar single-phase	9	9
Ceramic insulator	170×300 mm	15960	31920

Table 3-54 lists conductors in Malena substation, busbars are shown in Table 3-55 and ground wires in Malena substation are listed in Table 3-56.

Table 3-54 : Conductors in Malena substation

	AAC 4000 MCM	ACAR 1300 MCM
Total length of bundle conductors (m)	3600	2628
Total weight (ton)	40.2	19.1

Table 3-55 : Busbars in Malena substation

Wire type	ACAR 1300 MCM
Numbers of wires per phase	4
Total length of bundle	1800 m
Total weight	13.1 ton

Table 3-56 : Ground wires in Malena substation

Wire type	Alumoweld 7#8
Total length (m)	3030
Total weight (kg)	1491
Al weight (kg)	75
Steel weight (kg)	1416

Table 3-57 lists the construction structures, and Table 3-58 shows materials of access road in Malena 765 kV substations.

Table 3-57 : Construction structures in Malena 765 kV substation

Structure	Notes	Quantity during 60 years of service life
Gantries	Type 1 (supporting 765 kV conductors)	30 pieces
	Type 2 (supporting 765 kV busbar)	8 pieces
Gravel		14400 ton
Access road	consisting of 20 cm of concrete, 25 cm of stones and 5 cm of gravels	8800 m <sup>2</sup>

Table 3-58 : Materials of access road in Malena substation

Road	Concrete	Gravel +Stone
Volume (m <sup>3</sup> )	1760	2640
Density (ton/m <sup>3</sup> )	2.2	1.5
Weight (ton)	3872	3960

### 3.3.3 Materials Inventories of San Geronimo Substation

Figure 3-46 shows the single-line diagram of San Geronimo 765 kV substation and Table 3-59 lists the equipments in San Geronimo substation to be considered in LCA.

Table 3-59 : Calculated equipments in San Geronimo 765 kV substation

Equipment	Model	Quantity	Quantity during 60 years of service life
Circuit breaker	FX42 range (detailed type not specified)	51	102
Disconnecter	Alstom 765 kV disconnecter	126	252
Current transformer	Alstom OSKF 765 CT	51	102
Voltage transformer	Alstom OTCF 765 CVT	6	12
	Alstom OTEF 765 inductive VT	18	36
Surge Arrester	Alstom PSB 612 Z	18	36
Post insulator	Alstom 800 kV	126	252
Wave trap	Alstom 0.2mH/3150A	12	24
Coupling capacitor	Alstom 800 kV CC	12	24
Shunt reactor	100 MVar single-phase	9	9
Ceramic insulator	170×300 mm	18480	36960

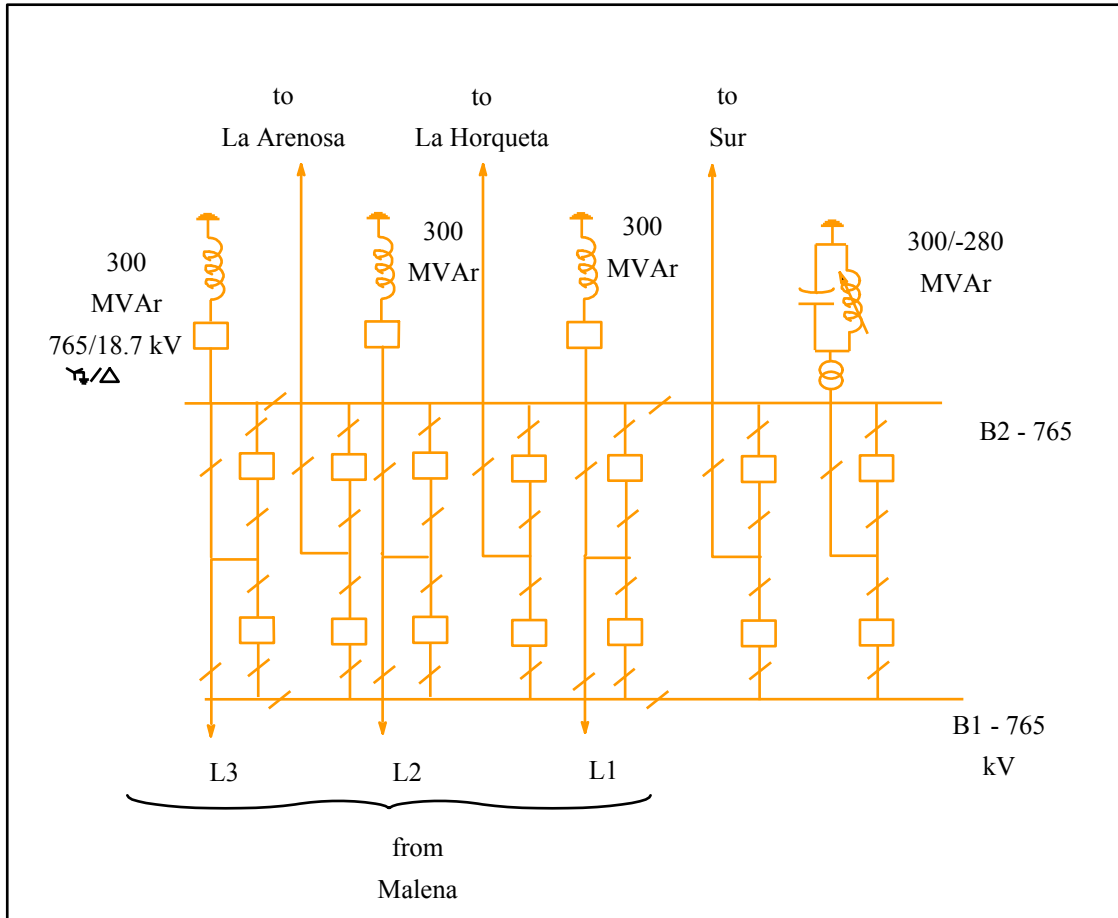

Fig. 3-46 : Single-line diagram of San Geronimo substation

Table 3-60 lists conductors in San Geronimo substation, busbars are shown in Table 3-61 and ground wires in San Geronimo substation are listed in Table 3-62.

Table 3-60 : Conductors in San Geronimo substation

	AAC 4000 MCM	ACAR 1300 MCM
Total length of bundle conductors (m)	4200	3066
Total weight (ton)	46.9	22.3

Table 3-61 : Busbars in San Geronimo substation

Wire type	ACAR 1300 MCM
Numbers of wires per phase	4
Total length of bundle	2100 m
Total weight	15.3 ton

Table 3-62 : Ground wires in San Geronimo substation

Wire type	Alumoweld 7#8
Total length (m)	3535
Total weight (kg)	1740
Al weight (kg)	87
Steel weight (kg)	1653

Table 3-63 lists the construction structures, and Table 3-64 shows materials of access road in San Geronimo 765 kV substation.

Table 3-63 : Construction structures in San Geronimo 765 kV substation

Structure	Notes	Quantity during 60 years of service life
Gantries	Type 1 (supporting 765 kV conductors)	34 pieces
	Type 2 (supporting 765 kV busbar)	10 pieces
Gravel		16800 ton
Access road	consisting of 20 cm of concrete, 25 cm of stones and 5 cm of gravels	9200 m <sup>2</sup>

Table 3-64 : Materials of access road in San Geronimo substation

Road	Concrete	Gravel +Stone
Volume (m <sup>3</sup> )	1840	2760
Density (ton/m <sup>3</sup> )	2.2	1.5
Weight (ton)	4048	4140

### 3.3.4 Materials Inventories of Yaracuy Substation

Figure 3-47 gives the single-line diagram of Yaracuy 765 kV substation and Table 3-65 lists the equipments in Yaracuy substation to be considered in LCA.

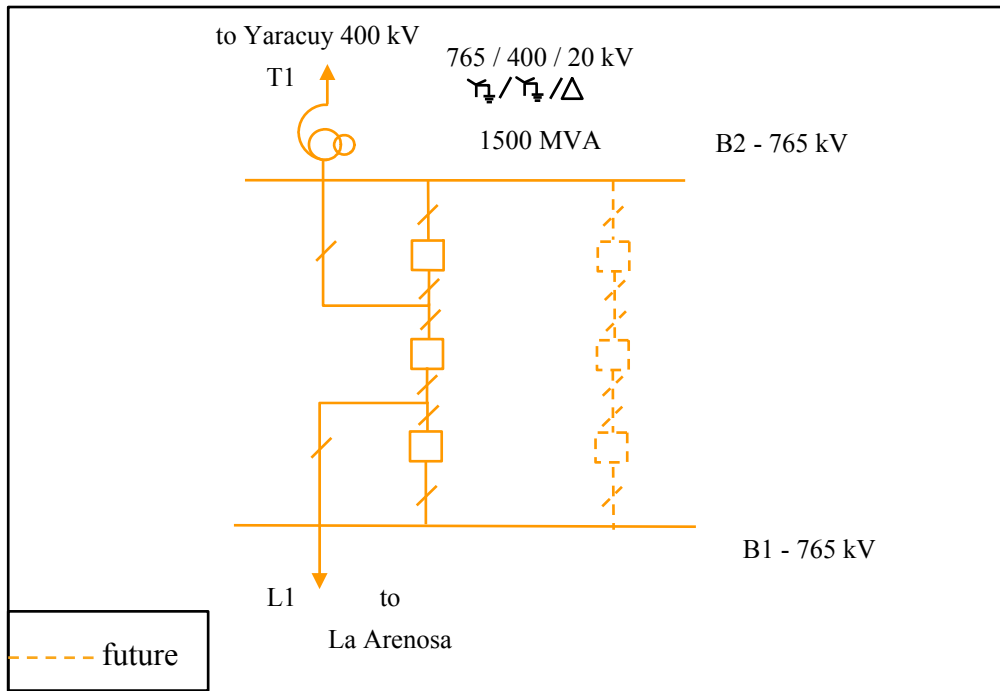

Fig. 3-47 : Single-line diagram of Yaracuy substation

Table 3-65 : Equipments in Yaracuy 765 kV substation

Equipment	Model	Quantity	Quantity during 60 years of service life
Transformer	Alstom 765/400/20kV 500 MVA Autotransformer	3	3
Circuit breaker	FX42	3	6
	FX42D R=360 Ω	3	6
	FX42D R=5040 Ω	3	6
Disconnecter	Alstom 765 kV disconnecter	24	48
Current transformer	Alstom OSKF 765 CT	9	18
	Alstom OSKF 400 CT	3	6
Voltage transformer	Alstom OTCF 765 CVT	2	4
	Alstom OTEF 765 inductive VT	3	6
	Alstom OTEF 400 inductive VT	3	6
Surge Arrester	Alstom PS2B 612 Z	6	12
	Alstom PSB 396 Z	3	6
Post insulator	Alstom 800 kV	18	36
Wave trap	Alstom 0.2mH/3150A	2	4
Coupling capacitor	Alstom 800 kV CC	2	4
Ceramic insulator	170×300 mm	4620	9240

Table 3-66 lists conductors in Yaracuy substation, busbars are shown in Table 3-67 and ground wires in Yaracuy substation are listed in Table 3-68.

Table 3-66 : Conductors in Yaracuy substation

	AAC 4000 MCM	ACAR 1300 MCM
Total length of bundle conductors (m)	936	942
Total weight (ton)	10.5	6.8

Table 3-67 : Busbars in Yaracuy substation

Wire type	ACAR 1300 MCM
Numbers of wires per phase	4
Total length of bundle	300 m
Total weight	2.2 ton

Table 3-68 : Ground wires in Yaracuy substation

Wire type	Alumoweld 7#8
Total length (m)	945
Total weight (kg)	465
Al weight (kg)	23
Steel weight (kg)	442

Table 3-69 lists the construction structures, and Table 3-70 shows materials of access road in Yaracuy 765 kV substations. Firewall (see Fig. 3-48) is built up between two transformers to protect one transformer in case of firing on the other transformer, which is made of reinforced concrete, and each firewall weighs 190 ton (including foundation).

Table 3-69 : Construction structures in Yaracuy 765 kV substation

Structure	Notes	Quantity during 60 years of service life
Gantry	Type 1 (supporting 765 kV conductors)	5 pieces
	Type 2 (supporting 765 kV busbar)	4 pieces
	Type 3 (supporting 400 kV conductors)	2 pieces

Firewall of transformer		4 pieces
Gravel		4800 ton
Access road	consisting of 20 cm of concrete, 25 cm of stones and 5 cm of gravels	4240 m <sup>2</sup>



Fig. 3-48 : Illustration of firewalls for power transformers

Table 3-70 : Materials of access road in Yaracuy substation

Road	Concrete	Gravel +Stone
Volume (m <sup>3</sup> )	848	1272
Density (ton/m <sup>3</sup> )	2.2	1.5
Weight (ton)	1866	1908

### 3.3.5 Materials Inventories of La Arenosa Substation

Figure 3-49 describes the single-line diagram of La Arenosa 765 kV substation and Table 3-71 lists the equipments in La Arenosa substation to be considered in LCA.



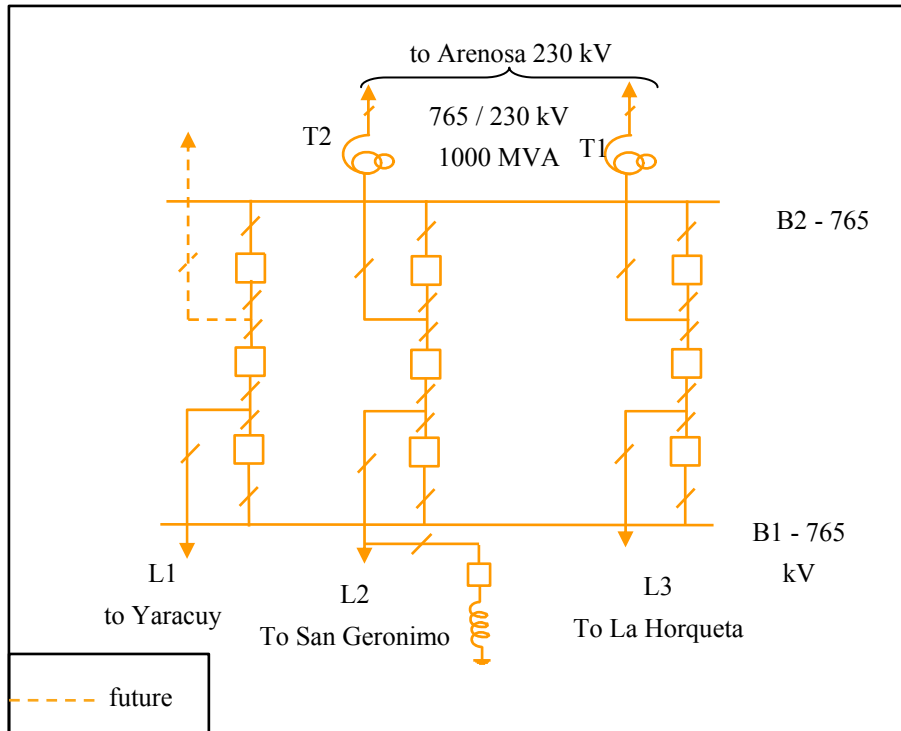

Fig. 3-49 : Single-line diagram La Arenosa substation

Table 3-71 : Equipments in La Arenosa 765 kV substation

equipment	Model	quantity	quantity during 60 years of service life
Transformer	Toshiba 765/230/20kV 333 MVA Autotransformer	6	6
Circuit breaker	FX42 range (type not specified)	30	60
Disconnecter	Alstom 765 kV disconnecter	72	144
Current transformer	Alstom OSKF 765 CT	30	60
	Alstom OSKF 230 CT	6	12
Voltage transformer	Alstom OTCF 765 CVT	2	4
	Alstom OTEF 765 inductive VT	9	18
	Alstom OTEF 230 inductive VT	6	12
Surge Arrester	Alstom PS2B 612 Z	15	30
	Alstom PSB 228 Z	6	12
Post insulator	Alstom 800 kV	54	108
Wave trap	Alstom 0.2mH/3150A	6	12
Coupling capacitor	Alstom 800 kV CC	6	12
Ceramic insulator	170×300 mm	8400	16800

Table 3-72 lists conductors in La Arenosa substation, busbars are shown in Table 3-73 and ground wires in La Arenosa substation are listed in Table 3-74.

Table 3-72 : Conductors in La Arenosa substation

	AAC 4000 MCM	ACAR 1300 MCM
Total length of bundle conductors (m)	2472	1647
Total weight (ton)	27.6	12

Table 3-73 : Busbars in La Arenosa substation

Wire type	ACAR 1300 MCM
Numbers of wires per phase	4
Total length of bundle	900 m
Total weight	6.5 ton

Table 3-74 : Ground wires in La Arenosa substation

Wire type	Alumoweld 7#8
Total length (m)	1979
Total weight (kg)	974
Al weight (kg)	49
Steel weight (kg)	925

Table 3-75 lists the construction structures, and Table 3-76 shows materials of access road in La Arenosa 765 kV substation.

Table 3-75 : Construction structures in La Arenosa 765 kV substation

Structure	Notes	Quantity during 60 years of service life
Gantry	Type 1 (supporting 765 kV conductors)	12 pieces
	Type 2 (supporting 765 kV busbar)	6 pieces
	Type 3 (supporting 230 kV conductors)	2 pieces
Firewall of transformer		6 pieces
Gravel		9135 ton
Access road	consisting of 20 cm of concrete, 25 cm of stones and 5 cm of gravels	5928 m <sup>2</sup>

Table 3-76 : Materials of access road in La Arenosa substation

Road	Concrete	Gravel +Stone
Volume (m <sup>3</sup> )	1186	1779
Density (ton/m <sup>3</sup> )	2.2	1.5
Weight (ton)	2608	2668

### 3.3.6 Materials Inventories of La Horqueta Substation

Figure 3-50 indicates the single-line diagram of La Horqueta substation and Table 3-77 lists the equipments in La Horqueta substation to be considered in LCA.

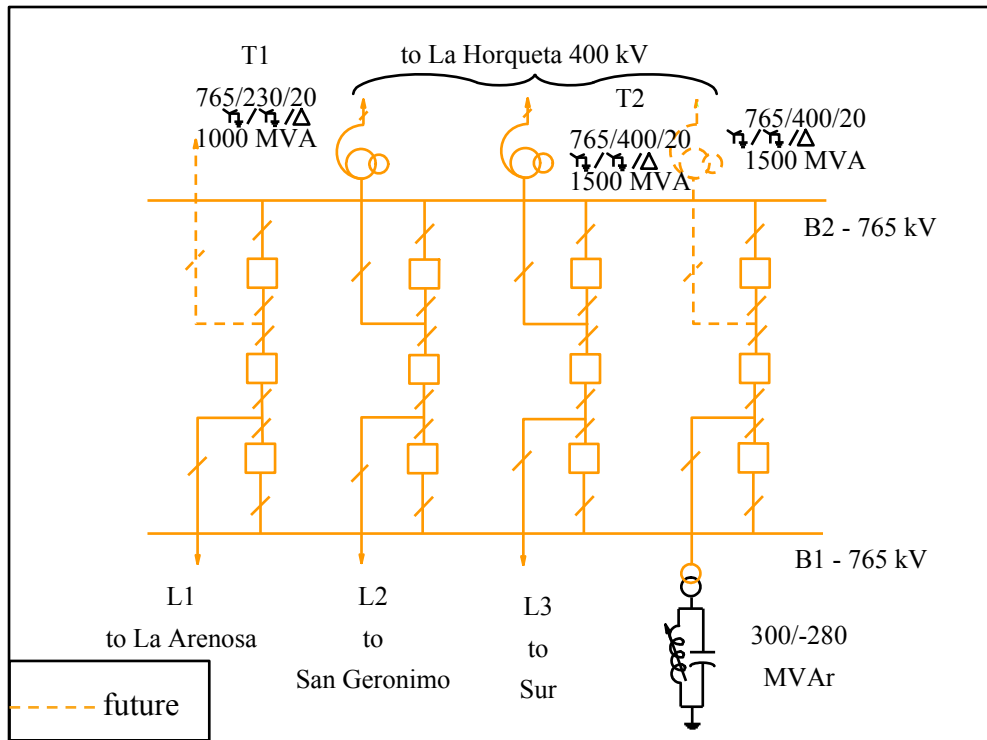

Fig.3-50 : La Horqueta substation

Table 3-77 : Equipments in La Horqueta 765 kV substation

Equipment	Model	Quantity	Quantity during 60 years of service life
Transformer	Toshiba 765/230/20kV 333 MVA	3	3

	Autotransformer		
	Alstom 765/400/20 kV 500 MVA Autotransformer	3	3
Circuit breaker	FX42 range (type not specified)	36	72
Disconnecter	Alstom 765 kV disconnecter	90	180
	Alstom 400 kV disconnecter	3	6
	Alstom 230 kV disconnecter	3	6
Current transformer	Alstom OSKF 765 CT	36	72
	Alstom OSKF 400 CT	3	6
	Alstom OSKF 230 CT	3	6
Voltage transformer	Alstom OTCF 765 CVT	2	4
	Alstom OTEF 765 inductive VT	12	24
	Alstom OTEF 400 inductive VT	3	6
	Alstom OTEF 230 inductive VT	3	6
Surge Arrester	Alstom PS2B 612 Z	18	36
	Alstom PSB 398 Z	3	6
	Alstom PSB 228 Z	3	6
Post insulator	Alstom 800 kV	72	144
Wave trap	Alstom 0.2mH/3150A	6	12
Coupling capacitor	Alstom 800 kV CC	6	12
Ceramic insulator	170×300 mm	10080	20160

Table 3-78 lists conductors in La Horqueta substation, busbars are shown in Table 3-79 and ground wires in La Horqueta substation are listed in Table 3-80.

Table 3-78 : Conductors in La Horqueta substation

	AAC 4000 MCM	ACAR 1300 MCM
Total length of bundle conductors (m)	3072	1965
Total weight (ton)	34.3	14.3

Table 3-79 : Busbars in La Horqueta substation

Wire type	ACAR 1300 MCM
Numbers of wires per phase	4
Total length of bundle	1200 m
Total weight	8.7 ton

Table 3-80 : Ground wires in La Horqueta substation

Wire type	Alumoweld 7#8
Total length (m)	2552
Total weight (kg)	1256
Al weight (kg)	63
Steel weight (kg)	1193

Table 3-81 lists the construction structures, and Table 3-82 shows materials of access road in La Horqueta 765 kV substation.

Table 3-81 : Construction structures in La Horqueta 765 kV substation

Structure	Notes	Quantity during 60 years of service life
Gantries	Type 1 (supporting 765 kV conductors)	16 pieces
	Type 2 (supporting 765 kV busbar)	6 pieces
	Type 3 (supporting 230 kV & 400 kV conductors)	2 pieces
Firewall of transformer	Made of reinforced concrete	6 pieces
Gravel		10500 ton
Access road	consisting of 20 cm of concrete, 25 cm of stones and 5 cm of gravels	8000 m <sup>2</sup>

Table 3-82 : Materials of access road in La Horqueta substation

Road	Concrete	Gravel +Stone
Volume (m <sup>3</sup> )	1600	2400
Density (ton/m <sup>3</sup> )	2.2	1.5
Weight (ton)	3520	3600

### 3.3.7 Materials Inventories of Sur Substation

Figure 3-51 shows the single-line diagram of Sur substation and Table 3-83 lists the equipments in Sur substation to be considered in LCA.

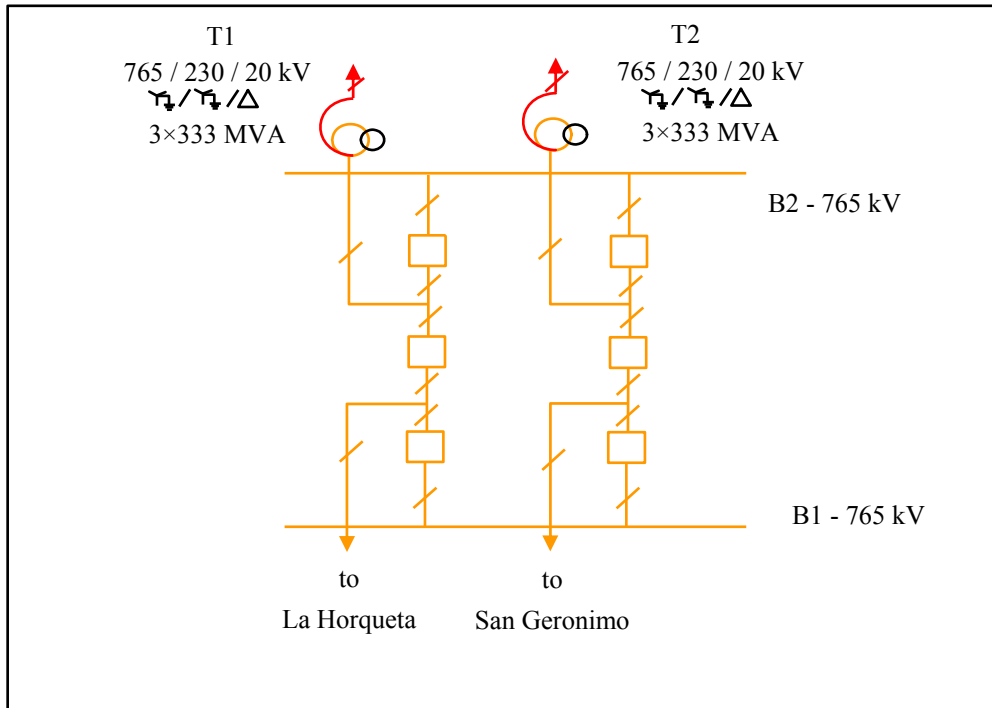

Fig. 3-51 : Single-line diagram of Sur 765 kV substation

Table 3-83 : Calculated equipments in Sur 765 kV substation

Equipment	Model	Quantity	Quantity during 60 years of service life
Transformer	Toshiba 765/230/20kV 333 MVA Autotransformer	6	6
Circuit breaker	FX42D R=360 Ω	12	24
	FX42D R=5040 Ω	6	12
Disconnecter	Alstom 765 kV disconnecter	48	96
	Alstom 230 kV disconnecter	6	12
Current transformer	Alstom OSKF 765 CT	18	36
	Alstom OSKF 245 CT	6	12
Voltage transformer	Alstom OTCF 765 CVT	2	4
	Alstom OTEF 765 inductive VT	6	12
	Alstom OTEF 245 inductive VT	6	12
Surge Arrester	Alstom PSB 612 Z	12	24
	Alstom PSB 228 Z	6	12
Post insulator	Alstom 800 kV	36	72
Wave trap	Alstom 0.2mH/3150A	4	8

Coupling capacitor	Alstom 800 kV CC	4	8
Ceramic insulator	170×300 mm	5880	11760

Table 3-84 lists conductors in Sur substation, busbars are shown in Table 3-85 and ground wires in Sur substation are listed in Table 3-86.

Table 3-84 : Conductors in Sur substation

	AAC 4000 MCM	ACAR 1300 MCM
Total length of bundle conductors (m)	1872	1326
Total weight (ton)	21	9.6

Table 3-85 : Busbars in Sur substation

Wire type	ACAR 1300 MCM
Numbers of wires per phase	4
Total length of bundle	540 m
Total weight	3.9 ton

Table 3-86 : Ground wires in Sur substation

Wire type	Alumoweld 7#8
Total length (m)	3156
Total weight (kg)	1553
Al weight (kg)	158
Steel weight (kg)	1345

Table 3-87 lists the construction structures, and Table 3-88 shows materials of access road in Sur 765 kV substation.

Table 3-87 : Construction structures in Sur 765 kV substation

Structure	Notes	quantity during 60 years of service life
Gantries	Type 1 (supporting 765 kV conductors)	8 pieces
	Type 2 (supporting 765 kV busbar)	4 pieces
	Type 3 (supporting 230 kV conductor)	2 pieces

Firewall of transformer	Made of reinforced concrete	6 pieces
Gravel		5880 ton
Access road	consisting of 20 cm of concrete, 25 cm of stones and 5 cm of gravels	5560 m <sup>2</sup>

Table 3-88 : Materials of access road in Sur substation

Road	Concrete	Gravel +Stone
Volume (m <sup>3</sup> )	1112	1668
Density (ton/m <sup>3</sup> )	2.2	1.5
Weight (ton)	2446.4	2502

### 3.3.8 Life Cycle Assessment of Total Substations

Materials inventories of the 7 individual substations are described hereinabove, then the total materials inventories are the sum of these individual substations and summarized hereinafter. Besides the materials inventories, then energy losses of different components are analyzed.

#### 3.3.8.1 Materials Inventories of Total Substations

Table 3-89 lists the equipments in the entire 7 substations to be considered in LCA.

Table 3-89 : Equipments in all the 765 kV substations

Equipment	Model	Quantity in site	Quantity during 60 years of service life
Transformer	Toshiba 765/230/20kV 333 MVA Autotransformer	9	9
	Alstom 765/400/20 kV	12	12



	500 MVA Autotransformer		
Circuit breaker	FX42	234	468
	FX42D R=360 Ω	15	30
	FX42D R=5040 Ω	9	18
Disconnecter	Alstom 765 kV disconnecter	651	1302
	Alstom 400 kV disconnecter	3	6
	Alstom 230 kV disconnecter	9	18
Current transformer	Alstom OSKF 765 CT	258	516
	Alstom OSKF 400 CT	6	12
	Alstom OSKF 230 CT	15	30
Voltage transformer	Alstom OTCF 765 CVT	52	104
	Alstom OTEF 765 inductive VT	75	150
	Alstom OTEF 400 inductive VT	6	12
	Alstom OTEF 230 inductive VT	15	30
Surge Arrester	Alstom PS2B 612 Z	96	192
	Alstom PSB 396 Z	6	12
	Alstom PSB 228 Z	15	30
Post insulator	Alstom 800 kV	594	1188
Line trap	Alstom 0.2mH/3150A	48	96
Coupling capacitor	Alstom 800 kV CC	48	96
Shunt reactor	Alstom $765/\sqrt{3}$ kV, 100 MVar	18	36
Ceramic insulator	170×300 mm	84000	168000

Table 3-90 lists conductors in all substations, busbars are shown in Table 3-91 and ground wires in all substations are listed in Table 3-92.

Table 3-90 : Conductors in all substations

	AAC 4000 MCM	ACAR 1300 MCM
Total weight (ton)	254.7	119.7

Table 3-91 : Busbars in all substations

Wire type	ACAR 1300 MCM
Total weight	70.2 ton

Table 3-92 : Ground wires in all substations

Wire type	Alumoweld 7#8
Total weight (kg)	9963.3
Al weight (kg)	579
Steel weight (kg)	933.6

Table 3-93 lists the construction structures, Table 3-94 shows materials of access road in all substations, and Table 3-95 indicates materials of total gantries in all substations.

Table 3-93 : Construction structures in all the 7 substations

Structure	Notes	Quantity during 60 years of service life
Gantries	Type 1 (supporting 765 kV conductors)	148 pieces
	Type 2 (supporting 765 kV busbar)	50 pieces
	Type 3 (supporting 230 kV conductor)	28 pieces
Firewall of transformer	Made of reinforced concrete	18 pieces
Gravel		84075 ton
Access road	consisting of 20 cm of concrete, 25 cm of stones and 5 cm of gravels	53168 m <sup>2</sup>

Table 3-94 : Materials of access road in all substations

Road	Concrete	Gravel +Stone
Weight (ton)	23394	23926

Table 3-95 : Materials of total gantries in all substations

Gantry	Steel (ton)	Zinc (ton)	Reinforced concrete foundation (ton)
Type 1	3129	53.9	29748
Type 2	755	13.1	10050
Type 3	14.72	0.34	162

### 3.3.8.2 Energy Losses of Total Substations

Use phase of all the substations is the sum of all the use phases of different equipments and conductors. These use phases of equipments include power transformers, circuit breakers, voltage transformers, current transformers, surge arresters, shunt reactors, disconnectors, line traps and coupling capacitors. All the use phase of equipments is defined as the electrical energy losses except for circuit breaker, whose use phase includes SF<sub>6</sub>-emissions and electrical energy losses as well. For the purpose of comparing different components' energy losses, their energy losses are listed below. Table 3-96 shows the energy losses of all power transformers in all the substations.

Table 3-96 : Energy losses of all power transformers in all the substations

Substations	Power loss (kW)	Energy loss during 60 years (kWh)
Yaracuy	1197	$6.29 \times 10^8$
La Arenosa	2394	$1.26 \times 10^9$
La Horqueta	2394	$1.26 \times 10^9$
Sur	2394	$1.26 \times 10^9$
Total substations	8379	$4.40 \times 10^9$

As the resistance of current path per phase of Alsthom FX42 range circuit breakers is 168  $\mu\Omega$ , the energy losses of all circuit breakers are calculated and listed in Table 3-97.

Table 3-97 : Energy losses of all circuit breakers in all the 7 Substations

Substations	Power loss (kW)	Energy loss during 60 years (kWh)
Guri	3.089	$1.6 \times 10^6$
Malena	5.571	$2.9 \times 10^6$
San Geronimo	6.314	$3.32 \times 10^6$
Yaracuy	0.233	$1.22 \times 10^5$

La Arenosa	0.909	$4.83 \times 10^5$
La Horqueta	0.484	$2.5 \times 10^5$
Sur	0.312	$1.6 \times 10^5$
Total substations	17.0	$8.9 \times 10^6$

Energy losses in conductors and busbars are calculated and shown in Table 3-98.

Table 3-98 : Energy losses of all conductors in all substations

Substations	Power loss (kW)	Energy loss during 60 years (kWh)
Guri	54.43	$2.88 \times 10^7$
Malena	86.24	$4.53 \times 10^7$
San Geronimo	88.86	$4.67 \times 10^7$
Yaracuy	11.94	$6.28 \times 10^6$
La Arenosa	22.01	$1.16 \times 10^7$
La Horqueta	21.21	$1.11 \times 10^7$
Sur	15.11	$7.94 \times 10^6$
Total substations	300.0	$1.58 \times 10^8$

The energy losses of all components in all substations are summarized in Table 3-99.

Table 3-99 : Energy losses of all components in all substations

Equipments	Power loss (kW)	Energy loss during 60 years (kWh)
Total power transformers	8379	$4.40 \times 10^9$
Total shunt reactors	4140	$2.18 \times 10^9$
Total conductors	300.0	$1.58 \times 10^8$
Total disconnectors	56.6	$2.97 \times 10^7$
Total coupling capacitors	44.1	$2.32 \times 10^7$
Total circuit breakers	17.0	$8.9 \times 10^6$
Total surge arresters	13.7	$7.19 \times 10^6$
Total current transformers	2.2	$1.15 \times 10^6$
Total voltage transformers	0.7	$3.38 \times 10^5$
Total line traps	0.1	$5.05 \times 10^4$
Total	12954	$6.81 \times 10^9$

Fig. 3-52 illustrates the energy losses percentage of different components in substations, it clearly shows that the power transformers take up 64.7% of total energy losses in substation, shunt reactors account for 32.0%, conductors for 2.3%, and the rest for only 1.0% (including disconnectors, coupling capacitors, circuit breakers, etc.).

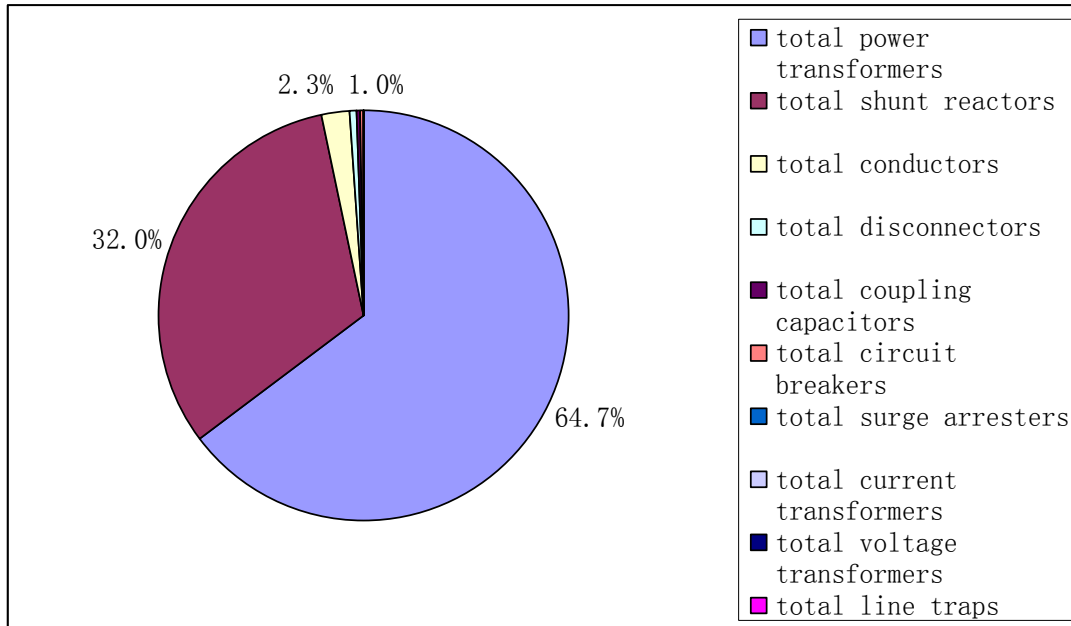

Fig. 3-52 : Energy losses percentage of components in all substations

### 3.3.8.3 Transportation Phase & End-of-life phase of Total Substations

The transportation phase of total substations is simulated as the sum of transportation phases of all the components in substations. The transportation phase of individual equipments are described in Section 3.2 “Life Cycle Assessment of Equipments in Substations”, herein summarizes the other components in substations.

The gantries, busbars, conductors and ground wires were manufactured in Venezuela, so their transportation phase is modeled as 500 km by truck.

The end-of-life phase of substations is the sum of end-of-life phases of all the components in substations. The end-of-life phase of individual equipments are described in Section 3.2 “Life Cycle Assessment of Equipments in Substations”, the gantries are treated as towers, whose end-of-life simulation is detailed in Section 3.1 “Life Cycle Assessment of Transmission Lines”. The end-of-life simulations for busbars, conductors and ground wires are also depicted in Section 3.1.

### 3.3.8.4 Life Cycle Impact Assessment Results of Total Substations

All the considered materials inventories, use phase, transportation phase and the end-of-life phase of total substations are summarized hereinbefore, then the Life Cycle Inventory of total substations are carried out by using software package SimaPro 7.1, through the analysis by the impacts assessment method EIDP/UMIP 97 version 2.03, the characterization result of Life Cycle Impact Assessment is shown in Fig. 3-53.

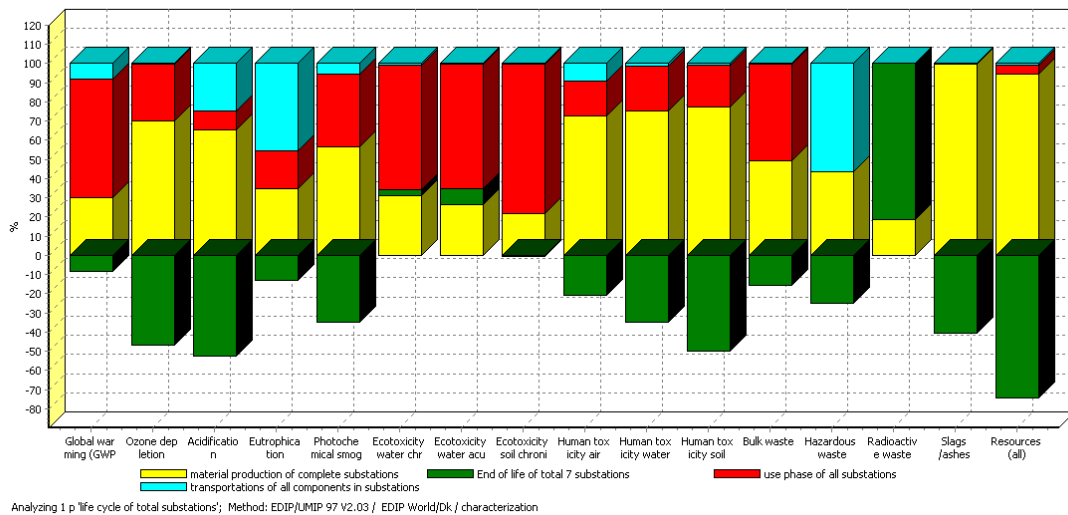

Fig. 3-53 : Characterization result of total substations

It’s noticed that during many impact indicators the use phase has a large amount of impacts, taking Global Warming as an example, the use phase accounts for 67.4% of CO<sub>2</sub>-equivalent emissions, materials production for 33.1%, while transportation for

9%. In the other impacts indicators, materials production is dominating the environmental impacts.

Single score result is shown in Fig. 3-54, which describes the impact magnitude of different life stages of substations, it's seen that use phase accounts for 58.8% of single score of environmental impacts of the total substations, materials (production plus end-of-life) for 38.5%, and the transportation phase for only 2.7%.

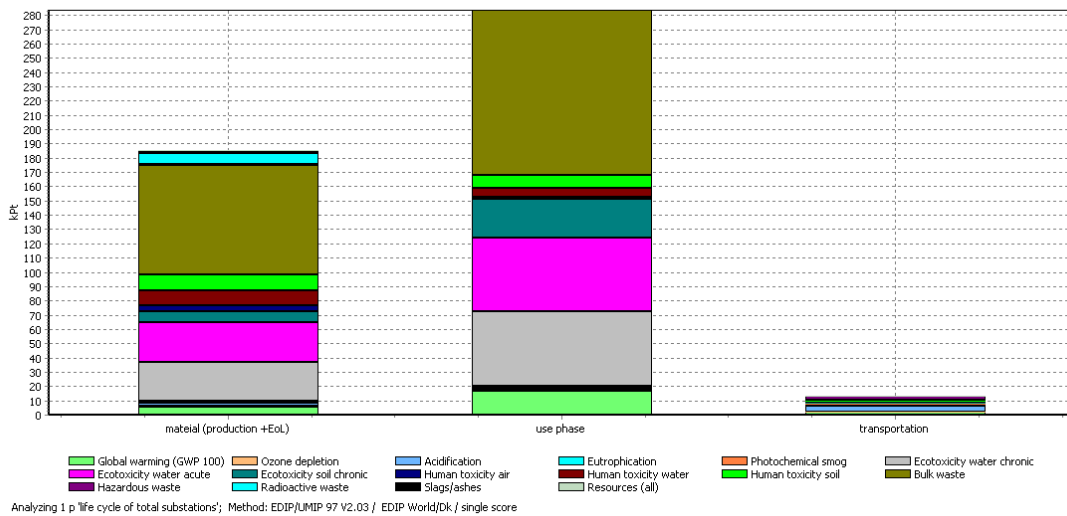

Fig. 3-54 : Single score result of total substations

These results reveal materials production and use phase are the key factor of improving the environmental impacts of the substations. If we want to decrease one substation's environmental burdens, the focus should be put on a better design of decreasing energy losses of equipments and reducing SF<sub>6</sub> emissions of circuit breakers (use phase is composed of these 2 factors), and decreasing materials and weights of equipments as far as possible.

The use phase is making the most environment impacts in the life cycle of the substations, however it contains use phases of many kinds of equipments, and who is or are the most impacting factor(s)? This question is answered by Fig. 3-55, which indicates clearly environmental impacts contribution of different equipments in their

use phase, and their environmental impacts are measured by single score. The chart contains 3 layers, the yellow block at top level signifies the use phase of total substations; the yellow blocks at the middle level represent use phase of different components in substations; and the grey blocks in the bottom level indicate the 2 kinds of processes causing the environmental impacts in the use phase of substations, i.e. electrical energy losses and SF<sub>6</sub> emissions. The thickness of connecting lines displays the environmental impacts contribution of each items, for example, use phase of power transformers accounts for 61.9% environmental impacts of total use phase of substations, shunt reactors for 30.6%, circuit breakers for 4.46%, busbars and conductors for 2.21%, whereas the rest equipments (surge arresters, current transformers, voltage transformers, etc) for only 0.83%. Thus, major environmental impacts during use phase of substations are from power transformers and shunt reactors. In view of impacts processes in use phase of substations, it's seen that the electrical energy losses take up for 95.7% of the total environmental impacts, while the SF<sub>6</sub> emissions for the rest 4.3%.

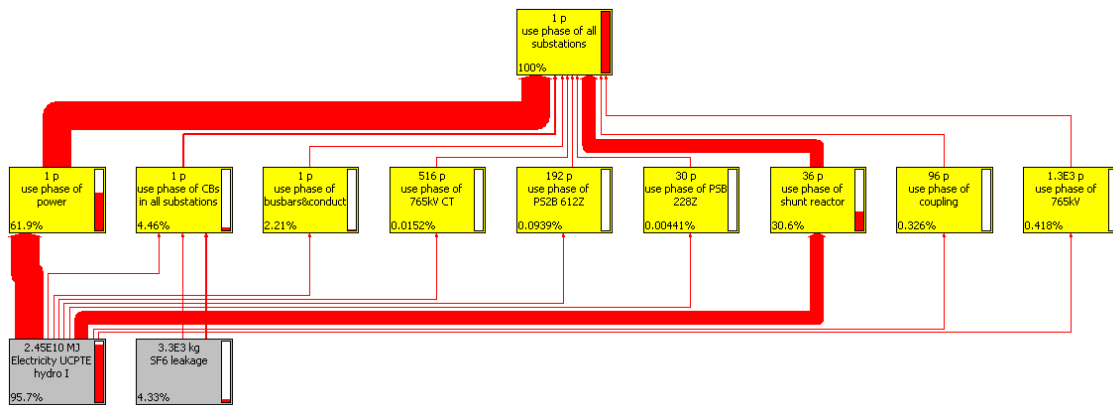

Fig. 3-55 : Environmental impacts contribution flow chart of use phase of total substations

For the detailed comparison analysis of the use phase impacts, the Fig. 3-56 shows the characterization result, and it reveals that circuit breakers are making the most CO<sub>2</sub>-equivalent emissions in substations (73.9% of total use phases in substations), the use phase of power transformers accounts for 16.9% CO<sub>2</sub>-equivalent emissions,



shunt reactors for 8.4%, busbars and conductors for 0.6%, and the rest for only 0.2%. As to the other impacts categories energy losses of power transformers have 64.7% impacts, shunt reactors have 32.0%, all kinds of conductors' energy losses for 2.3%, while the circuit breakers for 0.13%, and the rest for 0.9%.

Unlike the use phases of other equipments, the use phase of circuit breakers contains not only energy losses, but SF<sub>6</sub> emissions as well. In order to investigate the two factors' effects in use phase of circuit breakers, a comparison is done and shown in Fig. 3-57 that SF<sub>6</sub> emissions determine 99.95% CO<sub>2</sub>-equivalent emissions, the energy losses of circuit breaker for 0.05%. As the SF<sub>6</sub> emissions only have impact on Global Warming, it has no impact on the rest indicators, and this is why in Fig. 3-57 all indicators except GWP are in light blue. However, since the energy losses of circuit breakers account for only 0.13% of all the use phases' load on impacts indicators apart from Global Warming Potential, power transformers and shunt reactors are the major impacts except for CO<sub>2</sub>-equivalent emissions.

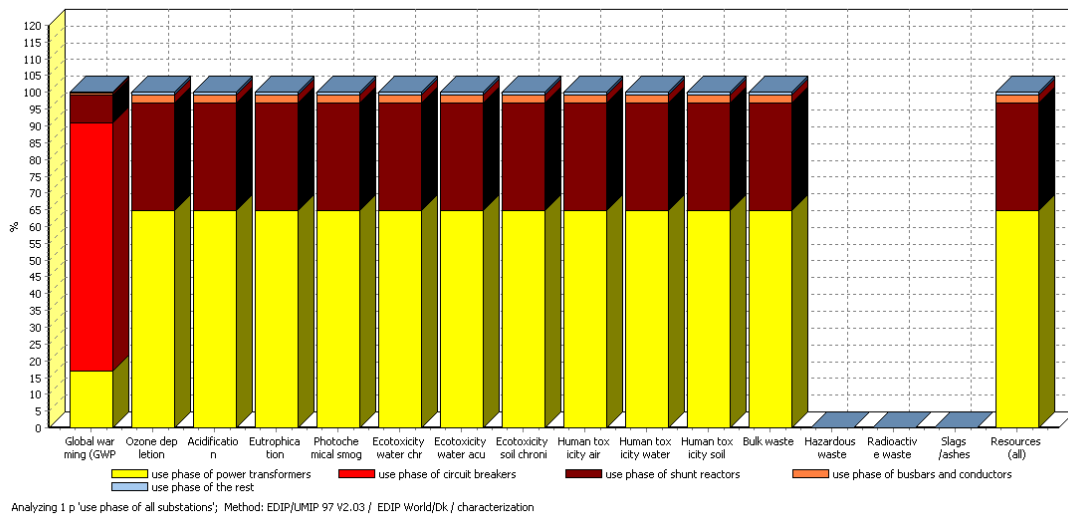

Fig. 3-56 : Characterization result of use phase of total substations

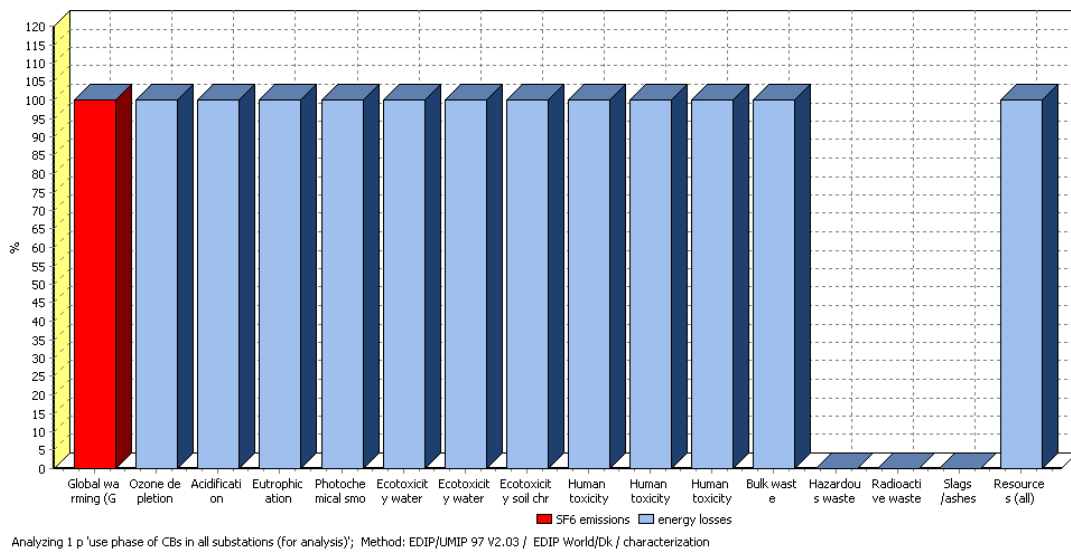

Fig. 3-57 : Characterization result of environmental impacts of use phase of circuit breakers

### 3.4 Life Cycle Assessment of Total Transmission System

Since the environmental impacts of transmission lines and substations have been analyzed separately, then the environmental impacts of this whole Venezuelan 765 kV AC transmission system are to be analyzed hereinafter.

#### 3.4.1 Life Cycle Impact Assessment of Total Transmission System

It's observed from Fig. 3-58 that environmental impacts of transmission lines are much bigger than that of substations, for example, Global Warming Potential of transmission lines is 3.2 times of substations', Ozone Depletion Potential is 7 times, Acidification Potential is 4.1 times, etc.

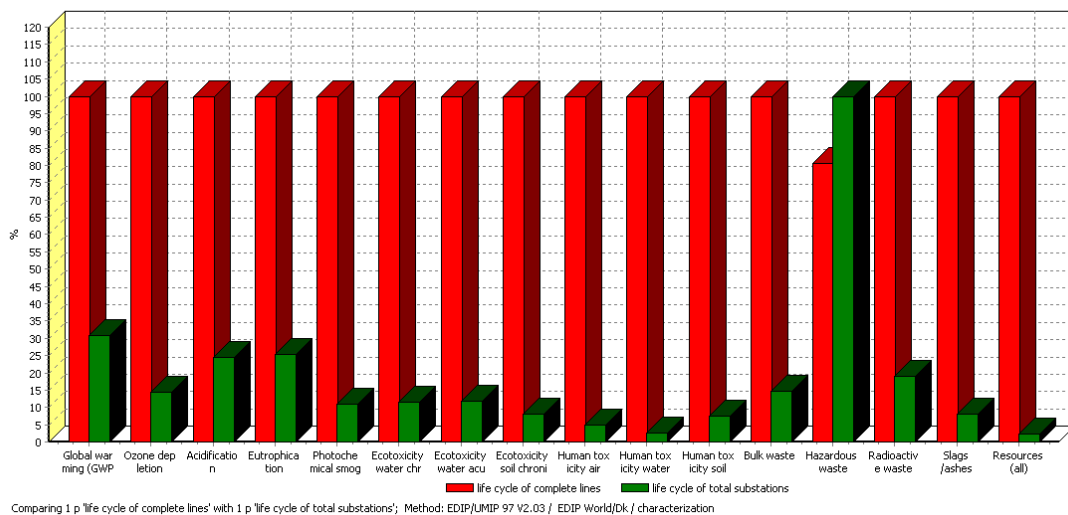

Fig. 3-58 : Comparison of environmental impacts between transmission lines and substations

Fig. 3-59 indicates the characterization result of the total transmission system, and it's seen that use phase gives the most environmental impacts on most of indicators. As to Global Warming Potential the use phase accounts for 55.9%, materials (production + end-of-life) for 39.3%, transport for 4.8%; regarding to Ozone Depletion Potential, the use phase accounts for 75.8%, materials (production + end-of-life) for 24.2%, transport for 0.06%, etc. It's also seen from the single score result (Fig. 3-60) of total transmission system that the use phase has the most environmental impacts.

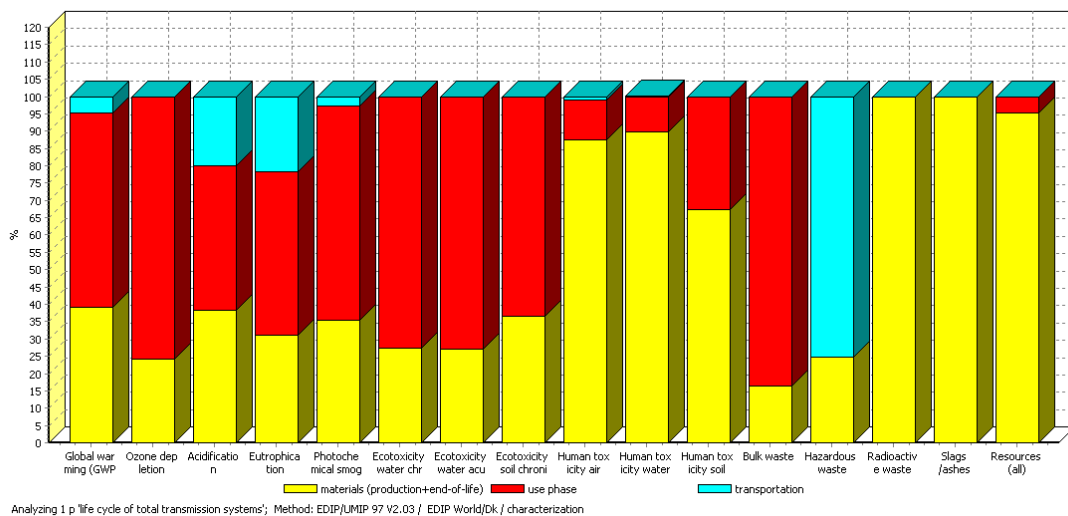

Fig. 3-59 : Characterization result of total transmission system

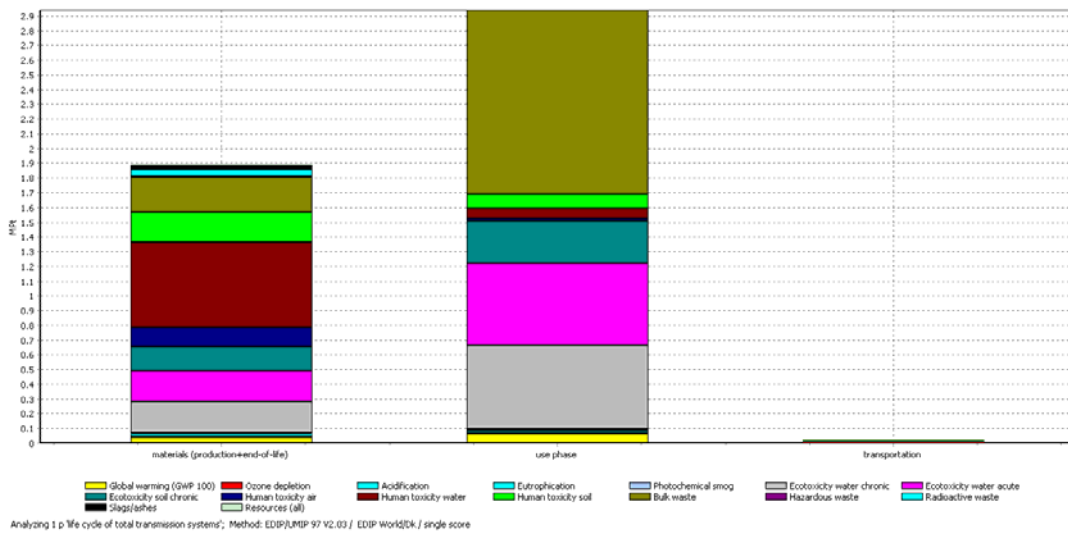

Fig. 3-60 : Single score result of total transmission system

The use phase of total transmission system is composed by SF<sub>6</sub> emissions of circuit breakers, energy losses in substations and energy losses in transmission lines, from the investigation of the comparison as shown in Fig. 3-61. It's seen that energy losses in transmission lines are the dominating environmental impacts in use phase, energy losses in substations is only around tenth of the transmission lines', SF<sub>6</sub> emissions of circuit breakers' impact is only on Global Warming, whose CO<sub>2</sub>-equivalent emissions are 28.9% of energy losses' in transmission lines.

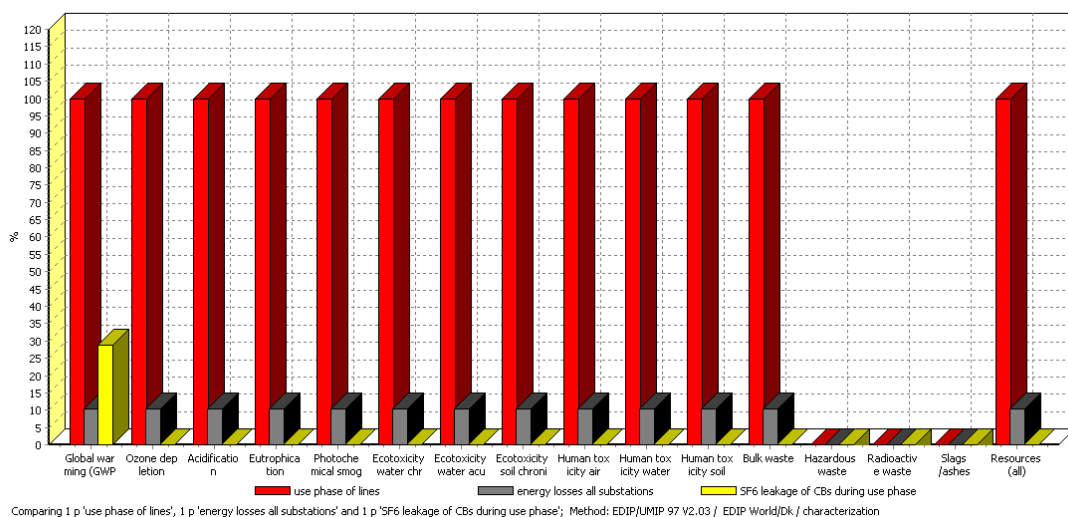

Fig. 3-61 : Comparisons of environmental impacts in use phase of total transmission system

Fig. 3-62 shows environmental impacts contribution in use phase of total transmission system, which are measured by single score of environmental impacts. It clearly indicates environmental impacts contribution of different components' use phases in this Venezuelan 765 kV AC transmission system. However, it's should noticed that the resources consumption indicator is not taken into account in the single score result, due to different weighting method for resources consumption.

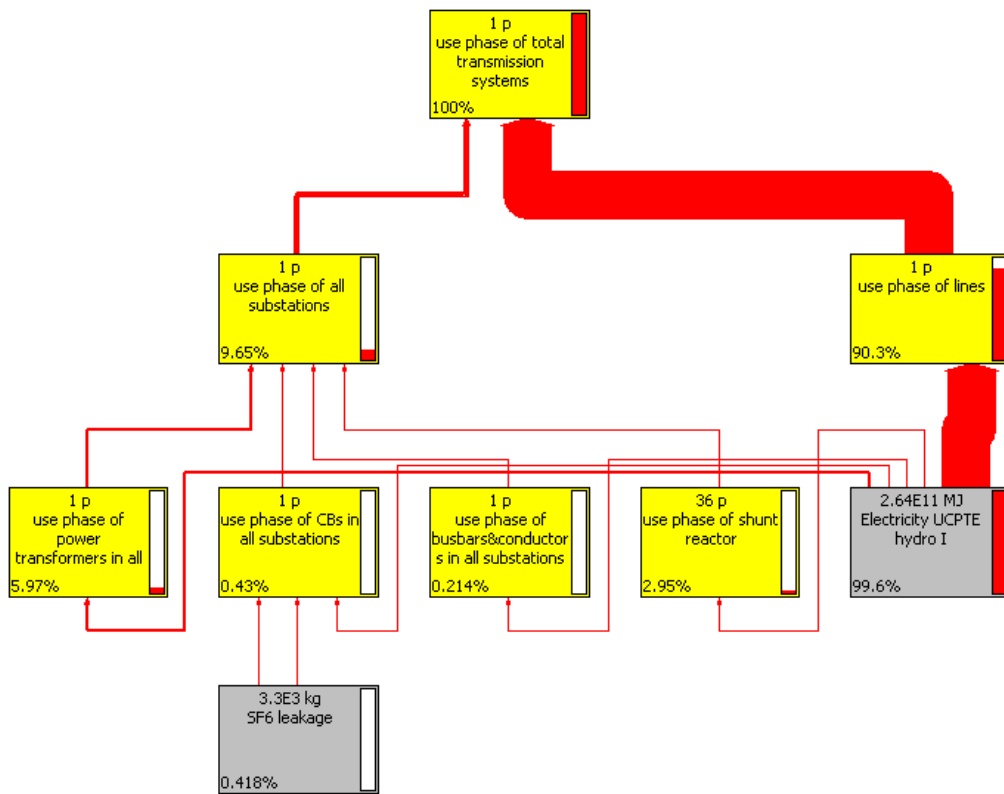

Fig. 3-62 : Environmental impacts contribution flow chart of use phase of total transmission system (cut-off rule: 0.2%)

The cut-off rule is set as 0.2%, this means that the component with impacts less than 0.2% of the total transmission system's impacts is not displayed in the flow chart. It reveals that the use phase of transmission lines gives 90.3% environmental impacts in the use phase of total transmission system. The energy losses are the most impacting factor (99.6% of total single score), while the SF<sub>6</sub> emissions of circuit breakers' are not the key issue regarding the environmental impacts. Regarding the equipments in

substations, use phase power transformers accounts for 5.97% of the total system use phase's environmental impacts, use phase of shunt reactors for 2.95%, use phase of circuit breakers for 0.43%, and use phase of all conductors in substations for 0.214%.

### 3.4.2 Environmental Comparisons of Different Generation Methods

The electrical energy transmitted in this Venezuelan 765 kV AC transmission system is generated by hydro-electric, if the generation method is changed into other ones, such as by coal or natural gas, the environmental impact of this transmission system will change accordingly.

Table 3-100 lists the use phase of this transmission system.

Table 3-100 : Use phase of total transmission system in 60 years

	Unit	Use phase of Total transmission system	Use phase of transmission lines	Use phase of substations
Electricity	MW	139.7	126.8	12.9
	MWh	$7.34 \times 10^7$	$6.66 \times 10^7$	$6.81 \times 10^6$
SF <sub>6</sub> emissions	ton	3.3	0	3.3

The different life cycle stages remains the same for this Venezuelan 765 kV AC transmission system, only the generation methods for electrical energy losses vary from hydro-electric (data using "Electricity UCPTE hydro I" from "IDEMAT 2001" library) to coal (data using "Electricity UCPTE coal I" from "IDEMAT 2001" library), then to natural gas (data using "Electricity UCPTE gas I" from "IDEMAT 2001" library). The comparisons of environmental impacts of this transmission system transmitting electricity generated by different methods are made, and Fig. 3-63 shows the result, and detailed value is shown in Annex B. It indicates that the coal generation method has the largest impacts, and the hydro-electric generation has the least impacts.

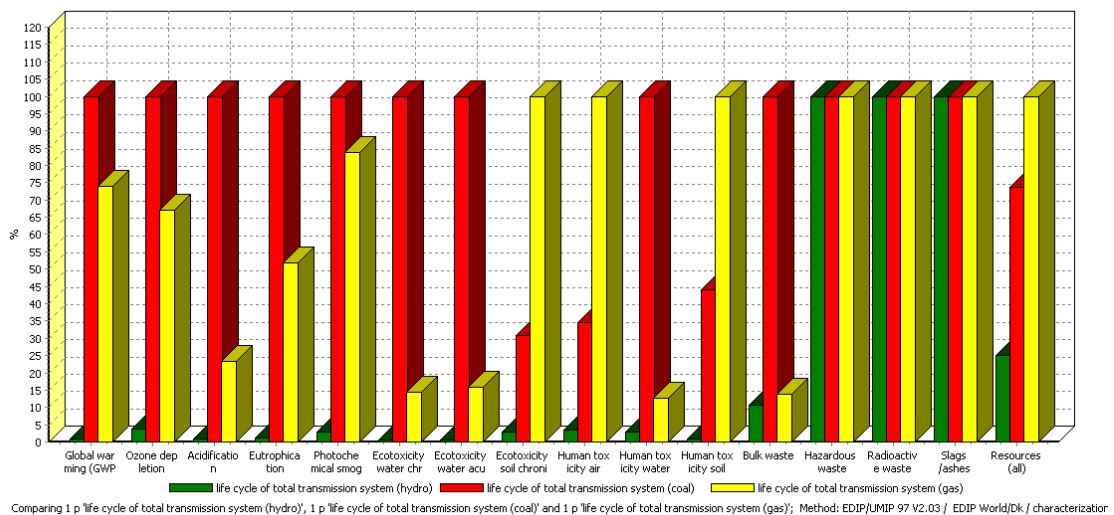

Fig. 3-63 : Environmental impacts comparisons of transmission system transmitting electricity generated by different methods

### 3.5 Conclusion

In this chapter a Life Cycle Assessment is conducted on a 765 kV AC transmission system, the functional unit of this LCA is to transmit 8000 MW hydro-electrical power to 760 km, during its service life of 60 years, and the average load factor is 60%.

The LCA of the whole transmission system is split up into 2 steps : LCA on transmission lines and LCA on substations.

In the LCA on transmission lines, the considered components include bundle conductors, ground wires, insulators, towers and foundations. In the LCA on substations, only the primary system is included, the so-called “secondary systems” - such as low voltage (lower than 1 kV) cables, lighting system, controlling systems (computers, electronic devices, IT, etc) - are not integrated. Thus the considered components include the access roads, gravels in substations, and the major equipments such as power transformers, circuit breakers, current transformers, voltage transformers, shunt reactors, etc, and their supporting frames, foundations.

Regarding the life cycle, materials production phase is defined as the production of all the necessary raw materials contained in the considered components listed hereinabove, however the manufacturing processes are not included. The use phase is defined as energy losses in conductors for transmission lines, energy losses of major equipments and SF<sub>6</sub> emissions for substations, during the service life of 60 years of this transmission system. End-of-life phase contains the relevant waste treatment scenarios, such as recycling of metal materials, mineral oil, SF<sub>6</sub>, landfill of porcelain and incineration, etc.

The LCIA results of the total transmission system indicate that use phase gives the most environmental impacts on most of indicators, e.g. regarding Global Warming Potential the use phase accounts for 55.9%, regarding Ozone Depletion Potential it accounts for 75.8%, regarding Acidification it determines 41.7%, etc. While use phase of total transmission system is composed by SF<sub>6</sub> emissions of circuit breakers, energy losses in substations and energy losses in transmission lines, which one is the most source of environmental impact? After investigation it's revealed that the energy losses in transmission lines is the dominating environmental impacts in use phase, which is roughly 10 times of that of energy losses in substations, and 3.5 times of that of circuit breakers' SF<sub>6</sub> emissions' Global Warming impact.

Results indicate that environmental impacts of transmission lines are much bigger than substations', e.g. Global Warming Potential of transmission lines is 3.3 times of substations', Ozone Depletion Potential is 7 times, Acidification Potential is 4.1 times, etc. Amongst the life cycle stages of transmission lines, the energy losses of conductors are largest part of environmental impacts of the transmission lines. As to the environmental impacts of substations, the use phase is also the key impacts, which include SF<sub>6</sub> emissions of circuit breakers and energy losses of different equipments. The circuit breakers' SF<sub>6</sub> emissions have most impacts on Global Warming in substations (73.9% of total use phase in substations). Energy losses of power



transformers are the most environmental burdens source impacts (61.9% of use phase of substations revealed by single score result), then the energy losses of shunt reactors (30.6% of use phase of substations revealed by single score result).

Through the LCA, it's known that energy losses in transmission lines and power transformers and SF<sub>6</sub> emissions of circuit breakers are the major sources of environmental impacts, of course, the materials production can not be ignored. This leads to the points to the eco-design of a transmission system, that is to say, if we are going to think of ways to decrease transmission system's environmental impacts, focus should be put on the methods of reducing energy losses of conductors of transmission lines and power transformers and decreasing the SF<sub>6</sub> emissions of circuit breakers. Besides, ways of minimizing materials used in equipments are also beneficial to the reduction of environment load.

The LCA of this 765 kV AC transmission system gives a quantitative analysis of environmental impacts of a transmission system, which makes it possible to choose or develop more environmental friendly transmission system, as further studies can go to an LCA of 765 kV AC gas-insulated substation (GIS) to determine which kind of substation has less environmental impacts, GIS or AIS (Air-Insulated Substation)? Or to an investigation of environmental development of integration of state-of-art equipments into transmission system, such as FACTS (Flexible AC Transmission System) components, etc. Or to study of Ultra High Voltage (UHV) AC transmission system's environmental impacts, to check whether UHV transmission system improves the environmental profile, compared with EHV transmission system, as investigated in next chapter.

## **Chapter 4**

# **Environmental Impacts Comparison between Ultra High Voltage and Extra High Voltage Transmission Lines**

Nowadays, Ultra High Voltage (UHV) transmission systems are widely constructed and commissioned around world, especially in China and India. In this context, it's of value to investigate the environmental impacts of UHV transmission systems.

In Chapter 2 the investigation results of energy efficiency indicate that UHV transmission line is more energy-efficient than Extra High Voltage (EHV) transmission line, in respect of transmission line losses, the UHV transmission lines are able to avoid CO<sub>2</sub>-equivalent emissions, compared to EHV transmission lines. Nevertheless, in order to compare the environmental impacts of UHV and EHV transmission lines, more aspects have to be considered, such as the different transmission line components' environmental impacts.

Therefore in this chapter, a Life Cycle Assessment is conducted on investigating the environmental impacts of one Chinese 1000 kV AC transmission line, and comparison between this UHVAC and EHVAC transmission line.

Jindongnan-Nanyang-Jingmen 1000 kV transmission system (see Fig. 4-1) is the first UHV transmission project built in China, and currently it's energized into commission. This single circuit line, sending 5000 MW power, starts from UHV Jindongnan

substation in Shanxi province and passes by UHV Nanyang switch-yard in Henan province to Jingmen UHV substation in Hubei province, the total length of line route is about 640 km.

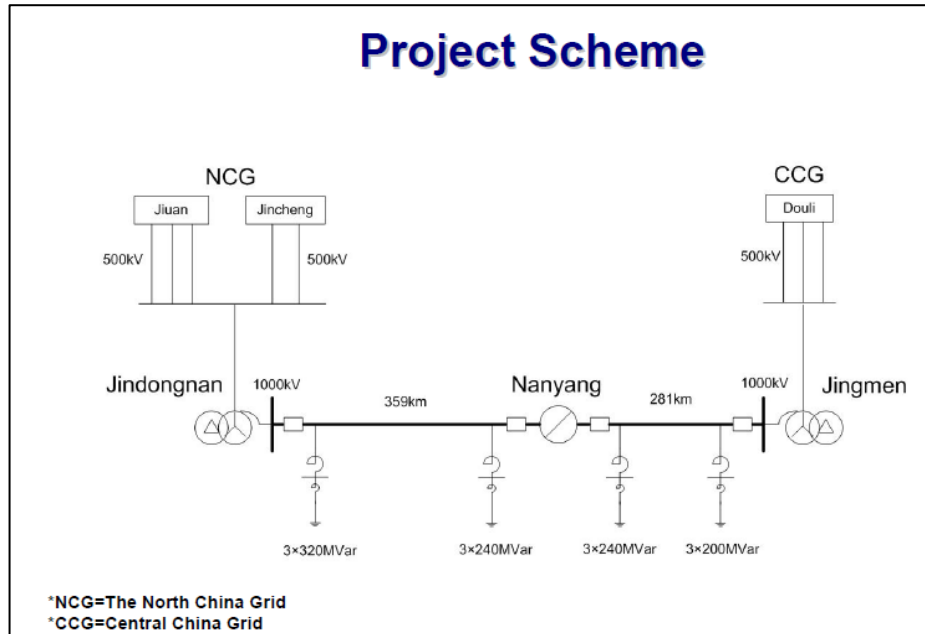

Fig. 4-1 : Project scheme of Chinese 1000 kV AC demo project [69]

In the LCA, the transmission line materials production, end-of-life, and use phase are to be modelled, while no transportation phase is to be simulated. This is because the transportation data is usually not so accurate, they are often based on assumptions, besides, the investigation in Chapter 3 shows that transportation phase is not dominating the impacts.

In order to compare the EHVAC and UHVAC transmission lines' environmental impacts, a 765 kV transmission line is set to fulfil the same function as the 1000 kV transmission line, which is to send 5000 MW power to 640 km, during the service life of 60 years. The establishment of this alternative 765 kV transmission line uses the realistic data from the Venezuelan 765 kV transmission line (described in detail in Chapter 3).

## 4.1 1000 kV AC Transmission Line

In this study, the transmission line materials production, end-of-life, and use phase are taken into account. Materials for transmission line include bundle conductors, ground wires, towers and insulators. The use phase is defined as energy loss in conductors during the service life of 60 years.

### 4.1.1 Materials Inventories

8-conductor bundles are used per phase, see illustration in Table 4-1, sub-conductor is LGJ-500/35, which is Chinese name for ACSR-500/35.

Table 4-1 : Parameters of Chinese 1000 kV AC transmission line

1000 kV AC	
Sub-conductors per phase	8×LGJ-500/35 497.01/34.36 mm <sup>2</sup>
Spacing	400 mm
Diameter of bundle conductor	1045 mm
Illustration of the bundle conductor	
AC resistance @ 75° (Ω/km)	0.00805 [70]

As total length of single circuit is 640 km, in which there are 3 phases, and each phase contains 8 sub-conductors. With regards to aluminium density of  $2.7 \times 10^3 \text{ kg/m}^3$  and steel density of  $7.85 \times 10^3 \text{ kg/m}^3$ , then total weight of aluminium used for 640km over head line is :

$$497.01 \times 10^{-6} \text{ m}^2 \times 640 \times 10^3 \text{ m} \times 2.7 \text{ ton/m}^3 \times 8 \times 3 = 20\,612 \text{ ton}$$

Total weight of steel used for 640km over head line is :

$$34.36 \times 10^{-6} \text{ m}^2 \times 640 \times 10^3 \text{ m} \times 7.85 \text{ ton/m}^3 \times 8 \times 3 = 4\,143 \text{ ton}$$

LBGJ-170-20AC is used as ground wire in this transmission line, which is also a kind of stranded aluminum-clad steel wire, in the finished size, it has an aluminum coating equal to about 43 percent of the cross-sectional area of the composite wire.

LBGJ-170-20AC has cross-section area of  $172.5 \text{ mm}^2$  (see Table. 4-2), in which aluminium area is  $74.2 \text{ mm}^2$  and steel area is  $97.3 \text{ mm}^2$ .

Table 4-2 : Ground wires specifications

<b>1000 kV AC</b>	
Ground wire type	LBGJ-170-20AC
Overall diameter	17 mm
Cross-section area	$172.5 \text{ mm}^2$
Aluminium area	$74.2 \text{ mm}^2$
Steel area	$97.3 \text{ mm}^2$

2 ground wires are equipped per single circuit, then total weight of aluminium used for 640 km ground wires is :

$$74.2 \times 10^{-6} \text{ m}^2 \times 640 \times 10^3 \text{ m} \times 2.7 \text{ ton/m}^3 \times 2 = 257 \text{ ton}$$

Total weight of steel used for 640 km ground wires is :

$$97.3 \times 10^{-6} \text{ m}^2 \times 640 \times 10^3 \text{ m} \times 7.85 \text{ ton/m}^3 \times 2 = 978 \text{ ton}$$

Self-supporting towers are used in this 1000 kV transmission line, Fig. 4-2 shows common used tower types towers, cat-head tower is used plain terrain, cup-shape tower is used in hill and mountainous terrain.

In the length of 640 km of transmission line, per km tower weight is 140 ton, then used steel is 89600 ton [71]; and per km concrete volume is  $230 \text{ m}^3$ , with regards to reinforced concrete density of  $2.4 \text{ ton/m}^3$ , then weight of concrete for tower

foundations is :

$$640 \text{ km} \times 230 \text{ m}^3/\text{km} \times 2.4 \text{ ton/m}^3 = 353 \text{ 280 ton}$$

Thus, average weight of reinforced concrete per tower is 275 ton. All types of towers are hot-dip galvanized, according to practical experience that Zn coatings are around 5% in weight of a tower, then Zn used in all towers are 4716 ton.

IVI type strings of insulators (see Fig. 4-3) are used for both cat-head towers and cup-shape tower, each string consists of 54 pieces insulators of 300 kN or 400 kN, both ceramic and glass type are used. However, in calculation of environmental impact, the assumption that all the insulators are ceramic is made, as it's hard to know the proportion of ceramic and glass insulations.

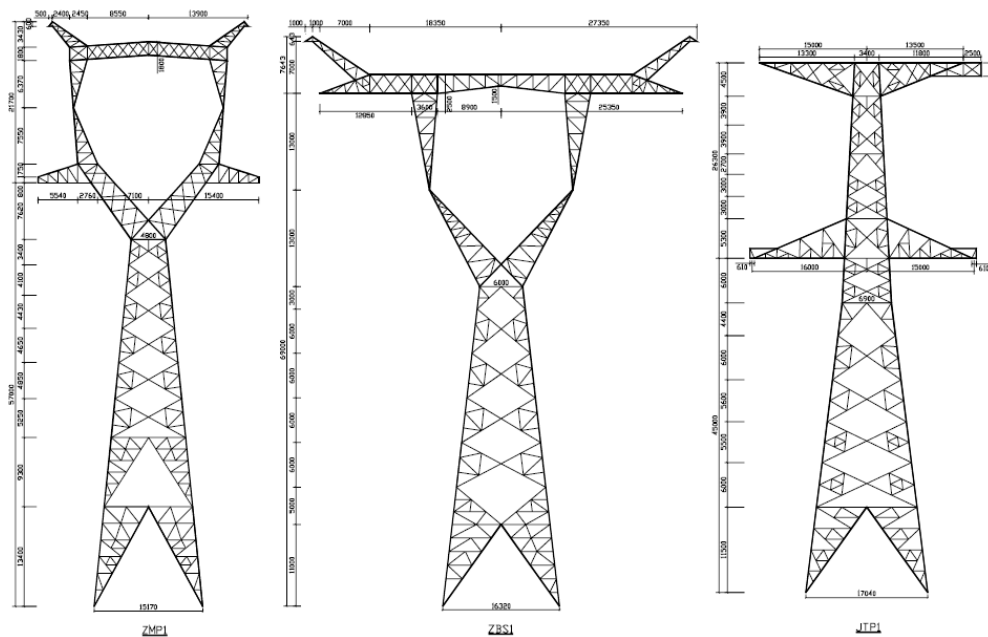

a) cat-head tower

b) cup-shape tower

c) tension tower

Fig. 4- 2 : Tower types in 1000 kV AC project [69]

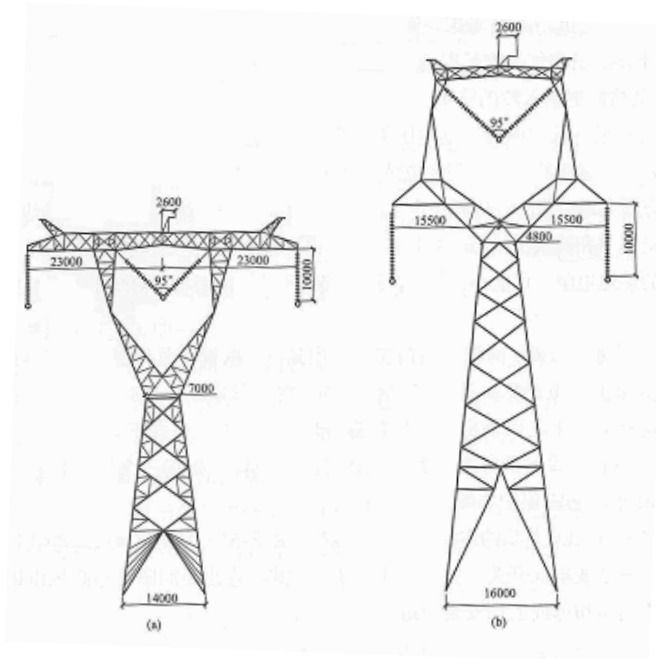

Fig. 4-3 : Illustrations of IVI insulator strings

1284 towers are constructed in transmission line [69]. Due to the lack of information on tension towers and their relatively minority in amount, 1284 towers are considered to be only the cat-head towers and cup-shape towers.

Although the end fittings are normally a malleable or ductile cast iron cap and a forged steel pin, for calculation of materials used for insulators, all cap and pin are regarded as cast iron, and no Zn coatings are taken into account. Calculation results are shown in Table 4-3, based on the assumption that 60% of total weight of one insulator is cast iron for cap and pin, and 40% is for ceramic.

Table 4-3 : insulators materials used in this project

Type	300 kN	400 kN	Total
approx. net weight per insulator	10.6 kg	14 kg	
number of pieces used in project	138672	138672	
cast iron (cap + pin) weight 60% weight per insulator	889.0 ton	1164.8 ton	2053.8 ton
ceramic weight 40% weight per insulator	588.0 ton	776.6 ton	1364.6 ton

Considering the lifespan of insulators are 30 years, and during the service life of 60 years of the transmission line, the total amount of materials of insulators are listed in Table 4-4.

Table 4-4 : Materials of insulators during lifetime of transmission line

	Material	Weight
Insulators	ceramic	2729 ton
	cast iron (cap + pin)	4108 ton

All the considered materials used in conductors, ground wires and towers of this 1000 kV AC transmission lines are listed in Table 4-5.

Table 4-5 : Materials used in 1000 kV AC transmission line during service life of 60 years

Components	material	weight
Conductors	Al	20612 ton
	steel	4143 ton
Ground wires	Al	257 ton
	steel	978 ton
Towers	steel	89600 ton
	concrete (reinforced)	353280 ton
	Zn coatings	4 716 ton
Insulators	ceramic	2729 ton
	cast iron (cap + pin)	4108 ton

#### 4.1.2 Use phase of Transmission Line

The use phase of transmission line is defined as the energy loss in conductors during the service life of 60 years of this transmission line. This 1000 kV transmission line is to transmit 5000 MW power from Jinnanyang substation to Jingmen substation, and the load factor is set as 60%, which is the same as the situation in Venezuelan 765 transmission system. Power factor is assumed to be 0.98, therefore, according to Eq. 4-1, Eq. 2-4 and Eq. 2-5 described in Chapter 2, with regards to transmission line length of 640 km and the resistance of bundle conductors is 0.00805  $\Omega$ /km, the



average current in each phase is 1.77 kA, total transmission line power loss is 48.3 MW, and in its service life of 60 years of this UHVAC line, electrical energy loss is  $2.5 \times 10^7$  MWh.

$$S = P / pf \quad (\text{Eq. 4-1})$$

in which :

$S$  – apparent power transmitted by 3 phases of AC line

$P$ – real power transmitted by 3 phases of AC line

$pf$ – power factor of transmission line

#### **4.1.3 End-of-Life Phase of Transmission Line**

In the end-of-life phase, steel and aluminium in conductors, ground wires and tower structures are recycled; ceramic of insulators is landfilled, pins and caps of insulators are recycled as steel; reinforced bar in concrete is recycled, the rest is landfilled; and the rest is landfilled.

#### **4.2 765 kV AC Transmission Line**

In order to compare a 765 kV with 1000 kV transmission lines' environmental impacts, the 765 kV transmission line should perform the same function as the 1000 kV transmission line, i.e. it should send 5000 MW power to 640 km.

According to the analysis of transmission capacity of different transmission lines discussed in Chapter 2, it's seen that in order to transmit 5000 MW power 2 circuits (3 phases per circuit) should be built for 765 kV transmission line, in contrast, 1000 kV transmission line only needs one single circuit.

In the investigation of 765 kV transmission line's environmental impacts, the realistic

data from the Venezuelan 765 kV transmission line are utilized, and the considered aspects are the same as the 1000 kV AC transmission line's.

In this study, the transmission line materials production, end-of-life, and use phase are taken into account. Materials for transmission line include bundle conductors, ground wires, towers and insulators. The use phase is defined as energy loss in conductors during the service life of 60 years.

#### **4.2.1 Materials Inventories**

The specifications of conductors for 765 kV transmission line are listed in detail in Table 3-2 in Chapter 3, the conductor type is ACAR 1300 MCM; in calculations all the weight of conductor is regarded as Aluminium weight. Taking regards to weight of ACAR of 1817 kg/km, aluminium for conductors for this 765 kV AC transmission line is 27910 ton.

The ground wire for 765 kV AC transmission line is Alumoweld 7#7 type wire (see Fig. 3-5). As there are 2 circuits, and each circuit is 640 km, and 2 ground wires are equipped per circuit, then according to the specifications shown in Table 3-5 total weight of Aluminium in ground wires used in the transmission lines is :

$$49.9 \text{ kg/km} \times 640 \text{ km} \times 2 \times 2 = 128 \text{ ton}$$

Total weight of steel in ground wires used in the transmission lines is :

$$442.1 \text{ kg/km} \times 640 \text{ km} \times 2 \times 2 = 1132 \text{ ton}$$

All kinds of towers constructed in Venezuelan 765 kV transmission lines are described in detail in Chapter 3, and average weight of one tower is 18 ton. The average distance between adjacent towers is 450 m, and total length of single-circuit line is 1280 km, then 2845 towers are needed in the transmission lines.

All types of towers are hot-dip galvanized, according to practical experience that Zn coatings are roughly 5% in weight of a tower, then Zn used in all towers are 2560 ton, see Table 4-6. The reinforced concrete for each tower weighs averagely 36.8 ton per tower, then total weight of reinforced concrete for 2845 towers is :

$$2845 \times 36.8 = 104696 \text{ ton}$$

Table 4-6 : Weight of steel and Zn coatings for towers

	765 kV AC
Tower numbers	2845
Average tower weight tower	18 ton
Total towers weight	51210 ton
Steel for towers (95% tower weight)	48650 ton
Zn coatings (5% tower weight)	2560 ton

As for the insulators, there are different layout types of several kinds of insulators in Venezuelan 765 kV transmission line, herein a simplification is applied by using the average weight of insulators per tower, which is calculated below in Table 4-7.

Table 4-7 : Materials of insulators per tower

	Material	Weight
Insulators per tower	ceramic	555 kg
	cast iron (cap + pin)	832 kg

Considering the lifespan of insulators are 30 years, and during the service life of 60 years of the transmission line, the total amount of materials of insulators are listed in Table 4-8.

Table 4-8 : Materials of insulators during lifetime of 765 kV transmission line

	Material	Weight
Insulators	ceramic	3159 ton
	cast iron (cap + pin)	4734 ton

The inventories of all the considered materials of 765 kV AC transmission line are summarized herein in Table 4-9.

Table 4-9 : Materials used in 765 kV AC transmission line

Components	Material	Weight
Conductors	Aluminium	27910 ton
Ground wires	Aluminium	128 ton
	steel	1132 ton
Towers	steel	48650 ton
	concrete (reinforced)	104696 ton
	Zn coatings	2560 ton
Insulators	ceramic	3159 ton
	cast iron (cap + pin)	4734 ton

#### 4.2.2 Use phase of Transmission Line

The use phase of 765 kV transmission line is also the energy loss in conductors during the service life of 60 years. Under the same method of calculations used for 1000 kV transmission line, with regards to sending power of 5000 MW power and the load factor of 60%, as for 765 kV transmission line, current in each phase is 1.16 kA, total transmission line power loss is 42.5 MW, and in its service life of 60 years electrical energy loss is  $3.8 \times 10^7$  MWh.

#### 4.2.3 End-of-Life Phase of Transmission Line

The same end-of-life phase is simulated as 1000 kV AC transmission line, steel and aluminium in conductors, ground wires and tower structures are recycled; ceramic of insulators is landfilled, pins and caps of insulators are recycled as steel; reinforced bar in concrete is recycled, the rest is landfilled; and the rest is landfilled

#### 4.3 Life Cycle Assessment of 1000 kV AC & 765 kV AC Transmission Lines

The materials and energy loss of 1000 kV AC transmission line and 765 kV AC transmission line are summarized in Table 4-10 and Table 4-11.

Table 4-10 : Comparisons of materials and energy loss between 1000 kV AC transmission line and 765 kV AC transmission line

Categories	Material	1000 kV transmission line	765 kV transmission line
Conductors	Aluminium	20612 ton	27910 ton
	steel	4143 ton	0
Ground wires	Aluminium	257 ton	128 ton
	steel	978 ton	1132 ton
Towers	steel	89600 ton	48650 ton
	concrete (reinforced)	353280 ton	104696 ton
	Zn coatings	4 716 ton	2360 ton
Insulators	ceramic	2729 ton	3159 ton
	cast iron (cap + pin)	4108 ton	4734 ton
Energy loss during 60 years		$2.5 \times 10^7$ MWh	$3.8 \times 10^7$ MWh

Table 4-11 : Comparisons of materials between 1000 kV AC transmission line and 765 kV AC transmission line

Material	1000 kV transmission line	765 kV transmission line
Aluminium	20869 ton	28038 ton
steel	94721 ton	49782 ton
concrete (reinforced)	353280 ton	104696 ton
Zn coatings	4716 ton	2360 ton
ceramic	2729 ton	3159 ton
cast iron	4108 ton	4734 ton

The life cycle impact assessment is conducted on these 2 transmission lines, with the

aid of software SimaPro 7.1, through the analysis by the impacts assessment method EIDP/UMIP 97 version 2.03. Characterization results of these 2 transmission lines are compared in Fig. 4-4, detailed value is shown in Annex C, besides all the detailed LCIA results of this Chapter are listed in Annex C. It's noticed that in most categories the environmental impacts of 1000 kV transmission line is smaller than that of 765 kV transmission line, e.g. 66.1% of 765 kV transmission line's in CO<sub>2</sub>-equivalent emissions, 66.1% of 765 kV transmission line's in Ozone Depletion, 66.3% of 765 kV transmission line's in Eutrophication, etc. Globally speaking, the UHVAC transmission line reduces environmental impacts compared with EHVAC transmission line, which is also seen in the single score result of LCIA (Fig. 4-5).

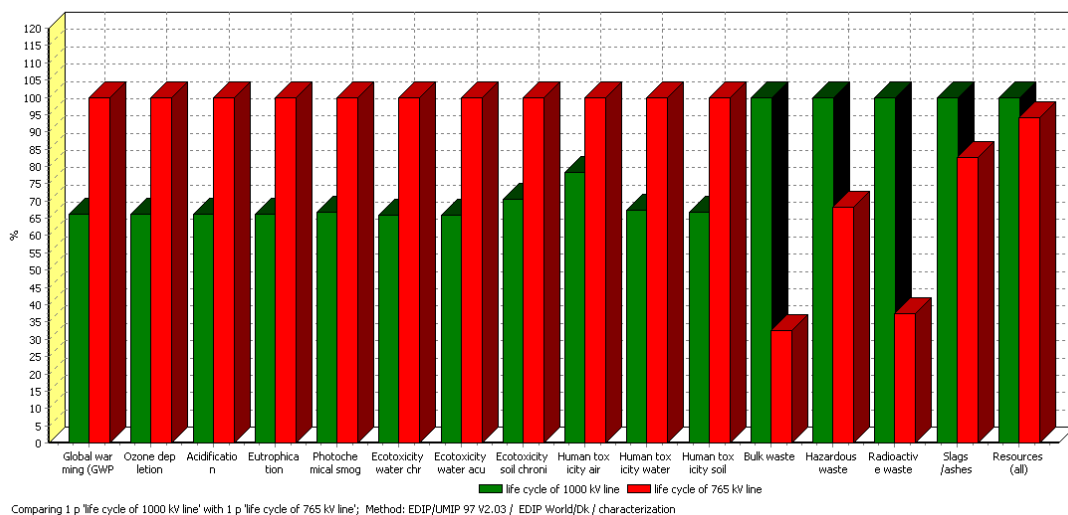

Fig. 4-4 : Environmental impacts comparison between  
1000 kV and 765 kV AC transmission line  
(by coal-generated method)

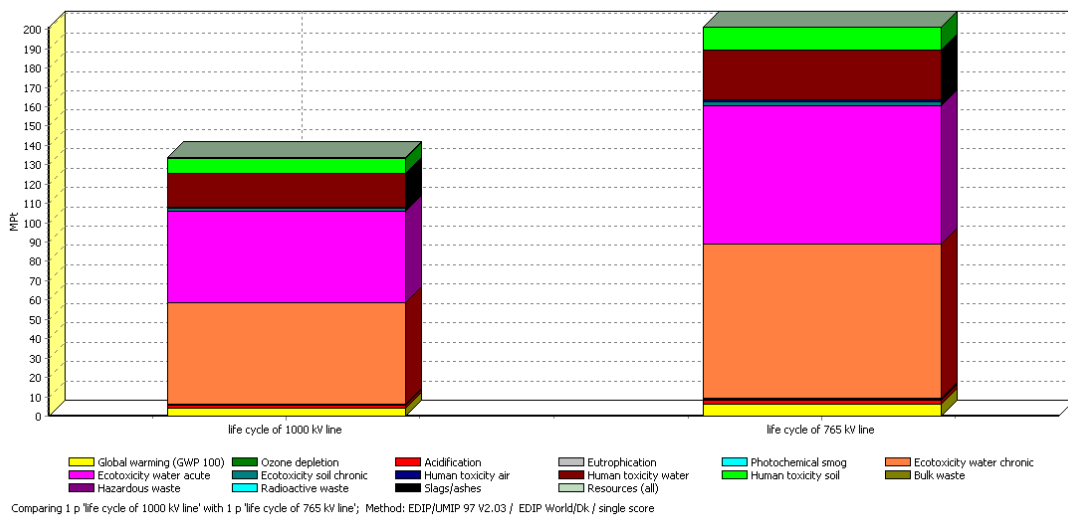

Fig. 4-5: Single score result of 1000 kV and 765 kV AC transmission line  
(by coal-generated method)

During the life cycle of the 1000 kV transmission line, which stage impacts more on environment? Is that use phase, similar to 765 kV AC Venezuelan transmission line (discussed in detail in Chapter 3)?

This question is answered by the results shown in Fig. 4-6, the energy loss in conductors during the service life of 60 years are the major source of environmental impacts, e.g. it gives 99.3% of total transmission line's CO<sub>2</sub>-equivalent emissions, 99% of total Ozone Depletion Potential, 99.1% of total Acidification Potential, etc, and as the single score result (Fig. 4-7) shows the energy loss comprises the 98.6% of environmental impacts of the total transmission line.

In this Chinese 1000 kV AC transmission line it's true that the energy loss is dominating the environmental impacts, however, we cannot draw a conclusion that the energy loss is always dominating environmental impacts in all the UHVAC transmission line. This is because the environmental impacts relating to use phase are varying with generation methods of electrical energy. The power transmitted in this Chinese UHVAC transmission line is generated by coal, what if it's transmitting the hydro-electric power?

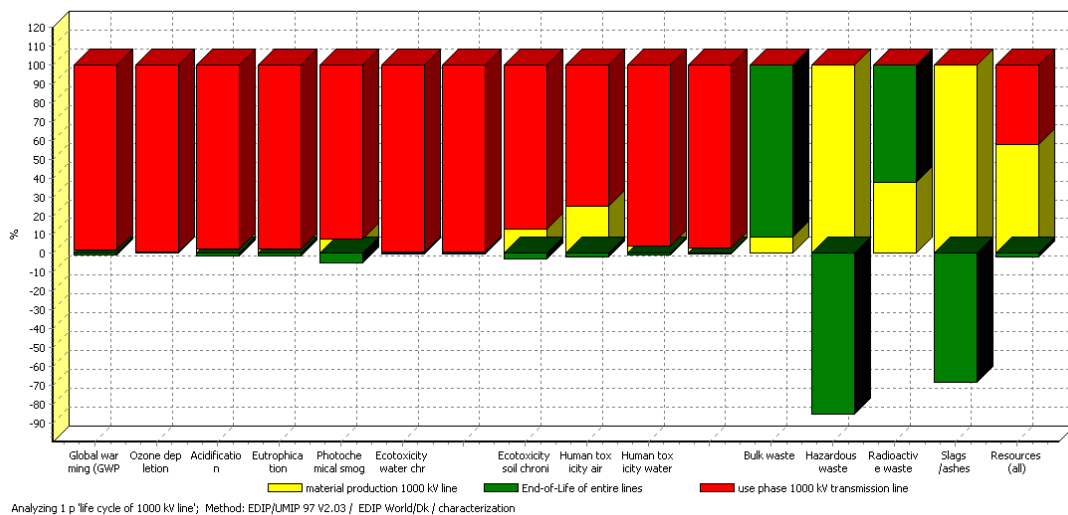

Fig. 4-6 : Characterization result of Chinese 1000 kV AC transmission line  
(by coal-generated method)

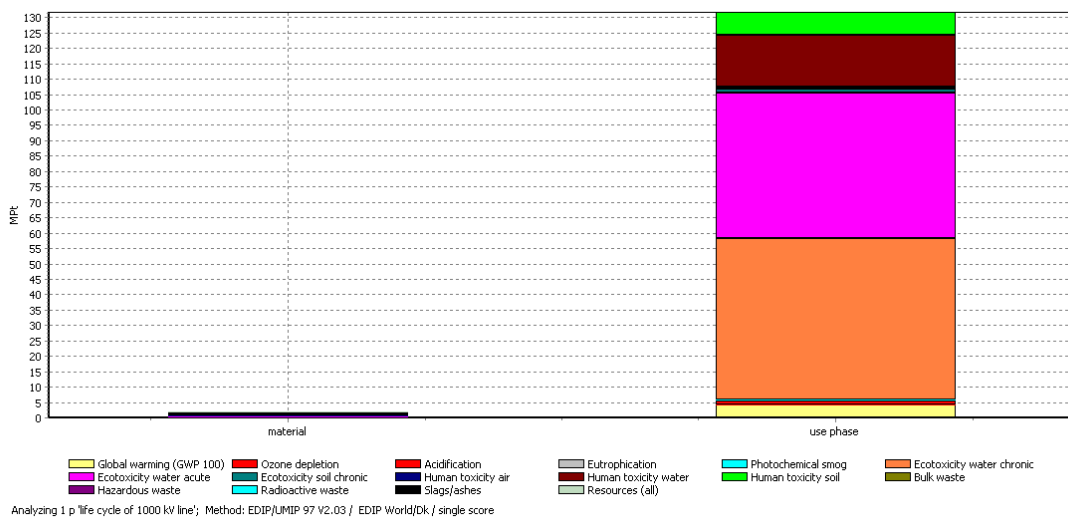

Fig. 4-7 : Single score results of 1000 kV AC transmission line  
(by coal-generated method)

The simulation is changed from electricity generated by coal to hydro-electric generation, the environmental impacts of raw materials production of transmission line and end-of-life remain the same, but the energy loss' s environmental impacts decrease dramatically (see Fig. 4-8), e.g. CO<sub>2</sub>-equivalent emissions turn to 0.37% of original situation, Ozone Depletion Potential become 2.93%, Acidification to 0.36%. This is because the coal-generated method is more polluting than hydro-electric generation.



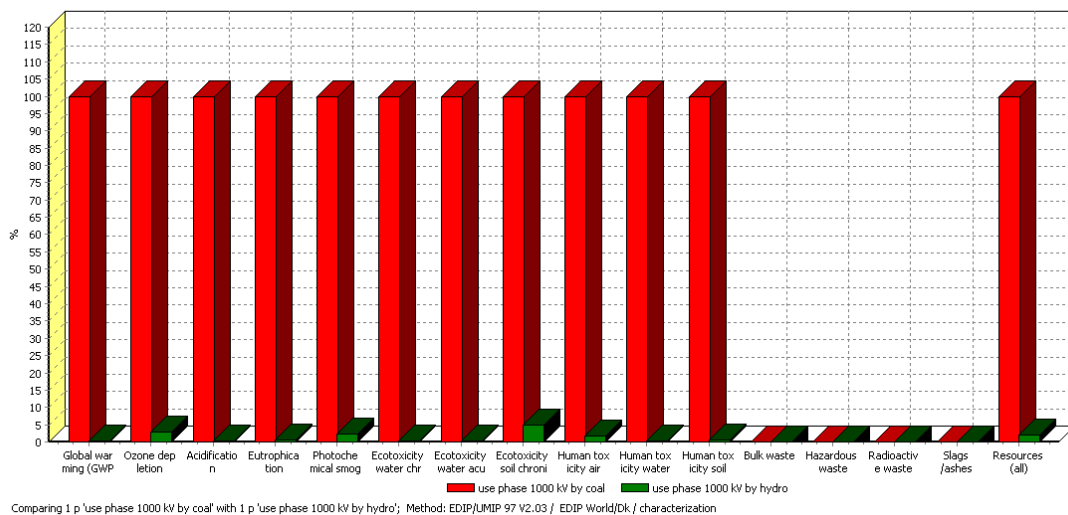

Fig. 4-8 : Environmental impacts comparison of energy loss of 1000 kV AC transmission line by different ways of generation (coal and hydro-electric)

Therefore, the proportion of energy loss's environmental impacts is changing accordingly, as shown in Fig. 4-9, its CO<sub>2</sub>-equivalent emissions turn to be 32.1% of total transmission line's, Ozone Depletion Potential become 74.9%, Acidification to be 28.8%, etc. The energy loss is not dominating the environmental impacts as coal-generation does, but still is not an ignorable part, as the single score result indicates that the use phase comprises a 23.3% of the total transmission line's impacts.

Apart from energy loss in conductors, the environmental impacts of materials in 1000 kV AC transmission line are even higher than that of 765 kV AC transmission line, which is revealed in the results shown in Fig. 4-10. This is because in 1000 kV AC transmission line more materials are contained in towers, especially the Zinc coating.

As a whole, the environmental impacts of 765 kV AC are higher than that of 1000 kV AC transmission line, with the fact that raw materials in 1000 kV AC transmission line have more impacts than that of 765 kV AC transmission line, this reveals that the improved energy efficiency is the key factor which reduces the UHVAC transmission

line's environmental impacts.

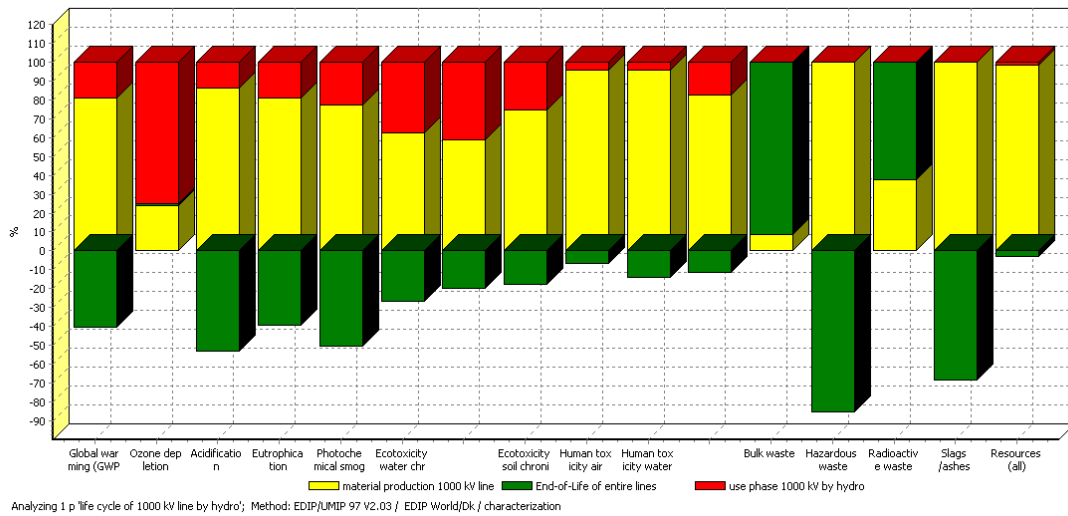

Fig. 4-9 : Characterization results of 1000 kV AC transmission line (by hydro-electric generation)

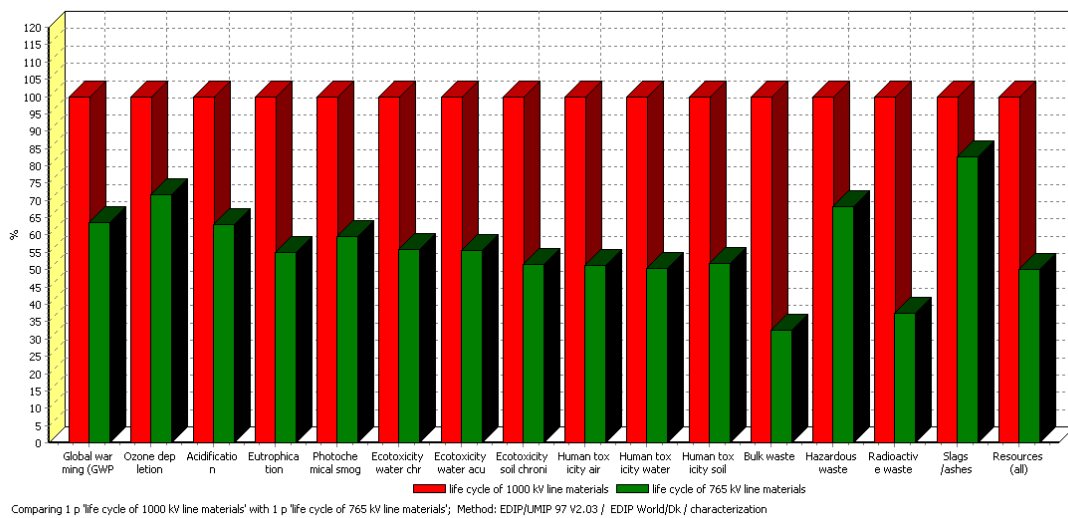

Fig. 4-10 : Environmental impacts comparisons of materials in 1000 kV and 765 kV transmission line

#### 4.4 Conclusion

In this chapter one Chinese 1000 kV UHVAC transmission line's environmental impacts are compared with a 765 kV EHVAC one. The functional unit is set as sending 5000 MW electrical power to 640 km, with a service life of 60 years. In the

life cycle, the transmission line materials production, end-of-life, and use phase are taken into account, no transportation phase is considered.

Life Cycle Assessment results show that UHVAC transmission line reduces environmental impacts compared with EHVAC transmission line, due to improved energy-efficiency by UHVAC transmission line. Aside from the energy losses in conductors of both transmission lines, the materials-based environmental impacts of UHVAC is even high than EHVAC's, which is due to the larger amount of materials in towers structures in UHVAC transmission line, especially zinc coatings.

The energy loss of transmission line's environmental impacts are not a constant value, it's varying according to the generation methods of the transmitted electricity. The electricity in Chinese UHVAC transmission line is coal-generated, if it's changed to hydro-electricity, the energy loss's environmental impacts decrease dramatically, but still comprises a 23.3% of the total environmental impacts of the whole life cycle of transmission line; in contrast, the environmental impacts of energy loss based on coal-generated method accounts for 98.6% of the total transmission line's environmental impacts.

The comparisons between UHVAC and EHVAC in this chapter are limited in the scope of transmission line, the further investigation could go to the integration of environmental impacts of UHVAC substations, whose difficulty lies in the acquisition of the relevant data relating to the kinds of equipments.

## CONCLUSIONS

Nowadays all around world, eco-design approach is widely investigated and applied by both academic and enterprise entities, in order to develop methods of reducing the environmental impacts of products and services, help protect the environment and realize the sustainable development.

In order to perform eco-design on whatever kind of product or service, its environmental aspects have to be assessed, which is commonly fulfilled by Life Cycle Assessment (LCA), it enables the quantitative analysis of the environmental impacts of a product or service throughout its entire life cycle, as well as the potential impacts on the environment. On most common occasions, simplifications are applied either by omission of certain phase or by substitutions of some processes, etc, when performing a LCA, as it's not always available for full LCA concerning time, cost and even data availability.

In Transmission & Distribution (T&D) fields, the eco-design approaches are also integrated, as the industrial products are a major source of environmental impacts, it's valuable to reduce the environmental impacts of T&D products in order to relieve the burden on environment. In general, these eco-design approaches can be categorized into "product approach", which focuses on individual product's reduction of environmental impacts, "system approach", which considers a scale of a system, and "decision-making approach", which deals with the environmental impacts in a higher strategic scale.

The eco-design for product approach is quite a well-developed trend in T&D fields, however, as only one single electrical product cannot provide the electrical power to uses, electrical system consists of a huge number of components, in order to investigate system's environmental profile, the entire environmental profiles of different composing products has to be integrated systematically, that is to say, a

system approach is needed.

In this context, this thesis “Eco-design of Power Transmission Systems”, based on “system approach” of eco-design, is focused on analyzing the transmission systems’ environmental impacts, locating major environmental burden sources, and developing methodologies of reducing its environmental impacts.

Speaking of “transmission systems”, there are different kinds of forms, and can be categorized by different criteria, such as current types (Alternating Current or Direct Current), voltage levels (High Voltage, Extra High Voltage or Ultra High Voltage), circuit breakers types (Air-Insulated Substation, Gas-Insulated Substation, or Hybrid type), etc. However, generally one transmission system consists of transmission lines and substations, its environmental impacts are split into impacts of transmission lines and substations.

In Chapter 2 “Energy Losses of Different Transmission Lines & Relevant CO<sub>2</sub>-equivalent Emissions”, a series of EHV and UHV transmission lines, i.e. 500kV AC, 765kV AC, 1200kV AC, ±500kV DC and ±800kV DC are set as targets to investigate their energy efficiency and CO<sub>2</sub>-equivalent emissions due to the energy loss through the transmission line.

Results indicate that UHV transmission line is more energy-efficient, as 1200 kV AC line loses 4.30% of power through the line when sending 6000 MW power to 1200 km far away, and ±800 kV DC line loses 4.63%, while 12.16% for 500 kV AC, 6.61% for 765 kV AC, and 7.17% for ±500 kV DC (see Fig. 1). Then CO<sub>2</sub>-equivalent emissions due to transmission line losses are calculated, and results show that UHV transmission lines are able to avoid CO<sub>2</sub>-equivalent emissions, compared to EHV transmission lines.

Meanwhile, UHV transmission line reduces the required right of way, especially ±800

kV DC line, which is obviously beneficial to environment, and helps lessen the visual impacts on landscape. Besides, for  $\pm 800$  kV DC, it needs fewer conductors, and there is no need to build sub-stations in a very long distance, therefore, it also shows its economic benefits.

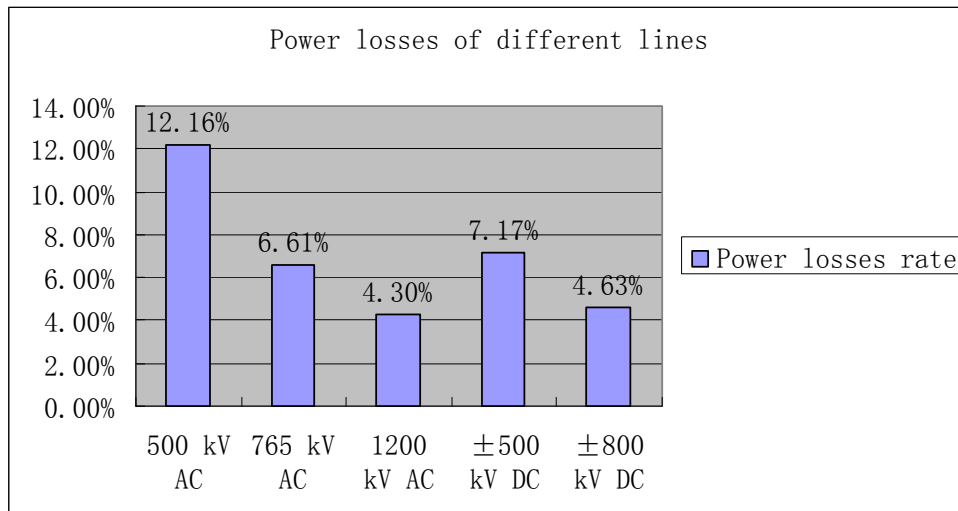

Fig. 1 : Power losses of different AC lines and DC lines sending 6000 MW power to 1200 km far away

On a whole, UHV transmission line shows its merits on environmental advantages, as well as technical benefits, such as higher capacity and higher energy efficiency, compared with EHV transmission lines.

Nevertheless, the investigation of CO<sub>2</sub>-equivalent emissions are only limited to over-head lines' energy losses, the construction of over-head lines, substations and energy use in substations are not taken into account, which also has to be considered in order to examine the whole transmission system's environmental impacts.

Therefore, in Chapter 3 "Environmental Impact of a Venezuelan 765 kV AC Transmission System", the environmental impacts relating to EHVAC substations are assessed, as well as the transmission line's, with the realistic data from this Venezuelan 765 kV AC project. Meanwhile, the major equipments in substations such

as power transformers, circuit breakers, current transformers, voltage transformers, shunt reactors, etc, have been conducted LCA in order to assess their environmental impacts individually.

In the Life Cycle Assessment conducted on this 765 kV AC transmission system, the functional unit is transmitting 8000 MW hydro-electrical power to 760 km, during its service life of 60 years, and the average load factor is 60%. Besides, in the LCA on substations, only the primary system is included, the so-called “secondary systems” - such as low voltage (lower than 1 kV) cables, lighting system, controlling systems (computers, electronic devices, IT, etc) - are not integrated.

The LCIA results of the total transmission system indicate that use phase gives the most environmental impacts on most of indicators, e.g. regarding Global Warming Potential the use phase accounts for 55.9%, regarding Ozone Depletion Potential it accounts for 75.8%, regarding Acidification it determines 41.7%, etc. While use phase of total transmission system is composed by SF<sub>6</sub> emissions of circuit breakers, energy losses in substations and energy losses in transmission lines, which one is the most source of environmental impact? After investigation it's revealed that the energy losses in transmission lines is the dominating environmental impacts in use phase (see Fig. 2), which is roughly 10 times of that of energy losses in substations, and 3.5 times of that of circuit breakers' SF<sub>6</sub> emissions' Global Warming impact.

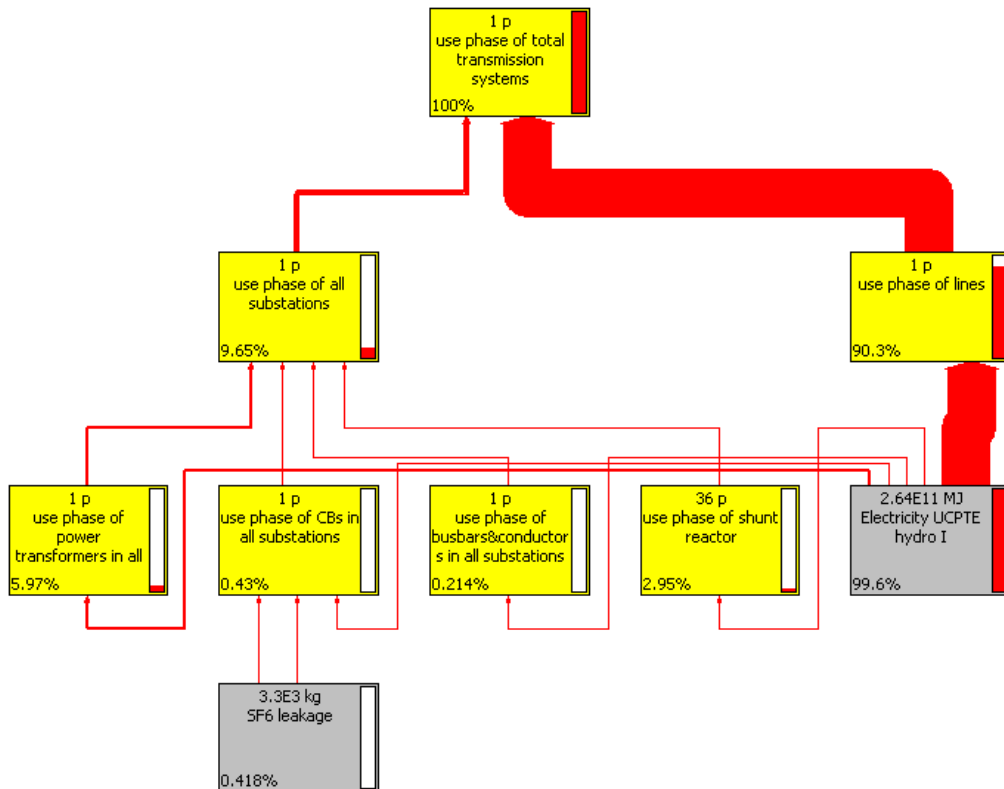

Fig. 2 : Single score flow chart of use phase of Venezuelan 765 kV transmission system (cut-off rule: 0.2%)

Through the LCA, it's known that energy losses in transmission lines and power transformers and SF<sub>6</sub> emissions of circuit breakers are the major sources of environmental impacts of transmission system, of course, the material-based environmental impacts can not be ignored. This leads to the point to the eco-design of a transmission system, that is to say, if we are going to think of ways to decrease transmission system's environmental impacts, focus should be put on the methods of reducing energy losses of conductors and power transformers and decreasing the SF<sub>6</sub> emissions of circuit breakers. Besides, ways of minimizing materials used in equipments are always beneficial to the reduction of environment load.

In Chapter 4 "Environmental Impacts Comparison between Ultra High Voltage and Extra High Voltage Transmission lines", a Life Cycle Assessment is conducted on investigating the environmental impacts of one Chinese 1000 kV AC transmission



line, and comparison between this UHVAC and EHVAC transmission line. This is the natural continuation of studies performed in Chapter 2, as material-based environmental impacts of UHVAC and EHVAC transmission lines have been taken into account in this chapter, which is a complement to analysis of energy-efficiency discussed in Chapter 2, in order to explain the environmental advantages of UHVAC transmission line, compared with its 765 kV EHVAC counterpart, whose data is taken from the Venezuelan 765 kV AC transmission line discussed in Chapter 3.

The Chinese first 1000 kV transmission line is set as target to be analyzed with regards to its environment impacts. The functional unit is set as sending 5000 MW electrical power to 640 km, with a service life of 60 years. In the life cycle, the transmission line materials production, end-of-life, and use phase are taken into account, no transportation phase is considered.

Life Cycle Assessment results show that UHVAC transmission line reduces environmental impacts compared with EHVAC transmission line, due to improved energy-efficiency by UHVAC transmission line. Aside from the energy losses in conductors of both transmission lines, the materials-based environmental impacts of UHVAC is even high than EHVAC's, which is due to the larger amount of materials in towers structures in UHVAC transmission line, especially zinc coatings.

The energy loss of transmission line's environmental impacts are not a constant value, it's varying according to the generation methods of the transmitted electricity. The electricity in Chinese UHVAC transmission line is coal-generated, if it's changed to hydro-electricity, the energy loss's environmental impacts decrease drastically, but still comprises a 23.3% of the total environmental impacts of the whole life cycle of transmission line; in contrast, the environmental impacts of energy loss based on coal-generated method accounts for 98.6% of the total transmission line's environmental impacts.

The comparisons between UHVAC and EHVAC in this Chapter 4 are limited in the scope of transmission line, however, according the findings in Chapter 3 that the environmental impacts of transmission line are dominating the total transmission system's impacts, it could be assumed that the total UHVAC transmission systems reduce the environmental loads, compared with EHVAC transmission systems. Nevertheless, this assumption is subject to further examination by a LCA fulfilled on the UHVAC substations in that system. Moreover, in LCA the electro-magnetic radiation is not included, which is also important to determine the environmental impacts of UHVAC transmission system.

In sum, many investigations on UHV and EHV transmission systems are performed in this thesis, this is because UHV transmission systems are currently the hot topics, especially in China and India, many UHV projects are commissioned and more projects are planed, therefore, it's of value to make environmental investigations on them.

As for the EHV transmission systems, around world there are many projects which have been energized for around 30 years, just arrive to the refurbishment time. The findings in this thesis that the energy losses in conductors of transmission lines, energy losses of power transformers and SF<sub>6</sub> emissions of circuit breakers are dominating the environmental impacts of the transmission system's impacts, are able to give guide to the utilities to help make decisions on more environmental friendly reactions on refurbishment of transmission system.

The LCA of 765 kV AC transmission system yields to a quantitative analysis of environmental impacts of a transmission system, which makes it possible to choose or develop more environmental friendly transmission system.

Further perspectives of continuations of the study:

As the studied 765 kV AC substations in Venezuela are equipped with Air-insulated

switchgears, LCA of 765 kV AC gas-insulated substation (GIS) could be investigated in order to determine which kind of substation has less environmental impacts, GIS or AIS (Air-Insulated Substation).

The investigation on the newly built Chinese 1000 kV transmission lines only addresses the issues relating to environmental impacts of lines, the environmental impacts of substations are not integrated, this is because of the difficulties in acquisition of data of this UHVAC substations.

## REFERENCES

[1] Directive 2005/32/EC of the European Parliament and of the council of 6 July 2005 establishing a framework for the setting of ecodesign requirements for energy-using products and amending Council Directive 92/42/EEC and Directives 96/57/EC and 2000/55/EC of the European Parliament and of the Council, Official Journal of the European Union, 22 May, 2005, L 191/29.

[2] W. Wang, N. Li, A. Bérroual, et al., Implementation of an Eco-design Methodology within AREVA T&D, CIGRE International Symposium on Operation and Development of Power Systems in the New Context, Guilin City, Guangxi Province, China, 28-30 Oct, 2009, Paper No. 185, p. 3.

[3] K. Lee, A. P. Park, ECODESIGN: Best Practice of ISO/TR 14062, Eco-product Research Institute (ERI), Korea, Ajou University, 2005, p. 7, p. 16, p. 18.

[4] ISO/TR 14062:2002 Environmental Management - Integrating Environmental Aspects into Product Design and Development.

[5] ISO 14040:2006 Environmental Management - Life Cycle Assessment - Principles and Framework.

[6] ISO 14044:2006 Environmental Management - Life Cycle Assessment - Requirements and Guidelines

[7] ISO/TR 14047:2003 Environmental Management - Life Cycle Impact Assessment - Examples of Application of ISO 14042.

[8] ISO/TR 14048:2002 Environmental Management - Life Cycle Assessment - Data Documentation Format.

[9] ISO/TR 14049:2000 Environmental Management - Life Cycle Assessment - Examples of Application of ISO 14041 to Goal and Scope Definition and Inventory Analysis.

[10] IEC 62430:2009 Environmentally Conscious Design for Electrical and Electronic Products.

[11] IEC Guide 114, Environmentally Conscious Design Integrating Environmental Aspects into Design and Development of Electrotechnical Products.

[12] SimaPro 7.0 software, PRé Consultants 2006, Netherlands.

[13] Gabi 4 software, PE GmbH, Germany.

[14] I. Huet, H. Aeschbach, C. Tschannen et al., Application of the Concept of Eco-Design to a Gas Insulated Substation 72.5kV, IEEE Proceedings of Transmission and Distribution Conference and Exhibition, 2005/2006 IEEE PES, p. 957-962.

[15] I. Huet, H. Aeschbach, C. Tschannen et al., Full Ecodesign of a 72.5KV GIS Substation, CIGRE SC A3&B3 Joint Colloquium, Tokyo, Japan, 26-28 Sept 2005, Paper No. 304.

[16] I. Huet, H. Aeschbach, C. Tschannen et al., Exemple d'Eco-conception au sein d'AREVA T&D: Cas d'un Poste Blindé 72.5kV, ELEC Expo 2004, Paris, France, 2004.

[17] IEC 62271-203:2003 High-Voltage Switchgear and Controlgear - Part 203: Gas-Insulated Metal-Enclosed Switchgear for Rated Voltages above 52 kV.

[18] IEC 60480-Ed. 2:2004 Guidelines for the Checking and Treatment of Sulfur Hexafluoride (SF<sub>6</sub>) Taken from Electrical Equipment and Specification for Its Re-use.

[19] K. Pohlink, E. Mikes, I. Huet et al., Evolution of High Voltage Gas Insulated Substations Considering Eco Design Aspects. CIGRE 2006, Paris, France, 27 August - 1 Sept 2006, Paper No. B3-302.

[20] P. Ponchon, O. Chniaud, R. Pages et al., Comparison of Environmental Impact of Singlephase or Three-phase Design 245KV GIS, Matpost 2007, Lyon, France, 15-16 Nov 2007, Paper No. S1-7.

[21] M. Hassanzadeh, F. Malpièce, C. Bilhère, Ecological Design Applied to Polymer Housed Surge Arresters, 16th International Conference on Electricity Distribution (CIRED), Amsterdam, Netherland, 18-21 June 2001.

[22] M. Hassanzadeh, R. Puyané, F. Malpièce, Ecological Design Up-grade of a Zinc Varistor Suitable for Distribution Polymeric Surge Arresters, 18th International Conference on Electricity Distribution (CIRED), Turin, Italy, 6-9 June 2005.

[23] M. Hassanzadeh, R. Puyané, F. Malpièce et al, Global Impact Assessment of An Optimised Environmentally Friendly Lightning Arrester, 19th International Conference on Electricity Distribution (CIRED), Vienna, Austria, 21-24 May 2007, Paper No. 0465.

[24] W. Qi, S. Li, I. R. James et al., Selection Method of Environmentally Friendly Materials for Power Equipment based on Fuzzy Performance Summation, International Energy and Power Conference, CEPEX, Beijing, China, 27-29 Oct 2005.

[25] S. Li, I.R. James, L. Falkingham et al., The Introduction of Environmentally Friendly Insulation Systems for Medium Voltage Applications, The Fifth

International Conference on Transmission and Distribution Technology, Beijing, China, 12-14 Oct 2005.

[26] W. Qi, Evaluation of Electrical Properties for Environmentally Friendly Insulation Materials Used in Medium Voltage Circuit Breaker, Master's Degree Thesis, Xi'an Jiaotong University, Xi'an, China, 2006.

[27] W. Wang, Evaluation of Thermal and Mechanical Properties of Environmentally-Friendly-Insulating Materials Used for Tie Rod in Medium Voltage Circuit Breaker, Master's Degree Thesis, Xi'an Jiaotong University, Xi'an, China, 2007.

[28] I.R. James, M. Hassanzadeh, Environmentally Friendly Materials for Medium-voltage Switchgear, AREVA Think T&D Magazine, Dec 2007, p 20.

[29] I.R. James, M. Hassanzadeh, W. Daoud, Selection Methods for Environmentally Friendly Dielectric Materials, INSUCON Proceedings 2006, p.30-35.

[30] M. Hassanzadeh, I.R. James, The Management Methodology Used for the Introduction of New "Eco-Friendly" Materials within Medium Voltage Switchgear Systems, 19th International Conference on Electricity Distribution (CIRED), Vienna, Austria, 21-24 May 2007, Paper No. 0409.

[31] S. Li, M. Hassanzadeh, I.R. James, Thermal Properties of Environmentally Friendly Dielectrics used in Medium Voltage Circuit Breakers, Proceedings of IEEE International Conference on Solid Dielectrics 2007 (ICSD 07), p.306-309.

[32] W. Daoud, M. Hassanzadeh, A. Cornier et al., Ecoselection of Materials and Process for Medium Voltage Products, Advances in Life Cycle Engineering for Sustainable Manufacturing Businesses, 2007, p. 273-278.

- [33] F. Leclerc, Impact of the Environmental Design for Switchgear Applications of High Voltage Substations, CIGRE 2004, C3-101.
- [34] M. Lauraire, P. Barbeta, S. Theoleyre, et al., Environmental Consideration in Product Design: A Reality for French Manufactures, 17<sup>th</sup> International Conference on Electricity Distribution, Barcelona, Spain, 12-15 May 2003, Session 1 Paper No. 71.
- [35] J. C. Alonso, J. Rodrigo, F. Castells, Design for Environment of Electrical and Electronic Automotive Components Based on Life Cycle Assessment, Gate to EHS: Life Cycle Management -Design for Environment, 17 March 2003, p. 17.
- [36] I. Mersiowsky, Summary of Life Cycle Assessment on SF<sub>6</sub>-GIS Technology for Medium Voltage Power Distribution, Life Cycle & Sustainability, Hannover, Germany, Nov 2003.
- [37] U. Macharey, A. Schnettler, T. Smolka, Life Cycle Assessment of Ultra High Voltage System Layout and Operation Compared to 420 kV AC Power Systems, IEC/CIGRE UHV Symposium, Beijing, China, 18 July 2007, Paper No. 1-1-4.
- [38] 1<sup>st</sup> General Report on Study on a Criteria for “Quantification” of benefits of T&D-systems with regard to EU 20/20/20 targets, University of Genoa and T&D Europe, July 2009.
- [39] Strategic Environmental Assessment for Power Developments, 2011, CIGRE WG C3.06.
- [40] F. D. Havenga, Strategic Environmental Assessment (SEA), A Tool for Sustainable Development, 2008 CIGRE SESSION, Paris, France. 24-29 August 2008, C3-201.



- [41] F. Serran, R. C. Furtado, H. M. Vieira et al., Sustainability Indicators for the Assessment of Strategic Studies of the Brazilian Power Sector, 2008 CIGRE SESSION, Paris, France, 24-29 August 2008, C3-204.
- [42] R. C. Furtado, R. C. Cavalcanti, C. F. Menezes et al., Methodology for Integrated Environmental Assessment of Hydrographic Basins, 2008 CIGRE SESSION, Paris, France, 24-29 August 2008, C3-210.
- [43] E. B. Breyer, C. F. Menezes, R. C. Cavalcanti, Strategic Environmental Assessment: Legislation and Technical Standards, 2008 CIGRE SESSION, Paris, France. 24-29 August 2008, C3-208.
- [44] V. Du Four, S. Jay, The Development of a Strategic Environmental Assessment Methodology for Transission Development Planning in Belgium, 2008 CIGRE SESSION, Paris, France, 24-29 August 2008, C3-211.
- [45] A. Motawi, M. Ceccqriglia, S. Viola, Development of HV Electricity Infrastructures in Italy: The Strategic Environmental Assessment (SEA) Approach, 2008 CIGRE SESSION, Paris, France, 24-29 August 2008, C3-206.
- [46] G. C. Stevens, B. Philpot, P. Haywood et al., Life Cycle Economic and Environmental Assessment of Transmission Systems (LEETS), 2008 CIGRE SESSION, Paris, France, 24-29 August 2008, C3-205.
- [47] Z. Liu, Ultra-high Voltage Grid, Beijing, China Economic Publishing House, Sept 2005, page 56.
- [48] C.V.G. Electrificacion Del Caroni C.A, Lista del Material Alta Tension, Sistema à 800 kV Guri, 1989, p. 11.

[49] Insulation Coordination for 800kV &1200kV in Indian Power System, CIGRE C4-09.

[50] W. Zhao, HVDC Technology, Beijing, China Electric Power Press, 2004, p. 80.

[51] W. Wang, T. Mehiri, R. Critchley et al., Problematic and Possible Solutions to Improve Energy Efficiency and Decrease CO<sub>2</sub>-equivalent Emissions in the Transmission of Electricity, Revue de l'Electricité et de l'Eletronique, France, No. 5, 2009, p. 46-51.

[52] AEP Interstate Project: "Why 765 kV AC?", American Electric Power, 24 August 2006, available at <http://www.docstoc.com/docs/36779178/AEP-INTERSTATE-PROJECT-WHY-765-KV-AC>

[53] L. Weimers, Bulk Power Transmission at Extra High Voltages, a Comparison between Transmission Lines for HVDC at Voltages above 600 kV DC and 800 kV AC, p. 3.

[54] [http://en.wikipedia.org/wiki/Carbon\\_dioxide\\_equivalent](http://en.wikipedia.org/wiki/Carbon_dioxide_equivalent)

[55] Southwire ACAR Specifications, <http://www.southwire.com/ProductCatalog>

[56] Rehabilitation of Units 1 to 6 of Powerhouse I the Simon Bolivar Hydroelectric Plant (Guri), Document of the Inter-American Development Bank, 2010.

[57] SimaPro 7 Database Manuals, PRé Consultants, Netherlands, 2006, p. 31-32.

[58] <http://www.aftele.com/products/aluminum-clad-steel/overhead-ground-wire>

[59] Alumoweld Overhead Ground Wire Physical and Electrical Characteristics, AFL Telecommunications Company, Revision 1.1, 1st Nov 2010.

[60] EPRI AC Transmission Line Reference Book - 200 kV and Above, Third Edition, Dec 2005, Electric Power Research Institute, USA, Chapter 3.

[61] SEDIVER Insulators Products Specifications

[62] Alstom Grid Internal Product Environmental Profile: Power Transformer G Range 600 MVA, 2007, p.6.

[63] BS EN ISO 1461:1999, Hot Dip Galvanized Coatings on Fabricated Iron and Steel Articles – Specifications and Test Methods.

[64] Alstom Grid Internal Product Environmental Profile: 245kV Air-insulated Circuit Breaker GL314.

[65] IEC 60099-4: 2009 Surge arresters - Part 4: Metal-oxide Surge Arresters without Gaps for A.C. Systems

[66] Alstom Grid Line Traps (Air Core, Dry Type, Up to 800 kV) Specifications, 2011, p. 2.

[67] Southwire AAC Specifications, <http://www.southwire.com/ProductCatalog>

[68] L. Liu, Problems of Access Roads in Substation and relevant Counter-Measures, China New Technology and Products, N. 21, 2009, p. 86.

[69] J. Fan, An Overview of Chinese UHV AC Pilot Project, IEC SB1 meeting, 3 Feb 2009, New Delhi, India.

[70] Z. Y. Xu, Z. Q. Du, L. Ran, A Current Differential Relay for a 1000-kV UHV Transmission Line, IEEE Transactions on Power Delivery, Vol. 22, No. 3, July 2007, p. 1396.

[71] Y. Li, Z. Liang, Jun Yuan, et al., Design of 1000kV UHV transmission line, International Symposium on International Standards for Ultra High Voltage, Beijing, China, 18-21 July 2007, Paper No. 2-2-1.



## **Annex A**

# **Calculations of Average Currents & Conductors' Energy Losses in Venezuelan 765 kV AC Transmission System**

The currents flowing in substations of the investigated Venezuelan 765 kV AC transmission system are varying in different bays and different equipments, and it is able to calculate exact values of currents in substations, which is however not very important in such kind of an environmental study. Thus, in this study, the average currents in circuit breaker bays, busbars and incoming and outlet transmission lines are calculated.

The average annual load factor of this transmission system is 0.6, and as the load is proportional to current flowing in the substation, current profile is then set as 0.6 for calculations of energy losses of different equipments and components.

### Guri Substation

Fig. A-1 shows the single-line diagram of Guri substation.

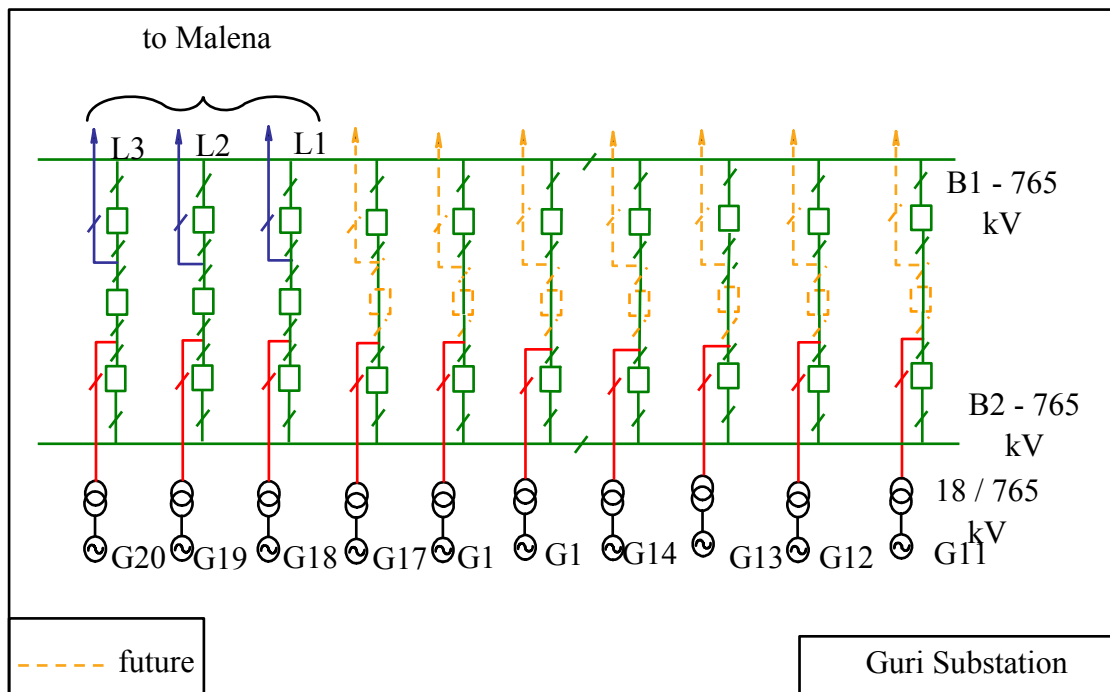

Fig. A-1 : Guri substation

According to the rate of generator step-up transformers (18/765 kV, 3×268.3 MVA) and power transformers (765/400/20 kV, 3×500 MVA), the average currents in different bays and lines are calculated and shown in Table A-1.

Table A-1 : Current profile in Guri substation

	Average current
Transmission lines from Guri (in blue)	$2023 \times 0.6 = 1214 \text{ A}$
CB bays and busbars (in green)	$607 \times 0.6 = 365 \text{ A}$
Incoming lines (in red)	$607 \times 0.6 = 365 \text{ A}$

Table A-2 summarizes conductors' lengths of different sections in Guri substation.

Table A-2 : Conductors' lengths of different sections in Guri substation

	AAC 4000 MCM	ACAR 1300 MCM
L1+ L2+ L3	$112 \times 9 = 1008 \text{ m}$	$97.5 \times 9 = 877.5 \text{ m}$
Busbars	0	2820 m
Lines connected to generator transformers	$112 \times 30 = 3360 \text{ m}$	$106.5 \times 30 = 3195 \text{ m}$
Circuit breaker bays	$88 \times 30 = 2640 \text{ m}$	0

Note: The length indicated herein is the total length for 3 phases added together.

Considering different current profiles in the relevant sections of conductor, taking into account conductor types and their resistance (described in Chapter 3), the energy loss of conductors in Guri substation during its service life of 60 years is calculated and listed in Table A-3.

Table A-3 : Energy losses of all kinds of conductors in Guri Substation

	Power loss (kW)	Energy loss during 60 years (kWh)
L1+ L2+ L3	34.42	$1.8 \times 10^7$



Busbars	5.32	$2.8 \times 10^6$
Lines connected to generator transformers	10.88	$5.7 \times 10^6$
Circuit breaker bays	3.82	$2.0 \times 10^6$
Total conductors	54.43	$2.9 \times 10^7$

### Malena Substation

Fig. A-2 shows the single-line diagram of Malena substation.

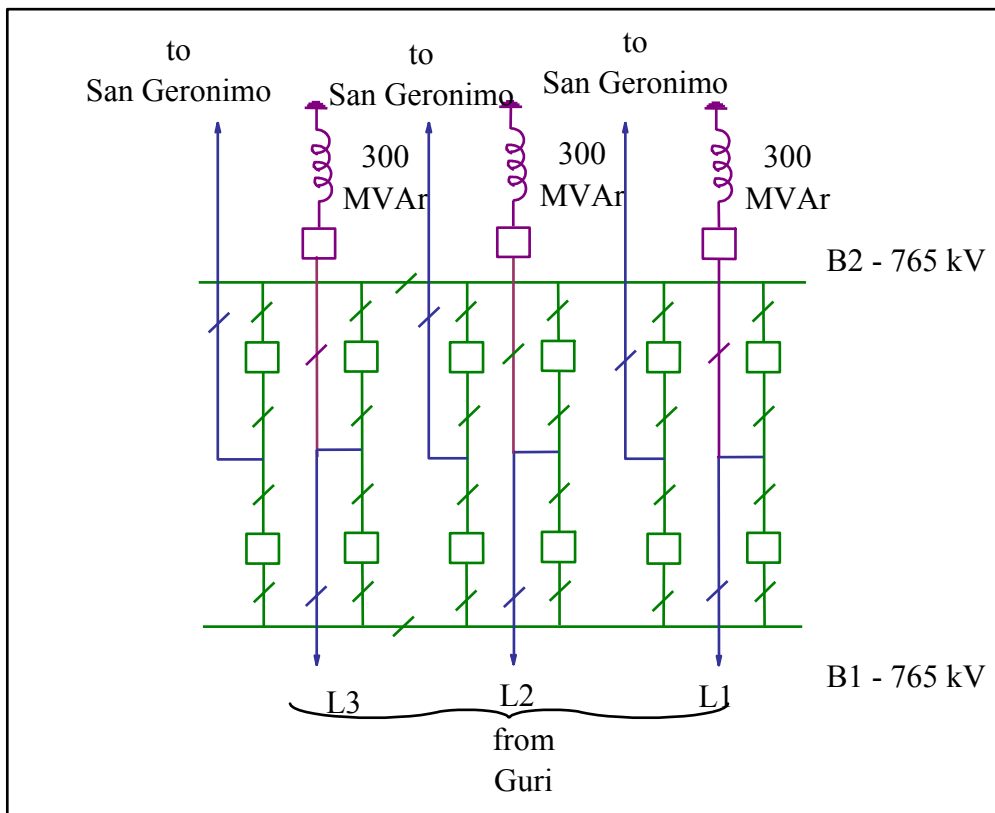

Fig. A-2: Malena substation

The average currents in different bays and lines of Malena substation are calculated and shown in Table A-4.

Table A-4 : Current profile in Malena substation

	Average current
Transmission lines	$2023 \times 0.6 = 1214 \text{ A}$

(in blue)	
CB bays and busbars (in green)	$1012 \times 0.6 = 607 \text{ A}$
Shunt reactor (in purple)	226 A

Table A-5 summarizes conductors' lengths of different sections in Malena substation, and Table A-6 lists energy losses of all kinds of conductors in Malena substation.

Table A-5 : Conductors' lengths of different sections in Malena Substation

	AAC 4000 MCM	ACAR 1300 MCM
Total transmission lines	2016 m	1836m
Busbars	0	1800 m
Circuit breaker bays	1584 m	0

Table A-6 : Energy losses of all kinds of conductors in Malena Substation

	Power loss (kW)	Energy loss during 60 years (kWh)
Total transmission lines	70.53	$3.7 \times 10^7$
Busbars	9.38	$4.9 \times 10^6$
Circuit breaker bays	6.33	$3.3 \times 10^6$
Total conductors	86.24	$4.5 \times 10^7$

### San Geronimo Substation

Fig. A-3 shows the single-line diagram of San Geronimo substation.

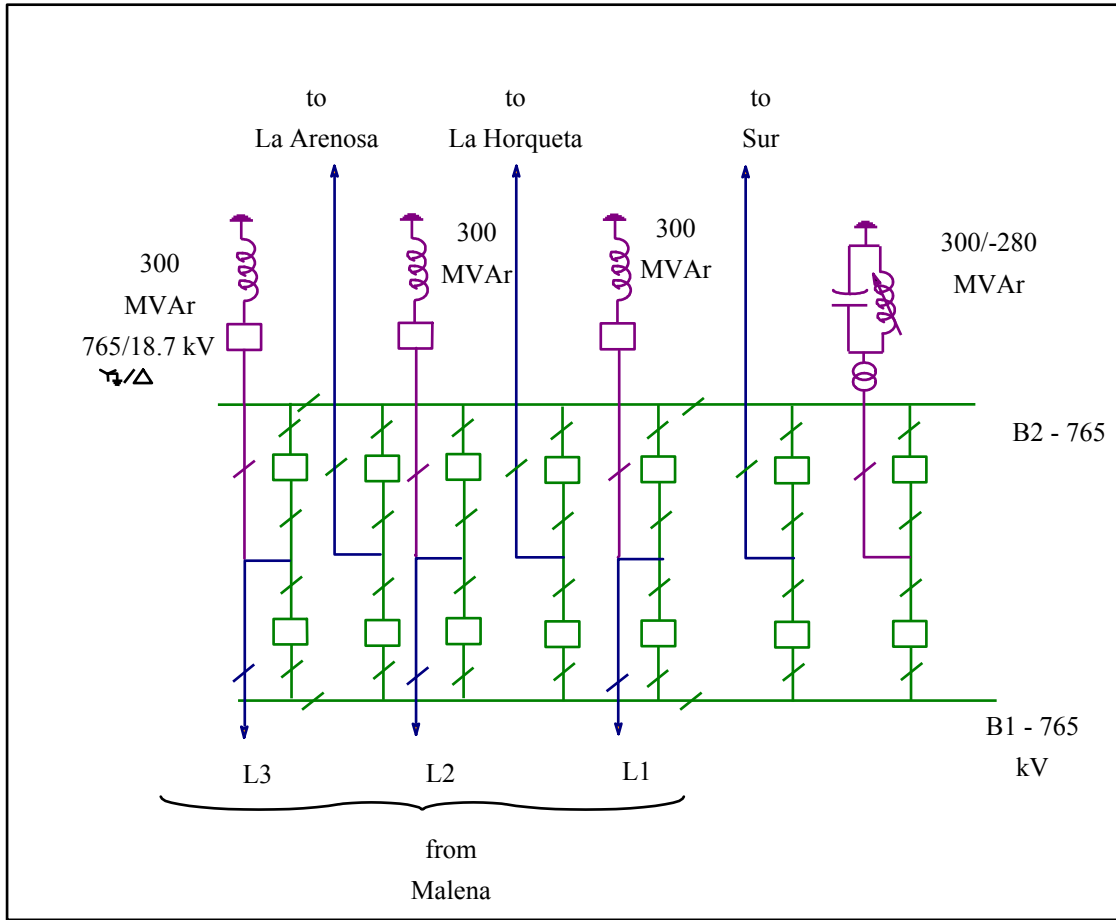

Fig. A-3 : San Geronimo substation

The average currents in different bays and lines of San Geronimo substation are calculated and shown in Table A-7.

Table A-7 : Current profile in San Geronimo substation

	Average current
Transmission lines (in blue)	$2023 \times 0.6 = 1214$ A
CB bays and busbars (in green)	$1012 \times 0.6 = 607$ A
Shunt reactor (in purple)	226 A

Table A-8 summarizes conductors' lengths of different sections in San Geronimo substation, and Table A-9 lists energy losses of all kinds of conductors in San Geronimo substation.

Table A-8 : Conductors' lengths of different sections in San Geronimo Substation

	AAC 4000 MCM	ACAR 1300 MCM
Total transmission lines	2016 m	1836m
Busbars	0	2100 m
Circuit breaker bays	1848 m	0

Table A-9 : Energy losses of all kinds of conductors in San Geronimo Substation

	Power loss (kW)	Energy loss during 60 years (kWh)
Total transmission lines	70.53	$3.7 \times 10^7$
Busbars	10.95	$5.8 \times 10^6$
Circuit breaker bays	7.39	$3.9 \times 10^6$
Total conductors	88.86	$4.7 \times 10^7$

Fig. A-4 shows the single-line diagram of Yaracuy substation.

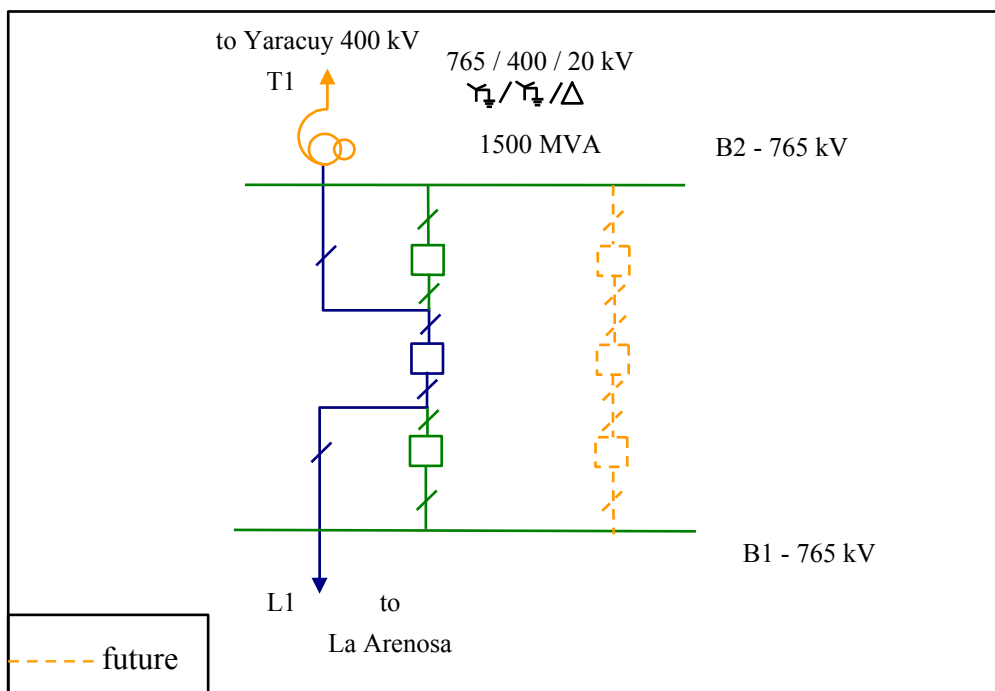

Fig. A-4 : Yaracuy substation

The average currents in different bays and lines of Yaracuy substation are calculated and shown in Table A-10.

Table A-10 : Current profile in Yaracuy substation

	Average current
Line connected to transformer T1 & transmission line L1 <b>(in blue)</b>	$1132 \times 0.6 = 680 \text{ A}$
CB bays and busbars <b>(in green)</b>	0 A

Table A-11 summarizes conductors' lengths of different sections in Yaracuy substation, and Table A-12 lists energy losses of all kinds of conductors in Yaracuy substation.

Table A-11 : Conductors' lengths of different sections in Yaracuy substation

	AAC 4000 MCM	ACAR 1300 MCM
Line connected to transformer T1 & transmission line L1 <b>(in blue)</b>	722 m	1836m
Busbars	0	300 m
Circuit breaker bays	1848 m	0

Table A-12 : Energy losses of all kinds of conductors in Yaracuy substation

	Power loss (kW)	Energy loss during 60 years (kWh)
Line connected to transformer T1 & transmission line L1 <b>(in blue)</b>	11.94	$6.3 \times 10^6$
Busbars	0	0
Total conductors	11.94	$6.3 \times 10^6$

## La Arenosa Substation

Fig. A-5 shows the single-line diagram of La Arenosa substation.

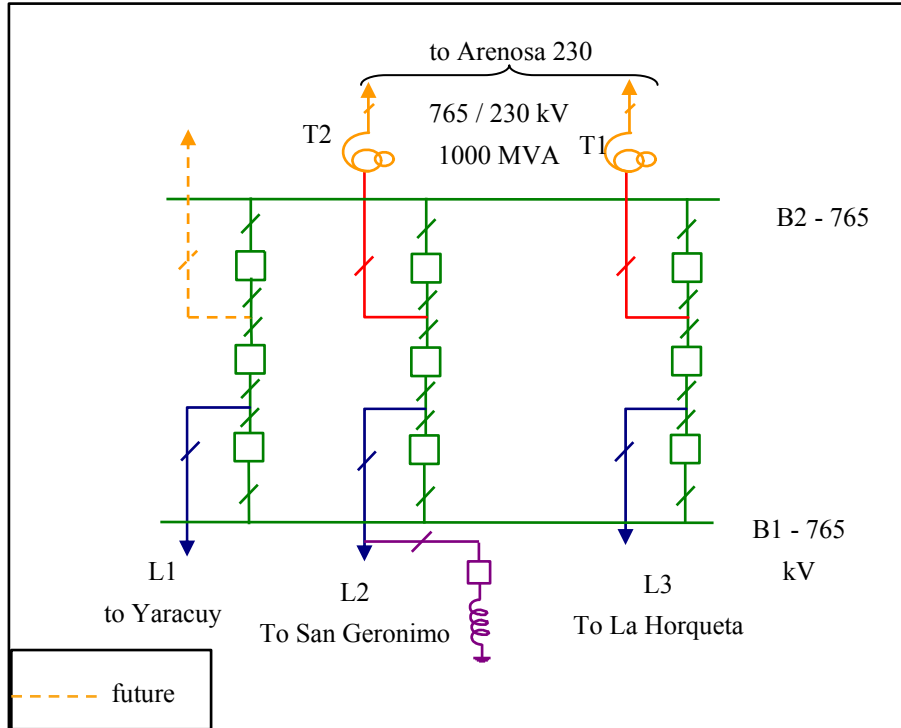

Fig. A-5 : La Arenosa substation

The average currents in different bays and lines of La Arenosa substation are calculated and shown in Table A-13.

Table A-13 : Current profile in La Arenosa substation

		Average current
Lines connected to transformer T1 <b>(in red)</b>		$755 \times 0.6 = 453 \text{ A}$
CB bays and busbars <b>(in green)</b>		$503 \times 0.6 = 302 \text{ A}$
Transmission lines <b>(in blue)</b>	L1	$1132 \times 0.6 = 680 \text{ A}$
	L2	$2023 \times 0.6 = 1214 \text{ A}$
	L3	$619 \times 0.6 = 371 \text{ A}$

Table A-14 summarizes conductors' lengths of different sections in La Arenosa substation, and Table A-15 lists energy losses of all kinds of conductors in La Arenosa substation.

Table A-14 : Conductors' lengths of different sections in La Arenosa Substation

	AAC 4000 MCM	ACAR 1300 MCM
Lines connected to power transformers	672 m	687 m
Busbars	0	900 m
Circuit breaker bays	792 m	0
L1	336 m	320 m
L2	336 m	320 m
L3	336 m	320 m

Table A-15: Energy losses of all kinds of conductors in La Arenosa Substation

	Power loss (kW)	Energy loss during 60 years (kWh)
Lines connected to power transformers	3.12	$1.6 \times 10^6$
Busbars	1.16	$6.1 \times 10^5$
Circuit breaker bays	0.78	$4.1 \times 10^5$
L1	3.78	$2.0 \times 10^6$
L2	12.05	$6.3 \times 10^6$
L3	1.13	$5.9 \times 10^5$
Total conductors	22.01	$1.2 \times 10^7$

### La Horqueta Substation

Fig. A-6 shows the single-line diagram of La Horqueta substation.

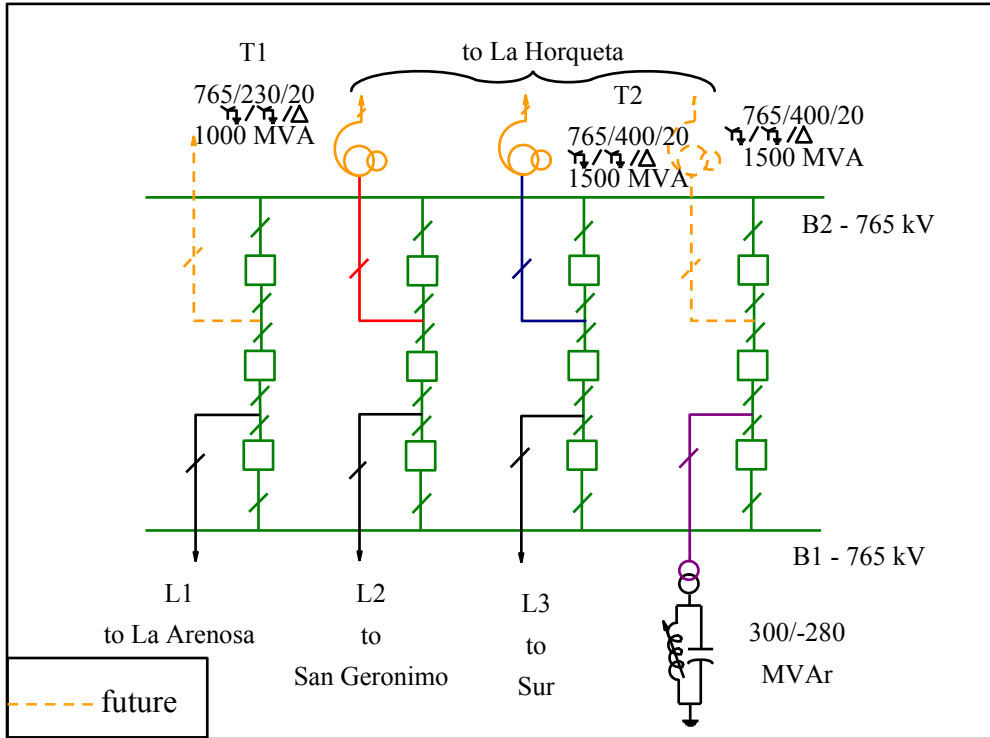

Fig. A-6 : La Horqueta substation

The average currents in different bays and lines of La Horqueta substation are calculated and shown in Table A-16.

Table A-16. : Current profile in La Horqueta substation

		Average current
Lines connected to transformer T1 <b>(in red)</b>		$755 \times 0.6 = 453 \text{ A}$
Lines connected to transformer T2 <b>(in blue)</b>		$1132 \times 0.6 = 680 \text{ A}$
CB bays and busbars <b>(in green)</b>		$472 \times 0.6 = 283 \text{ A}$
Transmission lines <b>(in black)</b>	L1	$619 \times 0.6 = 371 \text{ A}$
	L2	$2023 \times 0.6 = 1214 \text{ A}$
	L3	$483 \times 0.6 = 290 \text{ A}$

Table A-17 summarizes conductors' lengths of different sections in La Horqueta substation, and Table A-18 lists energy losses of all kinds of conductors in La



Horqueta substation.

Table A-17 : Conductors' lengths of different sections in La Horqueta Substation

	AAC 4000 MCM	ACAR 1300 MCM
Lines connected to transformer T1 (in red)	252 m	343.5 m
Lines connected to transformer T2 (in blue)	252 m	343.5 m
Busbars	0	1200 m
Circuit breaker bays	1056 m	0
L1	336 m	320 m
L2	336 m	320 m
L3	336 m	320 m

Table A-18 : Energy losses of all kinds of conductors in La Horqueta Substation

	Power loss (kW)	Energy loss during 60 years (kWh)
Lines connected to transformer T1 (in red)	1.56	$8.2 \times 10^5$
Lines connected to transformer T2 (in blue)	3.51	$1.8 \times 10^6$
Busbars	1.36	$7.1 \times 10^5$
Circuit breaker bays	0.92	$4.8 \times 10^5$
L1	1.13	$5.9 \times 10^5$
L2	12.05	$6.3 \times 10^6$
L3	0.69	$3.6 \times 10^5$
Total conductors	21.21	$1.11 \times 10^7$

### Sur Substation

Fig. A-7 shows the single-line diagram of Sur substation.

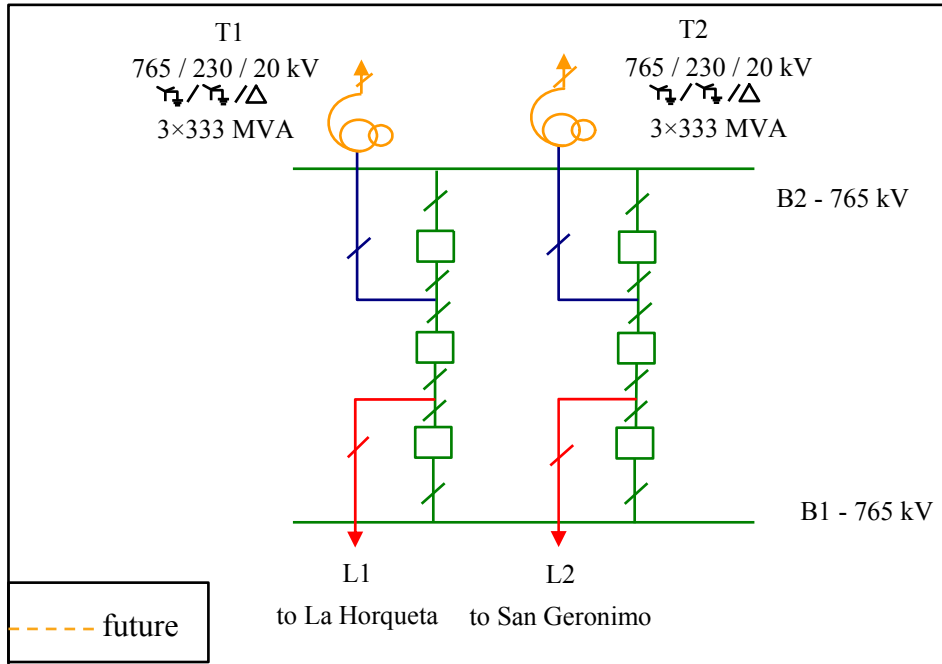

Fig. A-7: Single-line diagram of Sur substation

The average currents in different bays and lines of Sur substation are calculated and shown in Table A-19.

Table A-19 : Current profile in Sur substation

		Average current
Lines connected to transformers <b>(in blue)</b>		$755 \times 0.6 = 453 \text{ A}$
CB bays and busbars <b>(in green)</b>		$378 \times 0.6 = 227 \text{ A}$
Transmission lines <b>(in red)</b>	L1	$483 \times 0.6 = 290 \text{ A}$
	L2	$2023 \times 0.6 = 1214 \text{ A}$

Table A-20 summarizes conductors' lengths of different sections in Sur substation, and Table A-21 lists energy losses of all kinds of conductors in Sur substation.

Table A-20: Conductors lengths of different sections in Sur Substation

	AAC 4000 MCM	ACAR 1300 MCM
L1	$84 \times 3 = 252 \text{ m}$	$106.5 \times 3 = 319.5 \text{ m}$

L2	$84 \times 3 = 252$ m	$106.5 \times 3 = 319.5$ m
Busbars	0	540 m
Lines connected to transformers	$84 \times 6 = 504$ m	$114.5 \times 6 = 687$ m
Circuit breaker bays	$88 \times 6 = 528$ m	0

Table A-21: Energy losses of all kinds of conductors in Sur Substation

	Power loss (kW)	Energy loss during 60 years (kWh)
L1	0.61	$3.2 \times 10^5$
L2	10.69	$5.6 \times 10^6$
Busbars	0.39	$2.1 \times 10^5$
Lines connected to transformers	3.12	$1.6 \times 10^6$
Circuit breaker bays	0.30	$1.5 \times 10^5$
Total conductors	15.11	$7.94 \times 10^6$

## **Annex B**

# **Life Cycle Impact Assessment Results of Venezuelan 765 kV AC Transmission System**



Table B-1: Characterization result of bundle conductors

Impact category	Unit	Total	Material production of bundle conductors	End-of-life of bundle conductors	Use phase of bundle conductors	Transport of bundle conductors
Global warming (GWP 100)	g CO <sub>2</sub>	3.73E+11	6.51E+11	-5.65E+11	2.85E+11	1.85E+09
Ozone depletion	g CFC <sub>11</sub>	6.01E+04	2.28E+04	-1.60E+04	5.32E+04	0.00E+00
Acidification	g SO <sub>2</sub>	1.96E+09	3.69E+09	-3.21E+09	1.47E+09	1.41E+07
Eutrophication	g NO <sub>3</sub>	1.70E+09	1.40E+09	-1.19E+09	1.47E+09	2.45E+07
Photochemical smog	g ethene	1.35E+08	1.34E+08	-1.14E+08	1.15E+08	6.81E+05
Ecotoxicity water chronic	m <sup>3</sup>	1.16E+11	1.01E+11	-8.98E+10	1.05E+11	1.30E+05
Ecotoxicity water acute	m <sup>3</sup>	1.16E+10	9.38E+09	-8.38E+09	1.06E+10	1.04E+04
Ecotoxicity soil chronic	m <sup>3</sup>	3.63E+09	2.17E+09	-1.95E+09	3.41E+09	9.11E+01
Human toxicity air	m <sup>3</sup>	5.49E+13	4.50E+13	-3.94E+13	4.92E+13	1.60E+11
Human toxicity water	m <sup>3</sup>	1.69E+09	1.45E+09	-1.20E+09	1.43E+09	9.29E+04
Human toxicity soil	m <sup>3</sup>	1.25E+07	1.06E+07	-9.05E+06	1.09E+07	2.67E+02
Bulk waste	kg	1.40E+09	6.39E+07	-5.16E+07	1.39E+09	1.11E+03
Hazardous waste	kg	1.38E+02	1.38E+03	-1.24E+03	0.00E+00	0.00E+00
Radioactive waste	kg	0.00E+00	0.00E+00	0.00E+00	0.00E+00	0.00E+00
Slags/ashes	kg	5.24E+06	5.24E+07	-4.72E+07	0.00E+00	1.26E+03
Resources (all)	kg	1.24E+04	5.83E+03	-4.93E+03	1.15E+04	2.19E+01

Table B-2 : Characterization result of towers in transmission lines

Impact category	Unit	Total	Material production tower structures	End-of-life of tower structures	Life cycle of tower foundations	Transport of tower structures
Global warming (GWP 100)	g CO <sub>2</sub>	1,49E+11	1,06E+11	2,09E+10	1,92E+10	3,38E+09
Ozone depletion	g CFC <sub>11</sub>	7,20E+03	9,49E+02	5,52E+03	7,28E+02	0,00E+00
Acidification	g SO <sub>2</sub>	8,17E+08	1,06E+09	-3,74E+08	1,07E+08	2,57E+07
Eutrophication	g NO <sub>3</sub>	7,18E+08	8,37E+08	-2,84E+08	1,20E+08	4,46E+07
Photochemical smog	g ethene	4,75E+07	9,32E+07	-5,05E+07	3,55E+06	1,24E+06
Ecotoxicity water chronic	m <sup>3</sup>	2,66E+10	1,96E+10	1,75E+09	5,25E+09	2,37E+05
Ecotoxicity water acute	m <sup>3</sup>	2,66E+09	1,47E+09	6,68E+08	5,19E+08	1,90E+04
Ecotoxicity soil chronic	m <sup>3</sup>	1,86E+09	1,77E+09	-2,57E+07	1,15E+08	1,66E+02
Human toxicity air	m <sup>3</sup>	3,92E+14	3,91E+14	-2,07E+12	2,85E+12	2,92E+11
Human toxicity water	m <sup>3</sup>	1,33E+10	1,47E+10	-1,41E+09	9,54E+07	1,69E+05
Human toxicity soil	m <sup>3</sup>	2,15E+07	2,13E+07	-6,30E+05	8,63E+05	4,87E+02
Bulk waste	kg	1,91E+08	3,65E+06	7,80E+06	1,79E+08	2,02E+03
Hazardous waste	kg	1,08E+04	9,18E+04	-8,23E+04	1,40E+03	0,00E+00
Radioactive waste	kg	1,19E+03	6,25E+02	1,86E-13	5,61E+02	0,00E+00
Slags/ashes	kg	3,98E+06	4,66E+03	3,98E+06	2,02E+03	2,30E+03
Resources (all)	kg	2,62E+05	2,67E+05	-5,95E+03	1,06E+03	4,00E+01

Table B-3: Characterization result of ground wires in transmission lines

Impact category	Unit	Total	Material production of ground wires	End-of-life of ground wires	Transport of ground wires
Global warming (GWP 100)	g CO <sub>2</sub>	3.16E+09	5.18E+09	-2.10E+09	8.36E+07
Ozone depletion	g CFC <sub>11</sub>	1.68E+02	1.12E+02	5.56E+01	0.00E+00
Acidification	g SO <sub>2</sub>	1.47E+07	3.75E+07	-2.34E+07	6.36E+05
Eutrophication	g NO <sub>3</sub>	1.21E+07	2.30E+07	-1.21E+07	1.10E+06
Photochemical smog	g ethene	1.00E+06	2.67E+06	-1.70E+06	3.07E+04
Ecotoxicity water chronic	m <sup>3</sup>	2.70E+08	6.41E+08	-3.71E+08	5.86E+03
Ecotoxicity water acute	m <sup>3</sup>	2.38E+07	4.66E+07	-2.28E+07	4.69E+02
Ecotoxicity soil chronic	m <sup>3</sup>	1.27E+06	1.08E+07	-9.53E+06	4.11E+00
Human toxicity air	m <sup>3</sup>	2.33E+12	2.55E+12	-2.29E+11	7.22E+09
Human toxicity water	m <sup>3</sup>	3.17E+07	7.00E+07	-3.83E+07	4.19E+03
Human toxicity soil	m <sup>3</sup>	9.41E+04	1.50E+05	-5.61E+04	1.20E+01
Bulk waste	kg	2.59E+05	3.14E+05	-5.43E+04	5.01E+01
Hazardous waste	kg	2.14E+02	2.14E+03	-1.92E+03	0.00E+00
Radioactive waste	kg	0.00E+00	0.00E+00	0.00E+00	0.00E+00
Slags/ashes	kg	1.17E+05	2.40E+05	-1.23E+05	5.69E+01
Resources (all)	kg	4.50E+01	2.05E+02	-1.61E+02	9.90E-01



Table B-4 : Characterization result of total transmission lines

Impact category	Unit	Total	Material production lines	EoL of entire lines	Use phase of lines	Transportation phase of lines
Global warming (GWP 100)	g CO <sub>2</sub>	5.42E+11	7.85E+11	-5.46E+11	2.85E+11	1.78E+10
Ozone depletion	g CFC <sub>11</sub>	6.78E+04	2.41E+04	-9.59E+03	5.32E+04	1.88E+01
Acidification	g SO <sub>2</sub>	3.12E+09	4.95E+09	-3.66E+09	1.47E+09	3.58E+08
Eutrophication	g NO <sub>3</sub>	2.74E+09	2.43E+09	-1.53E+09	1.47E+09	3.62E+08
Photochemical smog	g ethene	1.83E+08	2.39E+08	-1.73E+08	1.15E+08	3.37E+06
Ecotoxicity water chronic	m <sup>3</sup>	1.43E+11	1.22E+11	-8.44E+10	1.05E+11	7.50E+07
Ecotoxicity water acute	m <sup>3</sup>	1.43E+10	1.10E+10	-7.25E+09	1.06E+10	6.90E+06
Ecotoxicity soil chronic	m <sup>3</sup>	5.48E+09	3.97E+09	-1.89E+09	3.41E+09	2.00E+06
Human toxicity air	m <sup>3</sup>	4.53E+14	4.49E+14	-4.79E+13	4.92E+13	2.63E+12
Human toxicity water	m <sup>3</sup>	1.50E+10	1.64E+10	-2.85E+09	1.43E+09	6.98E+06
Human toxicity soil	m <sup>3</sup>	3.43E+07	3.28E+07	-9.42E+06	1.09E+07	3.51E+04
Bulk waste	kg	1.60E+09	6.83E+07	1.38E+08	1.39E+09	4.29E+04
Hazardous waste	kg	6.30E+04	1.12E+05	-9.56E+04	0.00E+00	4.62E+04
Radioactive waste	kg	1.19E+03	6.25E+02	5.62E+02	0.00E+00	0.00E+00
Slags/ashes	kg	9.87E+06	5.30E+07	-4.31E+07	0.00E+00	4.47E+03
Resources (all)	kg	2.75E+05	2.75E+05	-1.14E+04	1.15E+04	2.26E+02

Table B-5 : Single score result of total transmission lines

Impact category	Unit	Total	Materials of lines (production + end-of-life)	Use phase of transmission lines	Transportation transmission lines
Total	Pt*	4370972	1703531	2654631	12810
Global warming (GWP 100)	Pt	81008	35749	42597	2661
Ozone depletion	Pt	7716	1654	6060	2
Acidification	Pt	32687	13572	15363	3751
Eutrophication	Pt	11032	3634	5938	1460
Photochemical smog	Pt	11007	3932	6873	202
Ecotoxicity water chronic	Pt	699057	185214	513476	367
Ecotoxicity water acute	Pt	684403	178210	505863	330
Ecotoxicity soil chronic	Pt	420095	159105	260837	153
Human toxicity air	Pt	138201	122393	15005	802
Human toxicity water	Pt	634549	573863	60391	295
Human toxicity soil	Pt	276746	188534	87929	283
Bulk waste	Pt	1302745	168413	1134298	35
Hazardous waste	Pt	3349	895	0	2454
Radioactive waste	Pt	37330	37330	0	0
Slags/ashes	Pt	31048	31034	0	14
Resources (all)	Pt	0	0	0	0

\* Pt : Personal Equivalent

Table B-6 : Comparison results of components of transmission lines

Impact category	Unit	Life cycle of bundle conductors	Life cycle of ground wires	Life cycle of insulators	Life cycle of towers
Global warming (GWP 100)	g CO <sub>2</sub>	3.73E+11	3.16E+09	1.66E+10	1.49E+11
Ozone depletion	g CFC <sub>11</sub>	6.01E+04	1.68E+02	3.00E+02	7.20E+03
Acidification	g SO <sub>2</sub>	1.96E+09	1.47E+07	3.30E+08	8.17E+08
Eutrophication	g NO <sub>3</sub>	1.70E+09	1.21E+07	3.07E+08	7.18E+08
Photochemical smog	g ethene	1.35E+08	1.00E+06	1.71E+04	4.75E+07
Ecotoxicity water chronic	m <sup>3</sup>	1.16E+11	2.70E+08	2.49E+08	2.66E+10
Ecotoxicity water acute	m <sup>3</sup>	1.16E+10	2.38E+07	4.69E+07	2.66E+09
Ecotoxicity soil chronic	m <sup>3</sup>	3.63E+09	1.27E+06	2.56E+06	1.86E+09
Human toxicity air	m <sup>3</sup>	5.49E+13	2.33E+12	3.64E+12	3.92E+14
Human toxicity water	m <sup>3</sup>	1.69E+09	3.17E+07	-4.83E+07	1.33E+10
Human toxicity soil	m <sup>3</sup>	1.25E+07	9.41E+04	1.41E+05	2.15E+07
Bulk waste	kg	1.40E+09	2.59E+05	3.27E+06	1.91E+08
Hazardous waste	kg	1.38E+02	2.14E+02	5.18E+04	1.08E+04
Radioactive waste	kg	0.00E+00	0.00E+00	2.70E-01	1.19E+03
Slags/ashes	kg	5.24E+06	1.17E+05	5.26E+05	3.98E+06
Resources (all)	kg	1.24E+04	4.50E+01	3.77E+02	2.62E+05

Table B-7: Characterization result of power transformer - Alsthom 765/400/20 kV, 500 MVA

Impact category	Unit	Total	Material production of power transformer	End-of-Life of power transformer	Transport of power transformer	Use phase of transformer (for 60 years)	Life cycle of foundation of power transformer
Global warming (GWP 100)	g CO <sub>2</sub>	1,31E+09	3,95E+08	-2,05E+08	1,99E+08	8,97E+08	2,00E+07
Ozone depletion	g CFC <sub>11</sub>	1,84E+02	1,75E+02	-1,60E+02	3,00E-01	1,68E+02	7,59E-01
Acidification	g SO <sub>2</sub>	1,15E+07	1,98E+07	-1,81E+07	5,07E+06	4,62E+06	1,11E+05
Eutrophication	g NO <sub>3</sub>	1,04E+07	2,16E+06	-1,18E+06	4,65E+06	4,64E+06	1,25E+05
Photochemical smog	g ethene	4,55E+05	1,50E+05	-8,17E+04	2,26E+04	3,61E+05	3,70E+03
Ecotoxicity water chronic	m <sup>3</sup>	3,84E+08	3,06E+07	1,71E+07	1,19E+06	3,30E+08	5,47E+06
Ecotoxicity water acute	m <sup>3</sup>	3,92E+07	2,75E+06	2,50E+06	1,10E+05	3,33E+07	5,41E+05
Ecotoxicity soil chronic	m <sup>3</sup>	1,16E+07	4,26E+05	2,54E+05	3,18E+04	1,07E+07	1,20E+05
Human toxicity air	m <sup>3</sup>	3,57E+11	2,27E+11	-6,24E+10	3,46E+10	1,55E+11	2,97E+09
Human toxicity water	m <sup>3</sup>	7,78E+06	4,51E+06	-1,44E+06	1,07E+05	4,50E+06	9,94E+04
Human toxicity soil	m <sup>3</sup>	4,89E+04	5,95E+04	-4,63E+04	5,47E+02	3,43E+04	9,00E+02
Bulk waste	kg	4,72E+06	3,57E+06	-3,42E+06	6,34E+02	4,38E+06	1,87E+05
Hazardous waste	kg	7,62E+02	3,65E+02	-3,41E+02	7,36E+02	0,00E+00	1,46E+00
Radioactive waste	kg	1,35E+00	7,58E-01	6,37E-03	0,00E+00	0,00E+00	5,85E-01
Slags/ashes	kg	7,50E+03	1,38E+01	7,47E+03	1,36E+01	0,00E+00	2,10E+00
Resources (all)	kg	6,31E+01	4,89E+02	-4,65E+02	2,59E+00	3,61E+01	1,11E+00

Table B-8 : LCA result of circuit breakers FX42 (3 phases)

Impact category	Unit	Total	Material production FX42	End of Life of FX42	SF <sub>6</sub> leakage in use phase (40 years)	Electrical energy losses in use phase (40 years)	Transport of FX42	Life cycle of supporting frame of CB (40 years)	Life cycle of foundation of CB (40 years)
Global warming (GWP 100)	g CO <sub>2</sub>	7,19E+08	5,86E+07	1,08E+07	6,27E+08	1,84E+06	1,14E+07	3,14E+06	5,90E+06
Ozone depletion	g CFC <sub>11</sub>	1,61E+01	1,58E+01	-3,97E-01	0,00E+00	3,44E-01	1,72E-02	1,59E-01	2,24E-01
Acidification	g SO <sub>2</sub>	4,29E+05	2,96E+05	-2,13E+05	0,00E+00	9,49E+03	2,90E+05	1,39E+04	3,28E+04
Eutrophication	g NO <sub>3</sub>	3,75E+05	9,89E+04	-4,88E+04	0,00E+00	9,53E+03	2,66E+05	1,17E+04	3,70E+04
Photochemical smog	g ethene	4,91E+03	5,48E+03	-4,73E+03	0,00E+00	7,41E+02	1,30E+03	1,03E+03	1,09E+03
Ecotoxicity water chronic	m <sup>3</sup>	3,40E+06	3,83E+06	-3,05E+06	0,00E+00	6,78E+05	6,81E+04	2,58E+05	1,62E+06
Ecotoxicity water acute	m <sup>3</sup>	3,39E+05	3,57E+05	-2,75E+05	0,00E+00	6,84E+04	6,27E+03	2,25E+04	1,60E+05
Ecotoxicity soil chronic	m <sup>3</sup>	8,09E+04	9,25E+04	-7,13E+04	0,00E+00	2,20E+04	1,82E+03	3,09E+02	3,56E+04
Human toxicity air	m <sup>3</sup>	7,90E+09	3,54E+09	-1,51E+09	0,00E+00	3,18E+08	1,98E+09	2,69E+09	8,79E+08
Human toxicity water	m <sup>3</sup>	1,20E+05	1,26E+05	-8,65E+04	0,00E+00	9,25E+03	6,13E+03	3,57E+04	2,94E+04
Human toxicity soil	m <sup>3</sup>	7,86E+02	6,73E+02	-3,56E+02	0,00E+00	7,05E+01	3,13E+01	1,02E+02	2,66E+02
Bulk waste	kg	7,53E+04	2,19E+04	-1,10E+04	0,00E+00	9,00E+03	3,63E+01	2,37E+02	5,53E+04
Hazardous waste	kg	6,76E+01	2,65E+01	-1,82E+00	0,00E+00	0,00E+00	4,22E+01	2,50E-01	4,32E-01
Radioactive waste	kg	1,75E-01	9,89E-04	8,68E-04	0,00E+00	0,00E+00	0,00E+00	0,00E+00	1,73E-01
Slags/ashes	kg	4,61E+02	1,80E+03	-1,45E+03	0,00E+00	0,00E+00	7,77E-01	1,09E+02	6,21E-01
Resources (all)	kg	2,45E+00	4,38E+00	-2,53E+00	0,00E+00	7,43E-02	1,48E-01	4,80E-02	3,27E-01

Table B-9 : Characterization result of current transformer OSKF 765 (plus supporting frame and foundation)

Impact category	Unit	Total	Material production OSKF 765	EoL of OSKF 765	Use phase of OSKF 765 (for 30 years)	Transportation of OSKF 765	Life cycle of supporting frame (30 years)	Life cycle of foundation (30 years)
Global warming (GWP 100)	g CO <sub>2</sub>	8,25E+06	7,54E+06	-5,36E+06	8,99E+03	3,12E+06	9,06E+05	2,03E+06
Ozone depletion	g CFC <sub>11</sub>	3,28E-01	2,89E+00	-2,70E+00	1,68E-03	4,71E-03	4,58E-02	7,72E-02
Acidification	g SO <sub>2</sub>	1,16E+05	1,85E+05	-1,64E+05	4,63E+01	7,95E+04	4,39E+03	1,13E+04
Eutrophication	g NO <sub>3</sub>	1,04E+05	3,03E+04	-1,55E+04	4,65E+01	7,30E+04	3,43E+03	1,27E+04
Photochemical smog	g ethene	1,69E+03	1,84E+03	-1,17E+03	3,62E+00	3,55E+02	2,88E+02	3,76E+02
Ecotoxicity water chronic	m <sup>3</sup>	1,68E+06	1,14E+06	-1,13E+05	3,31E+03	1,87E+04	7,89E+04	5,57E+05
Ecotoxicity water acute	m <sup>3</sup>	1,83E+05	1,21E+05	-2,54E+03	3,34E+02	1,72E+03	6,89E+03	5,51E+04
Ecotoxicity soil chronic	m <sup>3</sup>	3,04E+04	2,14E+04	-4,10E+03	1,08E+02	4,99E+02	2,91E+02	1,22E+04
Human toxicity air	m <sup>3</sup>	2,72E+09	2,10E+09	-9,73E+08	1,55E+06	5,43E+08	7,47E+08	3,03E+08
Human toxicity water	m <sup>3</sup>	6,27E+04	3,92E+04	1,77E+03	4,51E+01	1,68E+03	9,94E+03	1,01E+04
Human toxicity soil	m <sup>3</sup>	3,63E+02	9,92E+02	-7,60E+02	3,44E-01	8,59E+00	3,01E+01	9,16E+01
Bulk waste	kg	2,16E+04	2,94E+04	-2,69E+04	4,39E+01	9,95E+00	7,39E+01	1,90E+04
Hazardous waste	kg	1,52E+01	7,29E+00	-3,89E+00	0,00E+00	1,16E+01	7,93E-02	1,49E-01
Radioactive waste	kg	7,87E-02	1,88E-02	2,77E-04	0,00E+00	0,00E+00	-2,04E-19	5,96E-02
Slags/ashes	kg	1,23E+02	3,23E+02	-2,30E+02	0,00E+00	2,13E-01	2,99E+01	2,14E-01
Resources (all)	kg	7,79E-01	4,33E+00	-4,04E+00	3,62E-04	4,07E-02	3,36E-01	1,13E-01

Table B-10 : Characterization result of current transformer OSKF 420 (plus supporting frame and foundation)

Impact category	Unit	Total	Material production OSKF 420	EoL of OSKF 420	Use phase of OSKF 420 (30 years)	Transportation of OSKF 420	Life cycle of supporting frame (30 years)	Life cycle of foundation (30 years)
Global warming (GWP 100)	g CO <sub>2</sub>	4,27E+06	3,63E+06	-2,58E+06	7,87E+03	1,50E+06	6,34E+05	1,08E+06
Ozone depletion	g CFC <sub>11</sub>	1,72E-01	1,39E+00	-1,30E+00	1,47E-03	2,26E-03	3,21E-02	4,10E-02
Acidification	g SO <sub>2</sub>	5,72E+04	8,88E+04	-7,89E+04	4,05E+01	3,82E+04	3,01E+03	6,00E+03
Eutrophication	g NO <sub>3</sub>	5,14E+04	1,46E+04	-7,48E+03	4,07E+01	3,51E+04	2,39E+03	6,76E+03
Photochemical smog	g ethene	8,98E+02	8,83E+02	-5,62E+02	3,16E+00	1,71E+02	2,03E+02	2,00E+02
Ecotoxicity water chronic	m <sup>3</sup>	8,54E+05	5,47E+05	-5,45E+04	2,90E+03	8,98E+03	5,45E+04	2,96E+05
Ecotoxicity water acute	m <sup>3</sup>	9,22E+04	5,83E+04	-1,25E+03	2,92E+02	8,27E+02	4,75E+03	2,92E+04
Ecotoxicity soil chronic	m <sup>3</sup>	1,53E+04	1,03E+04	-1,98E+03	9,41E+01	2,40E+02	1,71E+02	6,50E+03
Human toxicity air	m <sup>3</sup>	1,49E+09	1,01E+09	-4,68E+08	1,36E+06	2,61E+08	5,27E+08	1,61E+08
Human toxicity water	m <sup>3</sup>	3,29E+04	1,88E+04	8,48E+02	3,95E+01	8,08E+02	7,01E+03	5,37E+03
Human toxicity soil	m <sup>3</sup>	1,86E+02	4,77E+02	-3,65E+02	3,01E-01	4,13E+00	2,10E+01	4,86E+01
Bulk waste	kg	1,14E+04	1,41E+04	-1,29E+04	3,84E+01	4,78E+00	5,08E+01	1,01E+04
Hazardous waste	kg	7,32E+00	3,50E+00	-1,87E+00	0,00E+00	5,56E+00	5,43E-02	7,90E-02
Radioactive waste	kg	4,08E-02	9,05E-03	1,33E-04	0,00E+00	0,00E+00	-6,74E-18	3,16E-02
Slags/ashes	kg	6,61E+01	1,55E+02	-1,11E+02	0,00E+00	1,02E-01	2,12E+01	1,14E-01
Resources (all)	kg	4,02E-01	2,09E+00	-1,95E+00	3,17E-04	1,96E-02	1,82E-01	5,98E-02

Table B-11 : Characterization result of current transformer OSKF 245 (plus supporting frame and foundation)

Impact category	Unit	Total	Material production current transformer OSKF 245	End of Life (EoL) of OSKF 245	Use phase of OSKF 245 (30 years)	Transportation of OSKF 245	Life cycle of supporting frame (30 years)	Life cycle of foundation (30 years)
Global warming (GWP 100)	g CO <sub>2</sub>	1,98E+06	1,67E+06	-1,19E+06	6,75E+03	6,92E+05	2,93E+05	5,08E+05
Ozone depletion	g CFC <sub>11</sub>	8,04E-02	6,41E-01	-5,97E-01	1,26E-03	1,04E-03	1,48E-02	1,93E-02
Acidification	g SO <sub>2</sub>	2,65E+04	4,09E+04	-3,63E+04	3,47E+01	1,76E+04	1,42E+03	2,83E+03
Eutrophication	g NO <sub>3</sub>	2,38E+04	6,72E+03	-3,44E+03	3,49E+01	1,62E+04	1,11E+03	3,19E+03
Photochemical smog	g ethene	4,16E+02	4,07E+02	-2,59E+02	2,71E+00	7,86E+01	9,31E+01	9,41E+01
Ecotoxicity water chronic	m <sup>3</sup>	3,98E+05	2,52E+05	-2,50E+04	2,48E+03	4,13E+03	2,55E+04	1,39E+05
Ecotoxicity water acute	m <sup>3</sup>	4,29E+04	2,69E+04	-5,66E+02	2,50E+02	3,81E+02	2,22E+03	1,38E+04
Ecotoxicity soil chronic	m <sup>3</sup>	7,18E+03	4,73E+03	-9,08E+02	8,06E+01	1,11E+02	9,37E+01	3,06E+03
Human toxicity air	m <sup>3</sup>	6,88E+08	4,65E+08	-2,16E+08	1,16E+06	1,20E+08	2,41E+08	7,57E+07
Human toxicity water	m <sup>3</sup>	1,52E+04	8,67E+03	3,93E+02	3,38E+01	3,72E+02	3,21E+03	2,53E+03
Human toxicity soil	m <sup>3</sup>	8,65E+01	2,20E+02	-1,68E+02	2,58E-01	1,90E+00	9,74E+00	2,29E+01
Bulk waste	kg	5,36E+03	6,50E+03	-5,96E+03	3,29E+01	2,20E+00	2,39E+01	4,76E+03
Hazardous waste	kg	3,37E+00	1,61E+00	-8,61E-01	0,00E+00	2,56E+00	2,56E-02	3,72E-02
Radioactive waste	kg	1,91E-02	4,17E-03	6,14E-05	0,00E+00	0,00E+00	-1,29E-18	1,49E-02
Slags/ashes	kg	3,04E+01	7,15E+01	-5,09E+01	0,00E+00	4,71E-02	9,66E+00	5,35E-02
Resources (all)	kg	2,09E-01	9,59E-01	-8,96E-01	2,72E-04	9,01E-03	1,08E-01	2,82E-02



Table B-12 : Characterization result of capacitor voltage transformer OTCF 765 (plus supporting frame and foundation)

Impact category	Unit	Total	material production OTCF 765	EoL of capacitor voltage transformer	Use phase of OTCF 765 (for 30 years)	Transportation of OTCF 765	Life cycle of supporting frame (for 30 years)	Life cycle of foundation of (for 30 years)
Global warming (GWP 100)	g CO <sub>2</sub>	3,39E+06	2,42E+06	-1,62E+06	5,62E+03	8,86E+05	8,86E+05	8,05E+05
Ozone depletion	g CFC <sub>11</sub>	1,21E-01	4,59E-01	-4,15E-01	1,05E-03	1,34E-03	4,48E-02	3,06E-02
Acidification	g SO <sub>2</sub>	3,62E+04	1,55E+04	-1,06E+04	2,89E+01	2,25E+04	4,30E+03	4,48E+03
Eutrophication	g NO <sub>3</sub>	3,36E+04	8,16E+03	-3,75E+03	2,91E+01	2,07E+04	3,36E+03	5,05E+03
Photochemical smog	g ethene	6,80E+02	5,34E+02	-3,88E+02	2,26E+00	1,01E+02	2,82E+02	1,49E+02
Ecotoxicity water chronic	m <sup>3</sup>	4,30E+05	3,48E+05	-2,23E+05	2,07E+03	5,29E+03	7,72E+04	2,21E+05
Ecotoxicity water acute	m <sup>3</sup>	4,26E+04	3,34E+04	-2,01E+04	2,09E+02	4,88E+02	6,74E+03	2,18E+04
Ecotoxicity soil chronic	m <sup>3</sup>	8,00E+03	7,76E+03	-5,10E+03	6,72E+01	1,42E+02	2,89E+02	4,85E+03
Human toxicity air	m <sup>3</sup>	1,23E+09	4,17E+08	-1,88E+08	9,70E+05	1,54E+08	7,30E+08	1,20E+08
Human toxicity water	m <sup>3</sup>	2,12E+04	9,02E+03	-2,02E+03	2,82E+01	4,77E+02	9,71E+03	4,01E+03
Human toxicity soil	m <sup>3</sup>	1,09E+02	1,64E+02	-1,24E+02	2,15E-01	2,44E+00	2,95E+01	3,63E+01
Bulk waste	kg	8,13E+03	2,96E+02	1,93E+02	2,75E+01	2,82E+00	7,24E+01	7,54E+03
Hazardous waste	kg	4,90E+00	2,02E+00	-5,33E-01	0,00E+00	3,28E+00	7,77E-02	5,89E-02
Radioactive waste	kg	2,52E-02	1,52E-03	6,28E-05	0,00E+00	0,00E+00	3,70E-19	2,36E-02
Slags/ashes	kg	5,13E+01	1,54E+02	-1,32E+02	0,00E+00	6,04E-02	2,92E+01	8,48E-02
Resources (all)	kg	4,23E-01	1,54E-01	-1,23E-01	2,26E-04	1,15E-02	3,36E-01	4,46E-02

Table B-13 : Characterization result of inductive voltage transformer OTEF 765 (plus supporting frame and foundation)

Impact category	Unit	Total	Material production OTEF 765	EoL of OTEF 765	Use phase of OTEF 765 (30 years)	Transportation of OTEF 765	Life cycle of supporting frame (30 years)	Life cycle of foundation (30 years)
Global warming (GWP 100)	g CO <sub>2</sub>	6.90E+06	5.38E+06	-3.66E+06	4.50E+03	2.55E+06	9.30E+05	1.70E+06
Ozone depletion	g CFC <sub>11</sub>	2.83E-01	2.59E+00	-2.43E+00	8.40E-04	3.85E-03	4.70E-02	6.46E-02
Acidification	g SO <sub>2</sub>	8.35E+04	1.08E+05	-1.04E+05	2.31E+01	6.49E+04	4.54E+03	9.46E+03
Eutrophication	g NO <sub>3</sub>	8.52E+04	2.22E+04	-1.08E+04	2.32E+01	5.96E+04	3.53E+03	1.07E+04
Photochemical smog	g ethene	1.45E+03	1.46E+03	-9.15E+02	1.81E+00	2.90E+02	2.95E+02	3.14E+02
Ecotoxicity water chronic	m <sup>3</sup>	1.28E+06	8.22E+05	-1.10E+05	1.65E+03	1.52E+04	8.14E+04	4.66E+05
Ecotoxicity water acute	m <sup>3</sup>	1.35E+05	8.40E+04	-4.07E+03	1.67E+02	1.40E+03	7.10E+03	4.61E+04
Ecotoxicity soil chronic	m <sup>3</sup>	3.93E+04	3.17E+04	-3.43E+03	5.38E+01	4.08E+02	3.15E+02	1.02E+04
Human toxicity air	m <sup>3</sup>	3.48E+09	2.78E+09	-7.62E+08	7.76E+05	4.43E+08	7.65E+08	2.53E+08
Human toxicity water	m <sup>3</sup>	6.41E+04	4.87E+04	-4.62E+03	2.26E+01	1.37E+03	1.02E+04	8.46E+03
Human toxicity soil	m <sup>3</sup>	5.12E+02	1.07E+03	-6.77E+02	1.72E-01	7.01E+00	3.10E+01	7.66E+01
Bulk waste	kg	1.54E+04	1.60E+04	-1.66E+04	2.20E+01	8.12E+00	7.64E+01	1.59E+04
Hazardous waste	kg	1.24E+01	6.30E+00	-3.53E+00	0.00E+00	9.43E+00	8.20E-02	1.24E-01
Radioactive waste	kg	6.25E-02	1.26E-02	1.85E-04	0.00E+00	0.00E+00	-3.56E-18	4.98E-02
Slags/ashes	kg	1.00E+02	2.11E+02	-1.42E+02	0.00E+00	1.74E-01	3.06E+01	1.79E-01
Resources (all)	kg	8.87E-01	3.09E+00	-2.70E+00	1.81E-04	3.32E-02	3.71E-01	9.41E-02

Table B-14: Characterization result of inductive voltage transformer OTEF 420 (plus supporting frame and foundation)

Impact category	Unit	Total	Material production OTEF 420	EoL of OTEF 420	Use phase of OTEF 420 (30 years)	Transportation of OTEF 420	Life cycle of supporting frame (30 years)	Life cycle of foundation (30 years)
Global warming (GWP 100)	g CO <sub>2</sub>	3.96E+06	3.01E+06	-2.05E+06	4.50E+03	1.43E+06	5.87E+05	9.76E+05
Ozone depletion	g CFC <sub>11</sub>	1.63E-01	1.45E+00	-1.36E+00	8.40E-04	2.16E-03	2.97E-02	3.71E-02
Acidification	g SO <sub>2</sub>	4.73E+04	6.07E+04	-5.81E+04	2.31E+01	3.64E+04	2.85E+03	5.43E+03
Eutrophication	g NO <sub>3</sub>	4.82E+04	1.24E+04	-6.06E+03	2.32E+01	3.35E+04	2.22E+03	6.12E+03
Photochemical smog	g ethene	8.39E+02	8.20E+02	-5.12E+02	1.81E+00	1.63E+02	1.86E+02	1.81E+02
Ecotoxicity water chronic	m <sup>3</sup>	7.27E+05	4.60E+05	-6.21E+04	1.65E+03	8.56E+03	5.12E+04	2.67E+05
Ecotoxicity water acute	m <sup>3</sup>	7.66E+04	4.70E+04	-2.31E+03	1.67E+02	7.88E+02	4.47E+03	2.65E+04
Ecotoxicity soil chronic	m <sup>3</sup>	2.21E+04	1.77E+04	-1.93E+03	5.38E+01	2.29E+02	1.95E+02	5.88E+03
Human toxicity air	m <sup>3</sup>	2.01E+09	1.55E+09	-4.27E+08	7.76E+05	2.49E+08	4.83E+08	1.45E+08
Human toxicity water	m <sup>3</sup>	3.67E+04	2.72E+04	-2.61E+03	2.26E+01	7.70E+02	6.42E+03	4.86E+03
Human toxicity soil	m <sup>3</sup>	2.90E+02	6.01E+02	-3.79E+02	1.72E-01	3.94E+00	1.96E+01	4.40E+01
Bulk waste	kg	8.87E+03	8.94E+03	-9.28E+03	2.20E+01	4.56E+00	4.80E+01	9.14E+03
Hazardous waste	kg	6.97E+00	3.53E+00	-1.98E+00	0.00E+00	5.30E+00	5.16E-02	7.14E-02
Radioactive waste	kg	3.57E-02	7.02E-03	1.04E-04	0.00E+00	0.00E+00	-1.98E-18	2.86E-02
Slags/ashes	kg	5.83E+01	1.18E+02	-7.94E+01	0.00E+00	9.76E-02	1.93E+01	1.03E-01
Resources (all)	kg	5.18E-01	1.73E+00	-1.51E+00	1.81E-04	1.87E-02	2.28E-01	5.41E-02

Table B-15: Characterization result of inductive voltage transformer OTEF 245 (plus supporting frame and foundation)

Impact category	Unit	Total	Material production OTEF 245	EoL	Use phase of OTEF 245 (30 years)	Transportation of OTEF 245	Life cycle of supporting frame (30 years)	Life cycle of foundation (30 years)
Global warming (GWP 100)	g CO <sub>2</sub>	1.83E+06	1.39E+06	-9.51E+05	4.50E+03	6.61E+05	2.66E+05	4.57E+05
Ozone depletion	g CFC <sub>11</sub>	7.57E-02	6.69E-01	-6.26E-01	8.40E-04	9.96E-04	1.34E-02	1.74E-02
Acidification	g SO <sub>2</sub>	2.20E+04	2.82E+04	-2.68E+04	2.31E+01	1.68E+04	1.30E+03	2.54E+03
Eutrophication	g NO <sub>3</sub>	2.23E+04	5.73E+03	-2.80E+03	2.32E+01	1.54E+04	1.01E+03	2.87E+03
Photochemical smog	g ethene	3.87E+02	3.78E+02	-2.37E+02	1.81E+00	7.51E+01	8.44E+01	8.46E+01
Ecotoxicity water chronic	m <sup>3</sup>	3.36E+05	2.12E+05	-2.94E+04	1.65E+03	3.95E+03	2.33E+04	1.25E+05
Ecotoxicity water acute	m <sup>3</sup>	3.54E+04	2.16E+04	-1.14E+03	1.67E+02	3.64E+02	2.03E+03	1.24E+04
Ecotoxicity soil chronic	m <sup>3</sup>	1.01E+04	7.97E+03	-9.06E+02	5.38E+01	1.06E+02	9.11E+01	2.75E+03
Human toxicity air	m <sup>3</sup>	9.10E+08	7.04E+08	-1.97E+08	7.76E+05	1.15E+08	2.19E+08	6.81E+07
Human toxicity water	m <sup>3</sup>	1.67E+04	1.24E+04	-1.22E+03	2.26E+01	3.55E+02	2.91E+03	2.28E+03
Human toxicity soil	m <sup>3</sup>	1.31E+02	2.74E+02	-1.74E+02	1.72E-01	1.82E+00	8.88E+00	2.06E+01
Bulk waste	kg	4.20E+03	4.15E+03	-4.28E+03	2.20E+01	2.10E+00	2.19E+01	4.28E+03
Hazardous waste	kg	3.21E+00	1.62E+00	-9.11E-01	0.00E+00	2.44E+00	2.35E-02	3.35E-02
Radioactive waste	kg	1.67E-02	3.21E-03	4.77E-05	0.00E+00	0.00E+00	-4.97E-20	1.34E-02
Slags/ashes	kg	2.67E+01	5.48E+01	-3.70E+01	0.00E+00	4.50E-02	8.74E+00	4.81E-02
Resources (all)	kg	2.39E-01	7.96E-01	-6.98E-01	1.81E-04	8.61E-03	1.08E-01	2.53E-02

Table B-16 : Characterization result of shunt reactor  $765/\sqrt{3}$  kV, 100 MVA<sub>r</sub>

Impact category	Unit	Total	Material production shunt reactor	EoL of shunt reactor	Use phase of shunt reactor	Transportation of shunt reactor
Global warming (GWP 100)	g CO <sub>2</sub>	4.18E+08	1.44E+08	-7.28E+07	2.59E+08	8.75E+07
Ozone depletion	g CFC <sub>11</sub>	5.54E+01	1.05E+02	-9.80E+01	4.83E+01	1.32E-01
Acidification	g SO <sub>2</sub>	4.14E+06	5.80E+06	-5.21E+06	1.33E+06	2.23E+06
Eutrophication	g NO <sub>3</sub>	3.75E+06	7.56E+05	-3.84E+05	1.34E+06	2.04E+06
Photochemical smog	g ethene	1.41E+05	5.88E+04	-3.21E+04	1.04E+05	9.95E+03
Ecotoxicity water chronic	m <sup>3</sup>	1.16E+08	1.36E+07	6.80E+06	9.51E+07	5.23E+05
Ecotoxicity water acute	m <sup>3</sup>	1.19E+07	1.27E+06	9.86E+05	9.60E+06	4.81E+04
Ecotoxicity soil chronic	m <sup>3</sup>	3.45E+06	2.33E+05	1.08E+05	3.09E+06	1.40E+04
Human toxicity air	m <sup>3</sup>	1.26E+11	9.40E+10	-2.80E+10	4.46E+10	1.52E+10
Human toxicity water	m <sup>3</sup>	2.58E+06	1.77E+06	-5.39E+05	1.30E+06	4.71E+04
Human toxicity soil	m <sup>3</sup>	1.60E+04	3.32E+04	-2.72E+04	9.88E+03	2.41E+02
Bulk waste	kg	1.31E+06	1.02E+06	-9.78E+05	1.26E+06	2.79E+02
Hazardous waste	kg	3.34E+02	1.81E+02	-1.70E+02	0.00E+00	3.24E+02
Radioactive waste	kg	3.62E-01	3.59E-01	2.73E-03	0.00E+00	0.00E+00
Slags/ashes	kg	2.85E+03	7.48E+00	2.84E+03	0.00E+00	5.96E+00
Resources (all)	kg	1.93E+01	1.53E+02	-1.45E+02	1.04E+01	1.14E+00

Table B-17 : Characterization result of 765 kV disconnecter

Impact category	Unit	Total	Material production disconnecter	EoL of 765kV disconnecter	Use phase of 765kV disconnecter	Transportation of 765kV disconnecter	Life cycle of foundation (30 years)
Global warming (GWP 100)	g CO <sub>2</sub>	5.55E+06	3.43E+06	-1.63E+06	9.78E+04	2.30E+06	1.36E+06
Ozone depletion	g CFC <sub>11</sub>	1.40E-01	7.27E-02	-5.74E-03	1.83E-02	3.46E-03	5.17E-02
Acidification	g SO <sub>2</sub>	7.96E+04	3.62E+04	-2.31E+04	5.03E+02	5.84E+04	7.57E+03
Eutrophication	g NO <sub>3</sub>	7.36E+04	1.67E+04	-5.77E+03	5.06E+02	5.37E+04	8.52E+03
Photochemical smog	g ethene	9.22E+02	1.04E+03	-6.67E+02	3.93E+01	2.61E+02	2.52E+02
Ecotoxicity water chronic	m <sup>3</sup>	5.61E+05	3.66E+05	-2.27E+05	3.60E+04	1.37E+04	3.73E+05
Ecotoxicity water acute	m <sup>3</sup>	5.45E+04	3.03E+04	-1.75E+04	3.63E+03	1.26E+03	3.69E+04
Ecotoxicity soil chronic	m <sup>3</sup>	1.10E+04	6.99E+03	-5.76E+03	1.17E+03	3.67E+02	8.19E+03
Human toxicity air	m <sup>3</sup>	1.39E+09	9.21E+08	-1.45E+08	1.69E+07	3.99E+08	2.02E+08
Human toxicity water	m <sup>3</sup>	1.90E+04	2.32E+04	-1.28E+04	4.91E+02	1.24E+03	6.77E+03
Human toxicity soil	m <sup>3</sup>	1.18E+02	7.54E+01	-2.92E+01	3.74E+00	6.32E+00	6.13E+01
Bulk waste	kg	1.52E+04	2.50E+03	-4.95E+02	4.78E+02	7.31E+00	1.27E+04
Hazardous waste	kg	1.37E+01	5.70E+00	-5.76E-01	0.00E+00	8.50E+00	9.95E-02
Radioactive waste	kg	4.00E-02	0.00E+00	1.73E-04	0.00E+00	0.00E+00	3.99E-02
Slags/ashes	kg	4.32E+01	1.55E+02	-1.12E+02	0.00E+00	1.57E-01	1.43E-01
Resources (all)	kg	6.06E-01	8.17E-01	-3.20E-01	3.94E-03	2.99E-02	7.53E-02

Table B-18 : Characterization result of 765 kV post insulator

Impact category	Unit	Total	Material production 765 kV post insulator	EoL of post insulator	Transportation of 765kV post insulator	Life cycle supporting frame (30 years)	Life cycle of foundation (30 years)
Global warming (GWP 100)	g CO <sub>2</sub>	1.62E+06	2.42E+05	-5.47E+04	3.18E+05	5.01E+05	6.16E+05
Ozone depletion	g CFC <sub>11</sub>	5.38E-02	2.98E-03	1.69E-03	4.79E-04	2.53E-02	2.34E-02
Acidification	g SO <sub>2</sub>	1.55E+04	2.06E+03	-5.70E+02	8.09E+03	2.54E+03	3.43E+03
Eutrophication	g NO <sub>3</sub>	1.46E+04	1.70E+03	-2.69E+02	7.43E+03	1.91E+03	3.86E+03
Photochemical smog	g ethene	3.37E+02	6.88E+01	-3.84E+01	3.61E+01	1.57E+02	1.14E+02
Ecotoxicity water chronic	m <sup>3</sup>	2.27E+05	1.71E+04	-5.36E+03	1.90E+03	4.49E+04	1.69E+05
Ecotoxicity water acute	m <sup>3</sup>	2.19E+04	1.30E+03	-1.94E+02	1.75E+02	3.93E+03	1.67E+04
Ecotoxicity soil chronic	m <sup>3</sup>	4.05E+03	2.87E+02	-2.18E+02	5.08E+01	2.22E+02	3.71E+03
Human toxicity air	m <sup>3</sup>	6.17E+08	7.06E+07	-5.24E+06	5.53E+07	4.04E+08	9.17E+07
Human toxicity water	m <sup>3</sup>	9.46E+03	1.68E+03	-8.45E+02	1.71E+02	5.38E+03	3.07E+03
Human toxicity soil	m <sup>3</sup>	4.83E+01	3.70E+00	-9.89E-01	8.74E-01	1.69E+01	2.78E+01
Bulk waste	kg	6.12E+03	1.13E+01	3.02E+02	1.01E+00	4.25E+01	5.77E+03
Hazardous waste	kg	2.13E+00	9.02E-01	-4.39E-02	1.18E+00	4.61E-02	4.51E-02
Radioactive waste	kg	1.81E-02	0.00E+00	2.92E-05	0.00E+00	1.70E-19	1.81E-02
Slags/ashes	kg	1.90E+01	6.33E+00	-3.57E+00	2.17E-02	1.61E+01	6.48E-02
Resources (all)	kg	3.26E-01	7.16E-03	-3.20E-03	4.14E-03	2.84E-01	3.41E-02

Table B-19 : Characterization result of 765 kV coupling capacitor

Impact category	Unit	Total	Material production coupling capacitors	EoL of coupling capacitor	Use phase of coupling capacitor (30 years)	Transportation of coupling capacitor	Life cycle of foundation (30 years)	Life cycle of supporting frame (30 years)
Global warming (GWP 100)	g CO <sub>2</sub>	4.17E+06	1.77E+06	-1.12E+06	1.03E+06	7.92E+05	8.05E+05	8.89E+05
Ozone depletion	g CFC <sub>11</sub>	3.04E-01	4.38E-01	-4.04E-01	1.93E-01	1.19E-03	3.06E-02	4.49E-02
Acidification	g SO <sub>2</sub>	3.87E+04	1.15E+04	-7.05E+03	5.32E+03	2.02E+04	4.48E+03	4.34E+03
Eutrophication	g NO <sub>3</sub>	3.62E+04	6.40E+03	-2.49E+03	5.34E+03	1.85E+04	5.05E+03	3.37E+03
Photochemical smog	g ethene	1.04E+03	3.59E+02	-2.56E+02	4.15E+02	9.01E+01	1.49E+02	2.82E+02
Ecotoxicity water chronic	m <sup>3</sup>	7.90E+05	2.49E+05	-1.43E+05	3.80E+05	4.73E+03	2.21E+05	7.78E+04
Ecotoxicity water acute	m <sup>3</sup>	7.90E+04	2.44E+04	-1.29E+04	3.83E+04	4.36E+02	2.18E+04	6.79E+03
Ecotoxicity soil chronic	m <sup>3</sup>	1.94E+04	5.05E+03	-3.32E+03	1.23E+04	1.27E+02	4.85E+03	3.04E+02
Human toxicity air	m <sup>3</sup>	1.29E+09	2.75E+08	-1.50E+08	1.78E+08	1.38E+08	1.20E+08	7.30E+08
Human toxicity water	m <sup>3</sup>	2.46E+04	5.46E+03	-1.70E+02	5.18E+03	4.26E+02	4.01E+03	9.72E+03
Human toxicity soil	m <sup>3</sup>	1.34E+02	1.42E+02	-1.15E+02	3.95E+01	2.18E+00	3.63E+01	2.97E+01
Bulk waste	kg	1.32E+04	2.37E+02	3.25E+02	5.05E+03	2.52E+00	7.54E+03	7.30E+01
Hazardous waste	kg	4.54E+00	1.96E+00	-4.83E-01	0.00E+00	2.93E+00	5.89E-02	7.85E-02
Radioactive waste	kg	2.51E-02	1.44E-03	6.28E-05	0.00E+00	0.00E+00	2.36E-02	0.00E+00
Slags/ashes	kg	4.42E+01	1.07E+02	-9.19E+01	0.00E+00	5.40E-02	8.48E-02	2.92E+01
Resources (all)	kg	4.75E-01	1.24E-01	-1.04E-01	4.16E-02	1.03E-02	4.46E-02	3.59E-01



Table B-20 : Characterization result of Alstom line trap 0.2mH/3150A

Impact category	Unit	Total	Material production line trap 0.2mH/3150A	EoL of Alstom line trap 0,2mH/3150A	Transportation of line trap	Use phase of line trap
Global warming (GWP 100)	g CO <sub>2</sub>	9.12E+05	3.79E+06	-3.19E+06	3.08E+05	2.25E+03
Ozone depletion	g CFC <sub>11</sub>	4.84E-02	1.38E-01	-9.01E-02	4.64E-04	4.20E-04
Acidification	g SO <sub>2</sub>	1.13E+04	2.15E+04	-1.81E+04	7.84E+03	1.16E+01
Eutrophication	g NO <sub>3</sub>	8.90E+03	8.43E+03	-6.74E+03	7.20E+03	1.16E+01
Photochemical smog	g ethene	1.72E+02	7.80E+02	-6.44E+02	3.50E+01	9.04E-01
Ecotoxicity water chronic	m <sup>3</sup>	1.04E+05	6.09E+05	-5.07E+05	1.84E+03	8.27E+02
Ecotoxicity water acute	m <sup>3</sup>	9.39E+03	5.64E+04	-4.73E+04	1.69E+02	8.34E+01
Ecotoxicity soil chronic	m <sup>3</sup>	2.44E+03	1.34E+04	-1.10E+04	4.92E+01	2.69E+01
Human toxicity air	m <sup>3</sup>	1.45E+08	3.14E+08	-2.22E+08	5.35E+07	3.88E+05
Human toxicity water	m <sup>3</sup>	2.52E+03	9.09E+03	-6.74E+03	1.66E+02	1.13E+01
Human toxicity soil	m <sup>3</sup>	1.46E+02	1.96E+02	-5.11E+01	8.47E-01	8.59E-02
Bulk waste	kg	9.16E+01	3.71E+02	-2.91E+02	9.81E-01	1.10E+01
Hazardous waste	kg	1.17E+00	3.44E-02	-7.02E-03	1.14E+00	0.00E+00
Radioactive waste	kg	5.70E-03	5.70E-03	0.00E+00	0.00E+00	0.00E+00
Slags/ashes	kg	2.96E+01	2.96E+02	-2.66E+02	2.10E-02	0.00E+00
Resources (all)	kg	2.05E-02	4.42E-02	-2.78E-02	4.01E-03	9.06E-05

Table B-21 : Characterization result of ceramic insulators in substations

Impact category	Unit	Total	Material production insulators	End-of-life of insulators in substations	Transportation of insulators in substations
Global warming (GWP 100)	g CO <sub>2</sub>	2,48E+09	7,34E+08	2,49E+08	1,50E+09
Ozone depletion	g CFC <sub>11</sub>	6,95E+01	1,39E+00	6,58E+01	2,26E+00
Acidification	g SO <sub>2</sub>	4,12E+07	7,32E+06	-4,32E+06	3,82E+07
Eutrophication	g NO <sub>3</sub>	3,87E+07	6,89E+06	-3,25E+06	3,51E+07
Photochemical smog	g ethene	-1,65E+05	2,49E+05	-5,84E+05	1,71E+05
Ecotoxicity water chronic	m <sup>3</sup>	5,07E+07	1,13E+07	3,04E+07	8,96E+06
Ecotoxicity water acute	m <sup>3</sup>	1,04E+07	7,55E+05	8,80E+06	8,25E+05
Ecotoxicity soil chronic	m <sup>3</sup>	3,75E+05	3,66E+05	-2,31E+05	2,40E+05
Human toxicity air	m <sup>3</sup>	6,11E+11	3,73E+11	-2,28E+10	2,61E+11
Human toxicity water	m <sup>3</sup>	-1,23E+07	3,18E+06	-1,63E+07	8,07E+05
Human toxicity soil	m <sup>3</sup>	2,96E+04	3,18E+04	-6,37E+03	4,12E+03
Bulk waste	kg	7,78E+05	1,04E+04	7,63E+05	4,78E+03
Hazardous waste	kg	6,90E+03	2,31E+03	-9,59E+02	5,55E+03
Radioactive waste	kg	6,46E-02	0,00E+00	6,46E-02	0,00E+00
Slags/ashes	kg	1,26E+05	7,92E+04	4,63E+04	1,02E+02
Resources (all)	kg	7,07E+01	1,19E+02	-6,81E+01	1,95E+01

Table B-22 : Characterization result of total substations

Impact category	Unit	Total	Material production of all substations	End of life of all substations	Use phase of all substations (60 years)	Transportations of all components in substations
Global warming (GWP 100)	g CO <sub>2</sub>	1.65E+11	5.48E+10	-1.57E+10	1.11E+11	1.48E+10
Ozone depletion	g CFC <sub>11</sub>	9.67E+03	1.27E+04	-8.49E+03	5.44E+03	2.21E+01
Acidification	g SO <sub>2</sub>	7.19E+08	9.96E+08	-8.02E+08	1.50E+08	3.75E+08
Eutrophication	g NO <sub>3</sub>	6.59E+08	2.63E+08	-9.92E+07	1.51E+08	3.45E+08
Photochemical smog	g ethene	2.01E+07	1.74E+07	-1.07E+07	1.17E+07	1.73E+06
Ecotoxicity water chronic	m <sup>3</sup>	1.64E+10	5.13E+09	4.99E+08	1.07E+10	8.77E+07
Ecotoxicity water acute	m <sup>3</sup>	1.67E+09	4.39E+08	1.47E+08	1.08E+09	8.08E+06
Ecotoxicity soil chronic	m <sup>3</sup>	4.46E+08	9.80E+07	-2.61E+06	3.48E+08	2.34E+06
Human toxicity air	m <sup>3</sup>	2.21E+13	2.04E+13	-5.87E+12	5.03E+12	2.57E+12
Human toxicity water	m <sup>3</sup>	4.03E+08	4.64E+08	-2.15E+08	1.46E+08	7.90E+06
Human toxicity soil	m <sup>3</sup>	2.56E+06	3.98E+06	-2.57E+06	1.11E+06	4.04E+04
Bulk waste	kg	2.36E+08	1.38E+08	-4.44E+07	1.42E+08	4.68E+04
Hazardous waste	kg	7.24E+04	4.20E+04	-2.39E+04	0.00E+00	5.43E+04
Radioactive waste	kg	2.26E+02	4.19E+01	1.84E+02	0.00E+00	0.00E+00
Slags/ashes	kg	8.08E+05	1.36E+06	-5.50E+05	0.00E+00	1.11E+03
Resources (all)	kg	6.54E+03	2.40E+04	-1.88E+04	1.17E+03	1.93E+02

Table B-23 : Comparisons of use phase total substations (60 years)

Impact category	Unit	Total	Use phase of power transformers	Use phase of circuit breakers	Use phase of shunt reactors	Use phase of busbars and conductors	Use phase of the rest
Global warming (GWP 100)	g CO <sub>2</sub>	1.11E+11	1.88E+10	8.23E+10	9.31E+09	6.74E+08	2.64E+08
Ozone depletion	g CFC <sub>11</sub>	5.44E+03	3.52E+03	7.11E+00	1.74E+03	1.26E+02	4.93E+01
Acidification	g SO <sub>2</sub>	1.50E+08	9.70E+07	1.96E+05	4.79E+07	3.47E+06	1.36E+06
Eutrophication	g NO <sub>3</sub>	1.51E+08	9.74E+07	1.97E+05	4.81E+07	3.48E+06	1.36E+06
Photochemical smog	g ethene	1.17E+07	7.57E+06	1.53E+04	3.74E+06	2.71E+05	1.06E+05
Ecotoxicity water chronic	m <sup>3</sup>	1.07E+10	6.93E+09	1.40E+07	3.42E+09	2.48E+08	9.71E+07
Ecotoxicity water acute	m <sup>3</sup>	1.08E+09	6.99E+08	1.41E+06	3.45E+08	2.50E+07	9.80E+06
Ecotoxicity soil chronic	m <sup>3</sup>	3.48E+08	2.25E+08	4.55E+05	1.11E+08	8.06E+06	3.16E+06
Human toxicity air	m <sup>3</sup>	5.03E+12	3.25E+12	6.57E+09	1.61E+12	1.16E+11	4.56E+10
Human toxicity water	m <sup>3</sup>	1.46E+08	9.45E+07	1.91E+05	4.67E+07	3.38E+06	1.32E+06
Human toxicity soil	m <sup>3</sup>	1.11E+06	7.20E+05	1.45E+03	3.56E+05	2.58E+04	1.01E+04
Bulk waste	kg	1.42E+08	9.20E+07	1.86E+05	4.55E+07	3.29E+06	1.29E+06
Hazardous waste	kg	0.00E+00	0.00E+00	0.00E+00	0.00E+00	0.00E+00	0.00E+00
Radioactive waste	kg	0.00E+00	0.00E+00	0.00E+00	0.00E+00	0.00E+00	0.00E+00
Slags/ashes	kg	0.00E+00	0.00E+00	0.00E+00	0.00E+00	0.00E+00	0.00E+00
Resources (all)	kg	1.17E+03	7.59E+02	1.53E+00	3.75E+02	2.72E+01	1.06E+01

Table B-24 : Characterization result of use phase total substations (60 years)

Impact category	Unit	Total	Materials (production+end-of-life)	Use phase	Transport
Global warming (GWP 100)	g CO <sub>2</sub>	7,05E+11	2,76E+11	3,96E+11	3,25E+10
Ozone depletion	g CFC <sub>11</sub>	7,72E+04	1,86E+04	5,86E+04	4,08E+01
Acidification	g SO <sub>2</sub>	3,82E+09	1,48E+09	1,61E+09	7,30E+08
Eutrophication	g NO <sub>3</sub>	3,38E+09	1,06E+09	1,62E+09	7,04E+08
Photochemical smog	g ethene	2,03E+08	7,15E+07	1,26E+08	5,08E+06
Ecotoxicity water chronic	m <sup>3</sup>	1,59E+11	4,30E+10	1,15E+11	1,62E+08
Ecotoxicity water acute	m <sup>3</sup>	1,59E+10	4,27E+09	1,16E+10	1,49E+07
Ecotoxicity soil chronic	m <sup>3</sup>	5,92E+09	2,17E+09	3,75E+09	4,32E+06
Human toxicity air	m <sup>3</sup>	4,73E+14	4,14E+14	5,42E+13	5,17E+12
Human toxicity water	m <sup>3</sup>	1,54E+10	1,38E+10	1,57E+09	1,48E+07
Human toxicity soil	m <sup>3</sup>	3,67E+07	2,46E+07	1,20E+07	7,52E+04
Bulk waste	kg	1,83E+09	2,99E+08	1,53E+09	8,94E+04
Hazardous waste	kg	1,35E+05	3,47E+04	0,00E+00	1,00E+05
Radioactive waste	kg	1,41E+03	1,41E+03	0,00E+00	0,00E+00
Slags/ashes	kg	1,06E+07	1,06E+07	0,00E+00	5,56E+03
Resources (all)	kg	2,82E+05	2,68E+05	1,26E+04	4,17E+02

Table B-25: Characterization result of total transmission system

Impact category	Unit	Total	Materials (production + end-of-life)	Use phase	Transportation
Global warming (GWP 100)	g CO <sub>2</sub>	7.09E+11	2.78E+11	3.96E+11	3.42E+10
Ozone depletion	g CFC <sub>11</sub>	7.74E+04	1.87E+04	5.87E+04	4.33E+01
Acidification	g SO <sub>2</sub>	3.88E+09	1.49E+09	1.62E+09	7.73E+08
Eutrophication	g NO <sub>3</sub>	3.43E+09	1.06E+09	1.62E+09	7.44E+08
Photochemical smog	g ethene	2.04E+08	7.22E+07	1.26E+08	5.28E+06
Ecotoxicity water chronic	m <sup>3</sup>	1.59E+11	4.34E+10	1.16E+11	1.72E+08
Ecotoxicity water acute	m <sup>3</sup>	1.60E+10	4.31E+09	1.17E+10	1.58E+07
Ecotoxicity soil chronic	m <sup>3</sup>	5.93E+09	2.17E+09	3.75E+09	4.59E+06
Human toxicity air	m <sup>3</sup>	4.75E+14	4.16E+14	5.42E+13	5.47E+12
Human toxicity water	m <sup>3</sup>	1.54E+10	1.38E+10	1.58E+09	1.57E+07
Human toxicity soil	m <sup>3</sup>	3.68E+07	2.48E+07	1.20E+07	7.98E+04
Bulk waste	kg	1.83E+09	3.00E+08	1.53E+09	9.48E+04
Hazardous waste	kg	1.41E+05	3.50E+04	0.00E+00	1.06E+05
Radioactive waste	kg	1.41E+03	1.41E+03	0.00E+00	0.00E+00
Slags/ashes	kg	1.07E+07	1.07E+07	0.00E+00	5.69E+03
Resources (all)	kg	2.82E+05	2.69E+05	1.27E+04	4.39E+02

Table B-26: Single score result of total transmission system

Impact category	Unit	Total	Materials (production + end-of-life)	Use phase	Transportation
Total	Pt	4854610	1889112	2938293	27205
Global warming (GWP 100)	Pt	105960	41600	59245	5115
Ozone depletion	Pt	8817	2133	6679	5
Acidification	Pt	40637	15607	16934	8096
Eutrophication	Pt	13838	4293	6545	3000
Photochemical smog	Pt	12226	4334	7575	317
Ecotoxicity water chronic	Pt	779594	212785	565966	843
Ecotoxicity water acute	Pt	764569	206236	557574	758
Ecotoxicity soil chronic	Pt	454263	166410	287501	352
Human toxicity air	Pt	145028	126820	16539	1669
Human toxicity water	Pt	651619	584389	66565	665
Human toxicity soil	Pt	297430	199867	96918	644
Bulk waste	Pt	1495105	244777	1250251	77
Hazardous waste	Pt	7506	1858	0	5647
Radioactive waste	Pt	44429	44429	0	0
Slags/ashes	Pt	33591	33573	0	18
Resources (all)	Pt	0	0	0	0

Table B-27 : Environmental impacts comparisons of transmission system transmitting electricity generated by different methods

Impact category	Unit	Life cycle of total transmission system (hydro)	Life cycle of total transmission system (coal)	Life cycle of total transmission system (gas)
Global warming (GWP 100)	g CO <sub>2</sub>	7.09E+11	7.97E+13	5.90E+13
Ozone depletion	g CFC <sub>11</sub>	7.74E+04	2.09E+06	1.41E+06
Acidification	g SO <sub>2</sub>	3.88E+09	4.48E+11	1.05E+11
Eutrophication	g NO <sub>3</sub>	3.43E+09	3.01E+11	1.56E+11
Photochemical smog	g ethene	2.04E+08	6.89E+09	5.78E+09
Ecotoxicity water chronic	m <sup>3</sup>	1.59E+11	2.90E+13	4.19E+12
Ecotoxicity water acute	m <sup>3</sup>	1.60E+10	2.67E+12	4.21E+11
Ecotoxicity soil chronic	m <sup>3</sup>	5.93E+09	6.05E+10	1.97E+11
Human toxicity air	m <sup>3</sup>	4.75E+14	4.87E+15	1.42E+16
Human toxicity water	m <sup>3</sup>	1.54E+10	5.14E+11	6.44E+10
Human toxicity soil	m <sup>3</sup>	3.68E+07	2.05E+09	4.65E+09
Bulk waste	kg	1.83E+09	1.73E+10	2.40E+09
Hazardous waste	kg	1.41E+05	1.41E+05	1.41E+05
Radioactive waste	kg	1.41E+03	1.41E+03	1.41E+03
Slags/ashes	kg	1.07E+07	1.07E+07	1.07E+07
Resources (all)	kg	2.82E+05	8.30E+05	1.13E+06





## **Annex C**

# **Life Cycle Impact Assessment Results of Chapter 4**

Table C-1 : Environmental impacts comparison between  
1000 kV and 765 kV AC transmission line  
(with coal generation method)

Impact category	Unit	Life cycle of 1000 kV line	Life cycle of 765 kV line
Global warming (GWP 100)	g CO <sub>2</sub>	2.74E+13	4.14E+13
Ozone depletion	g CFC <sub>11</sub>	1.19E+06	1.80E+06
Acidification	g SO <sub>2</sub>	1.32E+11	1.99E+11
Eutrophication	g NO <sub>3</sub>	7.39E+10	1.11E+11
Photochemical smog	g ethene	2.24E+09	3.35E+09
Ecotoxicity water chronic	m <sup>3</sup>	1.07E+13	1.63E+13
Ecotoxicity water acute	m <sup>3</sup>	9.87E+11	1.50E+12
Ecotoxicity soil chronic	m <sup>3</sup>	2.12E+10	3.01E+10
Human toxicity air	m <sup>3</sup>	1.75E+15	2.24E+15
Human toxicity water	m <sup>3</sup>	4.14E+11	6.16E+11
Human toxicity soil	m <sup>3</sup>	9.54E+08	1.43E+09
Bulk waste	kg	3.60E+08	1.18E+08
Hazardous waste	kg	1.85E+04	1.26E+04
Radioactive waste	kg	1.71E+03	6.40E+02
Slags/ashes	kg	7.08E+06	5.84E+06
Resources (all)	kg	4.81E+05	4.53E+05

Table C-2 : Single score result of comparison between  
1000 kV and 765 kV AC transmission line  
(with coal generation method)

Impact category	Unit	Life cycle of 1000 kV line	Life cycle of 765 kV line
Total	Pt*	1.34E+08	2.01E+08
Global warming (GWP 100)	Pt	4.09E+06	6.19E+06
Ozone depletion	Pt	1.36E+05	2.05E+05
Acidification	Pt	1.38E+06	2.09E+06
Eutrophication	Pt	2.98E+05	4.49E+05
Photochemical smog	Pt	1.34E+05	2.01E+05
Ecotoxicity water chronic	Pt	5.26E+07	7.98E+07
Ecotoxicity water acute	Pt	4.72E+07	7.16E+07
Ecotoxicity soil chronic	Pt	1.62E+06	2.30E+06
Human toxicity air	Pt	5.34E+05	6.83E+05
Human toxicity water	Pt	1.75E+07	2.60E+07
Human toxicity soil	Pt	7.70E+06	1.15E+07
Bulk waste	Pt	2.94E+05	9.60E+04
Hazardous waste	Pt	9.84E+02	6.71E+02
Radioactive waste	Pt	5.38E+04	2.01E+04
Slags/ashes	Pt	2.23E+04	1.84E+04
Resources (all)	Pt	0	0

\* Pt = Personal Equivalent

Table C-3 : Characterization result of Chinese 1000 kV AC transmission line  
(with coal generation method)

Impact category	Unit	Total	Material production	End-of-Life	use phase (60 years)
Global warming (GWP 100)	g CO <sub>2</sub>	2.74E+13	4.30E+11	-2.16E+11	2.71E+13
Ozone depletion	g CFC <sub>11</sub>	1.19E+06	1.10E+04	6.17E+02	1.18E+06
Acidification	g SO <sub>2</sub>	1.32E+11	2.99E+09	-1.83E+09	1.30E+11
Eutrophication	g NO <sub>3</sub>	7.39E+10	1.79E+09	-8.69E+08	7.30E+10
Photochemical smog	g ethene	2.24E+09	1.74E+08	-1.14E+08	2.18E+09
Ecotoxicity water chronic	m <sup>3</sup>	1.07E+13	6.55E+10	-2.82E+10	1.07E+13
Ecotoxicity water acute	m <sup>3</sup>	9.87E+11	5.61E+09	-1.91E+09	9.83E+11
Ecotoxicity soil chronic	m <sup>3</sup>	2.12E+10	2.78E+09	-6.69E+08	1.91E+10
Human toxicity air	m <sup>3</sup>	1.75E+15	4.48E+14	-3.04E+13	1.33E+15
Human toxicity water	m <sup>3</sup>	4.14E+11	1.64E+10	-2.37E+09	4.00E+11
Human toxicity soil	m <sup>3</sup>	9.54E+08	2.79E+07	-3.86E+06	9.30E+08
Bulk waste	kg	3.60E+08	3.15E+07	3.29E+08	0.00E+00
Hazardous waste	kg	1.85E+04	1.25E+05	-1.06E+05	0.00E+00
Radioactive waste	kg	1.71E+03	6.48E+02	1.06E+03	0.00E+00
Slags/ashes	kg	7.08E+06	2.23E+07	-1.53E+07	0.00E+00
Resources (all)	kg	4.81E+05	2.82E+05	-8.99E+03	2.08E+05

Table C-4 : Single score result of Chinese 1000 kV AC transmission line  
(with coal generation method)

Impact category	Unit	Total	Materials (production + end-of-life)	Use phase (60 years)
Total	Pt	133586478	1861213	131725265
Global warming (GWP 100)	Pt	4089877	32051	4057826
Ozone depletion	Pt	135540	1319	134220
Acidification	Pt	1379130	12095	1367035
Eutrophication	Pt	297892	3732	294160
Photochemical smog	Pt	134275	3606	130669
Ecotoxicity water chronic	Pt	52600542	182852	52417690
Ecotoxicity water acute	Pt	47211902	177355	47034547
Ecotoxicity soil chronic	Pt	1622107	162001	1460105
Human toxicity air	Pt	533678	127548	406131
Human toxicity water	Pt	17510092	593455	16916636
Human toxicity soil	Pt	7700566	194319	7506246
Bulk waste	Pt	293791	293791	0
Hazardous waste	Pt	984	984	0
Radioactive waste	Pt	53844	53844	0
Slags/ashes	Pt	22258	22258	0
Resources (all)	Pt	0	0	0

Table C-5 : Comparison of energy loss of 1000 kV AC transmission line by different ways of generation (coal and hydro-electric)

Impact category	Unit	Use phase by coal-generated electricity	Use phase by hydro-electric
Global warming (GWP 100)	g CO <sub>2</sub>	2.71E+13	1.01E+11
Ozone depletion	g CFC <sub>11</sub>	1.18E+06	3.45E+04
Acidification	g SO <sub>2</sub>	1.30E+11	4.67E+08
Eutrophication	g NO <sub>3</sub>	7.30E+10	4.26E+08
Photochemical smog	g ethene	2.18E+09	5.17E+07
Ecotoxicity water chronic	m <sup>3</sup>	1.07E+13	3.95E+10
Ecotoxicity water acute	m <sup>3</sup>	9.83E+11	3.92E+09
Ecotoxicity soil chronic	m <sup>3</sup>	1.91E+10	9.57E+08
Human toxicity air	m <sup>3</sup>	1.33E+15	2.11E+13
Human toxicity water	m <sup>3</sup>	4.00E+11	7.16E+08
Human toxicity soil	m <sup>3</sup>	9.30E+08	5.81E+06
Bulk waste	kg	0.00E+00	0.00E+00
Hazardous waste	kg	0.00E+00	0.00E+00
Radioactive waste	kg	0.00E+00	0.00E+00
Slags/ashes	kg	0.00E+00	0.00E+00
Resources (all)	kg	2.08E+05	4.24E+03

Table C-6 : Characterization results of 1000 kV AC transmission line  
(by hydro-electric generation)

Impact category	Unit	Total	Material production	End-of-Life	Use phase by hydro
Global warming (GWP 100)	g CO <sub>2</sub>	3.16E+11	4.30E+11	-2.16E+11	1.01E+11
Ozone depletion	g CFC <sub>11</sub>	4.61E+04	1.10E+04	6.17E+02	3.45E+04
Acidification	g SO <sub>2</sub>	1.62E+09	2.99E+09	-1.83E+09	4.67E+08
Eutrophication	g NO <sub>3</sub>	1.35E+09	1.79E+09	-8.69E+08	4.26E+08
Photochemical smog	g ethene	1.12E+08	1.74E+08	-1.14E+08	5.17E+07
Ecotoxicity water chronic	m <sup>3</sup>	7.68E+10	6.55E+10	-2.82E+10	3.95E+10
Ecotoxicity water acute	m <sup>3</sup>	7.62E+09	5.61E+09	-1.91E+09	3.92E+09
Ecotoxicity soil chronic	m <sup>3</sup>	3.07E+09	2.78E+09	-6.69E+08	9.57E+08
Human toxicity air	m <sup>3</sup>	4.39E+14	4.48E+14	-3.04E+13	2.11E+13
Human toxicity water	m <sup>3</sup>	1.48E+10	1.64E+10	-2.37E+09	7.16E+08
Human toxicity soil	m <sup>3</sup>	2.99E+07	2.79E+07	-3.86E+06	5.81E+06
Bulk waste	kg	3.60E+08	3.15E+07	3.29E+08	0.00E+00
Hazardous waste	kg	1.85E+04	1.25E+05	-1.06E+05	0.00E+00
Radioactive waste	kg	1.71E+03	6.48E+02	1.06E+03	0.00E+00
Slags/ashes	kg	7.08E+06	2.23E+07	-1.53E+07	0.00E+00
Resources (all)	kg	2.78E+05	2.82E+05	-8.99E+03	4.24E+03



Table C-7 : Environmental impacts comparisons of materials in  
1000 kV and 765 kV transmission line

Impact category	Unit	Life cycle of 1000 kV line materials	Life cycle of 765 kV line materials
Global warming (GWP 100)	g CO <sub>2</sub>	2.14E+11	1.36E+11
Ozone depletion	g CFC <sub>11</sub>	1.16E+04	8.29E+03
Acidification	g SO <sub>2</sub>	1.15E+09	7.27E+08
Eutrophication	g NO <sub>3</sub>	9.25E+08	5.10E+08
Photochemical smog	g ethene	6.01E+07	3.58E+07
Ecotoxicity water chronic	m <sup>3</sup>	3.73E+10	2.08E+10
Ecotoxicity water acute	m <sup>3</sup>	3.71E+09	2.06E+09
Ecotoxicity soil chronic	m <sup>3</sup>	2.12E+09	1.09E+09
Human toxicity air	m <sup>3</sup>	4.18E+14	2.14E+14
Human toxicity water	m <sup>3</sup>	1.40E+10	7.08E+09
Human toxicity soil	m <sup>3</sup>	2.41E+07	1.24E+07
Bulk waste	kg	3.60E+08	1.18E+08
Hazardous waste	kg	1.85E+04	1.26E+04
Radioactive waste	kg	1.71E+03	6.40E+02
Slags/ashes	kg	7.08E+06	5.84E+06
Resources (all)	kg	2.73E+05	1.37E+05

# THÈSE

Présentée devant

## L'ÉCOLE CENTRALE DE LYON

Pour obtenir le grade de

**DOCTEUR**

(Arrêté du 30/03/1992)

**Spécialité : Génie Électrique**

Préparée au sein de

**L'ÉCOLE DOCTORALE  
ÉLECTRONIQUE, ÉLECTROTECHNIQUE, AUTOMATIQUE  
DE LYON**

par

**Wenlu WANG**

---

## **ECO-DESIGN OF POWER TRANSMISSIONS SYSTEMS**

-----

## **ECO-CONCEPTION DES SYSTEMES DE TRANSMISSION DE L'ENERGIE ELECTRIQUE**

---

*Soutenue le 12 juillet 2011 devant la commission d'examen :*

**JURY : MM.**

<b>P.BROCHET</b>	Professeur – Ecole Centrale de Lille	<b>Rapporteur</b>
<b>M. INVERNIZZI</b>	Professeur – Université de Gênes - Italie	<b>Rapporteur</b>
<b>A. BEROUAL</b>	Professeur – AMPERE – Ecole Centrale de Lyon	<b>Examineur</b>
<b>H. RAZIK</b>	Professeur – Université Claude Bernard – Lyon 1	<b>Président</b>
<b>J-L. BESSEDE</b>	Docteur Ingénieur – Schneider-Electric, Grenoble	<b>Examineur</b>
<b>G. TREMOUILLE</b>	Ingénieur – ALSTOM GRID System	<b>Invité</b>



## INTRODUCTION

Les demandes pour la préservation de l'environnement ainsi que les préoccupations pour un développement durable, ont augmenté considérablement ces dernières décennies à travers le monde. Ce souci environnemental est également présent dans l'industrie électrique et les approches d'éco-conception sont de plus en plus présentes dans la conception et la réalisation des composants et systèmes de transmission et de distribution (T & D) de l'énergie électrique.

L'éco-conception est un concept international, élaboré par le « World Business Council for Sustainable Development » (WBCSD) lors du sommet de Rio. L'éco-conception signifie l'intégration des aspects environnementaux dans la conception et le développement d'un produit, dans le but d'améliorer ses performances environnementales tout au long de son cycle de vie. Le terme «cycle de vie» (Figure 1) désigne la production des matières premières ainsi que toutes les étapes de fabrication, de distribution, d'utilisation et d'élimination d'un produit, y compris toutes les mesures nécessaires à son transport ou liées à son existence. L'éco-conception est une approche amont qui permet d'optimiser les performances environnementales des produits, tout en conservant leur qualité fonctionnelle [1]. Toutefois, l'éco-conception ne peut exister seule; c'est juste une partie du processus de conception et de développement d'un produit ou d'un service.

En tant que méthode d'éco-conception, l'Analyse du Cycle de Vie (ACV) est un outil systématique qui permet l'évaluation des impacts environnementaux potentiels d'un produit ou d'un service tout au long de son cycle de vie [2].

Dans les industries T & D, l'ACV a été pratiquée très régulièrement pour analyser individuellement chaque produit et ses impacts environnementaux, et de rechercher les moyens d'améliorer sa performance environnementale. Cette éco-conception de «approche produit» est assez bien développée. Cependant, un seul produit (composant) électrique ne peut à lui seul fournir la puissance électrique aux utilisateurs ; en effet, le système électrique comporte un grand nombre de composants. Afin d'étudier le profil environnemental du système, les profils environnementaux de l'ensemble des

différents produits constituant doivent être intégrés de façon systématique, c'est-à-dire, qu'une «approche système» doit être adoptée.

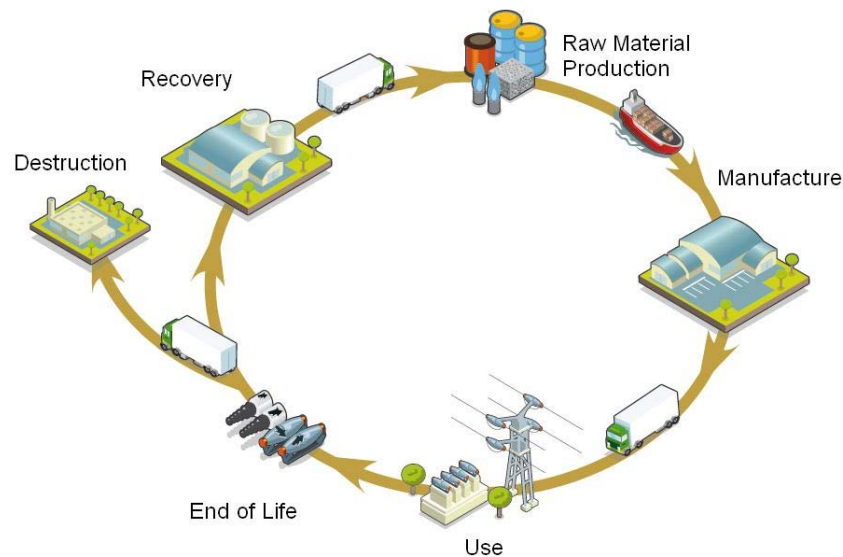

Fig. 1 : Illustration de « Cycle de Vie » [3]

Notre travail porte sur l'«Eco-conception des Systèmes de Transmission de l'Energie Electrique». L'objectif de cette thèse est d'analyser les impacts des systèmes de transmission de l'énergie électrique sur l'environnement, de localiser les principales sources de pollution environnementale, de sélectionner et/ou développer des méthodologies afin de réduire ces impacts environnementaux. Le manuscrit comporte quatre chapitres.

Le chapitre 1 fait une synthèse des méthodes d'éco-conception et des différentes approches relatives à l'examen des impacts environnementaux des industries de Transmission & Distribution de l'énergie. Celles-ci sont classées selon trois approches : «approche produit», «approche système» et «approche pour la prise de décision».

Le chapitre 2 est dédié à l'analyse des impacts environnementaux de l'Ultra Haute Tension (UHV) et Très Haute Tension (THT) de lignes de transmission, l'efficacité

énergétique d'une série de lignes de transmission (500 kV AC, 765 kV AC, 1200 kV AC,  $\pm$  500 kV DC et  $\pm$  800 kV DC) et les émissions de CO<sub>2</sub>-équivalent en raison des pertes d'énergie dans les lignes de transmission. L'impact des différents types de méthodes de production d'électricité est également considéré.

Le Chapitre 3 porte sur l'étude des impacts environnementaux d'un cas réel – le système de transmission à 765 kV AC du Venezuela, à l'aide de l'ACV. Les principales sources de pollution de l'environnement du système de transmission sont localisées. Et des comparaisons des impacts environnementaux entre les lignes et les postes d'une part et des différents stades de vie du réseau de transmission d'autre part, sont présentées. Par ailleurs, les impacts environnementaux de la plupart des équipements dans les postes tels que les transformateurs de puissance, les disjoncteurs et les transformateurs de mesure, sont analysés.

Dans le chapitre quatre, nous traitons les impacts environnementaux d'une ligne de transmission à 1000 kV AC nouvellement construite en Chine ; celle-ci est la première ligne UHV qui voit le jour en Chine. Une comparaison avec l'exemple traité dans le chapitre 2 est également effectuée.



## **Chapitre 1**

### **Etat de l'Art sur l'Eco-conception dans les Industries de Transmission et de Distribution (T & D) de l'Energie Electrique**

Comme les produits industriels sont les principales sources d'impacts environnementaux, les industries relevant de la transmission et de la distribution de l'énergie électrique (industries T & D) ainsi que diverses organisations intègrent l'éco-conception dans leurs produits et services. Le domaine de l'éco-conception est très vaste ; il va du simple produit à la décision stratégique. Cependant, la méthode d'évaluation du profil environnemental est axée sur l'ACV. Pour procéder à l'éco-conception dans les industries T & D, on applique l'ACV ou dans la plupart du temps l'ACV simplifiée, l'ACV pleine n'étant pas toujours disponible ou nécessaire, pour des raisons de temps, de coût ou de disponibilité de données.

Dans ce chapitre, nous présentons une synthèse des normes relatives à l'éco-conception [4-11], des procédures pour effectuer l'ACV ainsi que différentes approches d'éco-conception dans les industries T & D et organisations [12-42].

Les études menées dans cette thèse, sont basés sur l' « approche système » de l'éco- conception. Celle-ci porte principalement sur les impacts environnementaux des systèmes de transmission de l'énergie électrique.





## Chapitre 2

### Pertes d'Energie dans les Lignes de Transmission et Emissions de CO<sub>2</sub>-Equivalent

Différentes lignes de transmission, à différents niveaux de tensions, sont exploitées actuellement à travers le monde. Celles-ci sont classées selon le type de courant : les lignes à courant alternatif (AC) et les lignes à courant continu (DC). La tendance actuelle est de relever de plus en plus les niveaux de tension des systèmes de transmission, pour aller vers les Ultra Haute Tension (UHV), c'est-à-dire des tensions  $\geq 1000$  kV en AC et  $\geq 800$  kV en DC. Ce type de lignes est d'une importance capitale pour les pays à développement (croissance) très rapide et/ou les distances à couvrir sont très importantes comme c'est le cas de la Chine, de l'Inde, du Brésil ...

Les lignes de transmission UHV ont pour avantage une plus grande capacité de transmission de l'énergie et une meilleure efficacité énergétique, par rapport aux lignes THT de transmission (Très Haute Tension). En plus de leurs avantages techniques, les lignes UHV ont également des avantages environnementaux.

Pour analyser les impacts environnementaux des lignes de transport UHV et THT, une analyse du cycle de vie (ACV) pourrait être faite, mais les études [33] montrent que les pertes d'énergie des lignes de transmission sont le point clé, c'est donc dans cette direction que nous allons mener nos premières investigations. Concernant les indicateurs d'impact environnemental que nous allons considérer, aucun ne sera négligé mais le Potentiel de Réchauffement Global (PRG) sera particulièrement mis en avant.

Ainsi, dans ce chapitre, nous considérons des exemples de lignes de transmission THT et UHT en AC et en DC:

- Lignes AC : 500 kV, 765 kV, 1200kV
- Lignes DC :  $\pm 500$  kV et  $\pm 800$ kV

Notre étude sera menée sur les aspects efficacité énergétique et émissions de CO<sub>2</sub>-équivalent en raison des pertes d'énergie dans la ligne de transmission. L'impact des différents types de génération de l'énergie (hydraulique, gaz, charbon...) qui est un facteur majeur, est également analysé.

## **2.1 Pertes d'Énergie dans les Lignes Aériennes Différentes**

Le modèle en  $\pi$  est utilisé pour représenter quantitativement la ligne aérienne AC ainsi que pour calculer les différents paramètres de cette ligne tels que les pertes par effet Joule, les puissances inductive et capacitive ... Toutes ces pertes sont fonction de la longueur de transmission. Dans ce qui va suivre, nous considérons une longueur de 1200 km. Cette valeur correspond à une longueur réaliste de lignes de transmission UHV actuellement en service ou en construction dans le monde. La puissance caractéristique (Surge Impedance Loading - SIL) reflète la capacité de transmission d'une ligne de transmission AC permettant une auto-compensation de l'énergie réactive ; le SIL est la caractéristique intrinsèque de la ligne aérienne AC. Une fois le type et le tracé de la ligne aérienne fixés son SIL reste constant. Pour un type de ligne de transmission AC donné, les pertes de puissance et le taux de pertes varient avec la quantité de puissance transmise. A titre d'exemple, si on prend une ligne 500 kV AC, les pertes Joule diffèrent selon que la puissance transmise est de 50 MW ou de 100 MW. Cependant, dans la plupart des cas, le SIL est défini comme étant la quantité de puissance à transmettre par un type de ligne de transmission donné. Dans ce cas, la puissance réactive générée par la susceptance de la ligne et celle absorbée par la réactance de la ligne s'équilibrent entre elles, c'est-à-dire, qu'il n'y a pas de puissance réactive dans la ligne de transmission. Par exemple, 926 MW est une quantité raisonnable que l'on peut transmettre par une ligne de 500 kV AC, bien que la capacité de transmission pourrait être plus importante que 926 MW à ce niveau de tension. Elle ne peut cependant trop dépasser cette valeur. Dans le cas contraire, la compensation de puissance réactive est nécessaire ; cela peut se faire avec

l'introduction de condensateurs. Il est donc raisonnable de comparer les pertes de puissance des lignes aériennes AC quand elles transmettent la quantité de la puissance caractéristique (SIL).

Les différents paramètres et les pertes ohmiques calculés pour différentes lignes AC sont donnés dans le Tableau 2-1.

Tableau 2-1 : Pertes ohmiques calculées pour différentes lignes AC

	500 kV AC	765 kV AC	1200 kV AC
Tension nominale (kV)	500	765	1150
Facteur de puissance	0.98	0.98	0.98
SIL (MW)	926	2186	5347
Puissance électrique apparente (MVA)	945	2231	5456
Courant à ligne (kA)	1.09	1.68	2.74
Pertes ohmiques (MW)	113	144	230
Taux des pertes ohmiques	12.16%	6.61%	4.30%

Une ligne de  $\pm 500$  kV DC peut transmettre une puissance de 3000 MW alors qu'une ligne de  $\pm 800$  kV DC est capable de transmettre une puissance de 6400 MW. Les pertes ohmiques de ces lignes sont données dans le Tableau 2-2.

Tableau 2-2 : Pertes ohmiques dans les lignes  $\pm 500$  kV DC et  $\pm 800$  kV DC

	$\pm 500$ kV DC	$\pm 800$ kV DC
Puissance à l'envoi (MW)	3000	6400
Courant (kA)	3.00	4.00
Pertes ohmiques (MW)	215	296
Taux des pertes ohmiques	7.17%	4.63%

La Figure 2-1 résume les taux de pertes de puissance de différentes lignes. Nous remarquons que l'augmentation de la tension de transmission de la ligne entraîne une réduction des pertes de puissance dans la ligne quelque soit le type de tension, AC et DC.

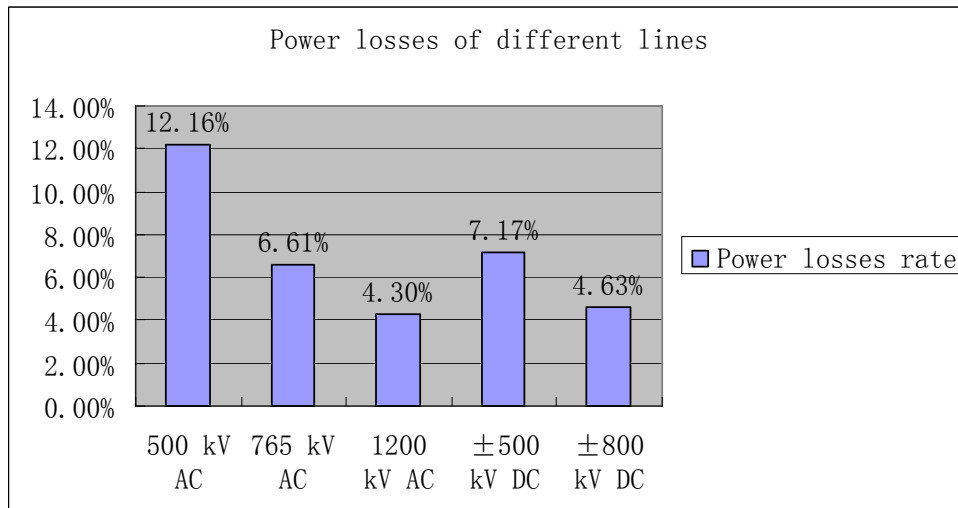

Fig. 2-1 : Pertes de puissance dans les lignes différentes

## 2.2 Emissions de CO<sub>2</sub>-Equivalent pour Différents Types de Lignes de Transmission

En raison des pertes de puissance, les lignes doivent transmettre une quantité de puissance plus importante que celle que l'on doit recevoir à une certaine distance.

La tendance actuelle est de transmettre de plus en plus les puissances sur de longues distances, au-delà de 1000 km, en particulier dans des pays comme la Chine et l'Inde, les centres de production dans ces pays étant trop éloignés des centres de consommation (charge). Pour cela, un scénario plus réaliste est conçu pour analyser les différentes émissions de CO<sub>2</sub>-équivalent pour une puissance de 6000 MW transmise à 1200 km, par les différentes lignes de transmission suivantes : 500 kV AC, 765 kV AC, 1200 kV AC, ± 500 kV DC et ± 800 kV DC.

Les circuits nécessaires pour les différentes lignes de transmission et leur droit de passage pour transmettre une puissance de 6000 MW, sont énumérés dans le Tableau 2-3 et la Figure 2-2. L'augmentation de la tension de transmission de la ligne permet de réduire le nombre de circuits nécessaires pour la ligne. La capacité de transmission d'une ligne est d'autant plus importante que le niveau de tension de transmission de la ligne est élevé ; ce qui a pour conséquence une réduction du droit de passage total. Cela permet de réduire l'occupation des terres le long de la ligne de transmission, et

contribue également à atténuer les impacts visuels sur le paysage.

Tableau 2-3: Nombre de circuits & droit de passage pour différentes lignes de transmission pour une puissance à transmettre de 6000MW

Capacité 6000 MW	500 kV AC	765 kV AC	1200 kV AC	±500 kV DC	±800 kV DC
Nombre de circuits*	7	3	2	2	1
Droit de passage (m)	7×61 [43]	3×75 [44]	2×91 [45]	2×50 [44]	1×50 [33]

\* Un circuit de ligne AC se compose de 3 phases et un circuit de ligne DC est constitué d'un di-pôle.

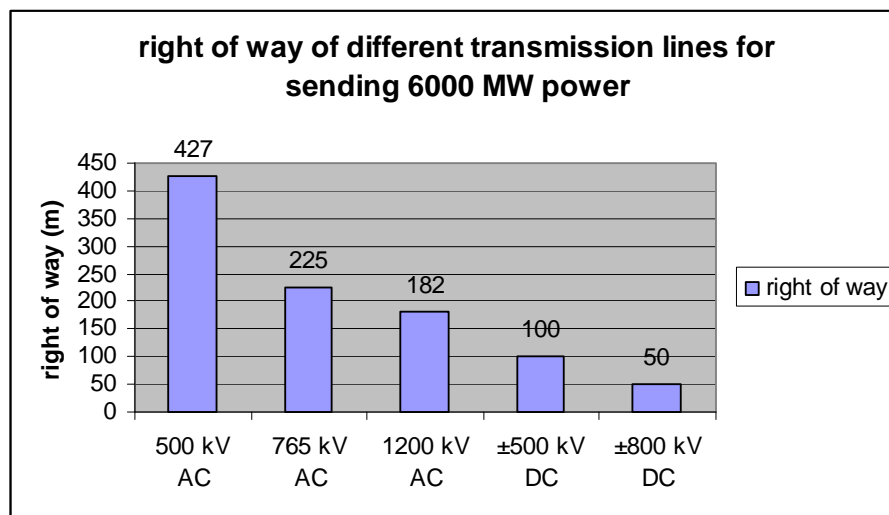

Fig. 2-2: Droit de passage pour différentes lignes pour une puissance à transmettre de 6000 MW

Les pertes de puissance de différentes lignes de transmission sont également présentées en Figure 2-3. Les lignes de transmission UHV (AC et DC) ont des pertes de puissance inférieures, soit seulement 1/3 des pertes de puissance de la ligne de transmission 500 kV AC ; cela permet d'économiser 9% de la puissance à transmettre (soit 6000 MW), censée être perdue sous forme de chaleur à travers la ligne de transmission 500 kV AC.

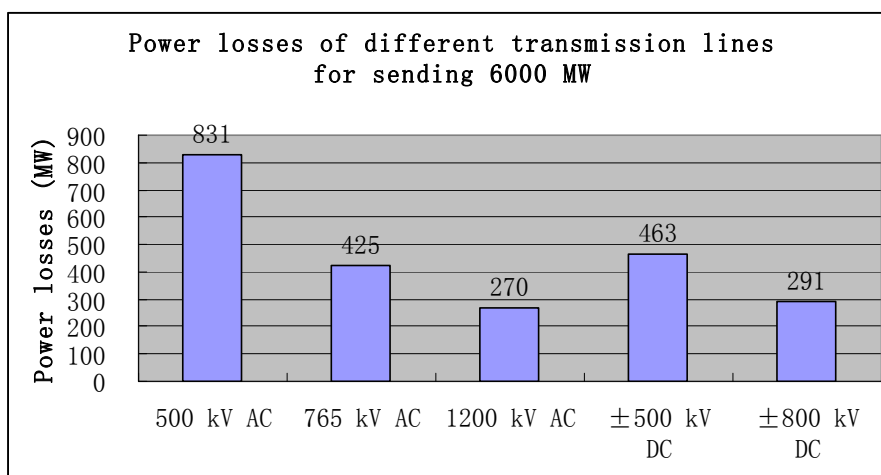

Fig. 2-3 : Pertes de puissance dans différentes lignes pour la transmission d'une puissance de 6000 MW à 1200 km de distance

L'énergie électrique peut être générée par différents moyens. Dans ce qui suit, nous analysons les méthodes traditionnelles de production d'électricité (hydroélectricité, gaz naturel, charbon) du point de vue des émissions de CO<sub>2</sub>-équivalent.

Le CO<sub>2</sub>-équivalent est une quantité qui décrit, pour un mélange et un volume de gaz à effet de serre donnés, la quantité de CO<sub>2</sub> qui auraient le même Potentiel de Réchauffement Global (PRG), lorsqu'elle est mesurée sur une échelle de temps déterminée (en général 100 ans). Par exemple, le PRG du méthane sur 100 ans, est de 25 ; il est de 298 pour l'oxyde nitreux. Cela signifie que les émissions de 1 kg de méthane et d'oxyde nitreux sont respectivement équivalentes aux émissions de 25 et 298 kg de dioxyde de carbone.

Les émissions de CO<sub>2</sub>-équivalent des différents types de production d'électricité sont tirées des bases de données de l'ETH - ESU 96, mise à jour en 2004 [46]. Ces données d'émissions de CO<sub>2</sub>-équivalent sont celles des pays européens de l'UCPTE ; les raisons de l'utilisation de ces données sont justifiées par le fait que, même si les projets UHVAC et UHVDC sont réalisés (ou en cours) en Chine et en Inde, la technologie est également avancée en Europe ; les émissions de CO<sub>2</sub>-équivalent sont pratiquement les mêmes qu'en Europe. Dans le processus d'inventaire du cycle de vie, l'extraction des carburants (matériaux), la construction de centrales électriques,

l'utilisation et le traitement des sols, sont pris en compte, ainsi que la production de l'électricité.

Dans le cas réel, le flux de puissance varie avec les charges en ligne. La ligne de transmission peut être légèrement chargée ou très surchargée selon la demande (et les périodes). Dans ce qui va suivre, on suppose que les lignes de transmission fonctionnent à capacité fixe durant toute l'année, indépendamment des indisponibilités dues à des pannes de courant et à la maintenance, c'est-à-dire, que les lignes fonctionnent (sont disponibles) à 100% toute l'année.

Le Tableau 2-4 présente les pertes d'énergie par an, pour différents types de lignes de transmission (AC et DC) de 6000 MW à 1200 km. Par exemple, pour qu'une ligne AC de 500 kV transmette durant toute l'année et sans interruption, 6831 MW à l'origine, il est nécessaire de produire 59,8 TWh d'énergie électrique par an ; 7,3 TWh d'électricité seront perdus dans la ligne de transmission. Et à 1200 km, la puissance électrique reçue sera de 6000 MW.

Les émissions de CO<sub>2</sub>-équivalent résultant des pertes d'énergie dans les différents types de lignes de transmission sont calculées et présentées dans le Tableau 2-5 et ce pour les différentes sources d'énergie (hydroélectrique, gaz et charbon).

Le Tableau 2-5 illustre également le fait que l'augmentation de la tension de transmission réduit les émissions de CO<sub>2</sub>-équivalent. D'autre part, pour un même niveau de tension (500kV, par exemple), les émissions de CO<sub>2</sub>-équivalent sont plus importantes en AC qu'en DC. En considérant une production hydro-électrique, par exemple, les lignes de transmission de 1200 kV AC et ± 800 kV DC permettent d'éviter respectivement  $1.96 \times 10^4$  tonnes et  $1.89 \times 10^4$  tonnes d'émissions de CO<sub>2</sub>-équivalent par an, par rapport à la ligne de transmission de 500 kV AC, pour une puissance à transmettre de 6000 MW à 1200 km (Figure 2-4).



Tableau 2-4 : Pertes d'énergie annuelles pour les différents types de lignes pour la transmission de 6000 MW à 1200 km

Type de lignes de transmission	Puissance à produire (MW)	Energie électrique à produire par année (TWh)	Pertes d'énergie annuelle (TWh)
500 kV AC	6831	59.8	7.3
765 kV AC	6425	56.3	3.7
1200 kV AC	6270	54.9	2.4
±500 kV DC	6463	56.6	4.1
±800 kV DC	6291	55.1	2.5

Tableau 2-5 : Emissions annuelles de CO<sub>2</sub>-équivalent en fonction des pertes d'énergie pour les différents types de lignes, pour la transmission de 6000 MW à 1200 km

Type de production de l'énergie électrique	Type de ligne	Pertes d'énergie dans ligne par année (TWh)	Emissions de CO <sub>2</sub> -équivalent en fonction des pertes d'énergie ( t/annum)	Réduction d'émissions de CO <sub>2</sub> -équivalent, comparé à ligne 500 kV AC (t/annum)
Hydraulique	500 kV AC	7.3	$2.91 \times 10^4$	-
	765 kV AC	3.7	$1.48 \times 10^4$	$1.43 \times 10^4$
	1200 kV AC	2.4	$0.95 \times 10^4$	$1.96 \times 10^4$
	±500 kV DC	4.1	$1.62 \times 10^4$	$1.29 \times 10^4$
	±800 kV DC	2.5	$1.02 \times 10^4$	$1.89 \times 10^4$
Gaz	500 kV AC	7.3	$6.71 \times 10^6$	-
	765 kV AC	3.7	$3.41 \times 10^6$	$3.30 \times 10^6$
	1200 kV AC	2.4	$2.18 \times 10^6$	$4.53 \times 10^6$
	±500 kV DC	4.1	$3.74 \times 10^6$	$2.97 \times 10^6$
	±800 kV DC	2.5	$2.35 \times 10^6$	$4.36 \times 10^6$
Charbon	500 kV AC	7.3	$7.93 \times 10^6$	-
	765 kV AC	3.7	$4.03 \times 10^6$	$3.90 \times 10^6$
	1200 kV AC	2.4	$2.58 \times 10^6$	$5.35 \times 10^6$
	±500 kV DC	4.1	$4.42 \times 10^6$	$3.51 \times 10^6$
	±800 kV DC	2.5	$2.78 \times 10^6$	$5.15 \times 10^6$

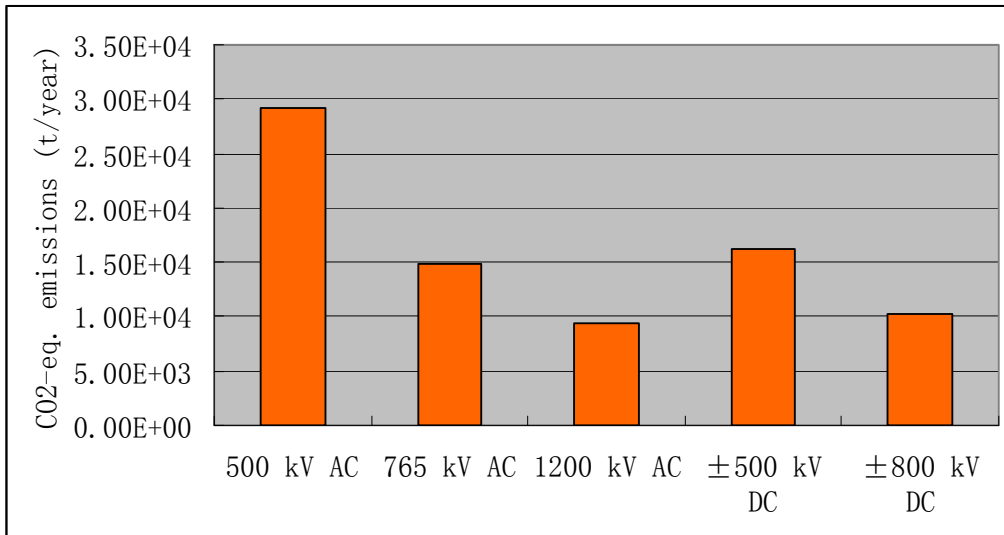

Fig. 2-4 : Emissions annuelles de CO<sub>2</sub>-équivalent résultant des différentes pertes d'énergie dans les lignes pour la transmission de 6000 MW (d'une centrale hydroélectrique) à 1200 km

Ce résultat indique que la ligne de transmission UHV réduit les impacts environnementaux par rapport aux lignes de transmission THT, en ce qui concerne les pertes d'énergie. Cependant, pour répondre à la question de savoir si le système de transmission UHV est plus bénéfique à l'environnement que le système de transmission THT, on doit tenir compte également des aspects matériaux relatifs aux lignes aériennes et des différents équipements. Et ce point ne peut être analysé que si l'ACV est disponible.

### 2.3 Conclusion

Les résultats indiquent que la ligne de transmission UHV est plus économe en énergie : les pertes pour la ligne à 1200 kV AC s'élèvent à 4,30% pour une puissance transmise de 6000 MW à 1200 km, et à 4,63% pour une ligne à ± 800 kV DC ; elles sont respectivement de 12,16%, 6,61% et 7,17% pour des lignes de 500 kV AC, 765 kV AC, et ± 500 kV DC. Le calcul des émissions de CO<sub>2</sub>-équivalent liées aux pertes dans les lignes de transmission montre que les lignes de transmission UHV permettent

de réduire les émissions de CO<sub>2</sub>-équivalent, par rapport aux lignes de transmission THT.

Il est à noter que la ligne de transmission UHV réduit le droit de passage et l'espace au sol nécessaire, et plus particulièrement la ligne  $\pm 800$  kV DC ; ce qui est évidemment bénéfique pour l'environnement et contribue à réduire les impacts visuels sur le paysage. En outre, pour la ligne  $\pm 800$  kV DC, il faut moins de conducteurs. Et il n'est pas nécessaire de construire des sous-stations intermédiaires comme cela est le cas pour la technologie AC. Par conséquent, Les lignes UHV montrent également leurs avantages économiques.

Globalement, la ligne de transmission UHV présente des avantages tant environnementaux que techniques tels que l'augmentation des capacités de transmission et une meilleure efficacité énergétique, par rapport aux lignes de transmission THT.

L'analyse des émissions de CO<sub>2</sub>-équivalent que nous avons faite dans ce chapitre n'a porté que sur les pertes d'énergie en lignes. La construction, les postes de transformation ainsi que leur consommation d'énergie n'ont pas été pris en compte ; ceux-ci doivent être intégrés dans l'analyse des incidences sur l'environnement de la totalité du système de transmission. Dans le chapitre qui suit, les impacts environnementaux induits par les matériaux des lignes aériennes et les postes seront affichés dans l'ACV. Pour cela, nous considérons un exemple de système de transmission à 765 kV AC construit au Venezuela.

## Chapitre 3

### Impact Environnemental du système de Transmission 765 kV AC du Venezuela

Un cas réel du système de transmission à 765 kV AC du Venezuela (Figure 3-1) a été sélectionné pour étudier les impacts environnementaux de l'ensemble du système.

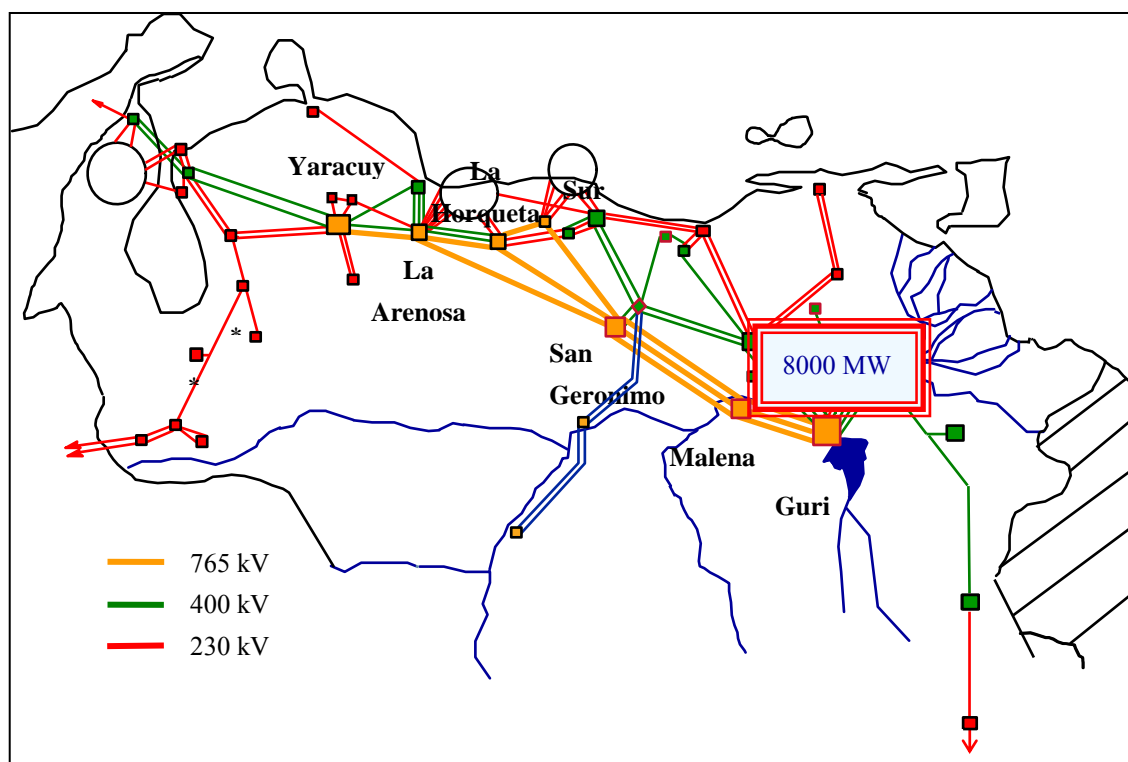

Fig. 3-1 : Illustration du système de transmission à 765 kV AC du Venezuela

La raison du choix de ce système de transmission 765 kV AC est qu'il existe actuellement, dans de nombreux pays, des lignes THT (Très haute tension) AC permettant de transmettre des puissances importantes à grandes distances. Il est donc utile d'étudier les impacts environnementaux de ces systèmes de transmission. La partie la plus difficile pour procéder à l'ACV, c'est la collecte des données nécessaires pour les différents équipements dans les postes (sous-stations) ; autrement

il serait impossible d'analyser les impacts environnementaux d'un système de transmission. D'autre part, le choix de cette ligne vénézuélienne de 765 kV AC est lié au fait que la plupart des équipements majeurs de ce système sont fournis par Alstom Grid. Par conséquent, les données nous sont accessibles. C'est pourquoi cet exemple constitue un modèle typique de système de transmission THT AC dont on peut évaluer les impacts environnementaux.

Ce système de transmission vénézuélien à 765 kV AC transmet 8000 MW d'origine hydroélectrique, de Guri aux centres de charge situés dans le nord du pays (Figure 3-1). Il y a 4 postes de fin de réception : Yaracuy, La Arenosa, La Horqueta et Sur. La distance de Guri à la fin de réception est d'environ 760 km. Deux sous-stations intermédiaires (Malena et San Geronimo) sont construites pour la compensation de l'énergie réactive. Toutes les sous-stations sont isolées à l'air.

Ainsi, l'unité fonctionnelle de l'ACV de ce système à 765 kV AC est de transmettre 8000 MW d'énergie hydroélectrique à 760 km, au cours de sa durée de vie qui est de 60 ans. La portée de cette ACV se concentre uniquement sur le système de transmission ; la centrale électrique et les transformateurs élévateurs (18/765 kV) ne sont pas inclus.

Comme le système de transmission est trop important, pour la clarté du raisonnement et la facilité de l'ACV, l'enquête est divisée en 2 étapes : l'ACV des lignes de transmission et l'ACV des sous-stations.

### **3.1 L'analyse du Cycle de Vie (ACV) des Lignes de Transmission**

Lors de l'ACV, les lignes de transmission sont constituées de conducteurs, des fils de terre, des pylônes et des isolateurs. Tous les composants des lignes de transmission sont étudiés séparément, en ce qui concerne leurs impacts environnementaux. Ainsi il est possible d'analyser le profil environnemental de l'ensemble des lignes de transmission.

Le Tableau 3-1 fait l'inventaire de tous les matériaux considérés dans les lignes de transmission. La phase d'utilisation des lignes de transmission est définie par les pertes d'énergie par effet Joule dans les conducteurs au cours de la durée de vie de 60 ans de ce système de transmission, soit  $6,66 \times 10^7$  MWh, c'est à dire une perte de puissance de 126,8 MW.

La phase de transport totale des lignes de transmission est la somme de la phase de transport individuel des différentes composantes des lignes de transmission, et par conséquent c'est la phase de fin-de-vie des lignes de transmission.

Tableau 3-1 : Matériaux utilisés dans les lignes de transmission 765 kV AC pendant 60 ans

Composants	Matériaux	Poids	
Conducteurs	aluminium	49714 ton	49714 ton
Câbles de garde	aluminium	227.6 ton	2243.6 ton
	acier	2016 ton	
Pylônes	acier	86475 ton	109159 ton
	béton armé	186466 ton	
	Zn revêtement	4218 ton	
Isolateurs	céramique	5624 ton	13984 ton
	fonte	8360 ton	

Soulignons que les matériaux considérés dans les lignes de transmission sont les principaux éléments des lignes de transmission. Les autres matériaux comme, par exemple, les quincailleries pour la fixation des isolateurs et des conducteurs, les entretoises pour les conducteurs ... ne sont pas inclus. En outre, la fabrication de tous les composants, comme par exemple la fabrication des pylônes et de l'acier nécessaire à cette fabrication, les processus de soudure et de fixation des structures d'acier du pylône, a un impact sur l'environnement. Cependant, l'étude des impacts environnementaux de ces processus nécessite la consultation des fabricants, et les données sont parfois difficiles à obtenir et moins précises. Ainsi, dans cette ACV, les processus de fabrication de tous les composants sont omis. En qui concerne la phase de transport, seul le transport des pylônes, des conducteurs, des fils de terre et des

isolateurs est simulé dans cette ACV ; le transport du béton n'est pas considéré. Dans cette étude, des omissions, substitutions et simplifications pertinentes sont appliquées, sinon l'ACV pourrait être trop longue et coûteuse. Notons que les résultats de l'ACV dépendent de la façon dont la simulation est menée et de la précision des données utilisées.

L'inventaire du cycle de vie de la totalité des lignes de transmission est réalisé à l'aide du logiciel SimaPro 7.1, grâce à l'analyse par la méthode d'évaluation des impacts EIDP / UMIP 97. Le résultat de caractérisation de l'évaluation des impacts du cycle de vie (EICV) est représenté sur la Figure 3-1. La caractérisation est une étape de l'évaluation des impacts du cycle de vie, qui vise à caractériser les entrants et les sortants en fonction de leur degré de contribution à un impact environnemental. Ceci amène à convertir tous les éléments participant à un impact en une mesure commune permettant de ressortir un indicateur numérique.

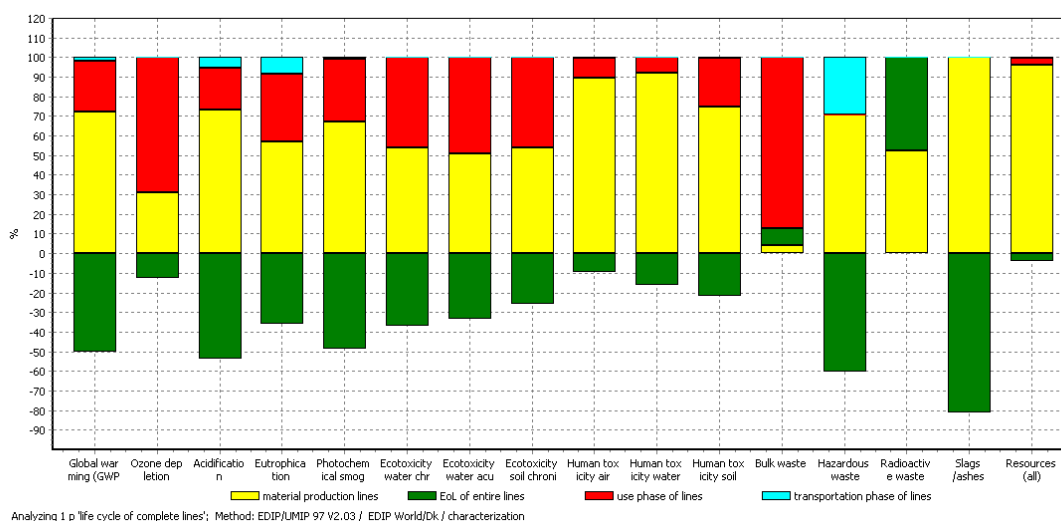

Fig. 3-1 : Résultat de caractérisation des lignes de transmission à 765 kV AC du Venezuela

La phase de production des matériaux domine les émissions de CO<sub>2</sub>-équivalent. Cependant, comme certains matériaux des lignes de transmission sont recyclés dans la phase de fin de vie, si on intègre la phase de production des matériaux et leur phase de fin de vie dans les impacts des matériaux, les pertes d'énergie des conducteurs

représenteront 52,6% des émissions de CO<sub>2</sub>-équivalent, les matériaux (production plus fin-de-vie) 44,1% et la phase de transport 3,3% (Figure 3-2).

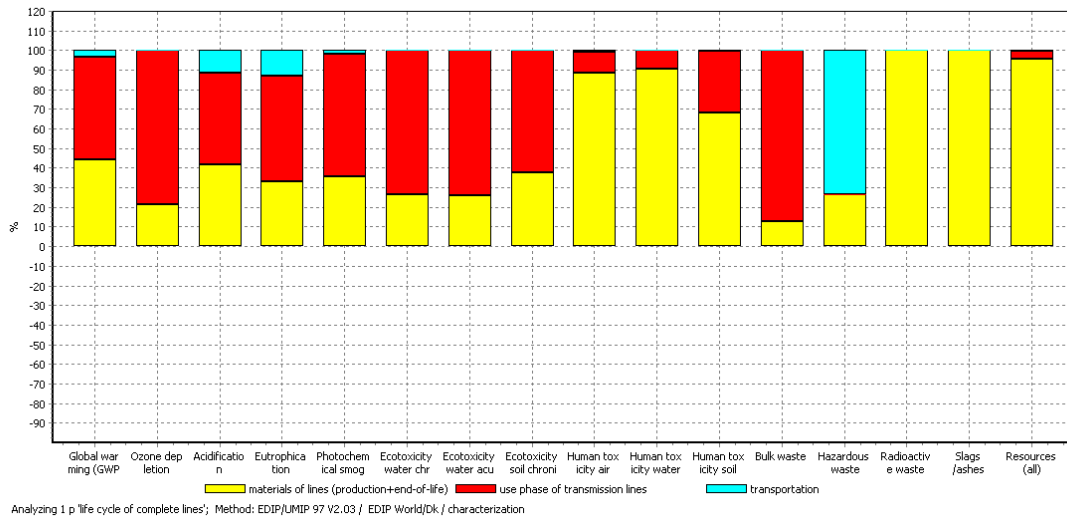

Fig. 3-2 : Résultat de caractérisation des lignes de transmission à 765 kV AC du Venezuela intégrant les phases de production des matériaux et de fin de vie dans les impacts de matériaux

La Figure 3-3 montre le résultat du score unique d'évaluation des impacts du cycle de vie (EICV) des lignes de transmission 765 kV AC.

Le score unique est le résultat des procédures d'évaluation des impacts du cycle de vie – normalisation, pondération et agrégation. En évaluation, les catégories d'impacts environnementaux ou la consommation de ressources peuvent être normalisés pour montrer l'ampleur relative à chaque catégorie. La normalisation donne une idée sur l'ampleur des différentes catégories d'impact, en les comparant à une référence commune. Les références de normalisation de la méthode EDIP/UMIP 97 sont l'impact environnemental annuel ou la consommation annuelle de ressources d'une personne dans chacune des catégories. L'impact potentiel ou la consommation de ressources d'une catégorie est divisée par la référence pertinente, et l'unité des résultats de normalisation est ramenée à une Personne-équivalent (Pt). Ceci afin que toutes les catégories d'impacts environnementaux et la consommation des ressources soient affectées de la même unité pour les rendre ainsi comparables. Dans la pondération, un poids peut être attribué à chaque catégorie, si elles sont d'importance



inégale. La méthode de pondération EDIP/UMIP 97 consiste à pondérer les impacts environnementaux par les objectifs de réduction politiques ; les ressources sont pondérées en fonction des réserves. Ainsi, par agrégation, le score unique est la somme des résultats pondérés des différentes catégories d'impacts sur l'environnement, et l'unité est le Pt (Personne-équivalent). Toutefois, la normalisation, la pondération et l'agrégation sont optionnelles dans l'évaluation des impacts du cycle de vie, et le score unique n'est pas recommandé par les auteurs de la méthode EDIP/UMIP 97 [46], car la consommation de ressources naturelles n'est pas incluse dans le score unique, en raison de la méthode de pondération qui est différente pour la consommation de ressources (en fonction des réserves plutôt que des cibles politiques).

Ici, le résultat de score unique est utilisé pour montrer l'ampleur de l'impact des différentes phases de lignes de transmission. Il apparaît que la phase d'utilisation constitue l'impact environnemental majeur ; elle représente 60,7% du score unique des impacts environnementaux des lignes de transmission alors que les matériaux (production plus fin-de-vie) et la phase de transport représentent 39,0%, 0,3% respectivement.

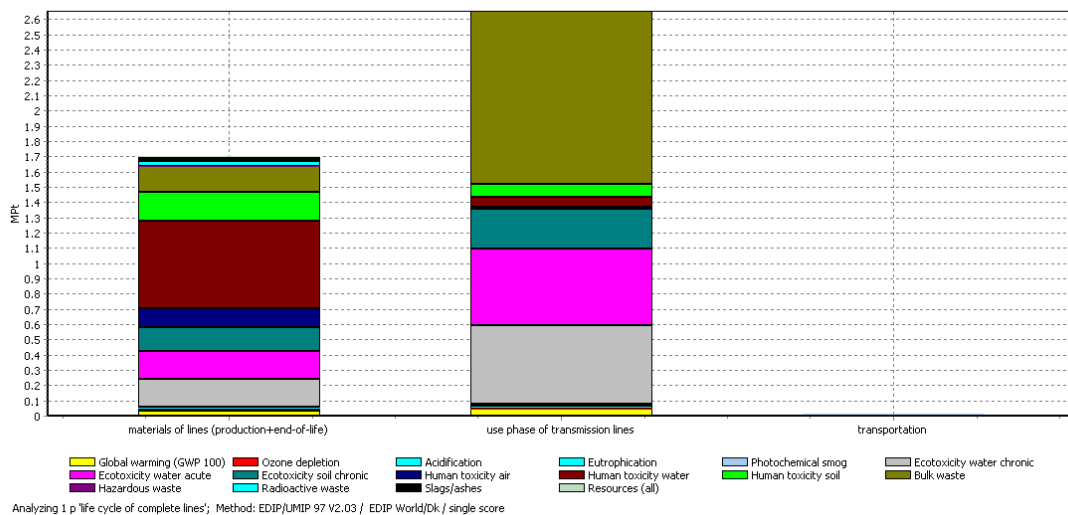

Fig. 3-3 : Résultat du score unique d'évaluation des lignes de transmission 765 kV du Venezuela

A travers l'ACV, on sait que les pertes d'énergie par effet Joule dans les

conducteurs représentent la plus grande partie des impacts environnementaux des lignes de transmission. Cependant, les impacts des matériaux ne peuvent être ignorés. Si nous devons réfléchir aux moyens de réduire les impacts environnementaux des lignes de transmission, l'accent devrait d'abord être mis sur les méthodes de réduction des pertes d'énergie des conducteurs et des matériaux utilisés dans les lignes. Dans le cas où il est difficile de diminuer la quantité des matériaux utilisés dans la construction des lignes de transmission, la réduction des pertes d'énergie est le meilleur moyen d'améliorer leurs impacts environnementaux.

La Figure 3-4 présente une comparaison des impacts environnementaux des composants individuels. On remarque que parmi toutes les composantes considérées, les conducteurs ont le plus d'impacts environnementaux en raison des pertes d'énergie pendant 60 ans. Les pylônes ont des impacts comparables car ils consomment une grande quantité de matières premières, notamment les aciers. Les isolateurs et la phase de transport ne sont pas les principales sources d'impacts environnementaux.

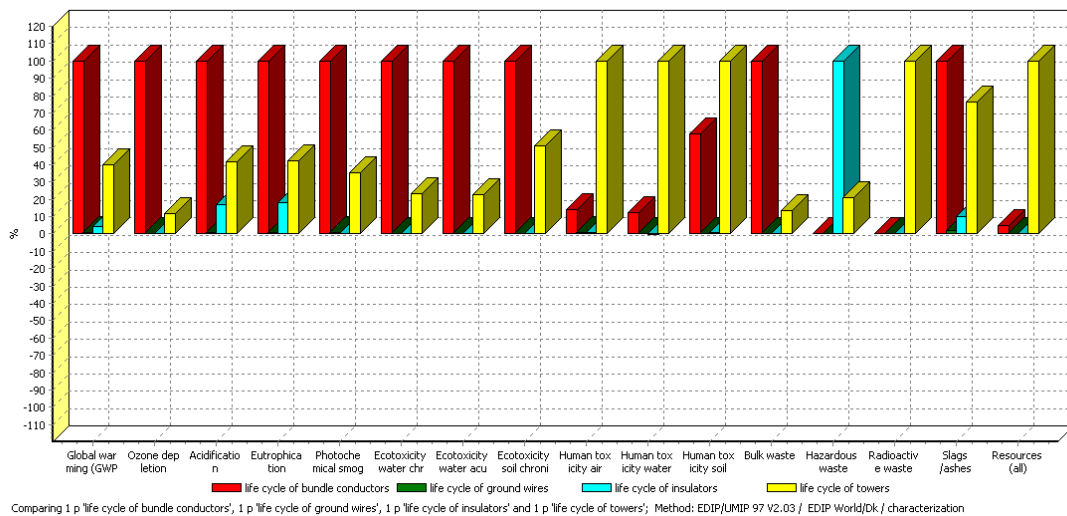

Fig. 3-4 : Comparaison des impacts environnementaux des différents composants des lignes de transmission

### 3.2 L'ACV des Equipements des Sous-stations

Dans ce cas, l'ACV est menée séparément sur la grande majorité des équipements des postes, c'est à dire les transformateurs de puissance, les disjoncteurs, les parafoudres, les transformateurs de courant, les transformateurs de tension, les isolateurs, les sectionneurs, les circuit bouchons et les condensateurs de couplage.

### 3.3 L'ACV des Sous-stations

Dans cette analyse de la totalité des sous-stations, seul le système primaire est inclus ; les systèmes dits "secondaires" tels que les câbles basse tension (inférieure à 1 kV), les système d'éclairage et de contrôle (ordinateurs, appareils électroniques, informatiques, etc.) ne sont pas considérés.

Les inventaires de tous les matériels considérés, la phase d'utilisation, la phase de transport et la phase de fin de vie de la totalité des sous-stations sont résumés dans la thèse. Les pertes d'énergie de tous les composants dans la totalité des postes sont résumées dans le Tableau 3-2.

Tableau 3-2 : Pertes d'énergie de tous les composants dans les postes

Equipements	Pertes de puissance (kW)	Pertes d'énergie pendant 60 ans (kWh)
Transformateurs de puissance	8379	$4.40 \times 10^9$
Réactances	4140	$2.18 \times 10^9$
Conducteurs	300.0	$1.58 \times 10^8$
Sectionneurs totaux	56.6	$2.97 \times 10^7$
Condensateurs de couplage	44.1	$2.32 \times 10^7$
Disjoncteurs	17.0	$8.9 \times 10^6$
Parafoudres	13.7	$7.19 \times 10^6$
Transformateurs de courant	2.2	$1.15 \times 10^6$
Transformateurs de tension	0.7	$3.38 \times 10^5$
Circuit bouchons	0.1	$5.05 \times 10^4$
Total	12954	$6.81 \times 10^9$

La Figure 3-5 illustre le pourcentage de pertes d'énergie des différents composants dans tous les postes. Nous remarquons que les transformateurs de puissance représentent 64,7% des pertes de l'énergie total dans tous les postes, les

réacteurs shunt 32,0%, les conducteurs dans les postes 2,3%, et le reste 1,0 % (y compris les sectionneurs, les condensateurs de couplage, disjoncteurs, etc.) seulement.

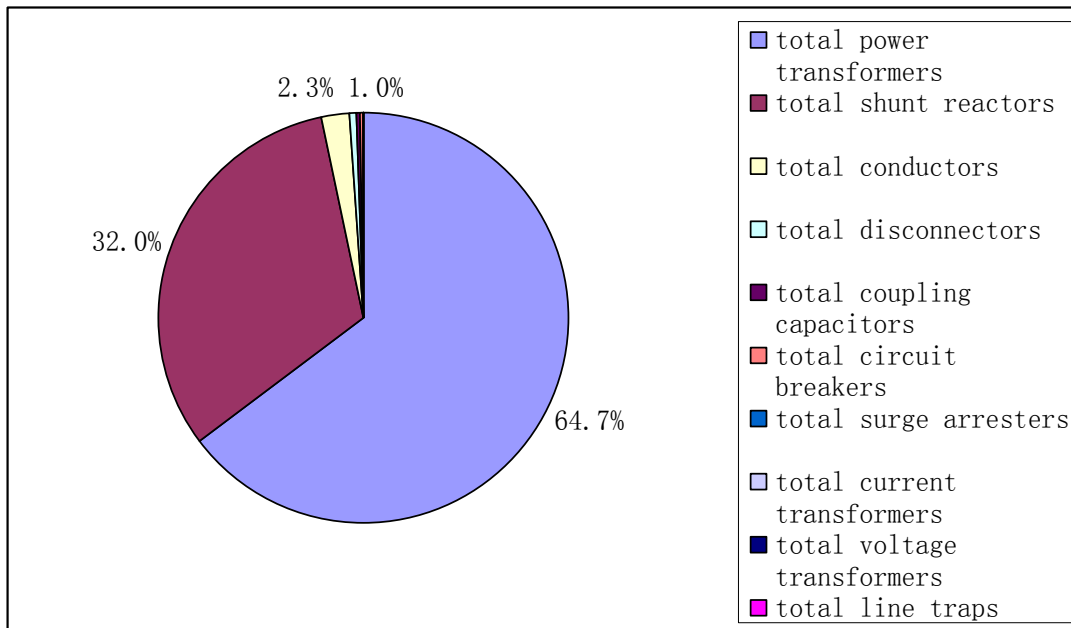

Fig. 3-5 : Pourcentage des pertes d'énergie des composants dans les postes entières

Le résultat de caractérisation d'évaluation des impacts du cycle de vie est représenté sur la Figure 3-6.

Il ressort de ce qui précède que la phase d'utilisation est pour beaucoup dans les impacts environnementaux. En considérant par exemple le réchauffement climatique, la phase d'utilisation représente 67,4% des émissions de CO<sub>2</sub>-équivalent, la production des matériaux 33,1%, alors que la phase de transport 9%. Dans les autres catégories d'impacts, la production des matières domine les impacts environnementaux.

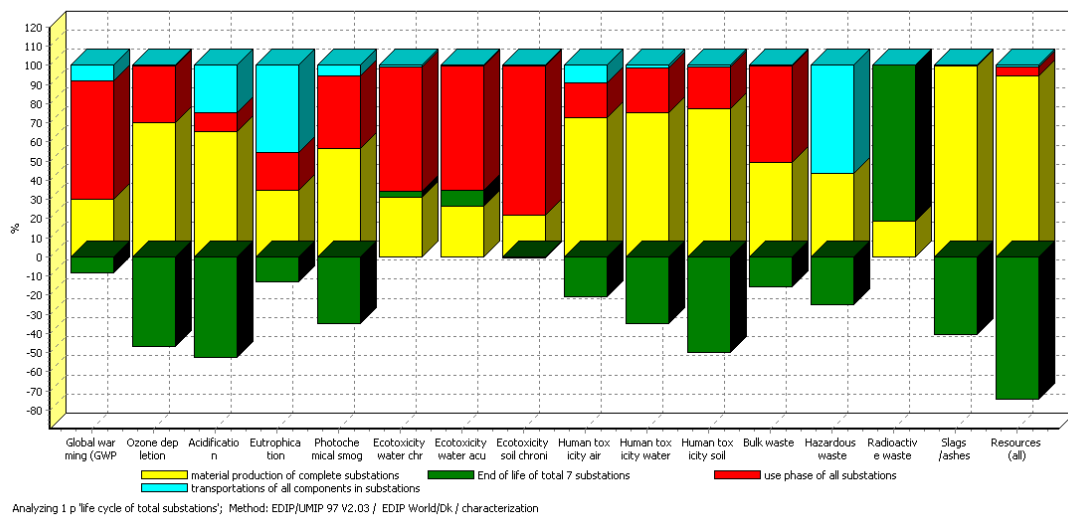

Fig. 3-6 : Résultat de caractérisation de l'ensemble des postes

Le résultat du score unique de tous les postes décrivant l'ampleur des impacts dans les différents stades de vie des sous-stations est représenté sur la Figure 3-7. Il indique que la phase d'utilisation représente 58,8% du score unique des impacts environnementaux de toutes les sous-stations, les matériaux (production plus fin-de-vie) 38,5%, et la phase de transport 2,7% seulement.

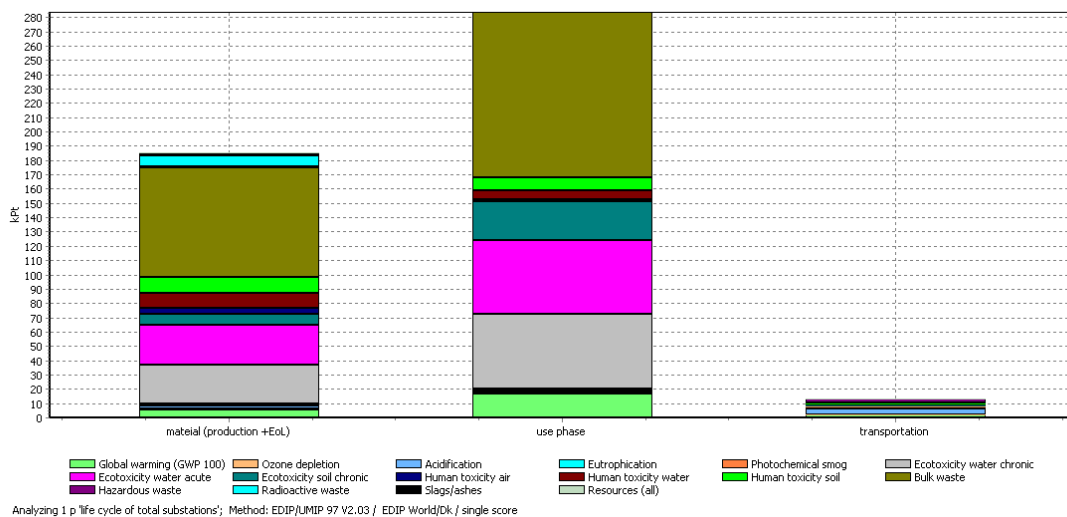

Fig. 3-7 : Résultat de score unique de l'ensemble des sous-stations

Ces résultats montrent que la production de matériaux et la phase d'utilisation constituent le facteur clé de l'amélioration des impacts environnementaux des

sous-stations. La réduction des impacts environnementaux d'un poste, doit passer par une meilleure conception des équipements de façon à réduire les pertes d'énergie, les émissions de SF<sub>6</sub> de disjoncteurs (la phase d'utilisation est composée de ces deux facteurs), ainsi que les matériaux et le poids des équipements autant que possible.

La phase d'utilisation a le plus d'impacts environnementaux dans le cycle de vie des sous-stations. Cependant, elle comporte les phases d'utilisation de nombreux types d'équipements, d'où la question qui se pose : quel est le facteur le plus influent? La réponse à cette question est donnée dans la Figure 3-8, qui indique clairement la contribution des impacts environnementaux des différents équipements dans leur phase d'utilisation ; leurs impacts environnementaux sont mesurés par le score unique. Le figure 3-8 montre trois niveaux, le bloc jaune au niveau supérieure signifie la phase d'utilisation de l'ensemble des postes, les blocs jaunes au niveau intermédiaire représente la phase d'utilisation des différents composants dans les postes, et les blocs gris au niveau du fond indiquent les deux types de processus causant des impacts environnementaux dans la phase d'utilisation des postes, c'est-à-dire, les pertes d'énergie électrique et les émissions de SF<sub>6</sub>. L'épaisseur des lignes reliant indique la contribution des impacts environnementaux de chaque composants, par exemple, la phase d'utilisation des transformateurs de puissance représente 61,9% des impacts environnementaux de la phase d'utilisation des postes, les réacteurs 30,6%, les disjoncteurs 4,46%, les jeux de barres et des conducteurs 2,21%, alors que le reste des équipements (parafoudres, transformateurs de courant, transformateurs de tension, etc.) 0,83% seulement. Les principaux impacts environnementaux lors de la phase d'utilisation des sous-stations sont les transformateurs de puissance et les réacteurs. Concernant les processus causant des impacts environnementaux dans la phase d'utilisation des postes, il est observé que les pertes d'énergie électrique expliquent 95,7% des impacts environnementaux totaux, tandis que les émissions de SF<sub>6</sub> pour 4,3%.

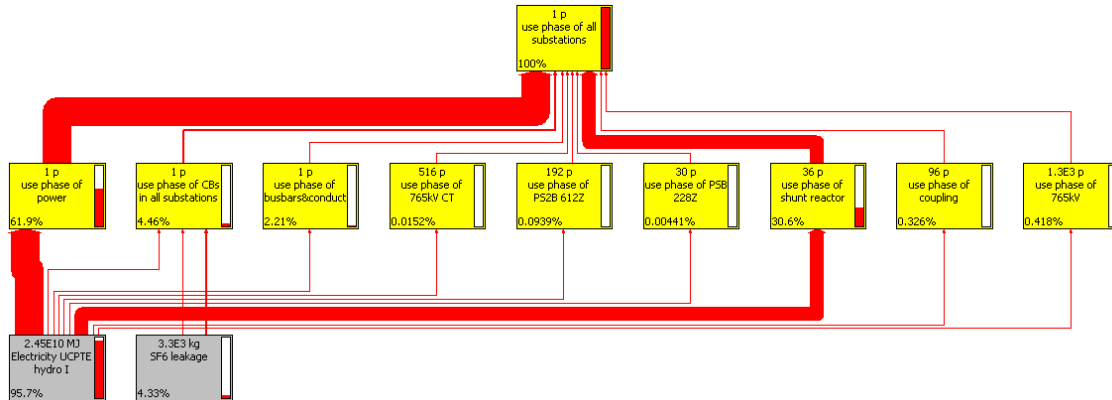

Fig. 3-8 : Contribution des impacts environnementaux de la phase d'utilisation des sous-stations

La Figure 3-9 montre le résultat de l'analyse comparative approfondie des impacts environnementaux de la phase d'utilisation des postes. Elle révèle que les disjoncteurs sont à l'origine de la plupart des émissions de CO<sub>2</sub>-équivalent dans les postes soit 73,9% de la phase d'utilisation dans les postes. La phase d'utilisation des transformateurs de puissance est pour 16,9% des émissions de CO<sub>2</sub>-équivalent, les réacteurs pour 8,4%, les jeux de barres et les conducteurs pour 0,6%, et le reste pour seulement 0,2%. En ce qui concerne les autres catégories d'impacts environnementaux, les pertes d'énergie des transformateurs de puissance sont pour 64,7% des impacts, les réacteurs 32,0%, la totalité des pertes d'énergie dans les conducteurs et les jeux de barres pour 2,3%, alors que les disjoncteurs représentent

0,13%, et le reste 0,9%.

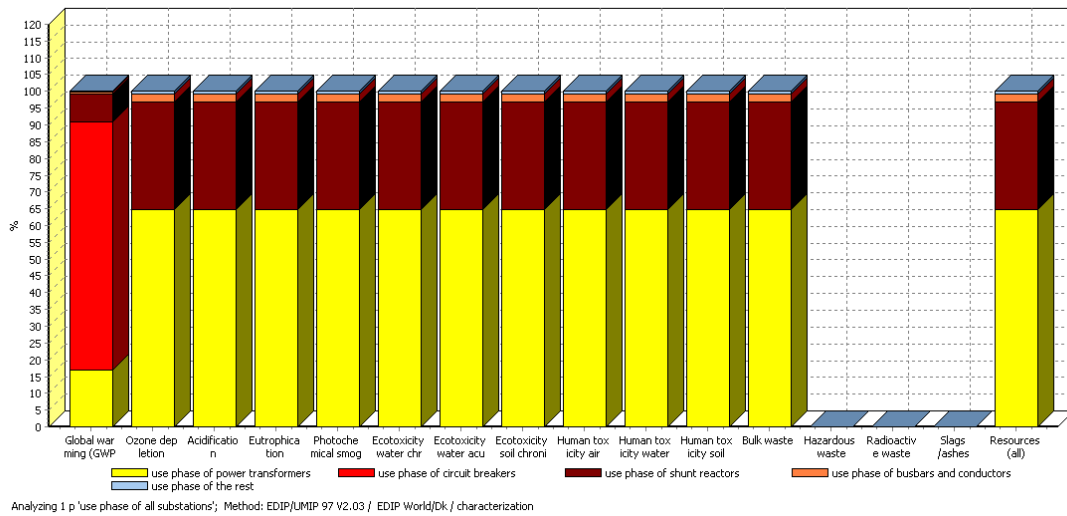

Fig. 3-9 : Résultat de caractérisation de la phase d'utilisation de l'ensemble des postes

Contrairement aux phases d'utilisation des autres équipements, la phase d'utilisation des disjoncteurs ne comporte pas que les pertes d'énergie, mais également les émissions de SF<sub>6</sub>. Pour étudier les effets de ces deux facteurs sur la phase d'utilisation des disjoncteurs, une comparaison est faite (Figure 3-10). Il ressort de cette comparaison que les émissions de SF<sub>6</sub> sont pour 99,95% des émissions de CO<sub>2</sub>-équivalent alors que les pertes d'énergie du disjoncteur le sont pour 0,05% uniquement. Comme les émissions de SF<sub>6</sub> n'ont un impact que sur le réchauffement global, le SF<sub>6</sub> n'a pas d'incidence sur les autres catégories d'impacts environnementaux, c'est pourquoi toutes les catégories sont bleu excepté le Potentiel de Réchauffement Global dans la Figure 3-10. Toutefois, étant donné que les pertes d'énergie des disjoncteurs représentent seulement 0,13% des charges environnementales de toutes les phases d'utilisation sur les autres catégories d'impacts à l'exception du Potentiel de Réchauffement Global (PRG), les transformateurs de puissance et les réacteurs constituent les impacts environnementaux majeurs, à l'exception des émissions de CO<sub>2</sub>-équivalent.



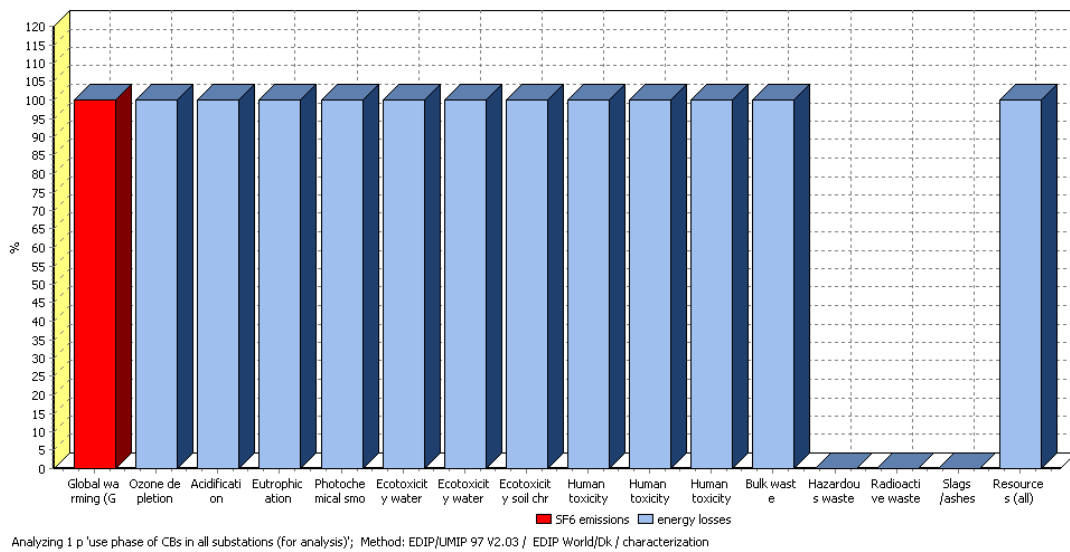

Fig. 3-10 : Résultat de caractérisation de la phase de disjoncteurs

### 3.4 L'ACV du Système de Transmission

Dans ce qui précède, les impacts environnementaux des lignes et des postes ont été analysés séparément, les impacts environnementaux de l'ensemble du système de transmission 765 kV AC du Venezuela seront analysés ci-après.

Les impacts environnementaux des lignes de transmission sont beaucoup plus importants que ceux des sous-stations, comme le montre la Figure 3-11. Par exemple, le Potentiel de Réchauffement Global des lignes de transmission est 3,2 fois celui des sous-stations ; le Potentiel de Déplétion Ozonique des lignes est 7 fois celui des sous-stations, le Potentiel d'Acidification l'est de 4,1 fois, etc.

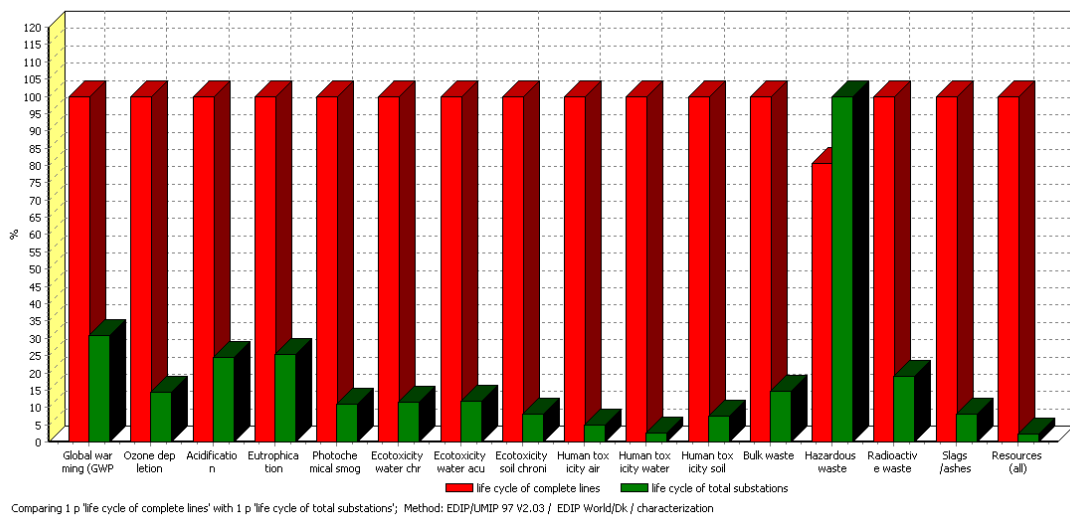

Fig. 3-11 : Comparaison des impacts environnementaux entre les lignes de transmission et les sous-stations.

La Figure 3-12 donne le résultat de caractérisation du système de transmission total. Elle montre que la phase d'utilisation a le plus d'effet sur la plupart des indicateurs des impacts environnementaux. Quant au Potentiel de Réchauffement Global, la phase d'utilisation y est pour 55,9%, les matériaux (production + fin-de-vie) représentent 39,3% et la phase de transport 4,8%. En ce qui concerne le Potentiel de Déplétion Ozonique, la phase d'utilisation y participe pour 75,8%, les matériaux (production + fin-de-vie) pour 24,2%, la phase de transport pour 0,06 ... Le résultat de score unique de l'ensemble du système de transmission montre que la phase d'utilisation a le plus d'impacts environnementaux (Fig. 3-13).

La phase d'utilisation de l'ensemble du système de transmission est composée des émissions de SF<sub>6</sub> de disjoncteurs, des pertes d'énergie dans les postes et des pertes d'énergie dans les lignes de transmission. On remarque que les pertes d'énergie dans les lignes de transmission dominent les impacts environnementaux dans la phase d'utilisation (Fig. 3-14) ; l'effet des pertes d'énergie dans les postes est d'environ un dixième de celui des lignes de transmission. Quant aux émissions de SF<sub>6</sub> des disjoncteurs, elles n'ont d'effets que sur le Potentiel de Réchauffement Global, dont

des émissions de CO<sub>2</sub>-équivalent sont 28,9% de ceux des pertes d'énergie dans les lignes de transmission.

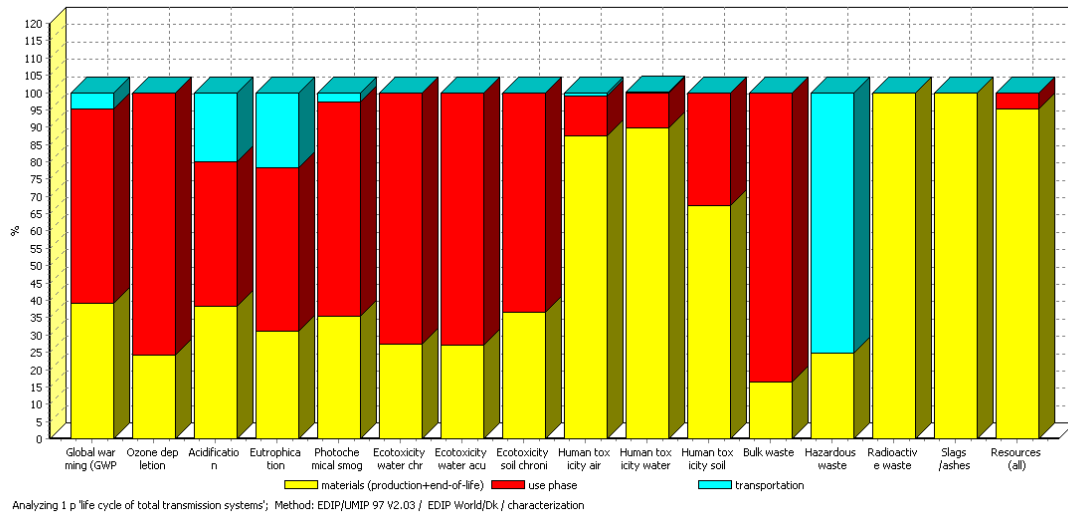

Fig. 3-12 : Résultat de caractérisation du système de transmission

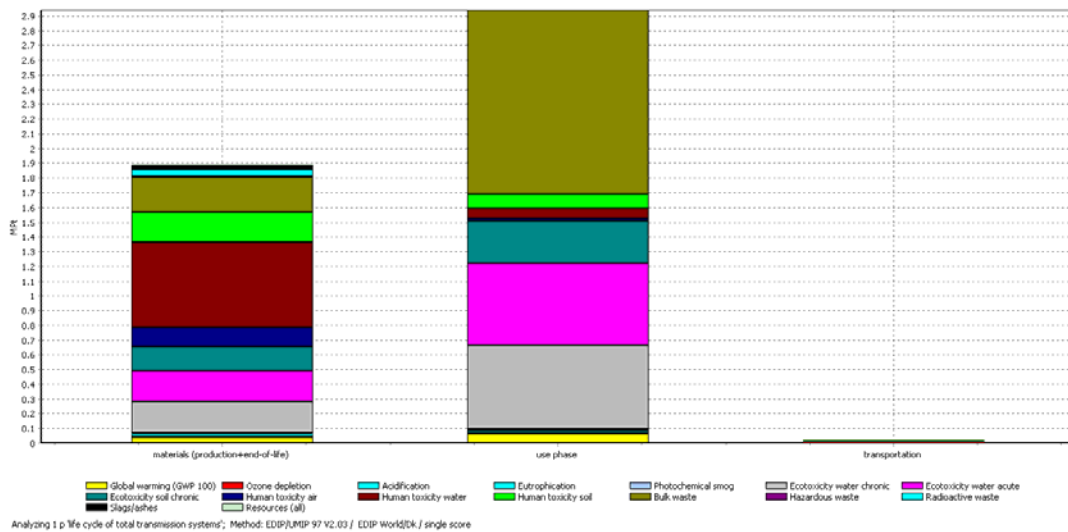

Fig. 3-13 : Résultat de score unique du système de transmission

La Figure 3-15 montre clairement la contribution des impacts environnementaux des composants dans la phase d'utilisation de ce système 765 kV AC du Venezuela, qui est mesuré par le score unique d'évaluation des impacts environnementaux. Toutefois, il est à noter que l'indicateur de consommation des ressources n'est pas pris en compte dans le calcul du score unique, en raison de la méthode de pondération

pour la consommation des ressources qui est différente.

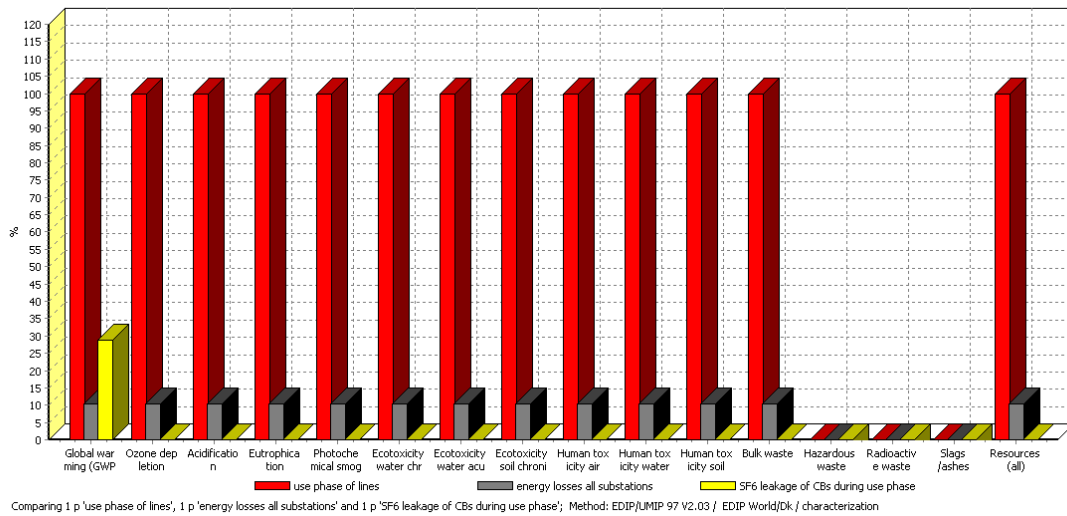

Fig. 3-14 : Comparaison des impacts environnementaux dans la phase d'utilisation de l'ensemble du système de transmission

Le seuil est fixé à 0,2%. Cela signifie que le composant dont les impacts sont inférieurs à 0,2% de ceux du système de transmission total, n'est pas affichée dans la Figure 3-15. Les blocs jaunes représentent la phase d'utilisation des différents composants dans les postes, et les blocs gris indiquent les deux types de processus causant des impacts environnementaux dans la phase d'utilisation des postes, c'est-à-dire, les pertes d'énergie électrique et les émissions de SF<sub>6</sub>. L'épaisseur des lignes reliant indique la contribution des impacts environnementaux de chaque composant, par exemple, la phase d'utilisation des lignes de transmission donne 90,3% des impacts environnementaux dans la phase d'utilisation de l'ensemble du système de transmission. Aussi, les pertes d'énergie constituent le facteur le plus influent (soit 99,6% de score unique) ; les émissions de SF<sub>6</sub> des disjoncteurs ne sont pas le paramètre principal quant aux impacts environnementaux. Pour ce qui est des équipements des postes, la phase d'utilisation des transformateurs de puissance représente 5,97% des impacts environnementaux de la phase d'utilisation de l'ensemble du système de transmission, la phase d'utilisation des réacteurs 2,95%, la phase d'utilisation des disjoncteurs 0,43%, et la phase d'utilisation de tous les

conducteurs dans les postes 0,214%.

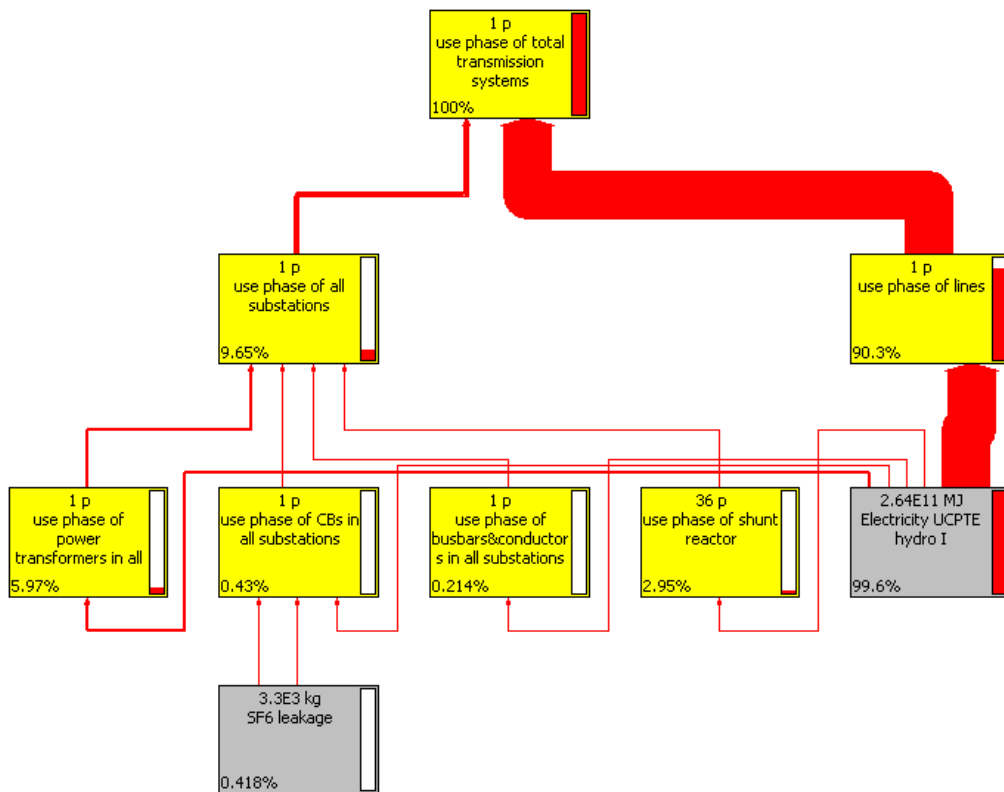

Fig. 3-15 : Contribution des impacts environnementaux de la phase d'utilisation de l'ensemble du système transmission (seuil: 0.2%)

L'énergie électrique transmise à travers ce système de transmission à 765 kV AC du Venezuela est générée par des centrales hydro-électriques. Si ce type de production est remplacé par d'autres, comme le charbon ou le gaz naturel, les impacts environnementaux de ce système de transmission seront modifiés en conséquence. La comparaison des impacts environnementaux est donnée sur la Fig. 3-16. Elle indique que le charbon a le plus fort impact environnemental et l'hydro-électrique a le moins impacts.

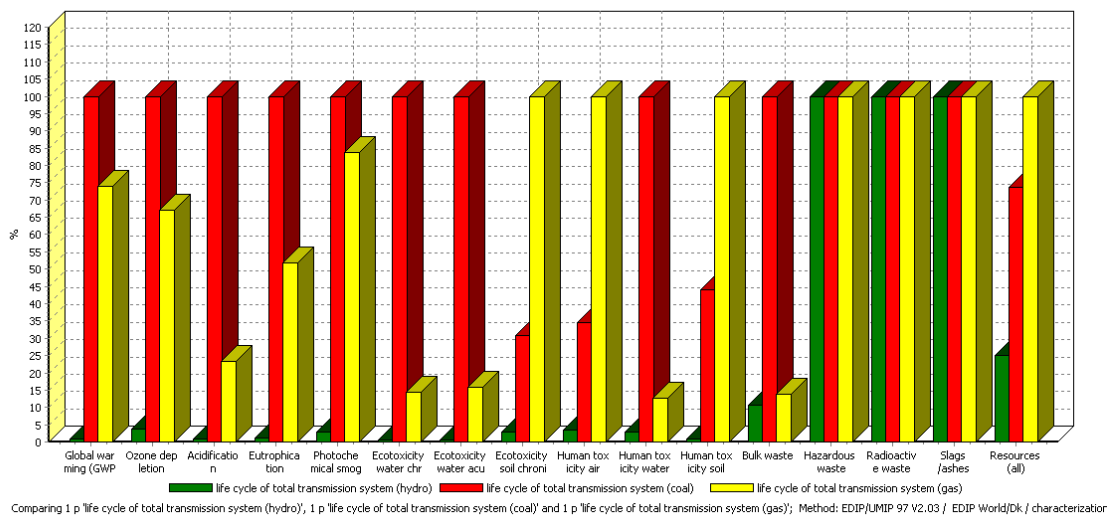

Fig. 3-16 : Comparaison des impacts environnementaux du système de transmission de l'énergie électrique produite par différentes sources

### 3.5 Conclusion

Dans ce chapitre, l'ACV a été effectuée sur un système de transmission à 765 kV AC. L'unité fonctionnelle de cette ACV est de transmettre 8000 MW d'énergie d'origine hydroélectrique à 760 km, pour une durée de vie de 60 ans, avec un coefficient de charge moyen de 60%.

Pour la clarté du raisonnement et pour faciliter l'ACV, l'étude a été divisée en 2 étapes : l'ACV des lignes de transmission et l'ACV des sous-stations.

Dans l'ACV sur les lignes de transmission, les composants considérés incluent les conducteurs, les fils de terre, les isolateurs, les pylônes et les fondations. Dans l'ACV sur les postes, seul le système primaire est inclus ; les "systèmes secondaires" tels que les câbles à basse tension (inférieure à 1 kV), le système d'éclairage et de contrôle des systèmes (ordinateurs, appareils électroniques, informatiques, etc.), n'ont pas été intégrés. Les éléments considérés comprennent les routes d'accès, les gravillons dans les postes et les principaux équipements tels que les transformateurs de puissance, les disjoncteurs, les transformateurs de courant, les transformateurs de tension et les réactances.

Concernant le cycle de vie, la phase de production des matériaux est définie comme la production de toutes les matières premières nécessaires, contenues dans les éléments considérés ; les processus de fabrication ne sont pas inclus. La phase d'utilisation est définie par les pertes d'énergie dans les conducteurs, les pertes d'énergie des principaux équipements et les émissions de SF<sub>6</sub> pour les postes, au cours de la durée de vie de 60 ans de ce système de transmission. La phase de fin de vie contient les scénarios pertinents de traitement des déchets, tels que le recyclage des métaux, l'huile minérale, le SF<sub>6</sub>, l'enfouissement et l'incinération de la porcelaine, etc.

Les résultats d'évaluation des impacts du cycle de vie de l'ensemble du système de transmission montrent que la phase d'utilisation induit les impacts environnementaux les plus importants sur la plupart des indicateurs. Par exemple, la phase d'utilisation compte 55,9% pour le Potentiel de Réchauffement Global, 75,8% pour le Potentiel d'Acidification et 41,7% pour le Potentiel d'Acidification ... Comme la phase d'utilisation de l'ensemble du système de transmission est composée des émissions de SF<sub>6</sub> de disjoncteurs, des pertes d'énergie dans les postes et des pertes d'énergie dans les lignes de transmission, la question qui se pose est : quelle est la source d'impact sur l'environnement la plus importante ? Notre analyse montre que les pertes d'énergie dans les lignes de transmission dominent les impacts environnementaux dans la phase d'utilisation, soit environ 10 fois ceux des pertes d'énergie dans les postes, et 3,5 fois ceux du Potentiel de Réchauffement Global des émissions de SF<sub>6</sub> des disjoncteurs.

Les résultats indiquent que les impacts environnementaux des lignes de transmission sont beaucoup plus importants que ceux des postes, par exemple, le Potentiel de Réchauffement Global des lignes de transmission est 3,3 fois celui des postes, le Potentiel de Déplétion Ozonique des lignes de transmission est 7 fois celui des postes, le Potentiel d'Acidification des lignes est 4,1 fois ... Parmi les étapes du cycle de vie des lignes de transmission, les pertes d'énergie des conducteurs représentent la plus grande partie des impacts environnementaux des lignes de transmission. Concernant les impacts environnementaux des sous-stations, la phase d'utilisation est la principale source d'impacts ; celle-ci comporte les émissions de SF<sub>6</sub>

des disjoncteurs et les pertes d'énergie des différents équipements. Les émissions de SF<sub>6</sub> des disjoncteurs ont le plus d'impacts sur le réchauffement climatique dans les postes (73,9% de la phase d'utilisation dans les postes). Dans les postes, les pertes d'énergie des transformateurs de puissance sont les principales sources d'impacts environnementaux (61,9% de la phase d'utilisation des sous-stations révélés par le score unique), puis viennent les pertes d'énergie des réactances (30,6% de la phase d'utilisation des sous-stations révélé par score unique).

Grâce à l'ACV, il est établi que les pertes d'énergie dans les lignes de transmission et les transformateurs de puissance ainsi que les émissions de SF<sub>6</sub> des disjoncteurs sont les principales sources d'impacts environnementaux du système de transmission. Cela conduit à définir les priorités en terme d'éco-conception des systèmes de transmission, qui permettront de diminuer les impacts environnementaux du système de transmission. L'accent doit être mis sur les méthodes de réduction des pertes d'énergie des conducteurs dans les lignes et transformateurs de puissance et la diminution des émissions de SF<sub>6</sub> des disjoncteurs. En outre, les moyens de réduire la quantité des matériaux utilisés dans les équipements sont toujours bénéfiques pour la réduction de la charge de l'environnement.

L'ACV de ce système de transmission à 765 kV AC donne une analyse quantitative des impacts environnementaux d'un système de transmission, ce qui permet de choisir ou de développer des systèmes de transmission plus écologiques. Des études approfondies peuvent porter sur l'ACV des postes 765 kV isolés au SF<sub>6</sub>, afin de déterminer quel type de poste a le moindre impact sur l'environnement ou sur l'étude du développement environnemental pour l'intégration de l'état de l'art des équipements dans le système de transmission, tels que des composants FACTS (Flexible AC Transmission System) ..., ou encore sur l'étude des impacts environnementaux du systèmes de transmission Ultra Haute Tension (UHV) pour vérifier si un tel système améliore le profil environnemental, par rapport aux systèmes de transmission THT, ce qui fera l'objet du prochain chapitre.





## **Chapitre 4**

### **Comparaison des Impacts Environnementaux entre Lignes de Transmission Ultra Haute Tension et Très Haute Tension**

De nombreux projets de systèmes de transmission Ultra Haute Tension (UHV) sont en cours de construction actuellement à travers le monde, en particulier en Chine et Inde. Il est donc fondamental d'analyser les impacts environnementaux de ces systèmes.

Dans le chapitre 2, nous avons montré que la ligne de transmission UHV est plus efficace que la ligne THT en ce qui concerne les pertes d'énergie ; les lignes de transmission UHV sont capables de réduire les émissions de CO<sub>2</sub>-équivalent, par rapport aux lignes de transmission THT. Néanmoins, pour comparer les impacts environnementaux des lignes de transmission UHV et des lignes de transmission THT, plusieurs aspects tels que les impacts environnementaux des différentes composantes utilisées doivent être considérés.

Dans ce chapitre, nous allons mener une ACV sur les impacts environnementaux d'une ligne UHV AC chinoise à 1000 kV AC, et la comparer à une ligne de transmission THT AC.

Le système de transmission Jindongnan - Nanyang- Jingmen 1000 kV (voir Figure 4-1) est le premier projet de transmission UHV construit en Chine et actuellement en service. Cette ligne transmettant une puissance de 5000 MW, part d'un poste UHV à Jindongnan dans la province de Shanxi et passe par un poste intermédiaire à Nanyang UHV dans la province du Henan, pour arriver à un poste UHV à Jingmen situé dans la province de Hubei. La longueur totale de la ligne est d'environ 640 km.

Dans l'ACV, la production de matériaux de la ligne de transmission, la phase de

fin de vie, et la phase d'utilisation sont modélisés, alors qu'aucune phase de transport n'est simulée. Comme les données de transport ne sont généralement pas précises, elles sont souvent fondées sur des hypothèses. D'ailleurs, l'analyse menée dans le chapitre 3 montre que la phase de transport ne domine pas les impacts environnementaux.

Pour comparer les impacts environnementaux des lignes THT AC et UHV AC, une ligne de transmission THT AC à 765 kV est simulée pour remplir la même unité fonctionnelle que la ligne de transmission UHV AC à 1000 kV. Il s'agit de transmettre une puissance de 5000 MW à 640 km, pour une durée de vie de 60 ans. La création de cette ligne de transmission 765 kV alternative utilise les données réalistes à partir de la ligne de transmission à 765 kV du Venezuela (décrite dans le chapitre 3).

#### 4.1 L'ACV des Lignes de Transmission à 1000 kV AC & 765 kV AC

Les matériaux et les pertes d'énergie des lignes de transmission à 1000 kV AC et 765 kV AC sont résumées dans le Tableau 4-1.

Tableau 4-1 : Comparaison des matériaux et des pertes d'énergie dans les lignes de transmission 1000 kV AC et 765 kV AC

Catégories	Matériaux	ligne de transmission 1000 kV	ligne de transmission 765 kV
Conducteurs	Aluminium	20612 ton	27910 ton
	Acier	4143 ton	0
Câbles de garde	Aluminium	257 ton	128 ton
	Acier	978 ton	1132 ton
Pylônes	Acier	89600 ton	48650 ton
	Béton armé	353280 ton	104696 ton
	Zn vêtement	4 716 ton	2360 ton
Isolateurs	Céramique	2729 ton	3159 ton
	Fonte	4108 ton	4734 ton
Pertes d'énergie pendant 60 ans	-	$2.5 \times 10^7$ MWh	$3.8 \times 10^7$ MWh

Les résultats de caractérisation de ces 2 lignes de transmission sont comparés dans la Figure 4-1. Il est à noter que dans la plupart des catégories, les impacts environnementaux de la ligne 1000 kV sont inférieures à ceux de la ligne 765 kV ; par exemple, pour une ligne 765 kV, les émissions de CO<sub>2</sub>-équivalent représentent 66,1%, le Potentiel de Déplétion Ozonique 66,1%, le Potentiel d'Eutrophisation 66,3% ... Globalement, la ligne de transmission UHV AC réduit les impacts environnementaux par rapport à la ligne de transmission THT AC, ce qui est également observé dans le résultat de score unique (Figure 4-2). Il indique que les impacts environnementaux de la ligne à 1000 kV AC sont environ 2/3 de ceux de la ligne à 765 kV AC.

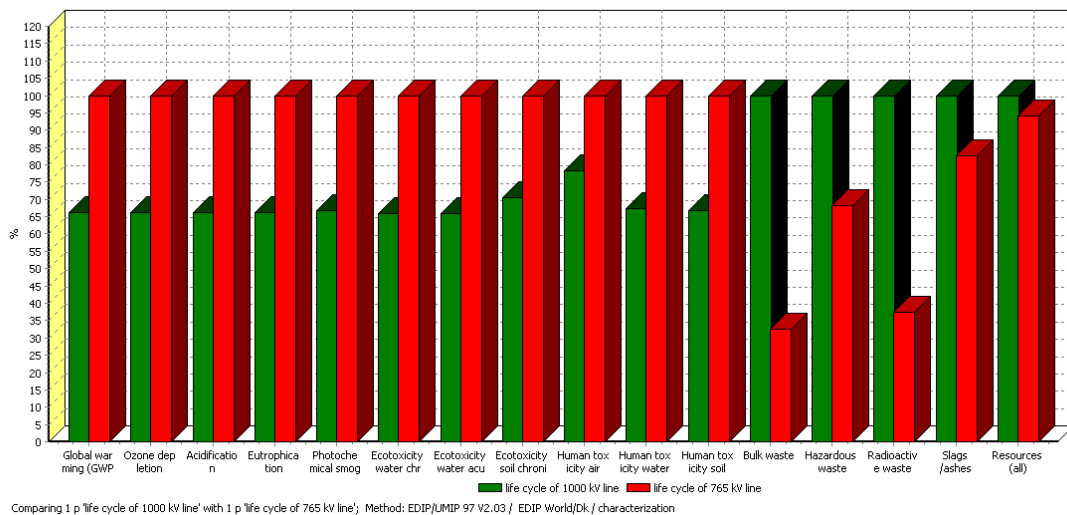

Fig. 4-1 : Comparaison des impacts environnementaux entre les lignes de transmission 1000 kV AC et 765 kV AC

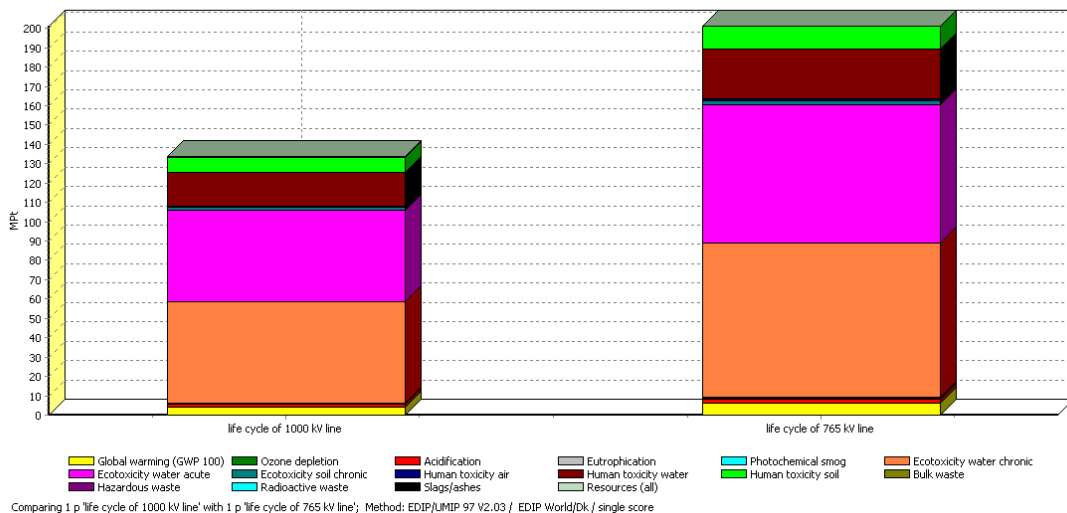

Fig. 4-2: Résultat de score unique des lignes de transmission  
1000 kV AC et 765 kV AC

La question que l'on peut se poser est : pendant le cycle de vie de la ligne de transmission 1000 kV, quelle étape qui a le plus impact sur l'environnement? Est-ce que cette phase d'utilisation est similaire à celle de la ligne de transmission 765 kV AC du Venezuela (examinée en détail au chapitre 3)?

La réponse à cette question est donnée dans la Figure 4-3. La perte d'énergie dans les conducteurs au cours de la durée de vie de 60 ans est la principale source des impacts environnementaux. Par exemple, la phase d'utilisation (en rouge) donne 99,3% des émissions de CO<sub>2</sub>-équivalent d'une ligne de transmission totale, 99% du Potentiel de Déplétion Ozonique, 99,1% du Potentiel d'Acidification de la ligne de transmission totale ... Aussi, le résultat de score unique d'évaluation des impacts du cycle de vie (Figure 4-4) montre que les pertes d'énergie constituent 98,6% des impacts environnementaux de la totalité de la ligne de transmission, puisque le score unique des impacts environnementaux des matériaux est environ 1,4% de celui de la perte d'énergie.

Dans cette ligne de transmission chinoise 1000 kV, il est vrai que les pertes d'énergie dominent les impacts environnementaux. Cependant, nous ne pouvons pas en conclure que les pertes d'énergie dominent toujours dans tous les impacts environnementaux de la ligne de transmission UHVAC. Ceci est dû au fait que les impacts environnementaux liés à l'utilisation de phase diffèrent selon le moyen (source) de génération de l'énergie électrique. La puissance transmise dans cette ligne de transmission UHVAC chinoise est produite par le charbon. Qu'en serait-il cette énergie était d'origine hydro-électrique?

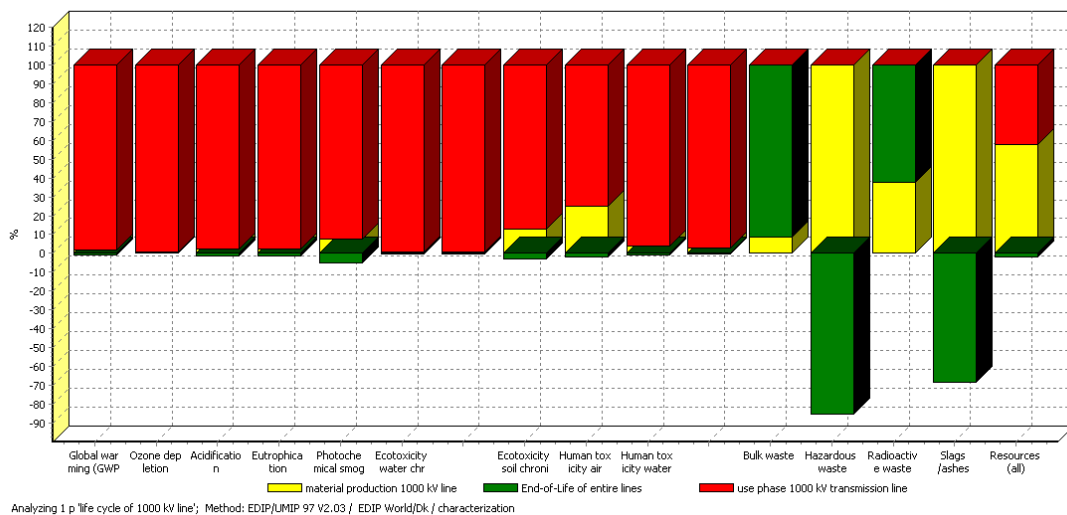

Fig. 4-3 : Résultat de la caractérisation de la ligne de transmission chinoise à 1000 kV

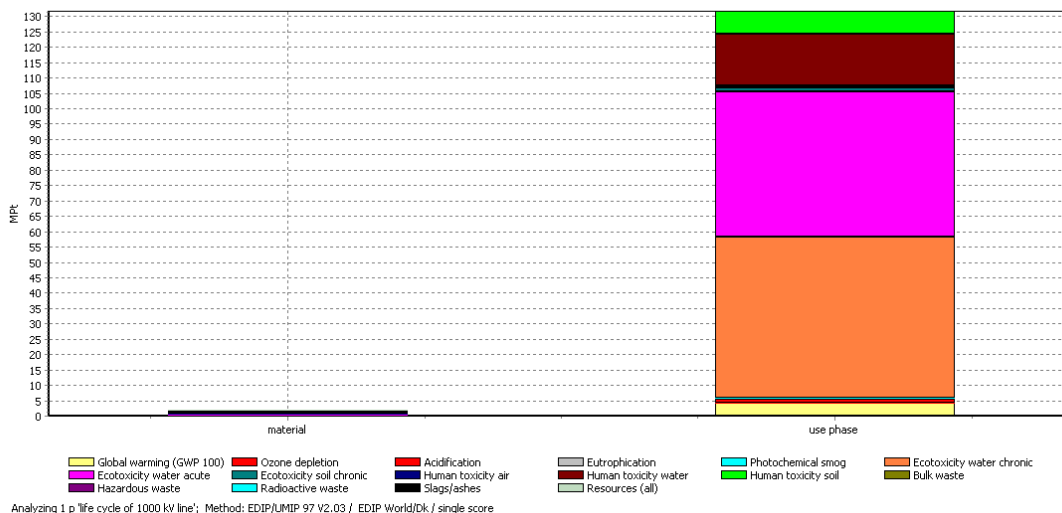

Fig. 4-4 : Résultat du score unique de la ligne de transmission chinoise à 1000 kV

En comparant les résultats de simulation pour une production de l'électricité à partir du charbon à celle d'origine hydro-électrique, nous remarquons que les impacts environnementaux de la production des matières premières des lignes de transmission et la phase de fin de vie restent les mêmes. Mais les impacts environnementaux des pertes d'énergie diminuent de manière spectaculaire (Figure 4-5). Par exemple, les émissions de CO<sub>2</sub>-équivalent seront de 0,37% de ceux de la situation initiale, le Potentiel de Déplétion Ozonique 2,93%, et le Potentiel d'Acidification est 0,36%. La production d'électricité à partir du charbon est plus polluante que la production

hydro-électrique.

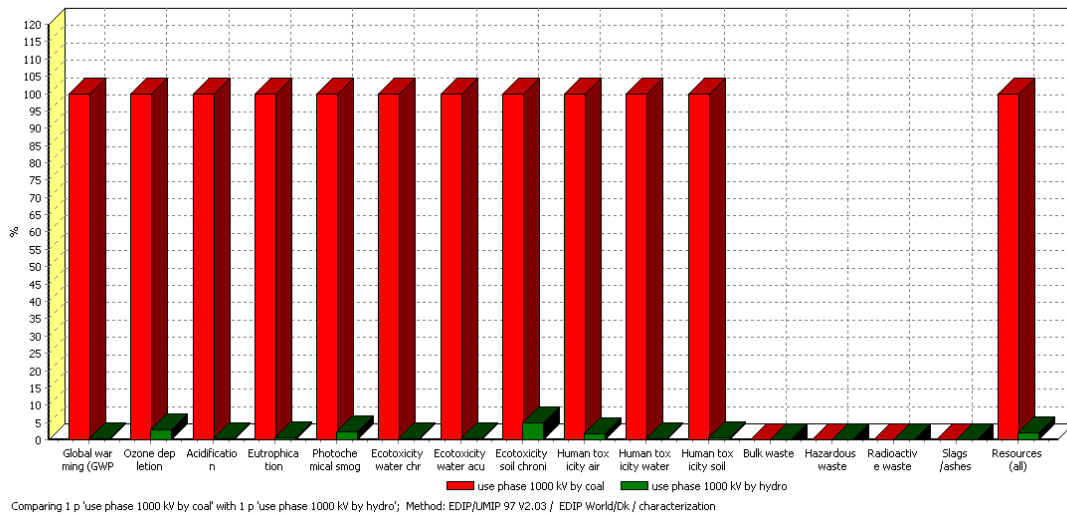

Fig. 4-5 : Comparaison des impacts environnementaux des pertes d'énergie de la ligne de transmission pour différentes sources de l'énergie électrique (charbon et hydroélectricité)

La proportion des impacts environnementaux des pertes d'énergie de cette ligne varie en conséquence, comme le montre la Figure 4-6. Les émissions de CO<sub>2</sub>-équivalent de cette ligne de transmission s'élève à 32,1%, le Potentiel de Déplétion Ozonique à 74,9%, le Potentiel d'Acidification à 28,8%, etc. Les pertes d'énergie ne constituent pas l'élément dominant sur les impacts environnementaux comme l'est le charbon. Cependant, les pertes d'énergie ne peuvent être ignorées, étant donné que le score unique indique que la phase d'utilisation constitue 23,3% de l'impact de la ligne de transmission.

Outre les pertes d'énergie dans les conducteurs, les impacts environnementaux des matériaux dans la ligne à 1000 kV AC sont encore plus élevées que celle de la ligne à 765 kV AC, comme le montre les résultats présentés dans la Figure 4-7. Ceci est dû au fait que dans la ligne 1000 kV AC, on a plus de matériaux contenus dans les pylônes et en particulier le revêtement de zinc.

Dans l'ensemble, les impacts environnementaux de la ligne 765 kV AC sont plus élevés que ceux de la ligne 1000 kV AC, sachant que les matières premières dans la

ligne 1000 kV AC ont plus d'effets que celles de la ligne 765 kV AC. Par conséquent, l'amélioration de l'efficacité énergétique est le facteur clé permettant de réduire les impacts environnementaux de la ligne de transmission UHV AC.

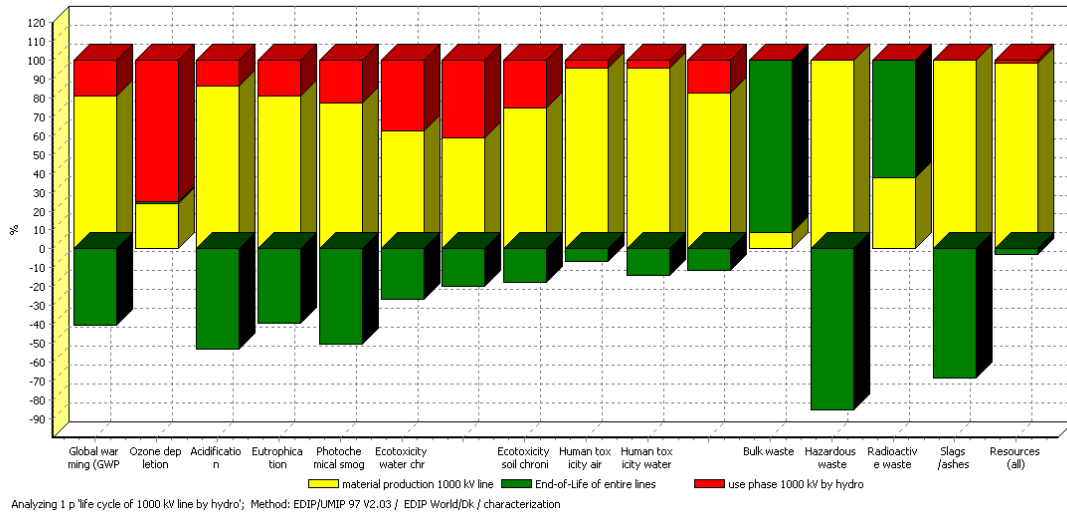

Fig. 4-6 : Résultats de la caractérisation de la ligne de transmission 1000 kV AC (électricité d'origine hydroélectrique)

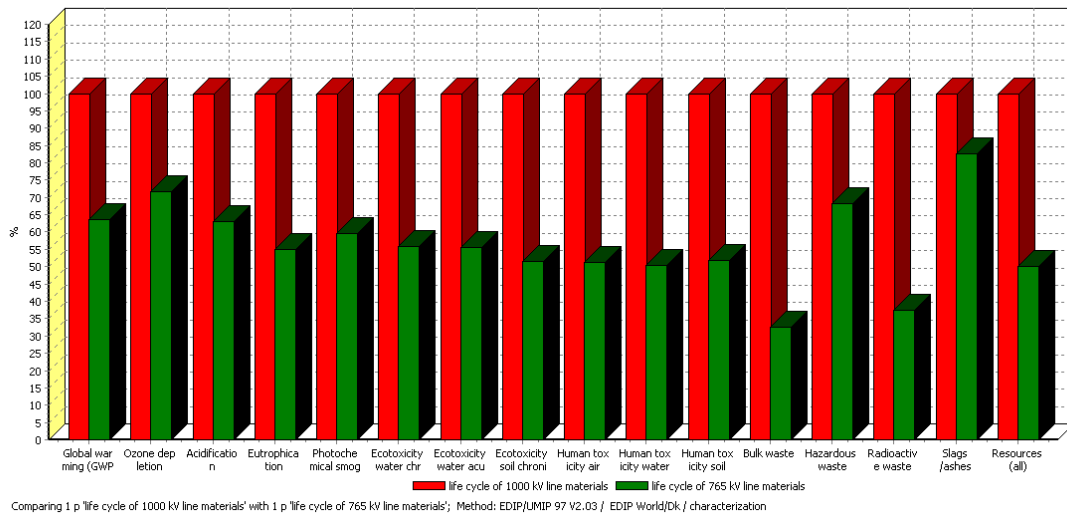

Fig. 4-7 : Comparaison des impacts environnementaux des matériaux dans les lignes de transmission 1000 kV et 765 kV

#### 4.4 Conclusion

Dans ce chapitre dédié à l'exemple de la ligne chinoise, les impacts sur



l'environnement de la ligne de transmission 1000 kV UHV AC, sont comparées avec ceux de la ligne 765 kV THT AC. L'unité fonctionnelle est définie comme la transmission de 5000 MW de puissance électrique à 640 km de distance, avec une durée de vie de 60 ans. Dans le cycle de vie, la production des matériaux de la ligne de transmission, la fin de vie et la phase d'utilisation sont prises en compte ; la phase de transport n'est pas considérée.

L'évaluation du cycle de vie montre que la ligne de transmission UHV AC permet de réduire les incidences environnementales par rapport à la ligne de transmission THT AC, en raison de l'efficacité énergétique qui se trouve améliorée par la ligne de transmission UHV AC. Mis à part les pertes d'énergie dans les conducteurs des deux lignes de transmission, les impacts sur l'environnement liés aux matériaux de la ligne UHV AC sont même plus élevés que ceux de la ligne THT AC. Ceci est dû à la quantité importante des matériaux dans les structures des pylônes de la ligne de transmission UHV AC, des revêtements en zinc en particulier.

Les impacts sur l'environnement dus aux pertes d'énergie de la ligne de transmission ne sont pas fixes. Ils dépendent du type de génération de l'énergie électrique. L'énergie électrique transmise par la ligne de transmission chinoise UHV AC est produite par une centrale au charbon. Si elle est remplacée par une centrale hydro-électrique, les impacts environnementaux liés aux pertes d'énergie, diminuent de façon drastique, mais reste toujours à 23,3% des impacts environnementaux globaux du cycle de vie de la ligne de transmission. En revanche, les impacts environnementaux dus aux pertes, dans le cas d'une centrale électrique au charbon, représentent 98,6% des impacts sur l'environnement de la ligne de transmission totale.

Les comparaisons entre les lignes UHV AC et THT AC que nous avons effectuées dans ce chapitre, ont été limitées à la seule ligne de transmission. Les analyses futures pourraient intégrer les impacts environnementaux des sous-stations UHV AC, sachant que la difficulté réside dans l'acquisition de données pertinentes sur ce type d'équipements.

## CONCLUSION GENERALE

De nos jours et à travers toute la planète, la démarche d'éco-conception est largement étudiée et appliquée tant par les universitaires que par les industrielles, pour développer des méthodes permettant de réduire les impacts environnementaux des produits et services, aider à protéger l'environnement et réaliser un développement durable.

Pour progresser dans cette démarche d'éco-conception sur tout type de produit ou service, les aspects environnementaux doivent être évalués. Cela est généralement réalisé au travers de l'ACV (Analyse de Cycle de Vie). Cela permet l'analyse quantitative des impacts environnementaux potentiels d'un produit ou d'un service tout au long de son cycle de vie. La plupart du temps, des simplifications sont utilisées soit par omission de certaines phases soit par substitution de certains processus, etc, lors de l'ACV. Cela est dû à l'indisponibilité de l'ensemble des données nécessaires et le coût de leur traitement qui n'est pas toujours compatible avec le cadre de l'étude.

Dans les systèmes de transmission de l'énergie, les approches d'éco-conception sont également intégrées. En général, ces approches d'éco-conception peuvent être classées en :

- « approche produit », qui met l'accent sur la réduction des produits individuels d'impacts sur l'environnement ;
- « approche systémique », qui considère l'échelle d'un système ;
- « approche pour la prise de décision », qui traite avec les impacts environnementaux à une plus grande échelle stratégique.

L'éco-conception relative à l'approche produit est une tendance très développée. Cependant, vu qu'un seul produit électrique ne peut fournir l'énergie électrique aux utilisateurs, le système électrique comporte un grand nombre de composants. Par conséquent, l'ensemble des profils environnementaux des différents composants doit être intégré, c'est-à-dire, que les investigations doivent être menées en considérant

une approche systémique.

Dans ce contexte, cette thèse « Eco-conception des Systèmes de Transmission de l'Energie Electrique », basée sur « approche système » de l'éco-conception, est axée sur l'analyse des impacts environnementaux potentiels des systèmes de transmission électrique et la localisation des principales sources de pollution.

Les "systèmes de transmission" peuvent être de différentes formes ; ils peuvent être classés selon différents critères, tels que le types de courant (courant alternatif ou courant continu), le niveau de tension (Haute Tension, Très Haute Tension ou Ultra Haute Tension) et la technologie utilisée (isolation à l'air, isolation au gaz tel le SF<sub>6</sub>, ou isolation de type hybride). Toutefois, comme le système de transmission est constitué de lignes et de postes, nous avons réalisé l'analyse environnementale sur ces deux parties.

Dans le chapitre 2 « Pertes en Energie des Différentes Lignes de Transmisison et Emissions Correspondantes de CO<sub>2</sub>-Equivalent », nous avons étudié une série de lignes THT et UHV (i.e. 500 kV AC, 765 kV AC, 1200kV AC, ± 500 kV DC et ± 800kV DC) sous l'angle de leur efficacité énergétique et des émissions de CO<sub>2</sub>-équivalent en raison des pertes d'énergie dans la ligne de transmission.

Les résultats indiquent que la ligne de transmission UHV est plus économe en énergie. En effet, la ligne à 1200 kV AC perd 4,30% de puissance lors de la transmission de 6000 MW à 1200 km de distance, et la ligne ± 800 kV DC en perd 4,63%, alors que les pertes sont de 12,16% pour la ligne 500 kV AC, 6,61% pour la ligne 765 kV AC, et 7,17% pour la ligne ± 500 kV DC (Figure 1). Le calcul des émissions de CO<sub>2</sub>-équivalent liées aux pertes dans la ligne de transmission montre que les lignes de transmission UHV sont en mesure de limiter les émissions de CO<sub>2</sub>-équivalent, comparées aux lignes de transmission THT.

Notons que la ligne de transmission UHV et plus particulièrement la ligne ± 800 kV DC, réduit le droit de passage et l'espace au sol, nécessaire. Ceci est évidemment bénéfique pour l'environnement et contribue à réduire les impacts visuels sur le paysage. En outre, pour la ligne ± 800 kV DC, il faut moins de conducteurs et il n'est pas nécessaire de construire des sous-stations intermédiaires comme dans le cas de la

technologie AC, ce qui représente des avantages économiques certains.

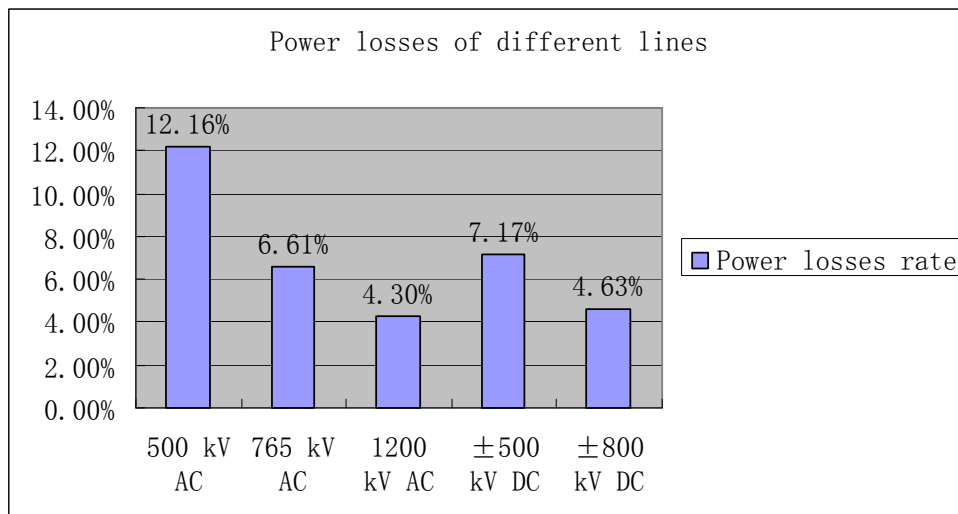

Fig. 1 : Pertes electriques des différentes lignes AC et DC,  
Pour une puissance transmise de 6000 MW à 1200 km

Globalement, la ligne de transmission UHV montre des avantages tant environnementaux que techniques tels que l'augmentation des capacités de transmission et une meilleure efficacité énergétique, par rapport aux lignes de transmission THT.

Cependant, l'analyse des émissions de CO<sub>2</sub>-équivalent est limitée aux seules pertes d'énergie dans les lignes ; la construction de la ligne aérienne, les postes de transformation ainsi que leurs consommations d'énergie ne sont pas considérées. Ceux-ci doivent être pris en compte pour une analyse fine des incidences environnementales de l'ensemble du système de transmission entier.

Dans le chapitre 3 « Impact Environnemental du Système de Transmission 765 kV AC du Venezuela », nous avons évalué les impacts environnementaux liés aux sous-stations THT AC ainsi que ceux de la ligne de transmission, en utilisant des données réalistes relatifs à cette ligne. En outre, l'ACV sur les principaux équipements dans les postes tels que les transformateurs de puissance, les disjoncteurs, les transformateurs de courant, les transformateurs de tension, les réactances, etc, a été menée afin d'évaluer leurs impacts environnementaux individuels; les structures

métalliques, les fondations en béton renforcées d'acier, les gravillons mis a la surface du sol, et les routes ... ont été pris en compte.

Dans l'ACV menée sur ce système 765 kV AC, l'unité fonctionnelle est la transmission de 8000 MW de puissance Hydro-électrique à 760 km, au cours de sa durée de vie de 60 ans, et le coefficient de charge moyen est de 60%. Par ailleurs, dans l'ACV sur les postes, seul le système primaire est inclus ; les "systèmes secondaires" - tels que les câbles basse tension (inférieure à 1 kV), les systèmes d'éclairage et de contrôle des systèmes (ordinateurs, appareils électroniques, informatiques, ...) - ne sont pas intégrés.

Les résultats d'évaluation des impacts du cycle de vie du système de transmission global montrent que la phase d'utilisation induit les impacts environnementaux les plus importants sur la plupart des indicateurs. Par exemple, la phase d'utilisation compte 55,9% pour le Potentiel de Réchauffement Global, 75,8% pour le Potentiel d'Acidification et 41,7% pour le Potentiel d'Acidification ... Alors que la phase d'utilisation de l'ensemble du système de transmission est composée des émissions de SF<sub>6</sub> des disjoncteurs, des pertes d'énergie dans les postes et dans les lignes de transmission. L'enquête révèle que les pertes d'énergie dans les lignes de transmission constituent l'élément dominant dans les impacts environnementaux, dans la phase d'utilisation (Figure 2). Cela représente environ 10 fois celle des pertes d'énergie dans les postes et 3,5 fois celle des émissions de SF<sub>6</sub> des disjoncteurs, par rapport à l'impact sur le réchauffement climatique.

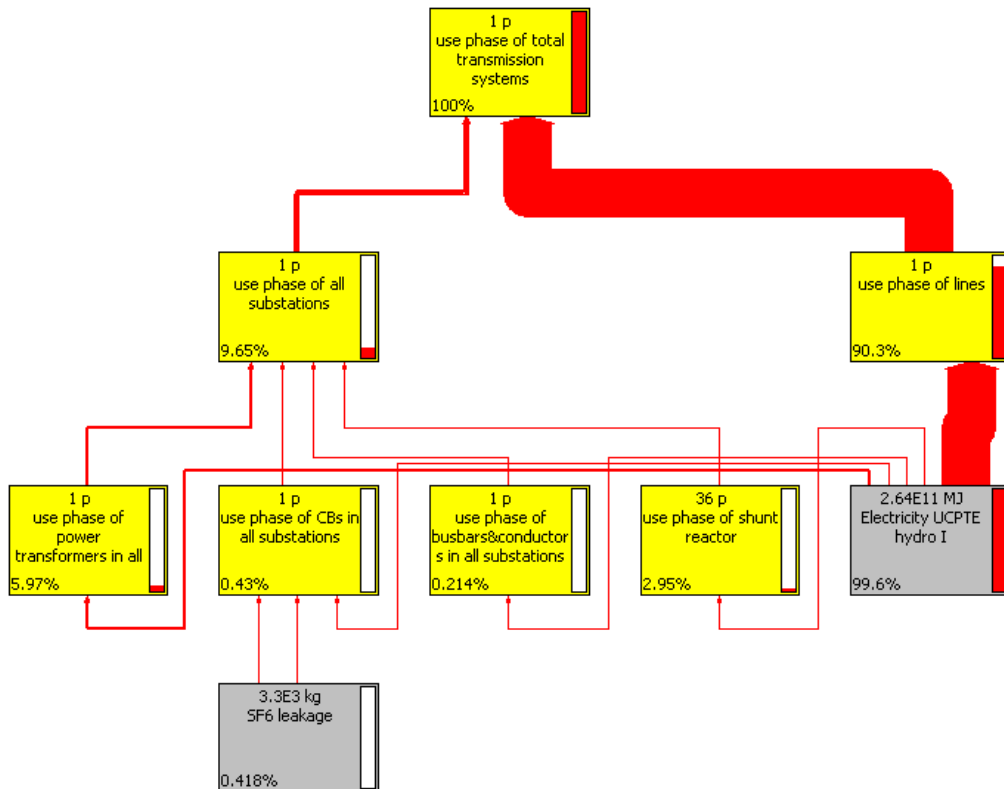

Fig. 2 : Contribution des impacts environnementaux de la phase d'utilisation du système 765 kV AC du Venezuela (seuil: 0.2%)

Grâce à l'ACV, on sait que les pertes d'énergie dans les lignes de transmission et les transformateurs de puissance ainsi que les émissions de SF<sub>6</sub> des disjoncteurs sont les principales sources d'impacts environnementaux du système de transmission. Cela conduit à définir les priorités en terme d'éco-conception des systèmes de transmission, qui permettront de diminuer les impacts environnementaux du système de transmission. L'accent doit être mis sur les méthodes de réduction des pertes d'énergie des conducteurs et des transformateurs de puissance ainsi que la diminution des émissions de SF<sub>6</sub> des disjoncteurs. En outre, les moyens de réduire la quantité des matériaux utilisés dans les équipements sont toujours bénéfiques pour la réduction de la charge de l'environnement.

Dans le chapitre 4 « Comparaison des Impacts Environnementaux entre Lignes de Ultra Haute Tension et Très Haute Tension », l'ACV a été menée sur les impacts environnementaux d'une ligne UHV AC chinoise 1000 kV AC et une ligne THT AC.

C'est le prolongement naturel du chapitre 2. Cette comparaison a été faite pour expliquer les avantages environnementaux de la ligne de transmission UHV AC, par rapport à la ligne 765 kV THT AC, dont les données sont tirées de la ligne vénézuélienne traitée au chapitre 3.

La première ligne de transmission chinoise 1000 kV a été analysée au regard de ses impacts sur l'environnement. Son unité fonctionnelle est la transmission de 5000 MW sur une distance de 640 km, avec une durée de vie de 60 ans. Dans le cycle de vie de la ligne de transmission, la production des matériaux, la fin de vie, et la phase d'utilisation sont prises en compte, alors que la phase de transport n'est pas considérée.

Il ressort de notre étude que l'impact environnemental d'une ligne de transmission UHV AC est réduit par rapport à celui d'une ligne de transmission THT AC, en raison de l'efficacité énergétique améliorée. Mis à part les pertes d'énergie dans les conducteurs des deux lignes de transmission, les impacts environnementaux des matériaux de la ligne THT AC sont plus élevés que ceux de la ligne THT AC. Ceci est dû à une plus grande quantité de matériaux dans les structures des pylônes des lignes UHV AC, en particulier des revêtements de zinc très pénalisant en termes d'environnement.

Les pertes énergétiques ont un impact variable selon le type de génération de l'électricité transmise. L'électricité dans la ligne de transmission chinoise UHVAC est produite par une centrale au charbon. Si elle avait été générée par une centrale hydroélectrique, les impacts environnementaux dus aux pertes d'énergie seraient considérablement réduits, mais cela représenterait toujours 23,3% de l'impact environnemental global du cycle de vie de l'ensemble de la ligne de transmission. En revanche, les impacts environnementaux dus aux pertes d'énergie, en se basant sur une génération à base de charbon, représente 98,6% des impacts environnementaux totaux de la ligne de transmission.

Les comparaisons entre les systèmes UHV AC et THT AC dans le chapitre 4 sont limitées au seul champ d'application des lignes de transmission. Toutefois, d'après les conclusions du chapitre 3, l'impact de la ligne de transmission est prédominant sur

l'impact du système de transmission global. On peut supposer que le système de transmission UHVAC réduit les impacts environnementaux, par rapport au système de transmission THT AC. Notons que dans l'ACV, le rayonnement électro-magnétique n'est pas pris en considération. Il convient, dans une étude complète, d'analyser les répercussions environnementales du système de transmission THT AC.

Les analyses que nous avons menées dans cette thèse sur les systèmes de transmission UHV et THT sont justifiées par l'actualité du sujet. En effet, de nombreux projets UHV sont en service et d'autres en cours de réalisation dans le monde, en particulier en Chine et en Inde.

En ce qui concerne les réseaux de transmission THT, de nombreux projets ont été réalisés et exploités pendant une trentaine d'années. Ces installations arrivent maintenant dans une phase où il faut les rénover ou réhabiliter. Ce travail montre que les pertes d'énergie dans les conducteurs de lignes de transmission et les transformateurs de puissance ainsi que les émissions de SF<sub>6</sub> de disjoncteurs dominent les impacts environnementaux du système de transmission. Cela peut servir de guide aux services publics et les aider à prendre des décisions tenant compte de l'environnement, dans cette phase de réhabilitation de leurs réseaux.

L'ACV réalisé sur le système de transmission 765 kV AC montre quantitativement les impacts environnementaux d'un système de transmission, ce qui permet de choisir ou de développer un système de transmission plus écologique.

Parmi les perspectives de cette étude:

- L'analyse de l'impact environnemental des nouvelles technologies digitales sur la partie contrôle et commande des sous-stations.
- Comme le système de transmission 765 kV AC au Venezuela utilise des postes isolés à l'air, l'ACV sur les postes 765 kV isolés au SF<sub>6</sub> peut être étudié, afin de déterminer quel type de poste a le moindre impact sur l'environnement.
- L'étude menée sur la nouvelle ligne de transmission chinoise 1000 kV lignes n'a traitée que les questions relatives aux impacts environnementaux de la ligne ; les impacts environnementaux des sou-stations peut être intégrés dans le futur.





## REFERENCES

[1] Directive 2005/32/EC of the European Parliament and of the council of 6 July 2005 establishing a framework for the setting of ecodesign requirements for energy-using products and amending Council Directive 92/42/EEC and Directives 96/57/EC and 2000/55/EC of the European Parliament and of the Council, Official Journal of the European Union, 22 May, 2005, L 191/29.

[2] K. Lee, A. P. Park, ECODESIGN: Best Practice of ISO/TR 14062, Eco-product Research Institute (ERI), Korea, Ajou University, 2005, p. 16.

[3] W. Wang, N. Li, A. Béréal, et al., Implementation of an Eco-design Methodology within AREVA T&D, CIGRE International Symposium on Operation and Development of Power Systems in the New Context, Guilin City, Guangxi Province, China, 28-30 Oct, 2009, Paper No. 185, p. 3.

[4] ISO/TR 14062:2002 Environmental Management - Integrating Environmental Aspects into Product Design and Development.

[5] ISO 14040:2006 Environmental Management - Life Cycle Assessment - Principles and Framework.

[6] ISO 14044:2006 Environmental Management - Life Cycle Assessment - Requirements and Guidelines

[7] ISO/TR 14047:2003 Environmental Management - Life Cycle Impact Assessment - Examples of Application of ISO 14042.

[8] ISO/TR 14048:2002 Environmental Management - Life Cycle Assessment - Data Documentation Format.

[9] ISO/TR 14049:2000 Environmental Management - Life Cycle Assessment - Examples of Application of ISO 14041 to Goal and Scope Definition and Inventory Analysis.

[10] IEC 62430:2009 Environmentally Conscious Design for Electrical and Electronic Products.

[11] IEC Guide 114, Environmentally Conscious Design Integrating Environmental Aspects into Design and Development of Electrotechnical Products.

[12] I. Huet, H. Aeschbach, C. Tschannen et al., Application of the Concept of Eco-Design to a Gas Insulated Substation 72.5kV, IEEE Proceedings of Transmission and Distribution Conference and Exhibition, 2005/2006 IEEE PES, p. 957-962.

[13] I. Huet, H. Aeschbach, C. Tschannen et al., Full Ecodesign of a 72.5KV GIS Substation, CIGRE SC A3&B3 Joint Colloquium, Tokyo, Japan, 26-28 Sept 2005, Paper No. 304.

[14] I. Huet, H. Aeschbach, C. Tschannen et al., Exemple d'Eco-conception au sein d'AREVA T&D: Cas d'un Poste Blindé 72.5kV, ELEC Expo 2004, Paris, France, 2004.

[15] K. Pohlink, E. Mikes, I. Huet et al., Evolution of High Voltage Gas Insulated Substations Considering Eco Design Aspects. CIGRE 2006, Paris, France, 27 August - 1 Sept 2006, Paper No. B3-302.

[16] P. Ponchon, O. Chniaud, R. Pages et al., Comparison of Environmental Impact of Singlephase or Three-phase Design 245KV GIS, Matpost 2007, Lyon, France, 15-16 Nov 2007, Paper No. S1-7.

[17] M. Hassanzadeh, F. Malpièce, C. Bihère, Ecological Design Applied to Polymer Housed Surge Arresters, 16th International Conference on Electricity Distribution (CIRED), Amsterdam, Netherland, 18-21 June 2001.

[18] M. Hassanzadeh, R. Puyané, F. Malpièce, Ecological Design Up-grade of a Zinc Varistor Suitable for Distribution Polymeric Surge Arresters, 18th International Conference on Electricity Distribution (CIRED), Turin, Italy, 6-9 June 2005.

[19] M. Hassanzadeh, R. Puyané, F. Malpièce et al, Global Impact Assessment of An Optimised Environmentally Friendly Lightning Arrester, 19th International Conference on Electricity Distribution (CIRED), Vienna, Austria, 21-24 May 2007, Paper No. 0465.

[20] W. Qi, S. Li, I. R. James et al., Selection Method of Environmentally Friendly Materials for Power Equipment based on Fuzzy Performance Summation, International Energy and Power Conference, CEPEX, Beijing, China, 27-29 Oct 2005.

[21] S. Li, I.R. James, L. Falkingham et al., The Introduction of Environmentally Friendly Insulation Systems for Medium Voltage Applications, The Fifth International Conference on Transmission and Distribution Technology, Beijing, China, 12-14 Oct 2005.

[22] W. Qi, Evaluation of Electrical Properties for Environmentally Friendly Insulation Materials Used in Medium Voltage Circuit Breaker, Master's Degree Thesis, Xi'an Jiaotong University, Xi'an, China, 2006.

- [23] W. Wang, Evaluation of Thermal and Mechanical Properties of Environmentally-Friendly-Insulating Materials Used for Tie Rod in Medium Voltage Circuit Breaker, Master's Degree Thesis, Xi'an Jiaotong University, Xi'an, China, 2007.
- [24] I.R. James, M. Hassanzadeh, Environmentally Friendly Materials for Medium-voltage Switchgear, AREVA Think T&D Magazine, Dec 2007, p 20.
- [25] I.R. James, M. Hassanzadeh, W. Daoud, Selection Methods for Environmentally Friendly Dielectric Materials, INSUCON Proceedings 2006, p.30-35.
- [26] M. Hassanzadeh, I.R. James, The Management Methodology Used for the Introduction of New "Eco-Friendly" Materials within Medium Voltage Switchgear Systems, 19th International Conference on Electricity Distribution (CIRED), Vienna, Austria, 21-24 May 2007, Paper No. 0409.
- [27] S. Li, M. Hassanzadeh, I.R. James, Thermal Properties of Environmentally Friendly Dielectrics used in Medium Voltage Circuit Breakers, Proceedings of IEEE International Conference on Solid Dielectrics 2007 (ICSD 07), p.306-309.
- [28] W. Daoud, M. Hassanzadeh, A. Cornier et al., Ecoselection of Materials and Process for Medium Voltage Products, Advances in Life Cycle Engineering for Sustainable Manufacturing Businesses, 2007, p. 273-278.
- [29] F. Leclerc, Impact of the Environmental Design for Switchgear Applications of High Voltage Substations, CIGRE 2004, C3-101.
- [30] M. Lauraire, P. Barbeta, S. Theoleyre, et al., Environmental Consideration in Product Design: A Reality for French Manufactures, 17<sup>th</sup> International Conference on Electricity Distribution, Barcelona, Spain, 12-15 May 2003, Session 1 Paper No. 71.

[31] J. C. Alonso, J. Rodrigo, F. Castells, Design for Environment of Electrical and Electronic Automotive Components Based on Life Cycle Assessment, Gate to EHS: Life Cycle Management -Design for Environment, 17 March 2003, p. 17.

[32] I. Mersiowsky, Summary of Life Cycle Assessment on SF<sub>6</sub>-GIS Technology for Medium Voltage Power Distribution, Life Cycle & Sustainability, Hannover, Germany, Nov 2003.

[33] U. Macharey, A. Schnettler, T. Smolka, Life Cycle Assessment of Ultra High Voltage System Layout and Operation Compared to 420 kV AC Power Systems, IEC/CIGRE UHV Symposium, Beijing, China, 18 July 2007, Paper No. 1-1-4.

[34] 1<sup>st</sup> General Report on Study on a Criteria for “Quantification” of benefits of T&D-systems with regard to EU 20/20/20 targets, University of Genoa and T&D Europe, July 2009.

[35] Strategic Environmental Assessment for Power Developments, 2011, CIGRE WG C3.06.

[36] F. D. Havenga, Strategic Environmental Assessment (SEA), A Tool for Sustainable Development, 2008 CIGRE SESSION, Paris, France. 24-29 August 2008, C3-201.

[37] F. Serran, R. C. Furtado, H. M. Vieira et al., Sustainability Indicators for the Assessment of Strategic Studies of the Brazilian Power Sector, 2008 CIGRE SESSION, Paris, France, 24-29 August 2008, C3-204.

[38] R. C. Furtado, R. C. Cavalcanti, C. F. Menezes et al., Methodology for Integrated Environmental Assessment of Hydrographic Basins, 2008 CIGRE SESSION, Paris, France, 24-29 August 2008, C3-210.

[39] E. B. Breyer, C. F. Menezes, R. C. Cavalcanti, Strategic Environmental Assessment: Legislation and Technical Standards, 2008 CIGRE SESSION, Paris, France. 24-29 August 2008, C3-208.

[40] V. Du Four, S. Jay, The Development of a Strategic Environmental Assessment Methodology for Transmission Development Planning in Belgium, 2008 CIGRE SESSION, Paris, France, 24-29 August 2008, C3-211.

[41] A. Motawi, M. Ceccoriglia, S. Viola, Development of HV Electricity Infrastructures in Italy: The Strategic Environmental Assessment (SEA) Approach, 2008 CIGRE SESSION, Paris, France, 24-29 August 2008, C3-206.

[42] G. C. Stevens, B. Philpot, P. Haywood et al., Life Cycle Economic and Environmental Assessment of Transmission Systems (LEETS), 2008 CIGRE SESSION, Paris, France, 24-29 August 2008, C3-205.

[43] AEP Interstate Project: "Why 765 kV AC?", American Electric Power, 24 August 2006, available at <http://www.docstoc.com/docs/36779178/AEP-INTERSTATE-PROJECT-WHY-765-KV-AC>

[44] L. Weimers, Bulk Power Transmission at Extra High Voltages, a Comparison between Transmission Lines for HVDC at Voltages above 600 kV DC and 800 kV AC, p. 3.

[45] Insulation Coordination for 800kV &1200kV in Indian Power System, CIGRE C4-09.

[46] SimaPro 7.0 software, PRé Consultants 2006, Netherlands.

[47] Rehabilitation of Units 1 to 6 of Powerhouse I the Simon Bolivar Hydroelectric Plant (Guri), Document of the Inter-American Development Bank, 2010.





## AUTORISATION DE SOUTENANCE

Vu les dispositions de l'arrêté du 7 août 2006,

Vu la demande du Directeur de Thèse

Monsieur A. BEROUAL

et les rapports de

Monsieur P. BROCHET  
Professeur - Ecole Centrale de Lille - Cité Scientifique - BP 48 - 59851 Villeneuve d'Ascq cedex

et de

Monsieur M. INVERNIZZI  
Professeur - University of Genoa - Department of Naval and Electrical Engineering - ISEP-NICES Lab.  
Via Opera Pia 11a - 16145 Genova - ITALY

**Monsieur WANG Wenlu**

est autorisé à soutenir une thèse pour l'obtention du grade de **DOCTEUR**

**Ecole doctorale ELECTRONIQUE, ELECTROTECHNIQUE ET AUTOMATIQUE**

Fait à Ecully, le 7 juillet 2011

P/Le Directeur de l'E.C.L.  
La Directrice des Etudes



**Titre : Eco-conception des Systèmes de Transmission de l'Energie Electrique****Résumé :**

Les demandes pour la préservation de l'environnement ainsi que les préoccupations pour un développement durable, ont augmenté considérablement ces dernières décennies à travers le monde. Ce souci environnemental est également présent dans l'industrie électrique et les approches d'éco-conception sont de plus en plus présentes dans la conception et la réalisation des composants et systèmes de transmission et de distribution (T & D) de l'énergie électrique. Cette étude est menée, dans le but d'analyser les impacts des systèmes de transmission de l'énergie électrique sur l'environnement, de localiser les principales sources de pollution environnementale. Les impacts environnementaux d'un cas réel du système de transmission à 765 kV AC du Venezuela sont étudiés, à l'aide de l'Analyse du Cycle de Vie (ACV). Les principales sources de pollution de l'environnement du système de transmission sont localisées, qui sont les pertes d'énergie dans les lignes de transmission et les transformateurs de puissance ainsi que les émissions de SF<sub>6</sub> des disjoncteurs. En outre, l'analyse des impacts environnementaux de l'Ultra Haute Tension (UHV) et Très Haute Tension (THT) de lignes de transmission est menée, concernant l'efficacité énergétique d'une série de lignes de transmission (500 kV AC, 765 kV AC, 1200 kV AC, ± 500 kV DC et ± 800 kV DC) et les émissions de CO<sub>2</sub>-équivalent en raison des pertes d'énergie dans les lignes de transmission ; et l'ACV d'une ligne de transmission à 1000 kV AC nouvellement construite en Chine.

**Mots-Clés :**

Eco-conception; Système de transmission de l'énergie électrique; Analyse du Cycle de Vie(ACV); 765 kV AC; 1000 kV AC; Ultra Haute Tension; Très Haute Tension

---

**Title : Eco-design of Power Transmission Systems****Abstract :**

The demand to preserve the environment and form a sustainable development is greatly increasing in the recent decades all over the world, and this environmental concern is also merged in electrical power industry, resulting in many eco-design approaches in Transmission & Distribution (T & D) industries. This study is conducted, with the purpose of analyzing the transmission systems' environmental impacts, locating the major environmental burden sources of transmission systems. One real case of 765 kV AC transmission system in Venezuela has been investigated regarding its environmental aspects, by Life Cycle Assessment (LCA). The major environmental burden sources of transmission system are located, which are energy losses in transmission lines and power transformers and SF<sub>6</sub> emissions from circuit breakers; of course, material-based environmental impacts can not be ignored. Moreover, environmental impacts comparison of Ultra High Voltage (UHV) and Extra High Voltage (EHV) transmission lines is made, with respect to energy efficiency of a series of transmission lines (500kV AC, 765kV AC, 1200kV AC, ±500kV DC and ±800kV DC) and CO<sub>2</sub>-equivalent emissions due to the energy loss (Joule loss) through the transmission lines; and through one LCA conducted on one Chinese newly-built 1000 kV AC transmission line.

**Keywords :**

Eco-design; Transmission System; Life Cycle Assessment (LCA); 765 kV AC; 1000 kV AC; Ultra High Voltage; Extra High Voltage

---

Laboratoire Ampère (CNRS UMR5005)

<http://www.ampere-lab.fr>

Direction de Recherche

Prof. A. BEROUAL

[abderrahmane.beroual@ec-lyon.fr](mailto:abderrahmane.beroual@ec-lyon.fr)

Ecole Centrale de Lyon

36 avenue Guy de Collongue

69134 Ecully CEDEX (France)