



HAL
open science

Équations de transport-fragmentation et applications aux maladies à prions

Pierre Gabriel

► **To cite this version:**

Pierre Gabriel. Équations de transport-fragmentation et applications aux maladies à prions. Mathématiques [math]. Université Pierre et Marie Curie - Paris VI, 2011. Français. NNT : . tel-00635281

HAL Id: tel-00635281

<https://theses.hal.science/tel-00635281>

Submitted on 24 Oct 2011

HAL is a multi-disciplinary open access archive for the deposit and dissemination of scientific research documents, whether they are published or not. The documents may come from teaching and research institutions in France or abroad, or from public or private research centers.

L'archive ouverte pluridisciplinaire **HAL**, est destinée au dépôt et à la diffusion de documents scientifiques de niveau recherche, publiés ou non, émanant des établissements d'enseignement et de recherche français ou étrangers, des laboratoires publics ou privés.

Équations de transport-fragmentation et applications aux maladies à prions

THÈSE

présentée et soutenue publiquement le 20 juin 2011

pour l'obtention du diplôme de

Doctorat de l'université Paris VI Pierre et Marie Curie
(spécialité mathématiques)

par

Pierre GABRIEL

après avis des rapporteurs

Philippe LAURENÇOT
Glenn WEBB

devant le jury composé de

Jean-Michel CORON	Président du jury
Marie DOUMIC	Directrice de thèse
Stéphane MISCHLER	Examineur
Benoît PERTHAME	Directeur de thèse
Human REZAEI	Examineur
Glenn WEBB	Rapporteur

Mis en page avec la classe thloria.

Remerciements

Je tiens tout d'abord à remercier mes directeurs de thèse, Marie Doumic et Benoît Perthame, de m'avoir proposé un sujet d'étude passionnant et de m'avoir encadré durant ces trois années. Ils ont su me communiquer leur goût pour les mathématiques appliquées à la biologie en me faisant profiter de leur expérience et de leurs contacts, aussi bien mathématiciens que biologistes. J'ai beaucoup apprécié la liberté qu'ils m'ont laissée dans le choix des sujets à aborder, tout en étant toujours disponibles pour répondre à mes questions et m'apporter leur aide précieuse. Leurs points de vue et leurs conseils m'ont été d'un grand secours et m'ont permis de mener à bien mes travaux de recherche. J'ai aussi pris beaucoup de plaisir à voyager pour participer à diverses conférences. Je n'oublie pas que tous ces voyages ont été principalement financés par l'ANR TOPPAZ de Marie Doumic, et je l'en remercie encore.

I am very grateful to Glenn Webb for having taken time to review my thesis and for his warm welcome in Nashville. I thank him for his kindness and for giving me the opportunity to collaborate with him and the biologists of the cancer department of Vanderbilt University. Je suis reconnaissant à la fondation Pierre Ledoux d'avoir financé ce voyage très instructif et productif. Je remercie très chaleureusement Philippe Laurençot d'avoir rapporté ma thèse et suis désolé de n'avoir pu trouver une date de soutenance lui permettant d'être présent. Je remercie Jean-Michel Coron, Stéphane Mischler et Human Rezaei qui m'ont fait l'honneur d'être membres du jury.

Je remercie Natacha Lenuzza et Franck Mouthon qui m'ont accueilli et encadré au CEA de Fontenay-aux-Roses lors de mon stage de Master. Tout au long de ma thèse, j'ai eu la chance de profiter des nombreuses idées de Vincent Calvez pour aborder les problèmes d'optimisation de valeur propre et je lui en suis très reconnaissant. Je tiens aussi à remercier Stéphane Gaubert pour nos discussions à propos du contrôle optimal, ainsi que Philippe Michel. Je remercie Léon Matar Tine de m'avoir fait découvrir la programmation en Fortran lors de nos séances de travail à Marseille puis à Lille et à Paris. J'ai apprécié la disponibilité de Jean-Pierre Françoise pour répondre à mes questions concernant les cycles limites ; ses éclaircissements m'ont été très précieux. Je suis très heureux de la collaboration initiée avec José Alfredo Cañizo et Daniel Balagué ; j'espère qu'elle sera fructueuse.

Mon épanouissement dans la vie quotidienne au labo doit beaucoup aux personnes que j'y ai côtoyées. Je pense en premier lieu à Alexis et Sepideh qui m'ont accompagnées de Chevaleret à Jussieu, mais aussi à toutes les conférences math-bio. Merci à tous les anciens du bureau 3D23 : Evelyne, Mathieu G., Jean-Marie, Benjamin A., Laurent, Jean-Paul, Malik, Alexander, Marie, Ange, Paul, Hassan, Suman et Paramjeet. Je n'oublie pas Giacomo avec qui j'ai partagé un bureau à Jussieu le temps d'un été. Mes remerciements vont aussi à Thomas, Matthieu L., Luna, Étienne, Karina, Min, Frédérique, Alexandra, Rachida, Maya, Benjamin B., Nicolas, Vincent, Cristina, Magali, Fawzia, Nastasia, Nicole, Charles, Lise-Marie, et à tous les autres doctorants et post-doctorants. Un merci tout particulier à Khashayar pour son aide indispensable en informatique et pour toutes ses théories peu communes. À Christian David aussi, pour avoir imprimé et relié les manuscrits de cette thèse. J'exprime plus généralement ma gratitude à tous les membres du LJLL, croisés dans les couloirs ou dans la salle café, pour leur gentillesse et leur amabilité.

Merci à toutes les personnes rencontrées ou retrouvées lors de conférences ou lors du Cemracs'09 : Seb (que je croise régulièrement depuis déjà pas mal d'années), Fred (pour les descentes matinales à Sugiton), Amélie, Anne, Séverine et Vanessa (pour m'avoir initié à la *coinche*), Ayman (pour sa shisha), Fede, J-J, Frédérique C., Laurent B., Vincent B. (ou l'intru), Erwan, Laurent P-M, Christophe, Nicolas M., Gaël, William, Nuria...

Je remercie aussi toutes les personnes que j'ai régulièrement croisées pendant ma thèse, mais en dehors du travail. Merci à Mathieu pour les séances ciné, à Ronan pour les sorties à l'opéra et autres soirées, à Michaël pour les entraînements de bad. Merci à la troupe des vénézuéliens (et assimilés) : Marianna et Romain, Ale, Eduardo, Iri, Saba, Charlie, Alejandra, Andrès, Daniel... Merci aussi à Ewelina et Fab, Sue et Lionel, Fabio et Sophie. Un grand merci à Julien pour avoir entretenu le contact en me rendant régulièrement visite.

Mes derniers remerciements vont à mes parents - sans qui je ne serais jamais arrivé là - et à ma soeur Clotilde, pour leur affection et leur soutien indéfectible.

À Eleo enfin, pour avoir supporté ma mauvaise "humour" quand je rentrais un peu stressé du bureau et pour avoir rendu ces dernières années aussi heureuses.

À mes parents,

Table des matières

Introduction générale	1
1 L'équation de transport-fragmentation linéaire	3
1.1 Dynamique d'une population structurée en taille	3
1.2 L'Entropie Relative Généralisée	4
1.3 Valeur propre principale et vecteurs propres associés	5
1.4 Comportement en temps long	6
2 Modèles de polymérisation non linéaires	8
2.1 Etats d'équilibre pour le système prion	8
2.2 Comportement en temps long pour des modèles non linéaires	11
2.3 Un modèle avec coalescence	12
3 Un problème de contrôle optimal	13
3.1 Modélisation de la PMCA	13
3.2 Optimisation de la première valeur propre	15
3.3 Contrôle périodique : Perron vs. Floquet	16
4 Directions de recherches futures	17

Chapitre 1

Existence et unicité d'éléments propres principaux

Mathematical Models and Methods in Applied Sciences, Vol. 20 No. 5 (2010)

1.1 Introduction	19
1.2 Coefficients	21
1.2.1 Assumptions	21
1.2.2 Exemples	22
1.3 Proof of the main theorem	24
1.3.1 A preliminary lemma	24
1.3.2 Truncated problem	25
1.3.3 Limit as $\delta \rightarrow 0$ for \mathcal{U}_η^δ and λ_η^δ	27
1.3.4 Limit as $\eta \rightarrow 0$ for \mathcal{U}_η and λ_η	29
1.3.5 Limit as $\delta, \eta \rightarrow 0$ for ϕ_η^δ	30
1.3.6 Proof of $\lambda > 0$	32
1.3.7 Uniqueness	32
1.4 Conclusion, Perspectives	34

1.5	Appendix	34
1.5.1	Assumption on κ	34
1.5.2	Krein-Rutman	35
1.5.3	Maximum principle	37

Chapitre 2

Dépendance par rapport aux paramètres : première application

Mathematical and Computer Modelling, Vol.53 (2011)

2.1	Introduction	39
2.2	Assumptions and Method	41
2.3	Results	42
2.4	Conclusion and Perspectives	44

Chapitre 3

Dépendance par rapport aux paramètres : étude approfondie

Soumis

3.1	Introduction	45
3.2	Self-similarity Result	48
3.2.1	Main theorem	48
3.2.2	Recall of existence results ([95, 41])	51
3.2.3	Proof of Theorem 3.2.2	52
3.3	Further Results	57
3.3.1	Critical case	57
3.3.2	Relaxed case	58
3.3.3	Generalized case	60
3.4	Applications	63
3.4.1	Numerical scheme based on Theorem 3.2.2	63
3.4.2	Steady States of the Prion Equation	65
3.4.3	Optimization of the PMCA protocol	67
3.4.4	Therapeutic optimization for a cell population	68

Chapitre 4

Comportement en temps long d'équations non linéaires

Soumis

4.1	Introduction	71
4.2	Technical Tools and General Method	74
4.2.1	Main Theorem	74
4.2.2	Eigenvectors and Self-similarity: Existence of an Invariant Manifold	75
4.2.3	General Relative Entropy: Attractivity of the Invariant Manifold	77
4.3	Nonlinear Drift Term: Convergence and Stability	79
4.4	Nonlinear Drift and Death Terms: Stable Persistent Oscillations	87
4.5	The Prion Equation: Existence of Periodic Solutions	91

4.6	Comparison between Perron and Floquet Eigenvalues	95
-----	---	----

Chapitre 5

Optimisation de la PMCA

5.1	The Eigenvalue Problem	102
5.1.1	Constant control: Perron eigenvalue	102
5.1.2	Periodic control: Floquet eigenvalue	105
5.2	The Optimal Control Problem	108
5.2.1	Existence of an optimal control	108
5.2.2	The Hamilton-Jacobi-Bellman equation	110

Chapitre 6

Un schéma d'ordre élevé pour des modèles avec coalescence

ESAIM Proc., Vol.30 (2010)

6.1	Introduction	115
6.2	Mass Conservation	117
6.2.1	Conservative formulation	117
6.2.2	Domain truncation	118
6.3	A High Order WENO Scheme	119
6.3.1	Numerical fluxes	119
6.3.2	WENO reconstruction	119
6.3.3	Integration method	121
6.3.4	Time discretization	122
6.4	Numerical Simulations	123
6.4.1	Parameters	123
6.4.2	Choice among the different flux splittings	124
6.4.3	Interpretation of the numerical results	126
6.5	Conclusion and future work	126

Bibliographie

Introduction générale

Cette thèse fait suite aux travaux réalisés en 2008 par Benoît Perthame et Vincent Calvez, alors à l'ENS de Paris, en collaboration avec l'équipe DSV/IMETI/SEPIA du CEA de Fontenay-aux-Roses. Cette équipe effectue des recherches en biologie dans un laboratoire entièrement dédié aux maladies à prions. Lors de mon stage de Master 2, effectué au sein de ce laboratoire sous la direction de Marie Doumic (ENS), Natacha Lenuzza (CEA) et Franck Mouthon (CEA), il m'a été donné de prendre part à des expériences de biologie. Cette opportunité m'a permis de me rendre compte des obstacles auxquels sont confrontés les expérimentateurs. La collaboration avec des biologistes s'est ensuite poursuivie dans le cadre du projet ANR TOPPAZ de Marie Doumic, en partenariat avec l'équipe de Human Rezaei à l'INRA de Jouy-en-Josas. Le projet TOPPAZ a pour objectif de mieux comprendre, en utilisant les outils des équations aux dérivées partielles, les phénomènes d'agrégation de protéines qui sont connus pour être à l'origine de maladies neurodégénératives telles que les maladies à prions ou d'Alzheimer. Nous nous attachons dans cette thèse à étudier l'équation de transport-fragmentation, en introduisant de nouvelles idées et méthodes pour traiter les cas dégénérés où le transport s'annule à l'origine. Ces questions sont à la fois difficiles d'un point de vue mathématique et fondamentales pour les applications à la polymérisation des protéines prions (les polymères de petite taille étant peu infectieux [83, 124]), *in vivo* à l'échelle d'une cellule, ou *in vitro*.

Les maladies à prions

Les maladies à prions, ou Encéphalopathies Spongiformes Transmissibles (EST), sont des maladies neurodégénératives mortelles et infectieuses qui affectent de nombreux mammifères. Elles incluent chez l'animal l'Encéphalopathie Spongiforme Bovine (ESB), responsable de la crise de la "vache folle" dans les années 1990, ou encore la Tremblante du mouton (Scrapie en anglais). Chez l'Homme, on trouve le Kuru qui a décimé une partie de la tribu Fore en Papouasie-Nouvelle-Guinée au cours du 20^e siècle. Plus récemment la maladie de Kreuzfeld-Jakob a été transmise entre êtres humains par injection d'hormones de croissance et par transfusion sanguine, mais aussi à partir de l'ESB par ingestion de produits bovins contaminés. Les maladies à prions s'attaquent au système nerveux central et l'on peut observer des trous dans le cerveau des individus malades, comme dans une éponge, d'où le nom d'Encéphalopathies Spongiformes.

L'agent responsable de ces maladies, connu sous le nom de prion, présente des propriétés de résistance à l'inactivation par la chaleur, les rayonnements et les traitements chimiques qui rendent peu probable la présence d'ADN comme ce serait le cas pour un virus. En 1967, Griffith [65] propose l'hypothèse d'un mécanisme purement protéique (Prion pour **P**roteinaceous **I**nfectious **O**nly) qui est aujourd'hui encore très convaincante et couramment admise. Selon cette hypothèse, l'agent responsable de la maladie est une protéine, la PrP ou protéine prion, qui s'accumule sous une forme anormalement repliée. Cette forme pathogène, appelée PrPres pour **r**ésistante ou PrPsc pour **s**crapie, a la capacité de se répliquer par un processus d'auto-propagation, en convertissant la forme normale de la protéine (PrPc pour **c**ellulaire) en PrPres. Cette hypothèse a été confortée par les travaux expérimentaux de Prusiner [115] en 1982, qui lui

ont valu d'obtenir le Prix Nobel de physiologie et de médecine en 1997.

En l'absence de contamination, la PrPc est impliquée dans le fonctionnement normal de la cellule. Ses fonctions ne sont pas encore connues précisément mais elles sont sans doute essentielles. Chez l'adulte, la PrPc est essentiellement produites dans le cerveau et la moelle épinière, ce qui explique que ces organes soient touchés par les maladies à prions.

Le mécanisme de polymérisation

Le mécanisme précis de conversion de la PrPc en PrPres reste encore mal déterminé. En raison de leur taille, les agents infectieux ne sont pas directement observables expérimentalement et le recours à des modèles théoriques est nécessaire. Depuis le modèle de Griffith, plusieurs autres modèles ont été proposés (voir [83] pour une revue complète). Celui que nous considérerons dans cette thèse est celui de polymérisation nucléée introduit par Lansbury [71]. Dans ce modèle, la PrPres est présente dans la cellule sous forme de polymères qui peuvent s'allonger en attachant des monomères de PrPc. Lors de ce processus de polymérisation, les monomères de PrPc sont transconformés en PrPres par un processus encore mal compris. L'agrégation des monomères aux petits polymères s'effectue de façon très lente jusqu'à ce que ceux-ci atteignent une taille critique qui les stabilise et accélère l'agrégation. Parallèlement à l'élongation, les polymères peuvent se fragmenter ; fragmentation qui a été mise en évidence par des études expérimentales. Ce modèle est le plus largement accepté à l'heure actuelle et a conduit à l'élaboration de la technique d'amplification des prions par PMCA (voir plus bas).

Les différents modèles de conversion ont été développés en lien étroit avec la modélisation mathématique, et ce depuis le premier modèle proposé par le mathématicien Griffith en 1967. Concernant le mécanisme de polymérisation nucléée, le modèle mathématique le plus étudié aujourd'hui est celui de Masel [92]. Ce modèle est constitué d'une infinité d'équations différentielles ordinaires (EDO) couplées. Il existe une version continue de ce modèle, introduite par Greer *et al.* [63], qui remplace le système infini d'EDO par le couplage d'une EDO avec une équation aux dérivées partielles (EDP). Cette EDP est une équation intégro-différentielle non-locale généralement appelée de transport-fragmentation ou croissance-fragmentation. Cette équation comporte deux termes bien distincts qui représentent, l'un le processus de polymérisation, et l'autre la fragmentation des polymères. Ces deux processus sont en compétition, la polymérisation augmentant la taille des polymères et la fragmentation la diminuant. Dans cette thèse, nous étudions les propriétés de l'équation de croissance-fragmentation d'un point de vue mathématique en jouant sur ces deux phénomènes antagonistes.

La PMCA (Protein Misfolded Cyclic Amplification)

En raison des différents incidents qui sont survenus ces dernières années (crise de la vache folle, affaire du sang contaminé et des hormones de croissance) et des durées d'incubation des maladies à prions (dans le cas de l'épidémie de Kuru, on a observé jusqu'à 40 années d'incubation), ces maladies représentent aujourd'hui encore un risque de santé publique important. La durée d'incubation d'une maladie est définie par la durée séparant l'infection par la maladie et la présentation des premiers symptômes cliniques. Durant cette période, un porteur de la maladie peut ignorer qu'il est atteint et transmettre l'agent pathogène à d'autres individus, propageant ainsi l'épidémie. Il est donc vital, pour prévenir une telle propagation, d'être capable de diagnostiquer la maladie chez un donneur de sang par exemple. Or, pour les maladies à prions, aucun diagnostic *ante mortem* efficace n'est pour le moment disponible. En effet les particules de PrPres se concentrent dans le système nerveux central et ne sont présentes qu'en très faible quantité dans les tissus tels que le sang. Il n'est ainsi pas possible aujourd'hui de diagnostiquer la maladie sans prélever un échantillon de tissu vital, et encore à un stade relativement avancé de la contamination.

L'idée pour remédier à ce problème est d'utiliser une technique d'amplification *in vitro* de la PrPres pour pouvoir la détecter à partir d'échantillons n'en contenant qu'une faible quantité. Parmi les techniques utilisées pour parvenir à ce résultat, le protocole de PMCA est très prometteur. Il a déjà permis de conforter l'hypothèse d'un mécanisme purement protéique en synthétisant des particules infectieuses à partir d'une faible dose d'infectiosité. Cependant, ce protocole n'est pas encore suffisamment efficace pour permettre une technique de diagnostic chez l'homme. La modélisation et les outils d'optimisation mathématiques peuvent permettre d'améliorer la technique de PMCA.

Le protocole consiste en une alternance de phases d'incubation et de sonication auxquelles on soumet un échantillon contenant une faible dose d'infectiosité (PrPres). L'échantillon de PrPres est mis en présence d'une grande quantité de PrPc, ce qui permet une polymérisation rapide lors des phases d'incubation pendant lesquelles l'échantillon est laissé au repos. Les brèves phases de sonication consistent à envoyer des ultrasons sur l'échantillon afin de briser les polymères en petits morceaux. La sonication augmente donc rapidement le nombre de polymères, qui vont pouvoir polymériser pendant la phase d'incubation suivante.

Le protocole de la PMCA est modélisé en introduisant un paramètre de contrôle devant le coefficient de fragmentation de l'équation de croissance-fragmentation. Ce paramètre représente la sonication et a un comportement en créneaux au cours du temps, reflétant ainsi le caractère alternatif du protocole. La question qui se pose alors est de trouver une stratégie de contrôle, en créneaux ou non, qui permette d'obtenir la plus grande quantité de PrPres possible en un temps donné.

Phénomène de souches

Les animaux atteints de maladies à prions peuvent développer différentes pathologies alors même que la protéine qui s'accumule est identique (protéine de l'hôte). Par analogie avec les agents infectieux classiques, ces variantes ont été appelées "souches" de prions. Ces différentes souches sont caractérisées par leur période d'incubation et leur profil de lésion au cerveau [57]. Dans le cadre de l'hypothèse d'un mécanisme purement protéique, il est supposé que la diversité de souches est due à des états de conformation de la PrPres différents, conduisant à des propriétés biologiques et biochimiques différentes [102, 118]. Du point de vue de la modélisation mathématiques, cela revient à considérer que les coefficients des équations dépendent de la souche. Une question naturelle est alors de se demander quels sont les coefficients qui varient le plus en fonction de la souche. Nous nous intéressons à cette question dans le chapitre 2 pour le modèle de polymérisation nucléée.

1 L'équation de transport-fragmentation linéaire

1.1 Dynamique d'une population structurée en taille

Le point de vue mathématique adopté dans cette thèse pour modéliser la prolifération des prions à l'intérieur d'une cellule est celui des populations structurées. On considère la population dont les individus sont les polymères de PrPres présents dans une cellule, et on attribue à chaque polymère une valeur positive représentant sa taille. La polymérisation et fragmentation s'inscrivent alors dans le cadre plus général des phénomènes de croissance-fragmentation. Nous donnons ici des propriétés générales de l'évolution d'une telle population et nous reviendrons plus en détails sur le cas particulier d'une population cellulaire de prions dans le paragraphe 2.

On s'intéresse à une population d'individus caractérisés par un trait $x > 0$ pouvant être par exemple leur taille mais aussi leur masse ou leur volume. En biologie il peut aussi s'agir du contenu d'une cellule en parasites, protéines, traitement, etc. Par la suite on appellera "taille" ce trait par soucis de clarté et par référence aux polymères de PrPres qui nous intéressent. La population considérée subit parallèlement deux processus : un processus de croissance par lequel chaque individu voit sa taille augmenter, et un processus de fragmentation ou division qui produit, à partir d'un individu, deux ou plusieurs individus de taille inférieure. Si l'on note $u(t, x)$ la densité de population de taille x à l'instant t , on obtient alors, pour une distribution initiale $u(t = 0, x) = u_0(x)$, l'équation d'évolution suivante

$$\frac{\partial}{\partial t} u(t, x) + \frac{\partial}{\partial x} (\tau(x)u(t, x)) + \beta(x)u(t, x) = \int_x^\infty b(y, x)u(t, y) dy \quad (1)$$

avec la condition au bord $u(t, 0) = 0$. On appellera cette équation l'équation de croissance-fragmentation ou transport-fragmentation linéaire. Il existe pour celle-ci un principe du maximum (voir [110] par exemple) qui assure que pour une donnée initiale u_0 positive, la solution reste positive pour tout temps. Cette propriété est cruciale puisque u représente une densité de population et doit donc rester positive.

Le terme de transport représente la croissance de chaque individu avec une vitesse $\tau(x) > 0$ pour $x > 0$. Cependant on considère que τ peut avoir une limite nulle en zéro. On remarque que la condition au bord est inutile lorsque $\frac{1}{\tau}$ n'est pas intégrable en zéro. Le terme intégral reflète quant à lui la fragmentation : $b(y, x) \geq 0$ représente le taux de formation d'un individu de taille x à partir d'un de taille $y > x$. Afin de rendre le mieux possible compte de la réalité, nous considérons que la fragmentation préserve la masse, c'est-à-dire que la taille de l'individu mère avant fragmentation est égale à la somme des tailles des individus filles formés. Pour cela, le terme $\beta(x) \geq 0$, qui représente le taux de fragmentation pour un individu de taille x , doit satisfaire la relation

$$x \beta(x) = \int_0^x y b(x, y) dy. \quad (2)$$

Le nombre moyen de fragments formés par la fragmentation d'un individu de taille x est alors donné par

$$n_0(x) := \frac{1}{\beta(x)} \int_0^x b(x, y) dy. \quad (3)$$

Ce nombre est nécessairement supérieur à un à cause de la relation

$$\int_0^x b(x, y) dy \geq \int_0^x \frac{y}{x} b(x, y) dy = \beta(x).$$

L'inégalité est stricte sauf pour la cas limite $b(x, y) = n_0(x)\beta(x)\delta_{x=y}$ qui ne correspond pas à une réelle fragmentation, les individus filles étant de la même taille que la mère. Nous ne considérons pas ce cas dans notre étude et donc nous avons $n_0(x) > 1$ pour tout x . Dans la réalité physique, on s'attend à ce que ce nombre soit supérieur ou égal à deux puisque la fragmentation d'un individu en produit au moins deux autres. Cependant, dans le formalisme mathématique, cette hypothèse n'est pas nécessaire et l'étude générale de l'équation peut se faire sans.

Sous l'hypothèse de conservation de masse (2), le processus de fragmentation n'influe pas sur la masse totale de la population. En effet, si l'on intègre formellement l'équation (1) contre $x dx$ sur \mathbb{R}_+ , on trouve grâce à une intégration par partie et au théorème de Fubini

$$\frac{d}{dt} \int_0^\infty x u(t, x) dx = \int_0^\infty \tau(x) u(t, x) dx. \quad (4)$$

Cette relation ne fait intervenir ni b ni β mais seulement le taux de croissance τ . La masse totale de la population n'augmente donc que par le phénomène de croissance. En revanche la fragmentation augmente le nombre d'individus, alors que le terme de transport le conserve. On obtient donc une équation sur le quantité totale d'individu qui ne fait intervenir que les coefficients de fragmentation

$$\frac{d}{dt} \int_0^\infty u(t, x) dx = \int_0^\infty (n_0(x) - 1) \beta(x) u(t, x) dx. \quad (5)$$

Ceci met en évidence les actions distinctes de la croissance et de la fragmentation sur la population. On peut même dire que ces actions sont antagonistes puisque le transport "pousse" la distribution $u(t, x)$ vers les x grands, alors que la fragmentation la ramène vers zéro.

1.2 L'Entropie Relative Généralisée

Pour étudier le comportement en temps long des solutions de l'équation de croissance-fragmentation linéaire, il existe un principe d'entropie introduit par Michel, Mischler et Perthame [98, 99]. Plus précisément il s'agit d'entropie relative, qui s'exprime en fonction de deux solutions de la même équation. Cette quantité décroît au cours du temps tant que les deux solutions sont distinctes.

L'équation de transport-fragmentation ne satisfaisant pas de loi de conservation, on ne peut pas appliquer l'entropie relative classique. L'astuce consiste alors à introduire l'équation duale associée à l'équation (1)

$$-\frac{\partial}{\partial t}\varphi(t, x) - \tau(x)\frac{\partial}{\partial x}\varphi(t, x) + \beta(x)\varphi(t, x) = \int_0^x b(x, y)\varphi(t, y) dy. \quad (6)$$

Si φ est une solution de l'équation (6) et u une solution de l'équation (1), alors nous avons, sous réserve d'intégrabilité,

$$\frac{d}{dt} \int_0^\infty \varphi(t, x)u(t, x) dx = 0.$$

Ainsi nous obtenons une quantité conservée au cours du temps, et un principe d'entropie associé appelé Entropie Relative Généralisée (General Relative Entropy ou GRE en anglais).

Théorème 1 (Michel, Mischler et Perthame 2004). *Si $u(t, x) > 0$ et $v(t, x) > 0$ sont des solutions de l'équation (1), et $\varphi(t, x) \geq 0$ est solution de l'équation adjointe (6), alors pour n'importe quelle fonction H on a*

$$\frac{d}{dt} \int_0^\infty \varphi(t, x)v(t, x)H\left(\frac{u(t, x)}{v(t, x)}\right) dx = -D_H$$

avec

$$D_H = \int_0^\infty \int_0^\infty b(y, x)\varphi(t, x)v(t, y) \left[H\left(\frac{u(t, x)}{v(t, x)}\right) - H\left(\frac{u(t, y)}{v(t, y)}\right) + H'\left(\frac{u(t, x)}{v(t, y)}\right) \left(\frac{u(t, y)}{v(t, y)} - \frac{u(t, x)}{v(t, x)}\right) \right] dx dy,$$

et si H est convexe alors $D_H \geq 0$.

Ce résultat signifie que toutes les solutions de l'équation de croissance-fragmentation se "rapprochent" dans le sens où l'entropie relative décroît et que la dissipation d'entropie D_H est nulle pour deux solutions identiques. Mais si le comportement asymptotique en temps long est bien le même pour toutes les solutions, alors quel est-il ?

1.3 Valeur propre principale et vecteurs propres associés

Pour tirer partie de l'Entropie Relative Généralisée, l'idée introduite par [100] est de chercher une solution particulière sous la forme $\mathcal{U}(x)e^{\Lambda t}$ où \mathcal{U} est une fonction positive. Cette idée est très naturelle pour l'équation considérée en raison de la compétition existant entre le transport et la fragmentation. La fonction $\mathcal{U}(x)$ représente alors un état d'équilibre dans cette compétition, et la valeur Λ le paramètre de croissance malthusien de la population. En raison des relations (4) et (5) sur l'évolution de la masse totale et de la quantité totale d'individus dans la population, si une telle solution existe alors nécessairement $\Lambda > 0$ et donc la population croît exponentiellement vite.

Rechercher une solution particulière sous la forme $\mathcal{U}(x)e^{\Lambda t}$ revient à résoudre le problème aux valeurs propres suivant

$$\begin{cases} \frac{\partial}{\partial x}(\tau(x)\mathcal{U}(x)) + (\beta(x) + \Lambda)\mathcal{U}(x) = \int_x^\infty b(y, x)\mathcal{U}(y)dy, & x \geq 0, \\ \tau\mathcal{U}(x=0) = 0, & \mathcal{U}(x) \geq 0, & \int_0^\infty \mathcal{U}(x)dx = 1. \end{cases} \quad (7)$$

Comme l'Entropie Relative Généralisée requiert une solution à l'équation duale, nous résolvons en même temps le problème aux valeurs propres adjoint

$$\begin{cases} -\tau(x)\frac{\partial}{\partial x}(\phi(x)) + (\beta(x) + \Lambda)\phi(x) = \int_0^x b(x, y)\phi(y)dy, & x \geq 0, \\ \phi(x) \geq 0, & \int_0^\infty \phi(x)\mathcal{U}(x)dx = 1. \end{cases} \quad (8)$$

Nous supposons désormais, pour tous les résultats à venir, que le nombre moyen de fragments n_0 défini par (3) est indépendant de x . Grâce à des estimations *a priori* précises sur les fonctions propres \mathcal{U} et ϕ , nous avons prouvé l'existence de solutions pour les problèmes (7) et (8) sous des conditions très générales reliant le transport à la fragmentation, et incluant les cas dégénérés où τ s'annule en zéro.

Théorème 2 (Doumic et G.). *Sous des hypothèses sur $b(y, x)$ précisées au chapitre 1, si le transport l'emporte sur la fragmentation au voisinage de zéro*

$$\frac{\beta}{\tau} \in L^1([0, \varepsilon]) \text{ pour un certain } \varepsilon > 0 \quad (9)$$

et si la fragmentation domine le transport en l'infini

$$\lim_{x \rightarrow +\infty} \frac{x\beta(x)}{\tau(x)} = +\infty, \quad (10)$$

alors il existe une unique solution $(\Lambda, \mathcal{U}, \phi)$ au problème aux valeurs propres (7)-(8) et nous avons

$$\begin{aligned} \Lambda &> 0, \\ \forall \alpha \geq 0, \forall p \in [1, \infty], \quad x^\alpha \tau \mathcal{U} &\in L^p(\mathbb{R}_+), \quad \forall \alpha \geq 0, \quad x^\alpha \tau \mathcal{U} \in W^{1,1}(\mathbb{R}_+), \\ \exists k > 0 \text{ s.t. } \frac{\phi}{1+x^k} &\in L^\infty(\mathbb{R}_+), \quad \tau \frac{\partial}{\partial x} \phi \in L_{loc}^\infty(\mathbb{R}_+). \end{aligned}$$

De plus, si $\beta(x) > 0$ pour tout $x > 0$, alors il en est de même pour les fonctions propres :

$$\forall x > 0, \quad \mathcal{U}(x) > 0 \quad \text{et} \quad \phi(x) > 0.$$

De tels éléments propres positifs sont couramment appelés éléments propres de Perron, en référence à la théorie de Perron-Frobenius qui assure leur existence en dimension finie pour des matrices positives (voir [110]). En dimension infinie, le théorème de Krein-Rutman (voir [110]) permet d'obtenir le même résultat pour des opérateurs compacts et positifs dans des espaces réguliers (l'espace des fonctions continues par exemple). Nous avons utilisé le théorème de Krein-Rutman sur un problème tronqué et régularisé qui permet de l'appliquer. Ensuite, nous avons obtenu des estimations sur les moments des vecteurs propres qui permettent d'obtenir de la compacité et de passer à la limite quand les paramètres de troncature et de régularisation tendent vers zéro. La principale difficulté est d'obtenir des estimations empêchant la concentration en une masse de Dirac en $x = 0$ quand $\tau(x = 0) = 0$, et d'autres permettant d'éviter la fuite en l'infini quand τ n'est pas borné. Ceci est rendu possible en jouant sur la compétition entre les termes de transport et de fragmentation, ce qui conduit aux deux hypothèses (9) et (10). Ces deux hypothèses sont de natures différentes : l'une est une condition d'intégrabilité et l'autre une condition de limite. Cependant, si l'on considère des coefficients en puissance de x ,

$$\tau(x) = \tau x^\nu \quad \text{et} \quad \beta(x) = \beta x^\gamma,$$

alors les hypothèses (9) et (10) sont toutes les deux équivalente à la condition

$$\gamma + 1 - \nu > 0.$$

Cette condition apparaît dans [95] où l'existence de vecteurs propres est démontrée pour des coefficients en puissance de x . Ainsi nous avons étendu ce résultat à des coefficients plus généraux.

1.4 Comportement en temps long

On peut maintenant donner un théorème sur le comportement asymptotique en temps grand des solution de l'équation de croissance-fragmentation sous les hypothèses d'existence d'éléments propres principaux.

Théorème 3 (Michel, Mischler et Perthame 2005). *Avec la notation $\rho := \int_0^\infty \phi(x) u_0(x) dx$, on a*

$$\forall p \in [1, \infty), \quad \lim_{t \rightarrow \infty} \|u(t, \cdot) e^{-\Lambda t} - \rho \mathcal{U}\|_{L^p(\mathcal{U}^{1-p} \phi dx)} = 0. \quad (11)$$

La preuve de ce résultat [99] repose sur l'utilisation de l'Entropie Relative Généralisée avec la fonction convexe $H(x) = |1 - x|^p$ et les solutions particulières $\rho\mathcal{U}(x)e^{\Lambda t}$ et $\phi(x)e^{-\Lambda t}$.

Un taux de convergence exponentiel dans (11) a été prouvé dans certains cas particuliers, et tout d'abord pour $p = 1$ avec des coefficients τ et β constants. Dans ce cas, le vecteur propre ϕ est constant égal à 1 et la norme $L^p(\mathcal{U}^{1-p}\phi dx)$ n'est rien d'autre que la norme L^1 sans poids. On trouve un premier résultat dans [111] pour l'équation de division cellulaire symétrique, c'est-à-dire pour $b(y, x) = 2\beta\delta_{x=\frac{y}{2}}$. Celui-ci a ensuite été étendu dans [79] à des coefficients de fragmentation b plus généraux satisfaisant l'hypothèse

$$\forall x > 0, \quad -\frac{\partial}{\partial y} \int_0^x b(y, z) dz \geq 0. \quad (12)$$

Cette hypothèse signifie que le nombre d'individus de taille inférieure à x produits par la fragmentation d'un individu de taille y diminue quand y croît. Dans ce cas, pour un nombre moyen de fragment $n_0 > 1$ (nous rappelons que maintenant n_0 est constant), nous avons le résultat suivant.

Théorème 4 (Laurençot et Perthame 2009). *Pour des coefficients β et τ constants et sous l'hypothèse (12), il existe une semi-norme $\|\cdot\|$ telle que*

$$\forall t \geq 0, \quad \int_0^\infty |u(t, x)e^{-\Lambda t} - \rho\mathcal{U}(x)| dx \leq \|u_0\| e^{-(1-\frac{1}{n_0})\beta t}.$$

La preuve de ce résultat repose sur l'étude de la fonction $M(x) := \int_0^x (u(t, z)e^{-\Lambda t} - \rho\mathcal{U}(z)) dz$, et celle-ci apparaît dans la définition de la semi-norme.

Plus récemment dans [15], l'existence d'un trou spectral pour l'équation de croissance-fragmentation dans l'espace $L^2(\mathcal{U}^{-1}\phi dx)$ (correspondant à $p = 2$ dans le Théorème 3) a été démontrée pour des coefficients en puissance de x :

$$\beta(x) = \beta x^\gamma, \quad \gamma \in (0, 2] \text{ et } \tau(x) = \tau \quad \text{ou} \quad \beta(x) = \beta x^\gamma, \quad \gamma \in (0, 1) \text{ et } \tau(x) = \tau x. \quad (13)$$

Ce résultat leur permet ensuite de démontrer la convergence exponentielle dans des espaces plus grands.

La méthode employée pour démontrer l'existence d'un trou spectral utilise l'Entropie Relative Généralisée. Si l'on note H_2 l'entropie associée à $H(x) = |1 - x|^2$ et aux solutions particulières $\rho\mathcal{U}(x)e^{\Lambda t}$ et $\phi(x)e^{-\Lambda t}$, et D_2 la dissipation d'entropie, alors le résultat du Théorème 1 s'écrit

$$\frac{d}{dt} H_2 = -D_2 \leq 0.$$

La méthode consiste ensuite à prouver, pour un certain $\bar{a} > 0$, l'inégalité de Poincaré

$$H_2 \leq \frac{1}{2\bar{a}} D_2. \quad (14)$$

Une telle inégalité est fautive dans le cas de la division en deux cellules égales par exemple et nécessite donc des hypothèses sur le noyau de fragmentation. Si l'on suppose que b satisfait la condition

$$\exists \bar{b} \geq \underline{b} > 0, \quad \forall x > y > 0, \quad \underline{b} \frac{\beta(x)}{x} \leq b(x, y) \leq \bar{b} \frac{\beta(x)}{x}, \quad (15)$$

alors l'inégalité de Poincaré (14) est valide et nous avons le résultat suivant.

Théorème 5 (Cacères, Cañizo et Mischler 2010). *Sous les hypothèses (13) et (15), il existe $\bar{r} \geq 3$ tel que, pour tout $a \in (0, \bar{a})$ et pour tout $r \geq \bar{r}$, il existe $C_{a,r} > 0$ tel que*

$$\forall t \geq 0, \quad \|u(t, \cdot)e^{-\Lambda t} - \rho\mathcal{U}\|_{L^2((x^r + \phi(x)) dx)} \leq C_{a,r} e^{-at} \|u_0 - \rho\mathcal{U}\|_{L^2((x^r + \phi(x)) dx)}.$$

Le résultat de ce théorème nous sera utile dans le chapitre 4 pour obtenir des résultats sur le comportement en temps long d'équations de transport-fragmentation non linéaires.

2 Modèles de polymérisation non linéaires

L'équation de croissance-fragmentation linéaire est le modèle continu de polymérisation le plus simple que l'on puisse espérer, bien souvent trop pour modéliser des phénomènes physiques ou biologiques. Nous présentons dans ce paragraphe des modèles non linéaires en justifiant leur pertinence pour modéliser des situations concrètes. Pour étudier ces modèles, les résultats sur l'équation linéaire sont cependant fort utiles comme nous allons le voir.

2.1 Etats d'équilibre pour le système prion

Le modèle. Dans une cellule, la quantité de PrPc pouvant être convertie par la PrPres n'est pas illimitée et l'on ne s'attend donc pas à avoir une croissance exponentielle de la population de polymères. Le modèle linéaire de croissance-fragmentation ne tient pas compte de cette limitation des ressources et des modèles non linéaires doivent donc être envisagés. C'est le cas du modèle discret de Masel [92] qui contient une équation régissant l'évolution de la quantité $V(t)$ de PrPc. Dans ce modèle, la taille des polymères est une valeur discrète $i \in \mathbb{N}^*$ correspondant à un agrégat de i protéines élémentaires. Comme suggéré par le modèle de polymérisation nucléée, il existe une taille critique i_0 en dessous de laquelle les polymères sont supposés être instables et se décomposent instantanément en monomères. Pour $i \geq i_0$, l'évolution de la quantité $u_i(t)$ d'agrégats de PrPres de taille i est décrite par une équation différentielle ordinaire. On obtient ainsi un système composé d'une infinité d'équations différentielles ordinaires couplées

$$\begin{cases} \frac{d}{dt}V(t) = \lambda - \delta V(t) - \tau V(t) \sum_{i \geq i_0} u_i(t) + 2\beta \sum_{i=1}^{i_0-1} \sum_{j>i} i u_j(t), \\ \frac{d}{dt}u_i(t) = -\mu u_i(t) - \beta i u_i - \tau V(t)(u_i(t) - u_{i-1}(t)) + 2\beta \sum_{j>i} u_j(t), \quad \text{pour } i \geq i_0. \end{cases} \quad (16)$$

Les coefficients λ et δ représentent respectivement les taux de production et de dégradation de la protéine PrPc par la cellule. Le terme μ représente la dégradation des polymères de PrPres par la cellule. Les autres coefficients τ et β ont la même signification que pour l'équation de croissance-fragmentation linéaire. Les polymères agrègent les monomères avec un taux τ qui ne dépend pas de leur taille, et chaque polymère de taille i peut se fragmenter avec un taux βi . Les fragments formés ont une probabilité uniforme $\frac{1}{j}$ d'être de taille $j \in [1, i-1]$. Puisque la quantité de monomères n'est pas constante au cours du temps, le terme de croissance dépend de $V(t)$. Cette dépendance est quadratique, suivant ainsi la loi d'action de masse courante en physique des particules. Cela signifie que la probabilité de rencontre entre un polymère de taille i et un monomère est proportionnelle à $V(t)u_i(t)$.

L'analyse est plus aisée dans le cadre d'une distribution continue des tailles de polymères car les outils analytiques permettent de trouver des formulations plus simples. Dans ce sens, Greer *et al.* [63] ont introduit une version continue de (16) où ils utilisent la variable $x \in (0, +\infty)$ pour caractériser la taille des agrégats au lieu de $i \in \mathbb{N}^*$. Cette procédure a été justifiée mathématiquement dans [38] en incluant la possibilité que les coefficients de polymérisation, de fragmentation et de dégradation dépendent de la taille des agrégats, et sous l'hypothèse que la taille moyenne des polymères est très grande devant la taille des monomères. Le fait de considérer des coefficients dépendants de la taille est très pertinent dans la modélisation de la prolifération des prions comme cela a été justifié dans [20, 19]. Finalement on obtient le système couplé

$$\begin{cases} \frac{d}{dt}V(t) = \lambda - V(t) \left(\delta + \int_0^\infty \tau(x)u(x,t) dx \right), \\ \frac{\partial}{\partial t}u(x,t) = -V(t) \frac{\partial}{\partial x}(\tau(x)u(x,t)) - (\mu(x) + \beta(x))u(x,t) + 2 \int_x^\infty \beta(y)\kappa(x,y)u(y,t) dy, \\ u(0,t) = 0. \end{cases} \quad (17)$$

La taille critique a ici disparu car elle est supposée être de l'ordre de quelques monomères, et donc négligeable devant la taille moyenne des polymères. Le système obtenu est composé de l'équation de

croissance-fragmentation linéaire couplée avec une ED0. Le terme $\kappa(x, y)$ représente la probabilité d'obtenir un polymère de taille x à partir de la fragmentation d'un polymère de taille $y > x$. On fait alors les hypothèses

$$\int_0^x \kappa(y, x) dy = 1 \quad (\kappa(\cdot, x) \text{ est un noyau de probabilité})$$

et

$$\int_0^x y\kappa(y, x) dy = \frac{y}{2}, \quad (\text{conservation de masse}).$$

Avec les notation du paragraphe 1, cela correspond à un coefficient de fragmentation $b(y, x) = 2\beta(y)\kappa(x, y)$ et à un nombre moyen de fragments $n_0 = 2$. L'existence de solutions pour l'équation (17) a été démontrée dans [125, 131, 80] lorsque la taille critique est conservée, comme c'est la cas dans le modèle de Greer *et al.*. De plus dans ce modèle les coefficients de polymérisation, de fragmentation et de dégradation des polymères sont ceux correspondant au modèle de Masel, c'est-à-dire $\tau(x) \equiv \tau$, $\beta(x) = \beta x$, $\kappa(x, y) = \frac{1}{y}\mathbb{1}_{0 \leq x \leq y}$ et $\mu(x) \equiv \mu$.

Les états d'équilibre. A cause du couplage avec l'équation sur V et des termes de dégradation δ et μ (supposé maintenant indépendant de x), les solutions de (17) sont bornées. En effet, en intégrant l'équation de croissance-fragmentation contre $x dx$ puis en sommant avec l'EDO, on obtient l'équation sur la masse totale de protéine

$$\frac{d}{dt} \left(V(t) + \int_0^\infty xu(t, x) dx \right) = \lambda - \delta V(t) - \mu \int_0^\infty xu(t, x) dx.$$

On cherche alors les états d'équilibre du système (17). Tout d'abord il y a l'état d'équilibre correspondant à un individu non infecté, c'est-à-dire sans agrégats de PrPres. Cet état sain s'écrit

$$\bar{V} = \frac{\lambda}{\delta}, \quad \bar{u} \equiv 0.$$

Recherchons maintenant les éventuels états d'équilibre malade, c'est-à-dire associés à une distribution de polymères positive. Pour ce faire, nous utilisons les fonctions propres de l'opérateur de transport-fragmentation. En effet, un état d'équilibre (V_∞, u_∞) satisfait les relations

$$0 = V_\infty \frac{\partial}{\partial x} (\tau(x)u_\infty(x)) - (\mu + \beta(x))u_\infty(x) + 2 \int_x^\infty \beta(y)\kappa(x, y)u_\infty(y) dy \quad (18)$$

et

$$0 = \lambda - V_\infty \left(\delta + \int_0^\infty \tau(x)u_\infty(x) dx \right). \quad (19)$$

L'équation (18) signifie que u_∞ est un vecteur propre de l'équation de transport-fragmentation avec des paramètres de transport V_∞ et de mort μ , associé à la valeur propre nulle. Nous noterons maintenant $\mathcal{U}(V; x)$ et $\Lambda(V, \mu)$ les éléments propres principaux associés aux paramètres V et μ . Ces éléments existent sous les mêmes hypothèses que celles du Théorème 2, et la fonction propre \mathcal{U} ne dépend pas de μ . Puisque u_∞ est positif et que $\mathcal{U}(V_\infty; x)$ est le seul vecteur propre positif, on conclut que nécessairement $u_\infty = \varrho_\infty \mathcal{U}(V_\infty; \cdot)$ avec $\varrho_\infty > 0$. La constante ϱ_∞ représente la quantité total de polymères à l'équilibre et est déterminée par l'équation (19)

$$\varrho_\infty = \frac{\lambda - \delta V_\infty}{V_\infty \int_0^\infty \tau(x)\mathcal{U}(V_\infty; x) dx}.$$

Cette quantité ne peut être positive que si $V_\infty < \frac{\lambda}{\delta} = \bar{V}$. A noter que la valeur V_∞ ne dépend que des caractéristiques du processus de polymérisation-fragmentation (coefficient de l'équation de croissance-fragmentation) alors que \bar{V} ne dépend que des caractéristiques de la cellule (production et dégradation de PrPc). Finalement, on obtient ainsi un unique état d'équilibre pour chaque valeur $V_\infty < \bar{V}$ telle que $\Lambda(V_\infty, \mu) = 0$. Ceci nous amène à étudier la dépendance de la première valeur propre de l'équation de

croissance-fragmentation par rapport au paramètre de transport V . La dépendance de Λ par rapport à μ est très simple : nous avons $\Lambda(V, \mu) = \Lambda(V, 0) - \mu$. Nous allons donc analyser la fonction $\Lambda(V) := \Lambda(V, 0)$.

Commençons tout d'abord par regarder le cas $\tau(x) = \tau x^\nu$ et $\beta(x) = \beta x^\gamma$. Comme nous l'avons vu plus haut, pour de tels coefficients l'existence d'éléments propres est assurée sous la condition $\gamma + 1 - \nu > 0$. Définissons alors le paramètre positif $k := \frac{1}{\gamma+1-\nu}$ et supposons en outre que le noyau de fragmentation κ est auto-similaire $\kappa(x, y) = \frac{1}{y} \kappa_0\left(\frac{x}{y}\right)$. Alors nous pouvons calculer explicitement la dépendance de Λ en fonction de V (voir le chapitre 2) et nous obtenons

$$\Lambda(V) = \Lambda(1)V^{k\gamma}.$$

La fonction $V \mapsto \Lambda(V)$ est une fonction puissance, donc il existe une et une seule valeur V_∞ telle que $\Lambda(V_\infty, \mu) = 0$. Cette valeur a pour expression $V_\infty = \left(\frac{\mu}{\Lambda(1)}\right)^{-k\gamma}$ et elle correspond à un état d'équilibre malade dès qu'elle est inférieure à \bar{V} .

Pour des coefficients quelconques, on ne peut pas en général obtenir d'expression explicite de la dépendance par rapport au terme de polymérisation. Cependant nous avons prouvé un résultat sur le comportement asymptotique de Λ quand V tend vers zéro ou l'infini, dans le cas où β et τ sont équivalents à des puissance de x en zéro et l'infini et où $\kappa(\cdot, x)$ est "asymptotiquement" auto-similaire quand x tend vers zéro et l'infini,

Théorème 6 (Calvez, Doumic et G.). *Pour $L = 0$ ou $L = +\infty$, on a*

$$\lim_{V \rightarrow L} \Lambda(V) = \lim_{x \rightarrow L} \beta(x).$$

Une conséquence immédiate de ce théorème est qu'il peut exister plusieurs états malade pour le système prion. Supposons que la limite de $\beta(x)$ soit nulle en zéro et l'infini, alors la limite de $\Lambda(V)$ est elle aussi nulle quand V tend vers zéro et l'infini. Or on sait que $\Lambda(V) > 0$ pour $V > 0$. Donc $\Lambda(V)$ ne peut pas être monotone et, pour μ suffisamment petit, il existe au moins deux racines à $\Lambda(V, \mu) = \Lambda(V) - \mu = 0$. Comme nous l'avons déjà remarqué, ces deux racines V_1 et V_2 ne dépendent pas de λ ni de δ . Ainsi pour $\bar{V} = \frac{\lambda}{\delta}$ suffisamment grand, V_1 et V_2 correspondent à deux états d'équilibre malade pour (17).

Stabilité des états d'équilibre. La stabilité de l'état d'équilibre sain $(\bar{V}, 0)$ a été analysée sous des hypothèses relativement générales dans [20, 19]. Celle-ci dépend du signe de la valeur propre Λ évaluée en \bar{V} .

Théorème 7 (Calvez *et al.* 2009, [20, 19]). *Si $\Lambda(\bar{V}, \mu) < 0$, alors l'état d'équilibre $(\bar{V}, 0)$ est localement non-linéairement stable. Si $\Lambda(\bar{V}, \mu) > 0$, alors les solutions restent éloignées de $(\bar{V}, 0)$.*

Sous des hypothèses plus restrictives, on trouve dans [20, 19] et dans [125, 131] des résultats de stabilité globale de l'état sain pour \bar{V} suffisamment petit.

En revanche, pour la stabilité des états d'équilibre malade, nous ne disposons que d'un résultat pour le modèle de Greer *et al.* correspondant à $\tau(x) = \tau$, $\beta(x) = \beta x$ et $\kappa(x, y) = \frac{1}{y}$. Dans ce cas il existe une unique racine à $\Lambda(V, \mu) = 0$ et celle-ci s'écrit $V_\infty = \frac{\mu^2}{\beta\tau}$. De plus l'équation (17) peut être réduite à un système couplé de trois EDO. La stabilité des états d'équilibre est analysée dans [43, 117] à partir de ce système réduit, et le comportement en temps long des solutions est entièrement déterminé.

Théorème 8 (Engler, Prüss, Pujon-Menjouet, Webb et Zacher 2006). *Si $\bar{V} < V_\infty$, alors il n'existe pas d'état d'équilibre malade et l'état d'équilibre sain est globalement asymptotiquement stable. Si $\bar{V} > V_\infty$, alors il existe un unique état d'équilibre malade et celui-ci est globalement asymptotiquement stable si $u_0 \neq 0$.*

Dans le cas général, la question de la stabilité des états d'équilibre malade est difficile, même pour le linéarisé (car celui-ci n'est plus positif).

2.2 Comportement en temps long pour des modèles non linéaires

Nous présentons ici des modèles de croissance-fragmentation non linéaires pour lesquels nous pouvons donner des résultats sur le comportement en temps long des solutions. Dans ces modèles, le terme de transport dépend de l'intégrale de la solution avec un poids. Cette dépendance reflète l'influence de la population totale sur la croissance de chaque individu. Pour tous les résultats, le terme de croissance $\tau(x)$ est linéaire, celui de mort μ est constant, le taux de fragmentation β est une puissance γ de x et b est autosimilaire $b(x, y) = n_0 \frac{\beta(x)}{x} \kappa_0\left(\frac{y}{x}\right)$. On notera \mathcal{F}_γ l'opérateur de fragmentation associé à ces coefficients β et b

$$(\mathcal{F}_\gamma u)(t, x) := n_0 \int_x^\infty \beta y^{\gamma-1} \kappa_0\left(\frac{x}{y}\right) u(t, y) dy - \beta x^\gamma u(t, x).$$

Nous considérons tout d'abord, pour une donnée initiale $u_0(x) \geq 0$, l'équation d'évolution

$$\frac{\partial}{\partial t} u(t, x) = -f\left(\int x^p u(t, x) dx\right) \frac{\partial}{\partial x} (x u(t, x)) - \mu u(t, x) + \mathcal{F}_\gamma u(t, x) \quad (20)$$

où $f : \mathbb{R}_+ \rightarrow \mathbb{R}_+$ est une fonction de classe \mathcal{C}^1 et p un paramètre positif. Les états d'équilibre non triviaux sont donnés par les points d'intersection de la fonction f avec la constante μ . Supposons que le nombre de ces points d'intersection est fini, que $\limsup_{I \rightarrow \infty} f(I) < \mu$ et que $\gamma \in (0, 2]$. Alors nous avons les résultats suivant sur le comportement en temps long des solutions de (20).

Théorème 9 (G.). *Toute solution de l'équation (20) converge vers un état d'équilibre. L'état d'équilibre trivial est localement exponentiellement stable si $f(0) < \mu$ et $p \geq 1$, et instable si $f(0) > \mu$. Tout état d'équilibre positif non trivial u_∞ est localement asymptotiquement stable si $f'(\int x^p u_\infty(x) dx) < 0$, localement exponentiellement stable si de plus $\kappa_0 \equiv 1$, et instable si $f'(\int x^p u_\infty(x) dx) > 0$.*

Corollaire 10. *S'il existe un unique état d'équilibre non trivial u_∞ et que $f'(\int x^p u_\infty(x) dx) < 0$, alors celui-ci est globalement asymptotiquement stable pour des données initiales $u_0 \neq 0$.*

Le comportement en temps long des solutions de l'équation (20) est ainsi complètement déterminé et on a toujours convergence vers un état d'équilibre. Considérons maintenant le cas où le terme de mort dépend lui aussi de la population totale

$$\frac{\partial}{\partial t} u(t, x) = -f\left(\int x^p u(t, x) dx\right) \frac{\partial}{\partial x} (x u(t, x)) - g\left(\int x^q u(t, x) dx\right) u(t, x) + \mathcal{F}_\gamma u(t, x). \quad (21)$$

La fonction g représente l'influence de la population totale sur la survie de chaque individu. Pour ce modèle contenant plus de non-linéarités que le précédent, a-t-on toujours convergence vers un état d'équilibre? La réponse négative est donnée par le théorème qui suit.

Théorème 11 (G.). *Il existe des fonctions f et g et des paramètres p et q pour lesquels l'équation (21) admet des solutions périodiques en temps. De plus il existe un ensemble ouvert de conditions initiales u_0 pour lesquelles il y a convergence en temps long vers une de ces solutions périodiques.*

Tous les résultats présentés sur le comportement en temps long des solutions des équations (20) et (21) ont lieu dans le cône des fonctions positives de $L^2((x + x^r) dx)$ avec r suffisamment grand. Les preuves sont données dans le chapitre 4.

On peut aussi considérer dans le système prion que la vitesse de polymérisation des protéines dépend de la quantité totale de polymères dans la cellule

$$\begin{cases} \frac{d}{dt} V(t) &= \lambda - \delta V(t) - V(t) f\left(\int x^p u\right) \int_0^\infty x u(t, x) dx, \\ \frac{\partial}{\partial t} u(t, x) &= -V(t) f\left(\int x^p u\right) \frac{\partial}{\partial x} (x u(t, x)) - \mu u(t, x) + \mathcal{F}_\gamma u(t, x). \end{cases} \quad (22)$$

Ce modèle a été introduit par [64] dans le cas du modèle de Greer *et al.* avec $p = 1$ et $f(I) = \frac{1}{1+\omega I}$ avec $\omega > 0$. Ils montrent alors que le comportement asymptotique des solutions est de même nature que dans le théorème 8, à savoir qu'il y a convergence vers l'état d'équilibre sain ou malade selon que l'état d'équilibre malade existe ou non. Ici nous considérons des fonctions f plus générales et montrons que l'on peut alors avoir existence de solution périodiques.

Théorème 12 (G.). *Il existe des fonctions f et des paramètres $\lambda, \delta, \mu, \gamma$ et p pour lesquels l'équation (22) admet des solutions périodiques.*

Ce résultat est démontré en considérant p comme un paramètre de bifurcation et en prouvant qu'une bifurcation de Hopf apparaît quand p croît.

2.3 Un modèle avec coalescence

Jusqu'ici nous n'avons pas considéré la possibilité d'agrégation de deux polymères entre eux, ni de dépolymérisation des polymères. La coalescence de deux agrégats conduit à l'introduction d'un terme quadratique avec des interactions non-locales qui sont extrêmement délicates à analyser. La dépolymérisation correspond au détachement d'un monomère et fait apparaître un terme négatif dans le transport. Nous présentons ici un modèle qui tient compte de ces deux processus dans un cadre *in vitro*, sans production ni dégradation de protéine

$$\begin{cases} \frac{d}{dt}V(t) &= - \int_0^\infty \mathcal{T}(V(t), x)u(t, x) dx, \\ \frac{\partial}{\partial t}u(t, x) &= - \frac{\partial}{\partial x} \left(\mathcal{T}(V(t), x)u(t, x) \right) + \mathcal{Q}(u)(t, x). \end{cases} \quad (23)$$

Dans ce modèle, les monomères s'agrègent aux polymères avec un taux $\tau_{\text{on}}(x) \geq 0$ et se détachent avec un taux $\tau_{\text{off}}(x) \geq 0$, ce qui conduit à un terme de transport

$$\mathcal{T}(V(t), x) = V(t)\tau_{\text{on}}(x) - \tau_{\text{off}}(x).$$

L'évolution de la quantité de monomères $V(t)$ est uniquement due à ce phénomène de polymérisation-dépolymérisation. L'opérateur $\mathcal{Q} = \mathcal{Q}_c - \mathcal{Q}_f$ représente la coagulation (\mathcal{Q}_c) et fragmentation (\mathcal{Q}_f) des polymères, avec les expressions

$$\mathcal{Q}_c(u)(x) = \frac{1}{2} \int_0^x b_c(y, x-y)u(y)u(x-y) dy - u(x) \int_0^\infty b_c(x, y)u(y) dy$$

et

$$\mathcal{Q}_f(u)(x) = \frac{1}{2}u(x) \int_0^x b_f(y, x-y) dy - \int_0^\infty b_f(x, y)u(x+y) dy.$$

La coalescence de deux polymères de tailles respectives x et y se produit avec le taux symétrique et positif $b_c(x, y) = b_c(y, x) \geq 0$, et un polymère de taille $x + y$ se fragmente en un polymère de taille x et un de taille y avec le taux $b_f(x, y) = b_f(y, x) \geq 0$.

Puisqu'il n'y a ni production ni dégradation de protéines, il y a conservation de la masse totale au cours du temps

$$\frac{d}{dt} \left(V(t) + \int_0^\infty xu(t, x) dx \right) = 0.$$

Nous proposons dans le chapitre 6 un schéma d'ordre élevé pour la résolution numérique de l'équation (23) qui préserve cette loi de conservation au niveau discret. Du point de vue des applications, cette propriété est essentielle si l'on veut obtenir des résultats numériques pertinents. Les méthodes de discrétisation classiques pour les équations de transport conservent la masse. L'idée est alors d'écrire l'opérateur \mathcal{Q} ,

qui préserve la masse des polymères, sous une forme conservative afin de pouvoir utiliser un schéma de transport. Suivant l'idée de [52], on écrit

$$x\mathcal{Q}_c(u)(x) = -\frac{\partial\mathcal{C}(u)}{\partial x}(x) \quad \text{et} \quad x\mathcal{Q}_f(u)(x) = -\frac{\partial\mathcal{F}(u)}{\partial x}(x),$$

où l'opérateur \mathcal{C} est défini par

$$\mathcal{C}(u)(x) := \int_0^x \int_{x-y}^{\infty} y b_c(y, z) u(y) u(z) dz dy,$$

et l'opérateur \mathcal{F} par

$$\mathcal{F}(u)(x) := \int_0^x \int_{x-y}^{\infty} y b_f(y, z) u(y+z) dz dy.$$

Finalement on obtient une équation sur l'évolution de la distribution en taille des polymères qui s'écrit

$$x \frac{\partial}{\partial t} u(t, x) + \frac{\partial}{\partial x} \left(\mathcal{T}(V(t), x) x u(t, x) + \mathcal{C}(u)(t, x) + \mathcal{F}(u)(t, x) \right) = \mathcal{T}(V(t), x) u(t, x).$$

On peut alors utiliser un schéma de transport conservatif pour résoudre cette équation. Nous avons choisi le schéma WENO d'ordre 5 pour ses propriétés anti-dissipatives.

3 Un problème de contrôle optimal

3.1 Modélisation de la PMCA

La PMCA (Protein Misfolded Cyclic Amplification) est un protocole d'amplification qui permet d'accélérer la conversion de la protéine PrPc en PrPres *in vitro*. La technique consiste à soumettre un échantillon contenant une faible quantité de PrPres à une alternance de phases d'incubation et de sonication. Les phases d'incubation ont pour but de favoriser la polymérisation des agrégats. Pour cela l'échantillon est laissé au repos en présence d'une grande quantité de PrPc. A l'inverse, les phases de sonication ont pour objectif d'augmenter fortement la fragmentation des polymères. L'échantillon est alors placé dans un sonicateur qui brise violemment les agrégats à l'aide d'ultrasons. Ce principe cyclique d'amplification est schématisé dans la Figure 1. L'efficacité du protocole dépend en partie de la durée des différentes phases, qui est laissée à la discrétion de l'expérimentateur. La modélisation mathématique et les outils d'optimisation peuvent permettre d'améliorer l'efficacité de la PMCA en fournissant aux biologistes des renseignements sur la durée optimale de chaque phase.

Pour modéliser le protocole de la PMCA, nous faisons un certain nombre d'hypothèses. Tout d'abord, puisque l'échantillon est saturé en PrPc, la variation de la quantité de monomères au cours de l'expérience est faible devant sa valeur initiale. On néglige ici cette variation, ce qui revient à supposer que la quantité de monomères reste constante. Ensuite on fait l'hypothèse simplificatrice que la sonication n'influence pas la dépendance en taille des coefficients de croissance et de fragmentation des polymères, mais uniquement leur "intensité". Ceci nous amène au modèle suivant, basé sur l'équation de transport-fragmentation linéaire,

$$\frac{\partial}{\partial t} u(t, x) = -r(\alpha(t)) \frac{\partial}{\partial x} (\tau(x) u(t, x)) - \alpha(t) \beta(x) u(t, x) + 2\alpha(t) \int_x^{\infty} \beta(y) \kappa(x, y) u(t, y) dy, \quad (24)$$

où $\alpha(t)$ est un terme de contrôle qui représente "l'intensité" de la sonication. La fonction $r(\alpha)$ est une fonction décroissante, rendant ainsi compte du fait que la polymérisation est moins importante pendant les phases de sonication.

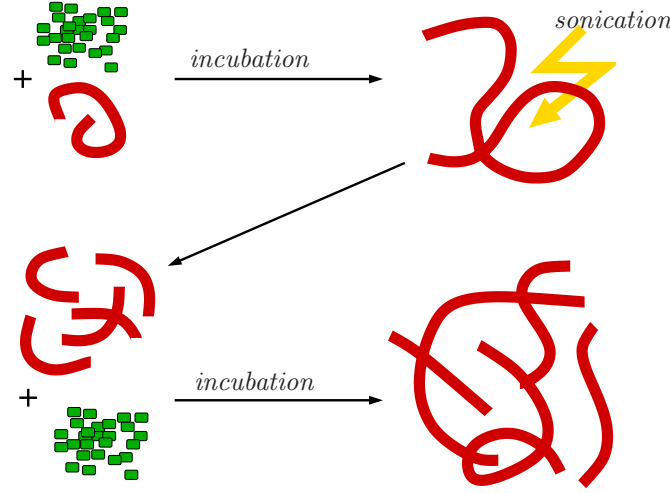

FIGURE 1 – Principe de la PMCA. Les polymères de PrPres sont représentés par les fibrilles rouges et les monomères par les billes vertes.

Parallèlement nous considérons un modèle discret de dimension fini inspiré du modèle de Masel *et al.* dans lequel la taille $i \in \mathbb{N}$ des polymères correspond à un agrégat composé de i monomères

$$\frac{d}{dt}u_i(t) = -r(\alpha(t))(\tau_i u_i(t) - \tau_{i-1} u_{i-1}(t)) - \alpha(t)\beta_i u_i(t) + 2\alpha(t) \sum_{j=i+1}^n \beta_j \kappa_{i,j} u_j(t), \quad 1 \leq i \leq n. \quad (25)$$

La taille maximale n des polymères est choisie suffisamment grande pour qu'aucun polymère de taille supérieure à n n'apparaisse au cours de l'expérience. Ce modèle peut s'écrire sous la forme matricielle

$$\dot{U}(t) = M(\alpha(t))U(t)$$

où $U(t) = {}^t(u_i(t))_{1 \leq i \leq n}$ est un vecteur de taille n , \dot{U} est la dérivée temporelle de U , et $M(\alpha) = r(\alpha)G + \alpha F$ avec G la matrice de croissance

$$G = \begin{pmatrix} -\tau_1 & & & & & \\ \tau_1 & -\tau_2 & & & & \\ & \ddots & \ddots & & & \\ & & & \tau_{n-2} & -\tau_{n-1} & \\ & & & & \tau_{n-1} & 0 \end{pmatrix},$$

et F la matrice de fragmentation

$$F = \begin{pmatrix} 0 & & & & & \\ & -\beta_2 & & (2\kappa_{ij}\beta_j)_{i < j} & & \\ & & \ddots & & & \\ & 0 & & & & \\ & & & & & -\beta_n \end{pmatrix}.$$

Les outils matriciels permettent une étude plus approfondie des questions d'optimisation comme nous allons le voir dans le paragraphe 3.3.

Dans le cadre des modélisations (24) et (25), le protocole de PMCA décrit plus haut correspond à un contrôle $\alpha(t)$ en créneaux

$$\alpha(t) = \begin{cases} \alpha_{min} & \text{pendant les phases d'incubation} \\ \alpha_{max} & \text{pendant les phases de sonication} \end{cases} \quad \text{avec } 0 < \alpha_{min} < \alpha_{max}. \quad (26)$$

La valeur α_{max} représente la puissance maximale du sonicateur, et α_{min} l'absence de sonication.

Nous pouvons maintenant formaliser le problème d'optimisation de la PMCA. Pour une classe de fonctions \mathfrak{C} et une durée d'expérience T données, on définit l'ensemble des contrôles admissibles

$$\mathcal{A} := \{\alpha : [0, T] \rightarrow [\alpha_{min}, \alpha_{max}] \mid \alpha \in \mathfrak{C}\}.$$

On définit ensuite pour une donnée initiale $u(0, x) = u_0(x)$ ou $U(0) = U_0$ le coût que l'on veut maximiser

$$c[\alpha] := g[u(T, \cdot)] := \int_0^{\infty} xu(T, x) dx \quad \text{ou} \quad c[\alpha] := g(U(T)) := \sum_{i=1}^n iu_i(T)$$

où $u(T, \cdot)$ est la solution de (24) à l'instant T pour la donnée initiale u_0 et le contrôle α , et $U(T)$ est la solution de (25) à l'instant T pour la donnée initiale U_0 et le contrôle α . Ce coût représente la masse totale de PrPres à la fin de l'expérience, que l'on cherche à maximiser car la présence de PrPres ne peut être détectée expérimentalement (par Western Blot, voir [83] pour plus de détails) que si sa masse est supérieure à un certain seuil. Le problème d'optimisation de la PMCA s'exprime alors ainsi :

$$\text{trouver un contrôle } \alpha^* \text{ qui maximise le coût } c \text{ dans l'ensemble } \mathcal{A}. \quad (27)$$

L'optimisation du protocole consistant à alterner des phases d'incubation et de sonication correspond au problème (27) avec pour classe \mathfrak{C} l'ensemble des fonctions périodiques en créneaux de la forme (26). Dans notre étude, nous considérons tout d'abord la classe des fonctions constantes, puis celle des fonctions périodiques. Les résultats obtenus fournissent des renseignements sur le problème de contrôle optimal général correspondant à la classe \mathfrak{C} des fonctions mesurables. Ce point est discuté dans le chapitre 5, en s'appuyant sur des simulations numériques.

3.2 Optimisation de la première valeur propre

Nous commençons par regarder le cas d'un contrôle α constant au cours du temps et d'une durée d'expérience très grande, ce que l'on formalisera mathématiquement en prenant $T = +\infty$. Dans ce cadre l'ensemble \mathcal{A} des contrôles admissibles est en bijection avec l'intervalle $[\alpha_{min}, \alpha_{max}]$, et le coût final $c[\alpha]$ à maximiser est remplacé par la valeur propre principale $\Lambda(\alpha)$ de l'opérateur de croissance-fragmentation. En effet, les résultats d'Entropie Relative Généralisée assurent que cette valeur propre correspond au taux de croissance asymptotique des solutions, indépendamment de la donnée initiale.

La fonction $\alpha \mapsto \Lambda(\alpha)$ est de classe \mathcal{C}^1 (voir [96]), elle est donc bornée sur l'intervalle compact $[\alpha_{min}, \alpha_{max}]$ et atteint son maximum. Comme la fragmentation augmente le nombre de polymères qui peuvent chacun convertir les monomères, on pourrait s'attendre à ce que le maximum de Λ soit atteint en α_{max} (au moins dans le cas où la sonication n'influence pas la polymérisation). Cependant nous avons montré que, pour le modèle discret comme pour le modèle continu, il existe des situations où le maximum est atteint en un point $\alpha^* \in (\alpha_{min}, \alpha_{max})$.

Nous présentons ici des résultats dans le cas où il n'y a pas d'influence de la sonication sur le transport, c'est-à-dire pour une fonction r constante. Pour des résultats dans le cas r non constant, on renvoie au chapitre 5.

Théorème 13 (Calvez, Doumic et G.). *Pour le modèle continu (24), nous avons pour $L = 0$ ou $L = +\infty$*

$$\lim_{\alpha \rightarrow L} \Lambda(\alpha) = \lim_{x \rightarrow \frac{1}{L}} \frac{\tau(x)}{x}.$$

Puisque $\Lambda(\alpha) > 0$ pour tout $\alpha > 0$, une conséquence de ce théorème est que si $\tau(x)$ est négligeable devant x en zéro et en l'infini, alors la fonction Λ admet un maximum global atteint en un point $\alpha^* > 0$. Ensuite, en multipliant $\beta(x)$ par une constante positive appropriée, on peut avoir $\alpha^* \in (\alpha_{min}, \alpha_{max})$. Finalement, pour α_{min} et α_{max} fixés, il existe des coefficients τ et β pour lesquels la valeur propre principale Λ est maximale en un point intérieur de l'intervalle $[\alpha_{min}, \alpha_{max}]$.

Ce résultat signifie que fragmenter au maximum les polymères n'est pas nécessairement la meilleure stratégie pour optimiser la conversion de monomères. Une forte fragmentation forme beaucoup de petits agrégats de PrPres qui peuvent transconformer la PrPc. Cependant, si ces petits polymères n'ont qu'une faible capacité de conversion, alors cela peut nuire à la croissance de la population. Pour avoir une idée plus claire de la stratégie optimale, nous regardons la quantité $\frac{\tau(x)}{x}$ qui représente la capacité de conversion des polymères ramenée à leur taille. Pour optimiser $\Lambda(\alpha)$, il faut former le plus possible d'agrégats avec une taille x pour laquelle l'efficacité $\frac{\tau(x)}{x}$ est grande. En effet, si l'on note $\mathcal{U}(\alpha; x)$ le vecteur propre principal associé à la valeur propre $\Lambda(\alpha)$, on a l'indentité

$$\Lambda(\alpha) \int_0^\infty x \mathcal{U}(\alpha; x) dx = \int_0^\infty \frac{\tau(x)}{x} x \mathcal{U}(\alpha; x) dx.$$

Si la fragmentation α est trop forte, alors $\mathcal{U}(\alpha; x)$ se concentre en $x = 0$ et, si $\frac{\tau(x)}{x}$ est faible en zéro, alors la croissance $\Lambda(\alpha)$ l'est aussi. Dans ces conditions, il y a un équilibre à trouver entre polymérisation et fragmentation, et cet équilibre est donné par α^* .

Nous donnons maintenant un résultat similaire dans le cas du modèle discret. La principale différence avec le modèle continu est que, comme $\tau_1 > 0$, la valeur propre principale ne tend pas vers zéro en l'infini.

Théorème 14 (Calvez et G.). *Pour le modèle discret (25), nous avons*

$$\Lambda(\alpha) \xrightarrow{\alpha \rightarrow 0} 0$$

et, si l'on note p le plus grand indice tel que $\tau_i = i\tau_1$ pour tout $i \leq p$, alors

$$\Lambda(\alpha) = \tau_1 + (\tau_{p+1} - (p+1)\tau_1) \prod_{i=1}^p \frac{\tau_i}{\beta_{i+1}} \alpha^{-p} + o_{\alpha \rightarrow \infty}(\alpha^{-p}).$$

Ainsi, si $\tau_{p+1} > (p+1)\tau_1$, alors il existe un maximum global pour $\Lambda(\alpha)$ et, comme pour le cas continu, ce maximum peut se trouver à l'intérieur de $[\alpha_{min}, \alpha_{max}]$ pour des β_i bien choisis.

3.3 Contrôle périodique : Perron vs. Floquet

On se place ici dans les cas où la valeur propre de Perron $\Lambda(\alpha)$ atteint son maximum en un point $\alpha^* \in (\alpha_{min}, \alpha_{max})$. On se demande alors si l'on peut obtenir une meilleure croissance en considérant une classe plus large de contrôles. Pour ce faire, on considère la classe des contrôles périodiques et on restreint notre étude au modèle discret (25). Pour un contrôle $\alpha(t)$ périodique, la théorie de Floquet permet de définir pour la matrice périodique $M(\alpha(t))$ une valeur propre principale $\Lambda_F[\alpha]$ associée à un vecteur propre positif et périodique $U_F[\alpha](t)$ (voir [110]).

Nous avons prouvé que, pour une fonction r décroissante et convexe par exemple, il existe des contrôles périodiques meilleurs que le contrôle constant α^* . Ce résultat tend à soutenir la recherche d'un protocole de PMCA optimal sous la forme d'alternance de périodes d'incubation et de sonication.

Théorème 15 (Calvez et G.). *Si la matrice $M(\alpha^*)$ est diagonalisable et que*

$$\frac{r''(\alpha^*)}{r(\alpha^*) - \alpha^* r'(\alpha^*)} > 0, \tag{28}$$

alors il existe des contrôles périodiques $\alpha(t)$ tels que $\Lambda_F[\alpha] > \Lambda(\alpha^*)$.

La preuve de ce théorème consiste à calculer la dérivée seconde directionnelle de la valeur propre de Floquet au point α^* en se plaçant dans la base de vecteurs propres de $M(\alpha^*)$. On montre alors que, sous la condition (28), cette dérivée seconde est positive pour des contrôles périodiques de fréquence suffisamment élevée.

4 Directions de recherches futures

Trou spectral et entropie non linéaire. Il s'agit dans un premier temps d'étendre les résultats de convergence exponentielle donnés dans le paragraphe 1.4 à des coefficients plus généraux et éventuellement dégénérés en zéro. La preuve du théorème 5 nécessite des estimations *a priori* précises sur les vecteurs propres \mathcal{U} et ϕ pour pouvoir obtenir une inégalité de Poincaré. Les bornes obtenues dans le chapitre 1 sont un bon point de départ, mais elles doivent être raffinées et complétées par des bornes inférieures.

Ensuite les techniques d'entropie doivent encore être développées pour pouvoir être appliquées à des modèles non linéaires comme ceux présentés au paragraphe 2. On aimerait ainsi pouvoir obtenir des résultats sur la stabilité des états d'équilibre malade du système prion, généraliser les résultats de convergence du paragraphe 2.2 à des coefficients plus généraux, et étudier le comportement en temps long de modèles avec coagulation. Certains résultats d'entropie non linéaire existent pour l'équation de renouvellement [97], mais le caractère non local plus marqué de l'opérateur de fragmentation les rend pour l'instant inutilisables dans le cadre de la croissance-fragmentation.

Le cas très dégénéré. Le problème est de savoir ce qui se passe lorsque les conditions d'existence de vecteurs propres du théorème 2 ne sont pas satisfaites. Cette question apparaît par exemple dans le cas d'une population de cellules infectées par des parasites et qui se divisent par mitose [7, 8]. Dans ce cas le coefficient de transport $\tau(x)$ est supposé être linéaire pour rendre compte de la prolifération exponentielle des parasites, et le terme de fragmentation $\beta(x)$ constant. Ces coefficients correspondent au cas limite où $\gamma + 1 - \nu = 0$ dans la classe des coefficients en puissance de x , et l'existence de vecteurs propres principaux n'est alors plus assurée. On se demande si dans ce cas il y a formation d'une masse de Dirac en zéro, ce qui correspondrait à une partie de la population de cellules qui ne serait plus infectée. On considère pour cela la population renormalisée

$$\tilde{u}(t, x) = \frac{u(t, x)}{\int_0^\infty u(t, y) dy}$$

qui satisfait l'équation

$$\partial_t \tilde{u}(t, x) + \tau \partial_x (x \tilde{u}(t, x)) + 2\beta \tilde{u}(t, x) = 2\beta \int_x^\infty \kappa(x, y) \tilde{u}(t, y) dy.$$

Si l'on suppose que le noyau de fragmentation est de la forme $\kappa(x, y) = \frac{1}{y} \kappa_0\left(\frac{x}{y}\right)$, alors le moment d'ordre α de la solution satisfait l'équation

$$\frac{1}{\alpha} \frac{d}{dt} \ln \left(\int_0^\infty x^\alpha \tilde{u}(t, x) dx \right) = \tau + 2\beta \int_0^1 \frac{z^\alpha - 1}{\alpha} \kappa_0(z) dz \xrightarrow{\alpha \rightarrow 0} \tau + \beta \int_0^1 \ln(z) \kappa_0(z) dz.$$

Donc si $\tau + \beta \int_0^1 \ln(z) \kappa_0(z) dz < 0$, les moments d'ordre α de la solution tendent vers zéro pour α suffisamment petit. Or comme le moment d'ordre 1 est constant par définition de \tilde{u} , cela signifie qu'il y a concentration d'une partie de la population en $x = 0$. On aimerait pouvoir étendre ce résultat à des coefficients plus généraux et obtenir des conditions précises qui assurent la formation d'une masse de Dirac en zéro.

Introduction d'une variable d'espace. Pour parvenir à une modélisation plus proche de la réalité biologique, une suite naturelle des travaux présentés est d'introduire une variable d'espace. Pour donner un modèle très général, on peut considérer l'équation de transport-coagulation-fragmentation (23) et ajouter de la diffusion en espace, avec un terme de diffusion dépendant à la fois de la taille et de l'espace

$$\begin{cases} \frac{d}{dt} V(t, y) &= - \int_0^\infty \mathcal{T}(V(t, y), x) u(t, x, y) dx - \operatorname{div}_y (d_1(y) \nabla_y V(t, y)), \\ \frac{\partial}{\partial t} u(t, x, y) &= - \frac{\partial}{\partial x} \left(\mathcal{T}(V(t, y), x) u(t, x, y) \right) + \mathcal{Q}(u)(t, x, y) - \operatorname{div}_y (d_2(x, y) \nabla_y u(t, x, y)). \end{cases}$$

De l'étude de problèmes semblables [47, 62, 74], nous savons que l'introduction de la variable d'espace y change complètement la structure de l'équation. Les bornes uniformes et l'analyse asymptotique requièrent des méthodes différentes qui doivent encore être développées pour ce modèle. On aimerait pouvoir montrer pour ce type d'équations des instabilités de Turing conduisant à la formation de motifs.

De telles questions apparaissent dans le cadre du vieillissement cellulaire observé récemment chez *E. Coli* [85]. Ce vieillissement semble être lié à des agrégations de protéines comme pour les maladies à prions, et ces agrégats se concentrent aux extrémités des cellules. La modélisation par agrégation-diffusion est toute indiquée pour simuler et étudier ces phénomènes. En outre, les cellules se divisent par mitose et les agrégats sont alors répartis dans les cellules filles [126, 132], ce qui conduit à des problématiques semblables à celles des cellules infectées par des parasites. Ce sujet d'étude sur le vieillissement d'*E. Coli* sera l'objet de mon post-doctorat l'année prochaine dans l'équipe INRIA BEAGLE à Lyon.

Perron vs. Floquet dans le cas continu. Dans le problème d'optimisation de la PMCA, on aimerait obtenir des comparaisons entre valeur propre de Floquet et valeur propre de Perron dans le cas continu. De telles comparaisons existent pour des modèles de division cellulaire structurés en âge [84] mais doivent encore être généralisées à l'équation de transport-fragmentation. Tout d'abord il faut démontrer l'existence d'éléments propres de Floquet pour le modèle continu. Les estimations obtenues pour démontrer l'existence d'éléments propres de Perron au chapitre 1 doivent pour cela être rendues uniformes en temps. Ensuite la preuve du théorème 15 utilise fortement la dimension finie et ne peut pas être appliquée au modèle continu. D'autres méthodes doivent donc être mises en place, en généralisant par exemple les idées du chapitre 4 ou bien en développant de nouveaux outils pour calculer les dérivées directionnelles de la valeur propre de Floquet.

Populations structurées en âge. Récemment, lors d'un séjour à Vanderbilt University avec Glenn Webb, je me suis intéressé à l'étude mathématique de modèles de populations structurées en âge. Ces modèles permettent de rendre compte du cycle cellulaire et d'étudier précisément des phénomènes liés à l'âge des cellules. Dans le sujet auquel nous nous intéressons, la population est composée de cellules cancéreuses sous traitement par Erlotinib. Les effets de ce traitement sur certains types de cellules n'est pas immédiat et des retards d'un vingtaine d'heures sont observés. Pour expliquer ce phénomène, les biologistes du centre de cancérologie de Vanderbilt suggèrent que l'âge des cellules joue un rôle. A l'aide d'un modèle structuré en âge, nous montrons que le retard peut être expliqué par le fait que le traitement affecte préférentiellement les jeunes cellules. Cette hypothèse doit encore être confirmée par des expériences biologiques, des simulations numériques et une étude mathématique.

Chapitre 1

Existence et unicité d'éléments propres principaux

Cet article en collaboration avec MARIE DOUMIC établit l'existence et l'unicité d'éléments propres de Perron pour l'équation de transport-fragmentation dans des cas dégénérés. Nous considérons des coefficients généraux pouvant s'annuler à l'origine et pouvant croître vers l'infini en l'infini, ce qui rend délicat la mise en place de bornes *a priori*. Pour résoudre ce problème, nous construisons des estimations dans des normes à poids en jonglant entre les termes de transport et de fragmentation. Nous obtenons ainsi des conditions d'existence précises qui généralisent celles obtenues dans [95]. L'article est paru dans *Mathematical Models and Methods in Applied Sciences* sous le titre *Eigenelements for a general aggregation-fragmentation model* [41].

1.1 Introduction

Competition between growth and fragmentation is a common phenomenon for a structured population. It arises for instance in a context of cell division (see, among many others, [2, 9, 10, 11, 37, 49, 66, 94, 112]), polymerization (see [13, 34]), telecommunication (see [3]) or neurosciences (see [107]). It is also a mechanism which rules the proliferation of prion's proteins (see [20, 63, 80]). These proteins are responsible of spongiform encephalopathies and appear in the form of aggregates in infected cells. Such polymers grow attaching non infectious monomers and converting them into infectious ones. On the other hand they increase their number by splitting.

To describe such phenomena, we write the following integro-differential equation,

$$\begin{cases} \frac{\partial}{\partial t}u(x, t) + \frac{\partial}{\partial x}(\tau(x)u(x, t)) + \beta(x)u(x, t) = 2 \int_x^\infty \beta(y)\kappa(x, y) u(y, t) dy, & x \geq 0, \\ u(x, 0) = u_0(x), \\ u(0, t) = 0. \end{cases} \quad (1.1)$$

The function $u(x, t)$ represents the quantity of individuals (cells or polymers) of structured variable (size, protein content...) x at time t . These individuals grow (*i.e.*, polymers aggregate monomers, or cells increase by nutrient uptake for instance) with the rate $\tau(x)$. Equation (1.1) also takes into account the fragmentation of a polymer (or the division of a cell) of size y into two smaller polymers of size x and $y-x$. This fragmentation occurs with a rate $\beta(y)$ and produce an aggregate of size x with the rate $\kappa(x, y)$.

Equation (1.1) is a particular case of the more general one

$$\frac{\partial}{\partial t}u(x, t) + \frac{\partial}{\partial x}(\tau(x)u(x, t)) + [\beta(x) + \mu(x)]u(x, t) = n \int_x^\infty \beta(y)\kappa(x, y)u(y, t)dy, \quad x \geq x_0, \quad (1.2)$$

with the bound condition $u(x_0, t) = 0$ (see [4, 20, 80]). Here, polymers are broken in an average of $n > 1$ smaller ones by the fragmentation process, there is a death term $\mu(x) \geq 0$ representing degradation, and a minimal size of polymers x_0 which can be positive. This more general model is biologically and mathematically relevant in the case of prion proliferation and is used in [19, 20, 63, 80] with a coupling to an ODE. Our results remain true for this generalization.

A fundamental tool to study the asymptotic behaviour of the population when $t \rightarrow \infty$ is the existence of eigenelements $(\lambda, \mathcal{U}, \phi)$ solution of the equation

$$\left\{ \begin{array}{l} \frac{\partial}{\partial x}(\tau(x)\mathcal{U}(x)) + (\beta(x) + \lambda)\mathcal{U}(x) = 2 \int_x^\infty \beta(y)\kappa(x, y)\mathcal{U}(y)dy, \quad x \geq 0, \\ \tau\mathcal{U}(x=0) = 0, \quad \mathcal{U}(x) \geq 0, \quad \int_0^\infty \mathcal{U}(x)dx = 1, \\ -\tau(x)\frac{\partial}{\partial x}(\phi(x)) + (\beta(x) + \lambda)\phi(x) = 2\beta(x) \int_0^x \kappa(y, x)\phi(y)dy, \quad x \geq 0, \\ \phi(x) \geq 0, \quad \int_0^\infty \phi(x)\mathcal{U}(x)dx = 1. \end{array} \right. \quad (1.3)$$

For the first equation (equation on \mathcal{U}) we are looking for \mathcal{D}' solutions defined as follows : $\mathcal{U} \in L^1(\mathbb{R}^+)$ is a \mathcal{D}' solution if $\forall \varphi \in \mathcal{C}_c^\infty(\mathbb{R}^+)$,

$$-\int_0^\infty \tau(x)\mathcal{U}(x)\partial_x\varphi(x)dx + \lambda \int_0^\infty \mathcal{U}(x)\varphi(x)dx = \int_0^\infty \beta(x)\mathcal{U}(x)\left(2 \int_0^\infty \varphi(y)\kappa(y, x)dy - \varphi(x)\right)dx. \quad (1.4)$$

Concerning the dual equation, we are looking for a solution $\phi \in W_{loc}^{1, \infty}(0, \infty)$ such that the equality holds in $L_{loc}^1(0, \infty)$, *i.e.* almost everywhere.

When such elements exist, the asymptotic growth rate for a solution to (1.1) is given by the first eigenvalue λ and the asymptotic shape is given by the corresponding eigenfunction \mathcal{U} . More precisely, it is proved for a constant fragmentation rate β that $u(x, t)e^{-\lambda t}$ converges exponentially fast to $\rho\mathcal{U}(x)$ where $\rho = \int u_0(y)dy$ (see [79, 111]). For more general fragmentation rates, one can use the dual eigenfunction ϕ and the so-called "General Relative Entropy" method introduced in [98, 110]. It provides similar results but without the exponential convergence, namely that

$$\int_0^\infty |u(y, t)e^{-\lambda t} - \langle u_0, \phi \rangle \mathcal{U}(y)|\phi(y)dy \xrightarrow[t \rightarrow \infty]{} 0$$

where $\langle u_0, \phi \rangle = \int u_0(y)\phi(y)dy$ (see [98, 99]).

The eigenvalue problem can also be used in nonlinear cases, such as prion proliferation equations, where there is a quadratic coupling of Equation (1.1) or (1.2) with a differential equation. In [19, 20, 43, 117] for instance, the stability of steady states is investigated. The use of entropy methods in the case of nonlinear problems remains however a challenging and widely open field (see [113] for a recent review).

Existence and uniqueness of eigenelements has already been proved for general fragmentation kernels $\kappa(x, y)$ and fragmentation rates $\beta(x)$, but with very particular polymerization rates $\tau(x)$, namely constant ($\tau \equiv 1$ in [110]), homogeneous ($\tau(x) = x^\mu$ in [95]) or with a compact support ($Supp \tau = [0, x_M]$ in [37]).

The aim of this article is to consider more general τ as [20, 124] suggest. Indeed, there is no biological justification to consider specific shapes of τ in the case when x represents a size (mass or volume) or some structuring variable and not the age of a cell (even in this last case it is not so clear that $\frac{dx}{dt} = 1$, since biological clocks may exhibit time distortions). For instance, for the prion proteins, the fact that the small aggregates are little infectious (see [83, 124]) leads us to include the case of rates vanishing at $x = 0$.

Considering fully general growth rates is thus indispensable to take into account biological or physical phenomena in their full diversity. The proof of [110] can be adapted for non constant rates but still positive and bounded ($0 < m < \tau(x) < M$). The paper [95] gives results for $\tau(0) = 0$, but for a very restricted class of shape for τ . The paper [37] gives results for τ with general shape in the case where there is also an age variable (integration in age then allows to recover Problem (1.1)), but requires a compact support and regular parameters. Here we consider polymerization rates that can vanish at $x = 0$, with general shape and few regularity for the all parameters (τ , β and κ).

From a mathematical viewpoint, relaxing as far as possible the assumptions on the rates τ, κ, β , as we have done in this article, also leads to a better understanding of the intrinsic mechanisms driving the competition between growth and fragmentation.

Theorem 1.1.1 (Existence and Uniqueness). *Under assumptions (1.5)-(1.13), there exists a unique solution $(\lambda, \mathcal{U}, \phi)$ (in the sense we have defined before) to the eigenproblem (1.3) and we have*

$$\begin{aligned} \lambda &> 0, \\ x^\alpha \tau \mathcal{U} &\in L^p(\mathbb{R}^+), \quad \forall \alpha \geq -\gamma, \quad \forall p \in [1, \infty], \\ x^\alpha \tau \mathcal{U} &\in W^{1,1}(\mathbb{R}^+), \quad \forall \alpha \geq 0 \\ \exists k > 0 \text{ s.t. } \frac{\phi}{1+x^k} &\in L^\infty(\mathbb{R}^+), \\ \tau \frac{\partial}{\partial x} \phi &\in L_{loc}^\infty(\mathbb{R}^+). \end{aligned}$$

The end of this paper is devoted to define precisely the assumptions and prove this theorem. It is organized as follows : in Section 1.2 we describe the assumptions and give some examples of interesting parameters. In Section 1.3 we prove Theorem 1.1.1 using *a priori* bounds on weighted norms and then we give some consequences and perspectives in Section 1.4. The proof of technical lemmas and theorem can be found in the Appendix.

1.2 Coefficients

1.2.1 Assumptions

For all $y \geq 0$, $\kappa(\cdot, y)$ is a nonnegative measure with a support included in $[0, y]$. We define κ on $(\mathbb{R}_+)^2$ as follows : $\kappa(x, y) = 0$ for $x > y$. We assume that for all continuous function ψ , the application $f_\psi : y \mapsto \int \psi(x) \kappa(x, y) dx$ is Lebesgue measurable.

The natural assumptions on κ (see [63] for the motivations) are that polymers can split only in two pieces which is taken into account by

$$\int \kappa(x, y) dx = 1. \quad (1.5)$$

So $\kappa(y, \cdot)$ is a probability measure and $f_\psi \in L_{loc}^\infty(\mathbb{R}^+)$. The conservation of mass imposes

$$\int x \kappa(x, y) dx = \frac{y}{2}, \quad (1.6)$$

a property that is automatically satisfied for a symmetric fragmentation (*i.e.* $\kappa(x, y) = \kappa(y-x, y)$) thanks to (1.5). For the more general model (1.2), assumption (1.6) becomes $\int x \kappa(x, y) dx = \frac{y}{n}$ to preserve the mass conservation.

We also assume that the second moment of κ is less than the first one

$$\int \frac{x^2}{y^2} \kappa(x, y) dx \leq c < 1/2 \quad (1.7)$$

(it becomes $c < 1/n$ for model (1.2)). We refer to the Examples for an explanation of the physical meaning.

For the polymerization and fragmentation rates τ and β , we introduce the set

$$\mathcal{P} := \{f \geq 0 : \exists \mu, \nu \geq 0, \limsup_{x \rightarrow \infty} x^{-\mu} f(x) < \infty \text{ and } \liminf_{x \rightarrow \infty} x^\nu f(x) > 0\}$$

and the space

$$L_0^1 := \{f, \exists a > 0, f \in L^1(0, a)\}.$$

We consider

$$\beta \in L_{loc}^1(\mathbb{R}^{+*}) \cap \mathcal{P}, \quad \exists \alpha_0 \geq 0 \text{ s.t. } \tau \in L_{loc}^\infty(\mathbb{R}^+, x^{\alpha_0} dx) \cap \mathcal{P} \quad (1.8)$$

satisfying

$$\forall K \text{ compact of } (0, \infty), \exists m_K > 0 \text{ s.t. } \tau(x) \geq m_K \text{ for a.e. } x \in K \quad (1.9)$$

(if τ is continuous, this assumption (1.9) is nothing but saying that for all $x > 0$, $\tau(x) > 0$) and

$$\exists b \geq 0, \text{ Supp}\beta = [b, \infty). \quad (1.10)$$

Assumption (1.10) is necessary to prove uniqueness and existence for the adjoint problem.

To avoid shattering (zero-size polymers formation, see [4, 80]), we assume

$$\exists C > 0, \gamma \geq 0 \text{ s.t. } \int_0^x \kappa(z, y) dz \leq \min\left(1, C\left(\frac{x}{y}\right)^\gamma\right) \quad \text{and} \quad \frac{x^\gamma}{\tau(x)} \in L_0^1 \quad (1.11)$$

which links implicitly τ to κ , and also

$$\frac{\beta}{\tau} \in L_0^1. \quad (1.12)$$

On the other hand, to avoid forming infinitely long polymers (gelation phenomenon, see [44, 46]), we assume

$$\lim_{x \rightarrow +\infty} \frac{x\beta(x)}{\tau(x)} = +\infty. \quad (1.13)$$

Remark 1.2.1. *In case when (1.11) is satisfied for $\gamma > 0$, then (1.7) is automatically fulfilled (see Lemma 1.5.1 in the Appendix).*

1.2.2 Examples

First we give some examples of coefficients which satisfy or not our previous assumptions.

For the fragmentation kernel, we first check the assumptions (1.5) and (1.6). They are satisfied for autosimilar measures, namely $\kappa(x, y) = \frac{1}{y}\kappa_0(\frac{x}{y})$, with κ_0 a probability measure on $[0, 1]$, symmetric in $1/2$. Now we exhibit some κ_0 .

General mitosis : a cell of size x divides in a cell of size rx and one of size $(1-r)x$ (see [96])

$$\kappa_0^r = \frac{1}{2}(\delta_r + \delta_{1-r}) \quad \text{for} \quad r \in [0, 1/2]. \quad (1.14)$$

Assumption (1.11) is satisfied for any $\gamma > 0$ in the cases when $r \in (0, 1/2]$. So (1.7) is also fulfilled thanks to Remark 1.2.1. The particular value $r = 1/2$ leads to equal mitosis ($\kappa(x, y) = \delta_{x=y}$).

The case $r = 0$ corresponds to the renewal equation ($\kappa(x, y) = \frac{1}{2}(\delta_{x=0} + \delta_{x=y})$). In this case, we cannot strictly speak of mitosis because the size of the daughters are 0 and x . It appears when x is the age of a cell and not the size. This particular case is precisely the one that we want to avoid with assumption (1.7) ; it can also be studied separately with different tools (see [113] for instance). For such a fragmentation

kernel, assumption (1.11) is satisfied only for $\gamma = 0$, and the moments $\int z^k \kappa_0(z) dz$ are equal to $1/2$ for all $k > 0$, so (1.7) does not hold true. However, if we consider a convex combination of κ_0^0 with another kernel such as κ_0^r with $r \in (0, 1/2]$, then (1.11) remains false for any $\gamma > 0$ but (1.7) is fulfilled. Indeed we have for $\rho \in (0, 1)$

$$\int z^2 (\rho \kappa_0^0(z) + (1 - \rho) \kappa_0^r(z)) dz = \frac{\rho}{2} + \frac{1 - \rho}{2} (r^2 + (1 - r)^2) = \frac{1}{2} (1 - 2r(1 - r)(1 - \rho)) < \frac{1}{2}.$$

Homogeneous fragmentation :

$$\kappa_0^\alpha(z) = \frac{\alpha + 1}{2} (z^\alpha + (1 - z)^\alpha) \quad \text{for} \quad \alpha > -1. \quad (1.15)$$

It gives another class of fragmentation kernels, namely in L^1 (unlike the mitosis case). The parameter $\gamma = 1 + \alpha > 0$ suits for (1.11) and so (1.7) is fulfilled. It shows that our assumptions allow fragmentation at the ends of the polymers (called depolymerization, see [83], when α is close to -1) once it is not the extreme case of renewal equation.

Uniform repartition ($\kappa(x, y) = \frac{1}{y} \mathbb{1}_{0 \leq x \leq y}$) corresponds to $\alpha = 0$ and is also included.

This last case of uniform repartition is useful because it provides us with explicit formulas for the eigenelements. For instance, we can consider the two following examples.

First example : $\tau(x) = \tau_0$, $\beta(x) = \beta_0 x$.

In this case, widely used by [63], the eigenelements exist and we have

$$\begin{aligned} \lambda &= \sqrt{\beta_0 \tau_0}, \\ \mathcal{U}(x) &= 2\sqrt{\frac{\beta_0}{\tau_0}} \left(X + \frac{X^2}{2} \right) e^{-X - \frac{X^2}{2}}, \quad \text{with } X = \sqrt{\frac{\beta_0}{\tau_0}} x, \\ \phi(x) &= \frac{1}{2} (1 + X). \end{aligned}$$

Second example : $\tau(x) = \tau_0 x$.

For such β for which there exists eigenelements, we have

$$\lambda = \tau_0 \quad \text{and} \quad \phi(x) = \frac{x}{\int y \mathcal{U}(y)}.$$

For instance when $\beta(x) = \beta_0 x^n$ with $n \in \mathbb{N}^*$, then the eigenelements exist and we can compute \mathcal{U} and ϕ and we have the formulas in Table 1.1. In this table we can notice that $\mathcal{U}(0) > 0$ but the boundary condition $\tau \mathcal{U}(0) = 0$ is fulfilled.

$n = 1$	$\lambda = \tau_0$	$\mathcal{U}(x) = \frac{\beta_0}{\tau_0} e^{-\frac{\beta_0}{\tau_0} x}$	$\phi(x) = \frac{\beta_0 x}{\tau_0}$
$n = 2$	$\lambda = \tau_0$	$\mathcal{U}(x) = \sqrt{\frac{2\beta_0}{\pi\tau_0}} e^{-\frac{1}{2} \frac{\beta_0}{\tau_0} x^2}$	$\phi(x) = \sqrt{\frac{\pi\beta_0}{2\tau_0}} x$
n	$\lambda = \tau_0$	$\mathcal{U}(x) = \left(\frac{\beta_0}{n\tau_0} \right)^{\frac{1}{n}} \frac{n}{\Gamma(\frac{1}{n})} e^{-\frac{1}{n} \frac{\beta_0}{\tau_0} x^n}$	$\phi(x) = \left(\frac{\beta_0}{n\tau_0} \right)^{\frac{1}{n}} \frac{\Gamma(\frac{1}{n})}{\Gamma(\frac{2}{n})} x$

Table 1.1: The example $\tau(x) = \tau_0 x$, $\beta(x) = \beta_0 x^n$ and uniform repartition $\kappa(x, y) = \frac{1}{y} \mathbb{1}_{0 \leq x \leq y}$. The table gives the eigenelements solution to (1.3).

Now we turn to non-existence cases. Let us consider constant fragmentation $\beta(x) = \beta_0$ with an affine polymerization $\tau(x) = \tau_0 + \tau_1 x$, and any fragmentation kernel κ which satisfies to assumptions (1.5)-(1.6). We notice that (1.13) is not satisfied and look at two instructive cases.

First case : $\tau_0 = 0$.

In this case assumption (1.12) does not hold true. Assume that there exists $\mathcal{U} \in L^1(\mathbb{R}^+)$ solution of (1.3) with the estimates of Theorem 1.1.1. Integrating the equation on \mathcal{U} we obtain that $\lambda = \beta_0$, but multiplying the equation by x before integration we have that $\lambda = \tau_1$. We conclude that eigenelements cannot exist if $\tau_1 \neq \beta_0$.

Moreover, if we take $\kappa(x, y) = \frac{1}{y} \mathbb{1}_{0 \leq x \leq y}$, then a formal computation shows that any solution to the first equation of (1.3) belongs to the plan $Vect\{x^{-1}, x^{-\frac{2\beta_0}{\tau_1}}\}$. So, even if $\beta_0 = \tau_1$, there does not exist an eigenvector in L^1 .

Second case : $\tau_0 > 0$.

In this case (1.12) holds true but the same integrations than before lead to

$$\int x\mathcal{U}(x) dx = \frac{\tau_0}{\beta_0 - \tau_1}.$$

So there cannot exist any eigenvector $\mathcal{U} \in L^1(x dx)$ for $\tau_1 \geq \beta_0$.

1.3 Proof of the main theorem

The proof of Theorem 1.1.1 is divided as follows. We begin with a result concerning the positivity of the *a priori* existing eigenvectors (Lemma 1.3.1). We then define, in Section 1.3.2, a regularized and truncated problem for which we know that eigenelements exist (see the Appendix 1.5.2 for a proof using the Krein-Rutman theorem), and we choose it such that the related eigenvalue is positive (Lemma 1.3.3). In Section 1.3.3, we give a series of estimates that allow us to pass to the limit in the truncated problem and so prove the existence for the original eigenproblem (1.3). The positivity of the eigenvalue λ and the uniqueness of the eigenelements are proved in the two last subsections.

1.3.1 A preliminary lemma

Before proving Theorem 1.1.1, we give a preliminary lemma, useful to prove uniqueness of the eigenfunctions.

Lemma 1.3.1 (Positivity). *Consider \mathcal{U} and ϕ solutions to the eigenproblem (1.3).*

We define $m := \inf_{x,y} \{x : (x, y) \in \text{Supp } \beta(y)\kappa(x, y)\}$. Then we have, under assumptions (1.5), (1.6), (1.9) and (1.10)

$$\begin{aligned} \text{Supp } \mathcal{U} &= [m, \infty) \quad \text{and} \quad \tau\mathcal{U}(x) > 0 \quad \forall x > m, \\ \phi(x) &> 0 \quad \forall x > 0. \end{aligned}$$

If additionally $\frac{1}{\tau} \in L^1_0$, then $\phi(0) > 0$.

Remark 1.3.2. *In case $\text{Supp } \kappa = \{(x, y)/x \leq y\}$, then $m = 0$ and Lemma 1.3.1 and Theorem 1.1.1 can be proved without the connexity condition (1.10) on the support of β .*

Proof. Let $x_0 > 0$, we define $F : x \mapsto \tau(x)\mathcal{U}(x)e^{\int_{x_0}^x \frac{\lambda + \beta(s)}{\tau(s)} ds}$. We have that

$$F'(x) = 2e^{\int_{x_0}^x \frac{\lambda + \beta(s)}{\tau(s)} ds} \int \beta(y)\kappa(x, y)\mathcal{U}(y) dy \geq 0. \quad (1.16)$$

So, as soon as $\tau\mathcal{U}(x)$ once becomes positive, it remains positive for larger x .

We define $a := \inf\{x : \tau(x)\mathcal{U}(x) > 0\}$. We first prove that $a \leq \frac{b}{2}$. For this we integrate the equation on $[0, a]$ to obtain

$$\int_0^a \int_a^\infty \beta(y)\kappa(x, y)\mathcal{U}(y) dy dx = 0,$$

$$\int_a^\infty \beta(y)\mathcal{U}(y) \int_0^a \kappa(x,y) dx dy = 0.$$

Thus for almost every $y \geq \max(a, b)$, $\int_0^a \kappa(x, y) dx = 0$. As a consequence we have

$$1 = \int \kappa(x, y) dx = \int_a^y \kappa(x, y) dx \leq \frac{1}{a} \int x\kappa(x, y) dx = \frac{y}{2a}$$

thanks to (1.5) and (1.6), and this is possible only if $b \geq 2a$.

Assume by contradiction that $m < a$, integrating (1.3) multiplied by φ , we have for all $\varphi \in \mathcal{C}_c^\infty$ such that $\text{Supp } \varphi \subset [0, a]$

$$\int \int \varphi(x)\beta(y)\kappa(x,y)\mathcal{U}(y) dy dx = 0. \quad (1.17)$$

By definition of m and using the fact that $m < a$, there exists $(p, q) \in (m, a) \times (b, \infty)$ such that $(p, q) \in \text{Supp } \beta(y)\kappa(x, y)$. But we can choose φ positive such that $\varphi(p)\mathcal{U}(q) > 0$ and this is a contradiction with (1.17). So we have $m \geq a$.

To conclude we notice that on $[0, m]$, \mathcal{U} satisfies

$$\partial_x(\tau(x)\mathcal{U}(x)) + \lambda\mathcal{U}(x) = 0.$$

So, thanks to the condition $\tau(0)\mathcal{U}(0) = 0$ and the assumption (1.9), we have $\mathcal{U} \equiv 0$ on $[0, m]$, so $m = a$ and the first statement is proved.

For ϕ , we define $G(x) := \phi(x)e^{-\int_{x_0}^x \frac{\lambda+\beta(s)}{\tau(s)} ds}$. We have that

$$G'(x) = -2e^{-\int_{x_0}^x \frac{\lambda+\beta(s)}{\tau(s)} ds} \beta(x) \int_0^x \kappa(y, x)\phi(y) dy \leq 0, \quad (1.18)$$

so, as soon as ϕ vanishes, it remains null. Therefore ϕ is positive on an interval $(0, x_1)$ with $x_1 \in \mathbb{R}_+^* \cup \{+\infty\}$. Assuming that $x_1 < +\infty$ and using that $x_1 > a = m$ because $\int \phi(x)\mathcal{U}(x)dx = 1$, we can find $X \geq x_1$ such that

$$\int_{x_1}^X G'(x) dx = -2 \int_{x_1}^X \int_0^{x_1} e^{\int_{x_0}^x \frac{\lambda+\beta(s)}{\tau(s)} ds} \phi(y)\beta(x)\kappa(y, x) dy dx < 0.$$

This contradicts that $\phi(x) = 0$ for $x \geq x_1$, and we have proved that $\phi(x) > 0$ for $x > 0$.

If $\frac{1}{\tau} \in L_0^1$, we can take $x_0 = 0$ in the definition of G and so $\phi(0) > 0$ or $\phi \equiv 0$. The fact that ϕ is positive ends the proof of the lemma. □

1.3.2 Truncated problem

The proof of the theorem is based on uniform estimates on the solution to a truncated equation. Let η, δ, R positive numbers and define

$$\tau_\eta(x) = \begin{cases} \eta & 0 \leq x \leq \eta \\ \tau(x) & x \geq \eta. \end{cases}$$

Then τ_η is lower bounded on $[0, R]$ thanks to (1.9) and we denote by $\mu = \mu(\eta, R) := \inf_{[0, R]} \tau_\eta$. The existence of eigenelements $(\lambda_\eta^\delta, \mathcal{U}_\eta^\delta, \phi_\eta^\delta)$ for the following truncated problem when $\delta R < \mu$ is standard (see Theorem 1.5.2 in the Appendix).

$$\left\{ \begin{array}{l} \frac{\partial}{\partial x}(\tau_\eta(x)\mathcal{U}_\eta^\delta(x)) + (\beta(x) + \lambda_\eta^\delta)\mathcal{U}_\eta^\delta(x) = 2 \int_x^R \beta(y)\kappa(x,y)\mathcal{U}_\eta^\delta(y) dy, \quad 0 < x < R, \\ \tau_\eta\mathcal{U}_\eta^\delta(x=0) = \delta, \quad \mathcal{U}_\eta^\delta(x) > 0, \quad \int \mathcal{U}_\eta^\delta(x)dx = 1, \\ -\tau_\eta(x)\frac{\partial}{\partial x}\phi_\eta^\delta(x) + (\beta(x) + \lambda_\eta^\delta)\phi_\eta^\delta(x) - 2\beta(x) \int_0^x \kappa(y,x)\phi_\eta^\delta(y) dy = \delta\phi_\eta^\delta(0), \quad 0 < x < R, \\ \phi_\eta^\delta(R) = 0, \quad \phi_\eta^\delta(x) > 0, \quad \int \phi_\eta^\delta(x)\mathcal{U}_\eta^\delta(x)dx = 1. \end{array} \right. \quad (1.19)$$

The proof of the theorem 1.1.1 requires $\lambda_\eta^\delta > 0$. To enforce it, we take $\delta R = \frac{\mu}{2}$ and we consider R large enough to satisfy the following lemma.

Lemma 1.3.3. *Under assumptions (1.5), (1.8) and (1.13), there exists a $R_0 > 0$ such that for all $R > R_0$, if we choose $\delta = \frac{\mu}{2R}$, then we have $\lambda_\eta^\delta > 0$.*

Proof. Assume by contradiction that $R > 0$ and $\lambda_\eta^\delta \leq 0$ with $\delta = \frac{\mu}{2R}$. Then, integrating between 0 and $x > 0$, we obtain

$$\begin{aligned} 0 &\geq \lambda \int_0^x \mathcal{U}(y) dy \\ &= \delta - \tau(x)\mathcal{U}(x) - \int_0^x \beta(y)\mathcal{U}(y) dy + 2 \int_0^x \int_z^R \beta(y)\kappa(z,y)\mathcal{U}(y) dy dz \\ &= \delta - \tau(x)\mathcal{U}(x) + \int_0^x \beta(y)\mathcal{U}(y) dy + 2 \int_x^R \left(\int_0^x \kappa(z,y) dz \right) \beta(y)\mathcal{U}(y) dy \\ &\geq \delta - \tau(x)\mathcal{U}(x) + \int_0^x \beta(y)\mathcal{U}(y) dy. \end{aligned}$$

Consequently

$$\tau(x)\mathcal{U}(x) \geq \delta + \int_0^x \frac{\beta(y)}{\tau(y)}\tau(y)\mathcal{U}(y) dy$$

and, thanks to Grönwall's lemma,

$$\tau(x)\mathcal{U}(x) \geq \delta e^{\int_0^x \frac{\beta(y)}{\tau(y)} dy}.$$

But assumption (1.13) ensures that for all $n \geq 0$, there is a $A > 0$ such that

$$\frac{\beta(x)}{\tau(x)} \geq \frac{n}{x}, \quad \forall x \geq A$$

and thus we have

$$\tau(x)\mathcal{U}(x) \geq \delta \left(\frac{x}{A} \right)^n, \quad \forall x \geq A.$$

Thanks to Assumption (1.8), we can choose n such that $x^{-n}\tau(x) \rightarrow 0$ when $x \rightarrow +\infty$. Then there exists $B > A$ such that $x^{-n}\tau(x) \leq \frac{\mu}{4A^n}$ for $x \geq B$, and we have, for $R > B$,

$$1 = \int_0^R \mathcal{U}(x) dx \geq \int_B^R \mathcal{U}(x) dx \geq \delta \int_B^R \frac{x^n}{A^n \tau(x)} dx \geq \frac{2}{R}(R - B)$$

what is a contradiction as soon as $R > 2B$; so Lemma 1.3.3 holds for $R_0 = 2B$. □

1.3.3 Limit as $\delta \rightarrow 0$ for \mathcal{U}_η^δ and λ_η^δ

Fix η and let $\delta \rightarrow 0$ (then $R \rightarrow \infty$ since $\delta R = \frac{\mu}{2}$).

First estimate: λ_η^δ upper bound. Integrating equation (1.19) between 0 and R , we find

$$\lambda_\eta^\delta \leq \delta + \int \beta(x) \mathcal{U}_\eta^\delta(x) dx,$$

then the idea is to prove a uniform estimate on $\int \beta \mathcal{U}_\eta^\delta$. For this we begin with bounding the higher moments $\int x^\alpha \beta \mathcal{U}_\eta^\delta$ for $\alpha \geq \max(2, \alpha_0 + 1) := m$.

Let $\alpha \geq m$, according to (1.7) we have

$$\int \frac{x^\alpha}{y^\alpha} \kappa(x, y) dx \leq \int \frac{x^2}{y^2} \kappa(x, y) dx \leq c < \frac{1}{2}.$$

Multiplying the equation on \mathcal{U}_η^δ by x^α and then integrating on $[0, R]$, we obtain for all $A \geq \eta$

$$\begin{aligned} \int x^\alpha ((1 - 2c)\beta(x)) \mathcal{U}_\eta^\delta(x) dx &\leq \alpha \int x^{\alpha-1} \tau_\eta(x) \mathcal{U}_\eta^\delta(x) dx \\ &= \alpha \int_{x \leq A} x^{\alpha-1} \tau_\eta(x) \mathcal{U}_\eta^\delta(x) dx + \alpha \int_{x \geq A} x^{\alpha-1} \tau(x) \mathcal{U}_\eta^\delta(x) dx \\ &\leq \alpha A^{\alpha-1-\alpha_0} \sup_{x \in (0, A)} \{x^{\alpha_0} \tau(x)\} + \omega_{A, \alpha} \int x^\alpha \beta(x) \mathcal{U}_\eta^\delta(x) dx, \end{aligned}$$

where $\omega_{A, \alpha}$ is a positive number chosen to have $\alpha \tau(x) \leq \omega_{A, \alpha} x \beta(x)$, $\forall x \geq A$. Thanks to (1.7) and (1.13), we can choose A_α large enough to have $\omega_{A_\alpha, \alpha} < 1 - 2c$. Thus we find

$$\forall \alpha \geq m, \exists A_\alpha : \forall \eta, \delta > 0, \quad \int x^\alpha \beta(x) \mathcal{U}_\eta^\delta(x) dx \leq \frac{\alpha A_\alpha^{\alpha-1-\alpha_0} \sup_{(0, A)} \{x^{\alpha_0} \tau(x)\}}{1 - 2c - \omega_{A_\alpha, \alpha}} := B_\alpha. \quad (1.20)$$

The next step is to prove the same estimates for $0 \leq \alpha < m$ and for this we first give a bound on $\tau_\eta \mathcal{U}_\eta^\delta$. We fix $\rho \in (0, 1/2)$ and define $x_\eta > 0$ as the unique point such that $\int_0^{x_\eta} \frac{\beta(y)}{\tau_\eta(y)} dy = \rho$. It exists because β is nonnegative and locally integrable, and τ_η is positive. Thanks to assumption (1.12), we know that $x_\eta \xrightarrow{\eta \rightarrow 0} x_0$ where $x_0 > 0$ satisfies $\int_0^{x_0} \frac{\beta(y)}{\tau(y)} dy = \rho$, so x_η is bounded by $0 < \underline{x} \leq x_\eta \leq \bar{x}$. Then, integrating (1.19) between 0 and $x \leq x_\eta$, we find

$$\begin{aligned} \tau_\eta(x) \mathcal{U}_\eta^\delta(x) &\leq \delta + 2 \int_0^x \int \beta(y) \mathcal{U}_\eta^\delta(y) \kappa(z, y) dy dz \\ &\leq \delta + 2 \int \beta(y) \mathcal{U}_\eta^\delta(y) dy \\ &= \delta + 2 \int_0^{x_\eta} \beta(y) \mathcal{U}_\eta^\delta(y) dy + 2 \int_{x_\eta}^\infty \beta(y) \mathcal{U}_\eta^\delta(y) dy \\ &\leq \delta + 2 \sup_{(0, x_\eta)} \{\tau_\eta \mathcal{U}_\eta^\delta\} \int_0^{x_\eta} \frac{\beta(y)}{\tau_\eta(y)} dy + \frac{2}{x_\eta^m} \int_0^\infty y^m \beta(y) \mathcal{U}_\eta^\delta(y) dy \\ &\leq \delta + 2\rho \sup_{(0, x_\eta)} \{\tau_\eta \mathcal{U}_\eta^\delta\} + \frac{2}{x_\eta^m} B_m. \end{aligned}$$

Consequently, if we consider $\delta \leq 1$ for instance, we obtain

$$\sup_{x \in (0, \underline{x})} \tau_\eta(x) \mathcal{U}_\eta^\delta(x) \leq \frac{1 + 2B_m/\underline{x}^m}{1 - 2\rho} := C \quad (1.21)$$

so $\tau_\eta \mathcal{U}_\eta^\delta$ is uniformly bounded in a neighborhood of zero.

Now we can prove a bound B_α for $x^\alpha \beta \mathcal{U}_\eta^\delta$ in the case $0 \leq \alpha < m$. Thanks to the estimates (1.20) and (1.21) we have

$$\begin{aligned} \int x^\alpha \beta(x) \mathcal{U}_\eta^\delta(x) dx &= \int_0^{\bar{x}} x^\alpha \beta(x) \mathcal{U}_\eta^\delta(x) dx + \int_{\bar{x}}^R x^\alpha \beta(x) \mathcal{U}_\eta^\delta(x) dx \\ &\leq \bar{x}^\alpha \sup_{(0, \bar{x})} \{\tau_\eta \mathcal{U}_\eta^\delta\} \int_0^{\bar{x}} \frac{\beta(y)}{\tau_\eta(y)} dy + \bar{x}^{\alpha-m} \int_{\bar{x}}^R x^m \beta(x) \mathcal{U}_\eta^\delta(x) dx \\ &\leq C \rho \bar{x}^\alpha + B_m \bar{x}^{\alpha-m} := B_\alpha. \end{aligned} \quad (1.22)$$

Combining (1.20) and (1.22) we obtain

$$\forall \alpha \geq 0, \exists B_\alpha : \forall \eta, \delta > 0, \quad \int x^\alpha \beta(x) \mathcal{U}_\eta^\delta(x) dx \leq B_\alpha, \quad (1.23)$$

and finally we bound λ_η^δ

$$\lambda_\eta^\delta = \delta + \int \beta \mathcal{U}_\eta^\delta \leq \delta + B_0. \quad (1.24)$$

So the family $\{\lambda_\eta^\delta\}_\delta$ belong to a compact interval and we can extract a converging subsequence $\lambda_\eta^\delta \xrightarrow{\delta \rightarrow 0} \lambda_\eta$.

Second estimate : $W^{1,1}$ bound for $x^\alpha \tau_\eta \mathcal{U}_\eta^\delta$, $\alpha \geq 0$. We use the estimate (1.23). First we give a L^∞ bound for $\tau_\eta \mathcal{U}_\eta^\delta$ by integrating (1.19) between 0 and x

$$\tau_\eta(x) \mathcal{U}_\eta^\delta(x) \leq \delta + 2 \int_0^R \beta(y) \mathcal{U}_\eta^\delta(y) dy \leq \delta + 2B_0 := D_0. \quad (1.25)$$

Then we bound $x^\alpha \tau_\eta \mathcal{U}_\eta^\delta$ in L^1 for $\alpha > -1$. Assumption (1.13) ensures that there exists $X > 0$ such that $\tau(x) \leq x\beta(x)$, $\forall x \geq X$, so we have for $R > X$

$$\begin{aligned} \int x^\alpha \tau_\eta(x) \mathcal{U}_\eta^\delta(x) dx &\leq \sup_{(0, X)} \{\tau_\eta \mathcal{U}_\eta^\delta\} \int_0^X x^\alpha dx + \int_X^R x^{\alpha+1} \beta(x) \mathcal{U}_\eta^\delta(x) dx \\ &\leq \sup_{(0, X)} \{\tau_\eta \mathcal{U}_\eta^\delta\} \frac{X^{\alpha+1}}{\alpha+1} + B_{\alpha+1} := C_\alpha. \end{aligned}$$

Finally

$$\forall \alpha > -1, \exists C_\alpha : \forall \eta, \delta > 0, \quad \int x^\alpha \tau_\eta(x) \mathcal{U}_\eta^\delta(x) dx \leq C_\alpha \quad (1.26)$$

and we also have that $x^\alpha \mathcal{U}_\eta^\delta$ is bounded in L^1 because $\tau \in \mathcal{P}$ (see assumption (1.8)).

A consequence of (1.23) and (1.26) is that $x^\alpha \tau_\eta \mathcal{U}_\eta^\delta$ is bound in L^∞ for all $\alpha \geq 0$. We already have (1.25) and for $\alpha > 0$, we multiply (1.19) by x^α , integrate on $[0, x]$ and obtain

$$x^\alpha \tau_\eta(x) \mathcal{U}_\eta^\delta(x) \leq \alpha \int_0^R y^{\alpha-1} \tau_\eta(y) \mathcal{U}_\eta^\delta(y) dy + 2 \int_0^R y^\alpha \beta(y) \mathcal{U}_\eta^\delta(y) dy \leq \alpha C_\alpha + 2B_\alpha := D_\alpha,$$

that give immediately

$$\forall \alpha \geq 0, \exists D_\alpha : \forall \eta, \delta > 0, \quad \sup_{x>0} x^\alpha \tau_\eta(x) \mathcal{U}_\eta^\delta(x) \leq D_\alpha. \quad (1.27)$$

To conclude we use the fact that neither the parameters nor \mathcal{U}_η^δ are negative and we find by the chain rule, for $\alpha \geq 0$

$$\int \left| \frac{\partial}{\partial x} (x^\alpha \tau_\eta(x) \mathcal{U}_\eta^\delta(x)) \right| dx \leq \alpha \int x^{\alpha-1} \tau_\eta(x) \mathcal{U}_\eta^\delta(x) dx + \int x^\alpha |\partial_x (\tau_\eta(x) \mathcal{U}_\eta^\delta(x))| dx$$

$$\leq \alpha \int x^{\alpha-1} \tau_\eta(x) \mathcal{U}_\eta^\delta(x) dx + \lambda_\eta^\delta \int x^\alpha \mathcal{U}_\eta^\delta(x) dx + 3 \int x^\alpha \beta(x) \mathcal{U}_\eta^\delta(x) dx \quad (1.28)$$

and all the terms in the right hand side are uniformly bounded thanks to the previous estimates.

Since we have proved that the family $\{x^\alpha \tau_\eta \mathcal{U}_\eta^\delta\}_\delta$ is bounded in $W^{1,1}(\mathbb{R}^+)$ for all $\alpha \geq 0$, then, because τ_η is positive and belongs to \mathcal{P} , we can extract from $\{\mathcal{U}_\eta^\delta\}_\delta$ a subsequence which converges in $L^1(\mathbb{R}^+)$ when $\delta \rightarrow 0$. Passing to the limit in equation (1.19) we find that

$$\begin{cases} \frac{\partial}{\partial x} (\tau_\eta(x) \mathcal{U}_\eta(x)) + (\beta(x) + \lambda_\eta) \mathcal{U}_\eta(x) = 2 \int_x^\infty \beta(y) \kappa(x, y) \mathcal{U}_\eta(y) dy, \\ \mathcal{U}_\eta(0) = 0, \quad \mathcal{U}_\eta(x) \geq 0, \quad \int \mathcal{U}_\eta = 1, \end{cases} \quad (1.29)$$

with $\lambda_\eta \geq 0$.

1.3.4 Limit as $\eta \rightarrow 0$ for \mathcal{U}_η and λ_η

All the estimates (1.20)-(1.28) remain true for $\delta = 0$. So we still know that the family $\{x^\alpha \tau_\eta \mathcal{U}_\eta\}_\eta$ belongs to a compact set of L^1 , but not necessarily $\{\mathcal{U}_\eta\}_\eta$ because in the limit τ can vanish at zero. We need one more estimate to study the limit $\eta \rightarrow 0$.

Third estimate: L^∞ bound for $x^\alpha \tau_\eta \mathcal{U}_\eta$, $\alpha \geq -\gamma$. We already know that $x^\alpha \tau_\eta \mathcal{U}_\eta$ is bounded for $\alpha \geq 0$. So, to prove the bound, it only remains to prove that $x^{-\gamma} \tau_\eta \mathcal{U}_\eta$ is bounded in a neighborhood of zero. Let define $f_\eta : x \mapsto \sup_{(0,x)} \tau_\eta \mathcal{U}_\eta$. If we integrate (1.29) between 0 and $x' < x$, we find

$$\tau_\eta(x') \mathcal{U}_\eta(x') \leq 2 \int_0^{x'} \int \beta(y) \mathcal{U}_\eta(y) \kappa(z, y) dy dz \leq 2 \int_0^x \int \beta(y) \mathcal{U}_\eta(y) \kappa(z, y) dy dz$$

and so for all x

$$f_\eta(x) \leq 2 \int_0^x \int \beta(y) \mathcal{U}_\eta(y) \kappa(z, y) dy dz.$$

We consider x_η and \underline{x} defined in the first estimate and, using (1.11) and (1.12), we have for all $x < x_\eta$

$$\begin{aligned} f_\eta(x) &\leq 2 \int_0^x \int \beta(y) \mathcal{U}_\eta(y) \kappa(z, y) dy dz \\ &= 2 \int \beta(y) \mathcal{U}_\eta(y) \int_0^x \kappa(z, y) dz dy \\ &\leq 2 \int_0^\infty \beta(y) \mathcal{U}_\eta(y) \min\left(1, C \left(\frac{x}{y}\right)^\gamma\right) dy \\ &= 2 \int_0^x \beta(y) \mathcal{U}_\eta(y) dy + 2C \int_x^{x_\eta} \beta(y) \mathcal{U}_\eta(y) \left(\frac{x}{y}\right)^\gamma dy + 2C \int_{x_\eta}^\infty \beta(y) \mathcal{U}_\eta(y) \left(\frac{x}{y}\right)^\gamma dy \\ &= 2 \int_0^x \frac{\beta(y)}{\tau_\eta(y)} \tau_\eta(y) \mathcal{U}_\eta(y) dy + 2Cx^\gamma \int_x^{x_\eta} \frac{\beta(y)}{\tau_\eta(y)} \frac{\tau_\eta(y) \mathcal{U}_\eta(y)}{y^\gamma} dy + 2C \int_{x_\eta}^\infty \beta(y) \mathcal{U}_\eta(y) \left(\frac{x}{y}\right)^\gamma dy \\ &\leq 2f_\eta(x) \int_0^{x_\eta} \frac{\beta(y)}{\tau_\eta(y)} dy + 2Cx^\gamma \int_x^{x_\eta} \frac{\beta(y)}{\tau_\eta(y)} \frac{f_\eta(y)}{y^\gamma} dy + 2C \|\beta \mathcal{U}_\eta\|_{L^1} \frac{x^\gamma}{x_\eta^\gamma}. \end{aligned}$$

We set $\mathcal{V}_\eta(x) = x^{-\gamma} f_\eta(x)$ and we obtain

$$(1 - 2\rho) \mathcal{V}_\eta(x) \leq K + 2C \int_x^{x_\eta} \frac{\beta(y)}{\tau_\eta(y)} \mathcal{V}_\eta(y) dy.$$

Hence, using Grönwall's lemma, we find that $\mathcal{V}_\eta(x) \leq \frac{Ke^{\frac{2C\rho}{1-2\rho}}}{1-2\rho}$ and consequently

$$x^{-\gamma}\tau_\eta(x)\mathcal{U}_\eta(x) \leq \frac{Ke^{\frac{2C\rho}{1-2\rho}}}{1-2\rho} := \tilde{C}, \quad \forall x \in [0, \underline{x}]. \quad (1.30)$$

This last estimate allows us to bound \mathcal{U}_η by $\frac{x^\gamma}{\tau}$ which is in L_0^1 by the assumption (1.11). Thanks to the second estimate, we also have that $\int x^\alpha \mathcal{U}_\eta$ is bounded in L^1 and so, thanks to the Dunford-Pettis theorem (see [14] for instance), $\{\mathcal{U}_\eta\}_\eta$ belong to a L^1 -weak compact set. Thus we can extract a subsequence which converges L^1 -weak toward \mathcal{U} . But for all $\varepsilon > 0$, $\{x^\alpha \mathcal{U}_\eta\}_\eta$ is bounded in $W^{1,1}([\varepsilon, \infty))$ for all $\alpha \geq 1$ thanks to (1.28) and so the convergence is strong on $[\varepsilon, \infty)$. Then we write

$$\begin{aligned} \int |\mathcal{U}_\eta - \mathcal{U}| &= \int_0^\varepsilon |\mathcal{U}_\eta - \mathcal{U}| + \int_\varepsilon^\infty |\mathcal{U}_\eta - \mathcal{U}| \\ &\leq 2\tilde{C} \int_0^\varepsilon \frac{x^\gamma}{\tau(x)} + \int_\varepsilon^\infty |\mathcal{U}_\eta - \mathcal{U}|. \end{aligned}$$

The first term on the right hand side is small for ε small because $\frac{x^\gamma}{\tau} \in L_0^1$ and then the second term is small for η small because of the strong convergence. Finally $\mathcal{U}_\eta \xrightarrow{\eta \rightarrow 0} \mathcal{U}$ strongly in $L^1(\mathbb{R}^+)$ and \mathcal{U} solution of the eigenproblem (1.3).

1.3.5 Limit as $\delta, \eta \rightarrow 0$ for ϕ_η^δ

We prove uniform estimates on ϕ_η^δ which are enough to pass to the limit and prove the result.

Fourth estimate : uniform ϕ_η^δ -bound on $[0, A]$. Let $A > 0$, our first goal is to prove the existence of a constant $C_0(A)$ such that

$$\forall \eta, \delta, \quad \sup_{(0, A)} \phi_\eta^\delta \leq C_0(A).$$

We divide the equation on ϕ_η^δ by τ_η and we integrate between x and x_η with $0 < x < x_\eta$, where x_η , bounded by \underline{x} and \bar{x} , is defined in the first estimate. Considering $\delta < \frac{\mu(1-2\rho)}{\bar{x}}$ (fulfilled for $R > \frac{\bar{x}}{2(1-2\rho)}$ since $\delta = \frac{\mu}{2R}$), we find

$$\begin{aligned} \phi_\eta^\delta(x) &\leq \phi_\eta^\delta(x_\eta) + 2 \int_x^{x_\eta} \frac{\beta(y)}{\tau_\eta(y)} \int_0^y \kappa(z, y) \phi_\eta^\delta(z) dz + x_\eta \frac{\delta}{\mu} \phi_\eta^\delta(0) \\ &\leq \phi_\eta^\delta(x_\eta) + \sup_{(0, x_\eta)} \{\phi_\eta^\delta\} \left(2 \int_0^{x_\eta} \frac{\beta(y)}{\tau_\eta(y)} \int_0^y \kappa(z, y) dz + x_\eta \frac{\delta}{\mu} \right) \end{aligned}$$

and we obtain

$$\sup_{x \in (0, \underline{x})} \phi_\eta^\delta(x) \leq \frac{1}{1-2\rho - \delta\bar{x}/\mu} \phi_\eta^\delta(x_\eta).$$

Using the decay of $\phi_\eta^\delta(x) e^{-\int_x^{x_\eta} \frac{\beta+\lambda_\eta^\delta}{\tau_\eta}}$, there exists $C(A)$ such that

$$\sup_{x \in (0, A)} \phi_\eta^\delta(x) \leq C(A) \phi_\eta^\delta(x_\eta).$$

Noticing that $\int \phi_\eta^\delta(x) \mathcal{U}_\eta^\delta(x) dx = 1$, we conclude

$$1 \geq \int_0^{x_\eta} \phi_\eta^\delta(x) \mathcal{U}_\eta^\delta(x) dx \geq \phi_\eta^\delta(x_\eta) \int_0^{x_\eta} e^{-\int_x^{x_\eta} \frac{\beta+\lambda_\eta^\delta}{\tau_\eta}} \mathcal{U}_\eta^\delta(x) dx,$$

so, as $x_\eta \rightarrow x_0$ and $\int_0^{x_0} \mathcal{U}(x)dx > 0$ (thanks to Lemma 1.3.1 and because $x_0 > b \geq a$), we have

$$\sup_{(0,A)} \phi_\eta^\delta \leq C_0(A). \quad (1.31)$$

Fifth estimate : uniform ϕ_η^δ -bound on $[A, \infty)$. Following an idea introduced in [111] we notice that the equation in (1.19) satisfied by ϕ_η^δ is a transport equation and therefore satisfies the maximum principle (see Lemma 1.5.3 in the Appendix). Therefore it remains to build a supersolution $\bar{\phi}$ that is positive at $x = R$, to conclude $\phi_\eta^\delta(x) \leq \bar{\phi}(x)$ on $[0, R]$.

This we cannot do on $[0, R]$, but on a subinterval $[A_0, R]$ only. So we begin with an auxiliary function $\bar{\varphi}(x) = x^k + \theta$ with k and θ positive numbers to be determined. We have to check that on $[A_0, R]$

$$-\tau(x) \frac{\partial}{\partial x} \bar{\varphi}(x) + (\lambda_\eta^\delta + \beta(x)) \bar{\varphi}(x) \geq 2\beta(x) \int \kappa(y, x) \bar{\varphi}(y) dy + \delta \phi_\eta^\delta(0),$$

i.e.

$$-k\tau(x)x^{k-1} + (\lambda_\eta^\delta + \beta(x))\bar{\varphi}(x) \geq \left(2\theta + 2 \int \kappa(y, x)y^k dy\right)\beta(x) + \delta \phi_\eta^\delta(0).$$

For $k \geq 2$, we know that $\int \kappa(y, x) \frac{y^k}{x^k} dy \leq c < 1/2$ so it is sufficient to prove that there exists $A_0 > 0$ such that we have

$$-k\tau(x)x^{k-1} + (\lambda_\eta^\delta + \beta(x))(x^k + \theta) \geq (2\theta + 2cx^k)\beta(x) + \delta C_0(1) \quad (1.32)$$

for all $x > A_0$, where C_0 is defined in (1.31). For this, dividing (1.32) by $x^{k-1}\tau(x)$, we say that if we have

$$(1 - 2c) \frac{x\beta(x)}{\tau(x)} \geq k + \frac{2\theta\beta(x) + \delta C_0(1)}{x^{k-1}\tau(x)}, \quad (1.33)$$

then (1.32) holds true. Thanks to assumptions (1.8) and (1.13) we know that there exists $k > 0$ such that for any $\theta > 0$, there exists $A_0 > 0$ for which (1.33) is true on $[A_0, +\infty)$.

Then we conclude by choosing the supersolution $\bar{\phi}(x) = \frac{C_0(A_0)}{\theta} \bar{\varphi}(x)$ so that

$$\bar{\phi}(x) \geq \phi_\eta^\delta(x) \quad \text{on } [0, A_0],$$

and on $[A_0, R]$, we have

$$\begin{cases} -\tau(x) \frac{\partial}{\partial x} \bar{\phi}(x) + (\lambda_\eta^\delta + \beta(x)) \bar{\phi}(x) \geq 2\beta(x) \int_0^x \kappa(y, x) \bar{\phi}(y) dy + \delta \phi_\eta^\delta(0), \\ \bar{\phi}(R) > 0, \end{cases} \quad (1.34)$$

which is a supersolution to the equation satisfied by ϕ_η^δ . Therefore $\phi_\eta^\delta \leq \bar{\phi}$ uniformly in η and δ and we get

$$\exists k, \theta, C \text{ s.t. } \forall \eta, \delta, \quad \phi_\eta^\delta(x) \leq (Cx^k + \theta). \quad (1.35)$$

Equation (1.19) and the fact that ϕ_η^δ is uniformly bounded in $L_{loc}^\infty(\mathbb{R}^+)$ give immediately that $\partial_x \phi_\eta^\delta$ is uniformly bounded in $L_{loc}^\infty(\mathbb{R}^+, \tau(x)dx)$, so in $L_{loc}^\infty(0, \infty)$ thanks to (1.9).

Then we can extract a subsequence of $\{\phi_\eta^\delta\}$ which converges $\mathcal{C}^0(0, \infty)$ toward ϕ . Now we check that ϕ satisfied the adjoint equation of (1.3). We consider the terms of (1.19) one after another.

First $(\lambda_\eta^\delta + \beta(x))\phi_\eta^\delta(x)$ converges to $(\lambda + \beta(x))\phi(x)$ in L_{loc}^∞ .

For $\partial_x \phi_\eta^\delta$, we have an L^∞ bound on each compact of $(0, \infty)$. So it converges L^∞ - *weak toward $\partial_x \phi$.

It remains the last term which we write, for all $x > 0$,

$$\int_0^x \kappa(y, x) (\phi_\eta^\delta(y) - \phi(y)) dy \leq \|\phi_\eta^\delta - \phi\|_{L^\infty(0,x)} \xrightarrow{\eta, \delta \rightarrow 0} 0.$$

The fact that $\int \phi \mathcal{U} = 1$ comes from the convergence $L^\infty - L^1$ when written as

$$1 = \int \phi_\eta^\delta(x) \mathcal{U}_\eta^\delta(x) dx = \int \frac{\phi_\eta^\delta(x)}{1+x^k} (1+x^k) \mathcal{U}_\eta^\delta(x) dx \longrightarrow \int \frac{\phi(x)}{1+x^k} (1+x^k) \mathcal{U}(x) dx = \int \phi \mathcal{U}.$$

At this stage we have found $(\lambda, \mathcal{U}, \phi) \in \mathbb{R}^+ \times L^1(\mathbb{R}^+) \times \mathcal{C}(\mathbb{R}^+)$ solution of (1.3). The estimates announced in Theorem 1.1.1 also follow from those uniform estimates. It remains to prove that $\lambda > 0$ and the uniqueness.

1.3.6 Proof of $\lambda > 0$

We prove a little bit more, namely that

$$\lambda \geq \frac{1}{2} \sup_{x \geq 0} \{ \tau(x) \mathcal{U}(x) \}. \quad (1.36)$$

We integrate the first equation of (1.3) between 0 and x and find

$$\begin{aligned} 0 \leq \lambda \int_0^x \mathcal{U}(y) dy &= -\tau(x) \mathcal{U}(x) - \int_0^x \beta(y) \mathcal{U}(y) dy + 2 \int_0^x \int_z^\infty \beta(y) \kappa(z, y) \mathcal{U}(y) dy dz \\ &\leq -\tau(x) \mathcal{U}(x) + 2 \int_0^\infty \int_z^\infty \beta(y) \kappa(z, y) \mathcal{U}(y) dy dz \\ &= -\tau(x) \mathcal{U}(x) + 2 \int_0^\infty \beta(y) \mathcal{U}(y) dy \\ &= -\tau(x) \mathcal{U}(x) + 2\lambda, \end{aligned}$$

Hence $2\lambda \geq \tau(x) \mathcal{U}(x)$ and (1.36) is proved.

1.3.7 Uniqueness

We follow the idea of [95]. Let $(\lambda_1, \mathcal{U}_1, \phi_1)$ and $(\lambda_2, \mathcal{U}_2, \phi_2)$ two solutions to the eigenproblem (1.3). First we have

$$\begin{aligned} \lambda_1 \int \mathcal{U}_1(x) \phi_2(x) dx &= \int \left(-\partial_x(\tau(x) \mathcal{U}_1(x)) - \beta(x) \mathcal{U}_1(x) + 2 \int_x^\infty \beta(y) \kappa(x, y) \mathcal{U}_1(y) dy \right) \phi_2(x) dx \\ &= \int \left(\tau(x) \partial_x \phi_2(x) - \beta(x) \phi_2(x) + 2\beta(x) \int_0^x \kappa(y, x) \phi_2(y) dy \right) \mathcal{U}_1(x) dx \\ &= \lambda_2 \int \mathcal{U}_1(x) \phi_2(x) dx \end{aligned}$$

and then $\lambda_1 = \lambda_2 = \lambda$ because $\int \mathcal{U}_1 \phi_2 > 0$ thanks to Lemma 1.3.1.

For the eigenvectors we use the General Relative Entropy method introduced in [98, 99]. For $C > 0$, we test the equation on \mathcal{U}_1 against $\text{sgn}\left(\frac{\mathcal{U}_1}{\mathcal{U}_2} - C\right) \phi_1$,

$$0 = \int \left[\partial_x(\tau(x) \mathcal{U}_1(x)) + (\lambda + \beta(x)) \mathcal{U}_1(x) - 2 \int_x^\infty \beta(y) \kappa(x, y) \mathcal{U}_1(y) dy \right] \text{sgn}\left(\frac{\mathcal{U}_1}{\mathcal{U}_2}(x) - C\right) \phi_1(x) dx.$$

Deriving $\left| \frac{\mathcal{U}_1}{\mathcal{U}_2}(x) - C \right| \tau(x) \mathcal{U}_2(x) \phi_1(x)$ we find

$$\begin{aligned} \int \partial_x(\tau(x) \mathcal{U}_1(x)) \text{sgn}\left(\frac{\mathcal{U}_1}{\mathcal{U}_2}(x) - C\right) \phi_1(x) dx &= \int \partial_x \left(\left| \frac{\mathcal{U}_1}{\mathcal{U}_2}(x) - C \right| \tau(x) \mathcal{U}_2(x) \phi_1(x) \right) dx \\ &+ \int \partial_x(\tau(x) \mathcal{U}_2(x)) \frac{\mathcal{U}_1}{\mathcal{U}_2}(x) \text{sgn}\left(\frac{\mathcal{U}_1}{\mathcal{U}_2}(x) - C\right) \phi_1(x) dx - \int \left| \frac{\mathcal{U}_1}{\mathcal{U}_2}(x) - C \right| \partial_x(\tau(x) \mathcal{U}_2(x) \phi_1(x)) dx \end{aligned}$$

and then

$$\begin{aligned} & \int \partial_x(\tau(x)\mathcal{U}_1(x))\operatorname{sgn}\left(\frac{\mathcal{U}_1}{\mathcal{U}_2}(x) - C\right)\phi_1(x) dx = \\ & 2 \int \left| \frac{\mathcal{U}_1}{\mathcal{U}_2}(x) - C \right| \left[\int_0^x \beta(y)\kappa(x,y)\mathcal{U}_2(y)\phi_1(x) dy - \int_x^\infty \beta(y)\kappa(x,y)\mathcal{U}_2(y)\phi_1(x) dy \right] dx \\ & + 2 \int \int_x^\infty \beta(y)\kappa(x,y)\mathcal{U}_2(y) dy \frac{\mathcal{U}_1}{\mathcal{U}_2}(x)\operatorname{sgn}\left(\frac{\mathcal{U}_1}{\mathcal{U}_2}(x) - C\right)\phi_1(x) dx \\ & - \int (\lambda + \beta(x)) \frac{\mathcal{U}_1}{\mathcal{U}_2}(x)\operatorname{sgn}\left(\frac{\mathcal{U}_1}{\mathcal{U}_2}(x) - C\right)\mathcal{U}_2(x)\phi_1(x) dx, \end{aligned}$$

$$\begin{aligned} & \int \partial_x(\tau(x)\mathcal{U}_1(x))\operatorname{sgn}\left(\frac{\mathcal{U}_1}{\mathcal{U}_2}(x) - C\right)\phi_1(x) dx = \\ & 2 \int \int \beta(y)\kappa(x,y) \left[\left| \frac{\mathcal{U}_1}{\mathcal{U}_2}(y) - C \right| - \left| \frac{\mathcal{U}_1}{\mathcal{U}_2}(x) - C \right| \right] \mathcal{U}_2(y)\phi_1(x) dx dy \\ & + 2 \int \int_x^\infty \beta(y)\kappa(x,y)\mathcal{U}_2(y) dy \frac{\mathcal{U}_1}{\mathcal{U}_2}(x)\operatorname{sgn}\left(\frac{\mathcal{U}_1}{\mathcal{U}_2}(x) - C\right)\phi_1(x) dx \\ & - \int (\lambda + \beta(x)) \frac{\mathcal{U}_1}{\mathcal{U}_2}(x)\operatorname{sgn}\left(\frac{\mathcal{U}_1}{\mathcal{U}_2}(x) - C\right)\mathcal{U}_2(x)\phi_1(x) dx. \end{aligned}$$

So

$$\begin{aligned} 0 &= 2 \int \int \beta(y)\kappa(x,y) \left[\left| \frac{\mathcal{U}_1}{\mathcal{U}_2}(y) - C \right| - \left| \frac{\mathcal{U}_1}{\mathcal{U}_2}(x) - C \right| \right] \mathcal{U}_2(y)\phi_1(x) dx dy \\ & + 2 \int \int_x^\infty \beta(y)\kappa(x,y)\mathcal{U}_2(y) dy \frac{\mathcal{U}_1}{\mathcal{U}_2}(x)\operatorname{sgn}\left(\frac{\mathcal{U}_1}{\mathcal{U}_2}(x) - C\right)\phi_1(x) dx \\ & - 2 \int \int_x^\infty \beta(y)\kappa(x,y)\mathcal{U}_1(y) dy \operatorname{sgn}\left(\frac{\mathcal{U}_1}{\mathcal{U}_2}(x) - C\right)\phi_1(x) dx \end{aligned}$$

$$0 = \int \int \beta(y)\kappa(x,y)\mathcal{U}_2(y) \left| \frac{\mathcal{U}_1}{\mathcal{U}_2}(y) - C \right| \left[1 - \operatorname{sgn}\left(\frac{\mathcal{U}_1}{\mathcal{U}_2}(x) - C\right)\operatorname{sgn}\left(\frac{\mathcal{U}_1}{\mathcal{U}_2}(y) - C\right) \right] \phi_1(x) dx dy.$$

Hence $\left[1 - \operatorname{sgn}\left(\frac{\mathcal{U}_1}{\mathcal{U}_2}(x) - C\right)\operatorname{sgn}\left(\frac{\mathcal{U}_1}{\mathcal{U}_2}(y) - C\right) \right] = 0$ on the support of $\kappa(x,y)$ for all C thus $\frac{\mathcal{U}_1}{\mathcal{U}_2}(x) = \frac{\mathcal{U}_1}{\mathcal{U}_2}(y)$ on the support of $\kappa(x,y)$ and

$$\partial_x \frac{\mathcal{U}_1}{\mathcal{U}_2}(x) = \int \beta(y)\kappa(x,y) \left(\frac{\mathcal{U}_1}{\mathcal{U}_2}(y) - \frac{\mathcal{U}_1}{\mathcal{U}_2}(x) \right) \frac{\mathcal{U}_2(y)}{\mathcal{U}_2(x)} dy = 0 \quad (1.37)$$

so $\frac{\mathcal{U}_1}{\mathcal{U}_2} \equiv cst = 1$.

We can prove in the same way that $\phi_1 = \phi_2$ even if we can have $\mathcal{U} \equiv 0$ on $[0, m]$ with $m > 0$. Indeed in this case we know that $\beta \equiv 0$ on $[0, m]$ and so

$$\phi_i(x) = \phi_i(0)e^{\int_0^x \frac{\lambda}{\tau(s)} ds} \quad \forall x \in [0, m], \quad i \in \{1, 2\}.$$

1.4 Conclusion, Perspectives

We have proved the existence and uniqueness of eigenlements for the aggregation-fragmentation equation (1.1) with assumptions on the parameters as large as possible, in order to render out the widest variety of biological or physical models. It gives access to the asymptotic behaviour of the solution by the use of the General Relative Entropy principle.

A following work is to study the dependency of the eigenvalue λ on parameters τ and β (see [96]). For instance, our assumptions allow τ to vanish at zero, what is a necessary condition to ensure that λ tends to zero when the fragmentation tends to infinity. Such results give precious information on the qualitative behaviour of the solution.

Another possible extension of the present work is to prove existence of eigenlements in the case of time-periodic parameters, using the Floquet's theory, and then compare the new λ_F with the time-independent one λ (see [23]). Such studies can help to choose a right strategy in order to optimize, for instance, the total mass $\int xu(t, x)dx$ in the case of prion proliferation (see [20]) or on the contrary minimize the total population $\int u(t, x)dx$ in the case of cancer therapy (see [23, 25]).

Finally, this eigenvalue problem could be used to recover some of the equation parameters like τ and β from the knowledge of the asymptotic profile of the solution, as introduced in [40, 114] in the case of symmetric division ($\tau = 1$ and $\kappa = \delta_{x=\frac{y}{2}}$), by the use of inverse problems techniques. The method of [114] has to be adapted to our general case, in order to model prion proliferation for instance, or yet to recover the aggregation rate τ ; this is another direction for future research.

Acknowledgment

The authors thank a lot Benoît Perthame for his precious help and his corrections.

1.5 Appendix

1.5.1 Assumption on κ

Lemma 1.5.1. *Assumptions (1.5),(1.6) and (1.11) with $\gamma > 0$ imply that*

$$\inf_y \lim_{\eta \rightarrow 0} \int_{\eta y}^{(1-\eta)y} \kappa(x, y) dx > 0,$$

which means that polymers undergo a decrease in the size during fragmentation process. As a consequence, assumption (1.7) holds true.

Proof. With the first assumption (1.5) we have

$$1 = \int_0^y \kappa(x, y) dx = \int_0^{\eta y} \kappa(x, y) dx + \int_{\eta y}^{(1-\eta)y} \kappa(x, y) dx + \int_{(1-\eta)y}^y \kappa(x, y) dx.$$

The two other assumptions (1.6) and (1.11) allow to control the mass of κ at the ends :

$$\begin{aligned} \int_{\eta y}^{(1-\eta)y} \kappa(x, y) dx &= 1 - \int_0^{\eta y} \kappa(x, y) dx - \int_{(1-\eta)y}^y \kappa(x, y) dx \\ &\geq 1 - C\eta^\gamma - \frac{1}{1-\eta} \int_{(1-\eta)y}^y \frac{x}{y} \kappa(x, y) dx \\ &\geq 1 - C\eta^\gamma - \frac{1}{2(1-\eta)} \xrightarrow{\eta \rightarrow 0} \frac{1}{2}, \end{aligned}$$

which gives the first assertion of the lemma.

Now we can prove (1.7) :

$$\begin{aligned}
\int_0^y \frac{x^2}{y^2} \kappa(x, y) dx &\leq \left[\int_0^{\eta y} \frac{x}{y} \kappa(x, y) dx + \int_{(1-\eta)y}^y \frac{x}{y} \kappa(x, y) dx \right] + \int_{\eta y}^{(1-\eta)y} \frac{x^2}{y^2} \kappa(x, y) dx \\
&\leq \left[\frac{1}{2} - \int_{\eta y}^{(1-\eta)y} \frac{x}{y} \kappa(x, y) dx \right] + (1-\eta) \int_{\eta y}^{(1-\eta)y} \frac{x}{y} \kappa(x, y) dx \\
&= \frac{1}{2} - \eta \int_{\eta y}^{(1-\eta)y} \frac{x}{y} \kappa(x, y) dx \\
&\leq \frac{1}{2} - \eta^2 \int_{\eta y}^{(1-\eta)y} \kappa(x, y) dx.
\end{aligned}$$

We use the first part of the proof to conclude. Taking $\eta = \min\left(\frac{1}{4}, \frac{1}{(4C)^{1/\gamma}}\right)$ for instance, we obtain

$$\int_{\eta y}^{(1-\eta)y} \kappa(x, y) dx \geq \frac{1}{3},$$

and the lemma is proved for $c = \frac{1}{2} - \frac{1}{48}$. \square

1.5.2 Krein-Rutman

We prove existence of solution for the truncated equation (1.19). In this part η and δ are fixed (with $\delta R < \mu$), so we will omit these indices for τ , λ , \mathcal{U} and ϕ but we keep in mind that $\tau(x) \geq \mu > 0$.

We use the Krein-Rutman theorem which requires working in the space of continuous functions (see [110] for instance). First we define regularized parameters as follows :

$$\tau_\varepsilon = \rho_\varepsilon * \tau, \quad \beta_\varepsilon = \rho_\varepsilon * \beta, \quad \text{and} \quad \forall y \geq 0, \quad \kappa_\varepsilon(\cdot, y) = \rho_\varepsilon * \kappa(\cdot, y),$$

where $\rho_\varepsilon(x) = \frac{1}{\varepsilon} \rho\left(\frac{x}{\varepsilon}\right)$ with $\rho \in \mathcal{C}_c^\infty((0, \infty))$, positive and such that $\int_0^\infty \rho = 1$. Then we have the theorem

Theorem 1.5.2. *Under assumptions (1.5)-(1.13) on the parameters and for all $\varepsilon > 0$, there is a unique solution $\lambda_\varepsilon \in \mathbb{R}$ and $\mathcal{U}_\varepsilon, \phi_\varepsilon \in \mathcal{C}^1([0, R])$ to the regularized eigenproblem*

$$\left\{ \begin{array}{l} \frac{\partial}{\partial x} (\tau_\varepsilon(x) \mathcal{U}_\varepsilon(x)) + (\beta_\varepsilon(x) + \lambda_\varepsilon) \mathcal{U}_\varepsilon(x) = 2 \int_0^R \beta_\varepsilon(y) \kappa_\varepsilon(x, y) \mathcal{U}_\varepsilon(y) dy, \quad 0 < x < R, \\ \tau_\varepsilon \mathcal{U}_\varepsilon(x=0) = \delta \int_0^R \mathcal{U}_\varepsilon(y) dy, \quad \mathcal{U}_\varepsilon(x) > 0, \quad \int_0^R \mathcal{U}_\varepsilon(x) dx = 1, \\ -\tau_\varepsilon(x) \frac{\partial}{\partial x} \phi_\varepsilon(x) + (\beta_\varepsilon(x) + \lambda_\varepsilon) \phi_\varepsilon(x) - 2\beta_\varepsilon(x) \int_0^R \kappa_\varepsilon(y, x) \phi_\varepsilon(y) dy = \tau_\varepsilon(0) \delta \phi_\varepsilon(0), \quad 0 < x < R, \\ \phi_\varepsilon(R) = 0, \quad \phi_\varepsilon(x) > 0, \quad \int_0^R \phi_\varepsilon(x) \mathcal{U}_\varepsilon(x) dx = 1. \end{array} \right. \quad (1.38)$$

Proof. We follow the proof of [110]. We define linear operators on $E := \mathcal{C}^0([0, R])$ to apply the Krein-Rutman theorem.

Direct equation. For $\nu > 0$ we consider the following equation on E

$$\left\{ \begin{array}{l} \frac{\partial}{\partial x} (n(x)) + \frac{\nu + \beta_\varepsilon(x)}{\tau_\varepsilon(x)} n(x) - 2 \int_0^R \frac{\beta_\varepsilon(y)}{\tau_\varepsilon(y)} \kappa_\varepsilon(x, y) n(y) dy = \frac{f(x)}{\tau_\varepsilon(x)}, \quad 0 \leq x \leq R, \\ n(x=0) = \delta \int_0^R \frac{n(y)}{\tau_\varepsilon(y)} dy, \end{array} \right. \quad (1.39)$$

and we prove that the linear operator $A : f \mapsto n$ (solution of (1.39)) satisfies to the assumptions of the Krein-Rutman theorem.

First step: construction of A . Fix $f \in E$ and for $m \in E$, we define $n = T(m) \in E$ as the (explicit) solution to

$$\begin{cases} \frac{\partial}{\partial x}(n(x)) + \frac{\nu + \beta_\varepsilon(x)}{\tau_\varepsilon(x)}n(x) = 2 \int_0^R \frac{\beta_\varepsilon(y)}{\tau_\varepsilon(y)}\kappa_\varepsilon(x, y)m(y) dy + \frac{f(x)}{\tau_\varepsilon(x)}, & 0 \leq x \leq R, \\ n(x=0) = \delta \int_0^R \frac{m(y)}{\tau_\varepsilon(y)} dy, \end{cases}$$

We prove that T is a strict contraction. Therefore it has a unique fixed point thanks to the Banach-Picard theorem. This fixed point is a solution to (1.39).

In order to prove that T is a strict contraction, we consider m_1 and m_2 two functions in E , we compute for $n = n_1 - n_2$, $m = m_1 - m_2$,

$$\begin{cases} \frac{\partial}{\partial x}(n(x)) + \frac{\nu + \beta_\varepsilon(x)}{\tau_\varepsilon(x)}n(x) = 2 \int_0^R \frac{\beta_\varepsilon(y)}{\tau_\varepsilon(y)}\kappa_\varepsilon(x, y)m(y) dy, & 0 \leq x \leq R, \\ n(x=0) = \delta \int_0^R \frac{m(y)}{\tau_\varepsilon(y)} dy, \end{cases}$$

therefore

$$\begin{cases} \frac{\partial}{\partial x}|n(x)| + \frac{\nu + \beta_\varepsilon(x)}{\tau_\varepsilon(x)}|n(x)| \leq 2 \int_0^R \frac{\beta_\varepsilon(y)}{\tau_\varepsilon(y)}\kappa_\varepsilon(x, y)|m(y)| dy, & 0 \leq x \leq R, \\ |n(x=0)| \leq \delta \int_0^R \frac{|m(y)|}{\tau_\varepsilon(y)} dy. \end{cases}$$

After integration, we obtain

$$|n(x)|e^{\int_0^x \frac{\nu + \beta_\varepsilon}{\tau_\varepsilon}} \leq \delta \int_0^R \frac{|m(y)|}{\tau_\varepsilon(y)} dy + \int_0^x e^{\int_0^{x'} \frac{\nu + \beta_\varepsilon}{\tau_\varepsilon}} \int_0^R \frac{\beta_\varepsilon(y)}{\tau_\varepsilon(y)}\kappa_\varepsilon(x', y)|m(y)| dy dx'$$

and thus

$$\begin{aligned} |n(x)| &\leq \delta \int_0^R \frac{|m(y)|}{\tau_\varepsilon(y)} dy + \int_0^x e^{-\int_{x'}^x \frac{\nu + \beta_\varepsilon}{\tau_\varepsilon}} \int_0^R \frac{\beta_\varepsilon(y)}{\tau_\varepsilon(y)}\kappa_\varepsilon(x', y)|m(y)| dy dx' \\ &\leq \|m\|_E \frac{1}{\mu} \left[\delta R + \int_0^x e^{-\int_{x'}^x \frac{\nu + \beta_\varepsilon}{\tau_\varepsilon}} \int_0^R \beta_\varepsilon(y)\kappa_\varepsilon(x', y) dy dx' \right] \\ &\leq \|m\|_E \frac{1}{\mu} \left[\delta R + \left\| \int_0^R \beta_\varepsilon(y)\kappa_\varepsilon(\cdot, y) dy \right\|_{L^\infty} \int_0^x e^{-\frac{\nu}{\|\tau_\varepsilon\|_{L^\infty}}(x-x')} dx' \right] \\ &\leq \|m\|_E \frac{1}{\mu} \underbrace{\left[\delta R + \nu^{-1} \|\tau_\varepsilon\|_{L^\infty} \left\| \int_0^R \beta_\varepsilon(y)\kappa_\varepsilon(\cdot, y) dy \right\|_{L^\infty} \right]}_{:=k}. \end{aligned}$$

Because $\delta R < \mu$ by assumption, we can choose ν large so that $k < 1$ and we obtain

$$\|n\|_E \leq k \|m\|_E.$$

Thus T is a strict contraction and we have proved the existence of a solution to (1.39).

Second step: A is continuous. This relies on a general argument which in fact shows that the linear mapping A is Lipschitz continuous. Indeed, arguing as above

$$|n(x)|e^{\int_0^x \frac{\nu + \beta_\varepsilon}{\tau_\varepsilon}} \leq \delta \int_0^R \frac{|n(y)|}{\tau_\varepsilon(y)} dy + \int_0^x e^{\int_0^{x'} \frac{\nu + \beta_\varepsilon}{\tau_\varepsilon}} \int_0^R \frac{\beta_\varepsilon(y)}{\tau_\varepsilon(y)}\kappa_\varepsilon(x', y)|n(y)| dy dx' + \int_0^x e^{\int_0^{x'} \frac{\nu + \beta_\varepsilon}{\tau_\varepsilon}} \frac{|f(x')|}{\tau_\varepsilon(x')} dx',$$

and thus

$$|n(x)| \leq k\|n\|_E + \int_0^R \frac{|f(x')|}{\tau_\varepsilon(x')} dx' \leq k\|n\|_E + \frac{R}{\mu}\|f\|_E.$$

This indeed proves that

$$\|n\|_E \leq \frac{R}{\mu(1-k)}\|f\|_E.$$

Third step: A is strongly positive. For $f \geq 0$, the operator T of the first step maps $m \geq 0$ to $n \geq 0$. Therefore the fixed point n is nonnegative. In other words $n = A(f) \geq 0$. If additionally f does not vanish, then n does not vanish either. Therefore $n(0) = \delta \int_0^R \frac{n(y)}{\tau_\varepsilon(y)} dy > 0$ and thus

$$n(x) \geq n(0) + e^{-\int_0^x \frac{\nu+\beta_\varepsilon}{\tau_\varepsilon}} \int_0^x e^{-\int_0^{x'} \frac{\nu+\beta_\varepsilon}{\tau_\varepsilon}} \frac{f(x')}{\tau_\varepsilon(x')} dx' > 0.$$

Fourth step: A is compact. For $\|f\|_E \leq 1$, the third step proves that n is bounded in E and thus

$$\frac{\partial}{\partial x} n = -\frac{\nu + \beta_\varepsilon}{\tau_\varepsilon} n + \int \frac{\beta_\varepsilon(y)}{\tau_\varepsilon(y)} \kappa(x, y) n(y) dy + \frac{f}{\tau_\varepsilon}$$

is also bounded in E . Therefore by the Ascoli-Arzelà theorem the family n is relatively compact in E .

Adjoint equation. A function ϕ is a solution to the adjoint equation of (1.38) if and only if $\tilde{\phi}(x) := \phi(R-x)$ satisfies

$$\begin{cases} \tilde{\tau}_\varepsilon(x) \frac{\partial}{\partial x} \tilde{\phi}(x) + (\tilde{\beta}_\varepsilon(x) + \lambda_\varepsilon) \tilde{\phi}(x) - 2\tilde{\beta}_\varepsilon(x) \int_0^R \kappa_\varepsilon(y, R-x) \tilde{\phi}_\varepsilon(y) dy = \delta \tilde{\phi}_\varepsilon(R), & 0 < x < R, \\ \tilde{\phi}_\varepsilon(0) = 0, \end{cases} \quad (1.40)$$

where $\tilde{\tau}_\varepsilon(x) = \tau_\varepsilon(R-x)$ and $\tilde{\beta}_\varepsilon(x) = \beta_\varepsilon(R-x)$. Then the same method than for the direct equation give the result, namely the existence of λ and $\tilde{\phi}$ solution to (1.40).

Finally we have proved existence of $(\lambda_{\mathcal{U}}, \mathcal{U}_\varepsilon)$ and $(\lambda_\phi, \phi_\varepsilon)$ solution to the direct and adjoint equations of (1.38). It remains to prove that $\lambda_{\mathcal{U}} = \lambda_\phi$ but it is nothing but integrating the direct equation against the adjoint eigenvector, what gives

$$\lambda_{\mathcal{U}} \int \mathcal{U}_\varepsilon \phi_\varepsilon = \lambda_\phi \int \mathcal{U}_\varepsilon \phi_\varepsilon.$$

□

To have existence of solution for (1.19), it remains to do $\varepsilon \rightarrow 0$. For this we can prove uniform bounds in L^∞ for \mathcal{U}_ε and ϕ_ε because we are on the fixed compact $[0, R]$. Then we can extract subsequences which converge L^∞ * -weak toward \mathcal{U} and ϕ , solutions to (1.19) because τ_ε and β_ε converge in L^1 toward τ and β . Concerning κ_ε , we have that for all $\varphi \in \mathcal{C}_c^\infty$, $\int \varphi(x) \kappa_\varepsilon(x, y) dx \rightarrow \int \varphi(x) \kappa(x, y) dx \quad \forall y$, and it is sufficient to pass to the limit in the equations.

1.5.3 Maximum principle

Lemma 1.5.3. *If there exists $A_0 > 0$ such that $\bar{\phi} \geq \phi$ on $[0, A_0]$ and $\bar{\phi}$ a supersolution of (1.3) on $[A_0, R]$ with $\bar{\phi}(R) \geq \phi(R)$, then $\bar{\phi} \geq \phi$ on $[0, R]$.*

Proof. The proof is based on the same tools than to prove uniqueness (see above) or to establish GRE principles (see [98, 99] for instance).

We know that $\bar{\phi} \geq \phi$ on $[0, A_0]$ and that $\bar{\phi}$ is a supersolution to the equation satisfied by ϕ on $[A_0, R]$, i.e. there exists a function $f \geq \delta\phi(0)$ such that

$$-\tau(x)\frac{\partial}{\partial x}\bar{\phi}(x) + (\lambda + \beta(x))\bar{\phi}(x) = 2\beta(x)\int_0^x \kappa(y, x)\bar{\phi}(y) dy + f(x), \quad \forall x \in [A_0, R].$$

So we have for all $x \in [A_0, R]$

$$-\tau(x)\frac{\partial}{\partial x}(\phi(x) - \bar{\phi}(x)) + (\lambda + \beta(x))(\phi(x) - \bar{\phi}(x)) = 2\beta(x)\int_0^x \kappa(y, x)(\phi(y) - \bar{\phi}(y)) dy - f(x).$$

Then, multiplying by $\mathbb{1}_{\phi \geq \bar{\phi}}$, we obtain (see [110] for a justification)

$$-\tau(x)\frac{\partial}{\partial x}(\phi - \bar{\phi})_+(x) + (\lambda + \beta(x))(\phi - \bar{\phi})_+(x) \leq 2\beta(x)\int_0^x \kappa(y, x)(\phi - \bar{\phi})_+(y) dy - f(x)\mathbb{1}_{\phi \geq \bar{\phi}}(x),$$

and this inequality is satisfied on $[0, R]$ since $(\phi - \bar{\phi})_+ \equiv 0$ on $[0, A_0]$.

If we test against \mathcal{U} we have, using the fact that $\phi(R) = 0 < \bar{\phi}(R)$,

$$\begin{aligned} & \int_0^R (\phi - \bar{\phi})_+(x) \frac{\partial}{\partial x}(\tau(x)\mathcal{U}(x)) dx + \int_0^R (\lambda + \beta(x))(\phi - \bar{\phi})_+(x)\mathcal{U}(x) dx \\ & \leq 2 \int_0^R (\phi - \bar{\phi})_+(y) \int_y^R \beta(x)\kappa(y, x)\mathcal{U}(x) dx dy - \int_0^R f(x)\mathbb{1}_{\phi \geq \bar{\phi}}(x)\mathcal{U}(x) dx. \end{aligned}$$

But if we test the equation (1.3) satisfied by \mathcal{U} against $(\phi - \bar{\phi})_+$, we find

$$\begin{aligned} & \int_0^R (\phi - \bar{\phi})_+(x) \frac{\partial}{\partial x}(\tau(x)\mathcal{U}(x)) dx + \int_0^R (\lambda + \beta(x))(\phi - \bar{\phi})_+(x)\mathcal{U}(x) dx \\ & = 2 \int_0^R (\phi - \bar{\phi})_+(y) \int_y^R \beta(x)\kappa(y, x)\mathcal{U}(x) dx dy, \end{aligned}$$

and finally, subtracting,

$$0 \leq - \int_0^R f(x)\mathbb{1}_{\phi \geq \bar{\phi}}(x)\mathcal{U}(x) dx,$$

so

$$\delta\phi(0) \int_0^R \mathbb{1}_{\phi \geq \bar{\phi}}(x)\mathcal{U}(x) dx \leq 0$$

and this can hold only if $\mathbb{1}_{\phi \geq \bar{\phi}} \equiv 0$ or $\phi(0) = 0$. But we deal with the truncated problem with $\tau(x) \geq \eta > 0$, so $\frac{1}{\tau} \in L_0^1$ and $\phi(0) > 0$ thanks to the lemma 1.3.1. Thus $\mathbb{1}_{\phi \geq \bar{\phi}} \equiv 0$ and the lemma 1.5.3 is proved. \square

Chapitre 2

Dépendance par rapport aux paramètres : première application

Dans cet article nous nous intéressons au phénomène de souche des maladies à prions. Plus précisément, nous nous demandons quel est le coefficient dans le système prion qui dépend le plus de la souche. Il est suggéré dans [136] qu'il s'agit du terme de fragmentation, mais une dépendance du terme de transport leur est malgré tout nécessaire pour coller correctement aux données expérimentales. Nous montrons ici, en utilisant une classe plus large de coefficients, qu'il est possible d'expliquer les valeurs expérimentales en ne supposant qu'une dépendance de la fragmentation par rapport à la souche de prion. Pour ce faire, nous considérons la classe de coefficients en puissance de x alors que [136] considérait un transport constant et une fragmentation linéaire. L'étude nous permet en outre d'obtenir la forme du taux de polymérisation $\tau(x)$ dans la classe des fonctions en puissance de x . L'article est paru dans *Mathematical and Computer Modelling* sous le titre *The shape of the polymerization rate in the prion equation* [59].

2.1 Introduction

Polymerization of prion proteins is a central event in the mechanism of prion diseases. The cells produce naturally the normal form of this protein (PrPc) but there exists a pathogenic form (PrPsc) present in infected cells as polymers. These polymers have the ability to transconform and attach the normal form by a polymerization process not yet very well understood. Mathematical modelling is a promising tool to investigate this mechanism provided we can find accurate parameters.

We consider the following model of prion proliferation (see [19, 20, 63, 80])

$$\left\{ \begin{array}{l} \frac{dV(t)}{dt} = \lambda - V(t) \left[\delta + \int_0^\infty \tau(x)u(x, t) dx \right], \\ \frac{\partial}{\partial t}u(x, t) = -V(t)\frac{\partial}{\partial x}(\tau(x)u(x, t)) - [\mu_0 + \beta(x)]u(x, t) + 2 \int_x^\infty \beta(y)\kappa(x, y) u(y, t) dy, \\ u(0, t) = 0, \\ u(x, 0) = u_0(x). \end{array} \right. \quad (2.1)$$

This equation is the continuous version of the discrete model of [92] (see [38] for the derivation). System (2.1) is a quite general model able to reproduce biological experimental results (see [83]). In this equation, $V(t)$ is the quantity of PrPc which is produced by the cell with a rate λ , and degraded with the

rate δ . The quantity of aggregates of PrPsc with size x at time t is denoted by $u(x, t)$. Polymers of PrPsc can attach monomers (PrPc) with rate τ and can split themselves in two smaller polymers with rate β . To fit with experimental observations [124], the polymerization and fragmentation rates should depend on the polymer size x (see [19, 20]). When fragmentation occurs, a polymer of size y produces two pieces of size x and $y - x$ with the probability $\kappa(x, y)$. The natural assumptions (see [98, 99, 110, 80]) on the kernel κ are then

$$\text{Supp } \kappa = \{(x, y), 0 \leq x \leq y\}$$

since fragmentation produces smaller aggregates than the initial one,

$$\forall y > 0, \quad \int \kappa(x, y) dx = 1 \quad (\kappa(\cdot, y) \text{ is a probability measure}) \quad (2.2)$$

and

$$\forall x \leq y, \quad \kappa(x, y) = \kappa(y - x, y) \quad (2.3)$$

because of indistinguishability of the two pieces of sizes x and $y - x$ after fragmentation. A consequence of the two assumptions (2.2) and (2.3) is that the mean size of the fragments obtained from a polymer of size y is $y/2$

$$\forall y, \quad \int x \kappa(x, y) dx = \frac{y}{2}. \quad (2.4)$$

In the discrete model of [91, 92, 93], a critical size n of polymers is considered. Under this size, the polymers are unstable so the proteins that compose them go back to their normal form PrPc. This effect is taken into account in the continuous model of [63, 64] with the critical size x_0 . As a consequence, there is one more integral term of apparition of monomers in the equation on V . Nevertheless, even if $n > 0$ in the discrete model, the value of x_0 can be taken equal to 0 in the continuous one as justified in [38]. Then the fact that small polymers are unstable, and so do not exist, is taken into account by the boundary condition $u(0, t) = 0$. The parameter μ_0 is a death term which will be discussed later.

In the article [136], model (2.1) with the specific parameters of [43, 63, 64, 91, 92, 93] is used. It assumes that the polymerization rate does not depend on polymer size ($\tau(x) \equiv \tau_0$) and the fragmentation is described by $\beta(x) = \beta_0 x$ and $\kappa(x, y) = \mathbb{1}_{0 \leq x \leq y} \frac{1}{y}$. In this case, equation (2.1) can be reduced to a non-linear system of ODEs (see [43, 63, 64] or even [91, 92, 93]). This system is used in [136] to investigate the parameters involved in the so-called ‘‘prion strain phenomenon’’. This phenomenon is the ability of the same encoded protein to encipher a multitude of phenotypic states. Prion strains are characterized by their incubation period (time elapsed between experimental inoculation of the PrPsc infectious agent and clinical onset of the disease) and their lesion profiles (patterns produced by the death of neurones) in brain [57]. A reason for the strain diversity can be that there exist various conformation states of PrPsc, namely various misfoldings of the prion protein, which lead to various biological and biochemical properties [102, 118]. These different conformations could be characterizable by their different stability against denaturation. Indeed, recent studies on prion disease have confirmed that the incubation time is related not only to the quantity of pathogenic protein inoculated ($\int u_0(x) dx$) and the level of expression of PrPc (λ), but also to the resistance of prion strains against denaturation [82] in terms of the concentration of guanide hydrochloride (Gdn-HCl) required to denaturate 50% of the disease-causing protein. Other studies have highlighted a strong relationship between the stability of the prion protein against denaturation and neuropathological lesion profiles [81, 123]. A natural question is then to know how the conformation states of the PrPsc protein affect the parameters of model (2.1) and more precisely which of these parameters is the most strain-dependent. One of the conclusions of [136] is that the key parameter describing strain-dependent replication kinetics is the fibril breakage rate β_0 . Using the model, some coefficients already defined in [92] are calculated from experimental data and the dependency between them indicates that the fragmentation rate β_0 is the most adapted parameter to be strain-dependent. But, in this framework, the fragmentation dependency is not sufficient to fit precisely the data and the polymerization rate τ_0 is also assumed to change with the strain. In particular, to keep a one-parameter family of models, the polymerization rate is assumed to depend on the fragmentation one through a power relation

$$\exists \phi \text{ s.t. } \tau_0 = \beta_0^\phi. \quad (2.5)$$

However, polymerization and fragmentation are two different biochemical processes which have no reason to be linked together.

In this paper we prove that we can get rid of such a relation by considering a larger class of parameters for model (2.1). We take advantage of a general framework developed in [19, 20, 80], where coefficients can be more general than in [43, 63, 64, 91, 92, 93, 136], and we consider power laws as in [45, 47, 80, 95]. Thanks to this extension, we find a shape for the polymerization rate allowing us to fit experimental data with only the fragmentation rate dependent on strain. The experimental data we use are the stability against denaturation G and the growth rate of the quantity of PrPsc (r) which is linked to the incubation time. These data are strain-dependent and we can find in [136] estimated empirical values for different strains. In Section 2.2 we present the class of coefficients we consider and give the necessary assumptions for mathematical investigations. Most of these assumptions are already made in [92, 136] and, thanks to them, we are able to link r and G to the mathematical model. In Section 2.3 we give the dependency of these parameters on polymerization and fragmentation rates. Then we give a relation between them using the only fragmentation dependency on strain and are able to fit data with an accurate shape of the polymerization rate.

2.2 Assumptions and Method

To avoid the use of a power relation like (2.5) between the polymerization and the fragmentation, we allow parameters τ and β to depend on the size x with power laws :

$$\exists \gamma, \nu \text{ and } \beta_0, \tau_0 \text{ s.t., } \forall x > 0, \quad \beta(x) = \beta_0 x^\gamma \text{ and } \tau(x) = \tau_0 x^\nu. \quad (2.6)$$

Concerning the fragmentation kernel κ , we assume that there exists a measure κ_0 on $[0, 1]$ such that

$$\forall x, y > 0, \quad \kappa(x, y) = \frac{1}{y} \kappa_0\left(\frac{x}{y}\right). \quad (2.7)$$

Then the natural assumptions on κ become

$$\int_0^1 \kappa_0(z) dz = 1 \quad \text{and} \quad \kappa_0(z) = \kappa_0(1 - z). \quad (2.8)$$

We assume that the exponents ν , γ , the kernel κ_0 and the death rate μ_0 are strain-independent unlike the ‘‘intensities’’ β_0 and τ_0 . First we look which of β_0 and τ_0 is the most characteristic of the strain. Then we find a value of ν allowing to fit experimental data as well as [136] but without assumption (2.5). We will see in Section 2.3 that the method naturally gives the parameter ν because it turns out that γ and κ_0 do not appear in the final argument.

The method proposed in [92, 136] is to investigate the dynamics of the system (2.1) linearized at the disease-free equilibrium. Then we can use the eigenelements as suggested in [19, 20]. To make this approximation valid, we make some classical assumptions. First we assume that, in the biological experiments (namely before the animal death), the amount of PrPc in cells remains close to the sane value $\bar{V} = \frac{\lambda}{\delta}$ (obtained by setting $u \equiv 0$ in the first equation of (2.1)). Quantity V being assumed to be constant, we consider the eigenelements r and \mathcal{U} of the equation for polymers associated with \bar{V}

$$\begin{cases} r\mathcal{U}(x) = -\bar{V} \frac{\partial}{\partial x} (\tau(x)\mathcal{U}(x)) - [\mu_0 + \beta(x)]\mathcal{U}(x) + 2 \int_x^\infty \beta(y)\kappa(x, y)\mathcal{U}(y) dy, \\ \mathcal{U}(0) = 0, \quad \int \mathcal{U}(x) dx = 1. \end{cases} \quad (2.9)$$

The principal eigenvalue r represents the growth rate of the solutions and the eigenvector \mathcal{U} is the corresponding size distribution of polymers. To consider that the size distribution is close to this profile along the experiments, we assume that the initial value $u_0(x)$ is already close to \mathcal{U} . It is a reasonable

assumption if contaminations are made from other infected individuals. Then the solution of (2.1) is reduced to

$$V(t) \simeq \bar{V} \quad \text{and} \quad u(x, t) \simeq \left[\int u_0(y) dy \right] \mathcal{U}(x) e^{rt}. \quad (2.10)$$

To solve our problem, we use the idea that the eigenelements r and \mathcal{U} change with the prion strains (see [20, 83] for instance). Because present experiments do not allow one to measure the size distribution \mathcal{U} , we link it to the stability against denaturation G by the relation

$$\exists a > 0, b \quad \text{s.t.} \quad G = a\bar{x} + b \quad (2.11)$$

where $\bar{x} = \int x \mathcal{U}(x) dx$ is the mean size of the polymers since $\int \mathcal{U}(x) dx = 1$. Such an affine dependency, suggested in [136], is based on the idea that the longer \bar{x} is, the larger G will be. In [81, 136] we can find estimated empirical values of G (as a concentration, in *Mol*, of Gnd-HCL required to denaturate 50% of PrPsc) and of the growth rate r (computed from measures of incubation times thanks to the assumption of an exponential growth homogeneous in the brain). These values are reported in Table 2.1.

Prion strain	139A	ME7	BSE	Sc237	RML	vCJD	Chandler Scrapie	301 V
$r(\text{day}^{-1})$	0.05	0.024	0.015	0.11	0.18	0.07	0.17	0.07
$G(\bar{M})$	2	2.9	2.8	1.6	1.7	1.85	2.2	2.2

Table 2.1: Estimated empirical values of the growth rate and the stability against denaturation for different prion strains (data from [81, 136]).

In the next section, we find a relation between r and \mathcal{U} by investigating their dependency on parameters. Then we show that this relation allows to fit the data of Table 2.1 with an accurate choice of the polymerization exponent ν .

2.3 Results

Proving the existence of solutions to the eigenvalue problem (2.9) is not easy and the theory was first developed in [111, 95]. In [41] we could treat singular polymerization and fragmentation rates as investigated here. It is proved in [41, 95] that solutions exist under the condition

$$\gamma + 1 - \nu > 0. \quad (2.12)$$

Moreover, following the idea of [47], we are able to give the dependency of r and \mathcal{U} on parameters V , μ_0 , β_0 and τ_0 for given γ , ν and κ_0 (unknown but strain-independent). Define r_1 and \mathcal{U}_1 by the eigenequation given for $\beta_0 = \bar{V}\tau_0 = 1$ and $\mu_0 = 0$ by

$$r_1 \mathcal{U}_1(x) = -\frac{\partial}{\partial x} (x^\nu \mathcal{U}_1(x)) - x^\gamma \mathcal{U}_1(x) + 2 \int_x^\infty y^\gamma \kappa_0 \left(\frac{x}{y} \right) \mathcal{U}_1(y) \frac{dy}{y}. \quad (2.13)$$

Then r_1 , \mathcal{U}_1 depend only on γ , ν , κ_0 and we have the following lemma which we use later on.

Lemma 2.3.1. *The eigenelements r and \mathcal{U} solution of (2.9) satisfy*

$$r = (V\tau_0)^{\frac{\gamma}{1+\gamma-\nu}} \beta_0^{\frac{1-\nu}{1+\gamma-\nu}} r_1 - \mu_0 \quad \text{and} \quad \mathcal{U}(x) = \left(\frac{\beta_0}{V\tau_0} \right)^{\frac{1}{1+\gamma-\nu}} \mathcal{U}_1 \left(\left(\frac{\beta_0}{V\tau_0} \right)^{\frac{1}{1+\gamma-\nu}} x \right). \quad (2.14)$$

Proof. The proof is based on a homogeneity argument. First we write (2.9) as

$$\frac{r + \mu_0}{V\tau_0} \mathcal{U}(x) = -\frac{\partial}{\partial x} (x^\nu \mathcal{U}(x)) - \frac{\beta_0}{V\tau_0} x^\gamma \mathcal{U}(x) + 2 \frac{\beta_0}{V\tau_0} \int_x^\infty y^\gamma \kappa_0 \left(\frac{x}{y} \right) \mathcal{U}(y) \frac{dy}{y} \quad (2.15)$$

and we set $\alpha = \frac{\beta_0}{V\tau_0}$ and $R = \frac{r+\mu_0}{V\tau_0}$. The rescaled function v defined by $\mathcal{U}(x) = \alpha^k v(\alpha^k x)$ satisfies the equation

$$\alpha^k R v(x) = -\alpha^{k(2-\nu)} \frac{\partial}{\partial x} (x^\nu v(x)) - \alpha^{k+1-k\gamma} x^\gamma v(x) + 2\alpha^{k+1-k\gamma} \int_x^\infty y^\gamma \kappa_0\left(\frac{x}{y}\right) v(y) \frac{dy}{y}. \quad (2.16)$$

We choose $k = \frac{1}{1+\gamma-\nu}$ (what is possible since (2.12) is satisfied) and obtain

$$\alpha^{\frac{\nu-1}{1+\gamma-\nu}} R v(x) = -\frac{\partial}{\partial x} (x^\nu v(x)) - x^\gamma v(x) + 2 \int_x^\infty y^\gamma \kappa_0\left(\frac{x}{y}\right) v(y) \frac{dy}{y}. \quad (2.17)$$

Comparing (2.13) and (2.17), the uniqueness of eigenelements ensures that

$$R = \alpha^{\frac{1-\nu}{1+\gamma-\nu}} r_1 \quad \text{and} \quad v(x) = \mathcal{U}_1(x) \quad (2.18)$$

because $\int v(x) dx = \int \mathcal{U}(x) dx$, and the lemma is proved. \square

We are now able to give the dependency of r and \bar{x} on parameters β_0 , τ_0 and μ_0 . The mean length of the aggregates at time t is defined as the quotient $\frac{\int x u(x, t) dx}{\int u(x, t) dx}$. So, using the approximation (2.10), we obtain that this quantity is constant in time and equal to

$$\bar{x} = \int x \mathcal{U}(x) dx. \quad (2.19)$$

Then, thanks to Lemma 2.3.1, we conclude to the following corollary.

Corollary 2.3.2. *Under assumptions (2.6)-(2.8) and (2.12), there are two constants r_1 and \bar{x}_1 (depending only on γ , ν and κ_0) such that*

$$r = (V\tau_0)^{\frac{\gamma}{1+\gamma-\nu}} \beta_0^{\frac{1-\nu}{1+\gamma-\nu}} r_1 - \mu_0 \quad \text{and} \quad \bar{x} = \left(\frac{V\tau_0}{\beta_0}\right)^{\frac{1}{1+\gamma-\nu}} \bar{x}_1. \quad (2.20)$$

Proof. Using Lemma 2.3.1, we immediately have $\bar{x} = \left(\frac{V\tau_0}{\beta_0}\right)^{\frac{1}{1+\gamma-\nu}} \bar{x}_1$ with $\bar{x}_1 = \int x \mathcal{U}_1(x) dx$. \square

We have obtained the dependency of r and \bar{x} on the *a priori* strain-dependent parameters β_0 and τ_0 . Using assumption (2.11), we deduce the dependency of the stability against denaturation G

$$G = a \left(\frac{V\tau_0}{\beta_0}\right)^{\frac{1}{1+\gamma-\nu}} \bar{x}_1 + b. \quad (2.21)$$

In paper [136], the exponent γ of the fragmentation rate is equal to 1. Here we do not impose any value for γ but, nevertheless, we consider that it is positive. Indeed the larger the polymers are, the easier they break themselves. Consequently a strain-dependency of τ_0 cannot lead to a decreasing correspondence between r and G , as observed in Figure 2.1, since we have assumed that $\gamma + 1 - \nu$ and a are positive. Thus it indicates that the key strain-dependent parameter should be β_0 . With this assumption, we obtain an implicit expression of G as a function of r

$$G = A(r + \mu_0)^{\frac{1}{\nu-1}} + b \quad (2.22)$$

where A and b are constants (namely strain-independent). This model is used to fit the data.

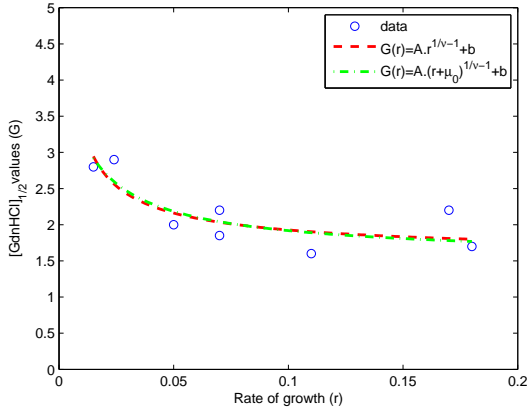

Figure 2.1: Experimental values of G and r for different strains are plotted (circles). Then these data are fitted using the reduced model (2.22) with $\mu_0 = 0$ and μ_0 free.

	$Ar^{\frac{1}{\nu}-1} + b$	$A(r + \mu_0)^{\frac{1}{\nu}-1} + b$
ν	-0.482	0.316
μ_0	0	0.023
A	0.083	0.01
b	1.54	1.69
R^2	0.7	0.72

Table 2.2: Best fitting parameters obtained with the two different models. The correlation coefficient R^2 is also reported in the last row.

First we assume as in [136] that the death rate μ_0 is equal to zero. Then we obtain a model already considered by [136] (Table 3, page 5). In our framework, we can also let μ_0 be free and fit the data with the model (2.22). As we can see in Table 2.2, the accuracy of the fitting is a little bit better with this generalisation than in the case $\mu_0 = 0$. But the most significant difference between the two fittings is the shape of τ : it is a decreasing function of x in the first case ($\nu < 0$) and it is an increasing function in the second case ($\nu > 0$).

2.4 Conclusion and Perspectives

Thanks to a larger class of parameters than [136], we are able to fit the experimental data by considering only the fragmentation rate to be dependent on strains. We even obtain a more general model and so a more accurate fitting. But, because the parameters profiles are not *a priori* known, we cannot find \bar{x} from experimental data and have to postulate a particular dependency (2.11) whereas this was a consequence of the model in [136]. To validate it, new data are necessary, for instance values of \bar{x} obtained by an experimental size distribution.

A consequence of the method is the prescription of the shape of the polymerization rate from experimental data, and also the death rate μ_0 . Nevertheless, we notice a significant difference between the two recovered exponents ν obtained by assuming that $\mu_0 = 0$ or not. Particularly one is negative and the other one positive (see Table 2.2). The idea to compare parameters from different strains has been deeply exploited here. But the fact that there are only few different strains in comparison to the number of fitting parameters is a weakness for precise fitting and precise determination of τ . Some parameters such as μ_0 or b should be previously determined by another method and other data. Furthermore the parameters of model (2.1) could have a size-dependency more general than power laws. A complete inverse problem is to recover all the size-dependent parameters from experimental data without the restriction to a class of shape. This problem is very complicated even though first elementary models are treated in [40, 114, 109]. Moreover it requires more information such as the size distribution \mathcal{U} and not only the mean size \bar{x} .

Acknowledgment

This work has been partly supported by ANR grant project TOPPAZ.

Chapitre 3

Dépendance par rapport aux paramètres : étude approfondie

Dans ce travail en collaboration avec VINCENT CALVEZ et MARIE DOUMIC, nous analysons la dépendance de la valeur propre principale de l'équation de croissance-fragmentation en fonction de paramètres. Cette question apparait dans la recherche des états d'équilibre pour le système du prion avec la dépendance par rapport au terme de transport, et dans le problème d'optimisation de la PMCA avec la dépendance par rapport à un paramètre de fragmentation. Grâce à une dilatation appropriée des vecteurs propres, nous donnons le comportement asymptotique de la valeur propre quand les paramètres tendent vers zéro ou l'infini. Pour des coefficients dégénérés nous obtenons des dépendances non monotones, contrairement à ce qui avait pu être conjecturé auparavant en se basant sur des cas simples.

3.1 Introduction

Growth and division of a population of individuals structured by a quantity conserved in the division process may be described by the following growth and fragmentation equation:

$$\begin{cases} \frac{\partial}{\partial t}u(x, t) + \frac{\partial}{\partial x}(\tau(x)u(x, t)) + \beta(x)u(x, t) = 2 \int_x^\infty \beta(y)\kappa(x, y) u(y, t) dy, & x \geq 0, \\ u(x, 0) = u_0(x), \\ u(0, t) = 0. \end{cases} \quad (3.1)$$

This equation is used in many different areas to model a wide range of phenomena. The quantity $u(t, x)$ may represent a density of dusts ([45]), polymers [19, 20], bacteria or cells [10, 11]. The structuring variable x may be size ([110] and references), label ([6, 5]), protein content ([37, 88]), proliferating parasite content ([7]); etc. In the literature, it is referred to as the "size-structured equation", "growth-fragmentation equation", "cell division equation", "fragmentation-drift equation" or Sinko-Streifer model.

The growth speed $\tau = \frac{dx}{dt}$ represents the natural growth of the variable x , for instance by nutrient uptake or by polymerization, and the rate β is called the fragmentation or division rate. Notice that if τ is such that $\frac{1}{\tau}$ is non integrable at $x = 0$, then the boundary condition $u(0, t) = 0$ is useless. The so-called fragmentation kernel $\kappa(x, y)$ represents the proportion of individuals of size $x \leq y$ born from a given dividing individual of size y ; more rigorously we should write $\kappa(dx, y)$, with $\kappa(dx, y)$ a probability

measure with respect to x . The factor “2” in front of the integral term highlights the fact that we consider here binary fragmentation, namely that the fragmentation process breaks an individual into two smaller ones. The method we use in this paper can be extended to more general cases where the mean number of fragments is $n_0 > 1$ (see [41]).

Well-posedness of this problem as well as the existence of eigenelements has been proved in [47, 41]. Here we focus on the first eigenvalue λ associated to the eigenvector \mathcal{U} defined by

$$\begin{cases} \frac{\partial}{\partial x}(\tau(x)\mathcal{U}(x)) + (\beta(x) + \lambda)\mathcal{U}(x) = 2 \int_x^\infty \beta(y)\kappa(x, y)\mathcal{U}(y)dy, & x \geq 0, \\ \tau\mathcal{U}(x=0) = 0, \quad \mathcal{U}(x) > 0 \text{ for } x > 0, \quad \int_0^\infty \mathcal{U}(x)dx = 1. \end{cases} \quad (3.2)$$

The first eigenvalue λ is the asymptotic exponential growth rate of a solution to Problem (3.1) (see [98, 99]). It is often called the *malthusian* parameter or the *fitness* of the population. Hence it is of deep interest to know how it depends on the coefficients: for given parameters, is it favorable or unfavorable to increase fragmentation? Is it more efficient to modify the transport rate τ or to modify the fragmentation rate β ? Such concerns may have deep impact on therapeutic strategy (see [10, 11, 37, 23]) or on experimental design of devices such as PMCA¹ (see [83] and references therein). Moreover, when modeling polymerization processes, Equation (3.1) is coupled with the density of monomers $V(t)$, which appears as a multiplier for the polymerization rate (*i.e.*, $\tau(x)$ is replaced by $V(t)\tau(x)$, and $V(t)$ is governed by one or more ODE - see for instance [63, 64, 20]). Asymptotic study of such polymerization processes thus closely depends on such a dependency (see [20, 19], where asymptotic results are obtained under the assumption of a monotonic dependency of λ with respect to the polymerization rate τ).

Based on simple cases already studied (see [63, 64, 117, 59]), the first intuition would be that the fitness always increases when polymerization or fragmentation increases. Nevertheless, a closer look reveals that it is not true.

To study the dependency of the eigenproblem on its parameters, we depart from given coefficients τ and β , and study how the problem is modified under the action of a multiplier of either the growth or the fragmentation rate. We thus consider the two following problems: first,

$$\begin{cases} \alpha \frac{\partial}{\partial x}(\tau(x)\mathcal{U}_\alpha(x)) + (\beta(x) + \lambda_\alpha)\mathcal{U}_\alpha(x) = 2 \int_x^\infty \beta(y)\kappa(x, y)\mathcal{U}_\alpha(y)dy, & x \geq 0, \\ \tau\mathcal{U}_\alpha(x=0) = 0, \quad \mathcal{U}_\alpha(x) > 0 \text{ for } x > 0, \quad \int_0^\infty \mathcal{U}_\alpha(x)dx = 1, \end{cases} \quad (3.3)$$

where $\alpha > 0$ measures the strength of the polymerization (transport) term, as in the prion problem (see [63]), and second

$$\begin{cases} \frac{\partial}{\partial x}(\tau(x)\mathcal{V}_\mathbf{a}(x)) + (\mathbf{a}\beta(x) + \Lambda_\mathbf{a})\mathcal{V}_\mathbf{a}(x) = 2\mathbf{a} \int_x^\infty \beta(y)\kappa(x, y)\mathcal{V}_\mathbf{a}(y)dy, & x \geq 0, \\ \tau\mathcal{V}_\mathbf{a}(x=0) = 0, \quad \mathcal{V}_\mathbf{a}(x) > 0 \text{ for } x > 0, \quad \int_0^\infty \mathcal{V}_\mathbf{a}(x)dx = 1, \end{cases} \quad (3.4)$$

where $\mathbf{a} > 0$ modulates the fragmentation intensity, as for PMCA or therapeutics applied to the cell division cycle (see discussion in Section 3.4).

To make things clearer, we give some intuition on the dependency of $\Lambda_\mathbf{a}$ and λ_α on their respective multipliers \mathbf{a} and α . First of all, one suspects that if \mathbf{a} vanishes or if α explodes, since transport dominates, the respective eigenvectors \mathcal{U}_α and $\mathcal{V}_\mathbf{a}$ tend to dilute, and on the contrary if \mathbf{a} explodes or if α vanishes, since fragmentation dominates, they tend to a Dirac mass at zero (see Figure 3.1 for an illustration). But

¹PMCA, Protein Misfolded Cyclic Amplification, is a protocol designed to amplify the quantity of prion protein aggregates due to periodic sonication pulses. In this application, u represents protein aggregates density and x their size; the division rate β is modulated by sound waves. See Section 3.4.3 for more details.

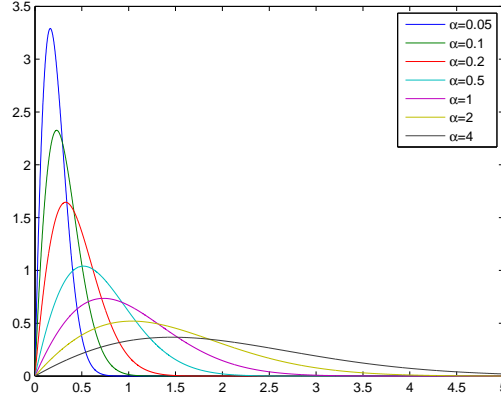

Figure 3.1: Eigenvectors $\mathcal{U}_\alpha(x)$ for different values of α when $\beta(x) \equiv 1$, $\kappa(x, y) = \frac{1}{y} \mathbb{1}_{0 \leq x \leq y}$ and $\tau(x) = x$. In this case we have an explicit expression $\mathcal{U}_\alpha(x) = 2\sqrt{\alpha} \left(\sqrt{\alpha}x + \frac{\alpha x^2}{2} \right) \exp \left(\sqrt{\alpha}x + \frac{\alpha x^2}{2} \right)$. One sees that if α vanishes, \mathcal{U}_α tends to a Dirac mass, whereas it dilutes when $\alpha \rightarrow +\infty$.

what happens to the eigenvalues λ_α and Λ_α ? Integrating Equation (3.4), we obtain the relation

$$\Lambda_\alpha = \alpha \int_0^\infty \beta(x) \mathcal{V}_\alpha(x) dx$$

which could give the intuition that Λ_α is an increasing function of α , what is indeed true if $\beta(x) \equiv \beta$ is a constant since we obtain in this case $\Lambda_\alpha = \beta\alpha$. However, when β is not a constant, the dependency of the distribution $\mathcal{V}_\alpha(x)$ on α comes into account and we cannot conclude so easily. A better intuition is given by integration of Equation (3.4) against the weight x , which gives

$$\Lambda_\alpha \int x \mathcal{V}_\alpha(x) dx = \int \tau(x) \mathcal{V}_\alpha(x) dx$$

and as a consequence we have that

$$\inf_{x>0} \frac{\tau(x)}{x} \leq \Lambda_\alpha \leq \sup_{x>0} \frac{\tau(x)}{x}.$$

This last relation highlights the link between the first eigenvalue Λ_α and the growth rate $\tau(x)$, or more precisely $\frac{\tau(x)}{x}$. For instance, if $\frac{\tau(x)}{x}$ is bounded, then Λ_α is bounded too, independently of α . Notice that in the constant case $\beta(x) \equiv \beta$, there cannot exist a solution to the eigenvalue problem (3.2) for $\frac{\tau(x)}{x}$ bounded since we have $\Lambda_\alpha = \beta\alpha$ which contradicts the boundedness of $\frac{\tau(x)}{x}$. In fact we check that the existence condition (3.27) in Section 3.2.2 imposes, for β constant, that $\frac{1}{\tau}$ is integrable at $x = 0$ and so $\frac{\tau(x)}{x}$ cannot be bounded.

Similarly, concerning Equation (3.3), an integration against the weight x gives

$$\lambda_\alpha = \frac{1}{\alpha} \frac{\int \tau \mathcal{U}_\alpha dx}{\int x \mathcal{U}_\alpha dx},$$

that could lead to the (false) intuition that λ_α decreases with α which is indeed true in the limiting case $\tau(x) = x$. A simple integration gives more insight: it leads to

$$\lambda_\alpha = \int \beta(x) \mathcal{U}_\alpha(x) dx, \quad \inf_{x>0} \beta(x) \leq \lambda_\alpha \leq \sup_{x>0} \beta(x).$$

This relation connects λ_α to the fragmentation rate β when the parameter α is in front of the transport term. Moreover, we have seen that when the growth parameter α tends to zero, for instance, the distribution $\mathcal{U}_\alpha(x)$ is expected to concentrate into a Dirac mass in $x = 0$, so the identity $\lambda_\alpha = \int \beta(x)\mathcal{U}_\alpha(x) dx$ indicates that λ_α should tend to $\beta(0)$. Similarly, when α tends to infinity, λ_α should behave as $\beta(+\infty)$.

These intuitions on the link between $\frac{\tau(x)}{x}$ and Λ_α on the one hand, β and λ_α on the other hand, are expressed in a rigorous way below. The main assumption is that the coefficients $\tau(x)$ and $\beta(x)$ have power-like behaviours in the neighbourhood of $L = 0$ or $L = +\infty$, namely that

$$\exists \nu, \gamma \in \mathbb{R} \quad \text{such that} \quad \tau(x) \underset{x \rightarrow L}{\sim} \tau x^\nu, \quad \beta(x) \underset{x \rightarrow L}{\sim} \beta x^\gamma. \quad (3.5)$$

Theorem 3.1.1. *Under Assumption (3.5), Assumptions (3.12)-(3.13) on κ , and Assumptions (3.22)-(3.28) given in [41] to ensure the existence and uniqueness of solutions to the eigenproblems (3.3) and (3.4), we have, for $L = 0$ or $L = +\infty$,*

$$\lim_{\alpha \rightarrow L} \lambda_\alpha = \lim_{x \rightarrow L} \beta(x) \quad \text{and} \quad \lim_{\alpha \rightarrow L} \Lambda_\alpha = \lim_{x \rightarrow \frac{1}{L}} \frac{\tau(x)}{x}.$$

This is an immediate consequence of our main result, stated in Theorem 3.2.2 of Section 3.2.1. As expected by the previous relations, for Problem (3.3) the eigenvalue behavior is given by a comparison between β and 1 in the neighbourhood of zero if polymerization vanishes ($\alpha \rightarrow 0$), and in the neighbourhood of infinity if polymerization explodes ($\alpha \rightarrow \infty$). For Problem (3.4), it is given by a comparison between τ and x (in the neighbourhood of zero when $\alpha \rightarrow \infty$ or in the neighbourhood of infinity when $\alpha \rightarrow 0$).

One notices that these behaviors are somewhat symmetrical. Indeed, the first step of our proof is to use a properly-chosen rescaling, so that both problems (3.3) and (3.4) can be reduced to a single one, given by Equation (3.18). Theorem 3.2.2 studies the asymptotic behaviour of this new problem, which allows us to quantify precisely the rates of convergence of the eigenvectors toward self-similar profiles.

A consequence of these results is the possible non-monotonicity of the first eigenvalue as a function of α or \mathbf{a} . Indeed, if $\lim_{x \rightarrow 0} \beta(x) = \lim_{x \rightarrow \infty} \beta(x) = 0$, then the function $\alpha \mapsto \lambda_\alpha$ satisfies $\lim_{\alpha \rightarrow 0} \lambda_\alpha = \lim_{\alpha \rightarrow \infty} \lambda_\alpha = 0$ and is positive on $(0, +\infty)$, because $\lambda_\alpha = \int \beta \mathcal{U}_\alpha > 0$ for $\alpha > 0$. If $\lim_{x \rightarrow 0} \frac{\tau(x)}{x} = \lim_{x \rightarrow \infty} \frac{\tau(x)}{x} = 0$, we have the same conclusion for $\mathbf{a} \mapsto \Lambda_\mathbf{a}$ (see Figure 3.2 for examples).

This article is organised as follows. In Section 3.2 is devoted to state and prove the main result, given in Theorem 3.2.2. We first detail the self-similar change of variables that leads to the reformulation of Problems (3.3) and (3.4) in Problem (3.18), as stated in Lemma 3.2.1. We then recall the assumptions for the existence and uniqueness result of [41]. We need these assumptions here not only to have well-posed problems, but also because the main tool to prove Theorem 3.2.2 is given by similar estimates to the ones used in [41] to prove well-posedness. In Section 3.3, we give more precise results in the limiting cases, *i.e.* when $\lim_{x \rightarrow L} \beta(x)$ or $\lim_{x \rightarrow L} \frac{\tau(x)}{x}$ is finite and positive, and conversely more general results under assumptions weaker than Assumption (3.5). Finally, Section 3.4 proposes possible use and interpretation of the results in various fields of application.

3.2 Self-similarity Result

3.2.1 Main theorem

The main theorem is a self-similar result, in the spirit of [47]. It considers the cases for Equation (3.3) or (3.4), and as parameter α or \mathbf{a} goes to zero or to infinity. It gathers the asymptotics of the eigenvalue and possible self-similar behaviors of the eigenvector, when τ and β have power-like behavior in the

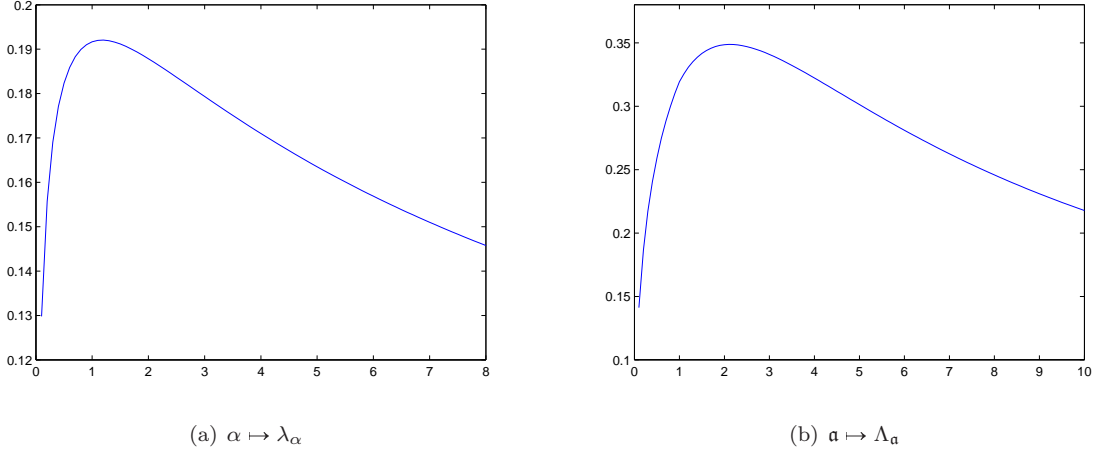

Figure 3.2: The dependencies of the first eigenvalue on polymerization and fragmentation parameters for coefficients which satisfy the assumptions of Theorem 3.1.1 are plotted. The coefficients are chosen to obtain non monotonic functions. 3.2(a): $\tau(x) = \frac{8x^{0.2}}{1+2x^{4.2}}$, $\beta(x) = \frac{x^3}{15+x^{4.5}}$ and $\kappa(x, y) = \frac{1}{y} \mathbb{1}_{0 \leq x \leq y}$. We have $\lim_{x \rightarrow 0} \beta(x) = \lim_{x \rightarrow \infty} \beta(x) = 0$, so $\lim_{\alpha \rightarrow 0} \lambda_\alpha = \lim_{\alpha \rightarrow \infty} \lambda_\alpha = 0$. 3.2(b): $\tau(x) = \frac{1.2x^{1.8}}{1+2x^{2.8}}$, $\beta(x) = \frac{4x^2}{10+x^{0.8}}$ and $\kappa(x, y) = \frac{1}{y} \mathbb{1}_{0 \leq x \leq y}$. We have $\lim_{x \rightarrow 0} \frac{\tau(x)}{x} = \lim_{x \rightarrow \infty} \frac{\tau(x)}{x} = 0$, so $\lim_{\mathfrak{a} \rightarrow 0} \Lambda_\mathfrak{a} = \lim_{\mathfrak{a} \rightarrow \infty} \Lambda_\mathfrak{a} = 0$.

neighbourhood of 0 or $+\infty$. We first explain in full detail how the study of both Equations (3.3) and (3.4) reduce to the study of the asymptotic behavior of a unique problem, as Lemma 3.2.1 states.

When fragmentation vanishes or polymerization explodes, one expects the eigenvectors \mathcal{U}_α and $\mathcal{V}_\mathfrak{a}$ to disperse more and more. When fragmentation explodes or polymerization vanishes on the contrary, we expect them to concentrate at zero. This leads to the idea of performing an appropriate scaling of the eigenvector (\mathcal{U}_α or $\mathcal{V}_\mathfrak{a}$), so that the rescaled problem converges toward a steady profile instead of a Dirac mass or a more and more spread out distribution.

For given k and l , we define v_α or $w_\mathfrak{a}$ by the dilation

$$v_\alpha(x) = \alpha^k \mathcal{U}_\alpha(\alpha^k x), \quad w_\mathfrak{a}(x) = \mathfrak{a}^l \mathcal{V}_\mathfrak{a}(\mathfrak{a}^l x). \quad (3.6)$$

The function v_α satisfies the following equation

$$\alpha^{1-k} \frac{\partial}{\partial x} (\tau(\alpha^k x) v_\alpha(x)) + (\lambda_\alpha + \beta(\alpha^k x)) v_\alpha(x) = 2 \int_x^\infty \beta(\alpha^k y) \kappa(\alpha^k x, \alpha^k y) v_\alpha(y) dy, \quad (3.7)$$

and similarly the function $w_\mathfrak{a}$ satisfies

$$\mathfrak{a}^{-l} \frac{\partial}{\partial x} (\tau(\mathfrak{a}^l x) w_\mathfrak{a}(x)) + (\Lambda_\mathfrak{a} + \mathfrak{a} \beta(\mathfrak{a}^l x)) w_\mathfrak{a}(x) = 2 \mathfrak{a} \int_x^\infty \beta(\mathfrak{a}^l y) \kappa(\mathfrak{a}^l x, \mathfrak{a}^l y) w_\mathfrak{a}(y) dy. \quad (3.8)$$

A vanishing fragmentation or an increasing polymerization will lead the mass to spread more and more, and thus to consider the behavior of the coefficients τ , β around infinity; on the contrary, a vanishing polymerization or an infinite fragmentation will lead the mass to concentrate near zero, and we then consider the behavior of the coefficients around zero. This consideration drives our main assumption (3.5) on the power-like behavior of the coefficients $\tau(x)$ and $\beta(x)$ in the neighbourhood of $L = 0$ and $L = +\infty$. We recall this assumption here

$$\exists \nu_L, \gamma_L \in \mathbb{R} \quad \text{such that} \quad \tau(x) \underset{x \rightarrow L}{\sim} \tau x^{\nu_L}, \quad \beta(x) \underset{x \rightarrow L}{\sim} \beta x^{\gamma_L}.$$

In the class of coefficients satisfying Assumption (3.5), Assumption (3.27) of Section 3.2.2 is equivalent to

$$\gamma_0 + 1 - \nu_0 > 0, \quad (3.9)$$

Assumption (3.28) coincides with

$$\gamma_\infty + 1 - \nu_\infty > 0, \quad (3.10)$$

and in Assumption (3.26), the condition linking $\bar{\gamma}$ to $\tau(x)$ becomes

$$\bar{\gamma} + 1 - \nu_0 > 0. \quad (3.11)$$

For the sake of simplicity, we omit the indices L in the sequel.

To preserve the fact that κ is a probability measure, we define

$$\kappa_\alpha(x, y) := \alpha^k \kappa(\alpha^k x, \alpha^k y), \quad \kappa_a(x, y) := a^l \kappa(a^l x, a^l y). \quad (3.12)$$

For our equations to converge, we also make the following assumption concerning the fragmentation kernels κ_α and κ_a :

$$\text{For } k > 0, \quad \exists \kappa_L \quad \text{s.t.} \quad \forall \varphi \in \mathcal{C}_c^\infty(\mathbb{R}_+), \quad \int \varphi(x) \kappa_\alpha(x, y) dx \xrightarrow{\alpha \rightarrow L} \int \varphi(x) \kappa_L(x, y) dx \quad \text{a.e.} \quad (3.13)$$

This assumption is the convergence in a distribution sense of $\kappa_\alpha(\cdot, y)$ for almost every y . This is true for instance for fragmentation kernels which can be written in homogeneous form as $\kappa(x, y) = \frac{1}{y} \tilde{\kappa}(\frac{x}{y})$. In this case κ_α is equal to κ for all α , so $\kappa_L \equiv \kappa$.

Under Assumption (3.5), in order to obtain steady profiles, we define

$$\tau_\alpha(x) := \alpha^{-k\nu} \tau(\alpha^k x), \quad \tau_a(x) := a^{-l\nu} \tau(a^l x), \quad \beta_\alpha := \alpha^{-k\gamma} \beta(\alpha^k x), \quad \beta_a := a^{-l\gamma} \beta(a^l x), \quad (3.14)$$

so that, if $k > 0$, there are local uniform convergences on \mathbb{R}_+^* of τ_α and $\beta_\alpha : \tau_\alpha \xrightarrow{\alpha \rightarrow L} \tau x^\nu$ and $\beta_\alpha \xrightarrow{\alpha \rightarrow L} \beta x^\gamma$.

Equations (3.7) and (3.8) divided respectively by $\alpha^{k\gamma}$ and $a^{l(\nu-1)}$, can be written as

$$\alpha^{1+k(\nu-1-\gamma)} \frac{\partial}{\partial x} (\tau_\alpha v_\alpha(x)) + (\alpha^{-k\gamma} \lambda_\alpha + \beta_\alpha) v_\alpha(x) = 2 \int_x^\infty \beta_\alpha(y) \kappa_\alpha(x, y) v_\alpha(y) dy, \quad (3.15)$$

$$\frac{\partial}{\partial x} (\tau_a w_a(x)) + (a^{l(1-\nu)} \Lambda_a + a^{1-l(\nu-1-\gamma)} \beta_a) w_a(x) = 2 a^{1-l(\nu-1-\gamma)} \int_x^\infty \beta_a(y) \kappa_a(x, y) w_a(y) dy. \quad (3.16)$$

In order to cancel the multipliers of τ_α and β_a , it is natural to define

$$k = \frac{1}{1 + \gamma - \nu} > 0, \quad l = -k = \frac{-1}{1 + \gamma - \nu} < 0, \quad (3.17)$$

which leads to

$$\frac{\partial}{\partial x} (\tau_\alpha(x) v_\alpha(x)) + (\theta_\alpha + \beta_\alpha(x)) v_\alpha(x) = 2 \int_x^\infty \beta_\alpha(y) \kappa_\alpha(x, y) v_\alpha(y) dy, \quad (3.18)$$

and

$$\frac{\partial}{\partial x} (\tau_a(x) w_a(x)) + (\Theta_a + \beta_a(x)) w_a(x) = 2 \int_x^\infty \beta_a(y) \kappa_a(x, y) w_a(y) dy, \quad (3.19)$$

with

$$\theta_\alpha = \alpha^{\frac{-\gamma}{1+\gamma-\nu}} \lambda_\alpha, \quad \Theta_a = a^{\frac{\nu-1}{1+\gamma-\nu}} \Lambda_a.$$

The signs of k and l express the fact that for $\alpha > 1$ or $a < 1$, v_α and w_a are contractions of $U_{\alpha, a}$, whereas for $\alpha < 1$ or $a > 1$ they are dilations, which is in accordance with our intuition of the respective roles of polymerization and fragmentation. Moreover, one notices that if we define $a := \frac{1}{\alpha}$, then $a^l = \alpha^k$, so Equations (3.18) and (3.19) are identical. By uniqueness of a solution to this eigenvalue problem, this implies that $\theta_\alpha = \Theta_{\frac{1}{\alpha}}$ and $v_\alpha = w_{\frac{1}{\alpha}}$. We are ready to state this result in the following lemma:

Lemma 3.2.1. *Eigenproblems (3.3) and (3.4) are equivalent to the eigenproblem (3.18) with k defined by (3.17), β_α , τ_α defined by (3.14), κ_α defined by (3.12), $\mathbf{a} = \frac{1}{\alpha}$ and the following relations linking the different problems:*

$$v_\alpha(x) = \alpha^k \mathcal{U}_\alpha(\alpha^k x) = \alpha^k \mathcal{V}_{\frac{1}{\alpha}}(\alpha^k x), \quad \theta_\alpha = \alpha^{\frac{-\gamma}{1+\gamma-\nu}} \lambda_\alpha = \alpha^{\frac{1-\nu}{1+\gamma-\nu}} \Lambda_{\frac{1}{\alpha}}. \quad (3.20)$$

Defining $(v_\infty, \theta_\infty)$ as the unique solution of the following problem

$$\begin{cases} \frac{\partial}{\partial x}(\tau x^\nu v_\infty(x)) + (\beta x^\gamma + \theta_\infty)v_\infty(x) = 2 \int_x^\infty \beta y^\gamma \kappa_L(x, y)v_\infty(y)dy, & x \geq 0, \\ \tau v_\infty(x=0) = 0, \quad v_\infty(x) > 0 \text{ for } x > 0, \quad \int_0^\infty v_\infty(x)dx = 1, \quad \theta_\infty > 0, \end{cases} \quad (3.21)$$

we expect θ_α to converge towards $\theta_\infty > 0$ and v_α towards v_∞ when α tends to L , so the expressions of λ_α , Λ_α given by (3.20) will provide immediately their asymptotic behavior. This result is expressed in the following theorem:

Theorem 3.2.2. *Let τ , β and κ verify Assumptions (3.22)-(3.28). Let $L = 0$ or $L = +\infty$, and τ and β verify also Assumption (3.5). Let κ_α defined by (3.12) with k defined by (3.17) verify Assumption (3.13). Let $(v_\alpha, \theta_\alpha)$ be the unique solution to the eigenproblem (3.19). We have the following asymptotic behaviors*

$$x^r v_\alpha(x) \xrightarrow{\alpha \rightarrow L} x^r v_\infty(x) \text{ strongly in } L^1 \text{ for all } r \geq 0, \text{ and } \theta_\alpha \xrightarrow{\alpha \rightarrow L} \theta_\infty.$$

Theorem 3.1.1 announced in the introduction follows immediately from Theorem 3.2.2 and the expression of λ_α and Λ_α given by (3.20).

3.2.2 Recall of existence results ([95, 41])

We first recall the assumptions of the existence and uniqueness theorem for the eigenequation (3.2) (see [41] for a complete motivation of these assumptions), which also ensures well-posedness of Problems (3.3) and (3.4). For all $y \geq 0$, $\kappa(\cdot, y)$ is a nonnegative measure with a support included in $[0, y]$. We define κ on $(\mathbb{R}_+)^2$ as follows: $\kappa(x, y) = 0$ for $x > y$. We assume that for all continuous function ψ , the application $f_\psi : y \mapsto \int \psi(x)\kappa(dx, y)$ is Lebesgue measurable.

Mass conservation and physical interpretation lead us to suppose that

$$\int \kappa(dx, y) = 1, \quad \int x\kappa(dx, y) = \frac{y}{2}, \quad (3.22)$$

so $\kappa(y, \cdot)$ is a probability measure and $f_\psi \in L_{loc}^\infty(\mathbb{R}_+)$. We moreover assume that the second moment of κ is uniformly less than the first one

$$\int \frac{x^2}{y^2} \kappa(x, y)dx \leq c < 1/2. \quad (3.23)$$

For the polymerization and fragmentation rates τ and β , we introduce the set

$$\mathcal{P} := \left\{ f \geq 0 : \exists \mu \geq 0, \limsup_{x \rightarrow \infty} x^{-\mu} f(x) < \infty \text{ and } \liminf_{x \rightarrow \infty} x^\mu f(x) > 0 \right\}.$$

We consider

$$\beta \in L_{loc}^1(\mathbb{R}_+^*) \cap \mathcal{P}, \quad \exists r_0 \geq 0 \text{ s.t. } \tau \in L_{loc}^\infty(\mathbb{R}_+, x^{r_0} dx) \cap \mathcal{P} \quad (3.24)$$

satisfying

$$\forall K \text{ compact of } (0, \infty), \exists m_K > 0 \text{ s.t. } \tau(x), \beta(x) \geq m_K \text{ for a.e. } x \in K \quad (3.25)$$

$$\exists C > 0, \bar{\gamma} \geq 0 \text{ s.t. } \int_0^x \kappa(z, y) dz \leq \min\left(1, C\left(\frac{x}{y}\right)^{\bar{\gamma}}\right) \quad \text{and} \quad \frac{x^{\bar{\gamma}}}{\tau(x)} \in L_0^1 \quad (3.26)$$

Notice that if Assumption (3.26) is satisfied for $\bar{\gamma} > 0$, then Assumption (3.23) is automatically fulfilled (see Appendix A in [41]). We assume that growth dominates fragmentation close to $L = 0$ in the following sense:

$$\frac{\beta}{\tau} \in L_0^1 := \{f, \exists a > 0, f \in L^1(0, a)\}. \quad (3.27)$$

We assume that fragmentation dominates growth close to $L = +\infty$ in the following sense:

$$\lim_{x \rightarrow +\infty} \frac{x\beta(x)}{\tau(x)} = +\infty. \quad (3.28)$$

Under these assumptions, we have existence and uniqueness of a solution to the first eigenvalue problem (see [95, 41]).

Theorem [41]. *Under Assumptions (3.22)-(3.28), for $0 < \alpha, \mathbf{a} < \infty$, there exist unique solutions (λ, \mathcal{U}) , respectively, to the eigenproblems (3.2), (3.3) and (3.4), and we have*

$$\begin{aligned} \lambda &> 0, \\ x^r \tau \mathcal{U} &\in L^p(\mathbb{R}_+), \quad \forall r \geq -\bar{\gamma}, \quad \forall p \in [1, \infty], \\ x^r \tau \mathcal{U} &\in W^{1,1}(\mathbb{R}_+), \quad \forall r \geq 0. \end{aligned}$$

We also recall the following corollary (first proved in [95]). We shall use it at some step of our blow-up analysis.

Corollary [95, 41]. *Let $\tau > 0, \beta > 0, \gamma, \nu \in \mathbb{R}$ such that $1 + \gamma - \nu > 0$, and κ_L verify Assumptions (3.22), (3.23) and (3.26). Then there exists a unique $(\theta_\alpha, v_\alpha)$ solution to the eigenproblem (3.2) with $\tau(x) = \tau x^\nu$ and $\beta(x) = \beta x^\gamma$:*

Indeed, in this particular case, assumptions of the above existence theorem are immediate, and as already said both assumptions (3.27) and (3.28) are verified if and only if $1 + \gamma - \nu > 0$.

3.2.3 Proof of Theorem 3.2.2

It is straightforward to prove that κ_α satisfies Assumptions (3.22)-(3.23) and (3.26) with the same constants c and C as κ , thus independent of α . We have local uniform convergences in \mathbb{R}_+^* $\tau_\alpha \xrightarrow{\alpha \rightarrow L} \tau x^\nu$ and $\beta_\alpha \xrightarrow{\alpha \rightarrow L} \beta x^\gamma$, if Assumption (3.5) holds, for $L = 0$ as well as $L = \infty$.

For the two cases, the result is based on uniform estimates on v_α and θ_α independent of α , in the same spirit as in the proof of the existence theorem (see [41]). When these estimates lead to compactness in $L^1(\mathbb{R}_+)$, we shall extract a converging subsequence, which will be a weak solution of Equation (3.21) ; the global convergence result will then be a consequence of the uniqueness of a solution to Equation (3.21). This type of proof is classical, and we refer for instance to [110, 41] for more details.

As in [41], the proofs of the estimates that are needed to obtain compactness in L^1 are strongly based on Assumptions (3.24), (3.26), (3.27) and (3.28). Lemmas 3.2.3, 3.2.4 and 3.2.5 prove, respectively, that $\beta_\alpha, \tau_\alpha$ and κ_α satisfy Assumption (3.28), (3.24) and (3.26)-(3.27) *uniformly* for all α .

Here we assume slight generalizations of Assumption (3.5), as specified in each lemma, in order to make clear where each part of Assumption (3.5) is necessary.

Lemma 3.2.3. *Suppose that*

$$\exists \nu, \gamma \in \mathbb{R} \quad \text{s.t.} \quad 1 + \gamma - \nu > 0, \quad \text{and} \quad \frac{\tau(x)}{\beta(x)} \underset{x \rightarrow L}{=} O(x^{\nu-\gamma}). \quad (3.29)$$

Then for all $r > 0$, there exist $A_r > 0$ and \mathcal{N}_L a neighbourhood of L such that

$$\text{for a.e. } x \geq A_r \text{ and for all } \alpha \in \mathcal{N}_L, \quad \frac{x\beta_\alpha(x)}{\tau_\alpha(x)} \geq r. \quad (3.30)$$

Proof. Let $r > 0$.

For all $\alpha > 0$, we define, using Assumption (3.28),

$$p_\alpha := \inf \left\{ p : \frac{x\beta(x)}{\alpha\tau(x)} \geq r, \text{ for a.e. } x \geq p \right\}.$$

Observe that p_α is nondecreasing. Let $\varepsilon > 0$ and by definition of p_α , there exists a sequence $\{\xi_\alpha\}$ with values in $[1 - \varepsilon, 1]$ such that

$$\frac{\xi_\alpha p_\alpha \beta(\xi_\alpha p_\alpha)}{\alpha\tau(\xi_\alpha p_\alpha)} \leq r. \quad (3.31)$$

From Assumptions (3.24) and (3.25) we have that $\frac{\tau}{x\beta} \in L_{loc}^\infty(\mathbb{R}_+^*)$ so that $p_\alpha \xrightarrow{\alpha \rightarrow +\infty} +\infty$ (otherwise, since it is nondecreasing, it would tend to a finite limit, which contradicts the definition of p_α), and also that $\frac{\tau}{x\beta} > 0$ on \mathbb{R}_+^* so that $p_\alpha \xrightarrow{\alpha \rightarrow 0} 0$. Hence, for some constant C

$$\frac{\tau(\xi_\alpha p_\alpha)}{\beta(\xi_\alpha p_\alpha)} \underset{\alpha \rightarrow L}{\leq} C(\xi_\alpha p_\alpha)^{\nu-\gamma}. \quad (3.32)$$

Then (3.31)-(3.32) lead to, for some absolute constant C

$$(1 - \varepsilon) \frac{p_\alpha}{\alpha^k} \leq \frac{\xi_\alpha p_\alpha}{\alpha^k} \leq \left[C \frac{\xi_\alpha p_\alpha \beta(\xi_\alpha p_\alpha)}{\alpha\tau(\xi_\alpha p_\alpha)} \right]^k \leq C^k r^k$$

which implies that $\limsup_{\alpha \rightarrow L} \frac{p_\alpha}{\alpha^k} \leq C^k r^k$ is finite. So we can define A_r by

$$A_r := 1 + \limsup_{\alpha \rightarrow L} \frac{p_\alpha}{\alpha^k}.$$

Then for any $x > A_r$ we have, when $\alpha \rightarrow L$, that $\alpha^k x > p_\alpha$, and so

$$\frac{\alpha^k x \beta(\alpha^k x)}{\alpha\tau(\alpha^k x)} \geq r,$$

and by definition of β_α and τ_α it gives us the desired result. \square

Lemma 3.2.4. *Suppose that*

$$\exists \nu \in \mathbb{R} \quad \text{s.t.} \quad \tau(x) \underset{x \rightarrow L}{=} O(x^\nu) \quad \text{and} \quad \exists r_0 > 0 \quad \text{s.t.} \quad x^{r_0} \tau(x) \in L_{loc}^\infty(\mathbb{R}_+). \quad (3.33)$$

Then for all $A > 0$ and $r \geq \max(r_0, -\nu)$, there exist $C > 0$ and \mathcal{N}_L a neighbourhood of L such that

$$\text{for a.e. } x \in [0, A] \text{ and for all } \alpha \in \mathcal{N}_L, \quad x^r \tau_\alpha(x) \leq C.$$

Suppose that

$$\exists \nu \in \mathbb{R} \quad \text{s.t.} \quad \tau^{-1}(x) \underset{x \rightarrow L}{=} O(x^{-\nu}) \quad \text{and} \quad \exists \mu > 0 \quad \text{s.t.} \quad \inf_{x \in [1, +\infty)} x^\mu \tau(x) > 0. \quad (3.34)$$

for all $\varepsilon > 0$ and $m \geq \max(\mu, -\nu)$, there exist $c > 0$ and \mathcal{N}_L a neighbourhood of L such that

$$\text{for a.e. } x \geq \varepsilon \text{ and for all } \alpha \in \mathcal{N}_L, \quad x^m \tau_\alpha(x) \geq c.$$

Proof. We treat separately the case $L = 0$ and $L = +\infty$.

Let us start with $L = 0$. Notice that in this case, if $\tau(x) = O(x^\nu)$, then due to Assumption (3.24), $r_0 = -\nu$, we have (3.33). Considering $r \geq -\nu$, we have for some constant $C > 0$

$$\begin{aligned} \sup_{x \in [0, A]} \text{ess } (x^r \tau_\alpha(x)) &= \sup_{y \in [0, \alpha^k A]} \text{ess } (\alpha^{-k(r+\nu)} y^r \tau(y)) \\ &\leq C \sup_{[0, \alpha^k A]} (\alpha^{-k(r+\nu)} y^{r+\nu}) = C A^{r+\nu}. \end{aligned}$$

For $m \geq \max(\mu, -\nu)$ and using Assumption (3.34) we have for some constants $c_1, c_2 > 0$:

$$\begin{aligned} \inf_{x \in [\varepsilon, \infty)} \text{ess } (x^m \tau_\alpha(x)) &= \inf_{y \in [\alpha^k \varepsilon, \infty)} \text{ess } (\alpha^{-k(m+\nu)} y^m \tau(y)) \\ &\geq \min \left(\inf_{[\alpha^k \varepsilon, 1]} \text{ess } (\alpha^{-k(m+\nu)} y^m \tau(y)), \inf_{[1, \infty)} \text{ess } (\alpha^{-k(m+\nu)} y^m \tau(y)) \right) \\ &\geq_{\alpha \rightarrow 0} \min \left(c_1 \inf_{[\alpha^k \varepsilon, 1]} (\alpha^{-k(m+\nu)} y^{m+\nu}), c_2 \alpha^{-k(m+\nu)} \right) = \min \left(c_1 \varepsilon^{m+\nu}, c_2 \alpha^{-k(m+\nu)} \right) \end{aligned}$$

Now we consider $L = +\infty$ and $r \geq \max(r_0, -\nu)$. Due to Assumption (3.33) we have for some constants $C_1, C_2 > 0$

$$\begin{aligned} \sup_{x \in [0, A]} \text{ess } (x^r \tau_\alpha(x)) &= \sup_{y \in [0, \alpha^k A]} \text{ess } (\alpha^{-k(r+\nu)} y^r \tau(y)) \\ &\leq \sup_{[0, 1]} \text{ess } (\alpha^{-k(r+\nu)} y^{r_0} \tau(y)) + \sup_{[1, \alpha^k A]} \text{ess } (\alpha^{-k(r+\nu)} y^r \tau(y)) \\ &\leq_{\alpha \rightarrow \infty} C_1 \alpha^{-k(r+\nu)} + C_2 A^{r+\nu}. \end{aligned}$$

For $m \geq -\nu$ and using Assumption (3.34), we have for some $c > 0$

$$\begin{aligned} \inf_{x \in [\varepsilon, \infty)} \text{ess } (x^m \tau_\alpha(x)) &= \inf_{y \in [\alpha^k \varepsilon, \infty)} \text{ess } (\alpha^{-k(m+\nu)} y^m \tau(y)) \\ &\geq_{\alpha \rightarrow \infty} c \inf_{[\alpha^k \varepsilon, \infty)} (\alpha^{-k(m+\nu)} y^{m+\nu}) = c \varepsilon^{m+\nu}. \end{aligned}$$

□

Lemma 3.2.5. *Suppose that*

$$\exists \nu, \gamma \in \mathbb{R} \quad \text{s.t.} \quad \gamma + 1 - \nu > 0, \quad \text{and} \quad \frac{\beta(x)}{\tau(x)} \underset{x \rightarrow L}{=} O(x^{\gamma-\nu}). \quad (3.35)$$

Then for all $\rho > 0$, there exist $\varepsilon > 0$ and \mathcal{N}_L a neighbourhood of L such that

$$\forall \alpha \in \mathcal{N}_L, \quad \int_0^\varepsilon \frac{\beta_\alpha(x)}{\tau_\alpha(x)} dx \leq \rho.$$

Proof. Due to Assumption 3.35 we have for some constant $C > 0$:

$$\int_0^\varepsilon \frac{\beta_\alpha(x)}{\tau_\alpha(x)} dx = \frac{1}{\alpha} \int_0^{\varepsilon \alpha^k} \frac{\beta(x)}{\tau(x)} dx \leq_{\alpha \rightarrow L} C \frac{1}{\alpha} \int_0^{\varepsilon \alpha^k} x^{\gamma-\nu} dx = C k \varepsilon^{\frac{1}{k}}.$$

The result follows for ε small enough. □

With these preliminary lemmas, we can prove Theorem 3.2.2.

Proof of Theorem 3.2.2. We prove estimates on $\{v_\alpha\}$ and $\{\theta_\alpha\}$, uniform in $\alpha \rightarrow L$, in order to have compactness. Then the convergence of the sequences is a consequence of the uniqueness of $(\theta_\infty, v_\infty)$.

First estimate: L^1 bound for $x^r v_\alpha$, $r \geq 0$. For $r \geq 2$, we have by definition and due to Assumption (3.23)

$$\begin{aligned} \int_0^y \frac{x^r}{y^r} \kappa_\alpha(x, y) dx &\leq \int_0^y \frac{x^2}{y^2} \kappa_\alpha(x, y) dx \\ &= \int_0^{\alpha^k y} \frac{x^2}{(\alpha^k y)^2} \kappa(x, \alpha^k y) dx \leq c. \end{aligned}$$

So, multiplying the equation (3.18) on v_α by x^r and then integrating on $[0, \infty)$, we find

$$\begin{aligned} \int (1 - 2c)x^r \beta_\alpha(x) v_\alpha(x) dx &\leq r \int x^{r-1} \tau_\alpha(x) v_\alpha(x) dx \\ &= r \int_{x \leq A} x^{r-1} \tau_\alpha(x) v_\alpha(x) dx + r \int_{x \geq A} x^{r-1} \tau_\alpha(x) v_\alpha(x) dx. \end{aligned} \quad (3.36)$$

Due to Lemma 3.2.3, and choosing $A = A_{\frac{\omega}{2}}$ in (3.36) with $\omega < 1 - 2c$, we obtain

$$\int x^r \beta_\alpha(x) v_\alpha(x) dx \leq \frac{r \sup_{(0, A_{\frac{\omega}{2}})} \{x^{r-1} \tau_\alpha\}}{1 - 2c - \omega},$$

and the right hand side is uniformly bounded for $r - 1 \geq \max(r_0, -\nu)$ when $\alpha \rightarrow L$, due to Lemma 3.2.4. Finally

$$\forall r \geq \max(2, 1 + r_0, 1 - \nu), \quad \exists C_r, \quad \int x^r \beta_\alpha(x) v_\alpha(x) dx \leq C_r. \quad (3.37)$$

Moreover for all α we have $\int v_\alpha dx = 1$. So, using Lemma 3.2.4 with $\beta^{-1}(x) = O(x^{-\gamma})$ instead of $\tau^{-1}(x) = O(x^{-\nu})$, we conclude that uniformly in $\alpha \rightarrow L$

$$x^r v_\alpha \in L^1(\mathbb{R}_+), \quad \forall r \geq 0. \quad (3.38)$$

Second estimate: θ_α upper bound. The next step is to prove the same estimate as (3.37) for $0 \leq r < \max(2, 1 + r_0, 1 - \nu)$ and for this we first give a bound on $\tau_\alpha v_\alpha$. Let $m = \max(2, 1 + r_0, 1 - \nu)$, then, using ε and $\rho < \frac{1}{2}$ defined in Lemma 3.2.5 and integrating (3.18) between 0 and $x \leq \varepsilon$, we find (noticing that the quantity $\tau_\alpha(x) v_\alpha(x)$ is well defined because Theorem [41] ensures that $\tau_\alpha v_\alpha$ is continuous)

$$\begin{aligned} \tau_\alpha(x) v_\alpha(x) &\leq 2 \int_0^x \int \beta_\alpha(y) v_\alpha(y) \kappa_\alpha(z, y) dy dz \\ &\leq 2 \int \beta_\alpha(y) v_\alpha(y) dy \\ &= 2 \int_0^\varepsilon \beta_\alpha(y) v_\alpha(y) dy + 2 \int_\varepsilon^\infty \beta_\alpha(y) v_\alpha(y) dy \\ &\leq 2 \sup_{(0, \varepsilon)} \{\tau_\alpha v_\alpha\} \int_0^\varepsilon \frac{\beta_\alpha(y)}{\tau_\alpha(y)} dy + 2\varepsilon^{-m} \int_0^\infty y^m \beta_\alpha(y) v_\alpha(y) dy \\ &\leq 2\rho \sup_{(0, \varepsilon)} \{\tau_\alpha v_\alpha\} + 2\varepsilon^{-m} C_m. \end{aligned}$$

Consequently, we obtain

$$\sup_{x \in (0, \varepsilon)} \tau_\alpha(x) v_\alpha(x) \leq \frac{1 + 2C_m \varepsilon^{-m}}{1 - 2\rho} := C. \quad (3.39)$$

Then we can write for any $0 \leq r < m$

$$\begin{aligned} \int x^r \beta_\alpha(x) v_\alpha(x) dx &= \int_0^\varepsilon x^r \beta_\alpha(x) v_\alpha(x) dx + \int_\varepsilon^\infty x^r \beta_\alpha(x) v_\alpha(x) dx \\ &\leq \varepsilon^r \sup_{(0, \varepsilon)} \{\tau_\alpha v_\alpha\} \int_0^\varepsilon \frac{\beta_\alpha(x)}{\tau_\alpha(x)} dx + \varepsilon^{r-m} \int_\varepsilon^\infty x^m \beta_\alpha(x) v_\alpha(x) dx \\ &\leq C\rho \varepsilon^r + C_m \varepsilon^{r-m} := C_r. \end{aligned}$$

Finally we have that

$$\forall r \geq 0, \quad \exists C_r, \quad \int x^r \beta_\alpha(x) v_\alpha(x) dx \leq C_r \quad (3.40)$$

and so

$$\theta_\alpha = \int \beta_\alpha v_\alpha \leq C_0. \quad (3.41)$$

Third estimate: L^∞ bound for $x^{-\tilde{\gamma}}\tau_\alpha v_\alpha$. First, integrating equation (3.18) between 0 and x we find

$$\tau_\alpha(x)v_\alpha(x) \leq 2 \int \beta_\alpha(y)v_\alpha(y) dy = 2\theta_\alpha \leq 2C_0, \quad \forall x > 0. \quad (3.42)$$

It remains to prove that $x^{-\tilde{\gamma}}\tau_\alpha v_\alpha$ is bounded in a neighborhood of zero.

Let us define $f_\alpha : x \mapsto \sup_{(0,x)} \tau_\alpha v_\alpha$. If we integrate (3.2) between 0 and $x' < x$, we find

$$\tau_\alpha(x')v_\alpha(x') \leq 2 \int_0^{x'} \int \beta_\alpha(y)v_\alpha(y)\kappa_\alpha(z,y) dy dz \leq 2 \int_0^x \int \beta_\alpha(y)v_\alpha(y)\kappa_\alpha(z,y) dy dz$$

and so for all x

$$f_\alpha(x) \leq 2 \int_0^x \int \beta_\alpha(y)v_\alpha(y)\kappa_\alpha(z,y) dy dz.$$

Considering ε and ρ from Lemma 3.2.5 and using (3.26), we have for all $x < \varepsilon$

$$\begin{aligned} f_\alpha(x) &\leq 2 \int_0^x \int \beta_\alpha(y)v_\alpha(y)\kappa_\alpha(z,y) dy dz \\ &= 2 \int \beta_\alpha(y)v_\alpha(y) \int_0^x \kappa_\alpha(z,y) dz dy \\ &\leq 2 \int_0^\infty \beta_\alpha(y)v_\alpha(y) \min\left(1, C\left(\frac{x}{y}\right)^{\tilde{\gamma}}\right) dy \\ &= 2 \int_0^x \beta_\alpha(y)v_\alpha(y) dy + 2C \int_x^\varepsilon \beta_\alpha(y)v_\alpha(y) \left(\frac{x}{y}\right)^{\tilde{\gamma}} dy + 2C \int_\varepsilon^\infty \beta_\alpha(y)v_\alpha(y) \left(\frac{x}{y}\right)^{\tilde{\gamma}} dy \\ &= 2 \int_0^x \frac{\beta_\alpha(y)}{\tau_\alpha(y)} \tau_\alpha(y)v_\alpha(y) dy + 2Cx^{\tilde{\gamma}} \int_x^\varepsilon \frac{\beta_\alpha(y)}{\tau_\alpha(y)} \frac{\tau_\alpha(y)v_\alpha(y)}{y^{\tilde{\gamma}}} dy + 2C \int_\varepsilon^\infty \beta_\alpha(y)v_\alpha(y) \left(\frac{x}{y}\right)^{\tilde{\gamma}} dy \\ &\leq 2f_\alpha(x) \int_0^\varepsilon \frac{\beta_\alpha(y)}{\tau_\alpha(y)} dy + 2Cx^{\tilde{\gamma}} \int_x^\varepsilon \frac{\beta_\alpha(y)}{\tau_\alpha(y)} \frac{f_\alpha(y)}{y^{\tilde{\gamma}}} dy + 2C\varepsilon^{-\tilde{\gamma}} \|\beta_\alpha v_\alpha\|_{L^1} x^{\tilde{\gamma}}. \end{aligned}$$

If we set $\mathcal{V}_\alpha(x) = x^{-\tilde{\gamma}}f_\alpha(x)$, we obtain when $\alpha \rightarrow L$

$$(1 - 2\rho)\mathcal{V}_\alpha(x) \leq K_\varepsilon + 2C \int_x^\varepsilon \frac{\beta_\alpha(y)}{\tau_\alpha(y)} \mathcal{V}_\alpha(y) dy$$

and, from Grönwall's lemma, we find that $\mathcal{V}_\alpha(x) \leq \frac{K_\varepsilon e^{\frac{2C\rho}{1-2\rho}}}{1-2\rho}$. Finally

$$\sup_{(0,\varepsilon)} \{x^{-\tilde{\gamma}}\tau_\alpha(x)v_\alpha(x)\} \leq \frac{K_\varepsilon e^{\frac{2C\rho}{1-2\rho}}}{1-2\rho}. \quad (3.43)$$

The bound (3.42) with Assumption (3.25) and the bound (3.43) with Lemma 3.2.5 (in which we replace $\beta_\alpha(x)$ by $x^{\tilde{\gamma}}$) ensure that the family $\{v_\alpha\}$ is uniformly integrable. This result, with the first estimate, gives that $\{v_\alpha\}$ belongs to a compact set in L^1 -weak due to the Dunford-Pettis theorem. The sequence $\{\theta_\alpha\}$ belongs also to a compact interval of \mathbb{R}_+ , so there is a subsequence of $\{(v_\alpha, \theta_\alpha)\}$ which converges in L^1 -weak $\times \mathbb{R}$. The limit is a solution to (3.21), but such a solution is unique, so the sequence converges. To have convergence in L^1 -strong, we need one more estimate.

Fourth estimate: $W^{1,1}$ bound for $x^r \tau_\alpha v_\alpha$, $r \geq 0$. First, the estimates (3.38) and (3.43) ensure that $x^r \tau_\alpha v_\alpha$ is uniformly bounded in L^1 for any $r > -1$. Then, equation (3.18) gives immediately that

$$\int \left| \frac{\partial}{\partial x} (x^r \tau_\alpha(x)v_\alpha(x)) \right| dx \leq r \int x^{r-1} \tau_\alpha(x)v_\alpha(x) dx + \theta_\alpha + 3 \int \beta_\alpha(x)v_\alpha(x) \quad (3.44)$$

is also uniformly bounded. For $r = 0$, the same computation works and finally $x^r \tau_\alpha v_\alpha$ is bounded in $W^{1,1}(\mathbb{R}_+)$ for any $r \geq 0$.

The consequence is, thanks to the Rellich-Kondrachov theorem, that $\{x^r \tau_\alpha v_\alpha\}$ is compact in L^1 -strong and so converges strongly to $\tau x^{r+\nu} v_\infty(x)$. Then, using Lemma 3.2.4 and estimate (3.43), we can write

$$\begin{aligned} \int x^r |v_\alpha(x) - v_\infty(x)| dx &\leq \int_0^\varepsilon x^r |v_\alpha(x) - v_\infty(x)| dx + \int_\varepsilon^\infty x^r |v_\alpha(x) - v_\infty(x)| dx \\ &\leq C \int_0^\varepsilon \frac{x^{r+\bar{\gamma}}}{\tau_\alpha(x)} dx + C \int_\varepsilon^\infty x^r |\tau_\alpha(x) v_\alpha(x) - \tau x^\nu v_\infty(x)| dx. \end{aligned}$$

The first term is small for ε small and the second term is small for α close to L due to the strong L^1 convergence of $\{x^r \tau_\alpha(x) v_\alpha(x)\}$. This proves the strong convergence of $\{x^r v_\alpha(x)\}$ and ends the proof of Theorem 3.2.2. \square

3.3 Further Results

3.3.1 Critical case

In the case when $\lim_{x \rightarrow 0} \beta(x)$ or $\lim_{x \rightarrow 0} \frac{\tau(x)}{x}$ is a positive constant, we can enhance the result of Theorem 3.1.1 if we know the higher order term in the series expansion. Assumptions (3.45) and (3.47) of Corollary 3.3.1 are stronger than Assumption (3.5), but provide a more precise result on the asymptotic behavior of λ_α , Λ_α .

Corollary 3.3.1. *If β admits an expansion of the form*

$$\beta(x) = \beta_0 + \beta_1 x^{\gamma_1} + o_{x \rightarrow 0}(x^{\gamma_1}), \quad \gamma_1 > 0 \quad (3.45)$$

with $\beta_0 > 0$ and $\beta_1 \neq 0$, then we have the following expansion for λ :

$$\lambda_\alpha = \beta_0 + \left(\beta_1 \int x^{\gamma_1} v_\infty(x) dx \right) \alpha^{k\gamma_1} + o_{\alpha \rightarrow 0}(\alpha^{k\gamma_1}). \quad (3.46)$$

In the same way, if τ admits an expansion of the form

$$\tau(x) = \tau_0 x + \tau_1 x^{\nu_1} + o_{x \rightarrow 0}(x^{\nu_1}), \quad \nu_1 > 1 \quad (3.47)$$

with $\tau_0 > 0$ and $\tau_1 \neq 0$, then we have

$$\Lambda_\alpha = \tau_0 + \left(\tau_1 \frac{\int x^{\nu_1} v_\infty(x) dx}{\int x v_\infty(x) dx} \right) \alpha^{l(\nu_1-1)} + o_{\alpha \rightarrow \infty}(\alpha^{l(\nu_1-1)}). \quad (3.48)$$

Proof. First we assume that β admits an expansion of the form (3.45) and we want to prove (3.46). By integrating Equation (3.18) we know that $\lambda_\alpha \int v_\alpha dx = \int \beta_\alpha(x) v_\alpha(x) dx$ and so multiplying by $\alpha^{-k\gamma_1}$ gives

$$\alpha^{-k\gamma_1} (\lambda_\alpha - \beta_0) = \int \alpha^{-k\gamma_1} (\beta_\alpha(x) - \beta_0) v_\alpha(x) dx.$$

Now the proof is complete if we prove the convergence

$$\int \alpha^{-k\gamma_1} (\beta_\alpha(x) - \beta_0) v_\alpha(x) dx \xrightarrow{\alpha \rightarrow 0} \int \beta_1 x^{\gamma_1} v_\infty(x) dx. \quad (3.49)$$

For this we use the expansion (3.45) which provides, for all $x \geq 0$,

$$\beta_\alpha(x) \underset{\alpha \rightarrow 0}{=} \beta_0 + \beta_1 x^{\gamma_1} \alpha^{k\gamma_1} + o(\alpha^{k\gamma_1}). \quad (3.50)$$

Let $m \geq \gamma_1$ such that $\limsup_{x \rightarrow \infty} x^{-m} \beta(x) < \infty$ (see Assumption (3.24)) and define

$$f_\alpha : x \mapsto \frac{\alpha^{-k\gamma_1} (\beta_\alpha(x) - \beta_0)}{x^{\gamma_1} + x^m}.$$

We know due to (3.50) that $f_\alpha(x) \xrightarrow{\alpha \rightarrow 0} \frac{\beta_1 x^{\gamma_1}}{x^{\gamma_1} + x^m}$ for all x . Moreover we have due to Theorem 3.2.2 that $(x^{\gamma_1} + x^m)v_\alpha(x) \xrightarrow{\alpha \rightarrow 0} (x^{\gamma_1} + x^m)v_\infty(x)$ in L^1 . So we simply have to prove that f_α is uniformly bounded to get (3.49) (see Section 5.2 in [61]). Due to (3.45) and the fact that $\limsup_{x \rightarrow \infty} x^{-m} \beta(x) < \infty$ with $m \geq \gamma_1 > 0$, we know that there exists a constant C such that

$$|\beta(y) - \beta_0| \leq C(y^{\gamma_1} + y^m), \quad \forall y \geq 0,$$

and so, because $\alpha \rightarrow 0$

$$\alpha^{-k\gamma_1} |\beta(y) - \beta_0| \leq C(\alpha^{-k\gamma_1} y^{\gamma_1} + \alpha^{-km} y^m),$$

which gives, for $x = \alpha^k y$

$$\alpha^{-k\gamma_1} |\beta(\alpha^k x) - \beta_0| \leq C(x^{\gamma_1} + x^m)$$

and we have proved that $f_\alpha(x) \leq C$.

The same method allows us to prove the result on Λ_α , starting from the identity

$$(\Lambda_\alpha - \tau_0) \int x w_\alpha(x) dx = \int (\tau_\alpha(x) - \tau_0 x) w_\alpha(x) dx$$

and using the fact that (3.47) provides the expansion

$$\tau_\alpha(x) \underset{\alpha \rightarrow \infty}{=} \tau_0 x + \tau_1 x^{\nu_1} \alpha^{l(\nu_1-1)} + o(\alpha^{l(\nu_1-1)}).$$

□

3.3.2 Relaxed case

Here we relax Assumption (3.5) and examine if the asymptotic behavior of λ_α and Λ_α obtained in Theorem 3.1.1 remains true. The case we are the most interested in is the case when the limits are zero (see the applications at Section 3.4). Is the condition $\lim_{x \rightarrow L} \beta(x) = 0$ (resp. $\lim_{x \rightarrow \frac{1}{L}} \frac{\tau(x)}{x} = 0$) necessary and sufficient to have $\lim_{\alpha \rightarrow L} \lambda_\alpha = 0$ (resp. $\lim_{\alpha \rightarrow L} \Lambda_\alpha = 0$)? The following theorem gives partial results in the direction of a positive answer to this question. The assumptions required are weaker, but the results also are weaker. We obtain asymptotic behavior for the eigenvalue, but cannot say anything yet on the eigenvector behavior.

Theorem 3.3.2. *Let us suppose that all assumptions of Theorem 3.2.2 are verified except Assumption (3.5).*

1. *If $\tau(x) \underset{x \rightarrow 0}{=} o(x^\nu)$, $\beta \underset{x \rightarrow 0}{=} O(x^\gamma)$ and $\beta(x)^{-1} \underset{x \rightarrow 0}{=} O(x^{-\gamma})$ with $\gamma + 1 - \nu > 0$, we have that*

$$\text{if } \gamma > 0, \text{ then } \lim_{\alpha \rightarrow 0} \lambda_\alpha = 0, \text{ and more precisely } \lambda_\alpha \underset{\alpha \rightarrow 0}{=} o(\alpha^{\frac{\gamma}{1+\gamma-\nu}}),$$

$$\text{if } \nu \geq 1, \text{ then } \lim_{\alpha \rightarrow \infty} \Lambda_\alpha = 0, \text{ and more precisely } \Lambda_\alpha \underset{\alpha \rightarrow \infty}{=} o(\alpha^{\frac{1-\nu}{1+\gamma-\nu}}).$$

2. *If $\beta(x) \underset{x \rightarrow \infty}{=} o(x^\gamma)$ and $\tau(x)^{-1} \underset{x \rightarrow \infty}{=} O(x^{-\nu})$ with $\gamma + 1 - \nu > 0$ and $\gamma \leq 0$ (so that $\nu < 1$), we have that*

$$\lim_{\alpha \rightarrow \infty} \lambda_\alpha = \lim_{\alpha \rightarrow 0} \Lambda_\alpha = 0, \text{ and more precisely } \lambda_\alpha \underset{\alpha \rightarrow +\infty}{=} o(\alpha^{\frac{\gamma}{1+\gamma-\nu}}), \Lambda_\alpha \underset{\alpha \rightarrow 0}{=} o(\alpha^{\frac{1-\nu}{1+\gamma-\nu}}).$$

Remark. In the second assertion of this theorem, we notice that Assumption (3.28) means $\frac{\tau(x)}{x} \underset{x \rightarrow \infty}{=} o(\beta(x))$, so the condition $\beta(x) = o(x^\gamma)$ with $\gamma \leq 0$ imposes $\lim_{x \rightarrow \infty} \frac{\tau(x)}{x} = 0$.

Proof of Theorem 3.3.2.1. We perform the dilation defined by (3.6): $v_\alpha(x) = \alpha^k \mathcal{U}_\alpha(\alpha^k x)$ with $k = \frac{1}{1+\gamma-\nu}$. Due to the assumption $\beta(x) \underset{x \rightarrow 0}{=} O(x^{-\gamma})$ and $\tau = O(x^\nu)$, the conclusions of Lemma 3.2.3 and Lemma 3.2.4 still hold true. Hence we have the following bound (see the first estimate in the proof of Theorem 3.2.2)

$$\int x^r \beta_\alpha(x) v_\alpha(x) dx \leq \frac{r \sup_{(0, A \frac{x}{\omega})} (x^{r-1} \tau_\alpha)}{1 - 2c - \omega}$$

where $\tau_\alpha(x)$ and β_α are defined by (3.14), and the right-hand side is bounded uniformly in α for $r \geq \max(2, 1 + r_0, 1 - \nu)$. Let $\varepsilon > 0$ and write

$$\begin{aligned} \alpha^{-\frac{\gamma}{1+\gamma-\nu}} \lambda_\alpha = \theta_\alpha &= \int \beta_\alpha v_\alpha \leq \int_0^\varepsilon \beta_\alpha(x) v_\alpha(x) dx + \varepsilon^{-r} \int_0^\infty x^r \beta_\alpha(x) v_\alpha(x) dx \\ &\leq \sup_{(0, \varepsilon)} \beta_\alpha + \varepsilon^{-r} \frac{r \sup_{(0, A \frac{x}{\omega})} (x^{r-1} \tau_\alpha)}{1 - 2c - \omega} \end{aligned}$$

Thus, since $\sup_{(0, A \frac{x}{\omega})} x^{r_0} \tau_\alpha \underset{\alpha \rightarrow 0}{\rightarrow} 0$, we obtain

$$\limsup_{\alpha \rightarrow 0} \theta_\alpha \leq \limsup_{\alpha \rightarrow 0} \sup_{(0, \varepsilon)} \beta_\alpha \leq C \varepsilon^\gamma.$$

This is true for all $\varepsilon > 0$, so the assertion 1 of Theorem 3.3.2 is proved (the same proof works with the fragmentation parameter \mathbf{a}). □

Proof of Theorem 3.3.2.2. We perform the dilation defined by (3.6) $v_\alpha(x) = \alpha^k \mathcal{U}_\alpha(\alpha^k x)$ with $k = \frac{1}{1+\gamma-\nu}$. Due to Assumption (3.35) for $L = +\infty$, we still have the conclusion of Lemma 3.2.5 and it is sufficient to bound $\tau_\alpha v_\alpha$ on $(0, \varepsilon)$ for $\varepsilon > 0$. We refer to the proof of Theorem 3.2.2 in Section 3.2.3, second estimate, and write:

$$\begin{aligned} \tau_\alpha(x) v_\alpha(x) &\leq 2 \sup_{(0, \varepsilon)} \{\tau_\alpha v_\alpha\} \int_0^\varepsilon \frac{\beta_\alpha(y)}{\tau_\alpha(y)} dy + 2 \int_\varepsilon^\infty \beta_\alpha(y) v_\alpha(y) dy \\ &\leq 2\rho \sup_{(0, \varepsilon)} \{\tau_\alpha v_\alpha\} + 2 \sup_{(\varepsilon, +\infty)} \beta_\alpha. \end{aligned}$$

Taking for instance ε small enough so that $\rho \leq \frac{1}{4}$ in this estimate, and α large enough so that $\sup_{(\varepsilon, +\infty)} \beta_\alpha \leq C$, we obtain the boundedness of $\tau_\alpha v_\alpha$ on $(0, \varepsilon_0)$. Then we write for $\varepsilon > 0$,

$$\begin{aligned} \alpha^{-\frac{\gamma}{1+\gamma-\nu}} \lambda_\alpha = \theta_\alpha &= \int \beta_\alpha v_\alpha \\ &\leq \underbrace{\sup_{(0, \varepsilon)} \tau_\alpha v_\alpha}_{\leq C} \underbrace{\int_0^\varepsilon \frac{\beta_\alpha}{\tau_\alpha}}_{\xrightarrow{\varepsilon \rightarrow 0} 0} + \underbrace{\sup_{(\varepsilon, \infty)} \beta_\alpha}_{\xrightarrow{\alpha \rightarrow \infty} 0} \end{aligned}$$

The latter estimate is a consequence of the assumption $\beta(x) \underset{x \rightarrow \infty}{=} o(x^\gamma)$.

We do the same computations for the parameter \mathbf{a} . □

3.3.3 Generalized case

In this section, we completely free ourselves of Assumption (3.5) and give some results about the asymptotic behavior of the first eigenvalues for general coefficients. The techniques used are completely different than the self-similar ones, but the results still give comparisons between λ_α and $\beta(x)$, and between Λ_α and $\frac{\tau(x)}{x}$.

Theorem 3.3.3. 1. **Polymerization dependency.**

$$\text{If } \beta \in L_{loc}^\infty(\mathbb{R}_+^*) \text{ and } \limsup_{x \rightarrow \infty} \frac{\tau(x)}{x} < \infty, \quad \text{then } \limsup_{\alpha \rightarrow 0} \lambda_\alpha \leq \limsup_{x \rightarrow \infty} \beta(x). \quad (3.51)$$

$$\text{If } \frac{1}{\tau} \in L_0^1 := \{f, \exists a > 0, f \in L^1(0, a)\}, \quad \text{then } \liminf_{\alpha \rightarrow \infty} \lambda_\alpha \geq \liminf_{x \rightarrow \infty} \beta(x). \quad (3.52)$$

2. **Fragmentation dependency.**

$$\text{If } \beta \in L_{loc}^\infty(\mathbb{R}_+), \text{ then there exists } r > 0 \quad \text{such that} \quad \limsup_{\alpha \rightarrow 0} \Lambda_\alpha \leq r \limsup_{x \rightarrow \infty} \frac{\tau(x)}{x}. \quad (3.53)$$

$$\text{If } \liminf_{x \rightarrow \infty} \beta(x) > 0, \text{ and if } \frac{1}{\tau} \in L_0^1, \quad \text{then} \quad \lim_{\alpha \rightarrow \infty} \Lambda_\alpha = +\infty. \quad (3.54)$$

We first state a lemma which links the moments of the eigenvector, the eigenvalue and the polymerization rate.

Lemma 3.3.4. *Let (\mathcal{U}, λ) solution to the eigenproblem (3.2). For any $r \geq 0$ we have*

$$\int x^r \mathcal{U}(x) dx \leq \frac{r}{\lambda} \int x^{r-1} \tau(x) \mathcal{U}(x) dx. \quad (3.55)$$

Proof. Integrating Equation (3.2) against x^r we find

$$\begin{aligned} & - \int r x^{r-1} \tau(x) \mathcal{U}(x) dx + \lambda \int x^r \mathcal{U}(x) dx + \int x^r \beta(x) \mathcal{U}(x) dx \\ &= 2 \int x^r \int_0^x \beta(y) \kappa(x, y) \mathcal{U}(y) dy dx \\ &= 2 \int \beta(y) \mathcal{U}(y) \int_0^y x^r \kappa(x, y) dx dy \\ &\leq 2 \int \beta(y) \mathcal{U}(y) y^{r-1} \int_0^y x \kappa(x, y) dx dy \\ &= \int y^r \beta(y) \mathcal{U}(y) dy. \end{aligned}$$

□

Proof of Theorem 3.3.3.1.(3.51). We only have to consider the case $\limsup_{x \rightarrow \infty} \beta(x) < \infty$. In this case, $\beta \in L_{loc}^\infty(\mathbb{R}_+)$ since it is assumed that $\beta \in L_{loc}^\infty(\mathbb{R}_+^*)$. So for $\varepsilon > 0$, we can define $\overline{\beta_\varepsilon} := \sup_{(0, \varepsilon)} \beta(x) < \infty$ and, due to Assumption (3.24), there exist positive constants C_ε and r such that $\beta(x) \leq C x^r$ for almost every $x \geq \varepsilon$. As a consequence, we have by integration of Equation (3.3)

$$\lambda_\alpha = \int \beta(x) \mathcal{U}_\alpha(x) dx \leq \overline{\beta_\varepsilon} + C \int x^r \mathcal{U}_\alpha(x) dx.$$

We can consider that $r \geq r_0 + 1$, with r_0 defined in Assumption (3.24), and thus Lemma 3.3.4 and Assumption $\limsup_{x \rightarrow \infty} \frac{\tau(x)}{x} < \infty$ give

$$\int x^r \mathcal{U}_\alpha(x) dx \leq \frac{\alpha r}{\lambda_\alpha} \int x^{r-1} \tau(x) \mathcal{U}_\alpha(x) dx \leq \frac{\alpha}{\lambda_\alpha} C \left(1 + \int x^r \mathcal{U}_\alpha(x) dx \right)$$

for a new constant C . Combining these two inequalities we obtain

$$\lambda_\alpha \leq \alpha C \left(1 + \frac{1}{\int x^r \mathcal{U}_\alpha(x) dx} \right) \leq \alpha C \left(1 + \frac{1}{\lambda_\alpha - \overline{\beta}_\varepsilon} \right).$$

Then, either $\lambda_\alpha \leq \overline{\beta}_\varepsilon$, or we obtain by multiplication by $\lambda_\alpha - \overline{\beta}_\varepsilon > 0$ that

$$\lambda_\alpha^2 - (\overline{\beta}_\varepsilon + \alpha C)\lambda_\alpha - (1 - \overline{\beta}_\varepsilon)\alpha C \leq 0,$$

and so

$$\lambda_\alpha \leq \frac{1}{2} \left(\overline{\beta}_\varepsilon + \alpha C + \sqrt{\overline{\beta}_\varepsilon^2 + 4\alpha C + \alpha^2 C^2} \right).$$

Finally we have

$$\limsup_{\alpha \rightarrow 0} \lambda_\alpha \leq \overline{\beta}_\varepsilon$$

and this is true for any $\varepsilon > 0$, so

$$\limsup_{\alpha \rightarrow 0} \lambda_\alpha \leq \limsup_{x \rightarrow 0} \beta(x).$$

□

Proof of Theorem 3.3.3.1.(3.52). Let $A > 0$ and define $\underline{\beta}_A := \inf_{(A, \infty)} \beta$. Since $\frac{1}{\tau} \in L^1_0$ and due to Assumption (3.25) we can define $I_A := \int_0^A \frac{dx}{\tau(x)} < \infty$. Then, we have by integration of Equation (3.3)

$$\begin{aligned} \lambda_\alpha &= \int \beta(y) \mathcal{U}_\alpha(y) dy \\ &\geq \underline{\beta}_A \int_A^\infty \mathcal{U}_\alpha(y) dy \\ &= \underline{\beta}_A \left(1 - \int_0^A \mathcal{U}_\alpha(y) dy \right). \end{aligned}$$

We know, by integration of Equation (3.3) between 0 and x , that for all $x > 0$, $\alpha \tau(x) \mathcal{U}_\alpha(x) \leq 2\lambda_\alpha$. Thus we obtain

$$\lambda_\alpha \geq \underline{\beta}_A \left(1 - \int_0^A 2\lambda_\alpha \frac{dy}{\alpha \tau(y)} \right)$$

which gives

$$\lambda_\alpha \geq \frac{\underline{\beta}_A}{1 + \frac{2}{\alpha} \underline{\beta}_A I}$$

and

$$\liminf_{\alpha \rightarrow \infty} \lambda_\alpha \geq \underline{\beta}_A.$$

Finally, since the previous inequality is true for all $A > 0$, we find

$$\liminf_{\alpha \rightarrow \infty} \lambda_\alpha \geq \liminf_{x \rightarrow +\infty} \beta(x).$$

□

Proof of Theorem 3.3.3.2.(3.53). The fact that $\beta \in L^{\infty}_{loc}(\mathbb{R}_+)$ associated to Assumption (3.24) ensures the existence of two positive constants C and r such that for almost every $x \geq 0$, $\beta(x) \leq C(1 + x^r)$. So, integrating Equation (3.4), we have

$$\Lambda_{\mathbf{a}} = \mathbf{a} \int \beta(x) \mathcal{V}_{\mathbf{a}}(x) dx \leq \mathbf{a} C \left(1 + \int_0^\infty x^r \mathcal{V}_{\mathbf{a}}(x) dx \right).$$

To prove (3.53), we only have to consider the case $\limsup_{x \rightarrow \infty} \frac{\tau(x)}{x} < \infty$. So, for any $A > 0$, we can define $\overline{\tau}_A := \sup_{x > A} \frac{\tau(x)}{x} < \infty$ and we have, due to Lemma 3.3.4 and considering $r \geq r_0 + 1$ where r_0 is defined in Assumption (3.24),

$$\int x^r \mathcal{V}_a(x) dx \leq \frac{r}{\Lambda_a} \int x^{r-1} \tau(x) \mathcal{V}_a(x) dx \leq \frac{r}{\Lambda_a} \left(C + \overline{\tau}_A \int x^r \mathcal{V}_a(x) dx \right).$$

Combining the two inequalities we obtain

$$\Lambda_a \leq r \left(\overline{\tau}_A + \frac{C}{\int x^r \mathcal{V}_a(x) dx} \right) \leq r \left(\overline{\tau}_A + \frac{aC}{\Lambda_a - aC} \right).$$

Then, either $\Lambda_a \leq aC$, or we obtain by multiplication by $\Lambda_a - aC > 0$ that

$$\Lambda_a^2 - (r\overline{\tau}_A + aC)\Lambda_a - r(1 - \overline{\tau}_A)aC \leq 0,$$

and so

$$\Lambda_a \leq \frac{1}{2} \left(r\overline{\tau}_A + aC + \sqrt{(r\overline{\tau}_A)^2 + 4raC + a^2C^2} \right).$$

In the two cases we obtain that

$$\limsup_{a \rightarrow 0} \Lambda_a \leq r\overline{\tau}_A,$$

and, letting $A \rightarrow \infty$, we conclude

$$\limsup_{a \rightarrow 0} \Lambda_a \leq r \limsup_{x \rightarrow \infty} \frac{\tau(x)}{x}.$$

□

Proof of Theorem 3.3.3.(3.54). Let $\varepsilon > 0$. Since $\liminf_{x \rightarrow \infty} \beta(x) > 0$, we have due to Assumption (3.25) that $\underline{\beta}_\varepsilon := \inf_{(\varepsilon, \infty)} \beta > 0$. Since $\frac{1}{\tau} \in L_0^1$, we have thanks to Assumption (3.25) that $I_\varepsilon := \int_0^\varepsilon \frac{dx}{\tau(x)} < \infty$ and that $\lim_{\varepsilon \rightarrow 0} I_\varepsilon = 0$. By integration of equation (3.4), we find

$$\begin{aligned} \Lambda_a &= a \int \beta(y) \mathcal{V}_a(y) dy \\ &\geq a \underline{\beta}_\varepsilon \int_\varepsilon^\infty \mathcal{V}_a(y) dy \\ &= a \underline{\beta}_\varepsilon \left(1 - \int_0^\varepsilon \mathcal{V}_a(y) dy \right). \end{aligned}$$

We know, as previously, by integration between 0 and x , that for all $x > 0$, $\tau(x) \mathcal{V}_a(x) \leq 2\Lambda_a$. Thus we obtain

$$\Lambda_a \geq a \underline{\beta}_\varepsilon \left(1 - \int_0^\varepsilon 2\Lambda_a \frac{dy}{\tau(y)} \right)$$

which gives

$$\Lambda_a \geq \frac{a \underline{\beta}_\varepsilon}{1 + 2a \underline{\beta}_\varepsilon I_\varepsilon}.$$

Finally we have

$$\liminf_{a \rightarrow \infty} \Lambda_a \geq \frac{1}{2I_\varepsilon} \xrightarrow{\varepsilon \rightarrow 0} +\infty$$

and it ends the proof of Theorem 3.3.3.(3.54). □

3.4 Applications

Before giving applications, we recall a regularity result whose proof can be found in [96].

Lemma 3.4.1. *Under the assumptions of Section 3.2.2, the functions $\alpha \mapsto \lambda_\alpha$ and $\mathbf{a} \mapsto \Lambda_\mathbf{a}$ are well defined and differentiable on $(0, \infty)$.*

3.4.1 Numerical scheme based on Theorem 3.2.2

We first present the method we use to compute numerically the principal eigenvector λ without considering any dependency on parameters. Then we explain how the self-similar change of variable (3.6) and the convergence result of Theorem 3.2.2 can be used to compute the dependencies $\alpha \mapsto \lambda_\alpha$ and $\mathbf{a} \mapsto \Lambda_\mathbf{a}$, when parameters α and \mathbf{a} are very large or very small.

The method used to compute the solution to Equation (3.2), is first to compute a numerical approximation of the first eigenvector \mathcal{U} , and then use the identity

$$\lambda = \int_0^\infty \beta(x)\mathcal{U}(x) dx.$$

The General Relative Entropy (GRE) introduced by [98, 99, 110] provides the long time asymptotic behavior of any solution to the fragmentation-drift equation (3.1). At sufficiently large times, these solutions look like $\mathcal{U}(x)e^{\lambda t}$ where \mathcal{U} and λ are the eigenelements defined at (3.2). More precisely we have

$$\int_0^\infty |u(x, t)e^{-\lambda t} - \langle u(\cdot, t=0), \phi \rangle \mathcal{U}(x)| \phi(x) dx \xrightarrow[t \rightarrow \infty]{} 0,$$

where ϕ is the dual eigenvector of Equation (3.2) (see [41, 99] for more details) and $\langle u, \phi \rangle = \int_0^\infty u(x)\phi(x) dx$. It is even proved in [79, 15], under some assumptions on the coefficients, that this convergence occurs exponentially fast. We use this convergence to compute numerically the eigenvector \mathcal{U} . We consider, for $u_0 \in L^1(\mathbb{R}_+)$, an initial function satisfying $\int_0^\infty u_0(x) dx = 1$, the solution $u(x, t)$ to the fragmentation-drift equation (3.1). Since we do not know yet the value of λ , we define the normalized function

$$\tilde{u}(x, t) := \frac{u(x, t)}{\int_0^\infty u(x, t) dx}.$$

We can easily check that \tilde{u} satisfies the equation

$$\partial_t \tilde{u}(x, t) + \partial_x (\tau(x)\tilde{u}(x, t)) + \left(\int_0^\infty \beta(y)\tilde{u}(y, t) dy \right) \tilde{u}(x, t) + \beta(x)\tilde{u}(x, t) = 2 \int_x^\infty \beta(y)\kappa(x, y)\tilde{u}(y, t) dy, \quad (3.56)$$

with the boundary condition $\tau(0)\tilde{u}(0, t) = 0$, and that the convergence occurs

$$\int_0^\infty |\tilde{u}(x, t) - \mathcal{U}(x)| \phi(x) dx \xrightarrow[t \rightarrow \infty]{} 0. \quad (3.57)$$

The scheme used to compute \mathcal{U} is based on the resolution of Equation (3.56) for large times and the use of (3.57) for the stop condition.

Numerically, Equation (3.56) is solved on a truncated domain $[0, R]$ so the integration bounds have to be changed and we obtain, for $x \in [0, R]$,

$$\partial_t \tilde{u}(x, t) + \partial_x (\tau(x)\tilde{u}(x, t)) + \left(\int_0^R \beta(y)\tilde{u}(y, t) dy \right) \tilde{u}(x, t) + \beta(x)\tilde{u}(x, t) = 2 \int_x^R \beta(y)\kappa(x, y)\tilde{u}(y, t) dy. \quad (3.58)$$

What we loose when we solve this truncated equation are the integral terms $\int_R^\infty \beta(x)\tilde{u}(x, t) dx$ and $\int_R^\infty \beta(y)\kappa(x, y)\tilde{u}(y, t) dy$, and the outgoing flux $\tau(R)\tilde{u}(R, t)$ at the boundary $x = R$. To be as close as

possible to the non-truncated solution, we have to choose R large enough so that these quantities are small enough. It is proved in [41] that $\beta(x)\mathcal{U}(x)$ and $\tau(x)\mathcal{U}(x)$ are fast decreasing when $x \rightarrow +\infty$. The value of R has to be adapted to have, when \tilde{u} is close to the equilibrium \mathcal{U} , values of $\tau(x)\tilde{u}(x, t)$ and $\beta(x)\tilde{u}(x, t)$ smaller than a fixed parameter ϵ for x close to R . Parameter ϵ is expected to be very small, it is also used for the stop condition (3.60).

We assume that $[0, R]$ is divided into N uniform cells and we denote $x_i = i\Delta x$ for $0 \leq i \leq N$ with $\Delta x = \frac{R}{N}$. The time is discretized with the time step Δt and we denote $t^n = n\Delta t$ for $n \in \mathbb{N}$. We adopt the finite difference point of view, namely we compute an approximation \tilde{u}_i^n of $\tilde{u}(x_i, t^n)$. It remains to explain how we go from the time t^n to the time t^{n+1} . To enforce that $\sum_{i=1}^N \tilde{u}_i^n = 1$ at each time step, we split the evolution into two steps. First we compute, from $(\tilde{u}_i^n)_{1 \leq i \leq N}$, a vector $(u_i^{n+1})_{1 \leq i \leq N}$ which is obtain with the formula

$$\frac{u_i^{n+1} - \tilde{u}_i^n}{\Delta t} = -\frac{\tau_i \tilde{u}_i^{n+1} - \tau_{i-1} \tilde{u}_{i-1}^n}{\Delta x} - \beta_i^{n+1} + 2\Delta x \sum_{j=1}^N \beta_j \kappa_{i,j} \tilde{u}_j^n, \quad (3.59)$$

where $\beta_i = \beta(x_i)$, $\tau_i = \tau(x_i)$ and $\kappa_{i,j} = \kappa(x_i, x_j)$. This is a semi-implicit Euler discretization of the growth-fragmentation equation (3.1). We choose this scheme to ensure the stability without any CFL condition, since the scheme is positive. Then we set

$$\tilde{u}_i^{n+1} := \frac{u_i^{n+1}}{\Delta x \sum_{j=1}^N u_j^{n+1}}$$

and we have that the discrete integral of $(\tilde{u}_i^{n+1})_{1 \leq i \leq N}$ satisfies $\Delta x \sum_{i=1}^N \tilde{u}_i^{n+1} = \Delta x \sum_{i=1}^N \tilde{u}_i^n = 1$. Using the L^1 convergence (3.57), we end the algorithm when

$$\frac{\Delta x}{\Delta t} \sum_{i=1}^N |\tilde{u}_i^n - \tilde{u}_i^{n-1}| < \epsilon \quad (3.60)$$

where $\epsilon \ll \Delta x$. Then we have

$$\lambda \simeq \Delta x \sum_{i=1}^N \beta_i \tilde{u}_i^n.$$

The semi-implicit scheme (3.59) is efficient to avoid oscillations on the numerical solution, but it is not conservative. This scheme has to be avoided if we want to solve Equation (3.1) for any time. Here we are only interested in the steady state of Equation (3.56), so the nonconservation does not matter, because the steady state is the same for an implicit or an explicit scheme.

Now we want to compute λ_α and $\Lambda_{\mathbf{a}}$ for a large range of α and \mathbf{a} . According to the discussion in the introduction, the eigenvectors \mathcal{U}_α and $\mathcal{V}_{\mathbf{a}}$ are concentrated at the origin for α small or \mathbf{a} large and, conversely, spread out for α large or \mathbf{a} small. Then, to avoid an adaptation of the truncation parameter R or an adaptation of the discretization size step Δx when α and \mathbf{a} vary, we compute θ_α defined in Equation (3.18). To this end, we have to compute the dilated eigenvector v_α defined in (3.6) which converges to a fixed profile v_∞ when $\alpha \rightarrow L$, as stated in Theorem 3.2.2. This convergence ensures that the vector v_α does neither disperse nor concentrate too much when α varies, and so we can find a truncation and a size step which work for any $\alpha \rightarrow L$. It remains to distinguish $L = 0$ from $L = +\infty$ by dividing $(0, +\infty)$ into two sets: for instance $(0, 1]$ and $(1, +\infty)$. For $0 < \alpha < 1$, we use the dilation coefficient k associated to ν and γ such that $\tau(x) \underset{x \rightarrow 0}{\sim} x^\nu$ and $\beta(x) \underset{x \rightarrow 0}{\sim} x^\gamma$. For $\alpha > 1$ we do the dilation associated to ν and γ such that $\tau(x) \underset{x \rightarrow \infty}{\sim} x^\nu$ and $\beta(x) \underset{x \rightarrow \infty}{\sim} x^\gamma$. Finally, we use Equation (3.20) in Lemma 3.2.1 to recover λ_α or $\Lambda_{\mathbf{a}}$ from the numerical value of θ_α (see Figure 3.2 for a numerical illustration).

3.4.2 Steady States of the Prion Equation

To model polymerization processes, Equation (3.1) can be coupled to an ODE which incorporates the evolution of the quantity of monomers. The so-called ‘‘prion equation’’ (see [63, 117])

$$\begin{cases} \frac{dV(t)}{dt} = \xi - V(t) \left[\delta + \int_0^\infty \tau(x)u(x,t) dx \right], \\ \frac{\partial}{\partial t}u(x,t) = -V(t)\frac{\partial}{\partial x}(\tau(x)u(x,t)) - [\beta(x) + \mu(x)]u(x,t) + 2 \int_x^\infty \beta(y)\kappa(x,y)u(y,t) dy, \\ u(0,t) = 0, \end{cases} \quad (3.61)$$

where the quantity of monomers is denoted by $V(t)$. In this model, the monomers are prion proteins, produced and degraded by the cells with rates ξ and δ , and attached to polymers of size x with respect to the rate $\tau(x)$. The polymers are fibrils of misfolded pathogenic proteins, which have the ability to transconform normal proteins (monomers) into abnormal ones by a polymerization process, which is not yet very well understood. The size distribution of polymers $u(x,t)$ is solution to the growth-fragmentation equation (3.1) in which $V(t)$ is added as a multiplier for the polymerization rate. A degradation rate $\mu(x)$ is also considered for the polymers. For the sake of simplicity, this rate is assumed to be size-independent in the following study ($\mu(x) \equiv \mu_0$).

Equation (3.61) models the proliferation of prion disease. An individual is said to be infected by prion disease when polymers of misfolded proteins are present, namely when $u(\cdot, t) \neq 0$ at the time t .

The coupling between $V(t)$ and $u(t, x)$ appears in the equation for u as a modulation of the polymerization rate. One sees immediately the link with the eigenproblem (3.3) satisfied by \mathcal{U}_α . Indeed, \mathcal{U}_α is the principal eigenvector linked to the linearization of the prion equation around a given monomer quantity $V = \alpha$. Investigating the dependency of the fitness λ_V , with respect to the polymerization and fragmentation coefficients, is a first step towards a better understanding of the disease propagation. Indeed it has been reported that the course of prion infection in the brain follows heterogeneous patterns. It has been postulated that the neuropathology of prion infection could be related to different kinetics in different compartments of the brain [31].

Modelling the propagation of prion in the brain requires a good understanding of possible dynamics (*e.g.* monostable, bistable etc). Such a study can be done through the dependency of the first eigenvalue on parameters. In [20, 19], it is shown that, under some conditions, the coexistence of two stable steady states can happen (one endemic and one disease-free). A steady state $(V_\infty, u_\infty(x))$ is a solution to

$$\begin{cases} 0 = \xi - V_\infty \left[\delta + \int_0^\infty \tau(x)u_\infty(x) dx \right], \\ \mu_0 u_\infty(x) = -V_\infty \frac{\partial}{\partial x}(\tau(x)u_\infty(x)) - \beta(x)u_\infty(x) + 2 \int_x^\infty \beta(y)\kappa(x,y)u_\infty(y) dy, \\ u_\infty(0) = 0. \end{cases} \quad (3.62)$$

The disease-free steady state corresponds to the solution without any polymer ($\bar{V} = \frac{\xi}{\delta}, \bar{u} \equiv 0$).

Other steady states can exist and are called endemic or disease steady states. They are solution to System (3.62) with $V_\infty > 0$ and $u_\infty \neq 0$ nonnegative. To know if such disease steady states exist, we recall briefly here the method of [19, 20]. A positive steady state u_∞ can be seen as an eigenvector solution of (3.3) with $\alpha = V_\infty$ such that

$$\lambda_\alpha = \lambda_{V_\infty} = \mu_0. \quad (3.63)$$

This shows the crucial importance of a study of the map $V \mapsto \lambda_V$. Any value V_∞ solution to (3.63) provides a size distribution of polymers

$$u_\infty(x) = \varrho_\infty \mathcal{U}_{V_\infty}(x).$$

The quantity of polymers ϱ_∞ is then prescribed by the equation for monomers and has to satisfy the relation

$$\varrho_\infty = \frac{\xi V_\infty^{-1} - \delta}{V_\infty \int \tau(x) \mathcal{U}_{V_\infty}(x) dx}.$$

The quantity of polymers has to be positive, which is equivalent to the condition

$$V_\infty < \frac{\xi}{\delta} = \bar{V}.$$

Finally, the disease steady states correspond exactly to the zeros of the map $V \mapsto \lambda_V - \mu_0$ in the interval $(0, \bar{V})$. Due to the different results of Sections 3.2 and 3.3, we know that this map is not necessarily monotonic, as assumed in [20]. Thus, by continuity of the dependency of λ on V (see Lemma 3.4.1), there can exist several disease steady states for μ_0 well chosen and $\bar{V} = \frac{\xi}{\delta}$ large enough. This point is illustrated on the example below, for which there exist two disease steady states.

We can investigate the stability of the disease-free steady state through the results obtained in [19, 20]. For this, we introduce the dual eigenvector $\bar{\varphi}$ of the growth-fragmentation operator with transport term \bar{V}

$$\begin{cases} -\bar{V}\tau(x)\frac{\partial}{\partial x}(\bar{\varphi}(x)) + (\beta(x) + \lambda)\bar{\varphi}(x) = 2\beta(x) \int_0^x \kappa(y, x)\bar{\varphi}(y)dy, & x \geq 0, \\ \bar{\varphi}(x) \geq 0, & \int_0^\infty \bar{\varphi}(x)\mathcal{U}_{\bar{V}}(x)dx = 1. \end{cases} \quad (3.64)$$

We assume that we are in a case when there exist two constants K_1 and K_2 such that

$$\left| \tau(x)\frac{\partial}{\partial x}\bar{\varphi}(x) \right| \leq K_1\bar{\varphi}(x), \quad \text{and} \quad \tau(x) \leq K_2\bar{\varphi}(x). \quad (3.65)$$

This assumption generally holds true when $\frac{\tau(x)}{x}$ is bounded because $\bar{\varphi}$ grows linearly at infinity according to general properties proved in [41, 95, 110, 111]. Then we can reformulate the theorems of [19, 20].

Theorem [20] (Local stability). *Suppose that assumption (3.65) holds true and that $\lambda_{\bar{V}} < \mu_0$. Then the steady state $(\bar{V}, 0)$ is locally non-linearly stable.*

Theorem [19] (Persistence). *Suppose that assumption (3.65) holds, $V(0) \leq \bar{V}$, $\int_0^\infty (1+x)u(t, x) dx$ is uniformly bounded, and that $\lambda_{\bar{V}} > \mu_0$. Then the system remains away from the steady state $(\bar{V}, 0)$. More precisely we have:*

$$\liminf_{t \rightarrow \infty} \int_0^\infty \bar{\varphi}(x)u(x, t) dx > 0.$$

Example. Let us consider the same coefficients as in Figure 3.2(a). We can choose μ_0 small enough to ensure the existence of two values $V_1 < V_2$ such that $\lambda_{V_1} = \lambda_{V_2} = \mu_0$. As a consequence, we know due to the previous study that there exists no disease steady state if $\bar{V} < V_1$, one if $V_1 < \bar{V} < V_2$, and two if $\bar{V} > V_2$. Concerning the stability of the disease-free steady state, we first notice that the fragmentation rate $\beta(x)$ satisfies the assumption $\beta(x) \leq A + Bx$, which is sufficient to have that $\int_0^\infty (1+x)u(t, x) dx$ is uniformly bounded (see [19] Theorem 2.1). Thus we can apply the previous theorems and we have that $(\bar{V}, 0)$ is stable if $\bar{V} < V_1$, unstable if $V_1 < \bar{V} < V_2$, and recovers its (local) stability if $\bar{V} > V_2$. In Figure 3.3, the graph of the negative fitness $V \mapsto \mu_0 - \lambda_V$ is plotted (because the quantity of polymers influences the evolution of $V(t)$ with a negative contribution) and the zones of stability and instability for \bar{V} are pointed out. The non intuitive conclusion is that an increase of the production rate ξ or a decrease of the death rate δ can stabilize the disease-free steady state. What happens in this situation is that the largest polymers are the most stable since $\lim_{x \rightarrow \infty} \beta(x) = 0$ (this situation is biologically relevant, see for instance [124]). When the quantity of polymers is large, the polymerization is strong and it results in long stable polymers. Because they do not break easily, their number does not increase very fast, *i.e.* the fitness of the polymerization-fragmentation equation is small. But the degradation term is assumed to be size-independent, and then the fitness λ_V becomes smaller than μ_0 for V large enough. This phenomenon stabilizes the disease-free steady state because, when polymers are injected in a cell, they tend to disappear immediately, since $\lambda_{\bar{V}} < \mu_0$.

Concerning the stability of the disease steady states, the study is much more complicated. Nevertheless, we can imagine that V_1 is stable and V_2 unstable. This postulate is based on Figure 3.3 and on the results obtained in [63, 64] in a case when System (3.61) can be reduced to a system of ODEs.

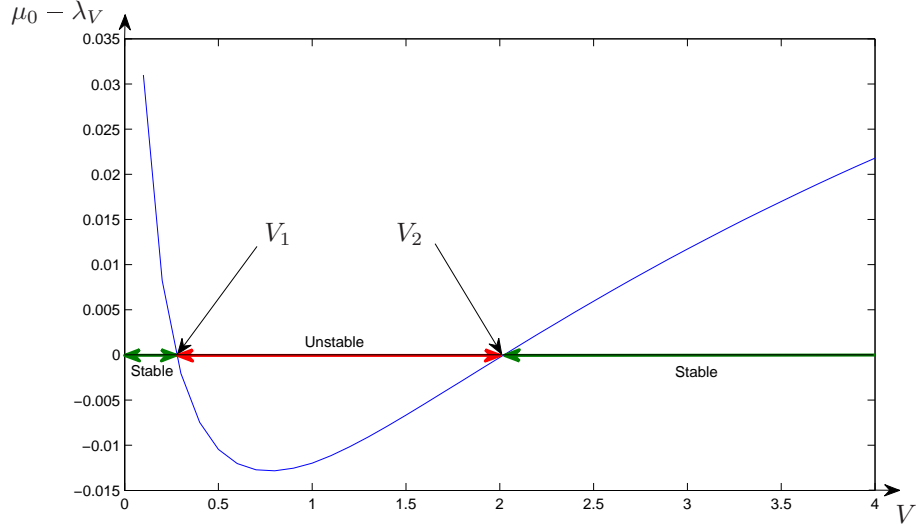

Figure 3.3: The negative fitness $V \mapsto \mu_0 - \lambda_V$ is plotted for the same coefficients as in Figure 3.2(a). The zeros V_1 and V_2 correspond to disease steady states and separate the areas of stability or instability of the disease-free steady state.

3.4.3 Optimization of the PMCA protocol

Prion diseases, briefly described in Section 3.4.2 (see [83] for more details), are fatal, infectious and neurodegenerative diseases with a long incubation time. They include bovine spongiform encephalopathies in cattle, scrapie in sheep and Creutzfeldt-Jakob disease in human. It is then of importance to be able to diagnose infected individuals to avoid propagation of the disease in a population. But the dynamics of proliferation is slow and the amount of prion proteins is low at the beginning of the disease. Moreover, these proteins are concentrated in vital organs like brain, and are present in minute quantities in tissues like blood. To be able to detect prions in these tissues, a solution is to amplify their quantity. A promising recent technique of amplification is the PMCA (Protein Misfolded Cyclic Amplification). Nevertheless, this protocol is not able to amplify prions for all the prion diseases from tissues with low infectivity. PMCA diagnosis remains to be improved and mathematical modelling and analysis can help to do so.

PMCA is an *in vitro* cyclic process that quickly amplifies very small quantities of prion proteins present in a sample. In this sample, the pathogenic proteins (polymers) are put in presence of a large quantity of normal proteins (monomers). Then the protocol consists in alternating two phases:

- a phase of incubation during which the sample is left to rest and the polymers can attach the monomers (increase of the size of polymers),
- a phase of sonication during which waves are sent on the sample in order to break the polymers into numerous smaller ones (increase of the number of polymers).

To model this process, we can use the growth-fragmentation equation (3.1) as in (3.61). The main difference is that the PMCA takes place *in vitro*, and there is no production of monomers. The monomers are in large excess to improve the polymerization, so we can assume that their concentration is constant during the PMCA. It remains to introduce the “sonication” in the equation. Because the sonication phase increases the fragmentation of polymers, a first modelling can be to add a time-dependent parameter $\alpha(t)$ in front of the fragmentation parameter $\beta(x)$. Then the alternating incubation-sonication corresponds to a rectangular function $\alpha(t)$ which is equal to 1 during the incubation time (since the sample is left to rest), and α_{max} during the sonication pulse (where α_{max} represents the maximal power of the sonicator).

We obtain the model

$$\frac{\partial}{\partial t}u(x, t) = -V_0 \frac{\partial}{\partial x}(\tau(x)u(x, t)) - \mathbf{a}(t)\beta(x)u(x, t) + 2\mathbf{a}(t) \int_x^\infty \beta(y)\kappa(x, y) u(y, t) dy, \quad (3.66)$$

where $u(x, t)$ still denotes the quantity of polymers of size x at time t .

With this model, the problem of PMCA improvement becomes an optimization mathematical problem: find a control $\mathbf{a}(t)$ which maximizes the quantity $\int xu(T, x) dx$ (total mass of pathogenic proteins) at a given final time T . The answer to this problem is difficult. First we can wonder if the rectangular strategy used in the PMCA (alternance incubation-sonication) is the best one or if there exists a constant control which is better. This last question leads naturally to the problem of the fitness optimization for Equation (3.66) when $\mathbf{a}(t) \equiv \mathbf{a}$ is a time-independent parameter. Is \mathbf{a}_{max} the best constant to maximize $\Lambda_{\mathbf{a}}$? Is there a compromise $\mathbf{a}_{opt} \in (1, \mathbf{a}_{max})$ to find? The answer depends on the coefficients τ and β as indicated by the different theorems of this paper. More precisely, Theorem 3.2.2 ensures that the situation when an optimum \mathbf{a}_{opt} exists between 1 and \mathbf{a}_{max} can happen, and an example is given below.

Example We consider the same coefficients as in Figure 3.2(b) and suppose that the sonicator can multiply by 4 the fragmentation at its maximal power. Then in our model $\mathbf{a}_{max} = 4$ and we can see on Figure 3.4 that the best strategy to maximize the fitness with a constant coefficient is not the maximal power, but an intermediate \mathbf{a}_{opt} between 1 and \mathbf{a}_{max} .

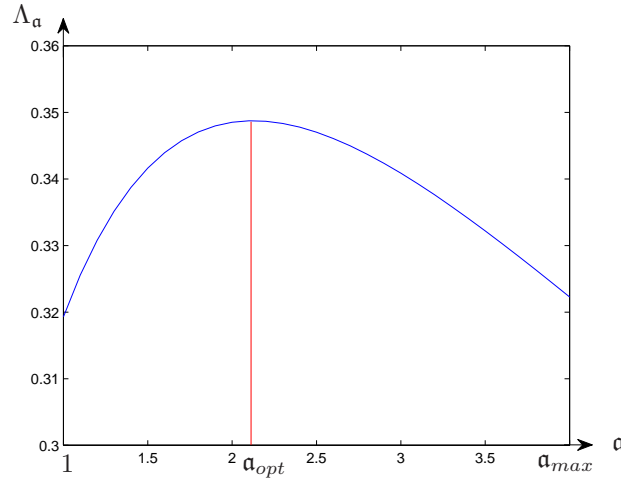

Figure 3.4: The fitness is plotted as a function of \mathbf{a} for the coefficients of Figure 3.2(b). There is a sonication value \mathbf{a}_{opt} in the interior of the window $[1, \mathbf{a}_{max}]$ which maximizes this fitness.

In [18], the time dependent optimization problem is investigated on a discrete model. The study highlights the link between the optimal control $\mathbf{a}(t)$ and the constant \mathbf{a}_{opt} which optimizes the fitness of the system.

3.4.4 Therapeutic optimization for a cell population

In the case when Problem (3.1) models the evolution of a size (or protein, or label, or parasite...)-structured cell population, τ represents the growth rate of the cells and β their division rate. It is of deep interest to know how a change on these rates can affect the Malthus parameter of the total population, see for instance [25, 23]. It is possible to act on the growth rate by changing the nutrient properties - the richer the environment, the faster the growth rate of the cells. We can model such an influence by Equation (3.3), and the question is then: how to make λ_{α} as large (if we want to speed up the population growth, for instance for tissue regeneration) or as small (in the case of cancerous cells) as possible ?

Plausible assumptions (see [39] for instance for the case of a size-structured population of E. Coli) for the growth of individual cells is that it is exponential up to a certain threshold, meaning that $\tau(x) = \tau x$ in a neighbourhood of zero, and tending to a constant (or possibly vanishing) around infinity, meaning that the cells reach some maximal size or protein-content, leading to $\tau \xrightarrow{x \rightarrow \infty} \tau_\infty < +\infty$.

Concerning the division rate β , it is most generally vanishing around zero, either of the form $\beta(x) \sim \beta x^\gamma$ with $\gamma > 1$ or with support $[b, \infty]$ with $b > 0$ and it has a maximum, and then decreases for large x - and is vanishing. Note that for τ as for β , very little is known about their precise behaviour for large sizes x , since such values are very rarely reached by cells in the real world.

These assumptions allow us to apply our results. Theorem 3.1.1 and Corollary 3.3.1 lead to vanishing Malthus parameter λ_α either for $\alpha \rightarrow 0$ or for $\alpha \rightarrow +\infty$. It means that for cancer drugs, stressing the cells by diminishing nutrients can be efficient, which is very intuitive and it is known and used for tumor therapy (by preventing vascularization for instance). What is less intuitive is that forcing tumor cells to grow too rapidly in size could also reveal an efficient strategy, as soon as it is established that the division rate decreases for large sizes (this last point could be studied by inverse problem techniques, see [114, 40, 39]). It recalls the same ideas as for prions, as said in Section 3.4.2.

On the opposite side, in order to optimize tissue regeneration for instance, these results tend to prove that there exists an optimal value for α such that the Malthus parameter is maximum. This value can be established numerically (see Section 3.4.1 and [60]) as soon as the shape of the division rate is known, for instance by the use of the previously-quoted inverse problem techniques.

Conclusion

The first motivation of our research was to investigate the dependency of the dominant eigenvalue of Problem (3.1) upon the coefficients β and τ , since a first and wrong intuition, based on simple cases, was that it should be monotonic (see [20, 19]). By the use of a self-similar change of variables, we have explored the asymptotic behaviour of the first eigenvalue when fragmentation dominates the transport term or *vice versa*. This leads us to counter-examples, where the eigenvalue depends on the coefficients in a non-monotonic way. Moreover, these counter-examples are far from being exotic and seem perfectly plausible in many applications, as shown in Section 3.4. A still open problem is thus to find what would be necessary and sufficient assumptions on τ and β , or still better on the ratio $\frac{x\beta}{\tau}$, so that λ_α or Λ_α be indeed monotonic with respect to α or \mathbf{a} .

Concerning our assumptions, a first sight at the statement of Theorem 3.1.1 gives the feeling that only the behaviour of the fragmentation rate β plays a role in the asymptotic behaviour of λ_α , and only the ratio $\frac{\tau}{x}$ in the one of Λ_α . This seems puzzling and counter-intuitive. In reality, things are not that simple: to ensure well-posedness of the eigenvalue problems (3.3) and (3.4), Assumptions (3.27) and (3.28) strongly link τ with β , so that a dependency on β hides a dependency on τ and *vice versa*. Moreover, the mathematical techniques used here (moment estimates, multiplication by polynomial weights) force us to restrict ourselves to the space \mathcal{P} of functions of polynomial growth or decay. The questions of how to relax these (already almost optimal, as shown in [41]) assumptions and how, if possible, to express them in terms of pure comparison between τ , κ and β like in Assumptions (3.27) and (3.28) are still open.

Chapitre 4

Comportement en temps long d'équations non linéaires

Le comportement en temps long des solutions d'équations de transport-fragmentation non linéaires est très varié et difficile à étudier d'un point de vue général. Nous illustrons dans ce chapitre la diversité de ces comportements à travers des cas particuliers pour lesquels nous avons réussi à montrer la convergence vers un état d'équilibre ou bien l'existence de solutions périodiques. Pour prouver la convergence nous exhibons une fonctionnelle de Lyapunov, alors que pour les solutions périodiques nous utilisons le théorème de Poincaré-Bendixon ou bien montrons une bifurcation de Hopf.

4.1 Introduction

We are interested in growth models which take the form of a *mass preserving* fragmentation equation complemented with a transport term. Such models are used to describe the evolution of a population in which each individual grows and splits or divides. The individuals can be for instance cells [10, 11, 66, 94] or polymers [13, 34, 60] and are structured by a variable $x > 0$ which may be size [39, 40], label [5], protein content [37, 88], proliferating parasites content [8]; etc. More precisely, we denote by $u = u(t, x) \geq 0$ the density of individuals of structured variable x at time t , and we consider that the time dynamic of the population is given by the following equation

$$\begin{cases} \frac{\partial}{\partial t} u(t, x) + \frac{\partial}{\partial x} (\tau(t, x) u(t, x)) + \mu(t, x) u(t, x) = (\mathcal{F}u)(t, x), & t \geq 0, x > 0, \\ u(t, x = 0) = 0, & t \geq 0, \\ u(t = 0, x) = u_0(x) \geq 0, & x > 0, \end{cases} \quad (4.1)$$

where \mathcal{F} is a *mass conservative* fragmentation operator

$$(\mathcal{F}u)(t, x) = \int_x^\infty b(t, y, x) u(t, y) dy - \beta(t, x) u(t, x). \quad (4.2)$$

The *mass conservation* for the fragmentation operator requires the relation

$$\beta(t, x) = \int_0^x \frac{y}{x} b(t, x, y) dy. \quad (4.3)$$

The coefficient $\beta(t, y) \geq 0$ represents the rate of splitting for a particule of size y at time t and $b(t, y, x) \geq 0$ represents the formation rate of a particule of size $x \leq y$ after the fragmentation. The velocity $\tau(t, x) > 0$

in the transport term represents the growth rate of each individual, and $\mu(t, x) \geq 0$ is a degradation or death term.

We consider that the time dependency of τ and μ is of the form

$$\tau(t, x) = V(t)\tau(x) \quad \text{and} \quad \mu(t, x) = R(t)\mu(x) \quad (4.4)$$

and moreover that the size dependency is a powerlaw

$$\tau(x) = \tau x^\nu \quad \text{and} \quad \mu(x) \equiv \mu. \quad (4.5)$$

The choice of the coefficients $V(t)$ and $R(t)$ depends on the cases we want to analyse. We give below four examples in which they are nonlinear terms or periodic controls. The fragmentation coefficients are assumed to be time-independent and of *self-similar* form

$$b(t, x, y) = \frac{\beta(x)}{x} \kappa\left(\frac{y}{x}\right) \quad (4.6)$$

with κ a nonnegative measure on $[0, 1]$. For b under this form, the quantity

$$n_0 := \int_0^1 \kappa(z) dz$$

represents the mean number of fragments produced by the fragmentation of an individual. We remark that under Assumption (4.6), relation (4.3) becomes $\int_0^1 z \kappa(z) dz = 1$ and then it enforces $n_0 > 1$. If κ is symmetric ($\kappa(z) = \kappa(1 - z)$), we have necessarily $n_0 = 2$. We also assume that β is a powerlaw coefficient

$$\beta(x) = \beta x^\gamma \quad (4.7)$$

and we denote by \mathcal{F}_γ the fragmentation operator associated to coefficients satisfying Assumptions (4.6) and (4.7).

Now we state our main results concerning different choices for $V(t)$ and $R(t)$. First we investigate the nonlinear growth-fragmentation equations corresponding to the case when V or/and R are functions of the solution $u(t, x)$ itself. We also consider a model of *polymerization* in which the transport term depends on u and on a solution to an ODE coupled to the growth-fragmentation equation. The long-time asymptotic behavior of these equations is investigated under the assumption that $\tau(x)$ is linear (*i.e.* $\nu = 1$) and β increasing (*i.e.* $\gamma > 0$). We finish with a study of the long-time asymptotics in the case when V and R are known periodic controls.

Example 1. Nonlinear drift-term. We consider that the death rate is time independent ($R \equiv 1$) and that the transport term depends on the solution itself through the nonlinearity

$$\frac{\partial}{\partial t} u(t, x) = -f\left(\int x^p u(t, x) dx\right) \frac{\partial}{\partial x} (x u(t, x)) - \mu u(t, x) + \mathcal{F}_\gamma u(t, x) \quad (4.8)$$

where $f: \mathbb{R}^+ \rightarrow \mathbb{R}^+$ is a continuous function which represents the influence of the wheighted total population $\int x^p u(t, x) dx$ ($p \geq 0$) on the growth process. Such weak nonlinearities are common in structured populations (see [69, 70, 133] for instance). The stability of the steady states for related models has already been investigated (see [36, 49, 50, 51, 100]) but never for the growth-fragmentation equation with the nonlinearities considered here. We prove in Section 4.3 convergence and nonlinear stability results for Equation (4.8) in the functional space $\mathcal{H} := L^2((x + x^r)dx)$ for r large enough, or more precisely in its positive cone denoted by \mathcal{H}^+ . These results are stated in the two following theorems. They require that f is continuous and satisfies

$$\mathcal{N} := \{I; f(I) = \mu\} \text{ is a finite set} \quad \text{and} \quad \limsup_{I \rightarrow \infty} f(I) < \mu. \quad (4.9)$$

Theorem 4.1.1 (Convergence). *Assume that f satisfies Assumption (4.9), that $\gamma \in (0, 2]$ and that the fragmentation kernel κ satisfies Assumption (4.33). Then the number of positive steady states of Equation (4.8) is equal to $\sharp\mathcal{N}$ and any solution with an initial distribution $u_0 \in \mathcal{H}^+$ either converges to one of these steady states or vanishes.*

Theorem 4.1.2 (Local stability). *Assume that $f \in \mathcal{C}^1(\mathbb{R}_+)$ satisfies Assumption (4.9), that $\gamma \in (0, 2]$ and that the fragmentation kernel κ satisfies Assumption (4.33). Then the trivial steady state is locally exponentially stable if $f(0) < \mu$ and $p \geq 1$, and unstable if $f(0) > \mu$. Any nontrivial steady state u_∞ is locally asymptotically stable if $f'(\int x^p u_\infty(x) dx) < 0$, locally exponentially stable if additionally $\kappa \equiv 2$, and unstable if $f'(\int x^p u_\infty(x) dx) > 0$.*

As an immediate consequence of these two theorems, we have the following corollary.

Corollary 4.1.3 (Global stability). *For $\gamma \in (0, 2]$ and under Assumption (4.33), if $f \in \mathcal{C}^1(\mathbb{R}_+)$ satisfies (4.9) with \mathcal{N} a singleton, then there is a unique nontrivial steady state u_∞ , and if additionally $f'(\int x^p u_\infty(x) dx) < 0$, then it is globally asymptotically stable in $\mathcal{H}^+ \setminus \{0\}$.*

The method combines several arguments. First it uses the General Relative Entropy principle introduced by [98, 99, 110] for the linear case. Secondly it reduces the system to a set of ODEs which has the same asymptotic behavior than Equation (4.8). Then we build a Lyapunov functional for this reduced system. Therefore our result extends to the case of the growth-fragmentation equation several stability results proved for the nonlinear renewal equation in [97, 113].

Example 2. Nonlinear drift and death terms. We can also treat several nonlinearities as in

$$\frac{\partial}{\partial t} u(t, x) = -f\left(\int x^p u(t, x) dx\right) \frac{\partial}{\partial x} (x u(t, x)) - g\left(\int x^q u(t, x) dx\right) u(t, x) + \mathcal{F}_\gamma u(t, x). \quad (4.10)$$

In this case, we show that oscillating behaviors can appear. The existence of non-trivial periodic solution for structured population models is a very interesting and difficult problem. It has been mainly investigated for age structured models with nonlinear renewal and/or death terms, but there are very few results [1, 12, 33, 73, 89, 90, 116, 128, 130]. Taking advantage of the Poincaré-Bendixon theorem, we prove the existence of oscillating solutions for Equation (4.10) and the “stability” of this behavior in a sense specified in the following theorem.

Theorem 4.1.4. *For $\gamma \in (0, 2]$ and under Assumption (4.33), there exist functions f and g and parameters p and q for which we can find an open set $\mathcal{V} \subset \mathcal{H}^+$ with the property that any solution to Equation (4.10) with an initial distribution $u_0 \in \mathcal{V}$ converges to a periodic solution.*

The proof of this result is given in Section 4.4.

Example 3. The prion equation. In Section 4.5, we are interested in a general so-called prion equation

$$\begin{cases} \frac{dV(t)}{dt} = -V(t)f\left(\int x^p u\right) \int_0^\infty x u(t, x) dx - \delta V(t) + \lambda, \\ \frac{\partial}{\partial t} u(t, x) = -V(t)f\left(\int x^p u\right) \frac{\partial}{\partial x} (x u(t, x)) - \mu u(t, x) + \mathcal{F}_\gamma u(t, x). \end{cases} \quad (4.11)$$

In this equation, the growth term depend on the quantity $V(t)$ of another population (monomers for the prion proliferation model). We prove for this system the existence of periodic solutions under some conditions on f . In age structured models, such solutions are usually built using bifurcation theory, particularly by Hopf bifurcation (see [86] for a general theorem). Here we consider the power p as a bifurcation parameter and we prove existence of periodic solution by Hopf bifurcation.

Theorem 4.1.5. *There exist a function f and parameters for which Equation (4.11) admits periodic solutions.*

Example 4. Perron vs. Floquet. Our method in Section 4.2.2 can also be applied to the situation when $V(t)$ and $R(t)$ are periodic controls

$$\frac{\partial}{\partial t}u(t, x) + V(t)\frac{\partial}{\partial x}(\tau x u(t, x)) + R(t)\mu u(t, x) = \mathcal{F}_\gamma u(t, x). \quad (4.12)$$

In this case, Theorem 4.2.1 allows to build a particular solution called the Floquet eigenvector, starting from the Perron eigenvector which correspond to constant parameters. Moreover, we can compare the associated Floquet eigenvalue to the Perron eigenvalue. The results about this problem are stated in Section 4.6.

Before treating the different examples, we explain in Section 4.2 the general method used to tackle these problems. It is based on the main result in Theorem 4.2.1 and the use of the eigenelements of the growth-fragmentation operator together with General Relative Entropy techniques. In Sections 4.3, 4.4, 4.5 and 4.6, we give the proofs of the results in Examples 1, 2, 3 and 4 respectively.

4.2 Technical Tools and General Method

4.2.1 Main Theorem

The proofs of the main theorems of this paper are based on the following result which requires to consider that $\tau(x)$ is linear (*i.e.* $\nu = 1$). In this case, there exists a relation between a solution to Equation (4.1) with time-dependent parameters $(V_1(t), R_1(t))$ and a solution to the same equation with parameters $(V_2(t), R_2(t))$. More precisely, we can obtain one from the other by an appropriate dilation. The following theorem generalizes the change of variable used in [47] to build self-similar solution to the pure fragmentation equation.

Theorem 4.2.1. *Consider that Assumptions (4.4)-(4.7) are satisfied with $\nu = 1$ and $\gamma > 0$. For $u_1(t, x)$ a solution to Equation (4.1) with parameters (V_1, R_1) , the function $u_2(t, x)$ defined by*

$$u_2(t, x) = W^{-k}(t)u_1(h(t), W^{-k}(t)x) e^{\mu \int_0^t (W(s)R_1(s) - R_2(s)) ds} \quad (4.13)$$

with $k = \frac{1}{\gamma}$, is a solution to Equation (4.1) with (V_2, R_2) if $W > 0$ and h satisfy

$$\begin{aligned} \dot{W} &= \frac{\tau W}{k}(V_2 - V_1 W), \\ \dot{h} &= W. \end{aligned} \quad (4.14)$$

Conversely, if $h : \mathbb{R}_+ \rightarrow \mathbb{R}_+$ is one to one and if u_2 is a solution with (V_2, R_2) , then u_1 defined by (4.13) is a solution with (V_1, R_1) .

The proof of this result is nothing but easy calculation that we leave to the reader.

Remark 4.2.2. *To check that h is one to one, we can take advantage that ODE (4.14) is a Bernoulli equation which can be integrated in*

$$W(t) = \frac{W_0 e^{\frac{\tau}{k} \int_0^t V_2(s) ds}}{1 + W_0 \frac{\tau}{k} \int_0^t V_1(s) e^{\frac{\tau}{k} \int_0^s V_2(s') ds'} ds}. \quad (4.15)$$

To tackle the different examples, we use Theorem 4.2.1 together with two techniques appropriate for this type of equations. First we recall the existence of particular solutions to the growth-fragmentation equation in the case of time-independent coefficients. They correspond to eigenvectors to the growth-fragmentation operator and we can give their self-similar dependency on parameters in the case of power-law coefficients (see [59, 17]). This dependency is the starting point which leads to Theorem 4.2.1 and it allows to build an invariant manifold for Equation (4.1) in the case $\nu = 1$. It also provides interesting properties on the moments of the solutions when $\nu \neq 1$. Then we recall results about the General Relative Entropy (GRE) introduced by [98, 99, 110] for the growth-fragmentation model. This method ensures that the particular solutions built from eigenvectors are attractive for suitable norms.

4.2.2 Eigenvectors and Self-similarity: Existence of an Invariant Manifold

When the coefficients of Equation (4.1) do not depend on time, one can build solutions $(t, x) \mapsto \mathcal{U}(x)e^{\Lambda t}$ by solving the Perron eigenvalue problem

$$\begin{cases} \Lambda \mathcal{U}(x) = -\frac{\partial}{\partial x}(\tau(x)\mathcal{U}(x)) - \mu(x)\mathcal{U}(x) + (\mathcal{F}\mathcal{U})(x), & x \geq 0, \\ \tau(0)\mathcal{U}(0) = 0, \quad \mathcal{U}(x) \geq 0, \quad \int_0^\infty \mathcal{U}(x)dx = 1. \end{cases} \quad (4.16)$$

The existence of such elements Λ and \mathcal{U} has been first studied by [95, 111] and is proved for general coefficients in [41]. The dependency of these elements on parameters is of interest to investigate the existence of steady states for nonlinear problems (see [20, 17]). In the case of powerlaw coefficients, we can work out this dependency on frozen transport parameter V and death parameter R (see [59]). Under Assumptions (4.5)-(4.7), the necessary condition which appears in [41, 95] to ensure the existence of eigenelements is $\gamma + 1 - \nu > 0$. Then we define a *dilation parameter*

$$k := \frac{1}{\gamma + 1 - \nu} > 0 \quad (4.17)$$

and we have explicit self-similar dependencies

$$\Lambda(V, R) = V^{k\gamma}\Lambda(1, 0) - R\mu \quad \text{and} \quad \mathcal{U}(V; x) = V^{-k}\mathcal{U}(1; V^{-k}x). \quad (4.18)$$

The eigenvector \mathcal{U} does not depend on R , that is why we do not label it. Thereafter $\Lambda(1, 0)$ and $\mathcal{U}(1; \cdot)$ are denoted by Λ and \mathcal{U} for the sake of clarity. The result of Theorem 4.2.1 is based on the idea to use these dependencies to tackle time-dependent parameters. An intermediate result between the formula (4.13) and the dependencies (4.18) is given by the following corollary.

Corollary 4.2.3. *Under the assumptions of Theorem 4.2.1, if W is a solution to*

$$\dot{W} = \frac{\Lambda(W, 0)}{k}(V - W) \quad (4.19)$$

then

$$u(t, x) = \mathcal{U}(W(t); x)e^{\int_0^t \Lambda(W(s), R(s))ds} \quad (4.20)$$

is a solution to Equation (4.1).

Proof. For $\nu = 1$, we can compute $\Lambda = \Lambda(1, 0)$ by integrating Equation (4.16) with $\mu \equiv 0$ against $x dx$. We obtain thanks to the *mass preservation* of \mathcal{F}

$$\Lambda \int_0^\infty x \mathcal{U}(x) dx = \tau \int_0^\infty x \mathcal{U}(x) dx$$

and so $\Lambda(1, 0) = \tau$. Thus using the dependency (4.18) we find that $\Lambda(W, 0) = \tau W$ and Equation (4.19) is nothing but a rewriting of Equation (4.14). We use this formulation (4.19) here to highlight the link with eigenelements, and because it allows after to obtain results in the cases when $\nu \neq 1$. Now we apply Theorem 4.2.1 for $V_1 \equiv 1$, $R_1 \equiv 0$ and $V_2 \equiv V$, $R_2 \equiv R$ and we obtain that

$$u_2(t, x) = W^{-k}\mathcal{U}(W^{-k}x)e^{\Lambda h(t) - \int_0^t R(s) ds} = \mathcal{U}(W(t); x)e^{\int_0^t \Lambda(W(s), R(s))ds}$$

is a solution to Equation (4.1). □

This corollary provides a very intuitive explicit solution in the spirit of dependencies (4.18). At each time t , the solution is an eigenvector associated to a parameter $W(t)$ with an instantaneous fitness $\Lambda(W(t), R(t))$ associated to the same parameter $W(t)$. The function $t \mapsto W(t)$ thus defined follows $V(t)$ with a delay explicitly given by ODE (4.19).

A very useful consequence for the different applications is the existence of an invariant manifold for the growth-fragmentation equation with time-dependent parameters of the form (4.4). Let define the *eigenmanifold*

$$\mathcal{E} := \{QU(W; \cdot), (W, Q) \in (\mathbb{R}_+^*)^2\} \quad (4.21)$$

which is the union of all the positive eigenlines associated to a transport parameter W . Then Corollary 4.2.3 ensures that, under the assumptions of Theorem 4.2.1, any solution to Equation (4.1) with an initial distribution $u_0 \in \mathcal{E}$ remains in \mathcal{E} for all time. Moreover the dynamics of such a solution reduces to the ODE (4.19) and this is the key point we use to tackle nonlinear problems.

For $\nu \neq 1$, the technique fails and we cannot obtain explicit solution with the method of Theorem 4.2.1. Nevertheless, we can still define W as the solution to ODE (4.19) and give properties of the functions defined as dilations of the eigenvector by (4.20). We obtain that the moments of these functions satisfy equations that are similar to the ones verified by the moments of the solution to the growth-fragmentation equation. In the special case $\nu = 0$, and $\gamma = 1$, we even obtain the same equation. More precisely, if we denote, for $\alpha \geq 0$,

$$\mathcal{M}_\alpha[W](t) := \int_0^\infty x^\alpha \mathcal{U}(W(t); x) e^{\int_0^t \Lambda(W(s), R(s)) ds} dx, \quad (4.22)$$

and

$$M_\alpha[u](t) := \int_0^\infty x^\alpha u(t, x) dx, \quad (4.23)$$

then we have the following result.

Lemma 4.2.4. *On the one hand, if W is a solution to Equation (4.19), then the moments \mathcal{M}_α satisfy*

$$\dot{\mathcal{M}}_\alpha = \alpha \Lambda a_\alpha V \mathcal{M}_{\alpha+\nu-1} + (1-\alpha) \Lambda b_\alpha \mathcal{M}_{\alpha+\gamma} - \mu R \mathcal{M}_\alpha \quad (4.24)$$

with

$$a_\alpha := \frac{M_\alpha[\mathcal{U}]}{M_{\alpha+\nu-1}[\mathcal{U}]} \quad \text{and} \quad b_\alpha := \frac{M_\alpha[\mathcal{U}]}{M_{\alpha+\gamma}[\mathcal{U}]}.$$

On the other hand, if u is a solution to the fragmentation-drift equation, then the moments M_α satisfy

$$\dot{M}_\alpha = \alpha \tau V M_{\alpha+\nu-1} + (c_\alpha - 1) \beta M_{\alpha+\gamma} - \mu R M_\alpha \quad (4.25)$$

with

$$c_\alpha := \int_0^1 z^\alpha \kappa(z) dz.$$

Proof. Thanks to a change of variable we can compute for all $\alpha \geq 0$

$$\mathcal{M}_\alpha[W] = M_\alpha[\mathcal{U}] W^{k\alpha} e^{\int_0^t \Lambda(W(s), R(s)) ds}$$

so we have

$$\begin{aligned} \dot{\mathcal{M}}_\alpha &= k\alpha \frac{\dot{W}}{W} \mathcal{M}_\alpha + \Lambda(W, R) \mathcal{M}_\alpha \\ &= \alpha \Lambda W^{k\gamma-1} (V - W) \mathcal{M}_\alpha + \Lambda W^{k\gamma} \mathcal{M}_\alpha - \mu R \mathcal{M}_\alpha \\ &= \alpha \Lambda V W^{k(\nu-1)} \mathcal{M}_\alpha + (1-\alpha) \Lambda W^{k\gamma} \mathcal{M}_\alpha - \mu R \mathcal{M}_\alpha \\ &= \alpha \Lambda V a_\alpha \mathcal{M}_{\alpha+\nu-1} + (1-\alpha) \Lambda b_\alpha \mathcal{M}_{\alpha+\gamma} - \mu R \mathcal{M}_\alpha. \end{aligned}$$

Integrating Equation (4.1) against $x^\alpha dx$ we obtain by integration by part and thanks to the Fubini

theorem

$$\begin{aligned}
\frac{d}{dt} \int x^\alpha u(t, x) dx &= \tau V \int x^\alpha \partial_x (x^\nu u(t, x)) dx - \mu R \int x^\alpha u(t, x) dx \\
&\quad - \beta \int x^{\alpha+\gamma} u(t, x) dx + \beta \int_0^\infty x^\alpha \int_x^\infty y^{\gamma-1} \kappa\left(\frac{x}{y}\right) dy dx \\
&= \alpha \tau V \int x^{\alpha+\nu-1} u(t, x) dx - \mu R \int x^\alpha u(t, x) dx \\
&\quad - \beta \int x^{\alpha+\gamma} u(t, x) dx + \beta \int_0^\infty y^{\alpha+\gamma} \int_0^y \frac{x^\alpha}{y^\alpha} \kappa\left(\frac{x}{y}\right) \frac{dx}{y} dy \\
&= \alpha \tau V M_{\alpha+\nu-1} + (c_\alpha - 1) \beta M_{\alpha+\gamma} - \mu R M_\alpha.
\end{aligned}$$

□

In the particular case $\nu = 0$, $\gamma = 1$ and κ symmetric, we can compute the constants a_α , b_α and c_α for $\alpha = 1$ or $\alpha = 2$. A consequence is the useful result given in the following corollary.

Corollary 4.2.5. *In the case when $\nu = 0$, $\gamma = 1$ and κ symmetric, the zero and first moments $(\mathcal{M}_0, \mathcal{M}_1)$ and (M_0, M_1) are both solution to*

$$\begin{pmatrix} \dot{U} \\ \dot{P} \end{pmatrix} = \begin{pmatrix} -\mu R & \beta \\ \tau V & -\mu R \end{pmatrix} \begin{pmatrix} U \\ P \end{pmatrix}. \quad (4.26)$$

This Corollary allows in Section 4.6 to compare the Perron and Floquet eigenvalues not only for $\nu = 1$ but also for $\nu = 0$, $\gamma = 1$. We do not have in this case a particular solution to the growth-fragmentation equation as in Corollary 4.2.3, but a particular solution of the reduced ODE system (4.26).

Proof. For κ symmetric, we have already seen that $c_0 = n_0 = 2$. Together with Assumption (4.3) which gives $c_1 = 1$, we conclude that (M_0, M_1) is solution to Equation (4.26).

Integrating Equation (4.16) against dx and $x dx$ we obtain

$$\Lambda = \beta \int x \mathcal{U}(x) dx \quad \text{and} \quad \Lambda \int x \mathcal{U}(x) dx = \tau.$$

It allows to compute

$$\int x \mathcal{U}(x) dx = \sqrt{\frac{\tau}{\beta}} \quad \text{and} \quad \Lambda = \sqrt{\tau \beta}.$$

Thus $a_1 = \sqrt{\frac{\tau}{\beta}}$ and $b_0 = \sqrt{\frac{\beta}{\tau}}$, and $(\mathcal{M}_0, \mathcal{M}_1)$ satisfies Equation (4.26) thanks to Lemma 4.2.4. □

4.2.3 General Relative Entropy: Attractivity of the Invariant Manifold

The existence of the invariant manifold \mathcal{E} is useful to obtain particular solutions to nonlinear growth-fragmentation equations. But what happens when the initial distribution u_0 does not belong to this manifold? The GRE method ensures that \mathcal{E} is attractive in a sense to be defined.

The GRE method requires to consider the adjoint growth-fragmentation equation

$$-\frac{\partial}{\partial t} \psi(t, x) = \tau(t, x) \frac{\partial}{\partial x} \psi(t, x) - \mu(t, x) \psi(t, x) + (\mathcal{F}^* \psi)(t, x) \quad (4.27)$$

where \mathcal{F}^* is the adjoint fragmentation operator

$$(\mathcal{F}^* \psi)(t, x) := \int_0^x b(t, x, y) \psi(t, y) dy - \beta(t, x) \psi(t, x).$$

If u and v are two solutions to Equation (4.1) and ψ is a solution to Equation (4.27), then we have for any function $H : \mathbb{R} \rightarrow \mathbb{R}$

$$\begin{aligned} \frac{d}{dt} \int_0^\infty \psi(t, x) v(t, x) H\left(\frac{u(t, x)}{v(t, x)}\right) dx &= - \int_0^\infty \int_y^\infty b(t, y, x) \psi(t, x) v(t, y) \\ &\times \left[H\left(\frac{u(t, x)}{v(t, x)}\right) - H\left(\frac{u(t, y)}{v(t, y)}\right) + H'\left(\frac{u(t, x)}{v(t, x)}\right) \left(\frac{u(t, y)}{v(t, y)} - \frac{u(t, x)}{v(t, x)}\right) \right] dx dy. \end{aligned}$$

When H is convex, the right hand side is nonpositive and we obtain a nonincreasing quantity called GRE.

In the case of time-independent coefficients, we can chose for v a solution of the form $\mathcal{U}(x)e^{\Lambda t}$. Then, to apply the GRE method, we need a solution to the adjoint equation and such solutions are given by solving the adjoint Perron eigenvalue problem

$$\begin{cases} \Lambda \phi(x) = \tau(x) \frac{\partial}{\partial x}(\phi(x)) - \mu(x)\phi(x) + (\mathcal{F}^* \phi)(x), & x \geq 0, \\ \phi(x) \geq 0, & \int_0^\infty \phi(x) \mathcal{U}(x) dx = 1. \end{cases} \quad (4.28)$$

Such a problem is usually solved together with the direct problem (4.16) and the first eigenvalue Λ is the same for the two ones (see [41, 95, 110]). Then the GRE ensures that any solution u to the growth-fragmentation equation behaves asymptotically like $\mathcal{U}(x)e^{\Lambda t}$. More precisely it is proved in [99, 110] under general assumptions that

$$\lim_{t \rightarrow \infty} \|\varrho_0^{-1} u(t, \cdot) e^{-\Lambda t} - \mathcal{U}\|_{L^p(\mathcal{U}^{1-p} \phi dx)} = 0, \quad \forall p \geq 1. \quad (4.29)$$

where $\varrho_0 = \int u_0(y) \phi(y) dy$ with $u_0(x) = u(t=0, x)$.

Now consider Equation (4.1) whose coefficients are time-dependent. Under the assumptions of Theorem 4.2.1 and for $p = 1$, the convergence result (4.29) can be interpreted as the attractivity of the invariant manifold \mathcal{E} in $L^1(\phi dx)$ with the distance

$$d(u, \mathcal{E}) := \inf_{\mathcal{U} \in \mathcal{E}} \|\varrho^{-1} u - \mathcal{U}\|_{L^1(\phi(x) dx)}$$

where $\varrho := \int u(y) \phi(y) dy$. Consider, for $V(t) \geq 0$, a solution W to

$$\dot{W} = \frac{W}{k} (\tau V - W)$$

with $W(0) = 1$. First we have $\dot{W} \geq -\frac{1}{k} W^2$, so $W \geq \frac{1}{1+\frac{t}{k}}$ and $h \geq k \ln(1 + \frac{t}{k})$. Thus $h : \mathbb{R}_+ \rightarrow \mathbb{R}_+$ is one to one and we can define from a solution $u(t, x)$ to Equation (4.1) the function

$$v(h(t), x) := W^k(t) u(t, W^k(t)x) e^{-\int_0^t (W(s) - \mu R(s)) ds} \quad (4.30)$$

which satisfies $v(0, x) = u(0, x) = u_0(x)$. Using Theorem 4.2.1, $v(t, x)$ is a solution to

$$\frac{\partial}{\partial t} v(t, x) = -\frac{\partial}{\partial x} (x v(t, x)) - v(t, x) + (\mathcal{F}_\gamma v)(t, x) \quad (4.31)$$

so, denoting by \mathcal{U} and ϕ the eigenfunctions of Equation (4.31), we have

$$\int_0^\infty v(t, x) \phi(x) dx = \int_0^\infty v(t=0, x) \phi(x) dx = \varrho_0$$

and

$$\lim_{t \rightarrow \infty} \|\varrho_0^{-1} v(t, \cdot) - \mathcal{U}\|_{L^1(\phi(x) dx)} = 0.$$

For $\nu = 1$, ϕ is linear (see examples in [41]), so we can compute from (4.30)

$$\varrho(t) = \int u(t, y)\phi(y) dy = \varrho_0 W^k(t) e^{\int_0^t (W(s) - \mu R(s)) ds}$$

and

$$d(u(t, \cdot), \mathcal{E}) \leq \|\varrho^{-1}(t)u(t, \cdot) - W^{-k}\mathcal{U}(W; \cdot)\| = \|\varrho_0^{-1}v(h(t), \cdot) - \mathcal{U}\| \rightarrow 0. \quad (4.32)$$

The exponential decay in (4.29) is proved in [111, 79] for $p = 1$ and for a constant fragmentation rate $\beta(x) \equiv \beta$. It is also proved in [15] for powerlaw parameters in the norm corresponding to $p = 2$ and this is the case we are interested in. Assume that the coefficients satisfy (4.5), (4.6) and (4.7) and assume also that the fragmentation kernel is upper and lower bounded

$$\exists \underline{\kappa}, \bar{\kappa} > 0, \quad \forall z \in [0, 1], \quad \underline{\kappa} \leq \kappa(z) \leq \bar{\kappa}. \quad (4.33)$$

Then a spectral gap result is proved in [15] for $\nu = 1$ in $L^2(\mathcal{U}^{-1}\phi dx)$ and then the result is extended to bigger spaces thanks to a general method for spectral gaps in Hilbert spaces.

Theorem [15]. *Under Assumption (4.5) with $\nu = 1$, Assumptions (4.6) and (4.33), and Assumption (4.7) with $\gamma \in (0, 2]$, there exist $\bar{a} > 0$ and $\bar{r} \geq 3$ such that, for any $a \in (0, \bar{a})$ and any $r \geq \bar{r}$, there exists $C_{a,r}$ such that for any $u_0 \in \mathcal{H} := L^2(\theta)$, $\theta(x) = x + x^r$, there holds*

$$\forall t > 0, \quad \|\varrho_0^{-1}u(t, \cdot)e^{-\Lambda t} - \mathcal{U}\|_{\mathcal{H}} \leq C_{a,r} \|\varrho_0^{-1}u_0 - \mathcal{U}\|_{\mathcal{H}} e^{-at}. \quad (4.34)$$

This result is very useful for Applications 1 and 2 because $L^2(\theta) \subset L^1(x^p)$ for $r \geq 2p + 1$. Moreover the exponential decay allows to prove exponential stability results for Equation (4.8) when κ is constant (see Section 4.3).

4.3 Nonlinear Drift Term: Convergence and Stability

Consider the nonlinear growth-fragmentation equation (4.8) where the transport term depends on the p -moment of the solution itself. This dependency may represent the influence of the total population of individuals on the growth process of each individual. We study the long-time asymptotic behavior of the solutions in the positive cone \mathcal{H}^+ with the weight $\theta(x) = x + x^r$ for

$$r \geq \max(\bar{r}, 2p + 1). \quad (4.35)$$

We prove that there is always convergence to a steady state, provided that the function f is less than μ at the infinity. This result is precised in Theorem 4.3.1 which immediately leads to Theorem 4.1.1 and the stability of the steady states is given in Theorem 4.1.2. We use the notation M_p for $M_p[\mathcal{U}] = \int x^p \mathcal{U}(x) dx$.

Theorem 4.3.1. *Assume that f is a continuous function on $[0, +\infty)$ which satisfies Assumption (4.9), that $\gamma \in (0, 2]$ and that the fragmentation kernel κ satisfies Assumption (4.33). Then the nontrivial steady states of Equation (4.8) write*

$$\frac{I_{\infty}}{M_p} \mu^{-kp} \mathcal{U}(\mu; \cdot) \quad \text{with} \quad I_{\infty} \in \mathcal{N},$$

and for any solution u , there exists $I_{\infty} \in \mathcal{N} \cup \{0\}$ such that

$$\lim_{t \rightarrow \infty} \left\| u(t, \cdot) - \frac{I_{\infty}}{M_p} \mu^{-kp} \mathcal{U}(\mu; \cdot) \right\|_{\mathcal{H}} = 0. \quad (4.36)$$

Proof of Theorem 4.3.1. First step: $u_0 \in \mathcal{E}$.

Consider an initial distribution $u_0 \in \mathcal{E}$ defined in (4.21), then there exist $W_0 > 0$ and $Q_0 \geq 0$ such that

$$u_0(x) = Q_0 \mathcal{U}(W_0 \mu; x).$$

Let $u(t, x)$ be the solution to Equation (4.8) and define W as the solution to

$$\begin{cases} \dot{W} &= \frac{W}{k} \left(f \left(\int x^p u(t, x) dx \right) - \mu W \right), \\ \dot{W}(0) &= W_0. \end{cases} \quad (4.37)$$

Then Corollary (4.2.3) ensures that

$$\forall t, x \geq 0, \quad u(t, x) = Q_0 \mathcal{U}(W(t) \mu; x) e^{\mu \int_0^t (W(s) - 1) ds}$$

and so we have

$$\int_0^\infty x^p u(t, x) dx = Q_0 W^{kp} \mu^{kp} \left(\int_0^\infty x^p \mathcal{U}(x) dx \right) e^{\mu \int_0^t (W(s) - 1) ds}.$$

Now defining

$$Q(t) := Q_0 e^{\mu \int_0^t (W(s) - 1) ds},$$

we obtain a system of ODEs equivalent to Equation (4.8) in \mathcal{E}

$$\begin{cases} \dot{W} &= \frac{W}{k} (f_p(W^{kp} Q) - \mu W), \\ \dot{Q} &= \mu Q (W - 1), \end{cases} \quad (4.38)$$

with the notation

$$f_p(I) := f \left(I \mu^{kp} \int_0^\infty x^p \mathcal{U}(x) dx \right),$$

and proving convergence of u is equivalent to prove convergence of (W, Q) . To study System (4.38), we change the unknown to $Z := W^{kp} Q$. Then (W, Z) is solution to

$$\begin{cases} \dot{W} &= \frac{W}{k} (f_p(Z) - \mu W), \\ \dot{Z} &= pZ (f_p(Z) - \mu W) + \mu Z (W - 1), \end{cases} \quad (4.39)$$

and the positive steady states satisfy $W_{Z_\infty} = \mu^{-1} f_p(Z_\infty) = 1$. If $p = 1$, Z is solution to $\dot{Z} = Z(f_1(Z) - \mu)$ so for $Z_0 \geq 0$, Z converges to $Z_\infty = \frac{I_\infty}{\mu^{kp} M_p}$ with $I_\infty \in \mathcal{N} \cup \{0\}$. When $Z_\infty > 0$, then $W \rightarrow 1$ because $f_1(Z) \rightarrow \mu$.

In the case when $p \neq 1$, we write System (4.39) as

$$\begin{cases} \dot{W} &= -\frac{1}{k} W (\mu - f_p(Z)) - \frac{\mu}{k} W (W - 1) \\ \dot{Z} &= -pZ (\mu - f_p(Z)) - (p-1) \mu Z (W - 1), \end{cases} \quad (4.40)$$

and we exhibit a Lyapunov functional for this equation. We define

$$G(W) := W - 1 - \ln(W)$$

and

$$F(Z) := \int_1^Z (\mu - f_p(z)) \frac{dz}{z},$$

then we look for a parameter α such that $k\mu G(W) + \alpha^2 F(Z)$ is a Lyapunov functional for Equation (4.40). We have

$$\frac{d}{dt} (k\mu G(W) + \alpha^2 F(Z)) = -\mu^2 (W - 1)^2 - \alpha^2 p (\mu - f_p(Z))^2 - \mu (1 + \alpha^2 (p-1)) (W - 1) (\mu - f_p(Z))$$

so, if we find α such that $1 + \alpha^2(p-1) = 2\alpha\sqrt{p}$, we will have

$$\frac{d}{dt} (k\mu G(W) + \alpha^2 F(Z)) = -(\mu(W-1) + \alpha\sqrt{p}(\mu - f_p(Z)))^2 \leq 0.$$

For $p \neq 1$, there are two roots to the binomial

$$(p-1)\alpha^2 - 2\sqrt{p}\alpha + 1 = 0$$

which are

$$\alpha = \frac{\sqrt{p} \pm 1}{p-1} = \frac{1}{\sqrt{p} \pm 1}.$$

For these two values, the dissipation is nonpositive but we want to have negativity outside of the steady states in order to conclude to convergence. We use a combination of this two values and the following lemma.

Lemma 4.3.2. *For any $\alpha \neq 1$, there exists $\omega > 0$ such that*

$$\forall a, b, \quad (a+b)^2 + (a+\alpha b)^2 \geq \omega(a^2 + b^2). \quad (4.41)$$

Proof. We prove the inequality

$$(a+b)^2 + (a+\alpha b)^2 \geq \Omega(\alpha-1)(a^2 + b^2) \quad (4.42)$$

where

$$\Omega(x) = \frac{4 - 2\sqrt{4+x^2} + x^2}{2 + \frac{x}{2}\sqrt{4+x^2} + \frac{x^2}{2}}.$$

This function is positive except at $x = 0$ where $\Omega(0) = 0$. Its maximum is $\Omega(-2) = 2$. To prove (4.42), we define $c := \frac{\alpha}{\alpha-1}$ and we prove that

$$\Omega(1-\alpha) = \min_c \left(\frac{(c+1)^2 + (c+\alpha)^2}{c^2 + 1} \right).$$

Define

$$\Gamma_\alpha(c) := \frac{(c+1)^2 + (c+\alpha)^2}{c^2 + 1},$$

compute

$$\Gamma'_\alpha(c) = \frac{(1+\alpha) - (\alpha^2-1)c - (1+\alpha)c^2}{(1+c^2)^2},$$

and we find that the minimum of Γ_α is reached for

$$c_\alpha = -\frac{1}{2} \left(\alpha - 1 + \sqrt{4 + (\alpha - 1)^2} \right).$$

As a consequence, for all $a \in \mathbb{R}$ and $b \neq 0$, we have

$$(a+b)^2 + (a+\alpha b)^2 \geq \Gamma_\alpha(c_\alpha)(a^2 + b^2)$$

and $\Gamma_\alpha(c_\alpha) = \Omega(1-\alpha)$. This is still true for $b = 0$ by passing to the limit. \square

Denoting $\alpha_+ = \frac{1}{\sqrt{p+1}}$ and $\alpha_- = \frac{1}{\sqrt{p-1}}$, we define $L(W, Z) := 2k\mu G(W) + (\alpha_+^2 + \alpha_-^2)F(Z)$. Then Lemma 4.3.2 ensures the existence of $\omega > 0$ such that

$$\begin{aligned} \frac{d}{dt} L(W(t), Z(t)) &= -(\mu(W-1) + \alpha_+\sqrt{p}(\mu - f_p(Z)))^2 - (\mu(W-1) + \alpha_-\sqrt{p}(\mu - f_p(Z)))^2 \\ &\leq -\omega (\mu^2(W-1)^2 + \alpha_+^2 p (\mu - f_p(Z))^2) := -D(W, Z), \end{aligned} \quad (4.43)$$

and $D(W, Z)$ is positive outside of the steady states. Moreover Assumption (4.9) ensures that L and D are coercive in the sense that $L(W, Z) \rightarrow +\infty$ and $D(W, Z) \rightarrow +\infty$ when $\|(W, Z)\| \rightarrow +\infty$. So L is a Lyapunov functional for System (4.40) and we can conclude to the convergence of the solution to a steady state. If $f(0) > \mu$, $L(W, Z) \rightarrow +\infty$ if W or Z tends to 0, so for any $(W_0 > 0, Z_0 > 0)$ the solution (W, Z) converges to a critical point of L , namely $(1, \frac{I_\infty}{\mu^{kp} M_p})$ with $I_\infty \in \mathcal{N}$. If $f(0) < \mu$, then for any $\bar{W} > 0$ we have that $L(W, Z) \xrightarrow{(W, Z) \rightarrow (\bar{W}, 0)} -\infty$. So either (W, Z) converges to $(1, \frac{I_\infty}{\mu^{kp} M_p})$ with $I_\infty \in \mathcal{N}$, or $Z \rightarrow 0$. To conclude to the convergence in \mathcal{H} , we write

$$\|u(t, \cdot) - Z_\infty \mathcal{U}(\mu; \cdot)\| = \int_0^\infty (Q(t) \mathcal{U}(W(t)\mu; x) - Z_\infty \mathcal{U}(\mu; x))^2 (x + x^r) dx$$

and we use dominated convergence. We know by Theorem 1 in [41] that under Assumption (4.33) and for $\nu = 1$, $x^\alpha \mathcal{U}(x)$ is bounded in \mathbb{R}^+ for all $\alpha \geq 0$, so it ensures that the integrand is dominated by an integrable function. Then the punctual convergence is given by the convergence of (W, Z) , so convergence (4.36) occurs.

Second step: general initial distribution u_0 .

Departing from u a solution to Equation (4.8) not necessarily in \mathcal{E} , we define as in Section 4.2.3

$$v(h(t), x) := W(t)^k u(t, W(t)^k x) e^{\mu(t-h(t))}$$

with

$$\dot{W} = \frac{W}{k} \left(f \left(\int x^p u \right) - \mu W \right)$$

and

$$\dot{h} = W.$$

We recall that in this case $h : \mathbb{R}_+ \rightarrow \mathbb{R}_+$ is one to one. We choose the initial values $W(0) = 1$ and $h(0) = 0$ to have $v(0, x) = u(0, x) = u_0(x)$. Then $v(t, x)$ is a solution to

$$\frac{\partial}{\partial t} v(t, x) = -\mu \frac{\partial}{\partial x} (xv(t, x)) - \mu v(t, x) + \mathcal{F}_\gamma v(t, x) \quad (4.44)$$

and, thanks to the GRE, we conclude that

$$v(t, x) \xrightarrow[t \rightarrow \infty]{} \varrho_0 \mathcal{U}(\mu; x)$$

where

$$\varrho_0 = \int_0^\infty \phi(\mu; x) v_0(x) dx = \int_0^\infty \phi(\mu; x) u_0(x) dx$$

and so

$$\int x^p u(t, x) dx \underset{t \rightarrow \infty}{\sim} \varrho_0 \mu^{kp} \left(\int x^p \mathcal{U}(x) dx \right) W(t)^{kp} e^{\mu(h(t)-t)} dx.$$

As a consequence it holds

$$\dot{W}(t) \underset{t \rightarrow \infty}{\sim} \frac{W}{k} (f_p(W^{kp} Q) - \mu W)$$

with $Q(t) = \varrho_0 e^{\mu(h(t)-t)}$ which satisfies the equation

$$\dot{Q} = \mu Q (W - 1).$$

The interpretation of this is that System (4.37) represents asymptotically the dynamics of the solutions to Equation (4.8). More rigorously, define

$$\varepsilon(t) := \frac{\int x^p u(t, x) dx}{\mu^{kp} M_p Q(t) W^{kp}(t)} - 1. \quad (4.45)$$

Then we have

$$\dot{W}(t) = \frac{W}{k} (f_p(W^{kp}Q(1 + \varepsilon(t))) - \mu W)$$

and, using the Cauchy-Schwarz inequality and the exponential decay theorem of [15],

$$\begin{aligned} |\varepsilon(t)| &= \frac{W^{-kp}e^{\mu(t-h(t))}}{\mu^{kp}M_p} \left| \int (\varrho_0^{-1}u(t, x) - \mathcal{U}(\mu; x)W^{kp}e^{\mu(h(t)-t)})x^p dx \right| \\ &= \frac{1}{\mu^{kp}M_p} \left| \int (\varrho_0^{-1}v(h(t), x) - \mathcal{U}(\mu; x))x^p dx \right| \\ &\leq \frac{1}{\mu^{kp}M_p} \left(\int |\varrho_0^{-1}v(h(t), x) - \mathcal{U}(\mu; x)|^2(\phi(x) + x^r) dx \right)^{\frac{1}{2}} \left(\int \frac{x^{2p}}{\phi(x) + x^r} dx \right)^{\frac{1}{2}} \\ &\leq \frac{C_p}{\mu^{kp}M_p} \|\varrho_0^{-1}u_0 - \mathcal{U}(\mu; \cdot)\| e^{-ah(t)}. \end{aligned} \quad (4.46)$$

The function $\frac{x^{2p}}{x+x^r}$ is integrable under Assumption (4.35). Finally the dynamics of the solution u to Equation (4.8) is given by

$$\begin{cases} \dot{W} &= -\frac{1}{k}W(\mu - f_p((1 + \varepsilon)Z)) - \frac{\mu}{k}W(W - 1) \\ \dot{Z} &= -pZ(\mu - f_p((1 + \varepsilon)Z)) - (p - 1)\mu Z(W - 1), \end{cases} \quad (4.47)$$

where $Z = W^{kp}Q$, and $\varepsilon(t) \xrightarrow[t \rightarrow \infty]{} 0$. Now we look what becomes the Lyapunov functional of the first step for this system and we obtain

$$\frac{d}{dt}L(W, Z) \leq -D(W, Z) + \underbrace{(\mu(W - 1) + (\alpha_+^2 + \alpha_-^2)p(\mu - f_p(Z)))(f_p((1 + \varepsilon)Z) - f_p(Z))}_{:=E(W, Z, \varepsilon)}. \quad (4.48)$$

Thanks to Assumption (4.9), we know that f_p is bounded, so W which is solution to

$$\dot{W} = \frac{W}{k} (f_p((1 + \varepsilon)Z) - \mu W)$$

is also bounded. Thus $E(W, Z, \varepsilon)$ is bounded and, because L and D are coercive, the trajectory (W, Z) is bounded. Moreover $E(W(t), Z(t), \varepsilon(t)) \xrightarrow[t \rightarrow \infty]{} 0$ because $\varepsilon(t) \rightarrow 0$, so (W, Z) converges to a steady state $(1, Z_\infty)$. Finally we write

$$\|u(t, \cdot) - Z_\infty \mathcal{U}(\mu; \cdot)\| \leq \|u(t, \cdot) - Q(t)\mathcal{U}(W(t)\mu; \cdot)\| + \|Q(t)\mathcal{U}(W(t)\mu; \cdot) - Z_\infty \mathcal{U}(\mu; \cdot)\|$$

and we know from the first step that $\|Q(t)\mathcal{U}(W(t)\mu; \cdot) - Z_\infty \mathcal{U}(\mu; \cdot)\| \rightarrow 0$. We treat the other term thanks to the spectral gap theorem of [15]

$$\begin{aligned} \|u(t, \cdot) - Q(t)\mathcal{U}(W(t)\mu; \cdot)\|_{\mathcal{H}} &= Q \left(\int |\varrho_0^{-1}v(h(t), x) - \mathcal{U}(\mu; x)|^2 (x + W^{(r-1)k}x^r) dx \right)^{\frac{1}{2}} \\ &\leq C \|\varrho_0^{-1}v(h(t), \cdot) - \mathcal{U}(\mu; \cdot)\| \\ &\leq C \|\varrho_0^{-1}u_0 - \mathcal{U}(\mu; \cdot)\| e^{-ah(t)}. \end{aligned} \quad (4.49)$$

So $\|u(t, \cdot) - Q(t)\mathcal{U}(W(t)\mu; \cdot)\| \rightarrow 0$ because $h(t) \rightarrow +\infty$, and the proof is complete. \square

Proof of Theorem 4.1.2. Stability of the trivial steady state.

We start with the stability of the zero steady state when $f(0) < \mu$ and $p \geq 1$. For this we integrate Equation (4.8) against x^p and find

$$\frac{d}{dt} \left(\int x^p u(t, x) dx \right) \leq \left(f \left(\int x^p u(t, x) dx \right) - \mu \right) \left(\int x^p u(t, x) dx \right)$$

thanks to the mass conservation assumption (4.3). Thus $\int x^p u(t, x) dx$ is a decreasing function if $f(M_p[u_0]) < \mu$. Then we integrate against $x + x^r$ for any $r \geq 1$ and we obtain

$$\frac{d}{dt} \left(\int u(t, x) (x + x^r) dx \right) \leq \left(f \left(\int x^p u(t=0, x) dx \right) - \mu \right) \left(\int u(t, x) (x + x^r) dx \right)$$

which ensures the exponential convergence

$$\|u(t, \cdot)\|_{\mathcal{H}} \leq \|u_0\|_{\mathcal{H}} e^{(f(M_p[u_0]) - \mu)t}.$$

For $r \geq p$, we have $M_p[u_0] \leq C\|u_0\|_{\mathcal{H}}$, so for $\|u_0\|$ small enough, we have $f(M_p[u_0]) < \mu$ and the exponential convergence occurs.

When $f(0) > \mu$, we have seen in the proof of Theorem 4.3.1 that $L(W, Z) \rightarrow +\infty$ when W or Z tends to zero. So the trivial steady state is unstable.

Stability of nontrivial steady states.

Let (W_∞, Z_∞) be a positive steady state to System (4.40). We want to prove that $Z_\infty \mathcal{U}(\mu; \cdot)$ is locally asymptotically stable. Since Theorem 4.3.1 ensures the convergence of any solution to Equation (4.8) toward a steady state, it only remains to prove the local stability of $Z_\infty \mathcal{U}(\mu; \cdot)$, namely

$$\forall \rho_1 > 0, \exists \rho_2 > 0, \quad \|u_0 - Z_\infty \mathcal{U}(\mu; \cdot)\| < \rho_2 \Rightarrow \forall t > 0, \|u(t, \cdot) - Z_\infty \mathcal{U}(\mu; \cdot)\| < \rho_1.$$

We have already seen that

$$\|u(t, \cdot) - Z_\infty \mathcal{U}(\mu; \cdot)\| \leq C \|\varrho_0^{-1} u_0 - \mathcal{U}(\mu; \cdot)\| + \|Q(t) \mathcal{U}(W(t); \mu; \cdot) - Z_\infty \mathcal{U}(\mu; \cdot)\|$$

with $\|Q \mathcal{U}(W; \mu; \cdot) - Z_\infty \mathcal{U}(\mu; \cdot)\| \rightarrow 0$ when $(W, Z) \rightarrow (W_\infty, Z_\infty)$.

Let first treat the term $\|\varrho_0^{-1} u_0 - \mathcal{U}(\mu; \cdot)\|$. We have

$$\begin{aligned} |\varrho_0 - Z_\infty| &= \left| \int (u_0 - Z_\infty \mathcal{U}(\mu; x)) \phi(\mu; x) dx \right| \\ &\leq \mu^{-k} \left(\int (u_0 - Z_\infty \mathcal{U}(\mu; x))^2 (x + x^r) dx \right)^{\frac{1}{2}} \left(\int \frac{x^2}{x + x^r} dx \right)^{\frac{1}{2}} \\ &= C \|u_0 - Z_\infty \mathcal{U}(\mu; \cdot)\| \end{aligned} \tag{4.50}$$

and then

$$\begin{aligned} \|\varrho_0^{-1} u_0 - \mathcal{U}(\mu; \cdot)\| &\leq \varrho_0^{-1} \|u_0 - \frac{I_\infty}{\mu^{kp} M_p} \mathcal{U}(\mu; \cdot)\| + \varrho_0^{-1} |\varrho_0 - Z_\infty| \|\mathcal{U}(\mu; \cdot)\| \\ &\leq \frac{C}{\varrho_0} \|u_0 - Z_\infty \mathcal{U}(\mu; \cdot)\| \\ &\leq \frac{C}{Z_\infty - |\varrho_0 - Z_\infty|} \|u_0 - Z_\infty \mathcal{U}(\mu; \cdot)\| \\ &\leq \frac{C \|u_0 - Z_\infty \mathcal{U}(\mu; \cdot)\|}{Z_\infty - C \|u_0 - Z_\infty \mathcal{U}(\mu; \cdot)\|} \end{aligned} \tag{4.51}$$

so $\|\varrho_0^{-1} u_0 - \mathcal{U}(\mu; \cdot)\|$ is small for $\|u_0 - Z_\infty \mathcal{U}(\mu; \cdot)\|$ small enough.

Now let turn to the term $\|Q \mathcal{U}(W; \mu; \cdot) - Z_\infty \mathcal{U}(\mu; \cdot)\|$. Since it tends to zero when (W, Z) tends to (W_∞, Z_∞) , it is sufficient to prove that (W_∞, Z_∞) is stable for System (4.47). For $\eta > 0$, denote by $\mathcal{V}_\eta(W_\infty, Z_\infty)$ the connex component of $\{(W, Z), L(W, Z) < L(W_\infty, Z_\infty) + \eta\}$ which contains (W_∞, Z_∞) . Since $f'(I_\infty) < 0$, (W_∞, Z_∞) is a strict local minimum of L so we have, denoting $B(X, \rho) = \{Y \in \mathbb{R}^2, \|X - Y\| < \rho\}$,

$$\forall \rho > 0, \exists \eta > 0, \quad \mathcal{V}_\eta(W_\infty, Z_\infty) \subset B((W_\infty, Z_\infty), \rho)$$

and reciprocally

$$\forall \eta > 0, \exists \rho > 0, \quad B((W_\infty, Z_\infty), \rho) \subset \mathcal{V}_\eta(W_\infty, Z_\infty).$$

So it is sufficient, to have the local stability of (W_∞, Z_∞) , to prove that $\mathcal{V}_\eta(W_\infty, Z_\infty)$ is stable. This is true for System (4.40) since in this case L is a Lyapunov functional. Then, by continuity of f , there exists ε_η such that $\mathcal{V}_\eta(W_\infty, Z_\infty)$ remains stable for System (4.47) if $|\varepsilon(t)| < \varepsilon_\eta$ for all $t > 0$. But we know from (4.46) that $|\varepsilon(t)| \leq C \|\varrho_0^{-1} u_0 - \mathcal{U}(\mu; \cdot)\|$ and from (4.51) that $\|\varrho_0^{-1} u_0 - \mathcal{U}(\mu; \cdot)\|$ is small for $\|u_0 - Z_\infty \mathcal{U}(\mu; \cdot)\|$ small enough. Finally $\|QU(W\mu; \cdot) - Z_\infty \mathcal{U}(\mu; \cdot)\|$ is small for $\|u_0 - Z_\infty \mathcal{U}(\mu; \cdot)\|$ small enough and the local asymptotical stability of the nontrivial steady states is proved.

Now assume that $\kappa \equiv 2$ and prove the local exponential stability of $Z_\infty \mathcal{U}(\mu; \cdot)$. In this case we have (see examples in [41]) the explicit formula

$$\mathcal{U}(x) = C e^{-\frac{\beta}{\gamma} x^\gamma} \quad (4.52)$$

and thanks to this we can estimate the quantity $\|QU(W\mu; \cdot) - Z_\infty \mathcal{U}(\mu; \cdot)\|$. We have

$$\begin{aligned} \|QU(W\mu; \cdot) - Z_\infty \mathcal{U}(\mu; \cdot)\|^2 &= \int |QU(W^k \mu; x) - Z_\infty \mathcal{U}(\mu; x)|^2 (x + x^r) dx \\ &\leq |Z - Z_\infty|^2 W^{-2kp} \int \mathcal{U}(W^k \mu; x)^2 (x + x^r) dx \quad (i) \\ &\quad + |W^{-k(p+1)} - 1|^2 Z_\infty^2 \int \mathcal{U}(W^{-k} \mu^{-k} x)^2 (x + x^r) dx \quad (ii) \\ &\quad + Z_\infty^2 \int |\mathcal{U}(W^{-k} \mu^{-k} x) - \mathcal{U}(\mu^{-k} x)|^2 (x + x^r) dx \quad (iii) \end{aligned}$$

and we prove exponential decay of (i), (ii) and (iii) in a neighbourhood of (W_∞, Z_∞) . We have thanks to the L'Hôpital rule

$$F(Z) \underset{Z \rightarrow Z_\infty}{\sim} \frac{1}{-2Z_\infty f'(Z_\infty)} (\mu - f(Z))^2 \quad (4.53)$$

and

$$G(W) \underset{W \rightarrow W_\infty}{\sim} \frac{1}{2W_\infty} (W - 1)^2, \quad (4.54)$$

so the following local ‘‘entropy - entropy dissipation’’ inequality holds

$$\exists C > 0, \rho > 0, \quad \forall (W, Z) \in B((W_\infty, Z_\infty), \rho), \quad L(W, Z) \leq CD(W, Z). \quad (4.55)$$

Fix such a ρ and fix $\eta > 0$ such that $\mathcal{V}_\eta(W_\infty, Z_\infty) \subset B((W_\infty, Z_\infty), \rho)$. Consider $\|u_0 - Z_\infty \mathcal{U}(\mu; \cdot)\|$ small enough so that $|\varepsilon(t)|$ remains smaller than ε_η for all time. Then $\mathcal{V}_\eta(W_\infty, Z_\infty)$ is stable for the dynamics of System (4.47). Now look at the term $E(W(t), Z(t), \varepsilon(t))$ for (W, Z) solution to System (4.47) in this stable neighbourhood. It satisfies

$$\begin{aligned} E &= \mu(W - 1)(f_p((1 + \varepsilon)Z) - f_p(Z)) + (\alpha_+^2 + \alpha_-^2)p(\mu - f_p(Z))(f_p((1 + \varepsilon)Z) - f_p(Z)) \\ &\leq \frac{\omega}{2}\mu^2(W - 1)^2 + \frac{\omega}{2}\alpha_+^2 p(\mu - f_p(Z))^2 + \frac{1}{2\omega} \left(1 + \left(\frac{\alpha_+^2 + \alpha_-^2}{\alpha_+} \right)^2 p \right) (f_p((1 + \varepsilon)Z) - f_p(Z))^2 \\ &= \frac{1}{2}D(W, Z) + C(f_p((1 + \varepsilon)Z) - f_p(Z))^2 \\ &\leq \frac{1}{2}D(W, Z) + C \sup_J |f'| \varepsilon^2 \end{aligned}$$

where $J = [Z_\infty - \rho - \varepsilon_\eta, Z_\infty + \rho + \varepsilon_\eta]$. As a consequence we have

$$\begin{aligned} \frac{d}{dt} L(W, Z) &\leq -\frac{1}{2}D(W, Z) + C\varepsilon^2 \\ &\leq -CL(W, Z) + C\|\varrho_0^{-1} u_0 - \mathcal{U}(\mu; \cdot)\|^2 e^{-2ah(t)} \end{aligned}$$

and so

$$L(W, Z) \leq L(W_0, Z_0)e^{-Ct} + C\|\varrho_0^{-1} u_0 - \mathcal{U}(\mu; \cdot)\|^2 e^{-2ah(t)}.$$

Then, thanks to the equivalences (4.53) and (4.54) and because $h(t) \sim t$ when $t \rightarrow \infty$, there are $b > 0$ and $C > 0$ such that

$$(W - 1)^2 + (\mu - f_p(Z))^2 \leq C(\mu - f_p(Z_0))^2 e^{-2bt} + C\| \varrho_0^{-1} u_0 - \mathcal{U}(\mu; \cdot) \|^2 e^{-2bt}$$

and, because $f'(I_\infty) \neq 0$, it holds

$$(W - 1)^2 + (Z - Z_\infty)^2 \leq C(Z_0 - Z_\infty)^2 e^{-2bt} + C\| u_0 - Z_\infty \mathcal{U}(\mu; \cdot) \|^2 e^{-2bt}.$$

Using the Cauchy-Schwarz inequality as in (4.50), we find that

$$(Z_0 - Z_\infty)^2 \leq C\| u_0 - Z_\infty \mathcal{U}(\mu; \cdot) \|^2,$$

so

$$(W - 1)^2 + (Z - Z_\infty)^2 \leq C\| u_0 - Z_\infty \mathcal{U}(\mu; \cdot) \|^2 e^{-2bt}.$$

This inequality ensures that the terms (i) and (ii) decrease to zero exponentially fast. It only remains to prove the same result for (iii), and for this we use the explicit formula (4.52). We obtain

$$\begin{aligned} \int_0^\infty (\mathcal{U}(W^{-k} \mu^{-k} x) - \mathcal{U}(\mu^{-k} x))^2 (\phi(x) + x^r) dx &= C \int \left(e^{-\frac{\beta}{\gamma\mu}(W^{-k}x)^\gamma} - e^{-\frac{\beta}{\gamma\mu}x^\gamma} \right)^2 (x + x^r) dx \\ &= C \int \left(e^{-\frac{2\beta}{\gamma\mu}(W^{-k}x)^\gamma} + e^{-\frac{2\beta}{\gamma\mu}x^\gamma} - 2e^{-\frac{\beta}{\gamma\mu}(1+W^{-1})x^\gamma} \right)^2 (x + x^r) dx \\ &= C \int e^{-\frac{2\beta}{\gamma\mu}y^\gamma} (W^k y + W^{rk} y^r) W^k dy + \int e^{-\frac{2\beta}{\gamma\mu}x^\gamma} (x + x^r) dx \\ &\quad - 2 \int e^{-\frac{2\beta}{\gamma\mu}z^\gamma} \left(\left(\frac{1+W^{-1}}{2} \right)^{-k} z + \left(\frac{1+W^{-1}}{2} \right)^{-rk} z^r \right) \left(\frac{1+W^{-1}}{2} \right)^{-k} dz \\ &= C\psi_1(W) \int e^{-\frac{2\beta}{\gamma\mu}x^\gamma} x dx + C\psi_r(W) \int e^{-\frac{2\beta}{\gamma\mu}x^\gamma} x^r dx \end{aligned}$$

where

$$\psi_r(W) := W^{(r+1)k} + 1 - 2 \left(\frac{1+W^{-1}}{2} \right)^{-(r+1)k}.$$

Thanks to a Taylor expansion, we find that, locally,

$$|\psi_r(W)| \leq C(W - 1)^2$$

and so

$$\int_0^\infty (\mathcal{U}(W^{-k} \mu^{-k} x) - \mathcal{U}(\mu^{-k} x))^2 (x + x^r) dx \leq C\| u_0 - Z_\infty \mathcal{U}(\mu; \cdot) \|^2 e^{-2bt}.$$

Finally there exists a constant $C > 0$ such that, for $\| u_0 - Z_\infty \mathcal{U}(\mu; \cdot) \|^2$ small enough so that (W, Z) stay in the neighbourhood $\mathcal{V}_\eta(W_\infty, Z_\infty)$, we have

$$\begin{aligned} \| u(t, \cdot) - Z_\infty \mathcal{U}(\mu; \cdot) \| &\leq \| u(t, \cdot) - QU(W\mu; \cdot) \| + \| QU(W\mu; \cdot) - Z_\infty \mathcal{U}(\mu; \cdot) \| \\ &\leq C\| u_0 - Z_\infty \mathcal{U}(\mu; \cdot) \|^2 e^{-bt} \end{aligned}$$

and it is the local exponential stability of the nontrivial steady states which satisfy $f'(I_\infty) < 0$ in the case when $\kappa \equiv 2$.

When $f'(I_\infty) > 0$, the steady state (W_∞, Z_∞) is a saddle point of L so it is unstable. \square

We remark that the structure of the reduced system (4.40) is different for $p < 1$ and $p > 1$. The nontrivial steady states are focuses in the case when $p < 1$ and nodes for $p \geq 1$ (see Figure 4.1 for a numerical illustration in the case of Corollary 4.1.3).

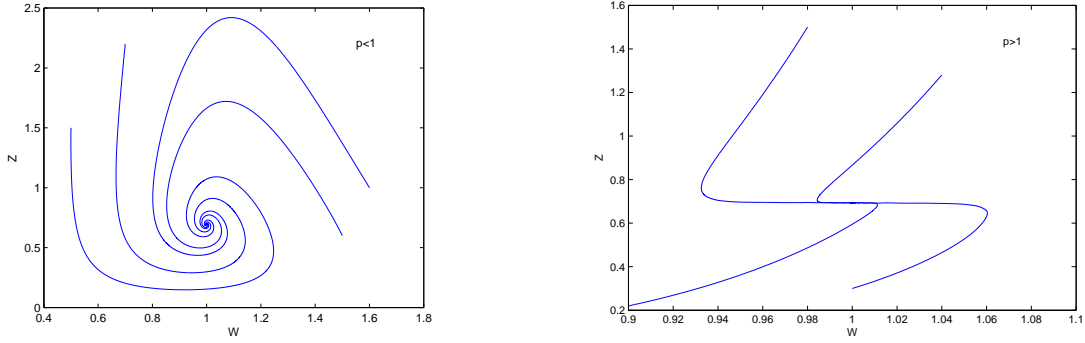

Figure 4.1: Solutions to System (4.40) are plotted in the phase plan (W, Z) for two different values of parameter p . The other coefficients are $\gamma = 0.1$, $\mu = 1$ and $f(x) = 2e^{-x}$. We can see that the steady state is a focus for $p < 1$ (left) and a node for $p > 1$ (right).

4.4 Nonlinear Drift and Death Terms: Stable Persistent Oscillations

We have seen in Theorem 4.1.1 that any solution to the nonlinear equation (4.8) converges to a steady state. Can this result be extended to Equation (4.10) where the death rate is also nonlinear? The result in Theorem 4.1.4 answer negatively to this question. Indeed it ensures the existence of functions f and g , and parameters p and q such that Equation (4.10) admits periodic solutions. Here we give examples of such functions and parameters and more precisely we prove, thanks to the Poincaré-Bendixon theorem, that any solution with an initial distribution in the eigenmanifold \mathcal{E} which is not a steady state converges to a periodic solution. Then we extend this result by surrounding this set of initial distributions by an open neighbourhood in \mathcal{H} .

In the proof, we need to know the dependency of some quantities on the parameters p and q . Since we do not know the dependencies of $M_p = \int x^p \mathcal{U}(x) dx$ on p , we consider an equation slightly different from (4.10), namely

$$\frac{\partial}{\partial t} u(t, x) = -f \left(\frac{\int x^p u(t, x)}{\int x^p \mathcal{U}(x)} \right) \frac{\partial}{\partial x} (xu(t, x)) - g \left(\frac{\int x^q u(t, x)}{\int x^q \mathcal{U}(x)} \right) u(t, x) + \mathcal{F}_\gamma u(t, x). \quad (4.56)$$

Clearly the existence of functions f and g for which persistent oscillations appear in Equation (4.56) ensures the same result for Equation (4.10) (up to a dilation of f and g). Now let set the assumptions on the two function f and g which allow to obtain periodic oscillations. We consider differentiable increasing functions f and g such that

$$f(0) > g(0) = 0 \quad \text{and} \quad f(\infty) < g(\infty) = \infty. \quad (4.57)$$

Moreover we assume that g is invertible and define on \mathbb{R}^+ the function

$$\psi(W) := f \left(W^{k(p-q)} g^{-1}(W) \right). \quad (4.58)$$

To ensure the existence and uniqueness of a nontrivial equilibrium, we assume that

$$\exists! W_\infty \geq 0, \quad \psi(W_\infty) = W_\infty \quad \text{and moreover} \quad \psi'(W_\infty) < 1. \quad (4.59)$$

This steady state is unstable if, denoting $Q_\infty := W_\infty^{-kq} g^{-1}(W_\infty)$, we have

$$Q_\infty \left(p W_\infty^{kp} f'(W_\infty^{kp} Q_\infty) - W_\infty^{kq} g'(W_\infty^{kq} Q_\infty) \right) - \frac{W_\infty}{k} > 0. \quad (4.60)$$

Then solutions to Equation (4.56) with initial distribution close to the set $\mathcal{E} \setminus \{Q_\infty \mathcal{U}(W_\infty; \cdot)\}$ exhibit asymptotically periodic behaviors. More precisely, we have the following result

Theorem 4.4.1. Consider increasing differentiable functions f and g satisfying conditions (4.57), (4.59) and (4.60), a parameter $\gamma \in (0, 2]$ and a fragmentation kernel κ which satisfies Assumption (4.33). Then there exists an open neighbourhood \mathcal{V} of $\mathcal{E} \setminus \{Q_\infty \mathcal{U}(W_\infty; \cdot)\}$ in \mathcal{H} such that, for any initial distribution $u_0 \in \mathcal{V}$, there exist periodic functions $W(t)$ and $Q(t)$ such that

$$\|u(t, \cdot) - Q(t)\mathcal{U}(W(t); \cdot)\|_{\mathcal{H}} \xrightarrow[t \rightarrow \infty]{} 0. \quad (4.61)$$

Before proving this theorem, we give examples of functions f and g such that conditions (4.57), (4.59) and (4.60) are satisfied. These examples, together with Theorem 4.4.1, give the proof of Theorem 4.1.4.

Example 1. Assume that there exists $C > 0$ such that for all $x \geq 0$, $g(x) \leq C x g'(x)$, then $\psi(W) = W$ has a unique solution for $k(q - p) > C$. Indeed, if we compute the derivative of ψ we find

$$\psi'(W) = W^{k(p-q)} \left(k(p-q) \frac{g^{-1}(W)}{W} + (g^{-1})'(W) \right)$$

and $g(x) \leq C x g'(x)$ implies that $x(g^{-1})'(x) \leq C g^{-1}(x)$. So if $k(q - p) > C$, ψ decreases and Assumption (4.59) is fulfilled. If moreover $f(1) = g(1) = 1$, then the unique nontrivial equilibrium is given by $W_\infty = 1$. Then condition (4.60) is satisfied for $p > \frac{g'(1) + \frac{1}{k}}{f'(1)}$.

Example 2. Consider the case $g(x) = x$ and $p = q$, and assume that $f(x) - x$ has a unique root x_0 and $f'(x_0) - 1 < 0$. Then $\psi(W) = f(W)$ and Assumption (4.59) is satisfied. Moreover, condition (4.60) writes $p f'(W_\infty) > 1 + \frac{1}{k}$ so it is satisfied for p large enough.

Now we give a lemma useful for the proof of Theorem 4.4.1.

Lemma 4.4.2. Consider a dynamical system in \mathbb{R}^n with a parameter $\varepsilon(t)$

$$\dot{X} = F(X; \varepsilon(t)) \quad (4.62)$$

with $F \in \mathcal{C}(\mathbb{R}^n \times \mathbb{R}^n)$. Assume that for any vanishing parameter $\|\varepsilon(t)\| \xrightarrow[t \rightarrow \infty]{} 0$ the solutions to Equation (4.62) are bounded. Then for any solution X^ε associated to $\|\varepsilon(t)\| \xrightarrow[t \rightarrow \infty]{} 0$, there exists a solution X^0 associated to $\varepsilon \equiv 0$ such that X^ε and X^0 have the same ω -limit set.

Proof of Lemma 4.4.2. Let $X(t)$ a solution to System (4.62) with $\|\varepsilon(t)\| \rightarrow 0$. By assumption, $X(t)$ is bounded, so $\dot{X}(t)$ is also bounded since F is continuous. Now consider a sequence $\{t_k\}_{k \in \mathbb{N}}$ which tends to the infinity and define the sequence $\{X_k(\cdot)\}$ by $X_k(t) = X(t + t_k)$. This sequence is bounded in $W^{1, \infty}(\mathbb{R}_+)$ so there exists a subsequence which converge to $X_\infty(\cdot)$. This limit is a solution to Equation (4.62) with $\varepsilon \equiv 0$. We take $X^0 := X_\infty$ that ends the proof of Lemma 4.4.2. \square

Proof of Theorem 4.4.1. We divide the proof in two parts: first the result for $u_0 \in \mathcal{E}$ and then the existence of a neighbourhood \mathcal{V} of \mathcal{E} in \mathcal{H} where the result persists.

First step: $u_0 \in \mathcal{E}$.

For $u_0 \in \mathcal{E} \setminus \{0\}$, there are $W_0 > 0$ and $Q_0 > 0$ such that

$$u_0(x) = Q_0 \mathcal{U}(W_0; x).$$

Then, if $u(t, x)$ is the solution to Equation (4.56) and W is the solution to

$$\dot{W} = \frac{W}{k} \left(f \left(\frac{M_p[u](t)}{M_p[W]} \right) - W \right)$$

with $W(0) = W_0$, the relation holds for all $t > 0$ and $x > 0$

$$u(t, x) = Q(t) \mathcal{U}(W(t); x)$$

where $Q(t) := Q_0 e^{\int_0^t (W(s) - g(M_q[u](s)/M_q[\mathcal{U}])) ds}$. Then we can compute

$$M_p[u](t) = \int_0^\infty x^p u(t, x) dx = W^{kp}(t) Q(t) M_p[\mathcal{U}]$$

and finally we obtain the reduced system of ODEs satisfied by (W, Q)

$$\begin{cases} \dot{W} &= \frac{W}{k} (f(W^{kp}Q) - W), \\ \dot{Q} &= Q(W - g(W^{kq}Q)). \end{cases} \quad (4.63)$$

We prove that System (4.63) has bounded solutions and a unique positive steady state which is unstable. Then we use the Poincaré-Bendixon theorem to ensure the convergence to a limit cycle.

The fact that $0 < f(0) \leq f \leq f(\infty) < \infty$ and that g increases from 0 to the ∞ ensures that the solution remains bounded. Let (W_∞, Q_∞) a positive steady state. It satisfies

$$W_\infty = f(W^{kp}Q) = g(W^{kq}Q)$$

and so, since g is invertible, $Q_\infty = W_\infty^{-kq} g^{-1}(W_\infty)$. Then W_∞ is solution to the equation

$$W_\infty = f(W_\infty^{k(p-q)} g^{-1}(W_\infty)) = \psi(W_\infty)$$

but Assumption (4.59) ensures the uniqueness of such a solution. Now look at the stability of this positive steady state. We write system (4.63) under the form

$$\begin{pmatrix} \dot{W} \\ \dot{Q} \end{pmatrix} = F \begin{pmatrix} W \\ Q \end{pmatrix},$$

and we have

$$Jac(F)_{eq} = \begin{pmatrix} pW_\infty^{kp} Q_\infty f'(W_\infty^{kp} Q_\infty) - \frac{1}{k} W_\infty & \frac{1}{k} W_\infty^{kp+1} f'(W_\infty^{kp} Q_\infty) \\ Q_\infty - kqW_\infty^{kq-1} Q_\infty^2 g'(W_\infty^{kq} Q_\infty) & -W_\infty^{kq} Q_\infty g'(W_\infty^{kq} Q_\infty) \end{pmatrix}.$$

The trace of this matrix is

$$T = Q_\infty (pW_\infty^{kp} f'(W_\infty^{kp} Q_\infty) - W_\infty^{kq} g'(W_\infty^{kq} Q_\infty)) - \frac{W_\infty}{k}$$

and the determinant is

$$D = \frac{W}{k} Q (W^{kq} g'(W^{kq} Q) - W^{kp} f'(W^{kp} Q)) + (q-p) W^{k(p+q)} Q^2 f'(W^{kp} Q) g'(W^{kq} Q).$$

We know from Assumption (4.59) that $\psi'(W_\infty) < 1$ and, if we compute $\psi'(W)$ we find

$$\psi'(W) = \left[k(p-q) W^{k(p-q)-1} g^{-1}(W) + \frac{W^{k(p-q)}}{g'(g^{-1}(W))} \right] f'(W^{k(p-q)} g^{-1}(W)).$$

Since $g^{-1}(W) = W^{kq} Q$ we finally obtain

$$D = \frac{1}{k} W_\infty^{kq+1} Q_\infty g'(W_\infty^{kq} Q_\infty) (1 - \psi'(W_\infty)) > 0.$$

Thus when $T > 0$, namely when Assumption (4.60) is satisfied, the two eigenvalues have positive real parts and the positive steady state is unstable. Now we prove that (W, Q) remains away from the boundaries of $(\mathbb{R}_+)^2$. For this we write that

$$\forall t > 0, \quad \underline{W} := \min(W_0, f(0)) \leq W(t) \leq \max(W_0, f(\infty)) := \overline{W}$$

and then

$$Q \geq \min(Q_0, \overline{W}^{-kp} g^{-1}(\underline{W})).$$

Since $f(0) > 0$, $\underline{W} > 0$ for $W_0 > 0$ so any solution with $W_0 > 0$ and $Q_0 > 0$ stays at positive distance of the boundaries of $(\mathbb{R}_+)^2$. Then the Poincaré-Bendixon theorem (see [68] for instance) ensures any solution to System (4.63) with $W_0 > 0$, $Q_0 > 0$ and $(W_0, Q_0) \neq (W_\infty, Q_\infty)$ converges to a limit cycle.

Second step: Existence of \mathcal{V} .

Let $u_0 \not\equiv 0$ in \mathcal{H} and define from $u(t, x)$ solution to Equation (4.56) with initial distribution u_0 a function v by

$$v(h(t), x) = W^k(t)u(t, W^k(t)x)e^{\int_0^t (g(M_q[u](s)/M_q[\mathcal{U}]) - W(s)) ds}$$

with W solution to

$$\dot{W} = \frac{W}{k} \left(f \left(\frac{M_p[u]}{M_p[\mathcal{U}]} \right) - W \right)$$

and h solution to $\dot{h} = W$ with $h(0) = 0$. We have already seen in Section 4.2.3 that $h : \mathbb{R}_+ \rightarrow \mathbb{R}_+$ is one to one since $h(t) \geq k \ln(1 + \frac{t}{k})$. We take $W(0) = 1$ to have $v(t = 0, \cdot) = u(t = 0, \cdot) = u_0$. Thanks to Theorem 4.2.1 we know that v is solution to

$$\partial_t v(t, x) + \partial_x(xv(t, x)) + v(t, x) = \mathcal{F}_\gamma v(t, x)$$

and the GRE ensures the convergence

$$v(t, x) \xrightarrow[t \rightarrow \infty]{} \left(\int \phi(x)u_0(x) dx \right) \mathcal{U}(x).$$

As a consequence we have the equivalences, for any $p \geq 0$,

$$M_p[u](t) \underset{t \rightarrow \infty}{\sim} \varrho_0 M_p[\mathcal{U}] W^{kp} e^{\int_0^t (W(s) - g(M_q[u](s)/M_q[\mathcal{U}])) ds}$$

so, if we define $Q(t) := \varrho_0 e^{\int_0^t (W(s) - g(M_q[u](s)/M_q[\mathcal{U}])) ds}$, we find that the reduced system (4.63) is “asymptotically equivalent” to Equation (4.56). More precisely we define as in the proof of Theorem 4.3.1

$$\varepsilon_p(t) = \frac{M_p[u](t)}{M_p[\mathcal{U}]W^{kp}(t)Q(t)} - 1$$

we have that $\varepsilon_p \rightarrow 0$ and (W, Q) is solution to

$$\begin{cases} \dot{W} &= \frac{W}{k} (f((1 + \varepsilon_p)W^{kp}Q) - W), \\ \dot{Q} &= Q(W - g((1 + \varepsilon_q)W^{kq}Q)). \end{cases} \quad (4.64)$$

Now we prove that if W_0 and Q_0 are positive and $(W_0, Q_0) \neq (W_\infty, Q_\infty)$, then if $\|u_0 - Q_0\mathcal{U}(W_0; \cdot)\|_{\mathcal{H}}$ is small enough, the solution u to Equation (4.56) converges to a periodic solution. Denote by d the distance between (W_0, Q_0) and (W_∞, Q_∞) . Since (W_∞, Q_∞) is a source for System (4.63), there exists a ball with radius $\rho < d$ such that the flux is outgoing, namely

$$\forall (W, Q) \in \partial B((W_\infty, Q_\infty), \rho), \quad F(W, Q) \cdot \mathbf{n} > 0 \quad (4.65)$$

where \mathbf{n} is the outgoing normal of $B((W_\infty, Q_\infty), \rho)$. Then if we define by $F(W, Q; \varepsilon_p, \varepsilon_q)$ the flux of Equation (4.64), we have by continuity of f and g that there exists ε_0 such that (4.65) remains true for $F(W, Q; \varepsilon_p, \varepsilon_q)$ provided that ε_p and ε_q stay less than ε_0 . But we know from the proof of Theorem 4.3.1 that there exists a constant $C_p > 0$ such that for all time $t > 0$, $\varepsilon_p \leq C_p \|u_0 - Q_0\mathcal{U}(W_0; \cdot)\|$. So for $\|u_0 - Q_0\mathcal{U}(W_0; \cdot)\| \leq \frac{\varepsilon_0}{C_p + C_q}$, the solution to System (4.64) cannot converge to the positive steady state (W_∞, Q_∞) . Thanks to the same arguments, if $\|u_0 - Q_0\mathcal{U}(W_0; \cdot)\|$ is small enough, then (W, Q) remains

away from the boundaries of $(\mathbb{R}_+)^2$. We obtain thanks to Lemma 4.4.2 that for $\|u_0 - Q_0\mathcal{U}(W_0; \cdot)\|$ small enough, $(W(t), Q(t))$ converges to a limit cycle $(\tilde{W}(t), \tilde{Q}(t))$. Then we write

$$\|u - \tilde{Q}\mathcal{U}(\tilde{W}; \cdot)\| \leq \|u - Q\mathcal{U}(W; \cdot)\| + \|Q\mathcal{U}(W; \cdot) - \tilde{Q}\mathcal{U}(\tilde{W}; \cdot)\|$$

and we conclude as in the proof of Theorem 4.3.1 that the solution u to Equation 4.10 converges in \mathcal{H} to $\tilde{Q}\mathcal{U}(\tilde{W}; \cdot)$. Finally we have proved, for any $(W_0, Q_0) \in (\mathbb{R}_+^*)^2 \setminus \{(W_\infty, Q_\infty)\}$, the existence of a ball centered in $Q_0\mathcal{U}(W_0; \cdot)$ such that any solution to Equation (4.56) with an initial distribution in this ball converges to a periodic solution. Then Theorem 4.4.1 is proved for \mathcal{V} the reunion of all these balls. \square

To illustrate the convergence to a periodic solution for solutions to Equation (4.56), we plot in Figure 4.2 a solution to Equation (4.63) with an initial condition close to the steady state (W_∞, Q_∞) and for coefficients which satisfy the assumptions of Theorem 4.4.1.

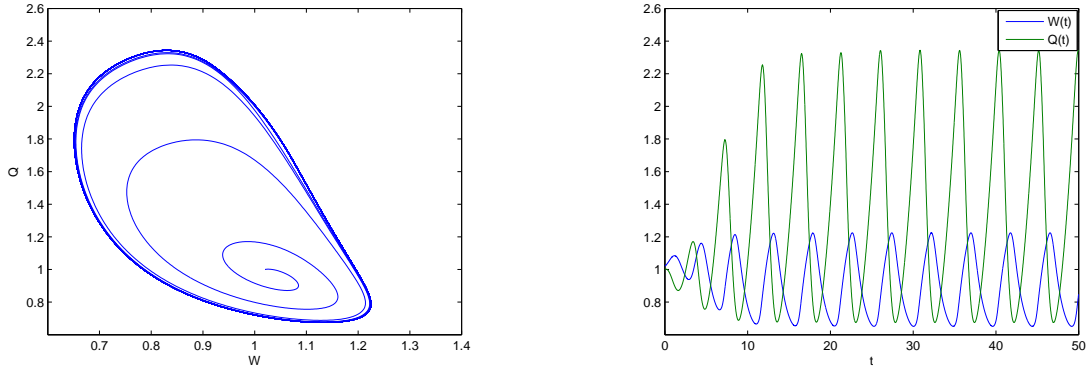

Figure 4.2: A solution to System (4.63) is plotted in the phase plan (W, Q) (left) and as a function of the time (right). The coefficients are $\gamma = 1$, $p = 2$, $q = 5$, $f(x) = 1 + e^{-1} - e^{-x^4}$ and $g(x) = 0.9x$.

4.5 The Prion Equation: Existence of Periodic Solutions

Prion diseases are believed to be due to self-replication of a pathogenic protein through a polymerization process not yet very well understood (see [83] for more details). To investigate the replication process of this protein, a mathematical PDE model was introduced by [63]. We recall this model here under a form slightly different from the original one (see [20, 38] for the motivations to consider this form)

$$\begin{cases} \frac{dV(t)}{dt} = \lambda - V(t) \left[\delta + \int_0^\infty \tau(x)u(t, x) dx \right], \\ \frac{\partial}{\partial t} u(t, x) = -V(t) \frac{\partial}{\partial x} (\tau(x)u(t, x)) - \mu(x)u(t, x) + \mathcal{F}u(t, x). \end{cases} \quad (4.66)$$

In this equation, $u(t, x)$ represents the quantity of polymers of pathogenic proteins of size x at time t , and $V(t)$ the quantity of normal proteins (also called monomers). The polymers lengthen by attaching monomers with the rate $\tau(x)$, die with the rate $\mu(x)$ and split into smaller polymers with respect to the fragmentation operator \mathcal{F} . The quantity of monomers is driven by an ODE with a death parameter δ and production rate λ . This ODE is quadratically coupled to the growth-fragmentation equation because of the polymerization mechanism which is assumed to follow the mass action law.

This system admits a trivial steady state, also called disease-free equilibrium since it corresponds to a situation where no pathogenic polymers are present: $V = \frac{\lambda}{\delta}$ and $u \equiv 0$. The stability of this steady state has been investigated under general assumptions on the coefficients in [19, 20, 125, 131]. The results indicate that the disease-free equilibrium is stable when it is the only steady state, and becomes unstable when a nontrivial steady state appears (also called endemic equilibrium). It is proved in [17] that several such nontrivial steady states can exist. But the stability (even linear) of these steady states is a difficult and still open problem for general coefficients. The only existing results concern the “constant case” (τ constant, β linear and κ constant) initially considered by [63], since then the model reduces to a closed system of ODEs. In this case, the problem has been entirely solved by [43, 63, 117]: the endemic equilibrium is unique and it is globally stable when it exists.

A new more general model has been introduced in [64] and takes into account the incidence of the *total mass* of polymers $P(t) := \int x u(t, x) dx$ on the polymerization process. More precisely, they consider that the presence of many polymers reduces the attaching process of monomers to polymers by multiplying the polymerization rate by $\frac{1}{1+\omega P(t)}$ with ω a positive parameter. Then they prove similar results about the existence and stability of steady states, still in the case of constant parameters.

Here we look at a generalization of the influence of polymers on the polymerization rate by considering the system

$$\begin{cases} \frac{dV(t)}{dt} = -V(t)f\left(\int_0^\infty x^p u\right) \int_0^\infty \tau(x)u(t, x) dx - \delta V(t) + \lambda, \\ \frac{\partial}{\partial t}u(t, x) = -V(t)f\left(\int_0^\infty x^p u\right) \frac{\partial}{\partial x}(\tau(x)u(t, x)) - \mu u(t, x) + \mathcal{F}u(t, x), \end{cases} \quad (4.67)$$

where $p \geq 0$ and $f : \mathbb{R}^+ \rightarrow \mathbb{R}^+$ is a differentiable function. In this framework, the model of [64] corresponds to $p = 1$ and $f(P) = \frac{1}{1+\omega P}$, together with τ constant, β linear and κ constant. Using the reduction method to ODEs, we prove that such a system can exhibit periodic solutions. For this we consider the following system, where $M_p = M_p[\mathcal{U}]$,

$$\begin{cases} \frac{dV(t)}{dt} = -V(t)f\left(\mu^{-kp} \frac{M_1}{M_p} \int_0^\infty x^p u\right) \int_0^\infty x u(t, x) dx - \delta V(t) + \lambda, \\ \frac{\partial}{\partial t}u(t, x) = -V(t)f\left(\mu^{-kp} \frac{M_1}{M_p} \int_0^\infty x^p u\right) \frac{\partial}{\partial x}(x u(t, x)) - \mu u(t, x) + \mathcal{F}_\gamma u(t, x), \end{cases} \quad (4.68)$$

which is a particular case of System (4.67) with coefficients satisfying the assumptions of Theorem 4.2.1 and up to a dilation of f . We prove that, under some conditions on the incidence function f , there exist values of p for which System (4.68) admits periodic solutions. The method is to consider p as a varying bifurcation parameter and prove that Hopf bifurcation occurs when p increases.

Theorem 4.5.1. *Define on $[0, \frac{\lambda}{\mu^{k+1}})$ the function*

$$g(x) := \frac{\delta \mu}{\lambda - \mu^{k+1}x}$$

and consider a positive differentiable function f satisfying

$$\exists! x_0 > 0 \quad \text{s.t.} \quad f(x_0) = g(x_0) \quad \text{and moreover} \quad 0 < f'(x_0) < g'(x_0). \quad (4.69)$$

Assume that $\mu \leq (k + \mu^{-1})\delta$, then there exists $p > 0$ for which Equation (4.68) admits a periodic solution. More precisely, there exist V, W and Q periodic such that

$$(V(t), Q(t)\mathcal{U}(W(t); x)) \text{ is solution to Equation (4.68).}$$

Proof. First step: reduced dynamic in \mathcal{E}

We look at the dynamic of System (4.68) on the invariant eigenmanifold \mathcal{E} . For any initial condition u_0 in \mathcal{E} , there exist Q_0 and W_0 such that u_0 writes

$$u_0(x) = \frac{1}{M_1} Q_0 \mathcal{U}(W_0; x).$$

Consider the solution to System (4.68) corresponding to this initial data and define W as the solution to

$$\begin{cases} \dot{W} &= \frac{W}{k} \left(f \left(\mu^{-kp} \frac{M_1}{M_p} \int x^p u \right) V - W \right), \\ \dot{W}(0) &= W_0. \end{cases} \quad (4.70)$$

Then we know from Theorem 4.2.1 that the solution satisfies

$$u(t, x) = \frac{Q_0}{M_1} \mathcal{U}(W(t); x) e^{\int_0^t (W(s) - \mu) ds}$$

and this allows to compute

$$\int_0^\infty x^p u(t, x) dx = Q_0 \frac{M_p}{M_1} W^{kp} e^{\int_0^t (W(s) - \mu) ds}$$

and

$$\int_0^\infty x u(t, x) dx = Q_0 W^k e^{\int_0^t (W(s) - \mu) ds}.$$

Thus, if define $Q(t) := Q_0 e^{\int_0^t (W(s) - \mu) ds}$, Equation (4.70) becomes

$$\dot{W} = \frac{W}{k} (f((\mu^{-1}W)^{kp}Q) V - W)$$

and System (4.68) reduces to

$$\begin{cases} \dot{V} &= \lambda - V (\delta + f((\mu^{-1}W)^{kp}Q) W^k Q), \\ \dot{W} &= \frac{W}{k} (f((\mu^{-1}W)^{kp}Q) V - W), \\ \dot{Q} &= Q (W - \mu). \end{cases} \quad (4.71)$$

Now we prove that System (4.71) admits a unique nontrivial steady state which undergoes a supercritical Hopf bifurcation when p increases from 0.

Second step: Hopf bifurcation for the reduced system

First we look for a positive steady state of System (4.71). Such a steady state is unique and given by

$$\begin{aligned} W_\infty &= \mu \\ V_\infty &= \frac{1}{\delta} (\lambda - \mu^{k+1} Q_\infty) \end{aligned}$$

where Q_∞ satisfies

$$f(Q_\infty) = \frac{\delta \mu}{\lambda - \mu^{k+1} Q_\infty} =: g(Q_\infty).$$

Such a Q_∞ exists and is unique by Assumption (4.69), moreover it satisfies $\lambda - \mu^{k+1} Q_\infty > 0$ and so V_∞ is positive. Finally there exists a unique positive steady state and we prove that a Hopf bifurcation occurs at this point. The linear stability of the steady state is given by the eigenvalues of the Jacobian matrix

$$Jac_{eq} = \begin{pmatrix} -\delta - \mu^k Q f(Q) & -k \mu^k V Q (f(Q) + p Q f'(Q)) & -\mu^k V (f(Q) + Q f'(Q)) \\ \frac{\mu}{k} f(Q) & p \mu V Q f'(Q) - \frac{\mu}{k} & \frac{\mu}{k} V f'(Q) \\ 0 & Q & 0 \end{pmatrix}$$

where the $_\infty$ indices are suppressed for the sake of clarity. The trace of this matrix is

$$T = -\delta - \mu^k Q f(Q) - \frac{\mu}{k} + p \mu V Q f'(Q)$$

which is negative for $p < p_1$ and positive for $p > p_1$ with

$$p_1 := \frac{\delta + \mu/k + \mu^k Qf(Q)}{\mu V Q f'(Q)} > 0.$$

The determinant is

$$D = \frac{\mu}{k} V Q (\delta f'(Q) - \mu^k f^2(Q)).$$

It is independent of p and negative since $f'(x_0) < g'(x_0)$ and

$$g'(x_0) = \frac{\delta \mu^{k+2}}{(\lambda - \mu^{k+1} x_0)^2} = \frac{\mu^k}{\delta} f^2(x_0).$$

The sum of the three 2×2 principal minors is

$$M = -\delta p V Q f'(Q) + \frac{\mu \delta}{k} + \mu^k \left(\mu + \frac{1}{k}\right) Q f(Q) - \frac{\mu}{k} V Q f'(Q).$$

To use the Routh-Hurwitz criterion, let define $\psi(p) := MT - D$ and look at its sign. For $p = 0$ we have

$$\begin{aligned} \psi(0) = -\frac{\mu}{k} \left[\delta^2 + \delta Q f(Q) + \frac{\mu \delta}{k} + (\delta(k + \mu^{-1}) - \mu) \mu^k Q f(Q) \right. \\ \left. + V Q (\mu^{k-1}(k + \mu^{-1}) f^2(Q) - f'(Q)) \left(\mu^k Q f(Q) + \frac{\mu}{k} \right) \right], \end{aligned}$$

and it is negative since $\mu \leq (k + \mu^{-1})\delta$ and $f'(Q) < g'(Q) = \frac{\mu^k}{\delta} f^2(Q) \leq \mu^{k-1}(k + \mu^{-1}) f^2(Q)$. For $p = p_1$, it is positive because $\psi(p_1) = -D > 0$. Now we investigate the variations of ψ between 0 and p_1 . The first derivative of T , D and M are given by

$$T'(p) = \mu V Q f'(Q), \quad M'(p) = -\delta V Q f'(Q), \quad D'(p) = 0,$$

and the second derivatives are all null

$$T''(p) = M''(p) = D''(p) = 0.$$

So we have

$$\psi''(p) = 2M'(p)T'(p) < 0$$

and ψ is concave. Thus there exists a unique $p_0 \in (0, p_1)$ such that $\psi(p_0) = 0$. Now we can use the Routh-Hurwitz criterion (see [68] for instance). For $0 \leq p < p_0$ we have $T < 0$, $D < 0$ and $MT < D$, so the steady state is linearly stable with one real negative eigenvalue and two complex conjugate eigenvalues with a negative real part. For $p_0 < p < p_1$ we have $T < 0$, $D < 0$ and $MT > D$, so the steady state is linearly unstable with one real negative eigenvalue and two complex conjugate eigenvalues with a positive real part. The two conjugate eigenvalues cross the imaginary axis when $p = p_0$ so there is a Hopf bifurcation at this point. To prove that a periodic solution appears with this bifurcation, it remains to check that the complex eigenvalues cross the imaginary axis with a positive speed (see [56] for instance). Denote by $a \pm ib$ the two conjugate eigenvalues and $c < 0$ the real one. We have to prove that the derivative $a'(p_0) > 0$. For this we express $\psi(p)$ in terms of $a(p)$, $b(p)$ and $c(p)$, and we use the concavity of ψ . We have for any p

$$T = 2a + c, \quad D = c(a^2 + b^2), \quad M = a^2 + b^2 + 2ac,$$

so

$$\psi(p) = 2a(a^2 + b^2) + 4a^2c + 2ac^2.$$

Then, using that $a(p_0) = 0$ by definition of p_0 , we obtain

$$\psi'(p_0) = 2(b^2 + c^2)a'.$$

But $\psi'(p_0) > 0$ because ψ is concave and increasing on a neighbourhood of p_0 , so necessarily $a'(p_0) > 0$. This proves the existence of a periodic solution (V, W, Q) to System (4.71) for a parameter $p \geq p_0$ close to p_0 . Then the functions $V(t)$ and $Q(t)\mathcal{U}(W(t), x)$ are periodic and solution to System (4.68). \square

The question to know if such a periodic solution is stable is difficult, even for the reduced dynamics (4.71). Nevertheless we give in Figure 4.3 evidences that it should be the case. This simulation is made with parameters and a function f satisfying Assumption (4.69), for a value of parameter $p > p_0$. It seems to indicate that the periodic solution persists for p away from p_0 .

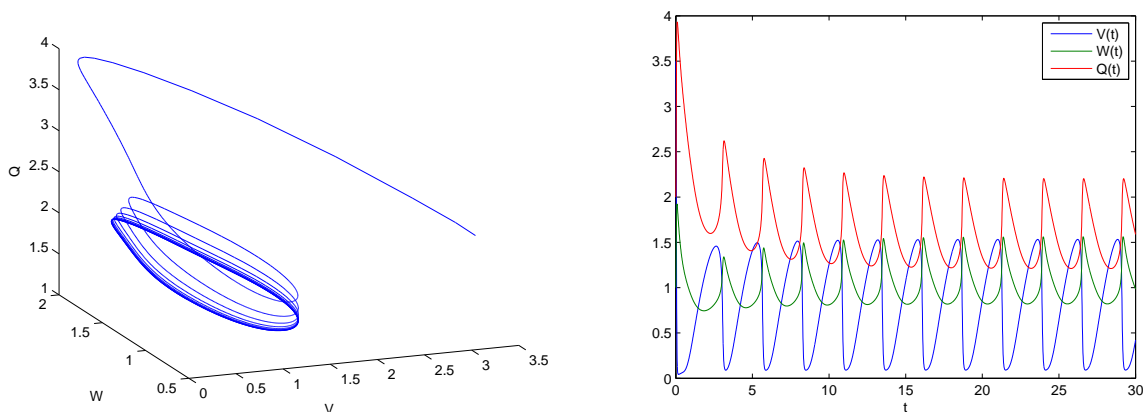

Figure 4.3: A solution to System (4.71) is plotted in the phase plan (W, Q) (left) and as a function of the time (right). The coefficients are $\lambda = 0.9$, $\delta = 0.2$, $\mu = \gamma = 1$, $f(x) = 6.3(1.1 - e^{-\frac{x^2}{20}})$ and $p = 4$.

4.6 Comparison between Perron and Floquet Eigenvalues

In this Section, we consider that the time-dependent terms $V(t)$ and $R(t)$ of the growth-fragmentation equation are T -periodic controls. Periodic controls are usually used in structured equations to model optimization problems. In the case of prion diseases (see Section 4.5), there exists an amplification protocole called PMCA (see [83] and references therein) which consists in periodically *sonicating* a sample of prion polymers in order the break them into smaller ones and thus increase their quantity. Between these phases of sonication, the sample is let in presence of a large quantity of monomers in order to allow a fast polymerization process. This protocole can be modeled by introducing in the growth-fragmentation equation a periodic control in front of the fragmentation operator [17, 18]. Then a problem is to find a periodic control which maximizes the proliferation rate of the polymers in the sample. Mathematically it can result into the problem to optimize the Floquet eigenvalue of the growth-fragmentation equation, namely the eigenvalue associated to periodic coefficients (see [110] for instance). Before solving this difficult question, a first step is to compare the Floquet eigenvalue to the Perron eigenvalue associated to constant coefficients, for instance the mean value on a period of the periodic ones, and to know if the Floquet one can be better than the Perron one. Such concerns are also investigated in the context of circadian rhythms for the optimization of chronotherapy (see [23, 24, 25]). The population is an age structured population of cells and the model is a system of renewal equations. The death and birth rates are assumed to be periodic, and the Floquet eigenvalue is compared to the Perron eigenvalue associated to geometrical or arithmetical time average of the periodic coefficients. Comparison results obtained show that the Floquet eigenvalue can be greater or less than the Perron one depending on parameters.

Here the controls are on the growth and death coefficients, and we give comparison results between Floquet and Perron eigenvalues in the case where $\nu = 1$ or $\nu = 0$ and $\gamma = 1$. The Floquet eigenelements $(\Lambda_F, \mathcal{U}_F)$ associated to periodic controls are defined by two properties: $\mathcal{U}_F(t, x)e^{\Lambda_F t}$ is a solution to Equation (4.12) and $\mathcal{U}_F(t, x)$ is a T -periodic function of the time. For any T -periodic function $P(t)$, we

use the notation

$$\overline{P} := \frac{1}{T} \int_0^T P(t) dt.$$

To ensure the uniqueness of Floquet eigenfunction, we impose $\overline{\int_0^T \mathcal{U}_F(t, x) dx} = 1$. Then we have the following comparison results.

Proposition 4.6.1. *Assume that conditions (4.5)-(4.7) are satisfied with $\nu = 1$, and define, from $V(t)$ the T -periodic control on growth, $W(t)$ as the periodic solution to*

$$\dot{W} = \frac{\tau W}{k}(V - W). \quad (4.72)$$

Then the identities hold

$$\exists C > 0, \quad \mathcal{U}_F(t, x) = C \mathcal{U}(W(t); x) e^{\int_0^t (\Lambda(W(s), R(s)) - \Lambda_F) ds} \quad (4.73)$$

and

$$\Lambda_F = \Lambda(\overline{V}, \overline{R}) = \overline{\Lambda(V, R)}. \quad (4.74)$$

Proof. Thanks to Corollary 4.2.3, we have that

$$\exists C > 0, \quad \mathcal{U}_F(t, x) e^{\Lambda_F t} = C \mathcal{U}(W(t); x) e^{\int_0^t \Lambda(W(s), R(s)) ds}$$

and so, integrating in x , we find

$$e^{\int_0^t \Lambda(W(s), R(s)) ds - \Lambda_F t} = C^{-1} \int_0^\infty \mathcal{U}_F(t, x) dx.$$

Then, by periodicity, we have

$$e^{\Lambda_F T - \int_0^T \Lambda(W(s), R(s)) ds} = 1$$

which gives

$$\Lambda_F = \frac{1}{T} \int_0^T \Lambda(W(s), R(s)) ds = \frac{1}{T} \int_0^T (\tau W(s) - \mu R(s)) ds.$$

Thanks to ODE (4.72) we have

$$\int_0^T V - W = 0$$

and so

$$\Lambda_F = \frac{1}{T} \int_0^T (\tau V(s) - \mu R(s)) ds = \frac{1}{T} \int_0^T \Lambda(V(s), R(s)) ds.$$

□

In the case $\nu = 0$ and $\gamma = 1$, we cannot ensure the existence of Floquet eigenlements with our method. Nevertheless, thanks to Corollary 4.2.5, we can compare the eigenvalues of the reduced system (4.26) which is satisfied by $M_0[u]$ and $M_1[u]$.

Proposition 4.6.2. *Assume that $\tau(x) = \tau$, $\beta(x) = \beta x$, $\mu(x) = \mu$ and κ is symmetric, then we have the comparison*

$$\overline{\Lambda(V, R)} \leq \Lambda_F \leq \Lambda(\overline{V}, \overline{R}). \quad (4.75)$$

Proof. Define W as the periodic solution to

$$\dot{W} = \frac{\Lambda(W, 0)}{k}(V - W).$$

We know thanks to Corollary 4.2.5 that

$$\mathcal{M}_0[W](t) = M_0[\mathcal{U}]e^{\int_0^t \Lambda(W(s), R(s)) ds}$$

and

$$\mathcal{M}_1[W](t) = M_1[\mathcal{U}]W^k(t)e^{\int_0^t \Lambda(W(s), R(s)) ds}$$

are solution to System (4.26). As a consequence

$$\Lambda_F = \frac{1}{T} \int_0^T \Lambda(W(s), R(s)) ds = \frac{1}{T} \int_0^T (\sqrt{\beta\tau W(s)} - \mu R(s)) ds.$$

Using the ODE satisfied by W , we have

$$0 = \int_0^T \frac{\dot{W}}{W} = \frac{\sqrt{\beta\tau}}{k} \int_0^T \frac{V - W}{\sqrt{W}}$$

and we obtain that

$$\int_0^T \sqrt{W} = \int_0^T \frac{V}{\sqrt{W}}.$$

Then the Cauchy-Schwartz inequality gives

$$\int_0^T \sqrt{V} = \int_0^T \frac{\sqrt{V}}{W^{\frac{1}{4}}} W^{\frac{1}{4}} \leq \sqrt{\int_0^T \frac{V}{\sqrt{W}}} \sqrt{\int_0^T \sqrt{W}} = \int_0^T \sqrt{W}$$

and so

$$\frac{1}{T} \int_0^T \Lambda(V, R) = \frac{1}{T} \int_0^T \sqrt{\beta\tau V} - \mu R \leq \frac{1}{T} \int_0^T \sqrt{\beta\tau W} - \mu R = \frac{1}{T} \int_0^T \Lambda(W, R) = \Lambda_F.$$

To obtain the second inequality in (4.75), we write using the ODE satisfied by W

$$0 = \int_0^T \frac{\dot{W}}{\sqrt{W}} = \frac{\sqrt{\beta\tau}}{k} \int_0^T V - W$$

and so

$$\int_0^T V = \int_0^T W.$$

Thus we have, using the Jensen inequality,

$$\frac{1}{T} \int_0^T \sqrt{W(s)} ds \leq \sqrt{\frac{1}{T} \int_0^T W(s) ds} = \sqrt{\frac{1}{T} \int_0^T V(s) ds}$$

and finally

$$\Lambda_F = \frac{1}{T} \int_0^T (\sqrt{\beta\tau W(s)} - \mu R(s)) ds \leq \sqrt{\frac{1}{T} \int_0^T \beta\tau V(s) ds} - \frac{1}{T} \int_0^T \mu R(s) ds = \Lambda(\bar{V}, \bar{R}).$$

□

Conclusion and Perspectives

We have introduced a new reduction method to investigate the long-time asymptotic behavior for growth-fragmentation equations with a nonlinear growth term. It allows to prove convergence and stability results but also to prove the existence of periodic solutions by using ODE methods. The technique is based on self-similar dependencies which require powerlaw coefficients, and the main theorem requires moreover a linear size-dependency of the growth coefficient. Nevertheless, we have given some results about the case when the growth rate is only assumed to be a powerlaw. A step further would be to adapt the ideas in this paper to build nonlinear entropy techniques adapted to general powerlaw growth coefficients.

Acknowledgment

The author would like to thank Jean-Pierre Françoise for helpful discussions about limit cycles.

Chapitre 5

Optimisation de la PMCA

Ce chapitre est une version préliminaire d'un travail avec VINCENT CALVEZ. Il s'agit d'analyser le problème d'optimisation du protocole de PMCA en utilisant un modèle discret de polymérisation-fragmentation. Nous nous intéressons tout d'abord au problème d'optimisation des valeurs propres de Perron et Floquet. Les résultats obtenus donnent une intuition de ce que pourrait être le contrôle optimal à horizon fini. Nous présentons des simulations numériques du contrôle optimal et de l'équation de Hamilton-Jacobi-Bellman qui illustrent ces intuitions et conjectures.

Introduction

Transmissible Spongiform Encephalopathies (TSE) are fatal, infectious, neurodegenerative diseases. They include bovine spongiform encephalopathies (BSE) in cattle, scrapie in sheep and Creutzfeldt-Jakob disease (CJD) in human. During the so-called “mad-cow crisis” in the 90's, people were infected by a variant of BSE by ingesting contaminated pieces of beef. More recently, CJD was transmitted between humans via blood or growth hormones. Because of the long incubation times (some decades), TSE still represent an important public health risk. Indeed, there is no *ante mortem* diagnosis currently available to detect infected individuals and prevent possible contaminations. A promising tool to design a diagnosis test is the protein misfolded cyclic amplification (PMCA) technique [83].

The PMCA principle is based on the “protein-only hypothesis”. According to this widely accepted hypothesis, the infectious agent of TSE, known as prions, may consist in misfolded proteins called PrPsc (for Prion Protein scrapie). The PrPsc replicates in a self-propagating process, by converting the normal form of PrP (called PrPc for Prion Protein cellular) into PrPsc. The PMCA enabled to consolidate the idea of an autocatalytic replication of PrPsc by nucleated polymerization [22, 134, 135]. In this model, PrPsc is considered to be a polymeric form of PrPc. Polymers can lengthen by addition of PrPc monomers, and they can replicate by splitting into smaller fragments. The PrPc is mainly expressed by the cells of the central nervous system, so PrPsc concentrates in this zone. The amount of PrPsc in tissues like blood is very small and this is why it is very difficult to diagnose an infected individual.

The PMCA mimics the nucleation/polymerization mechanism occurring *in vivo* with the aim to quickly amplify polymers present in minute amount in an infected sample. It is a cyclic process, where each cycle consists in two phases:

- *phase 1 - Incubation*: Minute amount of PrPsc are incubated with a large excess of PrPc, to induce the growing of PrPsc polymers.
- *phase 2 - Sonication*: The samples are subjected to ultrasounds in order to break down the polymers, and therefore, to multiply the number of aggregates.

The coefficients of these matrices are assumed to be positive

$$\forall i \in [1, n-1], \quad \tau_i > 0 \quad \text{and} \quad \beta_{i+1} > 0. \quad (5.7)$$

Then the optimization problem we are interested in is to find a control $\alpha(t)$ which maximizes the final quantity of PrPsc $\sum_{i=1}^n i u_i(T)$ for a given final time of experiment T . Indeed the presence of PrPsc can be detected experimentally (by Western Blot, see [83] for more details) only if this quantity is greater than a critical threshold. First we define the set of admissible controls

$$\mathcal{A} := \{\alpha(\cdot) : [0, \infty) \rightarrow [\alpha_{min}, \alpha_{max}] \mid \alpha(\cdot) \text{ measurable}\}$$

where α_{max} represents the maximal power of the *sonicator* and α_{min} the absence of sonication. Then we define the payoff which corresponds to the quantity we want to optimize

$$c[\alpha(\cdot)] := g(U(T)) := \sum_{i=1}^n i u_i(T) \quad (5.8)$$

where $U(\cdot)$ is the solution of (5.4) with control $\alpha(\cdot)$ and for a given initial data U^0 . Finally, the optimal control problem writes

$$\text{find } \alpha^* \in \mathcal{A} \text{ which maximizes } c[\alpha(\cdot)]. \quad (5.9)$$

Before tackling the optimal control problem (5.9), we look at another optimization problem for α constant or periodic. The matrix $M(\alpha)$ has positive extra-diagonal terms, so the Perron-Frobenius theory ensures that it admits a principal eigenvalue $\lambda_1(\alpha)$ for α constant in time. For $\alpha(t)$ periodic in time, the Floquet theory also allows to define a principal eigenvalue $\lambda_F[\alpha(\cdot)]$. Thanks to the General Relative Entropy principle, we know that these Perron and Floquet eigenvalues provide the asymptotic growth rate of any solution to Equation (5.4) when time tends to infinity. The problem of optimizing these eigenvalues with respect to α is then natural and provides useful informations to tackle Problem (5.9). We refer to [110] for more details and references about Perron-Frobenius, Floquet and General Relative Entropy theories.

The comparison between Perron and Floquet eigenvalues has been investigated in the context of circadian rhythms in view of chronotherapy optimization [84, 24]. It deals with a system of renewal equations which models the cell cycle with a parameter representing a treatment dose. It has been proved in [26, 27, 25, 23] that, depending on the parameters, the Floquet eigenvalue can be greater or less than the Perron eigenvalue corresponding to the arithmetical or geometrical time average of the periodic control. We can find such comparisons for the growth-fragmentation equation in [58] but here we prove a slightly different kind of results. We first give a condition to ensure the existence of a constant control which maximizes the Perron eigenvalue, and then we compare the Floquet eigenvalue to this Perron optimum.

Assume that r admits an expansion of the form

$$\exists q > 0, \quad r(\alpha) = r_0 + r_q \alpha^{-q} + o_{\alpha \rightarrow \infty}(\alpha^{-q}) \quad (5.10)$$

and that $(\tau_i)_{1 \leq i \leq n}$ satisfies the *discrete convexity condition*

$$\exists p \in \mathbb{N}^* \quad \text{such that} \quad \forall i \leq p, \quad \tau_i = i \tau_1 \quad \text{and} \quad \tau_{p+1} > (p+1) \tau_1. \quad (5.11)$$

Then there exists an optimal value α^\bullet which maximizes the Perron eigenvalue of the matrix $M(\alpha)$.

Theorem 5.0.3. *Under Assumptions (5.10)-(5.11), there exists an optimal value $\alpha^\bullet > 0$ such that*

$$\forall \alpha \geq 0, \quad \lambda_1(\alpha) \leq \lambda_1(\alpha^\bullet).$$

A natural question is then to know if this value $\lambda_1(\alpha^\bullet)$ is also a maximum in the class of periodic controls. The following result ensures that it is not the case if r is convex and decreasing for instance.

Theorem 5.0.4. *Under Assumptions (5.10)-(5.11), if $M(\alpha^\bullet)$ is diagonalisable and if*

$$\frac{r''(\alpha^\bullet)}{r(\alpha^\bullet) - \alpha^\bullet r'(\alpha^\bullet)} > 0 \quad (5.12)$$

then there exists periodic controls $\alpha(t)$ such that $\lambda_F[\alpha(\cdot)] > \lambda_1(\alpha^\bullet)$.

This theorem gives a condition for which the optimal control of Problem (5.9) is not expected to be constant.

In Section 5.1 we investigate the eigenvalue problems and prove Theorems 5.0.3 and 5.0.4. In Section 5.2 we tackle Problem 5.9 with the tools of the optimal control theory. We highlight the link with the eigenvalue problem results thanks to numerical simulations.

5.1 The Eigenvalue Problem

We consider the case when there is no final time and we want to optimize the fitness of the system for a constant or periodic control.

5.1.1 Constant control: Perron eigenvalue

For a constant control $\alpha(t) \equiv \alpha \in \mathbb{R}^+$, the Perron-Frobenius theorem ensures that $M(\alpha)$ has a first eigenvalue $\lambda_1(\alpha)$, which is simple, associated with a positive right eigenvector $V_1(\alpha)$ and a positive left eigenvector $\phi_1(\alpha)$

$$\begin{cases} M(\alpha)V_1 = \lambda_1 V_1, & V_1 > 0, \\ \phi_1 M(\alpha) = \lambda_1 \phi_1, & \phi_1 > 0. \end{cases} \quad (5.13)$$

We normalize these vectors by them

$$\|V_1(\alpha)\| = 1, \quad \phi_1(\alpha)V_1(\alpha) = 1,$$

so that they are now uniquely defined. Such eigenelements also exist for the continuous growth-fragmentation equation where the size $i \in \mathbb{N}$ is replaced by the variable $x \in \mathbb{R}^+$ (see [41] for instance), and their dependency on parameters is investigated in [17, 59].

Now we give results about the first eigenvalue λ_1 as a function of α . The proof of Theorem 5.0.3 is an immediate consequence of Lemma 5.1.1 and Theorem 5.1.2.

Lemma 5.1.1. *The eigenelements λ_1 , V_1 and ϕ_1 are continuous functions of α on \mathbb{R}^+ . Moreover we have*

$$\lambda_1(\alpha) > 0 \text{ for } \alpha > 0 \quad \text{and} \quad \lambda_1(0) = 0.$$

Proof. Since the function r is continuous, the coefficients of the matrix $M(\alpha)$ depend continuously on α . As a consequence, the characteristic polynomial of $M(\alpha)$ varies continuously with α . The first eigenvalue λ_1 is the largest root of this characteristic polynomial and the Perron-Frobenius theorem moreover ensures that the multiplicity of this root is 1. So λ_1 is a continuous function of α .

Let $\alpha \geq 0$ and $(\alpha_k)_{k \in \mathbb{N}}$ a positive sequence which converges to α . Since $\|V_1(\alpha_k)\| = 1$ by normalization, there exists a subsequence of $(V_1(\alpha_k))_k$ which converge to a limit V_∞ . By continuity of $\lambda_1(\alpha)$ and $M(\alpha)$, this limit satisfies $M(\alpha)V_\infty = \lambda_1(\alpha)V_\infty$ and $\|V_\infty\| = 1$. By uniqueness of the first eigenvector, we conclude that the whole sequence $(V_1(\alpha_k))_k$ converges to $V_\infty = V_1(\alpha)$ and so V_1 is a continuous function of α . Since $(V_1(\alpha_k))_k$ is a positive convergent sequence, it is lower bounded and we deduce from the normalization $\phi_1 V_1 = 1$ that the sequence $(\phi_1(\alpha_k))_k$ is bounded. As for V_1 we conclude from the uniqueness of the adjoint eigenvector that ϕ_1 is a continuous function of α .

Define $\theta := (1, 1, \dots, 1)$, then we have $\theta G = 0$ and Assumption (5.3) ensures that $\theta F = (0, \beta_2, \dots, \beta_n)^T$. So we have the identity

$$\lambda_1(\alpha) = \alpha \frac{\theta F V_1}{\theta V_1}$$

and it ensures that $\lambda_1(\alpha)$ is positive for α positive and null for $\alpha = 0$. \square

Theorem 5.1.2. *Under Assumptions (5.10) and (5.11), we have the expansions*

$$\begin{aligned} p < q, & \implies \lambda_1(\alpha) = r_0 \tau_1 + \left[r_0^{p+1} (\tau_{p+1} - (p+1)\tau_1) \prod_{i=1}^p \frac{\tau_i}{\beta_{i+1}} \right] \alpha^{-p} + o_{\alpha \rightarrow \infty}(\alpha^{-p}), \\ p = q, & \implies \lambda_1(\alpha) = r_0 \tau_1 + \left[r_0^{p+1} (\tau_{p+1} - (p+1)\tau_1) \prod_{i=1}^p \frac{\tau_i}{\beta_{i+1}} + r_p \tau_1 \right] \alpha^{-p} + o_{\alpha \rightarrow \infty}(\alpha^{-p}), \\ p > q, & \implies \lambda_1(\alpha) = r_0 \tau_1 + r_q \tau_1 \alpha^{-q} + o_{\alpha \rightarrow \infty}(\alpha^{-q}). \end{aligned}$$

This result can be related to Corollary 1 in [17] which provides an expansion of the first eigenvalue for the continuous growth-fragmentation model. The proof of Theorem 5.1.2 uses the following lemma which gives the asymptotic behavior of the eigenvector $V_1 = (v_1, v_2, \dots, v_n)^T$.

Lemma 5.1.3. *Assume that $r(\alpha)$ admits a limit r_0 when α tends to the infinity, then*

$$\forall i \in [1, n], \quad v_i(\alpha) \underset{\alpha \rightarrow \infty}{\sim} r_0^{i-1} \prod_{j=1}^{i-1} \frac{\tau_j}{\beta_{j+1}} \alpha^{1-i}. \quad (5.14)$$

Proof of Lemma 5.1.3. We prove by induction on i that

$$\alpha^i v_{i+1}(\alpha) \xrightarrow{\alpha \rightarrow \infty} r_0^i \prod_{j=1}^i \frac{\tau_j}{\beta_{j+1}} \quad \text{and} \quad \forall j > i+1, \quad \alpha^i v_j(\alpha) \xrightarrow{\alpha \rightarrow \infty} 0. \quad (\text{IH})$$

$i = 0$: We have by definition

$$(r(\alpha)G + \alpha F)V_1(\alpha) = \lambda_1(\alpha)V_1(\alpha) \quad \text{with} \quad \|V_1(\alpha)\| = 1. \quad (5.15)$$

We define

$$\psi := (1 \ 2 \ \dots \ n)$$

which satisfies $\psi F = 0$ thanks to Assumption (5.2). Then, testing (5.15) against ψ , we obtain

$$r(\alpha) \psi G V_1(\alpha) = \lambda_1(\alpha) \psi V_1(\alpha) \quad (5.16)$$

and so $\lambda_1(\alpha)$ is bounded since $\|V_1(\alpha)\| = 1$ and r is bounded. Dividing by α we find

$$\left(\frac{r(\alpha)}{\alpha} G + F \right) V_1(\alpha) = \frac{\lambda_1(\alpha)}{\alpha} V_1(\alpha).$$

The sequence $V_1(\alpha)$ is bounded and so convergence when $\alpha \rightarrow \infty$ occurs for a subsequence. The limit V_1^∞ satisfies

$$F V_1^\infty = 0$$

and so the whole sequence converges to

$$V_1^\infty = \delta := (1 \ 0 \ \dots \ 0)^T.$$

Passing to the limit in (5.16) we obtain that the limit λ_1^∞ of $\lambda_1(\alpha)$ when $\alpha \rightarrow \infty$ satisfies

$$r_0 \psi G \delta = \lambda_1^\infty \psi \delta. \quad (5.17)$$

Proof. For $n = 3$ and $r \equiv 1$, the characteristic polynomial of $M(\alpha) = G + \alpha F$ is

$$\chi = X^3 + (\tau_1 + \tau_2 + \alpha(\beta_2 + \beta_3))X^2 + (\tau_1\tau_2 + \alpha\tau_1(\beta_3 - \beta_2) + \alpha^2\beta_2\beta_3)X - \alpha\tau_1\tau_2\beta_3 - \alpha^2\tau_1\beta_2\beta_3.$$

We have that λ_1 is the largest zero of this polynomial, so $\chi(\lambda_1(\alpha)) = 0$ and, dividing by α^2 we recover that $\lim_{\alpha \rightarrow \infty} \lambda_1(\alpha) = \tau_1$. Then we compute

$$\chi(\tau_1) = 2\tau_1^2(\tau_1 + \tau_2) + \alpha\tau_1\beta_3(2\tau_1 - \tau_2) \quad (5.19)$$

and we find that $\tau_2 > 2\tau_1$ is a necessary and sufficient condition for $\chi(\tau_1)$ to change its sign when α increases from zero to the infinity. So this is a necessary and sufficient condition for $\lambda_1(\alpha)$ to become greater than τ_1 . But $\lambda_1(\alpha) \rightarrow \tau_1$ when $\alpha \rightarrow \infty$, so finally $\tau_2 > 2\tau_1$ is a necessary and sufficient condition for λ_1 to reach a global maximum.

Now assume that $\beta_3 \geq \beta_2$ and derive twice the equation $\chi(\lambda_1(\alpha)) = 0$. We find

$$0 = \lambda_1''(3\lambda_1^2 + 2(\tau_1 + \tau_2 + \alpha(\beta_2 + \beta_3))\lambda_1 + \tau_1\tau_2 + \alpha\tau_1(\beta_3 - \beta_2) + \alpha^2\beta_2\beta_3) + \lambda_1'f(\lambda_1, \alpha) + 2\beta_2\beta_3(\lambda_1 - \tau_1).$$

We look at the critical points of $\lambda_1(\alpha)$, namely the values of α such that $\lambda_1'(\alpha) = 0$. For such points, the seconde derivative of λ_1 writes

$$\lambda_1'' = \frac{2\beta_2\beta_3(\tau_1 - \lambda_1)}{3\lambda_1^2 + 2(\tau_1 + \tau_2 + \alpha(\beta_2 + \beta_3))\lambda_1 + \tau_1\tau_2 + \alpha\tau_1(\beta_3 - \beta_2) + \alpha^2\beta_2\beta_3}.$$

Since $\beta_3 \geq \beta_2$, $\lambda_1''(\alpha)$ has the same sign as $\tau_1 - \lambda_1(\alpha)$ so $\lambda_1(\alpha)$ can be a local minimum only if $\lambda_1(\alpha) \leq \tau_1$ and a local maximum only if $\lambda_1(\alpha) \geq \tau_1$. With this result we can easily conclude to the alternative announced in the proposition. \square

5.1.2 Periodic control: Floquet eigenvalue

We now consider a T -periodic control $\alpha(t)$. The Floquet theorem ensures that there is a first ‘‘Floquet eigenvalue’’ $\lambda_F[\alpha(\cdot)]$ and a T -periodic function $V_F[\alpha(\cdot)](t)$ solution to

$$\frac{d}{dt}V_F(t) = [M(\alpha(t)) - \lambda_F]V_F(t).$$

In the case when there exists a constant α^\bullet which maximizes the Perron eigenvalue among the constant controls, we look for a periodic control with a Floquet eigenvalue greater than $\lambda_1(\alpha^\bullet)$. For this we consider directional perturbations $\alpha(t) = \alpha^\bullet + \epsilon\gamma(t)$, where γ is a fixed T -periodic function and ϵ a varying parameter. For the sake of clarity we denote by $\lambda_F(\epsilon) := \lambda_F[\alpha^\bullet + \epsilon\gamma(\cdot)]$ the Floquet eigenvalue associated to ϵ , $V_F(\epsilon; t) := V_F[\alpha^\bullet + \epsilon\gamma(\cdot)](t)$ the eigenfunction and $V_F'(\epsilon; t) := \partial_\epsilon V_F(\epsilon; t)$ its derivative with respect to ϵ . We also use the notation

$$\langle f \rangle := \frac{1}{T} \int_0^T f(t) dt$$

for the time average of any T -periodic function $f(t)$.

Now we compute the derivatives of $\lambda_F(\epsilon)$ which correspond to the directional derivatives of the Floquet eigenvalue at the point α^\bullet . This kind of differentiation technique is used in [96] to prove results about the optimization of the Perron eigenvalue in the case of the continuous cell division problem. A formula which involves only the coefficients of the equation and the first eigenvectors is obtained for the first and second derivatives. Here the computation of the second derivative requires a basis of eigenvectors, and so cannot be extended to continuous models. For $M(\alpha^\bullet)$ diagonalisable, we denote by (V_1, V_2, \dots, V_n) and $(\phi_1, \phi_2, \dots, \phi_n)$ the bases of direct and adjoint Perron eigenvectors associated to the eigenvalues $\lambda_1 > \lambda_2 \geq \dots \geq \lambda_n$. Thus we have $V_1 = V_1(\alpha^\bullet) = V_F(\epsilon = 0)$ and $\lambda_1 = \lambda_1(\alpha^\bullet) = \lambda_F(0)$.

Proposition 5.1.5 (First order condition). *We have*

$$\frac{d\lambda_F}{d\epsilon}(0) = \langle \gamma \rangle \frac{d\lambda_1}{d\alpha}(\alpha^\bullet) = 0.$$

Hence, α^\bullet is a critical point also in the class of periodic control.

We need to go to the following order.

Proposition 5.1.6 (Second order condition). *If $M(\alpha^\bullet)$ is diagonalisable, we have*

$$\frac{d^2 \lambda_F}{d\epsilon^2}(0) = \langle \gamma^2 \rangle \phi_1 M''(\alpha^\bullet) V_1 + 2 \sum_{i=2}^n \langle \gamma_i^2 \rangle (\lambda_1 - \lambda_i) (\phi_1 M'(\alpha^\bullet) V_i) (\phi_i M'(\alpha^\bullet) V_1)$$

where $\gamma_i(t) := \phi_i V_F'(0; t) (\phi_i M'(\alpha^\bullet) V_1)^{-1}$ is the unique T -periodic solution to the ODE

$$\dot{\gamma}_i(t) + \lambda_1 \gamma_i(t) = \gamma(t) + \lambda_i \gamma_i(t). \quad (5.20)$$

Remark 5.1.7. *For $\gamma \equiv 1$, we obtain the second derivative of the Perron eigenvalue*

$$\frac{d^2 \lambda_1}{d\alpha^2}(\alpha^\bullet) = \phi_1 M''(\alpha^\bullet) V_1 + 2 \sum_{i=2}^n \frac{(\phi_1 M' V_i)(\phi_i M' V_1)}{\lambda_1 - \lambda_i}$$

which is negative since α^\bullet is a maximum. This formula appears in [129] without any further reference. There exists a physical interpretation in terms of repulsive/attractive forces among eigenvalues.

Proof of Proposition 5.1.5. First we give an expression of the first derivative for the Perron eigenvalue. By definition we have

$$M(\alpha) V_1 = \lambda_1 V_1,$$

which provides by derivation

$$\lambda_1' V_1 + \lambda_1 V_1' = M'(\alpha) V_1 + M(\alpha) V_1'. \quad (5.21)$$

Testing against the adjoint eigenvector ϕ_1 we obtain

$$\lambda_1' + \lambda_1 \phi_1 V_1' = \phi_1 M'(\alpha) V_1 + \phi_1 M(\alpha) V_1'$$

and so, since $\phi_1 M(\alpha^\bullet) = \lambda_1 \phi_1$,

$$\lambda_1' = \phi_1 M'(\alpha) V_1 = \phi_1 (r'(\alpha) G + F) V_1.$$

Now we start from the Floquet eigenvalue problem. We have

$$\partial_t V_F + \lambda_F(\epsilon) V_F = M(\alpha^\bullet + \epsilon \gamma) V_F,$$

which provide by derivation with respect to ϵ

$$\partial_t V_F' + \lambda_F'(\epsilon) V_F + \lambda_F(\epsilon) V_F' = \gamma(t) M'(\alpha^\bullet + \epsilon \gamma) V_F + M(\alpha^\bullet + \epsilon \gamma) V_F'. \quad (5.22)$$

We test the preceding equation against ϕ_1 and we evaluate at $\epsilon = 0$. We obtain

$$\partial_t (\phi_1 V_F') + \lambda_F' = \gamma \phi_1 M'(\alpha^\bullet) V_1$$

and, after integration in time,

$$\lambda_F' = \left(\frac{1}{T} \int_0^T \gamma(t) dt \right) \phi_1 M'(\alpha^\bullet) V_1 = \left(\frac{1}{T} \int_0^T \gamma(t) dt \right) \frac{d\lambda_1}{d\alpha}(\alpha^\bullet) = 0.$$

It proves the first order condition. □

Proof of Proposition 5.1.6. We test Equation (5.22) against another adjoint eigenvector ϕ_i and we evaluate at $\epsilon = 0$. We obtain for $\gamma_i(t) = \phi_i V_F'(t) (\phi_i M'(\alpha^\bullet) V_1)^{-1}$

$$\dot{\gamma}_i(t) + \lambda_1 \gamma_i(t) = \gamma(t) + \lambda_i \gamma_i(t).$$

Next, we differentiate twice and we get

$$\partial_t V_F'' + \lambda_F''(\epsilon) V_F + 2\lambda_F'(\epsilon) V_F' + \lambda_F V_F'' = \gamma^2 M''(\alpha^\bullet + \epsilon\gamma) V_F + 2\gamma M'(\alpha^\bullet + \epsilon\gamma) V_F' + M(\alpha^\bullet + \epsilon\gamma) V_F''.$$

We evaluate at $\epsilon = 0$ and we test against ϕ_1 to find

$$\partial_t(\phi_1 V_F'') + \lambda_F''(0) + \lambda_F \phi_1 V_F'' = \gamma^2 \phi_1 M''(\alpha^\bullet) V_1 + 2\gamma(t) \phi_1 M'(\alpha^\bullet) V_F' + \lambda_F \phi_1 V_F''. \quad (5.23)$$

We decompose the unknown V_F' along the basis (V_1, \dots, V_n)

$$V_F' = \sum \gamma_i(t) (\phi_i M'(\alpha^\bullet) V_1) V_i.$$

We have in particular

$$\phi_1 M'(\alpha^\bullet) V_F' = \sum_{i=2}^n \gamma_i(t) (\phi_i M'(\alpha^\bullet) V_1) (\phi_1 M'(\alpha^\bullet) V_i).$$

To conclude, we integrate (5.23),

$$\lambda_F''(0) = \langle \gamma^2 \rangle \phi_1 M''(\alpha^\bullet) V_1 + 2 \sum_{i=2}^n \langle \gamma \gamma_i \rangle (\phi_i M'(\alpha^\bullet) V_1) (\phi_1 M'(\alpha^\bullet) V_i) \quad (5.24)$$

and use the identity

$$(\lambda_1 - \lambda_i) \left(\int_0^T \gamma_i^2(t) dt \right) = \int_0^T \gamma(t) \gamma_i(t) dt.$$

□

Now we can prove Theorem 5.0.4 stated in the introduction by using the result of Proposition 5.1.6.

Proof of Theorem 5.0.4: frequency analysis. We consider a periodic control under the form

$$\gamma(t) = \cos(\omega t).$$

We compute the solution $\gamma_i(t)$ to Equation (5.20)

$$\gamma_i(t) = \frac{\lambda_1 - \lambda_i}{\omega^2 + (\lambda_1 - \lambda_i)^2} \cos(\omega t) + \frac{\omega}{\omega^2 + (\lambda_1 - \lambda_i)^2} \sin(\omega t)$$

and then we obtain the formula

$$\lambda_F''(0; \omega) = \frac{1}{2} \phi_1 M''(\alpha^\bullet) V_1 + \sum_{i=2}^n \frac{\lambda_1 - \lambda_i}{\omega^2 + (\lambda_1 - \lambda_i)^2} (\phi_1 F V_i) (\phi_i F V_1).$$

But we have

$$\phi_1 M''(\alpha^\bullet) V_1 = r''(\alpha^\bullet) \phi_1 G V_1$$

and we can compute $\phi_1 G V_1$ by doing the appropriate combination of

$$\lambda_1(\alpha^\bullet) = \phi_1 (r(\alpha^\bullet) G + \alpha^\bullet F) V_1$$

and

$$\lambda_1'(\alpha^\bullet) = 0 = \phi_1 (r'(\alpha^\bullet) G + F) V_1$$

to obtain

$$\phi_1 M''(\alpha^\bullet) V_1 = \frac{r''(\alpha^\bullet)}{r(\alpha^\bullet) - \alpha^\bullet r'(\alpha^\bullet)} \lambda_1(\alpha^\bullet).$$

Thus we have the limit

$$\lim_{\omega \rightarrow \infty} \lambda_F''(0; \omega) = \frac{1}{2} \frac{r''(\alpha^\bullet)}{r(\alpha^\bullet) - \alpha^\bullet r'(\alpha^\bullet)} \lambda_1 > 0.$$

The second directional derivative of λ_F is positive for ω large enough and it ends the proof of Theorem 5.0.4. □

5.2 The Optimal Control Problem

In this section we consider the optimal control problem (5.9).

5.2.1 Existence of an optimal control

The first question concerning Problem (5.9) is to know whether there exists a solution. If r is an affine function of α , the following lemma ensures that there is indeed a solution which maximizes the payoff $c[\alpha(\cdot)]$ in the set \mathcal{A} .

Lemma 5.2.1. *If there exist r_0 and r_1 such that*

$$\forall \alpha \in [\alpha_{min}, \alpha_{max}], \quad r(\alpha) = r_1\alpha + r_0,$$

then there exists an optimal control $\alpha^ \in \mathcal{A}$ solution to Problem (5.9).*

Proof. We take a maximizing sequence $(\alpha_k)_{k \in \mathbb{N}}$ for the payoff c . This sequence is bounded in L^∞ by α_{max} , so we can extract a subsequence which converges $*$ -weak toward α^* . It remains to prove that

$$c[\alpha^*(\cdot)] = \lim_{k \rightarrow \infty} c[\alpha_k(\cdot)].$$

We denote by $U^*(t)$ the solution to Equation (5.4) corresponding to the control $\alpha^*(t)$ and by $U_k(t)$ the solution for $\alpha_k(t)$. Using the function g defined in (5.8), the problem is to prove that $g(U_k(T)) \rightarrow g(U^*(T))$ when $k \rightarrow \infty$. For this we prove more, namely that for all time t we have $\|U_k(t) - U^*(t)\| \rightarrow 0$. First we write

$$\begin{aligned} \|U_k(t) - U^*(t)\| &\leq \int_0^t \|r_0G + \alpha_k(r_1G + F)\| \|U_k(s) - U^*(s)\| ds + \int_0^t (\alpha_k - \alpha^*) \|(r_1G + F)U^*(s)\| ds \\ &\leq (r_0\|G\| + \alpha_{max}\|r_1G + F\|) \int_0^t \|U_k(s) - U^*(s)\| ds + \int_0^t (\alpha_k - \alpha^*) \|(r_1G + F)U^*(s)\| ds. \end{aligned}$$

Then, using the Grönwall lemma, we obtain

$$\|U_k(t) - U^*(t)\| \leq \left[\sup_{t \in [0, T]} \int_0^t (\alpha_k - \alpha^*) \|(r_1G + F)U^*(s)\| ds \right] \exp((r_0\|G\| + \alpha_{max}\|r_1G + F\|)T).$$

For any $k \in \mathbb{N}$, denote by f_k the function defined on $[0, T]$ by

$$f_k(t) = \int_0^t (\alpha_k - \alpha^*) \|(r_1G + F)U^*(s)\| ds.$$

The sequence $(f_k)_k$ is uniformly bounded in $W^{1, \infty}(0, T)$ and converges punctually to zero because of the L^∞ - $*$ -weak convergence $\alpha_k \rightarrow \alpha^*$. So the sequence converges uniformly to zero and we obtain

$$\forall t \in [0, T], \quad \|U_k(t) - U^*(t)\| \xrightarrow[k \rightarrow \infty]{} 0.$$

Then we conclude that

$$c[\alpha_k(\cdot)] = g(U_k(T)) \xrightarrow[k \rightarrow \infty]{} g(U^*(T)) = c[\alpha^*(\cdot)].$$

□

In the case when there exists an optimal control, we can have informations on the shape of this control thanks to a maximum principle. First we define the *control theory Hamiltonian* associated to Equation (5.4)

$$H(u, p, a) := pM(a)u$$

for $u \in \mathbb{R}^n$ a row vector, $p \in \mathbb{R}^n$ a line vector and $a \geq 0$. Then we have the following theorem (see [48] for instance).

Theorem 5.2.2 (Pontryagin Maximum Principle). *Assume $\alpha^*(\cdot)$ is optimal for (5.4),(5.8), and $U^*(\cdot)$ is the corresponding trajectory. Then there exists a function $P^* : [0, T] \rightarrow \mathbb{R}^n$ such that*

$$\dot{U}^*(t) = \nabla_p H(U^*(t), P^*(t), \alpha^*(t)), \quad (5.25)$$

$$\dot{P}^*(t) = -\nabla_u H(U^*(t), P^*(t), \alpha^*(t)), \quad (5.26)$$

and

$$H(U^*(t), P^*(t), \alpha^*(t)) = \max_{a \in [\alpha_{min}, \alpha_{max}]} \{H(U^*(t), P^*(t), a)\}, \quad t \in [0, T]. \quad (5.27)$$

This theorem provides informations about the optimal control α^* when it exists. First, if $\alpha^*(t)$ remains close to a constant during a sufficiently large time, then it has to be close to

$$\alpha_{opt} := \arg \max_{\alpha \in [\alpha_{min}, \alpha_{max}]} \lambda_1(\alpha).$$

Indeed Equations (5.25) and (5.26) write

$$\dot{U}^* = M(\alpha^*)U^* \quad \dot{P}^* = -P^*M(\alpha^*).$$

So if α^* is constant during a long time interval, then in the middle of this interval U^* and P^* are close to the eigenvectors $V_1(\alpha^*)$ and $\phi_1(\alpha^*)$ because of the General Relative Entropy results. But

$$H(V_1(\alpha^*), \phi_1(\alpha^*), \alpha^*) = \phi_1(\alpha^*)M(\alpha^*)V_1(\alpha^*) = \lambda_1(\alpha^*)$$

so Equation (5.27) imposes $\lambda_1(\alpha^*)$ to be maximal in $[\alpha_{min}, \alpha_{max}]$.

This argument does not ensure that the optimal control remains close to a constant. Nevertheless, numerical simulations show that, for a large final time T , the optimal control seems to be essentially equal to α_{opt} . To compute numerically an approximation to the optimal control, we divide the interval $[0, T]$ into N time steps and we also discretize the interval $[\alpha_{min}, \alpha_{max}]$. Then we consider the controls which are constant on each time step of length $\Delta t = T/N$ and we optimize the final payoff $c[\alpha]$ among these piecewise constant controls thanks to a relaxation method. We can see on Figure 5.1 that, in the case when $r \equiv 1$ with $\alpha_{opt} \in (\alpha_{min}, \alpha_{max})$, the optimal control is close to α_{opt} if T is large enough. This comforts the argument based on the Pontryagin maximum principle.

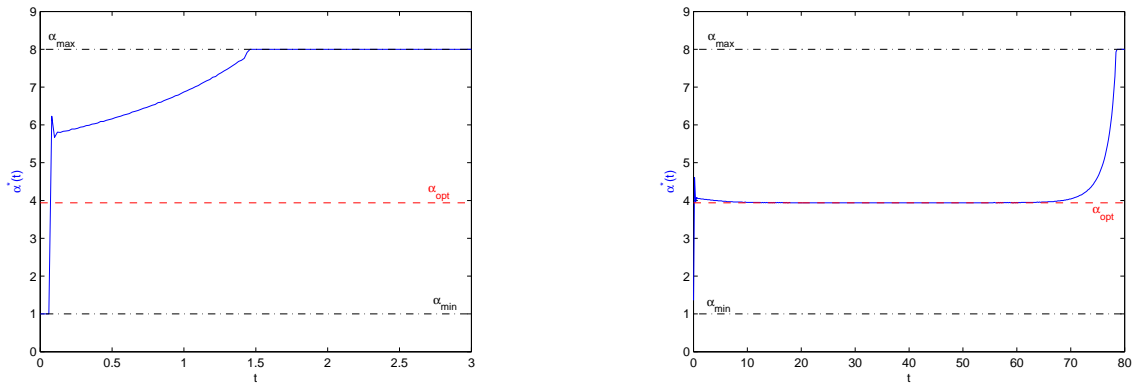

Figure 5.1: Optimal controls obtained thanks to a relaxation method for $r \equiv 1$, $n = 3$, $\tau_1 = 0.01$, $\tau_2 = 10$, $\beta_2 = 0.1$ and $\beta_3 = 0.9$. The optimal control is plotted in blue, and the value α_{opt} which maximizes the first eigenvalue in red. Left: final time $T = 3$. Right: final time $T = 80$.

Now we wonder what happens when the function r is not affine. Is there still an optimal control ? Consider for instance that r is a convex decreasing function on $[\alpha_{min}, \alpha_{max}]$ and that the first eigenvalue admits a global maximum $\lambda_1(\alpha^\bullet)$ with $\alpha^\bullet \in (\alpha_{min}, \alpha_{max})$. Then we know from Theorem 5.0.4 that there exist periodic controls which provide a Floquet eigenvalue greater than $\lambda_1(\alpha^\bullet)$ for sufficiently high frequencies. So we do not expect that the optimal control is constant in time close to $\alpha_{opt} = \alpha^\bullet$ but that it oscillates. In the numerical relaxation method we use, the maximal frequency of oscillations is controlled by the time step Δt . In Figure 5.2, we plot the optimal controls obtained for different values of Δt . We observe that the most we decrease Δt , the most the piecewise optimal control oscillates. That seems to indicate that there is no optimal control in \mathcal{A} , what was already suggested by the proof of Theorem 5.0.4.

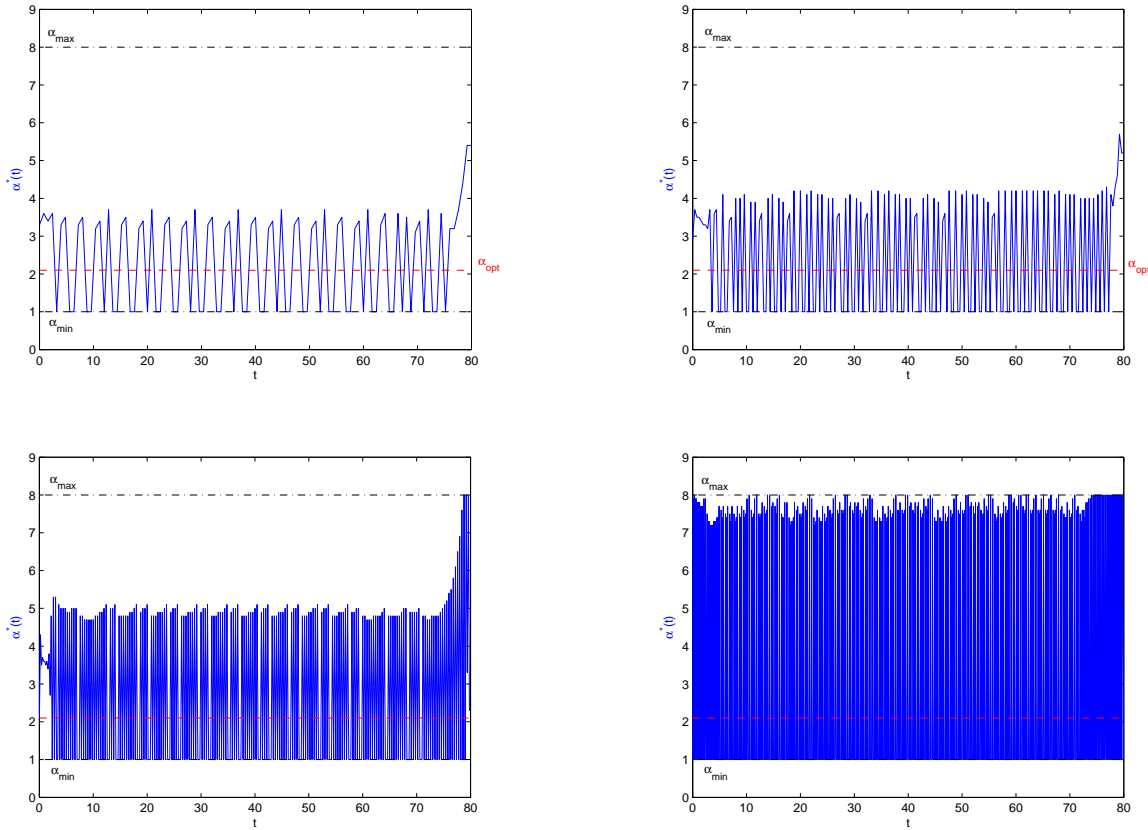

Figure 5.2: Piecewise optimal controls obtained for different values of Δt with $r(\alpha) = \frac{6}{1+\alpha}$ a decreasing convex function. The final time is $T = 80$, the space dimension is $n = 3$, and the coefficients are $\tau_1 = 0.01$, $\tau_2 = 10$, $\beta_2 = 0.1$ and $\beta_3 = 0.9$. The time step varies: $\Delta t = 0.8$ (top left), $\Delta t = 0.4$ (top right), $\Delta t = 0.2$ (bottom left) and $\Delta t = 0.1$ (bottom right).

5.2.2 The Hamilton-Jacobi-Bellman equation

We assume that there is no influence of α on the transport term by considering $r \equiv 1$. In this case we know that there exists an optimal control α^* for Problem (5.9). Define $c_{x,t}(\alpha(\cdot))$ as the payoff for the dynamical system

$$\begin{cases} \dot{U}(s) = M(\alpha(s))U(s), & t \leq s \leq T, \\ U(s = t) = x. \end{cases} \quad (5.28)$$

Then, the *value function* $v(x, t)$ defined by

$$v(x, t) := \sup_{\alpha(\cdot) \in \mathcal{A}} c_{x,t}(\alpha(\cdot))$$

satisfies the Hamilton-Jacobi-Bellman (HJB) equation

$$v_t(x, t) + \max_{a \in [\alpha_{min}, \alpha_{max}]} \{M(a)x \cdot \nabla_x v(x, t)\} = 0 \quad (5.29)$$

with the final condition

$$v(x, T) = g(x). \quad (5.30)$$

A proof of this result can be found in [48] for instance, it is also explained how the solution to Equation (5.29) allows to compute the optimal control α^* thanks to the dynamic programming method.

Here we solve numerically Equation (5.29) for $n = 3$. We consider coefficients satisfying $\tau_2 > 2\tau_1$ and $\beta_3 \geq \beta_2$ so that Proposition 5.1.4 ensures that there exists α^* which maximises the Perron eigenvalue, and that $\lambda_1(\alpha)$ increases from $\lambda_1(0) = 0$ to $\lambda_1(\alpha^*)$ and then decreases to $\lim_{\alpha \rightarrow \infty} \lambda_1(\alpha) = \tau_1$. First we reduce the dimension by noticing that if $v(x, t)$ satisfies (5.29), then for any $\lambda \in \mathbb{R}$, $v(\lambda x, t)$ is solution too. Using the fact that g is linear and so satisfies $g(\lambda x) = \lambda g(x)$, we have that the solution $v(x, t)$ to Equation (5.29)-(5.30) satisfies

$$\forall x, t, \lambda, \quad v(\lambda x, t) = \lambda v(x, t). \quad (5.31)$$

Then we define a new function $w(y, t)$ on the simplex $\Sigma_2 := \{(y_1, y_2) : y_1, y_2 \geq 0 \text{ and } y_1 + 2y_2 \leq 1\}$ by

$$\begin{aligned} v(x, t) &= g(x)v\left(\frac{x_1}{g(x)}, \frac{x_2}{g(x)}, \frac{x_3}{g(x)}, t\right) \\ &= g(x)v\left(y_1, y_2, \frac{1}{3}(1 - y_1 - 2y_2), t\right) \\ &= g(x)w(y_1, y_2, t). \end{aligned}$$

We compute the gradient of v in terms of w

$$\begin{aligned} \partial_{x_1} v &= w + (1 - y_1)\partial_{y_1} w - y_2\partial_{y_2} w \\ \partial_{x_2} v &= 2w - 2y_1\partial_{y_1} w + (1 - 2y_2)\partial_{y_2} w \\ \partial_{x_3} v &= 3w - 3y_1\partial_{y_1} w - 3y_2\partial_{y_2} w \end{aligned}$$

and obtain a new equation satisfied by w

$$\partial_t w + \max_a \left\{ [G + aF] \begin{pmatrix} y_1 \\ y_2 \\ \frac{1}{3}(1 - y_1 - y_2) \end{pmatrix} \cdot \begin{pmatrix} 1 & 1 - y_1 & -y_2 \\ 2 & -2y_1 & 1 - 2y_2 \\ 3 & -3y_1 & -3y_2 \end{pmatrix} \begin{pmatrix} w \\ \partial_{y_1} w \\ \partial_{y_2} w \end{pmatrix} \right\} = 0.$$

Denoting $p = \begin{pmatrix} 1 \\ 2 \\ 3 \end{pmatrix}$, this equation writes

$$\partial_t w + \max_a \left\{ [G + aF] \begin{pmatrix} y_1 \\ y_2 \\ \frac{1}{3}(1 - y_1 - y_2) \end{pmatrix} \cdot \left(w p - y_1 \partial_{y_1} w p - y_2 \partial_{y_2} w p + \begin{pmatrix} \nabla_y w \\ 0 \end{pmatrix} \right) \right\} = 0$$

or, since $p \in \text{Ker } F^T$,

$$\partial_t w + \text{Corr}(y)w + \max_a \left\{ [G + aF - \text{Corr}(y) \text{Id}] \begin{pmatrix} y_1 \\ y_2 \\ \frac{1}{3}(1 - y_1 - y_2) \end{pmatrix} \cdot \begin{pmatrix} \nabla_y w \\ 0 \end{pmatrix} \right\} = 0 \quad (5.32)$$

with $\text{Corr}(y) = G \begin{pmatrix} y_1 \\ y_2 \\ \frac{1}{3}(1 - y_1 - y_2) \end{pmatrix} \cdot p$.

Remark that Equation (5.32) is a retrograd equation with final data $w(y, T) \equiv 1$. Now we present numerical simulations of the solution at time $t = 0$, for different choices of coefficients. The final time is $T = 20$ so that the shape of the solution is observed to be stationary at time $t = 0$.

First case: $\alpha^\bullet \in (\alpha_{min}, \alpha_{max})$. We choose $\alpha_{min} = 1$ and $\alpha_{max} = 4$, and coefficients of the matrix M which allow to have $\alpha^\bullet \in (\alpha_{min}, \alpha_{max})$. The existence of α^\bullet is ensured by Proposition 5.1.4 for $\tau_2 > 2\tau_1$, and its value is between α_{min} and α_{max} for an accurate choice of β_2 and β_3 . The numerical solution to Equation (5.32) is plotted in Figure 5.3 on the simplex Σ_2 at time $t = 0$. In this case the simplex Σ_2 is divided into two zones: one where the maximum of the bracket is reached for $a = \alpha_{max}$ and the other where it is reached for $a = \alpha_{min}$. These zones are separated by a border which contains $V_1(\alpha^\bullet)$ and which is close to the line defined by

$$\mathcal{H} := \{y : \phi_1(\alpha_{opt})Fx = 0, x = (y_1, y_1, \frac{1}{3}(1 - y_1 - 2y_2))^T\}$$

as we can see in Figure 5.4. This line also contains $V_1(\alpha^\bullet)$ since $M'(\alpha^\bullet) = F$ and, thanks to Theorem 5.1.5, $\phi_1 M'(\alpha^\bullet)V_1 = \lambda_1'(\alpha^\bullet) = 0$.

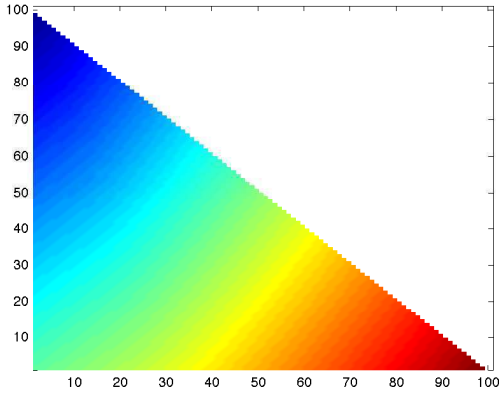

Figure 5.3: Solution to Equation (5.32) at time $t = 0$ plotted on the simplex Σ_2 for coefficients $\tau_1 = 0.1$, $\tau_2 = 4$, $\beta_3 = 2\beta_2 = 1$. For these coefficients, the maximal λ_1 is obtained for $\alpha^\bullet \in (\alpha_{min}, \alpha_{max}) = (1, 4)$.

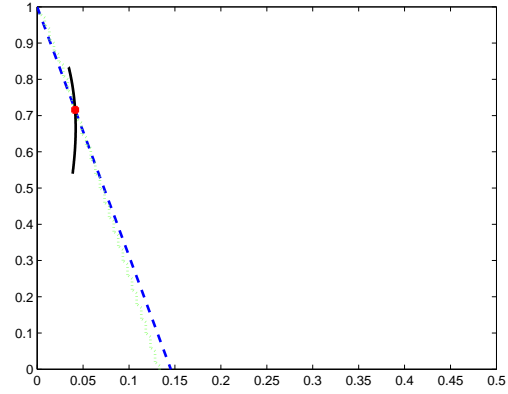

Figure 5.4: In green: the border between the zones where \max_a is reached in α_{min} (on the left) or α_{max} (on the right). In blue: the line \mathcal{H} . In black: the set $\{V_1(\alpha), \alpha \in (\alpha_{min}, \alpha_{max})\}$. In red: $V_1(\alpha^\bullet)$.

On both sides of the border, the solution appears to be almost linear as we can see by plotting the level sets or the gradient (see Figure 5.5).

Second case: $\alpha^\bullet > \alpha_{max}$ and $\lambda_1(\alpha_{max}) > \tau_1$. In this case $\alpha_{opt} = \alpha_{max}$ and we can see in Figure 5.6 that the border and the line \mathcal{H} are merged. But the border does not pass through $V_1(\alpha_{opt})$ and we try to understand why. Since for $r \equiv 1$ we have $M(a) = G + aF$, the maximum in Equation (5.29) is given by the sign of $Fx \cdot \nabla v$. Now we can check in Figure 5.7 that the gradient in the zone where the maximum is reached for $a = \alpha_{max}$ is constant. A good candidate for this constant gradient is $\phi_1(\alpha_{opt})$. Indeed we can easily check that $v(x, t) = \phi_1(\alpha_{opt})x e^{\lambda(\alpha_{opt})t}$ is a particular solution because $\alpha_{opt} = \alpha_{max}$. So, assuming that the gradient of v is indeed $\phi_1(\alpha_{opt})$, the border corresponds to the set of x where $\phi_1(\alpha_{opt})Fx$ changes its sign. We restrict to finding the intersection of the border with the set of eigenvectors $\{V_1(\alpha), \alpha \geq 0\}$.

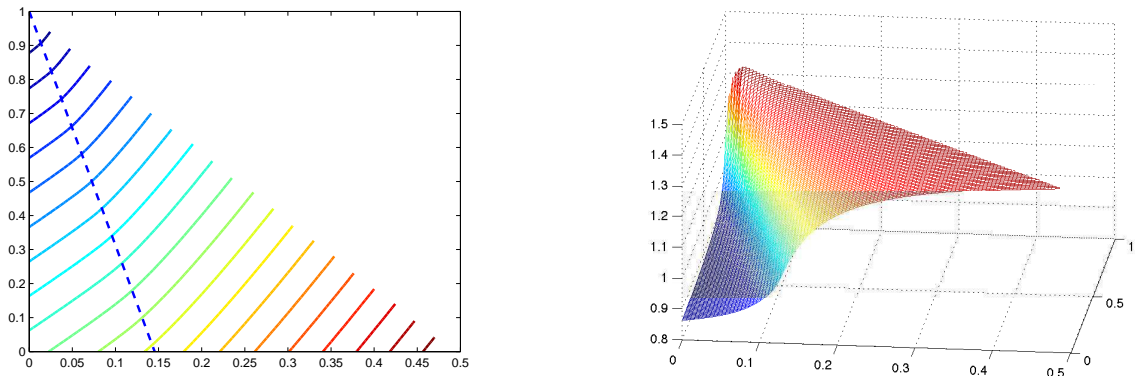

Figure 5.5: Left: Level sets of the solution to Equation (5.32) at time $t = 0$ and the border. Right: The partial derivative $\partial_{y_1} w(y, t = 0)$.

For this we write

$$\begin{aligned} \lambda_1(\alpha)\phi_1(\alpha_{opt})V_1(\alpha) &= \phi_1(\alpha_{opt})(G + \alpha F)V_1(\alpha) \\ &= \phi_1(\alpha_{opt})(G + \alpha_{opt}F)V_1(\alpha) + (\alpha - \alpha_{opt})\phi_1(\alpha_{opt})FV_1(\alpha) \\ &= \lambda_1(\alpha_{opt})\phi_1(\alpha_{opt})V_1(\alpha) + (\alpha - \alpha_{opt})\phi_1(\alpha_{opt})FV_1(\alpha) \end{aligned}$$

and we obtain

$$\phi_1(\alpha_{opt})FV_1(\alpha) = \frac{\lambda_1(\alpha) - \lambda_1(\alpha_{opt})}{\alpha - \alpha_{opt}} \phi_1(\alpha_{opt})V_1(\alpha). \quad (5.33)$$

This quantity is positive for $\alpha < \tilde{\alpha}$ and negative for $\alpha > \tilde{\alpha}$, where $\tilde{\alpha}$ is the only value greater than α^* such that $\lambda_1(\tilde{\alpha}) = \lambda_1(\alpha_{opt})$. That gives an explanation of the fact that $V_1(\alpha_{opt})$ does not belong to the border and conjectures that the intersection of the set $\{V_1(\alpha), \alpha \geq 0\}$ with the border is $V_1(\tilde{\alpha})$. Moreover the set $\{V_1(\alpha), \alpha \in (\alpha_{min}, \alpha_{max})\}$ is expected to be in the zone of α_{max} and it is indeed the case on numerical simulations (see Figure 5.6).

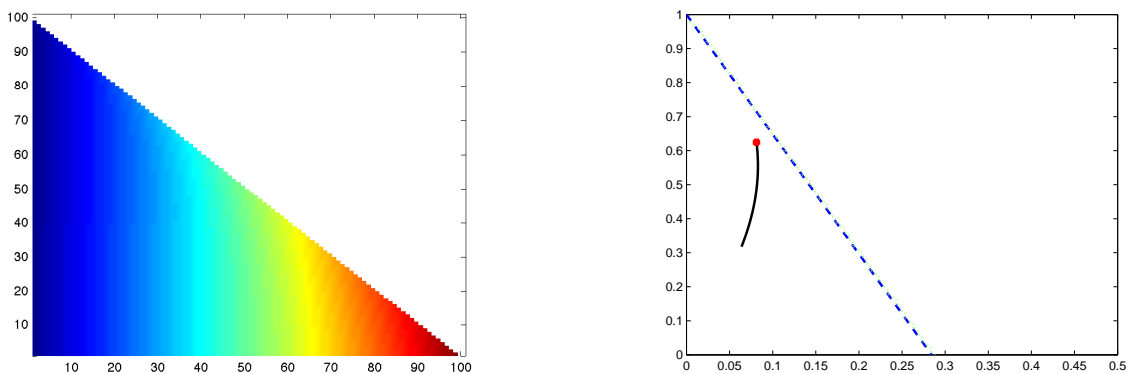

Figure 5.6: The same plots as in Figures 5.3 and 5.4 but for $\tau_1 = 0.4$.

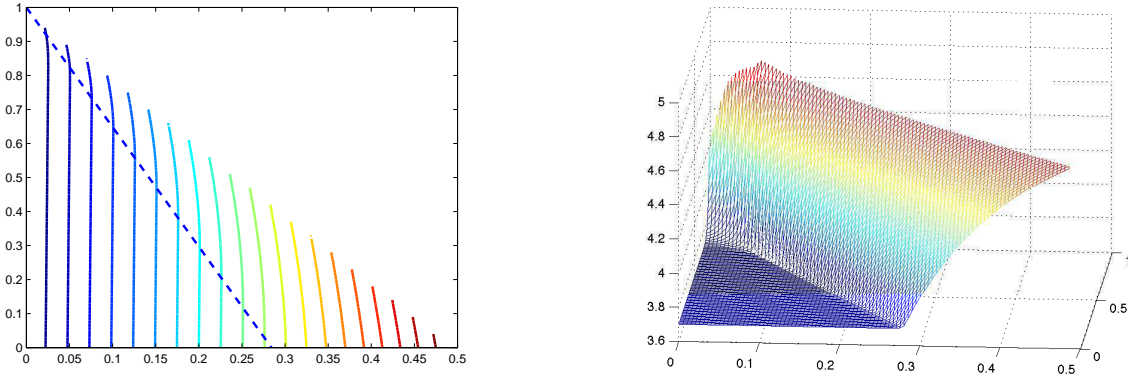

Figure 5.7: The same plots as in Figure 5.5 but for $\tau_1 = 0.4$.

Third case: $\alpha^\bullet > \alpha_{max}$ and $\lambda_1(\alpha_{max}) < \tau_1$. In this case there is no value $\tilde{\alpha} > \alpha^\bullet$ such that $\lambda_1(\tilde{\alpha}) = \lambda_1(\alpha_{opt})$. This is in accordance with the numerical simulations because \mathcal{H} is out of the simplex and there is no border in the interior of Σ_2 (see Figure 5.8). The maximum in HJB is reached everywhere for $a = \alpha_{max} = \alpha_{opt}$ and the solution is expected to be the particular solution $v(x, t) = \phi_1(\alpha_{opt})x e^{\lambda_1(\alpha_{opt})t}$, up to a multiplication by a constant.

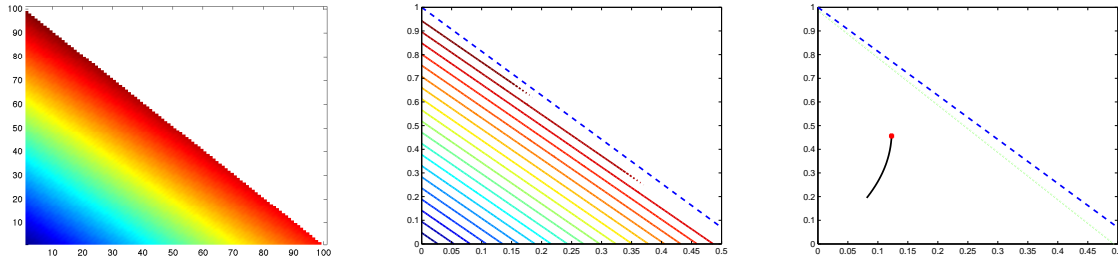

Figure 5.8: Simulations for coefficients $\tau_1 = 1$, $\tau_2 = 4$ and $\beta_3 = 2\beta_2 = 1$. Left: the solution $w(y, 0)$ on Σ_2 . Middle: the levelsets. Right: the border in green is merged with the edge of the simplex, and \mathcal{H} in blue is out of the simplex.

Aknowledgements.

The authors want to thank Stéphane Gaubert for precious help and discussions.

Chapitre 6

Un schéma d'ordre élevé pour des modèles avec coalescence

Ce travail a été réalisé lors du Cemracs'09 sur la modélisation mathématique en médecine, en collaboration avec LÉON MATAR TINE dans le projet PRION. L'objectif est d'écrire un schéma numérique d'ordre élevé et préservant la masse pour des modèles d'agrégation-fragmentation avec coagulation. Nous écrivons tout d'abord les termes intégraux de coagulation et de fragmentation sous forme conservative afin de pouvoir utiliser un schéma de transport qui préserve la masse. Nous choisissons alors une discrétisation WENO d'ordre 5 pour ses propriétés anti-dissipatives et nous présentons des simulations numériques obtenues à partir de données expérimentales. Ceci a fait l'objet d'une publication dans ESAIM-Proceedings sous le titre *High-order WENO scheme for polymerization-type equations* [60].

6.1 Introduction

The central mechanism of amyloid diseases is the polymerization of proteins : PrP in Prion diseases, APP in Alzheimer, Htt in Huntington. The abnormal form of these proteins is pathogenic and has the ability to polymerize into fibrils. In order to well understand this process, investigation of the size repartition of polymers is a crucial point. To this end, we discuss in this paper the mathematical modeling of these polymerization processes and we propose numerical methods to investigate the mathematical features of the models.

Mathematical models are already widely used to study the polymerization mechanism of Prion diseases [20, 38, 43, 63, 64, 80, 91, 92, 83, 117], Alzheimer [32, 87, 108] or Huntington [16]. Such models are also used for other biological polymerization processes [4, 13] and even for cell division [10, 37, 110] or in neurosciences [107].

Another field where we find aggregation-fragmentation equations is the physics of aggregates (aerosol and raindrop formation, smoke, sprays...). Among these models (see [77] for a review), one can mention the Smoluchowsky coagulation equation [45, 54, 55, 78, 101] with fragmentation [44, 46, 47, 75, 76, 74] and the Lifshitz-Slyosov system [21, 29, 30, 53, 103, 104, 105, 106]. In [28, 67] a Smoluchowsky coagulation term is added to the Lifshitz-Slyosov equation.

In this paper we are interested in a model including polymerization, coagulation and fragmentation phenomena. We consider a medium where there are monomers (normal proteins for instance) characterized by the concentration $V(t)$ at time t and polymers (aggregates of abnormal proteins) of size x with

the concentration $u(t, x)$. The dynamics of the density function $u(t, x)$ is driven by the system

$$\left\{ \begin{array}{l} \frac{d}{dt}V(t) = - \int_0^\infty \mathcal{T}(V(t), x)u(t, x) dx, \\ \frac{\partial}{\partial t}u(t, x) = - \frac{\partial}{\partial x} \left(\mathcal{T}(V(t), x)u(t, x) \right) + \mathcal{Q}(u)(t, x), \\ u(t, 0) = 0, \quad u(0, x) = u_0(x) \geq 0 \quad \text{and} \quad V(0) = V_0 \geq 0. \end{array} \right. \quad (6.1)$$

The monomers are attached by polymers of size x with the polymerization rate $k_{\text{on}}(x)$. Depolymerization occurs when monomers detach from polymers with a rate $k_{\text{off}}(x)$. Hence the transport term writes

$$\mathcal{T}(V, x) = Vk_{\text{on}}(x) - k_{\text{off}}(x). \quad (6.2)$$

The two functions k_{on} and k_{off} are piecewise derivable but can be discontinuous. They are positive except that k_{on} can vanish at zero. In this case, or more generally when $\mathcal{T}(V(t), 0) \leq 0$, the boundary condition on $u(t, 0)$ is not necessary since the characteristic curves outgo from the domain. The choice of the boundary condition $u(t, 0) = 0$ is justified later.

The coalescence of two polymers and the fragmentation of a polymer into two smaller ones are taken into account by the operator \mathcal{Q} . More precisely, denoting by A_x an aggregate of size x we have

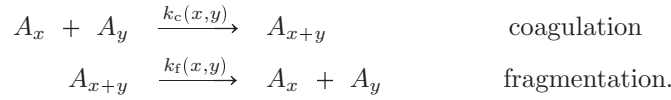

Thus the coagulation-fragmentation operator is $\mathcal{Q} = \mathcal{Q}_c - \mathcal{Q}_f$ with

$$\mathcal{Q}_c(u)(x) = \frac{1}{2} \int_0^x k_c(y, x-y) u(y)u(x-y) dy - u(x) \int_0^\infty k_c(x, y) u(y) dy, \quad (6.3)$$

$$\mathcal{Q}_f(u)(x) = \frac{1}{2} u(x) \int_0^x k_f(y, x-y) dy - \int_0^\infty k_f(x, y) u(x+y) dy. \quad (6.4)$$

The coalescence of two polymers of size x and y occurs with the symmetric rate $k_c(x, y) = k_c(y, x)$. This rate is a nonnegative function as the fragmentation symmetric rate $k_f(x, y) = k_f(y, x)$ with which a polymer of size $x + y$ produces two fragments of size x and y .

There is a difference between $V(t)$ and $u(t, x = 0)$. In biochemical polymerization processes, small polymers are very unstable and thus do not exist. When they appear by detachment from a longer polymer, they are immediately degraded into monomers. Thus, the quantity of small polymers vanishes while the quantity of monomers is very high. To reflect this in the mathematical model, a quantity $V(t)$ of monomers is introduced, which is different from the quantity of small polymers $u(t, x = 0)$. The evolution of the first one is given by an ODE while the second one is forced to be equal to zero through the boundary condition $u(t, 0) = 0$. A consequence of this distinction is that starting from $u_0(x) = 0$ and $V_0 > 0$ there is no evolution : the concentration of monomers is constant in time, $V(t) = V_0$, and the concentration of polymers remains null, $u(t, x) = 0$. This is a very intuitive and natural behaviour which is important to preserve for biological applications.

In the modeling, the distinction between V and $u(x = 0)$ induces a separation of the polymerization-depolymerization process from the coagulation-fragmentation. Indeed the aggregation of a monomer to a polymer can be seen as a coagulation but the resulting polymer has same size x than the initial one, since a monomer is very small compared to the typical size of a polymer. So a transport term is more accurate to model this phenomenon than an integral term (see [38]).

There is also the fact that when a small polymer is degraded into monomers, it increases the quantity of monomers. In a discrete model, this term appears in the equation on V (see n_0 in [92]). In the continuous model (6.1) this term can be neglected since the quantity of monomers produced by degradation of small polymers is very small compared to the total quantity of monomers.

6.2 Mass Conservation

The mechanism of polymerization is nothing but a rearrangement of the proteins, there is no creation and no disparition. So the total quantity of proteins has to be constant in time and this is the case in model (6.1). We define the total mass of the system as

$$P(t) = V(t) + \int_0^\infty xu(t, x) dx, \quad (6.5)$$

since a polymer of size x “contains x monomers”. Integrating the equation on $u(t, x)$ multiplied by x and adding the equation on V we obtain

$$\forall t > 0, \quad \frac{dP}{dt}(t) = 0, \quad (6.6)$$

so the total mass is conserved along time. This is a very important property that we want to keep in the numerical scheme and for this we rewrite equation (6.1) under a conservative form.

6.2.1 Conservative formulation

The classical discretization methods for transport equations are mass preserving. So the idea is to write the coagulation-fragmentation operator \mathcal{Q} , which preserves the mass, under a conservative form in order to use a transport scheme. For this we follow the paper [52] where such a transformation is made :

$$\begin{cases} x\mathcal{Q}_c(u)(x) = -\frac{\partial \mathcal{C}(u)}{\partial x}(x), \\ x\mathcal{Q}_f(u)(x) = -\frac{\partial \mathcal{F}(u)}{\partial x}(x), \end{cases}$$

where the operator $\mathcal{C}(u)$ is given by

$$\mathcal{C}(u)(x) := \int_0^x \int_{x-y}^\infty yk_c(y, z)u(y)u(z) dz dy, \quad (6.7)$$

and $\mathcal{F}(u)$ is

$$\mathcal{F}(u)(x) := \int_0^x \int_{x-y}^\infty yk_f(y, z)u(y+z) dz dy. \quad (6.8)$$

Under this form, the mass conservation is clearer and the use of conservative schemes possible.

A useful consequence of the property (6.6) for the numerical scheme is that the ODE on V can be replaced by a mass conservation equation (see [67])

$$\forall t > 0, \quad V(t) = V_0 + \int_0^\infty x(u_0(x) - u(t, x)) dx. \quad (6.9)$$

Numerically, this equation is much easier to compute than the ODE to be solved. Moreover (6.9) provides an explicit expression for V as a function of u . So we set

$$\mathcal{G}(u)(x) := \left(V_0 + \int_0^\infty y[u_0(y) - u(y)] dy \right) k_{\text{on}}(x) - k_{\text{off}}(x) \quad (6.10)$$

and we obtain a new equation equivalent to (6.1)

$$\begin{cases} x \frac{\partial}{\partial t} u(t, x) + \frac{\partial [\mathcal{G}(u)xu]}{\partial x}(t, x) + \frac{\partial \mathcal{C}(u)}{\partial x}(t, x) - \frac{\partial \mathcal{F}(u)}{\partial x}(t, x) = \mathcal{G}(u)u(t, x), \\ u(t, 0) = 0, \quad u(0, x) = u_0(x). \end{cases} \quad (6.11)$$

In this equation (6.11), we have written the transport term as

$$x \frac{\partial [\mathcal{G}(u)u]}{\partial x}(t, x) = \frac{\partial [\mathcal{G}(u)xu]}{\partial x}(t, x) - \mathcal{G}(u)u(t, x). \quad (6.12)$$

This formulation enhances the relation

$$\frac{d}{dt} \int_0^\infty xu(t, x) dx = \int_0^\infty \mathcal{G}(u)u(t, x) dx = -\frac{d}{dt} V(t) \quad (6.13)$$

and allows to preserve this property numerically when using conservative transport schemes.

6.2.2 Domain truncation

Numerically, equation (6.11) is solved on a truncated domain $[0, R]$ so the integration bounds have to be changed in order to keep the mass preservation. For the coagulation term, we introduce as in [52]

$$\begin{aligned} \mathcal{C}^R(u)(x) &:= \int_0^x \int_{x-y}^{R-y} yk_c(y, z)u(y)u(z) dz dy \\ &= \int_0^x \int_x^R yk_c(y, z-y)u(y)u(z-y) dz dy, \end{aligned}$$

and for the fragmentation

$$\begin{aligned} \mathcal{F}^R(u)(x) &:= \int_0^x \int_{x-y}^{R-y} yk_f(y, z)u(y+z) dz dy \\ &= \int_0^x \int_x^R yk_f(y, z-y)u(z) dz dy. \end{aligned}$$

With this truncation, we have $\mathcal{C}^R(u)(0) = \mathcal{C}^R(u)(R) = \mathcal{F}^R(u)(0) = \mathcal{F}^R(u)(R) = 0$. So the total mass does neither increase nor decrease with respect to time if we consider the coagulation and fragmentation processes. If we look at the effects of this truncation on the original coagulation and fragmentation operators we have

$$Q_c^R(u)(x) := -\frac{1}{x} \partial_x \mathcal{C}^R(u)(x) = \frac{1}{2} \int_0^x k_c(y, x-y)u(y)u(x-y) dy - u(x) \int_0^{R-x} k_c(x, y)u(y) dy$$

and

$$Q_f^R(u)(x) := -\frac{1}{x} \partial_x \mathcal{F}^R(u)(x) = \frac{1}{2} u(x) \int_0^x k_f(y, x-y) dy - \int_x^R k_f(x, y-x)u(y) dy.$$

In the coagulation term, the truncation corresponds to the assumption that a polymer of size x cannot coagulate with a polymer of size greater than $R-x$. Concerning the fragmentation term, it is nothing but the assumption that polymers of size greater than R cannot split. Biologically they are the natural assumptions to avoid the loss of mass.

Concerning the transport term, the only way to avoid the loss of mass is to set

$$\mathcal{G}^R(u)(R, t) = 0. \quad (6.14)$$

The meaning we give to this relation in the numerical scheme is exposed in Section 6.3.2. It is useless to do such a truncation for $x=0$ since $xu(t, x)$ vanishes when $x=0$.

Finally we obtain a conservative truncated equation for $x \in (0, R)$

$$\begin{cases} x \frac{\partial}{\partial t} u_R(t, x) + \frac{\partial [\mathcal{G}^R(u_R)xu_R]}{\partial x}(t, x) + \frac{\partial \mathcal{C}^R(u_R)}{\partial x}(t, x) - \frac{\partial \mathcal{F}^R(u_R)}{\partial x}(t, x) = \mathcal{G}(u_R)u_R(t, x), \\ u_R(t, 0) = 0, \quad u_R(0, x) = u_0(x). \end{cases} \quad (6.15)$$

When there is no transport term, convergence of the solution of Equation (6.15) to the solution of Equation (6.1) when $R \rightarrow \infty$ is proved in [42, 77, 75, 74, 127] under growth conditions on k_c and k_f .

6.3 A High Order WENO Scheme

In order to obtain a mass preserving scheme, we consider equation (6.11) as a transport equation and for high order accuracy we choose a fifth-order WENO (Weighted Essentially Non Oscillatory) reconstruction for the fluxes. This high order scheme is comonly used [35, 121] since it is not more complicated to implement than a third order WENO one for instance.

6.3.1 Numerical fluxes

Before using the WENO reconstruction we have to know if the fluxes are positive or negative in order to appropriately upwind the scheme. Concerning the coagulation and the fragmentation terms, we consider a positive upwinding as suggested in [52]. For the transport term $\partial_x [\mathcal{G}(u)xu]$ we have to make a flux splitting because \mathcal{G} has no sign. A natural splitting here is to put the terms of \mathcal{G} that are preceded by a plus sign in the positive part and the terms preceded by a minus sign in the negative part, namely $\mathcal{G} = \mathcal{G}_1^+ + \mathcal{G}_1^-$ where

$$\begin{cases} \mathcal{G}_1^+(u)(x) = \left(V_0 + \int_0^\infty y u_0(y) dy \right) k_{\text{on}}(x), \\ \mathcal{G}_1^-(u)(x) = - \left(\int_0^\infty y u(y) dy \right) k_{\text{on}}(x) - k_{\text{off}}(x). \end{cases} \quad (6.16)$$

An other decomposition is the polymerization-depolymerization one Existence et unicité d'éléments propres principaux

$$\begin{cases} \mathcal{G}_0^+(u)(x) = \left(V_0 + \int_0^\infty y [u_0(y) - u(y)] dy \right) k_{\text{on}}(x), \\ \mathcal{G}_0^-(u)(x) = -k_{\text{off}}(x). \end{cases} \quad (6.17)$$

The term \mathcal{G}_0^+ is necessarily positive because $V_0 + \int_0^\infty y [u_0(y) - u(t, y)] dy = V(t) \geq 0$. With these two flux splittings, we built others by convex combination. For any $\lambda \in [0, 1]$ we set $\mathcal{G}_\lambda = \lambda \mathcal{G}_1 + (1 - \lambda) \mathcal{G}_0$ which gives

$$\begin{cases} \mathcal{G}_\lambda^+(u)(x) = \left(V_0 + \int_0^\infty y [u_0(y) - u(y)] dy + \lambda \int_0^\infty y u(y) dy \right) k_{\text{on}}(x), \\ \mathcal{G}_\lambda^-(u)(x) = -\lambda \left(\int_0^\infty y u(y) dy \right) k_{\text{on}}(x) - k_{\text{off}}(x). \end{cases} \quad (6.18)$$

We also consider the Lax-Friedrichs scheme which corresponds to

$$\begin{cases} \mathcal{G}_{\text{LF}}^+(u) = \frac{1}{2}(\mathcal{G}(u) + m), \\ \mathcal{G}_{\text{LF}}^-(u) = \frac{1}{2}(\mathcal{G}(u) - m), \end{cases} \quad (6.19)$$

with $m = \max_{x \geq 0} |\mathcal{G}(u)|$. This term has to be computed at each time step because $\mathcal{G}(u)$ depends on time.

Finally, the WENO reconstruction is done with the fluxes

$$\begin{cases} H^+(u) = \mathcal{G}^+(u)xu + \mathcal{C}(u) - F(u), \\ H^-(u) = \mathcal{G}^-(u)xu, \end{cases} \quad (6.20)$$

and the choice among the different flux splittings is discussed in Section 6.4.2.

6.3.2 WENO reconstruction

The point of view adopted here is the finite difference one, as recommended in [122], because it is better than the finite volume in terms of operation counts. We assume the spatial domain $[0, R]$ is divided into N uniform cells and we denote $x_i = i\Delta x$ for $0 \leq i \leq N$ with $\Delta x = \frac{R}{N}$. We use the WENO formulation of Jiang and Peng [120] which consists in applying WENO to approach the spacial derivative directly on the nodes of the grid. The spatial derivative $\partial_x (H^+(v) + H^-(v))$ is approximated at the point x_i by

$$\frac{1}{\Delta x} \left[H_{i+\frac{1}{2}}^+ + H_{i+\frac{1}{2}}^- - H_{i-\frac{1}{2}}^+ - H_{i-\frac{1}{2}}^- \right]$$

where the fifth order accurate numerical flux $H_{i+\frac{1}{2}}^+$ is given by the WENO reconstruction. For each node x_i we denote by H_i^+ the numerical approximation of $H^+(v(x_i))$. The stencil choice for each flux is specified in Figure 6.1, and the fluxes $H_{i\pm\frac{1}{2}}^\pm$ are expressed as convex combination of the H_k^\pm of the stencil. Let us detail how we proceed :

- for $H_{i-\frac{1}{2}}^-$ we set $W_1 = H_k^-$, $W_2 = H_{k+1}^-$, $W_3 = H_{k+2}^-$, $W_4 = H_{k-1}^-$, $W_5 = H_{k-2}^-$,
- for $H_{i+\frac{1}{2}}^-$ we set $W_1 = H_{k+1}^-$, $W_2 = H_{k+2}^-$, $W_3 = H_{k+3}^-$, $W_4 = H_k^-$, $W_5 = H_{k-1}^-$,
- for $H_{i-\frac{1}{2}}^+$ we set $W_1 = H_{k-3}^+$, $W_2 = H_{k-2}^+$, $W_3 = H_{k-1}^+$, $W_4 = H_k^+$, $W_5 = H_{k+1}^+$,
- for $H_{i+\frac{1}{2}}^+$ we set $W_1 = H_{k-2}^+$, $W_2 = H_{k-1}^+$, $W_3 = H_k^+$, $W_4 = H_{k+1}^+$, $W_5 = H_{k+2}^+$.

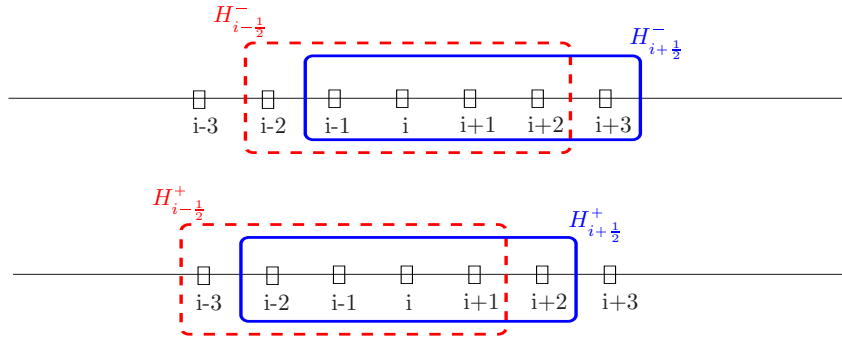

Figure 6.1: stencil choice

For the regularity coefficients we define for each previous flux

$$\begin{aligned} S_1 &= \frac{13}{12}(W_1 - 2W_2 + W_3)^2 + \frac{1}{4}(W_1 - 4W_2 + 3W_3)^2, \\ S_2 &= \frac{13}{12}(W_2 - 2W_3 + W_4)^2 + \frac{1}{4}(W_2 - W_4)^2, \\ S_3 &= \frac{13}{12}(W_3 - 2W_4 + W_5)^2 + \frac{1}{4}(3W_3 - 4W_4 + W_5)^2. \end{aligned}$$

Then we take the weights

$$w_r = \frac{a_r}{\sum_{j=1}^3 a_j}, \quad \text{with} \quad a_r = \frac{d_r}{(\epsilon + S_r)^2}, \quad d_1 = \frac{3}{10}, \quad d_2 = \frac{6}{10}, \quad d_3 = \frac{1}{10} \quad r = 1, 2, 3$$

where ϵ is introduced to prevent the denominator from vanishing. Finally we take the different flux parts given by

$$\begin{cases} H_{i\pm\frac{1}{2}}^- = w_1 \left(\frac{W_3}{3} - \frac{7W_2}{6} + \frac{11W_1}{6} \right) + w_2 \left(\frac{-W_2}{6} + \frac{5W_1}{6} + \frac{W_4}{3} \right) + w_3 \left(\frac{W_1}{3} + \frac{5W_4}{6} - \frac{W_5}{6} \right), \\ H_{i\pm\frac{1}{2}}^+ = w_1 \left(\frac{W_1}{3} - \frac{7W_2}{6} + \frac{11W_3}{6} \right) + w_2 \left(\frac{-W_2}{6} + \frac{5W_3}{6} + \frac{W_4}{3} \right) + w_3 \left(\frac{W_3}{3} + \frac{5W_4}{6} - \frac{W_5}{6} \right). \end{cases}$$

Concerning the boundaries $x = 0$ and $x = R$, we compute the fluxes using the WENO reconstruction with ghost points x_{-3} , x_{-2} , x_{-1} , and x_{N+1} , x_{N+2} , x_{N+3} . In the first three points we use that for all time $t \geq 0$,

$$xu(t, x) \Big|_{x=0} = \mathcal{C}^R(u)(x = 0, t) = \mathcal{F}^R(u)(x = 0, t) = 0$$

to set $H_{-3}^{\pm} = H_{-2}^{\pm} = H_{-1}^{\pm} = 0$. For the last three ones we use the truncation

$$\mathcal{G}^R(u)(x = R, t) = \mathcal{C}^R(x = R, t) = \mathcal{F}^R(x = R, t) = 0$$

to put $H_{N+1}^{\pm} = H_{N+2}^{\pm} = H_{N+3}^{\pm} = 0$.

6.3.3 Integration method

For the integral terms, we use a fifth order composite rule introduced in [121]. If f_k denotes an approximation of $f(x_k)$, the method can be written as

$$\int_{i\Delta x}^{j\Delta x} f(x) dx \simeq \Delta x \sum_{k=i}^j ' f_k$$

where

$$\begin{aligned} \sum_{k=i}^j ' f_k &= \frac{251}{720}f_i + \frac{299}{240}f_{i+1} + \frac{211}{240}f_{i+2} + \frac{739}{720}f_{i+3} \\ &+ \frac{739}{720}f_{j-3} + \frac{211}{240}f_{j-2} + \frac{299}{240}f_{j-1} + \frac{251}{720}f_j + \sum_{k=i+4}^{j-4} f_k \end{aligned}$$

if $j - i > 6$. This method is based on polynomial interpolations of the function f .

On the first interval, we integrate without using the boundary value $f_0 = 0$ because the solution can be discontinuous at $x = 0$. So we use the fifth accurate approximation

$$\sum_{k=0}^1 ' f_k = \frac{55}{24}f_1 - \frac{59}{24}f_2 + \frac{37}{24}f_3 - \frac{9}{24}f_4.$$

Finally for the intervals at the boundaries we have

$$\begin{aligned} \sum_0^2 ' f_k &= \frac{8}{3}f_1 - \frac{5}{3}f_2 + \frac{4}{3}f_3 - \frac{1}{3}f_4, \\ \sum_0^3 ' f_k &= \frac{21}{8}f_1 - \frac{9}{8}f_2 + \frac{15}{8}f_3 - \frac{3}{8}f_4, \\ \sum_0^4 ' f_k &= \frac{21}{8}f_1 - \frac{7}{6}f_2 + \frac{29}{12}f_3 + \frac{1}{6}f_4 - \frac{1}{24}f_5, \\ \sum_0^5 ' f_k &= \frac{21}{8}f_1 - \frac{7}{6}f_2 + \frac{19}{8}f_3 + \frac{17}{24}f_4 + \frac{1}{2}f_5 - \frac{1}{24}f_6, \\ \sum_0^6 ' f_k &= \frac{21}{8}f_1 - \frac{7}{6}f_2 + \frac{19}{8}f_3 + \frac{2}{3}f_4 + \frac{25}{24}f_5 + \frac{1}{2}f_6 - \frac{1}{24}f_7, \\ \sum_0^7 ' f_k &= \frac{21}{8}f_1 - \frac{7}{6}f_2 + \frac{19}{8}f_3 + \frac{2}{3}f_4 + f_5 + \frac{25}{24}f_6 + \frac{1}{2}f_7 - \frac{1}{24}f_8, \\ \sum_{N-1}^N ' f_k &= \frac{9}{4}f_N + \frac{19}{24}f_{N-1} - \frac{5}{24}f_{N-2} + \frac{1}{24}f_{N-3}, \\ \sum_{N-2}^N ' f_k &= \frac{1}{3}f_N + \frac{4}{3}f_{N-1} + \frac{1}{3}f_{N-2}, \end{aligned}$$

$$\begin{aligned} \sum_{N-3}^N {}' f_k &= \frac{1}{3}f_N + \frac{31}{24}f_{N-1} + \frac{7}{8}f_{N-2} + \frac{13}{24}f_{N-3} - \frac{1}{24}f_{N-4}, \\ \sum_{N-4}^N {}' f_k &= \frac{1}{3}f_N + \frac{31}{24}f_{N-1} + \frac{5}{6}f_{N-2} + \frac{13}{12}f_{N-3} + \frac{1}{2}f_{N-4} - \frac{1}{24}f_{N-5}, \\ \sum_{N-5}^N {}' f_k &= \frac{1}{3}f_N + \frac{31}{24}f_{N-1} + \frac{5}{6}f_{N-2} + \frac{25}{24}f_{N-3} + \frac{25}{24}f_{N-4} + \frac{1}{2}f_{N-5} - \frac{1}{24}f_{N-6}, \\ \sum_{N-6}^N {}' f_k &= \frac{1}{3}f_N + \frac{31}{24}f_{N-1} + \frac{5}{6}f_{N-2} + \frac{25}{24}f_{N-3} + f_{N-4} + \frac{25}{24}f_{N-5} + \frac{1}{2}f_{N-6} - \frac{1}{24}f_{N-7}. \end{aligned}$$

We use this quadrature method to discretize the operators \mathcal{C}^R and \mathcal{F}^R with

$$\mathcal{C}_i^R - \mathcal{F}_i^R = (\Delta x)^2 \sum_{j=0}^i {}' \sum_{l=i+1}^N {}' x_l (k_{j,l-j}^c u_j u_{l-j} - k_{j,l-j}^f u_l) \quad (6.21)$$

as suggested in [52]. Grouping the two terms in an unique summation is lighter regarding to operation counts.

6.3.4 Time discretization

The time step is denoted by Δt and changes along time because of the CFL stability condition that is time dependent. For the time discretization we choose a third order Runge-Kutta method. To approach the time evolution of an equation $\partial_t u = L(u)$, we compute at time $n\Delta t$

$$u^{(1)} = u^n + \Delta t L(u^n) \quad \text{and} \quad u^{(2)} = \frac{3}{4}u^n + \frac{1}{4}u^{(1)} + \frac{1}{4}\Delta t L(u^{(1)}),$$

where u^n is an approximation of $u(n\Delta t)$. Then the approximation of v at time $(n+1)\Delta t$ is given by

$$u^{n+1} = \frac{1}{3}u^n + \frac{2}{3}u^{(2)} + \frac{2}{3}\Delta t L(u^{(2)}).$$

This method is an explicit one, so to ensure the stability we compute the time step Δt at each iteration thanks to the CFL condition

$$\Delta t \leq \min \{(G + C + F)^{-1}\} \quad (6.22)$$

where

$$G = \frac{1}{\Delta x} \sup_i (\mathcal{G}_i^+ - \mathcal{G}_i^-), \quad C = \sup_i \left\{ \sum_{j=1}^N {}' k_{i,j}^c u_j \right\} \quad \text{and} \quad F = \sup_i \left\{ \frac{1}{2} \sum_{j=1}^{i-1} {}' k_{j,i-j}^f \right\}.$$

For instance the Lax-Friedrichs decomposition leads to $G_{\text{LF}} = m/\Delta x$.

Since we combine a fifth order WENO reconstruction and a third order time discretization, we predict that our scheme is convergent of third order. To validate it numerically, we compute the solution for different discretization grids with regular parameters and initial data. Comparing these solutions at time $T = 20$ in the L^∞ space norm (see Table 6.1 for the results), we obtain the numerical order 2.95 which validates the prediction.

Δx	5/40	5/80	5/160
error	81.84	12.44	1.37

Table 6.1: Error between different discrete solutions and the reference computed with $\Delta x = 5/320$.

6.4 Numerical Simulations

6.4.1 Parameters

Numerical values for the polymerization and fragmentation rates can be found in the biological literature (see [91, 119, 72] for instance). It is of importance to note that the models considered in these papers are discrete ones, so some computations are necessary to deduce adimensional numerical values for the continuous model (6.1). Another point is that the parameters of these models do not depend on the size of polymers, so we can only obtain mean values for the size-dependent parameters.

We choose to use the values of the recent paper [72] to do numerical simulations. The mean length of polymers for the initial distribution is estimated to be 1380. With the continuous model we reduce this value to 0.2 by considering an initial profile equal to a positive constant on $[0, 0.4]$ and null for $x > 0.4$ (see the first plot of Figure 6.5). Thus we define a parameter $\varepsilon = 0.2/1380 \approx 1,4 \times 10^{-4}$ which allows to go from a discrete model to a continuous one (see [38] for more details). The values we find are for instance $2.9 \times 10^{-2} \mu M^{-1} s^{-1}$ for the polymerization rate and $2.1 \times 10^{-9} s^{-1}$ for the fragmentation (where M represents the concentration in *mol* and s the time in *second*). The polymerization rate appears in a derivative term, so the value of the discrete model has to be multiplied by ε to obtain the continuous accurate value $4 \times 10^{-6} \mu M^{-1} s^{-1}$. Conversely, the fragmentation rate which appears in an integral term has to be divided by ε and we find $1.5 \times 10^{-5} s^{-1}$. Concerning the depolymerization and coagulation, they are neglected in the models of [91, 119, 72]. So we consider numerical values that seem to be reasonable compared to the previous ones.

In the present study, the parameters are assumed to be size dependent as suggested in [19, 20] and their choice is now presented and motivated. Concerning the numerical coefficients, they are chosen in order to have mean values of the same order than the values previously obtained from [72].

For the polymerization we assume that small polymers have a different behavior compared to the big ones. We consider a critical size $x_c = 0.5$ such that polymers of size $x < x_c$ convert monomers with the rate

$$k_{\text{on}}^{(1)}(x) = (4x + 0.2) \times 10^{-6} \mu M^{-1} s^{-1},$$

and for $x > x_c$ with a constant rate

$$k_{\text{on}}^{(2)}(x) \equiv 4 \times 10^{-6} \mu M^{-1} s^{-1}.$$

For the fragmentation kernel, we use the classical assumption that the fragmentation probability depends only on the size $x + y$ of the polymer and we set

$$k_{\text{f}}(x, y) = \frac{80(x + y)}{10 + (x + y)} \times 10^{-5} s^{-1}.$$

The depolymerization is assumed to be constant and of the same order as the fragmentation. We discuss the dependence on this parameter by considering different intensities

$$k_{\text{off}}(x) \equiv \eta \times 10^{-6} s^{-1} \quad \text{with } 2 \leq \eta \leq 8. \quad (6.23)$$

Concerning the coagulation kernel, we do not use a classical one. Even if there is no space in model (6.1), we use a kernel which reflect some space effects. Indeed we consider that small polymers are very mobile and that the big ones, plaques, are very attractant. So the coagulation occurs preferentially between big and small aggregates. The kernel we choose is of the form

$$k_{\text{c}}(x, y) = \frac{4|x - y|^{\frac{3}{2}}}{1 + (x + y)} \times 10^{-6} \mu M^{-1} s^{-1}.$$

This kernel satisfies the growth assumption that we can find in [42] to ensure the convergence of the solution when $R \rightarrow \infty$ if we consider the only coagulation-fragmentation process.

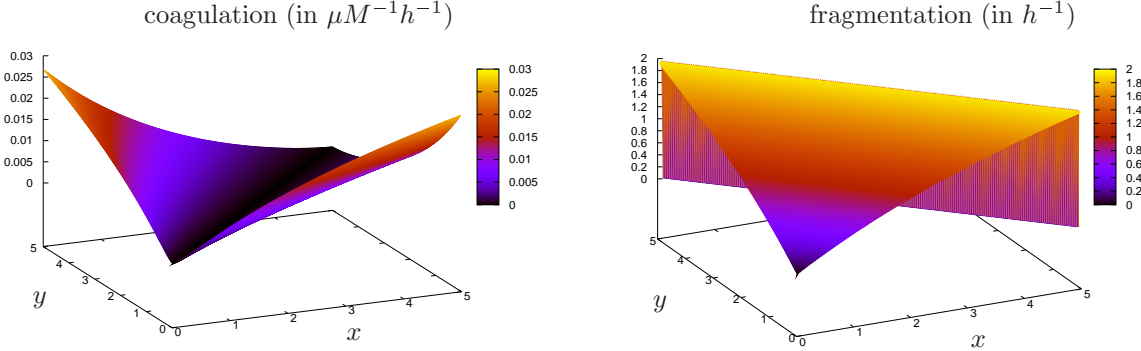

Figure 6.2: Profiles of the coagulation and fragmentation kernels.

In [72] we also find numerical values for the initial data $V_0 = 98 \mu M$ and $\int_0^R x u_0(x) dx = 0.21 \mu M$. This last value and the fact that the initial distribution of polymers is assumed to be under the form $u_0 = cst \times \mathbb{1}_{[0,0.4]}$ lead to

$$u_0(x) = \begin{cases} 2.6 & \text{if } 0 \leq x \leq 0.4 \\ 0 & \text{if } x > 0.4. \end{cases} \quad (6.24)$$

For the following simulations, the discretization is made on a domain $[0, 5]$ with a number of nodes $N = 200$, so the mesh size is $\Delta x = 0.025$.

6.4.2 Choice among the different flux splittings

First we deal with the CFL condition. Thanks to the triangular inequality, we obtain that $G_{LF} \leq G_0$. Moreover, there is an explicit expression for G_λ

$$G_\lambda^n = \frac{1}{\Delta x} \sup_i \left\{ \left(V_0 + \Delta x \sum_{j=1}^N ' x_j u_j^0 + (2\lambda - 1) \Delta x \sum_{j=1}^N ' x_j u_j^n \right) k_i^{on} + k_i^{off} \right\}$$

which shows that G_λ increases with λ . So if $0 \leq \lambda < \Lambda \leq 1$ then at each time step we have $G_{LF}^n \leq G_\lambda^n \leq G_\Lambda^n$. Notice also that, with the numerical values we have chosen, the quantity of polymers $\Delta x \sum_{j=1}^N ' x_j u_j^n$ increases with n . Indeed we can see in Figure 6.8 that the quantity of monomers $V^n \simeq V(n\Delta t)$ defined by the mass conservation $V^n + \Delta x \sum_{j=1}^N ' x_j u_j^n = V_0 + \Delta x \sum_{j=1}^N ' x_j u_j^0$ decreases. The consequence on the CFL condition is that G_λ^n increases with n if $\lambda > \frac{1}{2}$, decreases if $\lambda < \frac{1}{2}$ and is time independent when $\lambda = \frac{1}{2}$. Thus, regarding to the numerical computation, the fastest scheme is the Lax-Friedrichs one and then the computation time increases significantly with λ .

Let us now turn to the effects of the flux splitting on the size distribution. First we consider a depolymerization corresponding to $\eta = 8$ in (6.23) and investigate the differences between the solutions associated to the decompositions \mathcal{G}_{LF} , \mathcal{G}_0 and \mathcal{G}_1 . We can see in Figure 6.3 that the solutions for \mathcal{G}_0 and \mathcal{G}_1 are close together for small times and then the behavior of \mathcal{G}_0 becomes closer to the Lax-Friedrichs one. The less oscillating scheme for $t = 6h$ is the the Lax-Friedrichs one, but it is also the most oscillating at time $t = 12h$. Finally the solutions associated to the three flux decompositions are quite similar and

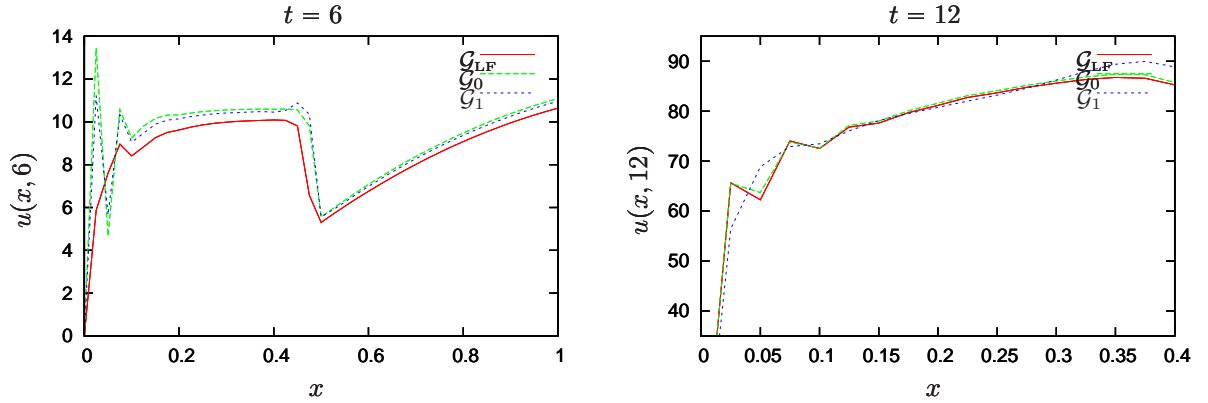

Figure 6.3: Comparison between the flux splittings \mathcal{G}_{LF} , \mathcal{G}_0 and \mathcal{G}_1 for $\eta = 8 \times 10^{-6} \text{s}^{-1}$.

they all present oscillations at some times, so we do not find with this simulation any reason to discard one of them.

If we change the depolymerization rate by considering $k_{\text{off}} = 6 \times 10^{-6} \text{s}^{-1}$, we remark that the Lax-Friedrichs scheme is unstable (see Figure 6.4) while \mathcal{G}_0 is stable. If we continue to decrease η , we find with $k_{\text{off}} = 2 \times 10^{-6} \text{s}^{-1}$ that the \mathcal{G}_0 -scheme becomes unstable while $\mathcal{G}_{0.2}$ is stable. Thus the Lax-Friedrichs scheme and the \mathcal{G}_λ -schemes with λ small has to be avoided to ensure stability when small depolymerization values are considered.

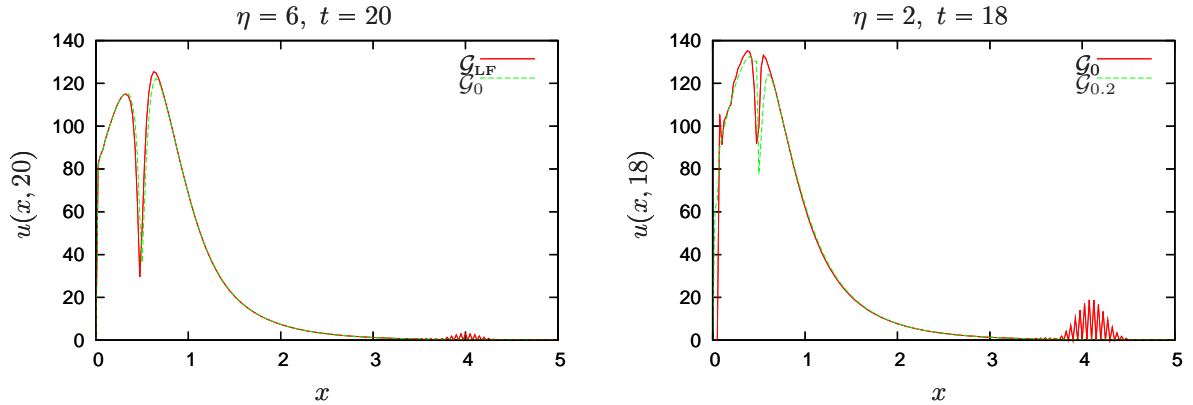

Figure 6.4: Unstability of some schemes when η decreases. Left: \mathcal{G}_{LF} becomes unstable for $\eta = 6$. Right: \mathcal{G}_0 becomes unstable for $\eta = 2$.

Knowing that, we compare different stable schemes, namely \mathcal{G}_λ with $0.2 \leq \lambda \leq 1$. We can see in Figure 6.5 that for large times ($t = 20h$), the three flux decompositions provide a good behavior where there are strong variations of the solution. These locations are $x = 0$ because of the boundary condition which enforces $u(t, 0)$ to vanish, and $x = 0.5$ because the transport term k_{on} is discontinuous at $x = 0.5$. If we look at smaller times ($t = 6h$ for instance) we can see that the larger λ is, the less oscillating the curves are. But, as we already remarked, the quantity G_λ is higher for λ close to 1 and it increases with time when $\lambda > \frac{1}{2}$. Thus it is penalizing for the computation time to use high values of λ . A good compromise could be to choose $\lambda = \frac{1}{2}$ since $G_{\frac{1}{2}}$ does not depend on time. The other solution is to adapt the λ when we change the parameters.

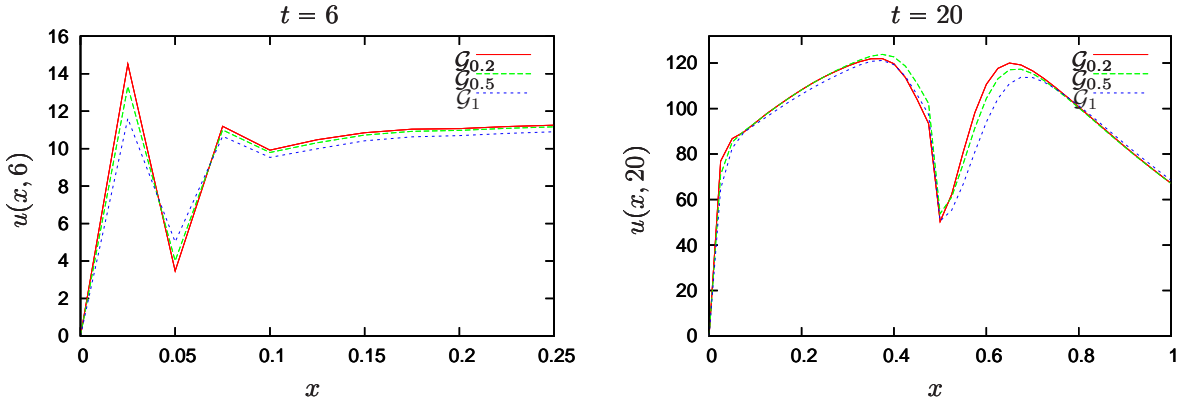

Figure 6.5: Comparison of the behavior of the solution for different λ with $\eta = 5$.

6.4.3 Interpretation of the numerical results

We have considered that the mean size of the polymers at the initial time $t = 0$ was 1380. This size can be multiplied by 5 along the polymerization process (see Figure 6.6 keeping in mind that the mean size is represented by 0.2 in this continuous model). So if we want to solve the discrete model, we have to consider a system of dimension close to 5000, and the computations are very heavy. If we limit this value to 200 keeping the discrete model, then we lose a lot of precision. It is the same for the continuous model if it is discretized with a first order scheme. That is why we use a high order discretization, and we can see the difference in Figures 6.6 and 6.7 : the high order scheme is able to capture strong variations of amplitude while the first order flattens them. We also remark that the size repartition converges to a bimodal distribution, as observed by [124]. This asymptotic profile is independent of the initial data (see the time $t = 20$ in Figures 6.6 and 6.7) and can be seen as an eigenvector of the operator $\mathcal{Q} - \partial_x \mathcal{T}$ (see [95, 41]).

The evolution of the quantity of monomers $V(t)$ is plotted in Figure 6.8 for different values of the depolymerization rate k_{off} . This quantity decreases since the monomers aggregate to polymers. Thus the mass of polymers increases and the speed of this evolution is similar to those observed by [72]. Concerning the dependence on k_{off} , the difference between the three curves is more significant when the time increases. For small times, when $V(t)$ is close to $V_0 = 98\mu M$, the depolymerization can be neglected since k_{off} is small compared to the product $V(t)k_{\text{on}}(x)$. Conversely, the equilibrium is reached when $\frac{d}{dt}V(t) = 0$, so when $k_{\text{off}} \simeq V k_{\text{on}}$ (see Equation (6.1)). That is why variations of η influence essentially the ratio between the quantity of monomers and the mass of polymers at the equilibrium as we can see in Figure 6.8.

6.5 Conclusion and future work

We have written a high order conservative scheme for a polymerization-type equation. The choice of the flux splitting for the transport term has been discussed but the accurate decomposition remains unclear. It seems that instabilities can be avoided by adapting the value of λ but the oscillations remain present for any choice of the flux decomposition, even for a regular initial size distribution. A possible explanation for these phenomena can be that the integration method is not “positive” for the intervals at the boundaries. These points remain to be investigated for a better understanding and improvement.

As we have remarked in Section 6.4.3, the size distribution converges toward an equilibrium which corresponds to an eigenvector. The high-order WENO scheme presented in this paper could be used to numerically compute such eigenvectors. Another application of the code is to solve inverse problems (see [40, 114]) in order to determine the size dependence of the different parameters.

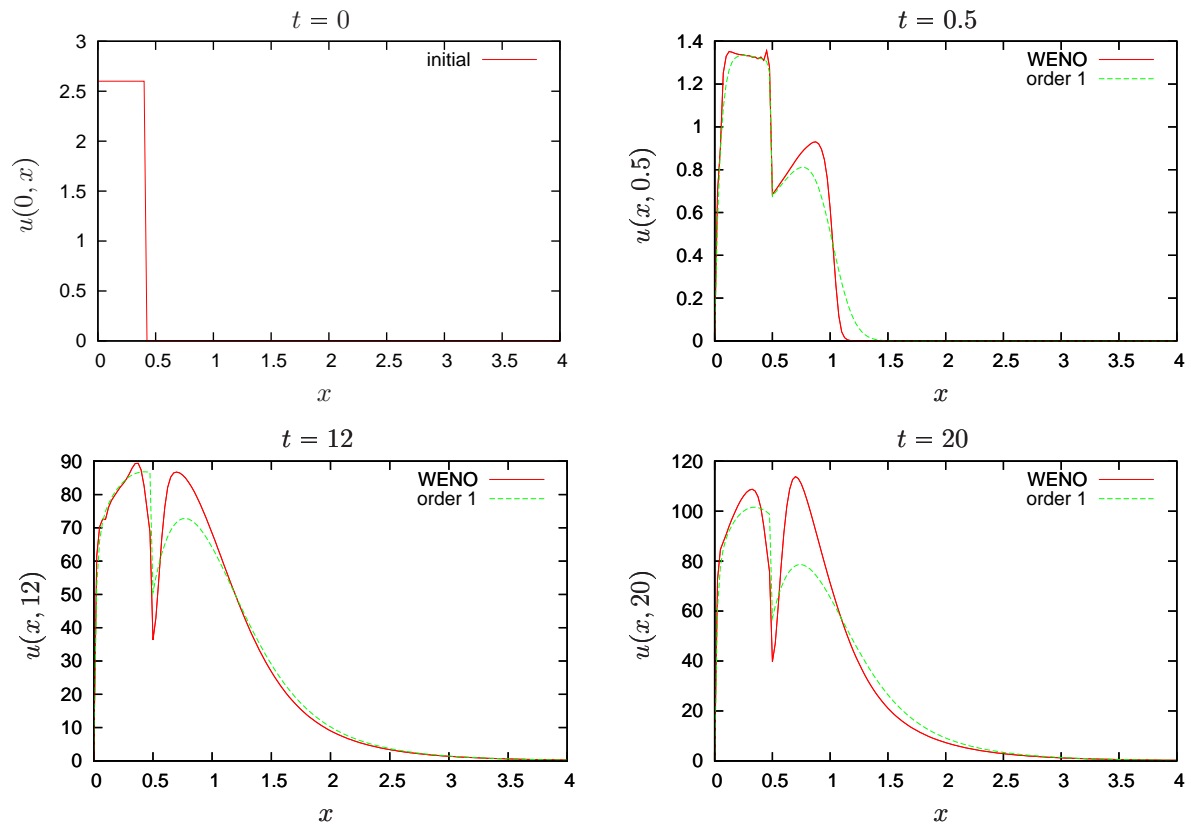

Figure 6.6: Comparison between the WENO scheme and a first order scheme for the initial size distribution (6.24), with the depolymerization value $k_{\text{off}} = 8 \times 10^{-6} \text{s}^{-1}$ and the flux splitting parameter $\lambda = 0.5$

Acknowledgement

The authors are thankful to Vincent Calvez, Marie Doumic Jauffret, Frédéric Lagoutière and Natacha Lenuzza for their help and support during the Cemracs'09 research session.

This work has been done with the financial supports of

- the ANR contract TOPPAZ, allocation grant No. 4243, <http://www-roc.inria.fr/bang/TOPPAZ/>

- the CEA-Institute of Emerging Diseases and Innovative Therapies, Route du Panorama, Bat.60, F-92265 Fontenay-aux-Roses.

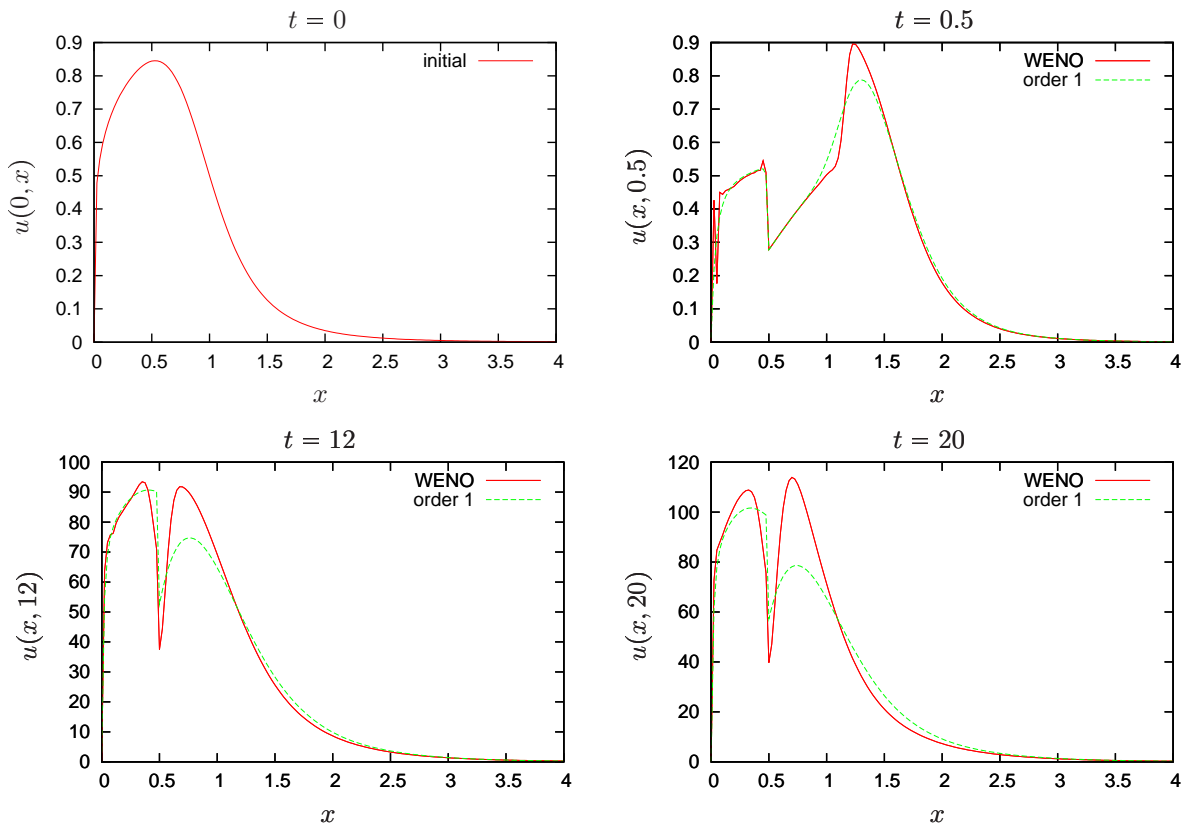

Figure 6.7: Comparison between the WENO scheme and a first order scheme for a regular initial size distribution, with the depolymerization value $k_{\text{off}} = 8 \times 10^{-6} \text{s}^{-1}$ and the flux splitting parameter $\lambda = 0.5$

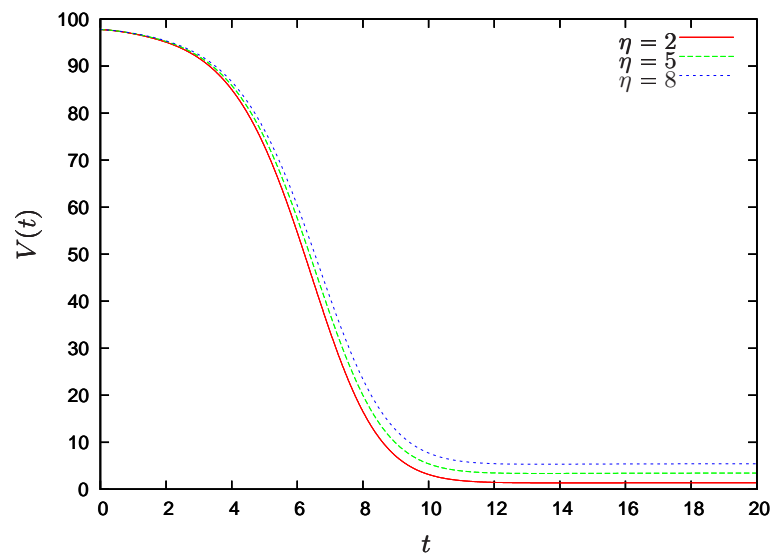

Figure 6.8: Evolution of the quantity of monomers for different depolymerization rates, with the scheme $\mathcal{G}_{0.2}$.

Bibliographie

- [1] M. Adimy, F. Crauste, M. L. Hbid, and R. Qesmi. Stability and Hopf bifurcation for a cell population model with state-dependent delay. *SIAM J. Appl. Math.*, 70(5) :1611–1633, 2010.
- [2] M. Adimy and L. Pujo-Menjouet. Asymptotic behaviour of a singular transport equation modelling cell division. *Dis. Cont. Dyn. Sys. Ser. B*, 3(3) :439–456, 2003.
- [3] F. Baccelli, D. R. McDonald, and J. Reynier. A mean-field model for multiple tcp connections through a buffer implementing red. *Performance Evaluation*, 49(1-4) :77 – 97, 2002.
- [4] J. Banasiak and W. Lamb. On a coagulation and fragmentation equation with mass loss. *Proc. Roy. Soc. Edinburgh Sect. A*, 136(6) :1157–1173, 2006.
- [5] H. Banks, F. Charles, M. Doumic, K. Sutton, and W. Thompson. Label structured cell proliferation models. *App. Math. Letters*, 23(12) :1412–1415, 2010.
- [6] H. Banks, K. Sutton, W. Thompson, G. Bocharov, D. Roosec, T. Schenkeld, and A. Meyerhanse. Estimation of cell proliferation dynamics using cfse data. *Bull. of Math. Biol.*, 2010.
- [7] V. Bansaye. Proliferating parasites in dividing cells : Kimmel’s branching model revisited. *Ann. Appl. Probab.*, 18(3) :967–996, 2008.
- [8] V. Bansaye and V. C. Tran. Branching feller diffusion for cell division with parasite infection. *ALEA*, to appear.
- [9] B. Basse, B. Baguley, E. Marshall, W. Joseph, B. van Brunt, G. Wake, and D. J. N. Wall. A mathematical model for analysis of the cell cycle in cell lines derived from human tumors. *J. Math. Biol.*, 47(4) :295–312, 2003.
- [10] F. Bekkal Brikci, J. Clairambault, and B. Perthame. Analysis of a molecular structured population model with possible polynomial growth for the cell division cycle. *Math. Comput. Modelling*, 47(7-8) :699–713, 2008.
- [11] F. Bekkal Brikci, J. Clairambault, B. Ribba, and B. Perthame. An age-and-cyclin-structured cell population model for healthy and tumoral tissues. *J. Math. Biol.*, 57(1) :91–110, 2008.
- [12] S. Bertoni. Periodic solutions for non-linear equations of structured populations. *J. Math. Anal. Appl.*, 220(1) :250–267, 1998.
- [13] T. Biben, J.-C. Geminard, and F. Melo. Dynamics of Bio-Polymeric Brushes Growing from a Cellular Membrane : Tentative Modelling of the Actin Turnover within an Adhesion Unit ; the Podosome. *J. Biol. Phys.*, 31 :87–120, 2005.
- [14] H. Brezis. *Analyse fonctionnelle*. Collection Mathématiques Appliquées pour la Maîtrise. [Collection of Applied Mathematics for the Master’s Degree]. Masson, Paris, 1983. Théorie et applications. [Theory and applications].

- [15] M. J. Cáceres, J. A. Cañizo, and S. Mischler. Rate of convergence to an asymptotic profile for the self-similar fragmentation and growth-fragmentation equations. To appear in *J. Math. Pures Appl.*, 2011.
- [16] B. Cajavec, S. Bernard, and H. Herzel. Aggregation in huntington's disease : insights through modelling. *Genome Inform.*, 16(1) :120–129, 2005.
- [17] V. Calvez, M. Doumic Jauffret, and P. Gabriel. Self-similarity in a general aggregation-fragmentation problem ; application to fitness analysis. preprint, arXiv :1011.5468, November 2010.
- [18] V. Calvez and P. Gabriel. Optimal control for a discrete aggregation-fragmentation model. in preparation.
- [19] V. Calvez, N. Lenuzza, M. Doumic, J.-P. Deslys, F. Mouthon, and B. Perthame. Prion dynamic with size dependency - strain phenomena. *J. of Biol. Dyn.*, 4(1) :28–42, 2010.
- [20] V. Calvez, N. Lenuzza, D. Oelz, J.-P. Deslys, P. Laurent, F. Mouthon, and B. Perthame. Size distribution dependence of prion aggregates infectivity. *Math. Biosci.*, 1 :88–99, 2009.
- [21] J. A. Carrillo and T. Goudon. A numerical study on large-time asymptotics of the Lifshitz-Slyozov system. *J. Sci. Comput.*, 20(1) :69–113, 2004.
- [22] J. Castilla, P. Saá, C. Hetz, and C. Soto. In vitro generation of infectious scrapie prions. *Cell*, 121(2) :195–206, 2005.
- [23] J. Clairambault, S. Gaubert, and T. Lepoutre. Comparison of Perron and Floquet eigenvalues in age structured cell division cycle models. *Math. Model. Nat. Phenom.*, 4(3) :183–209, 2009.
- [24] J. Clairambault, S. Gaubert, and T. Lepoutre. Circadian rhythm and cell population growth. *Math. Comput. Modelling*, 53(7-8) :1558–1567, 2011.
- [25] J. Clairambault, S. Gaubert, and B. Perthame. An inequality for the Perron and Floquet eigenvalues of monotone differential systems and age structured equations. *C. R. Math. Acad. Sci. Paris*, 345(10) :549–554, 2007.
- [26] J. Clairambault, P. Michel, and B. Perthame. Circadian rhythm and tumour growth. *C. R. Math. Acad. Sci. Paris*, 342(1) :17–22, 2006.
- [27] J. Clairambault, P. Michel, and B. Perthame. A mathematical model of the cell cycle and its circadian control. In I. Deutsch, L. Bruschi, H. Byrne, G. de Vries, and H. Herzel, editors, *Mathematical Modeling of Biological Systems*, volume 1, pages 247–259. Birkhäuser, 2007.
- [28] J.-F. Collet and T. Goudon. Lifshitz-Slyozov equations : the model with encounters. *Transport Theory Statist. Phys.*, 28(6) :545–573, 1999.
- [29] J.-F. Collet and T. Goudon. On solutions of the Lifshitz-Slyozov model. *Nonlinearity*, 13(4) :1239–1262, 2000.
- [30] J.-F. Collet, T. Goudon, and A. Vasseur. Some remarks on large-time asymptotic of the Lifshitz-Slyozov equations. *J. Statist. Phys.*, 108(1-2) :341–359, 2002.
- [31] J. Collinge and A. R. Clarke. A General Model of Prion Strains and Their Pathogenicity. *Science*, 318(5852) :930–936, 2007.
- [32] D. L. Craft, L. M. Wein, and D. J. Selkoe. A mathematical model of the impact of novel treatments on the a[β]burden in the alzheimer's brain, csf and plasma. *Bulletin of Mathematical Biology*, 64(5) :1011 – 1031, 2002.
- [33] J. M. Cushing. Bifurcation of time periodic solutions of the McKendrick equations with applications to population dynamics. *Comput. Math. Appl.*, 9(3) :459–478, 1983. Hyperbolic partial differential equations.

-
- [34] O. Destaing, F. Saltel, J.-C. Geminard, P. Jurdic, and F. Bard. Podosomes Display Actin Turnover and Dynamic Self- Organization in Osteoclasts Expressing Actin-Green Fluorescent Protein. *Mol. Biol. of the Cell*, 14 :407–416, 2003.
- [35] A. Devys, T. Goudon, and P. Lafitte. A model describing the growth and the size distribution of multiple metastatic tumors.
- [36] O. Diekmann, M. Gyllenberg, and J. A. J. Metz. Steady-state analysis of structured population models. *Theoretical Population Biology*, 63 :309–338, 2003.
- [37] M. Doumic. Analysis of a population model structured by the cells molecular content. *Math. Model. Nat. Phenom.*, 2(3) :121–152, 2007.
- [38] M. Doumic, T. Goudon, and T. Lepoutre. Scaling limit of a discrete prion dynamics model. *Comm. Math. Sci.*, 7(4) :839–865, 2009.
- [39] M. Doumic, P. Maia, and J. Zubelli. On the calibration of a size-structured population model from experimental data. *Acta Biotheoretica*, 2010.
- [40] M. Doumic, B. Perthame, and J. Zubelli. Numerical solution of an inverse problem in size-structured population dynamics. *Inverse Problems*, 25(electronic version) :045008, 2009.
- [41] M. Doumic Jauffret and P. Gabriel. Eigenelements of a general aggregation-fragmentation model. *Math. Models Methods Appl. Sci.*, 20(5) :757–783, 2010.
- [42] P. B. Dubovskii and I. W. Stewart. Existence, uniqueness and mass conservation for the coagulation-fragmentation equation. *Math. Methods Appl. Sci.*, 19(7) :571–591, 1996.
- [43] H. Engler, J. Prüss, and G. Webb. Analysis of a model for the dynamics of prions ii. *J. Math. Anal. Appl.*, 324(1) :98–117, 2006.
- [44] M. Escobedo, P. Laurençot, S. Mischler, and B. Perthame. Gelation and mass conservation in coagulation-fragmentation models. *J. Differential Equations*, 195(1) :143–174, 2003.
- [45] M. Escobedo and S. Mischler. Dust and self-similarity for the Smoluchowski coagulation equation. *Ann. Inst. H. Poincaré Anal. Non Linéaire*, 23(3) :331–362, 2006.
- [46] M. Escobedo, S. Mischler, and B. Perthame. Gelation in coagulation and fragmentation models. *Comm. Math. Phys.*, 231(1) :157–188, 2002.
- [47] M. Escobedo, S. Mischler, and M. Rodriguez Ricard. On self-similarity and stationary problem for fragmentation and coagulation models. *Ann. Inst. H. Poincaré Anal. Non Linéaire*, 22(1) :99–125, 2005.
- [48] L. C. Evans. An introduction to mathematical optimal control theory. <http://math.berkeley.edu/~evans/>.
- [49] J. Z. Farkas. Stability conditions for a nonlinear size-structured model. *Nonlin. Anal. Real World Appl.*, 6 :962–969, 2005.
- [50] J. Z. Farkas and T. Hagen. Stability and regularity results for a size-structured population model. *J. Math. Anal. Appl.*, 328(1) :119 – 136, 2007.
- [51] J. Z. Farkas and T. Hagen. Asymptotic analysis of a size-structured cannibalism model with infinite dimensional environmental feedback. *Comm. Pure Appl. Anal.*, 8 :1825–1839, 2009.
- [52] F. Filbet. An asymptotically stable scheme for diffusive coagulation-fragmentation models. *Commun. Math. Sci.*, 6(2) :257–280, 2008.
- [53] F. Filbet and P. Laurençot. Numerical approximation of the Lifshitz-Slyozov-Wagner equation. *SIAM J. Numer. Anal.*, 41(2) :563–588 (electronic), 2003.

- [54] F. Filbet and P. Laurençot. Mass-conserving solutions and non-conservative approximation to the Smoluchowski coagulation equation. *Arch. Math. (Basel)*, 83(6) :558–567, 2004.
- [55] F. Filbet and P. Laurençot. Numerical simulation of the Smoluchowski coagulation equation. *SIAM J. Sci. Comput.*, 25(6) :2004–2028 (electronic), 2004.
- [56] J.-P. Francoise. *Oscillations en biologie*, volume 46 of *Mathématiques & Applications (Berlin) [Mathematics & Applications]*. Springer-Verlag, Berlin, 2005. Analyse qualitative et modèles. [Qualitative analysis and models].
- [57] H. Fraser and A. G. Dickinson. Scrapie in mice : Agent-strain differences in the distribution and intensity of grey matter vacuolation. *Journal of Comparative Pathology*, 83(1) :29 – 40, 1973.
- [58] P. Gabriel. Long-time asymptotics for nonlinear growth-fragmentation equations. preprint, arXiv :1102.2871, February 2011.
- [59] P. Gabriel. The shape of the polymerization rate in the prion equation. *Math. Comput. Modelling*, 53(7-8) :1451–1456, 2011.
- [60] P. Gabriel and L. M. Tine. High-order WENO scheme for polymerization-type equations. *ESAIM Proc.*, 30 :54–70, 2010.
- [61] T. Goudon. Compactness in L^p spaces. <http://math.univ-lille1.fr/~goudon/talks.html>.
- [62] T. Goudon, F. Lagoutière, and L. M. Tine. The Lifschitz-Slyozov equation with space-diffusion of monomers. preprint, HAL :inria-00539391.
- [63] M. L. Greer, L. Pujo-Menjouet, and G. F. Webb. A mathematical analysis of the dynamics of prion proliferation. *J. Theoret. Biol.*, 242(3) :598–606, 2006.
- [64] M. L. Greer, P. van den Driessche, L. Wang, and G. F. Webb. Effects of general incidence and polymer joining on nucleated polymerization in a model of prion proliferation. *SIAM J. Appl. Math.*, 68(1) :154–170, 2007.
- [65] J. S. Griffith. Nature of the scrapie agent : Self-replication and scrapie. *Nature*, 215(5105) :1043–1044, 1967.
- [66] M. Gyllenberg and G. F. Webb. A Nonlinear Structured Population Model of Tumor Growth With Quiescence. *J. Math. Biol.*, 28 :671–694, 1990.
- [67] M. Herrmann, P. Laurençot, and B. Niethammer. Self-similar solutions with fat tails for a coagulation equation with nonlocal drift. *Comptes Rendus Mathématique*, 347(15-16) :909 – 914, 2009.
- [68] J. Hofbauer and K. Sigmund. *The theory of evolution and dynamical systems*, volume 7 of *London Mathematical Society Student Texts*. Cambridge University Press, Cambridge, 1988. Mathematical aspects of selection, Translated from the German.
- [69] F. Hoppensteadt. *Mathematical theories of populations : demographics, genetics and epidemics*. Society for Industrial and Applied Mathematics, Philadelphia, Pa., 1975. Regional Conference Series in Applied Mathematics.
- [70] M. Iannelli. *Mathematical theory of age-structured population dynamics*, volume 7 of *Applied mathematics monographs C.N.R.* Giardini editori e stampatori, Pisa, 1995.
- [71] J. T. Jarrett and P. T. Lansbury. Seeding "one-dimensional crystallization" of amyloid : A pathogenic mechanism in alzheimer's disease and scrapie? *Cell*, 73(6) :1055 – 1058, 1993.
- [72] T. P. J. Knowles, C. A. Waudby, G. L. Devlin, S. I. A. Cohen, A. Aguzzi, M. Vendruscolo, E. M. Terentjev, M. E. Welland, and C. M. Dobson. An Analytical Solution to the Kinetics of Breakable Filament Assembly. *Science*, 326(5959) :1533–1537, 2009.

-
- [73] T. Kostova and J. Li. Oscillations and stability due to juvenile competitive effects on adult fertility. *Computers & Mathematics with Applications*, 32(11) :57 – 70, 1996. BIOMATH-95.
- [74] P. Laurençot and S. Mischler. The continuous coagulation-fragmentation equations with diffusion. *Archive for Rational Mechanics and Analysis*, 162 :45–49, 2002.
- [75] P. Laurençot and S. Mischler. From the discrete to the continuous coagulation-fragmentation equations. *Proc. Roy. Soc. Edinburgh Sect. A*, 132(5) :1219–1248, 2002.
- [76] P. Laurençot and S. Mischler. Convergence to equilibrium for the continuous coagulation-fragmentation equation. *Bull. Sci. Math.*, 127(3) :179–190, 2003.
- [77] P. Laurençot and S. Mischler. On coalescence equations and related models. In *Modeling and computational methods for kinetic equations*, Model. Simul. Sci. Eng. Technol., pages 321–356. Birkhäuser Boston, Boston, MA, 2004.
- [78] P. Laurençot and S. Mischler. Liapunov functionals for Smoluchowski’s coagulation equation and convergence to self-similarity. *Monatsh. Math.*, 146(2) :127–142, 2005.
- [79] P. Laurençot and B. Perthame. Exponential decay for the growth-fragmentation/cell-division equation. *Commun. Math. Sci.*, 7(2) :503–510, 2009.
- [80] P. Laurençot and C. Walker. Well-posedness for a model of prion proliferation dynamics. *J. Evol. Equ.*, 7(2) :241–264, 2007.
- [81] G. Legname, H.-O. B. Nguyen, I. V. Baskakov, F. E. Cohen, S. J. DeArmond, and S. B. Prusiner. Strain-specified characteristics of mouse synthetic prions. *Proceedings of the National Academy of Sciences of the United States of America*, 102(6) :2168–2173, 2005.
- [82] G. Legname, H.-O. B. Nguyen, D. Peretz, F. E. Cohen, S. J. DeArmond, and S. B. Prusiner. Continuum of prion protein structures enciphers a multitude of prion isolate-specified phenotypes. *Proceedings of the National Academy of Sciences*, 103(50) :19105–19110, 2006.
- [83] N. Lenuzza. *Modélisation de la réplication des Prions : implication de la dépendance en taille des agrégats de PrP et de l’hétérogénéité des populations cellulaires*. PhD thesis, Paris, 2009.
- [84] T. Lepoutre. *Analyse et modélisation de phénomènes de croissance et mouvement issus de la biologie*. PhD thesis, Paris, 2009.
- [85] A. B. Lindner, R. Maden, A. Demarez, E. J. Stewart, and F. Taddei. Asymmetric segregation of protein aggregates is associated with cellular aging and rejuvenation. *PNAS*, 105(8) :3076–3081, 2008.
- [86] Z. Liu, P. Magal, and S. Ruan. Hopf bifurcation for non-densely defined Cauchy problems. *Zeitschrift für Angewandte Mathematik und Physik*, doi :10.1007/s00033-010-0088-x, 2010.
- [87] A. Lomakin, D. B. Teplow, D. A. Kirschner, and G. B. Benedek. Kinetic theory of fibrillogenesis of amyloid β -protein. *Proceedings of the National Academy of Sciences of the United States of America*, 94(15) :7942–7947, 1997.
- [88] P. Magal, P. Hinow, F. Le Foll, and G. F. Webb. Analysis of a model for transfer phenomena in biological populations. *SIAM J. Appl. Math.*, 70 :40–62, 2009.
- [89] P. Magal and S. Ruan. Center manifolds for semilinear equations with non-dense domain and applications to Hopf bifurcation in age structured models. *Mem. Amer. Math. Soc.*, 202(951) :vi+71, 2009.
- [90] P. Magal and S. Ruan. Sustained oscillations in an evolutionary epidemiological model of influenza A drift. *Proc. R. Soc. Lond. Ser. A Math. Phys. Eng. Sci.*, 466(2116) :965–992, 2010.

-
- [91] J. Masel, N. Genoud, and A. Aguzzi. Efficient inhibition of prion replication by prp-fc2 suggests that the prion is a prpsc oligomer. *Journal of Molecular Biology*, 345(5) :1243 – 1251, 2005.
- [92] J. Masel, V. Jansen, and M. Nowak. Quantifying the kinetic parameters of prion replication. *Biophysical Chemistry*, 77(2-3) :139 – 152, 1999.
- [93] J. Masel and V. A. Jansen. Designing drugs to stop the formation of prion aggregates and other amyloids. *Biophysical Chemistry*, 88(1-3) :47 – 59, 2000.
- [94] J. A. J. Metz and O. Diekmann, editors. *The dynamics of physiologically structured populations*, volume 68 of *Lecture Notes in Biomathematics*. Springer-Verlag, Berlin, 1986. Papers from the colloquium held in Amsterdam, 1983.
- [95] P. Michel. Existence of a solution to the cell division eigenproblem. *Math. Models Methods Appl. Sci.*, 16(7, suppl.) :1125–1153, 2006.
- [96] P. Michel. Optimal proliferation rate in a cell division model. *Math. Model. Nat. Phenom.*, 1(2) :23–44, 2006.
- [97] P. Michel. General Relative Entropy in a nonlinear McKendrick model. In G.-Q. Chen, E. Hsu, and M. Pinsky, editors, *Stochastic Analysis and Partial Differential Equations*, volume 429, pages 205–232. AMS : Contemporary Mathematics, 2007.
- [98] P. Michel, S. Mischler, and B. Perthame. General entropy equations for structured population models and scattering. *C. R. Math. Acad. Sci. Paris*, 338(9) :697–702, 2004.
- [99] P. Michel, S. Mischler, and B. Perthame. General relative entropy inequality : an illustration on growth models. *J. Math. Pures Appl. (9)*, 84(9) :1235–1260, 2005.
- [100] S. Mischler, B. Perthame, and L. Ryzhik. Stability in a nonlinear population maturation model. *Math. Models Methods Appl. Sci.*, 12(12) :1751–1772, 2002.
- [101] S. Mischler and M. Rodriguez Ricard. Existence globale pour l'équation de Smoluchowski continue non homogène et comportement asymptotique des solutions. *C. R. Math. Acad. Sci. Paris*, 336(5) :407–412, 2003.
- [102] R. Morales, K. Abid, and C. Soto. The prion strain phenomenon : Molecular basis and unprecedented features. *Biochimica et Biophysica Acta (BBA) - Molecular Basis of Disease*, 1772(6) :681 – 691, 2007. Prion-Related Disorders.
- [103] B. Niethammer and R. Pego. The LSW model for domain coarsening : asymptotic behavior for conserved total mass. *J. Statist. Phys.*, 104(5-6) :1113–1144, 2001.
- [104] B. Niethammer and R. Pego. Well-posedness for measure transport in a family of nonlocal domain coarsening models. *Indiana Univ. Math. J.*, 54(2) :499–530, 2005.
- [105] B. Niethammer and J. J. L. Velázquez. Global well-posedness for an inhomogeneous LSW-model in unbounded domains. *Math. Ann.*, 328(3) :481–501, 2004.
- [106] B. Niethammer and J. J. L. Velázquez. On the convergence to the smooth self-similar solution in the LSW model. *Indiana Univ. Math. J.*, 55(2) :761–794, 2006.
- [107] K. Pakdaman, B. Perthame, and D. Salort. Dynamics of a structured neuron population. (submitted), 2009.
- [108] M. M. Pallitto and R. M. Murphy. A mathematical model of the kinetics of [beta]-amyloid fibril growth from the denatured state. *Biophysical Journal*, 81(3) :1805 – 1822, 2001.
- [109] A. Perasso, B. Laroche, and S. Touzeau. Identifiability analysis of an epidemiological model in a structured population. Technical report, INRA, UR341 Mathématiques et Informatique Appliquées, F-78350 Jouy-en Josas, France, août 2009.

-
- [110] B. Perthame. *Transport equations in biology*. Frontiers in Mathematics. Birkhäuser Verlag, Basel, 2007.
- [111] B. Perthame and L. Ryzhik. Exponential decay for the fragmentation or cell-division equation. *J. Differential Equations*, 210(1) :155–177, 2005.
- [112] B. Perthame and T. Touaoula. Analysis of a cell system with finite divisions. *Boletín SEMA*, (44) :55–79, 2008.
- [113] B. Perthame and S. Tumuluri. Nonlinear renewal equations. In *Selected topics in cancer modeling*, Model. Simul. Sci. Eng. Technol., pages 65–96. Birkhäuser Boston, Boston, MA, 2008.
- [114] B. Perthame and J. Zubelli. On the inverse problem for a size-structured population model. *Inverse Problems*, 23(3) :1037–1052, 2007.
- [115] S. B. Prusiner. Novel proteinaceous infectious particles cause scrapie. *Science*, 216(4542) :136–144, 1982.
- [116] J. Prüss. On the qualitative behaviour of populations with age-specific interactions. *Comput. Math. Appl.*, 9(3) :327–339, 1983. Hyperbolic partial differential equations.
- [117] J. Prüss, L. Pujo-Menjouet, G. Webb, and R. Zacher. Analysis of a model for the dynamics of prion. *Dis. Cont. Dyn. Sys. Ser. B*, 6(1) :225–235, 2006.
- [118] H. Rezaei, Y. Choiset, F. Eghiaian, E. Treguer, P. Mentre, P. Debey, J. Grosclaude, and T. Haertle. Amyloidogenic unfolding intermediates differentiate sheep prion protein variants. *Journal of Molecular Biology*, 322(4) :799 – 814, 2002.
- [119] R. Rubenstein, P. Gray, T. Cleland, M. Piltch, W. Hlavacek, R. Roberts, J. Ambrosiano, and J.-I. Kim. Dynamics of the nucleated polymerization model of prion replication. *Biophysical Chemistry*, 125(2-3) :360 – 367, 2007.
- [120] G. shan Jiang and D. Peng. Weighted ENO schemes for hamilton-jacobi equations. *SIAM J. Sci. Comput.*, 21 :2126–2143, 1997.
- [121] J. Shen, C.-W. Shu, and M. Zhang. A high order WENO scheme for a hierarchical size-structured population model. *J. Sci. Comput.*, 33(3) :279–291, 2007.
- [122] C.-W. Shu. Essentially non-oscillatory and weighted essentially non-oscillatory schemes for hyperbolic conservation laws. pages 325–432. Springer, 1998.
- [123] C. J. Sigurdson, K. P. R. Nilsson, S. Hornemann, G. Manco, M. Polymenidou, P. Schwarz, M. Lelcerc, P. Hammarstrom, K. Wuthrich, and A. Aguzzi. Prion strain discrimination using luminescent conjugated polymers. *Nat. Methods*, 4 :1023–1030, 12 2007.
- [124] J. Silveira, G. Raymond, A. Hughson, R. Race, V. Sim, S. Hayes, and B. Caughey. The most infectious prion protein particles. *Nature*, 437(7056) :257–261, Sept. 2005.
- [125] G. Simonett and C. Walker. On the solvability of a mathematical model for prion proliferation. *J. Math. Anal. Appl.*, 324(1) :580–603, 2006.
- [126] E. J. Stewart, R. Madden, G. Paul, and F. Taddei. Aging and death in an organism that reproduces by morphologically symmetric division. *PLoS Biol.*, 3(2) :e45, 2005.
- [127] I. W. Stewart and E. Meister. A global existence theorem for the general coagulation-fragmentation equation with unbounded kernels. *Math. Methods Appl. Sci.*, 11 :627–648, 1989.
- [128] J. H. Swart. Hopf bifurcation and the stability of nonlinear age-dependent population models. *Comput. Math. Appl.*, 15(6-8) :555–564, 1988. Hyperbolic partial differential equations. V.

-
- [129] T. Tao. When are eigenvalues stable? <http://terrytao.wordpress.com/2008/10/28/>.
- [130] S. K. Tumuluri. *Age-Structured Nonlinear Renewal Equations*. PhD thesis, Paris, 2009.
- [131] C. Walker. Prion proliferation with unbounded polymerization rates. In *Proceedings of the Sixth Mississippi State-UBA Conference on Differential Equations and Computational Simulations*, volume 15 of *Electron. J. Differ. Equ. Conf.*, pages 387–397, San Marcos, TX, 2007. Southwest Texas State Univ.
- [132] P. Wang, L. Robert, J. Pelletier, W. L. Dang, F. Taddei, A. Wright, and S. Jun. Robust growth of escherichia coli. *Current Biology*, 20 :1099–1103, 2010.
- [133] G. F. Webb. *Theory of nonlinear age-dependent population dynamics*, volume 89 of *Monographs and Textbooks in Pure and Applied Mathematics*. Marcel Dekker Inc., New York, 1985.
- [134] P. Weber, A. Giese, N. Piening, G. Mitteregger, A. Thomzig, M. Beekes, and H. A. Kretzschmar. Cell-free formation of misfolded prion protein with authentic prion infectivity. *Proc. Natl. Acad. Sci. USA*, 103(43) :15818–15823, 2006.
- [135] P. Weber, A. Giese, N. Piening, G. Mitteregger, A. Thomzig, M. Beekes, and H. A. Kretzschmar. Generation of genuine prion infectivity by serial pmca. *Veterinary Microbiology*, 123(4) :346 – 357, 2007.
- [136] M. Zampieri, G. Legname, and C. Altafini. Investigating the conformational stability of prion strains through a kinetic replication model. *PLoS Comput. Biol.*, 5(7) :e1000420, 07 2009.

Résumé

Les phénomènes de croissance et de fragmentation des polymères jouent un rôle central dans le développement des maladies à prions. Pour les étudier, nous adoptons le formalisme des populations structurées et analysons l'équation intégro-différentielle de transport-fragmentation. Dans un premier temps, nous nous intéressons au problème aux valeurs propres pour l'opérateur de transport-fragmentation linéaire. Nous montrons l'existence et l'unicité de la valeur propre principale et des vecteurs propres associés sous des conditions générales incluant les cas dégénérés dans lesquels le coefficient de transport s'annule à l'origine. Nous analysons ensuite la dépendance de ces éléments propres par rapport aux paramètres de l'équation et mettons en évidence l'existence de comportements non monotones. Les résultats obtenus nous permettent d'aborder deux problèmes de natures différentes. La dépendance par rapport au transport est utilisée pour trouver les états d'équilibres et analyser le comportement en temps long de modèles non-linéaires, dont l'« équation du prion ». La dépendance par rapport à la fragmentation nous permet quant à elle d'étudier un problème d'optimisation. Celui-ci consiste à introduire un contrôle sur la fragmentation et à trouver la stratégie qui maximise la croissance de la population, ceci à des fins diagnostiques. Dans un dernier chapitre, nous présentons un schéma numérique conservatif pour des équations d'agrégation-fragmentation comprenant un terme de coagulation.

Abstract

Growth and fragmentation of polymers play a central role in the development of prion diseases. To study these phenomena, we use the formalism of structured populations and analyze the integro-differential transport-fragmentation equation. First we investigate the eigenvalue problem for the linear transport-fragmentation operator. We prove existence and uniqueness of the principal eigenvalue and the associated eigenvectors under general conditions including the degenerate cases where the transport term can vanish at zero. Then we investigate the dependence of these eigenvalues on the parameters in the equation and show existence of non-monotonic behaviors. The results obtained allow us to address two different types of problems. The dependence on the transport term is used to find the steady states and to investigate the long time behavior of nonlinear models, including the so-called “prion equation”. The dependence on the fragmentation term allows us to study an optimization problem. This means introducing a control on the fragmentation term and finding, for diagnostic purposes, the strategy which maximizes the growth of the population. In the last chapter, we present a conservative numerical scheme for aggregation-fragmentation equations including a coagulation term.

